

# User's Guide

## HP 8590 E-Series and L-Series Spectrum Analyzers



HP Part No. 08590-90301 Supersedes: 08590-90234  
Printed in USA July 1998

**Notice.**

The information contained in this document is subject to change without notice.

Hewlett-Packard makes no warranty of any kind with regard to this material, including but not limited to, the implied warranties of merchantability and fitness for a particular purpose. Hewlett-Packard shall not be liable for errors contained herein or for incidental or consequential damages in connection with the furnishing, performance, or use of this material.

---

## Certification

Hewlett-Packard Company certifies that this product met its published specifications at the time of shipment from the factory. Hewlett-Packard further certifies that its calibration measurements are traceable to the United States National Institute of Standards and Technology, to the extent allowed by the Institute's calibration facility, and to the calibration facilities of other International Standards Organization members.

---

## Warranty

This Hewlett-Packard instrument product is warranted against defects in material and workmanship for a period of one year from date of shipment. During the warranty period, Hewlett-Packard Company will, at its option, either repair or replace products which prove to be defective.

For warranty service or repair, this product must be returned to a service facility designated by HP. Buyer shall prepay shipping charges to HP and HP shall pay shipping charges to return the product to Buyer. However, Buyer shall pay all shipping charges, duties, and taxes for products returned to HP from another country.

HP warrants that its software and firmware designated by HP for use with an instrument will execute its programming instructions when properly installed on that instrument. HP does not warrant that the operation of the instrument, or software, or firmware will be uninterrupted or error-free.

## Limitation of Warranty

The foregoing warranty shall not apply to defects resulting from improper or inadequate maintenance by Buyer, Buyer-supplied software or interfacing, unauthorized modification or misuse, operation outside of the environmental specifications for the product, or improper site preparation or maintenance.

NO OTHER WARRANTY IS EXPRESSED OR IMPLIED. HP SPECIFICALLY DISCLAIMS THE IMPLIED WARRANTIES OF MERCHANTABILITY AND FITNESS FOR A PARTICULAR PURPOSE.

## Exclusive Remedies

THE REMEDIES PROVIDED HEREIN ARE BUYER'S SOLE AND EXCLUSIVE REMEDIES. HP SHALL NOT BE LIABLE FOR ANY DIRECT, INDIRECT, SPECIAL, INCIDENTAL, OR CONSEQUENTIAL DAMAGES, WHETHER BASED ON CONTRACT, TORT, OR ANY OTHER LEGAL THEORY.

---

## Assistance

***Product maintenance agreements and other customer assistance agreements are available for Hewlett-Packard products.***

***For any assistance, contact your nearest Hewlett-Packard Sales and Service Office.***

---

## Safety Symbols

The following safety symbols are used throughout this manual. Familiarize yourself with each of the symbols and its meaning before operating this instrument.

---

**Caution** Caution denotes a hazard. It calls attention to a procedure that, if not correctly performed or adhered to, would result in damage to or destruction of the instrument. Do not proceed beyond a caution sign until the indicated conditions are fully understood and met.

---

**Warning** **Warning denotes a hazard. It calls attention to a procedure which, if not correctly performed or adhered to, could result in injury or loss of life. Do not proceed beyond a warning note until the indicated conditions are fully understood and met.**

---



The instruction documentation symbol. The product is marked with this symbol when it is necessary for the user to refer to the instructions in the documentation.



The CE mark is a registered trademark of the European Community. (If accompanied by a year, it is when the design was proven.)



The CSA mark is a registered trademark of the Canadian Standards Association.



This symbol is used to mark the ON position of the power line switch.



This symbol indicates that the input power required is AC.



This symbol is used to mark the STANDBY position of the power line switch.



This symbol is used to mark the STANDBY/OFF position of the power line switch.



This symbol is used to mark the ON position of the power line switch.



This is a symbol of an Industrial Scientific and Medical Group 1 Class A product.

---

## General Safety Considerations

---

**Warning** This is a Safety Class I product (provided with a protective earthing ground incorporated in the power cord). The mains plug shall only be inserted in a socket outlet provided with a protective earth contact. Any interruption of the protective conductor, inside or outside the instrument, is likely to make the instrument dangerous. Intentional interruption is prohibited.

---

**Warning** No operator serviceable parts inside. Refer servicing to qualified personnel. To prevent electrical shock, do not remove covers.

---

**Warning** If this product is not used as specified, the protection provided by the equipment could be impaired. This product must be used in a normal condition (in which all means for protection are intact) only.

---

**Warning** For continued protection against fire hazard, replace fuse only with same type and ratings, (type 5A/250V). The use of other fuses or materials is prohibited.

---

**Warning** To prevent electrical shock, disconnect the HP 8590 Series equipment from mains before cleaning. Use a dry cloth or one slightly dampened with water to clean the external case parts. Do not attempt to clean internally.

---

**Warning** There are many points inside the instrument which can, if contacted, cause personal injury. Be extremely careful. Any adjustments or service procedures that require operation of the instrument with the protective covers removed should be performed only by trained service personnel. This product conforms to Enclosure Protection Standard IP 2 0 according to IEC-529, and protects against finger access to hazardous parts within the enclosure.

---

**Warning** This product presents a *significant risk of electrical shock* if operated when wet. This product conforms to Enclosure Protection Standard IP 2 0 according to IEC-529, and therefore, it does not protect against the admittance of water into the interior of the product.

---

**Caution** Before switching on this instrument, make sure that the line voltage selector switch is set to the voltage of the power supply and the correct fuse is installed.

---

**Caution** Always use the three-prong AC power cord supplied with this product. Failure to ensure adequate earth grounding by not using this cord may cause product damage.

---

---

**Caution**      **VENTILATION REQUIREMENTS:** When installing the product in a cabinet, the convection into and out of the product must not be restricted. The ambient temperature (outside the cabinet) must be less than the maximum operating temperature of the product by 4°C for every 100 watts dissipated in the cabinet. If the total power dissipated in the cabinet is greater than 800 watts, then forced convection must be used.

---

**Caution**      This product is designed for use in Installation Category II and Pollution Degree 2 per IEC-1010 and IEC-664 respectively.

---

---

## **Regulatory Information**

Regulatory Information is in the Calibration Guide shipped with this product.

---

# HP 8590 Series Spectrum Analyzer Documentation Description

## Manuals Shipped with Your Spectrum Analyzer

### ***HP 8590 E-Series and L-Series Spectrum Analyzers User's Guide***

Describes how to prepare the analyzer for use.  
Describes analyzer features.  
Describes common applications.  
Tells how to make measurements with your spectrum analyzer.  
Includes error messages.

### ***Calibration Guide***

Provides analyzer specifications and characteristics.  
Provides manual procedures to verify specifications.  
Indicates the test equipment required for verification.

### ***HP 8590 E-Series and L-Series Series Spectrum Analyzers Quick Reference Guide***

Describes how to make a simple measurement with your spectrum analyzer.  
Briefly describes the spectrum analyzer functions.  
Lists all the programming commands.

## Options

### **Option 910: Additional User's Documentation**

Provides an additional copy of the user's guide, the calibration guide, and the quick reference guide.

### **Option 915: Service Guide and Component-Level Information**

Describes troubleshooting and repair of the spectrum analyzer.  
Option 915 consists of two manuals:

***HP 8590 E-Series and L-Series Spectrum Analyzers, and HP 8591 C Cable TV Analyzer; Assembly-Level &pair Service Guide*** describes adjustment and assembly level repair of the analyzer.

***HP 8590 E-Series and L-Series Spectrum Analyzers, and HP 8591C Cable TV Analyzer; Component-Level &pair Service Guide*** provides information for component-level repair of the analyzer.

### **Options 041 and 043: HP 8590 E-Series and L-Series Spectrum Analyzer and HP 8591C Cable TV Analyzer Programmer's Guide**

The ***HP 8590 E-Series and L-Series Spectrum Analyzer and HP 8591C Cable TV Analyzer Programmer's Guide*** describes analyzer operation via a remote controller (computer) for Options 041 and 043. This manual is provided when ordering either Option 041 or Option 043.

## How to Order Manuals

Each of the manuals listed above can be ordered individually. To order, contact your local HP Sales and Service Office.

# Contents

---

## 1. Preparing For Use

|                                                                      |      |
|----------------------------------------------------------------------|------|
| What You'll Find in This Chapter . . . . .                           | 1-1  |
| Introducing the HP 8590 Series Spectrum Analyzers . . . . .          | 1-1  |
| Preparing Your Spectrum Analyzer for Use . . . . .                   | 1-2  |
| Initial Inspection . . . . .                                         | 1-3  |
| Power Requirements . . . . .                                         | 1-4  |
| Setting the Line Voltage Selector Switch . . . . .                   | 1-4  |
| Checking the Fuse . . . . .                                          | 1-5  |
| Power Cable . . . . .                                                | 1-6  |
| Turning on the Analyzer for the First Time . . . . .                 | 1-8  |
| Performing the Tracking-Generator Self-Calibration Routine . . . . . | 1-9  |
| Performing the YTF Self-Calibration Routine . . . . .                | 1-10 |
| Electrostatic Discharge . . . . .                                    | 1-11 |
| Reducing Damage Caused by ESD . . . . .                              | 1-12 |

## 2. Getting Started

|                                                                                                        |      |
|--------------------------------------------------------------------------------------------------------|------|
| What You'll Learn in this Chapter . . . . .                                                            | 2-1  |
| Getting Acquainted with the Analyzer . . . . .                                                         | 2-1  |
| Front-Panel Features . . . . .                                                                         | 2-1  |
| Rear-Panel Features . . . . .                                                                          | 2-5  |
| Data Controls . . . . .                                                                                | 2-8  |
| Hold Key . . . . .                                                                                     | 2-8  |
| Knob . . . . .                                                                                         | 2-8  |
| Number/Units Keypad . . . . .                                                                          | 2-8  |
| Step Keys . . . . .                                                                                    | 2-9  |
| Fine-Focus Control . . . . .                                                                           | 2-9  |
| Screen Annotation . . . . .                                                                            | 2-10 |
| Menu and Softkey Overview . . . . .                                                                    | 2-12 |
| Making a Measurement . . . . .                                                                         | 2-13 |
| Measurement Summary . . . . .                                                                          | 2-15 |
| Improving Accuracy with Self-Calibration Routines . . . . .                                            | 2-16 |
| Warm-Up Time . . . . .                                                                                 | 2-16 |
| Performing the Tracking Generator Self-Calibration Routine (Option 010 or 011 only) . . . . .          | 2-17 |
| Performing the YTF Self-Calibration Routine (HP 8592L, HP 85933, HP 85953, or HP 85963 Only) . . . . . | 2-18 |
| When Is Self-Calibration Needed? . . . . .                                                             | 2-18 |
| Memory Card Insertion and Battery Replacement . . . . .                                                | 2-19 |
| Changing the Memory Card Battery . . . . .                                                             | 2-20 |
| Procedure to Change the Memory Card Battery . . . . .                                                  | 2-21 |
| Analyzer Battery Information . . . . .                                                                 | 2-22 |



|                                                                                                                                      |      |
|--------------------------------------------------------------------------------------------------------------------------------------|------|
| <b>3. Making Basic Measurements</b>                                                                                                  |      |
| What You'll Learn in This Chapter . . . . .                                                                                          | 3-1  |
| Resolving Signals of Equal Amplitude Using the Resolution Bandwidth Function . . . . .                                               | 3-2  |
| Resolving Small Signals Hidden by Large Signals Using the Resolution Bandwidth Function . . . . .                                    | 3-4  |
| Increasing the Frequency Readout Resolution Using the Marker Counter . . . . .                                                       | 3-6  |
| Decreasing the Frequency Span Using the Marker Track Function . . . . .                                                              | 3-7  |
| Peaking Signal Amplitude with Preselector Peak . . . . .                                                                             | 3-8  |
| Tracking Unstable Signals Using Marker Track and the Maximum Hold and Minimum Hold Functions . . . . .                               | 3-9  |
| Comparing Signals Using Delta Markers . . . . .                                                                                      | 3-12 |
| Measuring Low-Level Signals Using Attenuation, Video Bandwidth, and Video Averaging . . . . .                                        | 3-15 |
| Identifying Distortion Products Using the RF Attenuator and Traces . . . . .                                                         | 3-20 |
| Distortion from the Analyzer . . . . .                                                                                               | 3-20 |
| Third-Order Intermodulation Distortion . . . . .                                                                                     | 3-22 |
| Using the Analyzer As a Receiver in Zero Frequency Span . . . . .                                                                    | 3-24 |
| Measuring Signals Near Band Boundaries Using Harmonic Lock . . . . .                                                                 | 3-26 |
| <br>                                                                                                                                 |      |
| <b>4. Making Measurements</b>                                                                                                        |      |
| What You'll Learn in This Chapter . . . . .                                                                                          | 4-1  |
| Measuring Amplitude Modulation with the Fast Fourier Transform Function . . . . .                                                    | 4-2  |
| Stimulus-Response Measurements . . . . .                                                                                             | 4-7  |
| What Are Stimulus-Response Measurements? . . . . .                                                                                   | 4-7  |
| Using a Spectrum Analyzer with a Tracking Generator . . . . .                                                                        | 4-8  |
| Stepping through the Measurement . . . . .                                                                                           | 4-8  |
| Tracking Generator Unleveled Condition . . . . .                                                                                     | 4-12 |
| Demodulating and Listening to an AM or FM Signal . . . . .                                                                           | 4-13 |
| Triggering on a Selected Line of a Video Picture Field . . . . .                                                                     | 4-15 |
| Making Reflection Calibration Measurements . . . . .                                                                                 | 4-17 |
| Reflection Calibration . . . . .                                                                                                     | 4-17 |
| Measuring the Return Loss . . . . .                                                                                                  | 4-18 |
| Using the Gate Utility to Simplify Time-Gated Measurements (Option 105 only) . . . . .                                               | 4-19 |
| Using the Time-Gated Spectrum Analyzer Capability Without the Gate Utility . . . . .                                                 | 4-22 |
| Introducing the Time-Gated Spectrum Analyzer Capability . . . . .                                                                    | 4-22 |
| Using the Time-Gated Spectrum Analyzer Capability to View Pulsed RF . . . . .                                                        | 4-24 |
| Example of a Time-Gated Pulsed RF Signal . . . . .                                                                                   | 4-26 |
| Setting the Gate Delay and Gate Length Properly, When NOT Using the Gate Utility . . . . .                                           | 4-33 |
| Using the Self-Calibration Routines with Option 105 . . . . .                                                                        | 4-35 |
| Performing a Functional Check of Option 105 . . . . .                                                                                | 4-36 |
| Using the One Button Measurements to Measure N dB Bandwidth, Percent Amplitude Modulation, and Third Order Intercept (TOI) . . . . . | 4-39 |
| N dB Bandwidth Measurement . . . . .                                                                                                 | 4-39 |
| Percent Amplitude Modulation Measurement . . . . .                                                                                   | 4-40 |
| Third Order Intermodulation Measurement (TOI) . . . . .                                                                              | 4-41 |
| Using the Power Measurement Functions to make Transmitter Measurements . . . . .                                                     | 4-43 |
| Occupied Bandwidth and Transmitter Frequency Error . . . . .                                                                         | 4-43 |
| Adjacent Channel Power Ratio (ACP) . . . . .                                                                                         | 4-45 |
| Channel Power Measurement . . . . .                                                                                                  | 4-48 |

## 5. Using Analyzer Features

|                                                                       |      |
|-----------------------------------------------------------------------|------|
| What You'll Learn in this Chapter . . . . .                           | 5-1  |
| Use the Marker Table to List All the Active Markers . . . . .         | 5-2  |
| Use the Peak Table to List the Displayed Signals . . . . .            | 5-4  |
| Saving and Recalling Data from Analyzer Memory . . . . .              | 5-6  |
| ToSaveaState . . . . .                                                | 5-6  |
| To Recall a State . . . . .                                           | 5-6  |
| ToSaveaTrace . . . . .                                                | 5-7  |
| To Recall a Trace . . . . .                                           | 5-7  |
| To Save a Limit-Line Table or Amplitude Correction Factors . . . . .  | 5-8  |
| To Recall Limit-Line Tables or Amplitude Correction Factors . . . . . | 5-8  |
| To Protect Data From Being Overwritten . . . . .                      | 5-8  |
| Saving and Recalling Data from the Memory Card . . . . .              | 5-10 |
| Preparing the Memory Card for Use . . . . .                           | 5-11 |
| To Enter a Prefix . . . . .                                           | 5-12 |
| ToSaveaState . . . . .                                                | 5-12 |
| To Recall a State . . . . .                                           | 5-13 |
| ToSaveaTrace . . . . .                                                | 5-13 |
| To Recall a Trace . . . . .                                           | 5-13 |
| To Save a Display Image . . . . .                                     | 5-14 |
| To Recall a Display Image . . . . .                                   | 5-14 |
| To Save Limit-Line Tables or Amplitude Correction Factors . . . . .   | 5-15 |
| To Recall Limit-Line Tables or Amplitude Correction Factors . . . . . | 5-15 |
| Saving and Recalling Programs with a Memory Card . . . . .            | 5-16 |
| To Save a Program . . . . .                                           | 5-16 |
| To Recall a Program . . . . .                                         | 5-16 |
| Using Limit-Line Functions . . . . .                                  | 5-18 |
| Procedure for Creating an Upper Limit Line . . . . .                  | 5-18 |
| Limit-Line Functions . . . . .                                        | 5-22 |
| Editing, Creating, or Viewing a Limit-Line . . . . .                  | 5-22 |
| Selecting the Type of Limit-Line Table . . . . .                      | 5-22 |
| Selecting the Limit-Line Table Format . . . . .                       | 5-23 |
| Selecting the Segment Number . . . . .                                | 5-23 |
| Selecting the Frequency or Time Coordinate . . . . .                  | 5-25 |
| Selecting the Amplitude Coordinate . . . . .                          | 5-25 |
| Selecting the Segment Type . . . . .                                  | 5-26 |
| Completing Table Entry and Activating Limit-Line Testing . . . . .    | 5-28 |
| Saving or Recalling Limit-Line Tables . . . . .                       | 5-28 |
| Procedure for Creating an Upper and Lower Limit Line . . . . .        | 5-29 |
| Learn About the Analog+ Display Mode (Option 101 only) . . . . .      | 5-32 |
| Learn About the Windows Display . . . . .                             | 5-33 |
| Learn How to Enter Amplitude Correction Factors . . . . .             | 5-35 |
| Procedure for Creating Amplitude-Correction Factors . . . . .         | 5-36 |
| Amplitude-Correction Functions . . . . .                              | 5-38 |
| Editing or Viewing the Amplitude-Correction Tables . . . . .          | 5-38 |
| Selecting the Amplitude-Correction Point . . . . .                    | 5-38 |
| Selecting the Frequency Coordinate . . . . .                          | 5-39 |
| Selecting the Amplitude Coordinate . . . . .                          | 5-39 |
| Completing Table Entry and Activating Amplitude Corrections . . . . . | 5-39 |
| Saving or Recalling Amplitude Correction Tables . . . . .             | 5-39 |
| External Keyboard . . . . .                                           | 5-40 |
| Using the External Keyboard . . . . .                                 | 5-42 |
| External Keyboard Installation . . . . .                              | 5-42 |
| To Enter a Screen Title . . . . .                                     | 5-42 |
| To Enter Programming Commands . . . . .                               | 5-43 |

|                                                              |      |
|--------------------------------------------------------------|------|
| To Enter a Prefix . . . . .                                  | 5-43 |
| <b>6. Printing and Plotting</b>                              |      |
| Printing or Plotting with HP-IB . . . . .                    | 6-1  |
| Printing Using an HP-IB Interface . . . . .                  | 6-4  |
| Equipment . . . . .                                          | 6-4  |
| Interconnection and Printing Instructions . . . . .          | 6-4  |
| Plotting Using an HP-IB Interface . . . . .                  | 6-7  |
| Equipment . . . . .                                          | 6-7  |
| Interconnection and Plotting Instructions . . . . .          | 6-7  |
| Printing or Plotting with RS-232 . . . . .                   | 6-10 |
| Printing Using an RS-232 Interface . . . . .                 | 6-10 |
| Equipment . . . . .                                          | 6-10 |
| Interconnection and Printing Instructions . . . . .          | 6-10 |
| Plotting Using an RS-232 Interface . . . . .                 | 6-14 |
| Equipment . . . . .                                          | 6-14 |
| Interconnection and Plotting Instructions . . . . .          | 6-14 |
| Printing after Plotting or Plotting after Printing . . . . . | 6-17 |
| To print after plotting, press: . . . . .                    | 6-17 |
| To plot after printing, press: . . . . .                     | 6-17 |
| Printing With a Parallel Interface . . . . .                 | 6-18 |
| Equipment . . . . .                                          | 6-18 |
| Interconnection and Printing Instructions . . . . .          | 6-18 |
| Plotting to an HP LaserJet Printer . . . . .                 | 6-21 |
| Equipment . . . . .                                          | 6-21 |
| Interconnection and Plotting Instructions . . . . .          | 6-21 |
| <b>7. Key Descriptions</b>                                   |      |
| Service Functions . . . . .                                  | 7-2  |
| Service Calibration Functions . . . . .                      | 7-2  |
| Service Diagnostic Functions . . . . .                       | 7-2  |
| Analyzer Functions . . . . .                                 | 7-4  |
| <b>8. Key Menus</b>                                          |      |
| <b>9. If You Have A Problem</b>                              |      |
| What You'll Find in This Chapter . . . . .                   | 9-1  |
| Before You Call Hewlett-Packard . . . . .                    | 9-2  |
| Check the Basics . . . . .                                   | 9-2  |
| Read the Warranty . . . . .                                  | 9-4  |
| Service Options . . . . .                                    | 9-4  |
| How to Call Hewlett-Packard . . . . .                        | 9-4  |
| How to Return Your Analyzer for Service . . . . .            | 9-6  |
| Service lag . . . . .                                        | 9-6  |
| Original Packaging . . . . .                                 | 9-6  |
| Other Packaging . . . . .                                    | 9-6  |
| Error Messages . . . . .                                     | 9-7  |

## 10. Measurement Personalities, Options, and Accessories

|                                                                                                        |       |
|--------------------------------------------------------------------------------------------------------|-------|
| What You'll Find In This Chapter . . . . .                                                             | 10-1  |
| Measurement Personalities . . . . .                                                                    | 10-2  |
| Broadcast Measurements Personality . . . . .                                                           | 10-2  |
| CATV Measurements Personality . . . . .                                                                | 10-2  |
| CATV System Monitor Personality . . . . .                                                              | 10-2  |
| Cable TV Measurements and System Monitor Personality . . . . .                                         | 10-2  |
| CDMA Measurements Personality . . . . .                                                                | 10-2  |
| CT2-CAI Measurements Personality . . . . .                                                             | 10-3  |
| DECT Measurements Personality . . . . .                                                                | 10-3  |
| Digital Radio Measurements Personality . . . . .                                                       | 10-3  |
| EMI Diagnostics Measurements Personality . . . . .                                                     | 10-3  |
| GSM900 and DCS1800 Transmitter Measurements Personalities . . . . .                                    | 10-3  |
| Link Measurement Personality . . . . .                                                                 | 10-4  |
| NADC-TDMA Measurements Personality . . . . .                                                           | 10-4  |
| Noise Figure Measurements Personality . . . . .                                                        | 10-4  |
| PDC Measurements Personality . . . . .                                                                 | 10-4  |
| PHS Measurements Personality . . . . .                                                                 | 10-4  |
| Scalar Measurements Personality . . . . .                                                              | 10-4  |
| Options . . . . .                                                                                      | 10-5  |
| 75 $\Omega$ Input Impedance (Option 001) . . . . .                                                     | 10-5  |
| Memory Card Reader (Option 003) . . . . .                                                              | 10-5  |
| Precision Frequency Reference (Option 004) . . . . .                                                   | 10-5  |
| LO and Sweep+Tune Outputs on Rear Panel (Option 009) . . . . .                                         | 10-5  |
| Tracking Generator (Option 010 and Option 011) . . . . .                                               | 10-6  |
| Protective Tan Operating/Carrying Case with Shoulder Strap (Option 015) . . . . .                      | 10-6  |
| Protective Yellow Operating/Carrying Case with Shoulder Strap (Option 016) . . . . .                   | 10-6  |
| HP-IB and Parallel Interface (Option 041) . . . . .                                                    | 10-6  |
| RS-232 and Parallel Interface (Option 043) . . . . .                                                   | 10-7  |
| Frequency Extension to 26.5 GHz with APC-3.5 Connector (Option 026) . . . . .                          | 10-7  |
| Frequency Extension to 26.5 GHz with N-Type Connector (Option 027) . . . . .                           | 10-7  |
| Front Panel Protective Cover (Option 040) . . . . .                                                    | 10-7  |
| Protective Soft Carrying Case/Back Pack (Option 042) . . . . .                                         | 10-7  |
| Improved Amplitude Accuracy for NADC bands (Option 050) . . . . .                                      | 10-8  |
| Improved Amplitude Accuracy for PDC bands (Option 051) . . . . .                                       | 10-8  |
| Improved Amplitude Accuracy for PHS (Option 052) . . . . .                                             | 10-8  |
| Improved Amplitude Accuracy for CDMA (Option 053) . . . . .                                            | 10-8  |
| Fast Time Domain Sweeps (Option 101) . . . . .                                                         | 10-8  |
| AM/FM Demodulator with Speaker and TV <b>Sync</b> Trigger Circuitry (Option 102) . . . . .             | 10-9  |
| Quasi-Peak Detector and AM/FM Demodulator With Speaker (Option 103) . . . . .                          | 10-9  |
| Time-Gated Spectrum Analysis (Option 105) . . . . .                                                    | 10-9  |
| CT2 Demodulator (Option 110) . . . . .                                                                 | 10-9  |
| Group Delay and Amplitude Flatness (Option 111) . . . . .                                              | 10-9  |
| DECT Demodulator (Option 112) . . . . .                                                                | 10-10 |
| Noise Figure (Option 119) . . . . .                                                                    | 10-10 |
| Narrow Resolution Bandwidths (Option 130) . . . . .                                                    | 10-10 |
| Narrow Resolution Bandwidths and Precision Frequency Reference (Option 140) . . . . .                  | 10-10 |
| DSP, Fast ADC and Digital Demodulator (Option 151) . . . . .                                           | 10-10 |
| PDC/PHS/NADC/CDMA Firmware for Option 151 (Option 160) . . . . .                                       | 10-11 |
| GSM/DCS1800 Firmware for Option 151 (Option 163) . . . . .                                             | 10-11 |
| TV Picture Display (Option 180) . . . . .                                                              | 10-11 |
| TV <b>Sync</b> Trigger Capability/Fast Time-Domain Sweeps and AM/FM Demodulator (Option 301) . . . . . | 10-12 |
| 500 to 75 $\Omega$ Matching Pad (Option 711) . . . . .                                                 | 10-12 |
| Reduced Frequency Accuracy (Option 713) . . . . .                                                      | 10-12 |

|                                                 |       |
|-------------------------------------------------|-------|
| Rack Mount Kit Without Handles (Option 908)     | 10-12 |
| Rack Mount Kit With Handles (Option 909)        | 10-12 |
| User's Guide and Calibration Guide (Option 910) | 10-12 |
| Service Documentation (Option 915)              | 10-12 |
| BenchLink Spectrum Analyzer (Option B70)        | 10-12 |
| Accessories                                     | 10-13 |
| RF and Transient Limiters                       | 10-13 |
| 50Ω Transmission/Reflection Test Set            | 10-13 |
| Scalar 50Ω Transmission/Reflection Test Set     | 10-13 |
| 50Ω/75Ω Minimum Loss Pad                        | 10-13 |
| 750 Matching Transformer                        | 10-13 |
| RF Bridges                                      | 10-13 |
| AC Power Source                                 | 10-14 |
| AC Probe                                        | 10-14 |
| Broadband Preamplifiers and Power Amplifiers    | 10-14 |
| Burst Carrier Trigger                           | 10-14 |
| Close Field Probes                              | 10-15 |
| External Keyboard                               | 10-15 |
| HP-IB Cable                                     | 10-15 |
| Memory Cards                                    | 10-15 |
| Parallel Interface Cable                        | 10-15 |
| PC Interface and Report Generator software      | 10-16 |
| Plotter                                         | 10-16 |
| Printer                                         | 10-16 |
| Rack Slide Kit                                  | 10-16 |
| RS-232 Cable                                    | 10-16 |
| Transit Case                                    | 10-16 |

**A. SRQ**

|                                     |     |
|-------------------------------------|-----|
| Service Requests                    | A-1 |
| Status Byte Definition              | A-1 |
| Service Request Activating Commands | A-2 |

**Glossary**

**Index**

# Figures

---

|                                                                                      |      |
|--------------------------------------------------------------------------------------|------|
| 1-1. HP 8590 Series Spectrum Analyzer . . . . .                                      | 1-1  |
| 1-2. Setting the Line Voltage Selector Switch . . . . .                              | 1-4  |
| 1-3. Checking the Line Fuse . . . . .                                                | 1-5  |
| 1-4. Reference Connector . . . . .                                                   | 1-8  |
| 1-5. Example of a Static-Safe Work Station . . . . .                                 | 1-11 |
| 2-1. Front-Panel Feature Overview . . . . .                                          | 2-2  |
| 2-2. Rear-Panel Feature Overview . . . . .                                           | 2-5  |
| 2-3. Adjusting the Fine Focus . . . . .                                              | 2-9  |
| 2-4. Screen Annotation . . . . .                                                     | 2-10 |
| 2-5. Relationship between Frequency and Amplitude . . . . .                          | 2-14 |
| 2-6. Reading the Amplitude and Frequency . . . . .                                   | 2-15 |
| 2-7. Inserting the Memory Card . . . . .                                             | 2-19 |
| 2-8. Memory Card Battery Date Code Location . . . . .                                | 2-20 |
| 2-9. Memory Card Battery Replacement . . . . .                                       | 2-21 |
| 2-10. Rear-Panel Battery Information Label . . . . .                                 | 2-22 |
| 3-1. Set-Up for Obtaining Two Signals . . . . .                                      | 3-2  |
| 3-2. Resolving Signals of Equal Amplitude . . . . .                                  | 3-3  |
| 3-3. Resolution Bandwidth Requirements for Resolving Small Signals . . . . .         | 3-4  |
| 3-4. Signal Resolution with a 10 kHz Resolution Bandwidth . . . . .                  | 3-5  |
| 3-5. Signal Resolution with a 30 kHz Resolution Bandwidth . . . . .                  | 3-5  |
| 3-6. Using the Marker Counter . . . . .                                              | 3-6  |
| 3-7. After Zooming In on the Signal . . . . .                                        | 3-7  |
| 3-8. Peaking Signal Amplitude Using Preselector Peak . . . . .                       | 3-8  |
| 3-9. Using Marker Tracking to Track an Unstable Signal . . . . .                     | 3-10 |
| 3-10. Viewing an Unstable Signal Using Max Hold A . . . . .                          | 3-11 |
| 3-1 1. Viewing an Unstable Signal With Max Hold, Clear Write, and Min Hold . . . . . | 3-11 |
| 3-12. Placing a Marker on the CAL OUT Signal . . . . .                               | 3-12 |
| 3-13. Using the Marker Delta Function . . . . .                                      | 3-13 |
| 3-14. Using the Marker to Peak/Peak Function . . . . .                               | 3-13 |
| 3-15. Frequency and Amplitude Difference between Signals . . . . .                   | 3-14 |
| 3-16. Low-Level Signal . . . . .                                                     | 3-15 |
| 3-17. Using 0 dB Attenuation . . . . .                                               | 3-16 |
| 3-18. Decreasing Resolution Bandwidth . . . . .                                      | 3-16 |
| 3- 19. Decreasing Video Bandwidth . . . . .                                          | 3-17 |
| 3-20. Using the Video Averaging Function . . . . .                                   | 3-19 |
| 3-2 1. Harmonic Distortion . . . . .                                                 | 3-20 |
| 3-22. RF Attenuation of 10 dB . . . . .                                              | 3-21 |
| 3-23. No Harmonic Distortion . . . . .                                               | 3-21 |
| 3-24. Third-Order Intermodulation Equipment Setup . . . . .                          | 3-22 |
| 3-25. Measuring the Distortion Product . . . . .                                     | 3-23 |
| 3-26. Viewing an AM Signal . . . . .                                                 | 3-25 |
| 3-27. Measuring Modulation in Zero Span . . . . .                                    | 3-25 |
| 3-28. Using Harmonic Lock . . . . .                                                  | 3-27 |
| 3-29. Harmonic Locking Off . . . . .                                                 | 3-27 |
| 4-1. FFT Annotation . . . . .                                                        | 4-2  |
| 4-2. Percent Amplitude Modulation Measurement . . . . .                              | 4-5  |

|                                                                                 |      |
|---------------------------------------------------------------------------------|------|
| 4-3. Block Diagram of a Spectrum Analyzer/Tracking-Generator Measurement System | 4-7  |
| 4-4. Transmission Measurement Test Setup                                        | 4-8  |
| 4-5. Tracking-Generator Output Power Activated                                  | 4-9  |
| 4-6. Spectrum Analyzer Settings According to the Measurement Requirement        | 4-9  |
| 4-7. Decrease the Resolution Bandwidth to Improve Sensitivity                   | 4-10 |
| 4-8. Manual Tracking Adjustment Compensates for Tracking Error                  | 4-10 |
| 4-9. Normalized Trace                                                           | 4-11 |
| 4-10. Measure the Rejection Range with Delta Markers                            | 4-12 |
| 4-11. Demodulation of an FM Signal                                              | 4-13 |
| 4-12. Continuous Demodulation of an FM Signal                                   | 4-14 |
| 4-13. Triggering on an Odd Field of a Video Format                              | 4-15 |
| 4-14. Triggering on an Even Field of a Video Format                             | 4-16 |
| 4-15. Reflection Measurement Short Calibration Test Setup                       | 4-17 |
| 4-16. Measuring the Return Loss of the Filter                                   | 4-18 |
| 4-17. Time-Gate Utility Display                                                 | 4-19 |
| 4-18. Viewing Time-Sharing of a Frequency with an Oscilloscope                  | 4-23 |
| 4-19. Viewing Time-Sharing of a Frequency with a Spectrum Analyzer              | 4-24 |
| 4-20. Pulse Repetition Interval and Pulse Width (with Two Signals Present)      | 4-25 |
| 4-21. Test Setup for Option 105                                                 | 4-27 |
| 4-22. Setting the Center Frequency, Span, and Reference Level                   | 4-28 |
| 4-23. Setting the Sweep Time                                                    | 4-28 |
| 4-24. Setting the Gate Delay and Gate Length Using an Oscilloscope              | 4-29 |
| 4-25. Using Time-Gating to View Signal 1                                        | 4-30 |
| 4-26. Placing the Gate Output During the Second Signal                          | 4-31 |
| 4-27. Viewing Both Signals with Time-Gating                                     | 4-32 |
| 4-28. Gate Not Occurring During the Pulse                                       | 4-33 |
| 4-29. Gate is Occurring at the Beginning of the Pulse                           | 4-33 |
| 4-30. Self-Calibration Data Results                                             | 4-36 |
| 4-31. Rear Panel Connections for Option 105                                     | 4-36 |
| 4-32. Gate On                                                                   | 4-37 |
| 4-33. Using the Level Gate Control                                              | 4-38 |
| 4-34. N dB Bandwidth Measurement                                                | 4-39 |
| 4-35. Percent Amplitude Modulation Measurement                                  | 4-40 |
| 4-36. Third-Order Intermodulation Measurement                                   | 4-42 |
| 4-37. Occupied Bandwidth                                                        | 4-44 |
| 4-38. Adjacent Channel Power                                                    | 4-46 |
| 4-39. Adjacent Channel Power Extended                                           | 4-46 |
| 4-40. Adjacent Channel Power Graph                                              | 4-47 |
| 4-41. Channel Power                                                             | 4-48 |
| 4-42. Channel Power Graph                                                       | 4-49 |
| 5-1. Marker Table Display                                                       | 5-2  |
| 5-2. Peak Table Display                                                         | 5-4  |
| 5-3. Inserting the Memory Card                                                  | 5-11 |
| 5-4. Typical Limit-Line Display                                                 | 5-19 |
| 5-5. The Completed Limit-Line Table                                             | 5-21 |
| 5-6. Limit-Line Segments                                                        | 5-24 |
| 5-7. Segment Types                                                              | 5-27 |
| 5-8. Upper and Lower Limit-Line Testing                                         | 5-30 |
| 5-9. Analog+ Display Mode                                                       | 5-32 |
| 5-10. Windows Display Mode                                                      | 5-33 |
| 5-11. Amplitude-Correction Display                                              | 5-35 |
| 5-12. Completed Amplitude-Correction Table                                      | 5-37 |
| 5-13. Amplitude-Correction Points                                               | 5-38 |
| 6-1. Three Printouts Per Page                                                   | 6-2  |
| 6-2. Plots Per Page                                                             | 6-3  |

|                                                              |      |
|--------------------------------------------------------------|------|
| 6-3. ThinkJet Printer Switch Settings . . . . .              | 6-4  |
| 6-4. HP-IB to Centronics Converter Setup . . . . .           | 6-5  |
| 6-5. Printer Configuration Menu Map . . . . .                | 6-5  |
| 6-6. HP 7475A Plotter Switch Settings . . . . .              | 6-7  |
| 6-7. Plot Configure Menu . . . . .                           | 6-8  |
| 6-8. 9600 Baud Settings for Serial Printers . . . . .        | 6-11 |
| 6-9. Printer Configure Menu . . . . .                        | 6-12 |
| 6-10. Connecting the HP 7550A/B Plotter . . . . .            | 6-15 |
| 6-11. Baud Rate Menu Map . . . . .                           | 6-15 |
| 6-12. Plot Configure Menu . . . . .                          | 6-16 |
| 6-13. Parallel Printer Switch Settings . . . . .             | 6-18 |
| 6-14. Printer Configuration Menu Map . . . . .               | 6-19 |
| 6-15. Plot Configure Menu . . . . .                          | 6-22 |
| 7-1. Memory Card Catalog Information . . . . .               | 7-17 |
| 7-2. Analyzer Memory Catalog Information . . . . .           | 7-18 |
| 7-3. CATALOG ON EVENT Display . . . . .                      | 7-20 |
| 7-4. Connecting a Printer to the Spectrum Analyzer . . . . . | 7-29 |



# Tables

---

|                                                                                            |      |
|--------------------------------------------------------------------------------------------|------|
| 1-1. Accessories Supplied with the Spectrum Analyzer . . . . .                             | 1-3  |
| 1-2. Power Requirements . . . . .                                                          | 1-4  |
| 1-3. AC Power Cables Available . . . . .                                                   | 1-7  |
| 1-4. Static-Safe Accessories . . . . .                                                     | 1-12 |
| 2-1. RF Output Frequency Range . . . . .                                                   | 2-4  |
| 2-2. Screen Annotation . . . . .                                                           | 2-11 |
| 2-3. Screen Annotation for Trace, Trigger, and Sweep Modes . . . . .                       | 2-12 |
| 4-1. Determining Spectrum Analyzer Settings for Viewing a Pulsed RF Signal . . . . .       | 4-26 |
| 4-2. Pulse Generator Test Setup Settings . . . . .                                         | 4-27 |
| 4-3. Signal Generator Test Setup Settings . . . . .                                        | 4-28 |
| 4-4. Gate Delay, Resolution Bandwidth, Gate Length, and Video Bandwidth Settings . . . . . | 4-34 |
| 4-5. Sweep Time Settings . . . . .                                                         | 4-35 |
| 5-1. Summary of Save and Recall Operations, Analyzer Memory . . . . .                      | 5-9  |
| 5-2. Comparison of Analyzer Memory and Memory Card Operations . . . . .                    | 5-10 |
| 5-3. Save and Recall Functions Using Memory Card . . . . .                                 | 5-17 |
| 5-8. External Keyboard Functions . . . . .                                                 | 5-40 |
| 7-1. Commands Not Available with Analog+ Operation . . . . .                               | 7-9  |
| 7-2. Center Frequency and Span Settings for Harmonic Bands . . . . .                       | 7-12 |
| 7-3. Memory Card Catalog Information . . . . .                                             | 7-17 |
| 7-4. Analyzer Memory Catalog Information * . . . . .                                       | 7-19 |
| 7-5. CATALOG ON EVENT Display Description . . . . .                                        | 7-20 |
| 7-6. Default Configuration Values . . . . .                                                | 7-32 |
| 7-7. Compatibility of FFT With Other Functions . . . . .                                   | 7-43 |
| 7-8. Commands Altered/Not Available within the Gate Utility . . . . .                      | 7-47 |
| 7-9. Functions Which Exit The Windows Display Format . . . . .                             | 7-61 |
| 7-10. Model Specific Preset Conditions . . . . .                                           | 7-66 |
| 7- 11. Common Preset Conditions . . . . .                                                  | 7-67 |
| 7-12. Preset Spectrum Conditions for All Models . . . . .                                  | 7-68 |
| 7-13. HP 85933, HP 8594E, HP 85953, and HP 8596E . . . . .                                 | 7-71 |
| 9-1. Hewlett-Packard Sales and Service Offices . . . . .                                   | 9-5  |
| A-1. Status Byte Definition . . . . .                                                      | A-2  |

## Preparing For Use

---

### What You'll Find in This Chapter

This chapter describes the process of getting the spectrum analyzer ready to use when you have just received it. See "Preparing Your Spectrum Analyzer For Use" for the process steps. The process includes initial inspection, setting up the unit for the selected ac power source, and performing automatic self-calibration routines. Information about static-safe handling procedures is also included in this chapter.

### Introducing the HP 8590 Series Spectrum Analyzers

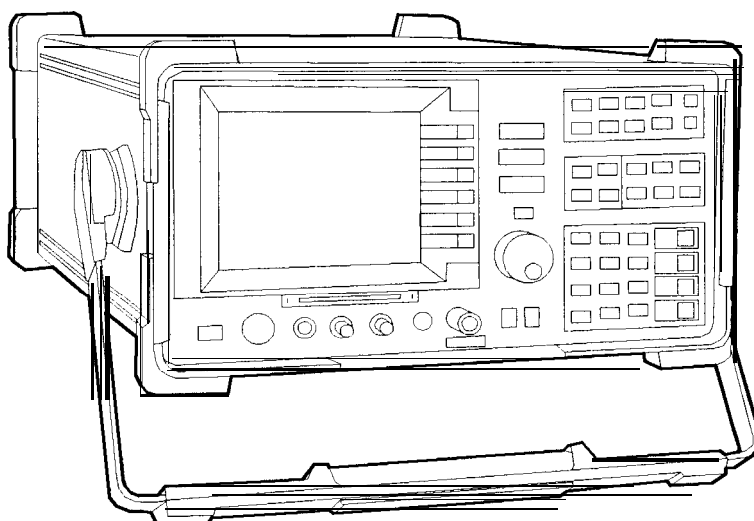

pu137e

**Figure 1-1. HP 8590 Series Spectrum Analyzer**

The HP 8590 Series spectrum analyzers are small, lightweight test instruments that cover the RF and microwave frequency ranges:

- HP 8590L, 9 kHz to 1.8 GHz
- HP 85913, 9 kHz to 1.8 GHz
- HP 8592L, 9 kHz to 22 GHz
- HP 85933, 9 kHz to 22 GHz
- HP 85943, 9 kHz to 2.9 GHz
- HP 8594L, 9 kHz to 2.9 GHz
- HP 85953, 9 kHz to 6.5 GHz
- HP 85963, 9 kHz to 12.8 GHz

---

## Preparing Your Spectrum Analyzer for Use

Detailed information for all of the steps in this process is included in this chapter.

1. Unpack the spectrum analyzer and inspect it.
2. Verify that all of the accessories and documentation has been shipped.
3. Check that the line voltage selector is set to the proper voltage.
4. Check that the correct fuse is in place.

---

**Warning**      **Failure to ground the spectrum analyzer properly can result in personal injury. Use an ac power outlet that has a protective earth contact. DO NOT defeat the earth grounding protection by using an extension cable, power cable, or autotransformer without a protective ground conductor.**

---

**Caution**      *Do not* connect ac power until you have verified that the line voltage is correct, the proper fuse is installed, and the line voltage selector switch is properly positioned, as described in the following paragraphs. Damage to the equipment could result.

---

5. Connect the power cable to the spectrum analyzer and turn it on.

---

**Warning**      **Install the product so that the detachable power cord is readily identifiable and easily reached by the operator. The detachable power cord is the product disconnecting device. It disconnects the mains circuits from the mains supply before other parts of the product. The front panel switch is only a standby switch and is not a LINE switch. Alternatively, an externally installed switch or circuit breaker (which is readily identifiable and is easily reached by the operator) may be used as a disconnecting device.**

---

6. Execute the self-calibration routines.

## Initial Inspection

Inspect the shipping container for damage. If the shipping container or cushioning material is damaged, keep it until you have verified that the contents are complete and you have tested the spectrum analyzer mechanically and electrically.

Table 1-1 contains the accessories shipped with the spectrum analyzer. If the contents are incomplete or if the spectrum analyzer does not pass the verification tests in the calibration guide, notify the nearest Hewlett-Packard office. If the shipping container is damaged or the cushioning material shows signs of stress, also notify the carrier. Keep the shipping materials for the carrier's inspection. The HP office will arrange for repair or replacement without waiting for a claim settlement.

If the shipping materials are in good condition, retain them for possible future use. You may wish to ship the spectrum analyzer to another location or to return it to Hewlett-Packard for service. See "How to Return Your Analyzer for Service," in Chapter 9 for more information about shipping materials.

**Note** If cleaning is necessary, use a damp cloth only.

**Table 1-1. Accessories Supplied with the Spectrum Analyzer**

| Description                      | HP Part Number | Comments                                                                                                                                 |
|----------------------------------|----------------|------------------------------------------------------------------------------------------------------------------------------------------|
| 32-kilobyte Memory Card          | 0950-1964      | Shipped with analyzer. HP 8590L, HP 8592L, and HP 8594L must include Option 003.                                                         |
| Memory Card Holder               | 9222-1545      | Shipped with analyzer. HP 8590L, HP 8592L, and HP8594L must include Option 003.                                                          |
| Adapter, Type N (m) to BNC (f)   | 1250-0780      | Not shipped with Option 001. Two adapters are shipped with Option 010.                                                                   |
| Two Adapters, BNC (m) to BNC (f) | 1250-0076      | Shipped with Option 105 only. The adapters can be used to connect cables to the rear-panel connectors.                                   |
| Adapter, BNC (m) to SMA (f)      | HP 1250-1700   | Shipped with Option 026 only.                                                                                                            |
| Connector, APC-3.5 mm (f) to (f) | HP 5061-5311   | Shipped with Option 026 only.                                                                                                            |
| Reference Connector              | 1250-1499      | Shipped connected between the 10 MHz REF OUT and the EXT REF IN on the rear panel of the analyzer. Not shipped with HP 8590L option 713. |
| Cable, 50Ω, BNC                  | 8120-2682      | Not shipped with Options 001, 011, or 026.                                                                                               |
| Cable, SMA (m) to type N (m)     | 8120-5148      | Shipped with HP 8592L, HP 85933, and HP 8596E. Not shipped with Option 026.                                                              |
| Cable, 75Ω, BNC                  | 5062-6452      | Shipped with Options 001 or 011 only.                                                                                                    |
| Cable, SMA (m) to SMA (m)        | 08592-60061    | Shipped with Option 026 only.                                                                                                            |
| Power cable                      | See Table 1-3  | Shipped with analyzer.                                                                                                                   |

---

## Power Requirements

The spectrum analyzer is a portable instrument and requires no physical installation other than connection to a power source.

---

**Warning**      **Failure to ground the spectrum analyzer properly can result in personal injury. Use an ac power outlet that has a protective earth contact. DO NOT defeat the earth grounding protection by using an extension cable, power cable, or autotransformer without a protective ground conductor.**

---

**Caution**      Do *not* connect ac power until you have verified that the line voltage is correct, the proper fuse is installed, and the line voltage selector switch is properly positioned, as described in the following paragraphs. Damage to the equipment could result.

---

**Table 1-2. Power Requirements**

| Characteristic | 115 V Requirement | 230 V Requirement |
|----------------|-------------------|-------------------|
| Input Voltage  | 90 to 132 V rms   | 198 to 264 V rms  |
| Frequency      | 47 to 440 Hz      | 47 to 66 Hz       |
| Power          | <500 VA, <180 W   | <500 VA, <180 W   |

## Setting the Line Voltage Selector Switch

---

**Caution**      Before connecting the spectrum analyzer to the power source, you must set the rear-panel voltage selector switch correctly to adapt the spectrum analyzer to the power source. An improper selector switch setting can damage the spectrum analyzer when it is turned on.

---

Set the instrument's rear-panel voltage selector switch to the line voltage range (115 V or 230 V) corresponding to the available ac voltage. See Figure 1-2. Insert a small screwdriver or similar tool in the slot and slide the switch so that the proper voltage label is visible.

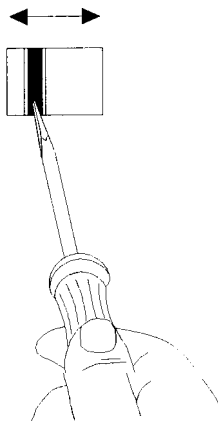

pu138e

**Figure 1-2. Setting the Line Voltage Selector Switch**

## Checking the Fuse

The recommended fuse is size 5 by 20 mm, rated F5A, 250 V (IEC approved). This fuse may be used with input line voltages of 115 V or 230 V. Its HP part number is 2110-0709.

With an input line voltage of 115 V an alternate fuse can be used. In areas where the recommended fuse is not available, a size 5 by 20 mm, rated fast blow, 5 A, 125 V (UL/CSA approved) fuse may be substituted. Its HP part number is 2110-0756.

The line fuse is housed in a small container beside the rear-panel power connector. See Figure 1-3. The container provides space for storing a spare fuse, as shown in the figure.

To check the fuse, insert the tip of a screwdriver in the slot at the middle of the container and pry gently to extend the container.

---

**Warning**      **For continued protection against fire hazard replace line fuse only with same type and rating (5A/250V). The use of other fuses or material is prohibited.**

---

**Note**            The fuse container is attached to the line module; it cannot be removed.

---

The fuse closest to the spectrum analyzer is the fuse in use. If the fuse is defective or missing, install a new fuse in the proper position and reinsert the fuse container.

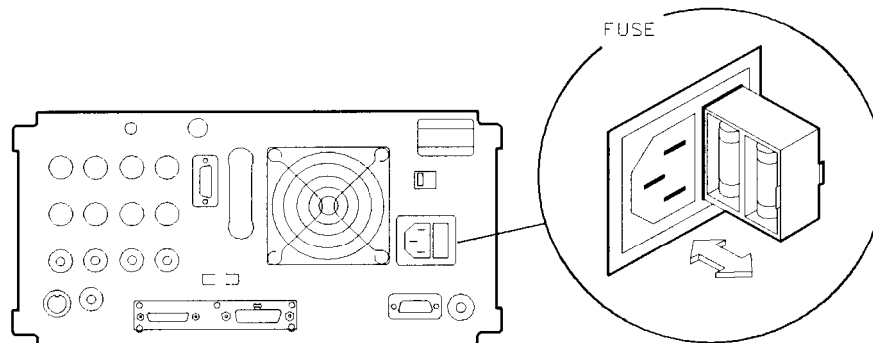

0u125e1

**Figure 1-3. Checking the Line Fuse**

## Power Cable

The spectrum analyzer is equipped with a three-wire power cable, in accordance with international safety standards. When connected to an appropriate power line outlet, this cable grounds the instrument cabinet.

---





**Warning**      **Failure to ground the spectrum analyzer properly can result in personal injury. Before turning on the spectrum analyzer, you must connect its protective earth terminals to the protective conductor of the main power cable. Insert the main power cable plug only into a socket outlet that has a protective earth contact. DO NOT defeat the earth-grounding protection by using an extension cable, power cable, or autotransformer without a protective ground conductor.**

**If you are using an autotransformer, make sure its common terminal is connected to the protective earth contact of the power source outlet socket.**

---

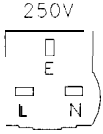
Various power cables are available to connect the spectrum analyzer to the types of ac power outlets unique to specific geographic areas. The cable appropriate for the area to which the spectrum analyzer is originally shipped is included with the unit. You can order additional ac power cables for use in different areas. Table 1-3 lists the available ac power cables, illustrates the plug configurations, and identifies the geographic area in which each cable is appropriate.

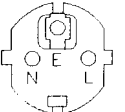
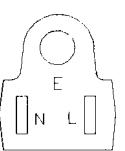
**Table 1-3. AC Power Cables Available**

| PLUG TYPE *                                                                                                                                                                                       | CABLE HP PART NUMBER   | PLUG DESCRIPTION                | CABLE LENGTH CM (INCHES) | CABLE COLOR                   | FOR USE IN COUNTRY                                                                                                             |
|---------------------------------------------------------------------------------------------------------------------------------------------------------------------------------------------------|------------------------|---------------------------------|--------------------------|-------------------------------|--------------------------------------------------------------------------------------------------------------------------------|
| 250V<br>                                                                                                         | 8120-1351<br>8120-1703 | Straight* BS1363A<br>90°        | 229 (90)<br>229 (90)     | Mint Gray<br>Mint Gray        | Great Britain,<br>Cyprus, Nigeria,<br>Singapore,<br><b>Zimbabwe</b>                                                            |
| 250V<br>                                                                                                         | 8120-1369<br>8120-0696 | Straight* NZSS198/ASC112<br>90° | 201 (79)<br>221 (87)     | Gray<br><b>Gray</b>           | Argentina,<br>Australia,<br>New Zealand,<br>Mainland <b>China</b>                                                              |
| 250V<br>                                                                                                         | 8120-1689<br>8120-1692 | Straight* CEE7-Y11<br>90°       | 201 (79)<br>201 (79)     | Mint Gray<br><b>Mint Gray</b> | East and West<br>Europe, Central<br>African Republic<br>United Arab<br>Republic<br>(unpolarized in<br>many nations)            |
| 125V<br>                                                                                                       | 8120-1348<br>8120-1538 | Straight* NEMA5-15P<br>90°      | 203 (80)<br>203 (80)     | Black<br><b>Black</b>         | United States<br>Canada,<br>Japan (100 V or<br>200 V), Brazil,<br>Colombia, Mexico,<br>Philippines,<br>Saudi Arabia,<br>Taiwan |
| 250V<br>                                                                                                       | 8120-1378              | Straight* NEMA5-15P             | 203 (80)                 | Jade Gray                     | Israel                                                                                                                         |
|                                                                                                                                                                                                   | 8120-4753              | Straight                        | 230 (90)                 | Jade Gray                     |                                                                                                                                |
|                                                                                                                                                                                                   | 8120-1521              | 90°                             | 203 (80)                 | Jade Gray                     |                                                                                                                                |
|                                                                                                                                                                                                   | 8120-4754              | 90°                             | 230 (90)                 | Jade Gray                     |                                                                                                                                |
| 250V<br>                                                                                                       | 8120-5182<br>8120-5181 | Straight* NEMA5-15P<br>90°      | 200 (78)<br>200 (78)     | Jade Gray<br>Jade Gray        |                                                                                                                                |
| <p>*Part number for plug is industry identifier for plug only. Number shown for cables is HP Part Number for complete cable, including plug.</p> <p>* E = Earth Ground; L = Line, N = Neutral</p> |                        |                                 |                          |                               |                                                                                                                                |

FORMAT80



---

## Turning on the Analyzer for the First Time

When you turn the spectrum analyzer on for the first time, you should perform frequency and amplitude self-calibration routines to generate correction factors and indicate that the unit is functioning correctly. The spectrum analyzer should be allowed to warm-up for 30 minutes before performing the self-calibration routines. See “When Is Self-Calibration Needed?” in Chapter 2 for helpful guidelines on how often the self-calibration routines should be performed.

Perform the following steps:

1. For an **HP 85901, HP 8592L, HP 8591 E, HP 85933, HP 8594E, HP 8594L, HP 8595E, or HP 85963** ensure the reference connector is connected between the 10 MHz OUTPUT and EXT REF IN rear-panel connectors. See Figure 1-4.

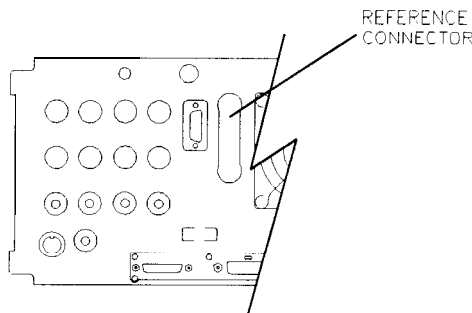

pu126e1

**Figure 1-4. Reference Connector**

If you wish to use an external 10 MHz source as the reference frequency, disconnect the reference connector from the rear-panel and connect an external reference source to the EXT REF IN connector on the rear panel.

2. Plug the power cord into the spectrum analyzer.
3. Press (LINE).

After a few seconds, the screen displays the firmware revision date in the YYMMDD format. For example, 930522 indicates May 22, 1993. This is a change from previous revisions where any firmware date used the DDMMYY format prior to 930506.

---

**Note** Record the firmware date and keep it for reference. If you should ever need to call Hewlett-Packard for service or with any questions regarding your spectrum analyzer, it will be helpful to have the firmware date readily available.

---

If your spectrum analyzer is equipped with Option 021 (HP-IB interface), the appropriate interface address (HP-IB ADRS : XX) also appears on the screen.

If your spectrum analyzer is equipped with Option 023 (RS-232 interface), the baud rate (RS232 : XXXX) is displayed.

4. To meet spectrum analyzer specifications, allow a 30 minute warm-up before attempting to make any calibrated measurements. Be sure to calibrate the spectrum analyzer only *after* the spectrum analyzer has met the operating temperature conditions.
5. Connect the type N (m) to BNC (f) connector (shipped with the spectrum analyzer) to the INPUT 50 $\Omega$ . Connect the 50 $\Omega$  coaxial cable (also shipped with the instrument) between the front-panel CAL OUT and the INPUT 500 connector. If the spectrum analyzer has Option

001 (75Ω input), use the 75Ω calibration cable shipped with the analyzer. Use only 750 connectors to avoid damage to the RF input connector.

---

**Note**      **Option 105** only: Remove all connections to the GATE TRIGGER INPUT rear-panel connector before performing the self-calibration routines.

---

6. Perform the frequency and amplitude self-calibration routine by pressing (CAL) and CAL FREQ & AMPTD . During the frequency routine, CAL: SWEEP, CAL: FREQ, and CAL: SPAN are displayed as the sequence progresses. For an Option 102, CAL: FM GAIN + OFFSET is also displayed.

During the amplitude routine, CAL; AMPTD, CAL: 3 dB BW, CAL: ATTEN, and CAL: LOGAMP are displayed as the sequence progresses. CAL: DONE appears when the routine is completed. Any failures or discrepancies produce a message on the screen; see Chapter 9.

7. When the frequency and amplitude self-calibration routines have been completed successfully, store the correction factors by pressing CAL STORE.

The self-calibration routines calibrate the spectrum analyzer by generating correction factors. The softkey CAL STORE stores the correction factors in the area of spectrum analyzer memory that is saved when the spectrum analyzer is turned off; the spectrum analyzer will automatically apply these factors in future measurements. If CAL STORE is not pressed, the correction factors remain in effect until the spectrum analyzer is turned off.

## Performing the Tracking-Generator Self-Calibration Routine

For spectrum analyzers with Option 010 or 011, the tracking-generator self-calibration routine should be performed prior to using the tracking generator.

---

**Note**      Since the tracking generator calibration routine depends on the accuracy of the absolute amplitude level of the spectrum analyzer, the spectrum analyzer amplitude calibration should be done prior to using CAL TRK GEM .

---

1. To calibrate the tracking generator, connect the tracking generator output (RF OUT 50Ω) to the spectrum analyzer INPUT 50Ω connector, using an appropriate cable and BNC-to-Type N adapters. If the spectrum analyzer has Option 001 (750 input), use the 75Ω calibration cable shipped with the analyzer. Use only 75Ω connectors to avoid damage to the RF input connector.

---

**Note**      A low-loss cable should be used for accurate calibration. Use the 50Ω cable shipped with the spectrum analyzer. If the analyzer has Option 001 (75Ω input), use the 75Ω cable shipped with the spectrum analyzer.

---

2. Press the following spectrum analyzer keys: (CAL), More 1 of 4 , More 2 of 4 , then CAL TRK GEN . TG SIGNAL NOT FOUND will be displayed if the tracking generator output is not connected to the spectrum analyzer input.

3. To save this data in the area of spectrum analyzer memory that is saved when the spectrum analyzer is turned off, press CAL STORE .

## Performing the YTF Self-Calibration Routine

For preselected spectrum analyzers (HP 8592L, HP 85933, HP 8595E, and HP 85963) only, the yig-tuned filter (YTF) self-calibration routine should be performed periodically. See “When Is Self-Calibration Needed?” in Chapter 2 for helpful guidelines on how often the self-calibration routines should be performed.

To perform the YTF self-calibration routine, use the following procedure:

1. Connect a low-loss cable (such as HP part number 8120-5148) from 100 MHz COMB OUT to the spectrum analyzer input. For the HP 85953, use the CAL OUT, instead of the COMB OUT, as the spectrum analyzer input.
2. Press (CAL) then CAL YTF . The YTF self-calibration routine completes in approximately:

| <u>Model Number YTF Cal Time</u> |  |
|----------------------------------|--|
|----------------------------------|--|

|                 |                  |
|-----------------|------------------|
| <b>HP 8592L</b> | <b>7 minutes</b> |
| <b>HP 85933</b> | <b>7 minutes</b> |
| <b>HP 85953</b> | <b>3 minutes</b> |
| <b>HP 85963</b> | <b>5 minutes</b> |

3. Press (CAL) then CAL STORE .

When the self-calibration routines have been completed successfully, the spectrum analyzer is ready for normal operation.

---

## Electrostatic Discharge

Electrostatic discharge (ESD) can damage or destroy electronic components. All work on electronic assemblies should be performed at a static-safe work station. Figure 1-5 shows an example of a static-safe work station using two types of ESD protection:

- Conductive table-mat and wrist-strap combination.
- Conductive floor-mat and heel-strap combination.

Both types, when used together, provide a significant level of ESD protection. Of the two, only the table-mat and wrist-strap combination provides adequate ESD protection when used alone.

To ensure user safety, the static-safe accessories must provide at least 1 M $\Omega$  of isolation from ground. Refer to Table 1-4 for information on ordering static-safe accessories.

---

**Warning**      **These techniques for a static-safe work station should not be used when working on circuitry with a voltage potential greater than 500 volts.**

---

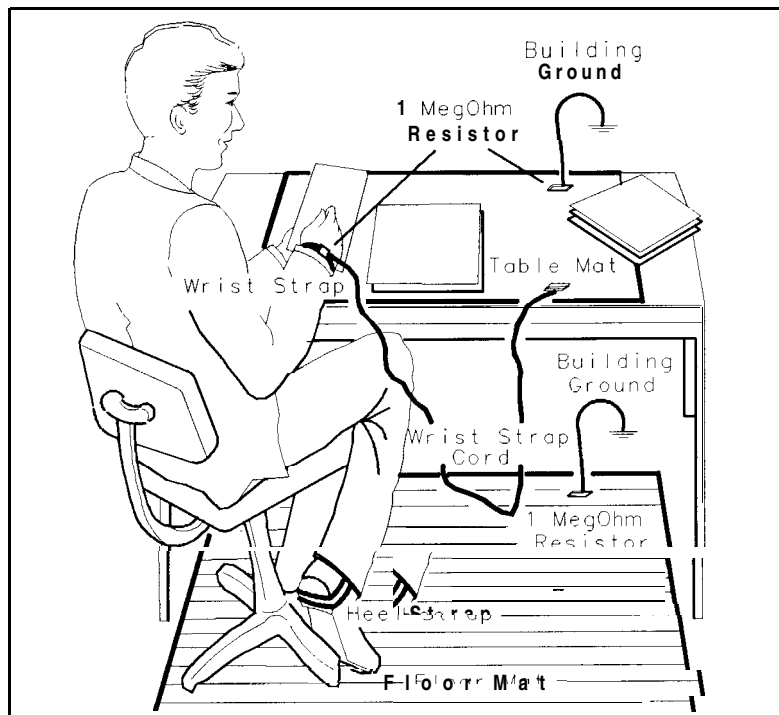

**Figure 1-5. Example of a Static-Safe Work Station**

## Reducing Damage Caused by ESD

The following suggestions may help reduce ESD damage that occurs during testing and servicing operations.

- Before connecting any coaxial cable to an spectrum analyzer connector for the first time each day, momentarily ground the center and outer conductors of the cable.
- Personnel should be grounded with a resistor-isolated wrist strap before touching the center pin of any connector and before removing any assembly from the unit.
- Be sure that all instruments are properly earth-grounded to prevent a buildup of static charge.

Table 1-4 lists static-safe accessories that can be obtained from Hewlett-Packard by using the HP part numbers shown.

**Table 1-4. Static-Safe Accessories**

| <b>HP Part Number</b> | <b>Description</b>                                                                                                                                                                        |
|-----------------------|-------------------------------------------------------------------------------------------------------------------------------------------------------------------------------------------|
| <b>9300-0797</b>      | Set includes: 3M static control mat 0.6 m x 1.2 m (2 ft x 4 ft) and 4.6 cm (15 ft) ground wire. (The wrist-strap and wrist-strap cord are not included. They must be ordered separately.) |
| 9300-0980             | Wrist-strap cord 1.5 m (5 ft)                                                                                                                                                             |
| 9300-1383             | Wrist-strap, color black, stainless steel, without cord, has four adjustable links and a 7 mm post-type connection.                                                                       |
| 9300-1 169            | ESD heel-strap (reusable 6 to 12 months).                                                                                                                                                 |

## Getting Started

---

### What You'll Learn in this Chapter

This chapter introduces the basic functions of the HP 8590 Series spectrum analyzers. In this chapter you will:

- Get acquainted with the front-panel and rear-panel features.
- Get acquainted with the menus and softkeys.
- Learn about screen annotation.
- Make a basic measurement (the calibration signal).
- Learn how to improve measurement accuracy by using self-calibration routines.
- Learn how to insert the memory card and about the memory card battery.
- Learn about the spectrum analyzer battery.

---

**Note** Before using your spectrum analyzer, please read Chapter 1 “Preparing for Use,” which describes how to set up your spectrum analyzer and how to verify that it is operational. Chapter 1 describes many safety considerations that should not be overlooked.

---

---

### Getting Acquainted with the Analyzer

#### Front-Panel Features

The following section provides a brief description of front-panel features. Refer to Figure 2-1.

- 1 **Active function block** is the space on the screen that indicates the active function. Most functions appearing in this block can be changed using the knob, step keys, or data keys.
- 2 **Message block** is the space on the screen where MEAS UNCAL and the asterisk (\*) appear. If one or more functions are manually set (uncoupled), and the amplitude or frequency becomes uncalibrated, MEAS UNCAL appears. (Use `AUTO_COUPLE` and AUTO ALL to recouple functions.) The asterisk indicates that a function is in progress.
- 3 **Softkey labels** are the annotation on the screen next to the unlabeled keys. Most of the labeled keys on the spectrum analyzer front panel (also called front-panel keys) access menus of related softkeys.
- 4 **Softkeys** are the unlabeled keys next to the screen.

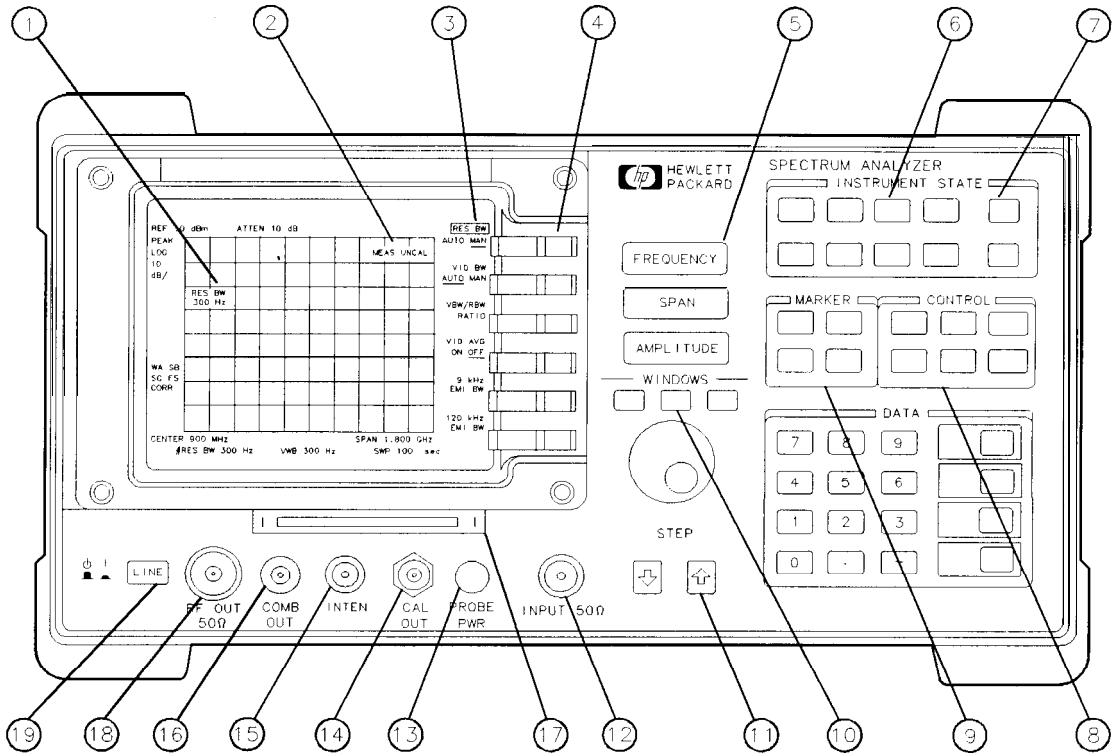

pu133e

**Figure 2-1. Front-Panel Feature Overview**

5 **FREQUENCY**, **SPAN**, and **AMPLITUDE** are the three large dark-gray keys that activate the primary spectrum analyzer functions and access menus of related functions.

6 **INSTRUMENT STATE** functions affect the state of the entire spectrum analyzer. Self-calibration routines and special-function menus are accessed with these keys. The green **PRESET** key resets the spectrum analyzer to a known state. The **MODE** key accesses the current operating mode of the spectrum analyzer and allows you to change to any operating mode available for your spectrum analyzer. All spectrum analyzers have the spectrum analyzer mode of operation (indicated by **SPECTRUM ANALYZER**). If an additional softkey label appears in the softkey label area, a program (also called a downloadable program or personality) has been loaded into the spectrum analyzer memory. This document covers the spectrum analyzer mode of operation only; consult the documentation accompanying the specific measurement personality that you are using for information about other modes of operation. (For example: the HP 85711A Cable Television Measurements Personality, the HP 85713A Digital Radio Measurements Personality, or the HP 85715A GSM Measurements Personality.)

**SAVE** and **RECALL** keys save and recall traces, states, limit-line tables, amplitude correction factors, and programs to or from a memory card. **SAVE** and **RECALL** keys also save and recall traces, states, limit-line tables, and amplitude correction factors to or from the spectrum analyzer memory.

---

**Note** If you wish to reset the spectrum analyzer configuration to the state it was in when it was originally shipped from the factory, use **DEFAULT CONFIG**. Refer to the **DEFAULT CONFIG** softkey description in Chapter 7 for more information.

---

- 7 **COPY** prints or plots screen data. (This requires Option 041 or 043.) Use **CONFIG**, Plot Conf **ig** or Print Conf **ig**, and COPY DEV PRMT PLT before using **COPY**. See Chapter 7 for more details.
- 8 **CONTROL** functions access menus that allow you to adjust the resolution bandwidth, adjust the sweep time, store and manipulate trace data, and control the instrument display.
- 9 **MARKER** functions control the markers, read out frequencies and amplitudes along the spectrum-analyzer trace, automatically locate the signals of highest amplitude, and keep a signal at the marker position in the center of the screen.
- 10 **WINDOWS** keys, turn on the windows display mode. They allow switching between windows and control the zone span and location. *For the HP 8591E, HP 8593E, HP 8594E, HP 8595E, and HP 85963 only.*
- HOLD** key. *For the HP 8590L, HP 8592L, and HP 8594L only.* **HOLD** deactivates an active function. *For the HP 85913, HP 8593E, HP 85943, HP 8595E, and HP 8596E,* the “hold” function is available as the **HOLD** softkey under **DISPLAY**.
- 11 **DATA** keys, **STEP** keys, and **knob** allow you to change the numeric value of an active function.
- 12 **INPUT 500** is the signal input for the spectrum analyzer. (INPUT 75Ω is the signal input for an Option 001 spectrum analyzer.)
- 

**Caution** Excessive signal input will damage the spectrum analyzer input attenuator and input mixer. Use extreme caution when using the spectrum analyzer around high-power RF sources and transmitters. The maximum input power that the spectrum analyzer can tolerate appears on the front panel and should not be exceeded.

Excessive dc voltage can also damage the input attenuator. For your particular instrument, note the maximum dc voltage that should not be exceeded on the spectrum analyzer front panel (beneath the INPUT 50Ω connector).

---

- 13 **PROBE PWR** provides power for high-impedance ac probes or other accessories.
- 14 **CAL OUT** provides a calibration signal of 300 MHz at -20 dBm (29 dBmV for Option 001 or 011).
- 15 **VOL-INTEN** or **INTENSITY**. *For the HP 85913, HP 8593E, HP 85943, HP 85953, or HP 8596E only.* The VOL-INTEN knob changes the brightness of the display. If Option 102, 103, or 110 is installed, it can also adjust the volume of the internal speaker. If it adjusts both, the inside part of the knob adjusts the intensity while the outside part adjusts the volume.

The **INTENSITY** knob changes the brightness of the display. *For the HP 8590L, HP 8592L, and HP 8594L only.*



- 16 **100 MHz COMB OUT** supplies a 100 MHz reference signal that has harmonics up to 22 GHz. *For the HP 85921, HP 8593E, or HP 8596E only.*
- 17 **Memory card reader** reads from or writes to a memory card. The memory card reader is standard with an HP 85913, HP 85933, HP 85943, HP 85953, and HP 85963. It is also available for the HP 8590L, HP 8592L, and HP 8594L as Option 003.
- 18 **RF OUT 50Ω** supplies a source output for the built-in tracking generator. *For Option 010 only. See Table 2-1.*

**Caution** If the tracking generator output power is too high, it may damage the device under test. Do not exceed the maximum power that the device under test can tolerate.

**RF OUT 75Ω** supplies a source output for the built-in tracking generator. *For Option 011 only. See Table 2-1.*

**Table 2-1. RF Output Frequency Range**

| <b>Model Number</b> | <b>Option 010<br/>Frequency Range</b> | <b>Option 011<br/>Frequency Range</b> |
|---------------------|---------------------------------------|---------------------------------------|
| HP 8590L            | 100 kHz to 1.8 GHz                    | 1 MHz to 1.8 GHz                      |
| HP 85913            | 100 kHz to 1.8 GHz                    | 1 MHz to 1.8 GHz                      |
| HP 85933            | 9 kHz to 2.9 GHz                      | not available                         |
| HP 85943            | 9 kHz to 2.9 GHz                      | not available                         |
| HP 85953            | 9 kHz to 2.9 GHz                      | not available                         |
| HP 85963            | 9 kHz to 2.9 GHz                      | not available                         |

- 19 **LINE** turns the instrument on and off. The symbols to the left of the line switch represent the up position of the switch when the instrument is off, and the down position of the switch when the instrument is on. An instrument self-check is performed every time the instrument is turned on. After applying power, allow the temperature of the instrument to stabilize for best measurement results.

**Note** The instrument continues to draw power when it is plugged into the ac power source even if the line power switch is off.

## Rear-Panel Features

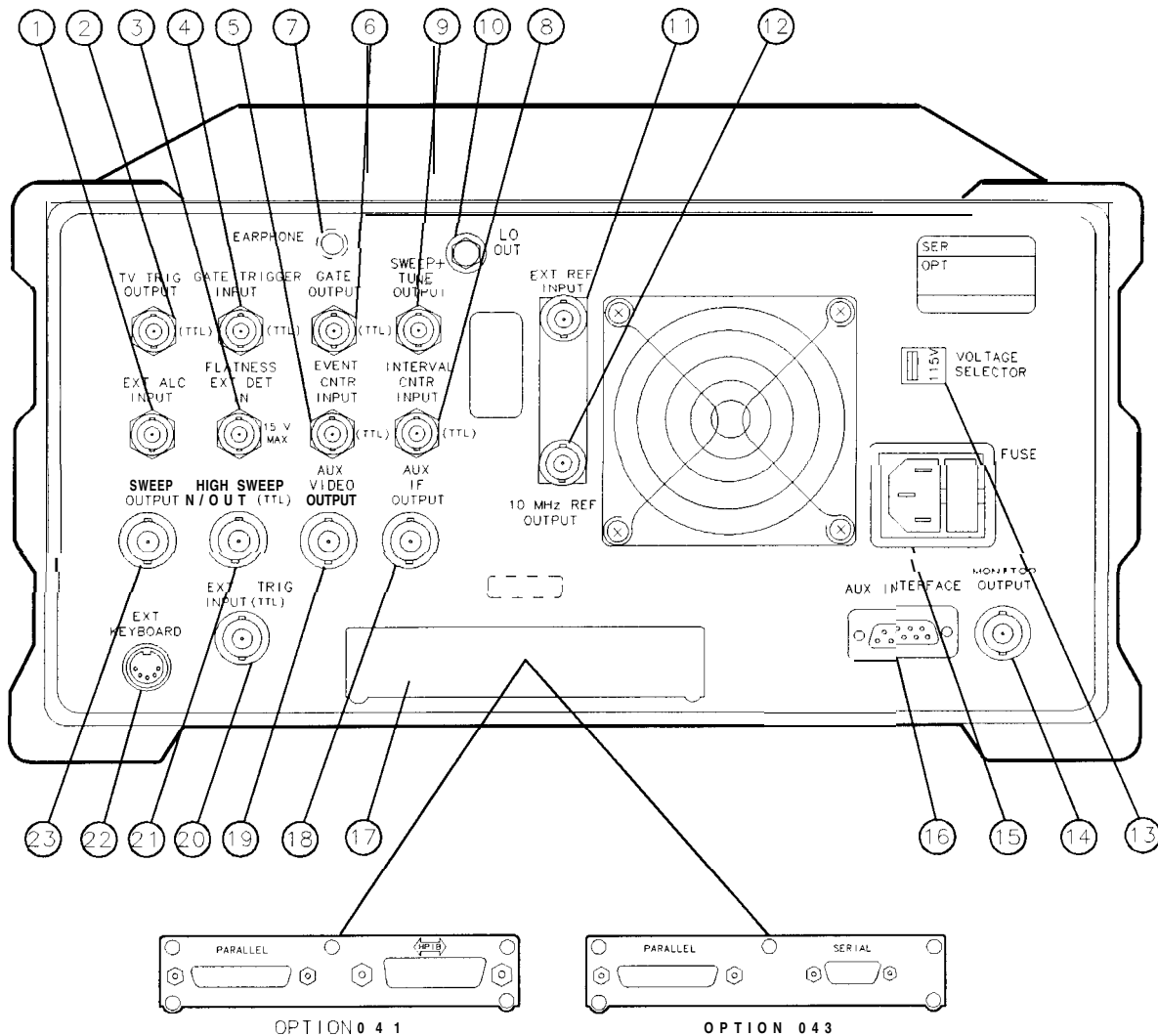

pu127e1

**Figure 2-2. Rear-Panel Feature Overview**

- 1 **EXT ALC INPUT** allows the use of an external detector or power meter for automatic leveling control of the tracking generator. *For an HP 8590L and HP 8591E Option 010 or 011 only.* Allows the use of an external detector for an *HP 8593E, HP 8594E, HP 85953, or HP 8596E Option 010 only.*
- 2 **TV TRIG OUTPUT (TTL)** provides TV trigger output using TTL and negative-edge triggering. *For Options 101 and 102 combined, or Option 301 only.*
- 3 **FLATNESS EXT DET IN** accepts a signal (16 V maximum) from an external crystal detector. This signal is used to correct the spectrum analyzer response to the detector's flatness. *Option E02 only.* This input is used for digital radio testing in an HP 11758T Digital Radio Test System.

- 4 **GATE TRIGGER INPUT (TTL)** accepts a TTL signal which acts as the gate trigger. In edge mode, the trigger event (positive or negative edge) initiates a gate delay. In level mode, the gate trigger input signal opens and closes the gate directly: TTL high sets the gate on; TTL low sets the gate off. When this input is unconnected, TTL is set high. ***For Option 105 only.***
- 5 **EVENT CNTR INPUT (TTL)** accepts a TTL signal and counts the negative pulses (a falling edge followed by a rising edge) that occur during the gate time interval. ***Option E02 only.*** This input is used to test for digital radio signal errors when using the HP 11758T Digital Radio Test System.
- 6 **GATE OUTPUT (TTL)** provides a TTL signal which indicates gate status when the when the gate is in edge trigger mode. A high TTL signal indicates the gate is on; a low TTL signal indicates the gate is off. GATE OUTPUT is not active in level mode. ***For Option 105 only,***
- 7 **EARPHONE** connector provides a connection for an earphone jack instead of using the internal speaker. ***For Option 102, 103, or 110 only.***
- 8 **INTERVAL CNTR INPUT (TTL)** accepts a TTL signal. It identifies negative pulses (a falling edge followed by a rising edge) and measures the accumulated time that a pulse is low during the gate time interval. ***Option E02 only.*** This input is used to test for digital radio signal errors when using the HP 11758T Digital Radio Test System.
- 9 **SWEEP + TUNE OUTPUT** provides a voltage ramp that is proportional to the spectrum analyzer span (0 to 10 V) plus the tuning voltage of the LO. ***For Option 009 only.***
- 10 **LO OUT** provides the output of the first LO, which is proportional to the frequency that the spectrum analyzer is tuned to. ***For Option 009 or 010 only.***
- 11 **EXT REF IN** accepts an external frequency source to provide the 10 MHz, -2 to + 10 dBm frequency reference used by the spectrum analyzer. ***Not available for HP 8590L with Option 713 or HP 8592L with Option 713.***
- 12 **10 MHz REF OUTPUT** provides a 10 MHz, 0 dBm minimum, time-based reference signal. ***Not available for HP 8590L with Option 713 or HP 8592L with Option 713.***
- 13 **VOLTAGE SELECTOR** adapts the unit to the power source: 115 V or 230 V.
- 14 **MONITOR OUTPUT** drives an external monitor with a signal that has a 15.7 kHz horizontal synchronizing rate. It can also be switched to provide an NTSC format output which is compatible with VHS video recorders or a PAL format which is compatible with PAL/SECAM video recorders.
- 15 **Power input** is the input for the line power source. Make sure that the line-power source outlet has a protective ground contact.
- 16 **AUX INTERFACE** provides a nine-pin "D" subminiature connector for control of external devices. Refer to specifications and characteristics in your calibration guide for a more detailed description.

---

**Caution** Turn off the spectrum analyzer before connecting the AUX INTERFACE connector to a device. Failure to do so may result in loss of factory-correction constants.

Do not exceed the current limits for the +5 V supply when using the AUX INTERFACE connector. Exceeding the current limits may result in loss of factory-correction constants.

Do not use the AUX INTERFACE as a video monitor interface. Damage to the video monitor will result.

---

- 17 **Interface connectors** are optional interfaces for HP-IB and parallel (Option 041) and RS-232 and parallel (Option 043) interface buses. They support remote instrument operation, direct plotting or printing, and parallel printing of screen data.
- 18 **AUX IF OUTPUT** is a 500, 21.4 MHz IF output that is the down-converted signal of the RF input of the spectrum analyzer. Amplitude-correction factors are not applied to this signal.
- 19 **AUX VIDEO OUTPUT** provides detected video output (before the analog-to-digital conversion) proportional to vertical deflection of the trace. Output is from 0 V to 1 V. Amplitude-correction factors are not applied to this signal.
- 20 **EXT TRIG INPUT (TTL)** accepts the positive edge of an external voltage input that triggers the spectrum analyzer internal sweep source.
- 21 **HIGH SWEEP IN/OUT (TTL)** indicates when the spectrum analyzer is sweeping or can be grounded to stop sweeping.
- 22 **EXT KEYBOARD** connector is provided with the optional interface connector. The external keyboard is not included with the spectrum analyzer. The external keyboard can be used to enter screen titles, prefixes, remote commands, and writing simple DLP's. For *Options 041 or 043 only*.

---

**Caution** Turn off the spectrum analyzer before connecting an external keyboard to the spectrum analyzer.

---

- 23 **SWEEP OUTPUT** provides a voltage ramp proportional to the sweep and the spectrum analyzer span (0 V to 10 V).

## Data Controls

Data controls are used to change values for functions such as center frequency, start frequency, resolution bandwidth, and marker position.

The data controls will change the active function in a manner prescribed by that function. For example, you can change center frequency in fine steps with the knob, in discrete steps with the step keys, or to an exact value with the number/units keypad. For example, resolution bandwidth, which can be set to discrete values only, is changed to predetermined values with any of the data controls.

### Hold Key

Deactivate functions with HOLD which is found under the **DISPLAY** key. On the HP 8590L, HP 8592L, and HP 8594L it is also available as a front panel key, (HOLD). The active function readout is blanked, indicating that no entry will be made inadvertently by using the knob, step keys, or keypad. (Pressing a function key re-enables the data controls.)

### Knob

The knob allows continuous change of functions such as center frequency, reference level, and marker position. It also changes the values of many functions that change in increments only. Clockwise rotation of the knob increases values. For continuous changes, the extent of alteration is determined by the size of the measurement range; the speed at which the knob is turned does not affect the rate at which the values are changed.

The knob enables you to change the center frequency, start or stop frequency, or reference level in smooth scrolling action. The smooth scrolling feature is designed to move the trace display to the latest function value as the knob is turned. When either center frequency or reference level is adjusted, the signal will shift right or left or up or down with the rotation of the knob before a new sweep is actually taken. An asterisk is placed in the message block (the upper right-hand corner of the spectrum analyzer display) to indicate that the data on-screen does not reflect data at the current setting.

---

**Note** When using the knob to change frequency or amplitude settings, the trace data is shifted. Therefore, when using MAX HOLD A , MAX HOLD B , or MIN HOLD C , moving the center frequency with the knob will not simulate a drifting signal.

---

### Number/Units Keypad

The number/units keypad allows entry of exact values for many of the spectrum analyzer functions. You may include a decimal point in the number portion. If not, the decimal point is placed at the end of the number.

Numeric entries must be terminated with a units key. The units keys change the active function in a manner prescribed by that function. For example, the units keys for frequency span are **GHz**, **MHz**, **kHz**, and **Hz**, whereas the units for reference level are **+dBm**, **-dBm**, **mV**, and **μV**.

---

**Note** If an entry from the number/units keypad does not coincide with an allowed function value (for example, that of a 12 MHz bandwidth), the spectrum analyzer defaults to the nearest allowable value.

---

## Step Keys

The step keys allow discrete increases or decreases of the active function value. The step size depends upon the spectrum analyzer measurement range or on a preset amount. Each press results in a single step change. For those parameters with fixed values, the next value in a sequence is selected each time a step key is pressed. Changes are predictable and can be set for some functions. Out-of-range values or out-of-sequence values will not occur using these keys.

## Fine-Focus Control

The fine-focus control is located on the side of the spectrum analyzer. Use the following procedure to adjust the fine-focus control:

1. Adjust the front-panel intensity control for a comfortable viewing intensity.
2. Use an adjustment tool or small screwdriver to access the fine-focus adjustment. See Figure 2-3. Adjust for a focused display.

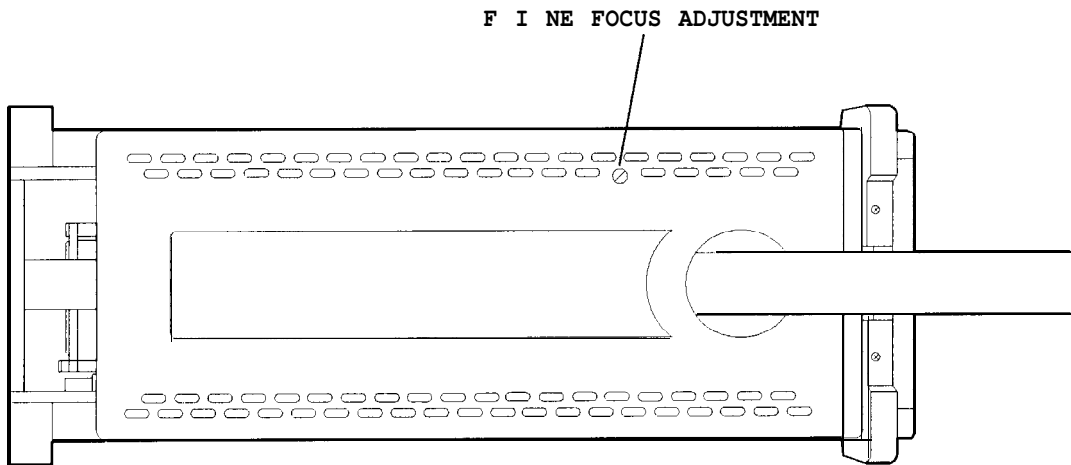

**Figure 2-3. Adjusting the Fine Focus**

## Screen Annotation

Figure 2-4 shows an example of the annotation that may appear on a spectrum analyzer screen. The screen annotation is referenced by numbers and is listed in Table 2-2. The function key column indicates which front-panel key or softkey activates the function related to the screen annotation. Refer to Chapter 7 for more information on a specific function key.

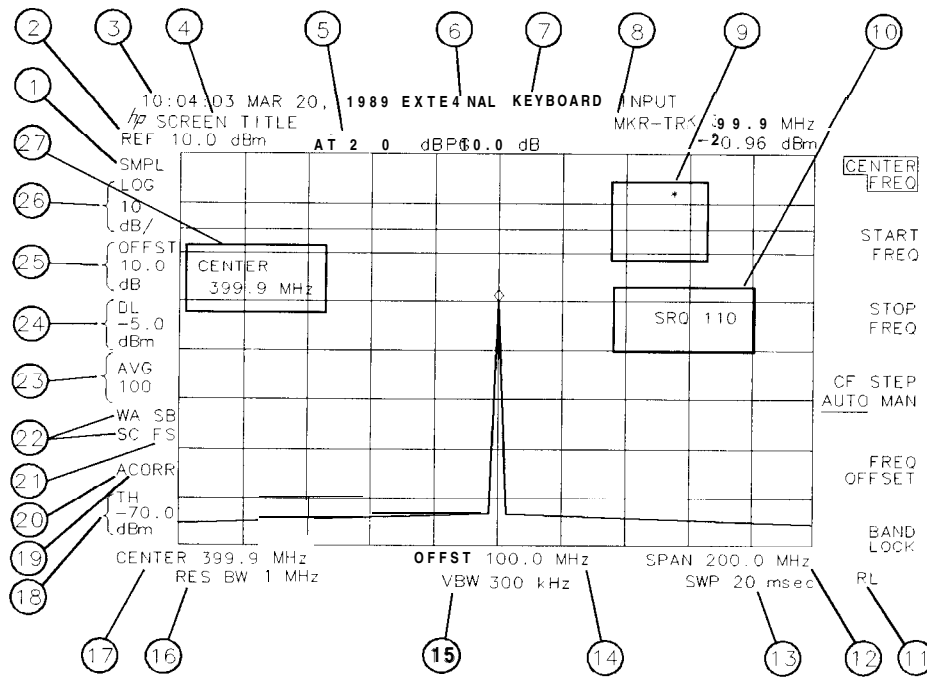

pu17de

**Figure 2-4. Screen Annotation**

In Figure 2-4, item 21 refers to the trigger and sweep modes of the spectrum analyzer. The first letter (“F”) indicates the spectrum analyzer is in free-run trigger mode. The second letter (“S”) indicates the spectrum analyzer is in single-sweep mode.

Item 22 refers to the trace modes of the spectrum analyzer. The first letter (“W”) indicates that the spectrum analyzer is in clear-write mode. The second letter is “A,” representing trace A. The trace B trace mode is “SB”, indicating trace B (“B”) is in the store-blank mode (“S”). The trace mode annotation for trace C is displayed under the trace mode annotation of trace A. In Figure 2-4, the trace C trace mode is “SC”, indicating trace C (“C”) is in the store blank mode (“S”).

Refer to Table **2-3** for the screen annotation codes for trace, trigger, and sweep modes.

The WINDOWS display mode splits the screen into two separate displays. Only one of these displays is active at a time. The currently active window will have a solid line around the graticule rather than a broken line. The complete annotation is not available for each window because of space limitations.

The display will be compressed slightly when using the PAL or NTSC format for the MONITOR OUTPUT, instead of the normal format. The PAL and NTSC formats have less vertical resolution than the spectrum analyzer display. The top and bottom of the spectrum analyzer display are compressed slightly so that all of the information can be fit into the size required by the MONITOR OUTPUT.

**Table 2-2. Screen Annotation**

| Item | Description                                               | Function Key                                                         |
|------|-----------------------------------------------------------|----------------------------------------------------------------------|
| 1    | detector mode                                             | DETECTOR SMP PK                                                      |
| 2    | reference level                                           | REF LVL                                                              |
| 3    | time and date display                                     | Time Date                                                            |
| 4    | screen title                                              | Change Title                                                         |
| 5    | RF attenuation                                            | ATTEN AUTO MAN                                                       |
| 6    | preamplifier gain                                         | EXTERNAL PREAMPG                                                     |
| 7    | external keyboard entry                                   | Refer to "External Keyboard" in Chapter 5.                           |
| 8    | marker readout                                            | (MKR), (MKR ->), (MKR FCTN), or (PEAK SEARCH)                        |
| 9    | measurement uncalibrated or function-in-progress messages | (AUTO COUPLE)                                                        |
| 10   | service request                                           | See Appendix A                                                       |
| 11   | remote operation                                          | See "(LOCAL)" in Chapter 7.                                          |
| 12   | frequency span or stop frequency                          | (SPAN), STOP FREQ                                                    |
| 13   | sweep time                                                | SWP TIME AUTO MAN                                                    |
| 14   | frequency offset                                          | FREQ OFFSET                                                          |
| 15   | video bandwidth                                           | VID BW AUTO MAN                                                      |
| 16   | resolution bandwidth                                      | RES BW AUTO MAN                                                      |
| 17   | center frequency or start frequency                       | CENTER FREQ , START FREQ                                             |
| 18   | threshold                                                 | THRESHLD ON OFF                                                      |
| 19   | correction factors on                                     | CORRECT ON OFF                                                       |
| 20   | amplitude correction factors on                           | See "Using Amplitude-Correction Factors" in Chapter 5.               |
| 21   | trigger                                                   | (TRIG)                                                               |
| 22   | trace mode                                                | (TRACE)                                                              |
| 23   | video average                                             | VID AVG ON OFF                                                       |
| 24   | display line                                              | DSP LINE ON OFF                                                      |
| 25   | amplitude offset                                          | REF LVL OFFSET                                                       |
| 26   | amplitude scale                                           | SCALE LOG LIN                                                        |
| 27   | active function block                                     | Refer to the description of the softkey function that was activated. |



**Table 2-3. Screen Annotation for Trace, Trigger, and Sweep Modes**

| <b>Trace Mode</b>              | <b>Trigger Mode</b>               | <b>Sweep Mode</b> |
|--------------------------------|-----------------------------------|-------------------|
| W = clear write (traces A/B/C) | F = free run                      | C = continuous    |
| M = maximum hold (traces A/B)  | L = line                          | S = single sweep  |
| V = view (traces A/B/C)        | V = video                         |                   |
| S = store blank (traces A/B/C) | E = external                      |                   |
| M = minimum hold (trace C)     | T = TV (Options 101 and 102 only) |                   |

---

## Menu and Softkey Overview

The keys labeled FREQUENCY, CAL, and MKR are all examples of front-panel keys. Pressing most front-panel keys accesses menus of functions that are displayed along the right side of the display. These menus are called softkey menus.

Softkey menus list functions other than those accessed directly by the front-panel keys. To activate a function on the softkey menu, press the unlabeled key immediately to the right of the annotation on the screen. The unlabeled keys next to the annotation on the display screen are called softkeys.

Front-panel keys are designated with a box around the key label, for example, **AMPLITUDE**; softkeys are designated by shading on the key label, for example, REF LVL . The softkeys that are displayed depend on which front-panel key is pressed and which menu level is enabled.

If a softkey function's value can be changed, it is called an active function. The function label of the active function appears in inverse video. For example, press **AMPLITUDE**. This calls up the softkey menu of related amplitude functions. Note the function labeled REF LVL appears in inverse video. REF LVL also appears in the active function block, indicating that it is the active amplitude function and can now be changed using any of the data entry controls.

A softkey with ON and OFF in its label can be used to turn the softkey's function on or off. To turn the function on, press the softkey so that ON is underlined. To turn the function off, press the softkey so that OFF is underlined. The following example demonstrates how an ON or OFF softkey function will be annotated: VID AVG ON OFF (ON).

A function with AUTO and MAN in the label can either be auto-coupled or have its value manually changed. The function's value can be changed manually by pressing the softkey until MAN is underlined, and then changing its value with the numeric keypad, knob, or step keys. To auto-couple a function, press the softkey so that AUTO is underlined. The following example demonstrates how an AUTO or MAN softkey function will be annotated: ATTN AUTO MAN (AUTO).

A summary of all front-panel keys and their related softkeys can be found in Chapter 8, "Key Menus".

---

## Making a Measurement

---

**Caution** Do not exceed the maximum input power.

The maximum input power for the HP 8590L and HP 85913 is +30 dBm (1 watt) continuous, 25 Vdc (with 10 dB or more attenuation).

The maximum input power for the HP 8592L and HP 85933 is +30 dBm (1 watt) continuous, 0 Vdc (with input attenuation of 10 dB or more in bands 1 through 4.)

The maximum input power for the HP 85943, HP 8594L, HP 85953, or HP 85963 is +30 dBm (1 watt) continuous and 50 Vdc (ac-coupled) or 0 Vdc (de-coupled). The input attenuation must be 10 dB or more.

---

Let's begin using the spectrum analyzer by measuring an input signal. Since the 300 MHz calibration signal (CAL OUT) is readily available, we will use it as our input signal.

You cannot hurt the spectrum analyzer by using the calibration signal and pressing any of the keys described in this section. Don't be afraid to play with the knob, step keys, or number/units keypad. (If you have experimented with other keys and wish to return to a known state, press the green **PRESET** key.)

1. First, turn the instrument on by pressing **LINE**. Wait for the power-up process to complete.
2. Press the green **PRESET** key.
3. Connect the spectrum analyzer CAL OUT to the INPUT 50Ω with an appropriate cable.
4. Set the frequency.

Press the **FREQUENCY** key. **CENTER** appears on the left side of the screen, indicating that the center-frequency function is active. The **CENTER FREQ** softkey label appears in inverse video to indicate that center frequency is the active function. The active function block is the space on the screen within the graticule where the center frequency messages appear. Functions appearing in this block are active: their values can be changed with the knob, step keys, or number/units keypad. Set the center frequency to 300 MHz with the **DATA** keys by pressing 300 (MHz). The knob and step keys can also be used to set the center frequency.

5. Set the span.

Press **SPAN**. **SPAN** is now displayed in the active function block, and the **SPAN** softkey label appears in inverse video to indicate it is the active function. Reduce the span to 20 MHz by using the knob, pressing the down key (**↓**), or pressing 20 **MHz**.

6. Set the amplitude.

When the peak of a signal does not appear on the screen, it may be necessary to adjust the amplitude level on the screen. Press **AMPLITUDE**. **REF LEVEL .0 dBm** appears in the active function block. The **REF LVL** softkey label appears in inverse video to indicate that reference level is the active function. The reference level is the top graticule line on the display and is set to 0.0 dBm. Changing the value of the reference level changes the amplitude level of the top graticule line.

If desired, use the reference level function to place the signal peak on the screen using the knob, step keys, or number/units keypad. (Marker functions determine the frequency and amplitude of a signal.)

Figure 2-5 demonstrates the relationship between center frequency and reference level. The box in the figure represents the spectrum analyzer screen. Changing the center frequency changes the horizontal placement of the signal on the screen. Changing the reference level changes the vertical placement of the signal on the screen. Increasing the span increases the frequency range that appears horizontally on the screen.

---

**Note** Spectrum analyzers with Option 001 or 011 display the amplitude values in dBmV. Options 001 and 011 are available only for an HP 8590L or HP 8591E.

---

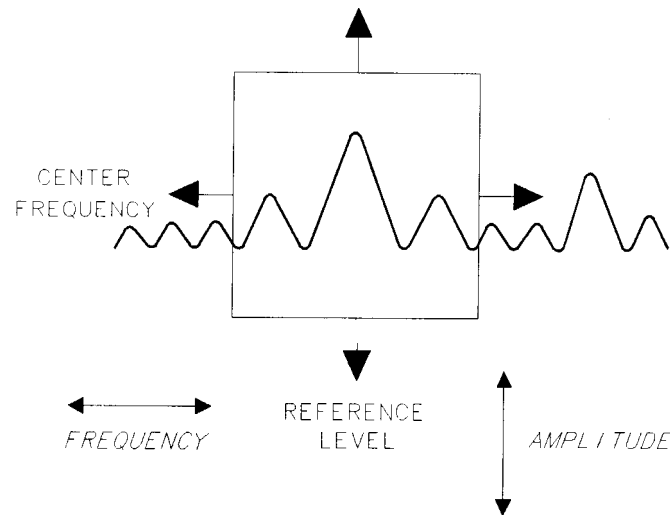

**Figure 2-5. Relationship between Frequency and Amplitude**

7. Set the marker.

You can place a diamond-shaped marker on the signal peak to find the signal's frequency and amplitude.

To activate a marker, press the **(MKR)** key (located in the MARKER section of the front panel). The MARKER NORMAL label appears in inverse video to show that the marker is the active function. Turn the knob to place the marker at the signal peak.

You can also use the **(PEAK SEARCH)** key, which automatically places a marker at the highest point on the trace.

Readouts of marker amplitude and frequency appear in the active function block and in the upper-right corner of the display. Look at the marker readout to determine the amplitude of the signal.

If another function is activated, the frequency and amplitude can still be identified by looking at the marker readout in the upper-right corner of the screen.

---

## Measurement Summary

1. Connect the spectrum analyzer CAL OUT to the INPUT  $50\Omega$  and press the (PRESET) key.
2. Set the center frequency by pressing the following keys: (FREQUENCY), 300 (MHz).
3. Set the span by pressing the following keys: (SPAN), 20 (MHz).
4. The calibration signal is 20 dB (two graticule divisions) below the top of the screen using these spectrum analyzer settings. If desired, adjust the reference level: press (AMPLITUDE) to activate the reference level, and use the knob or step keys to change the reference level.
5. Determine the amplitude and frequency of the signal. You can either press (PEAK\_SEARCH) or press (MKR) and move the marker to the signal peak. Read the amplitude and frequency. The display screen should look like the one in Figure 2-6. Frequency is displayed horizontally, and amplitude (power) is displayed vertically.

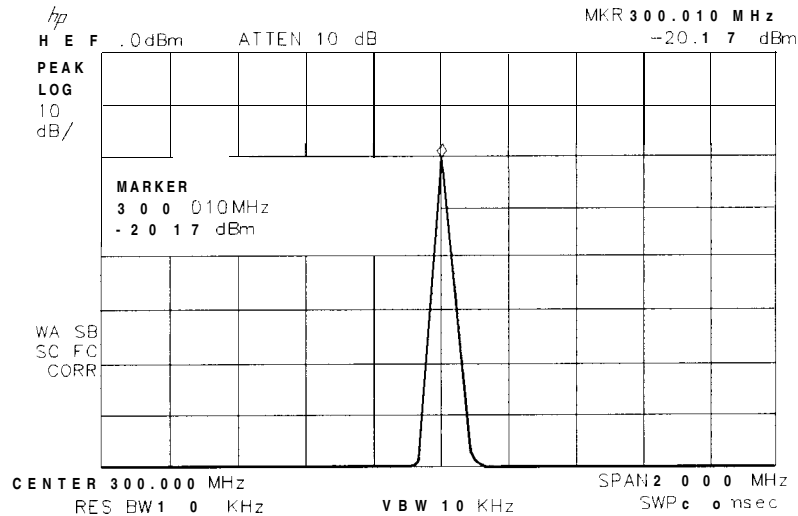

**Figure 2-6. Reading the Amplitude and Frequency**

---

### Note

Spectrum analyzers with Option 001 or 011 display the amplitude values in dBmV. Options 001 and 011 are available only for an HP 8590L or HP 85913.

---

---

## Improving Accuracy with Self-Calibration Routines

Data from the self-calibration routine is necessary for spectrum analyzer operation. Executing the self-calibration routine regularly ensures that the spectrum analyzer is using current calibration data that improves the spectrum analyzer frequency and amplitude accuracy. Press the **CAL** key to view the self-calibration routine menus. The last softkey on this menu, labeled More 1 of 4 , provides access to additional self-calibration functions. For more detailed information on the self-calibration softkeys, refer to Chapter 7.

The self-calibration routines add correction factors to internal circuitry. The addition of the correction factors is required to meet frequency and amplitude specifications.

When the correction factors are added to internal circuitry, CORR (corrected) appears on the left side of the screen.

### Warm-Up Time

In order for the spectrum analyzer to meet its specifications, allow the spectrum analyzer to warm up for 30 minutes after being turned on before attempting to make any calibrated measurements. Be sure to calibrate the spectrum analyzer only *after* it has met operating temperature conditions.

The spectrum analyzer frequency and amplitude self-calibration routines are initiated by the CAL FREQ & AMPTD softkey in the menu located under the **CAL** key.

1. To calibrate the instrument, connect the spectrum analyzer CAL OUT to the INPUT 50Ω connector with an appropriate cable.

---

**Note** A low-loss cable should be used for accurate calibration. Use the 50Ω cable shipped with the spectrum analyzer. (*Instruments equipped with Option 001 or 011 only: use the 75Ω cable shipped with the spectrum analyzer.*)

---

2. On the spectrum analyzer, press (CAL) and CAL FREQ & AMPTD . Cal signal not found will be displayed if CAL OUT is not connected to the spectrum analyzer input. The frequency and amplitude self-calibration functions take approximately 5 minutes to finish (9 minutes with Option 130), at which time the internal adjustment data is in working RAM.
3. To save this data in the area of spectrum analyzer memory that is saved when the spectrum analyzer is turned off, press CAL STORE .

---

**Note** To interrupt the calibration routines started by CAL FREQ , CAL AMPTD , or CAL FREQ & AMPTD , press **PRESET** , (CAL), More 1 of 4 , and CAL FETCH. CAL FETCH retrieves the previous correction factors. Improperly interrupting the self-calibration routines may result in corrupt correction factors. (If this occurs, press CAL FREQ & AMPTD to rerun the frequency and amplitude self-calibration routines.)

---

The frequency and amplitude self-calibration functions can be done separately by using the CAL FREQ or CAL AMPTD softkeys instead of CAL FREQ & AMPTD .

---

**Note** If the frequency calibration CAL **FREQ** and the amplitude calibration CAL **AMPTD** self-calibration routines are used, the frequency calibration should be performed before the amplitude calibration, unless the frequency data is known to be accurate.

---

The CAL **FREQ** softkey starts the frequency self-calibration routine. This routine adjusts the frequency, sweep time, and span accuracy in approximately 2 minutes.

The CAL **AMPTD** softkey starts the amplitude calibration routine. This routine takes approximately 3 minutes (7 minutes with Option 130) to adjust the bandwidths, log and linear switching, IF gains, IF frequency centering, RF attenuation, and log amplifier. When the amplitude calibration routine has finished, the preset display returns and CAL **DONE** is displayed.

Although the spectrum analyzer stores the correction factors in battery-backed RAM, the data will not be saved when the spectrum analyzer power is turned off unless the data has been stored with CAL **STORE** . Using CAL **STORE** stores the correction factors in an area of spectrum analyzer memory that is accessed when the spectrum analyzer is turned on. After the frequency and amplitude self-calibration routines are complete, **CORR** (corrected) now appears on the left side of the screen, indicating that the spectrum analyzer is using its frequency and amplitude correction factors. Correction factors can be turned off by pressing **CORRECT ON OFF** . When **OFF** is underlined, most amplitude correction factors and some frequency correction factors are not used.

If the self-calibration routines cannot be performed, see “Check the Basics” in Chapter 9.

## Performing the Tracking Generator Self-Calibration Routine (Option 010 or 011 only)

In order for the tracking generator to meet its specifications, allow the spectrum analyzer to warm up for 30 minutes after being turned on before attempting to make any calibrated measurements. Be sure to calibrate the spectrum analyzer and the tracking generator only *after* the spectrum analyzer has met operating temperature conditions.

---

**Note** Since the tracking-generator self-calibration routine uses the absolute amplitude level of the spectrum analyzer, the spectrum analyzer amplitude should be calibrated prior to using CAL **TRK GEM** .

---

1. To calibrate the tracking generator, connect the tracking generator output (RF OUT 500) to the spectrum analyzer INPUT 50Ω connector, using an appropriate cable and adapters.

---

**Note** A low-loss cable should be used for accurate calibration. Use the 50Ω cable shipped with the spectrum analyzer. (*For **Option 001 or 011**: use the 750 cable shipped with the spectrum analyzer.*)

---

2. Press the following spectrum analyzer keys: **CAL**, More 1 of 4, More 2 of 4, and CAL **TRK GEN** . TG **SIGNAL NOT FOUND** will be displayed if the tracking generator output is not connected to the spectrum analyzer input.
3. To save this calibration data in the area of spectrum analyzer memory that is saved when the spectrum analyzer is turned off, press (CAL) then CAL **STORE** .

## Performing the YTF Self-Calibration Routine (HP 8592L, HP 85933, HP 85953, or HP 85963 Only)

For HP 8592L, HP 85933, HP 85953, and HP 85963 spectrum analyzers only, the YTF self-calibration routine should be performed periodically. See “When Is Self-Calibration Needed?” in the following section for some helpful guidelines on how often the self-calibration routines should be performed.

1. For the HP 8592L, HP 85933, and HP 85963 connect a low-loss cable (such as HP part number 8120-5148) from 100 MHz COMB OUT to the spectrum analyzer input. For the HP 8595E connect the cable from the CAL OUT to the spectrum analyzer input.
2. Press **CAL**, then CAL YTF . The YTF self-calibration routine completes in approximately:

### Model Number Calibration Time

|                 |                  |
|-----------------|------------------|
| <b>HP 8592L</b> | <b>7 minutes</b> |
| <b>HP 85933</b> | <b>7 minutes</b> |
| <b>HP 85953</b> | <b>3 minutes</b> |
| <b>HP 85963</b> | <b>5 minutes</b> |

3. Press **CAL**, then CAL STORE to save the calibration factors in memory.
4. Press **PRESET** to return to normal operation.

## When Is Self-Calibration Needed?

While it is difficult to provide general advice for your specific measurement needs, the following suggestions may help you decide when to use the self-calibration features:

1. Perform the frequency and amplitude self-calibration routines whenever the instrument experiences significant environmental changes such as temperature ( $\pm 5$  °C), humidity, shock, or vibration (such as may occur during shipping or transport). This is especially important if the frequency and amplitude self-calibration routines were performed last in a different environment.
2. If the environment is relatively stable (for example, a lab environment), use CAL FREQ & AMPTD monthly. After being turned off overnight, the spectrum analyzer will need to warm up, but should not require self-calibration.
3. To achieve optimal amplitude accuracy for relative measurements:
  - a. Keep the spectrum analyzer in a stable environment.
  - b. Use CAL FREQ & AMPTD before beginning the first measurement.
  - c. Keep the spectrum analyzer turned on between measurements.
  - d. Do not use CAL FREQ & AMPTD before subsequent measurements (the amplitude drift is normally smaller than the self-calibration uncertainty).
4. If you change the input signal for EXT REF IN, run the frequency and amplitude self-calibration routines using CAL OUT. Amplitude calibration is required to improve IF centering.
5. If preselector peaking (PRESEL PEAK ) has more than a 2 dB effect on the signal amplitude when in BAND 1 or above, and in a single band sweep, then perform the YTF self-calibration routine and store the data with CAL STORE . The YTF self-calibration routine improves the preselector default values. (**HP 8592L, HP 85933, HP 8595E, or HP 8596E only.**)

6. If accurate self-calibration is needed temporarily in a different environment, use CAL FREQ & AMPTD , but do not press CAL STORE . The temporary correction factors will be used until the spectrum analyzer is turned off or until CAL FETCH is pressed.

---

## Memory Card Insertion and Battery Replacement

The memory card reader is available for the HP 8590L, HP 8592L, and HP 8594L as Option 003. Use the following information to ensure that the memory card is inserted correctly. Improper insertion causes error messages to occur, but generally does not damage the card or instrument. Care must be taken, however, not to force the card into place. The cards are easy to insert when installed properly.

1. Locate the arrow printed on the card's label.
2. Insert the card with its arrow matching the raised arrow on the bezel around the card-insertion slot. See Figure 2-7.

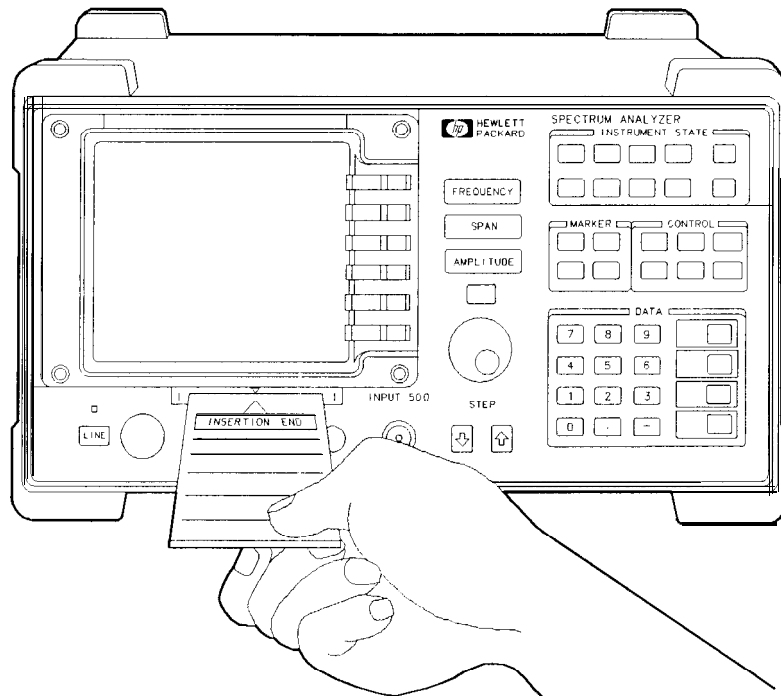

**Figure 2-7. Inserting the Memory Card**

3. Press the card into the slot. When correctly inserted, about 19 mm (0.75 in) of the card is exposed from the slot.



## Changing the Memory Card Battery

It is recommended that the memory card battery be changed every 2 years. The battery is a lithium commercial CMOS type battery, part number CR 2016 or **HP part number 1420-0383**.

---

**Note** The minimum lifetime of the battery (under ordinary conditions) is more than 2 years.

---

The date that the memory card battery was installed is either engraved on the side of the memory card or written on a label on the memory card.

If the memory card does not have a label with the date that the battery was installed, use the date code engraved on side of the memory card. The date code engraved on the memory card consists of numbers and letters engraved in the black plastic on the side of the memory card. See Figure 2-8. The first number indicates the year, the following two characters indicate the month, and the following number indicates the week in the month that the memory card battery was installed. For example, 80C3 indicates the battery was installed in the third week in October in 1988.

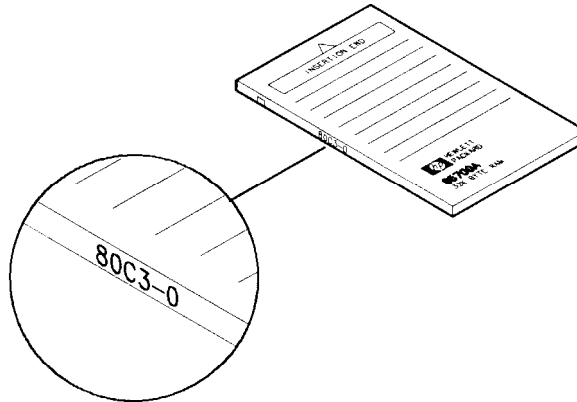

**Figure 2-8. Memory Card Battery Date Code Location**

## Procedure to Change the Memory Card Battery

The battery is located beside the card's write-protect switch on the end opposite the connector.

---

**Caution** The battery power enables the memory card's memory to retain data. You can lose the data when the battery is removed. Replace the battery while the card is installed in a powered-up instrument.

---

1. Locate the groove along the edge of the battery clip. See Figure 2-9.
2. Gently pry the battery clip out of the card. The battery fits within this clip.
3. Replace the battery, making sure the plus (+) sign on the battery is on the same side as the plus (+) sign on the clip.

HP Part Number: 1420-0383 or commercial Lithium CMOS type part number CR 2016.

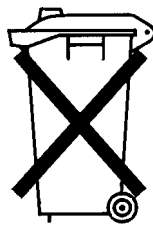

**DO NOT THROW BATTERIES AWAY BUT COLLECT AS SMALL CHEMICAL WASTE.**

sk780a

4. Insert the battery clip into the memory card, holding the clip as oriented in Figure 2-9. (Face the "open" edge of the clip toward the write-protect switch on the memory card.)
5. Write the date that the battery was replaced on the memory card label. This will help you to remember when the battery should be replaced.

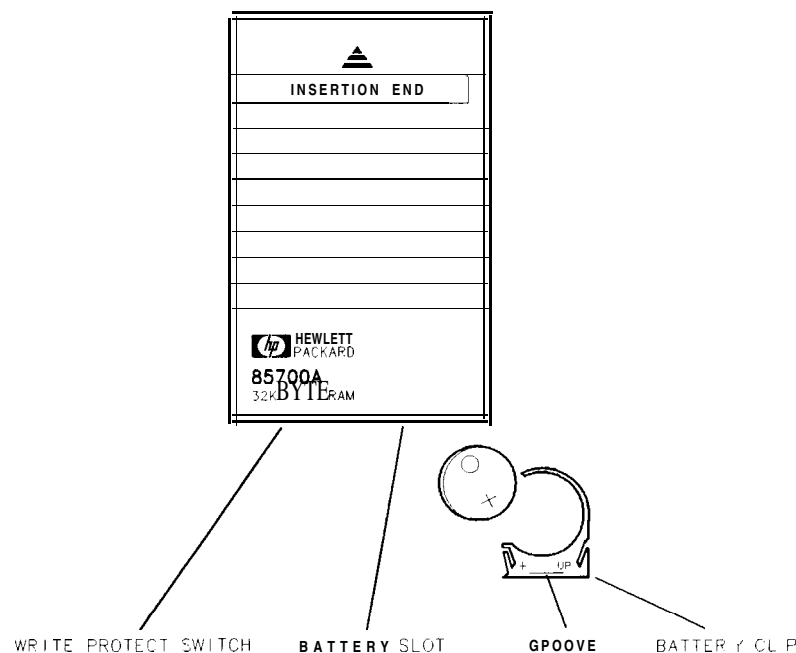

**Figure 2-9. Memory Card Battery Replacement**

---

## Analyzer Battery Information

The HP 8590 Series spectrum analyzers use a 3.6 V lithium battery to enable the spectrum analyzer memory to retain data. The date when the battery was installed is on a label on the rear panel of the spectrum analyzer. See Figure 2-10.

The minimum life expectancy of the battery is 8 years at 25 °C, or 1 year at 55 °C. If you experience problems with the battery or the recommended time period for battery replacement has elapsed, see “How to Return Your Analyzer for Service” in Chapter 9.

If you wish to replace the battery yourself, you can purchase the service documentation that provides all necessary test and maintenance information. The battery is soldered onto the spectrum analyzer processor board.

---

**Warning**      **There is a danger of explosion if the battery is incorrectly replaced. Replace only with the same or equivalent type recommended. Discard used batteries according to manufacture's instructions.**

---

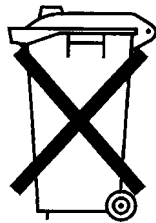

DO NOT THROW BATTERIES AWAY BUT  
COLLECT AS SMALL CHEMICAL WASTE.

sk780a

You can order the service documentation for an HP 8590 Series spectrum analyzer through your HP Sales and Service office. The documentation is described under “Service Documentation (Option 915)” in Chapter 10 of this manual.

After replacing the spectrum analyzer battery, write the date of battery replacement on the rear-panel label.

BATTERY **LIFE**  
8 YEARS A T 25°C  
1 YEAR EAP AT 55°C  
INSTALLED  
\_\_\_\_\_  
\_\_\_\_\_

pu132e

**Figure 2-10. Rear-Panel Battery Information Label**

## Making Basic Measurements

---

### What You'll Learn in This Chapter

This chapter demonstrates basic spectrum analyzer measurements with examples of typical measurements; each measurement focuses on different functions. The measurement procedures covered in this chapter are listed below.

- Resolving signals of equal amplitude using the resolution bandwidth function.
- Resolving small signals hidden by large signals using the resolution bandwidth function.
- Increasing the frequency readout resolution using the marker counter.
- Decreasing the frequency span using the marker track function.
- Peaking signal amplitude using preselector peak (**HP 8592L, HP 8593E, HP 85953, or HP 85963 only**).
- Tracking unstable signals using marker track and the maximum hold and minimum hold functions.
- Comparing signals using delta markers.
- Measuring low-level signals using attenuation, video bandwidth, and video averaging.
- Identifying distortion products using the RF attenuator and traces.
- Using the spectrum analyzer as a receiver in zero frequency span.
- Measuring signals near band boundaries using harmonic lock (**HP 8592L, HP 8593E, HP 85953, or HP 8596E only**).

To find descriptions of specific spectrum analyzer functions refer to Chapter 7 “Key Descriptions”.

---

## Resolving Signals of Equal Amplitude Using the Resolution Bandwidth Function

In responding to a continuous-wave signal, a swept-tuned spectrum analyzer traces out the shape of the spectrum analyzer intermediate frequency (IF) filters. As we change the filter bandwidth, we change the width of the displayed response. If a wide filter is used and two equal-amplitude input signals are close enough in frequency, then the two signals appear as one. Thus, signal resolution is determined by the IF filters inside the spectrum analyzer.

The resolution bandwidth (RES BW) function selects an IF filter setting for a measurement. Resolution bandwidth is defined as the 3 dB bandwidth of the filter. The 3 dB bandwidth tells us how close together equal amplitude signals can be and still be distinguished from each other.

Generally, to resolve two signals of equal amplitude, the resolution bandwidth must be less than or equal to the frequency separation of the two signals. If the bandwidth is equal to the separation a dip of approximately 3 dB is seen between the peaks of the two equal signals, and it is clear that more than one signal is present. See Figure 3-2.

In order to keep the spectrum analyzer calibrated, sweep time is automatically set to a value that is inversely proportional to the square of the resolution bandwidth. So, if the resolution bandwidth is reduced by a factor of 10, the sweep time is increased by a factor of 100 when sweep time and bandwidth settings are coupled. (Sweep time is proportional to  $1/BW^2$ .) For fastest measurement times, use the widest resolution bandwidth that still permits discrimination of all desired signals. The spectrum analyzer allows you to select from 30 Hz to 3 MHz resolution bandwidth in a 1, 3, 10 sequence, plus 5 MHz, for maximum measurement flexibility.

**Example:** Resolve two signals of equal amplitude with a frequency separation of 100 kHz.

1. To obtain two signals with a 100 kHz separation, connect the calibration signal and a signal source to the spectrum analyzer input as shown in Figure 3-1. (If available, two sources can be used.)

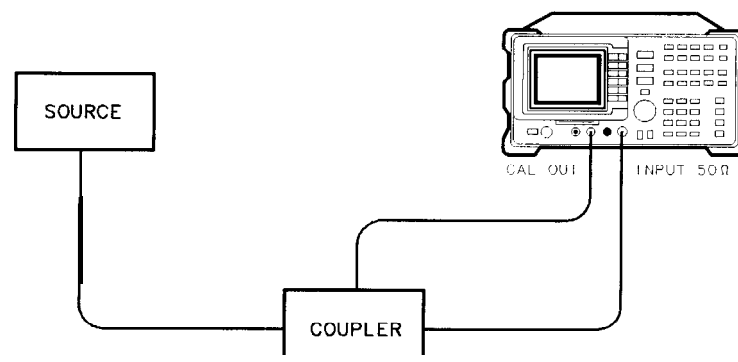

**Figure 3-1. Set-Up for Obtaining Two Signals**

2. If you are using the 300 MHz calibration signal, set the frequency of the source 100 kHz greater than the calibration signal (that is, 300.1 MHz). The amplitude of both signals should be approximately -20 dBm.
3. On the spectrum analyzer, press **PRESET**. Set the center frequency to 300 MHz, the span to 2 MHz, and the resolution bandwidth to 300 kHz by pressing **FREQUENCY** 300 **MHZ**, **SPAN** 2 **MHZ**, then **BW** 300 **KHZ**. A single signal peak is visible.

---

**Note**

When using an HP 8590L with Option 713 or an HP 8592L with Option 713, and the signal peak cannot be found, increase the span to 20 MHz by pressing **(SPAN) 20 (MHz)**. The signal should be visible. Press **(PEAK SEARCH)**, **(MKR FCTN)**, **MK TRACK ON OFF (ON)**, then **(SPAN) 2 (MHz)** to bring the signal to center screen. Then press **MK TRACK ON OFF** so that **OFF** is underlined to turn the marker track function off.

---

4. Since the resolution bandwidth must be less than or equal to the frequency separation of the two signals, a resolution bandwidth of 100 kHz must be used. Change the resolution bandwidth to 100 kHz by pressing **(BW) 100 (kHz)**. Two signals are now visible as in Figure 3-2. Use the knob or step keys to further reduce the resolution bandwidth and better resolve the signals.

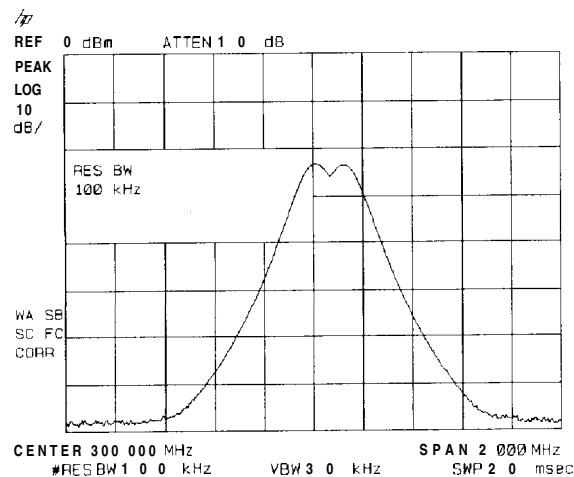

**Figure 3-2. Resolving Signals of Equal Amplitude**

As the resolution bandwidth is decreased, resolution of the individual signals is improved and the sweep time is increased. For fastest measurement times, use the widest possible resolution bandwidth. Under preset conditions, the resolution bandwidth is “coupled” (or linked) to span. Since the resolution bandwidth has been changed from the coupled value, a “#” mark appears next to RES BW in the lower-left corner of the screen, indicating that the resolution bandwidth is uncoupled. (Also see the **(AUTO COUPLE)** key description in Chapter 7.)

---

**Note**

To resolve two signals of equal amplitude with a frequency separation of 200 kHz, the resolution bandwidth must be less than the signal separation, and resolution of 100 kHz must be used. The next larger filter, 300 kHz, would exceed the 200 kHz separation and would not resolve the signals.

---

---

## Resolving Small Signals Hidden by Large Signals Using the Resolution Bandwidth Function

When dealing with resolution of signals that are not equal in amplitude, you must consider the shape of the IF filter as well as its 3 dB bandwidth. The shape of the filter is defined by the shape factor, which is the ratio of the 60 dB bandwidth to the 3 dB bandwidth. (Generally, the IF filters in this spectrum analyzer have shape factors of 15:1 or less.) If a small signal is too close to a larger signal, the smaller signal can be hidden by the skirt of the larger signal. To view the smaller signal, you must select a resolution bandwidth such that  $k$  is less than  $a$ . See Figure 3-3.

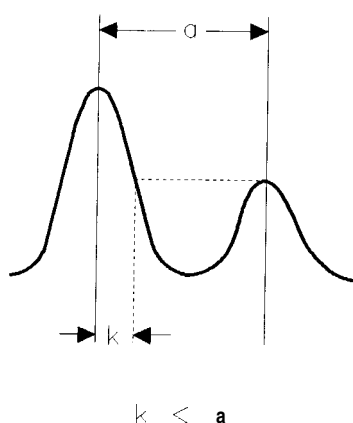

**Figure 3-3. Resolution Bandwidth Requirements for Resolving Small Signals**

The separation between the two signals must be greater than half the filter width of the larger signal at the amplitude level of the smaller signal.

**Example:** Resolve two input signals with a frequency separation of 200 kHz and an amplitude separation of 60 dB.

1. To obtain two signals with a 200 kHz separation, connect the equipment as shown in the previous section, “Resolving Signals of Equal Amplitude Using the Resolution Bandwidth Function”.
2. Set the center frequency to 300 MHz and the span to 2 MHz: press **FREQUENCY** 300 **MHz**, then **SPAN** 2 **MHz**.

---

### Note

When using an HP 8590L with Option 713 or an HP 8592L with Option 713, and the signal peak cannot be found, increase the span to 20 MHz by pressing **SPAN** 20 **MHz**. The signal should be visible. Press **PEAK SEARCH**, **MKR FCTN**, MK TRACK ON OFF so that ON is underlined. Then (SPAN) 2 **MHz** to bring the signal to center screen. Then press MK TRACK ON OFF to OFF to turn the marker track function off.

---

- Set the source to 300.2 MHz, so that the signal is 200 kHz higher than the calibration signal. Set the amplitude of the signal to -80 dBm (60 dB below the calibration signal).
- Set the 300 MHz signal to the reference level by pressing **PEAK SEARCH**, **MKR →**, then **MARKER → REF LVL**.

If a 10 kHz filter with a typical shape factor of 15: 1 is used, the filter will have a bandwidth of 150 kHz at the 60 dB point. The half-bandwidth (75 kHz) is narrower than the frequency separation, so the input signals will be resolved.

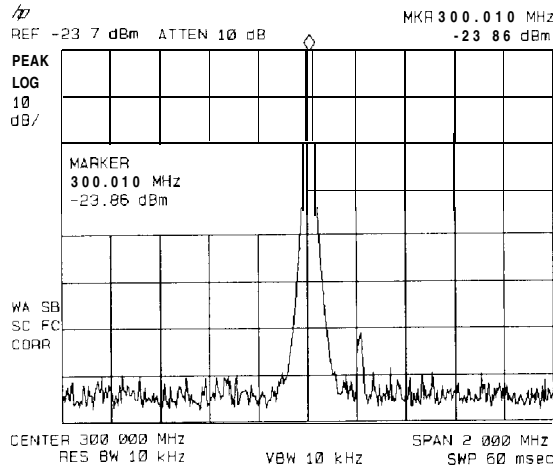

**Figure 3-4. Signal Resolution with a 10 kHz Resolution Bandwidth**

If a 30 kHz filter is used, the 60 dB bandwidth will be 450 kHz. Since the half-bandwidth (225 kHz) is wider than the frequency separation, the signals most likely will not be resolved. See Figure 3-5. (To determine resolution capability for intermediate values of amplitude level differences, consider the filter skirts between the 3 dB and 60 dB points to be approximately straight. In this case, we simply used the 60 dB value.)

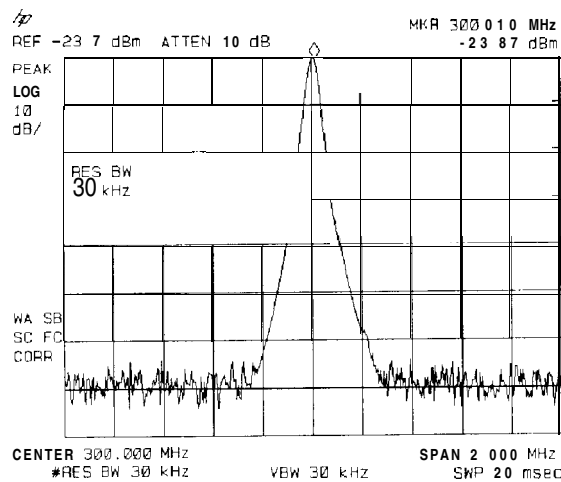

**Figure 3-5. Signal Resolution with a 30 kHz Resolution Bandwidth**



---

## Increasing the Frequency Readout Resolution Using the Marker Counter

---

**Note** This application cannot be performed using an HP 8590L with Option 713 or an HP 8592L with Option 713.

---

The marker counter increases the resolution and accuracy of frequency readout. When using the marker count function, if the bandwidth to span ratio is too small (less than 0.01), the Reduce Span message appears on the display. If Widen RES BW is displayed, it indicates that the resolution bandwidth is too narrow. Resolution bandwidths less than 300 Hz are not allowed if you are using firmware with a revision date prior to 930506. If the signal being counted is the largest signal within the 300 Hz bandwidth then the count will be correct. If there is another, larger signal (even off the display), the count will be for the larger signal.

**Example:** Increase the resolution and accuracy of the frequency readout on the signal of interest.

1. Place a marker on the signal of interest. (If you are using the CAL OUT signal, place the marker on the 300 MHz calibration signal. Press **FREQUENCY**, 300 **MHz**, **SPAN** 100 **MHz**, and **PEAK\_SEARCH**.)
2. Press **MKR FCTN**, then MK COUNT ON OFF (ON should be underlined) to turn the marker counter on. COUNTER and the frequency and amplitude of the marker will appear in the active function area.
3. Increase the counter resolution by pressing More 1 of 2 , CNT RES AUTO MAN and then entering the desired resolution using the step keys or the number/units keypad. For example, press 1 **kHz**. The marker counter readout is in the upper-right corner of the screen. The resolution can be set from 10 Hz to 100 kHz.
4. The marker counter remains on until turned off. Turn off the marker counter by pressing **MKR FCTN**, then MK COUNT ON OFF (until OFF is underlined). (MARKER ALL OFF also turns the marker counter off.)

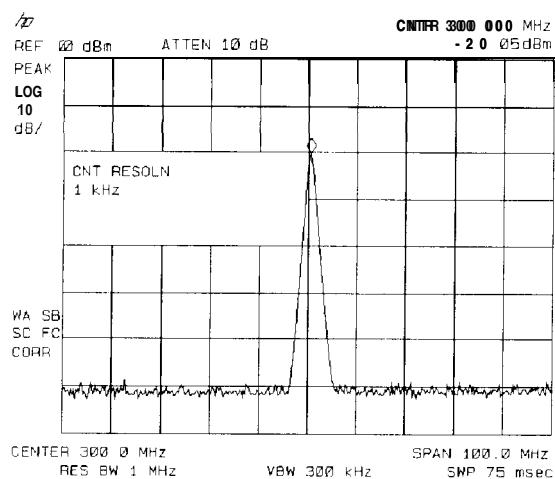

**Figure 3-6. Using the Marker Counter**

---

## Decreasing the Frequency Span Using the Marker Track Function

Using the spectrum analyzer marker track function, you can quickly decrease the span while keeping the signal at center frequency.

**Example:** Examine a carrier signal in a 200 kHz span.

1. Press (PRESET), tune to a carrier signal, and place a marker at the peak. (If you are using the CAL OUT signal, place the marker on the 300 MHz calibration signal. Press (FREQUENCY), 300 (MHz), (SPAN), 200 (MHz), and (PEAK SEARCH).)
2. Press (MKR FCTN), MKR TRACK ON OFF (ON) and the signal will move to the center of the screen, if it is not already positioned there (note that the marker must be on the signal). Because the marker track function automatically maintains the signal at the center of the screen, you can reduce the span quickly for a closer look. If the signal drifts off of the screen as you decrease the span, use a wider frequency span.
3. Press (SPAN), 200 (kHz). The span decreases in steps as automatic zoom is completed. See Figure 3-7. You can also use the knob or step keys to decrease the span or use the PEAK ZOOM function under (SPAN).

Press MKR TRACK ON OFF again so that (OFF) is underlined to turn off the marker track function.

---

**Note** When you are finished with the example, turn off the marker tracking function.

---

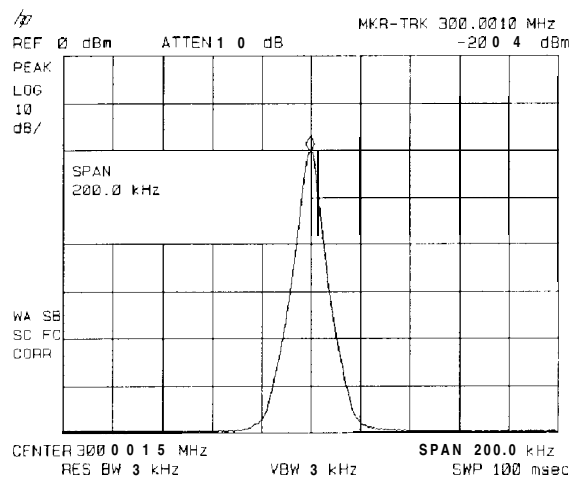

**Figure 3-7. After Zooming In on the Signal**

---

## Peaking Signal Amplitude with Preselector Peak

---

**Note** This application should only be performed using an HP 8592L, HP 8593E, HP 8595E, or HP 85963.

PRESEL PEAK works above 2.9 GHz only (bands 1 through 4).

---

The preselector peak function automatically adjusts the preselector tracking to peak the signal at the active marker. Using preselector peak prior to measuring a signal yields the most accurate amplitude reading at the specified frequency. To maximize the peak response of the preselector and adjust the tracking, tune the marker to a signal and press [AMPLITUDE], PRESEL PEAK .

---

**Note** PRESEL PEAK maximizes the peak response of the signal of interest, but may degrade the frequency response at other frequencies. Use PRESEL DEFAULT or **PRESET** to clear preselector-peak values before measuring a signal at another frequency.

PRESEL DEFAULT provides the best flatness for a full single-band, for viewing several signals simultaneously.

---

**Example:** Use the knob, step keys, or **PEAK SEARCH** to place the marker on your signal and then press **AMPLITUDE** and PRESEL PEAK . The message CAL : PEAKING appears in the active function block while the routine is working.

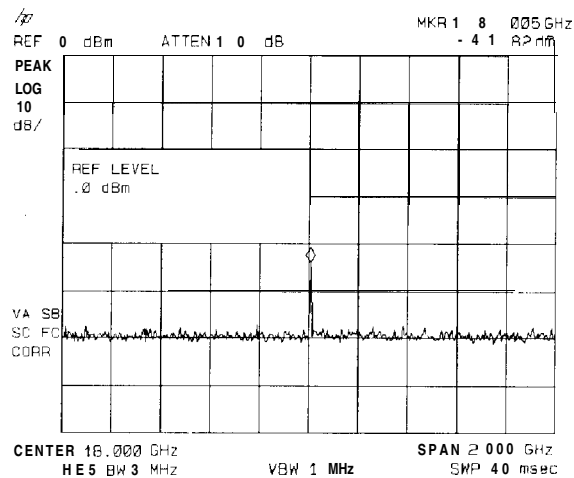

**Figure 3-8. Peaking Signal Amplitude Using Preselector Peak**

---

## Tracking Unstable Signals Using Marker Track and the Maximum Hold and Minimum Hold Functions

The marker track function is useful for tracking unstable signals that drift with time. The maximum hold and minimum hold functions are useful for displaying modulated signals which appear unstable, but have an envelope that contains the information-bearing portion of the signal.

MK TRACK ON OFF may be used to track these unstable signals. Use **PEAK SEARCH** to place a marker on the highest signal on the display. Pressing MK TRACK ON OFF (ON) will bring that signal to the center frequency of the graticule and adjust the center frequency every sweep to bring the selected signal back to the center. SPAN ZOOM is a quick way to perform the **PEAKSEARCH**, **MKR FCTN**, MK TRACK ON OFF , **SPAN** key sequence.

Note that the primary function of the marker track function is to track unstable signals, not to track a signal as the center frequency of the spectrum analyzer is changed. If you choose to use the marker track function when changing center frequency, check to ensure that the signal found by the tracking function is the correct signal.

**Example:** Use the marker track function to keep a drifting signal at the center of the display and monitor its change.

This example requires a modulated signal. An acceptable signal can be easily found by connecting an antenna to the spectrum analyzer input and tuning to the FM broadcast band (88 to 108 MHz). Set the spectrum analyzer center frequency for 100 MHz with a span of 20 MHz, an attenuator setting of 0 dB, and reference level setting of approximately -40 dBm. Your circumstances may be slightly different, depending on building shielding and proximity to transmitters.

1. Connect an antenna to the spectrum analyzer input.
2. Press **PRESET**, **FREQUENCY**, 100 **MHz**, **SPAN**, 20 **MHz**.

---

**Note** Use a different signal frequency if no signal is available at 100 MHz in your area.

---

3. Press **AMPLITUDE**, 40 **-dBm**, **ATTEN AUTO MAN** , 0 **+dBm**.
4. Press **SPAN**, **SPAN ZOOM**, 500 **kHz**.

Notice that the signal has been held in the center of the display.

---

**Note** If the signal you selected drifts too quickly for the spectrum analyzer to keep up with, use a wider span.

---

- The signal frequency drift can be read from the screen if both the marker track and marker delta functions are active. Press **(MKR)**, **MARKER Δ**, **(MKR FCTN)**, **MK TRACK ON OFF**; the marker readout indicates the change in frequency and amplitude as the signal drifts. See Figure 3-9.

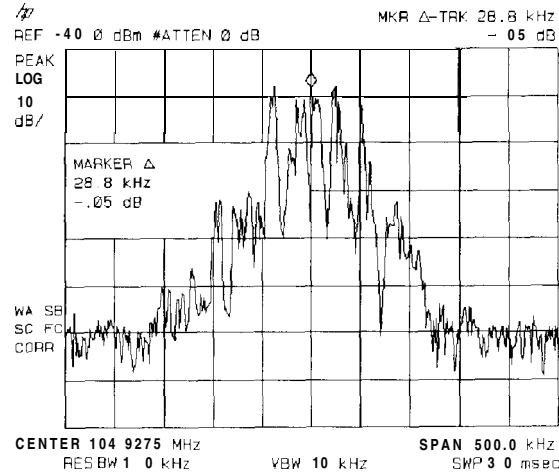

**Figure 3-9. Using Marker Tracking to Track an Unstable Signal**

The spectrum analyzer can measure the short- and long-term stability of a source. The maximum amplitude level and the frequency drift of an input signal trace can be displayed and held by using the maximum-hold function. The minimum amplitude level can be displayed by using minimum hold (available for trace C only).

You can use the maximum-hold and minimum-hold functions if, for example, you want to determine how much of the frequency spectrum an FM signal occupies.

**Example:** Using the maximum-hold and minimum hold functions, monitor the envelopes of a signal.

- Connect an antenna to the spectrum analyzer input.
- Press **(PRESET)**, **(FREQUENCY)**, 100 **(MHz)**, and **(SPAN)**, 20 **(MHz)**.
- Press **(AMPLITUDE)**, 40 **(-dBm)**, **ATTEN AUTO MAN**, 0 **(+dBm)**, **(SPAN)**, SPAN ZOOM, 500 **(kHz)**.

Notice that the signal has been held in the center of the display.

- Turn off the marker track function by pressing **MK TRACK ON OFF (OFF)**.
- To measure the excursion of the signal, press **[TRACE]** then **MAX HOLD A**. As the signal varies, maximum hold maintains the maximum responses of the input signal, as shown in Figure 3-10.

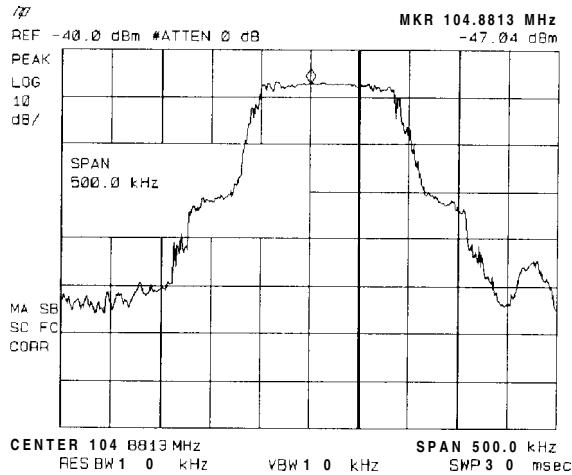

**Figure 3-10. Viewing an Unstable Signal Using Max Hold A**

Annotation on the left side of the screen indicates the trace mode. For example, MA SB SC indicates trace A is in maximum-hold mode, trace B and trace C are in store-blank mode. See “Screen Annotation” in Chapter 2.

6. Press **TRACE**, TRACE A B C to select trace B. (Trace B is selected when B is underlined.)  
 Press **CLEAR WRITE B** to place trace B in clear-write mode, which displays the current measurement results as it sweeps. Trace A remains in maximum-hold mode, showing the frequency shift of the signal.
7. Press **TRACE A B C** to select trace C (C should be underlined). Press **MIN HOLD C**. Trace C is in the minimum-hold mode and displays the minimum amplitude of the frequency drift of the signal.

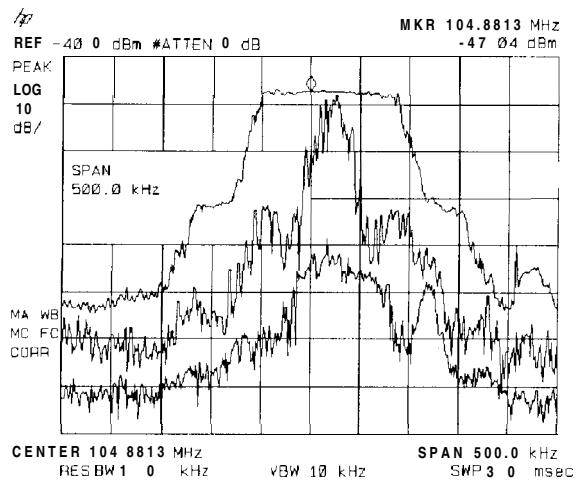

**Figure 3-11. Viewing an Unstable Signal With Max Hold, Clear Write, and Min Hold**

---

## Comparing Signals Using Delta Markers

Using the spectrum analyzer, you can easily compare frequency and amplitude differences between signals, such as radio or television signal spectra. The spectrum analyzer delta marker function lets you compare two signals when both appear on the screen at one time or when only one appears on the screen.

**Example:** Measure the differences between two signals on the same display screen.

1. Connect the spectrum analyzer CAL OUT to the INPUT 50Ω. Press **PRESET**. For the HP 85933 only, set the center frequency to 900 MHz and the span to 1.8 GHz: press **FREQUENCY**, **900** **(MHz)**, **(SPAN)**, 1.8 **(GHz)**.

The calibration signal and its harmonics appear on the display.

2. Press **PEAK SEARCH** to place a marker at the highest peak on the display. The **NEXT PK RIGHT** and **NEXT PK LEFT** softkeys move the marker from peak to peak. Press **NEXT PK RIGHT** to move the marker to the 300 MHz calibration signal. See Figure 3-12.

The signal that appears at the left edge of the screen is the spectrum analyzer local oscillator (LO) and represents 0 Hz.

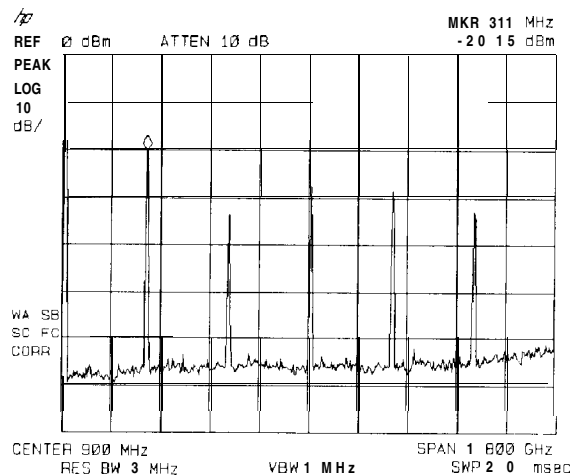

**Figure 3-12. Placing a Marker on the CAL OUT Signal**

3. Press **MARKER A** to activate a second marker at the position of the first marker. Move the second marker to another signal peak using the **NEXT PK RIGHT** or **NEXT PK LEFT** softkeys or the knob.
4. The amplitude and frequency difference between the markers is displayed in the active function block and in the upper-right corner of the screen. See Figure 3-13.

Press **(MKR)**, More 1 of 2, then **MARKER ALL OFF** to turn the markers off.

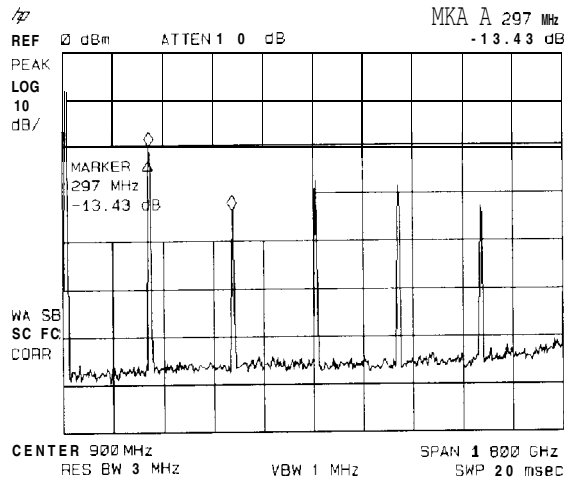

**Figure 3-13. Using the Marker Delta Function**

- The MARKER →PK-PK softkey can be used to find and display the frequency and amplitude difference between the highest- and lowest-amplitude signals. To use this automatic function, press **(MKR→)**, More 1 of 2, **MARKER →PK-PK**. See Figure 3-14.

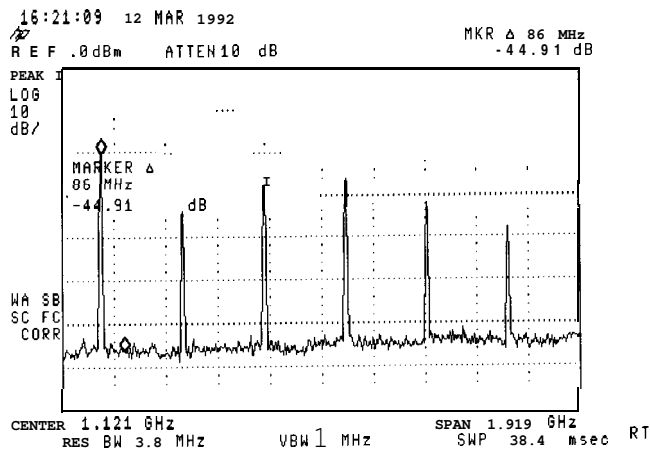

**Figure 3-14. Using the Marker to Peak/Peak Function**

The frequency and amplitude differences between the signals appear in the active function block. In addition, the softkeys accessed by **(MKR→)** appear on the screen.

**Example:** Measure the frequency and amplitude difference between two signals that do not appear on the screen at one time. (This technique is useful for harmonic distortion tests when narrow span and narrow bandwidth are necessary to measure the low-level harmonics.)

- Connect the spectrum analyzer CAL OUT to the INPUT 50Ω (if you have not already done so). Press **(PRESET)**, **(FREQUENCY)**, 300 **(MHz)**, **(SPAN)** and the step down key (**(↓)**) to narrow the frequency span until only one signal appears on the screen.
- Press **(PEAK SEARCH)** to place a marker on the peak.
- Press MARKER A to identify the position of the first marker.



4. Press **FREQUENCY** to activate center frequency. Turn the knob clockwise slowly to adjust the center frequency until a second signal peak is placed at the position of the second marker. It may be necessary to pause occasionally while turning the knob to allow a sweep to update the trace. The first marker remains on the screen at the amplitude of the first signal peak.

---

**Note** Changing the reference level changes the marker delta amplitude readout.

---

The annotation in the upper-right corner of the screen indicates the amplitude and frequency difference between the two markers. See Figure 3-15.

To turn the markers off, press **MKR**, More 1 of 2 , then **MARKER ALL OFF** .

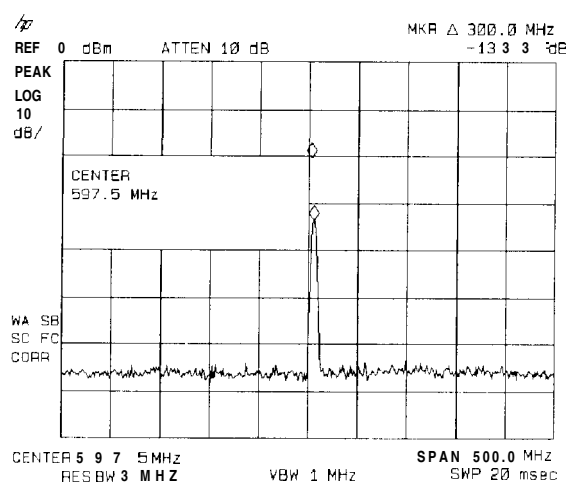

**Figure 3-15. Frequency and Amplitude Difference between Signals**

---

## Measuring Low-Level Signals Using Attenuation, Video Bandwidth, and Video Averaging

Spectrum analyzer sensitivity is the ability to measure low-level signals. It is limited by the noise generated inside the spectrum analyzer. The spectrum analyzer input attenuator and bandwidth settings affect the sensitivity by changing the signal-to-noise ratio. The attenuator affects the level of a signal passing through the instrument, whereas the bandwidth affects the level of internal noise without affecting the signal. In the first two examples in this section, the attenuator and bandwidth settings are adjusted to view low-level signals.

If, after adjusting the attenuation and resolution bandwidth, a signal is still near the noise, visibility can be improved by using the video-bandwidth and video-averaging functions, as demonstrated in the third and fourth examples.

**Example:** If a signal is very close to the noise floor, reducing input attenuation brings the signal out of the noise. Reducing the attenuation to 0 dB maximizes signal power in the spectrum analyzer.

---

**Note** The total power of all input signals at the spectrum analyzer input must not exceed the maximum power level for the spectrum analyzer.

---

1. Connect an antenna to the spectrum analyzer input. Press **PRESET**.
2. Reduce the frequency range to view a low-level signal of interest. For example, narrow the frequency span from 88 MHz to 108 MHz by pressing **FREQUENCY**, **START FREQ**, 88 (MHz), **STOP FREQ**, 108 **MHz**.
3. Place a marker on the low-level signal of interest. Press **MKR** and use the knob to position the marker at the signal's peak.
4. Place the signal at center frequency by pressing **MKR →**, then **MARKER -CF**.
5. Reduce the span to 10 MHz. Press **SPAN**, and then use the step-down key (**↓**). See Figure 3-16.

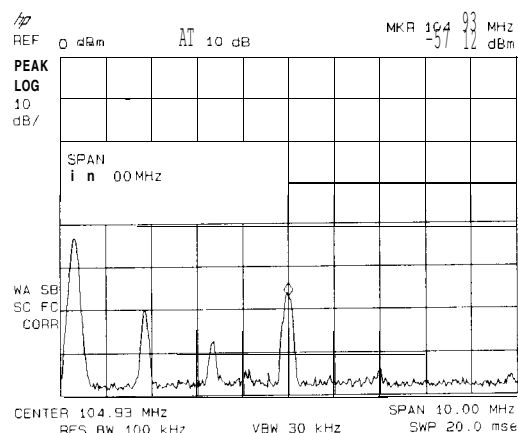

**Figure 3-16. Low-Level Signal**

6. Press (AMPLITUDE), ATTEN AUTO MAN . Press the step-up key ( $\uparrow$ ) once to select 20 dB attenuation. Increasing the attenuation moves the noise floor closer to the signal.  
A “#” mark appears next to the AT annotation at the top of the display, indicating the attenuation is no longer coupled to other spectrum analyzer settings.
7. To see the signal more clearly, press 0 (dBm). Zero attenuation makes the signal more visible. (As a precaution to protect the spectrum analyzer input mixer, 0 dB RF attenuation can be selected only with the number/units keypad.)

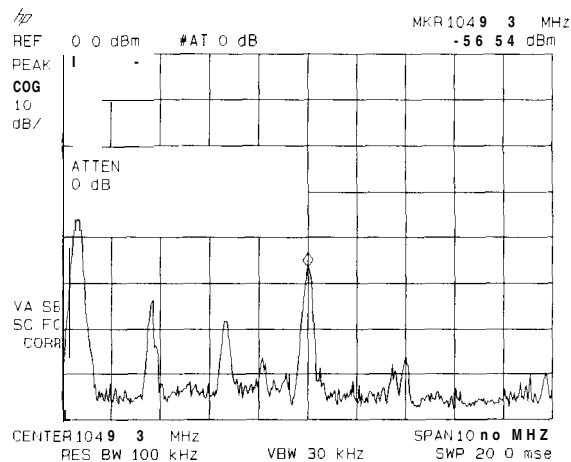
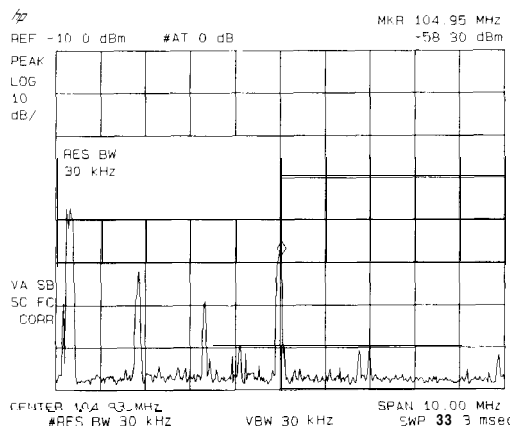

**Figure 3-17. Using 0 dB Attenuation**

Before connecting other signals to the spectrum analyzer input, increase the RF attenuation to protect the spectrum analyzer input mixer: press ATTEN AUTO MAN so that AUTO is underlined or press (AUTO COUPLE) and AUTO ALL.

**Example:** The resolution bandwidth can be decreased to view low-level signals.

1. As in the previous example, connect an antenna to the spectrum analyzer input. Set the spectrum analyzer to view a low-level signal.
2. Press (BW) then ( $\downarrow$ ). The low-level signal appears more clearly because the noise level is reduced. See Figure 3-18.



**Figure 3-18. Decreasing Resolution Bandwidth**

A “#” mark appears next to the RES BW annotation at the lower-left corner of the screen, indicating that the resolution bandwidth is uncoupled.

As the resolution bandwidth is reduced, the sweep time is increased to maintain calibrated data.

**Example:** The video-filter control is useful for noise measurements and observation of low-level signals close to the noise floor. The video filter is a post-detection low-pass filter that smoothes the displayed trace. When signal responses near the noise level of the spectrum analyzer are visually masked by the noise, the video filter can be narrowed to smooth this noise and improve the visibility of the signal. (Reducing video bandwidths requires slower sweep times to keep the spectrum analyzer calibrated.)

Using the video bandwidth function, measure the amplitude of a low-level signal.

1. As in the first example, connect an antenna to the spectrum analyzer input. Set the spectrum analyzer to view a low-level signal.
2. Narrow the video bandwidth by pressing **(BW)**, VID BW AUTO MAN , and the step-down key **(↓)**. This clarifies the signal by smoothing the noise, which allows better measurement of the signal amplitude.

A “#” mark appears next to the VBW annotation at the bottom of the screen, indicating that the video bandwidth is not coupled to the resolution bandwidth.

Instrument preset conditions couple the video bandwidth to the resolution bandwidth so that the video bandwidth is equal to or narrower than the resolution bandwidth. If the bandwidths are uncoupled when video bandwidth is the active function, pressing VID BW AUTO MAN (so that AUTO is underlined) recouples the bandwidths. See Figure 3-19.

---

**Note** The video bandwidth must be set wider than the resolution bandwidth when measuring impulse noise levels.

---

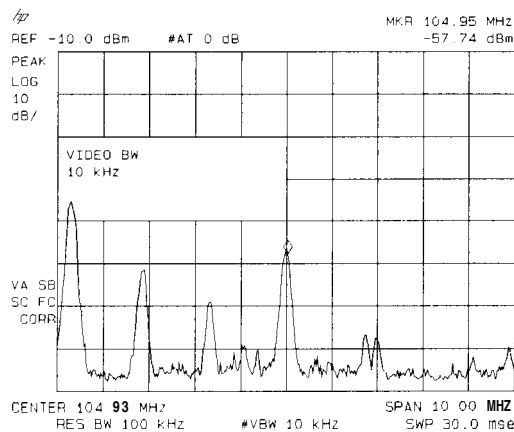

**Figure 3-19. Decreasing Video Bandwidth**

**Example:** If a signal level is very close to the noise floor, video averaging is another way to make the signal more visible.

---

**Note** The time required to construct a full trace that is averaged to the desired degree is approximately the same when using either the video-bandwidth or the video-averaging technique. The video bandwidth technique completes the averaging as a slow sweep is taken, whereas the video averaging technique takes many sweeps to complete the average. Characteristics of the signal being measured such as drift and duty cycle determine which technique is appropriate.

---

Video averaging is a digital process in which each trace point is averaged with the previous trace-point average. Selecting video averaging changes the detection mode from peak to sample. The result is a sudden drop in the displayed noise level. The sample mode displays the instantaneous value of the signal at the end of the time or frequency interval represented by each display point, rather than the value of the peak during the interval. Sample mode is not used to measure signal amplitudes accurately because it may not find the true peak of the signal.

Video averaging clarifies low-level signals in wide bandwidths by averaging the signal and the noise. As the spectrum analyzer takes sweeps, you can watch video averaging smooth the trace.

1. Position a low-level signal on the spectrum analyzer screen.
2. Press **TRACE**, More 1 of 3, then VID AVG ON OFF . When ON is underlined, the video-averaging routine is initiated. As the averaging routine smoothes the trace, low-level signals become more visible. VID AVG 100 appears in the active function block.

The number represents the number of samples (or sweeps) taken to complete the averaging routine.

3. To set the number of samples, use the number/units keypad. For example, press VID AVG ON OFF (so that ON is underlined), 25 **Hz**. Turn video averaging off and on again by pressing VID AVG ON OFF (OFF), VID AVG ON OFF (ON).

The number of samples equals the number of sweeps in the averaging routine.

During averaging, the current sample appears at the left side of the graticule. Changes in active functions settings, such as the center frequency or reference level, will restart the sampling. The sampling will also restart if video averaging is turned off and then on again.

Once the set number of sweeps has been completed, the spectrum analyzer continues to provide a running average based on this set number.

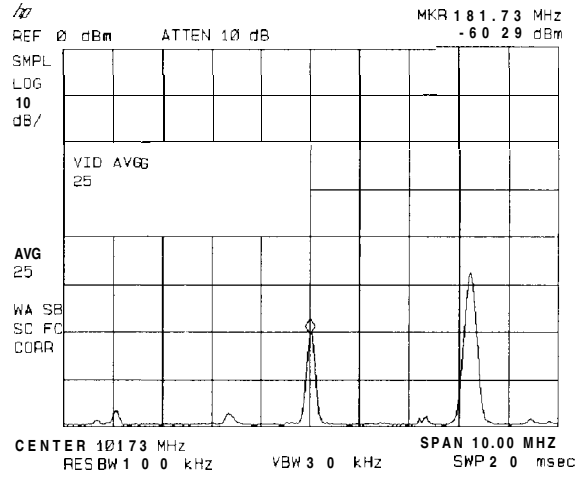

**Figure 3-20. Using the Video Averaging Function**

---

# Identifying Distortion Products Using the RF Attenuator and Traces

## Distortion from the Analyzer

High-level input signals may cause spectrum analyzer distortion products that could mask the real distortion measured on the input signal. Using trace B and the RF attenuator, you can determine which signals, if any, are internally generated distortion products.

**Example:** Using a signal from a signal generator, determine whether the harmonic distortion products are generated by the spectrum analyzer.

1. Connect a signal generator to the spectrum analyzer INPUT 500. Set the signal generator frequency to 200 MHz and the amplitude to 0 dBm.

Set the center frequency of the spectrum analyzer to 400 MHz and the span to 500 MHz: press **FREQUENCY**, 400 **MHz**, **SPAN** 500 **MHz**. The signal shown in Figure 3-21 produces harmonic distortion products in the spectrum analyzer input mixer.

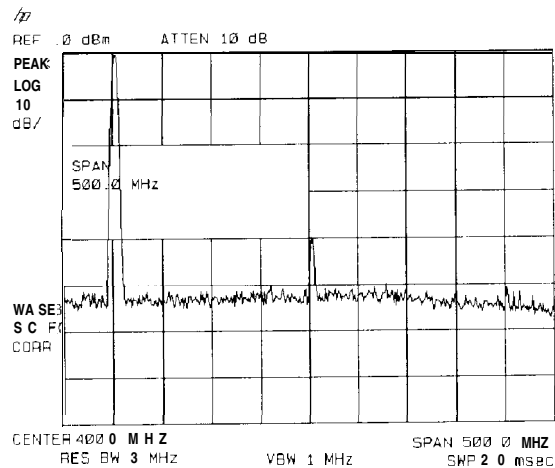
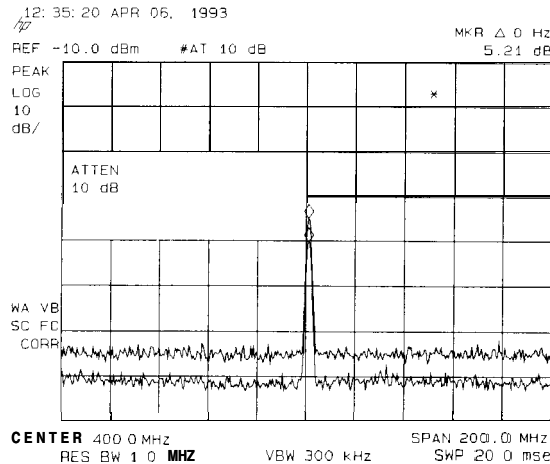

**Figure 3-21. Harmonic Distortion**

2. Change the span to 200 MHz: press **SPAN**, 200 **MHz**.
3. Change the attenuation to 0 dB: press **AMPLITUDE**, **ATTEN AUTO MAN**, 0 **dBm**.
4. To determine whether the harmonic distortion products are generated by the spectrum analyzer, first save the screen data in trace B.

Press **TRACE**, **TRACE A B C** (until trace B is underlined), then **CLEAR WRITE B**. Allow the trace to update (two sweeps) and press **VIEW B**, **PEAK SEARCH**, **MARKER A**. The spectrum analyzer display shows the stored data in trace B and the measured data in trace A.

5. Next, increase the RF attenuation by 10 dB: press **AMPLITUDE**, **ATTEN AUTO MAN**, and the step-up key (**↑**) once. See Figure 3-22.



**Figure 3-22. RF Attenuation of 10 dB**

- Compare the response in trace A to the response in trace B. If the distortion product decreases as the attenuation increases, distortion products are caused by the spectrum analyzer input mixer.

**Note**

When the source signal amplitude is changed between trace A and trace B and there is a resulting change in the distortion product, this is shown by a change in the marker amplitude (marker-delta value). An example of the marker-delta value produced by a change in the distortion product is shown in Figure 3-22. A change in the distortion product is indicative of high-level input signals causing circuit overload conditions and producing distortion. This distortion is a function of the internal hardware of the analyzer. The input signals must be attenuated to eliminate the interference caused by the internal distortion.

However, if there is no change in the distortion product with an increase in attenuation, the distortion is not caused internally but is a result of distortion that is present on the input signal as supplied from the signal source. An example of this is shown in Figure 3-23, where the source signal is not high enough to cause internal distortion in the spectrum analyzer, therefore, any distortion that is displayed is present on the input signal.

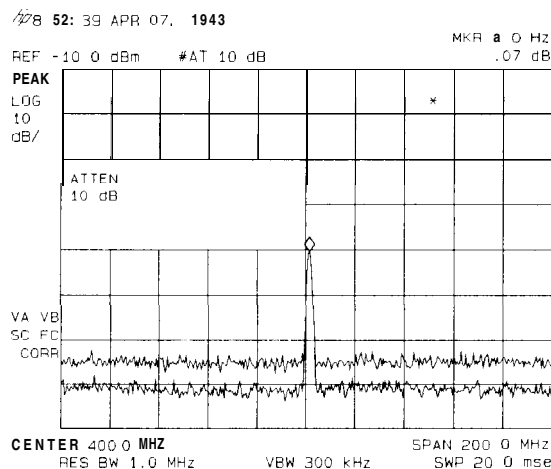

**Figure 3-23. No Harmonic Distortion**



## Third-Order Intermodulation Distortion

Two-tone, third-order intermodulation distortion is a common problem in communication systems. When two signals are present in a system, they can mix with the second harmonics generated and create third-order intermodulation distortion products, which are located close to the original signals. These distortion products are generated by system components such as amplifiers and mixers.

**Example:** Test a device for third-order intermodulation. This example uses two sources, one set to 300 MHz and the other to approximately 301 MHz. (Other source frequencies may be substituted, but try to maintain a frequency separation of approximately 1 MHz.)

1. Connect the equipment as shown in Figure 3-24.

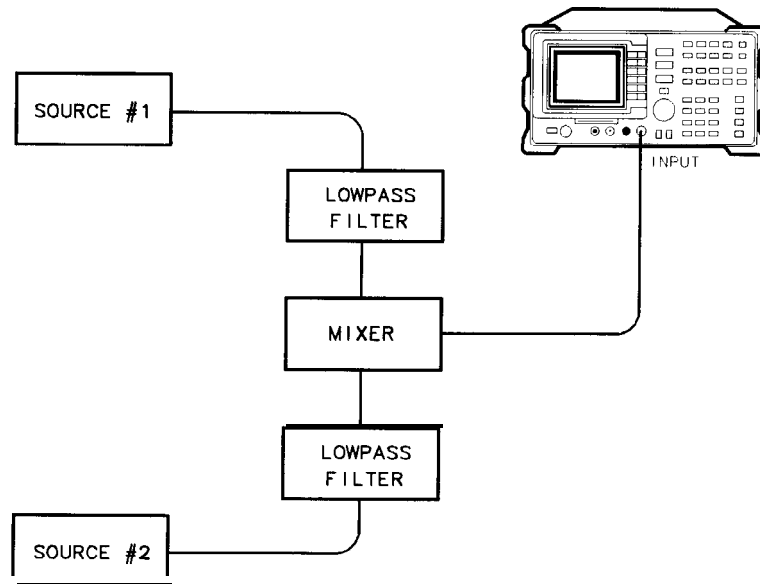

**Figure 3-24. Third-Order Intermodulation Equipment Setup**

2. Set one source to 300 MHz and the other source to 301 MHz for a frequency separation of 1 MHz. Set the sources equal in amplitude (in this example, the sources are set to -5 dBm)
3. Tune both signals onto the screen by setting the center frequency between 300 and 301 MHz. Then, using the knob, center the two signals on the display. Reduce the frequency span to 5 MHz for a span wide enough to include the distortion products on the screen. To be sure the distortion products are resolved, reduce the resolution bandwidth until the distortion products are visible. Press **[BW]**, RES BW, and then use the step-down key (**[↓]**) to reduce the resolution bandwidth until the distortion products are visible.

4. For best dynamic range, set the mixer input level to -40 dBm and move the signal to the reference level: press **[AMPLITUDE]**, More 1 of 3, MAX MXR LEVEL, 40 **[-dBm]**.

The spectrum analyzer automatically sets the attenuation so that a signal at the reference level will be a maximum of -40 dBm at the input mixer.

5. To measure a distortion product, press **[PEAK\_SEARCH]** to place a marker on a source signal. To activate the second marker, press MARKER A. Using the knob, adjust the second marker to the peak of the distortion product that is beside the test tone. The difference between the markers is displayed in the active function block.

To measure the other distortion product, press **(PEAK SEARCH)**, **NEXT PEAK** . This places a marker on the next highest peak, which, in this case, is the other product source signal. To measure the difference between this test tone and the second distortion product, press **MARKER A** and use the knob to adjust the second marker to the peak of the second distortion product. See Figure 3-25.

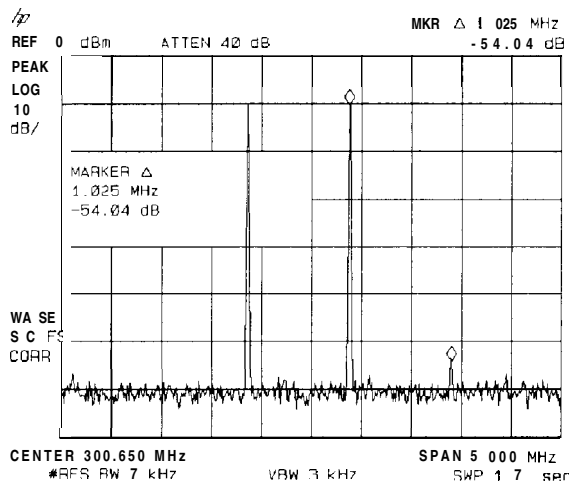

**Figure 3-25. Measuring the Distortion Product**

---

## Using the Analyzer As a Receiver in Zero Frequency Span

The spectrum analyzer operates as a fixed-tuned receiver in zero span. The zero span mode can be used to recover modulation on a carrier signal.

Center frequency in the swept-tuned mode becomes the tuned frequency in zero span. The horizontal axis of the screen becomes calibrated in time, rather than frequency. Markers display amplitude and time values.

The following functions establish a clear display of the video waveform:

- Trigger stabilizes the waveform trace on the display by triggering on the modulation envelope. If the signal's modulation is stable, video trigger synchronizes the sweep with the demodulated waveform.
- Linear mode should be used in amplitude modulation (AM) measurements to avoid distortion caused by the logarithmic amplifier when demodulating signals.
- Sweep time adjusts the full sweep time from 20 ms (20  $\mu$ s in zero span with Option 101), to 100 s. The sweep time readout refers to the full 10-division graticule. Divide this value by 10 to determine sweep time per division.
- Resolution and video bandwidth are selected according to the signal bandwidth.

Each of the coupled function values remains at its current value when zero span is activated. Video bandwidth is coupled to resolution bandwidth. Sweep time is not coupled to any other function.

---

|             |                                                                                                                                                                                                                               |
|-------------|-------------------------------------------------------------------------------------------------------------------------------------------------------------------------------------------------------------------------------|
| <b>Note</b> | Capability for measuring AM or FM demodulation is available if Option 102, 103, or 301 is installed in your spectrum analyzer. Refer to "Demodulating and Listening to an AM or FM Signal" in Chapter 4 for more information. |
|-------------|-------------------------------------------------------------------------------------------------------------------------------------------------------------------------------------------------------------------------------|

---

**Example:** View the modulation waveform of an AM signal in the time domain.

1. To obtain an AM signal, you can either connect an antenna to the spectrum analyzer input and tune to a commercial AM broadcast station or you can connect a source to the spectrum analyzer input and set the percent modulation of the source. (If a headset is used with the VIDEO OUT connector, the spectrum analyzer will operate as a radio.)
2. First, center and zoom in on the signal in the frequency domain (see "Decreasing the Frequency Span Using the Marker Track Function"). Be sure to turn off the marker track function, since the marker track function must be off for zero span. See Figure 3-26.

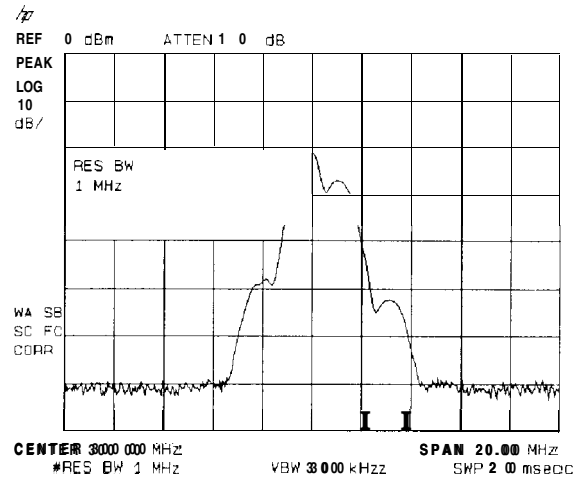

**Figure 3-26. Viewing an AM Signal**

3. To demodulate the AM, press **[BW]**. Increase the resolution bandwidth to include both sidebands of the signal within the passband of the spectrum analyzer.
4. Next, position the signal peak near the reference level and select a linear voltage display. Press **[AMPLITUDE]** and change the reference level, then press **SCALE LOG LIN** to underline LIN.
5. To select zero span, either press **(SPAN)**, 0 **[Hz]** or press **ZERO SPAN**. See Figure 3-27. If the modulation is a steady tone (for example, from a signal generator), use video trigger to trigger on the waveform and stabilize the display. Adjust the sweep time to change the horizontal scale.

Use markers and delta markers to measure time parameters of the waveform.

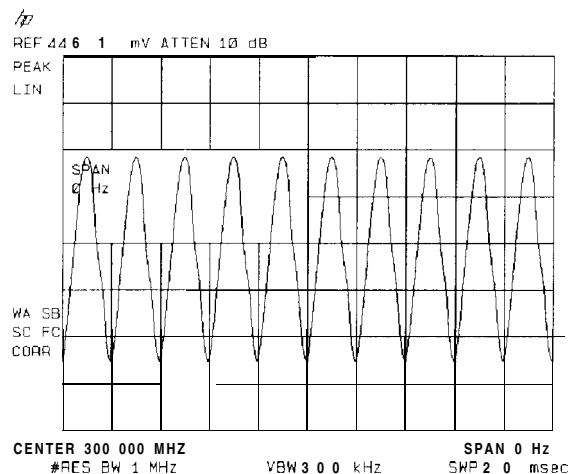

**Figure 3-27. Measuring Modulation in Zero Span**

---

## Measuring Signals Near Band Boundaries Using Harmonic Lock

---

**Note** This application should only be performed using an HP 8592L, HP 85933, HP 85953, or HP 85963.

---

When measuring signals at or near a band crossing, use the lowest band having a specified upper frequency limit that will include the signal of interest. See specifications and characteristics in your calibration guide for your instrument for harmonic band specifications. Using harmonic lock, and choosing the lowest possible band to analyze a signal, ensures the best specified measurement accuracy.

To lock onto a specific harmonic, press **FREQUENCY**, Band Lock , BND LOCK ON OFF (so that ON is underlined), or select a band (see specifications and characteristics in your calibration guide for your instrument for band specifications). After setting the harmonic lock, only center frequencies and spans within the frequency range of the harmonic band may be entered. The span is automatically reduced to accommodate a center frequency specified near the end of the band 'range.

### Example:

1. Connect 100 MHz COMB OUT to the spectrum analyzer input. The HP 85953 does not have a 100 MHz COMB OUT signal, so it cannot be used for this measurement example. (An external source must be substituted.)

2. Press **PRESET** and then the following keys:

**AUX CTRL** COMB GEN ON OFF (ON)

**SPAN** **350 (MHz)**

**FREQUENCY** 3 **(GHz)**

Band Lock BND LOCK ON OFF (ON)

3. Place a marker on the farthest peak to the left by using the **PEAK\_SEARCH** key.

4. Press MARKER A , NEXT PK RIGHT, NEXT PK RIGHT to show the frequency and amplitude difference between the two comb teeth.

You will see three comb teeth on your display. The spectrum analyzer is locked in band 1 and will not allow multiband sweeps. See Figure 3-28.

5. To see a multiband sweep, press the following keys:

**MKR** More 1 of 2 MARKER ALL OFF

**FREQUENCY** Band Lock BND LOCK ON OFF (OFF)

6. Place a marker on the farthest peak to the left by pressing **PEAK\_SEARCH**.

7. Press MARKER A . Use NEXT PK RIGHT to place a marker on the farthest peak to the right. The marker readout displays the frequency and amplitude difference between the two comb teeth. See Figure 3-29.

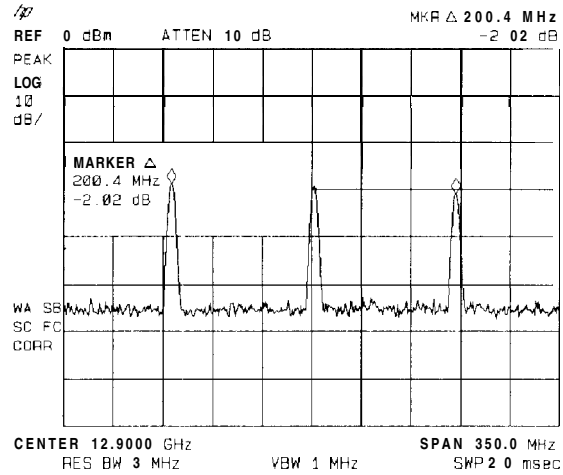
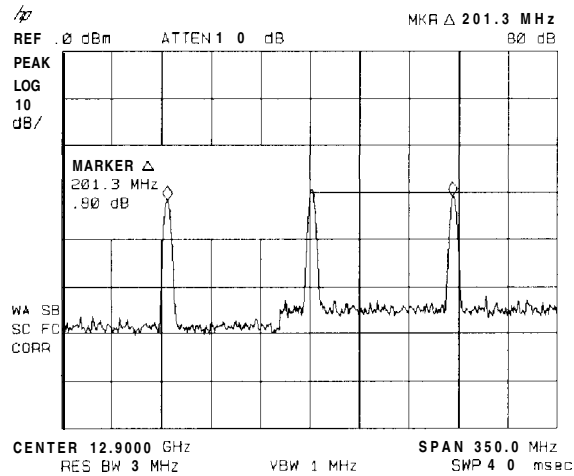

**Figure 3-28. Using Harmonic Lock**

---

**Note**            The comb frequencies have a 100 MHz spacing.

---



**Figure 3-29. Harmonic Locking Off**

## Making Measurements

---

### What You'll Learn in This Chapter

This chapter demonstrates spectrum analyzer measurement techniques with examples of typical applications; each application focuses on different features. The measurement procedures covered in this chapter are listed below.

- Measuring amplitude modulation using the fast Fourier transform function.
- Stimulus-response measurements using the built-in tracking generator (Option 010 or 011).
- Demodulating and listening to an AM or FM signal (Option 102 or 103 only).
- Triggering on a selected line of a video picture field (Options 101 and 102, or Option 301 only).
- Making a reflection calibration and measurements.
- Using the Gate Utility to simplify time-gated measurements (Option 105 only).
- Using the time-gated spectrum analyzer capability (Option 105 only).
- Using the one-button measurements to measure N dB bandwidth, percent amplitude modulation, and third order intercept (TOI).
- Using the power measurement functions to make transmitter measurements.

To find descriptions of specific spectrum analyzer functions refer to Chapter 7 “Key Descriptions”.

---

## Measuring Amplitude Modulation with the Fast Fourier Transform Function

A Fourier transform, transforms time domain data (zero span) into the frequency domain. The fast Fourier transform (FFT) function of the spectrum analyzer allows measurements of amplitude modulation (AM). It is commonly used to measure AM at rates that cannot be measured in the normal frequency domain due to spectrum analyzer limitations on narrow resolution bandwidths. For a given AM rate, the FFT function can generate a trace faster than using the frequency domain for the equivalent spectrum analyzer measurement.

---

**Note** The fast ADC Option 101 extends FFT operation. The standard spectrum analyzer has sweep times (in zero span) up to 20 ms and allows FFT stop frequencies from 20 Hz to 10 kHz. With Option 101, spans of 20  $\mu$ s can be used and FFT stop frequencies up to 10 MHz are available.

---

The FFT function calculates the magnitude of each frequency component from a block of time-domain samples of the input signal. It uses a flat top filter response. This implementation is a post-detection Fourier transform and it cannot be used to resolve continuous wave or carrier signals.

When **(MEAS/USER)**, FFT Menu , and SINGLE FFT are pressed, sample-detection mode is selected and a sweep is taken to obtain a sample of the input signal. Then the spectrum analyzer executes a series of computations on the time data to produce the frequency-domain results. CONTINUS FFT can be used instead of SINGLE FFT and the spectrum analyzer will be put in continuous sweep mode with an FFT being performed at the end of each sweep.

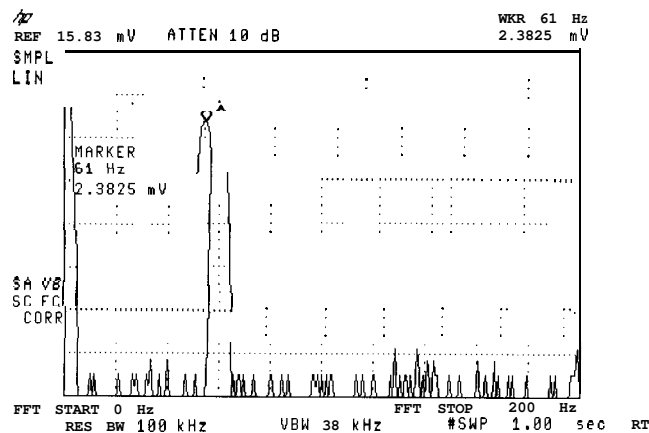

**Figure 4-1. FFT Annotation**

Some of the screen annotation is altered when the FFT function is active. The left edge of the graticule is relabeled FFT START and represents 0 Hz relative to the carrier. The right edge of the graticule is relabeled FFT STOP and is the maximum FFT frequency used in the transformation. The annotation LIN in the upper left corner refers to the scale of the incoming data being transformed. The FFT results, which are being displayed, are always in LOG scale. The carrier appears at the left edge of the graticule with the modulation sidebands and any distortion appearing along the horizontal axis. The amplitude relationships of all the signals are the same as they would be if the components were displayed with normal swept-tuned operation in log mode, 10 dB per division.



If the FFT stop frequency is less than the highest harmonic of the AM modulation, than the FFT results may include aliased signals. That is, it will include some signals that are being displayed at the wrong frequency. The sweep time affects the sample rate and must be optimized to avoid aliasing.

The single and continuous FFT functions require a specific spectrum analyzer setup before they can be activated. First, an AM signal is demodulated in the time domain. In order to do this, the resolution bandwidth is widened to include the signal sidebands within the passband of the spectrum analyzer. Next, zero span is selected so that the spectrum analyzer operates as a fixed-tuned receiver. Tuning is centered around the AM carrier.

The MARKER+ AUTO FFT softkey activates the FFT function with very little preliminary setup required. Two examples of using the FFT function are included in this section.

- First example: uses the manual FFT functions.
- Second example: uses the automatic FFT measurement.

---

**Note** After the FFT function is used, the markers are still in FFT mode for use in evaluating data. Turn off the FFT markers before attempting to use markers in the normal fashion. Press FFT OFF in the FFT menu to turn off the markers and exit the FFT measurement.

---

**Example 1:** Use the manual FFT measurement to look at 60 Hz AM modulation.

1. Connect a signal generator to the spectrum analyzer INPUT 500. Adjust the signal generator to produce an AM signal with a 60 Hz modulation frequency.
2. Press **FREQUENCY** and set the spectrum analyzer center frequency to the frequency of the modulated input signal. Press **SPAN**, 10 MHz. Press **FREQUENCY** again and center the signal on the spectrum analyzer display.
3. Press **SPAN**, 1 MHz. Press **FREQUENCY** and center the signal on the spectrum analyzer display again.
4. Press **BW**, 100 kHz. (Re-center the signal, if necessary.)  
Press **SPAN** 200 kHz, re-centering the signal again if it is necessary.
5. Press VID **BW AUTO MAN** , 1 kHz. The video bandwidth should be about ten times greater than the highest modulation frequency of interest for the best amplitude accuracy.
6. Press REF LVL and turn the knob to change the reference level, placing the signal peak within the top division of the screen. The signal peak must be below the reference level. The signal amplitude moves up and down because the spectrum analyzer catches the signal at different points of modulated amplitude each time it sweeps.
7. Change the amplitude scale to linear by pressing **AMPLITUDE** and SCALE LOG LIN so that LIN is underlined. The FFT will give incorrect results when the spectrum analyzer is in Log mode.  
Press REF LVL and place the signal peak within the top division of the screen.
8. Press **SPAN**, 0 Hz. The spectrum analyzer now operates as a fixed-tuned receiver.
9. Press **MEAS/USER**, FFT **Menu**, and CONTINUS FFT . The spectrum analyzer will now be taking FFTs continuously, updating the measurement at the end of every sweep.  
Press FFT STOP FREQ , 250 Hz. This sets the spectrum analyzer to include the fourth harmonic of the 60 Hz modulation signal on the screen.

10. To confirm that the resolution bandwidth and video bandwidth are correct for measuring the modulation amplitude, use the following procedure:
  - a. Press **(MKR)** and use the knob to move the marker to the desired modulation signal. In this example, place the marker on the 60 Hz fundamental modulation signal.

---

**Note** For HP 8590L with Option 713 or HP 8592L with Option 713 the resolution bandwidth must be left at about 100 kHz to accommodate frequency drift of the spectrum analyzer. If you are using an HP 8590L with Option 713, or an HP 8592L with Option 713, do not do step b.

---

- b. Press **(BW)** and decrease the resolution bandwidth using the **(↓)** key, until measured signal amplitude drops. Then press **(↑)** to increase the bandwidth until the signal amplitude stops increasing and stays the same, or until the maximum resolution bandwidth is reached. Use the narrowest bandwidth that does not cause a change in the signal amplitude.

---

**Note** As the resolution bandwidth is stepped down, the modulated signal must be re-centered in the filter bandwidth. This is a zero span display. To center the signal, select **(FREQUENCY)** and adjust the center frequency to maximize the amplitude of the trace. If this is not done, the signal amplitude can decrease due to off tuning of the spectrum analyzer and not because of the resolution bandwidth chosen.

---

For the best amplitude accuracy, the resolution bandwidth should be about 10 times greater than the highest modulation frequency of interest.

For the 60 Hz fundamental, a 1 kHz resolution bandwidth works well. (For the HP 85913, HP 8593E, HP 85943, HP 85953, and HP 8596E, if harmonics are not a concern, a 100 kHz resolution bandwidth can be used and it will provide a faster update rate.)

- c. Press **(BW)**, VID BW AUTO MAN (MAN) and use the step keys to decrease the video bandwidth until the amplitude of the measured signal drops. Then step the bandwidth up until the signal amplitude stops increasing, or until the maximum video bandwidth is reached. Use the narrowest video bandwidth that does not cause a change in the signal amplitude.

For the best amplitude accuracy, the video bandwidth should be about 10 times greater than the highest modulation frequency of interest.

For the 60 Hz fundamental, a 1 kHz video bandwidth works well.

11. Press **(MEAS/USER)** and **% AM ON OFF** so that ON is underlined. The spectrum analyzer reads out the percent AM of the largest modulation frequency. An arrow indicates the signal being measured (see Figure 4-1). This measurement does not include all of the harmonics of the modulating signal.

---

**Note** The percent AM function will not run if the SIGNAL CLIPPED error message is being displayed. Increase the reference level until the error message goes away.

---

---

**Note** When the FFT measurement is active, pressing the **MEAS/USER** key will cycle between the MEAS/USER and FFT menus.

---

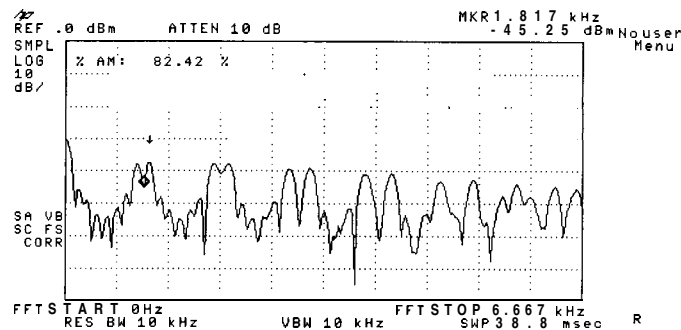

**Figure 4-2. Percent Amplitude Modulation Measurement**

**Example 2:** Use the automatic FFT measurement to look at 60 Hz AM modulation.

1. Connect a signal generator to the spectrum analyzer INPUT 50 $\Omega$ . Adjust the signal generator to produce an AM signal with a 60 Hz modulation frequency.
2. Press **FREQUENCY** and set the spectrum analyzer center frequency to the frequency of the modulated input signal. Press **SPAN**, 10 **MHz**. Press **FREQUENCY** to keep the signal on the spectrum analyzer display.
3. Press **MEAS/USER**, FFT Menu, and **MARKER**→ **AUTO FFT**. This initiates the FFT function and activates a marker.
4. Use the knob to place the marker on the AM modulated signal and press **MARKER**--> **AUTO FFT** again. The spectrum analyzer will perform the following steps:
  - a. Save the present instrument state in state register 8.
  - b. Reduce the span to zoom in on the signal.
  - c. Set the detector mode to sample.
  - d. Set the scale to linear.
  - e. Change the span to zero span.
  - f. Start the continuous FFT function.
  - g. Set the FFT stop frequency to 10 kHz.
5. Press **FFT STOP FREQ**, 250 **Hz**. This sets the spectrum analyzer to include the fourth harmonic of the 60 Hz modulation signal on the screen.
6. To confirm that the resolution bandwidth and video bandwidth are correct for measuring the modulation amplitude, use the following procedure:
  - a. Press **MKR** and use the knob to move the marker to the desired modulation signal. In this example, place the marker on the 60 Hz fundamental modulation signal.

---

**Note** For HP 8590L with Option 713 or HP 8592L with Option 713 the resolution bandwidth must be left at about 100 kHz to accommodate frequency drift of the spectrum analyzer. If you are using an HP 8590L with Option 713, or an HP 8592L with Option 713, do not do step b.

---

- b. Press **BW** and decrease the resolution bandwidth using the **↓** key, until measured signal amplitude drops. Then press **↑** to increase the bandwidth until the signal amplitude stops increasing and stays the same, or until the maximum resolution bandwidth is reached. Use the narrowest bandwidth that does not cause a change in the signal amplitude.

---

**Note** As the resolution bandwidth is stepped down, the modulated signal must be re-centered on the spectrum analyzer display. If this is not done, the signal amplitude can decrease due to off tuning of the spectrum analyzer and not because of the resolution bandwidth chosen.

---

For the best amplitude accuracy, the resolution bandwidth should be about 10 times greater than the highest modulation frequency of interest.

For the 60 Hz fundamental, a 1 kHz resolution bandwidth works well. (For the HP 8591E, HP 85933, HP 85943, HP 85953, and HP 85963, if harmonics are not a concern, a 100 kHz resolution bandwidth can be used and it will provide a faster update rate.)

- c. Press **BW**, VID BW AUTO MAN (MAN) and use the step keys to decrease the video bandwidth until the amplitude of the measured signal drops. Then step the bandwidth up until the signal amplitude stops increasing, or until the maximum video bandwidth is reached. Use the narrowest video bandwidth that does not cause a change in the signal amplitude.

For the best amplitude accuracy, the video bandwidth should be about 10 times greater than the highest modulation frequency of interest.

For the 60 Hz fundamental, a 1 kHz video bandwidth works well.

7. Press **MEAS/USER** and **% AM ON OFF** so that ON is underlined. The spectrum analyzer reads out the percent AM of the largest modulation frequency. An arrow indicates the signal being measured (see Figure 4-1). This measurement does not include all of the harmonics of the modulating signal.

---

**Note** The percent AM function will not run if the SIGNAL CLIPPED error message is being displayed. Increase the reference level until the error message goes away.

---

---

**Note** To return to the spectrum analyzer state prior to running the FFT function, press the FFT OFF softkey. This turns off the FFT function. Press **RECALL**, INTERNAL →STATE , and 8 to recall the state from state register 8.

---

---

**Note** When the FFT measurement is active, pressing the **MEAS/USER** key will cycle between the MEAS/USER and FFT menus.

---

---

## Stimulus-Response Measurements

---

**Note** This application should only be performed using an HP 8590L or HP 85913 with Option 010 or 011, or using an HP 85933, HP 85943, HP 85953, or HP 85963 with Option 010.

---

### What Are Stimulus-Response Measurements?

Stimulus-response measurements require a source to stimulate a device under test (DUT), a receiver to analyze the frequency-response characteristics of the DUT, and, for return-loss measurements, a directional coupler. Characterization of a DUT can be made in terms of its transmission or reflection parameters. Examples of transmission measurements include flatness and rejection. A reflection measurement is return loss.

A spectrum analyzer combined with a tracking generator forms a stimulus-response measurement system. With the tracking generator as the swept source and the spectrum analyzer as the receiver, operation is analogous to a single-channel scalar network analyzer. A narrow-band system has a wide dynamic measurement range, but the tracking generator's output frequency must be made to precisely track the spectrum analyzer input frequency. This wide dynamic range will be illustrated in the following example. Figure 4-3 shows the block diagram of a spectrum analyzer and tracking-generator system.

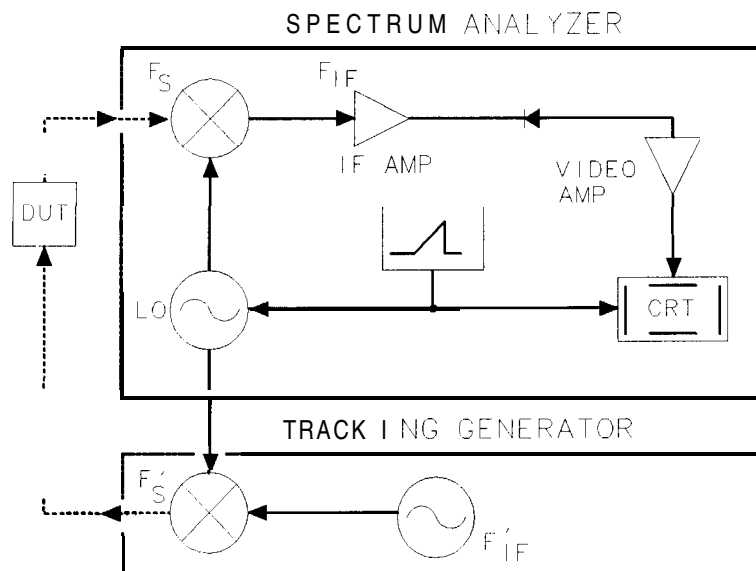

**Figure 4-3.**

### Block Diagram of a Spectrum Analyzer/Tracking-Generator Measurement System

---

**Note** The HP 85630A Transmission/Reflection Test Set with the HP 85714A Scalar Measurement Personality is recommended for making transmission and reflection measurements with your spectrum analyzer. The scalar measurement personality provides simple menu-driven functions to make fast, accurate scalar network analysis measurements with your spectrum analyzer and test set.

---

## Using a Spectrum Analyzer with a Tracking Generator

The procedure below describes how to use the built-in tracking generator system of the HP 85913 Option 010 spectrum analyzer to measure the rejection of a low-pass filter which is a type of transmission measurement. Illustrated in this example are the functions in the tracking-generator menu, such as adjusting the tracking-generator output power, source calibration, and normalization. Conducting a reflection measurement is similar and is covered in “Making Reflection Calibration Measurements”. Refer to the HP Spectrum Analyzer Seminar, or Application Note 150-7, for more information.

### Stepping through the Measurement

There are four basic steps in performing a stimulus-response measurement, whether it be a transmission or reflection measurement: set up the spectrum analyzer settings, calibrate, normalize, and measure.

1. If necessary, perform the self-calibration routine for the tracking generator described in “Performing the Tracking Generator Self-Calibration Routine” in Chapter 2.
2. To measure the rejection of a low-pass filter, connect the equipment as shown in Figure 4-4. This example uses a filter with a cut-off frequency of 300 MHz as the DUT.

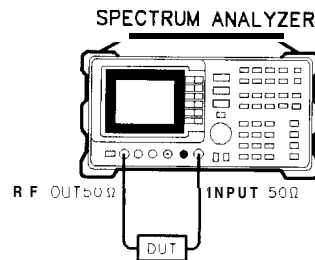

**Figure 4-4. Transmission Measurement Test Setup**

3. Activate the tracking generator menu by pressing **AUX CTRL** and Track Gen . To activate the tracking-generator power level, press SRC PWR ON OFF until ON is underlined (see Figure 4-5).

---

**Caution** Excessive signal input may damage the DUT. Do not exceed the maximum power that the device under test can tolerate.

---

**Note** To reduce ripples caused by source return loss, use 10 dB or greater tracking generator output attenuation. Tracking generator output attenuation is normally a function of the source power selected. However, the output attenuation may be controlled by using SRC ATN AUTO MAN . (There is no output attenuation in the HP 8590L with Option 010 or Option 011.) Refer to specifications and characteristics in your calibration guide for more information on the relationship between source power and source attenuation.

---

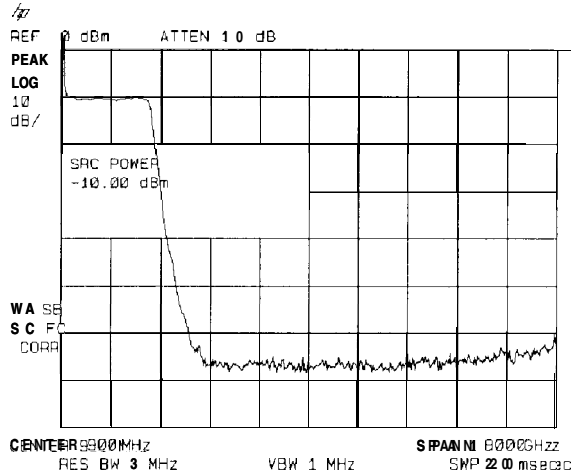

**Figure 4-5. Tracking-Generator Output Power Activated**

- Put the sweep time of the analyzer into stimulus-response auto-coupled mode by pressing More 1 of 2 , then SWP CPLG SR SA until SR (stimulus-response mode) is underlined. Auto-coupled sweep times are usually much faster for swept-response measurements than they are for spectrum analyzer measurements.

**Note**

In the stimulus-response mode, the Q (reactance versus resistance) of the DUT can determine the fastest rate at which the spectrum analyzer can be swept. To determine whether the analyzer is sweeping too fast, slow the sweep time and note whether there is a frequency or amplitude shift of the trace. Continue to slow the sweep time until there is no longer a frequency or amplitude shift.

- Since we are only interested in the rejection of the low-pass filter, tune the spectrum analyzer center frequency so that the roll-off of the filter comprises the majority of the trace on the display (see Figure 4-6).

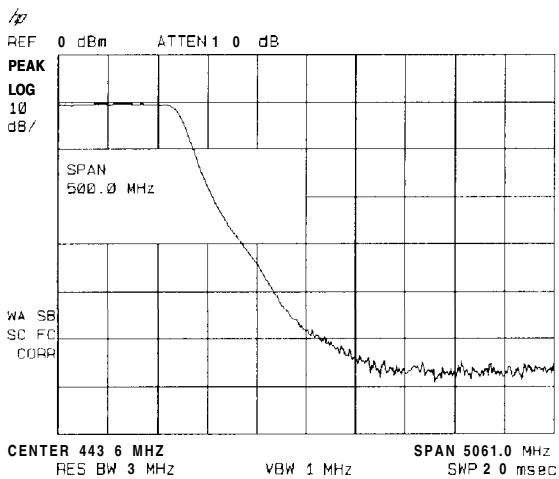

**Figure 4-6. Spectrum Analyzer Settings According to the Measurement Requirement**

- Decrease the resolution bandwidth to increase sensitivity, and narrow the video bandwidth to smooth the noise. In Figure 4-7, the resolution bandwidth has been decreased to 10 kHz.

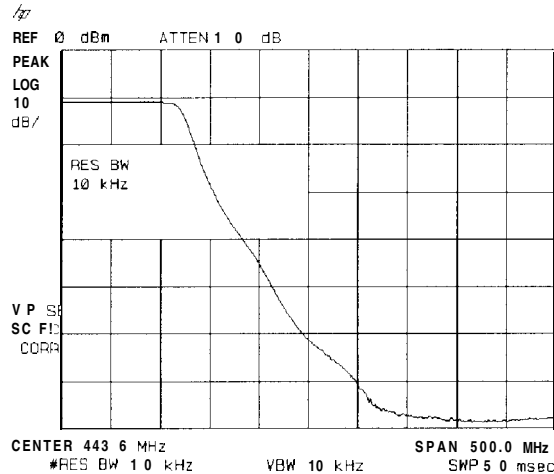

**Figure 4-7. Decrease the Resolution Bandwidth to Improve Sensitivity**

Adjusting the resolution bandwidth may result in a decrease in amplitude of the signal. This is known as a tracking error. Tracking errors occur when the tracking generator's output frequency is not exactly matched to the input frequency of the spectrum analyzer. Tracking errors are most notable when using narrow resolution bandwidths. Tracking error can be compensated manually or automatically. In narrow bandwidths, the manual method of adjusting the tracking is usually faster than the automatic tracking adjustment. To compensate for the tracking error manually, press **AUX CTRL**, Track Gen , and MAN TRK ADJUST , then use the knob to adjust the trace for the highest amplitude. To compensate for the tracking error automatically, press **AUX CTRL**, Track Gen , then TRACKING PEAK.

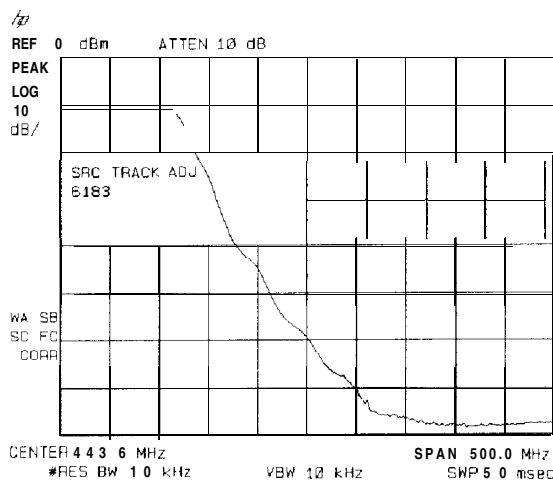

**Figure 4-8. Manual Tracking Adjustment Compensates for Tracking Error**



**Note** If the automatic tracking routine is activated in a narrow resolution bandwidth, it usually is not necessary to use the tracking adjust again when increasing the resolution bandwidth.

7. To make a transmission measurement accurately, the frequency response of the test system must be known. To measure the frequency response of the test system, connect the cable (but not the DUT) from the tracking generator output to the spectrum analyzer input. Press **TRACE**, TRACE A B C (so B is underlined), CLEAR WRITE B , BLANK B . The frequency response of the test system is now stored in trace B.
8. To normalize, reconnect the DUT to the spectrum analyzer. Press **TRACE**, More 1 of 3 , NORMLIZE ON OFF until ON is underlined. Press NORMLIZE POSITION to activate the display line. This display line marks the normalized reference position, or the position where 0 dB insertion loss (transmission measurements) or 0 dB return loss (reflection measurements) will normally reside. Using the knob results in a change in the position of the normalized trace, within the range of the graticule.

Normalization eliminates the frequency response error of the test system. When normalization is on, trace math is being performed on the active trace. The trace math performed is trace A minus trace B plus the display line, with the result placed into trace A. Remember that trace A contained the measurement trace, trace B contained the stored calibration trace, and DL (display line) represents the normalized reference position. Note that the units of the reference level, dB, reflect this relative measurement.

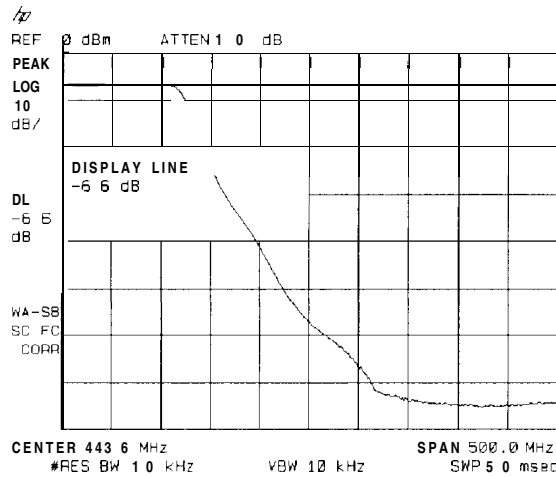

**Figure 4-9. Normalized Trace**

9. To measure the rejection of the filter at a given frequency, press **MKR**, and enter the frequency. For example, enter 350 MHz. The marker readout displays the rejection of the filter at 350 MHz (see Figure 4-10).

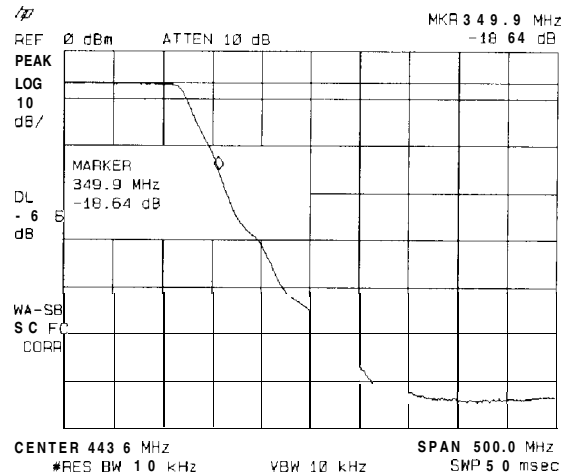

**Figure 4-10. Measure the Rejection Range with Delta Markers**

## Tracking Generator Unleveled Condition

When using the tracking generator, the message TG UNLVL may appear. The TG UNLVL message indicates that the tracking generator source power (SRC PWR ON OFF ) could not be maintained at the user-selected level during some portion of the sweep. If the unleveled condition exists at the beginning of the sweep, the message will be displayed immediately. If the unleveled condition occurs after the sweep begins, the message will be displayed after the sweep is completed. A momentary unleveled condition may not be detected when the sweep time is small. The message will be cleared after a sweep is completed with no unleveled conditions.

The unleveled condition may be caused by any of the following:

- Start frequency is too low or the stop frequency is too high. The unleveled condition is likely to occur if the true frequency range exceeds the tracking generator frequency specification (especially the low frequency specification). The true frequency range being swept may be significantly different than the start or stop frequency annotations indicate, depending on other spectrum-analyzer settings, especially the span (see specifications and characteristics in your calibration guide for your instrument). For better frequency accuracy, use a narrower span.
- . Tracking peak may be required (use TRACKING PEAK ).
- Source attenuation may be set incorrectly (select SRC ATN MAN AUTO (AUTO) for optimum setting).
- The source power may be set too high or too low, use SRC PWR ON OFF to reset it.
- The source power sweep may be set too high, resulting in an unleveled condition at the end of the sweep. Use PWR SWP ON OFF to decrease the amplitude.

---

## Demodulating and Listening to an AM or FM Signal

---

**Note** This application should only be performed using an HP 85913, HP 8593E, HP 85943, HP 85953, or HP 85963 with Option 102 or 103.

---

The functions listed in the menu under Demod allow you to demodulate and hear signal information displayed on the spectrum analyzer. Simply place a marker on a signal of interest, activate AM or FM demodulation, and then listen.

### Example:

1. Connect an antenna to the spectrum analyzer input.
2. Select a frequency range on the spectrum analyzer, such as the range for FM radio broadcasts. For example, the frequency range for FM broadcasts in the United States is 88 MHz to 108 MHz. Press **(PRESET)**, **(FREQUENCY)**, START FREQ , 88 **(MHz)**, STOP FREQ , 108 **(MHz)**.
3. Place a marker on the signal of interest by using **(PEAK SEARCH)** to place a marker on the highest-amplitude signal, or by pressing **(MKR)** , MARKER NORMAL and moving the marker to a signal of interest.
4. Press **(AUX CTRL)**, Demod, DEMOD ON OFF (so that ON is underlined), and DEMOD AM FM (so that FM is underlined). SPEAKER ON OFF is set to ON by the preset function. Use the front-panel volume control to control the speaker's volume.

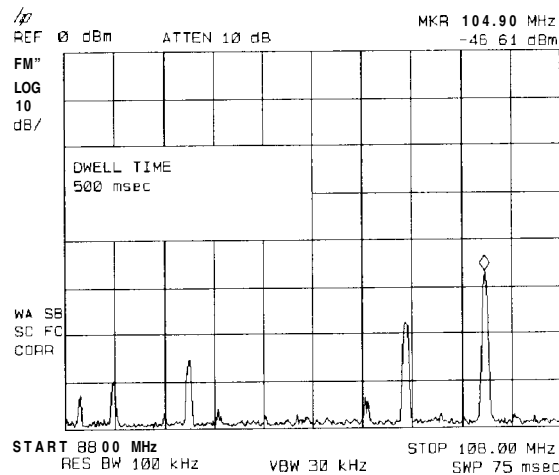

**Figure 4- 11. Demodulation of an FM Signal**

5. The signal is demodulated at the marker's position for the duration of the dwell time. Use the step keys, knob, or number/units keypad to change the dwell time. For example, press the step-up key (**(↑)**) twice to increase the dwell time to 2 seconds.
6. The peak search functions can be used to move the marker to other signals of interest. Press **(PEAK SEARCH)** to access **NEXT PEAK** , **NEXT PK RIGHT** , or **NEXT PK LEFT** .

**Example:** The signal can be continuously demodulated if the spectrum analyzer is in zero span.

1. Place the marker on a signal of interest as in steps 1 through 3 of the previous example.
2. If the signal of interest is the highest-amplitude on-screen signal, set the frequency of the signal to center frequency by pressing **(MKR FCTN)** then MK TRACK ON OFF (ON). If it is not the highest-amplitude on-screen signal, move the signal to center screen by pressing **(MKR →)** and MARKER -CF.
3. If marker track is on, press **(SPAN)** and 1 **(MHz)** to reduce the span to 1 MHz. If marker track is not used, use the step-down key **(↓)** to reduce the span and use MARKER →CF to keep the signal of interest at center screen.
4. Set the span to zero by pressing ZERO SPAN . ZERO SPAN turns off the marker track function.
5. Change the resolution bandwidth to 100 kHz by pressing **(BW)** and entering 100 **(kHz)**.
6. Set the signal in the top two divisions of the screen by changing the reference level. Press **(AMPLITUDE)**, and then the step-down key **(↓)** until the signal is in the top two divisions.
7. Press **(AUX CTRL)**, Demod , DEMOD ON OFF (ON), then DEMOD AM FM (FM). SPEAKER ON OFF is set to ON by the preset function. Use the front-panel volume control to control the speaker's volume.

For FM demodulation, use FM GAIN to adjust the top-to-bottom screen deviation of the signal with center screen as the reference (0 deviation). The top is the positive deviation and the bottom is the negative deviation. FM gain sensitivity is increased by decreasing the FM gain value. As the FM gain sensitivity is increased, the volume is increased. Pressing SQUELCH mutes the noise level.

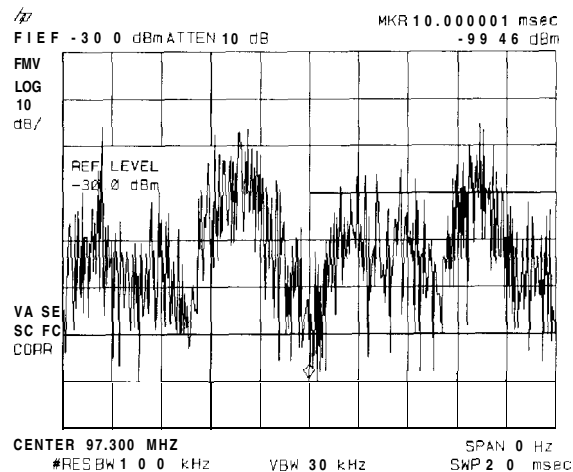

**Figure 4-12. Continuous Demodulation of an FM Signal**

## Triggering on a Selected Line of a Video Picture Field

**Note** This application should only be performed using an HP 85913, HP 85933, HP 85943, HP 85953, or HP 85963 with Option 301 (Options 101 and 102 combined).

With Option 301, you can trigger on a TV picture carrier signal. This example enables you to view a test signal transmitted during vertical retrace when the TV screen is blanked.

1. Press **PRESET**.
2. Set the frequency of a picture carrier signal to center frequency.
3. Press **TRIG]** and **TV TRIG** . If the spectrum analyzer is in a nonzero span, **TV TRIG** sets the amplitude scale to linear, places a marker on the signal peak, moves the marker to the reference level, changes the detector to sample, sets the sweep time to 100  $\mu$ s, sets the resolution bandwidth to 1 MHz, and sets the span to 0 Hz. The TV line number is the active function. The preset function sets the spectrum analyzer to trigger on an odd field of a video format and TV line number 17.

The sweep time of 100  $\mu$ s allows you to view two TV lines, line 17 and part of line 18. The multiburst is on TV line number 17, and the composite is on TV line number 18.

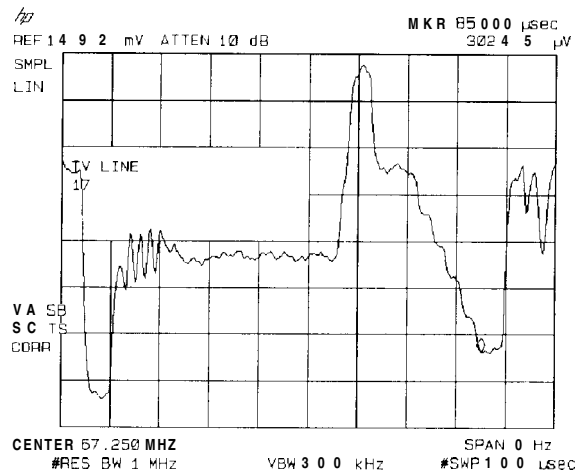

**Figure 4-13. Triggering on an Odd Field of a Video Format**

4. Press **TV TRIG EVEN FLD** to trigger on an even field of a video format.

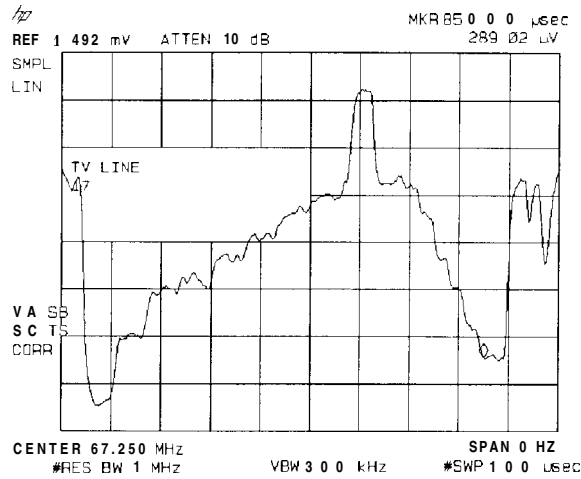

**Figure 4-14. Triggering on an Even Field of a Video Format**

The default video format is NTSC. Press TV Standard, then PAL-M, PAL , or SECAM-L to select a different video format. For non-interlaced video formats, press TV TRIG VERT INT

---

**Note** The video format selection (NTSC , PAL-M, PAL , or SECAM-L ) automatically selects the video modulation (negative or positive).

---

---

## Making Reflection Calibration Measurements

Typically, the calibration standard for reflection measurements is a short circuit connected at the reference plane (the point at which the test device will be connected—see Figure 4-15). A short circuit has a reflection coefficient of 1 (0 dB return loss); it thus reflects all incident power and provides a convenient 0 dB reference.

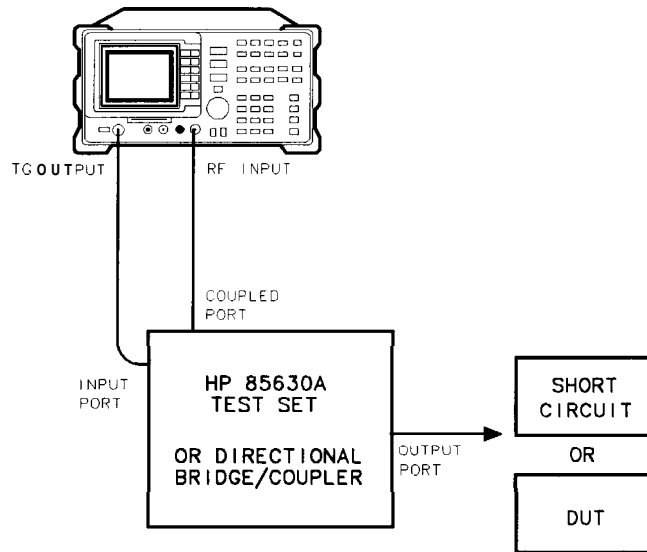

pu135e

**Figure 4-15. Reflection Measurement Short Calibration Test Setup**

**Example:** Measure the return loss of a filter.

The HP 85630A transmission/reflection test set is recommended for making reflection measurements with your spectrum analyzer. It must be used with the HP 85714A scalar measurement personality. The scalar measurement personality includes instructions on how to make fast, accurate scalar network analysis measurements with your spectrum analyzer and test set. The following procedure is written for making a reflection measurement using a coupler or directional bridge, instead of the test set.

### Reflection Calibration

---

**Note** The spectrum analyzer center frequency and span for this measurement can easily be set up using the transmission measurement setup. Tune the spectrum analyzer so that the passband of the filter comprises a majority of the display, then proceed with the steps outlined below.

---

1. Connect the DUT to the **output** port of a directional bridge or coupler. Terminate the unconnected port of the DUT.
2. Connect the tracking generator output of the spectrum analyzer to the **input** port of a directional bridge or coupler.
3. Connect the spectrum analyzer INPUT to the **coupled** port of a directional bridge or coupler.

4. Adjust the spectrum analyzer for measurement conditions or settings. Turn on the tracking generator and set the amplitude level by pressing **AUX CTRL**, Track Gen , and setting SRC PWR ON OFF to ON. Set center frequency, span, and other settings.
5. Replace the DUT with a short circuit
6. Normalize the trace by performing the following functions:
  - a. Press **TRACE**, select B using TRACE A B C , then CLEAR WRITE B to display the reference trace in B.
  - b. Press BLANK B to store the reference trace in B.
  - c. Press More 1 of 3 , then set NORMLIZE ON OFF to ON to activate the trace A minus trace B function, and display the results in trace A for each sweep. The normalized trace or flat line represents 0 dB return loss.

## Measuring the Return Loss

---

**Note** If possible, use a coupler or bridge with the correct test port connector for both calibrating and measuring. Any adapter between the test port and DUT degrades coupler/bridge directivity and system source match. Ideally, you should use the same adapter for the calibration and the measurement. Be sure to terminate the second port of a two-port device.

---

7. After calibrating the system with the above procedure, reconnect the filter in place of the short circuit without changing any spectrum analyzer settings.
8. Use the marker to read return loss. Press **MKR** and position the marker with the knob to read the return loss at that frequency (see Figure 4-16).

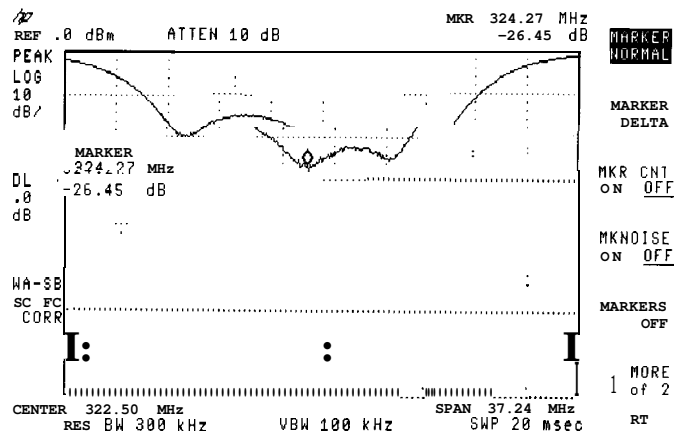

**Figure 4-16. Measuring the Return Loss of the Filter**



---

## Using the Gate Utility to Simplify Time-Gated Measurements (Option 105 only)

The time gate allows the user to control when a spectrum analyzer measurement begins and the length of time during which the measurement is made. The time gate is an RF signal switch that permits signal into the spectrum analyzer only while the switch, or gate, is closed. Since the spectrum analyzer receives the signal only when passed through the gate, it will only display the measurement results from the portion of the signal selected by the time position of the gate closure. The time gate acts as a time filter, rejecting signals and spectra not occurring at the desired time.

The time gate utility simplifies the use of the time gate. In the gate utility, the spectrum analyzer can display the time domain and the frequency domain simultaneously, using two separate windows. The user is able to adjust the time position of the gate closure relative to the input signal, using interactive graphic tools in the gate utility. The gate position relative to the signal is clearly shown in the time domain window. The spectral effects corresponding to an adjustment of the gate time position are displayed in the frequency domain window. Tools are provided to aid the user in determining the best gate position, and optimizing the spectrum analyzer settings for the input signal.

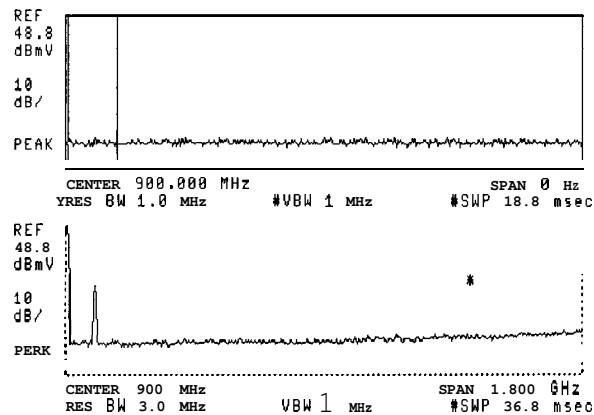

**Figure 4-17. Time-Gate Utility Display**

Gate utility features include:

- Displays time and frequency domains simultaneously.
- Measures continuously.
- Interactively controls and displays the gate's position in time.
- 

---

**Note** Option 105, time gate, is required. Option 101, fast ADC, is recommended  $\mu\text{sec}$   
(Sweep times down to 20 msec are available without Option 101.)

---

The gate utility provides tools to make pulsed RF measurements easy. If the user enters the optimize the resolution bandwidth, sweep time, and video bandwidth for these pulse parameters. Coupling the spectrum analyzer settings to pulse characteristics allows easy,

The types of signals that can be measured using the time gate function include:

- Pulsed RF signals
- Time domain multiple access (TDMA) communication system signals
- Interleaved or intermittent signals
- Signals with transient spectra

Time critical signals are present in many different applications. A few of the applications are listed below:

- Digital cellular communication systems require measurements on pulse modulated TDMA signals. Measurements must be accurately aligned with the time division multiple access (TDMA) burst of the communication carrier. The time gate can position spectrum analyzer measurement to assess TDMA burst timing and the quality of the burst modulation.
- Rotating head devices, such as VCRs and hard disks, have time interleaved signals multiplexed from alternate recording tracks on the storage media. The time gate can isolate the spectrum due to a single recording track.
- Tests required for mobile communication systems often require that the transient spectrum, due to pulse modulation, be excluded from measurement results.

**Example:** Measure a Pulsed RF signal.

1. The rear panel GATE OUTPUT must be connected to EXT TRIG INPUT.
2. A TTL trigger signal must be connected to GATE TRIGGER INPUT on the rear panel. If no trigger is present an error message is displayed and the gate utility will not be activated.
3. Press **PRESET**. Connect a pulsed RF signal to the spectrum analyzer INPUT 503.
4. Press **FREQUENCY** and enter the frequency of your input signal to place the signal at the spectrum analyzer center frequency.
5. Press **AMPLITUDE**, **PEAKSEARCH**, **MKR→** and **MARKER →REF LVL** to bring the signal to the top of the display.
6. Access the gate utility by pressing **[SWEEP]**, Gate Control , and **GATE UTILITY** .

---

**Note** If the gate menus are exited without turning the gate utility off (by pressing another front panel key), press the **SWEEP** key twice to return to the last gate utility menu used.

---

7. Press Define Time to set up the time domain window (the upper window.) Change the sweep time using the T WINDOW SWP TIME softkey so that the pulses are displayed. Press SWEEP DELAY and use the knob to center the pulses in the upper window.
8. The trigger marker reads out the time from the rear panel gate trigger point to the current marker position. Turn the trigger marker on by pressing TRIG MKR ON OFF (ON) and use the knob to move the trigger marker to the edge of the pulse. The marker readout indicates the position of the edge relative to the rear panel trigger. The trigger marker may be used to perform “settling time” measurements on the rising or falling edges of a digital communications signal. (Settling time is the time from the trigger to 90 percent of the stable pulse on/off value.)
9. Press Main Menu to exit the define time menu.

10. Press Define Gate. Use the GATE DELAY and GATE LENGTH keys to position the gate. Once gate delay or gate length are activated, use the knob and data entry keys can be used to position the two vertical gate markers. Select a time interval within the last half of the pulse is selected.
11. Turn the gate on by pressing GATE ON OFF so that ON is underlined. This activates the frequency domain window, which is the lower window. The spectrum selected with the current gate position can now be viewed in the frequency domain window. Press Main Menu.
12. The resolution bandwidth, video bandwidth, and sweep time are not optimized, so the frequency display may not look correct. There may be signal dropouts or poor frequency resolution. This can be corrected by entering the pulse parameters and turning on the coupling.  
  
The gate utility can optimize the setting of resolution bandwidth if the user enters the value of the pulse width and turns on the coupling. The video bandwidth will be optimized if the gate length is entered and coupled. The sweep time is optimized when the pulse repetition interval is entered and coupled.  
  
Press Define Coupling . Then press Pulse **Param** to enter the pulse parameters. (This activates the time domain window and turns off the time gate.) If pulse parameters have previously been entered, the values will be displayed.
13. Use the ENTER REF EDGE, ENTER WIDTH, and ENTER PRI softkeys to enter the pulse parameters. These parameter entry tools allow pulse parameters to be entered using a marker or through the keypad. Press Previous Menu to return to the coupling menu.
14. Press CPL RBW ON OFF (ON) to turn on the resolution bandwidth coupling. Press CPL VBW ON OFF (ON), and CPL SWP ON OFF (ON) to turn on the video bandwidth and sweep time coupling.
15. Press Main Menu and look at the signal in the time domain window.
16. Press UPDATE TIMEFREQ so that FREQ is underlined or press **(NEXT)**, to activate the frequency window instead of the time domain window. (If the gate was not on when the user left the frequency window, it may be necessary to press Define Gate and GATE ON OFF (ON) to turn the gate on again.)

---

## Note

another front panel key), press the **(SWEEP)** key twice to return to the last gate utility menu used.

---

---

## Using the Time-Gated Spectrum Analyzer Capability Without the Gate Utility

---

**Note** Option 105 is required to perform this application.

Option 101, fast time domain sweep, is recommended in addition to Option 105, because it significantly increases the resolution available in the time domain. With Option 101, sweep times (in zero span) as fast as 20  $\mu$ s can be used, otherwise the maximum sweep time is limited to >20 ms.

---

The measurement procedures in this section explain how to use the time gate capability without the convenience of the Gate Utility. The Gate Utility provides the user with simultaneous displays of the frequency and time domain to assist in setting up and manipulating the time gate. See “Using the Gate Utility To Simplify Time Gated Measurements” for information about using the Gate Utility. All the Gate Utility keys are listed under the **[SWEEP]** key in the key menu in Chapter 8. Descriptions of the different Gate Utility functions are found in Chapter 7.

This section provides the following information:

- Introduces the time-gated spectrum analyzer capability.
- Explains how to use Option 105 to view a pulsed RF signal.
- Explains how to use the self-calibration routines with Option 105.
- Explains how to perform a functional check of Option 105.

---

**Note** For more information about how to use Option 105 with other types of signals, see Product Note 8590-2 that is shipped with Option 105. Also, see the descriptions of individual functions in Chapter 7.

---

### Introducing the Time-Gated Spectrum Analyzer Capability

As the spectrum analyzer takes a measurement sweep, it displays a specific frequency as it sweeps across the frequency range of the spectrum analyzer. Since signals can vary in time, the spectrum analyzer can miss an event at one frequency because it is sweeping at a different frequency when the event occurs. With Option 105, the time-gated spectrum analyzer capability, the spectrum analyzer can provide a “window” of what is going on with a signal at any specific time, since a spectrum analyzer with Option 105 has the capability to selectively acquire data based on an external trigger signal. The “window” represents a periodic timed event during which data acquisition is enabled.

The following figures demonstrate how the time gate can be used to view a signal. For example, you could have two signals at the same frequency in alternating time slots so they can share a common system. You can use an oscilloscope to determine whether there are two signals (see Figure 4-18). However, you could not use a standard spectrum analyzer since both signals would contribute to the displayed frequency spectrum. By using the time-gate functions of Option 105, you can use a spectrum analyzer to mask out one signal at a time and measure each of the two signals separately (see Figure 4-19).

**Note**

When Option 105 is enabled, it interrupts the internal signal path of the spectrum analyzer, so several spectrum analyzer functions may not be available under all conditions. These conditions include: marker noise (MK NOISE ON OFF ), sample detection while in the frequency span mode, quasi-peak detection (Option 103), and AM/FM demodulation and TV sync trigger (Option 102). The marker counter function (MK COUNT ON OFF ) is not directly affected by the operation of Option 105, but many signals that are appropriate for time-gating (for example, pulsed RF signals) will not be counted correctly by the marker counter function.

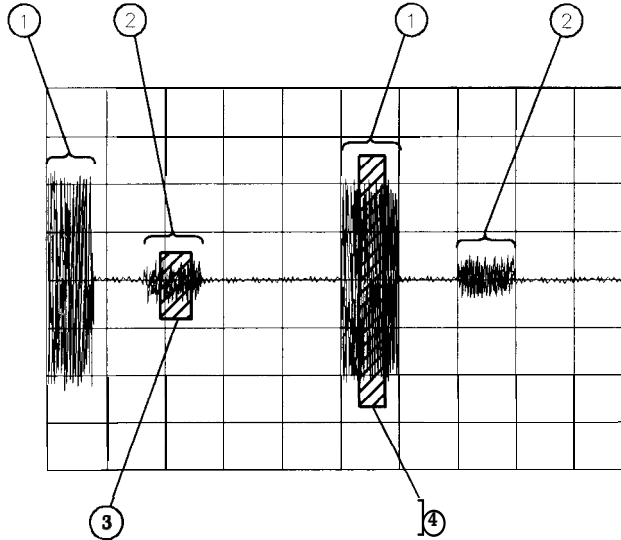

**Figure 4-18. Viewing Time-Sharing of a Frequency with an Oscilloscope**

| Item | Description of Items in Figure 4-18 | Item | Description of Items in Figure 4-18                            |
|------|-------------------------------------|------|----------------------------------------------------------------|
| 1    | First signal.                       | 3    | When the time gate will be actively viewing the second signal. |
| 2    | Second signal.                      | 4    | When the time gate will be actively viewing the first signal.  |

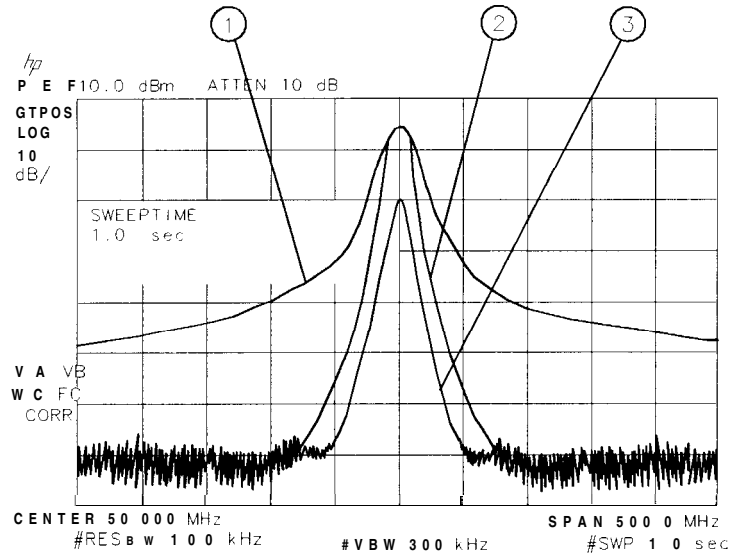

**Figure 4-19. Viewing Time-Sharing of a Frequency with a Spectrum Analyzer**

| Item | Description of Items in Figure 4-19                              |
|------|------------------------------------------------------------------|
| 1    | Trace display without the time-gate function on.                 |
| 2    | <b>Trace display of the first signal, with the time gate on.</b> |
| 3    | Trace display of the second signal, with the time gate on.       |

### Using the Time-Gated Spectrum Analyzer Capability to View Pulsed RF

This example demonstrates how to use Option 105 to view two different pulsed RF signals. The signals are at the same frequency, but they interleave in time. (This example uses the time gate function without using the gate utility.)

To use Option 105 to view the amplitude of a pulsed RF signal accurately, the spectrum analyzer settings of the sweep time, resolution bandwidth, video bandwidth, gate delay, and gate length must be set correctly. To set the spectrum analyzer settings correctly, you must determine the pulse repetition interval, pulse width, and signal delay (if any) of the pulsed RF signal. Figure 4-20 shows an example of two pulsed RF signals.

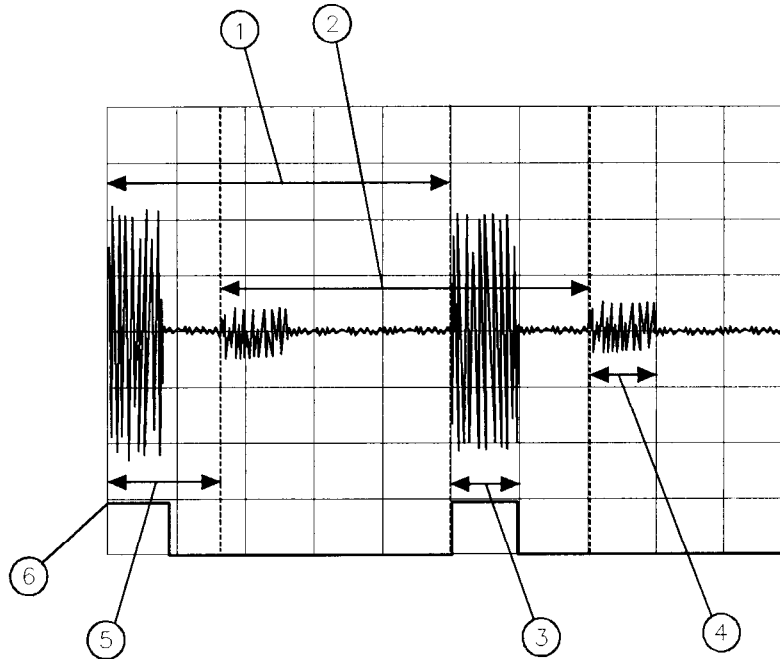

**Figure 4-20.**  
**Pulse Repetition Interval and Pulse Width**  
**(with Two Signals Present)**

| Item | Description of Items in Figure 4-20                                                                                                                     |
|------|---------------------------------------------------------------------------------------------------------------------------------------------------------|
| 1    | Pulse repetition interval (PRI) of signal 1. PRI is measured in time units. PRI is equivalent to $1/PRF$ , where PRF is the pulse repetition frequency. |
| 2    | Pulse repetition interval (PRI) of signal 2.                                                                                                            |
| 3    | Pulse width ( $\tau$ ) of signal 1. Pulse width is also referred to as $\tau$ (tau).                                                                    |
| 4    | Pulse width ( $\tau$ ) of signal 2.                                                                                                                     |
| 5    | Signal delay of signal 2. Notice that the signal delay is zero for signal 1.                                                                            |
| 6    | Gate trigger input for Option 105. The trigger input coincides with signal 1.                                                                           |

Use the guidelines in Table 4-1 when using Option 105 to view a pulsed RF signal. These are only guidelines, and the spectrum analyzer settings can be changed if necessary.

**Table 4-1.  
Determining Spectrum Analyzer Settings  
for Viewing a Pulsed RF Signal**

| <b>Spectrum Analyzer Function</b> | <b>Spectrum Analyzer Setting</b>                                                                                                                                                           | <b>Comments</b>                                                                                                                                                                                  |
|-----------------------------------|--------------------------------------------------------------------------------------------------------------------------------------------------------------------------------------------|--------------------------------------------------------------------------------------------------------------------------------------------------------------------------------------------------|
| Sweep Time                        | Set the sweep time to be 401 times greater than the pulse repetition interval (PRI):<br><br>Sweep time > 401 x PRI                                                                         | Because the gate must be on at least once per trace point, the sweep time has to be set to the pulse repetition interval times for every point of the trace. (Each trace has 401 points.)        |
| Gate Delay                        | The gate delay is equal to the signal delay plus half of the pulse width:<br><br>Gate Delay = Signal Delay + r/2                                                                           | The gate delay must be set so that the gating captures the pulse. If the gate delay is too short or too long, the gating can miss the pulse or include resolution bandwidth transient responses. |
| Gate Length                       | The gate length is equal to one-fourth the pulse width:<br><br>Gate Length = r/4                                                                                                           | If the gate length is too long, the signal display can include transients caused by the spectrum analyzer filters.                                                                               |
| Video Bandwidth                   | Set the video bandwidth to a value greater than 1 divided by the gate length:<br><br>Video Bandwidth > $\frac{1}{\text{gate length}}$                                                      | The video bandwidth must be wide enough so that the rise times of the video bandwidth do not attenuate the signal.                                                                               |
| Resolution Bandwidth              | Set the resolution bandwidth to a value greater than 2 divided by the gate delay minus the signal delay:<br><br>Resolution Bandwidth > $\frac{2}{\text{Gate Delay} - \text{Signal Delay}}$ | The resolution bandwidth must be wide enough so that the charging time for the resolution bandwidth filters is less than the pulse width of the signal.                                          |

### Example of a Time-Gated Pulsed RF Signal

The measurement procedures in this section explain how to **use** the time gate capability without the convenience of the Gate Utility functions. The Gate Utility provides the user with simultaneous displays of the frequency and time domain to assist in setting up and manipulating the time gate. An oscilloscope is not needed when using the Gate Utility. A list of all the Gate Utility keys can be found under the **[SWEEP]** key in the key menus in Chapter 8. Descriptions of the different Gate Utility functions are found in Chapter 7.

---

**Note** This example only applies to using Option 105 with a pulsed RF signal. For more information on using Option 105 to view other types of signals, see product note 8590-2 for Option 105.

---



The following example demonstrates the rules for setting up a time-gated measurement. In this example, we are using two signal generators to generate two signals at the same frequency (50 MHz). The pulse generators “space” (interleave) the signals in time as well as pulse modulate the signals.

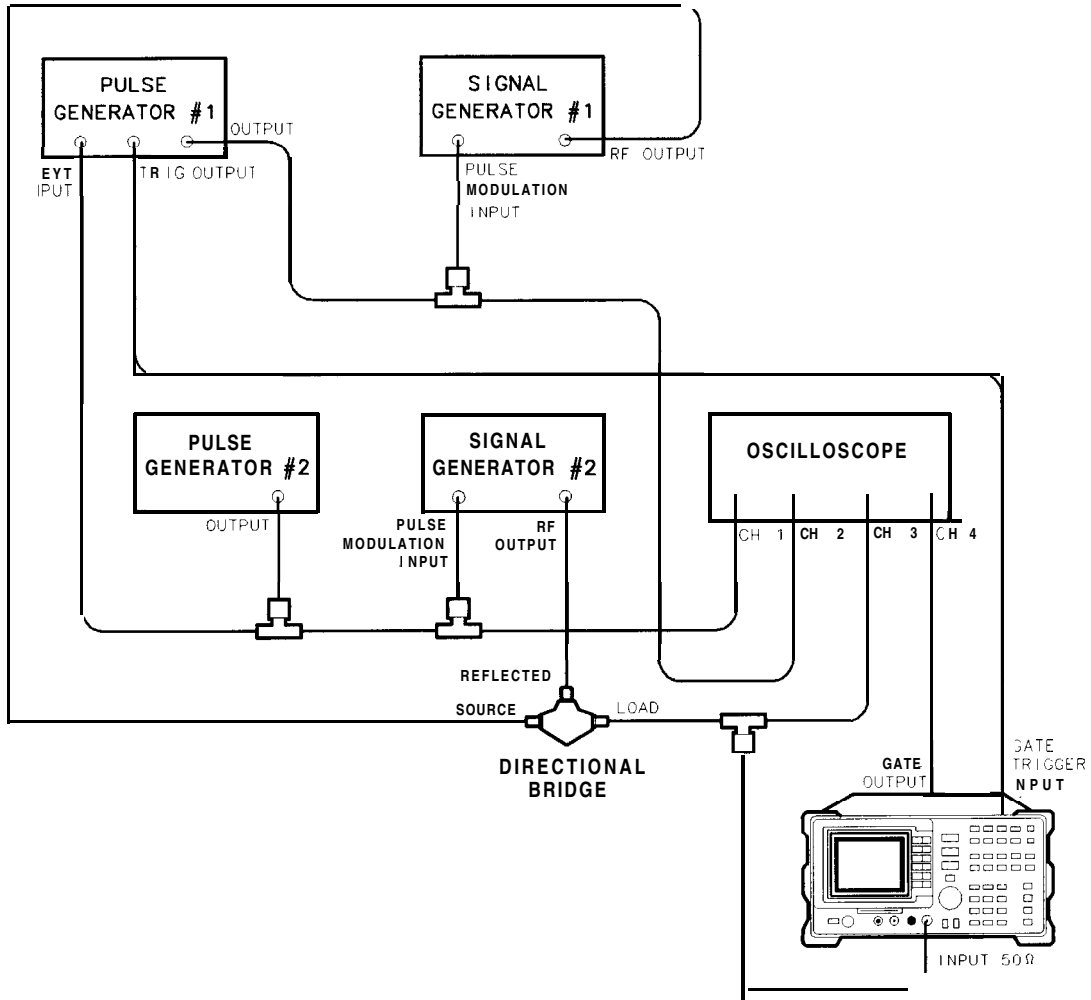

**Figure 4-21. Test Setup for Option 105**

**Note** Be sure that the input impedance for the oscilloscope channels is set to 1 MO.

**Table 4-2. Pulse Generator Test Setup Settings**

| Setting                       | Pulse Generator #1                  | Pulse Generator #2           |
|-------------------------------|-------------------------------------|------------------------------|
| <b>Period</b>                 | <b>280 <math>\mu</math>s</b>        | <b>280 <math>\mu</math>s</b> |
| <b>Width</b>                  | <b>50 <math>\mu</math>s</b>         | <b>50 <math>\mu</math>s</b>  |
| <b>Trigger</b>                | <b>Positive edge of square wave</b> | <b>Not applicable</b>        |
| <b>Voltage (peak-to-peak)</b> | <b>5 v</b>                          | <b>5 v</b>                   |
| <b>Trigger delay</b>          | <b>85 <math>\mu</math>s</b>         | <b>None</b>                  |

**Table 4-3. Signal Generator Test Setup Settings**

| Setting                 | Signal Generator 1 | Signal Generator 2 |
|-------------------------|--------------------|--------------------|
| <b>Frequency</b>        | 50 MHz             | 50 MHz             |
| <b>Amplitude</b>        | -1 dBm             | -10 dBm            |
| <b>Pulse Modulation</b> | On                 | On                 |

1. Set the center frequency of the spectrum analyzer to the frequency of the modulated signal. Decrease the frequency span of the spectrum analyzer. If necessary, adjust the reference level of the spectrum analyzer so that the peak signal is displayed near the top graticule.

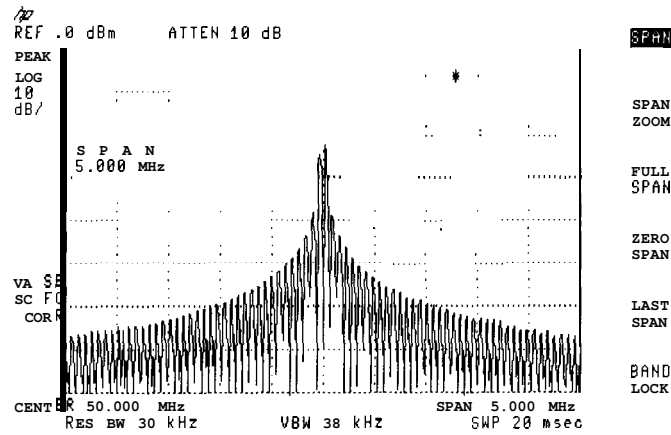

**Figure 4-22. Setting the Center Frequency, Span, and Reference Level**

**Note** The Gate Utility can be used to simplify the following steps. See Chapter 7 for descriptions of the gate utility softkeys.

2. Set the sweep time to be 401 times greater than the pulse repetition interval. For this example, the pulse repetition interval is 280  $\mu$ s, so the sweep time is set to greater than 401 times 280  $\mu$ s, or 0.112 s. For this example, we are using a sweep time of 120 milliseconds.' Press **[SWEEP]**, 120 **[ms]**.

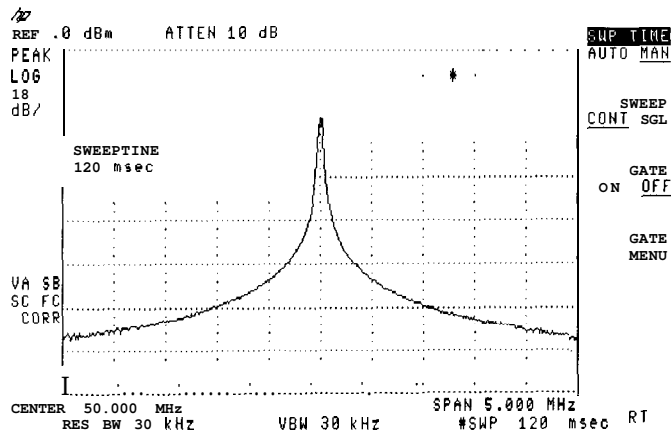

**Figure 4-23. Setting the Sweep Time**

- Turn the gate on by pressing **[SWEEP]**, GATE ON OFF (so that ON is underlined).

Using an oscilloscope makes it easier to ensure that the gate occurs during the pulsed RF signal. With GATE OUTPUT connected to the oscilloscope, you can adjust the gate length and gate delay so that the gate occurs near the end of the pulse (see Figure 4-24).

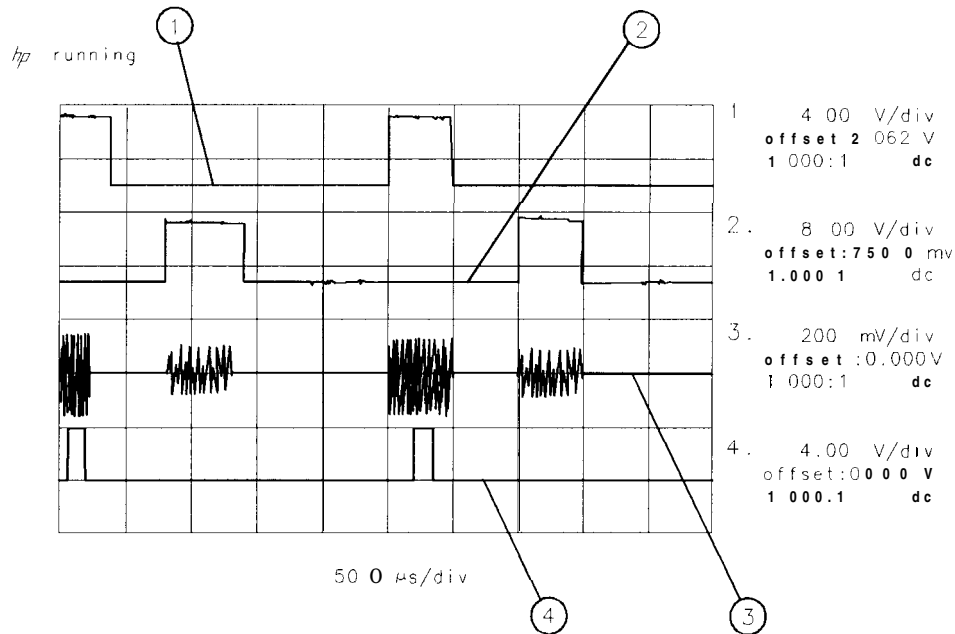

**Figure 4-24. Setting the Gate Delay and Gate Length Using an Oscilloscope**

| Item | Description of Items in Figure 4-24                                                         |
|------|---------------------------------------------------------------------------------------------|
| 1    | <b>Output from pulse generator 1.</b>                                                       |
| 2    | <b>Output from pulse generator 2.</b>                                                       |
| 3    | <b>Pulsed RF signal input to the spectrum analyzer.</b>                                     |
| 4    | <b>Gate output from Option 105. Notice that the gate output is directly below signal 1.</b> |

If you do not have an oscilloscope, it is very important to **use** the guidelines for determining gate length and gate delay. See “Setting the Gate Delay and Gate Length Properly” following this section.

- The gate delay must be equal to the signal delay plus the pulse width ( $\tau$ ) divided by 2. For the first signal, there is no signal delay, so the gate delay needs to be set to  $50 \mu\text{s}/2$ , or  $25 \mu\text{s}$ . Press **[SWEEP]**, Gate Control , GATE DELAY 25 **[μs]**.
- Set the gate length to a value equal to the pulse width ( $\tau$ ) divided by 4. For this example, the gate length is set to  $50 \mu\text{s}/4$ , or  $13 \mu\text{s}$ . Press GATE LENGTH , 13 **[μs]**.
- Set the resolution bandwidth to a value that is greater than 2 divided by the gate delay minus the signal delay. For this signal 1, there is no signal delay, so the resolution bandwidth is set greater than  $2/25 \mu\text{s}$ , or greater than 80 kHz. Press **[BW]**, 100 **[kHz]**.

- Set the video bandwidth to a value that is greater than 1 divided by the gate length. For this example, the video bandwidth must be greater than  $1/13 \mu\text{s}$ , or 80 kHz. Press **[BW]**, VID BW AUTO MAN, 100 **[kHz]**.

The spectrum analyzer displays only signal 1, not Both signal 1 and signal 2 (see Figure 4-25).

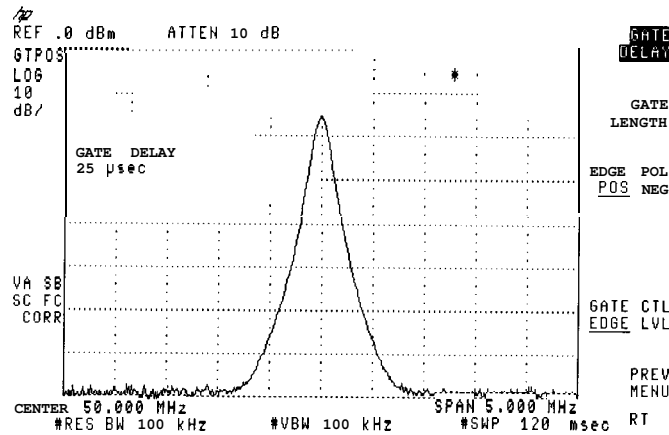

**Figure 4-25. Using Time-Gating to View Signal 1**

- To compare signal 1 to signal 2, we first place signal 1 (trace A) in the view mode. Press **[TRACE]**, VIEW A, TRACE A B C (so that B is underlined), CLEAR WRITE B .
- To view the second signal, change the gate delay so that the gate output is under the second signal. Since the second signal had a signal delay of approximately  $85 \mu\text{s}$ , we set the gate delay to  $85 \mu\text{s}$  plus the pulse width/2, or  $110 \mu\text{s}$ . Press **[SWEEP]**, Gate Control , GATE DELAY 110 **[ $\mu\text{s}$ ]** to set the gate delay to  $110 \mu\text{s}$ . Using an oscilloscope can be helpful in placing the gate output during the pulsed signal (see Figure 4-26).

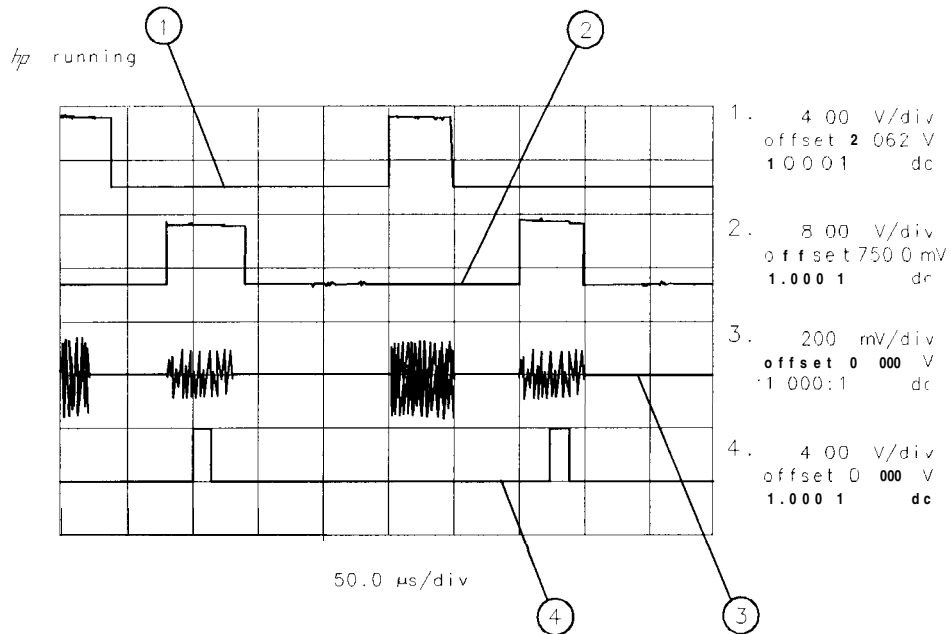
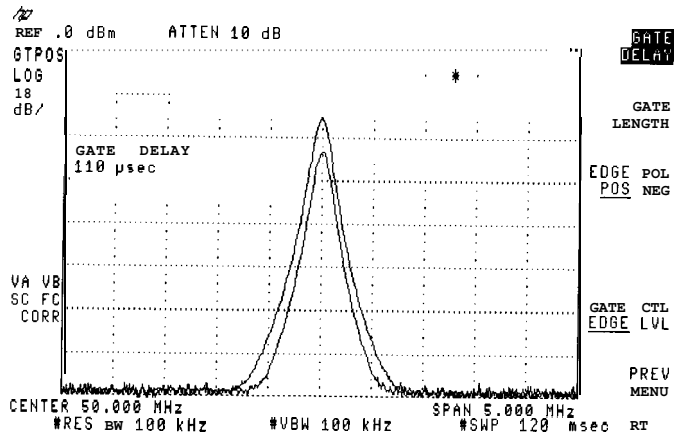

**Figure 4-26. Placing the Gate Output During the Second Signal**

| Item | Description of Items in Figure 4-26                                                  |
|------|--------------------------------------------------------------------------------------|
| 1    | Output from pulse generator 1.                                                       |
| 2    | Output from pulse generator 2.                                                       |
| 3    | Pulsed RF signal input to the spectrum analyzer.                                     |
| 4    | Gate output from Option 105. Notice that the gate output is directly below signal 2. |

10. Set the resolution bandwidth to a value that is greater than 2 divided by the gate delay (110  $\mu$ s) minus the signal delay (85  $\mu$ s). The resolution bandwidth should be set to greater than 2 divided by 25  $\mu$ s, or greater than 80 kHz. Press **[BW]**, RES BW , 100 **[kHz]**.
11. Since the gate length was not changed, the video bandwidth is still 100 kHz.

Figure 4-27 shows the first pulsed RF signal (contained in trace A), and the second pulsed RF signal (contained in trace B).



**Figure 4-27. Viewing Both Signals with Time-Gating**

## Setting the Gate Delay and Gate Length Properly, When NOT Using the Gate Utility

If the gate delay and gate length are not set properly, you may not be viewing an accurate representation of a signal. For example, If the gate does not occur during the RF pulsed signal, the amplitude of the signal displayed on the spectrum analyzer is lower than the actual signal (see Figure 4-28).

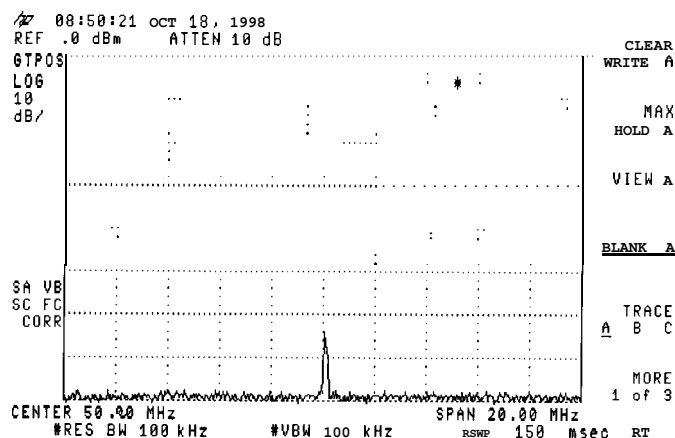

**Figure 4-28. Gate Not Occurring During the Pulse**

The time gate is implemented after the resolution bandwidth filtering and before the video filtering. The displayed signal is a result of the decay time for the resolution bandwidth filters and is not an accurate representation of the input signal.

If the gate occurs at the beginning of the RF pulse signal or at the end of the RF pulse signal, the signal displayed on the spectrum analyzer can be attenuated or contain transient signals caused by the spectrum analyzer (see Figure 4-29). If this happens, decrease the gate length and change the gate delay to place the gate output during the signal.

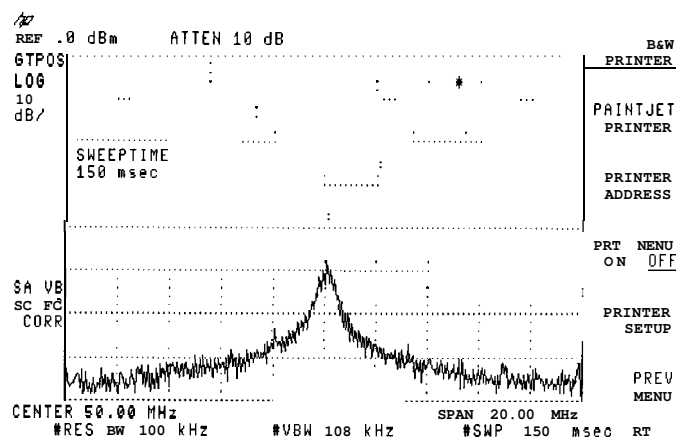

**Figure 4-29. Gate is Occurring at the Beginning of the Pulse**

In Figure 4-29, the peak amplitude has not been reached, and the transient response of the resolution bandwidth filters adds noise.

Table 4-4 and Table 4-5 provide the recommended initial spectrum analyzer settings when measuring a signal without signal delay.

---

Note Refer to the guidelines in Table 4-1 when measuring a signal with signal delay.

---

To use Table 4-4 and Table 4-5:

- Determine the pulse width of the signal you want to measure, then use Table 4-4 to determine the gate delay, resolution bandwidth, gate length, and video bandwidth spectrum analyzer settings.
- Determine the pulse repetition rate of the signal, then use Table 4-5 to determine the spectrum analyzer sweep-time setting.

---

Note The peak detection mode is recommended for making gated measurements.

---

**Table 4-4.**  
**Gate Delay, Resolution Bandwidth, Gate Length, and Video Bandwidth Settings**

| Pulse width ( $\tau$ ) | Gate Delay  | Resolution Bandwidth | Gate Length | Video Bandwidth |
|------------------------|-------------|----------------------|-------------|-----------------|
| 10 $\mu$ s             | 5 $\mu$ s*  | 1 MHz                | 3 $\mu$ s   | 1 MHz           |
| 50 $\mu$ s             | 25 $\mu$ s  | 100 kHz              | 13 $\mu$ s  | 100 kHz         |
| 63.5 $\mu$ s           | 32 $\mu$ s  | 100 kHz              | 16 $\mu$ s  | 100 kHz         |
| 100 $\mu$ s            | 50 $\mu$ s  | 100 kHz              | 25 $\mu$ s  | 100 kHz         |
| 500 $\mu$ s            | 250 $\mu$ s | 10 kHz               | 125 $\mu$ s | 10 kHz          |
| 1 ms                   | 500 $\mu$ s | 10 kHz               | 250 $\mu$ s | 10 kHz          |
| 5 ms                   | 2.5 ms      | 1 kHz                | 1.25 ms     | 1 kHz           |
| 10 ms                  | 5 ms        | 1 kHz                | 2.5 ms      | 1 kHz           |
| 16.6 ms                | 8.3 ms      | 1 kHz                | 4 ms        | 1 kHz           |
| 33 ms                  | 16.5 ms     | 1 kHz                | 8 ms        | 1 kHz           |
| 50 ms                  | 25 ms       | 1 kHz                | 13 ms       | 1 kHz           |
| 100 ms                 | 50 ms       | 1 kHz                | 25 ms       | 1 kHz           |
| $\geq$ 130 ms          | 65 ms       | 1 kHz                | 33 ms       | 1 kHz           |

When using the short gate delays, you may notice the gate delay time jitter by  $\pm 1 \mu$ s. This jitter is due to the spectrum analyzer 1 MHz gate clock, and it does not indicate a problem.



**Table 4-5. Sweep Time Settings**

| Pulse Repetition Interval (PRI)     | Pulse Repetition Frequency (PRF)                                            | Sweep Time (minimum) |
|-------------------------------------|-----------------------------------------------------------------------------|----------------------|
| $\leq 50 \mu\text{s}$               | $\geq 20 \text{ kHz}$                                                       | <b>21 ms</b>         |
| <b>100 <math>\mu\text{s}</math></b> | <b>10 kHz</b>                                                               | <b>41 ms</b>         |
| <b>500 <math>\mu\text{s}</math></b> | <b>2 kHz</b>                                                                | <b>201 ms</b>        |
| <b>1 ms</b>                         | <b>1 kHz</b>                                                                | <b>401 ms</b>        |
| <b>5 ms</b>                         | <b>200 Hz</b>                                                               | <b>2.01 s</b>        |
| <b>10 ms</b>                        | <b>100 Hz</b>                                                               | <b>4.01 s</b>        |
| <b>16.7 ms</b>                      | <b>60 Hz</b>                                                                | <b>6.7 s</b>         |
| <b>33.3 ms</b>                      | <b>30 Hz</b>                                                                | <b>13.4 s</b>        |
| <b>50 ms</b>                        | <b>20 Hz</b>                                                                | <b>20.1 s</b>        |
| <b>100 ms</b>                       | <b>10 Hz</b>                                                                | <b>40.1 s</b>        |
| <b>200 ms</b>                       | <b>5 Hz</b>                                                                 | <b>80.2 s</b>        |
| <b>249 ms</b>                       | <b>4 Hz</b>                                                                 | <b>100 s</b>         |
| $>249 \text{ ms}$                   | <b>Use the MAX HOLD trace function and take several measurement sweeps.</b> |                      |

## Using the Self-Calibration Routines with Option 105

The spectrum analyzer self-calibration routines (initiated by pressing CAL AMPTD or CAL FREQ & AMPTD ) should be performed prior to using the Option 105 functions. Use the following procedure to perform the self-calibration routines and to check the results of the self-calibration routines.

---

**Note** Be sure that the GATE TRIGGER INPUT connector (on the spectrum analyzer rear panel) is not connected to anything while performing the spectrum analyzer self-calibration routines.

---

1. Remove the cable from the GATE TRIGGER INPUT connector.
2. Connect the CAL OUT connector to the spectrum analyzer input connector with the calibration cable.
3. Press **CAL**. Press either CAL FREQ & AMPTD (to perform the frequency and amplitude self-calibration routines) or CAL AMPTD (to perform the amplitude self-calibration routine).
4. When the self-calibration routines have successfully completed, press CAL STORE .
5. Press **CAL**, More 1 of 4 , More 2 of 4, Service Diag , DISPLAY CAL DATA, then NEXT PAGE.
6. Verify that the number displayed for GATE, in the lower left corner, is between 0.98 and 1.0 (see Figure 4-30).

```

TUNING
CAL      300000000  Sweepsens <10M 0.000185303
ZERO    211996616  Sweepsens Wide 0.08002030
FAST    56503057   Main Coil Sens 0.098835200
MED     1114621728 FM Coilsens Er 0.958118558
SLOW    22348669   Wide Disc Err  2.590917587
PkOfst  28        Wdsc Sweepsens 0.000502140
TCXO    -98       EVO Δ slope    5E-10
Last Cal Freq 18:18:33 MAR 04, 1992
Last cal Amp 18:26:17 MAR 04, 1992

TRACKING GEN      FM DEMODULATION
AOFST      3051   ZERO          0
XOFST      3095   SLOPE         16893
OCORR      -22372 Narrow BW     1756
ASLOP      0.617283940 Wide BW      1751
FSLOP      0.000000168
XSLOP      8.307900012
GATE        0.999294639

```

**Figure 4-30. Self-Calibration Data Results**

If the number is not between 0.98 and 1.0, check that the GATE TRIGGER INPUT connector is **not** connected to anything, then repeat the previous steps of this procedure.

7. Press **PRESET**.

### Performing a Functional Check of Option 105

To check that the time-gated spectrum analyzer capability is operational, perform the following steps:

1. Connect the rear panel HIGH SWEEP IN/OUT connector to the GATE TRIGGER INPUT connector with a short BNC calibration cable (see Figure 4-31).

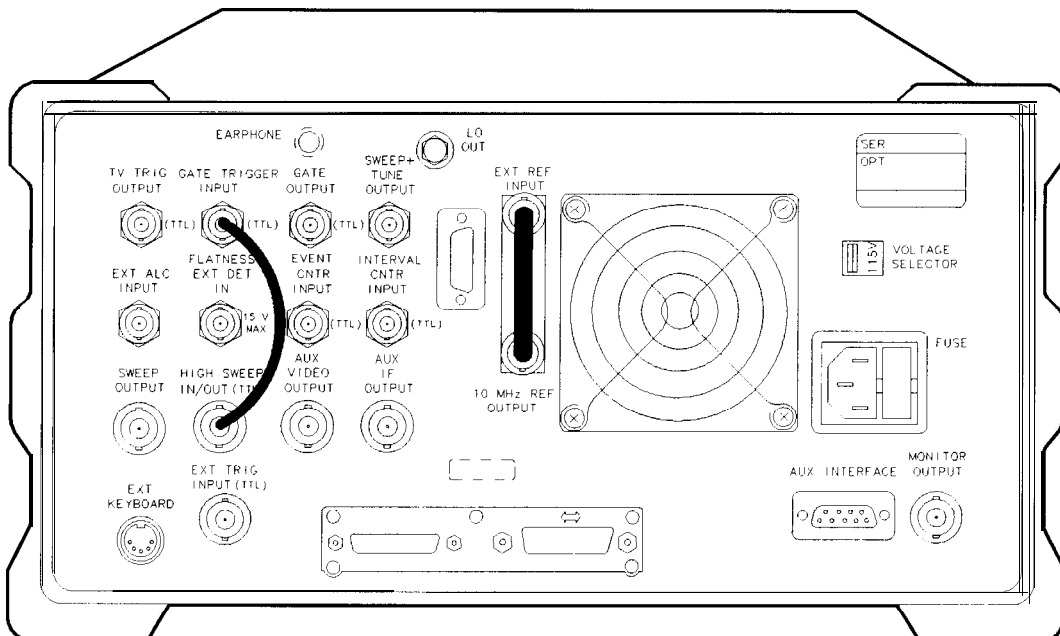

pu128e1

**Figure 4-31. Rear Panel Connections for Option 105**

- Press **PRESET**, **FREQUENCY**, 0 Hz, **SPAN**, **ZERO SPAN**, **SWEEP**, 200 ms, **Gate Control**, **GATE DELAY**, 60 ms, **GATE LENGTH**, 60 ms.

The **GATE CTL EDGE LVL** softkey should have **EDGE** underlined, and **EDGE POL POS NEG** should have **POS** underlined.

- Press Previous Menu, **GATE ON OFF** (so that **ON** is underlined) (see Figure 4-32).

**Note** This procedure offers a qualitative functional check only. Due to several factors, the accuracy of the marker readout of the gate delay and gate length can vary by several milliseconds. For more information about gate timing, see the Characteristics in specifications and characteristics in your calibration guide for your spectrum analyzer.

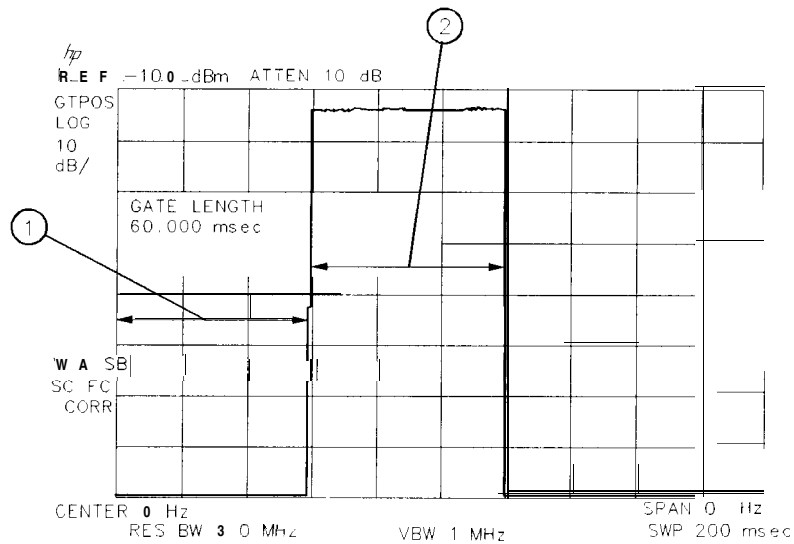

**Figure 4-32. Gate On**

| Item | Description of Items in Figure 4-32                                                      |
|------|------------------------------------------------------------------------------------------|
| 1    | Represents the gate delay. The gate is off during the gate delay.                        |
| 2    | Represents the gate length. The gate is on, and the HI SWEEP IN/OUT signal is displayed. |

4. To check the gate control function, press **[SWEEP]**, Gate Control, GATE CTL EDGE LVL so that LVL (level) is underlined (see Figure 4-33).

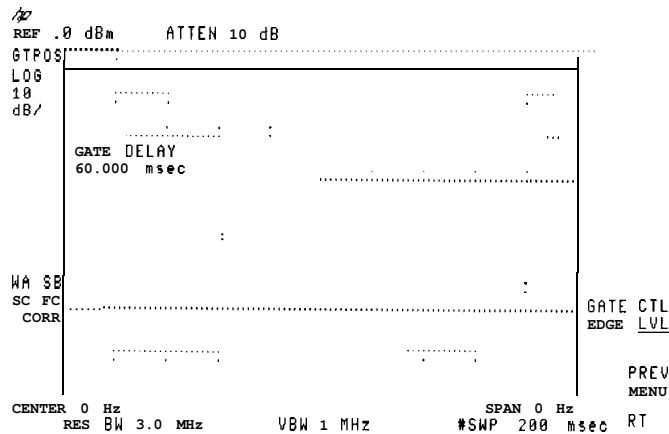

**Figure 4-33. Using the Level Gate Control**

When the GATE CTL EDGE LVL softkey function is set to edge, triggering occurs at the edge of the trigger input. When the GATE CTL EDGE LVL softkey function is set to level, the gate is on whenever the trigger input is high. Because the trigger input for this example is the HI SWEEP IN/OUT signal, and HI SWEEP IN/OUT signal is high (+ 5 V) during every sweep, the level of the signal on screen is high.

Notice that the GATE DELAY, GATE TIME, and EDGE POL NEG POS softkeys are blanked when the gate control is set to level. When the gate control is set to level (LVL), the functions of gate delay, gate length, and edge trigger polarity no longer apply.

---

## Using the One Button Measurements to Measure N dB Bandwidth, Percent Amplitude Modulation, and Third Order Intercept (TOI)

The spectrum analyzer includes one-button measurement functions. With one key press they make accurate measurements of:

- N dB Bandwidth
- Percent Amplitude Modulation
- Third Order Intermodulation

The signal or signals being measured must be displayed before activating the measurement. Measurements are made continuously, updating at the end of each sweep. This allows you to make adjustments and see changes as they happen. The single sweep mode can also be used, providing time to study or record the data. The individual measurements are described below.

---

### N dB Bandwidth Measurement

It is often necessary to measure a signal response's bandwidth, such as when testing a band-pass filter. The signal to be measured must be centered on the display with a span that includes the full response. Activate the measurement by turning the N dB PTS ON OFF key (ON). The spectrum analyzer places arrow markers at the -3 dB points on either side of the response and reads the bandwidth. For other bandwidth responses enter the number of dB down desired, from 1 dB to 80 dB.

No other signal can appear on the display within N dB of the highest signal. The measured signal cannot have more than one peak that is greater than or equal to N dB. A signal must have a peak greater than the peak excursion to be identified. The default value for the peak excursion is 6 dB.

The N dB bandwidth measurement error is typically:

- about  $\pm 2\%$  of the span, for spans  $< 10$  MHz
- about  $\pm 3\%$  of the span, for spans  $> 10$  MHz

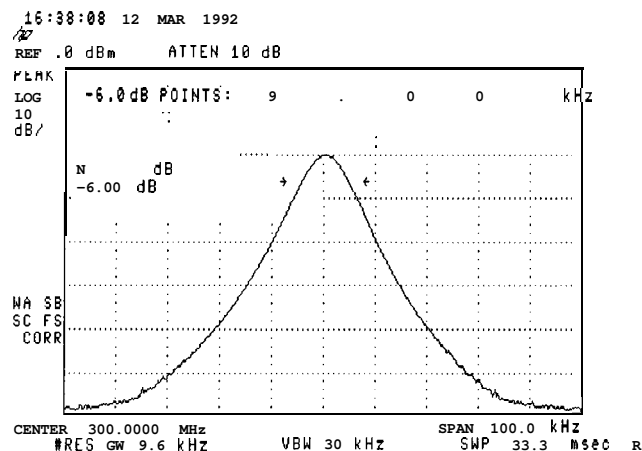

Figure 4-34. N dB Bandwidth Measurement

**Example:** Measure the 6 dB bandwidth of the spectrum analyzer internal 9 kHz EM1 bandwidth.

1. On the spectrum analyzer, press **PRESET**, **PEAK SEARCH**, **MKR FCTN**, **MK TRACK ON OFF** (ON), **SPAN**, and enter 200 kHz.
2. Select the 9 kHz EM1 bandwidth by pressing **BW**, EM1 BW Menu, and 9 kHz **EM1 BW**.
3. Press **MEAS/USER** and N dB PTS ON OFF (ON) to activate the N dB bandwidth function.
4. Read the measurement results in the upper left corner of the screen.
5. The knob or the data entry keys can be used to change the N dB value from 3 dB to 6 dB.
6. Press N dB PTS ON OFF (OFF) to turn the measurement off.

---

## Percent Amplitude Modulation Measurement

Percent amplitude modulation can be measured quickly and easily using the one-button % AM function. The signal and both its sidebands must be on the display. The sidebands are assumed to be entirely from amplitude modulation. The spectrum analyzer places arrow markers on the three signals to be used to compute percent amplitude modulation, and displays the value. If the sidebands are not in the frequency span or their frequency spacing is not equal, the measurement stops and an error message is displayed.

Percent AM measurement accuracy for close signals:

- typically about  $\pm 0.1\%$ , for log mode
- typically about  $\pm 3\%$ , for linear mode

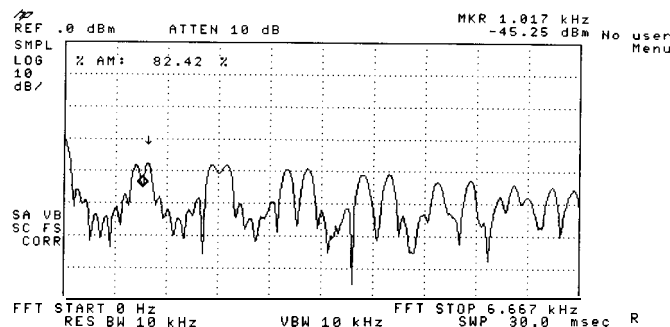

**Figure 4-35. Percent Amplitude Modulation Measurement**

**Example:** Use the % AM function to make a measurement.

1. Press **PRESET**. Connect a signal with amplitude modulation, to the spectrum analyzer INPUT 50Ω.
2. Press **FREQUENCY** and enter the frequency of your input signal to place the signal at the spectrum analyzer center frequency.
3. Press **SPAN**. Change the span until only the signal and its two sidebands appear on the display.
4. Press **MEAS/USER** and % AM ON OFF (ON) to activate the percent amplitude modulation function.

5. Read the measurement results in the upper left corner of the screen,
6. Press  $\%$  AM ON OFF (OFF) to turn the measurement off.

---

## Third Order Intermodulation Measurement (TOI)

Use the TO1 one-button measurement to make quick and easy intermodulation measurements of microwave spectrum analyzers, mixers or converters. When the TO1 measurement is turned on there must be four signals on the display, two test signals and their two associated distortion products. All of the signals must have peaks greater than the peak excursion value. (The default value for the peak excursion is 6 dB.) The two highest amplitude signals are assumed to be the test signals for the third-order intercept measurement.

The spectrum analyzer computes and displays the third order intercept (TOI) of the displayed signals, marking all four signals with arrows to confirm the correct signal selection. The measurement updates at the end of every sweep, which enables real-time optimization of devices or systems under test.

The third order intermodulation is calculated as follows:

$$\text{TOI} = \frac{2 \times \text{Ampl}_{\text{signal A}} - \text{Ampl}_{\text{distortion product A}} + \text{Ampl}_{\text{signal B}}}{2}$$

where the frequency of distortion product A is:

$$\text{Freq}_{\text{distortion product A}} = 2 \times \text{Freq}_{\text{signal A}} - \text{Freq}_{\text{signal B}}$$

### ***Third Order Intercept:***

Third order intercept is defined as the absolute power level at which the third-order distortion products intercept the level of two equal level test signals. If the distortion products are due to true third-order distortion, then the measurement result will be independent of the level of the test signals.

The measurement algorithm used by TO1 ON OFF (see above equation) corrects for the two test signals being different amplitudes. The result is a calculated value for the two test signals being equal amplitude, and is independent of the absolute level of either test signal. In order to minimize the measurement error, it is best to keep the test signals as close as possible to the same level and to the top of the screen.

The TO1 measurement accuracy (assuming the measured signals are near the top of the display) is typically about  $\pm 1.8$  dB.

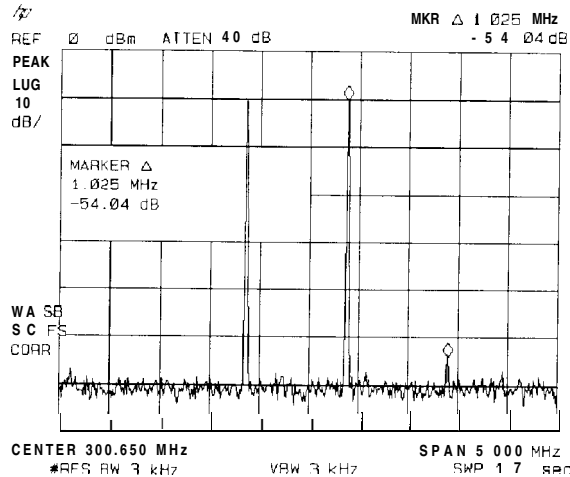

**Figure 4-36. Third-Order Intermodulation Measurement**

**Example:** Use the TO1 function to make a measurement

1. Press **[PRESET]**. Connect two equal amplitude signals with different frequencies, to the spectrum analyzer INPUT 500.
2. Press **[FREQUENCY]** and enter the frequency of one of your input signals to place the signal at the spectrum-analyzer center frequency.
3. Press **[SPAN]**. Change the span until only the two signals and their two distortion products appear on the display.
4. Press **[MEAS/USER]** and TO1 ON OFF (ON) to activate the third order intercept measurement function.
5. Read the measurement results in the upper left corner of the screen.
6. Press TO1 ON OFF (OFF) to turn the measurement off,

It is important to verify that the TO1 being measured is coming from the device under test and not from the spectrum analyzer. An easy way to do this is as follows:

1. Set up the TO1 measurement and turn it on.
2. Press **[AMPLITUDE]**, **ATTEN AUTO MAN (AUTO)** and increase the attenuation + 10 dB by pressing **[↑]**.
3. If the displayed result of the TO1 measurement remains constant, then the value is the result of the device under test.
4. If the displayed result of the TO1 measurement decreases, then the **value** is due to spectrum analyzer distortion and not the device under test. In this case, continue to increase the attenuator setting until the measurement result no longer changes as the attenuator is changed. When the value remains constant, the result is from the device under test.

Increasing the attenuator setting of the spectrum analyzer decreases the level of the signal internal to the spectrum analyzer and therefore decreases the distortion generated by the analyzer. Refer to the characteristics information in specifications and characteristics in your calibration guide for a graph of the typical distortion performance of the spectrum analyzer.



---

## Using the Power Measurement Functions to make Transmitter Measurements

The power menu provides several powerful transmitter measurement functions that are easy to use. The measurements include:

- Occupied Bandwidth
- Adjacent Channel Power Ratio
- Channel Power

These transmitter power measurements can be used to measure analog and continuous carrier digital radios. The transmitted signal can be tones, noise, or a combination of tones and noise, without affecting the measurement accuracy. The power is measured in an rms way, so that power and power ratio values are consistent with power meter results.

The signal or signals being measured should be displayed before activating the measurement. The spectrum-analyzer center frequency should be set to the carrier frequency and the reference level should be set so that the signal is near the top graticule. A power measurement may require the user to enter the channel spacing and/or channel bandwidth before activating the function.

The spectrum analyzer automatically selects all of the other settings for accurate and efficient measurements. There is also a manual mode where the user selects all of the spectrum-analyzer settings. The manual mode should be used carefully since it has limitations and requirements that are necessary to ensure the measurement is accurate.

Power measurements are made continuously, updating at the end of each sweep. This allows you to make adjustments and see changes as they happen. They can also be made on a single sweep, providing time to study or record the data.

---

### Note

Some spectrum-analyzer options may be required to make valid measurements, particularly in narrow bandwidths.

The built-in frequency counter is standard in the HP 8590L, HP 85913, HP 8592L, HP 85933, HP 85943, HP 8594L, HP 85953, and HP 85963. It is not available with HP 8590L with Option 713.

The precision frequency reference is available as Option 004 for the HP 85913, HP 85933, HP 85943, HP 85953, and HP 85963.

---

## Occupied Bandwidth and Transmitter Frequency Error

You often need to confirm a channel's 99% occupied bandwidth. The OCCUPIED BANDWIDTH function does this easily. The user enters the channel spacing and activates the occupied bandwidth function. Markers show the power bandwidth edges, and the spectrum analyzer calculates and displays:

- The total power in dBm (other units selectable)
- The occupied bandwidth (99% power bandwidth)
- The transmitter frequency error

The transmitter frequency error is the frequency difference between the midpoint of the power bandwidth and the spectrum analyzer center frequency.

For special applications you can change the percent power bandwidth from 1% to 99.99% using the OCC BW % POWER key.

**Example:** Measure the 99% occupied bandwidth.

1. Connect a signal to the spectrum analyzer INPUT 50Ω.
2. Press **FREQUENCY** and enter the frequency of your input signal to place the signal at the spectrum-analyzer center frequency.
3. Press **AMPLITUDE** and adjust the reference level to bring the signal near the top of the display.
4. Press **MEAS/USER** and Power Menu to access the power measurement functions. Press Setup and CHANNEL SPACING to enter the value for the channel spacing. The span is automatically set to be three times the channel spacing value. The center frequency step size is automatically set to be equal to the channel spacing. Press Previous Menu to return to the main power menu.
5. Press OCCUPIED BANDWIDTH to activate the function.

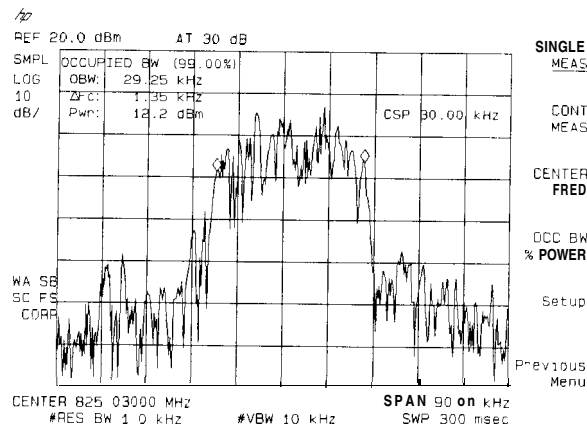

**Figure 4-37. Occupied Bandwidth**

6. If you want to change the percent power value press the OCC BW % POWER key and use the knob or the data entry keys to change the calculated percent power.

Press Previous Menu . Press **MEAS OFF** to turn the measurement off and exit the power menu, or press another measurement key to stop the current measurement and start a new measurement.

---

**Note** If the power menus have been exited without turning the power measurement off (by pressing another front panel key), press the **MEAS/USER** key twice to return to the last power menu used.

---

## Adjacent Channel Power Ratio (ACP)

The leakage of a transmitter into adjacent channels can be measured quickly and easily. Enter the channel spacing and channel bandwidth, and activate the adjacent channel power measurement. The spectrum analyzer computes and displays the ACP ratio of both the lower and upper adjacent channels, marking the higher of the two. The absolute carrier power is read out and vertical lines on the display mark the channel bandwidth edges.

Selecting ACPGRAPH **ON** OFF (ON) computes a graph showing the adjacent channel power ratio for the selected channel as a function of channel spacing, and disables the numerical adjacent channel power display.

Normally, the spectrum analyzer measurement parameters are set automatically. Parameter setting can be changed from automatic to manual control using PARAM AUTO MAN . The following conditions must be maintained to make a valid rms measurement. If these conditions are not met, errors of up to -2.5 dB can occur for noise-like signals.

- Video bandwidth is at least 10 times the resolution bandwidth.
- Detector mode is sample (SP). (You can use DETECTOR PK SP NG to change the detector mode.)
- Resolution bandwidth is less than or equal to 100 kHz.
- Video averaging is OFF.
- Neither MAX HOLD nor MIN HOLD trace mode is selected.

A wider dynamic range is available using the ADJ CHAN POWER extd function. This extended range is measured by taking two different sweeps with different reference levels and combining the trace data. The results are displayed in a 13 dB per division format. The extended ACP function does *not* provide a continuous measurement mode.

**Example:** Measure the adjacent channel power of a signal.

1. Connect a signal to the spectrum analyzer INPUT 500.
2. Press **FREQUENCY** and enter the frequency of your input signal to place the signal at the spectrum-analyzer center frequency.
3. Press **AMPLITUDE** and adjust the reference level to bring the signal near the top of the display.
4. Press **MEAS/USER** and Power Menu to access the power measurement functions.
5. Press Setup and CHANNEL BANDWIDTH . Enter the value for the channel bandwidth.
6. Press CHANNEL SPACING. Enter the value for the channel spacing. (The spectrum analyzer will use the last entered values for channel bandwidth and spacing, if they are not entered.)
7. Press Previous Menu to return to the main power menu.
8. Press ADJ CHAN POWER to activate the function.

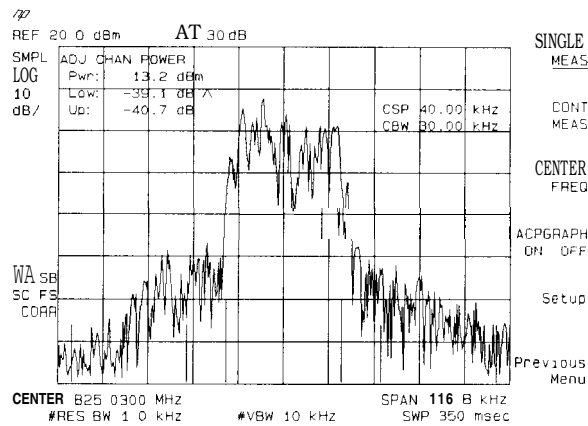

**Figure 4-38. Adjacent Channel Power**

- To use the extended Adjacent Channel Power function, press Previous Menu , then press ADJ CHAN POWER extd.

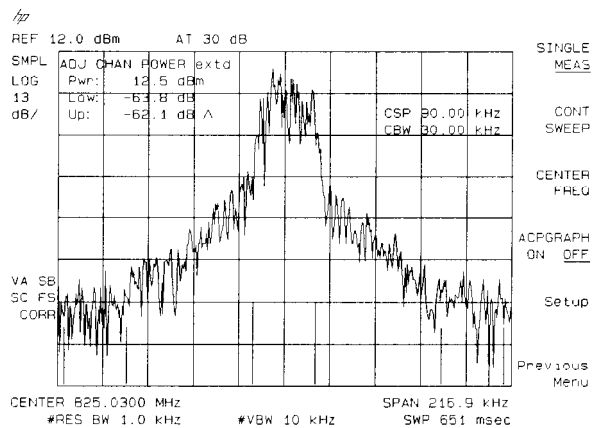

**Figure 4-39. Adjacent Channel Power Extended**

- A graph of the adjacent channel power ratio as a function of channel spacing can be calculated and displayed by pressing ACPGRAPH ON OFF so (ON) is underlined. The numerical ACP results are not displayed. The top graticule line represents an ACP ratio of 0 dB, and the horizontal center represents a channel spacing of zero hertz.

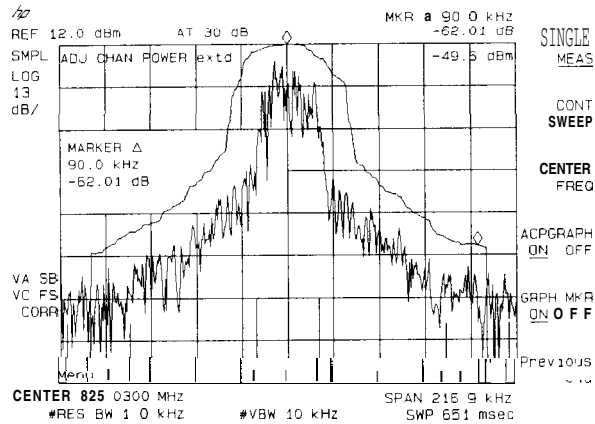

**Figure 4-40. Adjacent Channel Power Graph**

11. To enable the graph marker, press **GRPH MKR** ON OFF so (ON) is underlined. Delta frequency, delta amplitude, and absolute amplitude values are displayed for the marker position. The marker position can be changed with the RPG knob, step keys, or data keys.
12. Press Previous **Menu** . Press **MEAS** OFF to turn the measurement off and exit the power menu, or press another measurement key to stop the current measurement and start a new measurement.

---

**Note** If the power menus have been exited without turning the power measurement off (by pressing another front panel key), press the **MEAS/USER** key twice to return to the last power menu used.

---

## Channel Power Measurement

The channel power function measures the total power in the selected channel bandwidth. The signal can be noise, tones, or a combination of noise and tones. The channel power function measures the power using an rms method. Enter the channel bandwidth and activate the channel power measurement. The spectrum analyzer calculates and displays:

- The total power in dBm (other units selectable)
- The power spectral density in dBm/Hz (other units selectable)

**Example:** Measure the total power in a signal.

1. Connect a signal to the spectrum analyzer INPUT 50Ω.
2. Press **FREQUENCY** and enter the frequency of your input signal to place the signal at the spectrum-analyzer center frequency.
3. Press **AMPLITUDE** and adjust the reference level to bring the signal near the top of the display.
4. Press **MEAS/USER** and Power Menu to access the power measurement functions. Press Setup and CHANNEL BANDWIDTH . Enter the value for the channel bandwidth. (The spectrum analyzer will use the last entered value for channel bandwidth, if it is not entered.)
5. Press CHANNEL SPACING and enter the value for channel spacing. (This is optional and is only used to set the center frequency step size.)
6. Press Previous Menu to return to the main power menu.
7. Press CHANNEL POWER to activate the function.

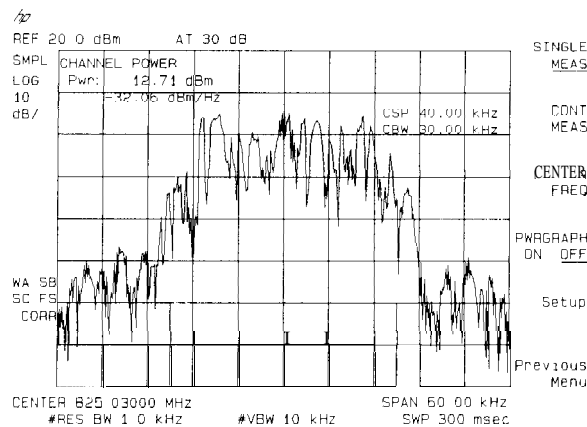

**Figure 4-41. Channel Power**

8. A graph of the channel power as a function of frequency can be calculated and displayed by pressing PWRGRAPH ON OFF so (ON) is underlined. The numerical channel power results are not displayed.

The top graticule line represents the power as indicated by the reference level (REF) displayed value.

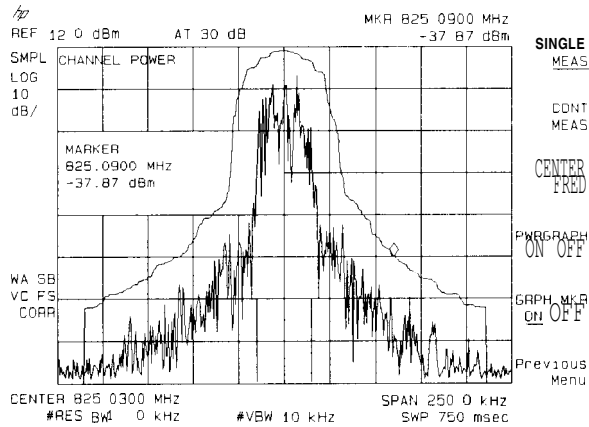

**Figure 4-42. Channel Power Graph**

9. To enable the graph marker, press GRPH MKR ON OFF so (ON) is underlined. Absolute frequency and amplitude are displayed.
10. Press Previous Menu . Press **MEAS OFF** to turn the measurement off and exit the power menu, or press another measurement key to stop the current measurement and start a new measurement.

---

**Note** If the power menus have been exited without turning the power measurement off (by pressing another front panel key), press the **MEAS/USER** key twice to return to the last power menu used.

---

## Using Analyzer Features

---

### What You'll Learn in this Chapter

This chapter introduces the features of the HP 8590 Series spectrum analyzers. These features can be used to manipulate measurement data and to make measurements more easily. In this chapter you will:

- Use the marker table to list all the active markers.
- Use the peak table to list the displayed signals.
- Save and recall data from analyzer memory.
- Save and recall data from the memory card.
- Learn about creating limit lines.
- Learn about the analog+ display mode (Option 101 only.)
- Learn about the windows display.
- Learn how to enter amplitude correction factors.
- Use the external keyboard (Option 041 or 043 only).



## Use the Marker Table to List All the Active Markers

The marker table function can be used to display a list of all of the active markers. It is sometimes necessary to keep track of several points on a signal trace. Multiple markers are

swept measurements. The multiple markers feature allows you to place up to four markers on a trace. Using the marker table all the markers on the display are annotated in a window

is activated or updated. Each marker can be independently set to read frequency, (sweep) time, inverse (sweep) time, or period (inverse frequency). This allows you to measure pulse

The marker information can be displayed in absolute amplitude and frequency or it can be in delta amplitude and frequency using one marker as the reference. The marker table can also

available when using the marker table function.

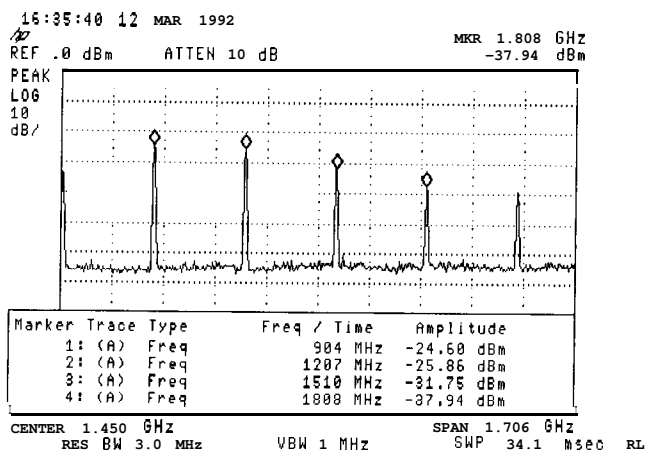

Figure 5-1. Marker Table Display

**Example:** Use the marker table to measure the calibrator signal.

1. Connect the CAL OUT signal to the spectrum analyzer INPUT 50Ω. Press **PRESET**, **FREQUENCY**, STOP **FREQ** , 2 GHz.
2. Press **PEAK SEARCH** and NEXT PK RIGHT to place the marker 1 on the 300 MHz cal signal.
3. Press **MKR FCTN**, MK TABLE ON OFF (ON) to turn on the marker table function.
4. Press **MKR** SELECT 1 2 3 4 (2) to select marker 2. Press MARKER ON OFF (ON) to activate marker 2. Use the NEXT PK RIGHT key, or move the marker using the key pad or knob to place marker 2 on the next harmonic. Repeat the process for markers 3 and 4.
5. Make marker 2 readout time, rather than frequency, by pressing **MKR** and pressing SELECT 1 2 3 4 until 2 is selected (underlined). Press More 1 of 2 , MK READ F T I P (T) to select time for the marker readout.
6. The marker table can be set to display the marker amplitudes relative to the display line. Press **MKR FCTN**, More 1 of 2, and TABLE ADL NRM key to underline **the** ADL. This accesses the delta display line format. The display line can be moved using the knob. The delta display line format is only available when using the marker table function.

---

**Note**            The marker table data **can** be printed by pressing the **COPY** key.  
                      The marker table cannot be saved or recalled.

---

---

## Use the Peak Table to List the Displayed Signals

The peak table function can be used to list the amplitude and frequency of up to 10 of the signals being displayed. This is done by pressing a single key, without having to put a marker on each signal. Multiple signals from components, such as oscillators and mixers, or from surveillance are automatically identified and listed. The information is updated at the end of each sweep. The peak table display can easily be copied to a printer.

It is often helpful to have the spectrum analyzer sort the signals. The peak table feature marks and list the signals based on the criteria selected. The signals can be sorted by increasing frequency or decreasing amplitude. The peak table function can be set to select all of the displayed signals, or only those signals above or below a specified display line.

---

**Note** A signal must have a peak of at least 6 dB to be recognized by the peak table function. This value can be changed using the peak excursion function.

---

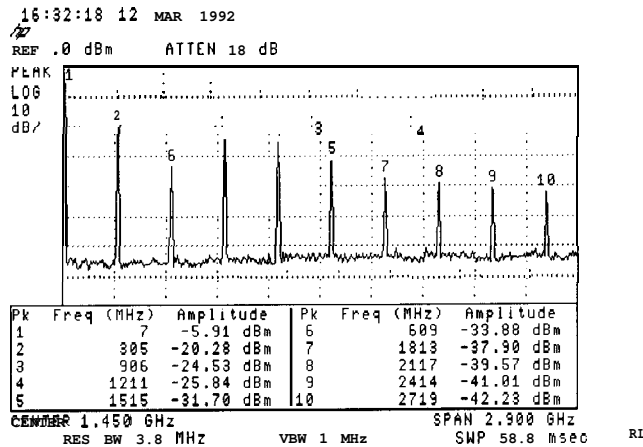

**Figure 5-2. Peak Table Display**

**Example:** Use the peak table function to measure the calibrator signal and its harmonics.

1. Connect the CAL OUT signal to the spectrum analyzer INPUT 500 and press **(PRESET)**.
2. Press **(PEAK SEARCH)**, **More 1 of 2** and **PK TABLE ON OFF (ON)** to turn on the peak table display.
3. The displayed peaks are listed by amplitude with the highest amplitude signal listed first. The table can be sorted by frequency, instead of amplitude. In this mode the lowest frequency peak is listed first, with the others listed in order of increasing frequency. Press **PK SORT FRQ AMP** to underline **FRQ** and list the signals by frequency.
4. The harmonics are numbered on the display in order of their listing in the peak table. The table can be limited to list only the signals above a certain power level. Change the peak table from the normal mode to the display line mode by pressing **PK MODE <>DL NRM** to underline **>DL**. The knob can then be used to move the display line to identify only the desired peaks above the display line.
5. Press **PK MODE <>DL MRM** again to underline **< DL** and move the display line to identify only the peaks that fall below the display line.

---

**Note**            The peak table data can be printed by pressing the **(COPY)** key.  
                      The peak table cannot be saved or recalled.

---

---

## Saving and Recalling Data from Analyzer Memory

This section explains how to save and recall state, trace, limit line, and amplitude correction factor data to and from spectrum analyzer memory. You can use STATE → INTRNL to store up to eight states in analyzer memory, and Trace → Intrnl to store many traces, limit-line tables, and amplitude-correction factors.

Saving state data saves the spectrum analyzer settings, but not the trace data. Saving trace data saves the trace data and the state data. Limit-line data and amplitude correction factors are stored in trace registers, but state and trace data are not recalled with the limit-line data or the amplitude correction factors. States, traces, limit-line tables, and amplitude correction factors are saved in spectrum analyzer memory even if the instrument is turned off or **PRESET** is pressed.

Refer to the Catalog Internal softkey description in Chapter 7 for more information about cataloging spectrum analyzer memory.

Refer to Table 5-1 at the end of this section for a summary of saving and recalling data to and from spectrum analyzer memory.

### To Save a State

1. Set up the spectrum analyzer settings to be saved.
2. Press (SAVE). If CARD is underlined, press INTERNAL CARD to select INTERNAL. Selecting INTERNAL selects the spectrum analyzer memory as the mass storage device.
3. Press STATE → INTRNL . SAVE: REG is displayed on the spectrum analyzer display.
4. Enter a number from one to eight using the numeric keypad and the state is saved automatically.

### To Recall a State

1. Press **RECALL**. If CARD is underlined, press INTERNAL CARD to select INTERNAL.
2. Press INTERNAL → STATE.
3. Enter the register number under which the state was saved and the state is recalled automatically.

State data can also be recalled by using the catalog:

1. Press **RECALL**. If CARD is underlined, press INTERNAL CARD to select INTERNAL.
2. Press Catalog Internal and CATALOG REGISTER. Use the knob to highlight the number of the state register to be retrieved. The state registers have a “ST” preceding the register number.
3. Press LOAD FILE.

---

**Note** Register 9 is a special register which can aid in recovering from inadvertent loss of line power (power failure). Press **RECALL**, INTERNAL → STATE, then 9 to place the spectrum analyzer in the state that existed just prior to the loss of power or set POWER ON LAST to do this automatically.

---

## To Save a Trace

Saving trace data is very similar to saving state data. Saving trace data saves both the trace data and the state data.

1. Enter a screen title, if desired, by using **DISPLAY** and Change Title .
2. Set up the trace to be stored.
3. Press **SAVE**. If CARD is underlined, press INTERNAL CARD to select INTERNAL.
4. Press Trace → Intrnl . This accesses a menu displaying TRACE A , TRACE B , and TRACE C.
5. Press the softkey for the trace that you want to save: TRACE A , TRACE B , or TRACE C . REGISTER # and MAX REG # = are displayed on the spectrum analyzer display. The number after MAX REG # = indicates the maximum register number that can be entered for trace storage in spectrum analyzer memory.
6. Use the numeric keypad to enter a number from 0 to the maximum register number and then press **ENTER**.

## To Recall a Trace

1. Press **RECALL**. If CARD is underlined, press INTERNAL CARD to select INTERNAL.
2. Press Internal → Trace. This accesses a menu displaying TRACE A , TRACE B , TRACE C , LIMIT LINES , and AMP COR .
3. Press TRACE A , TRACE B , or TRACE C to select the trace in which you want to place the trace data.
4. Enter the register number under which the trace was stored.
5. Press **ENTER**. The recalled trace is placed in the view mode and the spectrum analyzer state is changed to the state that was saved.

Trace data can also be recalled by using the catalog:

1. Press **RECALL**. If CARD is underlined, press INTERNAL CARD to select INTERNAL.
2. Press Catalog Internal , CATALOG REGISTER. Use the knob to highlight the number of the trace register to be retrieved. The trace registers have a “TR” preceding the trace register number.
3. Press LOAD FILE. The recalled trace is placed into trace B and the spectrum analyzer state is changed to the state that was saved.

## To Save a Limit-Line **Table** or Amplitude Correction Factors

The procedure for saving limit-line tables or amplitude correction factors is similar to saving trace data. State and trace data is not recalled with limit-line tables or amplitude-correction factors.

1. Enter a screen title, if desired, by using **DISPLAY**, Change Title . The screen title is displayed when CATALOG REGISTER is used to catalog the trace registers. The screen title is not recalled, however, with the limit-line tables or amplitude correction factors.
2. When saving limit-line tables, set up the limit-line table to be stored. See “Using the Limit-Line Functions” in this chapter. When saving amplitude correction factors, enter the data using the remote programming AMPCOR command or use the amplitude-correction function softkeys. See “Using Amplitude Correction Functions” in this chapter for more information about entering amplitude correction factors via the front-panel.
3. Press **SAVE**. If CARD is underlined, press INTERNAL CARD to select INTERNAL.
4. Press Trace → Intrnl . This accesses a menu with LIMIT LINES and AMP COR ,
5. Press LIMIT LINES to save limit-line tables. Press AMP COR to save amplitude-correction factors. REGISTER # and MAX REG # = are displayed on the spectrum analyzer screen. The number after MAX REG # = indicates the maximum register number that can be entered for storage in spectrum analyzer memory.
6. Use the numeric keypad to enter a number from 0 to the maximum register number and then press **ENTER**.

## To Recall Limit-Line **Tables** or Amplitude Correction Factors

1. Press (**RECALL**\_). If CARD is underlined, press INTERNAL CARD to select INTERNAL.
2. Press Internal → Trace. This accesses a menu with LIMIT LINES and AMP COR .
3. Press either LIMIT LINES to recall a limit-line table or, AMP COR to recall amplitude-correction factors.
4. Enter the register number under which the data was stored.
5. Press (**ENTER**).

## To Protect Data From Being Overwritten

If you want to protect all state, trace, limit line, and amplitude correction data from being overwritten, press **SAVE**, then SAV LOCK ON OFF so that ON is underlined. Table 5-1 summarizes the functions when saving and recalling data to and from spectrum analyzer memory.

---

**Note** This feature does not protect state, trace, limit line, and amplitude correction data from **ERASE MEM ALL**.

---

**Table 5-1. Summary of Save and Recall Operations, Analyzer Memory**

| Operation                           | Screen Title Available? | Register Range | Key Sequence                                                                                      |
|-------------------------------------|-------------------------|----------------|---------------------------------------------------------------------------------------------------|
| save state                          | No                      | 1 to 8         | <b>SAVE</b> STATE → INTRNL (register number)                                                      |
| recall state                        | No                      | 1 to 8*        | <b>RECALL</b> INTERNAL → STATE (register number)†                                                 |
| save trace                          | Yes                     | 0 to MAX REG # | <b>SAVE</b> Trace → Intrnl (TRACE A , TRACE B , or TRACE C ) (register number) <b>ENTER</b>       |
| recall trace                        | Yes                     | 0 to MAX REG # | <b>RECALL</b> Internal → Trace (TRACE A , TRACE B , or TRACE C ) (register number) <b>ENTER</b> † |
| save limit-line table               | Yes‡                    | 0 to MAX REG # | <b>SAVE</b> Trace → Intrnl LIMIT LINES (register number) <b>ENTER</b>                             |
| recall limit-line table             | No                      | 0 to MAX REG # | <b>RECALL</b> Internal → Trace LIMIT LINES (register number) <b>ENTER</b> †                       |
| save amplitude correction factors   | Yes‡                    | 0 to MAX REG # | <b>SAVE</b> Trace → Intrnl AMP COR (register number) <b>ENTER</b>                                 |
| recall amplitude correction factors | No                      | 0 to MAX REG # | <b>RECALL</b> Internal → Trace AMP COR (register number) <b>ENTER</b> †                           |

\* Registers 1 through 8 are available for the user to save a state. State register 0 contains **the** current state of the analyzer, state register 9 contains **the** previous state of **the** spectrum analyzer.

† The alternate method for recalling data uses the key sequence: **RECALL**, Catalog Internal, CATALOG REGISTER , use the step keys or knob to highlight the item to be recalled, LOAD FILE.

‡ The screen title is displayed when cataloging the trace registers with CATALOG REGISTER. The screen title is not recalled with the limit-line tables or amplitude correction factors.



## Saving and Recalling Data from the Memory Card

**Note**            Option 003 is required when using an HP 8590L or HP 8592L.

The memory card provides additional memory for saving instrument states, traces display images, limit-line tables, amplitude correction factors, and programs. Each HP 857'00A battery-backed RAM card provides 32 kilobytes of memory. Several different memory cards are available with up to 512 kilobytes of memory. See "Accessories" in Chapter 10. Instrument states, traces, display images, limit-line tables, amplitude-correction factors, and programs are easily retrievable without the need for an external controller to transfer data.

The process of saving and recalling data from the memory card is similar to saving and recalling data from the spectrum analyzer memory. Due to the expanded capabilities of the memory card, there are some important differences. For example, data is stored in spectrum analyzer memory as an item; on the memory card data is stored as a logical interchange file (LIF). Memory card data can be stored and recalled using a prefix. A prefix is an optional user-defined label for states, traces, and programs. The prefix becomes part of the file name. If you do not specify a prefix, the file name will be created without it. Table 5-2 compares the save and recall operations of spectrum analyzer memory and the memory card.

Refer to Table 5-3 at the end of this section for a summary of saving and recalling data to and from spectrum analyzer memory.

**Table 5-2.  
Comparison of Analyzer Memory and Memory Card Operations**

| Mass Storage Device    | Data Stored As | Stored with a Prefix? | Restriction on Register Number                                                                 | Types of Data That Can Be Stored*                                                                                 | Catalog Functions Available                                                                                                                                    |
|------------------------|----------------|-----------------------|------------------------------------------------------------------------------------------------|-------------------------------------------------------------------------------------------------------------------|----------------------------------------------------------------------------------------------------------------------------------------------------------------|
| <b>Analyzer Memory</b> | <b>Item</b>    | No                    | <b>1 to 8 for states, 3 to MAX REG # for traces, limit lines, amplitude correction factors</b> | <b>States, traces, limit-line tables, amplitude correction factors</b>                                            | <b>CATALOG ALL<br/>CATALOG REGISTER<br/>CATALOG VARIABLES<br/>CATALOG ON EVENT<br/>CATALOG PREFIX<br/>CATALOG DLP<br/>DELETE FILE<br/>LOAD FILE †</b>          |
| <b>Memory Card</b>     | <b>File</b>    | Yes                   | <b>Prefix + register # ≤ 8 characters</b>                                                      | <b>States, traces, limit-line tables, amplitude correction factors, display images, and downloadable programs</b> | <b>CATALOG ALL<br/>CATALOG STATES<br/>CATALOG TRACES<br/>CATALOG PREFIX<br/>CATALOG DLP<br/>CATALOG AMP COR<br/>CATALOG LMT LINE<br/>DELETE FILE LOAD FILE</b> |

\* Specifies types of data that can be stored by using normal front-panel operation.

† When cataloging analyzer memory, LOAD FILE is available for CATALOG REGISTER only.

## Preparing the Memory Card for Use

---

**Note** Improper insertion causes error messages to occur, but generally does not damage the card or instrument. Care must be taken, however, not to force the card into place. The cards are easy to insert when installed properly.

---

1. Locate the arrow printed on the card's label.
2. Insert the card with its arrow matching the raised arrow on the bezel around the card-insertion slot (see Figure 5-3).

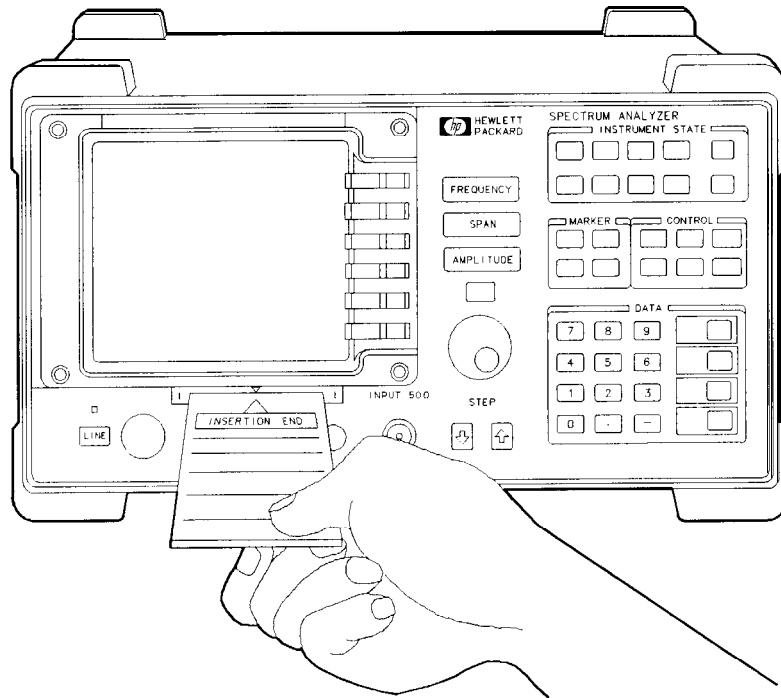

**Figure 5-3. Inserting the Memory Card**

3. Press the card into the slot. When correctly inserted, about 19 mm (0.75 in) of the card is exposed.
4. If this is a new memory card, it must be formatted before use. Since formatting a card deletes any data stored on the memory card, catalog the card before using the format card function if you suspect the memory card might contain data.

To format a new card, press **CONFIG**, More 1 of 3 , Card Conf ig , FORMAT CARD . The message If you are sure, press key again to purge data appears on the spectrum analyzer screen. Press FORMAT CARD again. (FORMAT CARD requires a double key press.)

To catalog a memory card, press **CONFIG**, More 1 of 3 , Card Conf ig , Catalog Card.

Catalog Card either displays any existing data that is on the memory card (if the memory card has been formatted) or, displays INVALID CARD: DIRECTORY if the card has not been formatted. Use BLANK CARD if you wish to delete the files from the memory card.

## To Enter a Prefix

Memory card data can be stored and recalled using a prefix. To enter a prefix, press **DISPLAY** or **CONFIG**, Change Prefix .

Pressing Change Prefix accesses a menu containing the letters of the alphabet, the underscore symbol (\_), the number symbol (#), a space, and the clear function. To select a character, press the softkey that displays the group of characters that contains the desired character. The softkey menu changes to allow you to select an individual character. If you make a mistake, press **BK SP** to space back over the incorrect character. Additional characters are available by pressing More 1 of 2 . Numbers may be selected with the numeric keypad.

The prefix can be from one to seven characters long. The longer the prefix, the shorter the register number must be. The total length of the prefix and register number cannot exceed eight characters. The prefix can be any character; however, the underscore should not be the first character of the prefix.

An existing prefix can be cleared with the clear function. Press **CONFIG** or **DISPLAY**, Change Prefix, YZ\_# Spc Clear , then Clear to clear the current prefix. To change a prefix, clear the existing prefix and then enter a new prefix.

## To Save a State

1. Press **DISPLAY** or **CONFIG**, Change Prefix . Use the softkeys to enter the prefix under which you want the state saved. A prefix can be one to seven characters long.  
If you do not specify a prefix, the state will be saved with a file name consisting of s-(register number).
2. Press **SAVE**. If INTERNAL is underlined, press INTERNAL CARD to select CARD. Selecting CARD selects the memory card as the mass storage device.
3. Press STATE → CARD . REGISTER # and PREFIX= are displayed on the spectrum analyzer display.
4. Use the numeric keypad to enter a register number and then press **ENTER**.

## To Recall a State

1. Press **(SAVE)** or **(RECALL)**. If INTERNAL is underlined, press INTERNAL CARD to select CARD.
2. Press Catalog Card then CATALOG STATES . Use the knob to highlight the state data to be retrieved.
3. Press LOAD FILE.

State data **can** also be recalled by specifying the prefix and **the** register number:

1. Use Change Prefix to enter the prefix, or use the existing prefix.
2. Press **(RECALL)**. If INTERNAL is underlined, press INTERNAL CARD to select CARD.
3. Press CARD → STATE.
4. Enter the register number that the state was saved under, and then press **(ENTER)**.

## To Save a Trace

Saving trace data saves the trace data and the state data.

1. Press **(DISPLAY)** or **(CONFIG)**, and then Change Prefix to enter a new prefix or change the existing prefix.

If you do not specify a prefix, the trace will be saved with a file name consisting of s\_(register number).

2. Enter a screen title, if desired, by using **(DISPLAY)** then Change Title .
3. Set up the trace to be stored.
4. Press (SAVE). If INTERNAL is underlined, press INTERNAL CARD to select CARD. Press Trace → Card to access **the** menu that displays TRACE A , TRACE B , and TRACE C .
5. Press the softkey label of the trace that you want to save: TRACE A , TRACE B , or TRACE C . REGISTER # and PREFIX= are displayed **on** the spectrum analyzer display.
6. Use the numeric keypad to enter a register number and then press **(ENTER)**.

The trace data is saved with a file name consisting of a “t,” the current prefix, an underscore (-), and the register number. The “t” denotes that the file contains trace data.

## To Recall a Trace

1. Press **(SAVE)** or **(RECALL)**. If INTERNAL is underlined, press INTERNAL CARD to select CARD.
2. Press Catalog Card then CATALOG TRACES . Use the knob to highlight **the** trace data to be retrieved.
3. Press LOAD FILE . The trace data is placed in trace B.

Trace data can also be recalled by specifying **the** prefix and the register number:

1. Use Change Prefix to enter the prefix, or use the existing prefix.
2. Press **(RECALL)**. If INTERNAL is underlined, press INTERNAL CARD to select CARD.

3. Press Card → Trace to access the menu that displays TRACE A , TRACE B , and TRACE C .
4. Select the trace in which you want the trace data stored by pressing TRACE A , TRACE B , or TRACE C .
5. Enter the register number that the trace was saved under and then press **ENTER**. The recalled trace is placed in view mode.

### To Save a Display Image

1. Press **DISPLAY** or **CONFIG**, Change Prefix . Use the softkeys to enter a prefix under which you want the state saved. A prefix can be one to seven characters long.  
If you do not specify a prefix, the display image will be saved with a file name consisting of i\_(register number).
2. Press **SAVE**. If INTERNAL is underlined, press INTERNAL CARD to select CARD. Selecting CARD selects the memory card as the mass storage device.
3. Press DISPLAY → CARD . REGISTER # and PREFIX= are displayed on the spectrum analyzer display.
4. Use the numeric keypad to enter a register number and then press **ENTER**.

### To Recall a Display Image

1. Use Change Prefix to enter the prefix, or use the existing prefix.
2. Press **SAVE** or **RECALL**. If INTERNAL is underlined, press INTERNAL CARD to select CARD.
3. Press Catalog Card then CATALOG ALL . Use the knob to highlight the display image data to be retrieved.
4. Press LOAD FILE.

---

**Note**            The intensity of some screen items may differ if the window configuration of the current spectrum analyzer state does not match the recalled display image. This will not affect the ability to copy the screen.

---

Display image data can also be recalled by specifying the prefix and the register number:

1. Press **RECALL**. If INTERNAL is underlined, press INTERNAL CARD to select CARD.
2. Press CARD →DISPLAY .
3. Enter the register number that the state was saved under, and then press **ENTER**.

## To Save Limit-Line **Tables** or Amplitude Correction Factors

The procedure for saving limit-line tables or amplitude correction factors is similar to saving trace data. State and trace data is not recalled when the limit-line tables or amplitude correction factors are recalled.

1. Press **DISPLAY** or **CONFIG**, Change Prefix to enter a new prefix or change the existing prefix.

If you do not specify a prefix, the limit-line table will be saved with a file name consisting of L(register number). A table of amplitude correction factors will be saved with a file name consisting of a(register number).

2. When saving tables, set up the table to be stored. See “Using the Limit-Line Functions” or “Using Amplitude Correction Functions” for more information about entering data.
3. Press **SAVE**. If INTERNAL is underlined, press INTERNAL CARD to select CARD. Press Trace → Card to access the menu with LIMIT LIMES and AMP COR .
4. Press either LIMIT LINES , to save limit-line tables, or AMP COR , to save amplitude-correction factors. REGISTER # and PREFIX= are displayed on the spectrum analyzer display.
5. Use the numeric keypad to enter a register number and then press **ENTER**.

The data is saved with a file name consisting of a “1” (for limit-line tables) or “a” (for amplitude-correction factors), the prefix that was entered, an underscore (\_), and the register number.

## To Recall Limit-Line **Tables** or Amplitude Correction Factors

1. Use Change Prefix to enter the prefix, or use the existing prefix.
2. press **RECALL**. If INTERNAL is underlined, press INTERNAL CARD to select CARD.
3. Press Card → Trace to access the menu with LIMIT LINES and AMP COR
4. Press either LIMIT LINES , to recall a limit-line table, or AMP COR , to recall amplitude-correction factors.
5. Enter the register number that the limit-line data or amplitude-correction factors was saved under and then press **ENTER**.

---

**Note** If LOAD FILE is used to recall limit-line files or amplitude-correction factor files, the traces are set to the store-blank mode. Press **TRACE**, CLEAR WRITE A to view trace A data, or press **PRESET**.

---

## Saving and Recalling Programs with a Memory Card

Programs (also called downloadable programs or DLPs) can be loaded into spectrum analyzer memory either by loading a program from a memory card or by defining a function with programming commands. (Remote programming ability is available with Option 041 or 043).

The process of saving and recalling programs from the memory card is similar to saving state data. To save program information to the memory card use ALL DLP → CARD.

---

**Note** ALL DLP → CARD saves an image of the spectrum analyzer memory. This means a program cannot be saved selectively if several programs are present in the spectrum analyzer memory at the time. Use Catalog Internal , DELETE FILE to delete the items in user memory that you do not wish to be saved on the memory card. ALL DLP → CARD saves all programs and key definitions that are in spectrum analyzer memory onto the memory card.

---

### To Save a Program

1. Press **CONFIG** or **DISPLAY**, then Change Prefix to enter a new prefix or change the existing prefix.  
If you do not specify a prefix, the program will be saved with a file name consisting of d\_(register number).
2. Press **SAVE**. If INTERNAL is underlined, press INTERNAL CARD to select CARD.
3. Press ALL DLP -CARD . REGISTER # and PREFIX= are displayed on the spectrum analyzer display.
4. Use the numeric keypad to enter a register number and then press **ENTER**.  
The data is saved with a file name consisting of a “d,” the prefix that was entered, an underscore (\_), and the register number. The “d” denotes that the file contains downloadable program data.

### To Recall a Program

1. Press **SAVE** or **RECALL**. If INTERNAL is underlined, press INTERNAL CARD to select CARD. (CARD is underlined when the memory card is selected).
2. Press Catalog Card, More 1 of 2 , then CATALOG DLP . Use the knob to highlight the data to be retrieved.
3. Press LOAD FILE.

Programs can also be recalled by specifying the prefix and the register number:

1. Use Change Prefix to enter the prefix, or use the existing prefix.
2. Press **RECALL**. If INTERNAL is underlined, press INTERNAL CARD to select CARD.
3. Press CARD → DLP , enter the register number that the program was saved under, and then press **ENTER**.

Table 5-3 summarizes the functions when saving and recalling data to and from the memory card.

**Table 5-3. Save and Recall Functions Using Memory Card**

| <b>Operation</b>                                                                                                                                                                                                                                                                                       | <b>Screen Title Available?</b> | <b>File Name</b>                   | <b>Register Range</b>                    | <b>Key Sequence</b>                                                                         |
|--------------------------------------------------------------------------------------------------------------------------------------------------------------------------------------------------------------------------------------------------------------------------------------------------------|--------------------------------|------------------------------------|------------------------------------------|---------------------------------------------------------------------------------------------|
| save state                                                                                                                                                                                                                                                                                             | No                             | s(current prefix)<br>-(register #) | Prefix +<br># ≤<br>8 characters          | <b>(SAVE)</b> STATE → CARD (register #) <b>(ENTER)</b>                                      |
| recall state                                                                                                                                                                                                                                                                                           | No                             | s(current prefix)<br>-(register #) | Prefix +<br>register # ≤<br>8 characters | <b>(RECALL)</b> CARD → STATE (register #) <b>(ENTER)*</b>                                   |
| save trace                                                                                                                                                                                                                                                                                             | Yes                            | t(current prefix)<br>-(register #) | Prefix +<br>register # ≤<br>8 characters | (SAVE) Trace → Card (TRACE A , TRACE B , or TRACE C ) (register #) <b>(ENTER)</b>           |
| recall trace                                                                                                                                                                                                                                                                                           | Yes                            | t(current prefix)<br>-(register #) | Prefix +<br>register # ≤<br>8 characters | <b>(RECALL)</b> Card → Trace (TRACE A , TRACE B , or TRACE C ) (register #) <b>(ENTER)*</b> |
| save display image                                                                                                                                                                                                                                                                                     | Yes†                           | i(current prefix)<br>-(register #) | Prefix +<br>register # ≤<br>8 characters | <b>(SAVE)</b> DISPLAY → CARD (register #) <b>(ENTER)</b>                                    |
| recall display image                                                                                                                                                                                                                                                                                   | Yes†                           | i(current prefix)<br>-(register #) | Prefix +<br>register # ≤<br>8 characters | <b>(RECALL)</b> CARD → DISPLAY (register #) <b>(ENTER)*</b>                                 |
| save limit-line table                                                                                                                                                                                                                                                                                  | No                             | l(current prefix)<br>(register #)  | Prefix +<br>register # ≤<br>8 characters | <b>(SAVE)</b> Trace → Card LIMIT LINES (register #) <b>(ENTER)</b>                          |
| recall limit-line table                                                                                                                                                                                                                                                                                | No                             | l(current prefix)<br>(register #)  | Prefix +<br>register # ≤<br>8 characters | <b>(RECALL)</b> Card → Trace LIMIT LINES (register #) <b>(ENTER)*</b>                       |
| save amplitude correction factors                                                                                                                                                                                                                                                                      | No                             | a(current prefix)<br>-(register #) | Prefix +<br>register # ≤<br>8 characters | (SAVE) Trace → Card AMP COR (register #) <b>(ENTER)</b>                                     |
| recall amplitude correction factors                                                                                                                                                                                                                                                                    | No                             | a(current prefix)<br>-(register #) | Prefix +<br>register # ≤<br>8 characters | <b>(RECALL)</b> Card → Trace AMP COR (register #) <b>(ENTER)*</b>                           |
| save DLP                                                                                                                                                                                                                                                                                               | No                             | d(current prefix)<br>-(register #) | Prefix +<br>register # ≤<br>8 characters | <b>(SAVE)</b> ALL DLP → CARD (register #) <b>(ENTER)</b>                                    |
| recall DLP                                                                                                                                                                                                                                                                                             | No                             | d(current prefix)<br>-(register #) | Prefix +<br>register # ≤<br>8 characters | <b>(RECALL)</b> CARD → DLP (register #) <b>(ENTER)*</b>                                     |
| <p>* An alternate method for recalling a file uses the key sequence: <b>(RECALL)</b>, Catalog Card , CATALOG ALL , use the knob to highlight the desired file, then LOAD FILE.</p> <p>† The screen title is part of the display image, but is an image only. It is <b>not</b> recalled as a title.</p> |                                |                                    |                                          |                                                                                             |



---

## Using Limit-Line Functions

Limit lines provide an easy way to compare trace data to a set of amplitude and frequency parameters while the spectrum analyzer is sweeping the measurement range. An upper and/or lower limit line can be displayed. Every measurement sweep of trace A is compared to the limit lines. If trace A is at or within the bounds of the limit lines, LIMIT PASS is displayed. If trace A is out of the limit-line boundaries, LIMIT FAIL is displayed. Figure 5-4 shows a sample limit-line display.

Limit lines are constructed from a table of frequency and amplitude coordinate pairs. Limit line segments are created by connecting these points. Everything except the segment length is defined by the entry for its beginning point. There are several different ways of entering the frequency/amplitude pairs. These are described in the following section.

---

**Note** Limit lines can only be created and edited from the front panel in the format of limit-line tables. Limit lines that are in a trace format can only be created using remote commands or a down-loadable program. See **HP 8590 E-Series and L-Series Spectrum Analyzer and HP 8591C Cable TV Analyzer Programmer's Guide** for more information.

---

Though coordinates of frequency and amplitude are used most often, limit line data can also be entered in terms of time and amplitude. Use the LIMITS FRQ TIME softkey, to underline the desired choice of either frequency or time parameters. Frequency is the default selection. If TIME is selected SELECT TIME will replace SELECT FREQ in the Edit Limit menus.

This section provides an overview of limit lines, a procedure for creating a sample upper limit line, and descriptions of the limit-line functions. A procedure for creating an upper and a lower limit line is at the end of this section. Refer to Chapter 7 for more information on a specific limit-line function.

### Procedure for Creating an Upper Limit Line

This procedure demonstrates how to create a sample upper limit line for the CAL OUT signal and activate testing. Detailed descriptions of the limit-line functions follow this procedure.

1. Press [PRESET].
2. Set the center frequency and span by pressing [FREQUENCY], 300 [MHz], and (SPAN), 500 [MHz].
3. Connect the spectrum analyzer CAL OUT and INPUT 50  $\Omega$  on the spectrum analyzer using an appropriate cable. (The calibration signal is used as the "test" signal for this demonstration.)

---

**Note** If the amplitude units are anything other than dBm at this time, change the amplitude units to dBm for this demonstration. Press [AMPLITUDE], More 1 of 2, Amptd Units, dBm.

---

4. Press [DISPLAY], Limit Lines to access the limit-line menus.

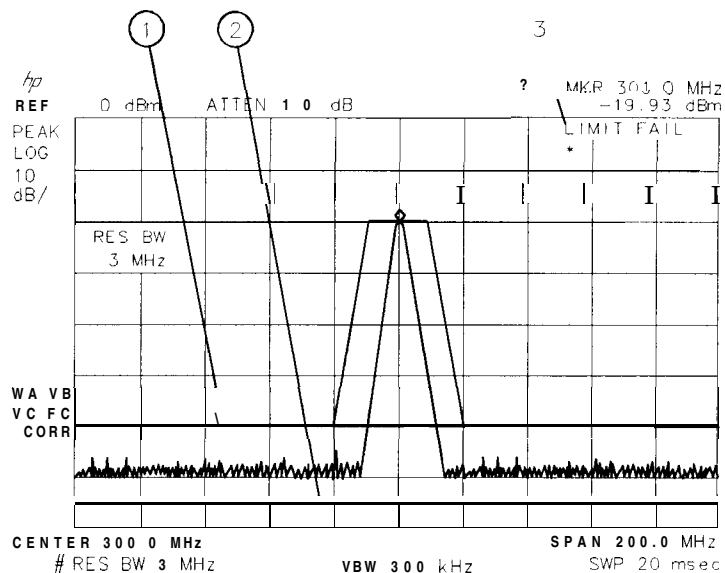

pu143e

**Figure 5-4. Typical Limit-Line Display**

| Item | Description of Items in Figure 5-4 |
|------|------------------------------------|
| 1    | Upper limit line                   |
| 2    | Lower limit line                   |
| 3    | Screen message                     |

5. Press Edit Limit then Edit Upper to create an upper limit line.

The table defaults to frequency parameters, the second column should be labeled START-FREQ. If it is labeled START-TIME, press More 1 of 2, EDIT DONE, and Edit Limit . Press LIMITS FRQ TIME so that FRQ is underlined. LIMITS FRQ TIME specifies that the limit line parameters be entered in either frequency or time.

#### Note

To clear an existing limit-line table, press More 1 of 2 . Then press PURGE LIMITS two times.

After pressing PURGE LIMITS the first time, the message If you are sure, press key again to purge data will appear. Pressing PURGE LIMITS a second time purges the limit-line table. **PRESET** turns limit-line testing off (if it is on), but does not clear an existing limit-line table.

6. Press Edit Upper to edit or create an upper limit line.

7. The table defaults to fixed parameters, the upper right corner of the table should be labeled **FIXED**. If it is labeled **RELATIVE**, press **More 1 of 2** . Then press **LIMITS FIX REL** so that **FIX** is underlined. **LIMITS FIX REL** specifies whether or not the limit line is relative to the spectrum analyzer center frequency and reference-level settings. When time parameters are used, the **RELATIVE** format only affects the amplitude part of the coordinate pairs. The time parameters are always fixed beginning at the left edge of the graticule.
8. Specify the first limit-line segment to begin at 50 MHz and have an amplitude of -60 dBm by using the following key sequence:  

```
SELECT FREQ 50 MHz 60 -dBm FLAT
```

---

**Note**            The coordinates for the second point must be entered before the first and limit-line segment is displayed.

---

9. Enter the second limit-line segment by pressing the following keys: 250 MHz 60 -dBm SLOPE.

---

**Note**            Table entries can be edited if you make a mistake. To edit an existing segment, use **SELECT SEGMENT** to specify the segment. Use **SELECT FREQ** , **SELECT AMPLITUD** , or **SELECT TYPE** to specify the column you wish to edit.

---

10. Specify the third limit-line segment by pressing the following keys: 400 MHz 15 -dBm FLAT.

You may notice that the end coordinate of segment three is drawn to a point off the top of the spectrum analyzer display. This assures that no trace data beyond the end of the limit line will cause the test to fail.

11. Specify the fourth limit-line segment by pressing the following keys: 600 MHz 15 -dBm POINT.

Since the limit line in this procedure has only four segments specified, the frequency value of segment four (the last segment) is set to 600 MHz, which is greater than the stop frequency of the display.

12. Press **More 1 of 2**, then **EDIT DONE** when all the segments have been entered.
13. Press **LMT TEST ON OFF** so that **ON** is underlined. This turns the limit testing on. For example, **LIMIT FAIL** is displayed because the calibration signal exceeds the limit line.
14. Disconnect the **CAL OUT** from the spectrum analyzer **INPUT 5052**. **LIMIT PASS** is displayed since no signal exceeds the limit line.

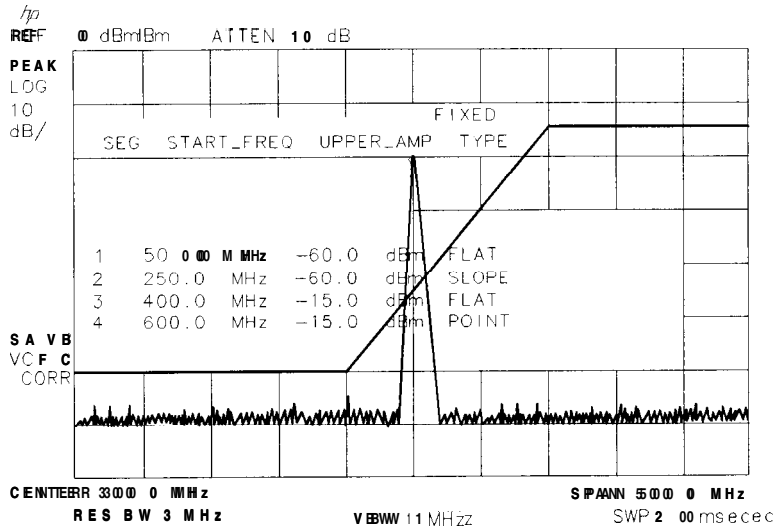

pu144e

**Figure 5-5. The Completed Limit-Line Table**

## Limit-Line Functions

This section describes the limit-line functions in the order that they are usually used.

### Editing, Creating, or Viewing a Limit-Line

Pressing **DISPLAY**, then Limit Lines accesses the softkey menus used for creating a limit line.

Press Edit Limit to edit an existing limit-line table or. If no limit-line table currently exists this will allow you to create one.

If a limit line exists currently, and you would like to purge it and create a new one, press Edit Upper, and More 1 of 2 . Then press PURGE LIMITS two times to clear the existing limit-line table and access the limit-line editing menu.

---

**Note** After pressing PURGE LIMITS the first time, the message If you are sure, press key again to purge data will appear. Pressing PURGE LIMITS a second time purges the limit-line table. **PRESET** turns limit-line testing off (if it is on), but does not clear an existing limit-line table.

---

### Selecting the Type of Limit-Line **Table**

The LIMITS FRQ TIME key selects the type of limit line parameters. Parameters can be entered as frequency/amplitude coordinates, or as time/amplitude coordinates. Use the LIMITS FRQ TIME key, to underline the desired choice of either frequency or time parameters. Frequency is the default selection. If TIME is selected SELECT TIME will replace SELECT FREQ in the Edit Limit menus.

The second column of the limit-line table is labeled START-FREQ when frequency is selected. It is labeled START-TIME when time is selected.

The LIMITS FIX REL key selects the type of limit line. There are two types of limit lines: fixed and relative. Fixed limit lines contain only absolute amplitude and frequency (or time) values. Relative limit lines consist of frequency values that are referenced to the spectrum analyzer center frequency and amplitude values that are relative to the analyzer reference level. The relative setting does not affect time values. They always begin at the left edge of the graticule.

As an example fixed versus relative limit lines, if a limit line is specified as fixed, entering a limit-line segment with a frequency coordinate of 300 MHz displays the limit-line segment at 300 MHz. If the same limit-line table is specified as relative, it is displayed relative to the spectrum analyzer center frequency and reference level. If the center frequency is at 1.2 GHz, a relative limit-line segment with a frequency coordinate of 300 MHz will display the limit-line segment at 1.5 GHz. If the amplitude component of a relative limit-line segment is -10 dB and the spectrum analyzer reference level is -15 dB, then -10 dB is added to the reference-level value and the amplitude component of the limit line will be at -25 dB.

RELATIVE is displayed in the limit-line table when the limit-line type is relative; FIXED is displayed when the limit-line type is fixed. A limit line entered as fixed may be changed to relative, and one entered as relative may be changed to fixed. When the limit-line type is changed, the frequency and amplitude values in the limit-line table are modified by the current center frequency and reference level settings to keep the limit line in the same position on the spectrum analyzer.

## Selecting the Limit-Line **Table** Format

Press **Edit Upper**, **Edit Lower**, **Edit Up/ Low**, or **Edit Mid/Delt** to editor create a limit-line table. Each of the edit softkeys represents a different type of limit-line table format. The choice of edit softkey depends upon whether you want an upper limit line only, a lower limit line only, or both an upper and a lower limit line. If you want both lower limit lines, then the characteristics of the limit lines being entered affect your choice of using the upper/lower or mid/delta functions.

The four limit-line table formats are described below:

- The upper limit-line table format is accessed by **Edit Upper** . With the upper limit-line table format, the coordinates of only the upper limit line are displayed for editing; lower limit-line coordinates are not specified. Even if lower limit-line values exist or the values had been entered as an upper and lower limit-line table, the upper limit-line values are treated as a separate table from the lower limit-line values. Upper limit-line entries can have independent frequency and amplitude coordinates from lower limit-line table entries.
- The lower limit-line table format is accessed by **Edit Lower** . With the lower limit-line table format, the coordinates of only the lower limit line are displayed for editing; upper limit-line coordinates are not specified. Even if upper limit-line values exist or the values had been entered as an upper and lower limit-line table, the lower limit-line values are treated as a separate table from the upper limit-line values. Lower limit-line entries can have independent frequency and amplitude coordinates from upper limit-line table entries.
- The upper and lower limit-line table format is accessed by **Edit Up/ Low** . With the upper and lower limit-line table format, the upper and lower limit-line coordinates can be entered at the same time: the frequency (or time), upper amplitude, lower amplitude, and type are specified. The frequency (or time) and upper amplitude comprise the coordinate point for the upper limit line; the frequency (or time) and lower amplitude value comprise the coordinate point for the lower limit line. It is not necessary to specify both an upper- and lower-amplitude component for every frequency component. Three asterisks in the table indicate that an amplitude value has not been entered for the segment.
- The mid/delta limit-line table format is accessed by **Edit Mid/Delt** . Like the upper and lower limit-line table format, the mid/delta limit-line table format provides a means of specifying the upper and lower limit lines at the same time. Unlike the upper and lower table format, the amplitude values are specified as a middle amplitude value with a delta: the upper and lower limit lines are then drawn at an equal positive and negative distance from the middle amplitude. With the mid/delta format, the frequency (or time) and the mid-amplitude plus the delta comprise the upper limit line; the frequency (or time) and the mid-amplitude minus the delta comprise the lower limit line. The difference between the mid/delta format and the upper/lower format is the way the amplitude values are entered; however, in both formats, the frequency coordinate begins a segment. The mid/delta format can be used if the upper and lower limit lines are symmetrical with respect to the amplitude axis.

---

**Note**            Editing a limit-line table can be done using a different format than the one that was used for creating it.

---

## Selecting the Segment Number

Pressing **SELECT SEGMENT** specifies the segment number to be entered or edited. Limit lines are created by entering frequency or time values and amplitude values into a limit-line table. The frequency/time and amplitude values specify a coordinate point from which a limit-line segment is drawn. The coordinate point is the lowest frequency or time point of the line

segment. Limit lines are constructed from left to right. The segment is defined by its beginning point (see Figure 5-6).

**Note** Up to 20 segments can be specified for an upper or lower limit-line table. When entering a limit-line segment, the frequency/time and amplitude values will be listed as asterisks (\*\*\*) until new values are entered. The new segment will be listed last until both the frequency (or time) and the amplitude values have been entered. Once the frequency/time and an amplitude value are entered, the segment will be sorted into the limit-line table according to frequency or time.

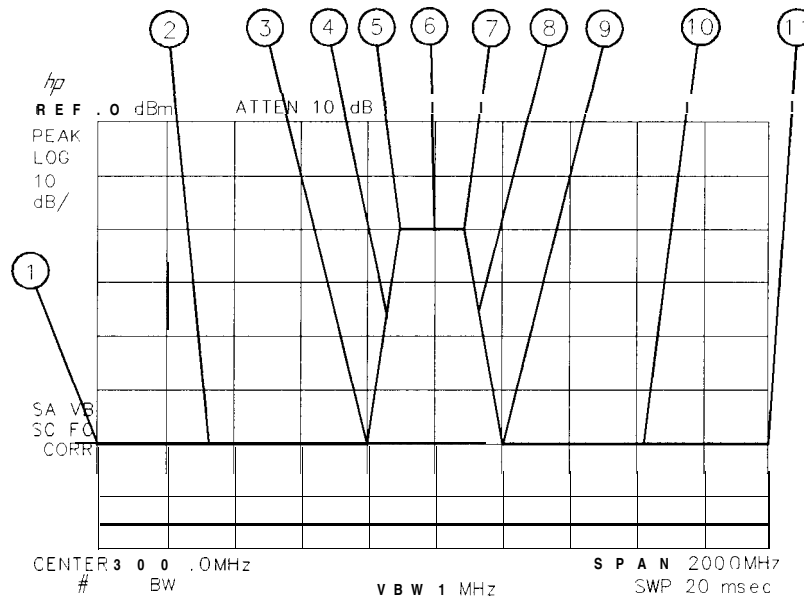

pu145e

**Figure 5-6. Limit-Line Segments**

| Item | Description of Items in Figure 5-6                                 |
|------|--------------------------------------------------------------------|
| 1    | Frequency and amplitude coordinate that starts the first segment.  |
| 2    | First segment.                                                     |
| 3    | Frequency and amplitude coordinate that starts the second segment. |
| 4    | Second segment.                                                    |
| 5    | Frequency and amplitude coordinate that starts the third segment.  |
| 6    | Third segment.                                                     |
| 7    | Frequency and amplitude coordinate that starts the fourth segment. |
| 8    | Fourth segment.                                                    |
| 9    | Frequency and amplitude coordinate that starts the fifth segment.  |
| 10   | Fifth segment.                                                     |
| 11   | Frequency and amplitude coordinate that starts the sixth segment.  |

## Selecting the **Frequency** or Time Coordinate

Press **SELECT FREQ** , then enter a frequency value, or press **SELECT TIME** and enter a time value, for the segment. Regardless of the table format, a frequency/time coordinate must be specified.

---

**Note** Limit line coordinates may be entered in terms of either frequency and amplitude, or time and amplitude. Press **LIMITS FRQ TIME** until the desired choice of either frequency or time has been selected (underlined). If **TIME** has been selected as the limit line parameter **SELECT TIME** will replace **SELECT FREQ** in the Edit Limit menus.

---

## Selecting the Amplitude Coordinate

In the previous procedure, pressing **SELECT AMPLITUD** and then entering an amplitude value, specified the amplitude coordinate for the upper limit line. The limit-line table formats dictate how the amplitude values are treated:

- With the upper limit-line table format, one amplitude component (representing an upper limit-line segment) is specified per frequency/time component. The amplitude value is entered by pressing **SELECT AMPLITUD** , entering an amplitude value, and pressing a units key.
- With the lower limit-line table format, one amplitude component (representing a lower limit-line segment) is specified per frequency/time component. The amplitude value is entered by pressing **SELECT AMPLITUD** , entering an amplitude value, and pressing a units key.
- With the upper/lower limit-line table format, two amplitude components (one each for the upper and lower limit-line segments) can be specified per frequency or time component. It is not necessary to specify both an upper and a lower amplitude value. Specifying only upper amplitude values results in an upper limit line, but not a lower limit line. Omitting an amplitude point on one limit line does not affect the other limit line. The amplitude of the upper limit line is entered by pressing **SELECT UPR AMPL** , entering an amplitude value, and pressing a units key. The amplitude of the lower limit line is entered by pressing **SELECT LWR AMPL** , entering an amplitude value, and pressing a units key.
- With the mid/delta limit-line table format, two amplitude components (one representing a mid-amplitude value, one representing a deviation [positive and negative values] from either side of this value) is specified per frequency component. If no deviation is entered, the deviation defaults to zero. The middle amplitude value is entered by pressing **SELECT MID AMPL** , entering an amplitude value, and pressing a units key. The deviation is entered by pressing **SELECT DLT AMPL** , entering an amplitude value, and pressing a units key.

---

**Note** Frequency or amplitude values that are not within the limit-line range will be modified. For example, a frequency value of 60 GHz will be modified to 30 GHz.

---



## Selecting the Segment Type

Press **SEGMENT TYPE** , then **FLAT**, **SLOPE**, or **POINT** to specify the segment type. The segment type determines how to connect the coordinate point of the current line segment with the coordinate point of the next line segment. The segment type determines whether the line segment is horizontal, vertical, sloped, or a single point. The three segment types are:

1. Flat draws a zero-slope line between the coordinate point of the current segment and the coordinate point of the next segment, producing limit-line values equal in amplitude for all frequencies or times between the two points. If the amplitude values of the two segments differ, the limit-line will “step” to the value of the second segment (see Figure 5-7).
2. Slope draws a straight line between the coordinate point of the current segment and the  
  
the two points.
3. Point specifies a limit value for the coordinate point. It specifies a limit at a single frequency  
  
indicated by a line drawn from the coordinate point, vertically off the top of screen. For a lower limit line, a point segment is indicated by a line drawn from the coordinate point,  
  
segment in the limit-line table. However, if the last segment in the table is not specified as the point segment type, an implicit point is automatically used. (If a visible point segment at  
  
limit-line table that is higher in frequency than the stop frequency.)

Figure 5-7 demonstrates the different segment types.

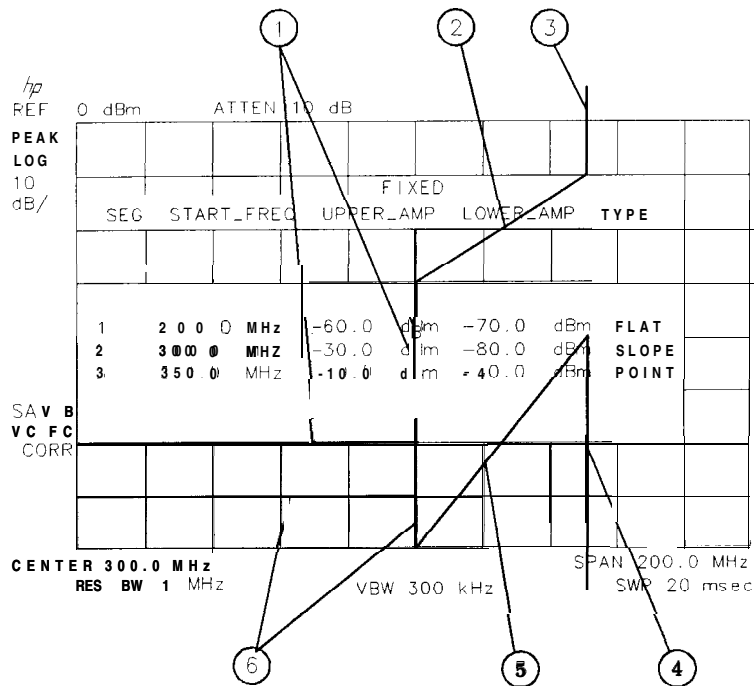

pu146e

**Figure 5-7. Segment Types**

| Item | Segment Types                   |
|------|---------------------------------|
| 1    | <b>Flat (upper limit line)</b>  |
| 2    | <b>Slope (upper limit line)</b> |
| 3    | <b>Point (upper limit line)</b> |
| 4    | <b>Point (lower limit line)</b> |
| 5    | <b>Slope (lower limit line)</b> |
| 6    | <b>Flat (lower limit line)</b>  |

## Completing **Table** Entry and Activating Limit-Line Testing

Pressing EDIT DONE blanks the limit-line table from the screen and accesses the menu with LMT TEST ON OFF and LMT DISP Y N AUTO softkeys.

Pressing LMT TEST UN OFF turns the limit-line testing on and off.

Pressing LMT DISP Y N AUTO (Y) turns the limit lines display on. Pressing LMT DISP Y N AUTO (N) turns the limit lines display off. Pressing LMT DISP Y N AUTO (AUTO) sets the limit line display to match the limit line test function. With AUTO underlined the limit lines are only displayed when limit line testing is turned on.

## Saving or Recalling Limit-Line **Tables**

Pressing **DISPLAY** then Limit Lines accesses SAVE LIMIT and RECALL LIMIT. These softkey functions provide an easy way to save or recall current limit-line tables. SAVE LIMIT saves the current limit-line tables in the current mass storage device (either spectrum analyzer memory or a memory card). To determine the current mass storage device, press SAVE LIMIT . If MAX REG # appears on the spectrum analyzer display, the current mass storage device is analyzer memory. If PREFIX= is displayed, the memory card is the mass storage device. Enter a register number, then press **ENTER** to save the current limit-line table in the current mass storage location.

RECALL LIMIT recalls limit-line tables from the current mass storage device (either spectrum analyzer memory or a memory card). To determine the current mass storage device, press RECALL LIMIT . If MAX REG # appears on the spectrum analyzer display, the current mass storage device is analyzer memory. If PREFIX= is displayed, the memory card is the mass storage device. To recall a limit line, enter the register number that the limit-line table was saved under, then press **ENTER**. When recalling a limit line from the memory card, it is necessary that the current prefix matches the prefix that the limit line was stored with. Use Change Prefix to change the current prefix.

## Procedure for Creating an Upper and Lower Limit Line

This is a basic procedure for creating a sample of upper and lower limit lines. The CAL OUT signal is used for the test signal.

1. Press **PRESET**.
2. Since this procedure uses the calibration signal as the test signal, connect the spectrum analyzer CAL OUT to the INPUT 50  $\Omega$  with an appropriate cable.
3. Set the spectrum analyzer controls as follows:
  - FREQUENCY** 300 MHz
  - SPAN** 50 MHz
  - BW** 3 MHz
4. Press **DISPLAY** and Limit Lines to access the limit-line menus.
5. At this point you may need to do the following:
  - a. To save the current limit-line table, press SAVE LIMIT and enter the register number. Then press **ENTER**.
  - b. To clear an existing limit-line table, press Edit Limit , Edit Upper , and More 1 of 2 . Then press PURGE LIMITS two times.
6. (If necessary, press Edit Limit to access the LIMITS FRQ TIME softkey.) Press LIMITS FRQ TIME so that FRQ is underlined to select **the** frequency type of limit line, if it is not already selected.)
7. Press Edit Up/Low to create upper and lower limit lines simultaneously.
8. Press More 1 of 2 , LIMITS FIX REL so that FIX is underlined to select the fixed type of limit line (if it is not already selected.)
9. Specify the first limit-line segment by using the following key sequence:
  - SELECT **FREQ** 275 MHz
  - 60 -dBm
  - 75 -dBm
  - FLAT
10. Repeat the above step for the values listed in the following table to complete the limit-line table. (It is not necessary to repeat the SELECT FREQ softkey for successive entries.)

| Segment Number | Frequency | Upper Amplitude | Lower Amplitude | Type  |
|----------------|-----------|-----------------|-----------------|-------|
| 2              | 290 MHz   | -60 dBm         | -75 dBm         | Slope |
| 3              | 295 MHz   | -15 dBm         | -75 dBm         | Slope |
| 4              | 297 MHz   | -15 dBm         | -75 dBm         | Slope |
| 5              | 300 MHz   | -15 dBm         | -29 dBm         | Slope |
| 6              | 303 MHz   | -15 dBm         | -75 dBm         | Slope |
| 7              | 305 MHz   | -15 dBm         | -75 dBm         | Slope |
| 8              | 310 MHz   | -60 dBm         | -75 dBm         | Flat  |
| 9              | 400 MHz   | -60 dBm         | -75 dBm         | Point |

**Note** When entering a limit-line segment, the frequency, and amplitude values will be listed as asterisks (\*\*\*) until new values are entered. The new segment will be listed last until both the frequency and amplitude values have been entered. Once the frequency and at least one amplitude value are entered, the segment will be sorted into the limit-line table according to frequency.

To edit an existing segment, use SELECT SEGMENT to specify the segment. Then use SELECT FREQ , SELECT AMPLITUDE , or SELECT TYPE to specify the column that you wish to edit.

11. Press More 1 of 2 , then EDIT DONE when all values have been entered into the limit-line table.
12. Press LMT TEST ON OFF so that ON is underlined. LIMIT PASS is displayed on the spectrum analyzer screen if the measurement sweep is within the limit lines. LIMIT FAIL is displayed if the measurement sweep is not within the limit lines.

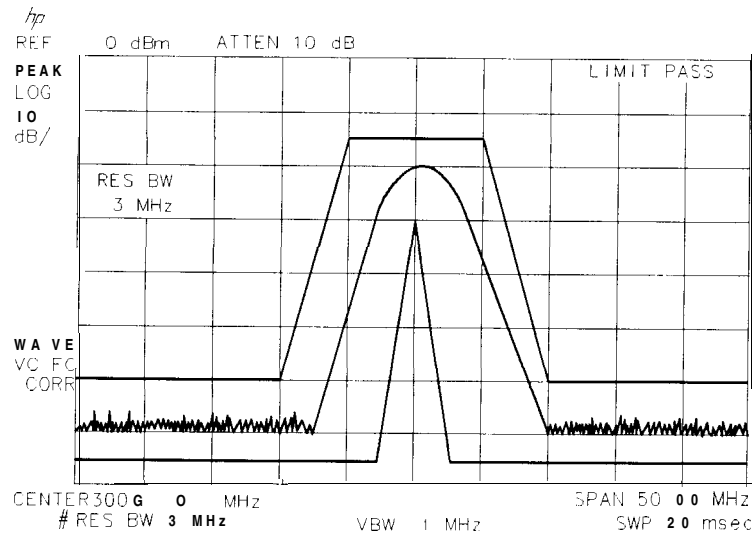

pu147e

**Figure 5-8. Upper and Lower Limit-Line Testing**

To turn the limit-line testing on and off, use LMT TEST ON OFF . Use PURGE LIMITS to clear the limit-line tables. To remove the limit lines from the display, use LMT DISP Y N AUTO . Underlining Y displays the limit lines, N turns them off, and AUTO displays them if the testing is turned on or turns them off if testing is turned off.

---

## Learn About the Analog+ Display Mode (Option 101 only)

The analog+ display mode combines traditional analog display performance with digital display benefits. Analog+ display mode gives the spectrum analyzer the look and feel of older analog displays, such as the HP 8558B, but it has the added benefit of features common to digital displays. Display features include:

- Hard-copy output directly to a printer
- Complete marker functionality such as peak search and noise readout
- Screen annotation functions such as title, linear and log scales, and graticule
- Negative peak detector (included with Option 101)

The analog+ display mode is only available on spectrum analyzers with Option 101. (It is also available with Option 301 which is a combination of 'Options 101 and 102.) Option 101 also includes a negative peak detector, useful for video modulator balance adjustments and intermodulation distortion measurements.

The analog+ display mode can be used to view interfering intermodulation products on a live television channel. It can be used to set the residual carrier level and check the linearity of a video modulator. Refer to Product Note 8590-3, HP part number 5091-2480, for more information about these measurements.

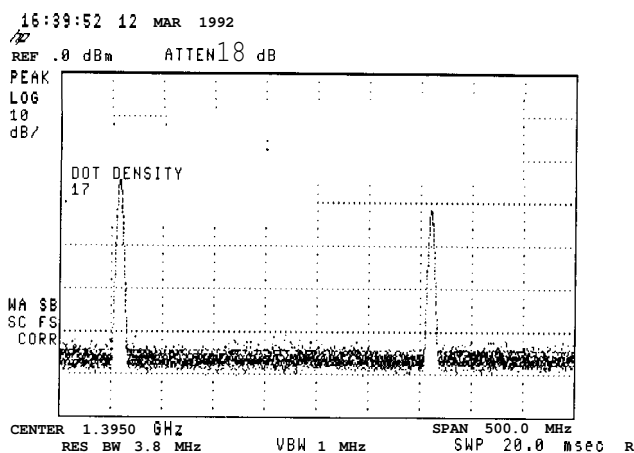

**Figure 5-9. Analog + Display Mode**

**Example:** Use the analog+ display mode to look at the calibrator signal.

1. Connect the CAL OUT signal to the spectrum analyzer INPUT 50Ω. Press **PRESET**, **FREQUENCY**, START FREQ 0 **Hz**, STOP FREQ 1.5 **GHz**.
2. **DISPLAY** and ANALOG+ ON OFF (ON) to turn on the analog+ display mode. Use the knob, step keys, or the data entry keys to change the DOT DENSITY.
3. Press **MKR** to activate a marker and use the knob to move it.
4. Press **DISPLAY**. Then press ANALOG+ ON OFF to underline OFF to turn the analog+ display off.

---

Note

displayed.

---

---

## Learn About the Windows Display

The windows display feature is only available on the HP 85913, HP 85933, HP 85943, HP 85953, and HP 85963. Windows display mode splits the spectrum analyzer display into two frequency or time displays.

When windows is first turned on, the top window will contain an inactive copy of the previous display. The lower window will be active and will display a subset of the frequency span of the upper window. The span of the lower window will be indicated on the upper window by two vertical lines called zone markers. The zone markers can be moved using the zone center and zone span softkeys to look at different portions of the upper window span.

The instrument state of the active window can be changed without affecting the state of the inactive window. The state of the active window will be used as the state of the spectrum analyzer for sweeping and updating trace data.

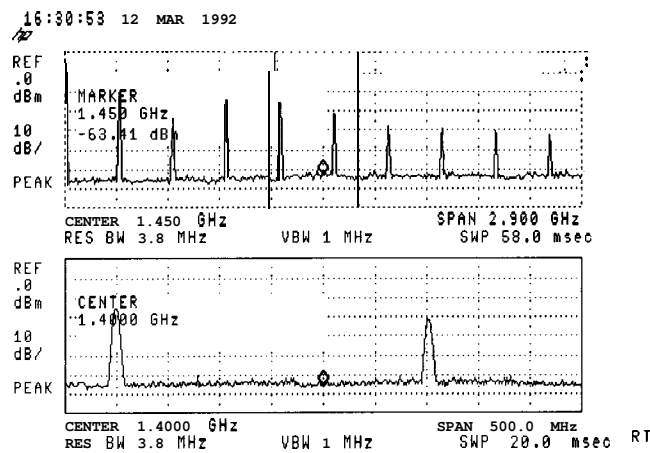

**Figure 5-10. Windows Display Mode**

**Example:** Use the windows display format to view the calibrator signal.

1. Connect the CAL OUT signal to the spectrum analyzer INPUT 500. Press **PRESET**, **FREQUENCY**, **START FREQ 0 (Hz)**, **STOP FREQ 2 (GHz)**.
2. Turn on the windows display by pressing the **WINDOWS (ON)** key. The active window is indicated by a solid line around the display, rather than a broken line. Press **ZONE CENTER** use the knob or step keys to move the zone to include one of the harmonics. Notice that the span marked by the zone markers in the upper window is shown as a full display in the lower window.

---

**Note** The upper window is not active so the trace is not updated, though the zone position is updated. The upper window must be activated by pressing **WINDOWS (NEXT)** to update the trace data.

---

3. Press **ZONE PK RIGHT**. The spectrum analyzer identifies the first signal to the right of the zone and moves the zone so that it is centered around the new signal.
4. Press **ZONE SPAN** and use the knob, step keys, or the data entry keys to change the zone span to include two signals. If the lower window is active you will notice that the span changes corresponding to the changes in the zone marked on the upper window. (If the lower window is not active press **WINDOWS (NEXT)** to make it active.)



5. Press ZONE PK RIGHT and ZONE PK LEFT and observe the movement of the **zone** and the changes in the lower window.
6. Press WINDOWS **(ZOOM)**. Now a full-sized display of the lower window will be displayed. Notice the increase in the displayed annotation.
7. Pressing WINDOWS **(NEXT)** activates the upper window. A full- sized display of it will be shown, and the inactive lower window will not be displayed. Press WINDOWS (NEXT) again to activate the lower window and display it again. Notice that the zone markers can be used to tell which window is active and being displayed while in the zoom state.
8. Press WINDOWS **(ZOOM)** to return to the dual windows display. The lower window will still be active.
9. Press WINDOWS OFF and the spectrum analyzer returns to normal operation with the active window as the spectrum analyzer state.
10. Pressing WINDOWS ION) at this point turns the windows display format on again with the current display as the new upper window. A new lower window will be generated based on the zone in the upper window.

---

|             |                                                                                                                                                                       |
|-------------|-----------------------------------------------------------------------------------------------------------------------------------------------------------------------|
| <b>Note</b> | Markers and limit lines can be used in both windows, but they must be turned on independently in each window. The current limit lines will be common to both windows. |
|-------------|-----------------------------------------------------------------------------------------------------------------------------------------------------------------------|

---

## Learn How to Enter Amplitude Correction Factors

This section provides an overview of amplitude correction, a procedure for creating amplitude-correction data, and descriptions of the amplitude-correction functions. Refer to “Key Descriptions” in Chapter 7 for more information on a specific amplitude-correction function.

Amplitude corrections provide an easy way to adjust trace data with a set of amplitude and frequency parameters while the spectrum analyzer is sweeping the measurement range. Every measurement sweep of data is adjusted by the amplitude-correction values. When using the amplitude-correction functions, an A is displayed at the left-hand side of the graticule edge.

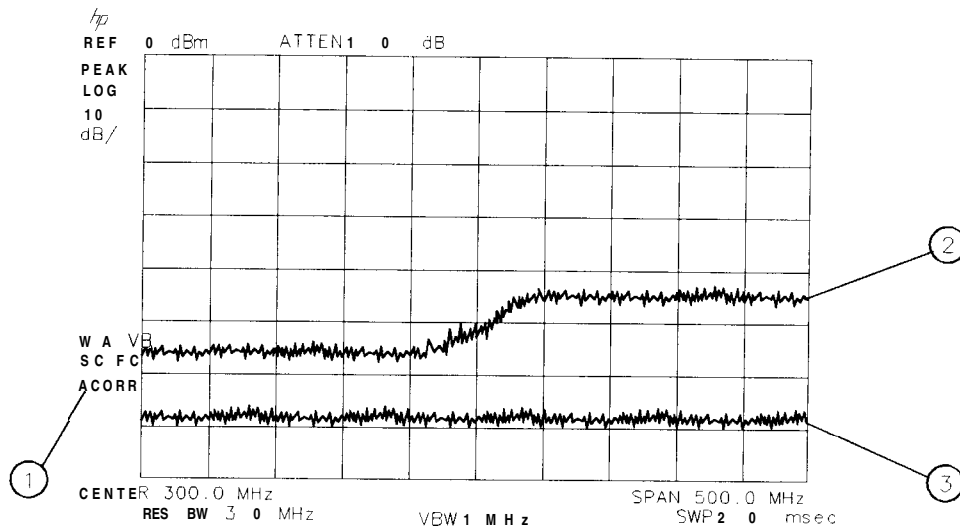

pu148e

**Figure 5-1 1. Amplitude-Correction Display**

| Item | Description of Items in Figure 5-11            |
|------|------------------------------------------------|
| 1    | Indicates amplitude-correction factors are on. |
| 2    | Amplitude corrections ON.                      |
| 3    | Amplitude corrections OFF.                     |

## Procedure for Creating Amplitude-Correction Factors

This procedure demonstrates how to create and activate amplitude-correction data. Detailed descriptions of the amplitude-correction functions follow this procedure.

1. Press **PRESET**.

---

**Note** A signal is not used in this procedure for demonstrating how to create amplitude-correction data. Disconnect any cable on the spectrum analyzer input.

---

2. Set the center frequency to 300 MHz and the span to 500 MHz by pressing:

**FREQUENCY** 300 **MHz**  
**SPAN** 500 **MHz**

3. Press (CAL), More 1 of 4, More 2 of 4, More 3 of 4, then Amp Cor to access the amplitude-correction menus.
4. Press Edit Amp Cor to access the editing menus for amplitude-correction factors.
5. To clear any existing amplitude-correction data, press PURGE AMP COR two times consecutively.

---

**Note** After pressing PURGE AMP COR the first time, the message If you are sure, press key again to purge data will appear. Pressing PURGE AMP COR a second time erases the amplitude-correction data.

---

6. Specify the first amplitude-correction point by pressing the following keys:

SELECT **FREQ**  
50 **MHz**  
12 **+dBm**

7. Specify the second amplitude-correction point by pressing the following keys:

250 **MHz**  
10 **+dBm**

---

**Note** Table entries can be edited if you make a mistake. To edit an existing point, use SELECT POINT to specify the point. Then use SELECT **FREQ** or SELECT **AMPLITUD** to specify the entry that you wish to edit.

---

8. Specify the third and fourth amplitude-correction points by using the following key sequence:

300 **MHz** 15 **+dBm**  
350 **MHz** 22 **+dBm**

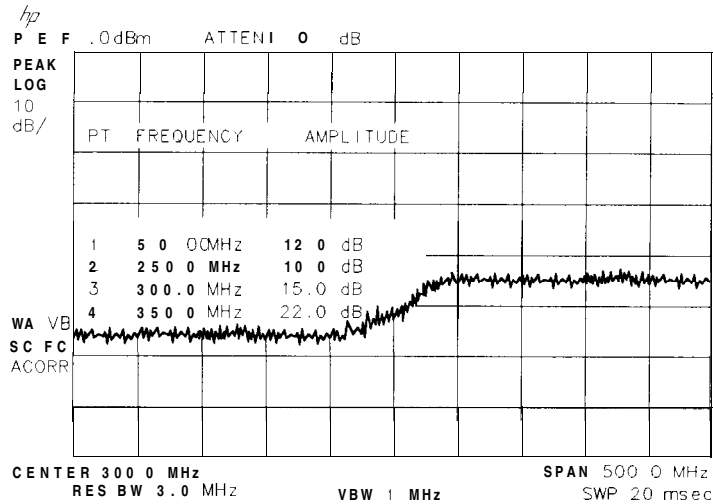

pu149e

**Figure 5-12. Completed Amplitude-Correction Table**

9. Press EDIT DONE when all the points have been entered.

Use steps 10 and 11 to display corrected versus uncorrected amplitude trace data for trace comparison.

10. Display the amplitude-corrected trace in trace A by pressing the following keys:

**TRACE**

CLEAR WRITE A

VIEW A

11. Display the uncorrected amplitude trace in trace B by pressing the following keys:

TRACE A B C until B is selected

CLEAR WRITE B

**CAL**, More 1 of 4, More 2 of 4, More 3 of 4, Amp Cor

AMP COR ON OFF until OFF is selected

## Amplitude-Correction Functions

This section describes the amplitude-correction functions in the order they are usually used.

### Editing or Viewing the Amplitude-Correction Tables

Pressing **CAL**, More 1 of 4, More 2 of 4, More 3 of 4, Amp Cor accesses the softkey menus for creating an amplitude-correction table.

---

**Note**            **(PRESET)** turns amplitude-correction factors off (if it is on), but does not clear an existing amplitude-correction table. Use **PURGE AMP COR** to clear an existing amplitude-correction table.

---

Press **Edit Amp Cor** to edit an existing amplitude-correction table or, if no amplitude-correction table currently exists, to create an amplitude-correction table.

Pressing **PURGE AMP COR** two times consecutively clears an existing amplitude-correction table.

### Selecting the Amplitude-Correction Point

Pressing **SELECT POINT** specifies the amplitude-correction point to be entered or edited. Amplitude-correction data is constructed from left to right and is created by entering frequency and amplitude values into an amplitude-correction table. The frequency and amplitude values specify a coordinate point from which amplitude-corrections are interpolated (see Figure 5-13). Up to 79 points can be specified for the amplitude-corrections table.

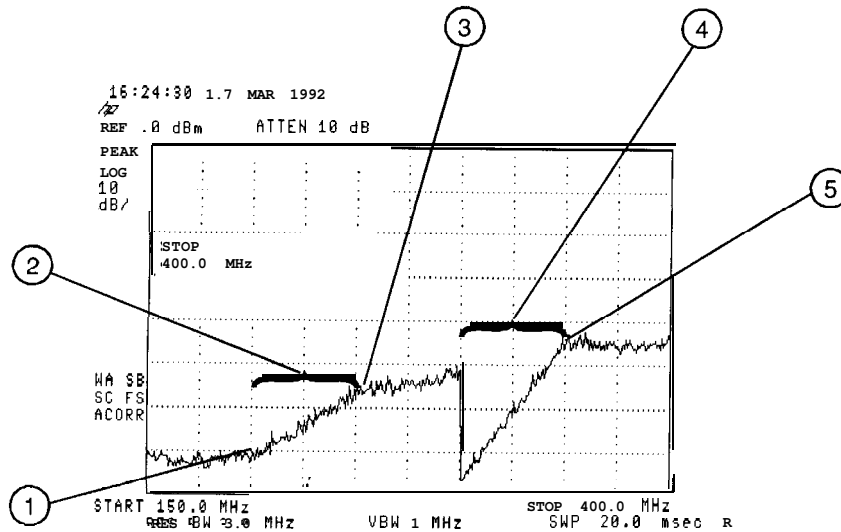

**Figure 5-13. Amplitude-Correction Points**

| Item | Description of Items in Figure 5-13                                |
|------|--------------------------------------------------------------------|
| 1    | Frequencies below first point use first amplitude level.           |
| 2    | First segment interpolated with the 10 dB amplitude level.         |
| 3    | Frequency and amplitude coordinate that starts the second segment. |
| 4    | Third segment interpolated with the - 10 dB amplitude level.       |
| 5    | Frequency and amplitude coordinate that starts the fourth segment. |

## Selecting the **Frequency** Coordinate

Press SELECT FREQ , then enter a frequency value for the point.

---

**Note** Only two entries per frequency are used. If more points with the same frequency are entered, only the first and last entries are used. All other amplitude values are ignored. See Figure 5-13 for an example of two entries at the same frequency.

---

---

**Note** When entering amplitude-correction data, the frequency and amplitude values will be listed as asterisks (\*\*\*) until new values are entered. Once the frequency value is entered, the segment is immediately sorted into the table according to this value.

---

## Selecting the Amplitude Coordinate

The amplitude value is entered by pressing SELECT AMPLITUD , entering an amplitude value, and pressing a units key.

---

**Note** Frequency or amplitude values that are not within range will be modified. For example, a frequency value of 60 GHz will be modified to 30 GHz.

---

## Completing **Table** Entry and Activating Amplitude Corrections

Pressing EDIT DONE blanks the amplitude-correction table from the screen and accesses the menu with AMP COR ON OFF.

Pressing AMP COR ON OFF turns the amplitude corrections on and off.

## Saving or Recalling Amplitude Correction **Tables**

Pressing Amp Cor under the **DISPLAY** key accesses SAVE AMP COR and RECALL AMP COR . These softkey functions provide an easy way to save or recall current amplitude-correction tables. SAVE AMP COR saves the current amplitude-correction table in the current mass storage device (spectrum analyzer memory or memory card). To determine the current mass storage device, press SAVE AMP COR . If MAX REG # appears on the spectrum analyzer display, the current mass storage device is analyzer memory. If PREFIX= is displayed, the memory card is the mass storage device. (Press **SAVE** or **RECALL**, INTERNAL CARD to change the current mass storage device.) Press SAVE AMP COR , enter a register number, then press **ENTER** to save the current amplitude-correction table in spectrum analyzer memory or on the memory card.

RECALL AMP COR recalls amplitude-correction tables from the current mass storage device (spectrum analyzer memory or memory card). To determine the current mass storage device, press RECALL AMP COR . If MAX REG # appears on the spectrum analyzer display, the current mass storage device is analyzer memory. If PREFIX= is displayed, the memory card is the mass storage device. (Press **SAVE** or **RECALL**, INTERNAL CARD to change the current mass storage device.) When recalling an amplitude-correction table from the memory card, it is necessary that the current prefix match the prefix that the table was originally stored with. Use Change Prefix to change the current prefix. To recall an amplitude-correction table, enter the register number that the table was saved under, then press **ENTER**.

---

## External Keyboard

The HP C1405B keyboard with an HP C140560015 Adapter, is an IBM AT compatible keyboard that can be connected to the external keyboard connector on the rear panel of the spectrum analyzer (Options 041 or 043 only). The external keyboard allows a convenient way to enter screen titles and remote programming commands directly into the spectrum analyzer or to access the softkey functions. Detailed information on using the external keyboard can be found in the *HP 8590 E-Series and L-Series Spectrum Analyzer and HP 8591 C Cable TV Analyzer Programmer's Guide*.

Options 041 or 043 provide the capability to control your spectrum analyzer from a computer that uses either an HP-IB (Option 041) or RS-232 (Option 043) interface bus.

The function keys of the external keyboard control the spectrum analyzer as follows:

**Table 5-8. External Keyboard Functions**

| Key                 | Description                                                       |
|---------------------|-------------------------------------------------------------------|
| F1-F6               | Softkeys 1 through 6 (respectively) of the current analyzer menu. |
| F7                  | Enter prefix mode.                                                |
| F8                  | Enter remote commands mode.                                       |
| F9                  | Accesses the <b>FREQUENCY</b> menu.                               |
| F10                 | Accesses the (SPAN) menu.                                         |
| F11                 | Accesses the <b>AMPLITUDE</b> menu.                               |
| F12                 | Retrieves the present screen title for editing.                   |
| <b>ESC</b>          | Accesses the enter title mode.                                    |
| <b>PRINT SCREEN</b> | Copies the analyzer screen display to the active copy device.     |
| <b>PAUSE</b>        | Accesses the DLP Editor and redefines F7–F12.                     |

**Table 5-8. External Keyboard Functions (continued)**

| Key                                                                                 | Description                                                   |
|-------------------------------------------------------------------------------------|---------------------------------------------------------------|
| <b>DELETE</b>                                                                       | Deletes the character over the cursor.                        |
| <b>INSERT</b>                                                                       | Toggles between the insert and replace mode at the cursor.    |
| <b>BACKSPACE</b>                                                                    | Erases the previous character to the left of the cursor.      |
| <b>ALT-DELETE</b> *                                                                 | Clears the keyboard line.                                     |
| <b>CTRL-DELETE</b> *                                                                | Clears to end of line.                                        |
| <b>◀</b>                                                                            | Moves the cursor to the left.                                 |
| <b>▶</b>                                                                            | Moves the cursor to the right.                                |
| <b>▼</b>                                                                            | Moves from later items to earlier items in the recall buffer. |
| <b>▲</b>                                                                            | Moves from earlier items to later items in the recall buffer. |
| <b>CTRL-C</b> *                                                                     | End-of-text.                                                  |
| <b>CTRL-J</b> *                                                                     | Line feed.                                                    |
| <b>CTRL-M</b> *                                                                     | Carriage return.                                              |
| <b>CTRL-N</b> *                                                                     | Turns on inverse video.                                       |
| <b>CTRL-O</b> *                                                                     | Turns enhancements (inverse video, underlining) off.          |
| <b>CTRL-P</b> *                                                                     | Turns on underlining.                                         |
| <b>CTRL-⏏</b> *                                                                     | Escape.                                                       |
| *The dash between keys indicates that both keys should be pressed at the same time. |                                                               |

The external keyboard operation with the spectrum analyzer is similar to its operation with a computer except for the following:

SCROLL LOCK and NUM LOCK are fixed and cannot be changed. Pressing **NUM LOCK** displays the keyboard mode on the spectrum analyzer screen. The analyzer will not recognize the control characters or function keys.

The keyboard supports a 244 character recall buffer. The longest single item is limited to 243 characters; subsequent characters are ignored. Using the **▲** or **▼** keys of the external keyboard to recall an item does not change the buffer contents. Recalling an item and then pressing the **ENTER** key does not store a new copy of the item in the recall buffer. If an item is recalled and then modified, a new copy will be made in the recall buffer. Adding new data into the keyboard line deletes the oldest data automatically.

When in command mode, the active line will append a semicolon to the keyboard entry if the line does not end with a semicolon and it is fewer than 243 characters long.



## Using the External Keyboard

The following three example procedures demonstrate how to use an external keyboard to enter a screen title, programming commands, and a prefix. However, a brief procedure on installing your external keyboard is described first. More detailed information on using the external keyboard is found in the ***HP 8590 E-Series and L-Series Spectrum Analyzer and HP 8591 C Cable TV Analyzer Programmer's Guide***.

### External Keyboard Installation

1. Turn off the spectrum analyzer.

---

**Caution** The spectrum analyzer ***must*** be turned off before connecting an external keyboard to the spectrum analyzer. Failure to do so may result in loss of factory-installed correction constants.

---

2. Connect the HP C1405B keyboard cable to the spectrum-analyzer rear-panel connector EXT KEYBOARD using the HP C1405-60015 adapter.
3. Press (LINE) to turn the spectrum analyzer on.
4. The external keyboard is now ready to use for entering a screen title, programming commands, or a prefix.

### To Enter a Screen Title

Refer to the ***HP 8590 E-Series and L-Series Spectrum Analyzer and HP 8591 C Cable TV Analyzer Programmer's Guide*** for more information.

1. Press (ESC) to enter the title mode.
2. Type in a screen title using the external keyboard. The entry appears at the top line of the spectrum analyzer display as it is entered.
3. Press (ENTER) on the external keyboard. Pressing (ENTER) moves the characters to the position on the display for screen title annotation.

---

**Note** To view more than 31 characters per line, turn off the time and date display by pressing the following keys: (CONFIG), TIMEDATE, TIMEDATE ON OFF (OFF).

---

### To Enter Programming Commands

Refer to the ***HP 8590 E-Series and L-Series Spectrum Analyzer and HP 8591C Cable TV Analyzer Programmer's Guide*** for more information.

1. Press **(F8)** on the external keyboard to enter the mode for executing remote commands.
2. Type in a programming command (for example, type IP).
3. Press **(ENTER)** on the external keyboard to execute the command.

---

**Note** Unlike entering a remote programming command using an external controller, entering the remote programming commands with the external keyboard does not require including the spectrum analyzer address. It is also not necessary to terminate the programming line with a semicolon. However, semicolons are necessary for separating the programming commands. For example, a program line is entered via the external controller as: OUTPUT 718; "CF 300MHZ; SP 1MHZ; ". The same program line is entered using the external keyboard as: CF 300MHZ;SP 1MHZ; **(ENTER)**.

---

After **(F8)** is pressed, the spectrum analyzer remains in command mode. To return to the title entry mode, press **(ESC)** (on the external keyboard).

### To Enter a Prefix

Refer to the ***HP 8590 E-Series and L-Series Spectrum Analyzer and HP 8591C Cable TV Analyzer Programmer's Guide*** for more information.

1. Press **(F7)** on the external keyboard to enter the mode for entering a prefix.
2. Type in the prefix.
3. Press **(ENTER)** on the external keyboard.

## Printing and Plotting

---

You may obtain a permanent record of data displayed on the spectrum analyzer screen by using the (copy) key of the spectrum analyzer, and a printer or plotter.

This chapter describes how to print or plot the results displayed on your spectrum analyzer screen. There are three different interfaces used for this purpose:

- HP-IB
- RS-232
- Parallel

---

### Printing or Plotting with HP-IB

More than one instrument can communicate on the same HP-IB. Therefore, each device must have a unique HP-IB address. This means that both a printer and a plotter can be connected to the spectrum analyzer at the same time (using two or more HP-IB cables).

The printer must be configured with an address which can be recognized by the spectrum analyzer.

The spectrum analyzer will not print if it senses another controller on the HP-IB. Therefore, other controllers, such as computers, must be disabled. In most cases, it is sufficient to simply turn the other controllers **OFF**.

# PRINTER....

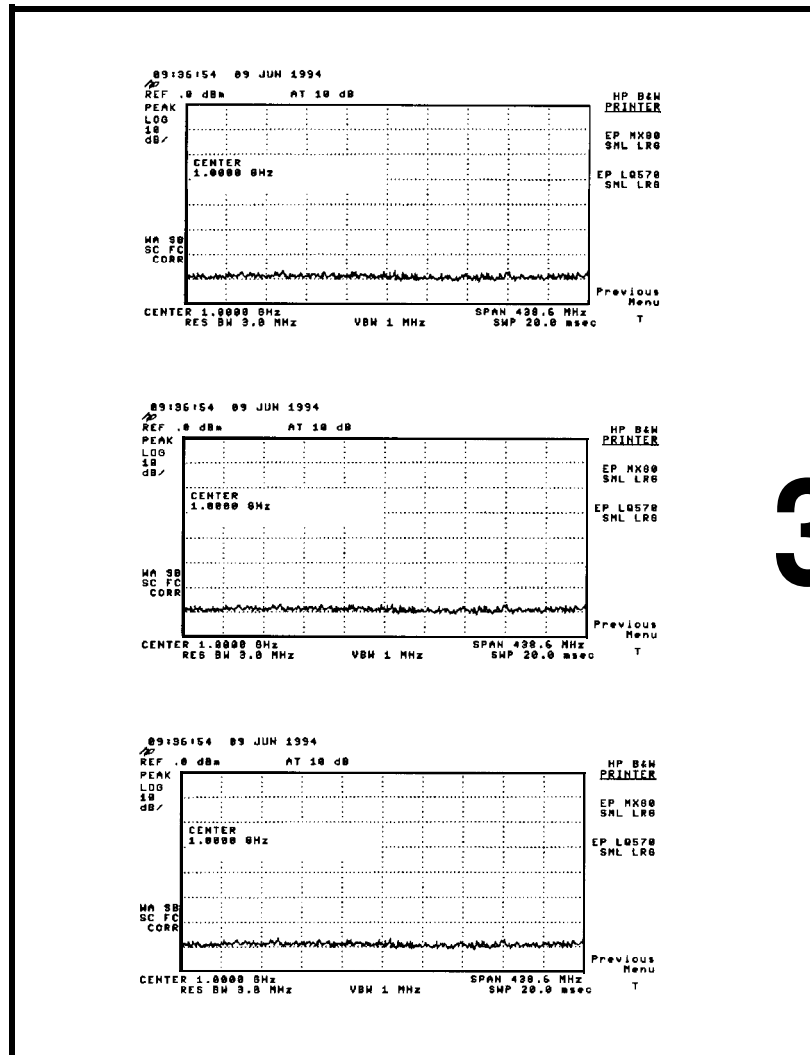

**3** per page

pu121e1

**Figure 6-1. Three Printouts Per Page**

Selecting any Hewlett-Packard printer results in three printouts per page before form feeding the page. One printout per page can be accomplished by manually form feeding each printout. This is done by pressing either the **FORM FEED** hard key on the printer or the **PRINTER SETUP** soft key under the **CONFIG** hard key on the analyzer.

# PLOTS...

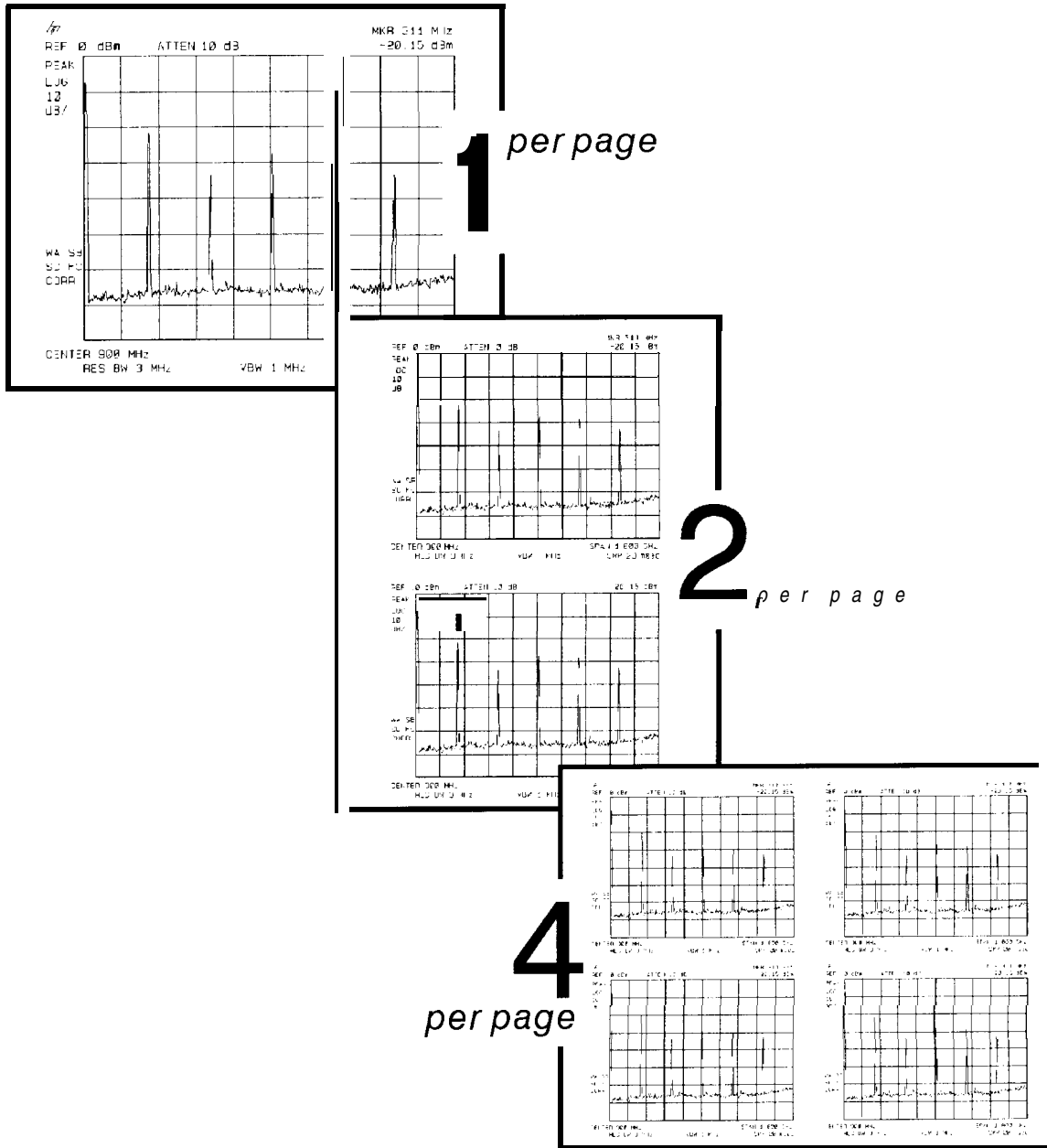

pu120e1

**Figure 6-2. Plots Per Page**

The PLTS/PG 1 2 4 softkey under **CONFIG**, Plot Config, allows you to select 1, 2, or 4 plots per page.

## Printing Using an HP-IB Interface

### Equipment

- HP 8590 Series spectrum analyzer equipped with Option 041.
- HP 10833A (or equivalent) HP-IB cable.
- Printer with HP-IB Interface, choose one of the following:
  - HP 2225A ThinkJet
  - HP 3630A PaintJet
  - HP 500 Series\* DeskJet (with HP-IB to Centronics converter) †
  - HP 310\* Portable DeskJet (with HP-IB to Centronics converter) †
  - HP LaserJet (with HP-IB to Centronics converter) †
  - MX-80 Epson (with HP-IB to Centronics converter) †
  - LQ-570 Epson (with HP-IB to Centronics converter) †

\* Some models support color printing.

† Part number HP ITEL-45CHVU, US and Canada, and Part number HP ITEL-45CHVE, international.

### Interconnection and Printing Instructions

1. Turn off the printer and the spectrum analyzer.
2. Connect the printer to **the** spectrum analyzer using **the** HP-IB cable.
3. The printer usually resides at device address 1. See figure Figure 6-3 for a typical HP-IB printer switch setup.

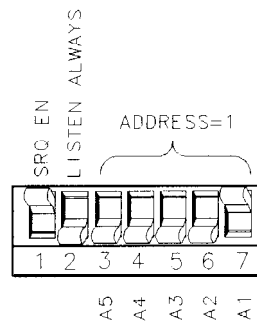

pu129e1

**Figure 6-3. ThinkJet Printer Switch Settings**

If using the HP-IB to centronics converter, connect it and set the switches as shown in Figure 6-4. The HP-IB to centronics converter must be powered up *after* the switches are set.

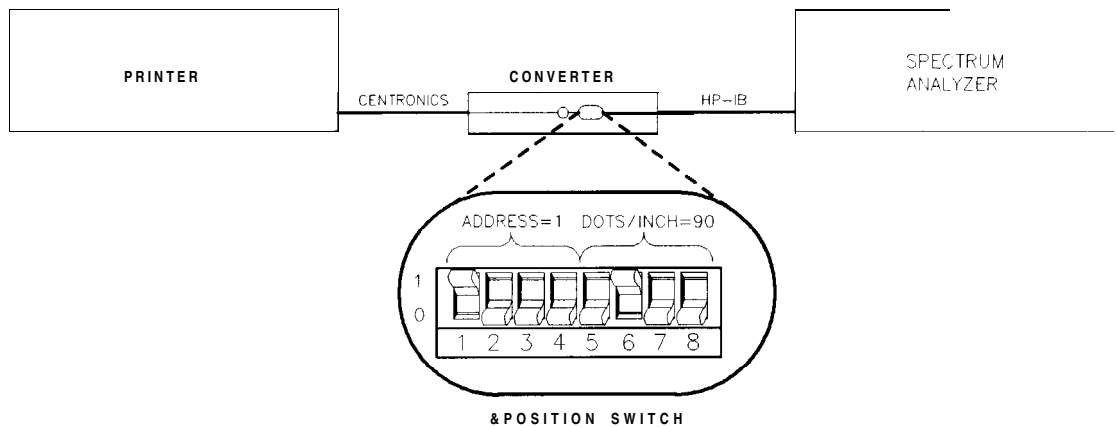

pu114el

**Figure 6-4. HP-IB to Centronics Converter Setup**

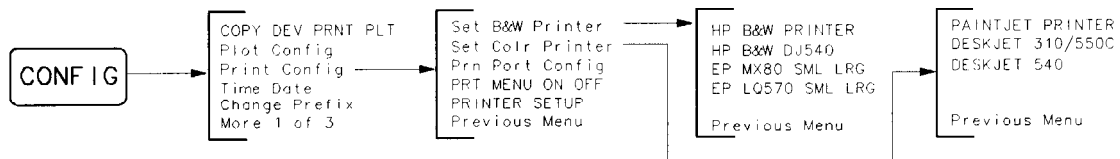

pu130el

**Figure 6-5. Printer Configuration Menu Map**

- Turn on the spectrum analyzer and printer. If using the HP-IB to centronics converter, connect its power cable.
- The printer usually resides at device address 1. To configure the spectrum analyzer to print to address 1, press:

**CONFIG** Press this key to access the configuration menu.  
**Print Config** Press this key to access the print menu.  
**Pm Port Config** Press this key to access the print configure menu.  
**PRN PORT HPIB PAR** (so that HPIB is underlined)

PRINTER ADDRESS

1

**Hz**

- Referring to Figure 6-5, select the printer configuration for your spectrum analyzer by pressing the appropriate keys:

**CONFIG** Press this key to access the configuration menu.  
**Print Config** Press this key to access the print configure menu.

|                   |                                                                                                                                                                                                                                                                                                                                                                                                                                         |
|-------------------|-----------------------------------------------------------------------------------------------------------------------------------------------------------------------------------------------------------------------------------------------------------------------------------------------------------------------------------------------------------------------------------------------------------------------------------------|
| PRINTER SETUP     | Press this key to send a PRINTER RESET command to the printer. This will cause a form feed if any data has been sent to the printer since the last form feed.                                                                                                                                                                                                                                                                           |
| Set Colr Printer  | Press if connected to a Hewlett-Packard compatible color printer, then select the appropriate printer.<br><br>Selecting any Hewlett-Packard printer results in three printouts per page. After three printouts the page will be in position to start again at the top of the page if the printer's perforation skip is <b>OFF</b> (see Figure 6-1).<br><br>One printout per page can be achieved by manually formfitting each printout. |
| Set B&W Printer   | Press this key to print in black and white, then select appropriate printer mode.                                                                                                                                                                                                                                                                                                                                                       |
| HP B&W PRINTER    | Press this key if the spectrum analyzer is connected to a Hewlett-Packard compatible printer.<br><br>Selecting any Hewlett-Packard printer results in three printouts per page. After three printouts the page will be in position to start again at the top of the page if the printer's perforation skip is <b>OFF</b> (see Figure 6-1).<br><br>One printout per page can be achieved by manually formfitting each printout.          |
| HP B&W DJ540      | Press this key if the spectrum analyzer is connected to a Hewlett-Packard DeskJet 540 printer.                                                                                                                                                                                                                                                                                                                                          |
| EP MX80 SML LRG   | Press this key if the spectrum analyzer is connected to a MX-80 Epson or other compatible 9-pin print-head printer.<br><br>Pressing this key to underline SML will allow two printouts per page and will print softkey labels if desired (see PRT MENU ON OFF ).<br>Pressing this key to underline LRG will allow only one printout per page and will not print the softkey labels.                                                     |
| EP LQ570 SML LRG  | Press this key if the spectrum analyzer is connected to a LQ-570 Epson or other compatible 24-pin print-head printer.<br><br>Pressing this key to underline SML will allow two printouts to a page and will print softkey labels if desired (see PRT MENU ON OFF ).<br><br>Pressing this key to underline LRG will allow only one printout per page and will not print the softkey labels.                                              |
| PRT MENU ON OFF   | Press this key so that ON is underlined to print the softkey labels with the spectrum analyzer printout.<br><br>This function is operational for Epson compatible printers only when SML is underlined.                                                                                                                                                                                                                                 |
| COPY DEV PRNT PLT | Press this key so PRNT is underlined.                                                                                                                                                                                                                                                                                                                                                                                                   |
| <b>COPY</b>       | Press this key to copy the spectrum analyzer display to the printer.                                                                                                                                                                                                                                                                                                                                                                    |



## Plotting Using an HP-IB Interface

### Equipment

- HP 8590 Series spectrum analyzer with Option 041.
- HP 10833A (or equivalent) HP-IB cable.
- Any of the following plotters:
  - HP 7440A ColorPro plotter with HP-IB
  - HP 7475A plotter with HP-IB
  - HP 7550A/B plotter with HP-IB

### Interconnection and Plotting Instructions

More than one instrument can communicate on the same HP-IB. Therefore, each device must have a unique HP-IB address. This means that both a printer and a plotter can be connected to the spectrum analyzer at the same time (using two or more HP-IB cables).

The plotter must be configured with an address which can be recognized by the spectrum analyzer.

The spectrum analyzer will not print if it senses another controller on the HP-IB. Therefore, other controllers, such as computers, must be disabled. In most cases, it is sufficient to simply turn the other controllers **OFF**.

1. Turn off the plotter and the spectrum analyzer.
2. Connect the plotter to the spectrum analyzer using the HP-IB cable.
3. Figure 6-6 shows an example of a typical plotter's switch setting.

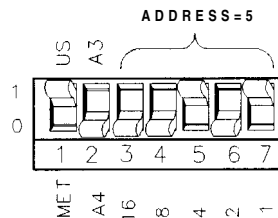

00131e1

Figure 6-6. HP 7475A Plotter Switch Settings

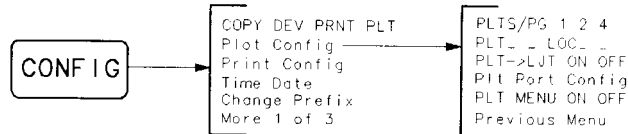

pu132e1

**Figure 6-7. Plot Configure Menu**

4. Turn on the spectrum analyzer and the plotter.
5. The plotter usually resides at device address 5. To configure the plotter address to 5 on the spectrum analyzer, press:

**CONFIG** Press this key to access the configuration menu.

Plot Config Press this key to access the plotter menu.

Plt Port Config Press this key to access the plotter configuration menu.

PLT PORT HPIB PAR (so that HPIB is underlined)

PLOTTER ADDRESS

5

6. Referring to Figure 6-7 select the plotter configuration for your spectrum analyzer by pressing the appropriate keys:

**CONFIG** Press this key to access the configuration menu.

Plot Config Press this key to access the plotter configuration menu,

PLTS/ PG 1 2 4 Press this key to underline the number of plots per page desired. Choose 1, 2, or 4 plots per page (see Figure 6-2).

PLT    
 LOC \_ Press this key to select the location on the paper for the plotter output. The upper and lower sections of the softkey label graphically represent where the plotter output will be located.

Press the softkey until the rectangular marker is in the desired section of the softkey label.

PLT  \_   
 LOC \_ \_ Press this key to select the location on the paper for the plotter output. The quadrant of the softkey label graphically represents where the plotter output will be located.

Press the softkey until the rectangular marker is in the desired section of the softkey label.

COPY DEV PRNT PLT Press this key so that PLT is underlined.

PLT->LJT ON OFF **Make sure that OFF is underlined unless you are plotting to a laserjet.**

**COPY** Press this key to copy the spectrum analyzer display to the plotter.

For a multi-pen plotter, the pens of the plotter draw the different components of the screen as follows:

| <b>Pen Number</b> | <b>Description</b>                                      |
|-------------------|---------------------------------------------------------|
| 1                 | Draws the annotation and graticule.                     |
| 2                 | Draws trace A.                                          |
| 3                 | Draws trace B.                                          |
| 4                 | Draws trace C and the display line.                     |
| 5                 | Draws user-generated graphics and the lower-limit line. |
| 6                 | Draws the upper-limit line.                             |

---

## Printing or Plotting with RS-232

### Printing Using an RS-232 Interface

This section describes how to print using an RS-232 interface. It is critical that the printer and spectrum analyzer be configured to be compatible with each other. Particular attention should be paid to:

|                |                        |
|----------------|------------------------|
| Character Size | 8-Bits                 |
| Parity         | OFF                    |
| Baud Rate      | 9600 (typical)         |
| Handshaking    | DTR= YES, DUPLEX= FULL |

### Equipment

- HP 8590 Series spectrum analyzer with Option 043 (RS-232 interface).
- One of the following cables:
  - HP 24542G 9-25 pin RS-232 cable
  - I HP C2932A 9-9 pin RS-232 cable (For use with LaserJet 4P and 4Plus)
- Printer with RS-232 interface, choose one of the following:
  - HP 500 Series\* DeskJet
  - HP 2225D ThinkJet
  - HP 3630A PaintJet
  - MX-80 Epson
  - LQ-570 Epson
  - HP LaserJet
  - HP QuietJet or QuietJet Plus

\* Some models support color printing. Some models do not support the RS-232 interface.

### Interconnection and Printing Instructions

The RS-232 interface allows only one device to be connected to the spectrum analyzer. Refer to the programmer's guide for more information on RS-232 protocol.

1. Turn off the spectrum analyzer and the printer.
2. Connect the printer using an RS-232 cable.

Figure 6-8 shows examples of some of the printers configuration switches set up for 9600 baud. See your printer's documentation for more specific information.

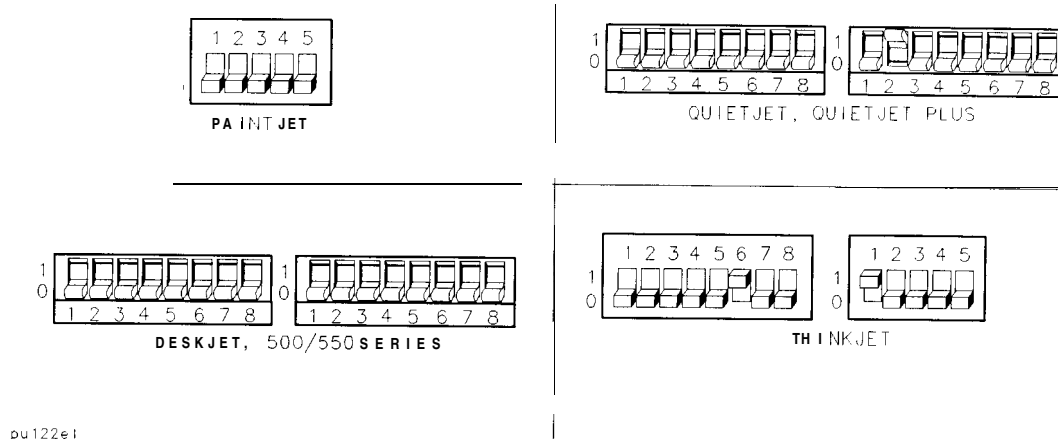

**Figure 6-8. 9600 Baud Settings for Serial Printers**

To set the spectrum analyzer baud rate to 9600, press:

**CONFIG**

Print Config

Pm Port Config

PRN PORT SER PAR (so that SER is underlined)

BAUD RATE

9600

**Hz**

To set the spectrum analyzer baud rate to 1200, press:

**CONFIG**

Print Config

Pm Port Config

PRN PORT SER PAR (so that SER is underlined)

BAUD RATE

1200

**Hz**

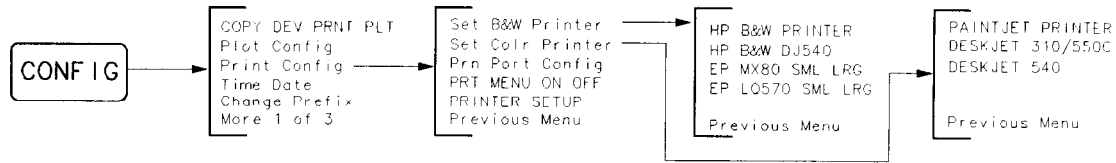

pu130e1

**Figure 6-9. Printer Configure Menu**

- Referring to Figure 6-9 select the printer configuration for your spectrum analyzer by pressing the appropriate keys:

**CONFIG**

Press this key to access the configuration menu.

**Print Config**

Press this key to access the printer configuration menu.

**PRINTER SETUP**

Press this key to send a PRINTER RESET command to the printer. This will cause a form feed if any data has been sent to the printer since the last form feed.

**Set Colr Printer**

Press this key to print in color if the spectrum analyzer is connected to a Hewlett-Packard compatible color printer, then select the appropriate printer.

Selecting any Hewlett-Packard printer results in three printouts per page. After three printouts the page will be in position to start again at the top of the page if the printer's perforation skip is **OFF** (see Figure 6-1).

One printout per page can be achieved by manually formfitting each printout.

**Set B&W Printer**

Press this key to print in black and white, then select appropriate printer mode.

**HP B&W PRINTER**

Press this key if the spectrum analyzer is connected to a Hewlett-Packard compatible printer.

Selecting any Hewlett-Packard printer results in three printouts per page. After three printouts the page will be in position to start again at the top of the page if the printer's perforation skip is **OFF** (see Figure 6-1).

One printout per page can be achieved by manually formfitting each printout.

**HP B&W DJ540**

Press this key if the spectrum analyzer is connected to a Hewlett-Packard DeskJet 540 printer.

**EP MX80 SML LRG**

Press this key if the spectrum analyzer is connected to a MX-80 Epson or other compatible 9-pin print-head printer.

Pressing this key to underline SML will allow two printouts per page and will print softkey labels if desired (see PRT MENU ON OFF ).

Pressing this key to underline LRG will allow only one printout per page and will not print the softkey labels.

- EP LQ570 SML LRG Press this key if the spectrum analyzer is connected to an LQ-570 Epson or other compatible 24-pin print-head printer.  
Pressing this key to underline SML will allow two printouts per page and will print softkey labels if desired (see PRT MENU ON OFF ).  
This function is operational for Epson compatible printers only when SML is underlined.
- PRT MENU ON OFF Press this key so that ON is underlined to print the softkey labels with the spectrum analyzer printout. This function is operational only when SML is underlined for the Epson compatible printers.
- COPY DEV PRNT PLT Press this key so PRNT is underlined.
- COPY** Press this key to copy the spectrum analyzer display to the printer.

## Plotting Using an RS-232 Interface

This section describes how to plot using an RS-232 interface. It is critical that the plotter and the spectrum analyzer be configured to be compatible with each other. Particular attention should be paid to:

|                |                      |
|----------------|----------------------|
| Character Size | 8-Bits               |
| Parity         | OFF                  |
| Baud Rate      | 1200 (typical)       |
| Handshaking    | DTR=YES, DUPLEX=FULL |

### Equipment

- HP 8590 Series spectrum analyzer with Option 043.
- HP 24542G 9-25 pin RS-232 cable
- HP C2932A 9-9 pin RS-232 cable (for use with LaserJet 4P and 4Plus.)
- Any of the following Plotters:
  - HP 7440A ColorPro plotter with an RS-232 interface.
  - HP 7475A plotter with an RS-232 interface.
  - HP 7550A/B plotter with an RS-232 interface.

### Interconnection and Plotting Instructions

The RS-232 interface allows only one device to be connected to the spectrum analyzer. Refer to the programmer's guide for more information on RS-232 protocol.

1. Turn off the spectrum analyzer and plotter.
2. Connect the plotter to the spectrum analyzer using an RS-232 cable.



If you are connecting an HP 7550A/B plotter you will need to use the 92224F (f-f) gender changer as shown in Figure 6-10.

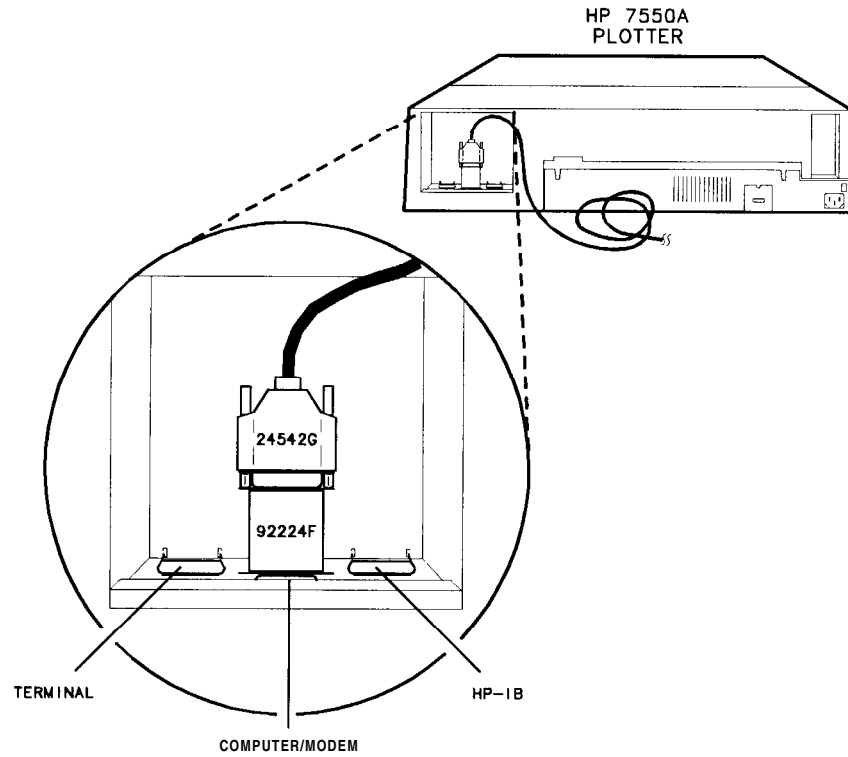

pu137e1

**Figure 6-10. Connecting the HP 7550A/B Plotter**

3. Turn on the spectrum analyzer and the plotter.
4. Set the spectrum analyzer baud rate (see Figure 6-11). To set the spectrum analyzer baud rate to 1200 baud, press:

```

CONFIG
Plot Config
Plt Port Config
PLT PORT SER PAR (so that SER is underlined)
BAUD RATE
1200
Hz
  
```

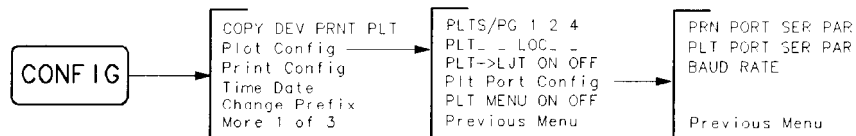

pu134e1

**Figure 6-1 1. Baud Rate Menu Map**

- Set **the** baud rate on your plotter. Depending on the model, it may need to be **OFF** to set the baud rate. Refer to your plotter's documentation.

If you have an HP 7550A/B plotter, you need to configure it as follows:

|           |                                   |
|-----------|-----------------------------------|
| MODE      | STANDARD SERIAL (not ENHANCED)    |
| DATA FLOW | REMOTE STANDALONE (not EAVESDROP) |
| BYPASS    | ON or OFF (don't care)            |
| HANDSHAKE | HARDWARE/DIRECT                   |
| PARITY    | 8-BITS/OFF                        |
| BAUD RATE | 1200 (it will work at 9600)       |
| DUPLEX    | FULL                              |

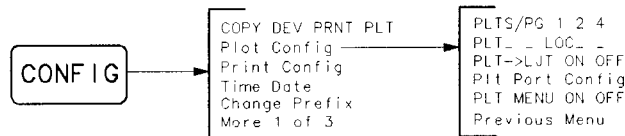

pu132e1

**Figure 6-12. Plot Configure Menu**

- Referring to Figure 6-12 select **the** plotter configuration for your spectrum analyzer by pressing the appropriate keys:

|                                |                                                                                                                                                                                                                                                                                                                                                               |
|--------------------------------|---------------------------------------------------------------------------------------------------------------------------------------------------------------------------------------------------------------------------------------------------------------------------------------------------------------------------------------------------------------|
| <b>CONFIG</b>                  | Press this key to access the configuration menu.                                                                                                                                                                                                                                                                                                              |
| Plot Conf ig                   | Press this key to access the plotter configuration menu.                                                                                                                                                                                                                                                                                                      |
| PLTS/ PG 1 2 4                 | Press this key to underline <b>the</b> number of plots per page desired. Choose 1, 2, or 4 plots per page (see Figure 6-2).                                                                                                                                                                                                                                   |
| PLT <input type="checkbox"/>   | If two plots per page are <b>chosen</b> , this function allows you to select the location on the paper for the plotter output. The upper and lower sections of <b>the</b> softkey label graphically represent where the plotter output will be located.<br><br>Press the softkey until the rectangular marker is in the desired section of the softkey label. |
| LOC _                          |                                                                                                                                                                                                                                                                                                                                                               |
| PLT <input type="checkbox"/> _ | If four plots per page are chosen, this function allows you to select the location on the paper for the plotter output. The quadrant of the softkey label graphically represents where the plotter output will be located.                                                                                                                                    |
| LOC _ _                        |                                                                                                                                                                                                                                                                                                                                                               |
| COPY DEV PRNT PLT              | Press this key so that PLT is underlined.                                                                                                                                                                                                                                                                                                                     |
| PLT->LJT ON OFF                | <b>Make sure that OFF is underlined unless you are plotting to a laserjet.</b>                                                                                                                                                                                                                                                                                |
| <b>COPY</b>                    | Press this key to copy <b>the</b> spectrum analyzer display to the plotter.                                                                                                                                                                                                                                                                                   |

For a multi-pen plotter, the pens of the plotter draw the different components of the screen as follows:

| <b>Pen Number</b> | <b>Description</b>                                      |
|-------------------|---------------------------------------------------------|
| 1                 | Draws the annotation and graticule.                     |
| 2                 | Draws trace A.                                          |
| 3                 | Draws trace B.                                          |
| 4                 | Draws trace C and the display line.                     |
| 5                 | Draws user-generated graphics and the lower-limit line. |
| 6                 | Draws the upper-limit line.                             |

### Printing after Plotting or Plotting after Printing

Pressing **COPY** without changing COPY DEV PRNT PLT produces the function last entered (a print or a plot).

To print **after** plotting, press:

**CONFIG**

COPY DEV PRNT PLT (so that PRNT is underlined)

**COPY**

To plot after printing, press:

**CONFIG**

COPY DEV PRNT PLT (so that PLT is underlined)

**COPY**

---

## Printing With a Parallel Interface

This section describes how to print using a parallel interface.

### Equipment

- HP 8590 Series spectrum analyzer equipped with Options 041 or 043 (parallel interface),
- HP C2950A parallel printer cable.
- Printer with parallel interface, choose one of the following:
  - HP 2225C ThinkJet
  - HP 310\* Portable DeskJet
  - HP 3630A PaintJet
  - HP 500 Series\* DeskJets
  - HP LaserJet
  - HP QuietJet or QuietJet Plus
  - LQ-570 Epson
  - MX-80 Epson

\* Some models support color printing.

### Interconnection and Printing Instructions

1. Turn off the printer and the spectrum analyzer.
2. Connect the printer to the spectrum analyzer using the parallel printer cable.
3. If your printer has configuration switches, now is the time to set them. See Figure 6-13 or refer to your printer's documentation for more specific information on your printer's configuration.
4. Turn on the spectrum analyzer and printer.

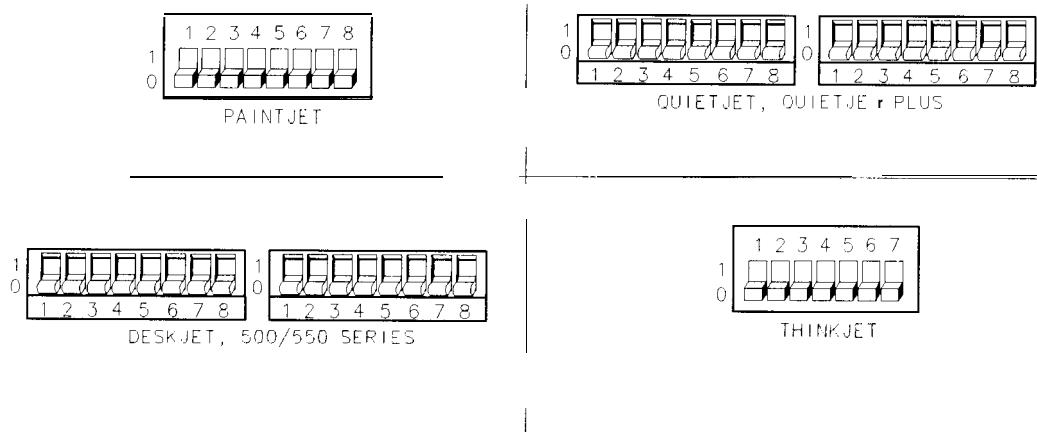

**Figure 6-13. Parallel Printer Switch Settings**

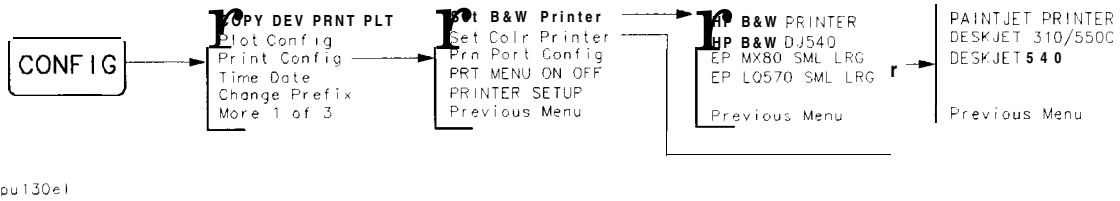

**Figure 6-14. Printer Configuration Menu Map**

5. To print with a parallel interface press the following keys:

- CONFIG** Press this key to access the configuration menu.
- Print Config** Press this key to access the printer menu.
- Pm Port Config** Press this key to access the printer configuration menu.
- PRN PORT HPIB PAR** (for Option 041, so that PAR is underlined)
- PRN PORT SER PAR** (for Option 043, so that PAR is underlined)

6. Select the printer configuration for your spectrum analyzer by pressing the appropriate keys:

- CONFIG** Press this key to bring up the configuration menu.
- Print Config** Press this key to access the printer menu.
- Pm Port Config** Press this key to access the printer configuration menu.
- PRINTER SETUP** Press this key to send a PRINTER RESET command to the printer. This will cause a form feed if any data has been sent to the printer since the last form feed.
- Set Colr Printer** Press this key to print in color if the spectrum analyzer is connected to a Hewlett-Packard color printer, then select the appropriate printer.  
  
Selecting any Hewlett-Packard printer results in three printouts per page. After three printouts the page will be in position to start again at the top of the page if the printer's perforation skip is OFF (see Figure 6-1).  
  
One printout per page can be achieved by manually formfitting each printout.
- Set B&W Printer** Press this key to print in black and white, then select appropriate printer mode.
- HP B&W PRINTER** Press this key if the spectrum analyzer is connected to a Hewlett-Packard compatible printer.  
  
Selecting any Hewlett-Packard printer results in three printouts per page. After three printouts the page will be in position to start again at the top of the page if the printer's perforation skip is OFF (see Figure 6- 1).  
  
One printout per page can be achieved by manually formfitting each printout.
- HP B&W DJ540** Press this key if the spectrum analyzer is connected to a Hewlett-Packard DeskJet 540 printer.

|                                                                                      |                                                                                                                                                                                                                                                                                                                                                                                                |
|--------------------------------------------------------------------------------------|------------------------------------------------------------------------------------------------------------------------------------------------------------------------------------------------------------------------------------------------------------------------------------------------------------------------------------------------------------------------------------------------|
| EP MX80 SML LRG                                                                      | <p>Press this key if the spectrum analyzer is connected to a MX-80 Epson or other compatible 9-pin print-head printer.</p> <p>Pressing this key to underline SML will allow two printouts per page and will print softkey labels if desired (see PRT MENU ON OFF ).</p> <p>Pressing this key to underline LRG will allow only one printout per page and will not print the softkey labels.</p> |
| EP LQ570 SML LRG                                                                     | <p>Press this key if the spectrum analyzer is connected to an LQ-570 Epson or other compatible 24-pin print-head printer.</p> <p>Pressing this key to underline SML will print two printouts Per page and will print softkey labels if desired (see PRT MENU ON OFF ).</p> <p>This function is operational for Epson compatible printers only when SML is underlined.</p>                      |
| PRT MENU ON OFF                                                                      | <p>Press this key so that <u>ON</u> is underlined to print the softkey labels with the spectrum analyzer printout. This function is operational for Epson compatible printers only when SML is underlined.</p>                                                                                                                                                                                 |
| COPY DEV PRNT PLT                                                                    | <p>Press this key so PRNT is underlined.</p>                                                                                                                                                                                                                                                                                                                                                   |
| <span style="border: 1px solid black; border-radius: 5px; padding: 2px;">COPY</span> | <p>Press this key to copy the spectrum analyzer display to the printer.</p>                                                                                                                                                                                                                                                                                                                    |

---

## Plotting to an HP LaserJet Printer

This section describes how to plot to a LaserJet printer using either an RS-232 or parallel interface.

### Equipment

- HP 8590 Series spectrum analyzer with RS-232 or parallel interface
- One of the following cables:
  - HP 24542G 9-25 pin RS-232 cable
  - HP C2932A 9-25 Pin RS-232 Cable (For use with LaserJet 4P and 4Plus)
  - HP C2950A parallel printer cable
- Any of the following HP LaserJets:
  - HP LaserJet IIP Plus
  - HP LaserJet III
  - HP LaserJet IIIP
  - HP LaserJet 4
  - HP LaserJet 4L
  - HP LaserJet 4P

### Interconnection and Plotting Instructions

The RS-232 or parallel interface allow only one device to be connected to **the** spectrum analyzer. Refer to the programmer's guide for more information on protocol and cable wiring.

1. Turn off the spectrum analyzer and LaserJet.
2. Connect the HP LaserJet to **the** analyzer.
3. Turn on the analyzer and the HP LaserJet printer.

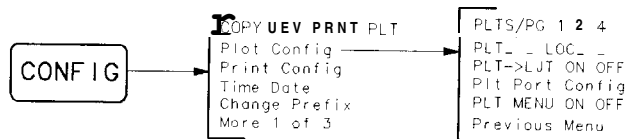

pu132e1

**Figure 6-15. Plot Configure Menu**

4. Referring to Figure 6-15 select the plotter configuration for your spectrum analyzer by pressing the appropriate keys:
5. Configure your analyzer to plot to the LaserJet by pressing:

**CONFIG**

Press this key to bring up the configuration menu.

COPY DEV PRNT PLT

so that PLT is underlined.

PLTS/PG 1 2 4

Press this key to underline the number of plots per page desired. Choose 1, 2, or 4 plots per page (see Figure 6-2).

PLT [ ]  
LOC -

If two plots per page are chosen, this function allows you to select the location on the paper for the plotter output. The upper and lower sections of the softkey label graphically represent where the plotter output will be located.

Press the softkey until the rectangular marker is in the desired section of the softkey label.

PLT [ ]\_  
LOC - -

If four plots per page are chosen, this function allows you to select the location on the paper for the plotter output. The quadrant of the softkey label graphically represents where the plotter output will be located.

Press the softkey until the rectangular marker is in the desired section of the softkey label.

PLT->LJT ON OFF

Press this key so that ON is underlined.

**COPY**

Press this key to plot the spectrum analyzer display to the LaserJet printer.



## Key Descriptions

---

This chapter describes functions and controls of the spectrum analyzer. The front-panel keys and softkey functions are listed alphabetically followed by a complete and detailed description.

Brief descriptions for service functions have also been included in this chapter. However, for more detailed descriptions and information about the use of each function, refer to the respective service guide for your instrument. A listing of all service calibration and service diagnostic functions has been provided in the following “Service Functions” section.

All softkeys and their relationship to the front-panel keys are shown in Chapter 8, “Key Menus.”

---

## Service Functions

Two types of functions are available for service use only:

- Service calibration functions.
- Service diagnostic functions.

These service functions are designed for service use only. However, brief descriptions for each function are provided in this chapter. For more detailed descriptions and information about the use of each function, refer to the Service Guide for your instrument.

Service documentation can be obtained by ordering Option 915 through your HP Sales and Service office. Option 915 is described in more detail under Chapter 10 “Measurement Personalities, Options, and Accessories” in this manual.

### Service Calibration Functions

Service Cal accesses the following service calibration softkeys:

CALMXR (HP 8592L, HP 85933, HP 85953, or HP 85963 only)

CAL TIMEBASE  
EDIT FLATNESS  
EXECUTE TITLE  
EXIT  
Flatness Data  
IDNUM  
INIT FLT  
SET ATTN ERROR  
STOR PWR ON UNITS

### Service Diagnostic Functions

Service Diag accesses the following diagnostic softkeys:

$\phi$  LOCK ON OFF  
+10V REF DETECTOR  
-10V REF DETECTOR  
2v REF DETECTOR  
ALC TEST (HP 8590L or HP 85913 with Option 010 or 011 only)

ANALYZER GAINS  
AUXB (HP 8590L or HP 85913 only)

BINARY SPAN (HP 8590L or HP 8591E only)

COARSE TUNE DAC  
DACS  
DISPLAY CAL DATA  
DROOP  
FINE TUNE DAC  
FM COIL DRIVE  
FM GAIN (Option 102 or 103 only)

|                          |                                                  |
|--------------------------|--------------------------------------------------|
| FM OFFST                 | (Option 102 or 103 only)                         |
| FM SPAN                  |                                                  |
| <b>FREQ DIAG</b>         |                                                  |
| <b>FRQ DISC NORM OFF</b> |                                                  |
| GND REF DETECTOR         |                                                  |
| MAIN COIL DR             |                                                  |
| MAIN SPAN                |                                                  |
| MIXER BIAS DAC           | (HP 8592L, HP 85933, HP 85953, or HP 85963 only) |
| PRESEL DAC               | (HP 8592L, HP 85933, HP 85953, or HP 85963 only) |
| QP DET ON OFF            | (Option 103 only)                                |
| QP GAIN ON OFF           | (Option 103 only)                                |
| QPD RST ON OFF           | (Option 103 only)                                |
| QPD OFFSET               | (Option 103 only)                                |
| STP GAIN ZERO            |                                                  |
| SWEEP RAMP               |                                                  |
| SWEEP TIME DAC           |                                                  |
| X FINE TUNE DAC          |                                                  |
| YTF DRIVER               | (HP 8592L, HP 85933, HP 85953, or HP 85963 only) |
| YTF SPAN                 | (HP 8592L, HP 85933, HP 85953, or HP 85963 only) |
| YTF TUNE COARSE          | (HP 8592L, HP 85933, HP 85953, or HP 8596E only) |
| YTF TUNE FINE            | (HP 8592L, HP 85933, HP 85953, or HP 85963 only) |

---

## Analyzer Functions

|                             |                                                                                                                                                                                                                                                                                                                                                                                                                                                                                                                                                                                                                                                                               |
|-----------------------------|-------------------------------------------------------------------------------------------------------------------------------------------------------------------------------------------------------------------------------------------------------------------------------------------------------------------------------------------------------------------------------------------------------------------------------------------------------------------------------------------------------------------------------------------------------------------------------------------------------------------------------------------------------------------------------|
| <b>%AM</b><br>ON OFF        | determines the percent of amplitude modulation of the largest displayed signal and its two sidebands. The sidebands are assumed to be entirely from amplitude modulation. If there are differences in the sideband amplitude, the larger value is used. The measurement runs continuously, re-executing at the end of each sweep.<br><br>All three signal must be displayed. The frequency spacing of the sideband signals must be the same within the span accuracy of the measurement. All of the signals must be greater than the PEAK EXCURSION above the THRESHOLD. The amplitude scale may be either linear or logarithmic.<br>Front-Panel Key Access: <b>MEAS/USER</b> |
| $\phi$ LOCK<br>ON OFF       | turns off the spectrum analyzer phase locking. The counter is turned off so frequency correction is no longer done at the start of each sweep. Turning the phase locking off increases measurement speed, but it decreases frequency accuracy. This is a service diagnostic function and is for service use.<br>Front-Panel Key Access: <b>CAL</b>                                                                                                                                                                                                                                                                                                                            |
| <b>+10V REF</b><br>DETECTOR | displays the output of the + 10 V reference from the A7 Analog Interface assembly as a horizontal line at the top graticule. This is a service diagnostic function and is for service use only.<br>Front-Panel Key Access: <b>CAL</b>                                                                                                                                                                                                                                                                                                                                                                                                                                         |
| <b>-10V REF</b><br>DETECTOR | displays the output of the -10 V reference from the A7 Analog Interface assembly as a horizontal line at the bottom graticule. This is a service diagnostic function and is for service use only.<br>Front-Panel Key Access: <b>CAL</b>                                                                                                                                                                                                                                                                                                                                                                                                                                       |
| <b>2v REF</b><br>DETECTOR   | displays the output of the 2 V reference produced on the A16 Processor/Video assembly as a horizontal line at the top graticule. This is a service diagnostic function and is for service use only.<br>Front-Panel Key Access: <b>CAL</b>                                                                                                                                                                                                                                                                                                                                                                                                                                     |
| <b>0-2.9 GHz</b><br>BAND 0  | <b>HP 8592L, HP 8593E, HP 8595E, and HP 8596E only.</b><br>locks onto harmonic band 0. Harmonic band 0 uses low-pass filtering instead of bandpass preselection. It has a specified tuning range of 0 to 2.9 GHz.<br>Front-Panel Key Access: <b>FREQUENCY</b>                                                                                                                                                                                                                                                                                                                                                                                                                 |
| <b>2.75-6.5</b><br>BAND 1   | <b>HP 8592L, HP 8593E, HP 8595E, and HP 8596E only.</b><br>locks onto harmonic band 1. Harmonic band 1 is preselected and has a specified tuning range of 2.75 GHz to 6.5 GHz.<br>Front-Panel Key Access: <b>FREQUENCY</b>                                                                                                                                                                                                                                                                                                                                                                                                                                                    |
| <b>6.0-12.8</b><br>BAND 2   | <b>HP 8592L, HP 8593E, and HP 8596E only.</b><br>locks onto harmonic band 2. Harmonic band 2 is preselected and has a specified tuning range of 6.0 to 12.8 GHz.<br>Front-Panel Key Access: <b>FREQUENCY</b>                                                                                                                                                                                                                                                                                                                                                                                                                                                                  |
| <b>12.4-19.</b><br>BAND 3   | <b>HP 8592L and HP 8593E only.</b><br>locks onto harmonic band 3. Harmonic band 3 is preselected and has a specified tuning range of 12.4 to 19.4 GHz.<br>Front-Panel Key Access: <b>FREQUENCY</b>                                                                                                                                                                                                                                                                                                                                                                                                                                                                            |

|                   |                                                                                                                                                                                                                                                                                                                                                                                                                                                                                                                                                                                                                                                                                                                                                                                                                                                                                                                                                                                                                                                                                                                                                                                                                                                                                                                                                                                                                                                                     |
|-------------------|---------------------------------------------------------------------------------------------------------------------------------------------------------------------------------------------------------------------------------------------------------------------------------------------------------------------------------------------------------------------------------------------------------------------------------------------------------------------------------------------------------------------------------------------------------------------------------------------------------------------------------------------------------------------------------------------------------------------------------------------------------------------------------------------------------------------------------------------------------------------------------------------------------------------------------------------------------------------------------------------------------------------------------------------------------------------------------------------------------------------------------------------------------------------------------------------------------------------------------------------------------------------------------------------------------------------------------------------------------------------------------------------------------------------------------------------------------------------|
| 19.1-22<br>BAND 4 | <p><b><i>HP 8592L and HP 8593E only.</i></b></p> <p>locks onto harmonic band 4. Harmonic band 4 is preselected and has a specified tuning range of 19.1 to 22 GHz.</p> <p>Front-Panel Key Access: <b>FREQUENCY</b></p>                                                                                                                                                                                                                                                                                                                                                                                                                                                                                                                                                                                                                                                                                                                                                                                                                                                                                                                                                                                                                                                                                                                                                                                                                                              |
| 9 kHz<br>EM1 BW   | <p>allows a 6 dB resolution bandwidth of 9 kHz. This bandwidth is useful when performing electromagnetic interference (EMI) measurements.</p> <p>Front-Panel Key Access: <b>BW</b></p>                                                                                                                                                                                                                                                                                                                                                                                                                                                                                                                                                                                                                                                                                                                                                                                                                                                                                                                                                                                                                                                                                                                                                                                                                                                                              |
| 120 kHz<br>EM1 BW | <p>allows a 6 dB resolution bandwidth of 120 kHz. This bandwidth is useful when performing electromagnetic interference (EMI) measurements.</p> <p>Front-Panel Key Access: <b>BW</b></p>                                                                                                                                                                                                                                                                                                                                                                                                                                                                                                                                                                                                                                                                                                                                                                                                                                                                                                                                                                                                                                                                                                                                                                                                                                                                            |
| 200 Hz<br>EM1 BW  | <p><b><i>For Option 130 only.</i></b></p> <p>allows a 6 dB resolution bandwidth of 200 Hz. This bandwidth is useful when performing electromagnetic interference (EMI) measurements.</p> <p>Front-Panel Key Access: <b>BW</b></p>                                                                                                                                                                                                                                                                                                                                                                                                                                                                                                                                                                                                                                                                                                                                                                                                                                                                                                                                                                                                                                                                                                                                                                                                                                   |
| A<-->B            | <p>exchanges the contents of the trace A register with the trace B register and puts trace A in view mode.</p> <p>Front-Panel Key Access: <b>TRACE</b></p>                                                                                                                                                                                                                                                                                                                                                                                                                                                                                                                                                                                                                                                                                                                                                                                                                                                                                                                                                                                                                                                                                                                                                                                                                                                                                                          |
| A-B → A<br>ON OFF | <p>when ON is underlined, subtracts the data in trace B from the measured data in trace A. A minus sign (-) appears between the trace A status and the trace B status in the screen annotation while the function is active.</p> <p>To deactivate this function, press A – B → A ON OFF so that OFF is underlined. The A-B → A and B-DL → B functions are math functions. Unlike operations on dBm units, math functions operate on measurement units. Measurement units are used to format trace data for data within the graticule limits. The displayed amplitude of each element falls on one of 8000 vertical points with the value of 8000 being equal to the reference level. For log scale data, each point is equal to 0.01 dB. The peak of a signal equal to -10 dBm, or one division below the reference level, is equal to 7000 measurement units (8000 – 1000 = 7000). In linear mode, each point has a resolution of [reference level in volts/8000].</p> <p>For example, if trace A contains amplitude values of -10 dBm and trace B contains amplitude values of -40 dBm, the result of the A – B → A function would be -10.004 dBm if dBm units were used. Since measurement units are used for the A – B → A function, the result of A – B → A is -50 dBm (- 10 dBm = 7000 measurement units, -40 dBm = 4000 measurement units; the result is 3000 measurement units, which is equal to -50 dBm).</p> <p>Front-Panel Key Access: <b>TRACE</b></p> |
| A - C             | <p>copies trace A into trace C.</p> <p>Front-Panel Key Access: <b>TRACE</b></p>                                                                                                                                                                                                                                                                                                                                                                                                                                                                                                                                                                                                                                                                                                                                                                                                                                                                                                                                                                                                                                                                                                                                                                                                                                                                                                                                                                                     |
| ABCDE F           | <p>accesses the softkey menu for selecting screen title characters A through F.</p> <p>Front-Panel Key Access: (CAL), <b>CONFIG</b>, <b>DISPLAY</b>, <b>RECALL</b>, or (SAVE_)</p>                                                                                                                                                                                                                                                                                                                                                                                                                                                                                                                                                                                                                                                                                                                                                                                                                                                                                                                                                                                                                                                                                                                                                                                                                                                                                  |

|                    |                                                                                                                                                                                                                                                                                                                                                                                                                                                                                                                                                                                                                                                                                                                                                                                                                                                                                                                                                                                                                                                                                                                                                                                                                                                                                                                                                                                                                                                                                                                                                                                                                                                                                                                                                                                                                                                                                                                                                                                                                                                                                                                    |
|--------------------|--------------------------------------------------------------------------------------------------------------------------------------------------------------------------------------------------------------------------------------------------------------------------------------------------------------------------------------------------------------------------------------------------------------------------------------------------------------------------------------------------------------------------------------------------------------------------------------------------------------------------------------------------------------------------------------------------------------------------------------------------------------------------------------------------------------------------------------------------------------------------------------------------------------------------------------------------------------------------------------------------------------------------------------------------------------------------------------------------------------------------------------------------------------------------------------------------------------------------------------------------------------------------------------------------------------------------------------------------------------------------------------------------------------------------------------------------------------------------------------------------------------------------------------------------------------------------------------------------------------------------------------------------------------------------------------------------------------------------------------------------------------------------------------------------------------------------------------------------------------------------------------------------------------------------------------------------------------------------------------------------------------------------------------------------------------------------------------------------------------------|
| ACCEPT<br>QP DATA  | <p><i>For Option 103 only.</i></p> <p>displays the quasi-peak amplitude value of the marker. See the HP 85913, HP 8593E, HP 85943, HP 85953, or HP 8596E Option 103 supplement documentation for more information.</p> <p>Front-Panel Key Access: <b>AUX CTRL</b></p>                                                                                                                                                                                                                                                                                                                                                                                                                                                                                                                                                                                                                                                                                                                                                                                                                                                                                                                                                                                                                                                                                                                                                                                                                                                                                                                                                                                                                                                                                                                                                                                                                                                                                                                                                                                                                                              |
| ACPGRAPH<br>ON OFF | <p>turns the adjacent channel power graph ON or OFF. With ACPGRAPH ON the ACP ratio graph is calculated and displayed and the numeric results are not displayed. The value of the ACP ratio is displayed at the selected marker frequency offset from the center frequency. This graph function is used after doing an adjacent channel power measurement with the ADJ CHAN POWER or ADJ CHAN PWR extd softkeys.</p> <p>Front-Panel Key Access: <b>MEAS/USER</b></p>                                                                                                                                                                                                                                                                                                                                                                                                                                                                                                                                                                                                                                                                                                                                                                                                                                                                                                                                                                                                                                                                                                                                                                                                                                                                                                                                                                                                                                                                                                                                                                                                                                               |
| ADJ CHAN<br>POWER  | <p>measures the power leakage into the adjacent channels and calculates the adjacent channel power ratio of both the upper and lower channels, with respect to the total power. The total power of the carrier is displayed. The adjacent channel power ratios of both channels are also displayed and the larger number is marked with a A. (Vertical lines on the display indicate the bandwidth edges of the three different channels being measured.)</p> <p>The measurement can be made on a single sweep or continuously updated at the end of each sweep. See SINGLE MEAS and CONT MEAS . The measurement stops and the spectrum analyzer is returned to its prior state when other measurement functions are activated.</p> <p>The center frequency must be set to the intended carrier frequency and the reference level set to optimize the displayed signal. The channel bandwidth and channel spacing must be entered by the user. If PARAM AUTO is selected (so AUTO is underlined), other spectrum analyzer settings will then be coupled and set automatically. The adjacent channel power measurement responds to signals like an rms power measurement. This means that the measurement of the total channel power and the adjacent channel power ratios are accurately reported, whether the transmitted signal contains tones, noise, or both. If PARAM AUTO is selected the parameters of the instrument state are set for a valid measurement. When using PARAM MAN, the following conditions must be maintained to make a valid rms measurement. If these conditions are not met, errors of up to -2.5 dB can occur for noise-like signals.</p> <ul style="list-style-type: none"> <li>■ Video bandwidth is at least 10 times the resolution bandwidth.</li> <li>■ Detector mode is sample (SMP). (You can use DETECTOR SMP PK to select the detector mode.)</li> <li>■ Resolution bandwidth is less than or equal to 100 kHz.</li> <li>■ Video averaging is OFF</li> <li>■ Neither MAX HOLD nor MIN HOLD trace mode is selected.</li> </ul> <p>Front-Panel Key Access: <b>MEAS/USER</b></p> |

ADJ CHAN  
PWR extd

measures the power leakage into the adjacent channels and calculates the adjacent channel power ratio of both the upper and lower channels, with respect to the reference channel. ADJ CHAN POWER extd has an extended dynamic range compared with ADJ CHAN POWER. The extended range is measured by taking two different sweeps with different reference levels **and** combining the trace data. The displayed dynamic range is 104 dB and the log scale is set to 13 dB/ division.

The total power of the channel is displayed. The adjacent channel power ratios of both channels are also displayed and the larger number is marked with a A. (Vertical lines on the display indicate the six edges of the upper, lower, and reference channels being measured.)

The measurement stops and the spectrum analyzer is returned to its prior state when other measurement functions are activated.

The center frequency must be set to the intended carrier frequency and the reference level set to optimize the displayed signal. The channel bandwidth and channel spacing must be entered by the user. If PARAM AUTO is selected (so AUTO is underlined), other spectrum analyzer settings will then be coupled and set automatically. The adjacent channel power measurement is an rms measurement. This means that the measurement of the total channel power and the adjacent channel power ratios are accurately reported, whether the transmitted signal contains tones, noise, or both. IF PARAM AUTO is selected the parameters of the instrument state are set for a valid measurement. When using PARAM MAN, the following conditions must be maintained to make a valid rms measurement:

- Video bandwidth is at least 10 times the resolution bandwidth.
- Detector mode is sample (SMP). (You can use DETECTOR SMP PK to select the detector mode.)
- Resolution bandwidth is less than or equal to 100 kHz.
- Video averaging is OFF.
- Neither MAX HOLD nor MIN HOLD trace mode is selected.

Front-Panel Key Access: **MEAS/USER**

ALC  
INT EXT

**HP 8593E, HP 8594E, HP 8595E, or HP 8596E with Option 010 only.**

activates internal (INT) leveling or external (EXT) leveling.

Front-Panel Key Access: **AUX CTRL**

ALC MTR  
INT XTAL

**HP 8590L or HP 8591E with Option 010 or 011 only.**

activates the automatic leveling control (ALC) function for internal (INT) leveling or external (XTAL or MTR) leveling. The external leveling input (located on the rear panel of the spectrum analyzer) can be used with a power meter or crystal that has a positive or negative voltage output. See specifications and characteristics in your calibration guide for the leveling input characteristics. External leveling increases the amplitude accuracy by improving the effective source match. The meter (MTR) position narrows ALC loop bandwidth so an HP power meter can be used.

Front-Panel Key Access: **AUX CTRL**

|                   |                                                                                                                                                                                                                                                                                                                                                                                                                                                                                                                                                                                                                                                                                                                    |
|-------------------|--------------------------------------------------------------------------------------------------------------------------------------------------------------------------------------------------------------------------------------------------------------------------------------------------------------------------------------------------------------------------------------------------------------------------------------------------------------------------------------------------------------------------------------------------------------------------------------------------------------------------------------------------------------------------------------------------------------------|
| ALC TEST          | <p><b>HP 8590L or HP 8591 E with Option 010 or 011 only.</b></p> <p>breaks the leveling loop of the automatic leveling control in the tracking generator. This is a service diagnostic function and is for service use only. Refer to the service guide for more information.</p> <p>Front-Panel Key Access: <b>CAL</b></p>                                                                                                                                                                                                                                                                                                                                                                                        |
| ALL DLP<br>→CARD  | <p><b>Requires Option 003 for an HP 8590L, HP 8592L, or HP 8594L.</b></p> <p>saves all the downloadable programs and key definitions that are in spectrum analyzer memory onto the memory card. If the downloadable program was stored using a prefix, the file name for the downloadable program consists of d(prefix)-(register number). If no prefix was specified, the data is stored with the file name d-(register number).</p> <p>Front-Panel Key Access: <b>SAVE</b></p>                                                                                                                                                                                                                                   |
| Amp Cor           | <p>accessed by <b>CAL</b>. Amp Cor accesses the menus for entering and editing the current amplitude-correction factors.</p> <p>Front-Panel Key Access: <b>CAL</b></p>                                                                                                                                                                                                                                                                                                                                                                                                                                                                                                                                             |
| AMP COR           | <p>when accessed by <b>SAVE</b>, AMP COR stores the current amplitude-correction factors table in spectrum analyzer memory or on the memory card.</p> <p>When accessed by <b>RECALL</b>, AMP COR recalls the amplitude-correction factors table from either spectrum analyzer memory or the memory card. Amplitude-correction factors are saved with an “a” before the memory-card file name. Screen titles are not recalled with the data. Refer to “To Save a Limit-Line Table or Amplitude Correction Factors” in Chapter 5 for more information.</p> <p>Amplitude-correction-factor memory-card tiles can be catalogued using CATALOG AMP COR.</p> <p>Front-Panel Key Access: <b>RECALL</b> or <b>SAVE</b></p> |
| AMP COR<br>ON OFF | <p>turns the current amplitude-correction factors on or off.</p> <p>Front-Panel Key Access: <b>CAL</b></p>                                                                                                                                                                                                                                                                                                                                                                                                                                                                                                                                                                                                         |
| <b>AMPLITUDE</b>  | <p>activates the reference level function and accesses the amplitude menu. The softkeys accessed when you press <b>AMPLITUDE</b> change reference level, input attenuation, vertical scale, mixer level, amplitude units, input impedance, and amplitude offset. For the HP 85933, HP 85943, HP 85953, or HP 8596E, pressing <b>AMPLITUDE</b> accesses the preselector peaking and preselector default functions also.</p>                                                                                                                                                                                                                                                                                         |
| Amptd<br>Units    | <p>accesses the softkeys that change the amplitude units. The amplitude units can be changed by pressing <b>dBm</b>, <b>dBmV</b>, <b>dBuV</b>, Volts, or Watts.</p> <p>Front-Panel Key Access: <b>AMPLITUDE</b></p>                                                                                                                                                                                                                                                                                                                                                                                                                                                                                                |



ANALOG+  
ON OFF

For the **HP 8591E, HP 8593E, HP 8594E, HP 8595E, or HP 8596E** only.  
Requires *Option 101 or 301*.

turns on the analog+ display mode. This is a digital implementation of an analog display, combining the advantages of both types of displays. The display is made up of 401 horizontal points or trace elements. In the analog+ display mode each trace element can display from 1 to 40 dots, or measurements. Pressing ANALOG+ ON OFF makes dot density the active function. The dot density function sets the desired number of measurements per trace element. Each dot requires an additional analog-to-digital conversion for each trace element, so the sweep time can limit the actual number of dots available. Lengthening the sweep time can increase the actual dot density.

Markers and marker functions as well as the screen text and title capabilities of a digital display are available along with the analog type trace information. Some functions are not available with analog+ display mode. See Table 7-1 for a list of functions that are not available with analog+ displays. If a trace is blanked while using an analog+ display, the data is permanently blanked and cannot be recalled, even if you use the view function.

The copy function can be used to provide a printout of the display. It must be configured to use a printer and not a plotter. After using other functions, press ANALOG+ ON OFF to return to the dot density function.

Limit lines can be used to test data in an analog+ display, but they cannot be displayed.

Front-Panel Key Access: DISPLAY

**Table 7-1. Commands Not Available with Analog + Operation**

| Command         | Description                                                                      |
|-----------------|----------------------------------------------------------------------------------|
| A <--> B        | exchanges trace A and trace B                                                    |
| A-B → A ON OFF  | puts the difference between trace A and trace B into trace A                     |
| B-DL →B         | puts the difference between trace B and the display line in trace B              |
| CLEAR WRITE B   | initially erases trace B and then displays it continuously                       |
| CLEAR WRITE C   | initially erases trace C and then displays it continuously                       |
| DEMOD ON OFF    | turns AM or FM demodulation on and off                                           |
| FFT             | changes zero span data to the frequency domain using an FFT                      |
| MKR CNT ON OFF  | turns the marker counter on and off                                              |
| MK PAUSE ON OFF | stops the analyzer sweep at the marker for the defined of the dwell time         |
| MAX HOLD A      | updates trace A with the maximum level at each point, each sweep                 |
| MAX HOLD B      | updates trace B with the maximum level at each point, each sweep                 |
| MIN HOLD C      | updates trace C with the minimum level at each point, each sweep                 |
| NORMLIZE ON OFF | the difference between A and B is added to the display line and put into trace A |
| MK TRACK ON OFF | moves the signal closest to the marker to center screen and keeps it centered    |
| SPAN ZOOM       | finds the highest signal peak, turns on marker track, and activates span         |
| THRESHLD ON OFF | sets a lower boundary to the active trace                                        |
| TRACKING PEAK   | starts a routine which adjusts tracking to peak the tracking generator signal    |
| YID AVG ON OFF  | starts a routine which digitally averages display signals and noise              |
| VIEW A          | holds and displays the trace A data when used after blanking trace A             |
| VIEW B          | holds and displays the trace B data                                              |
| VIEW C          | holds and displays the trace C data                                              |

|                     |                                                                                                                                                                                                                                                                                                                                                                                                                                                                                                                                                                     |
|---------------------|---------------------------------------------------------------------------------------------------------------------------------------------------------------------------------------------------------------------------------------------------------------------------------------------------------------------------------------------------------------------------------------------------------------------------------------------------------------------------------------------------------------------------------------------------------------------|
| ANALYZER<br>ADDRESS | <i>Option 041 only.</i><br>allows you to set the HP-IB address of the spectrum analyzer. The spectrum analyzer address is set to 18 by pressing DEFAULT CONFIG .<br>Front-Panel Key Access: <b>CONFIG</b>                                                                                                                                                                                                                                                                                                                                                           |
| ANALYZER<br>GAINS   | displays the current value of the gain for various functional blocks within the spectrum analyzer. The gain values will vary depending on the current spectrum analyzer settings. This is a service diagnostic function and is for service use only. Refer to the service guide for more information.<br>Front-Panel Key Access: <b>CAL</b>                                                                                                                                                                                                                         |
| ANNOTATN<br>ON OFF  | turns the screen annotation on or off. However, softkey annotation will remain on the screen. The screen annotation may not be required for prints or plots, or during remote operation. Refer to the HOLD softkey description regarding softkey annotation.<br>Front-Panel Key Access: <b>DISPLAY</b>                                                                                                                                                                                                                                                              |
| APND<br>CAT ITEM    | <i>For Options 041 and 043 only. Refer to Chapter 4 of the HP 8590 E-Series and L-Series Spectrum Analyzer and HP 8591 C Cable TV Analyzer Programmer's Guide for more information.</i><br>starts the DLP editor function and allows the highlighted item from the catalog of spectrum analyzer memory to be appended to the end of the item that is currently in the spectrum analyzer DLP editor memory. If the item to be appended will not fit in the available memory space, it will not be appended.<br>Front-Panel Key Access: <b>RECALL</b> or <b>SAVE_</b> |
| ATTEN<br>AUTO MAN   | sets the input attenuation in 10 dB increments. The spectrum analyzer input attenuator, which is normally coupled (linked) to the reference level control, reduces the power level of the spectrum analyzer input signal at the input mixer. The attenuator is recoupled when AUTO is underlined.<br>Front-Panel Key Access: <b>AMPLITUDE</b> or <b>AUTO COUPLE</b>                                                                                                                                                                                                 |
| <b>Caution</b>      | To prevent damage to the input mixer, the power level at the input mixer must not exceed +30 dBm. To prevent signal compression, power at the input to the input mixer must be kept below -10 dBm.                                                                                                                                                                                                                                                                                                                                                                  |
| <b>Note</b>         | To protect the mixer from possible damage, 0 dB RF attenuation (no input power reduction to the mixer) can be selected only from the number/units keypad.                                                                                                                                                                                                                                                                                                                                                                                                           |
| AUTO<br>ALL         | couples the following functions: resolution bandwidth, video bandwidth, attenuation, sweep time, center-frequency step, video bandwidth, and video-bandwidth to resolution-bandwidth ratio.<br>Front-Panel Key Access: <b>AUTO_COUPLE</b>                                                                                                                                                                                                                                                                                                                           |

**AUTO COUPLE** accesses the softkey menu of functions that can be coupled. (Coupled functions are functions that are linked: if one function is changed, the other function is changed.) The functions that can be auto-coupled are listed below:

- Resolution bandwidth couples to span.
- Video bandwidth couples to resolution bandwidth when the spectrum analyzer has a video-bandwidth to resolution-bandwidth ratio of 0.3.
- Sweep time couples to span, resolution bandwidth, and video bandwidth.
- RF attenuation couples to reference level.
- Center frequency step size couples to 10% of span.

During normal operation, the sweep time, resolution bandwidth, and video bandwidth are coupled to yield optimum performance. If any of these functions becomes uncoupled (that is, is manually set), a “#” will appear next to the screen annotation representing the function on the screen.

If one or more functions are manually set so that the amplitude or frequency becomes uncalibrated, MEAS UNCAL appears on the right side of the graticule.

Recouple a single function by pressing the function label (to activate the function), and pressing the function again so that AUTO is underlined.

Pressing **AUTO COUPLE**, AUTO ALL couples all coupled functions listed.

AUTO QP  
AT MKR

**For Option 103 only.**

executes a quasi-peak routine. See the HP 85913, HP 85933, HP 85943, HP 85953, or HP 85963 Option 103 supplement documentation for more information.

Front-Panel Key Access: **AUX CTRL**

Aux Conn  
Control

accesses the softkey menu used to control the auxiliary outputs and input. The auxiliary outputs are controlled by pressing CNTL A 0 1 , CNTL B 0 1 , CNTL C 0 1 , and CNTL D 0 1 . The status of the auxiliary input (control line I), can be displayed on the spectrum analyzer screen with DISPLAY CNTL I.

Front-Panel Key Access: **AUX CTRL**

**AUX CTRL**

accesses the softkey menu used for control of the auxiliary interface connector.

**For the HP 8592L, HP 8593E, and HP 8596E:** **AUX CTRL** also accesses the comb generator function. **For Option 102 or 103:** **AUX CTRL** accesses demodulation functions. **For Option 010 or 011:** it accesses tracking generator functions.

AUXB

**HP 8590L or HP 8591 E only.**

displays the voltage level present at an unused input to the Test Point MUX circuitry located on the A7 Analog Interface assembly. This is a service diagnostic function and is for service use only.

Front-Panel Key Access: (CAL)

B → C

copies trace B into trace C.

Front-Panel Key Access: **TRACE**

B <--> C

exchanges the contents of trace B with trace C and puts trace B in view mode.

Front-Panel Key Access: **TRACE**

B-DL → B

subtracts the display line from trace B and places the result in trace B. The B-DL → B function is a math operation. See the A-B → A ON OFF softkey description for information about math operations.

Front-Panel Key Access: **TRACE**

Band  
Lock

**HP 8592L, HP 8593E, HP 8595E, and HP 8596E only.**

accesses the harmonic band menu and the band lock function. Selecting a harmonic band causes the spectrum analyzer to lock onto the specified harmonic band and automatically select the settings shown in Table 7-2.

**Table 7-2.  
Center Frequency and Span Settings for Harmonic Bands**

| Softkey                                        | Center Frequency | Span    | Description                                      |
|------------------------------------------------|------------------|---------|--------------------------------------------------|
| O-2.9 Gz BAND 0                                | 1.45 GHz         | 2.9 GHz | <b>Low-pass filtered, first harmonic mixing.</b> |
| 2.75-6.5 BAND 1                                | 4.638 GHz        | 3.6 GHz | <b>Preselected, first harmonic mixing.</b>       |
| 6.0-12.8 BAND 2 *                              | 9.4 GHz          | 6.8 GHz | <b>Preselected, second harmonic mixing.</b>      |
| 12.4-19.4 BAND 3 †                             | 15.9 GHz         | 7 GHz   | <b>Preselected, third harmonic mixing.</b>       |
| 19.1-22 BAND 4 †                               | 20.55 GHz        | 2.9 GHz | <b>Preselected, fourth harmonic mixing.</b>      |
| * Not available with the HP 85953.             |                  |         |                                                  |
| † Not available with the HP 85953 or HP 85963. |                  |         |                                                  |

#### BND LOCK

ON OFF locks the spectrum analyzer onto a selected frequency band (local oscillator harmonic number). When only one frequency band is being swept the corresponding softkey will be underlined, even if band lock is off.

#### Note

When using the spectrum analyzer in a band lock mode, the span is limited to 3.6 GHz in band 0 and 1, and to 7 GHz in bands 2 through 4. To select the maximum span in a given band, use the start frequency, stop frequency, or span function.

Front-Panel Key Access: **FREQUENCY**

BAUD  
RATE

*Option 043 (AS-232 and parallel interface) only.*

sets the data transmission speed. (Also see the description for the **COPY** key.)

The baud rate is set to 1200 by pressing DEFAULT CONFIG .

Front-Panel Key Access: **CONFIG**

BINARY  
SPAN

**HP 8590L and HP 85913 only.**

displays the output of the span DAC that is located on the A7 Analog Interface assembly. This is a service diagnostic function and is for service use only.

Front-Panel Key Access: (CAL)

BLANK A

stores the amplitude data for trace A and removes it from the screen. The trace A register will not be updated as the spectrum analyzer sweeps.

Front-Panel Key Access: **TRACE**

BLANK B

stores the amplitude data for trace B and removes it from the screen. The trace B register will not be updated as the spectrum analyzer sweeps.

Front-Panel Key Access: **TRACE**

BLANK C

stores the amplitude data for trace C and removes it from the screen. The trace C register will not be updated as the spectrum analyzer sweeps.

Front-Panel Key Access: **TRACE**

**BLANK CARD** *Requires Option 003 for an HP 8590L, HP 8592L, or HP 8594L.*  
 deletes all the files from the memory card. Pressing BLANK CARD displays the message: If you are sure, press key again to purge data. Press BLANK CARD again if you want to delete all files from the memory card.  
 Front-Panel Key Access: **CONFIG**

**BND LOCK ON OFF** *HP 8592L, HP 85933, HP 8595E, and HP 8596E only.*  
 underlining ON locks the spectrum analyzer to the lowest frequency band (local oscillator harmonic number) containing the correct center frequency. Start and stop frequencies will be changed if necessary. Executing a band lock limits the spectrum analyzer tuning range to the selected harmonic number. Selecting the softkeys for band 0 through band 4 turns on the band lock function automatically.

If the start frequency is well within a lower band, turning band lock off will result, in a multiband sweep. If a specific band had been selected prior to changing to a multiband sweep, the selected band's softkey label will no longer be underlined indicating that it is not selected. Sweep of a single band is indicated by the selected band's softkey label being underlined.

---

**Note** Before changing the frequency range to another harmonic band, unlock the band by pressing BND LOCK ON OFF so that OFF is underlined.

---

Front-Panel Key Access: **FREQUENCY**

**BW** activates the resolution bandwidth function and accesses the softkeys that control the bandwidth functions: RES BW AUTO MAN , VID BW AUTO MAN , VBW/RBW RATIO , VID AVG ON OFF , and the **EMI BW** Menu. (Also see the RES BW AUTO MAN softkey description.)

**CAL** accesses the softkey menus used for the self-calibration, service-diagnostics, and service-calibration functions. For more information about self-calibrating the spectrum analyzer, see "Improving Accuracy with Self-Calibration Routines" in Chapter 2.

**CAL AMPTD** initiates an amplitude self-calibration routine. Connect CAL OUT to the spectrum analyzer input before pressing CAL AMPTD . If Option 105 is installed, remove the cable from the rear panel GATE INPUT before starting the self-calibration routine.

---

**Note** If the frequency calibration and amplitude calibration self-calibration routines are both used, the CAL **FREQ** softkey function should always be initiated before the CAL AMPTD softkey function.

---

Front-Panel Key Access: **CAL**

**CAL FETCH** retrieves stored self-calibration correction factors from the last calibration saved using CAL STORE .  
 Front-Panel Key Access: (CAL)

|                     |                                                                                                                                                                                                                                                                                                                                                                                                                                                                                                           |
|---------------------|-----------------------------------------------------------------------------------------------------------------------------------------------------------------------------------------------------------------------------------------------------------------------------------------------------------------------------------------------------------------------------------------------------------------------------------------------------------------------------------------------------------|
| CAL<br>FREQ         | initiates a frequency self-calibration routine. Connect CAL OUT to the spectrum analyzer input before pressing CAL FREQ . If Option 105 is installed, remove the cable from the rear panel GATE INPUT before starting the self-calibration routine.<br>Front-Panel Key Access: <b>CAL</b>                                                                                                                                                                                                                 |
| CAL FREQ<br>& AMPTD | initiates both the frequency and amplitude self-calibration routines. Connect CAL OUT to the spectrum analyzer input before pressing CAL FREQ & AMPTD . If Option 105 is installed, remove the cable from the rear panel GATE INPUT before starting the self-calibration routine.<br>Front-Panel Key Access: <b>CAL</b>                                                                                                                                                                                   |
| CAL MXR             | <b>HP 8592L, HP 85933, HP 8595E or HP 8596E only.</b><br>adjusts the bias-current DAC setting for the optimum displayed-signal amplitude. The HP 8592L, HP 85933, and HP 85963 use the 100 MHz COMB OUT signal for the test signal. The HP 85953 uses the 300 MHz CAL OUT signal. This is a service calibration function and is for service use only.<br>Front-Panel Key Access: <b>CAL</b>                                                                                                               |
| CAL<br>STORE        | stores the correction factors from the last calibration. The stored correction factors are automatically retrieved when the spectrum analyzer is turned on. If correction factors are not stored, they will be retained only until the spectrum analyzer is turned off. See the description for the CAL FETCH softkey.<br>Front-Panel Key Access: <b>CAL</b>                                                                                                                                              |
| CAL<br>TIMEBASE     | changes the setting of the 10 MHz reference (standard timebase) DAC that is located on the A25 Counter Lock assembly. This is a service calibration function and is for service use only.<br>Front-Panel Key Access: (CAL)                                                                                                                                                                                                                                                                                |
| CAL<br>TRK GEN      | <b>Option 010 or 011 only.</b><br>performs absolute amplitude, vernier, and tracking peak self-calibration routines. (It only performs the tracking peak self-calibration for the HP 8590L and HP 85913.) The spectrum analyzer should be amplitude calibrated by pressing CAL AMPTD prior to using the CAL TRK GEN function. Connect the tracking generator output to the spectrum analyzer input before pressing CAL TRK GEN .<br>Front-Panel Key Access: <b>CAL</b>                                    |
| CAL<br>YTF          | <b>HP 8592L, HP 8593E, HP 8595E, and HP 85963 only.</b><br>generates the best slope and offset adjustment to calibrate the YIG-tuned filter (YTF) for each harmonic band. Connect COMB OUT to the spectrum analyzer input before pressing CAL YTF on the HP 8592L, HP 85933, or HP 85963. <b>Connect the</b> CAL OUT to the spectrum analyzer input for an HP 85953. The frequency self-calibration routine should be performed before running the CAL YTF routine.<br>Front-Panel Key Access: <b>CAL</b> |
| Card<br>Config      | <b>Requires Option 003 for an HP 85901, HP 8592L, or HP 8594L.</b><br>accesses the softkey menu that allows you to catalog, format, and delete data from a memory card.<br>Front-Panel Key Access: <b>CONFIG</b>                                                                                                                                                                                                                                                                                          |

CARD →  
DISPLAY

**Requires Option 003 for an HP 85901, HP 8592L, or HP 8594L.**

recalls into spectrum analyzer memory a display image saved on the memory card. It does not recall the associated instrument state, but the restored display can be viewed and copied. Before recalling a display that was saved under a prefix other than the current prefix, change the current prefix to the prefix used when the display was saved.

The intensity of some screen items may differ if the current spectrum analyzer state does not match the state of the recalled image. This will not affect the spectrum analyzer ability to output a copy of the screen.

It is possible to have more functionality than just viewing and copying a recalled display image. For example, you can set the spectrum analyzer to the identical window configuration as when the display was saved. Then recall the trace that corresponds to the display image. This will restore the trace and state information. Finally, you can recall the display image. At this point, markers and display line can be used to examine the data. If an attempt is made to update the trace data, the display will be erased and redrawn to reflect the current instrument state.

Pressing LOAD FILE is an alternate way to load display image from the memory card into spectrum analyzer memory. See “Saving and Recalling Data from the Memory Card” in Chapter 5 for more information.

Front-Panel Key Access: **RECALL**

CARD  
→ DLP

**Requires Option 003 for an HP 85901, HP 85921, or HP 8594L.**

recalls into the spectrum analyzer memory a downloadable program (DLP) saved on the memory card. Before recalling data that was saved under a prefix other than the current prefix, change the current prefix to the prefix used when the data was saved. Pressing LOAD FILE is an alternate way to load program data from the memory card into spectrum analyzer memory. See “Saving and Recalling Data from the Memory Card” in Chapter 5 for more information. See also the Change Prefix softkey description.

Front-Panel Key Access: **RECALL**

CARD  
→ STATE

**Requires Option 003 for an HP 85901, HP 8592L, or HP 8594L.**

recalls into spectrum analyzer memory a state saved on the memory card.

CARD → STATE also displays the time and date when the state data was stored. Before recalling a state that was saved under a prefix other than the current prefix, change the current prefix to the prefix used when the state was saved.

If the windows display mode is being used, the instrument state can only be recalled into the active window.

Pressing LOAD FILE is an alternate way to load state data from the memory card into spectrum analyzer memory. See “Saving and Recalling Data from the Memory Card” in Chapter 5 for more information.

Front-Panel Key Access: **RECALL**

Card  
→ Trace

**Requires Option 003 for an HP 8590L, HP 8592L, or HP 8594L.**

recalls into spectrum analyzer memory a trace saved on the memory card. Limit lines and amplitude correction factors are recalled by pressing Card → Trace, LIMIT LINES or AMP COR. If the screen title does not exceed 34 characters, the time and date when the trace data was stored is also displayed with the recalled trace data. The screen title and date are not recalled with limit-line files or amplitude correction factor files. Before recalling a trace, limit-line file, or amplitude correction factors file that was

saved under a prefix other than the current prefix, change the current prefix to the prefix used when the data was saved. If windows are being used, only the trace of the active window can be recalled.

Pressing LOAD FILE is an alternate way to load trace data (but not recommended for recalling limit-line files or amplitude correction factor files) from the memory card into spectrum analyzer memory. See “Saving and Recalling Data from the Memory Card” in Chapter 5 for more information.  
Front-Panel Key Access: **RECALL**

CATALOG ALL catalogs all the programs and variables stored in spectrum analyzer memory in bytes along with the remaining memory available in bytes. Press CATALOG REGISTER to catalog states, traces, limit-line tables, and amplitude correction factors saved in spectrum analyzer memory. Pressing CATALOG ALL catalogs all traces, states, amplitude correction factors, programs, display images, and limit-line tables stored on the memory card when cataloging the memory card.  
Front-Panel Key Access: **RECALL** or (SAVE\_)

CATALOG AMP COR **Requires Option 003 for an HP 8590L, HP 8592L, or HP 8594L.** catalogs the amplitude correction factor files that are on the memory card. Use the CATALOG REGISTER softkey to catalog amplitude factors saved in spectrum analyzer memory (amplitude correction factors saved in analyzer memory are stored in trace registers). Amplitude correction factors are saved with an “a” before the memory card file name. Amplitude factors can be saved in spectrum analyzer memory by either loading in amplitude correction factors from a memory card, defining amplitude correction factors using a remote programming command (AMPCOR), or using EDIT AMP COR . See “Entering Amplitude Correction Factors” in Chapter 5 for more information.  
Front-Panel Key Access: **RECALL** or **SAVE**

Catalog Card **Requires Option 003 for an HP 8590L, HP 8592L, or HP 8594L.** accesses a menu with the cataloging functions for the memory card: CATALOG ALL, CATALOG STATES, CATALOG TRACES, CATALOG PREFIX, CATALOG DLP, CATALOG AMP COR, CATALOG LMT LINE, and CATALOG DISPLAY . Each catalog function displays catalog information and accesses a menu containing LOAD FILE and DELETE FILE. The catalog contains information about the items stored on the memory card ( see Figure 7-1 and Table 7-3).  
Use the step keys to view different sections of the directory, and the knob to select a file. Press LOAD FILE to load the selected file into spectrum analyzer memory. Press DELETE FILE to delete the selected file from the memory card.  
Unlike saving to the internal memory, data is saved as a file on the memory card. The files stored on the memory card are in the logical interchange format (LIF).  
Front-Panel Key Access: **RECALL** or (SAVE\_)



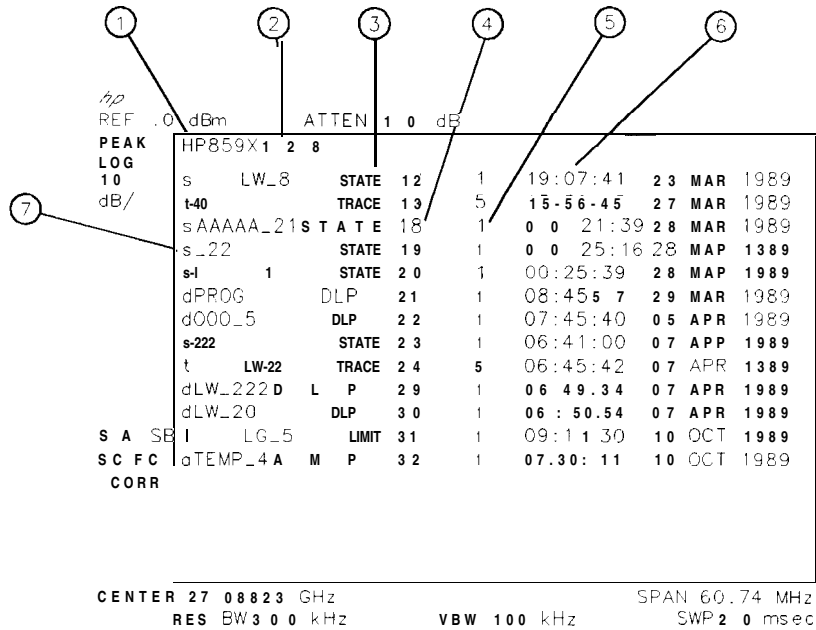

pu150e

**Figure 7-1. Memory Card Catalog Information**

**Table 7-3. Memory Card Catalog Information**

| Item | Title               | Description                                                                                                                                                                                                                                                                                                                                                           |
|------|---------------------|-----------------------------------------------------------------------------------------------------------------------------------------------------------------------------------------------------------------------------------------------------------------------------------------------------------------------------------------------------------------------|
| 1    | Volume Label        | A label to identify the memory card. FORMAT CARD automatically assigns the volume label "HP859X" to the card.                                                                                                                                                                                                                                                         |
| 2    | Number of kilobytes | Displays the size of the memory card. 128 is the number of 256-byte blocks or records. 128 indicates that the card is a 32-Kbyte memory card (128 blocks x 256 bytes per block).                                                                                                                                                                                      |
| 3    | Data Type           | Indicates the type of data-trace, state, downloadable program (DLP), limit line (LIMIT), amplitude factors (AMP), display image (DSPLY). The data type is determined by the letter t, s, d, l, a, or i preceding the filename.                                                                                                                                        |
| 4    | Starting Address    | Indicates the physical record number of the start of the file.                                                                                                                                                                                                                                                                                                        |
| 5    | File Length         | Indicates number of records in the file.                                                                                                                                                                                                                                                                                                                              |
| 6    | Time of Creation    | Indicates the time and date of file creation.                                                                                                                                                                                                                                                                                                                         |
| 7    | File name           | The letter preceding the file name indicates the type of data of the file: t = trace data, s = state data, d = program data (downloadable program), l = limit line, a = amplitude factors, i = display image. If the data was saved using a prefix, the prefix follows the first character in the file name. An underscore and the register number follow the prefix. |

CATALOG  
CARD

**Requires Option 003 for an HP 85901, HP 8592L, or HP 8594L.**

displays a catalog of the items stored on the memory card, while accessing the memory card configuration menu.

Front-Panel Key Access: **CONFIG**

CATALOG  
DISPLAY

**Requires Option 003 for an HP 8590L, HP 8592L, or HP 8594L.**

catalogs all of the display images that are on the memory card. A display image can be recalled to the spectrum analyzer by using the **CARD→DISPLAY** softkey.

Front-Panel Key Access: **RECALL** or **SAVE**

CATALOG  
DLP

catalogs all of the downloadable programs (DLPs) that are in spectrum analyzer memory or on the memory card. Downloadable programs can be saved in spectrum analyzer memory by either loading in a downloadable program from the memory card or defining a function using remote programming commands (**FUNCDEF** or **ACTDEF**).

Front-Panel Key Access: **RECALL** or **SAVE**

Catalog  
Internal

accesses a menu that has the cataloging functions for spectrum analyzer memory: **CATALOG ALL** , **CATALOG REGISTER**, **CATALOG VARIABLES** , **CATALOG PREFIX**, **CATALOG DLP** , and **CATALOG ON EVENT** . Each catalog function displays catalog information. The catalog contains information about the data stored in internal memory (see Figure 7-2 and Table 7-4).

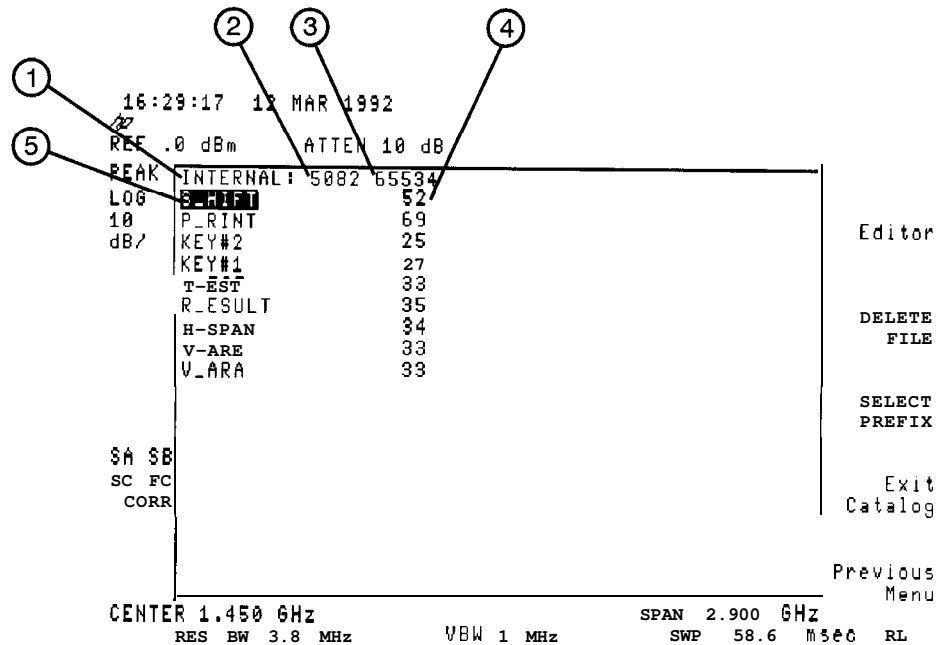

pq12el

**Figure 7-2. Analyzer Memory Catalog Information**

**Table 7-4. Analyzer Memory Catalog Information\***

| Callout Number                                                                 | Description of Items in Figure 7-2                         |
|--------------------------------------------------------------------------------|------------------------------------------------------------|
| 1                                                                              | Name of the catalog source. (Internal)                     |
| 2                                                                              | Bytes of spectrum analyzer memory used. (5082)             |
| 3                                                                              | Total bytes of spectrum analyzer memory available. (65534) |
| 4                                                                              | Bytes used by item. (52)                                   |
| 5                                                                              | Name of item. (S-HIFT)                                     |
| * This table is not applicable when using CATALOG REGISTER or CATALOG ON EVEWT |                                                            |

Unlike saving to the memory card, data is saved as an item in spectrum analyzer memory.

Use the step keys to view different sections of the directory, and the knob to select a file. The selected file is highlighted in inverse video.

Each of the catalog softkey functions access the menu that has the DELETE FILE function. Use DELETE FILE to delete the item from spectrum analyzer memory. (DELETE FILE will not delete a CATALOG ON EVENT item.)

Pressing CATALOG REGISTER accesses a menu that has the LOAD FILE function. Use LOAD FILE to load a state or trace from spectrum analyzer memory. Do not use LOAD FILE to load limit-line table and amplitude correction factor items.

Also see the CATALOG ALL and CATALOG VARIABLES softkey descriptions.  
Front-Panel Key Access: **RECALL** or (SAVE)

CATALOG  
LMT LINE

**Requires Option 003 for an HP 8590L, HP 8592L, or HP 8594L.**

catalogs the limit-lines on the memory card. Press CATALOG REGISTER to catalog limit-line tables stored in spectrum analyzer memory (limit-line tables saved in analyzer memory are stored in trace registers).

Front-Panel Key Access: **RECALL** or (SAVE)

CATALOG  
ON EVENT

displays the “on event” programming commands and their status. The on event programming commands are as follows:

|         |                                                    |
|---------|----------------------------------------------------|
| ONEOS   | Performs command list at end of every sweep.       |
| ONSWP   | Performs command list at beginning of every sweep. |
| TRMATH  | Performs trace math.                               |
| ONCYCLE | Performs command list periodically.                |
| ONDELAY | Performs command list once after a time period.    |
| ONMKR   | Performs command list at the marker.               |
| ONSRQ   | Performs command list on every service request.    |
| ONTIME  | Performs command list at a specific time.          |
| ONPWRUP | Performs command list once at power up.            |

**Note**

If you get into an infinite loop with ONPWRUP, press **PRESET** to abort the command list, then press ERASE DLP MEM to clear all DLPs.

The on event programming commands can be set remotely; see the **HP8590 E-Series and L-Series Spectrum Analyzer and HP 8591C Cable TV Analyzer Programmer's Guide** for more information about setting the commands.

When the on event programming commands have not been set, or when an instrument preset has been performed, pressing CATALOG ON EVENT displays the status of the on event programming commands as UNDEFINED. If the ONEOS, ONSWP, TRMATH, ONMKR, ONPWRUP, and ONSRQ commands have been set, pressing CATALOG ON EVENT displays their status as ACTIVE. When ONCYCLE, ONDELAY, or ONTIME have been set, pressing CATALOG ON EVENT displays the information in Table 7-5 (see Figure 7-3).

**Table 7-5. CATALOG ON EVENT Display Description**

| Programming Command | Description of CATALOG ON EVENT Display                                                                                                                                                                                                                      |
|---------------------|--------------------------------------------------------------------------------------------------------------------------------------------------------------------------------------------------------------------------------------------------------------|
| ONCYCLE             | The number of seconds left until the event occurs, followed by the number of seconds ONCYCLE was set for.                                                                                                                                                    |
| ONDELAY             | CATALOG ON EVENT displays either a positive number or negative number of seconds. A positive number indicates the number of seconds left until the event occurs. A negative number indicates the number of seconds that has passed since the event occurred. |
| ONTIME              | The date (in year, month, and day format) and the time (in 24 hour format) that ONTIME is set for.                                                                                                                                                           |

Front-Panel Key Access: **RECALL** or **SAVE**

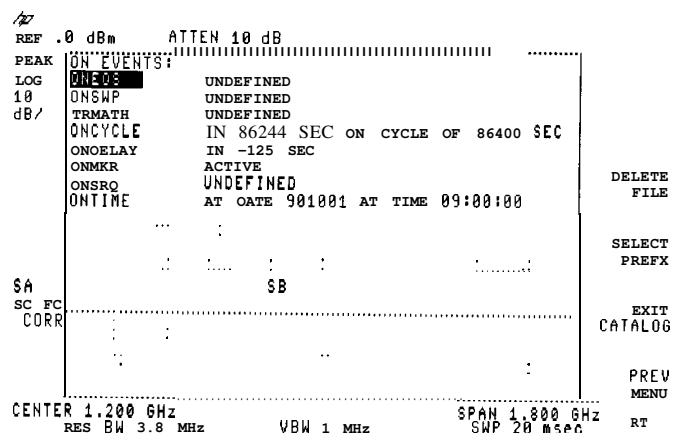

**Figure 7-3. CATALOG ON EVENT Display**

CATALOG  
PREFIX

catalogs all of the saved data, that has the specified prefix, that is either on the memory card or in spectrum analyzer memory. The entire prefix does not have to be specified. For example, if you want to catalog all the files beginning with the prefix S, specify S as the prefix and then use CATALOG PREFIX . Prefixed items can be saved in spectrum analyzer memory by either loading in from a memory card or using remote programming commands to define them.

Front-Panel Key Access: **RECALL** or **SAVE**

|                   |                                                                                                                                                                                                                                                                                                                                                                                                                                                                                                                                                                                                                                                                                                                                                                                                                                                                                                                                                                                                                                         |
|-------------------|-----------------------------------------------------------------------------------------------------------------------------------------------------------------------------------------------------------------------------------------------------------------------------------------------------------------------------------------------------------------------------------------------------------------------------------------------------------------------------------------------------------------------------------------------------------------------------------------------------------------------------------------------------------------------------------------------------------------------------------------------------------------------------------------------------------------------------------------------------------------------------------------------------------------------------------------------------------------------------------------------------------------------------------------|
| CATALOG REGISTER  | displays the status of state and trace registers in spectrum analyzer memory. States 1 through 8 are displayed with the center frequency (denoted by CF) and span (denoted by SP). The status of trace registers 0 to the maximum number of traces is displayed also. If a trace, limit-line tables, or amplitude correction factors have been saved in the trace register, the screen title (denoted by "TL:") is displayed, otherwise UNUSED is displayed. If the screen title length allows, or if no title is saved with the trace, the time and date are displayed. To load the contents of the state or trace register into spectrum analyzer memory, use the knob or step keys to select the register and press LOAD FILE . The DELETE FILE key can be used to delete a state or trace register from spectrum analyzer memory.                                                                                                                                                                                                   |
| Note              | Do not use LOAD FILE to load the contents of a trace register containing limit-line tables or amplitude correction factors.                                                                                                                                                                                                                                                                                                                                                                                                                                                                                                                                                                                                                                                                                                                                                                                                                                                                                                             |
| CATALOG STATES    | <p>Front-Panel Key Access: <b>RECALL</b> or <b>SAVE</b></p> <p><i>Requires Option 003 for an HP 8590L, HP 8592L, or HP 8594L.</i><br/>catalogs all of the states stored on the memory card.<br/>Front-Panel Key Access: <b>RECALL</b> or <b>SAVE</b></p>                                                                                                                                                                                                                                                                                                                                                                                                                                                                                                                                                                                                                                                                                                                                                                                |
| CATALOG TRACES    | <p><i>Requires Option 003 for an HP 8590L, HP 85921, or HP 8594L.</i><br/>catalogs all of the traces stored on the memory card.<br/>Front-Panel Key Access: <b>RECALL</b> or <b>SAVE</b></p>                                                                                                                                                                                                                                                                                                                                                                                                                                                                                                                                                                                                                                                                                                                                                                                                                                            |
| CATALOG VARIABLES | <p>catalogs all of the variables saved in spectrum analyzer memory. Variables can be saved in analyzer memory by loading in a downloadable program from the memory card or defining a function using remote programming commands (VARDEF or TRDEF).<br/>Front-Panel Key Access: <b>RECALL</b> or <b>SAVE</b></p>                                                                                                                                                                                                                                                                                                                                                                                                                                                                                                                                                                                                                                                                                                                        |
| CENTER FREQ       | <p>activates the center-frequency function to allow the selection of frequency that will be at the center of the screen.<br/>Front-Panel Key Access: <b>AUX CTRL</b>, <b>MEAS/USER</b>, or <b>FREQUENCY</b></p>                                                                                                                                                                                                                                                                                                                                                                                                                                                                                                                                                                                                                                                                                                                                                                                                                         |
| CF STEP AUTO MAN  | <p>changes the step size for the center frequency function. Once a step size has been selected and the center frequency function is activated, the step keys change center frequency by the step-size value. The step size function is useful for finding harmonics and sidebands beyond the spectrum analyzer current frequency span. When auto-coupled, the center frequency step size is set to one graticule (10 percent of the span).<br/>Front-Panel Key Access: <b>AUTO COUPLE</b> or <b>FREQUENCY</b></p>                                                                                                                                                                                                                                                                                                                                                                                                                                                                                                                       |
| Change Prefix     | <p>allows you to enter a prefix that can be used for saving and recalling data to and from the memory card, and for cataloging by the prefix. The prefix can be from one to seven characters long. The longer the prefix, the shorter the register number must be. The total length of the prefix and register number cannot exceed eight characters. The prefix can be any character; however, the underscore should not be the first character of the prefix. Pressing Change Prefix accesses a menu containing the letters of the alphabet, the underscore symbol (-), the number symbol (#), a space, and the clear function. To select a character, press the softkey that displays the group of characters that contains the desired character. The softkey menu changes to allow you to select an individual character. If you make a mistake, press <b>BK SP</b> to space back over the incorrect character. Additional characters are available by pressing More 1 of 2 . Numbers may be selected with the numeric keypad.</p> |

Change  
Title

A prefix can be cleared with the clear function. Press **CONFIG** or **DISPLAY**, Change Prefix , YZ\_# Spc Clear, Clear to clear the current prefix. The current prefix is blanked by pressing **DEFAULT CONFIG** .

Front-Panel Key Access: **CONFIG**, **DISPLAY**, **RECALL**, or **SAVE**

allows you to write a 53-character screen title across the top of the screen. The marker readout may interfere with the last 26 characters. The markers can be turned off by pressing **MKR**, More 1 of 2 , and **MARKER ALL OFF** .

Pressing Change Title accesses the softkey menus that contain the available characters and symbols. A programming command can be entered in the screen title area. It can then be executed from the front panel by pressing **EXECUTE TITLE**.

The screen title will remain on the screen until either Change Title is pressed again or a trace is recalled that was saved with a screen title. A screen title can also be cleared by using the clear function. Press **DISPLAY**, Change Title, YZ\_# Spc Clear, Clear to clear the current screen title.

Pressing Change Title accesses a menu containing the letters of the alphabet, the underscore symbol (-), the number symbol (#), a space, and the Clear softkey. To select a character, press the softkey that displays the group of characters that contains the desired character. The softkey menu changes to allow you to select an individual character. If you make a mistake, press **BK SP** to space back over the incorrect character. Additional characters are available by pressing More 1 of 2 . Numbers may be selected by using the numeric keypad.

Pressing **RPG TITLE** provides additional characters for the menu accessed by pressing Change Title . Pressing **RPG TITLE** provides lowercase letters, numbers, Greek letters, and punctuation symbols. To access additional characters, press **RPG TITLE** . When **RPG TITLE** is pressed, a character table appears on the screen. To select a character, turn the knob to position the cursor under the desired character and press the **ENTER** key. The step keys move the cursor between rows. When all desired characters have been entered, press **WINDOWS NEXT**, or for an HP 8590L or an HP 8592L press **HOLD**. All other spectrum analyzer functions are inoperative until the **NEXT** or **HOLD** key is pressed.

Front-Panel Key Access: (CAL) or **DISPLAY**

CHANNEL  
BANDWIDTH

allows the user to enter the channel bandwidth to set up the spectrum analyzer when using the measurement functions under the Power Menu softkey. When the power measurements are first accessed the initial value for channel bandwidth is 16 kHz. If the value is changed, the new value will be saved through an instrument preset or power on. An error message will occur for invalid values of channel bandwidth and channel spacing.

If one of the power measurements is active and the channel bandwidth is changed, with **PARAM AUTO** selected, then the coupled spectrum analyzer settings are immediately updated. If **CONT MEAS** is also selected, then another sweep is taken and the measured results are updated.

From-Panel Key Access: **MEAS/USER**

|                    |                                                                                                                                                                                                                                                                                                                                                                                                                                                                                                                                                                                                                                                                                                                                                                                                                                                                                              |
|--------------------|----------------------------------------------------------------------------------------------------------------------------------------------------------------------------------------------------------------------------------------------------------------------------------------------------------------------------------------------------------------------------------------------------------------------------------------------------------------------------------------------------------------------------------------------------------------------------------------------------------------------------------------------------------------------------------------------------------------------------------------------------------------------------------------------------------------------------------------------------------------------------------------------|
| CHANNEL<br>POWER   | <p>measures the power and power spectral density in the channel bandwidth specified by the user. Two vertical lines on the display indicate the edges of the channel bandwidth. The measurement can be made on a single sweep or to continuously update at the end of each sweep. The center frequency, reference level, and channel bandwidth must be set by the user. If <b>PARAM AUTO MAN</b> is selected (<u>AUTO</u> is underlined), other settings will be coupled and set automatically. <b>PARAM AUTO MAN</b> can be selected to manually control all settings by underlining MAN. The measurement stops and the spectrum analyzer is returned to its prior state when other functions are activated. The channel power measurement responds like an rms power measurement.</p> <p>Front-Panel Key Access: <span style="border: 1px solid black; padding: 2px;">MEAS/USER</span></p> |
| CHANNEL<br>SPACING | <p>allows the user to enter the channel spacing to set up the spectrum analyzer when using the measurement functions under the Power Menu softkey. When the power measurements are first accessed the initial value for channel spacing is 25 kHz. Once the value is changed, the new value will be saved through an instrument preset or power on. An error message will occur for invalid values of channel spacing and channel bandwidth.</p> <p>If one of the power measurements is active and the channel spacing is changed, with <b>PARAM AUTO</b> selected, then the coupled spectrum analyzer settings are immediately updated. If <b>CONT MEAS</b> is also selected, then another sweep is taken and the measured results are updated.</p> <p>Front-Panel Key Access: <span style="border: 1px solid black; padding: 2px;">MEAS/USER</span></p>                                    |
| Clear              | <p>clears the current screen title or prefix. This softkey is accessed under the <b>YZ_# Spc Clear</b> softkey when using Change Title or</p> <p>Change Prefix.</p> <p>Front-Panel Key Access: <span style="border: 1px solid black; padding: 2px;">CAL</span>, <span style="border: 1px solid black; padding: 2px;">CONFIG</span>, <span style="border: 1px solid black; padding: 2px;">DISPLAY</span>, (RECALL), or <span style="border: 1px solid black; padding: 2px;">SAVE</span></p>                                                                                                                                                                                                                                                                                                                                                                                                   |
| CLEAR<br>PARAM     | <p><b>Option 105 only. Option 101 is recommended.</b></p> <p>clears all of the pulse parameters in the gate utility. It sets the value of pulse width, pulse repetition interval, and reference edge to zero and turns off the coupling of the pulse parameters to the resolution bandwidth, video bandwidth, and sweep time.</p> <p>Front-Panel Key Access: <span style="border: 1px solid black; padding: 2px;">SWEEP</span></p>                                                                                                                                                                                                                                                                                                                                                                                                                                                           |
| CLEAR<br>QP DATA   | <p><b>for Option 103 only.</b></p> <p>clears the displayed quasi-peak amplitude and quasi-peak marker (represented by a diode symbol) from the spectrum analyzer screen. See the HP 85913, HP 85933, HP 8594E, HP 85953, or HP 8596E Option 103 supplement documentation for more information.</p> <p>Front-Panel Key Access: <span style="border: 1px solid black; padding: 2px;">AUX CTRL</span></p>                                                                                                                                                                                                                                                                                                                                                                                                                                                                                       |

CLEAR  
WRITE A

erases any data previously stored in trace A and continuously displays any signals during the sweep of the spectrum analyzer. This function is activated at power on and by pressing **PRESET**.

Changing the trace mode of trace C to clear write or minimum hold can change the trace mode of trace A. If trace A is in clear-write mode or maximum-hold mode when trace C is changed to clear write or minimum hold, the trace mode of trace A is changed to store blank. The following table shows the trace mode of trace A before and after changing trace C to clear-write or minimum-hold trace mode.

| <b>Trace Mode of Trace A<br/>Before</b> | <b>Trace Mode of Trace A<br/>After</b> |
|-----------------------------------------|----------------------------------------|
| Clear write                             | Store blank                            |
| Maximum hold                            | Store blank                            |
| View                                    | View                                   |

Changing the trace mode of trace A to clear write or maximum hold can change the trace mode of trace C. If trace C is in clear-write mode when trace A is changed to clear write or minimum hold, the trace mode of trace C is changed to minimum hold.

| <b>Trace Mode of Trace C<br/>Before</b> | <b>Trace Mode of Trace C<br/>After</b> |
|-----------------------------------------|----------------------------------------|
| Clear write                             | Minimum hold                           |
| Minimum hold                            | Minimum hold                           |
| View                                    | View                                   |

Front-Panel Key Access: **TRACE**



CLEAR  
WRITE B

erases any data previously stored in trace B and continuously displays any signals detected during the sweep of the spectrum analyzer. This function is activated at power on and by pressing (PRESET).

Changing the trace mode of trace C to clear write or minimum hold can change the trace mode of trace B. If trace B is in clear-write mode or maximum-hold mode when trace C is changed to clear write or minimum hold, the trace mode of trace B is changed to store blank.

The following table shows the trace mode of trace B before and after changing trace C to clear-write or minimum-hold trace mode.

| Trace Mode of Trace B<br>Before | Trace Mode of Trace B<br>After |
|---------------------------------|--------------------------------|
| <b>Clear write</b>              | <b>Store blank</b>             |
| <b>Maximum hold</b>             | <b>Store blank</b>             |
| <b>View</b>                     | <b>View</b>                    |

Changing the trace mode of trace B to clear write or maximum hold can change the trace mode of trace C. If trace C is in clear-write mode when trace B is changed to clear write or minimum hold, the trace mode of trace C is changed to minimum hold.

| Trace Mode of Trace C<br>Before | Trace Mode of Trace C<br>After |
|---------------------------------|--------------------------------|
| <b>Clear write</b>              | <b>Minimum hold</b>            |
| <b>Minimum hold</b>             | <b>Minimum hold</b>            |
| <b>View</b>                     | <b>View</b>                    |

Front-Panel Key Access: TRACE

CLEAR  
WRITE C

erases any data previously stored in trace C and continuously displays any signals detected during the sweep of the spectrum analyzer. This function is activated at power on and by pressing **PRESET**.

Changing the trace mode of trace C to clear write or minimum hold can change the trace mode of trace A and trace B. If trace A or trace B is in clear-write mode or maximum-hold mode when trace C is changed to clear write or minimum hold, the trace mode of trace A or trace B is changed to store blank. The following table shows the trace mode of trace A or trace B before and after changing trace C to clear-write or minimum-hold trace mode.

| Trace Mode of Trace A or B Before | Trace Mode of Trace A or B After |
|-----------------------------------|----------------------------------|
| Clear write                       | Store blank                      |
| Maximum hold                      | Store blank                      |
| View                              | View                             |

If you want to use trace A or trace B in the clear-write or maximum-hold mode and do not want trace C to blank it, use minimum-hold or view-trace mode for trace C.

Front-Panel Key Access: **TRACE**

CNT RES  
AUTO MAN

**Does not apply to HP 8590L with Option 013.**

allows the resolution of the marker counter to be selected manually or auto-coupled. The marker counter has a resolution range of 10 Hz to 100 kHz. The available resolution values are 1 Hz, 10 Hz, 100 Hz, 1 kHz, 10 kHz, and 100 kHz. The 1 Hz marker counter resolution is not specified. The resolution can be changed by using the step keys or by entering the resolution using the numeric keypad. The marker counter resolution can be auto coupled to the span by pressing CNT RES AUTO MAN so that AUTO is underlined. The CNT RES AUTO MAN softkey function is not affected by pressing AUTO ALL .

Front-Panel Key Access: **MKR FCTN**

CNTLA  
0 1

makes the auxiliary-interface control line A output high or low (TTL).

Front-Panel Key Access: **AUX CTRL**

CNTLB  
0 1

makes the auxiliary-interface control line B output high or low (TTL).

Front-Panel Key Access: **AUX CTRL**

CNTLC  
0 1

makes the auxiliary-interface control line C output high or low (TTL).

Front-Panel Key Access: **AUX CTRL**

CNTLD  
0 1

makes the auxiliary-interface control line D output high or low (TTL).

Front-Panel Key Access: **AUX CTRL**

|                    |                                                                                                                                                                                                                                                                                                                                                                                                                                                                                                                                                                                                                                                                                                                                                                                                                                                    |
|--------------------|----------------------------------------------------------------------------------------------------------------------------------------------------------------------------------------------------------------------------------------------------------------------------------------------------------------------------------------------------------------------------------------------------------------------------------------------------------------------------------------------------------------------------------------------------------------------------------------------------------------------------------------------------------------------------------------------------------------------------------------------------------------------------------------------------------------------------------------------------|
| COARSE<br>TUNE DAC | displays the analog output of the YTO coarse-tune DAC located on the A7 Analog Interface assembly. This is a service diagnostic function and is for service use only.<br>Front-Panel Key Access: <b>CAL</b>                                                                                                                                                                                                                                                                                                                                                                                                                                                                                                                                                                                                                                        |
| COMB GEN<br>ON OFF | <b>HP 8592L, HP 8593E, and HP 8596E only.</b><br>turns the internal comb generator on or off. Connect a cable between 100 MHz COMB OUT and the spectrum analyzer input.<br>Front-Panel Key Access: <b>AUX CTRL</b>                                                                                                                                                                                                                                                                                                                                                                                                                                                                                                                                                                                                                                 |
| CONF<br>TEST       | initiates a variety of tests to check the major functions of the spectrum analyzer. The confidence test function checks that the video bandwidths change, the noise floor level decreases as the resolution bandwidth narrows, the step gains switch, and the 3 dB bandwidths of the resolution bandwidths are correctly set. CNF TEST PASS is displayed if the confidence test passes.<br>Front-Panel Key Access: <b>CAL</b>                                                                                                                                                                                                                                                                                                                                                                                                                      |
| <b>CONFIG</b>      | accesses the softkey menu used for printer and plotter configurations, the time and date display functions, changing the current prefix, memory card configuration functions, disposing of user-defined variables and programs from spectrum analyzer memory, changing the spectrum analyzer address or the baud rate, displaying the installed options on screen, and changing the format of the MONITOR output. Pressing <b>CONFIG</b> will clear an SRQ error message from the screen. Pressing <b>CONFIG</b> after the spectrum analyzer has been placed in the remote mode places the spectrum analyzer in the local mode and enables front-panel control. During remote operation, an R appears in the lower-right corner of the screen indicating remote mode. Pressing <b>CONFIG</b> removes the R annotation from the lower-right corner. |
| CONT<br>MEAS       | sets the functions in the Power Menu so that they make the measurement at the end of every sweep. After a power measurement is activated, pressing CONT MEAS or SWEEP CONT puts the spectrum analyzer into a continuous sweep mode and recalculates the results at the end of each sweep.<br>Front-Panel Key Access: <b>MEAS/USER</b>                                                                                                                                                                                                                                                                                                                                                                                                                                                                                                              |
| CONTINUS<br>FFT    | initializes the fast Fourier transform (FFT) function, puts the spectrum analyzer in continuous sweep and performs an FFT at the end of each sweep. If the FFT function is already active, it puts the spectrum analyzer in continuous sweep and performs FFTs.<br><br>After using the FFT function, the display is in log mode. The markers are put in the FFT mode for use in evaluating the data. The signal being transformed is in trace A and the Fourier transform of the signal is in trace B. (Any information that was in trace B and C will be lost.) Press FFT OFF to return the spectrum analyzer to normal operation.<br><br>Refer to Chapter 4, "Measuring Amplitude Modulation Using the Fast Fourier Transform Function," for more information.<br>Front-Panel Key Access: <b>MEAS/USER</b>                                       |

**COPY**

*Option 041 or 043 only.*

initiates an output of the screen data, without an external controller, to a previously specified graphics printer or plotter. Refer to Chapter 6 of this manual or the **HP 8590 E-Series and L-Series Spectrum Analyzer and HP 8591C Cable TV Analyzer Programmer's Guide** for detailed information about printing and plotting.

The printer or plotter must have already been selected using **CONFIG** and either Plot Conf ig (for a plotter) or Print Conf ig (for a printer). To obtain a print, press **CONFIG**, COPY DEV PRNT PLT (so that PRNT is underlined), then Print Conf ig , Pm Port Conf ig .

For Option 041, use PRINTER ADDRESS to change the HP-IB address of the printer, if necessary. Press **CONFIG**, Print Conf ig , Pm Port Conf ig , PRN PORT HPIB PAR (so that HPIB is underlined), then press PRINTER ADDRESS.

For Option 043, use BAUD RATE to change the baud rate of the spectrum analyzer, if necessary. Press **CONFIG**, Print Conf ig , Pm Port Conf ig , PRN PORT SER PAR (so that SER is underlined), then press BAUD RATE.

If the spectrum analyzer is connected to an HP PaintJet printer and you want a color printout, press Set Colr Printer and then PAINTJET PRINTER. If the spectrum analyzer is connected to an HP PaintJet printer and you want a black and white printout, press Set B&W Printer and then HP B&W PRINTER . More printer information can be found in the **HP 8590 E-Series and L-Series Spectrum Analyzer and HP 8591C Cable TV Analyzer Programmer's Guide** and chapter 6 of this manual.

If you want the softkey labels to be printed with the spectrum analyzer display printout when using **COPY**, press PRT MENU ON OFF so that ON is underlined.

Press **COPY** and the process will begin. The screen remains frozen (no further sweeps taken) until the data transfer to the printer is complete. The spectrum analyzer works with many Hewlett-Packard printers.

The plotting process is similar to the printing process. On the spectrum analyzer, press **CONFIG**, Plot Conf ig . To obtain a plot, press **CONFIG**, COPY DEV PRNT PLT (so that PLT is underlined), then Plot Conf ig , Plt Port Conf ig .

For Option 041, use PLOTTER ADDRESS to change the HP-IB address for the plotter, if necessary. Press **CONFIG**, Plot Conf ig , Plt Port Conf ig , PLT PORT HPIB PAR (so that SER is underlined), then press PLOTTER ADDRESS.

For Option 043, use BAUD RATE to change the baudrate of the spectrum analyzer, if necessary Press **CONFIG**, Plot Conf ig , Plt Port Conf ig , PLT PORT SER PAR (so that SER is underlined), then press BAUD RATE .

With PLTS/PG 1 2 4 , you can choose a full-page, half-page, or quarter-page plot. Press PLTS/PG 1 2 4 to underline the number of plots per page desired. If two or four plots per page are chosen, a softkey function is displayed that allows you to select the location of the plotter output on the paper. If two plots per page are selected, PLT \_ \_LOC \_ \_ is displayed. If four plots per page are selected, PLT \_ \_LOC \_ \_ is displayed. Press the softkey until the rectangular marker is in the desired section of the softkey label. The upper and lower sections of the softkey label graphically represent the position of the page where the plotter output will be located.

**Note**

The HP 7470A Plotter does not support two plots per page output. If you use an HP 7470A Plotter with an HP 8590 Series Spectrum Analyzer, you can select one or four plots per page, but not two plots per page.

For a multipen plotter, the pens of the plotter draw the different components of the screen as follows:

| Pen Number | Description                                             |
|------------|---------------------------------------------------------|
| 1          | Draws the annotation and graticule.                     |
| 2          | Draws trace A.                                          |
| 3          | Draws trace B.                                          |
| 4          | Draws trace C and the display line.                     |
| 5          | Draws user-generated graphics and the lower limit line. |
| 6          | Draws the upper limit line.                             |

To plot, press Previous Menu, COPY DEV PRNT PLT (PLT should be underlined), and COPY.

Printing is usually faster than plotting, but plotting provides higher resolution output. The spectrum analyzer works with plotters such as the HP 7440A.

Figure 7-4 shows the rear view of a typical printer/spectrum-analyzer configuration.

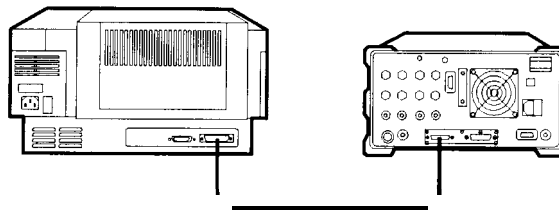

**Figure 7-4. Connecting a Printer to the Spectrum Analyzer**

---

**Note** Printing and plotting require an optional interface. Generally, spectrum analyzers with an HP-IB interface set the plotter address to 5 and the printer address to 1. Spectrum analyzers with an RS-232 interface must have the baud rate set to match the baud rate of the printer or plotter being used. The ***HP 8590 E-Series and L-Series Spectrum Analyzer and HP 8591C Cable TV Analyzer Programmer's Guide*** that comes with the optional interfaces details the different interfaces. Refer to Chapter 6 in this manual for more information about printing and plotting.

---

COPY DEV  
PRNT PLT ***Option 041 or 043 only.***  
changes between a printer and plotter. For example, if you have been printing and want to do a plot, press COPY DEV PRNT PLT to underline PLT before pressing **COPY**.  
Front-Panel Key Access: **CONFIG**

CORRECT  
ON OFF controls use of some of the correction factors. When ON is underlined, correction factors are used and CORR appears on the display. When OFF is underlined, correction factors are not used. Turning the correction factors off degrades amplitude accuracy.

---

**Note** Correction factors must be on for the spectrum analyzer to meet its specified performance.

---

COUPLE  
AC DC Front-Panel Key Access: **CAL**  
***HP 8594E, HP 8595E, or HP 8596E only.***  
specifies alternating-current (AC) or direct-current (DC) coupling at the spectrum analyzer input. Selecting ac coupling blocks any dc voltage at the spectrum analyzer input; however, the ac coupling also decreases the frequency range of the spectrum analyzer. The input coupling is set to ac by an instrument preset.  
Amplitude specifications apply only when coupling is set to DC.

---

**Caution** Do not use dc coupling if there is any dc voltage at the spectrum analyzer input.

---

CPL RBW  
ON OFF Front-Panel Key Access: **AMPLITUDE**  
***Option 105 only. Option 101 is recommended.***  
automatically selects the optimum resolution bandwidth for an unmodulated pulse if the pulse width has been entered. If the pulse width has not been determined, the resolution bandwidth will not be coupled to the pulse parameters and a warning message will occur. If a resolution bandwidth is entered manually, the coupling will be turned off.  
Front-Panel Key Access: **(SWEEP)**

CPL SWP  
ON OFF ***Option 105 only. Option 101 is recommended.***  
automatically selects the optimum sweep time if the pulse repetition interval has been entered. If the pulse repetition interval has not been determined, the sweep time will not be coupled and an error message will occur. If a sweep time is entered manually, the coupling will be turned off. Sweep time coupling only applies to the frequency domain window.  
Front-Panel Key Access: **(SWEEP)**

|                      |                                                                                                                                                                                                                                                                                                                                                                                                                                                                                                                                                  |
|----------------------|--------------------------------------------------------------------------------------------------------------------------------------------------------------------------------------------------------------------------------------------------------------------------------------------------------------------------------------------------------------------------------------------------------------------------------------------------------------------------------------------------------------------------------------------------|
| CPL VBW<br>ON OFF    | <p><b>Option 105 only. Option 101 is recommended.</b></p> <p>automatically selects the optimum video bandwidth if the gate length has been entered. If the gate length has not been determined, the video bandwidth will not be coupled to the gate length and an error message will occur. If a gate length is entered manually, the coupling will be turned off.</p> <p>Front-Panel Key Access: <b>SWEEP</b></p>                                                                                                                               |
| CRT HORZ<br>POSITION | <p>changes the horizontal position of the signal on the spectrum analyzer display. Press CAL STORE if you want the spectrum analyzer to use this position permanently, so that it is not lost when the power is turned off.</p> <p>Front-Panel Key Access: <b>CAL</b></p>                                                                                                                                                                                                                                                                        |
| CRT VERT<br>POSITION | <p>changes the vertical position of the signal on the spectrum analyzer display. Press CAL STORE if you want the spectrum analyzer to use this position permanently, so that it is not lost when the power is turned off.</p> <p>Front-Panel Key Access: <b>CAL</b></p>                                                                                                                                                                                                                                                                          |
| DACS                 | <p>changes the DAC numbers of the span, DAC YTO coarse-tune, DAC YTO fine-tune, and YTO FM tune DAC located on the A7 Analog Interface assembly. This is a service diagnostic function and is for service use only.</p> <p>Front-Panel Key Access: <b>CAL</b></p>                                                                                                                                                                                                                                                                                |
| DATEMODE<br>MDY DMY  | <p>changes the display of the date from a month-day-year format to a day-month-year format. It is set to a month-day-year format by pressing DEFAULTCONFIG.</p> <p>Front-Panel Key Access: <b>CONFIG</b></p>                                                                                                                                                                                                                                                                                                                                     |
| dBm                  | <p>changes the amplitude units to dBm for the current setting (log or linear).</p> <p>Front-Panel Key Access: <b>AMPLITUDE</b></p>                                                                                                                                                                                                                                                                                                                                                                                                               |
| dBmV                 | <p>changes the amplitude units to dBmV for the current setting (log or linear).</p> <p>Front-Panel Key Access: <b>[AMPLITUDE]</b></p>                                                                                                                                                                                                                                                                                                                                                                                                            |
| dBuV                 | <p>changes the amplitude units to dBμV for the current setting (log or linear).</p> <p>Front-Panel Key Access: <b>AMPLITUDE</b></p>                                                                                                                                                                                                                                                                                                                                                                                                              |
| DEFAULT<br>CAL DATA  | <p>accesses the factory-default correction factors. A special pass code is required for use. If the message Self cal needed appears when DEFAULT CAL DATA is pressed, the CAL FREQ and CAL AMPTD routines need to be run. The CAL FREQ and CAL AMPTD must be run to ensure specifications. If the spectrum analyzer maximum frequency is higher than 3 GHz, the CAL YTF routine must also be run. The calibration results must then be saved by pressing CAL STORE. See Chapter 9 for more information.</p> <p>Front-Panel Key Access: (CAL)</p> |
| DEFAULT<br>CONFIG    | <p>resets the spectrum analyzer configuration to the state it was in when it was originally shipped from the factory and performs an instrument preset. See Table 7-6 for the default user-configuration values set by pressing DEFAULTCONFIG.</p>                                                                                                                                                                                                                                                                                               |

**Table 7-6. Default Configuration Values**

| Configuration                          | Default Value           |
|----------------------------------------|-------------------------|
| Analyzer address (Option 041)          | 18                      |
| Copy device                            | printer                 |
| CRT position (Horizontal and Vertical) | 10, 48                  |
| Printer address (Option 041)           | 1                       |
| Plotter address (Option 041)           | 5                       |
| Baud rate (Option 043)                 | 1200                    |
| External preamp                        | 0 dB                    |
| Save lock (internal states or traces)  | Off                     |
| Printer                                | black and white printer |
| Print menu                             | on                      |
| Plots per page                         | 1                       |
| Time/date display                      | on                      |
| Date mode                              | month-day-year format   |
| Prefix                                 | (blank)                 |
| Analyzer state at power on             | instrument preset       |

Front-Panel Key Access: **CONFIG**

DEFAULT SYNC restores the factory default values of the horizontal and vertical synchronization constants for the rear panel MONITOR output. CRT SYNC DEFAULT can be used to exit from the NTSC or PAL modes to return to the normal monitor output and use the default synchronization constants.

Front-Panel Key Access: **CONFIG**

Define Coupling **Option 105 only. Option 101 is recommended.** accesses the time gate utility menu for coupling spectrum analyzer settings to the input pulsed signal parameters. It also accesses the pulsed signal parameter entry menus.

Front-Panel Key Access: **SWEEP**

Define Gate **Option 105 only. Option 101 is recommended.** accesses the menu for turning on and defining the gate, from within the time gate utility. Gate delay and gate length settings determine when the gate turns on and how long it remains on. The trigger marker can be activated from this menu. This menu also includes a function which switches the active window between the time domain window and the frequency domain window, allowing the corresponding trace to be updated.

Front-Panel Key Access: **SWEEP**

Define Time **Option 105 only. Option 101 is recommended.** accesses the menu for manipulating the time domain window in the gate utility. It will automatically make the time window active and turn off the gate. The trigger marker can be activated from this menu.

Front-Panel Key Access: **SWEEP**



DELETE FILE function allows you to delete an item from spectrum analyzer memory or a file from the memory card. Use the step keys to view different sections of the directory and use the knob to select the file or item to delete. Pressing DELETE FILE causes a message to appear on the spectrum analyzer screen: **if** you are sure, press key again to purge data. Press DELETE FILE again if you want to delete the memory item.

---

**Note** Deleting items beginning with an underscore from spectrum analyzer memory is not recommended and may have unexpected results. Items beginning with an underscore are used by the spectrum analyzer.

---

DELETE POINT Front-Panel Key Access: [RECALL] or (SAVE)  
deletes an amplitude-correction factor that was previously selected by SELECT POINT.  
Front-Panel Key Access: (CAL)

DELETE SEGMENT deletes the limit-line entry for the selected segment number. Press SELECT SEGMENT then enter the segment number to select the limit-line entry for deletion.  
Front-Panel Key Access: (DISPLAY)

Demod *Option 102 or 103 only.*  
accesses the softkeys controlling demodulation functions, speaker volume, squelch level, FM gain, and dwell time.  
Front-Panel Key Access: (AUX CTRL)

DEMODO AM FM *Option 102 or 103 only.*  
allows selection of amplitude (AM) or frequency (FM) demodulation.  
Activating AM detection turns off FM demodulation (if it is on). When the frequency span is greater than 0 Hz, a 30 kHz resolution bandwidth is used during demodulation, regardless of the screen annotation. When the span is equal to 0 Hz, the displayed bandwidth is used.  
Turning FM demodulation on turns off AM demodulation (if it is on). When the frequency span is greater than 0 Hz, a 100 kHz bandwidth is used during the demodulation, regardless of the screen annotation. When the span is equal to 0 Hz, the displayed bandwidth is used.  
Front-Panel Key Access: (AUX CTRL)

DEMODO ON OFF *Option 102 or 103 only.*  
turns the AM or FM demodulation on and off. If the spectrum analyzer is in a nonzero span, a marker is placed at center screen if an on-screen marker is not already present. The marker pause is changed to equal the current dwell time value. Demodulation takes place on any signal that is indicated by the marker position during the marker pause. There is no change to the display during marker pause, but the demodulation signal is present on the AUX VIDEO OUT. Also see the SPEAKER ON OFF softkey description.

Pressing DEMODO ON OFF selects the sample peak detector for AM demodulation, the FMV detector for FM demodulation. If the spectrum analyzer is in zero span, demodulation is done continuously, with or without an on-screen marker.  
Front-Panel Key Access: (AUX CTRL)

DESKJET 310/550C selects the HP DeskJet 310 or 550C for color printing. Use this function if you have one of these color printers. This softkey can be accessed by pressing **CONFIG**, then Set Colr Printer.

Front-Panel Key Access: **CONFIG**

DESKJET 540 selects the HP DeskJet 540 for color printing. Use this function if you have this color printer. This softkey can be accessed by pressing **CONFIG**, then Set Colr Printer.

Front-Panel Key Access: **CONFIG**

DETECTOR **Option 101 only.**

PK SP NG selects between positive peak, sample, and negative peak detection. Negative peak detection is only available with option 101. When sample detection is selected, SMPL appears in the upper-left corner of the screen. In sample mode, the instantaneous signal value at the present display point is placed in memory. Sample detection is activated automatically for noise level markers, during video averaging, and for FFT measurements.

When positive peak detection is selected, PEAK appears in the upper-left corner of the screen. Positive peak detection obtains the maximum video signal between the last display point and the present display point and stores this value in the trace memory address. Positive peak detection is selected at power on and by pressing **PRESET**.

Negative peak detection functions the same as positive peak detection but selects the minimum video signal. The PEAK message does not appear in the upper-left corner of the screen.

Front-Panel Key Access: **TRACE**

DETECTOR SMP PK selects between positive peak detection and sample detection. When sample detection is selected, SMPL appears in the upper-left corner of the screen. In sample mode, the instantaneous signal value at the present display point is placed in memory. Sample detection is activated automatically for noise level markers, during video averaging, and for FFT measurements.

When positive peak detection is selected, PEAK appears in the upper-left corner of the screen. Positive peak detection obtains the maximum video signal between the last display point and the present display point and stores this value in the trace memory address. Positive peak detection is selected at power on and by pressing **PRESET**.

Front-Panel Key Access: **TRACE**

**DISPLAY**

accesses softkeys that include the HOLD key and limit line menus, and activate the display line, threshold and analog+ display mode. They allow title and prefix entry, and control the display of the graticule and screen annotation.

DISPLAY CAL DATA

displays the current correction-factor data generated by the frequency and amplitude self-calibration routines. This is a service diagnostic function and is for service use only.

Front-Panel Key Access: **CAL**

|                     |                                                                                                                                                                                                                                                                                                                                                                                                                                                                                                                                                                                                                                                                                                                                                                                                                                                                        |
|---------------------|------------------------------------------------------------------------------------------------------------------------------------------------------------------------------------------------------------------------------------------------------------------------------------------------------------------------------------------------------------------------------------------------------------------------------------------------------------------------------------------------------------------------------------------------------------------------------------------------------------------------------------------------------------------------------------------------------------------------------------------------------------------------------------------------------------------------------------------------------------------------|
| DISPLAY<br>→CARD    | <p><i>Requires <b>Option 003</b> for the <b>HP 85901, HP 8592L, and HP 8594L.</b></i></p> <p>saves the current spectrum analyzer display image on the memory card for viewing or copying later. It does not save the spectrum analyzer state or trace, so it cannot be used to restore an instrument to the conditions at the time the image was saved.</p> <p>To save the current display image, press DISPLAY → CARD , use the numeric keypad to enter a number, and press <b>ENTER</b>. If you want the file name of the stored data to contain a prefix, press Change Prefix to enter a prefix before storing the data. If the display image was stored using a prefix, the file name for the display image consists of i(prefix)-(register number). If no prefix was specified, the file name is i_(register number).<br/>Front-Panel Key Access: <b>SAVE</b></p> |
| DISPLAY<br>CNTL I   | <p>displays the status of the auxiliary connector input (control line I) on the spectrum analyzer screen (high = 1 or low = 0, in TTL).<br/>Front-Panel Key Access: <b>AUX CTRL</b></p>                                                                                                                                                                                                                                                                                                                                                                                                                                                                                                                                                                                                                                                                                |
| Dispose<br>User Mem | <p>accesses the softkeys ERASE MEM CARD , ERASE DLP MEM , ERASE STATEALL, ERASE TRACEALL , and ERASE NEM ALL which are used to erase the user programs and variables that are in spectrum analyzer memory.</p>                                                                                                                                                                                                                                                                                                                                                                                                                                                                                                                                                                                                                                                         |

---

**Note** Use DELETE FILE to selectively delete stored programs or variables from spectrum analyzer memory.

---

|                    |                                                                                                                                                                                                                                                                                                                                                                                                                                                                                                                                                                                                                                                                                                                                                  |
|--------------------|--------------------------------------------------------------------------------------------------------------------------------------------------------------------------------------------------------------------------------------------------------------------------------------------------------------------------------------------------------------------------------------------------------------------------------------------------------------------------------------------------------------------------------------------------------------------------------------------------------------------------------------------------------------------------------------------------------------------------------------------------|
| DONE               | <p>Front-Panel Key Access: <b>CONFIG</b></p> <p><i>Option 105 only. Option 101 is <b>recommended</b>.</i></p> <p>exits the pulse parameter entry menus in the gate utility assigning the current marker value to be the value of the parameter being entered. Pressing DONE also restores the sweep delay and sweep time, of the time domain window, to the values that existed prior to any adjustments made during pulse parameter entry.<br/>Front-Panel Key Access: <b>SWEEP</b></p>                                                                                                                                                                                                                                                         |
| DROOP              | <p>disables the reset of the peak detector on the AI6 Processor/Video assembly after each analog-to-digital conversion. This is a service diagnostic function and is for service use only.<br/>Front-Panel Key Access: <b>CAL</b></p>                                                                                                                                                                                                                                                                                                                                                                                                                                                                                                            |
| DSP LINE<br>ON OFF | <p>activates an adjustable horizontal line that is used as a visual reference line. The line, which can be used for trace arithmetic, has amplitude values that correspond to its vertical position when compared to the reference level. The value of the display line appears in the active function block and on the left side of the screen. The display line can be adjusted using the step keys, knob, or numeric keypad. Pressing any digit, 0 through 9, on the numeric keypad brings up the selected terminator menu. To deactivate the display line, press DSP LINE ON OFF so that OFF is underlined. (Also see the VIDEO softkey description.)<br/>Front-Panel Key Access: <b>DISPLAY</b>, <b>MKR FCTN</b>, or <b>PEAK SEARCH</b></p> |

|                     |                                                                                                                                                                                                                                                                                                                                                                                                                                                                                                                                                                                                                                                                                                |
|---------------------|------------------------------------------------------------------------------------------------------------------------------------------------------------------------------------------------------------------------------------------------------------------------------------------------------------------------------------------------------------------------------------------------------------------------------------------------------------------------------------------------------------------------------------------------------------------------------------------------------------------------------------------------------------------------------------------------|
| DWEELL<br>TIME      | <p><b>Option 102 or 103 only.</b></p> <p>sets the dwell time for the marker pause, during which demodulation can take place in nonzero span sweeps. The dwell time can be set from 2 milliseconds to 100 seconds.</p> <p>Front-Panel Key Access: <b>AUX CTRL</b></p>                                                                                                                                                                                                                                                                                                                                                                                                                           |
| EDGE POL<br>POS NEG | <p><b>Option 105 only. Option 101 is recommended.</b></p> <p>determines whether the gate triggers on the positive-going or negative-going edge of the signal at the GATE TRIGGER INPUT connector (on the rear panel of the spectrum analyzer).</p> <p>If the gate utility is used and a pulse repetition interval has been entered, gate trigger position markers will be shown in the time domain window. A “↑” indicates positive triggering. A “↓” indicates negative triggering.</p> <p>Front-Panel Key Access: <b>SWEEP</b></p>                                                                                                                                                           |
| Edit<br>Amp Cor     | <p>allows you to edit the current amplitude-correction factors table by accessing the SELECT POINT, SELECT FREQ , SELECT AMPLITUD , DELETE POINT, Edit Done, and PURGE AMP COR softkeys.</p> <p>Front-Panel Key Access: <b>CAL</b></p>                                                                                                                                                                                                                                                                                                                                                                                                                                                         |
| EDIT<br>CAT ITEM    | <p><b>For options 021, 023, and 024 only. Refer to the HP 8590 E-Series and L-Series Spectrum Analyzer and HP 8591 C Cable TV Analyzer Programmer's Guide for more information.</b></p> <p>starts the DLP editor function and loads the highlighted item from the catalog of spectrum analyzer user memory to be displayed and edited. It copies the item into the spectrum analyzer DLP editor memory which is a 2500 byte memory buffer. If an item is edited, the new edited version will not be overwritten in the spectrum analyzer user memory until it is processed by the SAVE EDIT softkey.</p> <p>Front-Panel Key Access: <b>RECALL</b> or <b>SAVE</b></p>                           |
| Edit<br>Done        | <p>can be accessed through both the amplitude-correction menu and the the change prefix menu. When accessed from the amplitude-correction menu, the amplitude-correction factors table is erased from the spectrum analyzer screen and the amplitude-correction menu is restored on-screen. Use Edit Done when all the amplitude-correction factors have been entered.</p> <p>When accessed from the change prefix menu, Edit Done erases the prefix from the spectrum analyzer screen and restores the previous menu. Use Edit Done when prefix characters have all been entered.</p> <p>Front-Panel Key Access: <b>CAL</b>, <b>CONFIG</b>, <b>DISPLAY</b>, <b>RECALL</b>, or <b>SAVE</b></p> |
| EDIT<br>DONE        | <p>can be accessed through the limit-line menu. Pressing EDIT DONE erases the limit-line table from the spectrum analyzer screen and restores the menu accessed by the Limit Lines softkey. Use EDIT DONE when all the limit-line values have been entered.</p> <p>Front-Panel Key Access: <b>DISPLAY</b></p>                                                                                                                                                                                                                                                                                                                                                                                  |
| EDIT<br>FLATNESS    | <p>allows flatness-correction constants to be viewed or modified. This is a service calibration function and is for service use only.</p> <p>Front-Panel Key Access: <b>CAL</b></p>                                                                                                                                                                                                                                                                                                                                                                                                                                                                                                            |

EDIT  
LAST

*For options 021, 023, and 024 only. Refer to the HP 8590 E-Series and L-Series Spectrum Analyzer and HP 8591 C Cable TV Analyzer Programmer's Guide for more information.*

starts the DLP editor function and allows the most recent item that was being edited, in the DLP editor buffer, to be accessed again. The item will not be in the spectrum analyzer user memory until it is processed by the SAVE EDIT softkey. The DLP editor memory remains intact when the instrument is preset and when it is powered off.

Front-Panel Key Access: (RECALL] or (SAVE)

Edit  
Limit

allows you to edit the current limit-line tables by accessing Edit Upper , Edit Lower, Edit Up/ Low, and Edit Mid/Delt. Use PURGE LIMITS under any of the above edit menus to dispose of the current limit-line table.

Front-Panel Key Access: (DISPLAY)

Edit  
Lower

allows you to view or edit the lower limit-line table. Up to 20 entries are allowed for the lower limit-line table. With the lower limit-line table format, the coordinates for the lower limit-line are specified, but none are specified for the upper limit line. Even if upper limit-line values exist or the values had been entered as an upper and lower limit-line table, the lower limit-line values are treated as a separate table from the upper limit-line values. The lower limit-line entries can have independent frequency (or time) and amplitude coordinates from upper limit-line table entries.

Front-Panel Key Access: (DISPLAY)

Edit  
Mid/Delt

allows you to view or edit the upper and lower limit-line tables simultaneously. These tables are edited by entering a middle amplitude value and an amplitude deviation. Up to 20 entries are allowed for the upper and lower limit-line tables. Like the upper and lower limit-line table format, the mid/delta limit-line table format provides a means of specifying the upper and lower limit lines at the same time. Unlike the upper and lower table format, the amplitude values are specified as a middle amplitude value with a delta (the upper and lower limit lines are drawn an equal positive and negative distance from the middle amplitude).

With the mid/delta format the frequency (or time), and the middle amplitude plus the delta comprise the upper limit line; the frequency (or time), and the middle amplitude minus the delta comprise the lower limit line. The difference between the mid/delta and the upper/lower format is the way the amplitude values are entered; the frequency (time) coordinate begins a segment regardless of the format chosen. The mid/delta format can be used if the upper and lower limit lines are symmetrical with respect to the amplitude axis. An upper and lower amplitude component are specified for every frequency (or time) component.

Front-Panel Key Access: (DISPLAY)

|                 |                                                                                                                                                                                                                                                                                                                                                                                                                                                                                                                                                                                                                                                                                                                                                                                               |
|-----------------|-----------------------------------------------------------------------------------------------------------------------------------------------------------------------------------------------------------------------------------------------------------------------------------------------------------------------------------------------------------------------------------------------------------------------------------------------------------------------------------------------------------------------------------------------------------------------------------------------------------------------------------------------------------------------------------------------------------------------------------------------------------------------------------------------|
| Edit<br>Up/ Low | allows you to view or edit the upper and lower limit-line tables simultaneously. Up to 20 entries are allowed for the upper and lower limit-line tables. With the upper and lower limit-line table format, the upper and lower limit-lines can be entered at the same time.<br><br>With the upper and lower limit-line format, the frequency (or time), upper amplitude, and lower amplitude are specified. The frequency (or time) and upper amplitude value comprise the coordinate point for the upper limit line, the frequency (or time) and lower amplitude value comprise the coordinate point for the lower limit line. It is not necessary to specify both an upper and lower amplitude component for every frequency (or time) component.<br>Front-Panel Key Access: <b>DISPLAY</b> |
| Edit<br>Upper   | allows you to view or edit the upper limit-line table. Up to 20 entries are allowed for the upper limit-line table. With the upper limit-line table format, the coordinates of the upper limit line are specified, but none are specified for the lower limit line. Even if lower limit-line values exist or the values had been entered as an upper and lower limit-line table, the upper limit-line values are treated as a separate table from the lower limit-line values. The upper limit-line entries can have independent frequency (or time) and amplitude coordinates from lower limit-line table entries.<br>Front-Panel Key Access: <b>DISPLAY</b>                                                                                                                                 |
| EDIT<br>UPR LWR | selects upper or lower limit-line tables. It switches to the limit-line table that is not currently being edited.<br>Front-Panel Key Access: <b>DISPLAY</b>                                                                                                                                                                                                                                                                                                                                                                                                                                                                                                                                                                                                                                   |
| Editor          | <b><i>For options 041 and 043 only. Refer to the HP 8590 E-Series and L-Series Spectrum Analyzer and HP 8591C Cable TV Analyzer Programmer's Guide for more information.</i></b><br>accesses the menu of down loadable program (DLP) editor softkeys. With an external keyboard programming commands can be used to write a program to control the spectrum analyzer. The built-in DLP editor uses the spectrum analyzer rather than an external computer to create, view, or edit programs. These programs can then be sent to the spectrum analyzer command parser, which is similar to outputting them to the spectrum analyzer from an external computer.<br>Front-Panel Key Access: <b>RECALL</b> or (SAVE)                                                                              |
| EMI BW<br>Menu  | accesses the functions that set the spectrum analyzer resolution bandwidth to the values required for electromagnetic interference (EMI) testing.<br><b>(200 Hz EMI BW is only available with Option 130.)</b><br>Front-Panel Key Access: <b>BW</b>                                                                                                                                                                                                                                                                                                                                                                                                                                                                                                                                           |
| <b>ENTER</b>    | Pressing <b>Hz/<math>\mu</math>V/<math>\mu</math>s</b> which is also the ENTER key, terminates and enters into the spectrum analyzer a numerical value that has been entered from the front panel using the keypad, knob, or step up/down keys.                                                                                                                                                                                                                                                                                                                                                                                                                                                                                                                                               |

ENTER  
PRI            **Option 105 only. Option 101 is recommended.**  
                 accesses the menu for entering the value of the pulse repetition interval (PRI). A delta marker can be activated by pressing MARKER ON . The other menu functions can be used to manipulate the marker to indicate the pulse repetition interval value. Pressing DONE returns to the previous menu and makes the current value of the marker the pulse repetition interval. It also restores the time domain window to the state prior to any adjustments made during entry of the pulse repetition interval. When the pulse repetition interval is entered, an arrow will appear on the display indicating the position of the gate trigger (“↑” for positive triggering or “↓” for negative triggering).  
                 Front-Panel Key Access: **SWEEP**

ENTER  
REF EDGE       **Option 105 only. Option 101 is recommended.**  
                 accesses the menu used to define the edge of the pulse that will be used as the time reference. Press MARKER ON to activate a trigger marker. The other menu functions can be used to manipulate the marker to indicate the location of the reference edge. Pressing DONE returns to the previous menu and makes the current value of the marker the reference edge. It also restores the time domain window to the state prior to any adjustments made during entry of the reference edge.  
                 Front-Panel Key Access: **SWEEP**

ENTER  
WIDTH           **Option 105 only. Option 101 is recommended.**  
                 accesses the menu for entering the value of the pulse width. Press MARKER ON to activate a delta marker. The other menu functions can be used to manipulate the marker to indicate the pulse width value. Pressing DONE returns to the previous menu and makes the current value of the marker the pulse width. It also restores the time domain window to the state prior to any adjustments made during entry of the pulse width.  
                 Front-Panel Key Access: **SWEEP**

ERASE  
DLP MEM        allows you to dispose of the DLPs, all traces defined by TRDEF, and all VAREF variables that are in spectrum analyzer memory. Pressing Dispose User Mem and then pressing ERASE DLP MEM causes a message to appear on the spectrum analyzer screen: If you are sure, Press key againtopurge data. Press ERASE DLP MEM again if you want to dispose of the DLPs in memory. Press any other softkey if you do not want to dispose of the DLPs in memory.

---

**Note**            Use DELETE FILE to selectively delete stored programs or variables from spectrum analyzer memory.

---

                 Front-Panel Key Access: **CONFIG**

ERASE MEM ALL allows you to purge all user state registers, all user trace registers, all mode registers, the editor buffer, Group delay normalization, all DLP memory, and all microprocessor stack data. The stack pointer is set to its power-up value. No system globals are erased and the calibration data is preserved. Pressing ERASE MEM ALL causes a message to appear on the spectrum analyzer screen: If you are sure, Press key again to purge data. Press ERASE MEM ALL again if you want to dispose of all user memory. Press any other softkey if you do not want to dispose of all user memory.

---

**Note** ERASE MEN ALL ignores the state of the SAV LOCK. So, even if STATES and TRACES are locked, they will still be erased by ERASE MEM ALL .

---

Front-Panel Key Access: **CONFIG**

ERASE MEM CARD allows you to dispose of any data or programs stored on the memory card by formatting it. This is the same as FORMAT CARD . Pressing Dispose User Mem and then pressing ERASE MEM CARD causes a message to appear on the spectrum analyzer screen: If you are sure, Press key again to purge data. Press ERASE MEM CARD again if you want to dispose of the CARD's memory. Press any other softkey if you do not, want to dispose of the CARD's memory.

---

**Note** Use DELETE FILE to selectively delete stored programs or variables from spectrum analyzer memory.

---

Front-Panel Key Access: **CONFIG**

ERASE STATEALL allows you to purge all the user state registers 1 through 9. Pressing Dispose User Mem and then pressing ERASE STATEALL causes a message to appear on the spectrum analyzer screen: If you are sure, Press key again to purge data. Press ERASE STATEALL again if you want to dispose of the user state registers. Press any other softkey if you do not want to dispose of user state registers.

---

**Note**

- If SAVE LOCK ON OFF is set to (ON), this function is disabled.
- Use DELETE FILE to selectively delete stored programs or variables from spectrum analyzer memory.

---

Front-Panel Key Access: **CONFIG**



ERASE  
TRACEALL allows you to purge all the user trace registers 0 through TRCMEM. Pressing Dispose User Mem and then pressing ERASE TRACEALL causes a message to appear on the spectrum analyzer screen: If you are sure, Press key again to purge data. Press ERASE TRACEALL again if you want to dispose of the user trace registers. Press any other softkey if you do not want to dispose of user state registers.

---

Note

- If SAVE LOCK ON OFF is set to (ON), this function is disabled.
  - . Use DELETE FILE to selectively delete stored programs or variables from spectrum analyzer memory.
- 

EP LQ570  
SML LRG sets the spectrum analyzer to be compatible with an Epson LQ-570 compatible printer. Press Set B&W Printer then EP LQ570 SML LRG until LRG is underlined to set up the large screen printout. This will allow for one printout per page. The large screen printout format will not allow for printing of the menu keys. Press Set B&W Printer then EP LQ570 SML LRG until SML is underlined to set up the small screen printout. This will allow for two printouts per page.

Front-Panel Key Access: **CONFIG**

EP MX80  
SML LRG sets the spectrum analyzer to be compatible with an Epson MX80 compatible printer. Press Set B&W Printer then EP MX80 SML LRG until LRG is underlined to set up the large screen printout. This will allow for one printout per page. The large screen printout format will not allow for printing of the menu keys. Press Set B&W Printer then EP MX80 SML LRG until SML is underlined to set up the small screen printout. This will allow for two printouts per page.

Front-Panel Key Access: **CONFIG**

EXECUTE  
TITLE executes a programming command displayed in the screen title area of the spectrum analyzer. The Change Title function can be used to print programming commands in the screen title area of the display. The commands can then be executed from the front panel of the spectrum analyzer, without an external computer, by pressing the EXECUTE TITLE softkey.

Front-Panel Key Access: **CONFIG**

EXIT exits the EDIT FLATNESS softkey menu. This is a service calibration function and is designed for service use only.

Front-Panel Key Access: **CAL**

Exit  
Catalog returns the spectrum analyzer to the state it was in before the current catalog function was invoked. It clears the catalog display and returns to a normal spectrum analyzer display.

Front-Panel Key Access: **RECALL** or **SAVE**

|                     |                                                                                                                                                                                                                                                                                                                                                                                                                                                                                                                                                                                                                                                                                                                                                                                                                                                                                                                                                                                                                                                           |
|---------------------|-----------------------------------------------------------------------------------------------------------------------------------------------------------------------------------------------------------------------------------------------------------------------------------------------------------------------------------------------------------------------------------------------------------------------------------------------------------------------------------------------------------------------------------------------------------------------------------------------------------------------------------------------------------------------------------------------------------------------------------------------------------------------------------------------------------------------------------------------------------------------------------------------------------------------------------------------------------------------------------------------------------------------------------------------------------|
| EXIT<br>SHOW        | removes the screen annotation left after pressing SHOW OPTIONS .<br>Front-Panel Key Access: <b>CONFIG</b>                                                                                                                                                                                                                                                                                                                                                                                                                                                                                                                                                                                                                                                                                                                                                                                                                                                                                                                                                 |
| EXIT<br>UTILITY     | <b>Option 105 only. Option 101 is recommended.</b><br>exits the gate utility returning to the gate control menu. The spectrum analyzer is returned to normal operation. The state of the spectrum analyzer becomes the state of the window that was active when exiting the gate utility.<br>Front-Panel Key Access: <b>SWEEP</b>                                                                                                                                                                                                                                                                                                                                                                                                                                                                                                                                                                                                                                                                                                                         |
| EXTERNAL            | activates the trigger condition that allows the next sweep to start when an external voltage (connected to EXT TRIG INPUT on the rear panel) passes through approximately 1.5 volts. The external trigger signal must be a 0 V to + 5 V TTL signal.<br>Front-Panel Key Access: <b>TRIG</b>                                                                                                                                                                                                                                                                                                                                                                                                                                                                                                                                                                                                                                                                                                                                                                |
| EXTERNAL<br>PREAMPG | adds a positive or negative preamplifier gain value, which is subtracted from the displayed signal. The EXTERNAL PREAMPG function is similar to the REF LVL OFFSET function; however, with the EXTERNAL PREAMPG function, the attenuation may be changed depending on the preamplifier gain entered. A preamplifier gain offset is used for measurements that require an external preamplifier or long cables. The offset is subtracted from the amplitude readout so that the displayed signal level represents the signal level at the input of the preamplifier. The preamplifier gain offset is displayed at the top of the screen and is removed by entering zero. The preamplifier gain offset is entered using the numeric keypad. Press CAL STORE if you want the spectrum analyzer to use the current preamplifier gain offset when power is turned on. Preamplifier gain offset is set to zero when DEFAULT CONFIG is pressed. The preamplifier gain value is not affected by an instrument preset.<br>Front-Panel Key Access: <b>AMPLITUDE</b> |
| FFT<br>MARKERS      | if the FFT mode is already active, pressing FFT MARKERS only activates the FFT markers. If the FFT mode is not active, then the FFT marker will be activated and the FFT annotation will be displayed but an FFT will not be performed. Pressing the % AM ON OFF key will give a valid value for the signal in trace B. Press FFT OFF to return the spectrum analyzer to normal operation.<br><br>An FFT trace can be saved and recalled. If a trace has been recalled, FFT MARKERS can be used to activate the markers so that the trace can be evaluated.<br>Front-Panel Key Access: <b>MEAS/USER</b>                                                                                                                                                                                                                                                                                                                                                                                                                                                   |

**FFT Menu** accesses the menu of keys to initiate and evaluate a Fourier transform of the spectrum analyzer displayed data. Activating other spectrum analyzer functions will automatically exit the FFT function or will corrupt the display (see Table 7-7).

**Table 7-7. Compatibility of FFT With Other Functions**

| Function                       | Compatibility Info          |
|--------------------------------|-----------------------------|
| <b>Catalog functions</b>       | <b>corrupts the display</b> |
| <b>DLP Editor</b>              | <b>corrupts the display</b> |
| <b>Marker Table</b>            | <b>exits FFT</b>            |
| <b>N dB Points measurement</b> | <b>exits FFT</b>            |
| <b>Peak Table</b>              | <b>exits FFT</b>            |
| <b>Power Menu measurements</b> | <b>exits FFT</b>            |
| <b>Show Options</b>            | <b>corrupts the display</b> |
| <b>Time Gate functions</b>     | <b>exits FFT</b>            |
| <b>TO1 measurement</b>         | <b>exits FFT</b>            |
| <b>Windows</b>                 | <b>exits FFT</b>            |

Front-Panel Key Access: **MEAS/USER**

**FFT OFF** exits the FFT mode and menus, returning the spectrum analyzer to normal operation.

Front-Panel Key Access: **MEAS/USER**

**FFT STOP FREQ** allows the user to enter the stop frequency for the desired FFT span. This sets the spectrum analyzer sweep time by the relationship:

$$\text{FFT stop freq} = 400 / (\text{sweep time} \times 2)$$

---

**Note** When using the FFT stop frequency function, the knob and step key increments are not optimal for positioning the signal. To use the knob or step keys to position the signal, select sweep time as the active function.

---

Front-Panel Key Access: **MEAS/USER**

**FINE TUNE DAC** displays the output of the YTO fine-tune DAC, which is produced on the A7 Analog Interface assembly. This is a service diagnostic function and is for service use only.

Front-Panel Key Access: **CAL**

**FLAT** draws a zero-slope line between the coordinate point of the current segment and the coordinate point of the next segment, producing limit-line values equal in amplitude for all frequencies between the two points. If the amplitude values of the two segments differ, the limit line “steps” to the frequency value of the second segment.

Front-Panel Key Access: **DISPLAY**

**Flatness Data** provides access to the softkeys used for viewing or editing the flatness-correction constants. This is a service calibration function and is for service use only.

Front-Panel Key Access: **CAL**

|                       |                                                                                                                                                                                                                                                                                                                                                                                                                                                                                                                     |
|-----------------------|---------------------------------------------------------------------------------------------------------------------------------------------------------------------------------------------------------------------------------------------------------------------------------------------------------------------------------------------------------------------------------------------------------------------------------------------------------------------------------------------------------------------|
| FM COIL<br>DRIVE      | displays the output of the FM coil driver produced on the A7 Analog Interface assembly. This is a service diagnostic function and is for service use only.<br>Front-Panel Key Access: (CAL]                                                                                                                                                                                                                                                                                                                         |
| FM<br>GAIN            | <i>Option 102 or 103 only.</i><br>adjusts the FM deviation display. The center graticule represents zero deviation. The top graticule is the positive deviation set by FM GAIN. The bottom graticule is the negative deviation set by FM GAIN. The range for FM gain is from 10 kHz to 500 kHz. The default value is 100 kHz.<br>Front-Panel Key Access: (AUX CTRL) or (CAL)                                                                                                                                        |
| FM<br>OFFSET          | <i>Option 102, 103, or 301 only.</i><br>adjusts the horizontal trace for center-screen with no modulation on the carrier. This is a service diagnostic function and is for service use only.<br>Front-Panel Key Access: (CAL]                                                                                                                                                                                                                                                                                       |
| FM SPAN               | displays the FM-SPAN signal from the span dividers on the A7 Analog Interface assembly. This is a service diagnostic function and is for service use only.<br>Front-Panel Key Access: (CAL)                                                                                                                                                                                                                                                                                                                         |
| FORMAT<br>CARD        | <i>HP 8590L, HP 8592L, and HP 8594L must have Option 003.</i><br>formats a card in logical interchange format (LIF). This is the same as ERASE MEM CARD . The memory card is formatted with the volume label "HP859X." Pressing FORMAT CARD causes a message to appear on the spectrum analyzer screen: If you are sure,press key againtopurgedata. Press FORMAT CARD again if you want to format the memory card. Pressing FORMAT CARD deletes data stored on the memory card.<br>Front-Panel Key Access: (CONFIG) |
| FREE RUN              | activates the trigger condition that allows the next sweep to start as soon as possible after the last sweep.<br>Front-Panel Key Access: (TRIG)                                                                                                                                                                                                                                                                                                                                                                     |
| FREQ<br>DIAG          | <i>All E-Series and L-Series spectrum analyzers except HP 8590L with Option 713.</i><br>displays, in real-time, frequency diagnostic information for the LO section. This is a service diagnostic function and is for service use only.<br>Front-Panel Key Access: (CAL)                                                                                                                                                                                                                                            |
| FREQ DISC<br>NORM OFF | <i>All E-Series and L-Series spectrum analyzers except HP 8590L with Option 713.</i><br>indicates the status of the frequency discriminator as a function of LO span. This is a service diagnostic function and is for service use only.<br>Front-Panel Key Access: (CAL)                                                                                                                                                                                                                                           |

FREQ  
OFFSET

allows the user to input a frequency offset value that is added to the frequency readout, to account for frequency conversions external to the spectrum analyzer. Offset entries are added to all frequency readouts including marker, start frequency, and stop frequency. Entering an offset does not affect the trace. Offsets are not added to the span. Frequency offsets are entered using the numeric keypad.

When a frequency offset is entered, its value is displayed on the bottom of the screen (as opposed to reference level offsets, which are displayed on the left side of the screen). To eliminate an offset, press FREQ OFFSET and 0 **ENTER**. Pressing **PRESET** also sets the offset to zero.

Front-Panel Key Access: **FREQUENCY**

**FREQUENCY**

activates the center-frequency or start-frequency function and accesses the menu that has the frequency functions. The center frequency or start frequency value appears below the graticule on the screen.

Although the spectrum analyzer allows entry of frequencies greater than the specified frequency range, using frequencies greater than the frequency span of the spectrum analyzer is not recommended.

---

**Note**

When changing both the center frequency and the span, change the frequency first since the span can be limited by the frequency value.

---

FULL  
SPAN

changes the spectrum analyzer span to full span.

*For **an HP 8592L, HP 8593E, HP 8595E, and HP 8596E only**: span can be limited if harmonic band lock (BND LOCK ON OFF ) is set to ON.*

**Full Span Frequency Range**

| Model                               | Frequency Range            |
|-------------------------------------|----------------------------|
| <b>HP 8590L</b>                     | <b>9 kHz to 1.8 GHz</b>    |
| <b>HP 85913</b>                     | <b>9 kHz to 1.8 GHz</b>    |
| <b>HP 8592L</b>                     | 2.75 GHz to 22 GHz *       |
| <b>HP 85933</b>                     | 2.75 GHz to 22 GHz *       |
| <b>HP 85943</b>                     | <b>9 kHz to 2.9 GHz</b>    |
| <b>HP 8594L</b>                     | <b>9 kHz to 2.9 GHz</b>    |
| <b>HP 85953</b>                     | <b>9 kHz to 6.5 GHz *</b>  |
| <b>HP 8596E</b>                     | <b>9 kHz to 12.8 GHz *</b> |
| * Harmonic band lock is set to OFF. |                            |

Front-Panel Key Access: **SPAN**

Gate  
Control

*Option 105 only. Option 101 is recommended.*

accesses the menu of gate control functions and the entrance to the gate utility menus. The gate can be controlled independently or from within the gate utility. The gate utility makes it easier to set up and manipulate the gate.

When the gate control functions are accessed under the Gate Control menu, outside of the gate utility, they do not interact with the gate utility. Values that are changed using these keys will not affect the gate utility settings and

graphics unless the utility is entered with the new settings.

Front-Panel Key Access: **[SWEEP]**

GATE CTL  
EDGE LVL

**Option 105 only. Option 101 is recommended.**

determines if the gate is enabled on the edge of the trigger input or on a threshold level of the input signal. If the gate control is set to EDGE, the edge of the input signal triggers the timer for the gate delay. When the gate control is set to LVL, the gate follows the positive level of the signal connected to GATE TRIGGER INPUT.

When the gate control is set to level, the functions of gate delay and gate length no longer apply and therefore, the GATE DELAY , GATE LENGTH , and EDGE POL POS NEG softkeys are blanked. The gate utility does not allow level triggering. The gate will automatically be set to edge trigger on entry to the gate utility.

Front-Panel Key Access: **[SWEEP]**

GATE  
DELAY

**Option 105 only. Option 101 is recommended.**

sets the duration of the delay after an edge trigger before the gate switch closes. The gate delay can be set from 1  $\mu$ s to 65.535 ms in 1  $\mu$ s steps.

If the GATE DELAY softkey is accessed outside of the time gate utility, it turns off the gate markers but does not affect the gate utility settings. When the gate utility is entered, the current value of the gate delay will be used. The GATE DELAY softkey can be accessed from within the gate utility under the Define Gate menu.

Front-Panel Key Access: **[SWEEP]**

GATE  
LENGTH

**Option 105 only. Option 101 is recommended.**

sets the duration of the gate. The gate length can be set from 1  $\mu$ s to 65.535 ms in 1  $\mu$ s steps.

If the GATE LENGTH softkey is accessed outside of the time gate utility it turns off the gate markers but does not affect the gate utility settings. When the gate utility is entered, the current value of the gate length will be used. The GATE LENGTH softkey can be accessed from within the gate utility under the Define Gate menu.

Front-Panel Key Access: **[SWEEP]**

GATE  
ON OFF

**Option 105 only. Option 101 is recommended.**

turns on or off the gate for Option 105, the time-gated spectrum analyzer capability. The gate can be turned on outside, or from within, the gate utility. The gate utility makes it easier to set up and manipulate the gate.

If GATE ON OFF is accessed under the **[SWEEP]** menu it turns the gate on and off. If GATE ON OFF is accessed under the Define Gate softkey from within the gate utility, the gate can only be turned on when the frequency domain window is active. If the time domain window is made active the gate will be turned off. Gate manipulation with the gate turned on in the time domain window is difficult due to trace dropouts and triggering errors.

Front-Panel Key Access: **[SWEEP]**

GATE  
UTILITY

**Option 105 only. Option 101 is recommended.**

accesses the softkey functions used for Option 105, the time-gated spectrum analyzer capability. It creates related time domain and frequency domain windows to set up the time gate and make measurements. The center frequency and reference level must be set correctly before entering the gate utility. There must be a TTL signal at the GATE TRIGGER INPUT on the rear panel, and GATE OUTPUT must be connected to EXT TRIG INPUT. If no trigger is present an error message is displayed. Connect a trigger input or press instrument preset to exit the gate utility.

---

**Note** If the gate utility menus are exited by pressing one of the front panel keys they may be re-entered by pressing **(SWEEP)** twice.

---

Some spectrum analyzer functions are altered or are not available when the gate utility is active (see Table 7-8). From within the gate utility press EXIT UTILITY to return to normal spectrum analyzer operation. Press **(SWEEP)** twice, and EXIT UTILITY to return to the gate utility and then exit it properly.

**Table 7-8.  
Commands Altered/Not Available within the Gate Utility**

| Command                | Description of Change                           |
|------------------------|-------------------------------------------------|
| % AM                   | measurement function is not available           |
| Adjacent Channel Power | measurement function is not available           |
| Calibration            | no calibration functions can be accessed        |
| Channel Power          | measurement function is not available           |
| FFT                    | measurement function is not available           |
| N dB Points            | measurement function is not available           |
| Occupied Bandwidth     | measurement function is not available           |
| Peak Zoom              | routine is not available                        |
| Res BW                 | turns off resolution BW coupling to pulse width |
| Span                   | must be zero in the time domain window          |
| Sweep time             | turns off sweep time coupling to PRI            |
| T01                    | measurement function is not available           |
| Video BW               | turns off video BW coupling to gate length      |

Front-Panel Key Access: **(SWEEP)**

GHIJKL accesses the softkey menu used for selecting screen title or prefix characters G through L.

Front-Panel Key Access: **(CAL)**, **(CONFIG)**, **(DISPLAY)**, **(RECALL)**, or **(SAVE)**

GND REF  
DETECTOR displays the output of the analog-ground reference produced on the A16 Processor/Video assembly. This is a service diagnostic function and is for service use only.

Front-Panel Key Access: **(CAL)**

GRAT  
ON OFF turns the screen graticule on and off. This is helpful when alternative graphics are drawn on the screen through a remote controller and during plotting, when a graticule is not required.

Front-Panel Key Access: **(DISPLAY)**

|                    |                                                                                                                                                                                                                                                                                                                                                                                                                                           |
|--------------------|-------------------------------------------------------------------------------------------------------------------------------------------------------------------------------------------------------------------------------------------------------------------------------------------------------------------------------------------------------------------------------------------------------------------------------------------|
| GRPH MKR<br>ON OFF | turns the graph marker ON or OFF. This softkey is available when ACPGRAPH is ON (for ACP or ACP extended measurements), or when PWRGRAPH is ON (for channel power measurements). For the ACPGRAPH, the delta frequency, ACP ratio, and channel power are displayed at the marker position. For the channel power graph, the frequency and channel power are displayed at the marker position.<br>Front-Panel Access Key: <b>MEAS/USER</b> |
| <b>HOLD</b>        | <b>HP 8590L, HP 8592L, and HP 8594L only.</b><br>deactivates the active function and blanks the active function text from the display. No data can be accidentally entered using the knob, step keys, or keypad. Activating another function will turn off the hold function. The HOLD softkey can also be accessed by pressing the <b>DISPLAY</b> key.                                                                                   |
| HOLD               | deactivates the active function and blanks the active function text from the display. No data can be accidentally entered using the knob, step keys, or keypad. Activating another function will turn off the hold function.<br>Front-Panel Key Access: <b>DISPLAY</b>                                                                                                                                                                    |
| HP B&W<br>D 5540   | <b>Option 041 or 043 only.</b><br>selects a black and white printer. Use this function if you have a black and white HP DeskJet 540 printer. Press Set B&W Printer and then select the HP B&W PRINTER softkey. Start printing by pressing COPY DEV PRNT PLT (PRNT) and <b>COPY</b> .<br>Front-Panel Key Access: <b>CONFIG</b>                                                                                                             |
| HP B&W<br>PRINTER  | <b>Option 041 or 043 only.</b><br>selects a black and white printer. Use this function if you have a black and white HP printer, or if you are using a color printer, but want to have a black and white print. Press Set B&W Printer and then select the HP B&W PRINTER softkey. Start printing by pressing COPY DEV PRNT PLT (PRNT) and <b>COPY</b> .<br>Front-Panel Key Access: <b>CONFIG</b>                                          |
| IDNUM              | is used when the instrument is powered on the first time. It inputs the spectrum analyzer model number and option information. This is a service calibration function and is for service use only. Refer to the service guide for more information.<br>Front-Panel Key Access: <b>CAL</b>                                                                                                                                                 |
| INIT FLT           | is used when the instrument is powered on the first time. It sets the defaults for spectrum analyzer flatness including the start and stop frequencies and the step size. All of the correction values are set to zero. This is a service calibration function and is for service use only. Refer to the service guide for more information.<br>Front-Panel Key Access: (CAL)                                                             |



|                     |                                                                                                                                                                                                                                                                                                                                                                                                                                                                                                                                                                                                                                                                                                                                                                                                                                                                                                                                                                                                                                                                                                                                                                                                                  |
|---------------------|------------------------------------------------------------------------------------------------------------------------------------------------------------------------------------------------------------------------------------------------------------------------------------------------------------------------------------------------------------------------------------------------------------------------------------------------------------------------------------------------------------------------------------------------------------------------------------------------------------------------------------------------------------------------------------------------------------------------------------------------------------------------------------------------------------------------------------------------------------------------------------------------------------------------------------------------------------------------------------------------------------------------------------------------------------------------------------------------------------------------------------------------------------------------------------------------------------------|
| INPUT Z<br>50Ω 75Ω  | adjusts the voltage readout by 1.76 dB to correct for the difference between voltage and power measurements in a 75Ω system versus a 50Ω system. The impedance you select is for computational purposes only, since the actual impedance of 50Ω (75Ω for Option 001) is set by internal hardware. The preset value can be changed by using a service function. Select the computational input impedance by pressing INPUT Z 50Ω 75Ω or by entering 75 or 50 using the numeric keypad. For example, when making measurements in a 750 system, an analyzer with either a 75Ω input impedance (Option 001) or a 50Ω input impedance, using a 75Ω to 50Ω matching device, the INPUT Z should be set to 750.<br>Front-Panel Key Access: <b>AMPLITUDE</b>                                                                                                                                                                                                                                                                                                                                                                                                                                                              |
| INTERNAL<br>CARD    | <b>Requires Option 003 for an HP 8590L, HP 8592L, or HP 8594L.</b><br>selects between spectrum analyzer memory and the memory card for the save and recall functions.<br>Front-Panel Key Access: <b>RECALL</b> or <b>SAVE</b>                                                                                                                                                                                                                                                                                                                                                                                                                                                                                                                                                                                                                                                                                                                                                                                                                                                                                                                                                                                    |
| INTERNAL<br>→ STATE | recalls the saved spectrum analyzer state from the selected state register. Recalling a state from the spectrum analyzer memory displays the time and date when the state data was stored. To recall a state, press INTERNAL → STATE and use the numeric keypad to enter a state register number (valid state register numbers are 1 through 9). State register 9 contains a previous state; state register 0 contains the current state. If windows are being used, the instrument state can only be recalled into the active window.<br>Front-Panel Key Access: <b>RECALL</b>                                                                                                                                                                                                                                                                                                                                                                                                                                                                                                                                                                                                                                  |
| Internal<br>→ Trace | accesses a softkey menu that allows you to either select the trace in which the trace data is to be recalled (trace A, trace B, or trace C), recall the current limit-line tables, or recall amplitude correction factors. When recalling a trace, select the trace in which the trace data is to be recalled, enter the trace register number, and press <b>ENTER</b> . If windows are being used, only the trace of the active window can be recalled.<br><br>When recalling limit-line tables or amplitude correction factors, press LIMIT LINES or AMP COR respectively, enter the trace register number, and press <b>ENTER</b> . Valid trace register numbers are 0 through the maximum register number. The maximum register number is the number displayed after MAX REG # = during a save or recall operation. If a screen title is present, it is recalled with the trace data (but not with the limit-line table or the amplitude-correction factors). If the screen title does not exceed 34 characters, the time and date when the data was stored will also be displayed. INVALID SAVEREG is displayed if data has not been stored in the trace register.<br>Front-Panel Key Access: <b>RECALL</b> |
| LAST<br>SPAN        | changes the spectrum analyzer frequency span to the previous span setting.<br>Front-Panel Key Access: (SPAN)                                                                                                                                                                                                                                                                                                                                                                                                                                                                                                                                                                                                                                                                                                                                                                                                                                                                                                                                                                                                                                                                                                     |
| Limit<br>Lines      | accesses the limit-line menus.<br>Front-Panel Key Access: <b>DISPLAY</b>                                                                                                                                                                                                                                                                                                                                                                                                                                                                                                                                                                                                                                                                                                                                                                                                                                                                                                                                                                                                                                                                                                                                         |

LIMIT LINES When accessed by **SAVE**, pressing LIMIT LINES stores the current limit-line tables in spectrum analyzer memory or on the memory card. When accessed by **RECALL**, pressing LIMIT LINES recalls limit-line tables from spectrum analyzer memory or the memory card. See “To Save a Limit-Line Table or Amplitude Correction Factors” or “To Recall Limit-Line Tables or Amplitude Correction Factors” in Chapter 5 for more information.

Front-Panel Key Access: **RECALL** or **SAVE**

LIMITS allows you to choose fixed or relative type of limit lines. The fixed (FIX) type uses the current limit line as a reference with fixed frequency and amplitude values. The relative (REL) setting causes the current limit-line value to be relative to the displayed center frequency and reference-level amplitude values. When limit lines are specified with time, rather than frequency, the REL setting only affects the amplitude values. The current amplitude values will be relative to the displayed reference-level amplitude, but the time values will always start at the left edge of the graticule.

As an example, assume you have a frequency limit line. If the limit line is specified as fixed, entering a limit-line segment with a frequency coordinate of 300 MHz displays the limit-line segment at 300 MHz. If the same limit-line table is specified as relative, it is displayed relative to the spectrum analyzer center frequency and reference level. If the center frequency is at 1.2 GHz, a relative limit-line segment with a frequency coordinate of 300 MHz will display the limit-line segment at 1.5 GHz. If the amplitude component of the relative limit-line segment is -10 dB, then -10 dB is added to the reference level value to obtain the amplitude of the given component (reference level offset included).

RELATIVE is displayed in the limit-line table when the limit-line type is relative; FIXED is displayed when limit-line type is fixed.

A limit line entered as fixed may be changed to relative, and one entered as relative may be changed to fixed. When changing between fixed and relative limit-lines, the frequency and amplitude values in the limit-line table change so that the limit line remains in the same position for the current frequency and amplitude settings of the spectrum analyzer. If a time and amplitude limit line is used, the amplitude values change but the time values remain the same.

Front-Panel Key Access: **DISPLAY**

LIMITS FRQ TIME selects whether limit lines will be entered using frequency or sweep time to define the segments. Limit lines can be created by the user to test trace data. They can be specified as a table of limit-line segments of amplitude versus frequency, or of amplitude versus time. Time values are evaluated with respect to the spectrum analyzer sweep time. A time value of zero corresponds to the start of the sweep, which is the left edge of the graticule.

Switching the limit line definition between frequency and time will erase the current limit line table. The message If you are sure, press key again to purge data will appear. Press LIMITS FRQ TIME again to purge the limit line table and switch between frequency and time.

Front-Panel Key Access: **DISPLAY**

|                      |                                                                                                                                                                                                                                                                                                                                                                                                                                                                                                                                                                                                                                                                                                                           |
|----------------------|---------------------------------------------------------------------------------------------------------------------------------------------------------------------------------------------------------------------------------------------------------------------------------------------------------------------------------------------------------------------------------------------------------------------------------------------------------------------------------------------------------------------------------------------------------------------------------------------------------------------------------------------------------------------------------------------------------------------------|
| LINE                 | <p>activates the trigger condition that allows the next sweep to be synchronized with the next cycle of the line voltage.</p> <p>Front-Panel Key Access: <b>TRIG</b></p>                                                                                                                                                                                                                                                                                                                                                                                                                                                                                                                                                  |
| LMT DISP<br>Y N AUTO | <p>displays any portion of the limit lines that are currently within the spectrum analyzer display boundary. If Y (yes) is underlined the limit lines are displayed. If N (no) is underlined they are not displayed. If AUTO is underlined, the display of the limit lines is dependent on LMT TEST. The limit lines will be displayed while the limit test function is turned on, otherwise they will be turned off.</p> <p>Limit lines cannot be displayed while using the analog+ display mode. Limit testing can be done but the limit lines will not be displayed.</p> <p>Front-Panel Key Access: <b>DISPLAY</b></p>                                                                                                 |
| LMT TEST<br>ON OFF   | <p>turns the limit-line testing and (if LMT DISP AUTO is selected) turns the display of the limit lines on and off. When limit-line testing is enabled, every measurement sweep of trace A is compared to the limit lines. If trace A is at or within the bounds of the limit lines, LIMIT PASS is displayed. If trace A is out of the limit-line boundaries, LIMIT FAIL is displayed.</p> <p>Front-Panel Key Access: <b>DISPLAY</b></p>                                                                                                                                                                                                                                                                                  |
| LOAD<br>FILE         | <p>loads a file from the memory card into spectrum analyzer memory. When the memory card is selected, pressing any of the catalog softkeys (CATALOG ALL , CATALOG STATES, CATALOG TRACES, CATALOG PREFIX, CATALOG DLP, CATALOG AMP COR, CATALOG LMT LINE), or CATALOG DISPLAY accesses LOAD FILE . When cataloging spectrum analyzer memory using CATALOG REGISTER, press LOAD FILE to recall the contents of a state or trace register into spectrum analyzer memory. To use the LOAD FILE function, use the step keys to view sections of the directory, use the knob to select a file then press LOAD FILE. Trace data is loaded into trace B. See the softkey descriptions for CATALOG CARD and CATALOG REGISTER.</p> |

---

**Note** Use of the LOAD FILE softkey is not recommended for recalling limit-line tables or amplitude-correction factors stored in spectrum analyzer memory.

---

|                 |                                                                                                                                                                                                                                                                                                                                                                                                                                                                                                                                                                            |
|-----------------|----------------------------------------------------------------------------------------------------------------------------------------------------------------------------------------------------------------------------------------------------------------------------------------------------------------------------------------------------------------------------------------------------------------------------------------------------------------------------------------------------------------------------------------------------------------------------|
| <b>(LOCAL)</b>  | <p>Front-Panel Key Access: <b>RECALL</b> or <b>SAVE</b></p> <p>Pressing <b>CONFIG</b> <b>(LOCAL)</b> after the spectrum analyzer has been placed in the remote mode places the spectrum analyzer in the local mode and enables front-panel control. During remote operation, “R” appears in the lower-right corner of the screen indicating remote and talk. A “T” or “L” may appear during remote operation, indicating talk or listen. Pressing the <b>CONFIG</b> key removes the “R” symbol in the lower-right corner.</p> <p>Front-Panel Key Access: <b>CONFIG</b></p> |
| MAIN<br>COIL DR | <p>displays the output produced by the main-coil driver on the A7 Analog Interface assembly. This is a service diagnostic function and is for service use only.</p> <p>Front-Panel Key Access: <b>CAL</b></p>                                                                                                                                                                                                                                                                                                                                                              |

|                 |                                                                                                                                                                                                                                                                                                                                                                                                                                                                                                                                                                                                                                                                                                                                                                     |
|-----------------|---------------------------------------------------------------------------------------------------------------------------------------------------------------------------------------------------------------------------------------------------------------------------------------------------------------------------------------------------------------------------------------------------------------------------------------------------------------------------------------------------------------------------------------------------------------------------------------------------------------------------------------------------------------------------------------------------------------------------------------------------------------------|
| Main Menu       | <p><i>Option 105 only. Option 101 is recommended.</i></p> <p>returns to the main gate utility menu from within the gate utility. Pressing Main Menu accesses the Define Time, Define Gate, Define Coupling, UPDATE TIMEFREQ , and EXIT UTILITY softkeys.</p> <p>Front-Panel Key Access: <b>(SWEEP)</b></p>                                                                                                                                                                                                                                                                                                                                                                                                                                                          |
| MAIN SPAN       | <p>displays the main-coil-span signal, MC-SPAN, from the span dividers on the A7 Analog Interface assembly. This is a service diagnostic function and is for service use only.</p> <p>Front-Panel Key Access: <b>(CAL)</b></p>                                                                                                                                                                                                                                                                                                                                                                                                                                                                                                                                      |
| MAN QP AT MKR   | <p><i>Option 103 only.</i></p> <p>performs a subset of the routine executed by pressing AUTO QP AT MKR and then displays a menu of quasi-peak softkeys. See the HP 85913, HP 85933, HP 85943, HP 85953, or HP 85963 Option 103 supplement documentation for more information.</p> <p>Front-Panel Key Access: <b>(AUX CTRL)</b></p>                                                                                                                                                                                                                                                                                                                                                                                                                                  |
| MAN TRK AD JUST | <p><i>Option 010 or 011 only.</i></p> <p>allows the user to adjust the frequency of the tracking-generator oscillator manually using the step keys or knob. The tracking adjust is tuned to maximize the amplitude of the trace.</p> <p>Tracking error occurs when the output frequency of the tracking generator is not exactly matched to the input frequency of the spectrum analyzer. The resulting mixing product from the spectrum analyzer input mixer is not at the center of the IF bandwidth. Any tracking errors may be compensated for through manual adjustments of the tracking generator's oscillator, or through an automatic tracking routine, which is initiated by pressing TRACKING PEAK .</p> <p>Front-Panel Key Access: <b>(AUX CTRL)</b></p> |
| MARKER # ON OFF | <p>turns the selected marker on or off. One of the four markers must first be selected by the SELECT 1 2 3 4 key, otherwise marker 1, or the last selected marker, will be turned on or off. When a new marker is turned on by pressing MARKER # ON OFF, the MK TRACE AUTO ABC function always switches to AUTO and the marker is put on the trace that is selected by the AUTO mode.</p> <p>Front-Panel Key Access: <b>(MKR)</b></p>                                                                                                                                                                                                                                                                                                                               |
| MARKER Δ        | <p>activates a second marker at the position of the first marker. (If no marker is present, two markers appear at the center of the display.) The amplitude and frequency of the first marker is fixed, and the second marker is under your control. Annotation in the active function block and in the upper-right corner of the screen indicates the frequency and amplitude differences between the two markers. The display mode must not be changed between log and linear while using a delta marker.</p>                                                                                                                                                                                                                                                     |

---

**Note** If there are already four markers when MARKER A is pressed, a nonactive marker disappears, the active marker becomes a reference marker, and the delta marker becomes the active marker.

---

Front-Panel Key Access: **(MKR)** or **(PEAK\_SEARCH)**

|                      |                                                                                                                                                                                                                                                                                                                                                                                                                                                                                                                                                                                                                                                                                                                                 |
|----------------------|---------------------------------------------------------------------------------------------------------------------------------------------------------------------------------------------------------------------------------------------------------------------------------------------------------------------------------------------------------------------------------------------------------------------------------------------------------------------------------------------------------------------------------------------------------------------------------------------------------------------------------------------------------------------------------------------------------------------------------|
| MARKER<br>A-SPAN     | sets the start and stop frequencies to the values of the delta markers. The start and stop frequencies will not be set if the delta marker is off.<br>Front-Panel Key Access: <b>(MKR→)</b>                                                                                                                                                                                                                                                                                                                                                                                                                                                                                                                                     |
| MARKER→<br>AUTO FFT  | functions exactly like the CONTINUS FFT softkey, if the spectrum analyzer is already in zero span. If the spectrum analyzer is not in zero span it activates a marker which must be placed on the signal that will have an FFT performed on it and MARKER+ AUTO FFT must be pressed again. The resolution bandwidth setting must be wide enough to include the displayed modulation signals. Refer to Chapter 4 “Measuring Amplitude Modulation Using the Fast Fourier Transform” for more information.<br><br>Press FFT OFF to return the spectrum analyzer to normal operation. The spectrum analyzer state prior to pressing MARKER→ AUTO FFT can be recalled from register 8.<br>Front-Panel Key Access: <b>(MEAS/USER)</b> |
| MARKER<br>→CF        | changes the spectrum analyzer settings so that the frequency at the marker becomes the center frequency.<br>Front-Panel Key Access: <b>(MKR→)</b> or <b>(PEAK SEARCH)</b>                                                                                                                                                                                                                                                                                                                                                                                                                                                                                                                                                       |
| MARKER<br>→CF STEP   | changes the center-frequency step size to match the value of the active marker. Press <b>(FREQUENCY)</b> then CF STEP AUTO MAN to view the step size. If marker delta is active, the step size will be set to the frequency difference between the markers.<br>Front-Panel Key Access: <b>(MKR→)</b>                                                                                                                                                                                                                                                                                                                                                                                                                            |
| MARKER+<br>FFT STOP  | changes the FFT stop frequency to whatever the current value of the FFT marker frequency is, within the limitations of the available sweep times. This puts the marker on the right side of the graticule.<br>Front-Panel Key Access: <b>(MEAS/USER)</b>                                                                                                                                                                                                                                                                                                                                                                                                                                                                        |
| MARKER-t<br>MID SCRN | changes the frequency at the middle of the FFT display to whatever the current value of the FFT marker frequency is, within the limitations of the available sweep times. This puts the marker in the middle of the graticule.<br><br>When using the FFT function the MARKER→ MID SCRN softkey replaces the MARKER → CF softkey in the <b>(PEAK SEARCH)</b> and <b>(MKR→)</b> menus.<br>Front-Panel Key Access: <b>(MEAS/USER)</b> , <b>(MKR→)</b> , or <b>(PEAK SEARCH)</b>                                                                                                                                                                                                                                                    |
| MARKER-+<br>MINIMUM  | moves the active marker to the minimum detected amplitude value.<br>Front-Panel Key Access: <b>(MKR→)</b>                                                                                                                                                                                                                                                                                                                                                                                                                                                                                                                                                                                                                       |
| MARKER<br>→PK-PK     | finds and displays the frequency and amplitude differences between the highest and lowest trace points. Pressing MARKER →PK-PK performs the routine similar to pressing the following keys: <b>(PEAK SEARCH)</b> , MARKER A , and MARKER-,MINIMUM.<br>Front-Panel Key Access: <b>(MKR→)</b>                                                                                                                                                                                                                                                                                                                                                                                                                                     |
| MARKER<br>→REF LVL   | changes the spectrum analyzer settings so that the amplitude at the active marker becomes the reference level.<br>Front-Panel Key Access: <b>(MKR→)</b>                                                                                                                                                                                                                                                                                                                                                                                                                                                                                                                                                                         |
| MARKER<br>→START     | changes the start frequency so that it is equal to the frequency of the active marker. This moves the active marker to the left edge of the display.<br>Front-Panel Key Access: <b>(MKR→)</b>                                                                                                                                                                                                                                                                                                                                                                                                                                                                                                                                   |

|                   |                                                                                                                                                                                                                                                                                                                                                                                                                                                                                                                                                                                                                                                                                                                                                                                                                                                                                                   |
|-------------------|---------------------------------------------------------------------------------------------------------------------------------------------------------------------------------------------------------------------------------------------------------------------------------------------------------------------------------------------------------------------------------------------------------------------------------------------------------------------------------------------------------------------------------------------------------------------------------------------------------------------------------------------------------------------------------------------------------------------------------------------------------------------------------------------------------------------------------------------------------------------------------------------------|
| MARKER<br>--STOP  | changes the stop frequency so that it is equal to the frequency of the active marker. This moves the active marker to the right edge of the display.<br>Front-Panel Key Access: <b>(MKR→)</b>                                                                                                                                                                                                                                                                                                                                                                                                                                                                                                                                                                                                                                                                                                     |
| MARKER<br>ALL OFF | turns off all of the markers, including markers used for marker track and demodulation (demodulation is only available with Option 102 or 103). Marker annotation is also removed.<br>Front-Panel Key Access: <b>(MKR)</b>                                                                                                                                                                                                                                                                                                                                                                                                                                                                                                                                                                                                                                                                        |
| MARKER<br>AMPTD   | keeps the active marker at the requested amplitude on the screen. Once activated, the marker remains at the amplitude selected by the step keys, knob, or numeric keypad, even if the signal frequency is changed. Pressing any digit, 0 through 9, on the numeric keypad brings up the selected units terminator menu. The marker will be placed on the signal furthest left at that amplitude. If no signal exists at that amplitude, it will be placed above the highest signal amplitude (or below the lowest trace element if it is below all trace elements). When marker delta is active in addition to marker amplitude, the behavior of the active marker is useful for measuring signal bandwidths. For example, place a marker 20 dB below the peak of a signal, press MARKER A , MARKER AMPTD . The marker readout shows the 20 dB bandwidth.<br>Front-Panel Key Access: <b>(MKR)</b> |
| MARKER<br>NORM PK | <b><i>For Option 103 only.</i></b><br>provides a function similar to a normal marker when making quasi-peak measurements. When NORM is selected, the marker can be moved anywhere on the trace; when PK is selected, the marker is placed on the highest on-screen signal peak after each sweep.<br>Front-Panel Key Access: <b>(AUX CTRL)</b>                                                                                                                                                                                                                                                                                                                                                                                                                                                                                                                                                     |
| MARKER<br>NORMAL  | activates a single frequency marker at the center frequency on the active trace if an on-screen marker is not already displayed. If there is an on-screen marker before the MARKER NORMAL function is enabled, a frequency marker is enabled at the position of the first marker. Use the data controls to position the marker. Annotation in the active function block and in the upper-right corner indicates the frequency and amplitude of the marker. The marker stays on the trace at the horizontal screen position where it was left unless MK TRACK ON OFF , MARKER AMPTD , or a “marker to” softkey function (such as MARKER ⇒CF , MARKER →REF LVL , MARKER →CF STEP, MARKER A ⇒SPAN , or MARKER+ MINIMUM ) is selected.<br>Pressing MARKER NORMAL turns off the marker-delta function.<br>Front-Panel Key Access: <b>(MKR)</b>                                                         |
| MARKER<br>ON      | <b><i>Option 105 only. Option 101 is recommended.</i></b><br>activates a marker in the gate utility. The MARKER ON key is accessed from within the pulse parameter entry menus in the gate utility. If the reference edge parameter is being entered MARKER ON turns on a trigger marker. For pulse width and pulse repetition interval entry, it turns on a delta marker. The delta marker will be activated at the defined reference edge, if one is available. Otherwise, it will activate at mid screen.<br>Front-Panel Key Access: <b>(SWEEP)</b>                                                                                                                                                                                                                                                                                                                                            |

|                   |                                                                                                                                                                                                                                                                                                                                                                                                                                            |
|-------------------|--------------------------------------------------------------------------------------------------------------------------------------------------------------------------------------------------------------------------------------------------------------------------------------------------------------------------------------------------------------------------------------------------------------------------------------------|
| MAX<br>HOLD A     | maintains the maximum level for each trace point of trace A. Updates <b>each</b> trace point if a new maximum level is detected in successive sweeps.<br>Front-Panel Key Access: <b>TRACE</b>                                                                                                                                                                                                                                              |
| MAX<br>HOLD B     | maintains the maximum level for each trace point of trace B. Updates each trace point if a new maximum level is detected in successive sweeps.<br>Front-Panel Key Access: <b>TRACE</b>                                                                                                                                                                                                                                                     |
| MAX MXR<br>LVL    | lets you change the maximum input mixer level in 10 dB steps from -10 dBm to -100 dBm. The mixer level is equal to the reference level minus the attenuator setting. As the reference level changes, the input attenuator setting is changed to keep the power levels less than the selected level at the input mixer. Pressing <b>PRESET</b> resets the maximum input mixer level to - 10 dBm<br>Front-Panel Key Access: <b>AMPLITUDE</b> |
| MEAS OFF          | turns off the measurement functions under the Power Menu softkey and restores the spectrum analyzer to the state prior to initiating the power measurement. If another front-panel key is pressed, exiting the power menus. press the <b>MEAS/USER</b> key twice to return to the power menu.<br>Front-Panel Key Access: <b>MEAS/USER</b>                                                                                                  |
| <b>MEAS/USER</b>  | switches between the User Menu and the menu containing N dB PTS ON OFF , % AM ON OFF, TO1 ON OFF, Power Menu, and FFT Menu. If no keys have been defined in the user menu, No User Menu is displayed. See the <b>HP 8590 E-Series and L-Series Spectrum Analyzer and HP 8591C Cable TV Analyzer Programmer's Guide</b> for more information about defining keys in the user menu.                                                          |
| MEM LOCKED        | indicates that the save lock function is on. It replaces the ERASE STATEALL and ERASE TRACEALL softkeys under the <b>CONFIG</b> key, and it replaces STATE → INTERNAL and TRACE → INTERNAL under the (SAVE_) key when SAV LOCK ON OFF is ON. Pressing SAV LOCK ON OFF returns the menu to its unlocked state.<br>Front-Panel Key Access: <b>SAVE</b> or <b>CONFIG</b>                                                                      |
| MIN<br>HOLD C     | maintains the minimum level for each trace point of trace C. Updates each trace point if a new 'minimum level is detected in successive sweeps.<br>Front-Panel Key Access: <b>TRACE</b>                                                                                                                                                                                                                                                    |
| MIXER<br>BIAS DAC | <b>HP 8592L, HP 8593E, HP 8595E, or HP 85963 only.</b><br>displays the output of the mixer-bias DAC from the first-converter driver on the A7 Analog Interface assembly. This is a service diagnostic function and is for service use only.<br>Front-Panel Key Access: <b>CAL</b>                                                                                                                                                          |

MK COUNT  
ON OFF

*All E-Series and L-Series spectrum analyzers except HP 8590L with Option 713.*

turns on the marker counter when ON is underlined. If no marker is active before MK COUNT ON OFF is pressed, a marker is activated at center screen. Press MK COUNT ON OFF (so that OFF is underlined), to turn the marker counter off. Press CNT RES **AUTO** MAN to change the marker counter resolution to an uncoupled value.

An (\*) may appear in the upper right of the display along with the message Marker Count. The ratio of the resolution bandwidth to span must be greater than 0.01 for the marker count function to work properly. Reduce Span appears on screen if the bandwidth to span ratio is less than 0.01. If Option 130, narrow resolution bandwidth, is not installed, the marker count function is limited to resolution bandwidths  $\geq 300$  Hz. Widen RES BW indicates that the resolution bandwidth must be increased. The function will count the largest signal is a 300 Hz bandwidth even if a narrower bandwidth setting is used.

Front-Panel Key Access: **(MKR FCTN)**

MK NOISE  
ON OFF

reads out the average noise level, referenced to a 1 Hz noise power bandwidth, at the marker position. If no marker is present, a marker appears at the center of the screen. The root-mean-square noise level, normalized to a 1 Hz noise power bandwidth, is read out. The sample detector is activated.

Front-Panel Key Access: **(MKR FCTN)**

MK PAUSE  
ON OFF

stops the spectrum analyzer sweep at the marker position for the duration of the dwell time. The dwell time can be set from 2 milliseconds to 100 seconds.

Front-Panel Key Access: **(MKR FCTN)**

MK READ  
F T I P

selects the marker readout to be displayed in signal frequency, sweep time, the inverse of the sweep time, or **the** period which is the inverse of the frequency. When the instrument is in zero span the frequency type readout cannot **be** selected.

Front-Panel Key Access: **(MKR)**

MK TABLE  
ON OFF

provides a list of the four available markers which is updated at the end of each sweep or when a marker is used. The marker data can be displayed in different formats. It can be in absolute or delta frequency and amplitude formats. There is also a delta display line format, which can be accessed using the TABLE ADL NRM softkey.

The marker table is not saved with the **(SAVE)** and **(RECALL)** keys.

Front-Panel Key Access: **(MKR FCTN)**

MK TRACE  
AUTO ABC

assigns a marker to a trace. Pressing MK TRACE AUTO ABC will activate a marker on trace A if there are no markers turned on. If a marker is currently active, press MK TRACE AUTO ABC until A, B, or C are underlined. The active marker will be moved to the selected trace.

Selecting the AUTO mode will move the marker to the trace that is automatically selected. The selection order is to first look for a trace in the clear-write mode, in the order of trace A, then trace B, then trace C. If no traces are currently being written, it will select a trace in the view-store mode, again in the order of trace A, B, then C.

Front-Panel Key Access: **(MKR)**



MK TRACK  
ON OFF moves the signal that is nearest to the active marker to the center of the screen and keeps the signal there. MKR-TRK or CNTR-TRK appears in the upper-right corner of the display. An (\*) may appear in the upper-right corner of the display while the spectrum analyzer is verifying that it has the correct signal.

Pressing MK TRACK ON OFF , **PRESET**, MARKER NORMAL, or MARKER ALL OFF turns off the marker-track function.

When marker track is on and the span is reduced, an automatic zoom is performed: the span is reduced in steps so that the signal remains at the center of the screen. If the span is zero, marker track cannot be activated.

Front-Panel Key Access: **MKR FCTN**

**MKR** accesses the marker control softkeys which select the type and number of markers and turn them on and off. Markers are diamond-shaped characters that identify points of traces and allow the traces to be manipulated and controlled on the screen. During manual operation, four markers may appear on the display simultaneously; only one can be controlled at a time. The marker that is controlled is called the “active” marker. Pressing **MKR** activates the MARKER NORMAL softkey.

**MKR→** (read “marker to”) accesses the softkeys used for the transfer of marker information directly into other functions.

**MKR FCTN** accesses the marker function softkeys. These softkeys can be used to access the marker table and to turn on marker functions for tracking the signal and counting its frequency. Noise markers and the marker pause function are also accessed under **MKR FCTN**.

MNOPQR accesses the softkey menu for selecting screen title or prefix characters M through R.

Front-Panel Key Access: (CAL), **CONFIG**, **DISPLAY**, **RECALL**, or **SAVE**

**MODE** changes the softkey menus for the spectrum-analyzer mode and other modes of operation when SPECTRUM ANALYZER (located under **PRESET**) and PRESET SPECTRUM are selected, respectively. Other modes are available using the downloadable measurement personalities. The HP 8571 1A cable television measurements personality, the HP 85712D EM1 diagnostics measurements personality, and the HP 85713A digital radio measurements personality are examples of some of these modes. Others are described in “Measurement Personalities, Options, and Accessories.” Consult the documentation accompanying each personality for information about these other modes of operation.

|                    |                                                                                                                                                                                                                                                                                                                                                                                                                                                                                                                                                                                                                                                                                                                                                                                                                                                                                                                                                                                                                         |
|--------------------|-------------------------------------------------------------------------------------------------------------------------------------------------------------------------------------------------------------------------------------------------------------------------------------------------------------------------------------------------------------------------------------------------------------------------------------------------------------------------------------------------------------------------------------------------------------------------------------------------------------------------------------------------------------------------------------------------------------------------------------------------------------------------------------------------------------------------------------------------------------------------------------------------------------------------------------------------------------------------------------------------------------------------|
| N dB PTS<br>ON OFF | <p>automatically places two markers at points N dB from the highest point on the highest displayed signal, and determines the frequency difference between the two markers. N dB is the active function and the value of N is set by the user. The measurement defaults to 3 dB when it is first turned on. The measurement runs continuously re-executing at the end of each sweep.</p> <p>No other signal can appear on the display within N dB of the highest signal. The measured signal cannot have more than one peak that is greater than or equal to N dB. A signal must be greater than the peak excursion above the threshold to be identified. The setting for peak excursion may be increased from the 6 dB default value so that noise will not be identified as signals. Increasing the value too much may cause a smaller signal to be missed or misinterpreted as part of a larger signal. The amplitude scale may be either linear or logarithmic.</p> <p>Front-Panel Key Access: <b>MEAS/USER</b></p> |
| NEW<br>EDIT        | <p><b>For Options 041 and 043 only. Refer to the HP 8590 E-Series and L-Series Spectrum Analyzer and HP 8591C Cable TV Analyzer Programmer's Guide for more information.</b></p> <p>starts the DLP editor function, clearing the DLP editor memory to create a new item in the spectrum analyzer 2500 byte DLP editor memory. The item will not be in the spectrum analyzer user memory until it is processed by the SAVE EDIT softkey. The DLP editor memory buffer remains intact when the instrument is preset and when it is powered off.</p> <p>Front-Panel Key Access: <b>RECALL</b> or <b>SAVE</b></p>                                                                                                                                                                                                                                                                                                                                                                                                           |
| <b>NEXT</b>        | <p><b>HP 8591 E, HP 8593E, HP 8594E, HP 85953, or HP 8596E only.</b></p> <p>switches the active window between the two displayed windows, if the windows display mode has been turned on. The active window is marked by solid lines.</p> <p>If the zoom function has been used to expand an active window to the full screen, the <b>NEXT</b> key still switches the active window between the two windows. The windows remain zoomed (full screen) so the inactive window is not displayed as the active window is switched.</p>                                                                                                                                                                                                                                                                                                                                                                                                                                                                                      |
| NEXT<br>PEAK       | <p>places the marker on the next highest peak. The signal peak must exceed the threshold value. (Also see the PEAK EXCURSN and THRESHLD ON OFF softkey descriptions.)</p> <p>Front-Panel Key Access: <b>PEAK_SEARCH</b></p>                                                                                                                                                                                                                                                                                                                                                                                                                                                                                                                                                                                                                                                                                                                                                                                             |
| NEXT PK<br>LEFT    | <p>moves the marker to the next peak to the left of the current marker. The signal peak must exceed the threshold value. If there is no peak to the left, the marker will not move. (Also see the PEAK EXCURSN and THRESHLD ON OFF softkey descriptions.)</p> <p>Front-Panel Key Access: <b>PEAK_SEARCH</b></p>                                                                                                                                                                                                                                                                                                                                                                                                                                                                                                                                                                                                                                                                                                         |
| NEXT PK<br>RIGHT   | <p>moves the marker to the next peak to the right of the current marker. The signal peak must exceed the threshold value. If there is no peak to the right, the marker will not move. (Also see the PEAK EXCURSN and THRESHLD ON OFF softkey descriptions.)</p> <p>Front-Panel Key Access: <b>PEAK_SEARCH</b></p>                                                                                                                                                                                                                                                                                                                                                                                                                                                                                                                                                                                                                                                                                                       |

|                   |                                                                                                                                                                                                                                                                                                                                                                                                                                                                                                                                                                                                                                                                                                                                                                                                                                                                                                                                                                                                |
|-------------------|------------------------------------------------------------------------------------------------------------------------------------------------------------------------------------------------------------------------------------------------------------------------------------------------------------------------------------------------------------------------------------------------------------------------------------------------------------------------------------------------------------------------------------------------------------------------------------------------------------------------------------------------------------------------------------------------------------------------------------------------------------------------------------------------------------------------------------------------------------------------------------------------------------------------------------------------------------------------------------------------|
| No User Menu      | <p>is displayed if key number 1 has not been defined by the user. Key number 1 can be defined by remote programming commands (KEYCMD or KEYDEF).<br/>         Front-Panel Key Access: <b>MEAS/USER</b></p>                                                                                                                                                                                                                                                                                                                                                                                                                                                                                                                                                                                                                                                                                                                                                                                     |
| NORMLIZE ON OFF   | <p>subtracts trace B from trace A and adds the result to the display line. The result is displayed in trace A. The trace data is normalized with respect to the display line even if the value of the display line is changed. This function is executed on all subsequent sweeps until it is turned off. A minus sign (–) appears between the trace A status and the trace B status in the screen annotation while the function is active. To turn off the normalize function, press NORMLIZE ON OFF so that OFF is underlined.</p> <p>The normalize function is useful for applying correction data to a trace. For example, store a measurement sweep of the response of a system in trace B. Trace A can be used to measure the response of the system after a device is added. Set NORMLIZE ON OFF to ON to subtract the system response from the response of the device under test, to characterize the response of a device under test.</p> <p>Front-Panel Key Access: <b>TRACE</b></p> |
| NORMLIZE POSITION | <p>displays the display line and makes the display line function active. The trace data is normalized with respect to the display line even if the value of the display line is changed.</p> <p>Front-Panel Key Access: <b>TRACE</b></p>                                                                                                                                                                                                                                                                                                                                                                                                                                                                                                                                                                                                                                                                                                                                                       |
| NTSC              | <p><i>Options 101 and 102, or Option 301 only.</i></p> <p>allows you to trigger on the NTSC video format. Pressing NTSC alters the TV line number that the spectrum analyzer triggers on internally; the line number displayed when TV LINE # is pressed does not change. Pressing NTSC changes the video modulation to negative; set TV SYNC NEG POS so that POS is underlined if positive video modulation is required.</p> <p>Front-Panel Key Access: <b>TRIG</b></p>                                                                                                                                                                                                                                                                                                                                                                                                                                                                                                                       |
| occ BW<br>% POWER | <p>allows the user to enter the percent of the power desired when using the occupied bandwidth measurement under the Power Menu softkey. When the power measurements are first accessed the initial value for percent power is 99 percent. Once the value is changed, the new value will be saved through an instrument preset or power-on. If the occupied bandwidth measurement is active and the percent power is changed, another sweep is taken and measured.</p> <p>Front-Panel Key Access: <b>MEAS/USER</b></p>                                                                                                                                                                                                                                                                                                                                                                                                                                                                         |

OCCUPIED  
BANDWIDTH

integrates the power of the displayed spectrum and puts markers at the frequencies containing a selected percent of the power. The measurement defaults to 99% of the occupied bandwidth power. The power-bandwidth routine first computes the combined power of all signal responses contained in the trace. For 99% occupied power bandwidth, it then puts markers at the frequencies at which 0.5% of the power lies to the right of the right marker and to the left of the left marker. Thus 99% of the power lies between the markers. The difference of the marker frequencies is the 99% power bandwidth and is the value displayed.

The OCC BW % POWER softkey can be used to change the measured power value from 1% to 99.99% of the total displayed power. The occupied bandwidth function also indicates the value of the measured power in the occupied bandwidth, and the difference between the spectrum analyzer center frequency and the center frequency of the occupied bandwidth. The measurement can be made on a single sweep or to continuously update at the end of each sweep. The center frequency, reference level, and channel spacing must be set by the user. Press PARAM AUTO MAN so that AUTO is underlined and other spectrum analyzer settings will be set automatically set to make a valid measurement. Set PARAM AUTO MAN to (MAN) to manually control all settings. The measurement function stops and the spectrum analyzer is returned to its prior state when other functions are activated.

Front-Panel Key Access: **MEAS/USER**

WINDOWS (ON) **HP 85913, HP 85933, HP 8594E, HP 85953, or HP 8596E only.**

activates the windows display mode and accesses the menu of window zone functions. The windows display function splits the screen into two separate displays. Only one of these displays is active at a time. The currently active window will have a solid line around the graticule rather than a broken line. The WINDOWS (NEXT) key will switch the active display between the upper and lower windows. The instrument state of the active window can be changed without affecting the state of the inactive window. The complete annotation is not displayed for each window because of space limitations.

When the windows display mode is first turned on, the top window will contain an inactive copy of the previous full display. The lower window will be active and will display a subset of the frequency span of the upper window. The displayed span, or zone, of the lower window will be indicated on the upper window by two vertical lines called zone markers. The zone can be moved and changed using the zone keys which are accessed by pressing the WINDOWS **ON** key. Changing the span or center frequency of the lower window will change the corresponding zone markers on the upper window.

Most functions can be used from within the windows display mode. Some functions, like editing limit lines and showing the options, require a full-sized display. They will temporarily exit the windows display format. When the function is finished the instrument will return to a windows display. Other functions will permanently exit the windows display and it will be necessary to restart the windows display mode by pressing WINDOWS **ON** (see Table 7-9).

Limit lines can be displayed and tested within the windows display mode. Viewing and testing must be turned on independently in each window. The current limit lines will be common to both windows.

**SAVE** and **RECALL** do not save the windows display mode. If the windows display mode is being used, the save state function saves the state of the currently active window. The recall state function recalls the stored state into the currently active window. See the DISPLAY → CARD and CARD → DISPLAY softkeys for information about saving the display.

**Table 7-9. Functions Which Exit The Windows Display Format**

| Function               | Description                               |
|------------------------|-------------------------------------------|
| % AM                   | measures percent amplitude modulation     |
| Adjacent Channel Power | measures adjacent channel power           |
| Calibration Functions  | self-calibration routines                 |
| Channel Power          | measures channel power                    |
| Confidence Test        | built-in self test routine                |
| Dispose User Memory    | deletes user's items from analyzer memory |
| FFT                    | initiates FFT on zero span input          |
| Gate Utility           | accesses time gate functionality          |
| Instrument Preset      | returns analyzer to preset state          |
| Marker Table           | lists all of the active markers           |
| N dB Points            | measures N dB bandwidth                   |
| Occupied Bandwidth     | measures occupied bandwidth               |
| Peak Table             | lists displayed signal peaks              |
| Peak Zoom              | initiates the peak zoom routine           |
| TOI                    | makes a third-order intercept measurement |

PAINT JET  
PRINTER

*Option 041 or 043 only.*

selects a color print (for use with an HP PaintJet printer only). The traces are displayed in orange (trace A), blue (trace B), and red (trace C). The graticule, screen annotation, and user information are displayed in black.

Front-Panel Key Access: **CONFIG**

PAL

*Options 101 and 102, or Option 301 only.*

allows you to trigger on the PAL video format. Pressing PAL alters the TV line number that the spectrum analyzer triggers on internally; the line number displayed when TV LINE # is pressed does not change. Pressing PAL changes the video modulation to negative; set TV SYNC MEG POS so that POS is underlined if positive video modulation is required.

Front-Panel Key Access: **TRIG**

PAL-M

*Options 101 and 102, or Option 301 only.*

allows you to trigger on the PAL-M video format. PAL-M alters the TV line number the spectrum analyzer triggers on internally; the line number displayed by TV LINE # does not change. PAL-M changes the video modulation to negative; use TV SYNC NEG POS (POS) if positive video modulation is required.

Front-Panel Key Access: **TRIG**

**PARAM** lets the user choose between automatically or manually setting the parameters used for the measurement functions under the Power Menu softkey.  
**AUTO MAN** Parameters such as span, resolution bandwidth, video bandwidth, center frequency step size, detector mode, and sweep time are coupled so that they are automatically updated. With **AUTO** underlined when channel bandwidth or channel spacing are changed, the coupled parameters will be updated and another sweep will be taken and measured. If **MAN** is underlined the user must set all of the parameters correctly.  
Front-Panel Key Access: **MEAS/USER**

**PEAK** sets the minimum amplitude variation of signals that the marker can identify as a peak. If a value of 10 dB is selected, the marker moves only to peaks that rise and fall more than 10 dB above the threshold line (or the noise floor of the display). Pressing **PRESET** or turning on power resets the excursion to 6 dB, and the threshold to 70 dB below the reference level.  
**EXCURSM**

---

**Note** When a peak has a lump on its skirt that is the peak-excursion value above the threshold, the lump is considered a peak in its own right only if it has a peak excursion drop on both sides. Two peaks that are so close that only a valley divides them are not differentiated if the valley is not the peak-excursion value deep.

---

When the peak excursion value is less than 6 dB, the marker-peaking functions may not recognize signals less than 6 dB above the noise floor. To correct this, when measuring signals near the noise floor, the excursion value can be reduced even further. To prevent the marker from identifying noise as signals, reduce the noise floor variance to a value less than the peak-excursion value by reducing the video bandwidth or by using video averaging.  
Front-Panel Key Access: **PEAK SEARCH**

**Peak** accesses the same softkeys that are available when **PEAK SEARCH** is pressed.  
**Menu** See the key description for **PEAK SEARCH**. Pressing Peak Menu instead of **PEAK SEARCH** allows you to use the peak-search functions without initiating a new peak search.  
Front-Panel Key Access: **MKR→**

**PEAK SEARCH** automatically places a marker on the highest amplitude of a trace, displays the marker's amplitude and frequency. It also accesses the menus of marker peak functions including the peak table functions.

PEAK ZOOM finds the highest displayed signal and narrows the span to a value selected by the user. Pressing PEAK ZOOM the first time will make FINAL SPAN the active function so the user can input the destination span. The current FINAL SPAN value will be displayed. At that time the user can enter a span or press PEAK ZOOM again to use the displayed span.

The peak zoom function sets the reference level to the signal amplitude and sets the center frequency step size to the signal frequency. If the signal is in a microwave band, a preselector peak is executed.

For a signal to be found it must have a peak of at least 6 dB. If no signal is found, Signal not found will be displayed. (The routine will ignore the spectrum analyzer local oscillator feedthrough signal which is at 0 Hz.)

Front-Panel Key Access: **SPAN**

PK MODE **<>DLNRM** select which peaks will be listed in the peak table to include all peaks, or to exclude the peaks that are either above or below the display line, see table below. The display line is activated if it was not currently being displayed.

| Selection | Peaks Listed                    |
|-----------|---------------------------------|
| NRM       | all peaks listed                |
| >DL       | peaks above display line listed |
| < DL      | peaks below display line listed |

Front-Panel Key Access: **PEAK SEARCH**

PK SORT FRQ AMP switches the peak table sorting routine between listing the peaks in order by descending amplitude or by ascending frequency.

Front-Panel Key Access: **PEAK SEARCH**

PK TABLE ON OFF displays a list, of up to ten signal peaks, that is updated at the end of each sweep. The peaks can be sorted in order by descending amplitude or by ascending frequency. Peaks above or below the display line can be excluded from the table. The peak table function works with trace A only. The peak table is not saved with the **SAVE** and **RECALL** keys.

Front-Panel Key Access: **PEAK SEARCH**

Plot Config **Option 041 or 043 only.** accesses the menu used to address the plotter and to select plotter options. See the **COPY** key for more information.

Front-Panel Key Access: **CONFIG**

PLOTTER ADDRESS **Option 041 only.** changes the HP-IB address of the plotter. The plotter address is set to 5 when **DEFAULT CONFIG** is pressed.

Front-Panel Key Access: **CONFIG**

|                      |                                                                                                                                                                                                                                                                                                                                                                                                                                                                                                                                                                                                                                                                                                                                                                                                                                                                                                                                                   |
|----------------------|---------------------------------------------------------------------------------------------------------------------------------------------------------------------------------------------------------------------------------------------------------------------------------------------------------------------------------------------------------------------------------------------------------------------------------------------------------------------------------------------------------------------------------------------------------------------------------------------------------------------------------------------------------------------------------------------------------------------------------------------------------------------------------------------------------------------------------------------------------------------------------------------------------------------------------------------------|
| PLT _ _<br>LOC _ _   | <p><b>Option 041 or 043 only.</b><br/>         selects the position of the plotter output. The highlighted portion of the softkey label indicates where the plot is to be output on the page. This softkey function appears only if two or four plots per page are selected when PLTS/PG 1 2 4 is pressed.<br/>         Front-Panel Key Access: <b>CONFIG</b></p>                                                                                                                                                                                                                                                                                                                                                                                                                                                                                                                                                                                 |
| PLT MENU<br>ON OFF   | <p><b>Option 041 or 043 only.</b><br/>         allows the softkey labels to be plotted along with the spectrum analyzer display. This function operates when the <b>COPY</b> key is used in a plot configuration. The PLT MENU ON OFF function is set to OFF when DEFAULT CONFIG is pressed.<br/>         Front-Panel Key Access: <b>CONFIG</b></p>                                                                                                                                                                                                                                                                                                                                                                                                                                                                                                                                                                                               |
| Plt Port<br>Conf ig  | <p><b>Option 041 or 043 only.</b><br/>         accesses the menus used by Option 041 (HP-IB and Parallel Interface) and Option 043 (RS-232 and Parallel Interface) to select plotter options. See the <b>COPY</b> key for more information.<br/>         Front-Panel Key Access: <b>CONFIG</b></p>                                                                                                                                                                                                                                                                                                                                                                                                                                                                                                                                                                                                                                                |
| PLT PORT<br>HPIB PAR | <p><b>Option 041 only.</b><br/>         allows you to select between HP-IB or parallel plotter ports.</p>                                                                                                                                                                                                                                                                                                                                                                                                                                                                                                                                                                                                                                                                                                                                                                                                                                         |
| PLT PORT<br>SER PAR  | <p><b>Option 043 only.</b><br/>         allows you to select between serial or parallel plotter ports. The BAUD RATE softkey appears in this menu only when serial is selected.</p>                                                                                                                                                                                                                                                                                                                                                                                                                                                                                                                                                                                                                                                                                                                                                               |
| PLTS/PG<br>1 2 4     | <p><b>Option 041 or 043 only.</b><br/>         allows you to plot a full-page, half-page, or quarter-page output. Selecting two plots per page requires a plotter that has the rotate command (RO). The plotter will be set to a full-page output when DEFAULT CONFIG is pressed.<br/>         Front-Panel Key Access: <b>CONFIG</b></p>                                                                                                                                                                                                                                                                                                                                                                                                                                                                                                                                                                                                          |
| PLT->LJT<br>ON OFF   | <p><b>Option 041 or 043 only.</b><br/>         allows you to plot a full-page, half-page, or quarter-page output to an HP LaserJet printer. This softkey can be accessed by pressing <b>CONFIG</b>, then Plot Conf ig .<br/>         Front-Panel Key Access: <b>CONFIG</b></p>                                                                                                                                                                                                                                                                                                                                                                                                                                                                                                                                                                                                                                                                    |
| POINT                | <p>specifies a limit value for one coordinate point, <b>so that a POINT segment</b> specifies a limit value for a single frequency or time. For an upper limit line, a POINT segment is indicated by a line drawn vertically from the coordinate point to a point off the top of screen. For a lower limit line, a POINT segment is indicated by a line drawn vertically from the coordinate point to a point off the bottom of screen. The POINT segment type is generally used as the last segment in the limit-line table. However, if the last segment in the table is not of the POINT segment type, an implicit point is automatically added at the right-hand side of the screen. If a visible POINT segment at the right-hand edge of the display is not desired, add an explicit last-point segment to the limit-line table that is higher in frequency than the stop frequency.<br/>         Front-Panel Key Access: <b>DISPLAY</b></p> |



Power Menu accesses functions which make transmitter power measurements. The measurements are designed for analog radio or continuous carrier digital radio signals.

If another front-panel key is pressed, exiting the power menus, press the **MEAS/USER** key twice to return to the last power menu that was being used.  
Front-Panel Key Access: **MEAS/USER**

POWER ON IP LAST determines the state of the spectrum analyzer when the spectrum analyzer is powered on. If the POWER ON function is set to IP, the state of the spectrum analyzer is the same as it is after **PRESET** is pressed, when the spectrum analyzer is powered on. If the POWER ON function is set to LAST, then the state that the spectrum analyzer was left in when it was powered off is recalled.

The setting (IP or LAST) of the POWER ON function is not changed by pressing **PRESET**. Use the POWER ON IP LAST softkey function to change the setting of the spectrum analyzer state which is recalled at power on. Limit lines are not recalled when the spectrum analyzer is powered up.

---

**Note** If you have a downloadable program or “personality” installed in spectrum analyzer memory, the following changes apply to the operation of the POWER ON function: When using a downloadable program or personality, the last state of the personality is not recalled. We recommend that if you are using a downloadable program or personality, you set POWER ON IP LAST to IP. If POWER ON IP LAST is set to LAST, you must press **PRESET** whenever you power on the spectrum analyzer.

---

PRESEL DAC Front-Panel Key Access: **CONFIG**  
**HP 8592L, HP 8593E, HP 8595E, or HP 8596E only.**  
peaks the YTF preselector by allowing the user to manually adjust the YTF fine-tune DAC. This is a service diagnostic function and is for service use only.  
Front-Panel Key Access: (CAL)

PRESEL DEFAULT **HP 8592L, HP 85933, HP 85953, and HP 8596E only.**  
enables default preselector data for bands 1 through 4, to allow maximum frequency response without peaking the preselector. The CAL YTF routine should be performed before pressing PRESEL DEFAULT .  
Front-Panel Key Access: **AMPLITUDE**

PRESEL PEAK **HP 8592L, HP 8593E, HP 8595E, or HP 8596E only.**  
optimally centers the preselector on a given signal for the most accurate measurement of amplitude. The maximum response found for the frequency at the marker determines the future adjustment values that will be provided to the preselector.  
Front-Panel Key Access: **AMPLITUDE**

**PRESET**

provides a convenient starting point for making most measurements. Pressing **PRESET** displays softkeys used for accessing the operating modes available for your spectrum analyzer. See Table 7-10 and Table 7-11 for the conditions established by pressing **PRESET**.

The instrument preset function performs a processor test, but does not affect CAL data. Pressing **PRESET** clears both the input and output buffers, but does not clear trace B. The amplitude values of trace C are set to the reference level. Amplitude-correction factors are turned off. Limit-line testing is turned off, but the limit-line tables remain in spectrum analyzer memory. The status byte is set to 0. Instrument preset affects all operating modes. See the key description for **MODE** for more information about other operating modes. Pressing **PRESET** erases all “on time” functions-ONCYCLE, ONDELAY, ONEOS, ONMKR, ONSRQ, ONSWP, ONTIME, and TRMATH. These are remote programming commands. See the *HP 8590 E-Series and L-Series Spectrum Analyzer and HP 8591C Cable TV Analyzer Programmer’s Guide* for more information.

**Note**

Turning the spectrum analyzer on performs an instrument preset. Turning on the spectrum analyzer also fetches CAL data; completes a processor test; clears trace B, trace C, and both the input and output buffers; turns off amplitude correction factors; turns off limit-line testing; and sets the status byte to 0. The last state of the spectrum analyzer (before it was switched off) is recalled, unless IP has been set by the POWER ON function.

**Table 7-10. Model Specific Preset Conditions**

| Model    | Center Frequency | Span      | Start Frequency | stop Frequency | Sweep Time                       |
|----------|------------------|-----------|-----------------|----------------|----------------------------------|
| HP 8590L | 900 MHz          | 1.8 GHz   | 0 Hz            | 1.8 GHz        | 20 ms (auto-coupled)             |
| HP 8591E | 900 MHz          | 1.8 GHz   | 0 Hz            | 1.8 GHz        | 20 ms (auto-coupled)             |
| HP 8592L | 12.38 GHz        | 19.25 GHz | 2.75 GHz        | 22 GHz         | 385 ms, full span (auto-coupled) |
| HP 85933 | 12.38 GHz        | 19.25 GHz | 2.75 GHz        | 22 GHz         | 385 ms, full span (auto-coupled) |
| HP 85943 | 1.450 GHz        | 2.9 GHz   | 0 Hz            | 2.9 GHz        | 58 ms (auto-coupled)             |
| HP 8594L | 1.450 GHz        | 2.9 GHz   | 0 Hz            | 2.9 GHz        | 58 ms (auto-coupled)             |
| HP 85953 | 3.25 GHz         | 6.5 GHz   | 0 Hz            | 6.5 GHz        | 130 ms (auto-coupled)            |
| HP 85963 | 6.4 GHz          | 12.8GHz   | 0 Hz            | 12.8 GHz       | 256 ms (auto-coupled)            |

PRESET  
SPECTRUM

allows the spectrum-analyzer mode only to be preset. Table 7-12 lists the conditions affected by the PRESET SPECTRUM function. Other operating modes will not be affected. See the description of the **MODE** key.

In addition, pressing PRESET SPECTRUM erases user-generated graphics and blanks the active-function block that is on the spectrum analyzer screen.

Pressing PRESET SPECTRUM disposes of ONEOS, ONSWP, and TRMATH. These are remote programming commands; see the *HP 8590 E-Series and L-Series Spectrum Analyzer and HP 8591 C Cable TV Analyzer Programmer’s Guide* for more information.

Front-Panel Key Access: **MODE** or **PRESET**

**Table 7-11. Common Preset Conditions**

|                                                                                |                                                            |
|--------------------------------------------------------------------------------|------------------------------------------------------------|
| A - B - A                                                                      | Off                                                        |
| Amplitude correction factors                                                   | Off                                                        |
| Amplitude units                                                                | default values                                             |
| Annotation and graticule display                                               | on                                                         |
| Attenuation                                                                    | 10 dB (auto-coupled)                                       |
| Center frequency                                                               | Refer to Table 7-10.                                       |
| CF step size                                                                   | 10% of span                                                |
| Coupled functions                                                              | all set to AUTO                                            |
| Coupling *                                                                     | AC                                                         |
| Mass storage device (card or internal)                                         | INTERNAL                                                   |
| Detector                                                                       | positive peak                                              |
| Display line level                                                             | 2.5 graticule divisions below reference level, display off |
| Frequency offset                                                               | 0 Hz                                                       |
| Limit-line testing                                                             | Off                                                        |
| LIMIHI and LIMILO                                                              | cleared                                                    |
| Log scale                                                                      | 10 d B/division                                            |
| Marker counter †                                                               | Off                                                        |
| Marker counter resolution †                                                    | auto-coupled                                               |
| Markers                                                                        | Off                                                        |
| Mixer level                                                                    | -10 dBm                                                    |
| Operating mode                                                                 | spectrum analyzer                                          |
| Preselector peak ‡                                                             | reset                                                      |
| Reference level                                                                | 0 dBm in power-on units                                    |
| Reference level offset                                                         | 0 dB                                                       |
| Reference level position                                                       | top (8th) graticule                                        |
| Resolution bandwidth                                                           | 3 MHz (auto-coupled)                                       |
| Span                                                                           | Refer to Table 7-10.                                       |
| SRQ mask                                                                       | octal 50                                                   |
| Start Frequency                                                                | Refer to Table 7-10.                                       |
| Stop Frequency                                                                 | Refer to Table 7-10.                                       |
| State registers 1-8                                                            | unaffected                                                 |
| Sweep                                                                          | continuous                                                 |
| Threshold level                                                                | one graticule above baseline, display off                  |
| Title                                                                          | cleared                                                    |
| Trace A                                                                        | clear-write                                                |
| Trace B                                                                        | store-blank                                                |
| Trace C                                                                        | store-blank, at reference level                            |
| Trace registers                                                                | unaffected                                                 |
| Trigger                                                                        | free run                                                   |
| VBW/RBW ratio                                                                  | 0.3                                                        |
| Video averaging                                                                | off                                                        |
| Video bandwidth                                                                | 1 MHz (auto-coupled)                                       |
| * HP 85943, HP 85953, or HP 85963 only.                                        |                                                            |
| † All E-Series and L-Series spectrum analyzers except HP 8590L with Option 713 |                                                            |
| ‡ HP 8592L, HP 85933, HP 85953, or HP 85963 only.                              |                                                            |

**Table 7-12. Preset Spectrum Conditions for All Models**

|                                               |                                |
|-----------------------------------------------|--------------------------------|
| A - B - A                                     | Off                            |
| Analog+ display mode                          | Off                            |
| Annotation and graticule                      | on                             |
| Attenuation                                   | coupled                        |
| Center frequency                              | Refer to Table 7-10.           |
| Center frequency step size                    | 10% of span                    |
| Coupled functions                             | all set to AUTO                |
| Coupling *                                    | AC                             |
| Detector                                      | positive peak                  |
| Display line                                  | Off                            |
| Frequency offset                              | 0 Hz                           |
| Harmonic lock †                               | Off                            |
| Limit-line testing                            | off                            |
| Scale                                         | log 10 dB/div                  |
| Marker counter ‡                              | off                            |
| Marker counter resolution ‡                   | 2 kHz (auto-coupled)           |
| Markers                                       | off                            |
| Measure                                       | SA (spectrum analyzer)         |
| On end-of-sweep command (ONEOS)               | cleared                        |
| On-sweep command (ONSWP)                      | cleared                        |
| Reference level                               | 0 dBm in power-on units        |
| Reference level offset                        | 0 dB                           |
| Reference level position                      | top (8th) graticule            |
| Resolution bandwidth                          | 3 MHz (coupled)                |
| Span                                          | Refer to Table 7-10.           |
| Start frequency                               | Refer to Table 7-10.           |
| Stop frequency                                | Refer to Table 7-10.           |
| State registers 1-8                           | unaffected                     |
| Sweep                                         | continuous                     |
| Sweep time                                    | Refer to Table 7-10. (coupled) |
| Threshold                                     | off                            |
| Trace A                                       | clear-write                    |
| Trace B                                       | store-blank                    |
| Trace C                                       | store-blank                    |
| Trace math command (TRMATH)                   | cleared                        |
| Trace registers                               | unaffected                     |
| Trigger                                       | free                           |
| Video averaging                               | off                            |
| Video bandwidth                               | 3 MHz (coupled)                |
| Video bandwidth to resolution bandwidth ratio | 0.3                            |

\* HP 85943, HP 85953, or HP 85963 only.

† HP 8592L, HP 85933, HP 85953, or HP 85963 only.

‡ All E-Series and L-Series spectrum analyzers except HP 8590L with Option 713.

|                      |                                                                                                                                                                                                                                                                                                                                                                                                                                                                           |
|----------------------|---------------------------------------------------------------------------------------------------------------------------------------------------------------------------------------------------------------------------------------------------------------------------------------------------------------------------------------------------------------------------------------------------------------------------------------------------------------------------|
| Print<br>Config      | <p><b>Option 041 or 043 only.</b><br/>         accesses the softkey functions that are used to address the printer, select a black and white print or a color print, and reset the printer. See the <b>COPY</b> key for more information.<br/>         Front-Panel Key Access: <b>CONFIG</b></p>                                                                                                                                                                          |
| PRINTER<br>ADDRESS   | <p><b>Option 041 only.</b><br/>         allows you to change the HP-IB address of the printer. The printer address is set to 1 by pressing DEFAULT COMFIG.<br/>         Front-Panel Key Access: <b>CONFIG</b></p>                                                                                                                                                                                                                                                         |
| PRINTER<br>SETUP     | <p><b>Option 041 or 043 only.</b><br/>         resets the printer, sets the printer to 60 lines per page, and skips line perforations. This function enables you to obtain up to three printouts per page. The printer paper should be at the top of the form before using this function. The PRINTER SETUP function may not work with printers that are not recommended. See Chapter 10 for recommended printers.<br/>         Front-Panel Key Access: <b>CONFIG</b></p> |
| Pm Port<br>Config    | <p><b>Option 041 or 043 only.</b><br/>         accesses the menus used by Option 041 (HP-IB and Parallel Interface) and Option 043 (RS-232 and Parallel Interface) to select printer options. See the <b>COPY</b> key for more information.<br/>         Front-Panel Key Access: <b>CONFIG</b></p>                                                                                                                                                                        |
| PRN PORT<br>HPIB PAR | <p><b>Option 041 only.</b><br/>         allows you to select between HP-IB or parallel printer ports.</p>                                                                                                                                                                                                                                                                                                                                                                 |
| PRN PORT<br>SER PAR  | <p><b>Option 043 only.</b><br/>         allows you to select between serial or parallel printer ports. The BAUD RATE softkey appears in this menu only when serial is selected.</p>                                                                                                                                                                                                                                                                                       |

|                    |                                                                                                                                                                                                                                                                                                                                                                                                                                |
|--------------------|--------------------------------------------------------------------------------------------------------------------------------------------------------------------------------------------------------------------------------------------------------------------------------------------------------------------------------------------------------------------------------------------------------------------------------|
| PRT MENU<br>ON OFF | <p><b>Option 041 or 043 only.</b></p> <p>allows the softkey labels to be printed along with the spectrum analyzer display. This function operates when the (copy) key is used in a print configuration. The PRT MENU function is set to ON when DEFAULT CONFIG is pressed.</p> <p>Front-Panel Key Access: <b>CONFIG</b></p>                                                                                                    |
| Pulse<br>Param     | <p><b>Option 105 only. Option 101 is recommended.</b></p> <p>accesses the gate utility menus for entering the pulse parameters: reference edge, pulse width, and pulse repetition interval. If pulse parameters have previously been entered, pressing Pulse Param causes a list of the current values to be displayed.</p> <p>Front-Panel Key Access: <b>SWEEP</b></p>                                                        |
| PURGE<br>AMP COR   | <p>clears the current amplitude-correction factors table. Pressing PURGE AMP COR displays the message: If you are sure, press key again to purge data. Pressing PURGE AMP COR a second time clears the amplitude-correction data. Press SAVE AMP COR to save amplitude-correction factors, and then press PURGE AMP COR to clear the current amplitude-correction factors table.</p> <p>Front-Panel Key Access: <b>CAL</b></p> |
| PURGE<br>LIMITS    | <p>clears the current limit-line table from spectrum analyzer memory. Pressing PURGE LIMITS displays the message: If you are sure, press key again to purge data. Press PURGE LIMITS again if you wish to clear the current limit-line table. Press SAVE LIMIT to save the current limit-line table, and then press PURGE LIMITS to clear the current limit-line table.</p> <p>Front-Panel Key Access: <b>DISPLAY</b></p>      |
| PWRGRAPH<br>ON OFF | <p>turns the channel power graph ON or OFF. With the PWRGRAPH ON, the channel power graph is calculated and displayed and the numeric results are not displayed. The value of the channel power is displayed at the selected marker frequency. This graph function is used after doing a channel power measurement with the CHANNEL POWER softkey.</p> <p>Front-Panel Key Access: <b>MEAS/USER</b></p>                         |

PWR SWP  
ON OFF

**HP 8590L and HP 8591 E with Option 010 or 011. HP 85933, HP 8594E, HP 8595E, and HP 8596E with Option 010.**

activates (ON) or deactivates (OFF) the power-sweep function, which sweeps the output power of the tracking generator over the selected power-sweep range. The value of the power-sweep range is displayed in the active-function block when PWR SWP ON OFF is turned on. The available power-sweep range is a function of the source attenuator setting: For power sweeps, press SRC ATN MAN AUTO until (MAN) is underlined so the spectrum analyzer source attenuator is manually set (decoupled). For a given source attenuation setting, the maximum specified power-sweep range is given by the following:

**Power Sweep Range for the HP 8590L and HP 8591 E** is (– 15 dBm minus the source attenuation setting) to (0 dBm minus the source attenuation setting). For example, if the source attenuation setting is 20 dB, the maximum power sweep range is from -35 dBm (-15 dBm – 20 dB) to -20 dBm (0 dBm – 20 dB). The starting power level is the source power setting. The ending power level is the sum of the source power setting plus the source power sweep setting. Source power sweep may be set as high as 20 dB, but performance is specified only up to 15 dB.

**Power Sweep Range for the HP 8593E, HP 8594E, HP 85953, and HP 85963** is also related to the source attenuation setting. See Table 7-13.

**Table 7-13. HP 85933, HP 85943, HP 85953, and HP 85963**

| Attenuator Setting | Power Sweep Range |
|--------------------|-------------------|
| 0 dB               | -1 to -10         |
| 8 dB               | -10.1 to -18      |
| 16 dB              | -18.1 to -26      |
| 24 dB              | -26.1 to -34      |
| 32 dB              | -34.1 to -42      |
| 40 dB              | -42.1 to -50      |
| 48 dB              | -50.1 to -58      |
| 56 dB              | -58.1 to -66      |

The output power of the tracking generator is swept according to the sweep rate of the spectrum analyzer. The output power is always swept from the source power setting to a higher power setting (negative source power sweep values are not allowed). Refer to the calibration guide for your instrument for more information regarding source power and source attenuation relationships.

Power-sweep measurements are particularly useful in making gain compression measurements or output power versus frequency measurements.

Front-Panel Key Access: **AUX CTRL**

|                   |                                                                                                                                                                                                                                                                                                                                                                                                                                                                                                                                                                                                                                                                                                                                                 |
|-------------------|-------------------------------------------------------------------------------------------------------------------------------------------------------------------------------------------------------------------------------------------------------------------------------------------------------------------------------------------------------------------------------------------------------------------------------------------------------------------------------------------------------------------------------------------------------------------------------------------------------------------------------------------------------------------------------------------------------------------------------------------------|
| QP x10<br>ON OFF  | <p><b>Option 103 only.</b><br/>amplifies the video signal ten times (20 dB) in order to make an accurate measurement of a low quasi-peak signal. See the HP 85913, HP 85933, HP 85943, HP 85953, or HP 85963 Option 103 supplement documentation for more information.<br/>Front-Panel Key Access: <b>AUX CTRL</b></p>                                                                                                                                                                                                                                                                                                                                                                                                                          |
| QP DET<br>ON OFF  | <p><b>Option 103 only.</b><br/>turns the quasi-peak detector on and off. This is a service diagnostic function and is for service use only. See either the service documentation or the HP 85913, HP 8593E, HP 85943, HP 85953, or HP 85963 Option 103 supplement documentation for more information.<br/>Front-Panel Key Access: <b>AUX CTRL</b> or <b>CAL</b></p>                                                                                                                                                                                                                                                                                                                                                                             |
| QP GAIN<br>ON OFF | <p><b>Option 103 only.</b><br/>amplifies the video signal ten times (20 dB). This is a service diagnostic function and is for service use only.<br/>Front-Panel Key Access: <b>CAL</b></p>                                                                                                                                                                                                                                                                                                                                                                                                                                                                                                                                                      |
| QPD<br>OFFSET     | <p><b>Option 103 only.</b><br/>sets the offset of the quasi-peak detector. This is a service diagnostic function and is for service use only.<br/>Front-Panel Key Access: <b>CAL</b></p>                                                                                                                                                                                                                                                                                                                                                                                                                                                                                                                                                        |
| QPD RST<br>ON OFF | <p><b>Option 103 only.</b><br/>discharges and resets the quasi-peak detector. This is a service diagnostic function and is for service use only.<br/>Front-Panel Key Access: <b>CAL</b></p>                                                                                                                                                                                                                                                                                                                                                                                                                                                                                                                                                     |
| Quasi<br>Peak     | <p><b>Option 103 only.</b><br/>accesses the menu of quasi-peak softkey functions and, if there is not an on-screen marker, places a marker on the highest on-screen signal. See the HP 85913, HP 85933, HP 85943, HP 85953, or HP 85963 Option 103 supplement documentation for more information.<br/>Front-Panel Key Access: <b>AUX CTRL</b></p>                                                                                                                                                                                                                                                                                                                                                                                               |
| <b>RECALL</b>     | <p>accesses softkey menus that allow you to recall data from the memory card or spectrum analyzer memory. When INTERNAL is selected, states, traces, limit-line tables, amplitude-correction factors can be recalled from spectrum analyzer memory. When CARD is selected, states, traces, limit-line tables, and amplitude-correction factors, display images, and downloadable programs can be recalled from the memory card. Option 003 is required to use a memory card with the HP 8590L, HP 8592L, and HP 8594L only.</p> <p>In addition, pressing <b>RECALL</b> accesses the cataloging functions used to catalog the saved data that is in spectrum analyzer memory or on the memory card. It also accesses the DLP editor utility.</p> |



|                   |                                                                                                                                                                                                                                                                                                                                                                                                                                                                                                                                                                                                                                                                                                                                                                                                                                                                                                                                                                                                                                                                                                                                                    |
|-------------------|----------------------------------------------------------------------------------------------------------------------------------------------------------------------------------------------------------------------------------------------------------------------------------------------------------------------------------------------------------------------------------------------------------------------------------------------------------------------------------------------------------------------------------------------------------------------------------------------------------------------------------------------------------------------------------------------------------------------------------------------------------------------------------------------------------------------------------------------------------------------------------------------------------------------------------------------------------------------------------------------------------------------------------------------------------------------------------------------------------------------------------------------------|
| RECALL<br>AMP COR | <p>recalls an amplitude-correction factors table from the current mass-storage device (spectrum analyzer memory or memory card). To verify the current mass storage device, press RECALL AMP COR . If MAX REG # appears on the spectrum analyzer display, the current mass storage device is spectrum analyzer memory. If PREFIX= is displayed, the memory card is the mass storage device. Press <b>SAVE</b> or <b>RECALL</b>, then INTERNAL CARD to change the current mass storage device. To recall an amplitude-correction factors table, enter the register number that the table was previously saved under, then press <b>ENTER</b>. When recalling an amplitude-correction factors table from the memory card, it may be necessary to change the current prefix to the prefix with which the table was stored. Press Change Prefix to change the current prefix. When saved in spectrum analyzer memory, the register number is restricted to the range between 0 and the number x indicated by MAX REG# = x. The screen title is not recalled with the amplitude-correction factors table.</p> <p>Front-Panel Key Access: <b>CAL</b></p> |
| RECALL<br>LIMIT   | <p>recalls limit-line tables from the current mass-storage device (spectrum analyzer memory or memory card). To verify the current mass-storage device, press RECALL LIMIT . If MAX REG # appears on the spectrum analyzer display, the current mass-storage device is spectrum analyzer memory. If PREFIX= is displayed, the memory card is the mass-storage device. Press (SAVE) or <b>RECALL</b>, then INTERNAL CARD to change the current mass-storage device. To recall a limit line, enter the register number that the limit-line tables was saved under, then press <b>ENTER</b>. When recalling a limit line from the memory card, it may be necessary to change the current prefix to the prefix with which the limit line was stored. Press Change Prefix to change the current prefix. When saved in spectrum analyzer memory, the register number is restricted to the range between 0 and the number x indicated by MAX REG# = x. The screen title is not recalled with the limit-line tables.</p> <p>Front-Panel Key Access: <b>DISPLAY</b></p>                                                                                     |
| REF LVL           | <p>allows the reference level to be changed. This function is activated when <b>AMPLITUDE</b> is pressed. The reference level is the amplitude power or voltage represented by the top graticule line on the screen. Changing the value of the reference level changes the absolute amplitude level (in dBm) of the top graticule line. Pressing any digit, 0 through 9, on the numeric keypad brings up the selected terminator menu.</p> <p>Front-Panel Key Access: <b>AMPLITUDE</b></p>                                                                                                                                                                                                                                                                                                                                                                                                                                                                                                                                                                                                                                                         |
| REF LVL<br>OFFSET | <p>adds an offset value to the displayed reference level. Offsets are entered by using the number/units keypad. Entering an offset does not affect the trace or the attenuation value. Reference-level offsets are used when gain or loss occurs between a device under test and the spectrum-analyzer input. Thus, the signal level measured by the spectrum analyzer is the level at the input of an external amplitude-conversion device. When an amplitude offset is entered, its value is displayed on the left side of the screen (as opposed to frequency offsets which are displayed at the bottom of the screen). To eliminate an offset, press REF LVL OFFSET , 0 <b>-dBm</b> or <b>+dBm</b>. Pressing <b>PRESET</b> also sets the offset to zero. Reference-level offsets are entered using the numeric keypad. See also the EXTERNAL PREAMPG softkey description.</p> <p>Front-Panel Key Access: <b>AMPLITUDE</b></p>                                                                                                                                                                                                                  |

|                    |                                                                                                                                                                                                                                                                                                                                                                                                                                                                                                                                                                                                                                                                                                         |
|--------------------|---------------------------------------------------------------------------------------------------------------------------------------------------------------------------------------------------------------------------------------------------------------------------------------------------------------------------------------------------------------------------------------------------------------------------------------------------------------------------------------------------------------------------------------------------------------------------------------------------------------------------------------------------------------------------------------------------------|
| RES BW<br>AUTO MAN | changes the spectrum analyzer 3 dB resolution bandwidth. As the resolution bandwidth is decreased, the sweep time is increased to maintain amplitude calibration. Resolution bandwidth is also related to span. As span is decreased, the resolution bandwidth is decreased. A “#” mark appears next to RES BW on the screen to indicate that it is not coupled. To recouple the resolution bandwidth, press RES BW AUTO MAN so that AUTO is underlined. The resolution bandwidth can be changed using the step keys, the knob, or the numeric keypad.<br>Front-Panel Key Access: <b>AUTO COUPLE</b> or <b>BW</b>                                                                                       |
| RETURN             | <b>Option 103 only.</b><br>returns the spectrum analyzer to the settings that were present when MAN QP AT MKR was pressed, displays the quasi-peak amplitude value and the quasi-peak marker if ACCEPT QP DATA was pressed, and returns to the previous quasi-peak softkey menu. See the HP 85913, HP 85933, HP 85943, HP 85953, or HP 85963 Option 103 supplement documentation for more information.<br>Front-Panel Key Access: <b>AUX CTRL</b>                                                                                                                                                                                                                                                       |
| RPG<br>TITLE       | provides additional characters for the Change Title function. Pressing RPG TITLE provides lowercase letters, numbers, Greek letters, and punctuation symbols. When RPG TITLE is pressed, a character table appears on the screen. To select a character, turn the knob to position the cursor under the desired character and press the <b>ENTER</b> key. The step keys move the cursor between rows. When all characters have been entered, press WINDOWS <b>NEXT</b> , or for an HP 8590L or HP 8592L, press <b>HOLD</b> . All other spectrum analyzer functions are <b>unaccessible</b> until the <b>NEXT</b> or <b>HOLD</b> key is pressed.<br>Front-Panel Key Access: <b>CAL</b> or <b>DISPLAY</b> |
| SAV LOCK<br>ON OFF | locks all the current internal state and trace registers against further data storage, when ON is underlined. With the state and trace memory locked, the STATE → INTRNL and Trace → <b>Intrnl</b> softkey functions are no longer accessible; the MEM LOCKED softkey function is displayed instead. Pressing <b>DEFAULT CONFIG</b> or <b>PRESET</b> sets SAV LOCK ON OFF to OFF.                                                                                                                                                                                                                                                                                                                       |

---

**Note** When SAV LOCK ON OFF is set to ON, none of the state registers, (1-8), can be overwritten. The spectrum analyzer automatically updates state register nine with the last state.

ERASE MEM ALL ignores the state of the SAV LOCK . So, even if STATES and TRACES are locked, they will still be erased by ERASE MEM ALL .

---

Front-Panel Key Access: **SAVE**

(SAVE\_)

accesses softkey menus that allow you to store state data, trace data, limit-line tables, and amplitude-correction factors on a memory card or in spectrum analyzer memory. The SAVE function also allows you to save state data, trace data, limit-line tables, amplitude-correction factors, and program data on the memory card. In addition, pressing (SAVE) accesses the softkey menus used to catalog the saved data in spectrum analyzer memory or on the memory card.

To save to, or catalog from, spectrum analyzer memory press INTERNAL CARD so that INTERNAL is underlined. To save to, or catalog from, the memory card, press INTERNAL CARD so that CARD is underlined. The HP 8590L, HP 8592L, and HP 8594L must have Option 003 for memory card operation.

Saving state data saves the spectrum analyzer settings, but not the trace data. Saving trace data saves both the trace data and the state data. Display images and programs (also called downloadable programs or DLPS), can only be saved to or recalled from the memory card.

States and traces are saved in spectrum analyzer memory even if the instrument is turned off or (PRESET) is pressed. Eight spectrum analyzer-memory state registers and many trace registers are available for the user. The Catalog Internal softkey is used to access the catalog functions. It also accesses the DLP editor utility.

SAVE  
AMP COR

saves the current amplitude-correction factors table to the current mass-storage device (spectrum analyzer memory or memory card). To verify the current mass storage device, press SAVE AMP COR . If MAX REG # appears on the spectrum analyzer display, the current mass storage device is spectrum analyzer memory. If PREFIX= is displayed, the memory card is the mass storage device. Press (SAVE) or (RECALL), then INTERNAL CARD to change the current mass storage device. Press SAVE AMP COR , enter a register number, then press (ENTER) to save the current amplitude-correction factors table in spectrum analyzer memory or on the memory card. When saved on the memory card, amplitude-correction factors tables are stored with "a-", the prefix, and the register number entered. When saved in spectrum analyzer memory, the register number is saved in a trace register. Trace register values are restricted to a range between 0 and the number x indicated by MAX REG# = x.  
Front-Panel Key Access: (CAL)

SAVE  
EDIT

*For Option 041 or 043 only. Refer to the HP 8590 E-Series and L-Series Spectrum Analyzer and HP 8591 C Cable TV Analyzer Programmer's Guide for more information.*

passes the text from the DLP editor memory through the parser to execute as spectrum analyzer commands. Pressing SAVE EDIT is similar to outputting the text to the spectrum analyzer from an external controller. If the text (commands) is a valid user-defined function, it passes through the parser and into the spectrum analyzer user memory. It will replace an existing user defined function of the same name.

The DLP editor memory buffer remains intact when the spectrum analyzer is preset or powered off so the text being edited will not be lost.

Front-Panel Key Access: (RECALL) or (SAVE)

|                    |                                                                                                                                                                                                                                                                                                                                                                                                                                                                                                                                                                                                                                                                                                                                                                                                                                                                                                                                                                                                                        |
|--------------------|------------------------------------------------------------------------------------------------------------------------------------------------------------------------------------------------------------------------------------------------------------------------------------------------------------------------------------------------------------------------------------------------------------------------------------------------------------------------------------------------------------------------------------------------------------------------------------------------------------------------------------------------------------------------------------------------------------------------------------------------------------------------------------------------------------------------------------------------------------------------------------------------------------------------------------------------------------------------------------------------------------------------|
| SAVE<br>LIMIT      | <p>saves the current limit-line tables in the current mass-storage device (spectrum analyzer memory or memory card). To verify the current mass-storage device, press SAVE LIMIT. If MAX REG # appears on the spectrum analyzer display, the current mass-storage device is spectrum analyzer memory. If PREFIX= is displayed, the memory card is the mass-storage device. Press <b>(SAVE)</b> or <b>(RECALL)</b>, then INTERNAL CARD to change the current mass-storage device. Press</p> <p>SAVE LIMIT, enter a register number, then press <b>(ENTER)</b> to save the current limit-line table in spectrum analyzer memory or on the memory card. When saved on the memory card, limit-line tables are stored with "1-", the prefix, and the register number entered. When saved in spectrum analyzer memory, the register number is saved in a trace register. Trace-register values are restricted to a range between 0 and the number x indicated by MAX REG # = x. Front-Panel Key Access: <b>(DISPLAY)</b></p> |
| SCALE<br>LOG LIB   | <p>scales the vertical graticule divisions in logarithmic units when LOG is underlined. When the SCALE LOG LIN function is the active function, the logarithmic units per division can be changed. Values may range from 0.1 to 20 dB per division. When LIN is underlined, the vertical scale is in linear mode which has a range of 1 kW to 1 pW. The reference-level value is set to the top of the screen and the bottom graticule becomes zero volts. (Each division of the graticule is one-eighth of the reference level in volts.)</p> <p>Pressing SCALE LOG LIN always sets the units specified for the current amplitude scale. Pressing <b>(PRESET)</b> or powering on the spectrum analyzer sets the default units. Front-Panel Key Access: <b>(AMPLITUDE)</b></p>                                                                                                                                                                                                                                         |
| SECAM-L            | <p><b><i>Requires Option 301, or both Options 101 and 102.</i></b></p> <p>triggers on the SECAM-L video formats. Pressing SECAM-L alters the TV line number that the spectrum analyzer triggers on internally; the line number displayed when TV LINE # does not change. Pressing SECAM-L changes the video modulation to positive; set TV SYNC NEG POS to NEG if negative video modulation is required. Front-Panel Key Access: <b>(TRIG)</b></p>                                                                                                                                                                                                                                                                                                                                                                                                                                                                                                                                                                     |
| SELECT<br>1 2 3 4  | <p>selects one of the four possible markers. A marker can be turned on once it is selected. A marker that has already been turned on will become active when it is selected. If a marker has already been turned on and assigned to a specific trace it will become active on that trace and the MK TRACE AUTO ABC softkey will have the appropriate trace letter underlined. Front-Panel Key Access: <b>(MKR)</b></p>                                                                                                                                                                                                                                                                                                                                                                                                                                                                                                                                                                                                 |
| SELECT<br>AMPLITUD | <p>allows you to enter either the amplitude value for the displayed (upper or lower) limit-line segment or the amplitude value for the current amplitude-correction point. Enter the amplitude value for the selected frequency or time by using the data keys. Change an amplitude value by using the step keys or the knob. Press <b>(BK SP)</b> to correct errors. Front-Panel Key Access: <b>(CAL)</b> or <b>(DISPLAY)</b></p>                                                                                                                                                                                                                                                                                                                                                                                                                                                                                                                                                                                     |
| SELECT<br>DLT AMPL | <p>allows you to enter the delta amplitude value. The middle amplitude value and the delta amplitude value create an upper and lower limit-line segment. Enter the delta amplitude value for the selected frequency or time by using the knob or data keys. Press <b>(BK SP)</b> to correct errors. The default value is 0. Front-Panel Key Access: <b>(DISPLAY)</b></p>                                                                                                                                                                                                                                                                                                                                                                                                                                                                                                                                                                                                                                               |

**SELECT  
FREQ** allows you to enter the frequency value for a limit-line segment or for an amplitude-correction point. Enter the frequency value for the frequency by using the data keys. Change the frequency value by using the step keys or the knob. Press **(BK SP)** to correct errors.

A frequency coordinate must always be specified for either limit lines or amplitude-correction factors.

---

**Note** Limit-line data is sorted in frequency order in the limit-line table. The sorting occurs after you have entered the frequency and at least one amplitude value.

For amplitude-correction factors, only two entries with the same frequency are valid. Only the first and last points of a series with the same frequency values are used; the middle points are ignored.

Amplitude-correction data is sorted in the table by frequency. The sorting occurs immediately after you have entered the frequency value via the front-panel.

---

**SELECT  
LWR AMPL** allows you to enter the amplitude value for the lower limit-line segment. Enter the amplitude value for the selected frequency or time by using the knob or data keys. Press **(BK SP)** to correct errors.  
Front-Panel Key Access: **(DISPLAY)**

**SELECT  
MID AMPL** allows you to enter the middle amplitude value. The middle amplitude value and the delta amplitude value create upper and lower limit-line segments. Enter the amplitude value for the selected frequency or time by using the knob or data keys. Press **(BK SP)** to correct errors.  
Front-Panel Key Access: **(DISPLAY)**

**SELECT  
POINT** allows you to create or edit an amplitude-correction factor data point. Enter the point number to be created or edited by using the data keys, then press **(ENTER)**. Press **(BK SP)** to correct errors.  
Front-Panel Key Access: (CAL)

**SELECT  
PREFIX** allows you to select an already existing prefix of a cataloged file and changes the current prefix to this selected prefix. This provides a convenient method for saving and recalling data to and from the memory card and for cataloging by the prefix. Use either the knob or step keys to select the file.  
Front-Panel Key Access: **(RECALL)** or **(SAVE)**

**SELECT  
SEGMENT** allows you to create or edit a limit-line segment. Limit lines are created by entering frequency (or time) and amplitude values into a limit-line table. The frequency (or time) and amplitude values specify a coordinate point from which a limit-line segment is drawn. The coordinate point is the lowest frequency or time point of the line segment. Limit lines are constructed from left to right. To select a segment, press **SELECT SEGMENT**, enter the segment number you wish to specify, then press a units key.

Up to 20 segments can be specified per limit-line table.

Front-Panel Key Access: **(DISPLAY)**

**SELECT TIME** allows you to enter the time value for a limit-line segment. The time value is with respect to the spectrum analyzer sweep time. A time value of zero is the start of the sweep, which is the left edge of the graticule. Enter the time value by using the data keys. Change the time value by using the step keys or the knob. Press **ⓀⓈ** to correct errors.

---

**Note** Limit-line data is sorted in time order in the limit-line table. The sorting occurs after you have entered the time and at least one amplitude value.

---

Front-Panel Key Access: **ⓀⓈ**

**SELECT TYPE** accesses the softkey menu used to select the limit-line type of line. Press **FLAT** to select a flat line, press **SLOPE** to select a sloped line, or press **POINT** to select a point.

Front-Panel Key Access: **ⓀⓈ**

**SELECT UPR AMPL** allows you to enter the amplitude value for the upper limit-line segment. Enter the amplitude value for the selected frequency or time by using the knob or data keys. Press **ⓀⓈ** to correct errors.

Front-Panel Key Access: **ⓀⓈ**

**Service Cal** accesses several service calibration functions. The service calibration functions are designed for service use only. More detailed descriptions of the service functions are available in the service documentation. Service documentation can be obtained by ordering Option 915 through your HP Sales and Service office. For a listing of all available service calibration functions, refer to “Service Functions” at the beginning of this chapter.

Front-Panel Key Access: **Ⓚ**

**Service Diag** accesses several service diagnostic functions. The service diagnostic functions are designed for service use only. More detailed descriptions of the service diagnostic functions are available in the service documentation. Service documentation can be obtained by ordering Option 915 through your HP Sales and Service office. For a listing of all available service diagnostic functions, refer to “Service Functions” at the beginning of this chapter.

Front-Panel Key Access: **Ⓚ**

**SET ATTN ERROR** sets the calibration attenuator-error factors (this is not the same as the input attenuator). This is a service calibration function and is for service use only.

Front-Panel Key Access: **Ⓚ**

**Set B&W Printer** accesses the softkeys for setting up black and white HP and Epson compatible printers.

Front-Panel Key Access: **ⓀⓌ**

**Set Colr Printer** accesses the softkey for setting up the HP PaintJet and DeskJet printers.

Front-Panel Key Access: **ⓀⓌ**

|                 |                                                                                                                                                                                                                                                                                                                                                                                                                                                                                                                                                                                                                                                                                                                                                                                                                                                |
|-----------------|------------------------------------------------------------------------------------------------------------------------------------------------------------------------------------------------------------------------------------------------------------------------------------------------------------------------------------------------------------------------------------------------------------------------------------------------------------------------------------------------------------------------------------------------------------------------------------------------------------------------------------------------------------------------------------------------------------------------------------------------------------------------------------------------------------------------------------------------|
| SET<br>DATE     | allows you to set the date of the real-time clock. Enter the date in the YYMMDD format using the number keypad and press <b>ENTER</b> . Valid year (YY) values are 00 through 99. Valid month (MM) values are from 01 to 12, and valid day values are from 01 to 31.<br>Front-Panel Key Access: <b>CONFIG</b>                                                                                                                                                                                                                                                                                                                                                                                                                                                                                                                                  |
| SET<br>TIME     | allows you to set the time of the real-time clock. Enter the time in 24 hour, HHMMSS format, using the number keypad and pressing <b>ENTER</b> . Valid hour (HH) values are from 00 to 23. Valid minute (MM) and second (SS) values are from 00 to 59.<br>Front-Panel Key Access: <b>CONFIG</b>                                                                                                                                                                                                                                                                                                                                                                                                                                                                                                                                                |
| Setup           | accesses the menu used to set up parameters specific to the power measurements.<br><br>If another front-panel key is pressed, exiting the power menus, press the <b>MEAS/USER</b> key twice to return to the last power menu that was being used.<br>Front-Panel Key Access: <b>MEAS/USER</b>                                                                                                                                                                                                                                                                                                                                                                                                                                                                                                                                                  |
| <b>SGL SWP</b>  | changes the sweep control to single sweep if the spectrum analyzer is in the continuous sweep mode. It executes a sweep after the trigger condition is met.                                                                                                                                                                                                                                                                                                                                                                                                                                                                                                                                                                                                                                                                                    |
| SHOW<br>OPTIONS | displays the number and description of the options installed in your spectrum analyzer, the instrument model number of the spectrum analyzer, the last five digits of the spectrum analyzer serial number, and the firmware revision. Pressing SHOW OPTIONS changes the softkey label to EXIT SHOW . Press EXIT SHOW to erase the SHOW OPTIONS function information.<br><br>Pressing SHOW OPTIONS displays the individual option numbers. It will not show combination options such as Option 301, instead both options 101 and 102 will be displayed.<br>Front-Panel Key Access: <b>CONFIG</b>                                                                                                                                                                                                                                                |
| SIGNAL<br>ID    | activates an FFT marker that must be put on a signal to verify that it is not being displayed at the wrong frequency due to aliasing. Once the marker is on the signal press SIGNAL ID again to initiate the signal identification function. The signal should move half of a division to the right for 2 seconds. A marker will be put at the frequency that the signal should move to. If the marker appears on the signal when it is shifted, then the frequency readout of the signal is correct. Sweep time limitations may alter or stop the function from executing.<br><br>If the marker or the signal is less than half of a division from the right side of the display before SIGNAL ID is pressed, then the routine may not function correctly and a warning message can be displayed.<br>Front-Panel Key Access: <b>MEAS/USER</b> |

|                       |                                                                                                                                                                                                                                                                                                                                                                                                                                                                                                                                                                                                                                                                                                                                                                                                                                                                                                                                                                                                                                                                                       |
|-----------------------|---------------------------------------------------------------------------------------------------------------------------------------------------------------------------------------------------------------------------------------------------------------------------------------------------------------------------------------------------------------------------------------------------------------------------------------------------------------------------------------------------------------------------------------------------------------------------------------------------------------------------------------------------------------------------------------------------------------------------------------------------------------------------------------------------------------------------------------------------------------------------------------------------------------------------------------------------------------------------------------------------------------------------------------------------------------------------------------|
| SINGLE<br>FFT         | <p>initializes the fast Fourier transform (FFT) function. If the spectrum analyzer is in single sweep mode, an FFT is performed on trace A without taking a new sweep. If the spectrum analyzer is in continuous sweep, it is put in single sweep, a sweep is taken, and the FFT is performed. If the spectrum analyzer is already in the FFT mode it is put in single sweep, a sweep is taken, and an FFT is performed. Pressing SINGLE FFT again or pressing <b>(SGL SWP)</b> will take another sweep and perform an FFT.</p> <p>After using the FFT function, the display is in log mode. The markers are put in the FFT mode for use in evaluating the data. The signal being transformed is in trace A and the Fourier transform of the signal is in trace B. (Any information <b>that</b> was in trace B and C will be lost.) Press FFT OFF to return the spectrum analyzer to normal operation.</p> <p>Refer to Chapter 4, “Measuring Amplitude Modulation With the Fast Fourier Transform Function,” for more information.<br/>Front-Panel Key Access: <b>(MEAS/USER)</b></p> |
| SINGLE<br>MEAS        | <p>sets the functions in the Power Menu so that they make the measurement on a single sweep. After a power measurement is activated, pressing SINGLE MEAS or <b>(SGL SWP)</b> initiates a sweep and recalculates the measurement results.<br/>Front-Panel Key Access: <b>(MEAS/USER)</b></p>                                                                                                                                                                                                                                                                                                                                                                                                                                                                                                                                                                                                                                                                                                                                                                                          |
| SLOPE                 | <p>draws a straight line between the coordinate point of the current segment and the coordinate point of the next segment, producing limit-line values for all frequencies between the two points.<br/>Front-Panel Key Access: <b>(DISPLAY)</b></p>                                                                                                                                                                                                                                                                                                                                                                                                                                                                                                                                                                                                                                                                                                                                                                                                                                   |
| <b>(SPAN)</b> or SPAN | <p>activates the SPAN function and accesses the frequency-span functions. Pressing SPAN allows the user to change the frequency range symmetrically about the center frequency. The frequency-span readout describes the total displayed frequency range; to determine frequency span per horizontal graticule division, divide the frequency span by 10.<br/>Front-Panel Key Access: <b>(SPAN)</b></p>                                                                                                                                                                                                                                                                                                                                                                                                                                                                                                                                                                                                                                                                               |
| SPAN<br>ZOOM          | <p>finds the highest signal peak on-screen. If a marker is not already on the peak, it places a marker on it, turns on the marker-track function, and activates the span function. Pressing SPAN ZOOM performs the routine similar to pressing the following keys: <b>(PEAK SEARCH)</b>, <b>(MKR FCTN)</b>, MK TRACK ON OFF (ON), and <b>(SPAN)</b>.<br/>Front-Panel Key Access: <b>(SPAN)</b></p>                                                                                                                                                                                                                                                                                                                                                                                                                                                                                                                                                                                                                                                                                    |
| SPEAKER<br>ON OFF     | <p><b>Option 102, 103, or 301 only.</b><br/>turns the internal speaker on and off. The volume from the speaker is controlled by the front-panel volume control knob and FM GAIN (when using FM demodulation). There is no output from the speaker unless demodulation is turned on. Pressing <b>(PRESET)</b> sets SPEAKER ON OFF to ON.<br/>Front-Panel Key Access: <b>(AUX CTRL)</b></p>                                                                                                                                                                                                                                                                                                                                                                                                                                                                                                                                                                                                                                                                                             |
| SPECTRUM<br>ANALYZER  | <p>sets the spectrum analyzer to the spectrum analyzer operating mode and accesses the PRESET SPECTRUM softkey function.<br/>Front-Panel Key Access: <b>(MODE)</b> or <b>(PRESET)</b></p>                                                                                                                                                                                                                                                                                                                                                                                                                                                                                                                                                                                                                                                                                                                                                                                                                                                                                             |



|                     |                                                                                                                                                                                                                                                                                                                                                                                                                                                                                                                                                                                                                                                                                                                                                                                                                                                               |
|---------------------|---------------------------------------------------------------------------------------------------------------------------------------------------------------------------------------------------------------------------------------------------------------------------------------------------------------------------------------------------------------------------------------------------------------------------------------------------------------------------------------------------------------------------------------------------------------------------------------------------------------------------------------------------------------------------------------------------------------------------------------------------------------------------------------------------------------------------------------------------------------|
| SQUELCH             | <p><b>Option 102, 103, or 301 only.</b></p> <p>adjusts the squelch level. The squelch level mutes weak signals and passes strong signals. The squelch level affects the audio output only. If the internal speaker is on, audio signals are not output unless the signal strength exceeds the squelch threshold. The squelch level does not affect the rear-panel AUX VIDEO OUT signal. Squelch level is indicated on-screen by the unitless numbers 0 to 100, with 0 being minimum squelch threshold (all signals are passed), and 100 being maximum squelch threshold (no signals are passed). The default squelch value is 0.</p> <p>Front-Panel Key Access: <span style="border: 1px solid black; border-radius: 3px; padding: 2px;">AUX CTRL</span></p>                                                                                                  |
| SRC ATN<br>MAN AUTO | <p><b>Option 010 or 011 only. (Not available with HP 8590L.)</b></p> <p>allows you to select between automatic and manual adjustment of the tracking generator's switching attenuator. The HP 85913 can be manually adjusted from 0 to 60 dB in 10 dB steps. The HP 85933, HP 85943, HP 85953, and HP 85963 can be manually adjusted from 0 to 56 dB in 8 dB steps. When auto-coupled, the SRC ATN function automatically adjusts the attenuator to yield the source amplitude level specified by the SRC PWR ON OFF softkey function. Set SRC ATM MAN AUTO so that MAN is underlined (decoupled) for power sweeps greater than 10 dB for the HP 85913 (or greater than 8 dB for the HP 85933, HP 85943, HP 85953, and HP 85963).</p> <p>Front-Panel Key Access: <span style="border: 1px solid black; border-radius: 3px; padding: 2px;">AUX CTRL</span></p> |
| SRC PWR<br>OFFSET   | <p><b>Option 010 or 011 only.</b></p> <p>offsets the displayed power of the tracking generator (SRC). Offset values may range from -100 dB to + 100 dB.</p> <p>Using the source-power-offset capability of the tracking generator allows you to take system losses or gains into account, thereby displaying the actual power delivered to the device under test.</p> <p>Front-Panel Key Access: <span style="border: 1px solid black; border-radius: 3px; padding: 2px;">AUX CTRL</span></p>                                                                                                                                                                                                                                                                                                                                                                 |
| SRC PWR<br>ON OFF   | <p><b>Option 010 or 011 only.</b></p> <p>activates (ON) or deactivates (OFF) the output power of the tracking generator (SRC). The power level can then be adjusted using the data keys, step keys, or knob. Pressing any digit, 0 through 9, on the numeric keypad brings up the selected terminator menu. The available output power level varies for different spectrum analyzer models. See specifications and characteristics in your calibration guide for specific information for your spectrum analyzer.</p> <p>Front-Panel Key Access: <span style="border: 1px solid black; border-radius: 3px; padding: 2px;">AUX CTRL</span></p>                                                                                                                                                                                                                 |
| SRC PWR<br>STP SIZE | <p><b>Option 010 or 011 only.</b></p> <p>allows the user to set the step size of the source-power level, source-power offset, and power-sweep range functions. The step size may be values from -32.7 dB to 32.7 dB. The default setting is one vertical scale division.</p> <p>Front-Panel Key Access: <span style="border: 1px solid black; border-radius: 3px; padding: 2px;">AUX CTRL</span></p>                                                                                                                                                                                                                                                                                                                                                                                                                                                          |
| START<br>FREQ       | <p>sets the frequency at the left side of the graticule. The left and right sides of the graticule correspond to the start and stop frequencies. When these frequencies are activated, their values are displayed below the graticule in place of center frequency and span.</p> <p>Front-Panel Key Access: <span style="border: 1px solid black; border-radius: 3px; padding: 2px;">FREQUENCY</span></p>                                                                                                                                                                                                                                                                                                                                                                                                                                                     |

|                      |                                                                                                                                                                                                                                                                                                                                                                                                                                                                                                                                                                                                                                                                                                                 |
|----------------------|-----------------------------------------------------------------------------------------------------------------------------------------------------------------------------------------------------------------------------------------------------------------------------------------------------------------------------------------------------------------------------------------------------------------------------------------------------------------------------------------------------------------------------------------------------------------------------------------------------------------------------------------------------------------------------------------------------------------|
| STATE<br>→CARD       | <p><i>Requires Option 003 for the HP 8590L, HP 8592L, and HP 8594L.</i></p> <p>saves the current spectrum analyzer state on the memory card. To save the current state, press STATE → CARD, use the numeric keypad to enter a number, and press ENTER. If you want the file name of the stored data to contain a prefix, press Change Prefix to enter a prefix before storing the data. If the state data was stored using a prefix, the file name for the state data consists of s(prefix)_(register number). If no prefix was specified, the file name is s_(register number). If windows are being used, only the state of the active window will be saved.</p> <p>Front-Panel Key Access: <b>(SAVE)</b></p> |
| STATE<br>→ INTRNL    | <p>saves the current spectrum analyzer state in the selected state register. To save the current state, press STATE → INTRNL , and use the numeric keypad to enter a state register number (valid state register numbers are 1 through 8). If windows are being used, only the state of the active window will be saved.</p> <p>Front-Panel Key Access: <b>(SAVE)</b></p>                                                                                                                                                                                                                                                                                                                                       |
| STOP<br>FREQ         | <p>sets the frequency at the right side of the graticule. The left and right sides of the graticule correspond to the start and stop frequencies. When these frequencies are activated, their values are displayed below the graticule in place of center frequency and span.</p> <p>Front-Panel Key Access: <b>(FREQUENCY)</b></p>                                                                                                                                                                                                                                                                                                                                                                             |
| STOR PWR<br>ON UNITS | <p>sets the default settings for the units used in the linear and the logarithmic modes when the instrument is powered on. The settings for the units can be changed during normal instrument operation but they will return to the default settings when the instrument is powered on again. This is a service calibration function. Refer to the service guide for more information.</p> <p>Front-Panel Key Access: (CAL)</p>                                                                                                                                                                                                                                                                                 |
| STP GAIN<br>ZERO     | <p>disables the two 20 dB step-gain amplifiers on the AI2 Amplitude Control assembly. This is a service diagnostic function and is for service use only.</p> <p>Front-Panel Key Access: <b>(CAL)</b></p>                                                                                                                                                                                                                                                                                                                                                                                                                                                                                                        |
| STUVWX               | <p>accesses the softkey menu used for selecting screen title or prefix characters S through X.</p> <p>Front-Panel Key Access: <b>(CAL)</b>, <b>(CONFIG)</b>, <b>(DISPLAY)</b>, <b>(RECALL)</b>, or <b>(SAVE)</b></p>                                                                                                                                                                                                                                                                                                                                                                                                                                                                                            |
| <b>(SWEEP)</b>       | <p>accesses the sweep-time menu and accesses the sweep-time softkey functions SWP TIME AUTO MAN and SWEEP CONT SGL.</p> <p><i>Option 105 only</i></p> <p>The <b>(SWEEP)</b> key also accesses the GATE ON OFF softkey which turns on the gate function and the Gate Control softkey which accesses the gate menus.</p>                                                                                                                                                                                                                                                                                                                                                                                          |
| SWEEP<br>CONT SGL    | <p>switches the spectrum analyzer between the continuous-sweep mode and the single-sweep mode. If the spectrum analyzer is in single-sweep mode, SGL is underlined. Press <b>(SGL SWP)</b> to enable a sweep when in single-sweep mode. When continuous-sweep mode is in use, one sweep follows another as soon as it is triggered. Pressing <b>(PRESET)</b>, turning the power on, and pressing PRESET SPECTRUM , all select continuous sweep.</p> <p>Front-Panel Key Access: <b>(SWEEP)</b> or (TRIG)</p>                                                                                                                                                                                                     |

|                      |                                                                                                                                                                                                                                                                                                                                                                                                                                                                                                                                                                                                                                                                                                                                                                                                                                                                         |
|----------------------|-------------------------------------------------------------------------------------------------------------------------------------------------------------------------------------------------------------------------------------------------------------------------------------------------------------------------------------------------------------------------------------------------------------------------------------------------------------------------------------------------------------------------------------------------------------------------------------------------------------------------------------------------------------------------------------------------------------------------------------------------------------------------------------------------------------------------------------------------------------------------|
| SWEEP<br>DELAY       | <p><b>Option 105 only. Option 101 is recommended.</b></p> <p>delays the start of sweep with respect to the gate trigger edge in the time domain window of the gate utility. The time segment being displayed can be shifted up to 65 msec after the gate trigger edge in 1 <math>\mu</math>sec increments.</p> <p>Front-Panel Key Access: <b>SWEEP</b></p>                                                                                                                                                                                                                                                                                                                                                                                                                                                                                                              |
| SWEEP<br>RAMP        | <p>displays the RAMP signal from the sweep-ramp generator that is located on the A7 Analog Interface assembly. This is a service diagnostic function and is for service use only.</p> <p>Front-Panel Key Access: (CAL)</p>                                                                                                                                                                                                                                                                                                                                                                                                                                                                                                                                                                                                                                              |
| SWEEP<br>TIME DAC    | <p>displays the output of the sweep-time DAC (SWP_DAC) from the sweep-ramp generator that is on the A7 Analog Interface assembly. This is a service diagnostic function and is for service use only.</p> <p>Front-Panel Key Access: (CAL)</p>                                                                                                                                                                                                                                                                                                                                                                                                                                                                                                                                                                                                                           |
| SWP CPLG<br>SR SA    | <p><b>Option 010 or 011 only.</b></p> <p>selects stimulus-response (SR) or spectrum-analyzer (SA) auto-coupled sweep time. In stimulus-response mode, auto-coupled sweep times are usually much faster for swept-response measurements. Stimulus-response auto-coupled sweep times are typically valid in stimulus-response measurements when the system's frequency span is less than 20 times the bandwidth of the device under test.</p> <p>Front-Panel Key Access: <b>AUX CTRL</b></p>                                                                                                                                                                                                                                                                                                                                                                              |
| SWP TIME<br>AUTO MAN | <p>selects the length of time in which the spectrum analyzer sweeps the displayed frequency span. In all non-zero frequency spans, the sweep time varies from 20 milliseconds to 100 seconds. In zero frequency span, the fastest sweep time is 15 milliseconds. Reducing the sweep time increases the rate of sweeps. The sweep time can be changed using the step keys, the knob, or the numeric keypad.</p> <p><b>For Option 101 only:</b> Option 101 provides sweep times from 20 <math>\mu</math>s to 20 ms in zero span.</p> <p>Front-Panel Key Access: <b>AUTO COUPLE</b> or <b>SWEEP</b></p>                                                                                                                                                                                                                                                                    |
| SYNC CRD<br>TV TRIG  | <p><b>Options 101 and 102, or Option 301 only.</b></p> <p>provides sweep triggering on the selected line of a video picture field and accesses the softkey menu used to select the line number of the video picture field and the type of video picture frame.</p> <p>When SYNC CRD TV TRIG is pressed, the trigger mode is changed to TV trigger, TV LINE # becomes the active function, and the softkey menu for changing the TV line numbers and video field trigger is accessed.</p> <p>If the spectrum analyzer is in non-zero span, the resolution bandwidth is changed to 1 MHz, the frequency span is set to 0 Hz, the detector mode is changed to sample, the sweep time is changed to 100 <math>\mu</math>s, the amplitude scale is changed to linear, a sweep is taken, and a marker is placed on the signal peak.</p> <p>Front-Panel Key Access: (TRIG)</p> |

**SYNC**  
NRM NTSC

changes the rear panel MONITOR output between normal internal monitor horizontal and vertical synchronization constants or the NTSC video compatible format. In the NTSC mode the monitor output is compatible with NTSC video cassette recorders. In the normal mode the synchronization constants can be changed from the factory default settings by using CRT HORZ POSITION and CRT VERT POSITION softkeys. If the user has not changed the constants the default settings will be used.

The display will be compressed slightly when using the NTSC format, instead of the normal format. The NTSC format has less vertical resolution than the spectrum analyzer display. The top and bottom of the spectrum analyzer display are compressed slightly so that all of the information can be fit into the vertical resolution available with the NTSC format.

Front-Panel Key Access: **CONFIG**

**SYNC**  
NRM PAL

changes the rear panel MONITOR output between normal internal monitor horizontal and vertical synchronization constants or the PAL video compatible format. In the PAL mode the monitor output is compatible with PAL video cassette recorders. In the normal mode the synchronization constants can be changed from the factory default settings by using CRT HORZ POSITION and CRT VERT POSITION softkeys. If the user has not changed the constants the default settings will be used.

The display will be compressed slightly when using the PAL format, instead of the normal format. The PAL format has less vertical resolution than the spectrum analyzer display. The top of the spectrum analyzer display is compressed slightly so that all of the information can be fit into the vertical resolution available with the PAL format.

Front-Panel Key Access: **CONFIG**

T WINDOW  
RES BW

***Option 105 only. Option 101 is recommended.***

changes the resolution bandwidth in the time domain window of the gate utility.

Front-Panel Key Access: **SWEEP**

T WINDOW  
SWP TIME

***Option 105 only. Option 101 is recommended.***

changes the sweep time in the time domain window of the gate utility and re-scales the gate markers.

Front-Panel Key Access: **SWEEP**

TABLE  
ADL NRM

switches the marker table between the normal marker formats and the delta display line format. The marker information can be displayed in absolute amplitude and frequency. It can also be displayed in delta amplitude and frequency using one marker as the reference. These are normal marker modes.

Press the TABLE ADL NRM softkey to underline the ADL. This accesses the delta display line format, which is only available when using the marker table function. This format displays the marker amplitudes relative to the display line.

Front-Panel Key Access: **(MKR FCTN)**

THRESHLD  
ON OFF

sets a lower boundary to the active trace. The threshold line “clips” signals that appear below the line when this function is **on**. The boundary is defined in amplitude units that correspond to its vertical position when compared to the reference level.

The value of the threshold appears in the active-function block and on the lower-left side of the screen. The threshold level does not influence the trace memory or marker position. The peaks found by the markers must be at least the peak-excursion value above the threshold level. The value of the threshold level can be changed using the step keys, the knob, or the numeric keypad. Pressing any digit, 0 through 9, on the numeric keypad brings up the selected terminator menu. If a threshold is active, press THRESHLD ON OFF until OFF is selected to turn the threshold display off. The threshold value affects peak searching even when the THRESHLD function is set to off.

Front-Panel Key Access: **(DISPLAY)**

Time  
Date

accesses the softkey menu used to set and display the real-time clock.

Front-Panel Key Access: **(CONFIG)**

|                                   |                                                                                                                                                                                                                                                                                                                                                                                                                                                                                                                                                                                                                                                                                                            |
|-----------------------------------|------------------------------------------------------------------------------------------------------------------------------------------------------------------------------------------------------------------------------------------------------------------------------------------------------------------------------------------------------------------------------------------------------------------------------------------------------------------------------------------------------------------------------------------------------------------------------------------------------------------------------------------------------------------------------------------------------------|
| <p><b>TIMEDATE</b><br/>ON OFF</p> | <p>turns the display of the real-time clock on or off. Pressing <b>DEFAULT CONFIG</b> sets <b>TIMEDATE ON OFF</b> to ON.<br/>Front-Panel Key Access: <b>CONFIG</b></p>                                                                                                                                                                                                                                                                                                                                                                                                                                                                                                                                     |
| <p><b>TO1</b><br/>ON OFF</p>      | <p>finds the third-order intercept of the two highest amplitude signals and the two associated distortion products. The effect of unequal test signal amplitude is compensated for. The measurement runs continuously, re-executing at the end of each sweep. The units for the displayed value can be selected by pressing <b>Amptd Units</b> softkey. The two test signals and the two associated distortion products must all be displayed for the measurement to function. The relative amplitudes and frequencies of the displayed signals must fit the TO1 pattern. All of the signals must be greater than the peak excursion above the threshold.<br/>Front-Panel Key Access: <b>MEAS/USER</b></p> |
| <p><b>TRACE</b></p>               | <p>accesses the trace softkeys that allow you to store and manipulate trace information. Each trace is comprised of a series of data points that form a register where amplitude information is stored. The spectrum analyzer updates the information for any active trace with each sweep. If two traces are being written to, they are updated on alternating sweeps. (Also see “Screen Annotation” in Chapter 2.)</p>                                                                                                                                                                                                                                                                                   |
| <p><b>TRACE</b><br/>A B C</p>     | <p>selects the softkey menu used for trace A, trace B, or trace C functions. Press <b>TRACE A B C</b> until the letter of the desired trace is underlined.<br/>Front-Panel Key Access: <b>TRACE</b></p>                                                                                                                                                                                                                                                                                                                                                                                                                                                                                                    |
| <p><b>TRACE A</b></p>             | <p>sets up trace A for recalling previously-saved trace data into trace A or saving trace data from trace A.<br/>Front-Panel Key Access: <b>RECALL</b> or <b>SAVE</b></p>                                                                                                                                                                                                                                                                                                                                                                                                                                                                                                                                  |
| <p><b>TRACE B</b></p>             | <p>sets up trace B for recalling previously-saved trace data into trace B or saving trace data from trace B.<br/>Front-Panel Key Access: <b>RECALL</b> or <b>SAVE</b></p>                                                                                                                                                                                                                                                                                                                                                                                                                                                                                                                                  |
| <p><b>TRACE C</b></p>             | <p>sets up trace C for recalling previously-saved trace data into trace C or saving trace data from trace C.<br/>Front-Panel Key Access: <b>RECALL</b> or <b>SAVE</b></p>                                                                                                                                                                                                                                                                                                                                                                                                                                                                                                                                  |

Trace  
→ Card

begins the process used to save trace data, limit-line tables, or amplitude-correction factors on the memory card. Pressing Trace → Card accesses a softkey menu that allows you to select the trace to be saved (trace A, trace B, or trace C) and accesses the LIMIT LINES and AMP COR softkeys. To save a trace, press TRACE A , TRACE B , or TRACE C , **use** the numeric keypad to enter a trace register number, and press **ENTER**. To save limit-line tables or amplitude-correction factors, press LIMIT LINES or AMP COR , use the numeric keypad to enter a trace register number, and press **ENTER**. If windows are being used, only the trace of the active window will be saved.

If you want the file name of the stored data to contain a prefix, press Change Prefix to enter a prefix before storing the data. If the trace data was stored using a prefix, the file name is t(prefix)-(register number). If no prefix was available, the data is stored under t\_(register number). File names for limit-line tables and amplitude-correction factors are treated the same way as file names for trace data, except “1” or “a” is used instead of “t.” If a screen title is present, it is saved with the trace data. The time and date that the data was stored is appended to the screen title.

When comparing a trace displayed in view mode with a recalled trace, it is possible to over-write the displayed trace by recalling the trace data. This can happen because the instrument state is saved (and recalled) with the trace data.

For example, if you save trace A when it is in clear-write mode, place trace A in view mode, then recall the trace data into trace B, trace B will be placed in view mode, but the trace mode of trace A is changed to clear-write mode (since the trace mode of trace A was clear-write when it was saved). To avoid this problem, we change the trace mode of the traces to view or blank mode before saving the trace data.

Front-Panel Key Access: **SAVE**

Trace  
→ Intrnl

accesses a softkey menu that allows you to select the item to be stored in spectrum analyzer memory: the trace to be saved (trace A, trace B, or trace C), limit-line tables, or amplitude-correction factors. To save a trace, select the trace to be saved, enter the trace-register number and press **ENTER**. To save limit-line tables or amplitude-correction factors, press LIMIT LINES (to save limit-line tables) or AMP COR (to save amplitude-correction factors), enter the trace-register number and press **ENTER**. Valid trace-register numbers are 0 through the maximum register number. The maximum register number is the number x displayed after MAX REG # = x during a save or recall operation. If a screen title is present, it is saved with the trace data. The time and date that the trace was stored is appended to the screen title. If windows are being used, only the trace of the active window will be saved.

When comparing a trace displayed in view mode with a recalled trace, it is possible to over-write the displayed trace by recalling the trace data. This can happen because the instrument state is saved (and recalled) with the trace data. For example, if you save trace A when it is in clear-write mode, place trace A in view mode, then recall the trace data into trace B, trace B will be placed in view mode, but the trace mode of trace A is changed to clear-write mode (since the trace mode of trace A was clear-write when it was saved). To avoid this problem, change the trace mode of the traces to view or blank mode before saving the trace data.

Front-Panel Key Access: **SAVE**

Track  
Gen

**Option 010 or 011 only.**

displays softkey menus for use with a built-in tracking generator.

Front-Panel Key Access: **AUX CTRL**

TRACKING  
PEAK

**Option 010 or 011 only.**

activates a routine that automatically adjusts the tracking adjustment to obtain the peak response of the tracking generator on the spectrum-analyzer display.

---

Note

For tracking peak to function properly, the tracking generator must be connected to the spectrum analyzer.

Before making a stimulus-response measurement, care must be taken to maximize the tracking adjustment of the tracking generator to ensure maximum available dynamic range.

---

Front-Panel Key Access: **AUX CTRL**



TRIG

accesses softkeys that let you select the sweep mode and trigger mode. (Also see “Screen Annotation” in Chapter 1.)

---

Note

With some delayed trigger functions (for example, external or TV triggering), the softkey menu is not updated until after the trigger has occurred.

---

TRIG MKR  
ON OFF

**Option 105 only. Option 101 is recommended.**

activates a marker which indicates the time from the gate trigger to the current marker position. The trigger marker is in the time domain window of the gate utility. It is turned off when the menu is exited or if another active function is activated.

Front-Panel Key Access: **SWEEP**

TV  
LINE #

**Options 101 and 102, or Option 301 only.**

selects the line number of the video picture field. The values allowed are 1 to 1012. **PRESET** sets the TV line number to 17.

Front-Panel Key Access: **TRIG**

TV  
Standard

**Options 101 and 102, or Option 301 only.**

allows the spectrum analyzer to trigger on the standard video formats; NTSC, PAL, PAL-M, or SECAM-L.

Front-Panel Key Access: **TRIG**

TV SYNC  
NEG POS

**Options 101 and 102, or Option 301 only.**

selects the polarity of the modulation of the video format. NTSC uses the negative or positive modulation video format. NTSC, PAL, and PAL-M use negative modulation. SECAM-L uses positive modulation.

Front-Panel Key Access: (TRIG)

TV TRIG  
EVEN FLD

**Options 101 and 102, or Option 301 only.**

selects an even video field of an interlaced video format to trigger on.

Front-Panel Key Access: (TRIG)

TV TRIG  
ODD FLD

**Options 101 and 102, or Option 301 only.**

selects an odd video field of an interlaced video format to trigger on.

Front-Panel Key Access: (TRIG)

TV TRIG  
VERT INT

**Options 101 and 102, or Option 301 only,**

selects a vertical interval to trigger on. Triggering occurs on the next pulse edge. If it triggers on an even field, triggering will not alternate between odd and even fields. If it triggers on an odd field, triggering will alternate between odd and even fields. The vertical interval is used for non-interlaced video formats.

Front-Panel Key Access: **TRIG**

UPDATE  
TIMEFREQ

**Option 105 only. Option 101 is recommended.**

switches between the time domain and frequency domain windows in the gate utility. The window is updated to reflect the current state when it is activated. The WINDOWS **NEXT** key will also switch between the windows.

Front-Panel Key Access: **SWEEP**

|                    |                                                                                                                                                                                                                                                                                                                                                                                                                                   |
|--------------------|-----------------------------------------------------------------------------------------------------------------------------------------------------------------------------------------------------------------------------------------------------------------------------------------------------------------------------------------------------------------------------------------------------------------------------------|
| User<br>Menus      | accesses a menu available for your use for user-defined programs and key functions.<br>Front-Panel Key Access: <b>MEAS/USER</b>                                                                                                                                                                                                                                                                                                   |
| V                  | changes the amplitude units to V for the current setting (log or linear).<br>Front-Panel Key Access: <b>AMPLITUDE</b>                                                                                                                                                                                                                                                                                                             |
| VBW/RBW<br>RATIO   | selects the ratio between the video and resolution bandwidths. If signal responses near the noise level are visually masked by the noise, the ratio can be set to less than 1 to smooth this noise. The knob and step keys change the ratio in a 1, 3, 10 sequence. Pressing <b>PRESET</b> and AUTO ALL sets the ratio to 0.300 X. The ratio can be changed using the step keys or the knob.<br>Front-Panel Key Access: <b>BW</b> |
| VERIFY<br>TIMEBASE | <b>All E-Series and L-Series spectrum analyzers except HP 8590L with Option 713.</b><br>allows the time base digital-to-analog converter to be changed to verify that the 10 Mhz reference time base performs to specification. Pressing <b>PRESET</b> resets the time base to its original value. A pass code is required to access this function.                                                                               |

---

**Note** The VERIFY TIMEBASE softkey function is not available for the HP 8592L or spectrum analyzers with Option 004.

---

|                    |                                                                                                                                                                                                                                                                                                                                                                                                                                                                                                                                                                                                                                        |
|--------------------|----------------------------------------------------------------------------------------------------------------------------------------------------------------------------------------------------------------------------------------------------------------------------------------------------------------------------------------------------------------------------------------------------------------------------------------------------------------------------------------------------------------------------------------------------------------------------------------------------------------------------------------|
|                    | Front-Panel Key Access: <b>CAL</b>                                                                                                                                                                                                                                                                                                                                                                                                                                                                                                                                                                                                     |
| VID AVG<br>ON OFF  | initiates a digital averaging routine that averages displayed signals and noise. This function does not affect the sweep time, bandwidth, or other analog characteristics of the spectrum analyzer. Annotation on the left side of the screen indicates the current number of sweeps averaged. The default number of sweeps is 100. Increasing the number of sweeps smoothes the trace. To turn off the video averaging function, press VID AVG ON OFF so that OFF is underlined. The number of sweeps can be entered using the numeric keypad.<br>Front-Panel Key Access: <b>BW</b> , <b>TRACE</b> , or <b>MEAS/USER</b>              |
| VID BW<br>AUTO MAN | changes the spectrum analyzer post-detection filter from 30 Hz to 3 MHz in a 1, 3, 10 sequence. <b>For Option 130 only.</b> Option 130 provides additional narrow resolution bandwidths of 30 Hz, 100 Hz, and 300 Hz.<br><br>As the video bandwidth is decreased, the sweep time is increased to maintain amplitude calibration. A “#” mark appears next to VBW on the bottom of the spectrum analyzer display to indicate that it is not coupled. To couple the video bandwidth, press VID BW AUTO MAN so that AUTO is underlined.<br><br>The video bandwidth can be changed by using the step keys, the knob, or the numeric keypad. |

---

**Note** Coupling the video bandwidth function also couples the video bandwidth to resolution bandwidth ratio function. If you want to auto-couple the video bandwidth to a nonstandard ratio, you must set the video bandwidth to auto-couple before setting the video-bandwidth/resolution-bandwidth ratio.

---

Front-Panel Key Access: **AUTO\_COUPLE** or **BW**

|                 |                                                                                                                                                                                                                                                                                                                                                                                                                                                                                        |
|-----------------|----------------------------------------------------------------------------------------------------------------------------------------------------------------------------------------------------------------------------------------------------------------------------------------------------------------------------------------------------------------------------------------------------------------------------------------------------------------------------------------|
| VIDEO           | <p>activates the trigger condition that allows the next sweep to start if the detected RF envelope voltage rises to a level set by the display line. When VIDEO is pressed, the display line appears on the screen. For example, connect the CAL OUT signal to the spectrum analyzer input, change the trigger mode to video, and lower the display line. The spectrum analyzer triggers when the display line reaches the noise floor.</p> <p>Front-Panel Key Access: <b>TRIG</b></p> |
| VIEW A          | <p>holds and displays the amplitude data that is in the trace A register. The trace A register is not updated as the spectrum analyzer sweeps. If trace A is deactivated by pressing STORE BLANK A , the stored data can be retrieved by pressing VIEW A .</p> <p>Front-Panel Key Access: <b>TRACE</b></p>                                                                                                                                                                             |
| VIEW B          | <p>holds and displays the amplitude data that is in the trace B register. The trace B register is not updated as the spectrum analyzer sweeps. If trace B is deactivated by pressing STORE BLANK B , the stored data can be retrieved by pressing VIEW B .</p> <p>Front-Panel Key Access: <b>TRACE</b></p>                                                                                                                                                                             |
| VIEW C          | <p>holds and displays the amplitude data that is in the trace C register. The trace C register is not updated as the spectrum analyzer sweeps. If trace C is deactivated by pressing STORE BLANK C , the stored data can be retrieved by pressing VIEW C .</p> <p>Front-Panel Key Access: <b>TRACE</b></p>                                                                                                                                                                             |
| Volts           | <p>changes the amplitude units to volts.</p> <p>Front-Panel Key Access: <b>AMPLITUDE</b></p>                                                                                                                                                                                                                                                                                                                                                                                           |
| W               | <p>changes the amplitude units to W for the current setting (log or linear).</p> <p>Front-Panel Key Access: <b>AMPLITUDE</b></p>                                                                                                                                                                                                                                                                                                                                                       |
| Watts           | <p>changes the amplitude units to watts.</p> <p>Front-Panel Key Access: <b>AMPLITUDE</b></p>                                                                                                                                                                                                                                                                                                                                                                                           |
| WINDOWS OFF     | <p><b>HP 8591 E, HP 8593E, HP 8594E, HP 8595E, or HP 8596E only.</b></p> <p>turns off the windows display mode and returns to the normal full-sized instrument display. The state of the last active window will become the instrument state when the windows display is turned off.</p> <p>Front-Panel Key Access: WINDOWS ION)</p>                                                                                                                                                   |
| X FINE TUNE DAC | <p>displays the output of the YTO extra-fine-tune DAC (FM-TUNE) that is on the A7 Analog Interface assembly. This is a service diagnostic function and is for service use only.</p> <p>Front-Panel Key Access: <b>CAL</b></p>                                                                                                                                                                                                                                                          |
| YTF DRIVER      | <p><b>HP 8592L, HP 8593E, HP 85953, or HP 8596E only.</b></p> <p>displays the output of the sample-and-hold circuit in the YTF span divider and driver located on the A7 Analog Interface assembly. This is a service diagnostic function and is for service use only.</p> <p>Front-Panel Key Access: <b>CAL</b></p>                                                                                                                                                                   |

|                    |                                                                                                                                                                                                                                                                                                                                                                                                                                                                                                                                                                                                                                                                                                                                                                                                                |
|--------------------|----------------------------------------------------------------------------------------------------------------------------------------------------------------------------------------------------------------------------------------------------------------------------------------------------------------------------------------------------------------------------------------------------------------------------------------------------------------------------------------------------------------------------------------------------------------------------------------------------------------------------------------------------------------------------------------------------------------------------------------------------------------------------------------------------------------|
| YTF SPAN           | <b>HP 8592L, HP 85933, HP 8595E, or HP 8596E only.</b><br>displays a trace of the voltage driving the YTF as it sweeps through the displayed span. This is a service diagnostic function and is for service use only. Refer to the service guide for more information.<br>Front-Panel Key Access: (CAL)                                                                                                                                                                                                                                                                                                                                                                                                                                                                                                        |
| YTF TUNE<br>COARSE | <b>HP 8592L, HP 85933, HP 8595E, or HP 8596E only.</b><br>displays the output produced by the YTF coarse-tune DAC located on the A7 Analog Interface assembly. This is a service diagnostic function and is for service use only.<br>Front-Panel Key Access: (CAL)                                                                                                                                                                                                                                                                                                                                                                                                                                                                                                                                             |
| YTF TUNE<br>FINE   | <b>HP 8592L, HP 85933, HP 8595E, or HP 8596E only.</b><br>displays the output produced by the YTF fine-tune DAC located on the A7 Analog Interface assembly. This is a service diagnostic function and is for service use only.<br>Front-Panel Key Access: (CAL)                                                                                                                                                                                                                                                                                                                                                                                                                                                                                                                                               |
| YZ_# spc<br>Clear  | accesses the softkey menu used for selecting the characters Y, Z, underscore (-), #, space, or for clearing the screen title.<br>Front-Panel Key Access: (CAL), (CONFIG), (DISPLAY), (RECALL), or (SAVE)                                                                                                                                                                                                                                                                                                                                                                                                                                                                                                                                                                                                       |
| ZERO<br>MARKER     | <b>Option 105 only. Option 101 is recommended.</b><br>zeros the value of the delta marker to establish a new reference. The ZERO MARKER softkey is in the pulse parameter entry menus of the gate utility.<br>Front-Panel Key Access: [SWEEP]                                                                                                                                                                                                                                                                                                                                                                                                                                                                                                                                                                  |
| ZERO<br>SPAN       | changes the frequency span to zero and turns off marker track if it is on.<br>Front-Panel Key Access: (SPAN)                                                                                                                                                                                                                                                                                                                                                                                                                                                                                                                                                                                                                                                                                                   |
| ZONE<br>CENTER     | <b>HP 8591 E, HP 8593E, HP 8594E, HP 8595E, or HP 8596E only.</b><br>allows the zone markers to be moved in frequency without changing the zone span. The zone markers are vertical lines marking the zone on the upper window. They correspond with the frequency range displayed in the lower window. As the zone markers are moved the center frequency of the lower window is changed but the lower window will not be updated unless it is active.<br><br>The zone can be moved beyond the frequency range that is being displayed in the upper window. Its movement is limited to the frequency range of the spectrum analyzer. The zone markers will be displayed at the edges of the upper window when the zone is moved beyond the displayed frequency range.<br>Front-Panel Key Access: WINDOWS (ON) |

ZONE  
PK LEFT

**HP 8591 E, HP 8593E, HP 8594E, HP 8595E, or HP 8596E only.**

searches for the next frequency peak outside and to the left of the zone markers on the upper window trace and then moves the zone so that it is centered around the new peak. The zone span is not changed. The center frequency of the lower window changes to reflect the new zone center frequency. The lower window will not be updated until it is made active. If no peak is found the zone will not be moved. A signal must have a 6 dB peak excursion to be identified as a peak signal. The definition of a peak excursion can be changed by selecting PEAK EXCURSN while the upper window is active.

Pressing ZONE PK LEFT will have no effect if the upper window is in zero span.

Front-Panel Key Access: WINDOWS **(ON)**

ZONE  
PK RIGHT

**HP 8591 E, HP 8593E, HP 8594E, HP 8595E, or HP 8596E only.**

searches for the next frequency peak outside and to the right of the zone markers on the upper window trace and then moves the zone so that it is centered around the new peak. The zone span is not changed. The center frequency of the lower window changes to reflect the new zone center frequency. The lower window will not be updated until it is made active. If no peak is found the zone will not be moved. A signal must have a 6 dB peak excursion to be identified as a peak signal. The definition of a peak excursion can be changing by selecting PEAK EXCURSN while the upper window is active.

Pressing ZONE PK RIGHT will have no effect if the upper window is in zero span.

Front-Panel Key Access: WINDOWS **(ON)**

ZONE  
SPAN

**HP 8591E, HP 8593E, HP 85943, HP 8595E, or HP 8596E only.**

allows the span of the zone markers to be changed without changing the center frequency. The zone markers are vertical lines marking the zone on the upper window. They correspond with the frequency range displayed in the lower window. As the zone markers are moved the span of the lower window is changed but the lower window will not be updated unless it is active.

The zone can be expanded beyond the frequency range that is being displayed in the upper window. Its movement is limited to the frequency range of the spectrum analyzer. The zone markers will be displayed at the edges of the upper window when the zone is moved beyond the displayed frequency range.

Front-Panel Key Access: WINDOWS **(ON)**

**(ZOOM)**

**HP 8591 E, HP 8593E, HP 8594E, HP 8595E, or HP 8596E only.**

switches between the split-screen windows display and a full size display of the window that is currently active. Once the ZOOM function is active the **(NEXT)** key can be used to switch between the two windows while remaining zoomed (full sized).

## Key Menus

---

This chapter contains the key menu diagrams for the HP 8590 Series spectrum analyzers. The menus are documented for the:

- HP 8590L
- HP 85913
- HP 8592L
- HP 85933
- HP 85943
- HP 8594L
- HP 85953
- HP 85963

Each key menu diagram is arranged alphabetically according to the front-panel key name.

---

**Note**            Some of the softkeys in the key menus are model or option specific and may not appear on your spectrum analyzer.

---

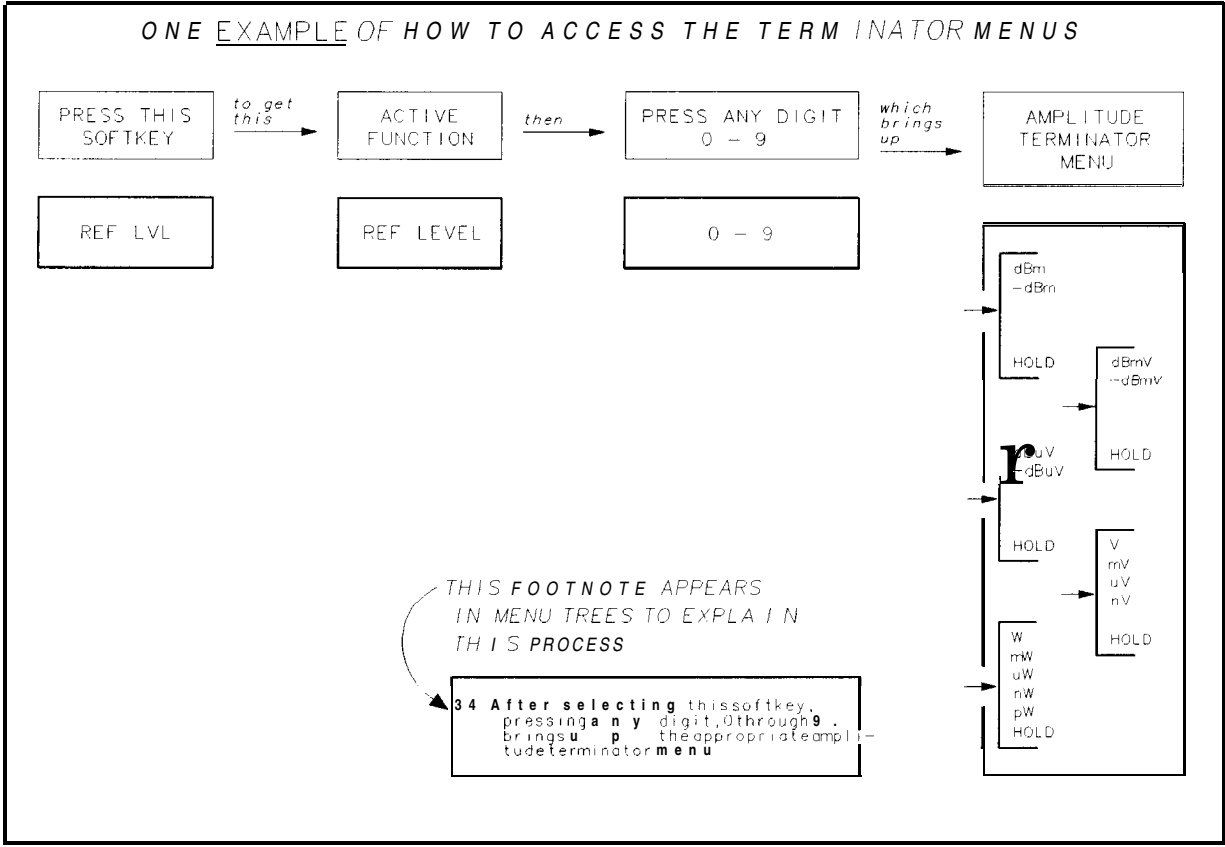
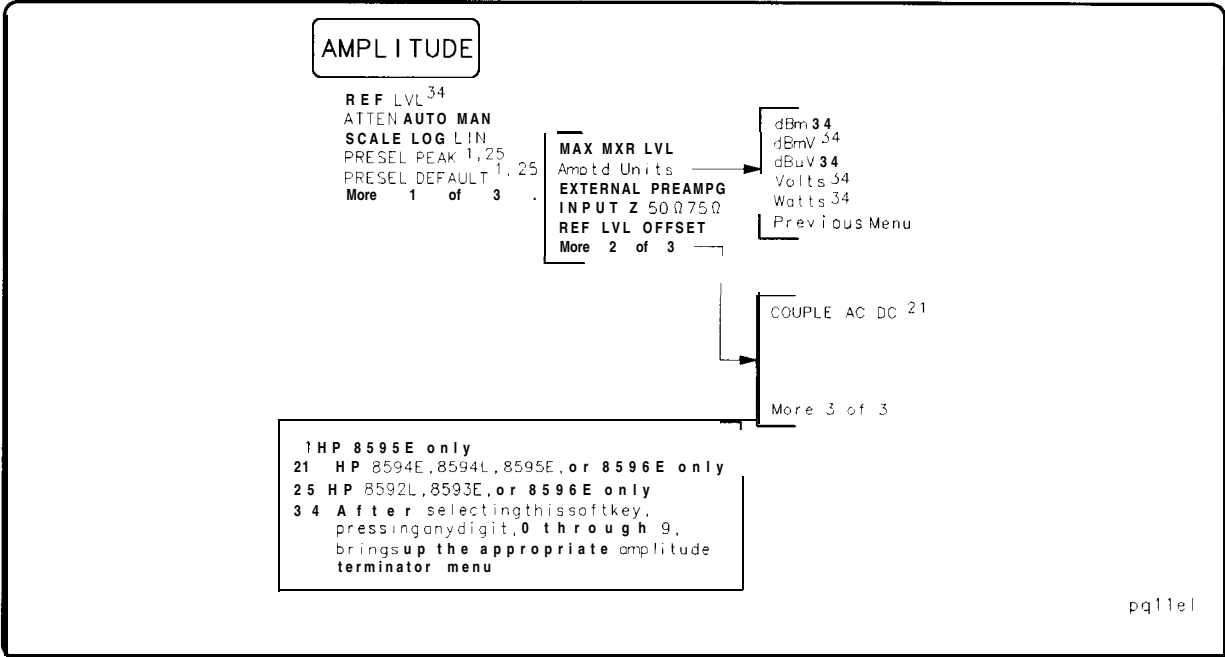

## AUTO COUPLE

AUTO ALL  
RES BW AUTO MAN  
VID BW AUTO MAN  
ATTEN AUTO MAN  
SWP TIME AUTO MAN  
CF STEP AUTO MAN

PU12

## AUX CTRL

Demod<sup>3</sup>  
Track Gen<sup>2</sup>  
Aux Conn Control  
COMB GEN ON OFF<sup>25</sup>  
Quasi Peak<sup>5</sup>

DEMOD ON OFF<sup>3</sup>  
DEMOD A M FM<sup>3</sup>  
SPEAKER ON OFF<sup>3</sup>  
SQUELCH<sup>3</sup>  
FM GAIN<sup>3</sup>  
DWELL TIME<sup>3</sup>

SRC PWR ON OFF<sup>2,34</sup>  
TRACKING PEAK<sup>2</sup>  
MAN TRK ADJUST<sup>2</sup>  
PWR SWP ON OFF<sup>2</sup>  
SRC ATN MAN AUTO<sup>2</sup>  
More 1 of 2<sup>2</sup>

SRC PWR STP SIZE<sup>2</sup>  
SRC PWR OFFSET<sup>2</sup>  
ALC INTEXT<sup>2,26</sup>  
SWP CPLG SR SA<sup>2</sup>

More 2 of 2<sup>2</sup>

CNTL A 0 1  
CNTL B 0 1  
CNTL C 0 1  
CNTL D 0 1

DISPLAY CNTL

AUTO QP AT MKR<sup>5</sup>  
MAN QP AT MKR<sup>5-</sup>  
CLEAP QP DATA<sup>5</sup>

CENTER FREQ<sup>5</sup>  
MARKER NORMPK<sup>5</sup>  
OP X10 ON OFF<sup>5</sup>  
OP DET ON OFF<sup>5</sup>  
ACCEPT QP DATA<sup>5</sup>  
RETURN<sup>5</sup>

1. HP 8595E only.
2. Option 010 or 011 only
3. option 102 or 103 only
5. Option 103 with the quasi-peak detector driver installed only
25. HP 85921, 8593E, or 8596E only
26. Changes to ALC MTR INT XTAL for an HP 8590L or HP 8591E.
34. After selecting this softkey, pressing any digit, 0 through 9, brings up the appropriate amplitude terminator menu.

PU13EL

## BW

RES BW AUTO MAN  
VID BW AUTO MAN  
VBW/RBW  
"ID AVG ON OFF

EM BW Menu

120 kHz EMI BW  
9 kHz EMI BW  
200 Hz EMI BW<sup>30</sup>

Previous Menu

30. Requires Option 130

PU14



# I CAL I

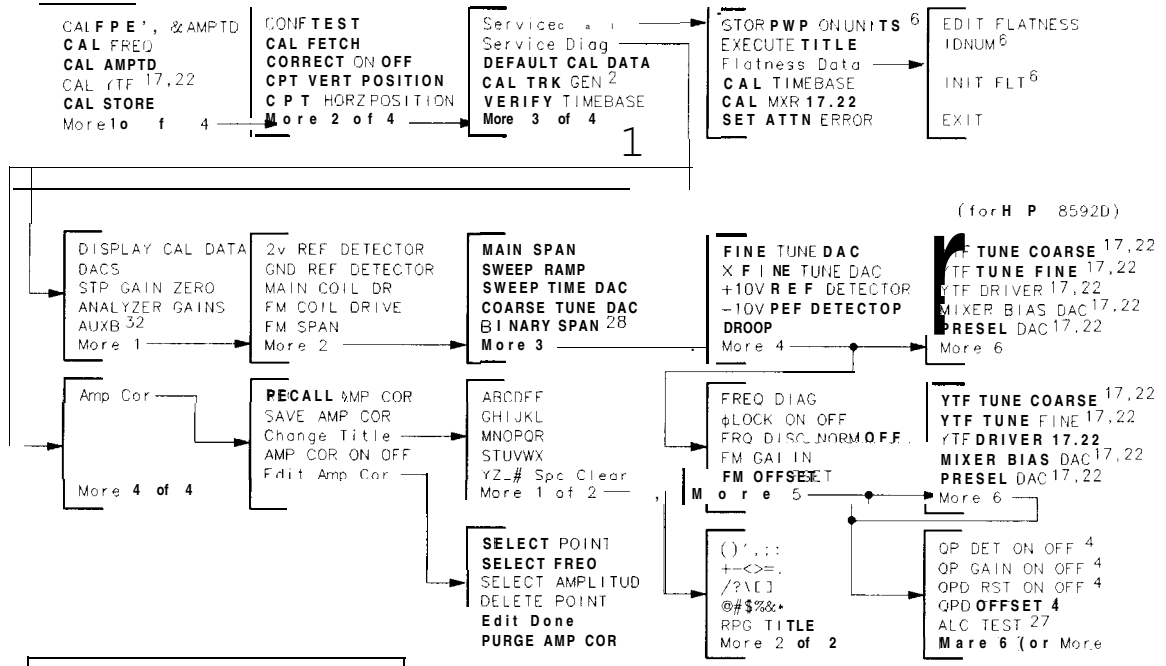

HP 8595E only  
 2 Option 010 or 011 only  
 Option 103 only  
 6 For service use only.  
 17 HP 8592L and HP 8593E only  
 22 HP 8595E and HP 8596E only.  
 27 HP 8590L and HP 8591E with  
 Option 010 or 011 only  
 2% Changes to YTF SPAN for an  
 HP 8592L, 8593E, 8595E,  
 and 8596E  
 32. HP 8590L or HP 8591E only

PU14EL

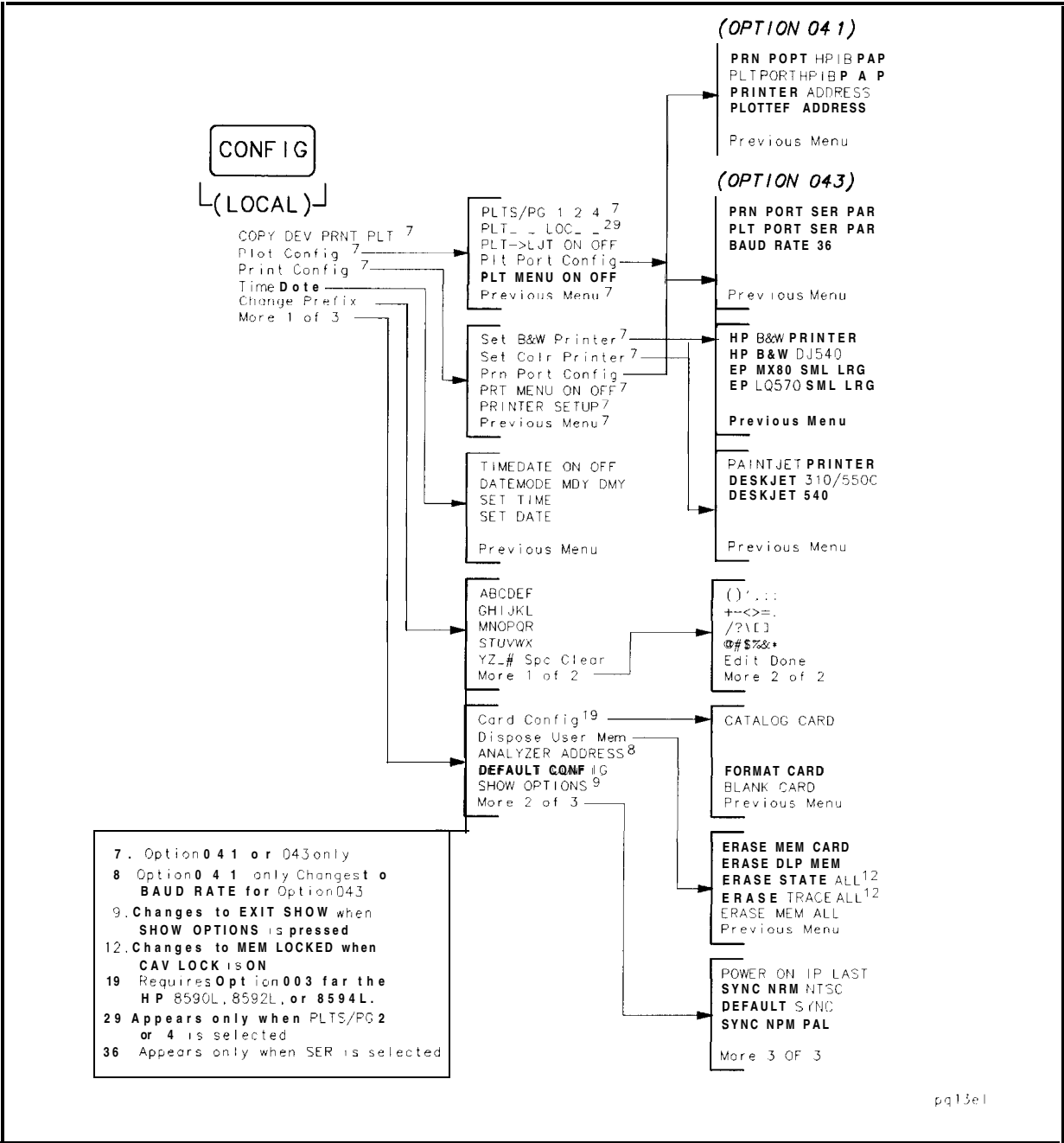

**COPY**

PU17

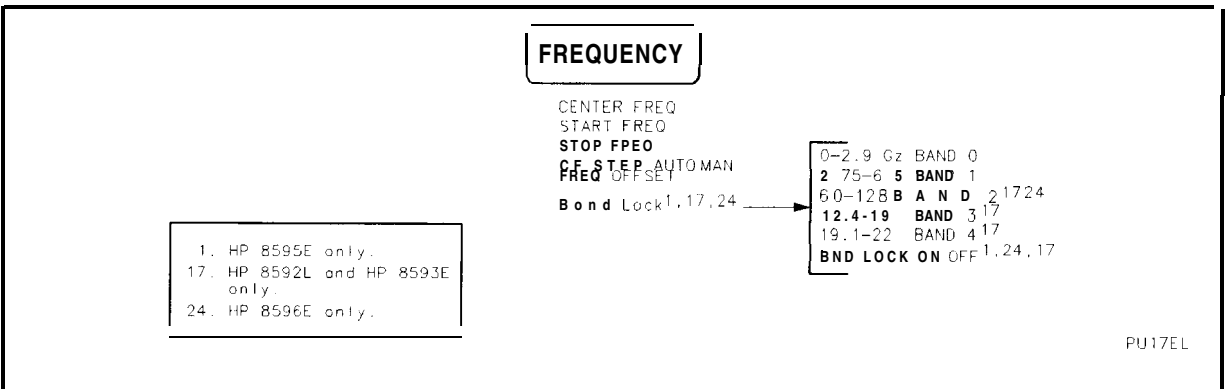
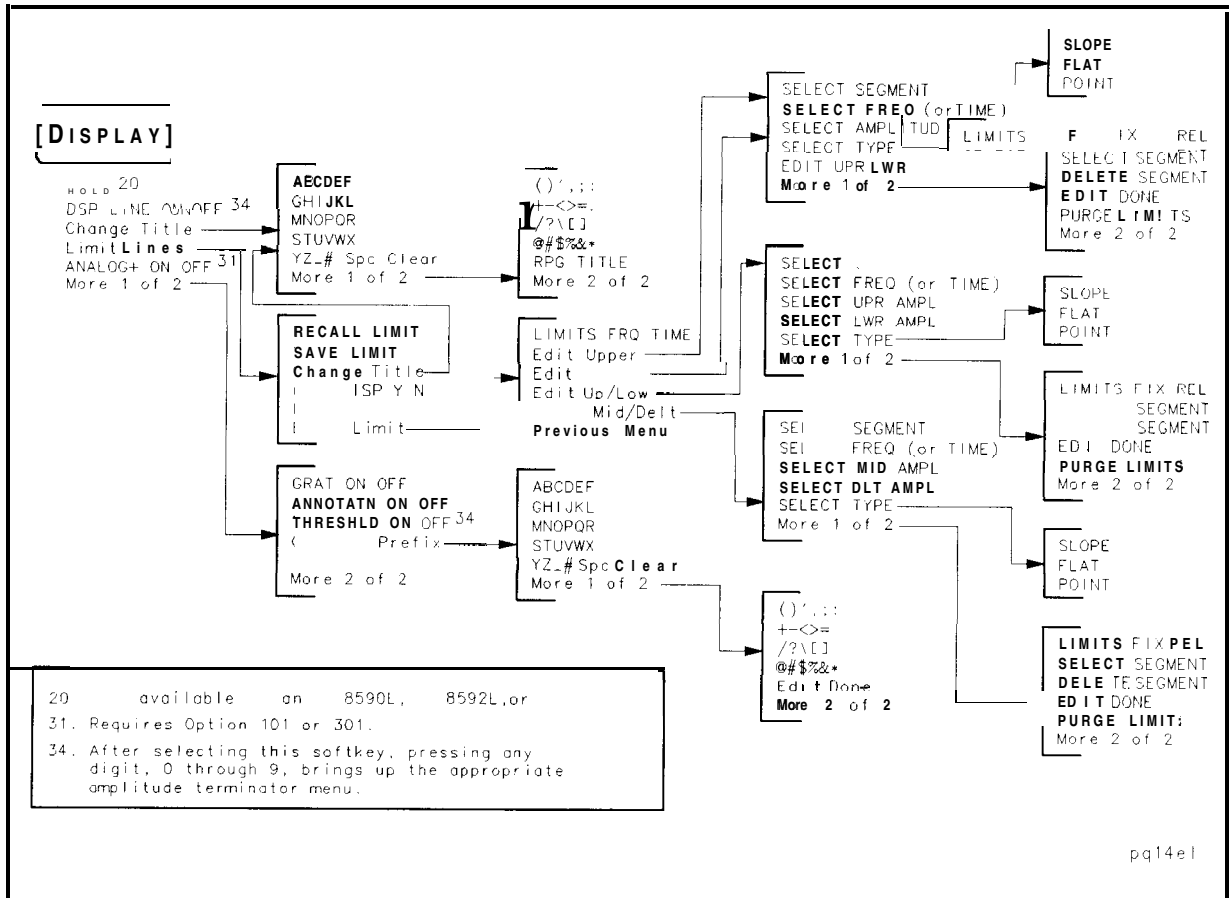

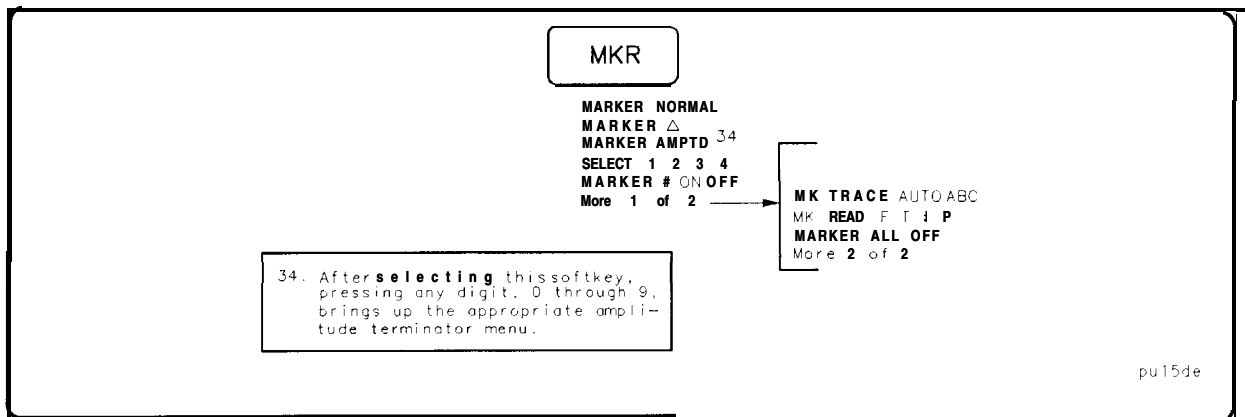
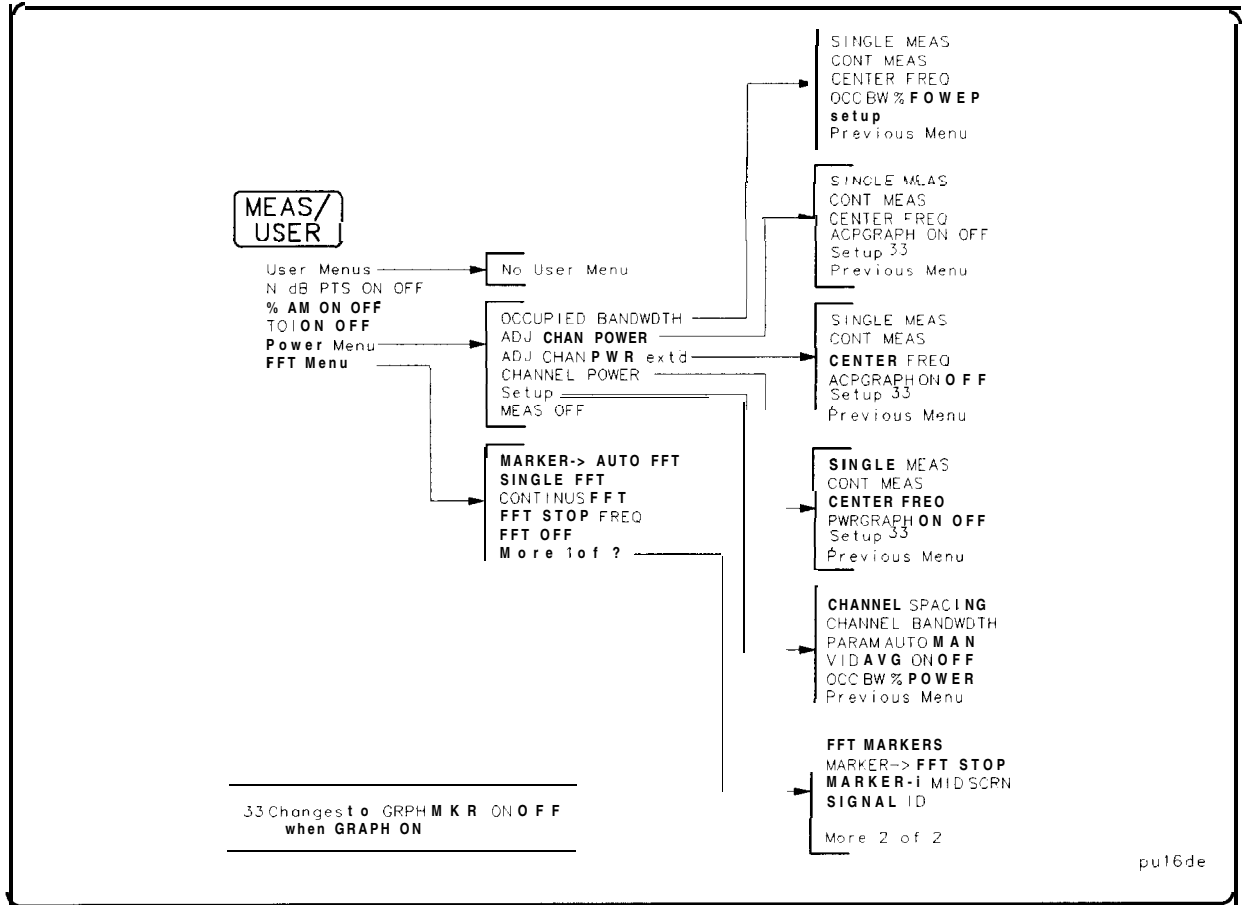

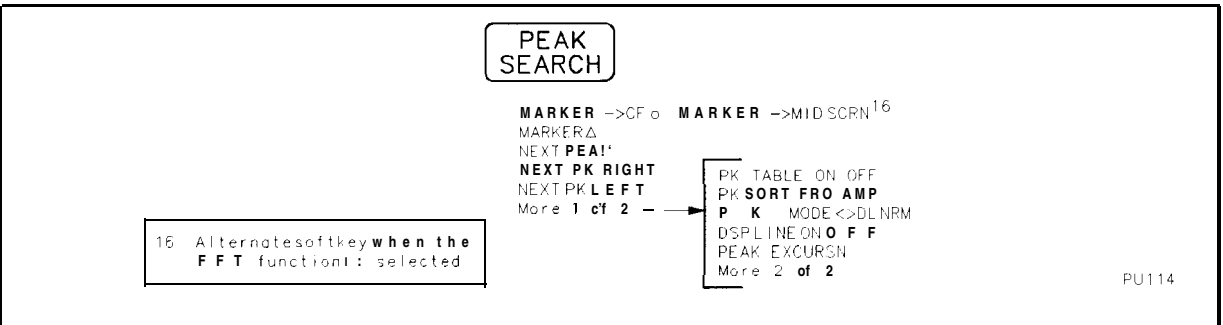
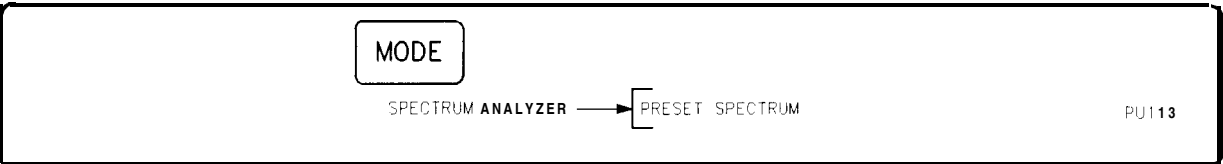
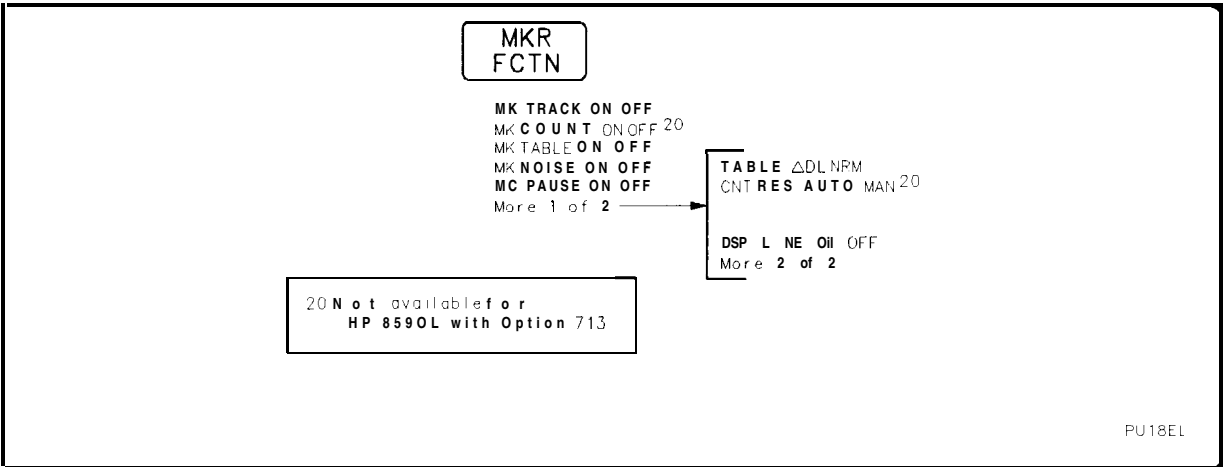
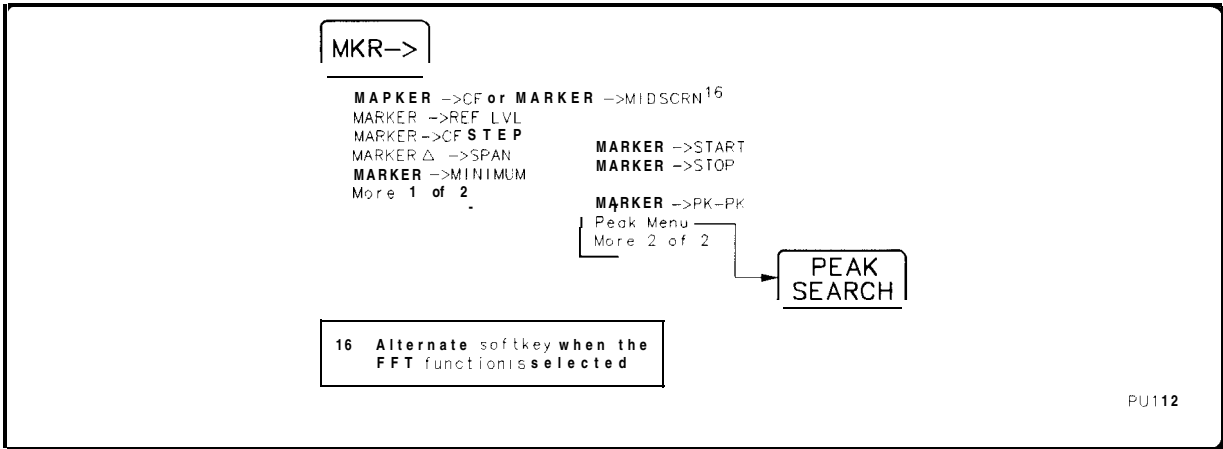

**PRESET**

SPECTRUM ANALYZER-& T S P E C T R U M

PU115

FOR RECALLING AND SAVING TO ANALYZER MEMORY:  
(that is, with INTERNAL selected)

**RECALL**

INTERNAL -> STATE  
Internal -> Trace

Catalog Internal  
INTERNAL CARD

TRACE A  
TRACE B  
TRACE C  
LIMIT LINES  
AMP COR  
Previous Menu

CATALOG ALL  
CATALOG REGISTER  
CATALOG VARIABLES  
CATALOG PREFIX  
Change Prefix  
More 1 of 2

Editor  
DELETE FILE  
SELECT PREFIX  
Exit Catalog  
Previous Menu

EDIT LAST  
EDIT CAT ITEM  
APND CAT ITEM  
SAVE EDIT  
NEW EDIT  
Previous Menu

LOAD FILE  
DELETE FILE  
SELECT PREFIX  
Exit Catalog  
Previous Menu

Editor  
DELETE FILE  
SELECT PREFIX  
Exit Catalog  
Previous Menu

EDIT LAST  
EDIT CAT ITEM  
APND CAT ITEM  
SAVE EDIT  
NEW EDIT  
Previous Menu

ABCDEF  
GHIJKL  
MNOPQR  
STUVWX  
YZ\_# Spc Clear  
More 1 of 2

()':::  
+<>=  
/?\|\_|  
@#%&\*  
Edit Done  
More 2 of 2

CATALOG DLP  
CATALOG ON EVENT  
Exit Catalog  
More 2 of 2

Editor  
DELETE FILE  
SELECT PREFIX  
Exit Catalog  
Previous Menu

EDIT LAST  
EDIT CAT ITEM  
APND CAT ITEM  
SAVE EDIT  
NEW EDIT  
Previous Menu

PU125

FOR RECALLING AND SAVING TO MEMORY CARD :  
 (that is, with CARD selected)

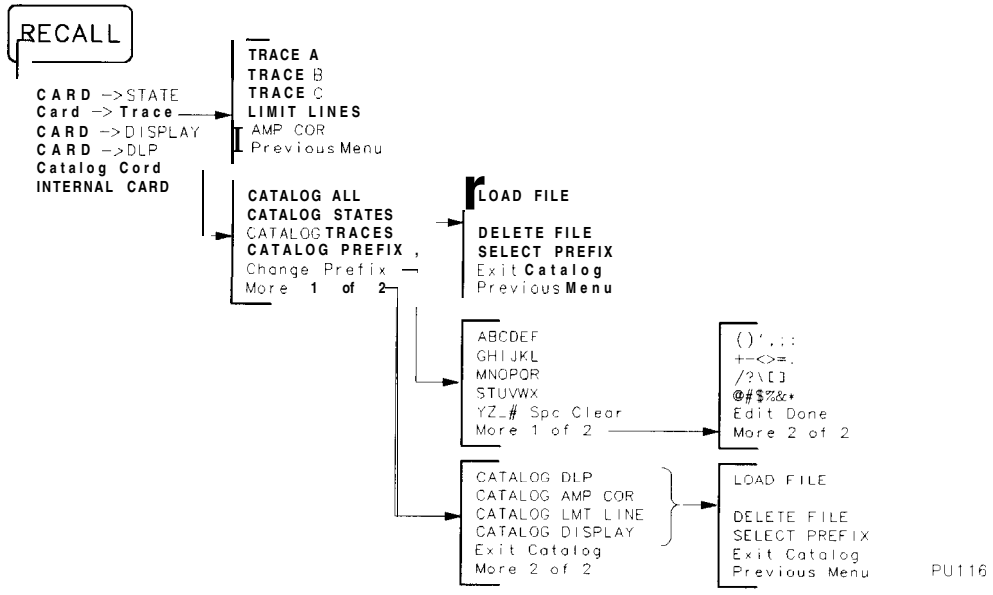

PU116

FOR RECALLING AND SAVING TO ANALYZER MEMORY:

(that is, with INTERNAL selected)

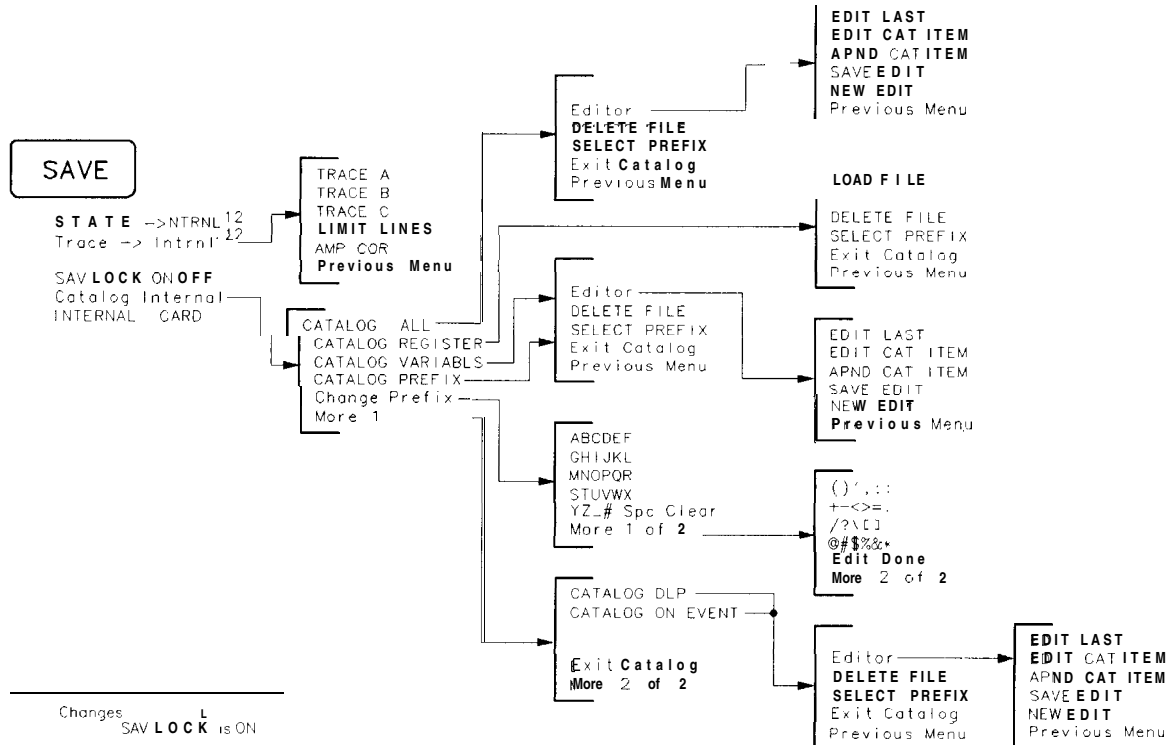

PU126



FOR RECALLING AND SAVING TO MEMORY CARD:  
(that is, with CARD selected)

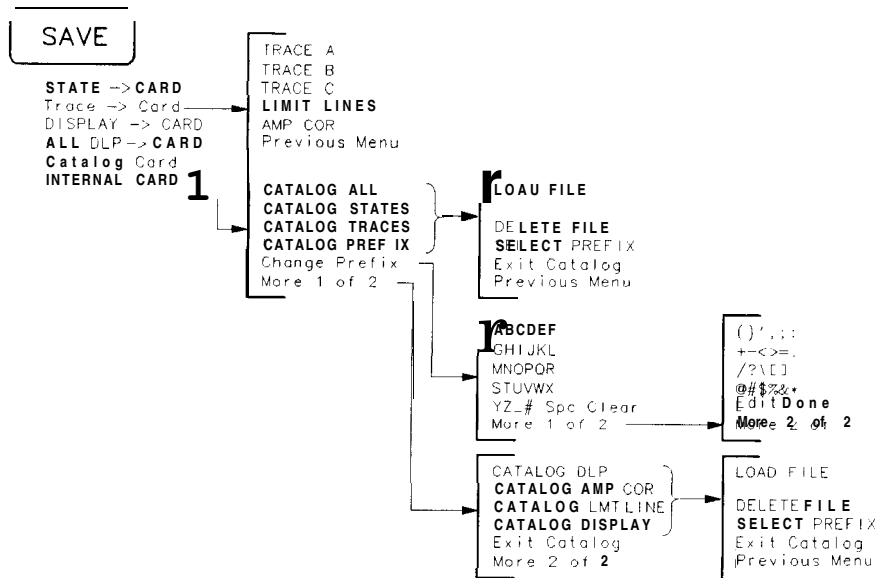

PU117

SGL  
SWP

PU128

SPAN

- SPAN
- SPAN ZOOM
- FULL SPAN
- ZERO SPAN
- LAST SPAN
- PEAK ZOOM

PU127

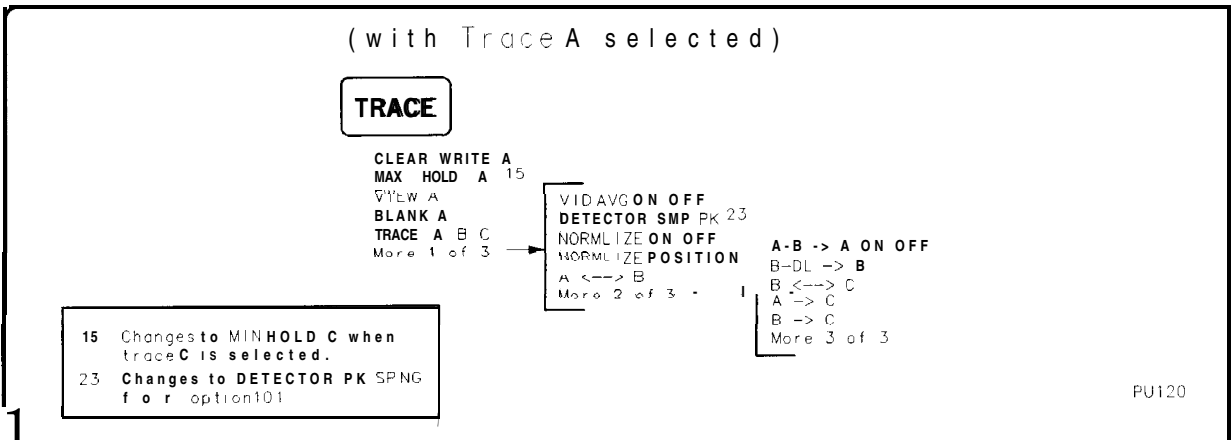
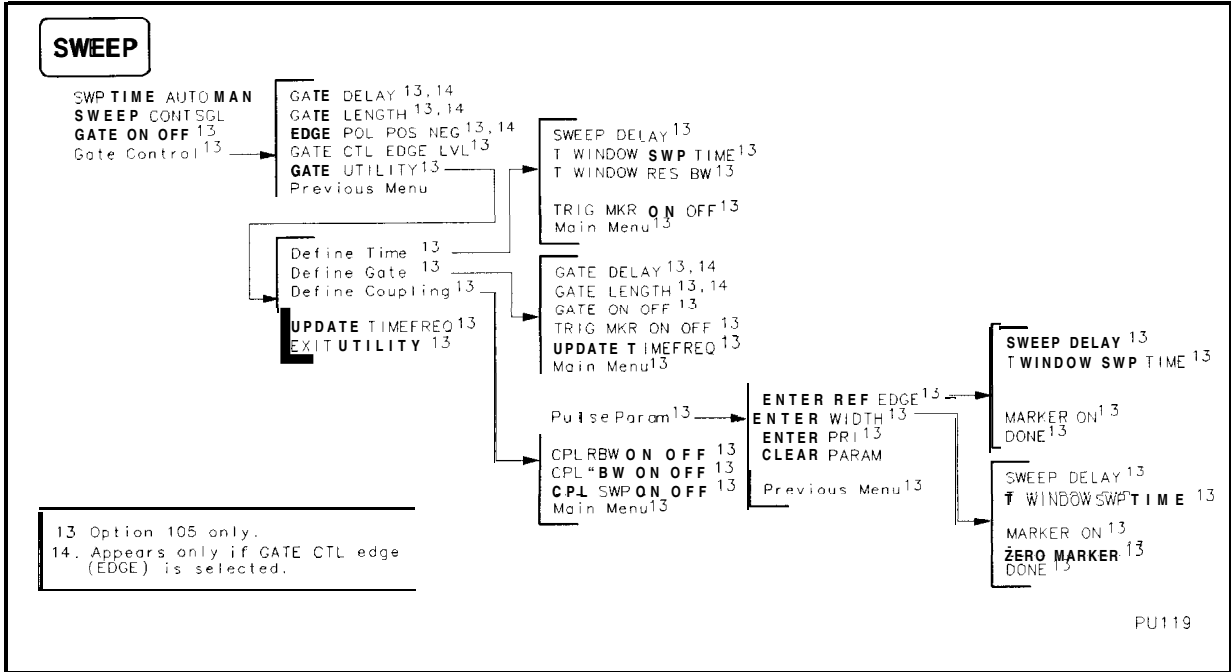

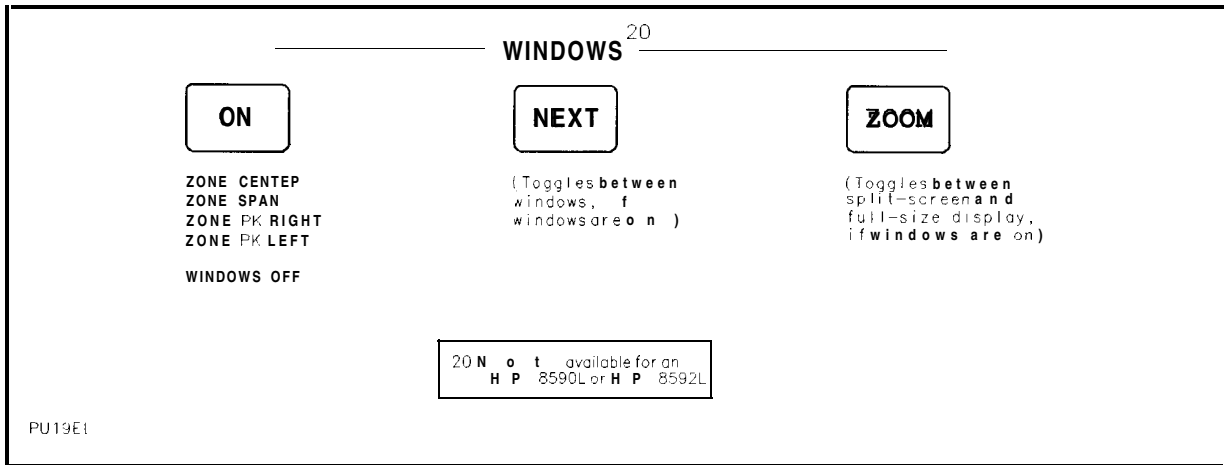
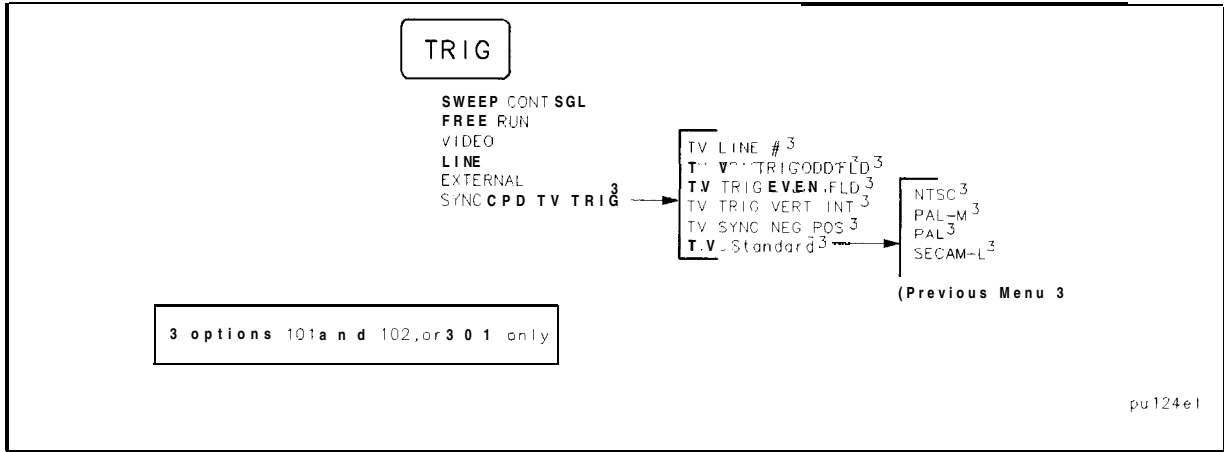

## If You Have A Problem

---

### What You'll Find in This Chapter

This chapter includes information on how to check for a problem with your HP 8590 Series spectrum analyzer and how to return it for service. It also includes descriptions of all of the spectrum analyzer built-in error messages.

Your spectrum analyzer is built to provide dependable service. However, if you experience a problem, or if you desire additional information or wish to order parts, options, or accessories, Hewlett-Packard's worldwide sales and service organization is ready to provide the support you need.

In general, a problem can be caused by a hardware failure, a software error, or a user error. Follow these general steps to determine the cause and to resolve the problem:

1. Perform the quick checks listed in the "Check the Basics" section; these checks may eliminate the problem altogether, or may give a clearer idea of its cause.
2. If the problem is a hardware problem, you have several options:
  - Repair it yourself; see the "Service Options" section.
  - Return the spectrum analyzer to Hewlett-Packard for repair; if the spectrum analyzer is still under warranty or is covered by an HP maintenance contract, it will be repaired under the terms of the warranty or plan (the warranty is at the front of this manual).

If the spectrum analyzer is no longer under warranty or is not covered by an HP maintenance plan, Hewlett-Packard will notify you of the cost of the repair after examining the unit. See "How to Call Hewlett-Packard" and "How to Return Your Analyzer for Service" for more information.

---

## Before You Call Hewlett-Packard

### Check the Basics

A problem often can be solved by rechecking what was being done when the problem occurred. A few minutes spent in performing some simple checks may save waiting for your instrument to be repaired. Before calling Hewlett-Packard or returning the spectrum analyzer for service, please make the following checks:

1. Is the rear-panel voltage selector switch set correctly? Is the line fuse good?
2. Does the line socket have power?
3. Is the analyzer plugged in to the proper ac power source?
4. Is the analyzer turned on? Check that the green light above **(LINE)** is on, indicating that the power supply is on.
5. If other equipment, cables, and connectors are being used with the HP 8590 Series spectrum analyzer, are they connected properly and operating correctly?
6. Review the procedure for the test being performed when the problem appeared. Are all the settings correct?
7. If the display is dark or dim, turn the intensity knob clockwise.
8. If the display focus is poor, reduce the brightness with the intensity knob, or adjust the focus as described in Chapter 2 of this user's guide.
9. If the display position is offset, press **(CAL)**, More 1 of 4 , CRT VERT POSITION and use the knob or step keys to adjust the vertical position. Press (CAL), More 1 of 4 , CRT HORZ POSITION to adjust the horizontal position. Press **(CAL)**, CAL STORE to save the new vertical and horizontal display position.
10. If you wish to reset the spectrum analyzer configuration to the state it was in when it was originally shipped from the factory, use DEFAULT CONFIG . To access DEFAULT CONFIG , press **(CONFIG)**, More 1 of 3 , DEFAULT CONFIG , DEFAULT CONFIG . (DEFAULT CONFIG requires a double key press.) See the softkey description for DEFAULT CONFIG in Chapter 7.
11. Is the test being performed, and the results that are expected, within the specifications and capabilities of the spectrum analyzer? See specifications and characteristics in your calibration guide, for spectrum analyzer specifications.
12. Are the spectrum analyzer measurements obviously inaccurate? If so, the spectrum analyzer correction factors may have been removed from the measurement results. If this occurs, perform the frequency and amplitude self-calibration routines given in "Improving Accuracy with Self-Calibration Routines" in Chapter 2. After running these routines, press CAL STORE , then perform the confidence test. Perform the confidence test by pressing (CAL), More 1 of 4 , CONF TEST. The spectrum analyzer performs a self-test by cycling through its major functions. The confidence test is performed within 1 to 2 minutes. If the unit does not function properly, messages appear on the screen. See "Error Messages" for explanations of error messages. If error messages appear, record the messages and refer to the spectrum analyzer service guide or contact the nearest Hewlett-Packard Sales and Service Office listed in Table 9- 1.

13. For a preselected spectrum analyzer (HP 8592L, HP 85933, HP 85953, and HP 85963) with low signal amplitudes above 2.75 GHz, perform a YTF calibration. For the HP 8592L, HP 85933, or HP 85963 connect a low-loss cable (such as HP part number 8120-5148) from 100 MHz COMB OUT to the spectrum analyzer input. For the HP 8595E connect a low-loss cable from CAL OUT to the spectrum analyzer input. Press (CAL), CAL YTF . Press (CAL), CAL STORE to save the correction values in memory. The YTF self-calibration routine completes in approximately:

| <u>Model Number</u> | <u>YTF Cal Time</u> |
|---------------------|---------------------|
| HP 8592L            | 7 minutes           |
| HP 85933            | 7 minutes           |
| HP 85953            | 3 minutes           |
| HP 85963            | 5 minutes           |

14. If the error message “FREQ UNCAL” stays on screen, run the frequency self-calibration routine by pressing CAL **FREQ** and then press CAL STORE .
15. Is the spectrum analyzer displaying an error message? If so, refer to “Error Messages”.
16. If the calibration routines cannot be performed or the calibration data is corrupt, use CAL FETCH to retrieve the correction data that has previously been saved. If the fetched correction data is corrupt, the procedure in step 18 can be used to set the correction data back to factory default values.
17. If the display is scrambled or filled with snow, first try adjusting the horizontal position by pressing (CAL), the bottom softkey, and then pressing the fifth softkey from the top. Turn the knob counterclockwise. The vertical position will not cause this symptom.
18. If the display is still scrambled, use DEFAULT CAL DATA per the following procedure to reinitialize the memory area for correction factors, instrument configuration, and miscellaneous constants. This procedure will not erase factory-installed calibration factors.
- Press (FREQUENCY), -37 (Hz), (CAL), the bottom softkey, the bottom softkey again, then softkey
  - FREQ** &  
Be sure CAL OUT is connected to the spectrum analyzer input.

---

**Note** If the CAL OUT signal cannot be found, press (FREQUENCY), -37 (Hz) before performing the CAL FREQ or CAL FREQ & AMPTD .

---

- For the HP 8592L, HP 85933, or HP 85963 connect a low-loss cable, such as HP part number 8120-5148, from 100 MHz COMB OUT to the spectrum analyzer input. For the HP 85953 connect a low-loss cable from CAL OUT to the spectrum analyzer input. Press (CAL), CAL YTF . The YTF self-calibration routine completes in approximately:

| <u>Model Number</u> | <u>YTF Cal Time</u> |
|---------------------|---------------------|
| HP 8592L            | 7 minutes           |
| HP 85933            | 7 minutes           |
| HP 85953            | 3 minutes           |
| HP 8596E            | 5 minutes           |

- d. Set the display position using (CAL), More 1 of 4 , CRT VERT POSITION and **CAL**,  
**More** 1 of 4, CRT HORIZ POSITION.
- e. Press [CAL), CAL STORE.

---

**Note**            Some user configurations may need to be reset.

---

DEFAULT CAL DATA can only be accessed by entering a center frequency of -37 Hz. The center frequency -37 Hz acts as a pass code for DEFAULT CAL DATA .

19. If a program in user memory is suspected of causing problems, use **CONFIG**, More 1 of 3 ,  
Dispose User Mem, ERASE DLP MEM . (ERASE DLP MEM requires a double key press.)  
ERASE DLP MEM erases all user programs, variables, personalities (DLPs), and user-defined traces in spectrum analyzer memory.
20. If the necessary test equipment is available, perform the performance verification tests given in the Calibration Guide for your spectrum analyzer. Record all results on an Performance Verification Test Record form which follows the tests.

## Read the Warranty

The warranty for your spectrum analyzer is at the front of this manual. Please read it and become familiar with its terms.

If your spectrum analyzer is covered by a separate maintenance agreement, please be familiar with its terms.

## Service Options

Hewlett-Packard offers several optional maintenance plans to service your spectrum analyzer after the warranty has expired. Call your Hewlett-Packard Sales and Service office for full details.

If you want to service the spectrum analyzer yourself after the warranty expires, you can purchase the service documentation that provides all necessary test and maintenance information.

You can order the service documentation, Option 915, through your Hewlett-Packard Sales and Service office. Service documentation is described under “Service Documentation for the HP 8590 Series (Option 915)” in Chapter 10 in this manual.

## How to Call Hewlett-Packard

Hewlett-Packard has Sales and Service offices around the world to provide you with complete support for your spectrum analyzer. To obtain servicing information or to order replacement parts, contact the nearest Hewlett-Packard Sales and Service Office listed in Table 9-1. In **any** correspondence or telephone conversations, refer to the instrument by its model number and full serial number.

**Table 9-1. Hewlett-Packard Sales and Service Offices**

| UNITED STATES                                                                                                                                       |                                                                                                                                                           |                                                                                                                                                            |
|-----------------------------------------------------------------------------------------------------------------------------------------------------|-----------------------------------------------------------------------------------------------------------------------------------------------------------|------------------------------------------------------------------------------------------------------------------------------------------------------------|
| Instrument Support Center<br><b>Hewlett-Packard Company</b><br>(800) 403-0801                                                                       |                                                                                                                                                           |                                                                                                                                                            |
| EUROPEAN FIELD OPERATIONS                                                                                                                           |                                                                                                                                                           |                                                                                                                                                            |
| Headquarters<br><b>Hewlett-Packard S.A.</b><br>150, Route du Nant-d'Avril<br>1217 Meyrin 2/Geneva<br>Switzerland<br>(41 22) 780.8111                | France<br><b>Hewlett-Packard France</b><br>1 Avenue Du Canada<br>Zone D'Activite De Courtaboeuf<br>F-91947 Les Ulis Cedex<br>France<br>(33 1) 69 82 60 60 | Germany<br><b>Hewlett-Packard GmbH</b><br>Hewlett-Packard Strasse<br>61352 Bad Homburg v.d.H<br>Germany<br>(49 6172) 16-0                                  |
| Great Britain<br><b>Hewlett-Packard Ltd.</b><br>Eskdale Road, Winnersh Triangle<br>Wokingham, Berkshire RG41 5DZ<br>England<br>(44 734) 696622      |                                                                                                                                                           |                                                                                                                                                            |
| INTERCON FIELD OPERATIONS                                                                                                                           |                                                                                                                                                           |                                                                                                                                                            |
| Headquarters<br><b>Hewlett-Packard Company</b><br>3495 Deer Creek Road<br>Palo Alto, California, USA<br>94304-1316<br>(415) 857-5027                | Australia<br><b>Hewlett-Packard Australia Ltd.</b><br>31-41 Joseph Street<br>Blackburn, Victoria 3130<br>(61 3) 895-2895                                  | Canada<br><b>Hewlett-Packard (Canada) Ltd.</b><br>17500 South Service Road<br>Trans-Canada Highway<br>Kirkland, Quebec H9J 2X8<br>Canada<br>(514) 697-4232 |
| China<br><b>China Hewlett-Packard Company</b><br>38 Bei San Huan XI Road<br>Shuang Yu Shu<br>Hai Dian District<br>Beijing, China<br>(86 1) 256-6888 | Japan<br><b>Hewlett-Packard Japan, Ltd.</b><br>9-1 Takakura-Cho, Hachioji<br>Tokyo 192, Japan<br>(81 426) 60-2111                                         | Singapore<br><b>Hewlett-Packard Singapore (Pte.) Ltd.</b><br>150 Beach Road<br>#29-00 Gateway West<br>Singapore 07 18<br>(65) 291-9088                     |
| Taiwan<br><b>Hewlett-Packard Taiwan</b><br>8th Floor, H-P Building<br>337 Fu Hsing North Road<br>Taipei, Taiwan<br>(886 2) 712-0404                 |                                                                                                                                                           |                                                                                                                                                            |



---

## How to Return Your Analyzer for Service

### Service Tag

If you are returning the spectrum analyzer to Hewlett-Packard for servicing, fill in and attach a blue service tag. Several service tags are supplied at the rear of this manual. Please be as specific as possible about the nature of the problem. If you have recorded any error messages that appeared on the screen, or have completed a Performance Test Record, or have any other specific data on the performance of the spectrum analyzer, please send a copy of this information with the unit.

### Original Packaging

Before shipping, pack the unit in the original factory packaging materials if they are available. If the original materials were not retained, see "Other Packaging."

### Other Packaging

---

**Caution**      Spectrum analyzer damage can result from using packaging materials other than those specified. Never use styrene pellets in any shape as packaging materials. They do not adequately cushion the equipment or prevent it from shifting in the carton. They cause equipment damage by generating static electricity and by lodging in the spectrum analyzer fan.

---

You can repack the instrument with commercially available materials, as follows:

1. Attach a completed service tag to the instrument.
2. If you have a front-panel cover, install it on the instrument; if not, protect the control panel with cardboard.
3. Wrap the instrument in antistatic plastic to reduce the possibility of damage caused by electrostatic discharge.
4. Use the original packaging material or a strong shipping container. A double-walled, corrugated cardboard carton with 159 kg (350 lb) bursting strength is adequate. The carton must be both large enough and strong enough to accommodate the spectrum analyzer. Allow at least 3 to 4 inches on all sides of the analyzer for packing material.
5. Surround the equipment with three to four inches of packing material and prevent the equipment from moving in the carton. If packing foam is not available, the best alternative is S.D.-240 Air Cap™ from Sealed Air Corporation (Commerce, California, 90001). Air Cap looks like a plastic sheet filled with 1-1/4 inch air bubbles. Use the pink-colored Air Cap to reduce static electricity. Wrapping the equipment several times in this material should both protect the equipment and prevent it from moving in the carton.
6. Seal the shipping container securely with strong nylon adhesive tape.
7. Mark the shipping container "FRAGILE, HANDLE WITH CARE" to assure careful handling.
8. Retain copies of all shipping papers.

---

## Error Messages

The spectrum analyzer can generate various messages that appear on its screen during operation to indicate a problem.

There are three types of messages: hardware error messages (H), user-created error messages (U), and informational messages (M).

- Hardware error messages indicate the spectrum analyzer hardware is probably broken.
- User-created error messages appear when the spectrum analyzer is used incorrectly. They are usually generated during remote operation (entering programming commands using either a controller or the external keyboard).
- Informational messages provide information indicating the spectrum analyzer progress within a specific procedure.

The messages are listed in alphabetical order on the following pages; each message is defined, and its type is indicated by an (H), (U), or (M).

### $\phi$ LOCK OFF

Indicates slow YTO tuning. This message may appear if the spectrum analyzer is using default correction factors. If this message appears constantly, perform the CAL FREQ routine to try to eliminate this message.  $\phi$  LOCK OFF appears briefly during the CAL FREQ routine, during instrument preset, or when the frequency value is changed; this is normal and does not indicate a problem. (U) and (H)

### ADC-2V FAIL

### ADC-GND FAIL

### ADC-TIME FAIL

### Cal harmonic > = 5.7 GHz NOT found

Indicates that the CAL YTF routine for an HP 85953 cannot find a harmonic of the 300 MHz calibration signal. If this happens, ensure that the CAL OUT connector is connected to the spectrum analyzer input, perform the CAL FREQ & AMPTD routine, and then perform the CAL YTF routine again. (U) and (H)

### CAL:- \_ \_

During the self-calibration routine, messages may appear on the display to indicate how the calibration routines are progressing. For example, sweep, freq, span, MC delay, FM coil, and atten can appear on the spectrum analyzer display.  $\phi$  LOCK OFF appears briefly during the CAL FREQ self-calibration routine; this is normal and does not indicate a problem. (M)

### CAL: DONE: Press CAL STORE to save

Indicates that the self-calibration routine is finished and that you should press CAL STORE . (M)

### CAL: cannot execute CALAMP enter: 0 dB PREAMP GAIN

The preamplifier gain should be set to 0 dB before the CAL AMPTD routine is performed. The preamplifier gain is set by using EXTERNAL PREAMPG . This message also sets SRQ 110. (U)

### CAL: DATA NOT STORED CAL AMP NEEDED

The correction factors are corrupt and cannot be stored. You need to perform the

CAL FREQ & AMPTD routine before trying to store the correction factors. This message also sets SRQ 110. (U)

**CAL: FM SPAN SENS FAIL**

The spectrum analyzer could not set up span sensitivity of the FM coil. (H)

**CAL: GAIN FAIL**

Indicates the signal amplitude is too low during the CAL AMPTD routine. This message also sets SRQ 110. (H)

**CAL: MAIN COIL SENSE FAIL**

The spectrum analyzer could not set up span sensitivity of the main coil. If this message appears, press **[FREQUENCY]**, **-37**, (Hz), (CAL), More 1 of 4 , More 2 of 4, DEFAULT CAL DATA , and perform the CAL FREQ routine again. (H)

**CAL: NBW 200 Hz notch amp failed**

Indicates that the 200 Hz resolution bandwidth is not the correct shape for the calibration routine. (H)

**CAL: NBW 200 Hz notch failed**

Indicates that the 200 Hz resolution bandwidth is not the correct shape for the calibration routine. (H)

**CAL: NBW 200 Hz width failed**

Indicates that the 200 Hz resolution bandwidth is not the correct bandwidth for the calibration routine. (H)

**CAL: NBW gain failed**

Indicates that one of the resolution bandwidths is not the correct amplitude for the calibration routine. (H)

**CAL: NBW width failed**

Indicates that one of the resolution bandwidths is not the correct width for the calibration routine. (H)

**CAL: PASSCODE NEEDED**

Indicates that the function cannot be accessed without the pass code. For the DEFAULT CAL DATA function, the pass code is setting the center frequency of the spectrum analyzer to **-37** Hz. (M)

**CAL: RES BW AMPL FAIL**

The relative insertion loss of the resolution bandwidth is incorrect. This message also sets SRQ 110. (H)

**CAL SIGNAL NOT FOUND**

Indicates the calibration signal (CAL OUT) cannot be found. Check that the CAL OUT and the spectrum analyzer input connectors are connected with an appropriate cable. If the calibration signal is connected to the spectrum analyzer input but cannot be found, press **[FREQUENCY]**, **-37**, **[Hz]**, (CAL), More 1 of 4, More 2 of 4, DEFAULT CAL DATA . If the calibration signal still cannot be found, press **[FREQUENCY]**, **-37**, **[Hz]** and perform the CAL FREQ or CAL FREQ & AMPTD self-calibration routines. This message also sets SRQ 110. (U) and (H)

**CAL: SPAN SENS FAIL**

The self-calibration span sensitivity routine failed. This message also sets SRQ 110. (H)

**CAL: USING DEFAULT DATA**

Indicates that the calibration data is corrupt and the default correction factors are being used. Interruption of **the** self-calibration routines or **an** error can cause this problem. (M)

**CAL: YTF FAILED**

Indicates that the CAL YTF routine could not be successfully completed. If this message appears, ensure that the CAL OUT connector (for the HP 85953) or 100 MHz COMB OUT connector (for the HP 8592L, HP 85933, or HP 85963) is connected to the spectrum analyzer input, perform the CAL FREQ & AMPTD routine, and then perform the CAL YTF routine again. (U) and (H)

**CAL: ZERO FAIL**

The spectrum analyzer could not set up the tuning sensitivity of the main coil. If this message appears, press **FREQUENCY**, -37, (Hz), **CAL**, More 1 of 4, More 2 of 4, DEFAULT CAL DATA , and perform the CAL FREQ routine again. (H)

**Cannot engage phase lock with current CAL FREQ data**

Indicates that the CAL FREQ routine needs to be performed before phase locking can be turned on. (U)

**Cannot reach N dB points**

Indicates that the number of dB specified for the N dB PTS function is greater than the distance of the signal peak from the spectrum analyzer noise floor or peak threshold. (U)

**Check trigger input**

Indicates that the spectrum analyzer needs an external trigger signal to use the time-gating functions. Before using the time-gating functions, you should ensure there is a trigger pulse connected to the GATE TRIGGER INPUT connector on the rear panel of spectrum analyzer and that the GATE OUTPUT is connected the EXT TRIG INPUT connector. (U)

**Comb harmonic at - - - GHz NOT found**

Indicates that the CAL YTF routine for the spectrum analyzer cannot find a harmonic of the comb generator at frequency displayed. If this happens, ensure that the 100 MHz COMB OUT connector (for an HP 8592L, HP 85933, or HP 8596E) or the CAL OUT connector (for an HP 85953) is connected to the spectrum analyzer input with a low-loss, short cable before the CAL YTF routine is performed. (U) and (H)

**COMB SIGNAL NOT FOUND**

The comb signal cannot be found. Check that 100 MHz COMB OUT is connected to the spectrum analyzer input. The comb generator is available with the HP 8592L, HP 85933, or HP 85963 only. (U) and (H)

**CMD ERR:- - -**

The specified programming command is not recognized by the spectrum analyzer. Press ANNOTATN ON OFF to clear, (U)

**CONF TEST FAIL**

Indicates that the confidence test failed. If this happens, ensure that the CAL OUT connector is connected to the spectrum analyzer input, perform the CAL FREQ & AMPTD routine, and then perform the confidence test again. This message also sets SRQ 110. (H) and (U)

**EMPTY DLP MEM**

Indicates that the user-defined items (user-defined functions, user-defined variables, user-defined traces, user-defined softkeys) and any personalities (for example, the HP 85716A CATV System Monitor Personality) in the spectrum analyzer memory have been deleted. If the message is continuously displayed at power up, it may indicate a hardware failure. See the spectrum analyzer Service Guide for more information. (U)

**Factory dlp, not editable**

Indicates that the downloadable program or variable that you have selected is used by a "personality" and cannot be edited. A personality is a program that is manufactured by Hewlett Packard and is available for use with the HP 8590 Series spectrum analyzer. An example of a personality is the HP 85716A CATV system monitor personality. (U)

**FAIL:- \_ \_**

An error was discovered during the power-up check. The 4-digit by 10-digit code indicates the type of error. Error codes are described in the spectrum analyzer service guide. (H)

**File type incompatible**

Indicates that the selected file is not a display image file. The file name for a display image file is always preceded by an "i." (U)

**FREQ UNCAL**

If the FREQ UNCAL message appears constantly, it indicates a YTO-tuning error. If this message appears constantly, perform the CAL FREQ routine. FREQ UNCAL appears briefly during the CAL FREQ routine; this is normal and does not indicate a problem. (U) and (H) (U) and (H)

**Function not available in current Mode**

Indicates that the function that you have selected can only be used with the spectrum analyzer mode. You can use the **MODE** key to select the spectrum analyzer mode. (U)

**Function not available with analog display**

Indicates that the function that you have selected is not compatible with the Analog+ display mode. To use the function, you must first turn off the Analog+ display mode with ANALOG+ ON OFF. (U)

**Gate card not calibrated**

This message can indicate that either the CAL AMPTD routine need to be performed before the time-gating functions can be used, or that something was connected to the GATE TRIGGER INPUT connector during the CAL AMPTD or CAL FREQ & AMPTD routines. If your spectrum analyzer has an Option 105 installed in it, you should ensure that nothing is connected to the GATE TRIGGER INPUT connector when the CAL AMPTD or CAL FREQ & AMPTD routines are performed. (U) and (H)

**INTERNAL LOCKED**

The spectrum analyzer internal trace and state registers have been locked. To unlock the trace or state registers, press SAV LOCK ON OFF so that OFF is underlined. For remote operation, use PSTATE OFF. (U)

**INVALID ACTDEF: \_ \_ \_**

The specified ACTDEF name is not valid. See the ACTDEF programming command. (U)

**INVALID AMPCOR: FREQ**

For the AMPCOR command, the frequency data must be entered in increasing order. See the description for the AMPCOR programming command for more information. (U)

**INVALID BLOCK FORMAT: IF STATEMENT**

An invalid block format appeared within the IF statement. See the description for the IF THEN ELSE ENDIF programming command for more information. (U)

**INVALID CARD**

Indicates one of the following conditions: a card reader is not installed, the memory card is write-protected (check the position of the switch on the memory card), the memory card is a read-only memory (ROM) card, or a memory card has not been inserted. This message can also occur if remote programming commands for the memory card capability are executed with an HP 8590L, HP 8592L, or HP 8594L that does not have an Option 003. (U)

**INVALID CARD: BAD MEDIA**

Indicates the formatting routine (FORMAT CARD ) for the memory card could not be completed. See the description for INVALID CARD above for more information about the possible causes of this message. (U) and (H)

**INVALID CARD: DATA ERROR**

Indicates the data could not be retrieved from the memory card. (U) and (H)

**INVALID CARD: DIRECTORY**

Indicates the memory card has not been formatted. (U)

**INVALID CARD: NO CARD**

Indicates a memory card has not been inserted. (U)

**INVALID CARD: TYPE**

Indicates one of the following conditions: a card reader is not installed, the memory card is write-protected (check the position of the switch on the memory card), the memory card is a read-only memory (ROM) card, or a memory card has not been inserted. This message can also occur if remote programming commands for the memory card capability are executed with an HP 8590L, HP 8592L, or HP 8594L that does not have an Option 003. (U)

**INVALID CHECKSUM: USTATE**

The user-defined state does not follow the expected format. (U)

**INVALID COMPARE OPERATOR**

An IF/THEN or REPEAT/UNTIL routine is improperly constructed. Specifically, the IF or UNTIL operands are incorrect. (U)

**INVALID DET: FM or TV option only**

Indicates that the selected detector cannot be used until the appropriate option is installed in the spectrum analyzer. (U)

**INVALID ENTER FORMAT**

The enter format is not valid. See the appropriate programming command description to determine the correct format. (U)

**INVALID <file name> NOT FOUND**

Indicates that the specified file could not be loaded into spectrum analyzer memory or purged from memory because the file name cannot be found. (U)

**INVALID FILENAME \_ \_ \_**

Indicates the specified file name is invalid. A file name is invalid if there is no file name specified, if the first letter of the file name is not alphabetic, or if the specified file type does not match the type of file. See the description SAVRCLW or STOR programming command for more information. (U)

**INVALID FILE: NO ROOM**

Indicates that there is insufficient space available on the memory card to store the data. (U)

**INVALID HP-IB ADRS/OPERATION**

An HP-IB operation was aborted due to an incorrect address or invalid operation. Check that there is only one controller (the spectrum analyzer) connected to the printer or plotter. (U)

**INVALID HP-IB OPERATION REN TRUE**

The HP-IB operation is not allowed. (This is usually caused by trying to print or plot when a controller is on the interface bus with the spectrum analyzer.) To use the spectrum analyzer print or plot functions, you must disconnect any other controllers on the HP-IB. If you are using programming commands to print or plot, you can use an HP BASIC command instead of disconnecting the controller. See the *HP 8590 E-Series and L-Series Spectrum Analyzer and HP 8591C Cable TV Analyzer Programmer's Guide* for more information. (U)

**INVALID ITEM:- \_ \_**

Indicates an invalid parameter has been used in a programming command. (U)

**INVALID KEYLBL: \_ \_ \_**

Indicates that the specified key label contains too many characters. A key label is limited to 8 printable characters per label line. (U)

**INVALID KEYNAME: \_ \_ \_**

The specified key name is not allowed. (The key name may have conflicted with a spectrum analyzer programming command.) To avoid this problem, use an underscore as the second character in the key name, or avoid beginning the key name with the following pairs of letters: LB, OA, OL, TA, TB, TR, MA, MF, TS, OT, and DR. (U)

**INVALID OUTPUT FORMAT**

The output format is not valid. See the appropriate programming command description to determine the correct format. (U)

**INVALID RANGE: Stop < Start**

Indicates that the first trace element specified for a range of trace elements is larger than the ending trace element. When specifying a trace range the starting element must be less than the ending element. For example, TRA[2,300] is legal but TRA[300,2] is not. (U)

**INVALID REGISTER NUMBER**

The specified trace register number is invalid. (U)

**INVALID REPEAT MEM OVFL**

Memory overflow occurred due to a REPEAT routine. This can occur if there is not enough spectrum analyzer memory for the REPEAT UNTIL declaration, or if the REPEAT UNTIL declaration exceeds 2047 characters. (U)

**INVALID REPEAT NEST LEVEL**

The nesting level in the REPEAT routine is improperly constructed. This can occur if too many REPEAT routines are nested. When used within a downloadable program (DLP), the maximum number of REPEAT UNTIL statements that can be nested is 20. (U)

**INVALID RS-232 ADRS/OPERATION**

An RS-232 operation was aborted due to an invalid operation. (U)

**INVALID SAVE REG**

Data has not been saved in the specified state or trace register, or the data is corrupt. (U)

**INVALID SCRMOVE**

Indicates the spectrum analyzer may have a hardware failure. See The spectrum analyzer Service Guide for more information. (H)

**INVALID START INDEX**

Indicates that the first trace element specified for a range of trace elements is not within the trace range of the specified trace. (U)

**INVALID STOP INDEX**

Indicates that the ending trace element specified for a range of trace elements is not within the trace range of the specified trace. (U)

**INVALID STORE DEST: \_ \_ \_**

The specified destination field is invalid. (U)

**INVALID TRACE: \_ \_ \_**

The specified trace is invalid. (U)

**INVALID TRACE NAME: \_ \_ \_**

The specified trace name is not allowed. Use an underscore as the second character in the trace name, or avoid beginning the trace name with the following pairs of letters: LB, OA, OL, TA, TB, TR, MA, MF, TS, OT, and DR. (U)

**INVALID TRACENAME: \_ \_ \_**

Indicates the specified trace could not be saved because the trace name is not allowed. To avoid this problem, use an underscore as the second character in the trace name, or avoid beginning the trace name with the following pairs of letters: LB, OA, OL, TA, TB, TR, MA, MF, TS, OT, and DR. (U)

**INVALID VALUE PARAMETER: \_ \_ \_**

The specified value parameter is invalid. (U)

**INVALID VARDEF: \_ \_ \_**

The specified variable name is not allowed. To avoid this problem, use an underscore as the second character in the variable label, or avoid beginning the variable label with the following pairs of letters: LB, OA, OL, TA, TB, TR, MA, MF, TS, OT, and **DR**. (U)

**INVALID WINDOW TYPE: \_ \_ \_**

The specified window is invalid. See the description for the TWINDOW programming command. (U)

**LOST SIGNAL**

For the HP 8592L, HP 8593E, or HP 85963, this message indicates that the cable from the 100 MHz COMB OUT connector to the spectrum analyzer input is defective or has become disconnected during the CAL YTF routine. For the HP 85953, this message indicates that the cable from the CAL OUT connector is defective or has been disconnected during the CAL YTF routine. Be sure to use a short, low-loss cable to connect the signal to the spectrum analyzer input when performing the CAL YTF routine. (U)

**LO UNLVL**

Indicates that the spectrum analyzer local oscillator distribution amplifier is not functioning properly. (H)

**Marker Count Reduce SPAN**

Indicates the resolution bandwidth to span ratio is too small to use the marker count function. Check the span and resolution bandwidth settings. (U)

**Marker Count Widen RES BW**

Indicates that the current resolution bandwidth setting is too narrow to use with the marker counter function. The marker counter function can be in narrow resolution bandwidths (bandwidths that are less than 1 kHz) with the following procedure:

1. Place the marker on the desired signal.
2. Increase the resolution bandwidth to 1 kHz and verify the marker is on the signal peak.
3. If the marker is on the signal peak, the marker count function can be used in either the 1 kHz resolution bandwidth or the original narrow resolution bandwidth setting. If the marker is not on the signal peak, it should be moved to the signal peak and the marker counter function should not be used with a resolution bandwidth setting of less than 1 kHz.

(U)

**MEAS UNCAL**

The measurement is uncalibrated. Check the sweep time, span, and bandwidth settings, or press **AUTO COUPLE**, AUTO ALL. (U)

**MEMORY OVERFLOWERASE DLP MEM and reload**

This message indicates that too many user-defined items (functions, variables, key definitions), or downloadable programs have been loaded into spectrum analyzer memory. If this message appears, use ERASE DLP MEM and then load the user-defined item or downloadable program into spectrum analyzer memory. (U)

**No card found**

Indicates that the memory card is not inserted. (U)

**No points defined**

Indicates the specified limit line or amplitude correction function cannot be performed because no limit line segments or amplitude correction factors have been defined. (U)



**OVEN COLD**

Indicates that the spectrum analyzer has been powered up for less than 5 minutes. (The actual temperature of the precision frequency oven is not measured.) (Option 004 only.) (M)

**PARAMETER ERROR: - - -**

The specified parameter is not recognized by the spectrum analyzer. See the appropriate programming command description to determine the correct parameters. (U)

**PASSCODE NEEDED**

Indicates that the function cannot be accessed without the pass code. (U)

**POS-PK FAIL**

Indicates the positive-peak detector has failed. (H)

**REF UNLOCK**

Indicates that the frequency reference is not locked to the external reference input. Check that the 10 MHz REF OUT connector is connected to the EXT REF IN connector, or, when using an external reference, that an external 10 MHz reference source of sufficient amplitude is connect to the EXT REF IN connector. (U) and (H)

**Require 1 signal > PEAK EXCURSION above THRESHOLD**

Indicates that the N dB PTS routine cannot locate a signal that is high enough to measure. The signal must be greater than the peak excursion above the threshold level to measure. (U)

**Require 3 signals > PEAK EXCURSION above THRESHOLD**

Indicates that the % AM routine cannot locate three signals that are high enough to measure. The signals must be greater than the peak excursion above the threshold level to measure. (U)

**Require 4 signals > PEAK EXCURSION above THRESHOLD**

Indicates that the TO1 routine cannot locate four signals that are high enough to measure. The signals must be greater than the peak excursion above the threshold level to measure. (U)

**Required option not installed** Some spectrum analyzer functions require that an option be installed in the spectrum analyzer. See the description for the function in the *HP 8590 E-Series and L-Series Spectrum Analyzers* User's Guide for more information about which option is required. (U)

**RES-BW NOISE FAIL**

Indicates the noise floor level is incorrect at the indicated bandwidth. (H)

**RES-BW SHAPE FAIL**

Indicates the 3 dB bandwidth is not within specifications. (H)

**RF PRESEL ERROR**

Indicates that the preselector peak routine cannot be performed. (H)

**RF PRESEL TIMEOUT**

Indicates that the preselector peak routine cannot be performed. (H)

**SAMPLE FAIL**

Indicates the sample detector has failed. (H)

**SETUP ERROR**

Indicates that the span, channel bandwidth, or channel spacing are not set correctly for the adjacent channel power or channel power measurement. (U)

**SIGNAL NOT FOUND**

Indicates the PEAK ZOOM routine did not find a valid signal. (U)

**SIGNAL CLIPPED**

Indicates that the current FFT measurement sweep resulted in a trace that is above the top graticule line on the spectrum analyzer display. If this happens, the input trace (trace A) has been “clipped,” and the FFT data is not valid. (U)

**Signals do not fit expected % AM pattern**

Indicates that the % AM routine cannot perform the percent AM measurement because the on-screen signals do not have the characteristics of a carrier with two sidebands. (U)

**Signals do not fit expected TO1 pattern**

Indicates that the TO1 routine cannot perform the third-order intermodulation measurement because the on-screen signals do not have the characteristics of two signals and two distortion products. (U)

**SMPLR UNLCK**

Indicates that the sampling oscillator circuitry is not functioning properly. If this message appears, check that the external frequency reference is correctly connected to the EXT REF INPUT. (U) and (H)

**SOFTKEYOVFL**

Softkey nesting exceeds the maximum number of levels. (U)

**SRQ ---**

The specified service request is active. Service requests are a form of informational message and are explained in Appendix A of the *HP 8590 E-Series and L-Series Spectrum Analyzers User's Guide*. (M)

**STEP GAIN/ATTN FAIL**

Indicates the step gain has failed. (H)

**Stop at marker not available with negative detection**

Indicates that the marker counter cannot be used when negative peak detection is selected. To use the marker counter, turn off negative peak detection with DETECTOR PK SP NG . (U)

**TABLE FULL**

Indicates the upper or lower table of limit lines contains the maximum number of entries allowed. Additional entries to the table are ignored. (U)

**TG SIGNAL NOT FOUND**

Indicates the tracking generator output signal cannot be found. Check that the tracking generator output (RF OUT 500 or RF OUT 75Ω) is connected to the spectrum analyzer input connector with an appropriate cable. (U)

**TG UNLVL**

This message can indicate the following: that the source power is set higher or lower than the spectrum analyzer can provide, that the frequency span extends beyond the specified frequency range of the tracking generator, or that the calibration data for the tracking generator is incorrect. See “Stimulus-Response Measurements” in Chapter 4 of the *HP 8590 E-Series and L-Series Spectrum Analyzers User's Guide* for more information. (17)

**Too many signal with valid N dB points**

Indicates the N dB PTS function has located two or more signals that have amplitudes within the specified dB from the signal peak. If this happens, you should decrease the span of the spectrum analyzer so that only the signal that you want to measure is displayed. (U)

**Trace A is not available**

Indicates that trace A is in the store-blank mode and cannot be used for limit-line testing. Use CLEAR WRITE A or VIEW A to change trace A from the store-blank mode to the clear write mode, and then turn on limit-line testing. (U)

**UNDF KEY**

The softkey number is not recognized by the spectrum analyzer. (U)

**USING DEFAULTS self cal needed**

Indicates that the current correction factors are the default correction factors and that the CAL FREQ & AMPTD routine needs to be performed. For the HP 8592L, HP 85933, HP 85953, or HP 85963, CAL YTF routine needs to be performed also. (U)

**Verify gate trigger input is disconnected before CAL AMPTD**

This message is meant to remind you that nothing should be connected to the GATE TRIGGER INPUT connector on the spectrum analyzer rear panel during the CAL AMPTD routine. (U)

**VID-BW FAIL**

Indicates the video bandwidths have failed. (H)

**Waiting for gate input . . .**

Indicates that the spectrum analyzer needs an external trigger signal to use the time-gating functions. Before using the time-gating functions, you should ensure there is a trigger pulse connected to the GATE TRIGGER INPUT connector on the rear panel of spectrum analyzer and that the GATE OUTPUT is connected the EXT TRIG INPUT connector. If you do not want to use the time-gating functions, press **PRESET**. (U)

**YTF is not available**

The YTF is only available for the HP 8592L, HP 85933, HP 85953, and HP 85963. (U)

# Measurement Personalities, Options, and Accessories

---

## What You'll Find In This Chapter

Many measurement personalities, options, and accessories are available to enhance the spectrum analyzer so that it will better meet the needs of your application. This chapter contains a list of the available measurement personalities, options, and accessories for your spectrum analyzer.

---

## Measurement Personalities

### Broadcast Measurements Personality

For use with the **HP 85913, HP 8593E, HP 8594E, HP 85953, or HP 8596E**. The HP 85724A Broadcast Measurements Personality provides customized RF video measurements for testing broadcast transmitters. The Broadcast Measurements Personality is a downloadable program on a memory card. It allows simple selection of either PAL-I or PAL-B/G systems. The channel bands CCIR VHF, CCIR UHF or CCIR CATV S can be selected. There are 14 measurements including: carrier level, carrier to noise, intermodulation, and NICAM level.

### CATV Measurements Personality

**The HP 85901, HP 8592L, and HP 8594L must have Option 003.** The HP 85711B cable television measurements personality provides a quick and easy way to adapt your spectrum analyzer for making cable TV measurements while retaining spectrum analysis capability. The CATV measurements personality is a downloadable program on a memory card that adds a set of eight functions to simplify cable TV testing: channel selection, carrier level, carrier-to-noise, power line hum, crossmodulation, composite triple beat, modulation depth, and system frequency response.

### CATV System Monitor Personality

**The HP 8590L, HP 8592L, and HP 8594L must have Option 003.** The HP 85716A CATV system monitor personality provides automatic measurements for testing and monitoring your cable TV system. It can continuously measure headend signal quality and simplify system proof-of-performance testing. The CATV system monitor personality is a downloadable program on a memory card. It has seven different channel tests and two system tests (for systems with NTSC format), and can do performance testing without interrupting service.

### Cable TV Measurements and System Monitor Personality

**The HP 8590L, HP 8592L, and HP 8594L must have Option 003.** The HP 85721A Cable TV Measurements Personality provides one-button diagnostic measurements, automatic system test and monitoring, and with Option 107, non-interfering RF and video measurements (including FCC proof of performance) are available. This downloadable program on a memory card additionally includes the functionality of both the HP 85711B and the HP 85716A Cable TV Measurement Personalities.

The use of this personality is limited in the HP 8590L and the HP 8592L spectrum analyzers.

### CDMA Measurements Personality

**For use with the HP 8591E, HP 85933, HP 8594E, HP 8595E, or HP 8596E.** The HP 85725B CDMA measurements personality provides RF transmitter measurements for testing CDMA cellular radio mobile stations and base stations. In addition, it provides channel plans for IS-95, J-STD-008, Korean and ARIB-T53 (Japan) Standards. The measurements include: transmit and receive RF channel power, in-band and out-of-band spurious emissions, standby output power, occupied bandwidth, gated output power, time response to open loop power control, and others.

The HP 85725B CDMA measurements personality is a downloadable program on a memory card. (See Option 053 in this chapter.)

## CT2-CAI Measurements Personality

*For use with the HP 8591E, HP 8593E, HP 8594E, HP 8595E, or HP 8596E.* The HP 85717A CT2-CAI measurements personality provides RF transmitter measurements for testing CT2 cordless telephone handsets and bases. The measurements include: mean carrier power, carrier-off power, adjacent channel power, out-of-band power, spurious emissions, intermodulation attenuation, and frequency error deviation. The CT2-CAI measurements personality is a downloadable program on a memory card.

## DECT Measurements Personality

*For use with the HP 8593E, HP 8594E, HP 8595E, and HP 85963 only.* The HP 85723A measurements personality provides RF transmitter measurements for testing DECT (Digital European Cordless Telephone) handsets and base stations. The measurements include: mean carrier power, adjacent channel power due to modulation, adjacent channel power due to switching transients, spurious emissions, intermodulation attenuation, frequency error, and frequency deviation. The DECT measurements personality is a downloadable program on a memory card.

## Digital Radio Measurements Personality

*For use with the HP 8592L, HP 8593E, HP 8594E, HP 8594L, HP 8595E, or HP 8596E. The HP 8592L and HP 8594L must have Option 003.* The HP 85713A digital radio measurements card provides an easy way to measure band occupancy and transmitter spurious outputs, as well as determine the sources of interference including external broadcast or multipath effects. The digital radio measurements personality is a downloadable program on a memory card. It qualifies the occupied bandwidth of a modulated digital radio signal, the mean power level of unmodulated carrier, and quantifies modulator alignment.

## EM1 Diagnostics Measurements Personality

*Use the HP 85712D EMI diagnostics measurements personality with the HP 85913, HP 85933, HP 8594E, HP 8595E, or HP 8596E.* The EM1 diagnostics measurements personality provides an easy way to find EM1 “hot spots” in your new-product designs quickly and easily with the HP 11940A or HP 11941A close-field probe. The EM1 diagnostics measurements personality is a downloadable program on a memory card. The field strength is measured directly at the probe tip in dB $\mu$ A/m, and antenna factors for the probe are automatically applied. A special function helps you to discriminate between narrowband and broadband signals.

## GSMSOO and DCS1800 Transmitter Measurements Personalities

*For use with the HP 8591E (GSMSOO only), HP 85933, HP 8594E, HP 8595E, or HP 85963.* The HP 85715B GSMSOO and HP 85722B DCS1800 measurements personalities provide customized measurements for testing GSMSOO and DCS1800 transmitters respectively. These measurement personalities are available as downloadable programs on memory cards. They provide real-time displays of measurements like mean transmitted carrier power, power versus time, output RF spectrum, spurious emissions, intermodulation attenuation, combiner tuning and phase and frequency error.

## Link Measurement Personality

**For use with the HP 85933, HP 8594E, HP 85953, and HP 8596E only. The spectrum analyzer must be configured with options 010 and 111.** The HP 11770A Link Measurement Personality is a downloadable program on a memory card. It provides a way to adapt your spectrum analyzer for making end-to-end and loop back measurements of group delay and amplitude flatness. These are important test requirements for digital microwave radio, satellite, cable, and other systems.

## NADC-TDMA Measurements Personality

**For use with HP 8590 E-Series spectrum analyzers.** The HP 85718B NADC-TDMA measurements personality provides the capability for the spectrum analyzer to make 9 transmitter RF tests and 7 transmitter modulation accuracy tests based on IS-54, IS-55, IS-56, IS-136, IS-137, and IS-138 standards. The HP 85913 is compatible with HP 85718B if no modulation accuracy tests are needed. (See Option 050 in this chapter.)

## Noise Figure Measurements Personality

**For use with HP 8590 E-Series spectrum analyzers with Option 119.** The HP 85719A noise-figure measurement personality along with the HP 8590 E-Series spectrum analyzer provide displayed swept noise-figure and gain measurements from 10 MHz to 2.9 GHz. Features include one-point measurement capability for quick results, noise-figure and spectrum analyzer mode-switching for stray signal detection, selectable measurement bandwidths to directly measure narrowband devices, and a repeatability calculator to determine measurement time and repeatability.

## PDC Measurements Personality

**For use with HP 85933, HP 8594E, HP 85953, and HP 8596E spectrum analyzers.** The HP 85720C PDC measurements personality simplifies testing of personal digital cellular (PDC) transmitters by providing power, frequency, timing, spurious emission, and modulation accuracy measurements based on RCR STD-27C. The HP 85913 is compatible with HP 85720C if no modulation accuracy tests are needed. (See Option 051 in this chapter.)

## PHS Measurements Personality

**For use with HP 8593E, HP 8594E, HP 85953, and HP 8596E spectrum analyzers.** The HP 85726B PHS measurements personality simplifies testing of personal handy phone system transmitters by providing power, frequency, timing, spurious emission, and modulation accuracy measurements based on RCR STD-28. (See Option 052 in this chapter.)

## Scalar Measurements Personality

**For use with the HP 85901, HP 8591E, HP 8593E, HP 8594E, HP 85953, or HP 85963 with tracking generator Option 010. The HP 8590L must have Option 003.** The HP 85714A scalar measurements personality uses the optional built-in tracking generator to make scalar network analysis measurements with your spectrum analyzer. The scalar measurements personality is a downloadable program on a memory card. It provides for high dynamic range measurements and can make simultaneous transmission and reflection measurements using the HP 85630A transmission/reflection test set. Marker measurements of frequency, power, return loss, VSWR, and reflection/transmission coefficients are quick and easy. The scalar measurement personality also includes simple one-button measurements for 3 dB or 6 dB bandwidth, Q factor, shape factor, and insertion loss/gain.

---

## Options

Options can be ordered by option number when you order the spectrum analyzer. Some of the options are also available as kits that can be ordered and installed after you have received your spectrum analyzer. The options are listed numerically by their option number.

### 750 Input Impedance (Option 001)

**For HP 8590L and HP 85913 only.** This option provides a 75Ω input impedance instead of the standard 50Ω impedance. Spectrum analyzers with this option use cables, circuit boards, and front panels that are different from the standard units.

### Memory Card Reader (Option 003)

**For HP 8590L, HP 8592L, and HP 8594L only.** This option provides a memory card reader to save and recall data from a memory card. Spectrum analyzers with this option have an opening on the front panel to insert the memory card. Option 003 includes a 32 Kbyte memory card and a memory card holder. The memory card reader is standard for the HP 85913, HP 8593E, HP 85943, HP 85953, and HP 85963.

Option 003 is also available as a retrofit kit (Option R03) after the purchase of your spectrum analyzer, or as a kit HP part number 5062-6456.

### Precision Frequency Reference (Option 004)

**For HP 8591E, HP 8593E, HP 8594E, HP 8595E, and HP 85963 only.** This option provides increased absolute frequency-reference accuracy because the internal oscillators are phase-locked to an internal precision-frequency reference.

Option 004 is also available as a retrofit kit (Option R04) after the purchase of your spectrum analyzer, or as a kit HP part number 5062-6459.

### LO and Sweep + Tune Outputs on Rear Panel (Option 009)

**For HP 8593E, HP 8594E, HP 85953, and HP 85963 only.** Option 009 provides local oscillator output and sweep + tune output at the rear panel for use with external tracking sources such as HP 85644A and HP 85645A.



## Tracking Generator (Option 010 and Option 011)

For **HP 8593E, HP 8594E, HP 8595E, and HP 8596E only**. Option 010 provides a 9 kHz to 2.9 GHz built-in tracking generator. This source-receiver combination makes insertion-loss, frequency response, and return-loss measurements. The tracking generator has a wide distortion-free dynamic range, plus good sensitivity and selectivity. Option 010 has the standard 50 $\Omega$  output impedance.

**HP 85933, HP 8594E, HP 8595E, and HP 85963:** Option 010 is also available, with factory installation (Option K10) after the purchase of your spectrum analyzer.

For **HP 8590L and HP 8591E only**, Option 010 (100 kHz to 1.8 GHz) or 011 (1 MHz to 1.8 GHz) provides a built-in tracking generator.

Option 010 has the standard 500 output impedance. Option 011 has 75 $\Omega$  output impedance.

**HP 8590L:** Options 010 and 011 are also available as retrofit kits (Option R10 or R11) after the purchase of your spectrum analyzer, or as kits HP part number 5062-6463 and 5062-6479 respectively.

**HP 8591E:** Options 010 and 011 are also available as retrofit kits (Option R10 or R11) after the purchase of your spectrum analyzer, or as kits HP part numbers 5062-6460 and 5062-6480 respectively.

## Protective 'Em Operating/Carrying Case with Shoulder Strap (Option 015)

This option lowers the maximum ambient operating temperature specification by 5 °C. It allows instrument operation while installed in the case.

It is a soft nylon operating and carrying case with a shoulder strap and a pouch for accessories. It includes a CRT viewing hood for operation in direct sunlight. Option 015 can be used to provide additional protection during travel.

## Protective Yellow Operating/Carrying Case with Shoulder Strap (Option 016)

This option lowers the maximum ambient operating temperature specification by 5 °C. It allows instrument operation while installed in the case.

It is a soft nylon operating and carrying case with a shoulder strap and a pouch for accessories. It includes a CRT viewing hood for operation in direct sunlight. Option 016 can be used to provide additional protection during travel.

## HP-IB and Parallel Interface (Option 041)

Option 041 allows you to control your spectrum analyzer from a computer that uses a Hewlett-Packard interface bus (HP-IB). Such computers include the HP 9000 Series 300, and the IIP Vectra PC. Option 041 includes a connector for an external keyboard, an HP-IB connector, a parallel interface connector for printers, and the **HP 8590 E-Series and L-Series Spectrum Analyzer and HP 8591C Cable TV Analyzer Programmer's Guide**.

Option 041 allows the spectrum analyzer to copy its screen to a printer or plotter and includes a separate connector that accepts programming commands from an external keyboard.

Option 041 is also available as a retrofit kit (Option R41) after the purchase of your spectrum analyzer, or as a kit HP part number 08590-60380.

---

**Note** Option 041 can be converted to an Option 043 by ordering the RS-232 and parallel interface connector assembly HP part number 08590- 60369.

---

### RS-232 and Parallel Interface (Option 043)

Option 043 allows you to control your spectrum analyzer from a computer that **uses an** RS-232 interface bus. Such computers include the HP Vectra PC, the IBM PC, the AT, and compatibles. It includes a connector for an external keyboard, an RS-232 9-pin connector, a parallel interface connector for printers, and the **HP 8590 E-Series and L-Series Spectrum Analyzer and HP 8591 C Cable TV Analyzer Programmer's Guide**.

Option 043 allows the spectrum analyzer to copy its screen to a printer or plotter and includes a separate connector that accepts programming commands from an external keyboard.

Option 043 is also available as a retrofit kit (Option R43) after the purchase of your spectrum analyzer, or as a kit HP part number 08590-60381.

---

**Note** Option 043 can be converted to an Option 041 by ordering the HP-IB and parallel interface connector assembly HP part number 08590- 60368.

---

### Frequency Extension to 26.5 GHz with APC-3.5 Connector (Option 026)

**For HP 8592L and HP 8593E only.** The frequency range of the spectrum analyzer is extended from 22 GHz to 26.5 GHz. Analyzers with this option use an APC-3.5 connector on the RF INPUT, and circuit boards and front panels that are different from the standard units.

### Frequency Extension to 26.5 GHz with N-Type Connector (Option 027)

**For HP 8592L and HP 8593E only.** The frequency range of the spectrum analyzer is extended from 22 GHz to 26.5 GHz. Analyzers with this option use an N-Type connector on the RF INPUT, and circuit boards and front panels that are different from the standard units.

---

**Note** The extended frequency specifications only apply when using the Type-N to SMA adaptor that is supplied with the option.

---

### Front Panel Protective Cover (Option 040)

The impact cover assembly snaps onto the front of your spectrum analyzer to protect the front panel during travel and when the unit is not in use.

Option 040 is also available as a kit (Impact Cover Assembly, HP part number 5062-4805).

### Protective Soft Carrying Case/Back Pack (Option 042)

Option 042 can be used to provide additional protection during travel. In addition, it provides a pouch for accessories. (Cannot operate instrument while installed in case.)

## Improved Amplitude Accuracy for NADC bands (Option 050)

**For HP 8591E, HP 8593E, HP 8594E, HP 8595E, and HP 8596E only.** This is an amplitude calibration that improves specifications to  $\pm 0.6$  dB at 20-30° C for NADC frequency bands 824 to 849 MHz and 869 to 894 MHz. In addition, it improves specifications to  $\pm 0.9$  dB at 20-30° C in the frequency bands 1850 to 1910 MHz and 1930 to 1990 MHz

Option 050 is also available as a service center only retrofit kit (Option R50) after the purchase of your spectrum analyzer.

## Improved Amplitude Accuracy for PDC bands (Option 051)

**For HP 8591E, HP 8593E, HP 8594E, HP 8595E, and HP 8596E only.** This is an amplitude calibration that improves specifications to  $\pm 0.5$  dB at 20-30° C for the PDC frequency bands in the 810 to 956 MHz and 1429 to 1501 MHz frequency ranges.

Option 051 is also available as a service center only retrofit kit (Option R51) after the purchase of your spectrum analyzer.

## Improved Amplitude Accuracy for PHS (Option 052)

**For HP 8593E, HP 8594E, HP 8595E, and HP 8596E only.** This is an amplitude calibration that improves specifications to  $\pm 0.5$  dB at 20-30° C for the PHS frequency band in the 1895 to 1918 MHz frequency range.

Option 052 is also available as a service center only retrofit kit (Option R52) after the purchase of your spectrum analyzer.

## Improved Amplitude Accuracy for CDMA (Option 053)

**For HP 8591E, HP 8593E, HP 8594E, HP 8595E, and HP 8596E only.** This is an amplitude calibration that improves specifications to  $\pm 0.6$  dB at 20-30° C for CDMA frequency bands 824 to 849 MHz and 869 to 894 MHz. In addition, it improves specifications to  $\pm 0.9$  dB at 20-30° C in the frequency bands 1850 to 1910 MHz and 1930 to 1990 MHz

Option 053 is also available as a service center only retrofit kit (Option R53) after the purchase of your spectrum analyzer.

## Fast Time Domain Sweeps (Option 101)

**For HP 8591E, HP 8593E, HP 8594E, HP 8595E, and HP 8596E only.** Option 101 allows sweep times down to 20  $\mu$ s in zero span. In fast sweep times (sweep times less than 20 ms), time domain sweeps are digitized. All trace functions are available for these fast zero-span sweeps. Also see Option 301 below.

Option 101 also adds the analog+ display mode and negative peak detection to the spectrum analyzer. The analog+ display mode provides traditional analog display operation combined with the advantages of digital display features like markers, screen titles, and hard copy output. The negative peak detector capability is useful for video modulator balance adjustments and intermodulation distortion measurements.

Option 101 is also available as a retrofit kit (Option R01) after the purchase of your spectrum analyzer, or as a kit HP part number 5062-6458.

## AM/FM Demodulator with Speaker and TV Sync Trigger Circuitry (Option 102)

*For HP 85913, HP 8593E, HP 8594E, HP 8595E, and HP 85963 only.* Option 102 enables you to use amplitude or frequency demodulation and to listen to a demodulated signal. Option 102 also allows you to TV trigger on the selected line of a TV video picture frame if both Option 101 and 102 are installed. The sweep triggering works with interlaced or noninterlaced displays for the NTSC, PAL, and SECAM formats. Also see Option 301 below.

Option 102 is also available as a retrofit kit (Option R02) after the purchase of your spectrum analyzer, or as a kit HP part number 5062-6457.

## Quasi-Peak Detector and AM/FM Demodulator With Speaker (Option 103)

*For HP 8591E, HP 8593E, HP 8594E, HP 85953, and HP 8596E only.* Option 103 enables you to make automatic or manual quasi-peak measurements, to listen to a demodulated signal, and to use amplitude or frequency demodulation.

Option 103 is available as a kit, order HP 11946A.

## Time-Gated Spectrum Analysis (Option 105)

*For HP 8591E, HP 85933, HP 8594E, HP 8595E, and HP 8596E only.* Option 105 allows you to selectively measure the spectrum of signals that may overlap in the frequency domain, but be separated in the time domain. By adjusting a time gate based on a user-supplied trigger signal, you can significantly increase the diagnostic capability of your spectrum analyzer for time-interleaved signals.

Option 105 is also available as a retrofit kit (Option R15) after the purchase of your spectrum analyzer, or as a kit 5062-8218.

Option 101 is recommended in addition to Option 105 since it significantly decreases sweep time and therefore the resolution in the time domain.

## CT2 Demodulator (Option 110)

*For HP 85913, HP 8593E, HP 8594E, HP 85953, and HP 8596E only.* Option 110 provides built-in demodulation capability for making CT2 transmitter measurements. It must be used with the HP 85717A CT2-CAI measurements personality to make frequency deviation measurements on CT2 cordless telephone handsets and bases.

Option 110 is also available as a retrofit kit (Option R05) after the purchase of your spectrum analyzer, or as a kit HP part number 5063-0244.

## Group Delay and Amplitude Flatness (Option 111)

*For HP 85933, HP 8594E, HP 8595E, and HP 8596E only.* Option 111 allows you to make end-to-end and loop back measurements of group delay and amplitude flatness. It must be used with HP 11770A Link Measurement Personality and the Option 010, Tracking Generator. HP 11768A Group Delay and Amplitude Flatness Retrofit Kit contains both the Option 111 and the HP 11770A Link Measurement Personality. This kit is factory retrofittable only.

## DECT Demodulator (Option 112)

**For HP 8593E, HP 8594E, HP 8595E, and HP 8596E only.** This option provides built-in demodulation capability for making DECT (Digital European Cordless Telephone) measurements. It must be used with HP 85723A measurements personality to make frequency and deviation measurements on DECT handsets and base stations.

Option 112 is also available as a retrofit kit (Option R06) after the purchase of your spectrum analyzer.

## Noise Figure (Option 119)

**For HP 85933, HP 85943, HP 8595E, and HP 8596E only.** This option along with the HP 85719A Noise-Figure Measurement Personality provide displayed swept noise-figure and gain measurements from 10 MHz to 2.9 GHz.

Option 119 is also available as a retrofit kit (Option R19) after the purchase of your spectrum analyzer, or as a kit HP part number 5063-0247.

## Narrow Resolution Bandwidths (Option 130)

**For HP 85913, HP 85933, HP 8594E, HP 85953, and HP 8596E only.** This option provides additional narrow resolution bandwidths of 30 Hz, 100 Hz, and 300 Hz. These bandwidths improve the spectrum analyzer sensitivity and allow you to resolve closely spaced signals.

Option 130 is also available as a retrofit kit (Option R30) after the purchase of your spectrum analyzer, or as a kit HP part number 5063-0246.

## Narrow Resolution Bandwidths and Precision Frequency Reference (Option 140)

**For HP 8591E, HP 8593E, HP 85943, HP 85953, and HP 85963 only.** This option is a combination of Option 130 and Option 004. Option 140 provides additional narrow resolution bandwidths of 30 Hz, 100 Hz, and 300 Hz. These bandwidths improve sensitivity and allow you to resolve closely spaced signals. The option also includes an internal precision-frequency reference that improves stability and provides increased absolute frequency accuracy. The precision frequency reference makes the narrow resolution bandwidths more effective and easier to use.

## DSP, Fast ADC and Digital Demodulator (Option 151)

**For HP 8593E, HP 8594E, HP 85953, and HP 85963 only.** Option 151 supplies the hardware required for fast time domain sweeps, digital demodulation measurements, and digital signal processor-assisted (DSP) measurements.

Option 151 provides a subset of Option 101 fast time domain functions. Option 101 allows zero span sweep times as low as 20  $\mu\text{sec}$  with a step resolution of 20  $\mu\text{sec}$  (20  $\mu\text{sec}$ , 40  $\mu\text{sec}$ , 60  $\mu\text{sec}$ , and so forth.) Option 151 allows zero span sweep times as low as 40  $\mu\text{sec}$  with a sequence of 40  $\mu\text{sec}$ , 80  $\mu\text{sec}$ , 160  $\mu\text{sec}$ , 320  $\mu\text{sec}$ , and 160  $\mu\text{sec}$  step size thereafter. All trace functions are available for these fast zero-span sweeps.

Since the sweep times offered by Option 151 are a subset of those offered by Option 101, the analog+ display mode is not supported for Option 151.

Option 101 or Option 151 support negative peak detection for an HP 85933, HP 85943, HP 8595E, and HP 85963. The negative peak detector capability is useful for video modulator balance adjustments and intermodulation distortion measurements. Option 101 allows negative peak detection with sweep times as high as 200 ms. Option 151 allows negative peak detection with sweep times as high as 800 ms.

Option 151 requires the installation of Option 160 or 163.

### **PDC/PHS/NADC/CDMA Firmware for Option 151 (Option 160)**

**for HP 85933, HP 8594E, HP 85953, and HP 85963 with Option 151 only.** Option 160 provides the digital signal processing (DSP) firmware ROMs necessary to perform PDC, PHS, or NADC digital demodulation-based measurements. It also includes DSP-assisted measurements for CDMA.

Option 160 implements a coherent downconversion, and calculates the minimum RMS error vector magnitude of a timeslot. Carrier frequency error and I-Q origin offset are also extracted from sampled data.

Option 151 with Option 160 and the HP 85718B NADC-TDMA measurements personality provide a complete NADC transmitter RF measurement solution including modulation metrics.

Option 151 with Option 160 and the HP 85720C PDC measurements personality provide a complete PDC transmitter RF measurement solution including modulation metrics.

Option 151 with Option 160 and the HP 85725B CDMA measurements personality provide a CDMA transmitter measurement solution with fast DSP-assisted measurements.

Option 151 with Option 160 and the HP 85726B PHS measurements personality provide a complete PHS transmitter RF measurement solution including modulation metrics.

### **GSM/DCS1800 Firmware for Option 151 (Option 163)**

**For HP 8593E, HP 8594E, HP 85953, and HP 85963 with Option 151 only.** Option 163 provides Option 151 Digital Demodulator hardware with a firmware algorithm that demodulates GSM and DCS1800 radio carriers in order to make modulation quality measurements.

Option 163 is also available as a retrofit kit (Option R63) for spectrum analyzers that already have Option 151 installed. For analyzers that do not have Option 151 installed, a retrofit kit (Option R73) is available to provide both options 151 and 163.

### **TV Picture Display (Option 180)**

**For HP 8591C, HP 8591E, HP 85933, HP 8594E, HP 8595E, and HP 8596E only.** Option 180 allows you to view an NTSC, PAL, or SECAM television picture on the spectrum analyzer display.

Option 180 is also available as a retrofit kit (Option R80) after the purchase of your spectrum analyzer, or as a kit HP part number 08591-60089.

## TV Sync Trigger Capability/Fast Time-Domain Sweeps and AM/FM Demodulator (Option 301)

*For HP 85913, HP 85933, HP 8594E, HP 85953, and HP 85963 only.* Option 301 is a combined option made of Options 101 and 102, allowing sweep times down to 20  $\mu$ s in zero span, enabling use of amplitude or frequency demodulation, and allowing a demodulated signal to be listened to. See Options 101 and 102 above for more detailed descriptions.

## 50 $\Omega$ to 75 $\Omega$ Matching Pad (Option 711)

*For E-Series and L-Series spectrum analyzers.* This option provides a 50 $\Omega$  to 75 $\Omega$  matching pad with dc block to be used on the spectrum analyzer input. The pad has a frequency range of 1 MHz to 1.8 GHz. It adapts your standard 50 $\Omega$  spectrum analyzer to be compatible with a 75 $\Omega$  system under test.

Option 711 is also available as HP part number 08590-60090.

## Reduced Frequency Accuracy (Option 713)

*For HP 8590L only.* Option 713 removes the built-in frequency counter from your spectrum analyzer. This reduces the frequency accuracy of your measurements.

## Rack Mount Kit Without Handles (Option 908)

This option provides the parts necessary to mount the spectrum analyzer in an HP System II cabinet or in a standard 19 inch (482.6 mm) equipment rack.

Option 908 is also available as a kit (HP part number 5062-4841).

## Rack Mount Kit With Handles (Option 909)

Option 909 is the same as Option 908 but includes front handles for added convenience.

Option 909 is also available as a kit (HP part number 5062-4840).

## User's Guide and Calibration Guide (Option 910)

An additional copy of the *HP 8590 E-Series and L-Series Spectrum Analyzers User's Guide*, the *HP 8590 E-Series and L-Series Series Spectrum Analyzers Quick Reference Guide*, and the *Calibration Guide* of the appropriate model number for your spectrum analyzer, are available as a set under Option 910.

## Service Documentation (Option 915)

Option 915 provides one copy of the assembly-level repair service guide and one copy of the component-level repair service guide. The assembly-level repair service guide describes assembly level troubleshooting procedures and adjustment procedures. The component-level repair service guide includes parts lists, component-location diagrams, and schematic diagrams for selected repairable assemblies. The manuals can be ordered separately.

## BenchLink Spectrum Analyzer (Option B70)

Option B70 provides the BenchLink Spectrum Analyzer software that can be used to capture screen images and trace data using a Personal Computer (PC). The captured information can then be used in other PC applications, including word processing and spreadsheets.

---

## Accessories

A number of accessories are available from Hewlett-Packard to help you configure your spectrum analyzer for your specific applications. They can be ordered through your local HP Sales and Service Office.

### RF and Transient Limiters

The HP 11867A and HP 11693A RF Limiters protect the spectrum analyzer input circuits from damage due to high power levels. The HP 11867A operates over a frequency range of DC to 1800 MHz and begins reflecting signal levels over 1 milliwatt up to 10 watts average power and 100 watts peak power. The HP 11693A microwave limiter (0.1 to 12.4 GHz, usable to 18 GHz) guards against input signals over 1 milliwatt up to 1 watt average power and 10 watts peak power.

The 11947A Transient Limiter protects the spectrum analyzer input circuits from damage due to signal transients. It specifically is needed for use with a line impedance stabilization network (NISN). It operates over a frequency range of 9 kHz to 200 MHz, with 10 dB of insertion loss.

### 50 $\Omega$ Transmission/Reflection Test Set

The HP 85044A Option H10 transmission/reflection test set provides the capability to simultaneously measure the impedance and transmission characteristics of 50 $\Omega$  devices. It is effective over a frequency range of 300 kHz to 3 GHz.

### Scalar 503 Transmission/Reflection Test Set

The HP 85630A scalar transmission/reflection test set provides the capability to simultaneously measure the impedance and transmission characteristics of devices. It is effective over a frequency range of 300 kHz to 2.9 GHz and must be used with the HP 85714A scalar measurements personality.

### 50 $\Omega$ /75 $\Omega$ Minimum Loss Pad

The HP 11852B is a low VSWR minimum loss pad that is required for measurements on 75 $\Omega$  devices using an spectrum analyzer with a 50 $\Omega$  input. It is effective over a frequency range of dc to 2 GHz. The minimum loss pad can be order as Option 004 at the time the instrument is ordered.

### 753 Matching Transformer

The HP 11694A allows you to make measurements in 75 $\Omega$  systems using a spectrum analyzer with a 50 $\Omega$  input. It is effective over a frequency range of 3 to 500 MHz.

### RF Bridges

The HP 86205A 50 $\Omega$  RF bridge and HP 86207A 75 $\Omega$  RF bridge can be used to make reflection measurements with the spectrum analyzer. These external directional bridges offer high directivity and excellent port match. The HP 86205A operates over a frequency range of 300 kHz to 6 GHz. The HP 86207A operates over a frequency range of 300 kHz to 3 GHz.



## AC Power Source

The HP 85901A provides 200 watts of continuous power for field and mobile application. The self-contained ac power source has outputs for either 115 V or 230 V and runs on its own internal battery, an external battery, or on another 12 V dc source. Typical operating time exceeds 1 hour for 100 watt continuous use at room temperature.

## AC Probe

The HP 85024A high frequency probe performs in-circuit measurements without adversely loading the circuit under test. The probe has an input capacitance of 0.7 pF shunted by 1 M $\Omega$  of resistance and operates over a frequency range of 300 kHz to 3 GHz. High probe sensitivity and low distortion levels allow measurements to be made while taking advantage of the full dynamic range of the spectrum analyzer.

---

**Caution** Do not use dc-coupled probes on HP 8592L and HP 85933 analyzers; they may cause damage to the spectrum analyzer input circuit.

When using a dc-coupled probe with an HP 85943, HP 85953, or HP 85963, the spectrum analyzer must be set to ac coupling. To set the analyzer to ac coupling, press AMPLITUDE, More 1 of 3, More 2 of 3, COUPLE AC DC so that AC is underlined.

---

## Broadband Preamplifiers and Power Amplifiers

Preamplifiers and power amplifiers can be used with your spectrum analyzer to enhance measurements of very low-level signals.

- The HP 10855A preamplifier provides a minimum of 22 dB gain from 2 MHz to 1300 MHz.
- The HP 8449B preamplifier provides a minimum of 30 dB gain from 1 GHz to 26.5 GHz.
- The HP 8447D preamplifier provides a minimum of 25 dB gain from 100 kHz to 1.3 GHz.
- The HP 84473 power amplifier provides a minimum of 22 dB gain from 0.1 GHz to 1.3 GHz.
- The HP 87405A preamplifier provides a minimum of 22 dB gain from 10 MHz to 3 GHz.
- The HP 85905A CATV 75 ohm preamplifier provides a minimum of 18 dB gain from 45 MHz to 1 GHz.

## Burst Carrier Trigger

**For use with HP 8590 E-Series spectrum analyzers.** The HP 85902A burst carrier trigger detects the burst RF carrier of a digital communication system and provides a TTL output trigger to synchronize a spectrum analyzer. The triggering function is especially useful when performing time-dependent measurements used as power versus time and adjacent channel power gated measurements. The HP 85902A is compatible with most digital communications formats, including NADC-TDMA, E-TDMA, JDC, GSM, DCS-1800, CT2-CAI, DECT, PHP, and CDMA.

## Close Field Probes

The HP 11945A close field probe set contains the HP 11940A and HP 11941A close-field probes. These are small, hand-held, electromagnetic-field sensors that provide repeatable, absolute, magnetic-field measurements over a wide frequency range. The HP 11941A operates from 9 kHz to 30 MHz. The HP 11940A from 30 MHz to 1 GHz. When attached to a source, the probes generate a localized magnetic field for electromagnetic interference (EMI) susceptibility testing.

The HP 11945A Option E51 also includes the HP 8447F Option H64 preamplifier and a convenient carrying bag.

## External Keyboard

*For use with Option 041 or 043.* The HP C1405B keyboard is an IBM AT compatible keyboard that can be connected to the external keyboard connector, using a C1405-60015 cable adapter, of the rear panel of the spectrum analyzer. Any IBM AT compatible keyboard with a small DIN connector will work. Screen titles and remote programming commands can be entered easily with the external keyboard.

## HP-IB Cable

*For use with Option 041.* The HP 10833 HP-IB cables interconnect HP-IB devices and are available in four different lengths. HP-IB cables are used to connect printers, plotters, and controllers to a spectrum analyzer.

## Memory Cards

*The HP 8590L and HP 8592L must have Option 003.* Blank memory cards are available for the storage and transfer of data and programs. Several different sizes of cards are available for use with the memory card reader, see table below. The memory card reader is standard for the HP 85913, HP 85933, HP 85943, HP 85953, and HP 85963. The memory card reader is Option 003 for the HP 8590L and HP 8592L.

| Model Number | Size of Memory Card |
|--------------|---------------------|
| HP 85700A    | 32 Kbytes           |
| HP 85702A    | 128 Kbytes          |
| HP 85704A    | 256 Kbytes          |
| HP 85705A    | 512 Kbytes          |

## Parallel Interface Cable

*For use with Option 041 and 043* The HP 92284A parallel interface cable is a 36-pin to 25-pin male-to-male 2 meter cable used to connect supported printers and plotters to a spectrum analyzer.

## PC Interface and Report Generator software

**For use with HP 8590 E-Series or L-Series spectrum analyzers with option 003 and HP 85716A CATV system monitor personality.** The HP 85916A PC Interface and Report Generator software provides easy setup and scheduling screens for immediate and timed measurements. This software allows you to create or edit test plans to suit your needs. You can download CATV system monitor data to the HP 85916A's database. The data can be reviewed on the PC screen in tabular or W-Y graph format. This software allows you to control the spectrum analyzer over telephone lines.

## Plotter

**For use with Option 041 or 043.** If you have access to an HP 7440A, HP 7475A, or HP 7550A, you can plot a permanent record of the display. Most HP LaserJet printers will support the PLT->LJT mode. (See RS-232 Cable in this chapter for the required cable.)

## Printer

**For use with Option 041 or 043.** The DeskJet personal printers provide black and white or color printing for another form of permanent records of your test results. The HP LaserJet series printers are also compatible. The printers can be ordered with RS-232 or parallel interfaces to correspond to the interface option installed on the spectrum analyzer.

## Rack Slide Kit

This kit (HP part number 1494-0060) provides the hardware to adapt rack-mount kits (Options 908 and 909) for mounting the spectrum analyzer on slides in an HP System II cabinet.

## RS-232 Cable

**For use with Option 043.** The HP 245426 is a 9-pin (f) to 25-pin (m) RS-232 cable. The HP 24542G cable can be used with HP plotters, HP DeskJet printers, HP LaserJet Series and PC printers with 25-pin (f) RS-232 connectors. The LaserJet 4P and 4Plus require an HP C2932A 9-pin (m) to 9-pin (f) cable for RS-232 connection. The modem cable required is HP 24542M 9-pin (f) to 25-pin (m), and the PC cable is HP 24542U.

## Transit Case

The transit case (HP part number 9211-5604) provides extra protection for your spectrum analyzer for frequent travel situations. The HP transit case protects your instrument from hostile environments, shock, vibration, moisture, and impact while providing a secure enclosure for shipping.

## SRQ

---

### Service Requests

This appendix describes the spectrum analyzer service request (SRQ) capability. A service request is a spectrum analyzer output that tells the operator or computer that a specific event has taken place in the spectrum analyzer.

When writing programs, service requests can be used to interrupt the computer program sequence, causing the program to branch to a subroutine. For example, by using service requests, the computer can perform other operations while the spectrum analyzer is sweeping. When the sweep is completed, the computer can service the spectrum analyzer by changing the spectrum analyzer state or reading data from the memory.

---

**Note** Service requests do not work with computers that have an RS-232 interface. Not all service requests are available with some HP-IB computers. Refer to the manuals supplied by your computer's manufacturer.

---

When making a service request, the spectrum analyzer places the I/O interface SRQ line true and the spectrum analyzer displays SRQ with an octal coded number. Setting the SRQ line true announces to the computer that the spectrum analyzer requires attention. The computer can then command the spectrum analyzer to send its "status byte." The status byte indicates the type of service request. The status byte is the binary equivalent of the octal SRQ number.

---

**Note** If the spectrum analyzer display annotation has been blanked, the service request notation will not appear.

A serial polling technique must be used by the computer to test for service requests. The spectrum analyzer does not respond to parallel polling.

---

A service request can be cleared from the display by pressing **CONFIG**, doing an instrument preset, or by executing a remote command query.

### Status Byte Definition

The status byte sent by the spectrum analyzer determines the nature of the service request. The meaning of each bit of the status byte is explained in Table A-1.

**Table A-1. Status Byte Definition**

| <b>Bit</b> | <b>Message</b>                                | <b>Display Message</b> |
|------------|-----------------------------------------------|------------------------|
| 0 (LSB)    | Unused                                        |                        |
| 1          | Unit Key Pressed                              | SRQ 102                |
| 2          | End of sweep                                  | SRQ 104                |
| 3          | Hardware broken                               | SRQ 110                |
| 4          | Command complete                              | SRQ 120                |
| 5          | Illegal spectrum analyzer command             | SRQ 140                |
| 6          | Universal HP-IB service request HP-IB RQS bit |                        |
| 7          | Unused                                        |                        |

The display message is an octal number based on the binary value of the status byte. This octal number always begins with a “1” since this is translated from bit 6, the universal service request bit. The status byte for an illegal spectrum analyzer command (SRQ 140) is as follows:

| <b>bit number</b> | <b>7 6</b> | <b>5 4 3</b> | <b>2 1 0</b> |
|-------------------|------------|--------------|--------------|
| status byte       | 0 1        | 1 0 0        | 0 0 0        |

This displays the octal equivalent of the status byte binary number: SRQ 140

The octal equivalent is based on the whole binary number:

01100000 (binary) = 140 (octal) One simple way to determine the octal equivalent of the binary number is to partition the binary number three bits at a time from the least significant bit, and treat each part as a single binary number:

| <b>binary</b> | <b>0 1</b> | <b>1 0 0</b> | <b>0 0 0</b> |
|---------------|------------|--------------|--------------|
| octal         | 1          | 4            | 0            |

The decimal equivalent of the octal number is determined as follows:

$$140 \text{ (octal)} = 1 \times (8) + 4 \times (8) + 0 \times (8) = 96 \text{ (decimal)}$$

More than one service request can be sent at the same time. For example, if an illegal spectrum analyzer command (SRQ 140) and the end of a sweep (SRQ 104) occurred at the same time, SRQ 144 appears on the spectrum analyzer display, because both bit 5 and bit 2 are set as shown below:

| <b>bit number</b> | <b>7 6</b> | <b>5 4 3</b> | <b>2 1 0</b> |
|-------------------|------------|--------------|--------------|
| status byte       | 0 1        | 1 0 0        | 1 0 0        |
| octal value       | 1          | 4            | 4            |

= SRQ 144

## Service Request Activating Commands

With the exceptions of SRQ 140 and SRQ 110, service requests can only be activated from a computer. (SRQ 140 and SRQ 110 are always activated.) Your programmer’s guide describes service request activating commands under RQS and SRQ.

# Glossary

---

## **absolute amplitude accuracy**

The degree of correctness or uncertainty (expressed in either volts or dB power). It includes relative uncertainties plus calibrator uncertainty. For improved accuracy, some spectrum analyzers specify frequency response relative to the calibrator as well as relative to the midpoint between peak-to-peak extremes. Refer also to **relative amplitude accuracy**.

## **active function readout**

The area of a display screen where the active function and its state are displayed. The active function is the one that was completed by the last key selection or remote-programming command.

## **active marker**

The marker on a trace that can be repositioned by front-panel controls or programming commands.

## **active trace**

The trace (commonly A, B, or C) that is being swept (updated) with incoming signal information.

## **adjacent channel power**

The measure of transmitter signal leakage into adjacent channels. The measured value is usually expressed as the ratio of the power in the adjacent channel to the channel power.

## **amplitude accuracy**

The general uncertainty of a spectrum analyzer amplitude measurement, whether relative or absolute.

## **analog + display mode**

A display mode of the HP 8590 Series Spectrum Analyzers that digitally simulates an analog display. The spectrum analyzer takes several samples of the signal amplitude at each horizontal point as it sweeps across the screen. The samples are displayed as individual dots on the screen that are not connected. This analog-like trace data is available along with the normal digital display features like hard copy output, screen annotation and titles, and complete marker functions.

## **analog display**

A display where the trace data is generated by deflecting the electron beam to match the signal amplitude as it sweeps across the screen. The refresh rate of the trace data is equal to the spectrum analyzer sweep rate. Refer also to **CRT persistence**.

## **ASCII**

The acronym for American Standard Code for Information Interchange. It is an eight-part code (7 bits plus parity check) used for data (information) interchange. An ASCII value is a specific combination of bits ranging from 0 to 255 that represent characters in machine language that computers and controllers can understand.

**attenuation**

A general term used to denote a decrease of signal magnitude in transmission from one point to another. Attenuation may be expressed as a scalar ratio of the input to the output magnitude in decibels.

**bandwidth selectivity**

This is a measure of the analyzer's ability to resolve signals unequal in amplitude. It is the ratio of the 60 dB bandwidth to the 3 dB bandwidth for a given resolution filter (IF). Bandwidth selectivity tells us how steep the filter skirts are. Bandwidth selectivity is sometimes called shape factor.

**battery-backed RAM**

Random access memory (RAM) data retained by a battery. RAM memory cards can contain data that is maintained with a battery. Refer also to **nonvolatile memory**.

**blank mode**

This is an analyzer function that stores any active trace in the analyzer's reserved memory, and blanks the display. The stored trace may be either A, B, or C.

**broadband response**

A signal whose spectrum is wider than the resolution bandwidth of a spectrum analyzer, and whose repetition frequency is lower than the bandwidth of the spectrum analyzer. Notice that it is a combination of signal and receiver characteristics that determines when a signal is classified as broadband. For refining incoming signal responses, select narrower spans and bandwidths. Refer also to **narrowband response**. The following checks can help verify whether or not the response is broadband:

- Change the resolution bandwidth. The displayed amplitude should change.
- Change the sweep time. The spacing of the responses on the display should change as you change the sweep time.
- Change the span. The spacing of the responses should not change. They should be independent of frequency span.
- Change the video bandwidth. If the video bandwidth is made narrower than the resolution bandwidth, the displayed amplitude of the responses should decrease.

**card reader**

**See memory card.**

**channel power**

A measure of the total mean power contained within a specified bandwidth. The measured power is the combination of all discrete signals, modulation, and noise within the bandwidth.

**character set**

The set of elementary symbols. These normally include both alpha and numeric codes, plus punctuation or any other symbol which may be read, stored, or written and used for organization, control, or representation of data.

**CISPR**

The acronym for the Comité International Spécial des Perturbations Radio-electriques (International Special Committee on Radio Interference) or the International Commercial EMC Advisory Committee.

**clear-write mode**

This is an analyzer function that clears the specified trace (A, B, or C) from the display, then sweeps (updates) the trace each time trigger conditions are met. When trigger conditions are met, the new input-signal data is displayed, then cleared, and the process begins again.

**conducted emissions**

Unwanted signals coupled onto the power or signal lines by a particular device.

**command**

A set of instructions that are translated into instrument actions. The actions are usually made up of individual steps that together can execute an operation. Generally, for spectrum analyzers it is a sequence of code that controls some operation of a spectrum analyzer. These codes can be keyed in via a controller, or computer. Refer also to **function**.

**continuous sweep mode**

The analyzer condition where traces are automatically updated each time trigger conditions are met.

**CORR**

Annotation indicating a corrected measurement condition exists. It appears when correction factors are being applied to measurement results. If the CORR message is not displayed, the measurements may not meet specifications.

**correction factor**

The factor by which a measurement reading must be multiplied to correct for the effects of errors due to spectrum analyzer circuitry. This factor is the product of the ratio and phase-angle correction factors for the existing conditions of operation.

**CRT persistence**

An indication of the rate at which the image fades on the display. In analyzers that digitize the trace information (video) before writing it to the screen, the refresh rate is high enough to prevent any flicker in the display; therefore, short-persistence displays are used. Purely analog analyzers typically use long-persistence or variable-persistence displays because the refresh rate equals the sweep rate.

**current probe**

A magnetic field sensor that is clamped around power lines to sense conducted emissions. It is the preferred transducer for most MIL-STD conducted emissions testing. The voltage at the output of the probe is proportional to the power line current and affected by probe characteristics. Probe characteristics are provided by the manufacturer in the form of transfer impedance,  $Z$ , which varies as a function of frequency. The equation below illustrates how probe characteristics may be stated:

$$Z(dB\Omega) = V(dB\mu V) - I(dB\mu A)$$

**default**

The preset conditions, options, or parameters of an instrument. The default state may be changed by choosing key selections or writing programming commands to use other conditions.

**delta marker**

An analyzer mode in which a fixed reference marker is established, then a second active marker becomes available so it can be placed anywhere along the trace. A readout indicates the relative frequency separation and amplitude difference between the reference and active markers.



**detector mode**

The manner in which analog, video information is processed prior to being digitized and stored in memory. Refer also to **negative peak, positive peak, quasi-peak detector, rosenfell**, and **sample**.

**digital display**

A display that uses vectors drawn between a series of data points (analog video) that are first digitized and stored in memory, then displayed. The number of stored data points is a function of the particular analyzer. The displayed information is refreshed (old data points are replaced with new data points stored in memory) at a flicker-free rate. The data in memory is updated at the sweep rate of the analyzer.

**display dynamic range**

The maximum dynamic range over which both the larger and smaller signal can be viewed simultaneously on the display. For analyzers with a maximum logarithmic display of 10 dB/division, the actual dynamic range may be greater than the display dynamic range. Refer also to **dynamic range**.

**display fidelity**

The measurement uncertainty of relative differences in amplitude on a spectrum analyzer. On purely analog analyzers (those analyzers that display trace information immediately and do not store, then recall the data to the screen), these differences are displayed on the screen and the graticule is used to evaluate the measurement. Many analyzers with digital displays (refer to digital display) have markers that can be used to measure the signal. As a result, measurement differences are stored in memory, and the ambiguity of the display is eliminated from the measurement.

**display range**

The calibrated range of the display for a particular display mode or scale factor. Refer also to **linear display, log display**, and **scale factor**.

**displayed average noise level**

The noise level viewed on the analyzer's display after narrowing the video bandwidth setting enough to reduce the peak-to-peak noise fluctuations. The resulting noise display is essentially a straight line. Usually this term refers to the analyzer's own internally generated noise as a measure of sensitivity. It is typically specified in dBm under conditions of minimum resolution bandwidth and minimum input attenuation.

**DLP**

The abbreviation for downloadable program. A single programming command or a sequence of programming commands used to perform specific operations. DLPs can be made up of several functions, variables, and traces defined by the program creator. The DLP can be downloaded from one electronic storage medium into another and executed without a controller.

**drift**

The slow (relative to sweep time) change of signal position on the display as a result of a change in local oscillator frequency versus sweep voltage. While analyzer drift may require periodic retuning, it does not impair frequency resolution.

**dynamic range**

The power ratio (dB) between the smallest and largest signals simultaneously present at the input of an analyzer that can be measured with some degree of accuracy. Dynamic range generally refers to measurement of distortion or intermodulation products.

**EM1**

The abbreviation for electromagnetic interference. An EM1 measurement determines how much an undesired electromagnetic disturbance impairs the reception of a desired electromagnetic signal.

**envelope detector**

A detector circuit whose output follows the envelope, but not the instantaneous variation of its input signal. This detector is sometimes called a peak detector. In superheterodyne spectrum analyzers, the input to the envelope detector comes from the final IF, and the output is a video signal. When we put the spectrum analyzer in zero span, the envelope detector demodulates the input signal, and we can observe the modulating signal as a function of time on the display.

**error message**

A message displayed on the screen indicating missing or failed hardware, improper user operation, or other conditions that require additional attention. Generally, the requested action or operation cannot be completed until the condition is resolved.

**external mixer**

An independent mixer, usually having a waveguide input port, used to extend the frequency range of those spectrum analyzers designed to use them. The analyzer provides the local oscillator signal and mixer bias (if needed), then returns the mixing products to the analyzer's IF input.

**FFT**

The abbreviation for fast Fourier transform. It is a mathematical operation performed on a time-domain signal to yield the individual spectral components that constitute the signal in the frequency domain. Refer also to **spectrum**.

**firmware**

An assembly made up of hardware and instruction code that are integrated to form a functional set which cannot be altered during normal operation. The instruction code, permanently installed in the circuitry of the instrument, is classified as ROM (read-only memory). The firmware determines the operating characteristics of the instrument or equipment. Each firmware version is identified by a revision code number, or date code.

**flatness**

The displayed amplitude variation corresponding to the tuned frequency range of the spectrum analyzer. Flatness of  $\pm 1$  dB indicates that maximum and minimum values of the analyzer's frequency response are less than 2 dB apart.

**Fourier transform**

See **FFT**.

**frequency accuracy**

The uncertainty with which the frequency of a signal or spectral component is indicated, either in an absolute sense or relative to some other signal or spectral component. Absolute and relative frequency accuracies are specified independently.

**frequency range**

The range over of frequencies which the spectrum analyzer performance is specified. The maximum frequency range of many microwave analyzers can be extended with the application of external mixers.

**frequency resolution**

The ability of a spectrum analyzer to separate closely spaced spectral components and display them individually. Resolution of equal amplitude components is determined by resolution bandwidth. Resolution of unequal amplitude signals is determined by resolution bandwidth and bandwidth selectivity.

**frequency response**

The peak-to-peak variation in the displayed signal amplitude over a specified center frequency range. Frequency response is typically specified in terms of  $\pm$ dB relative to the value midway between the extremes. It also may be specified relative to the calibrator signal.

**frequency span**

The magnitude of the displayed frequency component. Span is represented by the horizontal axis of the display. Generally, frequency span is given as the total span across the full display. Some analyzers represent frequency span (scan width) as a per-division value.

**frequency stability**

The stability of a frequency component to remain unchanged in frequency or amplitude over short- and long-term periods of time. Stability refers to the local oscillator's ability to remain fixed at a particular frequency over time. The sweep ramp that tunes the local oscillator influences where a signal appears on the display. Any long-term variation in local oscillator frequency (drift) with respect to the sweep ramp causes a signal to shift its horizontal position on the display slowly. Shorter-term local oscillator instability can appear as random FM or phase noise on an otherwise stable signal.

**front-panel key**

Keys, typically labeled, and located on the front panel of an instrument. The key labels identify the function the key activities. Numeric keys and step keys are two examples of front-panel keys.

**full span**

A mode of operation in which the spectrum analyzer scans the entire frequency band of an analyzer.

**function**

The action or purpose which a specific item is intended to perform or serve. The spectrum analyzer contains functions that can be executed via front-panel key selections, or through programming commands. The characteristics of these functions are determined by the firmware in the instrument. In some cases, a DLP (downloadable program) execution of a function allows you to execute the function from front-panel key selections.

**gain compression**

The signal level at the input mixer of a spectrum analyzer where the displayed amplitude of the signal is a specific number of dB too low due just to mixer saturation. The signal level is generally specified for 1 dB or 0.5 dB compression and is usually between -3 dBm and -10 dBm.

**gated measurement**

See **time-gate**.

**hard copy**

Information or data printed onto paper as opposed to its being stored on disk or in the instrument's memory.

**harmonic distortion**

Undesired frequency components added to signals as a result of nonlinear behavior of the device (for example, a mixer or an amplifier) through which signals pass. These unwanted components are harmonically related to the original signal.

**harmonic mixing**

The utilization of local oscillator harmonics generated in a mixer to extend the tuning range of a spectrum analyzer beyond the range achievable using just the local oscillator fundamental. The mathematical algorithm is:

$$F_{IN} = F_{LO} + F_{IF}$$

**HP-IB**

The abbreviation for Hewlett-Packard Interface Bus. It is a Hewlett-Packard proprietary parallel interface that allows you to “daisy-chain” more than one device to a port on a computer or instrument.

**IF**

The abbreviation for intermediate frequency. An IF frequency is a frequency to which a signal wave is shifted locally as an intermediate step in transmission or reception. On spectrum analyzers, this is the frequency resulting from conversion before demodulation.

**IF gain/IF attenuation**

A control that adjusts the vertical position of displayed signals without affecting the signal level at the input mixer. When changed, the value of the reference level is changed accordingly.

**IF feedthrough**

A condition that results in a rise in amplitude of the baseline trace. This occurs as a result of an input signal at the intermediate frequency (IF) passing through the input mixer. This is usually only a potential problem on nonpreselected spectrum analyzers. The entire baseline trace rises because the signal is always at the IF. (Mixing with the local oscillator is not required.)

**image response**

A displayed signal that is actually twice the intermediate frequency (IF) away from the frequency indicated by the spectrum analyzer. For each harmonic of the local oscillator there is an image pair. One is below the local oscillator frequency by the IF and the other is above. Images usually only appear on nonpreselected spectrum analyzers.

**impedance**

The apparent opposition in an electrical path to the flow of current. The specified nominal input impedance of a spectrum analyzer is stated for the input connector. The most common impedance for RF and microwave spectrum analyzers is 50Ω. However, 75Ω is typically used for cable television (CATV) work.

**impulse bandwidth**

The width of a rectangular filter that has the same peak voltage output as the actual analyzer filter. The impulse bandwidth of the synchronously-tuned, Gaussian-like resolution filters in the Hewlett-Packard spectrum analyzers is approximately 1.5 times the 3 dB bandwidth.

**incidental FM**

Undesired frequency modulation on the output of a device (for example a signal source or an amplifier) caused by or, incidental to, some other form of modulation, such as amplitude modulation.

**input attenuator**

An attenuator between the input connector and the first mixer of a spectrum analyzer (also called an RF attenuator). The input attenuator is used to adjust the signal level incident to the first mixer, and to prevent gain compression due to high-level or broadband signals. It is also used to set the dynamic range by controlling the degree of internally-generated distortion. For some analyzers, changing the input attenuator settings changes the vertical position of the signal on the display, which then changes the reference level accordingly. In Hewlett-Packard microprocessor-controlled spectrum analyzers, the IF gain is changed to compensate for changes in input attenuator settings. Because of this, the signals remain stationary on the display, and the reference level is not changed.

**input impedance**

The terminating impedance that the analyzer presents to the signal source. The nominal impedance for RF and microwave analyzers is usually  $50\Omega$ . For some systems, such as cable TV,  $75\Omega$  is standard. The degree of mismatch between the nominal and actual input impedance is called the VSWR (voltage standing wave ratio).

**interface**

The point at which different parts of a system interact. Also, the point at which operators and instruments interact.

**intermodulation distortion**

Undesired frequency components resulting from the interaction of two or more spectral components passing through a device having nonlinear behavior, such as a mixer or an amplifier. The undesired components are related to the fundamental components by sums and differences of the fundamentals and various harmonics. The algorithm is:

$$f_1 \pm f_2, 2 \times f_1 \pm f_2, 2 \times f_2 \pm f_1, 3 \times f_1 \pm 2 \times f_2, \text{ and so on}$$

**limit line**

A test limit made up of a series of line segments, positioned according to frequency and amplitude within the spectrum analyzer's measurement range. Two defined limit lines may be displayed simultaneously. One sets an upper test limit, the other sets a lower test limit. Trace data can be compared with the limit lines as the spectrum analyzer sweeps. If the trace data exceeds either the upper or lower limits, the spectrum analyzer displays a message or sounds a warning, indicating that the trace failed the test limits.

**limit,-line file**

The user-memory file that contains the limit-line table entries. Limit lines are composed of frequency and amplitude components that make up a trace array and this data is stored in the file. The limit-line file feature is available on spectrum analyzers that are capable of limit-line operation. Refer also to **limit line**.

**limit-line table**

The line segments of a limit line are stored in the limit-line table. The table can be recalled to edit the line segments, then restored in the limit-line file. Refer also to **limit line**.

**linear display**

The display mode in which vertical deflection on the screen is directly proportional to the voltage of the input signal. The bottom line of the graticule represents 0 V; the top line represents the reference level. The reference level is a non-zero value characteristic to the spectrum analyzer model. On the HP 140 series analyzers, select a specific scale factor in volts per division. On newer models of spectrum analyzers, select the reference level. The scale factor becomes the reference level value divided by the number of graticule divisions. Although the display is linear, analyzers with microprocessors allow reference level and marker values to be indicated in dBm, dBmV, dB $\mu$ V, volts, and in some cases, watts.

**linear input. level**

The maximum input-signal level where gain compression does not occur. Refer also to **gain compression**.

**LO**

The abbreviation for local oscillator. The local oscillator output in a superheterodyne system is mixed with the received signal to produce a sum or difference equal to the intermediate frequency (IF) of the receiver. Refer also to **IF**.

**LO feedthrough**

The response that occurs on a spectrum analyzer's display when the first local oscillator frequency is equal to the first IF. The LO feedthrough is a 0 Hz marker with no error, so it can be used to improve the frequency accuracy of spectrum analyzers with nonsynthesized LO systems.

**log display**

The display mode in which vertical deflection is a logarithmic function of the input-signal voltage. Log display is also referred to as logarithmic mode. The display calibration is set by selecting the value of the top graticule line (reference level), and scale factor in volts per division. On Hewlett-Packard analyzers, the bottom graticule line represents zero volts for scale factors of 10 dB/division or more. The bottom division, therefore, is not calibrated for those analyzers. Analyzers with microprocessors allow reference level and marker values to be indicated in dBm, dBmV, dB $\mu$ V, volts, and occasionally in watts. Nonmicroprocessor-based analyzers usually offer only one kind of unit, typically dBm.

**marker**

A visual indicator we can place anywhere along the displayed trace. A marker readout indicates the absolute value of the trace frequency and amplitude at the marked point. The amplitude value is displayed with the currently selected units. Refer also to **delta marker** and **noise marker**.

**maximum input level**

The maximum signal power that may be safely applied to the input of a spectrum analyzer. Typically 1 W (-30 dBm) for Hewlett-Packard spectrum analyzers.

**MEAS UNCAL**

Annotation indicating an uncalibrated measurement condition exists. It appears when instrument settings affect accuracy of measurement results to the extent that they no longer meet specifications.

**measurement bandwidth**

The resolution bandwidth required for a specific EM1 measurement. For MIL-STD measurements, the resolution bandwidth is often determined by the tester with the approval of the contracting agency.

For commercial testing the measurement bandwidths required usually follow the recommendations of CISPR:

Band A (10 kHz to 150 kHz): 200 Hz

Band B (150 kHz to 30 MHz): 9 kHz

Band C and D (30 MHz to 1 GHz): 120 kHz

**measurement range**

The ratio, expressed in dB, of the maximum signal level that can be measured (usually the maximum safe input level) to the lowest achievable average noise level. This ratio is almost always much greater than can be realized in a single measurement. Refer also to **dynamic range**.

**measurement units**

Trace information is stored in trace arrays made up of measurement units. The measurement-unit range is restricted to integers between -32,768 and +32,767. In a logarithmic scale, a measurement unit is one-hundredth of a dBm, or represented mathematically as: (value in dBm) x 100 = measurement units. As an example, -10.115 dBm x 100 = -1012 measurement units, not -1011.5. Measurement units for linear-trace information are from zero, for the bottom of the display, to 10,000 for the top of the display, or the reference level.

**memory**

A storage medium, device, or recording medium into which data can be stored and held until some later time, and from which the entire original data may be retrieved.

**memory card**

A small, credit-card-shaped memory device that can store data or programs. The programs are sometimes called personalities and give additional capabilities to your instrument. Typically, there is only one personality per memory card. Refer also to **personality**.

**menu**

The spectrum analyzer functions that appear on the display and are selected by pressing front-panel keys. These selections may evoke a series of other related functions that establish groups called menus.

**narrowband response**

A response measured under conditions in which there is only one spectral component at a time in the passband of a spectrum analyzer's resolution filter. This condition occurs for continuous wave signals and repetitive signals whose repetition rate is greater than about twice the resolution bandwidth of the analyzer. Note that a signal can have a spread spectrum and still be viewed in the narrowband mode on the spectrum analyzer. The same checks that were listed under **broadband response** are used here but with different results:

- Change the frequency span. The frequency separation of the components remains unchanged.
- Change the resolution bandwidth. The amplitude of the responses does not change with resolution bandwidth changes (as long as the bandwidth remains narrow relative to the separation of the responses).
- Change the sweep time. The separation of the responses is independent of sweep time.
- Change the video bandwidth. The amplitude of the responses is unaffected by changes in video bandwidth.

**negative peak**

The minimum, instantaneous value of an incoming signal. On digital displays, each displayed point of the signal indicates the minimum value of the signal for that part of the frequency span or time interval represented by the point.

**noise figure**

The ratio, usually expressed in dB, of the signal-to-noise ratio at the input of a device (mixer, amplifier, and so on) to the signal-to-noise ratio at the output of the device.

**noise marker**

A marker whose readout represents the noise level in a 1 Hz noise power bandwidth. When the noise marker is selected, the sample display detection mode is activated, the values of a number of consecutive trace points about the marker (the number depends on the type of analyzer) are averaged, and this average value is normalized to an equivalent value in a 1 Hz noise power bandwidth. The normalization process accounts for detection and bandwidth plus the effect of the log amplifier when we select the log-display mode.

**noise sidebands**

Modulation sidebands that indicate the short-term instability of the local oscillator (primarily the first local oscillator) system of a spectrum analyzer. The modulating signal is noise, in the local oscillator circuit itself or in the local oscillator stabilizing circuit, and the sidebands comprise a noise spectrum. The mixing process transfers any local oscillator instability to the mixing products, so the noise sidebands appear on any spectral component displayed on the analyzer far enough above the broadband noise floor. Because the sidebands are noise, their level relative to a spectral component is a function of resolution bandwidth. Noise sidebands are typically specified in terms of dBc/Hz (amplitude in a 1 Hz bandwidth relative to the carrier) at a given offset from the carrier, the carrier being a spectral component viewed on the display.

**nonvolatile memory**

Memory data that is retained in the absence of an ac power source. This memory is typically retained with a battery. Refer also to **battery-backed RAM**.

**occupied bandwidth**

A measure of the frequency bandwidth occupied by the carrier of a transmitter. It is usually the bandwidth that includes 99% of the total mean carrier power, and is equivalent to "99% power bandwidth". It is measured by determining the lower and upper frequency limits; where 0.5% of the total mean carrier power is below the lower frequency limit and 0.5% is above the upper frequency limit. Occasionally percentages other than 99% are specified.

**parameter units**

Standard units of measure, which include the following:

| <b>Measured Parameter</b> | <b>Unit Name</b>               | <b>Unit Abbreviation</b> |
|---------------------------|--------------------------------|--------------------------|
| frequency                 | hertz                          | Hz                       |
| power level               | decibel relative to milliwatts | dBm                      |
| power ratio               | decibel                        | dB                       |
| voltage                   | volt                           | V                        |
| time                      | second                         | s                        |
| electrical current        | ampere                         | A                        |
| impedance (resistance)    | ohm                            | Ω                        |

**peak detection mode**

The analyzer state where circuits calculate the peak value of a displayed signal. This value is determined by evaluating a series of measured values from an active trace.

**peak detector**

A detector that follows the peak or envelope of the signal applied to it. The standard detector in a spectrum analyzer is typically a peak detector. MIL-STD EM1 measurements usually call for peak detection. Refer also to **quasi-peak detector** and **envelope detector**.

**percent amplitude modulation**

A measure of the amount of amplitude modulation on a signal. The measurement value is a comparison of the power in the modulation signal to the power in the signal being modulated. Percent amplitude modulation can be calculated as follows, where dB is the ratio of the power of the signal to the power of the amplitude modulation sidebands.

$$%AM = 200 \times 10^{\frac{-dB}{20}}$$



**persistence**

See **CRT persistence**.

**personality**

Applications available on a memory card or other electronic media that extends the capability of an instrument for specific uses. Examples include digital radio personalities and cable TV personalities.

**phase noise**

Refer to **noise sidebands**.

**position units**

The position unit describes the location of a point along the horizontal axis of a trace. Position unit values of a trace begin on the left-hand side of the graticule and increase to a predefined value (specific to the spectrum analyzer model) on the right-hand side of the graticule.

**positive peak**

The maximum, instantaneous value of an incoming signal. On digital displays, each displayed point of the signal indicates the maximum value of the signal for that part of the frequency span or time interval represented by the point.

**preamplifier**

An external, low-noise-figure amplifier that improves system (preamplifier/spectrum analyzer) sensitivity over that of the analyzer itself.

**predefined trace**

Trace A, B, or C of a spectrum analyzer. Refer also to **trace**.

**preselector**

A tunable bandpass filter placed ahead of a frequency converter, or mixer, of a spectrum analyzer. It tracks the appropriate mixing mode and passes signals of a desired frequency and reduces others. Preselectors are typically used only above 2 GHz. They essentially eliminate multiple and image responses and, for certain signal conditions, improve dynamic range.

**quasi-peak detector**

A detector circuit designed with time constants that give a weighted value to the amplitude of a detected signal. The displayed signal output is an indication of the degree to which the detected signal would impair the intelligibility of a desired signal. The time constants (rise, fall, average) for EMI purposes are based on the recommendations of CISPR that are in turn based on subjective tests. Interference limits for commercial EMI tests are often given in quasi-peak values.

**random-access memory**

RAM (random-access memory) or read-write memory, is a storage area allowing access to any of its storage locations. Data can be written to or retrieved from RAM, but data storage is only temporary. When the power is removed, the information disappears. User-generated information appearing on a display is RAM data.

**raster display**

A television-like display in which the image is formed by scanning the electron beam rapidly across and slowly down the CRT face and gating the beam on as appropriate. The scanning rates are fast enough to produce a flicker-free display. Refer also to **vector display** and **sweep time**.

**read-only memory**

ROM (read-only memory) that is encoded into the analyzer's firmware. The data can be accessed (read) only; it cannot be altered by the user.

**reference level**

The calibrated vertical position on the display used as a reference for amplitude measurement in which the amplitude of one signal is compared with the amplitude of another regardless of the absolute amplitude of either.

**relative amplitude accuracy**

The uncertainty of an amplitude measurement in which the amplitude of one signal is compared with the amplitude of another, regardless of the absolute amplitude of either. Distortion measurements are relative measurements. Contributors to uncertainty include frequency response and display fidelity and changes of input attenuation, IF gain, scale factor, and resolution bandwidth.

**relative-marker mode**

The active marker is positioned relative to the position of the reference marker. Marker readout shows amplitude, frequency, or time differences between the two markers.

**residual FM**

The inherent short-term frequency instability of an oscillator in the absence of any other modulation. In the case of spectrum analyzers, we usually expand the definition to include the case where the local oscillator is swept. Residual FM is usually specified in peak-to-peak values, because they are most easily measured on the display, if they are visible at all.

**residual responses**

These are discrete responses seen on a spectrum analyzer display although no input signal is applied.

**resolution**

Refer to **frequency resolution**.

**resolution bandwidth**

The ability of a spectrum analyzer to display adjacent responses discretely (hertz, hertz decibel down). This term is used to identify the width of the resolution bandwidth filter of a spectrum analyzer at some level below the minimum insertion-loss point (maximum deflection point on the display). The 3 dB resolution bandwidth is specified; for others, it is the 6 dB resolution bandwidth.

**rosenfell**

For digital displays, this is the display detection mode in which the value displayed at each point on a trace is based upon whether or not the video signal both rose and fell during the frequency or time interval represented by the point. If the video signal only rose or only fell, the maximum value is displayed. If the video signal both rose and fell, the maximum value during the interval is displayed by odd-numbered points, and the minimum value by even-numbered points. To prevent the loss of a signal occurring during an even-numbered interval, the maximum value of the signal during this interval is preserved. At the next (odd-numbered) interval, the value displayed is the greater value carried over, or the maximum, that occurs during the current interval.

**sample**

The instantaneous value of an incoming signal. On digital displays, each displayed point of the signal indicates the instantaneous value of the signal for that part of the frequency span or time interval represented by the point.

**scale factor**

The per-division calibration of the vertical axis of the display.

**scan (frequency span) linearity**

The measured accuracy of the horizontal axis of the analyzer display. When two horizontal points are set with analyzer controls, then measured, the linearity is the calculated error between the two points compared with the analyzer settings.

**selectivity**

See **bandwidth selectivity**.

**sensitivity**

The level of the smallest sinusoid that can be observed on a spectrum analyzer, usually under optimized conditions of minimum resolution bandwidth, 0 dB input attenuation, and minimum video bandwidth. Hewlett-Packard defines sensitivity as the displayed average noise level. A sinusoid at that level appears to be about 2 dB above the noise.

**serial prefix**

Serial numbers that identify an instrument begin with a five-character prefix. The prefix in this case represents the version of firmware that particular instrument was shipped with. For HP 70000 Modular Measurement Systems, file numbers saved by the user in memory are preceded with letters that define the file type. Refer to the HP 70000 system operation manual for detailed information.

**shape factor**

Refer to **bandwidth selectivity**.

**signal resolution**

The ability of the spectrum analyzer to resolve two separate input signals. Closely spaced signals are more difficult to resolve than signals spaced far apart. Refer also to **resolution bandwidth** and **shape factor**.

**signal identification**

A routine that identifies whether or not a particular Fourier transform response on the spectrum analyzer's display is at the correct frequency. The displayed signal may be aliased by the FFT calculation because of inadequate sample rate. The signal identification routine indicates if the signal is being displayed at the wrong frequency.

**single-sweep mode**

The spectrum analyzer sweeps once when trigger conditions are met. Each sweep is initiated by pressing an appropriate front-panel key, or by sending a programming command.

**sinusoid**

A wave whose electric-field vector is proportional to the sine (or cosine) of an angle that is a linear function of time, or distance or both.

**softkey**

Key labels displayed on a screen or monitor which are activated by mechanical keys surrounding the display, or located on a keyboard. Softkey selections usually evoke menus that are written into the program software. Front-panel key selections determine which menu (set of softkeys) appears on the display.

**span**

Span equals the stop frequency minus the start frequency. The span setting determines the horizontal-axis scale of the spectrum analyzer display.

**span accuracy**

The uncertainty of the indicated frequency separation of any two signals on the display.

**spectral purity**

See **noise sidebands**.

**spectral component**

One of the sine waves comprising a spectrum.

**spectrum**

An array of sine waves differing in frequency and amplitude. They are properly related with respect to phase and, taken as a whole, constitute a particular time-domain signal.

**spectrum analyzer**

A device that effectively performs a Fourier transform and displays the individual spectral components (sine waves) that constitute a time-domain signal.



**spurious response**

The undesired responses that appear on a spectrum analyzer display as a result of the input signal. Internally generated distortion products are spurious responses, as are image and multiple responses. These can be either harmonic responses or nonharmonic responses. Harmonic responses are second, third, fourth, and so on, harmonics of the input signal. Nonharmonic responses are intermodulation and residual responses.

**state-register**

The area of user memory in the analyzer where measurement results and associated analyzer settings are stored.

**step**

The increment of change that results when you press the front-panel step keys,  and , or by program commands.

**stimulus-response mode**

The operating state that allows a spectrum analyzer to make measurements similar to those of a network-analysis measurement system. Spectrum analyzers with this ability use tracking generator functions. The tracking generator may be an external instrument (stand-alone tracking generators) or designed into the analyzer hardware. Measurement results are displayed in a relative-amplitude scale resulting from a variation, plus or minus, from a reference (normalized) value stored in a trace.

**stop/start frequency**

Terms used in association with the stop and start points of the frequency measurement range. Together they determine the span of the measurement range.

**sweep time**

The time it takes the local oscillator to tune across the selected span. Sweep time directly affects how long it takes to complete a measurement. It does not include the dead time between the completion of one sweep and the start of the next. It is usually a function of frequency span, resolution bandwidth, and video bandwidth. Resolution affects sweep time in that the IF filters are band-limited circuits requiring finite times to charge and discharge. The amount of time the mixing product remains in the IF filter passband is directly proportional to the bandwidth; inversely proportional to the sweep in Hz per unit of time. The rise time of a filter is inversely proportional to its bandwidth, and if the proportionality constant “k” is included, then we can make the rise time equal the “k” divided by resolution bandwidth. Mathematically, this is represented as:

$$\text{Time in Passband} = \frac{\text{resolution bandwidth}}{(\text{span} / \text{sweep time})} = \frac{(\text{resolution bandwidth} \times \text{sweep time})}{\text{span}}$$

$$\text{Rise Time} = \frac{k}{\text{resolution bandwidth}}$$

Solving for sweep time:

$$\text{sweep time} = \frac{k \times \text{span}}{\text{resolution bandwidth}^2}$$

**time-gate**

A time gate acts as a time filter, rejecting signals and spectra not corresponding to the desired time. It is an RF signal switch that admits the signal to the spectrum analyzer only while the switch, or gate, is closed. Since the spectrum analyzer receives the signal only when passed through the gate, it will only display the measurement results from the portion of the signal selected by the gate position in time.

**title line**

The area on a display where user-selected characters are displayed. These characters are selected from the front-panel keys.

**TO1**

Third order intermodulation distortion occurs in a system where two signals are present. The distortion products are a result of each signal mixing with the other’s second harmonic. If the two main signals are of equal power, the two third order distortion products will also be of equal power. As the power of the two main signals is increased by an equal amount, the power of the distortion products will increase three times that amount. Theoretically, there is a power level at which the power of each distortion product equals the power of the two main signals. (Practically, it may not be possible to reach this power level because of compression or limiting.) The Third Order Intercept (TOI) is defined as the power at which the third order distortion products equals the power of two equal level test signals.

**trace**

A trace is made up of a series of data points containing frequency and amplitude information. The series of data points is often referred to as an array. Traces A, B, and C are the typical names of traces that analyzer displays. The number of traces is specific to the instrument.

**units**

Dimensions on the measured quantities. Units usually refer to amplitude quantities because they can be changed. In spectrum analyzers with microprocessors, available units are dBm (dB relative to 1 mW (milliwatt) dissipated in the nominal input impedance of the analyzer), dBmV (dB relative to 1 mV (millivolt)), dB $\mu$ V (dB relative to 1  $\mu$ V), volts, and in some analyzers watts.

**update**

To make existing information current; to bring information up to date.

**upgrade**

To improve the quality or extend the capability of an instrument or product. Enhancements to upgrade the product. These enhancements can then be documented in an update package.

**variable persistence**

A property of the display that allows the adjustment of the trace-fade rate which is created by the display's electron beam. It is a capability of purely analog displays which provides flicker-free trace display regardless of sweep time.

**vector display**

The display type where the electron beam is directed so the image (consisting of trace, graticule, and annotation) is written directly onto the display face. It is not created from a series of dots as with the raster display.

**video**

A term describing the output of a spectrum analyzer's envelope detector. The frequency range extends from 0 Hz to a frequency that is typically well beyond the widest resolution bandwidth available in the analyzer. However, the ultimate bandwidth of the video chain is determined by the setting of the video filter.

**video amplifier**

A post-detection, dc-coupled amplifier that drives the vertical deflection plates of the display. Refer also to **video bandwidth** and **video filter**.

**video average**

The digital averaging of spectrum analyzer trace information. It is available only on analyzers with digital displays. Each point on the display is averaged independently and the average is computed based on the number of sweeps selected by the user. The averaging algorithm applies a factor to the amplitude value of a given point on the current sweep ( $1/n$ , where  $n$  is the number of the current sweep); applies another factor to the previously stored average  $[(n - 1)/n]$ ; and combines the two for a current average. After the designated number of sweeps are completed, the factors remain constant, and the display becomes a running average.

**video bandwidth**

The cut-off frequency (3 dB point) of an adjustable low-pass filter in the video circuit. When the video bandwidth is equal to or less than the resolution bandwidth, the video circuit cannot fully respond to the more rapid fluctuations of the output of the envelope detector. The result is a smoothing of the trace, or a reduction in the peak-to-peak excursion, of broadband signals such as noise and pulsed RF when viewed in broadband mode. The degree of averaging or smoothing is a function of the ratio of the video bandwidth to the resolution bandwidth.

**video filter**

A post-detection, low-pass filter that determines the bandwidth of the video amplifier. It is used to average or smooth a trace. Refer also to **video bandwidth**.

**windows display mode**

A display mode of the HP 8590 Series Spectrum Analyzers where the screen area is split into two separate displays. This allows two different frequency spans to be viewed simultaneously. The analyzer state of the two displays can be set independently.

**zero span**

The case in which a spectrum analyzer's local oscillator remains fixed at a given frequency so that the analyzer becomes a fixed-tuned receiver. In this state, the bandwidth is equal to the resolution bandwidth. Signal amplitude variations are displayed as a function of time. To avoid loss of signal information, the resolution bandwidth must be as wide as the signal bandwidth. To avoid any smoothing, the video bandwidth must be set wider than the resolution bandwidth.

**zoom**

A term referring to the process of looking at something more closely. This may require narrowing the resolution bandwidth or span to view a signal more closely. Or, it may mean increasing the size of the spectrum analyzer display from a partial screen to the full screen.

# Index

---

## 0

O-2.9 GHz BAND 0, 7-4

O-2.9 Gz BAND 0, 7-12

## 1

100 MHz COMB OUT, 2-4

10 MHz reference DAC setting, 7-14

10 MHz REF OUTPUT, 2-6

+10V REF DETECTOR, 7-2, 7-4

-10V REF DETECTOR, 7-2, 7-4

120 kHz EMI BW, 7-5

12.4-19. BAND 3, 7-4, 7-12

19.1-22 BAND 4, 7-5, 7-12

## 2

200 Hz EMI BW, 7-5

2.75-6.5 BAND 1, 7-4, 7-12

2v REF DETECTOR, 7-2, 7-4

## 3

3 dB bandwidth measurement, 7-58

## 5

50 $\Omega$ /75 $\Omega$  minimum loss pad, 10-13

500 RF bridge, 10-13

500 to 7561 matching pad (Option 71 1), 10-12

500 transmission/reflection test set, 10-13

## 6

6.0-12.8 BAND 2, 7-4, 7-12

## 7

750 input impedance (Option 001), 10-5

750 matching transformer, 10-13

75 $\Omega$  RF bridge, 10-13

## 9

9 kHz EMI BW, 7-5

## A

A  $\leftrightarrow$  B, 7-5

A-B  $\rightarrow$  A ON OFF, 7-5

A  $\rightarrow$  C, 7-5

ABCDEF, 7-5

ACCEPT QP DATA, 7-6

accessories

50 $\Omega$ /75 $\Omega$  minimum loss pad, 10-13

50 $\Omega$  transmission/reflection test set, 10-13

750 matching transformer, 10-13

AC power source, 10-14

AC probe, 10-14

broadband preamplifiers, 10-14

broadcast measurements personality, 10-2

burst carrier trigger, 10-14

cable TV measurements personality, 10-2

CATV measurements personality, 10-2

CATV system monitor personality, 10-2

CDMA measurements personality, 10-2

close-field probes, 10-15

CT2-CAI measurements personality, 10-3

DCS1800 measurements personality, 10-3

DECT measurements personality, 10-3

digital radio measurements personality,  
10-3

EMI diagnostics measurements personality,  
10-3

external keyboard, 10- 15

GSM900 measurements personality, 10-3

HP-IB cable, 10-15

link measurement personality, 10-4

memory card, 10-15

NADC-TDMA measurements personality,  
10-4

noise figure, 10-4

noise figure measurements personality,  
10-4

parallel interface cable, 10-15

PC interface and report generator software,  
10-16

PC software, 10-16

PDC measurements personality, 10-4

PHS measurements personality, 10-4

plotter, 10-16

printer, 10-16

rack slide kit, 10-16

RF bridge, 10-13

RF limiters, 10-13

RS-232 cable, 10-16

scalar 50 $\Omega$  transmission/reflection test set,  
10-13

scalar measurements personality, 10-4

transient limiters, 10-13



- transit case, 10-16
- accessories shipped with the analyzer, 1-3
- ac coupling, 7-30
- ACPGRAPH, 7-6
- AC power source, 10-14
- AC probe, 10-14
- active function, 2-12
- active function block, 2-1
- active function clearing, 7-48
- addressing printer, 7-69
- address of plotter, 7-63
- address of spectrum analyzer, 7-10
- adjacent channel power, 7-6
  - extended dynamic range, 7-7
  - using, 4-44-47
- adjacent channel power graph, 7-6
- adjacent channel power measurement, 4-43
- adjacent channel power ratio, 7-6
- ADJ CHAN POWER, 7-6
- ADJ CHAN PWR extd, 7-7
- ALC INT EXT, 7-7
- ALC MTR INT XTAL, 7-7
- ALC TEST, 7-2, 7-8
- aliasing
  - FFT function, 4-3
  - signal identification, 7-79
- ALL DLP → CARD, 5-16, 7-8
- alpha characters, 7-5, 7-47, 7-82, 7-92
- AM/FM demodulation
  - use with Option 105, 4-23
- AM/FM demodulator with speaker
  - and quasi-peak detector (Option 103), 10-9
  - and TV sync trigger circuitry (Option 102), 10-9
- % AM ON OFF, 4-40, 7-4
- Amp Cor, 5-38, 7-8
- AMP COR, 7-8
- AMP COR ON OFF, 5-37, 5-39, 7-8
- amplifiers, 10-14
- AMPLITUDE, 2-1, 2-13, 7-8
- amplitude accuracy, 7-30
- amplitude and frequency self-calibration
  - routine, 7-14
- amplitude correction
  - amplitude coordinate, 5-39
  - frequency coordinate, 5-39
  - point, 5-38
  - testing, 5-39
  - using RECALL AMP COR, 5-39
  - using SAVE AMP COR, 5-39
- amplitude-correction factors, 5-35-39
- amplitude correction factors, 5-35
  - cataloging, 7-16
  - delete point, 7-33
  - edit, 7-36
- edit done, 7-36
- menus, 7-8
- on or off, 7-8
- purge, 7-70
- recall table, 7-73
- save table, 7-75
- select amplitude, 7-76
- select frequency, 7-77
- select point, 7-77
- select sweep time, 7-78
- storing, 7-8
- amplitude-correction functions, 5-38
- amplitude-corrections
  - creating, 5-36
- amplitude corrections
  - creating, 5-37
  - editing, 5-36
- amplitude demodulation, 7-33
- amplitude menus, 7-8
- amplitude modulation, 7-4
- amplitude modulation measurement, 4-39
- amplitude scale, 7-76
- amplitude self-calibration, 7-13
- amplitude units, 7-8
  - dBm, 7-31
  - dBmV, 7-31
  - dBuV, 7-31
  - Volts, 7-9 1
  - Watts, 7-9 1
- Amptd Units, 7-8
- analog + display, 7-9
  - using, 5-31-32
- ANALOG+ ON OFF, 7-9
- ANALYZER ADDRESS, 7-10
- analyzer battery, 2-22
- analyzer distortion products, 3-20
- ANALYZER GAINS, 7-2, 7-10
- analyzer memory
  - cataloging functions, 7-18
  - catalog variables, 7-2 1
  - delete file, 7-33
  - DLP cataloging, 7-18
  - erase user programs and variables, 7-35
  - program and variable cataloging, 7-16
  - recalling amplitude-correction factors, 5-8
  - recalling a state, 5-6
  - recalling a trace, 5-7
  - recalling limit lines, 5-8
  - saving amplitude-correction factors, 5-8
  - saving and recalling data, 5-6
  - saving a state, 5-6
  - saving a trace, 5-7
  - saving limit lines, 5-8
  - saving to, 7-88
  - state and trace register status, 7-21

annotation, 2-10  
 ANNOTATN ON OFF, 7-10  
 APND CAT ITEM, 7-10  
 ATTEN AUTO MAN, 7-10  
 attenuation coupling, 7- 10  
 attenuator-error factors, 7-78  
 AUTO ALL, 7-10  
 AUTO COUPLE, 7-1 1  
 automatic FFT, 7-53  
 automatic leveling control, 7-7  
 automatic quasi-peak routine, 7- 1 I  
 AUTO QP AT MKR, 7-11  
 AUXB, 7-2, 7-11  
 Aux Conn Control, 7-11  
 AUX CTRL, 7-1 1  
 AUX IF OUTPUT, 2-7  
 auxiliary connector input, 7-35  
 auxiliary interface  
     connector, 7-1 1  
     control line A, 7-26  
     control line B, 7-26  
     control line C, 7-26  
     control line D, 7-26  
 AUX INTERFACE, 2-6  
 AUX VIDEO OUTPUT, 2-7  
 available memory, 7- 18  
  
**B**  
 B → C, 7-11  
 B <→ C, 7-11  
 B-DL → B, 7-11  
 band boundaries, measuring signals near,  
     3-26  
 band lock  
     band selection, 7-4, 7-5  
 Band Lock, 7-12  
 BAND LOCK, 3-26  
 band locking, 7-13  
 bandwidth  
     measurement, 4-39  
 bandwidth functions, 7-13  
 bandwidth measurement, 7-58  
 bandwidth ratio  
     video bandwidth to resolution bandwidth,  
     7-90  
 battery. See analyzer battery, memory card  
     changing the battery, 2-20  
 BAUD RATE, 7-12  
 benchlink spectrum analyzer  
     Option B70, 10-12  
 bias-current DAC adjustment, 7-14  
 binary, A-2  
 BINARY SPAN, 7-2, 7-12  
 black and white printing, 7-48  
 BLANK A, 7-12

BLANK B, 7-12  
 BLANK C, 7-12  
 BLANK CARD, 5-11, 7-13  
 BND LOCK ON OFF, 3-26, 7-13  
 broadband preamplifiers, 10-14  
 built-in tracking generator, 7-88  
 BW, 7-13  
 B&W PRINTER, 7-48  
  
**C**  
 cable TV measurements personality, 10-2  
 CAL, 2-16, 7-13  
 CAL AMPTD, 1-8, 2-16, 7-13  
 CAL FETCH, 2-16, 7-13  
 CAL FREQ, 1-8, 2-16, 7-14  
 CAL FREQ & AMPTD, 1-9, 2-16, 7-14  
 calibration, 7- 13  
     attenuator-error factors, 7-78  
     self-calibration routines, 2-16  
 CAL MXR, 7-2, 7-14  
 CAL OUT, 2-3  
 CAL STORE, 1-9, 2-16, 7-14  
 CAL TIMEBASE, 7-2, 7-14  
 CAL TRK GEN, 1-9, 2-17, 7-14  
 CAL YTF, 1-10, 2-18, 7-14  
 card  
     changing the battery, 2-20  
     inserting a memory card, 2-19  
 Card Config, 7-14  
 CARD → DISPLAY, 7-15  
 CARD → DLP, 7-15  
 CARD → STATE, 7-15  
 Card → Trace, 7-15  
 care  
     memory, 10-15  
 carrying case (Option 015), 10-6  
 carrying case (Option 016), 10-6  
 CATALOG ALL, 7-16  
 CATALOG AMP COR, 7-16  
 Catalog Card, 5-12, 7-16  
 CATALOG DISPLAY, 7- 18  
 CATALOG DLP, 7-18  
 Catalog Internal, 7-18  
 CATALOG LMT LINE, 7-19  
 CATALOG ON EVENT, 7-19  
 CATALOG PREFIX, 7-20  
 CATALOG REGISTER, 7-2 1  
 CATALOG STATES, 7-2 1  
 CATALOG TRACES, 7-2 1  
 CATALOG VARIABLES, 7-2 1  
 CATV measurements, 10-2  
 CATV system monitor, 10-2  
 CDMA firmware (Option 160), 10-11  
 CDMA measurements, 10-2  
 CENTER FREQ, 7-21

- center frequency, 7-21
  - window zone, 7-92
- center-frequency step size, 7-2 1
- CF STEP AUTO MAN, 7-21
- change function values, 2-8
- change prefix
  - edit done, 7-36
- Change Prefix, 7-21
- Change Title, 7-22
- changing windows, 7-58
- CHANNEL BANDWIDTH, 7-22
- channel power
  - using, 4-48-49
- CHANNEL POWER, 7-23
- channel power measurement, 4-43
- CHANNEL SPACING, 7-23
- characters, 7-5, 7-47, 7-82, 7-92
- checking the fuse, 1-5
- check spectrum analyzer operation, 7-27
- CISPR testing, 7-38
- Clear, 7-23
- clear display
  - active function area, 2-8
- clearing a service request, A-1
- clearing the active function, 7-48
- CLEAR PARAM, 7-23
- CLEAR QP DATA, 7-23
- CLEAR WRITE A, 7-24
- CLEAR WRITE B, 7-25
- CLEAR WRITE C, 7-26
- close-field probes, 10-15
- CNTL A 0 1, 7-26
- CNTL B 0 1, 7-26
- CNTL C 0 1, 7-26
- CNTL D 0 1, 7-26
- CNT RES AUTO MAN, 3-6, 7-26
- COARSE TUNE DAC, 7-2, 7-27
- COMB GEN ON OFF, 3-26, 7-27
- command complete, A-1
- commands
  - dispose all , 7-39, 7-40, 7-41
  - front panel execution, 7-41
- common measurements
  - stimulus-response, 4-7-12
- common preset conditions, 7-66
- comparing signals, 3- 12
- confidence test, 7-27, 9-2
- CONFIG, 7-27
- configuration
  - plotter, 7-63, 7-64
  - printer, 7-69
- CONF TEST, 7-27, 9-2
- connecting your spectrum analyzer to a
  - printer, 6-5
- connector
  - 100 MHz comb out, 2-4
  - 10 MHz ref output, 2-6
  - AUXB, 7-11
  - aux IF output, 2-7
  - aux video output, 2-7
  - cal output, 2-3
  - earphone, 2-6
  - event counter input, 2-6
  - ext alc input, 2-5
  - external detector flatness input, 2-5
  - external keyboard, 2-7
  - ext ref in, 2-6
  - ext trig input, 2-7
  - gate output, 2-6
  - gate trigger input, 2-6
  - hi sweep in/out, 2-7
  - HP-IB interface, 2-7
  - interval counter input, 2-6
  - LO output, 2-6
  - monitor output, 2-6
  - sweep output, 2-7
  - sweep + tune output, 2-6
  - TV trig output, 2-5
- connector, auxiliary interface, 7-1 1
- continuous sweep, 7-82
- CONTINUS FFT, 7-27
- CONT MEAS, 7-27
- control functions, 2-3
- control line A
  - auxiliary interface, 7-26
- control line B
  - auxiliary interface, 7-26
- control line C
  - auxiliary interface, 7-26
- control line D
  - auxiliary interface, 7-26
- controlling the gate
  - GATE CTL EDGE LVL, 7-46
  - GATE ON OFF, 7-46
- COPY, 2-3, 7-28
- COPY DEV PRNT PLT, 7-30
- correction factors, 2-16, 2-17, 7-30
  - data display, 7-34
  - default, 7-31
  - self-calibration, 7-13
  - storing, 7-14
- CORRECT ON OFF, 2-17, 7-30
- COUPLE AC DC, 7-30
- coupled functions menu, 7-11
- coupled sweep time, 7-83
- coupling
  - ac or dc, 7-30
  - all functions, 7-10
  - time gate utility, 7-23, 7-30, 7-31, 7-32
- coupling video bandwidth, 7-90

- CPL RBW ON OFF, 7-30
- CPL SWP ON OFF, 7-30
- CPL VBW ON OFF, 7-31
- creating amplitude-correction factors, 5-36
- creating limit lines, 5-18
- creating new programs, 7-58
- CRT HORZ POSITION, 7-31
- CRT VERT POSITION, 7-31
- CT2-CAI measurements, 10-3
- CT2 demodulator (Option 1 10), 10-9

## D

### DAC

- bias current adjustment, 7-14
- extra fine-tune, 7-91
- fine tune, 7-43
- mixer bias, 7-55
- sweep time, 7-83
- YTF coarse tune, 7-92
- YTF fine-tune, 7-92

### DACS, 7-2, 7-31

- data controls, 2-8

- data keys, 2-3, 2-8

- data protection, 5-8

- data recall, 7-72

- data transmission speed, 7-12

- DATEMODE MDY DMY, 7-31

- dBm, 7-31

- dBmV, 7-31

- dBuV, 7-31

- dc coupling, 7-30

- DC probes

- use of, 10-14

- DCS1800 measurements, 10-3

- deactivate function, 2-8

- deactivating the active function, 7-48

- DECT demodulator (Option 1 12), 10-10

- DECT measurements, 10-3

- DEFAULT CAL DATA, 7-31, 9-3

- DEFAULT CONFIG, 7-3 1

- DEFAULT SYNC, 7-32

- Define Coupling, 7-32

- Define Gate, 7-32

- Define Time, 7-32

- delay

- GATE DELAY, 7-46

- delaying sweep, time gate utility, 7-83

- DELETE FILE, 7-33

- delete files from memory card, 7-13

- delete frequency accuracy (Option 713), 10-12

- DELETE POINT, 7-33

- DELETE SEGMENT, 7-33

- delta display-line markers, 7-85

- delta marker, 3-12, 7-52

- Demod, 4-13, 7-33

- DEMODO AM FM, 4-13, 7-33

- DEMODO ON OFF, 4-13, 7-33

- demodulating an AM or FM signal, 4-13

- demodulation, 7-33

- AM, 7-33

- continuous, 4-14

- dwelt time, 7-36

- FM, 7-33

- FM gain, 7-44

- FM offset, 7-44

- FM span, 7-44

- on and off, 7-33

- speaker on off, 7-80

- squelch, 7-81

- demodulator

- optional, 10-9

- demodulator, AM/FM (Option 102), 10-9

- demodulator, AM/FM (Option 103), 10-9

- deskjet , 7-34

- DESKJET 310, 7-34

- DESKJET 540, 7-34

- DESKJET 550C, 7-34

- deskjet printer, 7-34

- detection mode

- negative peak, 7-34

- positive peak, 7-34

- sample, 7-34

- detector

- quasi peak, 7-72

- DETECTOR PK SP NG, 7-34

- DETECTOR SMP PK, 7-34

- determining gate delay, 4-26

- determining gate length, 4-26

- digital demodulator

- optional, 10-10

- digital radio measurements, 10-3

- disable peak detector reset, 7-35

- display

- analog + , 7-9

- cataloging, 7-18

- two windows, 7-60

- using windows, 5-33

- DISPLAY, 7-34

- DISPLAY CAL DATA, 7-2, 7-34

- DISPLAY CNTL I, 7-35

- display compression

- due to monitor output format, 2-10, 7-84

- display image

- saving and recalling, 5-18

- display line, 7-35

- DISPLAY → CARD, 7-35

- display zone

- change span, 7-93

- find left peak, 7-93

- find right peak, 7-93
- move center, 7-92
- Dispose User Mem, 7-35
- distortion products, 3-20
- DJ540, 7-48
- DLP, 5-16
  - cataloging, 7- 18
  - editor, 7-38
- DLP editor function
  - appending, 7- 10
  - display and edit item, 7-36
  - edit last item, 7-37
- DONE, 7-35
- double display, 7-60
- downloadable programs, 5-16
- DROOP, 7-2, 7-35
- DSP LINE ON OFF, 7-35
- DWELL TIME, 7-36

**E**

- earphone connector, 2-6
- EDGE POL POS NEG, 7-36
- edge triggering
  - time gate utility, 7-36
- edge triggering, gate control, 7-46
- Edit Amp Cor, 5-38, 7-36
- EDIT CAT ITEM, 7-36
- Edit Done, 7-36
- EDIT DONE, 5-20, 5-28, 5-37, 5-39, 7-36
- EDIT FLATNESS, 7-2, 7-36
- editing
  - DLPs, 7-38
- editing amplitude corrections, 5-36
- editing limit lines, 5-20
- EDIT LAST, 7-37
- Edit Limit, 5-22, 7-37
- Edit Lower, 5-23, 7-37
- Edit Lower limit line format, 5-25
- Edit Mid/Delt, 5-23, 7-37
- Edit Mid/Delt limit line format, 5-25
- Editor, 7-38
- Edit Up/Low, 5-23, 7-38
- Edit Up/Low limit line format, 5-25
- Edit Upper, 5-19, 5-23, 7-38
- Edit Upper limit line format, 5-25
- EDIT UPR LWR, 7-38
- electrostatic discharge, 1-1 1
- EM1 bandwidth
  - 120 kHz, 7-5
  - 200 Hz, 7-5
  - 9 kHz, 7-5
- EM1 BW Menu, 7-38
- EM1 close-field probe, 10-15
- EM1 diagnostics measurements, 10-3
- end of sweep, A-1

- ENTER, 7-38
- entering a prefix, 5-12
- ENTER PRI, 7-39
- ENTER REF EDGE, 7-39
- ENTER WIDTH, 7-39
- epson format, 7-41
- EPSON LARGE, 7-78
- epson lq570, 7-41
- epson mx80 , 7-41
- epson printer, 7-41
- EPSON SMALL, 7-78
- ERASE ALL, 7-40
- ERASE CARD, 7-40
- ERASE DLP, 7-39
- ERASE DLP MEM, 7-39
- ERASE MEM ALL, 7-40
- ERASE MEM CARD, 7-40
- ERASE STATE, 7-40
- ERASE STATEALL, 7-40
- ERASE TRACE, 7-41
- ERASE TRACEALL, 7-41
- erase user programs and variables, 7-35
- ESD, 1-11
  - reducing damage caused by ESD, 1-12
  - static-safe accessories, 1-12
  - static-safe work station, 1-1 1
- EVENT CNTR INPUT, 2-6
- exchange trace A and B, 7-5
- exchange trace B and C, 7-11
- execute a command
  - front panel, 7-41
- EXECUTE TITLE, 7-2, 7-41
- EXIT, 7-41
- Exit Catalog, 7-41
- EXIT SHOW, 7-42
- EXIT UTILITY, 7-42
- expanding a window, 7-93
- EXT ALC INPUT, 2-5
- EXTERNAL, 7-42
- external/internal leveling, 7-7
- external keyboard, 5-40, 10-15
  - prefix entry, 5-43
  - programming command entry, 5-43
  - screen title entry, 5-42
- external keyboard connector, 2-7
- external keyboard installation, 5-42
- external keyboard operation, 5-42-43
- EXTERNAL PREAMPG, 7-42
- EXT KEYBOARD, 2-7
- EXT REF INPUT, 2-6
- EXT TRIG INPUT, 2-7

## F

- fast ADC
  - optional, 10-10
- fast Fourier transform
  - stop frequency, 7-43
- fast Fourier transform function, 4-2, 7-43
- fast time domain sweeps (Option 101), 10-8
- features
  - front panel, 2-1
- FFT
  - markers, 7-53
- FFT compatibility, 7-43
- FFT display annotation, 4-2
- FFT marker frequency, 7-53
- FFT MARKERS, 7-42
- FFT measurement, 4-2, 7-27, 7-80
  - automatic, 4-5
  - manual, 4-3
  - setup, 4-3
- FFT Menu, 7-43
- FFT OFF, 7-43
- FFT STOP FREQ, 7-43
- fine-focus control, 2-9
- FINE TUNE DAC, 7-2, 7-43
- firmware
  - optional, 10-1 1
- firmware date, 1-8
- fixed, limit line type, 7-50
- fix-tuned receiver, 3-24
- FLAT, 5-26, 7-43
- flatness
  - factory defaults, 7-48
- flatness correction constants, 7-36, 7-43
- Flatness Data, 7-2, 7-43
- FLATNESS EXT DET IN, 2-5
- FM COIL DRIVE, 7-2, 7-44
- FM GAIN, 4-14, 7-2, 7-44
- FM OFFSET, 7-2, 7-44
- FM SPAN, 7-3, 7-44
- FORMAT CARD, 5-1 1, 7-44
- format date, 7-31
- Fourier transform
  - See also fast Fourier transform, 7-43
- Fourier transform measurement, 7-43
- FREE RUN, 7-44
- FREQ DIAG, 7-3, 7-44
- FREQ DISC NORM OFF, 7-44
- FREQ OFFSET, 7-45
- frequency
  - stop, 7-82
- FREQUENCY, 2-1, 2-13, 7-45
- frequency and amplitude self-calibration
  - routine, 1-8, 7-14
- frequency demodulation, 7-33

- frequency extension to 26.5 GHz (Option 026)
  - APC-3.5 connector, 10-7
- frequency extension to 26.5 GHz (Option 027)
  - N-Type connector, 10-7
- frequency offset, 7-45
- frequency self-calibration, 7-14
- frequency span, 7-80
  - changing to full span, 7-45
- front panel execution of programming
  - commands, 7-41
- front-panel features, 2-1-4
- front panel protective cover (Option 040), 10-7
- FRQ DISC NORM OFF, 7-3
- FULL SPAN, 7-45
- functional check of Option 105, 4-36
- function coupling, 7-10
- fuse, 1-5
- fuse holder, 2-6

## G

- gain
  - internal spectrum analyzer, 7-10
- gate
  - coupling functions, 7-32
    - using the gate utility, 4-19
- gate control, 7-32
  - edge or level triggering, 7-46
    - Option 105, 4-38
- Gate Control, 7-45
- GATE CTL EDGE LVL, 7-46
  - operation, 4-38
- gate definition, 7-32
- gate delay
  - determining the gate delay, 4-26
  - setting gate delay outside the Gate Utility, 4-33
- GATE DELAY, 7-46
- gate length
  - determining the gate length, 4-26
  - setting gate length outside the Gate Utility, 4-33
- GATE LENGTH, 7-46
- GATE ON OFF, 7-46
- GATE OUTPUT, 2-6
- GATE TRIGGER INPUT, 2-6
- gate utility
  - exit, 7-42
  - exiting, 7-47
  - use of, 4-19, 4-20
- GATE UTILITY, 7-47
- gate utility coupling, 7-32
  - resolution bandwidth, 7-30

- sweep time, 7-30
- video bandwidth, 7-31
- GHIJKL, 7-47
- GND REF DETECTOR, 7-3, 7-47
- graph markers, 7-48
- GRAT ON OFF, 7-47
- group delay and amplitude flatness (Option 111), 10-9
- GRPH MKR ON OFF, 7-48
- GSM900 measurements, 10-3
- GSM/DCS-1800 firmware (Option 163), 10-11
- guidelines for using Option 105, 4-26

## H

- hardware broken, A-1
- hardware error messages, 9-7
- hardware problems, 9-1
- harmonic band 0, 7-4
- harmonic band 1, 7-4
- harmonic band 2, 7-4
- harmonic band 3, 7-4
- harmonic band 4, 7-5
- harmonic band menu, 7-12
- harmonic band slope and offset adjust, 7-14
- harmonic lock, 3-26, 7-13
- highest peak
  - finding next, 7-58
- highest signal peak, 7-80
- HIGH SWEEP IN/OUT, 2-7
- HIOLD, 2-8, 7-48
- horizontal signal positioning, 7-31
- how to call Hewlett-Packard, 9-4
- how to return your analyzer for service, 9-6
- HP 8590 Series key menus, 8-2-14
- HP B&W PRINTER, 7-78
- HP-IB address, 7-10
- HP-IB and Parallel (Option 041), 10-6
- HP-IB cable, 10-15
- HP-IB interface connector, 2-7
- HP Paintjet, 7-61

## I

- identifying distortion products, 3-20
- identify the signal
  - FFT, 7-79
- IDNUM, 7-2, 7-48
- illegal spectrum analyzer command, A-1
- impact cover (Option 040), 10-7
- improved amplitude accuracy (Option 050), 10-8
- improved amplitude accuracy (Option 051), 10-8
- improved amplitude accuracy (Option 052), 10-8

- improved amplitude accuracy (Option 053), 10-8
- impulse noise
  - measurement, 3-17
- increase frequency readout resolution, 3-6
- informational messages, 9-7
- INIT FLT, 7-2, 7-48
- initial inspection, 1-3
- INPUT 50 $\Omega$ , 2-3
- INPUT 75 $\Omega$ , 2-3
- input and output
  - auxiliary control, 7-11
- input attenuation control, 7-10
- input impedance, 7-49
- INPUT Z 50 $\Omega$  750, 7-49
- inserting a memory card, 2-19
- installation, external keyboard, 5-42
- installation manual
  - see User's Guide, 10-12
- instrument preset, 7-66
- instrument state, 2-2
- intensity control, 2-3
- interface connectors, 2-7
- intermodulation distortion, third order, 3-22
- INTERNAL CARD, 7-49
- internal comb generator, 7-27
- internal/external leveling, 7-7
- INTERNAL  $\rightarrow$  STATE, 7-49
- Internal  $\rightarrow$  Trace, 7-49
- INTERVAL CNTR INPUT, 2-6

## K

- keyboard
  - external keyboard functions, 5-40
- keyboard, external, 5-40
- keyboard operation, external, 5-42
- key functions, external keyboard, 5-40
- key menus, 8-1
- knob, 2-3, 2-8

## L

- label, softkey, 2-1
- laserjet plots, 7-64
- LAST SPAN, 7-49
- length
  - GATE LENGTH, 7-46
- level triggering, gate control, 7-46
- limiters
  - RF and transient, 10-13
- LIMIT FAIL, 5-18
- limit-line functions, 5-22-28
- limit lines, 5-18
  - amplitude coordinate, 5-25
  - cataloging, 7-19
  - creating, 5-18, 5-22

- delete segment, 7-33
- displaying, 5-28, 7-51
- edit done, 7-36
- editing, 5-20
- edit lower table, 7-37
- edit mid/delta amplitude, 7-37
- edit table, 7-37
- edit upper and lower tables, 7-38
- edit upper table, 7-38
- fixed, 5-22
- fixed and relative, 7-50
- flat type, 7-43
- frequency or time, 5-22
- frequency or time coordinate, 5-25
- point, 7-64
- purge, 7-70
- recall table, 7-73
- relative, 5-22
- save table, 7-76
- segment number, 5-23
- SEGMENT TYPE, 5-26
- select amplitude, 7-76
- select delta amplitude, 7-76
- select frequency, 7-77
- select frequency or time, 7-50
- select lower amplitude, 7-77
- select middle amplitude, 7-77
- select segment, 7-77
- select time, 7-78
- select type, 7-78
- select upper amplitude, 7-78
- slope type, 7-80
- table format, 5-23
- table type, 5-22
- testing, 5-28, 7-51
- upper and lower, 5-29
- using RECALL LIMIT, 5-28
- using SAVE LIMIT, 5-28
- Limit Lines, 7-49
- LIMIT LINES, 5-22, 7-50
- LIMIT PASS, 5-18
- LIMITS FIX REL, 5-19, 5-20, 5-22, 7-50
- LIMITS FRQ TIME, 5-19, 5-22, 7-50
- LINE, 7-51
- linear scale, 7-76
- LINE front-panel key, 2-4
- LINE switch, 2-4
- line voltage selector switch, 1-4
- link measurement personality, 10-4
- list of markers, 7-56
  - marker table, 5-2
- list of peaks, 7-63
  - peak table, 5-4
- LMT DISP Y N AUTO, 5-28, 7-51
- LMT TEST ON OFF, 5-20, 5-28, 7-51

- LOAD FILE, 7-51
- (LOCALS, 7-51
- local operation, 7-27, 7-51
- lock harmonic band, 7-13
- lock internal state and trace registers, 7-74
- LO feedthrough, 3-12
- log scale, 7-76
- LO OUTPUT, 2-6
- LO output (Option 009), 10-5
- lower limit line, 5-23
  - editing, 7-37
- low-level signals, 3-15
  - reducing attenuation, 3-15
  - reducing resolution bandwidth, 3-16
  - reducing video bandwidth, 3-17
  - video averaging, 3-17

## M

- MAIN COIL DR, 7-3, 7-51
- Main Menu
  - time gate utility, 7-52
- MAIN SPAN, 7-3, 7-52
- making a measurement, 2-13-14
- MAN QP AT MKR, 7-52
- MAN TRK ADJUST, 4-10, 7-52
- manuals
  - extra user's and calibration guide (Option 910), 10-12
  - installation: see User's Guide, 10-12
  - operation: see User's Guide, 10-12
  - verification: see Calibration Guide, 10-12
- manual tracking adjustment, 7-52
- marker
  - delta display-line, 7-85
  - FFT, 7-42
  - gate utility trigger, 7-89
  - list of, 7-56
  - menu of controls, 7-57
  - menu of functions, 7-57
  - quasi peak, 7-54
  - selection, 7-76
  - table, 7-56
  - time gate utility, 7-54
  - trace selection, 7-56
  - zeroing delta marker in the gate utility, 7-92
- MARKER A, 3-12, 7-52
- MARKER  $\Delta$ →SPAN, 7-53
- MARKER ALL OFF, 7-54
- MARKER AMPTD, 7-54
- marker counter, 3-6, 7-56
  - resolution, 7-26
  - use with Option 105, 4-23
- marker delta, 3-12
- marker functions, 2-3



- marker noise, 7-56
  - use with Option 105, 4-23
- MARKER NORMAL, 2-14, 7-54
- MARKER NORM PK, 7-54
- MARKER ON, 7-54
- marker pause, 7-56
  - dwell time, 7-36
- marker readout modes, 7-56
- MARKER- AUTO FFT, 7-53
- MARKER →CF, 7-53
- MARKER →CF STEP, 7-53
- MARKER- FFT STOP, 7-53
- MARKER- MID SCR N, 7-53
- MARKER →MINIMUM, 7-53
- MARKER →PK-PK, 3-13, 7-53
- MARKER →REF LVL, 7-53
- MARKER -START, 7-53
- MARKER -STOP, 7-54
- markers
  - using multiple markers, 5-3
- marker table
  - mode, 7-85
  - using, 5-2-3
- marker to, 7-57
- marker tracking, 3-7, 7-57, 7-63
- mass** storage device
  - analyzer memory, 7-49
  - memory card, 7-49
- matching pad, 50Ω to 75Ω (Option 711), 10-12
- MAX HOLD A, 3-10, 7-55
- MAX HOLD B, 7-55
- maximum hold, 3-9
- maximum mixer level, 7-55
- MAX MXR LVL, 7-55
- MEAS OFF, 7-55
- measuring amplitude modulation, 4-2
- measuring low-level signals, 3-15
- measuring return loss, 4-18
- measuring signals near band boundaries, 3-26
- MEAS/USER, 7-55
- MEM LOCKED, 7-55, 7-74
- memory
  - amount available, 7-18
- memory card
  - battery, 2-20
  - blank card, 5-1 1
  - card configuration, 7- 14
  - catalog display images, 7-18
  - catalog DLPs, 7-18
  - catalog functions, 7-16
  - cataloging, 5-12, 7-17
  - cataloging amplitude correction factor files, 7-16
  - catalog limit lines, 7-19
  - catalog states, 7-2 1
  - catalog traces, 7-2 1
  - changing the battery, 2-20
  - delete file, 7-13, 7-33
  - display recall, 7- 15
  - formatting, 5- 11, 7-44
  - inserting a memory card, 2-19
  - preparation for use, 5-11
  - program and variable cataloging, 7-16
  - recalling a display image, 5-14
  - recalling a DLP, 7-15
  - recalling amplitude-correction factors, 5-15
  - recalling a program, 5-16
  - recalling a state, 5-13, 7-15
  - recalling a trace, 5-13, 7-15
  - recalling limit lines, 5-15
  - saving a display image, 5-14
  - saving amplitude-correction factors, 5-15
  - saving and recalling data, 5-10
  - saving and recalling programs, 5-16
  - saving a program, 5-16
  - saving a state, 5-12
  - saving a trace, 5-13
  - saving limit lines, 5-15
  - saving states, 7-82
  - saving to memory card, 7-87
  - write-protect switch, 2-21
- memory card reader, 2-4
- memory card reader (Option 003), 10-5
- menu and softkey overview, 2-12
- menus, 8-1
- message block, 2-1
- mid/delta limit line
  - editing amplitude, 7-37
- mid/delta limit-line format, 5-23
- MIN HOLD C, 3-1 1, 7-55
- minimum hold, 3-9
- minimum to marker, 7-53
- MIXER BIAS DAC, 7-3, 7-55
- mixer input level maximum, 7-55
- MK COUNT ON OFF, 3-6, 7-56
- MK NOISE ON OFF, 7-56
- MK PAUSE ON OFF, 7-56
- MKR, 2-14, 7-57
- MK READ F T I P, 7-56
- MKR FCTN, 7-57
- MKR-, 7-57
- MK TABLE ON OFF, 7-56
- MK TRACE AUTO ABC, 7-56
- MK TRACK ON OFF, 3-9, 7-57
- MNOPQR, 7-57
- MODE, 2-2, 7-57
- model specific preset conditions, 7-66
- MONITOR OUTPUT, 2-6

- display compression, 2-10, 7-84
- move trace A into C, 7-5
- multipen plotter, 7-29

N

- NADC firmware (Option 160), 10-11
- NADC-TDMA measurements personality, 10-4
- narrow resolution bandwidths and precision frequency reference (Option 140), 10-10
- narrow resolution bandwidths (Option 130), 10-10
- N dB bandwidth measurement, 4-39
- N dB PTS ON OFF, 4-39, 7-58
- negative peak detection mode, 7-34
- NEW EDIT, 7-58
- NEXT, 7-58
- NEXT PEAK, 7-58
- NEXT PK LEFT, 7-58
- NEXT PK RIGHT, 7-58
- noise figure, 10-10
- normalization, 4- 11
- normal marker, 7-54
  - quasi peak, 7-54
- NORMLIZE ON OFF, 4- 11, 7-59
- NORMLIZE POSITION, 7-59
- No User Menu, 7-59
- NTSC, 7-59
- NTSC video format, 7-84
- number/units keypad, 2-8

0

- OCC BW % POWER, 7-59
- OCCUPIED BANDWDTH, 7-60
- occupied bandwidth
  - using, 4-43-44
- occupied power bandwidth measurement, 4-43
- octal to binary, A-2
- ON, 7-60
- ONCYCLE command, 7- 19
- ONDELAY command, 7-19
- ONEOS command, 7-19
- on event commands
  - ONCYCLE, 7-19
  - ONDELAY, 7-19
  - ONEOS, 7-19
  - ONMKR, 7-19
  - ONPWRUP, 7-19
  - ONSRQ, 7-19
  - ONSWP, 7-19
  - ONTIME, 7-19
  - TRMATH, 7-19
- ONMKR command, 7-19
- on/off switch, 2-4

- ONPWRUP command, 7-19
- on-screen signal positioning
  - horizontal, 7-31
  - vertical, 7-31
- ONSRQ command, 7-19
- ONSWP command, 7-19
- ONTIME command, 7-19
- operating Option 105, 4-22
- operation
  - local, 7-5 1
- operation manual
  - see User's Guide, 10-12
- Option 101
  - used time gate Option 105, 4-22
  - used with FFT measurements, 4-2
- Option 105
  - example of using time-gating, 4-24
  - functional check, 4-36
  - operation, 4-22
  - self-calibration routines, 4-35
  - spectrum analyzer settings, 4-24, 4-26
  - table of spectrum analyzer settings, 4-34
- options
  - 50 $\Omega$  to 7561 matching pad (Option 711), 10-12
  - 75 $\Omega$  input impedance (Option 001), 10-5
  - AM/FM demodulator w/speaker and TV sync trigger circuitry (Option 102), 10-9
  - benchlink spectrum analyzer (Option B70), 10-12
  - carrying case (Option 015), 10-6
  - carrying case (Option 016), 10-6
  - CT2 demodulator (Option 1 10), 10-9
  - digital demodulator (Option 151), 10-10
  - digital european cordless telephone(Option 112), 10-10
  - DSP (Option 151), 10-10
  - extra calibration guide (Option 910), 10-12
  - extra user's guide (Option 910), 10-12
  - fast ADC (Option 151), 10-10
  - fast time domain sweeps (Option 101), 10-8
  - frequency extension to 26.5 GHz: APC-3.5 connector (Option 026), 10-7
  - frequency extension to 26.5 GHz: N-Type connector (Option 027), 10-7
  - front panel protective cover (Option 040), 10-7
  - group delay and amplitude flatness (Option 111), 10-9
  - GSM/DCS-1800 firmware (Option 163), 10-11
  - HP-IB and Parallel (Option 041), 10-6
  - impact cover (Option 040), 10-7

- improved amplitude accuracy (Option 050), 10-8
- improved amplitude accuracy (Option 051), 10-8
- improved amplitude accuracy (Option 052), 10-8
- improved amplitude accuracy (Option 053), 10-8
- LO output (Option 009), 10-5
- memory card reader kit, 10-5
- memory card reader (Option 003), 10-5
- narrow resolution bandwidths and precision frequency reference (Option 140), 10-10
- narrow resolution bandwidths (Option 130), 10-10
- noise figure (Option 119), 10-10
- PCD/PHS/NADC/CDMA firmware (Option 160), 10-11
- precision frequency reference (Option 004), 10-5
- protective soft carrying case (Option 042), 10-7
- quasi-peak detector and AM/FM demodulator with speaker (Option 103), 10-9
- rack mount kit (Option 908), 10-12
- rack mount kit with handles (Option 909), 10-12
- reduced frequency accuracy (Option 713), 10-12
- RS-232 and Parallel (Option 043), 10-7
- service documentation (Option 915), 10-12
- sweep+ tune output (Option 009), 10-5
- time-gated spectrum analysis (Option 105), 10-9
- tracking generator 500 (Option 010), 10-6
- tracking generator 75Ω (Option 011), 10-6
- TV Picture Display (Option 180), 10-11
- TV sync trigger capability/fast time-domain sweeps/AM/FM demodulator (Option 301), 10-12
- options displayed, 7-79
- output power, 7-81
- output screen data, 7-28
- overview, menus and softkeys, 2-12

**P**

- packaging, 9-6
- paintjet printer, 7-78
- PAINTJET PRINTER, 7-61
- PAL, 7-61
- PAL-M, 7-61
- PAL video format, 7-84
- parallel interface connector, 2-7
- parallel, plotting
  - laserjet, 6-21
  - parallel polling, A-1
  - PARAM AUTO MAN, 7-62
  - pass code, 7-31
  - PCD firmware (Option 160), 10-11
  - PDC measurements personality, 10-4
  - PDC/PHS/NADC/CDMA Firmware for Option 151 (Option 160), 10-11
  - peak
    - next, 7-58
    - next left, 7-58
    - next right, 7-58
  - peak detection mode
    - positive/negative, 7-34
  - PEAK EXCURSN, 7-62
  - peaking signal amplitude, 3-8
  - Peak Menu, 7-62
  - peak response routine, 7-88
  - peak search
    - outside of the zone, 7-93
  - PEAK SEARCH, 2-14, 7-62
  - peak table, 7-63
    - mode, 7-63
    - sorting, 7-63
    - using, 5-4-5
  - peak to peak measurement, 7-53
  - PEAK ZOOM, 7-63
  - percent amplitude modulation, 7-4
    - measurement, 4-40
  - percent amplitude modulation measurement, 4-39
  - personal digital cellular, 10-1 1
  - phase lock on/off, 7-4
  - ϕ LOCK ON OFF, 7-2, 7-4
  - PHS firmware (Option 160), 10-1 1
  - PHS measurements personality, 10-4
  - PK MODE <>DL NRM, 7-63
  - PK SORT FRQ AMP, 7-63
  - PK TABLE ON OFF, 7-63
  - Plot Config, 7-63
  - plot menu, 7-64
  - plotter, 10-16
  - PLOTTER ADDRESS, 7-63
  - plotter configuration, 7-27
  - plotter output, 7-64
  - plotting, 7-28, 7-30
    - HP-IB interface, 6-7
      - laserjet, 6-21
      - RS-232, 6-14
    - plotting, parallel
      - laserjet, 6-21
    - plotting, serial
      - laserjet, 6-21
    - plotting to laserjets, 7-64
    - PLT -- LOC --, 7-64

- PLT MENU ON OFF, 7-64
- Plt Port Config, 7-64
- PLT PORT HPIB PAR, 7-64
- PLT PORT SER PAR, 7-64
- PLTS/PAGE 1 2 4, 7-64
- POINT, 5-26, 7-64
- point deletion, 7-33
- positive peak detection mode, 7-34
- power amplifiers, 10-14
- power bandwidth, 7-60
- power bandwidth measurement, 4-43
- power cable, 1-6
- power input, 2-6
- power measurement, 7-65
  - adjacent channel power, 7-6
  - adjacent channel power extended, 7-7
  - channel bandwidth, 7-22
  - channel power, 7-23
  - channel spacing, 7-23
  - continuous sweep mode, 7-27
  - occupied bandwidth, 7-60
  - power bandwidth, 7-59
  - turning off, 7-55
- power measurement setup, 7-79
- Power Menu, 7-65
- POWER ON IP LAST, 7-65
- power-on state of spectrum analyzer, 7-65
- power requirements, 1-4
- preamplifier gain, 7-42
- preamplifiers, 10-14
- precision frequency reference (Option 004), 10-5
- predetermined correction factors, 7-31
- prefix
  - catalog of, 7-20
  - clearing, 7-23
  - entry, 7-2 1
  - selection, 7-77
- prefix entry, external keyboard, 5-43
- preparing memory card for use, 5-11
- preparing your spectrum analyzer for use, 1-2
- PRESEL DAC, 7-3, 7-65
- PRESEL DEFAULT, 3-8, 7-65
- preselector default, 7-65
- preselector peak, 3-8, 7-65
- PRESEL PEAK, 3-8, 7-65
- PRESET, 2-2, 7-66
- preset conditions
  - common, 7-66
  - for all models, 7-68
  - model specific, 7-66
- PRESET SPECTRUM, 7-66
- print
  - black and white, 7-48
- Print Config, 7-69
- printer, 10-16
  - HP Paintjet, 7-28
- PRINTER ADDRESS, 7-69
- printer configuration, 7-27
- PRINTER SETUP, 7-69
- printing, 7-28, 7-30
  - HP PaintJet, 7-61
- printing, HP-IB
  - address, 6-4
  - centronics converter, 6-4
  - deskjet, 6-4
  - epson, 6-4
  - laserjet, 6-4
  - paintjet, 6-4
  - thinkjet, 6-4
- printing, parallel
  - deskjet, 6-18
  - epson, 6- 18
  - laserjet, 6-18
  - paintjet, 6-18
  - thinkjet, 6-18
- printing, RS-232
  - baud rate , 6-10
  - deskjet, 6-10
  - epson , 6-10
  - handshaking , 6-10
  - laserjet , 6-10
  - paintjet , 6-10
  - parity , 6-10
  - thinkjet, 6-10
- print menu, 7-70
- Pm Port Config, 7-69
- PRN PORT HPIB PAR, 7-69
- PRN PORT SER PAR, 7-69
- PROBE PWR, 2-3
- probes
  - AC and DC, 10-14
- program cataloging, 7- 16
- program (DLP) editor, 7-38
- program editing and creating, 7-38
- programming command
  - dispose all , 7-39, 7-40, 7-41
  - front panel execution, 7-41
- programming command entry, external keyboard, 5-43
- protect data, 5-8
- PRT MENU ON OFF, 7-70
- pulsed RF
  - using Option 105, 4-24
- pulse edge definition, 7-39
- Pulse Param, 7-70
- pulse parameters
  - clearing, 7-23
  - gate length, 7-31

- PRI, 7-30, 7-39
- pulse width, 7-30, 7-39
- reference edge, 7-39
- time gate utility, 7-70
- pulse repetition interval, 4-25, 7-39
- pulse width, 4-25, 7-39
- PURGE AMP COR, 5-38, 7-70
- PURGE LIMITS, 5-19, 5-22, 7-70
- PWR SWP ON OFF, 7-71

## Q

- QP DET ON OFF, 7-3, 7-72
- QPD OFFSET, 7-3, 7-72
- QPD RST ON OFF, 7-3, 7-72
- QP GAIN ON OFF, 7-3, 7-72
- QP XI0 ON OFF, 7-72
- quasi-peak
  - clearing data, 7-23
  - detector, 7-72
  - marker amplitude value, 7-6
  - measurement routine, 7-52
  - normal marker, 7-54
  - signal amplification, 7-72
- Quasi Peak, 7-72
- quasi-peak detection
  - use with Option 105, 4-23
- quasi-peak detector and AM/FM demodulator
  - with speaker (Option 103), 10-9

## R

- rack mount kit (Option 908), 10-12
- rack mount kit with handles (Option 909), 10-12
- rack slide kit, 10-16
- ratio
  - video bandwidth to resolution bandwidth, 7-90
- real-time clock, 7-85
  - set date, 7-79
  - set time, 7-79
  - time and date display, 7-85
- rear-panel battery information label, 2-22
- rear-panel features, 2-5-7
- RECALL, 2-2, 7-72
- RECALL AMP COR, 7-73
- recalling a display image from the memory card, 5-14, 7-15
- recalling a DLP from the memory card, 7-15
- recalling amplitude correction factors from analyzer memory, 5-8-9
- recalling amplitude correction factors from the memory card, 5-15
- recalling a program from the memory card, 5-16
- recalling a state from analyzer memory, 5-6

- recalling a state from the memory card, 5-13, 7-15
- recalling a trace from analyzer memory, 5-7, 7-49
- recalling a trace from the memory card, 5-13-14, 7-15
- recalling limit lines from analyzer memory, 5-8-9
- recalling limit-line tables from the memory card, 5-15
- RECALL LIMIT, 7-73
- reduced frequency accuracy (Option 713), 10-12
- reference connector, 1-8
- reference detector
  - +10V, 7-4
  - 10V, 7-4
  - 2V, 7-4
  - ground, 7-47
- reference level, 7-73
- reference level offset, 7-73
- reflection calibration measurements, 4- 17
- REF LVL, 7-73
- REF LVL OFFSET, 7-73
- relative, limit line type, 7-50
- remote command
  - dispose all, 7-39, 7-40, 7-41
  - front panel execution, 7-41
- remote operation, 7-27
- RES BW AUTO MAN, 7-74
- resolution bandwidth, 7-74
  - resolving signals, 3-2-5
- resolution bandwidth coupling, 7-10
  - gate utility, 7-30
- resolution bandwidths
  - optional, 10-10
- resolution of marker counter, 7-26
- RETURN, 7-74
- return loss, measuring, 4-18
- RF bridge, 10-13
- RF limiters, 10-13
- RF OUT 500, 2-4
- RF OUT 753, 2-4
- RPG knob, 2-8
- RPG TITLE, 7-74
- RS-232 and Parallel (Option 043), 10-7
- RS-232 cable, 10-16
- RS-232 interface connector, 2-7

## S

- sales and service offices, 9-5
- sample detection
  - use with Option 105, 4-23
- sample detection mode, 7-34
- SAVE, 2-2, 7-75

SAVE AMP COR, 7-75  
 save current display, 7-35  
 save current state  
     memory card, 7-82  
     state register, 7-82  
 saved analyzer state, 7-49  
 SAVE EDIT, 7-75  
 SAVE LIMIT, 7-76  
 save lock on  
     MEM LOCKED, 7-55  
 saving a display image on the memory card,  
     5-14  
 saving a limit-line table into analyzer memory,  
     5-8  
 saving amplitude correction factors into  
     analyzer memory, 5-8  
 saving amplitude correction factors on the  
     memory card, 5-15  
 saving and recalling data from analyzer  
     memory, 5-6-9  
 saving and recalling data from the memory  
     card, 5-10-18  
 saving and recalling programs with a memory  
     card, 5-16  
 saving a program on the memory card, 5-16  
 saving a state into analyzer memory, 5-6  
 saving a state on the memory card, 5-12  
 saving a trace into analyzer memory, 5-7  
 saving a trace on the memory card, 5-13  
 saving DLPS from analyzer memory to card,  
     7-8  
 saving key definitions from analyzer memory  
     to card, 7-8  
 saving limit-line tables on the memory card,  
     5-15  
 saving to a memory card, 7-87  
 saving to spectrum analyzer memory, 7-88  
 SAV LOCK ON OFF, 5-8, 7-74  
 scalar 50Ω transmission/reflection test set,  
     10-13  
 scalar measurements, 10-4  
 SCALE LOG LIN, 7-76  
 screen annotation, 2-10-12  
     on or off, 7-10  
 screen characters, 7-47, 7-57, 7-82, 7-92  
 screen data output, 7-28  
 screen graticule, 7-47  
 screen title, 7-22  
     characters, 7-5  
     clearing, 7-23  
     RPG TITLE, 7-74  
 screen title, using an external keyboard,  
     5-42  
 SECAM-L, 7-76  
 segment deletion, 7-33  
 SELECT 1 2 3 4, 7-76  
 SELECT AMPLITUD, 5-25, 5-39, 7-76  
 SELECT DLT AMPL, 5-25, 7-76  
 SELECT FREQ, 5-25, 5-39, 7-77  
 SELECT LWR AMPL, 5-25, 7-77  
 SELECT MID AMPL, 5-25, 7-77  
 SELECT POINT, 5-38, 7-77  
 SELECT PREFIX, 7-77  
 SELECT SEGMENT, 5-23, 7-77  
 SELECT TIME, 7-78  
 SELECT TYPE, 7-78  
 SELECT UPR AMPL, 5-25, 7-78  
 self-calibration routine  
     CAL TRK GEN, 1-9  
     CAL YTF, 1-10  
 self-calibration routines, 1-8, 2-16-18  
     amplitude, 7-13  
     CAL, 7-13  
     correction factors, 7-13  
     frequency, 7-14  
     frequency and amplitude, 7-14  
     tracking generator, 7- 14  
 sensitivity  
     spectrum analyzer, 3- 15  
 serial polling, A-1  
 Service Cal, 7-2, 7-78  
 Service Diag, 7-2, 7-78  
 service documentation  
     Option 915, 10-12  
 service functions, 7-2  
     Service Cal, 7-2  
     Service Diag, 7-2  
 service options, 9-4  
 service request, A- 1  
     clearing, A-1  
 service tag, 9-6  
 SET ATTN ERROR, 7-2, 7-78  
 Set B&W\Printer, 7-78  
 Set Color printer, 7-78  
 SET DATE, 7-79  
 SET TIME, 7-79  
 setting gate delay, 4-33  
 setting gate length, 4-33  
 setting the amplitude, 2-13  
 setting the center frequency, 2-13  
 setting the marker, 2-14  
 setting the span, 2-13  
 setup  
     power measurement functions, 7-79  
     printer, 7-69  
 SGL SWP, 7-79  
 SHOW OPTIONS, 7-79  
 signal comparison, 3- 12  
 SIGNAL ID, 7-79  
 signal peak

- highest, 7-80
- signal tracking, 3-7, 7-63. See *also* marker tracking
- SINGLE FFT, 7-80
- SINGLE MEAS, 7-80
- single sweep, 7-79, 7-82
- SLOPE, 5-26, 7-80
- softkey label, 2-1
- softkey locations, 8-1
- softkey overview, 2-12
- softkeys, 2-1
- source power, 7-81
- space
  - character, 7-92
- span
  - 0 Hz, 7-92
  - LAST SPAN, 7-49
  - window **zone**, 7-93
- SPAN, 2-1, 2-13, 7-80
- SPAN ZOOM, 3-9, 7-80
- speaker, AM/FM demodulator
  - and quasi-peak detector (Option 103), 10-9
  - (Option 102), 10-9
- SPEAKER ON OFF, 7-80
- spectral density
  - channel power, 7-23
- SPECTRUM ANALYZER, 7-80
- spectrum analyzer attenuator, 7- 10
- spectrum analyzer auto-coupled sweep time, 7-83
- spectrum analyzer configuration
  - default, 7-31
- spectrum analyzer error messages, 9-7
- spectrum analyzer mode, 7-66
- spectrum analyzer state recalled, 7-65
- speed
  - data transmission, 7-12
- split screen, 7-60
- SQUELCH, 4-14, 7-81
- SRC ATN MAN AUTO, 7-81
- SRC PWR OFFSET, 7-81
- SRC PWR ON OFF, 4-8, 7-81
- SRC PWR STP SIZE, 7-81
- SRQ, A-1
- standard timebase, 7-14
- start and stop frequencies, 7-53
- START FREQ, 7-81
- state of spectrum analyzer at power on, 7-65
- state registers
  - locking, 7-74
- STATE → CARD, 7-82
- STATE → INTRNL, 7-82
- status byte, A-1
- status byte definition, A-1
- step keys, 2-3, 2-9

- step size, center frequency, 7-21
- step-size coupling, 7-10
- stimulus-response measurements, 4-7
- stimulus response mode, 7-83
- STOP FREQ, 7-82
- stop frequency, fft, 7-43
- store correction factors, 7-14
- storing
  - display, 7-35
- storing **the** correction factors
  - CAL STORE, 1-9
- STOR PWR ON UNITS, 7-2, 7-82
- STP GAIN ZERO, 7-3, 7-82
- STUVWX, 7-82
- subtract display line from trace B, 7-11
- subtract trace B from A, 7-5
- SWEEP, 7-82
- sweep control
  - continuous, 7-82
  - single, 7-79, 7-82
- SWEEP CONT SGL, 7-82
- SWEEP DELAY
  - gate utility, 7-83
- sweep modes, 2-10, 2-11
- SWEEP OUTPUT, 2-7
- SWEEP RAMP, 7-3, 7-83
- sweep time, 7-83
- sweep time coupling, 7-10
  - gate utility, 7-30
- SWEEP TIME DAC, 7-3, 7-83
- SWEEP+TUNE OUTPUT, 2-6
- sweep + tune output (Option 009), 10-5
- switch trace A and B, 7-5
- SWP CPLG SR SA, 4-9, 7-83
- SWP TIME AUTO MAN, 7-83
- SYNC CRD TV TRIG, 7-83
- synchronization constants, 7-32
- SYNC NRM NTSC, 7-84
- SYNC NRM PAL, 7-84

## T

- table
  - of markers, 7-56
- table of amplitude correction factors, 7-8
- table of signal peaks, 7-63
- TABLE ADL NRM, 7-85
- temperature conditions, 1-8
- test set
  - 50Ω transmission/reflection, 10-13
  - scalar 50Ω transmission/reflection, 10-13
- TG UNLVL message, 4-12
- third order intercept measurement, 4-39, 7-86
- third-order intermodulation distortion, 3-22

- third order intermodulation measurement, 4-41
  - verification of, 4-42
- THRESHLD ON OFF, 7-85
- threshold line, 7-85
- timebase verification, 7-90
- Time Date, 7-85
- TIMEDATE ON OFF, 7-86
- time domain window
  - definition, 7-32
  - gate utility, 7-32
- time gate
  - definition of, 7-32
  - delay, 7-46
  - faster sweep times: Option 101, 4-22
  - gate on/off, 7-46
  - length, 7-46
  - triggering, 7-46
  - using the gate utility, 4-19
- time-gated spectrum analysis (Option 105), 10-9
- time-gated spectrum analyzer capability
  - operation, 4-22
- time gate utility, 7-47
  - coupling, 7-32
  - delay sweep, 7-83
  - done, 7-35
  - entering, 7-45
  - exit, 7-42
  - marker on, 7-54
  - pulse parameters, 7-70
  - use of, 4-19
- time window
  - resolution bandwidth, 7-84
  - sweep time, 7-84
- TO1 ON OFF, 4-41, 7-86
- trace
  - blank trace A, 7-12
  - blank trace B, 7-12
  - blank trace C, 7-12
  - clear write trace A, 7-24
  - clear write trace B, 7-25
  - clear write trace C, 7-26
  - move trace B into C, 7-1 1
    - A <-> B, 7-5
    - A-B → A, 7-5
    - A → C, 7-5
    - B-DL → B, 7-11
  - view mode, 7-91
- TRACE, 7-86
- trace A
  - maximum hold, 7-55
- TRACE A, 7-86
- TRACE A B C, 7-86
- trace B
  - maximum hold, 7-55
- TRACE B, 7-86
- trace C
  - minimum hold, 7-55
- TRACE C, 7-86
- trace modes, 2-10, 2-1 1
- trace registers
  - locking, 7-74
- Trace → Card, 7-87
- Trace → Intrnl, 7-88
- Track Gen, 4-8, 7-88
- tracking generator, 7-88
  - external leveling input, 2-5
  - frequency adjustment, 7-52
  - internal/external leveling, 7-7
  - normalization, 4- 11
  - operation, 4-7
  - output, 2-4
  - output power, 7-81
  - peak response, 7-88
  - power sweep, 7-71
  - power sweep range, 7-81
  - self-calibration, 7-14
  - self-calibration routine, 1-9, 2-17
  - source attenuator, 7-81
  - source power offset, 7-81
  - source power step size, 7-81
  - stimulus-response, 4-7
  - warm-up time, 2-17
- tracking generator 50Ω (Option 010), 10-6
- tracking generator 7562 (Option 01 1), 10-6
- tracking generator self-calibration routine, 1-9
- tracking generator unlevelled condition, 4-12
- tracking peak
  - automatic adjustment, 4-10
  - manual adjustment, 4-10
- TRACKING PEAK, 4-10, 7-88
- tracking unstable signals, 3-9
- transient limiter, 10-13
- transit case, 10-16
- TRIG, 7-89
- trigger, 7-89
  - external, 7-42
  - free run, 7-44
  - line, 7-51
  - video, 7-91
- triggering
  - EDGE POL POS NEG, 7-36
  - gate: edge or level, 7-46
  - gate utility, 7-36
- triggering on a selected line, video picture field, 4-15
- trigger modes, 2-10, 2-11
- TRIG MKR ON OFF, 7-89



- TRMATH command, 7-19
- turning off markers, 7-54
- turning off the FFT function, 7-43
- turning off windows display, 7-91
- turning on the analyzer for the first time, 1-8
- turn off active function, 2-8
- TV LINE #, 7-89
- TV measurements personality, 10-2
- TV Picture Display (Option 180), 10-11
- TV Standard, 7-89
- TVSTND, 4-16
- TV SYNC NEG POS, 7-89
- TV sync trigger capability/fast time-domain sweeps/AM/FM demodulator (Option 301), 10-12
- TV sync trigger circuitry (Option 102), 10-9
- TV trig
  - even field, 7-89
  - NTSC video format, 7-59
  - odd field, 7-89
  - PAL-M video format, 7-61
  - PAL video format, 7-61
  - SECAM-L video format, 7-76
  - TV line number, 7-89
  - TV Standard, 7-89
  - TV sync, 7-89
  - vertical interval, 7-89
- TV TRIG, 4-15
- TV TRIG EVEN FLD, 4-15, 7-89
- TV triggering, 4-15
- TV TRIG ODD FLD, 7-89
- TV TRIG OUTPUT, 2-5
- TV TRIG VERT INT, 7-89
- T WINDOW RES BW, 7-84
- T WINDOW SWP TIME, 7-84
- two display windows, 7-60
- type of limit line, 7-78

**U**

- underscore
  - character, 7-92
- unit key pressed, A-1
- units, amplitude, 7-8
- universal HP-IB service request, A-1
- uneveled condition, tracking generator, 4-12
- UPDATE TIMEFREQ, 7-89
- upper and lower limit line, 5-23
- upper and lower limit lines, 5-29
  - editing, 7-38
- upper limit line, 5-23
- user-created error messages, 9-7
- User Menus, 7-90
- using limit-line functions, 5-18

- using the GATE CTL EDGE LVL, 4-38
- using the level gate control, 4-38
- using the self-calibration routines with Option 105, 4-35

## V

- v, 7-90
- variable cataloging, 7-16
- VBW/RBW RATIO, 7-90
- verification manual
  - see Calibration Guide, 10-12
- VERIFY TIMEBASE, 7-90
- vertical signal positioning, 7-3 1
- VHS video output, 7-84
- VID AVG ON OFF, 7-90
- VID BW AUTO MAN, 7-90
- VIDEO, 7-91
- video averaging, 3-17, 7-90
- video bandwidth, 7-90
- video bandwidth coupling, 7-10
  - gate utility, 7-31
- video bandwidth to resolution bandwidth ratio, 7-90
- video picture field
  - triggering on a selected line, 4-15
- VIEW A, 7-91
- VIEW B, 7-91
- VIEW C, 7-91
- VOL-INTEN, 2-3
- VOLTAGE SELECTOR, 2-6
- voltage selector switch, 1-4
- Volts, 7-91
- volume control, 2-3

## W

- w, 7-91
- warm-up, 1-8
- warm-up time, 2-16
- warranty, 9-4
- Watts, 7-91
- when self-calibration is needed, 2-18
- windows
  - NEXT, 7-58
  - ON, 7-60
  - switching between, 7-58
  - switching time and frequency windows, 7-89
  - using, 5-33-34
  - ZOOM, 7-93
- windows keys, 2-3
- WINDOWS OFF, 7-91
- write-protect switch, 2-2 1

## X

X FINE TUNE DAC, 7-3, 7-91

## Y

YTF DRIVER, 7-3, 7-91

YTF self-calibration routine, 1-10, 2-18

YTF slope and offset adjustment, 7-14

YTF SPAN, 7-3, 7-92

YTF TUNE COARSE, 7-3, 7-92

YTF TUNE FINE, 7-3, 7-92

YZ\_# Spc Clear, 7-92

## Z

ZERO MARKER, 7-92

ZERO SPAN, 3-7, 7-92

ZONE CENTER, 7-92

ZONE PK LEFT, 7-93

ZONE PK RIGHT, 7-93

ZONE SPAN, 7-93

ZOOM, 7-93

zooming a window, 7-93