



**HEWLETT
PACKARD**

OPERATING AND PROGRAMMING MANUAL

**8568B
SPECTRUM ANALYZER
100 Hz – 1.5 GHz**

SERIAL NUMBERS

This manual applies directly to Model 8568B RF Sections with serial numbers prefixed 2410A and IF-Display Sections with serial numbers prefixed 2403A.

© Copyright HEWLETT-PACKARD COMPANY 1984
1212 VALLEY HOUSE DRIVE, ROHNERT PARK, CALIFORNIA, 94928, U.S.A.

MANUAL PART NO. 08568-90041
Microfiche Part No. 08568-90044

Printed: March 1984

Section I

Manual Operation

- Chapter 1 – GETTING STARTED**
- Chapter 2 – DATA**
- Chapter 3 – FUNCTION**
- Chapter 4 – CRT DISPLAY**
- Chapter 5 – TRACE**
- Chapter 6 – MARKER**
- Chapter 7 – SCALE AND REFERENCE LINE**
- Chapter 8 – COUPLED FUNCTION**
- Chapter 9 – SWEEP AND TRIGGER**
- Chapter 10 – INSTRUMENT STATE**
- Chapter 11 – SHIFT KEY FUNCTIONS**
- Chapter 12 – USER DEFINED KEYS**
- Chapter 13 – PLOTTER OUTPUT**

E

C

C

GENERAL INFORMATION

This chapter describes the HP 8568B Spectrum Analyzer's general performance characteristics, hardware, and the initial turn on procedure.

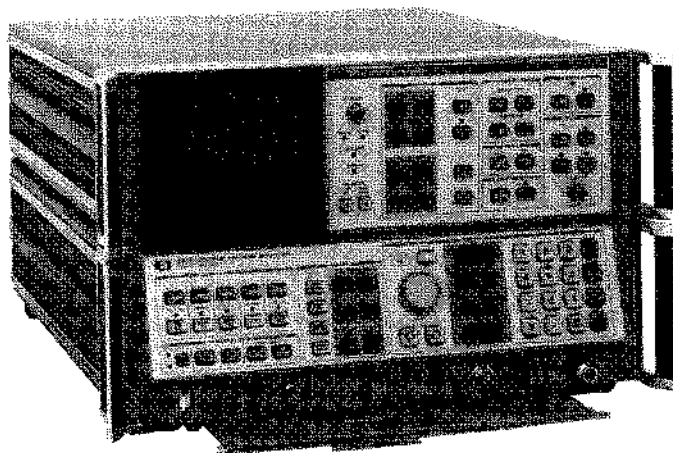

HP 8568B SPECTRUM ANALYZER

Connect interconnection cables as shown:

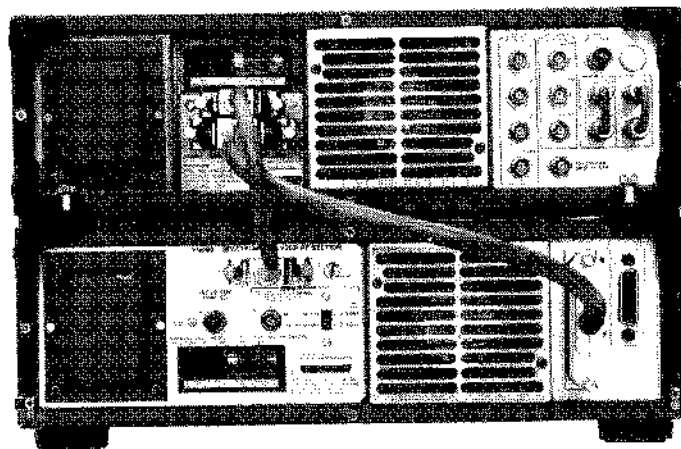

REAR PANEL CONNECTIONS

INITIAL POWER ON AND CALIBRATION

CAUTION

Before connecting the line power cords, make sure the appropriate line voltage and line fuse have been selected for both the RF and Display sections of the analyzer. For complete information on line voltage and fuse selection, refer to the HP 8568B Operator's Handbook. For information on line power cords for a specific country, contact the nearest Hewlett-Packard office.

After making the AC power line connections, the STANDBY lights of both the RF and Display section should be on. As long as the instrument is operating (LINE ON) or in STANDBY, the accuracy specifications of the internal frequency standard will be met. After a cold start, such as on-receipt of instrument, the analyzer requires 24 hours to stabilize prior to meeting specified performance.

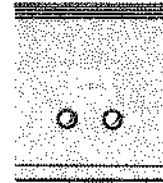
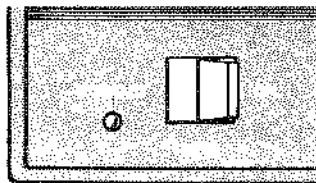

Upon LINE ON, the instrument will perform an automatic internal instrument check. If one or both of the red instrument check lights (INST CHECK I and II) remain on after this brief check routine, refer to the chart below to localize the problem.

LED On	Problem	Solution
I	Digital Storage failure in 85662A	Check bus interconnect cable (85662-60094)
II	Interface Failure	Check bus interconnect cable (85662-60094) and check if A12 board is connected tightly
I & II	Controller (A15)	Check if A15 is connected tightly in 85660B and that contacts are clean.

Manual Calibrator Signal Adjustment

To meet specified frequency and amplitude accuracy, periodically perform this calibration procedure and the error correction routine below.

1. With LINE power ON, press .
 2. Connect CAL OUTPUT to SIGNAL INPUT 2.
- 2 Manual Operation

3. Press
- | | | | |
|------------------|-------|---|-------------------------|
| CENTER FREQUENCY | 2 | 0 | MHz -dBm sec |
| FREQUENCY SPAN | 2 | | MHz -dBm sec |
| RES BW | 1 | | MHz -dBm sec |
| REFERENCE LEVEL | 7 | | MHz -dBm sec |
| LOG | ENTER | 1 | GHz +dBm dB PEAK SEARCH |
- or press **RECALL** **8**

4. Adjust AMPTD CAL for MKR amplitude of -10.00 dBm.

5. Press
- | | | | |
|----------------|-------|---|--------------|
| FREQUENCY SPAN | 0 | | MHz -dBm sec |
| RES BW | 3 | 0 | MHz -dBm sec |
| SWEEP TIME | 1 | 0 | MHz -dBm sec |
| SCALE LOG | ENTER | 1 | ENTER |
- or press **RECALL** **9**

6. Maximize response with FREQ ZERO adjustment.

Error Correction Routine

A 1½ minute internal error correction routine minimizes errors caused by changes in IF gain, resolution bandwidth, input attenuator or scale changes. To start the routine press **KEY FUNCTION** **SHIFT** **FREQUENCY SPAN**.

A readout "CORR'D" appears in the CRT display on completion of this routine.

If "Adjust FREQ ZERO and AMPTD CAL" appears in the display, repeat the manual calibration before running the error correction routine again.

Chapter 11, **SHIFT** **KEY FUNCTIONS**, discusses the details of this error correction routine.

SIGNAL INPUTS

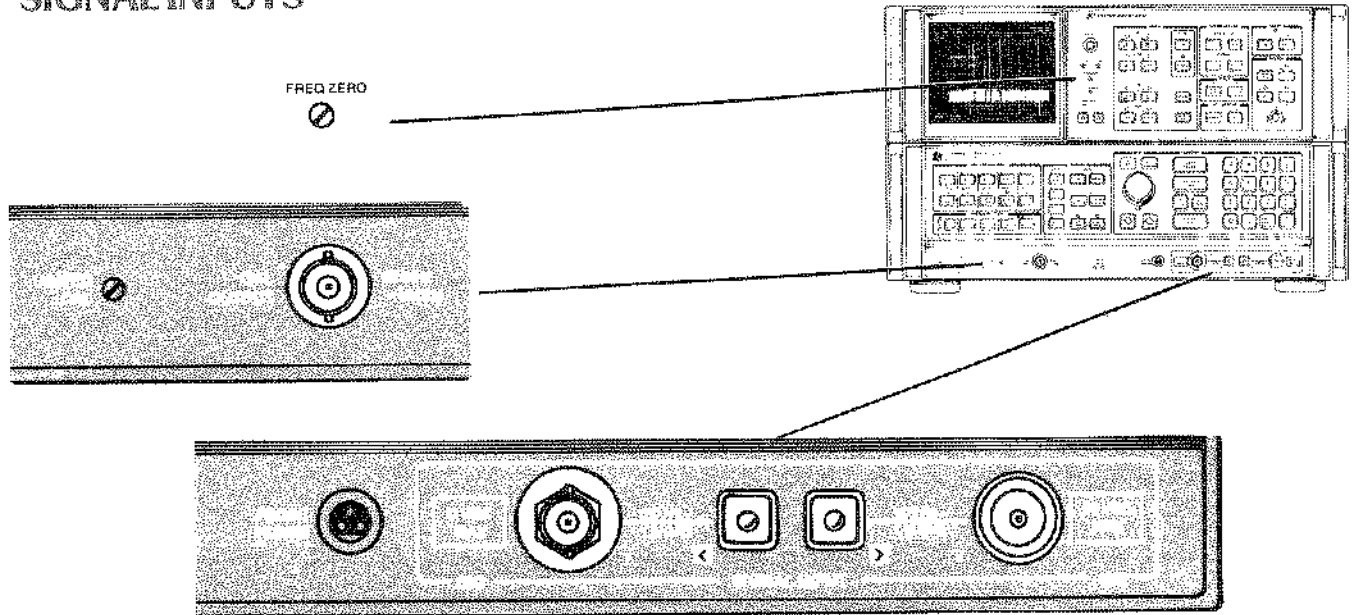

SIGNAL INPUT AND CALIBRATION CONTROLS

Either of the RF signal inputs can be selected:

INPUT 1: 100 Hz to 1500 MHz, dc coupled, BNC fused 50 Ω .

INPUT 2: 100 kHz to 1500 MHz, ac coupled, Type N 50 Ω .

Isolation between inputs is >90 dB.

CAUTION

Excessive signal INPUT power will damage the input RF attenuator and the input mixer. The spectrum analyzer total input power must not exceed the values listed:

INPUT	Maximum dc	Maximum RF
1	$\pm 0V$	+30 dBm (1 watt)
2	$\pm 50V$	+30 dBm (1 watt)

Probe Power

The probe power jack supplies power for high impedance 1:1 active probes, such as the HP 1121A 500 MHz AC Probe, or for 50-ohm preamplifiers, such as the HP 10855A. The voltage outputs are +15V, and -12.6V with a maximum current of 150 mA.

CAUTION

Active probes or amplifiers should not be used on RF Input 1, the dc coupled input, unless their output is specified ac only.

FRONT PANEL OVERVIEW

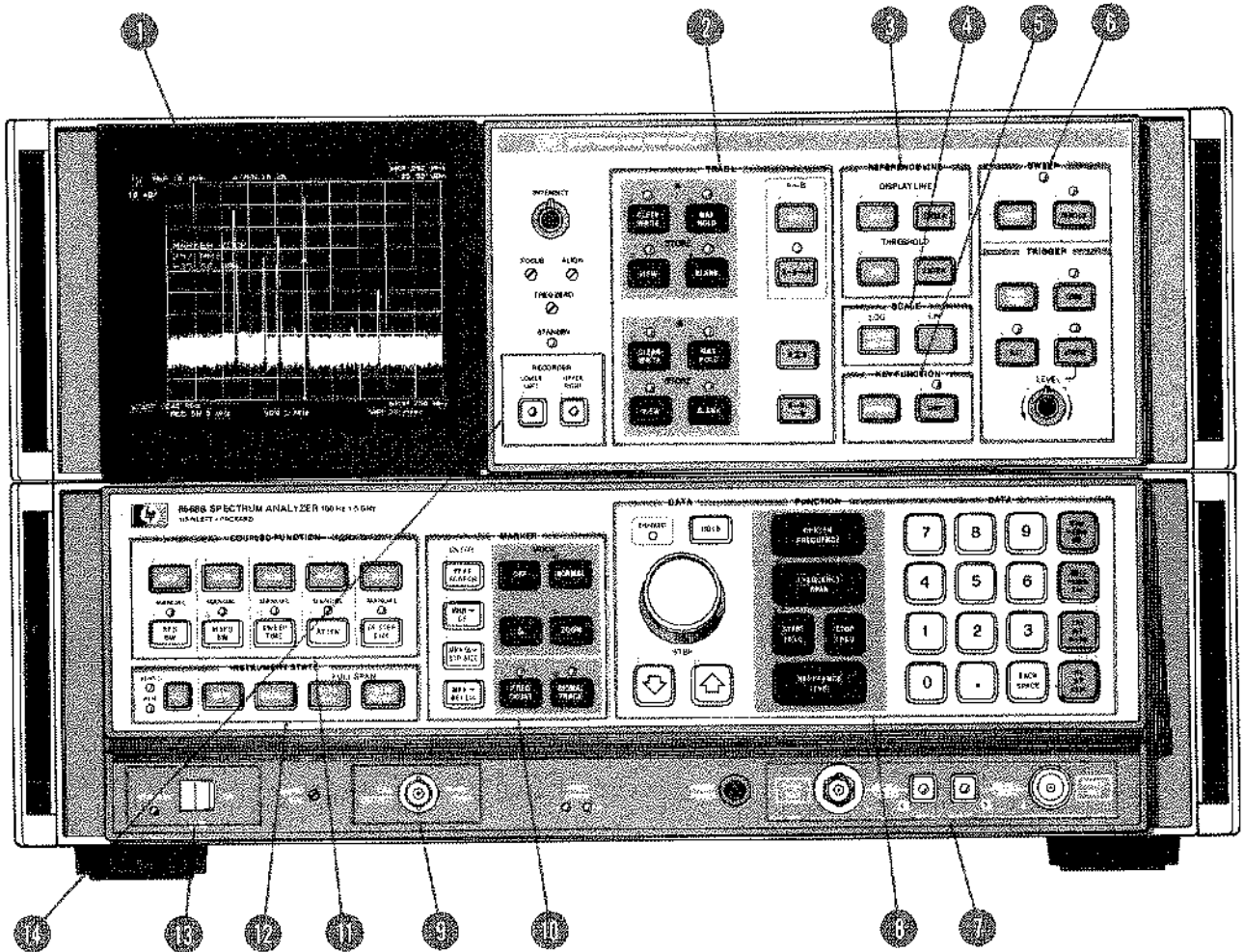

Control Groups

- | | |
|--|--|
| <p>1 CRT DISPLAY:</p> <p>2 TRACE:</p> <p>3 REFERENCE LINE:</p> <p>4 SCALE:</p> <p>5 KEY FUNCTION:</p> <p>6 SWEEP and TRIGGER:</p> <p>7 SIGNAL INPUT:</p> <p>8 DATA/FUNCTION:</p> <p>9 CAL OUTPUT:</p> <p>10 MARKER:</p> <p>11 COUPLED FUNCTION:</p> <p>12 INSTRUMENT STATE:</p> <p>13 LINE ON/STANDBY:</p> <p>14 RECORDER/PLOTTER FUNCTIONS:</p> | <p>Signal response and analyzer settings</p> <p>Control of signal response display</p> <p>Measurement and display aids</p> <p>Selects logarithmic or linear amplitude scale</p> <p>Access to special functions</p> <p>Selects trace update trigger</p> <p>100 Hz to 1500 MHz</p> <p>Fundamental analyzer control</p> <p>Calibration signal</p> <p>Movable bright dot markers for direct frequency and amplitude readout</p> <p>Maintenance of absolute amplitude and frequency calibration by automatically selecting certain analyzer control settings</p> <p>Local, remote and preset control settings. Saving and recalling control settings.</p> <p>Powers instrument and performs instrument check</p> <p>Controls output to recorder or HP-IB controlled plotter</p> |
|--|--|

CRT DISPLAY

The analyzer's CRT display presents the signal response trace and all pertinent measurement data. The active function area names the function under DATA control and shows the function values as they are changed. All the information necessary to scale and reference the graticule is provided.

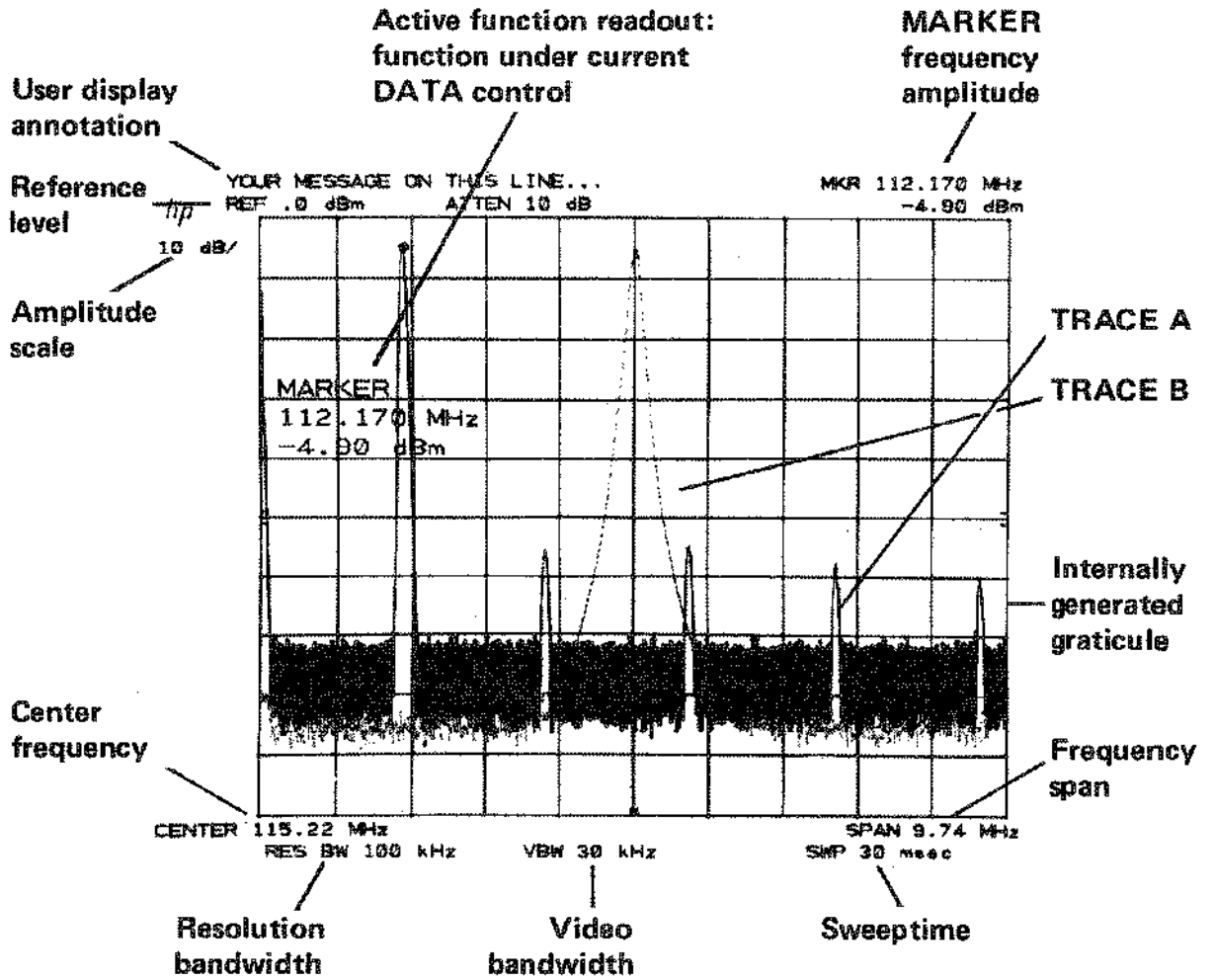

PLOTTER OUTPUT



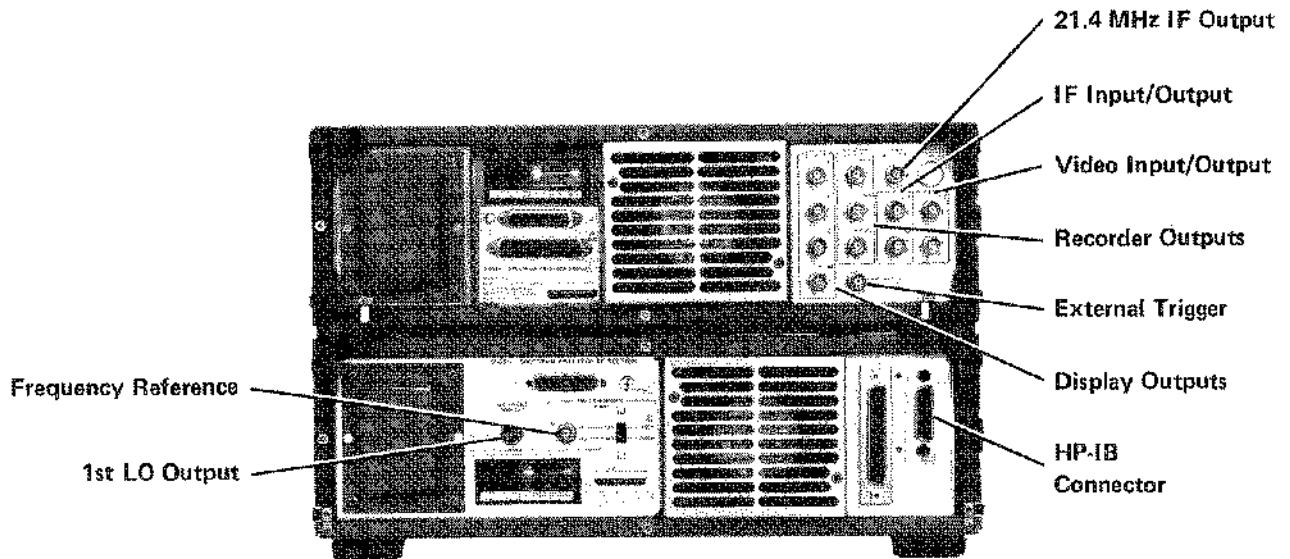

The trace data, graticule, and annotation on the analyzer screen can be sent directly via HP-IB to a Hewlett-Packard plotter (such as the HP 7245A/B, 7240A, 7470A, or 9872C) by pressing the LOWER LEFT key on the analyzer front panel.

REAR PANEL OUTPUTS







Display Outputs

Display outputs allow all the CRT information to be displayed on an auxiliary CRT display such as the HP 1310A Large Screen Display.

Display Outputs	Output
 X  Y  Z  BLANK	<p><75 nsec rise times. 1V full deflection.</p> <p><30 nsec rise time. Intensity: -1V blank, 0 to 1V intensity modulation.</p> <p>TTL level >2.4V for blanking. Compatible with most oscilloscopes.</p>

Recorder Outputs

The recorder outputs allow the x-y plot of trace data with x-y plotters using positive penlift coils or TTL penlift input. The front panel keys enable outputs for the calibration of x-y plotter reference points:

Recorder Outputs	RECORDER LOWER LEFT UPPER RIGHT  	RECORDER Outputs when keys or HP-IB commands are enabled	
		Lower Left	Upper Right
 SWEEP	A voltage proportional to the horizontal sweep of the CRT trace that ranges from 0V for the left edge and to +10V for the right edge.	0V left	10V right
 VIDEO		0V lower	+1V upper
 PENLIFT		+15V	+15V

1st LO Output

The 1st LO output allows the use of external mixers to expand the frequency range of the analyzer.

1st LO Output	Output
 1ST LO OUT	2 – 3.7 GHz, > +4 dBm; 50Ω output impedance.

21.4 MHz IF Output

21.4 MHz IF Output	
 21.4 MHz IF OUTPUT	A 50Ω, 21.4 MHz IF output related to the RF input to the analyzer. In log scales, the IF output is logarithmically related to the RF input signal; in linear, the output is linearly related. The output is nominally –20 dBm for a signal at the reference level. The analyzer's resolution bandwidth setting controls the bandwidth. The input attenuator and IF step gain positions control the amplitude.

HP-IB Input Output Connector

The Hewlett Packard Interface Bus allows remote operation of the analyzer as well as input and output of measurement data. See Section II of this manual.

Frequency Reference Input/Output

To lock the spectrum analyzer to an external frequency reference, set the **FREQ REFERENCE 10 MHz** switch to **EXT**. Analyzer phase noise performance may be degraded when an external frequency reference is used. To lock another spectrum analyzer to the spectrum analyzer internal frequency reference, set the **FREQ REFERENCE 10 MHz** switch to **INT**.

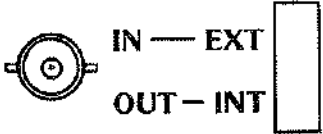

Frequency Reference Input/Output	Input/Output
	<p>External Frequency Reference Requirements:</p> <p>Frequency: 10 MHz \pm 50 MHz Power: 0 to 10 dBm Input Impedance: 50Ω</p> <p>Internal Frequency Reference Characteristics:</p> <p>Frequency: 10.000 MHz Power: 0 dBm nominal Output Impedance: 50Ω</p>



IF and Video Connectors

The IF and Video connectors allow the 85650A Quasi-Peak Adapter to be used with the analyzer for EMI measurements.

NOTE

When the Quasi-Peak Adapter is disconnected from the analyzer, make sure the IF INP connector connects to the IF OUT connector with one short BNC cable, and VIDEO INP connector connects to the VIDEO OUT connector with the other short BNC cable. Failure to connect the BNC cables will result in a loss of signal.

IF and Video Connectors	Input
 IF INP	21.4 MHz input. Input is nominally -11 dBm (with spectrum analyzer input attenuator set to 10 dB). 50Ω input impedance.
 VIDEO INP	0-2V. 139Ω input impedance.

IF and Video Connectors	Output
 IF OUT	21.4 MHz output. Output is nominally -11 dBm (with spectrum analyzer input attenuator set to 10 dB). 50Ω output impedance.
 VIDEO OUT	0-2V. Output impedance <10 kΩ.

External Sweep Trigger Input

The External Sweep Trigger input allows the analyzer's internal sweep source to be triggered by an external voltage.

External Sweep Trigger Input	Input
 EXT TRIGGER	Must be >2.4V (10V max). 1 kΩ nominal input impedance.





Chapter 1 GETTING STARTED

GENERAL DESCRIPTION

This chapter provides an overview of the use and capability of the Hewlett Packard 8568B Spectrum Analyzer. Chapters 2 through 12 provide details on each aspect of operation.

FRONT PANEL CONCEPT

The front panel keys control functions such as center frequency, frequency span, reference level, resolution bandwidth, and sweep time. Any function can be selected by pressing its key, and can then be changed by using the DATA control knob, step keys, or number/units keyboard. For example, to specify center frequency press **CENTER FREQUENCY**, then change the value, as read out on the CRT, with *any* or *all* of the DATA controls:

-  Continuous coarse and fine tune
-   Change in steps
-  Set the value exactly

The analyzer's CRT display presents the signal response trace and all pertinent measurement data.

FUNCTION/DATA CONTROLS

The front panel controls are grouped by function. Most measurements can be made from the FUNCTION/DATA control group. The other groups add to the measurement efficiency, convenience, and capability.

The FUNCTION and DATA controls can be used to measure the frequency and amplitude of a signal such as the one shown.

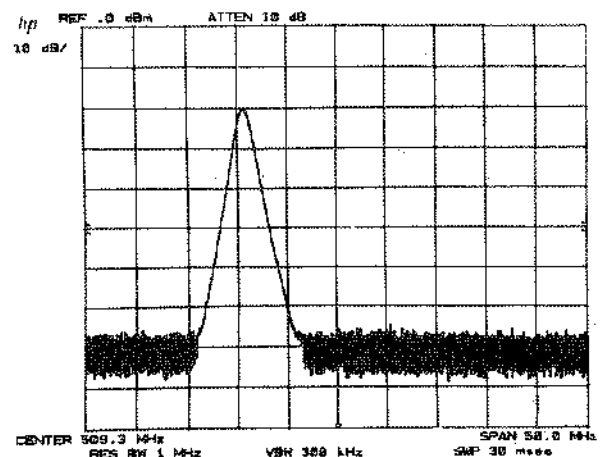

First, move the signal to the center of the display with



The readout gives the signal frequency. (The DATA step keys or number/units keys could also have been used.)

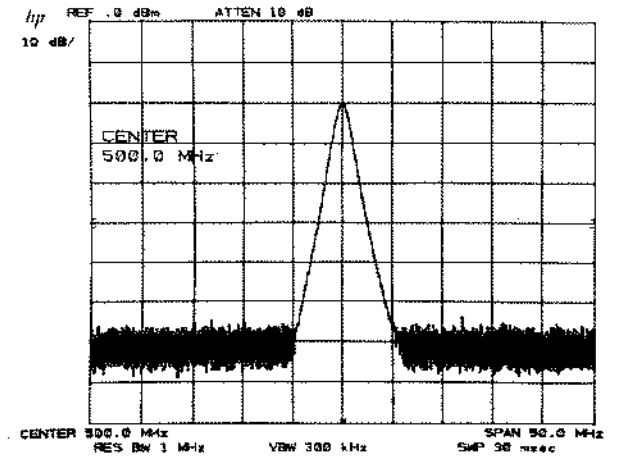

For better frequency resolution, narrow the frequency span with

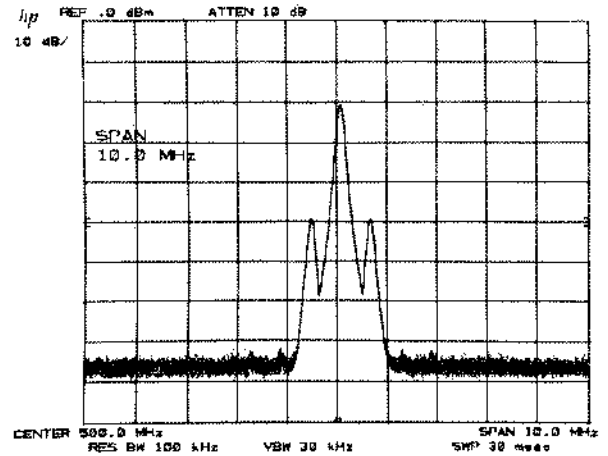

Now bring the signal peak to the reference level with



The reference level readout is the signal's power level.

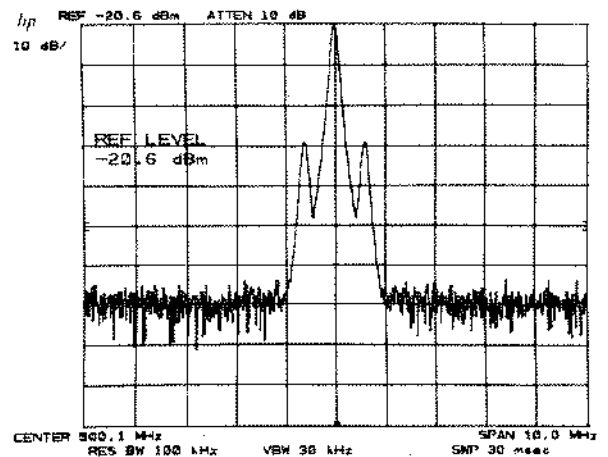

STARTING FROM FULL SPAN

A convenient place to start a new measurement is with a full 1500 MHz frequency span. A single key, **INSTN PRESET**, presets all the analyzer functions to give you a 0 Hz to 1500 MHz display with a 0 dBm reference level.

For example, after measurements in a narrow frequency span...

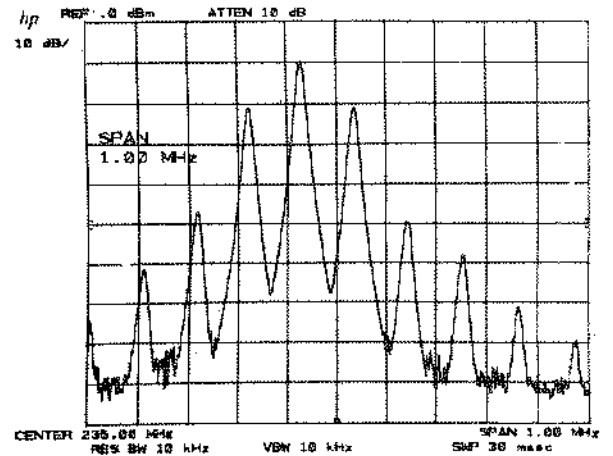

INSTN PRESET allows you to view the entire 1500 MHz span for selection of the next signal to investigate.

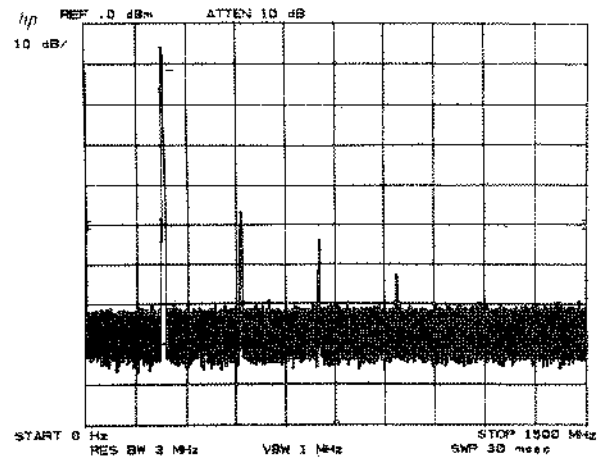

DIRECT SIGNAL FREQUENCY AND AMPLITUDE READOUT

Signal frequencies and amplitudes, as well as differences, can be read out directly with the **MARKER** and **DATA** controls, without changing center frequency or reference level.

Activate the marker with **MARKER** . Use the **DATA** knob to position the marker. The amplitude and frequency are read out continuously.

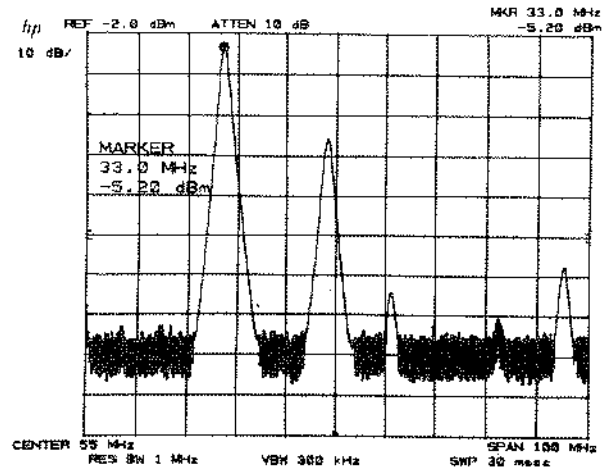

To measure the differences between this signal and any other on the display, press **Δ** and use to move the second marker. The amplitude and frequency differences are read out continuously.

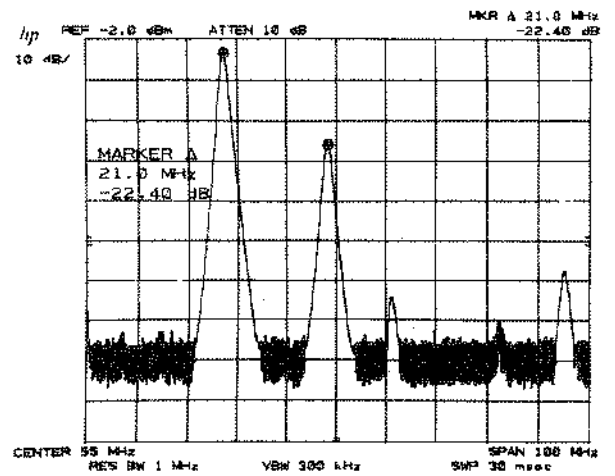

AUTOMATIC DISPLAY CALIBRATION

Unless you specifically override the analyzer's **COUPLED FUNCTION** state, the analyzer maintains absolute amplitude and frequency calibration during your measurements. Changes of frequency span automatically call for resolution bandwidths, video bandwidths, and sweep times that keep the amplitude calibrated while maximizing the trace sweep rate. You can take manual control over any of these functions with the **COUPLED FUNCTION** and **DATA** controls.



For example, for higher signal resolving capability, the analyzer's resolution bandwidth can be narrowed using the **COUPLED FUNCTION** .

GETTING STARTED

A signal with 40 kHz sidebands is viewed in a 2 MHz span. The sidebands are not visible, because of the 30 kHz resolution bandwidth.

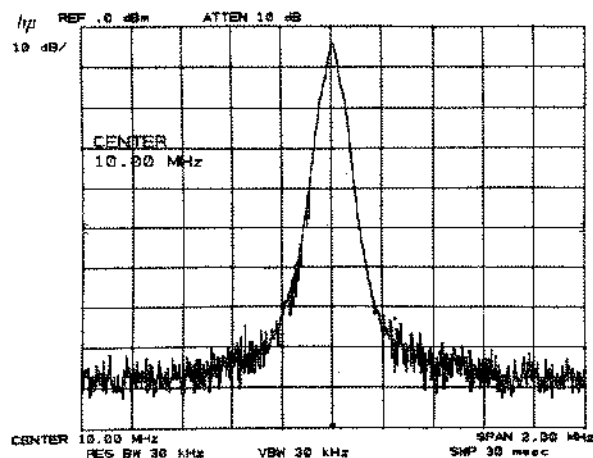
AUTOMATIC DISPLAY CALIBRATION



Reduce the resolution bandwidth without changing the span with  . (The DATA knob  or number/units keyboard could also have been used.)

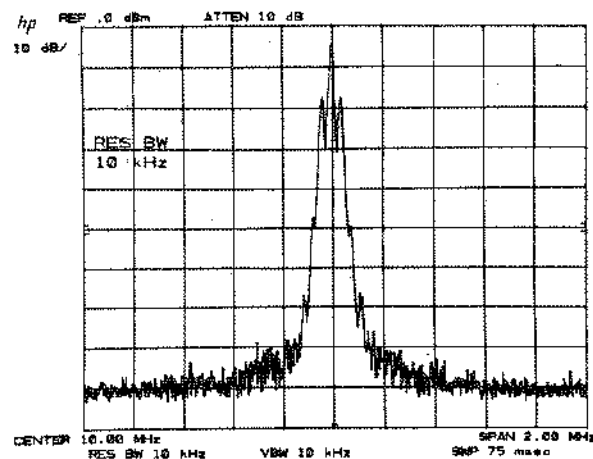

The sweep time is increased automatically to compensate for the narrower resolution bandwidth. If the sweep time were in the manual mode, the display could become uncalibrated.

Press  .

The display uncalibrated message appears in the display.

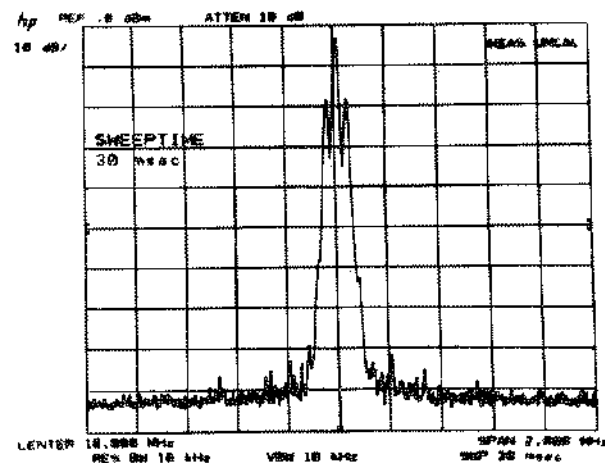

AUTOMATIC MEASUREMENTS

Just as the front panel keys call functions and change their values, simple programming codes from a computing controller can control the spectrum analyzer for automatic measurement through the Hewlett Packard Interface Bus (HP-IB). HP's implementation of IEEE Standard 488 and identical ANSI Standard MC1.1 "Digital interface for programmable instrumentation."

Detailed information on remote operation is the subject of Section II of this manual.

Chapter 2 DATA

GENERAL DESCRIPTION

DATA controls are used to change function values for functions such as center frequency, start frequency, resolution bandwidth, or marker position.

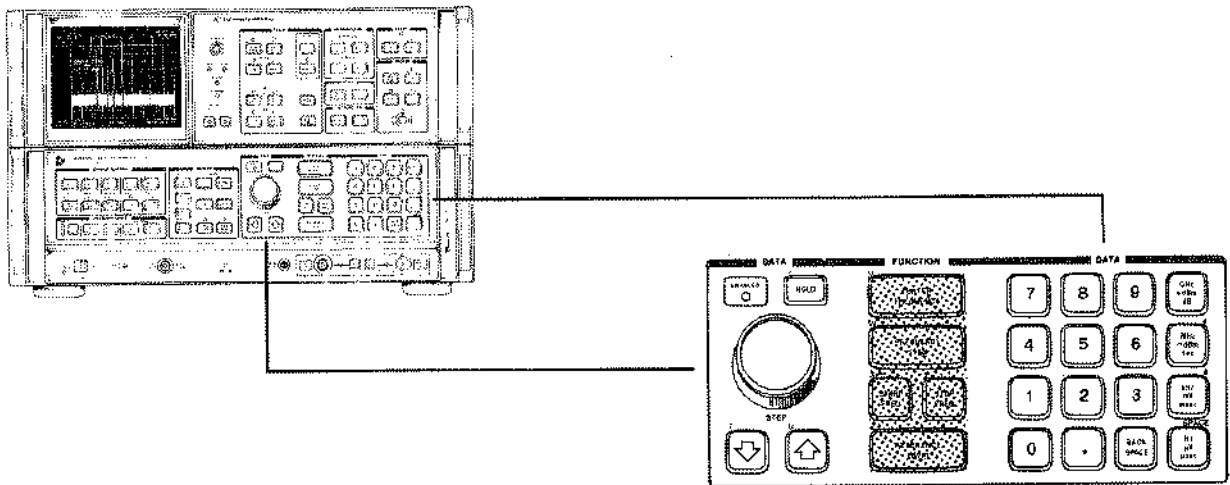





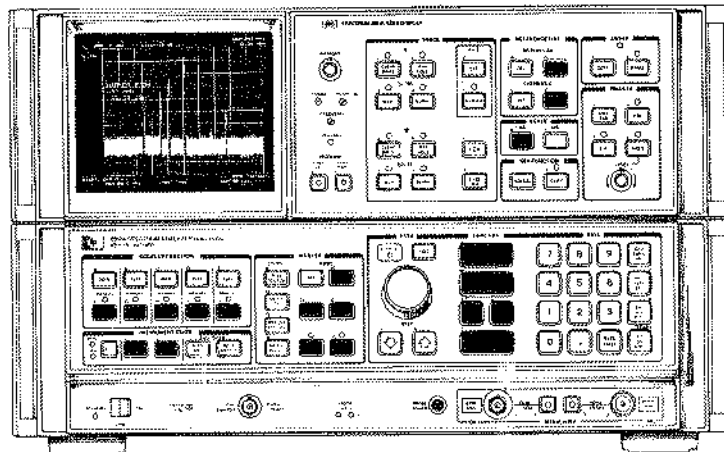



DATA CONTROLS

The DATA controls are clustered about the FUNCTION keys that “call up” or activate the most frequently used spectrum analyzer control functions: center frequency, frequency span (or start/stop frequency), and reference level. The other functions that accept DATA control are shown below:



FRONT PANEL FUNCTIONS USING DATA CONTROLS

To the left of the FUNCTION keys are the DATA knob  and the DATA STEP keys , which are used to make incremental changes to the activated function. To the right of the FUNCTION keys is the DATA number/units keyboard which allows changes to an exact value.

The DATA controls change the activated function in a manner prescribed by that function. For example, center frequency can be changed continuously with the DATA knob , or in steps proportional to the frequency span with the DATA STEP keys  , or set exactly with the DATA number/units keyboard. Resolution bandwidth, which can be set only to discrete values, can still be changed with any of the DATA controls. The DATA knob  and DATA STEP keys   advance the setting from one bandwidth to the next. A number/units keyboard entry that does not coincide with an allowable bandwidth selects the nearest bandwidth.

DATA ENTRY READOUT

DATA entries are read from the CRT display as they are changed.

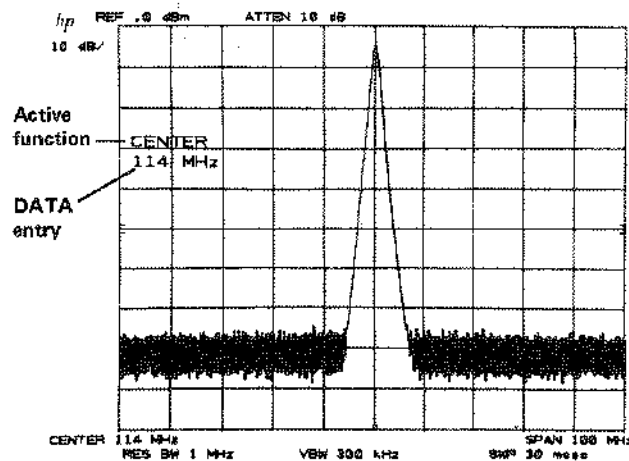

PREVENTING DATA ENTRY

A function can be deactivated by pressing . The active function readout is blanked and the ENABLED light goes out, indicating that no DATA entry can be made. Pressing a function key re-enables the DATA controls.







DATA KNOB

The DATA knob  allows the continuous change of center frequency, frequency span (or start/stop frequencies), reference level, and the positions of the marker, display line, and threshold. It can also change function values that are stepped in predefined increments.

Clockwise rotation of the DATA knob increases the function value. For continuous changes, the knob's sensitivity is determined by the measurement range and the speed at which the knob is turned. For example, when the center frequency is activated, rotating the DATA knob increases the value of the center frequency by one horizontal division of span per one quarter turn.

DATA STEP KEYS



The DATA STEP keys allow rapid increase  or decrease  of the active function value. The step size is dependent either upon the analyzer's measurements range, on a preset amount, or, for those parameters with fixed values, the next value in a sequence. Examples: Activate center frequency and  increase the center frequency value by an amount equal to one division of the frequency span (one tenth of the frequency span). If the center frequency step size  has been preset,  increases the center frequency by that preset amount. If frequency span were activated,  would change the span to the next lower value in predetermined sequence. Activate resolution bandwidth and  selects the next widest bandwidth.



Each press results in a single step.









DATA NUMBER/UNITS KEYBOARD



The DATA number/units keyboard (or DATA keyboard) allows exact value entries to center frequency, frequency span (or start/stop frequency), reference level, log scale, marker positions, display line, threshold, and the COUPLED FUNCTIONS.

An activated parameter is changed by entering the number (with the CRT display providing a readout), then selecting the appropriate units key. The value is not changed (entered) until the units key is pressed.

The number portion of the entry may include a decimal, . If it does not, the decimal is understood at the end of the number. Corrections to number entries are made with , which erases the last digit for each press.





Example: With center frequency activated,         



sets the center frequency to 1.250 GHz.







If the units key is pressed without a number entry, 1 is entered (except in zero frequency span).

Negative DATA Entry

Negative entries from the number units keyboard can be made for power and frequency, but not time and voltage.

Negative power entries can be made using . The “-dBm” key can enter -dBm, -dBmV, or -dBμV. For example, in reference level, with the dBmV units, an entry of    enters -50 dBmV.

Negative frequency entries can be made using  

as a prefix to the frequency entry. For example, to enter a negative start frequency, press       . This enters the frequency value as -100 MHz.

Not all functions accept negative entries (the sign is ignored).

MULTIPLE DATA CHANGES

A function, once activated, may be changed as often as necessary (see Chapter 3, FUNCTION).

Functions are not always activated to change their value. Sometimes they are activated just to read out an existing value. For example, start and stop frequency may be activated simply to allow the left and right display reference frequencies to be read out as start/stop frequencies.

Chapter 3 FUNCTION

GENERAL DESCRIPTION

This chapter describes the use of FUNCTION and DATA controls for establishing the desired amplitude and frequency display.

The FUNCTION group allows changes to the most used spectrum analyzer functions: center frequency, frequency span, and reference level. An alternate method of setting the frequency scale is provided with the start and stop frequency functions.

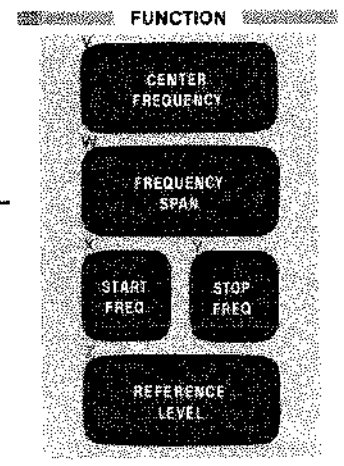
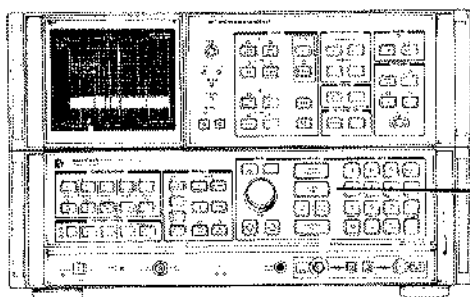

The changing value is read out from the display at the active function area and at the display position dedicated to that FUNCTION.

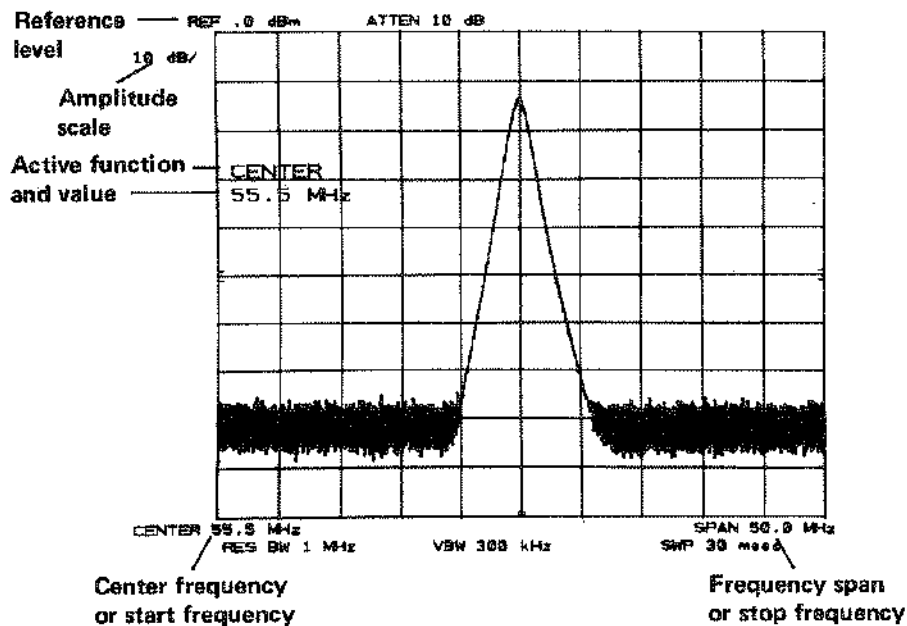

FUNCTION VALUE READOUTS

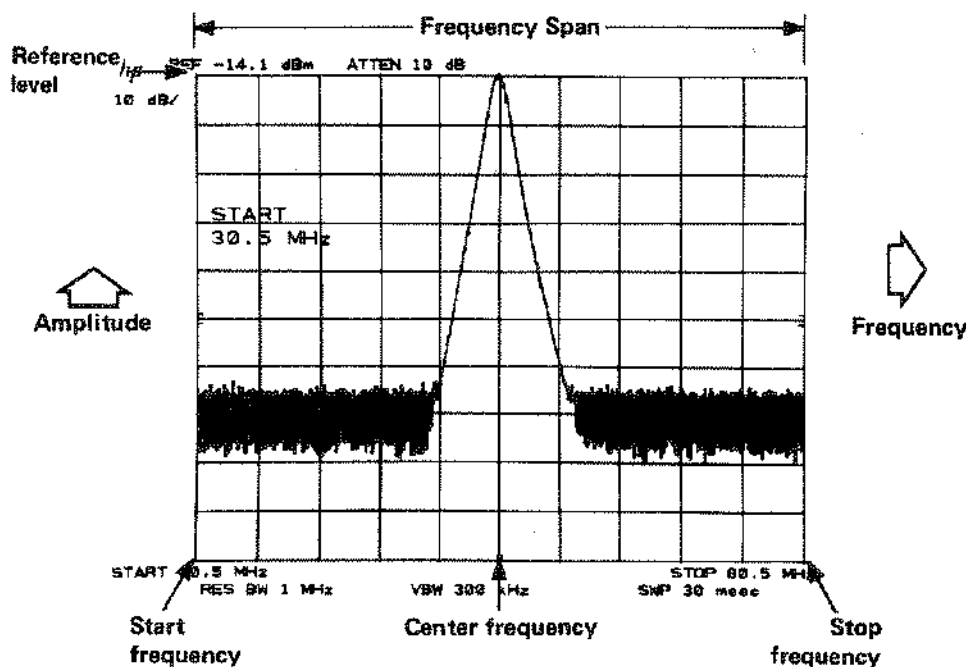

CRT GRATICULE SCALING WITH FUNCTION READOUTS

DISPLAY CALIBRATION

With changes to the displayed frequency range, the spectrum analyzer changes resolution bandwidth, video bandwidth, and sweep time to maintain absolute amplitude and frequency calibration if the COUPLED FUNCTIONS are set to automatic. The examples in this chapter assume this condition. See Chapter 8, COUPLED FUNCTION for additional information on amplitude and frequency calibration.

FREQUENCY DISPLAY RANGE

The frequency range of the horizontal axis can be entered using either of two FUNCTION modes:

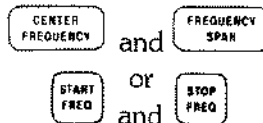

When a function from either mode is activated, only the function values of that mode will be displayed. Switching from one mode to the other with no DATA entry makes no change to the displayed frequency spectrum.

CENTER FREQUENCY

CENTER FREQUENCY (DATA entry) changes the center frequency. Center frequency will remain activated (i.e., capable of being changed) until **HOLD**, **METR PRESET** or another function requiring DATA entry is activated.

Measurement and Readout Range

Center frequencies from 0 Hz to 1500 MHz can be entered.

62.7 MHz is the frequency at the center of the display graticule.

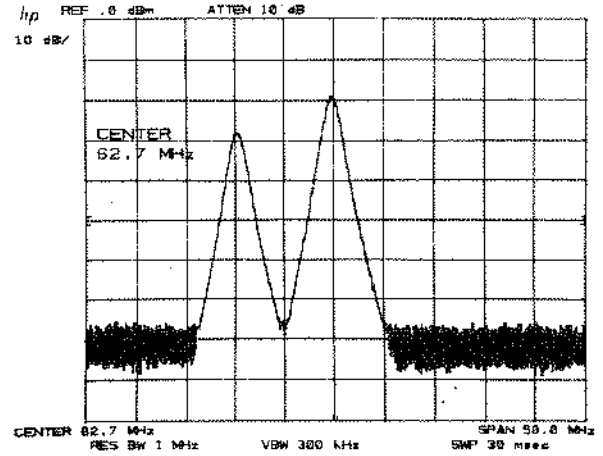

The number of significant digits in the readout depends on the frequency span selected. The narrower the span, the more significant digits.

The number of center frequency readout *digits to the right of the decimal* are as follows:

Center Frequency	Frequency Span						
	100 Hz to 999 Hz	1.00 kHz to 9.99 kHz	10.0 kHz to 99.9 kHz	100 kHz to 999 kHz	1.00 MHz to 9.99 MHz	10.0 MHz to 99.9 MHz	100 MHz to 1500 MHz
0 Hz to 999 Hz	0	0	0	0	0	0	0
1.000 kHz to 999.999 kHz	3	2	1	0	0	0	0
or 1.000000 MHz to 1499.999999 MHz	6	5	4	3	2	1	0

DATA Entry

	Changes the center frequency by about one-half the total frequency span each full turn.
	Changes the center frequency by one-tenth of the frequency span, i.e., by one division. COUPLED FUNCTION can be used to change this step size.
	Allows direct center frequency entry. The analyzer accepts a center frequency entry of up to 9 digits for frequencies less than 1000 MHz and 10 digits for frequencies of 1000 MHz to 1500 MHz. Even though the readout may show a fewer number of digits (due to wide frequency span), as the span is narrowed, the full entry will be read out. Abbreviated readouts are not rounded.

Only after a center frequency entry has been made will points along the trace reflect the spectrum change. For example, if the center frequency is changed when a slow sweep is in the middle of the graticule, signal responses on the left-hand side bear no relation to the new center frequency until the sweep passes through them.

SIGNAL TRACK – AUTOMATIC FREQUENCY CONTROL

The center frequency can be locked to a specific signal using the MARKER function . Chapter 6 discusses the procedure and examples.

FREQUENCY SPAN

 (DATA entry) changes the total display frequency range symmetrically about the center frequency. Frequency span is read from the display.

NOTE



Frequency span readout refers to the total display frequency range. Divide by 10 to determine frequency span per division.

Measurement and Readout Range

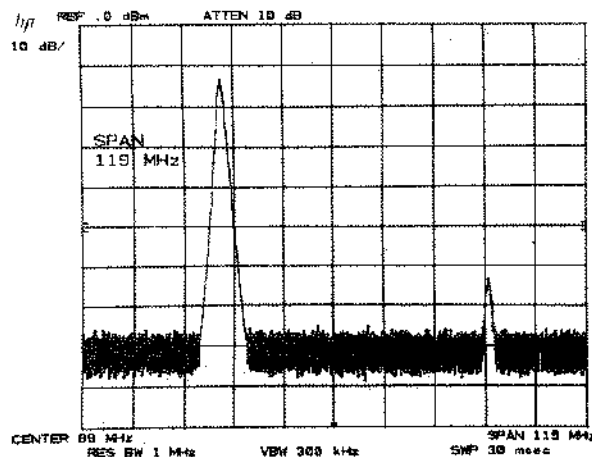
Frequency span can be varied from 100 Hz to 1500 MHz. Three significant digits are displayed for frequency spans up to 1000 MHz and four digits for spans of 1000 MHz to 1500 MHz.





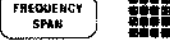



DATA Entry

	Changes the frequency span by about a factor of 2 for each half turn.
	Changes the frequency span to the next value in a 1, 2, 5, 10 sequence.
	Enters an exact value up to three or four digits, depending on span. Additional digits will be deleted without rounding.

Example of



Once a signal response is placed at the center of the display frequency range, the signal's frequency can be read from center frequency. Reduction of the frequency span will increase the frequency readout resolution.

A signal lower than the center frequency can be brought to the center with    , using  as a coarse tune, then fine tuning with .

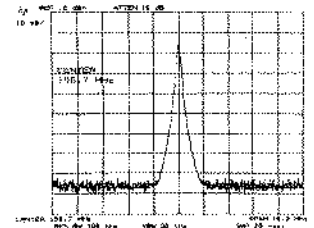
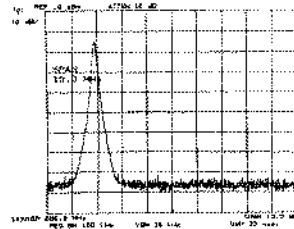



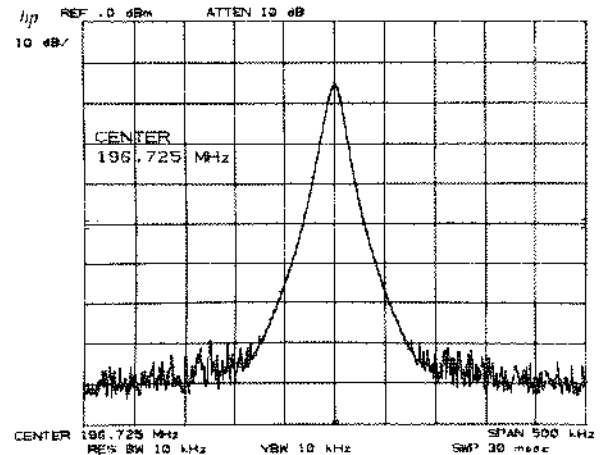

Narrowing the frequency span increases the center frequency resolution.



ZERO FREQUENCY SPAN – FIXED TUNED RECEIVER OPERATION

The spectrum analyzer can operate as a receiver fixed tuned to the center frequency. Modulation waveforms can be displayed in the time domain with calibrated sweep time.

To fix tune the spectrum analyzer press    and tune to the desired frequency with .

The horizontal display axis becomes calibrated in time. The following functions establish a clear display of the video waveform:

<p>TRIGGER/LEVEL</p> <p><input type="checkbox"/> VIDEO <input checked="" type="radio"/></p>	<p>Stabilizes the waveform trace on the display by triggering on the modulation envelope.</p>
<p>SCALE</p> <p><input type="checkbox"/> LIN</p>	<p>Voltage amplitude calibration.</p>

<p>COUPLED FUNCTIONS</p> <p><input checked="" type="checkbox"/> SWEEP TIME</p> <p><input type="checkbox"/> RES BW and <input type="checkbox"/> VIDEO BW</p>	<p>Adjusts the full sweep time. Sweep times down to 1 μsec full scale are available in zero span. Signal responses for sweep times <20 msec are not digitally stored.</p> <p>Select according to signal bandwidth.</p>
---	--

Each of the COUPLED FUNCTION values remain at their current values when zero span is activated.

Measurement and Readout Range

An example shows the readout:

Press to activate zero span.

Press , then fine tune with for optimum trace.

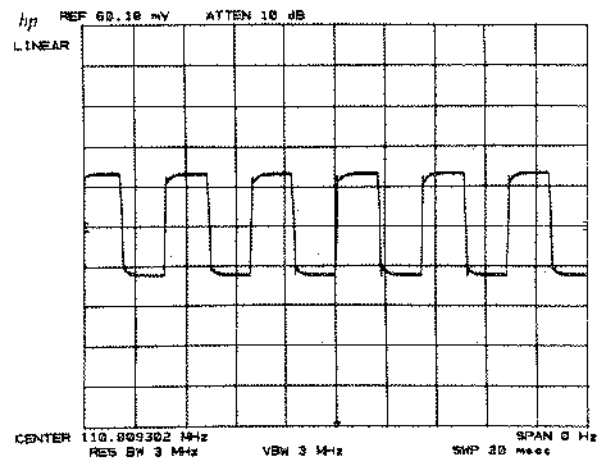

The analyzer is fixed tuned to 110 MHz. The time domain display shows a modulation waveform at 2 msec/division.





NOTE

The sweep time readout refers to the full 10 division display sweep time. Divide by 10 to determine sweep time per division.

In the time domain, sweep time range is 1 μ sec to 10 msec in a 1, 2, 5, 10 sequence, and 20 msec to 1500 sec in a 1, 1.5, 2, 3, 5, 7.5, 10 sequence.

The sensitivity of center frequency to the DATA  and   is dependent upon resolution bandwidth:

DATA ENTRY	CENTER FREQUENCY CHANGE
one revolution 	6 x (resolution bandwidth)
 or 	1 x (resolution bandwidth)

START AND STOP FREQUENCY



A specified frequency range can be displayed by using



 (DATA entry) to set left graticule frequency.

 (DATA entry) to set right graticule frequency.

Start and stop are mutually exclusive with the center frequency and frequency span active functions. Activating either start or stop causes both to read out in place of center frequency and frequency span.

Measurement and Readout Range

 can be varied from - 850 MHz to 1500 MHz, although entries less than 1700 MHz below stop frequency will effect the  readout.

 can be varied from 000 to 2500 MHz, although entries 1700 MHz above the start frequency will effect the  readout.

The number of readout digits depends upon the frequency span. Narrower frequency ranges add digits to the readout.

The key sequence    
    

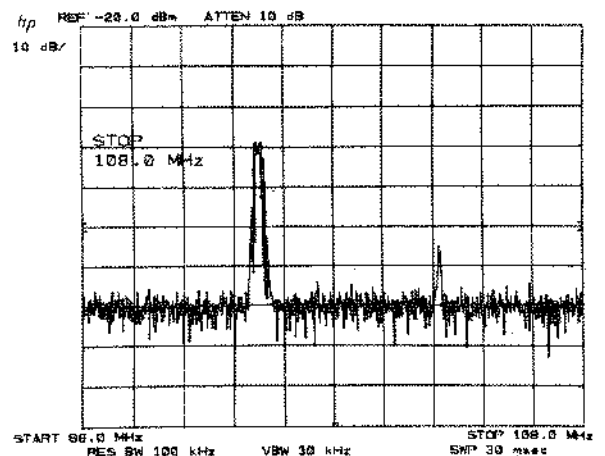

gives this readout.



The rules governing the number of significant readout digits are the same as for **CENTER FREQUENCY**

DATA Entry

Both start and stop frequencies can be entered from any of the DATA controls.

<p>START FREQ OR STOP FREQ</p> 	<p>Changes the start or stop frequency. The amount of change per turn is a constant percentage of the frequency span.</p>
<p>START FREQ OR STOP FREQ</p> 	<p>Changes the frequency by one tenth of the total frequency span.</p>
<p>START FREQ OR STOP FREQ</p> 	<p>Exact start or stop frequencies can be entered. The number of digits read out depends upon the frequency span.</p>

REFERENCE LEVEL

REFERENCE LEVEL (DATA entry) changes the absolute amplitude level of the top graticule line. The amplitude scale – that is, the number of amplitude units per division – is entered from the SCALE control group or **INSERT PRESET**.

Signal responses below the top graticule are measured by bringing the response to the reference level with **REFERENCE LEVEL** (DATA entry).

NOTE

In logarithmic 10 dB per division scaling, the top 9 divisions are calibrated.

The maximum reference level value is dependent on the input attenuator setting. Levels to the input mixer that could cause gain compression are displayed off the top of the reference level graticule. The maximum reference level limit can be extended with KEY FUNCTION **SHIFT** **ENTER**, allowing a maximum reference level of +60.0 dBm. See Chapter 11 for details concerning reference level ranges.

CAUTION

Even with the reference level set to + 60 dBm, the total input power should not exceed + 30 dBm.

Measurement and Readout Range

The reference level can be changed from + 30 dBm to - 89.9 dBm in 0.1 dB steps. The readout shows one significant digit to the right of the decimal.

RF attenuator: 10 dB
 Reference level: - 11.2 dBm

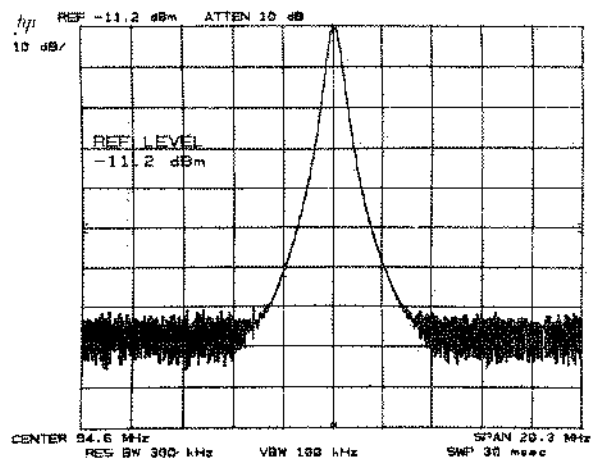

Reference level dBm units are selected with **INSTR PRESET**: dBmV, dBμV, and volts referred to the analyzer's input impedance can be selected with **KEY SHIFT FUNCTIONS**. The absolute power of the reference level remains constant when units are changed.

Full amplitude readout units information can be found in Chapter 11, **KEY SHIFT FUNCTIONS**, under **AMPLITUDE UNITS SELECTION**.

DATA Entry

	In logarithmic scale, the changes are in 0.1 dB steps: in linear scale, the changes are made to the least significant digit.
	In logarithmic scale, changes the reference level in steps according to dB/division scale. In linear scale, changes the reference level in 1 dB steps.
	Allows entry of exact reference levels. Digits entered beyond the displayed number of digits are deleted.

Example

A signal's power level is measured by setting the reference level equal to the signal level.

The signal level is roughly -35 dBm.

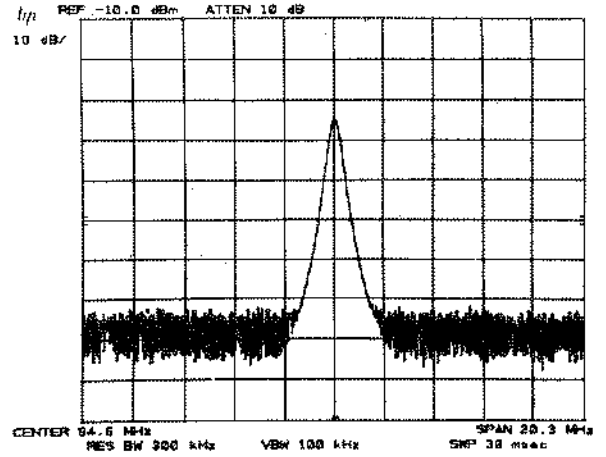

Change the reference level to the signal with



The signal level measured is -35.3 dBm.

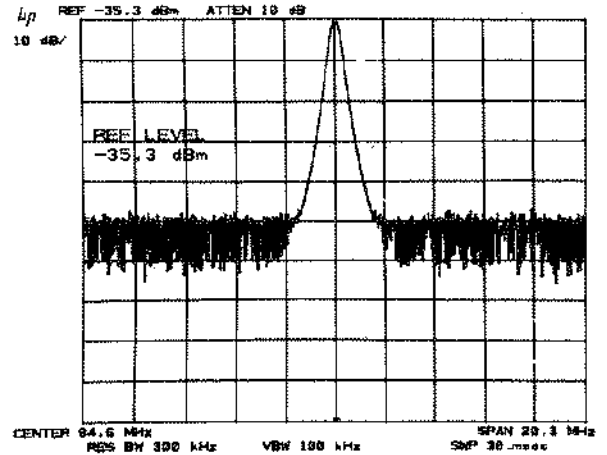

For voltage amplitude units, press

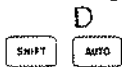

The corresponding level is 3.841 mV.

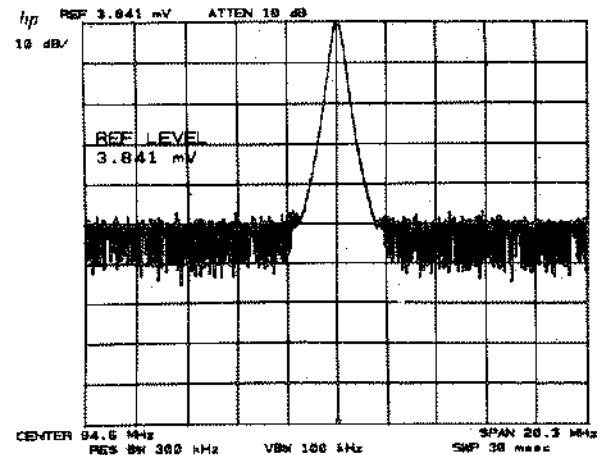

FREQUENCY AND AMPLITUDE OFFSETS

The display readout (HP-IB readout) of frequency and amplitude can be offset by values entered through **SHIFT** KEY FUNCTIONS. The offset values are read out on the display. Frequency offset is entered with

V

SHIFT **CENTER FREQUENCY** (DATA entry).

Frequency offset may be used, for example, to provide a baseband frequency display scale for a signal that has been converted up or down.

Amplitude offset is entered with

Z

SHIFT **REFERENCE LEVEL** (DATA entry).

External attenuation or gain in series with the analyzer RF input can be compensated for by offsetting the analyzer reference level. This calibrates the analyzer reference level readings to the input of the external attenuator or amplifier.

More details and examples are in Chapter 11, **SHIFT** KEY FUNCTIONS, under FREQUENCY AND AMPLITUDE OFFSET.

Chapter 4 CRT DISPLAY

GENERAL DESCRIPTION

This chapter describes the CRT display adjustments, readouts, and graphics.

ADJUSTMENT OF THE DISPLAY

Adjustments for intensity, focus, and alignment affect all the lines and characters on the display simultaneously.

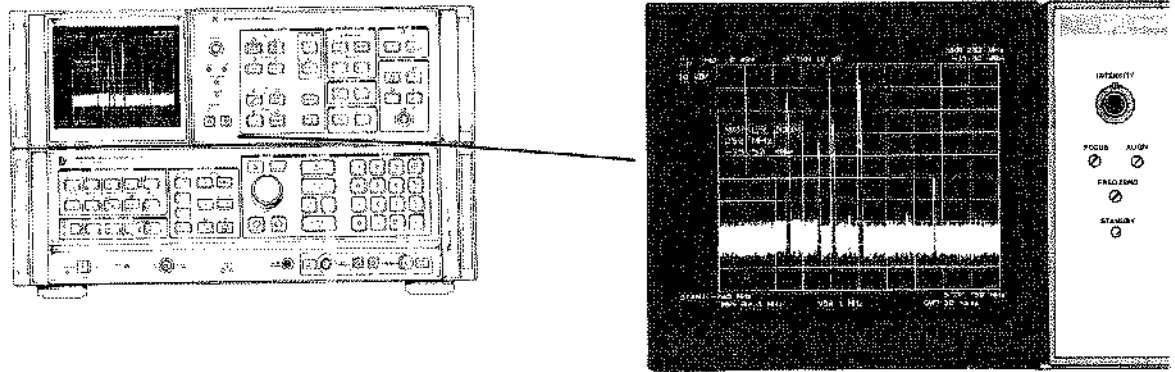

CRT Display and Adjustments



INTENSITY

Controls intensity for all the CRT writing



FOCUS

A screwdriver adjustment for focusing all the CRT writing. Focusing any one element on the CRT focuses all the writing.



ALIGN

A screwdriver adjustment for tilting all the displayed CRT information.

DISPLAY SECTION LINE POWER



STANDBY

A lamp that indicates the power condition of the Spectrum Analyzer Display section as dictated by the setting of the LINE power switch on the HP 85680B RF section.

CRT DISPLAY OVERVIEW

The cathode ray tube of the Spectrum Analyzer Display section displays:

- active function name and value
- graticule
- traces of the signal response
- values that calibrate the frequency, time, and amplitude axes
- values for the spectrum analyzer receiver parameters, that is, COUPLED FUNCTIONS
- operator originated labels and graphics

Active Function

The function that has been activated for DATA entry is read out in the graticule area shown.

Activating a function immediately writes its name in the active function area along with its present value.

The following summarizes the names and readout for mats for front-panel-controlled active functions.

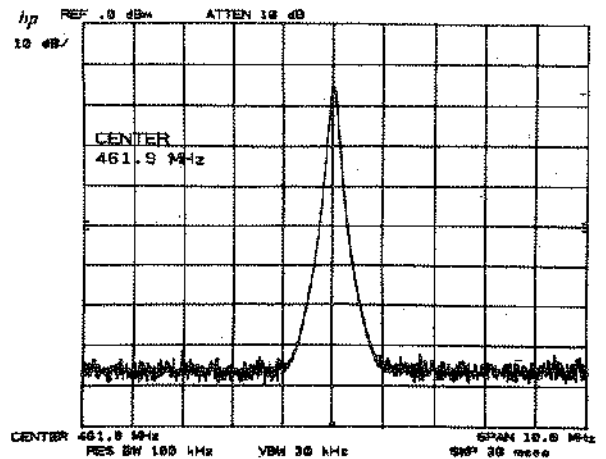

Function	Examples of Active Function Readout
FUNCTION	
<input type="button" value="CENTER FREQ"/>	CENTER 750 MHz
<input type="button" value="FREQUENCY SPN"/>	SPAN 1500 MHz
<input type="button" value="START FREQ"/>	START 0 Hz
<input type="button" value="STOP FREQ"/>	STOP 1500 MHz
<input type="button" value="REFERENCE LEVEL"/>	REF LEVEL .0 dBm

Function	Examples of Active Function Readout
COUPLED FUNCTION	
<input type="button" value="RES BW"/>	RES BW 3 MHz
<input type="button" value="VIDEO BW"/>	VIDEO BW 3 MHz
<input type="button" value="SWEEP TIME"/>	SWEEP TIME 20 msec
<input type="button" value="ATTN"/>	RF ATTN 10 dB
<input type="button" value="CF STEP SIZE"/>	CF STEP 150 MHz

MARKER	
<input type="button" value="NORMAL"/>	MARKER 550 kHz 19.8 dBm
<input type="button" value="Δ"/>	MARKER Δ 20.0 MHz - 12.4 dB
<input type="button" value="ZOOM"/>	MARKER ZOOM 20.5 MHz - 32.8 dBm
<input type="button" value="NORMAL"/> <input type="button" value="FREQ COUNT"/>	COUNTER 19.998 MHz - 12.0 dBm
<input type="button" value="Δ"/> <input type="button" value="FREQ COUNT"/>	COUNTER Δ 20.000 MHz - .2 dB
<input type="button" value="ZOOM"/> <input type="button" value="FREQ COUNT"/>	COUNTER ZOOM 20.000 MHz - .2 dBm
<input type="button" value="NORMAL"/> <input type="button" value="SHIFT"/> M	MARKER 16.3 MHz - 140.4 dBm (1 Hz)

REFERENCE LINE	
<input type="button" value="ENTER"/>	DISPLAY LINE - 45.0 dBm
<input type="button" value="ENTER"/>	THRESHOLD - 90.0 dBm

SCALE	
<input type="button" value="ENTER"/> <input type="button" value="AL/DIV"/>	LOG 10 dB/

KEY FUNCTION	
(See <input type="button" value="SHIFT"/> KEY FUNCTIONS, Chapter 11.)	

<input type="button" value="HOLD"/>	deactivates any active function (except for E), blanking the active parameter readout.
<input type="button" value="SHIFT"/>	

Graticule

The display graticule is an internally generated 10-division by 10-division rectangle for referencing frequency, time, and amplitude measurements. Double markings at the left, right, and bottom designate the center axes.

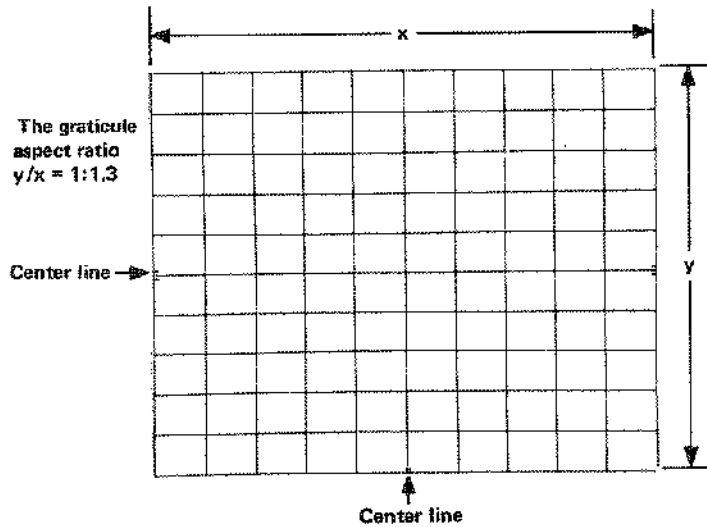

The graticule can be blanked from the display with KEY FUNCTION **SHIFT** **m** and restored with **SHIFT** **n**.

For CRT photography, the graticule can be intensified independent of the annotation and trace by pressing the following sequence:

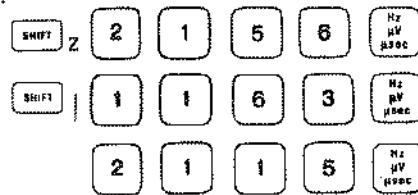

For more intensity, repeat the last two number entries, 1163 Hz and 2115 Hz. **INSTR PRESET** returns the graticule to normal.

Traces

Three separate traces, A, B, and C, can be written onto the display. Each trace consists of 1000 separate straight-line elements drawn between 1001 fixed points across the CRT. X and Y axis coordinates designate the particular points between which the elements are drawn. Terms used to describe trace composition are defined as follows:

Point A "point" in the context of this manual is a fixed location on the CRT display. There are 1,001 points along the X (horizontal) axis of the CRT graticule, numbered from 0 on the far left graticule line to 1000 on the far right graticule line. Similarly, there are 1,001 points along the Y (vertical) axis of the CRT graticule, numbered from 0 on the bottom graticule line to 1000 on the top graticule line. An additional 22 points of overrange available above the top graticule line provide the Y axis with a total of 1,023 points.

Display Unit One display unit is the distance between two points (see above) along an X or Y axis. The distance along the X axis between the far left graticule line and the far right graticule line is

1000 display units. The Y axis length between the bottom graticule line and the top graticule line is also 1000 display units. Although the Y axis can be extended another 22 display units above the top graticule line, the extended area is not calibrated.

X, Y coordinates to a particular point on the display are given in display units relative to X, Y coordinates 0,0 at the junction of the far left and bottom graticule lines.

Element An element is a distinct portion of the trace drawn on the CRT. It comprises a point and the visible straight line drawn to it from the preceding point. An element drawn parallel with a vertical or horizontal graticule line is one display unit long. An element drawn at an angle to the graticule lines is longer, its actual length depending on the angle.

Vector A vector is identical with an **element**, except that it can be either visible or blanked.

NOTE

When the analyzer is operated manually (i.e., with its front-panel controls), the display size remains constant and the above definitions are fully applicable. When it is operated remotely with a controller, however, three additional larger display sizes are available through the display-size programming commands. For these larger-than-normal display sizes, the lower left reference coordinates and the upper right trace limit expand beyond the CRT's outer graticule lines. For further information on remotely-controlled (i.e., programmed) display sizes, refer to commands D1, D2, and D3 under Programming Commands in Section II of this manual.

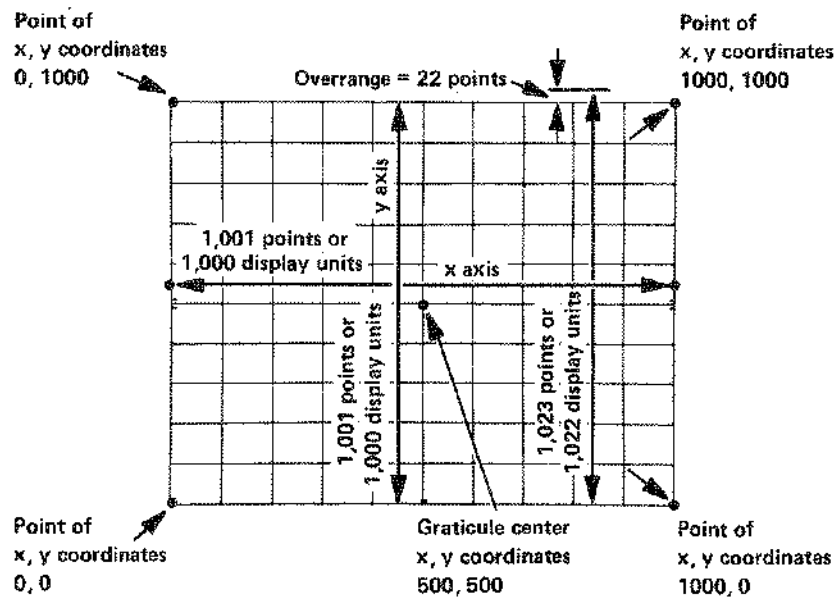

TRACE DISPLAY TERMS

Locations of Permanent Readouts

The vertical and horizontal graticule axes are scaled by these readouts:

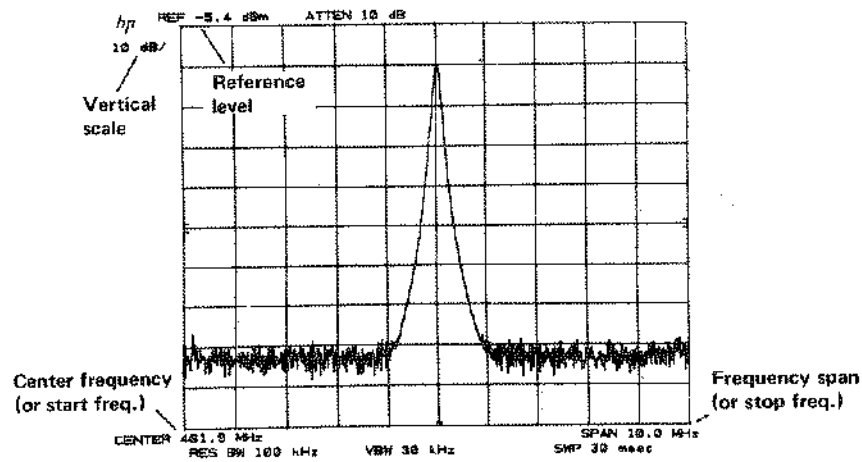

The COUPLED FUNCTIONS that describe the swept receiver characteristics of the spectrum analyzer are:

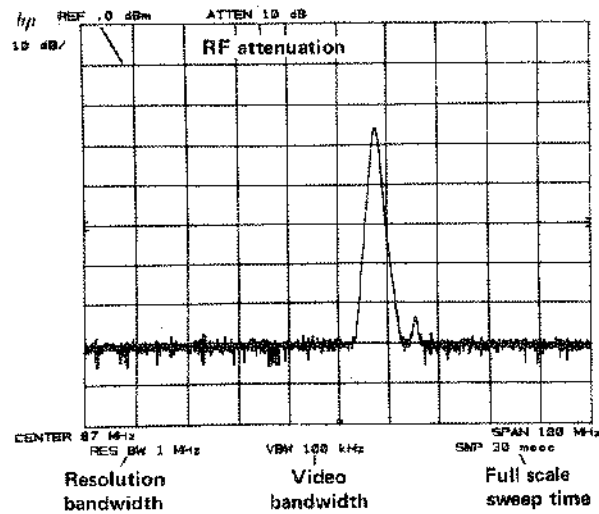

To blank all the character readouts, press KEY FUNCTION o. To restore, press p.

Other Readouts

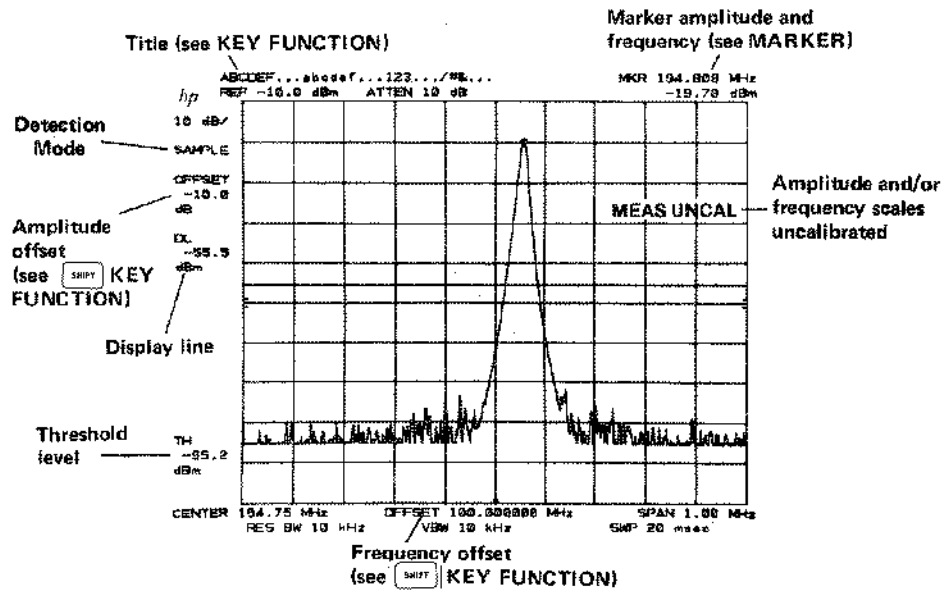

A number of other special function readouts can be activated. These are covered in Chapter 11.

Chapter 5 TRACE

GENERAL DESCRIPTION

This chapter describes the use of the TRACE functions for writing, storing, and manipulating trace data.

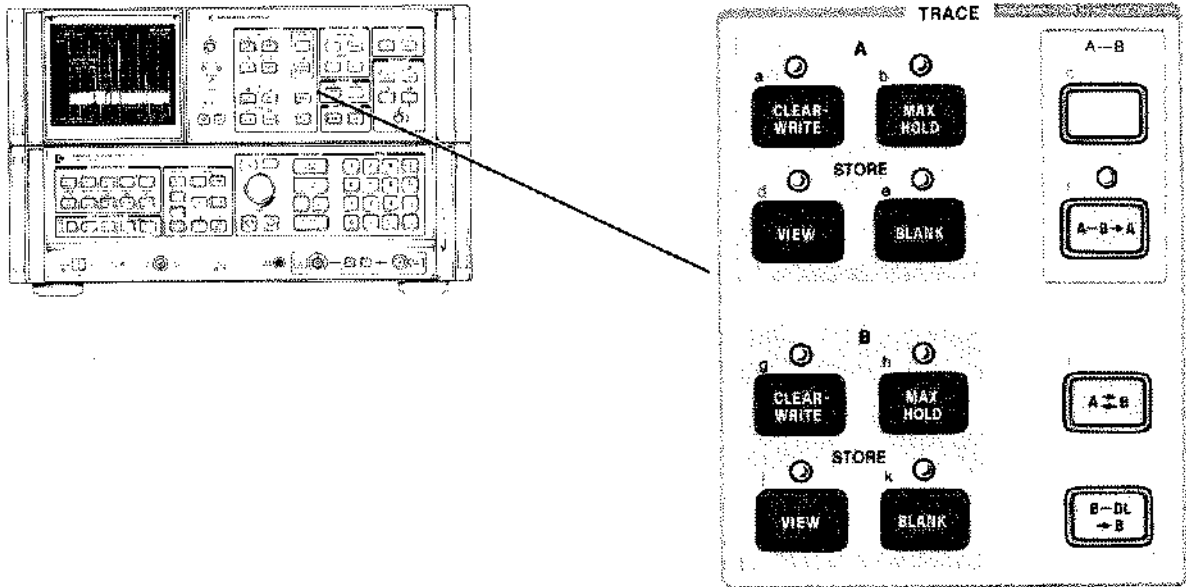

TRACE CONTROLS

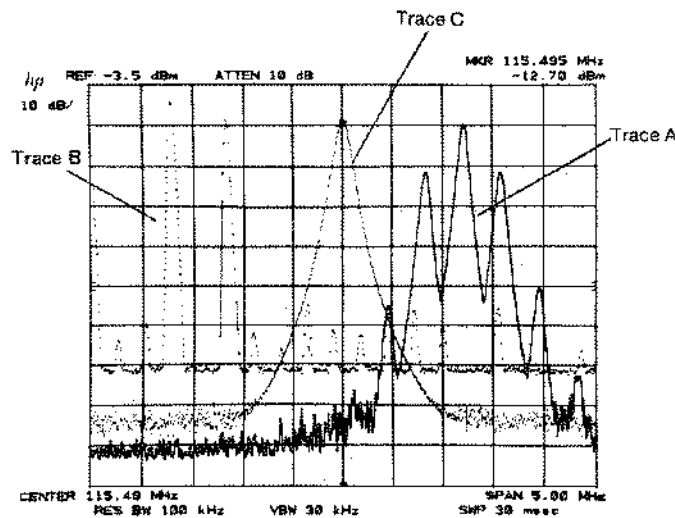

TRACE IDENTIFICATION

Traces are differentiated by intensity. Trace A is bright, trace B is of medium intensity, and trace C has the least intensity. **VIEW** and **BLANK** allow positive identification.

TRACE MODES

Four mutually exclusive functions or modes for trace A and trace B determine the manner in which the traces are displayed. Indicator lights by the keys show the current modes.

WRITE MODES (sweeping):



Displays the input signal response in trace selected.

Displays and holds the maximum responses of the input signal in trace selected.

STORE MODES (not sweeping):



Stores the current trace and displays it on the CRT display.

Stores the current trace and blanks it from the CRT display.

Trace Memory

An understanding of the TRACE modes requires a familiarity with the analyzer trace memory and trace data transfer functions.

Display traces are not written onto the CRT directly from the spectrum analyzer's IF section. Instead, the analog signal response is converted to digital information and stored in one trace memory. This information can then be transferred to the CRT display. The way in which the information is displayed depends upon the TRACE mode selected.

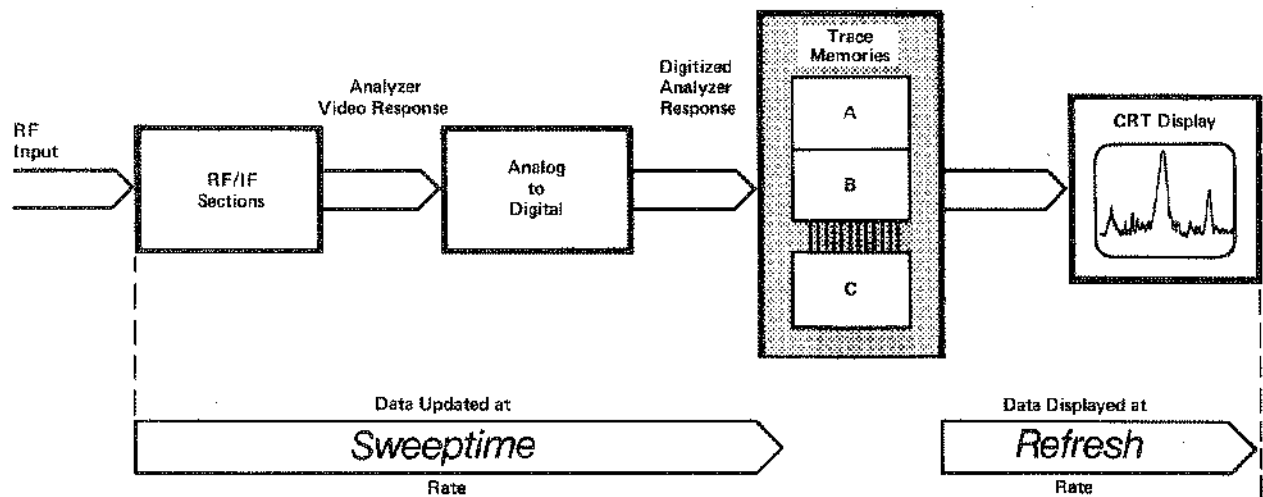

TRACE MODES DETERMINE HOW DATA IS ENTERED INTO AND DISPLAYED FROM TRACE MEMORIES

The analyzer's response is transferred into the trace memory at the sweep rate of the analyzer (that is, in accordance with the sweep time setting). The trace memory is written onto the CRT display at a refresh rate of about 50 Hz, which is rapid enough to prevent flickering of the trace on the CRT. Trace intensities remain constant as analyzer sweep times are changed.

NOTE

It is important to understand the difference between sweep and refresh.

- Sweep** refers to the spectrum analyzer sweeping from a start frequency to a stop frequency and storing measured amplitude data into a trace memory.
- Refresh** refers to the transfer of display memory data to the CRT display

Write Modes

For the write modes, the analyzer signal response is written into trace memory during the sweep and the memory contents are displayed on the CRT.

- A(B) Sets all the values in the trace memory A(B) to zero when first activated (bottom line graticule), then displays the signal response.
- A(B) Latest signal response is written into the trace A(B) memory only at the horizontal positions where the response is greater than the stored response.
- When both A and B modes are selected, the analyzer writes into (sweeps) A and B alternately.

STORE Modes

In the STORE modes, no updating of the trace memory is made. The current memory data is saved.

- A(B) The trace A(B) data are displayed on the CRT (refresh is enabled).
- A(B) The trace A(B) data are not displayed on the CRT (refresh is disabled).

Example

With TRACE modes, signals can be observed as the analyzer sweeps. Signals can also be stored for comparison, erased, or monitored for frequency drift.

Center and zoom in on a 20 MHz signal:

Press

Since has set A and B, only A is displayed.

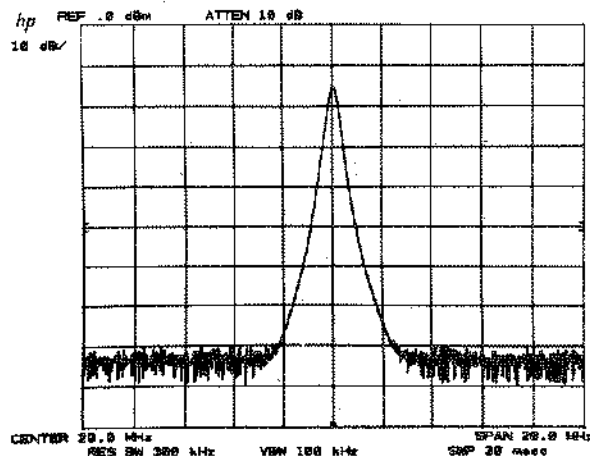

This response can be stored:
 Press A.

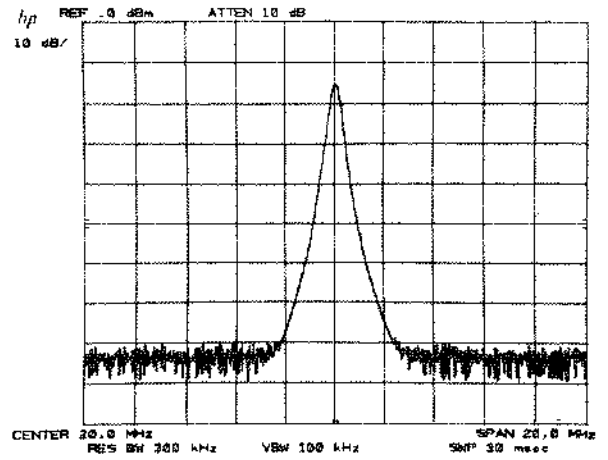

Write the same signal with B and change its position relative to trace A:

Press B.

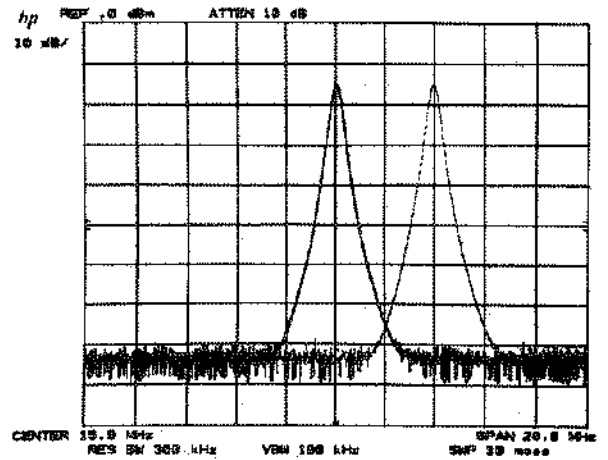

Blank trace A;

Press A.

This trace can be recalled with A as long as A or A is not used first.

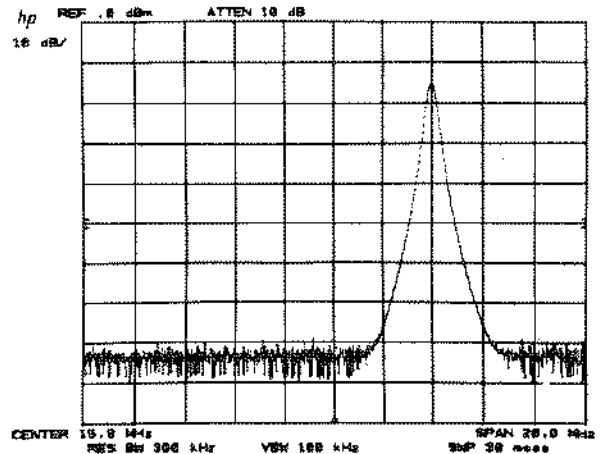

To display the drift of a signal, press **MAX HOLD** **A**. (Simulate frequency drift with **CENTER FREQUENCY**.)

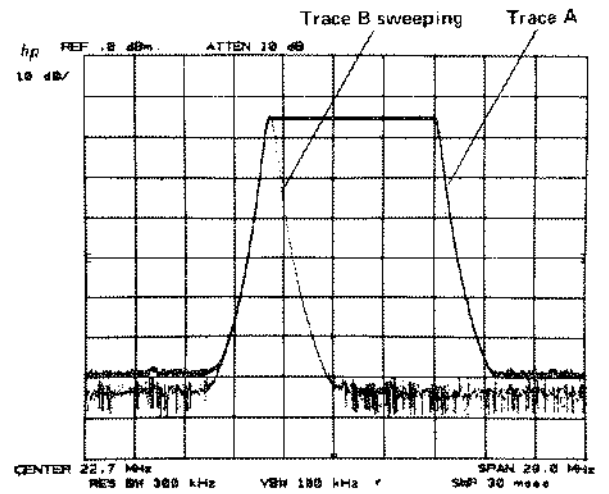

TRACE EXCHANGE

A=B exchanges traces A and B, changing their relative intensities and storage memory locations, and enables A and B **VIEW**. For example, in the trace display above, the modes and display appear.

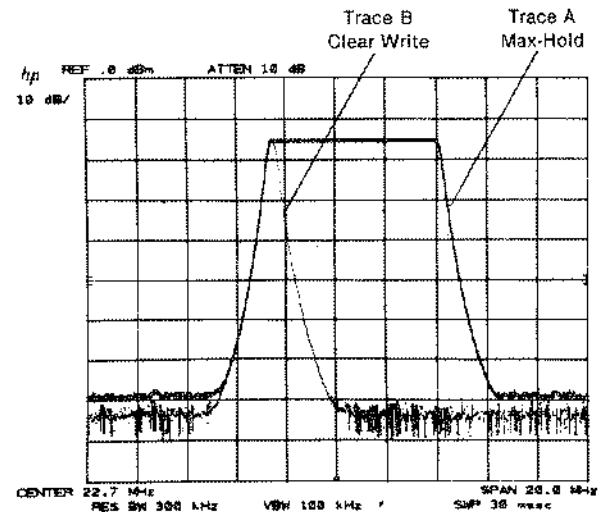
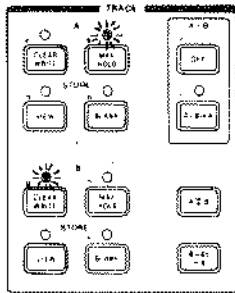

Press **A=B**

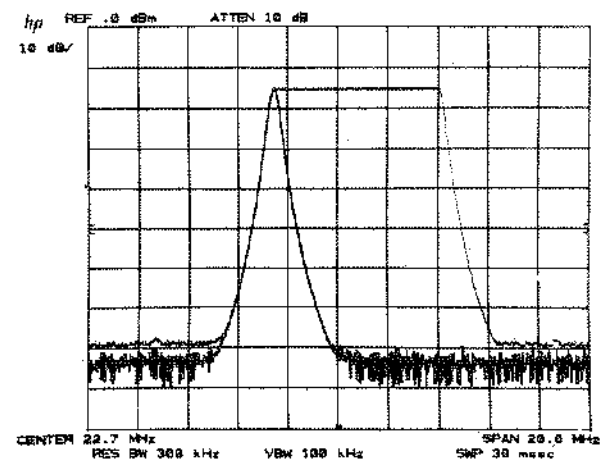
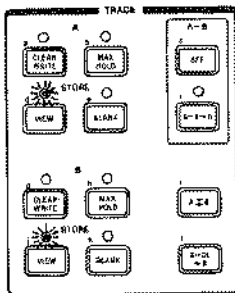

TRACE C MODES

A third trace, C, can be used to store a signal response. Trace C is not swept from the analyzer IF section as are traces A and B, but is input using a trace B into C function ($B \rightarrow C$) or a B and C exchange function ($B \rightleftharpoons C$).

Access to the trace C modes is through KEY FUNCTION . The modes are:

- View C: j Displays trace C.
- Blank C: k Blanks trace C from CRT display.
- $B \rightarrow C$: l Writes trace B into trace C. Trace A and B modes are not changed. If trace C is not displayed, it remains undisplayed.
- $B \rightleftharpoons C$: i Exchanges traces B and C. If trace B is displayed before the exchange, trace C is now displayed. If trace B is not displayed before the exchange, trace C is not displayed.

TRACE ARITHMETIC

TRACE arithmetic allows one trace to be modified by another trace or a display line position.

- $A - B$ Trace B amplitude (measured in divisions from the bottom graticule) is subtracted from trace A and the result written into trace A from sweep to sweep. Trace B is placed or kept in a STORE mode.
- $A - B$ Turns off.
- Subtracts the amplitude of the display line from trace B and writes the result into trace B. Trace B is placed or kept in . Details on display line are in Chapter 7, REFERENCE LINE.

Example

Trace arithmetic with the display line can be used to correct for the frequency response characteristics (flatness) of a swept measurement system typified by this setup:

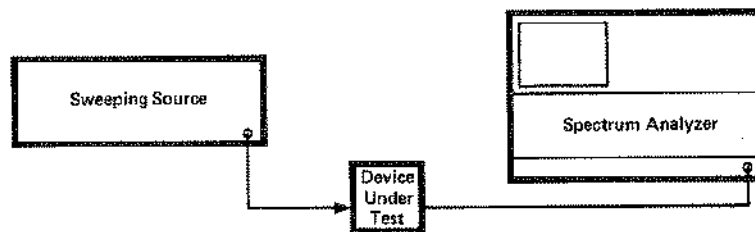

where the device under test is to be characterized for insertion loss over a specific frequency range.

The analyzer and source are set to the proper amplitude level and frequency span with the source output connected directly to the analyzer input.

B, sweep source, then B.

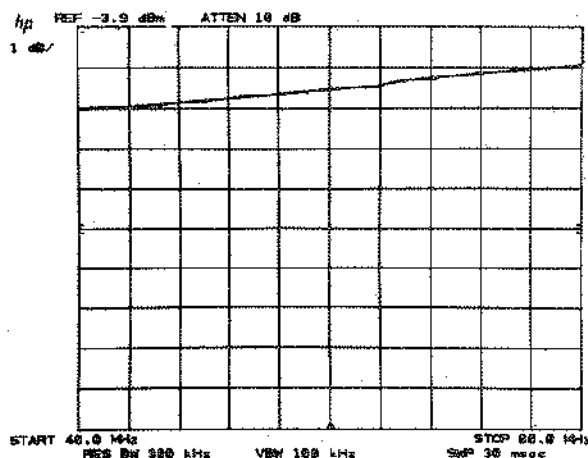

The display line is activated and set below the source/analyzer response.

DL

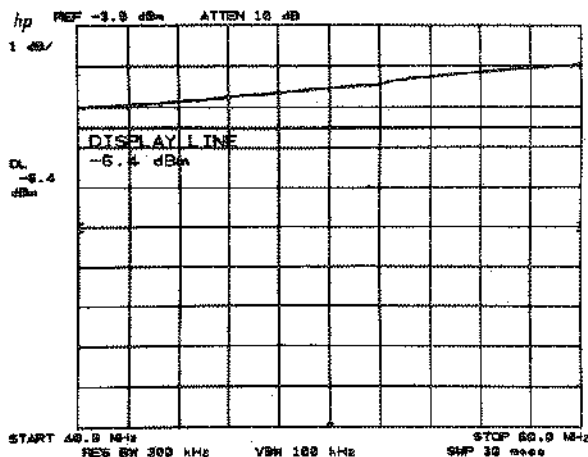

The difference between the display line (in display units) and the source/analyzer response is stored in trace B with .

Negative values of the line would be stored even though not displayed.

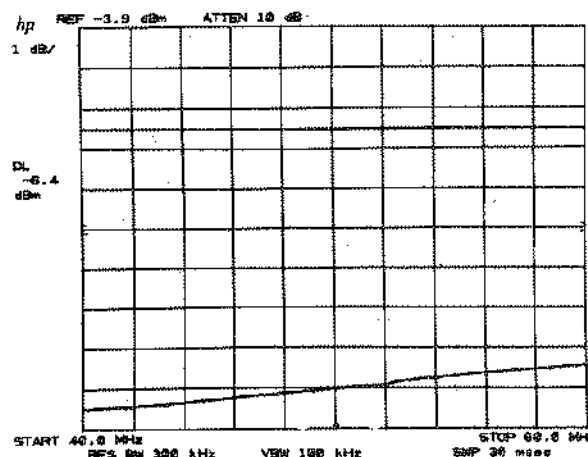

Now the device under test is connected between source and analyzer, and its response is corrected for source flatness uncertainty by using **MAX HOLD** A **A→d**.

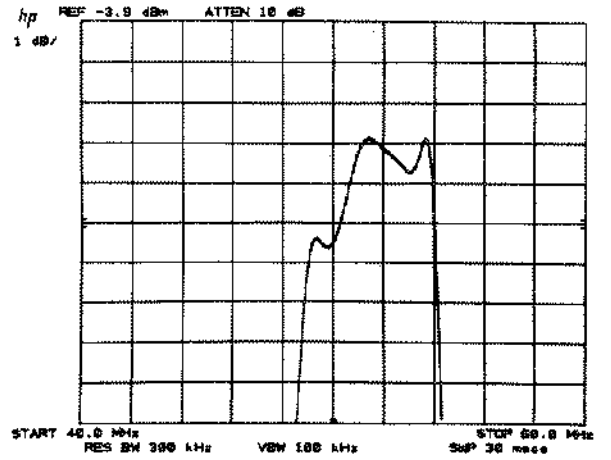

TRACE PRIORITY

Functions that act upon a trace always act upon the highest priority trace. Priority is defined by the trace modes as follows:

Highest priority



Lowest priority

- CLEAR-WRITE** A or **MAX HOLD** A
- CLEAR-WRITE** B or **MAX HOLD** B
- VIEW** A
- VIEW** B
- view C
- BLANK** A
- BLANK** B
- blank C

Marker functions, for example, use trace priority to decide which trace to mark. See Chapter 6.

Chapter 6 MARKER

GENERAL DESCRIPTION

This chapter describes the use of the MARKER and DATA controls for faster and more accurate measurements. Markers can be displayed only on TRACE A and TRACE B.

Two types of functions make up the MARKER group: MARKER MODEs, which enable or disable markers and their related functions; and MARKER ENTRY functions which allow the scaling of the display frequency and amplitude using marker information.

Markers are bright spots which lie directly on the display trace. The horizontal position of an activated marker is controlled by the DATA controls. The marker can be positioned at a specific frequency with the DATA number/units keyboard.

Readout of marker amplitude and frequency appears in the upper right of the display outside the graticule. When a MARKER MODE is active, its amplitude and frequency readout also appears in the active function area of the graticule.

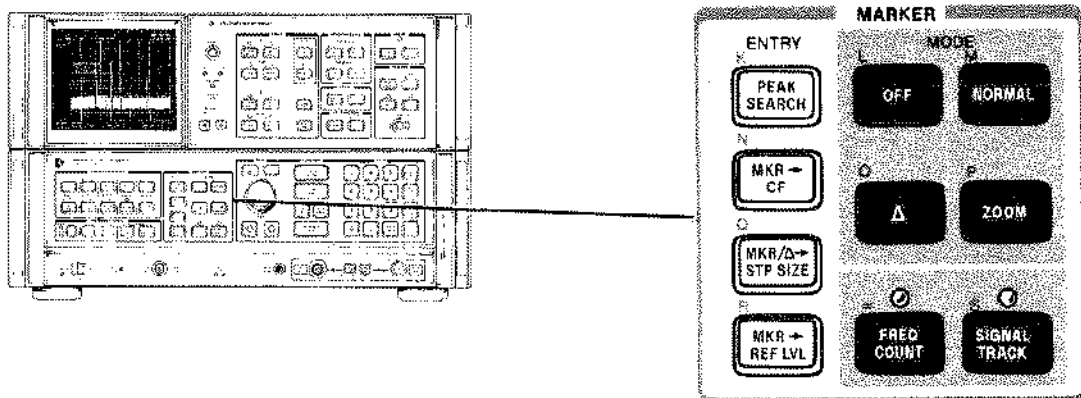

MARKER CONTROLS

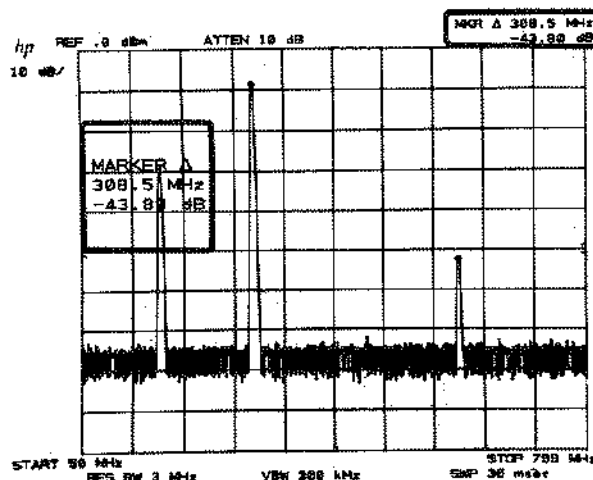

MARKER READOUT LOCATIONS

MARKER OVERVIEW

- Direct readout of the amplitude and frequency of a point along the trace.
- Direct readout of amplitude and frequency differences between points on the trace.
- Expansion of the span about a specific frequency.
- Placing a single marker at the highest response.
- Counter accuracy frequency measurements.
- Direct noise level readout.
- Analysis of stored traces.
- Amplitude and frequency display scaling.

FUNCTION:

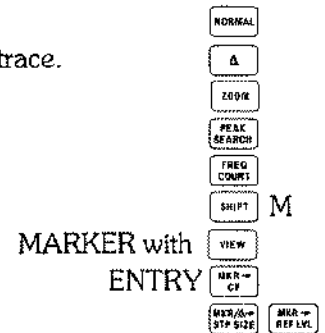

MARKER ON BUT NOT ACTIVE

An activated marker mode can be deactivated by activating another function, such as display line, or by DATA . This does not erase the marker itself nor the upper right display readout. If the marker mode is reactivated, DATA control and active function readout will continue from its last position.

If a marker mode is deactivated by a function (other than MARKER ENTRY) where a value change of the new function results in a rescaling of the amplitude or frequency axes, the marker will not stay on the trace. Reactivating the marker will start it at the display center.

MARKER OFF

disables any marker mode, including and , and blanks the marker readout from the CRT display. DATA controls are disabled if the marker was active.

MARKER IN VIEW

MARKER and may be used on traces A or B in the view mode. This allows detailed analysis of responses that are nonperiodic or unstable.

The markers are placed on a viewed trace according to the priority defined in Chapter 5, TRACE PRIORITY.





SINGLE MARKER – NORMAL

activates a single marker at the center of the display on the trace of highest priority. Trace priority is defined in Chapter 5. The marker does not activate on the TRACE modes , , view C, or blank C.

Measurement and Readout Range



The number of significant digits to the right of the decimal in the marker frequency readout is the same as for center frequency readout.

DATA Entry

	Moves the marker continuously along the trace at about 5 horizontal divisions each full turn. The marker moves in display unit increments.
	Moves the marker along the trace one tenth of the total width per step.  moves marker to the right.
	Places the marker at the frequency entered. An out-of-range entry results in placement of the marker at a graticule edge.

Example

Reading frequencies and amplitudes of signals is greatly simplified using MARKER  .

For a given display, activate the single marker with , then tune the marker with  to position it at the signal peak.

The frequency and amplitude is read out in two display areas.

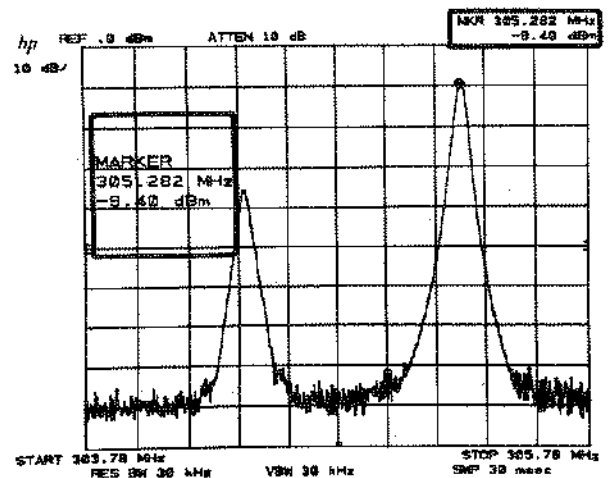

To read the left-hand signal's parameters move the marker to the signal peak with  .

The signal's amplitude and frequency is read out directly.

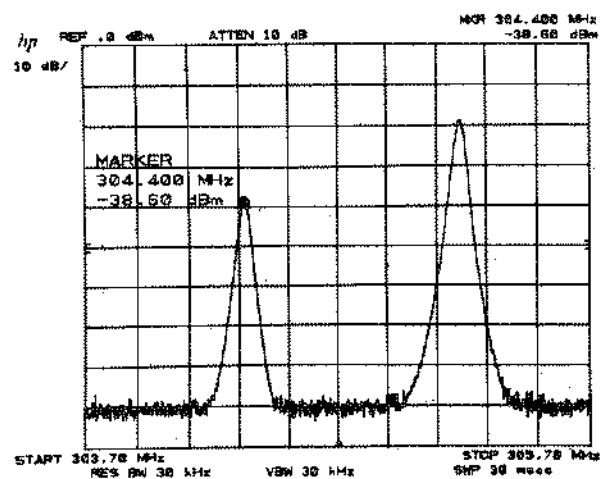

DIFFERENTIAL MARKERS – Δ

Δ activates a second marker at the position of a single marker already on the trace. (If no single marker has been activated, Δ places two markers at the center of the display.) The first marker's position is fixed. The second marker's position is under DATA control.

The display readout shows the difference in frequency and amplitude.

Example

Measuring the differences between two signals on the same display.

First set the marker on one of the signal peaks with

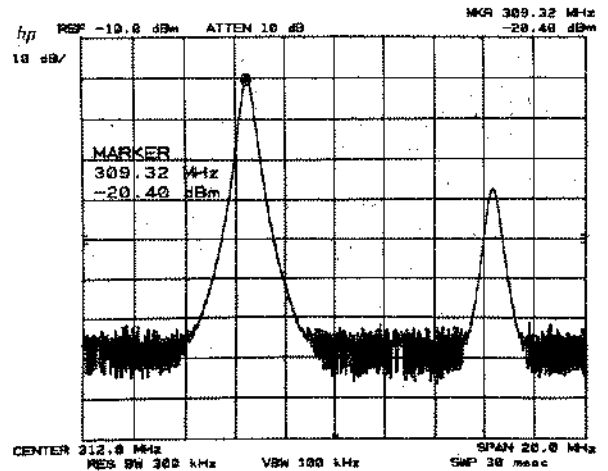

Activate Δ and move the second marker to the other signal peak with and read their differences directly.

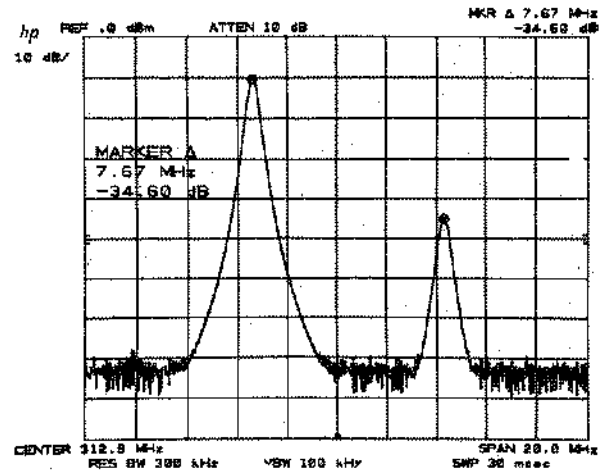

Fractional Differences

When the reference level is calibrated in voltage, marker Δ amplitudes are given as a fraction, the voltage ratio of two levels.

With *logarithmic* amplitude scale and the reference level in voltage, the fraction is based on the equation:

$$\text{fraction} = 10^{-\left(\frac{\text{dB difference}}{20}\right)}$$

Since this equation yields the harmonic distortion caused by a single harmonic, its distortion contribution can be read directly from the display.

Example

Set up Δ on the peaks of a fundamental (left) and its harmonic (right).

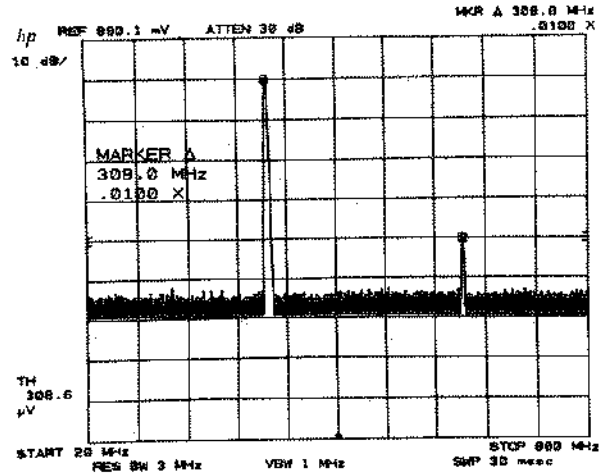

With the display referenced and scaled as shown, the readout “.0100X” designates the fractional harmonic content. Percent is calculated as $100X(.0100) = 1.0\%$.

With a *linear* amplitude scale and a reference level calibrated in voltage, the fractional amplitude readout is the simple linear ratio of the two markers.

Example

To measure % AM modulation from a spectral display, calibrate the display with the reference level in voltage and the amplitude scale in voltage.

Place the single marker on the carrier peak, NORMAL , and the second marker on one of the sideband peaks, Δ . The fractional amplitude readout gives one-half the modulation index .283.

$$\% \text{ AM} = 100 \times 2 \times .28 = 56\%$$

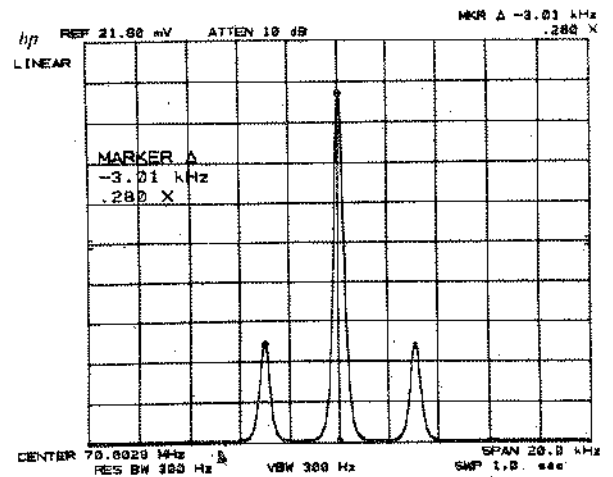



Measurement and Readout Range

The  function formats the amplitude readout according to reference level units and scale.

Reference Level Units	SCALE Logarithmic	SCALE Linear
dBm dBmV dBμV	Amplitude in dB	Amplitude in dB
Voltage	Amplitude ratio $10^{-\left(\frac{\text{dB difference}}{20}\right)}$	Ratio of marker amplitudes

AMPLITUDE READOUT FORMAT FOR MARKER 

















The frequency readout for all MARKER  conditions has up to 4 significant digits, depending on the portion of span measured.

The amplitude readout in dB has a resolution of ±.01 dB for linear scale. The resolution for logarithmic scale depends on the LOG  value:

LOG SCALE dB PER DIV	RESOLUTION
10	± 0.1 dB
5	± 0.05 dB
2	± 0.02 dB
1	± 0.01 dB

DATA Entry

The minimum incremental change for  frequency is 0.1% of the frequency span.

 	One full turn moves the active marker about one tenth of the horizontal span.
  	One step moves the marker one tenth of the horizontal span.
 	Positive entry places marker higher in frequency than the stationary marker, negative entry places marker lower in frequency. Larger entries than allowable place the marker on the adjacent graticule border. Negative frequencies can be entered using a   prefix as the minus sign. For example, to set a  span of 10 MHz with the second marker positioned to the left of the first, press      



MARKER ZOOM

ZOOM activates a single marker on the trace of highest priority (see TRACE PRIORITY, Chapter 5).

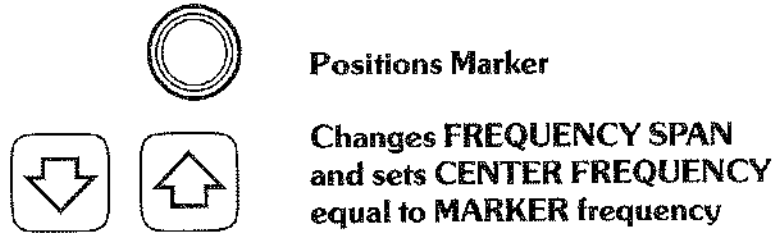
In **ZOOM**, the DATA knob and STEP keys change the values of *different functions*.



DATA Control Use for **ZOOM**

The marker can be moved along the trace with the DATA knob , and the frequency span can be changed about the marker with DATA step  and . Each step also sets center frequency equal to the marker frequency.

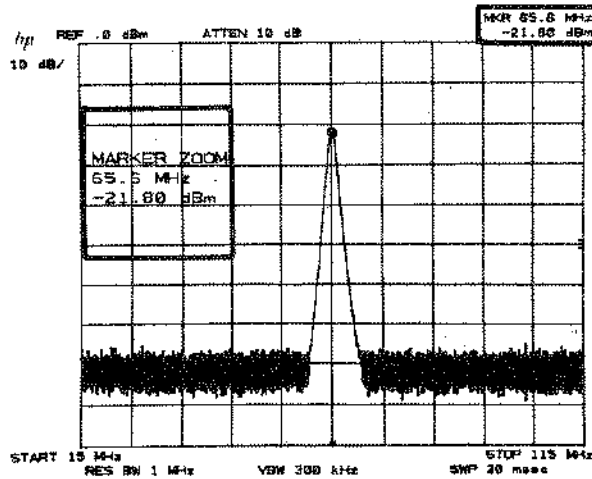



Measurement and Readout Range

The measurement and readout range for marker zoom is the same as marker **NORMAL**.

Better frequency count resolution and automatic recentering of a *signal* are additional zoom features when **FREQ COUNT** is activated.

DATA Entry

	Moves the marker continuously along the trace. Rate is dependent on speed of rotation. The marker moves in display unit increments.
	Changes the frequency span to the next value in the sequence and sets the center frequency equal to the marker frequency.
	Places the marker at the frequency entered. An out-of-range entry places the marker at a graticule border.

Example

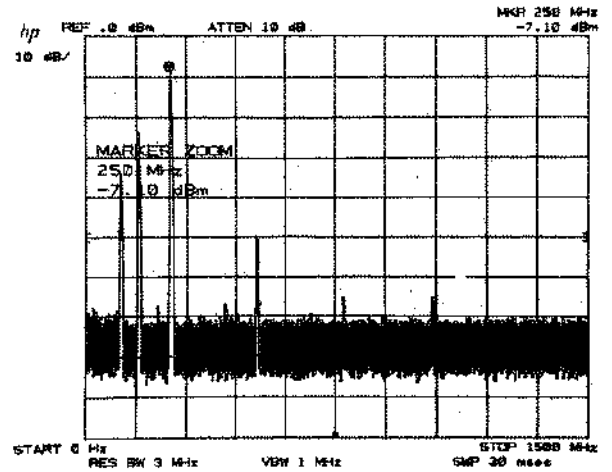

In wide frequency spans, it is often necessary to expand a portion of the frequency span about a specific signal in order to resolve modulation sidebands or track frequency drift.

From an **INSTR PRESET** full span, select a signal using the marker with **ZOOM** .

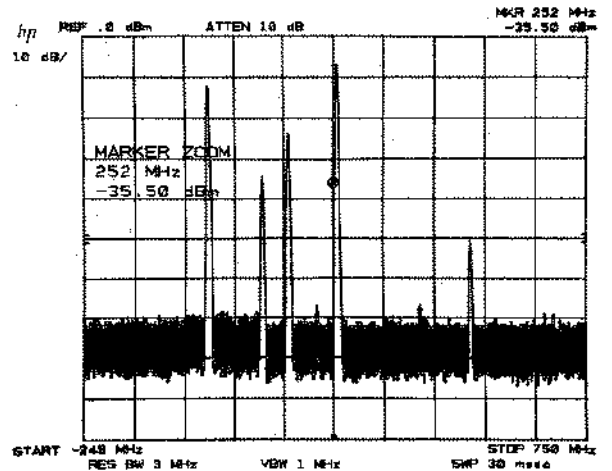

To center the marker and signal *and* expand the frequency span in one step, press .



Expanding twice more with   shows that the marker requires recentering on the signal.

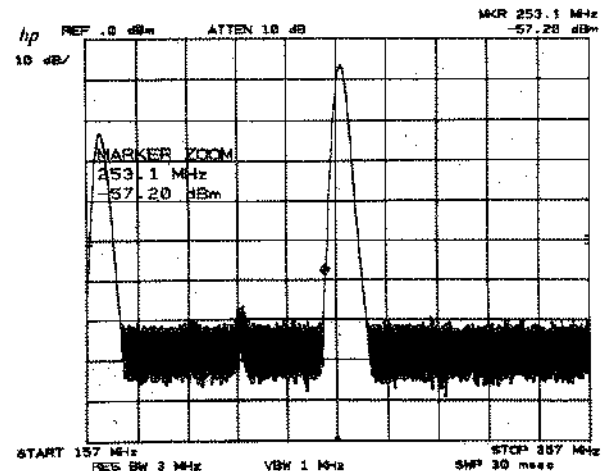

Recenter with 

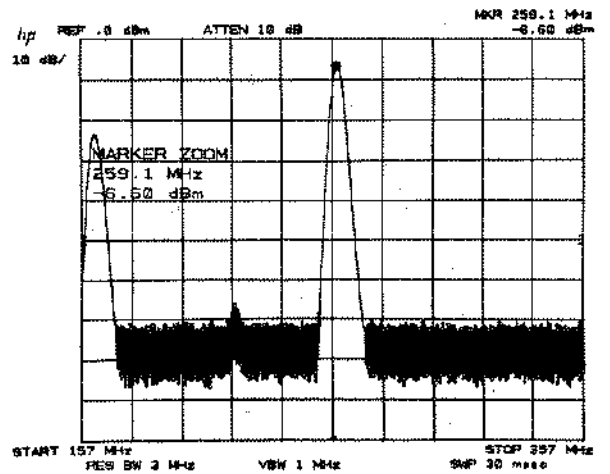

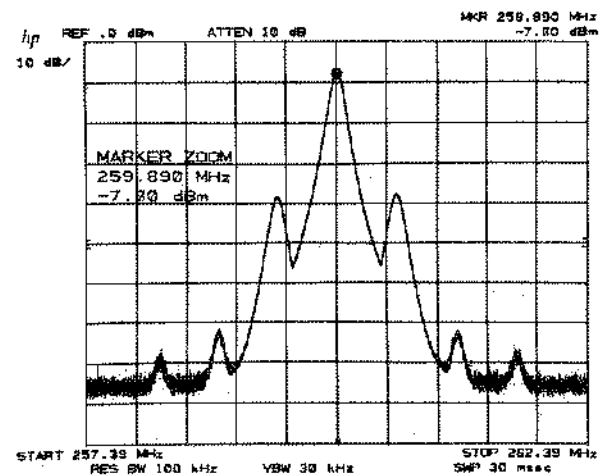

Continue using  (and recentering the marker on the signal when necessary) until the desired resolution is achieved.





AUTOMATIC ZOOM

The analyzer can automatically zoom in on a signal specified by a marker. The desired frequency span is received from the DATA number/units keyboard.

To use the automatic zoom function:

Use   to identify the signal to be zoomed in on.

Press   and enter the desired span with the DATA number/units keyboard.

When the units key is pressed, the zooming process begins.

Example

A single carrier needs to be examined in a 200 kHz span to see the sidebands.

PEAK SEARCH

MARKER

Place a marker on the carrier with **NORMAL** 
 Press **SIGNAL TRACK** **FREQUENCY SPAN**

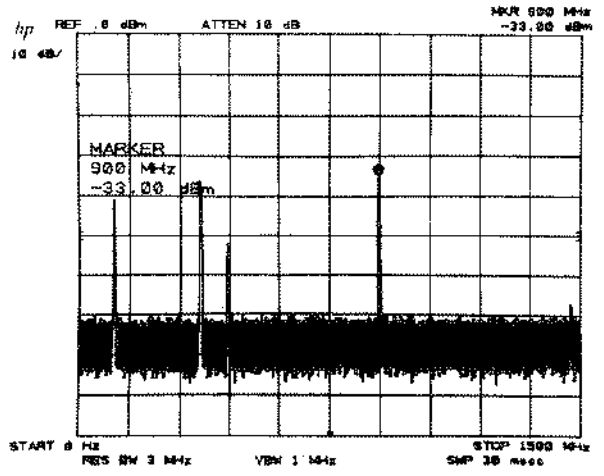

Enter the span.

Press **2** **0** **0** **kHz** and auto zoom will be completed.

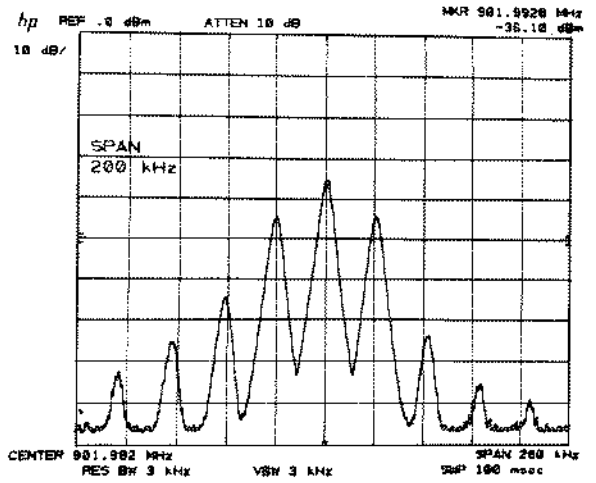

PEAK SEARCH

Peak search places a single marker at the highest trace position of the highest priority trace. The active function is not changed.

Example

PEAK SEARCH positions the marker at the peak of the highest signal response.

In a narrow span, the marker may be placed at the signal peak.

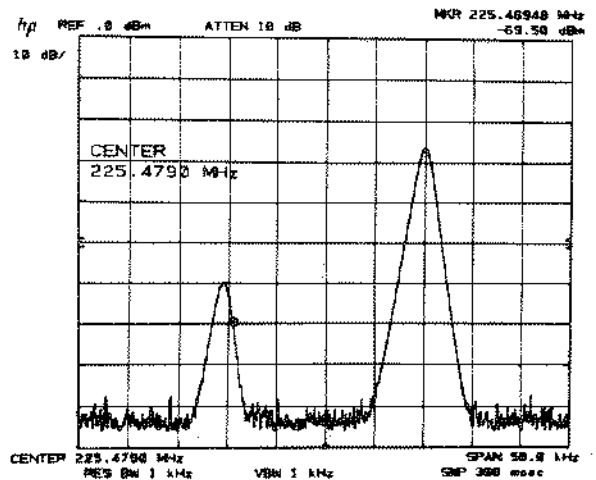

MARKER

MARKER ENTRY

Press **PEAK SEARCH**.

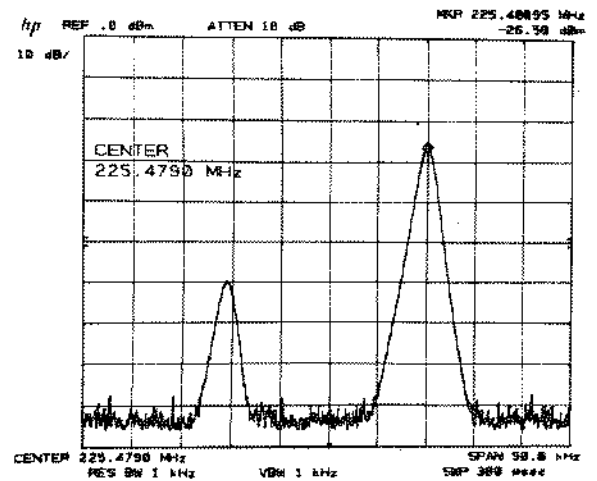

Note that the marker seeks the maximum trace response, no matter what the cause of the response. A larger signal, or the local oscillator feedthrough, would also have attracted the marker.

MARKER ENTRY

Press **MKR ← CF**, **MKR ← REF LVL**, and marker **Δ** into span. Immediately set the corresponding FUNCTION value equal to the readout of the active marker or markers:

ENTRY

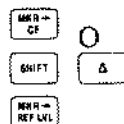

RESULT

marker frequency into **CENTER FREQUENCY**
 marker **Δ** frequency into **FREQUENCY SPAN** or **START FREQ** / **STOP FREQ**,
 marker amplitude into **REFERENCE LEVEL**

MKR ← STEP SIZE immediately records the single or the differential marker frequency in **COUPLED FUNCTION** **CF STEP SIZE** for use with **CENTER FREQUENCY** **DATA** **↑** **↓**.

A marker entry can be made any time a marker is on the trace. (**SHIFT** **Δ** with only one marker displayed takes 0 Hz as the lowest frequency.) The active function is not changed.

Example

One of the fastest, most convenient ways to bring a signal to the center of the display is by using **MKR ← CF**.

Activate a single marker and bring it to the desired signal: **NORMAL** **○**

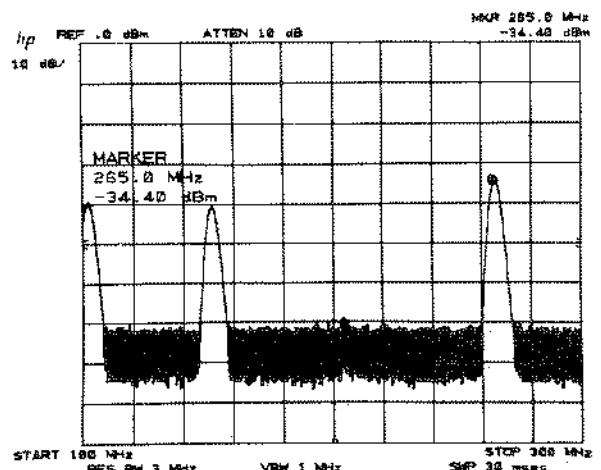

MARKER ENTRY

MARKER

Change the center frequency to the marker frequency.

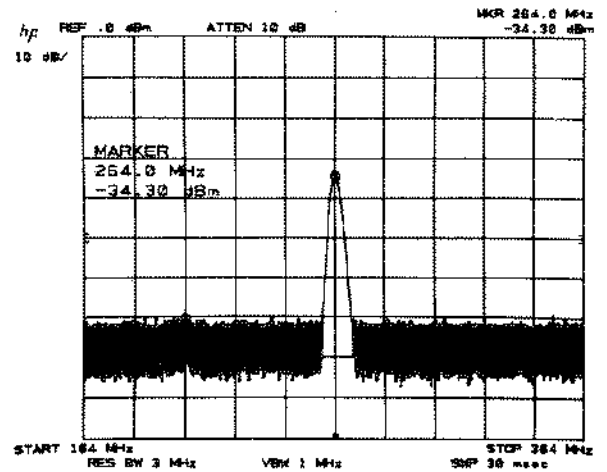

also works if start/stop frequencies are read out.

Example

One way to tune to a particular portion of a spectrum being displayed is to use the Δ \rightarrow span function.

Activate the single marker and place it at either end of the desired frequency span with .

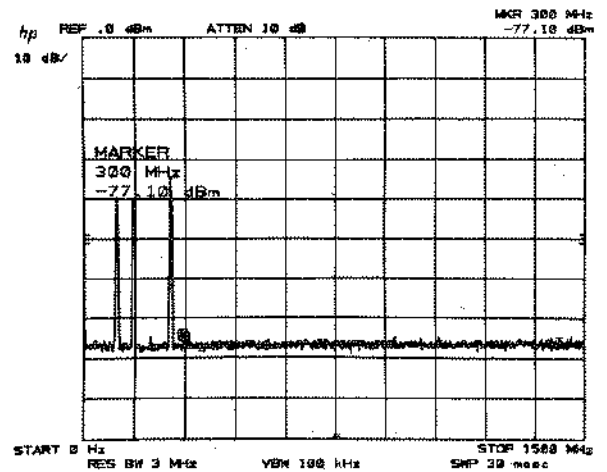

Activate the second marker and place it at the other end of the span with .

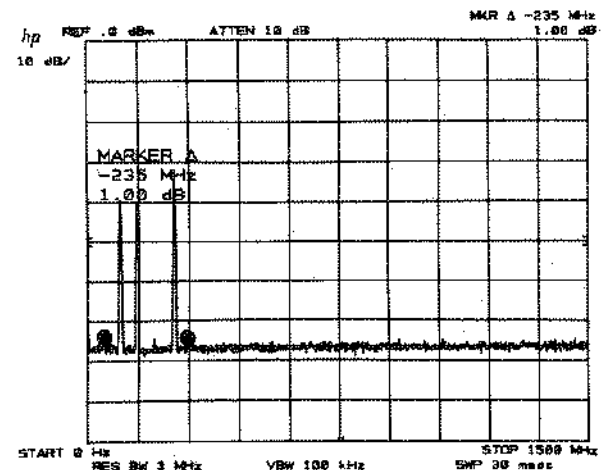

Set the start and stop frequencies equal to the left and right marker frequencies with **SMPT** **Δ**.

Marker **NORMAL** is activated.

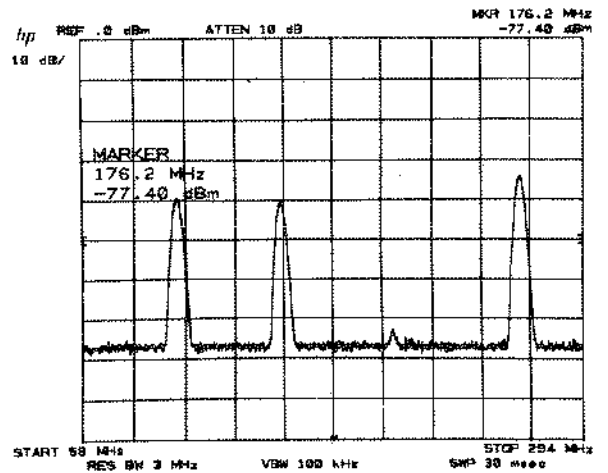

Δ → span works the same with start/stop frequency readout. Note that the markers can be placed at either end of the span.

Example

Here is a technique for viewing a fundamental and its harmonics (or any evenly spaced portions of the spectrum) with high resolution.

Narrow the span about the fundamental as necessary with **ZOOM**, centering the carrier.

Set the center frequency step size with **MAR/Δ** **STEP SIZE**.

Now enable center frequency. With each **↑**, successive harmonics are displayed.

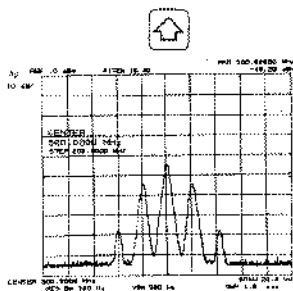
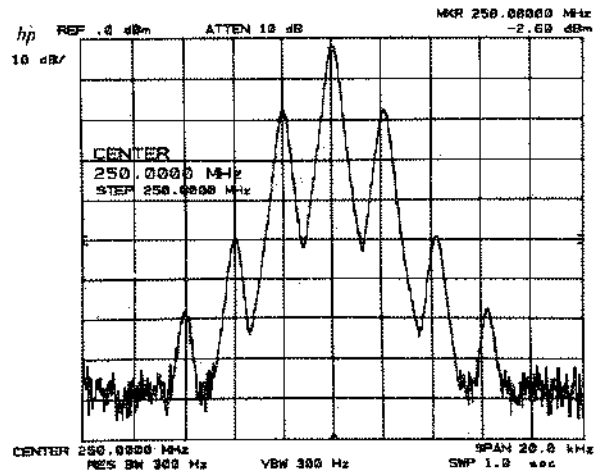

SECOND HARMONIC

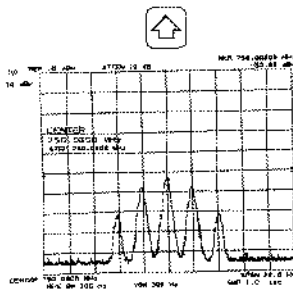

THIRD HARMONIC

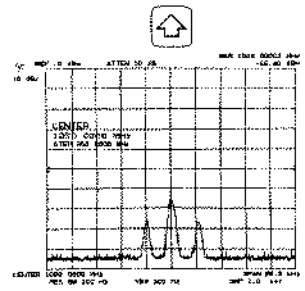

FOURTH HARMONIC

Similar stepping can be accomplished using marker **Δ** into step size for intermodulation products, or for other evenly spaced signals such as communication channels.

SIGNAL TRACK – AUTOMATIC FREQUENCY CONTROL

The analyzer is capable of automatically maintaining a drifting signal at the center of the display. To operate a signal tracking,

Press , and place the marker on the signal to be tracked with  .

Press to initiate the tracking. The light above the key indicates tracking. (Press again to turn off.)

As the signal drifts, the center frequency automatically changes to bring the signal and marker to the center of the display.

MARKER , any other MARKER mode, or the instrument preset turns the tracking function off.

Example

The upper sideband of a transmitter is to be monitored as the carrier frequency is tuned.

Locate the sideband with  .

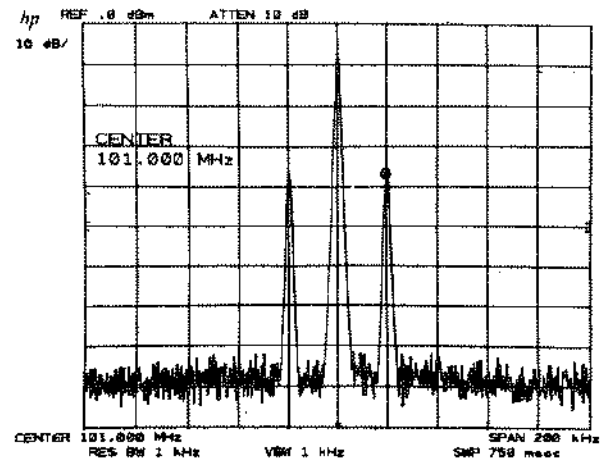

The upper carrier sideband is tracked with , then zoomed in with .

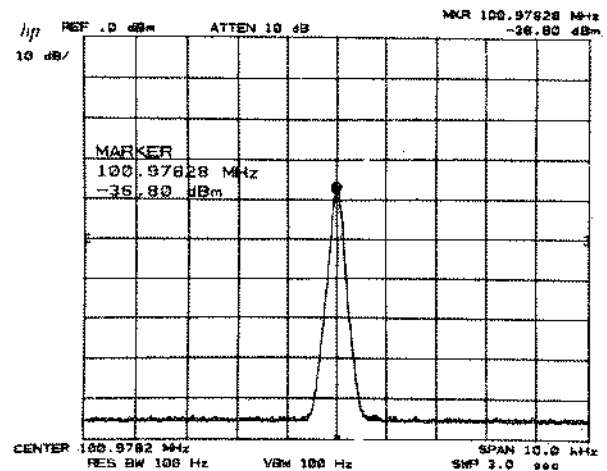

As the carrier frequency is changed, the sideband response will remain in the center of the display. Both the center frequency and marker frequency read out in the sideband's frequency.

A combination of and allows the “real time” signal frequency drift to be read on the display.

FREQUENCY COUNT

Frequency count allows a number of measurements beyond the standard capability of the standard marker modes. Each is used with one of the three active marker modes, **NORMAL**, **Δ**, or **ZOOM** and each uses the DATA controls in the same manner.

FREQ COUNT counts the frequency of signals with great precision and accuracy, even if the marker is not positioned at the signal peak.

When **FREQ COUNT** is on, and the active marker is placed on a signal response such that the marker is >20 dB out of the noise or the intersections of two signal responses and in the top 6 divisions of the graticule, the signal's frequency is read out directly. **FREQ COUNT** works only for frequency spans of 500 MHz and below.

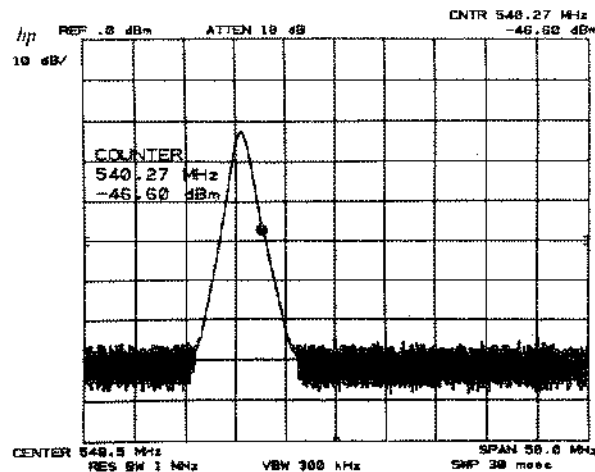

If the marker is not in the top 6 divisions, the display readout "CNTR" in the top right-hand marker area blinks, indicating the reading may be in error.



NOTE

The amplitude readout is for the absolute marker position and not the signal peak.



The marker mode combinations with **FREQ COUNT** are:

Readout	
FREQ COUNT + NORMAL	Signal frequency and marker amplitude.
FREQ COUNT + Δ	Frequency between the signal at the first marker, whose frequency has been stored, and the second marker's counted signal frequency. Amplitude between marker positions.
FREQ COUNT + ZOOM	Signal frequency and marker amplitude. Causes automatic recentering to exact signal frequency on each successive reduction of span with  .

Measurement and Readout Range



The measurement and readout range for frequency count is the same as the associated marker modes: normal, differential, and zoom. Counter resolution to 1 Hz is available using the KEY FUNCTION  . See Chapter 11.

DATA Entry

See MARKER , , and .

Example

Counted frequency differences between stable signals can be measured.

Activate the frequency counter in a 400 MHz span and position the marker with  .

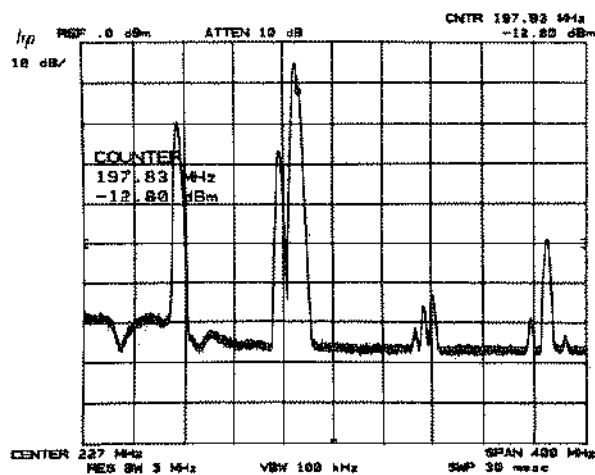

To count the difference between the signal and its neighbor, place the marker on one signal with ; then activate marker differential and count the next signal.

Press  .

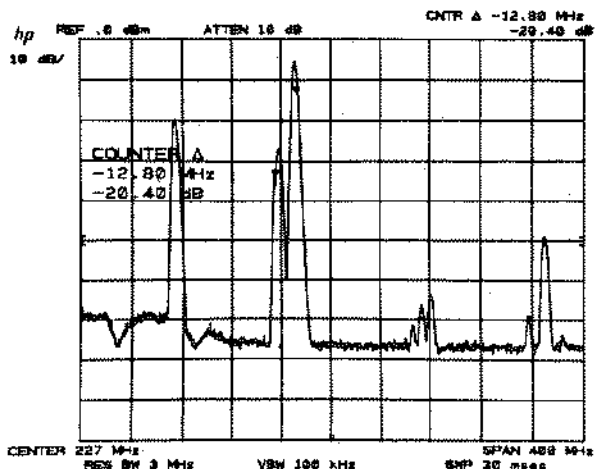

Note that the difference is not the difference between two current counter readings, but between one stored counter reading and the current counter reading.

NOISE LEVEL MEASUREMENT

When noise level is activated and the marker is placed in the noise, the rms noise level is read out normalized to a 1 Hz noise power bandwidth.

Noise level enabled: M
 SHIFT NORMAL

Noise level disabled: L
 SHIFT OFF

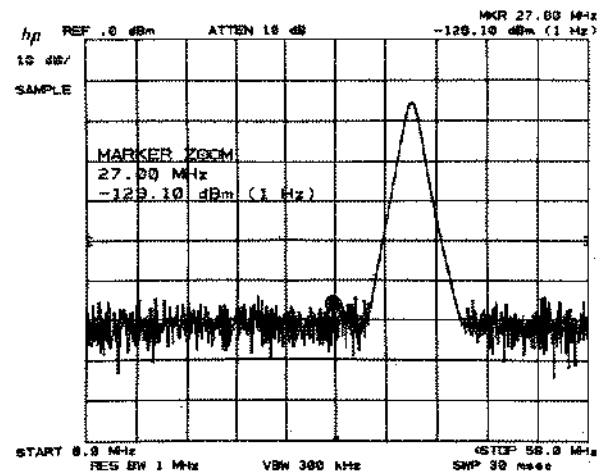

The noise level measurement readout is corrected for the analyzer's log amplifier response and detector response. The value is also normalized to a 1 Hz bandwidth.

Measurement and Readout Range

Noise level measures noise accurately down to 10 dB above the spectrum analyzer's noise level. The readout resolution is in steps of ± 0.1 dB.

DATA Entry

See MARKER NORMAL, Δ, and ZOOM.

Example

In a communication system, the baseband noise level as well as signal to noise ratio measurements are required.

Select a frequency in the baseband spectrum clear of signals with a single marker.

Press NORMAL .

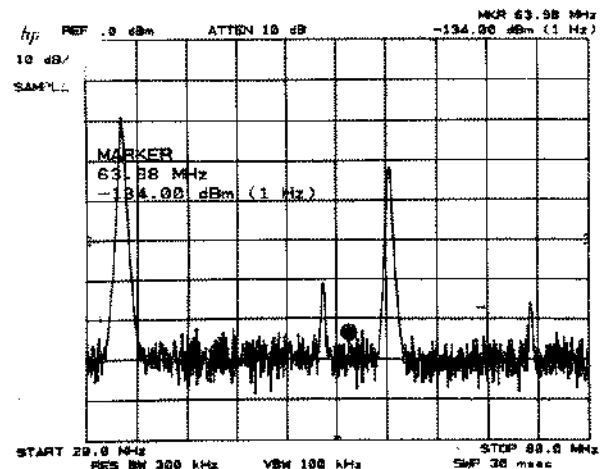

Read the noise at the marker by pressing **SHIFT** **M** **NORMAL**.

The noise at 64 MHz is -134 dBm in a 1 Hz bandwidth. This corresponds to $-134 \text{ dBm} + 36 \text{ dB}/4 \text{ kHz} = -98 \text{ dBm}$ in 4 kHz voice channel bandwidth.

Signal to noise measurements require the measurement of the noise level, as in the example above, and the measurement of the absolute signal level.*

Measure the power level of the adjacent signal. To turn the noise level off, press **SHIFT** **L** **OFF** and read the power level.

The signal to noise ratio referenced to 4 kHz bandwidth is $-32 \text{ dBm} - (-98 \text{ dBm}) = 66 \text{ dB}$.

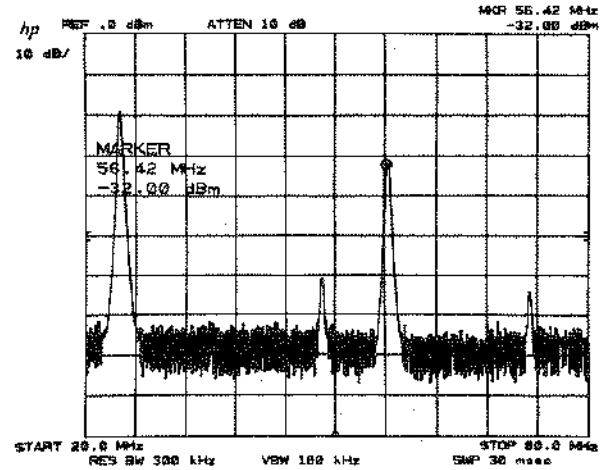

*Normalization to a desired bandwidth uses the equation $10 \log_{10} \left(\frac{\text{desired BW}}{1 \text{ Hz}} \right)$

Chapter 7 SCALE AND REFERENCE LINE

GENERAL DESCRIPTION

This chapter describes the use of SCALE and REFERENCE LINE control groups for setting the amplitude scale, and for making amplitude level measurements more conveniently.

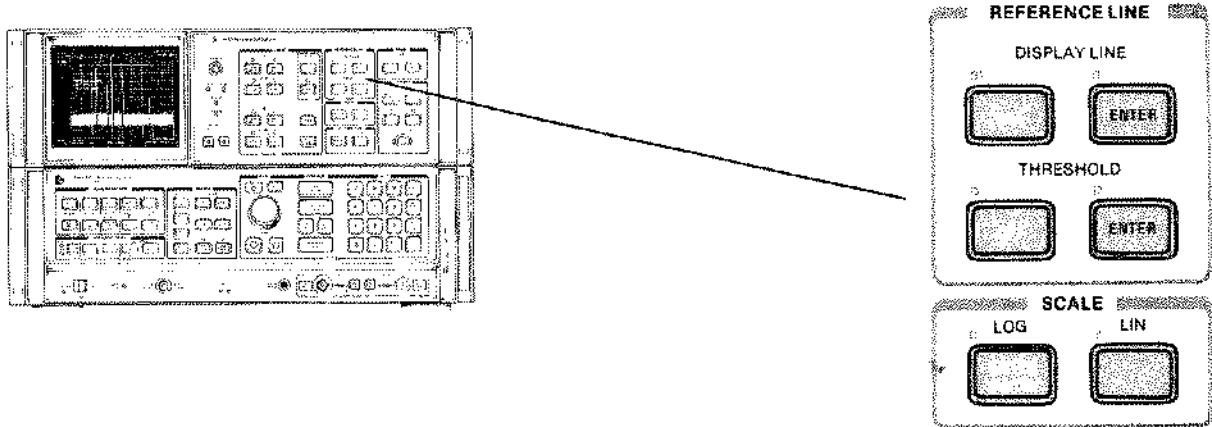

SCALE

SCALE keys allow the scaling of the vertical graticule divisions in logarithmic or linear units without changing the reference level value.

LOG

(DATA entry) scales the amplitude to 1 dB, 2 dB, 5 dB, or 10 dB per division.

If is pressed when the scale is linear, 10 dB per division is automatically entered. The subsequent (DATA), if any, then replaces the automatic 10 dB/div.

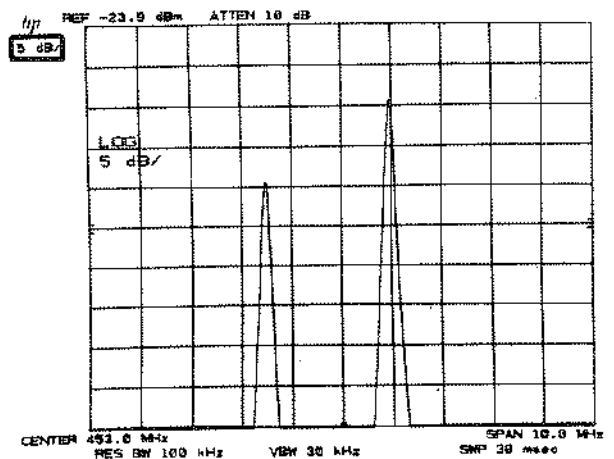

LIN

immediately scales the amplitude proportional to input voltage. The top graticule remains the reference level, the bottom graticule becomes zero voltage. Reference level, and all other amplitudes, are read out in voltage. However, other units may be selected. See AMPLITUDE UNITS SELECTION, Chapter 11.

If is pressed when the scale is linear, 10 dB per division is automatically entered.

Press LIN

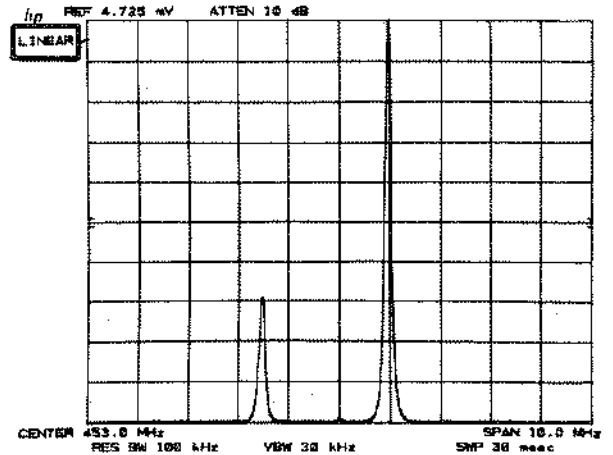

In LINEAR, a specific voltage per division scale can be set by entering a voltage reference level value. For example, to set the scale to 3 mV/division, key in 30 mV reference level. (Voltage entries are rounded to the nearest 0.1 dB, so the 30 mV entry becomes 30.16 mV, which equals -17.4 dBm.)

DATA Entry

	<p>Changes scale in allowable increments (1, 2, 5, or 10 dB per division).</p>
	<p>Enables direct scale selection of allowed values. Other entries are rounded to an adjacent value.</p>

No DATA entry will be accepted with the linear SCALE selection key, LIN

Example

It is convenient to observe AM sidebands in linear as well as logarithmic scales for analysis of both modulation percentages and distortion products.

Modulated AM signal displayed in the 10 dB /division scale shows the carrier, its sidebands, and distortion products.

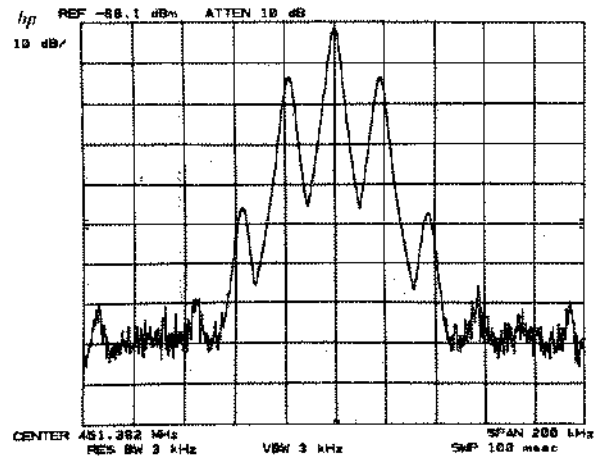

Linear scaling enables observation of the sidebands proportional to the carrier.

Press LIN .

As in the MARKER example, Chapter 6, a direct readout of the percent modulation can be made.

The fractional readout is one-half the modulation index (only one sideband is measured).

$$\% \text{ AM} = 2(.25) \times 100 = 50\%.$$

Note that the carrier signal need not be placed at the reference level for an index ratio measurement.

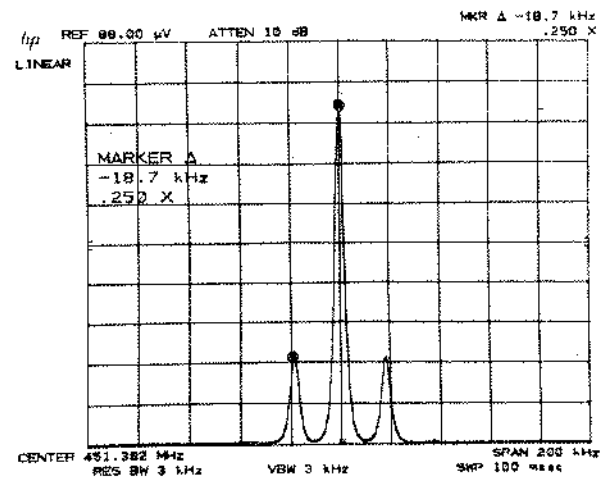

Change to a logarithmic scale with LOG and change the dB/ with and .

The sidebands are 12 dB down from the carrier, verifying the earlier measurement results.

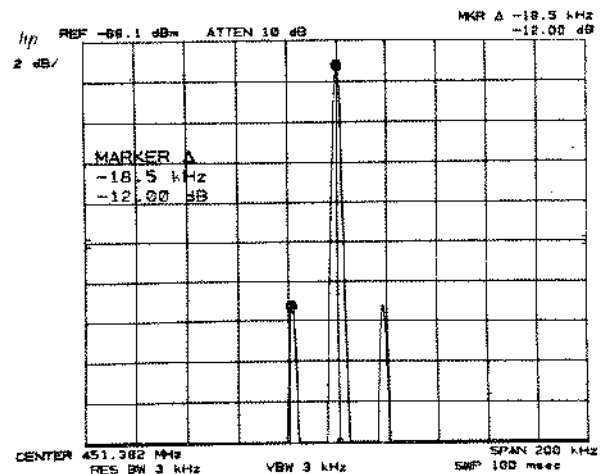

REFERENCE LINE

Harmonic distortion of the modulating signal can be measured as in MARKER 4, Chapter 6.

The modulation frequency is 18.8 kHz and the distortion caused by the second harmonic is 2.4% (read out as .024X).

SCALE AND REFERENCE LINE

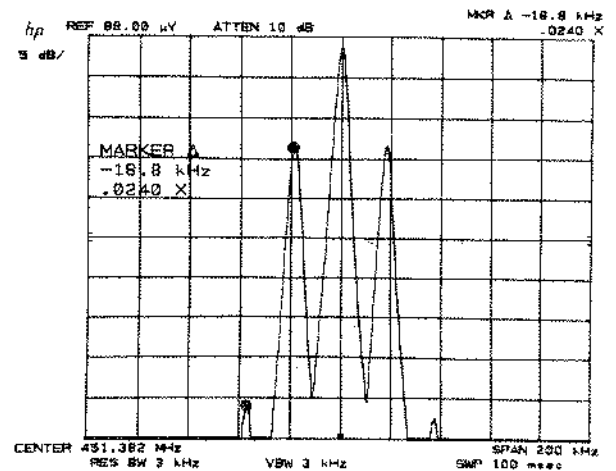

REFERENCE LINE

The reference line functions DISPLAY LINE (DL) and THRESHOLD (TH) place horizontal reference lines on the display. Their levels are read out.

DISPLAY LINE uses:

- measure signal levels with direct readout.
- establish a standard for go/no-go test comparisons.
- eliminate or reduce amplitude errors caused by system frequency response uncertainty with TRACE arithmetic.

THRESHOLD provides:

- a base line clipper whose level is read out.

DISPLAY LINE

Display line ENTER (DATA entry) places a horizontal reference line at any level on the graticule. The line's amplitude, in reference level units, is read out on the left-hand side of the CRT display.

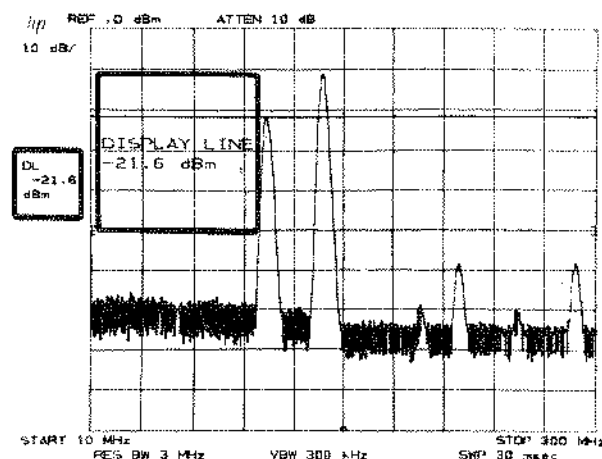



The display line can be positioned anywhere within the graticule. When activated after LINE power ON or **INSTR PRESET**, the display line is placed 4.5 divisions down from the reference level.

Display line **OFF** erases the line and readout from the CRT display but does not reset the last position. If the display line is activated again before LINE power ON or **INSTR PRESET**, it returns to its last position.

Display line position is always accessible for HP-IB and TRACE **←→**, even if never activated. See Chapter 5, TRACE ARITHMETIC.

The display line readout has the same number of significant digits as reference level.

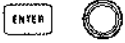
DATA Entry

	Moves the line about two divisions for each full turn. The line moves in display unit increments.
	Moves the line one tenth of the total amplitude scale per step.
	Positions the line to the exact entry level. Entry may be in mV, μ V, \pm dBm, \pm dBmV, or \pm dB μ V, depending upon which units are selected.

Example

When the amplitude of a number of signals in the same span require a quick readout, the display line can be used.

Activate the display line with **ENTER**.

With , place the line through the peak of a signal and read out its absolute amplitude level.

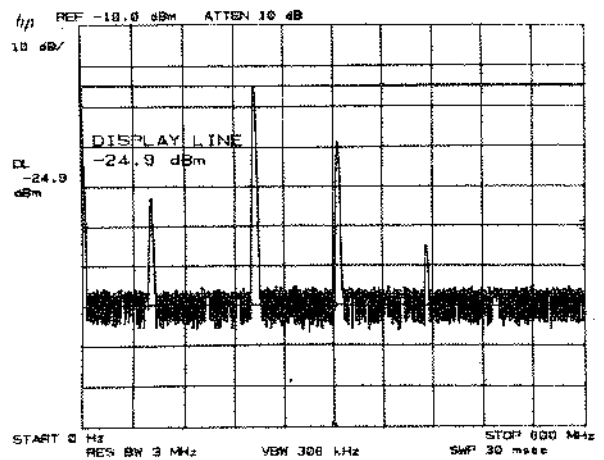

Moving the display line to each signal reads out its peak amplitude.

THRESHOLD

Threshold **ENTER** (DATA entry) moves a lower boundary to the trace, similar to a base line clipper on direct writing CRT spectrum analyzers. The boundary's absolute amplitude level, in reference level units, is read out on the lower left-hand side of the CRT display.

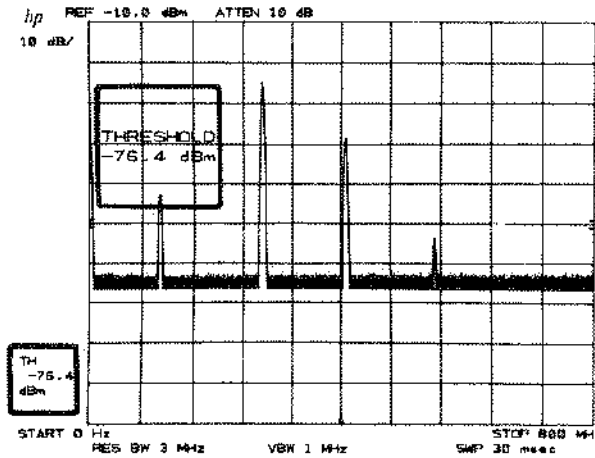

The threshold can be positioned anywhere within the graticule. It operates on TRACE **CLEAR-WRITE**, **MAX HOLD**, or **VIEW** for TRACES A, B, and C simultaneously. When activated after LINE power ON or **INSTA PRESET**, the threshold is placed 1 division from the bottom graticule.

The threshold level does not influence the trace memory, that is, the threshold level is not a lower boundary for trace information stored and output from the trace memories through the HP-IB. TH **OFF** removes the threshold boundary and readout from the CRT display, but does not reset the position. If threshold is activated again before LINE power ON or **INSTA PRESET**, it resumes at its last level.

The threshold readout has the same number of significant digits as reference level.

DATA Entry

	Moves the THRESHOLD about two divisions per rotation. The line moves display unit increments.
	Moves the THRESHOLD one tenth of the total amplitude scale per step.
	Positions the THRESHOLD to the exact entry level. Entry may be in mV, μ V, \pm dBm, \pm dBmV, or \pm dB μ V, depending upon units selected.

Example

The threshold can be used as a go/no-go test limit.

SCALE AND REFERENCE LINE

THRESHOLD

A series of signals can be tested for a specific threshold level by placing the threshold at the test level.

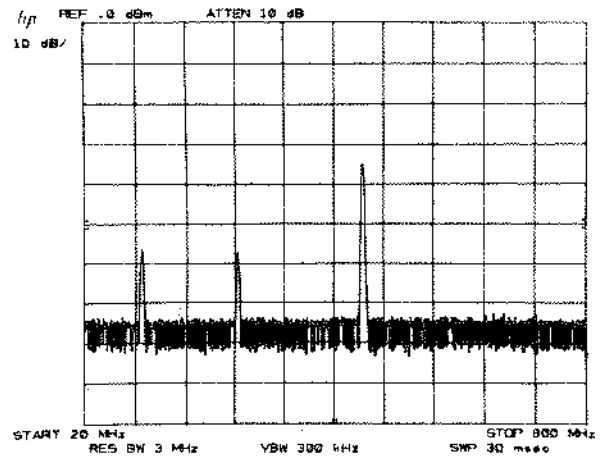

Press THRESHOLD

Only those signals > -55.2 dBm are displayed.

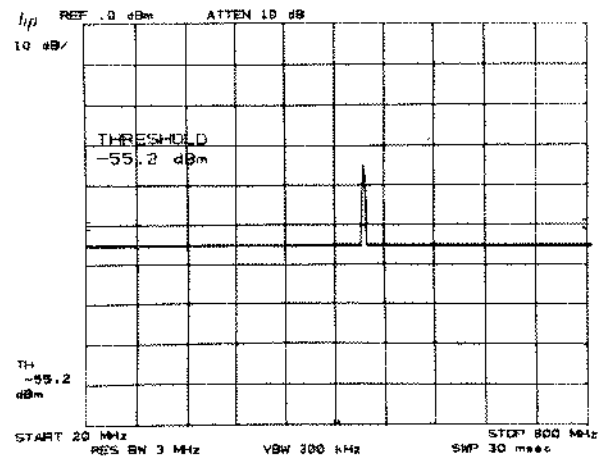

Chapter 8 COUPLED FUNCTION

GENERAL DESCRIPTION

This chapter describes the COUPLED FUNCTION group and its use in various measurements. The COUPLED FUNCTIONS control the receiver characteristics of the spectrum analyzer.

The values of the COUPLED FUNCTION are automatically selected by the analyzer to keep absolute amplitude and frequency calibration as frequency span and reference level are changed. * The functions are all coupled with LINE power ON, INSTR PRESET, or when their individual AUTO is activated. 0-1.5 GHz couples all functions but ATTN and CF STEP SIZE.

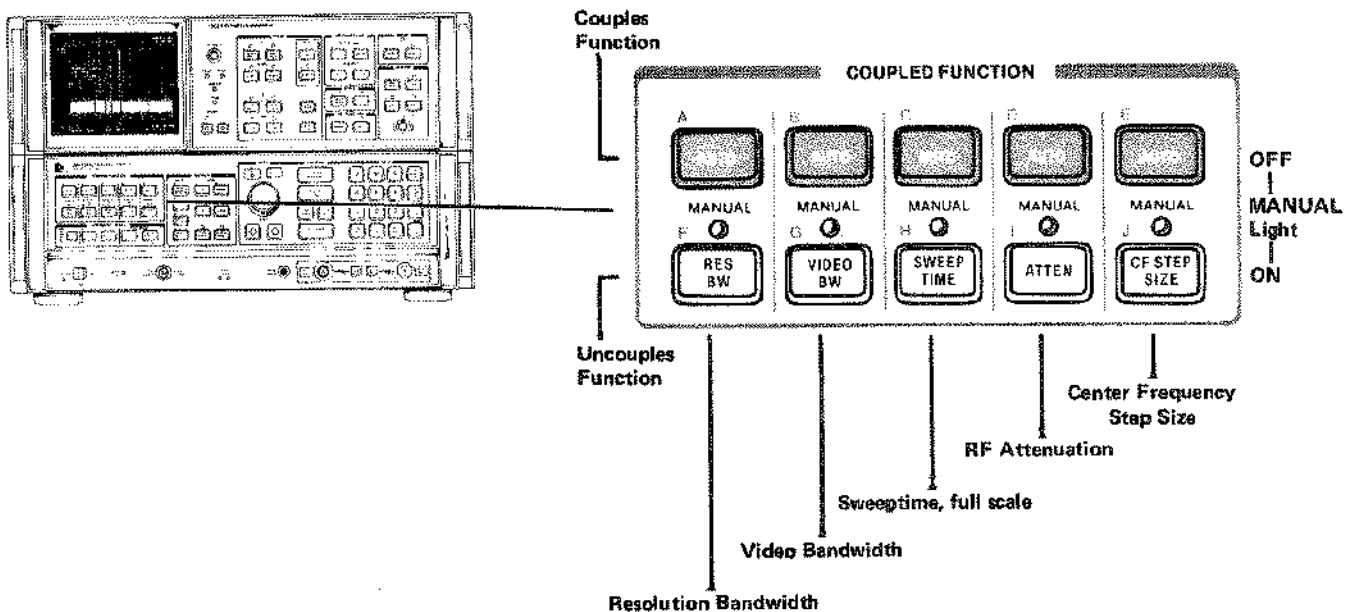

For each COUPLED FUNCTION:

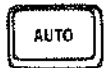

Sets the function to the preset value dictated by the analyzer's current state. The function is coupled.



Function value does not change with instrument state. DATA entry changes value. The MANUAL light turns on and stays on until the function is placed in AUTO once again.

In most cases the AUTO functions change values to maintain amplitude calibration when one or more of the others are manually set. If the amplitude or frequency becomes uncalibrated, "MEAS UNCAL" appears in the right-hand side of the graticule.

*Center frequency step size does not affect amplitude or frequency calibration.

Coupled Function

Selects

- RES BW 3 dB resolution bandwidth (IF filter) which largely determines the ability of the analyzer to resolve signals close together in frequency.
- VIDEO BW 3 dB bandwidth of the post detection low pass filter that averages noise appearing on the trace.
- SWEEP TIME The total time for the analyzer to sweep through the displayed frequency span or display a detected signal in zero frequency span.
- ATTEN The setting of the input RF attenuator which controls signal level at the input mixer.
- CV STEP SIZE Selects center frequency change for each DATA when is activated.

DATA ENTRY FOR COUPLED FUNCTIONS

Discrete values are entered for RES BW, VIDEO BW, SWEEP TIME, and ATTEN. The DATA entry from DATA and selects these values sequentially from the current value. A keyboard DATA entry that is not exactly equal to an allowable value selects an adjacent value. For example, RES BW RES BW MANU selects 30 kHz bandwidth, the next higher IF bandwidth.

RESOLUTION BANDWIDTH

RES BW (DATA entry) sets bandwidth selection to MANUAL and changes the analyzer's IF bandwidth. The bandwidths that can be selected are 10 Hz, 30 Hz, 100 Hz, 300 Hz, 1 kHz, 3 kHz, 10 kHz, 30 kHz, 100 kHz, 300 kHz, 1 MHz, and 3 MHz.

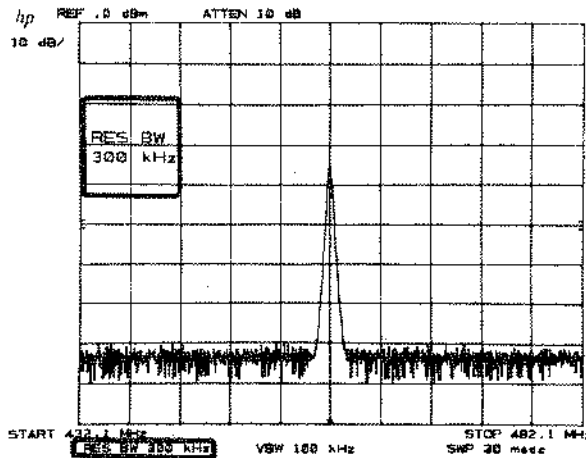

Example

A measurement requiring manual resolution bandwidth selection is the zero span (time domain) observation of modulation waveforms. An example can be found in Chapter 3, ZERO FREQUENCY SPAN – FIXED TUNED RECEIVER OPERATION.

Another use of manual resolution bandwidth is for better sensitivity over a given frequency span.

The low-level intermodulation products of two signals spaced 100 MHz apart need to be measured. With the functions coupled, the analyzer noise may mask these distortion products.

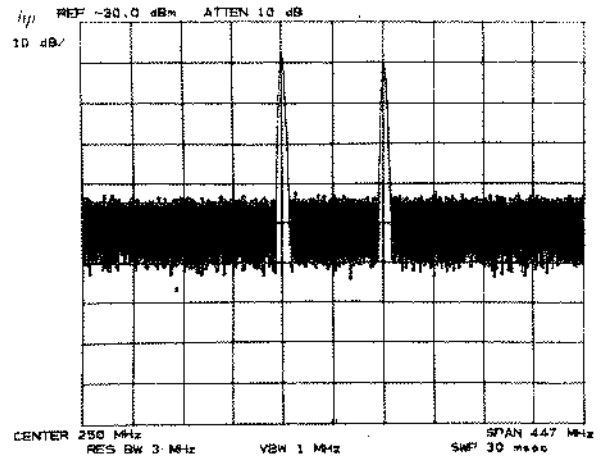

Reduction of the noise level by 10 dB (increased sensitivity) is achieved by decreasing the bandwidth by a factor of 10.



(THRESHOLD has been activated to clarify the display.)

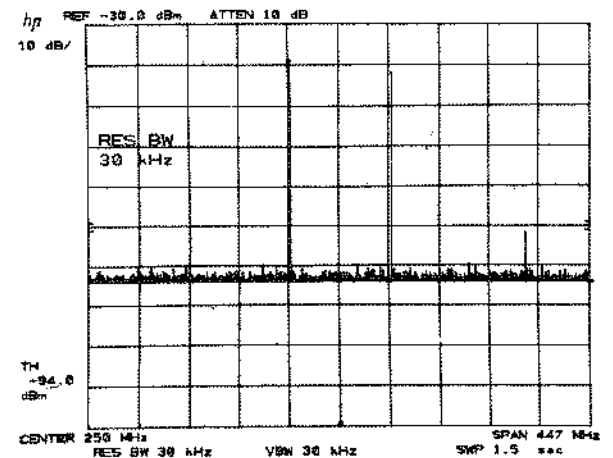

The sweep time automatically slows to maintain absolute amplitude calibration if SWEEP TIME is coupled.

VIDEO BANDWIDTH

VIDEO BW (DATA entry) sets the video bandwidth selection to manual and changes the analyzer's post detection filter bandwidth. The bandwidths that can be selected are 1 Hz, 3 Hz, 10 Hz, 30 Hz, 100 Hz, 300 Hz, 1 kHz, 3 kHz, 10 kHz, 30 kHz, 100 kHz, 300 kHz, 1 MHz, and 3 MHz.

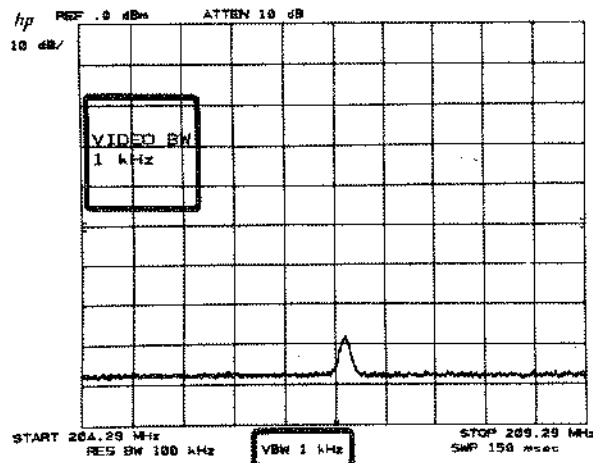

Example

Signal responses near the noise level of the analyzer are visually masked by the noise. The video filter can be narrowed to smooth this noise.

A low level signal at this center frequency can just be discerned from the noise.

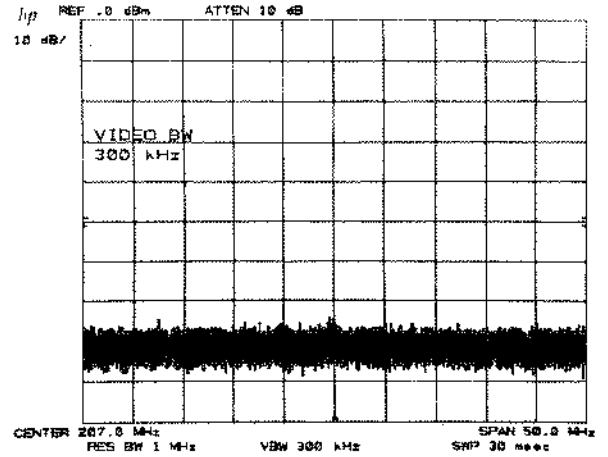

Narrowing the video bandwidth clarifies the signal and allows its amplitude measurement.

Press     

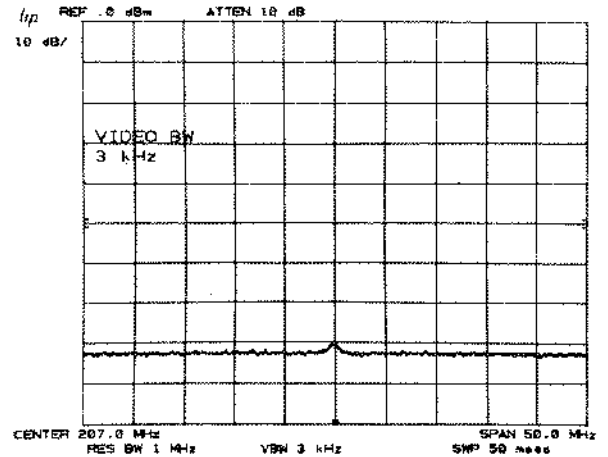

The sweep time increases to maintain amplitude calibration.

NOTE

The video bandwidth must be set wider or equal to the resolution bandwidth when measuring impulse noise levels.

Video Averaging

Narrowing the video filter requires a slower sweep time to keep amplitude calibration, since the narrower filter must have sufficient time to respond to each signal response. Video averaging is an internal routine which *digitally* averages a number of sweeps, allowing a more instantaneous display of spectral changes due to center frequency, frequency span or reference level changes. See Chapter 11.

SWEEP TIME

SWEEP TIME (DATA entry) sets the sweep time selection to manual and changes the rate at which the analyzer sweeps the displayed frequency or time span.

The sweep times that can be selected are:

	SWEEP TIME	SEQUENCE
FREQUENCY SPAN ≥ 100	20 msec to 1500 sec	1,1.5,2,3,5, 7.5 and 10
ZERO FREQUENCY SPAN	1 μsec to 10 msec	1, 2, 5, and 10
	20 msec to 1500 sec	1,1.5,2,3,5, 7.5 and 10

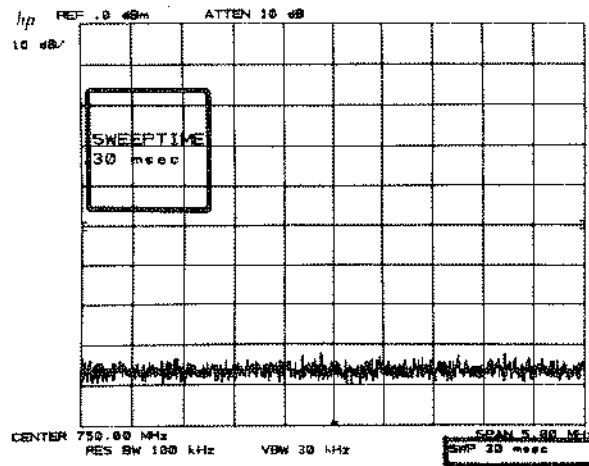

Example

To identify signals quickly in a very narrow frequency span (where the resolution bandwidth would be narrow), the sweep time can be temporarily reduced (e.g., speed up sweep rate).

A frequency span of 10 kHz has selected resolutions and video bandwidths of 100 Hz, and a sweep time of 3 seconds.

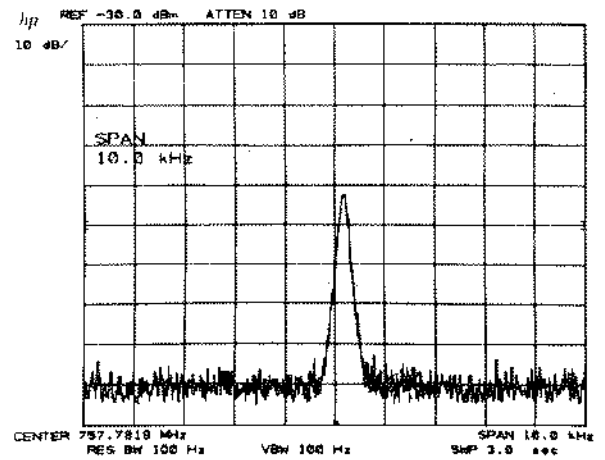

To quickly see signals present in the span, press **SWEEP TIME** and **↓** several times. When the sweep completes its span, couple sweep time again with **AUTO**.

Note that the DISPL UNCAL message appears automatically, as the faster sweep time causes some distortion of the spectral response.

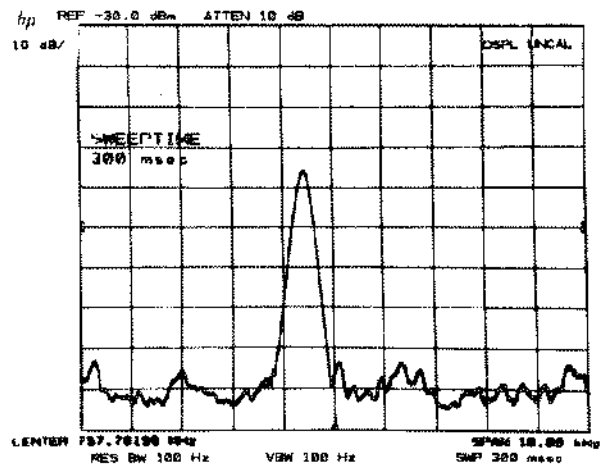

INPUT ATTENUATION

ATTEN (DATA entry) sets the attenuation function to MANUAL and changes the analyzer's RF input attenuation. The levels of attenuation that can be selected are 10 dB to 70 dB in 10 dB steps, or 0 dB under special conditions. Generally, the reference level does not change with attenuator settings.

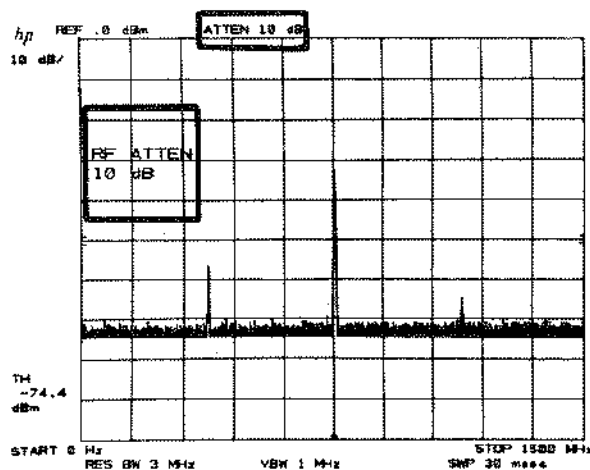

When the RF input attenuator function is coupled (AUTO), the value selected makes sure the level at the input mixer is less than -10 dBm (the 1 dB compression point) for on-screen signals. For example, if the reference level is $+28$ dBm, the input attenuator is set to 40 dB: $+28$ dBm $-$ 40 dB = -12 dBm at the mixer.

The input mixer level can be changed to ensure maximum dynamic range. See INPUT MIXER LEVEL, Chapter 11.

CAUTION

Greater than $+30$ dBm total input power will damage the input attenuator. Input powers greater than $+13$ dBm at the input mixer will be reduced by an internal limiter.

Zero Attenuation

As a precaution to protect the spectrum analyzer's input mixer, 0 dB RF attenuation can be selected from the number/units keyboard only by pressing **ATTEN** **0** **GHz +dBm dB**.

Reference Levels ≤ -100 dBm and $> +30$ dBm

Reference levels ≤ -100 dBm or between $+30$ dBm and $+60$ dBm can be called when the reference level extended range is activated. Low reference level limits depend on resolution bandwidth and scale.

Press **SHIFT** **ATTEN** to extend the reference level range.

See Chapter 3, FUNCTION **REFERENCE LEVEL**, and Chapter 11, **SHIFT** KEY FUNCTIONS.

Determining Distortion Products

If the total power to the analyzer is overloading the input mixer, distortion products of input signals can be displayed as input signals. The RF attenuator is used to determine which signals, if any, are internally generated distortion products.

Example

The two main signals shown are producing intermodulation products because the analyzer's input mixer is overloaded.

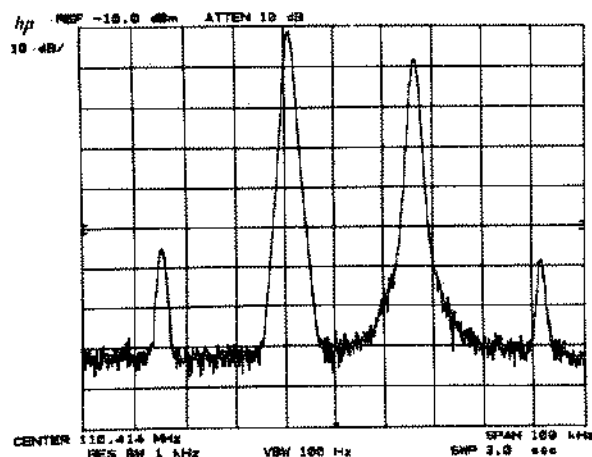

To determine whether these intermodulation products are generated by the analyzer, first save the spectrum displayed in B with B B.

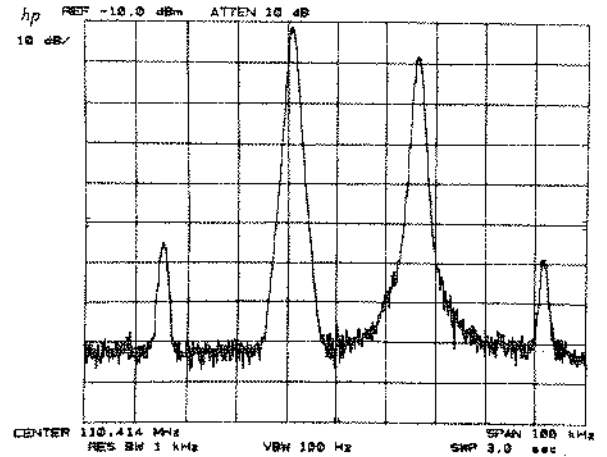

Increase the RF attenuation by 10 dB. Press . (If the reference level changes, it is necessary to return it to its original value.)

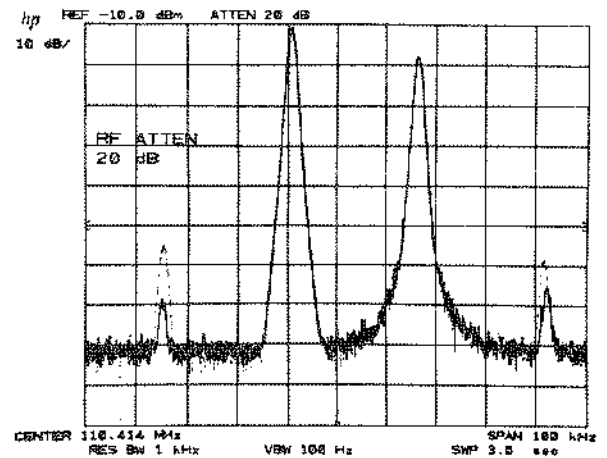

Since some of the signal responses decrease as the attenuation increases (by comparing the response in A with the stored trace in B), distortion products are caused by an overloaded input mixer. The high level signals causing the overload conditions must be attenuated to eliminate this condition.

CENTER FREQUENCY STEP SIZE

(DATA entry) sets step size to MANUAL. The step size can now be changed and stored. While is in MANUAL, and changes center frequency by the step size value stored in the register. Several functions can be used to enter step size value to the register. When a CF step size is AUTO, the center frequency steps are 10% of the frequency span, even through the CF step size register contains another value.

	Entry Value	<input type="button" value="CF STEP SIZE"/> State
step size <input type="button" value="AUTO"/> , <input type="button" value="INSTA-PRESET"/> FULL SPAN or LINE power ON	100 MHz	coupled (AUTO)
<input type="button" value="CF STEP SIZE"/> (DATA entry)	DATA entry value	uncoupled (MANUAL)
MARKER <input type="button" value="MARKER-STEP SIZE"/>	marker frequency readout	uncoupled (MANUAL)

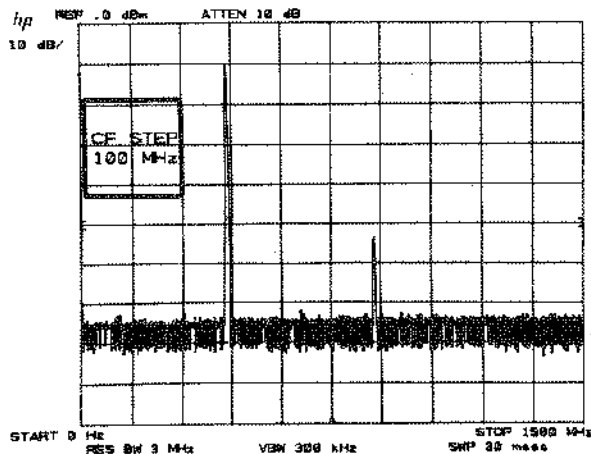

The step size can be varied from 0 Hz to 1500 MHz to a resolution equal of 1 Hz. It is displayed with the same resolution as center frequency.

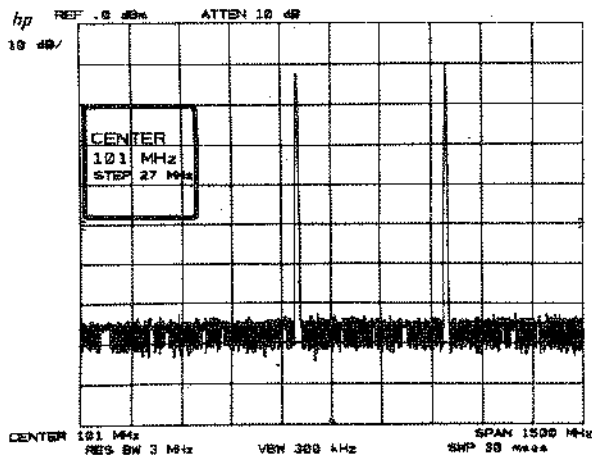

When the center frequency is activated with step size in MANUAL, the active function readout includes both the center frequency and the step size value.



DATA Entry

	<p>Changes the step size in display unit increments.</p>
	<p>Changes the step size in steps equal to one tenth of the frequency span.</p>
	<p>Selects a specific step size to a resolution equal to the current center frequency readout.</p>

Example

Surveillance of a wide frequency span sometimes requires high resolution. One fast way to achieve this is to take the span in sequential pieces using a tailored center frequency step. This example looks from 0 Hz to 1500 MHz in 50 MHz spans.

First, set a span and start frequency. For a span of 50 MHz press **FREQUENCY SPAN** **5** **0** **MHz -dBm sec**. Set the center frequency to 25 MHz with **CENTER FREQUENCY** **2** **5**

MHz -dBm sec

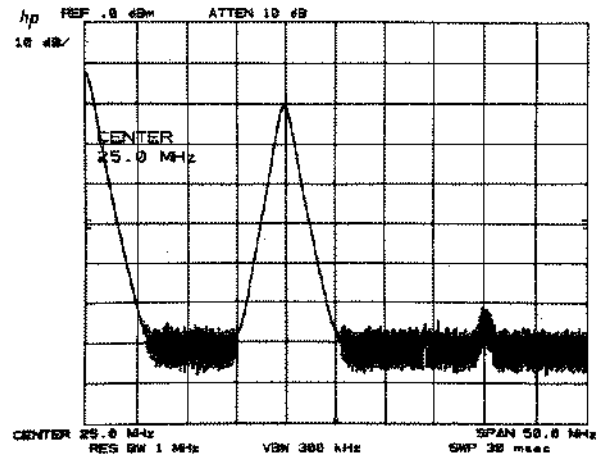

Set the step size to 50 MHz, **CF STEP SIZE** **5** **0** **MHz -dBm sec**, and reactivate center frequency with **CENTER FREQUENCY**.

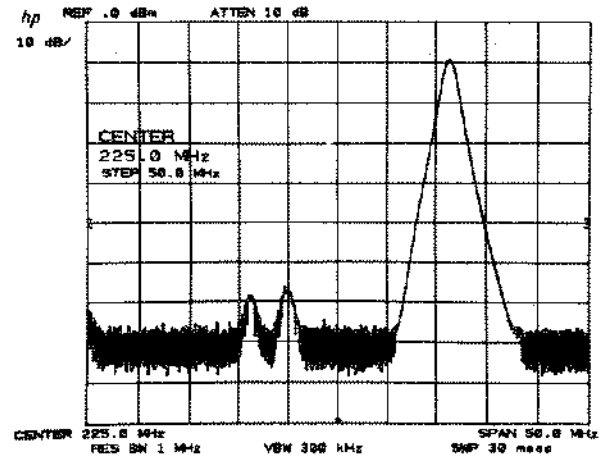

Now each **↑** sets the center frequency to the next 50 MHz span for a span-by-span surveillance of the spectrum. (Center frequency = 25 MHz, 75 MHz, 125 MHz, etc.) Center frequency step size can also be defined by the marker. See the **MARKER ENTRY** portion of Chapter 6.

Chapter 9 SWEEP AND TRIGGER

GENERAL DESCRIPTION

This chapter describes the use of SWEEP and TRIGGER control functions.

SWEEP controls enable:

- CONT continuous, or repetitive sweeping (sweep time ≥ 20 msec).
- SINGLE a single sweep, which will repeat only on demand (sweep time ≥ 20 msec).

TRIGGER controls select the function that begins a sweep:

- FREE RUN as soon as possible,
- LINE line voltage passes through zero on a positive swing,
- EXT an external signal voltage passes through $\sim 1.5V$ on a positive swing.
- VIDEO the level of a detected RF envelope reaches up to the level on the CRT display determined by the LEVEL knob.

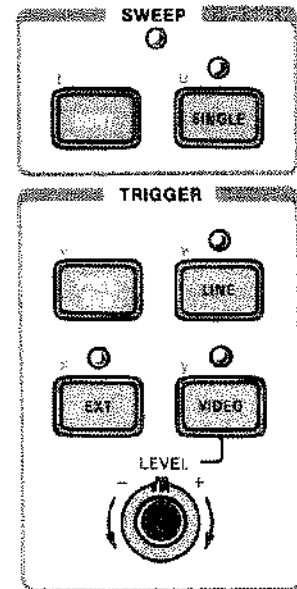
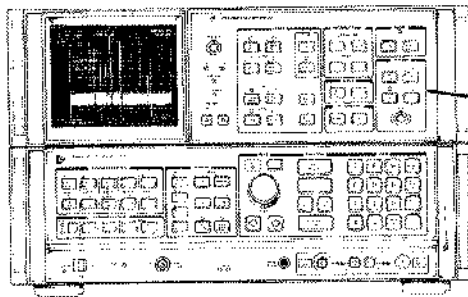

SWEEP AND TRIGGER CONTROLS

SWEEP

The spectrum analyzer frequency sweep (sweep times ≥ 20 msec), once triggered, continues at a uniform rate from the start frequency to the stop frequency unless new data entries are made to the analyzer from the front panel or the HP-IB. With faster sweeps, for example, changes to center frequency appear continuous. With long sweep times, a change in center frequency noticeably suspends the sweep while the analyzer updates its state and readout, then the sweep continues from where it was, tracing out the new spectrum.

The SWEEP light indicates a sweep is in progress. The light is out between sweeps, during data entry and during gating. (The light is out for sweep times ≤ 10 msec.)

After a sweep, the next sweep is initiated only if:

- continuous sweep mode is selected or a single sweep demand is made,
- the trigger conditions are met,
- data is not entered continuously from the front panel DATA controls or the HP-IB.

Continuous Sweep

CONT enables the continuous sweep mode. Provided the trigger and data entry conditions are met, one sweep follows another as soon as triggered. Pressing **CONT** initiates a new sweep.

Single Sweep

SINGLE enables the single sweep mode. Each time **SINGLE** is pressed (including when the SWEEP mode is changed from continuous), one sweep is initiated, provided the trigger and data entry conditions are met. A sweep in progress is terminated and restarted upon **SINGLE**.

Zero Frequency Span Sweep

In zero frequency span, sweep times from 1 μ sec to 10 msec are also available. In these sweep times the SWEEP **CONT** and **SINGLE** are disabled. The video signal response is *not* digitally stored (trace modes also disabled), but multiplexed directly onto the display along with the graticule and readouts. The graticule and readouts are refreshed following each fast sweep.

To avoid flicker of the display when external or video triggers are less frequent than once every 25 msec, the analyzer triggers internally. If *only* an external or video trigger is required, press

SHIFT **EXT** ^x disables "auto" external trigger feature
 or **SHIFT** **VIDEO** ^y disables "auto" video trigger feature

NOTE

For zero frequency span sweep times ≤ 10 msec and **SHIFT** **x** or **SHIFT** **y**, the CRT display graticule and readout depend on triggering. If no trigger is present, the CRT display is blank.

TRIGGER

The analyzer sweep is triggered in one of four selectable modes.

- **FREE RUN** allows the next sweep to start as soon as possible after the last sweep.
 - **LINE** allows the next sweep to start when the line voltage passes through zero, going positive.
 - **EXT** allows the next sweep to start when an external voltage level passes through $\approx 1.5V$, going positive.
- The external trigger signal level must be between 0V and +5V.

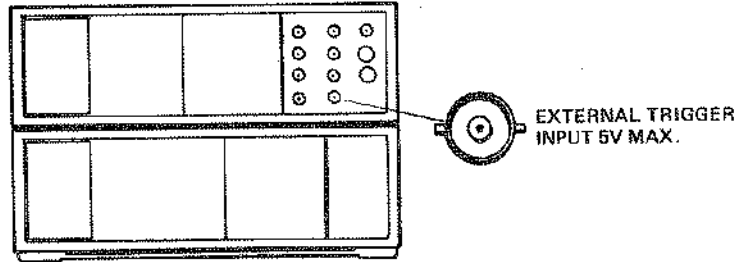

EXTERNAL TRIGGER INPUT

- **VIDEO** allows the next sweep to start if the detected RF envelope voltage rises to a level set by the LEVEL knob. The LEVEL corresponds to detected levels displayed on the CRT between the bottom graticule (full CCW) and the top graticule (full CW).

An RF envelope can trigger the sweep only if it is capable of being traced on the CRT display – that is, if the resolution bandwidth and video bandwidth are wide enough to pass the modulation waveform of an input signal.

Example

A zero span display of this video waveform will trigger for all LEVEL knob settings.

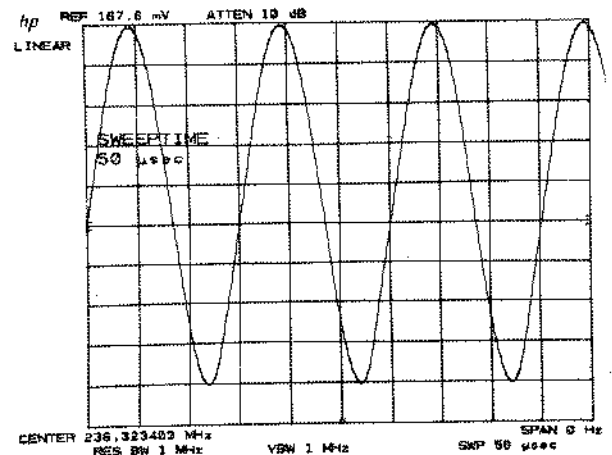
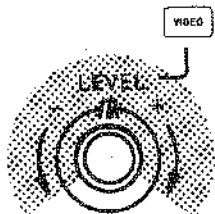

If the video signal lowers on the display, the LEVEL must be set towards the minus side.

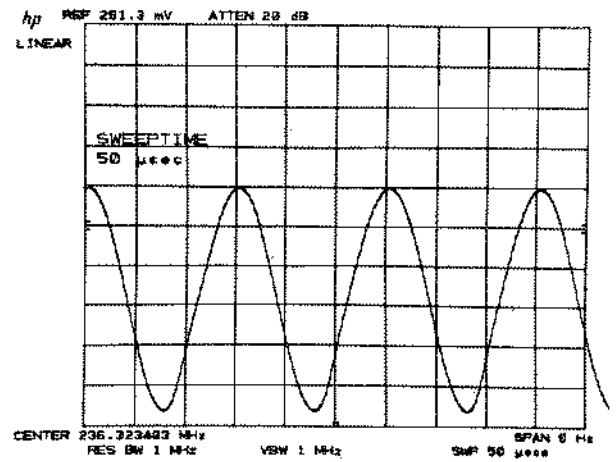
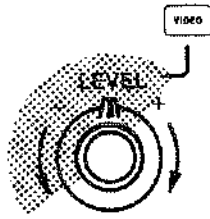

If the level does not cause a trigger within 25 msec, the sweep is triggered anyway to ensure a display. Note that this is true only for sweep times ≤ 10 msec.

Chapter 10 INSTRUMENT STATE

GENERAL DESCRIPTION

This chapter describes the INSTRUMENT STATE keys. Each key allows access to or activation of a specific set of functions and their values. Some of the sets are built in to the analyzer and some are user defined.

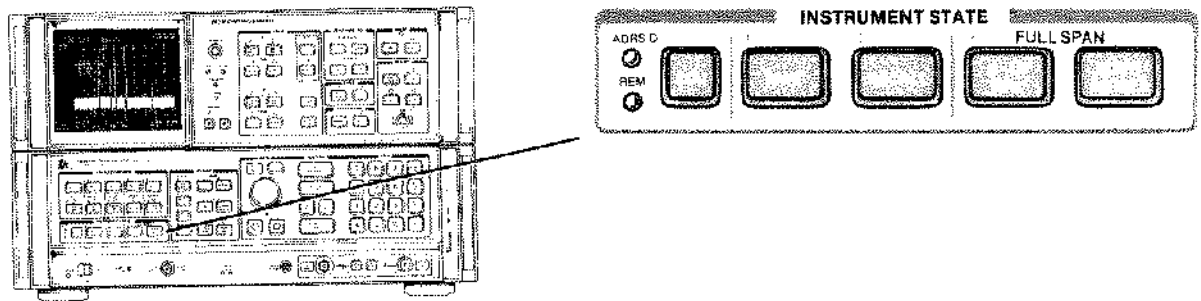

Instrument states that can be selected:

FULL SPAN



A full 0 Hz to 1500 MHz span with coupled operation and *all* the functions set to known states and values.

FULL SPAN



A full 0 Hz to 1500 MHz span with a minimum of other front panel functions changed.



1

Saves the complete set of current front panel function states and values for later recall. Registers 1 through 6 are available for storage.



1

Recalls the complete instrument state saved in the register called.



Calls for front panel control after the analyzer has been placed in a remote state by an HP-IB controller.

FULL SPAN INSTRUMENT PRESET



provides a convenient starting point for making most measurements. It calls for a full 1500 MHz span, coupled functions, and a 0 dBm reference level, to name a few. LINE power ON automatically calls for an instrument preset.

The states that are set include all the functions and values of

- front panel functions,
- and ● KEY FUNCTIONS,
- and ● functions accessible only by the HP-IB.

Front Panel Preset

INSTA PRESET enables all the front panel functions designated by keys with white lettering. It saves a trace response in TRACE B, but not in A or C.

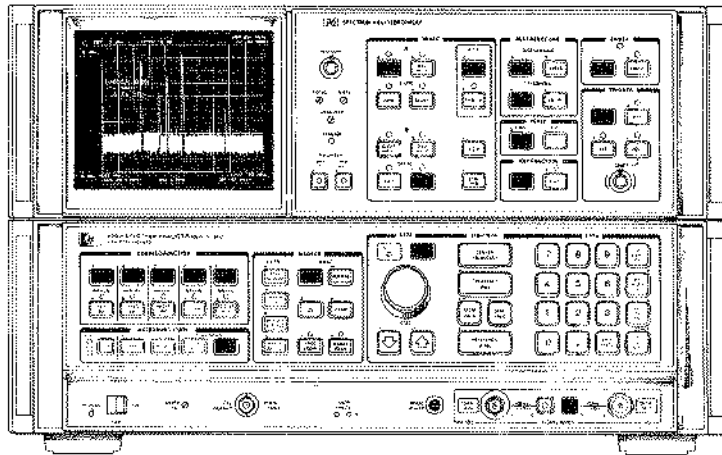

 FUNCTIONS ACTIVATED WITH **INSTA PRESET**

To be precise:

SIGNAL INPUT:	Input 2 selected	100 kHz – 1.5 GHz
FUNCTION:	Start Frequency	0 Hz
	Stop Frequency	1500 MHz
	Reference Level	0 dBm
DATA:	Hold	
COUPLED FUNCTION:	All set to AUTO , which corresponds to the following values:	
	Resolution Bandwidth	3 MHz
	Video Bandwidth	1 MHz
	Sweep time	20 msec full scale
	Attenuator	10 dB, coupled to maintain < -10 dBm at input mixer
	Center Frequency Step Size	100 MHz entered in register
TRACE:	A	Clear-Write
	B	Blanked but information in memory saved
	A – B	Off
MARKER:	Off	
INSTRUMENT STATE	States are saved, including the current state. See RECALL 7 below.	
SCALE:	Logarithmic, 10 dB/division	
REFERENCE LINE:	Display line off	5.5 divisions up
	Threshold off	1.0 divisions up

SWEEP:	Continuous										
TRIGGER:	Free run										
INSTR CHECK:	An internal instrument check routine is run. If a failure is detected, one or both INSTR CHECK LEDs remain lit.										
KEY FUNCTION:	Normal										
SHIFT FUNCTIONS:	All SHIFT functions are disabled. For example, all titling is erased after an instrument preset. Chapter 11, SHIFT KEY FUNCTIONS , discusses the implications of activating instrument preset during SHIFT FUNCTION use. If the key is activated (shift light on), INSTR PRESET unshifts the key. This is equivalent to pressing NORMAL .										
HP-IB FUNCTIONS:	<table> <tr> <td>“D1”</td> <td>Display size normal</td> </tr> <tr> <td>“EM”</td> <td>Erase trace C memory</td> </tr> <tr> <td>“O3”</td> <td>Output format ASCII absolute</td> </tr> <tr> <td>“PD”</td> <td>Pen down</td> </tr> <tr> <td>“DA”</td> <td>Display address set to 3072</td> </tr> </table> <p>Graphic information or control language written into the analyzer memory by HP-IB functions such as graph (GR), plot (PA), label (LB), or display write (DW) is erased unless stored in trace memory B. Instrument preset also rewrites all the display graticule and character readouts into the appropriate section of the display memory.</p>	“D1”	Display size normal	“EM”	Erase trace C memory	“O3”	Output format ASCII absolute	“PD”	Pen down	“DA”	Display address set to 3072
“D1”	Display size normal										
“EM”	Erase trace C memory										
“O3”	Output format ASCII absolute										
“PD”	Pen down										
“DA”	Display address set to 3072										

FULL SPAN 0 – 1.5 GHz

0-15 GHz immediately sets the COUPLED FUNCTIONS **HEB BW**, **VIDEO SW** and **SWEEP TIME** to automatic, the start frequency to 0 Hz, and the stop frequency to 1500 MHz. The other front panel functions, **SHIFT KEY FUNCTIONS** or HP-IB only states, are not changed.

SAVING AND RECALLING INSTRUMENT STATES

SAVE (DATA keyboard entry) and **RECALL** (DATA keyboard entry) save and recall complete sets of user defined front panel function values. The DATA entry from the keyboard names the register that stores the instrument state. Six registers, **1** through **6**, can be saved and recalled. Only another **SAVE** can erase a saved register. The registers contain the last instrument states received, even with a loss of line power (power failure). The registers are maintained with an internal battery supply for about 30 days after a line power failure.

RECALL 7 is a special recall function which recalls the instrument state prior to the *last* instrument preset or single function value change, whichever has most recently occurred. It aids in recovering from inadvertent entries.

The current instrument state, if the POWER switch is turned to STANDBY (or if there is a short-term loss of ac line power), can be recovered at POWER ON if **SHIFT** is activated previous to a power loss.

Some **SHIFT KEY FUNCTION** values or states cannot be saved. Neither can information in the display memories, such as a title or trace.

The **0** register is a buffer for instrument state transfer under remote operation. The **8** and **9** states are for calibration signal adjustments.

Example

When a test sequence is used over and over, the instrument states can be set up in the registers prior to testing for recall during the procedure.

Keying in a specific state:

8 **8**
 2 **0** **0**

 LIN SCALE

Then save with **1**.

Press .

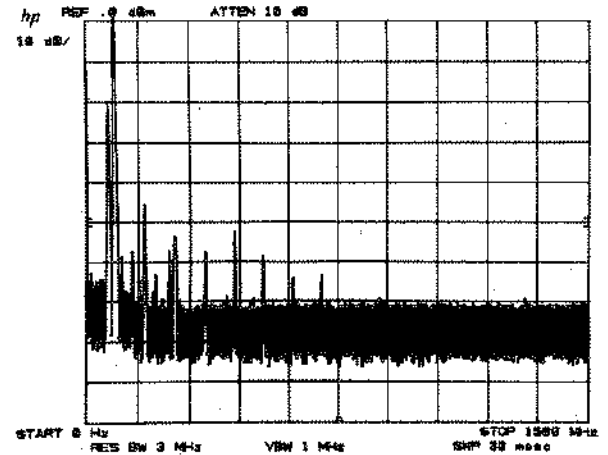
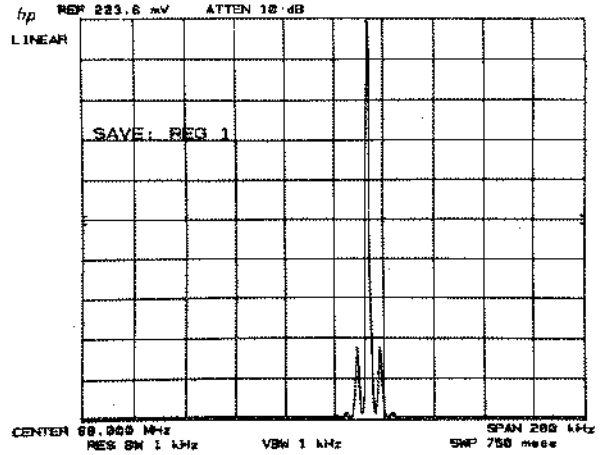

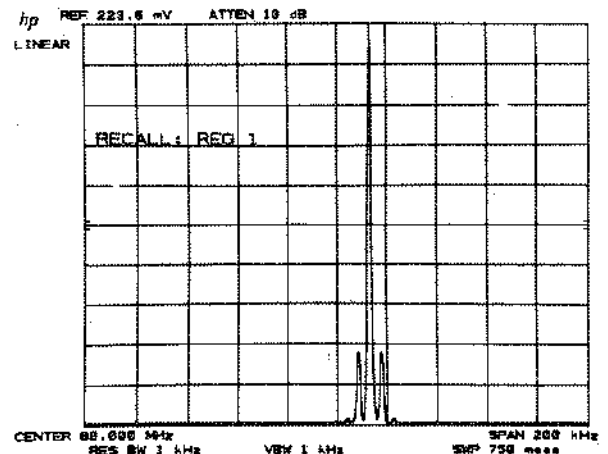

And recall the last state with **1**. Once the state has been recalled, any function can be used for more detailed measurements.

Note that in this case, the state could also have been recalled with **7**.



LOCAL OPERATION

 enables front panel control after an HP-IB remote LISTEN command has been executed. An HP-IB local lockout will disable  until an HP-IB REN false command is executed, or the LINE power switch is set to STANDBY then back to ON.

Indicates instrument has been addressed through HP-IB.

Indicates instrument is in remote operation.

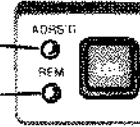

Chapter 11

SHIFT KEY FUNCTIONS

GENERAL DESCRIPTION

This chapter describes access and use of the SHIFT KEY FUNCTIONS.

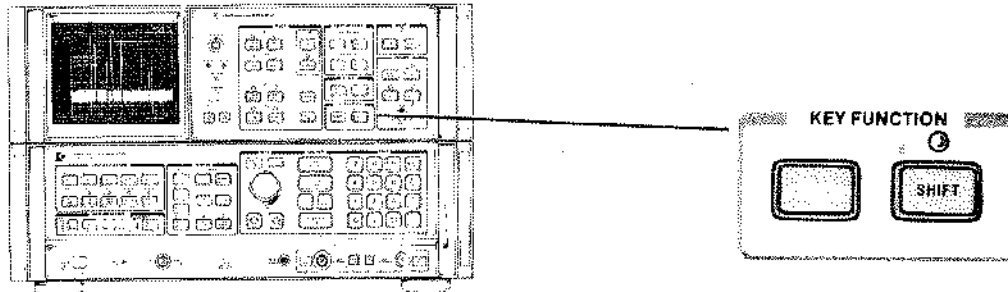

Shift functions supplement a front panel function or provide unique measurement capabilities. The SHIFT functions are not named on the front panel but are coded by the blue characters beside the keys. For example, the frequency offset function is designated by the code ν . On the front panel, the code ν is found in the FUNCTION section:

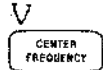

The shift functions are activated by pressing SHIFT and then the front panel key with the appropriate blue code. A complete summary of shift FUNCTIONS is on the facing page. There is an index to all shift functions at the end of this chapter.

Example

Activate the shift function ν (frequency offset) with:

Press SHIFT shift light on

Press ν CENTER FREQUENCY shift light off and offset function activated

The shift light can always be turned off with NORMAL, which returns the front panel keys to their designated function. NORMAL does not disable the selected shift function (except for title).

DATA Entry

An active shift function value is read out and identified in the active function area of the display, the same as any other function using DATA entry. Once the data has been entered, any other function can be activated. The shift function retains its last value until INSTR PRESET or the LINE power switch is set to STANDBY.

DATA entries to shift functions are made only from the number/units keyboard. The ENABLED light remains off even though data may be entered.

Data is entered (that is, changes the instrument state) only when a units key is pressed. If the entry has no units (an address, for example), use the HI/LO/UNIT key as the terminator. See Chapter 12 of this manual for further information about the terminator key.

FUNCTION SUMMARY

Amplitude		Display		Marker	
Amplitude offset	Z	Annotation blanked	o	Counter resolution	=
Units: dBm	A	Annotation on	p	Continue sweep from marker	t
dBmV	B	Display correction data	w	Enter $\Delta \rightarrow$ span	O
dB μ V	C	CRT beam off	g	Noise level on	M
voltage	D	CRT beam on	h	Noise level off	L
Extended reference level range	I	Graticule blanked	m	Stop single sweep at marker	u
Negative entry	-	Graticule on	n		
Preamp gain, input 1	<	Title	E		
Preamp gain, input 2	>				
		Error Correction		Trace	
		Execute routine	W	A + B \rightarrow A	c
		Use correction data	X	Detection:	
		Do not use correction data	Y	normal	a
		Display correction data	w	positive peak	b
				negative peak	d
				sampling	e
		Frequency		Trace C:	
		Counter resolution	=	blank trace C	k
		Frequency offset	V	B \neq C	i
		Negative entry	-	B \rightarrow C	l
				view trace C	j
		General		Video averaging on	G
		HP-IB Service request	r	Video averaging off	H
		Enter HP-IB address	P		
		Power on in last state	f	Trigger-Zero Span	
		Display Address	z	<input type="checkbox"/> Without 25 msec triggering	x
		Display Write		<input type="checkbox"/> Without 25 msec triggering	y
		Max mixer input level	,		
Instrument State					
Save registers locked	(
Save registers unlocked)				

ALPHABETICAL KEY CODE SUMMARY

A Amplitude in dBm	U Second LO shift up	o Annotation blanked
B Amplitude in dBmV	V Frequency offset	p Annotation on
C Amplitude in dB μ V	W Execute error correction routine	q Disable step gain
D Amplitude in voltage	X Use correction data	r HP-IB service request
E Title	Y Do not use correction data	t Continue sweep from marker
F Measure sweep time	Z Amplitude offset	u Stop single sweep at marker
G Video averaging on	a Normal detection	v Inhibit phase lock flags
H Video averaging off	b Positive peak detection	w Display correction data
I Extended reference level range	c A + B \rightarrow A	x <input type="checkbox"/> without 25 msec triggering
J Manual DACS control	d Negative peak detection	y <input type="checkbox"/> without 25 msec triggering
K Count pilot IF at marker	e Sample detection	z Display address
L Noise level off	f Power on in last state	- Negative entry
M Noise level on	g CRT beam off	= Counter resolution
N Count VTO at marker	h CRT beam on	(Save registers locked
O Enter $\Delta \rightarrow$ span	i B \neq C) Save registers, unlocked
P Set HP-IB address	j View trace C	< Preamp gain, input 1
Q Count signal IF at marker	k Blank trace C	> Preamp gain, input 2
R Frequency diagnostic on	l B \rightarrow C	Display write
S Second LO auto	m Graticule blanked	, Max mixer input level
T Second LO shift down	n Graticule on	

NEGATIVE DATA KEYBOARD ENTRY

Entering negative data from the DATA keyboard requires the use of a negative symbol prefix on the number entry.

Negative entry: SHIFT $\bar{\quad}$ HOLD

For example, to enter a negative 100 MHz offset frequency:

Press SHIFT CENTER FREQUENCY to activate frequency offset

Press SHIFT $\bar{\quad}$ HOLD 1 0 0 MHz -dBm SEC to enter a negative frequency.

Not all values can be entered with a negative prefix. For example, a negative entry to a voltage reference level enters the positive value.

Negative entries in dB can be made with the -dBm units key or the negative prefix with the +dBm units key. If both negative prefix and $\left[\begin{smallmatrix} \text{Hz} \\ \text{mV} \\ \text{dBm} \end{smallmatrix} \right]$ are used, the value is entered as positive.

FREQUENCY AND AMPLITUDE OFFSET

The CRT display amplitude and frequency readout can be offset. Entering an offset does not affect the trace.

Frequency offset: SHIFT CENTER FREQUENCY (DATA keyboard entry)

Amplitude offset: SHIFT REFERENCE LEVEL (DATA keyboard entry)

Offset entries are added to all the frequency or amplitude readouts on the CRT display, including marker, display line, threshold, start frequency, and stop frequency.

Function

To eliminate an offset, activate the offset and enter zero. $\left[\begin{smallmatrix} \text{MHz} \\ \text{dBm} \end{smallmatrix} \right]$ PRESET also sets the offsets to zero. Offsets are stored with the $\left[\begin{smallmatrix} \text{MHz} \\ \text{dBm} \end{smallmatrix} \right]$ SAVE functions for recall with $\left[\begin{smallmatrix} \text{MHz} \\ \text{dBm} \end{smallmatrix} \right]$ RECALL. When an offset is entered, its value is displayed on the CRT.

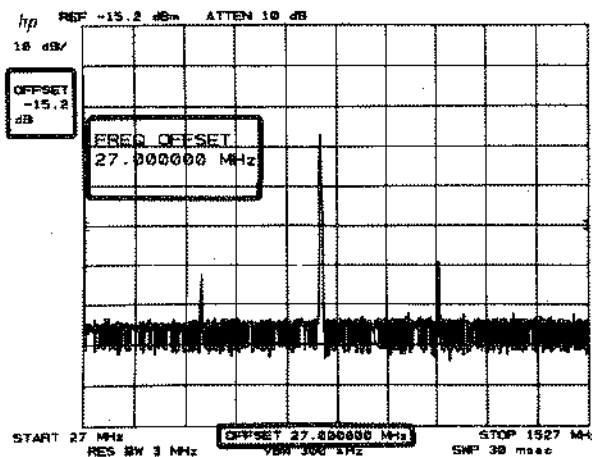

DATA entry from the keyboard can be in Hz, kHz, MHz, or GHz for frequency offset and in dB, -dB, mV, or μ V for amplitude offset. The amplitude offset readout is always in dB. An amplitude offset entry in voltage is converted to dB offset.

The offset range for frequency is -99.999999990 GHz to $+99.999999999$ GHz in 1 Hz steps. The amplitude offset range is greater than ± 100 dB in 0.1 dB steps. Least significant digits are rounded for frequency offset entries and dropped for amplitude offset entries.

Example

An 102.6 MHz up converter with 12.7 dB attenuation is placed between a signal source and the spectrum analyzer. The offsets can be set so that the CRT display shows the trace referenced to the signal as input to the converter.

Amplitude offset is entered as a positive value to compensate (offset) the loss of the converter.

Press **SHIFT** **Z** **REFERENCE LEVEL** **1** **2** **.** **7** **GHz +dBm dB**

Note that the original REF LEVEL of 0 dBm is now changed to 12.7 dBm also.

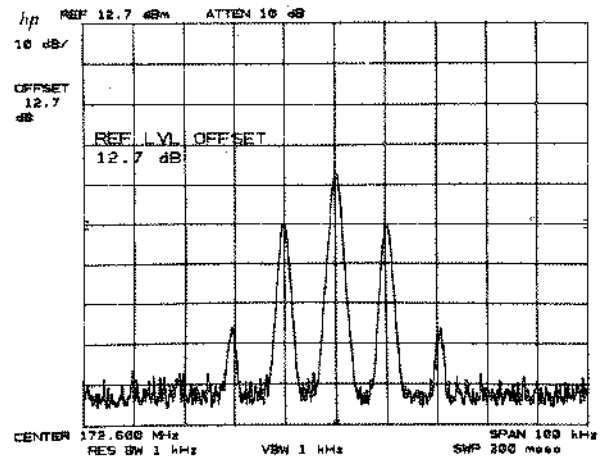

Frequency offset is entered as a negative value since the input frequency to the converter is lower than the output.

Press **SHIFT** **V** **CENTER FREQUENCY** **SHIFT** **HOLD** **1** **0** **2** **.** **6** **MHz -dBm 10C**

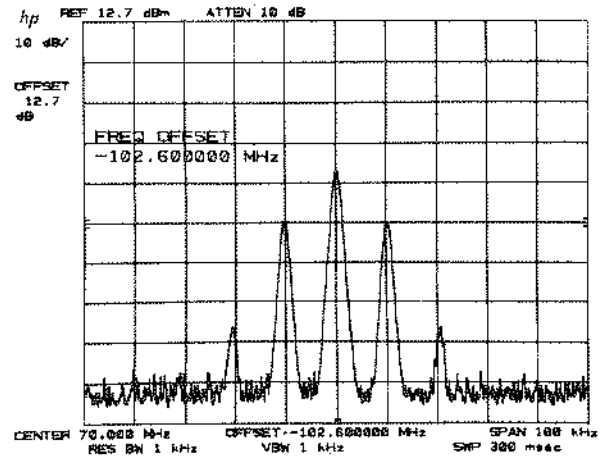

INPUT MIXER LEVEL

As the reference level is changed, the coupled input attenuator is changed to keep the power levels of on-screen signals below -10 dBm at the input mixer. (The input mixer level is the input signal level minus the attenuator setting.) This input mixer level can be changed in 10 dB steps by pressing

SHIFT **0-25 GHz** (DATA keyboard entry)

An input mixer level of -50 dBm ensures that the analyzer has best dynamic range, as long as the input signal's total power level is below the analyzer's reference level. Also see Appendix D.

Instrument preset resets the input mixer level to -10 dBm.

PREAMPLIFIER GAIN

Similar to the amplitude offset functions, the preamplifier gain function allows a positive or negative amplitude offset to all the amplitude readouts. The offsets are *subtracted* from the amplitude readouts so that the displayed amplitudes represent the power levels at the *input* of the preamplifier. Each signal input can be offset by different amounts.

Preamp gain, input 1: SHIFT < (DATA keyboard entry)

The < key is beside Input 1, and the > key is beside the Input 2.

Preamp gain, input 2: SHIFT > (DATA keyboard entry)

The offset is not read out on the CRT. Instrument preset resets the gains to 0 dB.

AMPLITUDE UNITS SELECTION

Shift key codes A through D each select a particular amplitude unit for the reference level scale, marker, display line, and threshold readouts. An amplitude units change does not affect the absolute power level calibration.

SHIFT KEY FUNCTION

SHIFT A
SHIFT B
SHIFT C
SHIFT D

or INSTR PRESET

AMPLITUDE UNITS

dBm
dBmV
dBμV
voltage

The keys for these functions are located in the COUPLED FUNCTION group.

EXTEND REFERENCE LEVEL RANGE

Normally the reference level can be set from -89.9 dBm to +30.0 dBm in coupled operation. The limits of the range can be extended to a maximum of -139.9 dBm and +60.0 dBm.

Press SHIFT ^I ATEN

The lower limit of reference level depends on resolution bandwidth, scale, and attenuation.

Scale	Resolution Bandwidth	Minimum reference level with extended reference level	
		10 dB attenuation	0 dB attenuation
log	≤1 kHz	-129.9 dBm	-139.9 dBm
log	≥3 kHz	-109.9 dBm	-119.9 dBm
linear	≤1 kHz	-109.9 dBm	-119.9 dBm
linear	≥3 kHz	-89.9 dBm	-99.9 dBm

When the reference level is set at a minimum, the level may change if either scale or resolution bandwidth is changed. The extended range is disabled with instrument preset.

COUNTER RESOLUTION

When **FREQ COUNT** is activated, the frequency of the signal marked by the active marker is counted. For more details, see **MARKER FREQ COUNT**, Chapter 6. In this mode, the resolution of the count is the same as the center frequency readout. To increase the resolution,

press **SHIFT FREQ COUNT** (DATA keyboard entry)

For spans ≤ 2 MHz, the data entry sets the least frequency digit to be counted. For example:

DATA entry	Readout for 100 MHz
100 kHz	100.0 MHz
10 kHz	100.00 MHz
1 kHz	100.000 MHz
100 Hz	100.0000 MHz
10 Hz	100.00000 MHz
1 Hz	100.000000 MHz

Counter resolution can be set between 1 Hz and 100 kHz. The resolution of the counter frequency will remain fixed until changed with a counter resolution data entry or until **INSTR PRESET** is used. The counter resolution cannot be stored with **SAVE**.

Values entered other than decade numbers, such as 25 Hz and 326 kHz, will be rounded to the next legal value. For example, a counter resolution data entry of 25 Hz will be entered as 10 Hz, and 326 kHz will become 100 kHz resolution.

MARKER SWEEPS

When a marker is displayed, the sweep can be made to stop at the active marker and to continue from the active marker. The front panel continuous sweep function is suspended, but the sweep trigger and data conditions must still be met. See Chapter 9, SWEEP AND TRIGGER.

Stop Sweep at Marker, TALK after Marker

To stop the sweep at the marker,
press **MARKER NORMAL** and
press **SHIFT u**.

A marker must be activated to enter this sweep function.

Each time a sweep is triggered, it stops at the marker, even if the marker has been moved. A marker being moved when the sweep passes may not stop the sweep.

To disable the stop sweep at marker functions,
press **MARKER OFF** or **INSTR PRESET**.

In remote operation, the analyzer will not TALK until the trace sweep stops at the marker. TALK is suspended by keeping the HP-IB Data-Valid line not true until the marker is placed.

Continue Sweep from Marker

To start the sweep at the active marker, it is first necessary to activate the stop-sweep-at-marker function above. Then
press **SHIFT t**.

Each time **SHIFT t** is pressed, the sweep will start at the active marker, continue through a full sweep back to the same marker, and stop.

GRATICULE AND ANNOTATION ON/OFF

The graticule and character readouts can be selectively blanked with key functions. This is valuable when alternative graphics are drawn on the CRT through the HP-IB.

Graticule

Blank: press m

Annotation **On:** press n

Blank: press o

On: press p

Display with annotation (characters) and graticule blanked.

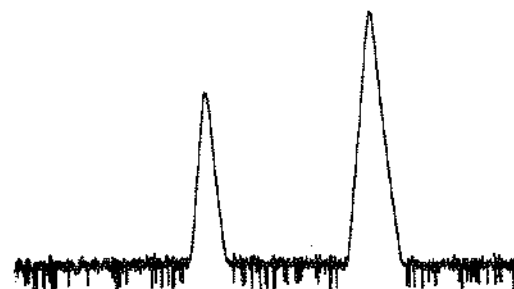

Display blanking does not affect HP-IB input/output of instrument function values or trace information.

CRT BEAM ON/OFF

The CRT beam power supply can be turned off to avoid unnecessary wear on the CRT if the analyzer is operated unattended. *Reducing intensity or blanking the trace does not reduce wear.*

Beam off: press g

Beam on: press h

CRT beam power does not affect HP-IB input/output of instrument function values or trace information.

DISPLAY CORRECTION DATA AND SPECIAL MESSAGES

The correction data generated from the error correction routine can be displayed.

Display correction data: press w (lower case)

Do not display correction data: press

The readout is detailed in this chapter under ERROR CORRECTION ROUTINE.

The instrument operating special messages can be displayed by disrupting the analyzer's operation.

Display warning messages: press v (by inhibiting phase lock flag)

Do not display special messages: press

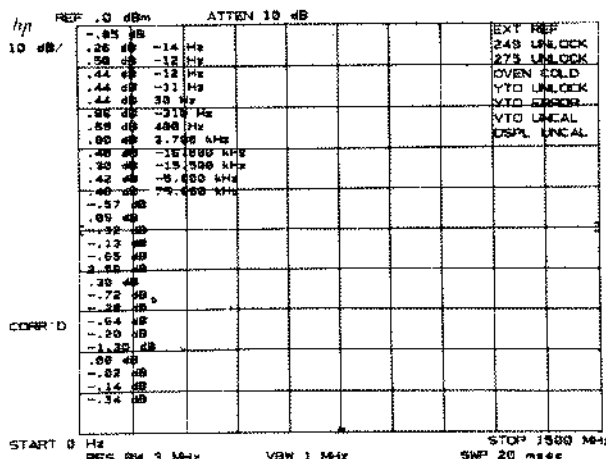

BOTH CORRECTION DATA AND SPECIAL MESSAGES DISPLAYED

TITLE

The user can write a message in the top CRT display line. When the title is activated, the front panel blue characters, number keyboard numbers, decimal, backspace, and space can be typed onto the top line starting at the left of the display. The full width of the display can be used; however, marker readout may interfere with the last 16 characters of the title.

Activate title: **SHIFT** E (shift light on)
Enter text: abcdefghijklmnopqrstuvwxyz
 ABCDEFGHIJKLMNOPQRSTUVWXYZ
 /#&=(),><
 0123456789. [space]
To end a title: press **NORMAL** (shift light off)

A title will remain on the display until the title function is activated again, **INSTR PRESET** is pressed, or an instrument state is recalled with **RECALL**.

To erase a title without changing the instrument state, end the title function if still active, then press **SHIFT** E **NORMAL**.

A + B → A

A + B → A enables the restoration of the original trace A after a **A→A** has been activated. A + B → A is executed with both Trace A and Trace B in **VIEW** ;
 press **SHIFT** c.

When executed, **A→A** is turned off and the amplitude in trace B is added to the amplitude in trace A (in display units). The result is then written into trace A.

Additional A + B → A executions will each add another trace B response to the cumulative trace A.

TRACE DETECTION MODES

One of four detection techniques can be selected for displaying trace information.

Mode	Access	Use
normal	INSTR PRESET or SHIFT a	<ul style="list-style-type: none"> ● Most measurements
sample	SHIFT e	<ul style="list-style-type: none"> ● Noise Level measurements ● Zero frequency span waveforms for sweep times ≥ 20 msec ● Video averaging
positive peak negative peak	SHIFT b SHIFT d	<ul style="list-style-type: none"> ● Diagnostic aids for servicing

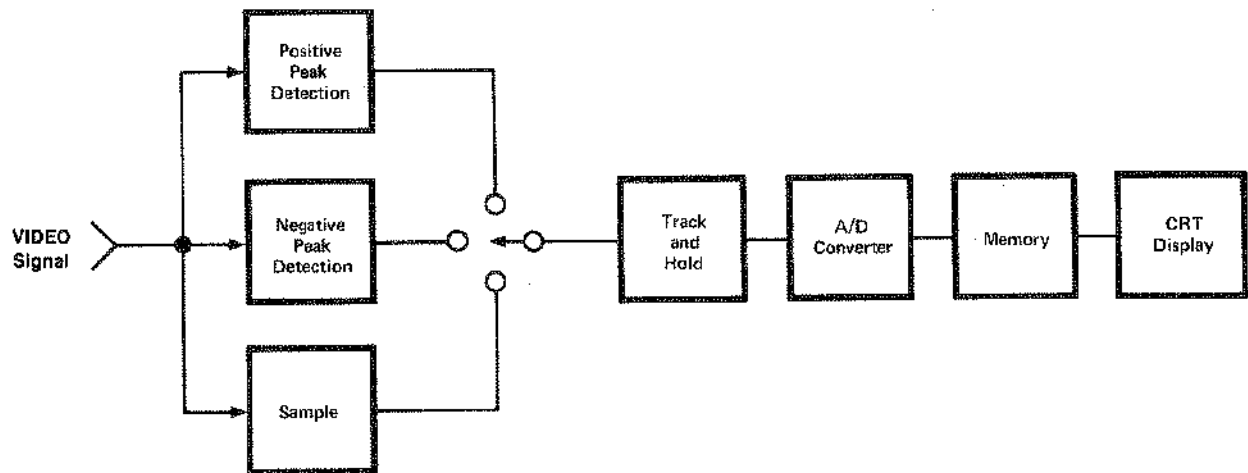

During a sweep, only a specified amount of time is available for writing data into each of the 1001 trace memory addresses. In two of these time periods, the positive and negative peak detectors obtain the maximum and minimum IF signal excursions, respectively, and store these values in *alternate* trace memory addresses. This technique allows a graphic presentation of noise on the CRT display.

Normal Mode

In normal mode, a detection algorithm selectively chooses between the positive and negative peak values to be displayed. The choice is made dependent upon the type of VIDEO signal present.

Data from the positive peak detector (signal maximums) will always be displayed in the odd addresses trace memories (1, 3, ...1001). If, within the time period following the storage of a value in an odd address memory, there is no change in VIDEO signal level, the positive peak detector value will also be stored in the even address. In other words, the even addressed memory will also contain positive peak detection data if the signal during that time period is monotonic. Negative peak detector data (VIDEO signal minimum) will be stored in the even addressed trace memory if the signal has a point of inflection during the time period.

Normal mode is selected with instrument preset.

Sample Mode

In the sample mode, the *instantaneous* signal value of the final analog-to-digital conversion for the time period is placed in memory. (As sweep time increases, many analog-to-digital conversions occur in each time period, but only the final, single value can be stored.)

Sample mode is selected automatically for video averaging and noise level.

Positive and Negative Peak Modes

Positive and negative peak modes store signal maximums and minimums, respectively, in all trace memories.

Readout

Here, the same signal response is displayed with each trace detection mode.

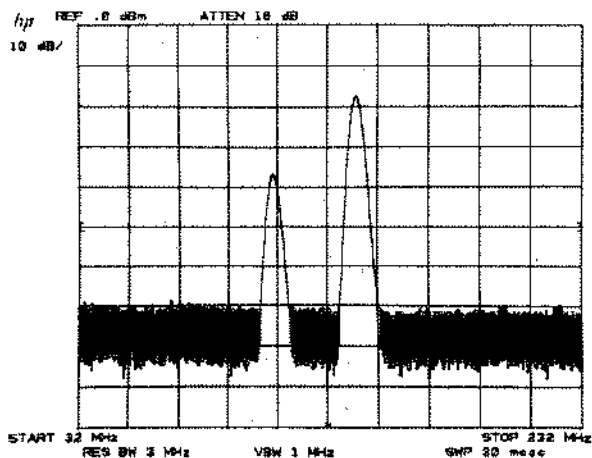

NORMAL

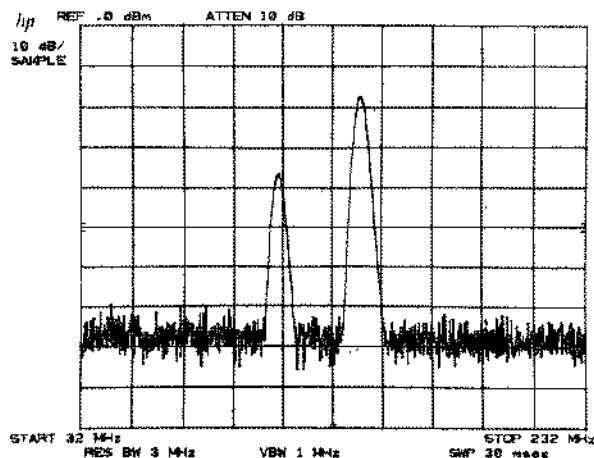

SAMPLE

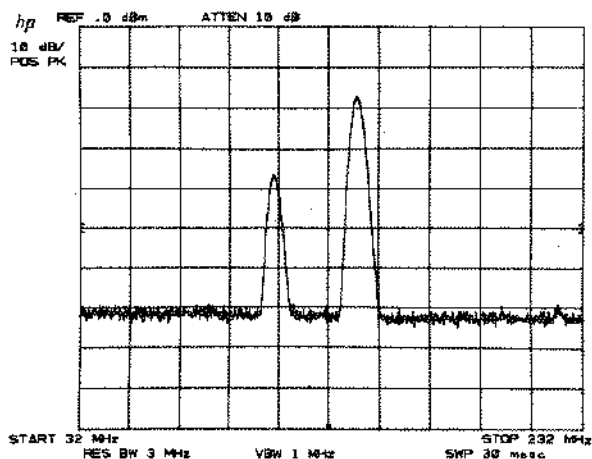

POSITIVE PEAK

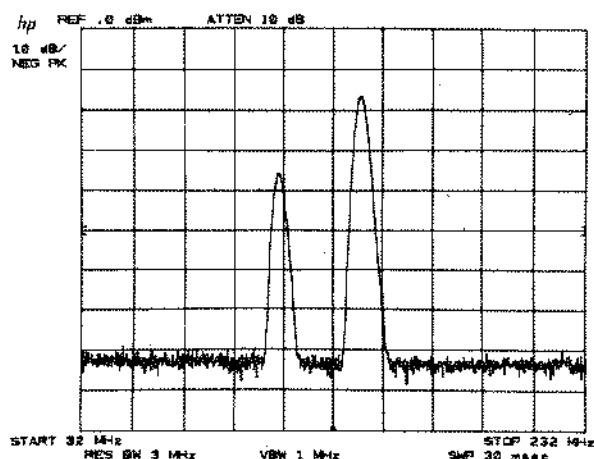

NEGATIVE PEAK

TRACE C

A third trace memory is available for the storage and display of trace information. Only the storage modes (view and blank) can be used.

View C: SHIFT j
Blank C: SHIFT k

These are analogous to the TRACE A and B modes discussed in Chapter 5.

Trace C cannot be written into directly from the analyzer except when video averaging is used.

Trace information from B can be transferred to C. To transfer from TRACE B to TRACE C, use

B → C: SHIFT B-DL → C

The sweep will be suspended, the trace in memory B will be read and written into trace C from left to right in about 20 msec. Trace C is viewed. Sweeping will then resume from where it was suspended. The trace information in B is not changed.

To exchange traces B and C,

B \rightleftharpoons C: **SHIFT** i

The trace information in B and C is interchanged point for point from left to right in about 20 msec. If trace B was not displayed, it remains undisplayed. If trace C was not displayed, it remains undisplayed.

To store TRACE A into trace C, the trace A data must first be transferred into trace B:

press **A \rightleftharpoons B** **SHIFT** l (which also erases last trace C)
 or press **A \rightleftharpoons B** **SHIFT** i (which also saves last trace C in B)

Example

Comparisons of up to three different signal traces can be made simultaneously using traces A, B, and C. In this example, the modulation level of a signal will be changed for each trace. To start, clear the display with **BLANK** A, **BLANK** B, and **SHIFT** k.

The signal with the desired level of modulation will be stored in trace C:

Press **CLEAR-WRITE** B and allow one sweep.

Press **SHIFT** l which writes the trace from B into C.

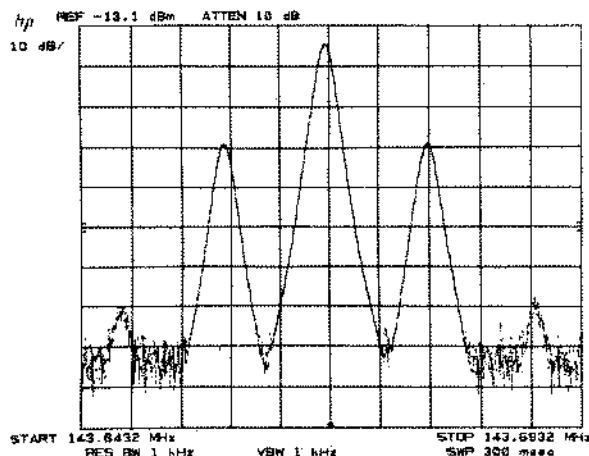

Change the modulation level, allow one sweep, and store in B with **VIEW** B.

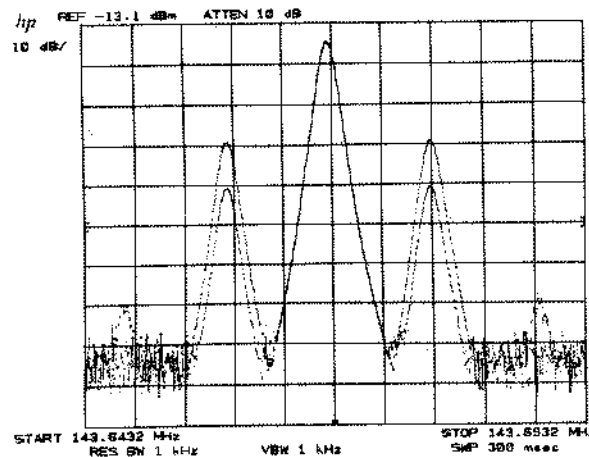

Change the modulation level again and store in A, press **CLEAR WRITE** A, allow one sweep, and press **VIEW** A. The three traces are differentiated by intensity.

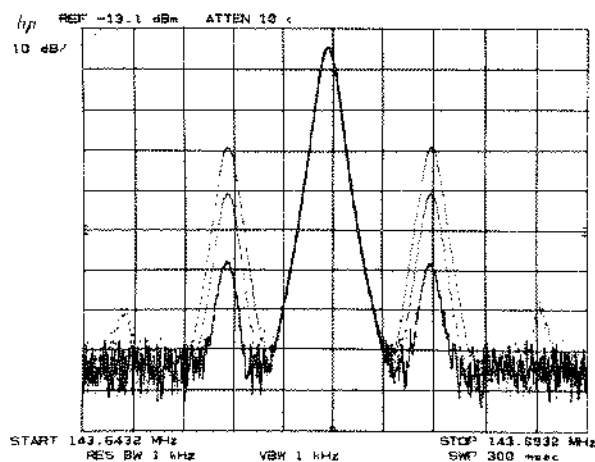

VIDEO AVERAGING

Video averaging is a trace display routine that averages trace responses from sweep to sweep without requiring a narrow video bandwidth. (Averaging with the video bandwidth is discussed in Chapter 8, **COUPLED FUNCTION** **VIDEO BW**). Both video averaging and reducing video bandwidth are primarily used to improve the analyzer's ability to measure low level signals by smoothing the noise response.

To activate video averaging (and sample detection mode),

press **SHIFT** **G** **VIDEO BW** (DATA keyboard entry)

To disable video averaging, press **SHIFT** **H** **SWEEP TIME**

CAUTION

Video averaging may result in an uncalibrated amplitude display when

$$\frac{\text{frequency span}}{\text{Resolution Bandwidth}} > 1000$$

Readout in the active function display is "VID AVG 100." The number represents the maximum number of samples (or sweeps) for complete averaging. The DATA entry can be used to change the maximum sample number in integers from 0 to 32767. A unity sample limit allows direct writing of analyzer response into Trace C (see Trace C below). A 100 sample limit is selected upon instrument preset. The higher the sample limit, the more smoothing possible. Averaging with high sample limits can provide more smoothing than the 1 Hz video bandwidth.

During video averaging, the current sample being taken is read out at the left of the display.

The advantage of video averaging over narrowing the video filter is the ability of the user to see changes made to the amplitude or frequency scaling of the display while smoothing the noise response. For example, when a 100 Hz video bandwidth is used with a 200 kHz frequency span, the sweep time is 2 seconds. With this sweep time almost a full sweep has to pass before any center frequency change can be seen on the trace. If video averaging is used instead of the narrow video bandwidth, any change to center frequency will be seen immediately, even though full averaging will take roughly 6 seconds. (Any change to control settings such as **CENTER FREQUENCY**, **FREQUENCY SPAN**, etc., will cause the video averaging process to be restarted.)

Example

To display very low level signal responses, very narrow resolution and video bandwidths are required. The accompanying increase in sweep time can make measurements cumbersome. Video averaging allows the display of low level signals without the long sweep time.

Viewing a low level signal with a video bandwidth of 1 Hz requires a 150 second sweep.

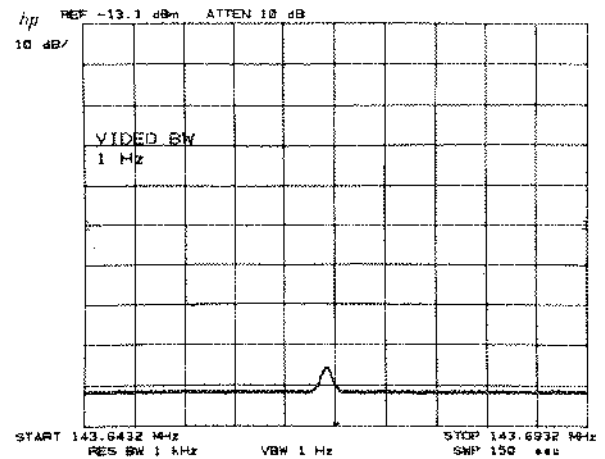

Disable the narrow resolution and video filters by pressing the **AUTO** key (above **VIDE BW**) and start video averaging by pressing **SHIFT G**.

Now the low level signals begin to show quickly. Changes to the frequency range or amplitude scale will restart the sampling to show the signals quickly, without having to wait 150 seconds. In fact, the video averaging shown took 42 x 300 msec = 12.6 sec, plus the internal computation time, 42 x 100 msec = 4.2 sec, for a total of 16.8 sec.

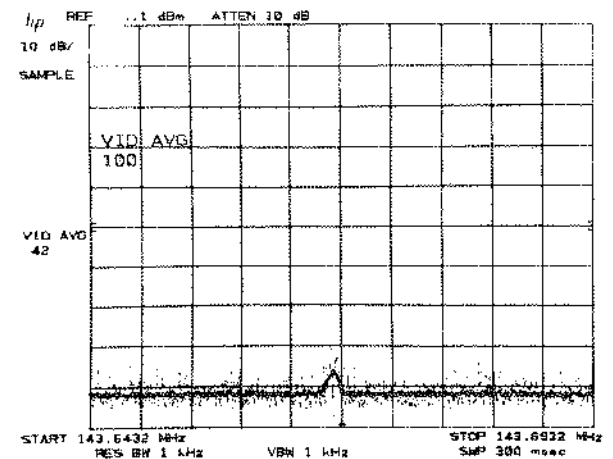

Video Averaging Algorithm

The averaging of each amplitude point depends upon the number of samples already taken and last average amplitude.

$$\bar{y}_n = \frac{n-1}{n} \times \bar{y}_{(n-1)} + \frac{1}{n} y_n$$

where \bar{y}_n latest average amplitude value in display units
n current sample number

\bar{y}_{n-1} last average amplitude in trace memory (TRACE A or B)
 y_n new amplitude entry from analyzer (Trace C)

The new amplitude value, y_n , is weighted more heavily by the last average amplitude \bar{y}_{n-1} than the new amplitude entry, y_n .

When n equals the limit set (e.g. 100, the preset limit), the last average amplitude is gradually replaced with new data. Thus, the average will follow a slowly changing signal response, particularly if the sample limit is small.

Trace C

Video averaging requires the use of trace memory C. When video averaging is activated, the input signal response is written into trace C, the averaging algorithm is applied to these amplitudes and the results written into TRACE A. Thus, two traces are displayed: the input signal in C and the averaged signal in A.

Trace C may be blanked without affecting the operation of video averaging.

Press SHIFT k

Trace C may be written into as traces A and B if a video average sample limit of one is selected.

Press SHIFT ^G VIDEO SW 1 ^H _{AV} _{RANC}

If either trace A or B is in a write trace mode, the analyzer response will also be written into trace C.

EXTERNAL AND VIDEO TRIGGER

The front panel EXT and VIDEO trigger modes automatically keep the display refreshed in zero frequency spans for sweep times less than 20 msec. To eliminate the automatic refresh feature:

For external triggering, press SHIFT ^X EXT

For video triggering, press SHIFT ^y VIDEO

LOCKING SAVE REGISTERS

After saving instrument states in one or more of the six registers, 1 through 6, the registers can be secured from being written over and destroyed. The recall function is not affected.

Lock: SHIFT SAVE

Unlocked: SHIFT RECALL or INSTR PRESET

When locked, an attempt to SAVE will write "SAVE LOCKED" on the CRT and no DATA entry can be made.

ERROR CORRECTION ROUTINE

A built-in analyzer routine measures and records the amplitude and frequency error factors due to a number of parameters, then corrects the display for them. The routine takes about 1½ minutes to run. When complete, instrument preset will be called and the correction factors applied.

Connect CAL OUT to SIGNAL INPUT 2.

Execute the routine: SHIFT W

Use correction factors: SHIFT X

Do not use correction factors: SHIFT Y

Display correction factors: SHIFT W

If "ADJUST FREQ ZERO" appears on the CRT, manual calibration adjustment is necessary before the routine can be successfully run. See GENERAL INFORMATION for the manual calibration procedure.

The correction factors are saved using an internal battery supply for about a 30-day period after line power failure. If the battery supply should be exhausted, all the values will be set to zero.

Indicates that the routine has been run and the display is corrected.

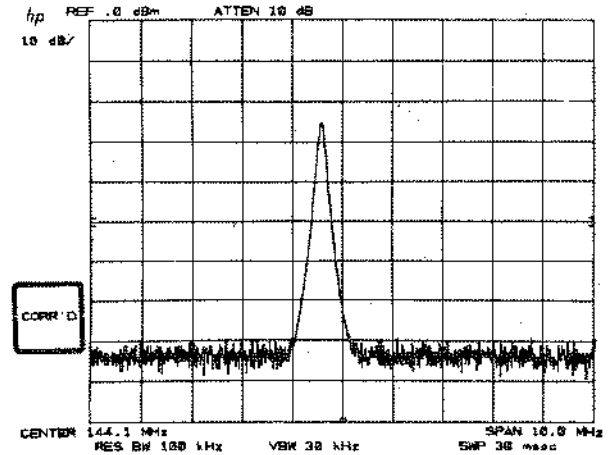

Correction can be turned on or off using SHIFT X and SHIFT Z after the routine has been successfully completed.

For more information on accuracy, see the HP 8568B Spectrum Analyzer Data Sheet.

The readout of the correction factors is as follows:

Line (top to bottom)	Parameter	Correction Values Displayed
1	LOG and LIN scale, BW <100 kHz	Amplitude
2	RES BW = 10 Hz	Both Amplitude (dB) and Frequency (Hz)
3	30 Hz	
4	100 Hz	
5	300 Hz	
6	1 kHz	
7	3 kHz	
8	10 kHz	
9	30 kHz	
10	100 kHz	
11	300 kHz	
12	1 MHz	
13	3 MHz	
14	LOG and LIN scale, BW ≥ 100 kHz	
15	2nd local oscillator frequency shift	
16	30 dB gain	
17	20 dB gain	
18	10 dB gain	
} LIN operation only		
19	50 dB step gain errors	
20	40 dB	
21	30 dB	
22	20 dB	
23	10 dB	
24	0 dB	
25	-10 dB	
26	-20 dB	
27	offset error 2 dB/ LOG	
28	offset error 5 dB/ LOG	
29	offset error 10 dB/ LOG	

SHIFT FUNCTION Index

All the shift functions are listed below. (DATA) indicates the functions that use a number and unit entry.

	CODE	DISABLE CODE OR KEY	PAGE			
GENERAL						
Display Address (DATA)	z		*	CRT beam off	g	99
Display Write (DATA)			*	CRT beam on	h	99
HP-IB service request	r		*	Display correction data	w	99
HP-IB address (DATA)	P		*	Frequency diagnostic on	R	*
Power on in last state	f		89	Graticule blanked	m	99
Max. mixer input level	,		96	Graticule on	n	99
				Title	E	<input type="checkbox"/> NORMAL 100
FREQUENCY AND AMPLITUDE						
Amplitude offset	Z		95	TRACE		
Amplitude units selection				A + B → A	c	100
dBm	A		97	Detection Modes:		
dBmV	B		97	normal	a	100
dBμV	C		97	positive peak	b	100
voltage	D		97	negative peak	d	100
Extended reference level	I		97	sample	e	100
range (DATA)				Trace C		
Frequency offset (DATA)	V		95	blank C	k	102
Input mixer level	,		96	B ≠ C	i	103
Negative entry (DATA)	-		95	B → C	l	102
Preamplifier gain, Input 1 (DATA)	<		97	view C	j	102
Preamplifier gain, Input 2 (DATA)	>		97	Video averaging on	G	104
				Video averaging off	H	104
MARKER						
Counter resolution	=	=	98	TRIGGER, ZERO SPAN, SWEEP <20 msec		
Continue sweep from marker	t	MARKER	98	<input type="checkbox"/> EXT without 25 msec trigger	x	<input type="checkbox"/> EXT 106
Enter Δ → Span	O	<input type="checkbox"/> OFF	57	<input type="checkbox"/> VIDEO without 25 msec trigger	y	<input type="checkbox"/> VIDEO 106
Noise Level on	M		63	INSTRUMENT STATE		
Noise Level off	L		63	Save Registers locked	(106
Stop single sweep at marker, TALK after marker	u	MARKER	98	Save Registers unlocked)	106
		<input type="checkbox"/> OFF		ERROR CORRECTION		
DISPLAY						
Annotation blanked	o		99	Execute Routine	W	106
Annotation on	p		99	Use data (display corrected)	X	106
				Do not use data (display not corrected)	Y	106
				Display correction data on CRT	w	106

DIAGNOSTIC AIDS

To aid in servicing the spectrum analyzer, there are a number of diagnostic shift functions. These functions

are listed here. Their operation and use are covered in the HP 8568B Service Manual.

	CODE		CODE		CODE
Count pilot IF at marker	K	Inhibit phase lock flags	v	Second LO auto	S
Count signal IF at marker	Q	Disable step gain	q	Second LO shift down	T
Count VTO at marker	N	Manual DACS control	J	Second LO shift up	U
Frequency diagnostic on	R	Scan time measure	F		

* See Section II of this manual.

Chapter 12 USER DEFINED KEYS

GENERAL DESCRIPTION

This chapter describes the procedure for defining a numeric key(s) to allow the storage and execution of command strings. The procedure for remote storage and execution of command strings is contained in Section II of this manual.

ENTERING A COMMAND STRING

The title mode must be activated to enter a command string. When the title mode is activated, the front panel blue characters, numeric keys, decimal, backspace, and space can be entered onto the top line starting at the upper left corner of the display. The full width of the display can be used (58 characters total).

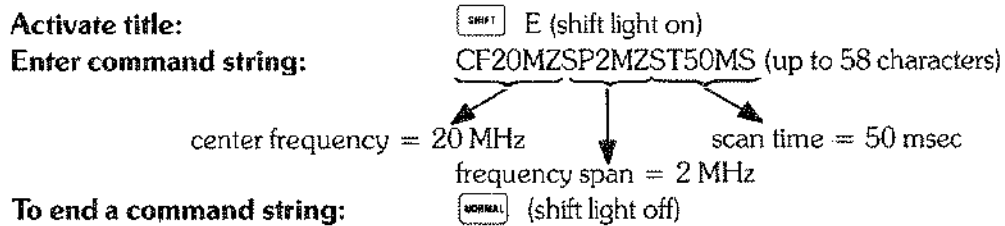

KEY DEFINITION

After a command string is entered into the title block, it is stored under a defined numeric key(s):

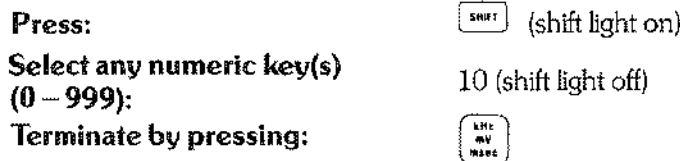



NOTE

The  key must be pressed to terminate the key definition procedure. If it is not, the command string will not be stored under the numeric key(s).

EXECUTING A SOFT KEY

After a command string is stored under a numeric key(s), it can be executed.

Press:  (shift light on)
Enter defined numeric
key(s): 10 (shift light off)
Terminate by pressing: 

NOTE

The  key must be pressed to terminate this execution procedure. If it is not, the command string will not be executed.

Chapter 13 PLOTTER OUTPUT

GENERAL DESCRIPTION

This chapter describes the procedure for executing the PLOTTER OUTPUT function, and provides information for preventing problems that may arise while attempting to execute it.

EXECUTING PLOTTER OUTPUT

Connect an HP plotter via HP-IB to the spectrum analyzer:



Set the HP-IB address on the plotter to address 5:

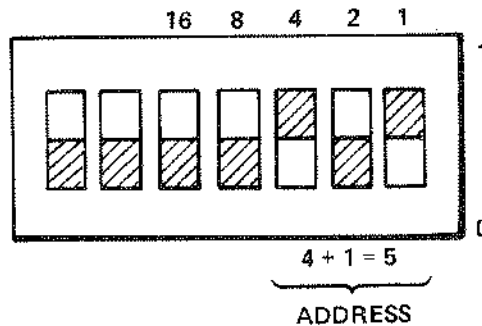

If the address switch on the plotter cannot be located, refer to the plotter's operation manual.

Press the lower left recorder key  to execute the PLOTTER OUTPUT function.

The function plots everything that is displayed on the CRT. If desired, traces A, B, and C, the annotation and the graticule can be individually blanked from the CRT using front-panel functions (refer to Chapters 5 and 11).

You can also blank the HP logo from the display. To do this from a computer, execute:

OUTPUT 718; "DA 2174; DW 32;32;"

Or, to execute it from the front panel, press:

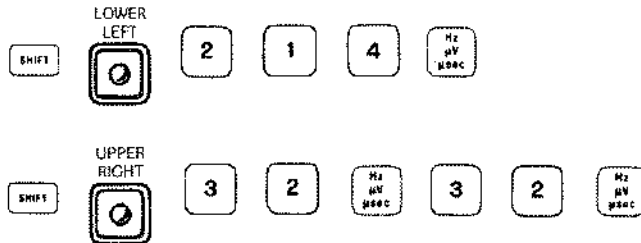

PLOTTER PENS

Traces A, B, and C, and the annotation and graticule are individually plotted with four different pens, provided there are four pen locations in the plotter. Pens 1, 2, and 4 plot traces A, B, and C, respectively, and pen 3 plots the annotation and graticule. For a two-pen plotter, pens 1 and 2 take the place of pens 3 and 4, respectively.

NOTE

There are certain types of equipment that prevent the PLOTTER OUTPUT function from being executed correctly. They are discussed in the next two sections.

CONTROLLER

The analyzer should not be connected via HP-IB to an active controller while attempting to execute the PLOTTER OUTPUT function from the front panel. This is because the analyzer will abort any attempts to execute the function from the front panel when an active controller is on the bus.

PLOTTER

The 7245A/B, 7240A, 9872C, and 7550 Graphics Plotters work readily for executing the PLOTTER OUTPUT function. However, the HP 7570A, 7585, 7470A, and 7475A plotters require special operating instructions. The HP 7570 and 7585 plotters work only in EMULATE MODE. For more information on EMULATE MODE, refer to the plotter's operating manual. On the HP 7470A plotter, set the US/A4 rocker switch to the US position. For the HP 7475 plotter, the US/MET and A4/A3 rocker switches must be set to the US and A4 positions.

Section II

Programming

FUNCTIONAL INDEX
PROGRAMMING COMMANDS
PROGRAMMING NOTES



This section describes remote operation of the spectrum analyzer.

The Functional Index contains all the remote commands arranged by functions.

The Programming Command section describes operation of the commands, which are listed in alphabetical order.

The appendices at the end of this section contain useful information:

Appendix A describes the contents of the spectrum analyzer display memory.

Appendix B contains programming techniques for custom graphics.

Appendix C lists the learn string contents.

Appendix D describes the service request commands and their use.

Appendix E describes some differences of operation between the HP 8568A and HP 8568B.

Appendix F lists new HP 8568B commands and original HP 8568A commands that function identically.

REMOTE OPERATION OVERVIEW

The standard HP 8568B Spectrum Analyzer with an HP-IB controller allows:

Remote operation of the analyzer front panel functions, including the shift key functions.

Output of any analyzer function value or trace amplitude. See individual commands, including OL. See Appendix C.

Input of special CRT display labels and graphics. See TRGRPH, LB, GR, TEXT, KSE, and DSPLY commands.

Interrupt of controller soft key functions. See KEYDEF, KEYEXC, FUNCDEF, IF, KSC, and REPEAT commands.

Creation of custom language using flow-of-control commands. See FUNCDEF, IF, and REPEAT commands.

Creation of user-defined variables. See VARDEF command.

Change Front Panel Functions

To set the center frequency to 258.7 MHz and the span to 10 MHz:

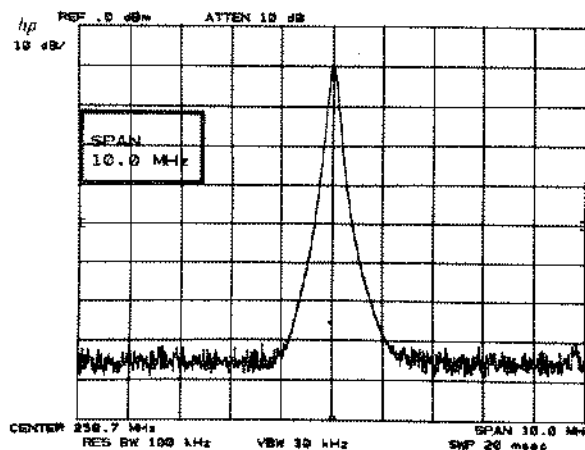
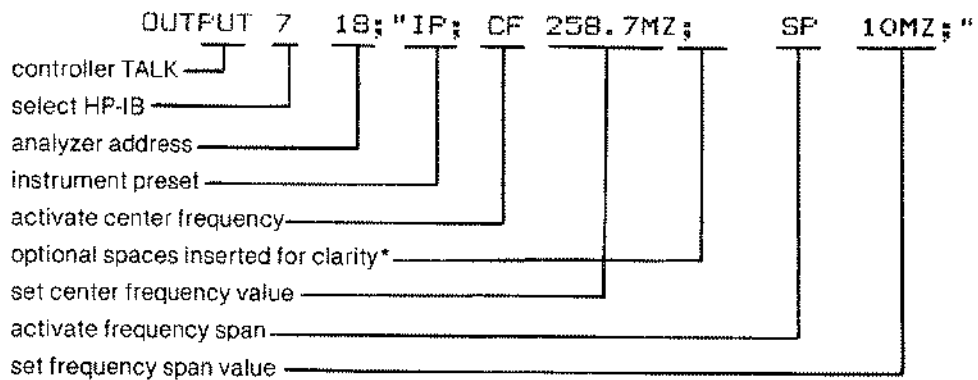

Output Value or Amplitude

To return the center frequency to the controller as variable F, first activate center frequency.

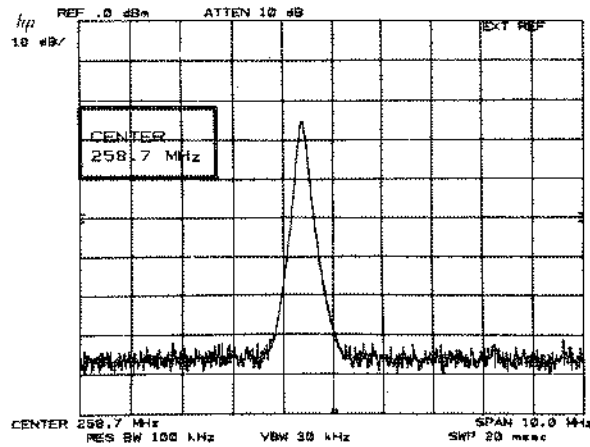

Then enable the output of the active parameter.

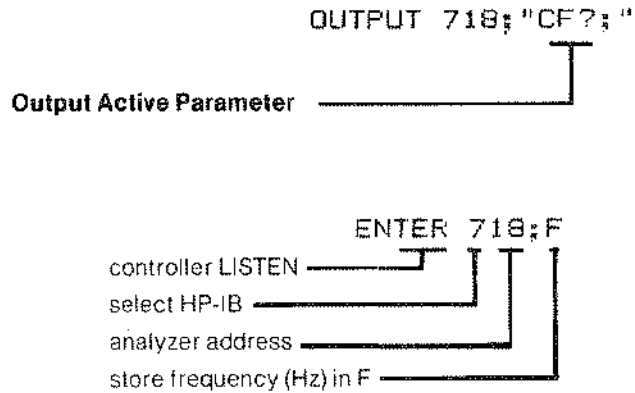

Input CRT Labels and Graphics

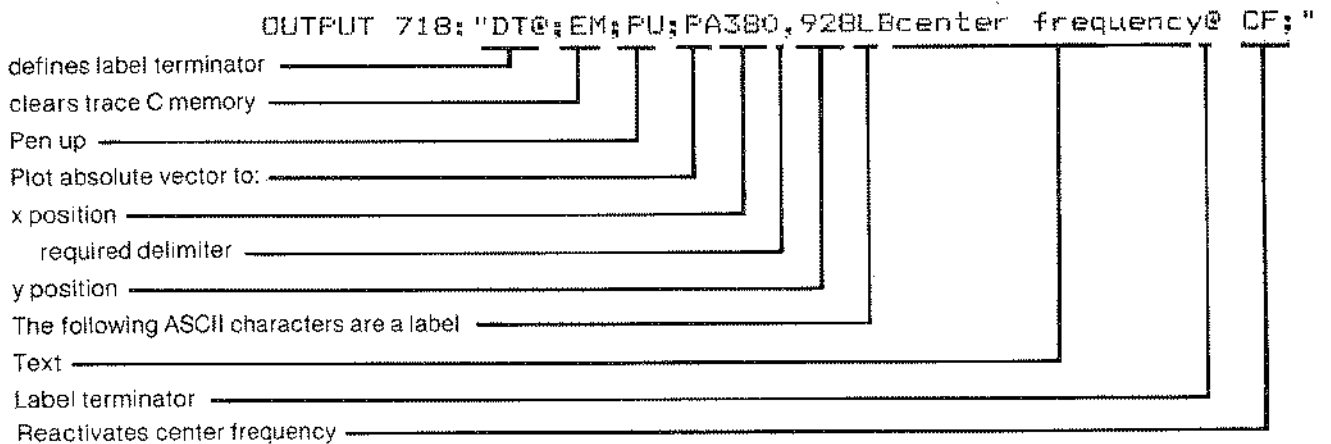

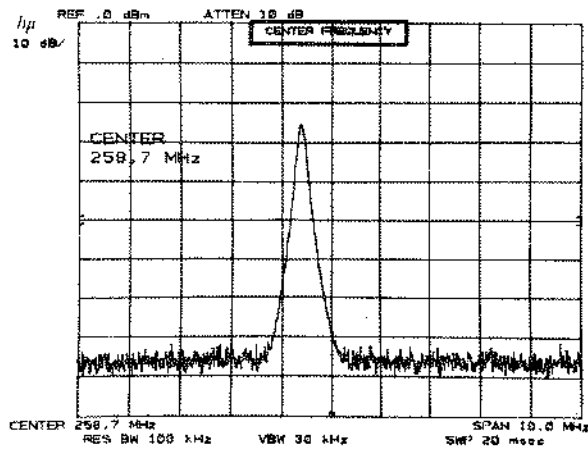

HP-IB Controller

Any HP-IB compatible controller can be used to operate the HP 8568B. The overall system measurement speed and capability depends, to a large extent, on the computing, storage, and interrupt capabilities of the controller.

The HP Series 200 Desktop Computers, HP Models 16, 26, and 36, are the computing controllers used in this manual.

Addressing the Spectrum Analyzer

Communications between instruments on the HP-IB require that addresses be assigned to each instrument. The analyzer address appears on the CRT display when the LINE power is turned from STANDBY to ON.

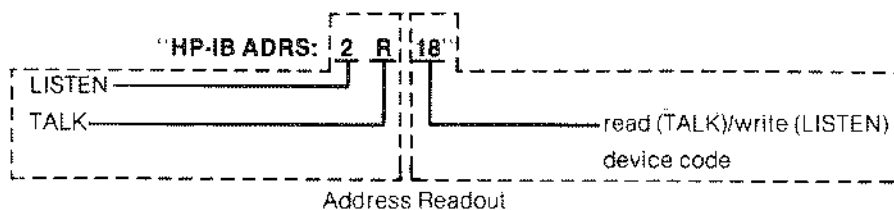
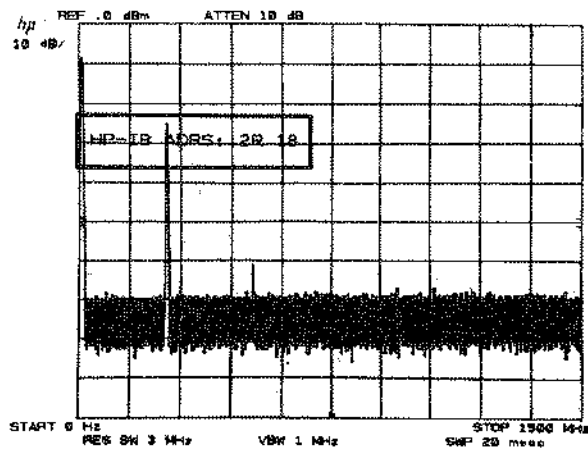

Two formats are available for addressing an HP-IB instrument or device. One command format uses separate addresses for TALKING ("R") and LISTEN ("2"). The other uses only a device code ("18") to designate the recipient of the command.

In all examples, the preset addresses of the HP computing controller is HP-IB SELECT CODE "7".

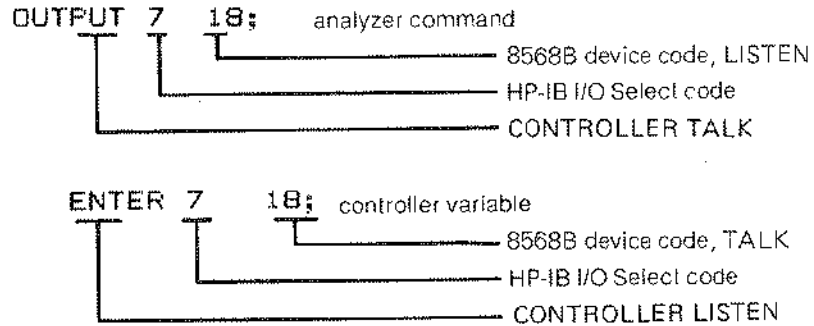

The read/write address of the HP 8568B can be changed from the front panel or via HP-IB by using the shift function P.

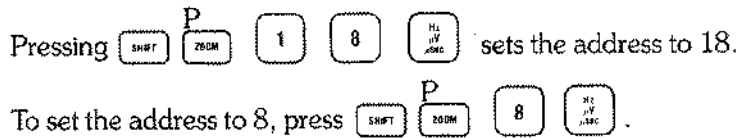

From the controller, the address can be set via HP-IB:

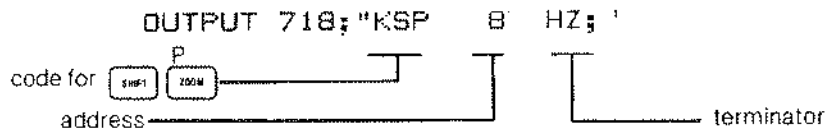

As long as the analyzer internal battery has power, the analyzer address remains unchanged. (Battery lasts one year.)

In addition to these features, an internal switch can be set which changes the default address at Power Up.

Call your nearest HP service office for more information.

Remote/Local Operation

If the controller has addressed the analyzer to TALK or LISTEN, the ADRS'D light will be on. When the analyzer is addressed with an HP-IB device command, the analyzer will go to remote, and the REM light will also go on.

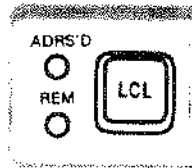

Remote operation generally prevents front panel control of the analyzer except by those functions that are not programmable: LINE power, calibration and display adjustments, and video trigger vernier.

Return to front panel, or local, control by pressing , or by executing a local device command from the controller such as

LOCAL 718.

CAUTION

An HP-IB transmission may be disrupted if the analyzer LINE power is cycled. An analyzer should be connected to an **operating** HP-IB only with POWER ON.

Similar HP-IB disruption may result from pressing  when the HP-IB is active. Thus, a local lockout is recommended during HP 8568B automatic operation.

Shift Function Codes

Programming a shift function requires a code sequence similar to the manual procedure for activating a shift function; that is, press , then press the key with the function's code (the front panel blue character).

For example, to select the video averaging shift function, blue code G, execute

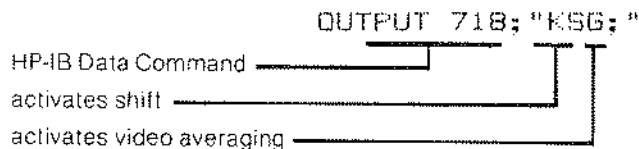

About half of the shift key function codes require ASCII lower case letters or symbols.

Data Entry Via HP-IB

A data entry through the HP-IB must meet the same requirements as a front panel DATA entry. It must have a number (value) and a message that terminates the entry, signaling the analyzer to assign the function value.

The number code within the quote field must be a string of (ASCII) decimal numbers plus an optional decimal point. It may be preceded by a minus or plus sign. If the decimal is not included in the entry, a decimal point is assumed to be at the end of the number. Either fixed or floating point notation may be used to make number entries. For example, the entries "12.3E6", "12.3e6", and "12300000" each enter the same number. Exercise caution when using the "E" exponent format, since several marker command mnemonics also begin with E.

The number of significant digits accepted and stored by the analyzer is dependent upon which function is active. For example, an entry of 10 significant digits for center frequency can be stored in the analyzer's center frequency register.

If no number is entered, a "1" is assumed.

Terminating the Data Entry

The units code is the most common data entry terminator. It sets the value units and enters the function value.

Unit Codes

Frequency	Code	Power	Code	Voltage	Code	Time	Code
Hz	HZ	dBm	DM	mV	MV	sec	SC
kHz	KZ	-dBm	-DM	μ V	UV	msec	MS
MHz	MZ	dB	DB			μ sec	US
GHz	GZ						

Some ASCII codes also can be used to terminate a data entry.

ASCII Codes Which Terminate a Numeric Data Entry

Symbol	Name	Decimal Equivalent (ASCII)
,	comma	44
CR	carriage return	13
LF	line feed	10
;	semi-colon	59
ETX	end of text	3

These non-unit code terminators originate in the controller's language.

A terminated entry without a units code defaults to the fundamental units for the function activated. The default units of power depend upon the amplitude readout units selected.

Default Units

Frequency	Hz
Power	dBm, dBmV, dB μ V, or dB
Voltage	volts
Time	seconds

Front-Panel Data Entry During Remote Control



Data may also be entered from the front panel when the analyzer is in remote control. This is done by following the analyzer command with the secondary keyword, EP. The syntax diagrams show which commands can be followed by EP. EP pauses program operation until data is entered from the front panel and terminated with one of the units keys listed in the Units Code table. Program operation then resumes. EP is especially useful when it is part of a programming routine that is stored in a soft key.

Custom Soft key Functions

The spectrum analyzer has soft keys that can be loaded into up to 16K bytes of memory, with or without a controller. These soft keys remain in nonvolatile memory for the life of the internal battery, which lasts for one year.

The functions of the soft keys are defined with the KEYDEF command. The original contents of a soft key are erased when the key is defined a second time with the KEYDEF command, or when the DISPOSE command is executed.

The soft keys can be executed four ways. To execute a soft key remotely, execute the KEYEXC command, or define the soft key as part of a user-defined function. Then, whenever the function name is encountered, the soft key is executed. (See FUNCDEF command.) Soft keys can also be nested inside another soft key. Thus, executing one key actually can cause the execution of several keys.

To manually execute a soft key from the front panel, press  , the key number, and then press .

FUNCTIONAL INDEX

FREQUENCY CONTROL

CF	Specifies center frequency
CS	Couples step size
*FA	Specifies start frequency
*FB	Specifies stop frequency
FOFFSET	Specifies frequency offset
FS	Specifies full frequency span as defined by instrument
KSV	Specifies frequency offset
KS =	Specifies resolution of frequency counter
MKFCR	Specifies resolution of frequency counter
SP	Specifies frequency span
SS	Specifies center frequency step size

INSTRUMENT STATE CONTROL

IP	Sets instrument parameters to preset values
KS(Locks save registers
KS)	Unlocks save registers
RC	Recalls previously saved state
RCLS	Recalls previously saved state
SAVES	Saves current state of the analyzer in the specified register
SV	Saves current state of analyzer in specified register
USTATE	Configures or returns configuration of user-defined states: ONEOS, ONSWP, TRMATH, VARDEF, FUNCDEF, TRDEF

AMPLITUDE CONTROL

AT	Specifies input attenuation
AUNITS	Specifies amplitude units for input, output and display
*CA	Couples input attenuation
E4	Moves active marker to reference level
*KSA	Selects dBm as amplitude units
KSB	Selects dBmV as amplitude units
KSC	Selects dBuV as amplitude units
KSD	Selects voltage as amplitude units
KSI	Extends reference level range
KSW	Performs amplitude error correction routine
KSX	Incorporates correction data in amplitude readouts
KSY	Does not incorporate correction data in amplitude readouts
KSZ	Specifies reference level offset
KSq	Decouples IF gain and input attenuation
KSw	Displays correction data
KS,	Sets mixer level
LG	Selects log scale
LN	Selects linear scale
MKRL	Moves active marker to reference level
ML	Specifies mixer level
RL	Specifies reference level
ROFFSET	Specifies reference level offset

BANDWIDTH CONTROL

*CR	Couples resolution bandwidth
*CV	Couples video bandwidth
RB	Specifies resolution bandwidth
VB	Specifies video bandwidth
VBO	Specifies coupling ratio of video bandwidth and resolution bandwidth

*Selected with instrument preset (IP)

SWEEP AND TRIGGER CONTROL

*CONTS	Selects continuous sweep mode
*CT	Couples sweep time
KSF	Measures sweep time
KSI	Continues sweep from marker
KSu	Stops sweep at active marker
KSx	Sets external trigger (eliminates auto-refresh)
KSy	Sets video trigger (eliminates auto-refresh)
ST	Specifies sweep time
SNGLS	Selects single sweep mode
*S1	Selects continuous sweep mode
S2	Selects single sweep mode
TM	Selects trigger mode: free run, video, line, external
TS	Takes a sweep
*T1	Sets trigger mode to free run
T2	Sets trigger mode to line
T3	Sets trigger mode to external
T4	Sets trigger mode to video

MARKER CONTROL

E1	Moves active marker to maximum signal detected
E2	Moves marker frequency into center frequency
E3	Moves marker or delta frequency into step size
E4	Moves active marker to reference level
KSL	Turns off average noise level marker
KSM	Returns average value at marker, normalized to 1 Hz bandwidth
KSO	Moves marker delta frequency into span
KSt	Continues sweep from marker
KSu	Stops sweep at active marker
KS=	Specifies resolution of marker frequency counter
KS{92}	Enters DL, TH, M2, M3 in display units
MA	Returns marker amplitude
*MC Ø	Turns off marker frequency count
MCI	Turns on marker frequency count
MF	Returns marker frequency
MKA	Specifies amplitude of active marker
MKACT	Specifies active marker: 1, 2, 3, or 4
MKCF	Enters marker frequency into center frequency
MKCONT	Continues sweep from marker
MKD	Moves delta marker to specified frequency
MKF	Specifies frequency of active marker
MKFC	Counts marker frequency for greater resolution (See MKFCR)
MKFCR	Specifies resolution of marker frequency counter
MKMIN	Moves active marker to minimum signal detected
MKN	Moves active marker to specified frequency or center screen
MKNOISE	Returns average value at marker, normalized to 1 Hz bandwidth
MKOFF	Turns all markers, or the active marker off
MKP	Specifies marker position horizontally, in display units
MKPAUSE	Pauses sweep at marker for duration of specified delay time (in seconds)
MKPK	Moves active marker to maximum signal detected, or to adjacent signal peaks
*MKPX	Specifies minimum excursion for peak identification. Preset value is 6 dB
MKREAD	Specifies marker readout mode
MKRL	Moves active marker to reference level
MKSP	Moves marker delta frequency into span
MKSS	Moves marker frequency to center frequency step size
MKSTOP	Stops sweep at active marker

*Selected with instrument preset (IP)

MKTRACE	Moves active marker to corresponding position on another specified trace
MKTRACK	Turns marker signal track on or off
MKTYPE	Sets marker type
*MT0	Turns off marker signal track
MT1	Turns on marker signal track
*M1	Turns off active marker
M2	Turns on active marker and moves it to center screen
M3	Turns on delta marker
M4	Turns on marker zoom

COUPLING CONTROL

*CA	Couples input attenuation
*CR	Couples resolution bandwidth
*CS	Couples step size
*CT	Couples sweep time
*CV	Couples video bandwidth
*VBO	Specifies coupling ratio of video bandwidth and resolution bandwidth

RF INPUT CONTROL

I1	Enables left RF input
*I2	Enables right RF input

DISPLAY CONTROL

*ANNOT	Turns annotation on or off. Preset condition is on.
AUNITS	Specifies amplitude units for input, output, and display
DL	Specifies display line level in dBm
DLE	Turns display line on and off
*GRAT	Turns graticule on or off. Preset condition is on.
KSg	Turns off CRT beam
*KSh	Turns on CRT beam
KSm	Turns off graticule
*KSn	Turns on graticule
KSo	Turns off annotation
*KSp	Turns on annotation
*LG	Selects log scale
LN	Selects linear scale
*L0	Turns off display line
TH	Specifies display threshold value
THE	Turns threshold on or off
*T0	Turns off threshold
TRGRPH	Dimensions and graphs a trace

READING AND WRITING DISPLAY MEMORY

*DA	Specifies display address
DD	Writes to display (binary) and advances address by 1.
DR	Reads display and advances address by 1
DSPLY	Displays the value of a variable on the analyzer screen
DT	Defines a character for label termination
DW	Writes to display and advances address by 1
*D1	Sets display to normal size
D2	Sets display to full CRT size
D3	Sets display to expanded size
*EM	Erases trace C memory

*Selected with instrument preset (IP)

GR	Graphs specified y values on CRT
*HD	Holds or disables data entry and blanks active function CRT readout
IB	Inputs trace B in binary units
KSE	Sets title mode
KS{39}	Writes to display memory in fast binary
KS{125}	Writes to display memory in binary
KS{127}	Prepares analyzer to accept binary display write commands
LB	Writes specified characters on CRT
OP	Returns lower left and upper right vertices of display window
PA	Draws vectors to specified x and y positions
*PD	Turns on beam to view vector
PR	Draws vector from last absolute position
PS	Skips to next display page
PU	Turns off beam, blanking vector
SW	Skips to next control instruction
TEXT	Writes text string to screen at current pen location

TRACE PROCESSING

*A1	Clear-writes trace A
A2	Max holds trace A
A3	Stores and views trace A
A4	Stores and blanks trace A
B1	Clear-writes trace B
B2	Max holds trace B
B3	Stores and views trace B
*B4	Stores and blanks trace B
BLANK	Stores and blanks specified trace register
CLRW	Clear-writes specified trace register
KSj	Stores and views trace C
KSk	Stores and blanks trace C
KS{39}	Writes to display memory in fast binary
KS{123}	Reads display in binary units
KS{125}	Writes to display memory in binary units
KS{126}	Outputs every nth value of trace
MOV	Moves source to the destination
MXMH	Max holds the specified trace register
TA	Outputs trace A
TB	Outputs trace B
TRDSP	Turns specified trace on or off, but continues taking information
VIEW	Views specified trace register

TRACE MATH

AMB	A - B into A
AMBPL	(A - B) + DL into A
APB	A + B into A
AXB	Exchanges A and B
BL	B - DL into B
BML	B - DL into B
BTC	B into C
BXC	Exchanges B and C
*C1	A - B off
C2	A - B into A
EX	Exchanges A and B
KSG	Turns on video averaging
*KSH	Turns off video averaging
KSc	A + B into A
KSi	Exchanges B and C
KSI	B into C
TRMATH	Executes trace math or user-operator commands at end of sweep
VAVG	Turns video averaging on or off

*Selected with instrument preset (IP)

OTHER TRACE FUNCTIONS

AUNITS	Specifies amplitude units for input, output, and display
COMPRESS	Compresses trace source to fit trace destination
CONCAT	Concatenates operands and sends new trace to destination
DET	Specifies input detector type
FFT	Performs a forward fast fourier transform
*KSa	Selects normal detection
KSb	Selects position peak detection
KSd	Selects negative peak detection
KSs	Selects sample detection
MEAN	Returns trace mean
ONEOS	Executes specified command(s) at end of sweep
ONSWP	Executes specified command(s) at start of sweep
PDA	Returns probability density of amplitude
PDF	Returns probability density of frequency
PEAKS	Returns number of peak signals
PWRBW	Returns bandwidth of specified percent of total power
RMS	Returns RMS value of trace in display units
SMOOTH	Smooths trace over specified number of points
STDEV	Returns standard deviation of trace amplitude in display units
SUM	Returns sum of trace element amplitudes in display units
SUMSQR	Squares trace element amplitudes and returns their sum
TRDEF	Defines user-defined trace name and length
TRGRPH	Dimensions and graphs a trace
TRPRST	Sets trace operations to preset values
TRSTAT	Returns current trace operations
TWINDOW	Formats trace information for fast fourier analysis (FFT)
VARIANCE	Returns amplitude variance of trace

USER-DEFINED COMMANDS

*DISPOSE	Frees memory previously allocated by user-defined functions. Instrument preset disposes ONEOS, ONSWP, and TRMATH functions.
FUNCDEF	Assigns specified program to function label
KEYDEF	Assigns function label or command list to softkey number (See FUNCDEF)
KEYEXC	Executes specified softkey
MEM	Returns amount of allocatable memory available for user-defined commands
ONEOS	Executes specified command(s) at end of sweep
ONSWP	Executes specified command(s) at start of sweep
TRDEF	Defines user-defined trace
TRMATH	Executes specified trace math or user-operator commands at end of sweep
USTATE	Configures or returns configuration of user-defined state: ONEOS, ONSWP, TRMATH, VARDEF, FUNCDEF, TRDEF
*VARDEF	Defines variable name and assigns real value to it. Preset reassigns initial value to variable identifier.

PROGRAM FLOW CONTROL

IF	Compares two specified operands. If condition is true, executes commands until next ELSE or ENDIF statements are countered
THEN	No-operation function
ELSE	Delimits alternate condition of IF command
ENDIF	Delimits end of IF command
REPEAT	Delimits the top of the REPEAT UNTIL looping construct

*Selected with instrument preset (IP)

UNTIL Compares two specified operands. If condition is true, commands are executed following this command. If condition is false operands are executed following the previous REPEAT command.

MATH FUNCTIONS

ADD	Operand 1 + operand 2 into destination
AVG	Operand is averaged into destination
CONCAT	Concatenates two operands and sends new trace to destination
CTA	Converts operand values from display units to vertical measurement units
CTM	Converts operand values from vertical measurement units to display units
DIV	Operand 1 / operand 2 into destination
EXP	Operand is divided by specified scaling factor before being raised as a power of 10
LOG	LOG of operand is taken and multiplied by specified scaling factor
MIN	Minimum between operands is stored in destination
MOV	Source is moved to destination
MPY	Operand 1 x operand 2 into destination
MXM	Maximum between operands is stored in destination
SQR	Square root of operand is stored in destination
SUB	Operand 1 - operand 2 into destination
XCH	Contents of the two destinations are exchanged

Operations on specific traces (A, B, and C) can be found in the Trace Math section.

INFORMATION AND SERVICE DIAGNOSTICS COMMANDS

BRD	Reads data word at analyzer's internal input/output bus
BWR	Writes data word to analyzer's internal input/output bus
ERR	Returns results of processor test
ID	Returns the HP model number of analyzer used (HP 8566B or HP 8568B)
KSF	Measures sweep time
KSJ	Allows manual control of DAC
KSK	Counts pilot IF at marker
KSN	Counts voltage-controlled oscillator at marker
KSQ	Counts signal IF
KSR	Turns frequency diagnostics on
* KSS	Second LO frequency is determined automatically
KST	Shifts second LO down
KSU	Shifts second LO up
KSf	Recovers last instrument state at power on
KSq	De-couples IF gain and input attenuation
KSr	Sets service request 102
KSt	Continues sweep from marker
KSu	Stops sweep at active marker
KSv	Inhibits phase lock
KS w	Displays correction data
KS =	Specifies resolution of frequency counter
KS >	Specifies preamp gain for signal input 1
KS <	Specifies preamp gain for signal input 2
MBRD	Reads specified number of bytes starting at specified address and returns to controller
MBWR	Writes specified block data field into analyzer's memory starting at specified address
MRD	Reads two-byte word starting at specified analyzer memory address and returns word to controller

*Selected with instrument preset (HP)

MRDB Reads 8-bit byte contained in specified address and returns byte to controller
MWR Writes two-byte word to specified analyzer memory address
MWRB Writes one-byte message to specified analyzer memory address
REV Returns analyzer revision number
RQS Returns decimal weighting of status byte bits which are enabled during service request

OUTPUT FORMAT CONTROL

DR Reads display and increments address
DSPLY Displays value of variable on analyzer screen
EE Enables front panel number entry
KSJ Allows manual control of DAC
KSP Sets HP-IB address
KS{91} Returns amplitude error
KS{123} Reads display in binary units
KS{126} Returns every nth value of trace
LL Provides lower left x-y recorder output voltage at rear panel
MA Returns marker amplitude
***MDS** Specifies measurement data size to byte or word. Preset condition is word.
MDU Returns values of CRT baseline and reference level
MF Returns marker frequency
OA Returns active function
OL Returns learn string
OT Returns display annotation
O1 Selects output format as integers (ASCII) representing display units or display memory instruction words
O2 Selects output format as two 8-bit bytes
***O3** Selects output format as real numbers (ASCII) in Hz, volts, dBm, or seconds
O4 Selects output format as one 8-bit byte
TA Outputs trace A
TB Outputs trace B
***TDF** Selects trace data output format as O1, O2, O3, O4, A-block data field, or I-block data field. Preset format is O3.
UR Provides upper right x-y recorder output voltage at rear panel

SYNCHRONIZATION

DONE Sends message to controller after preceding commands are executed
TS Takes a sweep

SERVICE REQUEST

KSr Allows service request 102
RQS Returns decimal weighting of status byte bits which are enabled during service request
R1 Resets service request 140
R2 Allows service request 140 and 104
***R3** Allows service request 140 and 110
R4 Allows service request 140 and 102
SRQ Sets service request is operand bits are allowed by RQS

SRQ	COMMAND	BIT	DEFINITION
102	R4	1	units key pressed
102	• KS{43}	1	frequency limit exceeded
104	R2	2	end of sweep
110	R3	3	hardware broken
120	RQS	4	command complete – input buffer empty
140	all	5	illegal command
1xx	–	6	universal HP-IB service

*Selected with instrument preset (IP)

PLOTTER OUTPUT

LL	Provides lower left x-y recorder output voltage at rear panel
PLOT	Plots CRT. Scaling points, P1 and P2 must be specified and must be compatible with plotter.
P1x	Represents first x-axis scaling point to be specified in PLOT command
P1y	Represents first y-axis scaling point to be specified in PLOT command
P2x	Represents second x-axis scaling point to be specified in PLOT command
P2y	Represents second y-axis scaling point to be specified in PLOT command
UR	Provides upper right x-y recorder output voltage at rear panel

MEMORY INFORMATION

*EM	Erases trace C memory
KSz	Sets display storage address
KS 	Writes to display storage
MEM	Returns amount of allocatable memory available for user-defined commands, in bytes

TRACKING GENERATOR APPLICATION

*KSS	Second LO frequency is determined automatically
KST	Shifts second LO down (necessary for HP 8444A-059 operation in spans < f MHz)
KSU	Shifts second LO up

OPERATOR ENTRY

EE	Enables front panel data number entry
EK	Enables DATA knob
EP	Enables manual entry into specified command
*HD	Holds or disables data entry and blanks active function CRT readout
KS	Shifts front panel keys

*Selected with instrument preset (1P)

PROGRAMMING COMMANDS

All the commands in this section are immediately executed.

Command syntax is represented pictorially. All characters enclosed by a rounded envelope must be entered exactly as shown.

Words enclosed by a rectangular box are names of items also used in the command statement. These items are described in the table below, and are also described in the tables below the syntax diagrams for each command. Statement elements are connected by lines. Each line can be followed in only one direction, as indicated by the arrow at the end of the line. Any combination of statement elements that can be generated by following the lines in the proper direction is syntactically correct. An element is optional if there is a path around it. Optional items usually have default values. The table or text following the diagram specifies the default value that is used when an optional item is not included in a statement.

In the diagrams, narrow ovals surround command names. Circles and wide ovals surround secondary keywords, or special numbers and characters.

Command Statement Elements Enclosed in Rectangular Boxes

A-Block Data Field	Absolute block data field consisting of #, A, Length , and Command List .
Average Count	Integer representing counter value. Default value is current counter value.
Average Length	Integer representing maximum number of sweeps executed for computing average.
Carriage Return	Asserts carriage return. (ASCII code 13.)
Character	Represents text displayed on screen. (ASCII codes 32 through 126.)
Command List	Alphanumeric character comprising any spectrum analyzer command. (ASCII characters 0 through 255.)
Data Bytes	8-bit bytes representing command list.
Display Address	Integer signifying 1 of 1008 elements (display units) of trace A, B, or C. Trace A comprises addresses 0 through 1023. Trace B comprises addresses 1024 through 2047. Trace C comprises addresses 3072 through 4095.
ETX	Marks end of text. (ASCII code 3.)

Function Label	User-defined label declared in FUNCDEF statement. Alpha character of 2 to 12 characters: AA through ZZ and “_” (ASCII character 95). Recommend “_” as second character.
I-Block Data Field	Indefinite block data field consisting of #, I, Command List , and END.
Key Number	Integer (0 to 999) representing number of user-defined key declared in KEYDEF statement.
Length	Two 8-bit bytes specifying length of command list in A-Block Data Field , in 8-bit bytes. The most significant byte is first: MSB LSB.
Line Feed	Asserts line feed. (ASCII code 10.)
Local	Returns spectrum analyzer to local control. Controller dependent.
Marker Number	Integer (1, 2, 3, or 4) specifying 1 of 4 markers.
Measurement-Variable Identifier	Alpha characters representing instrument identifiers, such as CF or MA.
Number of Points	Integer representing number of points for running average in SMOOTH command.
P1X and P1Y	Integer representing plotter-dependent values that specify lower-left plotter dimension.
P2X and P2Y	Integer representing plotter-dependent values that specify upper-right plotter dimension.
Real	The range of real numbers is $-1.797\ 693\ 134\ 862\ 315\ E+308$ through $-2.225\ 073\ 858\ 507\ 202\ E-308$, 0, and $+2.225\ 073\ 858\ 507\ 202\ E-308$ through $+1.797\ 693\ 134\ 862\ 315\ E+308$.
String Delimiter	!"\$%&'/:=@\~ (ASCII characters 33, 34, 36, 37, 38, 39, 47, 58, 61, 64, 92, 126, respectively).
Terminator	Character defined with DT command that marks end of text. (ASCII codes 0–255).
Trace Element	Any element (point) of trace A, B, or C, or a user-defined trace.
Trace Label	User-defined label declared in TRDEF statement. Alpha character of 2 to 12 characters: AA through ZZ and “_” (ASCII character 95). Recommend “_” as second character.
Trace Length	Integer determining number of elements (display units or points) in user-defined trace array, declared in TRDEF statement. Range is 1 to 1008. Default is 1001.
User-Defined Identifier	User-defined label declared in VARDEF statement. Alpha character of 2 to 12 characters: AA through ZZ and “_” (ASCII character 95). Recommend “_” as second character.

Variable Identifier

User-Defined Identifier declared in VARDEF statement.

Alpha character of 2 to 12 characters: AA through ZZ and “_” (ASCII character 95). Recommend “_” as second character.

or

Measurement-Variable Identifier

Alpha characters representing instrument identifiers:

AT, FB, KS>, MA, RL, VB, CF, KS<, MF, SP, DA, KSZ, OA, ST, DL, RB, TH, FA, KSP, LG, KS =

Trace Element

X Position

Integer value, in display units, that shifts trace position to right of specified **Display Address**. (See TRGRPH.)

Y Position

Integer value, in display units, that shifts trace position above specified **Display Address**. (See TRGRPH.)

Alphanumeric character comprising any spectrum analyzer command.

Secondary Keywords Enclosed in Circles

ALL	all
AMP	amplitude
AVG	average detection
B	8-bit byte
DB	decibel (unit)
DBM	absolute decibel milliwatt (unit)
DBMV	decibel millivolt
DBUV	decibel microvolt
DELTA	delta
DM	absolute decibel milliwatt (unit)
DN	decreases the parameter one step size
EP	pauses program operation for data entry from front panel
EQ	equal
EXT	external
FFT	fast fourier transform (MKREAD command only)
FIXED	fixed
FREE	free run
FRQ	frequency
GE	greater than or equal
GT	greater than
GZ	gigahertz (unit)
HI	highest
HZ	hertz
IST	inverse sweep time
KZ	kilohertz (unit)
LE	less than or equal
LINE	line, as in power line
LT	less than
MS	millisecond (unit)
MV	millivolts (unit)
MZ	megahertz (unit)
NE	not equal to
NEG	negative peak detection
NH	next highest
NL	next left
NR	next right
NRM	normal Rosenfell detection
OA	output active. Returns the value of the associated parameter.
OFF	turn function off

ON	turn function on
PER	period
PK-PIT	peak-to-peak average detection
PK-AVG	peak minus average detection
POS	positive peak detection
PSN	position
SC	seconds (unit)
SMP	sample detection
SWT	sweep time
TRA	trace A
TRB	trace B
TRC	trace C
UP	increases the parameter one step size
UV	microvolts (unit)
US	microseconds (unit)
V	volts (unit)
VID	video
W	2-byte word
?	returns a query response containing the value or state of the associated parameter

ADD

Add

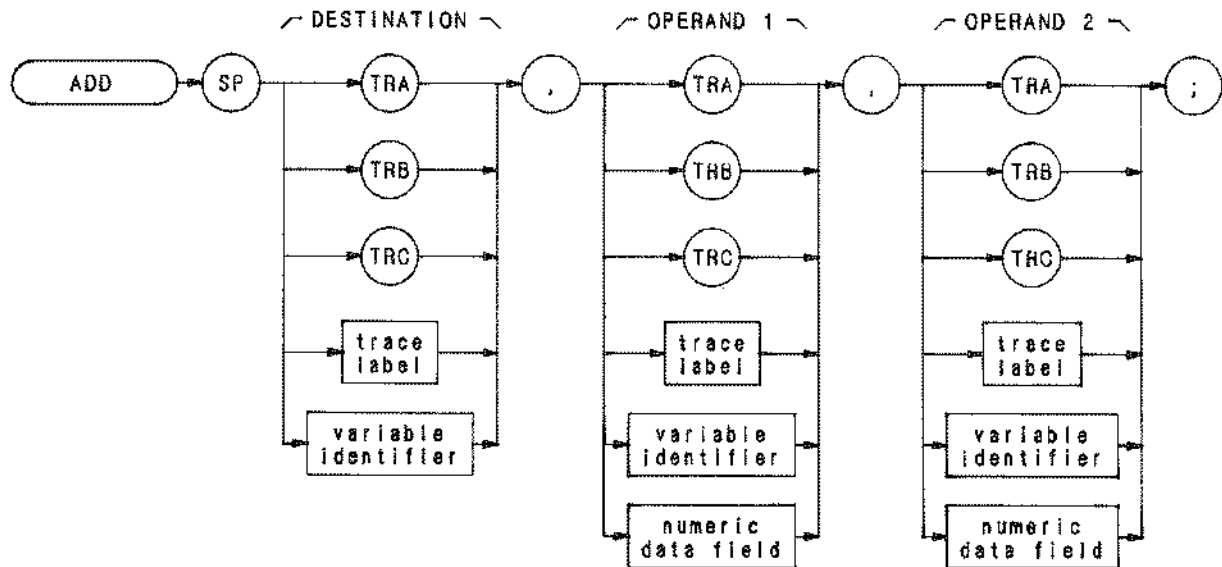

Item	Description/Default	Range Restriction
TRACE LABEL	Alpha character. User-defined label declared in TRDEF statement.	AA-ZZ and __ 2-12 characters required.
VARIABLE IDENTIFIER	Alpha character. User-defined identifier declared in VARDEF statement.	AA-ZZ and __ 2-12 characters required.
	or	
	Alpha character. Measurement-variable identifier, such as CF or MA.	
	Trace element, such as TRA	
NUMERIC DATA FIELD	Real	

The ADD command adds the operands, point by point, and sends the sum to the destination.

$$\text{operand 1} + \text{operand 2} \rightarrow \text{destination}$$

The operands and destination may be different lengths. The trace operands (TRA, TRB, TRC, and trace label) range from 1 to 1008 elements in length. A variable identifier or numeric data field is 1 element long. When operands differ in length, the last element of the shorter operand is repeated for the addition process. When the operands are longer than the destination, they are truncated to fit.

The following program demonstrates the ADD command.

```
10 OUTPUT 718;"SNGLS;"
20 OUTPUT 718;"VARDEF COUNT,0:VARDEF SCORE,0;"
30 OUTPUT 718;"FUNCDEF C__LOP,"""
40 OUTPUT 718;"REPEAT TS;"
50 OUTPUT 718;"ADD COUNT,COUNT,1;"
60 OUTPUT 718;"UNTIL COUNT,EQ,3,"""
70 OUTPUT 718;"REPEAT;"
80 OUTPUT 718;"C__LOP;"
90 OUTPUT 718;"ADD SCORE,SCORE,1;"
100 OUTPUT 718;"UNTIL SCORE,EQ,4;"
```

The operands and results of trace math are truncated if they are not within certain limits. If operating on traces A, B, or C, results must be within 1023. If operating on user-defined traces, results must be within 32,767.

AMB

A-B→A
(C2)



The AMB command subtracts trace B from trace A, point by point, and sends the difference to trace A.

$$A - B \rightarrow A$$

The functions of the command AMB, the command C2, and front panel  key are identical.

See C1 and C2. Also refer to Chapter 5 in Section I.

OUTPUT 718; "AMB;"

A-B + display line → A

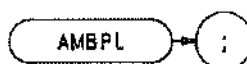

The AMBPL command subtracts trace B from trace A, point by point, adds the display line value to the difference, and sends the result to trace A, as demonstrated in the program below.

$$A - B + \text{display line} \rightarrow A$$

```
10 OUTPUT 718;"IP;SNGLS;TS;A3;"
20 OUTPUT 718;"RL-5ODM;TS;B3;"
30 OUTPUT 718;"DL-70;"
40 OUTPUT 718;"AMBPL;"
50 LOCAL 718
60 END
```

ANNOT

Annotation

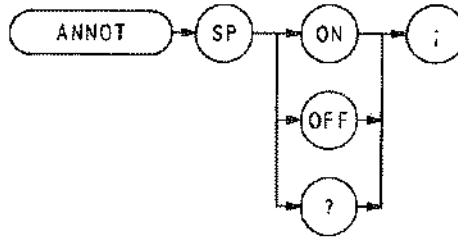

The ANNOT command turns the annotation on or off.

OUTPUT 718; "ANNOT ON;"

When queried (?), ANNOT returns the annotation state: on or off. The state is followed by carriage-return/line-feed (ASCII codes 13, 10). The end-of-identity state (EOI) is asserted with line feed.

(See KSo and KSp.)

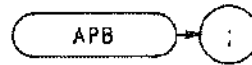

The APB command adds trace A and trace B, point by point, and sends the result to trace A. Thus, APB can restore the original trace after an A-minus-B function (AMB) is executed.

$$A + B \rightarrow A$$



To successfully add all trace elements, place trace A in VIEW or BLANK display mode before executing APB. The sample program below has both traces in STORE mode.

```

10 ASSIGN @Sa TO 718
20 OUTPUT @Sa; "IP;"
30 OUTPUT @Sa; "CF100MZ;SP2MZ;"
40 OUTPUT @Sa; "A3;"
50 OUTPUT @Sa; "B1;CF100MZ;"
60 OUTPUT @Sa; "B3;"
70 OUTPUT @Sa; "APB;"
80 END

```

Line 20: Presets the instrument.
 Line 30: Sets trace A to 100 MHz center frequency with 2 MHz frequency span.
 Line 40: Views trace A.
 Line 50: Selects trace B and sets center frequency to 200 MHz.
 Line 60: Views trace B.
 Line 70: Combines the amplitude of trace B with trace A and displays this combination as trace A.

The functions of the APB and KSc commands and the front panel   keys are identical.

AT

Attenuation

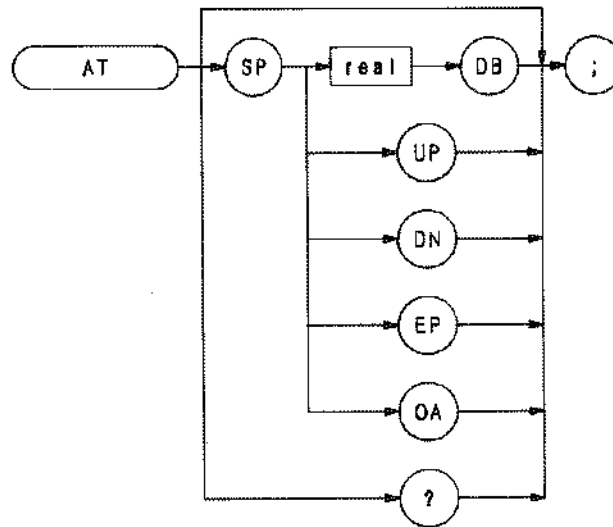

The AT command specifies the RF input attenuation from 0 to 70 dB, in 10 dB steps.

The input attenuator is coupled to the reference level. This coupling keeps the mixer input level at or below a threshold, when a continuous wave signal is displayed on the spectrum analyzer screen with its peak at the reference level. Instrument preset (IP) sets the threshold value to -10 dBm. (See KS, and ML.)

The AT command allows less than the threshold value at the mixer input. Executing CA (couple attenuator) resets the attenuation value so that a continuous wave signal displayed at the reference level yields -10 dBm (or the specified threshold value) at the mixer input.

When the attenuation is changed with the AT command, the reference level does not change. Likewise, when the reference level is changed with the RL command, the input attenuation changes to maintain a constant signal level on screen.

The following program lines illustrate proper syntax:

```
10 OUTPUT 718;"AT 60;"  
20 OUTPUT 718;"AT UP;"
```

Line 10: Sets attenuation to 60 dB.

Line 20: Sets attenuation to 70 dB.

When queried (OA or ?), AT returns the attenuation value as a real number, followed by a carriage-return/line-feed (ASCII codes 13, 10). The end-or-identify state (EOI) is asserted with line feed.

Refer to Chapter 8 in Section I.

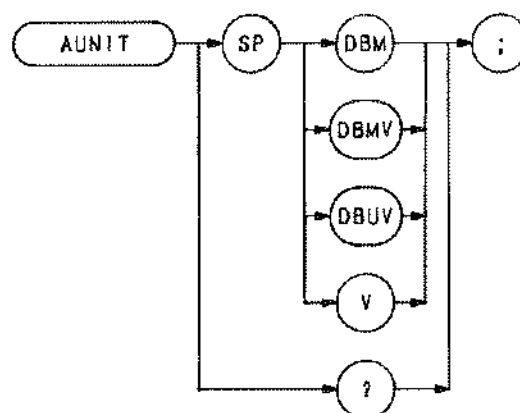

The AUNITS command sets the amplitude readouts (reference level, marker, display line, and threshold) to the specified units. (See KSA, KSB, KSC, and KSD.)

AVG

Average

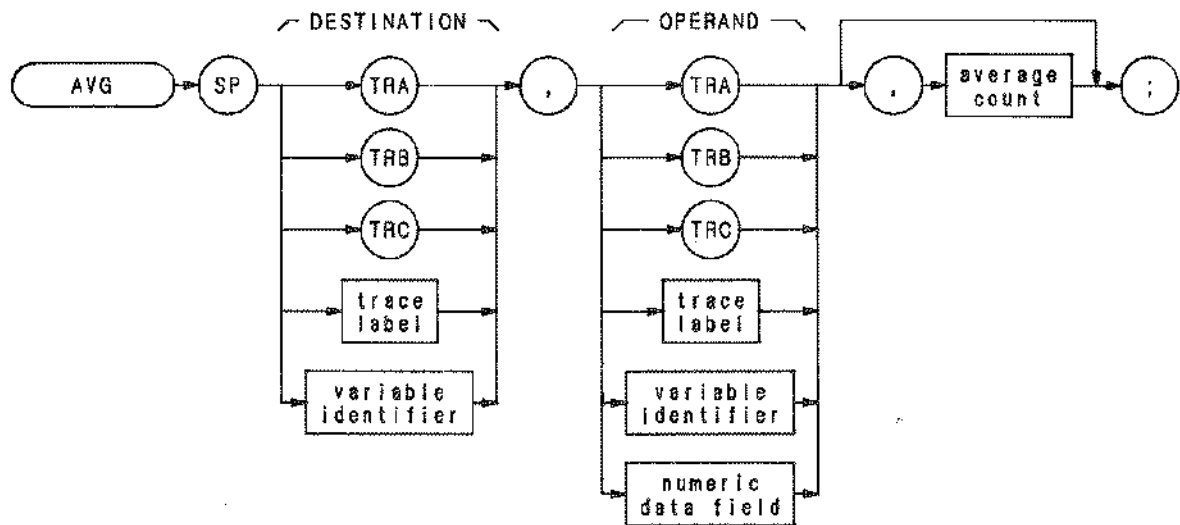

Item	Description/Default	Range Restriction
TRACE LABEL	Alpha character. User-defined label declared in TRDEF statement.	AA-ZZ and ___ 2-12 characters required.
VARIABLE IDENTIFIER	Alpha character. User-defined identifier declared in VARDEF statement.	AA-ZZ and ___ 2-12 characters required.
	Alpha character. Measurement-variable identifier, such as CF or MA.	
	Trace element, such as TRA	
NUMERIC DATA FIELD	Real	
AVERAGE COUNT	Selects counter value. Default is current counter value.	

The AVG command averages the operand and the destination according to the following algorithm.

$$\text{Average} = (\text{average count} - 1) \cdot (\text{destination}/\text{average count}) + (1/(\text{average count}) \cdot \text{OPERAND})$$

The average counter may be set to 1 with the **CLAVG** command.

```
10 OUTPUT 718;"SNGLS;A1;TS;RL; -50;B1;TS;"
20 For I = 1 TO 100
30 OUTPUT 718;"AVG TRB,TRA,1E10"
40 NEXT I
50 END
```

AXB

Exchange A and B
(EX)

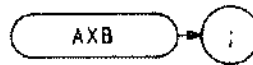

The AXB command exchanges trace A and B, point by point.

The functions of the AXB and EX commands are identical. (Refer to Chapter 5 in Section I.)

OUTPUT 718; "AXB;"

Only trace information in display addresses 1 through 1001 and 1025 through 2025 is exchanged.

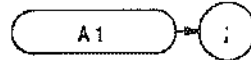

The A1 command enables the clear-write mode, which continuously displays any signals present at the spectrum analyzer input.

OUTPUT 718; "A1;"

The A1 command initially clears trace A, setting all trace A elements to a zero amplitude level. The sweep trigger then signals the start of the sweep, and trace A is continuously updated as the sweep progresses.



In addition, subsequent sweeps send new amplitude information to display memory addresses 1 through 1001. A1 also writes instruction word 1040* into address 0. Therefore, any information stored in memory address 0 is always lost whenever A1 is executed.

If you have used address 0 for a graphics program or label, you may wish to save the contents of address 0 before executing A1. For additional information, refer to Appendix A. The functions of the A1 command and front panel



key are identical. (See CLRW and B1.)

* 1040 is a machine instruction word that causes the analyzer to set address 1 through 1023 to zero, and draw trace A.

A2

Maximum Hold A

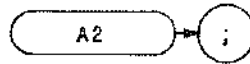

The A2 command updates each trace element with the maximum level detected, while the trace is active and displayed. The functions of the MXMH and A2 commands, and front panel ^b key are identical.

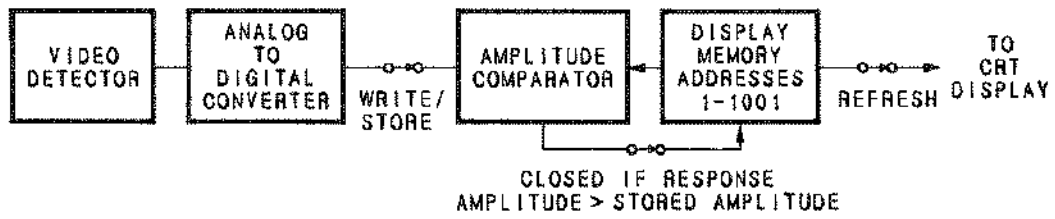

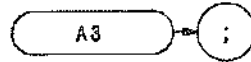

The A3 command displays trace A and stops the sweep. Thus, trace A is not updated.



When A3 is executed, the contents of trace are stored in display memory addresses 1 through 1001. A3 writes instruction word 1040* into address 0. Therefore, any information stored in memory address 0 is always lost whenever A3 is executed.

If you have used address 0 for a graphics program or label, you may wish to save its contents before executing A3.

For additional information, refer to Appendix A. The functions of the A3 command and front panel  key are identical. (See B3, VIEW, and TRSTAT.)

OUTPUT: "A3;"

* 1040 is a machine instruction word that causes the analyzer to set addresses 1 through 1023 to zero, and draws trace A.

A4

Blank A

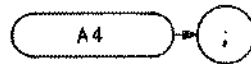

The A4 command blanks trace A and stops the sweep; the trace is not updated.



When A4 is executed, the contents of trace A are stored in display memory addresses 1 through 1001. A4 writes instruction word 1072* into address 0. Therefore, any information stored in address 0 is lost when A4 is executed.

If you have used address 0 for a graphics program or label, you may wish to save its contents before executing A4.

For additional information, refer to Appendix A. The functions of the A4 command and front panel  key are identical. (See BLANK, B4, and TRSTAT.)

OUTPUT 718; "A4;"

* 1072 is a machine instruction word that sets addresses 1 through 1023 to zero, and then skips to the next page of memory.

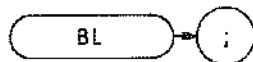

The BL command subtracts the display line from trace B and sends the difference to trace B.

$B - \text{display line} \rightarrow B$

The functions of the BL and BML commands, and the front panel  key are identical. (Refer to Chapter 7 in Section 1.)

The following program demonstrates the BL command.

```
10 OUTPUT 718;"IP;A4;S2;"
20 OUTPUT 718;"DL -85DM;"
30 OUTPUT 718;"B1;TS;BL;"
40 END
```

BLANK

Blank

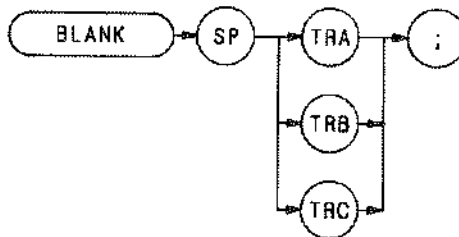

The BLANK command blanks trace A, B, or C and stops the sweep; the trace is not updated.

Trace A and C are discussed below. For detailed information about trace B, see B4 in this section.

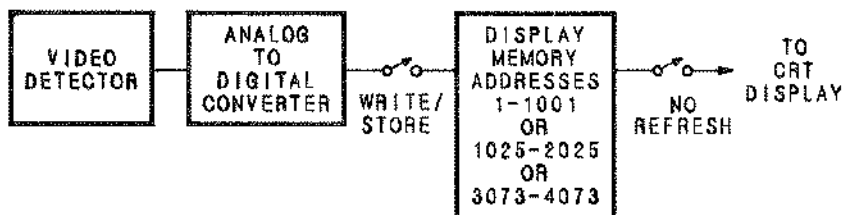

When BLANK TRA is executed, the contents of trace A are stored in display memory addresses 1 through 1023. Address 0 is reserved for the instruction word 1072*. Similarly, when BLANK TRB is executed, trace C contents are stored in addresses 3073 through 4095. Again, address 3072 is reserved for instruction word 1072*. Therefore, any information stored in address 0 is lost when BLANK TRA is executed. Likewise, the contents of address 3072 are lost when BLANK TRC is executed.

If you have used address 0 or 3072 for a graphics program or label, you may wish to save their contents before executing BLANK.

OUTPUT 718; "BLANK TRA;"

For additional information, refer to Appendix A. (See A4, B4, KSk, and TRSTAT.)

* 1072 is a machine instruction word that sets addresses 1 through 1023 (BLANK TRA) or 3073 through 4095 (BLANK TRC) to zero, and then skips to the next page memory.

B-display line → B

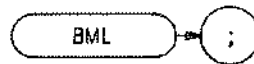

The BML command subtracts the display line from trace B, point by point, and sends the difference to trace B.

BML - display → B

The functions of the BML and BL commands, and the front panel  key are identical. (Refer to Chapter 5 in Section I.)

The following program demonstrates the BML command.

```
10 OUTPUT 718;"IP;A4;S2;"
20 OUTPUT 718;"DL -85DM;"
30 OUTPUT 718;"B1;TS;BML;"
40 END
```

BRD

Bus Read

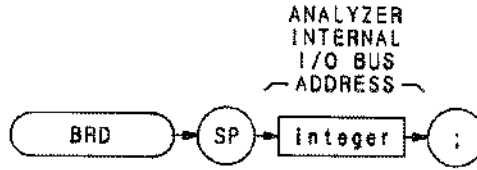

Item	Description/Default	Range Restriction
INTEGER	ASCII decimal number representing analyzer internal I/O bus address.	

The BRD command reads a two-byte word at the internal input/output bus of the spectrum analyzer, at the indicated address. BRD is a service diagnostic function only.

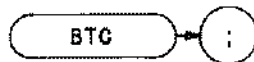

The BTC command transfers trace B to trace C.

Note that trace C is not a swept, active function. Therefore, transfer trace information to trace C as follows:

1. Select single sweep mode (S2).
2. Select desired analyzer settings.
3. Take one complete sweep (TS).
4. Transfer data.



This procedure ensures that the current settings of the analyzer are reflected in the transferred data.

```

10 OUTPUT 718;"IP;TS;SNGLS;A3;"
20 OUTPUT 718;"B1;CF 20MZ;TS;B4;"
30 OUTPUT 718;"BTC;KSI;"
31 LOCAL 718
40 END

```

When transferring trace data from one trace to another, only the trace information from 1001 display memory addresses is transferred out of the total 1024 available display memory addresses. Information in address 1024 and addresses 2026 through 2047 is not transferred. (Addresses 2026 through 2047 are usually used for custom graphics.)

The functions of the BTC and KSI commands and the front panel   keys are identical.

BWR

Bus Write Word

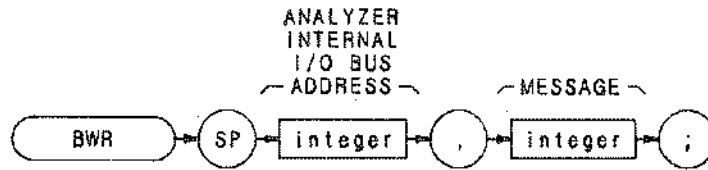

Item	Description/Default	Range Restriction
INTEGER	ASCII decimal number representing analyzer internal I/O bus address.	
INTEGER	ASCII decimal number representing two-byte word.	

The BWR command writes a two-byte word to the spectrum analyzer internal input/output bus, at the indicated address. BWR is a service diagnostic command.

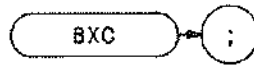

The BXC command exchanges traces C and B, point by point.

Note that trace C is not a swept, active function. Therefore, exchange traces C and B as follows:

1. Select single sweep mode (SNGLS).
2. Select desired analyzer settings.
3. Take one complete sweep (TS).
4. Exchange data.

This procedure ensures that the current settings of the analyzer are reflected in the transferred data.

When transferring data from one trace to another, only amplitude information is exchanged, located in display memory addresses 1025 through 2025 and 2049 through 3049.

The functions of the BXC and KSi commands are identical.

B1

Clear-Write B1

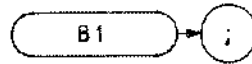

The B1 command enables the clear-write mode, which continuously displays any signals present at the spectrum analyzer input.

OUTPUT 718; "B1;"

The B1 command initially clears trace B, setting all trace B elements to a zero amplitude level. The sweep trigger then signals the start of the sweep, and trace B is continuously updated as the sweep progresses.



In addition, subsequent sweeps send new amplitude information to display memory addresses 1025 through 2025. B1 writes the instruction word 1048* to address 1024. Therefore, any information stored in memory address 1024 is always lost when B1 is executed.

If you have used address 1024 for a graphics program or label, you may wish to save its contents before executing B1.

For additional information, refer to Appendix A. The functions of the B1 command and front panel  key are identical. (See CLRW and A1.)

* 1048 is a machine instruction word that sets addresses 1025 through 2047 to zero, and draws trace B dimly.

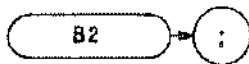

The B2 command updates each trace B element with the maximum level detected, while the trace is active and displayed.

OUTPUT 718; "B2;"

See MXMH.

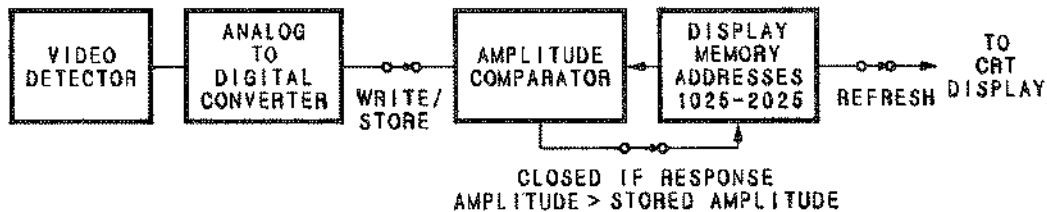

B3

View B

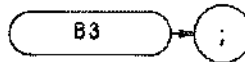

The B3 command displays trace B and stops the sweep. Thus, the trace is not updated.

OUTPUT 718; "B3;"

When B3 is executed, the contents of trace B are stored in display memory addresses 1025 through 2025. B3 writes the instruction word 1048* to address 1024. Therefore, any information stored in address 1024 is lost when B3 is executed.



If you have used address 1024 for a graphics program or label, you may wish to save its contents before executing B3.

For additional information, refer to Appendix A. The functions of the B3 command and front panel  key are identical. (See VIEW, A3, KSj, and TRSTAT.)

* 1048 is a machine instruction word that sets addresses 1025 through 2047 to zero, and draws trace B dimly.

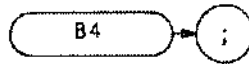

The B4 command blanks trace B and stops the sweep; the trace is not updated.



When B4 is executed, the contents of trace B are stored in display memory addresses 1025 through 2025. B4 writes the instruction word 1072* to address 1024. Therefore, any information stored in address 1024 is lost when B4 is executed.

If you have used address 1024 for a graphics program or label, you may wish to save its contents before executing B4.

For additional information, refer to Appendix A. The functions of the B4 command and front panel ^kBLANK key are identical. (See BLANK, A4, KSk, and TRSTAT.)

OUTPUT 718; "B4;"

* 1072 is a machine instruction word that sets addresses 1025 through 2047, and then skips to the next page of memory.

CA

Couple Attenuation

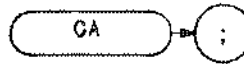

During normal operation, the spectrum analyzer is coupled to the reference level. This coupling keeps the mixer input level at or below a threshold, when a continuous wave signal is displayed on the spectrum analyzer screen so that its peak is at the reference level.

The CA command sets the threshold to -10 dBm (or a value specified by KS or ML). The counterpart to the CA command, the AT command, allows levels less than the threshold value at the mixer input.

OUTPUT 718; "CA;"

The functions of the CA command and the front panel  key are identical.

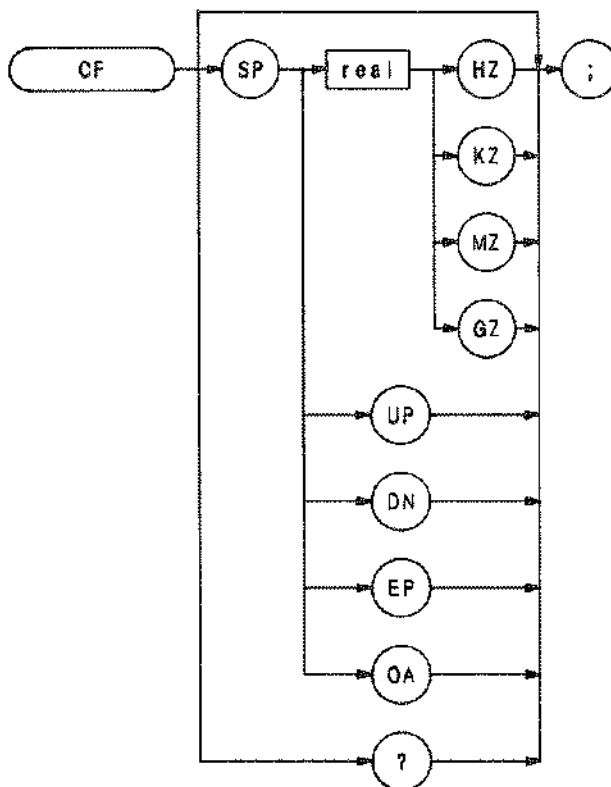

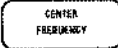
The CF command specifies the value of the center frequency, performing the same function as the front panel  key. (Refer to Chapter 3 in Section I.)

When queried (OA or ?), CF returns the center frequency value as a real number, followed by carriage-return/line-feed (ASCII codes 13, 10). The end-of-identity state (EOI) is asserted with line feed.

The following program returns a center frequency value of 350 MHz. The program displays the center frequency on the controller screen.

```

1  OUTPUT 718;"IP;01;"
10 OUTPUT 718;"CF 200MZ;"
20 OUTPUT 718;"CF UP;"
30 OUTPUT 718;"CF?;"
40 ENTER 718;N
50 PRINT N
60 END

```

CLRAVG

Clear Average

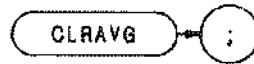

The CLRAVG command sets the average counter to 1. The average counter is active during execution of the AVG command.

OUTPUT 718: "CLRAVG;"

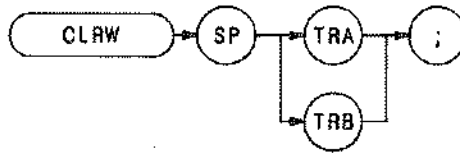

The CLR_W command enables the clear-write mode, which continuously displays any signals present at the spectrum analyzer input.

The CLR_W command operates on either trace A or trace B. Trace A is discussed below. For detailed information about the clear-write mode and trace B, see B1 in this section.

The CLR_W command initially clears trace A, setting all trace A elements to a zero amplitude level. The sweep trigger then signals the start of the sweep, and trace A is continuously updated as the sweep progresses.



In addition, subsequent sweeps send new amplitude information to display memory addresses 1 through 1023. Address 0 is reserved for the instruction word, 1040*. Therefore, any information stored in memory address 0 is always lost when CLR_W is executed.

If you have used address 0 for a graphics program or label, you may wish to save its contents before executing CLR_W.

OUTPUT 718; "CLR_W TRA;"

For additional information, refer to Appendix A. The functions of the CLR_W command and front panel  key are identical. (See B1 and A1.)

* 1040 is a machine instruction word that causes the analyzer to set addresses 1 through 1023 to zero, and draw trace A.

COMPRESS

Compress

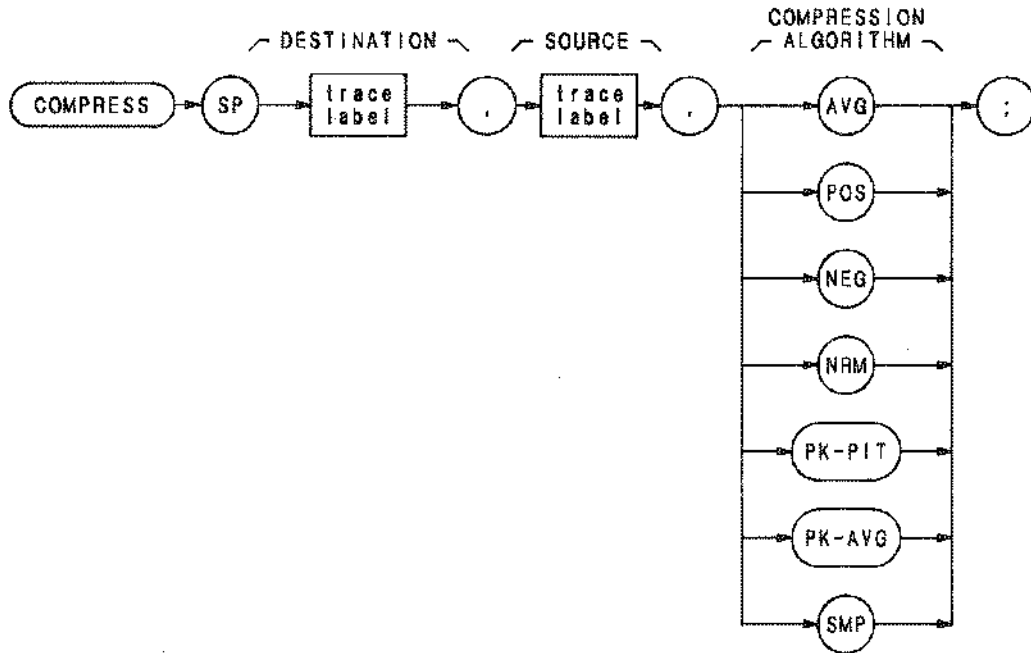

Item	Description/Default	Range Restriction
TRACE LABEL	Alpha character. User-defined label in TRDEF statement.	AA-ZZ and __ 2-12 characters required.

The COMPRESS command compresses the source trace to fit the destination trace, according to the compression algorithm, and ratio of source and destination trace sizes.

The source trace must be longer than the destination trace. The ratio of source trace length to destination trace length, in display units, equals K.

$$\text{source trace length} / \text{destination trace length} = K$$

$$\text{number of points in interval} = K$$

COMPRESS divides the source trace into intervals, and computes a compressed value for each interval. The compressed values become the amplitude values for all of the points in the destination trace. For example, if the source trace is 1000 points long, and the destination trace is 100 points long, K equals 10. COMPRESS divides the source trace into 100 intervals of 10 points each, and computes a compressed value for each interval. The 10 points are operated on by the compression algorithm, and the compressed value for the first interval becomes the amplitude of the first point in the destination trace. The 99 remaining compressed values determine the amplitude of the last 99 points of the destination trace.

The compression algorithms determine how the compressed values are computed.

Specifying AVG (average) computes the average value of the points in the interval as the compressed value.

Specifying POS (positive) selects the highest point in the interval as the compressed value.

Specifying NEG (negative) selects the lowest point in the interval as the compressed value.

Specifying NRM (normal) computes the compressed value of the interval using the Rosenfell algorithm, which chooses between negative and positive peak values.

Specifying PK-PIT (peak-pit) computes the greatest peak-to-peak deviation within the interval as the compressed value.

Specifying PK-AVG (peak average) selects the difference of the peak and average value of the interval as the compressed value.

Specifying SMP (sample) selects the last point in the interval as the compressed value.

The program below compresses a full sweep to one-fifth its size. The result is moved to trace A for display.

```

14  OUTPUT 718;"DISPOSE ALL;IP;A1;EM;S2;TS;"
21  OUTPUT 718;"TRDEF NEW__A,200;"
22  OUTPUT 718;"FUNCDEF C__P,!"
24  OUTPUT 718;"S2;TS;"
26  OUTPUT 718;"COMPRESS NEW__A,TRA,AVG;"
27  OUTPUT 718;"MOV TRA,NEW__A;"
28  OUTPUT 718;"!;"
31  OUTPUT 718;"C__P;"
36  END

```

CONCAT

Concatenate

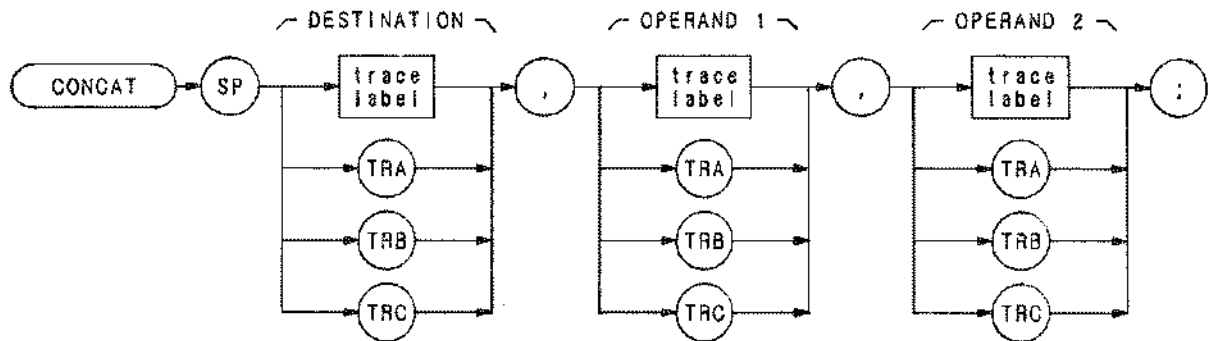

Item	Description/Default	Range Restriction
TRACE LABEL	Alpha character. User-defined label declared in TRDEF statement.	AA-ZZ and ___ 2-12 characters required.

The CONCAT command concatenates the operands and sends the new trace array to the destination.

The size of the destination varies from 1 to 1008 elements. Traces A, B, and C each contain 1001 elements. If necessary, use the COMPRESS command to reduce the length of the operands. Otherwise, the concatenated arrays may not fit in the destination, and trace information is lost.

```

10 OUTPUT 718;"IP;S2;B1;TS;B3;RL -3ODM;TS;A3;"
20 |
30 OUTPUT 718;"TRDEF XXX,500;"
40 OUTPUT 718;"COMPRESS XXX,TRA,AVG;"
50 |
60 OUTPUT 718;"EX;"
70 OUTPUT 718;"TRDEF ZZZ,500;"
80 OUTPUT 718;"COMPRESS ZZZ,TRA,AVG;"
90 |
100 OUTPUT 718;"B3;"
110 OUTPUT 718;"CONCAT TRB,XXX,ZZZ;"
120 |
130 END

```

CONTS

Continuous Sweep
(S1)



The CONTS command sets the analyzer to continuous sweep mode. In the continuous sweep mode, the analyzer continues to sweep (sweep times ≥ 20 ms) at a uniform rate from the start frequency to the stop frequency, unless new data entries are made from the front panel or via HP-IB. If the trigger and data entry conditions are met, the sweep is continuous.

The sweep light indicates that a sweep is in progress. The light is out between sweeps, during data entry, and for sweep times ≤ 10 ms.

OUTPUT 718: "CONTS;"

The functions of the CONTS and S1 commands, and front panel  key are identical.

CR

Couple Resolution Bandwidth

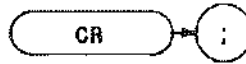

The CR command couples the resolution bandwidth with the video bandwidth and sweep time. The counterpart to the CR command, the RB command, breaks coupling. Use CR to reestablish coupling after RB has been executed.

OUTPUT 718; "CR;"

The functions of the CR command and the front panel key ^A are identical.

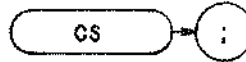

The CS command couples the center frequency step size to the span width, so that step size equals 10 percent of the span width, or one major graticule division. The counterpart to the CS command, the SS command, breaks coupling. Use CS to reestablish coupling after SS has been executed.

OUTPUT 718; "CS;"

The functions of the CS command and the front panel  key are identical.

CT

Couple Sweep Time

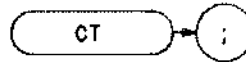

The CT command couples the sweep time with the resolution and video bandwidths. The counterpart to the CT command, the ST command, breaks coupling. Use CT to reestablish coupling after ST has been executed.

OUTPUT 718;"CT;"

The functions of the CT command and the front panel  key are identical.

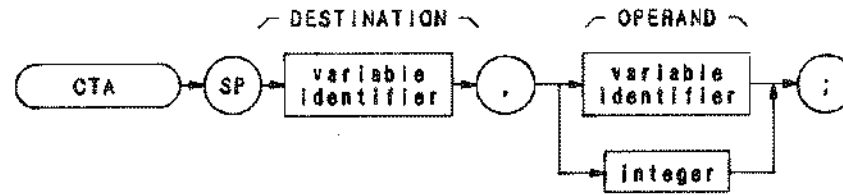

Item	Description/Default	Range Restriction
VARIABLE IDENTIFIER	Alpha character. User-defined identifier declared in VARDEF statement.	AA-ZZ and ___ 2-12 characters required.
NUMERIC DATA FIELD	Alpha character. Measurement-variable identifier representing amplitude value, such as MKA.	
	Real	

The CTA command converts the operand values from display units to the current absolute amplitude units.

CTM

Convert to Display Units

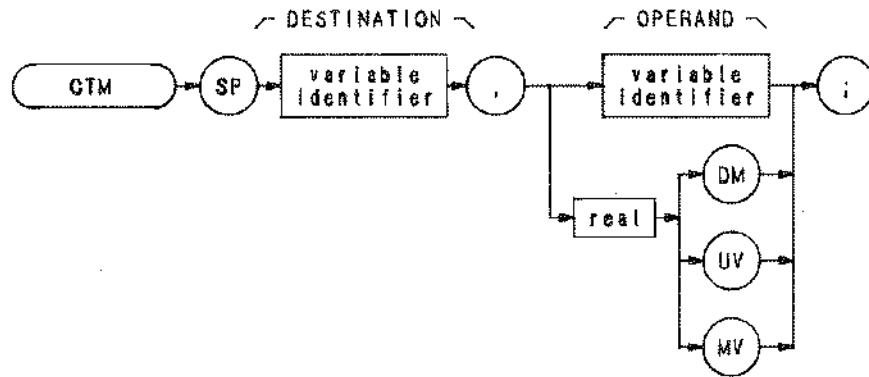

Item	Description/Default	Range Restriction
VARIABLE IDENTIFIER	Alpha character. User-defined identifier declared in VARDEF statement.	AA-ZZ and ___ 2-12 characters required.
NUMERIC DATA FIELD	Alpha character. Measurement-variable identifier representing amplitude value, such as MKA.	
	Real	

The CTM command converts the operand values to vertical display units.

OUTPUT 718; "VARDEF XXX,1; CTM XXX,12; DSPL XXX,13.6;"

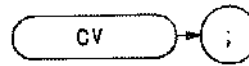

The CV command couples the video bandwidth with the resolution bandwidth and sweep time. The counterpart to the CV command, the VB command, breaks coupling. Use CV to reestablish coupling after VB has been executed.

OUTPUT 718; "CV;"

The functions of the CV command and the front panel ^B key are identical.

C1

A - B off

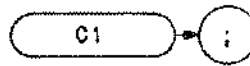

The C1 command turns off the A-minus-B mode.

OUTPUT 718; "C1;"

The functions of the C1 command and the front panel OFF key, located above the A-B-A key, are identical. (Refer to Chapter 5 in Section I. Also see AMB and C2.)

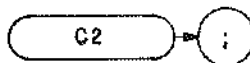

The C2 command subtracts trace B from trace A, point by point, and sends the difference to trace A.

$$A - B \rightarrow A$$

OUTPUT 718; "C2;"

The A-minus-B mode is turned off with the C1 command. The function of C2 is identical with that of the command AMB, and the front panel  key. (Refer to Chapter 5 in Section 1.)

DA

Display Address

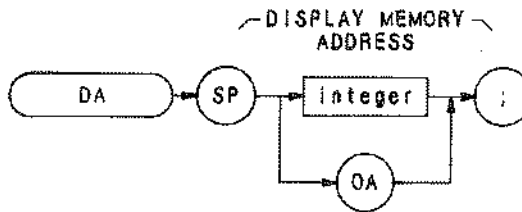

Item	Description/Default	Range Restriction
INTEGER	Represents analyzer display memory address.	0 - 4095

The DA command selects a specified display memory address to be the initial current (in-use) register. The display address register can then be accessed and advanced one address at a time with the DW, DD, and DR commands. Refer to Appendix B for additional information on the DA command.

A typical use of the DA command is shown in the sample program below.

```
10 OUTPUT 718;"01;DA;1024;"
20 FOR I= 1 TO 5
30 OUTPUT 718;"DA;OA;"
40 ENTER 718;A
50 OUTPUT 718;"DR;"
60 ENTER 718;W
70 OUTPUT 718;A,W
80 NEXT I
90 END
```

- Line 10: Addresses the analyzer, formats the output in decimal display units, and selects the first address to be read.
- Line 20-80: Reads and prints five successive display program addresses and their contents. The address is automatically advanced one address for each DR execution.
- Line 30: Activates the output of each display address.
- Line 50: Activates the output of each current display address.

Each display address contains twelve bits of information.



Item	Description/Default	Range Restriction
INTEGER	Represents 16-bit binary byte that is transmitted as two 8-bit bytes.	0 - 4095

The DD command writes two 8-bit bytes into the current or specified (with DA command) display memory address, and advances the address selection to the next higher address. If the DD command is followed by more than one pair of bytes, DD loads the pairs into consecutive display addresses. The display address is always advanced after a number is loaded into an address. (Each display address contains twelve bits.)

The bytes represent data or a display instruction.

Use the DD command in conjunction with the DR and DA commands to draw on the spectrum analyzer CRT. The functions of the DD and DW commands are identical, except that the controller must send instructions or data in binary form instead of decimal form. This difference is illustrated in the program below. The program tells the analyzer, in four different ways, to dim trace A. The number 1048 is an instruction word that means "dim trace."

```

10 OUTPUT 718;"A1;S2;TS;"
20 OUTPUT 718;"DA 0, DW 1048;"
30 PAUSE
40 OUTPUT 718;"A1;S2;TS;"
50 OUTPUT 718 USING "#,K,W";"DA 0;DD";1048
60 PAUSE
70 OUTPUT 718;"A1;S2;TS;"
80 OUTPUT 718 USING "#,K,B,B";"DA 1;DD",4,24
90 PAUSE
100 OUTPUT 718;"A1;S2;TS;"
110 A$ = CHR$(4)&CHR$(24)
120 OUTPUT 718 USING "#,K";"DA 0 DD",A$
130 END

```

Lines 10, 40, 70, 100: Sweeps trace and displays trace A once.
Line 20: Transmits instruction word 1048, in decimal form, to display address 0.
Line 50: Suppresses carriage-return/line-feed (#), transmits instruction word 1048 as one word (W for word, or 16 bits).
Line 80: Suppresses carriage-return/line-feed (#), transmits instruction word 1048 as two 8-bit bytes (B,B for byte,byte).
Line 110: Declares A4 equal to CHR\$(4) plus CHR\$(24).
Line 120: Transmits instruction word 1048, as A\$.

DD (Continued)

Refer to Appendix B for additional information about instruction words and display programming. The Consolidated Coding table in Appendix B is especially useful.

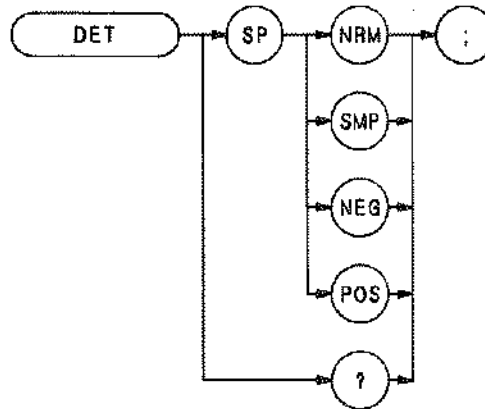

The DET command selects the kind of spectrum analyzer input detection: normal, sample, positive peak, or negative peak.

Normal (NRM) enables the Rosenfell detection algorithm that selectively chooses between positive and negative peak values. The IP command (instrument preset) also activates normal detection.

Sample (SMP) displays the instantaneous signal value detected at the analog-to-digital converter output. Video averaging and a noise-level marker, when active, also activate sample detection. (See MKNOISE, VAVG, or KSe.)

Positive peak detection (POS) displays the maximum signal value detected during the conversion period.

Negative peak detection (NEG) displays the minimum signal value detected during the conversion period. The program line below selects the negative peak detection.

```
OUTPUT 718;"DET NEG;"
```

When queried (?), DET returns the detection type to the controller (NRM, SMP, NEG, or POS) followed by carriage-return/line-feed (ASCII codes 13, 10). The line feed asserts the end-or-identify state (EOI).

DISPOSE

Dispose

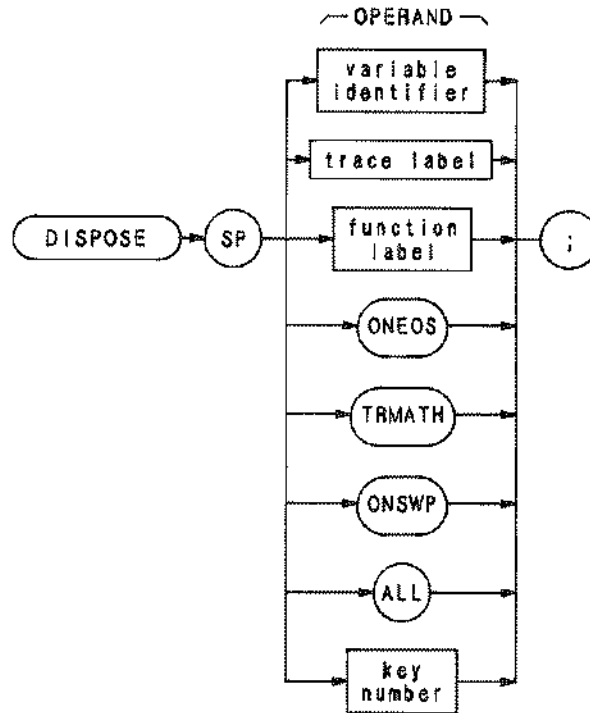

Item	Description/Default	Range Restriction
TRACE LABEL	Alpha character. User-defined label declared in TRDEF statement.	AA-ZZ and ___ 2-12 characters required.
VARIABLE IDENTIFIER	Alpha character. User-defined identifier declared in VARDEF statement.	AA-ZZ and ___ 2-12 characters required.
	Alpha character. Measurement-variable identifier, such as CF or MA.	
	Trace element, such as TRA [10]	
FUNCTION IDENTIFIER	Alpha character. User-defined label declared in FUNCDEF statement.	AA-ZZ and ___ 2-12 characters required.
KEY NUMBER	Integer representing number of user-defined key declared in KEYDEF statement.	0 - 999

The DISPOSE command clears any operand listed above. DISPOSE ALL clears all operands. The program line below disposes all command lists declared with a TRMATH command.

OUTPUT 718; "DISPOSE TRMATH;"

If the analyzer remains locked up — that is, it does not respond to remote commands but does respond to front panel commands — and interface clear (shift reset) does not free up the analyzer, then execute the following lines:

```
Send 7; LISTEN CMD 12  
Clear 718
```

This forces DISPOSE ALL.

DIV

Divide

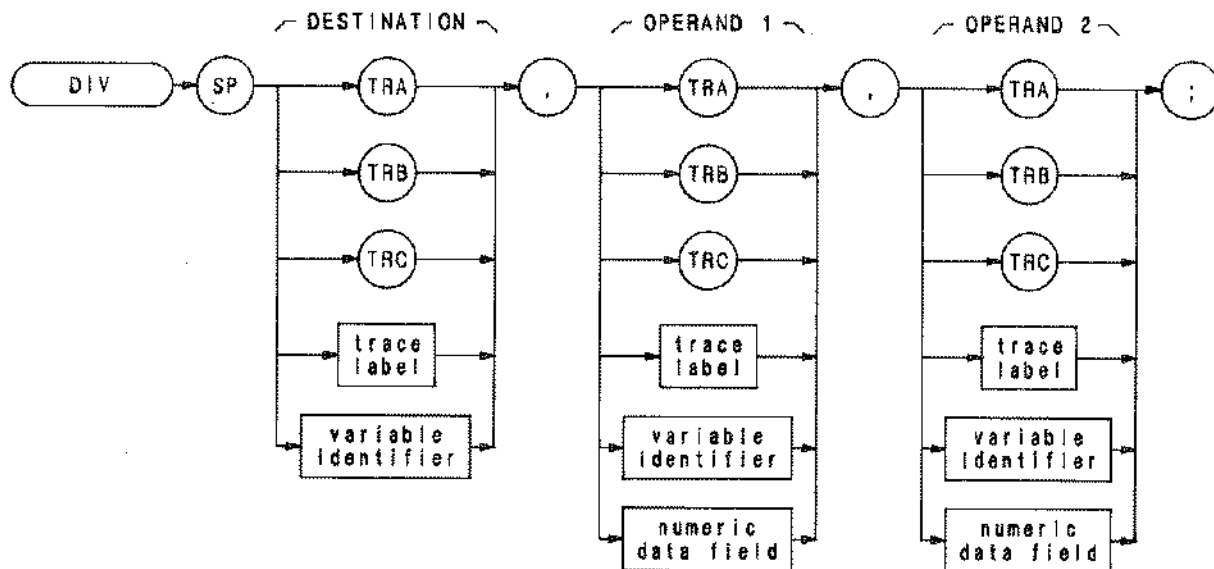

Item	Description/Default	Range Restriction
TRACE LABEL	Alpha character. User-defined label declared in TRDEF statement.	AA-ZZ and __ 2-12 characters required.
VARIABLE IDENTIFIER	Alpha character. User-defined identifier declared in VARDEF statement.	AA-ZZ and __ 2-12 characters required.
	Alpha character. Measurement-variable identifier, such as CF or MA.	
	Trace element, such as TRA [10]	
NUMERIC DATA FIELD	Real	

The DIV command divides operand 1 by operand 2, point by point, and sends the difference to the destination.

operand 1 / operand 2 → destination

The operands and destination may be of different length. The trace operands (TRA, TRB, TRC, and trace label) range from 1 to 1008 elements in length. A variable identifier or numeric data field is 1 element long. When operands are of different lengths, the last element of the shorter operand is repeated for operations with the remaining elements of the longer element. When the operands are longer than the destination, they are truncated to fit.

The operands and results of trace math are truncated if they are not within certain limits. If operating on traces A, B, or C, results must be within 1023. If operating on user-defined traces, results must be within 32,767.

DL

Display Line

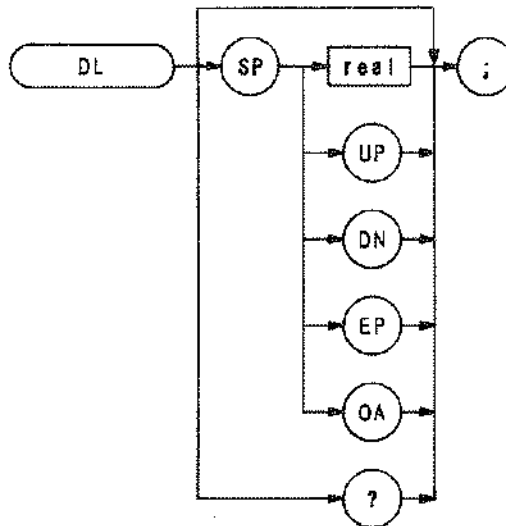

Item	Description/Default	Range Restriction
VARIABLE	Alpha character. User-defined identifier declared in VARDEF statement.	AA-ZZ and __ 2-12 characters required.
	Alpha character. Measurement-variable identifier, such as CF or MA.	
	Trace element, such as TRA [10]	

The DL command defines a display line level and displays it on the CRT. The level is in dBm and can be used in arithmetic functions, such as DIV or MXM.

The functions of the DL command and the front panel reference level key are identical. The display line also can be turned on or off by the DLE and LØ commands.

The following program lines compare a display line level of -10 dBm to the largest signal detected. If the display line level is greater than the signal level, the display line is lowered.

```
10 OUTPUT 718;"IP;DL -10DM;TS;MKPK;MA OA;"
20 ENTER 718;N
30 OUTPUT 718;"IF DL,GT,N THEN DL DN ENDIF;"
40 OUTPUT 718;80
50 END
```

When queried (? or OA), DL returns the display line level as a real number, followed by carriage-return/line-feed (ASCII codes 13, 10). The end-of-identify state (EOI) is asserted with line feed. (See DLE.)

DLE

Display Line Enable

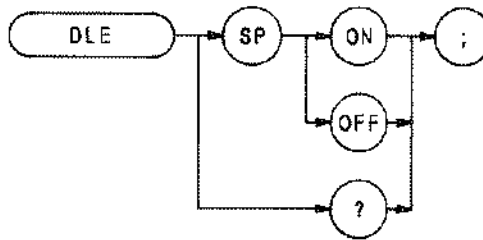

The DLE command enables or disables the display line.

The function of this command is similar to that of the DL and LØ commands, and the display line ^mOFF and ⁿENTER keys on the front panel.

When queried (?), DLE returns the display line state, ON or OFF, followed by carriage-return/line-feed (ASCII codes 13, 10). The line feed asserts the end-of-identify state (EOI).

```
10 OUTPUT 718;"IP;DLE ?;"
20 ENTER 718;A$
30 PRINT 718;A$
```

Since IP deactivates the display line, the query in the above program returns "OFF" to the controller.



Item	Description/Default	Range Restriction
COMMAND LIST	Any spectrum analyzer commands from this Remote section	

The DONE command is a synchronizing function. When DONE follows a command list, it sends the controller a 1 after the command list is executed. The TS command may also be a synchronizing function. If TS precedes the command list, list execution begins after the sweep is completed.

DR

Display Read

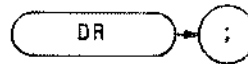

The DR command sends the contents of the current display address to the controller. Thus, the controller “reads” the contents of the display memory address. Use the DA command to specify the display memory address when executing DR for the first time. After DR is executed, the display address is automatically advanced to the next higher address. Thus, the DA command is only needed to specify the first address, because subsequent DR commands read consecutive addresses.

```
10 OUTPUT 718;"DA 501 DR"  
20 ENTER 718;A  
30 OUTPUT 718;"DA 1525 DR;"  
40 ENTER 718; B  
50 OUTPUT 718; "DR"  
60 ENTER 718; C
```

Line 10: Reads contents of address 501.
Line 30: Reads contents of address 1525.
Line 50: Reads contents of address 1526.
Lines 20, 40, and 60: Assigns address contents to variables A, B, and C.

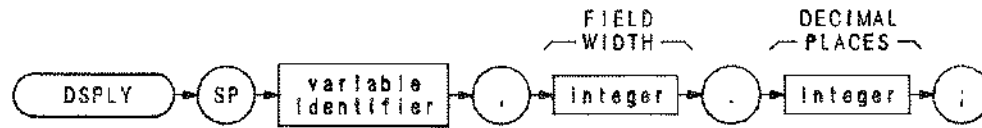

Item	Description/Default	Range Restriction
INTEGER	Specifies number of digits displayed, including sign and decimal point.	
INTEGER	Specifies number of digits to right of decimal point.	0 to 9
VARIABLE IDENTIFIER	Alpha character. User-defined identifier declared in VARDEF statement. Alpha character. Measurement-variable identifier, such as CF or MA. Trace element, such as TRA [10]	AA-ZZ and ___ 2-12 characters required.

The DSPLY command displays the value of a variable anywhere on the spectrum analyzer display.

Field width specifies the number of digits displayed, including sign and decimal point. Places to the right of the decimal point are limited by decimal places. For example, the number 123.45 has a field of 7, and 2 decimal places.

Use the DA, PU, PD, and PA commands to position the variable on the screen.

DT

Define Terminator



Item	Description/Default	Range Restriction
TERMINATOR	Marks end of text.	ASCII codes 0 – 255

The DT command defines any character as a title or label terminator. (Refer to the LB command.)

In the sample program below, the @ symbol is defined as a terminator by the DT command immediately preceding it. In line 30, @ separates the command string "RL -50DM" from the title string "CAL OUT 2ND HARMONIC." Without the @ symbol, "RL -50DM" would be written on the analyzer's CRT as part of the title instead of being executed as a command by the analyzer.

```
10 OUTPUT 718;"DT@"
20 OUTPUT 718;"CF 200MZ"
30 OUTPUT 718;"KSE CAL OUT 2ND HARMONIC@RL -50DM"
40 END
```

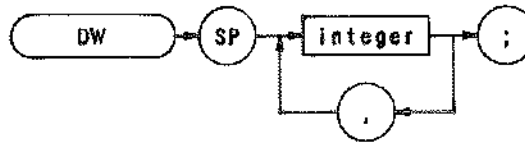
Item	Description/Default	Range Restriction
INTEGER	Integers representing display memory values or instruction words.	0 – 4095

The DW command sends a decimal number from the controller to the current or specified (with the DA command) display memory address, and advances the address selection to the next higher address. If the DW command is followed by more than one number, they are all loaded into consecutive display addresses. The display address is always advanced by one after a number is loaded into an address. (Each display address contains 12 bits. See DA.)

The decimal number represents data, or is an ASCII representation of a display instruction.

Use the DW command in conjunction with the DR and DA commands to draw on the spectrum analyzer CRT, when the O3 or O1 output format is active. Refer to Appendix B for additional information about display memory instructions and display programming. The Consolidated Coding table and Data Word Summary in Appendix B are especially useful.

The program line below contains an instruction word, 1026, followed by data, 500 and 600. The DW command writes the numbers 1026, 500, and 600 into display addresses 1024, 1025, and 1026, respectively. The DA command specifies 1024 as the first address.

```
OUTPUT 718;"DA 1024; DW 1026,500,600;"
```

The instruction word (1026) causes the analyzer to draw a vector from the current position to the X-Y coordinates 500,600. (See Chapter 4 in Section I for a description of display unit coordinates.)

- D1 Display Size Normal
- D2 Display Size Full CRT
- D3 Display Size Expand

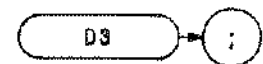
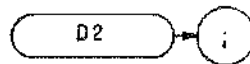
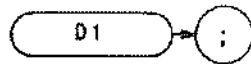

Display size commands D1, D2, and D3 set the display size for CRT graphics. BEX is a fourth display size that can only be accessed by a display control instruction: graph, label, or vector mode. 256 (big expand) must be added to the control word, i.e., graph (1024 + 256). Once a code is selected, it remains in effect until changed.

Positions on the CRT display are referenced in display units as x, some horizontal position, and y, some vertical position. The coordinates (x,y) represent distance from the lower left-hand corner of the graticule (0,0), which is also the origin. The upper right-hand corner is the (1000,1000) point.

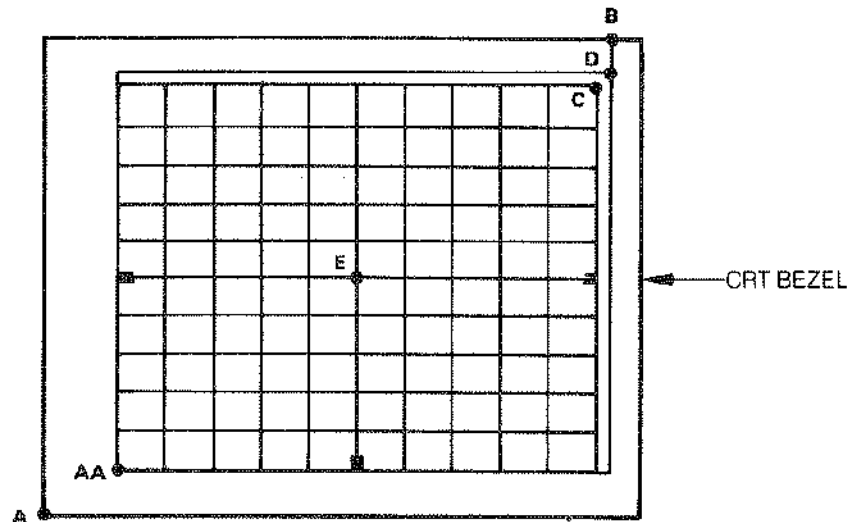

SIZE	(0,0)	AA	B	C	D	E
D1	AA	(0,0)	*	(1000,1000)	(1023,1023)	(500,500)
D2	A	(120,73)	(1023,1023)	(1005,957)	(785,978)	(562,515)
D3	A	(81,49)	(689,689)	(676,645)	(690,658)	(379,347)
Display size 4 cannot be accessed by the command code D4 .						
bex	AA	(0,0)	*	(671,671)	(686,686)	(336,336)

*No writing outside boundary marked by AA, D.

Display size 4 can only be accessed by a display control instruction such as graph, label, or vector mode. Big expand (256) must be added to the word selected (i.e., label is 1025 + 256).

A display program word can be a value from 0 to 4095. The value is stored as a 12-bit binary word. The bits define the type of word. Graphic representations used are defined as follows:

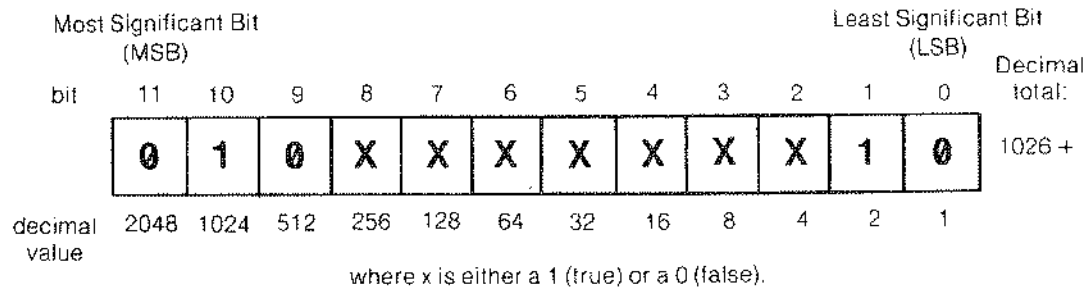

Changing the display size and beam intensity are controlled by setting various bits along with the control instructions and data words. These functions are called auxiliary functions to the instruction.

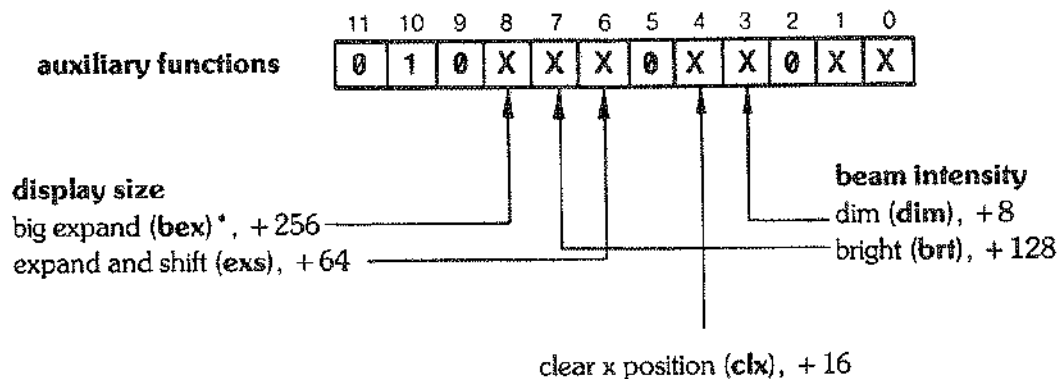

clear x position (clx):

Resets the axis display position to the far left (0, y).

big expand (bex):

Amplifies the x and y CRT beam deflection by a 1.49 factor.

expand and shift (exs):

Amplifies the x and y CRT beam deflection by a 1.13 factor (expand) and shifts the (0,0) reference point to the lower left of the CRT screen.

dim (dim):

Sets the CRT beam intensity below the normal level.

bright (brt):

Sets the CRT beam intensity to the maximum level.

* Abbreviations within the parentheses are useful as a shorthand notation for writing display programs. They are not programming codes.

D1, D2, D3 (Continued)

The display size commands combine the size instructions as follows:

Display Size	Consolidated Coding Instructions	Ratio to D1	Origin Shifted
D1	none	1.00	no
D2	exs	1.13	yes
D3	bex and exs	1.68	yes
big expand	bex	1.49	no

The display size determines the position and number of rows and columns for characters on the CRT display. This can be an important consideration when labeling graph lines or points.

D1 Display Size

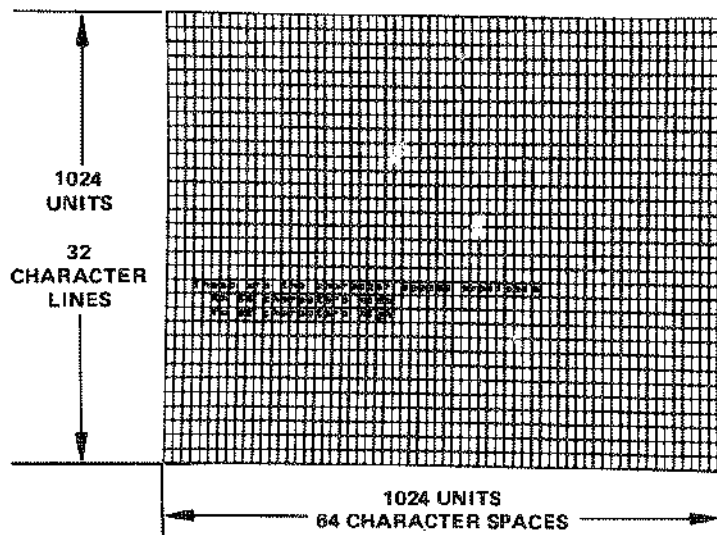

D2 Display Size

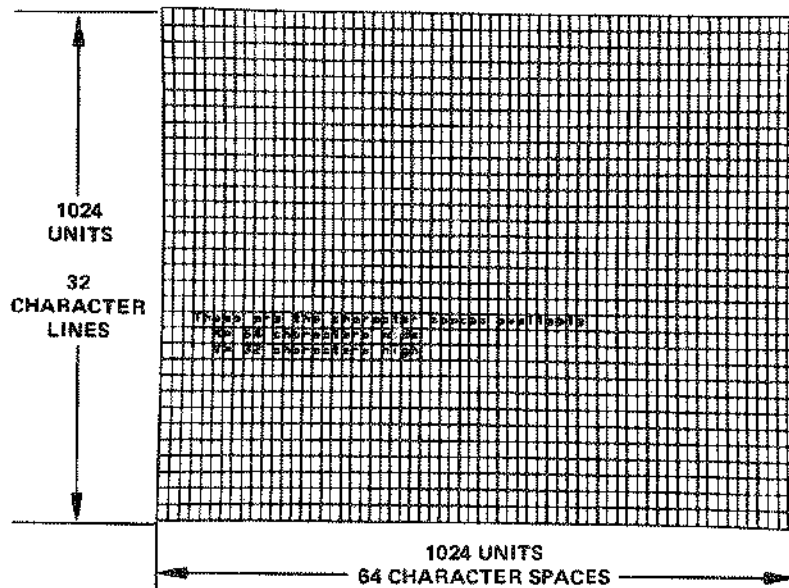

Display memory is set up to contain 64 character spaces per line with respect to display size 1. When using the third and fourth display sizes, a label can only be a maximum of 44 characters. The remaining 20 characters of the label will be stored in display memory, but will not show-up on the CRT display due to the expansion of D3 and bex. At character space 65, an automatic carriage-return and line-feed will occur, at which point labeling will continue to be written on the CRT display.

The automatic carriage-return and line-feed occur only when character space 65 is reached. Thus, in the third and fourth display sizes, the characters from the 44th character space through the 64th character space will not appear on the CRT display. Therefore, labeling with display size 3 and bex needs appropriate placement of characters because of the limited number of character spaces for these display sizes.

D3 Display Size

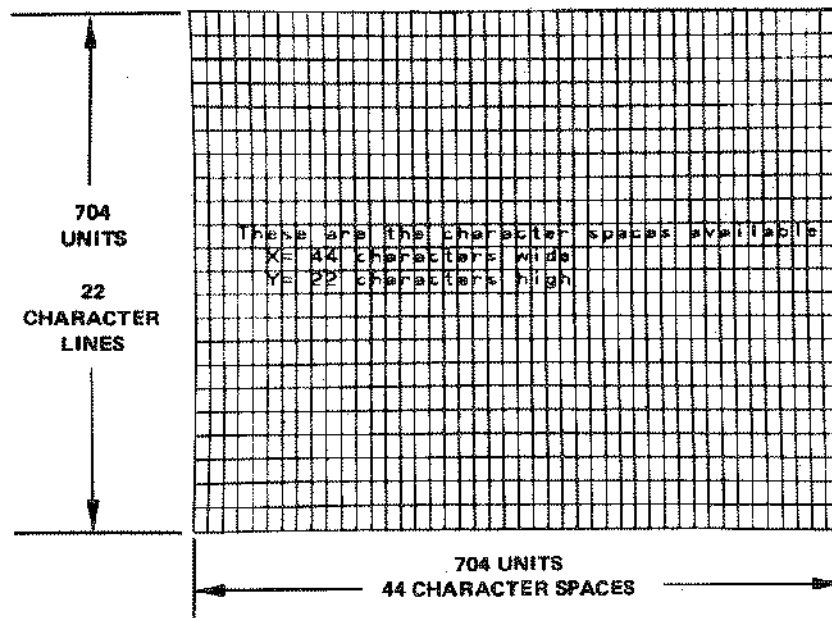

Big Expand (bex)

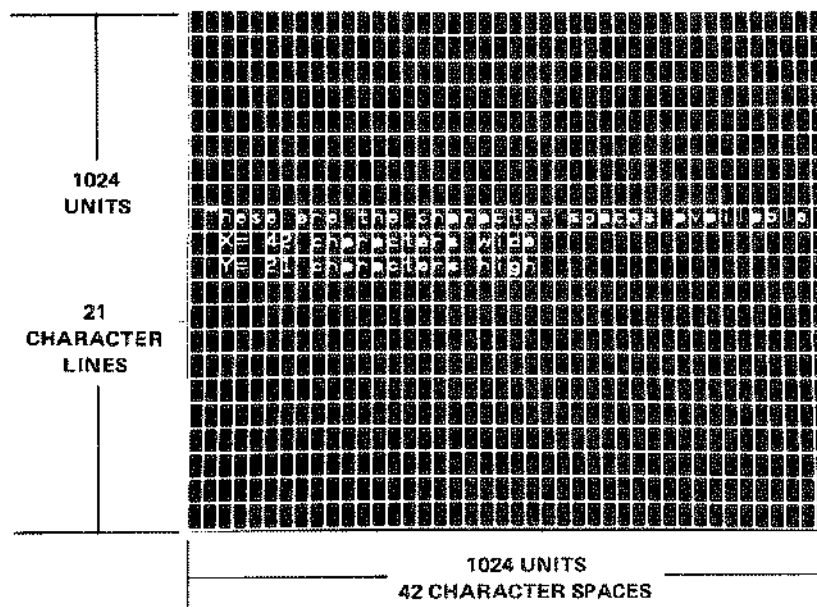

D1, D2, D3 (Continued)

OUTPUT 718; "D2;"

The above program line selects display size 2 for the CRT display of the analyzer.

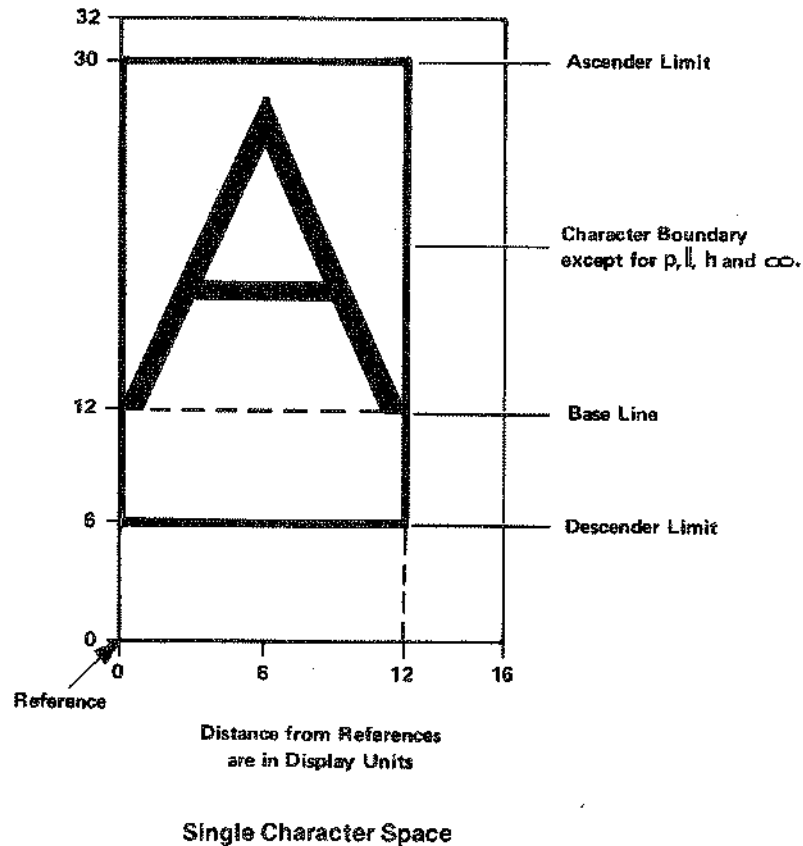

A single character space (see above) has an absolute outside limit of 16 (x) by 32 (y) units in any display size. A character position is referenced from the lower left corner of each character space. The actual "character boundary" is designated by the ascender and descender limits.

From the center of the character space, x may be changed as many as ± 7 units and y by as many as ± 15 units before the text begins at the next x and y character. If a plot absolute statement calls a position anywhere in the character space, the character will be placed within the "character boundary." If two characters are labeled into the same character space, they will be superimposed over one another.

Example:

To begin labeling text 6 characters up from the bottom and 24 characters from the left (in any display size), the plot absolute vector values are calculated for the center of the character location as follows:

$$\begin{aligned}x &= (\text{character spaces}) (16) - 8 \\ &= (24) (16) - 8 = 376\end{aligned}$$

$$\begin{aligned}y &= (\text{character spaces}) (32) - 16 \\ &= (6) (32) - 16 = 176 \\ &\text{"PA 376,176 LB <text>"}\end{aligned}$$

The first character of text will be positioned as shown:

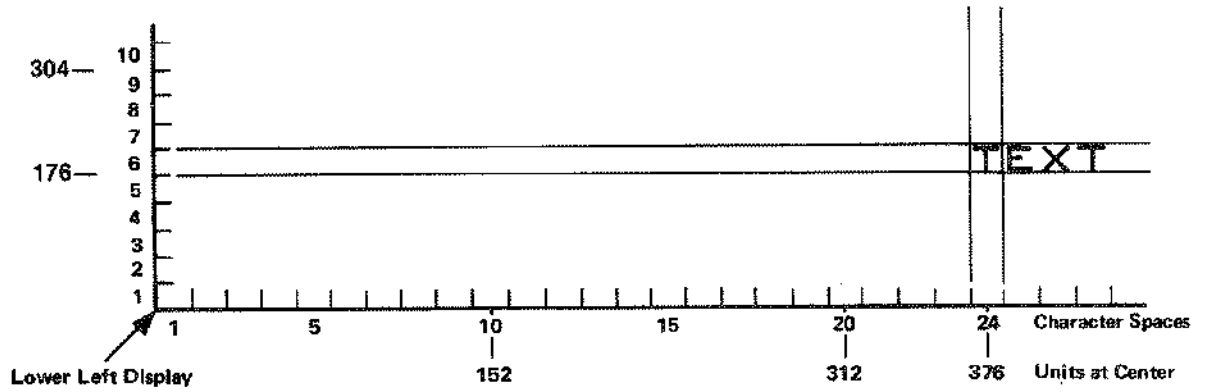

EE

Enable Entry

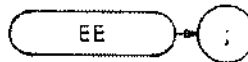

The EE command sends values entered by the operator on the analyzer DATA keyboard to the controller. Generally, the sequence of programmed events is as follows:

1. A program loop prevents the controller from using the entered value until the operator signals that the entry is complete.
2. The operator makes a DATA entry, which is stored in the analyzer internal data register.
3. The operator signals completion of the entry.
4. The controller reads the value of the entry and continues to the next program step.

Depending on the type of DATA entry required, one of two different methods is used. The first method does not require the use of service requests and is used only for entering positive single digits, the second is for entering positive integers from 0 to [10(12)-1].

Method 1: Testing for a non-zero entry.

```
10 OUTPUT 718;"EE;"
20 REPEAT
30   OUTPUT 718;"OA;"
40   ENTER 718;N
50   UNTIL N>0
60 PRINTER IS 710
70 PRINT N
80 END
```

Line 10: Allows data to be entered with the analyzer DATA keys and presets the entry to 0 (default value). The OA command transfers this value to the analyzer.

Lines 20 to 50: Forms a program loop that is exited when a single digit entry between 1 and 9 is made.

Line 20: Reads the current value of the DATA keys into the variable N.

Lines 60 to 70: Prints the entered number on a printer whose address is 701.

DATA Entry	Output	DATA Entry	Output
1	1.00	010 -dEm 00	1000000000.00
5	5.00	0112 -000 100	1000000.00
9	9.00	0110 -000 1000	1000.00
		0110 -000 1000	1.00

(There is no response to pressing DATA 0.)

Method 2: Testing when an entry has been completed, and then exiting the program loop with a service request.

```

10 OUTPUT 718;"R1;R4;EE;"
20 REPEAT
30   A = SPOLL(718)
40   UNTIL BIT (A,1)>0
50   OUTPUT 718;"OA;"
60   ENTER 718;N
70   PRINTER IS 701
80   PRINT N
90   END

```

- Line 10: Contains an EE command preceded by two service-request format commands. The R1 command clears the service request modes of the analyzer. The R4 command calls for a service request if a units key is pressed to signify the completion of an entry.
- Line 30: Reads the serial poll byte and sets it equal to variable A. The first bit of this byte denotes the status of the service request.
- Line 40: Forms the conditional statement of the program loop (lines 20-40). The BIT statement compares the first bit of variable A with 0. If the first bit of variable A is 0, indicating the units key has not been pressed, the program continues at line 30. If it is 1, indicating a units key has been pressed, the program continues at line 50.
- Line 50: Transfers the value of the active function to the controller. In this case, the active function contains the DATA keys entry.
- Line 60: Takes the DATA keys entry and sets it equal to the variable N.
- Lines 70 to 80: Prints the value of N on a printer whose address is 701.

EE (Continued)

Some DATA entries and the corresponding printed outputs, as executed by this program, are shown in the following table.

DATA Entry	Output
1 <input type="button" value="1"/> <input type="button" value="00.00"/>	1.00
<input type="button" value="1"/> <input type="button" value="2"/> <input type="button" value="3"/> <input type="button" value="."/> <input type="button" value="4"/> <input type="button" value="5"/> <input type="button" value="00.00"/>	123450.00
<input type="button" value="1"/> <input type="button" value="2"/> <input type="button" value="3"/> <input type="button" value="."/> <input type="button" value="4"/> <input type="button" value="5"/> <input type="button" value="00.00"/>	123.00

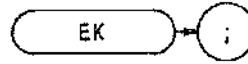

The EK command allows data entry with the front panel data knob when the analyzer is under remote control. The front panel ENABLED indicator lights, indicating the data knob is functional, but other front panel functions remain inoperative.

The following program requests the operator to position a marker on a signal that needs further analysis, while the program is paused.

```
10 OUTPUT 718:"M2;EK;"
20 PRINT "USE DATA KNOB TO PLACE MARKER ON SIGNAL. PRESS CONTINUE"
30 PAUSE
40 ! Analysis program here
50 END
```

The program above is continued by pressing the  key on the controller keyboard.

Be sure to pause program operation after executing EK. This gives the operator time to turn the data knob.

IF THEN ELSE ENDIF

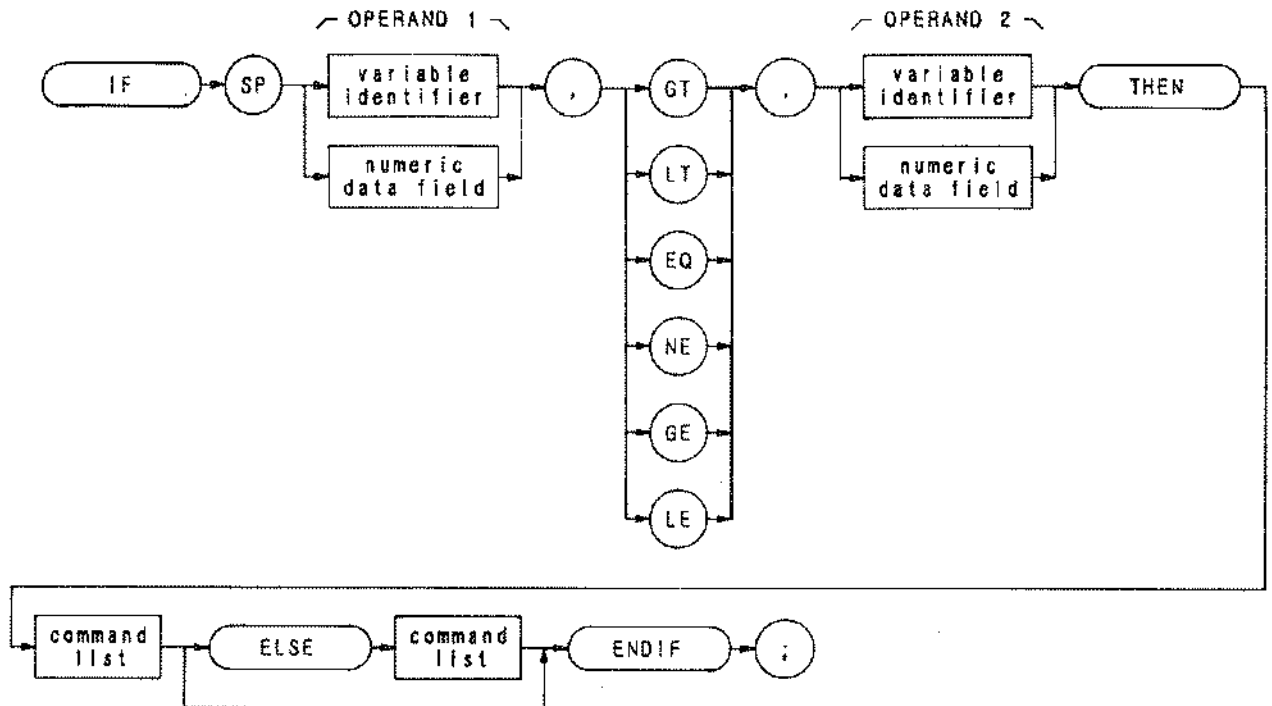

Item	Description/Default	Range Restriction
COMMAND LIST	Alphanumeric character. Any spectrum analyzer command from this section.	
VARIABLE IDENTIFIER	Alpha character. User-defined identifier declared in VARDEF statement.	AA-ZZ and _ 2-12 characters required.
	Alpha character. Measurement-variable identifier, such as CF or MA.	
	Trace element, such as TRA[10].	
NUMERIC DATA FIELD	Real	

The IF-THEN-ELSE-ENDIF commands form a decision and looping construct. They compare operand 1 to operand 2. If the condition is true, the command list is executed. Otherwise, commands following ELSE or ENDIF are executed.

The IF command must be delimited with the ENDIF command.

The following program uses the IF THEN ELSE ENDIF command to place a marker on the largest signal that is greater than the threshold level.

```
10 OUTPUT 718;"IP;TH -35DM;"
20 OUTPUT 718;"TS;MKPK HI;MA;"
30 OUTPUT 718;"IF MA,GT,TH"
40 OUTPUT 718;"THEN CF 20MZ;"
50 OUTPUT 718;"ELSE CF 100MZ;TS;MKPK HI;"
60 OUTPUT 718;"ENDIF;"
70 END
```

The program below does not incorporate the ELSE branch of the IF THEN ELSE ENDIF command. The program lowers any signal positioned about (off) the analyzer screen.

```
10 OUTPUT 718;"S2;TS;E1;"
20 OUTPUT 718;"IF MA,GT,RL THEN"
30 OUTPUT 718;"REPEAT RL UP;TS;E1;"
40 OUTPUT 718;"UNTIL MA,LE,RL "
50 OUTPUT 718;"ENDIF S1;" " "
60 END
```

EM

Erase Trace C Memory

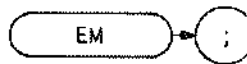

The EM command clears display memory addresses 3072 through 4095, which contain instruction words and amplitude information for trace C. The EM command loads the instruction word 1044 into addresses 3072 through 4095, and then establishes address 3072 as the current (in-use) address, placing this address in the display address register. (See Appendix A for more information about trace C.)

The EM command is often incorporated in a routine that blanks the spectrum analyzer screen in preparation for the display of custom graphics. Execute the following program line to blank the analyzer screen;

```
OUTPUT 718;"EM;BLANK TRA;BLANK TRB; GRAT OFF; KSo; DLE OFF;"
```

The line above clears trace C memory, and blanks the graticule, characters, display line, and traces A and B. Though the display can be blanked with the K_{Sg} command, which turns off the CRT beam, the above program line is advantageous. It clears the display faster than K_{Sg}. In addition, the contents of traces A and B are saved, the instrument state is not altered, and the beginning of trace C memory, address 3072, is established as the current address.

To reinstate the analyzer display, execute the following program line:

```
OUTPUT 718;"EM;CLR W TRA;CLR W TRB; GRAT ON; KSp;DLE ON;"
```

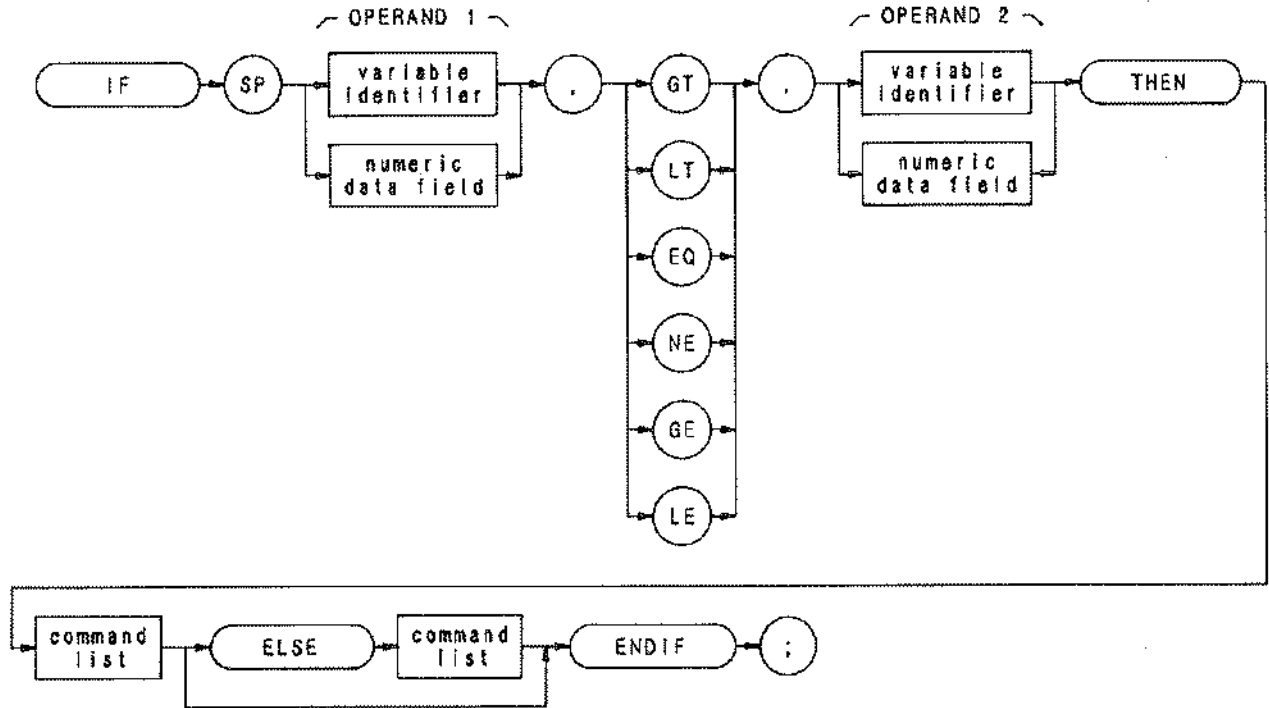

Item	Description/Default	Range Restriction
COMMAND LIST	Alphanumeric character. Any spectrum analyzer command from this section.	
VARIABLE IDENTIFIER	Alpha character. User-defined identifier declared in VARDEF statement.	AA-ZZ and _ 2-12 characters required.
	Alpha character. Measurement-variable identifier, such as CF or MA.	
	Trace element, such as TRA[10].	
NUMERIC DATA FIELD	Real	

The IF-THEN-ELSE-ENDIF commands form a decision and looping construct. They compare operand 1 to operand 2. If the condition is true, the command list is executed. Otherwise, commands following ELSE or ENDIF are executed.

The IF command must be delimited with the ENDIF command.

IF THEN ELSE ENDIF (Continued)

The following program uses the IF THEN ELSE ENDIF command to place a marker on the largest signal that is greater than the threshold level.

```
10 OUTPUT 718;"IP;TH -35DM;"
20 OUTPUT 718;"TS;MKPK HI;MA;"
30 OUTPUT 718;"IF MA,GT,TH"
40 OUTPUT 718;"THEN CF 20MZ;"
50 OUTPUT 718;"ELSE CF 100MZ;TS;MKPK HI;"
60 OUTPUT 718;"ENDIF;"
70 END
```

The program below does not incorporate the ELSE branch of the IF THEN ELSE ENDIF command. The program lowers any signal positioned above (off) the analyzer screen.

```
10 OUTPUT 718;"S2;TS;E1;"
20 OUTPUT 718;"IF MA,GT,RL THEN"
30 OUTPUT 718;"REPEAT RL UP;TS;E1;"
40 OUTPUT 718;"UNTIL MA,LE,RL "
50 OUTPUT 718;"ENDIF S1;" " "
60 END
```

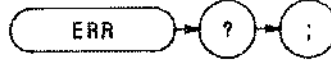



The spectrum analyzer performs a self-test when it is turned on. The ERR command queries the results of the processor test and returns a list of integer numbers to the controller, followed by carriage-return/line-feed (ASCII codes 12, 10). The line feed asserts the end-of-identify state (EOI).

OUTPUT 718;“ERR?;”

EX

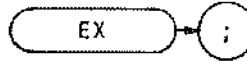
Exchange A and B
(**AXB**)



The EX command exchanges traces A and B, point by point.

OUTPUT 718; "EX;"

The functions of the AXB and EX commands are identical. (Refer to Chapter 5 in Section I.)

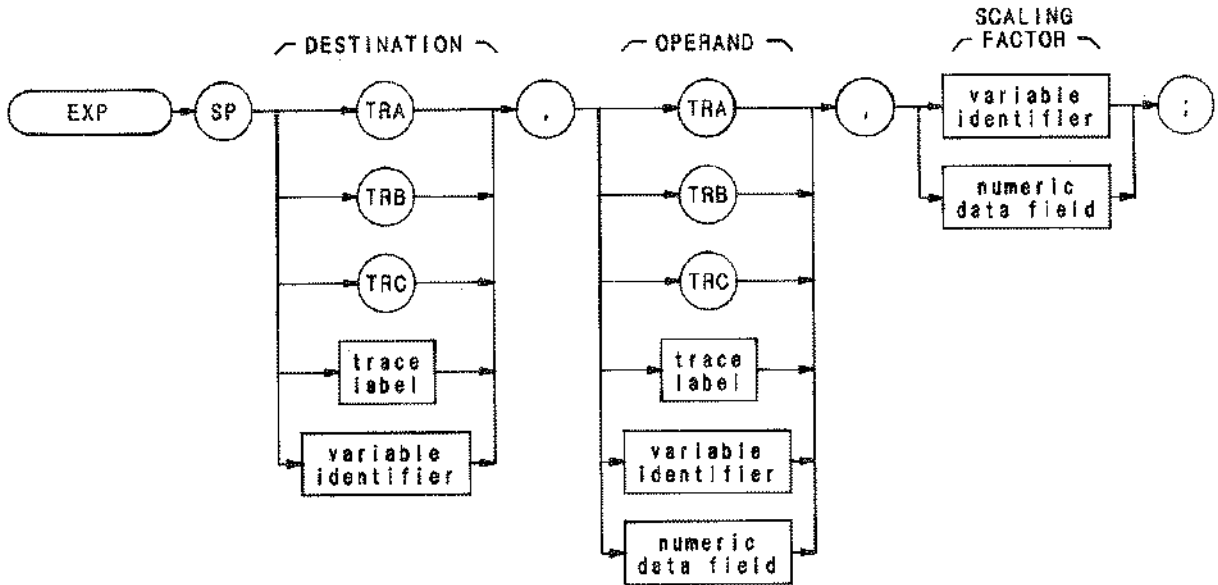

Item	Description/Default	Range Restriction
TRACE LABEL	Alpha character. User-defined label declared in TRDEF statement.	AA—ZZ and _ 2— 12 characters required.
VARIABLE IDENTIFIER	Alpha character. User-defined identifier declared in VARDEF statement.	AA—ZZ and _ 2— 12 characters required.
	Alpha character. Measurement-variable identifier, such as CF or MA.	
	Trace element, such as TRA[10].	
NUMERIC DATA FIELD	Real	

The EXP command processes the operand as follows:

$$10^{\text{operand/scaling factor}} \rightarrow \text{destination}$$

The operand and scaling factor are shown in the syntax chart above.

E1

Peak Search

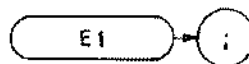

The E1 command positions the marker at the signal peak. See MKPK.

OUTPUT 718; "E1;"

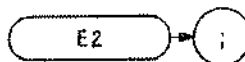

The E2 command centers the active marker on the analyzer screen, moving the marker to the center frequency.

OUTPUT 718; "E2;"

The functions of the E2 and MKCF commands, and the front panel  key are identical.

E3

Delta Marker Step Size
(MKSS)

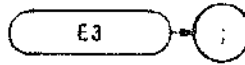

The E3 command establishes the center frequency step size as the frequency difference between the delta and active markers. (See M3 or MKD.)

OUTPUT 718; "E3;"

The functions of the MKSS and E3 commands are identical.

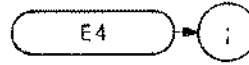

The E4 command moves the active marker to the reference level.

OUTPUT 718; "E4;"

The functions of the E4 and MKRL commands, and the front panel  key are identical.

FA

Start Frequency

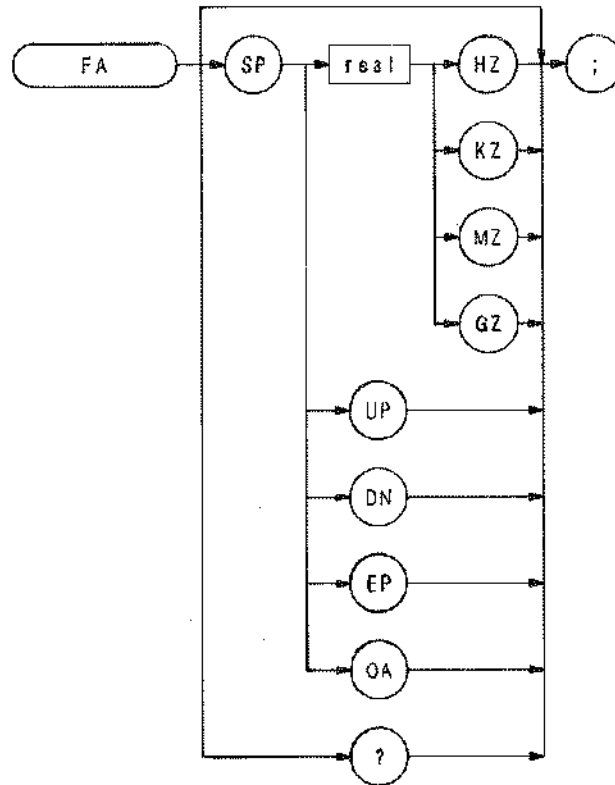

The FA command specifies the start frequency value. The function is identical with that of the front panel  key. The program line below illustrates command syntax.

```
OUTPUT 718;"FA 88MZ;"
```

When queried (? or OA), FA returns the start frequency value, a real number, followed by carriage-return/line-feed (ASCII codes 13, 10). The end-or-identify state (EOI) is asserted with line feed.

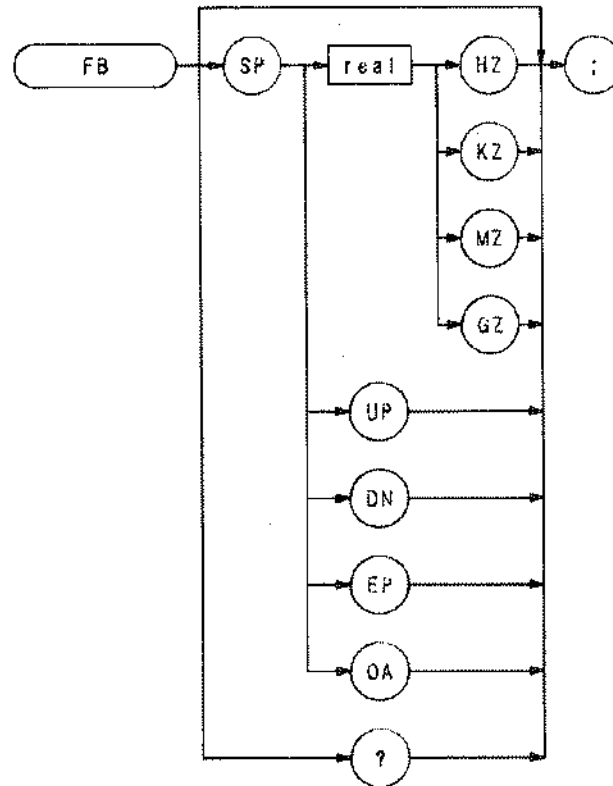

The FB command specifies the stop frequency value. The function is identical with that of the front panel  key. The program below illustrates command syntax.

OUTPUT 718; "FB 88MZ;"

When queried (? or OA), FB returns the stop frequency value, a real number, followed by carriage-return/line-feed (ASCII codes 13, 10). The end-or-identify state (EOI) is asserted with line feed.

FFT

Fast Fourier Transform

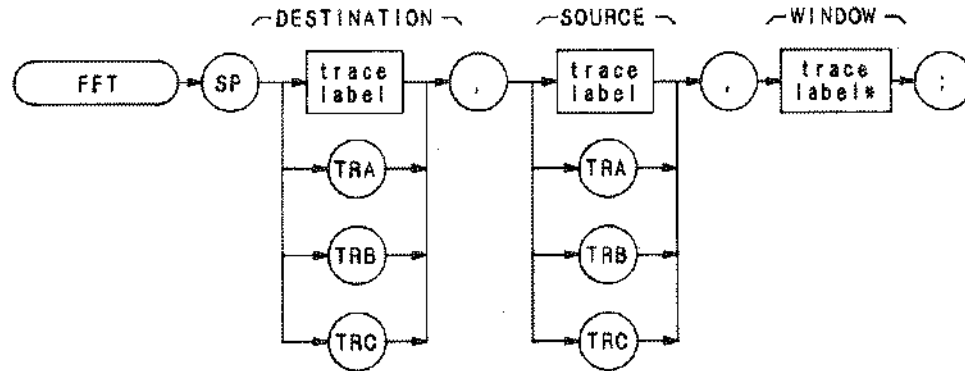

Item	Description/Default	Range Restriction
TRACE LABEL	Alpha character. User-defined label declared in TRDEF statement. For window, TRACE LABEL is also defined by TWINDOW.	AA-ZZ and _ 2— 12 characters required. Trace length must be 1008.

The FFT command performs a forward fast fourier transform on a trace array. The results of the transform contain logged magnitude components only.

The FFT algorithm assumes the source trace array is one period of an infinitely long string of concatenated, duplicate arrays. Thus, in order to avoid discontinuities when the source trace is concatenated, the beginning and end elements of the source trace array must gradually diminish to the same amplitude value. If the endpoints of the original trace array were of different amplitudes, the discontinuities in the resulting array series would introduce false frequency components into the fourier transform. This is illustrated in the following figure.

ORIGINAL
SAMPLED
WAVEFORM

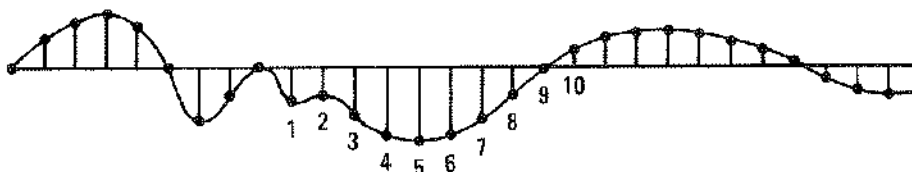

ANALYSIS
INTERVAL
=SWEEP TIME



SAMPLED
ANALYTIC
WAVEFORM

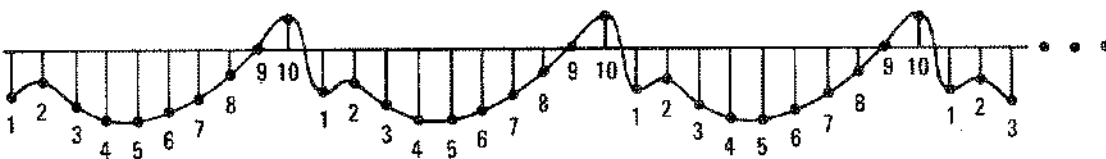

The TWINDOW command allows the source trace array to be modified so the amplitude of the trace endpoints gradually diminish to zero.

The TWINDOW command formats trace arrays with one of three built-in "window" algorithms: HANNING, UNIFORM, and FLATTOP. Each simulates a series of equally spaced filters (see figure below). The detected, spectral line traces the top of the passband while moving from $N\Delta f$ to $(N + 1)\Delta f$.

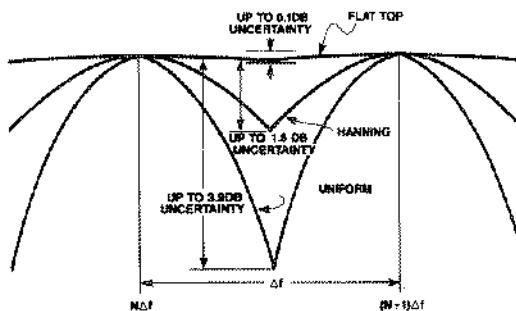

FFT (Continued)

The amplitude and frequency uncertainty of the FFT display depends on the choice of the window, and the analyzer sweeptime. Amplitude uncertainty is maximum when the spectral component falls midway between the filter shapes. Passbands that are flatter in shape, like the FLATTOP filter, contribute less amplitude uncertainty, but frequency resolution and sensitivity are compromised (see TWINDOW).

Of the three algorithms, the FLATTOP has the least amplitude uncertainty and greatest frequency uncertainty. Worst-case accuracy is -0.1 dB. Use this passband when transforming periodic signals.

The UNIFORM algorithm has the least frequency uncertainty and greatest amplitude uncertainty. Worst-case amplitude uncertainty is 3.9 dB and its 3 dB resolution bandwidth is 60% of the HANNING bandwidth. The UNIFORM algorithm contains no time domain window weighting. Use it for transforming noise signals or transients that fully decay within one sweeptime period.

The HANNING algorithm is a traditional passband window found in most real time analyzers. It offers a compromise between the FLATTOP and UNIFORM shapes. Its amplitude uncertainty is -1.5 dB, and its 3 dB bandwidth is 40% of the FLATTOP bandwidth.

The FFT results are displayed on the spectrum analyzer in logarithmic scale. For the X dimension, the frequency at the left side of the graph is 0 Hz, and at the right side is F_{max} . F_{max} can be calculated using a few simple equations and the sweeptime of the analyzer.

The sweeptime divided by the number of trace array elements containing amplitude information (in this case, 1000) is equal to the sampling period. The inverse of the sampling period is the sampling rate. The sampling rate divided by two yields F_{max} . For example, let the sweeptime of the analyzer be 20 msec. 20 msec divided by 1000 equals 20 μ sec, the value of the sampling period. The sampling rate is $1/20$ μ sec. F_{max} equals $1/20$ μ sec divided by 2, or 25 kHz.

The fourier transforms of the window functions are shown in the following figure. Use these graphs to estimate resolution and amplitude uncertainty of a fourier transform display. Each horizontal division of the graphs equals $1/\text{sweeptime}$ or $F_{max}/500$ (which can be calculated from the previous equations), and represents two trace array elements.

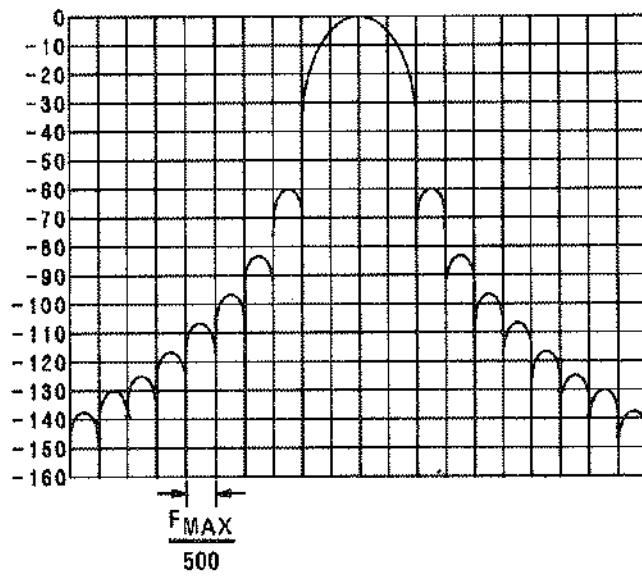

HANNING FILTER WINDOW

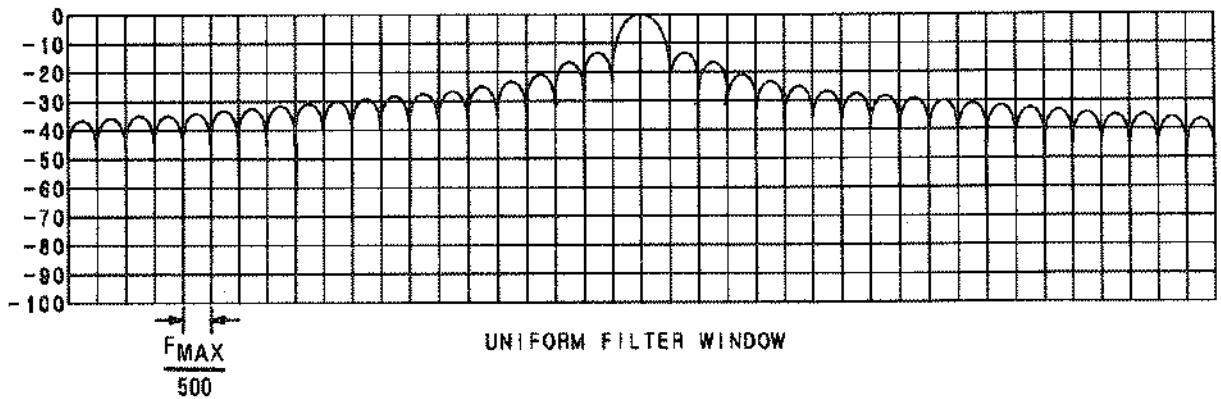

UNIFORM FILTER WINDOW

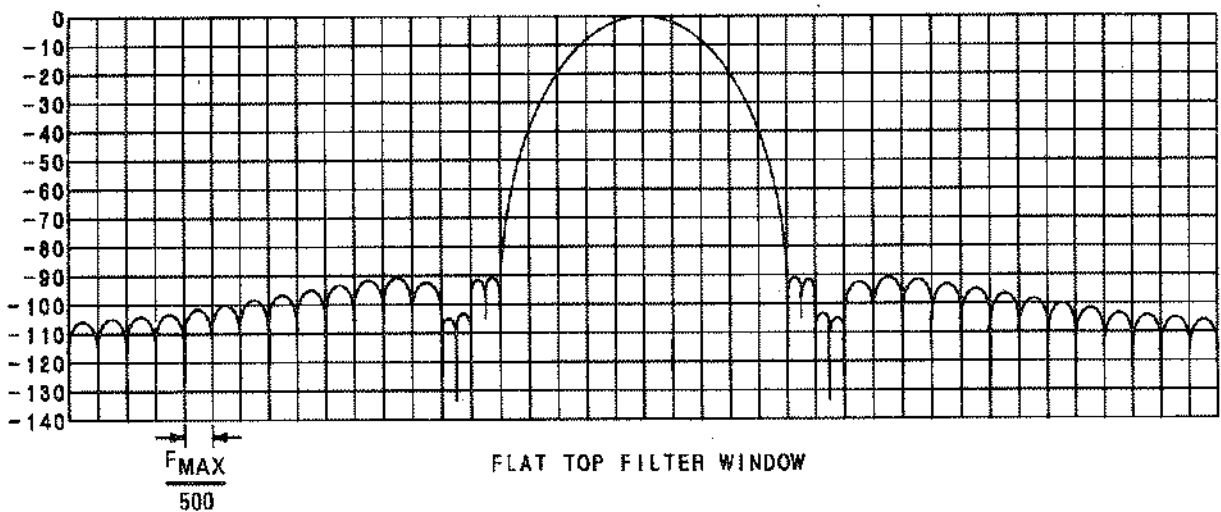

FLAT TOP FILTER WINDOW

FFT (Continued)

In summary, keep the following in mind when executing FFT:

Perform fourier transforms on trace A, B, or C, or user-defined traces containing 1008 elements only. (FFT automatically creates a 1008 point array from trace A, B, or C.)

FFT is designed to be used in transforming zero span information into the frequency domain. Performing FFT on a frequency sweep will result in inaccurate FFT data.

Define a trace window with the TWINDOW command before performing an FFT on a trace.

It is possible to get numbers outside the boundaries of the screen (0 – 1023) after executing an FFT. If the destination trace is trace A, then the results are automatically clipped. For traces B, C, and user-defined traces, the results are not automatically clipped. When using these traces, avoid writing in locations outside the boundaries of the screen.

To get an FFT frequency readout on the FFT trace, use the Marker Read command (MKREAD FFT;).

The following is an example of an FFT program.

```
10  OUTPUT 718;"TRDEF W__INDOW,1008;"
20  OUTPUT 718;"TWINDOW W__INDOW,HANNING;"
21
30  OUTPUT 718;"FFT TRB,TRA,W__INDOW;"
31
40  END
```

Line 10: A trace array of 1008 points is defined as W__INDOW.

Line 20: The trace array is formatted according to the HANNING algorithm.

Line 30: An FFT is performed on trace A and the results are stored in trace B.

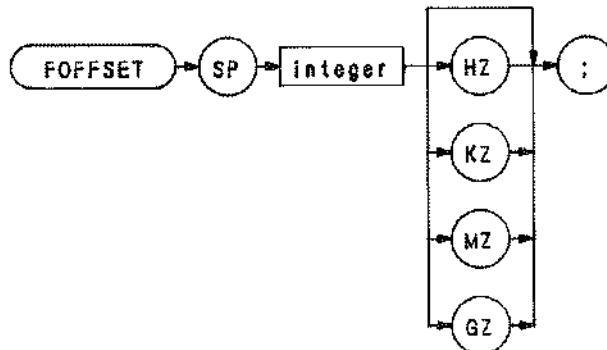

Item	Description/Default	Range Restrictions
INTEGER	Default is hertz.	

The FOFFSET command selects a value that offsets the frequency scale for all absolute frequency readouts, such as center frequency. Relative values, like span, and delta marker, are not offset.

After execution, the FOFFSET command displays the frequency offset in the active function readout. The offset value is always displayed beneath the CRT graticule line, as long as the offset is in effect.

The following program returns an offset value of 100 MHz to the controller and prints it on the controller screen.

```

10 OUTPUT 718;"FOFFSET 100MZ;FOFFSET?;"
20 ENTER 718;N
30 PRINT N
40 END

```

When queried (?), FOFFSET returns the offset value as a real number, followed by carriage-return/line-feed (ASCII codes 13, 10). The end-or-identify state (EOI) is asserted with the line feed.

FORMAT STATEMENTS
01, 02, 03, 04

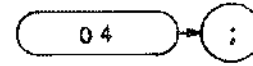
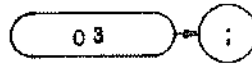
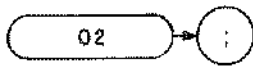
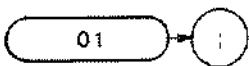

The spectrum analyzer outputs must be formatted appropriately for the controller and measurement requirements. The spectrum analyzer transmits decimal or binary values, via the Hewlett-Packard Interface Bus (HP-IB), to a controller or other HP-IB device, such as a printer. The decimal and binary values represent trace information or instructions.

The format characteristics are summarized in the table below.

Analyzer Output	Format Command	Output Example of Marker Amplitude. Marker is at — 10 dBm reference level.
Sends trace information only as a decimal value in Hz, dB, dBm, volts, or seconds.	03	— 10.00
Sends trace amplitude and position information, or instruction word as decimal values ranging from 0 to 4095: 0 to 1023 represent positive, unblanked amplitudes in display units. 1024 to 2047 are instruction words (analyzer machine language). 2048 to 3071 represent positive, blanked amplitudes in display units. 3072 to 4095 represent negative, blanked amplitudes in display units.	01	1001
Sends trace amplitude and position information, or instruction word as binary values in two 8-bit bytes, sending the most significant bit first. The four most significant bits are zeroes.	02	0000XXXX XXXXXXXX (3) (231) values 0 to 4095
Sends trace amplitude information only as binary value in one 8-bit byte, composed from the 02 output bytes: 0000XXX XXXXXXXX 02 11 ///// XXXXXXXX 04	04	XXXXXXXX (250) values 0 to 255 (full scale)

O3 Format

The O3 format transmits trace amplitude information only, in measurement units: Hz, dBm, dB, volts, or seconds. The O3 format cannot transmit instruction words.

A carriage-return/line-feed (ASCII codes 13, 10) always follows any data output. The end-or-identify state (EOI) is asserted with line feed.

Instrument preset (IP) automatically selects the O3 format.

O1 Format

The O1 format transmits trace amplitude information as decimal values in display units. (See Chapter 4 in Section I for a description of display units.)

Trace amplitude values can be positive and unblanked, positive and blanked, or negative and blanked. Positive, unblanked values (0 to 1023) cover the visible amplitude range on the spectrum analyzer CRT.

Negative trace values (3072 to 4095) usually result from trace arithmetic, and are not displayed because they are off (below) the screen. Negative values are represented by the 12-bit two's complement of the negative number, that is, $4096 - |\text{negative value}|$. For example, a -300 value is an output of 3796.

$$4096 - |-300| = 3796$$

Positive, blanked values (2048 to 3071) are those responses immediately ahead of the updated, sweeping trace. These values form the blank-ahead marker, and represent the amplitude responses of the previous sweep, plus 2048. Thus, they are off (above) the screen. (See Appendix B.)

The O1 format also transmits instruction words as decimal values. See the Instruction and Data Word Summary in Appendix B.

A carriage-return/line-feed (ASCII codes 13, 10) always follows any data output in the O1 format. The end-or-identify state (EOI) is asserted with line feed.

O2 Format

The O2 format transmits trace information or instruction words as two 8-bit binary numbers. The most significant bit is sent first. The four most significant bits are always zeroes.

Most Significant Byte	Least Significant Byte
OOOXXXX	XXXXXXXX

Refer to the Consolidated Coding table in Appendix B for instruction word information.

Note that the O2 format sends the same kind of information that the O1 format sends, except that O2 transmits the information in binary numbers instead of decimal numbers. Also, the end of transmission is **not** marked by carriage-return/line-feed (ASCII codes 13, 10) in the O2 format.

FORMAT STATEMENTS (Continued)

O4 Format

The O4 format transmits trace amplitude information only as a binary number. The binary number is one 8-bit byte composed from the bytes established with the O2 format.

```

OOOOXXXX XXXXXXXX   O2
      11 // // // //
XXXXXXXXX             O4
    
```

The O4 output is the fastest way to transmit trace data from the spectrum analyzer to the HP-IB bus. However, sign information is lost. Keep this in mind when transmitting delta marker information (MKD). The end of data transmission is **not** marked by a carriage-return/line-feed.

Format Statements and the HP-IB Bus

The table below shows a transmission sequence on the HP-IB bus for each of the four formats. Each format is transmitting the amplitude of a marker positioned at the -10 dBm reference line.

Format	O3	O1	O2	O4
Byte	NUM (-)	NUM ("1")	(3)	(250)
Byte	NUM (1)	NUM ("0")	(231)	
Byte	NUM (0)	NUM ("0")		
Byte	NUM (.)	NUM ("1")		
Byte	NUM (0)	13		
Byte	NUM (0)	10		
Carriage Return	13			
Line Feed (EOI asserted)	10			

Though the spectrum analyzer transmits either binary or digital information on the HP-IB bus, a decimal number is always returned to the controller display. This is illustrated in the program below, which reads the instruction word 1040 at display address 0, the first memory location of trace A. The program reads the instruction word, using each of the formats, and the DR command.

```

1  ASSIGN @Sa TO 718
2  PRINTER IS 701
4  OUTPUT @Sa;"A1;S2;TS;"
10 OUTPUT @Sa;"DA 0 O1 DR"
20 ENTER @Sa;Dr1
30 OUTPUT @Sa;" DA 0 O2 DR"
40 ENTER @Sa USING "# W";Dr2
    
```

```

50 OUTPUT @Sa;" DA 0 O3 DR"
60 ENTER @Sa;Dr3
70 OUTPUT @Sa;" DA 0 O4 DR"
80 ENTER @Sa USING "#,B";Dr4
90 PRINT Dr1,Dr2,Dr3,Dr4
100 END

```

Running the program above produces the following responses on the controller display. Note that all the responses are decimal numbers. Also note that the O3 and O4 formats do not return the correct data. (As mentioned above, O3 and O4 do not transmit instruction words.)

```

O1 FORMAT response: 1040
O2 FORMAT response: 1040
O3 FORMAT response: — 200.8
O4 FORMAT response: 4

```

Controller Formats

The format of the controller must be compatible with the output format of the analyzer.

Analyzer Format	Controller Format	
	Requirements	Example Statement and Analyzer Response
O1	free field	ENTER 718; PK_AMPLITUDE Response: 1001
O3	field size dependent on output, use free field format	ENTER 718; PK_AMPLITUDE Response: — 10.0
O2	binary, read twice for each value	ENTER 718 USING "#,W" Response: 1001
O4	binary, read once for each value	ENTER 718 USING "#,B" Response: 250

NOTE

The O in O1, O2, O3, and O4 is the letter O and not the number zero.

FS

Full Span

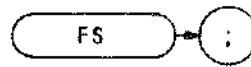

The FS command selects the full frequency span of 0 – 1.5 GHz.

OUTPUT 718;“FS;”

The functions of this command and the front-panel  function are identical.

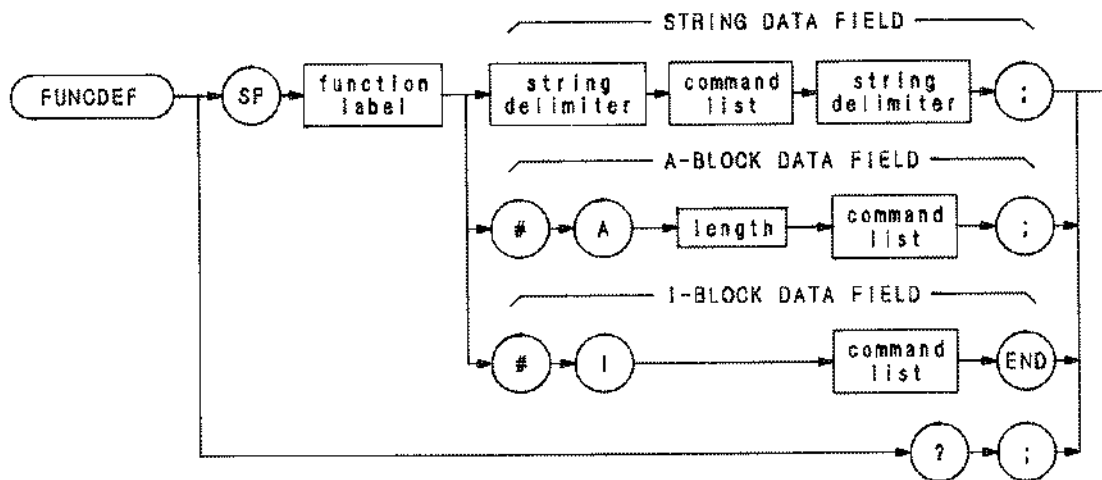

Item	Description/Default	Range Restriction
COMMAND LIST	Any spectrum analyzer commands from this Remote section.	Command list length is limited to 2015-characters, including carriage return (CR) and line feed (LF).
LENGTH	Two 8-bit bytes specifying length of command list, in 8-bit bytes. The most significant byte is first: MSB LSB.	
STRING DELIMITER	Must match. Marks beginning and end of command list.	!"\$%&'/:=@\~

The FUNCDEF command defines a program routine as a function label. After FUNCDEF is executed, the command list is executed whenever the function label is encountered.

Once the function label is defined, it can be loaded into a softkey which can be executed remotely, or locally from the front panel.

When queried (?), FUNCDEF returns the command list in an A-block data format.

(See KEYDEF and KEYEXC.)

GR

Graph

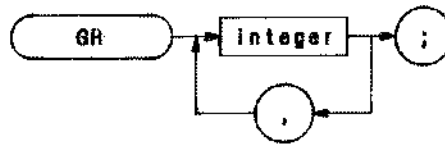

Item	Description/Default	Range Restriction
INTEGER	Represents display memory Y-axis values.	0—4095

The GR command, in the trace modes of operation only, plots HP-IB inputs as graphs on the analyzer CRT. It is also used with auxiliary function codes to modify the appearance on the CRT of stored trace data (highlighting a portion of the trace, for example). Following the GR command, HP-IB inputs in y (amplitude) display units are entered on the CRT, starting at the far left side of the display. For each y display unit added to the trace, the x (horizontal) coordinate is automatically advanced one display unit to the right.

Execution of the GR command tells the analyzer to start plotting a graph at the amplitude point indicated by the next y (amplitude) coordinate received from the HP-IB input. This first amplitude point, y₁, appears at the left of the display; successive points are then plotted, and the lines connecting them are drawn from left to right within the display area limits. (The display area size is established with display size command D1, D2, or D3, or the box programming instruction.)

A sample program using the GR command is shown below.

```
10 ASSIGN @Sa TO 718;FORMAT ON
20 OUTPUT @Sa;"IP;FA200KZ;FB5MZ;S2;GR;"
30 FOR N = 1 TO 400
40 OUTPUT @Sa;400—(3.5/4)*N
50 NEXT N
60 FOR N = 401 TO 1000
70 OUTPUT @Sa;300
80 NEXT N
90 OUTPUT @Sa;"KS1;TS;KSk;B3;C2;TS;"
100 OUTPUT @Sa;"HD;EM;KSo;DT@";
110 FOR N = 1 to 11 STEP 2
120 OUTPUT @Sa;"D2;PU;PA 50";(90*N)—20;"LB";(10*N)—10;"@"
130 NEXT N
140 OUTPUT @Sa;"B4"
150 OUTPUT @Sa USING "K,B,B,K";"D3;PU;PA 0,600 LBdB"; 10,13;OUT OF SPEC@"
160 OUTPUT @Sa;"D3;PA 100,500 LB RADIATED INTERFERENCE, 200kHz— 5MHz@"
170 END
```

- Line 20: Initiates the graph mode. The IP insures that the graphing starts at the beginning of trace C.
- Lines 30 to 80: Writes test limit values into the trace C memory.
- Line 90: Sends graph data to trace B memory and enables A—B—>A.
- Line 200: Clears the active function readout (HD), prepares trace C for input (EM), clears the display annotation (KSo), and sets the label terminator to @.
- Lines 110 to 160: Labels the graticule.

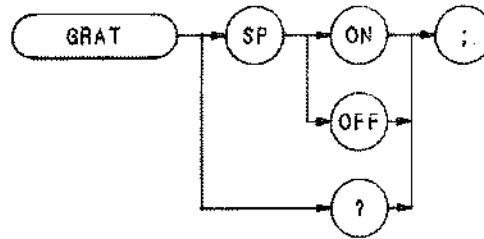

The GRAT command turns the graticule on and off.

OUTPUT 718; "GRAT;"

When queried (?), GRAT returns the graticule state: ON or OFF.

(See also KSn and KSm.)

HD

Hold Data Entry

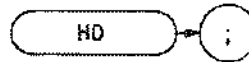

The HD command disables data entry via the front panel DATA keyboard and blanks the active function readout.

OUTPUT 718; "HD;"

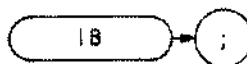

The IB command transmits the contents of an array, located in the controller to trace B memory. Use IB with the O2 format, which formats data in two 8-bit bytes.

The IB command cannot be executed when it is followed by a carriage-return/line-feed. Two examples of terminating the IB command are shown below:

```
OUTPUT 718;"IB;"
```

```
OUTPUT 718 USING "#, k";"IB;"
```

The program below demonstrates the use of IB.

```
10 ASSIGN @Sa TO 718;FORMAT ON
20 ASSIGN @Sa_bin TO 718;FORMAT OFF
30 INTEGER B200(1:1001)
40 OUTPUT @Sa;"CF200MZ B1;A4;RB30KZ;SP2MZ;S2;TS;"
50 OUTPUT @Sa;"O2TB"
60 ENTER @Sa_bin;B200(*)
70 OUTPUT @Sa;"CF100MZ;RB30KZ;SP1MZ;TS;"
80 PAUSE
90 OUTPUT @Sa;"IB";
100 OUTPUT @Sa_bin;B200(*)
110 END
```

Line 30: Declares, dimensions, and reserves memory for array B200.

Line 40: Blanks trace A and sets the analyzer to 200 MHz center frequency. Selects single sweep mode, and sweeps trace B.

Lines 50 and

60: Stores trace B (in binary) in controller array.

Line 70: Sets analyzer to 100 MHz center frequency. Sweeps trace B with new data.

Line 90: Prepares analyzer to receive previous trace B data.

Line 100: Sends trace B data to analyzer.

ID

Identify

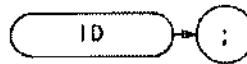

The ID command returns the instrument identity to the controller: HP 8568B or HP 8566B.

OUTPUT 718;"ID;"

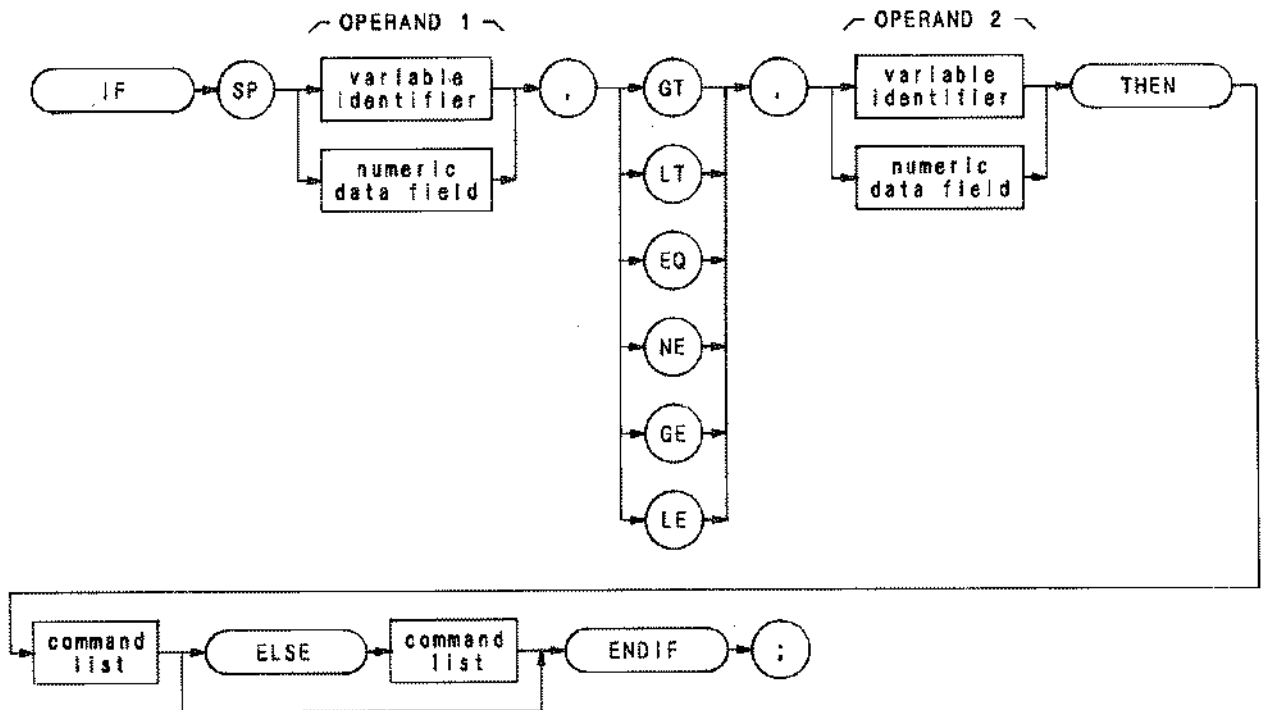

Item	Description/Default	Range Restriction
COMMAND LIST	Alphanumeric character. Any spectrum analyzer command from this section.	
VARIABLE IDENTIFIER	Alpha character. User-defined identifier declared in VARDEF statement. Alpha character. Measurement-variable identifier, such as CF or MA. Trace element, such as TRA[10].	AA-ZZ and _ 2— 12 characters required.
NUMERIC DATA FIELD	Real	

The IF-THEN-ELSE-ENDIF commands form a decision and looping construct. They compare operand 1 to operand 2. If the condition is true, the command list is executed. Otherwise, commands following ELSE or ENDIF are executed.

The IF command must be delimited with the ENDIF command.

IF THEN ELSE ENDIF (Continued)

The following program uses the IF THEN ELSE ENDIF command to place a marker on the largest signal that is greater than the threshold level.

```
10 OUTPUT 718;"IP;TH -35DM;"
20 OUTPUT 718;"TS;MKPK HI;MA;"
30 OUTPUT 718;"IF MA,GT,TH"
40 OUTPUT 718;"THEN CF 20MZ;"
50 OUTPUT 718;"ELSE CF 100MZ;TS;MKPK HI;"
60 OUTPUT 718;"ENDIF;"
70 END
```

The program below does not incorporate the ELSE branch of the IF THEN ELSE ENDIF command. The program lowers any signal positioned above (off) the analyzer screen.

```
10 OUTPUT 718;"S2;TS;E1; "
20 OUTPUT 718;"IF MA,GT,RL THEN"
30 OUTPUT 718;"REPEAT RL UP;TS;E1; "
40 OUTPUT 718;"UNTIL MA,LE,RL "
50 OUTPUT 718;"ENDIF S1;" " "
60 END
```

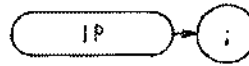

The instrument preset command, IP, executes the following commands:

CLRW A (A1)	Clears and writes trace A.
BLANK B (B4)	Blanks trace B.
CR	Couples resolution bandwidth.
CA	Couples input attenuation.
CS	Couples step size.
CT	Couples sweep time.
CV	Couples video bandwidth.
AMB OFF (C1)	Turns off A-B mode.
FA	Sets start frequency.
FB	Sets top frequency.
HD	Hold
I2	Enables 100 kHz to 1.5 GHz RF input.
AUNITS DBM (KSA)	Selects dBm amplitude units.
VAVG OFF (KSH)	Turns off video averaging.
DET NRM (KSa)	Selects normal detection mode.
MKNOISE OFF (KSL)	Turns off noise markers.
DET NRM (KSa)	Selects normal detection mode.
GRAT ON (KSn)	Turns on graticule.
KSp	Turns on characters.
LG	Selects 10dB/DIV log scale.
MKFC OFF (MCØ)	Turns off marker frequency counter.
MKTRACK OFF (MTØ)	Turns off marker tracking.
MKOFF (M1)	Turns off markers.
CONTS (S1)	Selects continuous sweep mode.
THE OFF (TØ)	Turns off threshold.
TM FREE (T1)	Selects free run trigger.
TDF P (O3)	Selects O3 output format.
DA	Selects 3072 as the current address.
D1	Selects normal display size.
PD	Puts pen down at current address.
R3	Allows SRQ 110.
MKPZ 6dB	MKPX 6 dB minimum exertion for peak identification.
MDS W	Selects data size of one word, which is two 8-bit bytes.
DISPOSE ONEOS	Erases command list associated with the end of the sweep. (See ONEOS.)
DISPOSE ONSWP	Erases command list associated with the beginning of the sweep. (See ONSWP.)
DISPOSE TRMATH	Erases command list associated with the end of the sweep. (See TRMATH.)
MKPAUSE OFF	Turns off marker pause mode.

In addition, IP re-assigns user-defined variables to their initial values, specified by the VARDEF command.

IP (Continued)

Instrument preset automatically occurs when you turn on the analyzer, and is a good starting point for many measurement processes, especially when followed by the TS command. (When IP is executed remotely, the analyzer does not necessarily execute a complete sweep.)

OUTPUT 718; "IP;TS;"

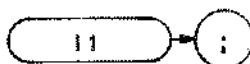

The I1 command enables the 100 Hz to 1500 MHz RF input.

OUTPUT 718; "I1;"

(Refer to the introduction in Section I of this manual for more information.)

I2

Input 2

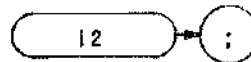

The I2 command enables the 100 kHz to 1500 MHz RF input.

```
OUTPUT 718;"I2;"
```

(Refer to the introduction in Section I of this manual for more information.)

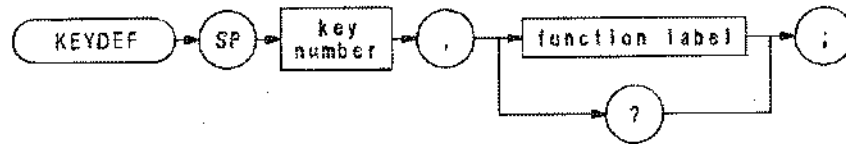

Item	Description/Default	Range Restriction
KEY NUMBER	Integer	0 through 999
FUNCTION LABEL	Alpha character. User-defined label declared in FUNCDEF statement.	AA—ZZ and _ 2—12 characters required.

The KEYDEF command associates a numbered key with a programming routine, which can be executed remotely or from the front panel.

The program below stores a routine in key 999. The program, contained in lines 20 through 70, increases the reference level until the signal peak is below the reference level. The routine is assigned a name with the FUNCDEF command, and then assigned to key 999. Note that the program is delimited with single " quotation marks.

```

10 OUTPUT 718;"FUNCDEF ROUTINE," " "
20 OUTPUT 718;"S2; TS;E1;"
30 OUTPUT 718;"IF MA,GT,RL THEN"
40 OUTPUT 718;"REPEAT RL UP;TS;E1;"
50 OUTPUT 718;"UNTIL MA,LE,RL"
60 OUTPUT 718;"ENDIF S1;" " "
70 OUTPUT 718;"KEYDEF 999,ROUTINE;"
80 END
  
```

Line 10: Assign ROUTINE as the name of the routine in lines 20 – 70.
 Lines 20 through 70: Execute a peak search. If the marker amplitude is greater than the reference level, increase the reference level until it is greater than the marker amplitude.
 Line 70: Store the routine in the analyzer, and assign it to key 999.

To execute key 999 remotely, use the KEYEXC command:

```
OUTPUT 718;"KEYEXC 999"
```

KEYDEF (Continued)

To execute key 999 from the front panel, press these front panel keys:



Once a key is defined, the routine is saved, even when the analyzer loses power or is preset. Use the DISPOSE command to clear a user-defined key.

When queried, KEYDEF returns the command list in a A-block data format. (See DISPOSE, KEYEXC, and FUNCDEF)

* When quotation marks are nested, use two quotes (""") for the inner marks, and one quote (") for the outer mark, as shown in lines 10 and 60.

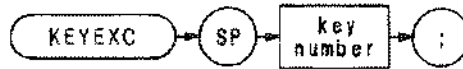

Item	Description/Default	Range Restriction
KEY NUMBER	INTEGER. User-defined key number declared in KEYDEF statement.	0 to 999

The KEYEXC command executes the specified defined key. The program below executes key 2, which contains a programming routine called M_AIN. The routine consists of several user-defined functions, declared with the FUNCDEF command, which sweep the analyzer over different frequency ranges.

```

1  OUTPUT 718;"FUNCDEF M_AIN," "PRESET;TS;FIRST;TS;SECOND;TS;THIRD;TS;" " "
10 OUTPUT 718;"FUNCDEF PRESET," "IP;82;" " "
20 OUTPUT 718;"FUNCDEF FIRST," "FA100MZ;FB300MZ;" " "
30 OUTPUT 718;"FUNCDEF SECOND," "FA500MZ;FB700MZ;" " "
40 OUTPUT 718;"FUNCDEF THIRD," "FA800MZ;FB1000MZ;" " "
50 OUTPUT 718;"KEYDEF 2,M_AIN;"
60 END
  
```

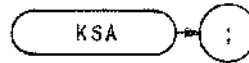

KSA

Amplitude in dBm



The KSA command sets the amplitude readouts (reference level, marker, display line, and threshold) to dBm units.

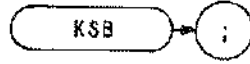

OUTPUT 718; "KSA;"

The KSA command is identical to manual operation of the front panel   keys. (See AUNITS.)



The KSB command sets the amplitude readouts (reference level, marker, display line, and threshold) to dBmV units.

OUTPUT 718; "KSB;"

The KSB command is identical to manual operation of the front panel   ^B keys. (See AUNITS.)

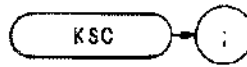

KSC

Amplitude in dBuV



The KSC command sets the amplitude readouts (reference level, marker, display line, and threshold) to dBuV units.

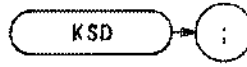

OUTPUT 718; "KSC;"

The KSC command is identical to manual operation of the front panel   keys. (See AUNITS.)



The KSD command sets the amplitude readouts (reference level, marker, display line, and threshold) to V units.

OUTPUT 718; 'KSD;'

The KSD command is identical to manual operation of the front panel   keys. (See AUNITS.)

KSE

Title Mode

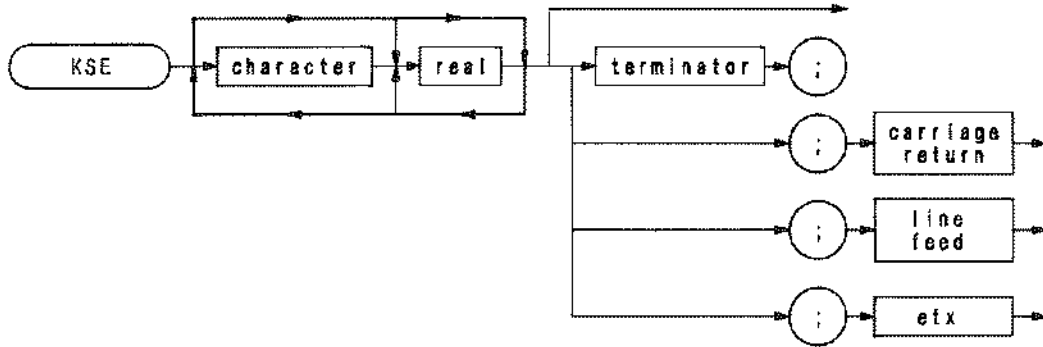

Item	Description/Default	Range Restriction
Character	Represents text displayed on screen.	ASCII codes 32 through 126.
REAL	Represents text displayed on screen.	
Terminator	Character defined in OT command that terminates text.	ASCII codes 0 through 255
Carriage Return	Terminates text.	ASCII code 13
Line Feed	Terminates text.	ASCII code 10
etx	Terminates text. (End-of-text)	

The KSE command activates the title mode. This function writes a message in the top CRT display line.

Any character on the controller keyboard can be written. The full width of the display is available for writing a maximum of 58 characters. However, the marker readout may interfere with the last sixteen characters of the title.

The message must be terminated. Terminate the message with one of the following:

- A terminator defined with the DT command.
- Carriage-return (ASCII 13).
- Line-feed (ASCII 10).
- End-of-text command (controller dependent).

To erase the message, execute instrument preset (IP) or recall an instrument state with the RCLS or RC command. The message can also be erased by executing a KSE command that does not contain a message, as in the program below.

Line 10: Instrument preset.
 Line 20: Activates the title mode and writes "Adjust Antenna" in the top CRT display line.
 Line 30: Pauses program until CONTINUE is pressed on the HP series 200 controller.
 Line 40: Prints a blank message on the screen; thus blanking the "Adjust Antenna" message.

The HP series 200 computers execute a carriage-return/line-feed whenever the ENTER key is pressed. Thus, lines 20 and 40 of the program above terminate the message this way. The same program is shown below, but the KSE command message is terminated with a terminator defined by the DT command.

```

10 OUTPUT 718;"DT@";
20 OUTPUT 718;"KSEAdjust Antenna@";
30 PAUSE
40 OUTPUT 718; "KSE"
50 END



```

Line 20 can also be terminated with a carriage-return this way:

```

20 OUTPUT 718; "KSEAdjust Antenna";CHR$(13)

```

The functions of the KSE command and the   keys are identical.

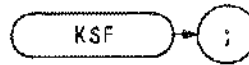

KSF

Measure Sweep Time



The KSF command is a diagnostic aid used for servicing the spectrum analyzer.

The KSF command measures analyzer sweep times up to 1500 seconds. Use KSF to determine if the A22 Sweep Generator is properly responding to its control settings. KSF displays the sweep generator time.

The functions of the KSF command and the   keys are identical.

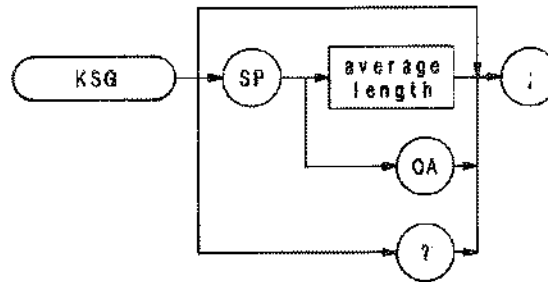



The KSG command enables video averaging. During video averaging, two traces are displayed simultaneously. Trace C contains signal responses as seen at the input detector. Trace A or B contains the same responses digitally averaged. The digital reduces the noise floor level, but does not affect the sweep time, bandwidth, or any other analog characteristics of the analyzer.

Before executing KSG, select trace A or B as the active trace (CLR W) and blank the remaining trace.

The active function readout indicates the number of sweeps averaged; the default is 100 unless otherwise specified. Increasing the number of sweeps averaged increases the amount of averaging.

Use KSG to view low level signals without slowing the sweep time. Video averaging can lower the noise floor more than a 1 Hz video bandwidth can, if a large number of sweeps is specified for averaging. Video average may also be used to monitor instrument state changes (such as changing bandwidths or center frequencies) while maintaining a low noise level. (See Chapter 11 in Section I. Also see KSH and VAVG.)



OUTPUT 718; "KSG;"

The functions of the KSG command and the   keys are identical.

KSH

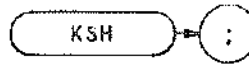
Video Averaging Off





The KSH command disables the video averaging function of the analyzer. The KSH command is identical with manual operation of the    keys.

OUTPUT 718, "KSH,"

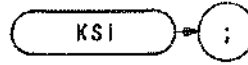
(See KSG and VAVG.)



The KSI command extends the analyzer reference level range to maximum limits of -139.9 dBm and $+60$ dBm. The functions of the KSI command and the   keys are identical.

The lower limit of the reference level depends on resolution bandwidth and scale selection, log or linear. When the reference level is set at minimum, the level may change if either resolution bandwidth or scale selection is changed. The table below shows the relationship between the scale and/or the resolution bandwidth, and the reference level range.

The extended reference level range is disabled with an instrument preset (IP.)

Scale	Resolution Bandwidth	Minimum reference level with extended reference level	
		10 dB attenuation	0 dB attenuation
log	≤ 1 kHz	-129.9 dBm	-139.9 dBm
log	≥ 3 kHz	-109.9 dBm	-119.9 dBm
linear	≤ 1 kHz	-109.9 dBm	-119.9 dBm
linear	≥ 3 kHz	-89.9 dBm	-99.9 dBm

Manual DAC Control

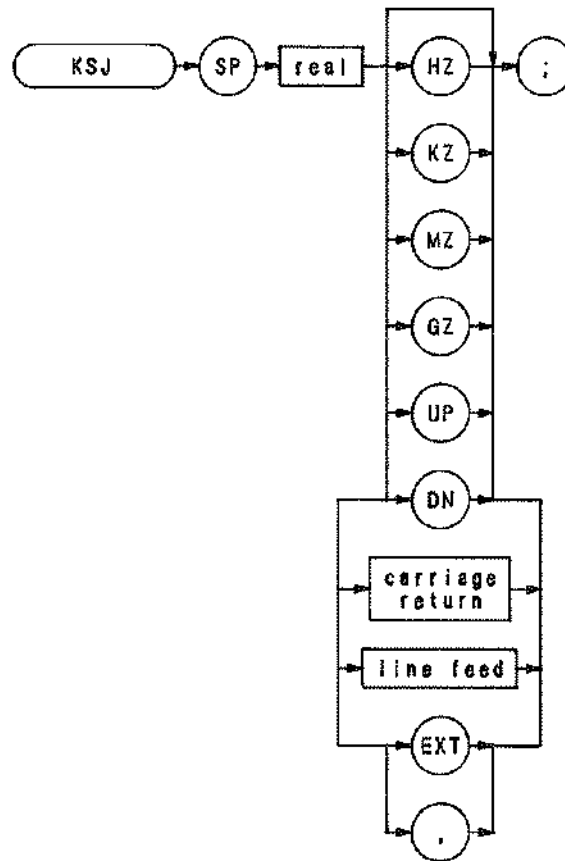



Item	Description/Default	Range Restriction
Carriage Return	Sets all DACs to the specified value.	ASCII code 13
Line Feed	Sets all DACs to the specified value.	ASCII code 10
etx	Asserts end of text.	

The KSJ command is a diagnostic aid used for servicing the spectrum analyzer.

The KSJ command allows all frequency control DACs to be manually controlled simultaneously from the front panel using the DATA knob and step keys.

Also, following units keys and numeric keyboard control these corresponding DACs:

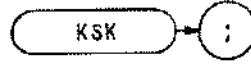

- GHz sets value of Sweep Attenuator DAC
- MHz sets value of YTO Tune DAC
- kHz sets value of most significant VTO Tune DAC
- Hz sets value of least significant VTO Tune DAC

The functions of the KSF command the   keys are identical.



The KSK command is a diagnostic aid used for servicing the spectrum analyzer.

The KSK command counts and displays the pilot IF frequency at the marker.

The functions of the KSK command and the    keys are identical.

KSL

Marker Noise Off

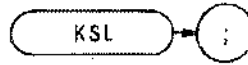

The KSL command disables the noise level function which displays the RMS noise level at the marker. (See MKNOISE or KSM.)

KSL does not blank the marker. Use MKOFF or M1 to blank the marker. (Because MKOFF and M2 remove the marker from the screen, they also disable the noise level mode.)



```
10 OUTPUT 718; "MKF 50 MZ;"
20 OUTPUT 718; "KSM;"
30 OUTPUT 718; "KSL;"
40 OUTPUT 718; "M1;"
50 END
```

Line 10: Positions marker at 50 MHz.

Line 20: Selects noise level mode.

Line 30: Turns off noise level mode.

Line 40: Blanks marker.

The functions of the KSL command and   keys are identical.

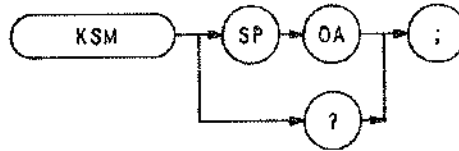



The KSM command displays the RMS noise level at the marker. The RMS value is normalized to a 1 Hz bandwidth.

The KSM command averages the amplitude of 32 elements about the location of the marker, in the frequency or time scale. The average value is converted to the current reference level unit (dBm, dBmV, dBuV, or volts).

The noise level function measures accurately to within 10 dB of the analyzer's own internal noise level. The readout resolution is ± 0.1 dB.

OUTPUT 718; "KSM;"

The functions of the KSM command and the   keys are identical. See also MKNOISE and KSO.

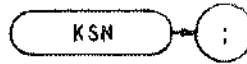

KSN

Count VCO at Marker



The KSN command is a diagnostic aid used for servicing the spectrum analyzer.

The KSN command counts and displays the A11 50 MHz voltage-tuned oscillator (VTO) output frequency.

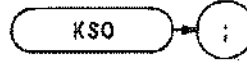

The functions of the KSN command and the   keys are identical." data-bbox="125 326 675 362"/>The text states that the functions of the KSN command and the SHIFT and N keys are identical. The keys are represented by a small rectangle labeled "SHIFT" and a small square labeled "N".



The KSO command operates only when the delta marker is on. (See MKD or M3.) When the delta marker is on, and KSO is executed, the delta marker and active marker specifies start frequency, and the right marker specifies stop frequency. If delta marker is off, there is no operation.

OUTPUT 718; "KSO;"

The functions of the MKSP and KSO command are identical.



The functions of the KSO command and the   keys are identical.

KSP

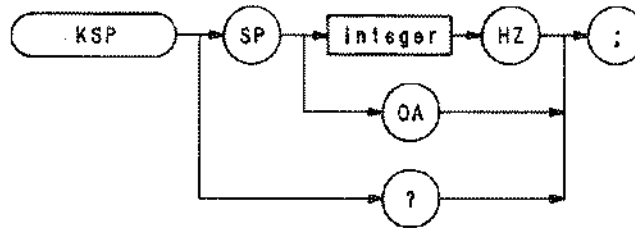
HP-IB Address



Item	Description/Default	Range Restriction
Integer		0 thru 30

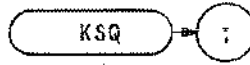

The KSP command enables the user to display or change the current read/write HP-IB address of the analyzer. The KSP command is identical with manual operation of the front panel   keys.

OUTPUT 718; "KSP 15HZ;"



The KSQ command is a diagnostic aid used for servicing the spectrum analyzer.

The KSQ command counts and displays the IF frequency of the response at the marker.

The functions of the KSQ command and the   keys are identical.

KSR

Diagnostics On

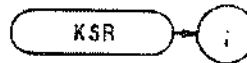

The KSR command is a diagnostic aid used for servicing the spectrum analyzer.

The KSR command displays specific internal frequency control parameters in the upper left corner of the CRT display. These parameters are the programmed values determined by the Controller Assembly, A15.

The following is a sample of what might appear when KSR is executed.

- (1) 387
- (2) 438
- (3) 439 - 2
- (4) 39 4 7 0
- (5) 51000000
- (6) 2514000000

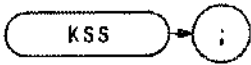

- Line 1: Displays the setting of the least significant 50 MHz VTO Tune DAC (A22U6).
- Line 3: Displays the programmed setting of the YTO Tune DAC (A22U4), and the difference between the programmed setting and the one actually needed to program the center frequency.
- Line 4: Displays N (the harmonic of 20 MHz to which the analyzer center frequency is locked), M and P numbers (of the variable modulus frequency divider on A8 249 MHz Phase Lock assembly), and either a 0 or 1 (indicating whether or not the second LO is shifted up 5 MHz in frequency).
- Line 5: Displays the programmed frequency center frequency of the A11 50 MHz VTO output.
- Line 6: Displays the frequency at which the A15 Controller has programmed the pilot third LO (output of the A7 249 MHz Phase Lock Oscillator).

The functions of the KSR command and the  keys are identical.



The KSS command is a diagnostic aid used for servicing the spectrum analyzer.

The KSS command forces the 5 MHz Second LO shift control back to automatic, and removes the CRT indication.

The functions of the KSS command and the   keys are identical."/>
The text states that the functions of the KSS command and the SHIFT and S keys are identical. The SHIFT key is represented by a small rectangular icon with the word 'SHIFT' inside. The S key is represented by a small rectangular icon with the letter 'S' above it and the words 'SERIAL TRACE' below it.

KST



Second LO Down



The KST command is a diagnostic aid used for servicing the spectrum analyzer.

The KST command forces the 5 MHz Second LO to shift down. Note that spurious responses may appear on the display when the KST command is in effect.

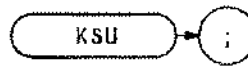

When using an HP 8444A Tracking Generator, the KST command must be in effect to prevent the second LO from shifting up, which causes loss of signal.

The functions of the KST command and the   keys are identical.



The KSU command is a diagnostic aid used for servicing the spectrum analyzer.

The KSU command forces the 5 MHz Second LO to shift up. Note that spurious responses may appear on the display when the KSU command is in effect.

The functions of the KSU command and the   keys are identical.

KSV

Frequency Offset

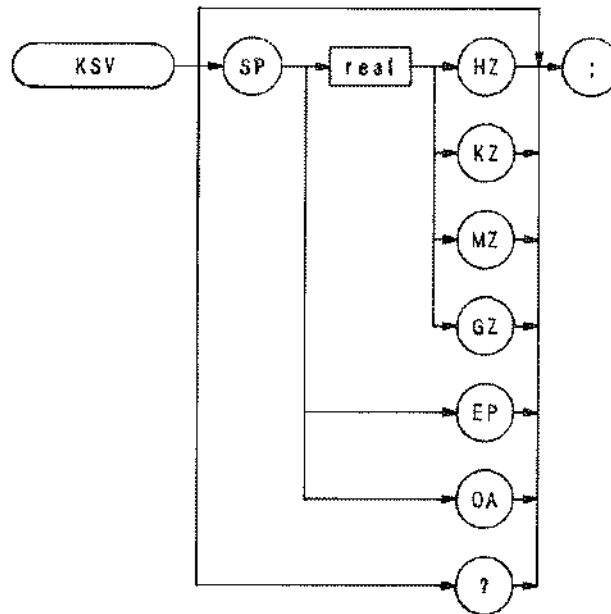

The KSV command selects a value that offsets the frequency scale for all absolute frequency readouts, such as center frequency. Relative values, like span and delta marker, are not offset.



After execution, the KSV command displays the frequency offset in the active function readout. The offset value is always displayed beneath the CRT graticule line, as long as the offset is in effect.

```
10 OUTPUT 718;"KSV 100MZ;"
20 ENTER 718;N
30 PRINT N
40 END
```

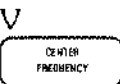
When queried(?), KSV returns the offset value as a real number, followed by carriage-return/line-feed (ASCII codes 13, 10). The end-or-identify (EOI) is asserted with the line feed.

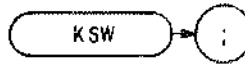
The functions of the KSV command and the   keys are identical.



The KSW command executes a built-in error correction routine. This routine takes approximately 30 seconds to run and when completed, the instrument returns to its previous state. The functions of the KSW command and the front panel   keys are identical.

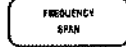

The error correction routine measures and records the amplitude and frequency error factors with reference to the 100 MHz calibration output (CAL OUT) signal, the 1 MHz resolution bandwidth, the 10 dB input attenuator, and the step gains. The "CORR'D" message to the left of the graticule indicates the routine has been run and the display has been corrected.

Use the error correction routine to ensure data has been corrected to the most recent calibration.

Before executing KSW, recall registers 8 and 9, follow the calibration procedure described in the introduction in Section I.

```

10 OUTPUT 718;"RCLS 8;"
20 PAUSE
30 OUTPUT 718;"RCLS 9;"
40 PAUSE
50 OUTPUT 718;"KSW;"

```



When the routine is completed, the error correction data can be displayed on the CRT with the KSw (display correction data) command. (See KSw.)

Accuracy of an amplitude measurement can be improved by taking advantage of the correction data stored in the analyzer by the KSW command. For additional information on improving the amplitude accuracy, see the KS91 command.

KSX

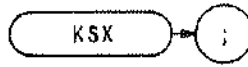
Correction Factors On



The KSX command automatically incorporates the error correction factors into measurements taken by the analyzer. The CRT readout values are automatically offset by the error correction value. The functions of the KSX command and the front panel   keys are identical.

The error correction factors are generated by an error correction routine. Use the KSW command to run the routine. (To view the correction factors, execute KSW.)

For additional information on amplitude accuracy, see KS91, KSW, KSw, and KSY.

OUTPUT 718; "KSX;"

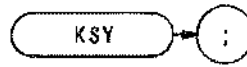

The KSY command prevents the error correction factors from being used in measurements taken by the analyzer. The functions of the KSY command and the front panel  keys are identical.

OUTPUT 718; "KSY;"



See KSW, KSw, and KSX.

KSZ

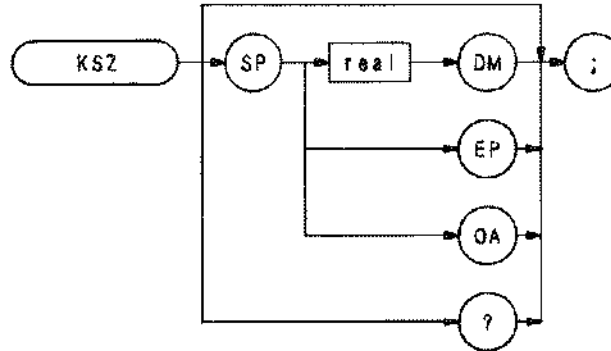
Reference Level Offset (ROFFSET)



Item	Description/Default	Range Restriction
REAL	Default value for units is dBm (DM).	+ - 300 dB

The KSZ command offsets all amplitude readouts on the CRT display without affecting the trace. The functions of the KSZ command and the front panel   keys are identical.

Once activated, the KSZ command displays the amplitude offset in the active function block. And, as long as the offset is in effect while doing other functions, the offset is displayed to the left of the graticule.

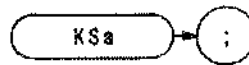

OUTPUT 718; "KSZ — 12DM;"

The functions of the KSZ and ROFFSET commands are identical.



The KSa command selects normal input detection for displaying trace information. This enables a detection algorithm called the Rosenfell detection, which selectively chooses between positive and negative peak values. The choice depends on the type of video signal present.

OUTPUT 718; "KSa;"

The KSa function and the front panel function   are identical. (See DET.)

KSb

Positive-Peak Detection

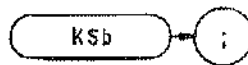

The KSb command selects positive-peak input detection for displaying trace information. During this mode, the trace elements are updated only when the detected signal level is greater than the previous signal level. (See DET.)

OUTPUT 718; "KSb;"

The KSb function and the front-panel  function are identical.

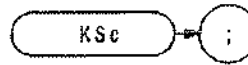

The KSc command adds trace A to trace B, point by point, and sends the result to trace A. Thus, KSc can restore the original trace after an A – minus – B function (AMB) is executed.

$$A + B \rightarrow A$$

To successfully add all trace elements, place trace A in VIEW or BLANK display mode before executing KSc.

```

10 ASSIGN @Sa TO 718
20 OUTPUT @Sa;"IP;"
30 OUTPUT @Sa;"CF100MZ;SP2MZ;"
40 OUTPUT @Sa;"A4;"
50 OUTPUT @Sa;"B1;CF200MZ;"
60 OUTPUT @Sa;"B4;"
70 OUTPUT @Sa;"A3;B3;"
80 OUTPUT @Sa;"KSc;"
90 END

```

- Line 20: Presets the instrument.
- Line 30: Sets trace A to 100 MHz center frequency with 2 MHz frequency span.
- Line 40: Blanks trace A.
- Line 50: Selects trace B and sets center frequency to 200 MHz.
- Line 60: Blanks trace B.
- Line 70: Views trace A and trace B.
- Line 80: Combines the amplitude of trace B with trace A and displays this combination as trace A.

The functions of the KSc and APB commands are identical.



The KSc function and the front-panel SHFT OFF ^C are identical.

KSd

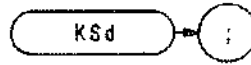
Negative-Peak Detection



The KSd command selects negative-peak input detection for displaying trace information. During this mode, the trace elements are updated only when the detected signal level is less than the previous signal level. (See DET.)

The functions of the KSd command and the   keys are identical.

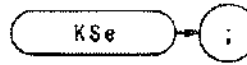

The KSe command selects the sample detection mode for displaying trace information. The KSe command is identical with manual operation of the front panel   keys.

In sample mode, the instantaneous signal value of the final analog-to-digital conversion for the sample period is stored in trace memory. As sweep time increases, many analog-to-digital conversions occur in each period, but only the final signal value is stored and displayed.

Sample detection mode is automatically selected for video averaging and noise level measurements.

```
OUTPUT 718;"KSe;"
```

The above program line selects the sample detection mode of the analyzer.

KSf

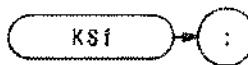

Protect Instrument State During Power Loss



Use the KSf command to recall any instrument configuration in the event of power loss.

If KSf is the last command executed, and the analyzer loses power, the instrument state at the time of power loss is restored when power returns.

If any spectrum analyzer command is executed, or any front panel key is pressed after KSf is executed, the analyzer configuration can not be regained if power is lost.

The functions of the KSf command and the   keys are identical.

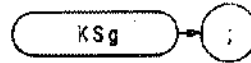

The KSg command turns off the CRT beam power supply to avoid unnecessary wear of the CRT in cases where the analyzer is in unattended operation. The KSg command is identical with manual operation of the front panel

 keys.

The KSg command does not affect HP-IB input/output of instrument function values or trace information.

```
OUTPUT 718;"KSg;"
```

The above program line turns the CRT beam power supply off.

KSh

CRT Beam On

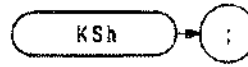

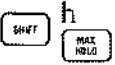
The KSh command turns the CRT beam on and is activated automatically with an instrument preset. The KSh command is identical with manual operating of the front panel  keys.

OUTPUT 718;"KSh;"

The above program line activates the CRT beam power supply of the analyzer.

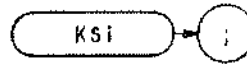

The KSi command exchanges traces C and B, point by point.



Note trace C is not a swept, active function. Therefore, exchange traces C and B as follows:

1. Select single sweep mode (SNGLS).
2. Select desired analyzer settings.
3. Take one complete sweep (TS).
4. Exchange data.

This procedure ensures that the current settings of the analyzer are reflected in the transferred data.

When transferring data from one trace to another, only amplitude information is exchanged, located in display memory addresses 1025 through 2025 and 2049 through 3049.

The functions of the KSi and BXC commands are identical.

The functions of the KSi command and the   keys are identical.

KSj

View Trace C

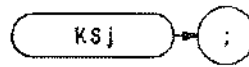

The KSj command displays trace C. Amplitude information for trace C is contained in display memory addresses 3073 through 4073. The KSj command displays this trace information on the analyzer display.

KSj also sends the instruction word, 1048*, to address 3072. Therefore, any information stored in address 3072 is lost when KSj is executed. If you have used address 3072 for a graphics program or a label, you may wish to save its contents before executing KSj.

Trace C is not a swept, active trace, as are traces A and B. Send data to trace C with these commands:

- BTC or KS1 transfers trace B amplitude information to trace C.
- BXC or KSi exchanges trace B and trace C amplitude information.
- DW or KS125 sends trace information to trace C.

Transfer trace amplitude information as follows:

1. Select single sweep mode (SNGLS or S2).
2. Select desired analyzer settings.
3. Sweep analyzer (TS).
4. Transfer data.

The program below demonstrates KSj.

```
10 ASSIGN @Sa TO 718
20 OUTPUT @Sa;"IP;"
30 OUTPUT @Sa;"A4;S2;"
40 OUTPUT @Sa;"B1;CF200MZ;SP2MZ;TS;"
50 OUTPUT @Sa;"KSj;"
60 OUTPUT @Sa;"B4;"
70 OUTPUT @Sa;"KSj;"
80 END
```

Line 20: Presets the instrument.

Line 30: Stores and blanks trace A. Selects single sweep mode (S2).

Line 40: Selects trace B. Sets the analyzer to 200 MHz center frequency with a 2 MHz frequency span. Takes one complete sweep of trace B at the current settings (TS).

Line 50: Exchanges trace B and trace C. Trace C (containing no trace data) now appears on the display as trace B. The asterisk (*) in the top right corner of the analyzer does not agree with the current display.

Line 60: Stores and blanks trace B (containing no trace data and an asterisk in the top right corner).

Line 70: Views trace C.

Commands BTC, KS1, BXC, and KSi manipulate trace amplitude information in display memory addresses 3074 through 4073. They do not manipulate data in the remaining display addresses that are allocated to trace C: addresses 4073 through 4095, and 3072. These addresses are available, in addition to address 3073 and 4074, for custom graphics programming or labels. (See Appendix B.)

The functions of the KSj command and   keys are identical. (See VIEW and BLANK.)

* 1048 is a machine instruction word that sets addresses 3073 through 4073 to zero and draws the trace dimly.

KSk

Blank Trace C

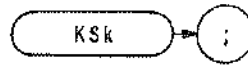

The KSk command blanks trace C. Amplitude information for trace C is contained in display memory addresses 3073 through 4073. The KSk command blanks trace C but does not alter the information stored in these addresses.

KSk also sends the instruction word, 1044*, to address 3072. Therefore, any information stored in address 3072 is lost when KSk is executed. If you have used address 3072 for a graphics program, or label, you may wish to save its contents before executing KSk.

The functions of the KSk command and   keys are identical. (See Ksj, VIEW, and BLANK.)

* 1044 is a machine instruction word that sets addresses 3073 through 4073 to zero and skips to the next page memory.

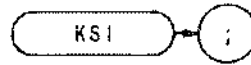

The KSI command transfers trace B to trace C.

Note trace C is not a swept, active function. Therefore, transfer trace information to trace C as follows:

1. Select single sweep mode (S2).
2. Select desired analyzer settings.
3. Take one complete sweep (TS).
4. Transfer data.

This procedure ensures that the current settings of the analyzer are reflected in the transferred data.



```

10 OUTPUT 718;"IP;TS;SNGLS;A3;"
20 OUTPUT 718;"B1;CF 20MZ;TS;B4;"
30 OUTPUT 718;"KSI;KSj"
31 LOCAL 718
40 END

```

When transferring trace data from one trace to another, only the trace information from 1001 display memory addresses is transferred out of the total 1024 available display memory addresses. Information in address 1024 and addresses 2026 through 2047 is not transferred. (Addresses 2026 through 2047 are usually used for custom graphics.)



The functions of the KSI and BTC commands are identical.

The functions of the KSI command and the   keys are identical.

KSm

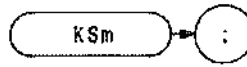
Graticule Off





The KSm command blanks the graticule on the analyzer display. The KSm command is identical with manual operation of the front panel   keys.

OUTPUT 718; "KSm;"

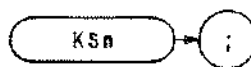
See also GRAT.



The KSn command turns on the graticule of the analyzer display. The KSn command is identical with manual operation of the front panel   keys.



OUTPUT 718, "KSn;"

See GRAT and KSm.

KSo

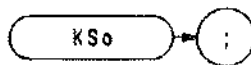
Characters Off





The KSo command blanks the annotation on the analyzer display. The functions of the KSo command and the front panel   keys are identical.

OUTPUT 718;"KSo;"

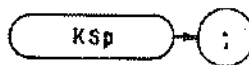
See ANNOT and KSp.



The KSp command turns on all annotation on the analyzer display. The functions of the KSp command and the front panel    keys are identical.

OUTPUT 718; "KSp;"

See KSo and ANNOT.

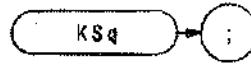

KSq

Step Gain Off





The KSq command is a diagnostic aid used for servicing the spectrum analyzer.

The KSq command uncouples the step gain amplifiers (from attenuator changes) of the IF section (A4A5 Step Gain and A4A8 Attenuator-Bandwidth Filter).

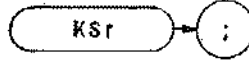
The functions of the KSq command and the   key are identical.





The KSr command sends service request 102 to the controller, notifying the controller that the operator has requested service. See Appendix D.

The functions of the KSr command and the   keys are identical.

KSt

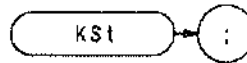
Marker Continue (MKCONT)



The KSt command takes a sweep, starting at the active marker, continues through a full sweep back to the same marker, and stops. The functions of the KSt command and the front panel   Sweep keys are identical.

A normal marker and the KSu (stop sweep at marker) command must be activated prior to executing the KSt command. Once the KSt command has been activated, the analyzer remains in single sweep mode. Each time KSt is initiated again, the sweep starts at the marker and continues through a full sweep until it again stops at the active marker.



The KSt command remains in effect until a marker off (M1) command or an instrument preset is done.

The KSt command syntax is shown in the sample program line below.

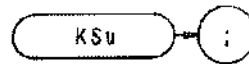
OUTPUT 718; "KSt;"



The KSu command stops the sweep at the active marker. (See also MKSTOP.)

The functions of the KSu command and the   keys are identical.

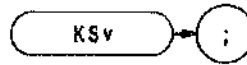

KSv

Inhibit Phase Lock





The KSv command is a diagnostic aid used for servicing the spectrum analyzer.



The KSv command permits the analyzer to sweep at normal sweep rates, ignoring any phase-lock flag indications.

The functions of the KSv command and the front panel   Trigger keys are identical.

The KSv (inhibit phase-lock flags) command does lock the YIG-tuned oscillator (YTO) to the center frequency, as in normal operation of the analyzer. Therefore, the displayed frequencies may not be accurate when KSv is in effect.

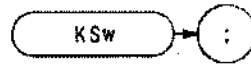
The functions of the KSv command and the   keys are identical.



The KSw command displays the correction data of the error correction routine of the analyzer. KSw executes the correction routine. (See KSW.) The functions of the KSw command and the front panel   keys are identical.

Correction data can also be transferred to the controller by executing the KSw (display correction routine) command. The correction data is transferred in sequence as a series of 43 strings using the following program:

```

10 DIM A$(1:43)(80)
20 OUTPUT 718;"KSw;"
30 FOR N = 1 TO 43
40 ENTER 718;A$(N)
50 NEXT N

```

Line 10: Dimensions string array storage (in the controller memory) for correction data.
Line 20: Sends correction data to controller.
Line 30 to 50: Sequentially stores correction data in array.

The content of each string is the error in dB or Hz for a specific control setting relative to a set of standard settings determined at the factory. Strings 6 through 29 contain the amplitude and frequency errors displayed on CRT lines 6 through 17. Data in strings 1 through 5 correspond to CRT lines 1 through 5, and data in strings 30 through 43 correspond to lines 18 through 31. The errors listed should be within the specification listed on the Error Correction Routine Table.



For additional information on the error correction routine, see Error Correction Routine in Chapter 11 of Section I.

Error Correction Table

Parameter	Specification	
LOG and LIN scale, BW <100 kHz	± 1 dB typical	
LOG 10 dB/	± (0.5 dB — 1 dB reading)	
LOG 5 dB/		
LOG 2 dB/		
LOG 1 dB/		
RES BW = 3 MHz		
1 MHz	± 0.5 dB	
300 kHz	± 1 dB*	
100 kHz	.	
30 kHz	± 0.5 dB*	
10 kHz		
3 kHz		
1 kHz		
300 Hz		
100 Hz		
30 Hz		
10 Hz		
LOG and LIN scale, BW ≥100 kHz		± 1 dB*
LOG and LIN scale, BW ≥100 kHz		± 1 dB typical
Step Gains = A20	± 0.6 dB	
A10		
SG20-2	± 1.0 dB	
SG20-1		
SG10		
LG20		
LG10	± 1.0 dB typical	
RF ATTENUATOR = 20 dB	± 0.2 dB typical	
20 dB		
30 dB		
40 dB		
50 dB		
60 dB		
70 dB		

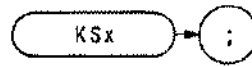
* Specifications for all Resolution Bandwidths are referenced to the 1 MHz Resolution Bandwidth. The frequency error terms are for error correction only.



The KSx command activates the normal external trigger mode, but eliminates the automatic refresh for sweep times less than 20 msec. (The T3 and TM commands do not inhibit the automatic refresh.) The functions of the KSx command and the front panel   keys are identical.



When the KSx command is executed, the RF input signal is displayed only when the external trigger signal exceeds the threshold of the trigger level.

OUTPUT 718; "KSx;"

KSy

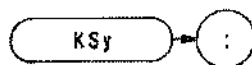
Video Trigger



The KSy command activates the normal video trigger mode, but eliminates the automatic refresh for sweep times less than 20 msc. (The T4 and TM commands do not inhibit the automatic refresh.) The functions of the KSy command and the front panel   Trigger keys are identical.

When the KSy command is executed, the RF input signal is displayed only when the video trigger signal, which is internally triggered off the input signal, exceeds the threshold of the trigger level.

OUTPUT 718; "KSy;"

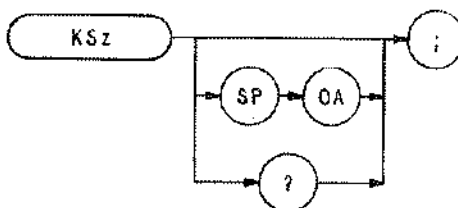

The KSz command displays the specified display memory address of the analyzer from 0 to 4095. If an address is not specified, the analyzer displays the current address. The functions of the KSz command and the front panel



keys are identical.

The KSz command has the same function as the DA command.

OUTPUT 718; "KSz;"

For additional information on the KSz command, see DA.

KS,

Mixer Level
(ML)

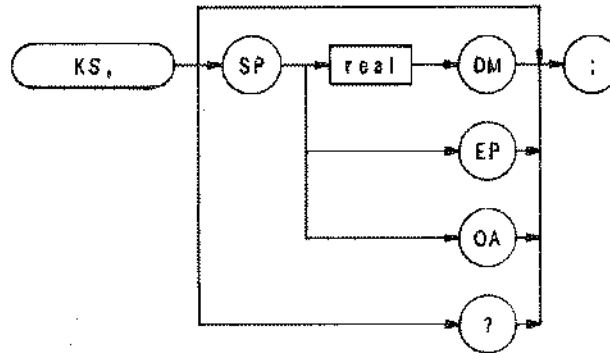



The KS, command specifies the maximum signal level that is applied to the input mixer for a signal that is equal to or below the reference level.

The effective mixer level is equal to the reference level minus the input attenuator setting. When KS, is activated, the effective mixer level can be set from -10 dBm* to -70 dBm in 10 dB steps. Instrument preset (IP) selects -10 dBm.

The program line below sets the mixer level to -40 dBm.

```
OUTPUT 718;"KS, -40DM;"
```

As the reference level is changed, the coupled input attenuator automatically changes to limit the maximum signal at the mixer input to -40 dBm for signals less than or equal to the reference level.

The functions of the KS, and ML commands, and the   keys are identical. See also AT.

* In the extended reference level range, the effective mixer level can be set to 0 dBm.

Marker Frequency Counter Resolution (MKFCR)

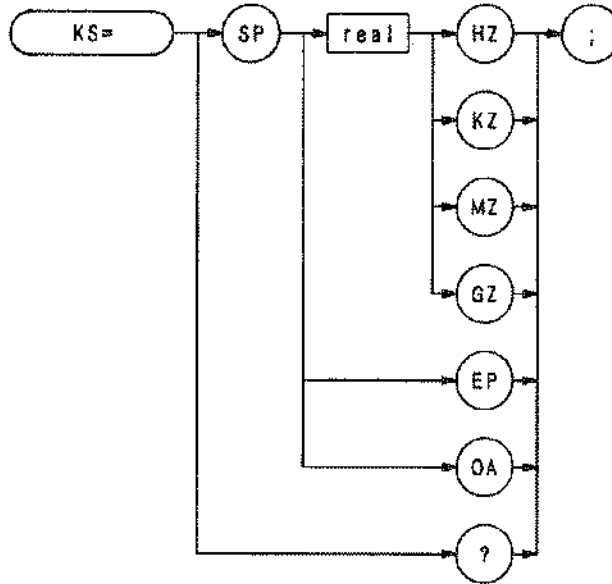

Item	Description/Default	Range Restriction
REAL	Default is 0 Hz.	

The KS = command specifies the number of significant digits in the marker frequency readout, for spans of 2 MHz or less. Execute MC1 or MKFC before executing KS = .



OUTPUT 718; "MKFC KS = 100HZ;"

The counter resolution can be set between 1 Hz and 100 kHz to obtain the following marker frequency resolutions:

Counter Resolution	Readout for 100 MHz Signal
100 kHz	100.0 MHz
10 kHz	100.00 MHz
1 kHz	100.000 MHz
100 Hz	100.0000 MHz
10 Hz	100.00000 MHz
1 Hz	100.000000 MHz

Counter resolution values entered in values other than specified above, such as 25 Hz and 326 kHz, are rounded to the closest power-of-ten value. For example, a counter resolution entry of 25 Hz is entered as 10 Hz.

The resolution of the counter frequency remains fixed until the resolution is changed again or until an instrument preset (IP).

The functions of the KS = and MKFCR commands, and the front panel   keys, are identical. See MKFC or MC1.

KS(

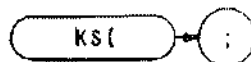

Lock Registers





The KS(command secures the contents of registers one through six. When the registers are secured, the SV and SAVE commands cannot save more instrument states in the registers, but instead write "SAVE LOCK" on the analyzer display. To save an instrument state in a locked register, first execute KS) to unlock the registers.



The recall function of the analyzer is not affected by this function.

OUTPUT 718; "KS(;"

The functions of the KS(command and the   keys are identical.

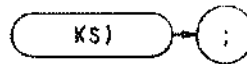
The KS(command also protects the contents of any user-defined softkeys when the analyzer is under **manual** operation. During manual operation, softkeys are loaded by pressing the  key. Loading a softkey with new information erases the original contents of the softkey. If KS(has been executed, pressing  does not load a softkey. Thus, existing softkey contents cannot be altered. Execute KS) to unsecure the softkeys.



The KS) command unlocks the registers where instrument states are stored with SV and SAVE commands. The functions of the KS) command and the front panel   keys are identical.

When the registers are unlocked, new instrument states can be saved in registers one through six. Each time new states are stored, the original register contents are erased.

The recall function of the analyzer is not affected by this function.

OUTPUT 718; "KS);"

The KS) command also unlocks user-defined softkeys, which are locked during manual operation only, by the KS(command.

See KS(.

KS|

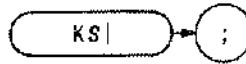

The KS| command writes the instruction word or data value into the specified display memory address. The functions of the KS| command, the front panel  keys, and the DW command are all identical.



The sample program lines below demonstrate how to format the KS| command.

```
10 OUTPUT 718;"KS|;"  
20 OUTPUT 718;"KS";CHR$(124)  
30 OUTPUT 718 USING "K,B";"KS",124
```

For additional information on display write, refer to the DW command.

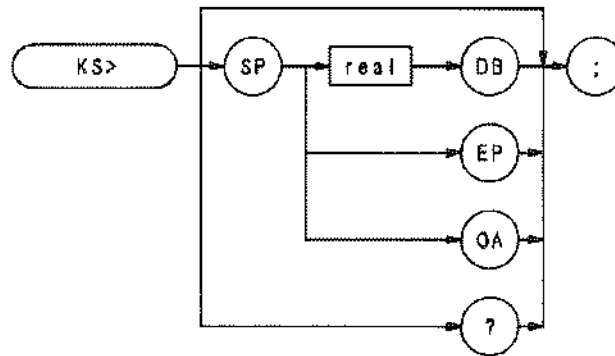



Use the KS> command when using a preamplifier at the 100 kHz to 1.5 GHz input. The KS> command offsets the amplitude readouts so the displayed amplitudes represent power levels at the preamplifier input.

The selected gain offset is displayed in the active function readout, and is always displayed above the graticule (PG) as long as the KS> offset is in effect.

Instrument preset (IP) removes the offset.

OUTPUT 718; "KS> 10;"

The functions of the KS> command and the front panel   keys are identical.

KS<

Preamp Gain – Input 1

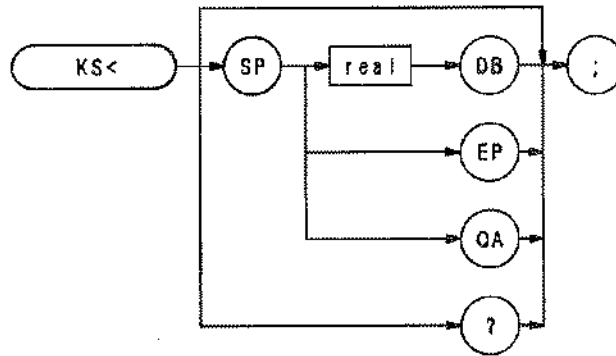



Use the KS< command when using a preamplifier at the 100 Hz to 1.5 GHz input. The KS< command offsets the amplitude readouts so the displayed amplitudes represent power levels at the preamplifier input.

The selected gain offset is displayed in the active function readout, and is always displayed above the graticule (PG) as long as the KS< offset is in effect.

Instrument preset (IP) removes the offset.

OUTPUT 718; "KS< 10;"

The functions of the KS< command and the front panel   keys are identical.

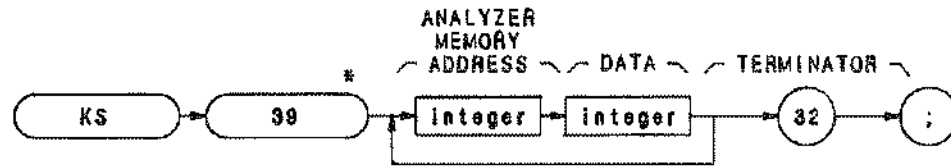

Item	Description/Default	Range Restriction
INTEGER	Represents the analyzer display memory address. Must be sent to analyzer as two 8-bit bytes.	1 to 4095
INTEGER	Represents amplitude data. Each data value must be sent to analyzer as two 8-bit bytes.	0 to 1022 Number of addresses between starting address and 4095.

KS39 is the general purpose command for writing data into the analyzer display memory. Any starting display address is allowed with KS39. Up to 4096 display memory values can be sent in one operation. Data sent with KS39 must be in 2-byte binary format, 02, and be terminated with a single binary byte value of 32. The number of bytes sent to the analyzer is limited by the number of addresses between the starting address and address 4095, the last display memory address. The display address must be sent to the analyzer in the 2-byte binary format.

KS123 and KS39 are often used together to read and write the contents of display memory. The following program demonstrates this.

```

10 OPTION BASE 1
20 DIM M$(8)[1024]
30 OUTPUT 718;"02;"
40 Da = 0
50 !
60 FOR I = 1 TO 8
70   OUTPUT 718;"DA";Da;"KS";CHR$(123)
80   ENTER 718 USING "#,1024A";M$(I)
90   Da = Da + 512
100 NEXT I
110 !
120 OUTPUT 718;"A3;B3;M1;L0;KSm;KSo;"
130 OUTPUT 718;"EM;KSi;EM;EX;KSi;EM;"
140 PRINT "OBSERVE BLANK SCREEN;PRESS CONTINUE"
150 PAUSE
160 !
170 OUTPUT 718 USING "#,K,B,W";"KS";39;0
180 OUTPUT 718 USING "8(K),B";M$(*);32
190 OUTPUT 718;"A1;"
200 END

```

KS39 (Continued)

- Lines 10 to 100: Sends the content of trace memory to the controller. Refer to the description of the KS123 mnemonic for a complete explanation of these lines.
- Lines 120 to 150: Erases trace A, B, and C memories and blanks the annotation and graticule.
- Line 170: Sends the KS39 command and the display memory address to the analyzer. The USING part of the OUTPUT statement formats the controller to send the KS as a compact field, the 39 as a single binary byte, and the Ø (display address) as a two byte binary word, the # sign suppresses the trailing CR/LF so it will not be send as part of the display memory data.
- Line 180: Sends the display memory data contained in array M\$ to the analyzer and terminates the KS39 command with a 32. The USING part of the OUTPUT statement formats the controller to end the contents of the array as eight strings and the 32 as a single binary byte.
- Line 190: A1 sets trace A to the clear-write mode. HD clears the active function block of the display, which contained a display address.

The KS39 command cannot be executed from the front panel.

NOTE

The syntax of the KS39 command is different for the HP 8568A and B analyzers. See Appendix I for details.

* This is the decimal ASCII equivalent and is transmitted to the analyzer as a single 8-bit byte.

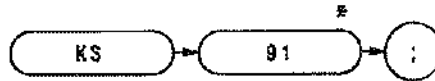

KS91 sends an amplitude correction value to the controller. This correction value improves measurement accuracy when it is subtracted from the amplitude measured by the analyzer.

The analyzer compiles the KS91 correction value from calibration data stored in its memory by the KSW command, the error correction routine. When the KS91 command is executed, the correction value is compiled from those parts of the KSW data that apply to the present instrument state. Execute KSW before KS91 to ensure the correction value is based on recent KSW data. Execute KS91 immediately after making your amplitude measurement to ensure the correction value is based on the right instrument settings.

The KSX (Use Correction Data) command puts the analyzer into a “corrected” mode. In this mode the analyzer automatically corrects its measurements with the data collected by the KSW command. The KSX command makes amplitude corrections by adjusting the IF gain. Because of the inaccuracies inherent in changing the IF gain, the correction mode established by the KSX command is up to 0.4 dB less accurate than the external mathematical correction made with the KS91 correction value.

The following program gives a sample readout of the KS91 correction value.

```

10 OUTPUT 718;"KSW;"
20 |
30 | Any amplitude measurement routine
40 |
50 OUTPUT 718 USING "K,B";"KS";91
60 ENTER 718;E
70 PRINT "AMPLITUDE ERROR IS ";E;" dB"
80 END

```

The correction value stored in variable E improves the amplitude measurement accuracy when it is subtracted from the measured amplitude.

The KS91 command cannot be executed from the front panel.

* This is the decimal ASCII equivalent and is transmitted to the analyzer as a single 8-bit byte.

KS 123

Read Display Memory

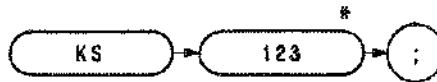

The KS123 command sends the contents of display memory to the controller. Thus, the controller “reads” display memory.

Starting at a designated address, KS123 sends 1001 of the 4096 analyzer display memory values to the controller. The analyzer output format and display memory address must be specified before executing KS123.

Follow the three steps listed below to send any section (up to 1001 addresses long) of display memory.

1. Specify the first display memory address of the section to be read.
2. Format a string or string array in the controller to store the exact number of values you need.
3. Terminate the KS123 command with a LOCAL 718 or an OUTPUT statement.

The KS123 command tells the analyzer to “wait” until 1001 memory values are read. If the controller does not read all 1001 memory values, the program must terminate this “wait” mode with step 3. The sample program below reads 10 memory values, starting at the center of trace A.

```
10 OPTION BASE 1
20 INTEGER A(10)
30 !
40 OUTPUT 718 USING "K,B";"01;DA 500;KS";123
50 ENTER 718;A(*)
60 OUTPUT 718;";"
70 LOCAL 718
80 !
90 FOR I = 1 to 10
100 PRINT A(I)
110 NEXT I
120 END
```

If KS123 is used with DA1 or DA1025, it imitates the TA and TB commands; however, TA and TB are slightly faster and therefore preferable. The only efficient way to read the entire contents of trace C memory, however, is with KS123. This is done by executing a DA3073 before the KS123 command, and dimensioning enough controller memory for 1001 display values. To read individual values of trace data, use the DR command.

KS123 can also send all display memory contents (4096 values) to the controller. This is done with a program loop that advances the display address by one and executes subsequent KS123 commands. The program below is an example of this application.

```

10 OPTION BASE 1
20 DIM M$(B)[1024]
30 OUTPUT 718;"02;"
40 Da = 0
50 !
60 FOR I = 1 TO 8
70     OUTPUT 718;"DA";Da;"KS";CHR$(123)
80     ENTER 718 USING "#,1024A";M$(I)
90     Da = Da + 512
100 NEXT I
110 !
120 OUTPUT 718;"A3;B3;M1;L0;KSm;KSo;"
130 OUTPUT 718;"EM;KSi;EM;EX;KSi;EM;"
140 PRINT "OBSERVE BLANK SCREEN;PRESS CONTINUE"
150 PAUSE
160 !
170 OUTPUT 718 USING "#,K,B,W,;"KS";39;0
180 OUTPUT 718 USING "8(K),B,K";M$(*);32;"
190 OUTPUT 718;"A1 HD"
200 END

```

- Line 20: Dimensions enough memory in M\$ to contain all 4096 values of display memory. (8192 bytes or 2 times 4096.)
- Line 30: Sets the analyzer output format to 2-byte binary. The KS39 command used in line 170 requires this format.
- Line 40: Sets the display address variable, Da, equal to the first address.
- Line 60: Defines the program loop. Eight cycles are necessary. The total number of display memory values (4096) is not evenly divisible by 1001, which is the number of values read by KS123. The next smallest number by which 4096 is evenly divisible is 512. $4096/512 = 8$.
- Line 70: Sets the display address and executes KS123. The 123 must be sent as a single binary byte.
- Line 80: Enters the display memory data into the string array M\$. (1024 or 2 times 512 bytes are entered.)
- Line 100: Continues the program at line 70. Line 70 readdresses the analyzer, clearing the "wait" mode. This "wait" mode is a result of using KS 123 to read less than 1001 display memory values.
- Lines 120 to 150: Erases trace A, B, and C memories and blanks the annotation and graticule.
- Line 170 to 190: Restores the analyzer display by writing the contents of M4 back into display memory.

The KS123 command cannot be executed from the front panel.

* This is the decimal ASCII equivalent and is transmitted to the analyzer as a single 8-bit byte.

KS125

Write to Display Memory

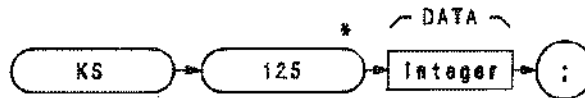

Item	Description/Default	Range Restriction
INTEGER	Represents amplitude data. Each trace data value must be sent as two 8-bit bytes. Up to 2002 bytes (1001 values) can be sent.	0—1022

The KS125 command writes data, which is formatted in 2-byte binary, into the analyzer display memory. The KS125 syntax requires a specified starting address that immediately precedes KS125. Specify the address with the DA command. Up to 1001 display memory values are written with each execution of KS125.

The following program first uses KS123 to send the contents of trace B memory to the controller array. The program then writes the contents of the array back to the analyzer trace B memory.

```
10 OPTION BASE 1
20 INTEGER B_store(1001)
30 !
40 OUTPUT 718;"A4;B1;TS;B3;"
50 OUTPUT 718 USING "K,B,#";"O2;DA1024;KS";123
60 ENTER 718 USING "W";B_store(*)
70 !
80 OUTPUT 718;"S1;A1;B1;"
90 LOCAL 718
100 PRINT "CHANGE ANALYZER DISPLAY;PRESS CONTINUE"
110 PAUSE
120 !
130 OUTPUT 718;"B3;"
140 OUTPUT 718;"DA 1024;"
150 OUTPUT 718 USING "K,B,#";"KS";125
160 OUTPUT 718 USING "W";B_store(*)
170 OUTPUT 718;";"
180 END
```

- Line 20: Dimensions enough memory to store the contents of trace B memory. The INTEGER statement automatically dimensions 2 bytes for each element of string B_store (1001 elements).
- Lines 40 to 60: Sweeps trace B and then sets it to the view mode. The analyzer is then set to the 2-byte binary display-units output format. Next, the contents of trace B are read by the controller and stored in string B_store.
- Lines 80 to 110: Clears trace B, places the analyzer in the LOCAL mode, and tells the operator to change the analyzer display (trace B display) and continue the program.

- Line 130: Places trace B in the view mode. This is necessary to prevent the analyzer from writing over the data placed back into trace B by KS125.
- Lines 40 to 150: Sets the analyzer display address to 1024 with the DA command and sends the KS125 command to the analyzer. The "125" in KS125 is sent as a single binary byte.
- Line 160: Writes the integer string B_store, which contains the display memory values for the original trace B display, into the analyzer trace B memory, restoring the original trace B display.

The KS125 command cannot be executed from the front panel.

* This is the decimal ASCII equivalent and is transmitted to the analyzer as a single 8-bit byte.

KS126

Read Every Nth Value

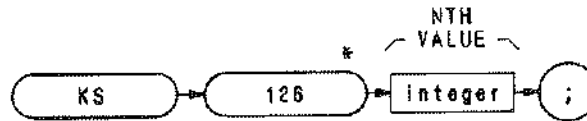

Item	Description/Default	Range Restriction
INTEGER	Represents every Nth value of trace A, B, or C display memory.	0–1022

KS126 sends every Nth value in display memory to the controller. This is useful when more trace data than required are available. For example, when displaying noise data in zero span, a small number of points can be sampled and averaged without a significant loss of data. Another example is when the resolution bandwidth is wide enough relative to the spanwidth so that only minimum display resolution is required.

Before executing the KS126 command, the analyzer output format and starting display memory address must be specified. All trace memories must be in a store mode (VIEW or BLANK) when they are read by KS126. Immediately following the command, the variable N must be specified as follows:

$$N = \text{point interval and is described by the formula } N = 1000 / (M - 1).$$
$$M = \text{the number of points to be read and is described by the formula } M = (1000 / N) - 1.$$

The value of N must be an integer and must be sent to the analyzer as a single binary byte. The resulting value of M dimensions memory in the controller.

The following program is an example of reading 11 values of trace B with KS126.

```
10 OPTION BASE 1
20 INTEGER A(11)
30 OUTPUT 718 USING "K,B,K";"01;DA1025;KS";126;"100;"
40 FOR I = 1 TO 11
50 ENTER 718;A(I)
60 PRINT A(I)
70 NEXT I
80 END
```

The KS126 command cannot be executed from the front panel.

* This is the decimal ASCII equivalent and is transmitted to the analyzer as a single 8-bit byte.

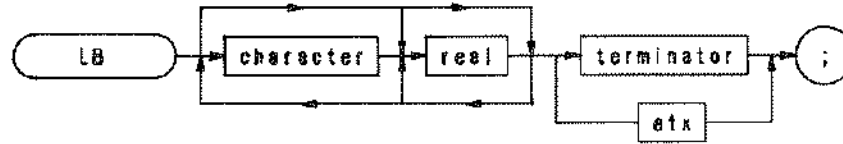

Item	Description/Default	Range Restriction
CHARACTER	Represents text displayed on screen.	ASCII codes 32—126
REAL	Represents text displayed on screen.	
TERMINATOR	Terminates text. Character defined in DT command.	ASCII codes 0—255
ETX	End of text.	ASCII code 3

The LB command writes text (label) on the CRT display with alphanumeric characters specified in the program. The text characters are each specified by 8 bits in a 12-bit data word which immediately follows the LB command. (The 4 most significant bits in the data word are set to 0.) The decimal equivalent of the binary number formed by the 12-bit data word corresponds to a particular one of the available alphanumeric characters. Decimal numbers 0 through 255 and their corresponding characters are shown in the Character Set Table at the end of this command description.

Characters generated for the LB command are aligned on the CRT in the same manner as typeset characters on a printed page (that is, in rows and columns). This alignment is important when you are labeling graph lines or points.

The display size specified by the display size command (D1, D2, D3), or the “big expand (bex)” instruction, determines the position of the text on the CRT, the number of rows and columns, and the size of the characters.

A typical use of the LB command is shown in the sample program below.

```

10 OUTPUT 718;"IP;"
20 OUTPUT 718;"A4;K80;D3;"
30 OUTPUT 718;"DT@";
40 OUTPUT 718;"PU PA 75,650 LB LABEL@";
50 END

```

Line 20: Blanks display and selects display size.

Line 30: Establishes a character (@) to terminate label text.

Line 40: Positions start of label text, writes text, and terminates label mode.

LB (Continued)

When using LB, the end of the text must be terminated. If the text is not terminated, instructions and other text following the actual label statement are displayed on the CRT. The label mode can be terminated with an ASCII end-of-text code (decimal code 3), or with a character specified by the DT command. The label terminator command, DT, suffixed with the character selected as the terminator (see line 30 above), must precede the label. The terminator character itself must immediately follow the label.

The character codes listed below provide special label functions. Instructions for a particular function are normally given in the function's decimal code.

Code*	Function**
0	null
8	back space (BS)
10	line feed
11	vertical tab (opposite of line feed) (VT)
12	form feed (move beam to 0,0) (FMFD)
13	carriage return (CR)
17	blink on (bkon)
18	blink off (bkof)
32	space (SP)
145	skip to next higher block of 16 addresses (sk 16)
146	skip to third higher block of 16 addresses (sk 16)
147	skip to fifth higher block of 16 addresses (sk 64)

* Character codes can be used with both the label instruction code (1025+) and the LB command.

** Abbreviations within the parenthesis are shorthand notation for writing display programs. They are **not** programming codes.

A blink-on instruction causes the label statement to blink until a subsequent blink-off or end-of-text instruction in the program is executed.

For the skip-to-next-block instructions, the 4096 addresses in the display memory are hypothetically divided into 256 blocks of 16 addresses each. Execution of a skip instruction causes the program to skip to the first address in the next higher block of 16 addresses (code 145), to skip over the next two higher blocks to the first address in the third higher block (code 146), or to skip over four blocks to the first address in the fifth higher block (code 147).

For example, if the program is at any address from 0 through 15 (the first block of 16 addresses) and a skip-to-next-16-block is executed, the program skips to address 16 (the first address in the second block of 16 addresses). Similarly, if the program is at address 84 in the sixth block of 16 addresses, and a skip-to-next-32-block is executed, the program skips over two blocks of 16 addresses to address 128 (the first address in the ninth block). Again, if the program is at address 84 in the sixth block, but the instruction this time is for a skip-to-next-64-block, the program skips over four blocks to address 160 in the eleventh block of 16 addresses.

A sample program using the blink-on and blink-off codes is shown below.

```
20 ASSIGN @Sa TO 718
30 OUTPUT @Sa;"IP;"
40 OUTPUT @Sa;"A4;KSo;D3;"
50 OUTPUT @Sa;"PU;PA 344,656;LB";CHR$(17);"LABEL";CHR$(18);CHR$(3);
60 END
```

For a binary format, line 50 can be written as follows:

```
50 OUTPUT @Sa USING "K,B,K,B,B";"PU;PA 344,656;LB";17;"LABEL";18.3;
```

Line 30: Presets the instrument.

Line 40: Blank trace A and characters and selects display size 3.

Line 50: Positions the beginning of the label, blinks the label, and terminates the label.

Character Set

The character set for the label command is the same as the ASCII set. There are 86 additional characters available.

Code	Char	Code	Char	Code	Char	Code	Char	Code	Char	Code	Char	Code	Char	Code	Char
0	(NULL)	32	SP	64	@	96	,	128		160	^	192	<	224	ψ
1		33	!	65	A	97	a	129		161	<	193	Δ	225	α
2		34	"	66	B	98	b	130		162	:	194	∫	226	β
3		35	#	67	C	99	c	131		163	≠	195	φ	227	χ
4		36	\$	68	D	100	d	132		164	ℙ	196	∇	228	δ
5		37	%	69	E	101	e	133		165	⊗	197		229	ε
6		38	&	70	F	102	f	134		166	⊕	198		230	φ
7		39	'	71	G	103	g	135		167	.	199	g	231	γ
8	(BS)	40	<	72	H	104	h	136		168	←	200	h	232	η
9		41	>	73	I	105	i	137		169	→	201	,	233	ι
10	(LF)	42	*	74	J	106	j	138		170	∞	202		234	ς
11	(VT)	43	+	75	K	107	k	139		171	±	203		235	κ
12	(FNFD)	44	,	76	L	108	l	140		172	↓	204	┌	236	λ
13	(CR)	45	-	77	M	109	m	141		173		205	└	237	μ
14		46	.	78	N	110	n	142		174	*	206	ο	238	ν
15		47	/	79	O	111	o	143		175	÷	207	ο	239	ο
16		48	0	80	P	112	p	144		176	o	208	ρ	240	π
17	(BKDN)	49	1	81	Q	113	q	145	(SK16)	177	-	209	σ	241	θ
18	(BKDF)	50	2	82	R	114	r	146	(SK32)	178	~	210	τ	242	ρ
19		51	3	83	S	115	s	147	(SK64)	179	≡	211	ω	243	α
20		52	4	84	T	116	t	148		180	≡	212	ϖ	244	τ
21		53	5	85	U	117	u	149		181	≡	213	ϗ	245	υ
22		54	6	86	V	118	v	150		182	≡	214	<	246	ϕ
23		55	7	87	W	119	w	151		183	√	215	∥	247	ω
24		56	8	88	X	120	x	152		184	~	216	∥	248	Γ
25		57	9	89	Y	121	y	153		185	R	217	∥	249	Δ
26		58	:	90	Z	122	z	154		186	≡	218	∥	250	Ω
27		59	;	91	[123	{	155		187	:	219	∥	251	Σ
28		60	<	92	\	124		156		188	∥	220	∥	252	Λ
29		61	≡	93]	125	}	157		189	≡	221	∥	253	Υ
30		62	>	94	↑	126	~	158		190	>	222	∥	254	∥
31		63	~	95	_	127		159		191	>	223		255	

LABEL COMMAND CHARACTER SET

Blank codes are either unassigned or character pieces. () indicates display machine language word. See Appendix B.

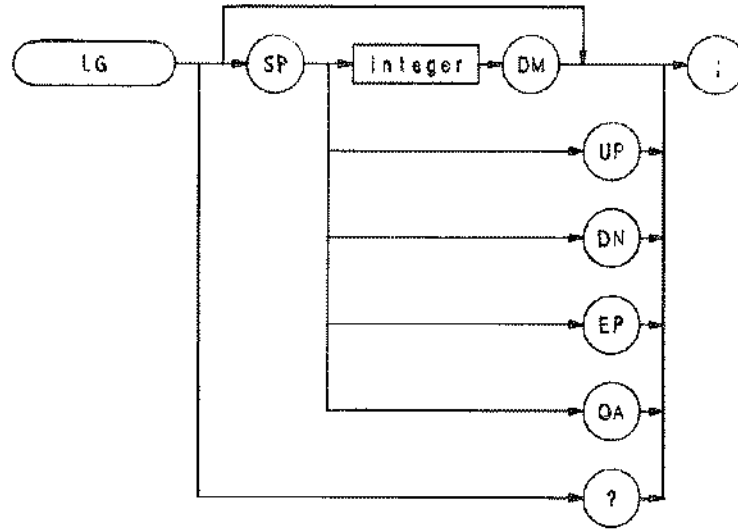

Item	Description/Default	Range Restriction
INTEGER		1, 2, 5, 10

The LG command specifies the vertical graticule divisions as logarithmic units without changing the reference level. The vertical scale may be specified as 1, 2, 5, or 10 dB per major division. If no value is specified, as shown below, the logarithmic scale is 10 dB per division.

OUTPUT 718; "LG;"

The functions of the LG command, and the front panel  key are identical.

When queried (? or OA), LG returns the current log scale as a real number, followed by a carriage-return/line-feed (ASCII codes 13, 10). The end-or-identify state (EOI) is asserted with line feed.

LL

Lower Left

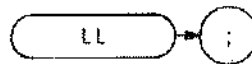

The LL command sends a voltage to the rear panel RECORDER OUTPUTS. The voltage level remains until a different command is executed. Use the LL command to calibrate the lower left dimension of a recorder. The LL command is illustrated in the sample program below.

```
10 OUTPUT 718;"LL;"  
20 PRINT "ALIGN PLOTTER PEN LOWER LEFT CORNER OF PAPER: PRESS CONTINUE."  
30 END
```

The functions of the LL command and front panel  key are identical. (See Introduction in Section I.)

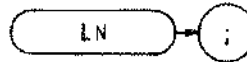

The LN command scales the amplitude (vertical graticule divisions) proportional to input voltage, without changing the reference level. The bottom graticule line represents a signal level of zero volts.

The LN command selects V, mV, or uV as the vertical scale, depending on the vertical scale before LN is executed.

Units other than V/DIV, MV/DIV, or uV/DIV can be selected by changing the reference level after executing LN. For example, to set the scale to 3 mV/DIV, specify a reference level of 30 mV.

OUTPUT 718; "LN; RL 30mV;"

Note that voltage entries are rounded to the nearest 0.1 dB. Thus, 30 mV becomes 30.16 mV, which equals -17.4 dBm.

The functions of the LN command and front panel  key are identical. (See also KSB, KSC, and KSD.)

LOG

Logarithm

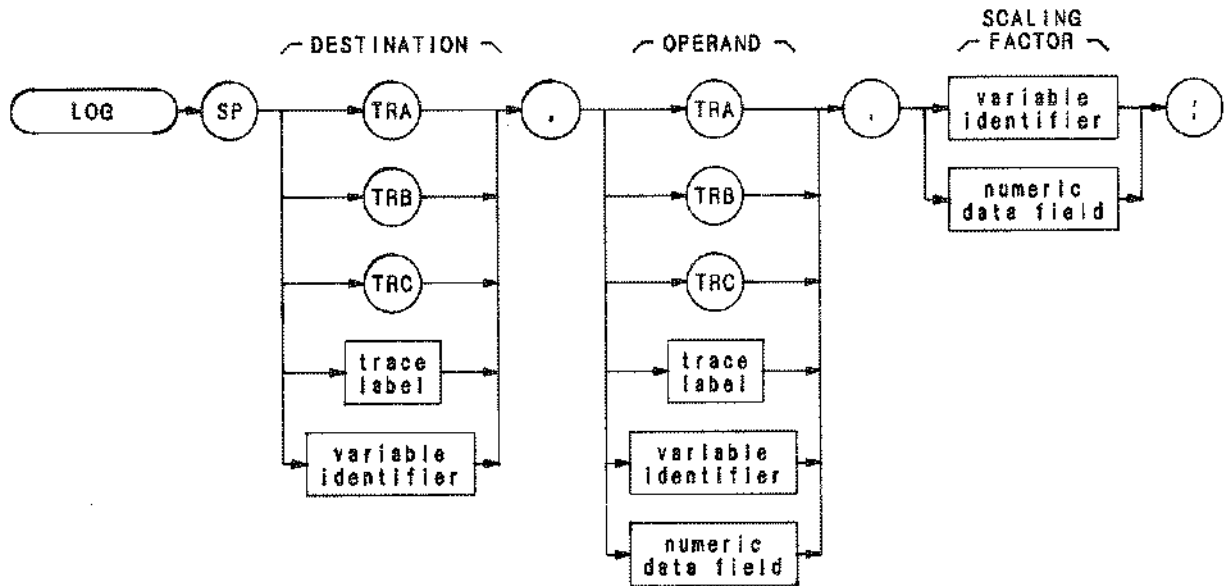

Item	Description/Default	Range Restriction
TRACE LABEL	Alpha character. User-defined label declared in TRDEF statement.	AA-ZZ and _ 2— 12 characters required.
VARIABLE IDENTIFIER	Alpha character. User-defined identifier declared in VARDEF statement.	AA-ZZ and _ 2— 12 characters required.
	Alpha character. Measurement-variable identifier, such as CF or MA.	
	Trace element, such as TRA[10].	
NUMERIC DATA FIELD	Real	

The LOG command modifies the operand:

$$\text{LOG operand 1} \times \text{scaling factor} \rightarrow \text{destination}$$

The operands and destination may be different lengths. The trace operands (TRA, TRB, TRC, and trace label) range from 1 to 1008 elements in length; a variable identifier or numeric data field is one element long. When

operands differ in length, the last element of the shorter operand is repeated for processing. When the operands are longer than the destination, they are truncated to fit.

OUTPUT 718; "LOG TRC, TRA 10;"

LØ

Display Line Off

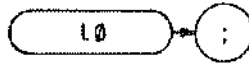

The **LØ** command disables the display line.

The functions of the **LØ** command and the front panel, reference line  key are identical. The display line also can be turned on or off by the **DLE** and **DL** commands.

OUTPUT 718; "LØ;"

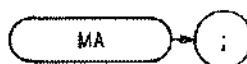

The MA command returns the amplitude level of the active marker to the controller, if the marker is on screen. If both the delta marker and active marker are on screen, MA returns the amplitude difference between the two markers. (See MKDELTA and M3.) The amplitude is also displayed in the upper right-hand corner of the analyzer display.

The output can be formatted in any of the four output formats. (Refer to FORMAT commands, O1, O2, O3, O4.) However, do not use output format O4 for marker delta output, because sign information is lost.

A typical use of the MA command is shown in the sample program below.

```

10 ASSIGN @Sa TO 718
20 PRINTER IS 701
30 OUTPUT @Sa;"FA 80MZ; FB 120MZ;"
40 OUTPUT @Sa;"M2;E1;"
50 OUTPUT @Sa;"MA;"
60 ENTER @Sa;A
70 PRINT A
80 END

```

Line 30: Selects start and stop frequencies.
 Line 40: Activates a normal marker and peak search.
 Line 50: Returns the amplitude to the controller.
 Line 60: Assigns the amplitude to variable A.
 Line 70: Prints the marker amplitude.

An ENTER command must follow each output command, or output data is lost. For example, the following program assigns only the marker amplitude to variable F, and the marker frequency value is lost.

```

OUTPUT 718;"MF;MA;"
OUTPUT 718;F,A

```

MBRD

Processor Memory Block Read

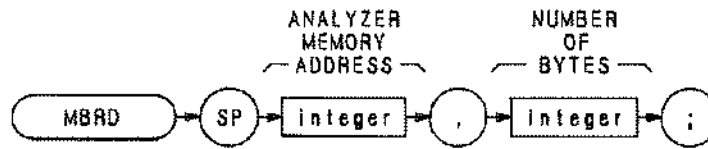

Item	Description/Default	Range Restriction
INTEGER	ASCII decimal number representing analyzer memory address.	
INTEGER	ASCII decimal number indicating number of bytes to read.	
NUMERIC DATA FIELD	Real	

The MBRD command reads an indicated number of bytes, beginning at the specified microprocessor address, and returns the bytes to the controller.

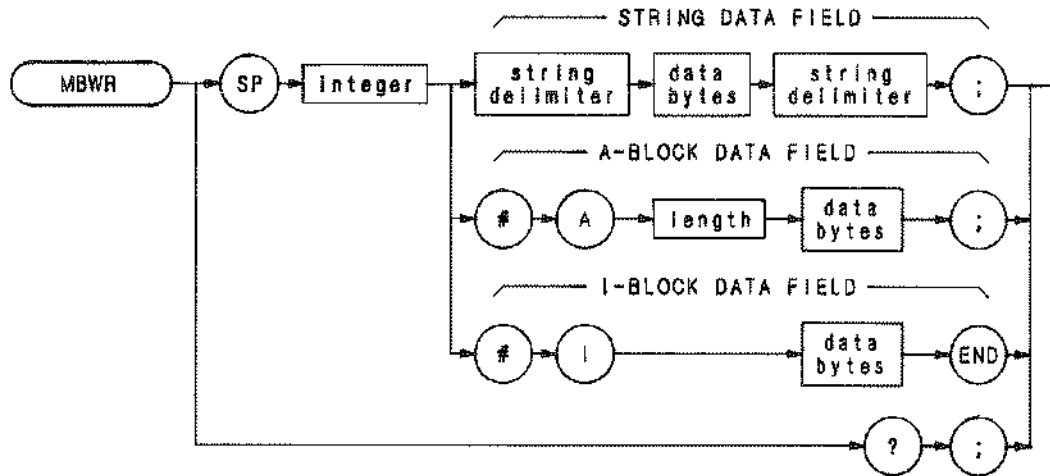

Item	Description/Default	Range Restriction
STRING DELIMITER	Mark beginning and end of command string. End and beginning delimiter must be identical.	!"\$%&'/:=@\~
LENGTH	Two 8-bit bytes specifying length of command list, in 8-bit bytes. The most significant byte is first: MSB LSB.	
DATA BYTES	8-bit bytes of data representing command list.	
INTEGER	ASCII decimal number representing analyzer memory address.	

The MBWR command writes a block message to analyzer memory, starting at specified address.

MC0

Marker Count Off

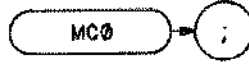

The MC0 command disables the marker frequency count mode. (See also MC1 and MKFC.)

```
OUTPUT 718; "MC0;"
```

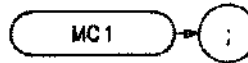

The MC1 command counts the marker frequency. Use this command to measure a signal frequency with greater accuracy. Measurement accuracy is determined by the MKFCR or KS = command.

Before executing MC1, position an active marker 20 dB above the noise floor, or in the upper six major divisions of the graticule. Otherwise, the measurement may be inaccurate. The message "CNTR" blinks if MC1 is executed and the active marker is in the lower four divisions.

The functions of the MC1 command and front panel  key are identical. (See also MKFC and MC0.)

OUTPUT 718; "MC1;"

MDS

Measurement Data Size

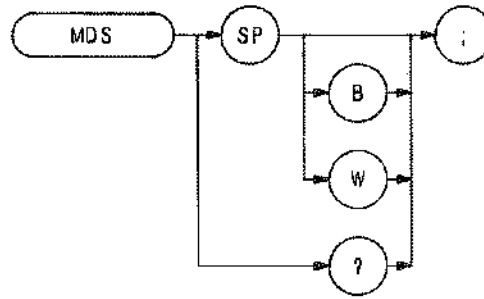

The MDS command formats binary measurement:

B selects a data size of one 8-bit byte.

W selects a data size of one word, which is two 8-bit bytes.

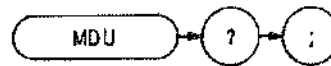

The MDU command returns values for the CRT base line and reference level, in display units and measurement units.

For example, the program below returns the following to the controller:

```
0 1000 -110 -10
```

This means the vertical scale spans 0 to 1000 display units, or 100 dB, and the reference level is -10 dBm.

```
10 OUTPUT 718;"IP;03;"
20 OUTPUT 718;"RL -10DM;"
100 OUTPUT 718;"MDU?;"
140 ENTER 718;A,B,C,D
150 PRINT A,B,C,D
160 END
```

MEAN

Mean

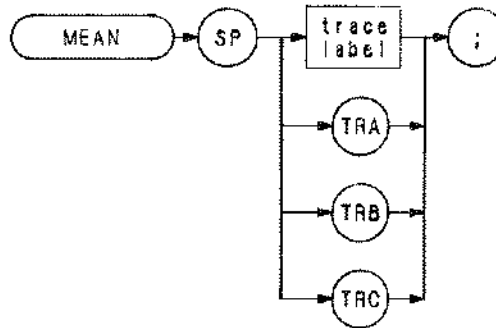

Item	Description/Default	Range Restriction
TRACE LABEL	Alpha character. User-defined label declared in TRDEF statement.	AA—ZZ and _ 2—12 characters required.

The MEAN command returns the mean value of the trace, in display units. Note that the value must be moved into a variable to be accessed.

```
OUTPUT 718; "TRDEF TEST; 1008; VARDEF DESTINATION, 0;"  
OUTPUT 718; "MOV DESTINATION, MEAN TEST;"
```

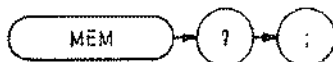

The MEM command returns the amount of unused memory available for user-defined functions. These functions include TRDEF, VARDEF, FUNCDEF, ONSWP, ONEOS, and TRMATH.

The MEM command returns the number of available bytes to the controller followed by a carriage-return/line-feed (ASCII codes 13, 10). The end-of-identify state (EOI) is asserted with line feed.

```
10 OUTPUT 718;"MEM?;"
20 ENTER 718;How_much_memory
30 PRINT How_much_memory
40 END
```

MF

Marker Frequency Output

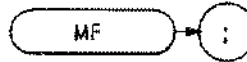

The MF command returns the frequency level of the active marker to the controller, if the marker is on screen. If both the delta marker and active marker are on screen, MF returns the frequency difference between the two markers. (See MKDELTA and M3.)

The output can be formatted in any one of the four output formats. (Refer to FORMAT command, O1, O2, O3, and O4.) However, do not use output format O4 for marker delta output, because sign information is lost.

A typical use of the MF command is shown in the sample program below.

```
10 ASSIGN @Sa to 718
20 PRINTER IS 701
30 OUTPUT @Sa;"FA 80MZ;FB 120MZ;"
40 OUTPUT @Sa;"M2;E1;"
50 OUTPUT @Sa;"MF;"
60 ENTER @Sa;A
70 PRINT A
80 END
```

Line 30: Selects start and stop frequencies.
Line 40: Activates a normal marker and peak search.
Line 50: Returns the frequency to the controller.
Line 60: Assigns the frequency to variable A.
Line 70: Prints the frequency amplitude.

An ENTER command must follow each output command, or output data is lost. For example, the following program assigns only the marker amplitude to variable F, and the marker frequency value is lost.

```
OUTPUT 718;"MF;MA;"
OUTPUT 718;F,A
```

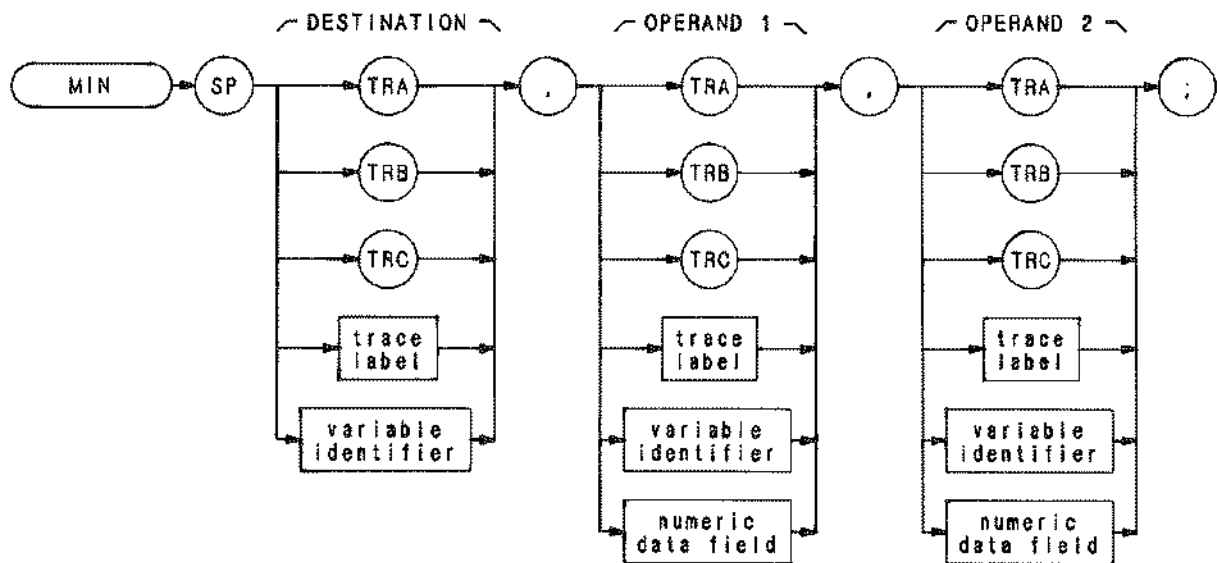

Item	Description/Default	Range Restriction
TRACE LABEL	Alpha character. User-defined label declared in TRDEF statement.	AA—ZZ and _ 2—12 characters required.
VARIABLE IDENTIFIER	Alpha character. User-defined identifier declared in VARDEF statement.	AA-ZZ and _ 2—12 characters required.
	Alpha character. Measurement-variable identifier, such as CF or MA.	
	Trace element, such as TRA[10].	
NUMERIC DATA FIELD	Real	

The MIN command compares operand 1 and operand 2, point by point, sending the lesser values of each comparison to the destination.

If one of the operands is a single value, it acts as a threshold, and all values equal to or less than the threshold pass to the destination.

OUTPUT 718: "MIN TRB,TRC,TRB;"

MKA

Marker Amplitude

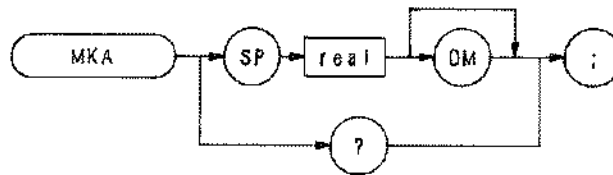

Item	Description/Default	Range Restriction
REAL		Amplitude range of analyzer screen.

The MKA command specifies the amplitude of the active marker in dBm, when the active marker is the fixed or amplitude type. (Instrument preset (IP) selects an amplitude marker. See MKTYPE.)

When queried (?), MKA returns the marker amplitude, a real number, followed by a carriage-return/line-feed (ASCII codes 13, 10). The end-of-identify state (EOI) is asserted with line feed.

OUTPUT ?18;"MKA -20DM;"

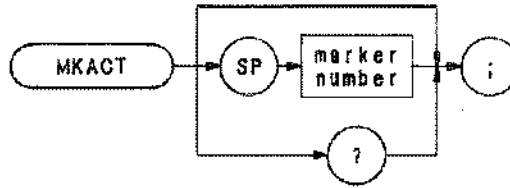

Item	Description/Default	Range Restriction
MARKER NUMBER	Integer. Default is 1.	1, 2, 3, 4

The MKACT command establishes the active marker. There can be four different numbered markers, but only one marker can be active at any time.

A variety of commands listed in this remote section operate on the active marker. Most of them begin with the letters "MK."

When MKACT is executed, the display readout indicates the active marker state.

OUTPUT 718; "MKACT 3;"

When queried (?), MKACT returns the number of the current active marker, followed by carriage-return/line-feed (ASCII codes 13, 10). The end-or-identify state (EOI) is asserted with line feed.

MKCF

Marker to Center Frequency
(E2)

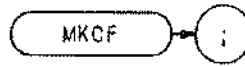

The MKCF command centers the active marker on the analyzer screen, moving the marker to the center frequency.

OUTPUT 718; "MKCF;"

The functions of the MKCF and E2 commands, and the front panel  key are identical.



The MKCONT command resumes the sweep after the execution of a MKSTOP command. Execute MKCONT after MKSTOP.

OUTPUT 718; "MKCONT;"

MKD

Marker Delta (M3)

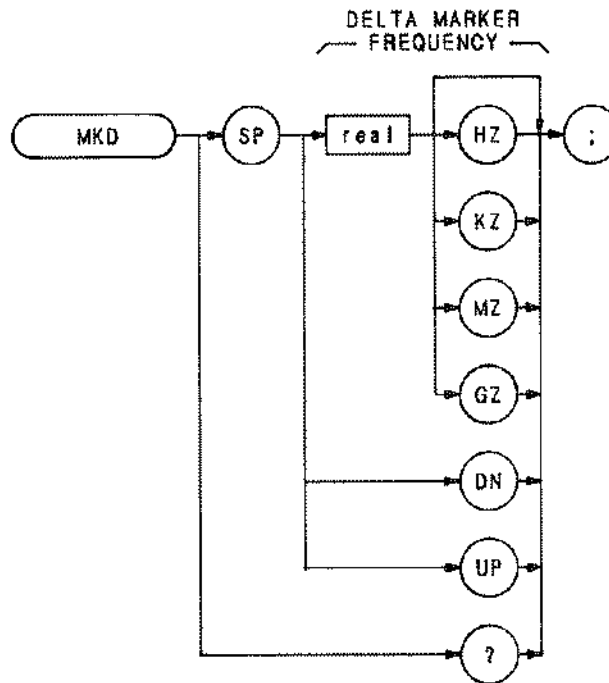

Item	Description/Default	Range Restriction
REAL	Selects delta marker frequency. Default units is Hz.	

The MKD command computes the frequency and amplitude difference of the active marker and a special marker, called the delta or differential marker. These values are displayed in the display readout.

$$\text{Differential value} = \text{active marker frequency} - \text{delta marker frequency}$$

$$\text{Differential value} = \text{active marker amplitude} - \text{delta marker amplitude}$$

If a delta marker is not on screen, MKD places one at the specified frequency, or at the right side of the CRT. If an active marker is not on screen, MKD positions an active marker at center screen. (The active marker is the number 1 marker, unless otherwise specified with the MKACT command.)

OUTPUT 718; "MKD 120MZ;"

The MKD command function is identical with that of the M3 command, and similar to that of the front panel Δ key.

When queried(?), MKD returns the frequency difference between the delta and active markers. The frequency difference is returned as a real number, followed by a carriage-return/line-feed (ASCII codes 13, 10). The end-of-identify state (EOI) is asserted with line feed.

MKF

Marker Frequency

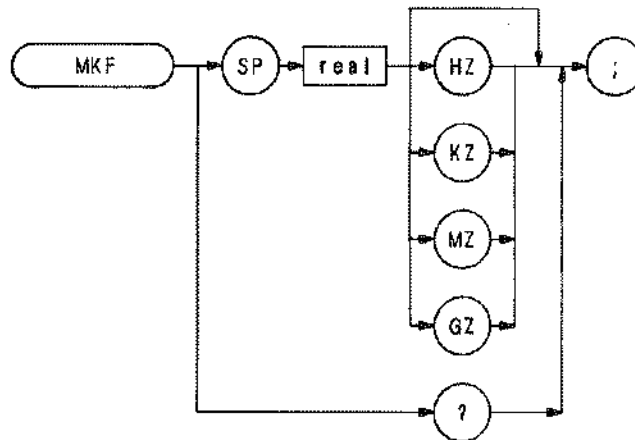

Item	Description/Default	Range Restriction
REAL	Represents marker frequency. Default value for units is Hz.	Marker frequency limited to frequency range of spectrum analyzer display.

The MKF command specifies the frequency value of the active marker.

```
OUTPUT 718; "MKF 100MZ;"
```

When queried (?), MKF returns the active marker frequency as a real number followed by a carriage-return/line-feed (ASCII codes 13, 10). The end-of-identify state (EOI) is asserted with line feed.

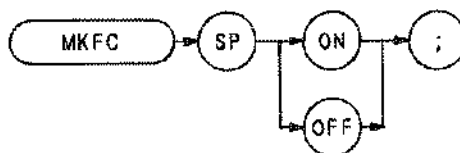

The MKFC command counts the marker frequency. Use this command to measure a signal frequency with greater accuracy. Measurement accuracy is determined by the MKFCR or KS = command.

Before executing MKFC, position an active marker 20 dB above the noise floor, or in the upper six major divisions of the graticule. Otherwise, the measurement may be inaccurate. The message "CNTR" blinks if MKFC is executed and the active marker is in the lower four divisions.

The functions of the MKFC command and front panel  key are identical. (See also MC1 and MC0.)

OUTPUT 718; "MKFC ON;"

MKFCR

Marker Frequency Counter Resolution
(KS =)

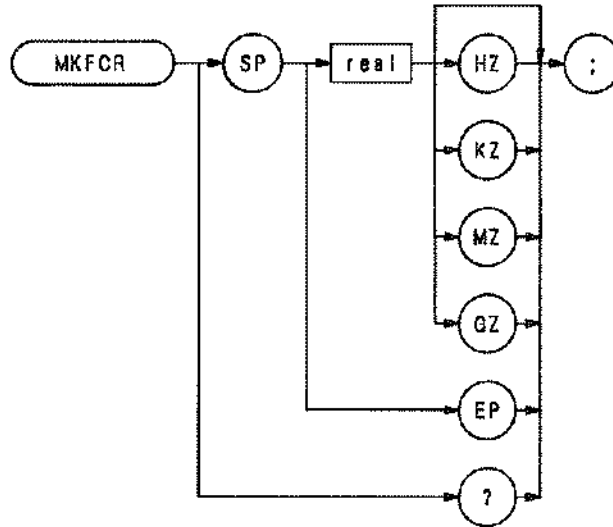

Item	Description/Default	Range Restriction
REAL	Default is 0 Hz.	

The MKFCR command specifies the number of significant digits in the marker frequency readout, for spans of 2 MHz or less. Execute MC1 or MKFC before executing MKFCR.

OUTPUT 718; "MKFC MKFCR 100HZ;"

When queried (?), MKFCR returns the resolution value as a real number followed by a carriage-return/line-feed (ASCII codes 13, 10). The end-of-identify state (EOI) is asserted with line feed.

The counter resolution can be set between 1 Hz and 100 kHz to obtain the following marker frequency resolutions:

Counter Resolution	Readout for 100 MHz Signal
100 kHz	100.0 MHz
10 kHz	100.00 MHz
1 kHz	100.000 MHz
100 Hz	100.0000 MHz
10 Hz	100.00000 MHz
1 Hz	100.000000 MHz

Counter resolution values entered in values other than specified above, such as 25 Hz and 326 kHz, are rounded to the closest power-of-ten value. For example, a counter resolution entry of 25 Hz is entered as 10 Hz.

The resolution of the counter frequency remains fixed until the resolution is changed again or until an instrument preset (IP).

The functions of the MKFCR and KS = commands are identical. See MKFC or MC1.

MKMIN

Marker Minimum

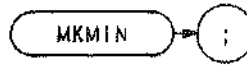

The MKMIN command moves the active marker to the minimum value detected.

OUTPUT 718; "MKMIN;"

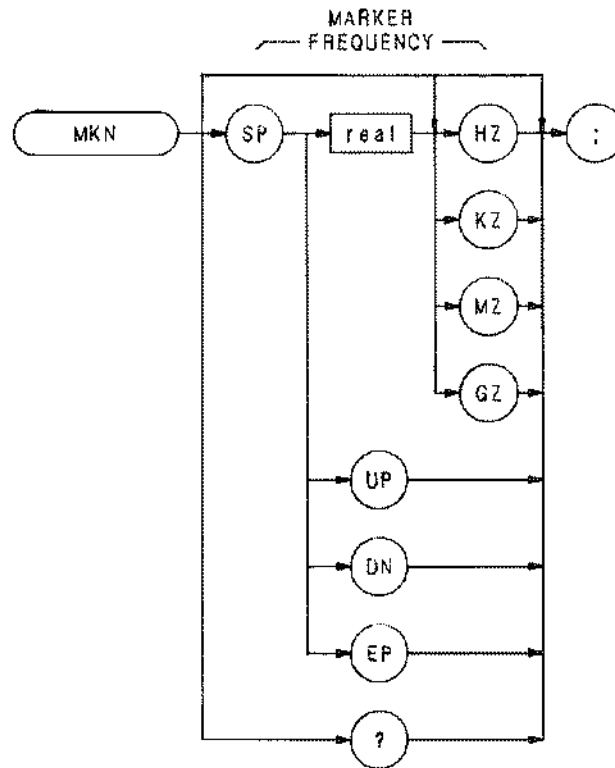

Item	Description/Default	Range Restriction
REAL	Default value for units is Hz.	

The MKN command moves the active marker to the marker frequency. If the active marker is not declared with MKACT, the active marker number is 1.

OUTPUT 718; "MKN;"

The functions of the MKN and M2 commands are identical.

MKNOISE

Marker Noise
(KSM)

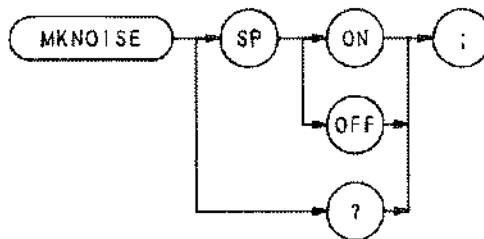

The MKNOISE command displays the RMS noise level at the marker. The RMS value is normalized to a 1 Hz bandwidth.

```
10 OUTPUT 718;"IP;O3;"
20 OUTPUT 718;"MKACT 1;"
30 OUTPUT 718;"MKF 1GZ;"
40 OUTPUT 718;"MKNOISE ON;"
50 OUTPUT 718;"MKNOISE?;"
60 ENTER 718;A$
70 PRINT A$
80 END
```

When queried (?), MKNOISE returns ON or OFF, followed by a carriage-return/line-feed (ASCII codes 13, 10). The end-or-identify state (EOI) is asserted with line feed.

The functions of the MKNOISE and KSM commands are identical.

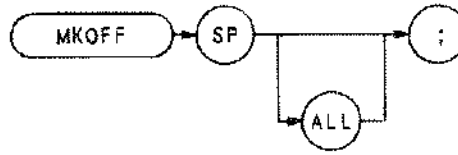

The MKOFF command turns off either the active or all markers displayed on the CRT. Up to four markers can be displayed at one time.

OUTPUT 718: "MKOFF;"

MKP

Marker Position

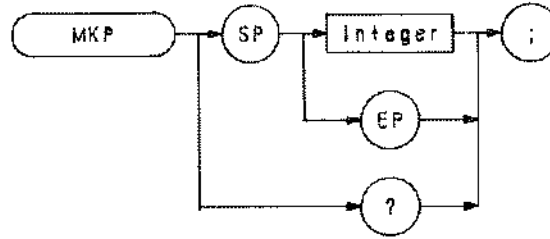

Item	Description/Default	Range Restriction
INTEGER		1 to 1001

The MKP command specifies the marker position horizontally, in display units.

The program line below positions the marker at the first major graticule line.

```
OUTPUT 718: "MKP 100;"
```

When queried (?), MKP returns the active marker frequency as a real number followed by a carriage-return/line-feed (ASCII codes 13, 10). The end-of-identify state (EOI) state is asserted with line feed.

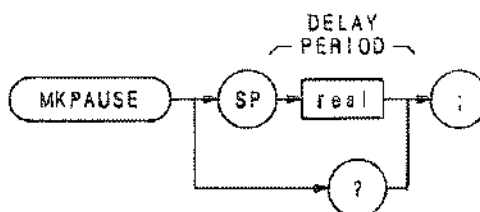

Item	Description/Default	Range Restriction
REAL	Delay time in seconds.	0 to 1000 seconds.

The MKPAUSE command pauses the sweep at the active marker for the duration of the delay period.

OUTPUT 718; "MKPAUSE 100;"

When queried (?), MKPAUSE returns the value of the delay period as a real number followed by a carriage-return/line-feed (ASCII codes 13, 10). The end-or-identify state (EOI) is asserted with line feed.

To turn pause off, turn off markers.

MKPK

Marker Peak

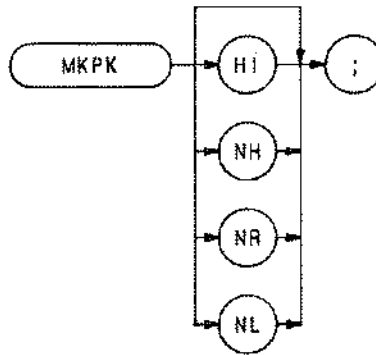

The MKPK command positions on the active marker on signal peaks.

OUTPUT 718; "MKPK NR;"

Executing MKPK HI, or simply MKPK, positions the active marker at the highest signal detected.

If an active marker is onscreen, NH, NR, and NL move the marker accordingly:

Specifying NH moves the active marker to the next signal peak of lower amplitude.

Specifying NR moves the active marker to the next signal peak of higher frequency.

Specifying NL moves the active marker to the next signal peak of lower frequency.

(See also E1.)

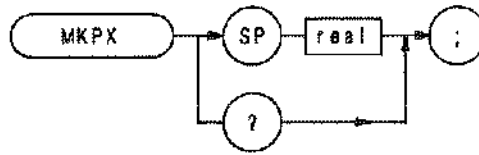

The MKPX command specifies the minimum signal excursion for the analyzer internal signal-identification routine.

The default value is 6 dB. In this case, any signal with an excursion of less than 6 dB on either side is not identified. If MKPK HI (peak search) were executed on such a signal, the analyzer would not place a marker at the signal peak.

OUTPUT 718; "MKPX 8dB;"

MKREAD

Marker Readout

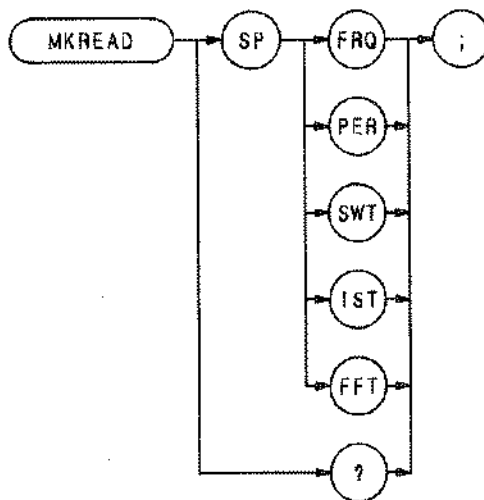

The MKREAD command selects the type of active trace information displayed by the analyzer marker readout: marker frequency, period, sweep time, inverse sweep time, or fast fourier transform readout.

When queried (?), MKREAD returns the marker readout type, followed by carriage-return/line-feed (ASCII codes 13, 10). The end-of-identify state (EOI) is asserted with line feed. The program prints "FFT" on the computer screen.

```
10 OUTPUT 718;"MKREAD FFT;"
20 OUTPUT 718;"MKREAD?;"
30 ENTER 718;A$
40 PRINT A$
50 END
```

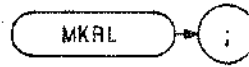
The MKRL command moves the active marker to the reference level.

OUTPUT 718; "MKRL;"

The functions of the MKRL and E4 commands, and the front panel  key are identical.

MKSP

Marker Span
(KSO)

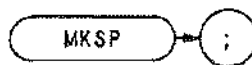

The MKSP command operates only when the delta marker is on. (See MKD or M3.) When the delta marker is on and MKSP is executed, the delta marker and active marker determine the start and stop frequencies. The left marker specifies start frequency, and the right marker specifies stop frequency. If marker delta is off, there is no operation.

OUTPUT 718; 'MKSP;'

The functions of the MKSP and KSO commands are identical.

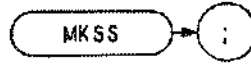

The MKSS command establishes the center frequency step size as the frequency difference between the delta and active markers. (See M3 or MKD.)

OUTPUT 718; "MKSS;"

The functions of the MKSS and E3 commands are identical.

MKSTOP

Marker Stop
(**KSu**)

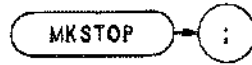

The MKSTOP command stops the sweep at the active marker. (See also KSu.)

OUTPUT 718; "MKSTOP;"

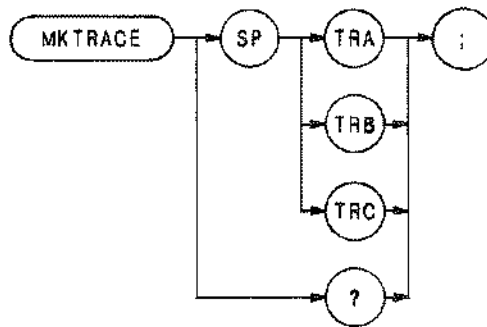



The MKTRACE command moves the active marker to a corresponding position in trace A, B, or C.

OUTPUT 718: "MKTRACE TRB;"

MKTRACK

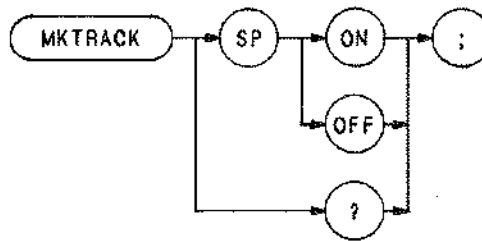
Marker Track



The MKTRACK command keeps the active marker at the center of the display. To keep a drifting signal at center screen, place the active marker at the desired signal before executing MKTRACK. (See MT1 and MT0. Also see  key in Section I.)

OUTPUT 718; "MKTRACK ON;"

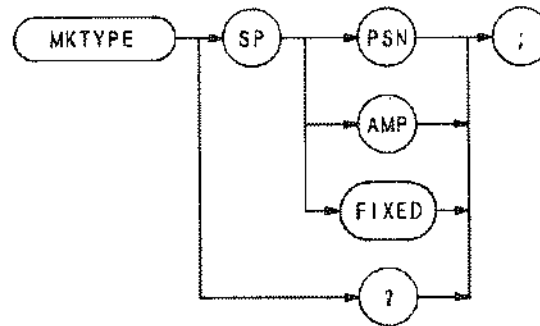

The MKTYPE command specifies the kind of marker.

Specifying MKTYPE AMP allows markers to be positioned according to amplitude, as shown in the line below, which positions a marker on a signal response at the -3 dBm level.

```
OUTPUT 718;"TS; MKTYPE AMP; MKA-3;"
```

The program line below returns the 3-dB bandwidth to the controller.

```
10 OUTPUT 718;"TS;MKPK HI; MKD;"
20 OUTPUT 718;"MKTYPE AMP;MKA-3;"
30 OUTPUT 718;" MKD; MF?"
40 END
```

Line 10 executes a sweep, places a reference marker at the signal peak, and enables the delta marker mode.

Line 20 searches for an amplitude that is 3 dB below the reference marker at the signal peak, because the delta marker mode is active.

The MKD in line 30 establishes the marker that is 3 dB below the peak as the new reference marker. However, since the amplitude and reference markers cannot occupy the same position, the analyzer searches again for an amplitude 3 dB below the signal peak and places another marker there. The MF? command returns the frequency difference between the markers.

Specifying MKTYPE PSN allows markers to be positioned according to a horizontal position in display units. The program line below positions a marker on the third major graticule.

```
OUTPUT 718;"MKTYPE PSN; MKP 300;"
```

Specifying MKTYPE FIXED allows a marker to be placed at any fixed point on the CRT.

ML

Mixer Level (KS,)

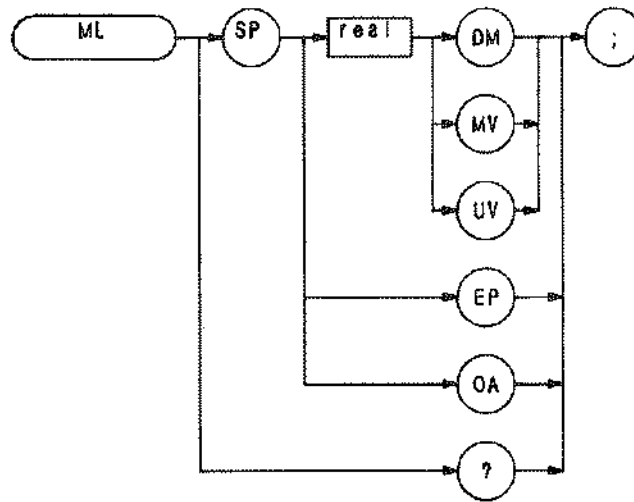



The ML command specifies the maximum signal level that is applied to the input mixer for a signal that is equal to or below the reference level.

The effective mixer level is equal to the reference level minus the input attenuator setting. When ML is activated, the effective mixer level can be set from -10 dBm* to -70 dBm in 10 dB steps. Instrument preset (IP) selects -10 dBm.

The program line below sets the mixer level to -40 dBm.

```
OUTPUT 718; "ML -40DM;"
```

As the reference level is changed, the coupled input attenuator automatically changes to limit the maximum signal at the mixer input to -40 dBm for signals less than or equal to the reference level.

The functions of the ML and KS, commands, and the   keys are identical. See also AT.

* In the extended reference level range, the effective mixer level can be set to 0 dBm.

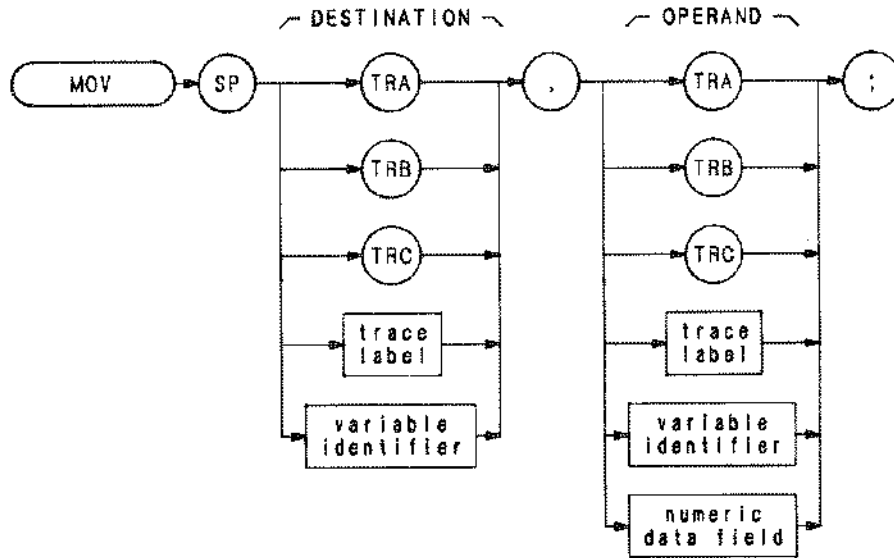

Item	Description/Default	Range Restriction
TRACE LABEL	Alpha character. User-defined label declared in TRDEF statement.	AA—ZZ and __ 2— 12 characters required.
VARIABLE IDENTIFIER	Alpha character. User-defined identifier declared in VARDEF statement.	AA-ZZ and __ 2— 12 characters required.
	Alpha character. Measurement-variable identifier, such as CF or MA.	
	Trace element, such as TRA[10].	
NUMERIC DATA FIELD	Real	

The MOV command moves the operand to the destination.

The operand and destination may be of different length: the trace operands (TRA, TRB, TRC, and trace label) range from 1 to 1008 elements in length, and a variable identifier or numeric data field is 1 element long. When the operand is longer than the destination, it is truncated to fit. When the operand is shorter than the destination, the last element is repeated to fill the destination.

MPY

Multiply

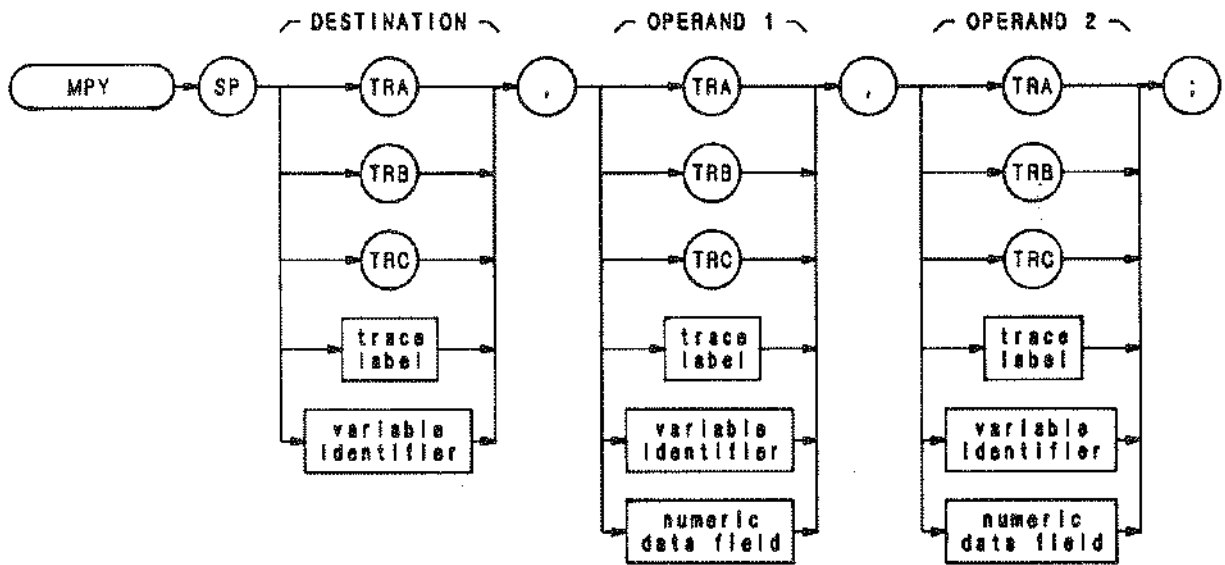

Item	Description/Default	Range Restriction
TRACE LABEL	Alpha character. User-defined label declared in TRDEF statement.	AA—ZZ and _ 2— 12 characters required.
VARIABLE IDENTIFIER	Alpha character. User-defined identifier declared in VARDEF statement.	AA-ZZ and _ 2— 12 characters required.
	Alpha character. Measurement-variable identifier, such as CF or MA.	
	Trace element, such as TRA[10].	
NUMERIC DATA FIELD	Real	

The MPY command multiplies the operands, point by point, and places the result(s) in the destination.

$$\text{operand 1} \times \text{operand 2} \rightarrow \text{destination}$$

The operands and destination may be of different length: the trace operands (TRA, TRB, TRC, and trace label) range from 1 to 1008 elements in length; and a variable identifier or numeric data field is 1 element long. When operands are of different lengths, the last element of the shorter operand is repeated and multiplied with the remaining elements of the longer element. When the operands are longer than the destination, they are truncated to fit.

The results and operands of trace math are truncated if they are not within certain limits. If operating on traces A, B, or C, results must be within 1023. If operating on user-defined traces, results must be within 32,767.

OUTPUT 718; "MPY TRA,TRC,TRB;"

MRD

Memory Read Word

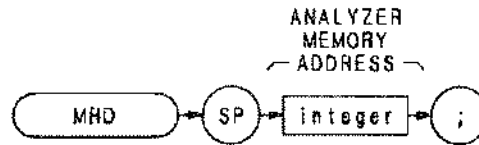

Item	Description/Default	Range Restriction
INTEGER	ASCII decimal number representing analyzer memory address.	Must be even.

The MRD command reads two bytes, starting at the indicated spectrum analyzer memory address, and returns the word to the controller.

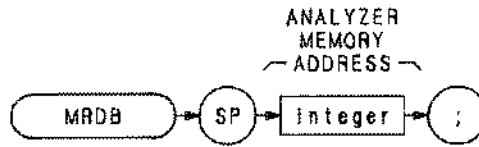



Item	Description/Default	Range Restriction
INTEGER	ASCII decimal number representing analyzer memory address.	

The MRDB command reads the 8-bit byte at the analyzer memory address, and returns the byte to the controller, as ASCII code.

MT0

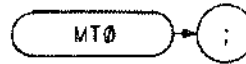
Marker Track Off



The MT0 command disables the marker tracking mode. (See MKTRACK and MT1. Also see  key in Section I.)

OUTPUT 718; "MT0;"

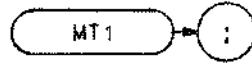

The MT1 command keeps the active marker at the center of the display. To keep a drifting signal at center screen, place the active marker at the desired signal before executing MT1. (See MKTRACK and MT0. Also see  key in Section I.)

OUTPUT 718; "MT1;"

MWR

Memory Write Word

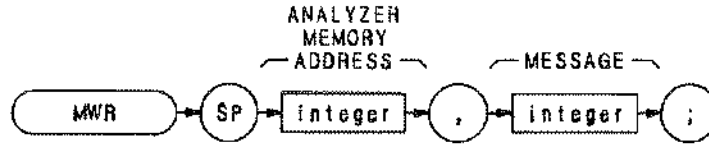

Item	Description/Default	Range Restriction
INTEGER	ASCII decimal number representing analyzer memory address.	Must be even number.
INTEGER	ASCII decimal number indicating number of bytes to read.	

The MWR command writes a two-byte message to spectrum analyzer memory, starting at the indicated address.

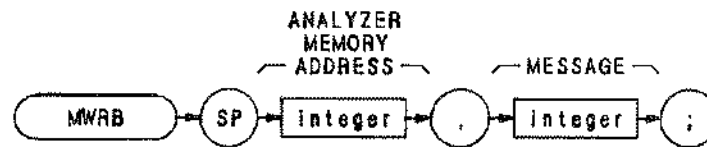

Item	Description/Default	Range Restriction
INTEGER	ASCII decimal number representing analyzer memory address.	
INTEGER	ASCII decimal number representing one 8-bit byte.	

The MWRB command writes a one-byte message to a memory address in the analyzer.

MXM

Maximum

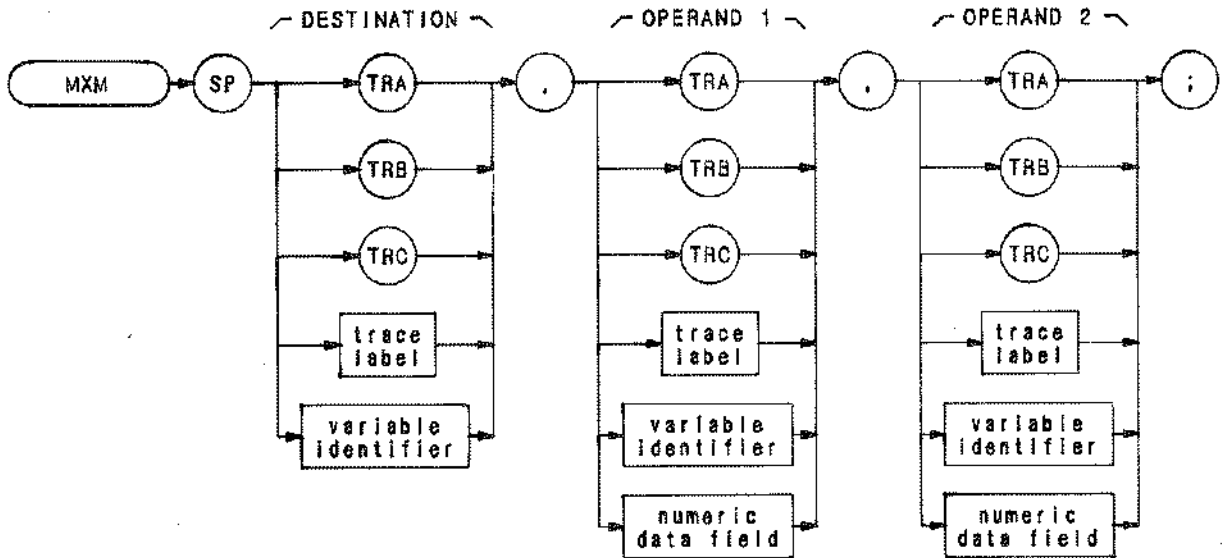

Item	Description/Default	Range Restriction
TRACE LABEL	Alpha character. User-defined label declared in TRDEF statement.	AA--ZZ and _ 2— 12 characters required.
VARIABLE IDENTIFIER	Alpha character. User-defined identifier declared in VARDEF statement.	AA-ZZ and _ 2— 12 characters required.
	Alpha character. Measurement-variable identifier, such as CF or MA.	
	Trace element, such as TRA[10].	
NUMERIC DATA FIELD	Real	

The MXM command compares operand 1 and operand 2, point by point, sending the greater value of each comparison to the destination.

If one of the operands is a single value, it acts as a threshold, and all values equal to or greater than the threshold pass to the destination.

The operands and destination may be of different length. However, the destination must be as long as the largest operand. The trace operands (TRA, TRB, and TRC, and trace label) range from 1 to 1008 elements in length, and a variable identifier or numeric data field is 1 element long.

The operands are truncated if they are not within certain limits. The limit for operands other than trace A, B, or C, is 32,767.

OUTPUT 718; "MXM TRA,TRC,TRB;"

MXMH

Maximum Hold

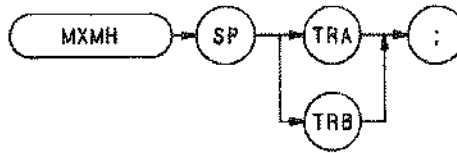

The MXMH command updates each trace element with the maximum level detected, while the trace is active and displayed. The functions of the MXMH and A2 commands, and front panel  key are identical.

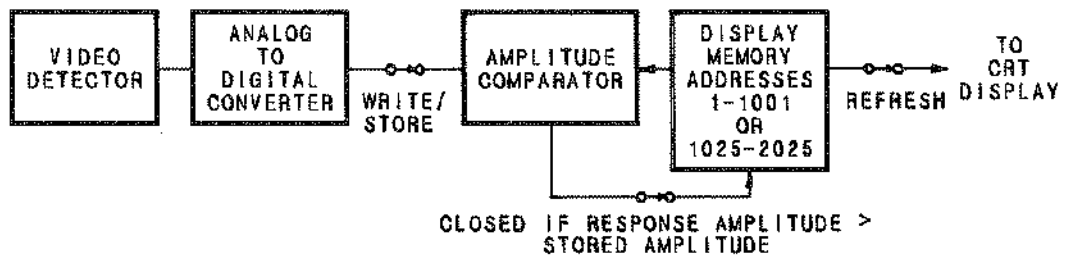

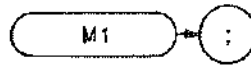

The M1 command blanks any markers present on the CRT. (See also M2, MKOFF, and MKN.)

```
OUTPUT 718; "M1;"
```

M2

Marker Normal
(MKN)

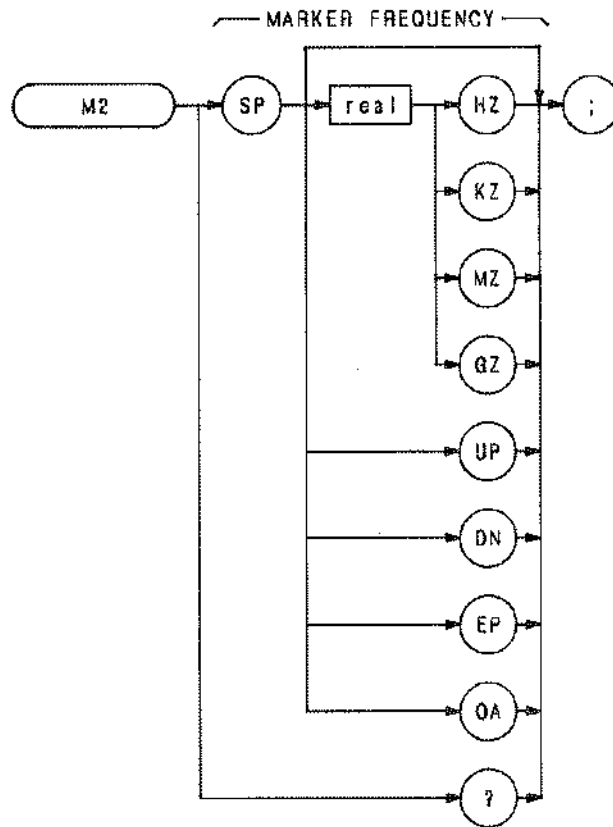

Item	Description/Default	Range Restriction
Real	Default value for units is Hz.	

The M2 command moves the active marker to the marker frequency. If the active marker is not declared with MKACT, the active marker number is 1.

OUTPUT 718; "M2;"

The functions of the M2 and MKN commands are identical.

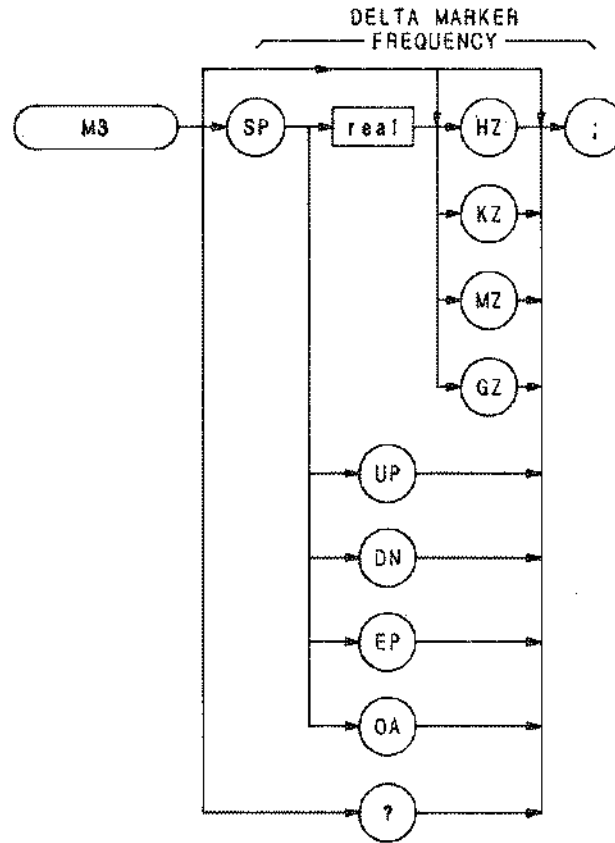

Item	Description/Default	Range Restriction
REAL	Selects delta marker frequency. Default value for units is Hz.	

The M3 command computes the frequency and amplitude difference of the active marker and a special marker, called the delta or differential marker. These values are displayed in the display readout.

$$\text{Differential value} = \text{active marker frequency} - \text{delta marker frequency}$$

$$\text{Differential value} = \text{active marker amplitude} - \text{delta marker amplitude}$$

If a delta marker is not on screen, MKD places one at the specified frequency, or at the right side of the CRT. If an active marker is not on screen, MKD positions an active marker at center screen. (The active marker is the number 1 marker, unless otherwise specified with the MKACT command.)

M3 (Continued)

OUTPUT 718; "M3 120MZ;"

The M3 command function is identical with that of the MKD command, and similar to that of the front panel key.

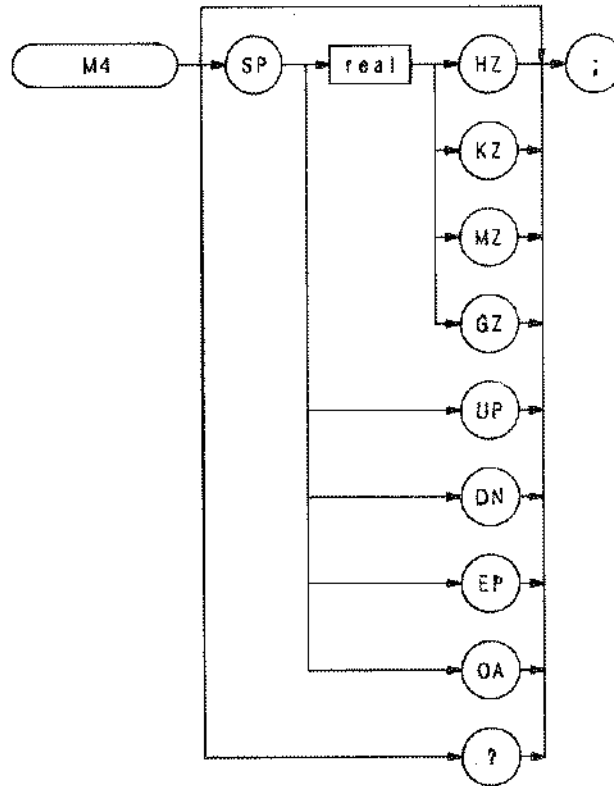

The M4 command activates a single marker at center frequency, the DATA knob changes the position of the marker and the STEP keys change the frequency span and sets the center frequency equal to the marker frequency. The functions of the M4 command and the front panel Marker Mode  key are identical.

Once a single marker is positioned anywhere on the display, executing the M4 command immediately positions the marker at center frequency.

OUTPUT 718: "M4;"

OL

Output Learn String

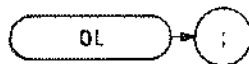

The OL command transmits information to the controller that describes the state of the analyzer when the OL command is executed. This information is called the learn string. The learn string can be sent from the controller memory back to the analyzer to restore the analyzer to its original state.

A list of the learn string contents and coding, and the control settings restored when the learn string is sent to the analyzer is provided in Appendix C. Note that the trace data and the state of some analyzer functions are not contained in the learn string.

The learn string requires 80 bytes of storage space. The program below sends the value of the resolution bandwidth to the controller.

```
10 DIM A$(80)
20 PRINTER IS 701
30 !
40 OUTPUT 718;"OL;"
50 ENTER 718 USING "80A";A$
60 Bandwidth = NUM(A${27,27})
70 PRINT SHIFT (Bandwidth,4)
80 !
90 END
```

Line 10: Dimensions enough storage to contain the 80-byte learn string.

Lines 40 to 50: Reads and stores the contents of the learn string.

Lines 60 to 70: Prints the numerical equivalent of bits 4 through 7 of byte 27.

When this program is run, the printer prints the code for the current bandwidth. The instrument state is not affected. Interpreting the codes of some function values, such as resolution bandwidth, requires additional program lines that equate these codes to specific function values.

Use OL command to return the state of most instrument functions to the controller simultaneously. Use a query (?) to return the state of a single instrument function. Below, a query returns the value of the input attenuation to the controller.

```
10 OUTPUT 718;"AT?;"
20 ENTER 718;N
30 END
```

The OL command and "?" do not alter the state of the spectrum analyzer, and for this reason, are the best way to send the states of the analyzer functions to the controller. An analyzer state may be returned to the controller with "OA", but this sometimes necessitates changing the analyzer state. For example, the program below changes the attenuation from the coupled state to the uncoupled state when the attenuation value is queried with OA.

```
10 OUTPUT 718;"AT; OA;"
20 ENTER 718;N
30 END
```

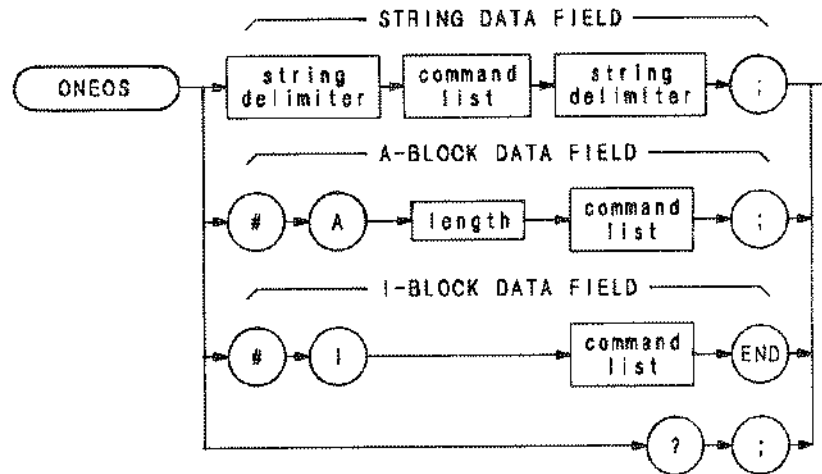

Item	Description/Default	Range Restriction
COMMAND LIST	Alphanumeric character. Any spectrum analyzer command from this section.	
STRING DELIMITER	Mark beginning and end of command string. End and beginning delimiters must be identical.	! " \$ % & ' { : = \ ~
COMMAND LIST	Any spectrum analyzer command from this section, except TS, ONSWP, or ONEOS.	
LENGTH	Two 8-bit bytes specifying length of command list, in 8-bit bytes. The most significant byte is first: MSB LSB.	

At the end of the sweep, the ONEOS command executes the contents of the data field.

OUTPUT 718; "ONEOS" "CF 100MZ;" " "

When queried (?), ONEOS returns the command list.

ONSWP

On Sweep

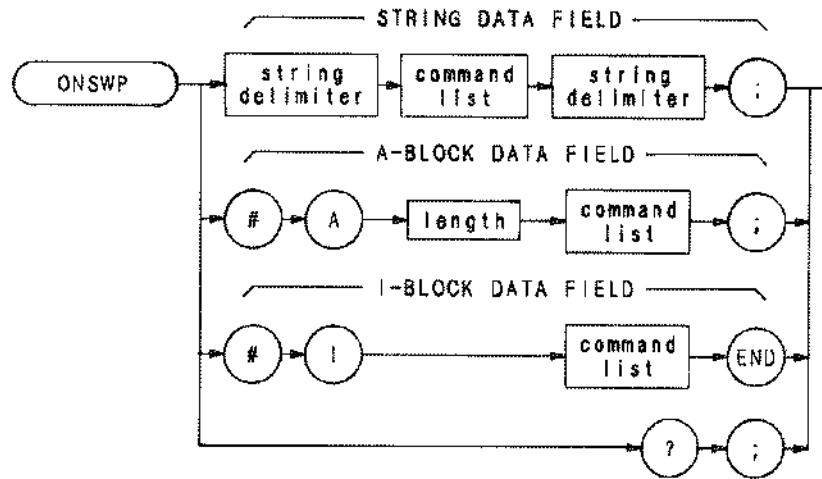

Item	Description/Default	Range Restriction
COMMAND LIST	Alphanumeric character. Any spectrum analyzer command from this section.	
STRING DELIMITER	Mark beginning and end of command string. End and beginning delimiters must be identical.	!"\$%&'{: = \ ~
COMMAND LIST	Any spectrum analyzer command from this section.	
LENGTH	Two 8-bit bytes specifying length of command list, in 8-bit bytes. The most significant byte is first: MSB LSB.	

At the beginning of the sweep, the ONSWP command executes the command list.

OUTPUT 718; "ONSWP" "CF 100MZ;" " "

When queried (?), ONSWP returns the command list.

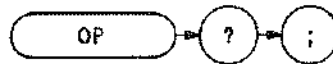

The OP command returns parameter values, P1 and P2, which represent the dimensions of the lower left, and upper right analyzer display. The values returned represent X and Y in display units.

A typical response to OP is 0,0,1023,1023;

0,	0,	1023,	1023
/	/	\	\
P1X	P1Y	P2X	P2Y

OUTPUT 718;"OP?;"

OT

Output Trace Annotations

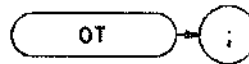

The output annotations command sends 32 character-strings, each up to 64 characters long, to the controller. These character strings contain all the CRT annotations except annotations written with the label command, LB, the title mode, KSE, or the text command, TEXT. The controller must read all 32 strings to successfully execute the command. The strings, listed below in the order they are sent, contain the following information:

String	Readout
1	"BATTERY"
2	"CORR'D"
3	resolution bandwidth
4	video bandwidth
5	sweep time
6	attenuation
7	reference level
8	scale
9	trace detection
10	center frequency or start frequency
11	span or stop frequency
12	reference level offset
13	display line
14	threshold
15	marker frequency
16	marker amplitude
17	frequency offset
18	video averaging
19	title
20	"YTO UNLOCK"
21	"249 UNLOCK"
22	"275 UNLOCK"
23	"OVEN COLD"
24	"EXT REF"
25	"VTO UNCAL"
26	"YTO ERROR"
27	"MEAS UNCAL" "*" "
28	frequency diagnostics
29	"2nd L.O.", "φ", "φ"
30	"SRQ"
31	center frequency "STEP"
32	active function

The following program stores all the CRT annotations in the string array, A\$:

```
10 DIM A$(32)(64)
20 PRINTER IS 701
30 |
```

```
40 OUTPUT 718:"OT"  
50 FOR N = 1 TO 32  
60 ENTER 718;A$(N)  
70 NEXT N  
80 !  
90 FOR N = 1 TO 32  
100 PRINT A$(N)  
110 NEXT N  
120 END
```

After turning line power on, an OT command and print routine print the following string array contents:

```
1  
2  
3     RES BW 3 MHz  
4     VBW 3 MHz  
5     SWP 500 msec  
6     ATTEN 10 dB  
7     REF 0.0 dBm  
8     10 dB/  
9  
10    START 2.0 GHz  
11    STOP 22.0 GHz  
12  
13  
14  
15  
16  
17  
18  
19  
20  
21  
22  
23  
24  
25  
26  
27  
28  
29  
30  
31  
32    HP-IB ADRS:
```

All blank lines represent empty strings.

FORMAT STATEMENTS

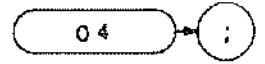
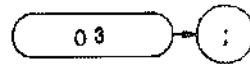
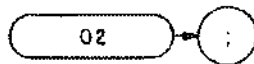
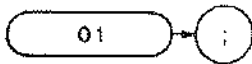

The spectrum analyzer outputs must be formatted appropriately for the controller and measurement requirements. The spectrum analyzer transmits decimal or binary values, via the Hewlett-Packard Interface Bus (HP-IB), to a controller or other HP-IB device, such as a printer. The decimal and binary values represent trace information or instructions.

The format characteristics are summarized in the table below.

Analyzer Output	Format Command	Output Example of Marker Amplitude. Marker is at - 10 dBm reference level.
Sends trace information only as a decimal value in Hz, dB, dBm, volts, or seconds.	O3	- 10.00
Sends trace amplitude and position information, or instruction word as decimal values ranging from 0 to 4095: 0 to 1023 represent positive, unblanked amplitudes in display units. 1024 to 2047 are instruction words (analyzer machine language). 2048 to 3071 represent positive, blanked amplitudes in display units. 3072 to 4095 represent negative, blanked amplitudes in display units.	O1	1001
Sends trace amplitude and position information, or instruction word as binary values in two 8-bit bytes, sending the most significant bit first. The four most significant bits are zeroes.	O2	0000 XXXX XXXXXXXX (3) (231) values 0 to 4095
Sends trace amplitude information only as binary value in one 8-bit byte, composed from the O2 output bytes: OOOOXXXX XXXXXXXX O2 11 // // XXXXXXXX O4	O4	XXXXXXXX (250) values 0 to 255 (full scale)

O3 Format

The O3 format transmits trace amplitude information only, in measure units: Hz, dBm, dB, volts, or seconds. The O3 format cannot transmit instruction words.

A carriage-return/line-feed (ASCII codes 13, 10) always follows any data output. The end-or-identify state (EOI) is asserted with line feed.

Instrument preset (IP) automatically selects the O3 format.

O1 Format

The O1 format transmits trace amplitude information as decimal values in display units. (See Chapter 4 in Section I for a description of display units.)

Trace amplitude values can be positive and unblanked, positive and blanked, or negative and blanked. Positive, unblanked values (0 to 1023) cover the visible amplitude range on the spectrum analyzer CRT.

Negative trace values (3072 to 4095) usually result from trace arithmetic, and are not displayed because they are off (below) the screen. Negative values are represented by the 12-bit two's complement of the negative number, that is, $4096 - |\text{negative value}|$. For example, a -300 value is an output of 3796.

$$4096 - |-300| = 3796$$

Positive, blanked values (2048 to 3071) are those responses immediately ahead of the updated, sweeping trace. These values form the blank-ahead marker, and represent the amplitude responses of the previous sweep, plus 2048. Thus, they are off (above) the screen (See Appendix B.)

The O1 format also transmits instruction words as decimal values. See the Instruction and Data Word Summary in Appendix B.

A carriage-return/line-feed (ASCII codes 13, 10) always follows any data output in the O1 format. The end-or-identify state (EOI) is asserted with line feed.

O2 Format

The O2 format transmits trace information or instruction words as two 8-bit binary numbers. The most significant bit is sent first. The four most significant bits are always zeroes.

Most Significant Byte

Least Significant Byte

0000XXXX

XXXXXXXX

Refer to the Consolidated Coding table in Appendix B for instruction word information.

Note that the O2 format sends the same kind of information that the O1 format sends, except that O2 transmits the information in binary numbers instead of decimal numbers. Also, the end of transmission is not marked by carriage-return/line-feed (ASCII codes 13, 10) in the O2 format.

O4 Format

The O4 format transmits trace amplitude information only as a binary number. The binary number is one 8-bit byte composed from the bytes established with the O2 format.

```

0000 XXXX  XXXXXXXX  O2
      11 // // // //
      XXXXXXXX  O4
    
```

The O4 output is the fastest way to transmit trace data from the spectrum analyzer to the HP-IB bus. However, sign information is lost. Keep this in mind when transmitting delta marker information (MKD). The end of data transmission is NOT marked by a carriage-return/line-feed.

Format Statements and the HP-IB Bus

The table below shows a transmission sequence on the HP-IB bus for each of the four formats. Each format is transmitting the amplitude of a marker positioned at the -10 dBm reference line.

Format	O3	O1	O2	O4
Byte	NUM (—)	NUM ("1")	(3)	(250)
Byte	NUM (1)	NUM ("0")	(231)	
Byte	NUM (0)	NUM ("0")		
Byte	NUM (.)	NUM ("1")		
Byte	NUM (0)	13		
Byte	NUM (0)	10		
Carriage Return	13			
Line Feed (EOI asserted)	10			

Though the spectrum analyzer transmits either binary or digital information on the HP-IB bus, a decimal number is always returned to the controller display. This is illustrated in the program below, which reads the instruction word 1040 at display address 0, the first memory location of trace A. The program reads the instruction word, using each of the formats, and the DR command.

```

1  ASSIGN @Sa TO 718
2  PRINTER IS 701
4  OUTPUT @Sa;"A1;S2;TS;"
10 OUTPUT @Sa;"DA 0 O1 DR"
20 ENTER @Sa;Dr1
30 OUTPUT @Sa;" DA 0 O2 DR"
    
```

```

40 ENTER @Sa USING "# W":Dr2
50 OUTPUT @Sa;" DA 0 O3 DR
60 ENTER @Sa;Dr3
70 OUTPUT @Sa;" DA 0 O4 DR"
80 ENTER @Sa USING "#,B";Dr4
90 PRINT Dr1,Dr2,Dr3,Dr4
100 END

```

Running the program above produces the following responses on the controller display. Note that all the responses are decimal numbers. Also note that the O3 and O4 formats do not return the correct data. (As mentioned above, O3 and O4 do not transmit instruction words.)

```

O1 FORMAT response: 1040
O2 FORMAT response: 1040
O3 FORMAT response: — 200.8
O4 FORMAT response: 4

```

Controller Formats

The format of the controller must be compatible with the output format of the analyzer.

Analyzer Format	Controller Format	
	Requirements	Example Statement and Analyzer Response
O1	free field	ENTER 718; PK_AMPLITUDE Response: 1001
O3	field size dependent on output, use free field format	ENTER 718; PK_AMPLITUDE Response: — 10.0
O2	binary, read twice for each value	ENTER 718 USING "#,W" Response: 1001
O4	binary, read once for each value	ENTER 718 USING "#,B" Response: 250

NOTE

The O in O1, O2, O3, and O4 is the letter O and not the number zero.

PA

Plot Absolute

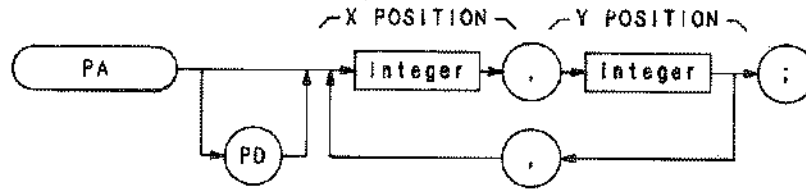

Item	Description/Default	Range Restriction
INTEGER	Represents x,y coordinates of vector endpoint(s), in display units.	0—1022

The PA command specifies in display units a vector location on the CRT relative to display reference coordinates 0,0. (See also display size commands D1, D2, and D3.) The vector is drawn on the CRT if the pen-down (PD) command is in effect. If the pen-up (PU) command is in effect, the vector does not appear of the CRT. A sample program using the PA command is shown below.

```

10 ASSIGN @Sa TO 718
20 OUTPUT @Sa;"IP;A4;K8m;K8o;"
30 OUTPUT @Sa;"D2;PU;"
40 OUTPUT @Sa;"PA 700,500;PD 900,500;"
50 OUTPUT @Sa;"900,300,700,300,700,500;"
60 END

```

- Line 20: Presets the analyzer and clears the display.
- Line 30: Specifies the full CRT display size. The pen-up command prevents the initial vector (to point 700,500) from being drawn.
- Line 40: Specifies the starting point of the rectangle to be drawn by the program (coordinates 700,500). The PD (pen-down) command causes a vector to be drawn on the CRT from the starting point coordinates to the next set of coordinates (900,500) specified in the program.
- Line 50: Plots the remainder of the rectangle on the CRT. The pen-down command remains in effect.

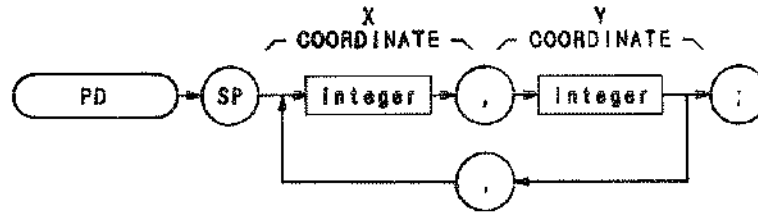

Item	Description/Default	Range Restriction
INTEGER	Represents x,y coordinates of vector endpoint(s), in display units.	0-1022

The PD command draws one or more vectors on the analyzer screen. The PA command, plot absolute, may be used to mark the starting point of the vector.

```

10 ASSIGN @Sa to 718
20 OUTPUT @Sa; "IP;A4;KSm;KSo;"
30 OUTPUT @Sa;"D3;PU;"
40 OUTPUT @Sa;"PA 300,500;PD 450,250;"
50 OUTPUT @Sa;"160,250,300,500;"
60 END
    
```

- Line 20: Presets the instrument and clears the display.
- Line 30: Specifies the expanded CRT display size. The pen-up command ensures that the initial vector to point (300,500) is not drawn.
- Line 40: Plot absolute command and the starting point of the triangle. The following pen-down command draws the vector from (300,500) to (450,250).
- Line 50: Plots the remainder of the triangle on the CRT. The pen-down condition is still in effect.

PDA

Probability Distribution in Amplitude

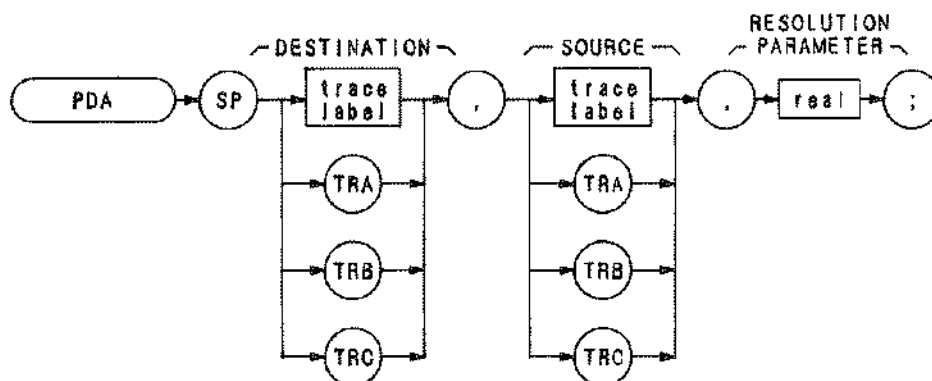

Item	Description/Default	Range Restriction
REAL TRACE LABEL	Default is dBm. Alpha character. User-defined label declared in TRDEF statement.	AA—ZZ and _ 2—12 characters required.

The PDA command loads the destination trace according to the pattern of amplitude values in the source trace. Thus, the destination trace represents the amplitude probability function of the source trace.

The assumption is that the source trace is taken from the display. Hence, the values of the source trace are in dBm (or dBmV or dB μ V) when the display is in the log mode, or in display units when the display is in the linear mode. The resolution parameter determines how the screen is divided vertically to create the probability function.

If the display is in the 10 dB/div log mode and the resolution parameter is specified as 5, then the screen is divided into twenty 5-dB increments. Each value of the source trace is tested in turn and the appropriate element of the destination trace is incremented by one. For example, if the first point of the source trace is 12 dB below the reference level (and thus falls in the eighteenth 5-dB increment from the bottom of the screen), then the 18th element of the destination trace is incremented. Note that the destination trace must have an appropriate number of points (in this case, 20).

If the display mode is linear, then the resolution parameter divides the screen into increments that are a percentage of the total number of display units within the graticule (1000). For example, if the resolution parameter is 5, the screen is divided into twenty 50-display-unit increments (5% of 1000 is 50). Otherwise, the procedure is the same as above.

The data need not be taken from the screen. PDA can be used on an array of calculated data. However, the resolution parameter must be chosen as if the data were in display units. For example, if the array values vary from 0 to 200, and you want to divide it into twenty increments (1—10, 11—20, 21—30, etc.), then the resolution parameter must be 1.0 (1.0% of 1000 is 10).

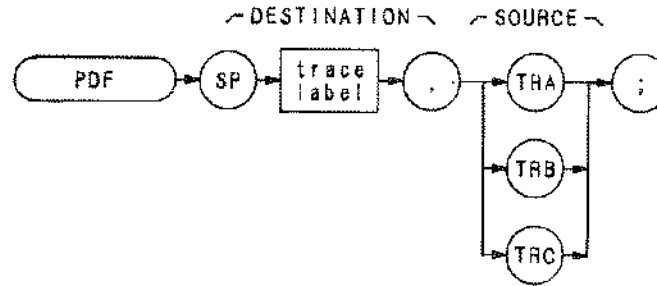

Item	Description/Default	Range Restriction
TRACE LABEL	Alpha character. User-defined label declared in TRDEF statement.	AA—ZZ and _ 2—12 characters required.

When the PDF command is executed, elements of the source trace that are above the threshold value cause corresponding elements in the destination trace to be increased in amplitude by one display unit. The threshold value may be specified by the TH command. Otherwise, its default value is nine major divisions below the reference level.

```
OUTPUT 718; "TRDEF S__AMPLE,50;"
OUTPUT 718; "PDF S__AMPLE,TRA;"
```

PEAKS

Peaks

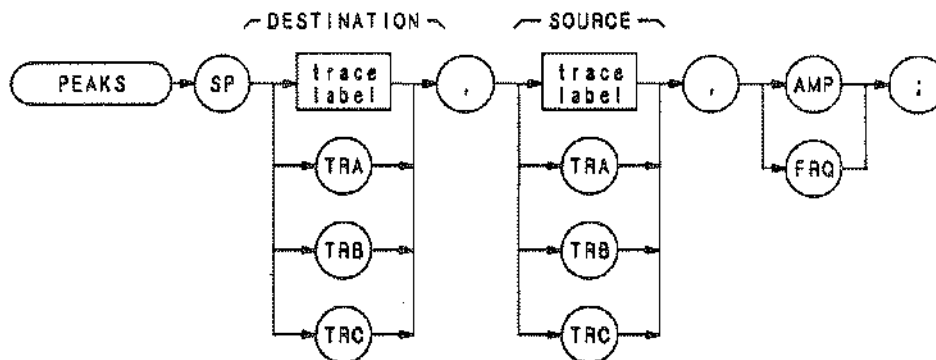

Item	Description/Default	Range Restriction
TRACE LABEL	Alpha character. User-defined label declared in TRDEF statement.	AA—ZZ and _ 2—12 characters required.

The PEAKS command sorts signal peaks by frequency or amplitude. PEAKS sorts the source trace and sends sorted results to the destination trace.

```

10 OUTPUT 718;"IP;"
20 OUTPUT 718;"TRDEF FREQ;"
30 OUTPUT 718;"TS;MOV FREQ,TRA;"
40 OUTPUT 718;"PEAKS TRC,FREQ,FRQ;"
50 END

```

When sorting by frequency, PEAKS first computes, in display units, the horizontal position of all peaks. These values are consecutively loaded into the destination trace, the lowest value occupying the first element. Thus, signal horizontal positions, from low to high, determine the amplitude of the destination trace from left to right. To obtain results in frequency units, scale the destination trace from display units to frequency units using either the center frequency and frequency span, or the start and stop frequencies.

When sorting by amplitude, PEAKS first computes the amplitudes of all peaks in the source trace. The horizontal position corresponding to each signal peak is loaded, in display units, into the destination trace. The horizontal position corresponding to the signal with the highest amplitude is loaded into the first element of the destination trace. The horizontal position corresponding to the signal with the second highest amplitude is loaded into the second element of the destination trace, and so on. It is in this manner that the horizontal positions corresponding to signals ranging from the highest amplitude to the lowest amplitude determine, from left to right, the amplitude of the destination trace.

PEAKS only sorts signals that are above the threshold value; to change the threshold, use the TH command before PEAKS is executed.

If necessary, the last sorted value is repeated to fill remaining elements of the destination trace.

PEAKS also returns the number of signal peaks found. To access this value, execute

```
ENTER 718;N  
PRINT N
```

after line 40 of the example program.

To access the data in the destination trace once PEAKS is executed, move the indexed trace data into a variable and display the variable on the screen, or return it to the controller by querying the variable. The following program example displays the first value of the destination trace, TRC, on the analyzer screen at the analyzer's current pen location.

```
10 OUTPUT 718;"VARDEF FIRST,0;"  
20 OUTPUT 718;"MOV FIRST,TRC[1];"  
30 OUTPUT 718;"DSPLY FIRST,4.5;"  
40 END
```

PLOT

Plot

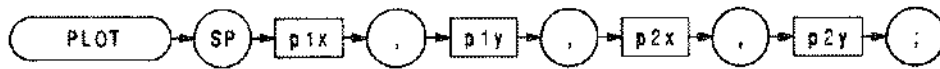

Item	Description/Default	Range Restriction
P1X P1Y	Plotter-dependent values that specify lower left plotter dimension.	Plotter dependent
P2X P2Y	Plotter-dependent values that specify upper right plotter dimension.	Plotter dependent

The trace data, graticule, and annotation of the analyzer's screen can be directly transferred via HP-IB to a Hewlett-Packard plotter such as the 7245A/B, 7240A, 7470A, 9872C, or 7550 using the PLOT command.

Before executing a program, set the HP-IB on the plotter to address 5:

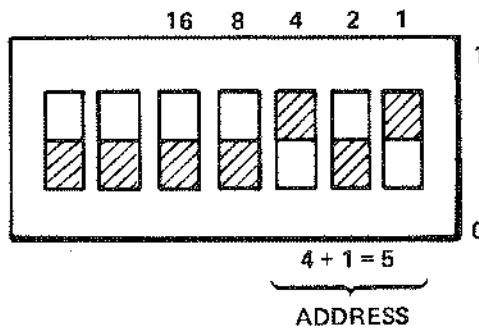

If the address switch on the plotter cannot be located, refer to the plotter's operation manual.

When using the PLOT command, the scaling points (P1x, P1y; P2x, P2y) must be specified. These scaling points specify the x,y coordinates which determine the size of the plot. (For more scaling point information, refer to the plotter's operation manual.)

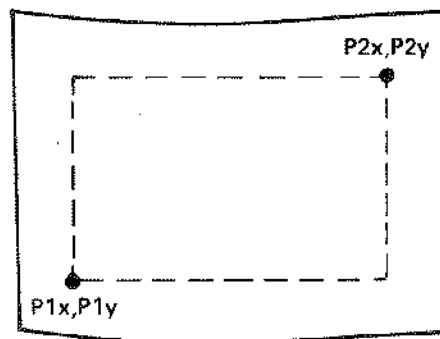

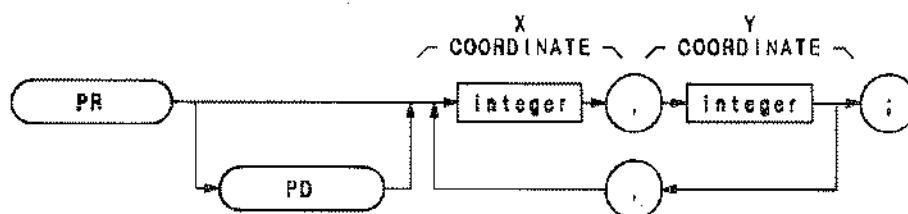

Item	Description/Default	Range Restriction
INTEGER	Represents CRT beam x and y coordinates, in display units, relative to the last beam position.	0—1022

The PR command specifies a plot location on the CRT relative to the last plot point coordinates. Vector coordinate sets (x,y pairs) following the PR command can be either positive or negative, depending on the direction the individual vectors are to be drawn. PU (pen-up) and PD (pen-down) commands tell the analyzer to draw or not draw the vectors on the CRT display.

A typical use of the PR command is shown in the sample program below.

```

10 ASSIGN @Sa TO 718
20 OUTPUT @Sa;"IP;A4;KSm;KSo;"
30 FOR X = 200 TO 600 STEP 200
40 OUTPUT @Sa;"PU PA",X,1,1*X
50 GOSUB Rectangle
60 NEXT X
70 STOP
80 Rectangle: !
90 OUTPUT @Sa;"PD PR 300,0,0—200,—300,0,0,200"
100 RETURN
110 END

```

- Line 20: Presets the analyzer and clears the display.
- Line 40: PA (plot absolute) command defines the starting point for the three rectangles to be drawn on the CRT display.
- Line 90: PD (pen-down) command tells the analyzer to display the vectors drawn in accordance with the vector coordinates (x,y pairs) that follow the PR command. Vectors are then drawn to the four corners of the current rectangle.

PS

Skip Page

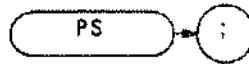

The PS command causes the address pointer to skip over the addresses in the remaining portion of the display memory page in use, and go to the first address at the beginning of the next display memory page. Display control work 1056 (DW 1056) can be substituted for the PS command.

If PS is executed when the address pointer is at an address in the fourth and last page (Trace C) of display memory, the pointer skips to address 0 in page 1. Because the program does not wait for a new refresh cycle* to begin before executing the next instruction, the skip may cause an increase in trace intensity as new data is written over the old. Increased trace intensity occurs only when the time span of the program is less than the default refresh rate. End-of-display control instruction word 1028 in the trace C page normally makes sure a refresh cycle occurs.

A typical use of the PS command is shown in the sample program below.

```
10  ASSIGN @Sa to 718
20  OUTPUT @Sa;"IP; S2; TS; DA100; PS;"
30  END
```

In the sample program above, the analyzer is preset (IP), put in the single-sweep mode (S1), instructed to take a single sweep (TS), and then, from address 100 (DA100) in display memory page 1 (trace A), skip over (PS) the remainder of the page 1 addresses to the first address in display memory page 2 (trace B).

(See Appendix B.)

* (Refresh means to update the display from the display memory. Refresh cycles occur at a rate of approximately 50 Hz.)

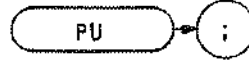

The PU command blanks the CRT beam to prevent plot vectors from being displayed on the CRT.

A typical use of the PU command is shown in the sample program below.

```
10 ASSIGN @Sa TO 718
20 OUTPUT @Sa;"IP; A4; KSm; KSo;"
30 OUTPUT @Sa;"D2; PU;"
40 OUTPUT @Sa;"PA 700,500 PD 900,500"
50 OUTPUT @Sa;"900,300,700,300,700,500"
60 END
```

- Line 20: Presets the instrument and clears the display.
- Line 30: Specifies display size D2 and, with the PU command, instructs the analyzer not to display the vector to the initial point specified by x,y coordinates 900,500.
- Line 40: PA (plot absolute) command establishes the starting point of the rectangle to be drawn on the CRT. The following PD (pen-down) command instructs the analyzer to display the vector to coordinates 700,500.
- Line 50: Plots and displays the remainder of the rectangle on the CRT.

PWRBW

Power Bandwidth

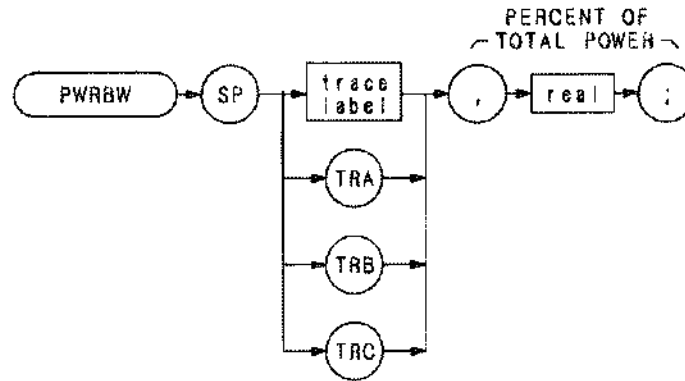

Item	Description/Default	Range Restriction
TRACE LABEL	Alpha character. User-defined label declared in TRDEF statement.	AA--ZZ and _ 2--12 characters required.
REAL		Ø to 100

The PWRBW command first computes the combined power of all signal responses contained in a trace array. The command then computes the bandwidth equal to a percentage of the total power, and returns this value to the controller.

For example, if the percent of total power is specified as 100%, the power bandwidth equals the frequency range of the CRT display, which is 100 MHz if the frequency span per division is 10 MHz. If 50% is specified, trace elements are eliminated from either end of the array until the combined power of the remaining signal responses equals half of the original power computed. The frequency span of these remaining trace elements is the power bandwidth returned to the controller.

The following example computes the power bandwidth of a trace, and returns 99% of the total power.

```
10 OUTPUT 718;"VARDEF P__BW,0;"
20 OUTPUT 718;"MOV P__BW,PWRBW TRA,99.0;"
30 OUTPUT 718;"DIV P__BW,P__BW,1E6;"
40 OUTPUT 718;"D2;EM;PU;PA380,1000;"
46 OUTPUT 718;"TEXT @99% POWER BANDWIDTH = @;DSPLY P__BW,6.3;"
46 OUTPUT 718;"TEXT @ MHZ@;HD;"
50 END
```

Line 10: Define a variable, P__BW, to store the power bandwidth.

Line 20: Find the power bandwidth and move it into P__BW.

Line 30: Convert P__BW to MHz.

Line 40: Set display size to D2, erase trace C memory (which sets the display address to 3072), and set pen position to x = 380, y = 1000.

Lines 45 and 46: Write the results on the analyzer screen.

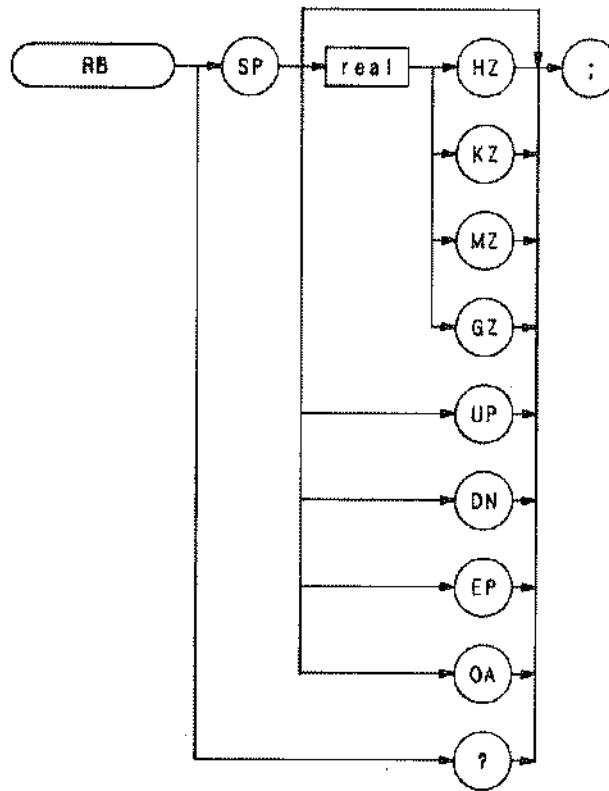

The RB command specifies the resolution bandwidth. Available bandwidths are 10 Hz, 30 Hz, 300 Hz, 1 kHz, 3 kHz, 30 kHz, 100 kHz, 300 kHz, 1 MHz, and 3 MHz. The resolution bandwidths, video bandwidths, and sweep time are normally coupled. Executing RB decouples them. Execute CR to reestablish coupling.

OUTPUT 718; "RB 1KZ;"

The execution of the RB command, and the  key is identical.

RC

Recall Last State
(RCLS)

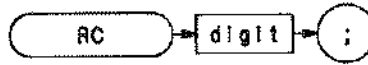

Item	Description/Default	Range Restriction
DIGIT	Specifies analyzer register.	1 through 9

The RC command recalls registers containing a set of instrument states. Registers one through six are reserved for the user, and contain instrument states (such as front panel configuration) sorted with the SAVES or SV commands.

Register 7 is a special register that contains the instrument state prior to the last instrument preset (IP) or single function change. Use the contents of register 7 to recover from inadvertent entries:

OUTPUT 718; "RC 7;"

Registers 8 and 9 recall factory-selected control settings for calibration purposes.

The functions of the RCLS and RC commands, and front-panel  key are identical. (Also see SAVES or SV.)



Item	Description/Default	Range Restriction
DIGIT	Specifies analyzer register.	1 through 9

The RCLS command recalls registers containing a set of instrument states. Registers one through six are reserved for the user, and contain instrument states (such as front panel configuration) stored with the SAVES or SV commands.

Register 7 is a special register that contains the instrument state prior to the last instrument preset (IP) or single function change. Use the contents of register 7 to recover from inadvertent entries:

OUTPUT 718; "RCLS 7;"

Register 8 and 9 recall factory-selected control settings for calibration purposes.

The functions of the RCLS and RC commands, and front-panel  key are identical. (Also see SAVES or SV.)

REPEAT UNTIL

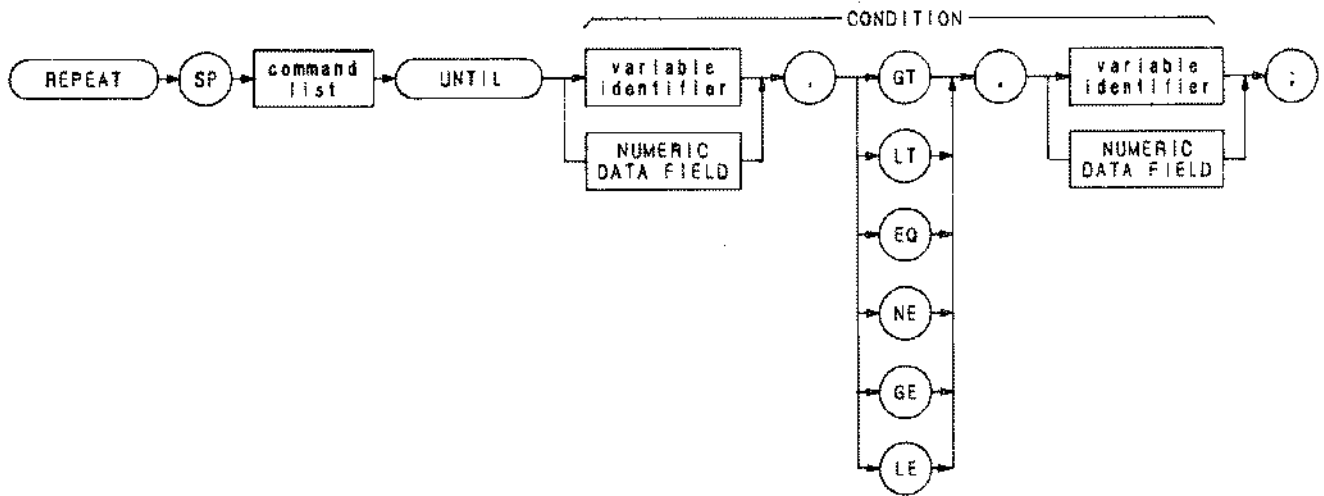

Item	Description/Default	Range Restriction
VARIABLE IDENTIFIER	Alpha character. User-defined identifier declared in VARDEF statement. Do not follow identifier with semicolon.	AA-ZZ and _ 2– 12 characters required.
	Alpha character. Measurement-variable identifier, such as CF or MA. Do not follow identifier with semicolon.	
	Trace element, such as TRA[10].	
NUMERIC DATA FIELD	Real	
COMMAND LIST	Any commands from this remote section.	

REPEAT and UNTIL commands form a looping construct. The command list is repeated until condition is true.

The following program lowers any off-screen signal.

```

10 OUTPUT 718;"S2;TS;E1;"
20 OUTPUT 718;"IF MA,GT,RL THEN"
30 OUTPUT 718;"REPEAT RL UP;TS;E1;"
40 OUTPUT 718;"UNTIL MA,LE,RL "
50 OUTPUT 718;"ENDIF S2;" "
60 END

```

Use the FUNCDEF command to nest a REPEAT UNTIL command within another REPEAT UNTIL looping construct. The program below defines "C_LOP" as a looping construct in lines 30 through 60. The construct is then nested into the REPEAT UNTIL command in line 80.

```

10  OUTPUT 718;"SNGLS;"
20  OUTPUT 718;"VARDEF COUNT,0;VARDEF SCORE,0;"
30  OUTPUT 718;"FUNCDEF C_LOP," " "
40  OUTPUT 718;"REPEAT TS;"
50  OUTPUT 718;"ADD COUNT,COUNT,1;"
60  OUTPUT 718;"UNTIL COUNT,EQ,3;" " "
70  OUTPUT 718;"REPEAT;"
80  OUTPUT 718;"C_LOP;"
90  OUTPUT 718;"ADD SCORE,SCORE,1;"
100 OUTPUT 718;"UNTIL SCORE,EQ,4;"

```

The program below does not work because the REPEAT UNTIL commands are nested without the use of the FUNCDEF command.

```

10  OUTPUT 718;"SNGLS;"
20  OUTPUT 718;"VARDEF COUNT,0;VARDEF SCORE,0;"
30  OUTPUT 718;"REPEAT;"
40  OUTPUT 718;"REPEAT;"
50  OUTPUT 718;"TS;"
60  OUTPUT 718;"ADD COUNT,COUNT,1;"
70  OUTPUT 718;"UNTIL COUNT,EQ,3;"
80  OUTPUT 718;"ADD SCORE,SCORE,1;"
90  OUTPUT 718;"UNTIL SCORE,EQ,4;"
100 END

```

REV

Revision

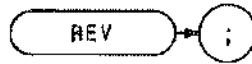

The REV command returns the firmware revision number and HP date code.

OUTPUT 718; "REV;"

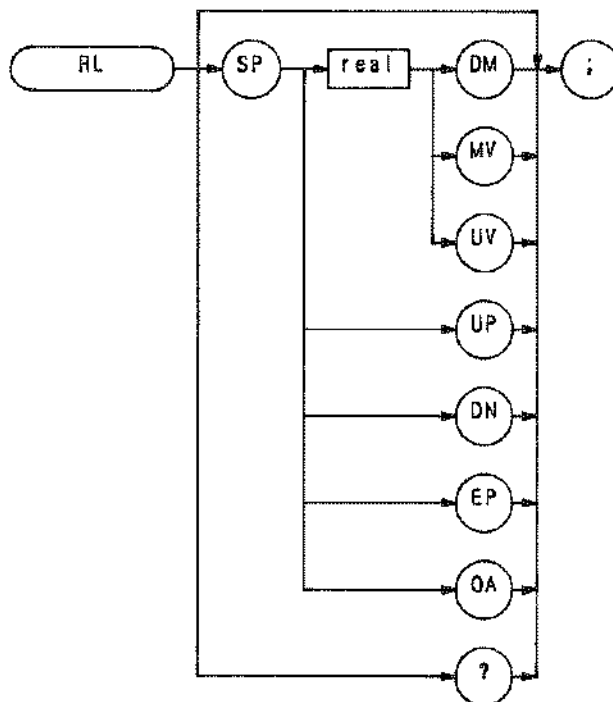

The RL command specifies the amplitude value of the top CRT graticule line, which is called the reference level. The reference level can be specified from -89.9 dBm to $+30$ dBm with 0.1 dB resolution.

The reference level and input attenuator are coupled to prevent gain compression. Any signals with peaks at or below the reference level are not affected by gain compression.

The reference level range can be extended from -129.9 dBm to $+60$ dBm with the KSI command. When the reference level range is extended, and the mixer level commands, KSI or ML, are used to change the threshold of the mixer input to values greater than -10 dBm, signals on the spectrum analyzer screen may be affected by gain compression. (See AT and ML.)

OUTPUT 718; "RL -10DM;"

The functions of the RL command and the  key are identical.

RMS

Root Mean Square

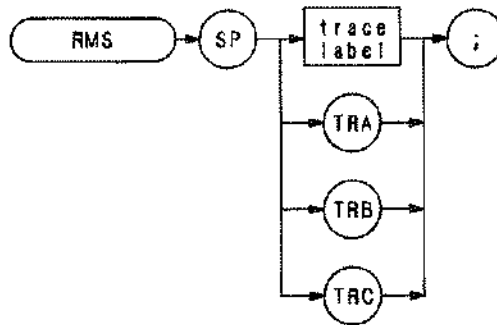

Item	Description/Default	Range Restriction
TRACE LABEL	Alpha character. User-defined label declared in TRDEF statement.	AA—ZZ and _ 2—12 characters required.

The RMS command returns the RMS value of the trace, in display units. Note that the value must be moved into a variable to be accessed.

```
OUTPUT 718;"VARDEF DESTINATION, 0;"  
OUTPUT 718;"MOV DESTINATION,RMS TRC;"
```

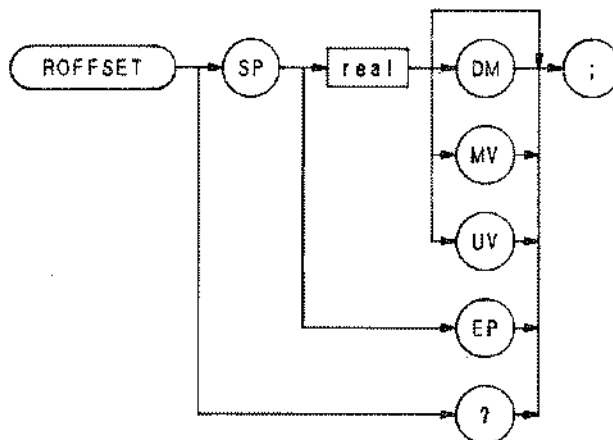

Item	Description/Default	Range Restriction
REAL	Default value for units is dBm (DM).	+ - 300 dB

The ROFFSET command offsets all amplitude readouts on the CRT display without affecting the trace. The functions of the ROFFSET command and the front panel   keys are identical.

Once activated, the ROFFSET command displays the amplitude offset in the active function block. And, as long as the offset is in effect while doing other functions, the offset is displayed to the left of the graticule.

Entering a zero with ROFFSET activated eliminates any amplitude offset.

OUTPUT 718; "ROFFSET -12DM;"

The functions of the ROFFSET and KSZ commands are identical.

RQS

SRQ Mask

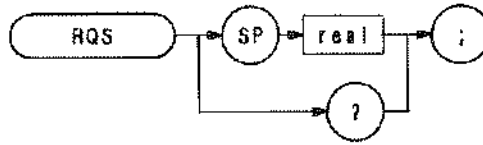

Item	Description/Default	Range Restriction
INTEGER	Integer representing a bit mask for service requests (SRQ).	0–255

The RQS command sets a bit mask for service requests (SRQ command).

On execution of a SRQ command, the analyzer logically ANDs the RQS mask with the binary equivalent of the SRQ operand. When the result of this AND operation is a non-zero number, the analyzer sends a service request to the HP-IB controller.

A query for the RQS command returns the RQS operand.

See also SRQ and Appendix D.

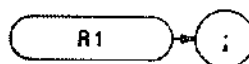

The R1 command deactivates all analyzer service requests (SRQs) except SRQ140, the illegal-command service request.

See Appendix D for more information on the R1 command.

R2

End-of-Sweep SRQ

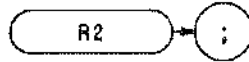

The R2 command activates the end-of-sweep and illegal-command service requests.

See Appendix D for more information on the R2 command.

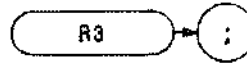

The R3 command activates the hardware-broken and illegal-command service requests.

See Appendix D for more information on the R3 command.

R4

Units-Key-Pressed SRQ

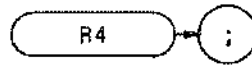

The R4 command activates the units-key-pressed and illegal-command service requests.

See Appendix D for more information on the R4 command.

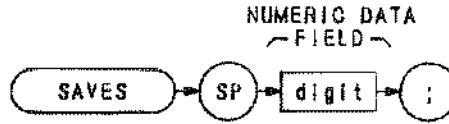

Item	Description/Default	Range Restriction
DIGIT	Specifies register for storage of instrument states.	1—6

The SAVES command saves the current spectrum analyzer state in any of registers one through six. Register contents are not affected by power loss, but previously saved data is erased when new data is saved in the same register.

The functions of the SAVES and SV commands, and front-panel  key are identical.

OUTPUT 718; "SAVES 5;"

SMOOTH

Smooth

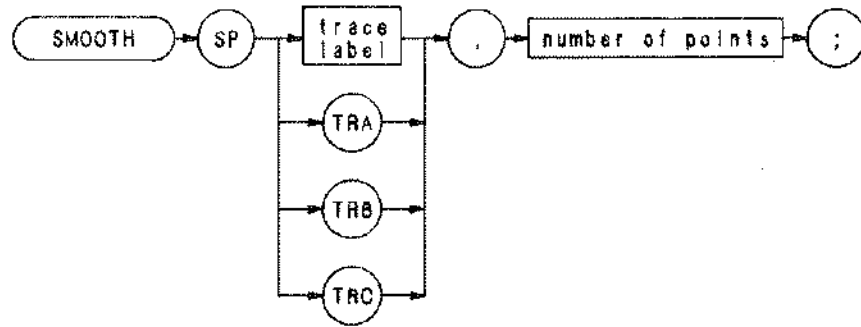

Item	Description/Default	Range Restriction
TRACE LABEL	Alpha character. User-defined label declared in TRDEF statement.	AA-ZZ and _ 2— 12 characters required.
NUMBER OF POINTS	Integer representing number of points for running average.	1 < number of points < 39 Must be odd number.

The SMOOTH command smooths the trace according to the number of points specified for the running average. Increasing the number of points increases smoothing.

OUTPUT 718; "SMOOTH TRA 23;"

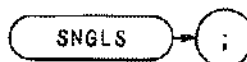

The SNGLS command sets the analyzer to single sweep mode. Each time single sweep is pressed, one sweep is initiated if the trigger and data entry conditions are met. The functions of the SNGLS and S2 commands, and front-panel  key are identical.

OUTPUT 718; "SNGLS;"

SP

Frequency Span

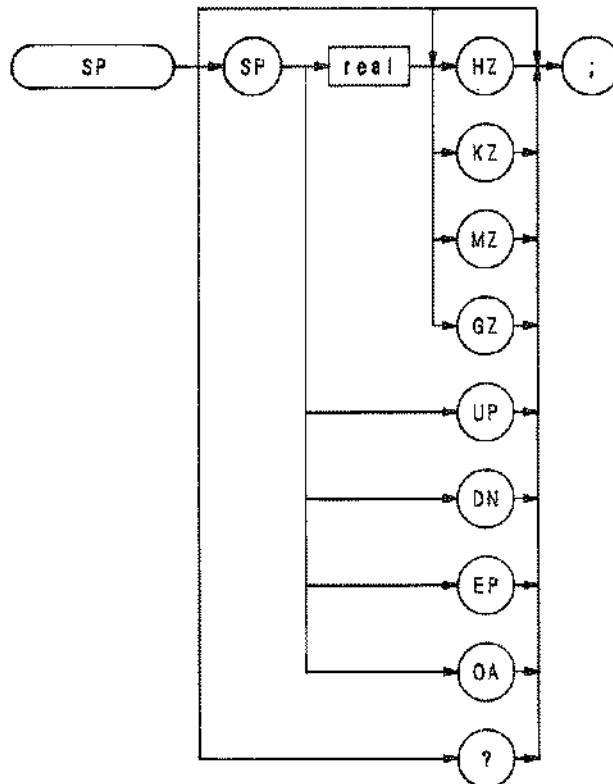

The SP command changes the total display frequency range symmetrically about the center frequency. The frequency span readout displays the total display frequency range. Divide the readout by ten to determine the frequency span per division.

Specifying 0 Hz enables zero span mode, which configures the analyzer as a fixed-tuned receiver.

The functions of the SP command and the front panel FREQUENCY SPAN key are identical. Thus, if span width is coupled to the resolution and video bandwidths, the bandwidths change with the span width to provide a predetermined level of resolution and noise averaging. Likewise, sweep time changes to maintain a calibrated display, if coupled. All of these functions are normally coupled, unless RB, VB, or ST have been executed. (See CR, CV, or CT)

OUTPUT 718: "SP 10MZ;"

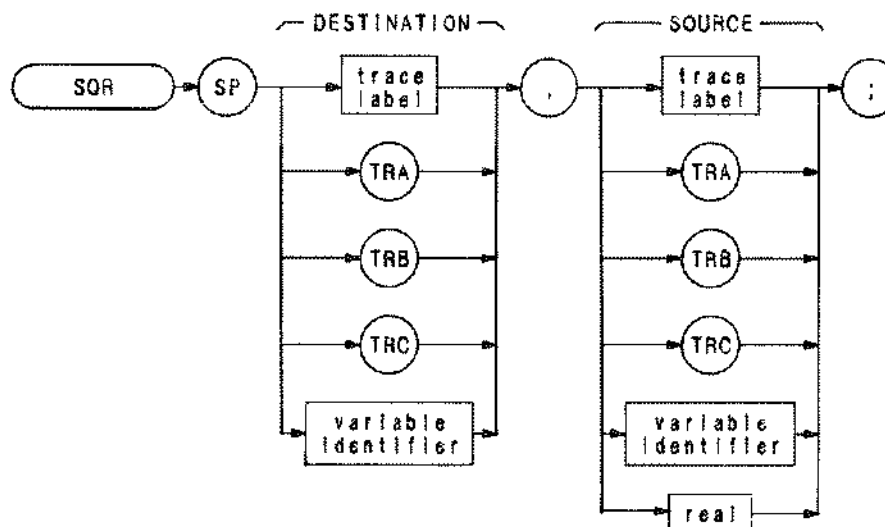

Item	Description/Default	Range Restriction
TRACE LABEL	Alpha character. User-defined label declared in TRDEF statement.	AA-ZZ and ___ 2-12 characters required.
VARIABLE IDENTIFIER	Alpha character. User-defined label declared in VARDEF statement.	AA-ZZ and ___ 2-12 characters required.
	Alpha character. Measurement-variable identifier, such as CF or MA.	
	Trace element, such as TRA [10].	

The SQR command computes the square root of the source trace amplitude, point-by-point. The results go to the destination trace.

OUTPUT 718; "SQR TRC, TRB;"

SRQ

User-defined SRQ

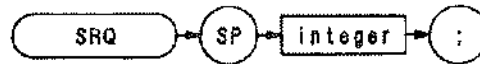

Item	Description/Default	Range Restriction
INTEGER	Integer representing a service request.	0–255

The SRQ command sends a service request to the controller when the SRQ operand fits the mask specified with the RQS command.

On execution of a SRQ command, the analyzer logically ANDs the RQS mask with the binary equivalent of the SRQ operand. When the result of this AND operation is a non-zero number, the analyzer sends a service request to the HP-IB controller.

See also RQS and Appendix D.

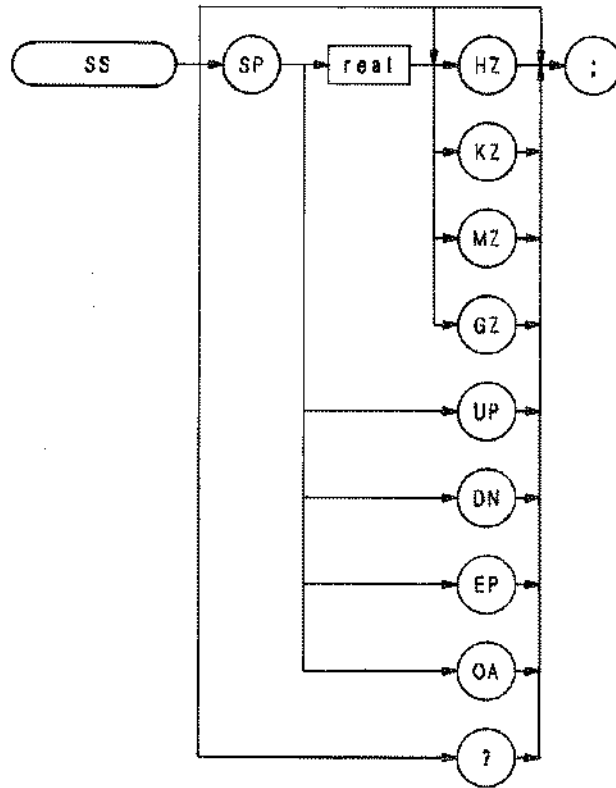

Item	Description/Default	Range Restriction
REAL	Default is Hz.	

The SS command specifies center frequency step size, and is the same function as the  key.

OUTPUT 718; "SS 10MZ;CF UP;"

The above program line changes center frequency by 10 MHz.

ST

Sweep Time

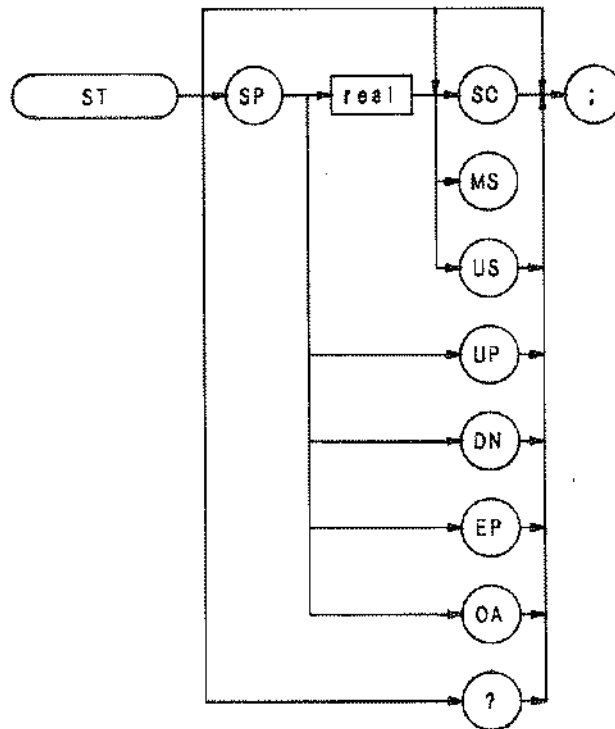

The ST command specifies the rate at which the analyzer sweeps the displayed frequency or time span.

The sweep times available are shown below.

	SWEEP TIME	SEQUENCY
FREQUENCY SPAN (≥ 100 Hz)	20 ms to 1500 sec	continuously
ZERO FREQUENCY SPAN (0 Hz)	1 us to 10 ms	1, 2, 5, and 10
	20 ms to 1500 sec	continuously

OUTPUT 718; "ST 100MS;"

The above program line sets the sweep time of the analyzer to 100 milliseconds.

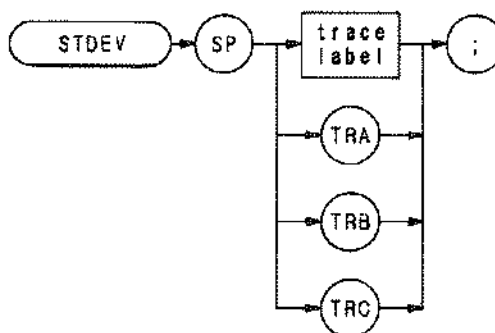

Item	Description/Default	Range Restriction
TRACE LABEL	Alpha character. User-defined label declared in TRDEF statement.	AA-ZZ and _ 2— 12 characters required.

The STDEV command returns to the controller the standard deviation of the trace amplitude in display units.

```

OUTPUT 718;"IP;TS;STDEV TRA;"
ENTER 718;N
PRINT N
END
  
```

SUB

Subtract

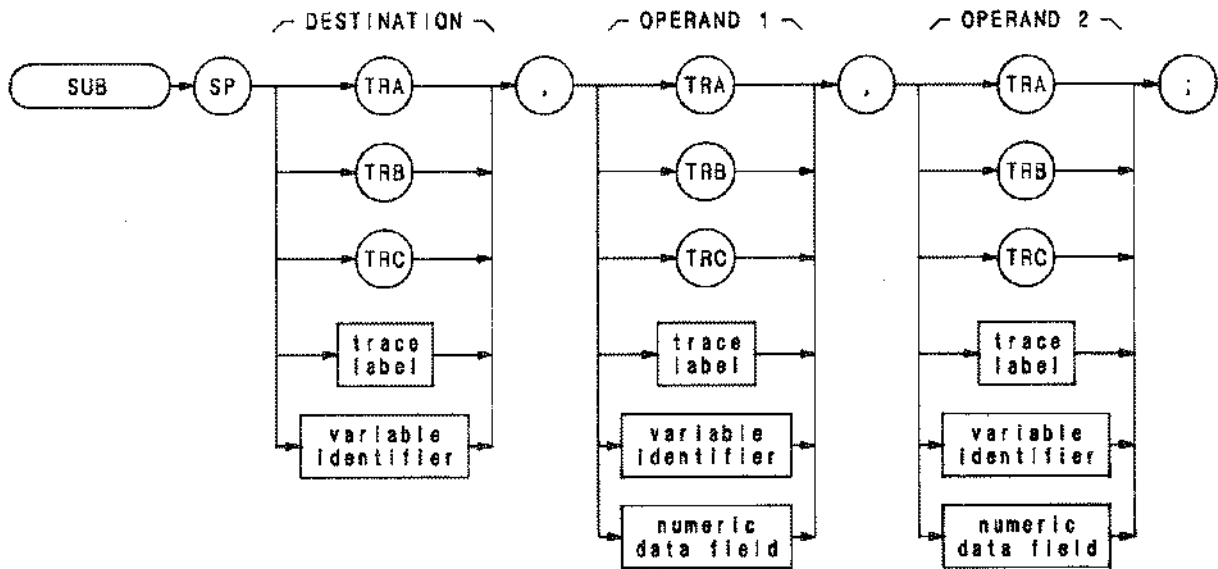

Item	Description/Default	Range Restriction
TRACE LABEL	Alpha character. User-defined label declared in TRDEF statement.	AA-ZZ and _ 2–12 characters required.
VARIABLE IDENTIFIER	Alpha character. User-defined identifier declared in VARDEF statement.	AA-ZZ and _ 2–12 characters required.
	Alpha character. Measurement-variable identifier, such as CF or MA.	
	Trace element, such as TRA[10].	
NUMERIC DATA FIELD	Real	

The SUB command subtracts operand 2 from operand 1, point by point, and send the difference to the destination.

$$\text{operand 1} - \text{operand 2} \rightarrow \text{destination}$$

The operands and destination may be different lengths. The trace operands (TRA, TRB, TRC, and trace label) range from 1 to 1008 elements in length. A variable identifier or numeric data field is one element long. When operands differ in length, the last element of the shorter operand is repeated for the subtraction process. When the operands are longer than the destination, they are truncated to fit.

The results and operands of trace math are truncated if they are not within certain limits. If operating on traces A, B, or C, results must be within 1023. If operating on user-defined traces, results must be within 32,767.

See TRMATH.

SUM

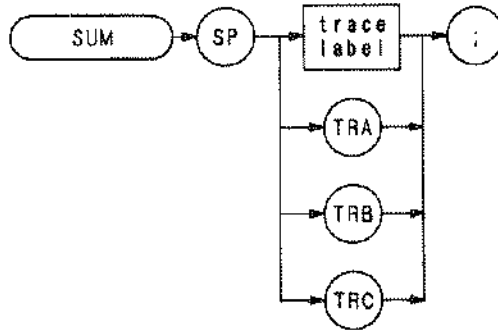

Item	Description/Default	Range Restriction
TRACE LABEL	Alpha character. User-defined label declared in TRDEF statement.	AA-ZZ and _ 2– 12 characters required.

The SUM command sums the amplitudes of the trace elements, and returns the sum to the controller.

```
10 OUTPUT 718;"IP; SNGLS; CLRW TRA; TS;"  
20 OUTPUT 718;"SUM TRA;"  
30 ENTER 718;N  
40 PRINT N  
50 END
```

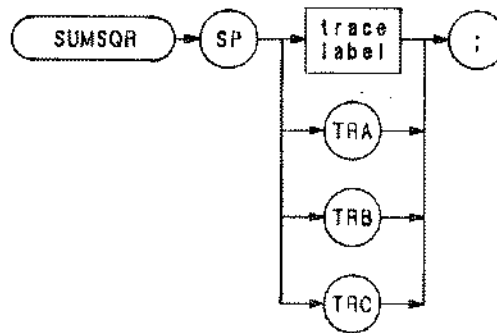
Item	Description/Default	Range Restriction
TRACE LABEL	Alpha character. User-defined label declared in TRDEF statement.	AA-ZZ and _ 2— 12 characters required.

The SUMSQR command squares the amplitude of each trace element, and returns the sum of the squares to the controller.

```

10 OUTPUT 718;"IP; SNGLS; CLRW TRA; TS;"
20 OUTPUT 718;"SUMSQR TRA;"
30 ENTER 718;N
40 PRINT N
50 END
  
```

SV

Save State
(SAVES)



Item	Description/Default	Range Restriction
DIGIT	Specifies register for storage of instrument states.	1—6

The SV command saves the current spectrum analyzer state in any of registers one through six. Register contents are not affected by power loss, but previously saved data is erased when new data is saved in the same register.

The functions of the SAVES and SV command, and front panel  key are identical.

OUTPUT 718: "SV 5;"

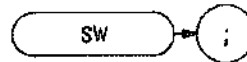

The skip-to-next-control-instruction command, SW, instructs the display to skip to the next control word from the present display memory address. Use SW to omit labels, markers, etc. from the display. Display control word 1027 (DW 1027) can be substituted for programming command SW.

```
10 ASSIGN @Sa TO 718
20 OUTPUT @Sa;"DA 2073 SW;"
30 END
```

In the example above, display memory address 2073 contains the label control word that places the center frequency "||" mark on the CRT. However, this marker is omitted from the display because the SW command has been added to the address.

(See Appendix B.)

S1

Continuous Sweep (CONT)

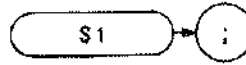

The S1 command sets the analyzer to continuous sweep mode. In the continuous sweep mode, the analyzer continues to sweep (sweep time ≥ 20 ms) at a uniform rate, from the start frequency to the stop frequency, unless new data entries are made from the front panel or via HP-IB. If the trigger and data entry conditions are met, the sweep is continuous.

The sweep light indicates a sweep is in progress. The light is out between sweeps, during data entry, and for sweep times ≤ 10 ms.

OUTPUT 718; "S1;"

The functions of the S1 and CONT commands and the front panel  key are identical.

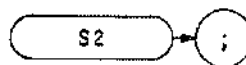

The S2 command sets the analyzer to single sweep mode. Each time single sweep is pressed, one sweep is initiated if the trigger and data entry conditions are met.

OUTPUT 718; "S2;"

The functions of the S2 and SNGLS commands and the front panel  key are identical.

TA

Transfer A

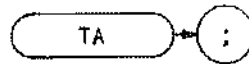

The TA command transfers trace A amplitude values, in display units, from the analyzer to the controller. The display unit values are transferred in sequential order (from left to right) as seen on the CRT display. Display unit values that are stored in the display memory can be transferred to the controller in any one of the four output formats of the analyzer (01, 02, 03, or 04).

Transfer of trace amplitude data should only be done as follows:

1. Select single sweep mode (S2).
2. Select desired analyzer settings.
3. Take one complete sweep (TS).
4. Transfer data.

This procedure ensures that the current settings of the analyzer are reflected in the transferred data.

When the TA command is executed, and the analyzer is in continuous sweep mode, the blank-ahead marker is also transferred as amplitude values in the 01 and 02 format. The blank-ahead marker is not transferred in the 03 and 04 formats.

The blank-ahead marker is composed of positive, blanked amplitude values and is immediately ahead of the updated, sweeping trace. These values represent the amplitude responses of the previous sweep, plus 2048. Thus, they are off (above) the screen.

The blank-ahead marker is eight display units wide and is transferred as such. For example, if an amplitude value of 100 falls within the blank-ahead marker area when the sweep is transferred, the amplitude value becomes 2148 (amplitude value 100 + data word 2048, in which bit number 11 of graph data is positive blanked). For further information on data word coding see Consolidated Coding Data in Appendix B.

When transferring amplitude data, only the data words from 1001 display memory addresses are transferred out of the total of 1024 available display memory addresses. Each of the 1024 display memory addresses contains a single data word. The 23 data words not transferred are at address 0 (used for the control instruction word) and at addresses 1002 through 1024 (not used by the analyzer for trace data, but available for programming custom graphics or labels).

The sample program below demonstrates how to store a trace similar to the one in the following illustration.

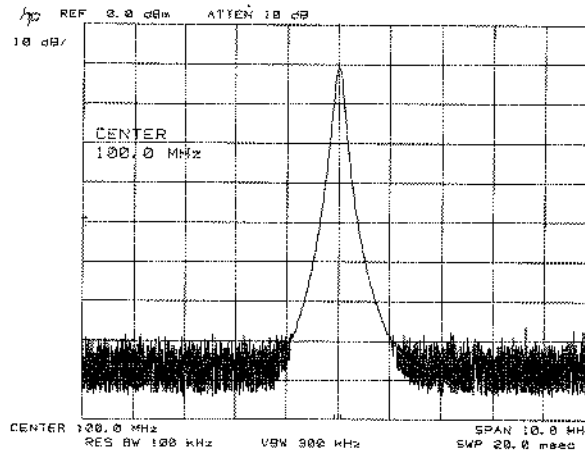

```

10 ASSIGN @Sa TO 718
20 PRINTER IS 701
30 DIM A(1001)
40 !
50 OUTPUT @Sa;"IP;"
60 OUTPUT @Sa;"CF100MZ;SP2MZ;SR;TS;"
70 OUTPUT @Sa;"O1;TA;"
80   FOR N = 1 TO 1001
90     ENTER @Sa;A(N)
100  NEXT N
110 !
120  FOR N = 490 TO 510
130    PRINT A(N)
140  NEXT N
150 END

```

- Line 30: Reserves controller memory for 1001 amplitude values.
- Line 50: Presets the instrument.
- Line 60: Sets analyzer to 100 MHz center frequency with 2 MHz frequency span. Selects single sweep mode and takes one complete sweep of the trace (graph) data.
- Line 70: Selects analyzer output to be in O1 format and commands the analyzer to transfer trace A amplitude values to the controller.
- Lines 80 to 100: Sequentially reads all 1001 trace A amplitude values into A(N) of the controller.
- Lines 120 to 140: Prints out trace A amplitude values at all 20 points between x-axis coordinates 490 and 510.

TB

Transfer B

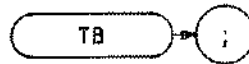

The TB command transfers trace B amplitude values, in display units, from the analyzer to the controller. The display unit values are transferred in sequential order (from left to right) as seen on the CRT display. Display unit values that are stored in the display memory can be transferred to the controller in any one of the four output formats of the analyzer (01, 02, 03, or 04).

Transfer of trace amplitude data should only be done as follows:

1. Select single sweep mode (S2).
2. Select desired analyzer settings.
3. Take one complete sweep (TS).
4. Transfer data.

This procedure ensures that the current settings of the analyzer are reflected in the transferred data.

When the TB command is executed, and the analyzer is in continuous sweep mode, the blank-ahead marker is also transferred as amplitude values in the 01 and 02 format. The blank-ahead marker is not transferred in the 03 and 04 formats.

The blank-ahead marker is composed of positive, blanked amplitude values and is immediately ahead of the updated, sweeping trace. These values represent the amplitude responses of the previous sweep, plus 2048. Thus, they are off (above) the screen.

The blank-ahead marker is eight display units wide and is transferred as such. For example, if an amplitude value of 100 falls within the blank-ahead marker area when the sweep is transferred, the amplitude value becomes 2148 (amplitude value 100 + data word 2048, in which bit number 11 of graph data is positive blanked). For further information on data word coding see Consolidated Coding Data in Appendix B.

When transferring amplitude data, only the data words from 1001 display memory addresses are transferred out of the total of 1024 available display memory addresses. Each of the 1024 display memory addresses contains a single data word. The 23 data words not transferred are at address 0 (used for the control instruction word) and at addresses 1002 through 1024 (not used by the analyzer for trace data, but available for programming custom graphics or labels).

The sample program below demonstrates how to store a trace similar to the one in the following illustration.

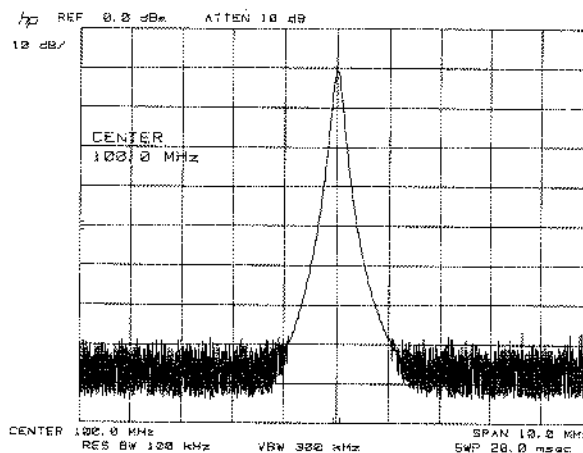

```

10 ASSIGN @Sa TO 718
20 PRINTER IS 701
30 DIM A(1001)
40 !
50 OUTPUT @Sa;"IP;LF;"
60 OUTPUT @Sa;"CF100MZ;SP2MZ;S2,TS;"
70 OUTPUT @SA;"O1;TB;"
80   FOR N = 1 TO 1001
90     ENTER @Sa;A(N)
100  NEXT N
110 !
120  FOR N = 490 TO 510
130    PRINT A(N)
140  NEXT N
150 END

```

Line 30: Reserves controller memory for 1001 amplitude values.

Line 50: Presets the instrument.

Line 60: Sets analyzer to 100 MHz center frequency with 2 MHz frequency span. Selects single sweep mode and takes one complete sweep of the trace (graph) data.

Line 70: Selects analyzer output to be in O1 format and commands the analyzer to transfer trace B amplitude values to the controller.

Lines 80 to 100: Sequentially reads all 1001 trace B amplitude values into A(N) of the controller.

Lines 120 to 140: Prints out trace B amplitude values at all 20 points between x-axis coordinates 490 and 510.

TDF

Trace Data Format

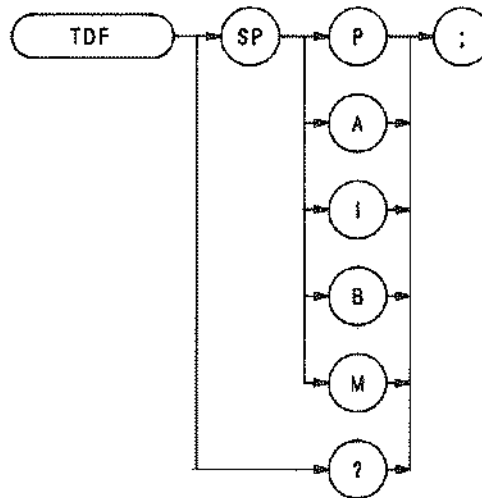

The TDF command formats trace information for return to the controller.

OUTPUT 718; "TDF B;"

Specifying M enables the 01 format and returns values in display units, from 0 to 1001.

Specifying P enables the 03 format and returns absolute measurement values, such as dBm or Hz.

Specifying A returns data as an A-block data field. The MDS command determines whether data comprises one or two 8-bit bytes. (See MDS.)

Specifying I returns data as an I-block data field. The MDS command determines whether data comprises one or two 8-bit bytes. (See MDS.)

Specifying B enables the 02 or 04 format. The MDS command determines whether data comprises one or two 8-bit bytes.

See the 01, 02, 03, and 04 FORMAT commands.

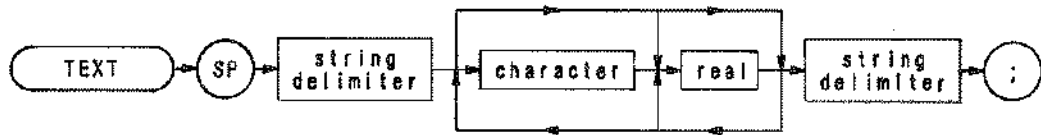

Item	Description/Default	Range Restriction
STRING DELIMITER	Must match. Marks beginning and end of command list.	!"\$%&'/:=@\~
Characters	Alphanumeric characters.	ASCII character 32 through 126.

The TEXT command writes text on the spectrum analyzer screen at the current pen position.

OUTPUT 718; "TEXT "CONNECT ANTENNA." ";"

TH

Threshold

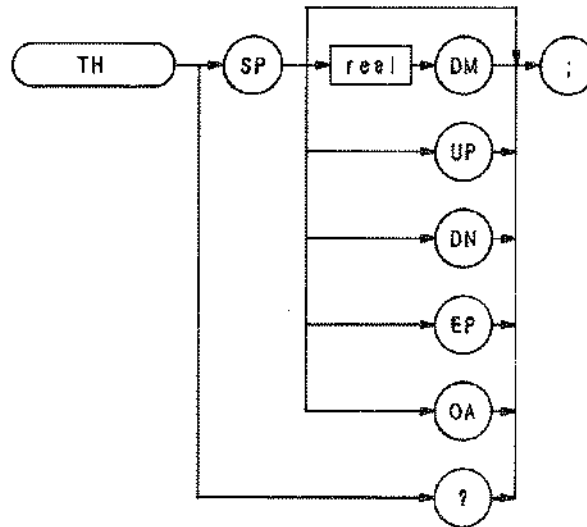

Item	Description/Default	Range Restriction
	Threshold value defaults to nine major divisions below reference level.	
	UP or DN to step threshold by 10 dB.	

The TH command blanks signal responses below the threshold level, similar to a base line clipper. The threshold level is nine major divisions below the reference level, unless otherwise specified. The UP and DN commands move the threshold 10 dB.

The threshold level is annotated in reference level units at the lower left-hand side of the CRT display. (See TØ and THE.)

The threshold can also be used as a variable. The program below places a marker on the largest signal that is greater than the threshold level.

```
10 OUTPUT 718;"IP;TH -3SDM;"
20 OUTPUT 718;"TS;MKPK HI;MA;"
30 OUTPUT 718;"IF MA,GT,TH "
40 OUTPUT 718;"THEN CF 20MZ;"
50 OUTPUT 718;"ELSE CF 100MZ;TS;MKPK HI;"
60 OUTPUT 718;"ENDIF;"
70 END
```

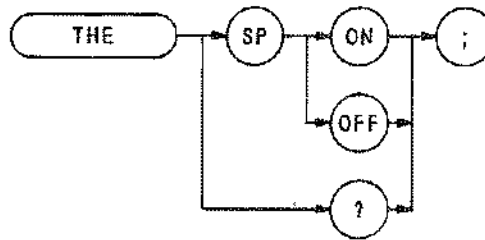

The THE command disables or enables the threshold level. The threshold level is specified by the TH command.

OUTPUT 718; "THE OFF;"

When queried (? or OA), TH returns the threshold line state, followed by carriage-return/line-feed (ASCII codes 13, 10). The end-of-identify state (EOI) is asserted with line feed.

IF THEN ELSE ENDIF

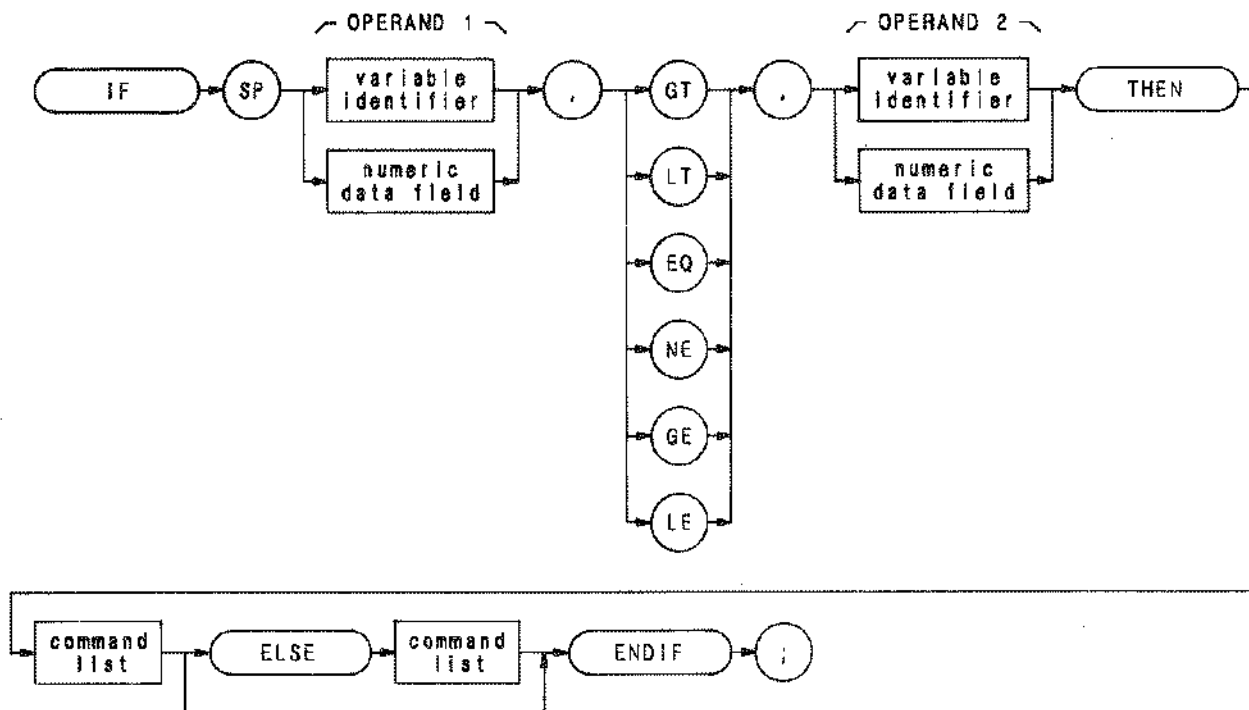

Item	Description/Default	Range Restriction
COMMAND LIST	Alphanumeric character. Any spectrum analyzer command from this section.	
VARIABLE IDENTIFIER	Alpha character. User-defined identifier declared in VARDEF statement. Alpha character. Measurement-variable identifier, such as CF or MA. Trace element, such as TRA[10].	AA-ZZ and _ 2— 12 characters required.
NUMERIC DATA FIELD	Real	

The IF-THEN-ELSE-ENDIF commands form a decision and looping construct. They compare operand 1 to operand 2. If the condition is true, the command list is executed. Otherwise, commands following ELSE or ENDIF are executed.

The IF command must be delimited with the ENDIF command.

The following program uses the IF THEN ELSE ENDIF command to place a marker on the largest signal that is greater than the threshold level.

```
10 OUTPUT 718;"IP;TH -36DM;"
20 OUTPUT 718;"TS;MKPK HI;MA;"
30 OUTPUT 718;"IF MA,GT,TH"
40 OUTPUT 718;"THEN CF 20MZ;"
50 OUTPUT 718;"ELSE CF 100MZ;TS;MKPK HI;"
60 OUTPUT 718;"ENDIF;"
70 END
```

The program below does not incorporate the ELSE branch of the IF THEN ELSE ENDIF command. The program lowers any signal positioned above (off) the analyzer screen.

```
10 OUTPUT 718;"S2;TS;E1; "
20 OUTPUT 718;"IF MA,GT,RL THEN"
30 OUTPUT 718;"REPEAT RL UP;TS;E1 "
40 OUTPUT 718;"UNTIL MA,LE,RL "
50 OUTPUT 718;"ENDIF S1;" "
60 END
```

TM

Trigger Mode

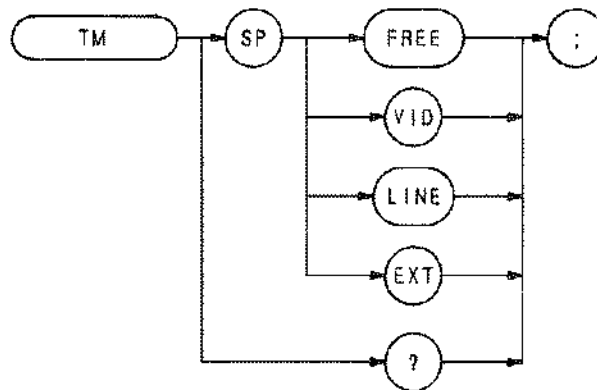

The TM command selects trigger mode: free, video, line, or external trigger. See T1, T2, T3, and T4.

The query response return the trigger mode.

OUTPUT 718; "TM EXT;"

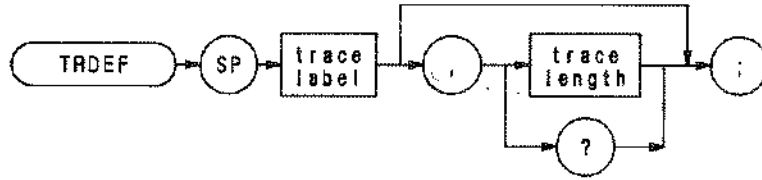

Item	Description/Default	Range Restriction
Trace Label	Alpha character. User-defined label declared in TRDEF statement.	AA—ZZ and __ 2— 12 characters required.
TRACE LENGTH	Determines the number of elements (points) in a trace. Default is 1001. INTEGER.	0 to 1008

The TRDEF statement establishes the length and name of user-defined trace. User-defined traces form the operand of many remote functions in this section. These functions show “TRACE LABEL” as an operand in their syntax diagrams. Following are some of the functions that operate on user-defined traces.

MOV, MPY, XCH, TRACE, TRGRPH, NEG, DIV, AVG, BLANK, ADD, MXM, SCALE, MXMH, SUB, MIN, TWINDOW

If two traces have different lengths, the largest length is used for the specified span. The shorter length accepts data until filled.

When a trace of a greater length is operated on and stored in a trace of lesser length, the trace is truncated to fit. Conversely, when a shorter trace is operated on and stored in a trace of longer length, the last trace element is extended for operations with the longer length. Thus, a single element trace acts like a display line in trace operations.

TRDSP

Trace Display

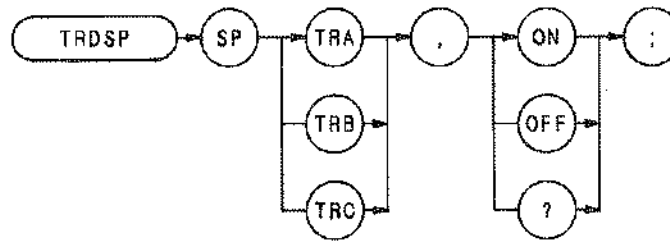

The TRDSP command displays a trace or turns it off. The command does not affect any other trace operations.

OUTPUT 718; "TRDSP TRC,ON;"

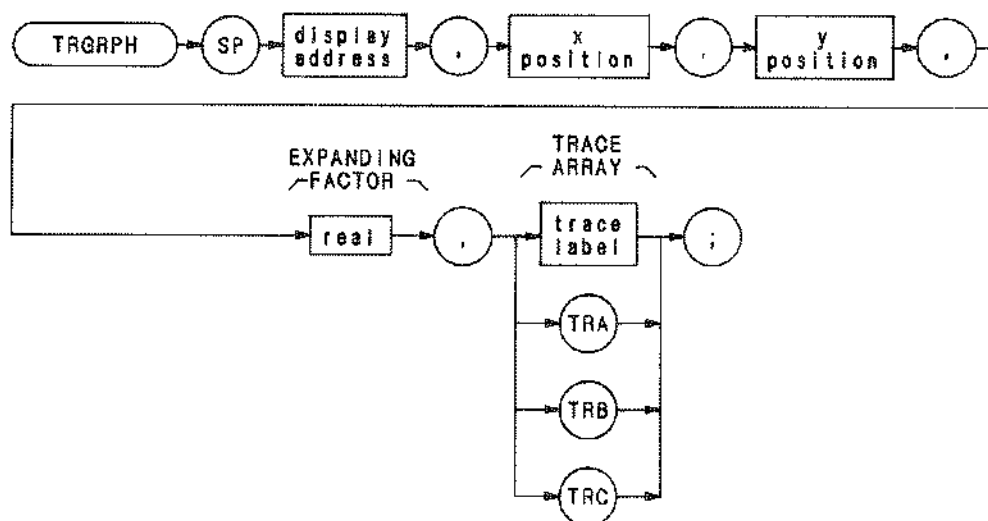

The TRGRPH command displays a trace A, B, or C, or a user-defined trace anywhere on the spectrum analyzer display. The X and Y positions orient the trace above and to the right of a point on the CRT, specified by the display address. The trace can be expanded, according to the scale determined by the expanding factor.

For example, the following command would display a user-defined trace named TEST occupying the length of the CRT at the base line, if TEST was originally full-scale, and was compressed by 10 with the COMPRESS command:

```
TRGRPH 0,0,0,10 TEST;
```

Note that the above TRGRPH command fills display addresses 0 through 1000 with the amplitude information of the TEST trace array. Thus, any original trace A information is lost.

The program below moves trace A data into a user-defined trace array, called TEST, then positions TEST 100 display units above the CRT baseline.

```

10 OUTPUT 718;"IP;LF;CF 100MZ;SP 20MZ;A1;S2;TS;"
20 OUTPUT 718;"TRDEF TEST, 1001;"
30 OUTPUT 718;"MOV TEST, TRA;"
40 OUTPUT 718"TRGRPH 0,0,100,1,TEST;"
50 END

```

Line 10: Sets up an active trace.
 Line 20: Defines user-defined trace array.
 Line 30: Moves trace A into array.
 Line 40: Display array, filling display addresses allocated for trace A.

To reposition traces A, B, and C without the use of a user-defined trace array, substitute the letter I for the display address.

TRMATH

Trace Math

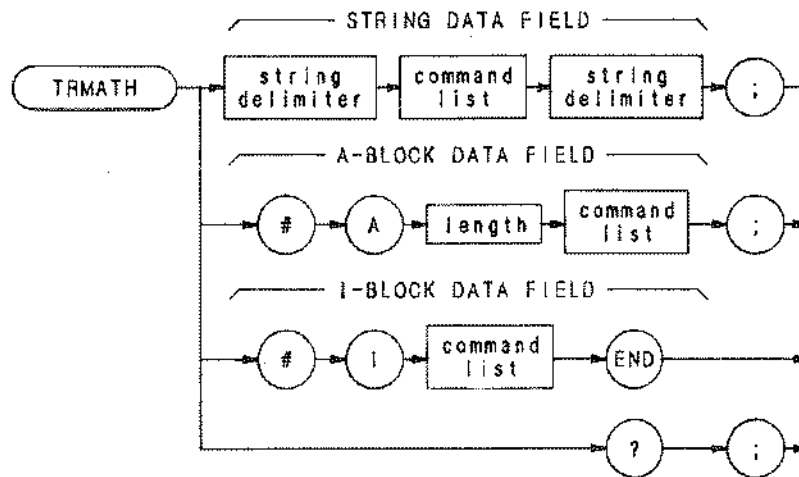

Item	Description/Default	Range Restriction
COMMAND LIST	Any spectrum analyzer commands from this Remote section.	
LENGTH	Two 8-bit bytes specifying length of command list, in 8-bit bytes. The most significant byte is first: MSB LSB.	
STRING DELIMITER	Must match. Marks beginning and end of command list.	!"\$%&'/: = @ \ ~

The TRMATH command executes a command list at the end of a sweep. Compose the command list with any of the following commands only.

Trace Math Commands:

AMB, AMBPL, APB, AXB, BL, BML, BTC, BXC, C1, C2, EX, KSG, KSH, KSc, KSi, KSl, VAVG

User-Operator Functions:

MOV, SUB, ADD, MPY, DIV, LOG, EXP, MXM, MIN, XCH, SQR, CONCAT, CTM, CTA, AVG

If an on-end-of-sweep command is encountered, it is executed after the contents of the TRMATH command are executed.

The operands and results of trace math are truncated if they are not within certain limits. If operating on traces A, B, or C, results must be within 1023. If operating on user-defined traces, results must be within 32,767.

The program below halves the amplitude of trace A and moves it to trace B. If trace A is in log mode, this is equivalent to the square root of trace A.

```
10 OUTPUT 718;"A1;B3;"
12 OUTPUT 718;"DISPOSE TRMATH;"
20 OUTPUT 718;"TRMATH! DIV TRB,TRA,2!;"
30 END
```

See DISPOSE.

TRPST

Trace Preset

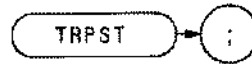

The TRPST command executes the following commands:

- A1
- B4
- C1
- KSK
- EM
- T0
- L0
- DISPOSE ONEOS
- DISPOSE TRMATH
- DISPOSE ONSWP

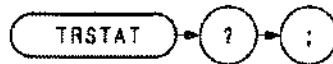

The TRSTAT command returns trace states to the controller: clear-write, off, view, or blank.

	Trace Is Swept and Updated	Trace Is Displayed
Trace Clear/Write CLRW	X	X
Trace Off TRDSP	X	
Trace View VIEW		X
Trace Blank BLANK		

TS

Take Sweep

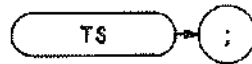

The take sweep command, TS, starts and completes one full sweep before the next command is executed. One TS command is required for each sweep in the single mode.

The function, marker, trace, coupled function, preselector peak, automatic zoom and video average commands, and a number of the shift functions require one complete sweep to update the display and trace memory. This is to avoid losing information for the output of measurement data on either the CRT display or through the HP-IB interface.

```
OUTPUT 718;"IP;CF 11.105GZ;SP20KZ;VIEW;"
```

In the example above, the command sequence does not allow sufficient time for a full sweep of the specified span, before VIEW is executed. Therefore, only the span set by the instrument preset is displayed in trace A.

A TS command inserted before VIEW, as shown in the program line below, makes the analyzer take one complete sweep before displaying trace A. This allows the analyzer sufficient time to respond to each command in the sequence.

```
OUTPUT 718;"IP;CF 11.105GZ;SP20KZ;TS;VIEW;"
```

A TS command is also recommended before HP-IB transmission of marker data (amplitude, frequency) on the HP-IB bus, and before marker operations (peak search, preselector peak). This is because the active marker is repositioned at the end of each sweep.

The TS command guarantees that the HP-IB bus transmission and CRT display contain marker position information that is relative to the current trace response.

When the analyzer receives a TS command, it is not ready to receive any more data via HP-IB until one full sweep has been completed. However, when slow sweep speeds are being used, the controller can be programmed to perform computations or to address other instruments on the HP-IB bus while the analyzer is completing its sweep.

In normal programming practice, a semicolon terminates each command statement. By using the semicolon as a terminator, an automatic carriage-return/line-feed is performed by the controller. However, the controller can perform computations or address other instruments while the analyzer is executing TS, if the carriage-return/line-feed is suppressed.

In the program line below, the semicolon at the end of the line (outside the quotation marks) suppresses the carriage-return/line-feed. The controller is now available to proceed to the next program line while the analyzer is completing its sweep.

```
OUTPUT 718;"ST5SC;R2;TS";
```

The R2 command in the program line above enables the end-of-sweep service request when the analyzer is finished sweeping. This service request interrupts the controller program to allow subsequent addressing of the analyzer. Refer to Appendix D for a complete description of the R2 Service Request.

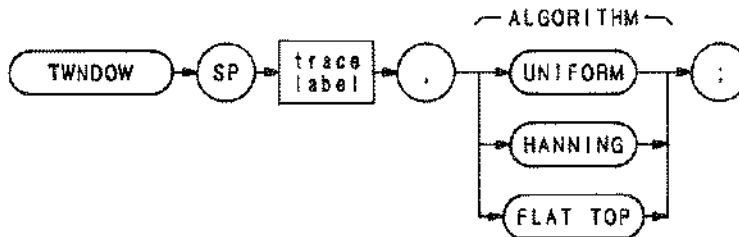

Item	Description/Default	Range Restriction
TRACE LABEL	Alpha character. User-defined label declared in TRDEF statement.	AA—ZZ and _ 2—12 characters required. Trace length must be 1008.

The TWNDOW function formats a trace array for the fast fourier transform function (FFT).

Execute TWNDOW on user-defined trace arrays containing 1008 elements, only.

The trace window function modifies the contents of a trace array according to three built-in algorithms: UNIFORM, HANNING, or FLATTOP. The filters are shown below, as graphs in the time domain. The TWNDOW command multiples a trace array with one of these windows.

The three algorithms simulate passband shapes that represent a give-and-take between amplitude uncertainty, sensitivity, and frequency resolution. See FFT for more information about these algorithms and the fast fourier transform function.

```

10 OUTPUT 718;"TRDEF TEST,1008;"
20 OUTPUT 718;"TWNDOW TEST,UNIFORM;"
  
```

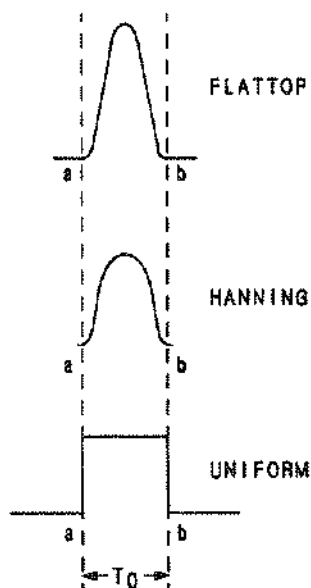

TØ

Threshold Off

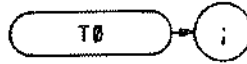

The TØ command removes the threshold boundary and its readout from the CRT display.

OUTPUT 718; "TØ;"

The function of the TØ command and the THRESHOLD  key are identical.

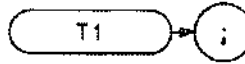

The T1 command sets the analyzer sweep to free run trigger mode. The functions of the T1 command and front panel  key are identical.

See TM.

OUTPUT "T1;"

T2

Line Trigger

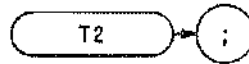

The T2 command sets the analyzer sweep to line trigger mode. This function triggers the analyzer sweep when the line voltage passes through zero in a positive direction. The functions of the T2 command and front panel LINE key are identical. (See TM.)

OUTPUT 718; "T2;"

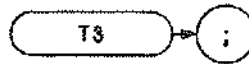

The T3 command sets the analyzer to external trigger mode. This function triggers the analyzer sweep when an external voltage passes through approximately 1.5 volts in a positive direction. The external trigger signal level must be between 0 and 5 volts.

The functions of the T3 command and front panel  trigger are identical. (See TM.)

OUTPUT 718; "T3;"

T4

Video Trigger

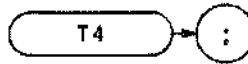

The T4 command sets the analyzer sweep to video trigger mode. This function triggers the analyzer sweep when the voltage level of a detected RF envelope reaches the level set by the trigger LEVEL knob. The level (set by the LEVEL knob) corresponds to detected levels displayed on the CRT between the bottom graticule (full CCW) and the top graticule (full CW).

The functions of the T4 command and front panel  trigger key are identical. (See TM.)

OUTPUT 718; "T4;"

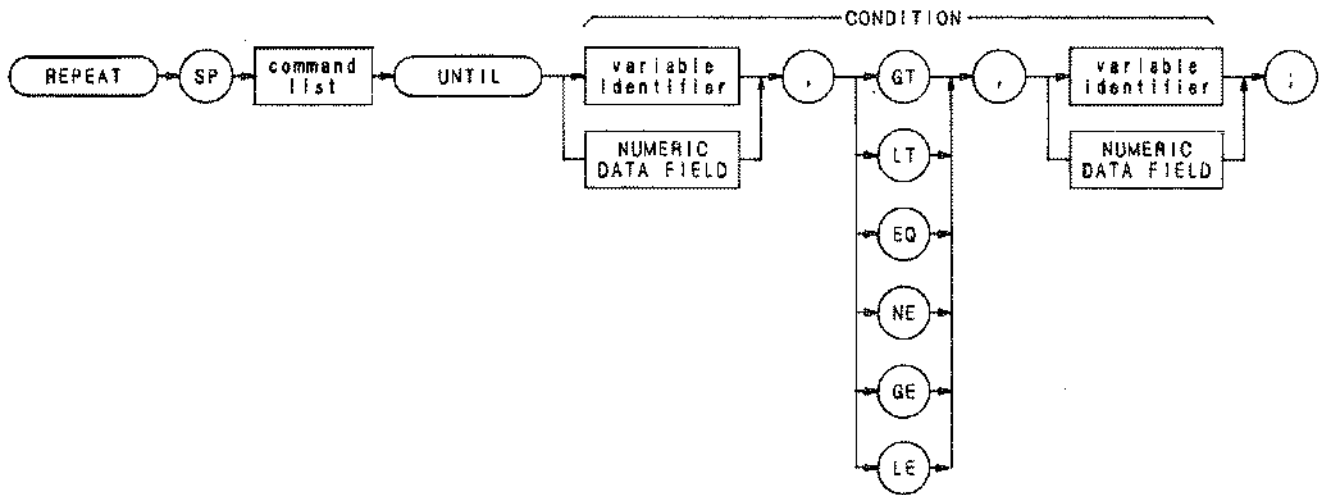

Item	Description/Default	Range Restriction
VARIABLE IDENTIFIER	Alpha character. User-defined identifier declared in VARDEF statement. Do not follow identifier with semicolon. Alpha character. Measurement-variable identifier, such as CF or MA. Do not follow identifier with semicolon. Trace element, such as TRA[10].	AA-ZZ and _ 2—12 characters required.
NUMERIC DATA FIELD	Real	
COMMAND LIST	Any commands from this remote section.	

The REPEAT and UNTIL commands form a looping construct. The command list is repeated until the condition is true.

The following program lowers any off screen-signal.

```

10 OUTPUT 718;"S2;TS;E1;"
20 OUTPUT 718;"IF MA,GT,RL THEN"
30 OUTPUT 718;"REPEAT RL UP;TS;E1;"
40 OUTPUT 718;"UNTIL MA,LE,RL "
50 OUTPUT 718;"ENDIF S1;" " "
60 END
  
```

REPEAT UNTIL (Continued)

Use the FUNCDEF command to nest a REPEAT UNTIL command within another REPEAT UNTIL looping construct. The program below defines "C_LOP" as a looping construct in lines 30 through 60. The construct is then nested into the REPEAT UNTIL command in line 80.

```
10 OUTPUT 718;"SNGLS;"
20 OUTPUT 718;"VARDEF COUNT,0;VARDEF SCORE,0;"
30 OUTPUT 718;"FUNCDEF C_LOP," " "
40 OUTPUT 718;"REPEAT TS;"
50 OUTPUT 718;"ADD COUNT,COUNT,1;"
60 OUTPUT 718;"UNTIL COUNT,EQ,3;" " "
70 OUTPUT 718;"REPEAT;"
80 OUTPUT 718;"C_LOP;"
90 OUTPUT 718;"ADD SCORE,SCORE,1;"
100 OUTPUT 718;"UNTIL SCORE,EQ,4;"
```

The program below does not work because the REPEAT UNTIL commands are nested without the use of the FUNCDEF command.

```
10 OUTPUT 718,"SNGLS;"
20 OUTPUT 718;"VARDEF COUNT,0;VARDEF SCORE,0;"
30 OUTPUT 718;"REPEAT;"
40 OUTPUT 718;"REPEAT;"
50 OUTPUT 718;"TS;"
60 OUTPUT 718;"ADD COUNT,COUNT,1;"
70 OUTPUT 718;"UNTIL COUNT,EQ,3;"
80 OUTPUT 718;"ADD SCORE,SCORE,1;"
90 OUTPUT 718;"UNTIL SCORE,EQ,4;"
100 END
```

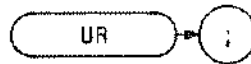
The UR command sends a voltage to the rear panel RECORDER OUTPUTS. The voltage level remains until a different command is executed. Use the UR command to calibrate the upper right dimension of a recorder.

OUTPUT 718; "UR;"

The functions of the UR command and front panel  key are identical (See Introduction in Section I.)

USTATE

State

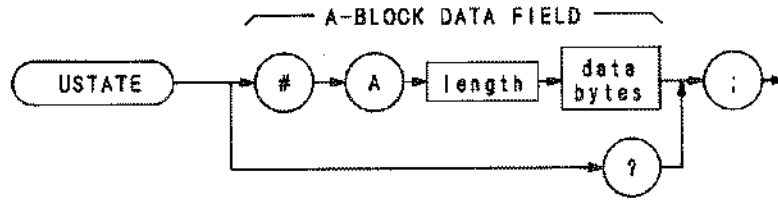

Item	Description/Default	Range Restriction
LENGTH	Two 8-bit bytes specifying length of command list, in 8-bit bytes. The most significant byte is first: MSB LSB.	
DATA BYTES	8-bit bytes of data representing command list.	ASCII characters 0 to 255.

The USTATE command configures or returns configuration of user-defined states defined by these commands:

ONEOS
ONSWP
KEYDEF
FUNCDEF
TRDEF
TRMATH



Item	Description/Default	Range Restriction
VARIABLE IDENTIFIER	User-defined identifier. Alphanumeric character.	AA-ZZ and _ 2–12 characters required.

The VARDEF command assigns a real value to a variable. The value is assigned immediately after VARDEF execution and reassigned during any instrument preset.

The following program demonstrates the VARDEF command.

```

10 OUTPUT 718;"SNGLS;"
20 OUTPUT 718;"VARDEF COUNT,0;VARDEF SCOR,0;"
30 OUTPUT 718;"FUNCDEF C_LOP;" " "
40 OUTPUT 718;"REPEAT TS;"
50 OUTPUT 718;"ADD COUNT,COUNT,1;"
60 OUTPUT 718;"UNTIL COUNT,EQ,3;" " "
70 OUTPUT 718;"REPEAT;"
80 OUTPUT 718;"C_LOP;"
90 OUTPUT 718;"ADD SCORE,SCORE,1;"
100 OUTPUT 718;"UNTIL SCORE,EQ,4;"
  
```

VARIANCE

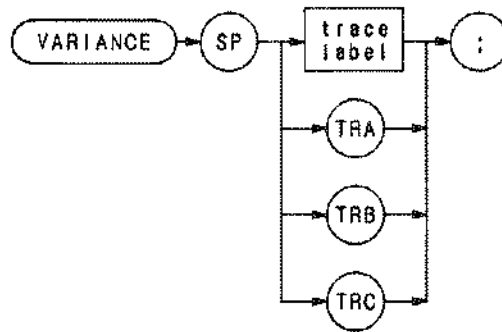

Item	Description/Default	Range Restriction
TRACE LABEL	Alpha character. User-defined label declared in TRDEF statement.	AA-ZZ and _ 2— 12 characters required.

The VARIANCE command returns to the controller the amplitude variance of the specified trace, in display units.

```
10 OUTPUT 718;"VARIANCE TRC;"  
20 ENTER 718;N  
30 PRINT N  
40 END
```

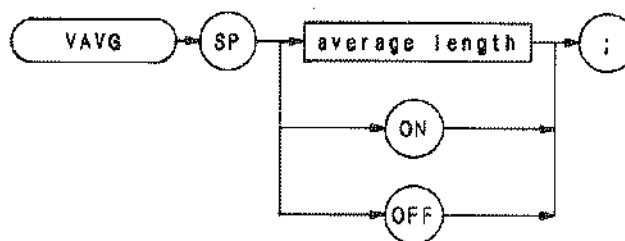

Item	Description/Default	Range Restriction
AVERAGE LENGTH	Real. Default is 100.	Represents maximum number of sweeps executed for averaging.

The VAVG command enables video averaging. During video averaging, two traces are displayed simultaneously. Trace C contains signal responses as seen at the input detector. Trace A or B contains the same responses digitally averaged. The digital reduces the noise floor level, but does not affect the sweep time, bandwidth, or any other analog characteristics of the analyzer.

Before executing VAVG, select trace A or B as the active trace (CLRW) and blank the remaining trace.

The active function readout indicates the number of sweeps averaged; the default is 100 unless otherwise specified. Increasing the number of sweeps averaged increases the amount of averaging.

Use VAVG to view low level signals without slowing the sweep time. Video averaging can lower the noise floor more than a 1 Hz video bandwidth, if a large number of sweeps is specified for averaging. Video average may also be used to monitor instrument state changes (changing bandwidths, center frequencies, etc.) while maintaining a low noise floor. (See Chapter 11 in Section I. Also see KSG and KSH.)

OUTPUT 718; "VAVG 125;"

VB

Video Bandwidth

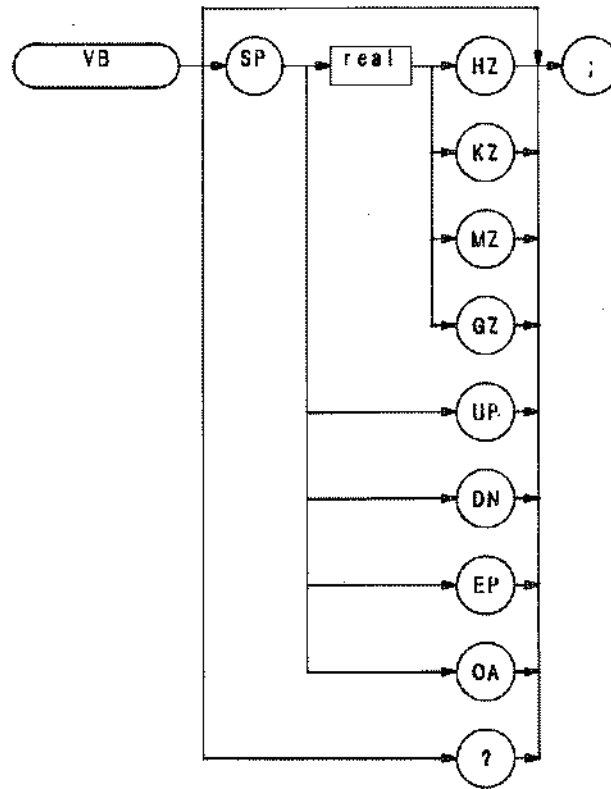

The VB command specifies the video filter bandwidth, which is a post-detection filter. Available bandwidths are 1 Hz, 3 Hz, 10 Hz, 30 Hz, 100 Hz, 300 Hz, 1 kHz, 3 kHz, 10 kHz, 30 kHz, 100 kHz, 1 MHz, and 3 MHz.

The program line below sets the video bandwidth to 10 kHz.

```
OUTPUT 718;"VB 10KZ;"
```

The functions of the VB command and front panel  key are identical.

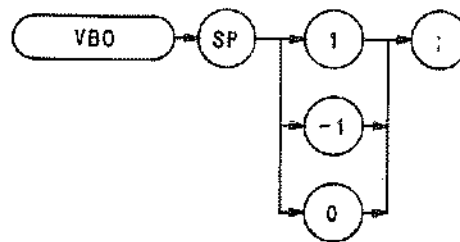

The VBO command specifies the relation between the video and resolution bandwidths that is maintained when these bandwidths are coupled. The bandwidths are usually coupled, unless the RB or VB commands have been executed.

Selecting \emptyset sets the ratio to one, that is, the resolution and video bandwidths are always equal.

Selecting 1 sets the video bandwidth one step wider than the resolution bandwidth:

Resolution Bandwidth	Video Bandwidth
3 MHz	3 MHz
1 kHz	1 MHz
100 kHz	300 kHz
30 kHz	100 kHz
10 kHz	30 kHz
3 kHz	10 kHz
1 kHz	3 kHz
300 Hz	1 Hz
100 Hz	300 Hz
30 Hz	100 Hz
10 Hz	30 Hz

Selecting - 1 sets the video bandwidth one step narrower than the resolution bandwidth:

Resolution Bandwidth	Video Bandwidth
3 MHz	3 MHz
1 MHz	1 kHz
300 kHz	100 kHz
100 kHz	30 kHz
30 kHz	10 kHz
10 kHz	3 kHz
3 kHz	1 kHz
1 Hz	300 Hz
300 Hz	100 Hz
100 Hz	30 Hz
30 Hz	10 Hz

VIEW

View

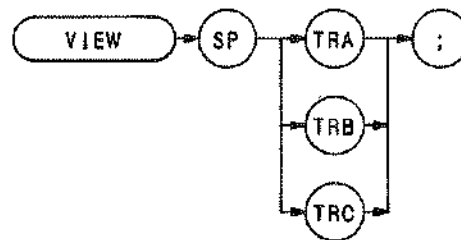

The VIEW command displays trace A, B, or C, and stops the sweep. Thus, the trace is not updated. Trace A and C are discussed below. For detailed information about trace B, see B3 in this section.

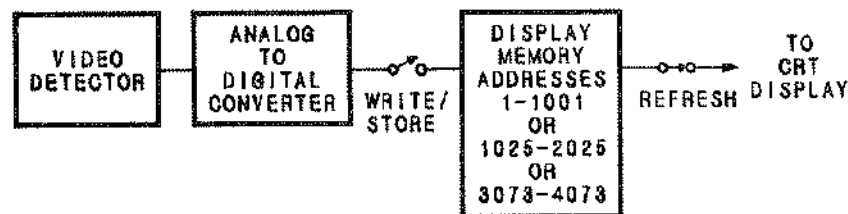

When VIEW TRA is executed, the contents of trace A are stored in display memory addresses 1 through 1023. Address 0 is reserved for the instruction word 1040*. Similarly, when VIEW TRC is executed, the contents of trace C are stored in display memory addresses 3073 through 4095, and address 3072 is reserved for the instruction word 1048*. Therefore, any information stored in address 0 is lost when VIEW TRA is executed. Likewise, the contents of address 3072 are lost when VIEW TRC is executed.

If you have used address 0 or 3072 for a graphics program, or label, you may wish to save their contents before executing VIEW.

```
OUTPUT 718; "VIEW TRC; "
```

For additional information, refer to Appendix A. (See B3, A3, KSj, and TRSTAT.)

* 1040 and 1048 are machine instruction words. 1040 sets addresses 1 through 1023 to zero, and draws trace A. 1048 does the same, but draws the trace dimly.

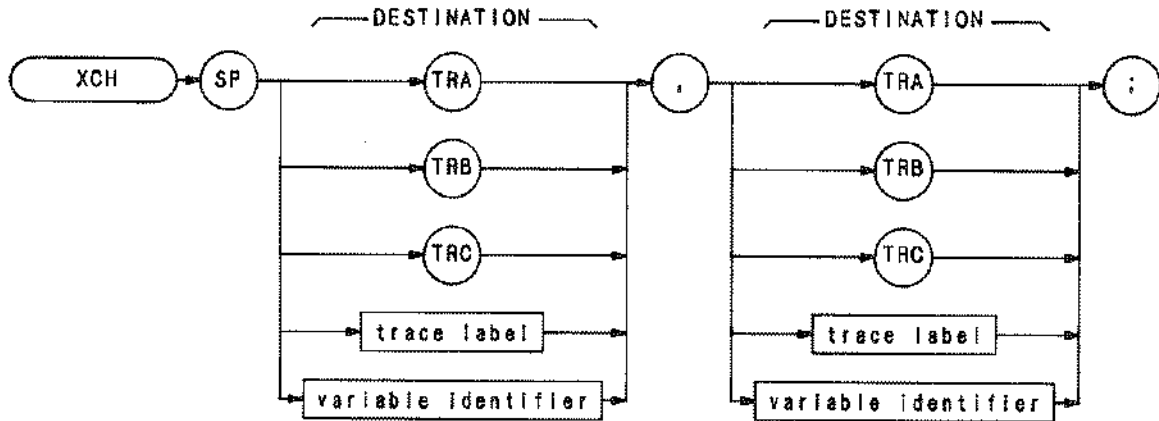

Item	Description/Default	Range Restriction
TRACE LABEL	Alpha character. User-defined label declared in TRDEF statement.	AA-ZZ and _ 2— 12 characters required.
VARIABLE IDENTIFIER	Alpha character. User-defined identifier declared in VARDEF statement.	AA-ZZ and _ 2— 12 characters required.
	Alpha character. Measurement-variable identifier, such as CF or MA.	
	Trace element, such as TRA[10].	

The XCH command exchanges the contents of the destinations. The destinations may be different lengths, as trace operands (TRA, TRB, TRC, and trace label) range from 1 to 1008 elements in length, and a variable identifier is 1 element long. During execution of the XCH command, the longer destination is truncated to fit the shorter destination.



Programming Note

HP 8566B/8568B/9816/9826/9836-1

FEBRUARY 1984

SUPERSEDES: NONE

Introductory Operating Guide for the 8566B/8568B Spectrum Analyzers with the 9816/9826/9836 Desktop Computers

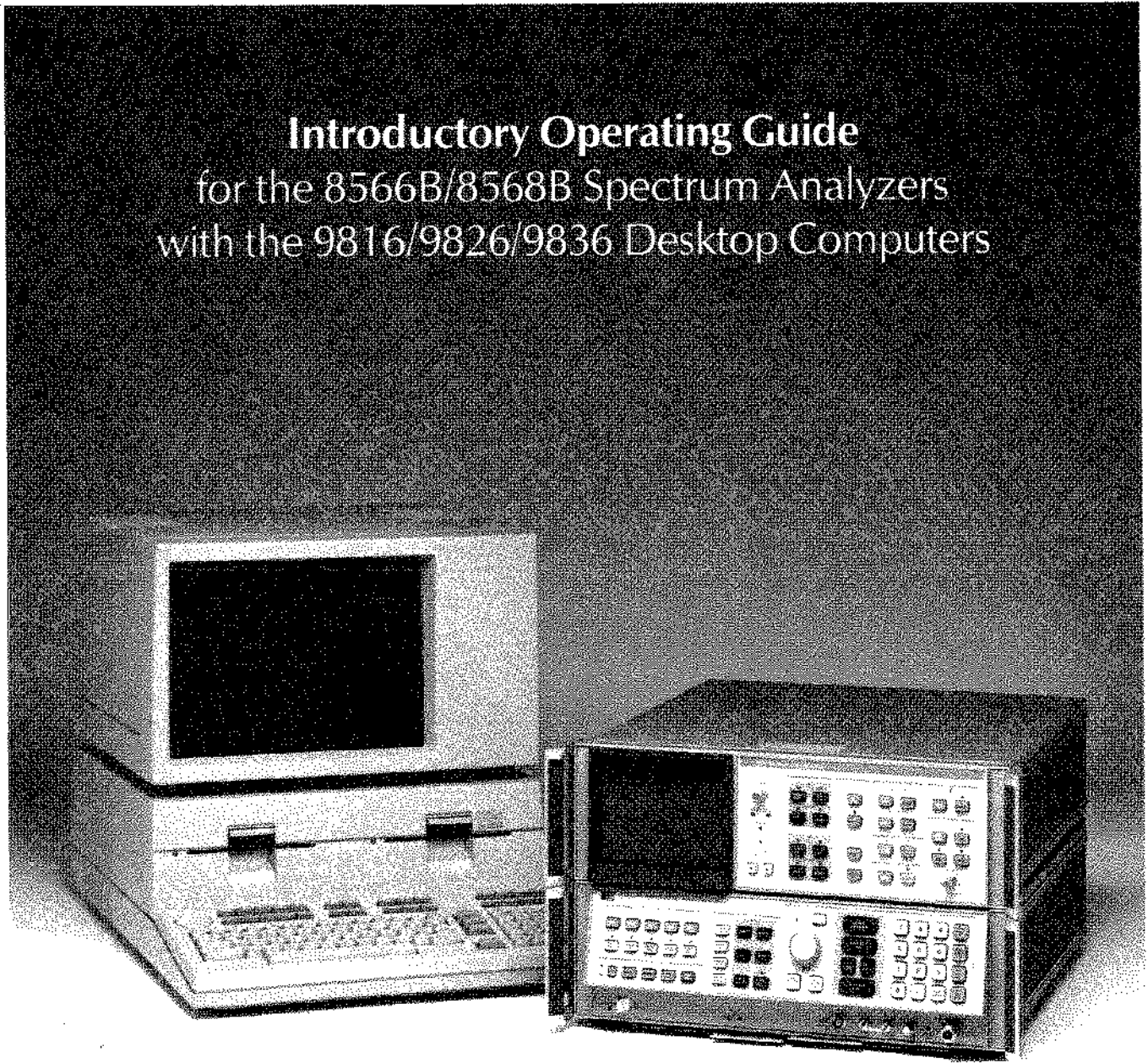

© HEWLETT PACKARD CO. 1984



HEWLETT
PACKARD

Introduction

This note is an introductory guide to remote operation and programming of HP 8566B and HP 8568B Spectrum Analyzers using either the HP 9816S, 9826A or 9836A Desktop Computer with BASIC. Included in this guide are system connections for remote operation and several example programs with descriptions of each step.

The HP 9816S, 9826A, and 9836A use HPL and Pascal as well as BASIC. Although this guide is based on BASIC, the setup and language independent programming techniques apply equally well to systems using HPL or Pascal.

The HP 8566B and HP 8568B are microprocessor-controlled, general-purpose spectrum analyzers which are compatible with the Hewlett-Packard Interface Bus (HP-IB). When used with an HP-IB controller, such as the HP 9816S, 9826A, or 9836A, programs can be developed on the controller and either run remotely or downloaded into the analyzer's internal RAM. Thus, the HP 8566B/8568B are truly programmable, fully automated spectrum analyzers with the following features:

- Precise, stable LO tuning
- High sensitivity and resolution
- Wide dynamic range
- Powerful built-in function set
- 16K of nonvolatile memory for custom measurement routines
- Direct CRT plot with or without a controller

Related Documents

Complete operating information for the HP 8566B/8568B Spectrum Analyzers can be found in these documents:

1. HP 8566B/8568B Spectrum Analyzer Operation Guide (P/N 08566-90040 or 08568-90041).
2. HP 8566B/8568B Spectrum Analyzer Pull-Out Information Cards
3. HP 8566B/8568B Spectrum Analyzer Quick Reference Guide (P/N 5955-8970).

The following manuals describe HP 9816S/9826A/9836A controller operation.

1. Basic Operating Manual (P/N 09826-90000)
2. Basic Programming Techniques (P/N 09826-90010)
3. Basic Interfacing Techniques (P/N 09826-90020)
4. Basic Language Reference (P/N 09826-90055)

Equipment Required

To perform the examples in this note, you will need the following equipment and accessories:

1. HP 8566B or 8568B Spectrum Analyzer
2. HP 9816S, 9826A or 9836A Desktop Computer with ROM-based or RAM-based BASIC language (Options 011 or 711)
3. 10833 A/B/C/D HP-IB Cable
4. HP 7240A, 7245A/B, 7470A, or 9872C Plotter (optional)

Setup

Figure 1 shows the system connections. To connect the system as shown, follow these steps.

1. Turn off the power to the HP 9816S/9826A/9836A and HP 8566B/8568B.
2. Attach an HP-IB cable to the 24-pin HP-IB connectors on the back panels of the HP 9816S/9826A/9836A and HP 8566B/8568B. The connectors are shaped to ensure proper orientation. (See Figure 1.)

CAUTION

Do not attempt to mate silver English threaded screws on one connector with black metric threaded nuts on another connector, or vice versa, as damage to the hardware may result. A metric conversion kit which will convert one cable and one or two instruments to metric hardware may be obtained by ordering HP P/N 5060-0138.

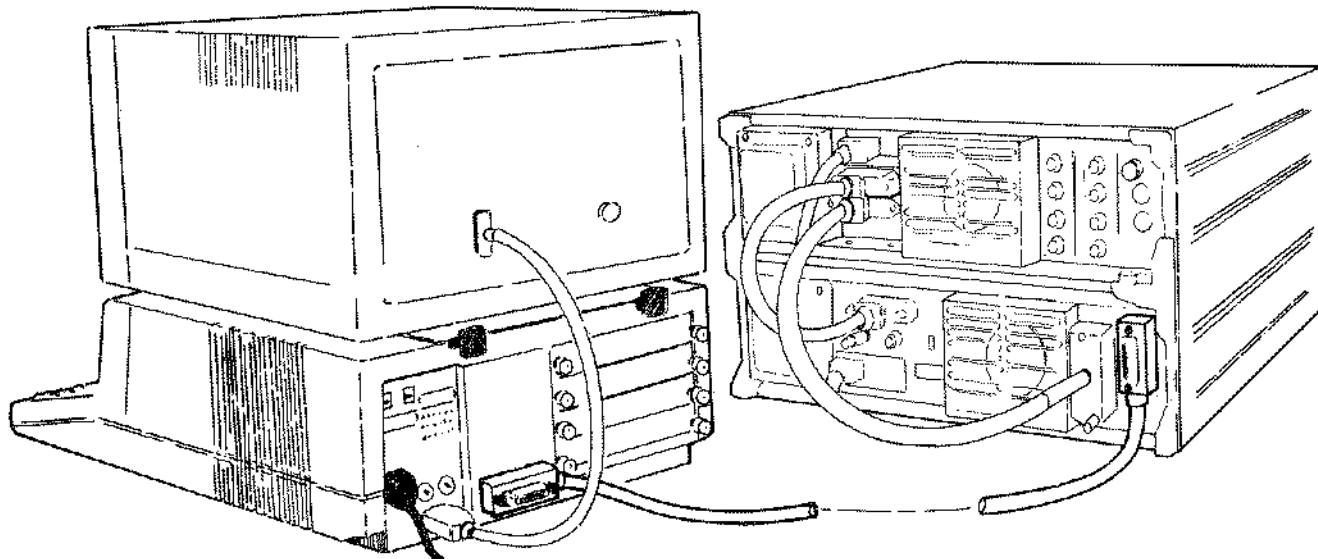

FIGURE 1. SYSTEM CONNECTION

Check-Out

Determine whether your HP 9816S/9826A/9836A has a soft-loaded (RAM) or built-in (ROM) language system and follow the appropriate procedure below:

Built-in System

1. Remove any discs from the drives and then press the power switch in.
2. A "BASIC READY" message should appear and the computer is now ready for use.
3. If more than one language system is built-in, BASIC (B) and HPL (H) for example, the computer will display

WHICH SYSTEM?
B H

Press the "B" key to select the BASIC system.

Soft-loaded System

1. Insert the BASIC language system disc into the disc drive and close the door.
2. Press the power switch in.
3. After a few seconds the "BASIC READY" message should appear and the computer is now ready for use.

If the computer does not display the "READY" message after the procedures above are completed, refer to the BASIC Operating Manual, Chapter 1.

After making AC power line connections to the analyzer, the STANDBY lights on both the RF and display sections should be illuminated. Set the analyzer to LINE ON.

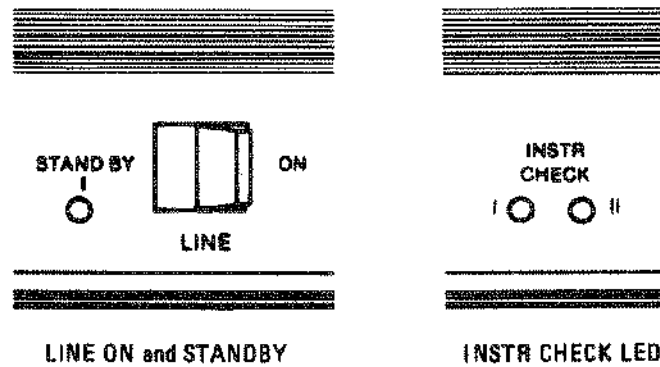

Upon LINE ON, the analyzer will perform an automatic internal instrument check, designated by the red INSTR CHECK indicators. Both LED's will turn on momentarily during the brief check routine and, if the instrument is operating properly, will go off during operation, except when another instrument check is triggered by an Instrument Preset. If one or both LED's remain on, refer to Section II, Performance Tests, in the HP 8566B/8568B Service Manual.

Verify that the analyzer's address is set to 18. The read/write address of the HP 8566B or HP 8568B can be determined and altered from the front panel by using the shift function P:

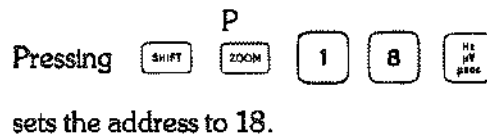

When the analyzer is turned on from a cold state, CRT messages OVEN COLD and REF UNLOCK may appear. These will go off typically ten minutes after AC power is connected. Type the following commands on the controller keyboard.

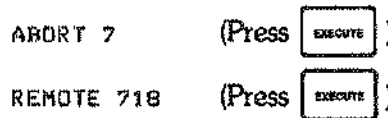

If ADRS'D and REM light up on the analyzer's front panel, proceed to the programming examples. If either ADRS'D or REM do not light, check to make sure that the interface cables are properly connected and the address in the REMOTE statement matches the address of the HP 8566B/8568B. Although 18 is the factory-set address and the address used in the following examples, other addresses are possible.

If both ADRS'D and REM still do not light, consult the HP 8566B/8568B Service Manual and the HP 9816S/9826A/9836A Service Manual for troubleshooting information.

Programming Examples

The following examples illustrate some of the ways to operate the HP 8566B/8568B using the HP 9816S/9826A/9836A controller.

The examples illustrate the operation of front panel controls both remotely and via user-defined softkeys. Also shown are procedures for reading various outputs from the analyzer, such as active functions, marker values, and trace data. If an HP plotter is available, an example of plotter output is also illustrated. Two examples of harmonic distortion measurements are shown. The first illustrates the techniques used in programming the analyzers in a strictly remote fashion. The latter shows the same harmonic distortion measurement as part of a user-defined routine which utilizes some of the expanded function set and is stored in the spectrum analyzer. This latter program can be run independently, without a controller, by simply pressing a softkey on the front panel of the analyzer, or by executing the softkey from the controller.

Before proceeding with the examples, connect the calibrator signal output (labeled CAL OUTPUT just below the front panel) to the RF input of the analyzer. The calibrator signal frequencies for the HP 8566B and the HP 8568B are 100 MHz and 20 MHz, respectively. The programming examples assume that an HP 8566B is used; therefore, if an HP 8568B is used, substitute 20 MHz wherever 100 MHz appears in the program code.

EXAMPLE 1: PROGRAMMING FRONT-PANEL FUNCTIONS

set the analyzer, and set center frequency to 100 MHz and span to 10 MHz, enter the following on the front panel of the 9816S/9826A/9836A controller: OUTPUT 718; "IP CF100MZ SP10MZ"

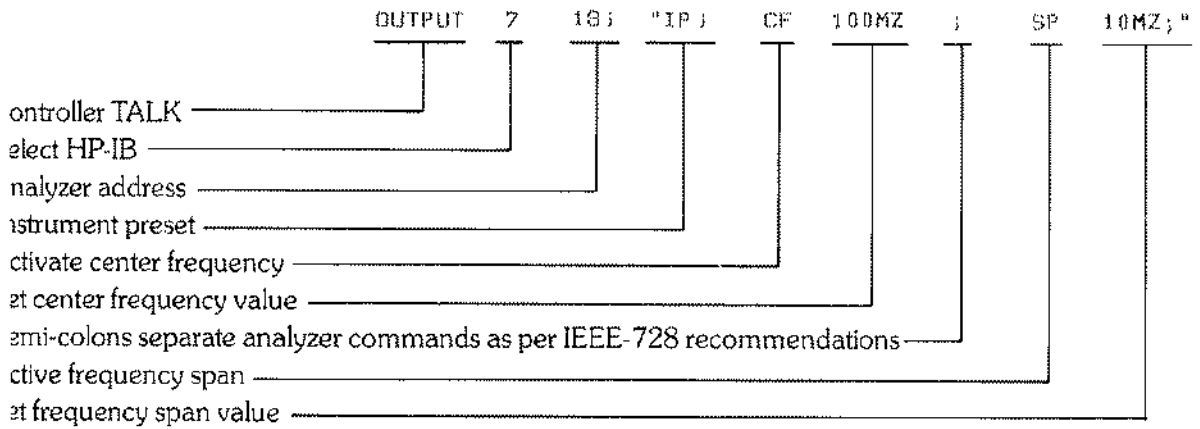

Entering this statement initiates the sequence of operations shown above. The final CRT display with a 100 MHz center frequency present should look like this:

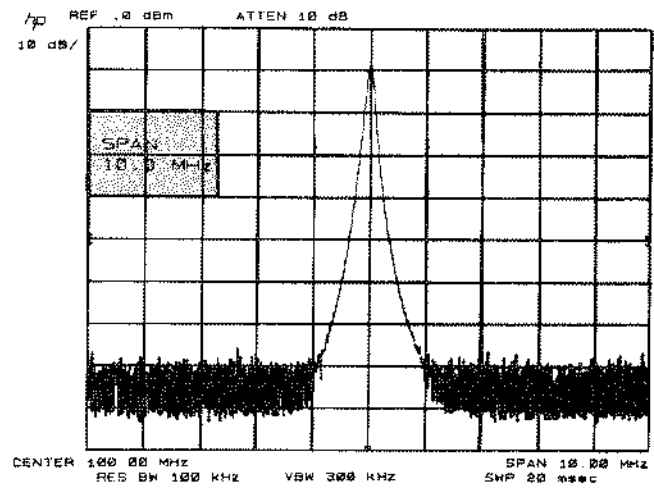

The last function activated, SPAN, will appear with its current value on the analyzer CRT as shown in the shaded box.

NOTE

An important concept in analyzer programming is worthy of special note here. The sequence of operations executed above could have been entered manually from the front panel of the analyzer to yield the same result. In fact, a manual sequence of keystrokes is usually developed first and then used as a basis for executing the same procedure under program control. This simple technique is recommended as a powerful tool for software development with the automatic spectrum analyzer.

EXAMPLE 2: PROGRAMMING USER-DEFINED ROUTINES

Any analyzer command can be incorporated in a user-defined softkey. This softkey, once it is loaded, can be executed independently without a controller, by simply pressing the softkey on the front panel of the analyzer, or by executing the softkey via the controller. The following program shows the front panel functions from example 1 incorporated in a softkey.

```

10  OUTPUT 718;"DISPOSE ALL;"      !Disposes of all predefined softkeys.
20  OUTPUT 718;"FUNCDEF Z_OOM, @IP;CF 100MZ;SP 10MZ;@"
30  END                             !Line 20 assigns the label, Z_OOM, to
40                                     !the indicated sequence of front panel
50                                     !commands.

```

Note that string delimiters must be used when denoting a string within a string. In this case the @ delimiter was used. Other string delimiters include the following symbols: ! " \$ % & ' / : = @ \ ^ _ ` | ~

PART I: ENTERING AND DOWNLOADING THE PROGRAM

To enter the program, press:

10_ should appear.

Type a line and press . Now 20_ should appear.

Continue entering program code line by line. After storing the last line, END, press to execute the program.* (Program lines beginning with "!" are for annotation only and can be omitted. These comments are provided for the reader's clarification only. Note that your line numbers need not correspond to those in this guide.)

PART II: EXECUTING THE ROUTINE

Running the above program stores the routine in the analyzer's internal RAM. The routine can be **executed** in the following three ways:

- via the analyzer's front panel using a softkey whose number is assigned by a KEYDEF declaration
- via the controller using a KEYEXC command
- via the controller using the label defined in the FUNCDEF statement

To execute this softkey from the analyzer's front panel, place the cursor after the END command in line 30.

```

10  OUTPUT 718;"DISPOSE ALL;"
20  OUTPUT 718;"FUNCDEF Z_OOM, @IP;CF 100MZ;SP 10MZ;@"
30  END
      ↑

```

Press the (insert line) key on the controller. Line 21 should appear after line 20. Key in the following program code on line 21:

```

21  OUTPUT 718;"KEYDEF 100, Z_OOM;"  !Assigns softkey 100 to the predefined
                                     !label, Z_OOM.

```

Press and . Then press the analyzer's local key, (located on the lower left corner of the front panel). This places the analyzer under front panel control to enable the operator to key in the softkey.

*For a brief introduction to the controller editing facilities, refer to the chapter entitled Entering, Running and Storing Programs in BASIC Programming Techniques for the HP 9816S/9826A/9836A.

Press the following keys:



Notice when the first data number, 1, is pressed, the entry block (shaded box) indicates the softkey being entered.

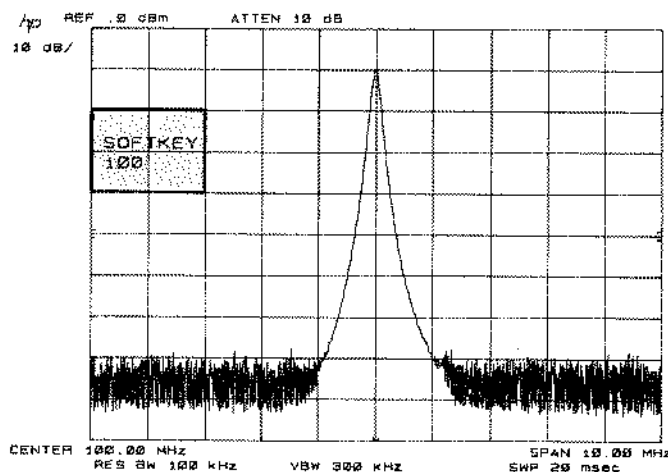



The  key terminates the data number entry and executes the softkey. Notice the controller need not be connected when executing the softkey in this manner.

To execute softkey 100 via the controller, again insert a line by placing the cursor after the END command. Line 22 should appear. Key in the program code indicated.

```

10  OUTPUT 718;"DISPOSE ALL;"
20  OUTPUT 718;"FUNCDEF Z_00M, @IP;CF 100MZ;SP 10MZ;@"
21  OUTPUT 718;"KEYDEF 100, Z_00M;"
22  OUTPUT 718;"KEYEXC 100;"          !Executes softkey 100 defined in line 21.
30  END

```



Press  then  to execute softkey 100 again.

The softkey may also be executed from the controller using the label, Z_00M defined in the FUNCDEF declaration. To do this, simply edit line 22 as follows:

```

22  OUTPUT 718;"Z_00M;"

```

Press  and . Notice that line 21 is not necessary in this program when the routine is executed in this manner. The softkey is executed whenever the label, Z_00M, is encountered.

EXAMPLE 3: PRODUCING A FUNCTION OR MARKER VALUE OUTPUT

In the first case, a BASIC program is shown which directs the analyzer to activate center frequency, and to prepare to output the current value in a subsequent statement. The value is then transferred into the variable F and printed.

```

10  OUTPUT 718;"CF;0A;"          !Activate center frequency, prepare
20  OUTPUT 718;"F;"              !to output value of active function.
30  ENTER 718;F                  !Transfer value to F.
40  PRINT "Center Frequency =";F;"Hz" !Print value.
50  END

```

To enter the new program, type SCRATCH A (but, if desired, store the existing program at this time) and press **EXECUTE** to clear the program memory.

Press **EDIT**, then **EXECUTE**, and type in the program lines shown above.

A typical output would be:

```
Center Frequency = 1.E+8 Hz
```

Next, we would like to output both the amplitude and frequency of the active marker. To illustrate this, connect the analyzer's CAL OUTPUT to the RF INPUT. Again, type SCRATCH A and press **EXECUTE** to clear the program memory, and enter the following program:

```
10  OUTPUT 718;"IP;FA 75MHZ;FB 150MHZ;S2;TS;E1;"
20                                     ! Instrument preset, set start and
30                                     ! stop frequencies, single sweep,
40                                     ! take sweep, peak search.
50  OUTPUT 718;"MA;"                   ! Prepare to output marker amplitude.
60  ENTER 718;A                         ! Transfer amplitude into variable A.
70  OUTPUT 718;"MF;"                   ! Prepare to output marker frequency.
80  ENTER 718;F                         ! Transfer frequency into variable F.
90  PRINT A;"dBm    ";F/1.E+6;"MHz"    ! Print A and F (scaled to megahertz).
100  END
```

The first line presets the analyzer, sets start and stop frequencies to 75 MHz and 150 MHz, and then instructs the analyzer to use the single sweep mode. To ensure that a trace is displayed which corresponds to the current instrument control settings, a take sweep command ("TS") is used. This arms the sweep, causing a sweep to be taken when trigger conditions are met, and prevents the analyzer from accepting further commands until the trace is complete.

Upon completion of this sweep, the peak search ("E1") command is invoked, placing a marker on the largest signal displayed. Lines 50 and 60 instruct the analyzer to output the amplitude value in dBm into the variable A, and lines 70 and 80 cause the frequency in hertz to be transferred into F. These two values are then printed with appropriate units. Note that the frequency in hertz has been divided by one million to yield megahertz.

Pressing **MIN** yields typical output:

```
10.4 dBm    100.2 MHz
```

EXAMPLE 4: TRACE DATA OUTPUT

An important capability of an automatic spectrum analyzer is to transfer trace amplitude data into an array in the controller for subsequent manipulation. A direct approach is shown in the first program:

```
10  DIM A(1000)                         ! Dimension array A from 0 to 1000.
20                                     ! (1001 points total).
30  OUTPUT 718;"S2;TS;O3;TA;"           ! Using O3 format (reference level units),
40                                     ! prepare to output trace A.
50  FOR N=0 TO 1000                     ! Begin FOR-NEXT loop.
60  ENTER 718;A(N)                       ! Transfer formatted data one point at a
70                                     ! time into A array.
80  NEXT N                               ! End of FOR-NEXT loop.
90  FOR N=0 TO 1000 STEP 100            !
100 PRINT N,A(N)                         ! Print every one-hundredth point.
110 NEXT N
120 END
```

After dimensioning the array, four commands are sent to the analyzer in the OUTPUT 718 statement. First, the analyzer is set to the single sweep mode, followed by a take sweep command. The single sweep mode ("S2") is

especially important when outputting trace data because it provides a static display while the values are being accessed. Following the TS command (discussed in Example 3) there is an output format command O3. (This is the letter O for Output, not zero!) The analyzer in this mode scales the display units from the ADC (analog-to-digital converter) to reference level units (in this example, dBm), and re-formats these values into a sequence of ASCII characters which will be transmitted over the interface bus. TA specifies trace A data, which are subsequently transferred one point at a time into the A array using the ENTER 718 statement repeated 1001 times.

Finally, to show what has happened, several data values are printed.

0	-86.5
100	-83.4
200	-83.8
300	-87.4
400	-82.9
500	-13
600	-79.1
700	-83.1
800	-84.5
900	-83.6
1000	-87.5

The execution time for the trace data transfer in O3 format using the HP 9826A is about 3.6 seconds. To achieve a faster transfer, avoid rescaling the ADC values and re-formatting into ASCII code by using O2 instead of O3 output format. The trace data can then be transferred as unformatted binary values by using an I/O path with the ASCII format off.

In the case below, a sequence of 8-bit bytes is transferred into the integer-valued A array. Note that the values in the A array are two bytes or sixteen bits long, as are the binary values to be transferred from the analyzer in the O2 format mode. The values printed from the A array are in display units. These range from 0 to 1023, and may be accessed as such for further processing. A typical execution time for this transfer using the HP 9826A is 150 milliseconds.

```

10   INTEGER A(1000)           ! Dimension A array from 0 to 1000
20                                     ! (1001 points total),
30   OUTPUT 718;"S2;TS;O2;TA;"  ! Single sweep,take sweep, using format O2
40                                     ! (binary units) prepare to output trace A.
50   ASSIGN @Sa TO 718;FORMAT OFF ! Assign I/O path @Sa to spectrum analyzer
60                                     ! and turn ASCII format off for this path.
70   ENTER @Sa;A(*)           ! Transfer data into array using specified
80                                     ! I/O path with format off.
90   FOR N=0 TO 1000 STEP 100   !
100  PRINT N,A(N)              ! Print every one-hundredth point.
110  NEXT N                    !
120  END

```

0	139
100	178
200	127
300	129
400	169
500	870
600	207
700	154
800	126
900	131
1000	160

This program illustrates how more advanced BASIC programming techniques can be implemented to produce significantly higher performance in the area of automatic instrument control. Such topics as advanced transfer techniques are treated in BASIC Interfacing Techniques for the HP 9816S/9826A/9836A.

NOTE

Correct format usage when transferring data and commands to and from the analyzer is essential for proper operation under remote control. Errors in formatting are a frequent cause of program failure; study the format codes if you are not certain of correct usage when debugging a program under development.

Data are transferred over the interface bus one 8-bit byte at a time. These may be ASCII-encoded alphanumeric characters, or binary values. For example, when the O3 format has been specified (this is the default mode on instrument preset) and a trace value is output from the analyzer, a sequence of ASCII characters is transmitted across the bus, as many as needed to specify the value of interest. The analyzer automatically performs the necessary formatting from an internally stored binary value to an ASCII string, and the controller reverses this process on receipt of such a string. As the number of characters transferred is variable, a free field format is required in the control program.

Alternatively, data values themselves may be transferred in 8-bit bytes (two bytes will be necessary to retain the full 10-bit precision of values stored in the analyzer). Here, the analyzer may be in the O2 format, and the controller in an unformatted or binary formatted mode (i.e., ASCII formatting must not occur). This is illustrated in the second trace output example involving the format off I/O path.

See the *Spectrum Analyzer Remote Operation* manual for further information on input/output formats.

EXAMPLE 5: PLOTTER OUTPUT

The trace data, graticule, and annotation on the analyzer's screen can be directly transferred via HP-IB to a Hewlett-Packard plotter such as the HP 7245A/B, 7240A, 7470A, or 9872C; this can be done using the analyzer's internal PLOT command. The program example shown below illustrates how a direct plot can be obtained using a controller; however, a direct plot can also be obtained by pressing the lower left recorded key on the front panel of the analyzer.

Before executing the program, connect an HP 7245A/B, 7240A, 7470A, or 9872C plotter (if available).

Set the HP-IB address on the plotter to address 5:

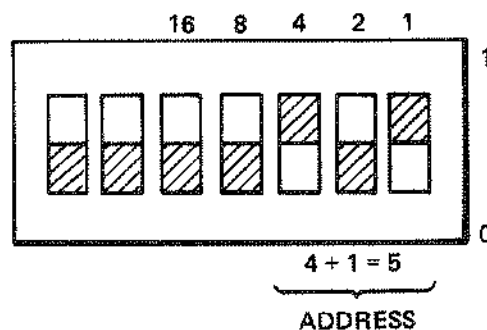

If the address switch on the plotter cannot be located, refer to the plotter's operation manual.

When using the PLOT command, the scaling points (labeled P1x, P1y, P2x, and P2y) must be specified. These scaling points specify the x-y coordinates which determine the size of the plot.

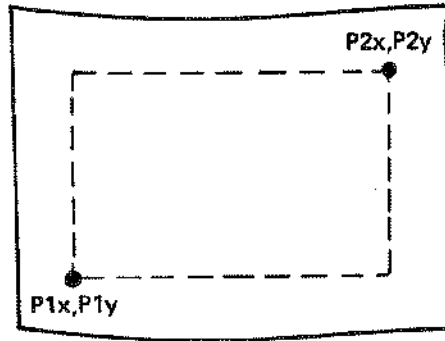

Special care must be taken to enter scaling point values which fall within the allowed scaling point range of the particular plotter being used. The following table shows the plotting ranges of each plotter exemplified here. Also shown are typical values of scaling points which can be used to give a typical plot size.

TABLE 1. P1, P2 RANGES AND TYPICAL VALUES

Plotter	Typical Scaling Points		Plotting Range*	
	P1x,P1y	P2x,P2y	X-Axis	Y-Axis
7240A	200,200	7400,11000	0 to 7544	-39800 to +51000
7245A/B	200,200	7400,11000	0 to 7544	-39800 to +51000
7470A	250,279	10250,7479	0 to 10300	0 to 7650
9872C	520,380	15720,10380	0 to 16000	0 to 11400

*For small plot sizes, type on line 20 below: OUTPUT 705;"IP P1x,P1y,P2x,P2y;"

When typing in the PLOT command, enter the scaling point values (P1x, P1y, P2x, P2y) indicated in Table 1 for the plotter being used.

To enter the new program, type SCRATCH A and press . Then press and as in the previous examples. Type in the following program lines:

```

10  OUTPUT 718;"PLOT P1x,P1y,P2x,P2y;"  ! Use values indicated in Table 1 for
20                                     ! P1x, P1y, P2x and P2y.
30  SEND 7;UNL LISTEN 5 TALK 18 DATA  ! Set plotter in listen mode, analyzer
40                                     ! in talk mode, and set attenuation
50                                     ! line low.
60  END
    
```

Press and the plotter will plot the information shown on the analyzer screen.

EXAMPLE 6: HARMONIC DISTORTION MEASUREMENT (DONE REMOTELY)

This example illustrates some of the techniques demonstrated above which utilize the analyzer in a strictly remote fashion. This program makes a harmonic distortion measurement by locating, measuring, and outputting a signal's second and third harmonics and calculating the percent distortion relative to the fundamental within the controller. The technique suggested in Example 1 – converting a manual sequence of keystrokes into a program to perform the same functions – was used in developing the present example.

```

10 ! HARMONIC DISTORTION MEASUREMENT
20 !
30 OUTPUT 718;"IP;"
40 LOCAL 718
50 DISP "Set analyzer to display the fundamental signal."
60 PAUSE
70 DISP ""
80 OUTPUT 718;"SP;03;0A;" ! Prepare to output the current span.
90 ENTER 718;Span ! Transfer value (in hertz) to "Span".
100 IF Span<=1.E+5 THEN 120 ! Use current value or 100KHz,
110 Span=1.E+5 ! whichever is smaller.
120 OUTPUT 718;"S2;TS;E1;MT1;SP";Span;"HZ;TS;MT0;E4;TS;E1;E3;MA;"
130 ! Acquire signal with peak search, auto-zoom, marker to
140 ! reference level, peak search; enter CF STEP SIZE with E3
150 ! command; use MA to prepare to output fundamental amplitude.
160 ENTER 718;Fund ! Transfer marker amplitude to "Fund".
170 OUTPUT 718;"MF;" ! Prepare to output marker frequency.
180 ENTER 718;Freq ! Transfer marker frequency to "Freq".
190 Freq=Freq/1.E+6 ! Scale frequency to megahertz.
200 OUTPUT 718;"CF UP;TS;E1;MA;" ! Increment center freq by fundamental freq.
210 ENTER 718;Second ! Transfer marker amplitude to "Second".
220 OUTPUT 718;"CF UP;TS;E1;MA;" ! Increment center freq by fundamental freq.
230 ENTER 718;Third ! Transfer marker amplitude to "Third".
240 Dist=100*SQR(FNLin(Second)^2+FNLin(Third)^2)/FNLin(Fund)
250 ! Compute root-sum-of-squares
260 ! total harmonic distortion using "Lin"
270 ! function defined below.
280 !
290 Format1: IMAGE 4A,X,SDDD.D,X,"dBm",3X,K,X,"MHz" !-----
300 PRINT USING Format1;"Fund",Fund,Freq !----- Formatted
310 Format2: IMAGE 2(4A,X,SDDD.D,X,"dBm",/) !----- output
320 PRINT USING Format2;"2nd ",Second,"3rd",Third !-----
330 PRINT USING "K,DDD.DD,K,//";"Harmonic Distortion = ";Dist;"%"
340 END
350 !!!!!!!!!!!!!!!!!!!!!!!!!!!!!!!!!!!!!!!
360 DEF FNLin(X) !
370 Lin_value=10^(X/20) ! Function to convert dB to linear values.
380 RETURN Lin_value !
390 FNEND !

```

Line 40 places the analyzer under front panel control allowing the operator to tune the analyzer to position the signal on screen. The span must be chosen such that the signal of interest is the largest response on the screen.

When ready, the operator presses . The program determines the present span and compares it to 100 kHz, choosing the smaller value. Then, a sweep is taken in single sweep mode, and peak search places the marker on the largest signal, i.e., the fundamental. Marker track is invoked to perform an Auto-Zoom to the span selected above. The signal is then moved to the reference level, the center frequency step size is set to the fundamental frequency, and the amplitude and frequency are output to the controller.

In line 200, the center frequency is incremented once to place the second harmonic on screen. Peak search locates the response and the marker amplitude is output. The same procedure is performed on the third harmonic in line 220.

In line 240, the percent distortion is computed as the root sum of the squares normalized to the fundamental amplitude. As linear values are required in this calculation, a function has been defined in lines 360–390 which converts the dBm values to linear values. The results are finally printed according to the output formats in lines 290–330*.

A typical harmonic distortion measurement might yield the following output:

```

Fund -10.3 dBm 20.0005 MHz
2nd -55.5 dBm
3RD -67.3 dBm

```

```

Harmonic Distortion = .57%

```

*A discussion of PRINT and IMAGE statements can be found in BASIC Programming Techniques for the HP 9816S/9826A/9836A.

EXAMPLE 7: HARMONIC DISTORTION MEASUREMENT AS A USER-DEFINED SOFTKEY

The harmonic distortion measurement from the previous example is shown here as a user-defined softkey.

```

10  OUTPUT 71B;"DISPOSE ALL;"          !Clears all variables and softkeys
20                                     !which might have been previously
30                                     !defined.
40  OUTPUT 71B;"FUNCDEF H_ARMDIST,"""  !Defines the label, H_ARMDIST to be
50                                     !all commands within the double
60                                     !quotes.
70                                     !The terminating double quotes are
80                                     !found in line 520.
90  OUTPUT 71B;"VARDEF FUNDD,0;VARDEF SECD,0;VARDEF THRDD,0;"
100 OUTPUT 71B;"VARDEF FUND,0;VARDEF SECONDD,0;VARDEF THIRDD,0;"
110 OUTPUT 71B;"VARDEF SECSQ,0;VARDEF THRSQ,0;VARDEF DISTORTION,0;"
120                                     !Declares the variables which will
130                                     !be used in the program and sets
140                                     !their value to zero.
150 OUTPUT 71B;"IF;"
160 OUTPUT 71B;"D3;DT#DA3072PUPA100,600 LBFRESS THE LOCAL KEY AND#;"
170 OUTPUT 71B;"PUPA100,550 LBENTER CENTER FREQUENCY#;HD;"
180 OUTPUT 71B;"CF EP;"
190 OUTPUT 71B;"EM;D3;DT#DA3072PUPA95,600 LBENTER FREQUENCY SPAN (100 KHZ OR L
ESS)#;"
200 OUTPUT 71B;"SP EP;"                !Instrument preset and enable the
210                                     !center frequency and span to be
220                                     !entered from the front panel.
230 OUTPUT 71B;"SNGLS;TS;MKPK HI;TS;"  !Single sweep mode, take a sweep and
240                                     !place marker on highest signal.
250 OUTPUT 71B;"IF SP,GT,IES;"         !If the span is greater than
260 OUTPUT 71B;" THEN MT1;SP100KZ;TS;" !100kHz then set to 100kHz.
270 OUTPUT 71B;"ENDIF;"
280 OUTPUT 71B;"MKPK HI;TS;MKRL;TS;MTO;" !Bring the signal to the reference
290 OUTPUT 71B;"MKCF;TS;"              !level, turn signal track off and
300                                     !bring signal to center screen.
310 OUTPUT 71B;"MOV FUNDD,MA;KSD;"     !Lines 310 - 390 determine the
320 OUTPUT 71B;"MOV FUND,MA;KSA;"       !amplitude values of the
330 OUTPUT 71B;"MKSS;CF UP;"           !fundamental,second harmonic, and
340 OUTPUT 71B;"TS;MKPK HI;"           !third harmonic in units of dBm
350 OUTPUT 71B;"MOV SECD,MA;KSD;"       !and in linear units. These values
360 OUTPUT 71B;"MOV SECONDD,MA;KSA;"    !are stored in the predefined
370 OUTPUT 71B;"CF UP;TS;MKPK HI;"     !variables.
380 OUTPUT 71B;"MOV THRDD,MA;KSD;"     !
390 OUTPUT 71B;"MOV THIRDD,MA;KSA;"    !
400 OUTPUT 71B;"MPY SECSQ,SECONDD,SECONDD;" !Lines 400 - 450 compute the
410 OUTPUT 71B;"MPY THRSQ,THIRDD,THIRDD;" !harmonic distortion of the
420 OUTPUT 71B;"ADD SECSQ,SECSQ,THRSQ;" !signal of interest using
430 OUTPUT 71B;"SQR SECSQ,SECSQ;"       !analyzer functions.
440 OUTPUT 71B;"MPY SECSQ,SECSQ,100;"   !
450 OUTPUT 71B;"DIV DISTORTION,SECSQ,FUND;" !
460 OUTPUT 71B;"DIV SS,SS,1E6;"         !Scale fundamental frequency
470 OUTPUT 71B;"TRDSP TRA,OFF;ANNOT OFF;BRAT OFF;" !to MHz and blank CRT.
480 OUTPUT 71B;"D3;DT#DA3072 PUPA150,550 LBFund #;DSPLY FUNDD,5.1;PUPA350,550
LBdBm #;DSPLY SS,8.4;PUPA550,550 LB  MHz#;" !The results are displayed
490                                     !on the analyzer screen
500 OUTPUT 71B;"PA150,479 LB2nd #;DSPLY SECD,5.1;PUPA350,479 LdBm#;"
510 OUTPUT 71B;"PA150,400 LB3rd #;DSPLY THRDD,5.1;PUPA350,400 LdBm#;"
520 OUTPUT 71B;"PA150,300 LBHarmonic Distortion = #;DSPLY DISTORTION,3.2;PUP
A 600,300 LB%#;"
530 OUTPUT 71B;"KEYDEF 101, H_ARMDIST;" !Assigns softkey 101 to the label,
540                                     !H_ARMDIST.
550  END

```

Lines 40–530 are the commands defined as H_ARMDIST. Although the program looks considerably different than the one in Example 6, the measurement is the same. The program codes used in this example are all codes in the analyzer firmware, thus the program can be executed independent of the controller and can be executed even after the analyzer's power has been off.

To illustrate, disconnect the HP-IB cable and turn the analyzer off and/or unplug it. Now turn the analyzer back on, leaving the HP-IB cable disconnected.

Press



to execute the program.

The program can also be executed via the controller by reconnecting the HP-IB cable and keying in

```
OUTPUT 71B; "H_ARMDIST; "
```

The results are displayed on the analyzer screen.

For more information on the HP 8566B/8568B function set, refer to the HP 8566B/8568B Spectrum Analyzer Operating and Programming Manual.

FOR MORE TRAINING

50003A
HP 8566B/8568B Spectrum Analyzer
Operation Course

The HP 50003A Spectrum Analyzer Operation Course provides comprehensive training in the remote operation of the HP 8566B and HP 8568B. This intensive four-day course teaches manual and remote operating techniques and signal measurement concepts as they apply to these analyzers. The curriculum is heavily hands-on oriented, using a mixture of interactive lectures and labs with the HP 9826A as instrument controller.

The HP 50003A is offered at selected HP training centers. Please contact your local HP sales office for scheduling and price information.

HP 8566B/8568B PROGRAMMING CODE LIST

Frequency Control

CF	Specifies center frequency
CS	Couples step size
*FA	Specifies start frequency
*FB	Specifies stop frequency
FOFFSET	Specifies frequency offset
FS	Specifies full frequency span as defined by instrument
●KSQL	Unlocks frequency band
KSV	Specifies frequency offset
●KSt	Locks frequency band
■KSt =	Specifies resolution of frequency counter
MKFCR	Specifies resolution of frequency counter
SP	Specifies frequency span
SS	Specifies center frequency step size

Instrument State Control

IP	Sets instrument parameters to preset values
●KST	Performs fast present 2 – 22 GHz
●KSU	Performs external mixer preset
KS(Locks save registers
KS)	Unlocks save registers
●LF	Presets 0 – 2.5 GHz
RC	Recalls previously saved state
RCLS	Recalls previously saved state
SAVES	Saves current state of analyzer in specified register
SV	Saves current state of analyzer in specified register
USTATE	Configures or returns configuration of user-defined states: ONEOS, ONSWP, TRMATH, VARDEF, FUNCDEF, TRDEF

Amplitude Control

AT	Specifies input attenuation
AUNITS	Specifies amplitude units for input, output and display
*CA	Couples input attenuation
E4	Moves active marker to reference level
*KSA	Selects dBm as amplitude units
KSB	Selects dBmV as amplitude units
KSC	Selects dBuV as amplitude units
KSD	Selects voltage as amplitude units
KSI	Extends reference level range
KSW	Performs amplitude error correction routine
KSX	Incorporates correction data in amplitude readouts
KSY	Does not incorporate correction data in amplitude readouts
KSZ	Specifies reference level offset
KSq	Decouples iF gain and input attenuation
KSw	Displays correction data
KS,	Sets mixer level
LG	Selects log scale
LN	Selects linear scale
MKRL	Moves active marker to reference level
ML	Specifies mixer level
RL	Specifies reference level
ROFFSET	Specifies reference level offset

Bandwidth Control

*CR	Couples resolution bandwidth
*CV	Couples video bandwidth
RB	Specifies resolution bandwidth
VB	Specifies video bandwidth
VBO	Specifies coupling ratio of video bandwidth and resolution bandwidth

Sweep and Trigger Control

*CONTS	Selects continuous sweep mode
*CT	Couples sweep time
■KSF	Measures sweep time
■KSt	Continues sweep from marker
KSu	Stops sweep at active marker
KSx	Sets external trigger (eliminates auto-refresh)
KSy	Sets video trigger (eliminates auto-refresh)
ST	Specifies sweep time
SNGLS	Selects single sweep mode
*S1	Selects continuous sweep mode
S2	Selects single sweep mode
TM	Selects trigger mode: free run, video, line, external
TS	Takes a sweep
*T1	Sets trigger mode to free run
T2	Sets trigger mode to line
T3	Sets trigger mode to external
T4	Sets trigger mode to video

Marker Control

E1	Moves active marker to maximum signal detected
E2	Moves marker frequency into center frequency
E3	Moves marker or delta frequency into step size
E4	Moves active marker to reference level
●KSK	Moves active marker to next highest peak
KSL	Turns off average noise level marker
KSM	Returns average value at marker, normalized to 1 Hz bandwidth
●KSN	Moves active marker to minimum value detected
KSO	Moves marker delta frequency into span
■KSt	Continues sweep from marker
KSu	Stops sweep at active marker
■KSt =	Specifies resolution of marker frequency counter
●KS<92>	Enters DL, TH, M2, M3 in display units
MA	Returns marker amplitude
■*MCO	Turns off marker frequency count
■MCI	Turns on marker frequency count
MF	Returns marker frequency
MKA	Specifies amplitude of active marker
MKACT	Specifies active marker: 1, 2, 3, or 4
MKCF	Enters marker frequency into center frequency
MKCONT	Continues sweep from marker

MKD	Moves delta marker to specified frequency
MKF	Specifies frequency of active marker
■MKFC	Counts marker frequency for greater resolution (See MKFCR)
■MKFCR	Specifies resolution of marker frequency counter
MKMIN	Moves active marker to minimum signal detected
MKN	Moves active marker to specified frequency or center screen
MKNOISE	Returns average value at marker, normalized to 1 Hz bandwidth
MKOFF	Turns all markers, or the active marker off
MKP	Specifies marker position horizontally, in display units
MKPAUSE	Pauses sweep at marker for duration of specified delay time (In seconds)
MKPK	Moves active marker to maximum signal detected, or to adjacent signal peaks
*MKPX	Specifies minimum excursion for peak identification. Preset value is 6 dB
MKREAD	Specifies marker readout mode
MKRL	Moves active marker to reference level
MKSP	Moves marker delta frequency into span
MKSS	Moves marker frequency to center frequency step size
MKSTOP	Stops sweep at active marker
MKTRACE	Moves active marker to corresponding position on another specified trace
MKTRACK	Turns marker signal track on or off
MKTYPE	Sets marker type
*MTO	Turns off marker signal track
MT1	Turns on marker signal track
*M1	Turns off active marker
M2	Turns on active marker and moves it to center screen
M3	Turns on delta marker
M4	Turns on marker zoom

Coupling Control

*CA	Couples input attenuation
*CR	Couples resolution bandwidth
*CS	Couples step size
*CT	Couples sweep time
*CV	Couples video bandwidth
*VBO	Specifies coupling ratio of video bandwidth and resolution bandwidth

*Selected with instrument preset (IP)

●Applies to HP 8566B only

■Applies to HP 8568B only

HP 8566B/8568B PROGRAMMING CODE LIST (Cont'd)

Preselector Control

●FPKA	Performs fast preselector peak and returns measured value of active marker
●KSJ	Allows manual control of DAC
●KS*	Turns off YTX self-heating correction
●KS/	Allows manual peaking of pre-selector
●KS=	Selects factory preselector setting
●PP	Peaks preselector

RF Input Control

■I1	Enables left RF input
■I2	Enables right RF input

External Mixing Commands

●KSU	Performs external mixer preset
●KSv	Identifies signals for external mixing frequency bands

Display Control

*ANNOT	Turns annotation on or off. Preset condition is on.
AUNITS	Specifies amplitude units for input, output, and display
DL	Specifies display line level in dBm
DLE	Turns display line on and off
*GRAT	Turns graticule on or off. Preset condition is on.
KSg	Turns off CRT beam
*KSh	Turns on CRT beam
KSm	Turns off graticule
*KSa	Turns on graticule
KSo	Turns off annotation
*KSp	Turns on annotation
*LG	Selects log scale
LN	Selects linear scale
*LO	Turns off display line
TH	Specifies display threshold value
THE	Turns threshold on or off
*TO	Turns off threshold
TRGRPH	Dimensions and graphs a trace

Writing and Reading Display Memory

*DA	Specifies display address
DD	Writes to display
DR	Reads display and increments address
DSPLY	Displays the value of a variable on the analyzer screen
DT	Defines a character for label termination
DW	Writes to display and increments address
*D1	Sets display to normal size
D2	Sets display to full CRT size
D3	Sets display to expanded size
*EM	Erases trace C memory
GR	Graphs specified y values on CRT
*HD	Holds or disables data entry and blanks active function CRT readout
IB	Inputs trace B in binary units
KSE	Sets title mode

KS<39>	Writes to display memory in fast binary
KS<125>	Writes to display memory in binary
KS<127>	Prepares analyzer to accept binary display write commands
LB	Writes specified characters on CRT
OP	Returns lower left and upper right vertices of display window
PA	Draws vectors to specified x and y positions
*PD	Turns on beam to view vector
PR	Draws vector from last absolute position
PS	Skips to next display page
PU	Turns off beam, blanking vector
SW	Skips to next control instruction
TEXT	Writes text string to screen at current pen location

Trace Processing

*A1	Clear-writes trace A
A2	Max holds trace A
A3	Stores and views trace A
A4	Stores and blanks trace A
B1	Clear-writes trace B
B2	Max holds trace B
B3	Stores and views trace B
*B4	Stores and blanks trace B
BLANK	Stores and blanks specified trace register
CLRw	Clear-writes specified trace register
KSj	Stores and views trace C
KSk	Stores and blanks trace C
KS<39>	Writes to display memory in fast binary
KS<123>	Reads display in binary units
KS<125>	Writes to display memory in binary units
KS<126>	Outputs every nth value of trace
MOV	Moves source to the destination
MXMH	Max holds the specified trace register
TA	Outputs trace A
TB	Outputs trace B
TRDSP	Turns specified trace on or off, but continues taking information
VIEW	Views specified trace register

Trace Math

AMB	A - B into A
AMBPL	(A - B) + DL into A
APB	A + B into A
AXB	Exchanges A and B
BL	B - DL into B
BML	B - DL into B
BTC	B into C
BXC	Exchanges B and C
*C1	A - B off
C2	A - B into A
EX	Exchanges A and B
KSG	Turns on video averaging
*KSH	Turns off video averaging
KSc	A + B into A
KSi	Exchanges B and C
KSI	B into C
TRMATH	Executes trace math or user-operator commands at end of sweep
VAVG	Turns video averaging on or off

Other Trace Functions

AUNITS	Specifies amplitude units for input, output, and display
COMPRESS	Compresses trace source to fit trace destination
CONCAT	Concatenates operands and sends new trace to destination
DET	Specifies input detector type
FFT	Performs a forward fast fourier transform
*KSa	Selects normal detection
KSb	Selects position peak detection
KSd	Selects negative peak detection
KSe	Selects sample detection
MEAN	Returns trace mean
ONEOS	Executes specified command(s) at end of sweep
ONSWP	Executes specified command(s) at start of sweep
PEAKS	Returns number of peak signals
PDA	Returns probability density of amplitude
PDF	Returns probability density of frequency
PWRBW	Returns bandwidth of specified percent of total power
RMS	Returns RMS value of trace in display units
SMOOTH	Smooths trace over specified number of points
STDEV	Returns standard deviation of trace amplitude in display units
SUM	Returns sum of trace element amplitudes in display units
SUMSQ	Squares trace element amplitudes and returns their sum
TRDEF	Defines user-defined trace
TRGRPH	Dimensions and graphs a trace
TRPRST	Sets trace operations to preset values
TRSTAT	Returns current trace operations
TWINDOW	Formats trace information for fast fourier analysis (FFT)
VARIANCE	Returns amplitude variance of trace

* Selected with instrument preset (IP)

● Applies to HP 8566B only

■ Applies to HP 8568B only

HP 8566B/8568B PROGRAMMING CODE LIST (Cont'd)

<p>User-Defined Commands</p> <p>*DISPOSE Frees memory previously allocated by user defined functions. Instrument preset disposes ONEOS, ONSWP, and TRMATH functions.</p> <p>FUNCDEF Assigns specified program to function label</p> <p>KEYDEF Assigns function label to softkey number (See FUNCDEF)</p> <p>KEYEXC MEM Executes specified softkey Returns amount of allocatable memory available for user-defined commands</p> <p>ONEOS Executes specified command(s) at end of sweep</p> <p>ONSWP Executes specified command(s) at start of sweep</p> <p>TRDEF TRMATH Defines user-defined trace Executes specified trace math or user-operator commands at end of sweep</p> <p>USTATE Configures or returns configuration of user-defined state: ONEOS, ONSWP, TRMATH, VARDEF, FUNCDEF, TRDEF</p> <p>*VARDEF Defines variable name and assigns real value to it. Preset reassigns initial value to variable identifier.</p>	<p>LOG LOG of operand is taken and multiplied by specified scaling factor</p> <p>MIN Minimum between operands is stored in destination</p> <p>MOV MPY Source is moved to destination Operand 1 * operand 2 into destination</p> <p>MXM Maximum between operands is stored in destination</p> <p>SQR Square root of operand is stored in destination</p> <p>SUB Operand 1 - operand 2 into destination</p> <p>XCH Contents of the two destinations are exchanged</p> <p>Operations on specific traces (A, B, and C) can be found in the Trace Math section.</p> <p>Information and Service Diagnostics Commands</p> <p>BRD Reads data word at analyzer's internal input/output bus</p> <p>BWR Writes data word to analyzer's internal input/output bus</p> <p>ERR ID Returns results of processor test Returns the HP model number of analyzer used (HP 8566B or HP 8568B)</p> <p>●KSF Shifts YTO by intermediate frequency</p> <p>■KSF Measures sweep time</p> <p>■KSJ Allows manual control of DAC</p> <p>■KSK Counts pilot IF at marker</p> <p>■KSN Counts voltage-controlled oscillator at marker</p> <p>●KSQ Unlocks frequency band</p> <p>■KSQ Counts signal IF</p> <p>■KSR Turns frequency diagnostics on</p> <p>■*KSS Second LO frequency is determined automatically</p> <p>■KST Shifts second LO down</p> <p>■KSU Shifts second LO up</p> <p>KSf Recovers last instrument state at power on</p> <p>KSq De-couples IF gain and input attenuation</p> <p>KSr Sets service request 102</p> <p>●KSr Locks frequency band</p> <p>■KSr Continues sweep from marker</p> <p>KSu Stops sweep at active marker</p> <p>■KSv Inhibits phase lock</p> <p>KSw Displays correction data</p> <p>■KS= Specifies resolution of frequency counter</p> <p>●KS= Selects factory preselector setting</p> <p>■KS> Specifies preamp gain for signal input 1</p> <p>■KS< Specifies preamp gain for signal input 2</p> <p>●KS# Turns off YTX self-heating correction</p> <p>●KS/ Selects manual preselector peak</p> <p>MRD Reads specified number of bytes starting at specified address and returns to controller</p> <p>MBWR Writes specified block data field into analyzer's memory starting at specified address</p>	<p>MRD Reads two-byte word starting at specified analyzer memory address and returns word to controller</p> <p>MRDB Reads 8-bit byte contained in specified address and returns byte to controller</p> <p>MWR Writes two-byte word to specified analyzer memory address</p> <p>MWRB Writes one-byte message to specified analyzer memory address</p> <p>REV Returns analyzer revision number</p> <p>RQS Returns decimal weighting of status byte bits which are enabled during service request</p> <p>Output Format Control</p> <p>EE Enables front panel number entry</p> <p>DR Reads display and increments address</p> <p>DSPLY Displays value of variable on analyzer screen</p> <p>KSJ Allows manual control of DAC</p> <p>KSP Sets HP-IB address</p> <p>●KSS Sets fast HP-IB</p> <p>KS<91> Returns amplitude error</p> <p>●KS<94> Returns code for harmonic number in binary</p> <p>KS<123> Reads display in binary units</p> <p>KS<126> Returns every nth value of trace</p> <p>LL Provides lower left x-y recorder output voltage at rear panel</p> <p>MA Returns marker amplitude</p> <p>*MDS Specifies measurement data size to byte or word. Preset condition is word.</p> <p>MDU Returns values of CRT baseline and reference level</p> <p>MF Returns marker frequency</p> <p>OA Returns active function</p> <p>OL Returns lean string</p> <p>OT Returns display annotation</p> <p>O1 Selects output format as integers (ASCII) representing display units or display memory instruction words</p> <p>O2 Selects output format as two 8-bit bytes</p> <p>*O3 Selects output format as real numbers (ASCII) in Hz, volts, dBm, or seconds</p> <p>O4 Selects output format as one 8-bit byte</p> <p>TA Outputs trace A</p> <p>TB Outputs trace B</p> <p>*TDF Selects trace data output format as O1, O2, O3, O4, A-block data field, or I-block data field. Preset format is O3.</p> <p>UR Provides upper right x-y recorder output voltage at rear panel</p> <p>Synchronization</p> <p>TS Takes a sweep</p> <p>DONE Sends message to controller after preceding commands are executed</p>
---	--	---

* Selected with instrument preset (IP)
 ● Applies to HP 8566B only
 ■ Applies to HP 8568B only

HP 8566B/8568B PROGRAMMING CODE LIST (Cont'd)

Service Request

		SRQ	COMMAND	BIT	DEFINITION
KSr	Allows service request 102				
●KS<43>	Allows service request 140 and 102	102	R4	1	units key pressed
RQS	Returns decimal weighting of status byte bits which are enabled during service request	102 104 110	●KS<43> R2 R3	1 2 3	frequency limit exceeded end of sweep hardware broken
R1	Resets service request 140	120	RQS	4	command complete – input buffer empty
R2	Allows service request 140 and 104	140	all	5	illegal command
*R3	Allows service request 140 and 110	1xx	–	6	universal HP-IB service
R4	Allows service request 140 and 102				
SRQ	Sets service request if operand bits are allowed by RQS				

Plotter Output

LL	Provides lower left x-y recorder output voltage at rear panel
PLOT	Plots CRT. Scaling points, P1 and P2, must be specified and must be compatible with plotter.
P1x	Represents first x-axis scaling point to be specified in PLOT command
P1y	Represents first y-axis scaling point to be specified in PLOT command
P2x	Represents second x-axis scaling point to be specified in PLOT command
P2y	Represents second y-axis scaling point to be specified in PLOT command
UR	Provides upper right x-y recorder output voltage at rear panel

Memory Information

*EM	Erases trace C memory
KSz	Sets display storage address
KSI	Writes to display storage
MEM	Returns amount of allocatable memory available for user-defined commands, in bytes

Tracking Generator Application

■*KSS	Second LO frequency is determined automatically
■KST	Shifts second LO down (necessary for 8444A-059 operation in spans <1 MHz)
■KSU	Shifts second LO up

Operator Entry

EE	Enables front panel data number entry
EK	Enables DATA knob
EP	Enables manual entry into specified command
*HD	Holds or disables data entry and blanks active function CRT readout
KS	Shifts front panel keys

* Selected with instrument preset (IP)

● Applies to HP 8566B only

■ Applies to HP 8568B only



For more information, call your local HP sales office listed in the telephone directory white pages. Ask for the Electronic Instruments Department. Or write to Hewlett-Packard: U.S.A. — P.O. Box 10301, Palo Alto, CA 94303-0890. Europe — P.O. Box 899, 1180 AZ Amstelveen, the Netherlands. Canada — 6877 Goreway Drive, Mississauga, L4V 1M8, Ontario. Japan — Yokogawa-Hewlett-Packard Ltd., 3-29-21, Takaido-Higashi, Suginami-ku, Tokyo 168. Elsewhere in the world, write to Hewlett-Packard Intercontinental, 3495 Deer Creek Road, Palo Alto, CA 94304.

5952-9389

Printed in USA



Programming Note

HP 8566B/8568B/Models 216/226/236-92

August 1985

Supersedes: None

AMPLITUDE MODULATION MEASUREMENTS USING THE FAST FOURIER TRANSFORM on the HP 8566B and 8568B Spectrum Analyzers

OVERVIEW

AM depth measurements using spectrum analyzers are generally made in the time domain or swept frequency domain. The advantages of making AM measurements in the Fast Fourier Transform (FFT) frequency domain are orders-of-magnitude improvement in speed, resolution, accuracy, and rejection of incidental FM. Many measurements which cannot be made in the swept frequency domain or time domain can easily be made in the FFT frequency domain. AM measurements in the FFT frequency domain are possible using an external controller. However, the advanced signal processing functions and downloadable program (DLP) capability of the HP 8566B and HP 8568B allow the user to make AM measurements in the FFT frequency domain quickly and directly from the front panel without using an external controller.

This Programming Note describes a DLP which makes AM measurements on carriers with levels ≥ -20 dBm, frequencies ≥ 10 MHz, modulation rates from 0.5 Hz to 15 kHz, modulation depths of 0.1% to 99%, and incidental FM having up to 10 kHz peak deviation. Basic percent AM accuracy is ± 0.2 dB (2.5% of reading). In some cases, measurement range can be extended by program modification.

Prerequisites

To more easily understand this programming note, some experience with HP 8566B/8568B remote and manual operation is required. An understanding of Programming Notes **HP 8566B/8568B/Models 216/226/236-90 Storage, Display and I/O of Variables and Traces** (publication number 5952-9398) and **HP 8566B/8568B/Models 216/226/236-99 A Structured Approach to Downloadable Programming** (publication number 5952-9392) is recommended. An understanding of HP Application Note 150-1 **Spectrum Analysis . . . Amplitude and Frequency Modulation** (publication number 5952-1051) is required.

Reference Materials

Analyzer reference materials include the **HP 8566B/8568B Quick Reference Guide** (publication number 5955-8970), the **HP 8566B/8568B/9816/9826/9836-1 Introductory Operating Guide** (publication number 5952-9389), and the "Command Syntax Reference" found in the **HP 8566B/8568B Operating and Programming Manual** (part numbers 8566-90040 and 8568-90041).

Equipment Used

HP 8566B or 8568B Spectrum Analyzer.
HP 9000, Series 200 Model 216, 226, or 236 Desktop Computers.

RUNNING THE PROGRAM

Overview

Appendixes A, B, and C show three versions of the same program, each designed to meet a particular user-requirement. The programs in Appendix A and B lead the operator through the AM measurement. No expertise making AM measurements in the FFT frequency domain is required. The program in Appendix A measures both AM depth and AM distortion with modulation rates to 8.25 kHz. The program in Appendix B measures AM rates to 15 kHz, but does not measure AM distortion. If AM distortion need not be measured, the Appendix B program is preferred because it runs more quickly and can measure higher modulation rates. The program in Appendix C is the core program which can be used for quick measurements that the operator must interpret.

Enter one of the programs into the computer. Save this program on a disk. Connect the computer to an HP 8566B or 8568B spectrum analyzer. Press [RUN] to download the program into analyzer memory. Load only one program at a time into analyzer memory (this purges analyzer memory). Follow the directions below.

© HEWLETT-PACKARD CO. 1985



AM Depth and AM Distortion Measurements in FFT Frequency Domain (Appendix A Program)

The signal used for the AM measurement examples is shown in Figure 1. Because it has relatively large FM, AM cannot be measured in the swept frequency domain, and the measurement is made in the FFT frequency domain. To do this, first place a marker on the signal of interest, then activate signal track. Zoom in on the signal by reducing the span to 1 MHz. **Run the program by pressing [Shift] [1] [Hz].** The program is fully automatic; no operator intervention is required at this point. Depending on the signal characteristics, one of several possible situations will occur. Refer to the program flowchart.

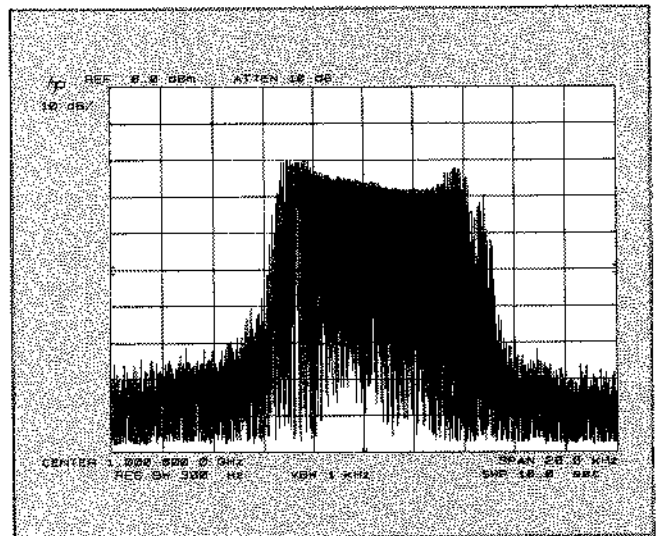
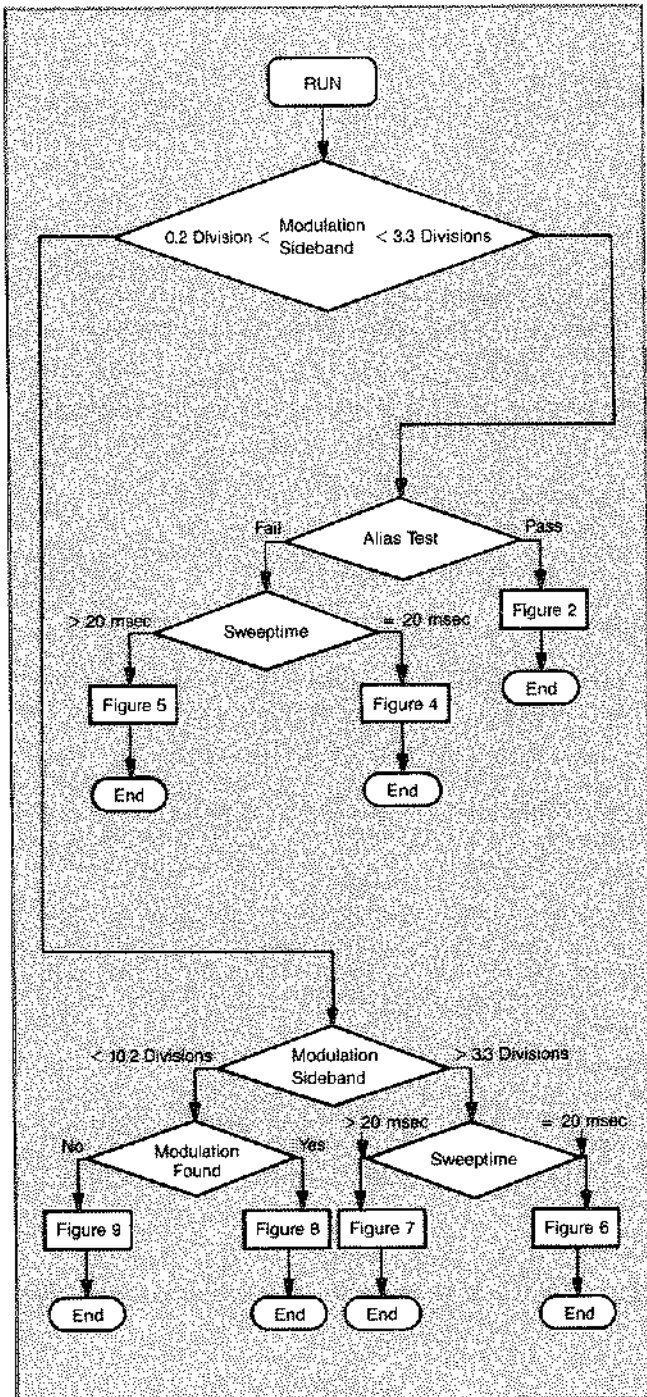

Figure 1. AM with relatively large FM cannot be measured in the swept frequency domain. This is the signal used for all the example measurements (except the one in Figure 3).



Flow Chart

0.2 Divisions < Modulation Sideband < 3.3 Divisions

If the AM depth is $\geq 0.1\%$ and the modulation sideband lies between 0.2 and 3.3 horizontal FFT frequency-axis divisions, an alias test is performed. Failure of the alias test means that either the sweep time is too slow or the modulation frequency is beyond the measurement range. If the signal passes the alias test, 16 averages are performed to improve repeatability, and the measurement results are displayed. An example is shown in Figure 2. Note the modulation has been translated back to baseband by the FFT. The carrier is shown at 0 Hz; the AM and distortion sidebands are to the right. At the end of the program, relative amplitude and frequency measurements can be made using delta marker. To show the extent of errors introduced by even small amounts of angle modulation, **the FFT and swept frequency domains may be compared by pressing [FREQUENCY SPAN] [2] [5] [kHz], [CLEAR-WRITE] Trace B, [CONT] Sweep, [AUTO] RES BW, [AUTO] Video BW, and [AUTO] SWEEP TIME.** Adjust center

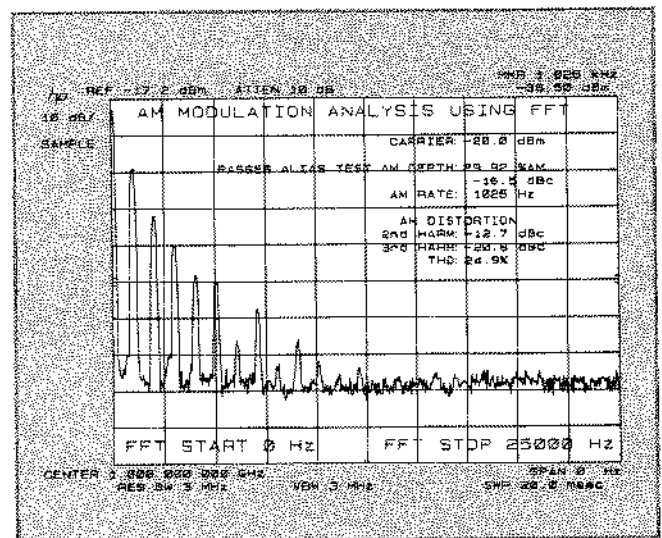

Figure 2. The signal shown in Figure 1 is easily measured in the FFT frequency domain.

frequency if necessary (see Figure 3). The program may be re-run by pressing [SHIFT] [1] [Hz]. If any control settings are changed, first press [RECALL] [1] to return to the previous analyzer control settings before re-running the program.

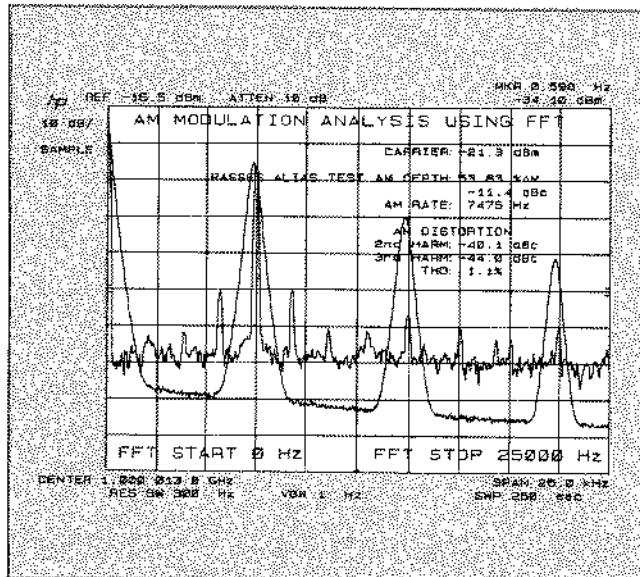

Figure 3. Comparison of FFT and swept frequency domain measurements of AM with small incidental angle modulation. Even small amounts of incidental angle modulation introduce large errors in the swept frequency domain.

If the signal fails the alias test, either the modulation rate is > 41.75 kHz or the sweep time selected is too slow. Modulation rates greater than 8.25 kHz are beyond the measurement range of this program (see Figure 4), and no further action can be taken. Sweep time determines the highest modulation frequency which can be measured. If the sweep time is too slow, the modulation rate is out of range (see Figure 5). The FFT frequency domain trace may be seen by pressing [VIEW] Trace A. To continue the

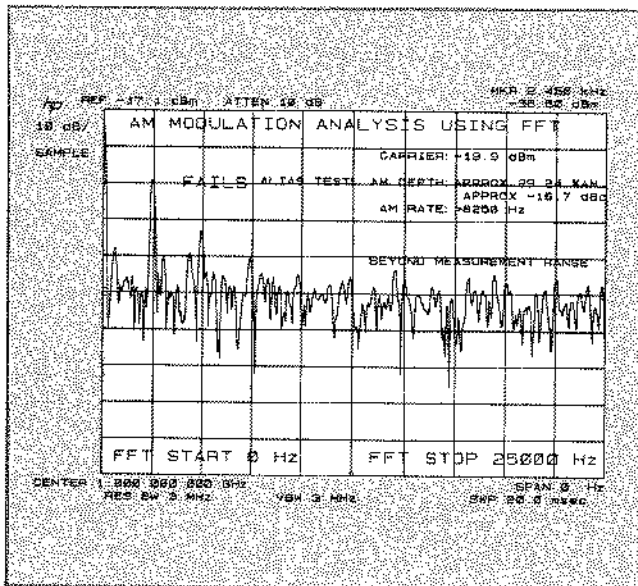

Figure 4. The 47.55 kHz rate AM "wraps around" the display, fails the alias test, and is beyond the measurement range. The measurement is not continuable.

measurement, decrease sweep time and re-run the program. In the example of Figure 5, press [SWEEP TIME] [2] [0] [msec] followed by [SHIFT] [1] [Hz] to re-run the program.

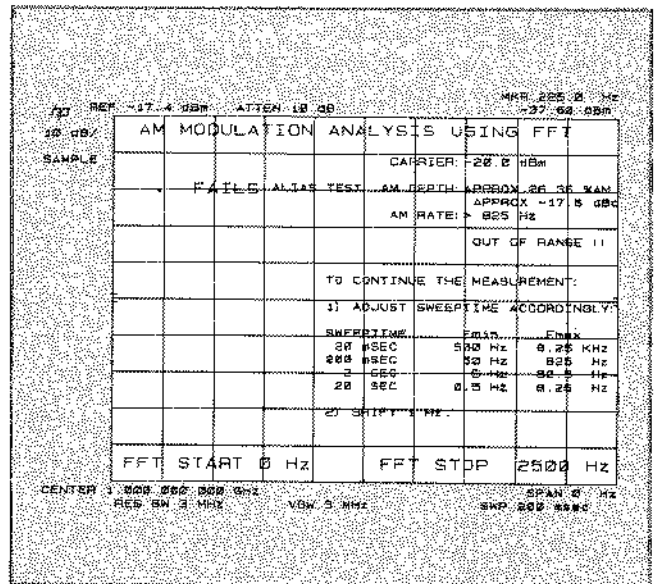

Figure 5. The 4.775 kHz rate AM wraps around the display and fails the alias test because the sweep time is too slow. Increase sweep time to continue the measurement.

Modulation Sideband > 3.3 Divisions

A modulation sideband greater than 3.3 divisions results in one of two possible displays, depending on whether the sweep time is 20 msec or greater than 20 msec. If the sweep time is 20 msec, then a modulation sideband > 3.3 divisions means that the modulation rate is > 8.25 kHz. This is beyond the measurement range of this program (see Figure 6). No further action can be taken. However, if the sweep time is slower than 20 msec, decrease sweep time by a factor of ten and re-run the measurement (see Figure 7). In the example of Figure 7, press [SWEEP TIME] [2] [0] [msec] [SHIFT] [1] [Hz].

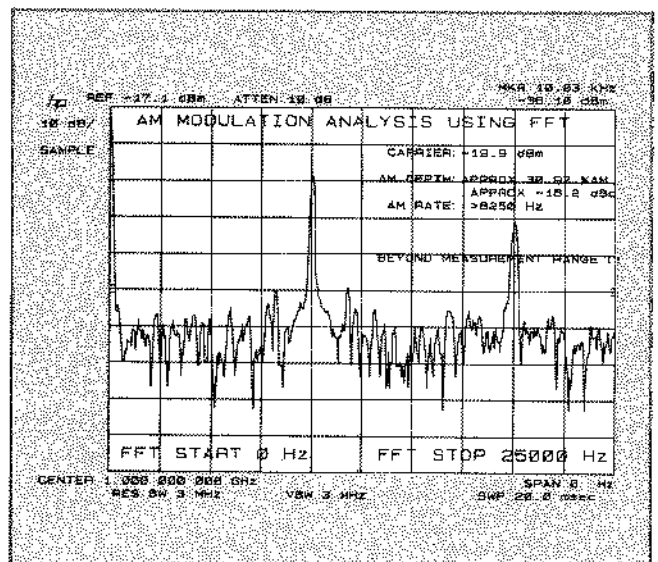

Figure 6. The 10 kHz rate AM is beyond the measurement range. The measurement is not continuable.

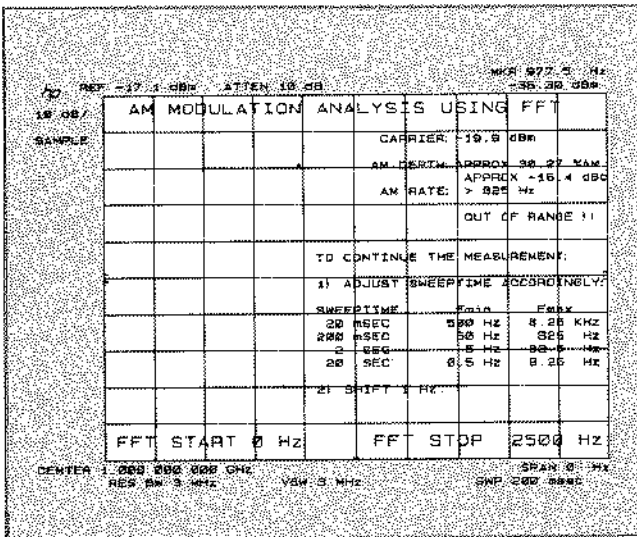

Figure 7. The 977.5 Hz rate AM is out of range because sweep time is too slow. Decrease sweep time to continue the measurement.

Modulation Sideband < 0.2 Divisions

A modulation sideband less than 0.2 divisions indicates that the sweep time is too fast. Under these conditions the AM sideband is too close to the carrier and may not be resolved at low modulation levels. See Figure 8. In this case, the AM sideband is resolved and the marker readout indicates 400 Hz. The FFT frequency domain trace may be seen by pressing [VIEW] Trace A. Figure 9 shows an AM rate so low that the AM sideband is not resolvable, and there is no marker readout. To continue the measurement, increase sweep time by a factor of 10. In the example of Figure 8, press [SWEPTIME] [2] [0] [0] [msec] followed by [SHIFT] [1] [Hz] to re-run the measurement.

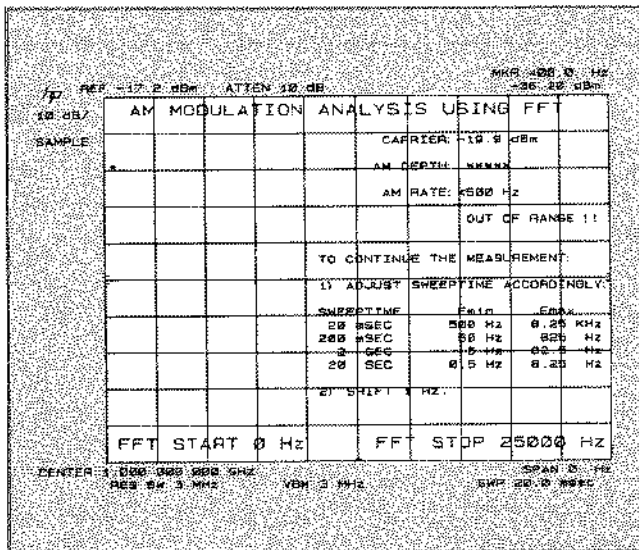

Figure 8. The 400 Hz rate AM is out of range because the sweep time is too fast. Decrease sweep time to continue the measurement.

Modulation < 0.1%

In this case, the AM cannot be measured in the FFT frequency domain using this program. Whatever sweep time is chosen results in a display that looks like Figure 9. Again, the FFT frequency domain may be seen by pressing [VIEW] Trace A.

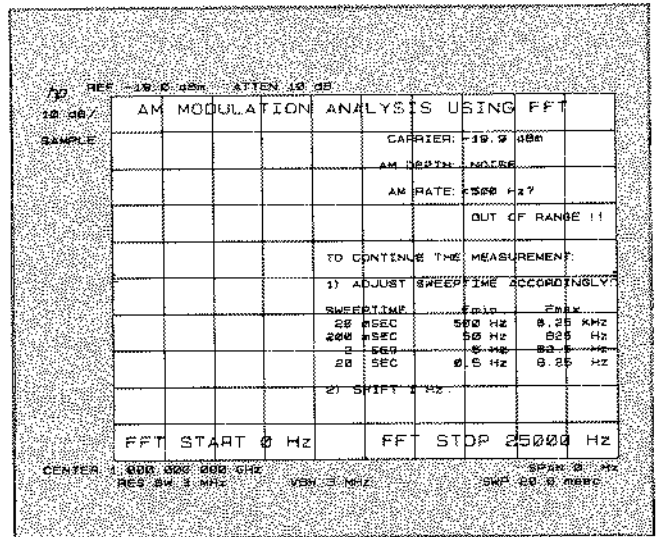

Figure 9. No modulation sideband has been found. Either there is no modulation, or the sweep time is too fast. Increase sweep time to continue the measurement.

AM Depth Measurement in the FFT Frequency Domain Program (Appendix B Program)

This program measures AM rates to 15 kHz, but does not measure AM distortion. If AM distortion does not need to be measured, this program is preferable because it runs more quickly and can measure higher modulation rates. The step-by-step procedure and the program operation are identical to the previous program with the following exceptions:

- 1) to start, press [SHIFT] [2] [Hz];
- 2) AM distortion is not measured;
- 3) averaging is performed only if the AM depth is less than approximately 1% AM;
- 4) AM rates to 15 kHz are measured; and
- 5) this program is faster.

Figure 10 shows a measurement made with this program.

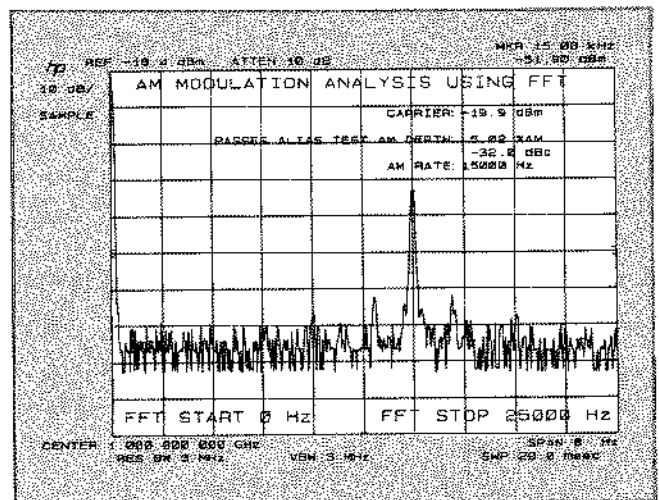

Figure 10. The 15 kHz rate AM is measured with the Appendix B program.

Core Program (Appendix C Program)

The core program is the shortest practical program possible, but the operator must interpret the results.

To make a measurement, first place a marker on the signal of interest, activate signal track, and zoom in on the signal by reducing the span to 1 MHz. Set the VBW (video bandwidth) to 3 MHz. Set the RBW (resolution bandwidth) to 3 MHz or narrower, as desired. Adjust the reference level to place the envelope peaks at or below the reference level. Press [SHIFT] [3] [Hz]. A single FFT is performed. The delta marker shows the AM depth in dBc. See Figure 11. The upper trace is the demodulated AM time domain waveform. The lower trace is the FFT frequency domain representation.

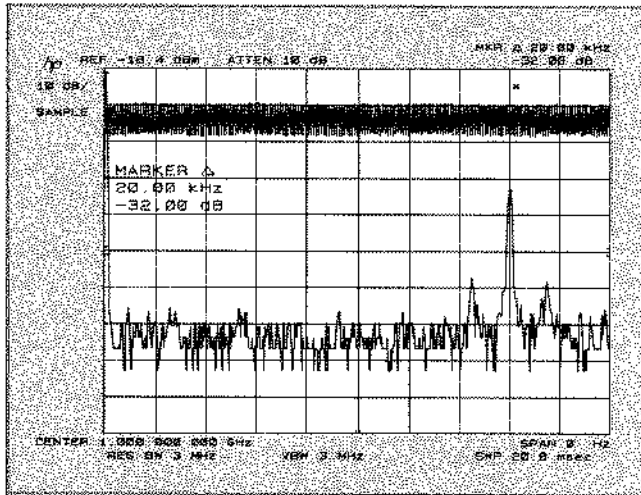

Figure 11. Higher rate AM can be measured with the core program of Appendix C. The operator must interpret the results.

FUNDAMENTALS OF AM MEASUREMENTS IN THE FFT FREQUENCY DOMAIN

Introduction

As discussed in HP Application Note 150-1, AM measurements using spectrum analyzers are generally made in either the swept frequency domain or the time domain. However, these measurement techniques have their limitations.

In the swept frequency domain, incidental angle modulation can significantly affect AM sideband levels (refer to HP Application Note 150-1). For example, microwave signal generators with pin diode modulators have high incidental phase modulation at high carrier frequencies and/or at high AM depth. It is common for these microwave signal generators to have an actual AM depth much less than the measurement in the swept frequency domain indicates. And there may be no tell-tale sideband asymmetry; no clue that the measurement is incorrect.

An alternative is to make the measurement in the time domain. For peak deviations much less than the resolution bandwidth (RBW), there is no FM-to-AM conversion. Hence, a time domain measurement using a sufficiently wide RBW strips off the incidental angle modulation. In this case, the incidental angle modulation does not affect measurement accuracy. However, a limitation of the time domain is that AM distortion and AM noise can significantly affect the measurement of AM depth. Also, AM distortion cannot be measured directly.

One solution to these limitations is to use downconversion, where one spectrum analyzer acts as a downconverter and a second low frequency spectrum analyzer or waveform recorder analyzes the demodulated waveform. For spectrum analyzers with digitized traces, a low-cost alternative is to use a controller to perform an FFT on the digitized time domain waveform. The most cost-effective solution, however, is to use a spectrum analyzer with sophisticated signal processing functions (such as FFT) and

downloadable program capability. No costly second spectrum analyzer or external controller is required. The measurement is made quickly and internally in the FFT frequency domain. The advantages of making AM measurements in the FFT frequency domain are orders-of-magnitude improvement in speed, resolution, accuracy, and rejection of incidental FM. Many measurements which cannot be made in the swept frequency or time domains can easily be made in the FFT frequency domain.

Maximum Frequency Range and Resolution

The FFT is one algorithm for transforming demodulated AM data from the time domain to the frequency domain. The maximum frequency range (Nyquist frequency) of the FFT is

$$F_{max} = \frac{N}{2} \cdot \frac{1}{\text{Period of Time Record}}$$

where N is the number of samples (generally 1001) and the Period of Time Record is the sweeptime. F max is the maximum modulation frequency which can be measured by the FFT. F max becomes higher as the sweeptime is reduced.

When sweeptime increases by a factor of 10, F max is reduced by a factor of 10, and frequency readout resolution is improved by a factor of 10. The formula is

$$\text{frequency readout resolution} = \frac{2}{N} \cdot F_{max}$$

Hence, a sweeptime of 20 msec yields an F max of 25 kHz and resolution of 50 Hz.

Aliasing

Due to a phenomenon called aliasing, modulation frequencies higher than F max are mixed down to the frequency range of the FFT. These alias products cause erroneous results. For example, if F max is 25 kHz, then 26 kHz, 74 kHz, or 76 kHz signals all appear at the same position on the display as does a 24 kHz signal. See Figure 12.

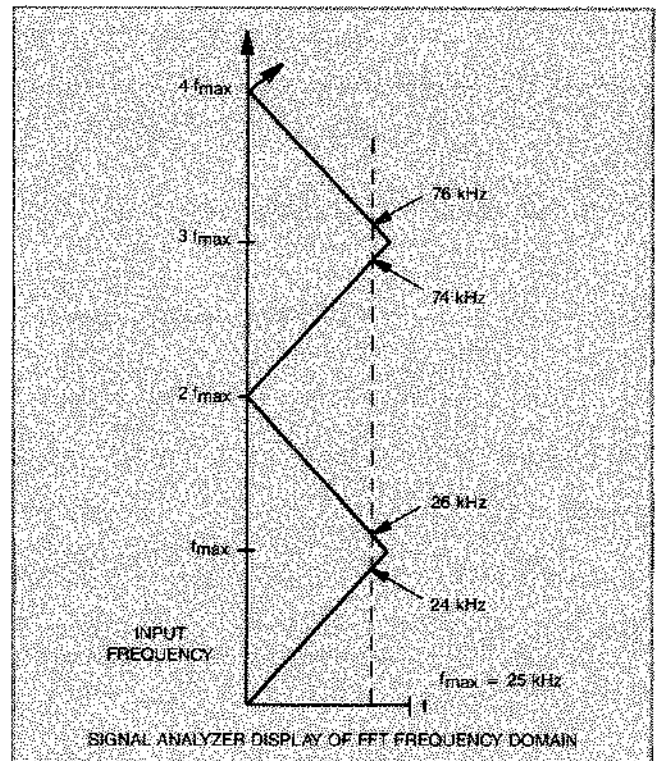

Figure 12. Aliasing in the FFT frequency domain. Signals higher in frequency than F max "wrap around" the display.

As long as the highest frequency component of the modulation is less than F_{max} , no aliasing can occur. Therefore, a filter can be used to remove the alias products. An ideal anti-aliasing filter is infinitely steep. However, since real filters have gradual roll-off and finite rejection, large signals which are not well-attenuated in the transition band can still alias into the FFT frequency range. There is no way to avoid this; hence the usable FFT frequency range is lower than F_{max} .

Although the RBWs and video bandwidths (VBWs) cannot be used as anti-aliasing filters since neither has sufficiently steep roll-off, both can be used for alias testing. It is best, though, to use the widest RBW for maximum FM rejection and use only the VBWs for the alias test.

Usable Frequency Range

When the VBWs are used for the alias test, the usable FFT frequency range for AM depth and AM distortion measurements is restricted to the shaded area shown in Figure 13. Regardless of sweep time and F_{max} , this corresponds to 0.2 to 3.3 divisions.

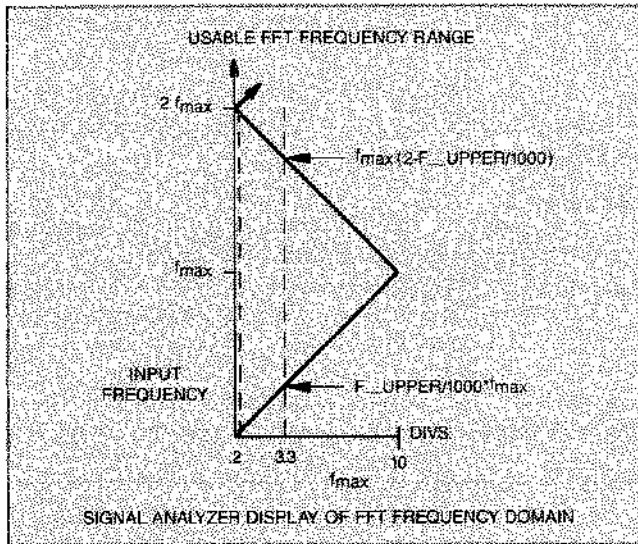

Figure 13. Usable FFT frequency range when measuring AM depth and AM distortion to the third harmonic (Appendix A program).

Low-depth modulation with a modulation frequency < 0.2 divisions results in a low-level sideband so close to the nearby large carrier (the d.c. term in the FFT frequency domain) that the sideband cannot be resolved. In this case, the sweep time must be increased. Because modulation rates greater than 3.3 divisions cause the third and higher harmonics to "wrap around" the display, the third harmonic cannot be measured for modulation rates greater than 3.3 divisions. If harmonic distortion does not need to be measured, the frequency range can be extended to six divisions as discussed in the "Extending Measurement Range" section below.

Table I shows the usable frequency range of the FFT as a function of sweep time. As long as the AM modulation rate lies within one of these four frequency ranges, the measurement of AM depth and AM distortion to the third harmonic can be made. No other values of sweep time are necessary.

For signals within the usable frequency range, make the aliasing test as follows. First make an FFT frequency domain measurement using the widest VBW. Make a second measurement using the VBW shown in Table I. If the fundamental (the AM sideband depth in dBc) changes less than eight dB, then it is not an alias product.

Table I. Usable frequency range, sweep time, and aliasing test for AM measurements in the FFT frequency domain when using the Appendix A program.

MOD Frequency				Aliasing Test	
.2 Divs	3.3 Divs	Fmax	Sweep time	VBW #1	VBW #2
500	8250	25 kHz	20 msec	3 MHz	10 kHz
50	825	2.5 kHz	200 msec	3 MHz	1 kHz
5	82.5	250 Hz	2 secs	3 MHz	100 Hz
0.5	8.25	25 Hz	20 secs	3 MHz	10 Hz

Window Functions

There is another property of the FFT which affects its use in frequency domain analysis. If the sweep does not contain an integral number of cycles of the demodulated AM waveform, the FFT algorithm is computed on the basis of a discontinuous, highly distorted waveform. The solution to this problem is windowing.

The FFT function has three windows to choose from: uniform, Hanning, and flattop. The uniform window is used for transients only. The Hanning window has better frequency accuracy but poorer amplitude accuracy than the flattop window. However, the better frequency accuracy of the Hanning window is not realizable because frequency accuracy also depends on sweep time accuracy. The flattop window is used for best amplitude accuracy when analyzing periodic waveforms such as demodulated AM. Table II shows its characteristics. The aspect ratio shows how many 3 dB bandwidths will fit into the frequency range, and is a figure of merit for resolution.

Shape factor is a figure of merit for selectivity; it shows how well low-level AM sidebands can be resolved from the nearby carrier. Both shape factor and aspect ratio are excellent. More information can be found in HP Application Notes 150 and 243.

Table II. Flattop window characteristics.

3 dB BW	0.72% of Fmax
Shape Factor: (60 dB BW/3 dB BW)	2.6
Aspect Ratio: (Fmax/3 dB BW)	140

MEASUREMENT CONSIDERATIONS

The advantages of AM measurements made in the FFT frequency domain are speed, resolution, accuracy, and rejection of incidental FM.

Accuracy

The basic accuracy of AM depth and AM distortion measurements is ±0.2 dB (±2.5% of reading). FFT noise degrades basic measurement accuracy by reducing linearity and generating phantom spectral components. These effects can be lumped together into the category of "noise."

Variance in the measurement due to noise is reduced by averaging a number of measurements. Refer to Figure 14. Above 1% AM (AM sideband < -46 dBc), averaging has no significant effect; the standard deviation of the measurement is approximately 0.1 dB or better. At 0.1% AM (AM sideband -66 dBc), 16 averages reduce the standard deviation by a factor of 2 (from 0.8 dB to 0.4 dB). Since each average requires roughly 0.5 sec, more than sixteen averages may not be worth the extra time. For

example, 128 averages further reduces the standard deviation by less than a factor of 2 (from 0.4 dB to 0.25 dB), but takes 8 times longer (over 60 seconds).

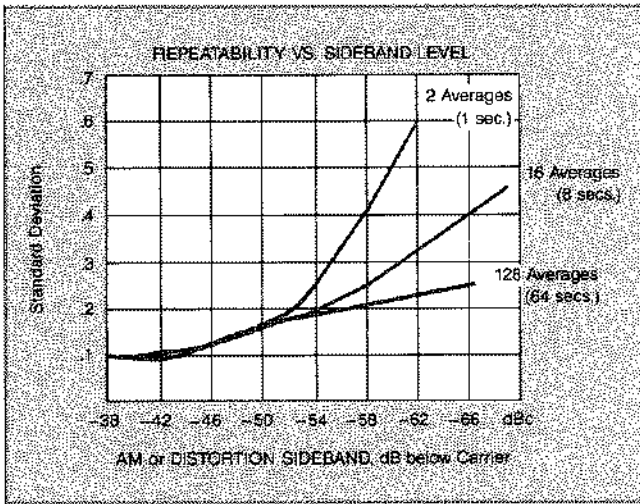

Figure 14. Repeatability in the FFT frequency domain depends on AM and AM distortion sideband levels.

The graph is only approximately correct for standard deviation in distortion measurements. At simultaneous high AM depths and high modulation rates, the standard deviation will increase somewhat due to the raised noise floor.

Modulation rate accuracy is a direct function of sweep time accuracy (10% of reading).

FM Rejection

Using the 3 MHz RBW results in a very high degree of immunity to angle modulation. FM rejection is < 0.1% AM for FM deviations < 10 kHz. This means that AM measurements can be made in the presence of relatively large FM or that incidental AM measurements can be made on FM.

Speed and Resolution

The FFT frequency domain provides improvement in resolution by at least a factor of 100 over measurements made in the swept frequency domain. For example, modulation rates below 10 Hz can be measured in the FFT frequency domain but not in the swept frequency domain. Even for equivalent resolutions, the FFT provides an advantage in speed of at least a factor of four.

Internal Distortion, Spurious and Dynamic Range

All distortion measurements are affected by internally generated distortion. The rule of thumb is, for less than 1 dB error due to internal distortion, the internal distortion must be more than 20 dB below the distortion being measured. Distortion measurements are also affected by noise. The rule of thumb here is, for less than 0.5 dB error due to noise, keep the Signal/Noise ratio greater than 10 dB.

Typical internally generated distortion is 50 dB below the AM sideband at 50% AM. The noise floor is 82.7 dB below the reference level at low depth AM. However, the noise floor rises at simultaneous, high AM depths and high modulation rates. Noise and distortion are plotted in Figure 15. The maximum dynamic range is > 50 dB for > 15% AM. From the rules given above, usable dynamic range is 40 dB at 15% AM. In other words, at 15% AM, 1% AM distortion can be measured to approximately 1 dB accuracy. Higher levels of distortion can be

measured more accurately. For example, the measurement in Figure 16 is essentially unaffected by internal distortion.

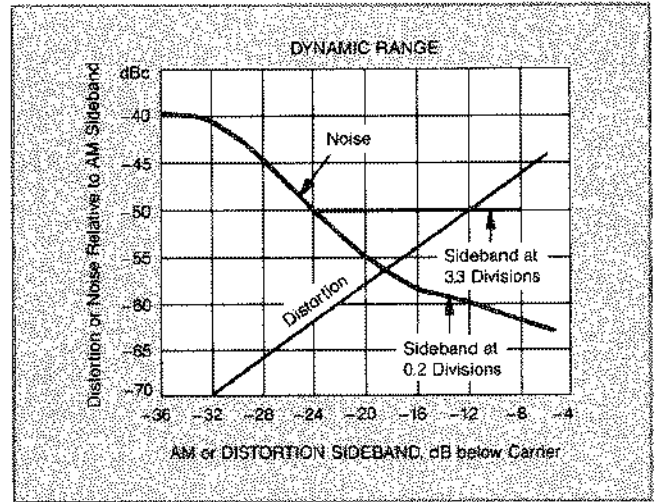

Figure 15. Dynamic Range of AM measurements in the FFT frequency domain.

Small non-linearities in the spectrum analyzer's sweep ramp cause spurious signals in the FFT frequency domain which are symmetrically spaced about the AM and AM distortion sidebands. These spurious signals are an FM phenomenon: as the modulation rate is increased by a factor of two, the spurious level increases 6 dB. The spurious sidebands do not affect measurement accuracy as long as the spurious sideband pair is at least 20 dB below its corresponding AM or AM distortion sideband.

Figure 16 shows spurious sidebands of a sample instrument at 1825 Hz and 3650 Hz about the large AM sideband. These are -32 dBc and -41 dBc respectively. Because they are more than 20 dB below the AM sideband, they do not affect the percent AM measurement accuracy. However, they may affect the second harmonic distortion measurement accuracy if the AM rate is near either of these two frequencies (1825 Hz or 3650 Hz). Also, the frequency and level of the spurious signals vary considerably from instrument to instrument.

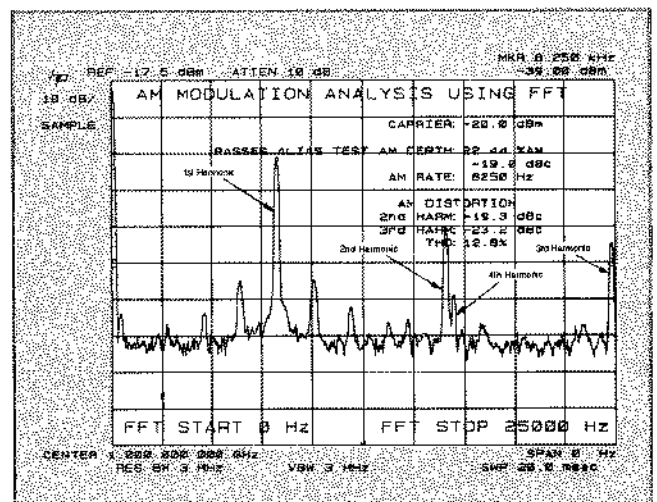

Figure 16. The modulation consists of an AM sideband and second, third, and fourth harmonics. The fourth harmonic has "wrapped around" the display due to aliasing. All other signals are spurious sidebands of the sample instrument. These vary considerably from unit to unit.

EXTENDING MEASUREMENT RANGE

Modulation Rates

Modulation rates below 0.5 Hz can be measured by increasing the sweep time appropriately. Modulation rates above 8.25 kHz can be measured, but the capability to measure harmonic distortion is sacrificed. If the second harmonic only is to be measured, the usable FFT frequency range can be extended to 4.95 divisions, regardless of sweep time (in a 20 msec sweep time this corresponds to an F max of 12.375 kHz). When harmonic distortion measurements are not needed, usable FFT frequency range can be pushed to 6 divisions and above. This change is made in line 430; a measurement range of 6 divisions corresponds to an F_upper of 600 cells. Above 3.3 divisions, however, the alias test value in line 440 should be determined experimentally, as it may be instrument dependent. Choose an alias test value such that modulation rates less than $F_upper/1000 * F_max$ — the highest modulation rate in the usable FFT frequency range of Figure 13 — pass the alias test, but modulation rates greater than $F_max * (2 - F_upper/1000)$ — the lowest frequency which “wraps around” into the usable FFT frequency range of Figure 13 — fail the alias test.

AM Depth

It is not possible to measure AM depths in excess of 100% due to severe waveform distortion. Measurements below 1% AM require averaging. Measurements below 0.1% AM are not reliable because of system noise.

Carrier Level < -20 dBm

The minimum carrier level required to make the measurement is shown in Table III. For AM depths greater than 1%, the carrier level can be reduced by approximately 20 dB. For lower carrier levels, an RBW < 3 MHz may be used to improve Signal/Noise ratio. However, each time the RBW is reduced by a factor of 10, the FM rejection is also reduced by a factor of 10. An RBW $\geq 13.3 * (\text{modulation rate})$ ensures that there will be no additional error in measured percent AM, and an RBW $\geq 40 * (\text{modulation rate})$ ensures that there will be no additional error in measured AM distortion. These minimum RBWs prevent roll-off of the filter bandwidth from affecting the measurement.

Carrier Frequency < 10 MHz

Carriers below 10 MHz can be measured. However, an RBW < 3 MHz must be used to eliminate LO feedthrough. The comments above also apply here.

Table III. Minimum carrier level for AM measurements in the FFT frequency domain.

Frequency Band	Minimum Carrier Level (3 MHz RBW, 10 dB RF Attenuator)
10 MHz - 2.5 GHz	-20 dBm
2 - 5.8 GHz	-20 dBm
5.8 - 12.5 GHz	-13 dBm
12.5 - 18.6 GHz	-10 dBm
18.6 - 22 GHz	-7 dBm

AM Depth and AM Distortion Measurement in the FFT Frequency Domain

PROGRAM DESCRIPTION

The code of the AM and AM Distortion Measurement in the FFT Frequency Domain Program is divided into the following functional sections:

Initialize

All variables and traces are defined in this section. Variables are assigned a pre-set value.

S__etup

This functional definition ensures the analyzer is set up in the proper state: single sweep, zero span, sample detection, free run trigger, 3 MHz RBW, and 3 MHz VBW are all required modes of operation. Only one of four sweep times is allowed. An RBW ≤ 3 MHz may be used as discussed in “Extending Measurement Range.”

A__utorange

This function places the AM modulation envelope peak at the reference level and selects linear detection.

A__lias

This function locates the highest amplitude AM sideband in the FFT frequency domain. If this sideband lies between 0.02 and 3.3 horizontal divisions, an aliasing test using the proper VBW is performed.

A__verage

For an AM sideband which lies between 0.02 and 3.3 horizontal divisions and which also passes the alias test, this function sequentially sweeps and averages 16 FFTs. Less averaging may be used to speed the measurement; however, the repeatability of low-distortion measurements and low-depth AM (< 1% AM) measurements is degraded.

M__easure

This function computes F max (Nyquist frequency), which is displayed as “FFT Stop Freq.” If a modulation sideband was found in the A__lias function, M__easure determines the modulation rate.

C__ompute

This function computes the carrier level in dBm, and AM depth in dBc and percent. The P__eaks array is searched for second and third harmonics. All other signals are ignored (except in the unlikely case that a higher harmonic “wraps around” the display and happens to lie in the same position as the second or third harmonic, or in the unlikely case that an AM distortion sideband coincides with a spurious signal). Second and third harmonic distortion is calculated in dBc. Total harmonic distortion is calculated in percent.

Disp__One

This function displays the annotation and measurement results for FFT Start and Stop frequency, AM depth, and AM rate. If the modulation sideband is greater than 3.3 horizontal divisions and the sweep time is 20 msec, or if the modulation fails the aliasing test, “Beyond Measurement Range” is displayed.

Disp__Two

If the AM sideband is out of range but the measurement is continuous, this function displays the sweep time selection table.

Disp__Three

For modulation rates in the usable frequency range of the FFT, this function displays second, third, and total harmonic distortion. It also displays the alias test results (pass or fail).

Main Program

This section assigns a name and a softkey to the main program. The main program sequentially executes the functions described above.

Annotated Program Listing

```

10  | File name: "FFT_ONE"      Date: 4/85
20  |                          DLP BYTES: 7530
30  | Description of Program:  This program performs an AM MODULATION
40  |                          ANALYSIS USING FFT on demodulated, time-domain
50  |                          waveforms. It measures CARRIER LEVEL, AM DEPTH,
60  |                          AM RATE, AM DISTORTION, and TOTAL HARMONIC
70  |                          DISTORTION.
80  |                          Restrictions: Carrier level >= -20 dBm,
90  |                          AM depth 0.1-99%
100 |                          AM rate 0.5 Hz to 8.25 kHz,
110 |                          8566B/68B VER 14.1.85 (REV C)
120 |                          OR LATER
130 |
140 | ASSIGN @Sa TO 718
150 | OUTPUT @Sa;"DISPOSE ALL;"
160 | OUTPUT @Sa;"MEM?"
170 | ENTER @Sa;M
180 |
190 | INITIALIZE:
200 |
210 | OUTPUT @Sa;"TRDEF P_PAKS,100;"  | Peaks location, cells
220 | OUTPUT @Sa;"VARDEF C_CARRIER,0;" | Carrier Level, dBm
230 | OUTPUT @Sa;"VARDEF F_IRST,0;"    | AM Depth, dBc
240 | OUTPUT @Sa;"VARDEF F_IRSTPOS,0;" | AM sideband position, cells
250 | OUTPUT @Sa;"VARDEF S_ECND,0;"    | AM 2nd harmonic distortion, dBc
260 | OUTPUT @Sa;"VARDEF S_UPPER,0;"   | upper, lower extreme positions
270 | OUTPUT @Sa;"VARDEF S_LOWER,0;"   | of 2nd harmonic, cells.
280 | OUTPUT @Sa;"VARDEF S_ECNDPOS,0;" | exact position of 2nd harmonic, cells
290 | OUTPUT @Sa;"VARDEF T_HIRD,0;"    | AM 3rd harmonic distortion, dBc
300 | OUTPUT @Sa;"VARDEF T_UPPER,0;"   | upper, lower extreme positions
310 | OUTPUT @Sa;"VARDEF T_LOWER,0;"   | of 3rd harmonic, cells
320 | OUTPUT @Sa;"VARDEF T_HIRDPOS,0;" | exact position of 3rd harmonic, cells
330 | OUTPUT @Sa;"VARDEF P_PERCENT,0;" | AM depth, %
340 | OUTPUT @Sa;"VARDEF R_RATE,0;"    | AM Rate, Hz
350 | OUTPUT @Sa;"VARDEF F_STOP,0;"    | FFT Stop Frequency, Hz
360 | OUTPUT @Sa;"VARDEF I_NDEX,1;"    | count variable
370 | OUTPUT @Sa;"VARDEF A_TWO,.0000001;" | relative level 2nd, linear units
380 | OUTPUT @Sa;"VARDEF A_THREE,.0000001;" | relative level 3rd, linear units
390 | OUTPUT @Sa;"VARDEF T_HD,0;"      | Total Harmonic Distortion, %
400 | OUTPUT @Sa;"VARDEF S_T,0;"       | Sweeptime, secs
410 | OUTPUT @Sa;"VARDEF T_EST,0;"     | Alias test results, dB
420 | OUTPUT @Sa;"VARDEF V_BW,0;"      | Video BW, Hz
430 | OUTPUT @Sa;"VARDEF F_UPPER,331;" | Upper limit to measurement range, cells
440 | OUTPUT @Sa;"VARDEF D_B,-8;"      | Alias test value, dB
450 |
460 | SUBROUTINES:
470 |
480 | S_ETUP
490 |
500 | OUTPUT @Sa;"FUNDEF S_ETUP,B"
510 | OUTPUT @Sa;"TRDEF WINDOW,1001;"  | N=1001 samples
520 | OUTPUT @Sa;"TWNDOW WINDOW,FLATTOP;"
530 | OUTPUT @Sa;"(FS);SAVES I;IP;RCLS I;"
540 | OUTPUT @Sa;"(SGLS;SFOHZ;DET SMP;TM FREE;"
550 | OUTPUT @Sa;"BLANK TRA;CLRW TRB;"
560 | OUTPUT @Sa;"RB3MZ;VB3MZ;HD;"
570 | OUTPUT @Sa;"MOV S_T,ST;"         | Selects one of four
580 | OUTPUT @Sa;"IF S_T,LT,.05;MOV S_T,.02;" | sweep times:

```



```

590 OUTPUT @Sa;"ENDIF;" 20 mSEC
600 OUTPUT @Sa;"IF S_T,GT,5;MOV S_T,20;" 200 mSEC
610 OUTPUT @Sa;"ENDIF;" 2 SEC
620 OUTPUT @Sa;"IF S_T,GT,.5;IF S_T,LT,5;" 20 SEC
630 OUTPUT @Sa;"MOV S_T,2;ENDIF;ENDIF;"
640 OUTPUT @Sa;"IF S_T,GT,.05;IF S_T,LT,.5;"
650 OUTPUT @Sa;"MOV S_T,.2;ENDIF;ENDIF;@"
660 !
670 ! A_UTORANGE
680 !
690 OUTPUT @Sa;"FUNCDEF A_UTORANGE,@"
700 OUTPUT @Sa;"DA3072;D3;PU;PA 96,592;"
710 OUTPUT @Sa;"TEXT /AUTORANGING LEVEL.../;"
720 OUTPUT @Sa;"DW1044;"
730 OUTPUT @Sa;"ST29C;RL300M;LB 100B;HD;TB;" ! Auto ranges AM modulation
740 OUTPUT @Sa;"MKPK HI;MKRL;MKOFF ALL;RL UP;LN;" ! envelop peak to Reference
750 OUTPUT @Sa;"HD;TB;MKPK HI;MKRL;RL UP;" ! Level. Saves State.
760 OUTPUT @Sa;"MKOFF ALL;MOV ST,S_T;SAVES 1;KS;@"
770 !
780 ! A_LIAS
790 !
800 OUTPUT @Sa;"FUNCDEF A_LIAS,@"
810 OUTPUT @Sa;"DA3072;PU;PA 96,592;"
820 OUTPUT @Sa;"TEXT /ALIAS TEST.../;"
830 OUTPUT @Sa;"DW1044;HD;"
840 OUTPUT @Sa;"TS;FFT TRA,TRB,WINDOW;VIEW TRA;"
850 OUTPUT @Sa;"MKPX 130B;PEAKS P_EAKS,TRA,AMP;"
860 OUTPUT @Sa;"MOV F_IRSTPOS,P_EAKS[1];"
870 OUTPUT @Sa;"IF F_IRSTPOS,GE,20;" ! Performs Aliasing Test
880 OUTPUT @Sa;" IF F_IRSTPOS,LE,F_UPPER;" ! for signals between
890 OUTPUT @Sa;" MOV T_EST,TR[F_IRSTPOS];" ! .02 and 3.3 horizontal
900 OUTPUT @Sa;" DIV V_BW,200,S_T;" ! Divisions.
910 OUTPUT @Sa;" MOV VB,V_BW;" ! VBW selected:
920 OUTPUT @Sa;" TS;FFT TRB,TRB,WINDOW;" ! 20 mSEC 10 kHz
930 OUTPUT @Sa;" SUB T_EST,TRB[F_IRSTPOS],T_EST;" ! 200 SEC 1 kHz
940 OUTPUT @Sa;" DIV T_EST,T_EST,10;" ! 2 SEC 100 Hz
950 OUTPUT @Sa;"ENDIF;ENDIF;" ! 20 SEC 10 Hz
960 OUTPUT @Sa;"@"
970 !
980 ! A_VERAGE
990 !
1000 OUTPUT @Sa;"FUNCDEF A_VERAGE,@"
1010 OUTPUT @Sa;"DA3072;PU;PA 96,592;"
1020 OUTPUT @Sa;"TEXT /AVERAGING.../;"
1030 OUTPUT @Sa;"DW1044;"
1040 OUTPUT @Sa;"VB3M7;HD;"
1050 OUTPUT @Sa;"IF F_IRSTPOS,GE,20;" ! For signals between .02
1060 OUTPUT @Sa;" IF F_IRSTPOS,LE,F_UPPER;" ! and 3.3 horizontal DIVs
1070 OUTPUT @Sa;" MOV I_NDEX,1;" ! which pass the alias
1080 OUTPUT @Sa;" IF T_EST,LT,0.8;" ! test, sequentially
1090 OUTPUT @Sa;" MOV I_NDEX,16;" ! sweep and average 16
1100 OUTPUT @Sa;" ENDIF;" ! FFT's.
1110 OUTPUT @Sa;" REPEAT;"
1120 OUTPUT @Sa;" TS;FFT TRB,TRB,WINDOW;"
1130 OUTPUT @Sa;" AVG TRA,TRB,16;"
1140 OUTPUT @Sa;" ADD I_NDEX,I_NDEX,1;"
1150 OUTPUT @Sa;" UNTIL I_NDEX,GE,16;"
1160 OUTPUT @Sa;"ENDIF;ENDIF;@"
1170 !
1180 ! M_MEASURE

```



```

1190      !
1200      OUTPUT @Sa;"FUNCDEF M_EASURE,@;"
1210      OUTPUT @Sa;"BLANK TRB;LG 10DB;"
1220      OUTPUT @Sa;"DIV F_STOP,500,S_T;"           ! Measure FFT Stop Freq
1230      OUTPUT @Sa;"IF FIRSTPOS,NE,0;"           ! If modulation exists
1240      OUTPUT @Sa;"  MKPX 12DB;PEAKS P_EAKS,TRA,AMP;" ! measure rate of
1250      OUTPUT @Sa;"  M2;MKP P_EAKS[I];MKREAD FFT;" ! largest signal.
1260      OUTPUT @Sa;"  HD;MOV R_RATE,MF;"
1270      OUTPUT @Sa;"  MKPX 12DB;PEAKS P_EAKS,TRA,FREQ;" ! Sort harmonics by freq
1280      OUTPUT @Sa;"ENDIF;@"
1290      !
1300      ! C_DMPUTE
1310      !
1320      OUTPUT @Sa;"FUNCDEF C_DMPUTE,@;"
1330      OUTPUT @Sa;"DA3072;PU;PA 96,592;"
1340      OUTPUT @Sa;"TEXT /COMPUTING... /;"
1350      OUTPUT @Sa;"DW1044;HD;"
1360      OUTPUT @Sa;"SUB C_ARRIER,TRAIL,1000;"       ! Compute CARRIER LEVEL
1370      OUTPUT @Sa;"DIV C_ARRIER,C_ARRIER,10;"
1380      OUTPUT @Sa;"ADD C_ARRIER,C_ARRIER,RL;"
1390      !
1400      OUTPUT @Sa;"IF FIRSTPOS,NE,0;"           ! If modulation exists,
1410      OUTPUT @Sa;"  SUB F_IRST,TRAC[FIRSTPOS],TRAIL;" ! Compute AM DEPTH,
1420      OUTPUT @Sa;"  DIV F_IRST,F_IRST,10;"       !          dbc
1430      OUTPUT @Sa;"  EXP P_ERCENT,F_IRST,20;"     !          %
1440      OUTPUT @Sa;"  MPY P_ERCENT,P_ERCENT,200;"
1450      OUTPUT @Sa;"ENDIF;"
1460      OUTPUT @Sa;"IF FIRSTPOS,GE,20;"           ! If signal is between
1470      OUTPUT @Sa;"  IF FIRSTPOS,LE,F_UPPER;"     ! .02 and 3.3 DIVs, then
1480      OUTPUT @Sa;"  MPY S_UPPER,F_IRSTPOS,2;"     ! Compute 2nd harmonic
1490      OUTPUT @Sa;"  ADD S_UPPER,S_UPPER,10;"     ! position to +/-10 cells.
1500      OUTPUT @Sa;"  SUB S_LOWER,S_UPPER,20;"
1510      OUTPUT @Sa;"  MPY T_UPPER,F_IRSTPOS,3;"     ! Compute 3rd harmonic
1520      OUTPUT @Sa;"  ADD T_UPPER,T_UPPER,10;"     ! position to +/-10 cells.
1530      OUTPUT @Sa;"  SUB T_LOWER,T_UPPER,20;"
1540      OUTPUT @Sa;"  MOV I_NDEX,1;"
1550      OUTPUT @Sa;"  REPEAT;"                     ! Locate positions
1560      OUTPUT @Sa;"    ADD I_NDEX,I_NDEX,1;"       ! of any 2nd or 3rd
1570      OUTPUT @Sa;"    IF P_EAKS[I_NDEX],LE,S_UPPER;THEN" ! harmonic peaks.
1580      OUTPUT @Sa;"      IF P_EAKS[I_NDEX],GE,S_LOWER;THEN"
1590      OUTPUT @Sa;"        MOV S_ECONDPOS,P_EAKS[I_NDEX];"
1600      OUTPUT @Sa;"      ENDIF;ENDIF;"
1610      OUTPUT @Sa;"    IF P_EAKS[I_NDEX],LE,T_UPPER;"
1620      OUTPUT @Sa;"      IF P_EAKS[I_NDEX],GE,T_LOWER;"
1630      OUTPUT @Sa;"        MOV T_HIRDPOS,P_EAKS[I_NDEX];"
1640      OUTPUT @Sa;"      ENDIF;ENDIF;"
1650      OUTPUT @Sa;"    IF P_EAKS[I_NDEX],GE,T_UPPER;MOV I_NDEX,100;"
1660      OUTPUT @Sa;"    ENDIF;"
1670      OUTPUT @Sa;"    IF P_EAKS[I_NDEX],EQ,P_EAKS[100];MOV I_NDEX,100;"
1680      OUTPUT @Sa;"    ENDIF;"
1690      OUTPUT @Sa;"  UNTIL I_NDEX,EQ,100;"
1700      OUTPUT @Sa;"  IF S_ECONDPOS,NE,0;"           ! Compute
1710      OUTPUT @Sa;"    SUB S_ECOND,TRAC[S_ECONDPOS],TRAC[FIRSTPOS];" ! 2nd
1720      OUTPUT @Sa;"    DIV S_ECOND,S_ECOND,10;"     ! HARMONIC.
1730      OUTPUT @Sa;"  ENDIF;"
1740      OUTPUT @Sa;"  IF T_HIRDPOS,NE,0;"           ! Compute
1750      OUTPUT @Sa;"    SUB T_HIRD,TRAC[T_HIRDPOS],TRAC[FIRSTPOS];" ! 3rd
1760      OUTPUT @Sa;"    DIV T_HIRD,T_HIRD,10;"     ! HARMONIC.
1770      OUTPUT @Sa;"  ENDIF;"
1780      OUTPUT @Sa;"ENDIF;ENDIF;"

```



```

1790 OUTPUT @Sa;" IF F_IRSTPOS,NE,0;"
1800 OUTPUT @Sa;"   IF S_ECONDPOS,NE,0;"
1810 OUTPUT @Sa;"     EXP A_TWO,S_ECOND,10;"
1820 OUTPUT @Sa;"   ENDIF;"
1830 OUTPUT @Sa;"   IF T_HIRDPOS,NE,0;"
1840 OUTPUT @Sa;"     EXP A_THREE,T_HIRD,10;"
1850 OUTPUT @Sa;"   ENDIF;"
1860 OUTPUT @Sa;"   ADD T_HD,A_TWO,A_THREE;"           ! Compute TOTAL
1870 OUTPUT @Sa;"   SQR T_HD,T_HD;MPY T_HD,T_HD,100;" ! HARMONIC
1880 OUTPUT @Sa;" ENDIF;"                             ! DISTORTION.
1890 OUTPUT @Sa;"e"
1900
1910 ! DISP_ONE
1920
1930 OUTPUT @Sa;"FUNCDEF DISP_ONE,0;"
1940 OUTPUT @Sa;"DA2B64;DW145;DA257B;DW147;DA3072;D2;"
1950 OUTPUT @Sa;"D3;PU;PA 112,608;"
1960 OUTPUT @Sa;"TEXT /AM MODULATION ANALYSIS USING FFT /;"
1970 OUTPUT @Sa;"D3;PU;PA 104,64;"
1980 OUTPUT @Sa;"TEXT /FFT START 0 Hz   FFT STOP /;"
1990 OUTPUT @Sa;"DSPLY F_STOP,S.0;TEXT / Hz/;"
2000 OUTPUT @Sa;"D2;PU;PA 600,848;"
2010 OUTPUT @Sa;"TEXT / CARRIER: /;"
2020 OUTPUT @Sa;"DSPLY CARRIER,3.1;TEXT / dBm/;"
2030 OUTPUT @Sa;"PU;PA 600,784"
2040 OUTPUT @Sa;"TEXT /AM DEPTH: /;"
2050 OUTPUT @Sa;"IF F_IRSTPOS,LT,20;"
2060 OUTPUT @Sa;"   IF F_IRSTPOS,EQ,0;"
2070 OUTPUT @Sa;"     THEN;TEXT / NOISE/;"
2080 OUTPUT @Sa;"     ELSE;TEXT / ****/;"
2090 OUTPUT @Sa;"ENDIF;ENDIF;"
2100 OUTPUT @Sa;"IF F_IRSTPOS,GT,F_UPPER;THEN;"
2110 OUTPUT @Sa;"   TEXT /APPROX /;"
2120 OUTPUT @Sa;"   DSPLY P_PERCENT,5.2;TEXT / %AM/;"
2130 OUTPUT @Sa;"ENDIF;"
2140 OUTPUT @Sa;"IF F_IRSTPOS,GE,20;THEN;"
2150 OUTPUT @Sa;"   IF F_IRSTPOS,LE,F_UPPER;THEN;"
2160 OUTPUT @Sa;"     IF T_EST,GT,D_B;"
2170 OUTPUT @Sa;"       THEN DSPLY P_PERCENT,5.2;TEXT / %AM/;"
2180 OUTPUT @Sa;"       ELSE TEXT /APPROX /;DSPLY P_PERCENT,5.2;TEXT / %AM/;"
2190 OUTPUT @Sa;"ENDIF;ENDIF;ENDIF;"
2200 OUTPUT @Sa;"PU;PA 760,752;"
2210 OUTPUT @Sa;"IF F_IRSTPOS,GT,F_UPPER;THEN;"
2220 OUTPUT @Sa;"   TEXT /APPROX /;"
2230 OUTPUT @Sa;"   DSPLY F_IRST,4.1;TEXT / dBc/;"
2240 OUTPUT @Sa;"ENDIF;"
2250 OUTPUT @Sa;"IF F_IRSTPOS,GE,20;"
2260 OUTPUT @Sa;"   IF F_IRSTPOS,LE,F_UPPER;"
2270 OUTPUT @Sa;"     IF T_EST,GT,D_B;"
2280 OUTPUT @Sa;"       THEN DSPLY F_IRST,4.1;TEXT / dBc/;"
2290 OUTPUT @Sa;"       ELSE;TEXT /APPROX /;DSPLY F_IRST,4.1;TEXT / dBc/;"
2300 OUTPUT @Sa;"ENDIF;ENDIF;ENDIF;"
2310 OUTPUT @Sa;"PU;PA 600,720;"
2320 OUTPUT @Sa;"TEXT / AM RATE: /;"
2330 OUTPUT @Sa;"IF F_IRSTPOS,LT,20;THEN;"
2340 OUTPUT @Sa;"   MOV I_NDEX,0;"
2350 OUTPUT @Sa;"   TEXT /< /;"
2360 OUTPUT @Sa;"   MPY R_RATE,F_STOP,.02;"
2370 OUTPUT @Sa;"   DSPLY R_RATE,3.0;"
2380 OUTPUT @Sa;"   IF F_IRSTPOS,EQ,0;"

```



```

2390 OUTPUT @Sa;" THEN;TEXT / Hz?/;"
2400 OUTPUT @Sa;" ELSE;TEXT / Hz/;"
2410 OUTPUT @Sa;"ENDIF;ENDIF;"
2420 OUTPUT @Sa;"IF F_IRSTPOS,GT,F_UPPER;THEN;"
2430 OUTPUT @Sa;" TEXT / > /;"
2440 OUTPUT @Sa;" MPY R_ATE,F_STOP,.33004;"
2450 OUTPUT @Sa;" DSPLY R_ATE,4.0;"
2460 OUTPUT @Sa;" TEXT / Hz/;"
2470 OUTPUT @Sa;" IF S_T,GT,.05;"
2480 OUTPUT @Sa;" THEN;MOV I_NDEX,0;"
2490 OUTPUT @Sa;" ELSE;PU;PA 600,592;"
2500 OUTPUT @Sa;" TEXT /BEYOND MEASUREMENT RANGE !!/;"
2510 OUTPUT @Sa;"ENDIF;ENDIF;"
2520 OUTPUT @Sa;"IF F_IRSTPOS,GE,20;"
2530 OUTPUT @Sa;" IF F_IRSTPOS,LE,F_UPPER;"
2540 OUTPUT @Sa;" IF T_EST,GT,D_B;"
2550 OUTPUT @Sa;" THEN DSPLY R_ATE,5.0;TEXT / Hz/;"
2560 OUTPUT @Sa;" ELSE TEXT/> /;"
2570 OUTPUT @Sa;" MPY R_ATE,F_STOP,.33004;"
2580 OUTPUT @Sa;" DSPLY R_ATE,4.0;TEXT / Hz/;"
2590 OUTPUT @Sa;" IF S_T,LT,.05;THEN;"
2600 OUTPUT @Sa;" PU,PA 600,592;"
2610 OUTPUT @Sa;" TEXT /BEYOND MEASUREMENT RANGE/;"
2620 OUTPUT @Sa;" ELSE;MOV I_NDEX,0;"
2630 OUTPUT @Sa;"ENDIF;ENDIF;ENDIF;ENDIF;@"
2640 !
2650 ! DISP_TWO
2660 OUTPUT @Sa;"FUNCDEF DISP_TWO,@;"
2670 OUTPUT @Sa;"IF I_NDEX,EQ,0;THEN;"
2680 OUTPUT @Sa;" PU;PA 760,656;"
2690 OUTPUT @Sa;" TEXT /OUT OF RANGE !!/;"
2700 OUTPUT @Sa;" BLANK TRA;"
2710 OUTPUT @Sa;" PU;PA 504,560;"
2720 OUTPUT @Sa;" TEXT /TO CONTINUE THE MEASUREMENT:/;"
2730 OUTPUT @Sa;" PU;PA 504,496;"
2740 OUTPUT @Sa;" TEXT /1) ADJUST SWEPTIME ACCORDINGLY/;"
2750 OUTPUT @Sa;" PU;PA 504,432;"
2760 OUTPUT @Sa;" TEXT /SWEPTIME Fmin Fmax/;"
2770 OUTPUT @Sa;" PU;PA 504,400;"
2780 OUTPUT @Sa;" TEXT / 20 mSEC 500 Hz 8.25 KHz/;"
2790 OUTPUT @Sa;" PU;PA 504,368;"
2800 OUTPUT @Sa;" TEXT /200 mSEC 50 Hz 825 Hz/;"
2810 OUTPUT @Sa;" PU;PA 504,336;"
2820 OUTPUT @Sa;" TEXT / 2 SEC 5 Hz 82.5 Hz/;"
2830 OUTPUT @Sa;" PU;PA 504,304;"
2840 OUTPUT @Sa;" TEXT / 20 SEC 0.5 Hz 8.25 Hz/;"
2850 OUTPUT @Sa;" PU;PA 504,240;"
2860 OUTPUT @Sa;" TEXT /2) SHIFT 1 Hz./;"
2870 OUTPUT @Sa;"ENDIF;@"
2880 !
2890 ! DISP_THREE
2900 !GOTO 2620
2910 !
2920 OUTPUT @Sa;"FUNCDEF DISP_THREE,@;"
2930 OUTPUT @Sa;"IF F_IRSTPOS,GE,20;THEN;"
2940 OUTPUT @Sa;" IF F_IRSTPOS,LE,F_UPPER;THEN;"
2950 OUTPUT @Sa;" IF T_EST,GE,D_B;THEN;"
2960 OUTPUT @Sa;" PU;PA 632,656;"
2970 OUTPUT @Sa;" TEXT /AM DISTORTION/;"
2980 OUTPUT @Sa;" PU;PA 600,624;"

```



```

2990 OUTPUT @Sa;"      TEXT /2nd HARM: /;"
3000 OUTPUT @Sa;"      IF S_ECONDPDS,EQ,0;"
3010 OUTPUT @Sa;"      THEN TEXT / NOISE/;"
3020 OUTPUT @Sa;"      ELSE DSPLY S_ECOND,4.1;TEXT / dBc/;"
3030 OUTPUT @Sa;"      ENDIF;"
3040 OUTPUT @Sa;"      PU;PA 600,592;"
3050 OUTPUT @Sa;"      TEXT /3rd HARM: /;"
3060 OUTPUT @Sa;"      IF T_HIRDPDS,EQ,0;"
3070 OUTPUT @Sa;"      THEN TEXT / NOISE/;"
3080 OUTPUT @Sa;"      ELSE DSPLY T_HIRD,4.1;TEXT / dBc/;"
3090 OUTPUT @Sa;"      ENDIF;"
3100 OUTPUT @Sa;"      PU;PA 600,560;"
3110 OUTPUT @Sa;"      TEXT /      THD: /;"
3120 OUTPUT @Sa;"      DSPLY T_HD,4.1;TEXT / % /;"
3130 OUTPUT @Sa;"ENDIF;ENDIF;ENDIF;"
3140 OUTPUT @Sa;"PU;PA 304,784;"
3150 OUTPUT @Sa;"IF T_EST,LT,D_B;"
3160 OUTPUT @Sa;"  THEN;D3;PU;PA 176,512;"
3170 OUTPUT @Sa;"  TEXT /FAILS/;"
3180 OUTPUT @Sa;"  D2;PU;PA 400,784;"
3190 OUTPUT @Sa;"  TEXT /ALIAS TEST/;"
3200 OUTPUT @Sa;"ENDIF;"
3210 OUTPUT @Sa;"IF T_EST,GT,D_B;"
3220 OUTPUT @Sa;"  IF T_EST,NE,0;THEN;TEXT /PASSES ALIAS TEST/;"
3230 OUTPUT @Sa;"ENDIF;ENDIF;"
3240 OUTPUT @Sa;"DW1044;HD;@"
3250 !
3260 ! MAIN PROGRAM
3270 !
3280 OUTPUT @Sa;"FUNCDEF FFT_ONE,@"
3290 OUTPUT @Sa;"S_ETUP;"
3300 OUTPUT @Sa;"A_UTORANGE;"
3310 OUTPUT @Sa;"A_LIAS;"
3320 OUTPUT @Sa;"A_VERAGE;"
3330 OUTPUT @Sa;"M_EASURE;"
3340 OUTPUT @Sa;"C_OMPUTE;"
3350 OUTPUT @Sa;"DISP_ONE;"
3360 OUTPUT @Sa;"DISP_TWO;"
3370 OUTPUT @Sa;"DISP_THREE;"
3380 OUTPUT @Sa;"@"
3390 OUTPUT @Sa;"KEYDEF 1, FFT_ONE;"
3400 !
3410 !
3420 OUTPUT @Sa;"MEM?"
3430 ENTER @Sa;Mem
3440 DISP M-Mem
3450 END

```

APPENDIX B

AM Depth Measurement in the FFT Frequency Domain

PROGRAM DESCRIPTION

The program description and flow chart are identical to the program in Appendix A except that

- 1) The usable frequency range has been extended to 15 kHz,
- 2) Harmonic distortion is not measured, and
- 3) Averaging is performed only on AM depths <1%.

ANNOTATED PROGRAM LISTING

This program is derived from the program in Appendix A by making the following deletions, additions, and changes.

Deletions

Delete lines 70, 250-320, 370-390, 1460-1880, and 2930-3130.

Additions

Add these lines:

```

10      ' File name: "FFT_TWO"      Date: 2/85
20      '                          DLP BYTES: 5422
60      '                          AM RATE.
100     '                          AM rate 0.5 Hz to 15 kHz.
430     OUTPUT @Sa;"VARDEF F_UPPER,601;" ' Upper limit to measurement range, cells
2440    OUTPUT @Sa;"  MPY R_ATE,F_STOP,.6;"
2450    OUTPUT @Sa;"  DSPLY R_ATE,5.0;"
2570    OUTPUT @Sa;"          MPY R_ATE,F_STOP,.6;"
2580    OUTPUT @Sa;"          DSPLY R_ATE,5.0;TEXT / Hz/;"
2780    OUTPUT @Sa;"  TEXT / 20 nSEC      500 Hz      15 kHz/;"
2800    OUTPUT @Sa;"  TEXT /200 nSEC      50 Hz      1500 Hz/;"
2820    OUTPUT @Sa;"  TEXT / 2 SEC        5 Hz      150 Hz/;"
2840    OUTPUT @Sa;"  TEXT / 20 SEC       0.5 Hz     15 Hz/;"
2860    OUTPUT @Sa;"  TEXT /2) SHIFT 2 Hz./;"
3280    OUTPUT @Sa;"FUNCDEF FFT_TWO,@"
3390    OUTPUT @Sa;"KEYDEF 2, FFT_TWO;"

```

Changes

Change the existing lines as follows:

```

1070    OUTPUT @Sa;"      IF TRALFIRSTPOSJ,LT,530;"
1071    OUTPUT @Sa;"      THEN MOV I_NDEX,1;"
1072    OUTPUT @Sa;"      ELSE MOV I_NDEX,16;"
1073    OUTPUT @Sa;"      ENDIF;"

```

APPENDIX C**Core Program****Program Listing**

```

10      OUTPUT 718;"FUNCDEF FFT_THREE,@"
20      OUTPUT 718;"TRDEF WINDOW,100;"
30      OUTPUT 718;"LN;K9@;MKOFF ALL;"
40      OUTPUT 718;"VIEW TRA;CLRW TRB;SNGLS;TS;"
50      OUTPUT 718;"TWNDW WINDOW,FLATTOP;"
60      OUTPUT 718;"FFT TRA,TRB,WINDOW;"
70      OUTPUT 718;"LB 10DB;MKREAD FFT;"
80      OUTPUT 718;"VIEW TRB;MKPK H1;N3;MKPK NH;@"
90      OUTPUT 718;"KEYDEF 3, FFT_THREE;"
100     END

```

APPENDIX D**Bibliography**

"Spectrum Analysis...Spectrum Analyzer Basics," Hewlett-Packard Application Note 150, 1974.

"Spectrum Analysis...Amplitude and Frequency Modulation," Hewlett-Packard Application Note 150-1, 1971.

"The Fundamentals of Signal Analysis," Hewlett-Packard Application Note 243, 1982.

"Teaming Up a 5180A Waveform Recorder and a Spectrum Analyzer for New Time-Domain Measurement Capabilities," Hewlett-Packard Application Note 313-2.



For more information, call your local HP sales office listed in the telephone directory white pages. Ask for the Electronic Instruments Department. Or write to Hewlett-Packard: U.S.A. — P.O. Box 10301, Palo Alto, CA 94303-0890. Europe — P.O. Box 999, 1180 AZ Amstelveen, the Netherlands. Canada — 6877 Goreway Drive, Mississauga, L4V 1M8, Ontario. Japan — Yokogawa-Hewlett-Packard Ltd., 3-29-21, Takaido-Higashi, Suginami-ku, Tokyo 168. Elsewhere in the world, write to Hewlett-Packard Intercontinental, 3495 Deer Creek Road, Palo Alto, CA 94304.

5954-2712 (D)

PRINTED IN U.S.A.

Supersedes: None

HP 8566B and 8568B Spectrum Analyzer BUILT-IN HIGH LEVEL FUNCTIONS

OVERVIEW

The HP 8566B and 8568B Spectrum Analyzers have high level functions that perform complex measurements and calculate results internally, allowing a computer to handle other tasks. Since trace data is not transferred to a computer, processing time is decreased.

This programming note illustrates how to execute and use four of these functions: PEAKS (returns the number of signal peaks in a trace), probability distribution of amplitude (PDA), probability distribution of frequency (PDF) and power bandwidth (PWRBW).

Prerequisites

To more easily understand this programming note, some experience with HP 8566B or 8568B manual and remote operation is required. The HP 8566B or 8568B Operating and Programming Manual can be used as a reference. An understanding of Programming Note HP 8566B/8568B/Models 216/226/236-90 (Storage, Display and I/O of Variables and Traces for the HP 8566B and 8568B) is recommended.

Reference Materials

Analyzer reference materials include the HP 8566B / 8568B Quick Reference Guide (publication number 5955-8970), the HP 8566B and 8568B Operating and Programming Manual (part numbers 8566-90040 and 8568-90041), the HP 8566B / 8568B / Models 216 / 226 / 236-90 Programming Note (publication number 5952-9398), and the HP Programming Note HP 8566B / 8568B / Models 216 / 226 / 236-99, "A Structured Approach to Downloadable Programming" (publication number 5952-9392).

Equipment Used

HP 8566B or 8568B Spectrum Analyzer
HP 9000 Series 200 Model 216, 226 or 236 Desktop Computer

EXAMPLES OF HIGH LEVEL FUNCTIONS

PEAKS

PEAKS is a built-in analyzer command that finds the number of maximum responses in a trace and sorts them either by frequency, from lowest to highest, or by amplitude, from highest to

lowest. Since this command is built into the analyzer, results are obtained without having to transfer the trace data to a controller for processing.

Since traces usually contain random amplitude fluctuations caused by noise, PEAKS uses two parameters, threshold and peak excursion, to distinguish noise and decrease the possibility of reporting a "false" peak.

Specifying a threshold (TH) value causes PEAKS to treat all lesser trace values as equal to the threshold. The peak excursion (MKPX) provides a way to establish the amount of superimposed noise to be ignored. A peak is confirmed only if data points exist on both sides of a candidate peak and if at least one point on each side has an amplitude less than the candidate peak by the peak excursion value. For example, performing PEAKS on the trace in figure 1, with a 10 dB peak excursion and a -80 dBm threshold, yields the reporting of the two peaks at the right. The leftmost signal is without data points on both sides of it, and the next signal in does not have a peak excursion of 10 dB on both sides. Refer to line 170 of the sample program for examples of TH and MKPX syntax.

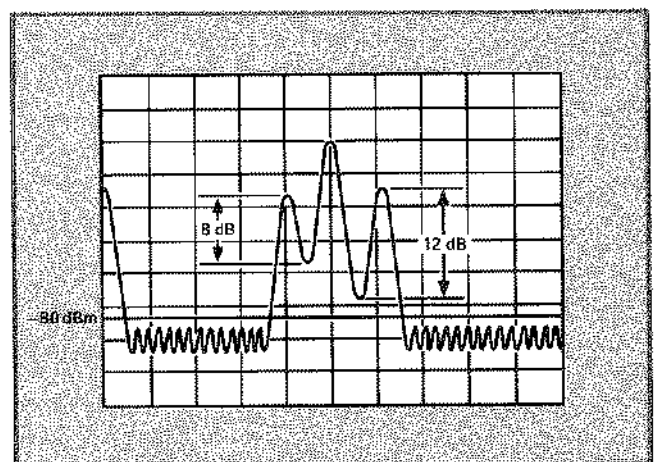

Figure 1. PEAKS reports only the peaks at the right.
Peak Excursion = 10 dB Threshold = -80 dBm

PEAKS records the x-axis position of the sorted peaks in a destination trace (trace A, B, C, or a user-defined trace). Destination traces are one-dimensional arrays. For example, trace A is a 1001-element array, and the value stored in any particular element can be accessed by specifying TRA[n], where n is the number of the desired element. If the destination trace is longer than the number of peaks found, the x-axis position of the last peak sorted is repeated for the remaining elements of the destination trace. Since the peak positions are recorded in display units, additional computation is required to find the frequency and power of the individual peaks. The sample program, PEAKS_EXAMPLE, shows how the number of peaks found and the frequency and amplitude of the first peak are sent to the controller.

To determine the actual frequency of individual peaks, each element of the destination trace must be converted from display units to Hz. The following algorithm performs this conversion:

$$\left(\frac{u \times sp}{t} \right) + sf$$

- where u = display unit to be converted
- sp = frequency span
- t = total number of display units (usually 1001)
- sf = start frequency

Lines 270-290 of the sample program below show how this algorithm is used in analyzer commands.

To determine the amplitude of each peak, be careful to preserve the amplitude data of the original trace that PEAKS was performed

on. Since PEAKS saves only the x-axis information of each peak found, the amplitude information must be taken from the original trace before it is overwritten. To determine the amplitude value (in display units) of a peak, use the x-axis information in the PEAKS destination array (trace B) to indicate the horizontal position of the peak of interest. Then determine the amplitude of the peak with the CTA command which converts data from display units to the current absolute-amplitude units. For example, to determine the amplitude value of the first peak in trace A, execute PEAKS on trace A, sorted by frequency. Since trace B is the destination trace, the first element of trace B contains the horizontal position of the first peak in trace A. Then use the CTA command to convert the first trace element value to amplitude units. TRB[1] is the element number of interest in trace A. Therefore, using TRA[TRB[1]] to indicate the amplitude value to be converted in the CTA command gives the desired result. In other words, if TRB[1] = 875, then converting TRA[TRB[1]] to amplitude units will give the amplitude of the 875th element of trace A, in dBm. This technique is used in line 350 of the program. The absolute-amplitude units in the program are dBm.

Note: To send to a computer the value of any variable, trace or array, simply query the variable name as in lines 320 and 390.

PEAKS can also report the number of signal peaks to the controller. To display or store that value in the controller, place a BASIC ENTER statement immediately after the PEAKS command. See line 220. The number of peaks found can also be stored in an analyzer variable using the MOV command. See line 250.

```

10      ! File name: PEAKS_EXAMPLE           Date: 30.11.84
20      ! Description of Program:          This program finds the peaks in trace A
30      !                                     and returns the number of peaks, and the
40      !                                     frequency and amplitude of the first
50      !                                     signal found to the controller.
60      !
70      !
80      ! Program begins here. . .
90      !
100     OUTPUT 718;"VARDEF F_REG,0;"        !Define a variable to use as a scratch
110     !                                     pad and to store the frequency value
120     !                                     of the first peak.
130     OUTPUT 718;"VARDEF A_MP,0;"        !Define a variable to store the ampli-
140     !                                     tude of the first peak.
150     OUTPUT 718;"VARDEF N_LMPEAKS,0;"    !Define a variable to store the number
160     !                                     of peaks found.
170     OUTPUT 718;"TH=-70dB;MKPX10DB;"    !Set the threshold value to -70 dBm
180     !                                     and peak excursion to 10 dB.
190     OUTPUT 718;"PEAKS TRB,TRA,FR3;"    !Find the peaks in trace A and record
200     !                                     their x-axis positions in trace B
210     !                                     in order of ascending frequency.
220     ENTER 718;Signal#                    !PEAKS returns the number of peaks to
230     PRINT Signal#                       !the controller. Simply enter and
240     !                                     print the value.
250     OUTPUT 718;"MOV N_LMPEAKS,PEAKS;"    !The number of peaks can also be stored
260     !                                     in a variable for later reference.
270     OUTPUT 718;"DIV F_REG,TRB[1],1001;" !Convert the first peak from display
280     OUTPUT 718;"MPY F_REG,F_REG,SP;"     !units to Hz:
290     OUTPUT 718;"ADD F_REG,F_REG,FR3;"    !
300     !                                     (display unit X span / total
310     !                                     number of display units) + start
320     !                                     frequency
330     OUTPUT 718;"F_REG?"                  !Use the query mode to return the
340     PRINT Frequency                       !frequency of the first peak to the
350     OUTPUT 718;"CTA A_MP,TRALTRB[1];"    !Convert to amplitude units (usually
360     !                                     dBm) the amplitude position of the
370     !                                     first peak found;
380     !                                     TRALTRB[1]
390     OUTPUT 718;"A_MP?"                  !Return the amplitude of first peak
400     ENTER 718;Amplitude                 !to the controller and print.
410     PRINT Amplitude
420     END
    
```

Probability Distribution of Frequency and Amplitude Functions (PDA & PDF)

The HP 8566B and 8568B offer the probability distribution of frequency (PDF) and probability distribution of amplitude (PDA) functions for statistical signal analysis of signals. These functions increase the speed of data collection for histograms and free the computer for other tasks. They have other uses, illustrated below.

Histograms

Histograms illustrate graphically the overall statistics of periodic or random signals. Obtain a histogram by dividing the expected parameter range into intervals (called bins) and counting the number of times the parameter value occurs within each bin. See Figures 2(a) and (b).

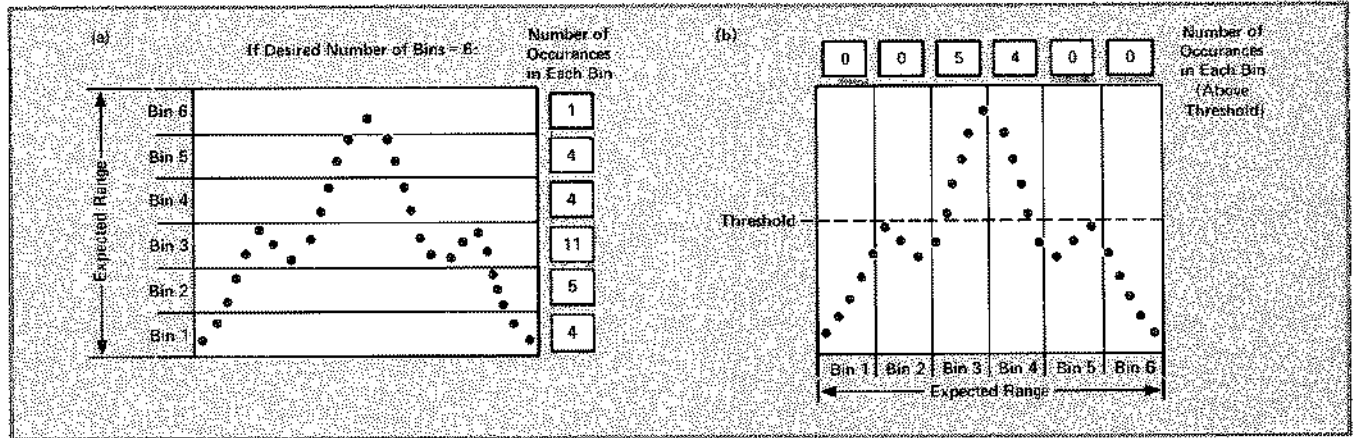

Figure 2. (a) Probability Distribution of y-axis. (b) Probability Distribution of x-axis.

As the bin size approaches zero, and as the number of samples approaches infinity, the histogram approaches the probability distribution of the signal. Therefore, for the PDA and PDF functions to accurately measure the probability distribution, the bin size should be small and data should be taken over a large number of sweeps. Details on specifying the bin size for PDA and PDF are found in the following sections. The histogram level in a particular bin is proportional to the integral of the probability density function over the parameter range included in that bin. The bin size depends on the characteristics of the signal being analyzed. If the bin size is too small, the average number of occurrences per bin will be very low and the histogram will consist of many empty bins interspersed with bins with one or two counts. This information may not be useful. Likewise, if the bin size is too large, all the data samples fall into one or two bins, and once again the information does not define sufficiently the probability distribution. The usual situation requires the generating of several histograms with different bin sizes, then selecting the most appropriate bin size for the quality and quantity of data available.

Histogram shape indicates a signal's characteristics over time. Bell shapes indicate Gaussian signals, convex shapes indicate sinusoidal signals, ramps indicate sliding signals, shapes showing Rayleigh's distributions indicate random noise signals, etc. Figure 3 shows a typical probability distribution of amplitude of a signal with sinusoidal amplitude modulation. The convex shape indicates that the sine wave values occurring most often are the maximum and minimum values.

PDA

The PDA command records the number of times that a trace or array amplitude value occurs within a designated amplitude range (or bin). The PDA command specifies bin size through the "resolution parameter." If a 10 dB/div log scale is used, the expected range is full screen (100 dB) and the resolution parameter is the desired number of dB in each bin. The following program returns the probability distribution of trace A amplitude to a computer. If 20 bins are desired, then the resolution parameter is 5 (100/20 = 5), and the results should be stored in a destination array of 20 elements.

The resolution parameter for 1, 2, and 5 dB log scales is similarly determined, except the expected range corresponds to the scale being used. The expected range for a 2 dB/division scale is 20 dB, etc.

Non-integer values are rounded when stored in trace elements; therefore, PDA is performed only on integer values. To avoid errors due to rounding, multiply data by an appropriate number (1000, for example) before storing the data in a trace, and then divide the data by the same number when it is taken out of the trace.

When data lies beyond the expected range, and the destination array is not large enough to indicate over-range values, PDA places over-range data in the closest bin (first or last). Data that lies exactly on a bin boundary is considered to be in the higher bin.

For linear scales, the expected range is 1000 display units and the resolution parameter is specified as the ratio of the number of display units in each bin to the total number of display units (1000), expressed in percent:

$$\text{resolution parameter (linear scale)} = \frac{\text{number of display units in each bin}}{1000} \times 100$$

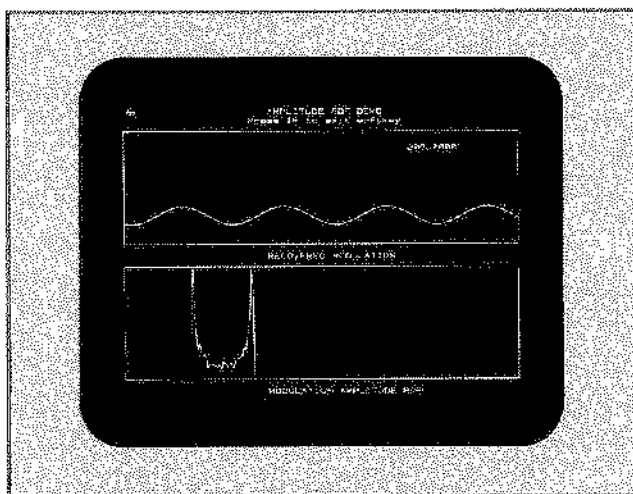

Figure 3. Probability distribution of amplitude function performed on a sine wave.

```

10  OUTPUT 718: "TRDEF P:ROBDIST,20:"
20  OUTPUT 718: "MOV P:ROBDIST,0:"
30  OUTPUT 718: "PDA P:ROBDIST,TRA,5:"
40
50
60  DIM A(20)
70  OUTPUT 718: "P:ROBDIST?:"
80  ENTER 718:A(*)
90  FOR I=1 TO 20
100 PRINT A(I)
110 NEXT I
120 END
    
```

Define the trace, P:ROBDIST, of length 20 and initialize all elements to 0. Store in P:ROBDIST the probability distribution of amplitude using a 5 dB resolution parameter of 5 dB. Return each element of P:ROBDIST to controller and print on the computer screen.

For example, if a linear scale is used on a signal that ranges 500 display units, the expected range is 500. To gather data in 25 bins over that range, each bin gathers data in increments of 20 (500/25). The resolution parameter is then determined from the equation given above; $(20/1000) \times 100 = 2$. If data ranges from elements 250 to 750, there is no information in the first and last 250 elements. See Figure 4. Since there are 20 display units per bin, the first and last 12 bins (or destination array elements) contain 0. To prevent this void in the first 12 elements of the destination array, convert the data in the trace to display units using the CTM command. Then subtract 250 from the trace, using SUB. If desired, convert the data back to the current amplitude units using CTA, and finally perform PDA. Refer to the HP 8566B or 8568B Operating and Programming Manual for more information on CTM, CTA and SUB.

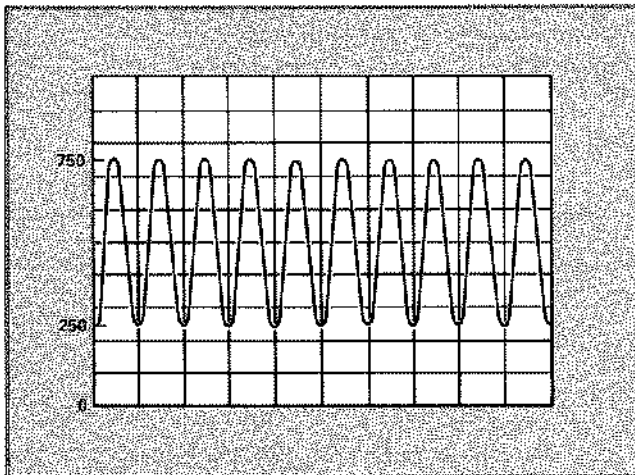

Figure 4. Trace with no data in vertical elements 0 through 250.

PDA can also be performed on a user-defined array. The resolution parameter is determined according to the current amplitude scale used.

When PDA is performed more than once on a trace, the destination trace is not cleared and accumulated information is stored.

PEAKS and PDA can be used together to function as a signal mask. For example, certain spans can be monitored for keyed signals that appear or disappear in a known signal environment which contains a consistent signal pattern. The PEAKS destination trace indicates the known signal pattern since this trace contains the horizontal position of all the signal peaks normally appearing. See Figure 5. The analyzer then performs PEAKS on every subsequent sweep using the ONEOS (on end of sweep) command. It checks for signals that appear or disappear by comparing the new PEAKS destination trace to the one containing the normal signal pattern. If the traces are different, this indicates a signal change. See Figure 6.

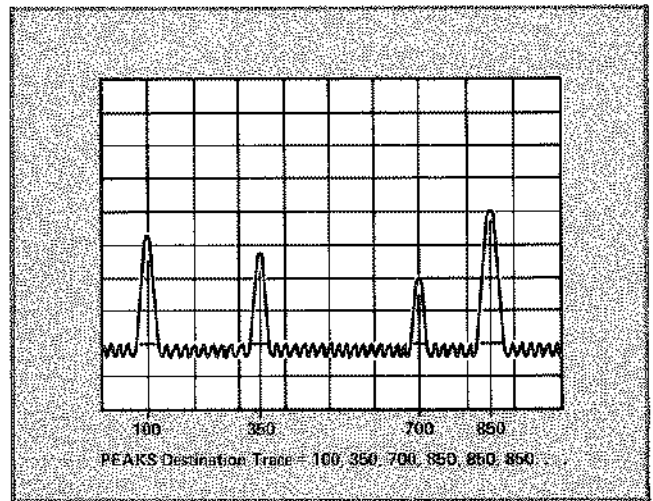

Figure 5. PEAKS destination trace representing normal signal locations.

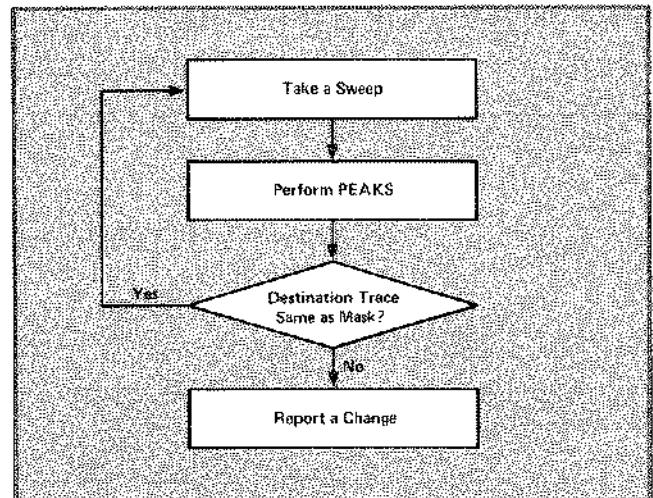

Figure 6. Signal monitor flow diagram.

The limitation of this approach is that from sweep to sweep, signals may alter slightly in frequency. Since PEAKS stores the exact horizontal position of the signal peak, if a signal moves even one horizontal trace element to the left or right, a change in signal pattern is reported even though a signal does not actually appear or disappear. To avoid this, the analyzer must tolerate small frequency changes in the signal pattern. PDA proves a solution, since it allows a bin size to be specified. If PDA is performed on the PEAKS destination trace, the PDA data can be used to represent the normal signal pattern, while allowing signals to move within the bin from sweep to sweep. In Figure 5, if on a subsequent sweep

the PEAKS destination trace signal pattern changes to 102, 348, 697, 858, 858 . . . , then a PDA with a 10-element bin size performed on this array will give the same array as a PDA performed on the original signal pattern array first shown in Figure 5a: 100,

350, 700, 850, 850, . . . PDA performed on the original PEAKS destination trace in Figure 5 allows the signals to move by 10 elements. Therefore, the PDA destination trace serves as the mask. The program below illustrates this masking technique.

```

10  !Filename: MASK                               Date: 30.11.84
20  !Description of Program: This program alerts the computer if
30  !                          a signal appears or disappears in the
40  !                          12 MHz to 810 MHz frequency range.
50  !                          Although the program is meant for real
60  !                          signal environments, the process can be
70  !                          illustrated using the analyzer's internal
80  !                          calibrator signal. Run the program with
90  !                          no signal connected, then connect the
100 !                          calibrator signal and observe. Or run
110 !                          the program with the signal connected,
120 !                          then disconnect the signal.
130 !
140 !Program begins here. . .
150 !
160 OUTPUT 718;"TRDEF P_EAK,100;TRDEF M_AXES,100;" !Define the PEAKS
170 !destination traces and
180 !set the length to 100
190 !since it is likely that
200 !no more than 100 signal
210 !peaks will be detected
220 !on screen.
230 OUTPUT 718;"TRDEF S_TANDARD,100;MOV S_TANDARD,0;" !Define the traces that
240 OUTPUT 718;"TRDEF T_EST,100;MOV T_EST,0;" !will hold the PDA
250 !information. Each
260 !element is set to 0
270 !since PDA gives actu-
280 !mulative information.
290 OUTPUT 718;"TRDEF R_RESULT,100;MOV R_RESULT,0;" !Define a trace, R_RESULT,
300 !that will be used to
310 !check for signal pattern
320 !changes.
330 OUTPUT 718;"VARDEF F_LAG,0;" !Define a variable called
340 !F_LAG and set its value
350 !to zero.
360 OUTPUT 718;"IF;FA12MZ;FB810MZ;" !Tune analyzer to span of
370 OUTPUT 718;"TH -60dB;MKPX 80B;TS;" !interest, set threshold to -60
380 !dBm, set peak excursion to 6
390 !dB, and take a sweep.
400 OUTPUT 718;"PEAKS P_EAK,TRA,FRQ;" !Find the signal peaks in trace
410 !A sorted by frequency and
420 !store in P_EAK.
430 OUTPUT 718;"PDA S_TANDARD,P_EAK,1;" !Store the probability distrib-
440 !ution of amplitude of P_EAK
450 !in S_TANDARD. To obtain a bin
460 !size of 10 display units, the
470 !amplitude value corresponding
480 !to 10 display units must be
490 !specified. Since a 10 dB per
500 !division log scale is being
510 !used, the resolution parameter
520 !specified is 1 dB. In a 10 dB
530 !log scale, 1 dB equals 10
540 !display units.
550 OUTPUT 718;"FUNDEF C_HANGES, %;" !Define the function, C_HANGES,
560 OUTPUT 718;"MOV T_EST,0;" !that finds the peaks of trace
570 OUTPUT 718;"PEAKS M_AXES,TRA,FRQ;" !A, stores them in M_AXES, and
580 OUTPUT 718;"PDA T_EST,M_AXES,1;" !stores the PDA of M_AXES in
590 OUTPUT 718;"SUB R_RESULT,S_TANDARD,T_EST;" !T_EST using a bin size of 10
600 OUTPUT 718;"MOV F_LAG,SUMSQR R_RESULT;" !elements. It checks that
610 !S_TANDARD and T_EST are equal
620 !by subtracting them. If the
630 !difference is zero, then the
640 !sum-of-the-squares (SUMSQR),
650 !stored in F_LAG will also be
660 !zero. If they are different,
670 !F_LAG will not be zero.**
680 OUTPUT 718;"IF F_LAG,NE,0 THEN %;" !If F_LAG is not zero, then a
690 OUTPUT 718;" KSP;" !signal change has occurred and
700 OUTPUT 718;"ENDIF;" !a service request is immedi-
710 OUTPUT 718;"%;" !ately set to alert the
720 !computer of the change.
730 OUTPUT 718;"ONEQS @ C_HANGES, @;" !C_HANGES is executed at the
740 END !end of every sweep.

```

**SUMSQR, rather than MEAN, is used to assure that positive and negative values in R_RESULT do not cancel each other out.

PDF

The probability distribution of frequency (PDF) function records the number of times that an analyzer trace or array horizontal value occurs above a specified threshold level. PDF can accumulate data over a number of sweeps. Gathering data in this manner and dividing by the number of sweeps taken yields a band occupancy statistic useful for long-term monitoring applications.

It is possible to specify a bin size using the COMPRESS command, which compresses a given trace into another trace of shorter length, according to a specified algorithm or trace detection mode. The ratio between the length of the two traces establishes the bin size. For example, to set the bin size of a 1001-point trace to 20, the length of the shorter trace should be 1001/20 or 50. The compression value determined in each interval depends on the com-

pression algorithm specified. Since the purpose of PDF is to find the number of times a signal appears above a threshold value, the compression algorithm used must assure that no signal peaks are missed. Thus, the positive (POS) algorithm of compression should be chosen. It selects the highest value in an interval as the compressed value. See the HP 8566B or 8568B Operating and Programming Manual for more information on COMPRESS.

The following program returns the PDF of trace A over one sweep to the controller. The bin size is determined by the ratio between the number of elements in trace A and in S__ETBIN (1001/20=50). Notice that trace A is first compressed into S__ETBIN, then PDF is performed on S__ETBIN. Connect the calibrator signal before running the program. If an HP 8566B is used, replace the start and stop frequencies in line 150 with "FA65MZ;FB310MZ;TH70DM;".

```

10  OPTION BASE 1                                !Specifies the default lower
20                                          !bound of computer arrays
30  DIM A(20)                                    !as 1.
40  DIM A(20)                                    !Dimension computer array, A,
50                                          !to 20.
60  ASSIGN @Sa TO 718                            !Assign I/O path name, @Sa.
70  OUTPUT @Sa;"TRDEF S_ETBIN,20;MOV S_ETBIN,0;" !Define a trace, S_ETBIN, of
80                                          !length 20, initialized to 0.
90  OUTPUT @Sa;"TRDEF P_DF,20;MOV P_DF,0;"      !Define a trace, P_DF, of
100                                          !length 20 and initialize
110                                          !each element to 0 since it
120                                          !will be used to hold the
130                                          !PDF data, which is accumu-
140                                          !lative.
150  OUTPUT @Sa;"SNGLS;FA10MZ;FB80MZ;TH-70DM;TS;" !Set single sweep mode, set
160                                          !start and stop frequencies
170                                          !to 10 and 80 MHz, respec-
180                                          !tively. Set threshold value
190                                          !to -70 dBm.
200  OUTPUT @Sa;"COMPRESS S_ETBIN,TRA,POS;"      !Set the bin size to 50
210                                          !elements by compressing
220                                          !trace A into the 20 element
230                                          !trace, S_ETBIN, using the
240                                          !positive algorithm of
250                                          !compression, to assure no
260                                          !signals in trace A are
270                                          !missed.
280  OUTPUT @Sa;"PDF P_DF,S_ETBIN;"            !Count the number of times
290                                          !that S_ETBIN has values
300                                          !above -70 dBm (the threshold
310                                          !value), element by element.
320  OUTPUT @Sa;"PDF M;"                        !Set the trace data output
330                                          !format to 01 format so that
340                                          !the analyzer does not con-
350                                          !vert the data to dBm.
360  OUTPUT @Sa;"P_DF?;"                        !Return P_DF to the control-
370  ENTER @Sa;A(*)                             !ler and print each element
380  FOR I=1 TO 20                               !value on the its screen.
390  PRINT A(I)
400  NEXT I
410  END

```

The contents of P__DF printed on the computer screen should be 1's and 0's, since the program takes data over one sweep only. If the bin size is 50, each bin occupies half a major frequency division. Check that a 1 appears properly in the array whenever a signal above the threshold level appears. Since the fundamental occurs in the 3rd and 4th 50-point bin, the 3rd and 4th element values of P__DF are equal to 1.

Typically, the following numbers should appear on the computer screen the first time the program is run:

For HP 8568B:

A(n) = 0,0,1,1,0,0,0,0,1,0,0,0,0,1,0,0,0,0,0,0

For HP 8566B:

A(n) = 0,0,1,1,0,0,0,0,0,0,1,1,0,0,0,0,0,0,0,1

To illustrate that PDF accumulates information, modify the program as follows by inserting lines 191, 192, 311, 312, 313 and 314 in the appropriate places; then run it.

Observe the "growing" trace in the upper right portion of the analyzer screen.

```

191 OUTPUT @Sa;"CONTS;"           !Set continuous sweep mode.
192 OUTPUT @Sa;"FUNCDEF A_CCUM, #!" !Define the function, A_CCUM.
200 OUTPUT @Sa;"COMPRESS S_ETBIN,TRA,POS;" !Set the bin size to 50
210                               !elements by compressing
220                               !trace A into the 20 element
230                               !trace, S_ETBIN, using the
240                               !positive algorithm of
250                               !compression, to assure no
260                               !signals in trace A are
270                               !missed.
280 OUTPUT @Sa;"PDF P_DF,S_ETBIN;" !Count the number of times
290                               !that S_ETBIN has values
300                               !above -70 dBm (the threshold
310                               !value), element by element.
311 OUTPUT @Sa;"TRBRPH 3072,600,600,10,P_DF;" !Graph P_DF on the analyzer
312 OUTPUT @Sa;"#;"              !screen. Terminate A_CCUM.
313 OUTPUT @Sa;"ONEDS @A_CCUM;@" !Execute A_CCUM at the end
314 STOP                          !of every sweep.

```

Power Bandwidth

The power bandwidth function (PWRBW) calculates the total power of a trace and returns the bandwidth corresponding to a specified percentage of that total. The bandwidth is the remainder after equal increments are removed from each end of the trace as illustrated in Figure 7. This function also places markers at the frequencies of the specified power bandwidth endpoints. PWRBW is useful for measuring many types of signals. For example, the modulation bandwidth of an FM transmitter can be measured for a user-specified percent of power. PWRBW also facilitates voice-modulated measurements in AM, Single Sideband and FM systems.

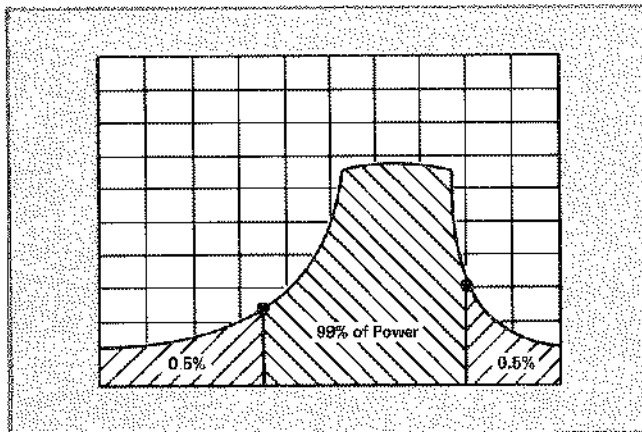

Figure 7. Endpoint determination for 99% power bandwidth.

```

10  OUTPUT 718;"VARDEF P_BW,0;"      ! Define a variable, P_BW
20                                     ! initialized to 0.
30  OUTPUT 718;"MXMH TRA;TS;TS;TS;" ! Maximum hold trace A and
40                                     ! take 3 sweeps to fill in
50                                     ! the trace.
60  OUTPUT 718;"MOV P_BW,PWRBW TRA,99.0;" ! Move the 99% power bandwidth
70                                     ! of trace A into P_BW.
80  OUTPUT 718;"DIV P_BW,P_BW,1E6;"  ! Convert P_BW to MHz.
90  OUTPUT 718;"P_BW?;"              ! Return P_BW to the controller
100 ENTER 718;Power_bandwidth        ! and print.
110 PRINT Power_bandwidth
120 END

```

PWRBW works in both log and linear modes. If linearized the trace data if a log scale is used, then computes the combined power of all elements in the trace array and moves in from each end of the array until one half of the difference between the specified power bandwidth and 100% is reached. For example, for 99% power bandwidth, the power is summed on each side until 0.5% of total power is reached. See Figure 7.

Full screen displays provide the best resolution. If possible, measure the signal with maximum vertical and horizontal on screen deflection. Broadband signals require an IF filter narrow enough to create a display in which the best power integration occurs; therefore, the IF filter should be an order of magnitude narrower than the occupied bandwidth of the signal being measured to ensure that the function does not integrate over the shape of the filter rather than the signal's spectral occupancy. To determine the optimum resolution bandwidth, narrow the IF filter until there is no change in PWRBW output. Increase the IF filter by one step to obtain the optimum bandwidth.

Spectral information at the bottom of the screen contributes little to the integration. For the best display of signal-to-noise on screen, scale modes other than 10 dB/division should be considered. Best performance occurs with signal-to-noise ratios greater than 40 dB, so that noise provides less than 1% of total power contribution.

Since the power bandwidth is calculated from a power integration of all the trace elements, the effect of time-varying functions (i.e., broadband signals) can be reduced by using the MAX-HOLD function on the trace before executing PWRBW.

The following program returns the 99% power bandwidth of trace A to the computer.



For more information, call your local HP sales office listed in the telephone directory white pages. Ask for the Electronic Instruments Department. Or write to Hewlett-Packard: **U.S.A.** — P.O. Box 10301, Palo Alto, CA 94303-0890. **Europe** — P.O. Box 999, 1180 AZ Amstelveen, the Netherlands. **Canada** — 6877 Goreway Drive, Mississauga, L4V 1M8, Ontario. **Japan** — Yokogawa-Hewlett-Packard Ltd., 3-29-21, Takaido-Higashi, Suginami-ku, Tokyo 168. Elsewhere in the world, write to Hewlett-Packard Intercontinental, 3495 Deer Creek Road, Palo Alto, CA 94304.

5954-2704

PRINTED IN U.S.A.



Programming Note

HP 8566B/8568B/Models 216/226/236-90

October 1984

Supersedes: None

STORAGE, DISPLAY AND I/O OF VARIABLES AND TRACES for the HP 8566B and 8568B Spectrum Analyzers

OVERVIEW

The HP 8566B and 8568B allow you to define, manipulate, and store variables and traces in the analyzer. Since processing data in the analyzer does not require data to be transferred to a controller, large data transfer times can be avoided. Once the analyzer has obtained the desired results, these results can be stored in traces or variables, transferred to a controller, or displayed on the analyzer screen in any desired format. Data can also be passed from the computer to analyzer variables or traces which can be useful when a measurement requires comparison to a standard, or when correction factors need to be incorporated into a measurement, as in millimeter or stimulus-response applications.

The purpose of this programming note is to show how to store and display variables and traces in the analyzer and how to input and output their values to a controller.

Prerequisites

To more easily understand this programming note, some experience with manual and remote operation of the HP 8566A/B or 8568A/B spectrum analyzers is required. Experience in programming using different display sizes (D1, D2, and D3) and using the concepts presented in Appendix A of the HP 8566B or 8568B Operating and Programming Manual is highly recommended. At least some familiarity with Appendix A and display sizes is required. A discussion of display sizes is found in the Programming Commands section of the Operating and Programming Manual under D1, D2 and D3.

Reference Materials

Analyzer reference materials include the HP 8566B/8568B Quick Reference Guide (literature number 5955-8970), the HP 8566B or 8568B Operating and Programming Manual (literature numbers 8566-90040 or 8568-90041), and Programming Note HP 8566B/8568B/Models 216/226/236-99 (literature number 5952-9392). The BASIC Language Reference for Series 200 Computers (part number 09826-90056) is also a useful reference.

Equipment Used

HP 8566B or 8568B Spectrum Analyzer
HP 9000 Series 200 Model 216, 226 or 236 Desktop Computers.

VARIABLES

Storage

To store a single value in the spectrum analyzer's RAM, a variable must be defined and set to an initial value. This allocates space in RAM for the variable name and value. An underscore should be used as the second letter of a variable name to avoid analyzer misinterpretation of the name. (See page 1 of Programming Note HP 8566B/8568B Models 216/226/236-99 for more information.) The value of a variable can be altered in many ways by using the variable name as the "destination" in various analyzer commands such as MOV, ADD, DIV, etc. (See the Programming Commands section of the HP 8566B/8568B Operating and Programming Manual.) Each time it is altered, the new value writes over the old value in memory. Instrument preset resets the variable to its initial value. The following example shows how the amplitude of a signal can be stored in a variable.

```
10 OUTPUT 718: "VARDEF A_MPLITUDE,0;" ;Define a variable named A_MPLITUDE
20                                     ;and initialize it to zero.
30 OUTPUT 718: "IP;SNGLS;FAL0MZ;FB110MZ;" ;Instrument preset, single sweep,
40                                     ;and set the start and stop
50                                     ;frequencies to 10 and 110 MHz, re-
60                                     ;spectively.
70 OUTPUT 718: "TS;MKPK HI;" ;Put a marker on the largest signal
80                                     ;on the trace.
90 OUTPUT 718: "MOV A_MPLITUDE,MKA;" ;Move the marker amplitude into
100 END ;A_MPLITUDE.
```

Display

The value of a variable can be displayed anywhere on the analyzer screen using the DSPLY command. A numeric field width must be specified in the DSPLY command after the variable name by two numbers. The first number specifies the total field width; i.e., the total amount of numbers to be displayed. The second number specifies the resolution; i.e., the amount of numbers to be displayed after the decimal point. These numbers should be separated by a decimal point. (See line 70 of the example below.)

Note: The field width must be greater than the resolution. If the field width is not large enough, more numbers will be displayed than specified.

To display a variable at a particular location on the CRT, the pen location must be specified using the PU (pen up) and PA (plot absolute) commands. For example, to display the value of A_MPLITUDE at center screen, the pen must be picked up and positioned accordingly. (See line 10 of the example.) The xy coordinates specified in the PA command indicate the pen's starting location (x = 500, y = 500). The numbers used as the xy coordinates depend on the display size selected (D1, D2, or D3). The display size also sets the size of the displayed characters. Refer to

the Programming Commands section of the HP 8566B or 8568B Operating and Programming Manual under D1, D2 and D3 for a discussion of display sizes, xy coordinate selection and character sizes.

A section of display memory must be used to store data to be displayed. A display address must be set to designate the beginning display memory position. It can be set to any address using the DA (display address) command or it can be set to a particular address (3072) using the EM (erase trace C memory) command, which erases the contents of the trace C memory and sets the display address to 3072, the beginning of trace C memory. (Refer to Appendix A of the HP 8566B or 8568B Operating and Programming Manual for an explanation of display memory structure.)

To show A_MPLITUDE complete with name and units, the TEXT command can be used. TEXT displays all ASCII characters appearing between delimiters at the current pen location. The @ delimiter is used in the example below. Other delimiters include "# / : = ' \$ % & ! ' " .

Note: When using TEXT in a function definition (FUNCDEF statement), do not use the same delimiters for TEXT as the delimiters used for the function definition.

```

10  OUTPUT 718;"EM;D2;PU;PA 500,500;HD;"  !Clear trace C memory, set display
20                                     !address to 3072, set display size
30                                     !to D2, pick the pen up and start
40                                     !writing to element 500,500. Clear
50                                     !the active function block.
60  OUTPUT 718;"TEXT @Amplitude = P;"    !Write "Amplitude = ".
70  OUTPUT 718;"DSPLY A_MPLITUDE,6.2;"  !Display A_MPLITUDE allowing a
80                                     !total of 6 digits to be displayed
90                                     !to 2 decimal places.
100 OUTPUT 718;"TEXT @ dBm@;HD;"        !Write "dBm".
110  END
    
```

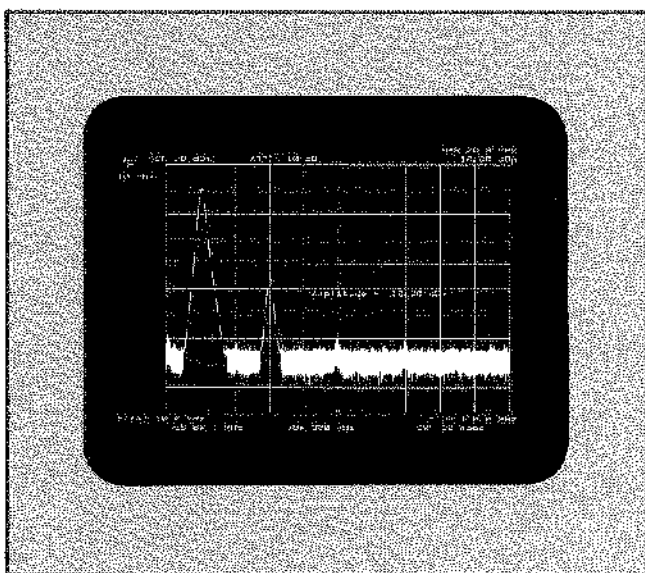

Figure 1. Display of variable value.

Output to Computer

To return the value of a variable to the computer, query the variable at the appropriate location in the program. For example, in the sample program, to return the value of A_MPLITUDE, simply add the following program lines at the end of the program:

```

10  OUTPUT 718;"A_MPLITUDE?"
20  ENTER 718;Amplitude
30  PRINT Amplitude
40  END
    
```

Variables can be queried as many times as desired and in any location in a program. Remember, variables are re-initialized after instrument preset is executed.

Input to Analyzer Variable

To enter or change the value of any front panel function, the EP (enable parameter) command can be used. For example, to allow the operator to specify the value of the start and stop frequencies, the sample program should be modified as follows.

```

10  OUTPUT 718;"VARDEF A MPLITUDE,0;"
20  OUTPUT 718;"IF;SNGLS;EM;D3;FU;FA 200,500;" !Set the display size and pen
30  !position.
40  OUTPUT 718;"TEXT @Enter Start Frequency@;" !Prompt operator to set the
50  !start frequency.
60  OUTPUT 718;"FA EP;" !Press the LCL key and enter
70  !any value into the start
80  !frequency.
90  OUTPUT 718;"FU;FA 200,400;" !Set the pen position.
100 OUTPUT 718;"TEXT @Enter Stop Frequency@;" !Prompt operator to set the
110 !stop frequency.
120 OUTPUT 718;"FB EP;" !Enter any value into the stop
130 !frequency.
140 OUTPUT 718;"TS;MKPK HI;"
150 OUTPUT 718;"MOV A_MPLITUDE,MKA;"
160  END

```

When lines 60 and 120 are executed, the analyzer pauses the program and waits for a front panel entry. Press the LCL key on the analyzer before entering the start frequency. The entry must be terminated with one of the units keys. Notice that this technique performs an internal pause and continue, similar to the PAUSE and CONTINUE keys on the controller. This technique is very useful for a pause and continue function in a downloadable program.

The EP command can be used to set or change the value of a variable. For example, to compare the value of A_MPLITUDE with a user-specified level, the level can be entered into a variable using the EP command and then compared with A_MPLITUDE.

Only positive real numbers can directly be entered into variables. (See the HELPFUL HINTS section of this note for an example of direct variable value entry.) Negative values are indirectly entered as illustrated in the program below. The minimum level of interest is entered into the display line since the display line allows negative entries. The entered value is then moved into the variable, C_OMPARIION. Add the following program lines to the end of the previous sample program. Now the program allows the user to specify the lowest signal level of interest and reports the value of A_MPLITUDE if its value is greater than the specified level. Otherwise, it reports that no signal is found.

```

160  OUTPUT 718;"VARDEF C_OMPARIION,0;" !Initialize the variable
170  OUTPUT 718;"EM;D3;PU;PA 50,600;" !and set the pen position.
180  OUTPUT 718;"TEXT @Enter Minimum Level of Interest, in dBm@;"
190  OUTPUT 718;"DL EP;" !Prompt operator to enter
200  !the minimum level of
210  !interest to the display
220  !line. (Press LCL first).
230  !Use the numeric data keys
240  !and <-dBm> key to enter a
250  !negative value.
260  OUTPUT 718;"MOV C_OMPARIION,DL;" !Move that value into
270  !C_OMPARIION.
280  OUTPUT 718;"IF A_MPLITUDE,GE,C_OMPARIION THEN;" !If A_MPLITUDE is
290  OUTPUT 718;" PU;PA 100,400;TEXT @Amplitude = @;" !greater than or equal
300  OUTPUT 718;" DSPLY A_MPLITUDE,6,3;" !to C_OMPARIION, then
310  OUTPUT 718;"ELSE PU;PA 100,400;" !report the amplitude,
320  OUTPUT 718;" TEXT @No Signal Found Above @;" !otherwise, report that
330  OUTPUT 718;" DSPLY C_OMPARIION,6,3;TEXT @ dBm@;" !no signal is found
340  OUTPUT 718;"ENDIF;" !above the user-specified
350  END !level.

```

TRACES

Storage

Arrays up to 1008 points in length can be stored in the analyzer's RAM. There are 16K bytes of available random access memory (RAM). Since each point uses 2 bytes, up to 8 1000-point arrays or 16 500-point arrays can be stored in RAM.

To store a trace in RAM, a trace array must be defined using the TRDEF command. TRDEF allocates the specified amount of

memory to a specified trace name. The trace name must consist of 2 to 12 capital letters. An underscore should always be used as the second letter of a trace label to avoid analyzer misinterpretation of the label. (See page 1 of Programming Note HP 8566B/8568B/Models 216/226/236-99 for more information.) Traces A, B, and C are 1001 points in length. Therefore, to store one of these traces, define a trace of 1001 points and move the active trace into the defined trace. The program below stores trace A in RAM under the trace label, R__EFERENCE. Trace A is not affected.

```

10  OUTPUT 718;"TRDEF R__EFERENCE,1001;"      'Define a 1001 point array labeled,
20                                          'R__EFERENCE.
30  OUTPUT 718;"MOV R__EFERENCE,TRA;"        'Store trace A in that array.
40  END
    
```

To initialize the values in a defined trace, simply use the MOV command as follows:

```

OUTPUT 718;"MOV R__EFERENCE,0;"
    
```

This initializes all 1001 points of R__EFERENCE to 0 (display units are assumed). A trace can be initialized to any integer value between -32,767 and 32,767. Practical integer values for displayed traces range between -1023 and 1023.

Display

The TRGRPH command displays trace A, B, or C, or a user-defined trace anywhere on the spectrum analyzer CRT. Separate display of more than one trace on the CRT usually requires the traces to be compressed in length and scaled in amplitude using the COMPRESS and MPY commands, respectively.

Compressed traces take up less space in RAM, thus more traces can be stored. The COMPRESS command compresses a trace of a given length into a trace of a smaller length according to a specified algorithm or trace detection mode. The ratio between the length of these two traces is the number of points to be compressed into each point of the compressed trace. For example, if trace A

were to be compressed to 50 points, then the length ratio would be $1001/50 = 20$ and the amplitude value for each 20-point interval would depend on the algorithm specified. If the average algorithm were used, then the amplitude values stored in each element of the compressed trace would be the average value over each 20-point interval of the trace to be compressed.

The indicated 3-letter mnemonics show the algorithms that can be used for the COMPRESS command.

- AVG (average) — selects the average value of the points in the interval
- POS (positive) — selects the highest point in the interval
- NEG (negative) — selects the lowest point in the interval
- NRM (normal) — computes the compressed value of the interval using the Rosenfell algorithm, which chooses between positive and negative peak values
- PK-PIT (peak-pit) — computes the greatest peak-to-peak deviation within the interval as the compressed value
- PK-AVG (peak average) — selects the difference of the peak and average value of the interval as the compressed value
- SMP (sample) — selects the last point in the interval as the compressed value

The program below compresses trace A to 50 points using the average algorithm.

```

10  OUTPUT 718;"TRDEF S__AMPLE,50;"          'Define a 50 point trace labeled
20                                          'S__AMPLE.
30  OUTPUT 718;"COMPRESS S__AMPLE,TRA,AVG;"  'Compress trace A to 50 points
40  END                                       'using the average algorithm of
50                                          'compression.
    
```

Traces can be scaled in amplitude using the MPY command which multiplies a trace, point by point, by either another trace or by a real number. (See the Programming Commands section of the HP 8566B or 8568B Operating and Programming Manual for

more information on MPY.) To change the amplitude of the elements in S__AMPLE to 1/3 scale, the program requires the following modification.

```

10  OUTPUT 718;"TRDEF S_AMPLE,50;"
20  OUTPUT 718;"COMPRESS S_AMPLE,TRA,AVG;"
30  OUTPUT 718;"MPY S_AMPLE,S_AMPLE,0.3;"
40  END
50

```

'Multiply each point in S_AMPLE
'by 0.3 and store the result in
'S_AMPLE.

The TRGRPH command can now be used to graph S__AMPLE anywhere on the analyzer screen. (See line 40 in the next example.) Five parameters must be specified in the TRGRPH command: the display address, the x and y coordinates of the trace origin, an expanding factor, and the trace array to be graphed.

The displayed data must be stored in display memory; therefore, a starting display address must be specified. (See Appendix A of the HP 8566B or 8568B Remote Operation Manual for a discussion of the display memory structure.) If trace C is not used in a program that uses TRGRPH, it is often convenient to use the starting address of trace C, 3072.

The analyzer screen's x-axis and y-axis positions of the trace origin must also be specified. These values depend on what display size is being used (D1, D2, or D3). (Refer to the Programming Commands section of the HP 8566B or 8568B Remote Operation Manual for more information on selecting xy coordinate values using the various display sizes.)

If a trace is compressed to save space in RAM, it might be desirable for the trace to be graphically expanded across the CRT when it is displayed. Hence an expanding factor is specified in the TRGRPH command to allow the trace to be displayed in any length. This expansion is a graphic expansion and does not actually change the trace data. If a 1001-point trace were compressed to 50 points, but the displayed trace width desired is half screen (500 points), then the expanding factor should be 10.

Finally, the trace to be graphed must be specified. The trace can be a trace label, trace A (TRA), trace B (TRB), or trace C (TRC).

The following program graphs S__AMPLE in the upper right corner of the CRT. To make the graph more interesting, connect the analyzer's calibrator signal and set the center frequency to 20 MHz for the HP 8568B and 100 MHz for the HP 8566B. Set the frequency span to 2 MHz, place trace A in CLEAR-WRITE and run the program.

```

10  OUTPUT 718;"TRDEF S_AMPLE,50;"
20  OUTPUT 718;"COMPRESS S_AMPLE,TRA,AVG;"
30  OUTPUT 718;"MPY S_AMPLE,S_AMPLE,0.3;"
40  OUTPUT 718;"TRGRPH 3072,500,700,10,S_AMPLE;"
50  END
60
70
80
90

```

'S_AMPLE is graphed with
'its origin at x=500 and
'y=700. The displayed data is stored in display
'memory beginning at display address 3072. S_AMPLE
'is expanded by a factor of 10, making the displayed
'trace 500 points in length.

Notice each time the program is run, the compressed trace is updated. This is useful for viewing more than one frequency span simultaneously. For example, to view a signal's fundamental, second harmonic and third harmonic simultaneously on the analyzer screen, the frequency spans containing these signals can be consecutively swept and graphed. This process can be repeated to simulate a real-time, simultaneous monitor of the three signals. The program below performs this function.

Note: If the HP 8566B is used, replace lines 390, 430 and 510 with

```

390  OUTPUT 718;"FA99MZ;FB101MZ;"
430  OUTPUT 718;"FA199MZ;FB201MZ;"
510  OUTPUT 718;"FA299MZ;FB301MZ;"

```



```

10  ! Filename: HARM MONITOR   Date: 15.9.84
20  ! Program Description:    This program simultaneously displays the
30  !                          fundamental, second, and third harmonics
40  !                          of a 20 MHz signal.
50  !
60  ! Program begins here. . .
70  !
80  ! INITIALIZE
90  !
100 OUTPUT 718;"TRDEF F_UND,50;TRDEF S_ECOND,50;" !Define 50 point traces
110 OUTPUT 718;"TRDEF T_HIRD,50;VARDEF C_DUNT,0;" !that will be used to
120 !                          store the signal's funda-
130 !                          mental, second, and third
140 !                          harmonic. Also define a
150 !                          variable to be used as a
160 !                          loop counter.
170 OUTPUT 718;"IP;SMGLS;ANNOT OFF;GRAT OFF;" !Instrument preset, set
180 !                          sweep mode, turn off the
190 !                          annotation and graticule.
200 OUTPUT 718;"TRDSP TRA,OFF;" !Turn off trace A's display
210 !                          but continue taking data.
220 OUTPUT 718;"D1;DA1024;PU;PA 400,950;" !Set the display size to
230 !                          D1, set the starting dis-
240 !                          play address to 1024 (the
250 !                          starting address of trace
260 !                          B). Set the pen location
270 !                          to x=400 and y=950.
280 OUTPUT 718;"TEXT @HARMONIC MONITORING@" !Put labels on the analyzer
290 OUTPUT 718;"PU;PA 100,700;TEXT @FUNDAMENTAL@" !screen.
300 OUTPUT 718;"PU;PA 100,500;TEXT @SECOND HARMONIC@"
310 OUTPUT 718;"PU;PA 100,300;TEXT @THIRD HARMONIC@"
320 !
330 ! BEGIN REPEAT LOOP
340 !
350 OUTPUT 718;"REPEAT ;" !Start a repeat loop.
360 !
370 ! FUNDAMENTAL
380 !
390 OUTPUT 718;"FA19MZ;FB21MZ;TS;" !Sweep the fundamental and
400 OUTPUT 718;"COMPRESS F_UND,TRA,AVG;" !compress the 1001-point
410 OUTPUT 718;"MPY F_UND,F_UND,0.3;" !trace A into the 50-point
420 !                          trace, F_UND, using the
430 !                          average algorithm. Scale
440 !                          F_UND to 1/3 amplitude.
450 OUTPUT 718;"FA39MZ;FB41MZ;TS;" !Perform the same process
460 OUTPUT 718;"COMPRESS S_ECOND,TRA,AVG;" !on the second and third
470 OUTPUT 718;"MPY S_ECOND,S_ECOND,0.3;" !harmonics.
480 !
490 ! THIRD HARMONIC
500 !
510 OUTPUT 718;"FA59MZ;FB61MZ;TS;"
520 OUTPUT 718;"COMPRESS T_HIRD,TRA,AVG;"
530 OUTPUT 718;"MPY T_HIRD,T_HIRD,0.3;"
540 !
550 ! GRAPH TRACES
560 !
570 OUTPUT 718;"TRGRPH 3072,500,600,10,F_UND;" !Graph F_UND, S_ECOND and
580 OUTPUT 718;"TRGRPH 3173,500,400,10,S_ECOND;" !T_HIRD expanded by a fac-
590 OUTPUT 718;"TRGRPH 3274,500,200,10,T_HIRD;" !tor of 10, (making the
600 !                          displayed length 500).
610 !                          The trace origins for
620 !                          F_UND, S_ECOND and T_HIRD
630 !                          are x=500 & y=600,400,200,
640 !                          respectively. The begin-
650 !                          ning display addresses are
660 !                          explained below.
670 ! TERMINATE LOOPING CONSTRUCT
680 !
690 OUTPUT 718;"ADD C_DUNT,C_DUNT,1;" !Increment the looping
700 OUTPUT 718;"UNTIL C_DUNT,EQ,15;" !counter and repeat the
710 END !process 15 times.

```

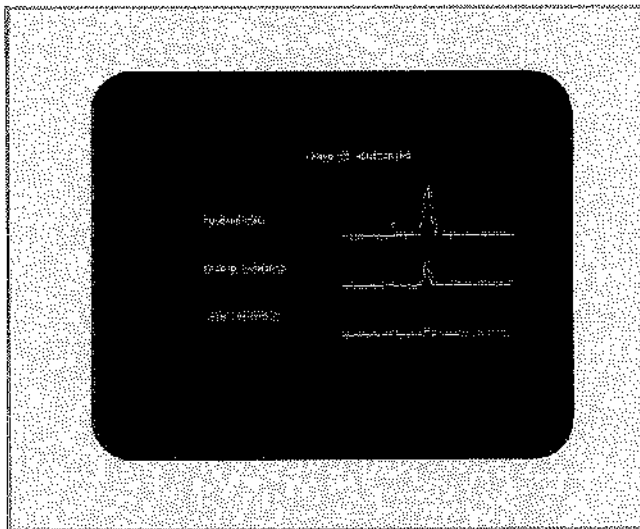



Figure 2. Display of compressed traces.

The starting display address in the first TRGRPH command (line 570) is 3072. The trace that is graphed, F__UND, is 50 points in length which means that the trace actually fills 100 bytes of display memory (2 bytes per point). Thus display addresses 3072 through 3172 are filled with the data contained in F__UND. This makes the starting display address of S__ECOND, in line 580, 3173. S__ECOND is also 50 points in length, filling display addresses 3173 through 3273, making the starting display address of T__HIRD, 3274 (line 590).

Note: When debugging programs that turn off the trace, graticule, and annotation, it is often useful to temporarily turn them on while debugging. The displayed error messages can reveal the source of the problem and give a better picture of what the program is doing.

Trace Output to a Computer

All elements of traces A, B, C, or a user-defined trace can be returned to a controller by querying the trace and entering the trace elements into a computer array. For example, to return data in a 1001-point user-defined trace and print every 100th point on the controller, key in the following.

```

10  OUTPUT 718;"TRDEF D_ATA,1001;"      !Define a 1001 point trace labeled
20  OUTPUT 718;"MOV D_ATA,TRA;"        !D_ATA and move trace A into it.
30  DIM A(1001)                        !Dimension a computer array to 1001.
40  OUTPUT 718;"D_ATA?;"              !Return the 1001 points in D_ATA to
50  ENTER 718:A(*)                     !the computer array.
60  FOR I=1 TO 1001 STEP 100           !Print every 100th element on the
70  PRINT A(I)                         !computer screen.
80  NEXT I
90  END

```

Specific trace elements of a user-defined trace can be returned to the controller by moving the elements to be transferred into trace A, B, or C. These elements can be queried and entered into a computer array. If there are only a few elements to be transferred, it is more practical to move the elements into an analyzer variable.

The variable is then queried and entered into a computer variable. This process is continued until all elements have been transferred. For example, every fifth element of F__UND (50-point trace used in a previous example) can be returned to the controller and displayed using the following program.

```

10  OUTPUT 718;"VARDEF T_EMP,0;"       !Define a variable to temporarily
20                                     !hold the value of each trace
30                                     !element as it is returned to the
40                                     !controller.
50  IMAGE K,K,K                        !Omit leading and trailing spaces
60                                     !for correct analyzer command
70                                     !interpretation in line 90.
80  FOR I=1 TO 50 STEP 5               !Move every 5th value of F__UND into
90  OUTPUT 718 USING 50;"MOV T_EMP,F__UNDI":I;"I;"
100 OUTPUT 718;"T_EMP?;"              !T_EMP and return each value to the
110 ENTER 718:N                        !controller. Print on controller
120 PRINT N                             !screen.
130 NEXT I
140 END

```

The image specifier in line 50 is necessary for the analyzer to correctly interpret line 90 of the program. Without using the image specifier, the trailing space which is automatically sent over the HP-IB after the first string, "MOV T___EMP,FUND[", would erroneously be interpreted by the analyzer as a command separator. (For further information refer to the BASIC Language Reference for Series 200 Computers.)

Data Input to an Analyzer Trace

Some applications require large amounts of data to be compared to, or used in measurements. For example, in millimeter applications the conversion loss of an external mixer at various frequencies can be added to measured values for amplitude-calibrated measurements. There are also applications that require comparison of a standard trace to measured values. The ability to put data in-

to an analyzer trace proves a convenient solution to many such applications. However, it is not without limitation. First, the maximum number of data points that can be stored in a trace is 1008. Second, the largest number that can be stored in an analyzer trace element is 32,767 ((2¹⁵)-1). Third, only integers can be stored. Both positive and negative numbers are accepted but non-integer numbers are rounded. If one- or two-decimal precision is required, the data can be pre-scaled before it is entered in the trace and scaled back to its original value when extracted. For example, to store the number 12.62 in a trace element, the number can be multiplied by 100 before it is stored, then divided by 100 before it is used in the measurement.

The following program asks the user to enter 10 data values. It then puts these values in the elements of an analyzer trace.

```

10  OUTPUT 718;"TRDEF E_LEMENTS,10;"  'Define a 10 point trace labeled
20  'E_LEMENTS.
30  FOR I=1 TO 10                      'Enter 10 values into the computer
40  IMAGE "ENTER TRACE ELEMENT ",K," AND PRESS RETURN"
50  OUTPUT 1 USING 40;I                'array, Element.
60  INPUT Element(I)
70  NEXT I
80  FOR I=1 TO 10                      'Move the 10 values in Element to
90  IMAGE K,K,K,K,K                    'the analyzer's trace, E_LEMENTS.
100 OUTPUT 718 USING 90;"MOV E_LEMENTS";I;"1,";Element(I);";"
110 NEXT I
120 END
    
```

HELPFUL HINTS

Data Input to an Analyzer Trace from the Analyzer's Front Panel

In the last example, data was put into an analyzer trace from a computer. This task can also be accomplished by entering the data from the analyzer's front panel. This is useful in applications where it is convenient to operate the analyzer without a controller. The data entry can be part of a downloadable program executed via softkey from the front panel. The EP command is used to pause the program for operator entry in the same manner as was used in the "Input to Analyzer Variable" section of this note. The values entered can also be viewed on the analyzer screen in columnar

format. The program below accomplishes this using the PU (pen up), PA (plot absolute), PR (plot relative), DSPLY (display a trace element value), and TEXT (write characters on the analyzer screen) commands. Refer to the HP 8566B or 8568B Operating and Programming Manual for more information on these commands.

To display characters on the analyzer screen in columnar format, it is important to know that each character written requires 16 display units on the x-axis and 32 display units on the y-axis. Therefore, pen positions indicated in plot absolute (PA) or plot relative (PR) commands should be integer multiples of 16 and 32 for the x and y axes, respectively. This convention will assure organized data columns. For example, data is columnated in line 570 of the program below by using integer multiples of 16 and 32 to indicate relative x and y positions in a REPEAT/UNTIL loop.

```

10  ' Filename: M_I_XER CORR
20  ' Program Description:
30  '
40  '
50  '
60  '
70  'Program begins here. . .
80  '
90  'INITIALIZE
100 '
110 OUTPUT 718;"VARDEF I_NDEX,1;"      ' Define the variables I_NDEX and
120 OUTPUT 718;"VARDEF E_NTRY,0;"     ' E_NTRY.
130 OUTPUT 718;"TRDEF F_ACTORS,10;"   ' Define 10 element trace F_ACTORS.
140 '
    
```



```

150 DEFINE FUNCTION
160
170 OUTPUT 718;"FUNCDEF M_I_XER CORR @;" ! Define function A RRAY to store and
! display 10 data elements.
180
190 OUTPUT 718;"BLANK TRA:GRAT OFF;ANNOT OFF;" ! Blank the analyzer screen.
200 OUTPUT 718;"REPEAT;" ! Start of data entry loop
210 OUTPUT 718;"EM;D2;PU;PA;192,480;" ! Clear trace C, set display address to
! 3072, set the display size to D2, pick
220 ! the pen up and start writing at x=192
230 ! and y=480.
240
250
260 PROMPT OPERATOR TO ENTER VALUE
270
280 OUTPUT 718;"TEXT / ENTER TRACE ELEMENT # /;DSPLY I_NDEX,2.0;"
290 OUTPUT 718;"TEXT / AND PRESS HZ/;"
300
310 ENTER THE VALUE AND INCREMENT THE INDEX
320
330 OUTPUT 718;"E_NTRY EP;" ! Enter the value into E_NTRY.
340 OUTPUT 718;"MOV F_ACTORS[I_NDEX],E_NTRY;" ! Move the entry into the
! appropriate trace element.
350
360 OUTPUT 718;"ADD I_NDEX,I_NDEX,1;" ! Increment the index by one
370 OUTPUT 718;"UNTIL I_NDEX,EO,11;" ! Perform the loop until all 10 elements
! are entered.
380
390 OUTPUT 718;"MOV I_NDEX,1;" ! Reset the index to 1.
400
410 DISPLAY THE ELEMENT VALUES ON THE ANALYZER SCREEN
420
430 OUTPUT 718;"EM;PU;PA;192,960;" ! Clear trace C, which sets the display
! address to 3072, pick the pen up and
440 ! start writing at x=192 (12*16) and
450 ! y=960 (30*32).
460
470 OUTPUT 718;"TEXT / ELEMENT # /;" ! Write column heading
480 OUTPUT 718;"PU;PA;512,960;" ! Pen up and start writing at element
! x=512 (32*16) and y=960 (30*32)
490
500 OUTPUT 718;"TEXT / DATA /;" ! Write column heading
510 OUTPUT 718;"PU;PA;256,960;" ! Pen up and start writing at
! y=256 (16*16) and y=960 (30*32). Data
520 ! will be written relative to this posi-
530 ! tion.
540
550 OUTPUT 718;"REPEAT;" ! Start loop to display indices in a
! column.
560
570 OUTPUT 718;"PU;PR;-16,-64;" ! Pen up and start writing -16,-64 from
! the last pen position.
580
590 OUTPUT 718;"DSPLY I_NDEX,2.0;" ! Display the current index value.
600 OUTPUT 718;"ADD I_NDEX,I_NDEX,1;" ! Increment the index by 1
610 OUTPUT 718;"UNTIL I_NDEX,EO,11;" ! Display the values of the index in a
! column until 10 values are displayed.
620
630 OUTPUT 718;"PU;PA;576,960;" ! Pen up and start second column at
! x=576 (36*16) and y=960 (30*32).
640
650 OUTPUT 718;"MOV I_NDEX,1;" ! Reset index to 1.
660 OUTPUT 718;"REPEAT;" ! Start loop to display trace elements
! in a column.
670
680 OUTPUT 718;"PU;PR;-64,-64;" ! Pen up and start writing data -64,-64
! relative to the last pen position.
690
700 OUTPUT 718;"DSPLY F_ACTORS[I_NDEX],S.0;" ! Display the trace element value
! indicated by the current value of the
! index.
710
720
730 OUTPUT 718;"ADD I_NDEX,I_NDEX,1;" ! Increment the index by 1
740 OUTPUT 718;"UNTIL I_NDEX,EO,11;" ! Continue the loop until all 10 trace
! elements are displayed.
750
760 OUTPUT 718;"@;" ! Terminate the function M_I_XER CORR
770 OUTPUT 718;"KEYDEF 88,M_I_XER CORR;" ! Assign the function to softkey 88.
780 END ! End program.

```

Trace Output to a Computer in Binary Format

Binary format is the fastest mode to transfer information between the controller and analyzer. Each trace element is transmitted as two 8-bit bytes. To return a 1001-point trace to a computer, 2002 bytes must be transferred to the controller. Binary format allows these bytes to be transferred quickly since it does not convert data to decimal numbers or to correct units, and each byte transferred is not followed by a carriage-return/line-feed.

The HP 8566A and 8568A analyzers allowed binary transfers with the TA and TB commands by specifying 02 format. TA and TB are the only trace output commands available in the A version analyzers. The 8566B and 8568B allow traces A, B, C or user-

defined traces to be transferred in binary format by using the trace data format (TDF) and measurement data size (MDS) commands. "TDF B" selects the binary mode and "MDS W" sets the measurement data size to two bytes per trace element.

The controller receives the bytes one at a time over the HP-IB and forms a 16-bit integer word in computer memory. This formatting is caused by specifying an integer array, which is 16 bits by definition. Also the format must be turned off (FORMAT OFF) in the I/O path.

The program below shows the commands that should be used before querying an analyzer trace to allow the trace to be sent in binary format.

```

10  OPTION BASE 1                !Start counting array elements from 1.
20  INTEGER Array(1001)         !Specify an integer array and set format
30                                !to 16 bit.
40  ASSIGN #Sa TO 718:FORMAT OFF !Set binary transfer format on HP-IB.
50  OUTPUT 718:"TDF B;MDS W;TRA?;" !Transfer trace A in binary, 2 bytes
60                                !per word.
70  ENTER #Sa:Array(*)         !Put binary data in Array.
80  END

```





For more information, call your local HP sales office listed in the telephone directory white pages. Ask for the Electronic Instruments Department. Or write to Hewlett-Packard: U.S.A. — P.O. Box 10301, Palo Alto, CA 94303-0890. Europe — P.O. Box 999, 1180 AZ Amstelveen, the Netherlands. Canada — 6877 Goreway Drive, Mississauga, L4V 1M8, Ontario. Japan — Yokogawa-Hewlett-Packard Ltd., 3-29-21, Takaido-Higashi, Suginami-ku, Tokyo 168. Elsewhere in the world, write to Hewlett-Packard Intercontinental, 3495 Deer Creek Road, Palo Alto, CA 94304.

6952-9398

PRINTED IN U.S.A.



Programming Note

HP 8566B/8568B/Models 216/226/236-99

August 1984

Supersedes: None

A STRUCTURED APPROACH TO DOWNLOADABLE PROGRAMMING

OVERVIEW

A downloadable program (DLP) is a program written in spectrum analyzer commands that is loaded into the analyzer's 16K bytes of RAM, and can be fully executed within the spectrum analyzer, whether run from the analyzer's front panel or from the computer. A DLP allows the analyzer to evaluate data it collects without the help of a controller. Powerful software can be written by using a DLP in a computer program, especially if the DLP and computer program utilize the high level functions of the "B".

The purpose of this programming note is to show how to structure a downloadable program for the HP 8566B and 8568B Spectrum Analyzers with emphasis on readability, modularity, and ease-of-debugging. It does not discuss in any detail the firmware commands available in the HP 8566B and 8568B. Trace processing, graphics, and special functions, such as FFT, PEAKS, and STDEV, will not be covered in this note. For more information, refer to the HP 8566B/8568B Operating and Programming Manual (part numbers 8566-90040 and 8568-90041).

Prerequisites

To more easily understand this programming note, some experience with HP 8566A/8568A manual and remote operation is required. An understanding of Programming Note HP 8566B/8568B/9816/9826/9836-1 (publication number 5952-9389) is recommended. No familiarity with the analyzers' graphics is required.

Reference Materials

Analyzer reference materials include the HP 8566/8568B Quick Reference Guide (publication number 5955-8970), the HP 8566B/8568B/9816/9826/9836-1 Introductory Operating Guide (publication number 5952-9389), and the Command Syntax Reference found in the HP 8566B/8568B Operating and Programming Manual (part numbers 8566-90040 and 8568-90041).

Equipment Used

HP 8566B or 8568B Spectrum Analyzer
HP 9000 Series 200 Model 216, 226, or 236 Desktop Computers.

READABILITY

Making a program easy to read also makes it easier to debug and document. Here are a few simple rules to follow which apply to any program (including a DLP) which make it more readable:

1. Write short program lines.

2. Use the standard indent format for looping, branching, and subroutines.
3. Use descriptive variable names and labels.
4. Clearly document program lines as necessary.

Recommended DLP Procedures

In addition to the general readability rules given above, there are several more procedures which apply specifically to a DLP in making it more readable and less prone to error.

5. Define all variables (VARDEF) and traces (TRDEF) at the beginning of the program — NOT within a FUNCDEF (i.e., softkey definition).

Variable definitions (VARDEF) and trace definitions (TRDEF) are explained in detail in the reference documents listed earlier.

VARDEFs and TRDEFs are global which means that variables and traces retain their values until redefined, disposed of, or altered by MOV or math commands. By defining variables and traces at the beginning of the program, potential problems can be avoided. If a variable or trace is defined within a function definition, querying the analyzer for available memory will result in an incorrect value. If they are defined at the beginning of the program, a correct value will be obtained. This is very important when linking several programs together where memory space is a prime concern. (The method for determining available analyzer memory is given in the HELPFUL HINTS section later in this note.)

6. Use an underscore as the second letter of all function labels, variable labels, and trace labels.

If this rule is not followed, there is a possibility that these labels could be misinterpreted by the analyzer as one of its own commands. For example, in the statement, "FUNCDEF STOP,@", the first two letters of STOP could be interpreted by the analyzer as the command for sweep time, ST. The correct statement would read as follows: "FUNCDEF S__TOP,@".

7. Use semi-colons between analyzer commands.

IEEE Standard 728 recommends the use of semi-colons between commands to avoid possible misinterpretation by the analyzer. For example, if the analyzer is commanded to execute "VBOA" (Video Bandwidth and Output Active function), a syntax error would result causing the program to stop or to be subject to a long delay in execution. Instead of interpreting VB and OA as separate commands, it first executes "VBO" (ratio of video bandwidth to resolution bandwidth) and then tries to execute "A", which results in the syntax error. The correct command sequence is "VB;OA;".



The sample program below illustrates the concepts discussed above. It checks to see if there are any signals on the analyzer screen that are above -60 dBm. If there are, the analyzer zooms in on the signal to a 100 kHz span and saves that trace in analyzer memory.

The @'s appearing in lines 60 and 200 delimit the function definition. All commands appearing between delimiters are as-

signed to the function label, C Heck.

Note: When code is indented in a function definition, each space takes two bytes of analyzer RAM. Care must be taken not to exceed the maximum length of a function definition (2015 bytes). To save space, the entire program line can be indented.

```

10  OUTPUT 718;"VARDEF P OWER,0;"          'Define a variable, P OWER,
20  'initialized to 0.
30  OUTPUT 718;"TRDEF S AVE,1001;"        'Define a 1001 point trace
40  'called S AVE.
50  '
60  OUTPUT 718;"FUNCDEF C HECK,@"        'Define a function called
70  'C HECK.
80  OUTPUT 718;"TS;MKPK HI;"             'Put a marker on the highest
90  'signal on the screen.
100 OUTPUT 718;"IF MA,GT,-60DBM THEN "   'If there is a signal higher
110 OUTPUT 718;"  MKTRACK ON;"           'than -60 dBm, zoom to a
120 OUTPUT 718;"  SP100KZ;"             '100 kHz span, center it
130 OUTPUT 718;"  MKTRACK OFF;IS;"       'and bring it to the reference
140 OUTPUT 718;"  MKPK HI;MKCF;MKRL;TS;" 'level. Then store it in a 1001
150 OUTPUT 718;"  MOV P OWER,MA;"        'point trace previously defined
160 OUTPUT 718;"  MOV S AVE,TRP;"        'as having the label, S AVE.
170 OUTPUT 718;"  SAVES 1;"              'Save the control settings in
180 'register 1.
190 OUTPUT 718;"ENDIF;"                  'End the IF statement.
200 OUTPUT 718;"@;"                       'End the definition of C HECK.
210  END

```

MODULARITY

The example in the previous section was a simple case of a DLP. However, it assumed that the analyzer was manually set to the correct span by the operator. To completely automate the operation, it is necessary to set the analyzer to the desired span. The following DLP steps the analyzer through four pre-defined

spans to find a signal higher than -60 dBm. If no signal is found in the first span, it steps to the next higher span. When a signal is found, the DLP zooms in on the signal, stores the signal and records its amplitude. If a signal is found in any of the four spans, the DLP halts execution and displays the last signal found.

```

10  ' File name: EXAMPLE           Date: 6/29/84           Author: NAME
20  ' Description of Program:      This program checks for signals above -60dBm
30  '                               in the following spans: 10-12 MHz, 12-14 MHz,
40  '                               14-16 MHz, and 16-110 MHz. If a signal is
50  '                               found, it "autozooms" to a 100kHz span, records
60  '                               the signal level, and displays the highest
70  '                               frequency signal found in trace B.
80  '
90  ' Program begins here. . . .
100 '
110 ' INITIALIZE:
120 '
130 OUTPUT 718;"VARDEF P OWER,0;"        'Define a variable, P OWER,
140 'initialized to 0.
150 OUTPUT 718;"TRDEF S AVE,1001;"        'Define a 1001 point trace
160 'called S AVE.
170 '
180 ' SUBROUTINES:
190 '
200 OUTPUT 718;"FUNCDEF S PANONE,@"      'Define functions called
210 OUTPUT 718;"  FA10MZ;FB12MZ;"        'S PANONE, S PAN TWO, S PANTHREE
220 OUTPUT 718;"@;"                       'and S PANFOUR that will set
230 'the start and stop frequencies
240 OUTPUT 718;"FUNCDEF S PAN TWO,@"     'to 10-12 MHz, 12-14 MHz, 14-16
250 OUTPUT 718;"  FA12MZ;FB14MZ;"        'MHz, and 16-110 MHz, respec-
260 OUTPUT 718;"@;"                       'tively.
270 '
280 OUTPUT 718;"FUNCDEF S PANTHREE,@"    '
290 OUTPUT 718;"  FA14MZ;FB16MZ;"        '
300 OUTPUT 718;"@;"                       '
310 '
320 OUTPUT 718;"FUNCDEF S PANFOUR,@"     '
330 OUTPUT 718;"  FA16MZ;FB110MZ;"      '
340 OUTPUT 718;"@;"                       '
350 '

```



```

360 OUTPUT 718:"FUNCDEF CHECK;"
370
380 OUTPUT 718:" TS;MKPK HI;"
390
400 OUTPUT 718:" IF NA,GT,-60DBM THEN "
410 OUTPUT 718:" MKTRACK ON;"
420 OUTPUT 718:" SP10KZ;"
430 OUTPUT 718:" MKTRACK OFF;TS;"
440 OUTPUT 718:" MKPK HI;MKCF;MKRL;TS;"
450 OUTPUT 718:" MOV P.OWER,NA;"
460 OUTPUT 718:" MOV S.AVE,TRA;"
470 OUTPUT 718:" SAVES I;"
480
490 OUTPUT 718:" ENDIF;"
500 OUTPUT 718:"@;"
510
520 * MAIN PROGRAM:
530
540 OUTPUT 718:"FUNCDEF E.XAMPLE;"
550 OUTPUT 718:" SNGLS;MOV S.AVE,0;"
560 OUTPUT 718:" REPEAT "
570 OUTPUT 718:" S.PANONE;C.CHECK;"
580 OUTPUT 718:" S.PANTWO;C.CHECK;"
590 OUTPUT 718:" S.PANTHREE;C.CHECK;"
600 OUTPUT 718:" S.PANFOUR;C.CHECK;"
610 OUTPUT 718:" UNTIL S.AVE,NE,0;"
620 OUTPUT 718:" MOV TRB,S.AVE;"
630 OUTPUT 718:" RCLS I;BLANK TRA;VIEW TRB;"
640 OUTPUT 718:"@;"
650
660
670
680 OUTPUT 718:"KEYDEF 20,E.XAMPLE;"
690 END
700
710
720

```

Define a function called C.CHECK.
Put a marker on the highest signal on the screen.
If there is a signal higher than -60 dBm, zoom to a 100 kHz span, center it and bring it to the reference level. Then store it in a 1001 point trace previously defined (as having the label, S.AVE).
Save the control settings in register I.
End the IF statement.
End the definition of C.CHECK.

The main program labeled E.XAMPLE, puts the analyzer in single sweep mode and sets all values in S.AVE to zero. Then it checks each span to see if a signal greater than -60 dBm is in any of them. It does this until a non-zero value is found in S.AVE. It then puts the signal found into trace B and recalls the analyzer settings that existed when the signal was found.
E.XAMPLE is assigned to softkey 20 so the program can be executed from the front panel by pressing: [SHIFT] [20] [Hz].

Notice that four subroutines have been added (S__PANONE, S__PANTWO, etc.). Each subroutine sets the analyzer to a different frequency range. The DLP from the previous section now becomes a subprogram. Each of the five subroutines is called from the main program, E__XAMPLE (lines 540-640). Line 680 loads the entire DLP into softkey 20 in the analyzer. Now, the controller can be removed and the program can be executed by pressing [SHIFT] [20] [Hz] on the analyzer front panel. To execute the DLP from the controller, type in:

```

OUTPUT 718:"E.XAMPLE;"

```

(and press EXECUTE).

This modular format offers three distinct advantages: it's (1) easy to read, (2) easy to change, and (3) easy to debug. This DLP uses descriptive labels, and it flows in a logical fashion, making it readable. In addition, it is easy to modify. For example, if the application requires the stop frequency of the last span to extend to 4 GHz, simply change FB110MZ in S__PANFOUR to FB4GZ.

Downloadable Program Structure

Now that the DLP has been designed for readability and modularity, it is important to insure that the format of the program follows a logical, structured order. The following steps are highly recommended for making all downloadable programs easy to read and easy to debug. The example DLP uses this format, as indicated by the line numbers.

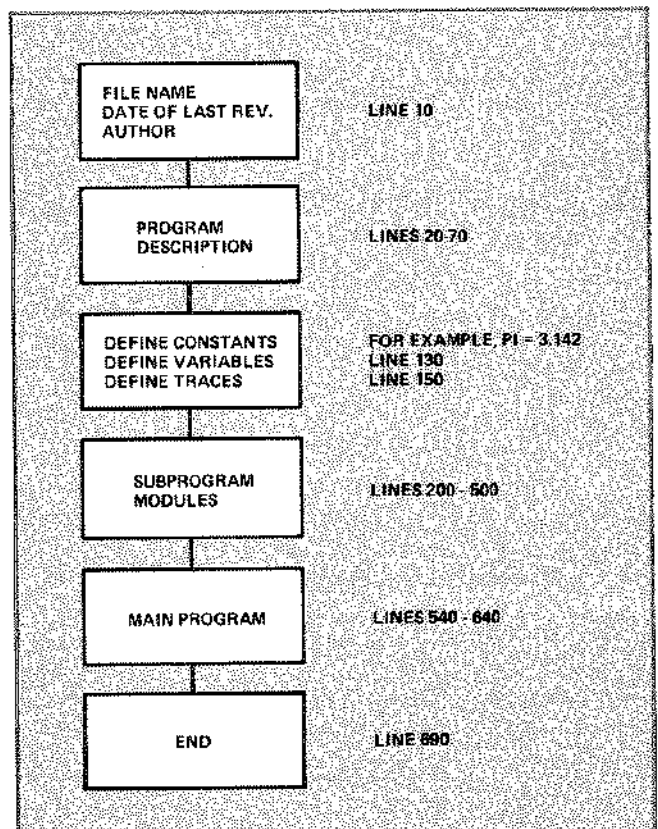

DEBUGGING

More often than not, a new program must be debugged. In downloadable programs, bugs may be manifested in three ways:

1. An error message comes up on the analyzer screen.
2. The DLP does the unexpected. For example, it halts execution or enters an infinite loop or starts executing before a command is given to execute.
3. An unexpected or out-of-range result or value is obtained.

Using the example program, some techniques will be illustrated which can be used to efficiently debug a DLP that has these symptoms.

Error Message

The discussion will start with the case where an error message comes up on the analyzer screen. For example, in line 290 of the example program,

```
290 OUTPUT 718:"FV14MZ:FV16MZ;"
```

FV16MZ is mistakenly typed in.

When the program, E__XAMPLE, is executed, this line will cause an HP-IB command error which will be indicated on the analyzer screen as shown in Figure 1.

Admittedly, in this short example program it would be simple to look through the program and find where FV has been mistakenly typed in. However, in larger programs it might be more difficult to locate exactly where an FV has been typed. If BASIC 2.1 Extensions to BASIC 2.0 are used, use the FIND command to locate FV. Type FIND "FV" at the top of the program and press EXECUTE. However, if another operating system is being used, such as BASIC 2.0, the line with FV can be located in other ways.

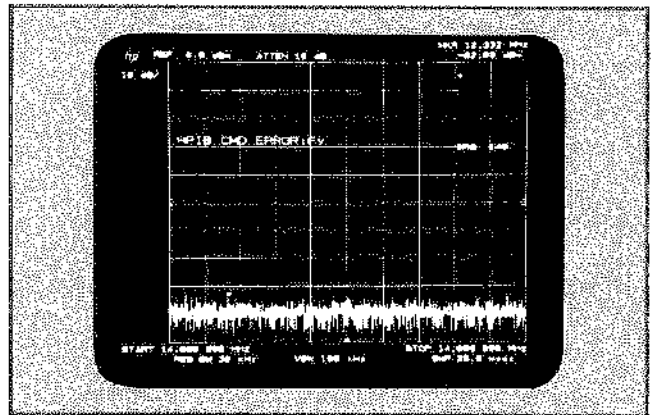

Figure 1. HP-IB command error message.

One way is to run the subroutines, then step through selected parts of the main program using the STEP key on the Series 200 controller. This can be done by placing a PAUSE statement on line 510. This will allow the program to be run up to the main program. In order to immediately execute the main program, the lines containing the FUNCDEF statement and its delimiters must first be eliminated by commenting them out (i.e., place an exclamation point at the beginning of lines 540 and 640). This must be done, because when the analyzer receives a FUNCDEF statement, it assigns all commands appearing between the delimiters (@ in the example) to the function label and will not allow the commands to be executed line by line by the STEP key. Also, lines containing looping constructs such as REPEAT, UNTIL, IF, THEN, ELSE, and ENDIF must be commented out to allow immediate execution. (Comment out lines 560 and 610.) The program should be modified as follows.

<pre>510 PAUSE 520 ! MAIN PROGRAM; 530 ! 540 !OUTPUT 718:"FUNCDEF E_XAMPLE,@" 550 OUTPUT 718:" SMOGLS:MOV S_AVE,0;" 560 !OUTPUT 718:" REPEAT " 570 OUTPUT 718:" S_PANTONE;C Heck;" 580 OUTPUT 718:" S_PANTNO;C Heck;" 590 OUTPUT 718:" S_PANTHREE;C Heck;" 600 OUTPUT 718:" S_PANTFOUR;C Heck;" 610 !OUTPUT 718:" UNTIL S_AVE,NE,0;" 620 OUTPUT 718:" MOV TRB,S_AVE;" 630 OUTPUT 718:" RCLS 1;BLANK TRA:VIEW TRB;" 640 !OUTPUT 718:"@;" 650 660 670 680 OUTPUT 718:"!EYDEF 20,E_XAMPLE;" 690 END 700 710 720</pre>	<pre>!The main program labeled !E_XAMPLE, puts the analyzer !in single sweep mode and !sets all values in S_AVE to !zero. Then it checks each !span to see if a signal !greater than -60 dBm is in !any of them. It does this !until a non-zero value is !found in S_AVE. It then puts !the signal found into trace B !and recalls the analyzer !settings that existed when !the signal was found. !E_XAMPLE is assigned to !softkey 20 so the program can !be executed from the front !panel by pressing: !(SHIFT) <20> <Hz>.</pre>
--	--

Press RUN, then STEP through the program from the controller. The HP-IB command error will appear when line 590 is executed. The search for FV has been narrowed to the S_PANTHREE and C Heck subroutines. To find which one is producing the error, immediately execute S_PANTHREE and C Heck one at a time from the controller or modify the program line to execute one subroutine at a time. When S_PANTHREE is executed, the HP-IB CMD ERROR:FV will appear on the analyzer screen.

Another way to selectively evaluate areas of a program is to use GOTO statements. These can be used instead of exclamation points. For example, GOTO 550 could have been placed after the PAUSE statement and GOTO 570 could have been put in after line 550 to selectively execute program lines instead of using comments.

Notice the advantage of keeping program lines short. The shorter the lines, the more easily the search is narrowed. Of course, using short lines causes more output activity on the HP-IB,

but if this is of concern, the carriage return/line feed can be suppressed by typing

```
OUTPUT Sa USING "#,." ; "command list ;"
```

at the beginning of each line, where Sa = 718.

Also note the advantage of keeping softkey definitions short. The shorter the softkey, again, the more the search has been narrowed. If S__PANTHREE had been large, it might have been difficult to find the line with FV in it. However, even if this had been the case, PAUSE and GOTO 290 could have been placed on lines 270 and 271, respectively, to step through S__PANTHREE line by line. (The maximum number of bytes that can be in a softkey definition is 2015, which far exceeds what is recommended here to easily debug a program.)

HP-IB command errors can also occur if variable, trace, or function names are not first defined in VARDEF, TRDEF, or FUNCDEF statements, respectively. If the names are not defined before they are used, the undefined name will appear on the analyzer screen in the argument of the HP-IB CMD ERROR. Also, errors occur if function, variable, or trace names are too long or an incorrect format is used. They must be 2 to 12 characters long using capital letters A through Z.

Unexpected Behavior

Another type of problem with a DLP might be that it just does the unexpected. After a DLP has been corrected for typing, spelling, and syntax errors, there are still possibilities for unexpected errors. These errors may not produce an error message but can have drastic effects on the proper execution of the DLP. The DLP might stop executing before it is supposed to, or it might continue executing even after the program should have halted. The DLP might cause the analyzer to "hang" or not respond to any subsequent commands. It might even start executing before the softkey has been executed. Although it can be frustrating when these kinds of problems occur, the type of behavior exhibited is usually a clue to the part(s) of the DLP that is causing the problem. The following paragraphs discuss the types of errors which can cause this behavior and some ways of searching for these errors in large DLP's.

When the DLP unexpectedly stops or does not stop execution, looping constructs may be improperly terminated in the program. Each REPEAT/UNTIL loop and IF/THEN/ELSE/ENDIF branch, whether nested or not, must always have a logical end. In the example, if the REPEAT/UNTIL loop was not terminated in line 610, the program would end whether or not a signal was present, since the REPEAT loop would not be active. Only one REPEAT/UNTIL loop appears in the program, so it is easy to check to see if the loop is terminated correctly. However, in larger DLP's there may be many nested REPEAT/UNTIL loops; therefore, checking for correct terminations will be more difficult.

The analyzer may "hang" or reach an undesired state from which the only exit is to press the instrument preset key on the front panel. A "hung" analyzer may be unresponsive to further execution of front panel keys or to execution of remote commands. It may indicate an error other than an HP-IB command error or the analyzer screen may start randomly writing characters or drawing vectors. Analyzer "hanging," which can have a number of causes, can be debugged systematically.

First, check that functions do not call themselves within their definitions. This is an unpermitted form of recursion. It may produce an "INVALID NEST LEVEL" error and/or it may cause strange characters to appear on the analyzer screen. The following section on looping and branching addresses this problem and shows ways of getting around this kind of recursion.

Second, if the DLP uses analyzer graphics, check that the graphics are used correctly. Refer to the HP 8566B/8568B Operating and Programming Manual and the HP 8566A/8568A Remote Operation Manual for details on analyzer graphics. If the analyzer screen appears to scroll, or if vectors are written randomly, check to see if label and text terminators are in the proper place.

Third, check that semi-colons are properly placed and command syntax is followed.

Improper use of delimiters may cause a DLP to begin execution before a command to execute is given. For example, if line 300 were omitted, S__PANTHREE would not be delimited. This would cause part of the DLP to be executed when it was downloaded to the analyzer (when RUN was pressed on the controller) because the beginning delimiter for S__PANFOUR would have been considered the terminating delimiter for S__PANTHREE. Then subsequent commands would be immediately executed. Remember, a delimiter must be placed just before the command list and a **matching** delimiter must be placed just after the command list. Also, make sure that the particular delimiter chosen is not used as a label or text terminator and is not used in text to be written to the analyzer screen.

The table below summarizes.

Symptom	Possible Cause
Stops or does not stop execution	Looping construct improperly terminated
Analyzer "hangs"	Recursion, improper use of analyzer graphics, improper use of semi-colons or command syntax
Program executes before command is given to execute	Improper use of function delimiters

Even with these hints of things to look for, there may still be a need to systematically search the DLP for the source of the problem. When these types of problems occur, the HP-IB command error message will not appear. But without the luxury of an error message, the problem can be located by examining the program as outlined in the Error Message section. First step through the main program without executing the looping constructs. If no problems are found, execute the program with the looping constructs. As each function label is executed, the function causing the unwanted behavior will hang the analyzer by not allowing the execution of any subsequent subroutines. Also, the program annunciator (the square on the lower right screen of the controller that indicates a program is running) will not disappear. This square indicates that the HP-IB line is busy.

Out-of-Range Result

The last type of problem that might occur in a DLP is when a variable or trace has an unexpected or out-of-range value. The value of variables and trace elements can be displayed on the analyzer screen through the use of the DSPLY command. In the example DLP, the variable, P__OWER, was used to store the marker amplitude value of the highest signal above -60 dBm (see line 450). To check that the variable value is correct, simply use the DSPLY command to display the value of P__OWER. If desired, display the value within the DLP by inserting the following line at the desired location in the program:

```
OUTPUT 718; "DSPLY P__OWER, 6.2;"
```

The number, 6.3, is simply the total field width, 6, and the desired number of displayed decimal places, 3. This number can be any specified number. For more information see the DSPLY command in the Operating and Programming Manual.

To display the value of P__OWER at the end of the program, insert the above line just after line 630. To monitor a value within a repeat loop, it may be convenient to put a PAUSE on the line after the DSPLY command since otherwise the value may be written repeatedly on the analyzer screen. The DSPLY command need not be inserted in the DLP itself. When debugging it is sometimes convenient to monitor the value of variables after the DLP has been executed. In this case, simply execute the above line from the controller.

To monitor the value of the 500th element of trace A, type in the following line at the desired location in the program:

```
OUTPUT 718:"DSPLY TRACE[0],6.3;"
```

Again, this can also be executed directly from the controller.

In summary, diligent use of PAUSE, GOTO < line number > , !, and DSPLY will be extremely useful in debugging a DLP. Although all of the problems and ways to debug are not covered here, some of the more common problems that might occur and ways to solve them have been discussed. This should make DLP development and maintenance run more smoothly.

LOOPING AND BRANCHING

The two main sets of program flow control (looping and branching) commands on the HP 8566B and 8568B are REPEAT/UNTIL and IF/THEN/ELSE/ENDIF. When using these commands, two important rules should be followed to avoid errors:

1. REPEAT/UNTIL LOOPS MUST NOT BE NESTED MORE THAN 5 LEVELS. Nesting can best be illustrated by the following diagram:

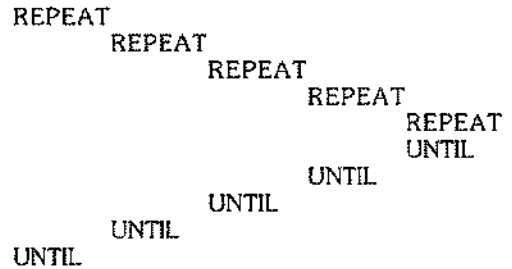

Note that each REPEAT has a corresponding UNTIL in this indented structure. Nesting higher than 5 levels will result in an error.

The following program is an example of illegal nesting. Although it does not look like the above nesting structure, it does nest REPEAT/UNTIL more than five times because recursion occurs in the program. (The function calls itself.)

```

10  OUTPUT 718:"VARDEF C_QUNT,0;"           ! Initialize and define the function.
20  OUTPUT 718:"FUNCDEF Z_OOM,0"          ! Z_OOM, which spans in on the
30  OUTPUT 718:" MKPK HI;MT1;SP100KZ;"    ! highest signal to 100 kHz, 100
40  OUTPUT 718:" MTO;TS;MKPK HI;MKCF;"    ! times.
50  OUTPUT 718:" ADD C_QUNT,C_QUNT,1;"
60  OUTPUT 718:" DSPLY C_QUNT,5.0;"
70  OUTPUT 718:" REPEAT "                 ! Lines 70, 80, and 90 attempt to
80  OUTPUT 718:" Z_OOM;"                  ! repeat Z_OOM 100 times except
90  OUTPUT 718:" UNTIL C_QUNT,EQ,100;"    ! each time the repeat loop is nested
100 OUTPUT 718:"R;"                       ! one level higher.
110 OUTPUT 718:"Z_OOM;"
120 END
    
```

Note that in line 60 the Z__OOM function calls itself 100 times. When it tries to perform the loop for the sixth time, the error message, "INVALID REPEAT NEST LEVEL" will appear on the analyzer CRT. As a result, the program must be modified such

that the REPEAT loop excludes the function definition, "Z__OOM". The following program builds the REPEAT loop around the command list rather than the entire function definition. It will now loop the desired 100 times.

```

10  OUTPUT 718:"VARDEF C_QUNT,0;"           ! Initialize and define the function.
20  OUTPUT 718:"FUNCDEF Z_OOM,R"          ! Z_OOM, which spans in on the
30  OUTPUT 718:" REPEAT "                 ! highest signal to 100 kHz, 100
40  OUTPUT 718:" MKPK HI;MT1;SP100KZ;"    ! times.
50  OUTPUT 718:" MTO;TS;MKPK HI;MKCF;"
60  OUTPUT 718:" ADD C_QUNT,C_QUNT,1;"
70  OUTPUT 718:" DSPLY C_QUNT,5.0;"
80  OUTPUT 718:" UNTIL C_QUNT,EQ,100;"
90  OUTPUT 718:"R;"
100 OUTPUT 718:"Z_OOM;"
110 END
    
```

2. AN IF/THEN/ELSE BRANCH MUST NOT BE NESTED HIGHER THAN 25 TIMES. Once again, a diagram can best illustrate this concept.

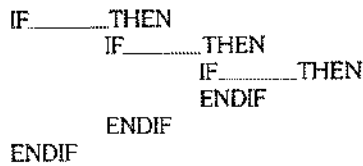

This example only shows 3 levels of nesting. An error would not occur until 26 levels were used. Note that each IF/THEN branch has an ENDIF associated with it.

The following is also an example of recursion. However, in this example the use of IF/THEN/ELSE is considered to be bad programming practice and should not be used since REPEAT/UNTIL is more appropriately used for looping. It is included in this note for illustration purposes only.

```

10 OUTPUT 718;"VARDEF C_QUNT,0;"
20 OUTPUT 718;"FUNCDEF Z_QQM,R"
30 OUTPUT 718;" MKF HI;MTI;SPLOKZ;"
40 OUTPUT 718;" NTO;TS;MKPK HI;MKCF;"
50 OUTPUT 718;" ADD C_QUNT,C_QUNT,1;"
60 OUTPUT 718;" DSPLY C_QUNT,E-7;"
70 OUTPUT 718;" UNTIL C_QUNT,EQ,100;"
80 OUTPUT 718;" IF C_QUNT,LT,100 THEN
90 OUTPUT 718;" Z_QQM;"
100 OUTPUT 718;" ENDIF;"
110 OUTPUT 718;"R;"
120 OUTPUT 718;"Z_QQM;"
130 END
  
```

Initialize and define the function, Z_QQM, which spans in on the highest signal to 100 kHz, 100 times.

Lines 80, 90, and 100 attempt to execute Z_QQM 100 times except each time Z_QQM is executed, the IF/THEN/ENDIF branch is nested one level higher.

This program will work fine for 25 loops, but on the 26th loop, "HP-IB COMMAND ERROR" and "PARAMETER ERROR" will appear on the analyzer CRT. Again, the problem is the function definition calling itself and the ENDIF is never seen. The solution is to use the REPEAT/UNTIL function given in the second program example in #1 above.

In summary, even though recursion is allowed by the analyzer for 5 REPEAT/UNTIL loops and 25 IF/THEN/ELSE loops, this practice is not recommended. The second program in #1 above is the recommended method.

HELPFUL HINTS

Available Memory

The HP 8566B and 8568B have 16K of user-defined RAM which can be used for many user-defined parameters such as traces, variables, functions, commands to be executed at the beginning or end of a sweep (ONSWP and ONEOS), and for math algorithms (TRMATH). To determine how much analyzer memory is required for a particular function or an entire DLP, the MEM command is used. The preceding DLP (E__XAMPLE) contains a variable, a trace, and several function definitions. To determine how much analyzer memory is used by the entire DLP, three steps are required. First, the current value of available analyzer memory must be determined (without the program being downloaded) by running the following program:

```

10 OUTPUT 718;"MEM";"
20 ENTER 718;Memory
30 PRINT Memory
40 END
  
```

Second, the DLP must be run. This step will download the entire DLP, and the required amount of analyzer memory will be taken. Third, the program above must be run to obtain the new value of available analyzer memory. Now it is simply a matter of subtracting the two values obtained in steps 1 and 3 to determine the memory used by the DLP. Incidentally, E__XAMPLE uses approximately

2,700 bytes of memory.

It is important to note that trace definitions require 2 bytes per trace element, so all unnecessary trace definitions should be eliminated to conserve memory.

If the analyzer memory is too full to allow another program to be downloaded, the error message, "INVALID SYMTAB OVERFLOW," will appear on the analyzer CRT. To allow memory space for a new program, the DISPOSE command can be used to eliminate DLP's already stored in the analyzer's 16K of RAM. Either individual programs or the entire contents of the analyzer's memory can be eliminated. For example, "DISPOSE E__XAMPLE" eliminates that specific program from the analyzer's memory while "DISPOSE ALL" eliminates the entire memory contents.

DLP Execution Time

To determine how long E__XAMPLE takes to execute, the following program should be run. Note that it uses the new HP 8566B and 8568B command, DONE.

```

10 T1=TIMEDATE
20 OUTPUT 718;"E__XAMPLE;DONE;"
30 ENTER 718;N
40 PRINT TIMEDATE-T1
50 END
  
```

Incidentally, E__XAMPLE takes about 2.75 seconds to execute.

BASIC 2.1 Helpful Features

There are numerous helpful features provided by the BASIC 2.1 Extension to the BASIC 2.0 Operating System which make typing DLP's much easier and faster. For example, Series 200 controller softkeys can be defined for repetitive statements such as OUTPUT 718 and ENTER 718. In addition, BASIC 2.1 includes a search-and-replace function (FIND, CHANGE) which allows variable names to be typed in very quickly in abbreviated form and later replaced easily with longer, more descriptive names. For example, P__AM is a short name which would be typed initially and later replaced with the more descriptive name, P__ERCENT__AM.



For more information, call your local HP sales office listed in the telephone directory white pages. Ask for the Electronic Instruments Department. Or write to Hewlett-Packard: **U.S.A.** — P.O. Box 10301, Palo Alto, CA 94303-0850. **Europe** — P.O. Box 999, 1180 AZ Amstelveen, the Netherlands. **Canada** — 8877 Coreway Drive, Mississauga, L4V 1M8, Ontario. **Japan** — Yokogawa-Hewlett-Packard Ltd., 3-29-21, Takaido-Higashi, Suginami-ku, Tokyo 168. Elsewhere in the world, write to Hewlett-Packard Intercontinental, 3495 Deer Creek Road, Palo Alto, CA 94304.

5952-9392

PRINTED IN U.S.A

HP 85863B BASIC Software Library



Modular Software to Aid Program Development
for the HP 8566B, 8567A, and 8568B Spectrum Analyzer

Technical Data

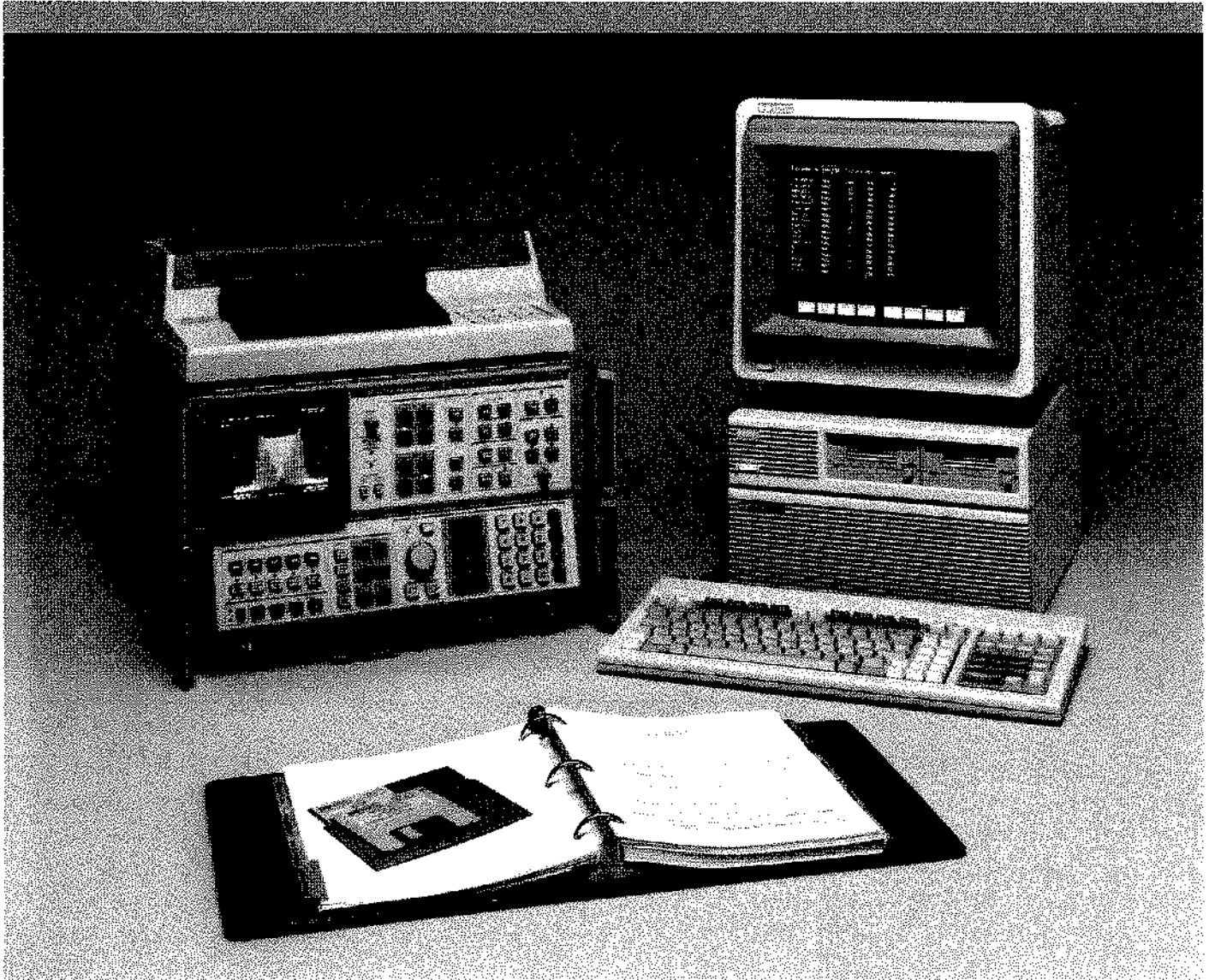

General Description

The HP 85863B BASIC Software Library is a set of subprograms and user documentation designed to help in the development of custom measurement programs for the HP 8566B, 8567A, and 8568B Spectrum Analyzers. The Software Library consists of general-purpose subprogram modules which can serve as the fundamental building blocks for a variety of spectrum analyzer measurement programs. Among these subprograms are routines which can plot the analyzer's display memory, search a trace for peaks, and calculate the equivalent noise or impulse bandwidth of the analyzer. The Software Library can improve programming productivity by reducing the time it takes to develop measurement software.

The HP 85863B consists of the Software Library disc and

a fully documented user manual. The major file on disc contains a main program header with the subprogram modules appended. Program development using the HP 85863B is illustrated with a harmonic distortion measurement program included on the Library disc. Also included is a program to check for proper system configuration.

The HP 85863B BASIC Software Library is written in BASIC 4.0 for the HP 9000 Series 200 Model 216, 226, 220 and 236, and Series 300 Model 310 and 320 computers. It is also compatible with BASIC 3.0 on the Series 200 computers. The HP 85863B is available in both 5¼ inch floppy format (option 655) and 3½ inch mini-floppy format (option 630). A minimum of 100K bytes of memory is recommended for the HP 85863B.

Extending Spectrum Analyzer's Capability

The HP 85863B extends the analyzer's measurement capability by providing software modules that can measure the equivalent noise or impulse bandwidth of the analyzer, set the RF attenuator for maximum dynamic range, or allow a bi-directional search for signal peaks.

Example: Eq_bw.sa

Subprogram Eq_bw.sa measures the equivalent noise or impulse bandwidth for a specified analyzer resolution filter. Equivalent bandwidth values are needed when measuring broadband signals such as impulse noise or random noise. Sub Eq_bw.sa has an optional pass parameter that allows you to specify a reference bandwidth so that a correction factor in dB may be computed.

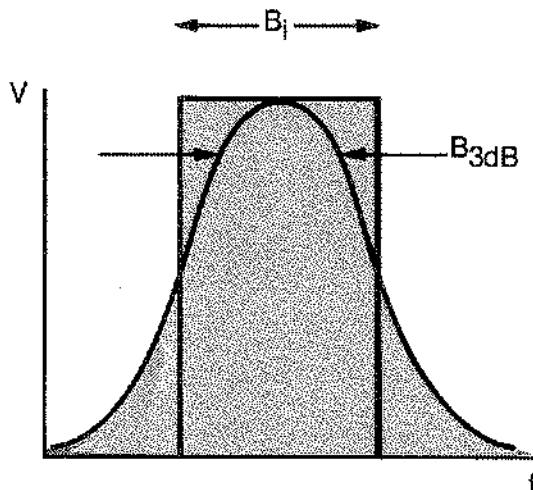

Impulse Bandwidth B_1 is Bandwidth of Rectangular Filter With Same Voltage Response as Actual Filter.

Fully-Documented User Manual

The user manual extensively documents how to use the subprograms to their full advantage. There are numerous application examples illustrating how to use the subprogram modules in spectrum analyzer measurement programs. The Program Development section shows how to develop a measurement program, using as an example a program for measuring oscillator harmonic distortion. The appendix contains annotated source code listings along with helpful hints on spectrum analyzer programming techniques.

Measurement Example

The HP 85863B Software Library contains a harmonic distortion program which illustrates proper spectrum analyzer measurement techniques as well as good programming practice. The program measures the amplitude and frequency of the fundamental and harmonics of an oscillator, and computes the total harmonic distortion. The program illustrates how to

- Measure CW signals
- Optimize analyzer's distortion-free dynamic range
- Select correct resolution bandwidth vs signal stability
- Peak preselector for microwave measurements on the HP 8566B
- Output test results

Before the harmonic distortion measurement is made, the program performs a series of tests on the input signal. The input signal is tested for frequency, amplitude and stability criteria as follows:

Frequency:

- HP 8566B: 100 kHz to 22 GHz
- HP 8567A and 8568B: 100 kHz to 1.5 GHz

Amplitude: -50 dBm to +30 dBm

Signal Stability:

- Amplitude: <1 dB
- Short-term frequency (peak to peak): <0.1% and <1 MHz

High-Level Routines

The high-level subprograms in the HP 85863B can minimize the time and cost required to design custom measurement programs. Additionally, the tutorial documentation can help users realize the full measurement capability of the spectrum analyzer.

In designing a measurement program, the preferred approach is to divide the measurement program into sub-tasks such as reading the amplitude or frequency of a marker, saving and recalling trace data, or plotting a CRT trace. Many of these sub-tasks are already completed for you in the HP 85863B so that you can concentrate on the measurement rather than on specific codes and formats.

Example: Mem_save.sa and Mem_recall.sa

Sub Mem_save.sa and Mem_recall.sa can be used to save a series of different analyzer displays on disc. The displays can be recalled later for plotting. Mem_save.sa saves the entire analyzer display memory that consists of trace A, trace B, trace C, graticule annotation, display markers, and active function area. Custom graphics displayed on the analyzer display can also be saved.

Example: Mem_plot

Make hard copies of the analyzer display using Sub Mem_plot. The Mem_plot subprogram plots the entire display memory of the spectrum analyzer to an HP-GL plotter. Mem_plot allows the analyzer to take new data while the previous data is being plotted. Optional parameters allow different pen colors or plot rotation to be specified.

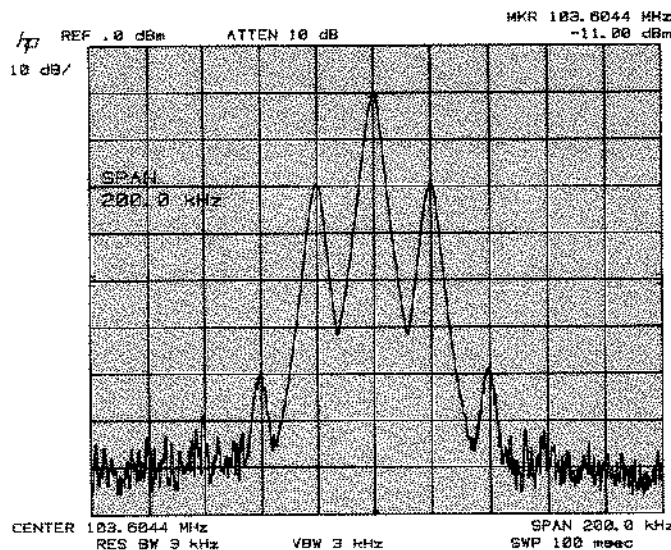

Save the spectrum analyzer display.

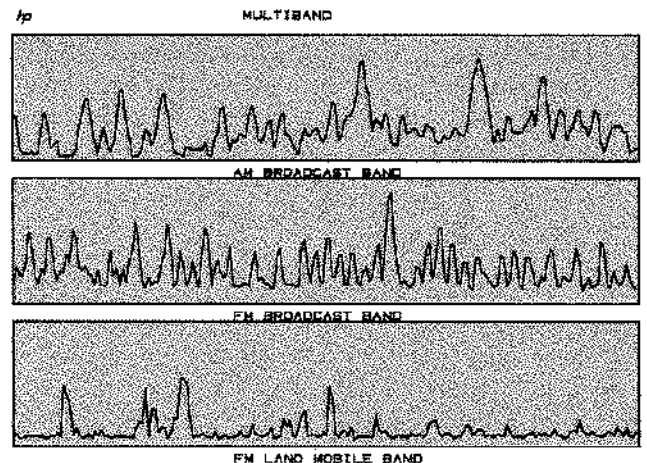

Save and plot custom graphics.

Subprogram

Description

Act.trace.sa	Returns active trace mnemonic and active marker number.
Ampl.scale.sa	Returns amplitude scale value and state.
Ampl.units	Returns amplitude value converted for units and impedance.
Atten.sa	Returns RF attenuation value in dB.
Center.freq.sa	Returns center frequency.
Cf.step.size.sa	Returns center frequency step-size.
Corr.state.sa	Returns self-correction state.
Cpl.states.sa	Returns function state and value.
Eq.bw.sa	Measures equivalent noise or impulse BW of analyzer.
Error	Displays error name, number and optional message.
Freq.mode.sa	Returns frequency display mode.
Freq.offset.sa	Returns frequency offset in Hz.
Freq.span.sa	Returns frequency span in Hz.
Identify.sa	Identifies and returns spectrum analyzer model number.
Instr.check.sa	Returns value of INSTR CHECK LEDs.
Learn.bits.sa	Returns value of bit field from learn string.
Ma.sa	Returns marker amplitude.
Mem.plot	Plots the CRT display on a plotter.
Mem.recall.sa	Restores display memory to spectrum analyzer.
Mem.save.sa	Saves spectrum analyzer display memory.
Mf.sa	Returns marker frequency.
Mkr.avg.sa	Returns average amplitude of specified frequency points.
Mkr.state.sa	Returns marker state.
Noise.sa	Calculates average noise based on analyzer settings.
Opt.range.sa	Sets RF attenuator for optimum dynamic range.
Peaks.sa	Finds X-axis position of trace peaks and minimums.
Pma.sa	Positions marker on trace and return marker amplitude.
Pmf.sa	Positions marker on trace and return marker frequency.
Presel.pk.sa	Returns code for preselector peaking action taken.
Recall.sa	Transfers learn string to analyzer.
Ref.level.sa	Returns reference level in current units.
Ref.offset.sa	Returns reference level offset.
Ref.units.sa	Returns reference level units.
Res.bw.sa	Returns resolution bandwidth in Hz.
Rf.input.sa	Returns RF input state.
Save.sa	Transfers learn string from analyzer to L\$.
Start.freq.sa	Returns start frequency in Hz.
Stop.freq.sa	Returns stop frequency in Hz.
Sweep.mode.sa	Returns sweep mode.
Sweep.time.sa	Returns sweep time in seconds.
Trace.ok.sa	Returns code to describe trace state.
Trace.recall.sa	Transfers 1001-point trace array to analyzer CRT.
Trace.save.sa	Transfers 1001-point trace array from Trace A, B, or C.
Trace.state.sa	Returns state of analyzer trace.
Video.bw.sa	Returns analyzer video BW in Hz.

REQUIRED EQUIPMENT

1. Spectrum analyzer: HP 8566B, HP 8567A, or HP 8568B
2. Computer: HP 9000 Series 200 or 300
3. Memory boards: HP 98256A (256 Kbyte) or HP 98257A (1 Mbyte)
4. BASIC 4.0 Language system: HP 98613B (RAM) or HP 98603A (ROM). Also compatible with BASIC 3.0
5. HP-IB cables: HP 10833A/B/C (one per device)

RECOMMENDED EQUIPMENT

1. HP-IB Printer: HP 2225A (Thinkjet) or HP 82906A
2. HP-IB Plotter: HP 7440A (ColorPro), HP 7475A or HP 7550A. Compatible with HP 9872A/B/C

ORDERING INFORMATION

HP 85863B BASIC Software Library
(must specify format option)
Option 630: 3½ inch disc format
Option 655: 5¼ inch disc format

The HP 85863B Software Library is developed and supported by Systems for Automatic Test in Sunnyvale, California.

For more information, call your local HP sales office listed in the telephone directory white pages. Ask for the Electronic Instruments Department. Or write to Hewlett-Packard: **U.S.A.** — P.O. Box 10301, Palo Alto, CA 94303-0890. **Europe** — P.O. Box 999, 1180 AZ Amstelveen, the Netherlands. **Canada** — 6877 Goreway Drive, Mississauga, L4V 1M8, Ontario. **Japan** — Yokogawa-Hewlett-Packard Ltd., 3-29-21, Takaide-Higashi, Suginami-ku, Tokyo 168. Elsewhere in the world, write to Hewlett-Packard Intercontinent, 3495 Deer Creek Road, Palo Alto, CA 94304.



Data Subject to Change
May 1, 1986

Printed in U.S.A.
5954-2728

Third Order Intermodulation Distortion Measurements

A Downloadable Procedure for HP 8566B and 8568B Spectrum Analyzers

Introduction

Third order intermodulation distortion (IMD) measurements are complex and can be tedious when performed manually, even when sophisticated measuring instruments such as HP 8566B or 8568B Spectrum Analyzers are used. Performing such measurements automatically from a computer is far more efficient, since less operator time and effort is required. The downloadable capability of an HP 8566B or 8568B Spectrum Analyzer adds to this efficiency by making it possible to execute programs that are stored in the analyzer and get results, instead of data, from the analyzer.

This product note contains a complete program that measures the third order IMD products of two input signals in the range of 10 MHz to 500 MHz. This program can be downloaded into an HP 8566B or 8568B Spectrum Analyzer and executed from the analyzer front panel, or run from a computer.

Prerequisites

To fully understand the third order IMD program, some experience in analyzer programming is necessary. *The Introductory Operation Guide* (HP publication number 5952-9389) and the HP 8566B or 8568B *Operating and Programming Manual* (HP part numbers 08566 - 90040 and 08568 - 90041, respectively) are good references for developing an understanding of analyzer programming. An understanding of downloadable programming concepts is also required. *A Structured Approach to Downloadable Programming* (HP publication number 5952 - 9392) is a good source for such information. Other references that may prove useful are *Spectrum Analysis . . . Distortion Measurements* (HP publication number 5952 - 9235), and *Quick Reference Guide for HP 8566B and HP 8568B Spectrum Analyzers* (HP publication number 5955 - 8970).

Equipment

A list of the equipment necessary to make third order IMD measurements follows:

- 1 — HP 8566B or 8568B Spectrum Analyzer
- 2 — Signal sources, ranging in frequency from 10 MHz to 500 MHz (such as HP 8640B and HP 8656B Signal Generators)
- 1 — Signal combiner, such as an HP 8721A Directional Coupler (up to 100 MHz), HP 11667A power splitter, or Weinschel 1502 Combiner
- 2 — 6 dB pads (recommended to improve isolation between signal sources)
- 2 — Low-pass filters (recommended if large IMD products are generated within the signal sources)
- Connecting cables, power cords, and adapters where necessary

Test Setup

To simulate a test for third order IMD, connect the equipment as shown in Figure 1:

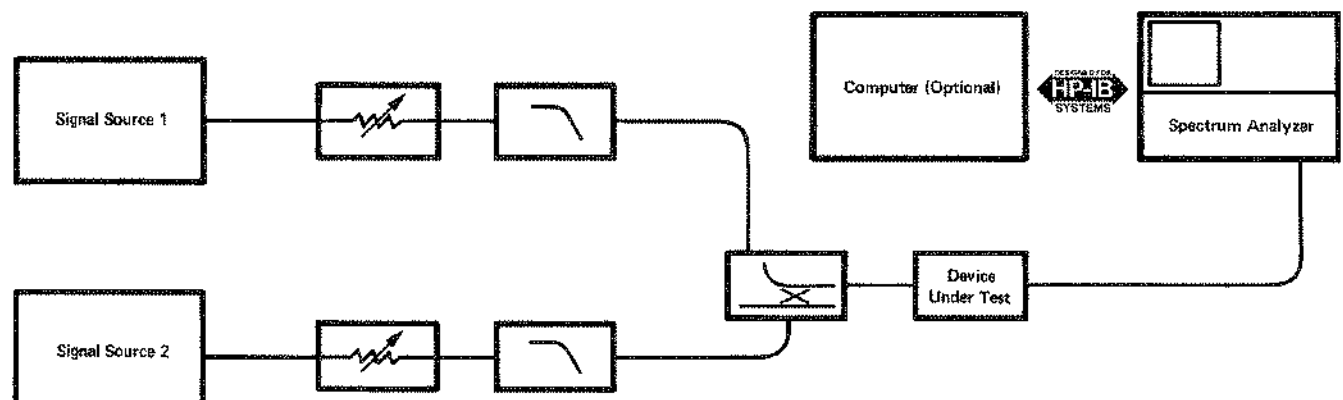

Figure 1. Test Setup for Third Order IMD Measurements

Why Measure Third Order Intermodulation Distortion?

Two-tone third order intermodulation is a common problem in narrow-band systems. When two (or more) signals are present in a system, strong harmonic components are often generated (See Figure 2). In cases where two signals are present, the two signals (f_1 and f_2) mix with each other's second harmonic ($2f_1$ and $2f_2$) and create distortion products evenly spaced about the fundamentals ($2f_1 - f_2$ and $2f_2 - f_1$). Components such as amplifiers, mixers, and filters can generate third order intermodulation distortion products.

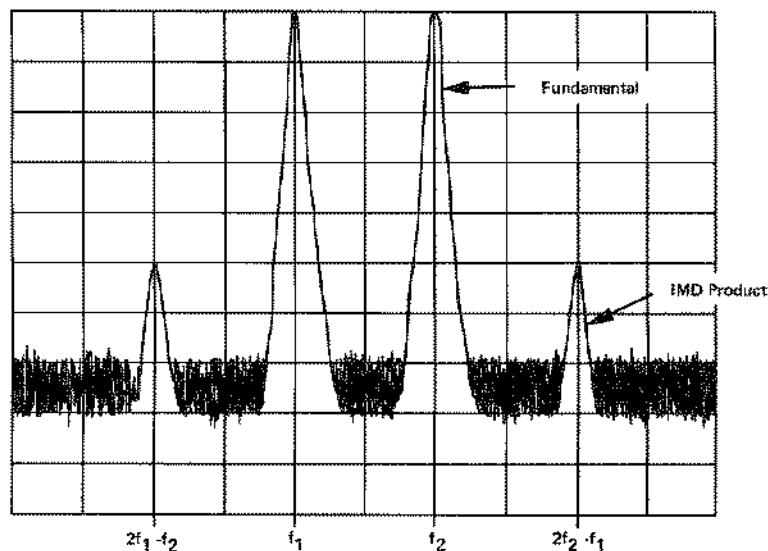

Figure 2. Two-Tone Third Order Intermodulation (Fundamentals and IMD Products)

These distortion products can degrade the performance of many communication systems, such as FM and AM transceivers and high frequency radio teletypes. For example, signals transmitted with excessive third order IMD can interfere with other transmissions. Receivers must also be distortion-free, especially in the preamplifier stages, to prevent crosstalk between adjacent channels.

Third Order Intermodulation Distortion Program

The program contained in this product note is designed to test for two-tone third order intermodulation distortion. The program begins by bringing the test tones on the analyzer display, setting the attenuator for optimum dynamic range, and measuring the amplitudes and frequencies of the input signals. It then locates the third order IMD products, measures them, and returns their amplitudes in dBc. It also reports the frequency separation and level of the test tones. If the third order IMD products are too low in amplitude to be measured, it reports this instead. The program can be executed from a computer or from the front panel of the analyzer.

The input signals must be in the range of 10 MHz to 500 MHz. They can be separated anywhere from 1 kHz to 10 kHz, and the difference in their amplitudes should be less than 2 dB. The program takes approximately 22 seconds to execute when measuring test tones that are 3 kHz to 10 kHz apart; it takes approximately 94 seconds to execute when measuring test tones that are 1 kHz and 3 kHz apart. The program is accurate to within ± 0.4 dB for signal separations from 3 kHz to 10 kHz, with the spectrum analyzer operating in the corrected* mode. For signal separations from 1 kHz to 3 kHz, accuracy is ± 1.5 dB, with the analyzer operating in the corrected* mode.

When typing the program into the computer, follow all HP 8566B and 8568B programming syntax requirements. By typing the program as shown, these requirements will be met. Program comments (text appearing on a line after an exclamation point) may be omitted.

If downloadable procedures are already stored in the analyzer's RAM, it may be necessary to dispose of some or all of these procedures to provide the 4802 bytes of memory space required for the third order IMD program. To dispose of all procedures stored in RAM, type:

```
OUTPUT 718;"DISPOSE ALL;"  
and press [EXECUTE].
```

*To access the corrected mode, press [SHIFT] [W], and [SHIFT] [X]. The analyzer must be operating in the 20°C to 30°C temperature range. The accuracy of the results is reduced when the analyzer is not operated in the corrected mode.

Program List

The following is a line-by-line listing of the program, followed by the program annotation.

```
10 ! Filename: T_HIRDIMOD Date: 25.12.84
20 ! Description of program: This is a downloadable program for the
30 ! HP 8566B and 8568B that measures the
40 ! third order intermodulation products of
50 ! two equal amplitude signals that are
60 ! separated in frequency from 1 kHz to
70 ! 10 kHz. The test tones must be within
80 ! the 10 MHz to 500 MHz frequency range.
90 ! The program sets the attenuator for opti-
100 ! mum dynamic range and tests that the test
110 ! tones are equal in amplitude (within 2 dB).
120 ! The program reports if no third order
130 ! products appear above the noise level.
140 ! Executable using: T_HIRDIMOD or <SHIFT> <2> <Hz>
150 ! Execution time: Separations from 3 kHz to 10 kHz; 22 sec.
160 ! Separations from 1 kHz to 3 kHz; 94 sec.
170 !
180 ! Required memory allocation: 4802 bytes
190 !
200 ! Program begins here. . .
210 !
220 ASSIGN @Sa TO 718
230 !
240 ! INITIALIZE VARIABLES AND TRACES
250 !
260 OUTPUT @Sa;"VARDEF O_PTRANGE,0;VARDEF T_ONE,0;VARDEF T_TWO,0;"
270 OUTPUT @Sa;"VARDEF T_ONEAMP,0;VARDEF T_TWOAMP,0;VARDEF H_EIGHT,0;"
280 OUTPUT @Sa;"VARDEF D_IFF,0;VARDEF N_OISE,0;"
290 OUTPUT @Sa;"VARDEF I_MRDBC,0;VARDEF I_MLDBC,0;"
300 OUTPUT @Sa;"VARDEF H_OLD,0;VARDEF L_EFT,0;"
310 OUTPUT @Sa;"TRDEF S_TORE,1008;"
320 !
330 ! FIND THE TEST TONES AND STORE THEIR FREQUENCY AND AMPLITUDE
340 ! IN PREDEFINED VARIABLES
350 !
360 OUTPUT @Sa;"FUNCDEF T_ESTTONES,@"
370 OUTPUT @Sa;"IP;SNGLS;EM;FA 10 MZ;FB 500 MZ;"
380 OUTPUT @Sa;"TS;MKPK HI;MKTRACK ON;"
390 OUTPUT @Sa;"SP30KZ;VB1KZ;TS;"
400 OUTPUT @Sa;"MKTRACK OFF;TS;MKPK HI;"
410 OUTPUT @Sa;"IF MA,GT,RL THEN;"
420 OUTPUT @Sa;" REPEAT;"
430 OUTPUT @Sa;" RL UP;TS;MKPK HI;"
440 OUTPUT @Sa;" UNTIL MA,LE,RL;"
450 OUTPUT @Sa;"ENDIF;"
460 OUTPUT @Sa;"ADD O_PTRANGE,MA,38;"
470 OUTPUT @Sa;"IF AT,LT,O_PTRANGE THEN;"
480 OUTPUT @Sa;" REPEAT;"
490 OUTPUT @Sa;" AT UP;"
500 OUTPUT @Sa;" UNTIL AT,GE,O_PTRANGE;"
510 OUTPUT @Sa;"ENDIF;"
520 OUTPUT @Sa;"MKRL;TS;"
530 OUTPUT @Sa;"MOV T_ONE,MF;"
540 OUTPUT @Sa;"MOV T_ONEAMP,MA;"
550 OUTPUT @Sa;"MKPX 10DB;"
560 OUTPUT @Sa;"MKPK NH;"
570 OUTPUT @Sa;"MOV T_TWO,MF;"
580 OUTPUT @Sa;"MOV T_TWOAMP,MA;"
590 OUTPUT @Sa;"@"
600 !
610 ! IF THE TEST TONES ARE NOT OF EQUAL AMPLITUDE
```

Program Annotation

Lines 10 - 200: Program name and description.

Line 220: Assign the spectrum analyzer address, 718, as @Sa.

Lines 260 - 310: Define the variables in the program and set their initial values.

Line 360: Define the function in Lines 370 - 590 as T___ESTTONES.

Lines 370 - 590: Set the spectrum analyzer's start frequency to 10 MHz and stop frequency to 500 MHz. Zoom in on the higher amplitude test tone to a 30 kHz span. If the peak of the signal is above the reference level, increase the reference level until the signal peak is at or below it. Set the attenuator for optimum dynamic range, then move the signal peak to the reference level and measure it. Store the signal's frequency value in variable T___ONE and its amplitude value in variable T___ONEAMP. Locate the second test tone, measure it, and store its frequency and amplitude values in variables T___TWO and T___TWOAMP, respectively.

```

1580 !
1590 ! MAIN FUNCTION
1600 !
1610 OUTPUT @Sa;"FUNCDEF T_HIRDIMOD, @"
1620 OUTPUT @Sa;"T_ESTONES;E_QUALAMP;P_PRODUCTS;M_EASURE;C_CHECK;"
1630 OUTPUT @Sa;"@"
1640 !
1650 ! DEFINE THE PROGRAM AS SOFTKEY TWO
1660 !
1670 OUTPUT @Sa;"KEYDEF 2,T_HIRDIMOD;"
1680 END

```

Line 1610: Define the main function in Line 1620 as **T_HIRDIMOD**.

Line 1620: Specify the sequence of the functions to test for third order IMD products: find the test tones, check for equal amplitude, locate and measure the third order IMD products, and ensure the products are above the noise level. If the products are above the noise level, report the measured results, or else report they are too low to be measured.

Line 1670: Make the program accessible from the front panel under softkey 2.

Program Execution

To execute the program from the analyzer front panel, press **[SHIFT][2][Hz]**. Or, to execute it from a controller, type:

```
OUTPUT 718:"T_HIRDIMOD;"
```

and press **[EXECUTE]**.

Application Example

To measure the internal third order IMD of an amplifier:

Before testing an amplifier (or any other device), run the program without the amplifier in the system to ensure the system is not producing intermodulation distortion products. If the program results show the products are above the noise, increase the attenuation at the output of the signal sources or check the low-pass filters to ensure they are not passing any test-tone harmonics. When the system distortion is eliminated, insert the amplifier between the output of the combiner and the input of the analyzer as shown in the section, Test Setup.

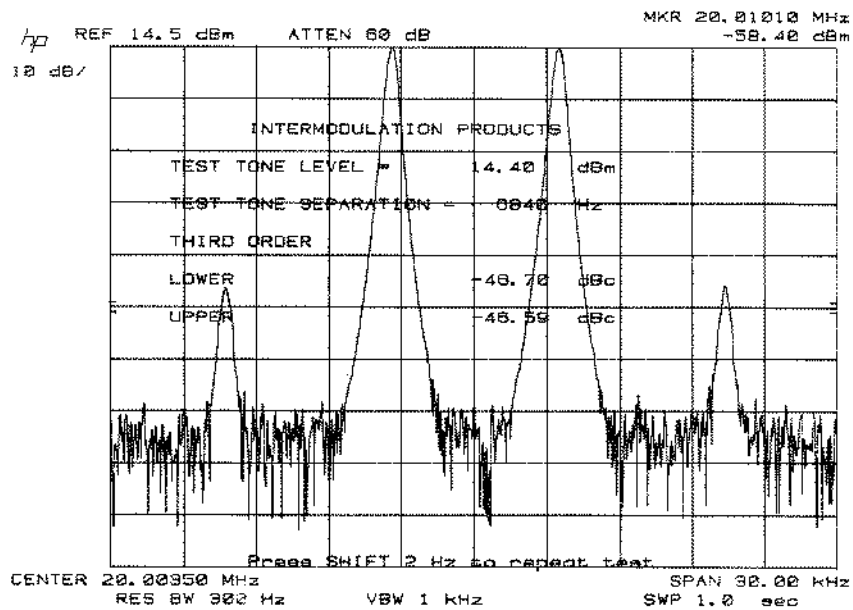

Figure 3. Example of T_HIRDIMOD Results.

For more information, call your local HP sales office listed in the telephone directory white pages. Ask for the Electronic Instruments Department. Or write to Hewlett-Packard: U.S.A. — P.O. Box 10301, Palo Alto, CA 94303-0890. Europe — P.O. Box 999, 1180 AZ Amstelveen, the Netherlands. Canada — 6877 Goreway Drive, Mississauga, L4V 1M8, Ontario. Japan — Yokogawa-Hewlett-Packard Ltd., 3-29-21, Takaido-Higashi, Suginami-ku, Tokyo 168. Elsewhere in the world, write to Hewlett-Packard Intercontinental, 3495 Deer Creek Road, Palo Alto, CA 94304.

```

620 ! OPERATOR IS PROMPTED TO ADJUST THEM WITHIN 2 dB
630 ! OF EACH OTHER
640 !
650 OUTPUT @Sa;"FUNCDEF E_QUALAMP,@"
660 OUTPUT @Sa;"SUB H_EIGHT,T_ONEAMP,T_TWOAMP;"
670 OUTPUT @Sa;"IF H_EIGHT,LT,0;"
680 OUTPUT @Sa;" THEN SUB H_EIGHT,0,H_EIGHT;"
690 OUTPUT @Sa;"ENDIF;"
700 OUTPUT @Sa;"IF H_EIGHT,GT,2 THEN;"
710 OUTPUT @Sa;" CONTS;DA3072;D3;PU;PA100,600;TEXT /ADJUST TEST TONES FOR
EQUAL/;HD;"
720 OUTPUT @Sa;" PU;PA100,550;TEXT /AMPLITUDE AND PRESS THE HZ KEY/;"
730 OUTPUT @Sa;" SS EP;"
740 OUTPUT @Sa;" EM;SNGLS;TS;MKPK HI;"
750 OUTPUT @Sa;" MOV T_ONE,MF;"
760 OUTPUT @Sa;" MOV T_ONEAMP,MA;"
770 OUTPUT @Sa;" MKPK NH;"
780 OUTPUT @Sa;" MOV T_TWO,MF;"
790 OUTPUT @Sa;" MOV T_TWOAMP,MA;"
800 OUTPUT @Sa;"ENDIF;"
810 OUTPUT @Sa;"@";
820 !
830 ! FIND THE THIRD ORDER PRODUCTS
840 !
850 OUTPUT @Sa;"FUNCDEF P_PRODUCTS,@"
860 OUTPUT @Sa;"IF T_ONE,GE,T_TWO THEN ;"
870 OUTPUT @Sa;" XCH T_ONE,T_TWO;"
880 OUTPUT @Sa;" XCH T_ONEAMP,T_TWOAMP;"
890 OUTPUT @Sa;"ENDIF;"
900 OUTPUT @Sa;"SUB D_IFF,T_TWO,T_ONE;"
910 OUTPUT @Sa;"DIV H_OLD,D_IFF,2;"
920 OUTPUT @Sa;"ADD CF,T_ONE,H_OLD;"
930 OUTPUT @Sa;"IF D_IFF,LT,3000 THEN;"
940 OUTPUT @Sa;" SP DN;"
950 OUTPUT @Sa;"ENDIF;"
960 OUTPUT @Sa;"TS;MOV S_TORE,TRA;"
970 OUTPUT @Sa;"SAVES 2;"
980 OUTPUT @Sa;"@";
990 !
1000 ! MEASURE THIRD ORDER PRODUCTS
1010 !
1020 OUTPUT @Sa;"FUNCDEF M_MEASURE,@"
1030 OUTPUT @Sa;"ADD CF,T_TWO,D_IFF;"
1040 OUTPUT @Sa;"SP;DN;DN;TS;"
1050 OUTPUT @Sa;"IF D_IFF,GE,3000 THEN;"
1060 OUTPUT @Sa;" MKPK HI;MKRL;MOV VB,RB;"
1070 OUTPUT @Sa;" VB;DN;TS;MKPK HI;"
1080 OUTPUT @Sa;"ELSE MKN;SP;DN;TS;MKPK HI;"
1090 OUTPUT @Sa;" MKRL;VB;DN;TS;MKPK HI;"
1100 OUTPUT @Sa;"ENDIF;"

```

Line 650: Define the function in Lines 660 - 810 as **E_QUALAMP**.

Lines 660 - 810: Measure the difference in amplitude between the test tones. If the difference is less than 0 dB, take the absolute value of the difference. If this absolute value is less than 2 dB, continue to the next function. If it is greater than 2 dB, instruct the operator to adjust the test tones for equal amplitude. Re-measure the frequency and amplitude of the test tones, store the new frequency and amplitude values in variables **T_ONE**, **T_ONEAMP**, **T_TWO** and **T_TWOAMP**.

Line 850: Define the function in Lines 860 - 980 as **P_PRODUCTS**.

Lines 860 - 890: If the frequency and amplitude values of the tone higher in frequency are stored in variables **T_ONE** and **T_ONEAMP**, exchange these values with the frequency and amplitude values stored in **T_TWO** and **T_TWOAMP**, respectively. This assures that variable **T_TWO** stores the frequency value of the tone higher in frequency.

Lines 900 - 980: Measure the difference in frequency between the test tones, store the difference in variable **D_IFF**, and set the center frequency to 1/2 way between the two test tones ($T_ONE + \frac{1}{2} D_IFF$). If the value of **D_IFF** is less than 3 kHz, also reduce the frequency span. Store the resulting trace in **S_TORE** and the instrument settings in Register 2.

Line 1020: Define the function in Lines 1030 - 1160 as **M_MEASURE**.

Lines 1030 - 1040: Add the values of variables **T_TWO** and **D_IFF**, and set the center frequency to the sum. This sum is equal to the frequency of the upper third order IMD product, which appears on the right side of the display.

Lines 1050 - 1100: If the tones are separated by more than 3 kHz, set the third order IMD product to the reference level and measure its amplitude. If the tone separation is less than 3 kHz, reduce the frequency span. This will also reduce the resolution bandwidth. (Shape factor constraints necessitate the narrower bandwidth, and the reduced scan prevents a lengthy sweep time.) Set the third order IMD product to the reference level and measure its amplitude.

```

1110 OUTPUT @Sa;"SUB I MRDBC,MA,T_TWOAMP;"
1120 OUTPUT @Sa;"SUB CF,T_ONE,D_IFF;"
1130 OUTPUT @Sa;"TS;MKPK HI;"
1140 OUTPUT @Sa;"MOV L_EFT,MA;"
1150 OUTPUT @Sa;"SUB I_MLDBC,MA,T_ONEAMP;"
1160 OUTPUT @Sa;"@";
1170 !
1180 ! REPORT RESULTS ON SCREEN
1190 !
1200 OUTPUT @Sa;"FUNCDEF R_EPORT,@"
1210 OUTPUT @Sa;"VIEW TRA;RCLS 2;MOV TRA,S_TORE;"
1220 OUTPUT @Sa;"DA3072;D2;PU;PA300,800;TEXT /INTERMODULATION PRODUCTS/;"
1230 OUTPUT @Sa;"PU;PA200,750;TEXT /TEST TONE LEVEL = /;DSPLY
T_ONEAMP,5.2;PU;PA 700,750;TEXT /dBm/;"
1240 OUTPUT @Sa;"PU;PA200,700;TEXT /TEST TONE SEPARATION = /;DSPLY
D_IFF,6.0;PU;PA700,700;TEXT /Hz/;"
1250 OUTPUT @Sa;"PU;PA200,630;TEXT /THIRD ORDER/;"
1260 OUTPUT @Sa;"PU;PA200,550;TEXT /LOWER/;PU;PA 564,550;DSPLY
I_MLDBC,5.2;PU;PA700,550;TEXT /dBc/;"
1270 OUTPUT @Sa;"PU;PA200,500;TEXT /UPPER/;PUPA 564,500;DSPLY
I_MRDBC,5.2;PU;PA700,500;TEXT /dBc/;"
1280 OUTPUT @Sa;"PU;PA300,82;TEXT /Press SHIFT 2 Hz to repeat test/;HD;"
1290 OUTPUT @Sa;"@";
1300 !
1310 ! THE FOLLOWING REPORTS THAT NO THIRD ORDER
1320 ! PRODUCTS ARE FOUND ABOVE THE NOISE LEVEL
1330 !
1340 OUTPUT @Sa;"FUNCDEF N_OTHIRD,@"
1350 OUTPUT @Sa;"RCLS 2;MOV TRA,S_TORE;"
1360 OUTPUT @Sa;"EM;D3;DA3072;PU;PA100,600;"
1370 OUTPUT @Sa;"TEXT /THIRD ORDER INTERMODULATION PRODUCTS/;"
1380 OUTPUT @Sa;"PU;PA100,550;TEXT /ARE AT OR BELOW THE NOISE LEVEL/;"
1390 OUTPUT @Sa;"PU;PA100,525;TEXT /Press SHIFT 2 Hz to repeat test/;"
1400 OUTPUT @Sa;"@";
1410 !
1420 ! IF NO THIRD ORDER PRODUCTS APPEAR
1430 ! ABOVE THE NOISE LEVEL, THE FOLLOWING
1440 ! BRANCHES THE PROGRAM TO READ OUT
1450 ! THAT THE INTERMOD PRODUCTS ARE
1460 ! AT OR BELOW THE NOISE LEVEL
1470 ! OTHERWISE IT REPORTS THE MEASURED
1480 ! RESULTS.
1490 !
1500 OUTPUT @Sa;"FUNCDEF C_HECK,@"
1510 OUTPUT @Sa;"SMOOTH TRA,32;MKMIN;"
1520 OUTPUT @Sa;"MOV N_OISE,MA;ADD N_OISE,N_OISE,15;"
1530 OUTPUT @Sa;"IF L_EFT,LE,N_OISE THEN;"
1540 OUTPUT @Sa;" N_OTHIRD;"
1550 OUTPUT @Sa;" ELSE R_EPORT;"
1560 OUTPUT @Sa;"ENDIF;"
1570 OUTPUT @Sa;"@";

```

Line 1110: Measure the difference between the value in variable **T_TWOAMP** and the amplitude of the upper third order IMD product, and store the result in variable **I_MRDBC**. This result is the relative amplitude of the third order IMD product, in dBc from the peak of the higher frequency tone.

Lines 1120 - 1160: Subtract the values of variables **T_ONE** and **D_IFF**, and set the center frequency to the difference. This difference is equal to the frequency of the lower third order IMD product, which appears on the left side of the display. Measure the amplitude of the IMD product, and store it in variable **L_EFT**. Measure the difference between the value in variable **T_ONEAMP** and the amplitude of the third order IMD product, and store the result in variable **I_MLDBC**. This result is the relative amplitude of the third order IMD product, in dBc from the peak of the lower frequency tone.

Line 1200: Define the function in Lines 1210 - 1290 as **R_EPORT**.

Lines 1210 - 1290: Display the user-defined trace, **S_TORE**, the settings stored in Register 2, the test tone amplitude and separation, and the relative amplitude values (in dBc) of the upper and lower third order IMD products. Prompt the user to press shift 2 Hz to re-run the test.

Line 1340: Define the function in Lines 1350 - 1400 as **N_OTHIRD**.

Lines 1350 - 1400: Display the user-defined trace, **S_TORE**, and the settings stored in Register 2. Report the third order IMD products are at or below the noise level.

Line 1500: Define the function in Lines 1510 - 1570 as **C_HECK**.

Lines 1510 - 1570: Smooth the trace. The minimum level of the smoothed trace is an approximation of the average noise level. Compare this minimum trace level to the amplitude of the lower third order IMD product, stored in variable **L_EFT**. If **L_EFT** is 15 dB higher than the approximate noise level, branch to **R_EPORT**. If **L_EFT** is not 15 dB higher than the approximate noise level, branch to **N_OTHIRD**.

Section III

Appendixes

- Appendix A – DISPLAY MEMORY STRUCTURE**
- Appendix B – ADVANCED DISPLAY PROGRAMMING**
- Appendix C – LEARN STRING CONTENT**
- Appendix D – SERVICE REQUESTS**
- Appendix E – OPERATING DIFFERENCES**
- Appendix F – EQUIVALENT HP 8568B AND HP 8568A
COMMANDS**



Appendix A DISPLAY MEMORY STRUCTURE

This appendix describes the spectrum analyzer display memory. A summary of trace data manipulation by the trace mode functions is also included.

The display memory is defined as the digital storage allocated in the spectrum analyzer for the information that is presented on the CRT display. It comprises four different memories: three trace memories and one annotation memory. Addresses are assigned as follows:

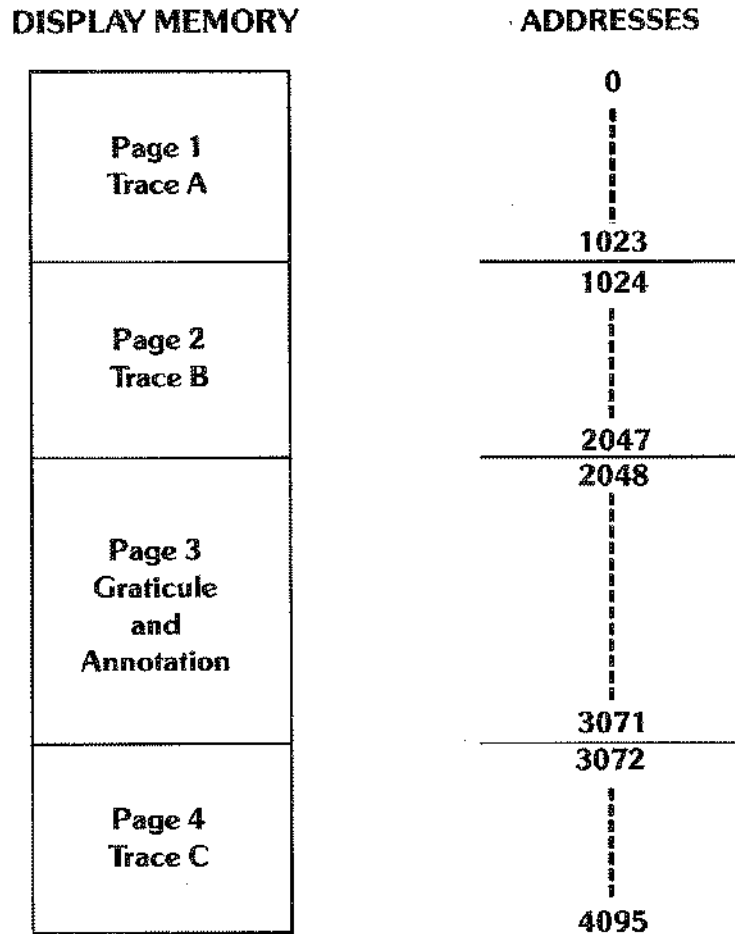

TRACES

The trace pages are used primarily to store analyzer response data to be displayed. Use is not restricted to the storage of trace data. Operator defined graphics and annotation can also be written into the memory for display on the CRT.

Each trace address may contain an integer from 0 to 4095. When drawing, trace values from 0 to 1023 are plotted on the CRT display as amplitude y position, in display units. Appendix B discusses these values in detail.

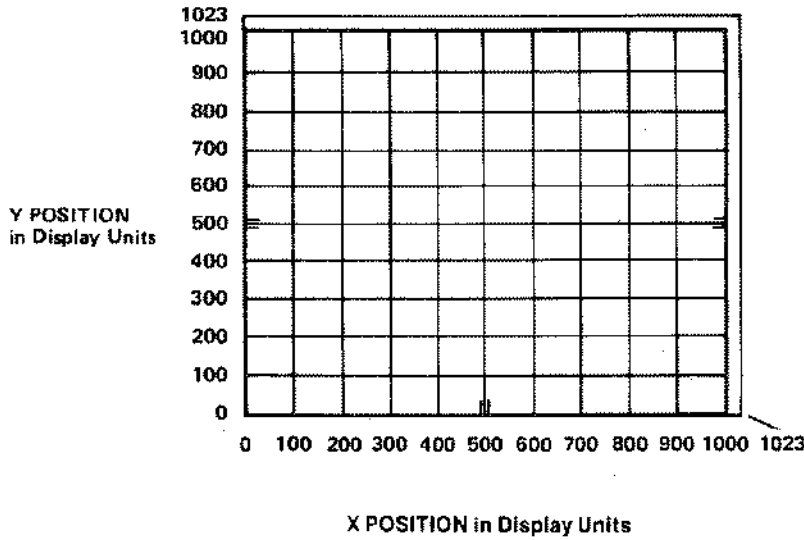

For each trace, A, B, or C, the display width on the CRT is determined by the instruction word in the first address for that trace. In the example below, the first address is 1024 and the instruction word is 1040.

	Address	Amplitude Value, Y	(x,y) Position on CRT
Trace B (Page 2) 1024 Addresses	1024	1040	Display Instruction
	1025	622	(0,622)
	1026	531	(1,531)
	⋮	⋮	⋮
	2023	181	(998,181)
	2024	162	(999,162)
	2025	185	(1000,185)
	2026	1072	} Overrange Addresses (Blanked)
	2027	1072	
	⋮	⋮	
	2046	1072	
	2047	1072	

Addresses 2023 and 2024 describe one trace line drawn from x,y coordinates (998,181) to x,y coordinates (999,162). The 1072 values shown for the overrange addresses tell the analyzer to blank these values instead of interpreting them as coordinates.

ANNOTATION AND GRATICULE

Page 3 of the display memory fills with instructions on instrument preset. These instructions draw the graticule and annotation on the displays.

The display memory in page 3 contains the information necessary to position and display (or blank) labels, graticule lines, and markers. A brief description of the contents of page 3 is given below. The first addresses on each line are those of the instructions for each readout.

Address	Contents*
2048 – 2049, 2060 – 2064	controls marker, display line, threshold annotation and graticule on/off functions
2050 – 2054	marker dot 1
2055 – 2059	marker dot 2
2065 – 2084	center line marks
2085 – 2099	marker symbols
2100 – 2114	display line
2115 – 2154, 2165 – 2167	graticule
2155 – 2159	marker dot 3
2160 – 2164	marker dot 4
2168 – 2175	"hp"
2176 – 2191	"BATTERY"
2192 – 2207	"CORR'D"
2208 – 2239	"RES BW"
2240 – 2271	"VBW"
2272 – 2303	"SWP"
2304 – 2335	"ATTEN"
2336 – 2367	"REF"
2368 – 2383	"dB/", "LINEAR"
2384 – 2399	trace detection mode: "SAMPLE", "POS PK", "NEG PK"
2401 – 2431	"START" or "CENTER"
2432 – 2463	"STOP" or "SPAN"
2464 – 2495	"OFFSET" for amplitude
2496 – 2527	"DL"
2528 – 2559	"TH"
2560 – 2623	"MKR" or "MKR Δ"
2624 – 2655	"OFFSET" for frequency
2656 – 2687	"VID AVG"
2688 – 2751	title
2752 – 2767	"YTO UNLOCK"
2768 – 2783	"249 UNLOCK"
2784 – 2799	"275 UNLOCK"
2800 – 2815	"OVEN COLD"
2816 – 2831	"EXT. REF"
2832 – 2847	"VTO UNCAL"
2848 – 2863	"YTO ERROR"
2864 – 2879	"MEAS UNCAL" or ""
2880 – 2943	frequency diagnostics
2944 – 2959	"2ND LO", "↑", "↑"
2960 – 2975	"SRQ" number
2976 – 3007	center frequency "STEP"
3008 – 3071	active function readout

* indicates the CRT annotation stored, values included where applicable.

DATA TRANSFER

The trace functions dictate the way in which data is entered into and extracted from the trace page.

This section describes each TRACE function in terms of the interactions of the analyzer response, trace page and CRT display. The events are listed in chronological order, starting from when the trace function is activated. In each case, the analyzer accepts the function command immediately.

Clear-Write A1 B1

1. Sweep is stopped.
2. Zero is written into each trace address and displayed in one refresh of the CRT.
3. On the next sweep trigger, the sweep is started and the trace amplitudes are written into memory.

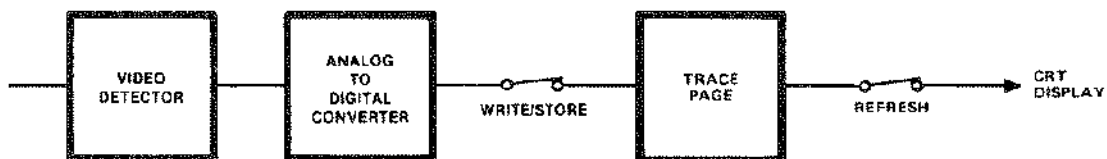

Max Hold A2 B2

1. Sweep is stopped, but restarts from the left on the next trigger.
2. During each subsequent refresh, the amplitude stored at each trace memory address is compared with the corresponding current analyzer response. The larger of the two is stored at the trace address.

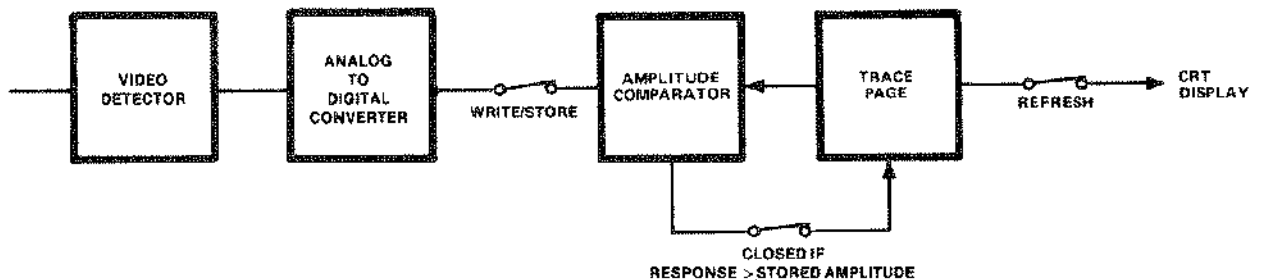

View A3 B3

1. The sweep is stopped and the trace is displayed on the CRT.

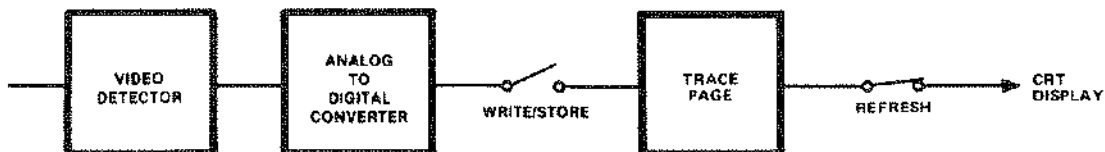

Blank A4 B4

1. The sweep is stopped and the trace is not displayed.

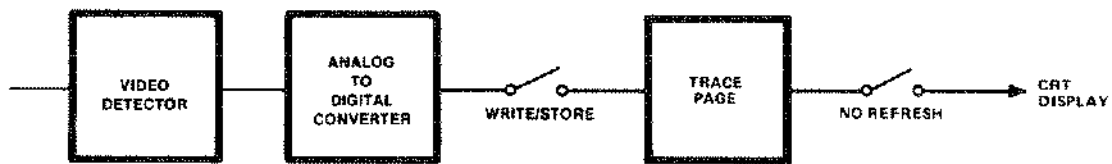
**Exchange A and B EX**

1. The sweep is stopped. If either trace is in a CLEAR WRITE or MAX HOLD mode, it is placed in VIEW.
2. The contents of traces A and B are exchanged.

A – B → A On C2

1. The sweep is stopped and trace B is placed in VIEW mode.
2. A is replaced with A – B (A minus B).
3. The sweep is continued from the left. Each new analyzer response point is reduced by the amount stored in the corresponding address of trace B, and the result is stored in trace A. This process continues at the sweep rate.
4. Subsequent sweeps continue the process.

A – B → A Off C1

1. Subsequent analyzer responses are written directly into trace A. Trace B and its mode are not changed.
2. The amplitude stored in the display line register is subtracted from the contents in each trace B address and the result is stored at the same trace B address.

B – DL → B BL

1. Trace B is placed in view. Trace A is not changed.
2. The amplitude stored in the display line register is subtracted from the contents in each trace B address. The result is stored at the same trace B address.

Appendix B ADVANCED DISPLAY PROGRAMMING

This appendix describes CRT display programming with the analyzer display language.

A display program increases the CRT graphics capability of the spectrum analyzer. Explicit display programming generally uses less display memory, allowing more efficient use of the 4,096 display addresses available.

Appendix A, Display Memory Structure, provides background material for information in this appendix.

DISPLAY PROGRAM DEFINED

A display program consists of a specific set of display commands which are followed by instructions and/or data words written into the display memory.

Use these commands to write display programs into memory.

DA	Display Address puts the address into the display memory address register (referred to as the current address).
DW	Instruction or Data Write writes the instruction or data word into the current display address. The current display address pointer is then automatically advanced to the next higher address.
DD	Binary Instruction or Data Word writes two 8-bit binary words into the current address.*
DR	Display Read places the contents of the current address on the HP-IB data lines. These contents are then read by the HP-IB controller according to the current Output format (01 to 04). Execution of each DR concludes by advancing the current address by one (1).

Instruction Words dictate the operating mode of the CRT circuitry, such as label, graph, or plot. The **data words** contain amplitude or position information.

Instruction and data words are written into memory when the above commands are used. For example, the code "PA 500,600" writes into the display memory the instruction word for vector, 1026, followed by the x and y data values 500 and 600. This same "plot absolute" command could also be done as a display program by writing "1026,500,600" into the display memory. The display program is "executed" each time the CRT is refreshed from memory.

LOADING AND READING A DISPLAY PROGRAM

Instruction and data words are loaded directly into the analyzer display memory by, first, specifying the beginning address of the program, then writing in the instructions and data serially. To write the "1026,500,600" program beginning at address 1024 (the first address of trace B), execute

```
OUTPUT 718:"DA 1024;DW 1026.500.600;"
```

This program instructs the display to draw a vector to the position (500,600) on the CRT.

*The first byte contains the four most significant bits, the second contains eight least significant bits of the 12-bit instruction or data word. DD must be executed for every 2 bytes input into the analyzer.

To read and print out the program, run:

```

10      PRINTER IS 701
20      !
30      OUTPUT 718:"01;DA 1024:"
40      FOR I=1 TO 3
50          OUTPUT 718:"DA DA;"
60          ENTER 718;A
70          OUTPUT 718;"DR"
80          ENTER 718;W
90          PRINT A,W
100     NEXT I
110     END
    
```

Address	Contents
1024	1026
1025	500
1026	600

- Line 30:** Sets format to decimal word values, and sets the address to 1024.
- Line 40 to 100:** Read and print three successive display program addresses and their contents. The address is automatically incremented by one after the execution of each DR command.
- Line 50:** Sends the display address to the controller.
- Line 5:** Reads the content of the current display address.

INSTRUCTION WORDS AND DATA WORDS

Instruction words and data words can be any value from 0 to 4095. The value is stored as a 12-bit binary word, and several of the bits define the type of word. Graphic representations used in this appendix are defined as follows:

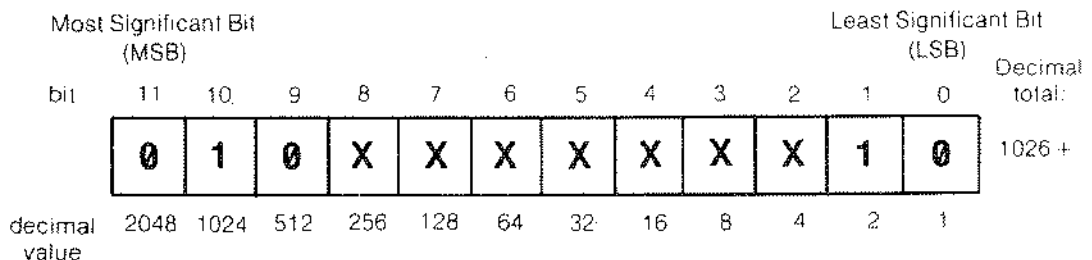

where x is either a 1 (true) or a 0 (false).

The sample word displayed is $1024 + 2 = 1026$, the instruction control word for vector used in the previous examples.

INSTRUCTION WORDS

There are three kinds of instruction words:

1: **Display control**

2: **Program control
including end of display**

3: **Count/Threshold**

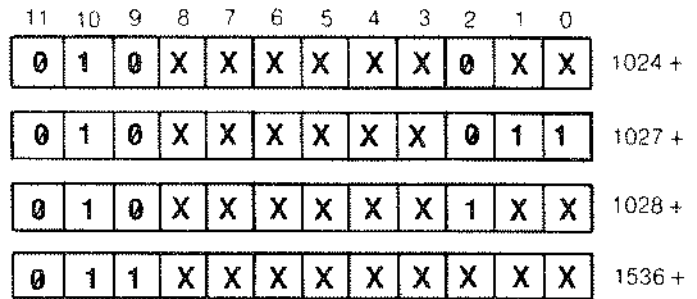

Display Control Instruction Words. The display control instruction words tell the CRT circuitry how to use the subsequent data words to direct the CRT beam. Instruction word 1026 **vector** is an example. Data values in a display program following 1026 direct the CRT beam to x,y positions. The two other display control instruction words are **label**, which writes characters on the CRT, and **graph**, which displays traces.

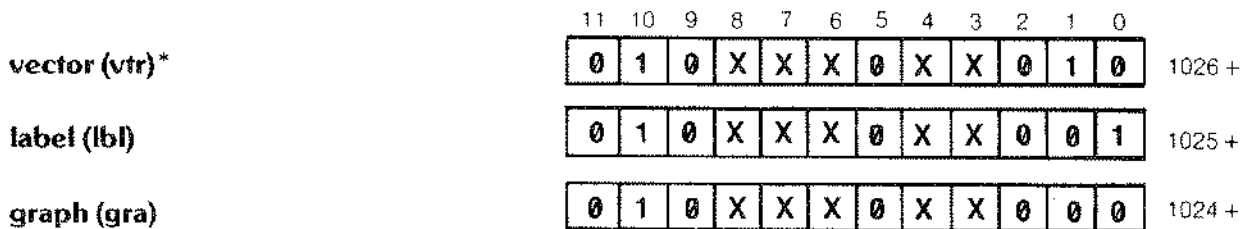

The syntax of vector, label, and graph are counterparts of commands PA, PR, LB, and GR. Pen up/down, display size, and beam intensity are controlled by setting various bits along with the instruction and data words. These functions are called auxiliary functions to the instruction.

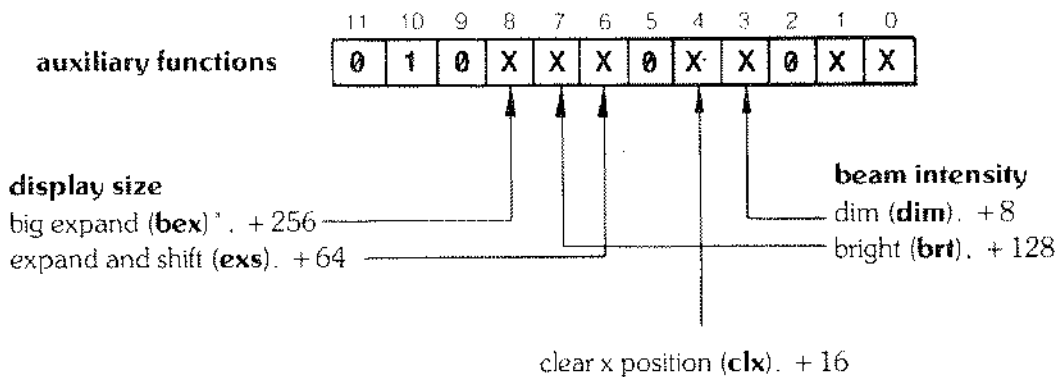

* Abbreviations within the parentheses are short hand notation for writing display programs. They are not programming codes.

- clear x position (clx):** Reset the x axis display position to the far left (0,y).
- big expand (bex):** Amplify the x and y CRT beam deflection by a 1.9 factor.¹
- expand and shift (exs):** Amplify the x and y CRT beam deflection by a 1.13 factor (expand) and shifts the (zero,zero) reference point to the lower left of the CRT screen.¹
- dim (dim):** Set the CRT beam intensity below the normal level.²
- bright (brt):** Set the CRT beam intensity to the maximum level.²

Flow-of-Control Instruction Words. The CRT refresh program normally executes the contents of memory starting with address 0 and working one address at a time to address 4095. Flow-of-control instruction words alter the normal flow of a refresh program by allowing program execution to be transferred anywhere in memory. They allow jumps to specific display addresses (jmp), jumps to a display program subroutine (jsb), returns (ret), skips to the next control instruction (skc), and a word that simulates a “for...next” loop, the decrement-and-skip-on-zero (dsz). Control instructions contain 010 in bits 11, 10, and 9, respectively.

	11	10	9	8	7	6	5	4	3	2	1	0	
jump (jmp)	0	1	0	X	0	0	0	X	1	0	1	1	1035
jump to subroutine (jsb)	0	1	0	X	1	0	0	X	1	0	1	1	1163
return (ret)	0	1	0	X	1	1	0	X	1	0	1	1	1227
skip to next control instruction (skc)	0	1	0	X	X	X	0	X	0	0	1	1	1027
skip to next memory page (skp)	0	1	0	X	X	X	1	X	0	0	0	0	1056
end of display (end)	0	1	0	X	X	X	X	X	X	1	X	X	1028 +
decrement and skip on zero (dsz)	0	1	0	X	0	1	0	X	1	0	1	1	1099

The address to be jumped to is the contents of the memory word following the jmp or jsb instruction. For example, “1035,2048” causes program execution to jump to address 2048. The address given should contain a control instruction. (If the address does not contain a control instruction, the program will go to the first control instruction following the specified address.) A return (ret) causes the program execution to return to the first control instruction following the jsb instruction that sent it to the subroutine.

¹The display size commands combine these size instructions as follows:

	instructions	ratio to D1	origin shifted
D1	none	1.00	no
D2	exs	1.13	yes
D3	bex and exs	1.68	yes
-	bex	1.49	no

²The intensity of the beam is also dependent upon line length. Lines longer than a preset length will be brighter because beam writing rate is slowed.

NOTE

Subroutines must not contain label or graph control words. A subroutine may not call another subroutine.

The skip-to-next control instruction (**skc**) causes program execution to go to the next instruction in memory. The skip-to-next page (**skp**) instruction causes program execution to go to the next address that is an integer multiple of 1024. (An instruction that combines **skp** and **skc**, $1056 + 3 = 1059$, executes as if it were a **skp** followed by a **skc**.)

The decrement and skip-on-zero (**dsz**) instruction decrements an internal count register then tests the contents for zero. If the contents are not zero, the program goes to the next control instruction. If the contents equal zero, the program will skip the next two addresses then go the next control instruction. For example, "1099, 1035, 1532, 1026" causes the program to skip to the control word 1026 if the counter register is zero; otherwise it executes the 1035, 1532, which is a jump to address 1532. See Load Counter and Threshold Instructions below.

The auxiliary control function clear x position (**clx**) can be added to any of the program control instructions.

Another method of causing skips in program execution is with the label mode (either LB or lb). This is discussed under Data Words.

End of Display Instruction. When executed, the end of display instruction terminates execution of the display program. The next execution of the program then begins at display address zero on the next display refresh trigger (note that refresh trigger and sweep trigger are not the same).

The end of display instruction bit supersedes all other coding in the instruction except the auxiliary function clear x position, **clx** (bit 4), which may be added. The end instruction causes a default-to-graph mode at the beginning of the next program execution if no display control instruction is at address zero.

Since fast sweeps (direct display of video and sweep for sweep times less than 20 msec) are displayed between program executions, an end instruction is required for proper operation of the fast sweep display.

An end-of-display in trace C is changed to a skip-to-next memory page, 1056, when a B \rightleftharpoons C exchange is executed.

Load-Counter and Load-Threshold Instructions. The load-counter instruction loads an internal count register with a value determined by bits 0 through 8 of the instruction. The internal register is used in either of two ways. In the graph (**gra**) mode, the display program interprets the register contents as the display THRESHOLD

position. The second use is the count register for the decrement and skip-on-zero (dsz) instruction. The interpretation for these two uses is shown below:

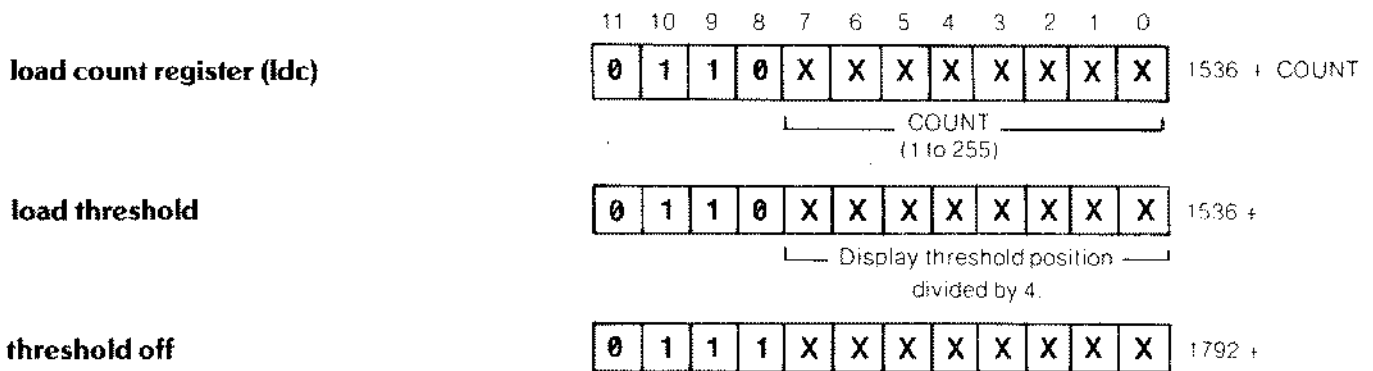

NOTE

The **ldc** and **dsz** instructions use the THRESHOLD level register. Therefore, load threshold instruction 1536 must be executed after all uses of **ldc** and **dsz**, and before the next graph command is executed. If the load threshold is not executed, the threshold may not function correctly.

DATA WORDS

Data words are differentiated from instruction words by the two most significant bits, bits 11 and 10. The following words are data words:

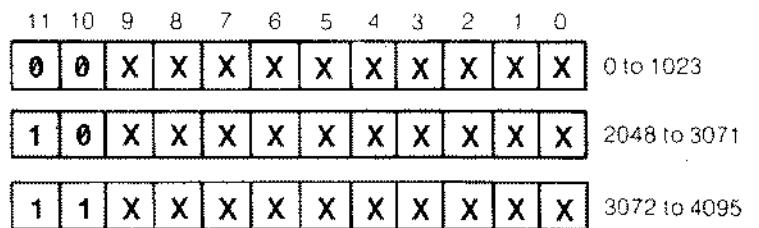

Interpretation of these data word formats by the CRT refresh program depends entirely on the preceding instruction word.

Graph. Each data word following a graph instruction is interpreted as an absolute y position. Y position values follow the general rule shown below:

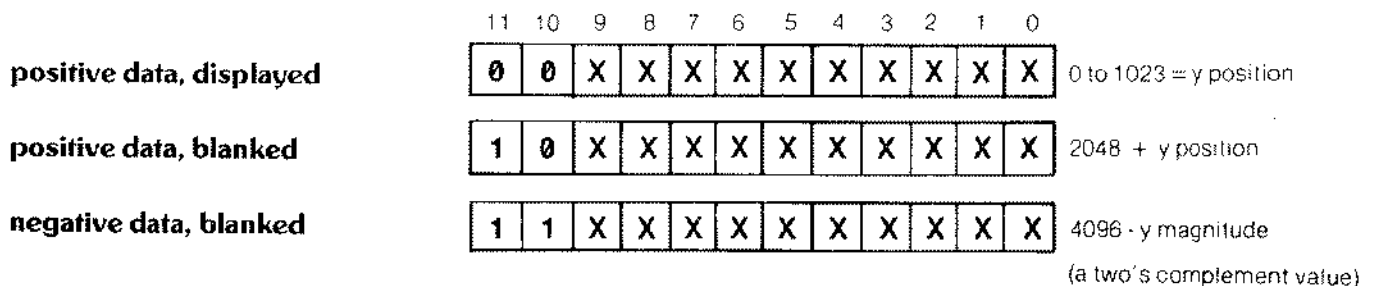

With negative data, the CRT beam goes to $y = 0$. Note that negative data can result from trace arithmetic functions $A - B \rightarrow A$ and $B - DL \rightarrow B$.

Vector. Data words following a vector (**vtr**) instruction are interpreted as x,y pairs. The data value determines whether the vector is blanked or displayed, absolute or relative. The x position data sets the absolute/relative auxiliary function; the y position data sets the blank/unblank auxiliary function.

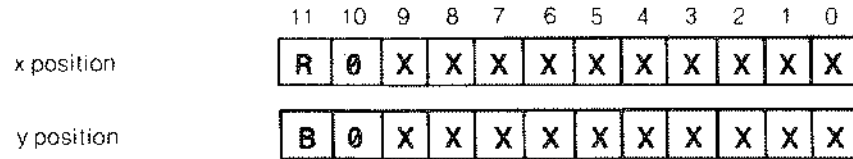

- when R = 1 (x position + 2048) vector is relative (both x and y are relative)
- R = 0 (x position + 0) vector is absolute (both x and y are absolute)
- B = 1 (y position + 2048) vector is blanked (pen up)
- B = 0 (y position + 0) vector is displayed (pen down)

Negative values for the plot relative x and y positions are entered as complementary values of 1024 to the ten least significant bits of the data word. For example, a plot relative -300 of x position is written in the data word as $(1024 - 300) = 724$. The actual plot "wraps around" the display to find the -300 position.

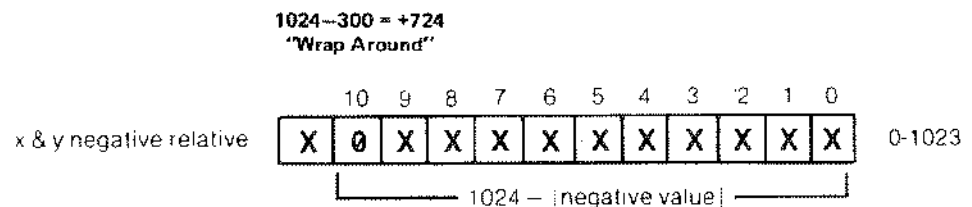
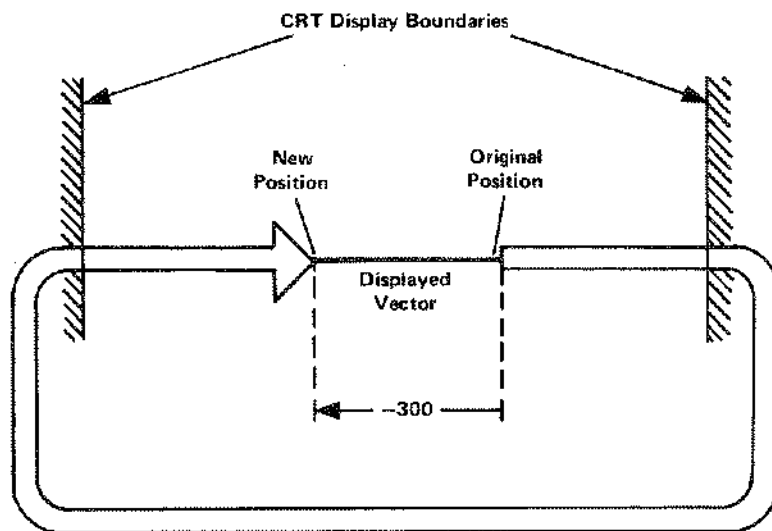

A specific set of character codes provide special label functions:

	Code
null	0
back space (BS)	8
line feed (LF)	10
vertical tab (opposite of line feed) (VT)	11
form feed (move beam to (0,0)) (FMFD)	12

carriage return (CR)	13
blink on (bkon)	17
blink off (bkof)	18
space (SP)	32
skip to next 16 block (sk16)	145
skip to next 32 block (sk32)	146
skip to next 64 block (sk64)	147

A blink on (bkon) will cause blinking of everything drawn on the display until a subsequent blink off (bkof) or an end of display (end) instruction is encountered with program execution.

A skip 16, 32, or 64 will cause program execution to go to the next address that is an integer multiple of 16, 32, or 64, respectively.

Note that these functions will work for both the lbl instruction code (1025 +) or the LB command.

PROGRAMMING WITH DISPLAY CONTROL INSTRUCTION WORDS

These examples illustrate the use of display control instructions and data words. The display memory commands described at the start of this appendix are used for loading and reading.

Vector (vtr)

Instructions can be used to draw lines on the CRT display. The data words each determine whether the data is plotted absolute/relative or blanked/unblanked (pen up/pen down). The auxiliary functions apply to the vector instructions.

For example, a line is to be plotted on the display with plot relative instructions in trace C memory beginning at address 3072.

address	description	program	word
3072	vector	vtr	1026
3073	x = 450 absolute	450 + 0	450
3074	y = 450 blanked	450 + 2048	2498
3075	x = -100 relative	(1024 - 100) + 2048	2972
3076	y = +100 relative pen down	100 + 0	100

The load program is:

```
OUTPUT 718;"DA 3072;DW 1026,450,2498,2972,100;"
```

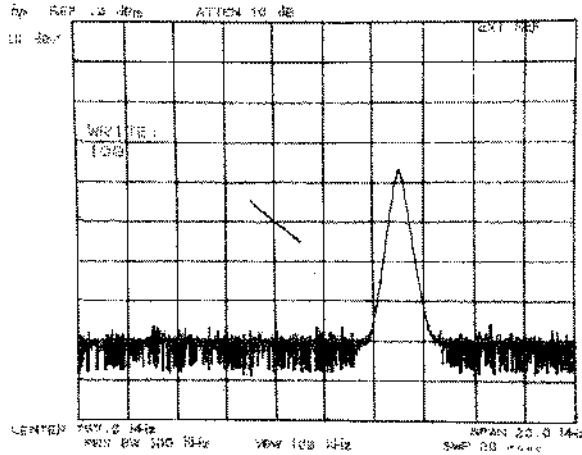

Vector and Label (vtr and lbl). To demonstrate the display instructions, a simple block diagram is drawn and labelled. Then the control words are modified with some of the auxiliary functions to demonstrate their use.

First a graphics plan is drawn:

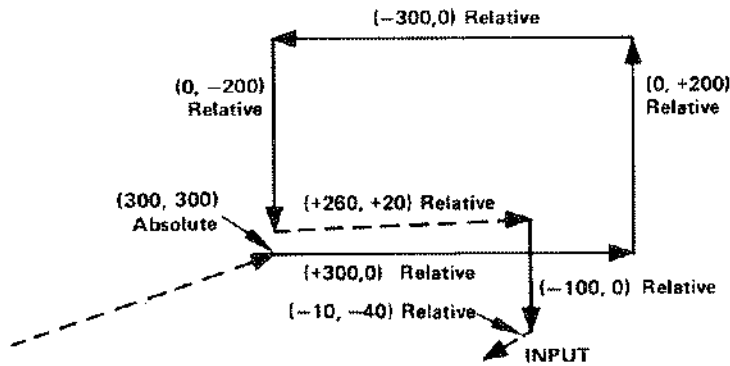

Graphics Plan

The vectors with + and - signs are relative vectors, the others are absolute points. Dashed lines are to be blanked.

address	description	program	word
3072	vector absolute	vtr	1026
3073	x = 300 absolute	300 + 0	300
3074	y = 300 pen up	300 + 2048	2348
3075	x = + 300 relative	300 + 2048	2348
3076	y = 0 pen down	0 + 0	0
3077	x = 0 relative	0 + 2048	2048
3078	y = + 200 pen down	200 + 0	200
3079	x = - 300 relative	(1024-300) + 2048	2772
3080	Y = 0 pen down	0	0
3081	x = 0 relative	0 + 2048	2048
3082	y = - 200 pen down	(1024-200) + 0	824
3083	x = + 260 relative	260 + 2048	2308
3084	y = + 20 pen up	20 + 2048	2068
3085	x = 0 relative	0 + 2048	2048
3086	y = - 100 pen down	(1024-100) + 0	924
3087	x = - 10 relative	(1024-10) + 2048	3062
3088	y = - 40 pen up	(1024-40) + 2048	3032
3089	label	lbl	1025
3090		I	73
3091		N	78
3092	the word	P	80
3093	"INPUT"	U	85
3094		T	84
3095	end of display	end	1028

The above plan can then be programmed and run.

```

10 OUTPUT 718;"IP;KSo:KSm;A4:"
20 OUTPUT 718;"DA 3072:DW 1026,300,2348."
30 OUTPUT 718;"2348, 0, 2048, 200,"
40 OUTPUT 718;"2772, 0, 2048, 824,"
50 OUTPUT 718;"2308, 2068, 2048, 924,"
60 OUTPUT 718;"3062, 3032,"
70 OUTPUT 718;"1025, 73, 78, 80, 85, 84, 1028:"
80 END

```

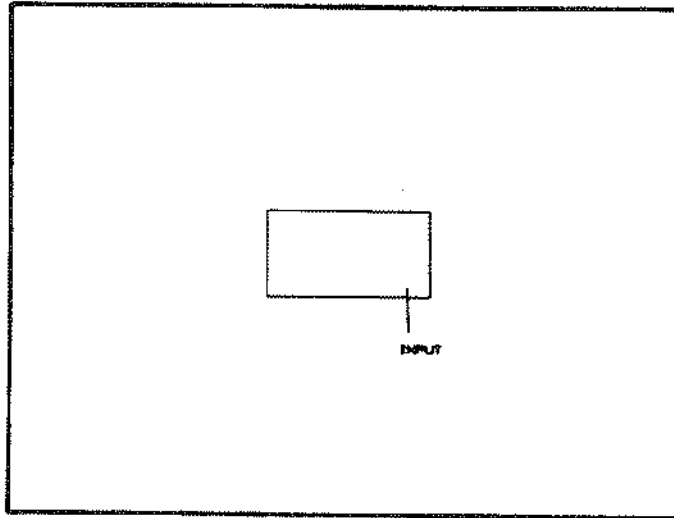

The display can now be modified by adding various auxiliary functions to the existing control words.

Brighten the "INPUT" term by adding 128 (brt) to the label address 3089 (1025 + 128 = 1153).

```
70      OUTPUT 718:"1153, 73, 78, 80, 85, 84, 1028:"
```

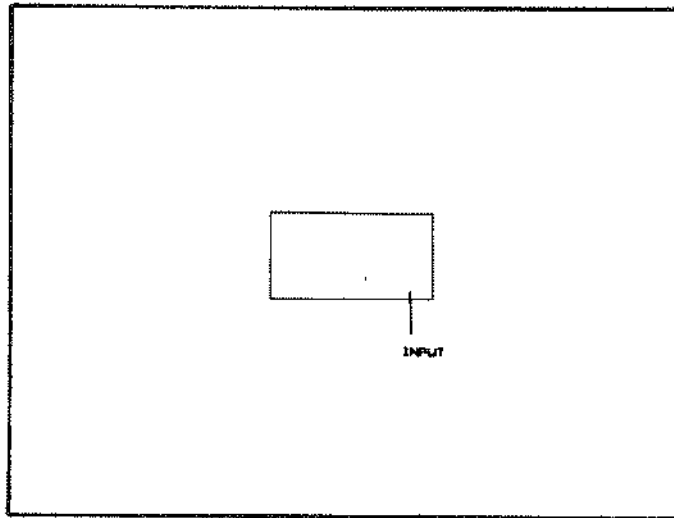

The label "INPUT" can be made to blink by adding blink on (bk on) and blink off (bk of) words before and after the "INPUT" label.

```
70      OUTPUT 718:"1025,17, 73, 78, 80, 85, 84, 18, 1028:"
```

Alternately, line 7 could have been replaced with the following lines:

```
61      OUTPUT 718:"DT@"
70      OUTPUT 718 USING "K.B,K,B,K":"LB":17:"INPUT:18:"@DW 1028"
```

Note that a write binary (wtb) is used to transmit a mix of characters and non-character codes.

PROGRAMMING WITH PROGRAM CONTROL INSTRUCTION WORDS

These examples use both the commands listed in Section II and instruction words.

End-of-Display (end) and Skip-to-Next-Memory-Page (skp) Instruction Words. To end the display after the first 100 points of trace A, write "DW 1028" into address 100.

```
OUTPUT 718:"IP:S2:TS:DA 100:DW 1028;"
```

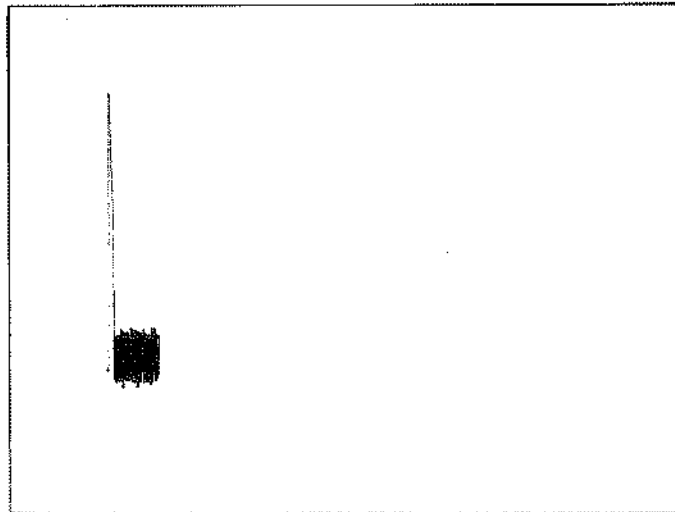

In this example, all display memory information beyond address 100 is ignored, including the annotation. Note that the analyzer is in single sweep, S2, to prevent signal response data from writing over the control word.

Skip control words allow certain portions of the display to be omitted. There are two kinds of skip control words. The first enables a skip over the remainder of the present memory page to the beginning of the next memory page, the second enables a skip to the next control word.

The skip-page and skip-to-next-control-word have been assigned two command codes, PS and SW, respectively.

In the example, the annotation was blanked because of the end-of-display written into address 100. If a skip had been written instead, the rest of the display memory would have been displayed, but the remainder of trace A would have been omitted.

OUTPUT 718: "IP:S2:TS:DA 100:DW 1056:"

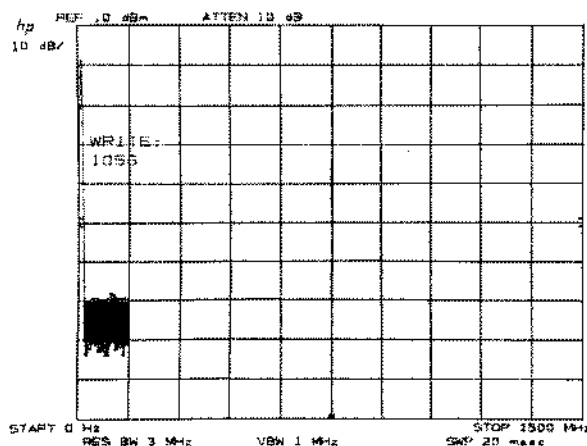

(Note that programming code PS can be substituted for DW 1056.)

A `skp` written into the trace C page skips the refresh pointer to DA 0 (trace A). This may cause an increase in the trace intensity because the program does not wait for a refresh trigger before beginning the next execution of the program. An end of display, 1028, is normally used in the Trace C page. This instruction allows a new refresh cycle to begin.

Skip-to-Next-Control-Instruction (skc). Program control is transferred to the next control instruction.

For example, address 2073 of the annotation memory page contains the label control word that places the center frequency "||" mark on the CRT. To omit this marker from the display, the label word is replaced by a `skc` word.

OUTPUT 718: "DA 2073:DW 1027:"

or

OUTPUT 718: "DA 2073:DW SW:"

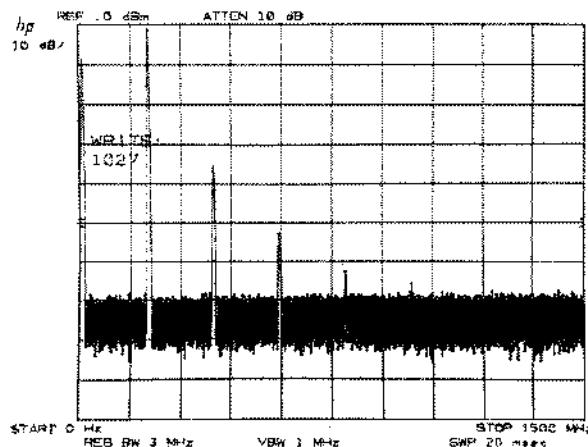

(Note that programming code SW can be used for DW 1027.)

Jump (jmp). The example demonstrates `jmp` by jumping over the data in addresses 100 to 500 in trace A. Since the jump should be made to a control word, `gra` is first written into DA 500.

Before the program is loaded the display might look like this:

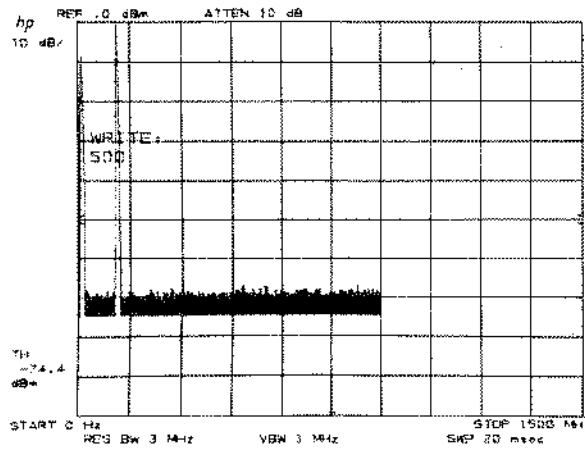

After the following lines are executed the CRT would appear like this:

```

10      OUTPUT 718:"IP:S2:TS:DA 500:DW 1024:"
11      OUTPUT 718:"DA 100:DW 1035. 500:"
13      END
    
```

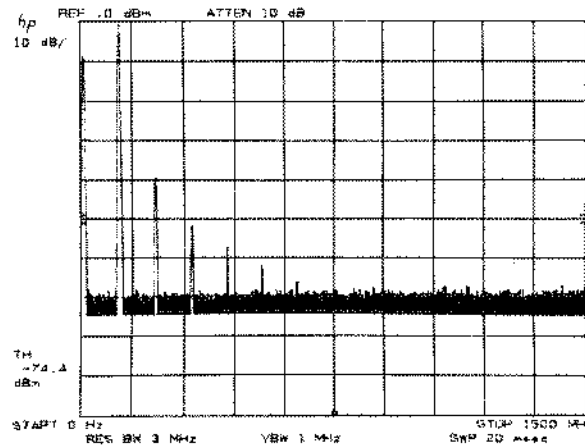

The trace data that would have been shown between display addresses 100 and 500 is omitted and the data for addresses 501 – 1001 is displayed at x positions 100 through 600.

Jump Subroutine (jsb) and Return (rtn). The jsb instruction transfers program control to the address specified. If the address does not contain a control word, the program skips to the next control word after that address. The rtn instruction transfers program control to the first control word following the jsb instruction.

The flow of the program is as follows:

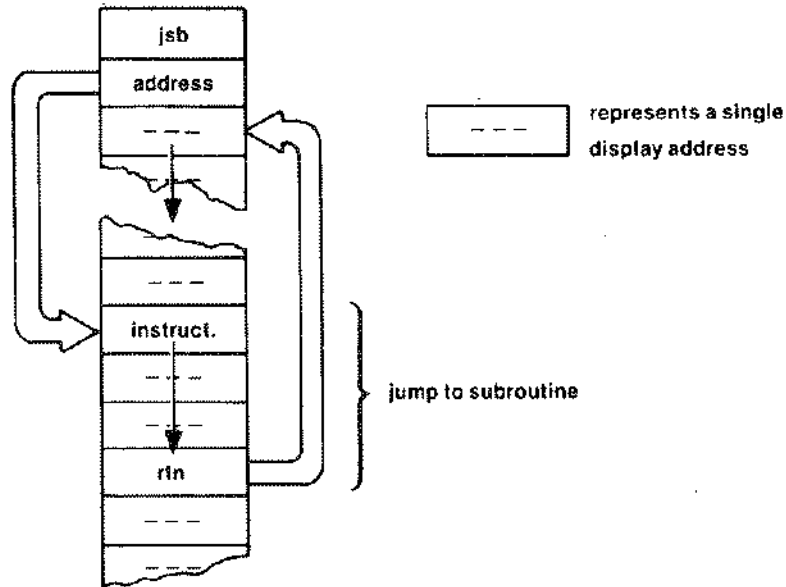

To demonstrate jsb/rtn, this example substitutes a new symbol for the preprogrammed marker symbol.

The marker symbol (a small diamond) is written as a subroutine in the annotation memory at address 2085. Substitution of the diamond symbol can be made by calling for and writing a new jsb routine with this program. The address for the marker subroutine call is located at display address 2054.

```

10      OUTPUT 718:"DA 2054:DW 3080:"
11      OUTPUT 718:"DA 3080:DW 1154,2148,100."
12      OUTPUT 718:"1227:M2:"
14      END
    
```

- Line 10:** Writes a new subroutine address, 3080, in place of the old one.
- Line 11:** Writes the new symbol vector subroutine starting at address 3080 (trace C).
- Line 12:** Return.

After running this program, the display memory contains the following:

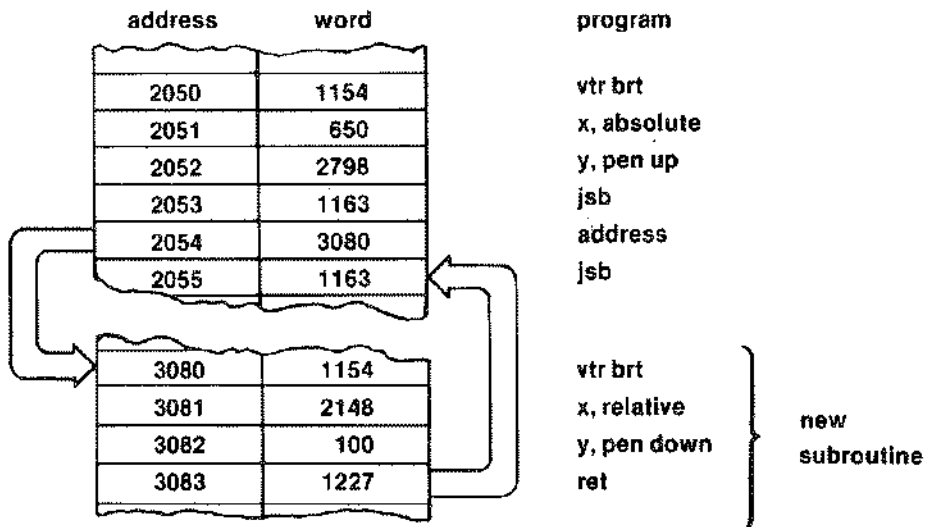

The display would appear similar to this:

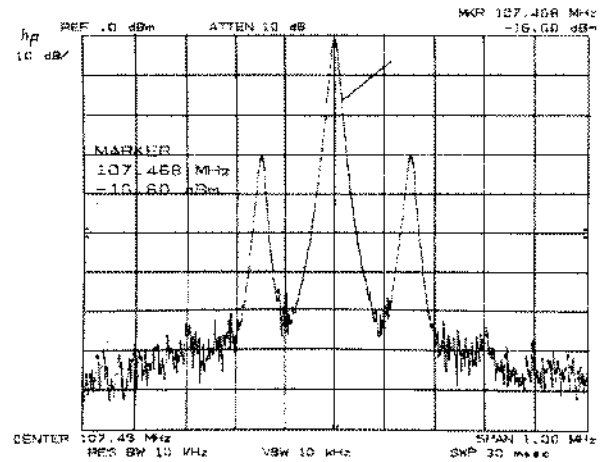

Once a subroutine is written in a given location, care must be exercised that it is not accidentally changed. For example, storing a trace in trace C would destroy the subroutine beginning at DA 3080.

LOOP INSTRUCTIONS

Load Counter Register (ldc) and Decrement and Skip on Zero (dsz). In the following example, looping is used to draw a grid in two places on the CRT display on refresh. The trace C page is programmed to contain the graphics.

	address	description	program	word
positioning vector	3072	plot absolute	vtr	1026
	3073	x = 600 (PA)	600	600
	3074	y = 300 (PU)	300 + 2048	2348
	3075	jump to subroutine	jsb	1163
	3076	at address	address	3199
	3077	plot absolute	vtr	1026
	3078	x = 100 (PA)	100	100
	3079	y = 300 (PU)	300 + 2048	2348
	3080	jump to subroutine	jsb	1163
	3081	at address	address	3199
3082	end of display	end	1028	
looping subroutine	3199	vector	vtr	1026
	3200	repeat 10 times	ldc + 10	1546
	3201	plot relative	vtr	1026
	3202	x = 0 (PR)	0 + 2048	2048
	3203	y = + 25 (PU)	25 + 2048	2073
	3204	x = + 300 (PR)	300 + 2048	2348
	3205	y = 0 (PD)	0	0
	3206	x = 0 (PR)	0 + 2048	2048
	3207	y = + 25 (PU)	25 + 2048	2073
	3208	x = - 300 (PR)	1024-300 + 2048	2772
	3209	y = 0 (PD)	0	0
	3210	decrement	dsz	1099
	3211	jump to	jmp	1035
3212	start	address	3201	
3213	return	rtn	1227	

The program can then be written, loading the words sequentially as listed in the prior plan.

```

10      OUTPUT 718:"IP;KS0:KSm:A4:"
20      OUTPUT 718;"DA 3072;DW 1026,600,2348,"
30      OUTPUT 718;"1163,3199,1026,100,2348,1163,"
40      OUTPUT 718;"3199,1028;"
50      OUTPUT 718;"DA 3199;DW 1026,1546,1026,"
60      OUTPUT 718;"2048,2073,2348,0,2048,2073,"
70      OUTPUT 718;"2772,0,1099,"
80      OUTPUT 718;"1035,3201,"
90      OUTPUT 718;"1227;HD;"
100     END

```

- Line 10:** Blanks the analyzer display.
- Lines 20 to 30:** Contain the positioning vectors.
- Line 40:** An end of memory instruction (1028) insures that the following loop (DA 3199) is not executed unless called from addresses 3075 and 3080, the jsb words.
- Lines 50 to 90:** Contain the grid subroutine.

Running the program results in the following display:

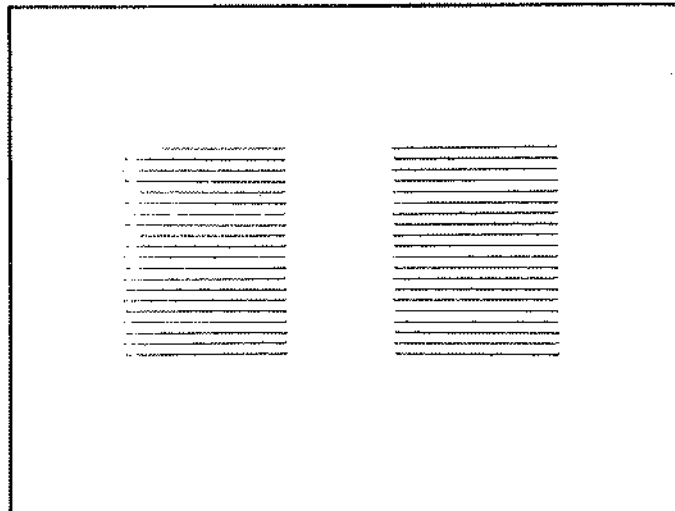

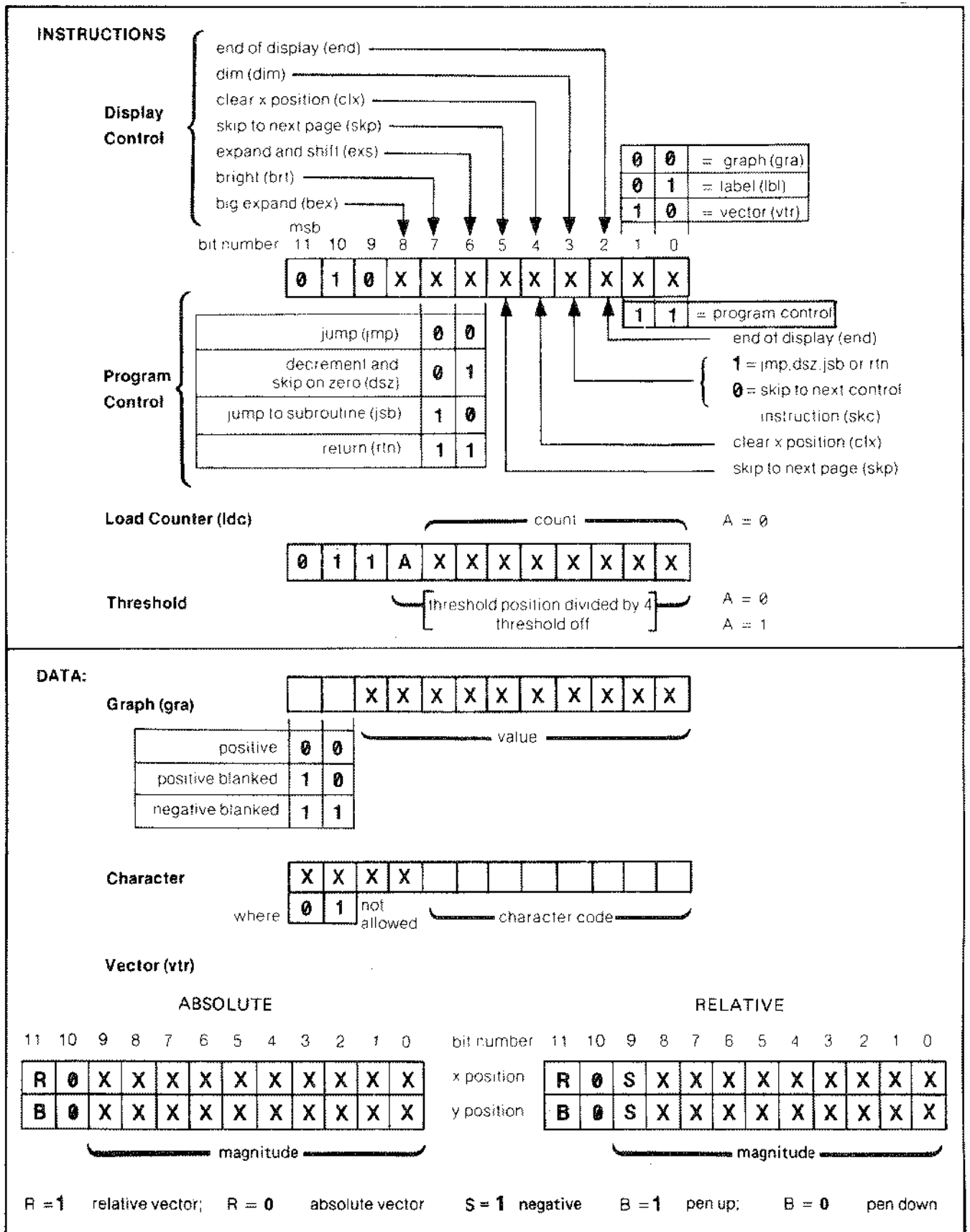

INSTRUCTION AND DATA WORD SUMMARY

Display Control Instruction	Data	Word
graph (gra)	amplitude: position unblanked position blanked negative blanked	1024 y y + 2048 4096 - y
label (lbl)	character blink on (bkon)* blink off (bkof)* skip to next 16 block (sk16)* skip to next 32 block (sk32)* skip to next 64 block (sk64)*	1025 ASCII or special character code (≤ 255) 17 18 145 146 147
vector	x position y position absolute vectors relative vectors pen down pen up (blanked)	1026 data in display units data in display units x + 0 x + 2048 y + 0 y + 2048
Auxiliary to gra, lbl, and vtr instruction word: big expand (bex) expand and shift (exs) bright (brt) dim (dim) clear x position		word + 256 word + 64 word + 128 word + 8 word + 16
Program Control Instruction	Data	Word
end of display (end) skip to next memory page (skp) skip to next control word ⁽¹⁾ (skc) jump ⁽¹⁾ (jmp) jump to subroutine ^{(1) (3)} (jsb) return ^{(1) (3)} (ret)	address address	1028 1056 or "PS" 1027 or "SW" 1035 0 to 4096 1163 0 to 4096 1227
decrement and skip two addresses on zero ^{(1) (2)} (dsz)		1099
load counter (THRESHOLD position) ⁽²⁾ (ldc)		1536 + (count)
<p>* These can also be accessed using the LB command. These functions can be initiated any time the label mode is active.</p> <p>(1) Jumps and skips will skip to an address containing a control word.</p> <p>(2) Loop should use only lbl and vtr control words. Ldc is not a control word.</p> <p>(3) Subroutines may use only vtr control words.</p>		

Appendix C LEARN STRING CONTENT

The following table describes the learn string contents and coding, and the control settings restored when the learn string command, OL, is executed. (See OL.)

HP 8568B LEARN STRING DECODING (1 OF 4)

BYTE NUMBER	BIT USAGE BY EXAMPLE 7 6 5 4 3 2 1 0	EXAMPLE	DESCRIPTION
1	0 0 0 1 1 1 1 1	31	Identifies Learn Code
2			Gain in INPUT #1 Path Units of 0.1 dB (Bits 7-0 of 2 and 7-1 of 3)
3	----- 0	+	Sign of center frequency; 0 = +, 1 = -
4	0 0 0 0 0 0 0 0	0 0	Center frequency; + + BCD, MSD in byte 4 (bits 7 to 4) Example: 1 2 3 4 5 6 7 8 9 0 Hz
5	0 0 0 0 0 0 1 0	1 2	
6	0 0 1 1 0 1 0 0	3 4	
7	0 1 0 1 0 1 1 0	5 6	
8	0 1 1 1 1 0 0 0	7 8	
9	1 0 0 1 0 0 0 0	9 0	
10			Output Format: 0 = O3, 1 = O1, 2 = O4, 3 = O2
11			Counter Time Base: 0 = Auto; N = 10 ^N μsec
12	0 0 0 0 0 0 0 0	0 0	Frequency Span BCD, MSD in byte 12 (bits 7 to 4) Example: 10001 Hz
13	0 0 0 0 0 0 0 0	0 0	
14	0 0 0 0 0 0 0 0	0 0	
15	0 0 0 0 0 0 0 1	0 1	
16	0 0 0 0 0 0 0 0	0 0	
17	0 0 0 0 0 0 0 1	0 1	
18	1 ----- - 1 ----- -- 1 ----- --- 1 ----- ---- 1 ----- ----- 1 ----- ----- 1 ----- ----- 1		85680A RF Section LEADS: Data Enables Signal Track Frequency Count Instr Check I Instr Check II CF Step Size RF Atten Sweep Time
19	1 ----- - 1 ----- -- 1 ----- --- 1 ----- ---- 1 ----- ----- 1 ----- ----- 1		85662A Display Section LEADS: Video BW Res BW Threshold On Display Line On Noise Marker (KSM) Frequency Mode: 0 = CF / Span 1 = Start / Stop
20	1 ----- - 1 ----- -- 1 ----- --- 1 ----- ---- 1 ----- ----- 1 ----- ----- 1 ----- ----- 1		85662A Display Section LEADS: Upper Right Lower Left Video Trigger External Trigger Line Trigger Single Sweep Shift Key Clear-Write B

HP 8568B LEARN STRING DECODING (2 OF 4)

BYTE NUMBER	BIT USAGE BY EXAMPLE 7 6 5 4 3 2 1 0	EXAMPLE	DESCRIPTION
21	1 - - - - - - 1 - - - - - - - 1 - - - - - - - 1 - - - - - - - 1 - - - - - - - 1 - - - - - - - 1		85662A Display Section LEDs: Clear-Write A A-B Blank B View B Max Hold B Blank A View A Max Hold A
22	1 1 1 1 1 0 0 1	- 10.0 dBm	Input Mixer Level Units of 0.1 dBm: Bits 7-0 of Byte 22 and 7-4 of Byte 23 (Low True)
23	0 0 0 0 1 - - - - - - - - 0 1 1	I2 30 dB	Input Selected 0 = I1 1 = I2 RF Attenuator Setting = N × 10 dB
24			Reference Level Units of 0.1 dBm (Binary): MSB = Bit 7 of Byte 24
25			
26	1 - - - - - - 1 1 - - - - - - - 1 - - - - - - - 1 - - - - - - - 1 -	LOG 1 dB/	Log/Linear: 0 = Linear 1 = Log Log Scale: 0 = 10 dB/ 1 = 5 dB/ 2 = 2 dB/ 3 = 1 dB/ XY Recorder Cal XY Recorder Zero CRT Beam Off (Ksg)
27	1 1 1 1 - - - -	3 MHz	Resolution BW: 2 = 10 Hz 10 = 10 kHz 3 = 30 Hz 11 = 30 kHz 4 = 100 Hz 12 = 100 kHz 5 = 300 Hz 13 = 300 kHz 6 = 1 kHz 14 = 1 MHz 9 = 3 kHz 15 = 3 MHz
27	- - - - 0 1 0 1	300 Hz	Video BW: Same as Resolution Bandwidth plus: 0 = 1 Hz 1 = 3 Hz
28			
29	- - 0 1 0 - - - - - - - - 0 1 0	Sample Max-Hold A	Trace Detection Mode: 0 = Neg Peak 1 = Pos. Peak 2 = Sample 4 = Normal Write Operation: 0 = Write A 1 = Write B 2 = Max Hold A 3 = Max Hold A, Write B 4 = Max Hold B 5 = Max Hold B, Write A 6 = Write A-B 7 = Max Hold A-B
30	- - - 0 1 - - -	EXT	Trigger: 0 = Free Run 1 = Ext. 2 = Line 3 = Video
31			

HP 8568B LEARN STRING DECODING (3 OF 4)

BYTE NUMBER	BIT USAGE BY EXAMPLE 7 6 5 4 3 2 1 0	EXAMPLE	DESCRIPTION
32 33	0 0 0 0 0 0 1 1 1 1 1 0 1 0 0 0	1000	Display line in display units: 0-1000
34 35	0 0 0 0 0 0 0 1 1 1 1 1 0 1 0 0	500	Threshold in display units: 0-1000
36			Reference Level Offset Units: 0.1 dB (Binary)
37			
38			Gain in INPUT #2 Path: Bits 7-0 of Byte 38 and Bits 7-1 of byte 39
39	- - - - - 1		Sign of Freq. Offset: 1 = -; 0 = +
40 41 42 43 44 45	0 0 0 1 0 0 1 0 0 0 1 1 0 1 0 0 0 1 0 1 0 1 1 0 0 1 1 1 1 0 0 0 1 0 0 1 0 0 0 0 0 0 0 1 0 0 1 0	1 2 3 4 5 6 7 8 9 0 1 2	Freq. Offset in Hz. BCD, MSD in byte 40 (7 to 4) Example: 1 2 3 4 5 6 7 8 9 0 1 2 Hz
46			Video Average Limit (Binary): Bits 7-0 of Byte 46 and Bits 7-1 of Byte 47
47	- - - - - 1		Sign of CF Step Size: 1 = -; 0 = +
48 49 50 51 52 53			CF Step Size BCD, MSD in byte 48 (bits 7 to 4) (See Freq. Offset for example, bytes 40 to 45)
54 55	0 0 0 0 0 0 0 0 0 0 0 0 0 0 1 0	2	Reference Marker X Position 1-1001 1-1001
56 57	0 0 0 0 0 0 1 1 1 1 1 1 1 1 1 1	1023	Reference Marker Y Position 1-1023
58 59			Active Marker X Position 1-1001
60 61			Active Marker Y Position 1-1023
62 63	0 0 0 0 0 0 0 0 0 0 0 1 0 1 1 1	Counter Zoom	Marker Mode: 0 = Off 18 = Normal 19 = Δ 20 = Zoom 21 = Counter Normal 22 = Counter Δ 23 = Counter Zoom
64			

HP 8568B LEARN STRING DECODING (4 OF 4)

BYTE NUMBER	BIT USAGE BY EXAMPLE 7 6 5 4 3 2 1 0	EXAMPLE	DESCRIPTION
65	-- 1 ----- --- 1 ----- ----- 1		Use Cal Data "Corr'd" (KSX) Calibrated Trace C View
66 67 68 69 70 71			Reference Marker Frequency BCD, MSD in byte 66 (See Center Freq. for example, bytes 4-9)
72	1 1 ----- --- 1 -----	Volts 75Ω	Reference Level Units 0 = dBm 1 = dBmV 2 = dBμV 3 = Volts Impedence: 1 = 75Ω 0 = 50Ω
73	- 1 ----- --- 1 ----- ----- 1 --		Power on in last state (KSF) Allow high level ref level (KSI) Video Averaging (KSG)
74			Scan Index: 0 - 32
75			
76			Sweep Time Word: 10 msec x Factor
77			
78			Fast Sweep Word: Bit 7 (1 = Enable)
79			
80	1 0 1 0 0 1 0 1		Code identifies 8568A learn string 245 (OCTAL) 165 (DEC)

Appendix D SERVICE REQUESTS

This appendix describes the analyzer service request (SRQ) capability and the use of service requests to interrupt an HP-IB controller to obtain service. A service request is an analyzer output that tells the controller a specific event has taken place in the analyzer. Service requests enable the analyzer to interrupt the controller program sequence, causing the program to branch to a subroutine.

For example, by using service requests, the controller can perform other operations while the analyzer is sweeping, and then service the analyzer when the sweep is completed. The analyzer sends its service request to the controller, which triggers the controller to take action, such as changing the instrument state or reading data from the display memory.

When making a service request, the analyzer places the HP-IB SRQ line true and the analyzer CRT display reads out "SRQ" with a number. Setting the SRQ line true announces to the HP-IB controller that the analyzer requires attention. The controller can then command the analyzer to send its "status byte". The status byte indicates the type of service request.

NOTE

If the CRT display annotation has been blanked, the service request notation will not appear.

DISPLAY DURING A SERVICE REQUEST

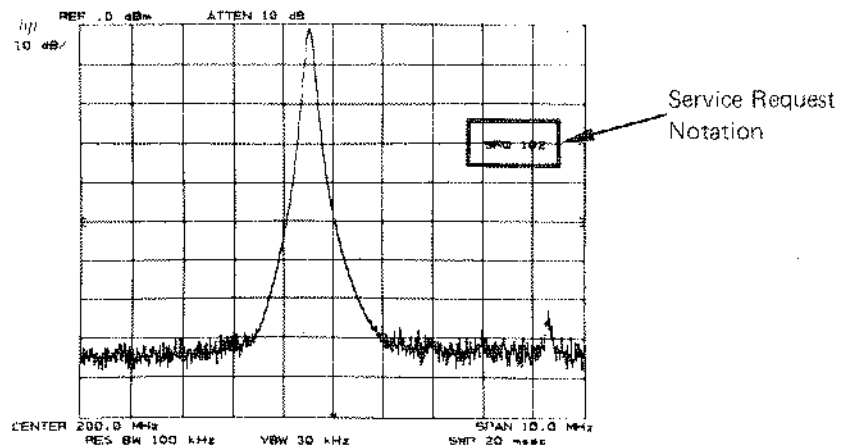

NOTE

A serial polling technique must be used by the HP-IB controller to test for service requests. The analyzer does not respond to HP-IB parallel polling.

INTERRUPT WITH SERVICE REQUEST

The HP-IB controller response to a service request depends on the controller. The operating manuals for each controller discuss that controller's reaction to setting the SRQ line true. Series 200 computers have a sequence of commands which enable a response to a service request. These commands allow monitoring the SRQ line and reading, interpreting, and then clearing the status byte. This sequence of commands and a subroutine, selected according to the type of service request, form a service routine. A general setup is given below.

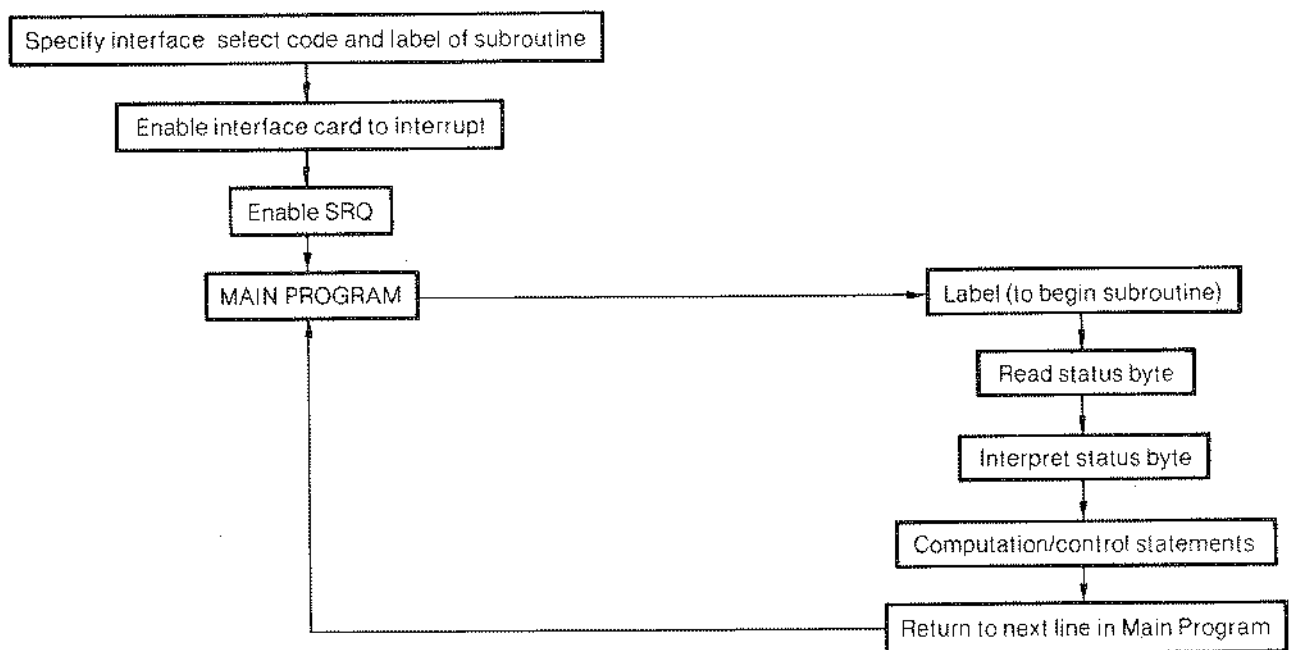

BASIC 2.0 SERVICE ROUTINE COMMANDS

Interrupt Statements	Example	Comments
ON INTR	ON INTR 7 GOSUB Shutoff	Declares the name of the service routine where program execution branches on interrupt from the peripheral specified by select code 7.
ENABLE INTR	ENABLE INTR 7;2	Enables the calculator to accept an SRQ interrupt from select code 7;2 (the HP-IB).
RETURN	RETURN	Signals the end of an interrupt service routine. While executing the service routine, the interrupt for the peripheral being serviced must be disabled to prevent cascading of interrupts.
SUBEXIT	SUBEXIT	Signals the end of an interrupt service subprogram.
Bit Functions		
SROLL	A = SROLL (718)	Reads the analyzer status byte, assigns its decimal value to A and clears the SRQ line.
BIT	BIT (A, N)	Returns the value of the Nth bit in A (0 or 1).

STATUS BYTE DEFINITION

The status byte sent by the analyzer in response to the controller SROLL command determines the nature of the service request. The meaning of each bit of the status byte is explained in the following chart.

Bit	Message	CRT Display Message
0 (LSB)	Unused.	—
1	Unit Key,  r pressed or frequency limit exceeded.	"SRQ 102"
2	End of sweep.	"SRQ 104"
3	Hardware broken.	"SRQ 110"
4	Unused.	—
5	Illegal analyzer command.	"SRQ 140"
6	Universal HP-IB service request. HP-IB RQS Bit	—
7	Unused.	—

The CRT SRQ number is an octal number based on the binary value of the status byte. This octal number always begins with a "1" since this is translated from bit 6, the universal HP-IB service request bit. For example, the status byte for an illegal analyzer command (SRQ 140) is as follows:

bit number	7	6	5	4	3	2	1	0
status byte	0	1	1	0	0	0	0	0

The CRT displays the octal equivalent of the status byte binary number:

"SRQ 140"

The octal equivalent is based on the whole binary number:

$$01100000 \text{ (binary)} = 140 \text{ (octal)}$$

One simple way to determine the octal equivalent of the binary number is to partition the binary number 3 bits at a time from the least significant bit, and treat each part as a single binary number:

binary	0 1	1 0 0	0 0 0
octal	1	4	0

The decimal equivalent of the octal number is determined as follows: $140 \text{ (octal)} = 1 * (8) + 4 * (8) + 0 * (8) = 96 \text{ (decimal)}$.

More than one service request can be sent at the same time. For example, if an illegal analyzer command and the end of a sweep occurred at the same time, "SRQ 144" appears on the CRT display.

bit number	7 6	5 4 3	2 1 0	= "SRQ 144"
status byte	0 1	1 0 0	1 0 0	
octal value	1	4	4	

Note if bit 1 is set, it has one of three meanings, depending on how SRQ 102 was activated. These meanings are explained in the following section.

SERVICE REQUEST ACTIVATING COMMANDS

Service requests do not occur unless the appropriate activating command has been given, except for two service requests: illegal command, SRQ 140, and [SHIFT r] command, SRQ 102 (local operation only). The following chart summarizes the service request activating commands.

Message	SRQ Activating Command	SRQ(s) Allowed	Cancelled By	Comments
Illegal Command	R1	140 only	None	Always activated, R1 disables all SRQ's but SRQ 140.
End of Sweep	R2	104 & 140	R1	Also gives SRQ on completion of CAL routine, video averaging, preselector peak, and auto-zoom.
Hardware Broken	R3 & IP	110 & 140	R1	
Units Key Pressed	R4	102 & 140	R1, pressing units key, or whenever SRQ is cleared.	R4 must be reactivated whenever it is used.
Front Panel SRQ shift r	Local Operation	102, 140	Remote Operation	Always activated when in local (manual) operation.

Note that R2, R3, and R4 can be activated simultaneously, allowing all the SRQ's.

Examples

This program interprets the SRQ status byte and prints its message.

```

10   OUTPUT 718;"R1;R3;R4;"
20   ON INTR 7 GOSUB Interpret_srq
30   ENABLE INTR 7;2
40   PRINT "Push Hz key on analyzer,"
50   PRINT "Press S on controller to stop program,"
60   !
70   Idle:REPEAT
80       ON KBD ALL GOSUB Stop
90       UNTIL Idle
100  Stop:OUTPUT 718;"R1;"
110  STOP
120  !
130  Interpret_srq:OFF INTR 7
140  Status_byte=SPOLL(718)
150  IF BIT(Status_byte,3)=1 THEN PRINT "HARDWARE BROKEN"
160  IF BIT(Status_byte,1)=1 THEN PRINT "UNITS KEY PRESSED"
170  WAIT .1
180  ON INTR 7 GOSUB Interpret_srq
190  OUTPUT 718;"R4;"
200  RETURN
210  END

```

Line 10: Enables all but the end of sweep SRQ. R1 clears former SRQ commands.

Line 20: Executes the "Interpret_srq" subroutine when an interrupt at select code 7 occurs.

Line 30: Enables the controller interrupt capability.

Lines 70 to 100: Any main program. These lines form a program loop that is interrupted when the analyzer requests service.

Lines 130 to 200:	The "Interpret__srq" subroutine.
Line 130:	Turns off further interrupts from the HP-IB. This prevents the cascading of interrupts generated by another service request from the analyzer.
Line 140:	Assigns the status byte to the variable "Status__byte". This clears the analyzer's SRQ (i.e., the status byte is reset).
Lines 150 to 160:	Compares the status byte to two analyzer SRQ codes, and prints the name of the SRQ.
Line 180:	Turns on the controller interrupt capability.
Line 190:	Re-enables the units-key-pressed SRQ.
Line 200:	Returns program execution to the main program.

In the following program, the analyzer sweeps to measure a signal. The controller continues to run its main program while the analyzer sweeps. An end-of-sweep service request tells the controller when the sweep is completed. The controller then re-addresses the analyzer and records the measurement data. This procedure ensures that test data is complete, and improves program execution speed when slow sweeps are used.

```

10   OPTION BASE 1
20   ON INTR 7 GOSUB Record_data
30   ENABLE INTR 7:2
40   !
50   OUTPUT 718;"IP;S2;FA1MZ;FB150MZ;"
60   OUTPUT 718;"ST3SC;R2;TS";
70   BEEP
80   !
90 Idle:REPEAT
100   PRINT "WORKING!"
110   Idle=Idle+1
120   WAIT 1
130   UNTIL Idle=7
140   PRINT "DONE"
150   BEEP
160   STOP
170   !
180 Record_data:OFF INTR 7
190   OUTPUT 718;"R1;"
200   Is_data_ready=SPOLL(718)
210   IF BIT(Is_data_ready,2)=1 THEN
220     OUTPUT 718;"E1;03;MF;"
230     ENTER 718;Freq
240     OUTPUT 718;"MA:"
250     ENTER 718;Ampl
260     PRINT "FREQUENCY = ";Freq;"Hz"
270     PRINT "AMPLITUDE = ";Ampl;"dBm"
280   ELSE
290     PRINT "Illegal analyzer command?"
300     BEEP
310   END IF
320   RETURN
330   !
340   END

```

Lines 20 and 30:	Executes the "Record__data" subroutine when an interrupt at select code 7 occurs. Enables interrupts from the HP-IB interface card.
Lines 50 and 60:	Sets the analyzer for the measurement. The TS command (take sweep) is the last command sent to the analyzer, and the controller CR/LF is suppressed with a semicolon terminator. This is necessary; otherwise, the next program line is not executed until the sweep is complete. (Refer to the description of the TS mnemonic for a detailed explanation of line 60.)
Lines 90 to 150:	Any main program.
Line 180:	"Record__data" subroutine. Turns off interrupts from the HP-IB. This prevents interrupts from cascading.
Line 190:	Clears the end-of-sweep SRQ. This prevents the SRQ from interrupting the program at the next sweep.
Line 200:	Reads the status byte and clears the SRQ.
Line 210 to 310:	Record data if end-of-sweep SRQ was sent.
Line 320:	Returns program execution to the main program.

The following program signals the controller when an operator has completed a data entry. With this information, the controller can read the data entry or branch to a subprogram.

```

10  ENABLE INTR 7;2
20  ON INTR 7 GOSUB Read_entry
30  OUTPUT 718;"R1;R4;EE;"
40  PRINT "Enter center frequency on analyzer's keyboard."
50  PRINT "Press S on controller to stop program."
60  !
70  Idle:REPEAT
80      ON KBD ALL GOSUB Stop
90      UNTIL Idle
100 Stop:OUTPUT 718;"R1;"
110  STOP
120  !
130 Read_entry:OFF INTR 7
140  Is_entry_ready=SPOLL(718)
150  IF BIT(Is_entry_ready,1)=1 THEN
160      OUTPUT 718;"QA;"
170      ENTER 718;Center_freq
180      PRINT "YOU ENTERED";Center_freq;"Hz"
190      OUTPUT 718;"R4;EE;"
200      ON INTR 7 GOSUB Read_entry
210  ELSE
220      PRINT "ILLEGAL ANALYZER COMMAND?"
230      BEEP
240  END IF
250  RETURN
260  END

```

Lines 10 and 20:	Executes the "Read__entry" subroutine when an interrupt at select code 7 occurs. Enables interrupts from the HP-IB interface card.
Lines 70 to 90:	Any main program.
Line 100:	Disables the R4 service request.
Lines 130 to 200:	Forms a subroutine that records the operator's entry.
Line 130:	Turns off interrupts from the HP-IB interface.
Line 140:	Clears the end-of-sweep SRQ and reads the status byte.
Line 150:	Checks the status byte to verify that the interrupt was caused by the units-key-pressed SRQ. If this is not the case, the program continues at line 220.
Lines 160 to 180:	Reads the operator's entry and displays it.
Lines 200 and 210:	Re-enables operator entry, units-key-pressed SRQ, and the controller interrupt capability.
Lines 220 to 250:	Notifies the operator if the illegal analyzer command SRQ triggered the interrupt.

SERVICE REQUEST FROM THE FRONT PANEL

When the spectrum analyzer is in local operation mode (unaddressed), the operator can call for service from a controller by pressing front panel key [SHIFT r]. This front panel request for service sends SRQ 102, the units-key-pressed SRQ. The SRQ command, R4, need not be enabled in order to use the front panel service request.

Example

The front panel service request can summon a controller for assistance. The following example shows one way to do this. During the data transfer, beginning at line 430, the CRT display appears as shown below, with the "DATA TRANSFER" message blinking.

```

OPERATOR?                               3
TEST DEVICE SERIAL NO?                 123
Press Hz key when ready.

DATA TRANSFER IN PROGRESS

```

Several analyzers, each with a different HP-IB address, can call for individual service. This requires serial polling at the beginning of the service subroutine.

```

10   DIM A(1001)
20   DIM A$(20)
30   ENABLE INTR 7:2
40   PRINT "Pressing S on the controller stops program when data is
received."
50   LOCAL 718
60   !
70   Idle:REPEAT
80     ON INTR 7 GOSUB Which_inst
90     ON KBD ALL GOSUB Stop
100  UNTIL Idle
110  Stop:STOP
120  !
130  !*****
140  Which_inst:OFF INTR 7
150  !*****
160  Analyzer_a=SPOLL(718)
170  IF BIT(Analyzer_a,1)>0 THEN
180    GOSUB Record_data
190  END IF
200  RETURN
210  !
220  !*****
230  Record_data:!
240  !*****
250  OUTPUT 718;"SV1;EM;01;KSm;KSo;A4;DT:"
260  OUTPUT 718;"D3;PU;PA64,544;LBOPERATOR NO.?:"
270  REPEAT
280    OUTPUT 718;"EE;0A;"
290    ENTER 718;Operator
300  UNTIL Operator>0
310  OUTPUT 718;"D3PU;PA512,544;LB";Operator;":"
320  !
330  OUTPUT 718;"D3PU;PA64,512;LBTEST DEVICE SERIAL NO?:"
340  OUTPUT 718;"D3-PU;PA64,490;LBPress Hz key when ready.:"
350  OUTPUT 718;"R1;R4;EE;"
360  REPEAT
370    Hz_key_pressed=SPOLL(718)
380  UNTIL BIT(Hz_key_pressed,1)>0
390  OUTPUT 718;"0A"
400  ENTER 718;Serial_number
410  OUTPUT 718;"PU;PA512,512;LB";Serial_number;":"
420  !
430  OUTPUT 718 USING "K,B,K,B,B";"PU;PA64,312;LB";17;"DATA TRANSFER
IN PROGRESS";18:3
440  OUTPUT 718;"TB;"
450  FOR N=1 TO 1001
460    ENTER 718;A(N)
470  NEXT N
480  OUTPUT 718;"EM;RC1;KSn;KSp;HD:"
490  LOCAL 718
500  RETURN
510  END

```

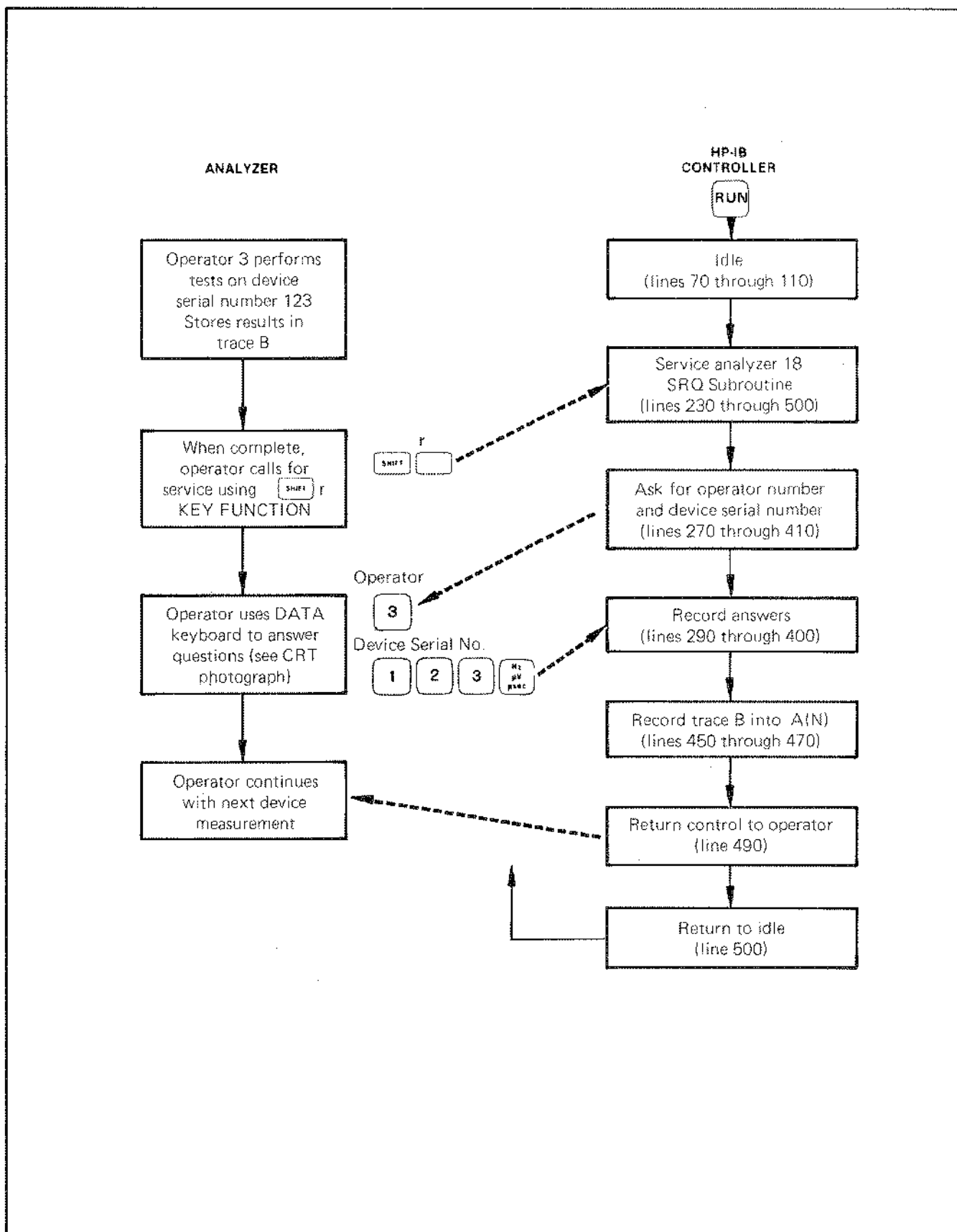

Appendix E

OPERATING DIFFERENCES

Because of the faster processing speed, the addition of new commands, the slight modification of some old commands, and the input buffering capability of the HP 8568B, there are a few minor operating differences between the HP 8568B and its predecessor, the HP 8568A. If you intend to use the HP 8568A and HP 8568B interchangeably, become familiar with the following differences.

EXPONENTIAL FORMAT

With the HP 8568B, any command that specifies the display address (e.g., DA, DR, DW), and which is given in the exponential format (i.e., with notation E1, E2, E3, etc.), executes its prescribed functions as described in this manual. The HP 8568A, however, interprets the exponential notation as an analyzer command. For example, the E1 notation is interpreted as a peak search command, the E2 notation as a marker-into-center-frequency command, etc.

RESETTING THE INPUT BUFFER AND INSTRUMENT PRESET

The HP 8568A does not have an input buffer, and the HP-IB can be reset with an interface clear (IFC). To reset the input buffer in the HP 8568B, use a device clear (CLEAR 718). This way, any commands in the input buffer in the HP 8568B are executed before instrument preset (IP) occurs. However, if device clear (CLEAR 718) is preceded by interface clear (ABORT 7), an instrument preset (IP) occurs and clears the input buffer immediately. Thus, all commands in the buffer are lost and not executed.

REMOTE INSTRUMENT PRESET

Execution of a remote Instrument Preset (IP) causes the HP 8568B merely to preset its controls. The same command causes the HP 8568A to preset its controls and run a check of its IO bus and memory. The HP 8568A also executes a full sweep; the HP 8568B does not.

CORRECTION DATA ROUTINE

On the HP 8568B, be sure to read all data into the controller before re-executing KSw (see KSw command description).

TIMING

The HP 8568B processes data faster than the HP 8568A. Therefore, if you attempt to use HP 8568A software with the HP 8568B, timing problems may occur.

ACTIVE FUNCTION

Occasionally a two-letter command to the HP 8568B might not activate the specified function. The reason is that the command mnemonic has been interpreted by the analyzer as the first two letters of a longer command mnemonic that starts with the same two letters. For example, the command ST for Sweep Time could be interpreted by the analyzer as the first two letters of STDEV, the command for Standard Deviation. In this situation, the analyzer simply waits for another character before activating the function. To prevent this problem, insert a space or a terminator immediately after the two-letter command.

KS39 COMMAND

The syntax of the KS39 command is different for the HP 8568A and HP 8568B. With the HP 8568B, the display memory address is specified immediately after KS39 and is sent to the analyzer as two 8-bit bytes. With the HP 8568A, the display memory address is specified immediately before KS39 with the DA (Display Address) command.

SOFTWARE INCOMPATIBILITY

If there are no spaces or semicolons between two-letter commands in HP 8568A software, certain "A" commands might be misinterpreted by the HP 8568B analyzer.

The following is a list of examples where "A" commands might be misinterpreted by the HP 8568B:

"A" SOFTWARE EXAMPLE		"B" MISINTERPRETATION	
CTA1	(Couple Sweeptime, View		
CTA	(Convert to dBm)		
	Trace A		
CTMT1	(Couple Sweeptime, Signal	CTM	(Convert to Display Units)
	Track On)		
DLE1	(Activate Display Line,	DLE	(Enable Display Line)
	Peak Search)		
GRAT	(Graph, Set Attenuator)	GRAT	(Graticule on or off)
PDA4	(Pen Down, Blank Trace A)	PDA	(Probability Distribution in
			Amplitude)
PDFA	(Pen Down, Start Frequency)	PDF	(Probability Distribution in
			Frequency)
THE1	(Activate Threshold, Peak	THE	(Enable Threshold)
	Search		
VBOA	(Activate Video Bandwidth,	VBO	(Set Video Bandwidth and
	Output Active Function		Resolution Bandwidth Ratio)

Examples that are least likely to occur are GRAT, PDA4, and PDFA because, in these sets of commands, the second command will not typically follow the first command. However, all examples have the potential to cause problems, because they don't follow "B" syntax requirements. The HP 8568B interprets "A" software written like the above examples as invalid commands. As a result, the commands are not executed and an HP-IB command error should appear on the analyzer CRT. Fortunately, this command error can be used as a method of finding software errors.

Appendix F

EQUIVALENT HP 8568B AND 8568A COMMANDS

The following list shows combinations of 8568B commands and secondary keywords that are equivalent to other 8568B commands common to the HP 8568A. The commands are interchangeable when programming the 8568B.

Alphabetical Listing of 8568B Commands	Equivalent Commands Common to the 8568A	Alphabetical Listing of 8568B Commands	Equivalent Commands Common to the 8568A
AMB ON	C2	MKNOISE ON	KSM
AMB OFF	C1	MKNOISE OFF	KSL
ANNOT ON	KSp	MKPK	E1
ANNOT OFF	KSo	MKPK HI	E1
APB	KSc	MKRL	E4
AUNITS DBM	KSA	MKSP	KSO
AUNITS DBMV	KSB	MKSS	E3
AUNITS DBUV	KSC	MKSTOP	KSu
AUNITS V	KSD	MKTRACK ON	MT1
AXB	EX	MKTRACK OFF	MT0
BLANK TRA	A4	ML	KS,
BLANK TRB	B4	MOV TRC, TRB	KSI
BLANK TRC	KSk	MXMH TRA	A2
BML	BL	MXMH TRB	B2
BTC	KSl	RCLS	RC
BXC	KSi	ROFFSET	KSZ
CLRW TRA	A1	SAVES	SV
CLRW TRB	B1	SNGLS	S2
CONTS	S1	TDF M	01
DET NRM	KSa	TDF P	03
DET SMP	KSe	TDF B	02 or 04
DET POS	Ksb	THE ON	TH
DET NEG	Ksd	THE OFF	T0
DLE OFF	L0	TM FREE	T1
FOFFSET	KSV	TM LINE	T2
GRAT ON	KSn	TM EXT	T3
GRAT OFF	KSm	TM VID	T4
MKA?	MA	VAVG	KSG
MKCF	E2	VAVG ON	KSG
MKD	M3	VAVG OFF	KSH
MKFC OFF	MC0	VIEW TRA	A3
MKFC ON	MC1	VIEW TRB	B3
MKFCR	KS =	VIEW TRC	KSj
MKF?	MF	XCH TRA, TRB	EX
MKN	M2	XCH TRB, TRC	KSi

Alphabetical Listing of Commands Common to the 8568A	Equivalent 8568B Command	Alphabetical Listing of Commands Common to the 8568A	Equivalent 8568B Command
A1	CLRW TRA	KS _i	XCH TRB, TRC or BXC
A2	MXMH TRA	KS _j	VIEW TRC
A3	VIEW TRA	KS _k	BLANK TRC
A4	BLANK TRA	KS _l	BTC or MOV TRC, TRB
B1	CLRW TRB	KS _m	GRAT OFF
B2	MXMH TRB	KS _n	GRAT ON
B3	VIEW TRB	KS _o	ANNOT OFF
B4	BLANK TRB	KS _p	ANNOT ON
BL	BML	KS _u	MKSTOP
C1	AMB OFF	KS,	ML
C2	AMB ON	KS =	MKFCR
EX	XCH TRA, TRB or AXB	L0	DLE OFF
E1	MKPK or MKPK HI	MA	MKA?
E2	MKCF	MC0	MKFC OFF
E3	MKSS	MC1	MKFC ON
E4	MKRL	MF	MKF?
KSA	AUNITS DBM	MT0	MKTRACK OFF
KSB	AUNITS DBMV	MT1	MKTRACK ON
KSC	AUNITS DBUV	M2	MKN
KSD	AUNITS V	M3	MKD
KSG	VAVG or VAVG ON	O1	TDF M
KSH	VAVG OFF	O3	TDF P
KSL	MKNOISE OFF	O2 or O4	TDF B
KSM	MKNOISE ON	RC	RCLS
KSO	MKSP	S1	CONTS
KSV	FOFFSET	S2	SNGLS
KSZ	ROFFSET	SV	SAVES
KS _a	DET NRM	TH	THE ON
KS _b	DET POS	T0	THE OFF
KS _c	APB	T1	TM FREE
KS _d	DET NEG	T2	TM LINE
KS _e	DET SMP	T3	TM EXT
		T4	TM VID

Section IV

INDEX

INDEX

A

A + B → A, 100
A → B, 43
Active function, 33
ADD, **22 – 23**
Alphabetical keycode summary, 94
AMB, **24**
AMBPL, **25**
Amplitude
 offset, 95
 units, 97
AMPTD CAL, 3
ANNOT, **26**
Annotation on/off, 99
APB, **27**
AT, **28**
Attenuation, 78
AUNITS, **29**
AUTO (coupled functions), 73
Automatic zoom, 53
 (see also Zoom to marker)
AVG, **30 – 31**
AXB, **32**
A1, **33**
A2, **34**
A3, **35**
A4, **36**

B

B – DL → B, 45
BL, **37**
Blank, 40
 annotation, 99
 display (CRT), 99
 graticule, 99
 outputs, 7
BLANK, **38**
BML, **39**
BRD, **40**
BTC, **41**
BWR, **42**
BXC, **43**
B1, **44**
B2, **45**
B3, **46**
B4, **47**

C

C (trace), 102, 106
CA, **48**
CENTER FREQUENCY, 22, 12
Center frequency step size, 80
CF, **49**
CF STEP SIZE, 80
CLEAR-WRITE, 41
CLRAVG, **50**
CLRW, **51**
Command list
 enter, 109
 execute, 110
COMPRESS, **52 – 53**
CONCAT, **54**
CONT, 79
CONTS, **55**
Continuous sweep, 84
CORR'D, 3
Correction data, 107
 displayed, 99
Coupled functions, 73
CR, **56**
CRT display, 33
 adjustments, 33
 beam on/off, 99
CRT refresh rate, 40
CS, **57**
CT, **58**
CTA, **59**
CTM, **60**
CV, **61**
C1, **62**
C2, **63**

D

DA, **64**
Data
 controls, 17, 19
 entries, 18
 keys, 11
 knob, 11, 17, 18
 number/units keyboard, 19
 step keys, 17, 19
dBm, 97
dBmV, 97
dBμV, 97

NOTE: Page numbers in regular typeface refer to Section I, Manual Operation. Page numbers in **bold** typeface refer to Section II, Programming.

DC precaution, 4
DD, **65 – 66**
Deactivate function, 18
Delta (Δ) marker, 46
DET, **67**
Detection modes, 100
Diagnostic aids, 108
Display
 CRT, 5
 line, 45
 memory structure, Appendix A
 programming (advanced), Appendix B
 units, 36
 terms, 35
 titling, 100
DISPOSE, **68 – 69**
DIV, **70 – 71**
DL, **72 – 73**
DLE, **74**
DONE, **75**
DR, **76**
DSPLY, **77**
DT, **78**
DW, **79**
D1, D2, D3, **80 – 85**

E

EE, **86 – 88**
Effective mixer level, 96
EK, **89**
Element, 36
ELSE, **90 – 91**
EM, **92**
ENABLED light, 18
ENDIF, **93 – 94**
Equivalent HP 8568A and HP 8568B commands,
 Appendix F
ERR, **95**
Error correction routine, 3, 106
EX, **96**
Excessive input power, 4
Exchange trace B and C, 103
EXP, **97**
Extend reference level, 97
External
 frequency reference, 9
 trigger, 83, 106
E1, **98**
E2, **99**
E3, **100**
E4, **101**

F

FA, **102**
FB, **103**
FFT, **104 – 108**
FOFFSET, **109**
FORMAT STATEMENTS, **110 – 113**
 (see also O1, O2, O3, O4)
FREE RUN (trigger), 85
FREQ REFERENCE, 9
Frequency
 offset, 95
 span, 12, 24
FREQUENCY SPAN, 12, 24
Front panel control groups, 5
FS, **114**
FULL SPAN, 13
 0 – 2.5 GHz, 12, 85
 2 – 22 GHz, 12
FUNCDEF, **115**
FUNCTION keys, 21
Function summary, 94

G

GR, **116**
GRAT, **117**
Graticule, 35
 on/off, 99
General information, 1

H

HD, **118**
Hewlett-Packard Interface Bus, 9, 16
HOLD, 18
HP-IB, 9, 16

I

IB, **119**
ID, **120**
IF
 INPUT connector, 10
 OUTPUT connector, 10
IF, **121 – 122**
Input
 attenuation, 74
 mixer level, 96

NOTE: Page numbers in regular typeface refer to Section I, Manual Operation. Page numbers in **bold** typeface refer to Section II, Programming.

Internal frequency reference, 9
INSTRUMENT PRESET, 13, 87
Instrument state, 87
 FULL SPAN, 0–1.5 GHz, 89
 instrument preset, 87
 local operation (LCL), 91
 SAVE and RECALL, 89
IP, **123 – 124**
I1, **125**
I2, **126**

K

KEYDEF, **127 – 128**
KEYEXC, **129**
Key functions, 93–108
KSA (amplitude in dBm), 97, **130**
KSA (normal detection), **157**
KSB (amplitude in dBmV), 97, **131**
KSB (positive peak detection), **158**
KSC (amplitude in dBμV), **132**
KSc (A + B → A), 100, **159**
KSD (amplitude in volts), **133**
KSD (negative peak detection), **160**
KSE (title mode), **134 – 135**
KSe (sample detection), **161**
KSF (measure sweep time), **136**
KSf (power on in last state), **162**
KSG (video averaging on), **137**
KSG (CRT beam off), 99, **163**
KSH (video averaging off), **138**
KSH (CRT beam on), 99, **164**
KSI (reference level range [extended]), **139**
KSi (exchange B and C), **165**
KSJ (manual DAC control), **140**
KSj (view trace C), **166 – 167**
KSK (count pilot IF at marker), **141**
KSk (blank trace C), **168**
KSL (marker noise off), **142**
KSl (transfer B to C), **169**
KSM (marker noise on), **143**
KSm (graticule off), 99, **170**
KSN (count VCO at marker), **144**
KSn (graticule on), 99, **171**
KSO (marker span), **145**
KSo (characters off), **172**
KSP (HP-IB address), **146**
KSp (characters on), **173**
KSQ (count signal IF), **147**
KSq (step gain off), **174**
KSR (diagnostics on), **148**

KSr (service request 102), **175**
KSS (second LO auto), **149**
KST (second LO down), **150**
KSt (marker continue), **176**
KSU (second LO up), **151**
KSu (marker stop), **177**
KSV (frequency offset), **152**
Ksv (inhibit phase lock), **178**
KSW (error correction routine), **153**
KSw (view correction data), 99, **179 – 180**
KSX (correction factors on), **154**
KSx (external trigger), **181**
KSY (correction factors off), **155**
KSy (video trigger), **182**
KSZ (reference level offset), **156**
KSz (storage address), **183**
KS, (mixer level), **184**
KS = (marker frequency counter resolution), **185**
KS((lock registers), 106, **186**
KS) (unlock registers), 106, **187**
KS|, **188**
KS> (preamp gain – input 2), **189**
KS< (preamp gain – input 1), **190**
KS39 (write to display memory), **191 – 192**
KS91 (read amplitude error), **193**
KS123 (read display memory), **194 – 195**
KS125 (write to display memory), **196 – 197**
KS126 (read every nth value), **198**

L

LB, **199 – 200**
Learn string content, Appendix C
LG, **203**
LIN, 66
Linear scale, 66
LINE, 83
Line trigger, 83
LL, **204**
LN, **205**
Local operation (LCL), 91
Lock save registers, 106
LOG, **206 – 207**
LØ, **208**

M

MA, **209**
Manual calibration procedure, 2

NOTE: Page numbers in regular typeface refer to Section I, Manual Operation. Page numbers in **bold** typeface refer to Section II, Programming.

Marker, 13, 47
 delta, 50
 entry, 57
 to center frequency, 57
 to step size, 57
 stop sweep, 98
 Maxhold, 40
 MBRD, **210**
 MBWR, **211**
 MCØ, **212**
 MC1, **213**
 MDS, **214**
 MDU, **215**
 MEAN, **216**
 MEM, **217**
 ME, **218**
 MIN, **219**
 MKA, **220**
 MKACTION, **221**
 MKCF, **222**
 MKCONT, **223**
 MKD, **224 – 225**
 MKF, **226**
 MKFC, **227**
 MKFCR, **228 – 229**
 MKMIN, **230**
 MKN, **231**
 MKNOISE, **232**
 MKOFF, **233**
 MKP, **234**
 MKPAUSE, **235**
 MKPK, **236**
 MKPX, **237**
 MKREAD, **238**
 MKRL, **239**
 MKSP, **240**
 MKSS, **241**
 MKSTOP, **242**
 MKTRACE, **243**
 MKTRACK, **244**
 MKTYPE, **245**
 ML, **246**
 MOV, **247**
 MPY, **248 – 249**
 MRD, **250**
 MRDB, **251**
 MTØ, **252**
 MT1, **253**
 MWR, **254**
 MWRB, **255**
 MXM, **256 – 257**
 MXMH, **258**

M1, **259**
 M2, **260**
 M3, **261 – 262**
 M4, **263**

N

Negative
 data entry, 95
 entries, 19
 peak detection, 100
 Noise level measurements, 63
 NORMAL marker, 13, 48

O

OL, **264**
 ONEOS, **265**
 ONSWP, **266**
 OP, **267**
 Operating differences between the 8568B
 and 8568A, Appendix E
 OT, **268 – 269**
 Outputs
 BLANK, 7
 display, 7
 PENLIFT, 8
 plotter, 7
 rear panel, 7
 RECORDER, 8
 SWEEP, 8
 VIDEO, 8, 9
 21.4 MHz IF Output, 8
 O1, O2, O3, O4, **270 – 273**
 (see also Format statements)

P

PA, **274**
 PD, **275**
 PDA, **276**
 PEAK SEARCH, 56
 PEAKS, **278 – 279**
 PLOT, **280**
 Plotter addresses, 112
 Plotter output, 7, 111 – 112
 Plotter pens, 112
 Positive peak detection, 100
 Power ON, 2

NOTE: Page numbers in regular typeface refer to Section I, Manual Operation. Page numbers in **bold** typeface refer to Section II, Programming.

PR, **281**
PS, **282**
PU, **283**
PWRBW, **284**

Q

Quasi-peak Adapter, **9**

R

RB, **285**
RC, **286**
RCLS, **287**
Readouts, 37
Rear panel
 connections, 2
 outputs, 7
Recorder outputs, 8
Reference level, 12, 28
Reference lines, 68
 display line, 68
 threshold line, 70
Refresh display, 40
REPEAT, **288 – 289**
RES BW, 74
Resolution bandwidth, 74
Resolution
 of markers, 48
REV, **290**
RF attenuation, 78
RL, **291**
RMS, **292**
ROFFSET, **293**
RQS, **294**
R1, **295**
R2, **296**
R3, **297**
R4, **298**

S

Sample detection mode, 100
SAVES, **299**
Scale, 65
 linear, 66
 logarithmic, 67
Service requests, Appendix D
SIGNAL TRACK, 55, 60

SMOOTH, **300**
SNGLS, **301**
SP, **302**
SQR, **303**
SRQ, **304**
SS, **305**
ST, **306**
Standby, 2
START and STOP frequencies, 27
STDEV, **307**
Step size, 80
Stop sweep at marker, 98
Store modes, 40
SUB, **308 – 309**
SUM, **310**
SUMSQR, **311**
SV, **312**
SW, **313**
Sweep, 40, 83
 time, 77
S1, **314**
S2, **315**

T

TA, **316 – 317**
TB, **318 – 319**
TDF, **320**
TEXT, **321**
TH, **322**
THE, **323**
THEN, **324 – 325**
THRESHOLD, 70
Title mode, 100
TM, **326**
Trace, 39
 A + B → A, 100
 B - DL → B, 45
 C (trace) modes, 44, 102, 106
 detection modes, 100
 exchange trace A and B, 43
 exchange trace B and C, 103
 functions, 39
 identification, 39
 memory, 40
 memory structure, 40
 modes, 40
 priority, 46
 store mode, 41
 transfer trace B to C, 102
TRDEF, **327**

NOTE: Page numbers in regular typeface refer to Section I, Manual Operation. Page numbers in **bold** typeface refer to Section II, Programming.

TRDSP, **328**
TRGRPH, **329**
Trigger, 83
 automatic, zero span, 84
 EXT (external), 85, 106
 FREE RUN, 83
 LINE, 83
 VIDEO, 83, 106
 video level, 86
TRMATH, **330 – 331**
TRPST, **332**
TRSTAT, **333**
TS, **334**
TWINDOW, **335**
T \emptyset , **336**
T1, **337**
T2, **338**
T3, **339**
T4, **340**

U

Units, 97 (see also Amplitude units)
UNTIL, **341 – 342**
UR, **343**
User defined keys, 109
USTATE, **344**

V

VARDEF, **345**
VARIANCE, **346**

VAVG, **347**
VB, **348**
VBO, **349**
Vector, 36
Video
 averaging, 104
 bandwidth, 75
 INP connector, 10
 OUT connector, 10
 trigger, 83, 106
 trigger level, 85
VIEW, 40 – 41, **350**
Voltage scale (linear), 67
Volts, 97

W

WRITE modes, 41

X

XCH, **351**

Z

Zero frequency span, 25, 84
Zero span, automatic trigger, 84
Zoom to marker, 53

NOTE: Page numbers in regular typeface refer to Section I, Manual Operation. Page numbers in **bold** typeface refer to Section II, Programming.

MANUAL UPDATE

HP 8568B OPERATING AND PROGRAMMING MANUAL

HP PART NUMBER 08568-90041

Printed March 1985

This update package contains information for updating the Operating and Programming Manual for the HP 8568B. These changes reflect upgrades in the product.

In this package, you will find pages which are to be placed in the Programming Commands section of this manual. These additions pertain to HP 8568B's with serial numbers of 2503A00971 and above.

REVISION INSTRUCTIONS

The attached sheets contain new functions which are installed in later versions of the HP 8568B as described above. Place the new function sheets in alphabetical order in the section marked Programming Commands. The attached sheets include:

ABS	ABSOLUTE VALUE
ENTER	ENTER FROM THE HP-IB
ERASE	ERASES ALL MEMORY
FFT	FAST FOURIER TRANSFORM
FFTKNL	FAST FOURIER TRANSFORM KERNAL
IFTKNL	SCALED FAST FOURIER TRANSFORM KERNAL
INT	INTEGER
MERGE	MERGES TRACES
MINPOS	MINIMUM POSITION
MIRROR	MIRROR IMAGE
MOD	MODULO
OUTPUT	OUTPUT TO THE HP-IB (two pages)
PKPOS	PEAK POSITION

ABS

ABSOLUTE

COMMAND SYNTAX:

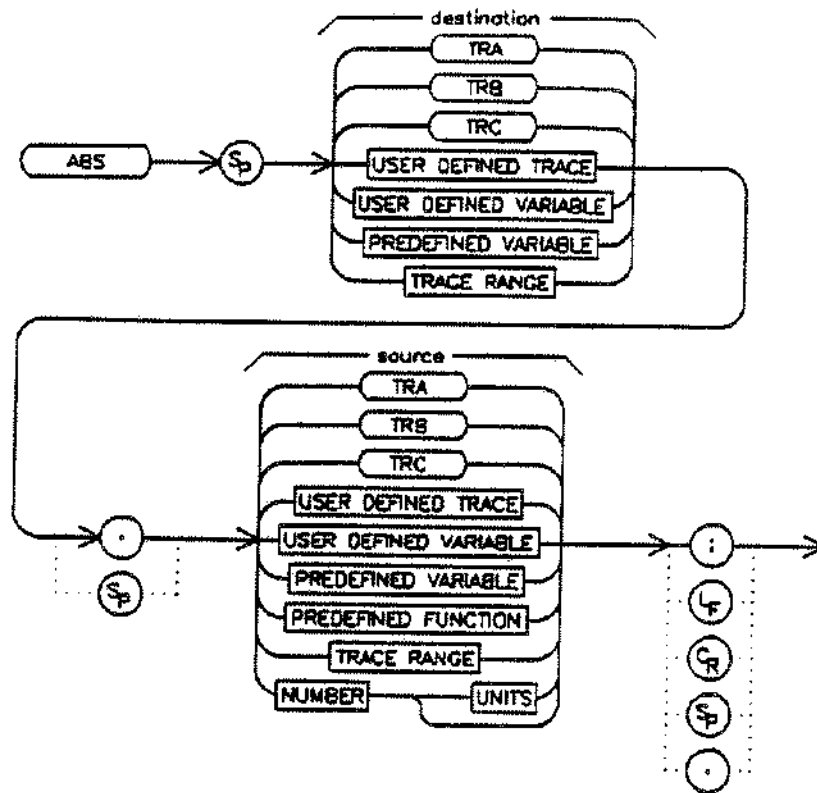

DESCRIPTION:

The absolute value of the source is put in the destination.

ENTER
ENTER FROM HP-IB

COMMAND SYNTAX:

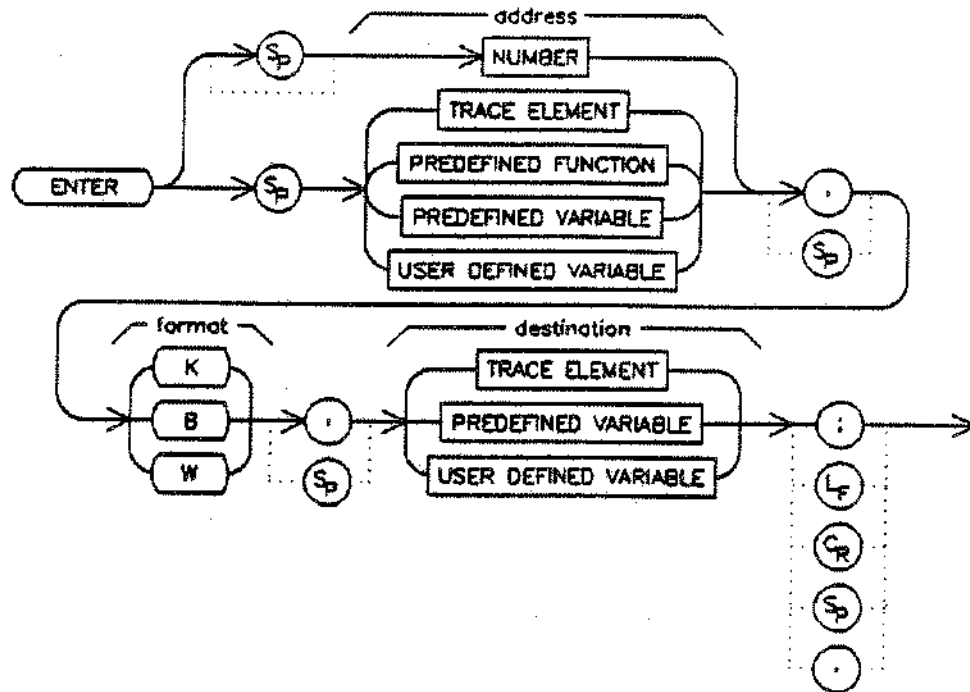

DESCRIPTION:

The command *ENTER FROM HP-IB* (*ENTER*) allows a function definition to enter data from the HP-IB port. If a controller is detected on HP-IB, the command is aborted. This command causes the analyzer to assume controller capabilities on HP-IB. The *RELEASE HP-IB* (*RELHPIB*) command may be used to disable these capabilities. The entered data is formatted according to the format specified in the format field.

K:

Free field. ASCII real number format.

B:

One byte binary.

W:

One word (2 bytes) binary.

ERASE

Erase

COMMAND SYNTAX:

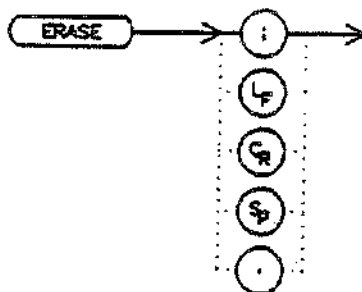

DESCRIPTION:

All user memory and save/recall registers are erased. The user memory is erased by first putting all 1's, then all zeros, into memory. The save/recall registers are erased by placing instrument preset in all registers.

FFT

FAST FOURIER TRANSFORM

COMMAND SYNTAX:

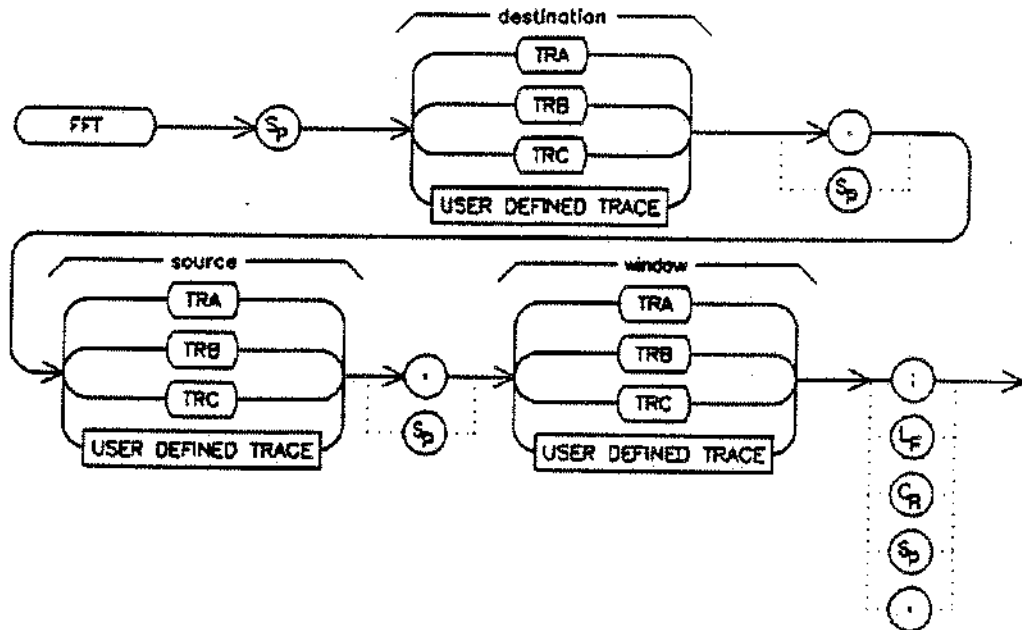

DESCRIPTION:

The *FAST FOURIER TRANSFORM (FFT)* command performs a Discrete Fourier Transform on the source trace array and stores the logs of the magnitudes of the results in the destination array. If necessary, the source trace is padded with zeros at the end to result in a sufficient number of points, and it is converted to linear values if stored logarithmically. The source array is then weighted with the function in the window trace to minimize amplitude inaccuracies, side lobes, etc. The transform is then computed and the results placed in the destination array. No phase or absolute sign information is preserved in the results. If needed, phase or absolute sign information may be obtained by using the *FAST FOURIER KERNEL (FFTKNL)* command instead.

The windowing function stored in the window trace may be created with the *TRACE WINDOW (TWINDOW)* command or by the user storing his own values in that trace. The values in the window trace are treated as fractional numbers. No offset is used. The average window value is computed and used to correct the results in absolute units. For maximum precision, the peak values of user created traces should approach +32767 or -32768. Windowing is described in greater detail under the *TWINDOW* command.

Due to aliasing, the *FFT* command only directly computes the values of the even points of the destination trace. The odd values are obtained by interpolation.

FAST FOURIER TRANSFORM KERNEL

COMMAND SYNTAX:

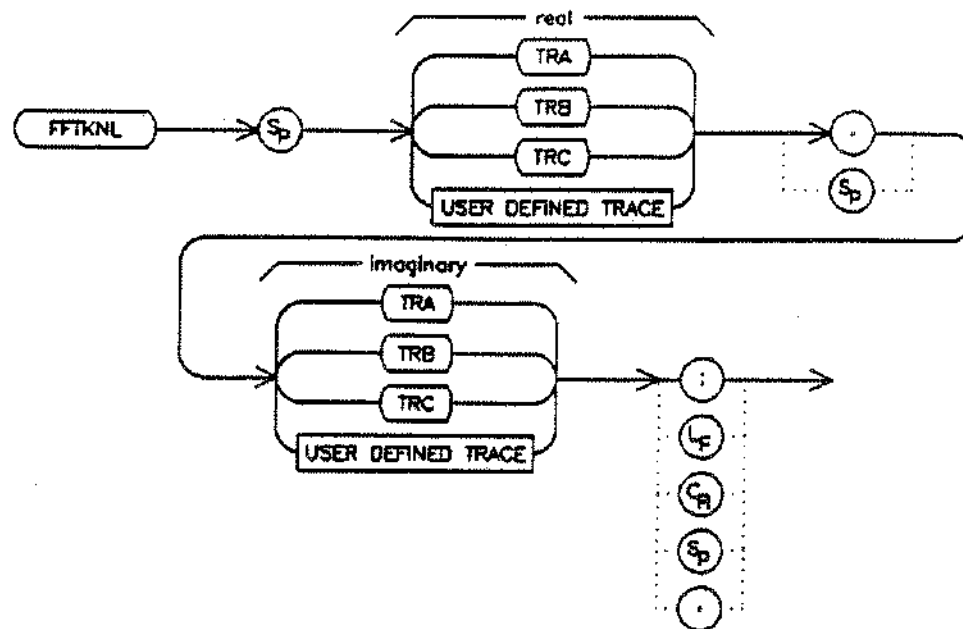

DESCRIPTION:

This command performs a 16 bit Discrete Fourier Transform on the specified traces, overlaying them with the results. Both traces must be the same length, and the length must be a power of two. The two traces represent the real and imaginary components of one complex valued trace. *FFTKNL* does no other normalization, scaling, clipping, or magnitude determination. Any such manipulation is the user's responsibility.

If the results of the Discrete Fourier Transform are to be multiplied by the length of the traces, the command *SCALED FAST FOURIER TRANSFORM (IFTKNL)* should be used instead of this command.

IFTKNL

SCALED FAST FOURIER TRANSFORM KERNAL

COMMAND SYNTAX:

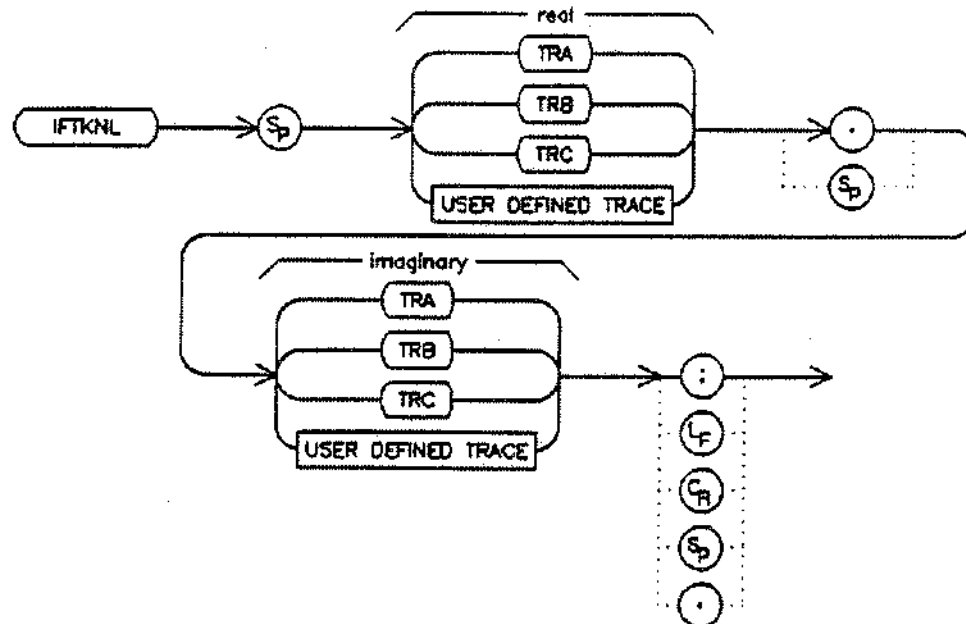

DESCRIPTION:

This command performs a 16 bit Discrete Fourier Transform on the specified traces, overlying them with the results multiplied by N (the length of each trace). Both traces must be the same length, and the length must be a power of two. The two traces represent the real and imaginary components of one complex valued trace. *IFTKNL* does no other normalization, scaling, clipping, or magnitude determination. Any such manipulation is the user's responsibility.

The only difference between *SCALED FAST FOURIER TRANSFORM KERNAL(IFTKNL)* and *FAST FOURIER TRANSFORM KERNAL(FFTKNL)* is that the former returns results which are scaled by the length of the traces. If *IFTKNL* is used as an Inverse Discrete Transform (IFT), the results are in time reversed order. To do an IFT, the imaginary trace must have its sign changed before and after the *IFTKNL*.

INT INTEGER

COMMAND SYNTAX:

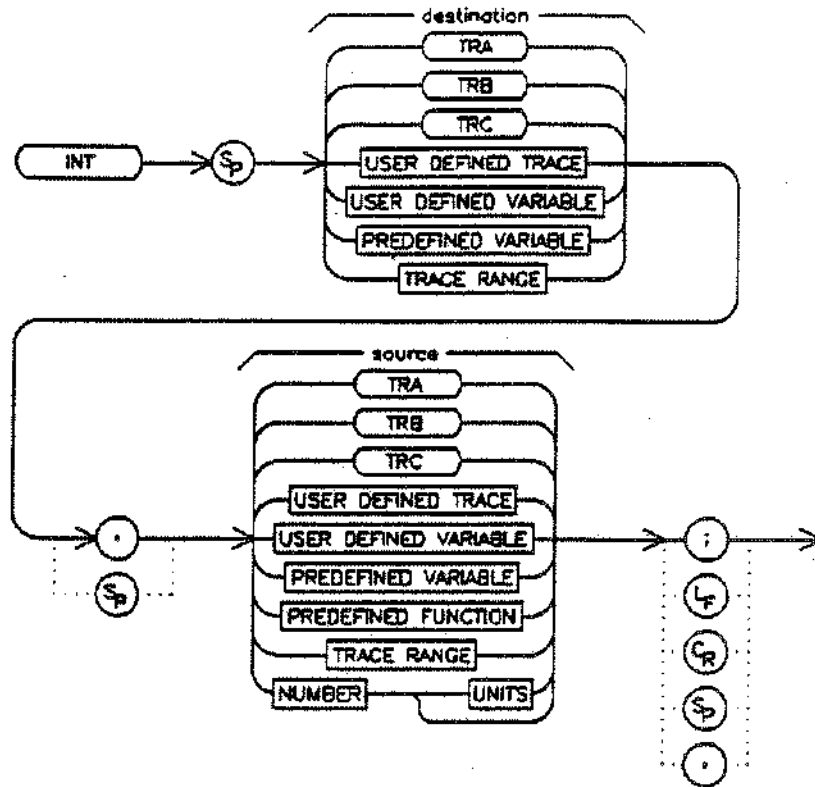

DESCRIPTION:

The greatest integer which is less than or equal to the source real number is stored in the destination.

MERGE

Merge

COMMAND SYNTAX:

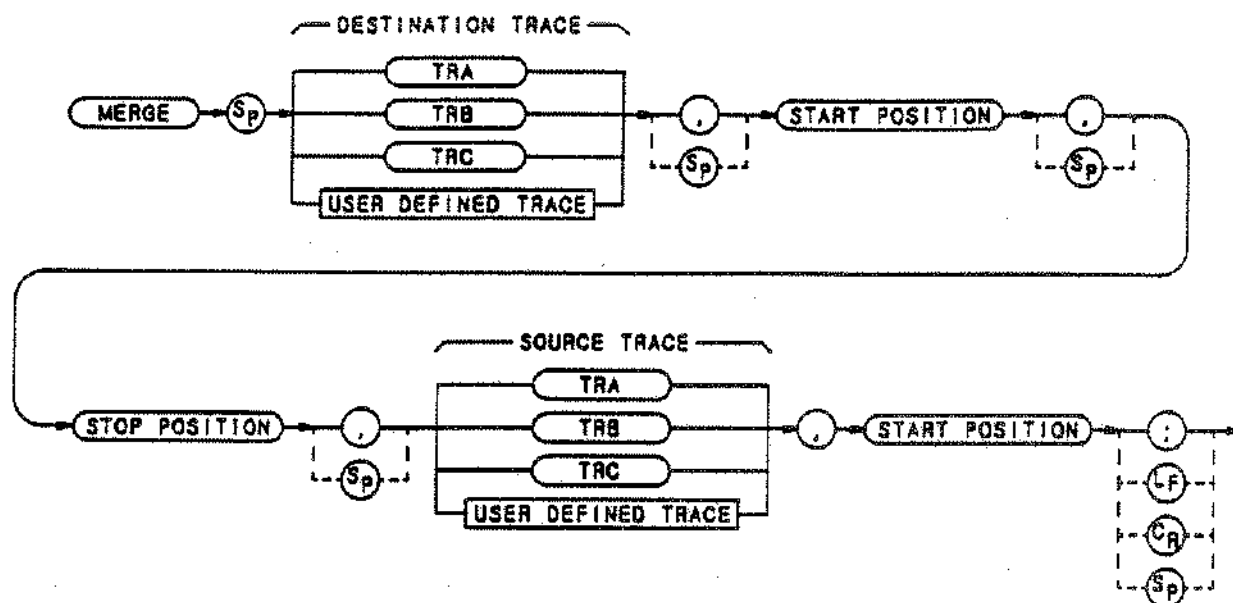

DESCRIPTION:

MERGE will move a portion of the source trace into the destination trace starting at a predetermined position. Specify the start position and the stop position in the destination trace by either a numeric value or a variable. The same holds true for the start position in the source trace.

10/11/11
10/11/11

10/11/11 10/11/11

MINPOS

Minimum Position

COMMAND SYNTAX:

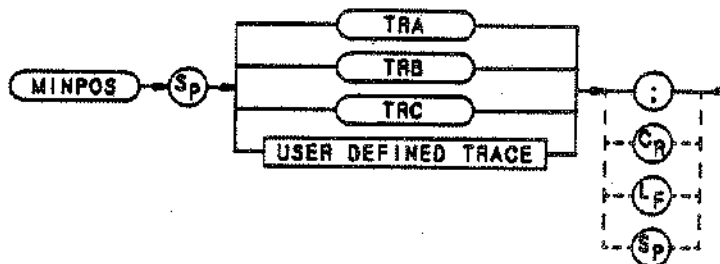

DESCRIPTION:

MINPOS returns a value which is the x position of the minimum value in trace A, trace B, trace C, or user defined trace.

ADN 128

1998-1999

ADN 128
1998-1999
ADN 128
1998-1999
ADN 128
1998-1999

ADN 128
1998-1999
ADN 128
1998-1999

MIRROR

Mirror

COMMAND SYNTAX:

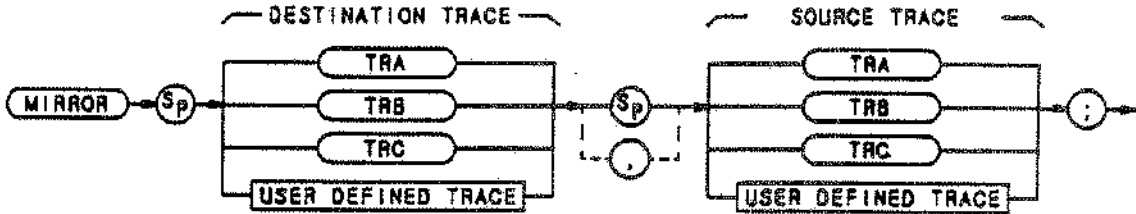

DESCRIPTION:

MIRROR command will take the mirror image of a source trace and move it into a destination trace. The source and destination trace can be trace A, trace B, trace C, or a user defined trace.

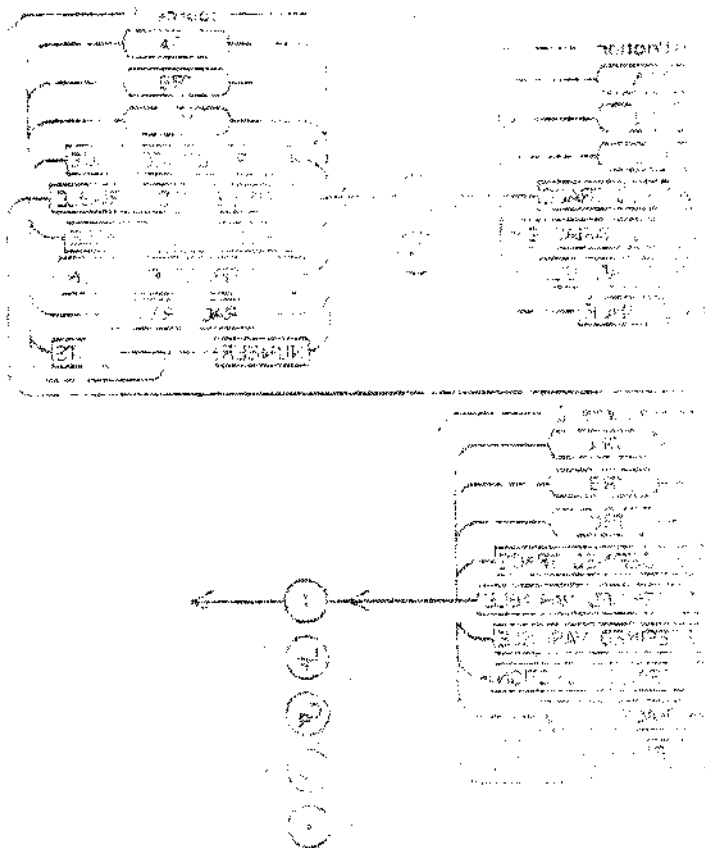

ni 5 rona el 5 entos ya l entos de colavie
 bre heitoged ad lile tota n. ores en 5 elvma
 l entos

MOD

MODULO

COMMAND SYNTAX:

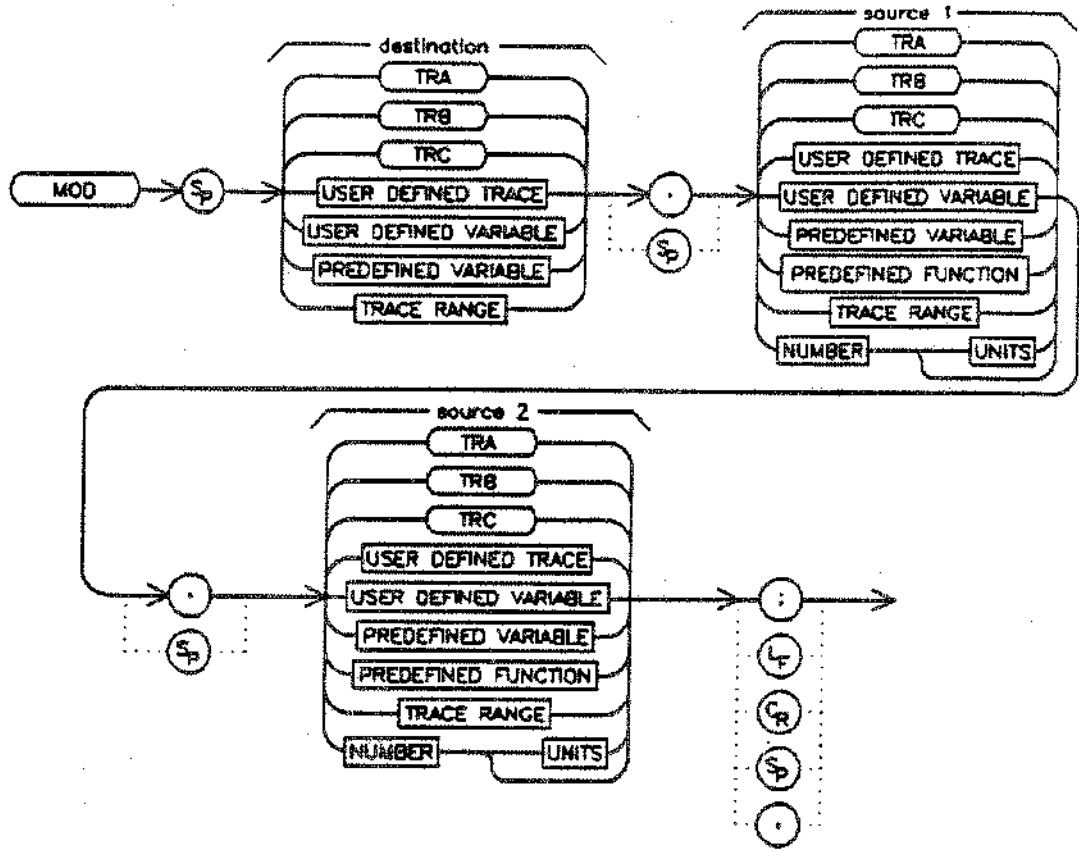

DESCRIPTION:

The remainder of the division of source 1 by source 2 is stored in the destination. If source 2 is zero, an error will be reported and the result will be source 1.

OUTPUT

SI-94 OT TUGTUG

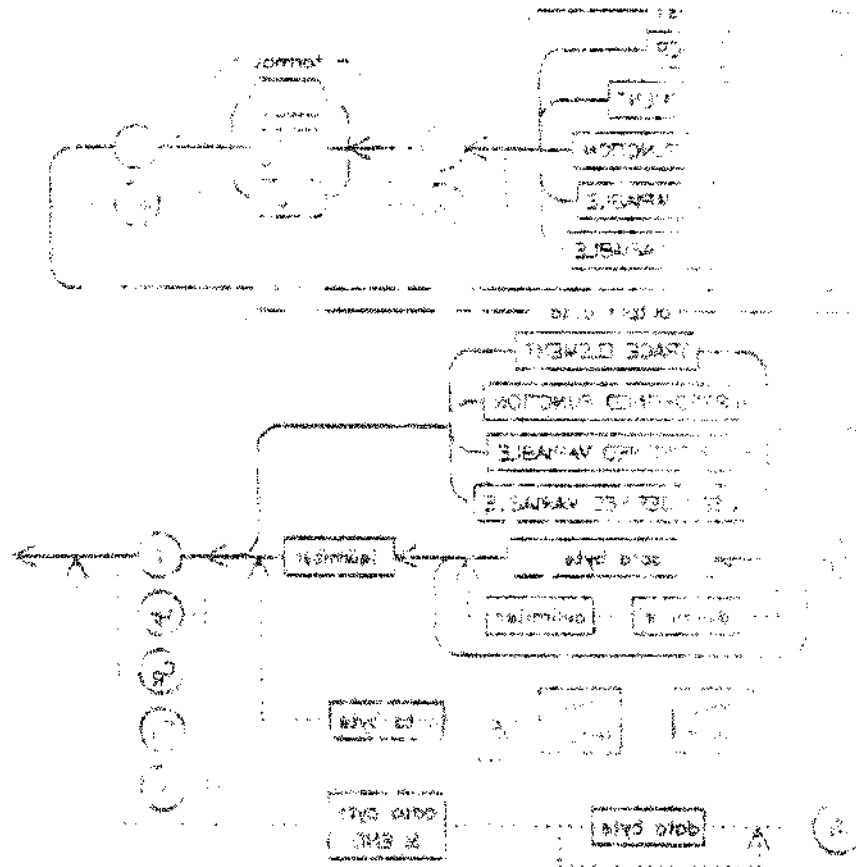

... output a unit ... SI-94 ... of road ...
... SI-94 ... reflected ...
... the release ...
... in the ...

... organized ...

OUTPUT OUTPUT TO HP-IB

COMMAND SYNTAX:

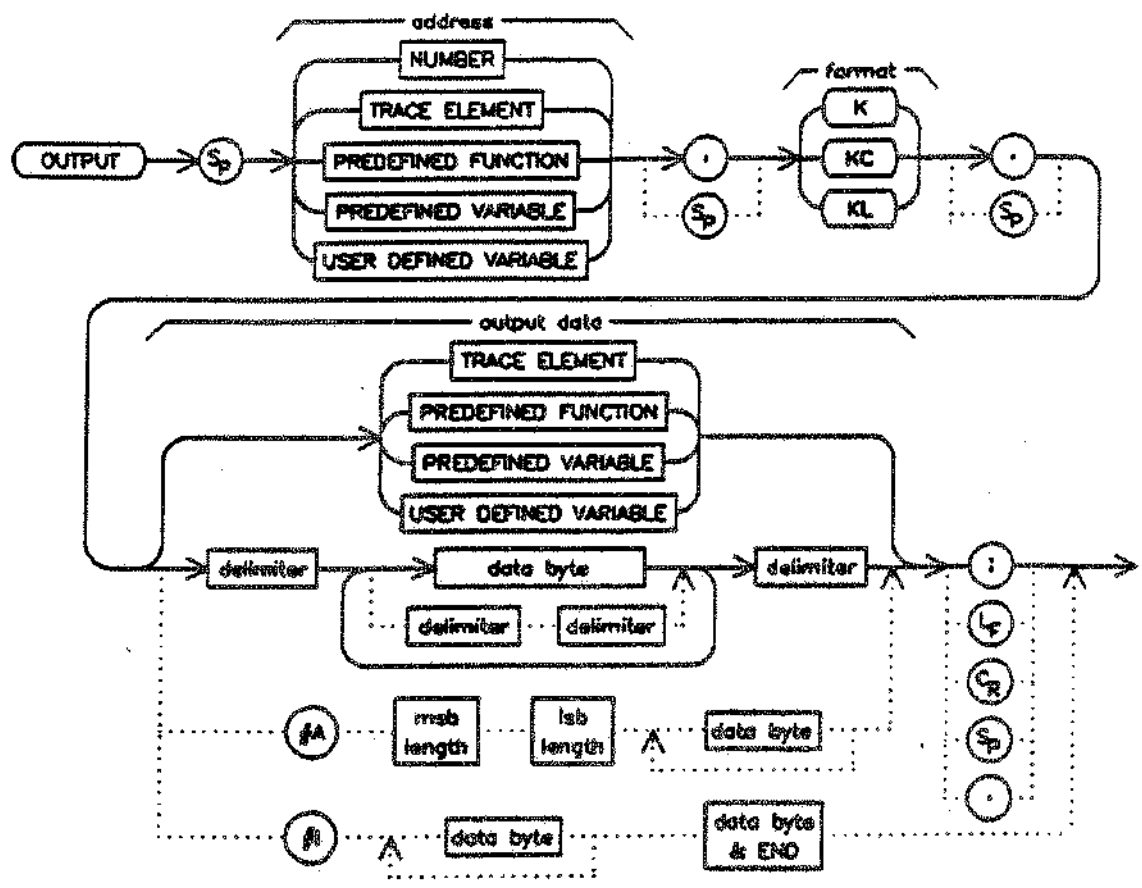

DESCRIPTION:

Output is provided for sending data to the HP-IB port from a function definition. If a controller is detected on HP-IB, the command is aborted. This command causes the analyzer to assume controller capabilities on HP-IB. The *RELEASE HP-IB (RELHPIB)* command may be used to disable these capabilities. The data is output according to the format specified in the format field.

FORMAT FIELD OPTIONS:

K:

Output in free field ASCII format with no terminator.

COMMAND SYNTAX:

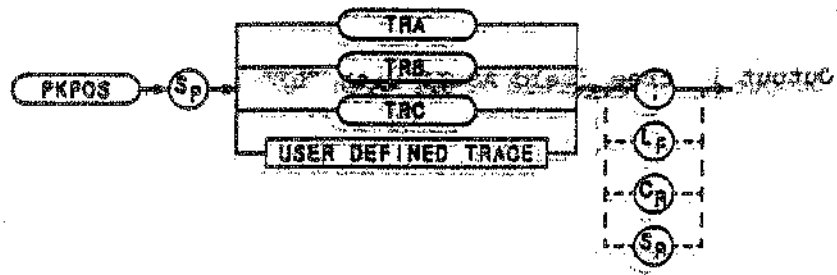

DESCRIPTION:

PKPOS returns a value which is the x position of the maximum value in trace A, trace B, trace C, or user defined trace.

