

OPERATING AND SERVICE MANUAL

**8566A**  
**SPECTRUM ANALYZER**  
**100 Hz—2.5 GHz/2—22 GHz**  
**(Including Options 400, 907, 908, 909 and 910)**

**SERIAL NUMBERS**

This manual applies directly to Model 8566A RF Sections with serial numbers prefixed 1950A and IF-Display Sections with serial numbers prefixed 1928A.

With changes described in Section VII, this manual also applies to RF Sections prefixed 1947A, 1939A, 1925A, 1921A, 1918A, 1904A, 1901A, 1842A, 1827A and IF Display Sections prefixed 1924A, 1922A, 1918A, 1915A, 1906A, 1901A, 1849A, 1838A, 1833A, 1826A, 1823A, 1820A, 1811A, 1805A, 1745A, and 1721A.

For additional information about serial number coverage, refer to INSTRUMENTS COVERED BY MANUAL in Section I.

© Copyright

HEWLETT-PACKARD COMPANY

1978, 1979

1400 FOUNTAIN GROVE PARKWAY, SANTA ROSA, CALIFORNIA 95404, U.S.A.

## HP 8566A SPECTRUM ANALYZER SERVICE DOCUMENTATION SUMMARY

The HP 8566A service documentation comprises several individual manuals. These manuals may be ordered individually or in combination as follows:

- |  |             |
|--|-------------|
| 1) Operating and Service Manual<br>(includes items 2, 3 and 4)           | 08566-90006 |
| 2) Operation Supplement  | 08566-90002 |
| 3) Remote Operation Supplement   | 08566-90003 |
| 4) Operation Verification Supplement                                     | 08566-90005 |
| 5) Operation Verification<br>(includes supplement and<br>tape cartridge) | 08566-60002 |

The Operating and Service Manual supplied with the HP 8566A at time of original instrument shipment contains the Operation Verification tape cartridge. Any subsequent shipment of an Operating and Service Manual for the HP 8566A includes only the Operation Verification supplement, not the tape cartridge. If a tape cartridge is desired, order Operation Verification, 08566-60002, in addition to the Operating and Service Manual, 08566-90006.

**CONTENTS**  
**—VOLUME 1—**

Section	Page	Section	Page
<b>I GENERAL INFORMATION</b> . . . . .	1-3	2-5. Preparation for Use . . . . .	2-1
1-1. Introduction . . . . .	1-3	2-6. Operating Environment . . . . .	2-1
1-3. Manual Organization . . . . .	1-3	2-10. Power Requirements . . . . .	2-1
1-5. Specifications . . . . .	1-3	2-12. Line Voltage and Fuse Selection . . . . .	2-1
1-7. Safety Considerations . . . . .	1-4	2-14. HP-IB Address Selection . . . . .	2-3
1-9. Instruments Covered by Manual . . . . .	1-4	2-19. Bench Operation . . . . .	2-3
1-10. Serial Numbers . . . . .	1-4	2-21. Front Handles (Option 907) . . . . .	2-3
1-12. Manual Changes Supplement . . . . .	1-4	2-23. Rack Mounting (Option 908) . . . . .	2-3
1-15. Manual Backdating Changes . . . . .	1-4	2-25. Rack Mounting with Front Handles (Option 909) . . . . .	2-6
1-18. Accessories Supplied . . . . .	1-4	2-27. Rack Mounting with Slides (Special Order Option) . . . . .	2-6
1-20. Equipment and Accessories Available . . . . .	1-5	2-29. Interconnection of Sections . . . . .	2-9
1-21. Service Accessories . . . . .	1-5	2-31. Cable Connections . . . . .	2-9
1-23. Desk-Top Computer . . . . .	1-5	2-35. Mating Connectors . . . . .	2-11
1-25. Options . . . . .	1-5	2-37. Storage and Shipment . . . . .	2-11
1-26. Option 400, 400 Hz Line Frequency . . . . .	1-5	2-38. Environment . . . . .	2-11
1-28. Option 907, Front Handles . . . . .	1-5	2-40. Packaging . . . . .	2-11
1-30. Option 908, Rack Mount Flanges . . . . .	1-5	8566A Spectrum Analyzer Operation Verification (Includes Table of Contents)	
1-32. Option 909, Front Handles and Rack Mount Flanges . . . . .	1-5	<b>III OPERATION</b>	
1-34. Option 910, Extra Manual . . . . .	1-5	8566A Spectrum Analyzer Operation (Includes Table of Contents)	
1-36. Rack Mount Slides . . . . .	1-5	8566A Spectrum Analyzer Remote Operation (Includes Table of Contents)	
1-38. Recommended Test Equipment . . . . .	1-5		
<b>II INSTALLATION/OPERATION VERIFICATION</b>			
2-1. Introduction . . . . .	2-1		
2-3. Initial Inspection . . . . .	2-1		

**—VOLUME 2—**

Section	Page	Section	Page
<b>IV PERFORMANCE TESTS</b> . . . . .	4-1	4-19. Resolution Bandwidth Accuracy Test . . . . .	4-13
4-1. Introduction . . . . .	4-1	4-20. Resolution Bandwidth Selectivity Test . . . . .	4-15
4-4. Operation Verification . . . . .	4-1	4-21. Resolution Bandwidth Switching Uncertainty Test . . . . .	4-18
4-6. 8566A Repair . . . . .	4-1	4-22. Log Scale Switching Uncertainty Test . . . . .	4-20
4-8. 8566A Repair and Certification . . . . .	4-2	4-23. IF Gain Uncertainty Test . . . . .	4-22
4-10. Calibration Cycle . . . . .	4-2	4-24. Scale Fidelity Test . . . . .	4-29
4-12. Equipment Required . . . . .	4-2	4-25. Calibrator Amplitude Accuracy Test . . . . .	4-33
4-14. Test Record . . . . .	4-2		
4-16. Frequency Reference Error Test . . . . .	4-3		
4-17. Center Frequency Readout Accuracy Test . . . . .	4-5		
4-18. Frequency Span Accuracy Test . . . . .	4-8		

# CONTENTS (Cont'd)

## —VOLUME 2—

Section	Page	Section	Page
4-26. Frequency Response Test . . . . .	4-34	5-23. 3-dB Bandwidth Adjustments . . . . .	5-57
4-27. Sweep Time Accuracy Test . . . . .	4-48	5-24. Step Gain and 18.4 MHz Local Oscillator Adjustments . . . . .	5-60
4-28. Sweep Time Accuracy Test (Alternate Procedure). . . . .	4-51	5-25. Down/Up Converter Adjustments . . . . .	5-66
4-29. Noise Sidebands Test . . . . .	4-55	5-26. 10 MHz Standard Adjustment . . . . .	5-68
4-30. Line Related Sidebands Test . . . . .	4-57	5-27. Sweep, DAC, and Main Coil Driver Adjustments . . . . .	5-70
4-31. Average Noise Level Test . . . . .	4-62	5-28. 100 MHz Voltage-Controlled Crystal Oscillator (VCXO) Adjustments . . . . .	5-80
4-32. Residual Responses Test . . . . .	4-64	5-29. M/N Loop Adjustments . . . . .	5-84
4-33. Harmonic and Intermodulation Distortion Test . . . . .	4-68	5-30. YTO Loop Adjustments . . . . .	5-88
4-34. Image, Multiple, and Out-of-Band Responses Test . . . . .	4-76	5-31. 20/30 Loop Phase Lock Adjustments . . . . .	5-92
4-35. Gain Compression Test . . . . .	4-80	5-32. RF Module Phase Lock Adjustments . . . . .	5-100
4-36. 1st LO Output Amplitude Test . . . . .	4-84	5-33. CAL Output Adjustment . . . . .	5-103
4-37. Sweep + Tune Out Accuracy Test . . . . .	4-85	5-34. Last Converter Adjustments . . . . .	5-106
 		5-35. Frequency Response Adjustments . . . . .	5-109
<b>V ADJUSTMENTS</b>		5-36. Analog-to-Digital Converter Adjustments . . . . .	5-131
5-1. Introduction . . . . .	5-1	5-37. Track and Hold Adjustments . . . . .	5-133
5-3. Equipment Required . . . . .	5-2	5-38. Digital Storage Display Adjustments . . . . .	5-136
5-5. Adjustment Tools . . . . .	5-2	 	
5-7. Factory Selected Components . . . . .	5-2	<b>VI REPLACEABLE PARTS</b>	
5-9. Related Adjustments . . . . .	5-2	6-1. Introduction . . . . .	6-1
5-11. Location of Test Points and Adjustments . . . . .	5-2	6-3. How to Determine a Replacement Part Number . . . . .	6-1
5-13. Safety Considerations . . . . .	5-2	6-8. Ordering Instructions . . . . .	6-1
5-15. Low Voltage Power Supply Adjustments . . . . .	5-16	6-10. Module Exchange Program . . . . .	6-1
5-16. High Voltage Adjustment . . . . .	5-19	 	
5-17. Preliminary Display Adjustments . . . . .	5-22	<b>VII MANUAL BACKDATING CHANGES</b>	
5-18. Final Display Adjustments . . . . .	5-34	7-1. Introduction . . . . .	7-1
5-19. Log Amplifier Adjustments . . . . .	5-37	7-4. Change Instructions for RF Sections . . . . .	7-3
5-20. Video Processor Adjustments . . . . .	5-41	7-16. Change Instructions for IF-Display Sections . . . . .	7-13
5-21. 3 MHz Bandwidth Filter Adjustments . . . . .	5-44		
5-22. 21.4 MHz Bandwidth Filter Adjustments . . . . .	5-49		



# AN INTRODUCTION TO DOWNLOADABLE PROGRAMMING

## USING THE HP 8566B/8568B SPECTRUM ANALYZERS

### MODULE #1

For Complete  
Application & Sales  
Information  
Call

**Robin Knight**

Your Sales  
Representative  
**HEWLETT PACKARD**  
NEELY  
Sales Region

24 INVERNESS PLACE EAST  
ENGLEWOOD, CO 80112  
(303) 649-5449



**HEWLETT  
PACKARD**



## INTRODUCTION

### I. DIFFERENCES BETWEEN THE 8566/88 "A" AND "B" VERSIONS

- A. Downloadable Capability
- B. Commands Unique To The "B"
- C. New "B" Commands With "A" Equivalents
- D. Operating Differences

### II. 8 PROGRAMMING METHODS FOR THE 8566/88 "A" AND "B" VERSIONS

- A. Computer Control Using "A" Commands On The 8566/88A
- B. Computer Control Using "A" Commands On The 8568/88B
- C. Computer Control Using "B" Commands On The 8568/88B
- D. 8568/88B DLP Loaded And Executed From A Controller
- E. 8566/88B DLP Loaded From A Controller And Executed From The Analyzer Front Panel
- F. 8568/88B DLP Loaded And Executed From The Analyzer Front Panel

A downloadable program (DLP) is a program written in Spectrum Analyzer commands which is loaded into the analyzer's internal RAM and allows the analyzer to run automatic routines independent of a controller. The DLP is initially loaded either from a controller or from the analyzer's front panel. It can then be executed (run) from either the controller or more conveniently from the analyzer's front panel. This DLP capability coupled with the new high level firmware functions allow the 8566B/8568B Spectrum Analyzers to run very powerful software routines. This seminar puts these concepts into perspective by comparing these new 8566B/-8568B ("B") capabilities with the former capabilities found on the 8566A/8568A ("A").

### COMMANDS UNIQUE TO THE "B"

ADD - addition of operands	MGRD - read mult. bytes
AMBPL - A-B plus Disp Line	MBWR - write mult bytes
AVG - average of operands	MDS - msat data size
BRD - reads 2 byte word	MOU? - disp or msat unit
BWR - writes 2 byte word	MEAN - trace mean value
CLRAVG - sets avg counter to 1	MEM? - memory available
COMPRESS - compresses trace	MIN - selects minimum
CONCAT - concatenates traces	MMACT - # of active mkr
CTA - convert disp units to dBm	MKCONT - swp from marker
CTM - convert dBm to disp units	MKP - horiz posn of mkr
DISPOSE - clears memory	MKPAUSE - pause at mkr
DIV - division of operands	MKPK NH - next peak
DONE - command execution done	MKPK NR - next right pk
DSPLY - display variable value	MKPK NL - next left pk
ELSE - conditional (IF/THEN)	MKPX - min pk excursion
ENDIF - conditional	MKREAD - mkr read mode
ERR? - queries processor test	MKTRACE - move mkr trace
EXP - exponent base 10	MKTYPE - type of mkr
FFT - forward FFT	MOV - move operand
FPKA - fast preselector peak	MPY - multip of operands
FUNCDEF - function label	MROB - read 8 bit byte
ID - returns model number	MRO - read 2 byte word
IF - conditional (IF/THEN)	MWR - write 2 byte msg
KEYDEF - softkey definition	MWRB - write 1 byte msg
KEYEXC - softkey execution	MXM - max of 2 operands
LOG - log of operand	

The "B" contains over 150 new firmware functions to complement the new DLP capability. Approximately 90 of these functions are "B" exclusives (not found on the "A"). The remaining 60 (or so) commands are merely new mnemonics for existing "A" commands.

This list concludes the exclusive "B" commands not found on the "A". Syntax diagrams and more detailed descriptions of each of these commands can be found in the 8566B/8568B Operating and Programming Manuals.

### COMMANDS UNIQUE TO THE "B" (Continued)

ONEOS - end of swp execute	TRGRPH- display compr trace
ONSWP - start of swp execute	TRMATH - trace math at EOS
OP - dimension LL and UR	TRPRST - preset trace oper.
PDA - ampli probability density	TRSTAT - return trace state
PDF - freq probability density	TWINDOW - FFT trace format
PEAKS - amp or freq peak sort	UNTIL - looping construct
PLOT - plot	USTATE - user state config.
PWRBW - power bandwidth	VARDEF - define variable
REPEAT - looping construct	VBO - VBW/RBW ratio
REV - firmware revision	VARIANCE- trace variance
RMS - rms value of trace	XCH - exchange contents
RQS - mask for SRQ	
SMOOTH - smooth trace	
SQR - square root of operands	
STDEV - trace std deviation	
SUB - subtraction of operands	
SUM - trace addition	
SUMSQR - trace sum of squares	
TDF - trace format	
TEXT - writes text on screen	
THEN - conditional	
TRDEF - define trace name/size	
TRDSP - info update/trace off	

	8566B Ext. Mixing Only
	CNVLOSS - ref level offset
	FULBAND - start/stop freq.
	IDSTAT? - status of Sig ID
	NSTART - start n#
	NSTOP - stop n#
	SIGDEL - Sig ID ampli diff.

In addition to the exclusive "B" command set, there is a set of new "B" commands which perform the same functions as the "A". As the accompanying list indicates, the "B" commands (i.e. the mnemonics) have been carefully chosen to more nearly describe the name of the function which they represent. For example, ANNOT OFF is the "B" command which turns off the CRT annotation.

### IDENTICAL "A" AND "B" COMMANDS

"B" COMMANDS	EQUIVALENT "A" COMMANDS	DESCRIPTION
AMB ON	C2	A - B into A on
AMB OFF	C1	A - B into A off
ANNOT ON	KSp	annotation on
ANNOT OFF	KSo	annotation off
APB	KSc	A + B into A
AUNITS DBM	KSA	amplitude units in dBm
AUNITS DBMV	KSB	amplitude units in dBmV
AUNITS DBUV	KSC	amplitude units in dBuV
AUNITS V	KSD	amplitude units in Volts
AXB	EX	exchange trace A and B
BLANK TRA	A4	store and blank trace A
BLANK TRB	B4	store and blank trace B
BLANK TRC	KSK	store and blank trace C
BML	BL	B - Display Line into B
BTC	KS1	trace B into trace C
BXC	KS1	exchange B and C
CLRW TRA	A1	clear write trace A
CLRW TRB	B1	clear write trace B
CONTS	S1	continuous sweep
DET NRM	KSa	normal detection
DET SMP	KSe	sample detection
DET POS	KSB	positive peak detection
DET NEG	KSD	negative peak detection
DLE OFF	LO	display line off
EXTMXR	KSU	(66) external mixer preset
FOFFSET	KSV	frequency offset

## IDENTICAL "A" AND "B" COMMANDS

(Continued)

"B" COMMANDS	EQUIVALENT "A" COMMANDS	DESCRIPTION
GRAT ON	KS <sub>n</sub>	graticule on
GRAT OFF	KS <sub>a</sub>	graticule off
HNLOCK	KSt (88)	harmonic band lock
HNUNLK	KSG (88)	harmonic band unlock
MKA?	MA	marker amplitude
MKCF	E2	marker to center freq.
MKD	M3	delta marker
MKF?	MF	marker frequency
MKFC OFF	MCO (88)	counter frequency off
MKFC ON	MC1 (88)	counter frequency on
MKFCR	KS <sub>r</sub> (88)	counter resolution
MKMIN	KSN (88)	marker to minimum
MKN	M2	move marker to spec. freq.
MKNOISE ON	KSM	noise marker on
MKNOISE OFF	KSL	noise marker off
MKPK	E1	peak search
MKPK HI	E1	peak search
MKPK NH	KSK (88)	next peak
MKRL	E4	marker to Ref level
MKSP	KSO	delta marker into span
MKSS	E3	marker into CF step size
MKSTOP	KSu	stop sweep at marker
MKTRACK ON	MT1	marker track on
MKTRACK OFF	MT0	marker track off
ML	KS.	mixer level

The list of new "B" commands and their "A" equivalents is continued here.

## IDENTICAL "A" AND "B" COMMANDS

(Continued)

"B" COMMANDS	EQUIVALENT "A" COMMANDS	DESCRIPTION
MOV TRC, TRB	KS1	move trace B into C
MXMH TRA	A2	Max Hold trace A
MXMH TRB	B2	Max Hold trace B
RCLS	RC	recall state
ROFFSET	KSZ	reference level offset
SAVES	SV	save state
SIGID	KS <sub>v</sub> (88)	ext mixing Sig ID
SNGLS	S2	single sweep
TDF M	O1	output format
TDF P	O3	output format
TDF B	O2 or O4	output format
THE ON	TH	threshold on
THE OFF	T0	threshold off
TM FREE	T1	free run trigger
TM LINE	T2	line trigger
TM EXT	T3	external trigger
TM VID	T4	video trigger
VAVG	KSG	video average on
VAVG ON	KSG	video average on
VIEW TRA	A3	store and view trace A
VIEW TRB	B3	store and view trace B
VIEW TRC	KS <sub>j</sub>	store and view trace C
XCH TRA, TRB	EX	exchange trace A and B
XCH TRB, TRC	KS1	exchange trace B and C

This completes the list of the common "A" and "B" functions. For a more detailed description of these commands and the correct syntax, consult the 8566B/68B Operating and Programming Manuals.

In addition to the new processor and the new command set of the "B", there are a few minor operating differences between the "A" and "B".

### OPERATING DIFFERENCES BETWEEN THE "A" AND "B" (8566 and 8568)

#### EXPONENTIAL FORMAT

If a display address command (e.g. DA, DR, DW) is given in exponential format (i.e. E1, E2, etc.), the "B" will execute it properly. The "A", however, interprets the exponential format as an analyzer command. For example, E1 is interpreted as the peak search command.

#### REMOTE INSTRUMENT PRESET

Execution of a remote IP causes the "B" to preset its controls. Likewise, the "A" does this and additionally checks its IO bus and memory.

#### RESETTING THE INPUT BUFFER AND INSTRUMENT PRESET

The "B" input buffer can be reset with a device clear (CLEAR 718). The "A" does not have an input buffer. However, the HP-IB can be reset with an interface clear (IFC).

#### SOFTWARE INCOMPATABILITY

If there are no spaces or semicolons between a pair of two-letter commands, the "B" can interpret the first two letters of the first command and the first letter of the second command as a new three-letter "B" command. This problem may show up when running "A" software on the "B". The next slide more fully illustrates this incompatibility.

"A" software will generally run properly on the "B". The major incompatibility occurs when "A" software which was "code-packed" (no spaces or semicolons between analyzer commands) is run on the "B". Illegal syntax errors can result.

### SOFTWARE INCOMPATABILITY EXAMPLES

"A" SOFTWARE EXAMPLE	"B" MISINTERPRETATION
CTA1 (Couple Sweptime, View Trace A)	CTA (Convert to dBm)
CTMT1 (Couple Sweptime, Signal Track On)	CTM (Convert to Display Units)
DLE1 (Activate Display Line, Peak Search)	DLE (Enable Display Line)
GRAT (Graph, Set Attenuator)	GRAT (Graticule on or off)
PDA4 (Pen Down, Blank Trace A)	PDA (Probability Distrib. in Amplitude)
PDFA (Pen Down, Start Freq.)	PDF (Probability Distrib. in Frequency)
THE1 (Activate Threshold, Peak Search)	THE (Enable Threshold)
VBOA (Activate Video BW, Output Active Function)	VBO (Set VBW to RBW ratio)

This "B" misinterpretation will usually result in an illegal syntax error. After the analyzer first executes the three-letter command, it then tries to execute the remaining one-letter command resulting in the syntax error.

OPERATING DIFFERENCES BETWEEN THE "A" AND "B"  
(8568 only)

**BAND CROSSING**

A band crossing can occur within the last ten display units of a sweep on the "A" but not on the "B".

**RELOCK**

The local oscillator is phaselocked to the reference oscillator after every data entry on the "A". Relock does not occur until the "B" needs to relock for taking data readings. Fewer relocks yield faster operation for the "B".

**SWEEP + TUNE OUTPUT**

The tuning algorithm in the "B" causes large pulses to appear at the end of a sweep or at a bandcrossing. They do not appear on the "A".

OPERATING DIFFERENCES BETWEEN THE "A" AND "B"  
(8568 only)

**CORRECTION DATA ROUTINE**

On the "B", be sure to read all data into the controller before re-executing KSw.

**KS39 COMMAND**

The syntax is different on the "A" and "B". On the "B", the display memory address is specified immediately before KS39 and is sent to the analyzer as two 8-bit bytes. On the "A", the display memory address is specified immediately before KS39 with the DA (Display Address) command.

There are several operating differences which are unique to either the 8566 or 8568. Some of these are due in part to the different internal LO/IF structures of the two analyzers.

II. 6 PROGRAMMING METHODS  
FOR THE 8566/68 "A" AND "B"

- A. Computer Control Using "A" Commands On The 8566/68A
- B. Computer Control Using "A" Commands On The 8566/68B
- C. Computer Control Using "B" Commands On The 8566/68B
- D. 8566/68B DLP Loaded And Executed From A Controller
- E. 8566/68B DLP Loaded From A Controller And Executed From The Analyzer Front Panel
- F. 8566/68B DLP Loaded And Executed From The Analyzer Front Panel

Up to this point, the seminar has focused on the differences between the "A" and the "B". The goal of this next section is to put the DLP (Downloadable Program) into perspective by briefly examining all the ways in which the "A" and "B" can be programmed. With this new DLP capability, the 8566B/8568B become the first two spectrum analyzers to be fully "programmable" (as opposed to simply being "controllable"). That is, they can operate automatically without a controller being present.

The example programs used here consist of a simple "auto-zoom" routine which puts a marker on the largest signal, tracks the signal down to a 10 MHz Frequency Span, moves the signal to the reference level, and stores the waveform in Trace A. The first three examples consist of the "controllable" approach. The second and third examples will both work properly on the "B". However, the third method is recommended since it uses more descriptive mnemonics which makes the program much easier to read. In addition, using the new "B" commands will make this programming code more compatible with future spectrum analyzer products.

This method is the first of three "programmable" examples which can be utilized on the "B". All three examples perform an Instrument Preset, set the Center Frequency to 100 MHz, and set the Frequency Span to 10 MHz. The difference between the three examples lies with the method by which the DLP is loaded into the analyzer's internal memory (RAM) and the method by which the DLP is executed. This example illustrates two methods of loading and executing the DLP from the controller. Line 10 loads the DLP from the controller in both cases. Line 20 executes the DLP using a label in the upper program while Lines 20 and 30 execute the DLP using analyzer softkey 100 in the lower program. An analyzer softkey is a convenient means of executing a DLP from the front panel of the analyzer, and they can be numbered from 1 to 999. The next 2 slides describe by far the most common use of softkey usage—the front panel. However, should the need arise, a method of executing a softkey from the controller is given here.

A. Computer Control Using "A"  
Commands on the 8566/68A

```
10 OUTPUT 718: "S2; TS; E1; MT1; SP10MZ; "
20 OUTPUT 718: "MT0; E4; TS; A3; "
30 END
```

B. Computer Control Using "A"  
Commands on the 8566/68B

```
10 OUTPUT 718: "S2; TS; E1; MT1; SP10MZ; "
20 OUTPUT 718: "MT0; E4; TS; A3; "
30 END
```

C. Computer Control Using "B"  
Commands on the 8566/68B

```
10 OUTPUT 718: "SNGLS; TS; MKPK HI; MKTRACK ON; SP10MZ; "
20 OUTPUT 718: "MKTRACK OFF; MKRL; TS; VIEW TRA; "
30 END
```

D. 8566/68B DLP LOADED AND  
EXECUTED FROM A CONTROLLER

(LABEL EXECUTE)

```
10 OUTPUT 718: "FUNCDEF Z_DOM; @IP; CF 100MZ; SP 10MZ; @ "
20 OUTPUT 718: "Z_DOM; "
30 END
```

(SOFTKEY EXECUTE)

```
10 OUTPUT 718: "FUNCDEF Z_DOM; @IP; CF 100MZ; SP 10MZ; @ "
20 OUTPUT 718: "KEYDEF 100, Z_DOM; "
30 OUTPUT 718: "KEYEXC 100; "
40 END
```



E. 8566/68B DLP LOADED FROM A CONTROLLER AND EXECUTED FROM THE ANALYZER FRONT PANEL

```

10 OUTPUT 718: "FUNCDEF Z_DOM, @IP: CF 100MZ; SP 10MZ; @"
20 OUTPUT 718: "KEYDEF 100, Z_DOM;"
30 END

```

1. Press
2. Press
3. Press

This is another "programmable" example. It differs from the previous example in that the program is executed manually from the analyzer's front panel. Pressing "RUN" loads the program into the analyzer. Since this puts the analyzer into remote, it is necessary to press the "lcl" key on the analyzer. Finally, the DLP is executed by accessing softkey 100 on the analyzer's front panel. With this DLP method, only 1 controller is required to download programs to multiple analyzers. Once downloaded, each analyzer becomes a stand-alone automatic test system completely independent of a controller.

F. 8566/68B DLP LOADED AND EXECUTED FROM THE ANALYZER FRONT PANEL

TO LOAD:

- E
- Press
- Type MKPK HI, MKTRACK ON, SP100KZ, TS, MKPL
- Press
- Press

TO EXECUTE:

- Press

TO SAVE LOCK:

- Press

TO UNLOCK:

- Press

The final programming method which involves loading and executing the DLP from the analyzer front panel is useful for writing short panel programs when a controller is not available. Softkeys up to 58 characters long and numbered from 1 to 999 can be loaded from the front panel using the Title Mode (KSE) of the analyzer. To prevent accidental erasure of a softkey from occurring from the front panel (which can occur by pressing shift softkey #XX followed by kHz), simply press SHIFT SAVE on the analyzer. However, this method will **not** prevent a softkey from being redefined from a controller using the "KEYDEF" command.

Softkeys can be linked together to accommodate DLP's longer than 58 characters by using the KEYEXC command. In this example, softkey 99 calls softkey 100 (which was loaded previously).

**F. (CONTINUED) 8566/68B SOFTKEY DLP EXECUTED FROM ANOTHER FRONT PANEL SOFTKEY DLP.**

TO LOAD SOFTKEY 99:

E

Press     **SHIFT**     **AUTO**

Type     FA10KZ, FB500KZ, TS, KEYEXC100

Press     **NORMAL**

Press     **SHIFT**     **9**     **9**     **KHz**

TO EXECUTE:

Press     **SHIFT**     **9**     **9**     **Hz**

(THE PREVIOUS SLIDE SHOWS HOW TO LOAD SOFTKEY 100.)

In summary, the 8566B/68B have over 150 new firmware functions, over 16K of user-definable RAM, and downloadable program capability which makes them truly programmable. A wide range of programming methods is available to suit a growing number of different automatic test environments. Some lend themselves to a controller being present while others do not require the presence of a controller. This slide summarizes the uses of these programming methods.

Supplementary DLP introductory information can be found in the Programming Note entitled "Introductory Operating Guide" (Pub. #5952-9389).

**A SUMMARY OF THE USES OF THE 6 PROGRAMMING METHODS FOR THE 8566/68 "A" AND "B"**

- A. Computer Control Using "A" Commands On The 8566/68A
  - \* Any fully automatic application using the "A".
- B. Computer Control Using "A" Commands On The 8566/68B
  - \* ATE applications where a "B" analyzer is used but "A" software already exists.
- C. Computer Control Using "B" Commands On The 8566/68B
  - \* ATE applications where there is a need for the new "B" firmware functions, and a computer is needed for other HP-IB instruments which do not have DLP capability.
- D. 8566/68B DLP Loaded And Executed From A Controller
  - \* Same as "C". However, this method provides a higher level of security from unauthorized code changes. After a program has been initially loaded, the software need only contain function labels (OUTPUT 7iB: "Z\_DOM") rather than complete code listings. (Useful for production test environments.)
- E. 8566/68B DLP Loaded From A Controller And Executed From The Analyzer Front Panel
  - \* Production test stations which consist of only instruments with DLP capability, and the number of controllers is limited.
- F. 8566/68B DLP Loaded And Executed From The Analyzer Front Panel
  - \* Front-panel entry of new "B" firmware functions. Also, allows entry and execution of short DLP's when no controller is present. (Very useful for R&D lab environments.)

A STRUCTURED  
APPROACH  
TO  
DOWNLOADABLE  
PROGRAMMING

USING THE HP 8566B/8568B  
SPECTRUM ANALYZERS

MODULE #2



HEWLETT  
PACKARD



- I. READABILITY & RECOMMENDED DLP PROCEDURES
- II. MODULARITY
- III. DLP STRUCTURE
- IV. DEBUGGING
- V. LOOPING AND BRANCHING
- VI. HELPFUL HINTS

## INTRODUCTION

The seminar module entitled "An Introduction To Downloadable Programming" compared the Downloadable Program (DLP) technique used on the 8566B/68B Spectrum Analyzer with the traditional "controller-run" program used on the 8566A/68A. This seminar module provides a structured approach to writing a DLP with emphasis on readability and modularity. It also emphasizes a systematic approach to debugging. It does not attempt to demonstrate the new firmware commands available on the 8566B/8568B. This seminar closely follows the material given in the Programming Note entitled "A Structured Approach To Downloadable Programming" (Pub. #5952-9392).

## READABILITY

- A. SHORT LINES
- B. INDENT FORMAT
- C. DESCRIPTIVE NAMES
- D. DOCUMENT LINES

## RECOMMENDED DLP PROCEDURES

- E. DEFINE VARIABLES AND TRACES AT THE BEGINNING OF THE PROGRAM
- F. USE UNDERScore ON VARIABLES
- G. USE SEMICOLONS BETWEEN COMMANDS

## READABILITY

Any type of program whether conventional or downloadable should be written in a way that makes it readable. Short lines, indented format for REPEAT/UNTIL loops and IF/THEN branches, descriptive variable names, and well-documented program lines all combine to make a program easy to read and understand. In addition to these general-purpose suggestions, there are 3 additional procedures which specifically apply to a DLP. The example program on the next slide incorporates all of these readability suggestions.

This program is an example of a DLP since it contains 8566B/68B variable, trace, and function definitions (lines 10, 30, and 60). Notice that it is loaded from a controller but that it is not executed either from the controller or the analyzer front panel. The reason that it is not executed is that it will be used as a subprogram module in a much longer program in the next section entitled "Modularity". It is included here merely as a simple example to illustrate good readability concepts. Note the indented format for the IF/ENDIF structure. Since each space takes up analyzer memory, an alternative approach is to indent the entire line and omit the spaces before the analyzer commands.

### PROGRAM #1: C\_CHECK

```

10 OUTPUT 718: "VARDEF P_DWNR, 0;"      | Define a variable.
20                                     | P_DWNR, init. to 0.
30 OUTPUT 718: "TRDEF S_AVE, 1001;"    | Define a 1001 point
40                                     | trace called S_AVE.
50 |
60 OUTPUT 718: "FUNCDEF C_CHECK, @"    | Define a function
70                                     | called C_CHECK.
80 OUTPUT 718: "TS: MKPK HI;"          | Put a marker on the
90                                     | highest signal.
100 OUTPUT 718: "IF MA, GT, -60DB THEN" | If a signal is
110 OUTPUT 718: "  MKTRACK ON;"        | higher than -60
120 OUTPUT 718: "  SP100KZ;"          | dBm, span down
130 OUTPUT 718: "  MKTRACK OFF; TS;"   | to 100 kHz, cen-
140 OUTPUT 718: "  MKPK HI; MKCF; MKRL; TS;" | ter it, and move
150 OUTPUT 718: "  MOV P_DWNR, MA;"    | it to ref level.
160 OUTPUT 718: "  MOV S_AVE, TRA;"    | Store ampl. in
170 OUTPUT 718: "  SAVES 1;"          | P_DWNR and trace
180                                     | in S_AVE. Save
                                     | the settings in
                                     | register 1.
190 OUTPUT 718: "ENDIF;"              | End the IF stat.
200 OUTPUT 718: "@;"                  | End the definition
210 END                                | of C_CHECK.

```

### MODULARITY

A modular DLP is one which consists of a short main program and numerous short subprogram modules. Although this particular slide does not show either the main program or the subprograms, it does illustrate the recommended structured format for the beginning of any modular DLP: file name, date, author, program description, and the variable and trace initializations. The subprograms will appear on the next two slides and the main program will appear on the fourth slide of this four-slide sequence.

### MODULARITY

#### PROGRAM #2: E\_EXAMPLE (Page 1 of 4)

```

10 | File name:  EXAMPLE   Date:  8/1/84   Author:  NAME
20 | Description of Program: The program checks for signals
30 | above -60 dBm in the following spans: 10-12 MHz, 12-14
40 | MHz, 14-18 MHz, and 18-110 MHz. IF a signal is found,
50 | it auto-zooms to a 100 kHz span, records the signal
60 | level, and displays the found signal in trace B.
70 |
80 |
90 | Program begins here . . .
100 |
110 | INITIALIZE:
120 |
130 OUTPUT 718: "VARDEF P_DWNR, 0;"    | Define the variable.
140                                     | P_DWNR, init. to 0.
150 OUTPUT 718: "TRDEF S_AVE, 1001;"   | Define a 1001 point
160                                     | trace called S_AVE.
170 |

```

PROGRAM #2: E\_XAMPLE (Page 2 of 4)

```

180 ! SUBROUTINES:
190 !
200 OUTPUT 718: "FUNCDEF S_PANONE, @" ! Define functions
210 OUTPUT 718: "FA10MZ; FB12MZ; " ! called S_PANONE,
220 OUTPUT 718: "@; " ! S_PANTWO, S_PAN-
230 ! ! THREE, & S_PAN-
240 OUTPUT 718: "FUNCDEF S_PANTWO, @" ! FOUR that will
250 OUTPUT 718: "FA12MZ; FB14MZ; " ! set the start &
260 OUTPUT 718: "@; " ! stop frequencies
270 ! ! to 10-12 MHz.
280 OUTPUT 718: "FUNCDEF S_PANTHREE, @" ! 12-14 MHz, 14-16
290 OUTPUT 718: "FA14MZ; FB16MZ; " ! MHz, & 16-110 MHz.
300 OUTPUT 718: "@; " ! respectively.
310 !
320 OUTPUT 718: "FUNCDEF S_PANFOUR, @"
330 OUTPUT 718: "FA16MZ; FB110MZ; "
340 OUTPUT 718: "@; "
350 !

```

The complete program consists of a main program and five subprograms. Four of these subprograms are listed on this slide. Each subprogram sets the analyzer to a specific start and stop frequency.

PROGRAM #2: E\_XAMPLE (Page 3 of 4)

```

380 OUTPUT 718: "FUNCDEF C_CHECK, @" ! Define a function
370 ! ! called C_CHECK.
380 OUTPUT 718: "TS; MKPK HI; " ! Put a marker on the
390 ! ! highest signal.
400 OUTPUT 718: "IF MA, GT, -60DB THEN" ! If a signal is
410 OUTPUT 718: " MKTRACK ON; " ! higher than -60
420 OUTPUT 718: " SP100KZ; " ! dBm, span down
430 OUTPUT 718: " MKTRACK OFF; TS; " ! to 100 kHz, cen-
440 OUTPUT 718: " MKPK HI; MKCF; MKRL; TS; " ! ter it, and move
450 OUTPUT 718: " MOV P_DWER, MA; " ! it to ref level.
460 OUTPUT 718: " MOV S_AVE, TRA; " ! Store ampl. in
470 OUTPUT 718: " SAVES 1; " ! P_DWER and trace
480 ! ! in S_AVE. Save
! ! the settings in
! ! register 1.
490 OUTPUT 718: "ENDIF; " ! End the IF stat.
500 OUTPUT 718: "@; " ! End the definition
510 ! ! of C_CHECK.

```

This is the fifth subprogram. You may remember that it was shown earlier in the "READABILITY" section as a good example of a readable program. Its function is to check a given frequency span for signals higher than -60 dBm. If a signal is found, the analyzer narrows the span to 100 kHz and stores the trace information.

Line 540 begins the main program, "E\_XAMPLE". Note that it calls the five subprograms which were defined on the previous two slides. Defining subprograms before they are called by the main program is an important part of a correctly structured DLP. The program uses a REPEAT/UNTIL loop to successively step through each span until a signal above -60 dBm is found. The final signal found is placed in Trace B. The entire program is loaded via the controller into the analyzer's softkey #20. The program can then be executed from the analyzer's front panel independent of the controller.

PROGRAM #2: E\_XAMPLE (Page 4 of 4)

```

520 !MAIN PROGRAM
530 !
540 OUTPUT 718: "FUNCDEF E_XAMPLE,@" !The main program
550 OUTPUT 718: " SINGLS;MOV S_AVE,0;" !called E_XAMPLE
560 OUTPUT 718: " REPEAT" !puts the analy-
570 OUTPUT 718: " S_PANONE;C_CHECK;" !zer in single
580 OUTPUT 718: " S_PANTWO;C_CHECK;" !sweep & sets all
590 OUTPUT 718: " S_PANTHREE;C_CHECK;" !values in S_AVE
600 OUTPUT 718: " S_PANFOUR;C_CHECK;" !to zero. It then
610 OUTPUT 718: " UNTIL S_AVE,NE,0;" !checks each span
620 OUTPUT 718: " MOV TRB,S_AVE;" !for signals
630 OUTPUT 718: " RCLS 1;BLANK TRA;VIEW TRB;"
640 OUTPUT 718: "E;" !greater than -80
650 !dBm until a non-
660 !zero S_AVE value
670 !is found. The
!signal is put in
!Trace B & the
!former settings
!are recalled.
680 OUTPUT 718: "KEYDEF 20,E_XAMPLE;" !E_XAMPLE is
690 END !assigned to soft
700 !key 20 on the
710 !analyzer. (Press:
720 !SHIFT 20 Hz).

```

The preceding program was written in a structured, modular, readable manner. This slide outlines the recommended approach for any structured DLP. Program line numbers have also been included to illustrate where each of these points has been incorporated in the preceding program. Since there are no constants to define in this program, an example is given here for completeness (i.e. VARDEF P\_I,3.142).

DLP STRUCTURE

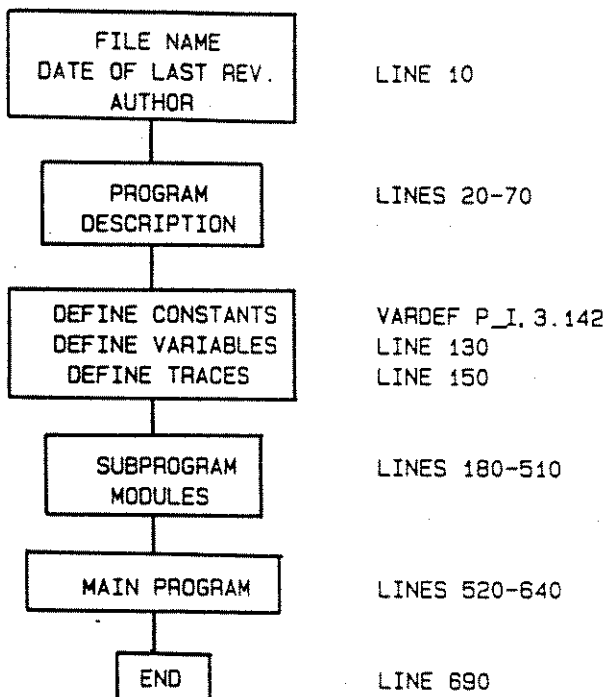



## DEBUGGING

### I. HP-IB COMMAND ERRORS

- A. TYPING ERRORS
- B. FUNCTIONS USED BEFORE BEING DEFINED
- C. FUNCTION LABELS TOO LONG

### II. UNEXPECTED BEHAVIOR

- A. PROGRAM UNEXPECTEDLY STOPS OR CONTINUES
- B. ANALYZER "HANGS"
- C. PROGRAM EXECUTES BEFORE COMMAND GIVEN

### III. OUT OF RANGE RESULT

## DEBUGGING

When a DLP does not run as expected, the problem will more than likely show up in one or more of the following areas: an HP-IB command error, some form of unexpected behavior, or an out of range result. Using the previous example program, each of these problem areas will be illustrated.

## HP-IB COMMAND ERRORS

TYPING ERROR: LINE 290

```
280 OUTPUT 718;"FUNCDEF S_PANTHREE,@"
290 OUTPUT 718;"FA14MZ:FV16MZ;"
300 OUTPUT 718;"@:"
```

TO FIND THE BUG:

- \* WHEN USING BASIC 2.0 WITH EXTENSIONS:
  1. USE "FIND" COMMAND TO LOCATE THE ERROR (FIND "FV")
- \* WHEN USING BASIC 2.0 W/O EXTENSIONS
  1. INSERT "PAUSE" AFTER SUBROUTINES (LINE 510)
  2. COMMENT OUT LINES WITH FUNCDEF'S, DELIMITERS, & LOOPING CONSTRUCTS (LINE 540, 580, 610, & 840); OR USE "GO TO" (LINE 511, 551)
  3. PRESS "RUN"
  4. STEP THROUGH THE REMAINDER OF THE PROGRAM

When an "HP-IB COMMAND ERROR" appears on the analyzer screen, the problem can generally be narrowed down to one of three areas listed on the previous slide. For example, a typing error is intentionally made in line 290. "FV" is typed instead of "FB". (FB is the code for Stop Frequency.) "HP-IB COMMAND ERROR:FV" will appear on the analyzer CRT. Finding the bug is a simple one-step operation if BASIC 2.0 or 2.1 Extensions to BASIC 2.0 is used. Alternatively, if the Operating System being used does not recognize the "FIND" command, the four-step procedure given on this slide can be followed.

The second major category of programming problems is entitled "Unexpected Behavior". The symptoms and associated possible causes are listed on this slide. First, looping constructs refer to REPEAT/UNTIL loops and IF/THEN branches. The "UNTIL" and "ENDIF" commands are the correct terminators which must be used for proper operation. Secondly, recursion refers to a function which calls itself over and over. Examples of this problem are shown later in the section entitled "LOOPING AND BRANCHING". Next, improper use of analyzer graphics can cause the screen to scroll or cause random vectors to appear on screen. This could result from improperly placed label or text terminators. Next, as seen in the previous seminar, packing code together without semi-colons to separate them can result in illegal syntax errors. Finally, omitting delimiters at the end of a function definition (i.e. FUNCDEF) can cause a program to execute before a command to execute is given.

UNEXPECTED BEHAVIOR	
SYMPTOMS	POSSIBLE CAUSES
PROGRAM UNEXPECTEDLY STOPS OR CONTINUES EXECUTION	LOOPING CONSTRUCT IMPROPERLY TERMINATED
ANALYZER "HANGS"	RECURSION, IMPROPER USE OF ANALYZER GRAPHICS, IMPROPER USE OF SEMI-COLONS OR COMMAND SYNTAX
PROGRAM EXECUTES BEFORE COMMAND IS GIVEN TO EXECUTE	IMPROPER USE OF FUNCTION DELIMITERS

The third major category of programming problems is entitled "Out Of Range Result". If a variable or trace value appears to be out of range, a useful debugging tool, the DSPLY command, can be used to determine what the present value actually is. The correct output format should be chosen to ensure enough space is reserved on the analyzer screen for the variable or trace values including the decimal places. For example, format "6.3" allows a total field width of 6 digits which includes 3 decimal places. Note: the analyzer treats variables as real values and trace elements as integer values.

OUT OF RANGE RESULT	
DEBUGGING TOOLS	
VARIABLE	
OUTPUT 718: "DSPLY VARIABLE, X.X: "	
(e.g. OUTPUT 718: "DSPLY P_POWER, 8.3: ")	
TRACE	
OUTPUT 718: "DSPLY TRA [Y], X.X: "	
(e.g. OUTPUT 718: "DSPLY TRA [500], 8.0: ")	

## LOOPING AND BRANCHING (REPEAT/UNTIL & IF/THEN)

\* NESTING

\* RECURSION

## LOOPING AND BRANCHING

Looping refers to the REPEAT/UNTIL commands while branching refers to the IF/THEN/ELSE/ENDIF commands. Two additional concepts, nesting and recursion, apply to both looping and branching. Nesting and recursion are illustrated in the next 2 slides.

## NESTING

1. REPEAT/UNTIL LOOPS MUST NOT BE NESTED MORE THAN 5 LEVELS

```
REPEAT
  REPEAT
    REPEAT
      REPEAT
        REPEAT
          UNTIL
        UNTIL
      UNTIL
    UNTIL
  UNTIL
```

2. IF/THEN BRANCHES MUST NOT BE NESTED MORE THAN 25 LEVELS

```
IF ____ THEN
  IF ____ THEN
    IF ____ THEN
      ENDF
    ENDF
  ENDF
ENDIF
```

Nesting is the process of starting with one simple loop or branch and successively adding more loops or branches around it. For example, this slide illustrates several nested REPEAT/UNTIL loops and several nested IF/THEN branches. Two general rules apply when using nesting within a DLP on the 8566B/68B. As indicated in the slide, the first rule applies to nested loops, and the second rule applies to nested branches. If these rules are not followed, an "INVALID REPEAT NEST LEVEL" error will result.

Recursion is a special case of nesting in which a function calls itself over and over. It applies to both loops and branches, and two rules once again apply. The two example programs on this slide demonstrate the use of recursion (line 60 in both programs) to perform an "auto-zoom" measurement 100 times. They both result in "ILLEGAL REPEAT NEST LEVEL" errors. Note: recursion is **not** recommended. It is only included here to illustrate the concept. The correct program solution is given on the next slide.

## RECURSION

### 1. A REPEAT/UNTIL LOOP MUST NOT CALL ITSELF MORE THAN 5 TIMES

```

1 | THIS PROGRAM WILL RESULT IN AN ERROR
10 OUTPUT 718: "VARDEF C_DUNT, 0"
20 OUTPUT 718: "FUNCDEF Z_DOM, 0"
30 OUTPUT 718: "MKPK HI; MT1: SP100KZ; MTO; TS; MKPK HI; MKCF; "
40 OUTPUT 718: "ADD C_DUNT, C_DUNT, 1; "
50 OUTPUT 718: "DSPLY C_DUNT, 5.0; "
60 OUTPUT 718: "REPEAT Z_DOM UNTIL C_DUNT EQ 100; "
70 OUTPUT 718: "0"
80 OUTPUT 718: "Z_DOM; "
90 END

```

### 2. AN IF/THEN BRANCH MUST NOT CALL ITSELF MORE THAN 25 TIMES

```

1 | THIS PROGRAM WILL RESULT IN AN ERROR
10 OUTPUT 718: "VARDEF C_DUNT, 0"
20 OUTPUT 718: "FUNCDEF Z_DOM, 0"
30 OUTPUT 718: "MKPK HI; MT1: SP100KZ; MTO; TS; MKPK HI; MKCF; "
40 OUTPUT 718: "ADD C_DUNT, C_DUNT, 1; "
50 OUTPUT 718: "DSPLY C_DUNT, 5.0; "
60 OUTPUT 718: "IF C_DUNT LT 100 THEN Z_DOM; "
70 OUTPUT 718: "ENDIF; "
80 OUTPUT 718: "0"
90 OUTPUT 718: "Z_DOM; "
100 END

```

This DLP uses a single REPEAT/UNTIL loop to correctly perform the measurement 100 times. Note that nesting and recursion are both absent from this program. Note further that the REPEAT/UNTIL loop is used to solve this measurement problem rather than the IF/THEN approach since the solution calls for a repetitive loop rather than a series of conditional branches.

## CORRECT METHOD OF LOOPING

```

1 | THIS PROGRAM WILL RUN PROPERLY
10 OUTPUT 718: "VARDEF C_DUNT, 0"
20 OUTPUT 718: "FUNCDEF Z_DOM, 0"
30 OUTPUT 718: "REPEAT"
40 OUTPUT 718: "MKPK HI; MT1: SP100KZ; MTO; TS; MKPK HI; MKCF; "
50 OUTPUT 718: "ADD C_DUNT, C_DUNT, 1; "
60 OUTPUT 718: "DSPLY C_DUNT, 5.0; "
70 OUTPUT 718: "UNTIL C_DUNT EQ 100; "
80 OUTPUT 718: "0"
90 OUTPUT 718: "Z_DOM; "
100 END

```

## HELPFUL HINTS

- \* AVAILABLE MEMORY
- \* CLEARING MEMORY
- \* DLP EXECUTION TIME
- \* BASIC 2.1 SHORTCUTS

## AVAILABLE MEMORY

```
10 OUTPUT 718: "MEM?: "  
20 ENTER 718: M_EMORY  
30 PRINT M_EMORY  
40 END
```

## CLEARING MEMORY

```
* ENTIRE CONTENTS:  
OUTPUT 718: "DISPOSE ALL"  
  
* INDIVIDUAL DLP:  
OUTPUT 718: "DISPOSE X_XX "  
(e.g. "DISPOSE E_XAMPLE")
```

## HELPFUL HINTS

This is the last section of the seminar, and it provides some useful techniques for determining the amount of available analyzer memory, for clearing memory, and measuring the execution time of a DLP. There are also some useful shortcuts which are made possible by the BASIC 2.1 EXTENSIONS to the BASIC 2.0 OPERATING SYSTEM.

The 8566B/8568B have over 16K of user-defined non-volatile memory (RAM). To determine how much memory is available at any one time, the "MEM?" command is used in the manner shown in this slide. If this routine is run both before and after loading a DLP, the preceding program (i.e. which consists of the main program, E\_XAMPLE, and the 5 subprogram modules) uses approximately 2700 bytes of analyzer memory. The most any one function definition (e.g. FUNCDEF "E\_XAMPLE") can contain is 2015 bytes. All of the FUNCDEF'S in the preceding program easily meet this criteria. Each DLP command requires 1 byte per character plus approximately 12-14 bytes of overhead to accomplish the function. Each trace element of a TRDEF requires 2 bytes. Spaces and carriage return/line feeds require 1 byte apiece. Finally, clearing the analyzer memory requires the use of the "DISPOSE" command. In addition to the two cases given on the slide, a softkey can also be cleared. For example, softkey label 20 can be cleared by "DISPOSE 20", and its contents can be cleared by "DISPOSE E\_XAMPLE".

Determining the execution time of a DLP can be accomplished quite simply using the new 8566B/68B command, "DONE", and the Series 200 Controller command, "TIMEDATE". This slide illustrates the use of these commands for determining the execution time for the DLP, "E\_XAMPLE."

Using BASIC 2.1 Extensions to the BASIC 2.0 Operating System on the Series 200 controllers provides some very useful time-saving typing shortcuts. For example, abbreviated variable names can be initially typed and later replaced with more descriptive names. In addition, the Series 200 controller softkeys can be defined to include repetitious typing entries such as "OUTPUT 718" and "ENTER 718".

## DLP EXECUTION TIME

```
10 T1 = TIMEDATE
20 OUTPUT 718: "E_XAMPLE: DONE: "
30 ENTER 718: N
40 PRINT TIMEDATE - T1
50 END
```

## BASIC 2.1 SHORTCUTS

### 1. SEARCH AND REPLACE:

CHANGE "X" TO "Y": ALL  
(e.g. CHANGE "P\_ER" TO "P\_ERCENT\_AM": ALL)

### 2. CONTROLLER SOFTKEY DEFINITION

e.g. OUTPUT 718: " "

e.g. ENTER 718:



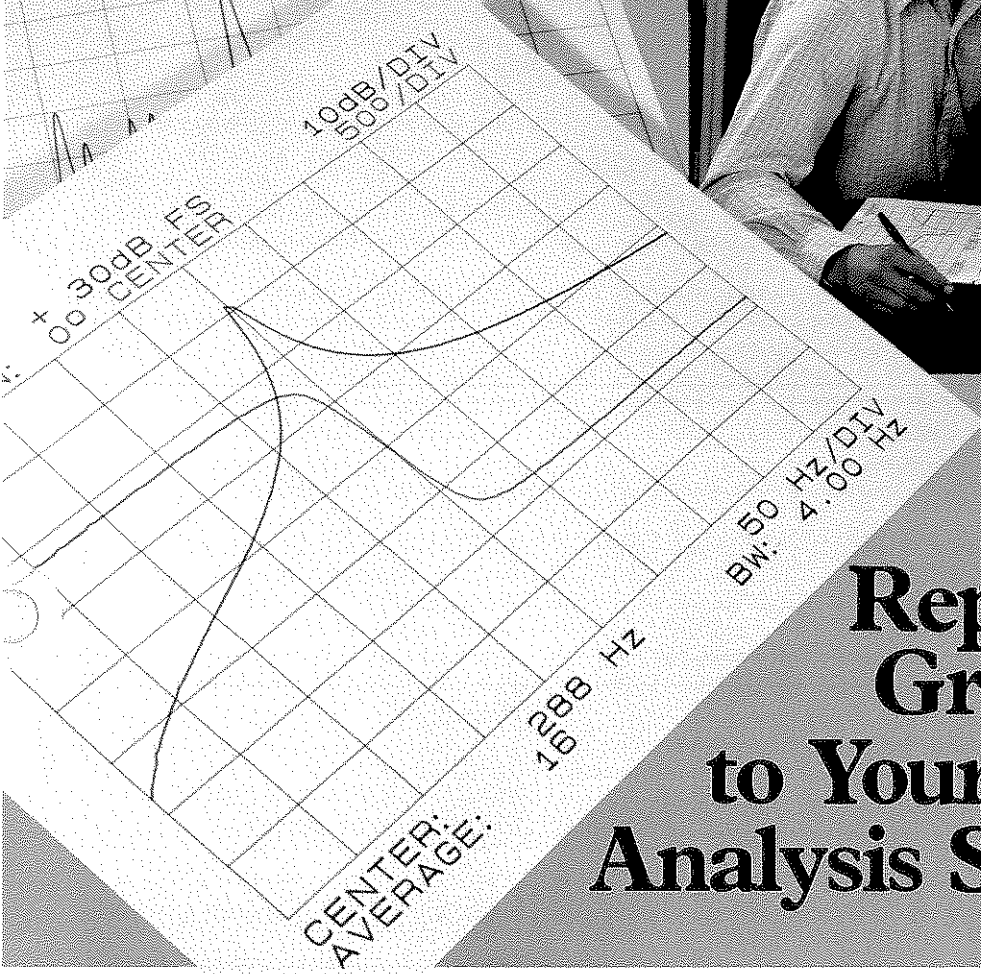
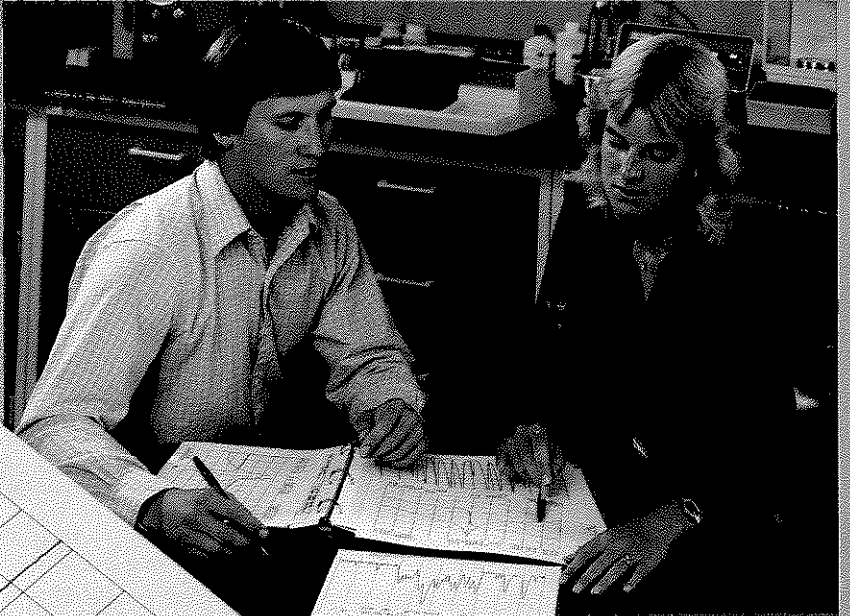

# Add Report Quality Graphics to Your Signal Analysis System

## and communicate your results

Record your signal analyzer measurements quickly and colorfully on a Hewlett-Packard plotter. Use economical plotter hardcopy to permanently record data for documentation or analysis, for reports, and for group presentations. No matter what frequency range you are recording, a compatible HP plotter makes it easy to document waveforms, performance standards, and test results.

### Hewlett-Packard 9872C/T and 7470A graphics plotters

- Automatic plotting for cost and time savings
- Data differentiation through 10 pen colors and multiple line widths
- High resolution for detailed analysis
- Overhead transparencies for graphics presentations

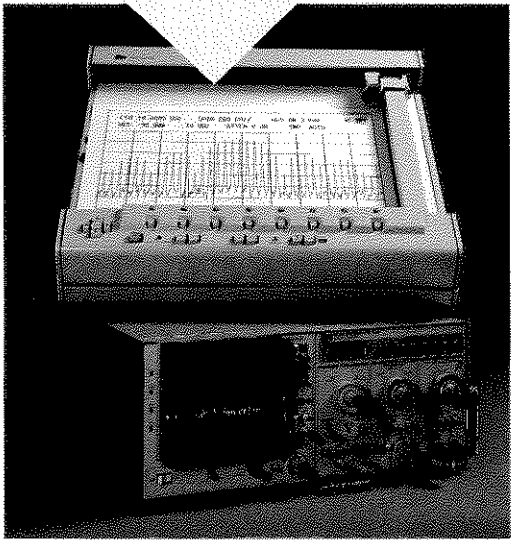

HP-IB: Not just IEEE-488, but the hardware, documentation and support that delivers the shortest path to a measurement system.



# ✕ What a plotter will do for your signal analyzer

Add an HP graphics plotter and you can create multicolor hardcopy records of your spectrum and signal measurements on paper or transparency film. With the appropriate hardware and software a plotter can add benefits to your application in the areas of efficiency, analysis, communication, and storage.

## ✕ SAVE TIME OVER MANUAL GRAPH MAKING

Copy the screen display or measurement values to the plotter quickly, easily, and accurately. Make professional camera-ready art for manuals, reports, and publications. The 9872 plotter can even use liquid ink pens for drafting quality drawings on paper, vellum, or film. No more manual graph making!

## ✕ SAVE COST OVER SCOPE CAMERA FILM

Save the cost and frustration of wasting film while trying to get the right exposure. Make as many copies as you need, at a fraction of the cost of instant development films.

## ✕ IMPROVE COMMUNICATION AND UNDERSTANDING

Use hardcopy graphics to communicate information clearly. Compare screen waveforms with measurements recorded earlier, or plot multiple traces on a single graph to identify differences easily.

## ✕ MAKE PERMANENT COPIES FOR ARCHIVAL STORAGE

Plots provide a permanent post-test reference of results for many documentation needs. Filing and retrieval are easy — and you can be confident that the measurements are accurately recorded.

## ✕ CREATE TRANSPARENCIES FOR DATA PRESENTATIONS

Present your measurements colorfully, clearly, professionally at meetings, seminars, or training sessions. Special pens and overhead transparency film make preparing for presentations easier than ever.

## ✕ RECORD DATA CLEARLY AND COMPLETELY

Record and analyze data relationships and variations with the help of high resolution plots which can be reproduced and photocopied easily. And the plotter's larger media size presents information more clearly than a photograph.

## Record directly to the 7470A or 9872C/T.

A number of Hewlett-Packard's microprocessor-based analyzers will record directly to the plotter via the HP-IB interface. It could hardly be easier to plot your grid and trace. These "smart" instruments include the 853A Spectrum Analyzer Display and its plug-ins (the 8557A, 8558B, and 8559C), the 5420B Digital Signal Analyzer, the 5423A Structural Dynamics Analyzer, and the 8569A Spectrum Analyzer. All except the low-cost 853A annotate the plots as well.

## Automated systems gain hardcopy benefits.

An external controller such as an HP 9826 or HP-85 with appropriate software brings similar plotting capability to these spectrum analyzer models: the 3044A, 3045A, 3582A, 3585A, 8566A, and the 8568A. Consult your HP sales office for the recommended controller for your instrument system.

## And there's more.

In fact, a controller brings additional plotting capabilities to all of Hewlett-Packard's HP-IB signal analyzers. With an external controller it is possible to digitize input to the CRT display, annotate plots in foreign languages with international characters, and control graph features such as labels, axes, pen selection, and plot location. You can tailor your plots by changing graph size or direction to cluster several plots on a page, and use techniques such as overlays and family plots to emphasize important comparisons.

## 9872C/T Graphics Plotters

- 8 pen automatic selection
- Paper, vellum, polyester and transparency film. Sizes up to A3 (11 × 17 in.)
- Drafting ink pens in addition to multi-color fiber tip pens
- Chart advance for unattended plotting (T model)

## 7470A Graphics Plotter

- 2 pen automatic selection
- A4 (8½ × 11 in.) size paper or transparency film
- Low budget price

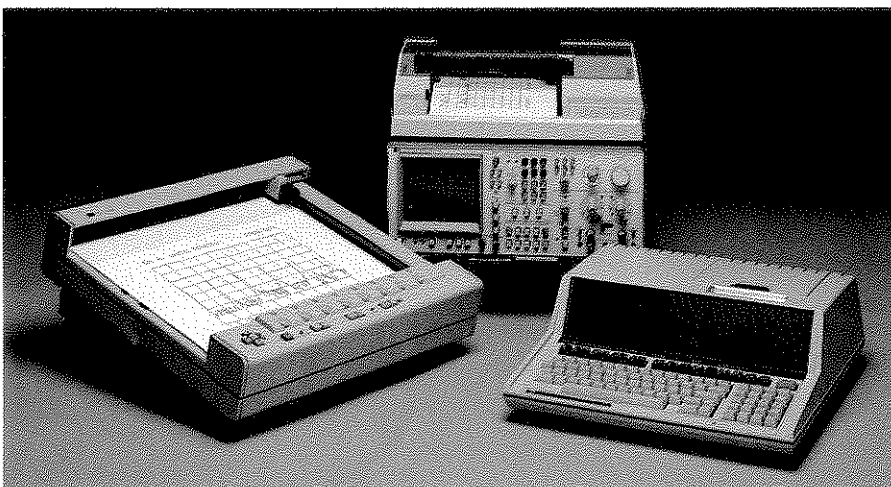

 **HEWLETT  
PACKARD**

Call your local  
Hewlett-Packard Sales office  
for quality results from data  
source to data presentation.



For more information, call your local HP Sales Office or nearest Regional Office: Eastern (301) 258-2000; Midwestern (312) 255-9800; Southern (404) 955-1500; Western (213) 877-1282; Canadian (416) 678-9430. Or Write Hewlett-Packard, 3000 Hanover Street, Palo Alto, CA 94304. In Europe: Hewlett-Packard S.A., 7, rue du Bois-du-Lan, P.O. Box, CH-1217 Meyrin 2, Geneva, Switzerland. In Japan: Yokogawa-Hewlett-Packard Ltd., 29-21 Takaido-Higashi 3-chome, Sugiyama-ku, Tokyo 168.

(11)5953-4144

PRINTED IN U.S.A.

OCTOBER 1982



## SAFETY CONSIDERATIONS

### Safety Symbols

The following safety symbols are used throughout this manual and in the instrument. Familiarize yourself with each of the symbols and its meaning before operating this instrument.



Instruction manual symbol: the apparatus will be marked with this symbol when it is necessary for the user to refer to the instruction manual in order to protect the apparatus against damage.

or destruction of part or all of the equipment. Do not proceed beyond a CAUTION sign until the indicated conditions are fully understood and met.



Indicates dangerous voltages.

#### WARNING

The WARNING sign denotes a hazard. It calls attention to a procedure, practice or the like, which, if not correctly performed or adhered to, could result in injury or loss of life. Do not proceed beyond a WARNING sign until the indicated conditions are fully understood and met.

#### CAUTION

The CAUTION sign denotes a hazard. It calls attention to an operation, procedure, practice, or the like, which, if not correctly performed or adhered to, could result in damage to

### Line Voltage and Fuse Selection

#### WARNING

BEFORE THIS INSTRUMENT IS SWITCHED ON, its protective earth terminals must be connected through the protective conductors of the AC power cables to socket outlets provided with protective earth contacts. Failure to ground the instrument can result in personal injury.

#### CAUTION

BEFORE SWITCHING ON THIS INSTRUMENT, make sure it is adapted to the voltage of the ac power source. Failure to set the ac power input of the instrument for the correct voltage level could cause damage to the instrument when plugged in.

### Service and Adjustments

#### WARNING

Power is still applied to this instrument with the LINE switch in STANDBY. There is no OFF position on the LINE switch. Before removing or installing any assembly or printed circuit board, remove the power cord from the rear of both instruments.

Capacitors inside the instrument may still be charged, even if the instrument has been disconnected from its source of supply.

#### WARNING

There are voltages at many points in the instrument which can, if contacted, cause personal injury. Be extremely careful. Adjustments should be performed only by trained service personnel.

Use a non-metallic adjustment tool whenever possible.

HP 8566A

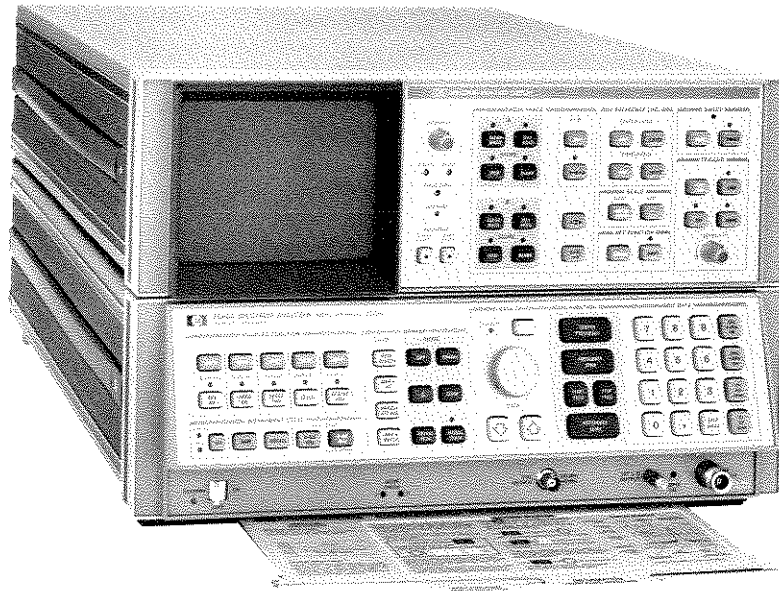

LINE POWER CABLE\*

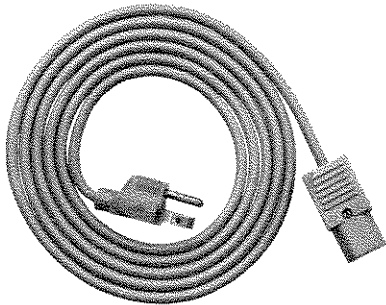

FREQ REFERENCE JUMPER

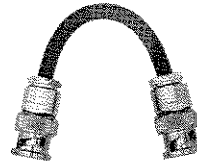

COAX  
INTERCONNECT  
CABLE

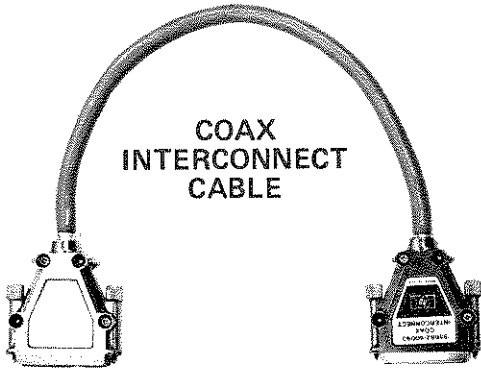

BUS INTERCONNECT  
CABLE

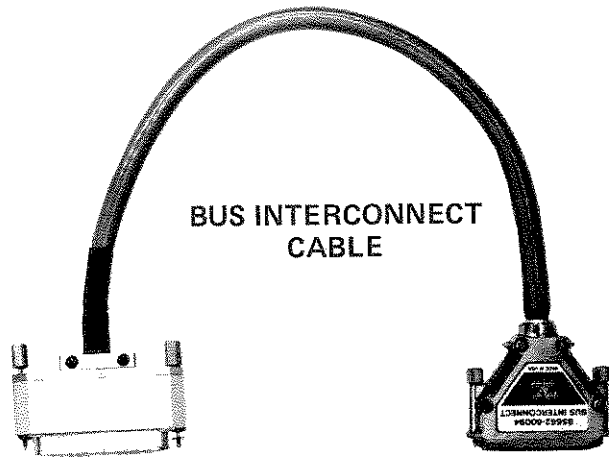

\*Power cable/plug supplied depends on country of destination. Refer to Section II for part number information.

Figure 1-1. Model 8566A Spectrum Analyzer and Accessories Supplied

# SECTION I GENERAL INFORMATION

## 1-1. INTRODUCTION

1-2. This Operating and Service manual contains information required to install, operate, test, adjust, and service the Hewlett-Packard Model 8566A Spectrum Analyzer. Figure 1-1 shows the instrument and accessories supplied. This section covers instrument identification, description, options, accessories, specifications, and other basic information.

## 1-3. MANUAL ORGANIZATION

1-4. This manual is divided into four volumes and nine sections as follows:

### Volume 1

SECTION I, GENERAL INFORMATION; contains the instrument description and specifications, explains accessories and options, and lists recommended test equipment.

SECTION II, INSTALLATION AND OPERATION VERIFICATION; contains information concerning initial mechanical inspection, verification of electrical operation, preparation for use, operating environment, and packaging and shipping.

SECTION III, OPERATION; contains detailed operating instructions for both manual front-panel and remote (using HP-IB) operation of the instrument. HP-IB (Hewlett-Packard Interface Bus) is Hewlett-Packard Company's implementation of IEEE Std. 488, "Digital Interface for Programmable Instrumentation."

### Volume 2

SECTION IV, PERFORMANCE TESTS; contains the necessary tests to verify that the electrical

operation of the instrument is in accordance with published specifications.

SECTION V, ADJUSTMENTS; contains the necessary adjustment procedures to properly adjust the instrument after repair.

SECTION VI, REPLACEABLE PARTS; contains the information necessary to order parts and/or assemblies for the instrument.

SECTION VII, MANUAL BACKDATING CHANGES; contains backdating information to make this manual compatible with earlier equipment configurations.

### Volume 3

SECTION VIII, IF DISPLAY SECTION SERVICE; contains schematic diagrams, block diagrams, component location illustrations, circuit descriptions, repair procedures, and troubleshooting information for the IF-Display Section of the instrument.

### Volume 4

SECTION IX, RF SECTION SERVICE; contains schematic diagrams, block diagrams, component location illustrations, circuit descriptions, repair procedures, and troubleshooting information for the RF Section of the instrument.

## 1-5. SPECIFICATIONS

1-6. Instrument specifications are listed in Tables 1-1 and 1-2. These specifications are the performance standards or limits against which the instrument is tested. Table 1-3 lists supplemental characteristics. Supplemental characteristics are not specifications but are typical characteristics included as additional information for the user.

## 1-7. SAFETY CONSIDERATIONS

1-8. Before operating this instrument, you should familiarize yourself with the safety markings on the instrument and safety instructions in this manual. This instrument has been manufactured and tested according to international safety standards. However, to ensure safe operation of the instrument and personal safety of the user and service personnel, the cautions and warnings in this manual must be followed. Refer to page 1-1 (first page of this section) for summary of safety considerations. Refer also to individual sections of this manual for detailed safety notation concerning the use of the instrument as described in those individual sections.

## 1-9. INSTRUMENTS COVERED BY MANUAL

### 1-10. Serial Numbers

1-11. Attached to the rear of each section of your instrument is a serial number plate. The serial number is in two parts. The first four digits and letter are the serial number prefix; the last five digits are the suffix. The prefix is the same for all identical instruments; it changes only when a change is made to the instrument. The suffix, however, is assigned sequentially and is different for each instrument. The contents of this manual apply to instruments with the serial number prefix(es) listed under SERIAL NUMBERS on the title page.

### 1-12. Manual Changes Supplement

1-13. An instrument manufactured after the printing of this manual may have a serial number prefix that is not listed on the title page. This unlisted serial number prefix indicates the instrument is different from those described in this manual. The manual for this newer instrument is accompanied by a yellow Manual Changes supplement. This supplement contains "change information" that explains how to adapt the manual to the newer instrument. This supplement is located in Volume 2 and referenced with a tab.

1-14. In addition to change information, the supplement may contain information for correcting errors in the manual. To keep this manual as current and accurate as possible, Hewlett-Packard recommends that you periodically request the latest Manual Changes supplement. The supplement for this manual is identified with this manual's print date and part number, both of which appear on the manual's title page. Complimentary copies of the supplement are available from Hewlett-Packard. Addresses of Hewlett-Packard offices are located at the rear of each volume of this manual.

### 1-15. Manual Backdating Changes

1-16. Instruments manufactured before the printing of this manual have been assigned serial number prefixes other than those for which this manual was written directly. Manual backdating information is provided in Volume 2 (Section VII) to adapt this manual to any such earlier assigned serial number prefix.

1-17. This information should not be confused with information contained in the yellow Manual Changes Supplement which is intended to adapt this manual to instruments manufactured after the printing of this manual.

## 1-18. ACCESSORIES SUPPLIED

1-19. Figure 1-1 shows the instrument and the accessories supplied. These accessories are as follows: two power cables (refer to Section II for part number information), instrument bus interconnect cable (HP Part No. 85662-60094), coaxial interconnect cable (HP Part No. 85662-60093), subminiature "A type" 50-ohm load (for 1ST LO OUTPUT), and FREQ REFERENCE jumper (HP Part No. 85660-60117).



## **1-20. EQUIPMENT AND ACCESSORIES AVAILABLE**

### **1-21. Service Accessories**

1-22. A service accessories package for the instrument is available for convenience in troubleshooting and aligning the instrument. This service accessories package is illustrated in Figure 1-2 including a complete list of contents. The complete package may be obtained from Hewlett-Packard by ordering HP Part Number 08566-60001.

### **1-23. Desk-Top Computer**

1-24. The HP Model 9825A Desk-Top Computer is compatible with the 8566A and can be used for remote operation of the instrument. Remote operation of the instrument using the 9825A as a controller can make testing and adjusting of the instrument much faster than manual operation from the front-panel keyboard.

## **1-25. OPTIONS**

### **1-26. Option 400, 400 Hz Line Frequency**

1-27. The standard 8566A requires that the power line frequency be 50 or 60 Hz. Option 400 allows the instrument to also operate with a 400 Hz power line frequency. Refer to Table 1-1 for detailed specifications.

### **1-28. Option 907, Front Handles**

1-29. Option 907 instruments are supplied with a front handle kit. Refer to Section II for detailed description of this kit and installation procedure.

### **1-30. Option 908, Rack Mount Flanges**

1-31. Option 908 instruments are supplied with a rack mount flange kit. Refer to Section II for detailed description of this kit and installation procedure.

### **1-32. Option 909, Front Handles and Rack Mount Flanges**

1-33. Option 909 instruments are supplied with a front handle and rack mount flange kit. Refer to Section II for detailed description of this kit and installation procedure.

### **1-34. Option 910, Extra Manual**

1-35. The standard instrument is supplied with one Operating and Service manual. Option 910 instruments are supplied with two Operating and Service manuals. Additional manual does not include Operation Verification cartridge.

### **1-36. Rack Mount Slides**

1-37. Some special order instruments are supplied with a rack mount slide adapter kit. Refer to Section II for detailed description of this kit and installation procedure.

## **1-38. RECOMMENDED TEST EQUIPMENT**

1-39. Equipment required to test, adjust, and troubleshoot the instrument is listed in Table 1-4. Equipment other than the model number listed may be substituted if it meets the critical specification(s) indicated in the table:

Table 1-1. 8566A Spectrum Analyzer Specifications (1 of 5)

Unless noted, all specifications are for AUTO COUPLED FUNCTION operation and are with the preselector tracking optimized using the MARKER PRESELECTOR PEAK function. Where specifications are subject to minimization with the error correction routine, corrected limits are given unless noted.

## FREQUENCY

### MEASUREMENT RANGE

100 Hz to 22 GHz, dc coupled input.

### DISPLAYED VALUES

#### Frequency Reference Error

$< 1 \times 10^{-9}$ /day and  $< 2 \times 10^{-7}$ /year.

#### Center Frequency

0 Hz to 22 GHz.

#### Readout Accuracy

##### Spans $\leq 5$ MHz:

$\pm(2\%$  of frequency span + frequency reference error x center frequency + 10 Hz)

##### Spans $> 5$ MHz:

$\pm(2\%$  of frequency span + n x 100 kHz + frequency reference error x center frequency) where n is the harmonic mixing number, depending upon center frequency:

n center frequency

1 100 Hz to 5.8 GHz

2 5.8 GHz to 12.5 GHz

3 12.5 GHz to 18.6 GHz

4  $> 18.6$  GHz

#### Zero Span

$\pm$  frequency reference error x center frequency

#### Frequency Span

0 Hz, 100 Hz to 22 GHz over 10 divisions CRT horizontal axis; variable in approximately 1% increments.

#### Full Span

0 — 2.5 GHz and 2 — 22 GHz.

#### Readout Accuracy

Spans 100 Hz to 5 MHz:  $\pm 1\%$  of indicated frequency separation.

Spans  $> 5$  MHz:  $\pm 3\%$  of indicated frequency separation.

#### Start/Stop Frequency

#### Readout Accuracy

Same as Center Frequency.

### RESOLUTION

#### Resolution Bandwidth

3 dB bandwidths of 10 Hz to 3 MHz in a 1, 3, 10 sequence. Bandwidth may be selected manually or coupled to frequency span (AUTO mode).

#### Bandwidth Accuracy<sup>1</sup>

3 dB bandwidths calibrated to

$\pm 20\%$ , 10 Hz to 3 MHz filters

$\pm 10\%$ , 3 kHz to 1 MHz filters

#### Bandwidth Selectivity

60 dB/3 dB bandwidth ratio:

$< 15:1$  3 MHz to 100 kHz

$< 13:1$  30 kHz to 10 kHz

$< 11:1$  3 kHz to 30 Hz

60 dB points on 10 Hz bandwidth are separated by  $< 100$  Hz.

#### Bandwidth Shape

Synchronously tuned, 5 pole filters for 10 Hz to 30 kHz bandwidths; 4 poles, 100 kHz to 3 MHz bandwidth. Approximate Gaussian shape optimized for minimum sweep time and smooth pulse response with calibrated display.

### SPECTRAL PURITY

#### Noise Sidebands

For Frequency Span  $\leq 25$  kHz (except 100 kHz offset) and Center Frequency from 100 Hz to 5.8 GHz.

Offset From Carrier	Sideband Level
320 Hz	-80 dBc/Hz
1 kHz	-85 dBc/Hz
10 kHz	-90 dBc/Hz
100 kHz	-105 dBc/Hz

#### Power Line Related Sidebands

For line conditions specified in Power Requirements section.

Offset From Carrier	Center Frequency	
	$\leq 100$ MHz	$> 100$ MHz to 5.8 GHz
$< 360$ Hz	-70 dBc	-60 dBc
360 Hz to 2 kHz	-75 dBc	

<sup>1</sup>30 kHz and 100 kHz bandwidth accuracy figures only applicable  $\leq 90\%$  relative humidity.

Table 1-1. 8566A Spectrum Analyzer Specifications (2 of 5)

**AMPLITUDE**

**MEASUREMENT RANGE**

Measurement range is the total amplitude range over which the analyzer can measure signal responses. The low value is determined by sensitivity (10 Hz resolution bandwidth and 0 dB RF input attenuation) and the high value by damage level.

Range	Tuned Frequency non-preselected	preselected
- 95 dBm to + 30 dBm	100 Hz to 50 kHz	2.0 GHz to 5.8 GHz
- 112 dBm to + 30 dBm	50 kHz to 1 MHz	5.8 GHz to 12.5 GHz
- 134 dBm to + 30 dBm	1 MHz to 2.5 GHz	12.5 GHz to 18.6 GHz
- 132 dBm to + 30 dBm		18.6 GHz to 22 GHz

**DISPLAYED VALUES**

**Scale**

Over a 10 division CRT vertical axis with the Reference Level (0 dB) at the top graticule line.

**Calibration**

**Log:** 10 dB/div for 90 dB display from Reference Level.

5 dB/div for 50 dB display      expanded from  
2 dB/div for 20 dB display      Reference Level  
1 dB/div for 10 dB display

**Linear:** 10% of Reference Level/div when calibrated in voltage.

**Fidelity**

**Log:**

Incremental	Cumulative
±0.1 dB/dB over 0 to 80 dB display	≤ ±1.0 dB max over 0 to 80 dB display, 20-30°C. ≤ ±1.5 dB max over 0 to 90 dB display.

**Linear:** ±3% of Reference Level.

**Reference Level**

**Range**

**Log:** +30.0 to -99.9 dBm or equivalent in dBmV, dBμV, Volts.

Readout expandable to +60.0<sup>1</sup> to -119.9 dBm (-139.9 dBm for ≤1 kHz resolution bandwidth) using SHIFT I.

**Linear:** 7.07 volts to 2.2 μvolts full scale.

Readout expandable to 223.6<sup>1</sup> volts to 2.2 μvolts (0.22 μvolts for <1 kHz resolution bandwidth) using SHIFT I.

**Accuracy**

The sum of several factors, listed in Table 1-2 Log Uncertainty, determines the accuracy of the reference level readout. Refer to Table 1-2.

**REFERENCE LINES**

**Accuracy**

Equals the sum of reference level accuracy plus the scale fidelity between the reference level and the reference line level.

**DYNAMIC RANGE**

**Spurious Responses** (signals generated by the analyzer due to input signals). For total signal power ≤ -40 dBm all harmonic and intermodulation distortion > 70 dB below input signal.

**Second Harmonic Distortion**

For mixer levels ≤ -40 dBm:  
< -80 dBc, 50 MHz to 700 MHz (non-preselected).  
< -70 dBc, 100 Hz to 2.5 GHz (non-preselected).

For mixer levels ≤ -10 dBm:  
< -100 dBc, 2 to 22 GHz (preselected).

**Third Order Intermodulation Distortion<sup>2</sup>**

Third order intercept (TOI)  
> +7 dBm, 100 Hz to 5.8 GHz.  
> +5 dBm, 5.8 to 18.6 GHz.

See Table 1-3 for typical second and third order distortion characteristics.

**Image Responses** (due to the mixing of signals two times the IF frequency, 2 x 321.4 MHz, above or below the tuned frequency.)

< -70 dBc, 100 Hz to 18.6 GHz.  
< -60 dBc, 18.6 GHz to 20 GHz.  
< -50 dBc, 20 GHz to 22 GHz

**Multiple Responses** (due to the input signal mixing with more than one local oscillator harmonic)

< -70 dBc, 100 Hz to 22 GHz.

**Out-of-Band Responses** (due to the mixing of input signals outside the preselector's frequency span):

< -60 dBc, 2 to 22 GHz.

<sup>1</sup>Maximum total input power not to exceed +30 dBm damage level.

<sup>2</sup>Dynamic range due to TOI and noise level can be calculated from 2/3 [TOI—displayed average noise level]. For example, at 18 GHz the analyzer's specified dynamic range when using the 10 Hz resolution BW is:

$$2/3 [ +5 \text{ dBm} - ( -120 \text{ dBm} ) ] = 2/3 ( 125 ) = 83 \text{ dB.}$$

### AMPLITUDE (Cont'd)

**Residual Responses** (signals generated by the analyzer independent of input signals). With 0 dB input attenuation and no input signal:

- < -100 dBm, 100 Hz to 5.8 GHz.
- < -95 dBm, 5.8 GHz to 12.5 GHz.
- < -85 dBm, 12.5 GHz to 18.6 GHz.
- < -80 dBm, 18.6 GHz to 22 GHz.

#### Gain Compression

< 1.0 dB, 100 Hz to 22 GHz with  $\leq -5$  dBm at input mixer.

Two tone intermodulation distortion products can be calculated from

$$2 (\text{TOI} - \text{signal level}).$$

For example, for two tones at -33 dBm, the IM products for a +5 dBm TOI will be

$$2 [+5 \text{ dBm} - (-33)] = 76 \text{ dB down.}$$

#### Displayed Average Noise Level (Sensitivity)

0 dB input attenuation and 10 Hz resolution bandwidth.

Level	Tuning Range
	<b>Non-Preselected</b>
< -95	100 Hz to 50 kHz
< -112	50 kHz to 1.0 MHz
< -134	1.0 MHz to 2.5 GHz
	<b>Preselected</b>
< -132	2.0 GHz to 5.8 GHz
< -125	5.8 GHz to 12.5 GHz
< -119	12.5 GHz to 18.6 GHz
< -114	18.6 GHz to 22 GHz

Figures 1 and 2 show sensitivity for various resolution bandwidths.

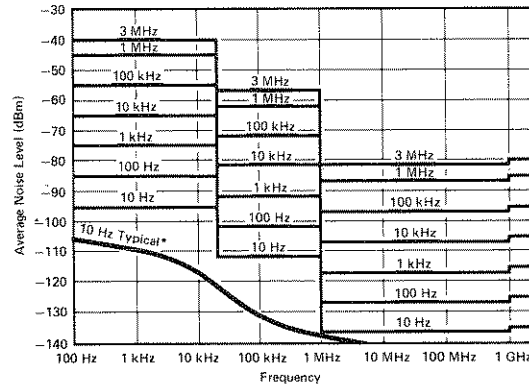

Figure 1. Specified Average Displayed Noise Level, 100 Hz to 2.5 GHz Non-Preselected Tuning Range.

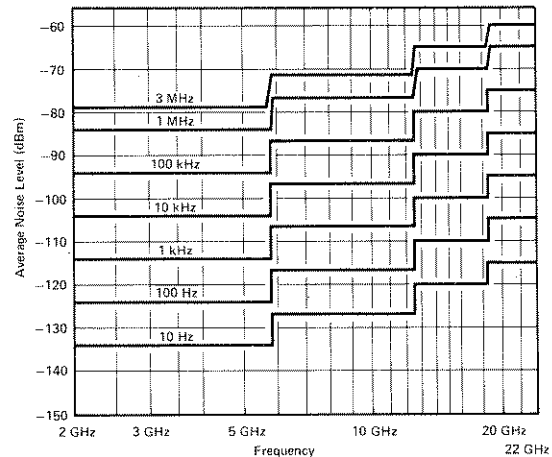

Figure 2. Specified Average Displayed Noise Level, 2.0 GHz to 22 GHz Preselected Tuning Range.

#### MARKER

The marker is a bright dot placed upon the display trace which is positioned horizontally by the DATA controls. The marker amplitude and frequency are read out continuously.

#### FREQUENCY

##### Accuracy

- Normal:** same as center frequency accuracy.
- $\Delta$ : same as frequency span accuracy.

#### AMPLITUDE Accuracy

**Normal:** same as reference level accuracy plus scale fidelity between the reference level and marker position.

$\Delta$ : same as frequency response uncertainty and scale fidelity between two markers.



Table 1-1. 8566A Spectrum Analyzer Specifications (4 of 5)



<b>SWEEP</b>	
<b>SWEEP TIME</b>	
<b>Accuracy</b>	
±10% ≤200 sec sweeptimes.	
±30% >200 sec sweeptimes.	
<b>INPUTS</b>	
<b>RF INPUT</b>	<b>DC</b>
100 Hz to 22 GHz, precision female type N connector, dc coupled.	20 volts with rise time of <1 volt/μsec.
<b>Maximum Input Level</b>	<b>Sensitivity</b>
<b>AC</b>	-30 dBm at 321.4 MHz produces full-scale CRT deflection ±1.0 dB when   (KSU) is executed.
Continuous power, +30 dBm (1 watt), from 50 ohm source. Mixer protected by diode limiter, 100 Hz to 2.5 GHz. ≤100 watts, 10 μsec pulse with ≥50 dB RF attenuation (≤0 dBm peak to input mixer).	
<b>DC</b>	<b>EXTERNAL SWEEP TRIGGER INPUT</b> (rear panel)
<100 mA current damage level.	Must be >2.4 volt (10 volt max). 1 kΩ nominal input impedance.
<b>Input Attenuator</b>	<b>EXTERNAL FREQUENCY REFERENCE INPUT</b> (rear panel)
0 to 70 dB in 10 dB steps. +30 dBm (1 watt) input damage level.	Must equal 5 MHz ±50 Hz or 10 MHz ±100 Hz, 0 to +10 dBm, 50Ω nominal input impedance. Analyzer performance will be degraded unless frequency reference phase noise and spurious signals are <-140 dBc single sideband (1 Hz) referred to 10 MHz at a 100 Hz to 10 kHz offset.
<b>IF INPUT</b>	
<b>Maximum Input Level</b>	
<b>AC</b>	
+10 dBm, continuous power, from 50Ω source.	
<b>CAL OUTPUT</b>	<b>OUTPUTS</b>
100 MHz ± (frequency reference error).	<b>IF OUTPUT</b>
-10 dBm ±0.3 dB, 50Ω impedance.	<b>Maximum Input Level</b>
<b>1st LO OUTPUT</b>	<b>AC</b>
2.3 to 6.1 GHz, >+5 dBm, 50Ω output impedance.	+10 dBm, continuous power, from 50Ω source.
<b>Maximum Input Level</b>	<b>DC</b>
+27 dBm (1/2 watt) total power into 50Ω impedance.	20 volts with rise time of <1 volt/μsec.
	<b>SWEEP + TUNE OUT</b> (rear panel)
	-1.0 volt per GHz of tune frequency, 10 kΩ minimum load.
	<b>Accuracy</b>
	-1V/GHz ±20% ±10 mV.
<b>ENVIRONMENTAL</b>	<b>GENERAL</b>
<b>Temperature</b>	<b>POWER REQUIREMENTS</b>
Operation 0°C to 55°C.	50 to 60 Hz; 100, 120, 220 or 240 volts (+5%, -10%); approximately 650 VA (40 VA in standby).
Increased internal temperatures may result if the rear panel air filters are not cleaned regularly.	400 Hz operation is available as Option 400.

Table 1-1. 8566A Spectrum Analyzer Specifications (5 of 5)

**GENERAL (Cont'd)**

**Humidity**

Operating, < 95% relative humidity, 0°C to 40°C except as noted in electrical specifications.

**EMI**

Conducted and radiated interference is within the requirements of CE 03 and RE 02 of MIL STD 461A, and within the requirements of VDE 0871 and CISPR publication 11.

**WARM-UP TIME**

**Operation**

Requires 30 minute warm-up from cold start, 0° to 55°C. Internal temperature equilibrium is reached after 2 hr. warm-up at stabilized outside temperature.

**Frequency Reference**

Frequency reference aging rate attained after 24 hr. warm-up from cold start at 25°C. Frequency is within  $1 \times 10^{-6}$  of final stabilized frequency within 30 minutes.

**WEIGHT**

Total net 50 kg (112 lb): IF-Display Section, 21 kg (47 lb); RF Section, 29 kg (65 lb). Shipping: IF-Display Section, 27 kg (60 lb); RF Section, 35 kg (78 lb).

**DIMENSIONS**

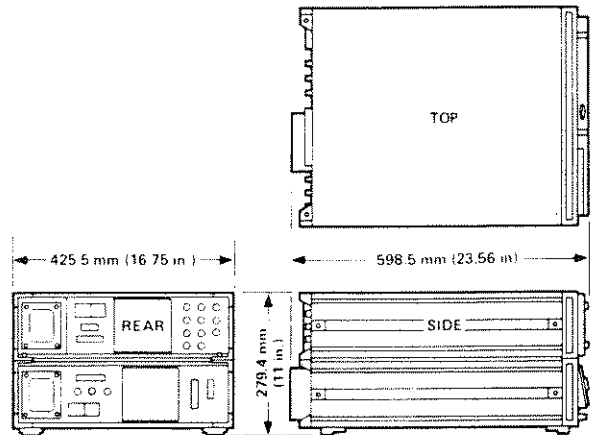

**OPTIONS**

All specifications for options are identical to standard 8566A except as noted.

**400 Hz POWER LINE FREQUENCY OPERATION — Option 400**

**Power Line Related Sidebands**

For Center Frequency from 100 Hz to 5.7 GHz

Offset From Carrier	Sideband Level
≤2 kHz	-55 dBc
2 kHz to 5.5 kHz	-65 dBc

**Power Requirements**

400 Hz ± 10% line frequency.  
100 or 120 volts (+5%, -10%) line voltage.

**Operating Temperature Range**

0° to 40°C, 50-60 Hz Power Line Frequency, service only, not for extended periods  
0°C to 55°C, 400 Hz Power Line Frequency

**HANDLE / MOUNTING KITS**

**Front Handle Kit (Option 907)**

Recommended for portability and front panel protection.

**Rack Flange Kit (Option 908)**

**Rack Flange and Front Handle Kit (Option 909)**

**Rack Mount Slide Kit (Special Order)**

**EXTRA MANUAL (Option 910)**

Additional manual does not include Operation Verification tape cartridge.

Table 1-2. Log Uncertainty

This table summarizes the amplitude measurement uncertainties along with their respective dependent variables (such as tuned frequency or reference level range) versus corrected and uncorrected conditions and ambient temperature ranges.				
Source of Uncertainty	Dependent Variable	With Uncorrected Readout (SHIFT Y)		With Corrected Readout (SHIFT W, SHIFT X)**
		20°C–30°C	0°C–55°C	20°C–30°C
<b>Calibrator</b>	None	±0.3 dB	±0.3 dB	±0.3 dB
<b>Frequency Response (Flatness)†</b> (input attenuation 10 dB)	<b>Tuned Frequency:</b> 100 Hz – 2.5 GHz 2.0 GHz – 12.5 GHz 12.5 GHz – 18.6 GHz 18.6 GHz – 20.0 GHz 20.0 GHz – 22 GHz	±0.6 dB ±1.7 dB ±2.2 dB ±2.2 dB ±3.0 dB	±1.0 dB ±1.7 dB ±2.2 dB ±3.3 dB ±4.1 dB	±0.6 dB ±1.7 dB ±2.2 dB ±2.2 dB ±3.0 dB
<b>Absolute Amplitude Calibration</b>	Applicable when making absolute amplitude measurements	±0.6 dB	±0.6 dB	±0.6 dB
<b>RF Gain</b>	<b>Tuned Frequency:</b> 100 Hz – 2.5 GHz 2.0 GHz – 22.0 GHz	±0.2 dB* ±0.7 dB*	±1.0 dB* ±1.0 dB*	0 dB 0 dB
<b>Resolution Bandwidth Switching *</b>	<b>Resolution BW:</b> 10 Hz – 3 MHz 30 Hz – 1 MHz	±1.0 dB ±0.5 dB	±4.0 dB ±2.0 dB	±0.1 dB ±0.1 dB
<b>Log Scale Switching</b>	Changing Log Scale	±0.5 dB	±0.5 dB <del>±1.0 dB</del>	±0.1 dB
<b>Log Fidelity *</b>	dB differential between calibration and measured signals	±0.1 dB/dB up to ±1.0 dB	±0.1 dB/dB	±0.1 dB/dB up to ±1.0 dB
<b>IF Gain‡ *</b>	<b>Reference Level:</b> 0 dBm – 55.0 dBm -56.0 dBm – -129.9 dBm	±0.6 dB ±1.0 dB	±1.0 dB ±1.5 dB	0 dB ±1.0 dB
<b>Log Digitizing</b>	<b>Log Scale:</b> 10 dB 5 dB 2 dB 1 dB	±0.2 dB ±0.1 dB ±0.04 dB ±0.02 dB	±0.2 dB ±0.1 dB ±0.04 dB ±0.02 dB	±0.2 dB ±0.1 dB ±0.04 dB ±0.02 dB
<b>Error Correction§</b>	CORR'D function off or on	0	0	±0.4 dB

\* Supplemental characteristic (typical, non-warranted performance parameter).

\*\* Requires executing the error correction function (SHIFT W) after stabilization at new ambient temperature. Otherwise typical amplitude drift may be ±0.03 dB/°C (at -10 dBm reference level, 10 dB input attenuation and 1 MHz resolution BW).

† Includes input attenuator in 10 dB position, mixing mode gain variations, and assuming PRESELECTOR PEAK in current instrument state. COUPLED FUNCTION not required as long as MEAS UNCAL message is not displayed.

‡ Assuming calibration signal is used to calibrate the reference level at -10 dBm and the input attenuator is fixed at 10 dB.

§ When the error correction function is used, amplitude uncertainty is introduced because additional IF gain is used offset the errors caused by resolution BW and scale switching and RF gain.

\* SEE CHANGE #8

Table 1-3. 8566A Spectrum Analyzer Performance Characteristics (1 of 6)

**NOTE :** Supplemental characteristics are intended to provide information useful in applying the instrument by giving typical, non-warranted, performance parameters.

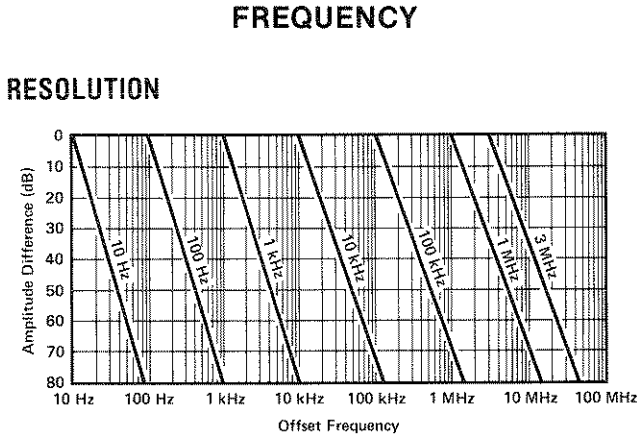

Figure 1. Typical Spectrum Analyzer Resolution.

**STABILITY**

**Residual FM**

For fundamental mixing (n = 1).  
 < 50 kHz peak to peak, frequency span > 5 MHz

**Drift**

Typical, after 1 hour warm-up at stabilized temperature. COUPLED FUNCTION not required.

<b>Frequency Span</b> ≤ 100 kHz	<b>Center Frequency Drift</b> < 10 Hz/minute of sweep time
100 kHz to 5 MHz	< 500 Hz/minute of sweep time
≥ 5 MHz	< 5 kHz/minute of sweep time

Because the analyzer is phase locked at the beginning of each sweep, drift occurs only during the time of one sweep.

**SPECTRAL PURITY**

**Noise Sidebands**

Refer to Figures 2 and 3 for typical noise sideband performance.

**Power Line Related Sidebands**

For line conditions specified in Power Requirements under GENERAL in Table 1-1.

Offset From Carrier	Center Frequency		
	5.8 to 12.6 GHz	12.6 to 18.6 GHz	18.6 to 22 GHz
< 360 Hz	-64 dBc	-60 dBc	-58 dBc
360 Hz to 2 kHz	-69 dBc	-65 dBc	-63 dBc
> 2 kHz	-74 dBc	-70 dBc	-68 dBc

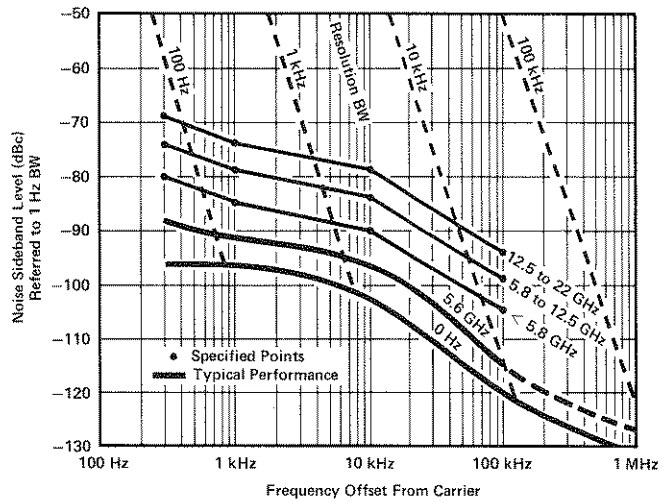

Figure 2. Single Sideband Noise Normalized to 1 Hz BW Vs. Offset from Carrier.

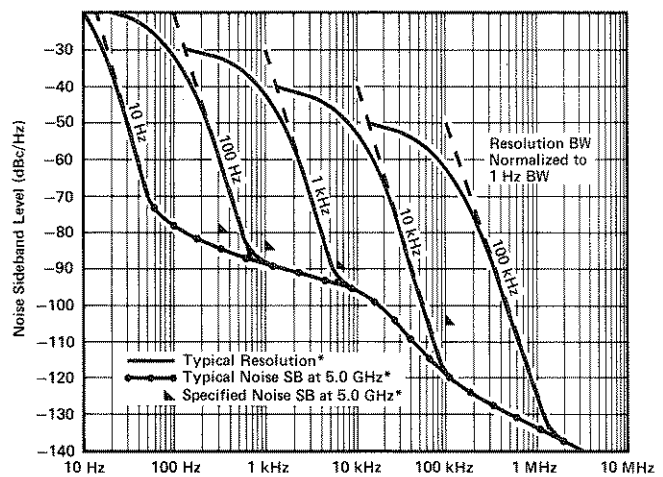

Figure 3. Typical SSB Noise at 5.0 GHz Center Frequency Normalized to 1 Hz BW Vs. Offset from Carrier and Analyzer Resolution. May be limited by average noise level.

Table 1-3. 8566A Spectrum Analyzer Performance Characteristics (2 of 6)

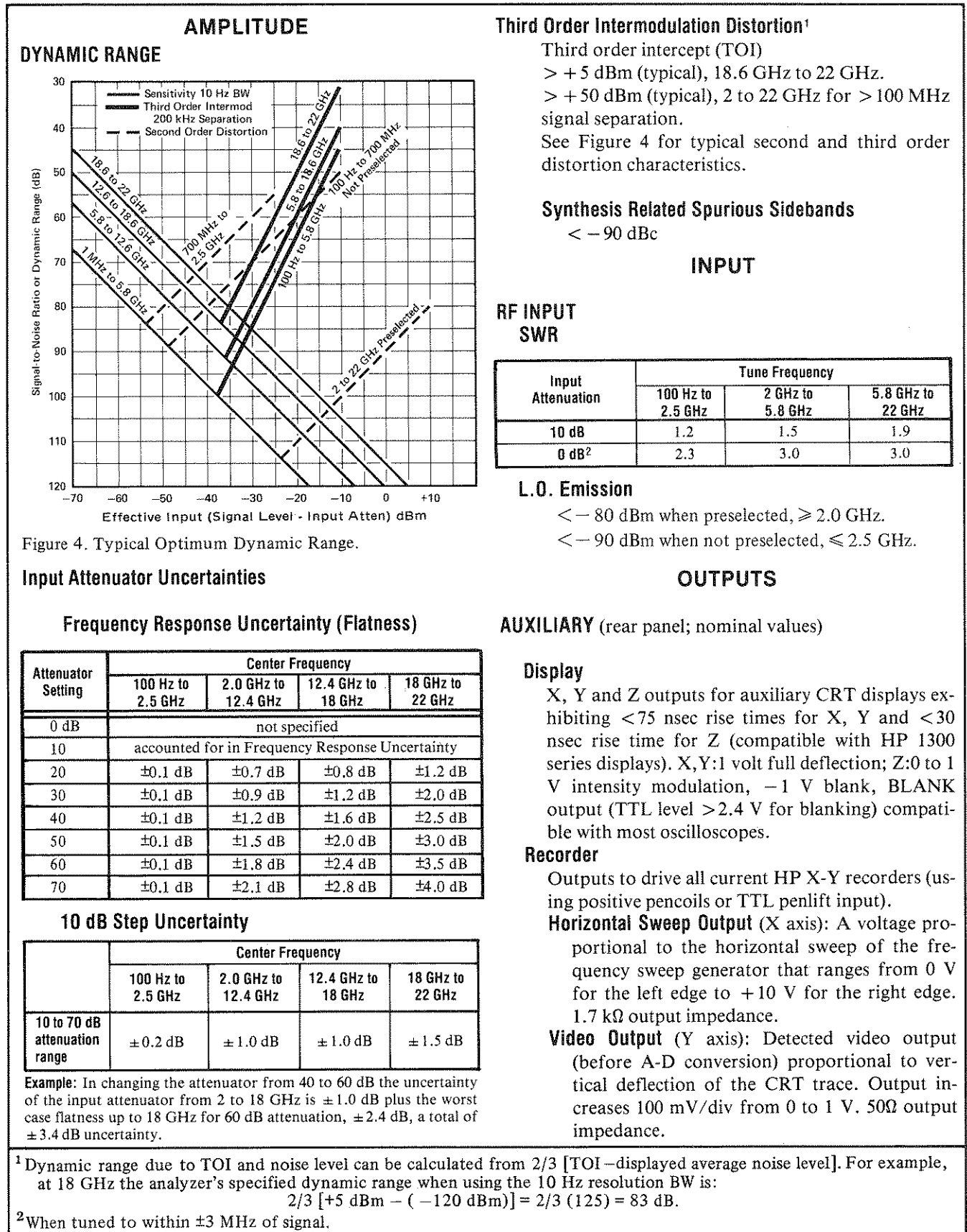



Table 1-3. 8566A Spectrum Analyzer Performance Characteristics (3 of 6)

## OUTPUTS (Cont'd)

**Penlift Output** (Z axis): A blanking output, 15 V from 10 K $\Omega$ , occurs during frequency sweep generator retrace; during sweep, output is low at 0 V with 10 $\Omega$  output impedance for a normal or unblanked trace (pen down).

LOWER LEFT and UPPER RIGHT pushbuttons calibrate the recorder sweep and video outputs with 0,0 and 10,1 volts respectively, for adjusting X-Y recorders.

### 21.4 MHz IF (rear panel)

A 50 $\Omega$ , 21.4 MHz output related to the RF input to the analyzer.

In log scales, the IF output is logarithmically related to the RF input signal; in linear, the output is linearly related. The output is nominally -20 dBm for a signal at the reference level.

Bandwidth is controlled by the analyzer's resolution bandwidth setting; amplitude controlled by the input attenuator, and IF step gain positions.

### Frequency Reference (rear panel)

10.000 MHz, 0 dBm; 50  $\Omega$  output impedance.

### 10 MHz Output (rear panel)

> -5 dBm, 50 $\Omega$  output impedance.

## FUNCTION DESCRIPTIONS

### SHIFT FUNCTIONS

In addition to their primary functions, the front panel push buttons of the analyzer have other key functions which are accessed by pressing the blue SHIFT key and the desired blue character code.

These SHIFT functions are described in the related function description sections.

### FREQUENCY

#### Center Frequency

Variable from data knob or numeric/unit keyboard in approximately 1% increments. Center frequency step size is normally 10% of frequency span but may be set to any value through the numeric keyboard or using the MKR/ $\Delta$ -STP SIZE key. Center frequency may also be set using MKR-CF or SIGNAL TRACK keys.

### Frequency Span

Variable from data knob, or numeric/unit keyboard in approximately 1% increments; step keys change span in a 1,2,5 sequence. In zero span, the instrument is fix tuned at the center frequency.

### Start-Stop Frequency

Continuously variable from data knob, step keys, or numeric keyboard. Permissible values must be consistent with those for center frequency and frequency span. SHIFT O sets the analyzer start and stop frequencies equal to the frequencies of the two  $\Delta$  markers.

### Band Edge Effects

Analyzer will avoid frequency spans which include the preselect/non-preselect band edge, 2.0 GHz to 2.5 GHz, by reducing span or changing center frequency, unless SWEEP is in SINGLE mode.

### Frequency Offset

CRT display frequency readouts may be offset from their actual values by the amount entered through the numeric/unit keyboard after executing SHIFT V.

### AMPLITUDE

#### Reference Level Range

Continuously variable from data knob or numeric keyboard with 0.1 dB resolution; step keys change level in 10% of full scale increments. Reference level may also be set using the MKR-REF LVL key.

Expandable from +30 dBm (7.07 volts) to -99.9 dBm (2.2  $\mu$ volts) to +60.0 dBm<sup>1</sup> (223.6 volts) to -119.9 dBm (0.22  $\mu$ volts) using SHIFT I.

Signals at the reference level in log translate to approximately full scale signals in linear, typically within  $\pm 1$  dB at room temperature.

#### Units Change

Amplitude units can be translated to dBm, dBmV, dB $\mu$ V, and volts using SHIFT A, B, C and D respectively.

<sup>1</sup>Maximum total input power not to exceed +30 dBm damage level.



Table 1-3. 8566A Spectrum Analyzer Performance Characteristics (4 of 6)

**FUNCTION DESCRIPTIONS (Cont'd)**

**Amplitude Offset**

CRT display amplitude readouts may be offset from their actual values by the amount entered through the numeric/unit keyboard after executing SHIFT Z.

**Reference Lines  
Display Line**

Movable horizontal line with amplitude readout.

**Threshold**

Movable horizontal trace threshold amplitude readout.

**Dynamic Range  
Mixer Level**

To establish a particular spurious free dynamic range (in the coupled attenuator mode), the input mixer drive level is specified using SHIFT, (comma) and entering the desired level through the keyboard.

**Average Noise Level**

When SHIFT M is used with the marker, the displayed noise level is adjusted to reflect the RMS noise level/1 Hz BW.

**Video Bandwidth:** Post detection low pass filter used to average displayed noise; bandwidth variable from 1 Hz to 3 MHz (nominal) in a 1,3,10 sequence.

Video bandwidth may be selected manually or coupled to resolution bandwidth.

**Digital Video Averaging:** Displays the sweep-to-sweep average of the trace over a specifiable number of sweeps with SHIFT G. Video averaging is turned off with SHIFT H

**MARKER**

**Frequency  
Normal**

Displays the frequency at the horizontal position of the tunable marker.

PEAK SEARCH positions the marker at the center of the largest signal response present on the display to within  $\pm 10\%$  of resolution bandwidth. Following peak search, SHIFT K moves marker to next higher trace maximum. Subsequent SHIFT K entries move marker to sequentially lower maxima.

MKR—CF sets the analyzer center frequency equal to the marker frequency; MKR/ $\Delta$ —STP SIZE sets the center frequency step size equal to the marker frequency.

**Signal Track**

Re-tunes the analyzer to place a signal identified by the marker at the center of the CRT and maintain its position (provided the signal remains on-screen during the period of one sweep). Useful when reducing frequency span to zoom-in on a signal; also keeps a drifting input signal centered.



Displays the frequency difference between the stationary and tunable markers. Reference frequency need not be displayed.

MKR/ $\Delta$ —STP SIZE sets the center frequency step size equal to the frequency difference between the markers. SHIFT O sets the analyzer start and stop frequencies equal to the frequencies of the two markers.

**Zoom**

Makes it possible to reduce the frequency span about the marker (or signal in the signal track mode) using the step down key.

**Amplitude  
Normal**

Displays the amplitude at the vertical position of the tunable marker.

PEAK SEARCH positions the marker at the peak of the largest signal present on the display. MKR—REF LVL sets the analyzer reference level equal to the marker amplitude.

RMS noise density in a 1 Hz bandwidth is read out using SHIFT M, by sampling the displayed trace and arithmetically correcting for the analyzer envelope detector response, log shaping, and measurement bandwidth.



Displays the amplitude difference between the stationary and tunable markers. Reference frequency need not be displayed.

**Preselector Peak**

With the marker at the peak of a displayed input signal, preselector peak automatically adjusts preselector tracking for maximum response.

Table 1-3. 8566A Spectrum Analyzer Performance Characteristics (5 of 6)

FUNCTION DESCRIPTIONS (Cont'd)	DISPLAY
<p><b>MARKER (Preselector Peak)</b>            SHIFT = resets the preselector tuning to the nominal factory preset condition.            If the marker is not activated when preselector peak is used, a peak search will be exercised prior to preselector peaking.</p>	<p><b>Trace</b>            A and B are two independent signal response memories each having 1001 horizontal data positions and vertical resolution of 0.1%. Memory contents are displayed on the CRT at a rate independent of the analyzer sweep time.</p>
<p><b>SWEEP</b>  <b>Trigger</b>  <b>Free Run</b>            Sweep triggered by internal source.  <b>Line</b>            Sweep triggered by power line frequency.  <b>Video</b>            Sweep triggered by detected waveform of input signal at an adjustable level; signal must be <math>\geq 0.5</math> div peak-to-peak. For sweeps of 10 msec and less (zero span) the signal must have <math>&gt; 40</math> Hz rate.            SHIFT y allows any envelope rate, but display will blank between triggers when sweep is <math>&lt; 20</math> msec.</p>	<p><b>Clear/Write</b>            Clears memory contents when first activated, then writes the analyzer signal response into the memory each sweep and displays memory.</p>
<p><b>External</b>            Sweep triggered by rising edge of signal input to rear panel BNC connector; trigger source must be <math>&gt; 2.4</math> volt (10 volt max). For sweep of 10 msec and less (zero span) trigger source must have <math>&gt; 40</math> Hz rate.            SHIFT x allows any trigger source rate but display will blank between low rep rate trigger when sweep is <math>&lt; 20</math> msec.</p>	<p><b>Max Hold</b>            Retains in memory and displays the largest signal level occurring at each horizontal data position over repetitive sweeps beginning at the time the function is activated.</p>
<p><b>Continuous</b>            Sequential sweeps initiated by the trigger: 20 msec full span to 1500 sec full span in <math>\approx 1\%</math> increments.  <b>Single</b>            Single sweep armed on activation and initiated by trigger (sweep <math>\geq 20</math> msec only).</p>	<p><b>View</b>            Stops writing into memory and displays memory without changing its contents.  <b>Blank</b>            Stops writing into memory and blanks the trace while retaining the last response in memory.</p>
<p><b>Sweep Time</b>  <b>Zero Frequency Span</b>            1 <math>\mu</math>sec full sweep (10 divisions) to 10 msec full sweep in 1,2,5 sequence (no digital storage); 20 msec full sweep to 1500 sec full sweep in <math>\approx 1\%</math> increments.</p>	<p><b>Arithmetic</b>  <b>A - B <math>\rightarrow</math> A:</b> Initially subtracts the stored memory contents of B from the current memory contents of A and writes the difference into A; this process continues as the A memory is updated at the sweep rate. To accomplish <b>A + B <math>\rightarrow</math> A</b> use SHIFT c.  <b>A <math>\leftrightarrow</math> B:</b> Exchanges A and B display memory contents.  <b>B - DL <math>\rightarrow</math> B:</b> Subtracts the amplitude of the display line from the memory contents of B and writes the difference into B.            A third signal response memory, C (also with a 1001 data positions), can be used for signal response storage. It is accessed indirectly by transferring memory contents between B and C.  <b>B <math>\rightarrow</math> C:</b> SHIFT i  <b>B <math>\leftarrow</math> C:</b> SHIFT i  <b>View C:</b> SHIFT j  <b>Blank C:</b> SHIFT k</p>
<p><b>Marker</b> (sweeps <math>\geq 20</math> msec only)  <b>Normal:</b> Displays time from beginning of sweep to marker position.  <b><math>\Delta</math>:</b> Displays time difference between stationary and tunable marker.</p>	<p><b>Trace Detection</b>            The 8566A uses a linear envelope detector to obtain video information from the IF signal. Positive and negative peak detectors obtain the maximum and minimum signal excursions that occur over time periods corresponding to one or two horizontal data positions on the display. This assures that impulse signals are not missed. When the video signal contains random noise, a detection algorithm is used to selectively choose between the positive and negative peak values to be displayed.</p>

Table 1-3. 8566A Spectrum Analyzer Performance Characteristics (6 of 6)

FUNCTION DESCRIPTIONS (Cont'd)	SERVICE DIAGNOSTIC AIDS
<b>DISPLAY (Trace cont'd)</b>	The following service diagnostic functions are accessible through SHIFT keys (refer to Section III for a description):
In addition, a sample mode with no peak detection is available. The video information before A-D conversion is available at the rear panel RECORDER VIDEO output.	Pretest Mode <span style="float:right">SHIFT F</span>
Detection modes may be selected from the front panel:	Manual DACS Control <span style="float:right">SHIFT J</span>
<b>Normal</b>	Frequency Diagnostics On <span style="float:right">SHIFT R</span>
SHIFT a: The detection algorithm defined above. (Normal operation.)	Step Gain Off <span style="float:right">SHIFT q</span>
<b>Positive Peaks</b>	Display Correction Data <span style="float:right">SHIFT w</span>
SHIFT b: Only maximum signal levels are displayed at each data position.	<b>INSTRUMENT STATE STORAGE</b>
<b>Negative Peaks</b>	Up to 6 complete sets of user-defined control settings may be stored and recalled by pressing SAVE or RECALL and the desired register number (1 to 6) from the keyboard. Register 0 stores the current state while register 7 stores the instrument state prior to the last function change via the numeric/unit keyboard, step keys or INSTR PRESET. Registers 8 and 9 store the two instrument calibration states. Save registers are locked using SHIFT (, and unlocked using SHIFT ).
SHIFT d: Only minimum signal levels are displayed at each data position.	Instrument state information stored in registers 0 through 7 is retained in memory indefinitely in STANDBY and approximately 30 days after the line power is terminated.
<b>Sample</b>	<b>REMOTE OPERATION</b>
SHIFT e: One sample signal level is displayed at each data position.	The standard 8566A operates on the Hewlett-Packard Interface Bus (HP-IB) <sup>1</sup> . All analyzer control settings (with the exception of VIDEO TRIGGER LEVEL, FOCUS, ALIGN, INTENSITY, FREQ ZERO, AMPTD CAL, and LINE power) are remotely programmable. Function values, marker frequency/amplitude, and A/B traces may be output; CRT labels and graphics may be input.
<b>Annotation</b>	<b>LCL</b>
<b>Title</b>	Returns analyzer to local control, if not locked out by controller.
Allows the user to write characters into a specified area on the CRT by pushing SHIFT E and typing the keys next to the blue front panel characters and data numbers desired. Use BACKSPACE for corrections.	<b>Service Request</b>
<b>Blank</b>	SHIFT r calls an HP-IB request for service.
SHIFT o blanks (SHIFT p unblanks) all CRT characters and control setting readouts SHIFT m blanks (SHIFT n unblanks) the CRT graticule.	
<b>Cathode Ray Tube</b>	
<b>Type</b>	
Post deflection accelerator, aluminized P31 phosphor, electrostatic focus and deflection.	
<b>Viewing Area</b>	
Approx. 9.6 cm vertically by 11.0 cm horizontally (3.8 in. x 4.7 in.).	
The CRT is completely turned off with SHIFT g (and on with SHIFT h) to avoid unnecessary aging of the CRT during long term unattended operation of the analyzer.	
<sup>1</sup> Hewlett-Packard Interface Bus (HP-IB) is Hewlett-Packard Company's implementation of instrument interface standard IEEE Std. 488-1975, "Digital interface for programmable instrumentation".	

Table 1-4. Recommended Test Equipment (1 of 5)

Instrument	Critical Specifications for Equipment Substitution	Recommended Model	Use*
<b>SIGNAL SOURCES</b>			
Signal Generator	Frequency: 20–800 MHz SSB Phase Noise: >130 dB below carrier at 20 kHz away Stability: <10 ppm/10 min.	HP 8640B, Opt. 002	P,A,T
Signal Generator	Frequency: 2–18 GHz Stability: <5 x 10 <sup>-10</sup> /day	HP 8672A	P,A
Signal Generator	Frequency Range: 2.3 to 6.1 GHz or greater Noise Sidebands: <-80 dBc (1 Hz) at 300 Hz offset <-85 dBc (1 Hz) at 1 kHz offset <-105 dBc (1 Hz) at 100 kHz offset	HP 8566A (1st LO Output)	P
Sweep Oscillator	Mainframe for RF Plug-Ins	HP 8620C	P,A,V
RF Plug-In	Frequency: 10 kHz–2 GHz Power: 0 dBm Leveling: Internal; External Power Meter	HP 86222A	P,A,V
RF Plug-In	Frequency: 2–22 GHz Power: +3 dBm Leveling: Internal, External Power Meter	HP 86290B–H08	P,A,V
Synchronizer	Internal Oscillator Frequency: 21.4 MHz Error Output Voltage Polarity: + or - selectable from front-panel switch	HP 8709A–H10	A
Automatic Synthesizer	Frequency: 0.1–10 MHz Resolution: ±0.1 Hz Stability: ±1 x 10 <sup>-8</sup> /day Attenuation: Range: 0 to -25 dB Accuracy: ±0.2 dB/10 dB step	HP 3330B or HP 3335A	P,V
Pulse Generator	Pulse Width: 30 nsec to 250 nsec Rise and Fall Times: 10 nsec Output Level: +2.5V	HP 8002A	A
Function Generator (2 required)	Output: Sine Wave, 10V p-p Range: 100 Hz to 500 kHz (Sweep Function Available)	HP 3312A	P,A

\*P = Performance Test; A = Adjustment; T = Troubleshooting; V = Operation Verification

Table 1-4. Recommended Test Equipment (2 of 5)

Instrument	Critical Specifications for Equipment Substitution	Recommended Model	Use*
<b>SIGNAL SOURCES (Cont'd)</b>			
Function Generator	Output: Sine Wave, Adjustable 15–18V p-p Frequency: Adjustable 20 to 200 Hz	HP 3310A	A
Comb Generator	1, 10, and 100 MHz combteeth up to 22 GHz, accurate to $\pm 0.01\%$ with external modulation capability	HP 8406A	P
Frequency Standard	Output: 1, 2, 5, or 10 MHz Accuracy: $< \pm 1 \times 10^{-10}$ Aging Rate: $< 1 \times 10^{-10}$ /day	HP 5061A	P,A
<b>ANALYZERS</b>			
Spectrum Analyzer	Frequency: 0.1 to 100 MHz Resolution Bandwidth: 10 Hz Frequency Span: 20 Hz	HP 8553B/8552B 141T	A,T
Tracking Generator	Compatible with 8553B/8552B/141T Spectrum Analyzer	HP 8443A	A
AC Probe	Active probe compatible with probe power connector on Spectrum Analyzer	HP 1121A	A
Spectrum Analyzer	Frequency: .04 to 325 MHz	HP 8557A/182T	A,T
Spectrum Analyzer	Frequency: 100 to 1500 MHz	HP 8558B/182T	A,T
Signature Analyzer	No known substitute. Provides preferred method for troubleshooting digital circuitry.	HP 5004A	T
<b>COUNTERS</b>			
Frequency Counter	Frequency: .02–20 GHz Sensitivity: –30 dBm	HP 5340A–H10	P,A,T
Electronic Counter	Frequency Standard Output: 1, 10, and 100 kHz; 1 and 10 MHz Period Averaging Capability: 100 $\mu$ sec to 10 sec	HP 5245L	P, A
Electronic Counter	Range: >10 MHz Resolution: $2 \times 10^{-9}$ /gate time Ext. Time Base: 1, 2, 5, or 10 MHz	HP 5345A	P

\*P = Performance Test; A = Adjustments; T = Troubleshooting; V = Operation Verification

Table 1-4. Recommended Test Equipment (3 of 5)

Instrument	Critical Specifications for Equipment Substitution	Recommended Model	Use*
<b>OSCILLOSCOPE</b>			
Oscilloscope	Frequency: 100 MHz Sensitivity: .005V/Div. Dual Channel: Third Channel Trigger View Display Storage	HP 1741A	A,T
Probe (2 required)	10:1 Divider, Compatible with Oscilloscope	HP 10004D	A,T
<b>METERS</b>			
Digital Voltmeter	Resolution: $\pm 0.1$ mV Range: 0 to 100 Vdc Input Impedance 100V Range: 10 M $\Omega$	HP 3455A	P,A,T,V
High Voltage Probe	1000:1 Divider Impedance: 10 M $\Omega$	HP 34111A	A,T
Power Meter	Range: -20 to +10 dBm Accuracy: $\pm 0.02$ dB Compatible with HP K486A Thermistor Mount	HP 432A	P,A,T
Thermistor Mount	Frequency: 18–22 GHz	HP K486A	P,A,T
Power Meter	Range: -20 to +10 dBm Accuracy: $\pm 0.02$ dB HP-IB Compatible	HP 436A	P,A,T,V
Power Sensor	Frequency: .01–18 GHz Compatible with HP 436A Power Meter	HP 8481A	P,A,T,V
<b>DC SUPPLY</b>			
DC Power Supply	Output: $\pm 35$ Vdc	HP 721A	A
<b>MISCELLANEOUS DEVICES</b>			
Power Splitter	Frequency: 10 MHz–18 GHz Tracking of Output Arms: $\leq 0.25$ dB Connectors: Type N (f) input; Type N (m) outputs	HP 11667A-C16	A,V
Reactive Power Divider	Range: 2–22 GHz Isolation: $\geq 20$ dB	Omni-Spectra 2090-6202-00	P
Diode Detector	Range: .01–22 GHz	HP 33330C	P
*P = Performance Test; A = Adjustments; T = Troubleshooting; V = Operation Verification			

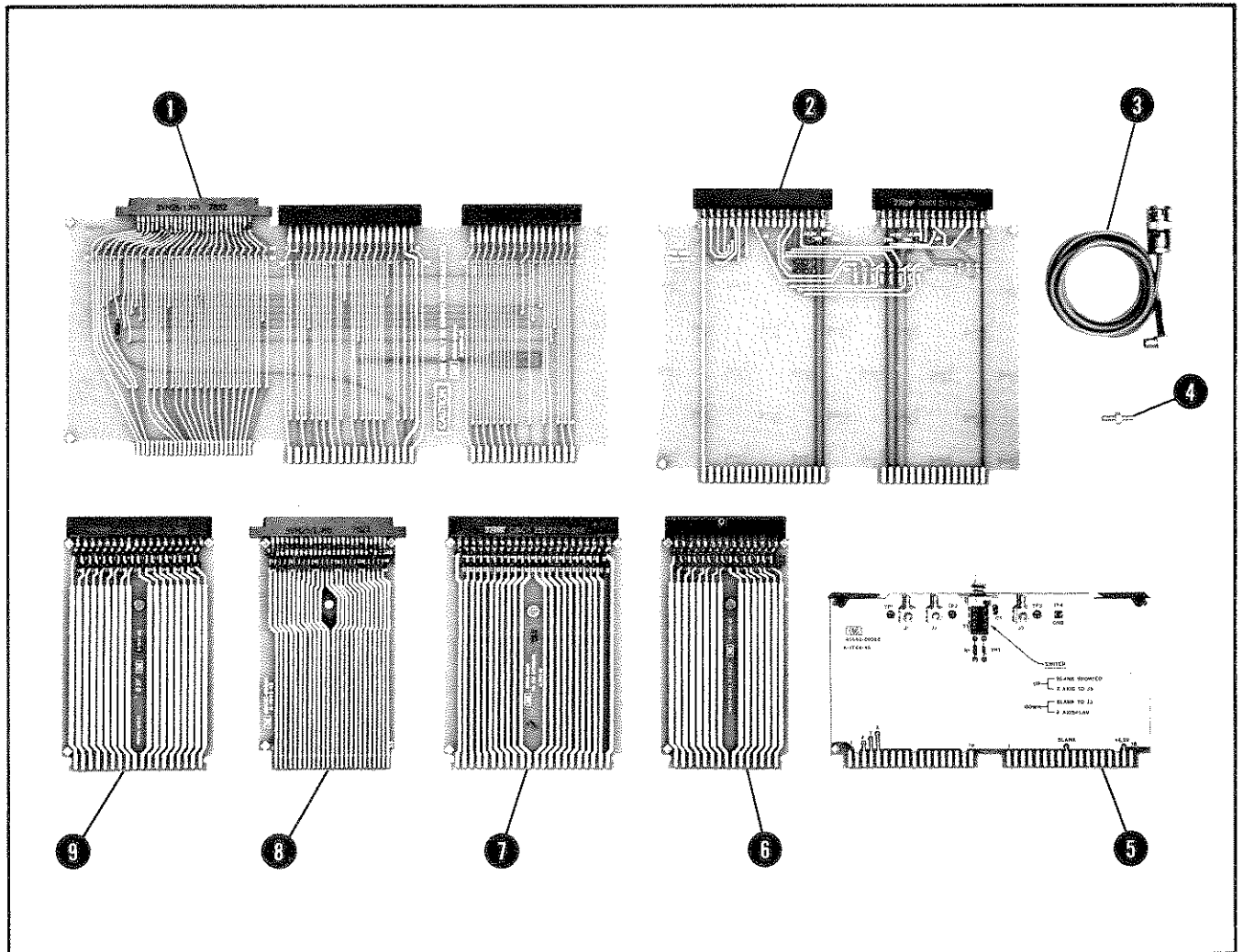

Table 1-4. Recommended Test Equipment (4 of 5)

Instrument	Critical Specifications for Equipment Substitution	Recommended Model	Use*
<b>ATTENUATORS</b>			
10 dB Step Attenuator	Steps: 10 dB from 0 to 90 dB Frequency: 5–100 MHz Calibrated to uncertainty error of $\pm (0.02 \text{ dB} + 0.01 \text{ dB}/10 \text{ dB steps})$ at 20 MHz from 0 dB to 90 dB	HP 355D–H89	P,A,T
1 dB Step Attenuator Attenuator	Steps: 1 dB from 0 to 10 dB Frequency: 20–100 MHz Calibrated to uncertainty error of $\pm (0.02 \text{ dB} + 0.01 \text{ dB}/10 \text{ dB step})$ at 20 MHz from 0 dB to 10 dB	HP 355C-H25	P, A, T
20 dB Attenuator	Frequency: 200 Hz to 18 GHz	HP 8491B, Option 020	P, A
10 dB Attenuator	Frequency: 200 Hz to 18 GHz	HP 8491B, Option 010	V
<b>TERMINATIONS</b>			
Termination	Type N Male Connector Frequency: dc–18 GHz Impedance: 50 $\Omega$	HP 909A, Option 012	P, V
Termination	SMA Male Connector Impedance: 50 $\Omega$	HP 1810-0018	A
<b>FILTERS</b>			
Low-Pass Filter	Cutoff Frequency: 250 MHz Rejection at 460 MHz: >60 dB	K&L 5L380-250-B/B	P
Low-Pass Filter	Cutoff Frequency: 8 GHz Rejection at 14 GHz: >80 dB	K&L 6L250-8000-NP/N	P
<b>SPECIAL DEVICES</b>			
Display Adjustment PC Board**	Required for preliminary display adjustments	HP 85662-60088	A,T
Low-Noise DC Supply (Optional)	Refer to Figure 5-78		A
Crystal Filter Bypass Network (4 required)	Refer to Figure 5-79		A
Tuning Voltage Circuit	Refer to Figure 5-80		A,V
* P = Performance Test; A = Adjustment; T = Troubleshooting; V = Operation Verification			
** Part of Service Accessories			

Table 1-4. Recommended Test Equipment (5 of 5)

Instrument	Critical Specifications for Equipment Substitution	Recommended Model	Use*
<b>CABLES</b>			
Test Cable** (2 required)	BNC Male to SMB Snap-on Female	HP 85680-60093	A,T
Test Cable	SMB Snap-on Female both ends	HP 85662-60042	T
Cable Assembly	Frequency Range: 200 Hz to 22 GHz SMA Male both ends Length: 61 cm (24 inches) SWR: <1.4 at 22 GHz	B&W 55-S142-55-24	P,A,T,V
<b>ADAPTERS</b>			
Adapter	Type N Male to SMA Female	HP 1250-1250	P,A,V
Adapter	Type N Female to SMA Female	HP 86290-60005	P,A
Adapter	Type N Female to BNC Male	HP 1250-0077	P,A,T
Adapter	BNC Female to SMA Male	HP 1250-1200	A
Adapter	SMA Male to SMA Male	HP 1250-1159	P
Adapter	K-Band Waveguide to SMA Female	Maury K210C	P,A
Adapter**	SMB Snap-on Male to SMB Snap-on Male	HP 1250-0669	A,T
Probe	SMB Male Bulkhead Connector	HP 1250-0691	A
<b>BOARD EXTENDERS</b>			
Extender**	A13 HP-IB Interface Extender (for Signature Analysis)	HP 85660-60111	T
Extender**	A12 RF Section Interface Extender (for Signature Analysis)	HP 85660-60114	T
Extender** (2 required)	PC Board: 50 contacts; 2 rows of 25	HP 85680-60034	T
Extender** (2 required)	PC Board: 44 contacts; 2 rows of 22	HP 08565-60107	T
Extender** (2 required)	PC Board: 36 contacts; 2 rows of 18	HP 08505-60042	A,T
Extender**	PC Board: 30 contacts, 2 rows of 15	HP 08505-60041	A,T
Extender	PC Board: 20 contacts; 2 rows of 10	HP 85680-60028	A,T
Extender	PC Board: 12 contacts; 2 rows of 6	HP 08505-60109	A,T
<p>* P = Performance Test; A = Adjustments; T = Troubleshooting; V = Operation Verification  ** Part of Service Accessories</p>			



ITEM	QTY	DESCRIPTION	HP PART NUMBER	C D
1	1	Extender Board: A12 RF Section Interface	85660-60114	5
2	1	Extender Board: A13 HP-IB Interface	85660-60111	2
3	2	Cable: 4-foot long; BNC to SMB snap-on	85680-60093	3
4	1	Adapter: SMB snap-on male to SMB snap-on male	1250-0669	9
5e	1	PC Board: Display Adjustment Test	85662-60088	4
6	1	Extender Board: 30 contacts; 2 rows of 15	08505-60041	7
7	2	Extender Board: 44 contacts; 2 rows of 22	08565-60107	8
8	2	Extender Board: 50 contacts; 2 rows of 25	85680-60034	2
9	2	Extender Board: 36 contacts; 2 rows of 18	08505-60042	8

Figure 1-2. Service Accessories, HP Part No. 08566-60001



## SECTION II INSTALLATION

### 2-1. INTRODUCTION

2-2. This section includes information on initial inspection, installation, storage/shipment, and electrical operation verification for the HP Model 8566A Spectrum Analyzer.

### 2-3. INITIAL INSPECTION

2-4. Inspect the shipping containers for damage. If the shipping containers or cushioning material is damaged, it should be kept until the contents of the shipment have been checked for completeness and the instrument has been checked mechanically and electrically. The contents of the shipment should be as shown in Figure 1-1. If the contents are incomplete, or if there is mechanical damage or defect, notify the nearest Hewlett-Packard office. If either shipping container is damaged or the cushioning material shows signs of stress, notify the carrier as well as the Hewlett-Packard office. Keep the shipping materials for carrier's inspection. The HP office will arrange for repair or replacement without waiting for claim settlement. Refer to Operation Verification portion of this manual section for verification of electrical operation.

### 2-5. PREPARATION FOR USE

#### 2-6. Operating Environment

2-7. **Temperature.** The instrument may be operated in temperatures from 0°C to +55°C.

2-8. **Humidity.** The instrument may be operated in environments with humidity from 5% to 95% at 0° to 40°C. However, the instrument should be protected from temperature extremes which might cause condensation within the instrument.

2-9. **Altitude.** The instrument may be operated at altitudes up to 4,572 metres (15,000 feet).

#### 2-10. Power Requirements

2-11. The Model 8566A requires a power source of 100, 120, 220, or 240 Vac +5% -10%, 50-60 Hz. Power consumption for the instrument sections combined is less than 650 volt-amperes.

#### 2-12. Line Voltage and Fuse Selection

#### WARNING

**BEFORE THIS INSTRUMENT IS SWITCHED ON, its protective earth terminals must be connected through the protective conductors of the AC power cables to socket outlets provided with protective earth contacts. DO NOT negate the earth-grounding protection by using extension cables, power cables, or auto-transformers without protective ground conductors. Failure to ground the instrument can result in personal injury. Refer to Paragraph 2-33.**

#### CAUTION

**BEFORE SWITCHING ON THIS INSTRUMENT, make sure it is adapted to the voltage of the ac power source. You must set the voltage selector cards correctly to adapt the 8566A to the power source. Failure to set the ac power input of the instrument for the correct voltage level could cause damage to the instrument when plugged in.**

2-13. Select the line voltages and fuses as follows:

- a. Determine the ac line voltage to be used.
- b. Position the power line module PC selector board (at the rear panel of each instrument section) shown in Figure 2-1 to select the line voltage (100V, 120V, 220V, 240V) closest to

RECEPTACLE FOR PRIMARY POWER CORD

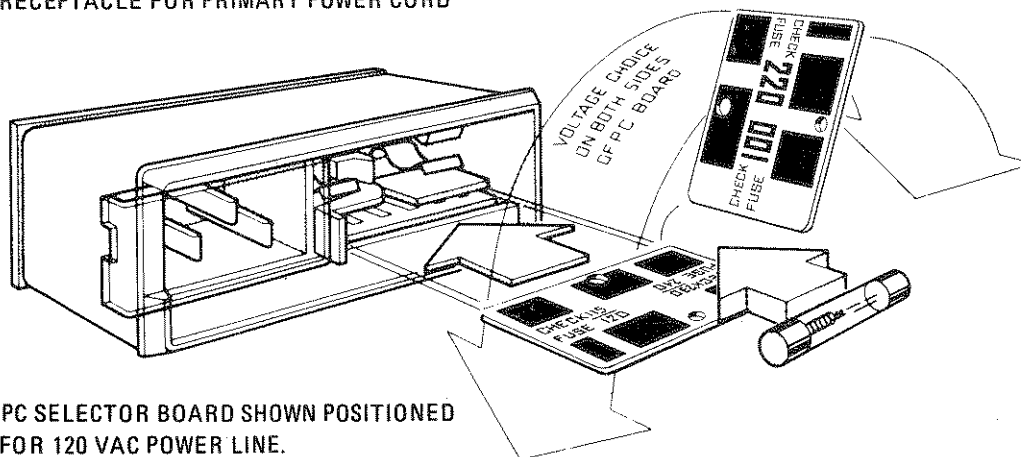

PC SELECTOR BOARD SHOWN POSITIONED FOR 120 VAC POWER LINE.

OPERATING VOLTAGE APPEARS IN MODULE WINDOW.

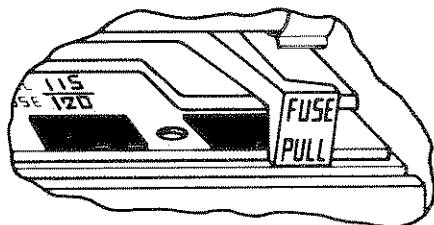

#### SELECTION OF OPERATING VOLTAGE

1. SLIDE OPEN POWER MODULE COVER DOOR AND PULL FUSE-PULL LEVER TO LEFT TO REMOVE FUSE.
2. PULL OUT VOLTAGE-SELECTOR PC BOARD. POSITION PC BOARD SO THAT VOLTAGE NEAREST ACTUAL LINE VOLTAGE LEVEL APPEARS IN MODULE WINDOW. PUSH BOARD BACK INTO ITS SLOT.
3. PUSH FUSE-PULL LEVER INTO ITS NORMAL RIGHT-HAND POSITION.
4. CHECK FUSE TO MAKE SURE IT IS OF CORRECT RATING AND TYPE FOR INPUT AC LINE VOLTAGE.
5. INSERT CORRECT FUSE IN FUSEHOLDER. REFER TO PARAGRAPH 2-13 TO DETERMINE CORRECT FUSE.

Figure 2-1. Voltage Selection with Power Module PC Board



the voltage you measured in step a. Line voltage must be within +5% or -10% of the voltage setting. If it is not, you must use an auto-transformer between the ac source and the 8566A.

- c. Make sure the correct fuses are installed in the fuse holders. The required fuse rating for each line voltage selection for both instrument sections is as follows:

Voltage	IF-Display Section	RF Section
100/120	2 amperes FAST BLO	4 amperes FAST BLO
220/240	1 ampere SLOW BLO	2 amperes SLOW BLO

#### 2-14. HP-IB Address Selection

2-15. The HP-IB address for the HP 8566A is preset at the factory for ASCII 2R (decimal 18). This address is stored in the instrument's CMOS memory which can remember for approximately 30 days with all line power removed. This stored address can be changed from the front panel or from a remote controller via HP-IB using a special shift key function. Refer to Remote Operation in Section III or the remote information pull-out card for further details. If this stored address is lost, the default address is the preset decimal 18.

2-16. The HP-IB address switch determines the address to be used on "power-up". The switch comprises five segments with each segment corresponding to one of the digits of a 5-digit binary equivalent of the address. The switch is preset at the factory for binary 11111 (decimal 31). This is a special code which commands the instrument to use the last input address (stored in memory) either from the front panel or from HP-IB.

#### WARNING

**Changing the HP-IB address by resetting the address switch on the HP-IB Interface requires the removal of the instrument's protective cover. This should be performed only by a qualified service person. Refer all such servicing of the instrument to qualified service persons.**

2-17. The "power-up" address may be changed to any of the addresses listed in Table 2-1 by setting the 5 segments of the HP-IB address switch to correspond to the binary equivalent of the desired ASCII character or decimal value as indicated in the table. The switch is illustrated in Figure 2-3 and is shown in its preset position (decimal 31). The switch is located on the HP-IB Interface in the RF section of the instrument. Refer to Volume 4, A13 HP-IB Interface tab, for details on location.

2-18. HP-IB address labels are available by ordering HP Part Number 7120-6853. (See Figure 2-2). These labels allow easy reference to the HP-IB address of each system component.

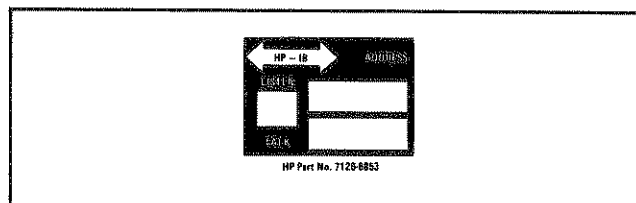

Figure 2-2. HP-IB Address Label

#### 2-19. Bench Operation

2-20. The instrument cabinet has plastic feet and foldaway tilt stands for convenience in bench operation. The tilt stands raise the front of the instrument for easier viewing of the control panel. The plastic feet are shaped to make full width modular instruments self-aligning when stacked.

#### 2-21. Front Handles (Option 907)

2-22. Instruments with Option 907 contain a Front Handle Kit. This kit supplies necessary hardware and installation instructions for mounting front handles on the instrument. Installation instructions are also given in Figure 2-4. See Section VI for part number information.

#### 2-23. Rack Mounting (Option 908)

2-24. Instruments with Option 908 contain a Rack Flange Kit. This kit supplies necessary hardware and installation instructions for preparing the instrument to be mounted on a rack of 482.6 mm (19 inch) spacing. Installation instructions are also given in Figure 2-5. See Section VI for part number information.

Table 2-1. Cross-Reference Between ASCII, Decimal, and Binary Address Codes

ASCII CHARACTER	DECIMAL VALUE	5-BIT BINARY EQUIVALENT	
@	SP	00	00000
A	!	01	00001
B	”	02	00010
C	#	03	00011
D	\$	04	00100
E	%	05	00101
F	&	06	00110
G	,	07	00111
H	(	08	01000
I	)	09	01001
J	*	10	01010
K	+	11	01011
L	,	12	01100
M	-	13	01101
N	.	14	01110
O	/	15	01111
P	Ø	16	10000
Q	1	17	10001
R	2	18	10010
S	3	19	10011
T	4	20	10100
U	5	21	10101
V	6	22	10110
W	7	23	10111
X	8	24	11000
Y	9	25	11001
Z	:	26	11010
[	;	27	11011
\	<	28	11100
]	=	29	11101
(	>	30	11110

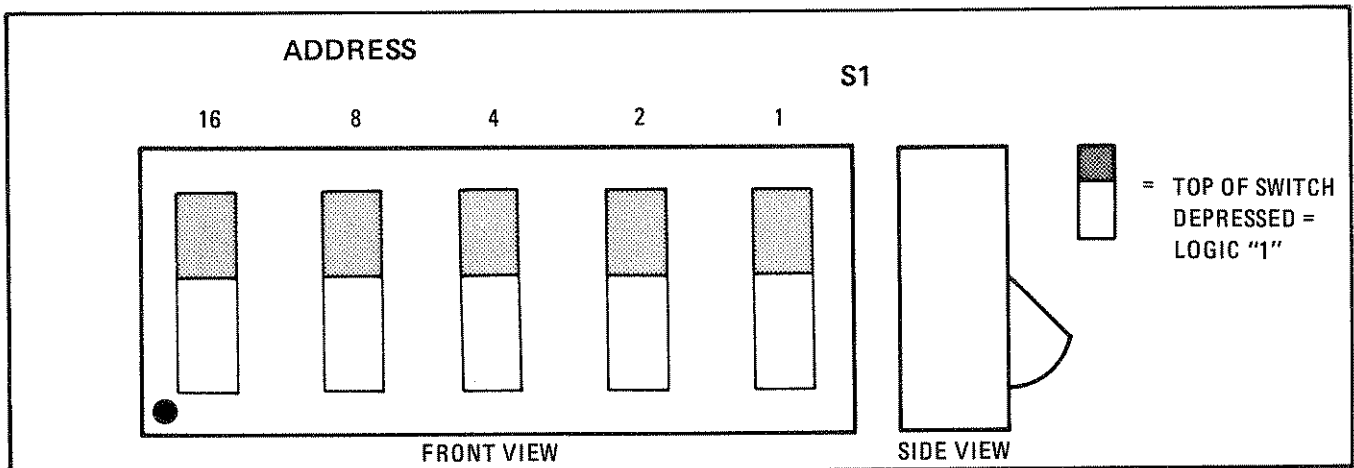

Figure 2-3. HP-IB Address Switch A13S1 (Shown In Factory Preset Position).

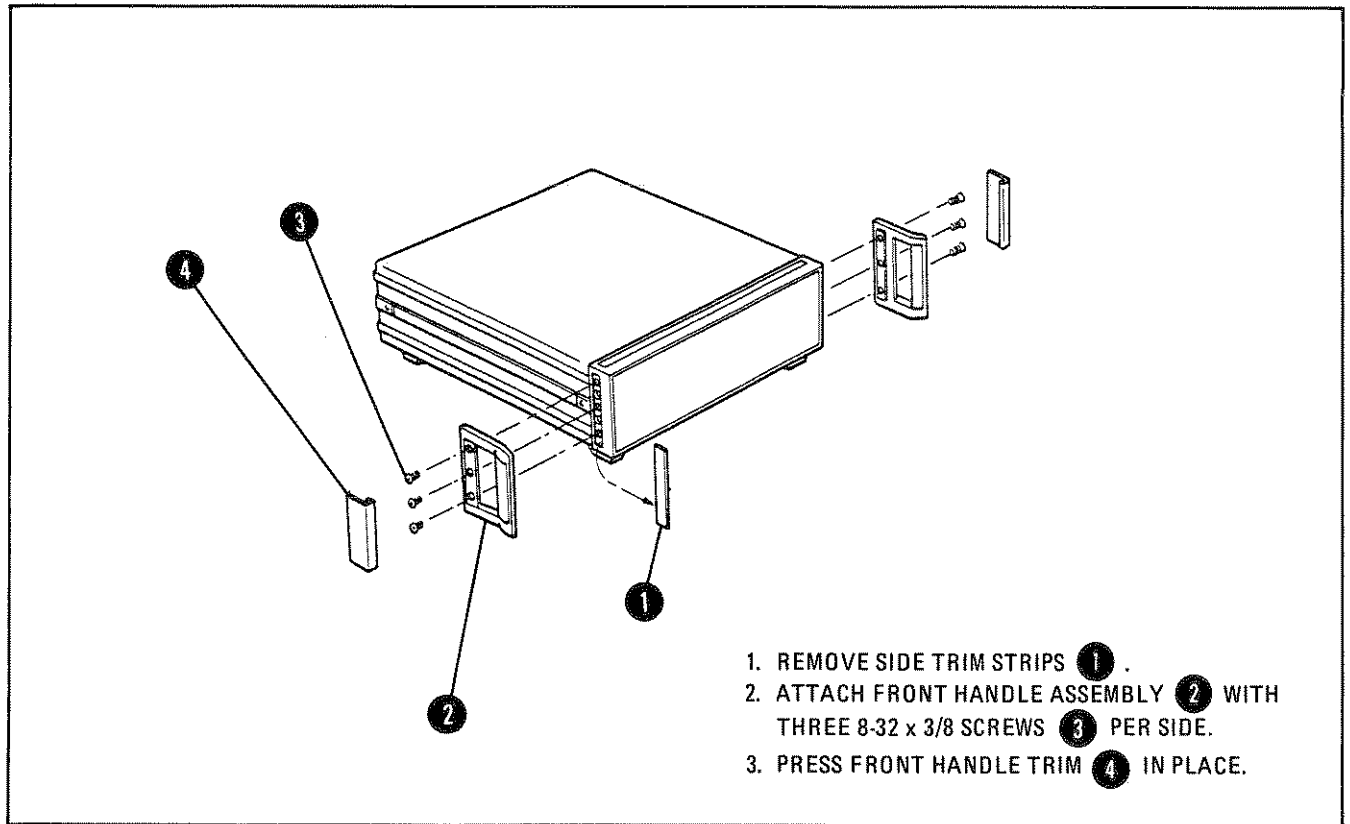

Figure 2-4. Attaching Front Handles

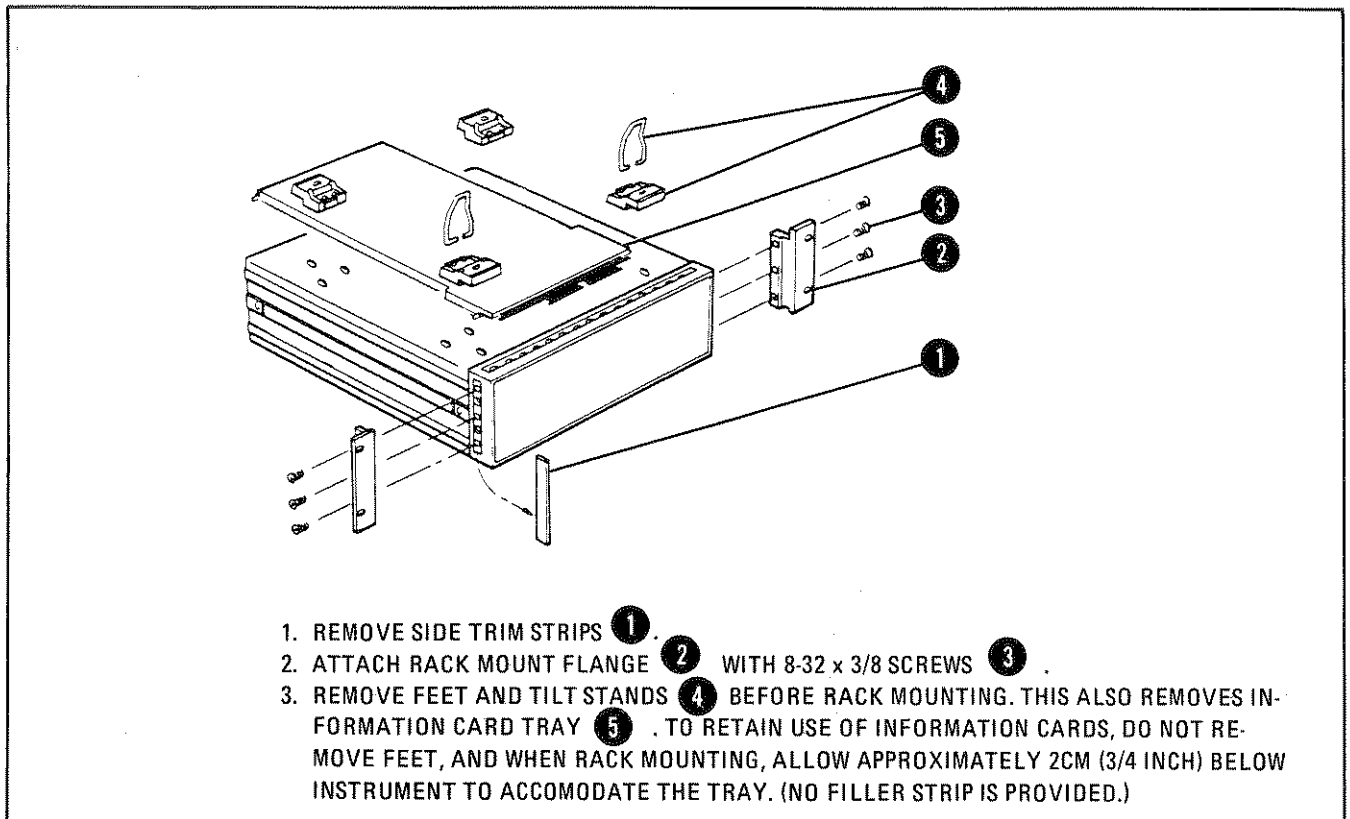
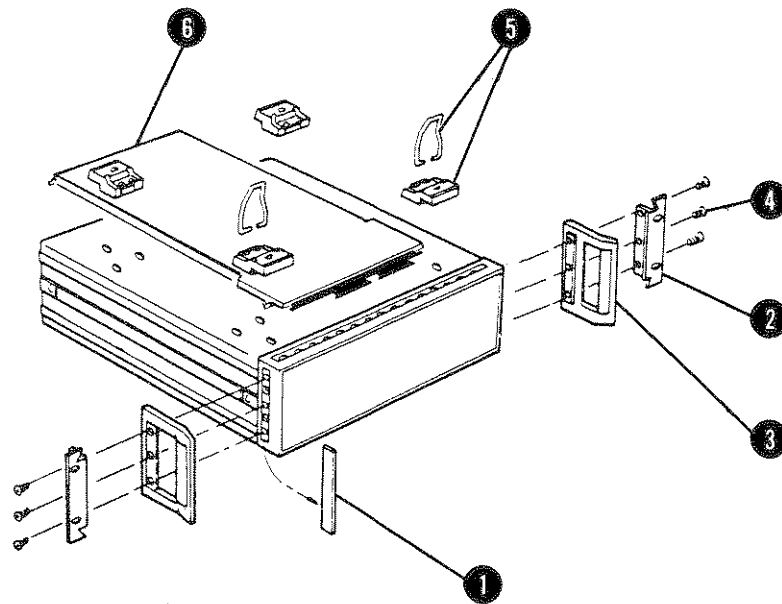

Figure 2-5. Attaching Rack Mount Flanges



1. REMOVE SIDE TRIM STRIPS **1**.
2. ATTACH RACK MOUNT FLANGE **2** AND FRONT HANDLE ASSEMBLY **3** WITH THREE 8-32 x 5/8 SCREWS **4** PER SIDE.
3. REMOVE FEET AND TILT STANDS **5** BEFORE RACK MOUNTING. THIS ALSO REMOVES INFORMATION CARD TRAY **6**. TO RETAIN USE OF INFORMATION CARDS, DO NOT REMOVE FEET, AND WHEN RACK MOUNTING, ALLOW APPROXIMATELY 2CM (3/4 INCH) BELOW INSTRUMENT TO ACCOMODATE THE TRAY. (NO FILLER STRIP IS PROVIDED.)

*Figure 2-6. Attaching Rack Mount Flanges with Handles*

### 2-25. Rack Mounting with Front Handles (Option 909)

2-26. Instruments with Option 909 contain a Rack Flange Front Handle Kit. This kit supplies necessary hardware and installation instructions for preparing the instrument, with the addition of front handles, to be mounted on a rack of 482.6 mm (19 inch) spacing. Installation instructions are also given in Figure 2-6. See Section VI for part number information.

### 2-27. Rack Mounting With Slides (Special Order Option)

2-28. Some special order instruments contain a rack mount Slide Adapter Kit. This kit supplies the necessary hardware and installation instructions for preparing the instrument, with the addition of slides, to be mounted on a rack of 482.6mm (19 inch) spacing. Installation instructions are also given in Figure 2-7. The slides provide extra support at the sides of the instrument in the

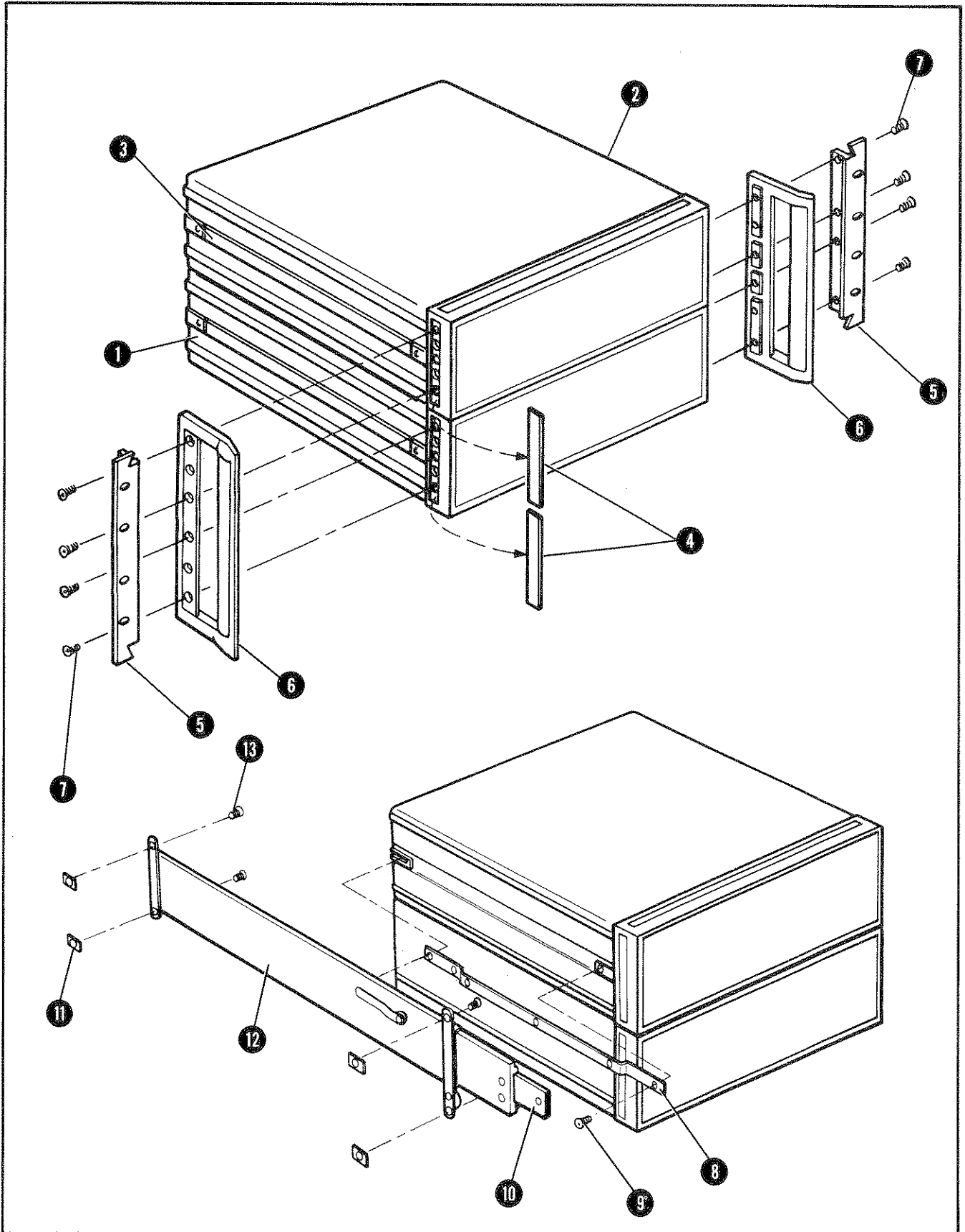

Figure 2-7. Attaching Slides with Rack Mount Flanges and Handles (1 of 2)

## PREPARATION

1. COMBINE INSTRUMENT SECTIONS AS SHOWN. REFER TO PARAGRAPH 2-29.
2. REMOVE LEFT SIDE COVER ① FROM RF SECTION AND RIGHT SIDE COVER ② FROM IF-DISPLAY SECTION. REAR FEET MUST BE REMOVED (AND STRAP HANDLE FROM ① ) TO REMOVE SIDE COVERS.
3. INSTALL SIDE COVER ① (COVER WITH STRAP HANDLE) ON RIGHT SIDE OF IF-DISPLAY SECTION AND REPLACE REAR FEET. DO NOT REINSTALL STRAP HANDLE.
4. INSTALL SIDE COVER ② (COVER WITHOUT STRAP HANDLE) ON LEFT SIDE OF RF SECTION.
5. REMOVE REMAINING STRAP HANDLE ③ .

## INSTALLING RACK MOUNT FLANGES AND HANDLES

6. REMOVE ADHESIVE SIDE TRIM STRIPS ④ FROM BOTH SIDES OF EACH INSTRUMENT SECTION.
7. ATTACH RACK MOUNT FLANGES ⑤ AND FRONT HANDLES ⑥ WITH FOUR 8-32x5/8-INCH SCREWS ⑦ PER SIDE.

## INSTALLING SLIDES

8. ATTACH SLIDE INNER MEMBER BRACKETS ⑧ TO SIDES OF IF-DISPLAY SECTION (TOP SECTION) WITH TWO 10-32x3/8-INCH SCREWS ⑨ PER SIDE.
9. ATTACH BRACKETS ⑧ TO INNER MEMBERS OF SLIDES ⑩ WITH THREE 10-32 FLAT HEAD SCREWS PER SIDE.
10. INSERT TWO UNISTRUT NUTS ⑪ IN EACH OF THE FOUR VERTICAL COLUMNS OF ENCLOSURE.
11. ATTACH SLIDE OUTER MEMBERS ⑫ TO EACH SIDE OF ENCLOSURE USING FOUR 10-32x7/16-INCH PAN HEAD SCREWS ⑬ PER SIDE.
12. INSTALL INSTRUMENT IN ENCLOSURE BY ALIGNING INNER MEMBERS ⑩ (ATTACHED TO INSTRUMENT) WITH OUTER MEMBERS ⑫ (ATTACHED TO ENCLOSURE).

Figure 2-7. Attaching Slides with Rack Mount Flanges and Handles (2 of 2)



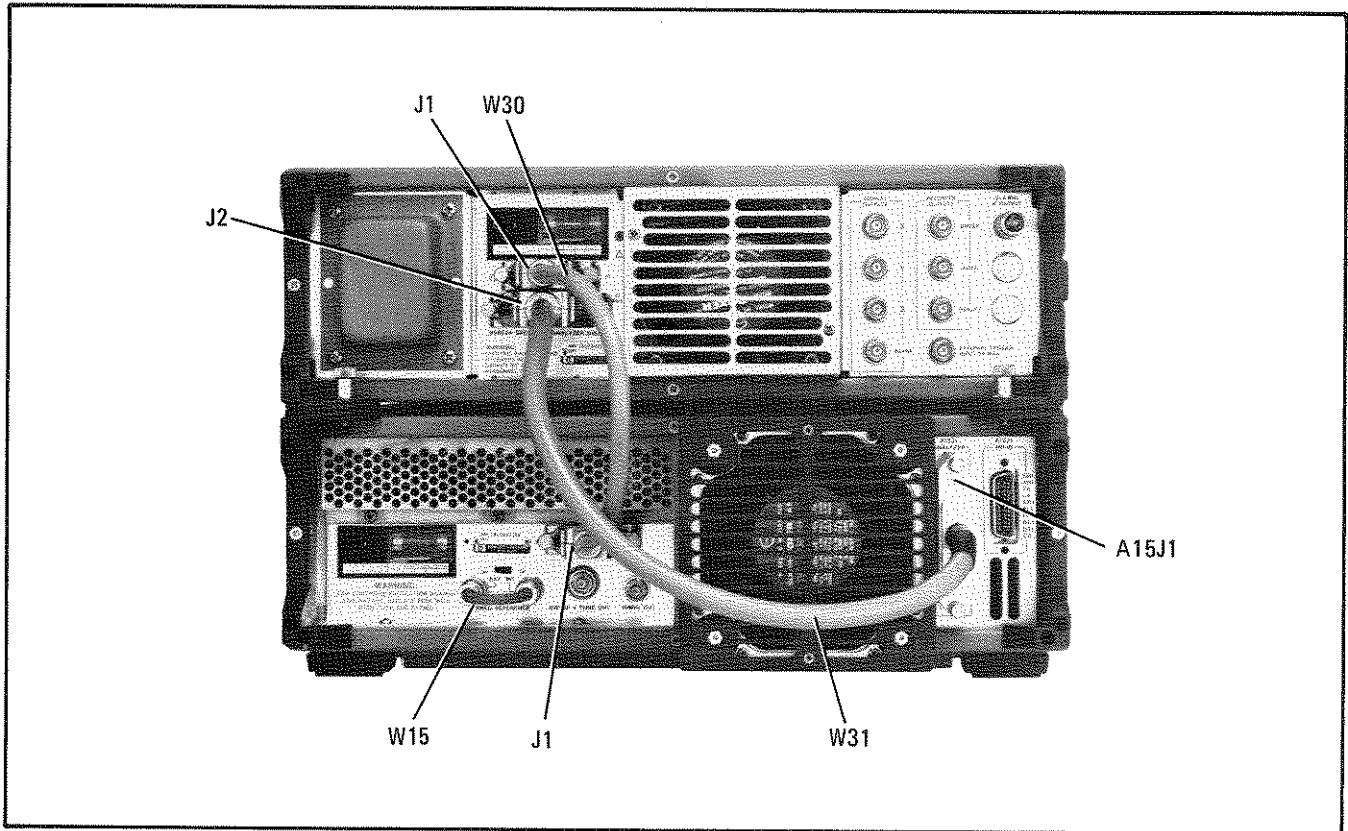

Figure 2-8. 8566A Rear Panel with Interconnect Cables Properly Installed

rack. Because of the weight of the 8566A, approximately 50 kg (112 lbs), the use of this slide kit is recommended. Special rack mount flanges and handles are included in the Slide Adapter Kit to be used in conjunction with the rack mount slides. Refer to Section VI for part number information.

### 2-29. Interconnection of Sections

2-30. Place the RF Section right side up on a level work surface. Place the IF-Display Section on top of the RF Section, so that the bottom front of the IF-Display Section is approximately one-half inch (1.3 cm) in front of the top of the RF Section. Slide the IF-Display section back until the hooks on top of the RF Section catch the bottom of the IF-Display Section. At this point the rear panel lock feet should be lined up. Tighten both lock feet thumb screws.

### 2-31. Cable Connections

2-32. **Interconnect Cables.** Connect W31 (Bus Interconnect Cable) to J2 on the IF-Display Section and to A15J1 on the RF Section. Connect W30 (Coaxial Interconnect Cable) to J1 on the IF-Display Section, and to J1 on the RF Section. W15 (Frequency Reference Jumper) is normally connected



between FREQ REFERENCE EXT and INT BNC connectors. The jumper provides the 8566A with its own internal 10 MHz frequency reference. W15 is disconnected when an external frequency reference is used. Figure 2-8 shows the 8566A with the interconnect cables properly installed.

2-33. **Power Cables.** In accordance with international safety standards, this instrument is equipped with two three-wire ac power cables. Table 2-2 shows the styles of plugs available on ac power cables supplied with HP instruments. The numbers for the plugs are part numbers for complete ac power cables. When connected to an appropriate power line outlet, these cables ground the instrument cabinet.

### WARNING

**If this instrument is to be energized through an autotransformer, make sure the common terminal of the auto transformer is connected to the protective earth contact of the power source outlet socket.**

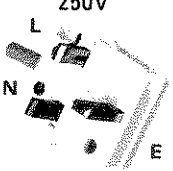
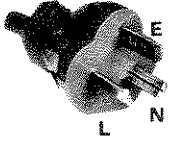
Table 2-2. AC Power Cables Available

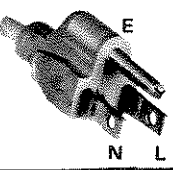
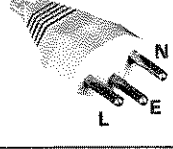
Plug Type **	Cable HP Part Number	C D	Plug Description	Cable Length cm (inches)	Cable Color	For Use In Country
 <p>250V L N E</p>	8120-1351 8120-1703	0 6	Straight*BS1363A 90°	229 (90) 229 (90)	Mint Gray Mint Gray	Great Britain , Cyprus, Nigeria, Rhodesia , Singapore , So. Africa, India
 <p>250V E L N</p>	8120-1369 8120-0696	0 4	Straight*NZSS198/ ASC112 90°	201 (79) 221 (87)	Gray Gray	Australia , New Zealand
 <p>250V E L N</p>	8120-1689 8120-1692	7 2	Straight*CEE7-Y11 90°	201 (79) 201 (79)	Mint Gray Mint Gray	East and West Europe, Saudi Arabia, United Arab Republic (unpolarized in many nations)
 <p>125V E N L</p>	8120-1348 8120-1398 8120-1754	5 5 7	Straight*NEMA5-15P 90° Straight*NEMA5-15P	203 (80) 203 (80) 91 (36)	Black Black Black	United States , Canada , Japan (100 or 200V) , Mexico , Phillippines , Taiwan
	8120-1378 8120-1521 8120-1676	1 6 2	Straight*NEMA5-15P 90° Straight*NEMA5-15P	203 (80) 203 (80) 91 (36)	Jade Gray Jade Gray Jade Gray	
 <p>250V N L E</p>	8120-2104	3	Straight*SEV1011 1959-24507 Type 12	201 (79)	Gray	Switzerland
<p>* Part number shown for plug is industry identifier for plug only. Number shown for cable is HP Part Number for complete cable including plug.</p> <p>** E = Earth Ground, L = Line; N = Neutral</p>						

**WARNING**

**Any interruption of the protective ground, inside or outside of the 8566A can make this instrument a shock hazard.**

2-34. Check to see that the voltage select cards are properly installed and that the proper fuses are installed. (See Paragraph 2-13.) Insert ac power cables into the rear of each instrument section, and plug the ac power cables into ac outlets.

**WARNING**

**Power is still applied to this instrument with the LINE switch in STANDBY. There is no OFF position on the LINE switch. To remove power from the instrument, it is necessary to remove the power cord from the rear of each of the instrument sections.**

**2-35. Mating Connectors**

2-36. A list of connectors on the front and rear panels of the Model 8566A is given in Table 2-3. An industry identification, HP part number, and alternate source for the mating connector is given for each connector on the instrument.

**2-37. STORAGE AND SHIPMENT**

**2-38. Environment**

2-39. The instrument may be stored or shipped in environments within the following limits:

Temperature . . . . .  $-40^{\circ}\text{C}$  to  $+75^{\circ}\text{C}$

Humidity . . . . . 5% to 90% at  $0^{\circ}$  to  $40^{\circ}\text{C}$

Altitude . . . . . Up to 15,240 metres (50,000 feet)

The instrument should be protected from temperature extremes which might cause condensation within the instrument.

**2-40. Packaging**

**2-41. Original Packaging.** It is recommended that the original factory packaging materials be retained for use when shipping the instrument. If original packaging material cannot be retained, packaging materials identical to those used in factory packaging is available through the Hewlett-Packard offices. Part numbers and descriptions of the packaging materials are listed in Figure 2-10. Figure 2-9 illustrates the proper method of packaging the instrument for shipment using original factory packaging materials.

2-42. The combined weight of the two instrument sections is approximately 50 kg (112 lbs). Because of the weight involved, do not package the instrument sections fastened together as one unit. The instrument sections must be separated and packaged in separate containers. The quantities of packaging materials in Figure 2-10 are for two cartons; one for the IF-Display Section and one for the RF Section. Instructions for preparing the instrument sections for shipment are contained in Figure 2-9.

2-43. If the instrument is being returned to Hewlett-Packard for servicing, attach a tag to each carton indicating the type of service required, return address, model number and full serial number. For your convenience, a supply of tags is included at the end of this section. Also, mark each container FRAGILE to assure careful handling. In any correspondence, refer to the instrument by model number and full serial number.

**2-44. Other Packaging.** If it is necessary to use packaging materials other than the type used in original factory packaging, the following general instructions should be followed.

- a. Separate the two instrument sections and wrap each in heavy paper or plastic.
- b. Place the instrument sections in separate containers with 8 to 10 cm (3 to 4 inches) of shock-absorbing material around all sides to

Table 2-3. Model 8566A Mating Connectors

Connector on RF Section	Mating Connector			
	Industry Identification	HP Part Number	C D	Alternate Source
A6J1 CAL OUTPUT	Type BNC, male connector	1250-0061	5	Bendix 056-1
A6J2 1ST LO OUTPUT	Type SMA, male connector	1250-1544	1	Seaelectro 55-628-9141-31
A6J3 RF INPUT	Type N, male connector	1250-0882	8	Specialty connector 25 P117-2
J1 IF/SWEEP	Series D, male connector	1251-4955	6	ITT Cannon DBM 5W5D
J2 EXT FREQ REFERENCE	Type BNC, male connector	1250-0061	5	Bendix 056-1
J3 INT FREQ REFERENCE	Type BNC, male connector	1250-0061	5	Bendix 056-1
J4 SWEEP + TUNE OUT	Type BNC, male connector	1250-0061	5	Bendix 056-1
J5 10 MHz OUT	Type BNC, male connector	1250-0061	5	Bendix 056-1
A15J1 Analyzer Bus	Series D, male connector 50 contact, 2 rows	1251-4400	6	Amphenol 57-30500-15
A13J1 HP-IB	Series D, male connector 24 contact, 2 rows	10631A/B/C (Cables)		None
Connector on IF-Display Section	Mating Connector			
	Industry Identification	HP Part Number	C D	Alternate Source
J1	Series D, male connector	1251-4955	6	ITT Cannon DBM 5W5D
J2	Series D, male connector	1251-2245	3	TRW DDM-50P
J3-J11	Type BNC, male connector	1250-0061	5	Bendix 056-1

provide firm cushioning and prevent movement inside the container. Protect front panels with cardboard. Double-wall corrugated cartons of 125 kg (275 lb) bursting strength are sufficient for shipping containers.

attach a tag to each container indicating type of service required, return address, model number and full serial number. For your convenience, a supply of tags is included at the end of this section.

- c. Seal each container securely and, if shipping to a Hewlett-Packard office or service center,
- d. Mark each container **FRAGILE** to assure careful handling.

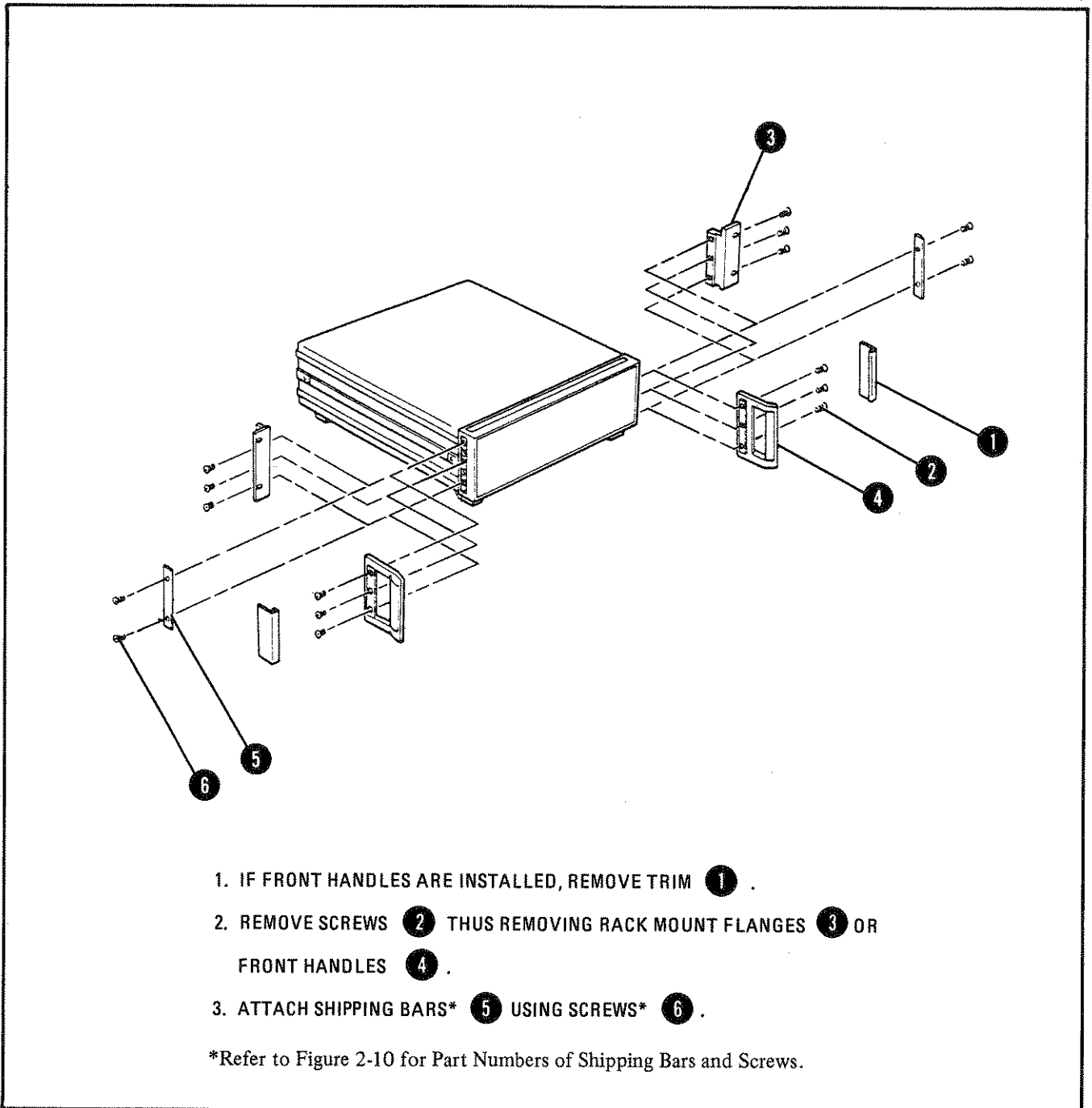
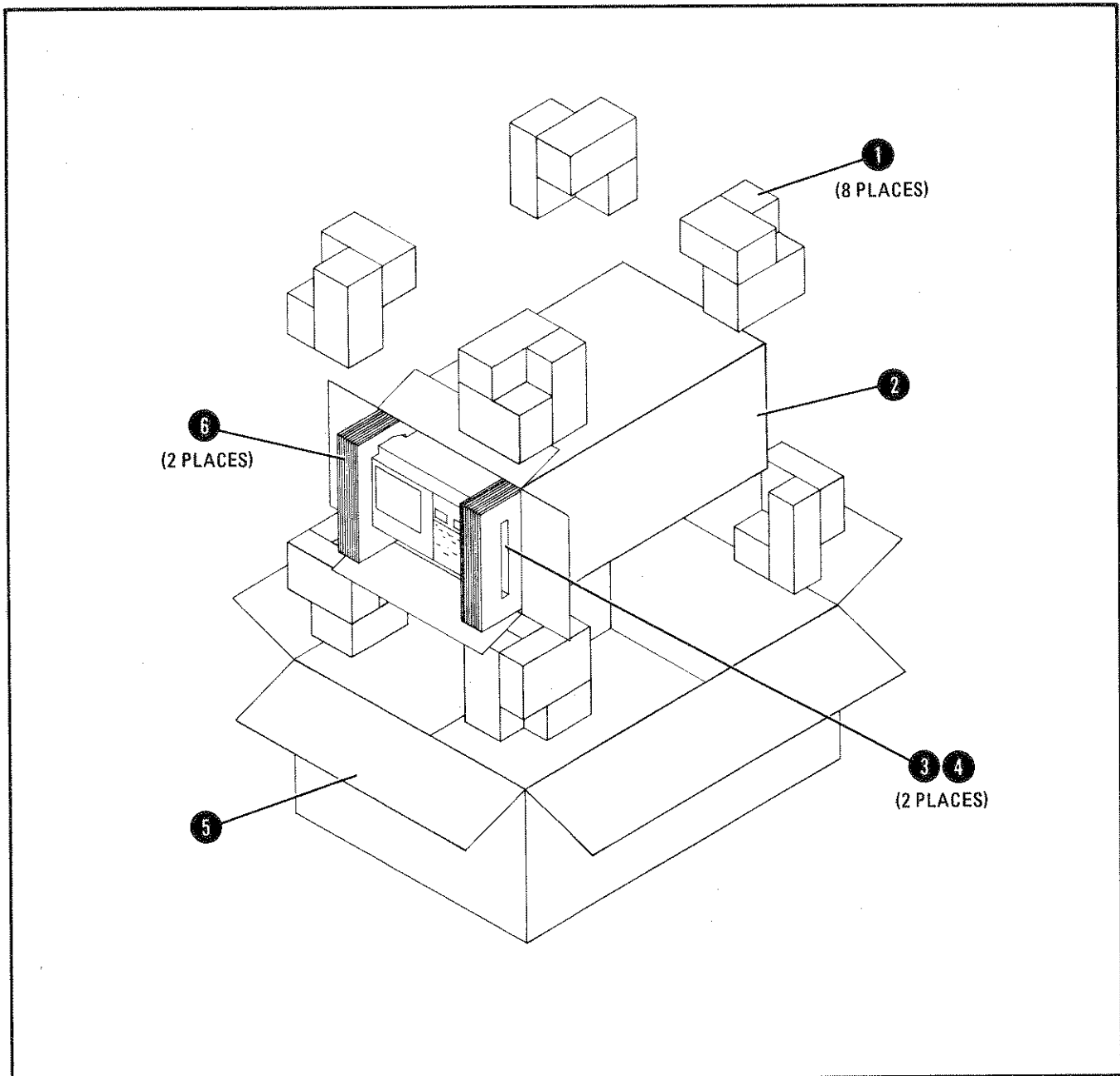

Figure 2-9. Preparing Instrument Section for Shipment





Item	Qty	HP Part No.	C D	Description
1	16	9220-2732	6	FOAM PADS—TOP, CORNER; BOTTOM CORNER
2	2	9211-2729	2	CARTON—INNER
3	4	5021-1722	6	BARS—SHIPPING, ALUMINUM
4	8	2510-0061	8	SCREW—FOR ATTACHING SHIPPING BARS
5	2	9211-2730	5	CARTON—OUTER
6	4	9220-2775	7	SIDE PADS, CORRUGATED CARDBOARD

NOTE: Quantities given are for two containers; one for the RF Section and one for the IF-Display Section.

Figure 2-10. Packaging for Shipment using Factory Packaging Materials



**8566A**  
**SPECTRUM ANALYZER**  
**OPERATION VERIFICATION**  
**REV A**

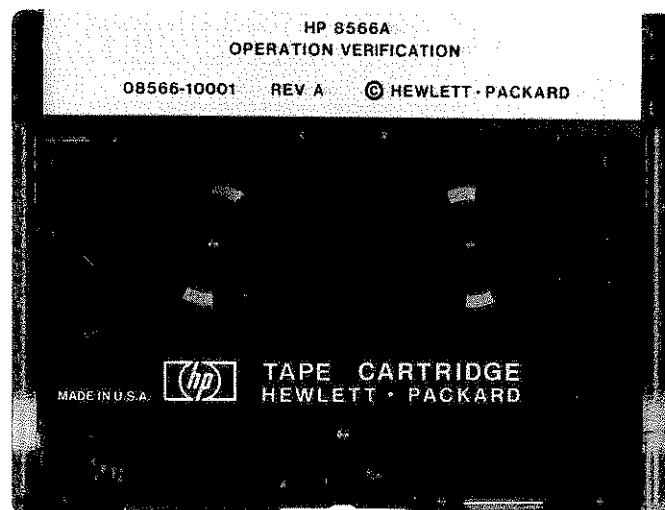

SEPTEMBER 1979  
© Copyright HEWLETT-PACKARD COMPANY 1979  
1400 FOUNTAIN GROVE PARKWAY, SANTA ROSA, CALIFORNIA, U.S.A.

HEWLETT  PACKARD



## Definition of OPERATION VERIFICATION

This test procedure is intended to check operation of the instrument's main functions. Its purpose is to provide a reasonable assurance that the instrument operates correctly by semi-automatically performing 14 of the 21 Performance Tests contained in Section IV, Volume 2, of the Operating and Service Manual. A complete list of functions checked is contained in Table 1 along with the equipment required to perform each of the tests. Approximate time to perform all tests (Test Number 0) is 45 minutes. A more detailed test of instrument specifications may be performed by referring to the Performance Tests in Section IV of the Operating and Service Manual.

If the printed test results indicate an **out of tolerance** condition for any test performed by the Operation Verification Program, the instrument under test may be either in or out of specification. Measurement uncertainties may cause the Operation Verification Program to indicate an instrument specification is out of tolerance even though the Performance Test in Section IV indicates it to be within tolerance. In this event, the Performance Test data is to be considered valid. Such measurement uncertainties will particularly affect the Frequency Response and Line Related Sidebands Tests.

Refer to the Performance Tests in Section IV, Volume 2, of the Operating and Service Manual. Perform the Performance Test with the same title as the Operation Verification test. If the instrument does not pass the Performance Test, refer to Adjustments in Section V. Perform all Adjustment procedures related to the function which did not pass, then perform the Performance Test again. If the instrument still does not pass, refer to Section VIII and Section IX, Volumes 3 and 4, of the Operating and Service Manual for troubleshooting information to correct the malfunction.

## CONTENTS

Paragraph	Page	Paragraph	Page
1. Introduction . . . . .	1	19. HP-IB Addresses . . . . .	2
5. Equipment Required . . . . .	1	25. Instructions . . . . .	3
9. Procedure . . . . .	1	27. Serial Number and Date Information . . . . .	4
10. Equipment Connections . . . . .	1	29. Pre-Adjustment Routine . . . . .	4
12. Equipment Warm-up . . . . .	2	31. Test Listing . . . . .	4
14. Tape Cartridge Loading . . . . .	2	33. Test Selection . . . . .	4
16. Program Operation . . . . .	2	37. Equipment Connections . . . . .	4
17. Equipment Required . . . . .	2	39. Test Results . . . . .	5

## ILLUSTRATIONS

Figure	Page	Figure	Page
1. Simplified Flow Chart of Operation Verification Program . . . . .	6	9. Frequency Span Accuracy Test . . . . .	59
2. File 0, Annotated Listing . . . . .	8	10. Line Related Sidebands Test . . . . .	65
3. File 1, Annotated Listing . . . . .	14	11. Resolution Bandwidth Test . . . . .	71
4. Pre-Test and Adjustment Routine . . . . .	25	12. SWEEP + TUNE OUT Accuracy Test . . . . .	83
5. IF Gain Uncertainty Test . . . . .	29	13. Average Noise Level Test . . . . .	89
6. Scale Fidelity (Log) Test . . . . .	37	14. Gain Compression Test . . . . .	95
7. Scale Fidelity (Linear) Test . . . . .	47	15. Frequency Response Test . . . . .	103
8. Log Scale Switching Uncertainty Test . . . . .	53	16. Tape Copy Program . . . . .	120
		17. Operating Instructions Program . . . . .	122

## TABLES

Table	Page	Table	Page
1. Tests Performed with Equipment Required and HP-IB Addresses . . . . .	2	2. Tape Program Organization (Track 0) . . . . .	5

## 8566A SPECTRUM ANALYZER OPERATION VERIFICATION

### 1. INTRODUCTION

2. Electrical operation of the HP 8566A Spectrum Analyzer is checked using a semi-automatic test procedure contained on a magnetic tape cartridge. Additional tapes may be ordered through your nearest HP office by ordering HP Part No. 08566-60002, which includes this operating information manual.

3. This test procedure is intended to check operation of the instrument's main functions. It is not intended to check all of the specifications of the instrument. A complete list of functions checked is contained in Table 1 along with the equipment required to perform each of the tests. Approximate time to perform all tests (Test Number 0) is 45 minutes. A more detailed test of instrument specifications may be performed by referring to the Performance Tests in Section IV of the Operating and Service Manual.

4. Annotated program listings for the individual tests contained in the program are shown in Figures 5 through 15. At the end of each of the listings is a check sum number. This number is a code representing the sum of the key strokes involved in each page of the program. If, after listing your program, the check sum numbers on your listing differ from those contained in this listing, you have different Operation Verification Program than the one illustrated here. Table 2 is a listing of the program contents indicating where on the tape each portion of the program is located.

### 5. EQUIPMENT REQUIRED

6. In addition to the test equipment listed in Table 1, an HP 9825A Desk Top Computer, HP 98210A String-Advanced Programming Plug-In, HP 98216A Plotter-General I/O-Extended I/O Plug-In, and an HP 98034A HP-IB Interface are needed for performing the Operation Verification Program. The HP 9866B or 9871A Printer and HP 98032A 16-Bit Interface are optional for added convenience.

7. A permanent record of test results may be obtained by use of either the HP 9866B or 9871A Printer. Test results are printed during the test thus providing a permanent record for comparison in future testing. It must be noted, however, that a change in data values for each test is to be expected over a period of time and that Hewlett-Packard warrants the specification range and not the repeatability of the data for any given specification.

8. If an external printer is not used, either "PASSED" or "Out of Tolerance" is printed on the HP 9825A Internal Strip Printer. Refer to Paragraph 39 for instructions concerning action to be taken if printed results indicate "Out of Tolerance".

### 9. PROCEDURE

#### 10. Equipment Connections

11. Set the select code dial on the HP 98034A HP-IB Interface to 7 and install in the HP 9825A Desk Top Computer and connect the cable on the Interface to the HP 8566A rear-panel HP-IB connector, A13J1. The HP-IB address of the HP 8566A must be set to 18 for operation of this program. Refer to Paragraph 2-14 in Section II of the Operating and Service Manual for information on setting the address. If it is necessary to use an address other than 18, refer to Paragraph 19 in this booklet. If using an HP 9866B or 9871A Printer, connect it to the HP 9825A through the HP 98032A 16-Bit Interface with the select code dial set to 6. Do not connect any other instrument to the HP-IB cable at this time.

#### NOTE

**If any instrument is connected to the HP-IB cable is not energized, the Bus is held LOW and no data transfer can take place on the Bus.**

Table 1. Tests Performed With Equipment Required and HP-IB Addresses

Test No.	Test Title	Equipment Required	Address*
0	All Tests	All Equipment Listed	
1	IF Gain Uncertainty	HP 3330B or 3335A** (Synthesizer)	04
2	Scale Fidelity (log)	HP 3330B or 3335A** (Synthesizer)	04
3	Scale Fidelity (linear)	HP 3330B or 3335A** (Synthesizer)	04
4	Log Scale Switching Uncertainty	HP 3330B or 3335A** (Synthesizer)	04
5	Frequency Span Accuracy	HP 3330B or 3335A** (Synthesizer)	04
6	Line Related Sidebands	HP 3330B or 3335A** (Synthesizer)	04
7	Resolution Bandwidths	None	
8	SWEEP + TUNE OUT Accuracy	HP 3455A (DVM)	22
9	Average Noise Level	HP 11593A (50Ω Load)	None
10	Gain Compression	HP 8620C, OPT. 011/86222A/B (Sweeper) HP 436A, OPT. 022/8481A (Power Meter) HP 11667A-C16 (Power Splitter)	06 13 None
11	Frequency Response	HP 3330B or 3335A** (Synthesizer) HP 8620C, OPT. 011/86290A/B-H08/86222A/B (Sweeper) HP 436A, OPT. 022/8481A (Power Meter) HP 11667A-C16 (Power Splitter) HP 8491B, OPT. 010 (10 dB Attenuator)	04 06 13 None None
<p>* If use of different addresses is desired, refer to Paragraph 19. ** If a 3330B Option 005 is used, a 10 dB attenuator must be attached to its output.</p>			

## 12. Equipment Warm-Up

13. Turn the HP 8566A LINE power ON and allow for a 1-hour warm-up. Also turn on all other equipment to be used and allow sufficient warm-up time as indicated in the Operating and Service manuals for that equipment. After specified warm-up time, turn HP 9825A power OFF.

## 14. Tape Cartridge Loading

15. Insert the Operation Verification Program tape cartridge into the HP 9825A Desk Top Computer. Refer to the HP 9825A Operating and Programming manual for instructions on loading the cartridge. Turn the HP 9825A LINE switch ON.

## 16. PROGRAM OPERATION

### 17. Equipment Required

18. The test equipment with the model numbers required to perform all of the tests contained in the program is listed on the HP 9825A Strip Printer and the operator is instructed to press the  key when ready.

### 19. HP-IB Addresses

20. The HP-IB addresses of the equipment used by the program are listed on the strip printer and the operator is instructed to press the  key when the HP 98034A HP-IB In-



interface has been connected to the HP 8566A. If HP-IB addresses other than those specified are used, it is necessary to change the program to accommodate the different addresses. The program may be changed at this time by keying in, on the HP 9825A, **STOP** **FETCH** **5** **EXECUTE**. Line 5 of the program (FILE 0) is now visible on the HP 9825A display. This line reads as follows:

```
5: "dev":dev "sa", 718, "osc", 704, "mtr", 713,
   "dvm", 722 "swp", 706
```

The address for the HP 8566A (sa) is 18, for the HP 3330B or 3335A (osc) is 04, for the HP 436A (mtr) is 13, for the HP 3455A (dvm) is 22, and for the HP 8620C (swp) is 06. The 7 preceding each of the instrument addresses is the select code for the HP 98034A HP-IB Interface. Refer to Remote Operation in Section III (Page 1.4, Addressing the Spectrum Analyzer) for more detailed explanation of HP-IB addressing.

21. Refer to Table 2-1 in the Operating and Service Manual for list of available HP-IB addresses. Paragraph 2-14 provides instructions for changing the HP-IB address of the HP 8566A. Refer to Operating and Service manuals for the HP 3330B or 3335A, HP 436A, HP 3455A, and HP 8620C for instructions on selecting or changing the HP-IB addresses of those instruments. It is important to note that each instrument connected on the HP-IB bus must have a different HP-IB address.

22. Once the desired HP-IB address has been selected on each of the instruments, these numbers can be entered into the Operation Verification Program, replacing those presently there. Locate the decimal equivalent of the selected HP-IB address in Table 2-1; this is the number to be entered into the program.

23. To change the addresses in the program, press the CHARACTER **BACK** key on the HP 9825A and hold it down until the cursor on the HP 9825A display is directly over the character to be replaced. (Refer to HP 9825A Operating and Programming manual for details on use of the editing keys.) Press the number keys corresponding to the

HP-IB address selected. If more than one of the addresses is to be changed, press **FWD** or **BACK** to place the cursor over the next characters to be replaced.

24. After all desired changes have been made, press **STORE**. The new addresses are now entered into the program stored in the HP 9825A memory and will remain until the HP 9825A is turned OFF or **ERASE** is pressed. The tape cartridge itself has not been changed, and should not be, therefore, it is necessary to perform this change each time the Operation Verification Program is used. To continue with the Operation Verification Program, press **RUN** on the HP 9825A. No further operating of the controller is necessary; all further inputs are made from the front panel of the HP 8566A Spectrum Analyzer. All instructions for proper operation of the program are indicated on the HP 8566A CRT display.

## 25. Instructions







26. If an external printer is used, the display on the HP 8566A CRT asks the operator if instructions are desired. These instructions include general information for the program, required test equipment and a list of the tests which may be performed. If a YES response is entered, these instructions are printed on either the HP 9866B or 9871A Printer. (HP 98032A 16-Bit Interface must be set to select code 6.) If an external printer is not used, the CRT display refers the operator to this manual supplement for instructions.

If an external printer is not used, the operator is asked if he desires the test data to be displayed on the 8566A CRT. If a YES response is entered, the address for the 8566A is substituted for the external printer select code and all test data is labeled on the 8566A CRT instead of on the external printer. Serial number and date information described in the next paragraph is bypassed in this mode of operation.

## 27. Serial Number and Date Information

28. The next display asks the operator if serial number and date information of the instrument to be tested is desired as part of the test record to be printed on the external printer or the HP 9825A Strip Printer. If a NO response is entered, the instructions for the entry of this information are not displayed. If a YES response is entered, the next five displays ask the operator to enter the serial number data for each of the instrument sections and the current date for the test record.



## 29. Pre-Adjustment Routine

30. The next two displays are equipment setup diagrams for amplitude and frequency calibration of the HP 8566A. These adjustment routines are contained in the internal firmware of the instrument and can be accessed by keying in   for amplitude calibration and   for frequency calibration. These routines are described in more detail in Section III. The next two displays ask the operator to perform the adjustments by adjusting the front panel AMPTD CAL and FREQ ZERO controls to set the CRT trace to designated levels on the CRT. Amplitude and frequency calibration must be within specified limits before program will advance. The 8566A then performs the internal calibration routine,   .



## 31. Test Listing

32. The next display is a complete listing, "Test Select", of the tests contained in the Operation Verification Program. This list is also contained in Table 1 along with the equipment required for each test.

## 33. Test Selection

34. **All tests.** All tests can be performed as one continuous test by entering   on the HP 8566A keyboard as indicated by the instructions on the CRT display. This test requires approximately 45 minutes for completion.

35. **Single Tests.** Individual functions may be checked by entering the indicated test number. These tests may be performed once or repetitively as desired, by terminating the entry with the proper key as stated in the instructions on the CRT display. The  key is used to perform a test once. When the test is completed, the external printer (if used) prints the specifications of the function tested and the test results obtained. If the results obtained are out of tolerance, a double asterisk (\*\*) is placed next to the recorded data which is out of tolerance. If not using an external printer, either "PASSED" or "Out of Tolerance" plus the data measured is printed on the HP 9825A Desk Top Computer Strip Printer. For an explanation of the data as it is printed on the strip printer, refer to Figures 5 through 15. The CRT display returns to the test listing and a YES or NO indication is displayed adjacent to the test performed indicating that the instrument either "PASSED" the test or part of the data obtained was "Out of Tolerance".

36. **Repetitive Testing.** Any test may be performed repetitively by terminating the test number entry with the  key. When the test is completed, the external printer (if used) prints the data the same as for a single test and then the test is immediately performed again. Each time the test is completed, the test results are printed. To stop (abort) this repetitive test loop it is necessary to press the  key. The test loop is stopped and, at the end of the test currently being performed, the CRT display returns to the test listing. If an HP external printer is not used, "PASSED" or "Out of Tolerance" plus the data measured is printed on the HP 9825A Strip Printer at the end of each test.

## 37. Equipment Connections

38. At the beginning of each test being performed, the CRT display indicates the equipment connections necessary for the performance of the test. After the equipment is connected as shown and the test continued as instructed, no further operator assistance is required. The test or tests are performed automatically and results printed until testing is complete or aborted by operator.

### 39. Test Results

40. If the printed test results indicate an out of tolerance indication for any test performed by the Operation Verification Program, refer to Section IV in Volume 2 of the Operating and Service Manual. Perform the Performance Test in section IV with the same title as the Operation Verifica-

tion test. If the instrument does not pass the Performance Test, refer to Adjustments in Section V. Perform all Adjustments related to the function which did not pass, then perform the Performance Test again. If the instrument still does not pass, refer to Section VIII and Section IX for troubleshooting information to correct the malfunction.

#### NOTE

The validity of the measurements in the Operation Verification program are based in part on the accuracy of the test equipment used to perform the test. Therefore, proper calibration of the test equipment must be verified before instrument operation can be checked using the Operation Verification Program.

#### NOTE

Microwave measurement uncertainties may cause the Operation Verification program to indicate an instrument specification is out of tolerance even though the Performance Test in Section IV indicates it to be within tolerance. In this event, the Performance Test data is to be considered more valid.

#### NOTE

It is recommended that a working copy of this tape be made and the master stored in a safe location. This can be done by loading and running the tape copy program located on Track 0, File 16, of this tape.

Table 2. Tape Program Organization (Track 0)

Test No.	File No.	Description	Program Size	File Size
—	0	Operating Instructions	4830	5500
—	1	Program Driver	6786	10000
1	2	IF Gain Uncertainty	2662	5000
2	3	Scale Fidelity (log)	2804	5000
3	4	Scale Fidelity (linear)	1658	5000
4	5	Log Scale Switching Uncertainty	1698	5000
5	6	Frequency Span Accuracy	2964	5000
6	7	Line Related Sidebands	2302	5000
7	8	Resolution Bandwidths	4114	5000
8	9	SWEEP + TUNE OUT Accuracy	1988	5000
9	10	Average Noise Level	2544	5000
10	11	Gain Compression	3628	5000
11	12	Frequency Response (Selection)	3056	5000
11	13	Frequency Response (Measurement)	1756	5000
11	14	Frequency Response (Print Out)	1320	5000
—	15	Pre-cal Routine	1366	5000
—	16	Tape Copy Program	702	5000

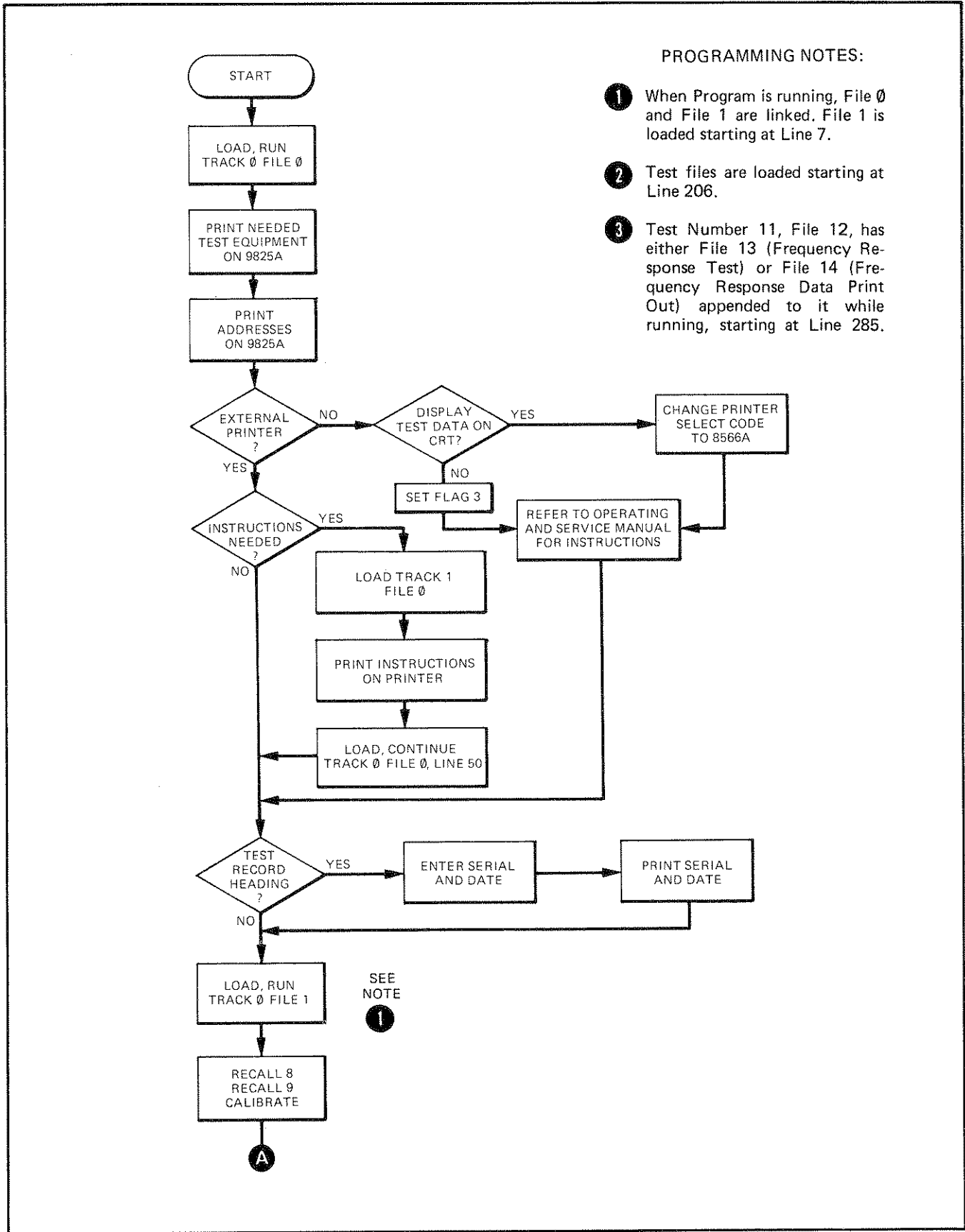

Figure 1. Simplified Flow Chart of Operation Verification Program (1 of 2)

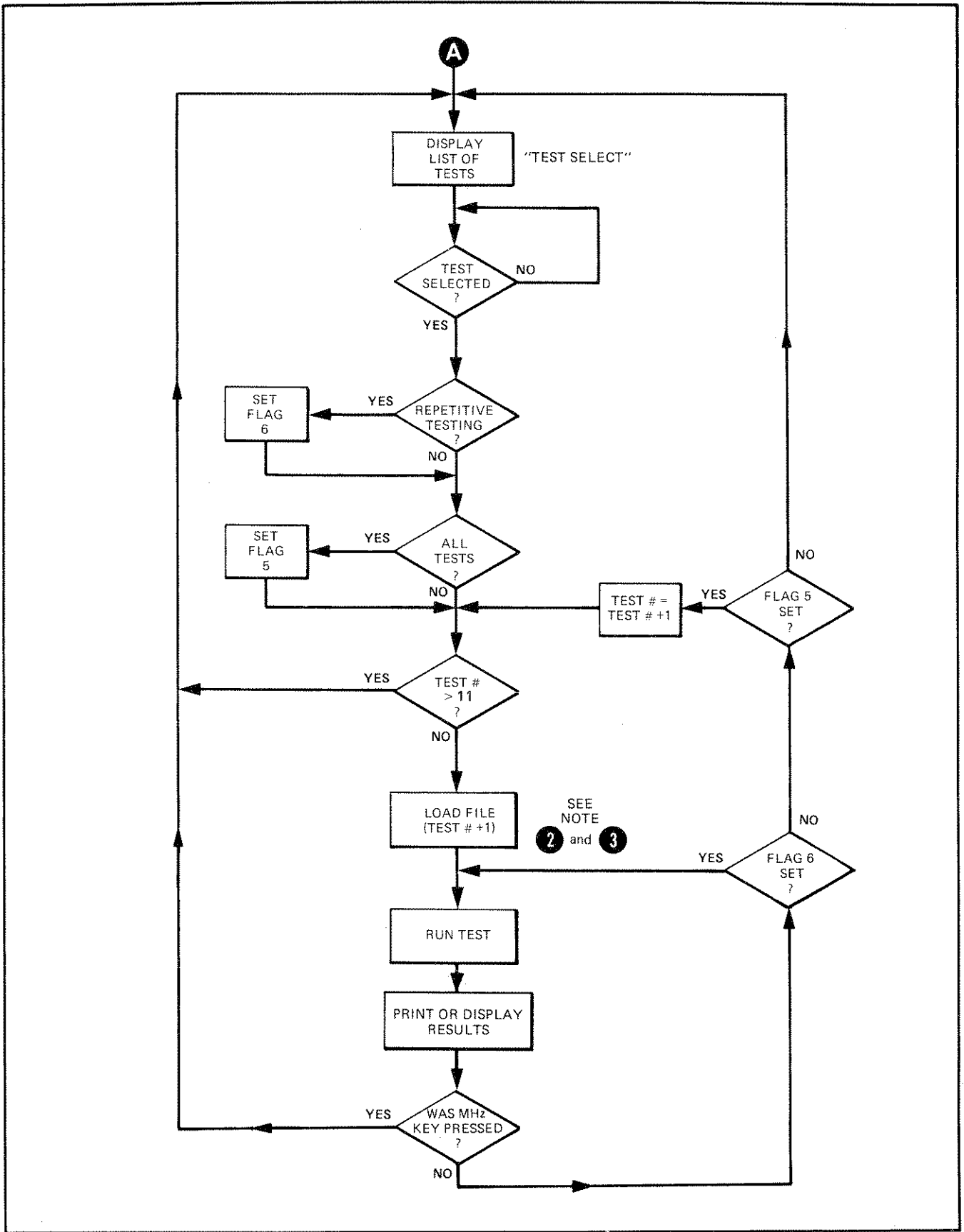

Figure 1. Simplified Flow Chart of Operation Verification Program (2 of 2)

```

0: "8566A OPERATION VERIFICATION PROGRAM TURN ON INSTRUCTIONS":
1: "REV A: t0F0: 791002":
2: "      Copyright by Hewlett-Packard   OCTOBER 1979":
3: "#1":
4:   on err "error"
5: "dev":dev "sa",718+Z,"osc",704,"mtr",713,"dvm",722,"swp",706
6:   dim A[10];6+P;if flg9;ret
7: "#2":
8:   prt "      8566A","      OPERATION"," VERIFICATION";spc ;spc
9:   prt "      REQUIRED","      TEST","      EQUIPMENT";spc ;spc
10:  prt "SYNTHESIZER---"," HP3330B or","      3335A";spc
11:  prt "SWEEP","OSCILLATOR---"," HP8620C Opt011";spc
12:  prt "RF PLUG-INS--- HP86222A/B and"
13:  prt " HP86290A/B or HP86290A/B-H08";spc
14:  spc ;prt "POWER METER---"," HP436A Opt.022";spc
15:  prt "POWER SENSOR---"," HP8481A";spc
16:  prt "DIGITAL","VOLTMETER---"," HP3455A";spc
17:  prt "POWER SPLITTER-- HP11667A";spc
18:  prt "50 OHM LOAD--- HP11593A";spc ;spc
19:  prt "READY ???"," Press Continue";spc ;spc ;stp
20: "#3":
21:  prt "The following","SELECT CODES andADDRESSES are","used in this"
22:  prt "program. Check the Operating"
23:  prt "and Service","manual for each instrument for"
24:  prt "instructions on setting the","proper select"
25:  prt "code or address.";spc ;spc
26:  spc ;prt "HP98034A HP-IB","INTERFACE","SELECT CODE 7"
27:  spc ;prt "HP9866A/B,9871A Printer","SELECT CODE 6";spc
28:  prt "HP8566A","SPECTRUM","ANALYZER"," ADDRESS 18"
29:  spc ;prt "HP3330B or 3335A","SYNTHESIZER"," ADDRESS 04"
30:  spc ;prt "HP8620C","SWEEP OSCILLATOR"," ADDRESS 06"
31:  spc ;prt "HP436A","POWER METER"," ADDRESS 13";spc
32:  prt "HP3455A","DIGITAL","VOLTMETER"," ADDRESS 22"
33:  spc ;prt "READY ???"," Press Continue";spc ;spc ;stp
34: "#4":
35:  dsp "See 8566A display instructions"
36:  wrt "sa","IP KSi EM A4 KSm KSo D3 DT@"
37:  if rds(P)=0;gsb "manual"
38:  if flg3 or P>15;gto +13;if P>15;gto "start"
39: "#5":
40:  wrt "sa","PUPAL00,358LBDO YOU NEED OPERATING INSTRUCTIONS ?"
41:  wrt "sa",""
42:  wrt "sa",""
43:  wrt "sa","      Yes   PUSH GHz KEY on 8566A"
44:  wrt "sa",""
45:  wrt "sa","      No    PUSH Hz KEY on 8566A@"
46:  gsb "wait"
47:  wait 500;if D=le9;trk 1;ldp 0
48:  if D#1;gto -8
49:  if D=0;sfg 9;gsb "dev"

```

Figure 2. File 0, Annotated Listing (1 of 6)



#1

Sets device select codes and addresses to be used in the Operation Verification program for equipment used.

#2

Outputs to HP 9825A strip printer test equipment required for Operation Verification.

#3

Outputs to HP 9825A strip printer device select codes and addresses necessary for operation of the program.

#4

Displays message on controller display to refer operator to analyzer CRT for further instructions and checks for the presence of an external printer. The variable P represents the select code of the external printer.

#5

Labels on analyzer CRT instructions to operator for obtaining operating instructions, if desired. Will load and run File 0, Track 1 if instructions are requested. Flag 9 is set to indicate the return from printing of instructions.

*Figure 2. File 0, Annotated Listing (2 of 6)*

```

50: "#6":
51:   wrt "sa", "EMPUPA32,320LBDO YOU WANT SERIAL NUMBER AND DATE "
52:   wrt "sa", "  INFORMATION PRINTED ON TEST RECORD"
53:   wrt "sa", ""
54:   wrt "sa", "  YES      push GHz KEY"
55:   wrt "sa", ""
56:   wrt "sa", "  NO      push Hz KEY@"
57:   gsb "wait"
58:   if D<le8;gto -7;if D=1;gto "start"
59: "#7":
60:   wrt "sa", "EMPUPA96,550LBenter 8566 serial number?@"
61:   wtb "sa", "PUPA96,520LB",17," (IF-DISPLAY SECTION)",18,3
62:   wrt "sa", "PUPA96,480LB (enter last 5 digits only)@"
63:   wrt "sa", "PUPA96,450LB (for example: enter - 123Hz)@"
64:   wrt "sa", "PUPA96,100LBTo CONTINUE, push Hz@"
65:   gsb "entry"
66:   gsb "wait"
67:   D→A[1];if D>99999;gto -7
68: "#8":
69:   wrt "sa", "EMPUPA96,550LBenter 8566 serial number?@"
70:   wtb "sa", "PUPA96,520LB",17," (RF SECTION)",18,3
71:   wrt "sa", "PUPA96,480LB (enter last 5 digits only)@"
72:   wrt "sa", "PUPA96,450LB (for example: enter - 456Hz)@"
73:   wrt "sa", "PUPA96,100LBTo CONTINUE, push Hz@"
74:   gsb "entry"
75:   gsb "wait"
76:   D→A[2];if D>99999;gto -7
77: "#9":
78:   wtb "sa", "EM PUPA96,500LBenter month ",17,"(number)",18,3
79:   wrt "sa", "PUPA96,100LBTo CONTINUE, push Hz@"
80:   gsb "entry"
81:   gsb "wait"
82:   D→A[3];if D>12 or D<1;gto -4
83: "#10":
84:   wtb "sa", "EMPUPA96,500PDLBenter ",17,"day ",18,"of the month",3
85:   wrt "sa", "PUPA96,100LBTo CONTINUE, push Hz@"
86:   gsb "entry"
87:   gsb "wait"
88:   D→A[4];if D>31 or D<1;gto -4
89: "#11":
90:   wtb "sa", "EMPUPA96,500PDLBenter ",17,"year",18,3
91:   wrt "sa", "PUPA96,100LBTo CONTINUE, push Hz@"
92:   gsb "entry"
93:   gsb "wait"
94:   D→A[5];if D<1900 or D>2000;D+1900→A[5];if D>2000;gto -4

```

Figure 2. File 0, Annotated Listing (3 of 6)

#6

Labels on analyzer CRT instructions to operator for printing serial numbers and date on test record, if desired.

#7

Instructs operator to enter serial number of IF-Display Section being tested. Returns value entered (D) into A[1].

#8

Instructs operator to enter serial number of RF Section being tested. Returns value entered (D) into A[2].

#9

Instructs operator to enter month for test date. Returns value entered (D) into A[3].

#10

Instructs operator to enter day for test date. Returns value entered (D) into A[4].

#11

Instructs operator to enter year for test date. Returns value entered (D) into A[5].

*Figure 2. File 0, Annotated Listing (4 of 6)*

```

95: "#12":
96:   if not flg3;gto +7
97:   prt "      8566A          OPERATION          VERIFICATION  "
98:   fmt 1,/,2fz2.0,f4.0,;/;wrt 16.1,"Date:",A[3],"/",A[4],"/",A[5]
99:   fmt 1,c,fz5.0;wrt 16.1,"I.F.-Display";wrt 16.1," serial no.",A[1]
100:  fmt 1,c,fz5.0;wrt 16.1,"R.F. Section";wrt 16.1," serial no.",A[2]
101:  fmt 6,16"_"",2;/;wrt 16.6;gto +9

102: "#13":
103:  fmt 2,2/,2lx,c;wrt P+.2,"***8566A OPERATION VERIFICATION DATA***"
104:  fmt 3,2/,7x,c,4lx,c;wrt P+.3,"Serial Numbers :", "Date :"
105:  fmt 1,9x,fz5.0,c,30x,2fz2.0,f4.0
106:  wrt P+.1,A[1],"(IF-DISPLAY SECTION)",A[3],"/",A[4],"/",A[5]
107:  fmt 7,9x,fz5.0,c;fmt 8,/,10x,60"-",/
108:  wrt P+.7,A[2],"(RF SECTION)";wrt P+.8
109: "#14":
110: "start":
111:  wrt "sa","D3 PUPA32,600LB8566A OPERATION VERIFICATION PROGRAM@"
112:  wrt "sa","PUPA48,350LB"
113:  wtb "sa",17,"  LOADING PRE-TEST ADJUSTMENT ROUTINE",18,3
114:  ldf 1,7,7
115: "#15":
116: "wait":eir 7,0;wrt "sa","R1R4EE"
117:   if bit(1,rds("sa"))#1;jmp 0
118:   wrt "sa","OA";red "sa",D;wrt "sa","EMKSiEM";ret

119: "#16":
120: "entry":wtb "sa","DW1035,3009,DA3009,D3PUPA16,400LB  ",3;ret

121: "#17":
122: "manual":
123:  wrt "sa","EMPUPA16,450LBA Printer is not connected to system,for"
124:  wrt "sa","Operating Instructions please refer to"
125:  wrt "sa","VOL. I, Section II of the Operating and"
126:  wrt "sa","Service manual."
127:  wrt "sa","";wrt "sa","If you want test data to be shown"
128:  wrt "sa","on 8566A display press, MHz key."
129:  wrt "sa","If not press, Hz key.@"
130:  gsb "wait"
131:  sfg 3;if D=1e6;cfg 3;Z+P
132:  ret

133: "error":on err "error"
134:   if rom=71 and ern=9;gto 7
135:   dsp "  ERROR  CHECK SETUP !!!!!!!";gto 7;stp
*15523
*15379

```

Figure 2. File Ø, Annotated Listing (5 of 6)

#12

Prints serial numbers and date on HP 9825A strip printer if Flag 3, indicating no external printer, is set.

#13

Prints serial numbers and date on HP 9866B or 9871A Printer, if used.

#14

Labels on CRT that Operation Verification has begun by loading the pre-test routine. Loads File 1 starting at Line 7 and continues running program at Line 7.

#15

Enables analyzer keyboard, allowing operator entry. Entry is stored in variable D.

#16

Moves 'entry' label on CRT from active function region to center left of CRT.

#17

Refers operator to Operating and Service Manual for instructions if printer is not used. Allows operator to select the HP 8566A display as the external printer if an HP 9866B or HP 9871A is not connected. The 'error' subroutine prevents program from stopping if an error occurs.

*Figure 2. File 0, Annotated Listing (6 of 6)*

```

0: "8566A OPERATION VERIFICATION DRIVER PROGRAM":
1: "t0fl: 790831":
2: "#1":
3:   dim B[5,12],D[2,27],X[12];if P=0;6→P
4:   on err "error";if rds(P)=0 and not flg3;Z→P
5: "pre-cal":ldf 15,206,206
6: "#2":
7: "test select":
8:   if flg5;r4+l→r4;gto +9
9:   if flg6;gto 206
10:  wrt "sa","EM KSi EM KSm KSo A4";wait 50
11:  cll 'menu'
12:  wrt "sa","DA1024,DW1090";eir 7,0
13:  wrt "sa","R1R4EE"
14:  if bit(1,rds("sa"))#1;jmp 0
15:  wrt "sa","OA";red "sa",D;gto 206;if D#r4 or r4=0;D+r4;gto +1
16:  if r4>999;sfg 6;r4/le3→r4
17:  if r4>11;cfg 5,6;gto -7
18:  0→X[r4+1];if r4=0;sfg 5;l→r4
19:  fmt 9,c,b,c,f2.0,b,b,c
20:  wrt "sa.9","DA1566LB",17,"LOADING TEST ",r4,18,3,"HD"
21:  ldf r4+1,206,206
22: "#3":
23: "menu":
24:   wrt "sa","DA1024,PS,D3PUPA208,640,LB8566A Test Listing  "
25:   wrt "sa"," "
26:   wrt "sa"," OK No. TEST OK No. TEST "
27:   wrt "sa"," 0. All Tests 6. Line Related "
28:   wrt "sa"," 1. IF Gains 7. Resolution BW "
29:   wrt "sa"," 2. Log Fidelity 8. Sweep + Tune "
30:   wrt "sa"," 3. Lin. Fidelity 9. Average Noise "
31:   wrt "sa"," 4. Log Switching 10. Gain Compres. "
32:   wrt "sa"," 5. Freq. Spans 11. Freq. Resp. "
33:   wrt "sa","";wrt "sa","";wrt "sa","";wrt "sa",""
34:   wtb "sa"," Enter Test Number on 8566A DATA KEYBOARD",10,13
35:   wrt "sa",""
36:   wrt "sa"," To run Test once, PUSH Hz KEY"
37:   wrt "sa"," To run Test repetitively, PUSH KHz KEY"
38:   wrt "sa",""
39:   wtb "sa"," To ABORT a repetitive Test,PUSH MHz KEY",3
40:   wtb "sa","PUPA224,320LB",18,"",18,3
41:   wtb "sa","DW1035,3009,DA3009,D3PUPA16,320LB",3
42: "#4":
43:   for I=0 to 5;if I=0;jmp 3
44:   l2l→M;l0l→O;l15→N;if X[I+1]>1;l10→M;l1l→O;32→N
45:   if X[I+1]>0;wrt "sa","DA",1103+47I,"DW",M,O,N
46:   l2l→M;l0l→O;l15→N;if X[I+7]>1;l10→M;l1l→O;32→N
47:   if X[I+7]>0;wrt "sa","DA",1125+47I,"DW",M,O,N
48:   next I;ret

```

Figure 3. File 1, Annotated Listing (1 of 10)



#1

Performs operator-assisted amplitude and frequency calibration of analyzer. Actual adjustment routines are located on Track 0, File 15 and will be loaded starting at Line 206. (Line 206 is the last line in the running program.)

#2

Lists available tests on CRT and loads proper file to perform test selected by operator. Actual test listing is not contained in subprogram 'menu' (Group #3). Flag 5 is set if all tests (Test No. 0) are selected. Flag 6 is set if repetitive testing is selected.

#3

Labels on CRT list of tests and instructions for selection.

#4

Determines the 'yes' or 'no' indication to be displayed on CRT test listing and places in memory the octal equivalent of characters to be displayed: 121 = y, 101 = e, 115 = s, 110 = n, 111 = o, and 32 = blank. If test has not been run, area under label 'OK' is left blank and X[\*] equals 0. If test has been run, X[\*] equals 1 if test passed and 2 if it did not pass.

*Figure 3. File 1, Annotated Listing (2 of 10)*

```

49: "#5":
50: "p/f":
51:   if flg5 and r4<11 or flg6 or flg3;ret
52:   if P<15;fmt 8,/ ,80" ",3/;wrt P+.8
53:   if max(X[*])>1;sfg I;if not flg5 and X[r4+1]<2;cfg 1
54:   if flg1;jmp 4
55:   fmt 5,15"","c,15"";if P>15;fmt 5,5"","c,5"
56:   wrt P+.5," 8566A HAS PASSED THE OPERATION VERIFICATION TEST "
57:   wrt P;ret

58:   wrt P,"** A MEASUREMENT IS OUT OF TOLERANCE IN THE FOLLOWING"
59:   wrt P," OPERATION VERIFICATION TEST(S). THE ERROR IS INDICATED BY"
60:   wrt P," DOUBLE ASTERISK(**) IN THE TEST RECORD";wrt P;if P>15;ret
61:   wrt P," REFER TO THE OPERATING AND SERVICE MANUAL SECTION IV "
62:   wtb P," TABLE 4-1 FOR PARAGRAPH NUMBER OF "
63:   wrt P,"PERFORMANCE TEST(S):";wrt P;cfg 1
64:   if not flg5;jmp r4+4
65:     for I=1 to 11
66:       if X[I+1]<=1;next I;ret
67:   gsb "end";jmp I+1
68: "end":wrt P;next I;ret

69:   wrt P," 1. IF GAIN UNCERTAINTY";ret
70:   wrt P," 2. SCALE FIDELITY (log)";ret
71:   wrt P," 3. SCALE FIDELITY (linear)";ret
72:   wrt P," 4. LOG SCALE SWITCHING UNCERTAINTY";ret
73:   wrt P," 5. FREQUENCY SPAN ACCURACY";ret
74:   wrt P," 6. LINE RELATED SIDEBANDS";ret
75:   wrt P," 7. RESOLUTION BANDWIDTHS";ret
76:   wrt P," 8. SWEEP + TUNE OUT ACCURACY";ret
77:   wrt P," 9. AVERAGE NOISE LEVEL";ret
78:   wrt P," 10. GAIN COMPRESSION";ret
79:   wrt P," 11. FREQUENCY RESPONSE";ret

80: "#6":
81: "error":on err "error";if rds(P)#32;gto +4
82:   wtb "sa","EM D3 PUPA176,352LB",17,"PRINTER IS OUT OF PAPER",18
83:   wtb "sa",10,10,13," LOAD PAPER AND PRESS 9825A ""CONTINUE"" KEY"
84:   wtb "sa",10,13,3;beep;gto "print out";stp

85:   fmt 1,c,f2.0,/ ,c,f2.0;wrt 16.1,"ERROR#",ern,"LINE#",erl
86:   prt "READY??...      press CONTINUE";spc ;spc
87:   beep;dsp "HP-IB ERROR; CHECK TEST SET-UP";wait 150;beep;stp
88:   gto "test select"

```

Figure 3. File 1, Annotated Listing (3 of 10)

#5

Prints 'passed' message on HP 9866B or HP 9871A Printer if measured values were within specification. If measured values were not within specification, an 'out of tolerance' message is printed, the operator is referred to the Operating and Service Manual, and the titles of tests that did not pass are printed.

#6

Labels on analyzer CRT or controller display the error encountered and instructions for correcting error.

*Figure 3. File 1, Annotated Listing (4 of 10)*

```

89: "#7":
90: "ana":
91: wrt "sa","EM KSi EM A4 KSo KSm DT@ D3"
92: fmt l,c,b,c,f2.0,b,c
93: if r4#0;wrt "sa.1","PUPA224,32LB",17,"Test Number ",r4,18,"@"
94: if r4#0;wrt "sa","PUPA100,64LBTO SELECT ANOTHER TEST, push MHz@"
95: wrt "sa","PUPA100,100LBTO CONTINUE, push Hz@"
96: wrt "sa","D2PUPA550,650PDPR 0,300,400,0,0,-300,-400,0"
97: wrt "sa","PU10,155PD0,130,140,0,0,-130,-140,0"
98: wrt "sa","PU-10,-10PD400,0PU-388,-120PD380,0"
99: wrt "sa","PU-20,-15PD0,0PU-40,0PD0,0PU-20,0PD0,0"
100: wrt "sa","D3PUPA480,500LB8566A@D2PUPA550,650";ret

101: "#8":
102: "cbl":
103: gsb "ana"
104: wrt "sa","PUPR310,10PD0,-50,60,0,0,50PU5,-5"
105: wrt "sa","PD10,-80PU-80,80PD-50,-40"
106: wrt "sa","D3PUPA616,368LBRF@PUPA616,336LBINPUT@"
107: wrt "sa","PUPA504,400LBCAL@PUPA456,368LBOUTPUT@"
108: wrt "sa","PUPA96,208LBCONNECT BNC CABLE FROM CAL OUTPUT@"
109: wrt "sa","PUPA96,176PDLBTO RF INPUT @DW1044";gsb "wait"
110: ret

111: "#9":
112: "load":
113: gsb "ana"
114: wrt "sa","D2PUPR360,10PD20,0,0,-10,-5,0,0,-15,5,0"
115: wrt "sa","0,-20,-20,0,0,20,5,0,0,15,-5,0,0,10"
116: wtb "sa","PU0,-30PD-80,-40D3PUPA520,400LB50",250,"@"
117: wrt "sa","PUPA520,368LBLEAD@"
118: wrt "sa","PUPA96,300LBCONNECT 50 ohm LOAD TO RF INPUT @"
119: wrt "sa","DW1044";gsb "wait"
120: ret

121: "#10":
122: "syn":
123: gsb "ana"
124: wrt "sa","PUPR-50,-100PD0,200,-400,0,0,-200,400,0PU-400,160PD400,0"
125: wrt "sa","PU-15,-130PD0,0PU-5,-5PD-150-80PU155,85"
126: wrt "sa","PD440,0,0,80PU5,-5PD40,-80PU-420,290"
127: wrt "sa","PD-400,0,0,-115PU25,0PD0,70,375,0,PU0,-170"
128: wrt "sa","D3PUPA176,568LBHP-IB CABLE@"
129: wtb "sa","PUPA160,304LBOUTPUT@PAPU160,272LB(50 ",250,")@"
130: wrt "sa","PUPA160,432LB3330B/@PUPA160,400LB3335A@"
131: wrt "sa","PUPA632,368LBRF@PUPA584,336LBINPUT@"
132: wrt "sa","PUPA96,208LBCONNECT SYNTHESIZER TO 8566A AS SHOWN"
133: wtb "sa",3,"DW1044";gsb "wait"
134: gsb "syn 2";if D>1;ret
135: ret

```

Figure 3. File 1, Annotated Listing (5 of 10)

#7

Draws HP 8566A Spectrum Analyzer on CRT and labels test instructions.

#8

Draws on CRT the cable from analyzer CAL OUTPUT to RF INPUT; labels instructions.

#9

Draws on CRT the 50-ohm load connected to analyzer input; labels instructions.

#10

Draws on CRT the automatic synthesizer connected to analyzer; labels instructions.

*Figure 3. File 1, Annotated Listing (6 of 10)*

```

136: "#11":
137: "wait":if flg5;beep;wait 150;beep
138:   eir 7,0;wrt "sa","R1R4EE";wait 50
139:   if bit(1,rds("sa"))=0;jmp -1
140:   wrt "sa","OA";red "sa",D;wrt "sa","EMKSiEM";ret

141: "#12":
142: "entry":wtb "sa","DW1035,3009,DA3009,D3PUPA16,400LB   ",3;ret

143: "#13":
144: "synthesizer":
145:   pl*1e6+p0
146:   if not flg8;gto +6
147:   fmt 2,fz.2,c,fz.2;fmt 3,fz.2
148:   if p2<0;wrt "osc.2","F",p0,"HA",abs(p2),"M"
149:   if p2>=0;wrt "osc.2","F",p0,"HA",p2,"K"
150:   if p3#0;wrt "osc.3","AI",abs(p3),"M"
151:   wait 200;ret

152:   conv 46,58;fmt 2,fz.2,c,fz.2;fmt 3,fz.2
153:   if p2<0;wrt "osc.2","^L",p0,"=N",abs(p2),"<"
154:   if p2>=0;wrt "osc.2","^L",p0,"=N",p2,";"
155:   if p3#0;wrt "osc.3","O",abs(p3),"<"
156:   wait 200;conv ;ret

157: "#14":
158: "syn up/down":
159:   if not flg8;gto +3
160:   if pl=1;wrt "osc","U";wait 500;ret
161:   wrt "osc","D";wait 500;ret

162:   if pl=1;wrt "osc",")";wait 500;ret
163:   wrt "osc","(";wait 500;ret

164: "#15":
165: "top lin":
166:   wrt "sa","LG TS RLOA";red "sa",V
167:   wrt "sa","LN TS RLOA";red "sa",B
168:   cll 'synthesizer'(7.6,V)
169:   wrt "sa","M2 TS MA";red "sa",A
170:   if A>B/1.001 and A<1.001B;ret
171:   gsb "top log";if A>0;V-20log(A/B)+V;gto -3
172:   gto -7

```

Figure 3. File 1, Annotated Listing (7 of 10)



#11

Enables analyzer keyboard and allows entry by operator. This entry is stored in variable D.

#12

Moves 'entry' label on CRT from active function region to center left of CRT.

#13

Sets automatic synthesizer frequency, amplitude, and step size as determined by values from test file. Flag 8 is set if an HP 3335A Frequency Synthesizer is being used.

#14

Steps automatic synthesizer up or down in amplitude the amount specified by the step size set in test file. Flag 8 is set if an HP 3335A Frequency Synthesizer is being used.

#15

Places signal peak at reference level on analyzer CRT in linear mode of operation. V is the amplitude to which the automatic synthesizer is to be set. A is the measured linear voltage level. B is the reference level in linear voltage units.

*Figure 3. File 1, Annotated Listing (8 of 10)*

```

173: "#16":
174: "top log":
175:   wrt "sa","M1 LG TS RLOA";red "sa",V;V→R
176:   cll 'synthesizer'(7.6,V)
177:   wrt "sa","M2 TS MA";red "sa",A
178:   if abs(A-R)<.1;ret
179:   V-(A-R)→V;gto -3;if V>13;-10→V
180: "#17":
181: "on interrupt":if not flg5 and not flg6;ret
182:   oni 7,"interrupt";wrt "sa","DT@R1R4";eir 7
183:   wrt "sa","D3PUPA50,150LBTO ABORT a repetitive TEST, push MHz"
184:   wrt "sa","      (wait for end of TEST)@";ret

185: "#18":
186: "interrupt":rds("sa")→A;cfg 5,6;iret

187: "#19":
188: "syn 2":
189:   wrt "osc","^L10:00?N0:0;"
190:   wrt "osc","F20.0MA0.0M";wait 1000
191:   wrt "sa","IP SP20MZ CF15MZ LG5DB TS E1 A4 MF";red "sa",F
192:   if int(F/1e6+.5)=20;sfg 8;ret
193:   if int(F/1e6+.5)#10;2→D
194:   ret

195: "#20":
196: "spc":if flg5 and P<15;for Z=1 to pl;wrt P;next Z
197:   ret

198:
*5147

```

Figure 3. File 1, Annotated Listing (9 of 10)

#16

Places signal peak at reference level on analyzer CRT in log mode of operation. V is the amplitude to which the automatic synthesizer is set. A is the measured amplitude level. R is the reference level amplitude.

#17

Labels on analyzer CRT instructions for aborting a test and enables the interrupt request.

#18

Reads status of analyzer and clears Flags 5 and 6 when program is interrupted by MHz key.

#19

Determines whether HP 3330B Automatic Synthesizer or HP 3335A Frequency Synthesizer is being used. Sets each to a different frequency, then checks to find which frequency is present. Flag 8 is the indicator; set = HP 3335A, cleared = HP 3330B.

#20

Spaces between test record listings for all tests (Test No. 0) the required number of spaces for page formatting.

*Figure 3. File 1, Annotated Listing (10 of 10)*



## PRE-TEST AND ADJUSTMENT ROUTINE

### DESCRIPTION:

The CAL OUTPUT signal of the analyzer is checked for its specified output level and then used to calibrate the amplitude and frequency of the analyzer before testing begins. This is done using two routines which are contained in the operating program of the analyzer: RECALL 8 and RECALL 9. Then the Internal CAL Routine (KSW) is performed.

The first display, shown below, instructs the operator to measure the output level of the CAL OUTPUT.

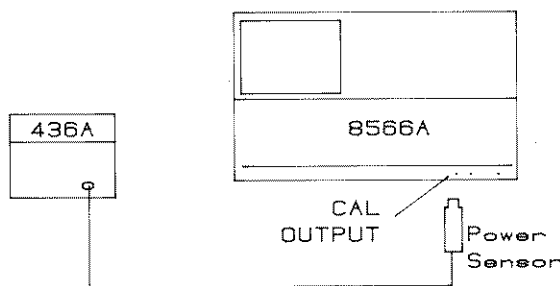

CONNECT POWER METER TO CAL OUTPUT  
AND VERIFY LEVEL IS  $-10\text{dBm} \pm 0.3\text{dB}$ .  
IF NOT REFER TO SECTION V OF  
OPERATING AND SERVICE MANUAL.

To CONTINUE, push Hz

The next display indicates the equipment setup to perform RECALL 8 and RECALL 9 calibration routines.

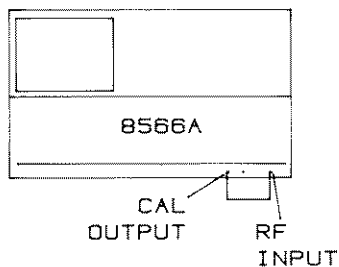

CONNECT BNC CABLE FROM CAL OUTPUT  
TO RF INPUT

To CONTINUE, push Hz

Figure 4. Pre-Test and Adjustment Routine (1 of 3)

```

0: "PRE-TEST AND ADJUSTMENT ROUTINE":
1: "t0f15: 790801":
2: "#1":
3: "Test set-up to check CAL OUTPUT amplitude":gsb "pwr mtr"
4: "#3":
5: "Test set-up for pre-cal":gsb "cbl"
6: "Amplitude calibration":wrt "sa","RC8 EM DT@"
7:   wrt "sa","D3PUPA96,368LBADJUST ""AMPTD CAL"" FOR A"
8:   wrt "sa","          MARKER AMPLITUDE READING"
9:   wtb "sa","          OF -10.00dBm ",171,"0.02dB",10,13,3
10:  wrt "sa","PUPA96,96LBTO CONTINUE, push Hz@"
11:   gsb "wait"
12:   wrt "sa","MA";red "sa",A;if abs(A+10)>.5;gto -7
13: "#4":
14: "Frequency calibration":wrt "sa","RC9 EM DT@"
15:   wrt "sa","D3PUPA96,368LBADJUST ""FREQ ZERO"" FOR A"
16:   wrt "sa","          MAXIMUM SIGNAL LEVEL ON DISPLAY@"
17:   wrt "sa","PUPA96,96LBTO CONTINUE, push Hz@"
18:   gsb "wait"
19:   wrt "sa","KSW"
20:   gto "test select"

21: "#2":
22: "pwr mtr":
23:
24:   gsb "ana"
25:   wrt "sa","D2PUPR-170,-30PD0,150,-150,0"
26:   wrt "sa","0,-150,150,0PU0,100PD-150,0"
27:   wrt "sa","PU112,-80PD0,-180,513,0,0,60"
28:   wrt "sa","15,0,0,80,-5,0,0,15,-15,0,0,-15,-5,0,0,-80,15,0"
29:   wrt "sa","PU-10,135PD-75,-70"
30:   wrt "sa","D3PUPA600,368LBPower@PUPA600,336LBSensor@"
31:   wrt "sa","PUPA472,400LBCAL@PUPA424,368LBOUTPUT@"
32:   wrt "sa","PUPA176,496LB436A@PUPA224,432LB0@"
33:   wrt "sa","PUPA64,256LBCONNECT POWER METER TO CAL OUTPUT"
34:   wtb "sa","          AND VERIFY LEVEL IS -10dBm ",171," 0.3dB.",10,13
35:   wrt "sa","          IF NOT REFER TO SECTION V OF"
36:   wtb "sa","          OPERATING AND SERVICE MANUAL.",3,10,13;gsb "wait"
37:   ret

```

\*24429

Figure 4. Pre-Test and Adjustment Routine (2 of 3)



#1

Instructs operator to check CAL OUTPUT level. Actual routine for drawing setup is 'pwr mtr' (Group #2).

#2

Draws equipment setup and labels instructions for operator to check CAL OUTPUT level.

#3

Instructs operator to adjust AMPTD CAL for specified CAL OUTPUT signal level on CRT.

#4

Instructs operator to adjust FREQ ZERO for specified indication on CRT.

*Figure 4. Pre-Test and Adjustment Routine (3 of 3)*



## 1. IF GAIN UNCERTAINTY

### SPECIFICATION:

0.0 dBm to -55.9 dBm;  $\pm 0.6$  dB  
-56.0 dBm to -129.9 dBm;  $\pm 1.0$  dB

### DESCRIPTION:

A signal source of known amplitude is input to the spectrum analyzer and the analyzer is adjusted for a reference level. The amplitude of the signal peak is measured in .1 dB steps from -0.1 dB to -1.9 dB, in 2 dB steps from -1.9 dB to -9.9 dB, in 10 steps from -10 dB to -120 dB.

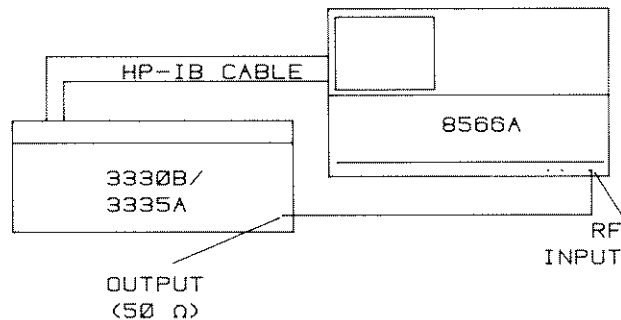

To CONTINUE, push Hz  
To SELECT ANOTHER TEST, push MHz  
Test Number 1

### EQUIPMENT:

Automatic Synthesizer . . . . . HP 3330B or 3335A

### PROCEDURE:

1. Select Test No. 1 by keying in   (  if continuous testing is desired) on the 8566A Keyboard.
2. The display shown above will appear on the 8566A CRT. Connect equipment as shown.
3. Follow the instructions as they appear on the 8566A CRT display.
4. The following is an annotated listing of the test procedure.

Figure 5. IF Gain Uncertainty Test (1 of 8)

```

0: "IF GAIN UNCERTAINTY":
1: "tof2: 790801":
2: "#1":
3:   if flg6 and X[2]>0;gto +4
4:   gsb "syn"
5:   if D>1;gto -1;if D=le6;gto "test select";cfg 5,6
6: "#2":
7: "test":
8:
9:   wrt "sa","IP CF7.6MZ RB1KZ "
10:  wrt "sa","SP2KZ VB100HZ LG1DB S2 TS"
11:  cll 'synthesizer'(7.6,-3,0)
12:  wrt "sa","KSI TS ELE2 TS MA";red "sa",A
13:  if A<-9;gto -9
14:  wtb "sa","D3PUPA224,592LBIF GAIN UNCERTAINTY",3
15:  cll 'on interrupt'
16:  gto +8

17: "#3":
18: "measure step":L-D→L
19:  cll 'synthesizer'(7.6,L-3)
20:  fmt 2,c,f.2,c;wrt "sa.2","RL",L,"DM"
21:  wtb "sa","TS MA";red "sa",A;if I=1;wrt "sa","M3 M3";ret
22:  A→D[2,I-1];L→D[1,I-1];ret

```

Figure 5. IF Gain Uncertainty Test (2 of 8)

#1

Draws equipment setup on CRT and checks for proper keyboard entry to continue test or abort. D is returned value from keyboard entry.

#2

Sets analyzer controls to proper setting for test. Verifies that output signal of automatic synthesizer is present on spectrum analyzer CRT and labels test title on CRT. A is amplitude of signal measured.

#3

The program flow is as follows:

- 1) Reference level value is established using variables L and D supplied by for/next loops #4, #5, and #6.
- 2) Automatic synthesizer output level is set to 3 dB below this established value of L.
- 3) Spectrum analyzer reference level is set to established value of L.
- 4) Marker Delta is used to measure the amplitude difference between current signal and first signal measured.
- 5) Reference level setting is stored in variable  $D[1, I - 1]$  and measured amplitude A is stored in variable  $D[2, I - 1]$ ; return to for/next loop.

*Figure 5. IF Gain Uncertainty Test (3 of 8)*

```

23: "#4":
24:   .1→L;.1→D
25:   for I=1 to 11
26:     if I=4;.2→D
27:     gsb "measure step"
28:   next I
29: "#5":
30:   .1→L;2→D
31:   for I=12 to 16
32:     gsb "measure step"
33:   next I
34: "#6":
35:   0→L;10→D
36:   for I=17 to 23
37:     if I=23;wrt "sa","VB10HZ"
38:     gsb "measure step"
39:   next I
40: "#7":
41:   wrt "sa","KSq VB100HZ";c11 'synthesizer'(7.6,-23,10)
42:   for I=24 to 28
43:     L-10→L;wrt "sa","RL",L,"DM";c11 'syn up/down'(0)
44:     if I=26;wrt "sa","VB10HZ"
45:     wrt "sa","TS MA";red "sa",D[2,I-1]
46:     L→D[1,I-1]
47:   next I

```

Figure 5. IF Gain Uncertainty Test (4 of 8)



#4

In the for/next loop, the spectrum analyzer reference level is stepped in either .1-dB or .2-dB steps from  $- .1$  dB to  $-1.8$  dB to measure all .1-dB gain steps. The actual measurements are performed in 'measure step' (#3). Variable L is the reference level setting, and variable D is the step size.

#5

In the for/next loop, the spectrum analyzer reference level is stepped in 2-dB steps from  $-1.9$  dB to  $-9.9$  dB to measure all 2-dB gain steps. The actual measurements are performed in 'measure step' (#3). Variable L is the reference level setting and variable D is the step size.

#6

In the for/next loop, the spectrum analyzer reference level is stepped in 10-dB steps from  $-10$  dB to  $-70$  dB to measure the 10-dB gain steps. The actual measurements are performed in 'measure step' (#3). Variable L is the reference level setting, and variable D is the step size.

#7

The 10-dB gain steps for reference level settings from  $-80$  dB to  $-120$  are measured by stepping the spectrum analyzer reference level in 10-dB steps and reducing the automatic synthesizer output level a corresponding 10 dB. Reference level settings are stored in variable  $D[1, I - 1]$  and measured signal levels are stored in variable  $D[2, I - 1]$ .

Figure 5. IF Gain Uncertainty Test (5 of 8)

```

48: "#8":
49: "print out":
50:
51:   if flg3;gto +14
52:   if P>15;wrt "sa","IP KSi EM KSm KSo A4 D2 DA0PUPA0,1000LB"
53:   wtb P,"          1. IF GAIN UNCERTAINTY",10,10,13
54:   fmt 5,/,10x,c
55:   wrt P+.5,"SPECIFICATION: Reference Level (uncorrected)"
56:   fmt 5,/,25x,c;wrt P+.5,"Range          Error"
57:   fmt 5,19x,c;wrt P+.5,"0.0 to  -55.9dBm      +/-0.6dB"
58:   wrt P+.5,"-56 to -129.9dBm      +/-1.0dB";wrt P
59:   wrt P,"          MEASURED:  (attenuator set at 10dB)"
60:   fmt 5,/,27x,c;wrt P+.5,"1kHz Bandwidth";wrt P
61:   fmt 5,19x,c;wrt P+.5,"Reference          Error in dB"
62:   fmt 2,21x,"Level",15x,"(Ref to",/,21x,"(dBm)",13x,f7.2,"dBm)",/
63:   wrt P+.2,0
64: "#9":
65:   for I=1 to 27;32+A
66:   .6+r1;if I>21;l+r1
67:   if abs(D[2,I])>r1;42+A;sfg 1
68:   if flg3;next I;gto +14
69:   if I=11 or I=16 or I=23;wrt P
70:   if I=1;fmt 4,26x,"0.1dB GAIN STEPS";wrt P+.4
71:   if I=11;fmt 4,26x,"2.0dB GAIN STEPS";wrt P+.4
72:   if I=16;fmt 4,26x,"10 dB GAIN STEPS";wrt P+.4
73:   fmt 3,14x,f12.1,f20.2,b,b
74:   wrt P+.3,D[1,I],D[2,I],A,A
75:   if I=10 and P>15;wrt "sa","          To CONTINUE, press Hz"
76:   if I=10 and P>15;wtb "sa",3;gsb "wait"
77:   if I=10 and P>15;wtb "sa","A1 A4 B1 B4 D2 DA0PUPA0,1000LB"
78:   next I;cll 'spc'(10)
79:   gto +12

80: "#10":
81: "print out for 9825A printer":
82:   prt "          TEST NO. 1          I.F. gains          ";if not flg1;gto +6
83:   spc ;prt "out of tolerance";spc
84:   fmt 5,f6.1,"dB",f6.2,"dB"
85:   for I=1 to 27;wrt 16.5,D[1,I],D[2,I];next I
86:   prt "REFER TO          OPERATING AND          SERVICE MANUAL          SECTION IV"
87:   spc ;gto +2

88:   spc ;prt "          PASSED          ";spc
89:   fmt 6,16" _",2/;wrt 16.6
90: "#11":
91:   l+flg1+X[2];cfg 1;gsb "p/f"
92:   if P>15;wrt "sa","          To CONTINUE, press Hz"
93:   if P>15;wtb "sa",3;gsb "wait"
94:   gto "test select"

```

\*14938

Figure 5. IF Gain Uncertainty Test (6 of 8)

#8

Prints specifications and headings for measured values on HP 9866B or HP 9871A Printer, if used. Displays data on CRT if P is equal to analyzer address.

#9

Prints measured values for IF step gains on HP 9866B or HP 9871A Printer, if used. Flag 1 is set if a value is out of tolerance, and double asterisks (\*\*) are printed next to incorrect data.

#10

Prints test title and either 'passed' or 'out of tolerance' on HP 9825A strip printer if external printer is not used (Flag 3 set).

#11

Prints either 'passed' or 'out of tolerance' message on external printer, returns to test listing, and labels 'yes' or 'no' adjacent to test titles on CRT, depending on value of X[2].

*Figure 5. IF Gain Uncertainty Test (7 of 8)*

TEST NO. 1  
I.F. gains

out of tolerance

Reference Level Setting	-0.1dB	0.02dB	dB Error Referenced to 0 dB Ref Level
	-0.2dB	0.02dB	
	-0.4dB	0.02dB	
	-0.6dB	0.02dB	
	-0.8dB	0.02dB	
	-1.0dB	0.02dB	
	-1.2dB	0.02dB	
	-1.4dB	0.02dB	
	-1.6dB	1.10dB	
	-1.8dB	0.02dB	
	-1.9dB	0.02dB	
	-3.9dB	0.02dB	
	-5.9dB	0.02dB	
-7.9dB	0.02dB		
-9.9dB	0.02dB		
-10.0dB	0.02dB		
-20.0dB	0.02dB		
-30.0dB	0.02dB		
-40.0dB	0.02dB		
-50.0dB	0.02dB		
-60.0dB	0.02dB		
-70.0dB	0.02dB		
-80.0dB	0.02dB		
-90.0dB	0.02dB		
-100.0dB	0.02dB		
-110.0dB	0.02dB		
-120.0dB	0.02dB		

REFER TO  
OPERATING AND  
SERVICE MANUAL  
SECTION IV

-----

Figure 5. IF Gain Uncertainty Test (8 of 8)

## 2. SCALE FIDELITY (log)

### SPECIFICATIONS:

$\leq \pm 1.0$  dB max over 0 to 80 dB display.

$\leq \pm 1.5$  dB max over 0 to 90 dB display.

### DESCRIPTION:

The specification listed is for cumulative error. Only cumulative error is measured in this procedure.

A signal source of known amplitude is input to the spectrum analyzer and the analyzer adjusted for a reference. The signal source is stepped down in 2 dB steps and the displayed signal amplitude on the analyzer measured at each step. This measurement is performed in both the 3 kHz and 300 kHz bandwidths.

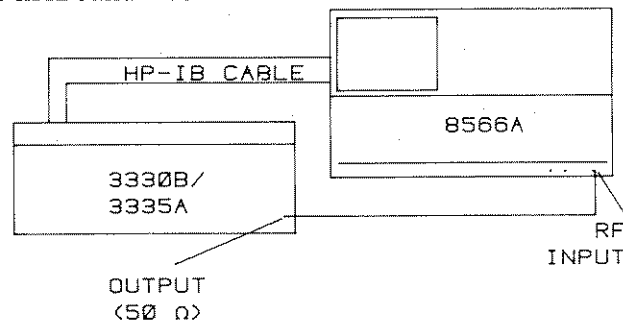

CONNECT SYNTHESIZER TO 8566A AS SHOWN

To CONTINUE, push Hz  
To SELECT ANOTHER TEST, push MHz  
Test Number 2

### EQUIPMENT:

Automatic Synthesizer..... HP 3330B or 3335A

### PROCEDURE:

1. Select test no. 2 by keying in  (   (    if continuous testing is desired) on the 8565A Keyboard.
2. The display shown above will appear on the 8566A CRT. Connect equipment as shown.
3. Follow the instructions as they appear on the 8566A CRT display.
4. The following is an annotated listing of the test procedure.

Figure 6. Scale Fidelity (Log) Test (1 of 10)

```

0: "SCALE FIDELITY (log)":
1: "t0f3: 791002":
2: "#1":
3:   if flg5 or flg6 and X[3]>0;gto +3
4: "Test set up for Log Fidelity":gsb "syn"
5:   if D>1;gto -1;if D=le6;gto "test select";cfg 5,6
6: "#2":
7: "test":
8:
9:   wtb "sa","IPD3PUPA272,592LBLOG FIDELITY",3
10:  cll 'on interrupt'
11:  wrt "sa","CF7.6MZ SPOHZ RB3KZ RL10DM AT30DB S2"
12:  cll 'synthesizer'(7.6,10,2)
13:  wrt "sa","TS E1 MA";red "sa",A;if A<2;gto -8
14: "#3":
15: "Sets signal to reference level":gsb "top log"
16:  0→B;wrt "sa","M3 KSM TS"
17: "Tests 90dB of Log Fidelity 3kHz BW":for I=1 to 45
18:   if I=35;wrt "sa","VB30HZ TS"
19:   if I=42;wrt "sa","VB3HZ TS"
20:   if I=10;wrt "sa","AT20DB TS MA";red "sa",B;B-A→B
21: "Steps synthesizer down":cll 'syn up/down'(0);wait 250
22:  wrt "sa","TS MA";red "sa",A
23:   if I<5;A-B+2*I→D[2,I];2I→D[1,I]
24:   if not I mod 5;A-B+2*I→D[2,I/5+4];2I→D[1,I/5+4]
25:  next I

```

Figure 6. Scale Fidelity (Log) Test (2 of 10)



#1

Draws equipment setup on CRT and checks for proper keyboard entry to continue test or abort.

#2

Sets analyzer controls to proper settings for test. Verifies that output signal of automatic synthesizer is present on spectrum analyzer and labels test title on CRT.

#3

Sets signal peak to reference level and tests 90 dB of log fidelity in the 3-kHz bandwidth. The program flow is as follows:

- 1) The signal peak is placed at the reference level for the first setting. A reference is then established using the Marker Delta mode with the signal peak at the reference level.
- 2) A for/next loop is established to step the synthesizer amplitude down in 2-dB steps from +10 dB to -60 dB.
- 3) The amplitude is measured at each 2-dB step.
- 4) At  $I=10$ , the attenuator is changed from 30 dB to 20 dB, and the error is measured and subtracted from future measurements.
- 5) Measured value is subtracted from expected value, and error is stored in variable  $D[2,I]$ . Input signal level is stored in  $D[1,I]$ . The values stored are only the first five (-2, -4, -6, -8, and -10 dB), and each 10-dB increment thereafter to -90 dB.

*Figure 6. Scale Fidelity (Log) Test (3 of 10)*

```

26: "#4":
27:   wrt "sa","RB300KZ AT30DB TS"
28:   cll 'synthesizer'(7.6,10,2)
29:   gsb "top log"
30:   0→B;wrt "sa","VB30HZ M3 KSM TS"
31: "#5":
32: "Tests 70dB of Log Fidelity 300kHz BW":for I=1 to 35
33:   if I=10;wrt "sa","AT20DB TS MA";red "sa",B;B-A→B
34:   cll 'syn up/down'(0);wait 250
35:   wrt "sa","TS MA";red "sa",A
36:   if I<5;2I→D[1,I+13];A-B+2*I→D[2,I+13]
37:   if not I mod 5;2I→D[1,I/5+17];A-B+2*I→D[2,I/5+17]
38:   next I

```

Figure 6. Scale Fidelity (Log) Test (4 of 10)

#4

The spectrum analyzer bandwidth is changed to 300 kHz, analyzer and synthesizer control settings are reset to initial settings used for measurement in 3-kHz bandwidth, and a new reference is established.

#5

Tests 70 dB of log fidelity in the 300-kHz bandwidth. The program flow is as follows:

- 1) The signal peak is placed at the reference level, and a reference is then established using the Marker Delta mode with the signal peak at the reference level.
- 2) A for/next loop is established to step the synthesizer amplitude down in 2-dB steps from +10 dB to -60 dB.
- 3) The amplitude is measured at each 2-dB step.
- 4) At  $I=10$ , the attenuator is changed from 30 dB to 20 dB, and the error is measured and subtracted from future measurements.
- 5) Measured value is subtracted from expected value, and the error is stored in variable  $D[2,I+13]$ . Input signal levels are stored in variable  $D[1,I+13]$ . The values stored are the first five steps (-2, -4, -6, -8, and -10 dB) and each 10-dB thereafter to -70 dB.

*Figure 6. Scale Fidelity (Log) Test (5 of 10)*

```

39: "#6":
40: "print out":
41:
42:   if flg3;gto +12
43:   if P>15;wrt "sa","IP KSi EM KSm KSo A4 D2 DAOPUPAO,1000LB"
44:   wtb P,"          2. SCALE FIDELITY (Log)",10,10,13
45:   fmt 5,/,10x,c,/
46:   wrt P+.5,"SPECIFICATION : Cumulative Error"
47:   fmt 5,20x,c;wrt P+.5,"<= +/-1.0dB over 0-80dB display"
48:   wrt P+.5,"<= +/-1.5dB over 0-90dB display"
49:   wrt P;wrt P,"          MEASURED:"

50:   fmt 5,20x,c;wrt P+.5,"          3 kHz Bandwidth"
51:   wrt P+.5,"dB Down          Cumulative"
52:   wrt P+.5,"From Ref          Error in dB"
53: "#7":
54:   for I=1 to 13
55:     32+A>B;l+r1;if I=13;1.5>r1
56:     if abs(D[2,I])>r1;42>A;sfg 1
57:     if flg3;gto +3
58:     fmt 3,10x,f15.1,f17.1,b,b,f15.1,b,b
59:     wrt P+.3,D[1,I],D[2,I],A,A
60:     next I;if flg3;gto +9
61: "#8":
62:   if P>15;wrt "sa","          To CONTINUE, press Hz"
63:   if P>15;wtb "sa",3;gsb "wait"
64:   if P>15;wrt "sa","A1 A4 B1 B4 D2 DAOPUPAO,1000LB"
65: "#9":
66:   fmt 5,20x,c;wrt P;wrt P+.5,"          300 kHz Bandwidth"
67:   wrt P+.5,"dB Down          Cumulative"
68:   wrt P+.5,"From Ref          Error in dB"

```

Figure 6. Scale Fidelity (Log) Test (6 of 10)

#6

Prints specifications and headings for measured values in 3-kHz bandwidth on HP 9866B or HP 9871A Printer, if used, or displays data on analyzer CRT if P is equal to analyzer address.

#7

Prints measured values for 3-kHz bandwidth on HP 9866B or HP 9871A Printer, if used. Sets Flag 1 if error is detected in data to be printed.

#8

Waits for operator to press Hz key to continue if data is displayed on analyzer CRT.

#9

Prints headings for measured values in 300-kHz bandwidth on HP 9866B or HP 9871A Printer, if used.

*Figure 6. Scale Fidelity (Log) Test (7 of 10)*

```

69: "#10":
70:     for I=14 to 24
71:         32→A→B;l→r1
72:         if abs(D[2,I])>r1;42→A;sfg 1
73:         if flg3;next I;gto +5
74:     wrt P+.3,D[1,I],D[2,I],A,A
75:     next I;c11 'spc'(3)
76: "#11":
77:     gto +11

78: "#12":
79: "print out for 9825A printer":
80:     prt "    TEST NO. 2    log fidelity  ";if not flg1;gto +5
81:     spc ;prt "out of tolerance";spc
82:     fmt 5,2f6.2,"dB";for I=1 to 24;wrt 16.5,D[1,I],"dB",D[2,I];next I
83:     prt "REFER TO    OPERATING AND    SERVICE MANUAL    SECTION IV"
84:     spc ;gto +2

85:     spc ;prt "    PASSED    ";spc
86:     fmt 6,16" _",2/;wrt 16.6
87: "#13":
88:     l+flg1+X[3];cfg 1;gsb "p/f"
89:     if P>15;wrt "sa","    To CONTINUE, press Hz"
90:     if P>15;wtb "sa",3;gsb "wait"
91:     gto "test select"
*8765

```

Figure 6. Scale Fidelity (Log) Test (8 of 10)



#10

Prints measured values for 300-kHz bandwidth on HP 9866B or HP 9871A Printer, if used. Sets Flag 1 for error. Prints measured values (– 10 to – 70 dBm) for 300-kHz bandwidth on HP 9866B or HP 9871A Printer, if used. Sets Flag 1 for error.

#11

Prints titles and either 'passed' or 'out of tolerance' on HP 9825A strip printer. If 'out of tolerance' is printed, all measured values for the 3-kHz bandwidth are printed also.

#12

Prints 'passed' or 'out of tolerance' message on external printer, returns to test listing, and labels 'yes' or 'no' adjacent to test title on CRT.

#13

Prints 'passed' or 'out of tolerance' message on external printer, returns to test listing, and labels 'yes' or 'no' adjacent to test titles on CRT, depending on value of X[3].

*Figure 6. Scale Fidelity (Log) Test (9 of 10)*

TEST NO. 2  
log fidelity

out of tolerance

3 kHz BW Change in Input Level	}	2.00dB	0.30dB	}	Cumulative Error Referenced to 10 dB Input Level
		4.00dB	0.30dB		
		6.00dB	0.30dB		
		8.00dB	0.30dB		
		10.00dB	0.30dB		
		20.00dB	0.30dB		
		30.00dB	0.30dB		
		40.00dB	0.30dB		
		50.00dB	0.30dB		
		60.00dB	1.40dB		
300 kHz BW Change in Input Level	}	70.00dB	0.30dB	}	Cumulative Error Referenced to 10 dB Input Level
		80.00dB	0.30dB		
		90.00dB	0.30dB		
		2.00dB	0.30dB		
		4.00dB	0.30dB		
		6.00dB	0.30dB		
		8.00dB	0.30dB		
		10.00dB	0.30dB		
		20.00dB	0.30dB		
		30.00dB	0.30dB		
40.00dB	0.30dB				
50.00dB	0.30dB				
60.00dB	0.30dB				
70.00dB	0.30dB				

REFER TO  
OPERATING AND  
SERVICE MANUAL  
SECTION IV

Figure 6. Scale Fidelity (Log) Test (10 of 10)

### 3. SCALE FIDELITY (linear)

#### SPECIFICATION:

$\pm 3\%$  of Reference level

#### DESCRIPTION:

A signal source of known amplitude is input to the spectrum analyzer and the analyzer adjusted for a reference. The signal source is stepped down from  $-10$  dB to  $-30$  dB in 10 dB steps and the amplitude of the displayed signal measured using the marker function. This measured value is used to calculate the percent error from the reference level established.

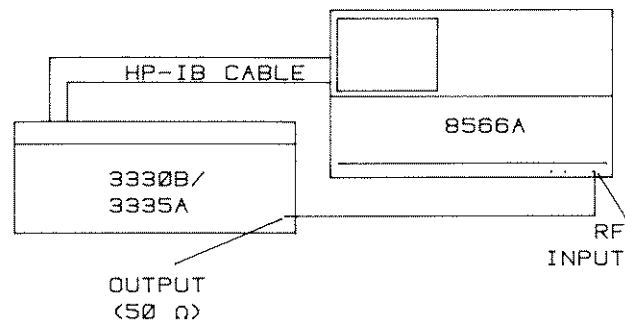

CONNECT SYNTHESIZER TO 8566A AS SHOWN

To CONTINUE, push Hz  
To SELECT ANOTHER TEST, push MHz  
Test Number 3

#### EQUIPMENT:

Automatic Synthesizer . . . . . HP 3330B or 3335A

#### PROCEDURE:

1. Select Test No. 3 by keying in **3** (**Hz** **μV** **μsec**) (**KHz** **mV** **msec** if continuous testing is desired) on the 8566A Keyboard.
2. The display shown above will appear on the 8566A CRT. Connect equipment as shown.
3. Follow the instructions as they appear on the 8566A CRT display.
4. The following is an annotated listing of the test procedure.

Figure 7. Scale Fidelity (Linear) Test (1 of 6)

```

0: "SCALE FIDELITY (linear)":
1: "t0f4: 791002":
2: "#1":
3:   if flg5 or flg6 and X[4]>0;gto +5
4: "Test set up for Linear Fidelity":gsb "syn"
5:   if D>1;gto -1;if D=le6;gto "test select";cfg 5,6
6: "#2":
7: "test":
8:
9:   wrt "sa","IP CF7.6MZ SPOHZ RB3KZ LN S2 TS"
10:  cll 'synthesizer'(7.6,0,10)
11:  wrt "sa","TS M1 MA";wait 500;red "sa",A;if A<.02;gto -7
12:  gsb "top lin"
13:  wtb "sa","D3PUPA256,592LBLINEAR FIDELITY",3
14:  cll 'on interrupt'
15: "#3":
16:  wrt "sa","M2 TS MA";wait 100;red "sa",A
17: "Steps synthesizer down":c1l 'syn up/down'(0)
18:  wrt "sa","TS MA";wait 100;red "sa",B
19:  cll 'syn up/down'(0)
20:  wrt "sa","TS MA";wait 100;red "sa",C
21:  100(B/A-.316)→A[1];100(C/A-.1)→A[2]

```

Figure 7. Scale Fidelity (Linear) Test (2 of 6)

#1

Draws equipment setup on CRT and checks for proper keyboard entry to continue test or abort.

#2

Sets analyzer controls to proper settings for test. Sets synthesizer to proper frequency and amplitude for test. Verifies that output signal of synthesizer is present on analyzer and labels test title on CRT.

#3

Measures linear fidelity over a 20-dB range. Program flow is as follows:

- 1) With input signal level set at 0 dBm, signal amplitude is measured using Marker Normal function, and value is stored in variable A.
- 2) Synthesizer output level is stepped down 10 dB, signal amplitude is measured again, and value is stored in variable B.
- 3) Synthesizer output level is stepped down another 10 dB, signal amplitude is measured again, and value is stored in variable C.
- 4) Percent of error for each 10-dB step is calculated and stored in variables A[1] and A[2].

*Figure 7. Scale Fidelity (Linear) Test (3 of 6)*

```

22: "#4":
23: "print out":
24:
25: 32→A→B
26: if abs(A[1])>3;42→A;sfg 1
27: if abs(A[2])>3;42→B;sfg 1
28: if flg3;gto +15
29: if P>15;wrt "sa","IP KSi EM KSm KSo A4 D2 DA0PUPA0,1000LB"
30: wtb P,10,10,13," 3. SCALE FIDELITY (Linear)",10,10,13
31: wrt P," SPECIFICATION:"
32: fmt 5,/,20x,"+/-3% of Reference Level",/;wrt P+.5
33: wrt P," MEASURED:"
34: fmt 5,20x,"dB Down",11x,"Error in %";wrt P+.5
35: fmt 5,20x,"From Ref",10x,"of Reference",/;wrt P+.5
36: "#5":
37: fmt 3,22x,f2.0,"dB",14x,f5.2,"%",b,b
38: wrt P+.3,10,A[1],A,A
39: wrt P+.3,20,A[2],B,B;c11 'spc'(6)
40: gto +11

41: "#6":
42: "print out for 9825A printer":
43: prt " TEST NO. 3 linear fidelity ";if not flg1;gto +5
44: spc ;prt "out of tolerance";spc
45: fmt 5,f14.2," %";for I=1 to 2;wrt 16.5,A[I];next I
46: prt "REFER TO OPERATING AND SERVICE MANUAL SECTION IV"
47: spc ;gto +2

48: spc ;prt " PASSED ";spc
49: fmt 6,16"_"",2/;wrt 16.6
50: "#7":
51: 1+flg1→X[4];cfg 1;gsb "p/f"
52: if P>15;wrt "sa"," To CONTINUE, press Hz"
53: if P>15;wtb "sa",3;gsb "wait"
54: gto "test select"

```

\*7401

Figure 7. Scale Fidelity (Linear) Test (4 of 6)

#4

Prints specifications and headings for measured values on HP 9866B or HP 9871A Printer, if used. Sets Flag 1 if data measured is in error.

#5

Prints measured values on HP 9866B or HP 9871A Printer, if used, or displays data on analyzer CRT if P is equal to analyzer address.

#6

Prints test title and either 'passed' or 'out of tolerance' on HP 9825A strip printer. If 'out of tolerance' is printed, measured values are printed also.

#7

Prints 'passed' or 'out of tolerance' on external printer, returns to test listing, and labels 'yes' or 'no' adjacent to test title on CRT.

*Figure 7. Scale Fidelity (Linear) Test (5 of 6)*



TEST NO. 3  
linear fidelity

out of tolerance

10 dB down	1.60 %	} Error in % of Ref Level
20 dB down	3.20 %	

REFER TO  
OPERATING AND  
SERVICE MANUAL  
SECTION IV

-----

Figure 7. Scale Fidelity (Linear) Test (6 of 6)

#### 4. LOG SCALE SWITCHING UNCERTAINTY

##### SPECIFICATION:

$\pm 0.5$  dB

##### DESCRIPTION:

A signal source of known amplitude is input to the spectrum analyzer and the analyzer adjusted for a reference in LOG 1 dB/Division. The analyzer is then switched to each of the other LOG scales (2 dB, 5 dB, and 10 dB) and the amplitude of the signal is measured at each setting.

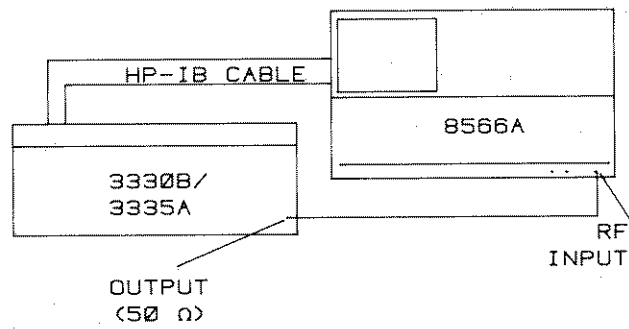

CONNECT SYNTHESIZER TO 8566A AS SHOWN

To CONTINUE, push Hz  
To SELECT ANOTHER TEST, push MHz  
Test Number 4

##### EQUIPMENT:

Automatic Synthesizer . . . . . HP 3330B or 3335A

##### PROCEDURE:

1. Select Test No. 4 by keying in   (  if continuous testing is desired) on the 8566A Keyboard.
2. The display shown above will appear on the 8566A CRT. Connect equipment as shown.
3. Follow the instructions as they appear on the 8566A CRT display.
4. The following is an annotated listing of the test procedure.

Figure 8. Log Scale Switching Uncertainty Test (1 of 6)

```

0: "LOG SCALE SWITCHING UNCERTAINTY":
1: "tof5: 790801":
2: "#1":
3:   if flg5 or flg6 and X[5]>0;gto +6
4: "Test set-up for log switching":gsb "syn"
5:   if D>1;gto -1;if D=1e6;gto "test select";cfg 5,6
6: "#2":
7: "test":
8:
9:   wrt "sa","IP CF7.6MZ SPOHZ RB3KZ LG1DB RL-5DM S2 TS DT@"
10:  cll 'synthesizer'(7.6,-7,0)
11:  wrt "sa","TS E1 MA";red "sa",A;if A<-13;gto -7
12:  wrt "sa","D3PUPA256,592LBLOG SWITCHING@"
13:  cll 'on interrupt'
14: "#3":
15: "Sets the signal to reference line":gsb "top log"
16:  V→F
17:  wrt "sa","LG2DB TS";gsb "top log"
18:  V-F→A[1]
19:  wrt "sa","LG5DB TS";gsb "top log"
20:  V-F→A[2]
21:  wrt "sa","LG10DB TS";gsb "top log"
22:  V-F→A[3]
23: "#4":
24: "print out":
25:
26:   if flg3;gto +9
27:   if P>15;wrt "sa","IP KSi EM KSm KSo A4 D2 DA0PUPA0,1000LB"
28:   wtb P,"          4. LOG SCALE SWITCHING UNCERTAINTY",10,13
29:   fmt 5,2/,10x,c
30:   wrt P+.5,"SPECIFICATION: Referenced to 1dB/div"
31:   fmt 5,/,20x,"+/-0.5dB (uncorrected)",/;wrt P+.5
32:   wrt P,"          MEASURED: (Ref to 1dB/div)"
33: "#5":
34:   fmt 5,20x,c,10x,c;wrt P+.5,"Log Scale","Error in dB"
35:   32→A→B→C
36:   if abs(A[1])>.5;42→A;sfg 1
37:   if abs(A[2])>.5;42→B;sfg 1
38:   if abs(A[3])>.5;42→C;sfg 1
39:   if flg3;gto +8
40:   fmt 3,20x,f2.0,"dB/div",f18.2,b,b
41:   wrt P+.3,2,A[1],A,A
42:   wrt P+.3,5,A[2],B,B
43:   wrt P+.3,10,A[3],C,C;c11 'spc'(4)
44:   gto +11

```

Figure 8. Log Scale Switching Uncertainty Test (2 of 6)

#1

Draws equipment setup on CRT and checks for proper keyboard entry to continue test or abort.

#2

Sets analyzer controls to proper settings for test. Sets synthesizer frequency and amplitude for test. Verifies that output signal of synthesizer is present on analyzer and labels test title on CRT.

#3

With a reference established in 1 dB log, each of the other three log scales (2 dB, 5 dB, and 10 dB) is selected, and signal peak is set to reference level in each scale by changing reference level. Each signal level is referenced to the 1 dB/Div scale, and the difference is stored in variables A[1], A[2], and A[3].

#4

Prints specifications and headings for measured values on HP 9866B or HP 9871A Printer, if used, or displays the data on the analyzer CRT if P is equal to the analyzer address.

#5

Checks measured values against specifications and prints measured values on HP 9866B or HP 9871A Printer, if used. Sets Flag 1 if data measured is in error.

*Figure 8. Log Scale Switching Uncertainty Test (3 of 6)*

```

45: "#6":
46: "print out for 9825A printer":
47:   prt "  TEST NO. 4    log switching  ";spc ;if not flgl;gto +5
48:   prt "out of tolerance";spc

49:   fmt 5,f14.2,"dB";for I=1 to 3;wrt 16.5,A[I];next I
50:   prt "REFER TO          OPERATING AND  SERVICE MANUAL  SECTION IV"
51:   spc ;gto +2

52:   prt "    PASSED";spc
53:   fmt 6,16" _",2/;wrt 16.6;gto +2

54: "#7":
55:  l+flgl>X[5];cfg 1;gsb "p/f"
56:   if P>15;wrt "sa","    To CONTINUE, press Hz"
57:   if P>15;wtb "sa",3;gsb "wait"
58:   gto "test select"
*29222

```

Figure 8. Log Scale Switching Uncertainty Test (4 of 6)

#6

Prints test title and either 'passed' or 'out of tolerance' on HP 9825A strip printer. If 'out of tolerance' is printed, measured values are also printed.

#7

Prints 'passed' or 'out of tolerance' message on external printer, returns to test listing, and labels 'yes' or 'no' adjacent to test title on CRT.

*Figure 8. Log Scale Switching Uncertainty Test (5 of 6)*

TEST NO. 4  
log switching  
out of tolerance

2 dB/	0.20dB	} Error Referenced to 1 dB/div
5 dB/	0.40dB	
10 dB/	1.30dB	

REFER TO  
OPERATING AND  
SERVICE MANUAL  
SECTION IV

-----

Figure 8. Log Scale Switching Uncertainty Test (6 of 6)



## 5. FREQUENCY SPAN ACCURACY

### SPECIFICATION:

For spans  $> 5$  MHz;  $\pm 3\%$  of indicated frequency separation.

For spans  $\leq 5$  MHz;  $\pm 1\%$  of indicated frequency separation.

### DESCRIPTION:

Frequency spans  $> 5$  MHz are measured using the LO feedthrough signal. The span is stepped down from 10 GHz to 5.001 MHz in a 10, 5, 1 sequence. For frequency spans  $\leq 5$  MHz, stable signal source is input to the spectrum analyzer, and the analyzer center frequency and span set to measure spans of 5 MHz and 100 kHz.

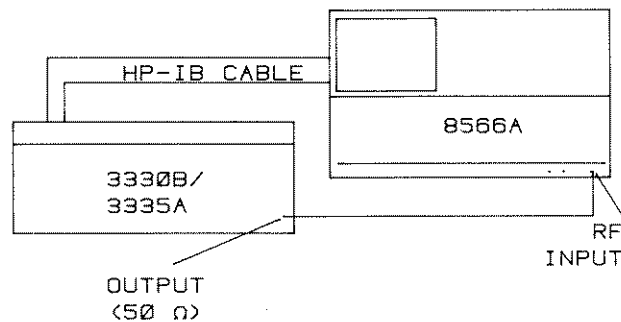

CONNECT SYNTHESIZER TO 8566A AS SHOWN

To CONTINUE, push Hz  
To SELECT ANOTHER TEST, push MHz  
Test Number 5

### EQUIPMENT:

Automatic Synthesizer . . . . . HP 3330B or 3335A

### PROCEDURE:

1. Select Test No. 5 by keying in **5** (**Hz** **μV** **μsec**) (**kHz** **mV** **msec** if continuous testing is desired) on the 8566A Keyboard.
2. The display shown above will appear on the 8566A CRT. Connect equipment as shown.
3. Follow the instructions as they appear on the 8566A CRT display.
4. The following is an annotated listing of the test procedure.

Figure 9. Frequency Span Accuracy Test (1 of 6)

```

0: "FREQUENCY SPAN ACCURACY":
1: "t0f6: 791003": "t0f6: 7912270"
2: "#1":
3:   if flg5 or flg6 and X[6]>0;gto +3
4: "Test set-up for SPANS":gsb "syn"
5:   if D>1;gto -1;if D=1e6;gto "test select";cfg 5,6
6: "#2":
7: "test":
8:
9:   wtb "sa","IP D3PUPA192,592LBFREQUENCY SPAN ACCURACY",3
10:  cll 'on interrupt'
11:  cll 'synthesizer'(7.6,-80)
12:    for I=0 to 1;9>X;if I=1;4>X
13:      for J=1 to 4;if J=4 and I=1;4.001>X
14:        wrt "sa","S2 CR FB",X*10^(10-J),"HZ FA",-10^(10-J),"HZ TS"
15:        wrt "sa","RBDN TS El MF";red "sa",A[J+4I]
16:        A[J+4I]/1e3>A[J+4I];next J;next I
17:    32>B>C
18: "5 MHz span":'span'(7.6,5)>A[9];if flg1;42>B
19: "100 KHz span":'span'(7.6,.1)>A[10];if flg1;42>C
20:   if max(B,C)=42;sfg 1
21:   if max(A[9],A[10])=0;gto -17
22: "#7":
23: "print out":
24:
25:   if flg3;gto +14
26:   if P>15;wrt "sa","IP KSi EM KSm KSo A4 D2 DA0PUPA0,1000LB"
27:   wtb P,"          5. FREQUENCY SPAN ACCURACY",10,10,13
28:   wrt P,"          SPECIFICATION:"
29:   fmt 5,18x,c;wrt P+.5," +/-1% of indicated separation"
30:   wrt P+.5," for spans <=5MHz"
31:   wrt P;wrt P+.5," +/-3% of indicated separation"
32:   wrt P+.5," for spans >5MHz"
33:   wrt P;wrt P,"          MEASURED:"
34:   fmt 5,16x,c
35:   if flg2;wrt P+.5,"*** CHECK CENTER FREQUENCY ACCURACY ***"
36:   wrt P+.5,"Frequency Span      Max Freq      Max Freq"
37:   wrt P+.5,"      Setting      Error Measured      Error Allowed"
38:   wrt P+.5,"      (MHz)      (kHz)      (kHz)"
39: "#8":
40:   5>X;10>Y
41:   for K=1 to 4;32>A>E;if K=4;5.001>X
42:     if abs(A[K])>Y*10^(6-K)*.023;sfg 1;42>A
43:     if abs(A[K+4])>X*10^(6-K)*.026;sfg 1;42>E
44:     if flg3;next K;gto +9
45:     fmt 2,16x,f10.3,9x,f8.2,b,b,10x,f8.1
46:     wrt P+.2,Y*10^(4-K),abs(A[K]),A,A,Y*10^(6-K)*.023
47:     wrt P+.2,X*10^(4-K),abs(A[K+4]),E,E,X*10^(6-K)*.026
48:     next K
49:     wrt P+.2,5,A[9],B,B,r15*1e3
50:     wrt P+.2,.1,A[10],C,C,r16*1e3;c11 'spc'(6)
51:     gto +11

```

Figure 9. Frequency Span Accuracy Test (2 of 6)

#1

Draws equipment setup on CRT and checks for proper keyboard entry to continue test or abort.

#2

Sets analyzer controls to proper setting for test. Labels test title on CRT. Measures LO feedthrough frequency error for spans  $>5$  MHz. Calls up a subprogram to measure spans of 5 MHz and 100 kHz. Span errors measured are returned to variables A[1] through A[10].

#7

Prints test title, specification, and headings for measured values on HP 9866B or HP 9871A Printer, if used, or displays data on analyzer CRT if P is equal to analyzer address.

#8

Prints measured span errors on HP 9866B or HP 9871A Printer, if used.

*Figure 9. Frequency Span Accuracy Test (3 of 6)*

```

52: "#9":
53: "print out for 9825A printer":
54:   prt "   TEST NO. 5   frequency span ";if not flgl;gto +5
55:   spc ;prt "out of tolerance";spc
56:   fmt 5,fl3.2,"kHz";for I=1 to 10;wrt 16.5,A[I];next I
57:   prt "REFER TO","OPERATING AND","SERVICE MANUAL","SECTION IV"
58:   spc ;gto +2

59:   spc ;prt "   PASSED";spc
60:   fmt 6,16"_"",2/;wrt 16.6
61: "#10":
62:  l+flgl→X[6];cfg 1,2;gsb "p/f"
63:  if P>15;wrt "sa","   To CONTINUE, press Hz"
64:  if P>15;wtb "sa",3;gsb "wait"
65:  gto "test select"

66: "#3":
67: "Computes actual span error":
68: "span":
69:   fmt 9,c,f.l,c,f.l,c;cfg 1
70:   wrt "sa.9","CF",p1,"MZ SP",p2,"MZ"
71:   wrt "sa","RBDN";0→K
72: "#4":
73:   for F=p1-.4p2 to p1+.4p2 by .1p2
74:   cll 'synthesizer'(F,-10,0)
75:   wrt "sa","TS E1 MF";red "sa",r(5+K);r(5+K)/1e6→r(5+K)
76:   if K=0;wrt "sa","MA";red "sa",Z;if Z<-60;0→p3;ret p3
77:   if p2=.1 and abs(p1-r(5+K))>.01 and F=p1;sfg 2
78:   K+1→K;next F;wrt "sa","CR"
79: "#5":
80:   if p2=5;.01p2→r15
81:   if p2<5;.01p2→r16
82:   0→p3;for I=0 to 7
83:     for J=I+1 to 7
84:       .1(J-I)p2→p4
85:       if p2=5;if abs(r(5+J)-r(5+I)-p4)>p3;.01p4→r15
86:       if p2<5;if abs(r(5+J)-r(5+I)-p4)>p3;.01p4→r16
87:       max(abs(r(5+J)-r(5+I)-p4),p3)→p3
88:     next J;next I
89: "#6":
90:   if p2=5;if p3>r15;sfg 1
91:   if p2<5;if p3>r16;sfg 1
92:   ret p3*1e3
*32765
*23534

```

Figure 9. Frequency Span Accuracy Test (4 of 6)

#9

Prints test title and either 'passed' or 'out of tolerance' on HP 9825A strip printer. If 'out of tolerance' is printed, measured errors are also printed

#10

Prints 'passed' or 'out of tolerance' message on external printer, returns to test listing, and labels 'yes' or 'no' adjacent to test title on CRT.

#3

Sets analyzer center frequency and span to values specified in #2. Values transferred are values in parentheses where first number is p1 and second is p2; for example: (7.6,10); p1 = 7.6 = center frequency; p2 = 10 = span.

#4

A for/next loop is established to step synthesizer output frequency from -4 divisions of center frequency to +4 divisions of center frequency and to store the marker frequency at each step in variable r(5+K).

#5

Allowable frequency separation for each step measured in #4 is calculated and stored in variables r14, r15, and r16. The maximum error for a span being measured is placed in variable p3.

#6

Error measured in #5 is compared with maximum allowable error calculated in #5, and error p3\*1e3 is returned to #2 as variables A[9] and A[10]. Flag 1 is set if measured data is in error.

Figure 9. Frequency Span Accuracy Test (5 of 6)

TEST NO. 5  
frequency span  
out of tolerance

SPAN {	10 MHz	20000.00 kHz	} Max Span Error Measured for any Span Separation
	1 MHz	10000.00 kHz	
	500 kHz	2000.00 kHz	
		1000.00 kHz	
		100.00 kHz	
		50.00 kHz	
		35.00 kHz	
		4.50 kHz	
		4.00 kHz	
		0.80 kHz	

REFER TO  
OPERATING AND  
SERVICE MANUAL  
SECTION IV

-----

Figure 9. Frequency Span Accuracy Test (6 of 6)

## 6. LINE RELATED SIDEBANDS

### SPECIFICATIONS:

50-60 Hz Line Frequency		400 Hz Line Frequency	
Offset from Carrier	Sideband Level	Offset from Carrier	Sideband Level
<360 Hz	-70 dBc	<2 kHz	-55 dBc

### DESCRIPTION:

A stable signal source is connected to the analyzer input and the necessary front-panel control settings made for the test. The operator is asked to input the line frequency used by entering the value on the 8566A Keyboard. The multiples (harmonics) of the line frequency are calculated, the necessary front-panel control settings made to view the frequencies, and the amplitude of the signal measured at each of the frequencies.

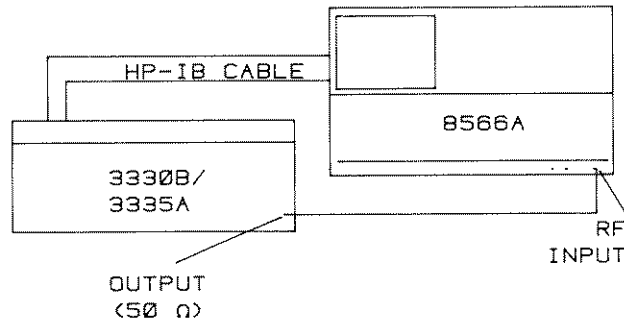

CONNECT SYNTHESIZER TO 8566A AS SHOWN

To CONTINUE, push Hz  
 To SELECT ANOTHER TEST, push MHz  
 Test Number 6

### EQUIPMENT:

Automatic Synthesizer . . . . . HP 3330B or 3335A

### PROCEDURE:

1. Select Test No. 6 by keying in **6** **Hz** (**μV** **μsec** if continuous testing is desired) on 8566A Keyboard.
2. The display shown above will appear on the 8566A CRT. Connect equipment as shown.
3. Follow the instructions as they appear on the 8566A CRT display.
4. The following is an annotated listing of the test procedure.

Figure 10. Line Related Sidebands Test (1 of 6)



```

0: "LINE RELATED SIDEBANDS":
1: "tOf7: 790828":
2: "#1":
3:   if flg5 or flg6 and X[7]>0;gto +4
4: "Line related sidebands test set up":gsb "syn"
5:   if D>1;gto -1;if D=le6;gto "test select";cfg 5,6
6: "#2":
7:   wrt "sa","IP A4 KSo KSm DT@"
8:   wrt "sa","D3PUPA16,496LBENTER LINE. FREQUENCY IN Hz ON 8566"
9:   wrt "sa"," DATA KEYBOARD.@ "
10:  gsb "entry"
11:  wrt "sa","R1R4EE";eir 7,0
12:  if bit(1,rds("sa"))=0;jmp 0
13:  wrt "sa","OA";red "sa",D;2D>F;if D>100;D>F
14: "#3":
15: "test":
16:
17:  wtb "sa","IPD3PUPA192,592LBLLINE RELATED SIDEBANDS",3
18:  cll 'on interrupt'
19:  cll 'synthesizer' (7.6,-10,0)
20:  wrt "sa","CF7.6MZ SP100HZ S2 TS E1 MA";red "sa",A
21:  wrt "sa","E2 E4 M1 CFOA";red "sa",B
22:  wrt "sa","A1"
23: "#4":
24:   for J=2 to 4
25:     J>G;if D>100;J-1>G
26:     for K=-1 to 1 by 2
27:       -120>A[J-1]
28:       wrt "sa","CF",B+GKD+40,"HZ VBlHZ"
29:       wrt "sa","CT M1 M2",B+GKD+10,"HZ KSu TS"
30:       for I=1 to 20
31:         wrt "sa","M2",B+GKD+10-I,"HZ KSM MA";red "sa",C
32:         max(C+7.8-A,A[J-1])>A[J-1]
33:       next I;next K;next J
34: "#5":
35: "print out":
36:
37:  32>A>B>C
38:  360>X;2>Y;32>Z;if D>=400;2>X;5.5>Y;107>Z
39:  70>r1;75>r2;if D>=400;55>r1;65>r2
40:  if flg3;gto +13
41:  if P>15;wrt "sa","IP KSi EM KSm KSo A4 D2 DAOPUPA0,1000LB"
42:  wtb P,10,10,13,"          6. LINE RELATED SIDEBANDS",10,10,13
43:  wrt P,"          SPECIFICATION:"
44:  fmt 2,24x,f3.0,c,/
45:  wrt P+.2,D," Hz POWER LINE FREQUENCY"
46:  fmt 5,19x,"Offset from Carrier",5x,"Sideband Level";wrt P+.5
47:  fmt 5,/,25x,"<",f3.0,b,"Hz",13x,f4.0,"dBc";wrt P+.5,X,Z,-r1
48:  fmt 5,20x,f3.0,b,"Hz to ",f3.1," kHz",8x,f4.0,"dBc"
49:  wrt P+.5,X,Z,Y,-r2
50:  wrt P;wrt P,"          MEASURED:"

```

Figure 10. Line Related Sidebands Test (2 of 6)

#1

Draws equipment setup on CRT and checks for proper keyboard entry to continue test or abort.

#2

Asks operator to enter frequency of power line used. This value is entered in 'entry' and returned as variable D.

#3

Labels test title on CRT and places peak of signal exactly at selected center frequency using Marker functions. Center frequency value is placed in variable B and amplitude in A.

#4

A for/next loop is established to measure the signal level at 2, 3, and 4 times (or 1, 2, and 3 times if line frequency is 400 Hz) the line frequency away from the center frequency on both sides. The signal is positioned so that the sideband to be measured falls within the first two divisions from the left of the display. Sweep Marker function is then used to make measurement. The maximum level measured for each pair of sidebands is placed in variable A[J-1].

#5

Prints test title, specification, and headings for measured values on HP 9866B or HP 9871A Printer, if used, or displays data on analyzer CRT if P is equal to the analyzer address.

*Figure 10. Line Related Sidebands Test (3 of 6)*

```

51: "#6":
52:   fmt 5,19x,c,5x,c,;/wrt P+.5,"Offset from Carrier","Sideband Level"
53:   if A[1]>-r1;42→A;sfg 1
54:   if A[2]>-r1;42→B;sfg 1
55:   if A[3]>-r1;42→C;sfg 1
56:   if flg3;gto +8
57:   fmt 3,24x,f4.0,"Hz",13x,f7.1,"dBc",b,b
58:   wrt P+.3,F,A[1],A,A
59:   wrt P+.3,D+F,A[2],B,B
60:   wrt P+.3,2D+F,A[3],C,C;cll 'spc'(8)
61:   gto +11

62: "#7":
63: "print out for 9825A printer":
64:   prt "   TEST NO. 6   line sidebands ";if not flg1;gto +5
65:   spc ;prt "out of tolerance";spc
66:   fmt 5,f13.1,"dBc";for I=1 to 3;wrt 16.5,A[I];next I
67:   prt "REFER TO           OPERATING AND   SERVICE MANUAL SECTION IV"
68:   spc ;gto +2

69:   spc ;prt "           PASSED           ";spc
70:   fmt 6,16"_"",2;/wrt 16.6
71: "#8":
72:   l+flg1→X[7];cfg 1;gsb "p/f"
73:   if P>15;wrt "sa","   To CONTINUE, press Hz"
74:   if P>15;wtb "sa",3;gsb "wait"
75:   gto "test select"

```

\*26975

Figure 10. Line Related Sidebands Test (4 of 6)

#6

Checks measured values against specifications and prints measured values on HP 9866B or HP 9871A Printer, if used. Sets Flag 1 if measured data is in error.

#7

Prints test title and either 'passed' or 'out of tolerance' on HP 9825A strip printer. If 'out of tolerance' is printed, measured values are also printed.

#8

Prints either 'passed' or 'out of tolerance' message on external printer, returns to test listing, and labels 'yes' or 'no' adjacent to test title on CRT.

*Figure 10. Line Related Sidebands Test (5 of 6)*

TEST NO. 6  
line sidebands  
out of tolerance

harmonic	{ 2nd	-76.4dBc	} Level of Sideband Below Carrier Level
	3rd	-69.3dBc	
	4th	-82.9dBc	

REFER TO  
OPERATING AND  
SERVICE MANUAL  
SECTION IV

-----

Figure 10. Line Related Sidebands Test (6 of 6)

## 7. RESOLUTION BANDWIDTHS

### SPECIFICATION:

Bandwidth: <del>10</del> <sup>30</sup> Hz to 1 kHz and 3 MHz; $\pm 20\%$	Selectivity: (60 dB/3 dB Ratio)
3 kHz to 1 MHz; $\pm 10\%$	3 MHz to 100 kHz; $< 15:1$
	30 kHz to 10 kHz; $< 13:1$
Amplitude: 3 MHz to 10 Hz; $\pm 1.0$ dB	3 kHz to 30 Hz; $< 11:1$
1 MHz to 30 Hz; $\pm 0.5$ dB	10 Hz; $< 100$ Hz separation of 60 dB points

### DESCRIPTION:

The spectrum analyzer CAL OUTPUT signal is connected to the analyzer input. The analyzer steps through the bandwidths from 3 MHz to 30 Hz, centers the signal, sets signal peak to near the reference level, and measures the frequency of the 3-dB points for each bandwidth. The 3-dB bandwidths is then calculated by determining the difference in frequency between the 3-dB points. Amplitude difference between bandwidths is also measured.

Next the analyzer steps through the bandwidths, centers the signal, sets signal peak to near the reference level, and measures the frequency of the 60-dB points of the 100 kHz, 30 kHz, 3 kHz, and 10 Hz bandwidths. The 60-dB bandwidth is then calculated by determining the frequency difference between the 60-dB points.

The shape factor is then calculated by dividing the 60-dB bandwidth by the 3-dB bandwidth.

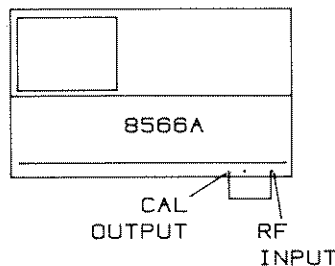

CONNECT BNC CABLE FROM CAL OUTPUT  
TO RF INPUT

To CONTINUE, push Hz  
To SELECT ANOTHER TEST, push MHz  
Test Number 7

### EQUIPMENT:

No equipment required.

### PROCEDURE:

1. Select test no. 7 by keying in **7** (**Hz**  $\mu$ sec) (**kHz** mV msec) if continuous testing is desired) on the 8566A Keyboard.
2. The display shown above will appear on the 8566A CRT. Connect cable as shown.
3. Follow the instructions as they appear on the 8566A CRT display.
4. The following is an annotated listing of the test procedure.

Figure 11. Resolution Bandwidth Test (1 of 12)

```
0: "RESOLUTION BANDWIDTH":
1: "t0f8: 790801":
2: "#1":
3:   if flg6 and X[8]>0;gto +4
4: "Test set up for resolution BW":gsb "cbl"
5:   if D>1;gto -1;if D=le6;gto "test select";cfg 5,6
6: "#2":
7: "test":
8:
9:   cfg 2;wrt "sa","IP CF100MZ LN RL-8DM KSA RB3MZ S2"
10:  wtb "sa","D3PUPA224,592LBRESOLUTION BANDWIDTH",3
11:  cll 'on interrupt'
```

*Figure 11. Resolution Bandwidth Test (2 of 12)*

#1

Draws equipment setup on CRT and checks for proper keyboard entry to continue test or abort.

#2

Sets analyzer controls to proper settings for measurement and labels test title on CRT.

*Figure 11. Resolution Bandwidth Test (3 of 12)*



```

12: "#3":
13: "Test for 3dB BW from 3MHz to 30Hz":
14:   for I=1 to 11
15:     0→K; if I=9; sfg 2
16:     wrt "sa", "RBOA"; red "sa", B[1,I]; max(100, 2B[1,I])→S
17:     wrt "sa", "SP", S, "HZ"
18:     wrt "sa", "TS E1 MA"; red "sa", B[3,I]; if B[3,1]<-17; gto -14
19:     wrt "sa", "MF"; red "sa", B[4,I]
20:     wrt "sa", "CFOA"; red "sa", F
21:     if abs(B[4,I]-F)>S/5; wrt "sa", "E2 TS E1"; gto -2
22:     l→N; if not flg2; wrt "sa", "M3"
23:     B[1,I]/2.5→C
24:     if not flg2; wrt "sa", "MF", C, "HZ"; wrt "sa", "MA"; red "sa", D
25:     if flg2; gsb "dig"
26:     if abs(D+3)<.1; gto +4
27:     K+1→K; if K>50; gto +3
28:     l2→Z; if I=11; 25→Z
29:     NB[1,I](D+3)/Z+C→C; gto -5

30:     if N=1; -1→N; C→E; -C→C; 0→K; gto -6
31:     E-C→B[2,I]; wrt "sa", "M1 RBDN"; next I; gto +7

```

Figure 11. Resolution Bandwidth Test (4 of 12)

#3

Measures eleven 3-dB bandwidths from 3 MHz to 30 Hz. The program flow is as follows:

- 1) A for/next loop is established to step bandwidth down from 3 MHz to 30 Hz.
- 2) Bandwidths setting is placed in variable B[1,I], and analyzer span (set to twice bandwidth setting) is placed in variable S.
- 3) Marker is placed on peak of signal, and amplitude is placed in variable B[3,I].
- 4) Marker frequency is placed in variable B[4,I].
- 5) Marker frequency and center frequency are compared. If the signal peak is greater than 2 divisions from center of display, Marker into Center Frequency is activated, and signal is checked again.
- 6) Marker Delta mode is selected, and a value one-fourth of frequency span selected is placed into variable C.
- 7) The delta marker is stepped by frequency C, and the marker amplitude difference is measured and placed into variable D.
- 8) The marker amplitude is then compared to 3 dB; if it is not within .1 dB of 3 dB, variable C is incremented by a portion of the difference between the value D measured and 3 dB
- 9) When the positive 3-dB point is reached, the negative of variable C is placed into C, and steps 7 and 8 are repeated. Original value of C is saved in variable E.
- 10) The final positive and negative values of C are added to provide the 3-dB bandwidth, which is placed into variable B[2,I].

Figure 11. Resolution Bandwidth Test (5 of 12)

```
32: "#4":
33: "Reads display memory and returns amplitude of signal":
34: "dig":
35:   1000(B[4,I]-F)/S+500+1000C/S→X
36:   wrt "sa","DA",X,"DR";red "sa",A
37:   A-B[3,I]→D;ret

38: "#5":
39: "shape factor":
40:   wrt "sa","IP CF100MZ AT0DB RL-8DM RB100KZ S2 TS"
41:   wtb "sa","D3PUPA208,592LBBANDWIDTH SELECTIVITY",3
42:   cll 'on interrupt'
43:   cfg 2;10→B[1,12];B[4,11]→B[4,12]
```

*Figure 11. Resolution Bandwidth Test (6 of 12)*

#4

For resolution bandwidths of 3 kHz, 100 Hz, and 30 Hz, Flag 2 is set and the amplitude at the 3-dB points is measured directly from display memory by subroutine 'dig.' Variable X is the approximate digital storage address of the 3-dB point. Its amplitude value is read and placed into D.

#5

The analyzer settings are changed to those needed to measure shape factor (60-dB points). A new label is placed on the CRT display.

*Figure 11. Resolution Bandwidth Test (7 of 12)*

```

44: "#6":
45: "Tests for 60dB points at 100,30,3kHz and 10Hz BW":
46:   for I=4 to 12
47:     if I=6;7→I;wrt "sa","RB3KZ VB10HZ"
48:     if I>7;12→I;wrt "sa","RB10HZ"
49:     B[1,I]*18→S
50:     wrt "sa","SP",S,"HZ TS"
51:     wrt "sa","CFOA";red "sa",F
52:     if abs(B[4,I]-F)>S/10;wrt "sa","E1 E2 TS";gto -1
53:     1→N;wrt "sa","E1 M3"
54:     B[1,I]5→C
55:     wrt "sa","MF",C,"HZ";wrt "sa","MA";red "sa",D
56:     if abs(D+60)<.2;gto +3
57:     K+1→K;if K>20;gto +2
58:     NB[1,I](D+60)/8+C→C;gto -3

59:     if N=1;-1→N;C→E;-C→C;0→K;gto -4
60:     E-C→B[5,I];wrt "sa","M1 RBDN"
61:     next I
62: "#7":
63: "print out":
64:
65:   if flg3;gto +21
66:   if P>15;wrt "sa","IP KSi EM KSm KSo A4 D2 DAOPUPA0,1000LB"
67:   wtb P,10,10,13," 7. RESOLUTION BANDWIDTH",10,10,13
68:   fmt 1,10x,"SPECIFICATION:",2;/wrt P+.1
69:   fmt 5,15x,c;wrt P+.5,"Bandwidth 3MHz-10Hz +/-20%"
70:   wrt P+.5,"Accuracy 1MHz-3kHz +/-10%"
71:   wrt P;wrt P;wrt P+.5,"Amplitude (ref to 1MHz amplitude)"
72:   wrt P+.5,"(switching 3MHz-10Hz +/-1.0dB"
73:   wrt P+.5,"uncertainty) 1MHz-30Hz +/-0.5dB";wrt P;wrt P
74:   wrt P+.5,"60dB/3dB RATIO 3MHz-100kHz <15:1"
75:   wrt P+.5,"(Selectivity) 30kHz-10kHz <13:1"
76:   fmt 5,31x,c;wrt P+.5,"3kHz - 30Hz <11:1"
77:   wrt P+.5,"10Hz <100Hz between 60dB points";wrt P;wrt P
78:   if P>15;wrt "sa"," To CONTINUE, press Hz"
79:   if P>15;wtb "sa",3;gsb "wait"
80:   if P>15;wrt "sa","A1 A4 B1 B4 D2 DAOPUPA0,1000LB"
81:   fmt 1,10x,"MEASURED:";wrt P+.1
82:   fmt 2,13x,3"Res BW ", "Amplitude";wrt P+.2
83:   fmt 2,12x,"Setting",4x,"Reading",5x,"%Error",5x,"Deviation",/
84:   wrt P+.2

```

Figure 11. Resolution Bandwidth Test (8 of 12)

#6

Measures four 60-dB bandwidths: 100 kHz, 30 kHz, 3 kHz, and 10 Hz. The program flow is as follows:

- 1) A for/next loop is established to step bandwidths down from 100 kHz to 10 Hz.
- 2) At for/next loop counter values of 6 and 8, the counter values are changed to 7 and 12 respectively, corresponding to 3-kHz and 10-kHz bandwidths.
- 3) The analyzer span is set to 18 times the bandwidth setting, and the span value is placed into variable S.
- 4) The center frequency setting is compared with the signal frequency. Marker into Center Frequency is executed if the signal is greater than one division from center of display.
- 5) Marker Delta mode is set, and 5 times the bandwidth setting is placed into variable C.
- 6) The marker is incremented in frequency by C, and the amplitude difference is measured and placed into variable D.
- 7) D is compared with 60. If the difference is equal to or greater than .2 dB, C is incremented by a portion of the difference between D and 60 dB, and step 6 is repeated.
- 8) When difference between D and 60 is less than .2 dB, C is saved in variable E. The value of C is changed to the negative, and steps 6 and 7 are repeated.
- 9) The two values of C are added and placed into B[5,I]. This represents the 60-dB bandwidth.

#7

Prints test title, specification, and headings for measured values on HP 9866B or HP 9871A Printer, if used, or displays the data on analyzer CRT if P is equal to the analyzer address.

*Figure 11. Resolution Bandwidth Test (9 of 12)*

```

85: "#8":
86:   B[3,2]→D
87:   for I=1 to 11
88:     32→A→B
89:     B[5,I]/B[2,I]→B[5,I]
90:     100(B[2,I]-B[1,I])/B[1,I]→B[4,I]
91:     B[3,I]-D→B[3,I]
92:     10→r1;.5→r2
93:     if 1=I or I>7;20→r1
94:     if abs(int(B[4,I]))>r1;42→A;sfg 1
95:     if abs(B[3,I])>r2;42→B;sfg 1
96:     if flg3;gto +3
97:     fmt 2,10x,f9.0,2x,f9.0,f9.0," %",b,b,f9.2," dB",b,b
98:     wrt P+.2,B[1,I],B[2,I],B[4,I],A,A,B[3,I],B,B
99:     next I
100: "#9":
101:   32→A→B→C→D;if abs(int(B[5,4]+.5))>15;42→A;sfg 1
102:   if abs(int(B[5,5]+.5))>13;42→B;sfg 1
103:   if abs(int(B[5,7]+.5))>11;42→C;sfg 1
104:   if abs(int(B[5,12]+.5))>100;42→D;sfg 1
105:   if flg3;gto +9
106:   wrt P;wrt P;fmt 2,13x,c,f3.0,c,b,b,c
107:   wrt P+.2,"60dB/3dB RATIO   100KHz BW --- ",B[5,4],":1",A,A
108:   wrt P+.2,"(Selectivity)    30KHz BW --- ",B[5,5],":1",B,B
109:   wrt P+.2,"                 3KHz BW --- ",B[5,7],":1",C,C
110:   wrt P+.2,"      at 60dB points 10Hz BW --- ",B[5,12],":1",D,D
111:   wrt P;gto +12

112: "#10":
113: "print out for 9825A printer":
114:   prt "   TEST NO. 7      bandwidths   ";if not flg1;gto +6
115:   spc ;prt "out of tolerance";spc
116:   fmt 5,f3.0,"%",f10.2,"dB";for I=1 to 11;wrt 16.5,B[4,I],B[3,I]
117:   next I;fxd 0;spc ;prt B[5,4];prt B[5,5];prt B[5,7];prt B[5,12]
118:   prt "REFER TO          OPERATING AND    SERVICE MANUAL  SECTION IV"
119:   spc ;gto +2

120:   spc ;prt "   PASSED";spc
121:   fmt 6,16" _",2/;wrt 16.6
122: "#11":
123:   1+flg1→X[8];cfg 1;gsb "p/f"
124:   if P>15;wrt "sa"," To CONTINUE, press Hz"
125:   if P>15;wtb "sa",3;gsb "wait"
126:   gto "test select"

```

\*27130

Figure 11. Resolution Bandwidth Test (10 of 12)

#8

A for/next loop is established and the following values are calculated: 60 dB/3 dB ratio into B[5,I], percent 3-dB bandwidth error into B[4,I], amplitude error with respect to 1-MHz bandwidth amplitude into B[3,I]. The computed values are checked to specification. Flag 1 is set if an error is detected. The results are then printed on the external printer, if used.

#9

The 60 dB/3 dB ratios are checked to specification and printed on the external printer, if used. Flag 1 is set if an error is detected.

#10

Prints test title and either 'passed' or 'out of tolerance' message on HP 9825A strip printer. If 'out of tolerance' is printed, measured values are also printed.

#11

Prints 'passed' or 'out of tolerance' message on external printer, returns to test listing, and labels 'yes' or 'no' adjacent to test title on CRT.

*Figure 11. Resolution Bandwidth Test (11 of 12)*



TEST NO. 7  
bandwidths

out of tolerance

BW % Error	AMPLITUDE change	
-11%	0.43dB	3 MHz
7%	0.00dB	1 MHz
2%	1.00dB	300 kHz
2%	0.19dB	100 kHz
-3%	0.59dB	30 kHz
1%	0.00dB	10 kHz
-1%	-0.06dB	3 kHz
5%	-0.07dB	1 kHz
4%	-0.07dB	300 Hz
6%	-0.15dB	100 Hz
3%	-0.37dB	30 Hz

BW		
{	100 kHz	14
	30 kHz	10
	3 kHz	10
	10 Hz	96

60/3 dB Ratio  
Width at 60 dB  
Points

REFER TO  
OPERATING AND  
SERVICE MANUAL  
SECTION IV

-----

Figure 11. Resolution Bandwidth Test (12 of 12)

## 8. SWEEP + TUNE OUT ACCURACY

### SPECIFICATION:

$-1\text{V/GHz} \pm 2\% \pm 10\text{ mV}$ .

### DESCRIPTION:

A Digital Voltmeter is used to monitor the rear-panel SWEEP + TUNE OUT voltage while the analyzer's Center Frequency is set to several arbitrary values. The output voltage for each Center Frequency setting is checked against the specification.

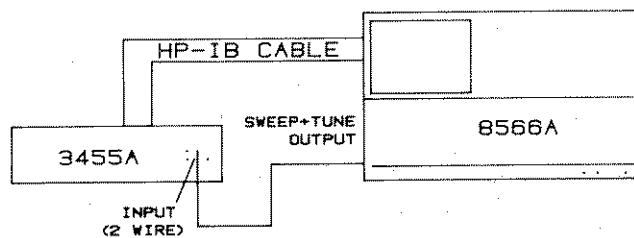

CONNECT SWEEP + TUNE OUTPUT  
TO VOLTmeter INPUT AS SHOWN  
CONNECT HP-IB CABLE TO VOLTmeter

To CONTINUE, push Hz  
To SELECT ANOTHER TEST, push MHz  
Test Number 8

### EQUIPMENT:

Digital Voltmeter ..... HP 3455A

### PROCEDURE:

1. Select Test No. 8 by keying **8**  Hz   $\mu\text{V}$   msec (  kHz  mV  msec if continuous testing is desired) on the 8566A Keyboard.
2. The display shown above will appear on the 8566A CRT. Connect equipment as shown.
3. Follow the instructions as they appear on the 8566A CRT display.
4. The following is an annotated listing of the test procedure.

Figure 12. SWEEP + TUNE OUT Accuracy Test (1 of 6)

```

0: "SWEEP + TUNE":
1: "tOf9: 790829":
2: "#1":
3:   if flg6 and X[9]>0;gto "test"
4:   gsb "ds"
5:   if D>1;gto -1;if D=1e6;gto "test select";cfg 5,6
6: "#2":
7: "test":
8:
9:   wtb "sa","IP D3 PUPA232,598LBSWEEP + TUNE CHECK",3,"SPOHZ"
10:   for I=0 to 4 by .5;1.25*2^I+Z;wrt "sa","CF",Z,"GZ"
11:   wrt "dvm","F1 R7 T1";red "dvm",V;abs(V)->A[2I+1];next I
12: "#3":
13: "print out":
14:
15:   if flg3;gto +16
16:   if P>15;wrt "sa","IP KSi EM KSm KSo A4 D2 DAOPUPA0,1000LB"
17:   wrt P,10,10,13,"      8. SWEEP + TUNE OUTPUT",10,10,13
18:   wrt P,"      SPECIFICATION:"
19:   fmt 1,19x,"-1V/GHz +/- (2%+10mV)",/;wrt P+.1
20:   fmt 1,10x,"MEASURED:",/;wrt P+.1
21:   fmt 1,20x,"CENTER",20x,"DVM";wrt P+.1
22:   fmt 1,19x,"FREQUENCY",16x,"READING";wrt P+.1
23:   fmt 2,19x,f5.2," GHz",15x,f6.2," V",b,b
24: "#4":
25:   for I=1 to 9;32+A;1.25*2^((I-1)/2)+Z
26:   if abs(A[I]-Z)>Z*.02+.01;42+A;sfg 1
27:   wrt P+.2,Z,-A[I],A,A;next I;c11 'spc'(5)
28:   gto +11

29: "#5":
30: "Print out for 9825A printer":
31:   prt " TEST NO. 8      sweep + tune";if not flg1;gto +5
32:   spc ;prt "out of tolerance";spc
33:   fmt 5,f14.2,"V";for I=1 to 9;wrt 16.5,A[I];next I
34:   prt "REFER TO      OPERATING AND SERVICE MANUAL SECTION IV"
35:   spc ;gto +2

36:   spc ;prt "      PASSED";spc
37:   fmt 6,16" _",2;/;wrt 16.6
38: "#6":
39:   1+flg1->X[9];cfg 1;gsb "p/f"
40:   if P>15;wrt "sa"," To CONTINUE, press Hz"
41:   if P>15;wtb "sa",3;gsb "wait"
42:   gto "test select"

```

Figure 12. SWEEP + TUNE OUT Accuracy Test (2 of 6)

#1

Draws equipment setup on CRT and checks for proper keyboard entry to continue test or abort.

#2

Labels test title on CRT and measures SWEEP + TUNE OUT voltage at selected center frequencies. Measured values are stored in variable A[2I + 1].

#3

Prints test title, specifications, and headings for measured values on HP 9866B or HP 9871A Printer, if used, or displays data on analyzer CRT if the value of P is equal to the address of the analyzer.

#4

Checks measured values against specification and prints measured values on HP 9866B or HP 9871A Printer, if used. Flag 1 is set if error is detected.

#5

Prints test title and either 'passed' or 'out of tolerance' on HP 9866B or HP 9871A Printer. If 'out of tolerance' is printed, measured values are also printed.

#6

Prints 'passed' or 'out of tolerance' message on external printer, returns to test listing, and labels 'yes' or 'no' adjacent to test title on CRT.

*Figure 12. SWEEP + TUNE OUT Accuracy Test (3 of 6)*

```
43: "#7":
44: "ds":
45:
46:   gsb "ana"
47:   wrt "sa", "D2PUPR-200,0PD-300,0,0,100,300,0,0,-100"
48:   wrt "sa", "PU-50,40PD0,0PU0,15PD0,0PU15,0PD0,0PU0,-15PD0,0"
49:   wrt "sa", "PU15,0PD0,0PU-15,15PD0,-135,105,0,0,110,130,0"
50:   wrt "sa", "PU-240,10PD-25,-75"
51:   wrt "sa", "PU265,250PD-300,0,0,-115,-40,0,0,155,340,0"
52:   wrt "sa", "D3PUPA88,464LB3455A@PUPA184,600LBHP-IB CABLE@"
53:   wrt "sa", "D2PUPA384,750LBSWEEP+TUNE@PUPA448,718LBOUTPUT@"
54:   wtb "sa", "PUPA528,686LB",172,"@PUPA220,590LBINPUT@"
55:   wrt "sa", "PUPA178,558LB(2 WIRE)@"
56:   wrt "sa", "D3PUPA96,240LBCONNECT SWEEP + TUNE OUTPUT @"
57:   wrt "sa", "D3PUPA96,208LBTO VOLTMETER INPUT AS SHOWN@"
58:   wrt "sa", "D3PUPA96,176LBCONNECT HP-IB CABLE TO VOLTMETER@"
59:   gsb "wait"
60:   ret
*20938
```

Figure 12. SWEEP + TUNE OUT Accuracy Test (4 of 6)

#7

Subprogram to draw equipment setup on CRT and label connections and instructions.

*Figure 12. SWEEP + TUNE OUT Accuracy Test (5 of 6)*

TEST NO. 8  
sweep + tune

out of tolerance

8566A Center Frequency Setting (GHz)	{	1.25	-1.25V	}	Voltmeter Reading
		1.77	-1.77V		
		2.50	-3.65V		
		3.54	-3.80V		
		5.0	-5.00V		
		7.07	-7.07V		
		10.00	-10.00V		
		14.14	-14.14V		
20.00	-20.00V				

REFER TO  
OPERATING AND  
SERVICE MANUAL  
SECTION IV

-----

Figure 12. SWEEP + TUNE OUT Accuracy Test (6 of 6)

## 9. AVERAGE NOISE LEVEL

### SPECIFICATION:

Non-Preselected		Preselected	
Level	Tuning Range	Level	Tuning Range
<-95 dBm	100 Hz to 50 kHz	<-132 dBm	2.0 GHz to 5.8 GHz
<-112 dBm	50 kHz to 1.0 MHz	<-125 dBm	5.8 GHz to 12.5 GHz
<-134 dBm	1.0 MHz to 2.5 GHz	<-119 dBm	12.5 GHz to 18.6 GHz
		<-114 dBm	18.6 GHz to 22 GHz

### DESCRIPTION:

The signal input of the spectrum analyzer is terminated using a 50-ohm load. The necessary front-panel control settings are made and the average noise level measured at four non-preselected and four preselected frequencies.

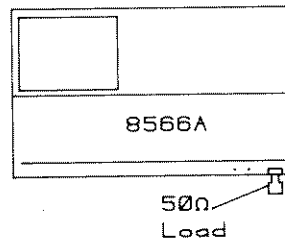

CONNECT 50 ohm LOAD TO RF INPUT

To CONTINUE, push Hz  
 To SELECT ANOTHER TEST, push MHz  
 Test Number 9

### EQUIPMENT:

50-Ohm Load ..... HP 11593A

### PROCEDURE:

1. Select Test No. 9 by keying in **9** **Hz** **µsec** ( **MHz** **msec** if continuous testing is desired) on the 8566A Keyboard.
2. The display shown above will appear on the 8566A CRT. Install load as shown.
3. Follow the instructions as they appear on the 8566A CRT display.
4. The following is an annotated listing of the test procedure.

Figure 13. Average Noise Level Test (1 of 6)



```

0: "AVERAGE NOISE LEVEL":
1: "t0f10: 791004":
2: "#1":
3:   if flg6 and X[10]>0;gto "test"
4: "Average noise level test set up":gsb "load"
5:   if D>1;gto -1;if D=1e6;gto "test select";cfg 5,6
6: "#2":
7: "test":
8:
9:   wrt "sa","IP SPOHZ AT0DB RB10HZ VB1HZ RL-80DM"
10:  wrt "sa","ST20SC S2 KSi EM"
11:  wtb "sa","DA1024D3PUPA232,592LB",18,"AVERAGE NOISE LEVEL",18,3,"HD"
12:  cll 'on interrupt'
13: "#3":
14:   for J=0 to 7
15: "set center frequency":
16:   if J<4;wrt "sa","CF",(212.4-70J)*10^(3J),"HZ TS"
17:   if J>3;wrt "sa","CF",5.5(J-3),"GZ TS"
18:   0>B;wrt "sa","DA1028 DW17 HD O3 TA"
19: "read data from display trace A":
20:   for I=1 to 1000;red "sa",A;A+B>B;next I
21: "compute average noise level":
22:   B/1000>A[J+1];wtb "sa","DA1028 DW18 HD"
23:   next J
24: "#4":
25: "print out":
26:
27:   if flg3;gto +19
28:   if P>15;wrt "sa","IP KSi EM KSm KSo A4 D2 DA0PUPA0,1000LB"
29:   wtb P,"          9. AVERAGE NOISE LEVEL",10,13
30:   fmt 5,15x,c
31:   wrt P+.5,"(Measured in 10 Hz BW"
32:   wrt P+.5," and with 0 dB input attenuation.)"
33:   fmt 1,/,10x,"SPECIFICATION:";wrt P+.1
34:   fmt 5,22x,"LEVEL",12x,"TUNING RANGE",/;wrt P+.5
35:   fmt 4,39x,"non-preselected";wrt P+.4
36:   fmt 6,20x,"<",f4.0," dBm",7x,f5.1,x,b,"Hz to ",f4.1,x,b,"Hz"
37:   wrt P+.6,-95,100,32,50,107;wrt P+.6,-112,50,107,1,77
38:   fmt 3,/,41x,"preselected"
39:   wrt P+.6,-134,1,77,2.5,71;wrt P+.3
40:   wrt P+.6,-132,2,71,5.8,71;wrt P+.6,-125,5.8,71,12.5,71
41:   wrt P+.6,-119,12.5,71,18.6,71;wrt P+.6,-114,18.6,71,22,71
42:   fmt 1,10x,"MEASURED:";wrt P+.1
43:   fmt 1,22x,"LEVEL",11x,"FREQUENCY",/;wrt P+.1

```

Figure 13. Average Noise Level Test (2 of 6)

#1

Draws equipment setup on CRT and checks for proper keyboard entry to continue test or abort.

#2

Sets analyzer controls for test and labels test title on CRT.

#3

Average noise level is measured at selected points over the frequency range of analyzer. The program flow is as follows:

- 1) A for/next loop is established to set the analyzer center frequency to selected values.
- 2) With the analyzer in zero frequency span, trace data is stored in display memory.
- 3) Trace data (1000 points in variable A) is output, summed, and placed in variable B.
- 4) Average level of trace is calculated by dividing total of trace data (variable B) by 1000 (number of points of data).

#4

Prints test title, specifications, and headings for measured values on HP 9866B or HP 9871A Printer, if used, or displays data on analyzer CRT if P is equal to analyzer address.

*Figure 13. Average Noise Level Test (3 of 6)*

```

44: "#5":
45: "check data against spec. and print":
46:     for I=0 to 7;32→A
47:     if I=0;32→Z;if A[1]>-95;42→A;sfg 1
48:     if I=1;107→Z;if A[2]>-112;42→A;sfg 1
49:     if I=2;77→Z;if A[3]>-134;42→A;sfg 1
50:     if I=3;71→Z;if A[4]>-134;42→A;sfg 1
51:     if I=4;71→Z;if A[5]>-132;42→A;sfg 1
52:     if I=5;if A[6]>-125;42→A;sfg 1
53:     if I=6;if A[7]>-119;42→A;sfg 1
54:     if I=7;if A[8]>-114;42→A;sfg 1
55:     if flg3;next I;gto +8
56:     if I<4;212.4-70I→G
57:     if I>3;5.5(I-3)→G;if I=4 and P<15;wrt P
58:     fmt 3,21x,f4.0," dBm",b,b,2x,"at",2x,f5.1,x,b,"Hz"
59:     wrt P+.3,A[I+1],A,A,G,Z;next I;cll 'spc'(1)
60:     gto +11

61: "#6":
62: "print out for 9825A printer":
63:     prt " TEST NO. 9 average noise ";if not flg1;gto +5
64:     spc ;prt "out of tolerance";spc
65:     fmt 5,f12.2," dBm";for I=1 to 7;wrt 16.5,A[I];next I
66:     prt "REFER TO OPERATING AND SERVICE MANUAL SECTION IV"
67:     spc ;gto +2

68:     spc ;prt " PASSED";spc
69:     fmt 6,16" ",2/;wrt 16.6
70: "#7":
71:     1+flg1→X[10];cfg 1;gsb "p/f"
72:     if P>15;wrt "sa"," To CONTINUE, press Hz"
73:     if P>15;wtb "sa",3;gsb "wait"
74:     gto "test select"

```

\*31160

Figure 13. Average Noise Level Test (4 of 6)

#5

Checks measured values against specifications and prints measured values on HP 9866B or HP 9871A Printer, if used. Flag 1 is set if error is detected.

#6

Prints test title and either 'passed' or 'out of tolerance' on HP 9825A strip printer. If 'out of tolerance' is printed, measured values are also printed.

#7

Prints 'passed' or 'out of tolerance' message on external printer, returns to test listing, and labels 'yes' or 'no' adjacent to test title on CRT.

*Figure 13. Average Noise Level Test (5 of 6)*

TEST NO. 9  
average noise  
out of tolerance

122 Hz	-103.32	dBm	} Avg. Noise Level
62 kHz	-126.09	dBm	
2 MHz	-107.90	dBm	
5.5 GHz	-136.60	dBm	
11.00 GHz	-131.20	dBm	
16.50 GHz	-126.73	dBm	
2.2 GHz	-117.00	dBm	

REFER TO  
OPERATING AND  
SERVICE MANUAL  
SECTION IV

-----

Figure 13. Average Noise Level Test (6 of 6)

## 10. GAIN COMPRESSION

### SPECIFICATION:

< 1.0 dB, 100 Hz to 22 GHz with  $\leq -5$  dBm at input mixer.

### DESCRIPTION:

Gain compression is measured by changing the power level at the input mixer from  $-15$  dBm to  $-5$  dBm and measuring the change in display level using the analyzer's Marker function. This is done at two frequencies; 2 GHz and 2.2 GHz to check both the first Mixer and YIG Tuned Mixer, respectively.

CONNECT EQUIPMENT AS SHOWN

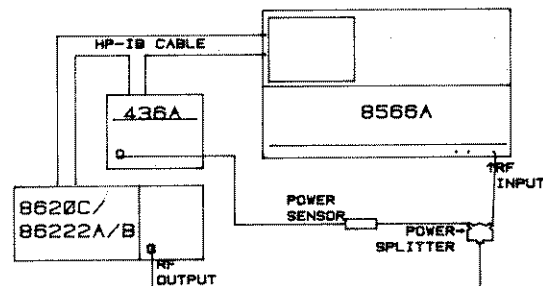

To CONTINUE, push Hz  
To SELECT ANOTHER TEST, push MHz  
Test Number 10

### EQUIPMENT:

Sweep Oscillator/RF Plug-In . . . HP 8620C, Opt 011/86290A/B  
Power Meter/Power Sensor . . . . . HP 436A, Opt 022/8481A  
Power Splitter . . . . . HP 11667A-C16

### PROCEDURE:

1. Select Test No. 10 by keying in    (  if continuous testing is desired) on 8566A Keyboard.
2. The display shown above will appear on the 8566A CRT. Connect equipment as shown.
3. Follow the instructions as they appear on the 8566A CRT display.
4. The following is an annotated listing of the test procedure.

Figure 14. Gain Compression Test (1 of 8)

```

0: "GAIN COMPRESSION":
1: "t0f11: 791002":
2: "#1":
3:   if flg6 and X[11]>0;gto "test"
4:   gsb "gc"
5:   if D>1;gto -1;if D=le6;cfg 5,6;gto "test select"
6: "#2":
7: "test":
8:
9:   l+I;wrt "sa","IP KSi EM KSI FB5.8GZ TS KSt CF2.2GZ SP30MZ AT20DB"
10:  wrt "sa","RB1MZ RL6DM LN KSA KS,0DM DT@ KSm KSo A4 S2 TS"
11:  cll 'on interrupt'
12:  lcl 7;rem 7;cll 'freq'(2400-200I)
13:  wtb "sa","KSX D3PUPA64,500LB"
14:  wrt "sa","ADJUST 86222 POWER LEVEL FOR +5dBm"
15:  wtb "sa","      ",171,"0.01dB INDICATION ON POWER METER@",10,13
16:  wtb "sa","PUPA64,560LB"
17:  fmt 1,c,b,f3.1,c,b,b,c
18:  wrt "sa.1","GAIN COMPRESSION CHECK AT ",17,2.4-.2I," GHz",18,3
19:  wrt "sa","PUPA96,32LBTO CONTINUE, press Hz@";gsb "wait"
20:  wrt "sa","EM A1 TS PP E1 MA";red "sa",M
21:  if abs(M-5)>5;gto -17
22:  wrt "sa","M3 AT10DB TS E1 MA";red "sa",A[I]
23:  if I=1;wrt "sa","IP KSI CF2GZ SP30MZ AT20DB M1";2+I;jmp -13
24: "#3":
25: "print out":
26:
27:   if flg3;gto +9
28:   if P>15;wrt "sa","IP KSi EM KSm KSo A4 D2 DA0PUPA0,1000LB"
29:   wtb P,10,13,"      10. GAIN COMPRESSION TEST",10,10,13
30:   fmt 1,10x,"SPECIFICATION:";wrt P+.1
31:   fmt 1,20x,c;wrt P+.1,"<1.0dB, 100Hz to 22GHz with <=-5dBm"
32:   wrt P+.1,"at input mixer. ";wrt P
33:   fmt 1,10x,"MEASURED:";wrt P+.1
34:   fmt 2,21x,"CENTER",20x,"GAIN";wrt P+.2
35:   fmt 2,20x,"FREQUENCY",15x,"COMPRESSION";wrt P+.2
36:   for J=2 to 1 by -1;fmt 3,21x,f3.1," GHz",17x,f5.2," dB",b,b
37:   32+A;if abs(A[J])>1;sfg 1;42+A
38:   if flg3;next J;gto +5
39:   wrt P+.3,2.4-.2J,abs(A[J]),A,A;next J;cll 'spc'(2)
40:   gto +11

```

Figure 14. Gain Compression Test (2 of 8)

#1

Draws equipment setup on CRT and checks for proper keyboard entry to continue test or abort.

#2

Checks gain compression at 2 GHz (non-preselected) and 2.2 GHz (preselected). The program flow is as follows:

- 1) Analyzer is set to 2.2 GHz center frequency with 20 dB input attenuation.
- 2) Operator is asked to adjust input signal level to +5 dBm.
- 3) Test is continued, and analyzer measures signal amplitude using Marker Delta function to establish a reference.
- 4) Input attenuation is changed to 10 dB, placing level of input signal to input mixer at -5 dBm.
- 5) The difference between signal levels is measured using Marker Delta function, and value is placed in variable A[I].
- 6) Measurement is repeated at 2 GHz.

#3

Prints test title, specification, and headings for measured values on HP 9866B or HP 9871A Printer, if used, or displays data on analyzer CRT if P is equal to analyzer address. Checks measured values against specification, then prints measured values. Flag 1 is set if an error is detected.

*Figure 14. Gain Compression Test (3 of 8)*



```

41: "#4":
42: "print out for 9825A printer":
43:   prt " TEST NO. 10   gain compression";if not flgl;gto +5
44:   spc ;prt "out of tolerance";spc
45:   fmt 5,f13.2," dB";for K=2 to 1 by -1;wrt 16.5,abs(A[K]);next K
46:   prt "REFER TO          OPERATING AND   SERVICE MANUAL SECTION IV"
47:   spc ;gto +2
48:   spc ;prt "          PASSED";spc
49:   fmt 6,16" _ ",2/;wrt 16.6
50: "#5":
51:   l+flgl+X[11];cfg 1;gsb "p/f"
52:   if P>15;wrt "sa"," To CONTINUE, press Hz"
53:   if P>15;wtb "sa",3;gsb "wait"
54:   gto "test select"

55: "#6":
56: "gc":
57:   gsb "ana"
58:   wrt "sa","PUPR-95,-205PD-300,0,0,150,300,0,0,-150"
59:   wrt "sa","PU-100,0PD0,150PU20,-125PD0,-85,525,0"
60:   wrt "sa","PD0,90,5,0,0,5,15,0,0,20,-5,5,5,5,-5,5,-5,-5"
61:   wrt "sa","-10,5,-10,-5,-5,5,-5,-5,5,-5,-5,0,-20,15,0,0,-5,5,0"
62:   wrt "sa","PU20,35PD5,145PU-40,-140PD-150,0,0,10-50,0,0,-20"
63:   wrt "sa","50,0,0,10PU-50,0PD-180,0,0,140,-180,0PU130,-25"
64:   wrt "sa","PD-150,0,0,150,150,0,0,-150PU-10,100PD-130,0"
65:   wrt "sa","PU25,50PD0,80PU25,0PD0,-80PU0,80"
66:   wrt "sa","PD190,0PU0,40PD-330,0,0,-300PU30,0"
67:   wrt "sa","PD0,260,85,0"
68:   wrt "sa","D3 PUPA118,360LB8620C/@"
69:   wrt "sa","PUPA118,328LB86222A/B@"
70:   wrt "sa","PUPA232,496LB436A@"
71:   wrt "sa","PUPA96,684LBCONNECT EQUIPMENT AS SHOWN@"
72:   wrt "sa","D2 PUPA376,456LBO@PUPA328,656LBO@"
73:   wtb "sa","PUPA376,424LB",172,"RF@"
74:   wtb "sa",3,"PUPA392,392LBOUTPUT@"
75:   wtb "sa",3,"PUPA920,624LB",94,"RF",3
76:   wrt "sa","PUPA936,592LBINPUT@"
77:   wrt "sa","PUPA600,552LBPOWER@PUPA600,520LBSENSORE@"
78:   wrt "sa","PUPA296,880LBHP-IB CABLE@"
79:   wtb "sa","PUPA786,504LBPOWER",169,"@PUPA738,476LBSPLITTER@"
80:   gsb "wait"
81:   if D=1;gsb "20C"
82:   ret

```

Figure 14. Gain Compression Test (4 of 8)

#4

Prints test title and either 'passed' or 'out of tolerance' on HP 9825A strip printer. If 'out of tolerance' is printed, measured values are also printed.

#5

Prints 'passed' or 'out of tolerance' message on external printer, returns to test listing, and labels 'yes' or 'no' adjacent to test title on CRT.

#6

Draws equipment setup on CRT and labels connections and instructions.

*Figure 14. Gain Compression Test (5 of 8)*

```

83: "#7":
84: "20C":
85:   wrt "sa","EM D3 PUPA0,592,LB8620C SETTINGS:"
86:   wtb "sa",10,13," TRIGGER MODE ..... MANUAL"
87:   wtb "sa",10,10,13," *1kHz SQWV/OFF ..... OFF"
88:   wtb "sa",10,10,13,"RF PLUG-IN SETTINGS:"
89:   wtb "sa",10,10,13," RF OFF/ON ..... ON"
90:   wtb "sa",10,10,13," ALC ..... INT"
91:   wtb "sa",10,10,13," *FM-NORM-PL SWITCH ..... NORM"
92:   wtb "sa",10,10,13," * SWITCH IS ON REAR PANEL"
93:   wtb "sa",10,10,13," To CONTINUE, press Hz@"
94:   gsb "wait"
95:   ret
96: "#8":
97: "freq":
98:   10000/2390+r6
99:   (p1-10)*r6+p4
100:  fmt 1,"M1B",f.0,"v",f4.0,"E"
101:  wrt "swp.1",1,p4-(p4>9999.5);wait 250;ret
*31414

```

Figure 14. Gain Compression Test (6 of 8)

#7

Labels on CRT the necessary control settings for the sweeper.

#8

Computes the proper tuning voltage to tune the sweeper to the frequency called for in #2, outputs this tuning voltage to the sweeper, and returns to #2.

*Figure 14. Gain Compression Test (7 of 8)*

TEST NO. 10  
gain compression

out of tolerance

Band		
0-2.5 GHz	1.29 dB	} Change in Reading at -5 dBm to Mixer
2-5.8 GHz	0.09 dB	

REFER TO  
OPERATING AND  
SERVICE MANUAL  
SECTION IV

-----

Figure 14. Gain Compression Test (8 of 8)

## 11. FREQUENCY RESPONSE

### SPECIFICATION:

Center Frequency	Flatness (20° – 30°C)
100 Hz to 2.5 GHz non-preselected band	±0.6 dB (1.2 dB)
2 to 5.8 GHz preselected band	±1.7 dB (3.4 dB)
5.8 to 12.5 GHz preselected band	±1.7 dB (3.4 dB)
12.5 to 18.6 GHz preselected band	±2.2 dB (4.4 dB)

### DESCRIPTION:

A CW signal, stepped over the applicable frequency range, is input to the 8566A analyzer. The signal amplitude is measured with a power meter and the value compared to the displayed amplitude on the analyzer. The maximum and minimum differences between the two readings are obtained for the frequency range being tested, and these are compared with the specification.

Frequency Response (flatness) is checked in five segments; 200 Hz to 10 MHz, 10 MHz to 2.5 GHz, 2.0 to 5.8 GHz, 5.8 to 12.5 GHz, and 12.5 GHz to 18.6 GHz.

#### FREQUENCY RESPONSE TEST, RANGE SELECTION

(1) 200Hz to 18.6GHz	(4) 2.0GHz to 5.8GHz
(2) 200Hz to 10MHz	(5) 5.8GHz to 12.5GHz
(3) 10MHz to 2.5GHz	(6) 12.5GHz to 18.6GHz
(7) Return to Test List	

To SELECT, press the number on the 8566A keyboard for the frequency range desired then press Hz.

### PROCEDURE:

1. Select Test No. 11 by keying in    (    if continuous testing is desired) on 8566A Keyboard.
2. The display shown above will appear on the 8566A CRT.
3. Select the frequency range to be tested and key in the corresponding number on the 8566A Keyboard.
4. The following pages contain equipment lists and instructions for five tests covering the four specified frequency ranges.

Figure 15. Frequency Response Test (1 of 17)

## 11. FREQUENCY RESPONSE (Cont'd) 200 Hz to 10 MHz

### SPECIFICATION:

Center Frequency	Flatness
100 Hz to 2.5 GHz	$\pm 0.6$ dB (1.2 dB)

### DESCRIPTION:

An HP 3330B or 3335A Automatic Synthesizer is used to input a signal to the analyzer and the frequency is stepped in increments from 200 Hz to 10 MHz. The frequency range between 100 Hz and 200 Hz is not tested. If an HP 3330B, Option 005 is used, a 10 dB attenuator must be attached to its output.

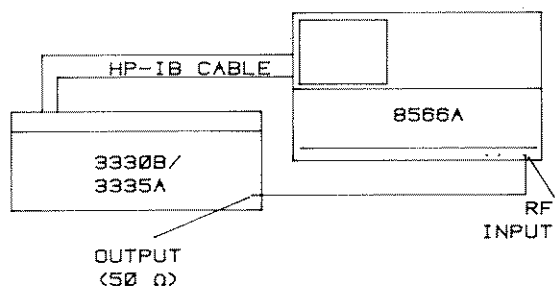

CONNECT SYNTHESIZER TO 8566A AS SHOWN

To CONTINUE, push Hz  
 To SELECT ANOTHER TEST, push MHz  
 Test Number 11

### EQUIPMENT:

Automatic Synthesizer . . . . . HP 3330B or 3335A

### PROCEDURE:



1. Select the 200 Hz to 10 MHz frequency range by pressing **2**  on the 8566A Keyboard (Test No. 11 already selected).
2. The display shown above will appear on the CRT.
3. Connect equipment as shown and press  key to continue.
4. Follow instructions as they appear on the 8566A CRT.

Figure 16. Frequency Response Test (2 of 17)

**11. FREQUENCY RESPONSE (Cont'd) 10 MHz – 2.4 GHz**

**SPECIFICATIONS:**

<b>Center Frequency</b>	<b>Flatness</b>
100 Hz to 2.5 GHz	±0.6 dB (1.2 dB)

**DESCRIPTION:**

An HP 8620C/86222A/B Sweep Oscillator is used to input a CW signal, stepped from 10 MHz to 2.4 GHz, to the analyzer. The signal amplitude is measured with an HP 436A Power Meter and the value compared to the 8566A marker amplitude. The maximum and minimum differences between the two readings are obtained for the frequency band being tested.

CONNECT EQUIPMENT AS SHOWN

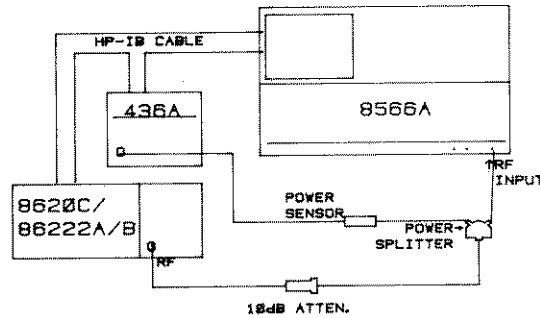

To CONTINUE, push Hz  
 To SELECT ANOTHER TEST, push MHz  
 Test Number 11

**EQUIPMENT:**

- Sweep Oscillator/RF Plug-In . . . HP 8620C, Opt 011/86222A/B
- Power Meter/Power Sensor . . . . . HP 436A, Opt 022/8481A
- Power Splitter . . . . . HP 11667A-C16
- 10 dB Attenuator . . . . . HP 8491B, Opt 010

**PROCEDURE:**

1. Select the 10 MHz to 2.5 GHz frequency range by pressing **3** **Hz μV μsec** on the 8566A Keyboard (Test No. 11 already selected).
2. The display shown above will appear on the CRT.
3. Connect equipment as shown and press **Hz μV μsec** key to continue.
4. Follow instructions as they appear on 8566A CRT.

Figure 17. Frequency Response Test (3 of 17)



## 11. FREQUENCY RESPONSE (Cont'd) 2.0 – 5.8 GHz

### SPECIFICATION:

Center Frequency	Flatness
2.0 to 5.8 GHz	±1.7 dB (3.4 dB)

### DESCRIPTION:

An HP 8620C/86290A/B Sweep Oscillator is used to input a CW signal, stepped from 2.0 to 5.8 GHz, to the analyzer. The signal amplitude is measured with an HP 436A Power Meter and the value compared to the 8566A marker amplitude. The maximum and minimum differences between the two readings are obtained for the frequency band being tested.

CONNECT EQUIPMENT AS SHOWN

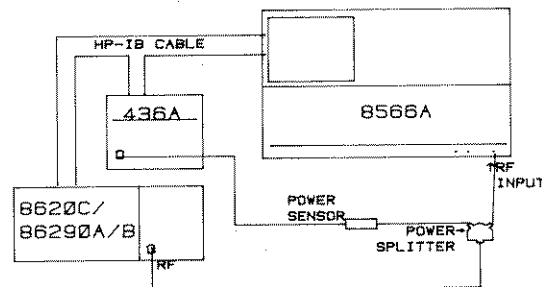

To CONTINUE, push Hz  
 To SELECT ANOTHER TEST, push MHz  
 Test Number 11

### EQUIPMENT:

Sweep Oscillator/RF Plug-In . . . HP 8620C, Opt. 022/86290A/B  
 Power Meter/Power Sensor . . . . . HP 436A, Opt 011/8481A  
 Power Splitter . . . . . HP 11667A-C16

### PROCEDURE:

1. Select the 2.0 to 5.8 GHz frequency range by pressing **4** **Hz** **μV** **μsec** on the 8566A Keyboard (Test No. 11 already selected).
2. The display shown above will appear on the CRT.
3. Connect equipment as shown and press **Hz** **μV** **μsec** key to continue.
4. Follow instructions as they appear on 8566A CRT.

Figure 18. Frequency Response Test (4 of 17)

## 11. FREQUENCY RESPONSE (Cont'd) 5.8 to 12.5 GHz

### SPECIFICATION:

Center Frequency	Flatness
5.8 to 12.5 GHz	±1.7 dB (3.4 dB)

### DESCRIPTION:

An HP 8620C/86290A/B Sweep Oscillator is used to input a CW signal, stepped from 5.8 to 12.5 GHz, to the analyzer. The signal amplitude is measured with an HP 436A Power Meter and the value compared with the 8566A marker amplitude. The maximum and minimum differences between the two readings are obtained for the frequency band being tested.

CONNECT EQUIPMENT AS SHOWN

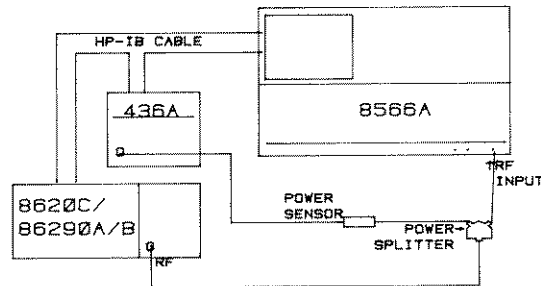

To CONTINUE, push Hz  
 To SELECT ANOTHER TEST, push MHz  
 Test Number 11

### EQUIPMENT:

Sweep Oscillator/RF Plug-In . . . HP 8620C, Opt. 011/86290A/B  
 Power Meter/Power Sensor . . . . . HP 436A, Opt 022/8481A  
 Power Splitter . . . . . HP 11667A-C16

### PROCEDURE:

1. Select the 5.8 to 12.5 GHz frequency range by pressing the **5** **Hz μV μsec** on the 8566A Keyboard (Test No. 11 already selected).
2. The display shown above will appear on the CRT.
3. Connect equipment as shown and press **Hz μV μsec** key to continue.
4. Follow instructions as they appear on 8566A CRT.

Figure 19. Frequency Response Test (5 of 17)

**11. FREQUENCY RESPONSE (Cont'd) 12.5 – 18.6 GHz**

**SPECIFICATION:**

Center Frequency	Flatness
12.5 to 18.6 GHz	±2.2 dB (4.4 dB)

**DESCRIPTION:**

An HP 8620C/86290A/B Sweep Oscillator is used to input a CW signal, stepped from 12.5 to 18.6 GHz, to the analyzer. The signal amplitude is measured with an HP 436A Power Meter and the value compared to the 8566A marker amplitude. The maximum and minimum differences between the two readings are obtained for the frequency band being tested.

CONNECT EQUIPMENT AS SHOWN

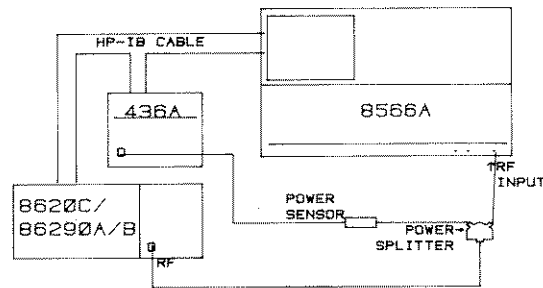

To CONTINUE, push Hz  
 To SELECT ANOTHER TEST, push MHz  
 Test Number 11

**EQUIPMENT:**

Sweep Oscillator/RF Plug-In . . . HP 8620C, Opt. 011/86290A/B  
 Power Meter/Power Sensor . . . . . HP 436A, Opt 022/8481A  
 Power Splitter . . . . . HP 11667A-C16

**PROCEDURE:**

1. Select the 12.5 to 18.6 GHz frequency range by pressing 6 Hz  
µV  
µsec on the 8566A Keyboard (Test No. 11 already selected).
2. The display shown above will appear on the CRT.
3. Connect equipment as shown and press Hz  
µV  
µsec key to continue.
4. Follow instructions as they appear on 8566A CRT.

*Figure 20. Frequency Response Test (6 of 17)*

TEST NO. 11  
freq. response

Frequency Range 0 - 10MHz

out of tolerance

1.2 dB

Flatness REFER TO  
OPERATING AND  
SERVICE MANUAL  
SECTION IV

TEST NO. 11  
freq. response

Frequency Range 10 - 2400MHz

out of tolerance

1.2 dB

Flatness REFER TO  
OPERATING AND  
SERVICE MANUAL  
SECTION IV

TEST NO. 11  
freq. response

Frequency Range 2000 - 5800MHz

out of tolerance

1.2 dB

Flatness REFER TO  
OPERATING AND  
SERVICE MANUAL  
SECTION IV

TEST NO. 11  
freq. response

Frequency Range 5800 - 12500MHz

out of tolerance

1.2 dB

Flatness REFER TO  
OPERATING AND  
SERVICE MANUAL  
SECTION IV

TEST NO. 11  
freq. response

Frequency Range 12500 - 18600MHz

out of tolerance

1.2 dB

Flatness REFER TO  
OPERATING AND  
SERVICE MANUAL  
SECTION IV

Figure 15. Frequency Response Test (7 of 17)

```

0: "FREQUENCY RESPONSE":
1: "t0fl2: 790828":
2: "#1":
3:   if flg5;l→S;gto "st"
4: "list":wrt "sa","EM KSi EM A4 KSo KSm DT@"
5:   wrt "sa","D3PUPA32,592LBFREQUENCY RESPONSE TEST,RANGE SELECTION"
6:   wtb "sa",10,13,"(1) 200Hz to 18.6GHz (4) 2.0GHz to 5.8GHz"
7:   wtb "sa",10,10,13,"(2) 200Hz to 10MHz (5) 5.8GHz to 12.5GHz"
8:   wtb "sa",10,10,13,"(3) 10MHz to 2.5GHz (6) 12.5GHz to 18.6GHz"
9:   wtb "sa",10,10,13,17," (7) Return to Test List",18,10,10,13
10:  wrt "sa"," To SELECT, press the number on the 8566A"
11:  wrt "sa"," keyboard for the frequency range desired"
12:  wrt "sa"," then press Hz.@PUPA340,560PD340,370 R1R4EE"
13:  eir 7,0;if bit(1,rds("sa"))=0;jmp 0
14:  wrt "sa","OA";red "sa",D;D→S;if D>7 or D=0;gto "list"
15: "#2":
16: "st":.0002→A[9];10→A[10];if S=7;gto "e"
17:   if S>2;10→A[9];2500→A[10];86222→A;if S>3;86290→A
18:   if S>3;2000→A[9];5800→A[10];if S>4;5800→A[9];12500→A[10]
19:   if S>5;A[10]→A[9];18600→A[10]
20:   cfg 1;ldf 13,284,227
21: "#3":
22:   gsb "syn";if S>2;gto +7
23:   if D>1;gto -1;if D=1e6;cfg 5;gto "list"
24:   gsb "meas 1"
25:   ldf 14,284,232
26:   gsb "print out"
27:   gto "list";if S=1;sfg 5;3→S;gto "st"
28: "#4":
29:   gsb "res";if flg5 and (S=5 or S=6);gto +2
30:   if D>1;gto -1;if D=1e6;cfg 5;gto "list"
31:   gsb "meas 2"
32:   ldf 14,284,239
33:   gsb "print out"
34:   gto "list";if flg5;S+1→S;gto "st"
35: "#5":
36: "e":if flg7;cfg 1,7;gsb "p/f"
37:   gto "test select"

```

Figure 15. Frequency Response Test (8 of 17)

#1

Labels test selections for frequency response testing on CRT and asks operator to enter selection on keyboard. The number of this entry is stored in variable S.

#2

Places lower and upper frequencies of range to be tested in variables A[9] and A[10] and necessary sweeper plug-in in variable A, based on keyboard entry. Also loads File 13 (Track 0), which is the location of the actual measurement routines.

#3

Draws equipment setup ('syn') on CRT for frequency ranges from 200 Hz to 10 MHz, performs frequency response measurement ('meas 1'), loads File 14 (Track 0), which is location of 'printout' routines, prints specifications and measurement values ('print out'), and returns to frequency response selection list ('list').

#4

Draws equipment setup ('res') on CRT for frequency ranges from 10 MHz to 18.6 GHz, performs frequency response measurement ('meas 2'), loads File 14 (Track 0), which is location of 'print out' routine, prints specifications and measurement values ('print out'), and returns to frequency response selection list ('list').

#5

Prints either 'passed' or 'out of tolerance' message on external printer, returns to test listing, and labels 'yes' or 'no' adjacent to test title on CRT.

*Figure 15. Frequency Response Test (9 of 17)*

```

38: "#6":
39: "res":gsb "ana"
40: wrt "sa","PUPR-95,-205PD-300,0,0,150,300,0,0,-150"
41: wrt "sa","PU-100,0PD0,150PU20,-125PD0,-85,215,0"
42: if S=3;wrt "sa","0,10,40,0,0,5,10,0,0,-30,-10,0,0,5,-40,0,0,10"
43: if S=3;wrt "sa","PU50,0"
44: if S#3;wrt "sa","50,0"
45: wrt "sa","PD260,0,0,90,5,0,0,5,15,0,0,20,-5,5,5,5,-5,5,-5,-5"
46: wrt "sa","-10,5,-10,-5,-5,5,-5,-5,5,-5,-5,-5,0,-20,15,0,0,-5,5,0"
47: wrt "sa","PU20,35PD5,145PU-40,-140PD-150,0,0,10-50,0,0,-20"
48: wrt "sa","50,0,0,10PU-50,0PD-180,0,0,140,-180,0PU130,-25"
49: wrt "sa","PD-150,0,0,150,150,0,0,-150PU-10,100PD-130,0"
50: wrt "sa","PU25,50PD0,80PU25,0PD0,-80PU0,80"
51: wrt "sa","PD190,0PU0,40PD-330,0,0,-300PU30,0PD0,260,85,0"
52: wrt "sa","D3 PUPA118,360LB8620C/@"
53: fmt l,c,f5.0,c
54: wrt "sa.l","PUPA118,328LB",A,"A/B@PUPA232,496LB436A@"
55: wrt "sa","PUPA96,684LBCONNECT EQUIPMENT AS SHOWN@"
56: wrt "sa","D2 PUPA376,456LBO@PUPA328,656LBO@"
57: wtb "sa","PUPA376,424LB",172,"RF@PUPA392,392OUTPUT@"
58: if S=3;wrt "sa","PUPA536,328LB10dB ATTEN.@"
59: wtb "sa","PUPA920,624LB",94,"RF@PUPA936,592LBINPUT@"
60: wrt "sa","PUPA600,552LBPOWER@PUPA600,520LBSSENSOR@"
61: wrt "sa","PUPA296,880LBHP-IB CABLE@"
62: wtb "sa","PUPA786,504LBPOWER",169,"@PUPA738,476LBSPLITTER@"
63: gsb "wait"
64: if D=1;gsb "20C"
65: ret

66: "#7":
67: "20C":wrt "sa","EM D3 PUPA0,592,LB8620C SETTINGS"
68: wtb "sa",10,13," TRIGGER MODE ..... MANUAL"
69: wtb "sa",10,10,13," *1kHz SQWV/OFF ..... OFF"
70: wtb "sa",10,10,13,"RF PLUG-IN SETTINGS"
71: wtb "sa",10,10,13," RF OFF/ON ..... ON"
72: wtb "sa",10,10,13," ALC ..... INT"
73: wtb "sa",10,10,13," *FM-NORM-PL SWITCH ..... NORM"
74: wtb "sa",10,10,13," * REAR PANEL"
75: wtb "sa",10,10,13," To CONTINUE, press Hz@";gsb "wait"
76: ret

77:
*10206

```

Figure 15. Frequency Response Test (10 of 17).

#6

Draws equipment setup on CRT for frequency ranges requiring a sweep oscillator (10 MHz to 18.6 GHz). Setup is changed here to indicate use of HP 86222 or HP 86290 plug-in. This is done using variable S, which is test selected from Group #1.

#7

Labels on CRT the necessary control settings for the sweeper.

*Figure 15. Frequency Response Test (11 of 17)*



```

0: "FREQUENCY RESPONSE;MEASUREMENT SUBROUTINE":
1: "t0f13: 790827":
2: "#1":
3: "meas 1":wrt "sa","IP LN KSA SP200HZ RB30HZ RL-2DM M2 TS S2"
4:   cll 'on interrupt';-17→A[1];17→A[2]
5:   for I=.0002 to 10 by .099998;cll 'synthesizer'(I,-5,0)
6:   cll 'synthesizer'(I,-5)
7:   wrt "sa","CF",I*1e6,"HZ TS E1 MA";red "sa",M
8:   max(M,A[1])→A[1];min(M,A[2])→A[2];next I;A[1]-A[2]→A[3];ret

9: "#2":
10: "meas 2":lcl 7;rem 7
11:   wrt "swp","M1B4V:000E";wrt "sa","IP TS E1 TS MF";red "sa",G
12:   2400+15600(G>2.6e9)+600(G>1.83e10)+3400(G>2e10)→G
13:   if G-A[9]<1000;cfg 5;0→A[3];ret
14:   min(A[10],G)→A[10];cll 'freq'(A[9])
15:   cll 'on interrupt';-17→A[1];17→A[2]
16: "#3":
17:   wtb "sa","EM KSm KSo A4 DT@ D3 PUPA16,432LB"
18:   wrt "sa","SET POWER LEVEL OF PLUG-IN FOR A POWER"
19:   wtb "sa"," METER INDICATION OF -5.0dBm ",171,"0.1dB",10,13,3
20:   wrt "sa","PUPA96,96LBTO CONTINUE, press Hz@";gsb "wait"

```

Figure 15. Frequency Response Test (12 of 17)

#1

Performs frequency response measurement for 200 Hz to 10 MHz frequency range. The program flow is as follows:

- 1) A for/next loop is established to set the synthesizer frequency and the analyzer center frequency from 200 Hz to 10 MHz in 100 steps.
- 2) At each frequency step, the signal amplitude is measured and the value placed in either A[1] or A[2], depending on whether it is larger or smaller than the previous measurement.
- 3) The difference between the highest measurement and the lowest measurement is determined, and this value is placed in variable A[3].

#2

Sets the sweeper to its high-frequency end and then reads into variable G the frequency measured by the analyzer. The value of G is rounded off to the exact high frequency in MHz of the sweeper plug-in (2400, 86222; 18000; 86290A; 18600, 86290B; 22000, 86290-HO8). If the plug-in used cannot test range selected, operation is returned to the test list. The high frequency of the testing range (A10) is changed to value of G if 86290A is used and 12.5 to 18.6 GHz range is selected.

#3

Sets analyzer center frequency to low end of frequency range (A[9]) being tested and asks operator to set level of signal input.

*Figure 15. Frequency Response Test (13 of 17)*

```

21: "#4":
22:   wtb "sa","EM KSn KSp A1 S2 M1 PUPA32,560LB"
23:   wrt "sa","FREQUENCY RESPONSE MEASUREMENT IN PROGRESS@"
24:   wrt "sa","FA",A[9],"MZ FB",A[10],"MZ KSt SP80MZ LG2DM RB1MZ"
25:   wrt "sa","CF",A[9],"MZSS",(A[10]-A[9]*T)/100,"MZ TS"
26:   if G<3000;wrt "sa","SPDNDN";4→r6
27:   for I=0 to 100;0→J;cll 'freq'(A[9]+I*T/100,G)
28:     wrt "sa","TS El PP MA";red "sa",M;if J>6;gto +5
29:     if M<-10;gto -1;wrt "sa","M1 KS=";J+1→J;if J>4;wrt "sa","LGUP"
30:     wrt "mtr","DT";red "mtr",r7
31:     max(M-r7,A[1])→A[1];min(M-r7,A[2])→A[2]
32:     wrt "sa","O1MF";red "sa",F;if F<300 or F>700;wrt "sa","E2 TS"
33:     if I<100;wrt "sa","O3 LG2DM CF UP"
34:     next I;abs(A[1]-A[2])→A[3];wrt "sa","KS=";cfg 2;ret

35: "#5":
36: "freq":if p1<2000;sfg 2
37:   2000→r11;6000→r12;12000→r13;if flg2;10→r13
38:   10000/4200→r14;10000/6400→r15;10000/(p2-r13)→r16
39:   (p1>6100)+(p1>12200)+1→p3;if flg2;3→p3
40:   (p1-r(10+p3))*r(13+p3)→p4
41:   fmt 1,"M1B",f1.0,"V",f4.0,"E"
42:   wrt "swp.1",p3,p4-(p4>9999.5);wait 1000;ret

```

\*12516

Figure 15. Frequency Response Test (14 of 17)

#4

Performs frequency response measurement for frequency ranges using a sweep oscillator. The program flow is as follows:

- 1) A for/next loop is established to step analyzer over selected frequency range (A[9] to A[10]) in 100 steps.
- 2) At each frequency step, the signal amplitude (M) is measured, after a Preselector Peak has been executed, compared with the power meter indication (r7) at the same point, and difference placed in either A[1] or A[2], depending on whether the difference is larger or smaller than the previous measurement.
- 3) The difference between the highest measurement and the lowest measurement is determined and placed in variable A[3] after all 100 points have been measured.

#5

Determines the tuning voltage and band needed to tune the sweep oscillator to the desired frequency called in #4. Sends this information to the sweeper.

*Figure 15. Frequency Response Test (15 of 17)*

```

0: "FREQUENCY RESPONSE PRINT OUT SUBROUTINE":
1: "t0f14: 790801":
2: "#1":
3: "print out":
4:   1.2→r2;if S>3;3.4→r2;if S>5;4.4→r2
5:   32→B;if A[3]>r2;sfg 1;42→B
6:   if flg7 and P<15;gto "s"
7:   if flg3;gto +21
8:   if P>15;wrt "sa","IP KSm KSo A4 D2 DA0PUPA0,1000LB"
9:   wtb P,"          11. FREQUENCY RESPONSE"
10:  fmt 1,2/,10x,"SPECIFICATION:",/;wrt P+.1
11:  fmt 2,22x,"TUNED",18x,"RESPONSE";wrt P+.2
12:  fmt 3,20x,"FREQUENCY",15x,"(Flatness)",/;wrt P+.3
13:  fmt 1,16x,f5.1,c,"-",f5.1,c,8x,"+/-",fz3.1,"dB"," (",f3.1,"dB)"
14:  wrt P+.1,200," Hz",2.5,"GHz",.6,1.2
15:  wrt P+.1,2,"GHz",5.8,"GHz",1.7,3.4
16:  wrt P+.1,5.8,"GHz",12.5,"GHz",1.7,3.4
17:  wrt P+.1,12.5,"GHz",18.6,"GHz",2.2,4.4
18:  fmt 1,/,10x,"MEASURED:";wrt P+.1;wrt P+.2;wrt P+.3
19: "#2":
20: "s":le3→Z→Y;71→X→W;if S<3;le-6→Z;1→Y;77→W;32→X
21:   if S=3;1→Z;77→X
22:   fmt 4,14x,f5.1,x,b,c,"-",f5.1,x,b,c,12x,f4.1,"dB",b,b
23:   wrt P+.4,A[9]/Z,X,"Hz",A[10]/Y,W,"Hz",A[3],B,B
24:   sfg 7;max(1+flgl,X[12])→X[12];if P<15;ret
25:   wrt "sa"," To CONTINUE, press Hz"
26:   wtb "sa",3;gsb "wait"
27:   ret

28: "#3":
29:   prt " TEST NO. 11      freq. response";spc
30:   fmt 5,f5.0," - ",f5.0,"MHz";wrt 16.5,A[9],A[10];if flgl;gto +2
31:   spc ;prt "          PASSED";jmp 4
32:   spc ;prt "out of tolerance";spc
33:   fmt 5,f13.1," dB";wrt 16.5,A[3]
34:   prt "REFER TO","OPERATING AND","SERVICE MANUAL","SECTION IV"
35:   fmt 6,/,16" _",2/;wrt 16.6;ret

```

\*32233

Figure 15. Frequency Response Test (16 of 17)

#1

Checks measured values against specifications and prints test title, specifications, and headings for measured values on HP 9866B or HP 9871A Printer, if used, or displays data on the analyzer CRT if P is equal to analyzer address. Flag 1 is set if an error is detected.

#2

Prints measured values on HP 9866B or HP 9871A Printer, if used. Flag 7 is set to indicate that measurement has been made at least once. This prevents heading from being printed more than once.

#3

Prints test title and either 'passed' or 'out of tolerance' on HP 9825A strip printer. If 'out of tolerance' is printed, measured values are also printed.

*Figure 15. Frequency Response Test (17 of 17)*

```

0: "OPERATION VERIFICATION COPY PROGRAM":
1: "t0f16: 790801":
2: "#1":
3:   dim A$(43,72),B$(43,72),C$(43,72);ent "How many copies ?",N
4:   dsp "Write Protect Master Tape";stp
5:   fxd 0;for I=0 to 18;dsp "Insert Master";stp
6:   trk 0;I>F;if I>16;I-17>F;trk 1
7:   dsp "Loading FILE",F," TRACK",I>16;fdf F;idf F,T,S
8:   gto "data";if T=6;ldf F,23,9
9:   for J=1 to N;dsp "Insert copy number",J;stp
10:  dsp "Recording FILE",F," TRACK",I>16;if F=0;rew
11:  if F#0;fdf F
12:  mrk 1,S*1.2;rcf F,23
13:  next J;next I
14: "#2":
15: "data":ldf F,A$
16:   ldf F+1,B$
17:   ldf F+2,C$
18:   for L=1 to N;dsp "Insert copy number",L;stp
19:   dsp "Recording Data FILE",F;fdf F;mrk 3,S*1.2;rcf F,A$
20:   dsp "Recording Data FILE",F+1;rcf F+1,B$
21:   dsp "Recording Data FILE",F+2;rcf F+2,C$
22:   next L;next I;dsp "   Done";stp
*9223

```

Figure 16. Tape Copy Program (1 of 2)

#1

Displays instructions for operator to write-protect and load master tape in controller. A for/next loop is initialized to load and record all files from master to copies. N equals number of copies. Displays operator instructions and records program files on selected number of copies.

#2

Displays operator instructions and records data files on selected number of copies.

*Figure 16. Tape Copy Program (2 of 2)*



```

0: "8566A OPERATION VERIFICATION PROGRAM OPERATING INSTRUCTIONS":
1: "tlf0: 790801":
2: "      Copyright by Hewlett-Packard   MARCH 1979":
3: "#1":
4:   dev "sa",718;cfg
5: "#2":
6:   dim A$(43,72)
7:   wtb "sa","IP DT@ D3 KSm KSo A4 PUPA96,320LBSEE PRINTER FOR "
8:   wrt "sa","INSTRUCTIONS@"
9:     for J=1 to 3;trk 1;ldf J,A$
10:      for I=1 to 43
11:        fmt 1,6x,c;wrt 6.1,A$(I);next I;next J
12: "#3":
13:   fmt 1,/,80" ",/;wrt 6.1
14:   wrt "sa","EMPUPA100,350LBTO CONTINUE, push Hz@"
15:   wrt "sa","R1R4EE"
16:   if bit(1,rds("sa"))#1;jmp 0
17:   rew;trk 0;ldp 0,0,49
*1269

```

Figure 17. Operating Instructions Program (1 of 2)

#1

Sets device select codes and addresses to be used by program for equipment used.

#2

Prints instructions on HP 9866B or HP 9871A Printer. Data is actually located in Files 1, 2, and 3 of Track 1.

#3

Continues with Operation Verification program when proper entry is made by operator.

*Figure 17. Operating Instructions Program (2 of 2)*



# 8566A Spectrum Analyzer Operation

NOVEMBER 1978



Copyright Hewlett Packard Co., 1978  
1400 Fountain Grove Parkway  
Santa Rosa, California, U.S.A.

Printed in U.S.A.

08566-90002

i.

# CHAPTERS

	Page
1. General Information .....	1.1
2. Getting Started .....	2.1
3. DATA .....	3.1
4. FUNCTION.....	4.1
5. CRT Display.....	5.1
6. TRACE .....	6.1
7. MARKER .....	7.1
8. SCALE and REFERENCE LINE .....	8.1
9. COUPLED FUNCTION .....	9.1
10. SWEEP and TRIGGER .....	10.1
11. INSTRUMENT STATE.....	11.1
12. Shift KEY FUNCTION .....	12.1
13. Appendices .....	13.1
Index.....	13.5
Front Panel Outline .....	Foldout Inside (Back Cover)

# CONTENTS

Chapter	Page
<b>1. General Information</b> .....	1.1
Performance Summary .....	1.1
Initial Power On .....	1.2
RF Input .....	1.3
Front Panel Overview .....	1.5
CRT Display .....	1.6
Rear Panel Outputs .....	1.7
<b>2. Getting Started</b> .....	2.1
Front Panel Concept .....	2.1
Making a Measurement .....	2.2
Direct Signal Frequency and Amplitude Readout .....	2.4
SAVE/RECALL .....	2.4
SHIFT Keys .....	2.5
Automatic Measurements .....	2.5
<b>3. DATA</b> .....	3.1
DATA Entry Readout .....	3.2
Preventing DATA Entry .....	3.2
DATA Knob .....	3.2
DATA Step Keys .....	3.2
DATA Number/Units Keyboard .....	3.2
Multiple DATA Changes .....	3.3
<b>4. FUNCTION</b> .....	4.1
Center Frequency .....	4.2
Frequency Span .....	4.3
Start/Stop Frequency .....	4.6
Reference Level .....	4.7
FUNCTION/DATA Summary .....	4.9
<b>5. CRT Display</b> .....	5.1
Adjustment of the Display .....	5.1
Display Section Line Power .....	5.1
CRT Display Overview .....	5.1
<b>6. TRACE</b> .....	6.1
TRACE Identification .....	6.1
TRACE Modes .....	6.1
TRACE Exchange .....	6.4
TRACE C Modes .....	6.5
TRACE Arithmetic .....	6.5
TRACE Priority .....	6.7

# CONTENTS

Chapter	Page
<b>7. MARKER</b> .....	7.1
MARKER Overview .....	7.2
MARKER On But Not Active .....	7.2
MARKER Off .....	7.2
MARKER in VIEW .....	7.2
Single Marker - NORMAL .....	7.2
Differential Markers .....	7.3
MARKER ZOOM .....	7.6
Automatic Zoom .....	7.9
PEAK SEARCH .....	7.10
MARKER ENTRY .....	7.11
SIGNAL TRACK - Automatic Frequency Control .....	7.14
Frequency and Noise Level Measurements .....	7.14
PRESELECTOR PEAK .....	7.15
Noise Level Measurement .....	7.17
<b>8. SCALE and REFERENCE LINE</b> .....	8.1
SCALE .....	8.1
REFERENCE LINE .....	8.4
DISPLAY LINE .....	8.4
THRESHOLD .....	8.5
<b>9. COUPLED FUNCTION</b> .....	9.1
DATA Entry for COUPLED FUNCTIONS .....	9.2
Resolution Bandwidth .....	9.2
Video Bandwidth .....	9.3
Sweep Time .....	9.4
Input Attenuation .....	9.6
Center Frequency Step Size .....	9.8
<b>10. SWEEP and TRIGGER</b> .....	10.1
SWEEP .....	10.1
TRIGGER .....	10.2
<b>11. INSTRUMENT STATE</b> .....	11.1
FULL SPAN INSTRUMENT PRESET .....	11.1
FULL SPAN 0-2.5 GHz .....	11.2
Saving and Recalling Instrument States .....	11.3
Local Operation .....	11.4

# CONTENTS

Chapter	Page
<b>12. SHIFT KEY FUNCTION</b> .....	12.1
General Description .....	12.1
Function Summary .....	12.2
Alphabetical Key Code Summary .....	12.2
Negative DATA Keyboard Entry .....	12.3
Frequency and Amplitude Offset .....	12.3
Effective Mixer Levels .....	12.4
Amplitude Units .....	12.5
Extend REFERENCE LEVEL Range .....	12.5
Factory/Manual Preselector Setting .....	12.5
MARKER Sweeps .....	12.6
MARKER to Next Peak/MARKER to Minimum .....	12.6
Gaticule and Annotation ON/OFF .....	12.6
CRT Beam On/Off .....	12.7
Display Connection DATA .....	12.7
Title .....	12.7
A + B – A .....	12.8
TRACE Detection Modes .....	12.8
TRACE C .....	12.10
Video Averaging .....	12.11
EXTERNAL and VIDEO TRIGGER .....	12.13
Locking Save Registers .....	12.13
Error Connection Routine .....	12.13
Fast Preset/HP-IB .....	12.15
Band Lock .....	12.15
External Mixer .....	12.15
FUNCTION Index .....	12.16
<b>13. APPENDIX A</b> .....	13.1
Tuning Curves .....	13.1
<b>APPENDIX B</b> .....	13.2
Center Frequency/Span Tuning Characteristics .....	13.2
<b>APPENDIX C</b> .....	13.4
1st LO Output .....	13.4
<b>INDEX</b> .....	13.5
Front Panel Outline .....	Foldout Inside Back Cover





# Chapter 1

## GENERAL INFORMATION

The HP 8566A is a high-performance spectrum analyzer which operates from 100 Hz to 2.5 GHz in the low frequency band and 2 - 22 GHz in the preselected microwave band. It uses a synthesized LO to provide accurate frequency tuning and an internal micro-computer to automate controls and provide useful operating features.

### Performance Summary

#### Frequency

**Range:** 100 Hz — 2.5 GHz / 2 — 22 GHz  
**Resolution:** 10 Hz to 3 MHz  
**Spectral Purity:** < -78 dBc, 300 Hz offset, 5.6 GHz.  
**Accuracy:** Internal frequency standard aging =  $1 \times 10^{-9}$  / day. Frequency accuracy is a function of frequency span and center frequency where:  
accuracy =  $\pm$  (center frequency x frequency standard error + 2% frequency span + 10 Hz)  
for span < 5 MHz.

#### Amplitude

**Range:** -137 dBm to +30 dBm with 90 dB calibrated display  
**Scale Resolution:** 10, 5, 2 or 1 dB/Div or linear with amplitude readout in dBm, dBmV, dB $\mu$ V or volts.  
**Dynamic Range:** Up to 90 dB  
**Flatness:**  $\pm 2.2$  dB

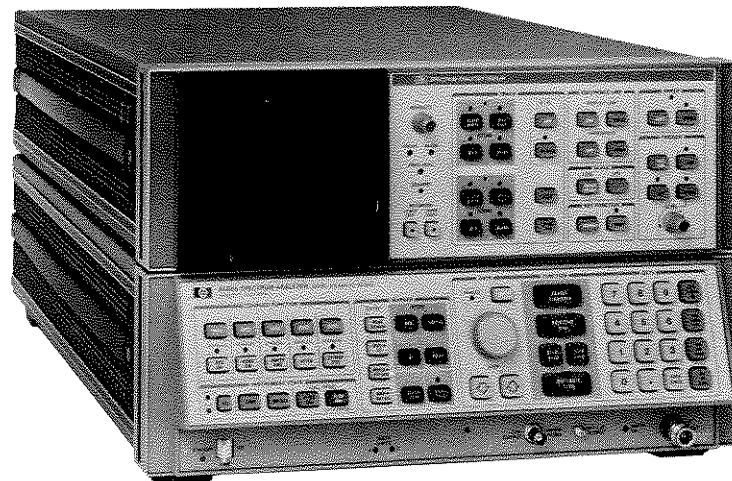

HP 8566A Spectrum Analyzer

## GENERAL INFORMATION

The HP 8566A consists of an 85662A Display Section and an 85660A RF Section. Connect the two sections along with the inter-connection cables as shown in the illustration below.

### CAUTION

Make sure that the proper line voltage and line fuse have been selected for both the RF and the Display section of the analyzer.

Connect interconnection cables as shown:

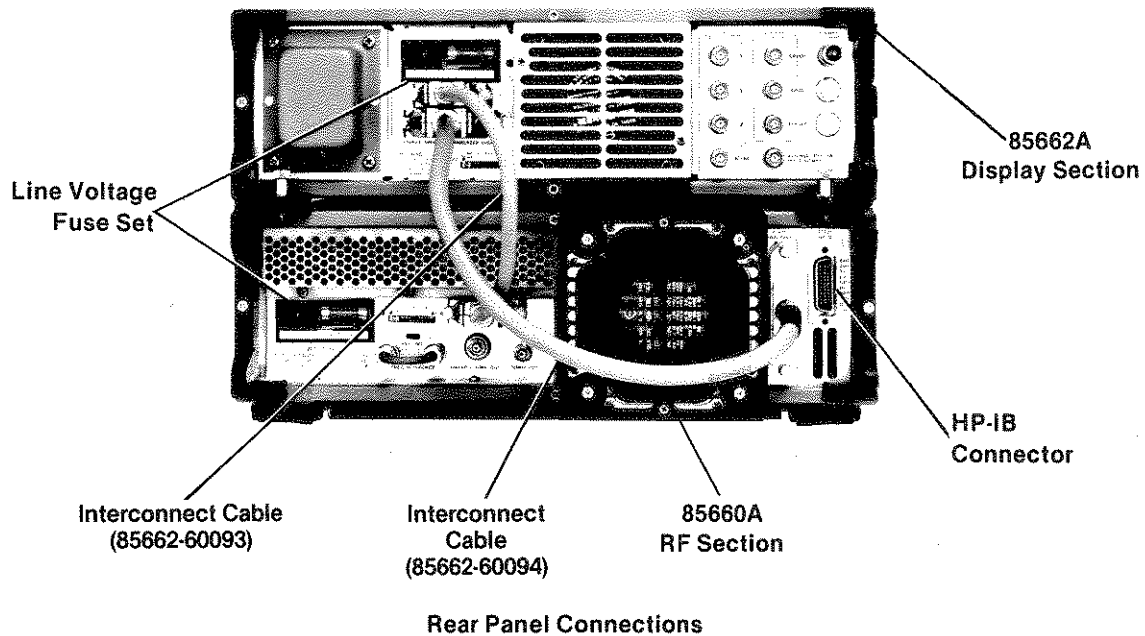

## Initial Power On

After making the AC power line connections the STANDBY lights of both the RF and Display section should be on. As long as the instrument is operating (LINE ON) or in STANDBY, the accuracy specifications of the internal frequency standard will be met. After a cold start up, such as on-receipt of instrument, the analyzer requires 24 hours to stabilize prior to meeting specified performance.

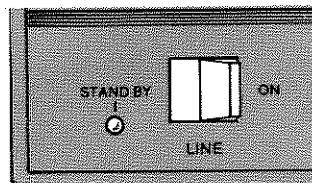

LINE ON and STANDBY

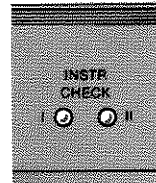

INSTR CHECK LED

Upon LINE ON, the instrument will perform an automatic internal instrument check, designated by the red INSTR CHECK lights. Both lights will turn on momentarily during the brief check routine and, if the instrument is operating properly, will remain off. If one or both LED's remain on, refer to the chart below to localize the problem.

LED On	Problem	Solution
I	Digital Storage failure in 85662A	Check bus interconnect cable (85662-60094)
II	Interface Failure	Check bus interconnect cable (85662-60094) and check if A12 board is connected tightly
I & II	Memory (A14) and Processor (A15)	Check if A14 and A15 are connected tightly in 85660A and that contacts are clean.

### Calibration

In order to meet specified frequency and amplitude accuracy, the analyzer's calibration must be checked periodically to insure the highest performance.

## RF Input

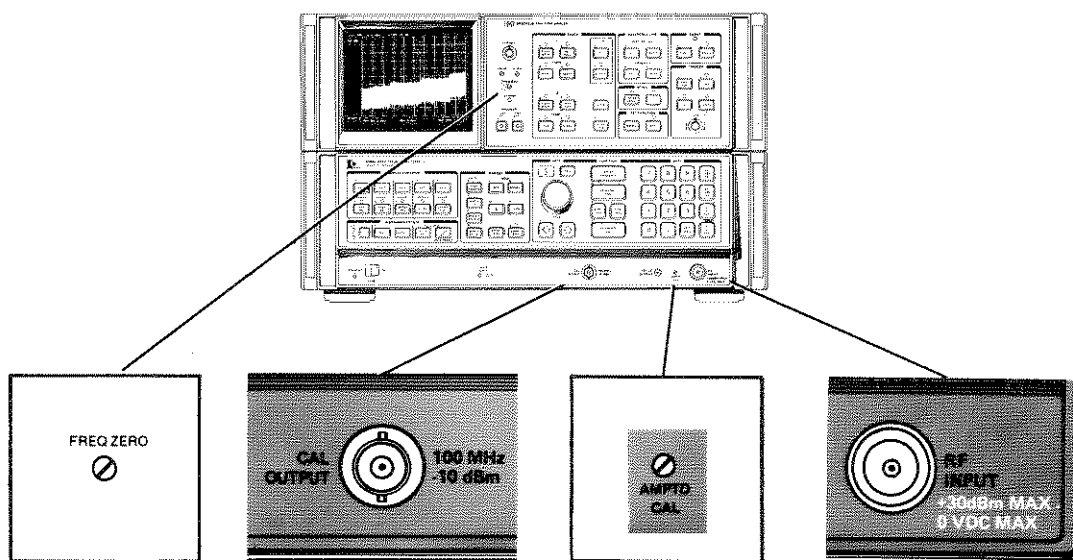



Connect cable from CAL OUTPUT signal to RF input to perform initial calibration

### CAUTION

Excessive signal input power will damage the input attenuator and the input mixer. The spectrum analyzer total RF power must not exceed +30 dBm (1 watt).



DC Precaution: The HP 8566A cannot accept DC voltages in 0 dB ATTEN. With 10 dB or greater input attenuation, a maximum of  $\pm 7$  Volts DC can be accepted without damage. A blocking capacitor is recommended at the input when DC is present with an RF signal.

## Manual Calibration Procedure

1. After instrument has stabilized, press 
2. Press  **8** ; this recalls the following stored control settings from the analyzer's internal memory:
  - Center Frequency = 100 MHz
  - Frequency Span = 2 MHz
  - Reference Level = - 7 dBm
  - Res BW = 1 MHz
  - Scale = 1 dB/Div
  - Marker = Normal
3. Adjust AMPTD CAL for a marker amplitude of - 10 dBm.\*
4. Press  **9** ; this recalls the following
  - Center Frequency = 100 MHz
  - Frequency Span = 0 Hz
  - Reference Level = - 7 dBm
  - Res BW = 30 Hz
  - Scale = 1 dB/Div
  - Sweep Time = 10 Sec.
5. Maximize amplitude response with FREQ ZERO adjustment.

\*If connection cable has significant loss it must be accounted for separately.

## Error Correction Routine

A 30 second internal error correction routine minimizes uncertainties due to control changes in the analyzer. To start the routine, press  **W** 

A "CORR'D" readout will appear on the left edge of the CRT upon completion of this routine. If the message "Adjust AMPTD CAL" appears in the display, repeat the manual calibration before running the error correction routine again.



# Front Panel Overview

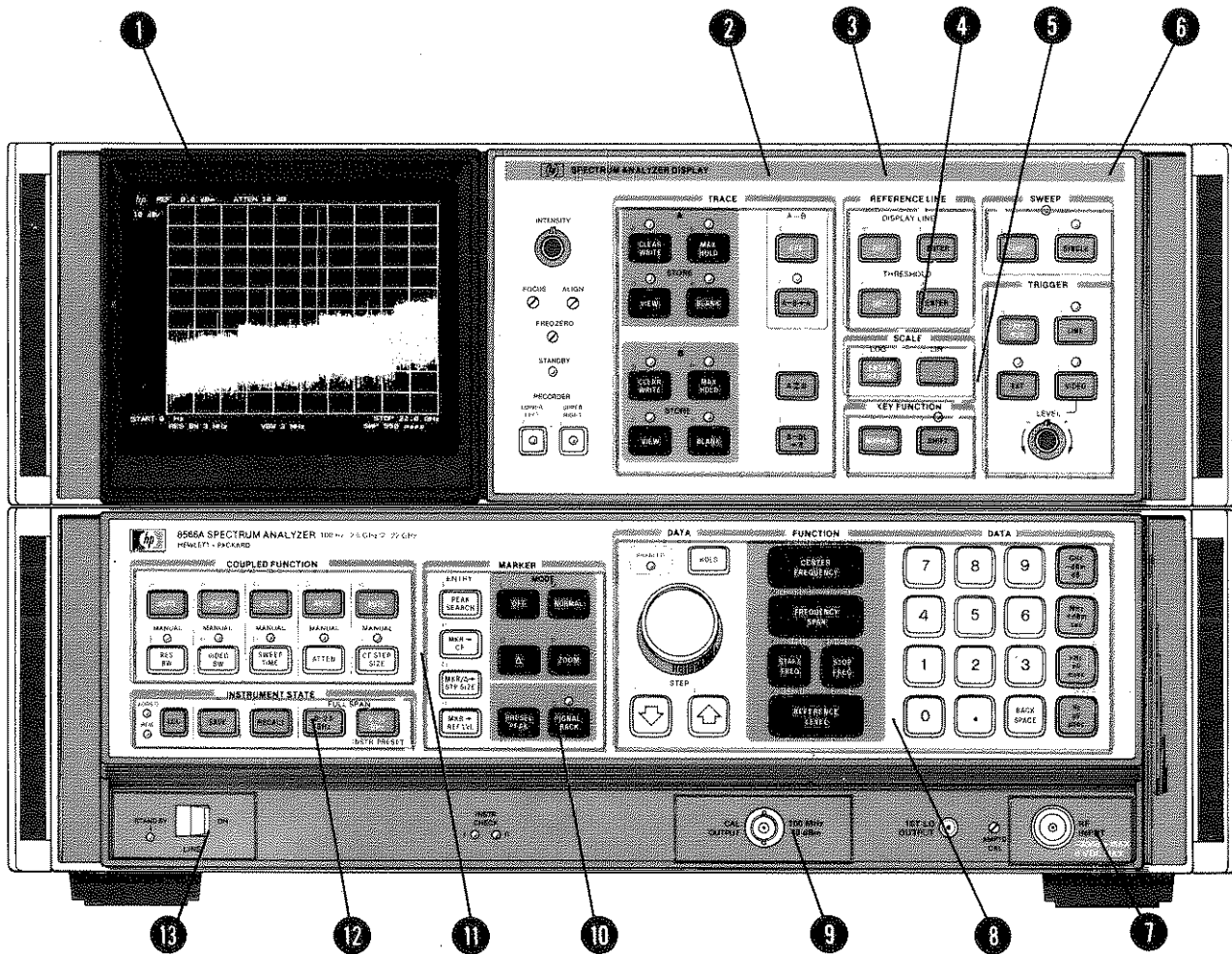

## CONTROL GROUPS

- 1 CRT DISPLAY:** Signal response and analyzer settings
- 2 TRACE:** Control of signal response display
- 3 REFERENCE LINE:** Measurement and display aids
- 4 SCALE:** Selects logarithmic or linear amplitude scale
- 5 KEY FUNCTION:** Access to special functions
- 6 SWEEP and TRIGGER:** Selects trace update trigger
- 7 RF INPUT:** 100 Hz to 22 GHz (+ 30 dBm max. power)
- 8 DATA/FUNCTION:** Fundamental analyzer control
- 9 CAL OUTPUT:** Calibration signal
- 10 MARKER:** Movable bright dot markers for direct frequency and amplitude readout
- 11 COUPLED FUNCTION:** Maintenance of absolute amplitude and frequency calibration by automatically selecting certain analyzer control settings
- 12 INSTRUMENT STATE:** Local (lcl) select key, SAVE and RECALL keys and FULL SPAN keys.
- 13 LINE ON&STANDBY** Powers instrument and performs instrument check

# CRT Display

The analyzer's CRT display presents the signal response trace and all pertinent measurement data. The active function area names the function under DATA control and shows the function values as they are changed. All the information necessary to scale and reference the graticule is provided.

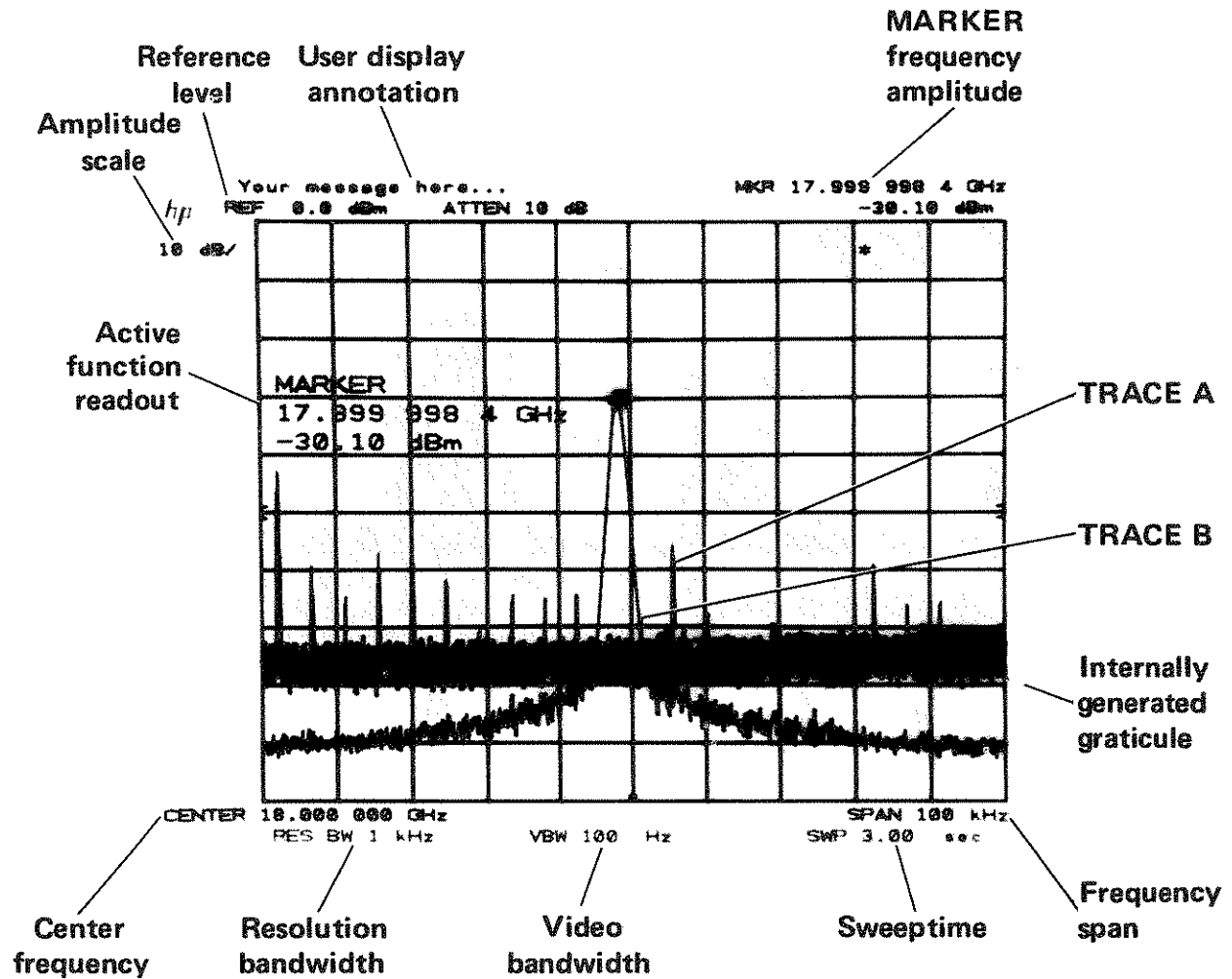

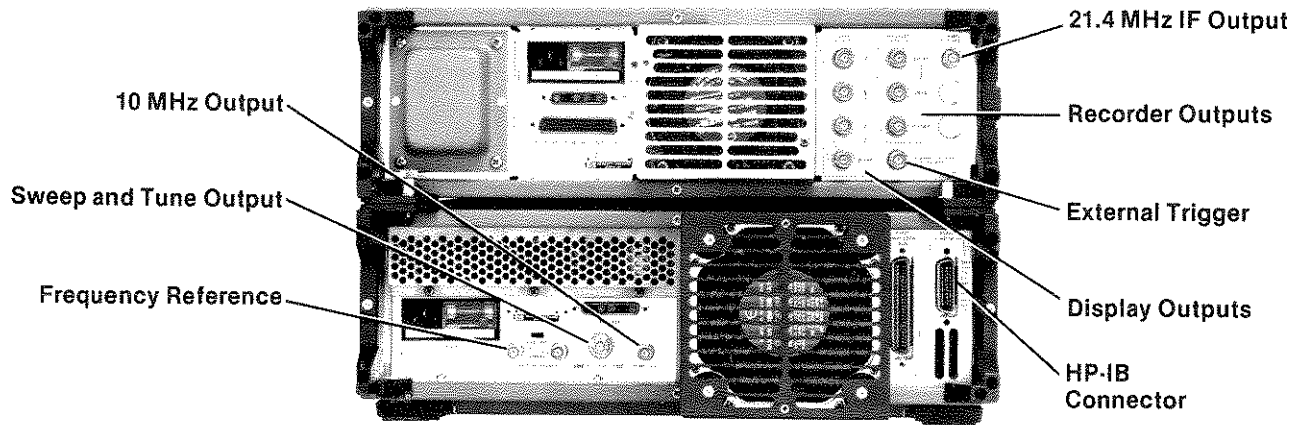

## Rear Panel Outputs







### Display Outputs

Display outputs allow all the CRT information to be displayed on an auxiliary CRT display such as the HP 1310A Large Screen Display.

Display Outputs	Output
 X  Y  Z	0 to +1 V  Intensity: -1 V blank, 0 to 1 V intensity modulation

### Recorder Outputs

The recorder outputs allow the x-y plot of trace data with x-y plotters using positive penlift coils or TTL penlift input. The front panel keys enable outputs for the calibration of x-y plotter reference points:

Recorder Outputs	RECORDER LOWER LEFT UPPER RIGHT  	RECORDER Outputs when keys or HP-IB commands are enabled	
		Lower Left	Upper Right
 SWEEP	A voltage proportional to the horizontal sweep of the CRT trace that ranges from 0 V for the left edge and to +10 V for the right edge.  Detected video output (before A-D conversion) proportional to vertical deflection of the CRT trace. Output increases 100 mV/div from 0 to 1 V.  A blanking output, 15 V, occurs during CRT retrace; otherwise output is low at 0 V (pen down).	0 V left	10 V right
 VIDEO		0 V lower	+1 V upper
 PENLIFT		+15 V	+15 V

### HP-IB Input Output Connector

The Hewlett Packard Interface Bus allows remote operation of the analyzer as well as input and output of measurement data. See 8566A Spectrum Analyzer Remote Operation, HP part number 08566-90003.



# Chapter 2 GETTING STARTED

This chapter is intended to provide you with a quick overview of the use and capability of the HP 8566A Spectrum Analyzer. The chapters following provide the details on each aspect of operation.

## Front Panel Concept

The basic controls on the HP 8566A front panel consists of FUNCTION keys and DATA control keys. Functions are activated by pressing the appropriate key; its value is then changed via the DATA control knob, step keys or numeric keyboard. The activated FUNCTION will appear on the CRT as well as its current value.

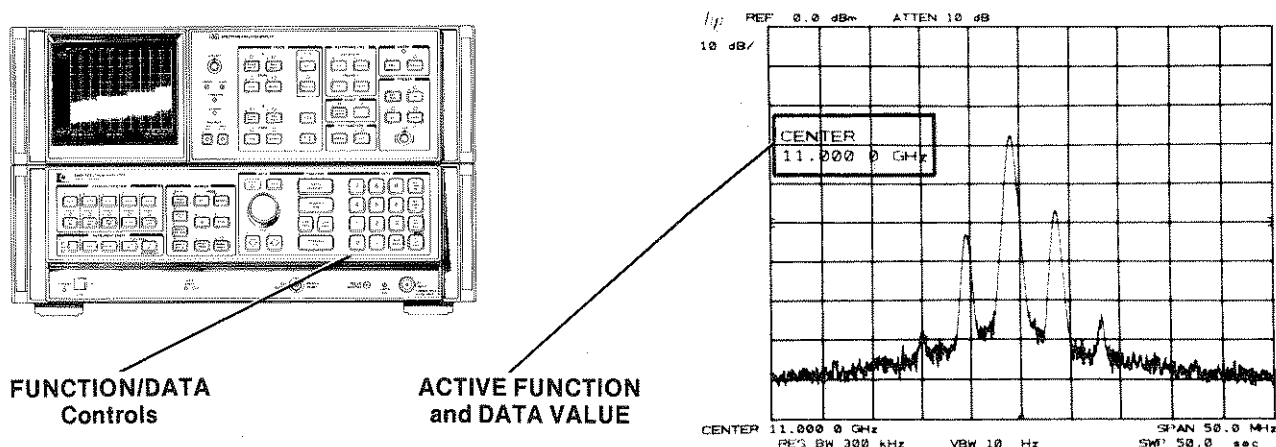

The front panel controls are divided into functional groups. The majority of measurements can be made with only the FUNCTION/DATA group illustrated. The major FUNCTION controls are CENTER FREQUENCY, FREQUENCY SPAN (or START/STOP FREQ) and REFERENCE LEVEL. The value of the activated FUNCTION can be changed continuously with the knob, incrementally with STEP KEYS or exactly with the numeric keyboard.

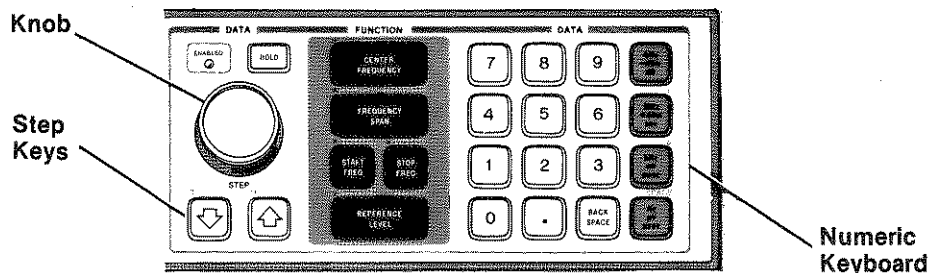

# Making a Measurement

Two FULL SPAN keys allow you to select a wide 0 — 2.5 GHz or 2 — 22 GHz\* frequency span. Both keys presets all the analyzer functions to automatically maintain a calibrated display during the course of the measurement.

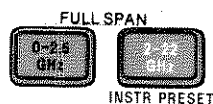





## EXAMPLE

Connect the CAL OUTPUT signal to RF INPUT.

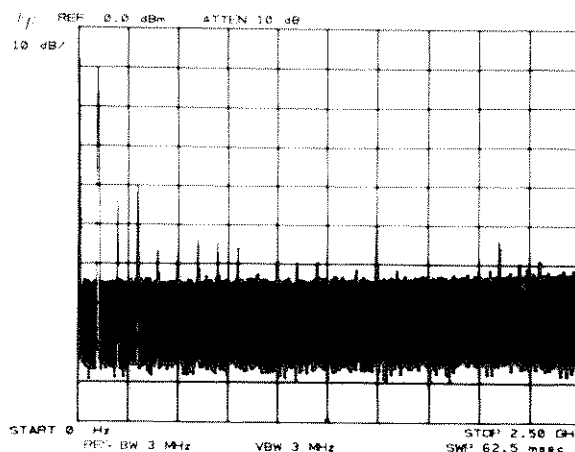
Press 

This presets the analyzer to a full 0 — 2.5 GHz span with 0 dBm Reference level and automatically couples all secondary receiver functions.



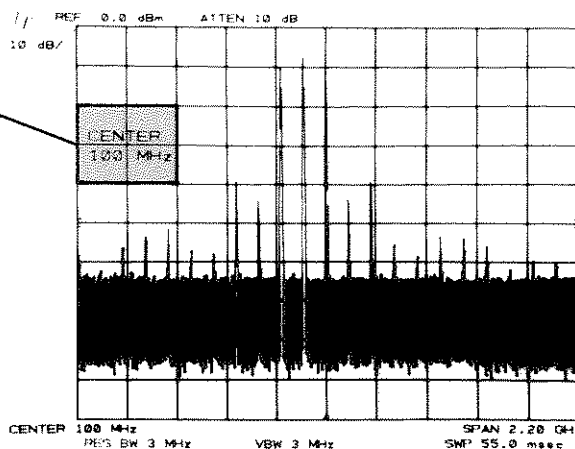

Press  and use the knob  step keys   or the numeric keyboard to tune the center frequency to 100 MHz. Note that the activated FUNCTION (CENTER FREQUENCY), appears on the CRT graticule field.

CENTER FREQUENCY





\*The  key is also activated with LINE ON.

# GETTING STARTED

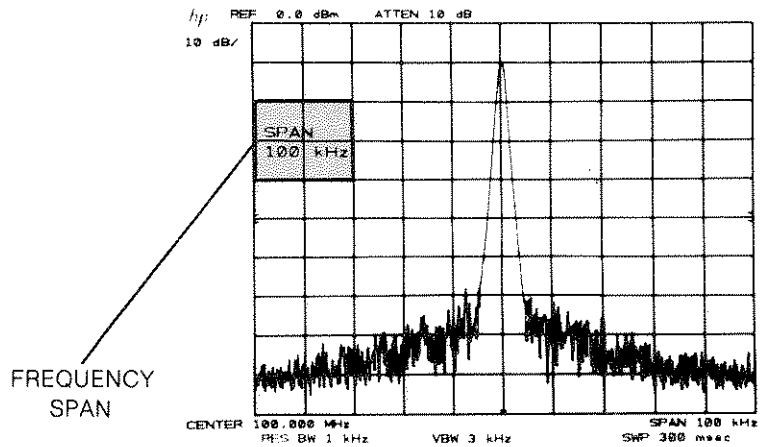
Press **FREQUENCY SPAN** and use the knob , step keys   or numeric keyboard to reduce the frequency span to 100 kHz.



Press **REFERENCE LEVEL** and use the knob , step keys   or numeric keyboard to position the peak of the signal on the top graticule line.

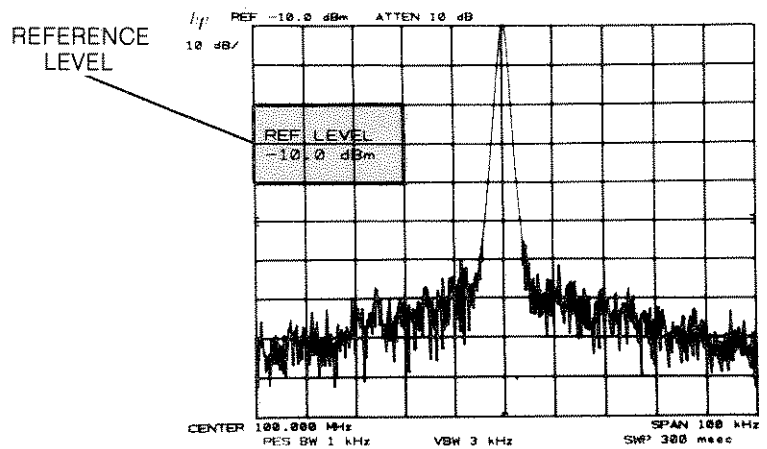

The frequency and amplitude of the signal are read out from the graticule border. All secondary analyzer functions (resolution bandwidth, video bandwidth, sweep time and attenuation) were automatically adjusted to maintain a fully calibrated display. The coupled functions can also be uncoupled to allow manual operation.

For instance, to manually control the resolution bandwidth, press **RES BW** and change bandwidth with any combination of DATA control. The above also applies to **VIDEO BW**, **SWEEP TIME**, **ATTEN** or **CFSTEP SIZE**.

# Direct Frequency and Amplitude Readout

Markers can be used to quickly identify signal frequency and amplitudes — delta ( $\Delta$ ) markers are available to measure signal separation or amplitude differences.

Activate a marker on the display with **NORMAL**. Tune marker with . The frequency and amplitude of the signal are read out with the marker.

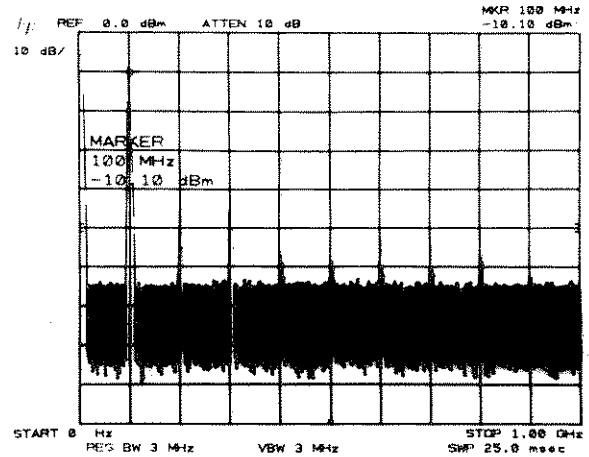

To measure the harmonic(s) of the signal, press  $\Delta$  and tune the second marker to the signal's harmonic. The frequency separation and amplitude difference are read out.

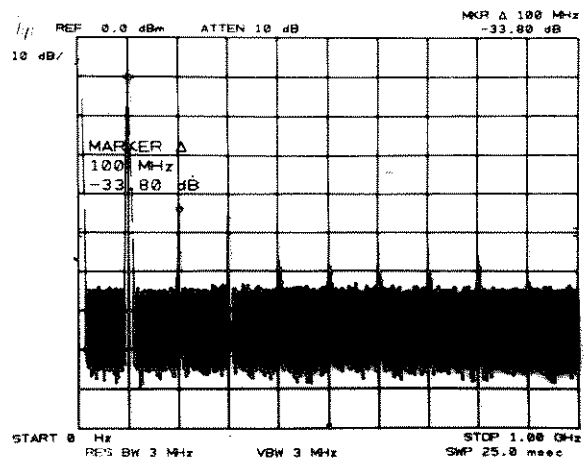

## SAVE / RECALL

The HP 8566A instrument control settings can be saved in an internal memory and later recalled to make a measurement. **SAVE** / **RECALL** **1** to **6** provide access to the six internal storage registers.

## SHIFT Keys

In addition to the front panel functions listed on the keys, another set of functions can be assigned to the same keys by pressing the blue  key prior to activating a front panel key. These will be covered in more detail in Chapter 12.

## Automatic Measurements

The HP8566A is fully programmable via the Hewlett-Packard Interface Bus (HP-IB) — HP's implementation of IEEE Std 488-1975. Internationally, HP-IB is in concert with the IEC main interface document.

A computing controller/calculator can be used with the HP 8566A to configure an automatic measurement system. Just as the analyzer's front panel is keyed manually to control functions and change values, simple program codes are transmitted via the HP-IB with a controller to make measurements automatically. These program codes are listed in the Remote Operation section of the instrument pull-cards.

Detailed information on remote operation is the subject of another manual entitled "8566A Spectrum Analyzer Remote Operation", HP part number 08566A-90003.

## Chapter 3

# DATA

DATA controls are used to change function values for functions such as center frequency, start frequency, resolution bandwidth or marker position.

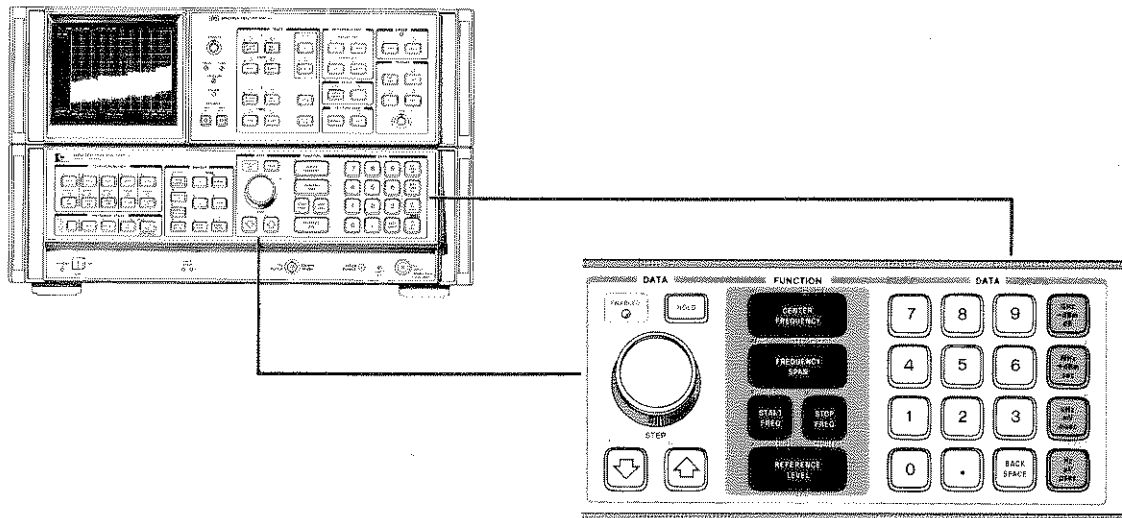





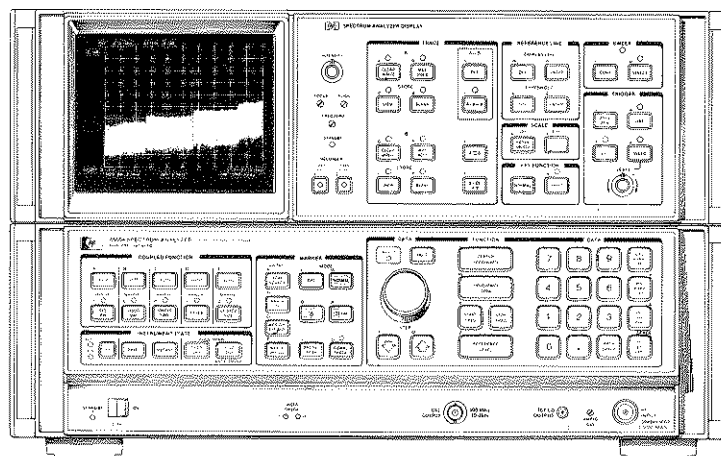



**DATA Controls**

The DATA controls are clustered about the FUNCTION keys which “call up” or activate the most frequently used spectrum analyzer control functions: center frequency, frequency span (or start/stop frequency) and reference level. The other functions that accept DATA control are shown below:



**Front Panel Functions Using DATA Controls**

To the left of the FUNCTION Keys are the DATA knob  and the DATA STEP keys   which are used to make incremental changes to the activated function. To the right of the FUNCTION keys is the DATA number/units keyboard which allows changes to an exact value.

The DATA controls will change the activated function in a manner prescribed by that function. For example, center frequency can be changed continuously with the DATA knob , or in steps proportional to the frequency span with the DATA STEP keys  , or set exactly with the DATA number/units keyboard. Resolution bandwidth, which can be set only to discrete values, can still be changed with any of the DATA controls. The DATA knob  and DATA STEP keys   increment the setting from one bandwidth to the next. An entry from the number/units keyboard which may not coincide with an allowable bandwidth will select the nearest bandwidth.

# DATA Entry Readout

DATA entries are read from the CRT display as they are changed.

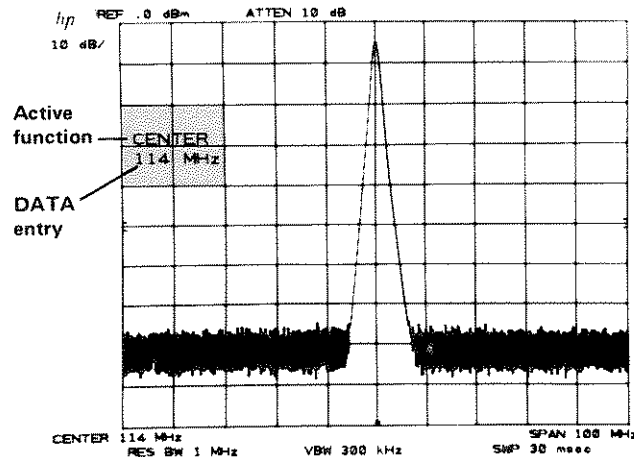

## Preventing DATA Entry







A function can be deactivated by pressing **HOLD**. The active function readout is blanked and the ENABLED light goes out, indicating no DATA entry can be made. Pressing a function key re-enables the DATA controls.

## DATA Knob

The DATA knob  allows the continuous change of center frequency, frequency span (or stop/stop frequencies), reference level, and the positions of the marker, display line and threshold. It can also change the function values which are only incremented.

Clockwise rotation of the DATA knob will increase the function value. For continuous changes, the knob's sensitivity is determined by the measurement range and the speed at which the knob is turned. For example, when the center frequency is activated,  increases the value of the center frequency one horizontal division of span per one quarter turn.

## DATA STEP Keys

The DATA STEP keys allow rapid increase  or decrease  of the active function value. The step size is dependent either upon the analyzer's measurements range, on a preset amount or, for those parameters with fixed values, the next value in a sequence. Examples: Activate center frequency and  will increase the center frequency value by an amount equal to one division of the frequency span (one tenth of the frequency span). If the center frequency step size  has been preset,  will increase the center frequency by that preset amount. If frequency span were activated,  would change the span to the next lower value in predetermined sequence. Activate resolution bandwidth and  will select the next widest bandwidth.

Each press results in a single step.

## DATA Number/Units Keyboard

The DATA number/units keyboard (or DATA keyboard) allows exact value entries to center frequency, frequency span (or start/stop frequency), reference level, log scale and the positions of the markers, display line, threshold and the COUPLED FUNCTIONS.



An activated parameter is changed by entering the number (with the CRT display providing a readout) then selecting the appropriate units key. The value is not changed (entered) until the units key is pressed.

The number portion of the entry may include a decimal, . If not, the decimal is understood at the end of the number. Corrections to number entries are made with  which erases the last digit for each press.

Example: With center frequency activated







will set the center frequency to 1.250 GHz.

If the units key were pressed without a number entry, 1 is entered (except in zero frequency span).







### Negative DATA Entry

Negative entries from the number units keyboard can be made for power and frequency but not time and voltage.

Negative power entries can be made using . The "-dBm" key will enter -dBm, -dBmV or -dBμV. For example in reference level, with the dBmV units, an entry of    will enter -50 dBmV.

Negative frequency entries can be made using



as a prefix to the frequency entry. For example, to enter a negative start frequency, press       . This enters the frequency value as -100 MHz.

Not all functions will accept negative entries (the sign will be ignored).

## Multiple DATA Changes

A function, once activated, may be changed as often as necessary without reactivating that function (see Chapter 4, FUNCTION). Any of the DATA controls can be used in any order.\*

It is not always necessary to make a DATA entry. For example, start and stop frequency may be activated simply to allow readout of the left and right display reference frequencies as start/stop frequencies.

\*Exceptions are the SHIFT KEY FUNCTIONS which use only DATA number/units keyboard. See Chapter 12.



# Chapter 4

## FUNCTION

This chapter describes the use of the major function block — CENTER FREQUENCY, FREQUENCY SPAN (or START/STOP FREQUENCY) and REFERENCE LEVEL.

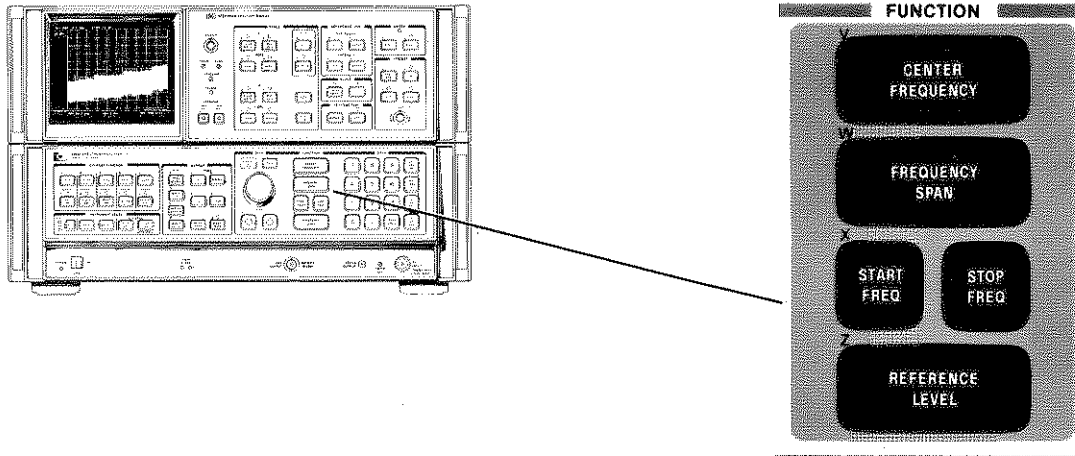

A FUNCTION is enabled by pressing the desired FUNCTION key. Once enabled, the function along with its current data value is displayed in the active graticule area of the CRT as well as outside the graticule border. To change the value of the active function, use either the DATA knob, step keys, numeric keyboard or a combination of all three. The HOLD key above the DATA knob can be used to retain the present instrument state and prevent inadvertent entry of DATA. HOLD clears the active function area of the CRT as well as de-activates any function.

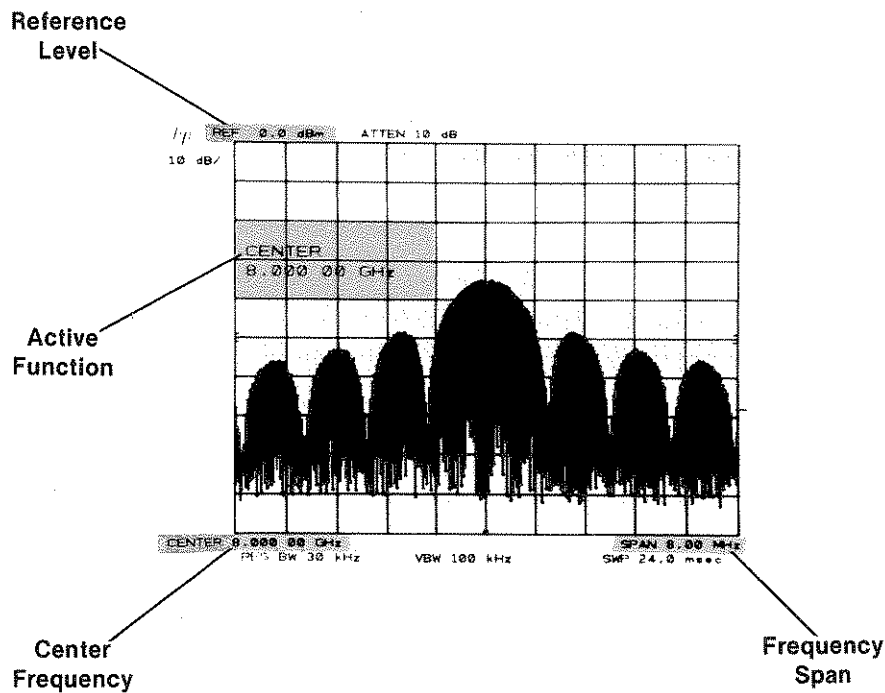



# Center Frequency

The center frequency can be tuned continuously from 0 to 22 GHz using any combination of DATA controls. Additional band overlap enables the center frequency to tune up to 24 GHz and below to - 1 GHz.

The center frequency can be set with 1 Hz resolution. Readout resolution is 1% of the frequency span, hence the highest readout resolution is obtained with narrow frequency spans. Data entered however, is always accurate to 1 Hz even though the center frequency readout may display less resolution.

During band crossings (from 0 — 2.5 GHz low band to 2 — 22 GHz microwave band) or at band edges (below 0 Hz or above 22 GHz), the frequency span may change to enable the desired center frequency to be set. (See Appendix for detailed information.)

## DATA Entry with CENTER FREQUENCY

	Changes the center frequency by about one half the total frequency span each full turn.
	Changes the center frequency by one tenth of the frequency span, i.e., by one division. COUPLED FUNCTION  can be used to change this step size.
	Allows direct center frequency entry. The analyzer will accept a center frequency entry with 1 Hz resolution. Even though the readout may show a fewer number of digits (due to wide frequency span), as the span is narrowed, the full entry will be read out. Abbreviated readouts are not rounded.

### Example:

Once a signal response is placed at the center of the display, the frequency of the signal can be read out from CENTER FREQUENCY. The input signal is an 9 GHz synthesized source.

Press for a full span display.

Tune signal to center of display with

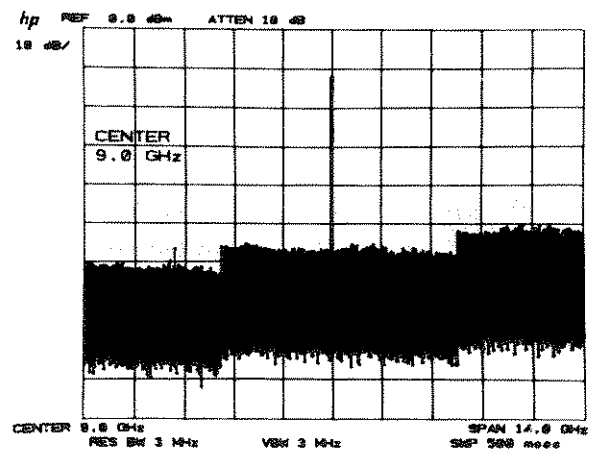
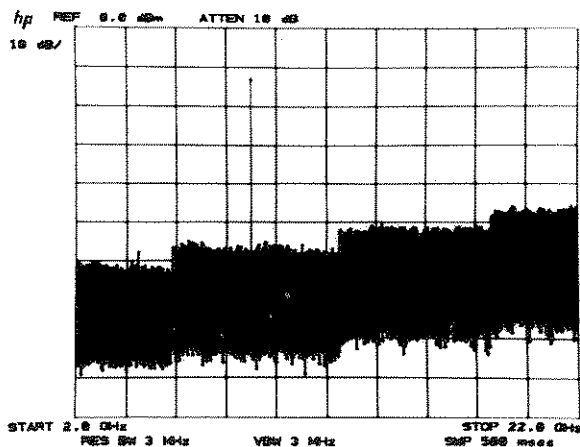

## FUNCTION

CENTER  
FREQUENCY

Reducing the frequency span will increase the center frequency readout resolution.

press   

then 

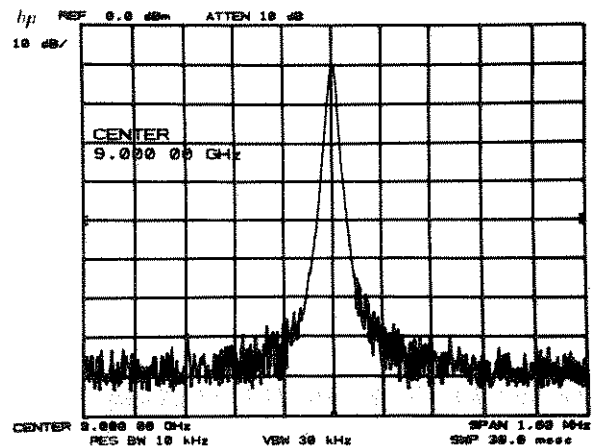



## Frequency Span

The frequency span changes the total display frequency range symmetrically about the center frequency. Note that the frequency span readout refers to the total display frequency range; to determine frequency span per division, divide by 10.

As the frequency span is changed, resolution bandwidth and video bandwidth automatically change to provide a predetermined level of resolution and noise averaging respectively. Sweep time also changes automatically to maintain a calibrated display.

The analyzer can be adjusted to span a maximum of 2.5 GHz in the low band and 22 GHz (2 to 24 GHz range) in the microwave band. A minimum span of 100 Hz is allowed in both bands as well as 0 Hz (zero span) which enables the analyzer to function as a fixed-tune receiver. In zero span, the analyzer can display modulation waveforms in the time domain.

## DATA Entry with FREQUENCY SPAN

	Changes the frequency span continuously.
	Changes the frequency span to the next value in a 1, 2, 5, 10 sequence.
	Enters an exact value up to three digits, depending on span. Additional digits will be deleted without rounding.

FREQUENCY SPAN

**Example:**

Use FREQUENCY SPAN to zoom-in on signals.

Connect CAL OUTPUT to RF INPUT press

**0-2.5 GHz**. This selects a convenient full span display from 0 to 2.5 GHz.

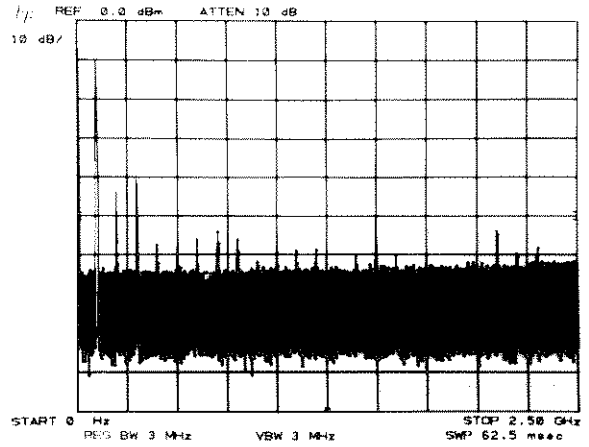

Tune center frequency to 100 MHz with:

**CENTER FREQUENCY** 100 MHz.

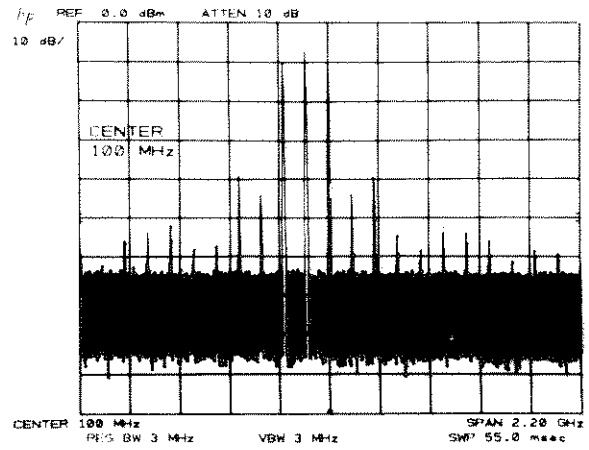

Reduce span with:



The desired span can also be selected with the numeric keyboard. Note that narrow frequency spans provide increased center frequency resolution.

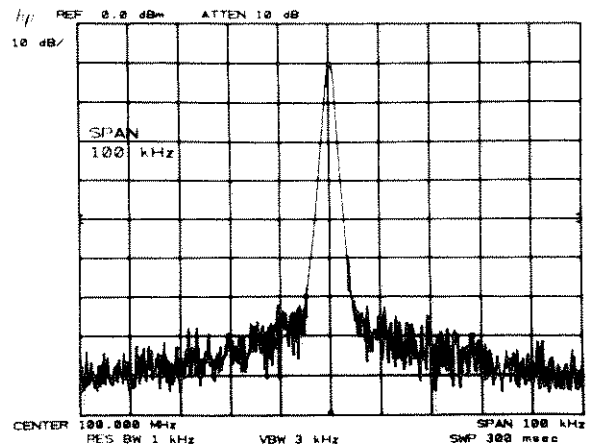

In the microwave band, pressing **2-22 GHz** enables a 20 GHz full span.

**FUNCTION**

FREQUENCY SPAN

**Example:**

Operating the spectrum analyzer in zero span. The modulation waveform of an AM signal can be displayed in the time domain.

In the frequency domain, we can accurately determine the modulation frequency and level.

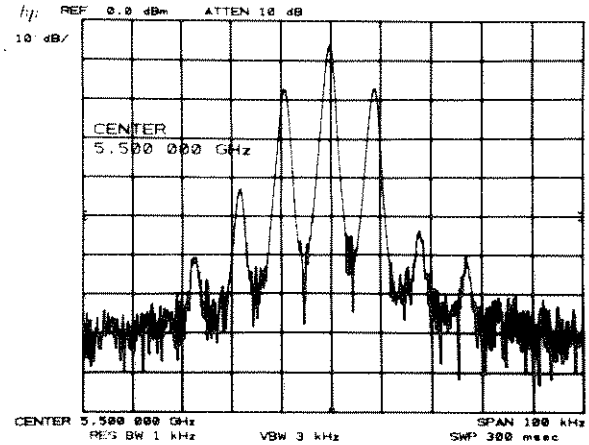

To demodulate the AM, increase the resolution bandwidth to include both sidebands within the IF passband.

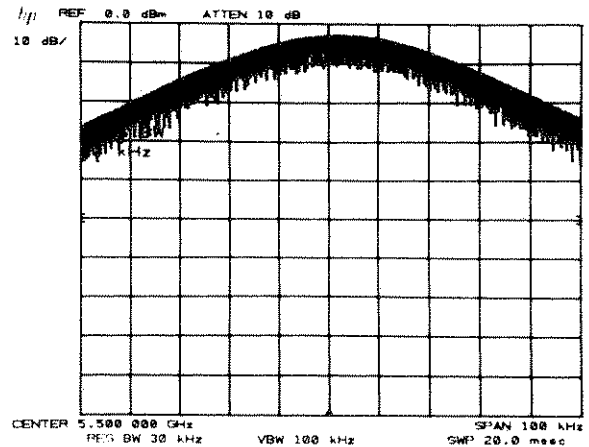

Position the signal at the reference level and select a linear voltage display.

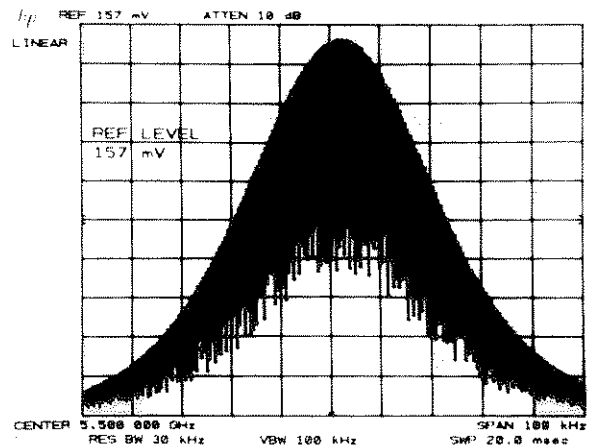



To select zero span, press **FREQUENCY SPAN** **0** **Hz** **OFF** **SWEEP**.  
 Video trigger can be used to trigger on the waveform. The sweep time control can be adjusted to change the horizontal scale.

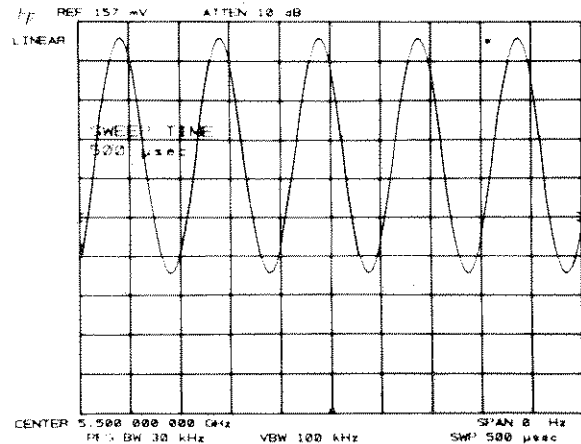

## START/STOP Frequency

Another way to adjust the frequency range is by using START/STOP FREQUENCY instead of CENTER FREQUENCY and FREQUENCY SPAN. Activating START FREQ or STOP FREQ causes both to read out in place of CENTER FREQUENCY and SPAN on the CRT. START FREQ sets the left graticule frequency and STOP FREQ sets the right graticule frequency; both are mutually exclusive with CENTER FREQUENCY and FREQUENCY SPAN.

The INSTRUMENT STATE keys, **0-2.5 GHz** and **2-22 GHz** select a start/stop frequency from 0 to 2.5 GHz and 2 to 22 GHz respectively. Additional over-range allows start frequency setting of -1 GHz and stop frequency of 24 GHz. The maximum start/stop frequency span allowable is 22 GHz; the minimum span is 100 Hz and zero span (START FREQ = STOP FREQ).

Start/Stop frequency readout resolution is 1% of the span (span = stop frequency - start frequency). Both start or stop frequencies can be entered with 1 Hz resolution.

### DATA Entry with START/STOP Frequency

<p>START FREQ OR STOP FREQ</p>	<p>Changes the start or stop frequency. The amount of change per turn is a constant percentage of the frequency span.</p>
<p>START FREQ STOP FREQ</p>	<p>Changes the frequency by one tenth of the total frequency span.</p>
<p>START FREQ OR STOP FREQ</p>	<p>Exact start or stop frequencies can be entered. The number of digits readout depends upon the frequency span.</p>

## FUNCTION



### Example:

Set start/stop frequency to monitor FM broadcast band.

Press:

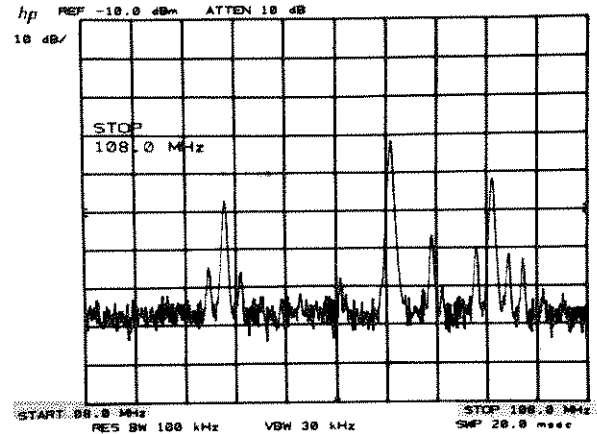
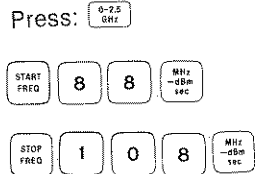

Press . Note that horizontal scaling is unchanged although the START/STOP frequency readouts are replaced by center frequency and span (108 - 88 = 20 MHz)

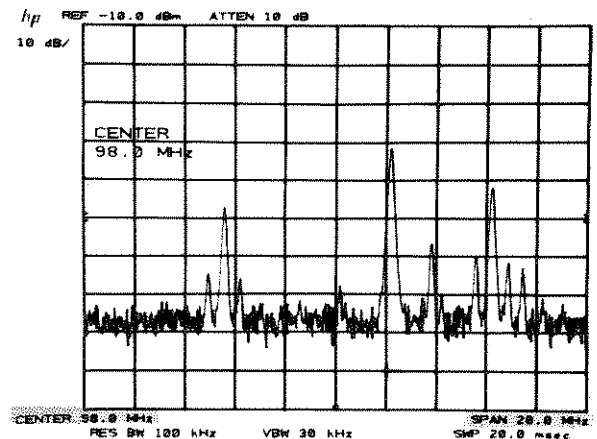

## Reference Level

The REFERENCE LEVEL function changes the absolute amplitude level of the top graticule line. The vertical scale (amplitude units per division) is selected from the SCALE control group. To measure signal level, the peak of the signal's response is positioned on the top graticule line and its amplitude is read out from REF LEVEL.

The reference level can be adjusted from -89.9 dBm to +30 dBm (-139.9 dBm to +60 dBm with extended range) with 0.1 dB resolution. The input attenuator is automatically coupled with the reference level to prevent gain compression; signals which are above the gain compression point will be displayed above the reference level line. Different mixer input levels as well as amplitude units can be selected (see SHIFT FUNCTIONS Chapter 12).



### DATA Entry with REFERENCE LEVEL

	<p>In logarithmic scale the changes are in 0.1 dB steps: in linear scale the changes are made to the least significant digit.</p>
	<p>In logarithmic scale, changes the reference level in steps according to dB/division scale. In linear scale, changes the reference level in 1 dB steps.</p>
	<p>Allows entry of exact reference levels. Digits entered beyond the displayed number of digits are deleted.</p>

#### Example:

Measure amplitude of calibration signal.

Press

100 MHz

2 MHz

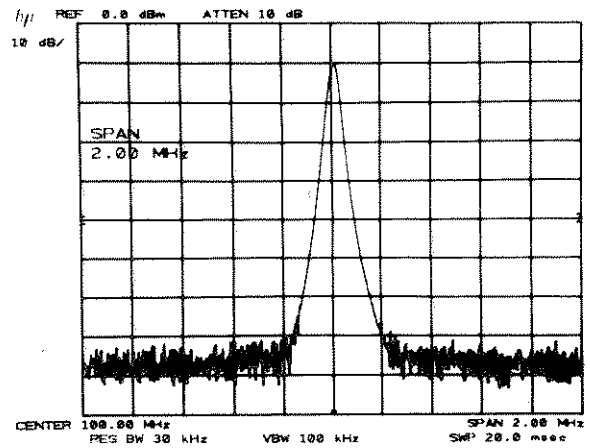





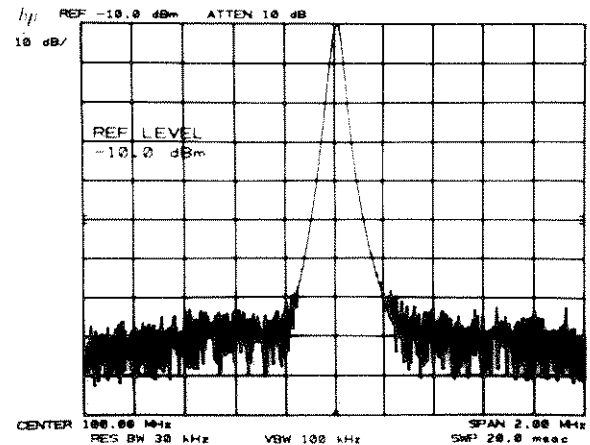

To measure signal amplitude, press

and position signal peak to top graticule line. Read amplitude from REF LEVEL.





## Function/Data Summary

FUNCTION DATA	CENTER FREQUENCY	FREQUENCY SPAN	START/STOP FREQUENCY	REFERENCE LEVEL
<b>KNOB</b> 	Change continuously with up to 1 Hz resolution in narrow spans.	→	Change continuously with n x 2Hz resolution*	Continuous with 0.1 dB tuning resolution
<b>STEP KEYS</b> 	Change frequency in one division steps, (i.e. 10% of frequency span.)	→	Change span in 1, 2, 5, 10 sequence	Incremental change in accordance with log scale. In Linear, changes incrementally in 1 dB steps.
<b>NUMERIC KEYBOARD</b> 	Enter exact frequency with up to 1 Hz resolution	→	Enter exact frequency with n x 2Hz resolution*	Enter exact reference level. Digits entered beyond last displayed digit are deleted.
<b>ADJUSTMENT RANGE</b>	- 1.000000000 GHz to 23.999999950 GHz	 - 1 to 2.5 GHz  2 to 24 GHz	 100 Hz to 22 GHz and zero span  100 Hz to 2.5 GHz and zero span	- 139.9 dBm to + 60 dBm
<b>READOUT RESOLUTION</b>	1% of SPAN (Up to 1 Hz in narrow span)	→	→	0.1 dB in log; 4 significant digits in linear.

\*where n = harmonic number

# Chapter 5

## CRT DISPLAY

This chapter describes the CRT display adjustments, readouts and graphics.

### Adjustment of the Display

The adjustments for intensity, focus and alignment simultaneously affect all the lines and characters on the display.

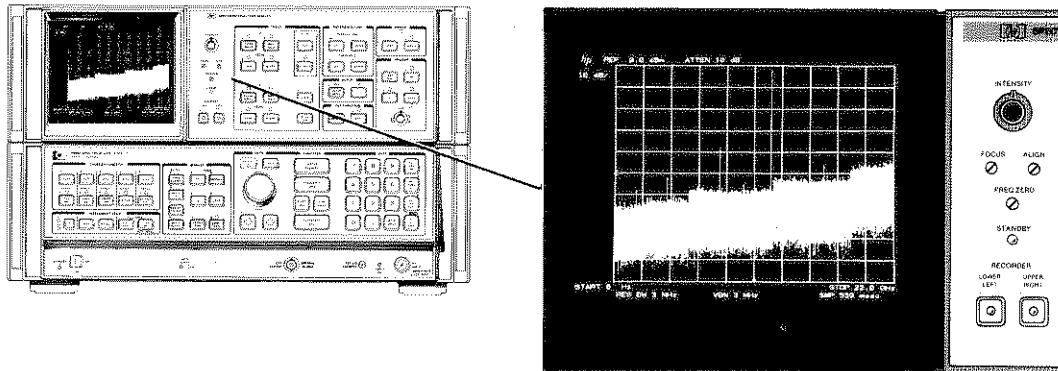

### CRT Display and Adjustments

INTENSITY



Controls intensity for all the CRT writing.

FOCUS



A screwdriver adjustment which focuses all the CRT writing. Focusing any one element on the CRT focuses all the writing.

ALIGN



A screwdriver adjustment which tilts all the displayed CRT information.

### Display Section Line Power

STANDBY



The light indicates power condition of the Spectrum Analyzer Display section as dictated by the LINE power switch on the 85660A RF section.

### CRT Display Overview

The cathode ray tube of the Spectrum Analyzer Display section displays:

- active function name and value
- graticule
- traces of the signal response
- values that calibrate the frequency, time and amplitude axes.
- values for the spectrum analyzer receiver parameters, that is, COUPLED FUNCTIONS.
- operator originated labels and graphics

#### Active Function

The function which has been activated for DATA entry is read out in the graticule area shown.

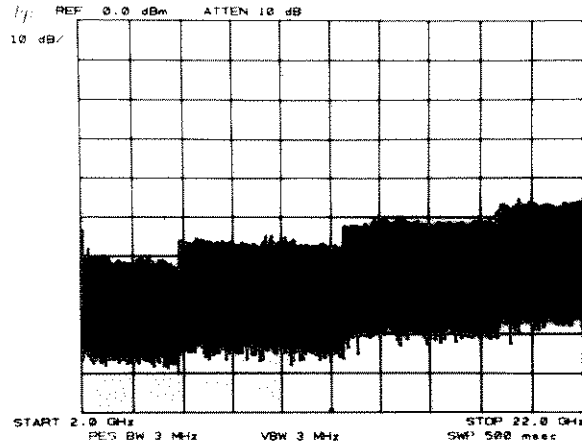

Activating a function immediately writes its name in the active function area along with its present value. The following summarizes the names and readout formats for the front panel designated active functions after an INSTRUMENT PRESET.

Function	Examples of Active Function Readout	Function	Examples of Active Function Readout
<p><b>FUNCTION</b></p> <p>CENTER FREQUENCY: CENTER 12.0 GHz</p> <p>FREQUENCY SPAN: SPAN 20 GHz</p> <p>START FREQ: START 2 GHz</p> <p>STOP FREQ: STOP 22 GHz</p> <p>REFERENCE LEVEL: REF LEVEL .0 dBm</p>		<p><b>MARKER</b></p> <p>NORMAL: MARKER 12.0 GHz 19.8 dBm</p> <p>Δ: MARKER Δ 20.0 MHz -12.4 dB</p> <p>ZOOM: MARKER ZOOM 12.0 GHz -32.8 dBm</p> <p>NORMAL SHIFT M: MARKER 12.0 GHz -140.4 dBm (1 Hz)</p>	
<p>HOLD: deactivates the active function and blanks the active readout.</p>		<p><b>REFERENCE LINE</b></p> <p>ENTER: DISPLAY LINE -45.0 dBm</p> <p>ENTER: THRESHOLD -90.0 dBm</p>	
<p><b>COUPLED FUNCTION</b></p> <p>RES BW: RES BW 3 MHz</p> <p>VIDEO BW: VIDEO BW 3 MHz</p> <p>SWEEP TIME: SWEPTIME 500 msec</p> <p>ATTEN: RF ATTEN 10 dB</p> <p>CFSTEP SIZE: CF STEP 100 MHz</p>		<p><b>SCALE</b></p> <p>ENTER: LOG 10 dB/</p>	
		<p><b>KEY FUNCTION</b></p> <p>(See KEY FUNCTION, Chapter 12.)</p>	

## Graticule

The display graticule is an internally generated 10 division by 10 division rectangle for referencing frequency, time and amplitude measurements. Double markings at the left, right and bottom designate the center axes.

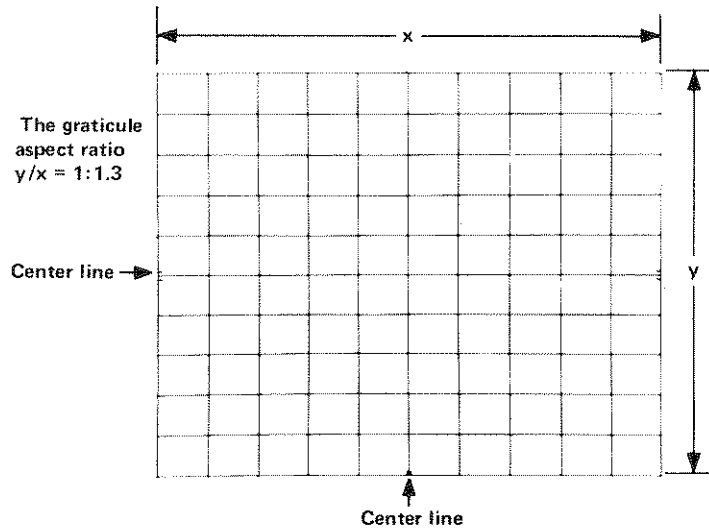

The graticule may be blanked from the display with KEY FUNCTION **SHIFT** **m** and restored with **SHIFT** **n**.

For CRT photography, the graticule may be intensified independent of the annotation and trace by pressing the following sequence:

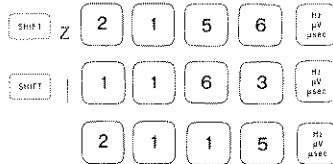

For more intensity, repeat the last two number entries, 1163 Hz and 2115 Hz. **2-22** **0Hz** returns the graticule to normal.

## Traces

Three separate traces, A, B and C, can be written onto the display. Each trace is generated from 1001 points across the graticule, connected by 1000 point-to-point straight line vectors. The location of each point is designated by an x and y location using the graticule as rectangular coordinates.

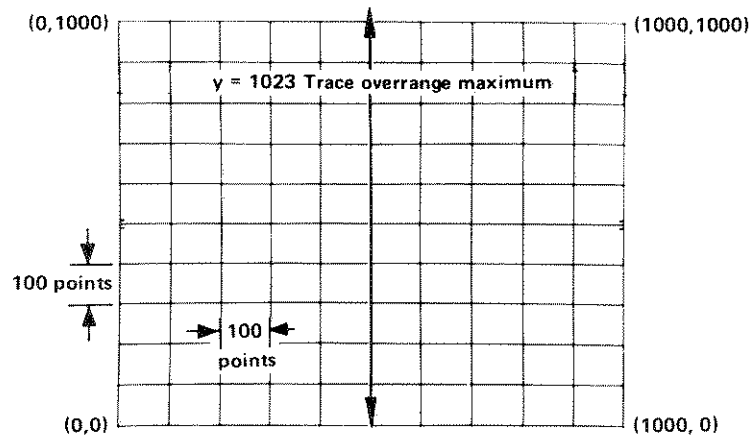

Graticule Referenced in Display Units

Display locations may be referenced in terms of these display units for HP-IB input and output. See Chapter 6 and 8566A Spectrum Analyzer Remote Operation, HP part number 08566-90003.

Trace overrange is an additional 23 display units above the top reference level graticule. This display area is not calibrated.

### Locations of Permanent Readouts

The vertical and horizontal graticule axes are scaled by these readouts:

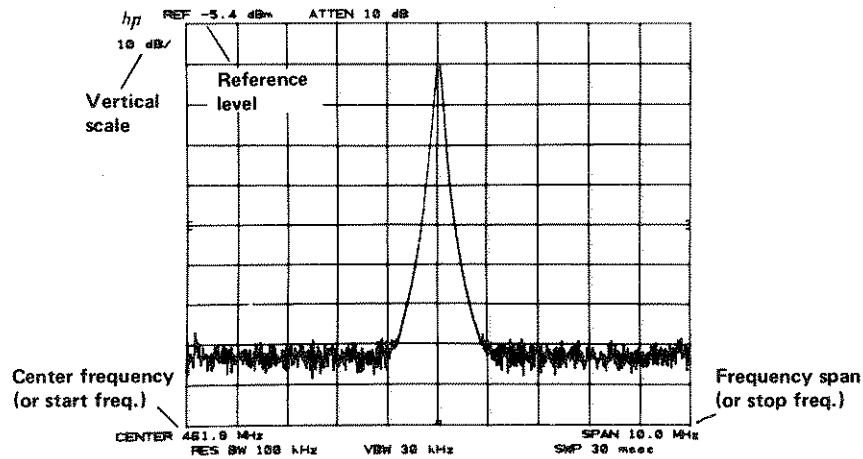

The COUPLED FUNCTIONS that describe the swept receiver characteristics of the spectrum analyzer are:

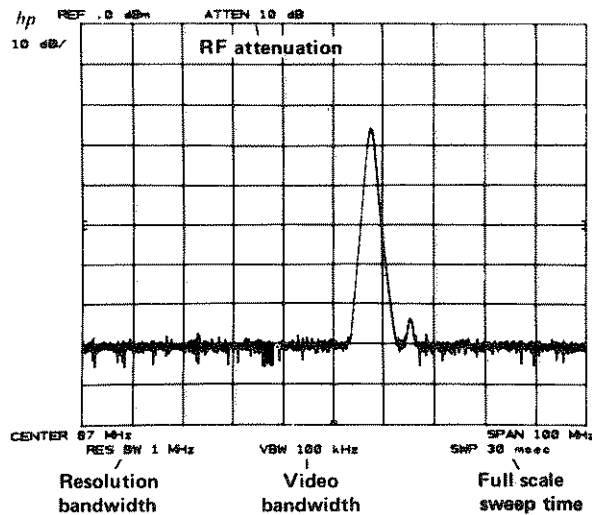

To blank all the character readouts, press KEY FUNCTION  o. To restore, press  p.

### Other Readouts

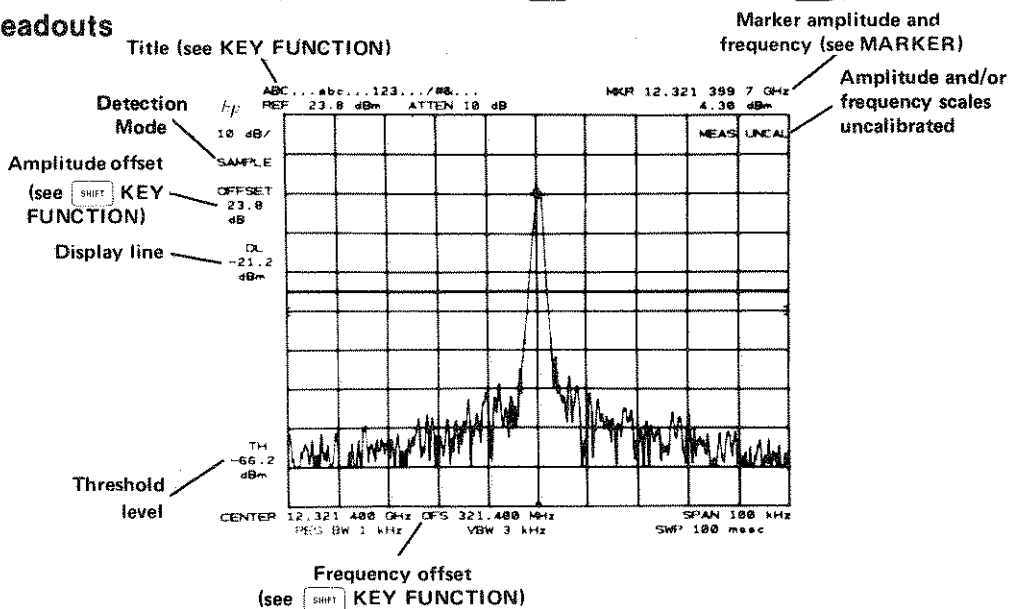

A number of other special function readouts can be activated. These are covered in chapter 12.

# Chapter 6

# TRACE

This chapter describes the use of the TRACE functions for writing, storing and manipulating trace data.

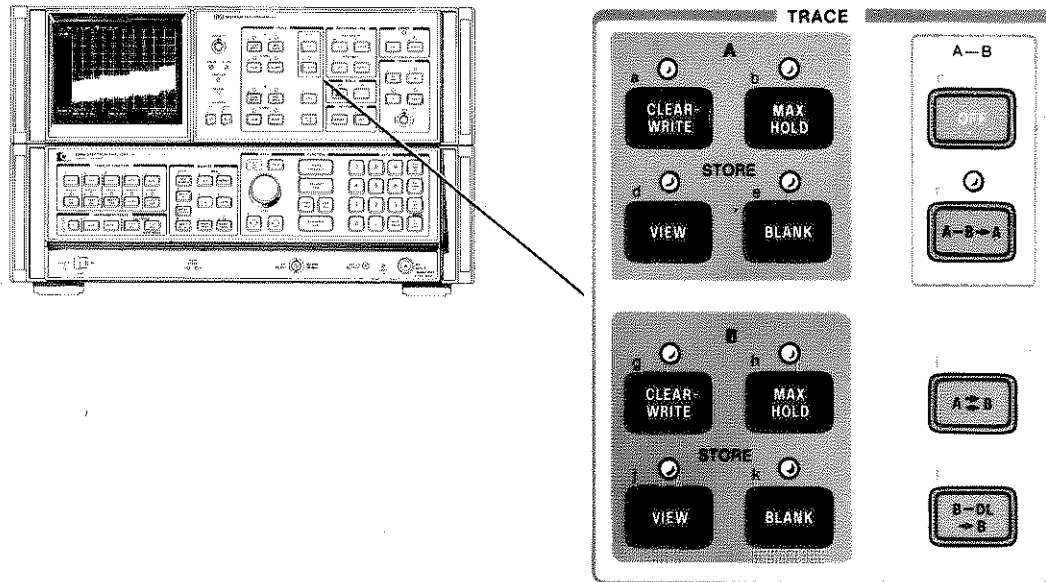

TRACE Controls

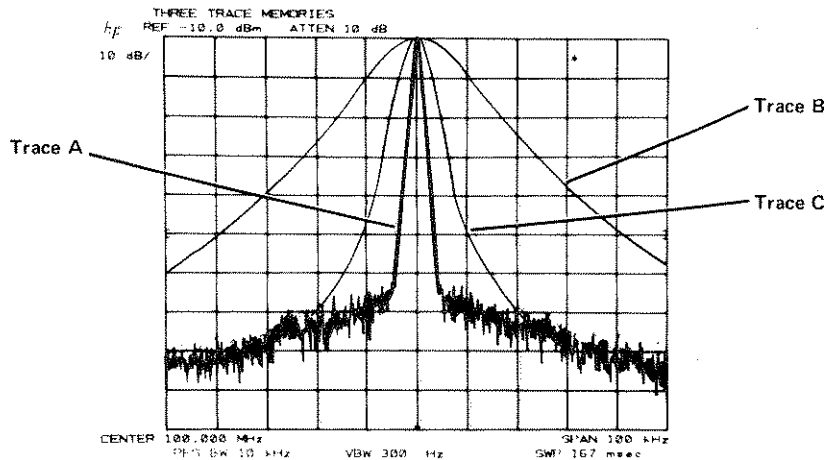

## TRACE Identification

Traces are differentiated by intensity. Trace A is bright, trace B and trace C are dim. **VIEW** and **BLANK** allow positive identification.

## TRACE Modes

Four mutually exclusive functions or modes for trace A and trace B determine the manner in which the traces are displayed. Indicator lights by the keys show the current modes.

### WRITE Modes (sweeping):

**CLEAR-WRITE**

Displays the input signal response in trace selected.

**MAX HOLD**

Displays and holds the maximum responses of the input signal in trace selected.

### STORE Modes (not sweeping):

**VIEW**

Stores the current trace and displays it on the CRT display.

**BLANK**

Stores the current trace and blanks it from the CRT display.

## Trace Memory

An understanding of the TRACE modes requires a description of the trace memory and trace data transfer within the analyzer.

Display traces are not written onto the CRT directly from the spectrum analyzer's IF section. Instead, the analog signal response is converted to digital information and stored in one trace memory which can then be transferred to the CRT display. The way in which the information is displayed depends upon the TRACE mode selected.

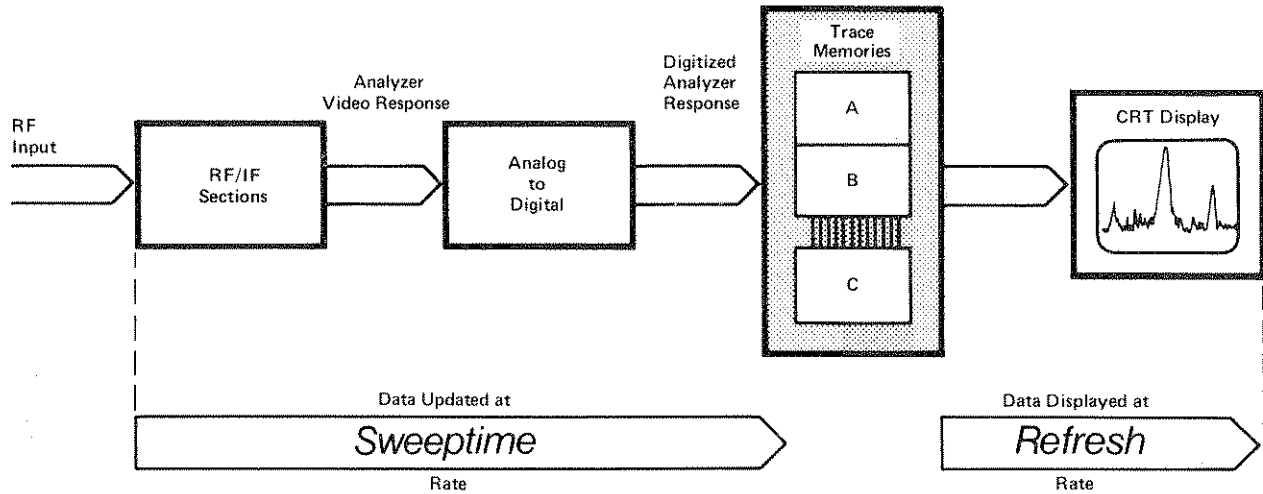

**TRACE Modes determine how data is entered into and displayed from trace memories.**

The analyzer's response is transferred into the trace memory at the sweep rate of the analyzer; that is, its sweep time. The trace memory is written onto the CRT display at a refresh rate of about 50 Hz, rapid enough to prevent flickering of the trace on the CRT. Trace intensities remain constant as analyzer sweep times are changed.

### NOTE

It is important to understand the difference between sweep and refresh.

**Sweep** - refers to the spectrum analyzer sweeping from a start frequency to a stop frequency and storing measured amplitude data into a trace memory.

**Refresh** - refers to the transfer of display memory data to the CRT display.

## WRITE Modes

For the write modes, the analyzer signal response is written into trace memory during the sweep and the memory contents are displayed on the CRT.



A(B)

Sets all the values in the trace memory A(B) to zero when first activated (bottom line graticule), then displays the signal response.



A(B)

Latest signal response is written into the trace A(B) memory only at the horizontal positions where the response is greater than the stored response.

When both A and B modes are selected, the analyzer writes into (sweeps) A and B alternately.

## STORE Modes

In the STORE modes, no updating of the trace memory is made. The current memory data is saved.



A(B)

The trace A(B) data are displayed on the CRT (that is, the refresh is enabled).



A(B)

The trace A(B) data are not displayed on the CRT (that is, the refresh is disabled).



### Example

With TRACE modes, signals can be observed as the analyzer sweeps, can be stored for comparison, erased, or monitored for frequency drift.

Center and zoom in on a 20 MHz signal:

Press

Since  has set  A and  B, only A is displayed.

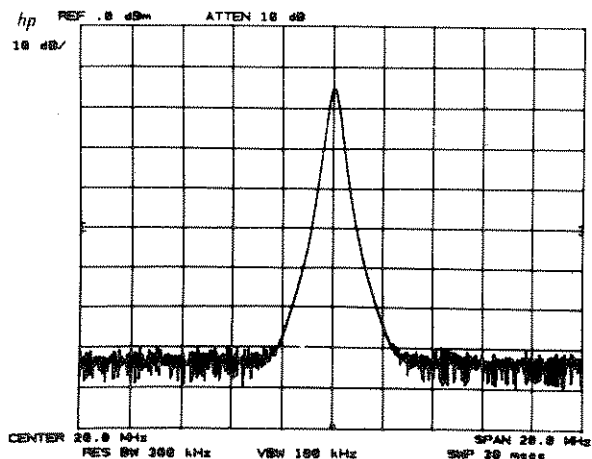

This response can be stored:

Press  A.

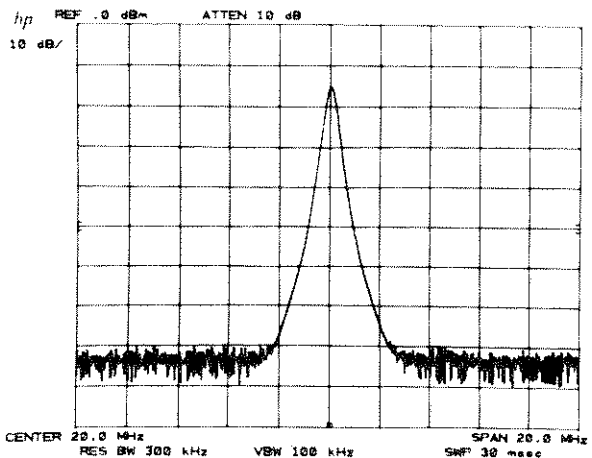

Write the same signal with B and change its position relative to trace A:

Press  B

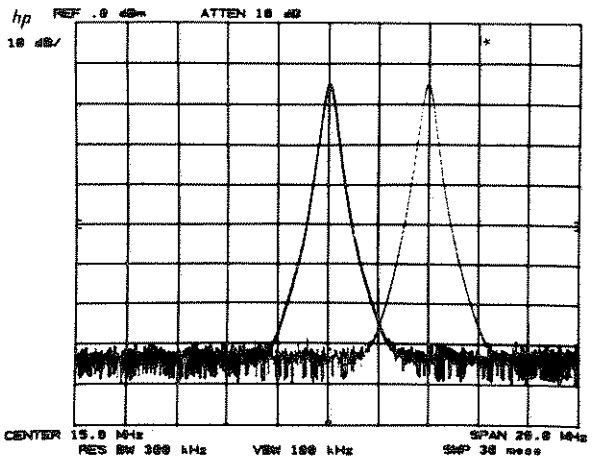

### NOTE

The \* on the top right corner of the CRT indicates that the CRT readouts may not correspond to the trace(s). In this case the readouts apply only to TRACE B and not TRACE A.



# TRACE

Blank trace A;

Press **BLANK** A.

This trace can be recalled with **VIEW** A as

long as **CLEAR WRITE** A or **MAX HOLD** A is not used first.

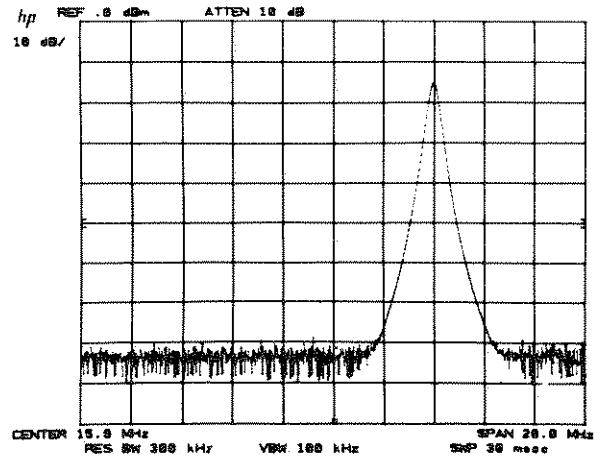

To display the drift of a signal press **MAX HOLD**

A.

(Simulate frequency drift with



**CENTER FREQUENCY**

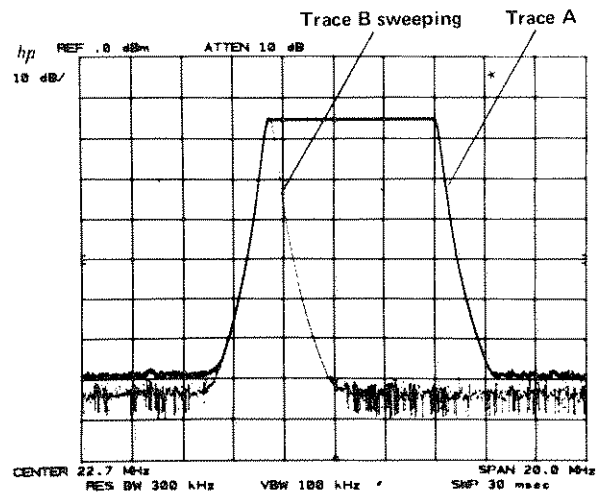

# TRACE Exchange

**A=B** Exchanges trace A and B, changing their relative intensities and storage memory locations and enables A and B

**VIEW** For example, in the trace display above, the modes and display appear.

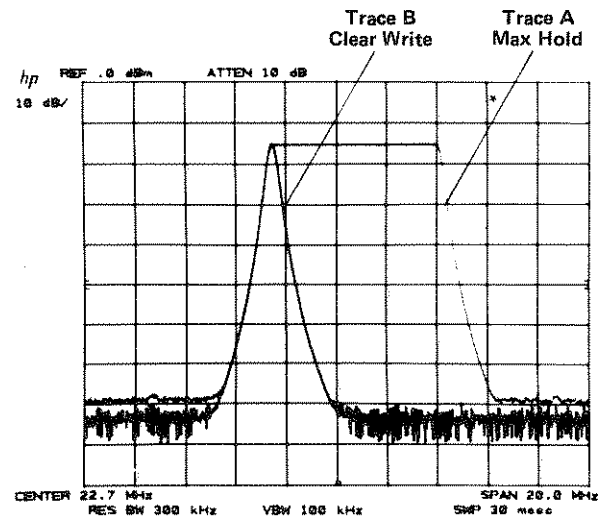
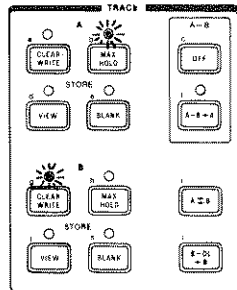

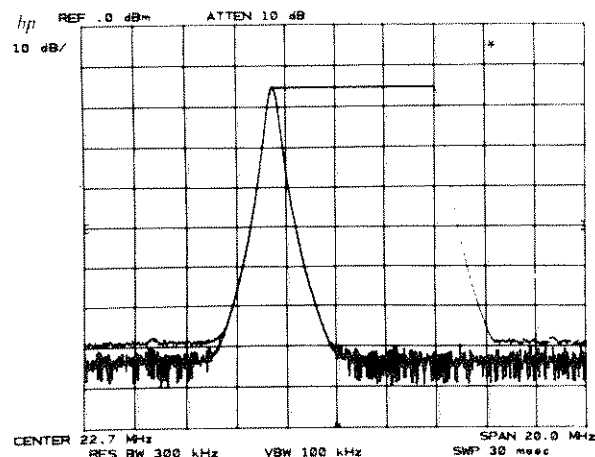
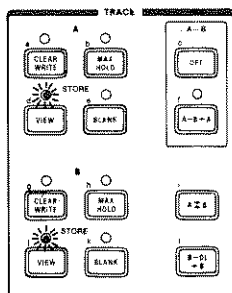
Press **A-Z**

## TRACE C Modes

A third trace, C, can be used to store a signal response. Trace C is not swept from the analyzer IF section as are traces A and B, but is input using a trace B into C function (B → C) or a B and C exchange function (B ↔ C).

Access to the trace C modes is through KEY FUNCTION **SHIFT**. The modes are:

- |          |                |  |
|----------|----------------|--|
| View C:  | <b>SHIFT</b> j | Displays trace C.  |
| Blank C: | <b>SHIFT</b> k | Blanks trace C from CRT display.   |
| B → C:   | <b>SHIFT</b> l | Writes trace B into trace C. Trace A and B modes are not changed. If trace C was blanked it remains blanked.                     |
| B ↔ C:   | <b>SHIFT</b> i | Exchanges traces B and C. If trace B is not blanked, trace C will not be blanked. If trace C is blanked trace B will be blanked. |

## TRACE Arithmetic

TRACE arithmetic allows one trace to be modified by another trace or a display line position.

- |     |                 |  |
|-----|-----------------|--|
| A-B | <b>A-B-A</b>    | Trace B amplitude (measured in divisions from the bottom graticule) is subtracted from trace A and the result written into trace A from sweep to sweep. Trace B is placed or kept in a STORE mode. |
| A-B | <b>OFF</b>      | Turns <b>A-B-A</b> off.  |
|     | <b>B-DL → B</b> | Subtracts the amplitude of the display line from trace B and writes the result into trace B. Trace B is placed or kept in <b>VIEW</b> . Details on display line are in Chapter 8, REFERENCE LINE.  |

### Example

Trace arithmetic with the display line can be used to correct for the frequency response characteristics (flatness) of a swept measurement system typified by this setup:

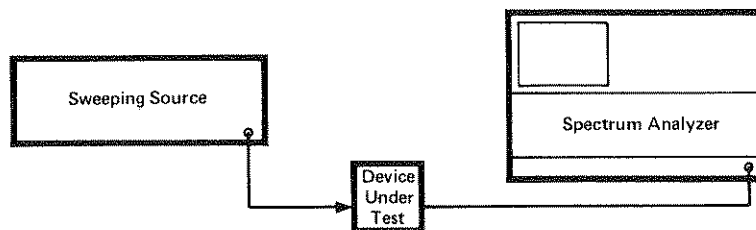

where the device under test is to be characterized for insertion loss over a specific frequency range.

# TRACE

The analyzer and source are set to the proper amplitude level and frequency span with the source output connected directly to the analyzer input.

- B, sweep source then
- B.

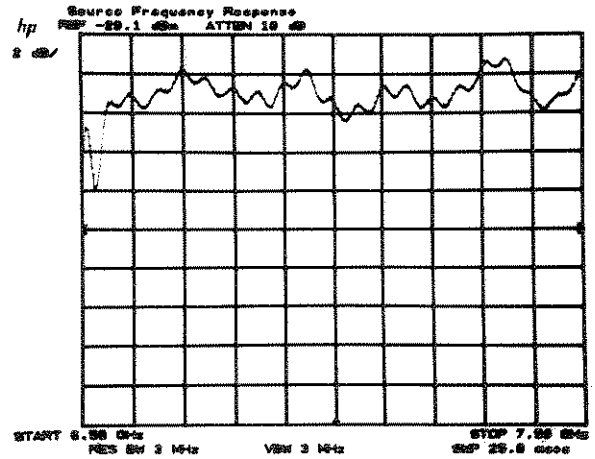

The display line is activated and set below the source/analyzer response.

- DL

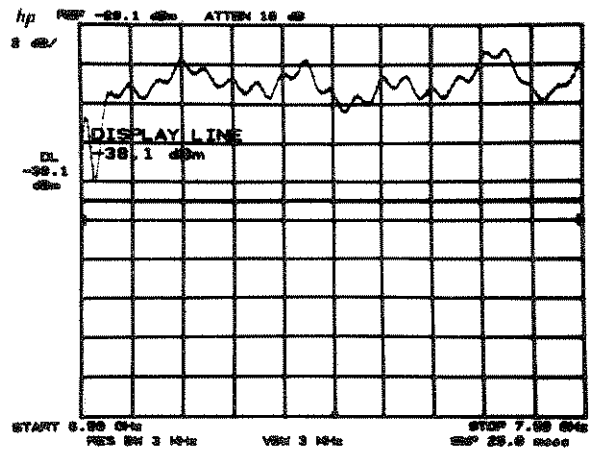

The difference between the display line (in display units) and the source/analyzer response is stored in trace B with .

Negative values of the  line would be stored even though not displayed.

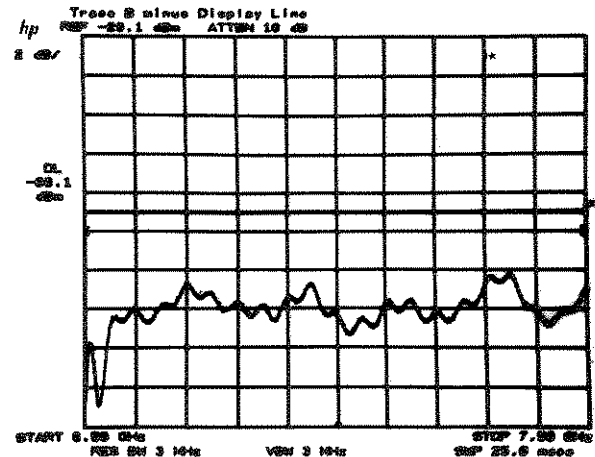

Now the device under test is connected between source and analyzer and its response is corrected for source flatness uncertainty by using

A

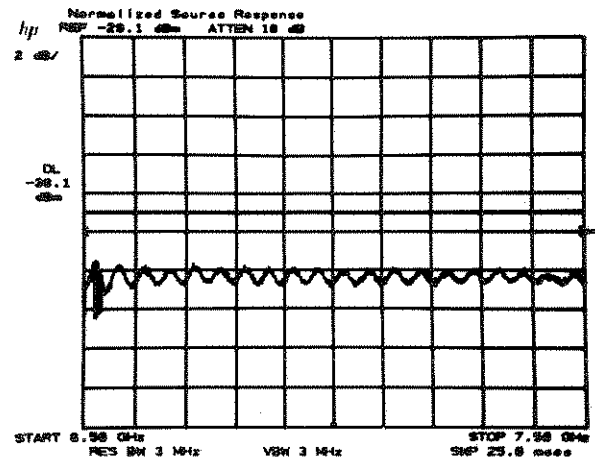

## Trace Priority

Functions which act upon a trace always act upon the highest priority trace. Priority is defined by the trace modes as follows:

Highest priority

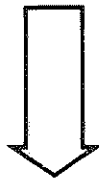

Lowest priority

A or  A

B or  B

A

B

view C

A

B

blank C

Marker functions, for example, use trace priority to decide which trace to mark. See chapter 7.

# Chapter 7

## MARKER

This chapter describes the use of the MARKER and DATA controls for making many measurements faster and with greater accuracy. Markers can be displayed only on TRACE A and TRACE B.

Two types of functions make up the MARKER group: MARKER MODEs, which enable or disable markers and their related functions; and MARKER ENTRY functions which allow the scaling of the display frequency and amplitude using marker information.

Markers are bright spots which lie directly on the display trace. The horizontal position of an activated marker is controlled by the DATA controls. The marker can be positioned at a specific frequency with the DATA number/units keyboard.

Readout of marker amplitude and frequency appears in the upper right of the display outside the graticule. When a MARKER MODE is active, its amplitude and frequency readout also appears in the active function area of the graticule.

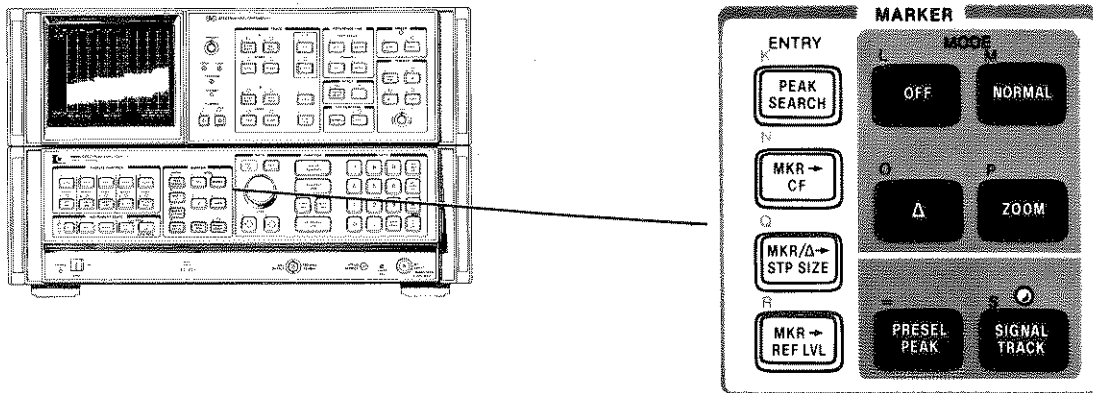

**MARKER Controls**

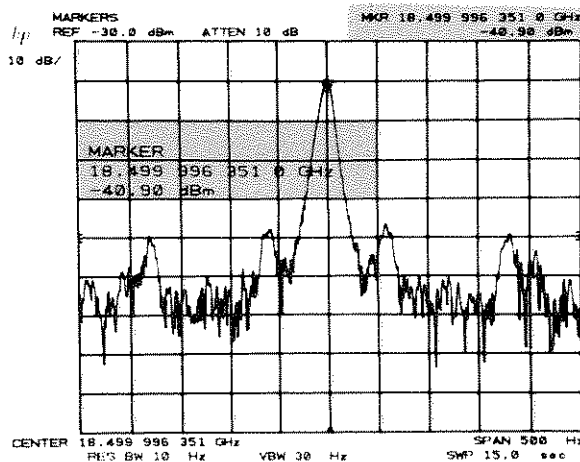

**Marker Readout Locations**

# MARKER Overview

- Direct readout of the amplitude and frequency of a point along the trace
- Direct readout of amplitude and frequency differences between points on the trace.
- Expansion of the span about a specific frequency.
- Placing a single marker at the highest response.
- Automatic peaking of preselector.
- Direct noise level readout.
- Analysis of stored traces.
- Amplitude and frequency display scaling.

## FUNCTION

NORMAL

Δ

ZOOM

PEAK SEARCH

PRESEL PEAK

SHIFT M

MARKER with

VIEW

ENTRY

MKR ← OF

MARKER ← STD SIZE

MKR ← REF LVL

## MARKER On But Not Active

An activated marker mode can be deactivated by activating another function, such as display line, or by DATA **HOLD**. This does not erase the marker itself nor the upper right display readout. If the marker mode is reactivated, DATA control and active function readout will continue from its last position.

If a marker mode is deactivated by a function, other than MARKER ENTRY, where a value change of the new function results in a rescaling of the amplitude or frequency axes, the marker will not stay on the trace. Reactivating the marker will start it at the display center.

## MARKER Off

**OFF** disables any marker mode, and blanks the marker readout from the CRT display. DATA controls are disabled if the marker was active.

## MARKER in VIEW

MARKER **NORMAL** and **Δ** may be used on traces A or B in the view mode. This allows detailed analysis of responses which are nonperiodic or unstable.

The markers will be placed on a viewed trace according to the priority defined in Chapter 6, TRACE PRIORITY.





## Single Marker - NORMAL

**NORMAL** activates a single marker at the center of the display on the trace of highest priority. Trace priority is defined in Chapter 6. The marker will not activate on the TRACE modes **BLANK** A, **BLANK** B, view C or blank C.

### Measurement and Readout Range

Marker frequency has one digit more resolution than center frequency and marker amplitude has one digit more resolution than reference level.

### DATA Entry

<p><b>NORMAL</b> </p>	<p>Moves the marker continuously along the trace at about 5 horizontal divisions each full turn. The marker moves in display unit increments.</p>
<p><b>NORMAL</b>  </p>	<p>Moves the marker along the trace one tenth of the total width per step.  moves marker to the right.</p>
<p><b>NORMAL</b> </p>	<p>Places the marker at the frequency entered. An out-of-range entry results in placement of the marker at a graticule edge.</p>

# MARKER



## Example

Reading frequencies and amplitudes of signals is greatly simplified using MARKER

For a given display activate the single marker with then tune the marker with to position it at the signal peak. The frequency and amplitude is read out in two display areas.

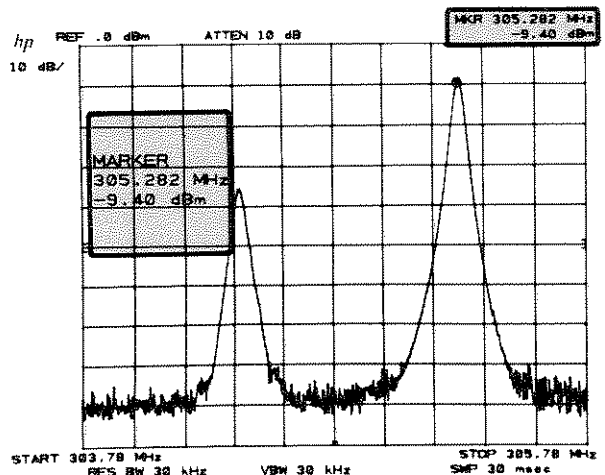

To read the left-hand signal's parameters move the marker to the signal peak with .

The signal's amplitude and frequency is read out directly.

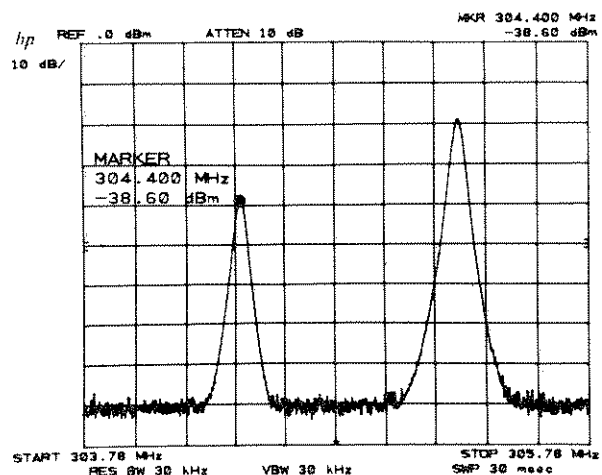

## Differential Markers - Δ

activates a second marker at the position of a single marker already on the trace. (If no single marker has been activated, places two markers at the center of the display.) The first marker's position is fixed. The second marker's position is under DATA control.

The display readout shows the difference in frequency and amplitude.

## Example

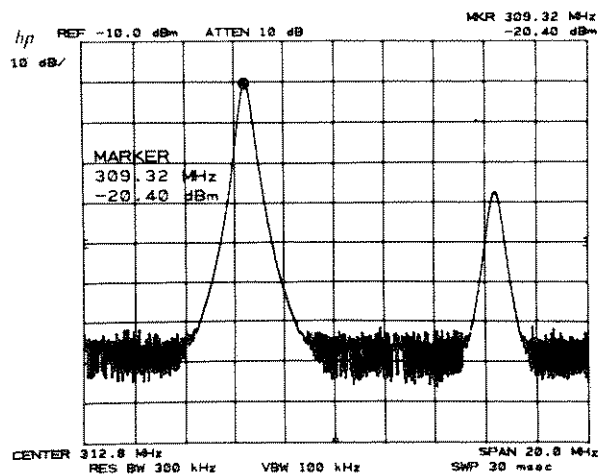

Measuring the differences between two signals on the same display.

First set the marker on one of the signal peaks with .







Activate  and move the second marker to the other signal peak with  and read their differences directly.

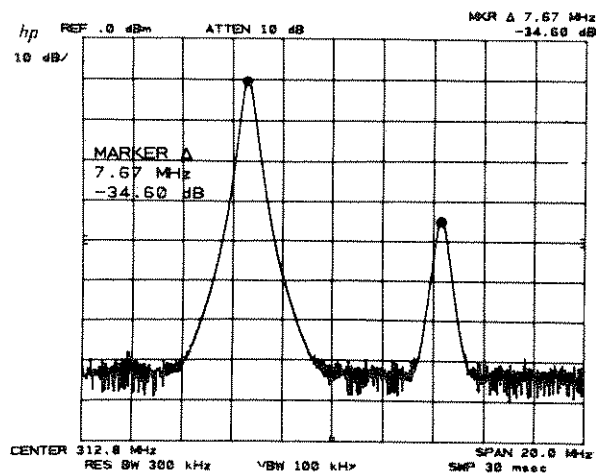

### Fractional Differences

When the reference level is calibrated in voltage, marker  amplitudes are given as a fraction, the voltage ratio of two levels.

With *logarithmic* amplitude scale and the reference level in voltage, the fraction is based on the equation

$$\text{fraction} = 10^{-\left(\frac{\text{dB difference}}{20}\right)}$$

Since this equation yields the harmonic distortion due to a single harmonic, its distortion contribution can be read directly from the display.

### Example

Set up  on the peaks of a fundamental (left) and its harmonic (right).

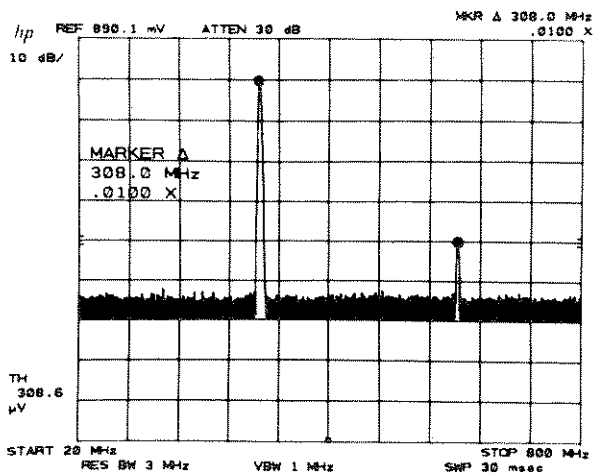

With the display referenced and scaled as shown, the readout ".0100X" designates the fractional harmonic content. Percent is calculated as  $100X(.0100) = 1.0\%$ .

With a *linear* amplitude scale and a reference level calibrated in voltage, the fractional amplitude readout is the simple linear ratio of the two markers.



**MARKER**



**Example**

To measure % AM modulation from a spectral display, calibrate the display with the reference level in voltage and the amplitude scale in voltage.

Place the single marker on the carrier peak, , and the second marker on one of the sideband peaks, . The fractional amplitude readout gives one half the modulation index .283.  
 $\%AM = 100 \times 2 \times .28 = 56\%$

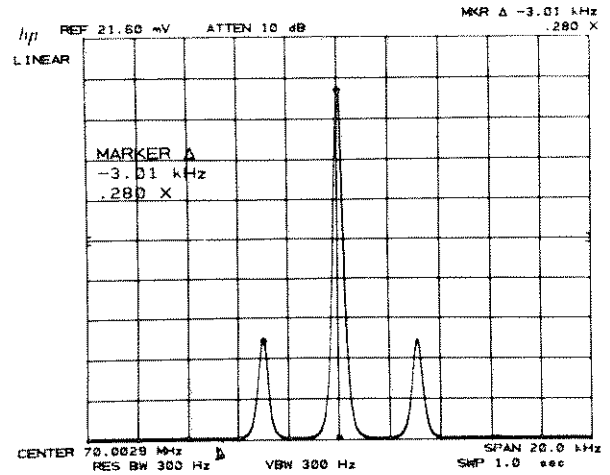

**Measurement and Readout Range**

The function formats the amplitude readout according to reference level units and scale.

Reference Level Units	SCALE Logarithmic	SCALE Linear
dBm dBmV dBμV	Amplitude in dB	Amplitude in dB
Voltage	Amplitude ratio $10^{-\left(\frac{\text{dB difference}}{20}\right)}$	Ratio of marker amplitudes

**Amplitude Readout Format for MARKER**





The frequency readout for all MARKER conditions has up to 4 significant digits, depending upon the portion of span measured.

The amplitude readout in dB has a resolution of ±.01 dB for linear scale. The resolution for logarithmic scale depends upon the LOG value:

LOG SCALE dB PER DIV	RESOLUTION
10	±0.1 dB
5	±0.05 dB
2	±0.02 dB
1	±0.01 dB

### DATA Entry

The minimum incremental change for  $\Delta$  frequency is 0.1% of the frequency span.

	<p>One full turn moves the active marker about one tenth of the horizontal span.</p>
	<p>One step moves the marker one tenth of the horizontal span.</p>
	<p>Positive entry places marker higher in frequency than the stationary marker, negative entry places marker lower in frequency. Larger entries than allowable will place the marker on the adjacent graticule border.</p> <p>Negative frequencies can be entered using a <math>\overline{\text{SHIFT}}</math> <math>\overline{\text{HOLD}}</math> prefix as the minus sign. For example, to set a <math>\Delta</math> span of 10 MHz with the second marker positioned to the left of the first, press <math>\Delta</math> <math>\overline{\text{SHIFT}}</math> <math>\overline{\text{HOLD}}</math> 1 0</p> 



## MARKER ZOOM

$\overline{\text{ZOOM}}$  activates a single marker on the trace of highest priority (see TRACE PRIORITY, Chapter 6).

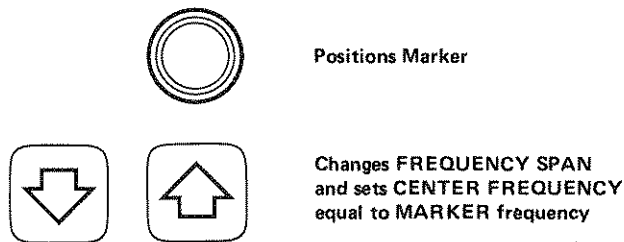
In  $\overline{\text{ZOOM}}$  the DATA knob and STEP keys change the values of *different functions*.



### DATA Control Use for $\overline{\text{ZOOM}}$

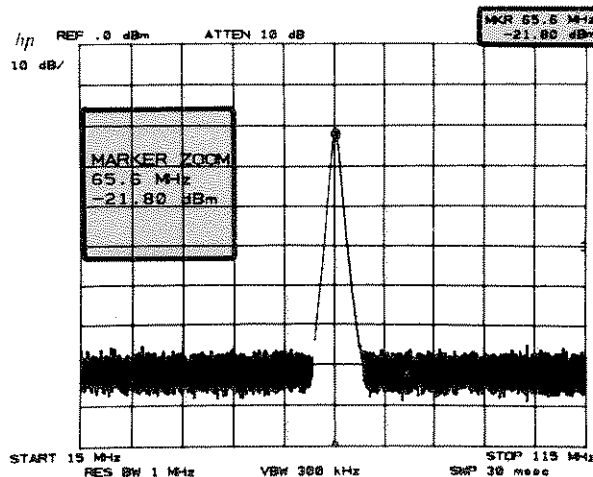

The marker can be moved along the trace with the DATA knob , and the frequency span can be changed about the marker with DATA step  and . Each step also sets center frequency equal to the marker frequency.



### Measurement and Readout Range

The measurement and readout range for marker zoom is the same as marker .

### DATA Entry

	Moves the marker continuously along the trace. Rate dependent on speed of rotation. The marker moves in display unit increments.
	Changes the frequency span to the next value in the sequence and sets the center frequency equal to the marker frequency.
	Places the marker at the frequency entered. An out-of-range entry places the marker at a graticule border.

### Example

In wide frequency spans it is often necessary to expand a portion of the frequency span about a specific signal in order to resolve modulation sidebands or track frequency drift.

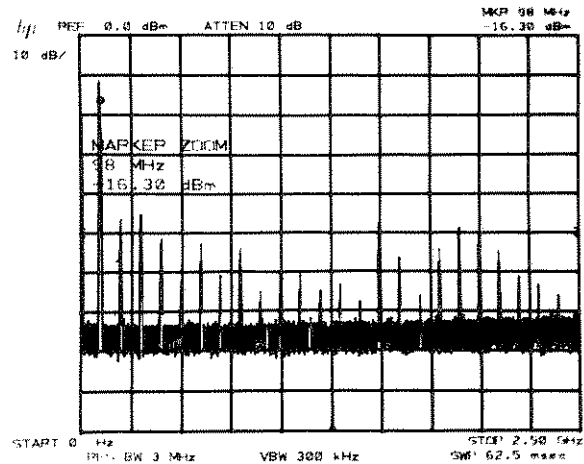

From a full span, select a signal using the marker with .



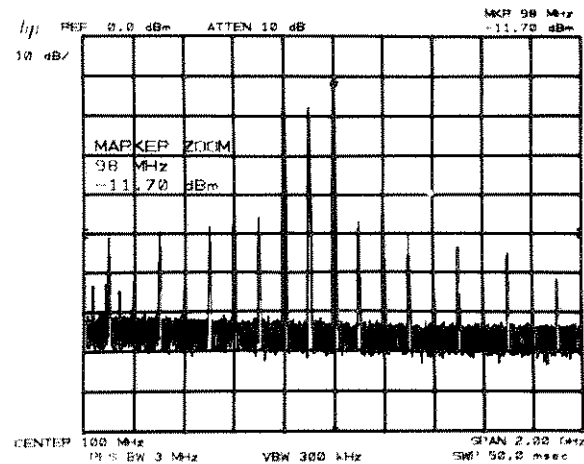

To center the marker and signal *and* expand the frequency span in one step, press .



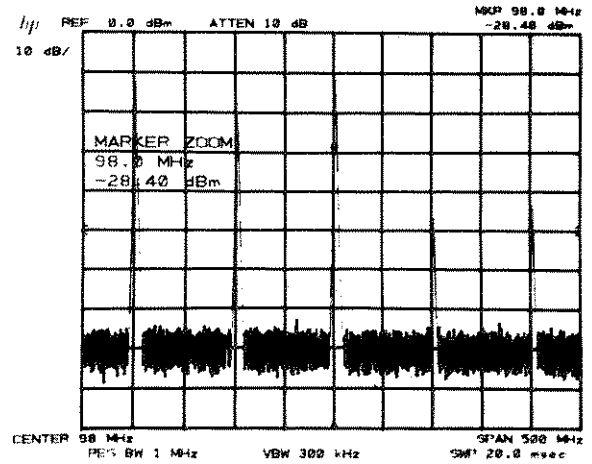

ZOOM

Expanding twice more with   shows the marker requires recentering on the signal.

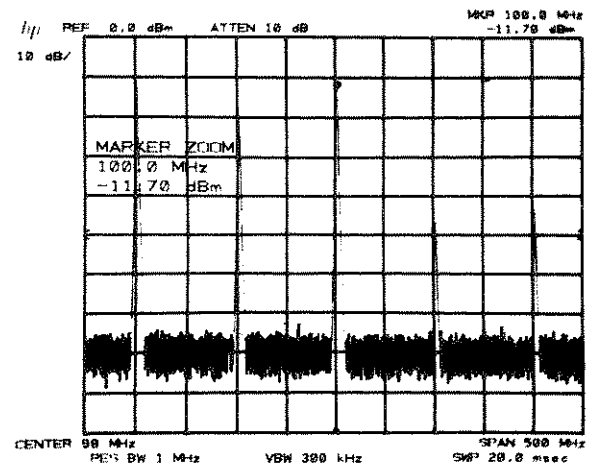

Recenter with 



Continue using  (and recentering the marker on the signal when necessary) until the desired resolution is achieved.

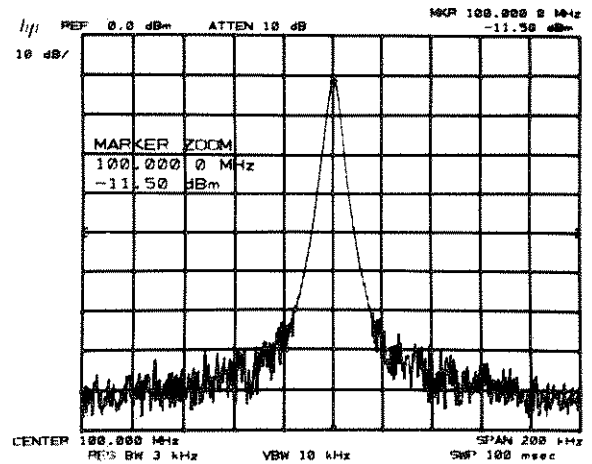

# MARKER

ZOOM

## Automatic Zoom

The analyzer can automatically zoom in on a signal specified by a marker. The desired frequency span is input from the DATA number/units keyboard.

To use the automatic zoom function

Use **NORMAL**  to identify the signal to be zoomed in on.

Press **SIGNAL TRACK** **FREQUENCY SPAN** and enter the desired span with the DATA number/units keyboard.

When the units key is pressed the zooming process will begin.

### Example

A single carrier needs to be examined in a 200 kHz span to see the sidebands. Because the SIGNAL TRACK function automatically maintains the signal on the center of the CRT, you can zoom automatically from a very wide span to a narrow span to look close-in at the signal.

Place a marker on the carrier with **NORMAL** 

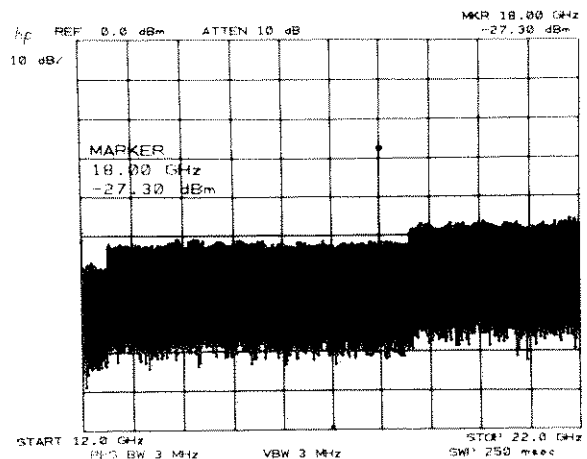

Press **SIGNAL TRACK** **FREQUENCY SPAN**  
 Enter the span,  
 Press **2** **0** **0** **KHz** and auto zoom  
 will be completed.

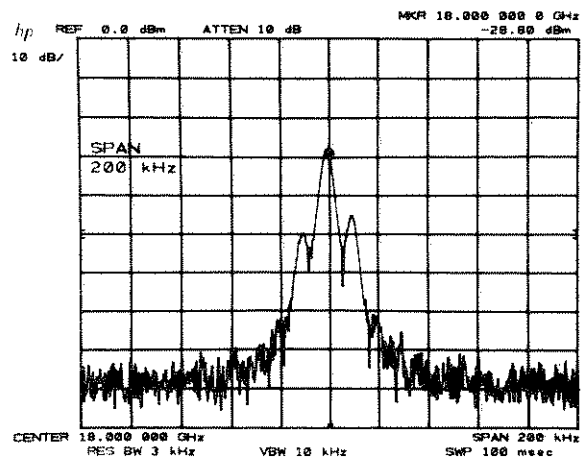

# PEAK SEARCH

## Peak Search

Peak search places a single marker at the highest trace position of the highest priority trace. The active function is not changed.

## Example

Use PEAK SEARCH to position the marker at the peak of the signal response.

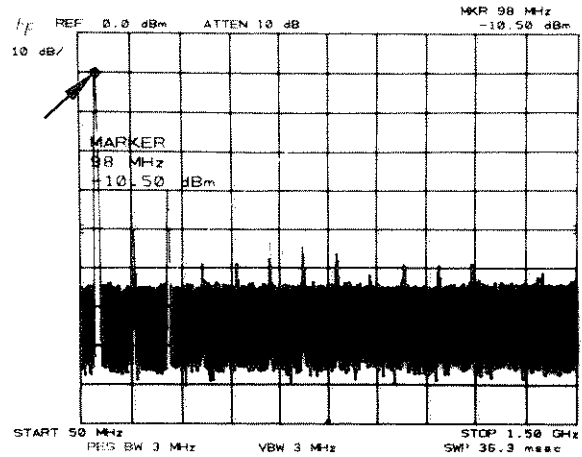

In a narrow span the marker may be placed at the signal peak.

Press .



Note that the marker seeks the maximum trace response, no matter what the cause of the response. A larger signal, or the local oscillator feedthrough, would have attracted the marker.

## MARKER to Next Peak

The marker can also find the next highest peaks by successively pressing   .

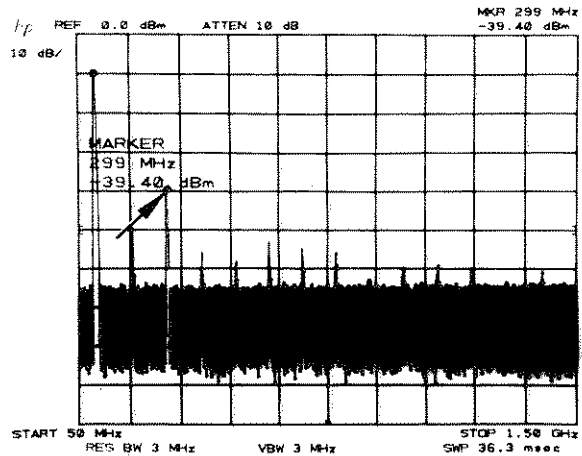

# MARKER

PEAK SEARCH

## Marker to Minimum

The minimum trace value can be located by pressing **SHIFT** **N**.

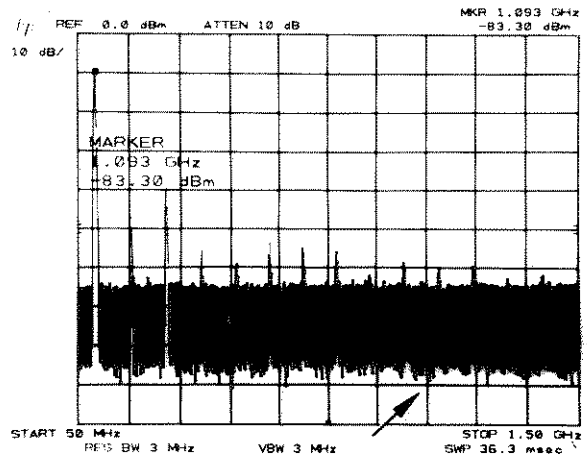

# MARKER ENTRY

**MKR → CF**, **MKR → REF LVL** and marker  $\Delta$  into span. Immediately set the corresponding FUNCTION value equal to the readout of the active marker or markers:

ENTRY	RESULT
<p><b>MKR → CF</b></p> <p><b>SHIFT</b> <math>\Delta</math></p> <p><b>MKR → REF LVL</b></p>	<p>marker frequency into <b>CENTER FREQUENCY</b></p> <p>marker <math>\Delta</math> frequency into <b>FREQUENCY SPAN</b> or <b>START FREQ</b> / <b>STOP FREQ</b></p> <p>marker amplitude into <b>REFERENCE LEVEL</b></p>

**MKR → STOP SIZE** immediately records the single or the differential marker frequency in COUPLED FUNCTION **CFSTEP SIZE** for use with **CENTER FREQUENCY** **DATA** **↑** **↓**.

A marker entry can be made any time a marker is on the trace. (**SHIFT**  $\Delta$  with only one marker displayed takes 0 Hz as the lower frequency.) The active function will not be changed.



### Example

One of the fastest, most convenient ways to bring a signal to the center of the display is by using .

Activate a single marker and tune it to the desired signal:

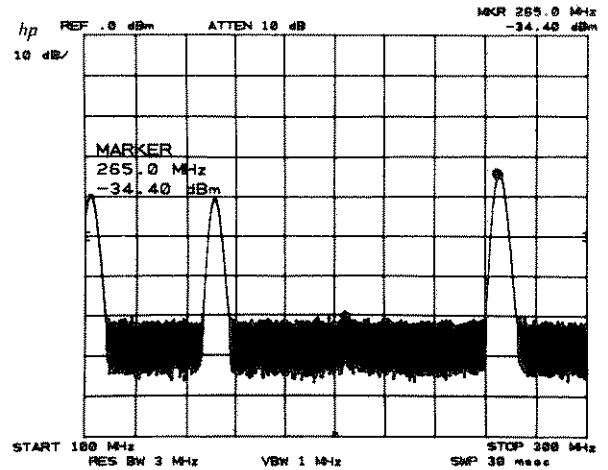

Change the center frequency to the marker frequency.

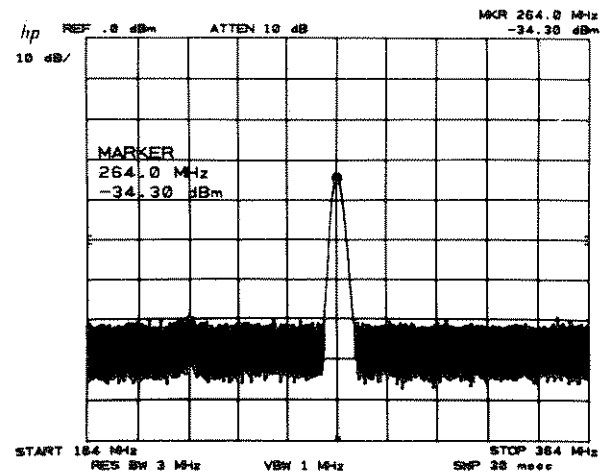

will also work if start/stop frequencies are read out.

### Example

One way to tune to a particular portion of a spectrum being displayed is to use the  $\Delta$ — span function.

Activate the single marker and place it at either end of the desired frequency span with

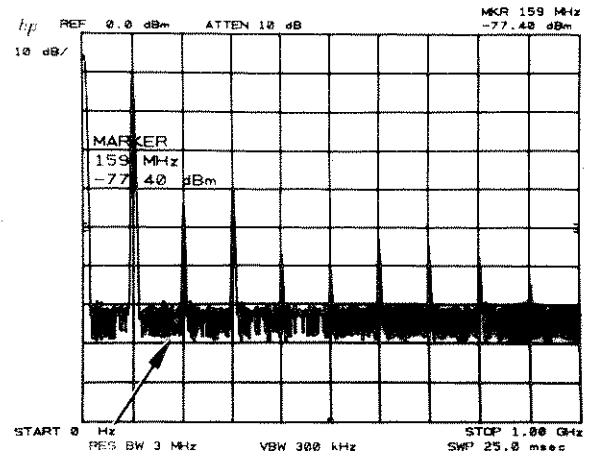



# MARKER



Activate the second marker and place it at the other end of the span with

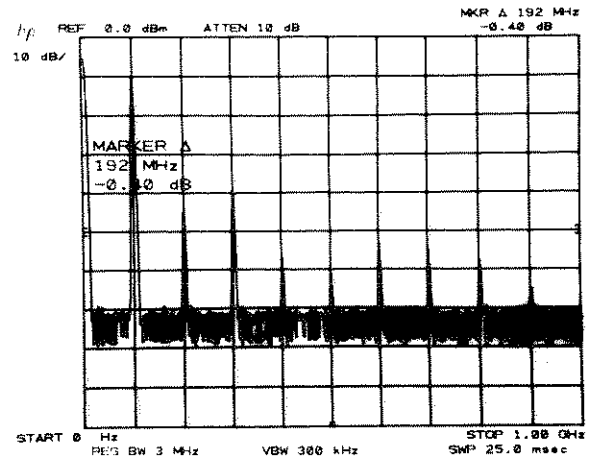

Set the start and stop frequencies equal to the left and right marker frequencies



Marker  NORMAL is activated.

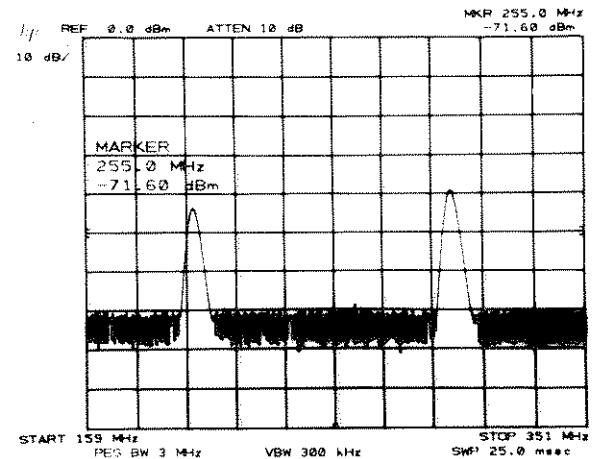

Δ → span will work the same with start/stop frequency readout. Note that the markers can be placed at either end of the span.

## Example

Here is a technique for viewing a fundamental and its harmonics (or any evenly spaced portions of the spectrum) with high resolution.

Narrow the span about the fundamental as necessary with  ZOOM, centering the carrier.

Set the center frequency step size with



Now enable center frequency. With each  HOME, successive harmonics will be displayed.

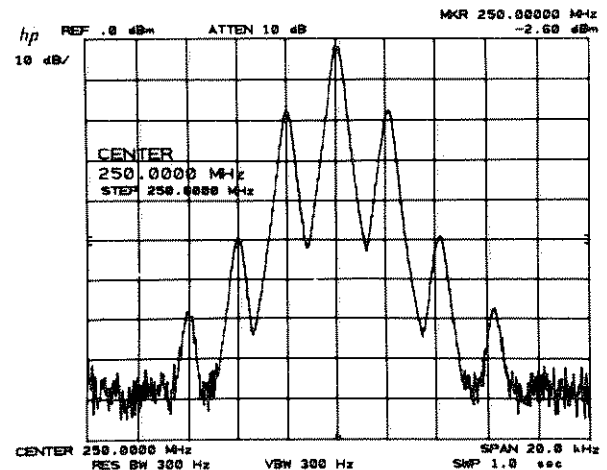

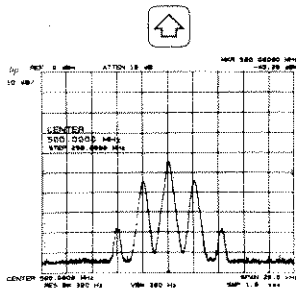

Second Harmonic

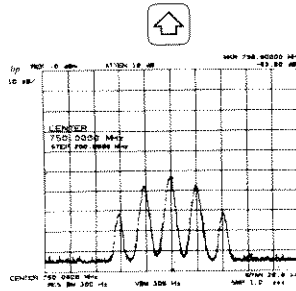

Third Harmonic

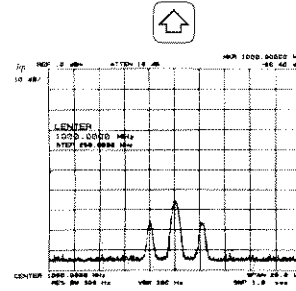

Fourth Harmonic

Similar stepping can be accomplished using marker  into step size for intermodulation products or other evenly spaced signals such as communication channels.

## SIGNAL TRACK - Automatic Frequency Control

The analyzer is capable of automatically maintaining a drifting signal at the center of the display. To operate SIGNAL TRACK:

Press , and place the marker on the signal to be tracked with .

Press  to initiate the tracking. The light above the key indicates tracking. (Press again to turn off.)

As the signal drifts, the center frequency will automatically change to bring the signal, and marker to the center of the display.

MARKER , any other MARKER mode or the instrument preset turns the tracking function off.

The upper sideband of a transmitter is to be monitored as the carrier frequency is tuned.

Locate the sideband with  .

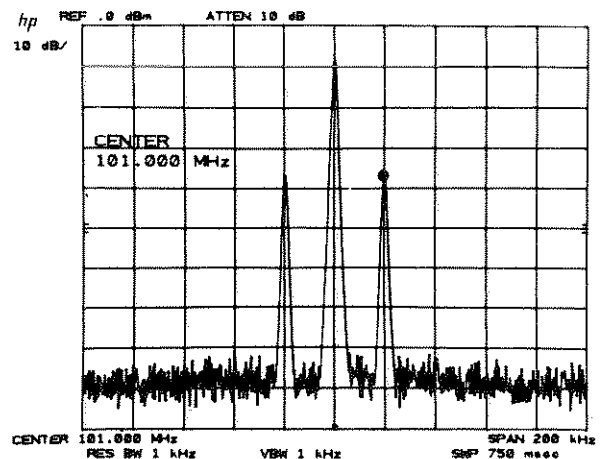

## MARKER

The upper carrier sideband is tracked

with **SIGNAL TRACK** then zoomed in with **FREQUENCY SPAN** **1**

**0** **KHz**  
**mV**  
**PKSC**

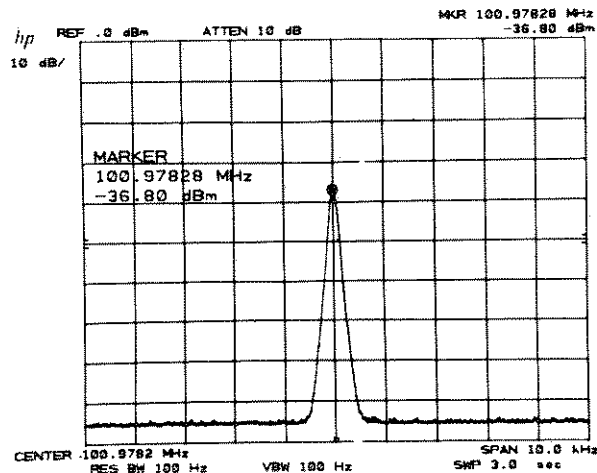

As the carrier frequency is changed, the sideband response will tend to remain in the center of the display. The center frequency and marker frequency reads out the sideband's frequency.

A combination of **SIGNAL TRACK** and **Δ** allows the "real time" signal frequency drift to be read on the display.

## PRESELECTOR PEAK

Preselector peak automatically adjusts the preselector tracking to peak the signal at the active marker. When the marker is tuned to a signal and **PRESEL PEAK** is pressed, an internal routine searches for the peak response of the preselector and adjusts the tracking accordingly. Using preselector peak prior to measuring a signal yields the most accurate amplitude reading.

Preselector peak operates with the **NORMAL**, **ZOOM** or **Δ** markers. If the marker is OFF, pressing **PRESEL PEAK** will initiate a peak search routine and then peak the response at that marker. A "PEAKING!" message appears on the active graticule area to indicate operation of the peaking routine. PRESELECTOR PEAK only operates in the 2 — 22 GHz preselected band.

### EXAMPLE

Peak the signal for accurate amplitude measurement.

Tune marker to signal of interest.

Press **NORMAL**

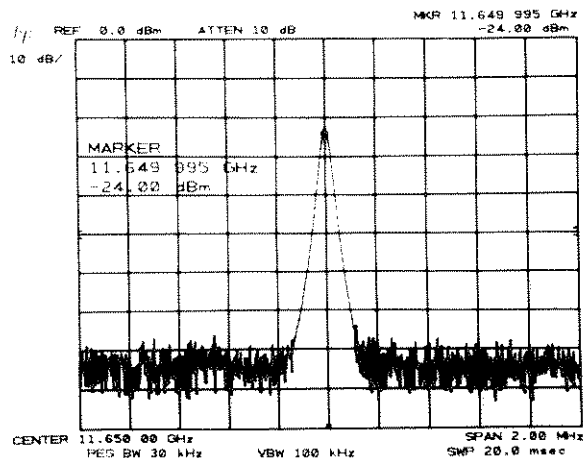

Press **PRESEL PEAK** to peak preselector tracking.  
 Measure amplitude by reading marker.

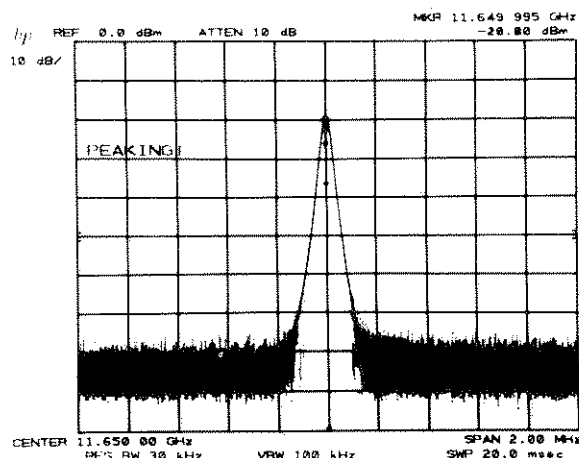

The specific preselector correction factor applied in the example above is stored. A **2-22 GHz** INSTRUMENT PRESET will not erase the correction factor, however, another PEAKING routine in the same band will store a new correction factor in that band.

The factory set preselector tracking can be recalled with **SHIFT** = **PRESEL PEAK**. The preselector can be manually adjusted by pressing **SHIFT** / **GHz +dBm dB**. (See page 12.5).

## How It Works

The internal preselector peaking routine automatically searches and sets the peak response of the YIG filter at the marker frequency. Each peaking operation only affects the frequency band in which the signal is located (4 possible bands). A correction factor, representing the tracking offset, is stored in memory for that particular band each time the peaking routine is used. Correction factors (one per band) remain in memory unless a new peaking routine is initiated that may result in a different number. The last **PRESEL PEAK** correction factors are saved along with control settings in the internal storage registers upon execution of a **SAVE** followed by a number from 1 to 6. Thus, up to six correction factors could be saved for any of the frequency ranges listed in the chart below:

BAND	FREQUENCY RANGE
1	2.0 — 5.8 GHz
2	5.8 — 12.5 GHz
3	12.5 — 18.6 GHz
4	18.6 — 22 GHz

## MARKER

# Noise Level Measurement

When noise level is activated and the marker is placed in the noise, the rms noise level is read out normalized to a 1 Hz noise power bandwidth.

Noise level enabled:

Noise level disabled:

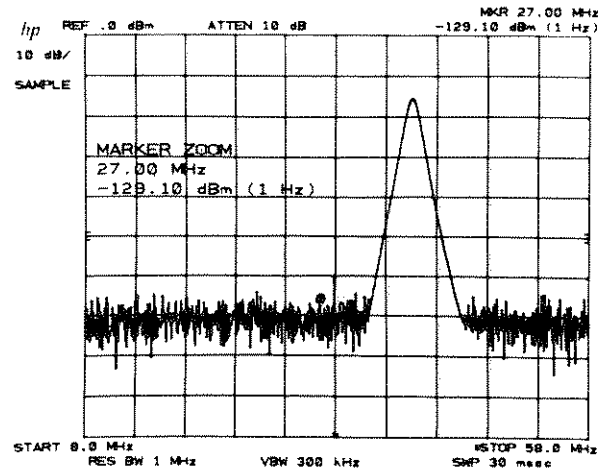

The noise level measurement readout is corrected for the analyzer's log amplifier response, and the detector response. The value is also normalized to a 1 Hz bandwidth.

## Measurement and Readout Range

Noise level measures noise accurately down to 10 dB above the spectrum analyzer's noise level. The readout resolution is in steps of  $\pm 0.1$  dB.

## DATA Entry

See MARKER , , and .

## Example

In a communication system the baseband noise level as well as signal to noise ratio measurements are required.

Select a frequency in the baseband spectrum clear of signals with a single marker.

Press  .

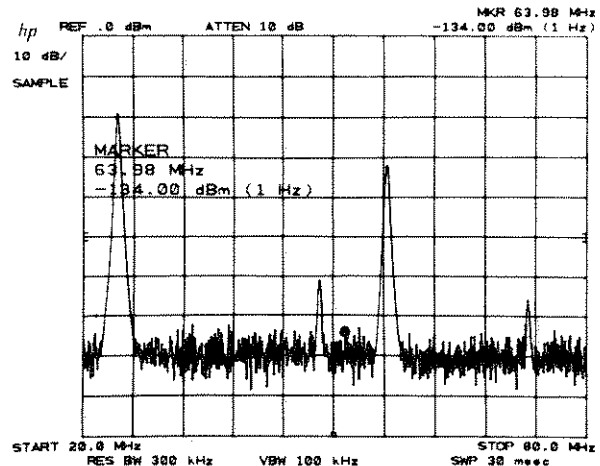

Read the noise at the marker by pressing  .

The noise at 64 MHz is  $-134 \text{ dBm}$  in a  $1 \text{ Hz}$  bandwidth. This corresponds to  $-134 \text{ dBm} + 36 \text{ dB}/4 \text{ kHz} = -98 \text{ dBm}$  in  $4 \text{ kHz}$  voice channel bandwidth.

Signal to noise measurements require the measurement of the noise level, as the example above, and the measurement of the absolute signal level. \*

Measure the power level of the adjacent signal. To turn the noise level off, press

**L**  **SHFT**  **OFF** and read the power level.

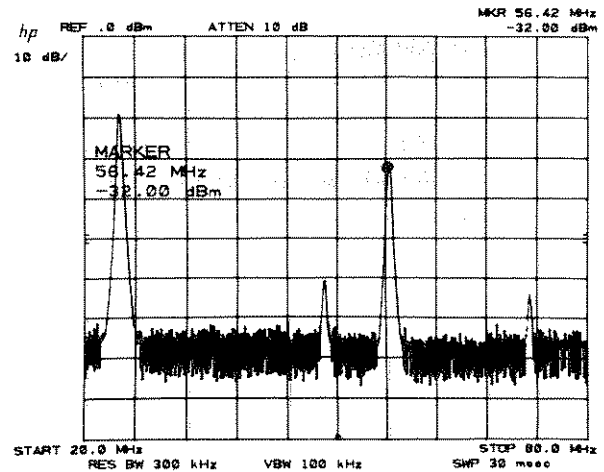

The signal to noise ratio referenced to  $4 \text{ kHz}$  bandwidth is  $-32 \text{ dBm} - (-98 \text{ dBm}) = 66 \text{ dB}$ .

\*Normalization to a desired bandwidth uses the equation

$$10 \log_{10} \left( \frac{\text{desired BW}}{1 \text{ Hz}} \right)$$

## Chapter 8

# SCALE AND REFERENCE LINE

This chapter describes the use of SCALE and REFERENCE LINE control groups for setting the amplitude scale, and for making amplitude level measurements more conveniently.

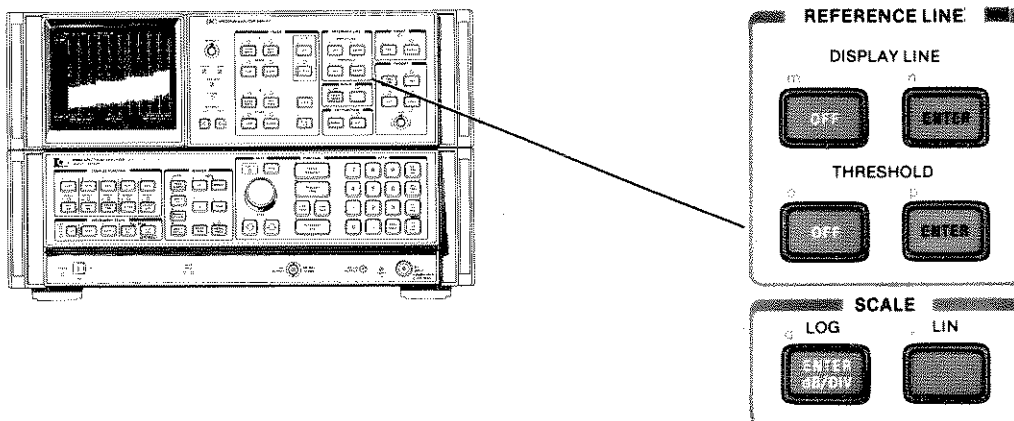

## SCALE

SCALE keys allow the scaling of the vertical graticule divisions in logarithmic or linear units without changing the reference level value.

### LOG

(DATA entry) scales the amplitude to 1 dB, 2 dB, 5 dB or 10 dB per division.

If  is pressed when the scale is linear, 10 dB per division will be automatically entered. The subsequent (DATA), if any, will then replace the automatic 10 dB/div.

LOG  
Press  5

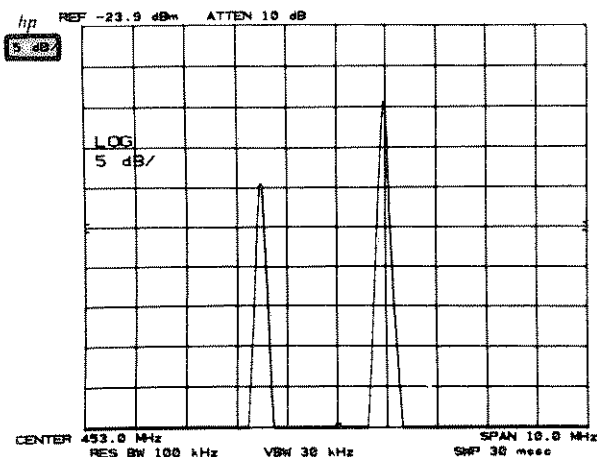

### LIN

immediately scales the amplitude proportional to input voltage. The top graticule remains the reference level, the bottom graticule becomes zero voltage. Reference level, and all other amplitudes, are read out in voltage. However, other units may be selected. See Amplitude Units Selection, Chapter 12.



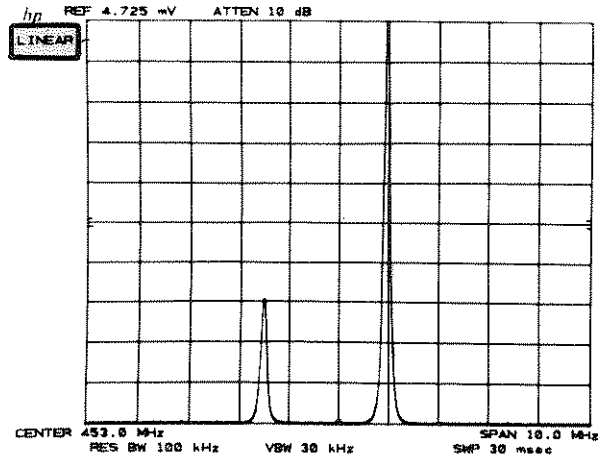

If  is pressed when the scale is linear, 10 dB per division will be automatically entered.

LIN  
Press



In LINEAR, a specific voltage per division scale can be set by entering a voltage reference level value. For example, to set the scale to 3 mV/division, key in 30 mV reference level. (Voltage entries are rounded to the nearest 0.1 dB, so the 30 mV entry becomes 30.16 mV, which equals -17.4 dBm.)

**DATA Entry**

 	<p>Changes scale in allowable increments (1, 2, 5 or 10 dB per division).</p>
 	<p>Enables direct scale selection of allowed values. Other entries are rounded to an adjacent value.</p>

LIN

No DATA entry will be accepted with the linear SCALE selection key, .

**Example**

It is convenient to observe AM sidebands in linear as well as logarithmic scales for analysis of both modulation percentages and distortion products.

Modulated AM signal displayed in the 10 dB/division scale shows the carrier, its sidebands and distortion products.

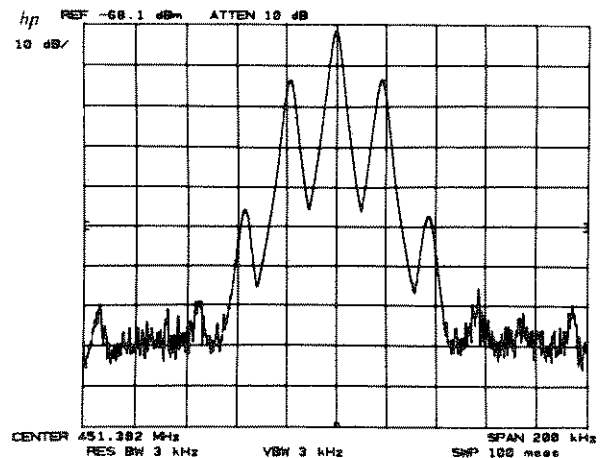



# SCALE

Linear scaling enables the observation of the sidebands proportional to the carrier.

LIN  
Press

As in the MARKER  example, Chapter 7, a direct readout of the percent modulation can be made.

The fractional readout is one half the modulation index (only one sideband is measured).

$$\% \text{ AM} = 2(.25) \times 100 = 50\%$$

Note that the carrier signal need not be placed at the reference level for an index ratio measurement.

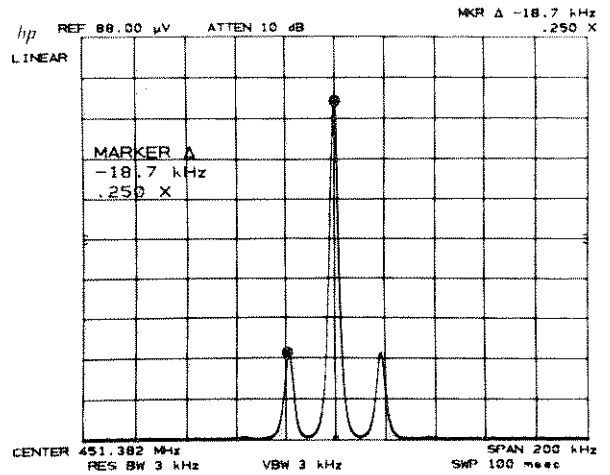

LOG  
Change to a logarithmic scale with  and change the dB/ with  .

The sidebands are 12 dB down from the carrier, verifying the earlier measurement results.

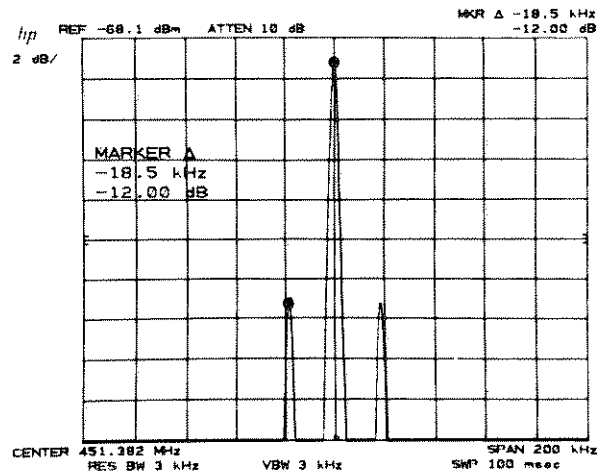

Harmonic distortion of the modulating signal can be measured as in MARKER , Chapter 7.

The modulation frequency is 18.8 kHz and the distortion caused by the second harmonic is 2.4%, (read out as .024X).

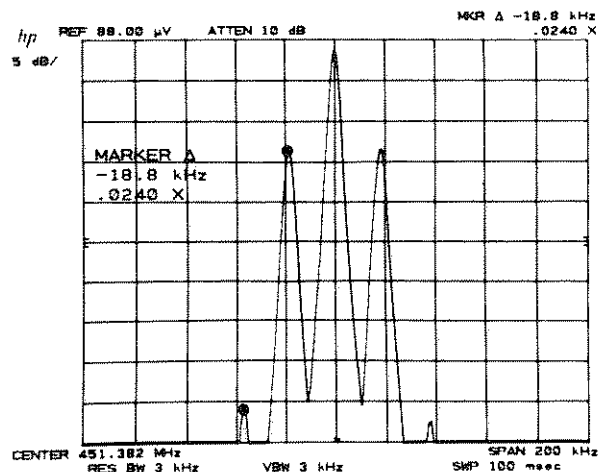

## REFERENCE LINE

The reference line functions DISPLAY LINE (DL) and THRESHOLD (TH) place horizontal reference lines on the display. Their levels are read out in absolute amplitude units.

### DISPLAY LINE uses:

- measure signal levels with direct readout.
- establish a standard for go/no go test comparisons.
- eliminate or reduce amplitude errors due to system frequency response uncertainty.

### THRESHOLD provides:

- a base line clipper whose level is read out.
- a minimum threshold level that can be set.

## DISPLAY LINE

DISPLAY LINE  (DATA entry) places a horizontal reference line at any level on the graticule. The line's amplitude, in reference level units, is read out on the left-hand side of the CRT display.

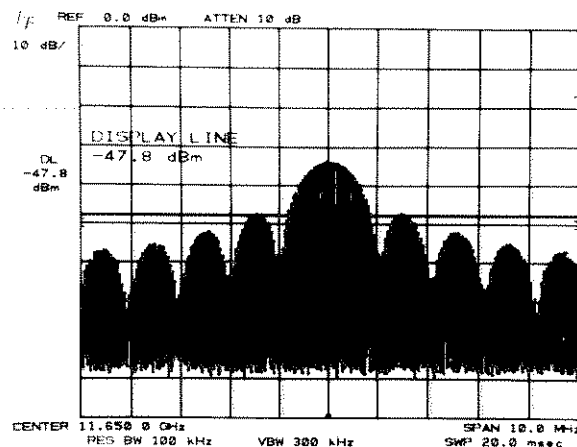

The DISPLAY LINE can be positioned anywhere within the graticule. When activated after LINE power ON or  the display line is placed 4.5 divisions down from the reference level.



DISPLAY LINE  erases the line and readout from the CRT display but does not reset the last position. If the display line is activated again before LINE power ON or , it will return to its last position.

DISPLAY LINE position is always accessible for HP-IB and TRACE , even if never activated. See Chapter 6, TRACE arithmetic.

The DISPLAY LINE readout has the same number of significant digits as reference level.

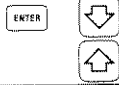

**REFERENCE  
LINE**

**DATA Entry**

	Moves the line about one division for each full turn. The line moves in display unit increments.
	Moves the line one tenth of the total amplitude scale per step.
	Positions the line to the exact entry level. Entry may be in mV, $\mu$ V, $\pm$ dBm, $\pm$ dBmV, or $\pm$ dB $\mu$ V depending upon which units are selected.

**Example**

When the amplitude of a number of signals in the same span require a quick readout, the DISPLAY LINE can be used.

Activate the DISPLAY LINE with .  
 With  place the line through the peak of a signal and read out its absolute amplitude level.

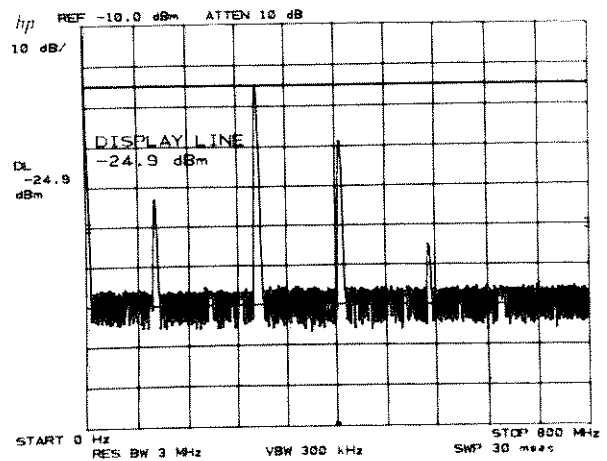

Moving the DISPLAY LINE to each signal reads out its amplitude.

**THRESHOLD**

THRESHOLD  (DATA entry) moves a lower boundary to the trace, similar to a base line clipper on direct writing CRT spectrum analyzers. The boundary's absolute amplitude level, in reference level units, is read out on the lower left-hand side of the CRT display.

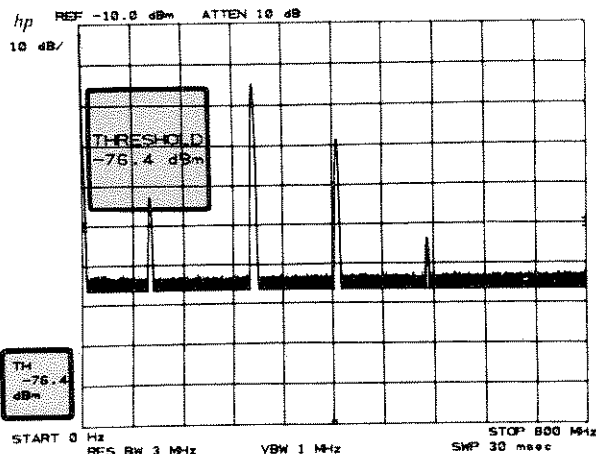





The THRESHOLD can be positioned anywhere within the graticule. It operates on TRACE  ,  or  for TRACES A, B and C simultaneously. When activated after LINE power ON or  , the THRESHOLD is placed 1 division from the bottom graticule.

The THRESHOLD level does not influence the trace memory, that is, the threshold level is not a lower boundary for trace information stored and output from the trace memories through the HP-IB. TH  removes the THRESHOLD boundary and readout from the CRT display but does not reset the position. If threshold is activated again before LINE power ON or  it will resume at its last level.

The THRESHOLD readout has the same number of significant digits as reference level.

## DATA Entry

<input type="button" value="ENTER"/> 	Moves the THRESHOLD about one division per rotation. The line moves in display unit increments.
<input type="button" value="ENTER"/>  	Moves the THRESHOLD one tenth of the total amplitude scale per step.
<input type="button" value="ENTER"/> 	Positions the THRESHOLD to the exact entry level. Entry may be in mV, $\pm$ dBm, $\pm$ dBmV, or $\pm$ dB $\mu$ V depending upon units selected.

## Example

The THRESHOLD can be used as a go/no go test limit.

A series of signals can be tested for a specific THRESHOLD level by placing the THRESHOLD at the test level.

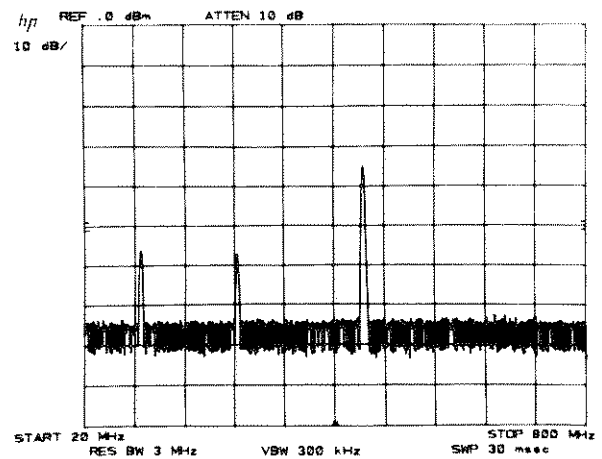

Press THRESHOLD  55.2 dBm. Only those signals > -55.2 dBm will be displayed.

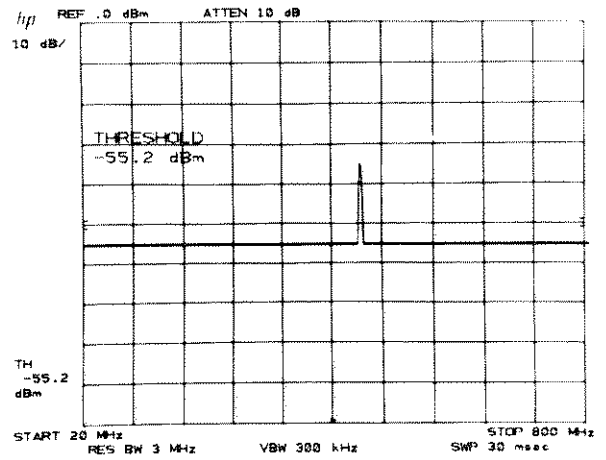

# Chapter 9

## COUPLED FUNCTION

This chapter describes the COUPLED FUNCTION group and its use in various measurements. The COUPLED FUNCTIONS control the receiver characteristics of the spectrum analyzer.

The values of the COUPLED FUNCTION are automatically selected by the analyzer to keep absolute amplitude and frequency calibration as frequency span and reference level are changed.\* The functions are all coupled with LINE power ON, a 1-12 GHz or 0-2.5 GHz FULL SPAN key, or when their individual AUTO is activated.

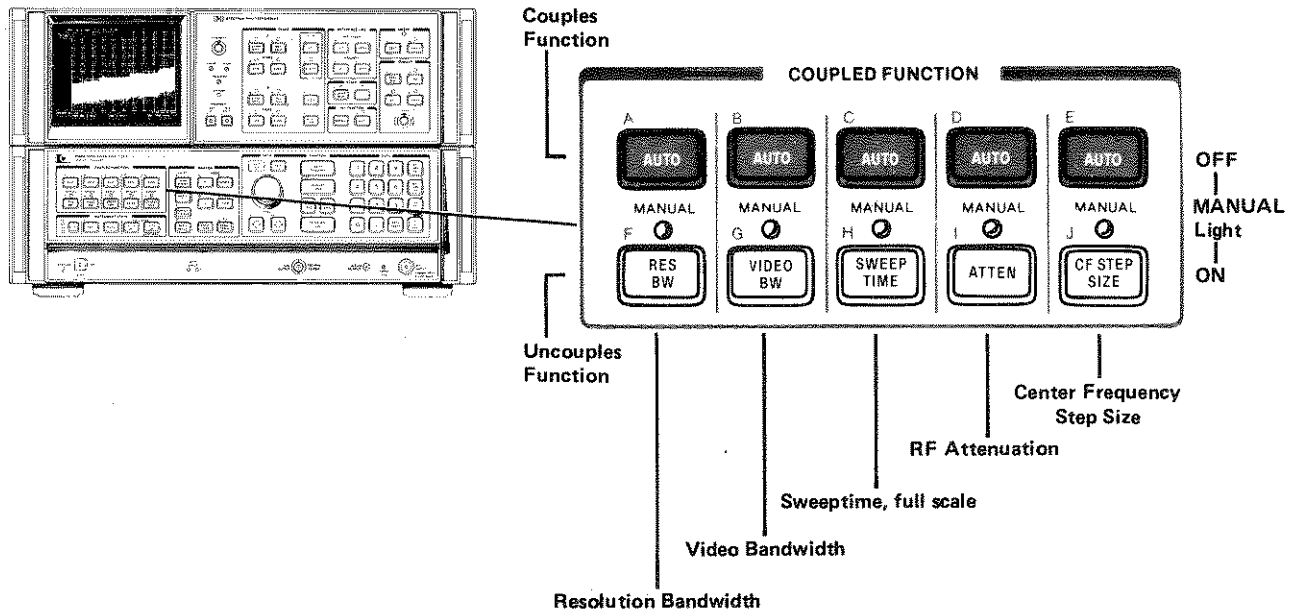

### For each COUPLED FUNCTION:



Sets the function to the preset value dictated by the analyzer's current state. The function is coupled.



Function value will not change with instrument state. DATA entry changes value. The MANUAL light goes on and stays on until the function is placed in AUTO once again.

In most cases the AUTO coupled functions will change values to maintain amplitude calibration when one or more of the others are manually set. If the amplitude or frequency becomes uncalibrated, "MEAS UNCAL" appears in the right-hand side of the graticule.

### Coupled Function



**Selects**  
3 dB resolution bandwidth (IF filter) which largely determines the ability of the analyzer to resolve signals close together in frequency.



3 dB bandwidth of the post detection low pass filter that averages noise appearing on the trace.



The total time for the analyzer to sweep through the displayed frequency span or display a detected signal in zero frequency span.



The setting of the input RF attenuator which controls signal level at the input mixer.



Selects center frequency change for each DATA when is activated.

\*Center frequency step size does not affect amplitude or frequency calibration.

# DATA Entry For COUPLED FUNCTIONS

Discrete values are entered for RES  
BW, VIDEO  
BW, SWEEP  
TIME and ATTEN. The DATA ○ and ↑ ↓ selects these values sequentially from the current value. A DATA entry from the keyboard which is not exactly equal to an allowable value will select an adjacent value. For example, RES  
BW 1 5 kHz  
mv  
msec will select 30 kHz bandwidth, the next higher IF bandwidth.

## Resolution Bandwidth

RES  
BW (DATA entry) sets bandwidth selection to MANUAL and changes the analyzer's IF bandwidth. The bandwidths that can be selected are 10 Hz, 30 Hz, 100 Hz, 300 Hz, 1 kHz, 3 kHz, 10 kHz, 30 kHz, 100 kHz, 300 kHz, 1 MHz and 3 MHz.

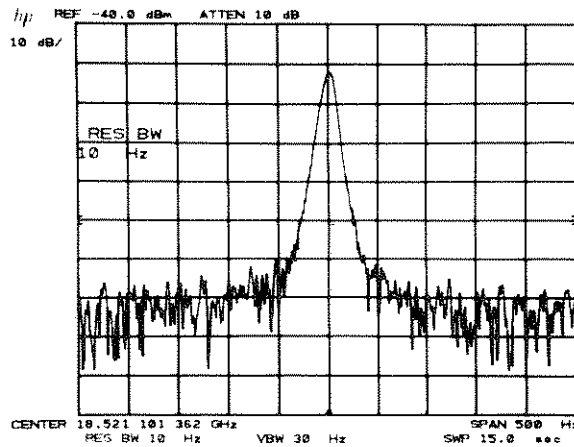

### Example

A measurement requiring manual resolution bandwidth selection is the zero span (time domain) observation of modulation waveforms. An example can be found in Chapter 4, Zero Frequency Span - Fixed Tuned Receiver Operation.

Another use of manual resolution bandwidth is for better sensitivity over a given frequency span.

The low level intermodulation products of a signal needs to be measured. With the functions coupled the analyzer noise may mask the distortion products.

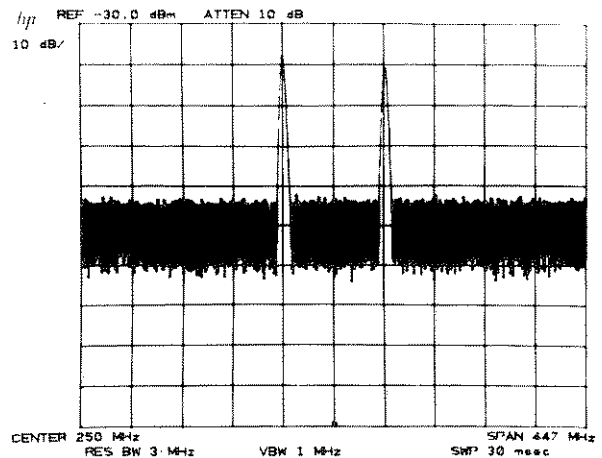

Reduction of the noise level by 10 dB (increased sensitivity) is achieved by decreasing the bandwidth by a factor of 10.



(THRESHOLD has been activated to clarify the display.)

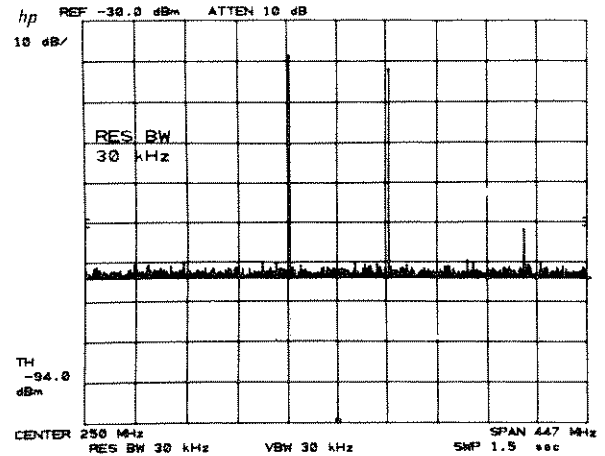

The sweep time automatically slows to maintain absolute amplitude calibration if  SWEEP TIME is coupled.

## Video Bandwidth

VIDEO BW (DATA Entry) sets the video bandwidth selection to manual and changes the analyzer's post detection filter bandwidth. The bandwidths that can be selected are 1 Hz, 3 Hz, 10 Hz, 30 Hz, 100 Hz, 300 Hz, 1 kHz, 3 kHz, 10 kHz, 30 kHz, 100 kHz, 300 kHz, 1 MHz and 3 MHz.

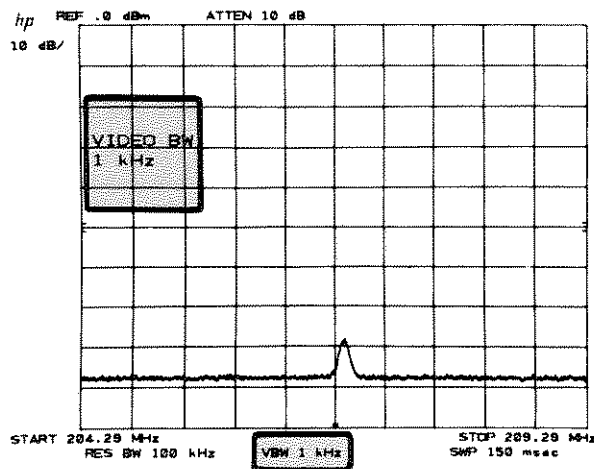

### Example:

Signal responses near the noise level of the analyzer will be visually masked by the noise. The video filter can be narrowed to smooth this noise.

A low level signal at this center frequency can just be discerned from the noise.

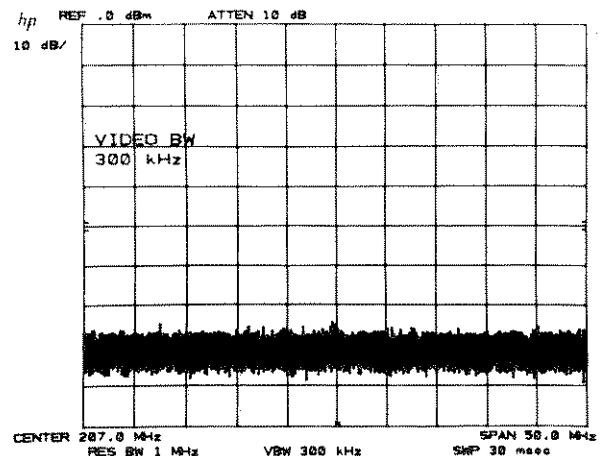



Narrowing the video bandwidth clarifies the signal and allows its amplitude measurement.

Press     

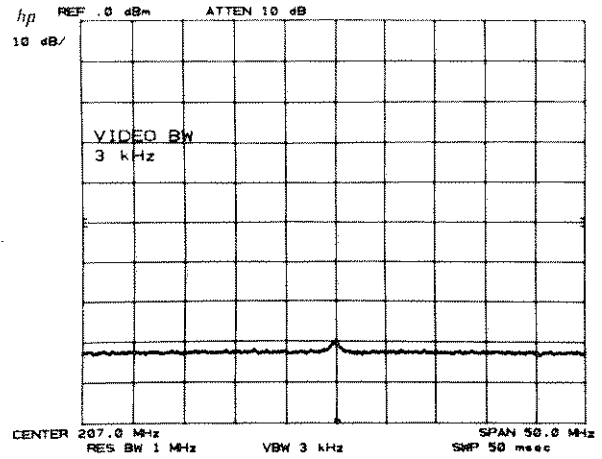

The sweep time will increase to maintain amplitude calibration.

**NOTE**

The video bandwidth must be set wider or equal to the resolution bandwidth when measuring pulsed RF or impulse noise levels.

**Video Averaging**

Narrowing the video filter requires a slower sweep time to keep amplitude calibration since the narrower filter must have sufficient time to respond to each signal response. Video averaging is an internal routine which *digitally* averages a number of sweeps, allowing a more instantaneous display of spectral changes due to center frequency, frequency span or reference level changes. See Chapter 12, page 12.11.

**Sweep Time**

 (DATA entry) sets the sweep time selection to manual and changes the rate at which the analyzer sweeps the displayed frequency or time span.

The sweep times that can be selected are:

	SWEEP TIME	SEQUENCE
FREQUENCY SPAN (≥ 100 Hz)	20 ms to 1500 sec	continuously
ZERO FREQUENCY SPAN (0 Hz)	1 μs to 10 ms	1, 2, 5 and 10
	20 ms to 1500 sec	continuously

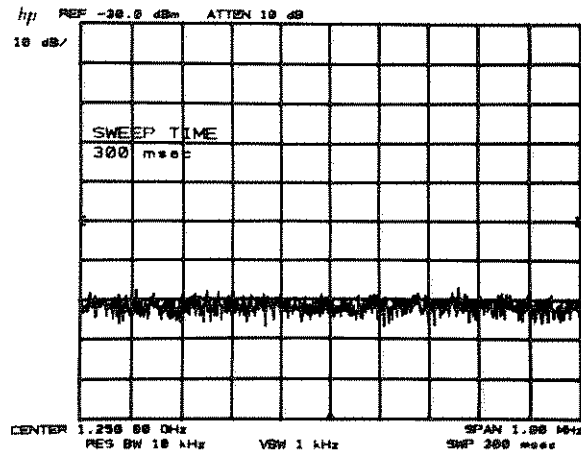

### Example

To identify signals quickly in a very narrow frequency span (where the resolution bandwidth would be narrow) the sweep time can be temporarily reduced. (e.g. speed up sweep rate).

A frequency span of 10 kHz will have a selected resolution bandwidth of 100 Hz and a sweep time of 3 seconds.

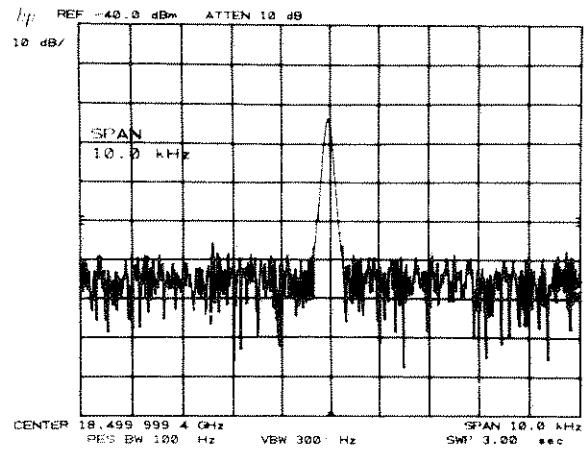

To quickly see signals present in the span press SWEEP TIME and ↓ several times. When the sweep completes its span, couple sweep time again with AUTO.

Note the MEAS UNCAL message appears automatically as the faster sweep time causes some distortion of the spectral response.

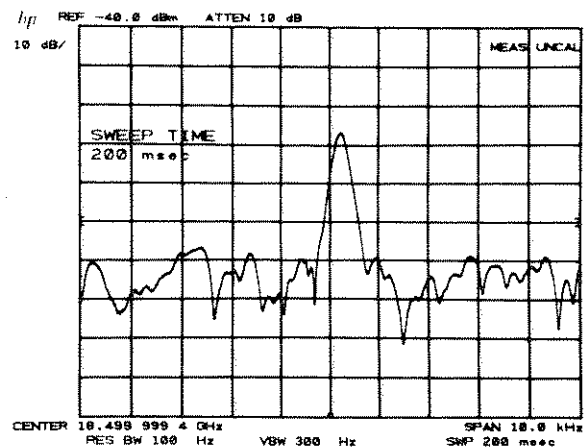

# Input Attenuation

 (DATA entry) sets the attenuation function to MANUAL and changes the analyzer's RF input attenuation. The levels of attenuation that can be selected are 10 dB to 70 dB in 10 dB steps, or 0 dB under special conditions. Generally the reference level does not change with attenuator settings.

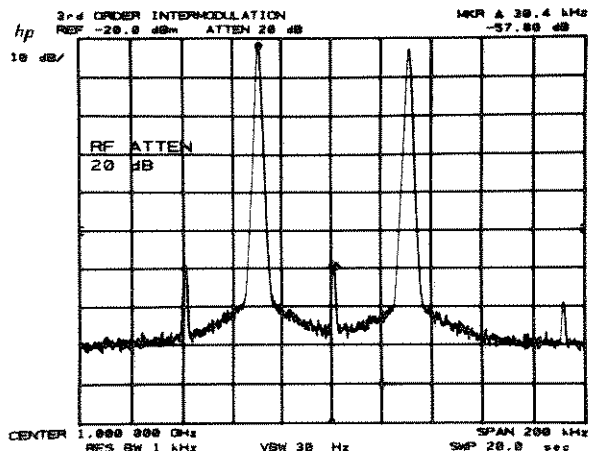



When the RF input attenuator function is coupled (AUTO), the value selected assures that the level at the input mixer is less than -10 dBm (the 1 dB compression point) for on-screen signals. For example, if the reference level is +28 dBm the input attenuator will be set to 40 dB: +28 dBm -40 dB = -12 dBm at the mixer.

The input mixer level can be changed to assure maximum dynamic range. See Input Mixer Level, Chapter 12.

**CAUTION**



Greater than +30 dBm total input power will damage the input attenuator and the input mixer.

## Zero Attenuation

As a precaution to protect the spectrum analyzer's input mixer, 0 dB RF attenuation can only be selected from the number/units keyboard, press   .

## Reference Levels < = -100 dBm and > +30 dBm

Reference levels < = -100 dBm or between +30 dBm and +60 dBm can be called when the reference level extended range is activated. Low reference level limits depend upon resolution bandwidth and scale.

Press   to extend the reference level range.

See Chapter 4, FUNCTION , and Chapter 12, KEY FUNCTION, page 12.5.

## Determining Distortion Products

If the total power to the analyzer is overloading the input mixer, distortion products of the input signals can be displayed as real signals. The RF attenuator can be used to determine which signals, if any, are internally generated distortion products.

### Example

The two main signals shown are producing intermodulation products because the analyzer's input mixer is overloaded.

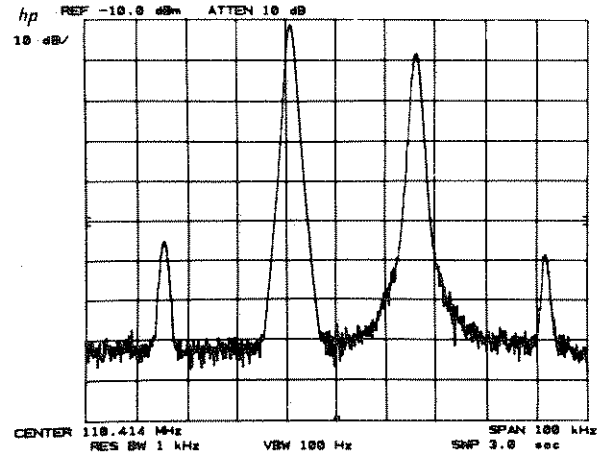

To determine whether these intermod products are generated by the analyzer, first save the spectrum displayed in B with CLEAR-WRITE B VIEW B

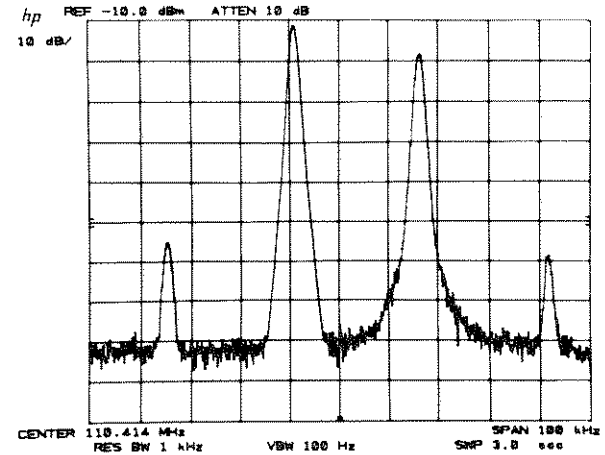

Increase the RF attenuation by 10 dB. Press ATTEN ↑. (If the reference level changes it will be necessary to return it back to its original value.)

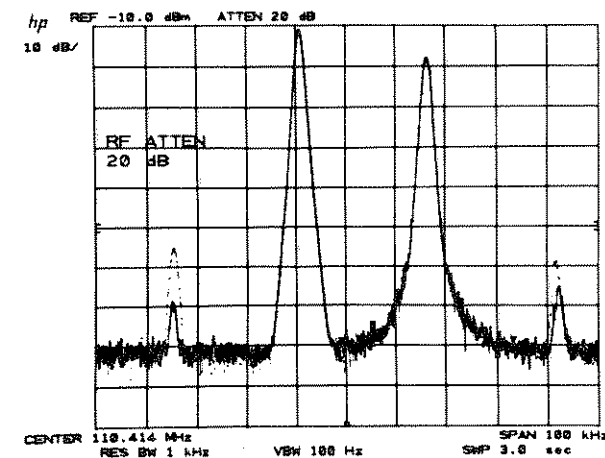

Since some of the signal responses decrease as the attenuation increases (by comparing the response in A with the stored trace in B), distortion products are caused by an overloaded input mixer. The high level signals causing the overload conditions must be attenuated to eliminate this condition.

# ↑ CENTER FREQUENCY STEP SIZE

(DATA entry) sets step size to MANUAL, changes and stores the step size entered into a register. While  is in MANUAL,  and  changes center frequency by the step size value stored in the register. Several functions can be used to enter step size value to the register. When a CF STEP SIZE is AUTO, the center frequency steps will be 10% of the frequency span, even though the CF STEP SIZE register contains another value.

	Entry Value	<input type="checkbox"/> State
step size <input type="checkbox"/> AUTO, <input type="checkbox"/> 2-22 GHz FULL SPAN or LINE power ON	100 MHz	coupled (AUTO)
<input type="checkbox"/> (DATA entry)	DATA entry value	uncoupled (MANUAL)
MARKER <input type="checkbox"/> MARKER STEP SIZE	marker frequency readout	uncoupled (MANUAL)

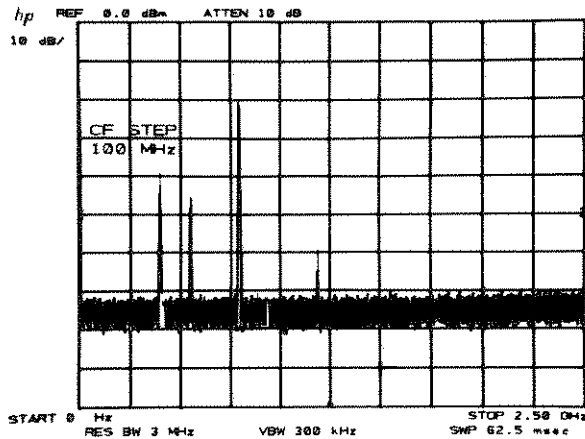

The step size can be varied from 0 Hz to greater than 20 GHz with 1 Hz resolution. It is displayed with the same resolution as center frequency.

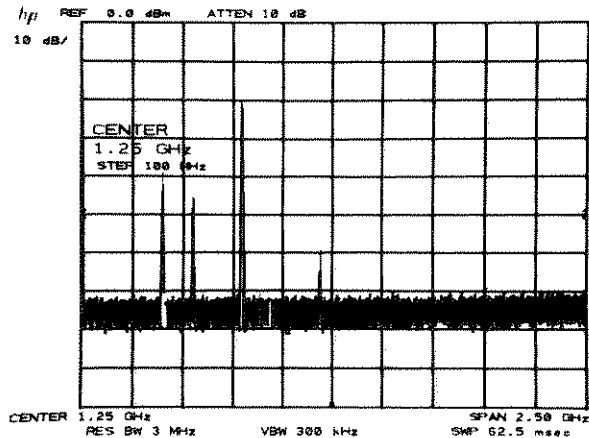

When the center frequency is activated with step size in MANUAL, the active function readout includes both the center frequency and the step size value.



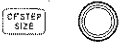







## DATA Entry

	Changes the step size in display unit increments.
	Changes the step size in steps equal to one tenth of the frequency span.
	Selects a specific step size to a resolution equal to the current center frequency readout.





## Example

Surveillance of a wide frequency span sometimes requires high resolution. One fast way to achieve this is to take the span in sequential pieces using a tailored center frequency step. This example looks from 0 Hz to 2.5 GHz in 50 MHz spans.

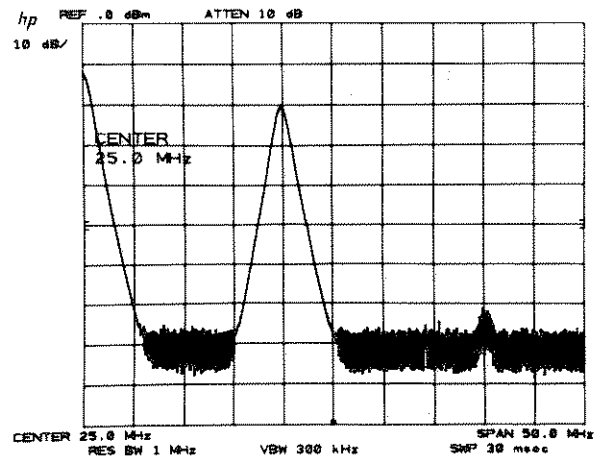
First set the span and center frequency:

For a span of 50 MHz press    . Set the center frequency to 25 MHz with    .



Set the step size to 50 MHz,    ; reactivate center frequency with  and step to 225 MHz.

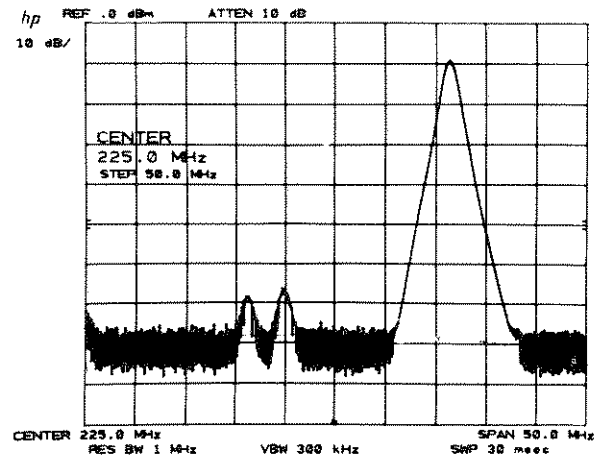

Now each  sets the center frequency to the next 50 MHz span for a span by span surveillance of the spectrum. (Center frequency = 25 MHz, 75 MHz, 125 MHz, etc.) Center frequency step size can also be defined by the marker, see the MARKER ENTRY portion of Chapter 7, page 7.11.

# Chapter 10

## SWEEP and TRIGGER

This chapter describes the use of SWEEP and TRIGGER control functions.

### SWEEP controls enable:

- CONT continuous, or repetitive sweeping (sweep time  $\geq 20$  ms).
- SINGLE a single sweep which will repeat only on demand (sweep time  $\geq 20$  ms).

### TRIGGER controls select the function which will begin a sweep:

- FREE RUN as soon as possible,
- LINE line voltage passes through zero on a positive swing,
- EXT an external signal voltage passes through  $\sim 1.5$  volts on a positive swing.
- VIDEO the level of a detected RF envelope reaches up to the level on the CRT display determined by the LEVEL knob.

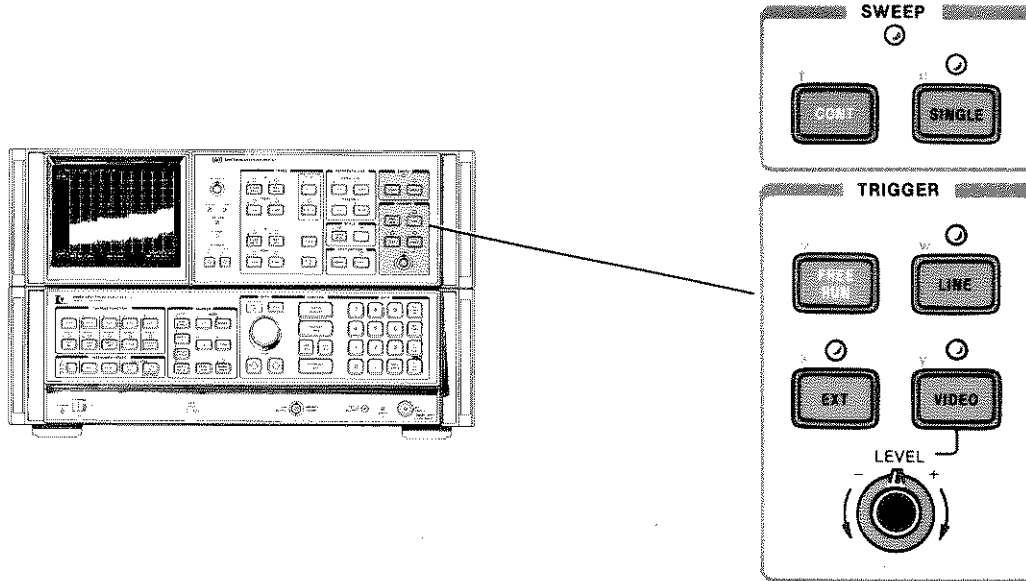

SWEEP and TRIGGER Controls

## SWEEP

The spectrum analyzer frequency sweep (sweep times  $\geq 20$  ms), once triggered, continues at a uniform rate from the start frequency to the stop frequency unless new data entries are made to the analyzer from the front panel or the HP-IB. With faster sweeps, changes to center frequency, for example, appear continuous. With long sweep times, a change in center frequency noticeably suspends the sweep while the analyzer updates its state and readout, then the sweep continues from where it was, tracing out the new spectrum.

The SWEEP light indicates that a sweep is in progress. The light is out between sweeps and during data entry. (The light is out for sweep times  $\leq 10$  ms.)

After a sweep, the next sweep will be initiated only if:

- continuous sweep mode is selected or a single sweep demand is made,
- the trigger conditions are met,
- data is not entered continuously from the front panel DATA controls or the HP-IB.

### Continuous Sweep

CONT enables the continuous sweep mode. Provided the trigger and data entry conditions are met, one sweep will follow another as soon as triggered. Pressing  CONT initiates a new sweep.

### Single Sweep

SINGLE enables the single sweep mode. Each time  SINGLE is pressed, including when the SWEEP mode is changed from continuous, one sweep is initiated provided the trigger and data entry conditions are met. A sweep in progress will be terminated and restarted upon  SINGLE.

## Zero Frequency Span Sweep

In zero frequency span, sweep times from 1  $\mu$ sec to 10 msec are also available. In these sweep times the SWEEP **CONT** and **SINGLE** are disabled. The video signal response is *not* digitally stored (trace modes also disabled), but multiplexed directly onto the display along with the graticule and readouts. The graticule and readouts are refreshed following each fast sweep.

To avoid flicker of the display when external or video triggers are less frequent than 25 msec, the analyzer will trigger internally. If triggers dependent *only* on external or video trigger are required press

**SHIFT** **x** **EXT** disables "auto" external trigger feature

or **SHIFT** **y** **VIDEO** disables "auto" video trigger feature

### NOTE

For zero frequency span sweep times  $\leq$  10 msec and **SHIFT** **x** or **SHIFT** **y**, the CRT display graticule and readout depend upon triggering. If no trigger is present the CRT display will be blank.

## TRIGGER

The analyzer sweep is triggered by one of four modes selected.

- **FREE RUN** allows the next sweep to start as soon as possible after the last sweep.
- **LINE** allows the next sweep to start when the line voltage passes through zero, going positive.
- **EXT** allows the next sweep to start when an external voltage level passes through  $\approx$  1.5 volts, going positive.

The external trigger signal level must be between 0 V and + 5 V.

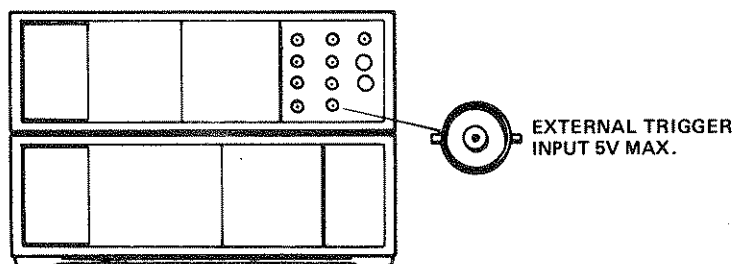

**External TRIGGER Input**

- **VIDEO** allows the next sweep to start if the detected RF envelope voltage rises to a level set by the LEVEL knob. The LEVEL corresponds to detected levels displayed on the CRT between the bottom graticule (full CCW) and the top graticule (full CW).

An RF envelope will trigger the sweep only if it is capable of being traced on the CRT display, that is, the resolution bandwidth and video bandwidth are wide enough to pass the modulation waveform of an input signal.



# TRIGGER

## Example

A zero span display of this video waveform will trigger for all LEVEL knob settings.

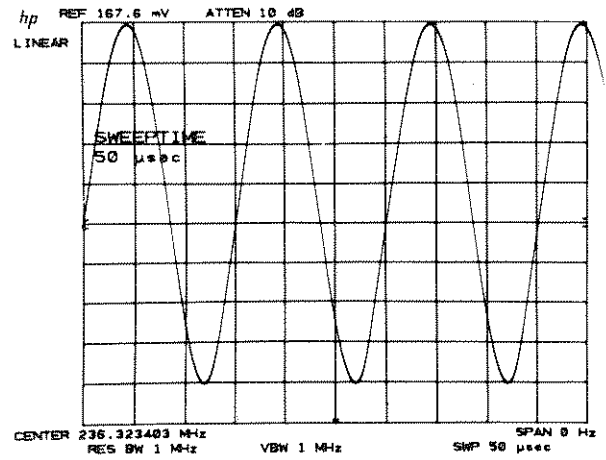
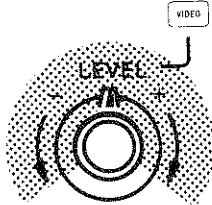

If the video signal lowers on the display, the LEVEL must be set towards the minus side.

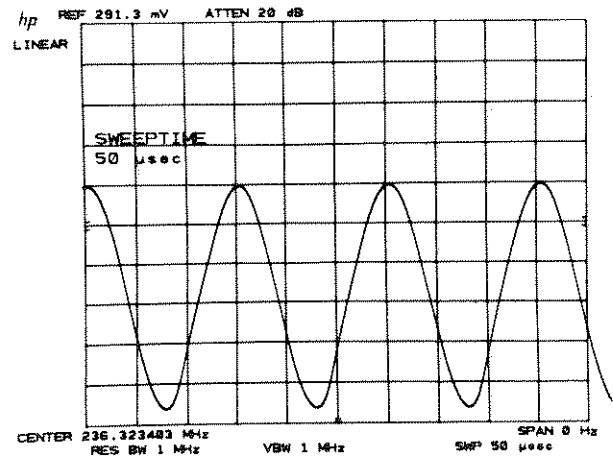
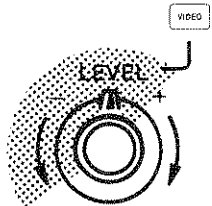

If the level does not cause a trigger within 25 msec, the sweep will be triggered anyway to insure a display. Note that this is true only for sweep times  $\leq 10$  msec.

# Chapter 11

## INSTRUMENT STATE

This chapter describes the INSTRUMENT STATE keys. Each key allows access to or activation of a specific set of functions and their values. Some of the sets are built in to the analyzer and some are user defined.

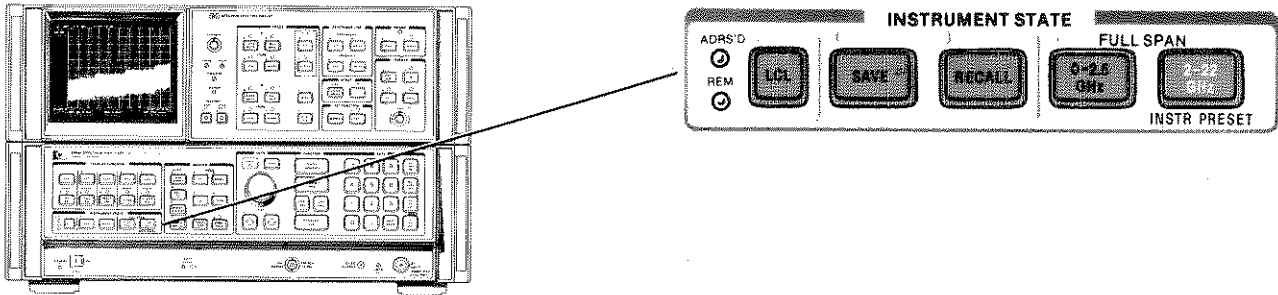

### Instrument states that can be selected:

#### FULL SPAN

2-22 GHz

A full 2 — 22 GHz span with coupled operation and *all* the functions set to known states and values.

#### FULL SPAN

0-2.5 GHz

A full 0 Hz to 2.5 GHz span with coupled operation and all the functions set to known states and values.

SAVE

1

Saves the complete set of current front panel function states and values for later recall. Registers 1 through 6 are available for storage.

RECALL

1

Recalls the complete instrument state saved in the register called.

LCL

Calls for front panel control after the analyzer has been placed in a remote state by an HP-IB controller.

## FULL SPAN Instrument Preset (2 - 22 GHz)

2-22 GHz provides a convenient starting point for making most measurements. That is, it calls for a full 2 — 22 GHz span, coupled functions and a 0 dBm reference level, to name a few. LINE power ON automatically calls for an instrument preset.

The states that are set include all the functions and values of

- front panel functions,
- and ●  SHIFT KEY FUNCTIONS,
- and ● functions accessible only by the HP-IB.

### Front Panel Preset

2-22 GHz enables all the front panel functions designated by keys with white lettering. It will save a trace response in TRACE B, but not A or C.

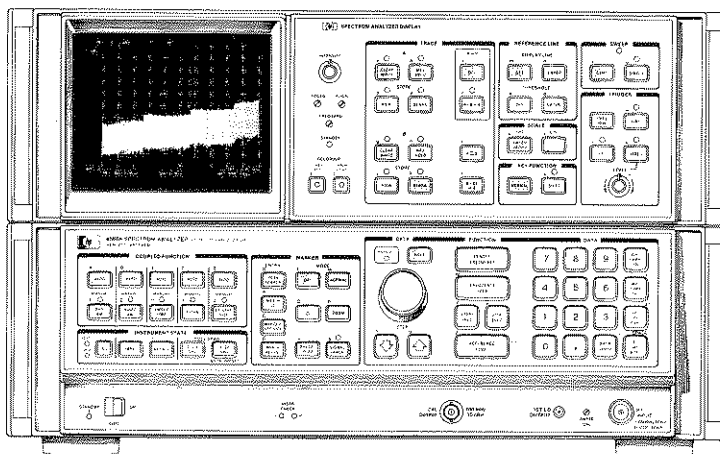

Functions Activated with FULL SPAN key

## INSTRUMENT STATE

### To be precise:

<b>FUNCTION:</b>	Start Frequency	2 GHz
	Stop Frequency	22 GHz
	Reference Level	0 dBm
<b>DATA:</b>	Hold	
<b>COUPLED FUNCTION:</b>	All set to <b>AUTO</b> which corresponds to the following values:	
	Resolution Bandwidth	3 MHz
	Video Bandwidth	1 MHz
	Sweep time	500 msec full scale
	Attenuator	10 dB, coupled to maintain < -10 dBm at input mixer
	Center Frequency Step Size	100 MHz entered in register
<b>TRACE:</b>	A	Clear-Write
	B	Blanked but information in memory saved
	A — B	Off
<b>MARKER:</b>	Off	

### INSTRUMENT STATE

**SAVE** and **RECALL** :

States are saved including the current state. See **RECALL** **7** below.

### SCALE:

Logarithmic, 10 dB/division

### REFERENCE LINE:

Display line off 5.5 divisions up  
Threshold off 1.0 divisions up

### SWEEP:

Continuous

### TRIGGER:

Free run

### INSTR CHECK:

An internal instrument check is made. If the check is false, lights will stay on.

### KEY FUNCTION:

Normal

### **SHIFT** FUNCTIONS:

Chapter 12 **SHIFT** KEY FUNCTION, discusses the implications of activating instrument preset during **SHIFT** FUNCTION use.

If the key is activated (shift light on), **0-22 GHz** unshifts the key. This is equivalent to pressing **NORMAL**.

### HP-IB FUNCTIONS:

"D1"	Display size-normal
"EM"	Erase trace C memory
"03"	Output format ASCII absolute
"PD"	Pen down
"DA"	Display address set to 3072

Graphic information or control language written into the analyzer memory by HP-IB functions such as graph (GR), plot (PA), label (LB), or display write (DW) will be erased unless stored in trace memory B. Instrument preset also rewrites all the display graticule and character readouts into the appropriate section of the display memory.

See 8566A Spectrum Analyzer Remote Operation (HP part number 8566-90003) for further information.

## FULL SPAN 0 - 2.5 GHz

The 0 - 2.5 GHz FULL SPAN key selects a start/stop frequency of 0 Hz and 2.5 GHz respectively, a reference level of 0 dBm and sets all the COUPLED FUNCTIONS to AUTO. Basically, **0-2.5 GHz** is the equivalent of an instrument preset in the low band. It presets everything that **0-22 GHz** does except that **0-2.5 GHz** will not execute the instrument check sequence.

# Saving and Recalling Instrument States

(DATA keyboard entry) and  (DATA keyboard entry) save and recall complete sets of user defined front panel function values. The DATA entry from the keyboard names the register which stores the instrument state. Six registers,  through , can be saved and recalled. Only another  will erase a saved register. The registers contain their last states even with a loss of line power (power failure). The registers are maintained with an internal battery supply for about a 30 day period after line power failure.

is a special recall function which recalls the instrument state prior to the *last* instrument preset or single function value change, which ever has most recently occurred. It aids in recovering from inadvertent entries.

Registers 8 and 9 contain preset control settings that are used for calibration purpose. (See Calibration procedure in Chapter 1). Register 0 restores the current state of the analyzer which is useful for servicing.

The current instrument state, if the POWER switch is turned to STANDBY, (or a short term loss of ac line power) can be recovered at POWER ON if   is activated previous to a power loss.

Some  KEY FUNCTION values or states cannot be saved. Neither can information in the display memories, such as a title or trace.

## Example

When a test sequence is used over and over, the instrument states can be set up in the registers prior to testing for recall during the procedure.

Keying in a specific state:

LIN  SCALE   
 Then save with   .

Press .

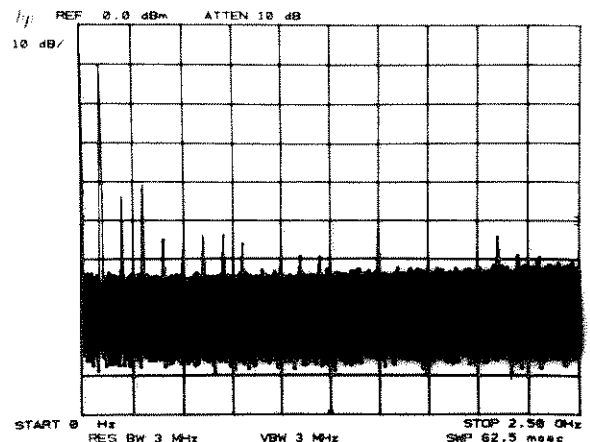
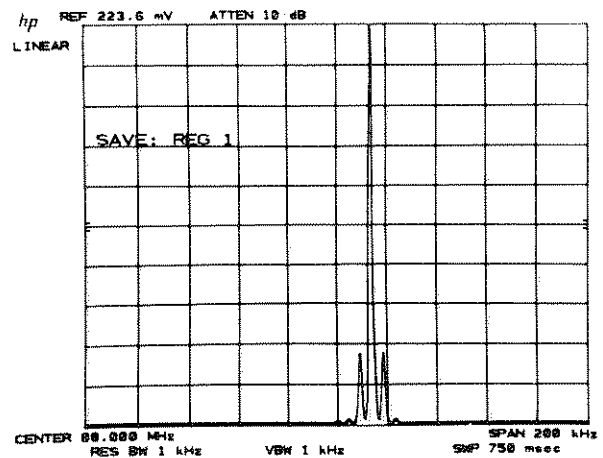

And recall the last state with  .

Once the state has been recalled, any function can be used for more detailed measurements.

Note that in this case, the state could also have been recalled by  .

Registers 1-6 can also be locked to prevent any loss or change in the contents of the storage registers.   locks the registers and   unlocks the registers.

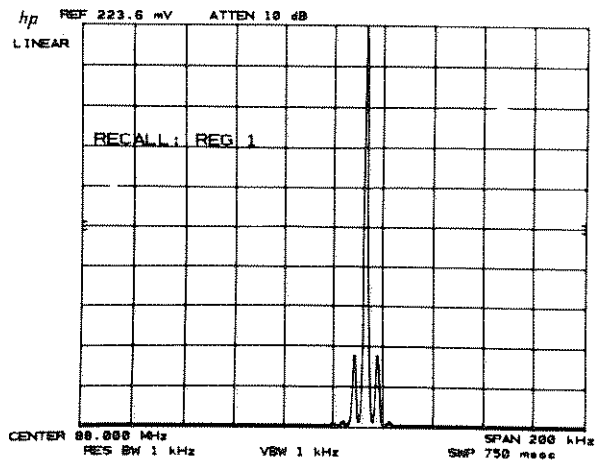

## Local Operation

enables front panel control after an HP-IB remote LISTEN or TALK command has been executed. An HP-IB local lockout will disable  until an HP-IB return to local command is executed or the LINE power is turned to STANDBY then ON again.

Indicates instrument has been addressed through HP-IB

Indicates instrument is in remote operation

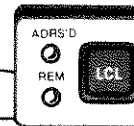

The addressed light remains on until an HP-IB device clear command or any unlisten command is executed. See 8566A Spectrum Analyzer Remote Operation, HP part number 8566-90003, for more detailed information.

## Chapter 12

# SHIFT KEY FUNCTIONS

This chapter describes access and use of the **SHIFT** KEY FUNCTION

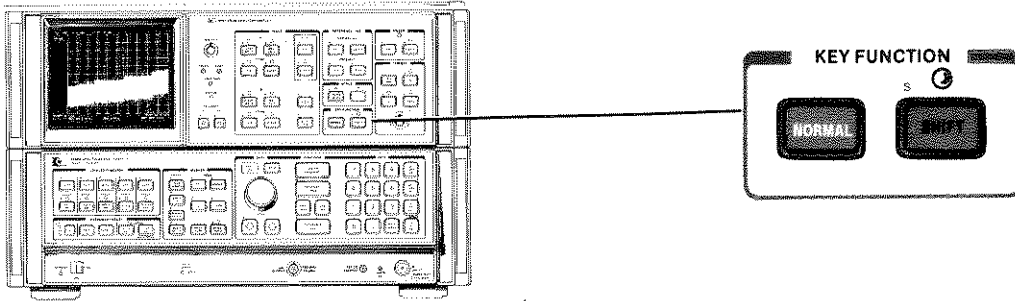

## General Description

Shift functions supplement a front panel function or provide unique measurement capabilities. The **SHIFT** functions are not named on the front panel but are coded by the blue characters beside the keys. For example, the frequency offset function is designated by the code  $\nu$ . On the front panel the code  $\nu$  is found in the FUNCTION section:



The shift functions are activated by pressing **SHIFT** and then the front panel key with the appropriate blue code. A complete summary of shift FUNCTIONS is on page 12.2. An index to all shift functions is on page 12.16.

### Example

Activate the shift function  $\nu$  (frequency offset) with

press **SHIFT** shift light on

press  $\nu$  **CENTER FREQUENCY** shift light off and offset function activated

The shift light can always be turned off with **NORMAL**, which returns the front panel keys to their designated function. **NORMAL** does not disable the selected shift function (except for title).

### DATA Entry

An active shift function value is readout and identified in the active function area of the display the same as any other function using DATA entry. Once the data has been entered, any other function can be activated. The shift function will retain its last value until **2-12 GHz** or LINE power STANDBY.

DATA entries to shift functions are made only from the number/units keyboard. The ENABLED light remains off even though data may be entered.

Data is entered, that is, changes the instrument state, only when a units key is pressed. If the entry has no units (an address for example), use the **Hz** key as the terminator.



## FUNCTION SUMMARY

<p><b>General</b></p> <p>r HP-IB Service request  P Enter HP-IB address  f Power on in last state  z Display Address    Display Write</p> <p><b>Frequency</b></p> <p>V Frequency offset  - Negative entry  v Signal identifier ext. mixer</p> <p><b>Amplitude</b></p> <p>Z Amplitude offset  A Units: dBm  B dBmV  C dB<math>\mu</math>  D voltage  I Extended reference level range  - Negative entry  , Mixer level</p> <p><b>Marker</b></p> <p>K Marker to next peak  N Marker to minimum  O Enter <math>\Delta \rightarrow</math> span  M Noise level on  L Noise level off  u Stop single sweep at marker  = Factory preselector setting  / Manual preselector setting</p>	<p><b>Display</b></p> <p>o Annotation blanked  p Annotation on  w Display correction data  g CRT beam off  h CRT beam on  m Graticule blanked  n Graticule on  E Title</p> <p><b>Trace</b></p> <p>c A + B <math>\rightarrow</math> A  Detection:  a normal  b positive peak  d negative peak  e sampling  Trace C:  k blank trace C  i B <math>\rightleftharpoons</math> C  l B <math>\rightarrow</math> C  j view trace C  G Video averaging on  H Video averaging off</p>	<p><b>Trigger - Zero Span</b></p> <p>x Without 25 msec triggering  y Without 25 msec triggering</p> <p><b>Instrument State</b></p> <p>( Save registers locked  ) Save registers unlocked  T Fast preset 2 - 22 GHz  U Fast preset external mixer  S Fast HP-IB operation  t Band lock  Q Band unlock</p> <p><b>Error Correction</b></p> <p>W Execute routine  X Use correction data  Y Do not use correction data  w Display data</p> <p><b>Diagnostics</b></p> <p>w Display correction data  q Disable step gain  R Frequency diagnostic on  F YTO pretest mode  J Manual DACS control</p>
---	---	---

## ALPHABETICAL KEY CODE SUMMARY

<p>*A Amplitude in dBm  B Amplitude in dBmV  C Amplitude in dB<math>\mu</math>V  D Amplitude in voltage  E Title  F YTO pretest mode  G Video averaging on  *H Video averaging off  I Extended reference level range  J Manual DACS control  K Marker to next peak  *L Noise level off  M Noise level on  N Marker to minimum  O Enter <math>\Delta \rightarrow</math> span  P Set HP-IB address  *Q Band unlock  R Frequency diagnostic on  S Fast HP-IB operation</p>	<p>T Fast preset 2-22 GHz  U Fast preset external mixer  V Frequency offset  W Execute error correction routine  X Use correction data  *Y Do not use correction data  Z Amplitude offset  *a Normal detection  b Positive peak detection  c A + B <math>\rightarrow</math> A  d Negative peak detection  e Sample detection  f Power on in last state  g CRT beam off  *h CRT beam on  i B <math>\rightleftharpoons</math> C  j View trace C  *k Blank trace C  l B <math>\rightarrow</math> C</p>	<p>m Graticule blanked  *n Graticule on  o Annotation blanked  *p Annotation on  q Disable step gain  r HP-IB service request  t Band lock  u Stop single sweep at marker  v Signal identifier ext. mixer  w Display correction data  x Without 25 msec triggering  y Without 25 msec triggering  z Display address  - Negative entry  = Factory preselector setting  / Manual preselector setting  ( Save registers locked  ) Save registers, unlocked    Display write  , Mixer level</p>
---	---	---

\*These functions selected with 2-22 GHz INSTRUMENT PRESET

## Negative DATA Keyboard Entry

Entering negative data from the DATA keyboard requires the use of a negative symbol prefix on the number entry.  
negative entry:

For example to enter a negative 100 MHz offset frequency:

Press    to activate frequency offset

Press       to enter a negative frequency.

Not all values can be entered with a negative prefix, for example a negative entry to a voltage reference level will result in entering the positive value.

Negative entries in dB can be made with the -dBm units key or the negative prefix with the +dBm units key. If both negative prefix and  are used, the value will be entered as positive.

## Frequency and Amplitude Offset

The CRT display amplitude and frequency readout can be offset. Entering an offset does not affect the trace.

**Frequency offset:**    (DATA keyboard entry)

**Amplitude offset:**    (DATA keyboard entry)

Offset entries are added to all the frequency or amplitude readouts on the CRT display including marker, display line, threshold, start frequency and stop frequency.

### FUNCTION

To eliminate an offset, activate the offset and enter zero. A FULL SPAN key also sets the offsets to zero.

Offsets are stored with the  functions for recall with .

When an offset is entered its value is displayed on the CRT.

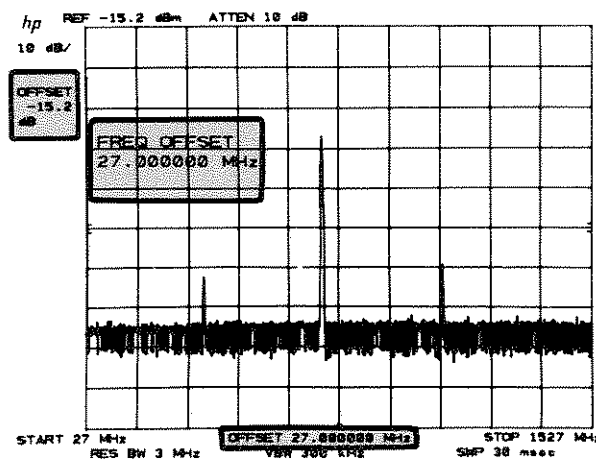

DATA entry from the keyboard can be in Hz, kHz, MHz or GHz for frequency and dB, -dB, mV and  $\mu$ V for amplitude. The amplitude offset readout is always in dB. An entry in voltage can be made and will be converted to dB offset.

The offset range for frequency is -99.999999990 GHz to +99.999999999 GHz in 1 Hz steps. The amplitude offset range is greater than  $\pm 100$  dB in 0.1 dB steps. Least significant digits will be truncated for frequency and amplitude offset entries.



### Example

An 102.6 MHz up converter with 12.7 dB attenuation is placed between a signal source and the spectrum analyzer. The offsets can be set so that the CRT display shows the trace referenced to the signal as input to the converter.

Amplitude offset is entered as a positive value to compensate (offset) the loss of the converter.

Press **Z** **SHIFT** **REFERENCE LEVEL** **1** **2** **.** **7** **dBm**

Note that the original REF LEVEL of 0 dBm is now changed to 12.7 dBm also.

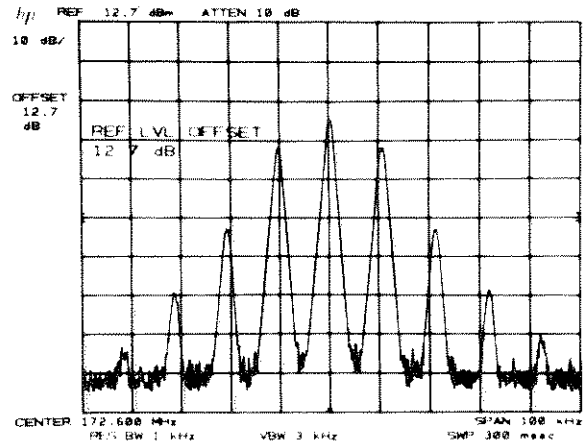

Frequency offset is entered as a negative value since the input frequency to the converter is lower than the output.

Press **V** **SHIFT** **CENTER FREQUENCY** **SHIFT** **HOLD** **1** **0** **2** **.** **6** **MHz**

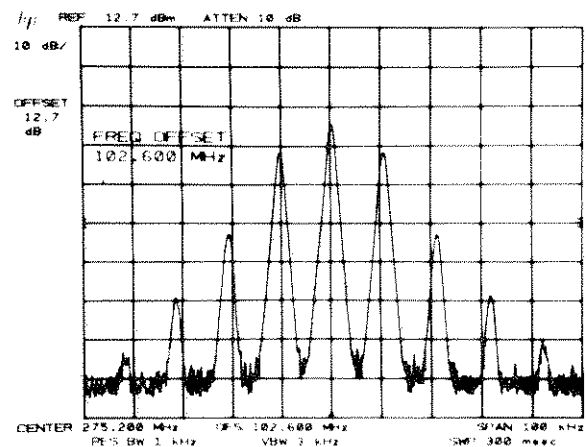

## Effective Mixer Level

The effective mixer level is equal to the REFERENCE LEVEL minus the INPUT ATTENUATOR setting. It specifies the maximum signal level that will be applied to the input mixer for a signal that is equal to or below the REFERENCE LEVEL. A FULL SPAN key (0-2.5 GHz or 2-22 GHz) sets the mixer level to -10 dBm which is 5 dB below the analyzer's 1 dB compression point. The effective mixer level can be manually set from -10 dBm\* to -70 dBm in 10 dB steps by pressing **SHIFT** , (comma sign) and entering the desired level through the numeric keyboard. For instance, to set a mixer level at -40 dBm, press: **SHIFT** , **4** **0** **MHz**. As the analyzer's REFERENCE LEVEL is changed, the coupled input attenuator will automatically change to limit the maximum signal at the mixer to -40 dBm for signals  $\leq$  REFERENCE LEVEL.

\* In the Extended Reference Level Range (Shift I, page 12.5) the effective mixer level can be set to 0 dBm.

# Amplitude Units

The following shift key codes immediately select the corresponding units for all the amplitude readouts: reference level, marker, display line and threshold.

When a units change is made, all readouts are converted so as to preserve the absolute power levels of all the readouts. For example, a 0 dBm threshold level converts to 47.0 dBmV (50 ohm input) when dBmV units are called.

SHIFT KEY FUNCTION	AMPLITUDE UNITS
SHIFT A. .... (or FULL SPAN key) .....	dBm
SHIFT B. ....	dBmV
SHIFT C. ....	dBμV
SHIFT D. ....	volts

The keys for these functions are located in the COUPLED FUNCTION group.

## Extend Reference Level Range

Normally the reference level can be set to from -89.9 dBm to +60.0 dBm in coupled operation. The limits of the range can be extended to a maximum of -139.9 dBm and +30 dBm.



The lower limit of reference level depends upon resolution bandwidth and scale.

Scale	Resolution Bandwidth	Minimum reference level with extended reference level	
		10 dB attenuation	0 dB attenuation
log	≤ 1 kHz	-129.9 dBm	-139.9 dBm
log	≥ 3 kHz	-109.9 dBm	-119.9 dBm
linear	≤ 1 kHz	-109.9 dBm	-119.9 dBm
linear	≥ 3 kHz	-89.9 dBm	-99.9 dBm

When the reference level is set at a minimum, the level may change if either scale or resolution bandwidth is changed. The extended range is disabled with instrument preset.

## Factory Preselector Setting

Activating **SHIFT** will reset the internal preselector to a factory set 2 - 22 GHz tracking range. The factory setting provides a preset adjustment for each of the four frequency bands in the 2 - 22 GHz range. These preset adjustments optimize the preselector tracking over the full 2 - 22 GHz frequency range. The tracking can be optimized at any single frequency with the **PRESEL PEAK** key. A **PRESEL PEAK** adjustment in one band will not affect the preselector tracking in the other three bands. (See page 7.15 for more information).

## Manual Preselector Tracking

The internal preselector can be manually adjusted for a peak response in the 2 - 22 GHz band. **SHIFT** / **GHz +dBm dB** enables manual entry of a DAC number from 0 - 63 with the DATA knob, step keys or numeric keyboard. The DAC reading corresponds to a voltage which sets a particular preselector tracking offset. The location of the MARKER determines the band (four independently adjustable bands) to be adjusted.

The Manual Preselector Tracking function is useful for peaking the preselector at locations where a stable CW signal is absent. For instance, drifting signals or pulse modulated signals do not easily lend themselves to the use of **PRESEL PEAK**. The automatic preselector peak routine depends on a stable CW signal. In this situation, a means for manually tracking the preselector may provide a more reliable setting.

# Marker Sweeps

## Stop Sweep at Marker, TALK after Marker

To stop the sweep at the marker,

press MARKER **NORMAL** and  
press **SHIFT** u

A marker must be activated to enter this sweep function.

Each time a sweep is triggered, it will stop at the marker, even if the marker has been moved. A marker being moved when the sweep passes may not stop the sweep.

To disable the stop sweep at marker functions

press MARKER **OFF** or **2-22 GHz**.

In remote operation, the analyzer will not TALK until the trace sweep stops at the marker. TALK is suspended by keeping the HP-IB Data Valid line not true until the marker is placed.

## Marker to Next Peak/Marker to Minimum

Successive peaks can be identified by continuously using **SHIFT** K. If a trace displays many different signal levels, a **PEAK SEARCH** can be used to find the largest signal. Then **SHIFT** K can be used successively to find the next largest signal.

### Example

Press **PEAK SEARCH** to find largest signal

**SHIFT** K to find next largest signal

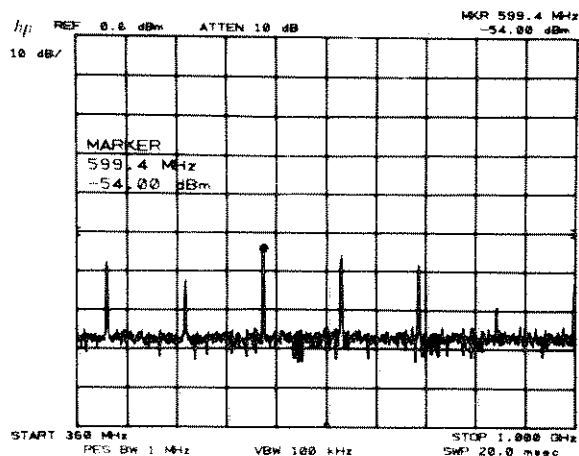

### Marker to Minimum

The minimum data value in a trace can be quickly located with **SHIFT** N

## Graticule and Annotation On/Off

The graticule and character readouts can be selectively blanked with key functions. This is valuable when alternative graphics are drawn on the CRT through the HP-IB.

### Graticule

**Blank:** press **SHIFT** m

**On:** press **SHIFT** n

### Annotation

**Blank:** press **SHIFT** o

**On:** press **SHIFT** p

## CRT Beam On/Off

The CRT beam power supply can be turned off to avoid unnecessary wear of the CRT if the analyzer is operated unattended. *Reducing intensity or blanking the traces does not reduce wear on the CRT.*

**Beam off:** press  g

**Beam on:** press  h

CRT beam power off does not affect HP-IB input/output of instrument function values or trace information.

## Display Correction Data

The correction data generated from the error correction routine, can be displayed.

Display correction data: press  w

Do not display correction data: press

The readout is detailed on page 12.14.

More on the meaning of these messages can be found in the 8566A Operating and Service Manual, Section VIII.

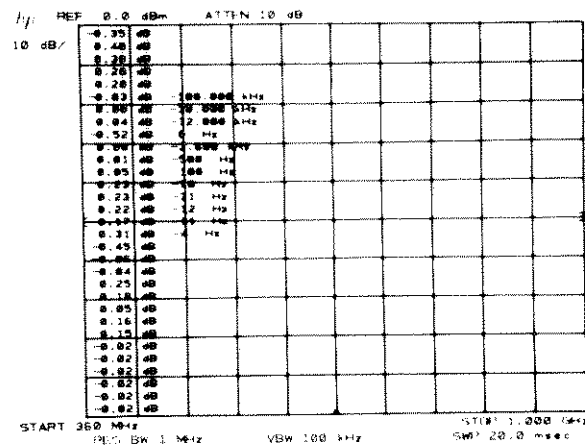

Correction Data Displayed

## Title

The user can write a message in the top CRT display line. When the title is activated, the front panel blue characters, number keyboard numbers, decimal, backspace and space can be typed onto the top line starting at the left of the display. The full width of the display can be used, however, marker readout may interfere with the last 16 characters of the title.

**Activate title:**  E (shift light on)

**Enter text:** abcdefghijklmnopqrstuvwxyz  
 ABCDEFGHIJKLMNOPQRSTUVWXYZ  
 /#&=(),><  
 0123456789. [space]

**To end a title:** press  (shift light off)

A title will remain on the display until the title function is activated again,  is pressed or an instrument state is recalled with .

To erase a title without changing the instrument state, end the title function if still active, then

press SHIFT E NORMAL

## A + B → A

A + B → A enables the restoration of the original trace A after a  $A \rightarrow A+B$  has been activated. A + B → A is executed with both Trace A and Trace B in VIEW :

press SHIFT c.

When executed,  $A \rightarrow A+B$  is turned off and the amplitude in trace B is added to the amplitude in trace A (in display units) and the result is written into trace A.

Additional A + B → A executions will each add another trace B response to the cumulative trace A.

## Trace Detection Modes

One of four detection techniques can be selected for displaying trace information.

Mode	Access	Use
normal	FULL SPAN key or SHIFT a	<ul style="list-style-type: none"> <li>• Most measurements.</li> </ul>
sample	SHIFT e	<ul style="list-style-type: none"> <li>• Noise Level Measurements</li> <li>• Zero frequency span waveforms for sweep times <math>\geq 20</math> msec</li> <li>• Video averaging</li> </ul>
positive peak negative peak	SHIFT b SHIFT d	<ul style="list-style-type: none"> <li>• Diagnostic aids for servicing.</li> </ul>

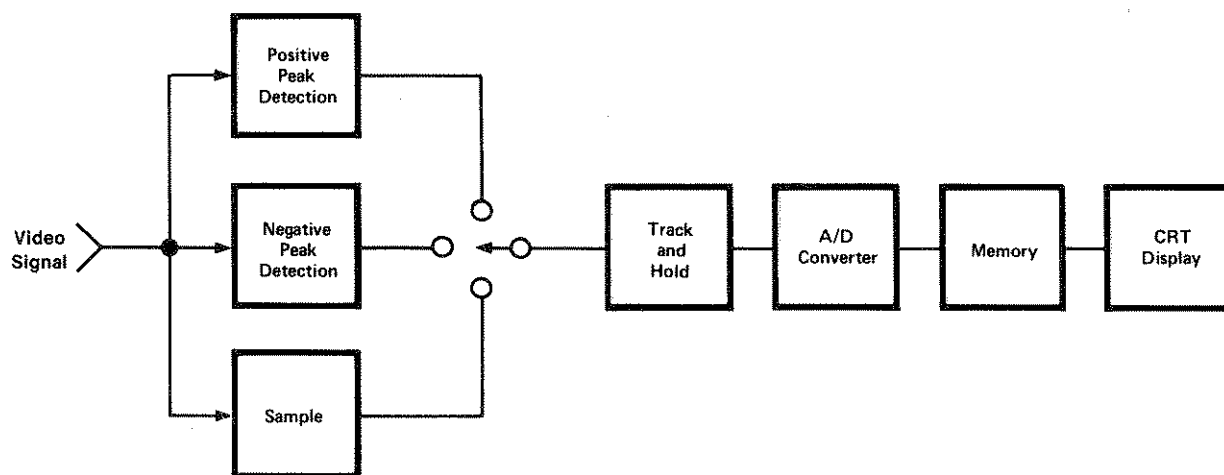

During a sweep, only a specified amount of time is available for writing data into each of the 1001 trace memory addresses. In two of these time periods, the positive and negative peak detectors obtain the maximum and minimum video signal excursions, respectively, and store these values in *alternate* trace memory addresses. This technique allows a graphic presentation of noise on the CRT display.

## Normal Mode

In normal mode a detection algorithm selectively chooses between the positive and negative peak values to be displayed. The choice is made dependent upon the type of video signal present.

Data from the positive peak detector (signal maximums) will always be displayed in the odd addressed trace memories (1,3,...1001). If, within the time period following the storage of a value in an odd address memory, there is no change in video signal level, the positive peak detector value will also be stored in the even address. In other words, the even addressed memory will also contain positive peak detection data if the signal during that time period is monotonic. Negative peak detector data (video signal minimum) will be stored in the even addressed trace memory if the signal has a point of inflection during the time period.

Normal mode is selected with instrument preset.

## Sample Mode

In the sample mode, the *instantaneous* signal value of the final analog-to-digital conversion for the time period is placed in memory. (As sweptime increases, many analog-to-digital conversions occur in each time period but only the final, single value can be stored.)

Sample mode is selected automatically for video averaging and noise level.

## Positive and Negative Peak Modes

Positive and negative peak modes store signal maximums and minimums respectively, in all trace memories.

## Readout

Here, the same signal response is displayed with each trace detection mode.

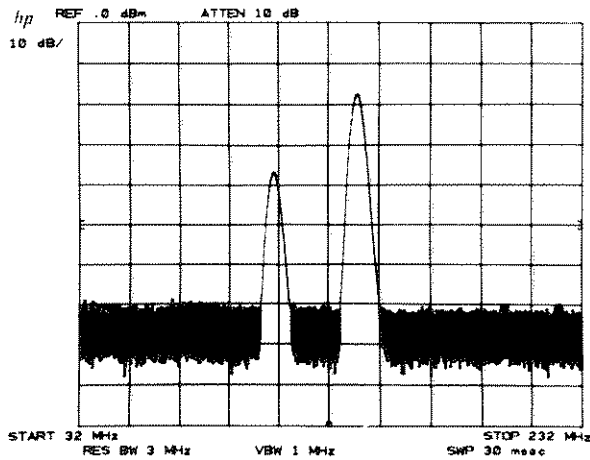

Normal

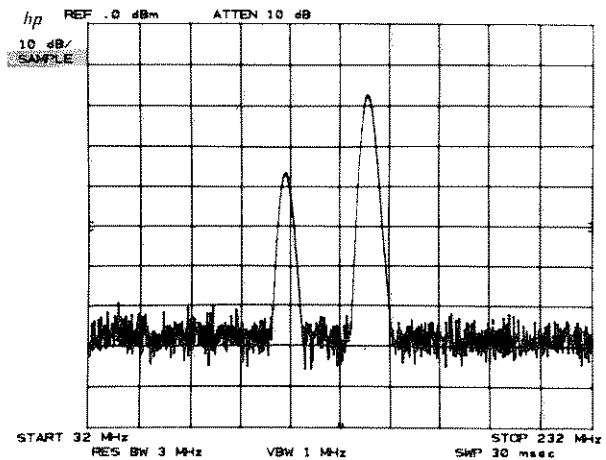

Sample

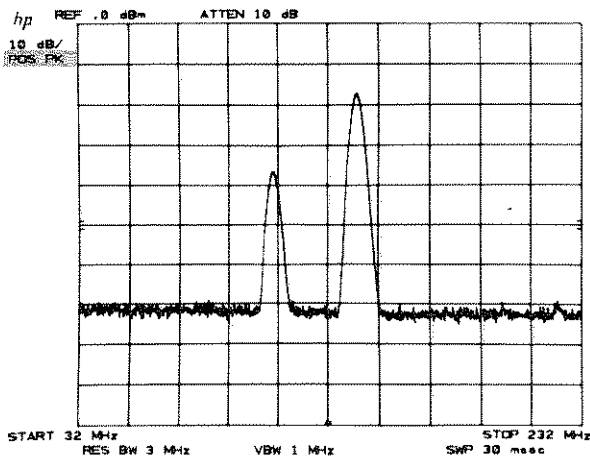

Positive Peak

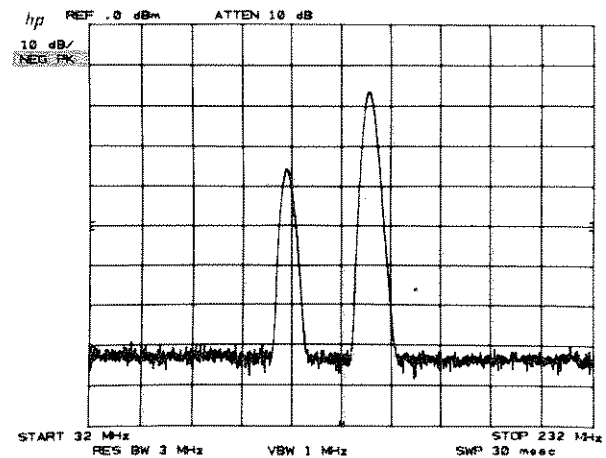

Negative Peak

# Trace C

A third trace memory is available for the storage and display of trace information. Only the storage modes (view and blank) can be used.

**View C:** SHIFT j

**Blank C:** SHIFT k

These are analogous to the TRACE A and B modes discussed in Chapter 6.

Trace C cannot be written into directly from the analyzer except when video averaging is used.

Trace information from B can be transferred to C. To transfer from TRACE B to TRACE C, use

**B → C:** SHIFT B=DL =0

The sweep will be suspended, the trace in memory B will be read and written into trace C from left to right in about 20 msec. Trace C is viewed. Sweeping will then resume from where suspended. The trace information in B is not changed.

To exchange traces B and C

**B ↔ C:** SHIFT i

The trace information in B and C is interchanged point for point from left to right in about 20 msec. If TRACE B was blanked, it stays blanked. If trace C was blanked, it stays blanked.

To store TRACE A into trace C, the trace A data must first be transferred into trace B:

press A↔B SHIFT l (which also erases last trace C)

or press A↔B SHIFT i (which also saves last trace C in B)

## Example

Comparisons of up to three different signal traces can be made simultaneously using traces A, B and C. In this example, the modulation level of a signal will be changed for each trace. To start, clear the display with BLANK A and BLANK B.

The signal with the desired level of modulation will be stored in trace C:

Press CLEAR WRITE B and allow one sweep.

Press SHIFT l which writes the trace from B into C.

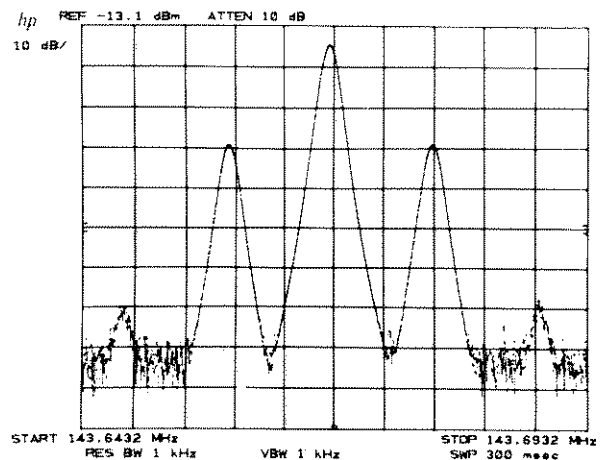

Change the modulation level, allow one sweep and store in B with VIEW B.

To view C press SHIFT j.

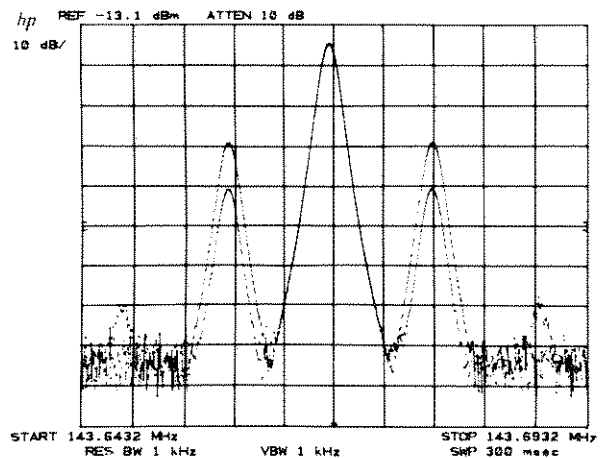



Change the modulation level again and

press **CLEAR-WRITE** A, and store with **VIEW** A.

The three traces are differentiated by intensity.

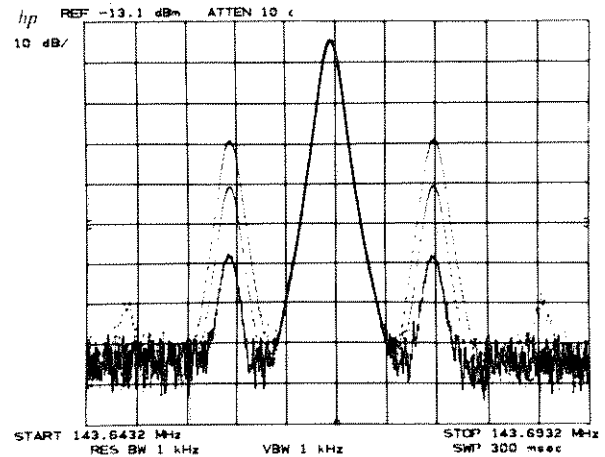

## Video Averaging

Video averaging is a trace display routine that averages trace responses from sweep to sweep without requiring a narrow video bandwidth. (Averaging with the video bandwidth is discussed in Chapter 9, COUPLED FUNCTION **VIDEO BW**.) Both video averaging and reducing video bandwidth are primarily used to improve the analyzer's ability to measure low level signals by smoothing the noise response.

To activate video averaging (and sample detection mode)

press **SHIFT** **G** **VIDEO BW** (DATA keyboard entry).

To disable video averaging press **SHIFT** **H** **SWEEP TIME**

### CAUTION

Video averaging may result in an uncalibrated amplitude display when

$$\frac{\text{frequency span}}{\text{Resolution Bandwidth}} > 1000$$

Readout in the active function display area is "VID AVG 100". The number represents the maximum number of samples (or sweeps) for complete averaging. The DATA entry can be used to change the maximum sample number in integers from 0 to 1000. A unity sample limit allows direct writing of analyzer response into Trace C (see Trace C below). A 100 sample limit is selected upon instrument preset. The higher the sample limit, the more smoothing possible. Averaging with high sample limits can provide more smoothing than the 1 Hz video bandwidth.

During video averaging the current sample being taken is read out at the left of the display.

The advantage of video averaging over narrowing the video filter is the ability of the user to see changes made to the amplitude or frequency scaling of the display while smoothing the noise response. For example, when a 100 Hz video bandwidth is used with a 200 kHz frequency span, the sweep time is 2 sec. Almost a full sweep time duration would have to pass before any center frequency change effect on the trace could be seen. If video averaging is used instead of the narrow video bandwidth, any change to center frequency will be seen immediately, even though full averaging will take roughly 6 sec. (Any change to control settings such as CENTER FREQUENCY, FREQUENCY SPAN, etc., will cause the video averaging process to be restarted.)

### Example

To display very low level signal responses, very narrow resolution and video bandwidths are required. The accompanying increase in sweep time can make measurements cumbersome. Video averaging allows the display of low level signals without the long sweep time.



Viewing a low level signal with a video bandwidth of 1 Hz requires a 150 second sweep.

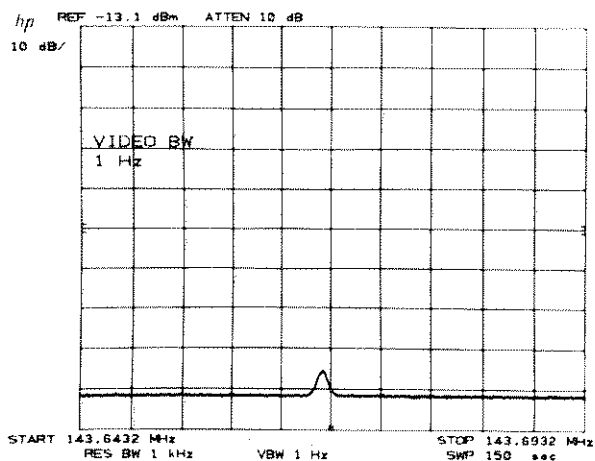

Take out the narrow video filter with video bandwidth  and start

video averaging, press

Now the low level signals begin to show quickly. Changes to the frequency range or amplitude scale will restart the sampling to show the signals quickly, without having to wait 150 seconds. In fact, the video averaging shown took 42 x 300 ms = 12.6 sec.

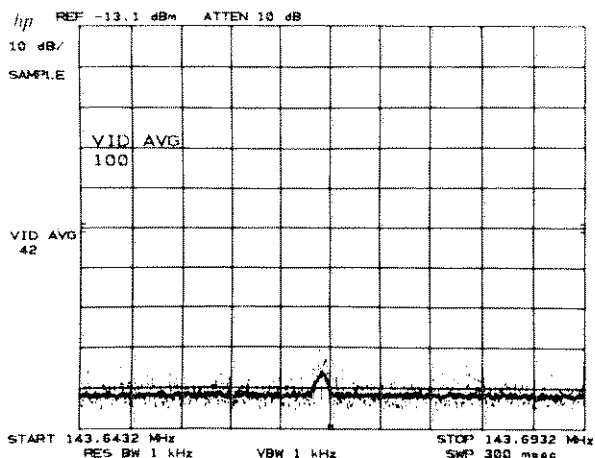

### Video Averaging Algorithm

The averaging of *each* amplitude point depends upon the number of samples already taken and last average amplitude.

$$\bar{y}_n = \frac{n-1}{n} \bar{y}_{n-1} + \frac{1}{n} y_n$$

where  $\bar{y}_n$  latest average amplitude value in display units  
 $n$  current sample number

$\bar{y}_{n-1}$  last average amplitude in trace memory (TRACE A or B)  
 $y_n$  new amplitude entry from analyzer (Trace C)

The new amplitude value,  $\bar{y}_n$  is weighted more heavily by the last average amplitude  $\bar{y}_{n-1}$  than the new amplitude entry,  $y_n$ .

When  $n$  equals the limit set (e.g. 100, the preset limit), the last average amplitude is gradually replaced with new data. Thus, the average will follow a slowly changing signal response, particularly if the sample limit is small.

### Trace C

Video averaging requires the use of trace memory C. When video averaging is activated, the input signal response is written into trace C, the averaging algorithm is applied to these amplitudes and the results written into TRACE A. Thus two traces are displayed, the input signal in C and the averaged signal in A.

Trace C may be blanked without affecting the operation of video averaging.

Press  k

Trace C may be written into as traces A and B if a video average sample limit of one is selected.

G

Press SHIFT VIDEO BW 1 Hz 100 kHz

If either trace A or B is in a write trace mode the analyzer response will also be written into trace C.

## External and Video Trigger

The front panel EXT and VIDEO trigger modes automatically keep the display refreshed in zero frequency spans for sweep times less than 20 ms. To eliminate the automatic refresh feature:

For external triggering

x

Press SHIFT EXT

For video triggering

y

Press SHIFT VIDEO

## Locking Save Registers

After saving instrument states in one or more of the six registers, 1 through 6, the registers can be secured from being written over and destroyed. The recall function is not affected.

Lock: SHIFT SAVE

Unlocked: SHIFT RECALL

When locked, an attempt to SAVE will write "SAVE LOCK" on the CRT and no DATA entry can be made.

## Error Correction Routine

A built-in analyzer routine measures and records the amplitude and frequency error factors due to a number of parameters, then corrects the display for them. The routine takes about 30 seconds to run. When complete, instrument preset will be called and the correction factors applied.

Connect CAL OUT to RF INPUT.

Execute the routine: SHIFT W

Use Correction factors: SHIFT X

Do not use correction factors: SHIFT Y

Display correction factors: SHIFT W

If "ADJUST AMP/TD CAL" appears on the CRT, manual calibration adjustment is necessary before the routine can be successfully run. See Chapter 1 for the manual calibration procedure.

Indicates that the routine has been run and the display is corrected.

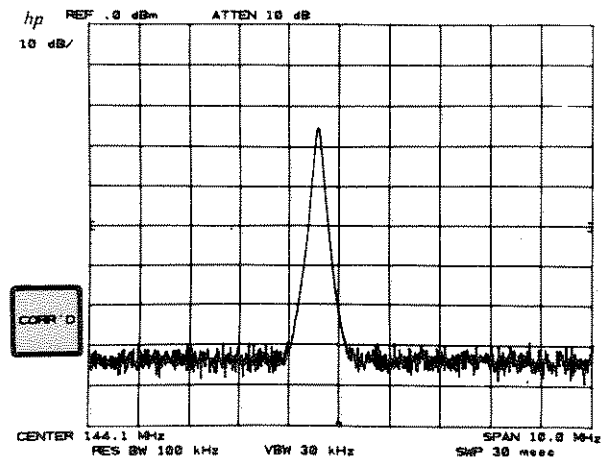

Correction can be turned on or off using SHIFT X and SHIFT Y after the routine has been successfully completed. Display of the correction factors is discussed on page 12.7 in this chapter.

For more information on accuracy, see the 8566A Spectrum Analyzer Data Sheet.

The readout of the correction factors is as follows:

Line	Parameter	Correction Values Displayed
1	LOG and LIN scale (Res BW $\geq$ 100 kHz)	Amplitude offset error between log and linear scale. Reference at 1 dB log.
2	10 dB/	Amplitude errors due to changing log scale. Reference to -10 dBm CAL OUTPUT signal.
3	5 dB/	
4	2 dB/	
5	1 dB/	
6	3 MHz	Amplitude errors due to switching bandwidths. Reference to 1 MHz resolution bandwidth. Frequency offset errors due to center frequency tuning inaccuracies of resolution bandwidth.
7	1 MHz	
8	300 kHz	
9	100 kHz	
10	30 kHz	
11	10 kHz	
12	3 kHz	
13	1 kHz	
14	300 Hz	
15	100 Hz	
16	30 Hz	
17	10 Hz	
18	LOG and LIN Scale (Res BW < 100 kHz)	Same as line 1..
19	A20	Amplitude error due to changing IF step gain. Reference to -10 dBm REFERENCE LEVEL.
20	A10	
21	SG 20-2	
22	SG 20-1	
23	SG 10	
24	LG 20	
25	LG 10	
26	20 dB	Amplitude error due to switching attenuator. Reference to 10 dB Attenuator position.
27	30 dB	
28	40 dB	
29	50 dB	
30	60 dB	
31	70 dB	

The total amplitude correction value composed of linear/log scale offsets, bandwidth errors, and attenuator errors can be output to a computer/controller with KS < 91 >. This error can then be corrected with software to yield a more accurate amplitude measurement.

Correction values are stored in memory for a 30 day period in the event of power line failure.

## Fast Preset/HP-IB

A partial instrument preset can be initiated with **SHIFT** T or **SHIFT** U. These key functions operate essentially the same as the **2-22 GHz** instrument preset in that a specific full span is set, functions automatically coupled and shift functions turned-off. The difference is that the fast presets do not exercise the instruments internal self-test routine which control the two check LEDs and as a result, can be executed much faster.

Fast preset 2 — 22 GHz: press **SHIFT** T

Fast preset external mixer: press **SHIFT** U\*

Under remote operation, an HP-IB operation mode can be set which allows the analyzer to operate faster than normal. The Fast HP-IB mode is enabled with a **SHIFT** S. A **2-22 GHz** instrument preset will disable the Fast HP-IB mode whereas the Fast presets will not disable the Fast HP-IB mode.

Fast HP-IB: press **SHIFT** S

## Band Lock

If desired, the analyzer can be locked on either the low band (0 - 2.5 GHz) or the microwave band (2 — 22 GHz). In normal operation, CENTER FREQUENCY enables the analyzer to tune continuously from 0 to 22 GHz (– 1 to 24GHz over-range). By executing a band lock, the analyzer's tuning range will be restricted to the band selected. To execute band lock, select frequency range with **0-2.5 GHz** or **2-22 GHz**:

Band lock: **SHIFT** t

Band unlock: **SHIFT** Q or FULL SPAN key

## External Mixer\*

Two shift functions are available to specific usage with an external mixer. Shift U selects an LO tuning range for external mixer operation. Shift v enables a signal identifier routine which uses the marker to automatically identify the signal under observation.

Fast preset external mixer: **SHIFT** U

Signal identifier external mixer: **SHIFT** v

\*for future option

# SHIFT FUNCTION Index

All the shift functions are listed below. (DATA) indicates the functions that use a number and unit entry.

	CODE	PAGE		CODE	PAGE
<b>GENERAL</b>					
Display Address (DATA)	z	*	Graticule blanked	m	12.6
Display Write (DATA)		*	Graticule on	n	12.6
HP-IB service request	r	*	Title	E	12.7
HP-IB address (DATA)	p	*			
Fast HP-IB operation	S	*			
Power on in last state	f	11.3			
Mixer input level	,	12.4			
<b>FREQUENCY AND AMPLITUDE</b>					
Amplitude offset	Z	12.3			
Amplitude units selection					
dBm	A	12.5			
dBmV	B	12.5			
dB $\mu$ V	C	12.5			
voltage	D	12.5			
Extended reference level					
range (DATA)	I	12.5			
Frequency offset (DATA)	V	12.3			
Mixer level	,				
Negative entry (DATA)	—	12.3			
<b>MARKER</b>					
Marker to next peak	K	12.6			
Marker to minimum	N	12.6			
Enter $\Delta$ → Span	O	7.11			
Noise Level on	M	7.17			
Noise Level off	L	7.17			
Stop single sweep at marker	u	12.6			
Factory preselector setting	=	12.5			
<b>DISPLAY</b>					
Annotation blanked	o	12.6			
Annotation on	p	12.6			
CRT beam off	g	12.7			
CRT beam on	h	12.7			
			<b>TRACE</b>		
			A + B → A	c	12.8
			<b>Detection Modes:</b>		
			normal	a	12.8
			positive peak	b	12.8
			negative peak	d	12.8
			sample	e	12.8
			<b>Trace C</b>		
			blank C	k	12.10
			B ↔ C	i	12.10
			B — C	l	12.10
			view C	j	12.10
			Video averaging on	G	12.11
			Video averaging off	H	12.11
			<b>TRIGGER, ZERO SPAN, SWEEP &lt; 20 msec</b>		
			<input type="checkbox"/> without 25 msec trigger	x	12.13
			<input type="checkbox"/> without 25 msec trigger	y	12.13
			<b>INSTRUMENT STATE</b>		
			Save Registers locked	(	12.13
			Save Registers unlocked	)	12.13
			<b>ERROR CORRECTION</b>		
			Execute Routine	W	12.13
			Use data (display corrected)	X	12.13
			Do not use data		
			(display not corrected)	Y	12.13
			Display correction data	w	
			on CRT		12.13

## DIAGNOSTIC AIDS

To aid in servicing the spectrum analyzer, there are a number of diagnostic shift functions. These functions are listed here, their operation and use is covered in the 8566A Operating and Service Manual, Section VIII.

	CODE
Frequency diagnostic on	R
Disable step gain	q
Manual DACS control	J
Display correction data	w
YTO pretest mode	F

\*See 8566A Spectrum analyzer Remote Operation, HP part number 08566-90003.

# Chapter 13 Appendix A

## Tuning Curves

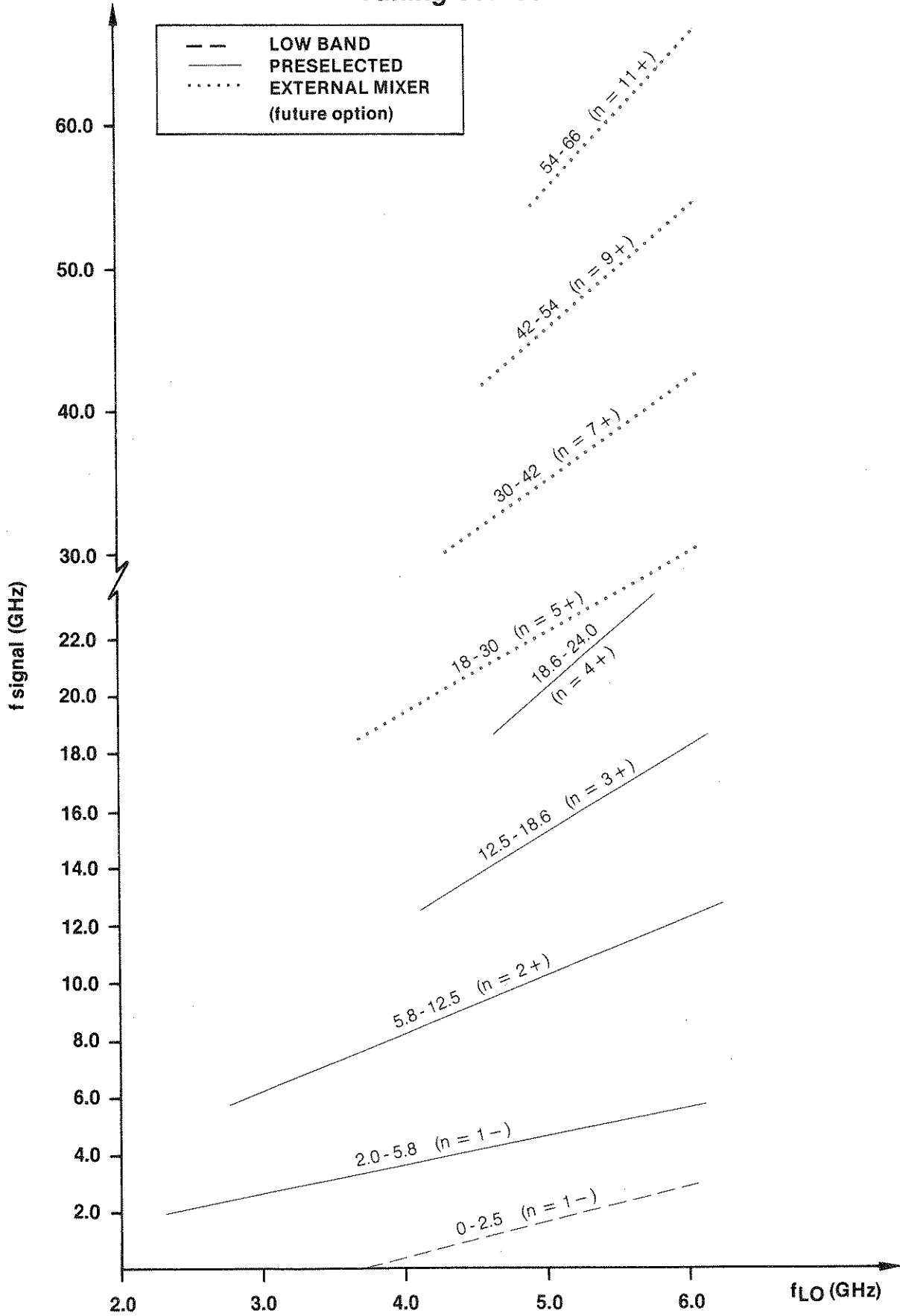

### Center Frequency/Span Tuning Characteristics

At the location of the band overlap (2.0 - 2.5 GHz) or on band edges (-1.0 GHz and 24 GHz), the frequency span may change as center frequency is tuned near the above locations. This situation occurs when the frequency span is such that the equivalent start/stop frequency exceeds the tuning range of the analyzer.

#### Example

Analyzer Settings: 0 - 2.5 GHz Band  
FREQUENCY SPAN = 1 GHz  
CENTER FREQUENCY = 2 GHz

Note that the equivalent Start/Stop Frequency are 1.5 GHz and 2.5 GHz.

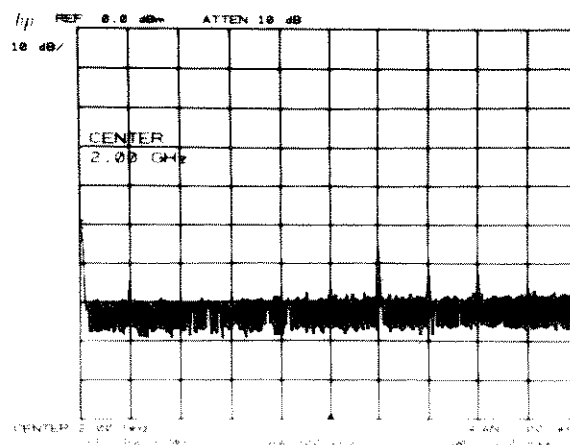

Now tune to 2.2 GHz

**CENTER FREQUENCY** 2.2 GHz

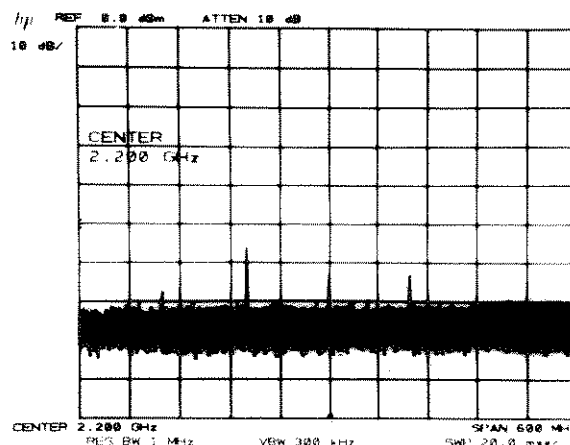

Since the maximum stop frequency in low band is 2.5 GHz, the analyzer will reduce the span by changing the START FREQ in order to enable the center frequency to be tuned to 2.2 GHz. Hence, the equivalent START/STOP FREQ is now 1.9 GHz/2.5 GHz which yields a 600 MHz span. If the CENTER FREQUENCY is tuned to 2.25 GHz, the SPAN will be reduced to 500 MHz, a CENTER FREQUENCY greater than 2.25 GHz will automatically switch the analyzer to the microwave (2 - 22 GHz) band while maintaining a 500 MHz span.

The CENTER FREQUENCY/SPAN TUNING CHART below graphically illustrates the aforementioned tuning characteristics.

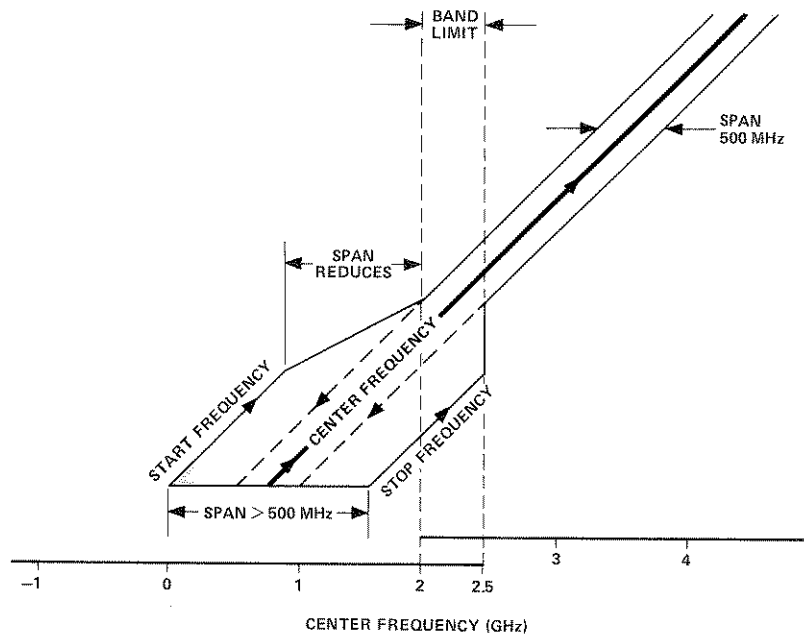



# Appendix C

## 1st LO Output

The 1st LO OUTPUT provides a nominal +5 dBm signal that is tunable from 2.3214 - 6.1214 GHz. Since the HP 8566A is synthesized, the 1st LO can be used as a precise tunable microwave source.

### Example

Using the 1st LO OUTPUT as a precision source. Connect equipment as shown:

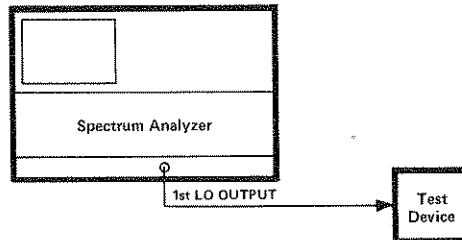

Instrument Preset:

Select zero span with:  0 Hz

Offset IF with:  F. This removes the 321.4 MHz IF offset.

By pressing , you now have a precision source that can be tuned from 2.3214 - 6.1214 GHz with 1 Hz resolution.

### Example

Using the 1st LO OUTPUT as a tracking signal source from 2 - 5.8 GHz; connect equipment as shown:

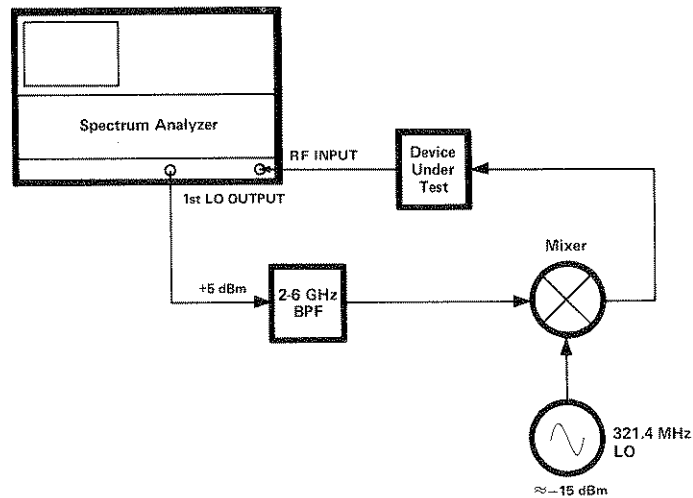

Instrument Present:

Set START/STOP FREQ:  2 GHz,  5.8 GHz

The dynamic range will depend on the conversion loss and isolation characteristics of the mixer. Flatness variations can be normalized through trace arithmetic.

# Index

- A --
- Active Function . . . . . 5.1, 1.6
  - ALIGN . . . . . 5.1
  - Amplitude Calibration . . . . . 1.4
  - Amplitude Modulation Index . . . . . 7.5
  - Amplitude Offset . . . . . 12.3
  - Amplitude Units Selection . . . . . 12.5, 7.5
  - Annotation on/off . . . . . 12.6
  - Attenuation . . . . . 9.6
  - AUTO . . . . . 9.1,  
(also see COUPLED FUNCTION)
  - Automatic Spectrum Analyzer . . . . . 2.5
- B --
- BACK SPACE . . . . . 3.3
  - Band lock . . . . . 12.15
  - Baseline Clipper  
(see THRESHOLD)
  - BLANK . . . . . 6.2
  - Blank
    - Annotation . . . . . 12.6
    - Display (CRT) . . . . . 12.7
    - Graticule . . . . . 5.3, 12.6
  - Blue Front Panel Characters . . . . . 12.1
- C --
- CAL OUTPUT . . . . . 1.3
  - Calibration Procedures . . . . . 1.3, 12.13
  - CENTER FREQUENCY . . . . . 4.2
  - CENTER FREQUENCY STEP SIZE . . . . . 9.8
  - CLEAR-WRITE . . . . . 6.1
  - COUPLED FUNCTION . . . . . 9.1
    - ATTENUATION . . . . . 9.6, 9.1
    - AUTO . . . . . 9.1
    - CF STEP SIZE . . . . . 9.8, 9.1
    - RESOLUTION BW . . . . . 9.2, 9.1
    - SWEEP TIME . . . . . 9.4, 9.1, 4.6
    - VIDEO BW . . . . . 9.3, 9.1
  - CRT Display . . . . . 5.1, 1.6
    - Beam Off/On . . . . . 12.7  
(also see Display)
  - CRT Photography . . . . . 5.3
- D --
- DATA . . . . . 3.1
    - ENABLED . . . . . 3.2
    - HOLD . . . . . 3.2
    - Knob . . . . . 3.1
    - Negative Entry . . . . . 3.3, 12.3
    - Number/Units Keyboard . . . . . 3.2
  - STEP Keys . . . . . 3.2
  - dBm . . . . . 12.5
  - dBmV . . . . . 12.5
  - dB $\mu$ V . . . . . 12.5
  - Detection Modes  
(see Trace Detection Modes) . . . . . 12.8
  - Diagnostic Aids . . . . . 12.16
  - Display . . . . . 5.1
    - Readout . . . . . 5.1
    - Titling . . . . . 12.7
    - Units . . . . . 12.5
- E --
- ENABLED . . . . . 3.2
  - Error Correction . . . . . 1.4, 12.13, 12.14
  - External mixer . . . . . 12.15
- F --
- Fast preset . . . . . 12.15
  - FOCUS . . . . . 5.1
  - FREQ ZERO . . . . . 1.3
  - Frequency Calibration . . . . . 1.4
  - Frequency Display Range . . . . . 1.4
  - Frequency Drift Compensation . . . . . 7.14  
(see SIGNAL TRACK)
  - Frequency Offset . . . . . 12.3
  - Frequency Response Measurement . . . . . 6.5  
(Example)
  - FREQUENCY SPAN . . . . . 4.3
  - Front Panel . . . . . 1.5, 2.1  
(also see foldout)
  - FULL SPAN . . . . . 11.1, 2.2
  - FUNCTION . . . . . 4.1  
(also see individual functions)
- G --
- Graticule . . . . . 5.3
    - High Intensity . . . . . 5.3
    - On/Off . . . . . 12.6
- H --
- Harmonic Distortion . . . . . 7.4
  - HOLD . . . . . 3.2
  - HP-IB . . . . . 2.5, 11.4
- I, J --
- INPUT . . . . . 1.3
  - Input Attenuation . . . . . 9.6  
(see COUPLED FUNCTION ATTENUATION)
  - Input Mixer Level . . . . . 12.4
  - INSTR CHECK . . . . . 1.3
  - INSTRUMENT PRESET . . . . . 11.1
  - INSTRUMENT STATE . . . . . 11.1
    - FULL SPAN, 0-2.5 GHz . . . . . 11.2
    - INSTRUMENT PRESET . . . . . 11.1
    - LCL (Local Operation) . . . . . 11.4
    - SAVE and RECALL . . . . . 11.3, 12.13
  - INTENSITY . . . . . 5.1
- K --
- KEY FUNCTIONS . . . . . 12.1
    - Index . . . . . 12.16
    - NORMAL . . . . . 12.1
    - SHIF . . . . . T12.1
- L --
- LINE Power
    - ON . . . . . 1.2
    - STANDBY . . . . . 5.1
  - LINEAR . . . . . 1.2, 8.1
  - LCL (Local) . . . . . 11.4
  - LOG . . . . . 8.1

<b>--- M ---</b>	
MARKER .....	7.1, 2.4
Active .....	7.1
Differential, $\Delta$ .....	7.3
ENTRY .....	7.11
Noise Level Measurement .....	7.17
NORMAL .....	7.2
OFF .....	7.2
ON .....	7.2
PEAK SEARCH .....	7.10
PRESELECTOR PEAK .....	7.15
SIGNAL TRACK .....	7.14
ZOOM .....	7.6, 7.9
MAX HOLD .....	6.1
Mixer level .....	12.4

<b>--- N ---</b>	
Noise Level Measurement .....	7.17

<b>--- O ---</b>	
Operating Precautions .....	1.3
Outputs .....	1.7
HP-IB .....	1.7
Recorder .....	1.7
x, y and z .....	1.7

<b>--- P ---</b>	
Peak Detection Modes .....	12.8
Peak Search .....	7.10
Performance .....	1.1
Preselector peak .....	7.15, 12.5

<b>--- Q,R ---</b>	
<b>--- R ---</b>	
Readouts .....	5.4, 12.7
RECALL .....	11.3, 12.13
RECORDER	
Lower Left Output .....	1.7
Upper Right Output .....	1.7
REFERENCE LEVEL .....	4.7
Extended Range .....	12.5
REFERENCE LINE .....	8.4
DISPLAY LINE .....	8.4
THRESHOLD .....	8.5, 8.4
Refresh .....	6.2
REM Light .....	11.4
Remote Operation .....	2.5, 11.4
Resolution Bandwidth .....	9.2
RF Attenuation .....	9.6

<b>--- S ---</b>	
Sample Detection Mode .....	12.8
SAVE .....	11.3, 12.13
SCALE .....	8.1
Linear .....	8.1
Logarithmic .....	8.1
SIGNAL TRACK .....	7.14
SHIFT .....	12.1
Span .....	4.3
START FREQUENCY .....	4.6

STOP FREQUENCY .....	4.6
SWEEP .....	10.1, 6.2
Continuous .....	10.1
Single .....	10.1
Sweep Time .....	9.4
Swept Measurement (Example) .....	6.5

<b>--- T ---</b>	
THRESHOLD .....	8.5
Time Domain Measurement (see Zero Frequency Span)	
Title .....	12.7, 5.4
TRACE .....	6.1
A + B $\rightarrow$ A .....	12.8
A - B $\rightarrow$ A .....	6.5
A - B OFF .....	6.5
A $\rightarrow$ B .....	6.4
Arithmetic .....	6.5
B - DL $\rightarrow$ B .....	6.5
BLANK .....	6.1
C .....	6.5, 12.10, 12.12
CLEAR-WRITE .....	6.1, 6.2
Detection Modes .....	12.8
Identification .....	6.1
MAX HOLD .....	6.2
Priority .....	6.7
STORE Modes .....	6.2
VIEW .....	6.1, 6.2
Write Modes .....	6.2
TRIGGER .....	10.2
Automatic, Zero Span .....	10.2
EXTERNAL .....	10.2, 12.13
FREE RUN .....	10.1
LINE .....	10.1
VIDEO .....	10.2, 12.13
VIDEO Level .....	10.3

<b>--- U ---</b>	
Units .....	12.5
(see Amplitude Units Selection)	

<b>--- V ---</b>	
Video Averaging .....	12.12, 9.4
Video Bandwidth .....	9.3
VIEW .....	6.1, 6.2
Voltage .....	12.5
(also see LINEAR)	

<b>--- W,X,Y,Z ---</b>	
Zero Frequency Span .....	4.5, 10.2
Zoom .....	7.6
Automatic, Zero Span .....	7.9



**hp SPECTRUM ANALYZER DISPLAY**

**TRACE**

A: CLEAR-WHITE, MAX HOLD, STORE, VIEW, BLANK

B: CLEAR-WHITE, MAX HOLD, STORE, VIEW, BLANK

**REFERENCE LINE**

DISPLAY LINE: OFF, ENTER

THRESHOLD: OFF, ENTER

**SCALE**

LOG: ENTER, IN/DIV

LIN: ENTER, IN/DIV

**KEY FUNCTION**

FORMAL, SHIFT

**SWEEP**

CONT, SINGLE

**TRIGGER**

PRE-ADD, LINE, VIDEO, EXT, LEVEL

**INTENSITY**

**FOCUS**

ALIGN

**FREQZERO**

**STANDBY**

**RECORDER**

LOWER LEFT, UPPER RIGHT

**hp 8566A SPECTRUM ANALYZER 100 Hz - 2.5 GHz / 2 - 22 GHz**  
HEWLETT - PACKARD

**COUPLED FUNCTION**

A: AUTO, MANUAL, RES BW

B: AUTO, MANUAL, VIDEO SW

C: AUTO, MANUAL, SWEEP TIME

D: AUTO, MANUAL, ATTN

E: AUTO, MANUAL, CF STEP SIZE

**INSTRUMENT STATE**

1: EDIT, SAVE, RECALL

2: 2-22 GHz, INSTR PRESET

**MARKER MODE**

K: ENTRY, PEAK SEARCH, MKR CF, MKR STP SIZE, MKR REF LVL

L: OFF, NORMAL, ZOOM, PRESEL PEAK, SIGNAL TRACK

**FUNCTION**

CENTER FREQ, FREQ SPAN, START FREQ, STOP FREQ, REFERENCE LEVEL

**DATA**

ENABLED, DATA, DATA

**STEP**

←, →

**OUTPUTS**

CALL OUTPUT 10 dBm

INST. I/O OUTPUT 0 VDC MAX

INST. CHECK

**STANDBY**

ON, LINE



