



**HEWLETT
PACKARD**

OPERATION AND SERVICE MANUAL

**853A
SPECTRUM ANALYZER DISPLAY
(Includes Option 001)**

SERIAL NUMBERS

This manual applies directly to instruments with serial numbers prefixed 2223A.

For additional important information about serial numbers, see INSTRUMENTS COVERED BY MANUAL in Section I.

Copyright © 1982, HEWLETT-PACKARD COMPANY
1400 FOUNTAIN GROVE PARKWAY, SANTA ROSA, CALIFORNIA, 95404, U.S.A.

MANUAL PART NUMBER 00853-90001
Microfiche Part Number 00853-90002

Printed: AUGUST 1982

SAFETY CONSIDERATIONS

Safety Symbols

The following safety symbols are used throughout this manual and in the instrument. Familiarize yourself with each of the symbols and its meaning before operating this instrument.



Instruction manual symbol: the apparatus will be marked with this symbol when it is necessary for the user to refer to the instruction manual in order to protect the apparatus against damage.



Indicates dangerous voltages.

CAUTION

The CAUTION sign denotes a hazard. It calls attention to an operation procedure, practice, or the like, which, if not correctly performed or adhered to, could result in damage to or destruc-

tion of part or all of the equipment. Do not proceed beyond a CAUTION sign until the indicated conditions are fully understood and met.

WARNING

The WARNING sign denotes a hazard. It calls attention to a procedure, practice, or the like, which, if not correctly performed or adhered to, could result in injury or loss of life. Do not proceed beyond a WARNING sign until the indicated conditions are fully understood and met.

Operation

WARNING

BEFORE THIS INSTRUMENT IS SWITCHED ON, its rear panel power module protective earth terminal must be connected through the protective conductor of the ac power cable to a socket outlet provided with protective earth contact. Failure to ground the instrument can result in personal injury.

WARNING

The HP 853A Spectrum Analyzer Display should not be operated without protective covers. Adjustments and ser-

vice procedures which require operation of the HP 853A with the covers removed should be performed only by trained service personnel.

CAUTION

BEFORE THIS INSTRUMENT IS SWITCHED ON, make sure that its rear panel power module switch is set to the voltage of the ac power source. Failure to set the ac power input to the correct voltage could cause damage to the instrument when the ac power cable is plugged in.

Service and Adjustments

WARNING

There are voltages at many points in the instrument which can, if contacted, cause personal injury. Be extremely careful. Service and adjustments should be performed only by trained service personnel.

WARNING

Any interruption of the protective (grounding) conductor, inside or outside the instrument, or disconnection of the protective earth terminal may cause personal injury.

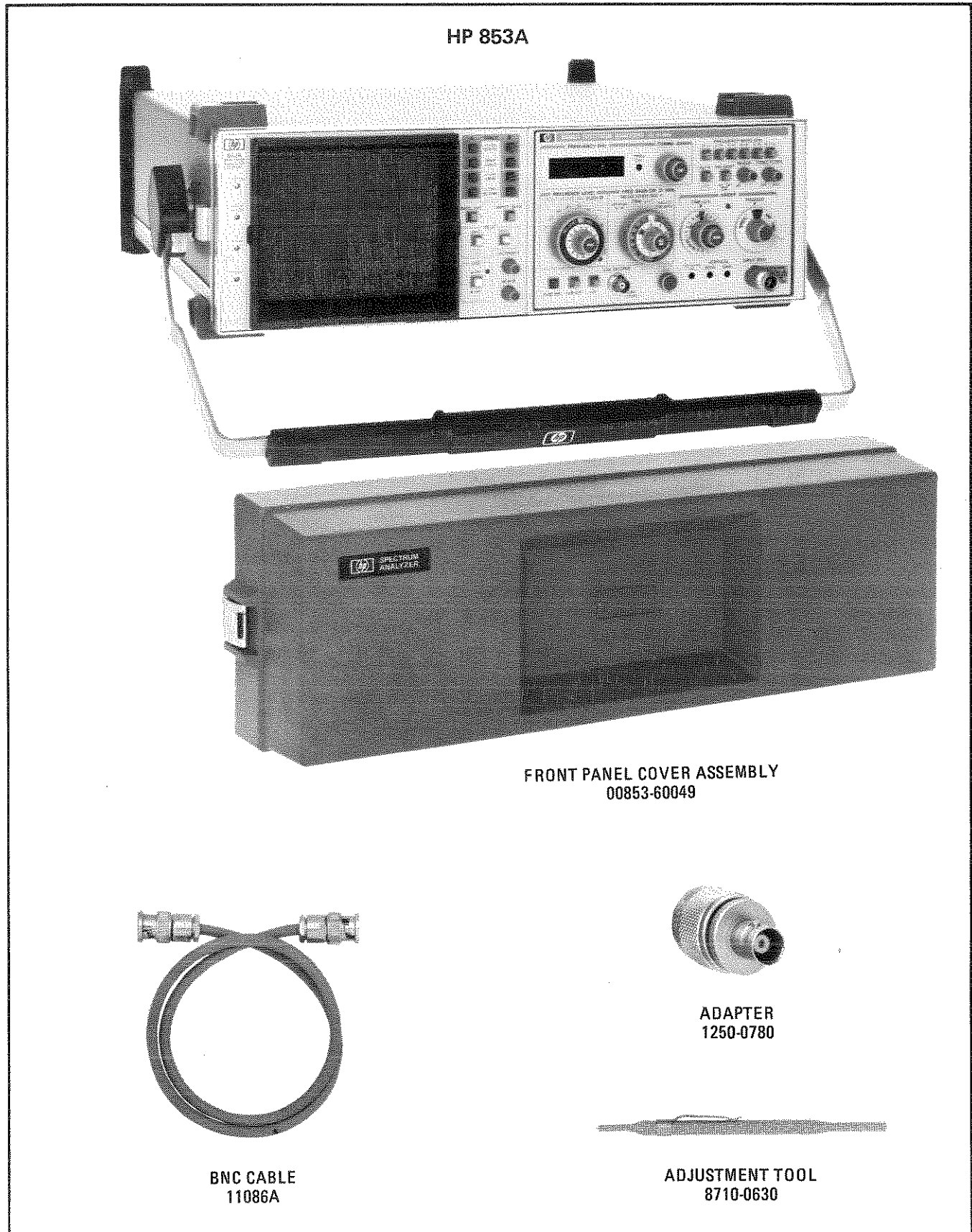

Figure 1-1. HP 853A Spectrum Analyzer Display and Accessories

1-14. Manual Changes Supplement

1-15. An instrument manufactured after the printing of this manual might have a serial number prefix that is not listed on the title page. This unlisted serial number prefix indicates that the instrument is different from those described in this manual. The manual shipped with this newer instrument is accompanied by a yellow Manual Changes supplement. The supplement contains information that explains how to adapt the manual to the newer instrument.

1-16. In addition to change information, the supplement may contain information for correcting errors in the manual. To keep this manual as current and accurate as possible, Hewlett-Packard recommends that you periodically request the latest Manual Changes supplement. The supplement carries a manual identification block which includes the model number, print date of the manual, and manual part number. Complimentary copies of the supplement are available from Hewlett-Packard. Addresses of Hewlett-Packard offices are listed at the back of this manual.

1-17. ACCESSORIES SUPPLIED

1-18. The following accessories supplied with the HP 853A are shown in Figure 1-1:

Adjustment tool, HP Part Number 8710-0630

BNC cable, HP Part Number 11086A

Adapter, type N (f) to BNC (m), HP Part Number 1250-0780

1-19. These accessories are stored in a compartment in the instrument's protective front cover. They are not supplied with the HP 853A Option 001. A Side Stop Kit (refer to paragraph 2-33) is supplied with both the standard and Option 001 instruments.

1-20. EQUIPMENT REQUIRED BUT NOT SUPPLIED**1-21. Plug-In Spectrum Analyzer**

1-22. The HP 853A is completely functional only when a compatible plug-in is installed in it. The three plug-ins used with the 853A are the HP 8557A Spectrum Analyzer, 0.01 to 350 MHz; the HP 8558B Spectrum Analyzer, 0.1 to 1500 MHz; and the HP 8559A Spectrum Analyzer, 0.01 to 21 GHz. (See also **MODIFICATION KITS** below.)

1-23. MODIFICATION KITS

1-24. Newer HP 8557A, HP 8558B, and HP 8559A plug-in Spectrum Analyzers are fully compatible with the HP 853A Spectrum Analyzer Display. Older plug-ins require modification before they can be used with the HP 853A. A list of modification requirements and appropriate kits is shown in Table 1-2. All necessary hardware and instructions are supplied with the kits.

1-25. OPTIONS**1-26. Option 908, Rack Flange Kit (HP 853A Option 001 Only)**

1-27. Option 908, HP Part Number 5061-0077, includes flanges and hardware required to mount the Option 001 HP 853A (without its front handles) in an equipment rack with horizontal spacing of 482.6 mm (19 inches) See Figure 2-5 for installation procedure.

1-28. Option 913, Rack Flange/Front Handle Kit (HP 853A Option 001 Only)

1-29. Option 913, HP Part Number 5061-2071, includes the hardware required to mount the Option 001 HP 853A (with its front handles) in an equipment rack with horizontal spacing of 482.6 mm (19 inches). See Figure 2-5 for installation procedure.

1-30. Option 910, Additional Operation and Service Manual

1-31. One additional Operation and Service Manual is provided for each Option 910 ordered. To obtain Option 910 after shipment of the instrument, specify the manual part number printed on the title page of the manual.

1-32. SERVICE ACCESSORIES

1-33. Service accessories recommended for use with the HP 853A are shown in Figure 1-3.

1-34. RECOMMENDED TEST EQUIPMENT

1-35. Equipment required for adjustments, and troubleshooting of the HP 853A is listed in Table 1-3. Other equipment may be substituted if it meets or exceeds the critical specifications listed in the table.

Table 1-2. Plug-In Modification Requirements

Plug-In Model No.	Serial Number Prefix	Modification Requirement
HP 8557A	2203A and above	Fully compatible with HP 853A; no modification required.
HP 8557A	2106A and lower	Requires Modification Kit, HP Part Number 00853-60057.
HP 8558B	2147A and above	Fully compatible with HP 853A; no modification required.
HP 8558B	2145A and lower	Requires Modification Kit, HP Part Number 00853-60058.
HP 8559A	2218A and above	Fully compatible with HP 853A; no modification required.
HP 8559A	2208A and lower	Requires Modification Kit, HP Part Number 00853-60059.
NOTE		
<p>HP 8755-series and HP 1800-series plug-ins cannot be adapted to the HP 853A Spectrum Analyzer Display, even though they are mechanically compatible (i.e., they can be plugged into the display). HP 8550-series plug-ins, other than those listed above, are both mechanically and electrically incompatible with the HP 853A.</p>		

Table 1-3. Recommended Test Equipment

Instrument	Critical Specifications	Recommended Model	Use*
Digital Voltmeter	Range: -1000V to +1000V Accuracy: $\pm 0.004\%$ of reading plus 0.001% of range Input Impedance: 10 Meg ohms	HP 3455A	A, T
Oscilloscope	Frequency: 100 MHz	HP 1741A	A, T
Spectrum Analyzer plug-in	Fully compatible with HP 853A (See Table 1-2 for a list of compatible plug-ins)	HP 8559A	A, T
Signature Analyzer	Maximum clock frequency: 10 MHz	HP 5004A	T
Probe	10:1 Divider	HP 10004D	A, T
Probe	1:1 Divider	HP 10007D	A, T
Probe	High Voltage, 4 kV	HP 34111A	A, T
Adapter	Type N (m) to BNC (f)	HP 1250-0780	A, T
Cable	Banana Plug to Alligator Clips	HP 11102A	A, T
BNC Cable 20 cm (9 in)	50-ohm coaxial cable with BNC (m) connectors on both ends	HP 10502A	A, T
*A = Adjustment; T = Troubleshooting			

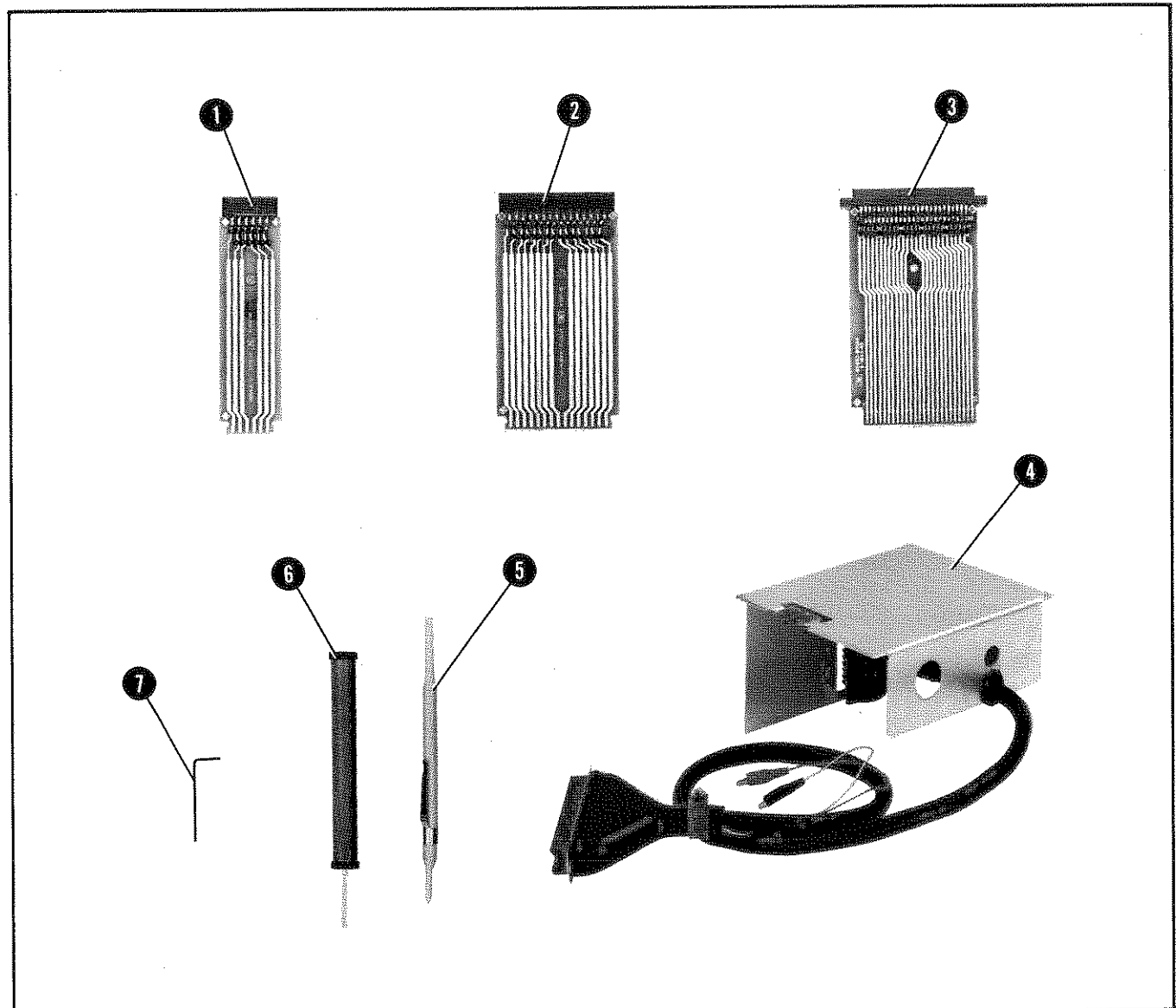

Item	Description	CD	HP Part Number
1	Extender Board, 6 pin, 12 contacts	8	08505-60109
2	Extender Board, 15 pin 30 contacts	7	08505-60041
3	Extender Board, 25 pin, 50 contacts	2	85680-60034
4	Extender Cable Assembly, for plug-in operation out of display mainframe	9	5060-0303
5	Alignment tool, metal tip in plastic	7	8710-0630
6	Alignment tool, non-metallic	4	8710-0033
7	Wrench, No. 2 Bristol	0	8710-0055
Not Shown	TFC Thin Film Cleaner, for cleaning glass RFI shield in front of CRT. Supplied in Aerosol can, net weight 15 oz (425g).	0	8500-2163

Figure 1-3. Service Accessories

SECTION II INSTALLATION AND OPERATION VERIFICATION

2-1. INTRODUCTION

2-2. This section includes information about initial inspection of the HP 853A, preparing it for use, storing and shipping it, and verifying its operation.

2-3. INITIAL INSPECTION

2-4. Inspect the shipping container for damage. If the shipping container or cushioning material is damaged, it should be kept until the contents of the shipment have been checked for completeness and the instrument has been checked mechanically and electrically. The contents of the shipment should be as shown in Figure 1-1. The electrical performance is checked with the operation verification procedure in this section. If the contents are incomplete, if there is mechanical damage or a defect, or if the instrument does not pass the operation verification test, notify the nearest Hewlett-Packard office. If the shipping container is damaged, or if the cushioning material shows signs of stress, notify the carrier as well as the Hewlett-Packard office. Keep the shipping materials for inspection by the carrier. The HP office will arrange for repair or replacement of the instrument without waiting for a claim settlement.

2-5. PREPARATION FOR USE

2-6. Power Requirements

2-7. The HP Model 853A Spectrum Analyzer Display requires a power source of 100 or 120 Vac + 5% - 10%, 48 to 440 Hz, single-phase; or a power source of 220 or 240 Vac + 5% - 10%, 48 to 66 Hz, single-phase. When operated with a compatible HP plug-in spectrum analyzer (HP Model 8557A, 8558B, or 8559A), the HP 853A power consumption is less than 200 Volt-amperes.

WARNING

BEFORE THIS INSTRUMENT IS SWITCHED ON, its protective earth terminals must be connected to the protective conductor of the main power cable (cord). The main power cable plug shall be inserted only in a socket outlet that is provided with a

protective earth contact. DO NOT defeat the earth-grounding protection by using an extension cable, a power cable, or an autotransformer without a protective ground conductor. Failure to ground the instrument properly can result in serious personal injury.

CAUTION

BEFORE SWITCHING ON THIS INSTRUMENT, make sure it is adapted to the voltage of the ac power source. You must correctly set the HP 853A rear-panel voltage selector switches to adapt the HP 853A to the power source. Failure to set the ac power input of the instrument for the correct voltage level could cause damage to the instrument when the power is switched on.

2-8. Line Voltage and Fuse Selection

2-9. Select the line voltage and fuse as follows:

1. Measure the ac line voltage.
2. See Figure 2-1. Set rear-panel ac power level switches to select line voltage (100V, 120V, 220V, 240V) closest to voltage measured in step 1. Line voltage must be within + 5% or - 10% of voltage setting. If line voltage is not within limits, an autotransformer must be connected between ac source and HP 853A.
3. Make sure correct fuse is installed in fuse holder. Required fuse rating depends on ac line voltage, and is indicated next to fuse holder and in the table below. Part numbers for replacement fuses are shown in Section VI, Replaceable Parts.

Line Voltage	Recommended Fuse
100/120 Vac 220/240 Vac	2-amp FAST BLO 1-amp FAST BLO

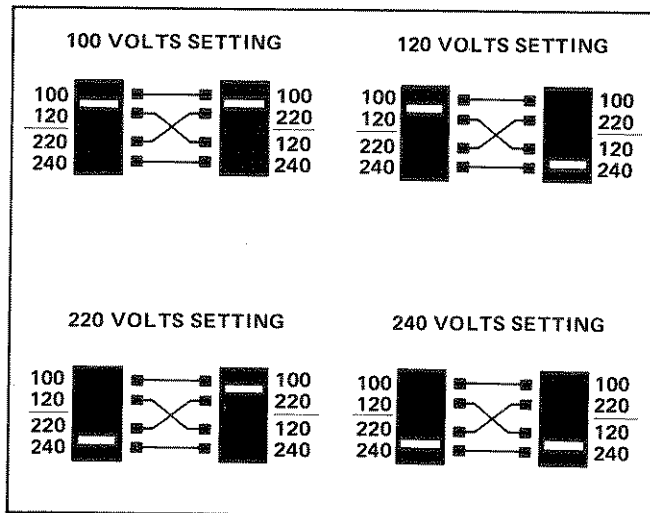

Figure 2-1. AC Voltage Selector Switch Positions

2-10. HP-IB Address Selection

2-11. The HP-IB address for the HP 853A is preset at the factory for address 18. (This decimal value corresponds to a talk address of R and a listen address of 2.) The HP-IB address label (Figure 2-2) is a convenient way to note this. Figure 2-3 show the HP-IB address switch in its preset position. The addresses listed in Table 2-1 can be selected by setting the five segments of the HP-IB address switch on the rear panel to correspond with the five-bit binary equivalent of the desired device address. If the HP-IB settings are changed while the instrument is on, ac power must be removed then reapplied to activate the new settings.

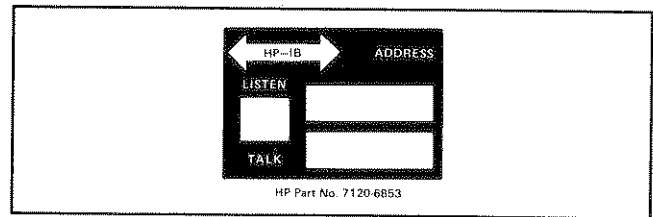

Figure 2-2. HP-IB Address Label

2-12. HP-IB address labels can be obtained by ordering HP Part Number 7120-6853. These labels allow easy reference to the HP-IB address of each system component.

2-13. Cable Connections

2-14. **Power Cable.** In accordance with international safety standards, this instrument is equipped with a three-wire power cable. When connected to an appropriate power line outlet, this cable grounds the instrument cabinet. Table 2-2 shows the styles of plugs available on power cables supplied with HP instruments. Note that the power cord shipped with the instrument has a 90-degree plug on the instrument end. Although a straight plug can be used, a 90-degree plug is recommended for all applications of the standard (portable model) instrument, and for most applications of the Option 001 instrument. When the instrument is placed rear-panel down, the 90-degree plug clears the supporting surface; a straight plug does not.

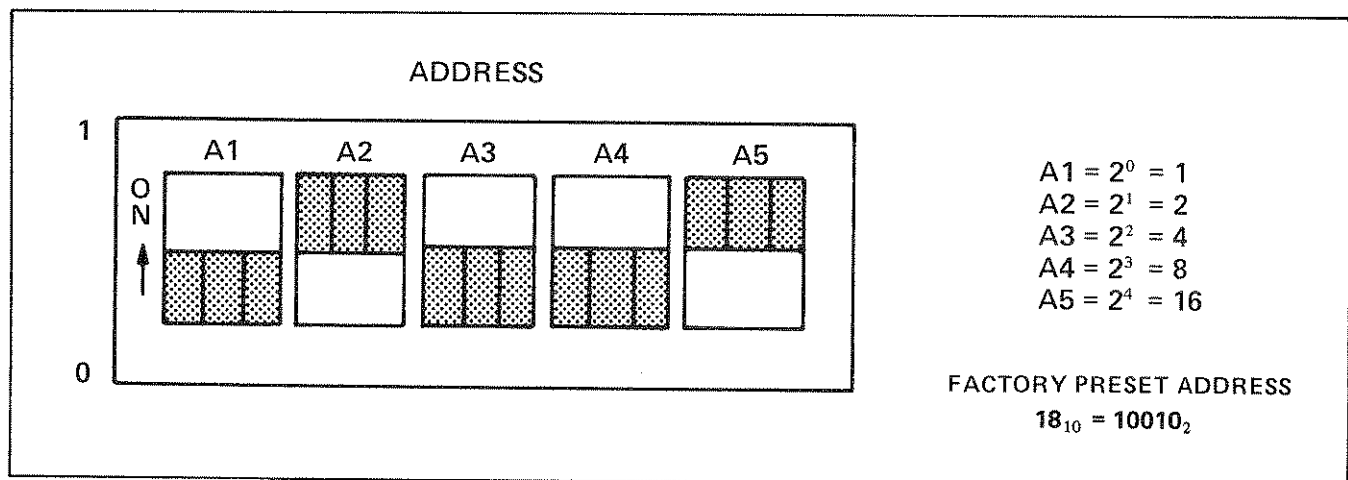

Figure 2-3. HP-IB Address Switch

Table 2-1. Cross Reference Between Decimal and Binary Address Codes

DEVICE ADDRESS DECIMAL VALUE	5-BIT BINARY EQUIVALENT	TALK ADDRESS	LISTEN ADDRESS
00	00000	@	SP
01	00001	A	!
02	00010	B	"
03	00011	C	#
04	00100	D	\$
05	00101	E	%
06	00110	F	&
07	00111	G	'
08	01000	H	(
09	01001	I)
10	01010	J	*
11	01011	K	+
12	01100	L	,
13	01101	M	-
14	01110	N	.
15	01111	O	/
16	10000	P	∅
17	10001	Q	1
18	10010	R	2
19	10011	S	3
20	10100	T	4
21	10101	U	5
22	10110	V	6
23	10111	W	7
24	11000	X	8
25	11001	Y	9
26	11010	Z	:
27	11011	[;
28	11100	\	<
29	11101]	=
30	11110	(>

2-15. A U-shaped aluminum power plug retainer, supplied with the standard (portable) instrument in Power Cord Plug Retainer Kit HP 00853-60053, can be installed after the power cord is connected to the instrument to prevent inadvertent disconnection of the power cord plug. Instructions for installing the power plug retainer are contained in the kit. During transit of the standard instrument, the power cord is stored by wrapping it around the instrument's rear feet. Retainer installation and the manner in which the power cord is stored are shown in Figure 2-4.

WARNING



If this instrument is to be energized through an autotransformer, make sure the common terminal of the au-

totransformer is connected to the protective earth contact of the power source outlet socket.

Any interruption of the protective ground, inside or outside the instrument, can make it a shock hazard.

2-16. **Rear-Panel Connections.** All input and output cable connections to and from the HP 853A are made at receptacles on the instrument's rear panel. The RF and blanking (penlift) output receptacles are BNC female connectors; the IB interface receptacle is a 24-pin CINCH connector. Signal level and impedance information for the RF and blanking outputs is provided next to each BNC connector.

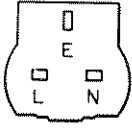
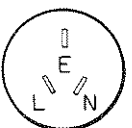
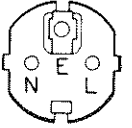
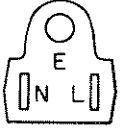
Table 2-2. AC Power Cables Available

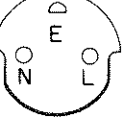
Plug Type,* AC Source End	Cable,* HP Part Number	C D	Plug Description, Instrument End	Length cm (inches)	Color	Country of Use
250V  BS1363A	8120-1351 8120-1703	0 6	Straight 90°	229 (90) 229 (90)	Mint Gray Mint Gray	United Kingdom, Cyprus, Nigeria, Rhodesia, Singapore, South Africa, India
250V  NZSS198/ASC112	8120-3169 8120-0696	0 4	Straight 90°	201 (79) 221 (87)	Gray Gray	Australia, New Zealand
250V  CEE7-Y11	8120-1689 8120-1692	7 2	Straight 90°	201 (79) 201 (79)	Mint Gray Mint Gray	East and West Europe, Saudi Arabia, Egypt, South Africa, India, (unpol- arized in many nations)
125V  NEMA5-15P	8120-1348 8120-1398 8120-1754 8120-1378 8120-1521 8120-1676	5 5 7 1 6 2	Straight 90° Straight Straight 90° Straight	203 (80) 203 (80) 91 (36) 203 (80) 203 (80) 91 (36)	Black Black Black Jade Gray Jade Gray Jade Gray	United States, Canada, Japan (100V or 200V), Mexico, Philip- pines, Taiwan
250V  SEV1011 1959-24507 Type 12	8120-2104	3	Straight	201 (79)	Gray	Switzerland
220V  DHCK 107	8120-1957 8120-2956	2 3	Straight 90°	201 (79) 201 (79)	Gray Gray	Denmark

*Part number shown for source end plug is industry identifier for plug only. Number shown for cable is HP Part Number for complete cable including plugs.
E = Earth Ground; L = Line; N = Neutral

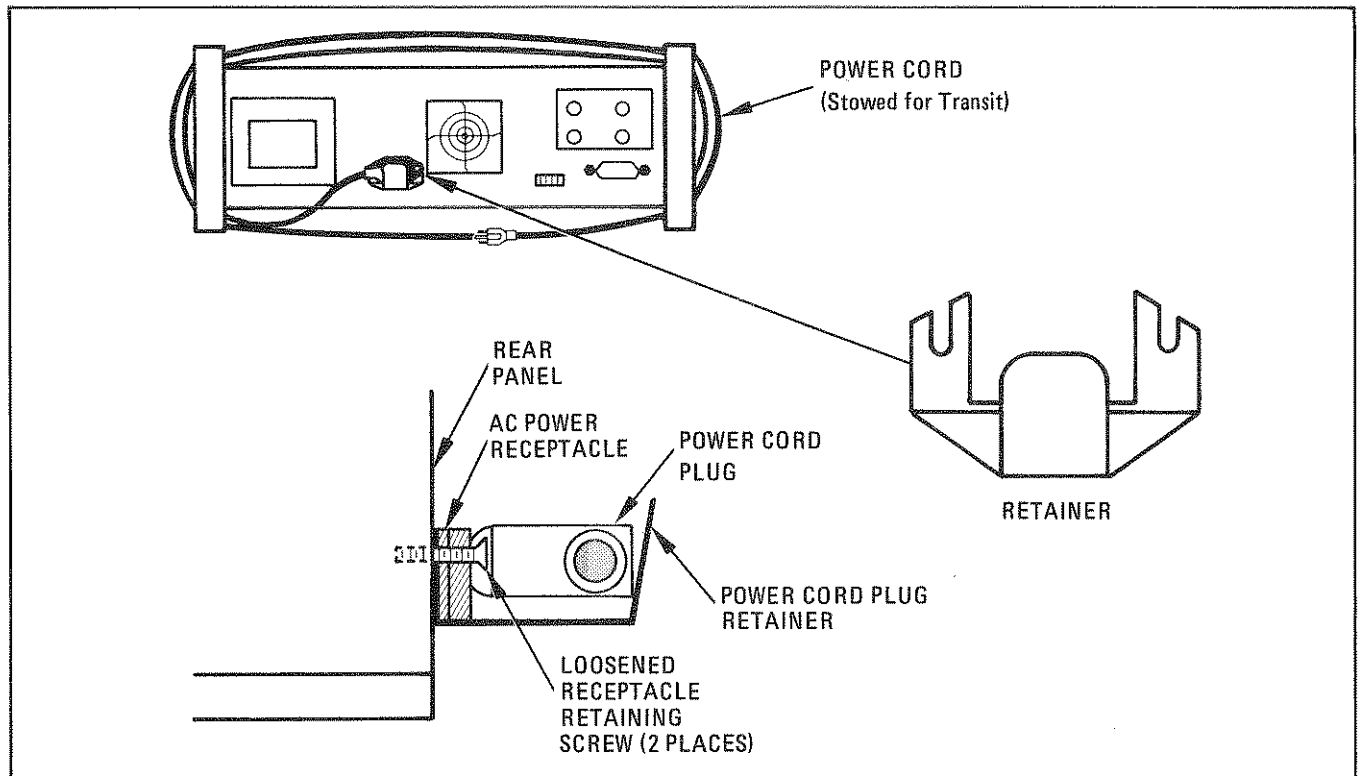

Figure 2-4. Power Cord Plug Retainer Installation and Power Cord Storage

2-17. A plug on the rear panel of the plug-in spectrum analyzer mates with a receptacle in the HP 853A to interconnect the two units.

2-18. COMPATIBILITY CONSIDERATIONS

2-19. The HP 853A is for use exclusively with HP Model 8557A, 8558B, and 8559A plug-in spectrum analyzers. You **must not** attempt to use any other plug-in in the HP 853A. You could damage one or both instruments. Although the HP 8755P Network Analyzer, the HP 8755S Test Set, and the HP 1800-series plug-ins all “fit” into the HP 853A display, their different supply voltages and signal interface connections make them electrically incompatible with the HP 853A.

2-20. Older HP 8557A, 8558B, and 8559A plug-ins might not be fully operational in the HP 853A. They can, however, be modified to make them fully operational (see Table 1-2). In any event, installing an unmodified one of these plug-ins in the HP 853A will not cause any damage. Instead, you will probably note that the Manual Sweep and Single Sweep modes do not function properly, and an INCREASE SWP TIME/DIV annotation might appear on the display in Auto Sweep Time/Div for some control setting combinations.

2-21. Operating Environment

2-22. **Temperature.** The instrument may be operated in temperatures from 0 degrees C to +55 degrees C.

2-23. **Humidity.** The instrument may be operated in environments with humidity from 5% to 95% at 0 degrees C to 40 degrees C. However, the instrument must be protected from temperature extremes that might produce internal condensation.

2-24. **Altitude.** The instrument may be operated at altitudes up to 4572 meters (15,000 feet).

2-25. Bench Operation

2-26. The cabinet of the standard (portable configuration) HP Model 853A Spectrum Analyzer Display has special rubber feet which enable it to be operated in a vertical position with its rear panel down. This is convenient when the instrument must be set on the floor. The Model 853A can also be set on a bench with its heavy, bail carrying handle functioning as a tilt stand.

CAUTION

Cooling air circulates through the standard HP 853A via vents in its bottom cover. (The Option 001 HP 853A has vented side panels.) If you stack the standard HP 853A on top of another instrument, you must make sure the air flow through its bottom vents is not impeded.

2-27. The cabinet of the HP Model 853A Option 001 Spectrum Analyzer Display has plastic feet and foldaway tilt stands for bench operation. The tilt stands raise the front of the instrument for easier viewing of the front panel controls and display. The plastic feet are shaped to make full-width modular instruments self-aligning when they are stacked. The HP 853A Option 001 can also be rack mounted (see below).

2-28. Rack Mounting (Option 001 Displays Only)

2-29. Option 908. Instruments ordered with Option 908 are shipped with a Rack Flange Kit, which includes all necessary hardware and installation instructions for mounting the instrument in a standard 482.6 mm (19-inch) equipment rack. Parts included in the Option 908 Rack Flange Kit are listed in Table 2-3. The rack mounting instructions are duplicated in Figure 2-5.

2-30. Option 913. Instruments ordered with Option 913 are shipped with a Rack Flange/Front Handle Kit, which includes all necessary hardware and installation instructions for adding front handles and mounting the instrument in a standard 482.6

mm (19-inch) equipment rack. Parts included in the Option 913 Rack Flange/Front Handle Kit are listed in Table 2-3. The installation instructions are duplicated in Figure 2-5.

2-31. Front Handles (Option 001 Displays Only)

2-32. Option 001 instruments ordered without either of the options indicated above are shipped with a Front Handle Kit. This kit contains two front handles, and the hardware and instructions for attaching them to the instrument. The instructions for attaching the handles are also shown in Figure 2-5.

2-33. Side Stop Kit

2-34. Installation of a Side Stop Kit, HP Part Number 00853-60050, in an HP 853A Spectrum Analyzer Display mainframe, prevents the plug-in spectrum analyzer from being removed from the mainframe without the use of hand tools. Table 2-4 is a list of parts contained in the kit.

2-35. To install side stops:

WARNING

Before removing top cover from display mainframe, make sure mainframe ac line cord is disconnected to remove all power from the instrument. If ac line power is left connected, removal of top cover exposes voltages that could, if contacted, cause serious injury or death.

Table 2-3. Rack-Mounting Kits for HP 853A

Description	CD	HP Part Number	Quantity
OPTION 908	6	5061-0077	1
Rack Flange	7	5020-8862	2
Machine Screw, Pan Head, 8-32 x 0.375 inch	7	2510-0193	8
OPTION 913	4	5061-2071	1
Handle Assembly	6	5060-9899	2
Rack Flange	1	5020-8874	2
Machine Screw, Pan Head, 8-32 x 0.625 inch	8	2510-0194	8

Table 2-4. Side Stop Kit (HP Part Number 00853-60050)

Quantity	Description	HP Part Number	CD
2	Side Stop	00853-00042	7
2	Screw, Machine M3.0 x 10 mm	0515-0407	4
1	Label, Front Panel	7120-8131	7

- Remove HP 853A top cover. Note that if you have a standard HP 853A (i.e., the portable version), you must first remove its tilt-bail handle. A handle mounting screw is located under each pop-off plastic cap.
- Slide the spectrum analyzer plug-in (HP 8559A, 8558B, or 8557A) into the HP 853A and lock it into place. Install a side stop in both black plastic upper guides of the HP 853A, using the screws provided in the kit. Orient each side stop for the least amount of gap between the side stop and the plug-in guide rail (see Figure 2-6). Note that there are three possible ways to orient each side stop.
- Reinstall the HP 853A top cover.
- Place CAUTION label on upper right hand corner of the spectrum analyzer plug-in front panel to indicate spectrum analyzer is secured with side stops.

2-36. Mainframe/Plug-In Interconnections

2-37. When the plug-in spectrum analyzer is inserted and locked into the mainframe, a male plug on the back of the spectrum analyzer mates with female receptacle J1 in the mainframe. Signals on individual pins of mainframe receptacle J1 are identified in Table 2-5.

Table 2-5. HP Model 853A Display/Plug-In Interconnections

Pin on J1	Signal or Voltage	Pin on J1	Signal or Voltage
1	NC	19	GROUND
2	GROUND	20	AST
3	NC	21	BEAM FINDER
4	L NORM	22	NC
5	NC	23	NC
6	NC	24	GROUND
7	EXT TRIGGER	25	NC
8	GROUND	26	NC
9	H MANUAL Input	27	NC
10	NC	28	-12.6 VDC to plug-in
11	HORIZONTAL Output (to mainframe rear panel)	29	+15 VDC to plug-in
12	21.4 MHz IF Output (to mainframe rear panel)	30	+100 VDC to plug-in
13	PENLIFT Output (to mainframe rear panel)	31	30V p-p to plug-in (for LINE TRIGGER)
14	AUX VERT Output (to mainframe rear panel)	32	NC
15	GROUND	Top Deflection Contact, Yellow Wire	+VERT
16	NC	Bottom De- flection Contact, Orange Wire	--VERT
17	BLANKING		
18	NC		

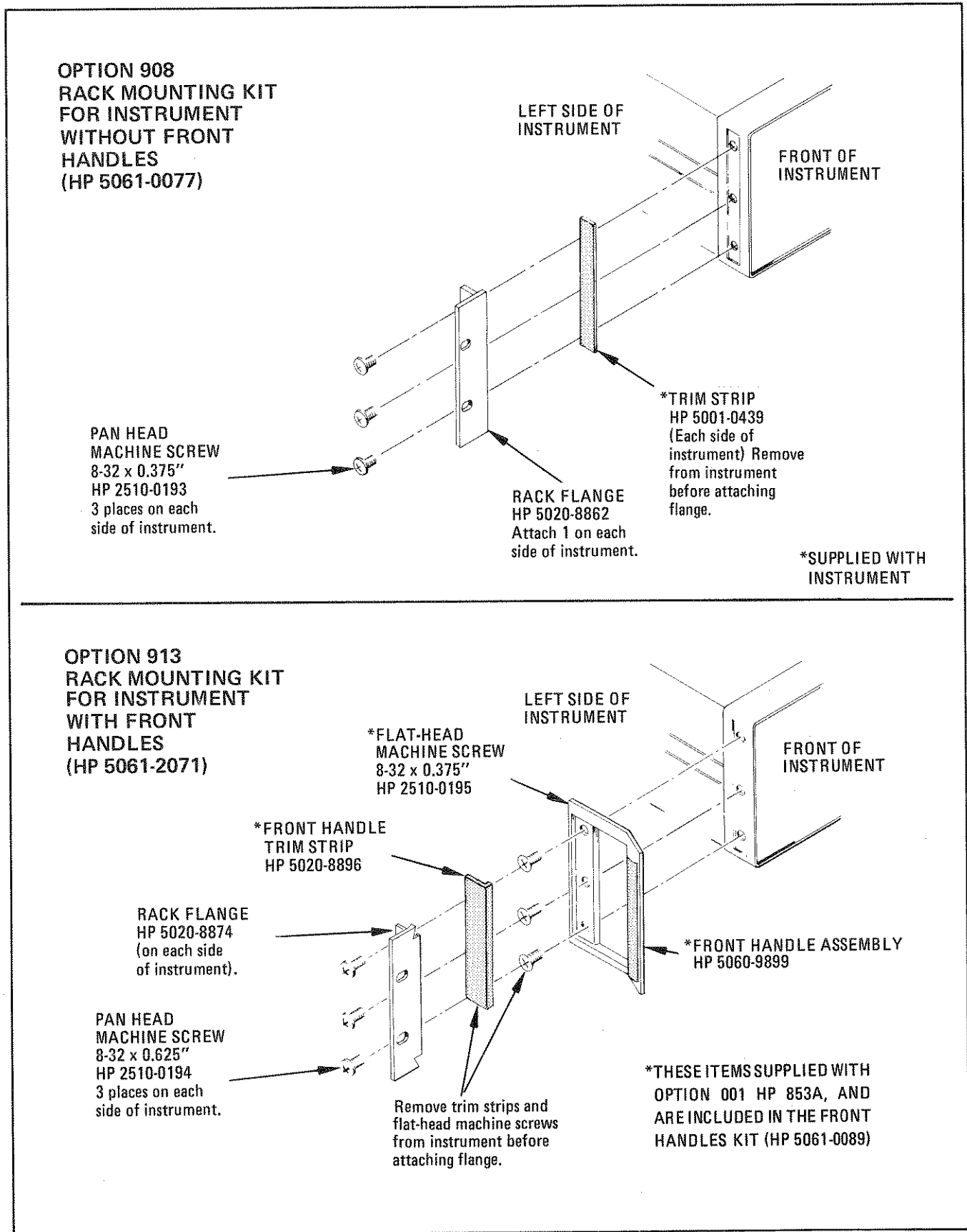

Figure 2-5. Attaching Rack Mounting Hardware and Handles

2-38. STORAGE AND SHIPMENT

2-39. Environment

2-40. The instrument may be stored or shipped in environments within the following limits:

Temperature - 40 degrees C to + 75 degrees C
 Humidity 5% to 95% at
 0 degrees C to 40 degrees C
 Altitude Up to 15 240 meters (50,000 feet)

2-41. During storage or shipment, the instrument must be protected from temperature extremes that might produce internal condensation.

2-42. Packaging

2-43. Original Packaging. Containers and materials identical with those used in factory packaging are available through Hewlett-Packard offices. Figures 2-7 and 2-8 illustrate the proper method of packaging the instrument for shipment using factory packaging materials. If the instrument is being returned to Hewlett-Packard for servicing, attach a tag indicating the kind of service required, return address, the instrument model number, and its full serial number. A supply of these tags is provided at the end of this section. Also mark the container FRAGILE to ensure careful handling. In any correspondence, refer to the instrument by its model number and full serial number.

2-44. Other Packaging. The following general instructions should be used to repackage the instrument with commercially available materials:

1. Wrap the instrument in heavy paper or plastic. If you are shipping it to a Hewlett-Packard office or service center, attach a tag indicating the kind of service required, your return address, the instrument model number, and its full serial number. A supply of these tags is supplied at the back of this section.
2. Use a strong shipping container. A double-wall carton made of 350-pound test material is adequate.
3. Use enough shock-absorbing material (3-inch to 4-inch layer) around all sides of the instrument to provide a firm cushion and prevent movement of the instrument inside the container. Protect the control panel with cardboard when shipping an Option 001 HP 853A. Attach the protective front-panel cover when shipping a standard HP 853A.
4. Mark the shipping container FRAGILE to ensure careful handling.

2-45. OPERATION VERIFICATION

2-46. The Operation Verification procedure tests the operating features of the instrument. It is recommended that you use these procedures for verifying overall operation of the instrument, either as part of incoming inspection or after a repair.

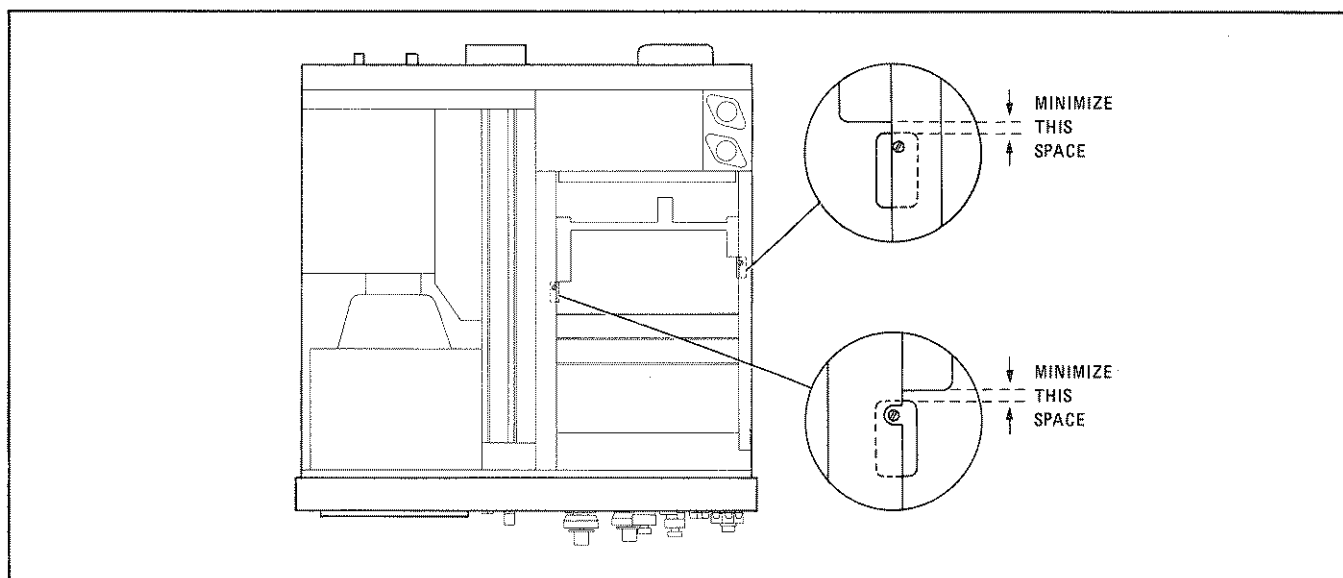
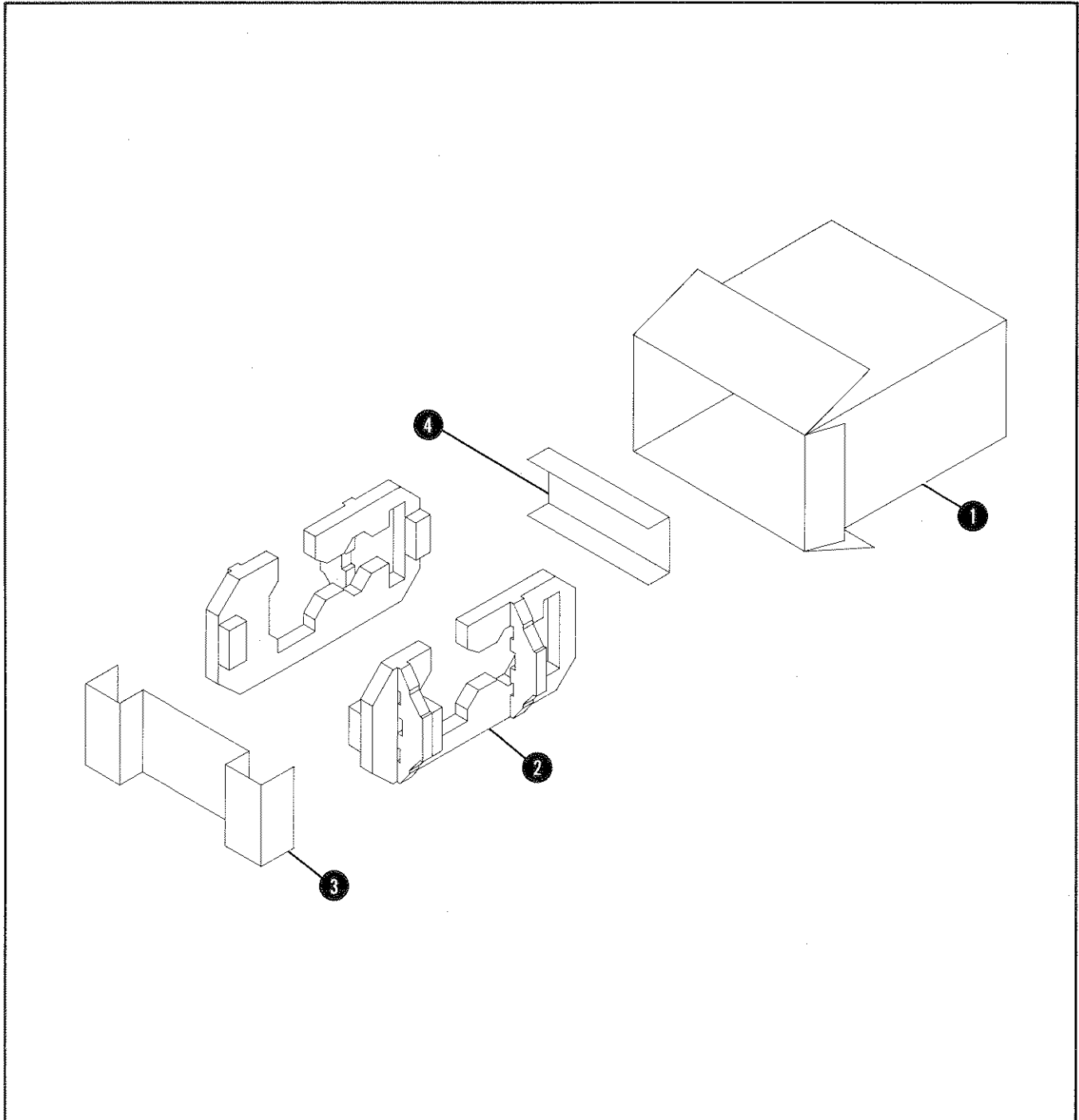

Figure 2-6. Side Stop Positioning



Item	Qty	HP Part Number	C D	Description
1	1	9211-4151	8	CARTON
2	2	9220-3885	2	SIDE PADS
3	1	9220-3884	1	FRONT PAD
4	1	9211-3906	9	REAR PAD

Figure 2-7. Packaging for Shipment of Standard HP 853A Using Factory Packaging Materials

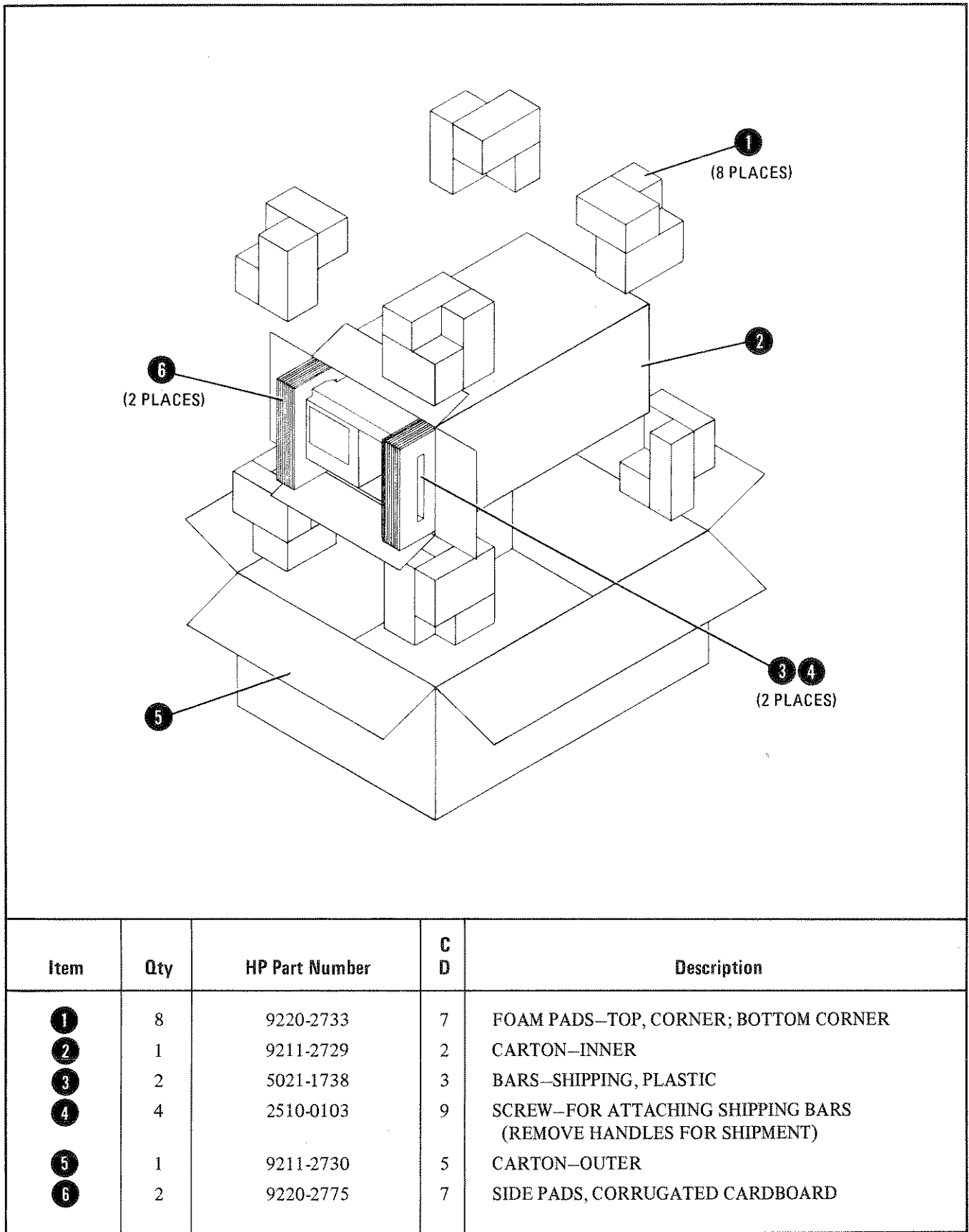

Figure 2-8. Packaging for Shipment of Option 001 HP 853A Using Factory Packaging Materials

OPERATION VERIFICATION

EQUIPMENT:

Spectrum Analyzer Plug-In HP 8559A, 8558B, or 8557A
 Adapter, Type N (m) to BNC (f) HP 1250-6780

NOTE

The spectrum analyzer plug-in used in this procedure must be fully compatible with the HP 853A (see Table 1-2 for a list of compatible instruments).

PROCEDURE:

1. Install spectrum analyzer plug-in in HP 853A.
2. Set LINE power switch to ON. The 853A Display will perform an automatic power-on verification test, which takes about five seconds to complete. This test checks the system memory (RAM), system program memory (ROM), and stroke memory (RAM), all of which are accessed by the control microprocessor. A memory failure is indicated by a straight line trace at the 0 dB or a -dB graticule line, or by a repeated letter in the display annotation area (see Memory Fault Location Table in Section V). If the automatic test reveals a failure, or if the routine will not run at all, refer to the troubleshooting and service information in Section VIII, and to the adjustments information in Section V.
3. Do the Front Panel Adjustment procedure described in Section III.
4. Connect the spectrum analyzer CAL OUTPUT through a short BNC cable to the INPUT connector. Set the spectrum analyzer and display controls as follows:

Spectrum Analyzer:

FREQ SPAN/DIV 2 MHz (uncoupled)
 RESOLUTION BW 10 kHz
 INPUT ATTEN 10 dB
 Amplitude Scale 10 dB/DIV
 SWEEP TIME/DIV AUTO
 SWEEP TRIGGER FREE RUN
 BASELINE CLIPPER OFF
 VIDEO FILTER OFF

Display Mainframe:

TRACE A STORE BLANK
 TRACE B STORE BLANK
 DGTL AVG OFF (out)
 INPUT - B→A OFF (out)

5. Adjust the spectrum analyzer TUNING and REFERENCE LEVEL controls as necessary to center the CAL OUTPUT signal on the display CRT, and place its peak at the top graticule line.
6. Do the routines described in Table 2-6 and check for the required indications.

Table 2-6. Operation Verification Test Routines (1 of 2)

Function	Operation	Indication
TRACE A	<p>Press CLEAR WRITE.</p> <p>Press MAX HOLD. Vary spectrum analyzer tuning.</p> <p>Press STORE VIEW. Vary spectrum analyzer control settings.</p> <p>Press STORE BLANK.</p>	<p>HP 853A switches from analog to digital display mode. WRITE A is annotated in upper left corner of CRT (except when overlapped by a signal trace).</p> <p>Maximum signal value is held at each point on CRT trace.</p> <p>Trace is held on CRT and is unaffected by any changes made to spectrum analyzer control settings (except for SWEEP TIME/DIV control settings of 10 msec. and faster).</p> <p>Analog signal is displayed (without display mode annotation).</p>
TRACE B	Repeat operations described for TRACE A.	Same indications as for TRACE A (except that WRITE B, etc. appears in upper left corner of CRT).
TRACE A and TRACE B	Press STORE VIEW A and STORE VIEW B.	Two traces are simultaneously displayed on CRT.
Press TRACE A and TRACE B CLEAR WRITE and recenter the CAL OUTPUT signal on the CRT with the spectrum analyzer TUNING control.		
Digital Averaging	Press DGTL AVG.	Successive input traces are digitally averaged to smooth baseline noise, and the result is displayed as trace A.
Press DGTL AVG again to turn off (push button out) digital averaging. Then press TRACE B STORE BLANK.		
Input minus trace B (Trace normalization)	Press INPUT-B→A. Vary spectrum analyzer TUNING control.	Input signal is normalized point-by-point by subtracting contents of trace B memory from it, and the result is displayed as trace A.
Press INPUT-B→A again to turn off (push button out) normalizing function.		
Plot display graticule	Press PLOT GRAT momentarily.	PLOT GRAT is momentarily annotated on upper right corner of CRT. If a plotter is connected via the HP 853A rear-panel HP-IB connector, and is set for the listen-only mode, it will plot the display graticule pattern.
Plot trace	Press PLOT TRACE momentarily.	PLOT TRACE is momentarily annotated on upper right corner of CRT. If a plotter is connected via the HP 853A rear-panel HP-IB connector, and is set for the listen-only mode, it will plot the trace or traces present on the display.
CRT background illumination.	Vary display SCALE control.	Display background illumination varies according to position of SCALE control. SCALE control is ineffective when ANALOG DISPLAY mode is selected.

Table 2-6. Operation Verification Test Routines (2 of 2)

Function	Operation	Indication
Manual sweep	Press TRACE A CLEAR WRITE. Set spectrum analyzer SWEEP TIME/DIV control to MAN and vary sweep with MAN control.	Manually-swept trace is updated in either direction.
Set spectrum analyzer SWEEP TIME/DIV control to .1 second.		
Single sweep	Set spectrum analyzer SWEEP TRIGGER control to SINGLE. Turn SWEEP TRIGGER control clockwise several times.	Rotating SWEEP TRIGGER control starts and stops a single sweep.
Set spectrum analyzer SWEEP TRIGGER control to FREE RUN, and SWEEP TIME/DIV control to 1 second.		
Sweep retriggering	Press TRACE A MAX HOLD, then CLEAR WRITE.	Sweep retriggers each time display mode is changed.
Set spectrum analyzer SWEEP TIME/DIV control to 5 msec.		
Indication of excessive sweep speed	Press both CLEAR WRITE push buttons.	Display switches to ANALOG MODE with message to increase SWEEP TIME/DIV control setting.