HP 85060C Electronic Calibration Control Unit

Operating, Programming, and Service Manual

SERIAL NUMBERS

This manual applies directly to any HP 85060C Control Unit having serial prefix US3444 and above.



Printed in USA

HP Part Number: 85060-90002
Printed in USA 1995
First Edition
© Copyright 1995 Hewlett-Packard Company

This manual and any examples contained herein are provided “as is” and are subject to change without notice. Hewlett-Packard makes no warranty of any kind with regard to this material, including but not limited to, the implied warranties of merchantability and fitness for a particular purpose. Hewlett-Packard shall not be liable for errors contained herein or for incidental or consequential damages in connection with the furnishing, performance, or use of this material.

Note

This instrument has been designed and tested in accordance with IEC Publication 348, Safety Requirements for Electronic Measuring Apparatus, and has been supplied in a safe condition. The instruction documentation contains information and warnings which must be followed by the user to ensure safe operation and to maintain the instrument in a safe condition.

Safety

Warning No operator serviceable parts inside. Refer servicing to qualified personnel. To prevent electrical shock, do not remove covers.

Warning If this instrument is used in a manner not specified by Hewlett-Packard Co., the protection provided by the instrument may be impaired.

Warning For continued protection against fire hazard replace line fuse only with same type and rating (see the rear panel of the instrument). The use of other fuses or material is prohibited.

Warning This is a Safety Class I product (provided with a protective earth ground incorporated in the power cord). The mains plug shall only be inserted in a socket outlet provided with a protective earth contact. Any interruption of the protective conductor, inside or outside the instrument, is likely to make the instrument dangerous. Intentional interruption is prohibited.

Warning If this instrument is to be energized via an external autotransformer for voltage reduction, make sure that its common terminal is connected to a neutral (earthed pole) of the power supply.

Warning These servicing instructions are for use by qualified personnel only. To avoid electrical shock, do not perform any servicing unless you are qualified to do so.

Warning The opening of covers or removal of parts is likely to expose dangerous voltages. Disconnect the instrument from all voltage sources while it is being opened.

Warning The power cord is connected to internal capacitors that may remain live for 10 seconds after disconnecting the plug from its power supply.

Caution Always use the three-prong ac power cord supplied with this instrument. Failure to ensure adequate earth grounding by not using this cord may cause instrument damage.

Caution This instrument has autoranging line voltage input; be sure the supply voltage is within the specified range.

Caution **Ventilation Requirements:** When installing the instrument in a cabinet, the convection into and out of the instrument must not be restricted. The ambient temperature (outside the cabinet) must be less than the maximum operating temperature of the instrument by 4 °C for every 100 watts dissipated in the cabinet. If the total power dissipated in the cabinet is greater than 800 watts, then forced convection must be used.

Instrument Markings



The CE mark is a registered trademark of the European Community. (If accompanied by a year, it is when the design was proven.)

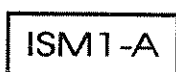

This is a symbol of an Industrial Scientific and Medical Group 1 Class A product.



The ETL mark is a registered trademark of ETL Testing Laboratories, Inc.

Caution

Caution denotes a hazard. It calls attention to a procedure that, if not correctly performed or adhered to, would result in damage to or destruction of the instrument. Do not proceed beyond a caution sign until the indicated conditions are fully understood and met.

Warning

Warning denotes a hazard. It calls attention to a procedure which, if not correctly performed or adhered to, could result in injury or loss of life. Do not proceed beyond a warning note until the indicated conditions are fully understood and met.

ASSISTANCE

Product maintenance agreements and other customer assistance agreements are available for Hewlett-Packard products. For any assistance, contact your nearest Hewlett-Packard Sales and Service Office.

CERTIFICATION

Hewlett-Packard Company certifies that this product met its published specifications at the time of shipment from the factory. Hewlett-Packard further certifies that its calibration measurements are traceable to the United States National Institute of Standards and Technology, to the extent allowed by the Institute's calibration facility, and to the calibration facilities of other International Standards Organization members.

WARRANTY

This Hewlett-Packard instrument product is warranted against defects in material and workmanship for a period of one year from date of shipment. During the warranty period, Hewlett-Packard Company will, at its option, either repair or replace products which prove to be defective.

For warranty service or repair, this product must be returned to a service facility designated by Hewlett-Packard. Buyer shall prepay shipping charges to Hewlett-Packard and Hewlett-Packard shall pay shipping charges to return the product to Buyer. However, Buyer shall pay all shipping charges, duties, and taxes for products returned to Hewlett-Packard from another country.

Hewlett-Packard warrants that its software and firmware designated by Hewlett-Packard for use with an instrument will execute its programming instructions when properly installed on that instrument. Hewlett-Packard does not warrant that the operation of the instrument, or software, or firmware will be uninterrupted or error-free.

LIMITATION OF WARRANTY

The foregoing warranty shall not apply to defects resulting from improper or inadequate maintenance by Buyer, Buyer-supplied software or interfacing, unauthorized modification or misuse, operation outside of the environmental specifications for the product, or improper site preparation or maintenance.

NO OTHER WARRANTY IS EXPRESSED OR IMPLIED. HEWLETT-PACKARD SPECIFICALLY DISCLAIMS THE IMPLIED WARRANTIES OF MERCHANTABILITY AND FITNESS FOR A PARTICULAR PURPOSE.

EXCLUSIVE REMEDIES

THE REMEDIES PROVIDED HEREIN ARE BUYER'S SOLE AND EXCLUSIVE REMEDIES. HEWLETT-PACKARD SHALL NOT BE LIABLE FOR ANY DIRECT, INDIRECT, SPECIAL, INCIDENTAL, OR CONSEQUENTIAL DAMAGES, WHETHER BASED ON CONTRACT, TORT, OR ANY OTHER LEGAL THEORY.

1
2
3
4
5
6
7
8
9
10
11
12
13
14
15
16
17
18
19
20
21
22
23
24
25
26
27
28
29
30
31
32
33
34
35
36
37
38
39
40
41
42
43
44
45
46
47
48
49
50
51
52
53
54
55
56
57
58
59
60
61
62
63
64
65
66
67
68
69
70
71
72
73
74
75
76
77
78
79
80
81
82
83
84
85
86
87
88
89
90
91
92
93
94
95
96
97
98
99
100

Contents

1 GENERAL INFORMATION

1-1	Description	1-1
1-2	Documentation	1-1
1-3	Specifications	1-1
1-4	Safety Considerations	1-1
1-5	Instruments Covered by this Manual	1-2
1-6	Options	1-2
1-7	Accessories Supplied	1-2
1-8	Accessories Available	1-2
1-9	Cables	1-2

2 INSTALLATION

2-1	Introduction	2-1
2-2	Initial Inspection	2-1
2-3	Preparation for Use	2-1
2-3.1	Installation Checklist	2-1
2-3.2	Power Requirements	2-1
2-3.3	Line Voltage and Fuse Selection	2-2
2-3.4	Power Cables	2-2
2-3.5	HP-IB Address Selection for the Control Unit	2-4
2-3.6	HP-IB Address Selection for the Network Analyzer	2-4
2-3.7	Additional Switch Settings	2-4
2-3.8	Interconnections	2-4
2-3.9	Mating Connectors	2-4
2-3.10	Operating Environment	2-4
2-3.11	Bench Operation	2-5
2-3.12	Rack Mounting	2-5
2-4	Storage and Shipment	2-6
2-4.1	Environment	2-6
2-4.2	Packaging	2-6

3 OPERATION

3-1	Introduction	3-1
3-1.1	ESD Cautions	3-1
3-2	Theory of Operation	3-1
3-3	Operating Characteristics	3-4
3-4	Turn-on Information	3-4
3-5	Connecting / Disconnecting Modules	3-5
3-6	Panel Features	3-7

3-6.1	Front Panel and Rear Panel Features for the Standard and Optional Configurations	3-7
3-7	Stand-alone (Manual) Operation	3-9
3-7.1	System Configuration for Stand-alone Operation	3-9
3-7.2	Accessing Menus	3-9
3-7.3	Types of Analyzers	3-9
3-7.4	Setting Calibration Parameters	3-10
3-7.5	Selecting Modules	3-10
3-7.6	Performing Calibrations	3-11
3-7.6.1	Optimizing Performance in the Overlapping Frequency Range	3-12
3-7.7	Calibration Procedures	3-13
3-7.7.1	To Perform an S11 1-PORT Calibration	3-13
3-7.7.2	To Perform an S22 1-PORT Calibration	3-14
3-7.7.3	To Perform a FULL 2-PORT Calibration	3-15
3-7.7.4	To Perform an OMIT ISOL 2-PORT Calibration	3-16
3-7.7.5	To Perform an ADAPTER 2-PORT Calibration	3-17
3-7.7.6	To Perform an OMIT ISOL ADP 2-PORT Calibration	3-18
3-7.8	Performing the Confidence Check	3-19
3-7.8.1	To Perform a Confidence Check	3-20
3-8	Remote Operation	3-21
3-8.1	System Configuration for Remote Operation	3-21
3-8.2	Communicating with Host Computers	3-21
3-8.2.1	Sending Commands Which Require Pass Control	3-22
3-8.2.2	Sending Commands Which Do Not Require Pass Control	3-23
3-8.3	Setting Calibration Parameters for Remote Operation	3-23
3-8.4	Selecting Modules for Remote Operation	3-23
3-8.5	Performing Calibrations by Remote Operation	3-23
3-8.5.1	Host Initiated Manual Calibration	3-24
3-8.5.2	Host Directed Full Calibration	3-24
3-8.5.3	Host Directed Adapter Calibration	3-25
3-8.6	Responding to the ECal "RUN" Key	3-26

4 COMMAND REFERENCE

4-1	Command Types	4-1
4-1.1	SCPI Command Format	4-1
4-1.2	Common Command Format	4-1
4-2	SCPI Command Reference	4-2
4-3	Common Command Reference	4-8
4-4	Quick Reference for SCPI and IEEE-488 Commands	4-13

5 TROUBLESHOOTING

5-1	Introduction	5-1
5-2	Recommended Test Equipment	5-1
5-3	Diagnostic Software	5-1

5-4	Troubleshooting Sequence	5-1
5-5	Troubleshooting Procedures	5-4
5-5.1	For a No DC Power Condition	5-4
5-5.2	If the Control Unit Does Not Recognize the Module	5-4
5-5.3	If the Calibration Results are Unsatisfactory	5-4

6 REPLACEMENT PROCEDURES

6-1	Introduction	6-1
6-2	Equipment Needed (but not supplied)	6-1
6-3	Assembly Replacement Procedures	6-3
6-3.1	Preliminary Precautions	6-3
6-3.2	To Remove the Cover	6-3
6-3.3	To Remove the Fan Assembly (FAN1)	6-3
6-3.4	To Remove the IEEE 488 Adapter Board Assembly (A1)	6-3
6-3.5	To Remove the Microprocessor Board Assembly (A2)	6-4
6-3.6	To Remove the Control Logic Board Assembly (A3)	6-4
6-3.7	To Remove the 24V Power Supply Assembly (A4)	6-4
6-3.8	To Remove the 5V Power Supply Assembly (A5)	6-5
6-3.9	To Remove the Display Board (A6)	6-5
6-3.10	To Remove the HP-IB Switch Board (A7)	6-5
6-3.11	To Remove the 3.5 Inch Floppy Drive Assembly (D1)	6-5

7 REPLACEABLE PARTS

7-1	Introduction	7-1
7-2	Replaceable Parts List	7-1
7-3	Ordering Information	7-1
7-4	To Order Parts...Fast	7-1

List of Figures

Figure 2-1. Power Cable and Line (Main) Plug Part Numbers	2-3
Figure 2-2. Rear Panel HP-IB Address Selection DIP Switches	2-4
Figure 2-3. HP 85060C ECal System Bench Set-up Example	2-5
Figure 3-1. HP 85060C ECal System Conceptual Block Diagram	3-2
Figure 3-2. Typical Operating Sequence	3-3
Figure 3-3. Front and Rear Panel Features	3-6
Figure 3-4. Sample Network Analyzer ECal Menus	3-8
Figure 3-5. Adapter Calibration Connection Diagram	3-17
Figure 5-1. Front Panel LED Status Conditions	5-2
Figure 6-1. Assembly Locations	6-2

List of Tables

Table 1-1.	Electrical and Mechanical Characteristics	1-3
Table 1-2.	Environmental Specifications	1-3
Table 2-1.	Fuse Ratings	2-2
Table 3-1.	Operating Characteristics	3-4
Table 4-1.	ECal Event Status Register	4-8
Table 4-2.	ECal Status Byte Register	4-11
Table 4-3.	SCPI Commands - Quick Reference	4-13
Table 4-4.	IEEE-488.2 Common Commands - Quick Reference	4-14
Table 6-1.	Equipment Needed to Replace ECal Control Unit Major Assemblies	6-1
Table 7-1.	Replaceable Parts List	7-2

1
2
3
4
5
6
7
8
9
10
11
12
13
14
15
16
17
18
19
20
21
22
23
24
25
26
27
28
29
30
31
32
33
34
35
36
37
38
39
40
41
42
43
44
45
46
47
48
49
50
51
52
53
54
55
56
57
58
59
60
61
62
63
64
65
66
67
68
69
70
71
72
73
74
75
76
77
78
79
80
81
82
83
84
85
86
87
88
89
90
91
92
93
94
95
96
97
98
99
100

1 GENERAL INFORMATION

1-1 Description

The HP 85060C Electronic Calibration (ECal) Control Unit is the controller for electronic calibration of vector network analyzers. It performs one-port or full two-port calibrations using the HP 8506x series of two-port electronic calibration modules.

Using a single connection to a variable impedance, solid-state calibration standard (the calibration module) the HP 85060C can create either a 12-Term, two-port error model, or a 3-Term, one-port error model. The single connection setup can be applied to connector configurations including insertable and non-insertable.

The HP 85060C is designed for use with HP 8510B, HP 8510C, HP 8719C, HP 8720C, HP 8722C, HP 8753C, and HP 8753D network analyzer systems. It houses a central processing unit with built-in firmware and controls the entire calibration process from either the front panel of the network analyzer or through an external system controller.

1-2 Documentation

This manual contains the information required to install, operate, program, and service the HP 85060C Electronic Calibration Control Unit.

This manual is divided into seven major chapters:

CHAPTER 1 GENERAL INFORMATION

CHAPTER 2 INSTALLATION

CHAPTER 3 OPERATION

CHAPTER 4 COMMAND REFERENCE

CHAPTER 5 TROUBLESHOOTING

CHAPTER 6 REPLACEMENT PROCEDURES

CHAPTER 7 REPLACEABLE PARTS

Additional copies of this manual can be ordered separately through your nearest Hewlett-Packard office. The part number is listed on the inside of the title page of this manual.

1-3 Specifications

Electrical and mechanical characteristics are listed in Table 1-1. These characteristics are the standards or limits against which the instrument may be tested.

Environmental specifications are listed in Table 1-2.

1-4 Safety Considerations

This product is a Safety Class I instrument, that is, one provided with a protective earth terminal. The ECal Control Unit and all documentation should be reviewed for familiarization with safety markings and instructions before operation. Refer to the Safety Considerations page found at the beginning of this manual for a summary of the safety information. Safety information for installation, operation, and performance testing is found in appropriate places throughout this manual.

1-5 Instruments Covered by this Manual

Attached to the rear panel of this instrument is a serial number plate which shows the instrument's model and serial numbers. The serial number is in the form; 0000000000. The first six digits form the serial number prefix (the first two digits are a country code, the next four are a year/week designation). The last four digits form the suffix (a simple counting sequence). The contents of this manual apply directly to instruments having the serial numbers prefix(es) listed under SERIAL NUMBERS on the title page.

1-6 Options

- Option 001 provides front panel ECal module interconnections.
- Option 908 provides a rack mount kit which does not retain the Control Unit front handles.
- Option 910 provides an additional Operating, Programming, and Service Manual.
- Option 913 provides a rack mount kit which retains the Control Unit front handles.

1-7 Accessories Supplied

The accessories supplied with the ECal Control Unit are listed on the packing slip. The line power cable is supplied in one of several configurations, depending on the destination of the original shipment. Refer to Power Cables in Chapter 2 of this manual.

1-8 Accessories Available

Rack Mounting Kit

Two rack mount kits are available as options (see Options above). Both rack mounting kits contain all of the necessary hardware to allow the ECal Control Unit to be solidly mounted into an equipment rack.

1-9 Cables

The ECal Control Unit-to-ECal Module tuner control cable is a DB-25 style, 25 pin, male-to-male, D connector. The HP part number for this and other parts is listed in Chapter 7.

Table 1-1. Electrical and Mechanical Characteristics

Characteristics	Performance Limits
Power Requirements Line Voltage Line Frequency	90 to 250 Vac. 47 to 63 Hz.
Power Dissipation	200 VA maximum.
Safety	Meets requirements of IEC 348 and CETM 755.
Weight Net Weight Shipping Weight	40 kg (18 lbs.) 50 kg (22.5 lbs.)
Dimensions Height Width Length	100 mm (3.875 in.) 458 mm (18 in.) 569 mm (22.375 in.)

Table 1-2. Environmental Specifications

Specification	Limits
Operating Temperature ^a	0 to 55 °C (+68 to +79 °F).
Error-Corrected Temperature Range ^b	±1 °C of measurement calibration temperature.
Storage Temperature	-40 to 75 °C (-40 to +167 °F).
Barometric Pressure (Altitude) Operation Storage	<4,500 meters (15,000 feet). <15,000 meters (50,000 feet).
Relative Humidity Operation Storage	Non-condensing at all times. 0 to 80% (26 °C maximum dry bulb). 0 to 95%
EMI Conducted Susceptibility Radiated Susceptibility Radiated Emissions Magnetic Emissions	CETM 765 EN 50082-1 / IEC 801-3 CISPR11 CETM 765

- a. The temperature at which the calibration standards maintain performance to their specifications.
- b. The allowable network analyzer ambient temperature drift during measurement calibration and during measurements when the network analyzer correction is turned on. Also, the range over which the network analyzer maintains its specified performance while correction is turned on.

1
2
3
4
5
6
7
8
9
10
11
12
13
14
15
16
17
18
19
20
21
22
23
24
25
26
27
28
29
30
31
32
33
34
35
36
37
38
39
40
41
42
43
44
45
46
47
48
49
50
51
52
53
54
55
56
57
58
59
60
61
62
63
64
65
66
67
68
69
70
71
72
73
74
75
76
77
78
79
80
81
82
83
84
85
86
87
88
89
90
91
92
93
94
95
96
97
98
99
100

2 INSTALLATION

2-1 Introduction

This chapter provides the information to install the HP 85060C Electronic Calibration (ECal) Control Unit. Included is information pertinent to initial inspection, power requirements, line voltage and fuse selection, power cables, interconnection, mating connectors, operating environment, bench operations, rack mounting, and storage and shipment. In addition, this chapter contains the procedures for HP-IB address selection.

2-2 Initial Inspection

Warning To avoid hazardous electrical shock, do not turn on the instrument when there are signs of shipping damage to any portion of the outer enclosure (covers, panels, display).

If the shipping container or cushioning material is damaged, keep it until the contents of the shipment are checked for completeness, and the instrument is checked both mechanically and electrically.

Procedures for checking electrical performance are given in Chapter 3. If the ECal Control Unit does not pass the electrical performance tests, refer to the troubleshooting paragraphs located in Chapter 5.

Notify Hewlett-Packard if any of the following conditions exist:

- The instrument does not pass the performance tests and, using the troubleshooting procedures in Chapter 5, you cannot correct the problem.
- The instrument does not pass the performance tests and you do not wish to troubleshoot the instrument yourself.
- The shipping contents are incomplete.
- There is mechanical damage or defect.

2-3 Preparation for Use

2-3.1 Installation Checklist

Before plugging the Control Unit into the line (Main) voltage, ensure that the following steps are taken:

- Check the line (Main) voltage to ensure compatibility with Control Unit requirements (see paragraph 2-3.2, Power Requirements).
- Ensure that the fuse rating is appropriate for the line voltage used. Fuse ratings are listed in Table 2-1.
- Ensure that the power cable to be used is the required type (See paragraph 2-3.4, Power Cables).
- Plug in the power cable.

Caution BEFORE PLUGGING THIS INSTRUMENT into the line (Main) voltage, ensure that the correct voltage and fuse have been selected.

2-3.2 Power Requirements

The Control Unit requires a power source of 90 to 250 Vac, 47 to 63 Hz single phase. Power consumption is 200 VA maximum.

2-3.3 Line Voltage and Fuse Selection

Caution BEFORE PLUGGING THIS INSTRUMENT into the line (Main) voltage, ensure that the correct voltage and fuse have been selected.

Verify that the fuse is matched to the power source. See Table 2-1 for fuse ratings. Part numbers for these and other parts are listed in Chapter 7.

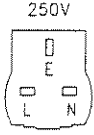

Table 2-1. Fuse Ratings

Line Voltage	Fuse Rating
115/120 VAC	4 Amperes
230/240 VAC	2 Amperes

2-3.4 Power Cables

Warning BEFORE CONNECTING THIS INSTRUMENT, the protective earth terminals of this instrument must be connected to the protective conductor of the line (Main) power cable. The line plug shall only be inserted into a socket provided with a protective earth circuit. The protective action must not be negated by the use of an extension cord (power cable) without a protective conductor (grounding). Grounding one conductor of a two conductor outlet is not sufficient protection.

This instrument is equipped with a three wire power cable. When connected to an appropriate ac power receptacle, this cable grounds the instrument chassis. The type of power cable plug shipped with each instrument depends on the country of destination. See Figure 2-1, Power Cable and Line (Main) Plug Part Numbers, for the part numbers of these power cables. Cables are available in different lengths and some with right angle plugs to the instrument. Check with your nearest HP service center for descriptions and part numbers for these cables.

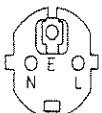
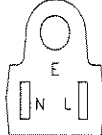
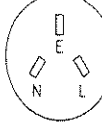
Plug Type ¹	HP Part Number ²	Plug Description ³	Cable Length cm (in)	Cable Color	For Use in Country
	8120-1351 8120-1703	Straight BS1363A 90°	229 (90) 229 (90)	Mint Gray Mint Gray	Great Britain, Cyprus, Nigeria, Singapore, Zimba- bwe
	8120-1369 8120-0696	Straight NZSS198/ASC112 90°	201 (79) 221 (87)	Gray Gray	Argentina, Austra- lia, New Zealand, Mainland China
	8120-1689 8120-1692	Straight CEE7-Y11 90°	201 (79) 201 (79)	Mint Gray Mint Gray	East a nd West Europe, Central African Republic, United Arab Republic (unpolar- ized in many nations)
	8120-1348 8120-1538	Straight NEMA5-15P 90°	203 (80) 203 (80)	Black Black	United States, Cana- da, Japan (100V or 200V), Brazil, Columbia, Mex- ico, Philippines, Saudi Arabia, Tai- wan
	8120-1378 8120-4553 8120-1 521 8120-4754	Straight NEMA5-15P Straight 90° 90°	203 (80) 230 (90) 203 (80) 230 (90)	Jade Gray Jade Gray Jade Gray Jade Gray	
	8120-5182 8120-5181	Straight NEMA5-15P 90°	200 (78) 200 (78)	Jade Gray Jade Gray	Israel

¹ E = Earth Ground, L = Line, N = Neutral
² The HP part number shown is for the complete cable, including the plug.
³ Part number is the industry identifier for the plug only.

Figure 2-1. Power Cable and Line (Main) Plug Part Numbers

2-3.5 HP-IB Address Selection for the Control Unit

The HP-IB address for the ECal control unit is selectable from the rear panel using the DIP switch shown in Figure 2-2. When shipped from the factory the address of the HP 85060C is 18. HP-IB addresses from 0 to 30 can be used.

2-3.6 HP-IB Address Selection for the Network Analyzer

The HP-IB address for the network analyzer is selectable from the rear panel using the DIP switches shown in Figure 2-2. When shipped from the factory, the address of the network analyzer is typically 16. Refer to your network analyzer for the actual address. HP-IB addresses from 0 to 30 can be used.

2-3.7 Additional Switch Settings

Both DIP switches contain additional switches labeled "A", "B", and "T" or "S". Switches "A" and "B" are for future options and should be left in the "0" position. "T" is a factory test switch and should be left in the "0" position. "S" is used to specify the system controller mode; in the "1" position, the ECal Control Unit functions as the system controller, in the "0" position, it does not.

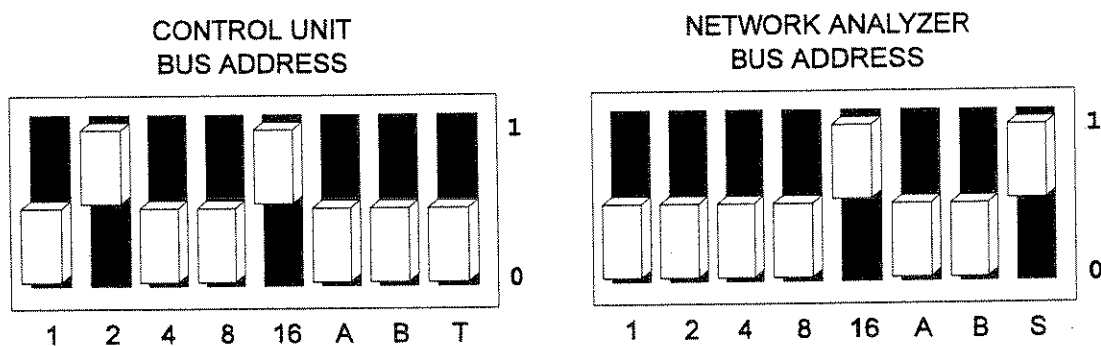

Figure 2-2. Rear Panel HP-IB Address Selection DIP Switches

2-3.8 Interconnections

The connection from the ECal Control Unit to the ECal Module is made through Tuner Control cables. These cables are specifically designed for this application, including EMI considerations, and are the only cables which should be used.

2-3.9 Mating Connectors

HP-IB Interface Connector. The HP-IB mating connector is standard IEEE-488. Note that the two securing screws are metric.

2-3.10 Operating Environment

The operating environment for the ECal Control Unit is specified in Table 1-2, *Environmental Specifications*.

The operating environment for the ECal Modules is specified in the applicable Operating and Service manual(s).

2-3.11 Bench Operation

The instrument has plastic feet and fold away tilt stands for convenience in bench operation. The plastic feet are designed to ensure self aligning of instruments when stacked. The tilt stands raise the front of the instrument for easier viewing of the front panel.

A stacked bench setup diagram is provided as an example in Figure 2-3.

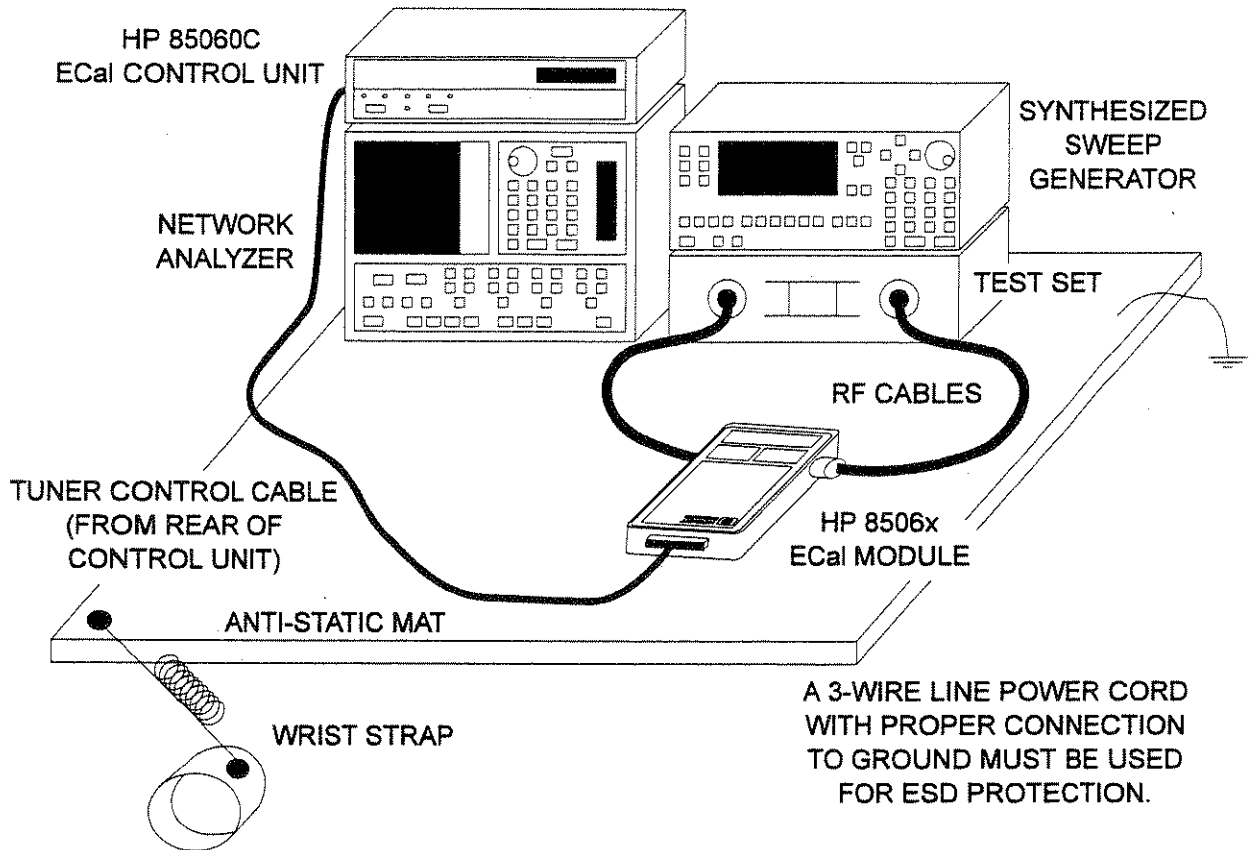

Figure 2-3. HP 85060C ECal System Bench Set-up Example

2-3.12 Rack Mounting

The Control Unit may be rack mounted using Hewlett-Packard sub-module cabinets. Rack mounting information is provided with the rack mounting kits. If the kits were not ordered with the instrument as options, they may be ordered through the nearest Hewlett-Packard office. Refer to Options in Chapter 1 for information regarding rack mounting kits.

2-4 Storage and Shipment

2-4.1 Environment

The storage and shipment environment for the ECal Control Unit is specified in Table 1-2, *Environmental Specifications*. The storage and shipment environment for the ECal Modules is specified in the applicable Operating and Service manual(s).

2-4.2 Packaging

Tagging for Service. If the instrument is being returned to Hewlett-Packard for service, please provide the following information (attach to the instrument if possible):

- a. COMPANY NAME
- b. COMPANY ADDRESS
- c. TECHNICAL CONTACT PERSON
- d. TELEPHONE NUMBER and EXTENSION
- e. MODEL NUMBER
- f. SERIAL NUMBER
- g. P.O. NUMBER
- h. DATE
- i. ACCESSORIES RETURNED WITH INSTRUMENT
- j. TYPE OF SERVICE NEEDED (REPAIR, CALIBRATION, etc...)
- k. FAILURE DESCRIPTION

To minimize repair time, be as specific as possible when describing the failure. Keep the following two items in mind when describing the failure:

1. Describe what makes you think the instrument is failing. An example might be "The network analyzer menus do not appear when I push the RUN button on the Control Unit".
2. If the failure occurs only under certain conditions, explain how to duplicate the failure. An example might be "The Control Unit will not calibrate the network analyzer in the 45 MHz to 1.5 GHz range."

Original Packaging. Containers and materials identical to those used in factory packaging are available through Hewlett-Packard offices. Mark the container "FRAGILE" to encourage careful handling. In any correspondence, refer to the instrument by model number and full serial number.

Other Packaging. The following general instructions should be used for repackaging with commercially available materials.

1. Wrap the instrument in heavy paper or ESD protective packaging. If shipping to a Hewlett-Packard office or repair center, supply the information mentioned above (in Tagging For Service) and attach it to the instrument.
2. Use a strong shipping container. A double-wall carton made of 2.4 MPa (350 psi) test material is adequate.
3. Use enough shock-absorbing material (75 to 100 mm layer; 3 to 4 inches) around all sides of the instrument to provide a firm cushion and prevent movement in the container. Protect the front panel with an appropriate type of cushioning material to prevent damage during shipment.
4. Seal the shipping container securely.
5. Mark the shipping container "FRAGILE" to encourage careful handling.

3 OPERATION

3-1 Introduction

This chapter describes the operation and characteristics of the ECal system, illustrates the features and functions of the standard and optional front and rear panels of the ECal control unit and explains the setup and use of the control unit in a system.

3-1.1 ESD Cautions

Always use an antistatic wrist strap when calibrating or verifying the test set or when using the test set to measure devices. Never touch test port or ECal module center conductors or the exposed pins of the tuner control cable.

3-2 Theory of Operation

The ECal (Electronic Calibration) system determines the systematic errors of a vector network analyzer through a one-time connection of the ECal module to the network analyzer port(s). The random error of connector non-repeatability is reduced substantially through the one-time connection when compared to the frequent connects and disconnects of the conventional method (open / short / load).

The ECal Module is a solid state, microwave, two-port device which is capable of establishing a plurality of reflection coefficients at each of its ports, a low-loss transmission coefficient between its ports, and also high isolation between its ports. This allows the module to simulate a wide variety of conventional calibration standards. These coefficients are characterized (pre-calibrated) for each module at the factory, and the characterization is stored within each module. The characterization is traceable to the National Institute of Standards and Technology (NIST).

Since the response of the ECal module is known—to a high degree of accuracy—the ECal system can present one or more of these modules, use the results of these uncorrected measurements to produce error coefficients, and provide these error coefficients for use by the accuracy enhancement algorithms of the network analyzer. The network analyzer can then use this data in a model of the measurement system, measure a device, and utilize vector mathematics to compute actual device response by removing error contributions.¹

Figure 3-1 shows a typical ECal system conceptual diagram. Figure 3-2 shows a typical operating sequence.

1. For more information, please reference “A Novel Approach for Network Analyzer Calibration and Verification”, by Vahé Adamian, ARFTG Digest, Spring 1993.

Note

Drawing is not to scale.

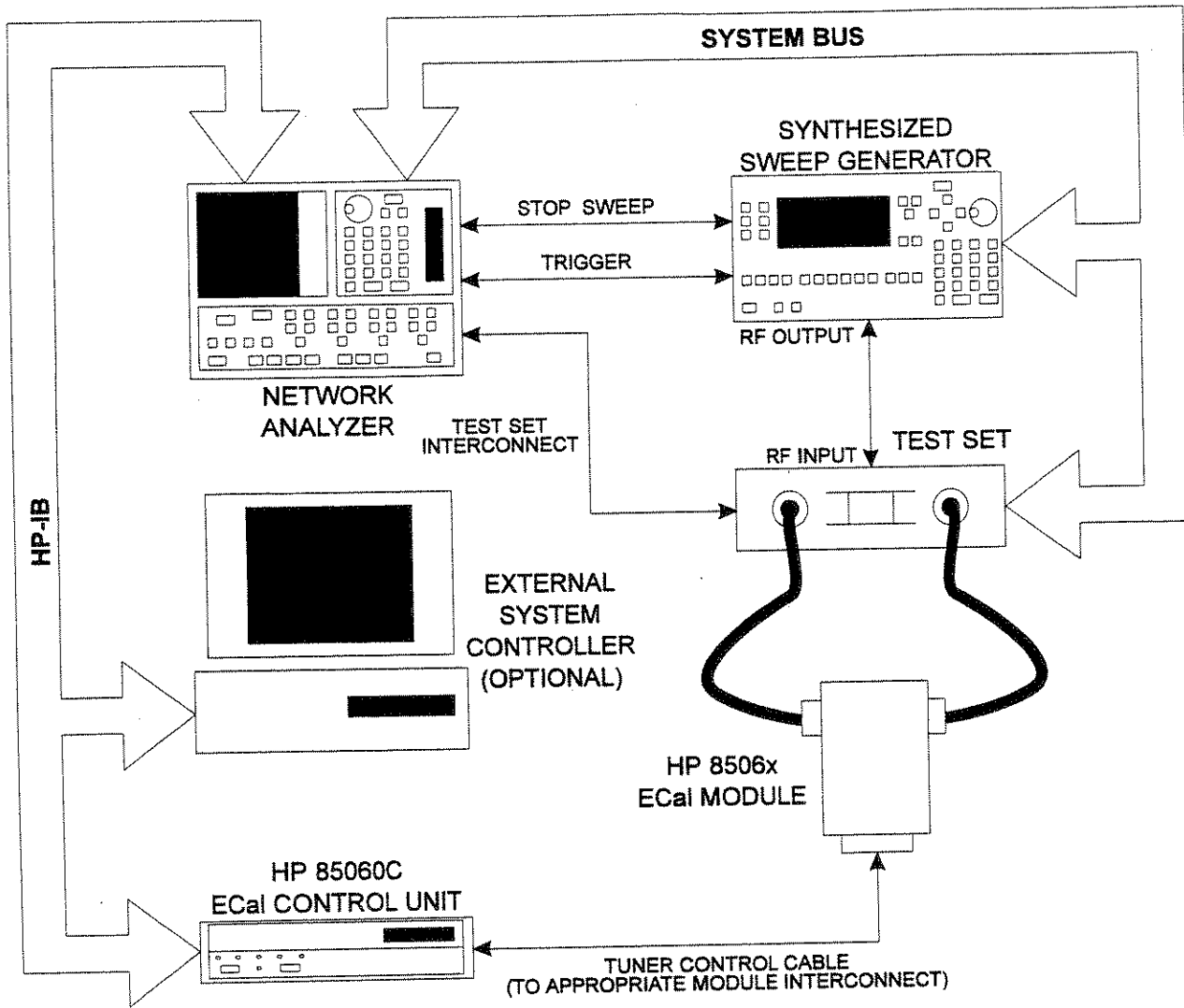

Figure 3-1. HP 85060C ECal System Conceptual Block Diagram

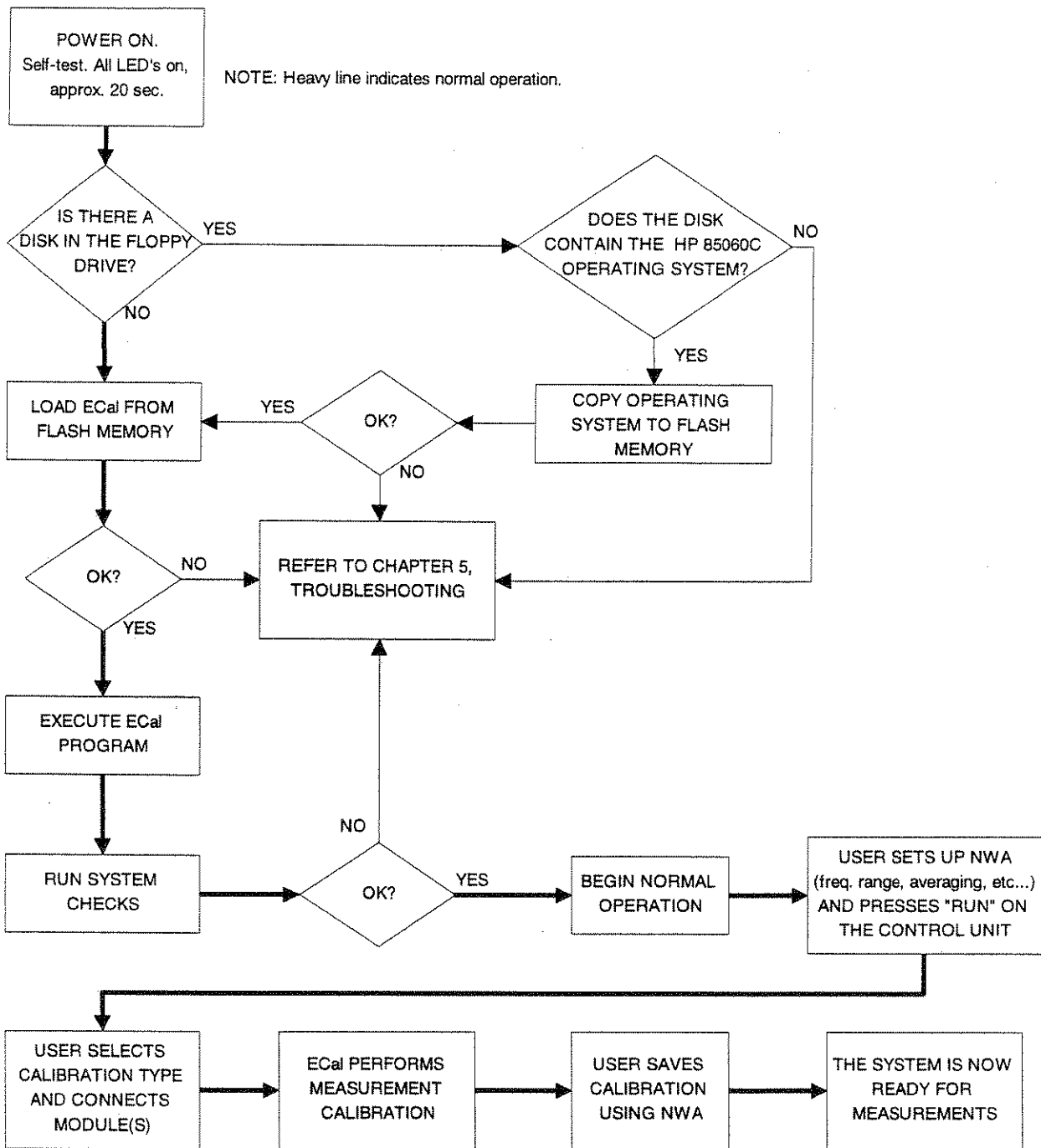

Figure 3-2. Typical Operating Sequence

3-3 Operating Characteristics

The operating characteristics of the ECal control unit are largely module dependent. Table 3-1 briefly summarizes the major operating characteristics of the ECal System, i.e.; the control unit with module(s). This table is not intended to be an in-depth listing of all operations and ranges but gives an idea of the instruments capabilities.

RF Input Power is +20 dBm maximum, any module, any condition.

Table 3-1. Operating Characteristics

Module Part Number	Connector Type	Frequency Range
85060-60001	7 millimeter	45 MHz to 2 GHz
85060-60002	7 millimeter	1 to 18 GHz
85062-60001	3.5 millimeter, insertable	45 MHz to 2 GHz
85062-60002	3.5 millimeter, insertable	1 to 26.5 GHz
85062-60003	3.5 mm, non-insertable male	45 MHz to 2 GHz
85062-60004	3.5 mm, non-insertable male	1 to 26.5 GHz
85062-60005	3.5 mm, non-insertable female	45 MHz to 2 GHz
85062-60006	3.5 mm, non-insertable female	1 to 26.5 GHz
85064-60001	Type N, insertable	45 MHz to 2 GHz
85064-60002	Type N, insertable	1 to 18 GHz
85064-60003	Type N, non-insertable male	45 MHz to 2 GHz
85064-60004	Type N, non-insertable male	1 to 18 GHz
85064-60005	Type N, non-insertable female	45 MHz to 2 GHz
85064-60006	Type N, non-insertable female	1 to 18 GHz

3-4 Turn-on Information

Warning

Before the instrument is switched on, all protective earth terminals, extension cords, autotransformers, and devices connected to it should be connected to a protective earth grounded socket. Any interruption of the protective earth grounding will cause a potential shock hazard that could result in personal injury. Only fuses listed in Table 2-1 should be used. Do not use repaired fuses or short circuited fuseholders. To do so could cause a shock or fire hazard.

Turn-on Procedure.

If the control unit is already plugged in, press the line switch to ON. If the power cable is not plugged in, follow these instructions:

1. Check that the fuse rating is appropriate for the line voltage used (see Table 2-1).
2. Plug in the power cable.
3. Insure that there is no diskette in the floppy drive unless an ECal System firmware upgrade is to be performed.
4. On the front panel, press the LINE switch to ON.

When the control unit is turned on, all of the front panel LED's will come on until the power up is complete. When power up is complete all of the LED's, except the Line Power LED, will turn off.

If any of the LED's fail to come on, the Line Power LED fails to remain on, or the other LED's remain on after power up, refer to Chapter 5, Troubleshooting.

3-5 Connecting / Disconnecting Modules

Warning DO NOT connect or disconnect calibration modules while loading system software using the floppy drive. Doing so may cause internal damage to the control unit.

At other times, modules may be connected or disconnected during control unit operation, although sufficient module warm-up time must be allowed before initiation of the calibration process (see note below).

Ensure that only HP 8506x ECal Modules are connected to the ECal control unit module interface, and that only Tuner Control Cables provided with the ECal Control Unit are used.

Note *Valid calibration can not be guaranteed without proper warm-up. Refer to the appropriate calibration kit Operating and Service Manual.*

The control unit automatically recognizes ECal modules as they are connected. Any of the four module interconnections may be used for any ECal module. The ECal system will recognize a module as Module A, B, C, or D based on the module interconnection used.

Unused modules, or modules that have completed the calibration process, may be left connected and, therefore, warmed up and ready for use. Insure that proper care is taken with ECal modules at all times, refer to the appropriate calibration kit Operating and Service Manual for more information.

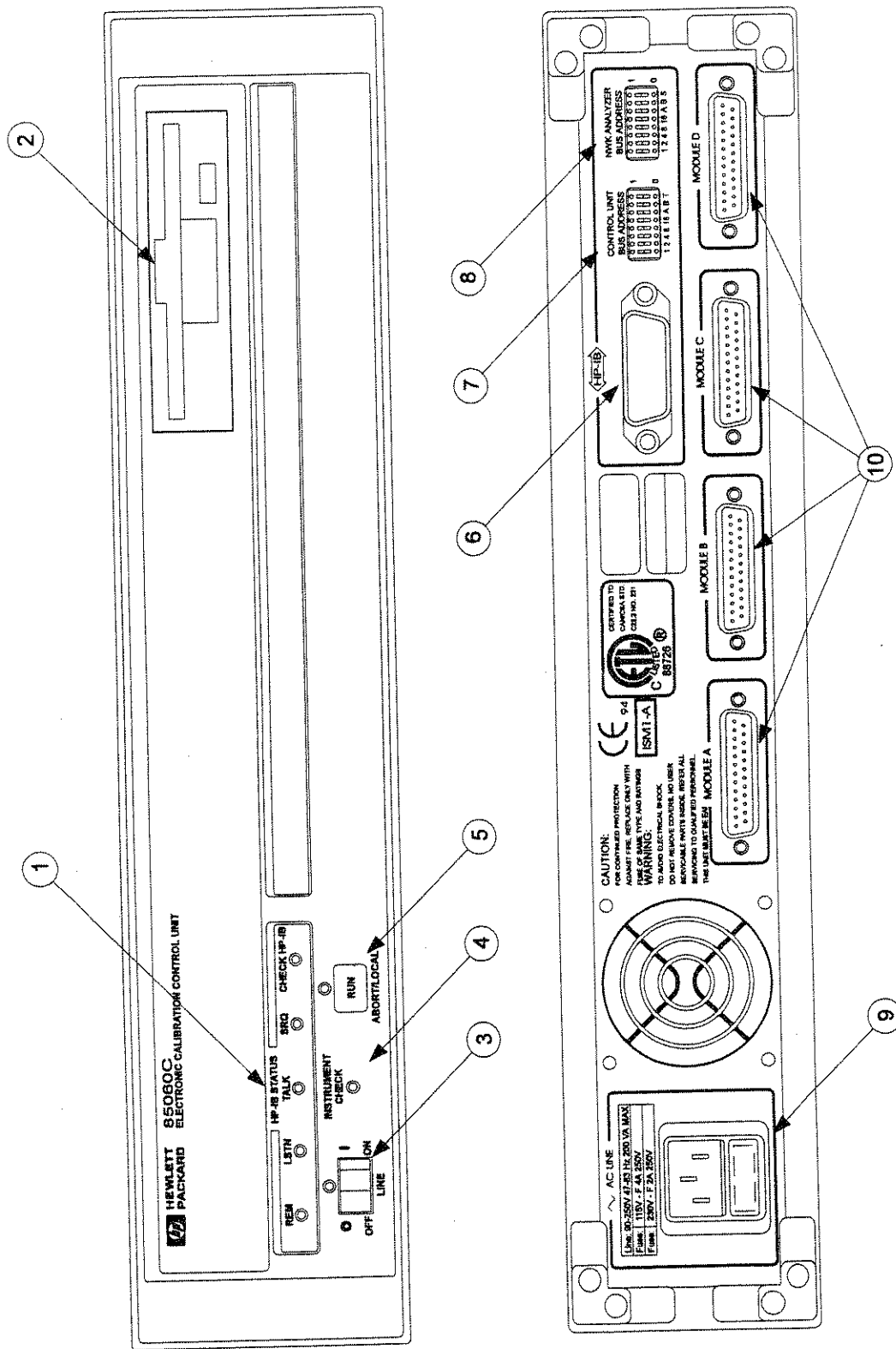

Figure 3-3. Front and Rear Panel Features

3-6 Panel Features

3-6.1 Front Panel and Rear Panel Features for the Standard and Optional Configurations

Figure 3-3 shows the ECal control unit front and rear panel features for the standard configuration (rear panel ECal module interconnections).

In the optional configuration (front panel ECal module connections) the functionality of all of the features remain the same as in the standard configuration. Only the location of the module interconnections is changed.

Refer to Figure 3-3 for the following panel feature descriptions.

1. **HP-IB Status LED's.** These LED's show the HP-IB interface status as follows:
REM: When illuminated this LED indicates the interface is in the REMOTE mode.
LSTN: When illuminated this LED indicates the ECal control unit is addressed as LISTENER.
TALK: When illuminated this LED indicates the ECal control unit is addressed as TALKER.
SRQ: When illuminated this LED indicates the ECal control unit is asserting a SERVICE REQUEST.
Check HP-IB: When illuminated this LED indicates an HP-IB (IEEE-488) fault.
2. **3.5 inch Floppy Disk Drive.** Used for ECal firmware upgrades. Floppy drive usage is not required for operation.
3. **Line Switch and Line LED.** The line switch turns the ECal control unit on and off. When the side of the switch labeled 0 is depressed, the control unit is off; 1 is on. The line LED goes on and off with the control unit line switch.
4. **Instrument Check LED.** Continued illumination of this LED after turn-on indicates a that the built-in diagnostic routine has detected some problem. Refer to Chapter 5, Troubleshooting.
5. **Run Switch.** The RUN switch controls test set calibration from the front panel of the control unit. Depressing this switch begins the calibration process. This switch also functions as an ABORT to stop the calibration process.
6. **System Bus Connector.** This connector is used for HP-IB communications with the network analyzer.
7. **Control Unit Bus Address Switch.** This eight-pole weighted switch sets the system bus address of the control unit. The binary weight of each pole is indicated on the rear panel, as are the on and off positions. Decimal 18 is the default setting. See paragraph 2-3.5 and 2-3.7 for more information.
8. **Network Analyzer Bus Address Switch.** This eight-pole weighted switch sets the system bus address of the network analyzer. The binary weight of each pole is indicated on the rear panel, as are the on and off positions. Decimal 16 is the default setting. See paragraph 2-3.6 and 2-3.7 for more information.
9. **Line Module.** This assembly houses the line cord connector and line fuse. Pull out the bottom of the line module cover to replace or change the fuse. Recommended fuse values are printed on the rear panel.
10. **ECal Module Interconnects.** These connectors transmit the control information to the appropriate calibration module. The connections for the individual modules are printed on the rear panel (Module A, B, C, or D).

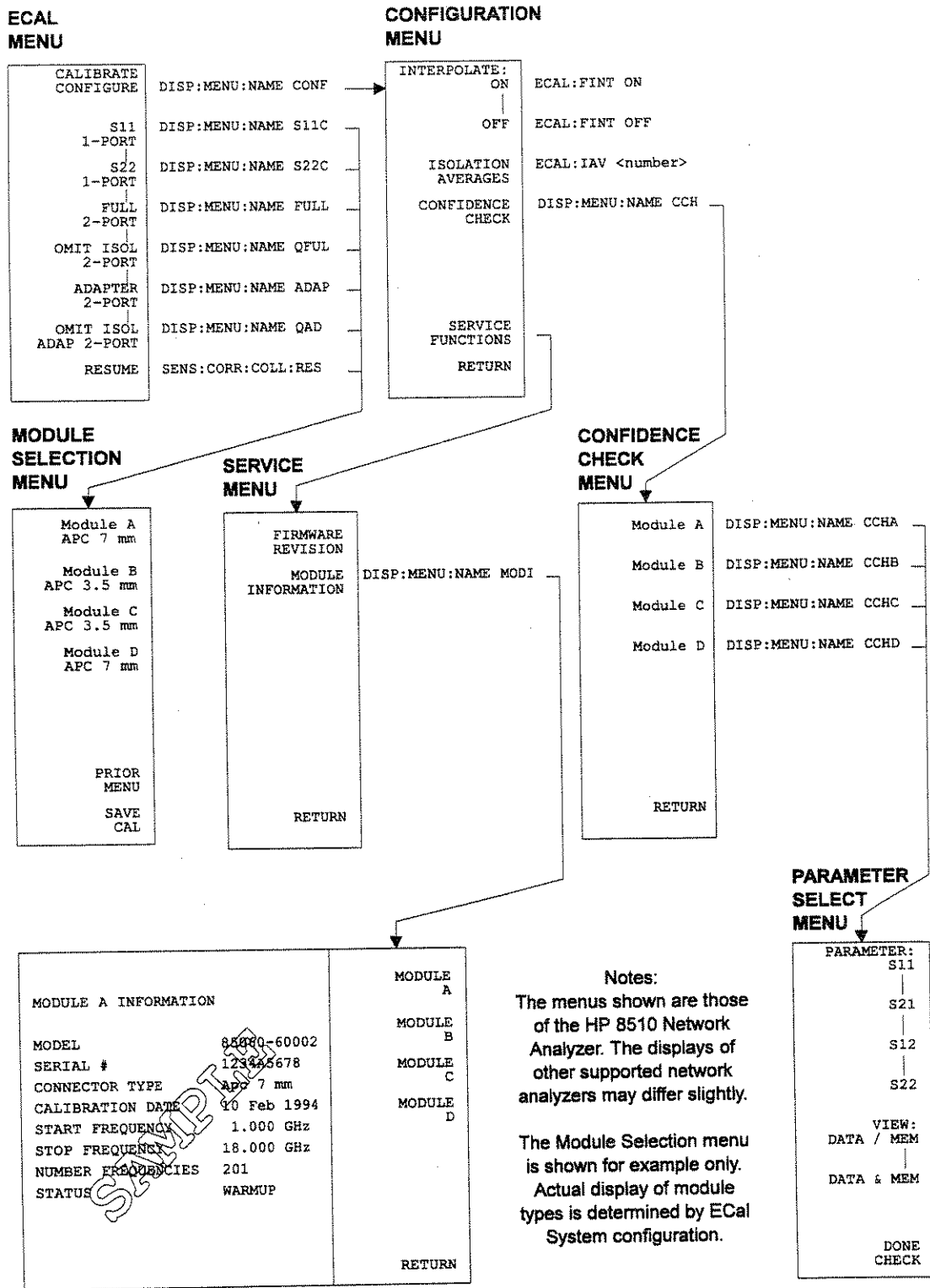

Figure 3-4. Sample Network Analyzer ECal Menus

3-7 Stand-alone (Manual) Operation

This section describes typical stand-alone (manual) operation of the ECal calibration process and provides step-by-step instructions on performing specific calibrations.

3-7.1 System Configuration for Stand-alone Operation

- Connect the network analyzer to the ECal control unit via HP-IB cable (when using the HP 8510, use the HP-IB connector as opposed to the 8510 Interconnect).
- Insure ECal is set as the system controller, see paragraph 2-3.7 for DIP switch settings. Other instruments may be on the bus, but ECal must be the only controller.
- The ECal control unit and the network analyzer each must have unique HP-IB addresses as defined on the ECal rear panel. Defaults are 18 for the ECal control unit, 16 for the network analyzer. Again, see paragraph 2-3.7 for DIP switch settings.

Note *DIP switch settings are only read during the boot cycle. After changing settings, remember to cycle power to use the new settings.*

3-7.2 Accessing Menus

All calibration menus and prompts required in the ECal process will be displayed on the network analyzer.

- Pressing "RUN" on the ECal control unit initiates the calibration process as follows:
- Illuminates the ECal control unit "RUN" LED.
- Accesses the ECal top level menu on the network analyzer display using commands appropriate to the module type(s). Pressing one of the softkeys will then access ECal sub-menus, shown in Figure 3-4. The ECal menus will remain on the display until a network analyzer action accesses a non-ECal menu, or the ECal front panel "RUN" button is pressed.

If the ECal menus do not appear, note the condition of the ECal front panel LED's and refer to Chapter 5, Troubleshooting.

3-7.3 Types of Analyzers

The ECal System is designed to work with a variety of network analyzers. Supported models are listed in paragraph 1-1 of this manual.

3-7.4 Setting Calibration Parameters

Calibration parameters define specific calibration settings or provide the user with information on the ECal setup. Select "CALIBRATION CONFIGURE" in the top level ECal menu to access the configuration menu (see Figure 3-4). The function of each calibration parameter is as follows:

Interpolate <ON | OFF>. The Interpolate <ON | OFF> function is used to enable or disable the frequency interpolation capability of the ECal system. With interpolation ON (enabled), any frequencies within the span of the characterized modules may be measured. With interpolation OFF (disabled), only frequencies which correspond to characterization frequencies of the modules will be allowed.

Isolation Averages. For all calibration measurements other than Isolation, calibration measurements will be performed with the averaging value specified in the network analyzer setup. Typically, the user will increase the number of averages significantly if Isolation measurements are to be performed. The Isolation Averages function is used to set the number of averages to a user specified value (1-4096 for the HP 8510, 1-999 for the HP 87xx series).

Confidence Check. This function provides a comparison of the current ECal module measurements vs. the factory characterization measurements. Results are displayed using the network analyzer.

Service Functions:Firmware Revision. This function will display the ECal system firmware revision on the network analyzer display.

Service Functions:Module Information. This function will display the following module information on the network analyzer display; Model Number, Serial Number, Connector Type, Calibration Date, Start Frequency, Stop Frequency, Number of Frequencies, and Current Module Status.

Return. This function will return the user to the top level menu.

3-7.5 Selecting Modules

ECal module selection is performed by the user and should be based on connector type and frequency range of the device-under-test. Available modules are listed by part number and description in Table 3-1.

3-7.6 Performing Calibrations

The calibration type and procedure to be used depends on the type and accuracy of measurement required for the device-under-test. The following paragraphs provide information regarding the six available calibration types, including the best application for each type and a brief description. For more detailed information, refer to the appropriate network analyzer user's manual or Hewlett-Packard application notes.

Calibrations are performed using the network analyzer configuration settings (number of averages, etc...) with the exception of isolation calibrations which are performed using the number of averages set in the ECal configuration menu.

When using HP 8510 series network analyzers, calibrations cannot be performed in the ramp sweep mode. If ramp sweep is required during measurement of the device-under-test, calibrate in step mode and perform measurements in ramp mode. When switching from step to ramp mode, the message CAUTION: CORRECTION MAY BE INVALID will be displayed. It is the users responsibility to determine whether the change invalidates the calibration. This can be accomplished by comparing the DUT response in step vs. ramp mode. In general, ramp sweep is recommended only for tuning purposes; for accurate device measurements, use step sweep.

Likewise, for HP 8720 series network analyzers, "swept" mode calibrations are not allowed. Calibrations should be performed using sweep type "STEPPED ON". If swept measurements are required, calibrate in step mode (STEPPED ON) and perform measurements in swept mode (STEPPED OFF). The network analyzer will display the message "C?" to indicate that the sweep type was changed.

Paragraphs 3-7.6.1 through 3-7.6.6 describe the calibration procedures in detail.

Notes

Insertable devices are those in which the mating connectors are of the same type, opposite gender. For example; a device where the input connector is male, and the output connector is female. Non-Insertable devices are those in which the mating connectors are of the same type, and same gender. For example; a device where both input and output connectors are female.

For adapter calibrations using multiple (more than one) calibration modules, all modules must be measured before adapters are measured.

The **S11 1-PORT** calibration is best applied to high accuracy reflection measurements of one-port devices using Port 1 of the test set.

This calibration determines the directivity, source match, and reflection tracking error terms. These terms are then loaded into the network analyzer to be used in vector error correction for reflection measurements.

The **S22 1-PORT** is essentially the same calibration as the S11 1-PORT, but uses Port 2 of the test set.

The **FULL 2-PORT** calibration is best applied to high accuracy magnitude and phase measurements (including isolation) of insertable two-port devices.

This 12-term calibration provides full directivity, isolation, source match, load match, and frequency response vector error correction for transmission and reflection measurements. It requires measurement of all four S-parameters and is therefore more time consuming.

The **OMIT ISOL 2-PORT** calibration is best applied to high accuracy magnitude and phase measurements (excluding isolation) of insertable two-port devices.

This calibration provides all of the functionality of the FULL 2-PORT calibration with the exception of isolation measurements, and is therefore quicker.

The **ADAPTER 2-PORT** calibration is best applied to high accuracy magnitude and phase measurements (including isolation) of non-insertable two-port devices. This is essentially the same calibration as the **FULL 2-PORT** with the exception that metrology grade adapters are used.

This 12-term calibration provides full directivity, isolation, source match, load match, and frequency response vector error correction for transmission and reflection measurements. It requires measurement of all four S-parameters and is therefore more time consuming.

The **OMIT ISOL ADP 2-PORT** calibration is best applied to high accuracy magnitude and phase measurements (excluding isolation) of non-insertable two-port devices. This is essentially the same calibration as the **OMIT ISOL 2-PORT** with the exception that metrology grade adapters are used.

This calibration provides all of the functionality of the **ADAPTER 2-PORT** calibration with the exception of isolation measurements, and is therefore quicker.

3-7.6.1 Optimizing Performance in the Overlapping Frequency Range

The HP 85060 series calibration kits may contain two modules, lowband and highband, which overlap in frequency coverage. For example; the HP 85060A with Option 001 contains a lowband (0.045-2 GHz) module and a high band (1-18 GHz) module. In the overlapping frequency range, the module specifications may vary.

When performing measurements in the overlapping frequency range, use the module with the best specifications over the overlapping frequency range. Consult the *HP 85060 Family Electronic Calibration System Product Overview* or the network analyzer verification software for specifications.

When performing broadband calibrations that span the overlapping frequency range, e.g. 0.045-18 GHz, the HP 85060C control unit uses the data from the module which was connected *last* during the calibration sequence. For best performance, connect the highest performance module last during the calibration sequence.

3-7.7 Calibration Procedures

3-7.7.1 To Perform an S11 1-PORT Calibration

1. Set up the network analyzer as required (see the appropriate network analyzer user's manual for more information).
2. Select the appropriate ECal module(s) for frequency range and connector type (see Table 3-1 for a listing).
3. Connect ECal module to the control unit to begin the warm-up. Refer to the appropriate calibration kit Operating and Service Manual.
4. Press "RUN" on the control unit.
5. Select "S11 1-PORT" from the top level menu of the network analyzer (see Figure 3-4). This will access the measurement menus.
6. Connect the module to Port 1 of the network analyzer (although module Port A or B may be used interchangeably for single port measurements, module Port A is preferred).
7. Press the appropriate measurement key for the module type connected. The ECal system will now begin the calibration process, progress is indicated on the network analyzer display. Upon calibration completion, the module designation (Module A, B, etc...) will be underlined on the network analyzer menu.
8. Repeat as necessary using all modules required to cover the desired frequency band.
9. Press "SAVE CAL" on the measurement menu.
10. Select a storage register from the network analyzer save register menu. The HP 8510B/C will request the user to select a calset register, this is optional on the HP 87xx series network analyzers. The ECal control unit floppy drive can not be used for this purpose.
11. Calibration is now complete. The network analyzer display returns to the top level menu.

3-7.7.2 To Perform an S22 1-PORT Calibration

1. Set up the network analyzer as required (see the appropriate network analyzer user's manual for more information).
2. Select the appropriate ECal module(s) for frequency range and connector type (see Table 3-1 for a listing).
3. Connect ECal module to the control unit to begin the warm-up. Refer to the appropriate calibration kit Operating and Service Manual.
4. Press "RUN" on the control unit.
5. Select "S22 1-PORT" from the top level menu of the network analyzer (see Figure 3-4). This will access the measurement menus.
6. Connect the module to Port 2 of the network analyzer (although module Port A or B may be used interchangeably for single port measurements, module Port A is preferred).
7. Press the appropriate measurement key for the module type connected. The ECal system will now begin the calibration process, progress is indicated on the network analyzer display. Upon calibration completion, the module designation (Module A, B, etc...) will be underlined on the network analyzer menu.
8. Repeat as necessary using all modules required to cover the desired frequency band.
9. Press "SAVE CAL" on the measurement menu.
10. Select a storage register from the network analyzer save register menu. The HP 8510B/C will request the user to select a calset register, this is optional on the HP 87xx series network analyzers. The ECal control unit floppy drive can not be used for this purpose.
11. Calibration is now complete. The network analyzer display returns to the top level menu.

3-7.7.3 To Perform a FULL 2-PORT Calibration

1. Set up the network analyzer as required (see the appropriate network analyzer user's manual for more information).
2. Select the appropriate ECal module(s) for frequency range and connector type (see Table 3-1 for a listing).
3. Connect ECal module to the control unit to begin the warm-up. Refer to the appropriate calibration kit Operating and Service Manual.
4. Press "RUN" on the control unit.
5. Select "FULL 2-PORT" from the top level menu of the network analyzer (see Figure 3-4). This will access the measurement menus.
6. Connect the module to the network analyzer.
7. Press the appropriate measurement key for the module type connected. The ECal system will now begin the calibration process, progress is indicated on the network analyzer display. Upon calibration completion, the module designation (Module A, B, etc...) will be underlined on the network analyzer menu.
8. Repeat as necessary using all modules required to cover the desired frequency band.
9. Press "SAVE CAL" on the measurement menu.
10. Select a storage register from the network analyzer save register menu. The HP 8510B/C will request the user to select a calset register, this is optional on the HP 87xx series network analyzers. The ECal control unit floppy drive can not be used for this purpose.
11. Calibration is now complete. The network analyzer display returns to the top level menu.

3-7.7.4 To Perform an OMIT ISOL 2-PORT Calibration

1. Set up the network analyzer as required (see the appropriate network analyzer user's manual for more information).
2. Select the appropriate ECal module(s) for frequency range and connector type (see Table 3-1 for a listing).
3. Connect ECal module to the control unit to begin the warm-up. Refer to the appropriate calibration kit Operating and Service Manual.
4. Press "RUN" on the control unit.
5. Select "OMIT ISOL 2-PORT" from the top level menu of the network analyzer (see Figure 3-4). This will access the measurement menus.
6. Connect the module to the network analyzer.
7. Press the appropriate measurement key for the module type connected. The ECal system will now begin the calibration process, progress is indicated on the network analyzer display. Upon calibration completion, the module designation (Module A, B, etc...) will be underlined on the network analyzer menu.
8. Repeat as necessary using all modules required to cover the desired frequency band.
9. Press "SAVE CAL" on the measurement menu.
10. Select a storage register from the network analyzer save register menu. The HP 8510B/C will request the user to select a calset register, this is optional on the HP 87xx series network analyzers. The ECal control unit floppy drive can not be used for this purpose.
11. Calibration is now complete. The network analyzer display returns to the top level menu.

3-7.7.5 To Perform an ADAPTER 2-PORT Calibration

1. Set up the network analyzer as required (see the appropriate network analyzer user's manual for more information).
2. Select the appropriate ECal module(s) for frequency range and connector type (see Table 3-1 for a listing). Also, select the appropriate adapter(s).
3. Connect ECal module to the control unit to begin the warm-up. Refer to the appropriate calibration kit Operating and Service Manual.
4. Press "RUN" on the control unit.
5. Select "ADAPTER 2-PORT" from the top level menu of the network analyzer (see Figure 3-4). This will access the measurement menus.
6. Connect the module(s) to Port 2 of the network analyzer as shown in Figure 3-5.
7. Press the appropriate measurement key for the module type connected. The ECal system will now begin the calibration process, progress is indicated on the network analyzer display. Upon calibration completion, the module designation (Module A, B, etc...) will be underlined on the network analyzer menu.
8. Repeat as necessary using all modules required to cover the desired frequency band.
9. Press "NEXT MENU" to continue.
10. Connect the adapter to Port 2 of the network analyzer as shown in Figure 3-5.

Notes

For adapter calibrations using multiple (more than one) calibration modules, all modules must be measured before adapters are measured.

For best accuracy, once connected to Port 2 the adapter should remain connected until calibration is complete.

11. Connect the module between Port 1 of the network analyzer and the adapter as shown in Figure 3-5.
12. Repeat step 7.
13. Repeat as necessary using all modules required to cover the desired frequency band.
14. Press "SAVE CAL" on the measurement menu.
15. Select a storage register from the network analyzer save register menu. The HP 8510B/C will request the user to select a calset register, this is optional on the HP 87xx series network analyzers. The ECal control unit floppy drive can not be used for this purpose.
16. Calibration is now complete. The network analyzer display returns to the top level menu.

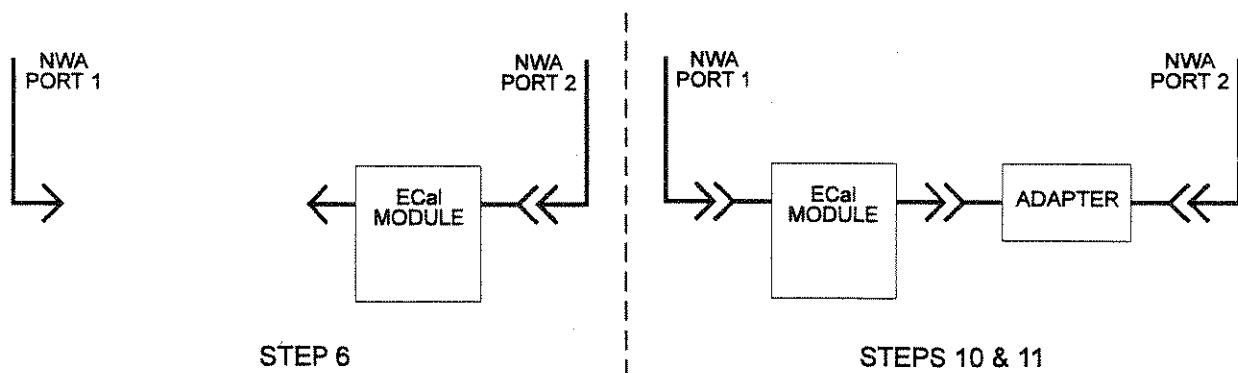

Figure 3-5. Adapter Calibration Connection Diagram

3-7.7.6 To Perform an OMIT ISOL ADP 2-PORT Calibration

1. Set up the network analyzer as required (see the appropriate network analyzer user's manual for more information).
2. Select the appropriate ECal module(s) for frequency range and connector type (see Table 3-1 for a listing). Also, select the appropriate adapter(s).
3. Connect ECal module to the control unit to begin the warm-up. Refer to the appropriate calibration kit Operating and Service Manual.
4. Press "RUN" on the control unit.
5. Select "OMIT ISOL ADP 2-PORT" from the top level menu of the network analyzer (see Figure 3-4). This will access the measurement menus.
6. Connect the module(s) to Port 2 of the network analyzer as shown in Figure 3-5.
7. Press the appropriate measurement key for the module type connected. The ECal system will now begin the calibration process, progress is indicated on the network analyzer display. Upon calibration completion, the module designation (Module A, B, etc...) will be underlined on the network analyzer menu.
8. Repeat as necessary using all modules required to cover the desired frequency band.
9. Press "NEXT MENU" to continue.
10. Connect the adapter to Port 2 of the network analyzer as shown in Figure 3-5.

Notes

For adapter calibrations using multiple (more than one) calibration modules, all modules must be measured before adapters are measured.

For best accuracy, once connected to Port 2 the adapter should remain connected until calibration is complete.

11. Connect the module between Port 1 of the network analyzer and the adapter as shown in Figure 3-5.
12. Repeat step 7.
13. Repeat as necessary using all modules required to cover the desired frequency band.
14. Press "SAVE CAL" on the measurement menu.
15. Select a storage register from the network analyzer save register menu. The HP 8510B/C will request the user to select a calset register, this is optional on HP 87xx series network analyzers. The ECal control unit floppy drive can not be used for this purpose.
16. Calibration is now complete. The network analyzer display returns to the top level menu.

3-7.8 Performing the Confidence Check

The CONFIDENCE CHECK function is provided as a means of checking the accuracy of a stored (saved) calibration. Each ECal module has a special state, the confidence state, which has been pre-measured. The pre-measured corrected data has been stored in nonvolatile, or permanent, module memory.

The confidence check has been designed for use after a two-port calibration. It can, however, be used after a one-port calibration provided the unused module port is terminated with a 50 ohm load with a minimum of 30 dB of return loss.

When the confidence check is selected, the ECal control unit will read the pre-measured corrected data, store it into network analyzer memory, and then use the calibration stored in the network analyzer to make a corrected measurement of the confidence state. These measurements are then presented in a graphical way.

The graphical options available depend on the type of calibration being checked. If the confidence check is used for a two-port calibration, all four S-parameters are available. For a one-port calibration, the reflection option S11 or S22 will be available, depending on the calibration type.

In any case, the data may be displayed in one of two ways:

- With the "BOTH" option, the pre-measured data *and* the current data are displayed, and a visual comparison of these measurements may be made.
- With the "DIV" option, only a ratio of the pre-measured data to the current data is displayed.

The confidence check will change many network analyzer parameters for data presentation. Choosing "DONE CHECK" will complete the confidence check and restore the network analyzer conditions—with the exception of data in memory—that were in effect before the confidence check was invoked.

3-7.8.1 To Perform a Confidence Check

1. Set up the network analyzer as required (see the appropriate network analyzer user's manual for more information).
2. Select the appropriate ECal module(s) for frequency range and connector type (see Table 3-1 for a listing). Also, select the appropriate adapter(s).
3. Connect ECal module to the control unit to begin the warm-up. Refer to the appropriate calibration kit Operating and Service Manual.
4. Press "RUN" on the control unit.
5. Select "CALIBRATE CONFIGURE" from the top level menu of the network analyzer (see Figure 3-4). This will access the configuration menu.
6. Select "CONFIDENCE CHECK" from the configuration menu. This will access the confidence check module selection menu.
7. Connect the module(s) to the network analyzer as appropriate.
8. Select a module from the module selection menu. This will access the parameter selection menu.
9. Select a parameter and / or a display option from the parameter selection menu. This will cause a series of events which include downloading the corrected pre-measured parameter data and measurement of the confidence state. The data will be presented in the manner selected.
10. If another parameter or display option is desired, repeat step 9.
11. When finished, select "DONE CHECK". This will reset the network analyzer to the conditions that were in effect when the confidence check was invoked. If this is not done, noncritical scales, parameters, and display options may be left in place.
12. Confidence check is now complete. The network analyzer display returns to the top level menu.

3-8 Remote Operation

The ECal system is capable of remote operation via the Hewlett-Packard Interface Bus (HP-IB) and is compliant with IEEE 488.2-1987, *IEEE Standard Codes, Formats, Protocols, and Common Commands for use with ANSI/IEEE Standard 488.2-1987*.

Instructions pertinent to HP-IB operation cover considerations and instructions specific to remote operation including capabilities, addressing, input and output formats, the status byte, and service requests.

3-8.1 System Configuration for Remote Operation

- Connect the host computer and network analyzer to the ECal control unit via HP-IB cable (when using the HP 8510, use the HP-IB connector as opposed to the 8510 Interconnect).
- Insure ECal is not set as the system controller, see paragraph 2-3.7 for DIP switch settings. Other instruments may be on the bus, but ECal must be the only controller.
- The host computer, the ECal control unit, and the network analyzer each must have unique HP-IB addresses as defined on the ECal rear panel. Defaults are 18 for the ECal control unit, 16 for the network analyzer. Again, see paragraph 2-3.7 for DIP switch settings.

Note

DIP switch settings are only read during the boot cycle. After changing settings, remember to cycle power to use the new settings.

3-8.2 Communicating with Host Computers

ECal functions can be grouped into two categories, those which require active control (specifically, ECal commands which talk to the network analyzer) and those which do not.

The following seven commands require active control:

- DISP:MENU:NAME
- SENS:CORR:COLL:ACQ
- SENS:CORR:COLL:SAVE
- SENS:CORR:COLL:RESU
- SENS:CORR:COLL:DONE
- SENS:CORR:COLL:NEXT
- SENS:CORR:COLL:PRI

All other commands are handled solely by the ECal control unit, and therefore do not require active control.

3-8.2.1 Sending Commands Which Require Pass Control

Commands listed in paragraph 3-8.2 require access to the network analyzer, and therefore require that the host pass control to the ECal control unit.

The following example sends the DISP:MENU:NAME ECal command which tells the control unit to display the top level ECal system menu.

```
10  OUTPUT 718;"DISP:MENU:NAME ECal"
20  CALL Pass_control
30  END
40  SUB Pass_control
50  OUTPUT 718;"*ESR?"           ! Read the Event Status Register
60  ENTER 718;Esr
70  IF NOT BIT (Esr,1) THEN      ! Ensure that ECal wants control
80      PRINT "Ecal does not want control"
90  ELSE
100     REMOTE 7
110     PASS CONTROL 718         ! Pass control to ECal
120     PRINT "CONTROL PASSED TO ECal"
130     LOOP
140         STATUS 7,3;Stat      ! Monitor Interface Status
150         EXIT IF BIT (Stat,6) ! Finish when Control is returned
160     END LOOP
170     PRINT "CONTROL RETURNED FROM ECal"
180 END IF
190 SUBEND
```

When this example is run, the DISP:MENU:NAME command is sent in line 10. You should then see the "CONTROL PASSED TO ECal" message on the host, and the top level ECal menu on the network analyzer display. You may move through the ECal menus as desired. When finished, exit the ECal menus (press the ECal "RUN" key or select a network analyzer menu). The message "CONTROL RETURNED FROM ECal" will be displayed on the host.

Note

*The ECal system will pass control back to the host when it is finished with the network. It expects to find the host at address 21 unless that address has been changed with the *PCB command. If your host is not at address 21, you should include an OUTPUT statement with the *PCB command before line 10 in this example.*

3-8.2.2 Sending Commands Which Do Not Require Pass Control

Most ECal commands are sent and received very simply as shown in the following example:

```
10 DIM Iden${80}
20 OUTPUT 718;"*IDN?"
30 ENTER 718; Iden$
40 END
```

Line 10 sends a command to the ECal control unit requesting its identity (identification query). Line 20 reads the string back from the ECal control unit.

3-8.3 Setting Calibration Parameters for Remote Operation

The majority of the parameters used for calibration are configured by setting the network analyzer as desired before initiating the calibration, but, as in the manual measurement mode, there are several parameters which are specific to ECal and may need to be set. They are:

- ECAL : FINT - Frequency Interpolation
- ECAL : IAV - Isolation Averages

See paragraph 3-7.4 for details.

3-8.4 Selecting Modules for Remote Operation

ECal module selection is performed by the user and should be based on connector type and frequency range of the device-under-test. Available modules are listed by part number and description in Table 3-1.

3-8.5 Performing Calibrations by Remote Operation

The calibration type and procedure to be used depends on the type and accuracy of measurement required for the device-under-test. Paragraph 3-7.6 provides information regarding the six available calibration types, the best application for each type, and a brief description. For more detailed information, refer to the appropriate network analyzer user's manual or Hewlett-Packard application notes. In all cases, performing calibrations by Remote Operation is very similar to performing calibrations by Stand-Alone Operation.

A host application may direct a calibration in one of two fashions as follows:

1. Initiate the calibration remotely and then allow the user to use ECal menus to measure each module.
2. The application may control each step of the calibration, prompting the user to connect specific modules.

Paragraphs 3-8.5.1 through 3-8.5.3 describe calibrations of each type.

3-8.5.1 Host Initiated Manual Calibration

If an application requires a calibration, but the parameters (module, frequency range, connector type) vary from day to day, it may be appropriate for the application to initiate a calibration, and then allow the user perform the calibration. An example of this is as follows:

```
10 OUTPUT 716;"PRES" ! Commands to set up NWA
20 OUTPUT 716;"STAR 2 GHZ;STOP 18 GHZ"
30 OUTPUT 718;"DISP:MENU:NAME FULL" ! Goto FULL 2-PORT Menu
40 CALL Pass_control
50 ! The application continues here
60 END
```

See paragraph 3-8.2.1 for the listing of the Pass_control subprogram.

This example will set up the network analyzer as required for the measurement, and then command the ECal control unit to begin a FULL 2-PORT calibration. The Module Selection menu will be displayed on the network analyzer, and the user will be able to select and calibrate using appropriate modules. When the calibration is completed, control will be returned to the host application.

3-8.5.2 Host Directed Full Calibration

For many production applications, the same exact calibration procedures will be used day in and day out. For these, it is appropriate to have the application prompt the user with the specific steps to follow. This sample executes a FULL 2-PORT calibration remotely.

```
10 OUTPUT 716;"PRES" ! Set up the network analyzer
20 OUTPUT 716;"STAR 2 GHZ;STOP 18 GHZ"
30 OUTPUT 718;"SENS:CORR:COLL:METH FULL" ! Start Cal
40 INPUT "Connect Module A to NWA, then Press ENTER",Dum$
50 OUTPUT 718;"SENS:CORR:COLL:ACQ A" ! Cal with Module A
60 CALL Pass_control
70 INPUT "Connect Module B to NWA, then Press ENTER",Dum$
80 OUTPUT 718;"SENS:CORR:COLL:ACQ B" ! Cal with Module B
90 CALL Pass_control
100 OUTPUT 718;"SENS:CORR:COLL:SAVE 5" ! Save in calset 5
110 CALL Pass_control
120 ! The application continues here
130 END
```

See paragraph 3-8.2.1 for the listing of the Pass_control subprogram.

3-8.5.3 Host Directed Adapter Calibration

The adapter calibration can be controlled remotely as shown in the following example:

```
10  OUTPUT 716;"PRES"                ! Set up NWA
20  OUTPUT 716;"STAR 2 GHZ;STOP 18 GHZ"
30  OUTPUT 718;"SENS:CORR:COLL:METH FULL"    ! Start Cal
40  INPUT "Connect Module A to NWA Port 2, then Press ENTER",Dum$
50  OUTPUT 718;"SENS:CORR:COLL:ACQ A"        ! Cal with Module A
60  CALL Pass_control
70  INPUT "Connect Module B to NWA Port 2, then Press ENTER",Dum$
80  OUTPUT 718;"SENS:CORR:COLL:ACQ B"        ! Cal with Module B
90  CALL Pass_control
100 OUTPUT 718;"SENS:CORR:COLL:NEXT"         ! Go to 2nd phase
110 CALL Pass_control
120 PRINT "Connect Adapter to NWA Port 2"
130 INPUT "Connect Module A between Port 1 and Adapter, then Press ENTER",Dum$
140 OUTPUT 718;"SENS:CORR:COLL:ACQ A"        ! Cal with Module A
150 CALL Pass_control
160 INPUT "Connect Module A between Port 1 and Adapter, then Press ENTER",Dum$
170 OUTPUT 718;"SENS:CORR:COLL:ACQ B"        ! Cal with Module B
180 CALL Pass_control
190 OUTPUT 718;"SENS:CORR:COLL:SAVE 5"      ! Save in Calset 5
200 CALL Pass_control
210                                     ! The application continues here
220  END
```

See paragraph 3-8.2.1 for the listing of the Pass_control subprogram.

3-8.6 Responding to the ECal "RUN" Key

For a particular application, it might be desirable to have the user calibrate the analyzer manually. The sample in paragraph 3-8.5.1 is one possible means of this. This example shows another method, where the user will press the ECal control unit "RUN" button when they wish to perform a calibration. The control unit will then interrupt the application program to get control and allow the user to perform the calibration.

```
10                                     ! Set up ECal masks, and
                                       interrupt handlers
20  OUTPUT 718;"*SRE 32"               ! Enable Interrupt on Event
                                       Status Bit
30  OUTPUT 718;"*ESE 2"               ! Enable Interrupt on Request
                                       Control
40  ON INTR 7,2 CALL Srq_handler
50  LOOP                               ! The application continues here
60      PRINT "Count is ";I           ! Dummy application
70      I=I+1
80  END LOOP
90  END
100 SUB Srq_handler
110 IF NOT BIT(SPOLL(718),5) THEN
120     PRINT "ECal is not causing Interrupt"
130 ELSE
140     OUTPUT 718;"*ESR?"            ! Read the Event Status Register
150     ENTER 718;Esr
160     IF NOT BIT (Esr,1) THEN       ! Ensure that the ECal wants
                                       Control
170         PRINT "ECal does not want control"
180     ELSE
190         PASS CONTROL 718          ! Pass control to ECal
200         PRINT "CONTROL PASSED TO ECAL"
210         LOOP
220             STATUS 7,3;Stat       ! Monitor Interface Status
230             EXIT IF BIT(Stat,6)   ! Finish when Control is returned
240         END LOOP
250         PRINT "CONTROL RETURNED FROM ECAL"
260     END IF
270 END IF
280 SUBEND
```

4 COMMAND REFERENCE

4-1 Command Types

HP-IB (Hewlett-Packard Interface Bus) commands are separated into two types: SCPI (Standard Commands for Programmable Instruments) commands and IEEE 488.2 Common Commands.

4-1.1 SCPI Command Format

The SCPI commands perform functions like setting parameters, making measurements, and querying instrument states or retrieving data. A subsystem command structure is a hierarchical structure that usually consists of a top level (or root) command, one or more lower level commands, and their parameters. The following example shows part of a typical subsystem:

DISP:MENU[:NAME] <ECAL|CONF|SERV|MODI|etc...>

DISP is the root command, :MENU is the second level command, and [:NAME] is a third level command with parameters.

In this manual the following conventions are used:

- Bracketed commands, for example [:NAME], indicate defaults, and are therefore optional.
- Commands in angle brackets, <MODI>, are required parameters.
- Commands separated by vertical lines within angle brackets, <SERV|MODI>, indicate available choices.
- Lowercase choices, *n*, indicate that a value must be specified.

4-1.2 Common Command Format

The IEEE 488.2 standard defines the Common Commands that perform functions like reset, self-test, status byte query, etc... Common commands are four or five characters in length, always begin with an asterisk character (*), and may include one or more parameters. The command keyword is separated from the first parameter by a space character. Some examples of common commands are shown below:

***CLS, *IDN?, *SRE**

4-2 SCPI Command Reference

This section describes the SCPI commands for the System Instrument. Commands are listed alphabetically by subsystem and also within each subsystem. Commands which require pass control in the remote operation mode are identified as such.

DISP:MENU

Requires Pass Control

DISP:MENU[:NAME] <ECAL|CONF|SERV|MODI|S11C|S22C|FULL|QFUL|ADAP|QAD|CCH|CCHA|CCHB|CCHC|CCHD>

The DISP:MENU subsystem commands provide the user with local access to the ECal menu functions via the front panel and CRT of the network analyzer. The available selections follow.

:MENU ADAPter	The module select menu for ADAPTER 2-PORT calibrations. ¹
:MENU CCH	The module select menu for the confidence check.
:MENU CCHA	The parameter select menu for the Module A confidence check.
:MENU CCHB	The parameter select menu for the Module B confidence check.
:MENU CCHC	The parameter select menu for the Module C confidence check.
:MENU CCHD	The parameter select menu for the Module D confidence check.
:MENU CONFigure	The configuration menu.
:MENU ECALibration	The top level ECal menu.
:MENU FULL	The module select menu for FULL 2-PORT calibrations. ¹
:MENU MODInformation	The module information menu.
:MENU SERVICE	The service menu.
:MENU S11C	The module select menu for S11 1-PORT calibrations. ¹
:MENU S22C	The module select menu for S22 1-PORT calibrations. ¹
:MENU QADapter	The module select menu for OMIT ISOL ADP 2-PORT calibrations. ¹
:MENU QFUL	The module select menu for OMIT ISOL 2-PORT calibrations. ¹

1. See SENS:CORR:COLL:METH for more information.

ECALibration

ECAL

The ECAL subsystem commands access the functions and variables used to perform the electronic calibration.

ECAL:FINTinterpolate

ECAL:FINT <ON|OFF|?>

The ECAL:FINT subsystem command is used to enable or disable the frequency interpolation capability of the ECal system.

:FINT ON

With interpolation enabled (ON), any frequencies within the span of the characterized module may be measured.

:FINT OFF

With interpolation disabled (OFF), only those frequencies which correspond to the actual characterization frequencies of the ECal module will be allowed.

:FINT?

Returns a 1 if frequency interpolation is enabled, returns a 0 if frequency interpolation is disabled.

ECAL:IAVerages

ECAL:IAV <numeric_value|?>

:IAV <numeric_value>

The ECAL:IAV command allows the ECal system to override, for isolation calibrations, the averaging value specified in the network analyzer setup.

For all other calibrations, measurements are performed using the averaging value specified in the network analyzer setup. However, isolation calibrations typically require significantly increased averaging.

This command will set the averaging value used for isolation measurements to the specified numeric value. If the numeric value is not included, the user will be prompted to enter the desired averaging value using the active entry capability of the network analyzer (softkeys).

:IAV?

ECAL:IAV?

The ECAL:IAV? command returns the averaging value specified in the network analyzer setup.

SENSe:CORRection:COLLect

SENS:CORR:COLL

The SENS:CORR:COLL subsystem commands are used by the host computer to initiate, measure, and bring closure to calibrations.

:ACQuire

Requires Pass Control

SENS:CORR:COLL:ACQ <module_name>

This command is used to initiate the measurement of a specific ECal module (module A, B, C, or D) after a calibration or confidence check has begun using SENS:CORR:COLL:METH.

:DONE

Requires Pass Control

SENS:CORR:COLL:DONE

This command is used to indicate completion of the confidence check, set the module to its idle state, and restore the network analyzer display.

:METHod

SENS:CORR:COLL:METH <method_name>

The SENS:CORR:COLL:METH subsystem commands initiate a calibration of the specified type. Use this command to initiate a calibration from the host computer only if the host will also be specifying the modules to be measured (SENS:CORR:COLL:ACQ), and executing the save (SENS:CORR:COLL:SAVE).

Use the DISP:MENU:NAME command to have the host initiate the calibration. The the user will be prompted to select modules using the active entry capability of the network analyzer (softkeys).

:METH ADAPter

This command is used to initiate the ADAPTER 2-PORT calibration. This is a two-step process for performing non-insertable calibrations using an insertable ECal module with an adapter. The first step uses the ECal module connected directly to Port 2 of the network analyzer to establish the S22 reference plane. The second step of the process uses the ECal module connected to Port 1 of the network analyzer, and an appropriate adapter connected between the ECal module and Port 2 of the network analyzer.

:METH CCH

This command is used to perform a confidence check of the network analyzer calibration.

:METH FULL

This command is used to initiate the FULL 2-PORT calibration of the network analyzer including the isolation terms. After selecting this function, all of the necessary modules must be connected and measured before saving the calibration coefficients to the network analyzer's calibration registers.

:METH QADapter

This command is used to initiate the OMIT ISOL ADP 2-PORT calibration of the network analyzer. This calibration is the same as the ADAPTER 2-PORT calibration with the exception that isolation measurements are omitted.

:METH QFUL

This command is used to initiate the OMIT ISOL 2-PORT calibration of the network analyzer. This calibration is the same as the FULL 2-PORT calibration with the exception that isolation measurements are omitted.

:METH S11C

This command is used to initiate the S11 1-PORT calibration using Port 1 of the network analyzer. After selecting this function, all of the necessary modules must be connected and measured before saving the calibration coefficients to the network analyzer's calibration registers.

:METH S22C

This command is used to initiate the S22 1-PORT calibration using Port 2 of the network analyzer. After selecting this function, all of the necessary modules must be connected and measured before saving the calibration coefficients to the network analyzer's calibration registers.

:NEXT

SENS:CORR:COLL:NEX

Requires Pass Control

This command is used to progress from Phase 1 to Phase 2 of the adapter calibration. All Phase 1 measurements must be completed or errors will be generated.

:PARAMeter

SENS:CORR:COLL:PAR <S11 | S21 | S12 | S22>

This command is used to determine which parameter is displayed when the SENS:CORR:CORR:ACQ command is executed.

:PRIor

SENS:CORR:COLL:PRI

Requires Pass Control

This command is used to return from Phase 2 to Phase 1 of the adapter calibration. Any completed Phase 1 measurements will be lost.

:RESume

SENS:CORR:COLL:RES

Requires Pass Control

This command is used to resume a calibration already in process.

:SAVE

Requires Pass Control

SENS:CORR:COLL:SAVE [calset number]

This command is used to end the calibration process after all required modules have been measured, and then load the error coefficients into the network analyzer.

If a calset number is included in the command, the calibration is saved in that register. Otherwise, the user is prompted via the standard network analyzer menus.

:VIEW

SENS:CORR:COLL:VIEW <BOTH|DIV>

This command is used to set the display mode when the SENS:CORR:CORR:ACQ command is executed.

:VIEW BOTH

Displays DATA & MEMORY.

:VIEW DIV

Displays DATA divided by MEMORY.

SYSTem

Subsystem Syntax

SYST

The SYST subsystem commands access certain standard SCPI commands not related to instrument performance.

:ERRor?

SYST:ERR?

Returns the error number and message associated with the latest actions of the ECal system. The errors will be contained in a two element FIFO (First In, First Out) queue. If more than 2 errors occur between readings by the host, the most recent errors will be lost, and the second entry will be replaced with the QUEUE OVERFLOW message.

See Table 4-1 for a listing of error messages.

:PRESet

SYST:PRES

Presets the ECal system to its power-up state. Equivalent to the *RST command.

:VERSion?

SYST:VERS?

Returns the SCPI version to which the instrument complies. The returned value is 1994.0.

4-3 Common Command Reference

This section describes the IEEE-488.2 Common Commands that can be used to program instruments in the mainframe. For additional information on any Common Commands, refer to the IEEE Standard 488.2-1987.

*CLS

Clear Status. This command clears the status byte register (STB) and the event status register (ESR) for the instrument.

*ESE [n]

Set Event Status Enable Mask. Enables specific bits to be summarized in the ESB bit of the status byte. See *ESR? for more details.

*ESE?

Read Event Status Enable Mask. Places the current value of the event status enable register in the output queue.

*ESR?

Read Event Status Register. Bit numbers, decimal values, and corresponding functions are shown in Table 4-1.

Table 4-1. ECal Event Status Register

BIT #	DECIMAL VALUE	FUNCTION
7	128	Power On
6	64	User Request (not used)
5	32	Command Error
4	16	Execution Error
3	8	Device Error
2	4	Query Error
1	2	Request Control
0	1	Operation Complete

***IDN?**

Identification Query. Returns a string containing the current revision of the ECal firmware in the following format:

Hewlett Packard, 85060C, 0, XX.YY

The revision varies with the revision of the firmware installed in the system. This is the only indication of which version of firmware is in use. The major number (XX) indicates whether there have been functional changes made in the firmware. The minor number (YY) indicates only that bug fixes and minor changes have been made.

Example: Get the ID fields from the system and print them;

10 DIM A\$[50]	Dimension string for ID fields
20 OUTPUT 718;"*IDN?"	Sends identification query
30 ENTER 718;A\$	Places ID fields in string
40 PRINT A\$	Print ID fields
50 END	

***OPC**

Operation Complete. This command prompts ECal to generate the operation complete message in the Event Status Register (ESR) when all pending operations are complete.

***OPC?**

Operation Complete Query. Since ECal processes all commands sequentially, this command will always place an ASCII 1 in the ECal output buffer when all pending operations are complete.

***PCB [n]**

Set the Passback Address. Sets the address of the host computer. In the non-system controller mode, the ECal Control Unit will return active control to the address specified by this command. The default value is 21.

*RST

Reset Command. Resets an instrument to a known state (the power-on state) as follows:

- Aborts all pending operations.
- Disables the *OPC and *OPC? modes.
- Resets the Frequency Interpolation to "ON".
- Resets Isolation Averages to the default values.

*RST does not affect:

- The state of the HP-IB interface.
 - The HP-IB address.
 - The output queue.
 - The Status Request register.
 - Calibration data.
-

*SRE [n]

Service Request Enable. When a service request occurs, it sets a corresponding bit in the Status Byte Register. This happens whether or not the event has been enabled (unmasked) by *SRE. The *SRE command allows you to identify which of these events will assert an HP-IB service request (SRQ).

When an event is enabled by *SRE and that event occurs, it sets a bit in the status byte register and issues an SRQ to the computer (sets the HP-IB SRQ line true). You enable an event by specifying its decimal weight for [n]. To enable more than one event, specify the sum of the decimal weights.

Example:

```
OUTPUT 718; "*SRE 9"      Enables bits 0 & 3.  
                           Respective weights are  
                           1+8=9
```

***SRE?**

Status Register Enable Query. Returns the weighted sum of all enabled (unmasked) events (those enabled to assert SRQ) in the Status Byte Register.

Example:

```
10 OUTPUT 718; "*SRE?"   Sends Status Register
                           Enable Query
20 ENTER 718; A          Places response in vari-
                           able
30 PRINT A               Prints response
40 END
```

***STB?**

Status Byte Enable Query. Returns the current value of the status byte including the master summary bit. The serial poll response is this byte which includes the RSV bit.

Reading this byte with STB? does not clear the status byte, the master summary bit, or the RSV bit. Reading this byte with a serial poll clears only the RSV bit.

The status byte can only be cleared by clearing all of the bytes which are summarized within it.

Bit numbers, decimal values, and corresponding functions are shown in Table 4-2.

Table 4-2. ECal Status Byte Register

BIT #	DECIMAL VALUE	FUNCTION
7	128	not used
6	64	RSV bit - Master Summary bit (MSS)
5	32	Event Status Summary (ESB)
4	16	Message Available (MAV)
3	8	not used
2	4	Error Queue
1	2	not used
0	1	not used

***TST?**

Self Test. Returns a 0 indicating that no internal failures have occurred.

***WAI**

Wait to Continue. This command prevents the execution of any further commands until pending operations are complete.

Since ECal processes commands sequentially, this command has no effect on ECal operation. It is processed for compliance with IEEE-488.2 standards.

4-4 Quick Reference for SCPI and IEEE-488 Commands

The following tables summarize SCPI and IEEE 488.2 Common Commands for the HP 85060C ECal Control Unit.

Table 4-3. SCPI Commands - Quick Reference

Command	Description
DISP:MENU [:NAME]	Display the specified [:NAME] ECal menu on the network analyzer.
ECAL:IAV <numeric_value ?>	Sets amount or returns value of averages for use in isolation measurements.
ECAL:FINT <ON OFF ?>	Enable or disable frequency interpolation, or show current frequency interpolation status.
SENS:CORR:COLL:ACQ <A B C D>	Initiate the measurement of a specific ECal module.
SENS:CORR:COLL:DONE	Used to indicate confidence check completion, set the module to its idle state, and restore the network analyzer display.
SENS:CORR:COLL:METH <method_name>	Performs the appropriate (specified) calibration.
SENS:CORR:COLL:METH ADAP	Performs an ADAPTER 2-PORT calibration.
SENS:CORR:COLL:METH CCH	Performs a CONFIDENCE CHECK of the NWA calibration.
SENS:CORR:COLL:METH FULL	Performs a FULL 2-PORT calibration including the isolation terms.
SENS:CORR:COLL:METH QAD	Performs an OMIT ISOL ADP 2-PORT calibration.
SENS:CORR:COLL:METH QFUL	Performs an OMIT ISOL 2-PORT calibration.
SENS:CORR:COLL:METH S11C	Performs an S11 1-PORT calibration using NWA Port 1.
SENS:CORR:COLL:METH S22C	Performs an S22 1-PORT calibration using NWA Port 2.
SENS:CORR:COLL:NEX	Progress from calibration Phase 1 to Phase 2.
SENS:CORR:COLL:PAR	Used to determine which parameter is displayed when the SENS:CORR:COLL:ACQ command is executed.
SENS:CORR:COLL:PRI	Return to calibration Phase 1 from Phase 2.
SENS:CORR:COLL:RES	Resume a calibration already in process.
SENS:CORR:COLL:SAVE [calset number]	End the calibration process, load the error coefficients into the network analyzer.
SENS:CORR:COLL:VIEW <BOTH DIV>	Used to set the display mode when the SENS:CORR:COLL:ACQ command is executed.
SYST:ERR?	Return the latest error number and message.
SYST:VERS?	Return the ECal firmware revision. Equivalent to the *IDN command.
SYST:PRES	Preset the ECal system to its power-up state. Equivalent to the *RST command.

Table 4-4. IEEE-488.2 Common Commands - Quick Reference

Command	Description
*CLS	Clear Status. Sets the ECal Control Unit status byte to 0.
*ESE	Set Event Status Enable mask.
*ESE?	Read Event Status Enable mask.
*ESR?	Read Event Status Enable register.
*IDN?	Identification Query. Returns the ECal firmware revision. Equivalent to the SYST:VERS? command.
*OPC	Operation Complete.
*OPC?	Operation Complete Query.
*PCB [n]	Set the passback address.
*RST	Presets the ECal system to its power-up state. Equivalent to the SYST:PRES command.
*SRE [n]	Service Request Enable. Masks selected bits of the status byte.
*SRE?	Status Register Enable Query. Returns the current value of the Serial Poll Mask.
*STB?	Status Byte Enable Query.
*TST?	Self Test.
*WAI	Wait to Continue.

5 TROUBLESHOOTING

5-1 Introduction

Instrument problems usually fall into three general categories: operator errors, turn-on errors, and run-time errors. The troubleshooting strategy is different for each category.

- **Operator Errors:** Apparent failures often result from operator errors. Refer to Chapter 3, Operation, for proper operation information.
- **Turn-on Errors and Run-Time Errors:** An error signified by continued illumination of the Instrument Check LED at turn-on or during otherwise normal operation, with or without illumination of other front panel LED's, indicates that the built-in diagnostic routine has detected some problem. Turn the instrument off, then on again. If the error repeats, see paragraph 5-4. The information there can be used to isolate a setup error, operator error, or failure of one of the major assemblies in the instrument. Additionally, problems may occur that are not indicated by front panel LED status. See paragraph 5-5.

5-2 Recommended Test Equipment

In addition to the equipment listed in Table 6-1, a voltmeter may be required for troubleshooting.

5-3 Diagnostic Software

A factory test diagnostic program is built into firmware. Instructions for use are included where applicable in the troubleshooting procedures below.

5-4 Troubleshooting Sequence

Prior to troubleshooting, please insure that normal ECal operation—described in Chapter 3—is fully understood. Figure 3-2 shows the typical operating sequence and should be particularly helpful in determining whether a failure condition exists.

Troubleshooting should begin with a comparison of the front panel LED status against the conditions shown in Figure 5-1. The descriptions should offer corrective action or lead you to the appropriate troubleshooting procedure(s).

If there is a problem which is not indicated by front panel LED status, see paragraph 5-5.

Condition 1

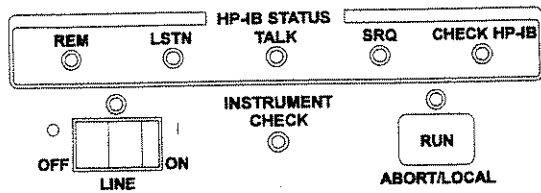

Condition 7

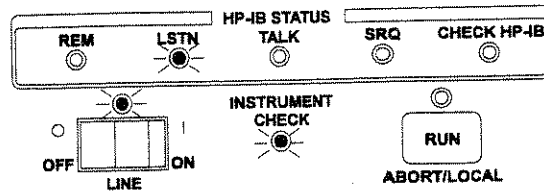

Condition 2

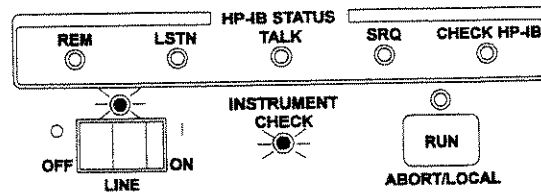

Condition 8

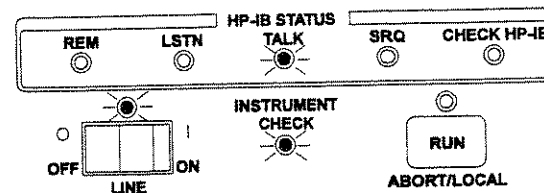

Condition 3

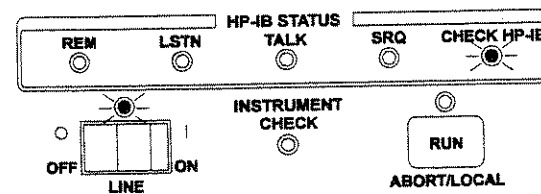

Condition 9

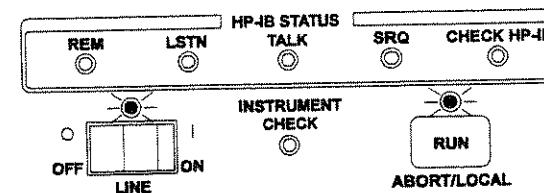

Condition 4

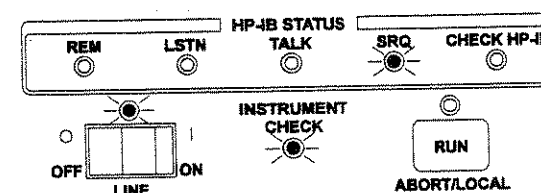

Condition 10

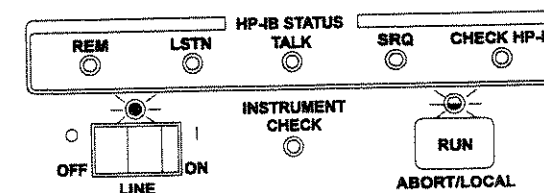

Condition 5

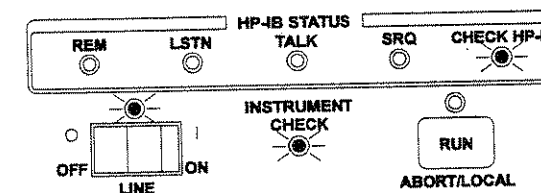

Condition 11

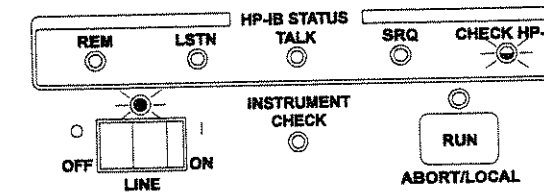

Condition 6

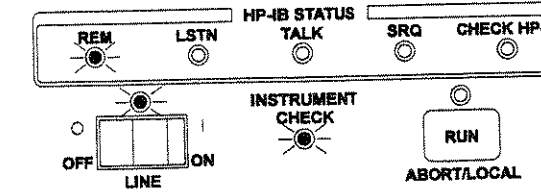

Condition 12

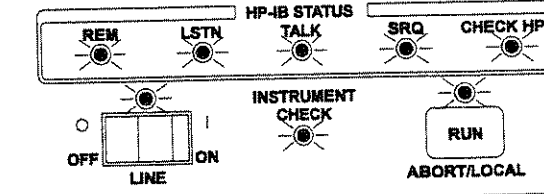

Figure 5-1. Front Panel LED Status Conditions

Note

Prior to troubleshooting, please insure that normal ECal operation—described in Chapter 3—is fully understood.

Refer to Figure 5-1 for the following front panel LED status condition descriptions.

- **Condition 1: All LED's off.** Indicates a No DC Power condition. Refer to paragraph 5-5.1.
- **Condition 2: LINE and INSTRUMENT CHECK LED illuminated.** Indicates that the built-in diagnostic routine has detected some problem. Check connections and restart.
- **Condition 3: LINE and CHECK HP-IB LED illuminated.** Indicates an HP-IB fault, Check connections and restart. If the problem continues, suspect the HP-IB board.
- **Condition 4: LINE, INSTRUMENT CHECK, and SRQ LED illuminated.** Indicates that the factory test switch is on, and the ECal control unit is not the system controller. This is not an allowable condition for normal use. Check and reset HP-IB address settings (refer to Chapter 2 for HP-IB address selection).
- **Condition 5: LINE, INSTRUMENT CHECK, and CHECK HP-IB LED illuminated.** During the boot sequence (turn-on), this is not an error condition; it indicates that the control unit has passed its self-test and is loading firmware. A continuation of this condition after turn-on indicates that ECal firmware could not initialize the HP-IB hardware. Check connections and restart. If the problem continues, suspect the HP-IB board.
- **Condition 6: LINE, INSTRUMENT CHECK, and REM LED illuminated.** Indicates that the firmware cannot be loaded from flash memory. Suspect a firmware problem or failed flash memory (microprocessor board). Restart using the ECal system floppy disk provided with the control unit.
- **Condition 7: LINE, INSTRUMENT CHECK, and LSTN LED illuminated.** Indicates that an attempt to execute the program from floppy disk has failed. Suspect an incorrect floppy disk format or a bad floppy disk.
- **Condition 8: LINE, INSTRUMENT CHECK, and TALK LED illuminated.** Indicates that an attempt to copy the program from floppy disk to flash memory has failed. Suspect an incorrect floppy disk format, a bad floppy disk, or failed flash memory (microprocessor board).
- **Condition 9: LINE and RUN LED illuminated.** Indicates that ECal is controlling the network analyzer. This is not an error condition.
- **Condition 10: LINE LED illuminated, and RUN LED flashing.** Indicates that ECal is requesting control from the network analyzer. This is not an error condition. Control must be passed from the host or ECal must be set to function as the non-system controller. Refer to Chapter 3 for more information.
- **Condition 11: LINE LED illuminated, and CHECK HP-IB LED flashing.** Indicates that the network analyzer is not responding to the control unit. Check HP-IB cables and verify that the control unit and network analyzer address selections are correct. Refer to Chapters 2 and 3 for more information.
- **Condition 12: All LED's remain illuminated.** Either the CPU has not booted properly, or the control logic printed circuit board cannot control the display printed circuit board.

1
2
3
4
5
6
7
8
9
10
11
12
13
14
15
16
17
18
19
20
21
22
23
24
25
26
27
28
29
30
31
32
33
34
35
36
37
38
39
40
41
42
43
44
45
46
47
48
49
50
51
52
53
54
55
56
57
58
59
60
61
62
63
64
65
66
67
68
69
70
71
72
73
74
75
76
77
78
79
80
81
82
83
84
85
86
87
88
89
90
91
92
93
94
95
96
97
98
99
100

6 REPLACEMENT PROCEDURES

6-1 Introduction

Warning These servicing instructions are for use by qualified personnel only. To avoid electrical shock, do not perform any servicing unless you are qualified to do so.

Procedures are provided for disassembly and reassembly of the following items:

- Cover
- Fan Assembly (reference designator FAN1)
- IEEE 488 Adapter Board Assembly (A1)
- Microprocessor Board Assembly (A2)
- Control Logic Board Assembly (A3)
- 24V Power Supply Assembly (A4)
- 5V Power Supply Assembly (A5)
- Display Board (A6)
- HP-IB Switch Board (A7)
- 3.5 Inch Floppy Drive Assembly (D1)

Figure 6-1 shows the location of these assemblies within the HP 85060C ECal Control Unit for reference. Part numbers for these and other parts are listed in Chapter 7, "Replaceable Parts."

Warning Capacitors inside the instrument may still be charged even if the instrument has been disconnected from its source of supply.

6-2 Equipment Needed (but not supplied)

Table 6-1 lists all the equipment required for assembly replacement. Any equipment that satisfies the requirements in the table may be substituted.

Table 6-1. Equipment Needed to Replace ECal Control Unit Major Assemblies

Tool	Used For	HP Part Number
anti-static mat	all components	9300-0797
wrist strap	all components	9300-1257
Torx screwdriver (T15)	all components	8710-1816
Phillips screwdriver (#4 & #6)	all components	any supplier
Torque Screwdriver	all components	any supplier

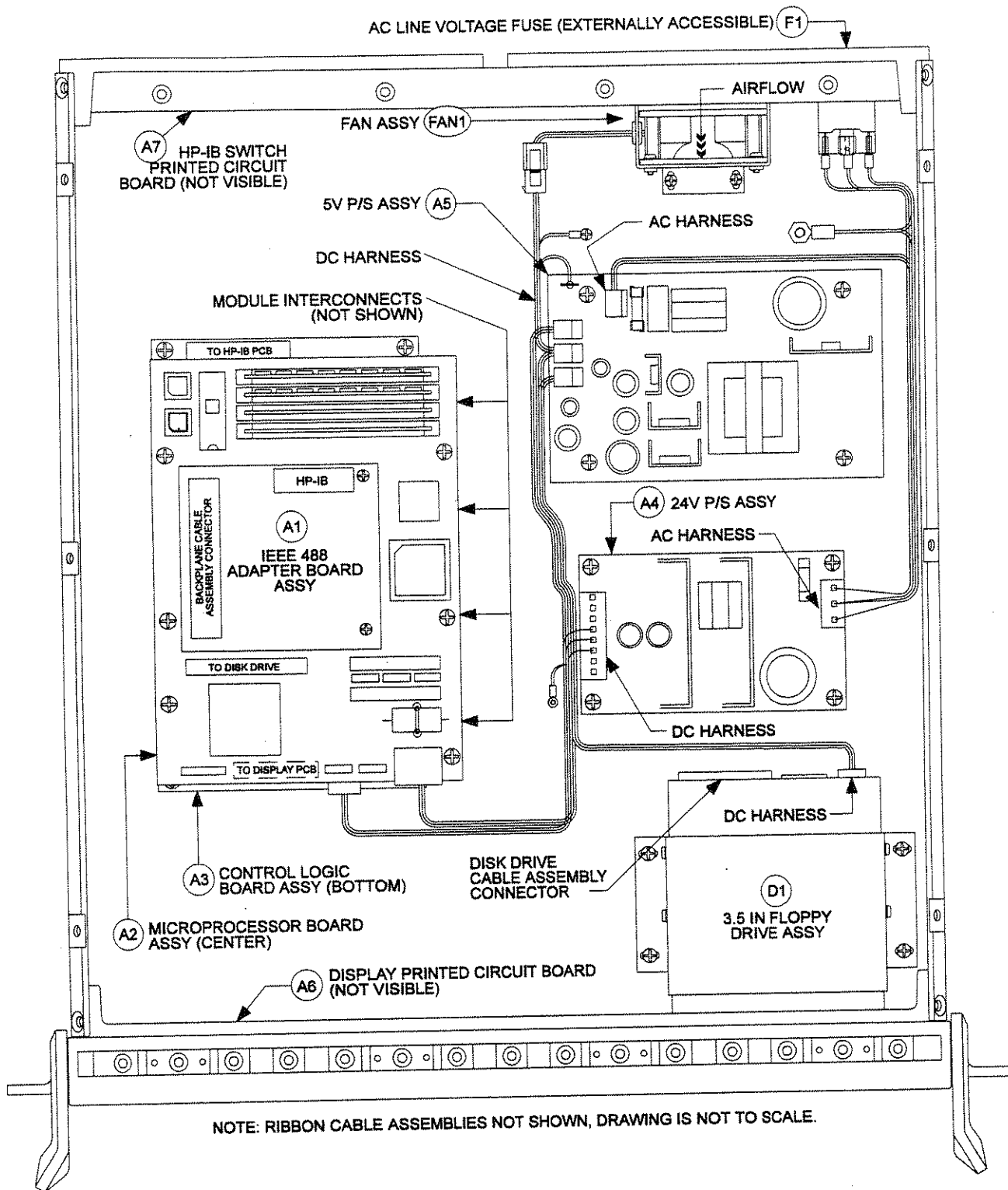

Figure 6-1. Assembly Locations

6-3 Assembly Replacement Procedures

6-3.1 Preliminary Precautions

Caution The assemblies handled in these procedures are very sensitive to damage by static electricity. They may or may not continue to function if subjected to an electrostatic discharge. Their reliability will, however, be impaired.

1. To prevent electrostatic discharge damage, ground the work area and yourself.
2. Turn the control unit off.
3. Disconnect the power cord.
4. Exercise caution when handling ribbon cable connections.
5. To install a part, reverse the appropriate procedure.

6-3.2 To Remove the Cover

Warning The opening of covers or removal of parts is likely to expose dangerous voltages. Disconnect the instrument from all voltage sources while it is being opened.

1. Set power to OFF, and remove the power cable.
2. Remove the two top rear endcaps from the mainframe (one Torx T-15 screw each).
3. Disengage the cover screw from the top rear center of the mainframe.
4. Slide the cover towards the rear and remove.
5. Reverse order to reinstall the cover.

6-3.3 To Remove the Fan Assembly (FAN1)

1. Remove the cover (see paragraph 6-3.2).
2. Disconnect the DC harness.
3. Remove the two #4 Phillips head screws holding the fan bracket to the mainframe, then the Fan Assembly.
4. Remove the four #4 Phillips head screws holding the fan bracket to the fan.
5. Reverse order to reinstall the Fan Assembly (install so that the air flow is in the direction illustrated). Torque all #4 screws to 7 inch-pounds.

6-3.4 To Remove the IEEE 488 Adapter Board Assembly (A1)

1. Remove the cover (see paragraph 6-3.2).
2. Disconnect the HP-IB cable assembly and the backplane cable assembly.
3. Remove the two #4 Phillips head screws, then lift the Adapter Board Assembly vertically.
4. Reverse order to reinstall the Printed Circuit Assembly. Torque all #4 screws to 7 inch-pounds.

6-3.5 To Remove the Microprocessor Board Assembly (A2)

1. Remove the cover and the IEEE 488 Adapter Board Assembly (see paragraphs 6-3.2 and 6-3.4).
2. Disconnect the disk drive cable assembly and the DC harness.
3. Remove the six #6 Phillips head screws, then the Microprocessor Board Assembly.
4. Reverse order to reinstall the Microprocessor Board Assembly. Torque all #4 screws to 7 inch-pounds, all #6 screws to 11 inch-pounds.

6-3.6 To Remove the Control Logic Board Assembly (A3)

1. Remove the cover and the IEEE 488 Adapter Board Assembly (see paragraphs 6-3.2 and 6-3.4).
2. On the microprocessor board, remove the disk drive cable assembly and the DC harness. Then remove the three #6 Phillips head screws from the side of the microprocessor board opposite the hinge and swing the microprocessor board up to access the control logic board.
3. On the control logic board, remove the following:
 - Four module cable assemblies.
 - HP-IB switch cable assembly.
 - Display cable assembly.
 - DC harness.
 - Backplane cable assembly.
4. Remove the eight #6 Phillips head screws, then the Microprocessor Board Assembly.
5. Reverse order to reinstall the Microprocessor Board Assembly. Torque all #4 screws to 7 inch-pounds, all #6 screws to 11 inch-pounds.

6-3.7 To Remove the 24V Power Supply Assembly (A4)

1. Remove the cover (see paragraph 6-3.2).

Warning AC line voltage is present on this printed circuit assembly. Ensure that the power cable is disconnected for a minimum of one minute before proceeding to allow capacitors to discharge.

2. Disconnect the DC harness and the AC harness.
3. Remove the four #6 Phillips head screws and the 24V Power Supply Assembly.
4. Reverse order to reinstall the 24V Power Supply Assembly. Torque all #6 screws to 11 inch-pounds.

6-3.8 To Remove the 5V Power Supply Assembly (A5)

1. Remove the cover (see paragraph 6-3.2).

Warning AC line voltage is present on this printed circuit assembly. Ensure that the power cable is disconnected for a minimum of one minute before proceeding to allow capacitors to discharge.

2. Disconnect the DC harness (four connectors) and the AC harness.
3. Remove the four #6 Phillips head screws and the 5V Power Supply Assembly.
4. Reverse order to reinstall the 5V Power Supply Assembly. Torque all #6 screws to 11 inch-pounds.

6-3.9 To Remove the Display Board (A6)

1. Remove the cover (see paragraph 6-3.2).
2. Disconnect the ribbon cable assembly.
3. Remove the five #4 Phillips head screws and the Display Board.
4. Reverse order to reinstall the Display Board. Torque all #4 screws to 7 inch-pounds.

6-3.10 To Remove the HP-IB Switch Board (A7)

1. Remove the cover (see paragraph 6-3.2).
2. Disconnect the ribbon cable assembly.
3. Remove the four #4 Phillips head screws and the HP-IB Switch Board.
4. Reverse order to reinstall the HP-IB Switch Board. Torque all #4 screws to 7 inch-pounds.

6-3.11 To Remove the 3.5 Inch Floppy Drive Assembly (D1)

1. Remove the cover (see paragraph 6-3.2).
2. Disconnect the DC harness and the disk drive cable assembly from the rear of the floppy drive assembly.
3. Remove the four #4 Phillips head screws holding the floppy drive assembly bracket to the mainframe.
4. Slide the floppy drive assembly towards the rear of the mainframe before lifting out vertically.
5. Remove the six #4 Phillips head screws holding the floppy drive bracket to the floppy drive.
6. Reverse order to reinstall the Floppy Drive Assembly. Follow these steps to insure floppy drive alignment with the mainframe faceplate:
 - Install the bracket loosely to the floppy drive.
 - Slide the assembly into place within the mainframe.
 - Align the front of the floppy drive assembly with the mainframe faceplate. Tighten the four rear #4 Phillips head screws which hold the floppy drive in the bracket. Torque all #4 screws to 7 inch-pounds.
 - Because the two front #4 Phillips head screws—which hold the floppy drive in the bracket—are inaccessible, remove the assembly again to tighten the two front screws. Again, torque all #4 screws to 7 inch-pounds.
 - Continue with the reverse order from above. Torque all #6 screws to 11 inch-pounds.

1
2
3
4
5
6
7
8
9
10
11
12
13
14
15
16
17
18
19
20
21
22
23
24
25
26
27
28
29
30
31
32
33
34
35
36
37
38
39
40
41
42
43
44
45
46
47
48
49
50
51
52
53
54
55
56
57
58
59
60
61
62
63
64
65
66
67
68
69
70
71
72
73
74
75
76
77
78
79
80
81
82
83
84
85
86
87
88
89
90
91
92
93
94
95
96
97
98
99
100

7 REPLACEABLE PARTS

7-1 Introduction

This section contains information to order replaceable parts for the HP 85060C ECal Control Unit. The replaceable parts include major subassemblies, but not parts of subassemblies.

7-2 Replaceable Parts List

Figure 6-1 should be used to assist in locating and identifying all replaceable parts. Table 7-1 provides the following information:

- Reference Designator.
- Part description.
- Part quantity. There may or may not be more of the same part located elsewhere in the instrument.
- Hewlett-Packard part number.

7-3 Ordering Information

To order a part listed in the replaceable parts list, quote the Hewlett-Packard part number, indicate the quantity required, and address the order to the nearest Hewlett-Packard office.

To order a part that is not listed in the replaceable parts list, include the instrument model number, complete instrument serial number, the description and function of the part, and the number of parts required. Address the order to the nearest Hewlett-Packard office.

7-4 To Order Parts...Fast

Call (800) 227-8164

Monday through Friday, 6 am to 5 pm (Pacific Standard Time)

The parts replacement specialists have direct online access to replacement parts inventory corresponding to the replaceable parts listed in this manual. Four day delivery is standard, but one-day delivery is available at extra cost... After hours and holidays, call (415) 968-2347.

This fast service applies to the United States only. Outside the United States, contact your nearest HP office.

Table 7-1. Replaceable Parts List

HP PART NUMBER	DESCRIPTION [REFERENCE DESIGNATOR ^a]	QTY. PER UNIT
85060-60011	Microprocessor Board Assembly [A2]	1
85060-60012	IEEE-488 Adapter Board Assembly [A1]	1
85060-60014	5V Power Supply Assembly [A5]	1
85060-60015	24V Power Supply Assembly [A4]	1
85060-60019	Control Logic Board Assembly [A3]	1
85060-60021	Fuse, AC Line Voltage (4 AMP) [F1]	1
85060-60022	Tuner Control Cable [CABLE1]	4
85060-60023	Base Plate	1
85060-60024	Base Plate Hinge	1
85060-60025	Rear Plate	1
85060-60026	Rear Plate - Option 001	1
85060-60027	AC Receptacle - Filter	1
85060-60028	Bracket - Floppy Drive	1
85060-60029	Bracket - Fan	1
85060-60030	Finger Guard	1
85060-60031	Display Printed Circuit Board [A6]	1
85060-60032	HP-IB Switch Printed Circuit Board [A7]	1
85060-60033	AC Harness	1
85060-60034	DC Harness	1
85060-60035	Module Cable Assembly	4
85060-60036	Module Cable Assembly - Option 001	2
85060-60037	Disk Drive Cable Assembly	1
85060-60038	HP-IB Switch Cable Assembly	1
85060-60039	HP-IB Cable Assembly (Internal)	1
85060-60040	Display Cable Assembly	1
85060-60041	Backplane Cable Assembly	1

Table 7-1. Replaceable Parts List

HP PART NUMBER	DESCRIPTION [REFERENCE DESIGNATOR ^a]	QTY. PER UNIT
85060-60042	Front Panel Lexan	1
85060-60043	Front Panel Lexan - Option 001	1
85060-60044	HP 85060C Operating System Disk	1
85060-60045	EPROM Software	1
85060-60046	Fuse (2 AMP)	2
0950-2075	3.5 Inch Floppy Drive Assembly [D1]	1
3160-0497	Fan Assembly [FAN1]	1
8120-1348	AC Line Cord	1
8120-3445	HP-IB Cable Assembly (External)	1
5062-3735	Cover, Top	1

a. From Figure 6-1.

1
2
3
4
5
6
7
8
9
10
11
12
13
14
15
16
17
18
19
20
21
22
23
24
25
26
27
28
29
30
31
32
33
34
35
36
37
38
39
40
41
42
43
44
45
46
47
48
49
50
51
52
53
54
55
56
57
58
59
60
61
62
63
64
65
66
67
68
69
70
71
72
73
74
75
76
77
78
79
80
81
82
83
84
85
86
87
88
89
90
91
92
93
94
95
96
97
98
99
100

Index

A

- Accessing Menus 3-9
- Accessories
 - Available 1-2
 - Supplied 1-2
- active control 3-21
- ADAPTER 2-PORT Calibration
 - Description of 3-11
 - To Perform 3-17
- Adapter Calibration Connections 3-17
- Adapter Calibration, Host Directed 3-25

B

- Bench Operation 2-5

C

- CALIBRATION CONFIGURE 3-10
- Calibration Parameters
 - Confidence Check 3-10
 - Interpolate 3-10
 - Isolation Averages 3-10
 - Return 3-10
 - Service Functions
 - Firmware Revision 3-10
 - Module Information 3-10
 - Setting 3-10
- Calibration Procedures 3-13
- Calibrations, Performing 3-11
- Check HP-IB 3-7
- COMMAND REFERENCE 4-1
- Command Types 4-1
- Common Command
 - Format 4-1
 - Reference 4-8
- Common Commands
 - *CLS 4-8
 - *ESE 4-8
 - *ESE? 4-8
 - *ESR? 4-8
 - *IDN? 4-9
 - *OPC 4-9
 - *OPC? 4-9
 - *PCB 4-9
 - *RST 4-10
 - *SRE 4-10
 - *SRE? 4-11
 - *STB? 4-11
 - *TST? 4-12
 - *WAI 4-12
- Quick Reference 4-14
- Confidence Check

- Description 3-19
- To Perform 3-20
- Connecting / Disconnecting Modules 3-5
- Control Unit Bus Address Switch 3-7

D

- Diagnostic Software 5-1
- Dimensions 1-3
- DISP
 - MENU
 - NAME 3-22
 - MENU subsystem 4-2
- DONE CHECK 3-19

E

- ECAL
 - FINT 4-3
 - IAV 4-3
- ECal Module Interconnects 3-7
- ECAL subsystem 4-3
- ECal System Conceptual Block Diagram 3-2
- electronic calibration modules 1-1, 2-6
- Environment
 - Operating 2-4
 - Storage and Shipment 2-6
- ESD Cautions 3-1

F

- Floppy Disk Drive, 3.5 inch 3-7
- Front Panel LED Status 5-2
- FULL 2-PORT Calibration
 - Description 3-11
 - To Perform 3-15
- Full Calibration, Host Directed 3-24
- fuse ratings 2-2

G

- GENERAL INFORMATION 1-1

H

- Host Computers, Communicating with 3-21
- HP 8510, In Remote Operation 3-21
- HP-IB
 - addresses 3-9
 - connector 3-21
 - fault indication 3-7
 - Status LED's 3-7
- HP-IB Address Selection
 - Control Unit 2-4
 - Network Analyzer 2-4

Index

I

- IEEE-488
 - fault indication 3-7
- Initial Inspection 2-1
- INSTALLATION 2-1
- Installation Checklist 2-1
- Instrument Check LED 3-7
- Interconnections, Control Unit to Module 2-4

L

- Line Module 3-7
- Line Switch and Line LED 3-7
- line voltage 2-1
- Line Voltage and Fuse Selection 2-2
- LISTENER 3-7
- LSTN 3-7

M

- Manual Calibration, Host Initiated 3-24
- Mating Connectors, HP-IB Interface 2-4

N

- National Institute of Standards and Technology 3-1
- Network Analyzer Bus Address Switch 3-7
- Network Analyzers, Supported Models 1-1

O

- OMIT ISOL 2-PORT Calibration
 - Description of 3-11
 - To Perform 3-16
- OMIT ISOL ADP 2-PORT Calibration
 - Description of 3-11
 - To Perform 3-18
- Operating Characteristics 3-4
- OPERATION 3-1
- Options 1-2
- Overlapping Frequency Range, Optimizing Performance in 3-12

P

- Packaging 2-6
- Panel Features 3-6, 3-7
- Part Numbers
 - Power Cable and Line (Main) Plug 2-3
 - Replaceable Parts List 7-1
- Pass Control
 - Sending Commands Which Do Not Require 3-23
 - Sending Commands Which Require 3-22
- Power Cables 2-2
- Power Dissipation 1-3

- Power Requirements 1-3, 2-1
- Preparation for Use 2-1

R

- Rack Mounting 1-2, 2-5
- REM 3-7
- REMOTE 3-7
- Remote Operation 3-21
 - Performing Calibrations by 3-23
 - Selecting Modules for 3-23
 - Setting Calibration Parameters for 3-23
 - System Configuration for 3-21
- REPLACEABLE PARTS 7-1
 - Ordering Information 7-1
- Replaceable Parts List 7-2
- REPLACEMENT PROCEDURES 6-1
 - Preliminary Precautions 6-3
 - To Remove the 24V Power Supply Assembly (A4) 6-4
 - To Remove the 3.5 Inch Floppy Drive Assembly (D1) 6-5
 - To Remove the 5V Power Supply Assembly (A5) 6-5
 - To Remove the Control Logic Board Assembly (A3) 6-4
 - To Remove the Cover 6-3
 - To Remove the Display Board (A6) 6-5
 - To Remove the Fan Assembly (FAN1) 6-3
 - To Remove the HP-IB Switch Board (A7) 6-5
 - To Remove the IEEE 488 Adapter Board Assembly (A1) 6-3
 - To Remove the Microprocessor Board Assembly (A2) 6-4
- Replacement Procedures
 - Assembly Locations 6-2
- Responding to the ECal "RUN" Key 3-26
- RF Input Power 3-4
- Run Switch 3-7

S

- S11 1-PORT Calibration
 - Description of 3-11
 - To Perform 3-13
- S22 1-PORT Calibration
 - Description of 3-11
 - To Perform 3-14
- Safety 1-1, 1-3
- Sample Network Analyzer ECal Menus 3-8
- SCPI
 - Command Format 4-1
 - Command Reference 4-2
 - Quick Reference 4-13
- Selecting Modules 3-10
- SENS
 - CORR
 - COLL

Index

- ACQ 4-4
- DONE 4-4
- METH 4-4
- NEX 4-5
- PAR 4-5
- PRI 4-5
- RES 4-5
- SAVE 4-6
- VIEW 4-6
- COLL subsystem 4-4
- SERVICE REQUEST 3-7
- Specifications
 - Environmental 1-3
 - General 1-1
- SRQ 3-7
- Stand-alone (Manual) Operation 3-9
- Storage and Shipment 2-6
- SYST
 - ERR 4-7
 - PRES 4-7
 - VERS 4-7
- SYST subsystem 4-7
- System Bus Connector 3-7
- System Configuration for Stand-alone Operation 3-9

T

- TALK 3-7
- TALKER 3-7
- Test Equipment, Recommended 5-1
- Theory of Operation 3-1
- To Order Parts...Fast 7-1
- TROUBLESHOOTING 5-1
- Troubleshooting
 - Procedures 5-4
 - Sequence 5-1
- tuner control cable 1-2, 3-1
- Turn-on Procedure 3-4
- Types of Analyzers 3-9
- Typical Operating Sequence 3-3

W

- Weight 1-3

1
2
3
4
5
6
7
8
9
10
11
12
13
14
15
16
17
18
19
20
21
22
23
24
25
26
27
28
29
30
31
32
33
34
35
36
37
38
39
40
41
42
43
44
45
46
47
48
49
50
51
52
53
54
55
56
57
58
59
60
61
62
63
64
65
66
67
68
69
70
71
72
73
74
75
76
77
78
79
80
81
82
83
84
85
86
87
88
89
90
91
92
93
94
95
96
97
98
99
100