

OPERATING AND PROGRAMMING MANUAL
HP8152A OPTICAL AVERAGE POWER METER

SERIAL NUMBERS

This manual applies directly to instruments with serial number 2550G00101 and higher. Any change made in instruments having serial numbers higher than the above number will be found in a "Manual Changes" supplement supplied with this manual. Be sure to examine the supplement for changes which apply to your instrument and record these changes in the manual.

© HEWLETT-PACKARD GMBH 1986
HERRENBERGER STR. 130, D-7030 BOBLINGEN
FEDERAL REPUBLIC OF GERMANY

MANUAL PART No. 08152-90001
MICROFICHE PART No. 08152-95001

PRINTED: MAY 1986

SAFETY

This product has been designed and tested according to International Safety Requirements. To ensure safe operation and to keep the product safe, the information, cautions, and warnings in this manual must be heeded.

CERTIFICATION

Hewlett-Packard Company certifies that this product met its published specifications at the time of shipment from the factory. Hewlett-Packard further certifies that its calibration measurements are traceable to the United States National Bureau of Standards, to the extent allowed by the Bureau's calibration facility, and to the calibration facilities of other International Standards Organization members.

WARRANTY

This Hewlett-Packard product is warranted against defects in material and workmanship for a period of one year from date of shipment. During the warranty period, Hewlett-Packard Company will, at its option, either repair or replace products which prove to be defective.

For warranty service or repair, this product must be returned to a service facility designated by HP. However, warranty service for products installed by HP and certain other products designated by HP will be performed at Buyer's facility at no charge within the HP service travel area. Outside HP service travel areas, warranty service will be performed at Buyer's facility only upon HP's prior agreement and Buyer shall pay HP's round trip travel expenses.

For products returned to HP for warranty service, Buyer shall prepay shipping charges to HP and HP shall pay shipping charges to return the product to Buyer. However, Buyer shall pay all shipping charges, duties, and taxes for products returned to HP from another country.

LIMITATION OF WARRANTY

The foregoing warranty shall not apply to defects resulting from improper or inadequate maintenance by Buyer, Buyer-supplied software or interfacing, unauthorized modification or misuse, operation outside of the environmental specifications for the product, or improper site preparation or maintenance.

NO OTHER WARRANTY IS EXPRESSED OR IMPLIED. HP SPECIFICALLY DISCLAIMS THE IMPLIED WARRANTIES OF MERCHANTABILITY AND FITNESS FOR A PARTICULAR PURPOSE.

EXCLUSIVE REMEDIES

THE REMEDIES PROVIDED HEREIN ARE BUYER'S SOLE AND EXCLUSIVE REMEDIES. HP SHALL NOT BE LIABLE FOR ANY DIRECT, INDIRECT, SPECIAL, INCIDENTAL, OR CONSEQUENTIAL DAMAGES, WHETHER BASED ON CONTRACT, TORT, OR ANY OTHER LEGAL THEORY.

ASSISTANCE

Product maintenance agreements and other customer assistance agreements are available for Hewlett-Packard products.

For any assistance, contact your nearest Hewlett-Packard Sales and Service Office. Addresses are provided at the back of this manual.

The following general safety precautions must be observed during all phases of operation, service, and repair of this instrument. Failure to comply with these precautions or with specific warnings elsewhere in this manual violates safety standards of design, manufacture, and intended use of the instrument. Hewlett-Packard Company assumes no liability for the customer's failure to comply with these requirements.

GENERAL — This is a Safety Class I instrument (provided with terminal for protective earthing) and has been manufactured and tested according to international safety standards.

OPERATION — BEFORE APPLYING POWER comply with the installation section. Additionally, the following shall be observed:

Do not remove instrument covers when operating.

Before the instrument is switched on, all protective earth terminals, extension cords, auto-transformers and devices connected to it should be connected to a protective earth via a ground socket. Any interruption of the protective earth grounding will cause a potential shock hazard that could result in serious personal injury.

Whenever it is likely that the protection has been impaired, the instrument must be made inoperative and be secured against any unintended operation.

Make sure that only fuses with the required rated current and of the specified type (normal blow, time delay, etc.) are used for replacement. The use of repaired fuses and the short-circuiting of fuseholders must be avoided.

Adjustments described in the manual are performed with power supplied to the instrument while protective covers are removed. Energy available at many points may, if contacted, result in personal injury.

Any adjustment, maintenance, and repair of the opened instrument under voltage should be avoided as much as possible, and when inevitable, should be carried out only by a skilled person who is aware of the hazard involved. Do not attempt internal service or adjustment unless another person, capable of rendering first aid and resuscitation is present. Do not replace components with power cable connected.

Do not operate the instrument in the presence of flammable gases or fumes. Operation of any electrical instrument in such an environment constitutes a definite safety hazard.

Do not install substitute parts or perform any unauthorized modification to the instrument.

Capacitors inside the instrument may still be charged even if the instrument has been disconnected from its source of supply.

SAFETY SYMBOLS



The apparatus will be marked with this symbol when it is necessary for the user to refer to the instruction manual in order to protect the apparatus against damage.



Indicates dangerous voltages.



Earth terminal

WARNING

The **WARNING** sign denotes a hazard. It calls attention to a procedure, practice or the like, which, if not correctly performed or adhered to, could result in injury or loss of life. Do not proceed beyond a **WARNING** sign until the indicated conditions are fully understood and met.

CAUTION

The **CAUTION** sign denotes a hazard. It calls attention to an operating procedure, practice, or the like, which, if not correctly performed or adhered to, could result in damage to or destruction of part or all of the equipment. Do not proceed beyond a **CAUTION** sign until the indicated conditions are fully understood and met.



Dangerous voltages, capable of causing serious personal injury, are present in this instrument. Use extreme caution when handling, testing, and adjusting.



CONTENTS

SECTION	Page
1 GENERAL INFORMATION	
INTRODUCTION	1-1
HOW TO USE THIS MANUAL	1-1
SPECIFICATIONS	1-1
SAFETY CONSIDERATIONS	1-2
INSTRUMENTS COVERED BY THIS MANUAL	1-2
DESCRIPTION	1-2
ACCESSORIES SUPPLIED	1-2
OPTIONS AVAILABLE	1-3
2 INSTALLATION	
INTRODUCTION	2-1
INITIAL INSPECTION	2-1
PREPARATION FOR USE	2-1
Power Requirements	2-1
Line Voltage Selection	2-1
Power Cable	2-2
Optical Connections	2-3
HP-IB Connector	2-4
HP-IB Logic Levels	2-4
OPERATING ENVIRONMENT	2-4
CLAIMS AND REPACKAGING	2-4
STORAGE AND SHIPMENT	2-4
3 OPERATING AND PROGRAMMING	
INTRODUCTION	3-1
SPECIAL OPERATING CONSIDERATIONS	3-1
OPERATORS CHECKS	3-1
GETTING TO KNOW YOUR INSTRUMENT	3-2
Keys 6 to 9 in SET Mode	3-2
Keys 6 to 9 in MEASure Mode	3-3
POWER MEASUREMENTS	3-5
Basic Considerations	3-5
Zero-Adjustment Before Measurement	3-5
MAKING ABSOLUTE POWER MEASUREMENTS	3-5
Settings	3-6
Measurements	3-6
Compensating for Known Losses With The CAL Key	3-6
MAKING RELATIVE POWER MEASUREMENTS	3-7
... With Current Measurement as Reference	3-7
... With Given Value as Reference	3-8
MAKING CHANNELB/CHANNEL A RATIO MEASUREMENTS	3-9

CONTENTS (CONTD)

SECTION	Page
3 OPERATING AND PROGRAMMING (CONTD)	
AUXILIARY FEATURES	3-10
Standard Parameter Set	3-10
Filter	3-10
Transducer Outputs	3-10
Trend Meters For Manual Ranging	3-10
Overrange/Underrange Indicators	3-10
PROGRAMMING	3-11
WHAT YOU NEED TO KNOW ...	3-11
... About The HP8152A's HP-IB Capabilities	3-11
... About Programming Examples in This Section	3-11
... About The HP8152A's Command Syntax	3-12
GETTING STARTED	3-12
Setting The Address	3-12
Checking Remote Operation	3-12
SENDING DATA TO THE HP8152A (LISTENER FUNCTION)	3-13
RECEIVING DATA FROM THE HP8152A (TALKER FUNCTION)	3-14
Settings	3-14
Measurement Results	3-15
STATUS/ERROR REPORTING (TALKER FUNCTION)	3-16
Status Register and Status Byte	3-16
Setting The SRQ Mask	3-18
Condition Register	3-18
PROGRAMMING EXAMPLES	3-19
COMMAND SUMMARY	3-25
4 FUNCTION TESTS	
INTRODUCTION	4-1
EQUIPMENT REQUIRED	4-1
TEST RECORD	4-2
TEST FAILURE	4-2
INSTRUMENT SPECIFICATIONS	4-2
FUNCTION TESTS	4-2

HP81000BS OPTICAL POWER SPLITTER

GENERAL INFORMATION

Specifications

The following specifications are measured at 1300nm with an LED source, CW.

Wavelength Range: 1200 - 1650 nm
Connector Types: Diamond® HMS-10/HP and DIN
Applicable Fiber Type: All fibers with ≤ 0.3

Insertion Loss [IL]

(Including coupling loss of connectors and excess loss of the splitter)

	HMS-10/HP		DIN	
	SM/9 μ m	MM/50 μ m	SM/9 μ m	MM/50 μ m
Typical	2.0 dB	1.0 dB	2.5dB	1.0dB
Worst Case	4.0 dB	2.0 dB	5.0dB	2.0dB

Splitting Ratio [SR]

(Depends on actual insertion loss)

SM/9 μ m	10 dB +3 dB/-2 dB
MM/50 μ m	12.5 dB \pm 1dB

Stability of Splitting Ratio within ± 2 C Temperature Window

SM/9 μ m	$\leq \pm 0.06$ dB
MM/50 μ m	$\leq \pm 0.01$ dB

Supplementary Specifications

Thermal Stability of Splitting Ratio:

SM/9 μ m	≤ 0.03 dB/°C
MM/50 μ m	≤ 0.005 dB/°C

Polarization Sensitivity of Splitting Ratio (360°): $\leq \pm 4\%$
Not mode selective

Environmental

Storage Temperature: -40 to +75°C
Operating Temperature: 0 to +55°C



© HEWLETT-PACKARD GMBH 1986
HERRENBERGER STR. 130, D-7030 BOEBLINGEN
FEDERAL REPUBLIC OF GERMANY

General

The Model HP81000 BS Optical Power Splitter is used in combination with the HP8152A Optical Average Power Meter and Optical Heads in the wavelength range 1200 - 1650 nm. Designed for multimode and single-mode applications, it can accept all fibers with $NA \leq 0.3$.

Figure 1 shows how the splitter should be connected between an optical source and the HP8152A Optical Average Power Meter.

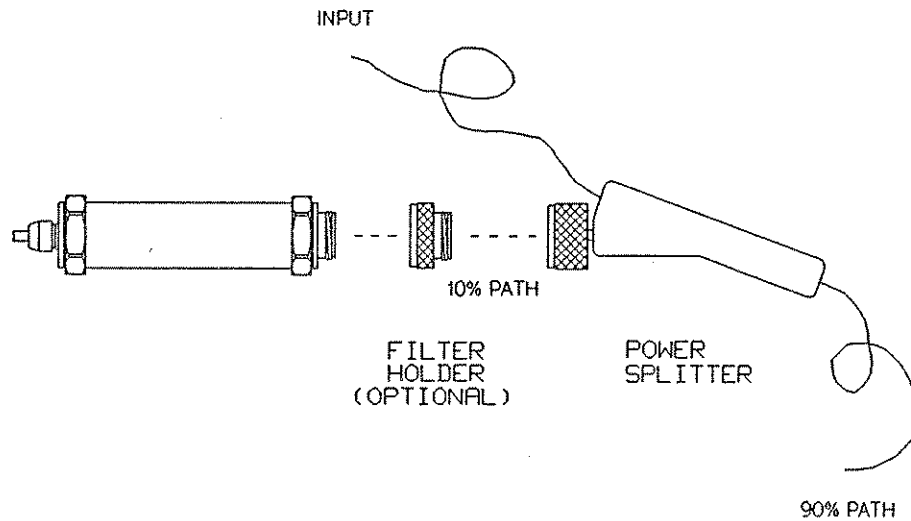

Figure 1

As can be seen from Figure 1, the optical source **must** be connected to the connector marked as "INPUT". The "90%" path is then via the connector marked as "OUTPUT"; the "10%" path is via the output marked as "OPTICAL HEAD", which enables the optical head to be attached directly.

NOTE: When connecting an optical head to the "OPTICAL HEAD" output, ensure that there is no lens fitted to the optical head.

The splitting ratio is calculated from the following formula:

$$SR = 10 \log P(\text{OUTPUT})/P(\text{OPTICAL HEAD})$$

where $P(\text{OUTPUT})$ is the power at the "OUTPUT" connector and $P(\text{OPTICAL HEAD})$ is the power at the "OPTICAL HEAD" output.

NOTE

When the DIN connector, Opt.013, is used, make sure that the connection between the splitter and the cable is secure as the connector does not have a guiding key. If the connection is not correct then the splitter will not work to the specifications given.

PRINTED IN THE FEDERAL REPUBLIC OF GERMANY

SECTION I

GENERAL INFORMATION

INTRODUCTION

This manual contains the information required to install, test, and operate the Hewlett-Packard Model 8152A Optical Average Power Meter and Model 81520 Series Optical Heads.

HOW TO USE THIS MANUAL

Operation of the HP8152A is dependent on the optical heads that are connected to the inputs. You can consider the HP8152A as a "mainframe" in a control function, and each optical head as a "plug-in" module which determines the measurement function. For this reason, this Operating and Programming Manual is provided in modular form so that it can be exactly tailored to the configuration you have ordered. The individual modules are as follows:

- The "mainframe" module for the HP8152A containing the first 4 Sections:

SECTION I - GENERAL INFORMATION
SECTION II - INSTALLATION
SECTION III - OPERATING & PROGRAMMING
SECTION IV - PERFORMANCE TESTS

In this module, general references are made to operation with an optical head, e.g., connection procedure, measurement making etc., but no information on a specific optical head is given. This module is always installed in the binder at delivery.

- An "appendix" module for each optical head in the HP81520 Series that you have ordered. The optical head determines the operating wavelength, sensitivity, etc., and this module therefore contains:

General Information about the optical head
Specifications of the optical head
Performance Tests for the optical head

This module is delivered as a separately bound package to be installed in your binder behind the "mainframe" module.

SPECIFICATIONS

Specifications of the HP8152A are given in Table 1-1. These specifications are the performance standards or limits against which the instrument is tested.

SAFETY CONSIDERATIONS

The HP8152A is a Safety Class I instrument (instrument with an exposed metal chassis that is directly connected to earth via the power supply cable). The symbol used to indicate a protective earth terminal in the instrument is ⊕.

Before operation, the instrument and manual, including the red safety page, should be reviewed for safety markings and instructions. These must then be followed to ensure safe operation and to maintain the instrument in safe condition.

INSTRUMENTS COVERED BY THIS MANUAL

Each HP8152A has a two-part serial number. The first 4 digits and the letter comprise the serial number prefix; the last 5 digits a sequential suffix which is unique to each Model 8152A. The contents of this manual apply directly to average optical power meters having the serial prefix 2550G.

DESCRIPTION

The HP8152A is a fully programmable, dual channel, optical average power meter designed for applications in the wavelength region 100-19999nm. The 2 channels can be operated independently at different wavelengths and power levels (useful in the evaluation of wavelength division multiplexers), or in combination for making power ratio measurements. Featuring

- autoranging for automatic selection of the best measurement range
- power-on selftest and error reporting
- microprocessor-driven menu concept that guides the user through the settings to be made for the current task
- power level display in relative or absolute values

. . . the user is assured of fast familiarization and minimum operating errors.

ACCESSORIES SUPPLIED

The HP8152A is supplied complete with the following accessories:

Item	HP Part No.
800 mA Fuse slow-blow (100/120V)*	2110-0020
400 mA Fuse slow-blow (220/240V)*	2110-0340
Power Cord	see Figure 2-2

* one fitted and one supplied

OPTIONS AVAILABLE

The following lists the options available for the HP8152A:

- Option 907 Front Handle Kit
- Option 908 Rack Flange Kit
- Option 909 Combination Kit
- Option 910 Additional Operating and Programming Manual (P/N 08152-90001)
- P/N 5061-9701 Bail Handle Kit

Table I-1. Specifications

Specifications describe the instrument's warranted performance.

Measurement Features and Operating Modes

Display: 4 1/2 digits, decimal point, polarity, units (dB, dBm, mW, uW, nW, pW, nm), HP-IB address, error conditions, status information (CAL \neq 0, REF \neq 0, HEAD), 3Hz refresh rate

Display Measurement Ranges: +30dBm (1000mW) to -80dBm (10pW))

Resolution: 0.01pW, 0.01dBm/dB, 1nm

Set Mode

All adjustable parameters are accessible (λ , CAL, REF). The last adjusted parameter will be displayed.

- λ : Independent display and selection of wavelength for channel A and B (adjustable range depending on connected optical head). Correction factors are individually measured and stored in each head.
- Cal: Independent entry of calibration factor for channel A and B. Range ± 199.99 dB.
- Ref: Independent entry of reference level setting for channel A and B. Range ± 199.99 dBm. In B/A mode, value in dB.

Measure Mode

AUTO, ZERO and FLTR function are available. Measured power of selected channel is displayed.

- Auto: Automatically selects proper measurement range independently for channel A and B.
- Zero: Automatic compensation of amplifier drifts, offsets and dark currents.
- Fltr: Activates additional 2Hz lowpass filter for selected channel.

Channel Selection

- A: Activates channel A. In measure mode measured power level is displayed
- B: Activates channel B. In measure mode measured power level is displayed
- B/A: Power level ratio of channel B to A is displayed in dB.

Clear: Clears calibration factors and reference settings for both channel A and B

Disp

- \rightarrow Ref: Defines momentary power/power ratio reading as reference (power) level and sets the dB reading to 0dB
- dB: Reading as ratio relative to selectable reference level setting
- dBm: Logarithmic reading relative to 1mW=0dBm
- Watt: Linear reading

Inputs and Outputs

A: Input connector for optical head

B: Input connector for optical head

Transducer Output

Output impedance: 600 Ohm typ.

Output voltage: 0 to 2V into open.

Max. input voltage: $\pm 10V$

Bandwidth dependent on optical head.

General

Recalibration period: 1 year

Warm-up time: 15 min

HP-IB Capability

All modes and parameters can be programmed.

Listen (time for HP 8152A to receive, verify and execute a message).

REF, CAL, λ : < 120 ms

ZERO (filter off): < 5s/channel

Receive time: < 1 ms/character

Talk (time for HP 8152A to transmit a message).

Learn mode, error condition, measured value, status: < 1ms/char

HP-IB Interface Function Code: SH1, AH1, T6, L4, SR1, RL1, PP0, DC1, DT1, C0

Environmental

Storage temperature: -40°C to +75°C

Operating temperature: 0°C to +55°C

Humidity: <95% R.H. from 0°C to 40°C

Power: 100/120/220/240Vrms, +5%, -10%, 90VA max., 48-400Hz

Battery back up (for non-volatile memory): with instrument switched off all current modes and data will be maintained for at least 10 years after instrument delivery

Dimensions: 89mm H, 212.3mm W, 345mm D (3.5"x8.36"x13.6")

Weight: net 4.3 kg (9.5 lbs), shipping 8.6 kg (19 lbs)

For information on optical heads see individual manuals.

Data subject to change.

SECTION II

INSTALLATION

INTRODUCTION

This section provides installation instructions for the Model 8152A and its accessories. It also includes information about initial inspection and damage claims, preparation for use, packaging, storage and shipment.

INITIAL INSPECTION

Inspect the shipping container for damage. If the container or cushioning is damaged, it should be kept until the contents of the shipment have been checked for completeness and the instrument has been verified both mechanically and electrically.

Procedures for checking the optical operation are given in Section 4. If the contents are incomplete, mechanical damage or defect is apparent, or if an instrument does not pass the operator's checks, notify the nearest Hewlett-Packard office. Keep the shipping materials for carrier's inspection. The HP office will arrange for repair or replacement without waiting settlement.

PREPARATION FOR USE

WARNING

To avoid hazardous electrical shock, do not perform electrical tests when there are signs of shipping damage to any portion of the outer enclosure (covers, panels, etc.).

Power Requirements

The instrument requires a power source of 100/120/220/240 Vrms (+5%, -10%) at a frequency of 48-400 Hz single phase. The maximum power consumption is 90 VA.

Line Voltage Selection

CAUTION

BEFORE SWITCHING ON THE INSTRUMENT, make sure that the instrument is set to the local line voltage.

The switch is combined with the power line voltage receptacle on the rear panel. If it is necessary to change the setting, **THE POWER CORD MUST FIRST BE DISCONNECTED**. Then insert a screwdriver into the recess at the left-hand side of the assembly and prise open the cover. Figure 2-1 shows the main details of the assembly. To change the voltage setting, the selector must be removed

and then replaced with the new setting value displayed. If necessary, change the fuse in accordance with the new voltage setting.

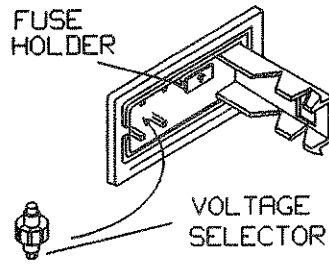

Figure 2-1. Line Voltage Switch Assembly.

The fuse values for the voltage settings are as follows:

VOLTAGE	100/120V	220/240V
FUSE	T 800mA	T 400mA

Power Cable

In accordance with international safety standards, this instrument is equipped with a three-wire power cable. When connected to an appropriate ac power receptacle, this cable grounds the instrument cabinet. The type of power cable shipped with each instrument depends on the country of destination. Refer to Figure 2-2 for the part numbers of the power cables available.

WARNING

To avoid the possibility of injury or death, the following precautions must be followed before the instrument is switched on.

- a) *If this instrument is to be energised via an autotransformer for voltage reduction, ensure that the Common terminal is connected to the grounded pole of the power source.*
- b) *The power cable plug shall only be inserted into a socket outlet provided with a protective ground contact. The protective action must not be negated by the use of an extension cord without a protective conductor.*
- c) *Before switching on the instrument, the protective ground terminal of the instrument must be connected to a protective conductor. This is verified by using the power cord which is supplied with the instrument.*

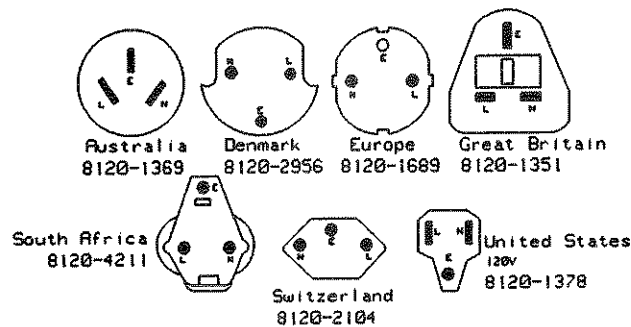

Figure 2-2. Power Cables - Plug Identification

The following work should be carried out by a qualified electrician - all local electrical codes being strictly observed. If the plug on the cable does not fit the power outlet, or the cable is to be attached to a terminal block, cut the cable at the plug end and re-wire it.

The colour coding used in the cable will depend on the cable supplied. If a new plug is to be connected, it should meet local safety requirements and include the following features:

- Adequate load-carrying capacity (see table of specifications in Section 1).
- Ground connection.
- Cable clamp.

Optical Connections

Each optical head that can be connected to the HP8152A is also equipped with various accessories to aid measurement. Depending on which accessories have been ordered, the following Figure 2-3 shows the sequence in which they are attached to the optical head.

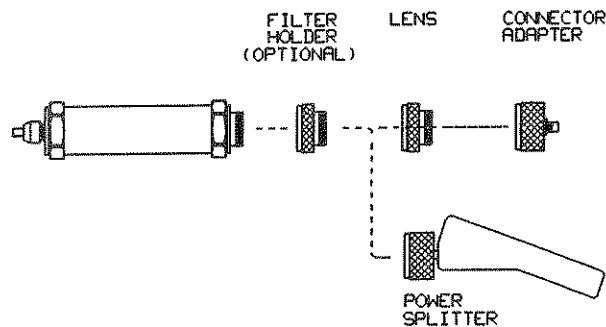

Figure 2-3. Optical Connections

Note that the optical head and its various accessories are marked with coloured dots to indicate wavelength and fiber type. The convention used is as follows:

Wavelength

- Brown $\lambda = 850\text{nm}$
- Red $\lambda = 1300\text{nm}$
- Orange $\lambda = 1550\text{nm}$

Fiber Type

- White single-mode ($9\ \mu\text{m}$)
- Green Multimode ($50\ \mu\text{m}/125\ \mu\text{m GI}$)
- Blue Multimode ($62.5\ \mu\text{m}/125\ \mu\text{m GI}$)
- Violet Multimode ($85\ \mu\text{m}/125\ \mu\text{m GI}$)
- Grey Multimode ($100\ \mu\text{m}/140\ \mu\text{m SI}$)
- Black Multimode ($> 200\ \mu\text{m SI}$)

HP-IB Connector

The rear panel HP-IB connector (Fig 2-4), is compatible with the connector on Cable Assemblies 10833A, B, C and D. If a cable is to be locally manufactured, use connector male, HP part number 1251-0293.

HP-IB Logic Levels

The 8152A HP-IB lines use standard TTL logic, the levels being as follows:

True = Low = digital ground or 0V dc to 0.4V dc,

False = High = open or 2.5V dc to 5V dc.

All HP-IB lines have LOW assertion states. High states are held at 3.0V d.c. by pull-ups within the instrument. When a line functions as an input, approximately 3.2mA of current is required to pull it low through a closure to digital ground. When a line functions as an output, it will sink up to 48mA in the low state and approximately 0.6mA in the high state.

NOTE: Isolation, the HP-IB line screens are not isolated from ground.

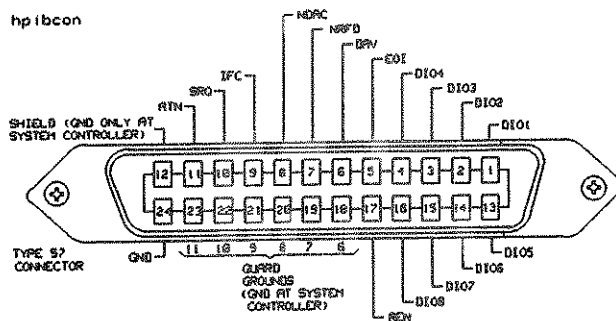

Figure 2-4. HB-IB Connector

OPERATING ENVIRONMENT

The operating temperature limits are 0 deg C to 55 deg C. The specifications also apply over this range.

CLAIMS AND REPACKAGING

If physical damage is evident or if the instrument does not meet specification when received, notify the carrier and the nearest Hewlett-Packard Service Office. The Sales/Service Office will arrange for repair or replacement of the unit without waiting for settlement of the claim against the carrier.

STORAGE AND SHIPMENT

The instrument can be stored or shipped at temperatures between minus 40 deg C and plus 75 deg C. The instrument should be protected from temperature extremes which may cause condensation within it.

If the instrument is to be shipped to a Hewlett-Packard Sales/Service Office, attach a tag showing owner, return address, model number and full serial number and the type of service required.

The original shipping carton and packing material may be reusable, but the Hewlett-Packard Sales/Service Office will also provide information and recommendations on materials to be used if the original packing is no longer available or reusable. General instructions for repacking are as follows:

1. Wrap instrument in heavy paper or plastic.
2. Use strong shipping container. A double wall carton made of 350-pound test material is adequate.
3. Use enough shock-absorbing material (3 to 4 inch layer) around all sides of the instrument to provide a firm cushion and prevent movement inside container. Protect control panel with cardboard.
4. Seal shipping container securely.
5. Mark shipping container FRAGILE to encourage careful handling.
6. In any correspondence, refer to instrument by model number and serial number.

SECTION III

OPERATING AND PROGRAMMING

INTRODUCTION

This section explains the functions of controls, indicators and connectors, as well as providing operating and programming information. Figure 3-1 provides a numbered illustration of the front and rear panel controls, and should be folded out when reading the description "Getting to Know Your Instrument" on the following pages. This description should be read before continuing with the more detailed operating information. Programming information is located at the end of this section.

SPECIAL OPERATING CONSIDERATIONS

The following points should be noted before applying power to the instrument:

- ☞ Read the safety summary at the beginning of this manual.
- ☞ Ensure that the VOLTAGE SELECTOR switch on the rear panel is set for operation at the local line voltage.

If any change is made to the setting of the VOLTAGE SELECTOR switch, the fuse must also be changed. Before making either of these changes, switch the instrument off and disconnect the power cord.

OPERATORS CHECKS

The HP8152A performs a self-test routine at power switch-on. At the start of this routine, all front panel LEDs and indicators should be momentarily lit. In the event of a fault being detected, an error code will appear in the digital display. The error codes and required action are listed as follows:

- ☐ Keyboard test failed. Check that no key is stuck in pressed position.
- Exxx where xxx is a 3-digit number. Indicates a serious fault and instrument and optical head should be returned to the nearest Hewlett-Packard Service Office.

These error codes that indicate a serious fault are in the ranges E140 → E199 and E240 → E390. Any other error code appearing in the display during operation indicates a zero routine error. In this case, check that there is no light input to the optical head.

GETTING TO KNOW YOUR INSTRUMENT

The following should be read in conjunction with Figure 3-1 which can be folded out to aid understanding.

1. LINE switch. Power on/off switch.
2. LCL key. This key returns the 8152A to local manual operation when the instrument is under program control. Note that this return-to-local function is disabled when the LOCAL LOCKOUT command has been sent by the system controller to the instrument. In this case, pressing the key is the same as in local mode i.e. the currently selected HP-IB address is displayed.
3. Program status LEDs. When illuminated, the following is indicated.
 - RMT: Indicates remote control. All front panel pushbuttons (except the LCL pushbutton) are disabled.
 - ADS: Indicates that the instrument is being addressed under program control, although the front panel pushbuttons may still be enabled depending on the status of the RMT LED.
 - SRQ: Indicates that a Service Request has been sent by the instrument to the controller.
4. Mode key and associated LEDs. Toggle key used to select SET mode or MEASure mode. Illuminated LED indicates the current selection. Operation in each mode is as follows:

SET mode	for entering parameter values prior to measuring the input power (λ , REFERENCE value, CAL factor)
MEASure mode	for making power measurements and selecting auxiliary measurement functions (AUTO-ranging, ZERO, FLTR)
5. Channel key and associated LEDs. Used to select single channels (A or B) for parameter settings and power measurements, or dual channel (B/A) for power ratio measurements. Illuminated LED indicates current selection.

Keys 6 to 9 in SET Mode

6. CLR key. Used to reset the currently displayed parameter (λ , CAL or REF). The reset values are as follows:

λ	Optical head dependent (850, 1300 or 1550nm)
CAL	0.00 dB
REF	0.00 dBm (1000 μ W) with channel A or B selected 0.00 dB with B/A selected

For each parameter, the reset value only applies to the currently selected channel.

This key is also used to recall the standard parameter set by pressing the key for approximately 5 seconds. A list of the standard settings is given under 'STANDARD SETTINGS (LISTENER FUNCTION)' on the blue pages at the end of this section.

The following descriptions for keys 7 to 9 apply when the corresponding key LED is illuminated. In each case, the displayed parameter value can be changed via the VERNIER rocker keys.

7. λ key. Used to make λ settings for channel A or channel B (disabled if B/A selected by 5). Because the λ setting is dependent on the optical head, the following should be noted:
 - When an optical head is connected whose wavelength range covers the current λ setting, the λ setting remains active.
 - When an optical head is connected whose wavelength range does not cover the current λ setting, the λ setting is automatically changed to the default setting for that optical head.
8. CAL key. Used to enter the CAL factor for channel A or channel B.
9. REF key. Used to set a measurement REFERENCE value for channel A or channel B. In B/A operation, an entered REFERENCE value is treated as a ratio reference (not an absolute reference) e.g. for comparison of power splitter ratios.

Keys 6 to 9 in MEASURE Mode

6. Not used.
7. When activated (key LED illuminated), autoranging is performed during the measurement cycle. This ensures that the measurement range with the best signal-to-noise ratio is automatically selected.
8. Used to activate zero-routine for the optical head. The head is then recalibrated to a ZERO reference. The key LED remains illuminated until the zero-routine ends.
9. When activated (key LED illuminated), a lowpass filter is switched into the signal path of the currently selected channel.
10. DISP \rightarrow REF key. Used in MEASURE mode to set the current power measurement (shown in the display) as the new REFERENCE value. NOTE: In overrange or underrange conditions, DISP \rightarrow REF operation is ignored.
11. dB key. Used in MEASURE mode to display the power measurements in dB's relative to the currently selected REF value.
12. dBm/WATT key. Used in MEASURE mode for channel A or channel B to display the power measurements as dBm or Watts (toggle function). If B/A operation is selected at (5), this key is disabled. In SET mode, this key can only be used in single channel operation for setting the REFERENCE value.

13. Status LEDs. When illuminated, they indicate the following:

- CAL \neq 0: Indicates that a non-zero value is currently selected for the CAL factor
- REF \neq 0: Indicates a non-zero REFERENCE value is currently selected. Only illuminated when dB's are the currently selected display units.
- HEAD: Indicates that no optical head is connected to the currently selected channel.

14. Value display. 4 1/2 digit display for settings and measurement values when dB, dBm or nm are the selected units; 3 1/2 digit display when WATT is selected. Overrange is indicated by "+1" appearing in this display; underrange is indicated by "-1".
15. Unit LEDs. Operate in conjunction with the value display (14) to indicate the base units of the currently selected parameter or measurement.
16. VERNIER rocker keys. In SET mode, used to vary parameter values. In MEASURE mode, any of these keys can be used to display the current range selection. Pressing the upper half displays the channel A range selection; pressing the lower half displays the channel B range selection.
17. RANGE rocker key. In SET mode, used for range selection when setting the REF value in Watts for channel A or B. In MEASURE mode, used to select the display range for the current power measurement on channel A or B. In both modes, this key is disabled when B/A operation is selected.
18. Trend meter. Used to determine the optical coupling efficiency on channel B and aid the user to select the best measurement range.
19. XDCR OUT BNC connector. Channel B transducer output whose electrical signal level is proportional to the displayed optical power.
20. B INPUT connector. Channel B connector for signal from optical head.
21. Trend meter. Used to determine the optical coupling efficiency on channel A and aid the user to select the best measurement range.
22. XDCR OUT BNC connector. Channel A transducer output whose electrical signal level is proportional to the displayed optical power.
23. A INPUT connector. Channel A connector for signal from optical head.

Rearpanel Connectors

24. HP-IB address switch.
25. HP-IB connector.
26. LINE connector assembly (including VOLTAGE SELECTOR switch). A three-pronged receptacle to provide chassis ground through the power cable for operator protection.

POWER MEASUREMENTS

Basic Considerations

The HP8152A has 2 operating modes you can select via the front panel mode key (4):

- | | |
|--------------|--|
| SET mode | for entering parameter values prior to measuring the input power (λ , REFERENCE value, CAL factor). |
| MEASure mode | for making power measurements and selecting auxiliary measurement functions (AUTO ranging, ZERO, FLTR). |

Because the responsivity of the optical detector is different for each wavelength, correction factors for the entire wavelength range have been measured and stored in your optical head. Your first consideration is therefore the λ setting for each channel. This must correspond to the operating wavelength of the optical input signal to ensure measurement accuracy.

The next consideration is whether you want to make absolute or relative power measurements. These are detailed in the following using typical measurement setups to aid explanation.

Zero-Adjustment Before Measurement

In prolonged operation, measurement accuracy can be affected by dark currents and amplifier offsets in the optical head. It is therefore recommended that you initiate the zero routine at regular intervals by pressing ZERO key (8).

NOTE Ensure that there is no light input to the optical head during zero routine, e.g. by using the supplied protective cap. If any light is present at the optical input, either the head will not be properly zeroed or an error code will appear in the display. The zero routine must then be repeated with no light input.

MAKING ABSOLUTE POWER MEASUREMENTS

Consider the setup given in Figure 3-2. You have a calibrated optical source with -20 dBm (10 μ W) CW output power at 1300 nm. The output fiber and reference fiber are spliced, and you want to measure the power at the optical head. From this measurement, you could then determine the total loss of splice, reference fiber and optical head lens.

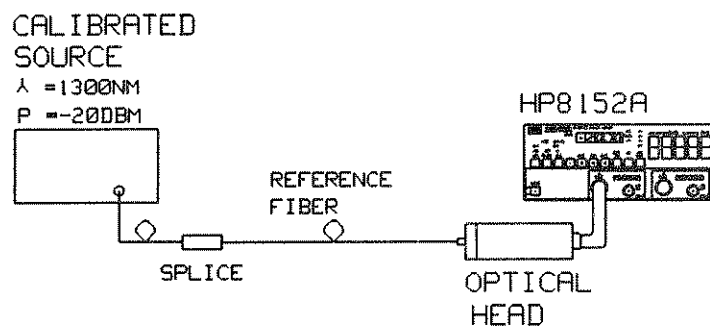

Figure 3-2

As can be seen from Figure 3-2, the fiber is connected to the channel A optical head of the HP8152A, so your setting procedure is as follows.

Settings

1. Select SET mode at key (4) and Channel A at key (5)

The parameter menu is now highlighted above keys (7) to (9), and the last parameter entry you made in single channel operation is displayed. Now make the following entries:

2. Press the λ key to display the current wavelength entry. This must correspond to the operating wavelength of the optical input i.e. 1300nm. If necessary, use the VERNIER rocker keys to change the entry.
3. Press the CAL key to display the current CAL factor entry. To measure the absolute power at the input to the optical head, the CAL factor must be set to 0.00 dB. If a non-zero value is displayed, simply press the CLR key.

As no further entries need to be made (the REF factor has no effect on absolute measurements), select MEASure mode at key (4) to begin measurement.

Measurements

In Measure mode, the HP8152A automatically begins measuring the input power on the selected channel. To get a fast, accurate measurement, do the following:

1. dBm or watts must be selected for absolute measurements. If the current display units are dB, press dBm/WATT key (12) once to select dBm, or twice to select watts. To aid explanation, it is assumed that dBm is now selected.
2. Activate the AUTO-ranging key (7). As measurement accuracy is dependent on range selection, this is the most convenient way of finding the optimum range.

You can now read the measured power in the display and thus determine the splice/fiber/lens loss.

Compensating for Known Losses With The CAL Key

Continuing with the previous measurement example, let us assume that the displayed reading is -20.70 dBm. This would indicate a total loss of -0.70 dB. Knowing this loss, you can now enter a CAL factor, as follows, so that the displayed reading always corresponds to the output power of the source:

1. Select SET mode at key (4).
2. As the CAL factor was your last entry, 0.00 dB will now be displayed. Use the VERNIER keys to enter -0.70 dB.
3. Select MEASure mode again at key (4).

The reading in the display should now be -20.00 dBm. Note that the 'CAL \neq 0' status LED is now illuminated. This informs you that the displayed reading has been corrected via the following formula to include the CAL factor:

$$\text{Input (dBm)} - \text{CAL (dB)} = \text{Display Reading}$$

Substituting the values in the example gives the following:

$$-20.70\text{dBm} - (-0.70 \text{ dB}) = -20.00 \text{ dBm}$$

MAKING RELATIVE POWER MEASUREMENTS

To make relative power measurements, you must select dB display units via key (11) in MEASure mode. Power is then displayed relative to the entered REFERENCE value which can be set as follows:

- in MEASure mode at any time by pressing the DISP → REF key. This sets the current power measurement (including CAL factor) as reference. NOTE: During relative power measurements (dB selected), pressing the DISP → REF sets the display to 0.00 dB.
- in SET mode as a REF value entry.

Both cases with typical examples are now explained in more detail.

... With Current Measurement Value as Reference

Again continuing with the measurement example in 'MAKING ABSOLUTE MEASUREMENTS', the current front panel display is as shown in Figure 3-3.

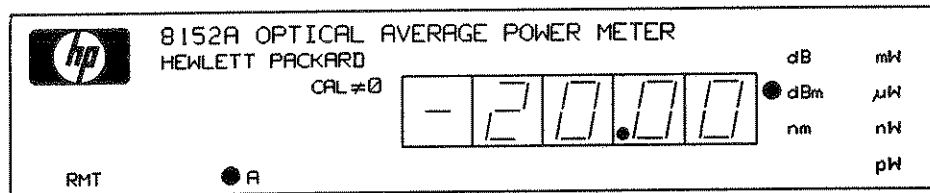

Figure 3-3

The -20 dBm reading includes the known splice/fiber loss, and can now be made the reference value by pressing DISP → REF key (10). Now press dB key (11) to make relative measurements. As there is no change in the optical connections, the initial display reading is 0.00 dB. Note that the REF ≠ 0 status LED is now illuminated. This informs you that the displayed reading has been corrected via the following formula to include the REFERENCE value:

$$\text{Input (dBm)} - \text{CAL (dB)} - \text{REF (dBm)} = \text{Display Reading}$$

Substituting the values in the example gives the following:

$$-20.7 \text{ dBm} - (-0.70 \text{ dB}) - (-20.00 \text{ dBm}) = 0.00 \text{ dB}$$

A typical development of the current setup would now be connector loss measurements as shown in Figure 3-4.

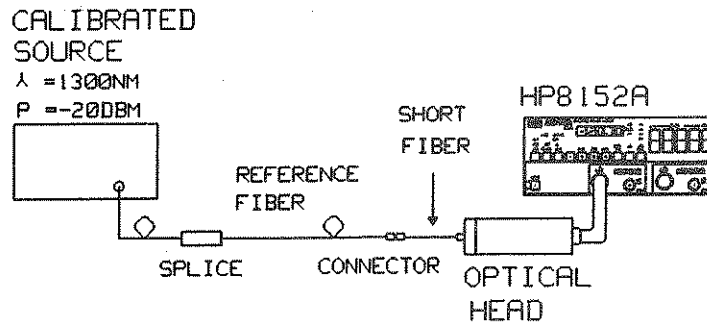

Figure 3-4

The connector-under-test, together with a short fiber of negligible loss, is inserted between the reference fiber and optical head. As measurements are now being performed relative to the original setup, your new display reading is the connector loss.

... With a Given Value as Reference

Another typical example of relative power measurements is the power budget verification on an optical link. Consider the situation where you know that -38 dBm is the minimum power requirement at the receiver end of the link. By entering -38 dBm as REFERENCE value, relative measurement at each stage in the link gives you a direct indication of where you are within the power budget.

This is illustrated in Figure 3-5, which is just a simple continuation of the previous measurement examples in this section.

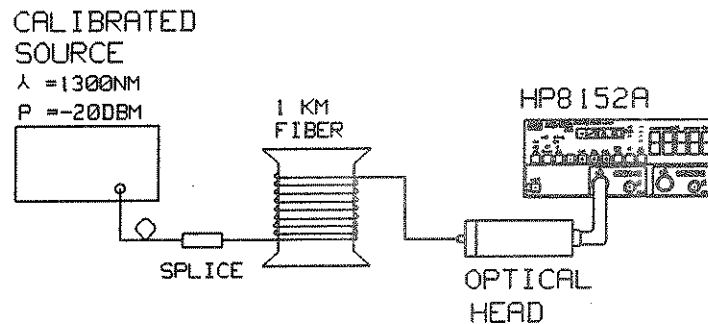

Figure 3-5

Assuming the spliced 1 km fiber represents the first stage in the link, you now make the following settings:

1. Select SET mode at key (4).
2. As the CAL factor was your last entry in previous examples, this is now displayed. Press CLR key (6) to set the CAL factor to 0.00 dB. (For this measurement, no loss compensation is required)
3. Press REF key (9) to display the current REFERENCE value. Use the VERNIER keys to change the value to -38.00 dBm.

Now select MEASure mode again to begin measurement. The displayed reading is a direct indication of how much power remains in your budget for the following stages in the link:

- A positive value indicates how much power is still available e.g. 11.00 dB reading indicates that the output power is still 11 dB above the minimum receiver requirement.
- A negative value indicates that the power is already below the minimum receiver requirement e.g. -2.00 dB reading indicates that the output power is already 2 dB below the minimum receiver requirement.

MAKING CHANNEL B/CHANNEL A RATIO MEASUREMENTS

A typical example of channel B/channel A ratio measurements is shown in Figure 3-6.

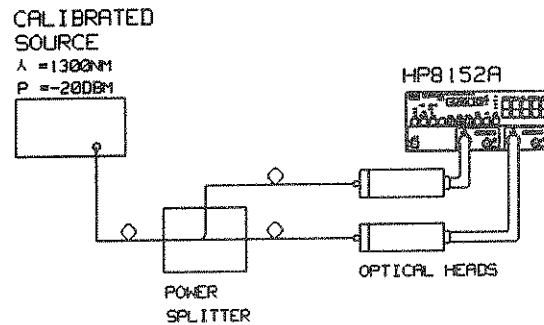

Figure 3-6

In this setup, you have a power splitting device and want to measure the total split ratio, including connectors and fibers. The result can then be taken into consideration for future measurements.

The HP8152A settings are then as follows:

1. Select SET mode and channel A at keys (4) and (5), respectively.
2. Press λ key (7) and CAL key (8), in turn, to display the current setting for each key. For this example, the settings are:
 $\lambda = 1300 \text{ nm}$. Use the VERNIER rocker keys to make any necessary change.
CAL factor = 0.00 dB. Press CLR key (6) if any other value is displayed.
3. Select channel B at key (5) and repeat step 2 using the same settings.
4. Select B/A operation at key (5) and check that the displayed REFERENCE value is 0.00 dB. Press CLR key (6) if any other value is displayed.

NOTE: Once B/A operation is selected, only the REFERENCE value can be changed. The λ and CAL factor settings for each channel remain active.

When MEASure mode is now selected at key (4), measurement begins automatically so activate AUTO key (7) to ensure optimum range selection on both channels. The displayed value is the splitting ratio.

AUXILIARY FEATURES

Standard Parameter Set

The standard parameter set can be recalled in SET mode by pressing the CLR key for approximately 5 seconds. This provides a fast means of returning the HP8152A to a pre-defined state. A list of the standard settings is given under 'STANDARD SETTINGS (LISTENER FUNCTION)' on the blue pages at the end of this section.

Filter

When performing measurements with an unstabilized source, activating FLTR key (9) reduces the input bandwidth from 8Hz to 2 Hz on the selected channel for better averaging. The tradeoff is then slower response to any change on the input power level.

Transducer Outputs

Each channel is equipped with a transducer output which provides the electrical equivalent of low frequency optical inputs.

The wavelength correction factors stored in the optical head are also implemented for the transducer output.

Trend Meters for Manual Ranging

Each channel is equipped with a trend meter which provides analog level indication of the measured power within the currently selected range. This provides a visual aid for optimum range selection.

Overrange/Underrange Indicators

When making measurements, overrange or underrange is indicated in the front panel display as follows:

- '+1' is the **OVERRANGE** indicator. This appears when the optical signal is above the current range capability. All vertical bars on the trend meter will also be illuminated
- '-1' is the **UNDERRANGE** indicator. When dB or dBm are the current display units, this indicates that the measured power is 0 or less (due to negative offset). If watts are the currently selected units, this indicates that the negative offset exceeds -48 counts.

PROGRAMMING

WHAT YOU NEED TO KNOW

Programming information in this section is restricted to HP8152A specifics, and assumes that you have a working knowledge of HP-IB intrinsics. If you are not familiar with HP-IB, then refer to the following publications:

- HP Publication 5952-0156, "Tutorial Description of HP-IB"
- ANSI/IEEE-488-1978, "Digital Interface for Programmable Instrumentation" published by the Institute of Electrical and Electronic Engineers

For a complete list of the HP8152A programming commands, refer to the blue pages at the end of this section.

. . . About The HP8152A's HP-IB Capabilities

The HP8152A interfaces to the HP-IB as defined by the IEEE Standard 488-1978. The interface functional subset which the HP8152A implements is specified in Table 3-1.

Table 3-1. HP-IB Capabilities

MNEMONIC	INTERFACE FUNCTION NAME
SH1	SOURCE HANDSHAKE CAPABILITY
AH1	ACCEPTOR HANDSHAKE CAPABILITY
T6	BASIC TALKER, SERIAL POLL, UNADDRESSED IF MY LISTEN ADDRESS
L4	BASIC LISTENER, UNADDRESSED IF MY TALK ADDRESS
SR1	SERVICE REQUEST CAPABILITY
RL1	REMOTE/LOCAL CAPABILITY
PP0	NO PARALLEL POLL CAPABILITY
DC1	DEVICE CLEAR CAPABILITY
DT1	DEVICE TRIGGER CAPABILITY
CO	NO CONTROLLER CAPABILITY

. . . About Programming Examples in This Section

Programming examples are given in this section to aid explanation. These examples assume the following:

- an HP9000, Series 200 or 300 Computer is controller
- that BASIC is the programming language
- the HP8152A is set to HP-IB address 22 (factory setting)

... About the HP8152A's Command Syntax

The HP8152A has a flexible interpreter that simplifies program generation and allows you to use the data format you prefer. To aid explanation of the command syntax, consider the following programming example:

```
10 OUTPUT 722;"WVL1,1300 NM;caL 1,3.2;REf1,0dbm"  
20 END
```

This sets the HP8152A's channel A parameter values: wavelength 1300nm, CAL factor 3.2dB and REFERENCE value 0 dBm. The points to note on the command "string" are as follows:

- Each command in the string must be terminated by a ";"
- Either upper or lower case may be selected (cal is the same as CAL)
- Any of 3 different data formats may be used. The following settings are equivalent and will be interpreted correctly:
wvl1,1300 nm
WVL1,1.3 um
WVL1,1300 e-09 m
- For any parameter setting, the channel indicator must be separated from the parameter value by a ",". For example:

WVL 1,1300nm - WVL is wavelength parameter; 1 is the channel A indicator; 1300nm the parameter value and units.
- If no unit is specified, then the default unit will be assumed. The default unit is meter for wavelength, dB for CAL factor, and watt or dBm for REFERENCE value depending on the currently selected units.

A complete list of commands is given on the blue pages at the end of this section.

GETTING STARTED

If this is the first time you are programming the HP8152A, the following gives you a few simple tasks to carry out prior to detailed program development. The benefits are twofold in that it gets you started on programming the HP8152A, at the same time checking remote operation of your instrument.

Setting the Address

Each instrument that you connect to the interface bus has a unique "address", and the HP8152A is no different. The address used in a typical BASIC statement takes the form "7xx" where:

- 7 = the interface select code
- xx = the instrument address, which can be any integer from 00 to 30 (21 is usually reserved for the controller)

The HP8152A is preset at the factory to address 22 as shown in the following illustration of the rear panel address switch (you can check this by pressing the front panel LCL key to display the address). If you are satisfied with this address, then continue with the next task "Checking Remote Operation".

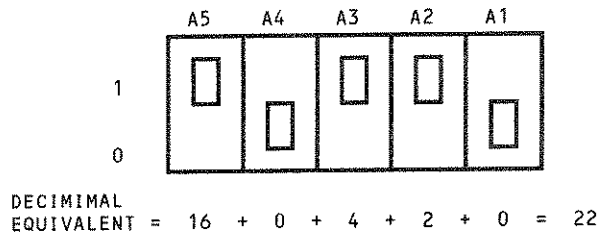

If you want to change the address, first ensure that the HP8152A is in local mode and not addressed (i.e. the ADS and RMT LEDs (3) are not illuminated), then change the bit settings on rear panel address switch (24). Now press the front panel LCL key, and the new address will be activated and displayed.

Checking Remote Operation

You can now check remote operation using a few simple commands as follows:

<pre>10 DIM A\$(11) 20 CLEAR 722 30 OUTPUT 722; "WVL1,1300nm" 40 OUTPUT 722; "WVL?1" 50 ENTER 722;A\$ 60 PRINT A\$ 70 END</pre>	<pre>-clears HP8152A's input/output buffers -sets wavelength of channel A to 1300nm -interrogates channel A wavelength setting</pre>
---	--

The controller output should read "0.1300E-05" which indicates that both the Listener and Talker functions of the HP8152A are operating correctly.

SENDING DATA TO THE HP8152A (LISTENER FUNCTION)

The data that your program sends to the HP8152A falls into 2 categories:

- setting commands
- measurement commands

In contrast to local front panel operation, remote operation allows you to access and change any setting - irrespective of the current operating mode (SET or MEASURE) which remains unchanged.

To make measurements, however, the HP8152A must be set to MEASURE mode via the "M2" command:

e.g. OUTPUT 722;"M2;CH1" Selects MEASURE mode and channel A

The HP8152A then performs measurements continuously, and the output register holding data for transfer to the controller is constantly updated. As update and transfer via the "ENTER" command is asynchronous in continuous operation, you can use the "T1" command (single cycle operation - HPIB only) to synchronize measurements with data transfer. This is illustrated as follows:

```
10 DIM A$(7)
20 OUTPUT 722;"WVL 1,1300NM;CAL 1,0;ARI;CH1;M2;U0;T1"
```

Comment: Sets channel A wavelength 1300nm, channel A CAL factor 0 dB, autoranging on, channel A, MEASure mode, units dBm, single cycle operation.

```
30 TRIGGER 722           - Triggers the HP8152A to make one measurement
40 ENTER 722;A$(         - Transfer result to controller
50 PRINT A$(             - Print result
60 END
```

When set to single cycle operation, the HP8152A will not respond to the "ENTER" command until the optimum range has been found and a measurement performed.

A complete list of commands is given on the blue pages at the end of this section.

RECEIVING DATA FROM THE HP8152A (TALKER FUNCTION)

Just as your program can send setting and measurement commands to the HP8152A, it can also receive data regarding:

- settings
- measurement results

Whereas settings can be interrogated at any time - irrespective of the current operating mode, measurement results can only be transferred in MEASure mode. A more detailed explanation is given in the following.

Settings

The settings can be interrogated either individually or as a complete set (learn string). From the programming example given in the previous sub-section, the channel A wavelength was set to 1300nm. If you now want to interrogate this setting, you could use the following simple program:

```
10 DIM A$(11)           -dimensions string A$ for 11 characters
20 OUTPUT 722;"WVL?1"   -interrogates the channel A wavelength setting
30 ENTER 722;A$(        -transfer setting data to controller
40 PRINT A$(            -prints the setting data
50 END                  Controller printout: 0.1300E-05 (with leading space)
```

Depending on which setting is being interrogated, the length of the character string returned to the controller varies from 1 to 35 characters. A complete list of the interrogating commands and the returned character strings is given on the blue pages at the end of this section.

You can also interrogate the complete settings using a single command as follows:

```
10 DIM A$(200)
20 OUTPUT 728;"LRN?"
30 ENTER 728;A$
40 PRINT A$
50 END
```

The Model 8152A then returns its settings as a 200 character string to the controller. The setting sequence is always the same and is listed on the blue pages at the end of this section.

Measurement Results

As already mentioned, the HP8152A must be in MEASure mode to transfer a measurement result to the controller. Transfer is then dependent on whether single cycle operation or continuous operation is selected:

Single cycle operation is selected by sending "T1" to the HP8152A.
e.g. OUTPUT 722;"T1"
In this case, the HP8152A must be triggered to make a measurement **before** the result can be transferred to the controller. A typical measurement program would be as follows, assuming parameters such as λ have already been set:

```
10 DIM A$(7)
20 OUTPUT 722;"M2;t1;ar1;u0"
30 TRIGGER 722
40 ENTER 722;A$
50 PRINT A$
60 END
```

Continuous operation is selected by sending "T0" to the HP8152A
e.g. OUTPUT 722;"T0"
In this case, measurements are performed continuously in MEASure mode, and the output register holding the measurement result is constantly updated. Resultant update and transfer via the "ENTER" command is therefore asynchronous.

In either case, the length of the character string transferred to the controller is:

7 characters floating point if dB or dBm are the currently selected units.
e.g. -20.68 (with leading space).
11 characters exponential if watts are the currently selected units.
e.g. 0.0008E-02 (with leading space).

NOTE: If **underrange** or **overrange** occurs during a measurement, one of the following strings will be returned to the controller when the measurement result is interrogated:

999.99	for overrange in dB or dBm
9.9999E+99	for overrange in watts
-999.99	for underrange in dB or dBm
-9.9999E-99	for underrange in watts

STATUS/ERROR REPORTING (TALKER FUNCTION)

Another important feature of the HP8152A is that you can program it to interrupt the controller when certain status/error conditions are met. The Require Service (SRQ) message is used to implement this feature and is independent of all other HP-IB activity. However, the HP8152A must be programmed for the interrupt, via the SRQ mask, before the interrupt will take place. The possible interrupt conditions that can be programmed via the SRQ mask are listed as follows:

System Error.	If an error is detected by the self-test at power-on, or a head/mainframe error occurs in normal operation.
Head Disconnection.	The head has been disconnected from the currently active channel.
Measurement Complete After Trigger.	In single cycle operation, measurement result is ready for transfer to the controller.
Parameter/Limit Error.	A wrong value has been set for a parameter.
Message Available.	When the HP8152A is ready to respond to an interrogation command.
Syntax Error.	An invalid instruction has been sent.
Zero Complete	The zero routine is completed.

These 7 interrupt conditions are monitored by an 8-bit Status Register, the content of this register being referred to as the Status Byte.

Status Register and Status Byte

The following shows which bit in the Status Register is allocated to which interrupt condition:

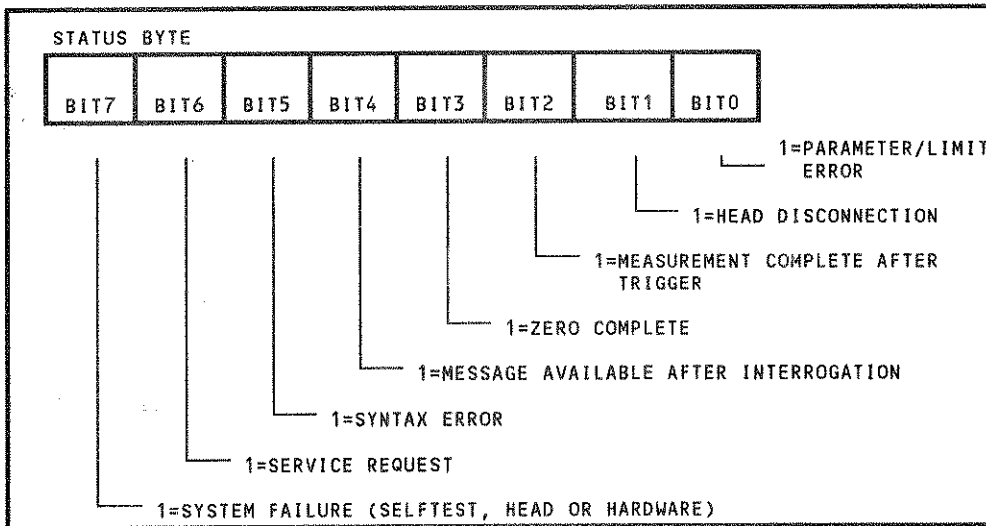

When an interrupt condition is true, the corresponding bit in the status Register is set to 1 - independent of the SRQ mask setting. It is therefore possible for one or more bits of the Status Register to be true without the HP8152A causing an interrupt - because the SRQ mask has not been set for these bits.

This is typically the case at power-on or after "Device Clear" - as the SRQ mask is then set to decimal 000 and all interrupts are disabled. If the HP8152A is now serial polled or receives the "STB?" command, the decimal equivalent of the Status Byte is returned to the controller - but the Status Byte remains unchanged. To clear the Status Byte, the "CSB" (Clear Status Byte) command must be used. For example:

10	DIM A\$[7]	- Dimension of A-string
20	CLEAR 722	- Clears HP8152A's I/O buffers; SRQ mask = 000
30	OUTPUT 722;"CSB"	- Clear status Byte
30	OUTPUT 722;"M2;CH1;AR1;T1;U0"	- MEASure mode;channel A; AUTO-ranging on; single cycle; units dBm
40	TRIGGER 722	- Trigger HP8152A for one measurement
50	S=SPOLL(722)	- Serial poll of HP8152A
60	IF BIT(S,2) = 0 THEN GOTO 50	- Check Status Byte; if Bit 2=0,repeat Serial poll; if Bit 2=1, measurement complete
70	ENTER 722;A\$	- Transfer measurement result to controller
80	PRINT A\$	- Print result
90	OUTPUT 722;"CSB"	- Clear Status Byte
100	END	

If the SRQ mask is set for certain conditions, and one of these conditions occur, bit 6 of the Status Register will go true ("1" state), the SRQ LED on the front panel will illuminate, and the HP-IB SRQ message will be sent. At this point, it will be necessary to address the HP8152A as talker by using the Serial Poll command or "STB?" command:

10	A=SPOLL(722)	- transfers Status Byte to variable "A"
20	PRINT A	
30	END	

or

10	OUTPUT 722;"STB?"	- Interrogates the Status Byte
20	ENTER 722;A	- transfers the Status Byte to variable "A"
30	PRINT A	
40	END	

The Status Byte is returned to the controller as a decimal number which can be broken down into its 8 binary components to determine which bit has gone true. At the same time, the Status Register is cleared and SRQ set false.

NOTES

- Once SRQ is set true, the Status Byte remains unchanged until serial polled or interrogated via the "STB?" command. For any interrupt condition going true during this period, the corresponding bit in the Status Register will not be set. Instead, the "1" state will be held in HP8152A memory and loaded into the Status Register after it is cleared e.g. by serial poll.
- For this reason, if several conditions are enabled by the SRQ mask and they all go true, only the condition that occurred first will have its bit set in the Status Register. The bit settings for the other conditions will be held in HP8152A memory, and loaded simultaneously into the Status Register after it is cleared by a Serial Poll. If you have set more than one condition by the SRQ mask, therefore, your program should serial poll the HP8152A twice to ensure that the Status Register is cleared and SRQ set false.

SETTING THE SRQ MASK

The SRQ mask can be set to mask bits 0-5 and bit 7 on the Status Register. Default mask value is 0 i.e. all interrupt conditions are disabled and no SRQ can be generated. To set the mask first determine which interrupt conditions you want to interrupt the controller, e.g., parameter error, syntax error, etc. Determine the decimal number (1-191) corresponding to those conditions. A "1" in the mask byte enables the corresponding interrupt condition. Then output the "SRE" instruction mnemonic followed by the decimal number. The following shows the Status Register and the SRQ mask set for bit 1 and bit 5, syntax error and parameter error. (OUTPUT 722:"SRE33").

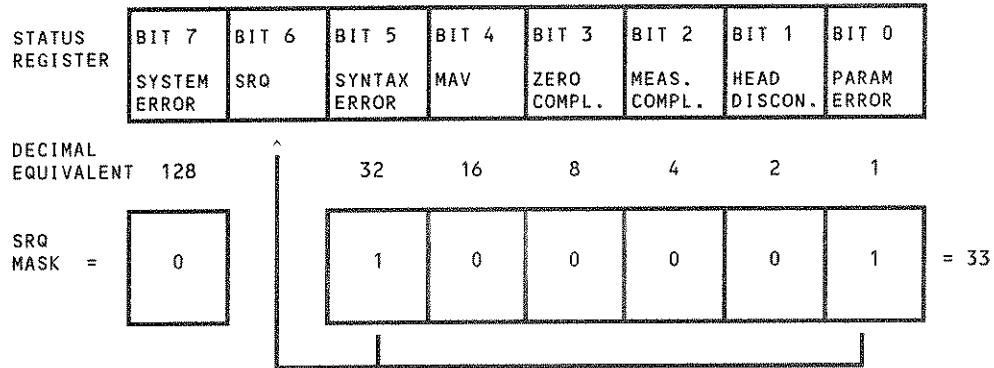

Condition Register

Whereas the Status Register monitors events, i.e. when an interrupt condition occurs, a bit is set and remains set until the register is cleared, the condition register monitors the current status regarding underrange, overrange and head connection.

The bit allocation in the condition register is as follows:

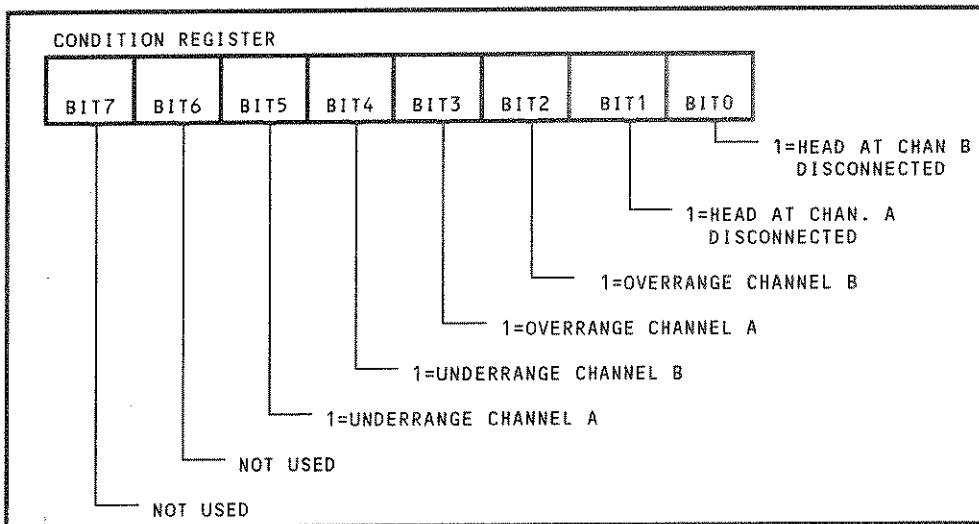

When the condition register is interrogated via the "CNB?" command, the contents are returned to the controller as a decimal number. This number can then be broken down into its binary components to determine which bit has been set to "1".

PROGRAMMING EXAMPLES

The following programming examples may help you to get started on programming the HP8152A. The programs are divided into functional blocks to aid understanding, each block being preceded by a comment line indicating the function.

Printout of Individual Settings in the Learn String

```
10  ! Task Callup From a Main Program
20  ! Calls a subprogram with parameter passing (by value). In this case, the
30  ! HP-IB address of the HP8152A,
40  !
50  INTEGER Powermeter
60  Powermeter = 722
70  CALL Read_Lrn(Powermeter)
80  END
90  !
100 !
110 !Subprogram for reading the learn string and providing a set of variables
120 !describing the complete settings of the power meter
130 !
140 SUB Read_Lrn(INTEGER Pwmtr) ! 722 is passed to INTEGER Pwmtr
150 !
160 !Variable Declaration Section
170 DIM Mode$(3),Channel$(4)                !main keys
180 DIM Ranging$(4),Zeroing$(5),Filter$(1:3)(5),Unit$(3) !measure keys
190 DIM Lambda$(1:2)(17),Cal$(1:2)(13),Ref$(1:3)(17)  !set keys
200 DIM Range$(1:2)(13)                    !active range
210 DIM Trigger$(3),Srq_enable$(7)        !HP-IB specials
220 DIM Lrn$(200)                          !8152A response
230 DIM New_page$(2)                       !printer control
240 INTEGER Printer                        !device select
250 !
260 !Assign Constants
270 New_page$=CHR$(13)&CHR$(12)             !formfeed
280 Printer=CRT                            !output to CRT
290 !
300 !Start Program
310 OUTPUT Pwmtr;"LRN?"
320 ENTER Pwmtr;Lrn$
330 !
340 !Main Keys
350 Mode$=Lrn$(1:3)
360 Channel$=Lrn$(18:4)
370 !
380 !MEASure mode keys/functions
390 Ranging$=Lrn$(13:4)
400 Zeroing$=Lrn$(41:5)
410 Filter$(1)=Lrn$(23:5)
420 Filter$(2)=Lrn$(29:5)
430 Filter$(3)=Lrn$(35:5)
```

```

440 Unit$=Lrn${9;3}
450 !
460 !Active measurement range
470 Range$(1)=Lrn${55;13}
480 Range$(2)=Lrn${69;13}
490 !
500 !SET mode keys/parameters
510 Lambda$(1)=Lrn${165;17}
520 Lambda$(2)=Lrn${183;17}
530 Cal$(1)=Lrn${83;13}
540 Cal$(2)=Lrn${97;13}
550 Ref$(1)=Lrn${111;17}
560 Ref$(2)=Lrn${129;17}
570 Ref$(3)=Lrn${147;17}
580 !
590 !HP-IB specials
600 Trigger$=Lrn${5;3}
610 Srq_enable$=Lrn${47;7}
620 !
630 GOSUB Print_status
640 SUBEXIT
650 !
660 !Subroutine to print the 8152A settings
670 Print_status:
680     OUTPUT Printer;New_page$
690     OUTPUT Printer;"operating mode .....:           ";Mode$
700     OUTPUT Printer;"active channel .....:           ";Channel$
710     OUTPUT Printer;"AUTO ranging .....:           ";Ranging$
720     OUTPUT Printer;"range channel A .....:           ";Range$(1)
730     OUTPUT Printer;"range channel B .....:           ";Range$(2)
740     OUTPUT Printer;"ZERO status .....:           ";Zeroing$
750     OUTPUT Printer;"filter channel A .....:           ";Filter$(1)
760     OUTPUT Printer;"filter channel B .....:           ";Filter$(2)
770     OUTPUT Printer;"filter channel B/A .....:           ";Filter$(3)
780     OUTPUT Printer;"active display units .....:       ";Units$
790     OUTPUT Printer;"_____ "
800     OUTPUT Printer;"wavelength channel A .....:       ";Lambda$(1)
810     OUTPUT Printer;"wavelength channel B .....:       ";Lambda$(2)
820     OUTPUT Printer;"CAL factor channel A .....:       ";Cal$(1)
830     OUTPUT Printer;"CAL factor channel B .....:       ";Cal$(2)
840     OUTPUT Printer;"reference channel A .....:         ";Ref$(1)
850     OUTPUT Printer;"reference channel B .....:         ";Ref$(2)
860     OUTPUT Printer;"reference channel B/A .....:       ";Ref$(3)
870     OUTPUT Printer;"_____ "
890     OUTPUT Printer;"current trigger mode .....:       ";Trigger$
900     OUTPUT Printer;"SRQ enable status .....:         ";Srq_enable$
910 RETURN
920 !
930 SUBEND

```

!skip subroutine

Program to Perform the Front Panel DISP to REF Function and Check for Erroneous Measurements

```

1000 !Declare variables
1010 !
1020 INTEGER Powermeter           ! HP-IB address of the 8152A
1030 INTEGER Message_device       ! Output device e.g. CRT or printer
1040 DIM Reference$(1:3)[22]      ! Reference values for channels A,B,B/A
1050 DIM Result$(43)              ! Feedback for programming result
1060 DIM New_page$(2),New_line$(2) ! Output device control
1070 !
1080 !Initialize variables and constants
1090 !
1100 Powermeter=722
1110 Message_device=CRT           ! May also be a printer-address, e.g.701
1120 !
1130 New_page$=CHR$(13)&CHR$(12)  ! Carriage-return, form-feed
1140 New_line$=CHR$(13)&CHR$(10)  ! Carriage-return, line-feed
1150 !
1160 Reference$(1)="
1170 Reference$(2)="
1180 Reference$(3)="
1190 Result$=""
1200 !
1210 !Start main program
1220 !
1230 CALL Disp_to_ref(Powermeter,Reference$(*),Result$)
1240 !
1250 !Report results
1260 !
1270 OUTPUT Message_device;New_page$
1280 OUTPUT Message_device;"***** reference status *****"
1290 OUTPUT Message_device;New_line$;
1300 OUTPUT Message_device;"result : ";Result$
1310 OUTPUT Message_device;New_line$;
1320 OUTPUT Message_device;"channel A ..... : ";Reference$(1)
1330 OUTPUT Message_device;"channel A ..... : ";Reference$(2)
1340 OUTPUT Message_device;"channel B/A ..... : ";Reference$(3)
1350 !
1360 END
1370 !
1380 SUB Disp_to_ref(INTEGER Pwmtr,Reference$(*),Success$)
1390 !

```

Comment: The following is a sub-program which performs the HP8152A DISP → REF front panel function. The advantage of this sub-program is that it allows any user-program to keep track of the actual reference values and possible error conditions. i.e. It ensures that no differences occur between what the user thinks is being performed and what is actually performed.

The sub-program is structured as follows:

Measure and check
If no error, then store to reference
Report status to caller

Input: HP-IB address of the HP8152A
Output: Reference values as given in the learn string.
Success reporting in "text"

```
1400 !Variable declaration section
1410 !
1420 DIM Mode${3},Channel${4}           ! Active operating parameters
1430 DIM Unit${3}                       ! Active measurement unit
1440 DIM Lrn${200}                      ! 8152A current setting
1450 DIM Channel_select${1}            ! Selector for channel of REFERENCE
1460 DIM Setting${20}                  ! Program string (to powermeter)
1470 DIM Power${11}                    ! Result from power-measurement
1480 DIM Uf${5}                         ! Unit suffix channel A and B (feedb.)
1490 DIM Us${3}                         ! Unit suffix channel A and B (prog. )
1500 DIM Um${3}                         ! Unit suffix for measurement (prog. )
1510 !
1520 INTEGER Set_new,False,True        ! Program control variables
1530 !
1540 !Assign constants
1550 !
1560 False=0
1570 True=1
1580 !
1590 !Start program
1600 !
1610 OUTPUT Pwmtr;"LRN?"               ! What's the current settings ?
1620 ENTER Pwmtr;Lrn$                  ! Enter the current setting
1630 !
1640 Mode$=Lrn${1;3}                   ! Save current active mode
1650 Channel$=Lrn${18;4}                ! Determine active channel
1660 Unit$=Lrn${9;3}                   ! Save current active unit
1670 !
1680 !
1690 SELECT Unit$                      ! Determine active power unit
1700   CASE "U 0"                       ! dBm is active
1710     Uf$=" dBm"                     ! Single channel unit feedback
1720     Um$="U 0"                       ! Measurement unit for ref
1730     Us$="dBm"                       ! Suffix for programming
1740   !
1750   CASE "U 2"                       ! dB is active
1760     SELECT Channel${4;1}            ! Determine active channel
1770       CASE "1","2"                  ! Channel A or B
1780         Uf$=" dBm"                   ! Single channel unit feedback
1790         Um$="U 0"                     ! Measurement unit for ref
1800         Us$="dBm"                     ! Suffix for programming
1810       !
1820     CASE ELSE                       ! Channel B/A
```

```

1830     Uf$=" dBm"           ! Single channel unit feedback
1840     Um$="U 0"           ! Measurement unit for ref
1850     Us$="dB"            ! Suffix for programming
1860     END SELECT          ! End select channel
1870     !
1880     CASE ELSE           ! Watt is active
1890     Uf$=" Watt"         ! Single channel unit feedback
1900     Um$="U 1"          ! Measurement unit for ref
1910     Us$="W"             ! Suffix for programming
1920     END SELECT          ! End select unit
1930     !
1940     !
1950     !Start measurement of reference value
1960     !

```

Comment: No need to check if the HP8152A is in an unfavorable mode. Just program the necessary conditions to make a measurement, and restore the initial settings after measurement.

```

1970     Setting$="m2;"&Um$   ! Measure mode and valid reference unit
1980     OUTPUT Pwmtr;Setting$
1990     TRIGGER Pwmtr        ! Ensures measurement independent of
2000                         ! trigger mode setting
2010     ENTER Pwmtr;Power$   ! Get measurement result for your reference
2020     !
2030     !Restore initial settings
2040     !
2050     Setting$=Mode$&" "&Unit$
2060     OUTPUT Pwmtr;Setting$
2070     !
2080     !Test measurement result for validity
2090     !

```

Comment: The performance of this test check can be improved by using the 8152A's status byte, but for this example, a simple "demonstration" is chosen to show the principles of operation.

```

2100     SELECT Power$
2110     CASE "NO DATA"     ! May be no head or error occurred
2120     Success$="no valid data" ! No value to store to REF available
2130     Set_new=False       ! Suppress programming
2140     !
2150     CASE " 999.99","-999.99" ! Overload or underrange if no watt
2160     Success$="power exceeds limits"
2170     Set_new=False       ! Suppress programming
2180     !
2190     CASE " 9.9999E+99","-9.9999E-99" ! Overload or underrange in watt
2200     Success$="power exceeds limits"
2210     Set_new=False       ! Suppress programming
2220     !
2230     CASE ELSE
2240     IF Um$="U 1" THEN   ! If measurement in Watt then
2250     IF VAL(Power$)<=0 THEN ! reference MUST always be > 0 Watt
2260     Success$="value =< 0 Watt" ! Feedback to caller
2270     Set_new=False       ! Suppress programming

```

```

2280     ELSE
2390         Success$="reference is set"           ! Feedback to caller
2300         Set_new=True                       ! Allow programming
2310     END IF                                ! End if test for power =< zero
2320     ELSE                                   ! Measurement in dBm or dB
2330         Success$="reference is set"       ! Valid measurement
2340         Set_new=True                       ! Allow programming
2350     END IF                                ! End if test for watt
2360     !
2370 END SELECT
2380 !
2390 !Send reference to the power meter
2400 !
2410 IF Set_new THEN                          ! No error therefore set new reference
2420     Channel_select$=Channel${4;1}        ! Select active channel
2430     Setting$="REF "&Channel_select$      ! Build command header
2440     Setting$=Setting$&" "&Power$        ! Add data
2450     Setting$=Setting$&Us$              ! Add suffix (e.g. dBm if dB is active)
2460     OUTPUT Pwmtr;Setting$              ! Set new reference
2470     OUTPUT Pwmtr;"lrn?"               ! Get new formatted data from the
2480     ENTER Pwmtr;Lrn$                  ! 8152A, which performs formatting!
2490 ELSE                                    ! Error condition, no programming
2500     Success$=Success$&"", old REF still active"
2510 END IF
2520 !
2530 !Return current reference to caller
2540 !
2550 Reference$(1)=Lrn${11;17}&Uf$          ! Return channel A data
2560 Reference$(2)=Lrn${129;17}&Uf$        ! Return channel B data
2570 Reference$(3)=Lrn${147;17}&" dB"      ! Return channel B/A data
2580 !
2590 SUBEND

```

HP8152A COMMAND SUMMARY

SETTINGS (LISTENER FUNCTION)

Parameter/Operation	Mnemonic	Data	Unit	Comment
Select SET Mode	M	1		
Select MEASure Mode	M	2		
Select Channel A	CH	1		
Select Channel B	CH	2		
Select B/A Operation	CH	3		
Autoranging Off	AR	0		
Autoranging On	AR	1		
Zero Off	ZER	0		
Zero On	ZER	1		
Filter Off Settings	F	1,0		for Channel A.
	F	2,0		for Channel B.
	F	3,0		for B/A operation.
Filter On Settings	F	1,1		for Channel A.
	F	2,1		for Channel B.
	F	3,1		for B/A operation.
Select dBm Units	U	0		
Select Watts	U	1		
Select dB Units	U	2		
Select Trigger Off	T	0		continuous operation.
Select Trigger On	T	1		single cycle operation.
Set Channel A Range	RNG	1,value	DBM or DB(MW)	value = +30..-90; head dependent.
Set Channel B Range	RNG	2,value	DBM or DB(MW)	value = +30..-90; head dependent.
Set Channel A λ	WVL	1,value	M MM UM NM PM	meter. Default if no unit defined. millimeter micrometer nanometer picometer
Set Channel B λ	WVL	2,value	M MM UM NM PM	meter. Default if no unit defined. millimeter micrometer nanometer picometer

SETTINGS (LISTENER FUNCTION) contd.

Parameter/Operation	Mnemonic	Data	Unit	Comment
Set CAL for Channel A	CAL	1,value	DB	default is dB if no units defined
Set CAL for Channel B	CAL	2,value	DB	default is dB if no units defined
Set REF for Channel A	REF	1,value	DBM or DB(MW) W MW UM NM PM	watts milliwatts microwatts nanowatts picowatts If no units defined, default is determined by the "U" setting
Set REF for Channel B	REF	2,value	"	"
Set REF for B/A Mode	REF	3,value	DB	default is dB if no units defined
Set SRQ Mask	SRE	value		value = decimal number (0-191). A "1" in the binary equivalent sets SRQ on this condition.
Clear Status Byte	CSB			Always clears Status Byte independent of SRQ state
Clear Device	CLR			Clears all I/O buffers. Same as Universal Device Clear Command.
Trigger	TRG			Perform one measurement in single cycle operation

STANDARD PARAMETER SET (LISTENER FUNCTION)

Parameter/Operation	Mnemonics	Comment
Recall Standard Parameter Set	RST	The settings are as follows: Measure mode Channel A AUTOranging on ZERO off Filter off Units dBm Range 0 dBm REFerence value 0 dB/1 mW CAL factor 0 dB λ - head dependent

INTERROGATING SETTINGS (TALKER FUNCTION)

Parameter/Operation	Mnemonics	Comment																																							
Learn Mode	LRN?	Returns 200-character string detailing all settings. Setting sequence is always the same and listed as follows:																																							
		<table border="1"> <thead> <tr> <th>Setting</th> <th>Byte Position</th> <th>Length</th> </tr> </thead> <tbody> <tr> <td>Mode</td> <td>1-4</td> <td>4</td> </tr> <tr> <td>Trigger</td> <td>5-8</td> <td>4</td> </tr> <tr> <td>Units</td> <td>9-12</td> <td>4</td> </tr> <tr> <td>AUTO ranging</td> <td>13-17</td> <td>5</td> </tr> <tr> <td>Channel</td> <td>18-22</td> <td>5</td> </tr> <tr> <td>Filter A, B and B/A</td> <td>23-28,29-34,35-40</td> <td>6,6,6</td> </tr> <tr> <td>Zero</td> <td>41-46</td> <td>6</td> </tr> <tr> <td>SRQ mask</td> <td>47-54</td> <td>8</td> </tr> <tr> <td>Range A and B</td> <td>55-68,69-82</td> <td>14,14</td> </tr> <tr> <td>CAL factors A and B</td> <td>83-96,97-110</td> <td>14,14</td> </tr> <tr> <td>REF values A, B and B/A</td> <td>111-128,129-146, 147-164</td> <td>18,18, 18</td> </tr> <tr> <td>λ A and B</td> <td>165-182,183-200</td> <td>18,18</td> </tr> </tbody> </table>	Setting	Byte Position	Length	Mode	1-4	4	Trigger	5-8	4	Units	9-12	4	AUTO ranging	13-17	5	Channel	18-22	5	Filter A, B and B/A	23-28,29-34,35-40	6,6,6	Zero	41-46	6	SRQ mask	47-54	8	Range A and B	55-68,69-82	14,14	CAL factors A and B	83-96,97-110	14,14	REF values A, B and B/A	111-128,129-146, 147-164	18,18, 18	λ A and B	165-182,183-200	18,18
		Setting	Byte Position	Length																																					
		Mode	1-4	4																																					
		Trigger	5-8	4																																					
		Units	9-12	4																																					
		AUTO ranging	13-17	5																																					
		Channel	18-22	5																																					
		Filter A, B and B/A	23-28,29-34,35-40	6,6,6																																					
		Zero	41-46	6																																					
		SRQ mask	47-54	8																																					
		Range A and B	55-68,69-82	14,14																																					
CAL factors A and B	83-96,97-110	14,14																																							
REF values A, B and B/A	111-128,129-146, 147-164	18,18, 18																																							
λ A and B	165-182,183-200	18,18																																							
Interrogate setting	M?	Returns integer (1 or 2) for mode setting																																							
	CH?	Returns integer (1,2 or 3) for channel setting																																							
	AR?	Returns integer (0 or 1) for autorange off/on																																							
	ZER?	Returns integer (0 or 1) for zero off/on																																							
	U?	Returns integer (0,1 or 2) for current units																																							
	T?	Returns integer (0 or 1) for trigger off/on																																							
	F? 1,2 or 3	Returns integer (0 or 1) for filter off/on for the selected channel (A,B or B/A)																																							
	F?	Returns 3 integers separated by commas to indicate all 3 filter settings																																							
	RNG? 1 or 2	Returns 7-character string for range selection on the selected channel (A or B)																																							
	RNG?	Returns 15-character string to indicate range selections of both channels																																							
	WVL? 1 or 2	Returns 11-character string for λ setting on the selected channel (A or B). Always in meters.																																							
	WVL?	Returns 23-character string for λ settings of both channels. Always in meters.																																							
	CAL? 1 or 2	Returns 7-character string for CAL setting of selected channel (A or B). Always in dB.																																							
	CAL?	Returns 15-character string for CAL settings of both channels. Always in dB.																																							
	REF? 1,2 or 3	Returns 7-character string for REF setting of the selected channel (A,B or B/A) if dB or dBm are the current units. Returns 11-character string if watts are current units.																																							
REF?	Returns 23-character string for all REF settings (A,B,B/A) if dB or dBm are the current units. Returns 31-character string if watts are the current units.																																								

STATUS/ERROR REPORTING (TALKER FUNCTION)

Interrogation	Mnemonics	Comment
Status Byte	STB?	Returns 3-digit integer (000-191). With SRQ false, does not clear Status Byte.
Status Byte Mask	SRE?	Returns 3-digit integer (000-191).
Condition Byte	CNB?	Returns 2-digit integer (00-63).
Self-test	TST?	Executes self-test and returns 0 or 1 to indicate passed or failed.
Error Number	ERR?	Returns 3-digit integer representing HP8152A error code (details given in Service info). 000 means no error. An error code is only available if bit 7 (System Error) in the Status Byte has been set. Other error conditions in the Status Byte will not cause an error code. On readout, the error code is transferred to the 'Last Error Number' register.
Last Error Number	LERR?	Returns 3-digit integer for last active error. This is a destructive readout.
Operation Complete	OPC?	1 if no further command to interpret and execute in the input buffer. 0 if further commands in the input buffer.
Identifier	IDN? IDN?1 or 2	Returns 56-character string identifying currently installed firmware, manufacturer model no. and serial number. Returns 26-character string indentifying currently installed firmware, manufacturer model no. and serial number of channel A or B optical head.

UNIVERSAL COMMANDS

Command	ASCII Character	Equivalent Forms		
		Binary	Octal	Decimal
Device Clear	DC ₄	00010100	024	20
Selected Device Clear	EOT	00000100	004	4
Group Execute Trigger	BS	00001000	010	8

Both "CLEAR" commands clear all input/output buffers, reset SRQ mask to all disabled and SRQ to false, but have no effect on HP8158B mode/parameter settings.

The HP8152A performs one measurement in response to the trigger command in single cycle operation. The measurement result overwrites any pending response to an interrogation command.

SECTION IV

FUNCTION TESTS

4-1 INTRODUCTION

4-2 The procedures in this section test the electrical performance of the instrument. The complete specifications to which the HP8152A is tested are given in Table 1-1. All tests can be performed without access to the interior of the instrument.

4-3 EQUIPMENT REQUIRED

4-4 Equipment required for the function test is listed in Table 4-1. Recommended Test Equipment. Any equipment which satisfies the critical specifications given in the table may be substituted for recommended models.

Table 4-1. Recommended Test Equipment

Instrument/Accessory	Rec. Model	Critical Specification
Test Box	HP8100AT	
Test Cable	HP15414-61603	
BNC to BNC cable	HP15402A	
Digital Voltmeter	HP3466A	0.01mV Resolution
BNC (f) Dual Banana Adapter	HP1251-2277	
DC Standard		Accuracy 50ppm \pm 20uV

4-5 TEST RECORD

4-6 Results of the function test may be tabulated on the Test Record provided at the end of the test procedures. It is recommended that you fill out the Test Record and refer to it while doing the test. Since the test limits and setup information are printed on the Test Record for easy reference, the record can be also be used as an abbreviated test procedure (if you are familiar with test procedures). The Test Record can also be used as a permanent record and may be reproduced without written permission from Hewlett-Packard.

4-7 TEST FAILURE

4-8 If the HP8152A fails any function test, return the instrument to the nearest Hewlett-Packard Sales/Service Office for repair.

4-9 INSTRUMENTS SPECIFICATION

4-10 Specifications are the performance characteristics of the instrument which are certified. These specifications, listed in Table 1-1 are the performance standards or limits against which the HP8152A can be tested. Table 1-1 also lists some supplemental characteristics of the HP8152A and should be considered as additional information.

4-11 Any changes in the specifications due to manufacturing changes, design, or traceability to the National Bureau of Standards will be covered in a manual change supplement or revised manual. The specifications listed here supersede any previously published.

4-12 FUNCTION TESTS

4-13 The function tests given in this section are separated into Function Test without Optical Head and Voltage Status and Accuracy Test. Perform each step in the tests in the order they are given using the corresponding test equipment.

4-14 8152A FUNCTION AND ACCURACY TEST

Equipment required:

81000AT Test Box
15414-61603 Test Cable
10502A BNC to BNC cable
DC Standard
Digital Voltmeter
1251-2277 BNC (f) Dual Banana Adapter

8152A Function Test without Optical Heads connected.

1. Turn the 8152A on and check that all LEDs and are on for approx. 0.5 seconds.
2. Press the LCL key and check that the selected HP-IB address is displayed.
3. Set the 8152A to SET mode and select input A.
4. Press the λ key and using the VERNIER keys check that λ can be set from 100nm to 19999nm. Then press CLR and 1300nm should be displayed.
5. Press the CAL key and using the VERNIER check that the CAL factor can be set from -199.99dB to 199.99dB. Press CLR and the display should show 0.00dB.
6. Press REF, select display in dBm and check that the REF value can be set from 199.99dBm to -199.99dBm. Press CLR and 0.00dBm should be displayed.
7. Press WATT and using the RANGE rocker key, check that following ranges can be selected:

1000	mW	1000	pW
100.0	mW	100.0	pW
10.00	mW	10.00	pW
1000	uW	1.00	pW
100.0	uW	0.10	pW
10.00	uW	0.01	pW
1000	nW		
100.0	nW		
10.00	nW		

8. Select B/A and check that the display can be set from 199.99dB to -199.99dB and then press CLR to get a 0.00dB display.

Voltage, Status and Accuracy Test.

1. Connect the equipment as shown in Figure 4-1 and set the toggle switch on the 81000AT Test Box to NO position.

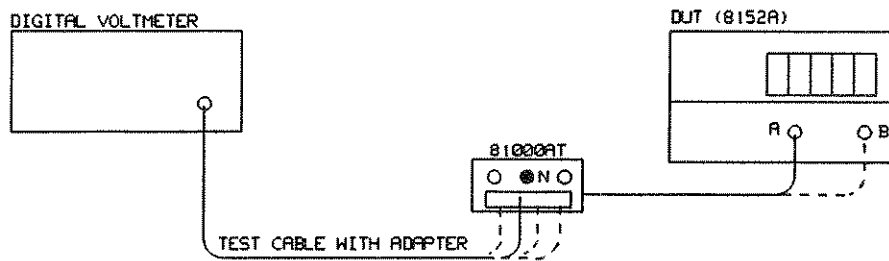

Figure 4-1

2. Set the 8152A to MEASure, select INPUT A and display in dBm.
3. Using the Test Cable measure first the following DC levels and states.

ON/OFF	+ 5 Volt	±0.5 Volt
+ 15 V	+ 15 Volt	±0.8 Volt
- 15 V	- 15 Volt	±0.8 Volt
MODE 0	Low	
MODE 1	Low	
RANGE 0	High in the 30dBm to -30dBm ranges	
	Low in the -40dBm to -90dBm ranges	
RANGE 1	High in the 30dBm to -10dBm ranges	
	Low in the -20dBm to -90dBm ranges	
STATUS	High	
CLOCK	High	

4. Set the DC Standard to +0.000 Volt and connect the equipment as shown in Figure 4-2.

CAUTION: Check polarity of DC Standard connection.

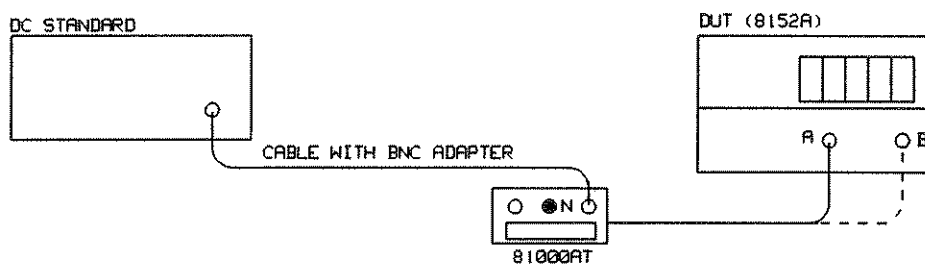

Figure 4-2

5. Select the 0dBm Range display in μW and switch AUTOrange off. Press the ZERO key and check the 8152A display readings at following DC Standard settings:

DC Standard Setting	8152A Reading (± 4 counts)
0.000 Volt	0 μW
+ 0.100 Volt	100 μW
+ 0.300 Volt	300 μW
+ 0.500 Volt	500 μW
+ 0.700 Volt	700 μW
+ 0.900 Volt	900 μW
+ 1.000 Volt	1000 μW
+ 1.100 Volt	1100 μW
+ 1.300 Volt	1300 μW
+ 1.500 Volt	1500 μW
+ 1.700 Volt	1700 μW
+ 1.900 Volt	1900 μW
+ 1.990 Volt	1990 μW

6. Set the DC Standard to 0.010 Volt and check the 8152A display with the -50dBm range and then with the -60dBm range selected.

-50dBm range = 1.00nW ± 4 counts,

-60dBm range = 1000pW ± 4 counts.

7. Repeat steps 2 to 6 for INPUT B.

Hewlett-Packard Model 8152A

Test Performed By _____

Optical Average Power Meter

Date _____

Serial Number _____

Comments _____

4-14 FUNCTION AND ACCURACY TEST

Test Condition: Function Test without Optical Heads connected

Step	Description	Test Pass	Test Fail
1.	All LED's and Displays on for approx. 0.5 sec.	_____	_____
2.	HP-IB address displayed when pressing LCL key	_____	_____
4	Lambda selectable from 100nm to 19999nm	_____	_____
	Lambda CLR function (1300nm)	_____	_____
5.	CAL setting -199.99dB to 199.99dB	_____	_____
	CAL CLR function	_____	_____
6.	REF setting from 199.99dB to -199.99dB	_____	_____
	REF CLR function	_____	_____
7.	RANGE selection		
	1000 mW	1000 pW	
	100.0 mW	100.0 pW	
	10.00 mW	10.00 pW	
	1000 uW	1.00 pW	
	100.0 uW	0.10 pW	
	10.00 uW	0.01 pW	
	1000 nW		
	100.0 nW		
	10.00 nW		
8.	B/A display setting from 199.00dB to -199.99dB	_____	_____
	B/A CLR function	_____	_____

Hewlett-Packard Model 8152A

Test Performed By _____

Optical Average Power Meter

Date _____

Serial Number _____

Comments _____

4-14 FUNCTION AND ACCURACY TEST

INPUT A

Test Condition: Function Test with HP81000AT connected

Step	Description	Test Pass	Test Fail
Voltage, Status and Accuracy Test			
4.	ON / OFF	_____	_____
	+ 5 Volt +/- 0.5 Volt	_____	_____
	+ 15 Volt	_____	_____
	+ 15 Volt +/- 0.8 Volt	_____	_____
	- 15 Volt	_____	_____
	- 15 Volt +/- 0.8 Volt	_____	_____
	MODE 0	_____	_____
	Low	_____	_____
	MODE 1	_____	_____
	Low	_____	_____
	RANGE 0	_____	_____
	High in the 30dBm to -30dBm ranges	_____	_____
	Low in the -40dBm to -90dBm ranges	_____	_____
	RANGE 1	_____	_____
	High in the 30dBm to -10dBm ranges	_____	_____
	Low in the -20dBm to -90dBm ranges	_____	_____
	STATUS	_____	_____
	High	_____	_____
	CLOCK	_____	_____
	High	_____	_____
6.	DC Standard Setting	8152A Reading (+/-4 counts)	
	0.000 Volt	_____	_____
	0 uW	_____	_____
	+ 0.100 Volt	_____	_____
	100 uW	_____	_____
	+ 0.300 Volt	_____	_____
	300 uW	_____	_____
	+ 0.500 Volt	_____	_____
	500 uW	_____	_____
	+ 0.700 Volt	_____	_____
	700 uW	_____	_____
	+ 0.900 Volt	_____	_____
	900 uW	_____	_____
	+ 1.000 Volt	_____	_____
	1000 uW	_____	_____
	+ 1.100 Volt	_____	_____
	1100 uW	_____	_____
	+ 1.300 Volt	_____	_____
	1300 uW	_____	_____
	+ 1.500 Volt	_____	_____
	1500 uW	_____	_____
	+ 1.700 Volt	_____	_____
	1700 uW	_____	_____
	+ 1.900 Volt	_____	_____
	1900 uW	_____	_____
	+ 1.990 Volt	_____	_____
	1990 uW	_____	_____
7.	+ 0.010 Volt -50dBm range	_____	_____
	1.00 nW (+/-4 counts)	_____	_____
	+ 0.010 Volt -60dBm range	_____	_____
	1000 pW (+/-4 counts)	_____	_____

Hewlett-Packard Model 8152A

Test Performed By _____

Optical Average Power Meter

Date _____

Serial Number _____

Comments _____

4-14 FUNCTION AND ACCURACY TEST

INPUT B

Test Condition: Function Test with HP81000AT connected

Step	Description	Test Pass	Test Fail
Voltage, Status and Accuracy Test			
4.	ON / OFF	_____	_____
	+ 5 Volt +/- 0.5 Volt	_____	_____
	+ 15 Volt	_____	_____
	+ 15 Volt +/- 0.8 Volt	_____	_____
	- 15 Volt	_____	_____
	- 15 Volt +/- 0.8 Volt	_____	_____
	MODE 0	_____	_____
	Low	_____	_____
	MODE 1	_____	_____
	Low	_____	_____
	RANGE 0	_____	_____
	High in the 30dBm to -30dBm ranges	_____	_____
	Low in the -40dBm to -90dBm ranges	_____	_____
	RANGE 1	_____	_____
	High in the 30dBm to -10dBm ranges	_____	_____
	Low in the -20dBm to -90dBm ranges	_____	_____
	STATUS	_____	_____
	High	_____	_____
	CLOCK	_____	_____
	High	_____	_____
6.	DC Standard Setting	8152A Reading (+/-4 counts)	
	0.000 Volt	0 uW	_____
	+ 0.100 Volt	100 uW	_____
	+ 0.300 Volt	300 uW	_____
	+ 0.500 Volt	500 uW	_____
	+ 0.700 Volt	700 uW	_____
	+ 0.900 Volt	900 uW	_____
	+ 1.000 Volt	1000 uW	_____
	+ 1.100 Volt	1100 uW	_____
	+ 1.300 Volt	1300 uW	_____
	+ 1.500 Volt	1500 uW	_____
	+ 1.700 Volt	1700 uW	_____
	+ 1.900 Volt	1900 uW	_____
	+ 1.990 Volt	1990 uW	_____
7.	+ 0.010 Volt -50dBm range	1.00 nW (+/-4 counts)	_____
	+ 0.010 Volt -60dBm range	1000 pW (+/-4 counts)	_____

OPERATING MANUAL

HP81521B OPTICAL HEAD 850nm to 1700nm

SERIAL NUMBERS

This manual applies directly to instruments with serial number 2602G00101 and higher. Any change made in instruments having serial numbers higher than the above number will be found in a "Manual Changes" supplement supplied with this manual. Be sure to examine the supplement for changes which apply to your instrument and record these changes in the manual.

© HEWLETT-PACKARD GMBH 1986
HERRENBERGER STR. 130, D-7030 BOBLINGEN
FEDERAL REPUBLIC OF GERMANY

MANUAL PART No. 81521-90011
MICROFICHE PART No. 81521-95011

PRINTED: MAY 1986

SAFETY

This product has been designed and tested according to International Safety Requirements. To ensure safe operation and to keep the product safe, the information, cautions, and warnings in this manual must be heeded.

CERTIFICATION

Hewlett-Packard Company certifies that this product met its published specifications at the time of shipment from the factory. Hewlett-Packard further certifies that its calibration measurements are traceable to the United States National Bureau of Standards, to the extent allowed by the Bureau's calibration facility, and to the calibration facilities of other International Standards Organization members.

WARRANTY

This Hewlett-Packard product is warranted against defects in material and workmanship for a period of one year from date of shipment. During the warranty period, Hewlett-Packard Company will, at its option, either repair or replace products which prove to be defective.

For warranty service or repair, this product must be returned to a service facility designated by HP. However, warranty service for products installed by HP and certain other products designated by HP will be performed at Buyer's facility at no charge within the HP service travel area. Outside HP service travel areas, warranty service will be performed at Buyer's facility only upon HP's prior agreement and Buyer shall pay HP's round trip travel expenses.

For products returned to HP for warranty service, Buyer shall prepay shipping charges to HP and HP shall pay shipping charges to return the product to Buyer. However, Buyer shall pay all shipping charges, duties, and taxes for products returned to HP from another country.

LIMITATION OF WARRANTY

The foregoing warranty shall not apply to defects resulting from improper or inadequate maintenance by Buyer, Buyer-supplied software or interfacing, unauthorized modification or misuse, operation outside of the environmental specifications for the product, or improper site preparation or maintenance.

NO OTHER WARRANTY IS EXPRESSED OR IMPLIED. HP SPECIFICALLY DISCLAIMS THE IMPLIED WARRANTIES OF MERCHANTABILITY AND FITNESS FOR A PARTICULAR PURPOSE.

EXCLUSIVE REMEDIES

THE REMEDIES PROVIDED HEREIN ARE BUYER'S SOLE AND EXCLUSIVE REMEDIES. HP SHALL NOT BE LIABLE FOR ANY DIRECT, INDIRECT, SPECIAL, INCIDENTAL, OR CONSEQUENTIAL DAMAGES, WHETHER BASED ON CONTRACT, TORT, OR ANY OTHER LEGAL THEORY.

ASSISTANCE

Product maintenance agreements and other customer assistance agreements are available for Hewlett-Packard products.

For any assistance, contact your nearest Hewlett-Packard Sales and Service Office. Addresses are provided at the back of this manual.

The following general safety precautions must be observed during all phases of operation, service, and repair of this instrument. Failure to comply with these precautions or with specific warnings elsewhere in this manual violates safety standards of design, manufacture, and intended use of the instrument. Hewlett-Packard Company assumes no liability for the customer's failure to comply with these requirements.

GENERAL — This is a Safety Class I instrument (provided with terminal for protective earthing) and has been manufactured and tested according to international safety standards.

OPERATION — BEFORE APPLYING POWER comply with the installation section. Additionally, the following shall be observed:

Do not remove instrument covers when operating.

Before the instrument is switched on, all protective earth terminals, extension cords, auto-transformers and devices connected to it should be connected to a protective earth via a ground socket. Any interruption of the protective earth grounding will cause a potential shock hazard that could result in serious personal injury. Whenever it is likely that the protection has been impaired, the instrument must be made inoperative and be secured against any unintended operation.

Make sure that only fuses with the required rated current and of the specified type (normal blow, time delay, etc.) are used for replacement. The use of repaired fuses and the short-circuiting of fuseholders must be avoided.

Adjustments described in the manual are performed with power supplied to the instrument while protective covers are removed. Energy available at many points may, if contacted, result in personal injury.

Any adjustment, maintenance, and repair of the opened instrument under voltage should be avoided as much as possible, and when inevitable, should be carried out only by a skilled person who is aware of the hazard involved. Do not attempt internal service or adjustment unless another person, capable of rendering first aid and resuscitation is present. Do not replace components with power cable connected.

Do not operate the instrument in the presence of flammable gases or fumes. Operation of any electrical instrument in such an environment constitutes a definite safety hazard.

Do not install substitute parts or perform any unauthorized modification to the instrument.

Capacitors inside the instrument may still be charged even if the instrument has been disconnected from its source of supply.

SAFETY SYMBOLS



The apparatus will be marked with this symbol when it is necessary for the user to refer to the instruction manual in order to protect the apparatus against damage.



Indicates dangerous voltages.



Earth terminal



The WARNING sign denotes a hazard. It calls attention to a procedure, practice or the like, which, if not correctly performed or adhered to, could result in injury or loss of life. Do not proceed beyond a WARNING sign until the indicated conditions are fully understood and met.



The CAUTION sign denotes a hazard. It calls attention to an operating procedure, practice, or the like, which, if not correctly performed or adhered to, could result in damage to or destruction of part or all of the equipment. Do not proceed beyond a CAUTION sign until the indicated conditions are fully understood and met.

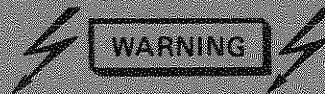

Dangerous voltages, capable of causing serious personal injury, are present in this instrument. Use extreme caution when handling, testing, and adjusting.





CONTENTS

SECTION	Page
A-1 GENERAL INFORMATION	
INTRODUCTION	A-1
SPECIFICATIONS	A-1
SAFETY CONSIDERATIONS	A-1
OPTICAL HEADS COVERED BY THIS APPENDIX	A-1
DESCRIPTION	A-1
ACCESSORIES AVAILABLE	A-1
A-2 INSTALLATION	
INITIAL INSPECTION	A-5
HANDLING PRECAUTION	A-5
OPTICAL CONNECTIONS	A-5
STORAGE AND SHIPMENT ENVIRONMENT	A-6
RETURN SHIPMENTS TO HEWLETT-PACKARD	A-6
A-3 OPERATION	
SPECIAL OPERATING CONSIDERATIONS	A-7
COMPENSATING FOR LENS LOSS	A-7
CLEANING THE LENS	A-7
TRANSDUCER OUTPUTS	A-8
A-4 PERFORMANCE TESTS	
INTRODUCTION	A-9
EQUIPMENT REQUIRED	A-10
TEST RECORD	A-10
TEST FAILURE	A-10
INSTRUMENT SPECIFICATIONS	A-10
PERFORMANCE TESTS	A-10
81521B ACCURACY AND LINEARITY TEST	A-11

SECTION A-1

GENERAL INFORMATION

INTRODUCTION

This appendix provides the supplementary information required when an HP81521B Optical Head is connected to the HP8152A Optical Average Power Meter. The information is HP81521B specific and covers installation, operation and performance tests.

SPECIFICATIONS

Specifications of the HP81521B are given in Table A-1. These specifications are the performance standards or limits against which the optical head is tested.

SAFETY CONSIDERATIONS



Before connecting the optical head to the HP8152A, ensure that the HP8152A is connected to protective (earth) ground.

OPTICAL HEADS COVERED BY THIS APPENDIX

Each optical head has a two-part serial number. The first 4 digits and the letter comprise the serial prefix; the last 5 digits a sequential suffix which is unique to each HP81521B. The contents of this appendix apply directly to optical heads having the serial prefix 2602G.

DESCRIPTION

The HP81521B is the standard optical head for the HP8152A Optical Average Power Meter when operating in the wavelength range 850nm → 1700nm. This head covers single- and multimode fibers up to 100 μm core diameter.

At the factory, correction factors over the entire wavelength range are individually measured and stored in each optical head. This ensures precise power measurements, even when the source-under-test has an operating wavelength other than 1300nm. The dynamic range is +3 → -80dBm with the noise floor being well below -70dBm to provide the sensitivity needed for a wide range of applications.

A large variety of optical adapters is available to simplify connection of the HP81521B to the device-under-test. If it is necessary to measure power levels above +3dBm, fixed attenuation filters can be easily inserted into an optional filter holder.

ACCESSORIES AVAILABLE

A number of accessories are available to aid measurement and simplify connection to either bare or terminated fibers. The accessories are listed as follows:

- **CONNECTOR ADAPTERS**

- 81000AA for connection with Diamond HMS-10/HP connector
- 81000BA for connection with bare fiber (125 μm cladding)
- 81000FA for connection with FC or PC connectors
- 81000GA for connection with NEC D4 connector
- 81000JA for connection with AMP SMA or Amphenol 906 connectors
- 81000LA for connection with F & G 3702 connector
- 81000NA for connection with Stratos 430 connector
- 81000WA for connection with Biconic connector
- 81000YA for connection with Diamond HFS-1 connector
- 81000ZA blank adapter for connection with any other connectors

- **LENSES**

- 81010BL lens for 1300nm, 1550nm, and 9/125 μm or 10/125 μm fiber.
- 81050BL lens for 1300nm, 1550nm, and 50/125 μm or 62.5/125 μm fiber

- **FILTERHOLDER**

- 81000AF filterholder for filters with 1-inch diameter

- **POWER SPLITTER**

- 81000BS 10:1 power splitter for single- and multimode; fiber core diameters from 9 μm to 85 μm (NA \leq 0.3).

An additional accessory for the HP81521B is the HP15475A Cleaning Kit. This kit includes cleaning material (brush, tissue, tape, etc.) to clean optical surfaces such as connectors and is supplied in a plastic carrying case.

Table A-1. Specifications

Specifications describe the instrument's warranted performance. They apply to optical input signals transmitted in parallel beam. Use appropriate lenses and connector adapters for the optical head to accommodate light emerging from optical fibers.

Optical Characteristics

Wavelength Range: 850nm to 1700nm, actual wavelength user-selectable. Each optical head is individually calibrated over wavelength between 850nm and 1700nm. Correction factors are stored in its non-volatile memory.

Sensor Element: Cooled Ge PIN diode
Sensor Diameter: 5mm
Maximum Power Density: 10mW/mm²

Power Measurements

Accuracy specifications measured at DC power levels and "Zero" enabled prior to measurement. They are valid between 1000nm and 1600nm.

Measurement Range: 3dBm to -80dBm
Resolution: 4 1/2 digits, 0.01dB, 10pW best case

Accuracy

Traceable calibration accuracy: ±5%

Accuracy (rel. to calibration at 1300nm and -20dBm log. reading, 0 to 40°C ambient temp., 10 to 100% full scale, -50dBm range 100pW to 100%):

Range [dBm]	Average Power ±(of read + Watts)
0	0.15dB
-10	0.15dB
-20	0.15dB
-30	0.15dB
-40	0.15dB
-50	0.15dB + 100pW

Accuracy derating factor over temperature:



Accuracy at 25°C±5°C between 3dBm and -60dBm: typ.<±0.05dB

Accuracy of lens coating over wavelength (typical):

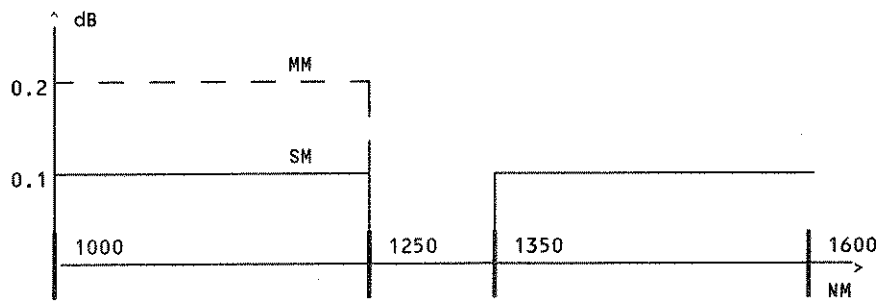

General

Recalibration period: 1 year

Warm-up time: 5 minutes

Bandwidth (-3dB) at XDCR OUT of 8152A: typ. 700Hz

Environmental

Storage temperature: -40°C to +75°C

Operating temperature: 0°C to 55°C

Humidity: <95% R.H. from 0°C to 40°C

Dimensions: 37.7mm diameter, 140mm length (1.5"x5.5")

Weight: net 0.45kg (1lbs), shipping 1kg (2.2lbs)

SECTION A-2

INSTALLATION

INITIAL INSPECTION

Inspect the shipping container for damage. If the container or cushioning is damaged, it should be kept until the contents of the shipment have been checked for completeness and the optical head has been verified both mechanically and optically.

Procedures for checking the optical operation are given in Section A-4. If the contents are incomplete, mechanical damage or defect is apparent, or if an optical head does not pass the operator's checks, notify the nearest Hewlett-Packard office. Keep the shipping materials for carrier's inspection. The HP office will arrange for repair or replacement without waiting settlement.

HANDLING PRECAUTION



*Do not drop or otherwise mechanically damage the optical head.
Do not install the optical head in an environment where strong vibrations or self-heating may occur.*

OPTICAL CONNECTIONS

For each optical head, various accessories can be ordered that aid measurement as well as connection to bare or terminated fibers. Depending on which accessories have been ordered, the following Figure A-1 shows the sequence in which they are attached to the optical head.

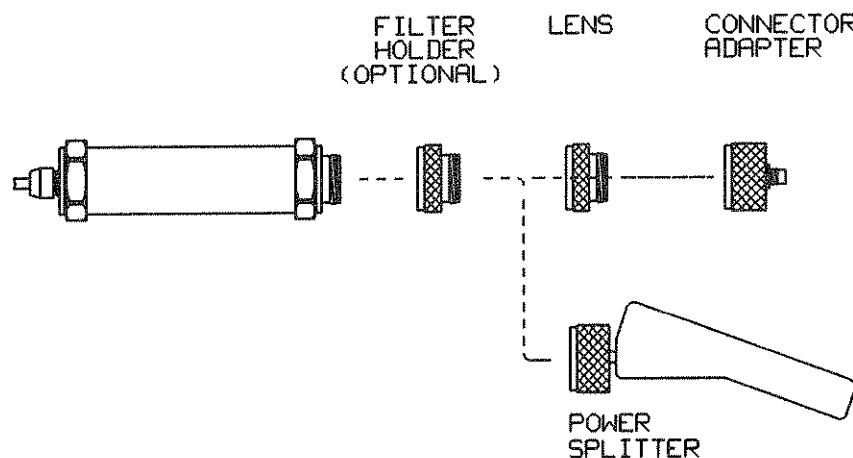

Figure A-1. Optical Connections

Note that the optical head and its various accessories are marked with coloured dots to indicate wavelength and fiber type. The convention used is as follows:

Note that the optical head and its various accessories are marked with coloured dots to indicate wavelength and fiber type. The convention used is as follows:

Wavelength

- Red 2nd λ -window (1300nm)
- Orange 3rd λ -window (1550nm)

Fiber Type

- White single-mode (9 μm)
- Green Multimode (50 μm /125 μm GI)
- Blue Multimode (62.5 μm /125 μm GI)
- Violet Multimode (85 μm /125 μm GI)
- Grey Multimode (100 μm /140 μm SI)
- Black Multimode (> 200 μm SI)

STORAGE AND SHIPMENT ENVIRONMENT

The optical head should be stored in a clean, dry, vibration-free environment. The following limitations apply to both storage and shipment:

- Temperature: -40°C to +70°C
- Humidity: <95% R.H. from 0°C to 40°C

RETURN SHIPMENTS TO HEWLETT-PACKARD

If the instrument is to be shipped to a Hewlett-Packard Sales/Service Office, attach a tag showing owner, return address, model number and full serial number and the type of service required.

NOTE: When returning the optical head to Hewlett-Packard for service or damage claim, your Model 8152A should also be returned. A second tag showing owner and return address should be attached to the Model 8152A.

The original shipping carton and packing material may be reusable, but the Hewlett-Packard Sales/Service Office will also provide information and recommendations on materials to be used if the original packing is no longer available or reusable. General instructions for repacking are as follows:

1. Wrap instrument in heavy paper or plastic.
2. Use strong shipping container. A double wall carton made of 350-pound test material is adequate.
3. Use enough shock-absorbing material (3 to 4 inch layer) around all sides of the instrument to provide a firm cushion and prevent movement inside container. Protect control panel with cardboard.
4. Seal shipping container securely.
5. Mark shipping container FRAGILE to encourage careful handling.
6. In any correspondence, refer to instrument by model number and serial number.

SECTION A-3

OPERATION

SPECIAL OPERATING CONSIDERATIONS

WARNING

How To Avoid Potential Exposure To Radiation

When connecting a fiber between the optical head and an optical source, make the optical head connection before the source connection. This avoids any potential exposure to radiation.

COMPENSATING FOR LENS LOSS

The HP81521B specifications apply to a parallel beam incident at the detector window. If the HP81521B is being used with a fiber, then a lens must be inserted between the connector adapter and detector window to convert the divergent light from the fiber into a parallel beam. For any lens that you order with the HP81521B, the attenuation loss has been individually measured at the factory to within 0.01dB. The measured value has then been marked on the lens casing as a 'CAL' factor, e.g. CAL -19dB.

As explained in the HP8152A manual, you can make CAL factor entries to compensate for any known losses. If you want to compensate for the lens attenuation in your measurement, the entry procedure is as follows:

1. Select SET mode at key (4), and the channel to which the optical head is connected at key (5)

The parameter menu is now highlighted above keys (7) to (9), and the last parameter entry you made in single channel operation is displayed. Now make the following entry:

2. Press the CAL key to display the current CAL factor entry. Use the VERNIER rocker keys to enter the value marked on the lens casing, e.g. if -19dB is marked, then enter -0.19dB.

No further key operation is required as the CAL factor is now automatically stored and activated.

CLEANING THE LENS

CAUTION

The lens must not be cleaned via ultra-sonic bath or immersion in a fluid. Only wipe-clean is allowed to ensure optical specifications.

For lens cleaning, especially the multimode lens, it is recommended that you carry out the following procedure in which the HP Model 15457A Cleaning Kit is used.

1. Unscrew the lens from the optical head.
2. Hold the lens so that the surface to be cleaned is facing downwards. For multimode lenses in which a two-lens construction is used, this is critical as it ensures that no cleaning fluid can leak into the cavity between the two lenses.
3. Apply a small amount of the Head Cleaner to a Q-tip and carefully clean the lens surface. Wait until the lens surface is dry.
4. Repeat steps 2 and 3 for the opposite lens surface using a new Q-tip.
6. Rescrew the lens onto the optical head.

NOTE: Never use abrasive materials to clean the lens. The use of such materials can damage the lens and drastically affect the performance of an optical system. Use only the cleaning agent supplied with the kit, or a similar product.

TRANSDUCER OUTPUTS

The XDCR output for each channel on the mainframe HP8152A provide the electrical equivalent of low frequency inputs to the HP81521B on that channel. The 3dB_{elec} cutoff frequency is 700Hz.

NOTE: Since the output voltage represents input power, there is a conversion factor of 2 from dB_{opt} to dB_{elec} . The 3dB_{opt} frequency (6dB_{elec}) is 1.2kHz.

SECTION A-4

PERFORMANCE TESTS

4-1 INTRODUCTION

4-2 The procedures in this section test the optical performance of the instrument. The complete specifications to which the HP81521B is tested are given in Table A-1. All tests can be performed without access to the interior of the instrument.

4-3 EQUIPMENT REQUIRED

4-4 Equipment required for the performance test is listed in Table A-2. Recommended Test Equipment. Any equipment which satisfies the critical specifications given in the table may be substituted for recommended models.

Table A-2. Recommended Test Equipment

Instrument/Accessory	Rec. Model	Critical Specification
Power Meter Standard	HP8152A 81521B	Accuracy < 2%
Optical Attenuator	HP8158B	0.01dB Resolution
Lens Adapter for single-mode	HP81010BL	
Connector Adapter	HP81000AA	
Single-Mode Fiber	HP81101AC	
13000 nm Laser Source		0dBm into single-mode fiber
Single-Mode Fiber	HP81101xx	Source dependent
Cleaning Kit	HP15475A	

4-5 TEST RECORD

4-6 Results of the performance test may be tabulated on the Test Record provided at the end of the test procedures. It is recommended that you fill out the Test Record and refer to it while doing the test. Since the test limits and setup information are printed on the Test Record for easy reference, the record can also be used as an abbreviated test procedure (if you are familiar with test procedures). The Test Record can also be used as a permanent record and may be reproduced without written permission from Hewlett-Packard.

4-7 TEST FAILURE

4-8 If the HP81521B fails any performance test, return the instrument to the nearest Hewlett-Packard Sales/Service Office for repair.

4-9 INSTRUMENTS SPECIFICATION

4-10 Specifications are the performance characteristics of the instrument which are certified. These specifications, listed in Table A-1 are the performance standards or limits against which the HP81521B can be tested. Table A-1 also lists some supplemental characteristics of the HP81521B and should be considered as additional information.

4-11 Any changes in the specifications due to manufacturing changes, design, or traceability to the National Bureau of Standards will be covered in a manual change supplement or revised manual. The specifications listed here supersede any previously published.

4-12 PERFORMANCE TEST

4-13 The performance tests given in this section are separated into Accuracy Test and Linearity Test. Perform each step in the tests in the order they are given using the corresponding test equipment.

NOTE

Make sure that all optical connections of the test setups given in the procedure are dry and clean. For cleaning use accessory kit Model HP15475A.

The Optical Cables from the Laser Source to and from the 8158B Attenuator to the Power Meter must be fixed on the table to ensure minimum cable movement during the tests.

4-14 81521B ACCURACY and LINEARITY TEST

Equipment required:

Power Meter Standard HP8152A with 81521B Optical Head
Optical Attenuator HP8158B
Lens Adapter for single-mode HP81010BL
Connector Adapter HP81000AA
Single-Mode Fiber HP81101AC
13000 nm Laser Source (0dBm into single mode fiber)
Single-Mode Fiber HP8181101xx (Source dependent)

Specifications:

Traceable accuracy: $\pm 5\%$
Accuracy (rel. to calibration at 1300nm and -20dBm) in the 0dBm, -10dBm, -20dBm, -30dBm and -40dBm Range : $\pm 0.15\text{dB}$ of reading
-50dBm Range : $\pm 0.15\text{dB} + 100\text{pW}$.

CALIBRATION ACCURACY TEST

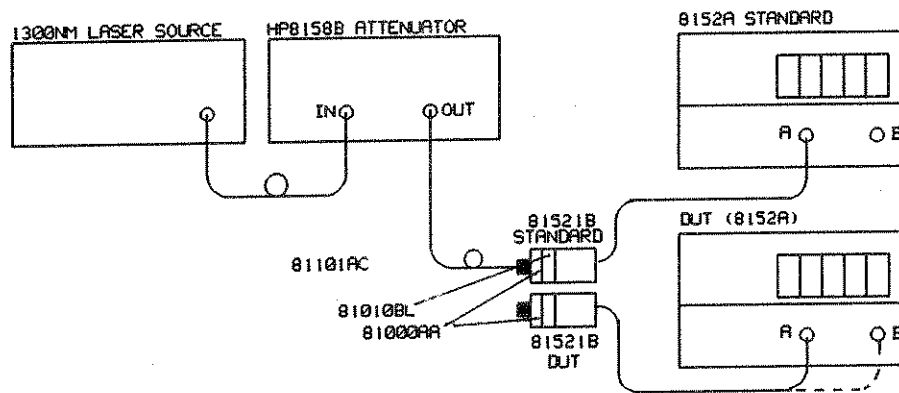

Figure A-2

1. Make sure that cable connectors, lenses and detector windows are clean.
2. Connect the equipment as shown in Figure A-2. Ensure that the cables to and from the Attenuator are fixed on the table and both optical heads (Standard and DUT) are close together so that minimum cable movement is achieved when connecting the cable to the Standard Head or to the DUT Head.
3. Turn the instruments on and allow to warm up for at least 30 minutes.
4. Set the CAL factor of both instruments to the lens calibration factor marked on the corresponding 81010BL lens.
5. Set the WAVELENGTH of both instruments to the wavelength of the Laser Source.

6. Set both instruments to MEASure, switch AUTOrange off and select the -20dBm range.
7. Disable the 8158B output and ZERO the Power Meter Standard.
8. Enable the 8158B output and change the attenuation until the Power Meter Standard displays -20.00 dBm.
9. Disable the 8158B output and connect the cable to the DUT.
10. ZERO the DUT, enable the 8158B output and check that the DUT display is between -19.79dBm and -20.22dBm.

LINEARITY TEST

11. Select display in dB on the DUT and set DISPlay to REFerence.
12. Reconnect the 8158B output cable to the Power Meter Standard, select display in dB and set DISPlay to REFerence on the Standard too.
13. Set the Power Meter Standard and the DUT to the 0dBm range and using the attenuator adjust the power level so that the Standard displays 16.50dB.
14. Connect the 8158B output cable to the DUT and check that the DUT display reading is between 16.65 dB and 16.35 dB.
15. Repeat the level comparison as described in steps 13 and 14 at following range and level settings:

Standard and DUT Range	Power Level set on Standard	DUT Reading	
		max.	min.
0dBm	12.50dB	12.65dB	12.35dB
-10dBm	12.50dB	12.65dB	12.35dB
	10.00dB	10.15dB	9.85dB
	3.00dB	3.15dB	2.85dB
-20dBm	2.50dB	2.65dB	2.35dB
	0.00dB	0.15dB	-0.85dB
	-7.00dB	-6.85dB	-7.15dB
-30dBm	-7.50dB	-7.35dB	-7.65dB
	-10.00dB	-9.85dB	-10.15dB
	-17.00dB	-16.85dB	-17.15dB
-40dBm	-17.50dB	-17.35dB	-17.65dB
	-20.00dB	-19.85dB	-20.15dB
	-27.00dB	-26.85dB	-27.15dB
-50dBm	-27.50dB	-27.33dB	-27.67dB
	-30.00dB	-29.81dB	-30.19dB
	-37.00dB	-36.64dB	-37.36dB

Hewlett-Packard Model 81521B

Test Performed By _____

Optical Optical Head

Date _____

Serial Number _____

Comments _____

4-14 ACCURACY AND LINEARITY TEST

Test Condition: 1300nm wavelength with single-mode fibers

Step	Description			Test	
				Pass	Fail
Accuracy Test					
	Standard and DUT Range	Power Level set on Standard	DUT reading in dBm max. act. min.		
8-10.	-20dBm	-20.00dBm	-19.79	_____	-20.22 _____
Linearity Test					
	Standard and DUT Range	Power Level set on Standard	DUT reading in dB max. act. min.		
15.	0dBm	12.50dB	12.65	_____	12.35 _____
	-10dBm	12.50dB	12.65	_____	12.35 _____
		10.00dB	10.15	_____	9.85 _____
		3.00dB	3.15	_____	2.85 _____
	-20dBm	2.50dB	2.65	_____	2.35 _____
		0.00dB	0.15	_____	-0.85 _____
		-7.00dB	-6.85	_____	-7.15 _____
	-30dBm	-7.50dB	-7.35	_____	-7.65 _____
		-10.00dB	-9.85	_____	-10.15 _____
		-17.00dB	-16.85	_____	-17.15 _____
	-40dBm	-17.50dB	-17.35	_____	-17.65 _____
		-20.00dB	-19.85	_____	-20.15 _____
		-27.00dB	-26.85	_____	-27.15 _____
	-50dBm	-27.50dB	-27.33	_____	-27.67 _____
		-30.00dB	-29.81	_____	-30.19 _____
		-37.00dB	-36.64	_____	-37.36 _____

OPERATING MANUAL

HP81521B OPTICAL HEAD 850nm to 1700nm

SERIAL NUMBERS

This manual applies directly to instruments with serial number 2602G00101 and higher. Any change made in instruments having serial numbers higher than the above number will be found in a "Manual Changes" supplement supplied with this manual. Be sure to examine the supplement for changes which apply to your instrument and record these changes in the manual.

**© HEWLETT-PACKARD GMBH 1986
HERRENBERGER STR. 130, D-7030 BOBLINGEN
FEDERAL REPUBLIC OF GERMANY**

**MANUAL PART No. 81521-90011
MICROFICHE PART No. 81521-95011**

PRINTED: MAY 1986

SAFETY

This product has been designed and tested according to International Safety Requirements. To ensure safe operation and to keep the product safe, the information, cautions, and warnings in this manual must be heeded.

CERTIFICATION

Hewlett-Packard Company certifies that this product met its published specifications at the time of shipment from the factory. Hewlett-Packard further certifies that its calibration measurements are traceable to the United States National Bureau of Standards, to the extent allowed by the Bureau's calibration facility, and to the calibration facilities of other International Standards Organization members.

WARRANTY

This Hewlett-Packard product is warranted against defects in material and workmanship for a period of one year from date of shipment. During the warranty period, Hewlett-Packard Company will, at its option, either repair or replace products which prove to be defective.

For warranty service or repair, this product must be returned to a service facility designated by HP. However, warranty service for products installed by HP and certain other products designated by HP will be performed at Buyer's facility at no charge within the HP service travel area. Outside HP service travel areas, warranty service will be performed at Buyer's facility only upon HP's prior agreement and Buyer shall pay HP's round trip travel expenses.

For products returned to HP for warranty service, Buyer shall prepay shipping charges to HP and HP shall pay shipping charges to return the product to Buyer. However, Buyer shall pay all shipping charges, duties, and taxes for products returned to HP from another country.

LIMITATION OF WARRANTY

The foregoing warranty shall not apply to defects resulting from improper or inadequate maintenance by Buyer, Buyer-supplied software or interfacing, unauthorized modification or misuse, operation outside of the environmental specifications for the product, or improper site preparation or maintenance.

NO OTHER WARRANTY IS EXPRESSED OR IMPLIED. HP SPECIFICALLY DISCLAIMS THE IMPLIED WARRANTIES OF MERCHANTABILITY AND FITNESS FOR A PARTICULAR PURPOSE.

EXCLUSIVE REMEDIES

THE REMEDIES PROVIDED HEREIN ARE BUYER'S SOLE AND EXCLUSIVE REMEDIES. HP SHALL NOT BE LIABLE FOR ANY DIRECT, INDIRECT, SPECIAL, INCIDENTAL, OR CONSEQUENTIAL DAMAGES, WHETHER BASED ON CONTRACT, TORT, OR ANY OTHER LEGAL THEORY.

ASSISTANCE

Product maintenance agreements and other customer assistance agreements are available for Hewlett-Packard products.

For any assistance, contact your nearest Hewlett-Packard Sales and Service Office. Addresses are provided at the back of this manual.

The following general safety precautions must be observed during all phases of operation, service, and repair of this instrument. Failure to comply with these precautions or with specific warnings elsewhere in this manual violates safety standards of design, manufacture, and intended use of the instrument. Hewlett-Packard Company assumes no liability for the customer's failure to comply with these requirements.

GENERAL — This is a Safety Class I instrument (provided with terminal for protective earthing) and has been manufactured and tested according to international safety standards.

OPERATION — BEFORE APPLYING POWER comply with the installation section. Additionally, the following shall be observed:

Do not remove instrument covers when operating.

Before the instrument is switched on, all protective earth terminals, extension cords, auto-transformers and devices connected to it should be connected to a protective earth via a ground socket. Any interruption of the protective earth grounding will cause a potential shock hazard that could result in serious personal injury. Whenever it is likely that the protection has been impaired, the instrument must be made inoperative and be secured against any unintended operation.

Make sure that only fuses with the required rated current and of the specified type (normal blow, time delay, etc.) are used for replacement. The use of repaired fuses and the short-circuiting of fuseholders must be avoided.

Adjustments described in the manual are performed with power supplied to the instrument while protective covers are removed. Energy available at many points may, if contacted, result in personal injury.

Any adjustment, maintenance, and repair of the opened instrument under voltage should be avoided as much as possible, and when inevitable, should be carried out only by a skilled person who is aware of the hazard involved. Do not attempt internal service or adjustment unless another person, capable of rendering first aid and resuscitation is present. Do not replace components with power cable connected.

Do not operate the instrument in the presence of flammable gases or fumes. Operation of any electrical instrument in such an environment constitutes a definite safety hazard.

Do not install substitute parts or perform any unauthorized modification to the instrument.

Capacitors inside the instrument may still be charged even if the instrument has been disconnected from its source of supply.

SAFETY SYMBOLS



The apparatus will be marked with this symbol when it is necessary for the user to refer to the instruction manual in order to protect the apparatus against damage.



Indicates dangerous voltages.



Earth terminal

WARNING

The WARNING sign denotes a hazard. It calls attention to a procedure, practice or the like, which, if not correctly performed or adhered to, could result in injury or loss of life. Do not proceed beyond a WARNING sign until the indicated conditions are fully understood and met.

CAUTION

The CAUTION sign denotes a hazard. It calls attention to an operating procedure, practice, or the like, which, if not correctly performed or adhered to, could result in damage to or destruction of part or all of the equipment. Do not proceed beyond a CAUTION sign until the indicated conditions are fully understood and met.



Dangerous voltages, capable of causing serious personal injury, are present in this instrument. Use extreme caution when handling, testing, and adjusting.





CONTENTS

SECTION	Page
A-1 GENERAL INFORMATION	
INTRODUCTION	A-1
SPECIFICATIONS	A-1
SAFETY CONSIDERATIONS	A-1
OPTICAL HEADS COVERED BY THIS APPENDIX	A-1
DESCRIPTION	A-1
ACCESSORIES AVAILABLE	A-1
A-2 INSTALLATION	
INITIAL INSPECTION	A-5
HANDLING PRECAUTION	A-5
OPTICAL CONNECTIONS	A-5
STORAGE AND SHIPMENT ENVIRONMENT	A-6
RETURN SHIPMENTS TO HEWLETT-PACKARD	A-6
A-3 OPERATION	
SPECIAL OPERATING CONSIDERATIONS	A-7
COMPENSATING FOR LENS LOSS	A-7
CLEANING THE LENS	A-7
TRANSDUCER OUTPUTS	A-8
A-4 PERFORMANCE TESTS	
INTRODUCTION	A-9
EQUIPMENT REQUIRED	A-10
TEST RECORD	A-10
TEST FAILURE	A-10
INSTRUMENT SPECIFICATIONS	A-10
PERFORMANCE TESTS	A-10
81521B ACCURACY AND LINEARITY TEST	A-11

SECTION A-1

GENERAL INFORMATION

INTRODUCTION

This appendix provides the supplementary information required when an HP81521B Optical Head is connected to the HP8152A Optical Average Power Meter. The information is HP81521B specific and covers installation, operation and performance tests.

SPECIFICATIONS

Specifications of the HP81521B are given in Table A-1. These specifications are the performance standards or limits against which the optical head is tested.

SAFETY CONSIDERATIONS



Before connecting the optical head to the HP8152A, ensure that the HP8152A is connected to protective (earth) ground.

OPTICAL HEADS COVERED BY THIS APPENDIX

Each optical head has a two-part serial number. The first 4 digits and the letter comprise the serial prefix; the last 5 digits a sequential suffix which is unique to each HP81521B. The contents of this appendix apply directly to optical heads having the serial prefix 2602G.

DESCRIPTION

The HP81521B is the standard optical head for the HP8152A Optical Average Power Meter when operating in the wavelength range 850nm → 1700nm. This head covers single- and multimode fibers up to 100 μm core diameter.

At the factory, correction factors over the entire wavelength range are individually measured and stored in each optical head. This ensures precise power measurements, even when the source-under-test has an operating wavelength other than 1300nm. The dynamic range is +3 → -80dBm with the noise floor being well below -70dBm to provide the sensitivity needed for a wide range of applications.

A large variety of optical adapters is available to simplify connection of the HP81521B to the device-under-test. If it is necessary to measure power levels above +3dBm, fixed attenuation filters can be easily inserted into an optional filter holder.

ACCESSORIES AVAILABLE

A number of accessories are available to aid measurement and simplify connection to either bare or terminated fibers. The accessories are listed as follows:

- **CONNECTOR ADAPTERS**

- 81000AA for connection with Diamond HMS-10/HP connector
- 81000BA for connection with bare fiber (125 μm cladding)
- 81000FA for connection with FC or PC connectors
- 81000GA for connection with NEC D4 connector
- 81000JA for connection with AMP SMA or Amphenol 906 connectors
- 81000LA for connection with F & G 3702 connector
- 81000NA for connection with Stratos 430 connector
- 81000WA for connection with Biconic connector
- 81000YA for connection with Diamond HFS-1 connector
- 81000ZA blank adapter for connection with any other connectors

- **LENSES**

- 81010BL lens for 1300nm, 1550nm, and 9/125 μm or 10/125 μm fiber.
- 81050BL lens for 1300nm, 1550nm, and 50/125 μm or 62.5/125 μm fiber

- **FILTERHOLDER**

- 81000AF filterholder for filters with 1-inch diameter

- **POWER SPLITTER**

- 81000BS 10:1 power splitter for single- and multimode; fiber core diameters from 9 μm to 85 μm (NA \leq 0.3).

An additional accessory for the HP81521B is the HP15475A Cleaning Kit. This kit includes cleaning material (brush, tissue, tape, etc.) to clean optical surfaces such as connectors and is supplied in a plastic carrying case.

Table A-1. Specifications

Specifications describe the instrument's warranted performance. They apply to optical input signals transmitted in parallel beam. Use appropriate lenses and connector adapters for the optical head to accommodate light emerging from optical fibers.

Optical Characteristics

Wavelength Range: 850nm to 1700nm, actual wavelength user-selectable. Each optical head is individually calibrated over wavelength between 850nm and 1700nm. Correction factors are stored in its non-volatile memory.

Sensor Element: Cooled Ge PIN diode
Sensor Diameter: 5mm
Maximum Power Density: 10mW/mm²

Power Measurements

Accuracy specifications measured at DC power levels and "Zero" enabled prior to measurement. They are valid between 1000nm and 1600nm.

Measurement Range: 3dBm to -80dBm
Resolution: 4 1/2 digits, 0.01dB, 10pW best case

Accuracy

Traceable calibration accuracy: ±5%

Accuracy (rel. to calibration at 1300nm and -20dBm log. reading, 0 to 40°C ambient temp., 10 to 100% full scale, -50dBm range 100pW to 100%):

Range [dBm]	Average Power ±(of read + Watts)
0	0.15dB
-10	0.15dB
-20	0.15dB
-30	0.15dB
-40	0.15dB
-50	0.15dB + 100pW

Accuracy derating factor over temperature:

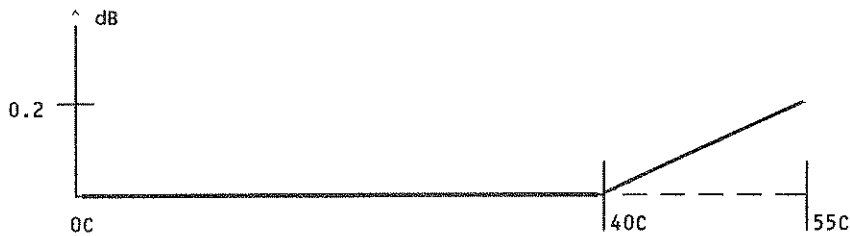

Accuracy at 25°C±5°C between 3dBm and -60dBm: typ.<±0.05dB

Accuracy of lens coating over wavelength (typical):

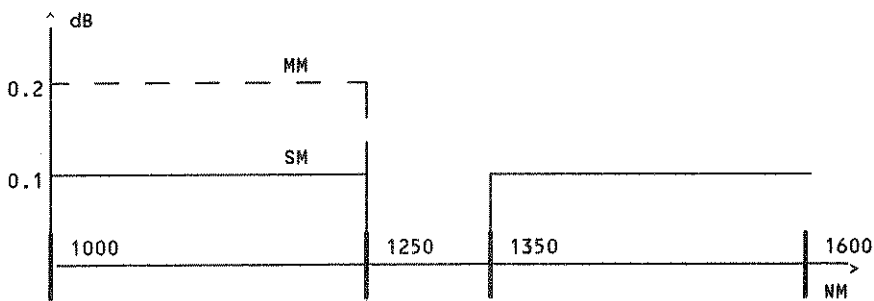

General

Recalibration period: 1 year
Warm-up time: 5 minutes

Bandwidth (-3dB) at XDCR OUT of 8152A: typ. 700Hz

Environmental

Storage temperature: -40°C to +75°C
Operating temperature: 0°C to 55°C
Humidity: <95% R.H. from 0°C to 40°C

Dimensions: 37.7mm diameter, 140mm length (1.5"x5.5")

Weight: net 0.45kg (1lbs), shipping 1kg (2.2lbs)

SECTION A-2

INSTALLATION

INITIAL INSPECTION

Inspect the shipping container for damage. If the container or cushioning is damaged, it should be kept until the contents of the shipment have been checked for completeness and the optical head has been verified both mechanically and optically.

Procedures for checking the optical operation are given in Section A-4. If the contents are incomplete, mechanical damage or defect is apparent, or if an optical head does not pass the operator's checks, notify the nearest Hewlett-Packard office. Keep the shipping materials for carrier's inspection. The HP office will arrange for repair or replacement without waiting settlement.

HANDLING PRECAUTION



*Do not drop or otherwise mechanically damage the optical head.
Do not install the optical head in an environment where strong vibrations or self-heating may occur.*

OPTICAL CONNECTIONS

For each optical head, various accessories can be ordered that aid measurement as well as connection to bare or terminated fibers. Depending on which accessories have been ordered, the following Figure A-1 shows the sequence in which they are attached to the optical head.

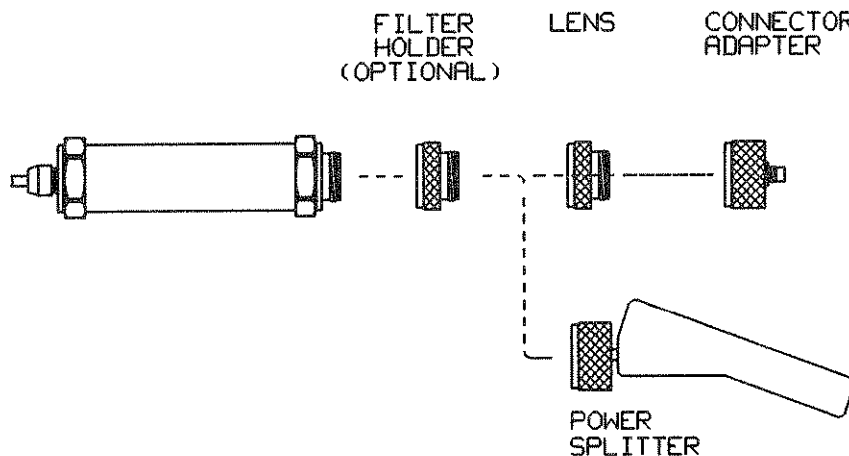

Figure A-1. Optical Connections

Note that the optical head and its various accessories are marked with coloured dots to indicate wavelength and fiber type. The convention used is as follows:

Note that the optical head and its various accessories are marked with coloured dots to indicate wavelength and fiber type. The convention used is as follows:

Wavelength

- Red 2nd λ -window (1300nm)
- Orange 3rd λ -window (1550nm)

Fiber Type

- White single-mode (9 μ m)
- Green Multimode (50 μ m/125 μ m GI)
- Blue Multimode (62.5 μ m/125 μ m GI)
- Violet Multimode (85 μ m/125 μ m GI)
- Grey Multimode (100 μ m/140 μ m SI)
- Black Multimode (> 200 μ m SI)

STORAGE AND SHIPMENT ENVIRONMENT

The optical head should be stored in a clean, dry, vibration-free environment. The following limitations apply to both storage and shipment:

- Temperature: -40°C to +70°C
- Humidity: <95% R.H. from 0°C to 40°C

RETURN SHIPMENTS TO HEWLETT-PACKARD

If the instrument is to be shipped to a Hewlett-Packard Sales/Service Office, attach a tag showing owner, return address, model number and full serial number and the type of service required.

NOTE: When returning the optical head to Hewlett-Packard for service or damage claim, your Model 8152A should also be returned. A second tag showing owner and return address should be attached to the Model 8152A.

The original shipping carton and packing material may be reusable, but the Hewlett-Packard Sales/Service Office will also provide information and recommendations on materials to be used if the original packing is no longer available or reusable. General instructions for repacking are as follows:

1. Wrap instrument in heavy paper or plastic.
2. Use strong shipping container. A double wall carton made of 350-pound test material is adequate.
3. Use enough shock-absorbing material (3 to 4 inch layer) around all sides of the instrument to provide a firm cushion and prevent movement inside container. Protect control panel with cardboard.
4. Seal shipping container securely.
5. Mark shipping container FRAGILE to encourage careful handling.
6. In any correspondence, refer to instrument by model number and serial number.

SECTION A-3

OPERATION

SPECIAL OPERATING CONSIDERATIONS

WARNING

How To Avoid Potential Exposure To Radiation

When connecting a fiber between the optical head and an optical source, make the optical head connection before the source connection. This avoids any potential exposure to radiation.

COMPENSATING FOR LENS LOSS

The HP81521B specifications apply to a parallel beam incident at the detector window. If the HP81521B is being used with a fiber, then a lens must be inserted between the connector adapter and detector window to convert the divergent light from the fiber into a parallel beam. For any lens that you order with the HP81521B, the attenuation loss has been individually measured at the factory to within 0.01dB. The measured value has then been marked on the lens casing as a 'CAL' factor, e.g. CAL -.19dB.

As explained in the HP8152A manual, you can make CAL factor entries to compensate for any known losses. If you want to compensate for the lens attenuation in your measurement, the entry procedure is as follows:

1. Select SET mode at key (4), and the channel to which the optical head is connected at key (5)

The parameter menu is now highlighted above keys (7) to (9), and the last parameter entry you made in single channel operation is displayed. Now make the following entry:

2. Press the CAL key to display the current CAL factor entry. Use the VERNIER rocker keys to enter the value marked on the lens casing, e.g. if -.19dB is marked, then enter -0.19dB.

No further key operation is required as the CAL factor is now automatically stored and activated.

CLEANING THE LENS

CAUTION

The lens must not be cleaned via ultra-sonic bath or immersion in a fluid. Only wipe-clean is allowed to ensure optical specifications.

For lens cleaning, especially the multimode lens, it is recommended that you carry out the following procedure in which the HP Model 15457A Cleaning Kit is used.

1. Unscrew the lens from the optical head.
2. Hold the lens so that the surface to be cleaned is facing downwards. For multimode lenses in which a two-lens construction is used, this is critical as it ensures that no cleaning fluid can leak into the cavity between the two lenses.
3. Apply a small amount of the Head Cleaner to a Q-tip and carefully clean the lens surface. Wait until the lens surface is dry.
4. Repeat steps 2 and 3 for the opposite lens surface using a new Q-tip.
6. Rescrew the lens onto the optical head.

NOTE: Never use abrasive materials to clean the lens. The use of such materials can damage the lens and drastically affect the performance of an optical system. Use only the cleaning agent supplied with the kit, or a similar product.

TRANSDUCER OUTPUTS

The XDCR output for each channel on the mainframe HP8152A provide the electrical equivalent of low frequency inputs to the HP81521B on that channel. The 3dB_{elec} cutoff frequency is 700Hz.

NOTE: Since the output voltage represents input power, there is a conversion factor of 2 from dB_{opt} to dB_{elec} . The 3dB_{opt} frequency (6dB_{elec}) is 1.2kHz.

SECTION A-4

PERFORMANCE TESTS

4-1 INTRODUCTION

4-2 The procedures in this section test the optical performance of the instrument. The complete specifications to which the HP81521B is tested are given in Table A-1. All tests can be performed without access to the interior of the instrument.

4-3 EQUIPMENT REQUIRED

4-4 Equipment required for the performance test is listed in Table A-2. Recommended Test Equipment. Any equipment which satisfies the critical specifications given in the table may be substituted for recommended models.

Table A-2. Recommended Test Equipment

Instrument/Accessory	Rec. Model	Critical Specification
Power Meter Standard	HP8152A 81521B	Accuracy < 2%
Optical Attenuator	HP8158B	0.01dB Resolution
Lens Adapter for single-mode	HP81010BL	
Connector Adapter	HP81000AA	
Single-Mode Fiber	HP81101AC	
13000 nm Laser Source		0dBm into single-mode fiber
Single-Mode Fiber	HP81101xx	Source dependent
Cleaning Kit	HP15475A	

4-5 TEST RECORD

4-6 Results of the performance test may be tabulated on the Test Record provided at the end of the test procedures. It is recommended that you fill out the Test Record and refer to it while doing the test. Since the test limits and setup information are printed on the Test Record for easy reference, the record can be also be used as an abbreviated test procedure (if you are familiar with test procedures). The Test Record can also be used as a permanent record and may be reproduced without written permission from Hewlett-Packard.

4-7 TEST FAILURE

4-8 If the HP81521B fails any performance test, return the instrument to the nearest Hewlett-Packard Sales/Service Office for repair.

4-9 INSTRUMENTS SPECIFICATION

4-10 Specifications are the performance characteristics of the instrument which are certified. These specifications, listed in Table A-1 are the performance standards or limits against which the HP81521B can be tested. Table A-1 also lists some supplemental characteristics of the HP81521B and should be considered as additional information.

4-11 Any changes in the specifications due to manufacturing changes, design, or traceability to the National Bureau of Standards will be covered in a manual change supplement or revised manual. The specifications listed here supersede any previously published.

4-12 PERFORMANCE TEST

4-13 The performance tests given in this section are separated into Accuracy Test and Linearity Test. Perform each step in the tests in the order they are given using the corresponding test equipment.

NOTE

Make sure that all optical connections of the test setups given in the procedure are dry and clean. For cleaning use accessory kit Model HP15475A.

The Optical Cables from the Laser Source to and from the 8158B Attenuator to the Power Meter must be fixed on the table to ensure minimum cable movement during the tests.

4-14 81521B ACCURACY and LINEARITY TEST

Equipment required:

Power Meter Standard HP8152A with 81521B Optical Head
Optical Attenuator HP8158B
Lens Adapter for single-mode HP81010BL
Connector Adapter HP81000AA
Single-Mode Fiber HP81101AC
1300 nm Laser Source (0dBm into single mode fiber)
Single-Mode Fiber HP8181101xx (Source dependent)

Specifications:

Traceable accuracy: $\pm 5\%$
Accuracy (rel. to calibration at 1300nm and -20dBm) in the 0dBm, -10dBm, -20dBm, -30dBm and -40dBm Range : $\pm 0.15\text{dB}$ of reading
-50dBm Range : $\pm 0.15\text{dB} + 100\text{pW}$.

CALIBRATION ACCURACY TEST

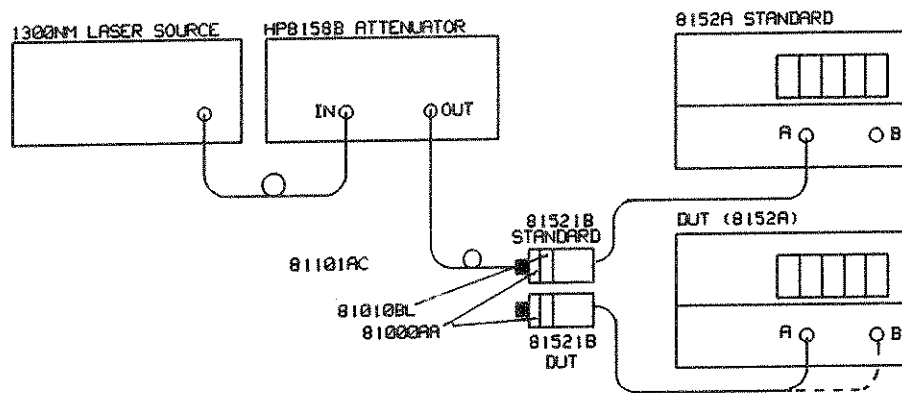

Figure A-2

1. Make sure that cable connectors, lenses and detector windows are clean.
2. Connect the equipment as shown in Figure A-2. Ensure that the cables to and from the Attenuator are fixed on the table and both optical heads (Standard and DUT) are close together so that minimum cable movement is achieved when connecting the cable to the Standard Head or to the DUT Head.
3. Turn the instruments on and allow to warm up for at least 30 minutes.
4. Set the CAL factor of both instruments to the lens calibration factor marked on the corresponding 81010BL lens.
5. Set the WAVELENGTH of both instruments to the wavelength of the Laser Source.

6. Set both instruments to MEASure, switch AUTOrange off and select the -20dBm range.
7. Disable the 8158B output and ZERO the Power Meter Standard.
8. Enable the 8158B output and change the attenuation until the Power Meter Standard displays -20.00 dBm.
9. Disable the 8158B output and connect the cable to the DUT.
10. ZERO the DUT, enable the 8158B output and check that the DUT display is between -19.79dBm and -20.22dBm.

LINEARITY TEST

11. Select display in dB on the DUT and set DISPlay to REFerence.
12. Reconnect the 8158B output cable to the Power Meter Standard, select display in dB and set DISPlay to REFerence on the Standard too.
13. Set the Power Meter Standard and the DUT to the 0dBm range and using the attenuator adjust the power level so that the Standard displays 16.50dB.
14. Connect the 8158B output cable to the DUT and check that the DUT display reading is between 16.65 dB and 16.35 dB.
15. Repeat the level comparison as described in steps 13 and 14 at following range and level settings:

Standard and DUT Range	Power Level set on Standard	DUT Reading	
		max.	min.
0dBm	12.50dB	12.65dB	12.35dB
-10dBm	12.50dB	12.65dB	12.35dB
	10.00dB	10.15dB	9.85dB
	3.00dB	3.15dB	2.85dB
-20dBm	2.50dB	2.65dB	2.35dB
	0.00dB	0.15dB	-0.85dB
	-7.00dB	-6.85db	-7.15dB
-30dBm	-7.50dB	-7.35dB	-7.65dB
	-10.00dB	-9.85dB	-10.15dB
	-17.00dB	-16.85dB	-17.15dB
-40dBm	-17.50dB	-17.35dB	-17.65dB
	-20.00dB	-19.85dB	-20.15dB
	-27.00dB	-26.85dB	-27.15dB
-50dBm	-27.50dB	-27.33dB	-27.67dB
	-30.00dB	-29.81dB	-30.19dB
	-37.00dB	-36.64dB	-37.36dB

Hewlett-Packard Model 81521B

Test Performed By _____

Optical Optical Head

Date _____

Serial Number _____

Comments _____

4-14 ACCURACY AND LINEARITY TEST

Test Condition: 1300nm wavelength with single-mode fibers

Step	Description	Test	
		Pass	Fail
Accuracy Test			
	Standard and DUT Range	Power Level set on Standard	DUT reading in dBm max. act. min.
8-10.	-20dBm	-20.00dBm	-19.79 _____ -20.22 _____
Linearity Test			
	Standard and DUT Range	Power Level set on Standard	DUT reading in dB max. act. min.
15.	0dBm	12.50dB	12.65 _____ 12.35 _____
	-10dBm	12.50dB	12.65 _____ 12.35 _____
		10.00dB	10.15 _____ 9.85 _____
		3.00dB	3.15 _____ 2.85 _____
	-20dBm	2.50dB	2.65 _____ 2.35 _____
		0.00dB	0.15 _____ -0.85 _____
		-7.00dB	-6.85 _____ -7.15 _____
	-30dBm	-7.50dB	-7.35 _____ -7.65 _____
		-10.00dB	-9.85 _____ -10.15 _____
		-17.00dB	-16.85 _____ -17.15 _____
	-40dBm	-17.50dB	-17.35 _____ -17.65 _____
		-20.00dB	-19.85 _____ -20.15 _____
		-27.00dB	-26.85 _____ -27.15 _____
	-50dBm	-27.50dB	-27.33 _____ -27.67 _____
		-30.00dB	-29.81 _____ -30.19 _____
		-37.00dB	-36.64 _____ -37.36 _____

A-13



Product Line Sales/Support Key

Key Product Line

- A Analytical
- CM Components
- C Computer Systems
- E Electronic Instruments & Measurement Systems
- M Medical Products
- P Personal Computation Products
- * Sales only for specific product line
- ** Support only for specific product line

IMPORTANT: These symbols designate general product line capability. They do not insure sales or support availability for all products within a line, at all locations. Contact your local sales office for information regarding locations where HP support is available for specific products.

HEADQUARTERS OFFICES

If there is no sales office listed for your area, contact one of these headquarters offices.

NORTH/CENTRAL AFRICA

Hewlett-Packard S.A.
7, rue du Bois-du-Lan
CH-1217 **MEYRN** 1, Switzerland
Tel: (022) 83 12 12
Telex: 27836 hmea
Cable: HEWPACKSA Geneve

ASIA

Hewlett-Packard Asia Ltd.
47/F, 26 Harbour Rd.,
Wanchai, **HONG KONG**
G.P.O. Box 863, Hong Kong
Tel: 5-8330833
Telex: 76793 HPA HX
Cable: HPASIAL TD

CANADA

Hewlett-Packard (Canada) Ltd.
6877 Goreway Drive
MISSISSAUGA, Ontario L4V 1M8
Tel: (416) 678-9430
Telex: 610-492-4246

EASTERN EUROPE

Hewlett-Packard Ges.m.b.H.
Liebigasse 1
P.O. Box 72
A-1222 **VIENNA**, Austria
Tel: (222) 2500-0
Telex: 1 3 4425 HEPA A

NORTHERN EUROPE

Hewlett-Packard S.A.
Uilenstede 475
P.O. Box 999
NL-1183 AG **AMSTELVEEN**
The Netherlands
Tel: 20 437771
Telex: 18 919 hpner nl

SOUTH EAST EUROPE

Hewlett-Packard S.A.
World Trade Center
110 Avenue Louis Cassai
1215 Cointrin, **GENEVA**, Switzerland
Tel: (022) 96 96 51
Telex: 27225 hpser

MEDITERRANEAN AND MIDDLE EAST

Hewlett-Packard S.A.
Mediterranean and Middle East
Operations
Atrina Centre
32 Klifissias Ave.
Paradissos-Amarousion, **ATHENS**
Greece
Tel: 682 88 11
Telex: 21-6588 HPAT GR
Cable: HEWPACKSA Athens

UNITED KINGDOM

Hewlett-Packard Ltd.
Nine Mile Ride
Easthamstead, **WOKINGHAM**
Berkshire, IRGII 3LL
Tel: 0344 773100
Telex: 848805

EASTERN USA

Hewlett-Packard Co.
4 Choke Cherry Road
ROCKVILLE, MD 20850
Tel: (301) 258-2000

MIDWESTERN USA

Hewlett-Packard Co.
5201 Tollview Drive
ROLLING MEADOWS, IL 60008
Tel: (312) 255-9800

SOUTHERN USA

Hewlett-Packard Co.
2000 South Park Place
P.O. Box 105005
ATLANTA, GA 30348
Tel: (404) 955-1500

WESTERN USA

Hewlett-Packard Co.
3939 Lankershim Blvd.
P.O. Box 3919
LOS ANGELES, CA 91604
Tel: (213) 506-3700

OTHER INTERNATIONAL AREAS

Hewlett-Packard Co.
Intercontinental Headquarters
3495 Deer Creek Road
PALO ALTO, CA 94304
Tel: (415) 857-1501
Telex: 034-8300
Cable: HEWPACK

Canberra, Australia

Capital Territory Office

Hewlett-Packard Australia Ltd.
121 Wollongong Street
FYSHWICK, A.C.T. 2609
Tel: 80 4244
Telex: 62650
Cable: HEWPARD Canberra
C,CM,E,P

Melbourne, Victoria

Office

Hewlett-Packard Australia Ltd.
31-41 Joseph Street
BLACKBURN, Victoria 3130
Tel: 895-2895
Telex: 31-024
Cable: HEWPARD Melbourne
A,C,CM,E,M,P

Perth, Western Australia

Office

Hewlett-Packard Australia Ltd.
261 Stirling Highway
CLAREMONT, W.A. 6010
Tel: 383-2188
Telex: 93859
Cable: HEWPARD Perth
A,C,CM,E,M,P

Sydney, New South

Wales Office

Hewlett-Packard Australia Ltd.
17-23 Talavera Road
P.O. Box 308
NORTH RYDE, N.S.W. 2113
Tel: 888-4444
Telex: 21561
Cable: HEWPARD Sydney
A,C,CM,E,M,P

AUSTRIA

Hewlett-Packard Ges.m.b.H.
Verkaufsbüro Graz
Grottenhofstrasse 94
A-8052 **GRAZ**
Tel: (0316) 291 56 60
Telex: 32375
C,E

Hewlett-Packard Ges.m.b.H.
Liebigasse 1
P.O. Box 72
A-1222 **VIENNA**
Tel: (0222) 2500-0
Telex: 134425 HEPA A
A,C,CM,E,M,P

BAHRAIN

Green Salon
P.O. Box 557
MANAMA
Tel: 255503-255950
Telex: 8441
P

Wael Pharmacy
P.O. Box 648
MANAMA
Tel: 256123
Telex: 8550 WAEL BN
E,M

Zayani Computer Systems
218 Shaik Mubarak Building
Government Avenue
P.O. Box 5918
MANAMA
Tel: 276278
Telex: 9015
P

ANGOLA

Telectra Angola LDA
Empresa Técnica de Equipamentos
Rua Conselheiro Julio de Vilhema, 16
Caixa Postal 6487
LUANDA
Tel: 35515,35516
Telex: 3134
E,C*

ARGENTINA

Hewlett-Packard Argentina S.A.
Montaneses 2140/50
1428 **BUENOS AIRES**
Tel: 783-4886/4836/4730
Cable: HEWPACKARG
A,C,CM,E,P
Biotron S.A.C.I.e.I.
Av. Paso Colon 221, Piso 9
1399 **BUENOS AIRES**
CM

Laboratorio Rodriguez
Corswant S.R.L.
Misiones, 1156 - 1876
Bernal, Oeste
BUENOS AIRES
Tel: 252-3958, 252-4991
A

Argentina Esanco S.R.L.
Avasco 2328
1416 **BUENOS AIRES**
Tel: 541-58-1981, 541-59-2767
A

AUSTRALIA

Adelaide, South Australia Office

Hewlett-Packard Australia Ltd.
153 Greenhill Road
PARKSIDE, S.A. 5063
Tel: 272-5911
Telex: 82536
Cable: HEWPARD Adelaide
A*,C,CM,E,M,P

Brisbane, Queensland

Hewlett-Packard Australia Ltd.
10 Payne Road
THE GAP, Queensland 4061
Tel: 30-4133
Telex: 42133
Cable: HEWPARD Brisbane
A,C,CM,E,M,P

BELGIUM

Hewlett-Packard Belgium S.A./N.V.
Bivd de la Woluwe, 100
Woluwedal
B-1200 **BRUSSELS**
Tel: (02) 762-32-00
Telex: 23-494 paloben bru
A,C,CM,E,M,P

BERMUDA

Applied Computer Technologies
Atlantic House Building
Par-La-Ville Road
Hamilton 5
Tel: 295-1616
P

BRAZIL

Hewlett-Packard do Brasil
I.e.C. Ltda.
Alameda Rio Negro, 750
Alphaville
06400 **BARUERI SP**
Tel: (011) 421.1311
Telex: (011) 33872 HPBR-BR
Cable: HEWPACK Sao Paulo
A,C,CM,E,M,P

Hewlett-Packard do Brasil
I.e.C. Ltda.
Praia de Botafago 228
6° Andar-conj 614
Edificio Argentina - Ala A
22250 **RIO DE JANEIRO**
Tel: (021) 552-6422
Telex: 21905 HPBR-BR
Cable: HEWPACK Rio de Janeiro
A,C,CM,E,P*

Convex/Van Den
Rua Jose Bonifacio
458 Todos Os Santos
CEP 20771
RIO DE JANEIRO, RJ
Tel: 591-0197
Telex: 33487 EGLB BR
A

ANAMED I.C.E.I. Ltda.
Rua Bage, 103
04012 **SAO PAULO**, SP
Tel: (011) 572-6537
Telex: 24720 HPBR-BR
M

Datatronix Electronica Ltda.
Av. Pacaembu 746-C11
SAO PAULO, SP
Tel: (118) 260111
CM

Datatronix Electronica Ltda.
Av. Pacaembu 746-C11
SAO PAULO, SP
Tel: (118) 260111
CM

CAMEROON

Beriac
B. P. 23
DOUALA
Tel: 420153
Telex: 5351
C,P

CANADA

Alberta
Hewlett-Packard (Canada) Ltd.
3030 3rd Avenue N.E.
CALGARY, Alberta T2A 6T7
Tel: (403) 235-3100
A,C,CM,E*,M,P*

Hewlett-Packard (Canada) Ltd.
11120-178th Street
EDMONTON, Alberta T5S 1P2
Tel: (403) 486-6666
A,C,CM,E,M,P

CANADA (Cont'd)**British Columbia**

Hewlett-Packard (Canada) Ltd.
10691 Shelbridge Way

RICHMOND,

British Columbia V6X 2W7

Tel: (604) 270-2277

Telex: 610-922-5059

A,C,CM,E*,M,P*

Hewlett-Packard (Canada) Ltd.

121 - 3350 Douglas Street

VICTORIA, British Columbia V8Z 3L1

Tel: (604) 381-6616

C

Manitoba

Hewlett-Packard (Canada) Ltd.

1825 Inkster Blvd.

WINNIPEG, Manitoba R2X 1R3

Tel: (204) 694-2777

A,C,CM,E*,M,P*

New Brunswick

Hewlett-Packard (Canada) Ltd.

814 Main Street

MONCTON, New Brunswick E1C 1E6

Tel: (506) 855-2841

C

Nova Scotia

Hewlett-Packard (Canada) Ltd.

Suite 111

900 Windmill Road

DARTMOUTH, Nova Scotia B3B 1P7

Tel: (902) 469-7820

C,CM,E*,M,P*

Ontario

Hewlett-Packard (Canada) Ltd.

3325 N. Service Rd., Unit 3

BURLINGTON, Ontario L7N 3G2

Tel: (416) 335-8644

C,M*

Hewlett-Packard (Canada) Ltd.

496 Days Road

KINGSTON, Ontario K7M 5R4

Tel: (613) 384-2088

C

Hewlett-Packard (Canada) Ltd.

552 Newbold Street

LONDON, Ontario N6E 2S5

Tel: (519) 886-9181

A,C,CM,E*,M,P*

Hewlett-Packard (Canada) Ltd.

6877 Goreway Drive

MISSISSAUGA, Ontario L4V 1M8

Tel: (416) 678-9430

A,C,CM,E,M,P

Hewlett-Packard (Canada) Ltd.

2670 Queensview Dr.

OTTAWA, Ontario K2B 8K1

Tel: (613) 820-6483

A,C,CM,E*,M,P*

Hewlett-Packard (Canada) Ltd.

The Oaks Plaza, Unit #9

2140 Regent Street

SUDBURY, Ontario, P3E 5S8

Tel: (705) 522-0202

C

Hewlett-Packard (Canada) Ltd.

3790 Victoria Park Ave.

WILLOWDALE, Ontario M2H 3H7

Tel: (416) 499-2550

C

Quebec

Hewlett-Packard (Canada) Ltd.

17500 Trans Canada Highway

South Service Road

KIRKLAND, Quebec H9J 2X8

Tel: (514) 697-4232

A,C,CM,E,M,P*

Hewlett-Packard (Canada) Ltd.

1150 rue Claire Fontaine

QUEBEC CITY, Quebec G1R 5G4

Tel: (418) 648-0726

C

Hewlett-Packard (Canada) Ltd.

130 Robin Crescent

SASKATOON, Saskatchewan S7L 6M7

Tel: (306) 242-3702

C

CHILE

ASC Ltda.

Austria 2041

SANTIAGO

Tel: 223-5946, 223-6148

Telex: 340192 ASC CK

C,P

Isical Ltda.

Av. Italia 634 Santiago

Casilla 16475

SANTIAGO 9

Tel: 222-0222

Telex: 440283 JCYCL CZ

CM,E,M

Metrolab S.A.

Monjitas 454 of. 206

SANTIAGO

Tel: 395752, 398296

Telex: 340866 METLAB CK

A

Olympia (Chile) Ltda.

Av. Rodrigo de Araya 1045

Casilla 256-V

SANTIAGO 21

Tel: 225-5044

Telex: 340892 OLYMP

Cable: Olympiachile Santiagochile

C,P

CHINA, People's**Republic of**

China Hewlett-Packard, Ltd.

47/F China Resources Bldg.

26 Harbour Road

HONG KONG

Tel: 5-8330833

Telex: 76793 HPA HX

Cable: HP ASIA LTD

A*,M*

China Hewlett-Packard, Ltd.

P.O. Box 9610, Beijing

4th Floor, 2nd Watch Factory Main

Bldg.

Shuang Yu Shu, Bei San Huan Rd.

Hai Dian District

BEIJING

Tel: 28-0567

Telex: 22601 CTSHP CN

Cable: 1920 Beijing

A,C,CM,E,M,P

COLOMBIA

Instrumentación

H. A. Langebaek & Kier S.A.

Carrera 4A No. 52A-26

Apartado Aereo 6287

BOGOTA 1, D.E.

Tel: 212-1466

Telex: 44400 INST CO

Cable: AARIS Bogota

CM,E,M

Nefromedicas Ltda.

Calle 123 No. 9B-31

Apartado Aereo 100-958

BOGOTA D.E., 10

Tel: 213-5267, 213-1615

Telex: 43415 HEGAS CO

A

Compumundo

Avenida 15 # 107-80

BOGOTA D.E.

Tel: 214-4458

Telex: 45466 MARICO

P

Carvajal, S.A.

Calle 29 Norte No. 6A-40

Apartado Aereo 46

CALI

Tel: 368-1111

Telex: 55650

C,E,P

CONGO

Seric-Congo

B. P. 2105

BRAZZAVILLE

Tel: 815034

Telex: 5262

COSTA RICA

Cientifica Costarricense S.A.

Avenida 2, Calle 5

San Pedro de Montes de Oca

Apartado 10159

SAN JOSE

Tel: 24-36-20, 24-08-19

Telex: 2367 GALGUR CR

CM,E,M

CYPRUS

Telerex Ltd.

P.O. Box 4809

14C Stassinos Avenue

NICOSIA

Tel: 62698

Telex: 2894 LEVIDO CY

E,M,P

DENMARK

Hewlett-Packard A/S

Datavej 52

DK-3460 **BIRKEROD**

Tel: (02) 81-66-40

Telex: 37409 hpas dk

A,C,CM,E,M,P

Hewlett-Packard A/S

Rolighedsvej 32

DK-8240 **RISKOV**, Aarhus

Tel: (06) 17-60-00

Telex: 37409 hpas dk

C,E

DOMINICAN REPUBLIC

Microprog S.A.

Juan Tomás Mejía y Cotes No. 60

Arroyo Hondo

SANTO DOMINGO

Tel: 565-6268

Telex: 4510 ARENTA DR (RCA)

P

ECUADOR

CYEDE Cia. Ltda.

Avenida Eloy Alfaro 1749

y Belgica

Casilla 6423 CCI

QUITO

Tel: 450-975, 243-052

Telex: 22548 CYEDE ED

CM,E,P

Medtronics

Valladolid 524 Madrid

P.O. 9171. **QUITO**

Tel: 223-8951

Telex: 2298 ECKAME ED

A

Hospitalar S.A.

Robles 625

Casilla 3590

QUITO

Tel: 545-250, 545-122

Telex: 2485 HOSPTEL ED

Cable: HOSPITALAR-Quito

M

Ecuador Overseas Agencies C.A.

Calle 9 de Octubre #818

P.O. Box 1296, Guayaquil

QUITO

Tel: 306022

Telex: 3361 PBCGYE ED

M

EGYPT

Sakro Enterprises

70, Mossadak Str.

Dokki, Giza

CAIRO

Tel: 706440

Telex: 93146

C

International Engineering Associates

24 Hussein Hegazi Street

Kasr-el-Ain

CAIRO

Tel: 23829, 21641

Telex: 93830 IEA UN

Cable: INTEGASSO

E,M*

S.S.C. Medical

40 Gezerat El Arab Street

Mohandessin

CAIRO

Tel: 803844, 805998, 810263

Telex: 20503 SSC UN

M*

EL SALVADOR

IPESA de El Salvador S.A.

29 Avenida Norte 1223

SAN SALVADOR

Tel: 26-6858, 26-6868

Telex: 20539 IPESA SAL

A,C,CM,E,P

ETHIOPIA

Seric-Ethiopia

P.O. Box 2764

ADDIS ABABA

Tel: 185114

Telex: 21150

C,P

FRANCE (Cont'd)

Hewlett-Packard France
Zone Industrielle de Courtaboeuf
Avenue des Tropiques
91947 Les Ulis Cedex **ORSAY**
Tel: (6) 907-78-25
Telex: 600048F
A.C.C.M.E.M.P

Hewlett-Packard France
Paris Porte-Maillet
15, boulevard de L'Amiral-Bruix
75782 **PARIS** Cedex 16
Tel: (1) 502-12-20
Telex: 613663F
C.M.P

Hewlett-Packard France
124, Boulevard Tourasse
64000 **PAU**
Tel: (59) 80 38 02

Hewlett-Packard France
2 Allée de la Bourgonnette
35100 **RENNES**
Tel: (99) 51-42-44
Telex: 740912F
C.C.M.E.M.P*

Hewlett-Packard France
98 avenue de Bretagne
76100 **ROUEN**
Tel: (35) 63-57-66
Telex: 770035F
C

Hewlett-Packard France
4, rue Thomas-Mann
Boîte Postale 56
67033 **STRASBOURG** Cedex
Tel: (88) 28-56-46
Telex: 890141F
C.E.M.P*

Hewlett-Packard France
La Péripole III
20, chemin du Pigeonnier de la Céprière
F-31083 **TOULOUSE** Cedex
Tel: (61) 40-11-12
Telex: 531639F
A.C.E.P*

Hewlett-Packard France
9, rue Baudin
26000 **VALENCE**
Tel: (75) 42 76 16

Hewlett-Packard France
Carolor
ZAC de Bois Briand
57640 **VIGY** (Metz)
Tel: (8) 771 20 22
C

Hewlett-Packard France
Parc d'activité des Prés
1, rue Papin
59658 **VILLENEUVE D'ASCQ** Cedex
Tel: (20) 47 78 78
Telex: 160124F
C.E.M.P*

GABON

Sho Gabon
P.O. Box 89
LIBREVILLE
Tel: 721 484
Telex: 5230

GERMAN FEDERAL REPUBLIC

Hewlett-Packard GmbH
Geschäftsstelle
Keithstrasse 2-4
D-1000 **BERLIN** 30
Tel: (030) 21 99 04-0
Telex: 018 3405 hpbln d
A.C.E.M.P

Hewlett-Packard GmbH
Vertriebszentrum Südwest
Schickardstrasse 2
D-7030 **BÖBLINGEN**
Tel: (07031) 645-0
Telex: 7265 743 hep
A.C.C.M.E.M.P

Hewlett-Packard GmbH
Vertriebszentrum West
Berliner Strasse III
D-4030 **RATINGEN** 3
Tel: (02102) 494-0
Telex: 589 070 hprad
A.C.E.M.P

Hewlett-Packard GmbH
Geschäftsstelle
Schleefstr. 28a
D-4600 **DORTMUND**-41
Tel: (0231) 45001
Telex: 822858 hepdad
A.C.E

Hewlett-Packard GmbH
Vertriebszentrum Mitte
Hewlett-Packard-Strasse
D-6380 **BAD HOMBURG**
Tel: (06172) 400-0
Telex: 410 844 hpbhg
A.C.E.M.P

Hewlett-Packard GmbH
Vertriebszentrum Nord
Kapstadtring 5
D-2000 **HAMBURG** 60
Tel: (040) 63804-1
Telex: 021 63 032 hphh d
A.C.E.M.P

Hewlett-Packard GmbH
Geschäftsstelle
Heidering 37-39
D-3000 **HANNOVER** 61
Tel: (0511) 5706-0
Telex: 092 3259
A.C.C.M.E.M.P

Hewlett-Packard GmbH
Geschäftsstelle
Rosslauer Weg 2-4
D-6800 **MANNHEIM**
Tel: (0621) 70 05-0
Telex: 0462105
A.C.E

Hewlett-Packard GmbH
Geschäftsstelle
Messerschmittstrasse 7
D-7910 **NEU ULM**
Tel: (0731) 70 73-0
Telex: 0712816 HP ULM-D
A.C.E*

Hewlett-Packard GmbH
Geschäftsstelle
Emmericher Strasse 13
D-8500 **NÜRNBERG** 10
Tel: (0911) 5205-0
Telex: 0623 860 hpnbg
C.C.M.E.M.P

Hewlett-Packard GmbH
Vertriebszentrum Süd
Eschenstrasse 5
D-8028 **TAUFKIRCHEN**
Tel: (089) 61 20 7-0
Telex: 0524985
A.C.C.M.E.M.P

Hewlett-Packard GmbH
Geschäftsstelle
Ermisallee
7517 **WALDBRONN** 2
Tel: (07243) 602-0
Telex: 782 838 hep
A.C.E

GREAT BRITAIN**See United Kingdom****GREECE**

Hewlett-Packard A.E.
178, Kilissias Avenue
6th Floor
Halandri-**ATHENS**
Greece
Tel: 6471543, 6471673, 6472971
Telex: 221 286 HPHLGR
A.C.C.M.**E.M.P

Kostas Karayannis S.A.
8, Omirou Street
ATHENS 133
Tel: 32 30 303, 32 37 371
Telex: 215962 RKAR GR
A.C.*C.M.E

Impexin
Intelect Div.
209 Mesogion
11525 **ATHENS**
Tel: 6474481/2
Telex: 216286
P

Haril Company
38, Mihalakopoulou
ATHENS 612
Tel: 7236071
Telex: 218767
M*

Hellamco
P.O. Box 87528
18507 **PIRAEUS**
Tel: 4827049
Telex: 241441
A

GUATEMALA

IPESA
Avenida Reforma 3-48, Zona 9
GUATEMALA CITY
Tel: 316627, 314786
Telex: 3055765 IPESA GU
A.C.C.M.E.M.P

HONG KONG

Hewlett-Packard Hong Kong, Ltd.
G.P.O. Box 795
5th Floor, Sun Hung Kai Centre
30 Harbour Road
HONG KONG
Tel: 5-8323211
Telex: 66678 HEWPA HX
Cable: HEWPACK Hong Kong
E.C.P

CET Ltd.
10th Floor, Hua Asia Bldg.
64-66 Gloucester Road
HONG KONG
Tel: (5) 200922
Telex: 85148 CET HX
CM

Schmidt & Co. (Hong Kong) Ltd.
18th Floor, Great Eagle Centre
23 Harbour Road
HONG KONG
Tel: 5-8330222
Telex: 74766 SCHMC HX
A.M

ICELAND

Hewlett-Packard Iceland
Hoefdabakka 9
110 **Reykjavik**
Tel: (1) 67 1000
A.C.C.M.E.M.P

INDIA

Computer products are sold through
Blue Star Ltd. All computer repairs and
maintenance service is done through
Computer Maintenance Corp.

Blue Star Ltd.
Sabri Complex 2nd Floor
24 Residency Rd.
BANGALORE 560 025
Tel: 55660, 578881
Telex: 0845-430
Cable: BLUESTAR
A.C.*C.M.E

Blue Star Ltd.
Band Box House
Prabhadevi
BOMBAY 400 025
Tel: 4933101, 4933222
Telex: 011-71051
Cable: BLUESTAR
A.M

Blue Star Ltd.
Sahas
414/2 Vir Savarkar Marg
Prabhadevi
BOMBAY 400 025
Tel: 422-6155, 422-6556
Telex: 011-71193 BSSS IN
Cable: FROSTBLUE
A.C.*C.M.E.M

Blue Star Ltd.
Kalyan, 19 Vishwas Colony
Akapuri, **BORODA**, 390 005
Tel: 65235, 65236
Cable: BLUE STAR
A

Blue Star Ltd.
7 Hare Street
CALCUTTA 700 001
Tel: 230131, 230132
Telex: 021-7655
Cable: BLUESTAR
A.M

Blue Star Ltd.
133 Kodambakkam High Road
MADRAS 600 034
Tel: 472056, 470238
Telex: 041-379
Cable: BLUESTAR
A.M

Blue Star Ltd.
13 Community Center
New Friends Colony
NEW DELHI 110 065
Tel: 633773, 634473
Telex: 031-61120
Cable: BLUEFROST
A.C.*C.M.E.M

Blue Star Ltd.
15/16 C Wellesley Rd.
PUNE 411 011
Tel: 22775
Cable: BLUE STAR
A

Blue Star Ltd.
2-2-47/1106 Bolaram Rd.
SECUNDERABAD 500 003
Tel: 72057, 72058
Telex: 0155645
Cable: BLUEFROST
A.E

Blue Star Ltd.
T.C. 7/603 Poornima
Maruthunkuzhi
TRIVANDRUM 695 013
Tel: 65799, 65820
Telex: 0884-259
Cable: BLUESTAR
E

Computer Maintenance Corporation
Ltd.
115, Sarojini Devi Road
SECUNDERABAD 500 003
Tel: 310-184, 345-774
Telex: 031-2960
C**

INDONESIA

BERCA Indonesia P.T.
P.O. Box 496/Jkt.
Jl. Abdul Muis 62

JAKARTA
Tel: 21-373009
Telex: 46748 BERSAL IA
Cable: BERSAL JAKARTA
P

BERCA Indonesia P.T.
P.O. Box 2497/Jkt
Antara Bldg., 12th Floor
Jl. Medan Merdeka Selatan 17
JAKARTA-PUSAT
Tel: 21-340417, 341445
Telex: 46748 BERSAL IA
A.C.E.M

BERCA Indonesia P.T.
Jalan Kutai 24
SURABAYA
Tel: 67118
Telex: 31146 BERSAL SB
Cable: BERSAL-SURABAYA
A*,E.M.P

IRAQ

Hewlett-Packard Trading S.A.
Service Operation
Al Mansoor City 9B/3/7
BAGHDAD
Tel: 551-49-73
Telex: 212-455 HEPAlRAQ IK
C

IRELAND

Hewlett-Packard Ireland Ltd.
82/83 Lower Leeson Street
DUBLIN 2
Tel: 0001 608800
Telex: 30439
A.C.C.M.E.M.P

Cardiac Services Ltd.
Kilmore Road
Artane
DUBLIN 5
Tel: (01) 351820
Telex: 30439
M

ISRAEL

Eidan Electronic Instrument Ltd.
P.O.Box 1270
JERUSALEM 91000
16, Ohaliav St.
JERUSALEM 94467
Tel: 533 221, 553 242
Telex: 25231 AB/PAKRD IL
A,M

Computation and Measurement
Systems (CMS) Ltd.
11 Masad Street
67060
TEL-AVIV
Tel: 388 388
Telex: 33569 Motil IL
C,C,M,E,P

ITALY

Hewlett-Packard Italiana S.p.A.
Traversa 99C
Via Giulio Petroni, 19
I-70124 **BARI**
Tel: (080) 41-07-44
C,M

Hewlett-Packard Italiana S.p.A.
Via Emilia, 51/C
I-40011 **BOLOGNA** Anzola Dell'Emilia
Tel: (051) 731061
Telex: 511830
C,E,M

Hewlett-Packard Italiana S.p.A.
Via Principe Nicola 43G/C
I-95126 **CATANIA**
Tel: (095) 37-10-87
Telex: 970291
C

Hewlett-Packard Italiana S.p.A.
Via G. Di Vittorio 9
I-20063 **CERNUSCO SUL**
NAVIGLIO
(Milano)
Tel: (02) 4459041
Telex: 334632
A,C,C,M,E,M,P

Hewlett-Packard Italiana S.p.A.
Via C. Colombo 49
I-20090 **TREZZANO SUL**
NAVIGLIO
(Milano)
Tel: (02) 4459041
Telex: 322116
C

Hewlett-Packard Italiana S.p.A.
Via Nuova San Rocco a
Capodimonte, 62/A
I-80131 **NAPOLI**
Tel: (081) 7413544
Telex: 710698
A**,C,E,M

Hewlett-Packard Italiana S.p.A.
Viale G. Modugno 33
I-16156 **GENOVA PEGLI**
Tel: (010) 68-37-07
Telex: 215238
C,E

Hewlett-Packard Italiana S.p.A.
Via Pelizzo 15
I-35128 **PADOVA**
Tel: (049) 664888
Telex: 430315
A,C,E,M

Hewlett-Packard Italiana S.p.A.
Viale C. Pavese 340
I-00144 **ROMA EUR**
Tel: (06) 54831
Telex: 610514
A,C,E,M,P*

Hewlett-Packard Italiana S.p.A.
Via di Casellina 57/C
I-50018 **SCANDICCI-FIRENZE**
Tel: (055) 753863
C,E,M

Hewlett-Packard Italiana S.p.A.
Corso Svizzera, 185
I-10144 **TORINO**
Tel: (011) 74 4044
Telex: 221079
A*,C,E

IVORY COAST

S.I.T.E.L.
Societe Ivoirienne de
Telecommunications
Bd. Giscard d'Estaing
Carrefour Marcory
Zone 4.A.
Boite postale 2580
ABIDJAN 01
Tel: 353600
Telex: 43175
E

S.I.T.I.
Immeuble "Le General"
Av. du General de Gaulle
01 BP 161
ABIDJAN 01
Tel: 321227
C,P

JAPAN

Yokogawa-Hewlett-Packard Ltd.
152-1, Onna
ATSUGI, Kanagawa, 243
Tel: (0462) 25-0031
C,C,M,E

Yokogawa-Hewlett-Packard Ltd.
Meiji-Seimei Bldg. 6F
3-1 Hon Chiba-Cho
CHIBA, 280
Tel: 472 25 7701
C,E

Yokogawa-Hewlett-Packard Ltd.
Yasuda-Seimei Hiroshima Bldg.
6-11, Hon-dori, Naka-ku
HIROSHIMA, 730
Tel: 82-241-0611

Yokogawa-Hewlett-Packard Ltd.
Towa Building
2-3, Kaigan-dori, 2 Chome Chuo-ku
KOBE, 650
Tel: (078) 392-4791
C,E

Yokogawa-Hewlett-Packard Ltd.
Kumagaya Asahi 82 Bldg
3-4 Tsukuba
KUMAGAYA, Saitama 360
Tel: (0485) 24-6563
C,C,M,E

Yokogawa-Hewlett-Packard Ltd.
Asahi Shinbun Daiichi Seimei Bldg.
4-7, Hanabata-cho
KUMAMOTO, 860
Tel: (096) 354-7311
C,E

Yokogawa-Hewlett-Packard Ltd.
Shin-Kyoto Center Bldg.
614, Higashi-Shioji-cho
Karasuma-Nishiiru
Shioji-cho-dori, Shimogyo-ku
KYOTO, 600
Tel: 075-343-0921
C,E

Yokogawa-Hewlett-Packard Ltd.
Mito Mitsui Bldg
4-73, Sanno-maru, 1 Chome
MITO, Ibaraki 310
Tel: (0292) 25-7470
C,C,M,E

Yokogawa-Hewlett-Packard Ltd.
Meiji-Seimei Kokubun Bldg. 7-8
Kokubun, 1 Chome, Sendai
MIYAGI, 980
Tel: (0222) 25-1011
C,E

Yokogawa-Hewlett-Packard Ltd.
Nagoya Kokusai Center Building
47-1, Nagono, 1 Chome
Nakamura-ku
NAGOYA, 450
Tel: (052) 571-5171
C,C,M,E,M

Yokogawa-Hewlett-Packard Ltd.
Saikyoren Building
1-2 Dote-machi, **OHMIYA**
Saitama 330
Tel: (0486) 45-8031

Yokogawa-Hewlett-Packard Ltd.
Chuo Bldg.,
4-20 Nishinakajima, 5 Chome
Yodogawa-ku
OSAKA, 532
Tel: (06) 304-6021

Telex: YHPOSA 523-3624
A,C,C,M,E,M,P*

Yokogawa-Hewlett-Packard Ltd.
27-15, Yabe, 1 Chome
SAGAMIHARA Kanagawa, 229
Tel: 0427 59-1311

Yokogawa-Hewlett-Packard Ltd.
Daiichi Seimei Bldg.
7-1, Nishi Shinjuku, 2 Chome
Shinjuku-ku, **TOKYO** 160
Tel: 03-348-4611
C,E

Yokogawa-Hewlett-Packard Ltd.
29-21 Takaido-Higashi, 3 Chome
Suginami-ku **TOKYO** 168
Tel: (03) 331-6111
Telex: 232-2024 YHPTOK
A,C,C,M,E,M,P*

Yokogawa Hokushin Electric Corp.
9-32 Nokacho 2 Chome
2 Chome Musashino-shi
TOKYO, 180
Tel: (0422) 54-1111
Telex: 02822-421 YEW MTK J
A

Yokogawa-Hewlett-Packard Ltd.
Meiji-Seimei
Utsunomiya Odori Building
1-5 Odori, 2 Chome
UTSUNOMIYA, Tochigi 320
Tel: (0286) 33-1153
C,E

Yokogawa-Hewlett-Packard Ltd.
Yasuda Seimei Yokohama Nishiguchi
Bldg.
30-4 Tsuruya-cho, 3 Chome
YOKOHAMA 221
Tel: (045) 312-1252
C,E

JORDAN

Scientific and Medical Supplies Co.
P.O. Box 1387
AMMAN
Tel: 24907, 39907
Telex: 21456 SABCO JO
C,E,M,P

KENYA

ADCOM Ltd., Inc., Kenya
P.O.Box 30070
NAIROBI
Tel: 331955
Telex: 22639
E,M

KOREA

Samsung Hewlett-Packard Co. Ltd.
Dongbang Yeoeuido Building
12-16th Floors
36-1 Yeoeuido-dong
Yongdeungpo-ku
SEOUL
Tel: 784-2666, 784-4666
Telex: 25166 SAMSAN K
A,C,C,M,E,M,P

Young In Scientific Co., Ltd.
Youngwha Building
547 Shinsa Dong, Kangnam-ku
SEOUL 135
Tel: 5467771
Telex: K23457 GINSCO
A

KUWAIT

Al-Khaldiya Trading & Contracting
P.O. Box 830
SAFAT
Tel: 424910, 411726
Telex: 22481 AREEG KT
Cable: VISCOUNT
E,M,A

Gulf Computing Systems
P.O. Box 25125
SAFAT
Tel: 435969
Telex: 23648
P

Photo & Cine Equipment
P.O. Box 270
SAFAT
Tel: 2445111
Telex: 22247 MATIN KT
Cable: MATIN KUWAIT
P

W.J. Towell Computer Services
P.O. Box 5897
SAFAT
Tel: 2462640
Telex: 30336 TOWELL KT
C

LEBANON

Computer Information Systems S.A.L.
Chammas Building
P.O. Box 11-6274 Dara
BEIRUT
Tel: 89 40 73
Telex: 42309
C,E,M,P

LIBERIA

Unichemicals Inc.
P.O. Box 4509
MONROVIA
Tel: 224282
Telex: 4509
E

MADAGASCAR

Technique et Precision
12, rue de Nice
P.O. Box 1227
101 **ANTANANARIVO**
Tel: 22090
Telex: 22255
P

LUXEMBOURG

Hewlett-Packard Belgium S.A./N.V.
Bldv de la Woluwe, 100
Woluwedal
B-1200 **BRUSSELS**
Tel: (02) 762-32-00
Telex: 23-494 paloben bru
A,C,C,M,E,M,P

MALAYSIA

Hewlett-Packard Sales (Malaysia)
Sdn. Bhd.
9th Floor
Chung Khiaw Bank Building
46, Jalan Raja Laut
KUALA LUMPUR
Tel: 03-986555
Telex: 31011 HPSM MA
A,C,E,M,P*

Protel Engineering
P.O.Box 1917
Lot 6624, Section 64
23/4 Pending Road
Kuching, **SARAWAK**
Tel: 36299
Telex: 70904 PROMAL MA
Cable: PROTELENG
A,E,M

MALTA

Philip Toledo Ltd.
Birkirkara P.O. Box 11
Notabile Rd.
MRIEHEL
Tel: 447 47, 455 66
Telex: 1649
E,M,P

MAURITIUS

Blanche Birger Co. Ltd.
18, Jules Koenig Street
PORT LOUIS
Tel: 20828
Telex: 4296
P

MEXICO

Hewlett-Packard de Mexico, S.A.
Francisco J. Allan #30
Colonia Nueva
Los Angeles 27140
COAHUILA, Torreón
Tel: 37220
P

Hewlett-Packard de Mexico, S.A.
Monti Morelos 299
Fraccionamiento Loma Bonita 45060
GUADALAJARA, Jalisco
Tel: 316630/314600
Telex: 0684 186 ECOMEX
P

MEXICO (Cont'd)

Microcomputadoras Hewlett-Packard, S.A.
Monti Pelvoux 115
LOS LOMAS, Mexico, D.F.
Tel: 520-9127
P

Hewlett-Packard Mexicana, S.A. de C.V.
Av. Periferico Sur No. 6501
Tepepan, Xochimilco
16020 **MEXICO D.F.**
Tel: 6-76-46-00
Telex: 17-74-507 HEWPACK MEX
A,C,C,M,E,M,P

Hewlett-Packard De Mexico (Polanco)
Avenida Ejercito Nacional #579
2da y 3er piso
Colonia Granada 11560
MEXICO D.F.
Tel: 254-4433
P

Hewlett-Packard De Mexico, S.A. de C.V.
Czda. del Valle
409 Ote. 4th Piso
Colonia del Valle
Municipio de Garza García
66220 **MONTERREY**, Nuevo León
Tel: 78 42 41
Telex: 038 410
P

MOROCCO

Etablissement Hubert Dolbeau & Fils
81 rue Karachi
B.P. 11133

CASABLANCA

Tel: 3041-82, 3068-38
Telex: 23051, 22822
E

Gerep

2, rue Agadir
Boite Postale 156

CASABLANCA 01

Tel: 272093, 272095
Telex: 23 739
P

Sema-Maroc

Dept. Seric
6, rue Lapebie

CASABLANCA

Tel: 260980
Telex: 21641
C,P

NETHERLANDS

Hewlett-Packard Nederland B.V.
Startbaan 16
1187 XR **AMSTELVEEN**
P.O. Box 667
NL 1180 AR **AMSTELVEEN**
Tel: (020) 547-6911
Telex: 13 216 HEPAC NL
A,C,C,M,E,M,P

Hewlett-Packard Nederland B.V.
Bongerd 2
NL 2906VK **CAPELLE A/D IJSEL**
P.O. Box 41
NL 2900AA **CAPELLE A/D IJSEL**
Tel: (10) 51-54-44
Telex: 21261 HEPAC NL
C,E

Hewlett-Packard Nederland B.V.
Pastoor Petersstraat 134-136
NL 5612 LV **EINDHOVEN**
P.O. Box 2342
NL 5600 CH **EINDHOVEN**
Tel: (040) 326911
Telex: 51484 hepae nl
A,C,C,M,E,M,P

NEW ZEALAND

Hewlett-Packard (N.Z.) Ltd.
5 Owens Road
P.O. Box 26-189
Epsom, **AUCKLAND**
Tel: 687-159
Cable: HEWPAK Auckland
C,C,M,E,P*

Hewlett-Packard (N.Z.) Ltd.
4-12 Cruickshank Street
Kilbirnie, **WELLINGTON 3**
P.O. Box 9443
Courtenay Place, **WELLINGTON 3**
Tel: 877-199
Cable: HEWPAK Wellington
C,C,M,E,P

Northrop Instruments & Systems Ltd.
369 Khyber Pass Road
P.O. Box 8602
AUCKLAND
Tel: 794-091
Telex: 60605
A,M

Northrop Instruments & Systems Ltd.
110 Mandeville St.
P.O. Box 8388
CHRISTCHURCH
Tel: 488-873
Telex: 4203
A,M

Northrop Instruments & Systems Ltd.
Sturdee House
85-87 Ghuznee Street
P.O. Box 2406
WELLINGTON
Tel: 850-091
Telex: NZ 3380
A,M

NIGERIA

Elmeco Nigeria Ltd.
46, Calcutta Crescent Apapa
P.O. Box 244and
LAGOS
E

NORTHERN IRELAND

See United Kingdom

NORWAY

Hewlett-Packard Norge A/S
Folke Bernadottes vei 50
P.O. Box 3558
N-5033 **FYLLINGSDALEN** (Bergen)
Tel: 0047/5/16 55 40
Telex: 76621 hpnas n
C,E,M

Hewlett-Packard Norge A/S
Osterdalen 16-18
P.O. Box 34
N-1345 **OSTERÅS**
Tel: 0047/2/17 11 80
Telex: 76621 hpnas n
A,C,C,M,E,M,P

OMAN

Khimji Ramdas
P.O. Box 19
MUSCAT/SULTANATE OF OMAN
Tel: 745601
Telex: 5289 BROKER MB MUSCAT
P

Suhail & Saud Bahwan
P.O.Box 169

MUSCAT/SULTANATE OF OMAN
Tel: 734201
Telex: 5274 BAHWAN MB
E

Imtac LLC

P.O. Box 8676
MUTRAH/SULTANATE OF OMAN
Tel: 601695
Telex: 5741 Tawoos On
A,C,M

PAKISTAN

Mushko & Company Ltd.
House No. 16, Street No. 16
Sector F-6/3

ISLAMABAD

Tel: 824545
Cable: FEMUS Islamabad
A,E,M,P*

Mushko & Company Ltd.

Oosman Chambers
Abdullah Haroon Road
KARACHI 0302
Tel: 524131, 524132
Telex: 2694 MUSKO PK
Cable: COOPERATOR Karachi
A,E,M,P*

PANAMA

Electronico Balboa, S.A.
Calle Samuel Lewis, Ed. Alfa
Apartado 4929
PANAMA 5
Tel: 64-2700
Telex: 3483 ELECTRON PG
A,C,M,E,M,P

PERU

Cia Electro Médica S.A.
Los Flamencos 145, Otc. 301/2
San Isidro
Casilla 1030
LIMA 1
Tel: 41-4325, 41-3705
Telex: Pub. Booth 25306 PEC PISIDR
C,M,E,M,P

SAMS

Arenida Republica de Panama 3534
San Isidro, LIMA
Tel: 419928/417108
Telex: 20450 PE LIBERTAD
A,C,P

PHILIPPINES

The Online Advanced Systems Corp.
2nd Floor, Electra House
115-117 Esteban Street
Legaspi Village, Makati
P.O. Box 1510
Metro **MANILA**
Tel: 815-38-10 (up to 16)
Telex: 63274 ONLINE PN
A,C,E,M,P

PORTUGAL

Mundinter Intercambio
Mundial de Comércio S.A.R.L.
Av. Antonio Augusto Aguiar 138
Apartado 2761
LISBON
Tel: (19) 53-21-31, 53-21-37
Telex: 16691 munter p
M

Soquimica
Av. da Liberdade, 220-2
1298 **LISBOA** Codex
Tel: 56-21-82
Telex: 13316 SABASA
A

Telectra-Empresa Técnica de
Equipamentos Eléctricos S.A.R.L.
Rua Rodrigo da Fonseca 103
P.O. Box 2531
LISBON 1
Tel: (19) 68-60-72
Telex: 12598
C,M,E

C.P.C.S.I.
Rua de Costa Cabral 575
4200 **PORTO**
Tel: 499174/495173
Telex: 26054
C,P

PUERTO RICO

Hewlett-Packard Puerto Rico
101 Muñoz Rivera Av
Esu. Calle Ochoa
HATO REY, Puerto Rico 00918
Tel: (809) 754-7800
A,C,C,M,E,M,P

QATAR

Computer Arabia
P.O. Box 2750
DOHA
Tel: 428555
Telex: 4806 CHPARB
P

Nasser Trading & Contracting
P.O.Box 1563

DOHA

Tel: 422170
Telex: 4439 NASSER DH
M

SAUDI ARABIA

Modern Electronics Establishment
Hewlett-Packard Division
P.O. Box 281
Thouqbah
AL-KHOBAR 31952
Tel: 895-1760, 895-1764
Telex: 671 106 HPMEEK SJ
Cable: ELECTA AL-KHOBAR
C,E,M

Modern Electronics Establishment
Hewlett-Packard Division
P.O. Box 1228

JEDDAH

Tel: 644 96 28
Telex: 4027 12 FARNAS SJ
Cable: ELECTA JEDDAH
A,C,C,M,E,M,P

Modern Electronics Establishment
Hewlett-Packard Division
P.O.Box 22015
RIYADH 11495
Tel: 476-3030
Telex: 202049 MEERYD SJ
A,C,C,M,E,M,P

Abdul Ghani El Ajou Corp.
P.O. Box 78

RIYADH

Tel: 40 41 717
Telex: 200 931 EL AJOU
P

SCOTLAND

See United Kingdom

SENEGAL

Societe Hussein Ayad & Cie.
76, Avenue Georges Pompidou
B.P. 305
DAKAR
Tel: 32339
Cable: AYAD-Dakar
E

Moneger Distribution S.A.
1, Rue Parent

B.P. 148

DAKAR

Tel: 215 671
Telex: 587
P

Systeme Service Conseil (SSC)
14, Avenue du Parachois

DAKAR ETOILE

Tel: 219976
Telex: 577
C,P

SINGAPORE

Hewlett-Packard Singapore (Sales)
Pte. Ltd.

08-00 Inchcape House
450-2 Alexandra Road
Alexandra P.O. Box 58
SINGAPORE, 9115

Tel: 4731788

Telex: 34209 HPSGSO RS
Cable: HEWPACK, Singapore
A,C,E,M,P

Dynamar International Ltd.
Unit 05-11 Block 6

Kolam Ayer Industrial Estate
SINGAPORE 1334

Tel: 747-6188
Telex: 26283 RS
CM

SOUTH AFRICA

Hewlett-Packard So Africa (Pty.) Ltd.
P.O. Box 120

Howard Place **CAPE PROVINCE** 7450
Pine Park Center, Forest Drive, Pine-lands

CAPE PROVINCE 7405

Tel: (021) 53 7954
Telex: 57-20006
A,C,C,M,E,M,P

Hewlett-Packard So Africa (Pty.) Ltd.
2nd Floor Juniper House

92 Overport Drive
DURBAN 4067
Tel: (031) 28-4178
Telex: 6-22954
C

Hewlett-Packard So Africa (Pty.) Ltd.
6 Linton Arcade

511 Cape Road
Linton Grange
PORT ELIZABETH 6001

Tel: 041-301201
Telex: 24-2916
C

SOUTH AFRICA (Cont'd)

Hewlett-Packard So Africa (Pty.) Ltd.
Fountain Center
Kalkden Str.
Monument Park Ext 2
PRETORIA 0105
Tel: (012) 45 57258
Telex: 3-21063
C,E

Hewlett-Packard So Africa (Pty.) Ltd.
Private Bag Wendywood
SANDTON 2144
Tel: 802-5111, 802-5125
Telex: 4-20877 SA
Cable: HEWPACK Johannesburg
A,C,CM,E,M,P

SPAIN

Hewlett-Packard Española S.A.
Calle Entenza, 321
08029 **BARCELONA**
Tel: 3/322 24 51, 321 73 54
Telex: 52603 hpbee
A,C,E,M,P

Hewlett-Packard Española S.A.
Calle San Vicente S/N
Edificio Albia II-7B
48001 **BILBAO**
Tel: 4/423 83 06
A,C,E,M

Hewlett-Packard Española S.A.
Cta. de la Coruña, Km. 16, 400
Las Rozas
E-MADRID
Tel: (1) 637.00.11
Telex: 23515 HPE
C,M

Hewlett-Packard Española S.A.
Avda. S. Francisco Javier, S/N
Planta 10. Edificio Sevilla 2
41005 **SEVILLA**
Tel: 54/64 44 54
Telex: 72933
A,C,M,P

Hewlett-Packard Española S.A.
Isabel La Católica, 8
46004 **VALENCIA**
Tel: 0034/6/351 59 44
C,P

SWEDEN

Hewlett-Packard Sverige AB
Ostra Tullgatan 3
S-21128 **MALMÖ**
Tel: (040) 70270
Telex: (854) 17886 (via Spånga
office)
C,P

Hewlett-Packard Sverige AB
Skaholmsgatan 9, Kista
Box 19
S-16393 **SPÅNGA**
Tel: (08) 750-2000
Telex: (854) 17886
Telefax: (08) 7527781
A,C,CM,E,M,P

Hewlett-Packard Sverige AB
Fröbällsgatan 30
S-42132 **VÄSTRA-FRÖLUNDA** (Gothen-
burg)
Tel: (031) 49-09-50
Telex: (854) 17886 (via Spånga
office)
A,C,CM,E,M,P

SUDAN

Mediterranean Engineering & Trading
Co. Ltd.
P.O. Box 1025
KHARTOUM
Tel: 41184
Telex: 24052
C,P

SWITZERLAND

Hewlett-Packard (Schweiz) AG
Clarastrasse 12
CH-4058 **BASEL**
Tel: (61) 33-59-20
A

Hewlett-Packard (Schweiz) AG
7, rue du Bois-du-Lan
Case postale 365
CH-1217 **MEYRIN** 1
Tel: (0041) 22-83-11-11
Telex: 27333 HPAG CH
C,CM

Hewlett-Packard (Schweiz) AG
Allmend 2
CH-8967 **WIDEN**
Tel: (0041) 57 31 21 11
Telex: 53933 hpag ch
Cable: HPAG CH
A,C,CM,E,M,P

SYRIA

General Electronic Inc.
Nuri Basha Ahnaf Ebn Kays Street
P.O. Box 5781
DAMASCUS
Tel: 33-24-87
Telex: 411 215
Cable: ELECTROBOR DAMASCUS
E

Middle East Electronics
P.O.Box 2308
Abu Rumaneh
DAMASCUS
Tel: 33 45 92
Telex: 411 771
M

TAIWAN

Hewlett-Packard Taiwan
Kaohsiung Office
11/F, 456, Chung Hsiao 1st Road
KAOHSIUNG
Tel: (07) 2412318
C,E

Hewlett-Packard Taiwan
8th Floor, Hewlett-Packard Building
337 Fu Hsing North Road
TAIPEI
Tel: (02) 712-0404
Telex: 24439 HEWPACK
Cable: HEWPACK Taipei
A,C,CM,E,M,P

Ing Lih Trading Co.
3rd Floor, 7 Jen-Ai Road, Sec. 2
TAIPEI 100
Tel: (02) 3948191
Cable: INGLIH Taipei
A

THAILAND

Unimesa Co. Ltd.
30 Patpong Ave., Suriwong
BANGKOK 5
Tel: 235-5727
Telex: 84439 Simonco TH
Cable: UNIMESA Bangkok
A,C,E,M

Bangkok Business Equipment Ltd.
5/5-6 Dejo Road
BANGKOK
Tel: 234-8670, 234-8671
Telex: 87699-BEQUIPT TH
Cable: BUSQUIPT Bangkok
P

TOGO

Societe Africaine De Promotion
Immeuble Sagap
22, Rue d'Atakpame
B.P. 4150
LOME
Tel: 21-62-88
Telex: 5304
P

TRINIDAD & TOBAGO

Caribbean Telecoms Ltd.
Corner McAllister Street &
Eastern Main Road, Laventille
P.O. Box 732
PORT-OF-SPAIN
Tel: 624-4213
Telex: 22561 CARTEL WG
Cable: CARTEL, PORT OF SPAIN
CM,E,M,P

Computer and Controls Ltd.
P.O. Box 51
66 Independence Square
PORT-OF-SPAIN
Tel: 62-279-85
Telex: 3000 POSTLX WG, ACCT
LO090 AGENCY 1264
A,P

Feral Assoc.
8 Fitzgerald Lane
PORT-OF-SPAIN
Tel: 62-36864, 62-39255
Telex: 22432 FERALCO
Cable: FERALCO
M

TUNISIA

Precision Electronique S.A.R.L.
31 Avenue de la Liberté
TUNIS
Tel: 893937,
Telex: 13238
P

Tunisie Electronique S.A.R.L.
94, Av. Jugurtha, Mutuelleville
1002 **TUNIS-BELVEDERE**
Tel: 280144
Telex: 13238
C,E,P

Corema S.A.
23, bis Rue de Marseille
TUNIS
Tel: 253-821
Telex: 14812 CABAM TN
M

TURKEY

E.M.A
Mediha Eldem Sokak No. 41/6
Yenisehir
ANKARA
Tel: 319175
Telex: 46912 KTX TR
Cable: EMATRADE ANKARA
M

Teknim Company Ltd.
Iran Caddesi No. 7
Kavaklıdere
ANKARA
Tel: 275800
Telex: 42155 TKNM TR
E,CM

Sarıva Bilgisayar Sistemleri A.S.
Buyukdere Caddesi 103/6
Gayrettepe
ISTANBUL
Tel: 1727030
Telex: 26345 SANI TR
C,P

Best Inc.
Esentepe, Gazeteciler Sitesi
Keskın Kaiemy
Sokak 6/3, Gayrettepe
ISTANBUL
Tel: 1721328
Telex: 42490
A

UNITED ARAB**EMIRATES**

Emitac Ltd.
P.O. Box 1641
SHARJAH
Tel: 591181
Telex: 68136 EMITAC EM
Cable: EMITAC SHARJAH
E,C,M,P,A

Emitac Ltd.
P.O. Box 2711
ABU DHABI
Tel: 820419-20
Cable: EMITACH ABUDHABI

Emitac Ltd.
P.O. Box 8391
DUBAI,
Tel: 377591

Emitac Ltd.
P.O. Box 473
RAS AL KHAIMAH
Tel: 28133, 21270

UNITED KINGDOM**GREAT BRITAIN**

Hewlett-Packard Ltd.
Trafalgar House
Navigation Road
ALTRINCHAM
Cheshire WA14 1NU
Tel: 061 928 6422
Telex: 668068
A,C,E,M,P

Hewlett-Packard Ltd.
Miller House
The Ring, **BRACKNELL**
Berks RG12 1XN
Tel: 0344 424898
Telex: 848733
E

Hewlett-Packard Ltd.
Eistree House, Eistree Way
BOREHAMWOOD, Herts WD6 1SG
Tel: 01 207 5000
Telex: 8952716
C,E

Hewlett-Packard Ltd.
Oakfield House, Oakfield Grove
Clifton **BRISTOL**, Avon BS8 2BN
Tel: 0272 736806
Telex: 444302
C,E,P

Hewlett-Packard Ltd.
Bridewell House
9 Bridewell Place
LONDON EC4V 6BS
Tel: 01 583 6565
Telex: 298163
C,P

Hewlett-Packard Ltd.
Pontefract Road
NORMANTON, West Yorkshire WF6 1RN
Tel: 0924 895566
Telex: 557355
C,P

Hewlett-Packard Ltd.
The Quadrangle
106-118 Station Road
REDHILL, Surrey RH1 1PS
Tel: 0737 68655
Telex: 947234
C,E,P

Hewlett-Packard Ltd.
Avon House
435 Stratford Road
Shirley, **SOLIHULL**, West Midlands
B90 4BL
Tel: 021 745 8800
Telex: 339105
C,E,P

Hewlett-Packard Ltd.
West End House
41 High Street, West End
SOUTHAMPTON
Hampshire SO3 3DQ
Tel: 0703 476767
Telex: 477138
C,P

Hewlett-Packard Ltd.
Harmon House
No. 1 George Street
UXBRIDGE, Middlesex UX8 1YH
Tel: 895 720 20
Telex: 893134/5
C,CM,E,M,P

Hewlett-Packard Ltd.
King Street Lane
Winnersh, **WOKINGHAM**
Berkshire RG11 5AR
Tel: 0734 784774
Telex: 847178
A,C,E,M,P

IRELAND

NORTHERN IRELAND
Hewlett-Packard (Ireland) Ltd.
Carrickfergus Industrial Centre
75 Belfast Road, Carrickfergus
BELFAST BT38 8PH
Tel: 09603 67333
Telex: 747626
C,E

SCOTLAND

Hewlett-Packard Ltd.
8 Woodside Place
GLASGOW, G3 7QF
Tel: 041 332 6232
Telex: 779615
C,E

Hewlett-Packard Ltd.
SOUTH QUEENSFERRY
West Lothian, EH30 9TG
Tel: 031 331 1188
Telex: 72682
C,CM,E,M,P

UNITED STATES**Alabama**

Hewlett-Packard Co.
700 Century Park South, Suite 128
BIRMINGHAM, AL 35226
Tel: (205) 822-6802
A.C.M.P.*

Hewlett-Packard Co.
420 Wynn Drive
HUNTSVILLE, AL 35805
Tel: (205) 830-2000
C,CM,E,M*

Alaska

Hewlett-Packard Co.
3601 C St., Suite 1416
ANCHORAGE, AK 99503
Tel: (907) 563-8855
C.E

Arizona

Hewlett-Packard Co.
8080 Pointe Parkway West
PHOENIX, AZ 85044
Tel: (602) 273-8000
A,C,CM,E,M,P

Hewlett-Packard Co.
3400 East Britannia Dr.
Bldg. C, Suite 124
TUCSON, AZ 85706
Tel: (602) 573-7400
C,E,M**

California

Hewlett-Packard Co.
99 South Hill Dr.
BIRSBANE, CA 94035
Tel: (415) 330-2500
C

Hewlett-Packard Co.
5060 E. Clinton Avenue, Suite 102
FRESNO, CA 93727
Tel: (209) 252-9652
C,M

Hewlett-Packard Co.
1421 S. Manhattan Av.
FULLENTON, CA 92631
Tel: (714) 999-6700
C,CM,E,M

Hewlett-Packard Co.
7408 Hollister Ave. #A
GOLETA, CA 93117
Tel: (805) 685-6100
C,E

Hewlett-Packard Co.
5400 W. Rosecrans Blvd.
LAWDALE, CA 90260
Tel: (213) 643-7500
Telex: 910-325-6608
C,M

Hewlett-Packard Co.
2525 Grand Avenue
Long Beach, CA 90815
Tel: (213) 498-1111
C

Hewlett-Packard Co.
3155 Porter Drive
PALO ALTO, CA 94304
Tel: (415) 857-8000
C,E

Hewlett-Packard Co.
4244 So. Market Court, Suite A
SACRAMENTO, CA 95834
Tel: (916) 929-7222
A*,C,E,M

Hewlett-Packard Co.
9606 Aero Drive
SAN DIEGO, CA 92123
Tel: (619) 279-3200
C,CM,E,M

Hewlett-Packard Co.
5725 W. Las Positas Blvd.
Pleasanton, CA 94566
Tel: (415) 460-0282
C

Hewlett-Packard Co.
3003 Scott Boulevard
SANTA CLARA, CA 95054
Tel: (408) 988-7000
Telex: 910-338-0586
A,C,CM,E

Hewlett-Packard Co.
2150 W. Hillcrest Dr.
THOUSAND OAKS, CA 91320
(805) 373-7000
C,CM,E

Colorado

Hewlett-Packard Co.
2945 Center Green Court South
Suite A
BOULDER, CO 80301
Tel: (303) 938-3005
A,C,E

Hewlett-Packard Co.
24 Inverness Place, East
ENGLEWOOD, CO 80112
Tel: (303) 649-5000
A,C,CM,E,M

Connecticut

Hewlett-Packard Co.
500 Sylvan Av.
BRIDGEPORT, CT 06606
Tel: (203) 371-6454
C,E

Hewlett-Packard Co.
47 Barnes Industrial Road South
WALLINGFORD, CT 06492
Tel: (203) 265-7801
A,C,CM,E,M

Florida

Hewlett-Packard Co.
2901 N.W. 62nd Street
FORT LAUDERDALE, FL 33309
Tel: (305) 973-2600
C,E,M,P*

Hewlett-Packard Co.
6800 South Point Parkway
Suite 301
JACKSONVILLE, FL 32216
Tel: (904) 398-0663
C*,M**

Hewlett-Packard Co.
6177 Lake Ellenor Drive
ORLANDO, FL 32809
Tel: (305) 859-2900
A,C,CM,E,P*

Hewlett-Packard Co.
4700 Bayou Blvd.
Building 5
PENSACOLA, FL 32503
Tel: (904) 476-8422
A,C,M

Hewlett-Packard Co.
5550 W. Idlewild, 150
TAMPA, FL 33614
Tel: (813) 884-3282
C,E,M,P

Georgia

Hewlett-Packard Co.
2000 South Park Place
ATLANTA, GA 30339
Tel: (404) 955-1500
Telex: 810-766-4890
A,C,CM,E,M,P*

Hewlett-Packard Co.
3607 Parkway Lane
Suite 300
NORCROSS, GA 30092
Tel: (404) 448-1894
C,E,P

Hawaii

Hewlett-Packard Co.
Kawaiahao Plaza, Suite 190
567 South King Street
HONOLULU, HI 96813
Tel: (808) 526-1555
A,C,E,M

Idaho

Hewlett-Packard Co.
11309 Chinden Blvd.
BOISE, ID 83707
Tel: (208) 323-2700
C

Illinois

Hewlett-Packard Co.
304 Eldorado Road
P.O. Box 1607
BLOOMINGTON, IL 61701
Tel: (309) 662-9411
C,M**

Hewlett-Packard Co.
525 W. Monroe, 1308
CHICAGO, IL 60606
Tel: (312) 930-0010
C

Hewlett-Packard Co.
1200 East Diehl Road
NAPEVILLE, IL 60566
Tel: (312) 357-8800
C

Hewlett-Packard Co.
5201 Tollview Drive
ROLLING MEADOWS, IL 60008
Tel: (312) 255-9800
Telex: 910-687-1066
A,C,CM,E,M

Indiana

Hewlett-Packard Co.
11911 N. Meridian St.
CARMEL, IN 46032
Tel: (317) 844-4100
A,C,CM,E,M

Hewlett-Packard Co.
3702 Rupp Drive
FT. WAYNE, IN 46815
Tel: (219) 482-4283
C,E

Iowa

Hewlett-Packard Co.
4070 22nd Av. SW
CEDAR RAPIDS, IA 52404
Tel: (319) 390-4250
C,E,M

Hewlett-Packard Co.
4201 Corporate Dr.
WEST DES MOINES, IA 50265
Tel: (515) 224-1435
A**,C,M**

Kansas

Hewlett-Packard Co.
7804 East Funston Road, 203
WICHITA, KS 67207
Tel: (316) 684-8491
C,E

Kentucky

Hewlett-Packard Co.
10300 Linn Station Road, 100
LOUISVILLE, KY 40223
Tel: (502) 426-0100
A,C,M

Louisiana

Hewlett-Packard Co.
160 James Drive East
ST. ROSE, LA 70087
P.O. Box 1449
KENNER, LA 70063
Tel: (504) 467-4100
A,C,E,M,P

Maryland

Hewlett-Packard Co.
3701 Koppers Street
BALTIMORE, MD 21227
Tel: (301) 644-5800
Telex: 710-862-1943
A,C,CM,E,M

Hewlett-Packard Co.
2 Choke Cherry Road
ROCKVILLE, MD 20850
Tel: (301) 948-6370
A,C,CM,E,M

Massachusetts

Hewlett-Packard Co.
1775 Minuteman Road
ANDOVER, MA 01810
Tel: (617) 682-1500
A,C,CM,E,M,P*

Hewlett-Packard Co.
32 Hartwell Avenue
LEXINGTON, MA 02173
Tel: (617) 861-8960
C,E

Michigan

Hewlett-Packard Co.
4326 Cascade Road S.E.
GRAND RAPIDS, MI 49506
Tel: (616) 957-1970
C,M

Hewlett-Packard Co.
39550 Orchard Hill Place Drive
NOVI, MI 48020
Tel: (313) 349-9200
A,C,E,M

Hewlett-Packard Co.
1771 W. Big Beaver Road
TROY, MI 48064
Tel: (313) 643-6474
C

Minnesota

Hewlett-Packard Co.
2025 W. Larpenteur Ave.
ST. PAUL, MN 55113
Tel: (612) 644-1100
A,C,CM,E,M

Missouri

Hewlett-Packard Co.
1001 E. 101st Terrace Suite 120
KANSAS CITY, MO 64131-3368
Tel: (816) 941-0411
A,C,CM,E,M

Hewlett-Packard Co.
13001 Hollenberg Drive
BRIDGETON, MO 63044
Tel: (314) 344-5100
A,C,E,M

Nebraska

Hewlett-Packard
10824 Old Mill Rd., Suite 3
OMAHA, NE 68154
Tel: (402) 334-1813
C,E,M

New Jersey

Hewlett-Packard Co.
120 W. Century Road
PARAMUS, NJ 07653
Tel: (201) 265-5000
A,C,CM,E,M

Hewlett-Packard Co.
20 New England Av. West
PISCATAWAY, NJ 08854
Tel: (201) 562-6100
A,C,CM,E

New Mexico

Hewlett-Packard Co.
7801 Jefferson N.E.
ALBUQUERQUE, NM 87109
Tel: (505) 292-1330
C,E,M

New York

Hewlett-Packard Co.
5 Computer Drive South
ALBANY, NY 12205
Tel: (518) 458-1550
A,C,E,M

Hewlett-Packard Co.
9600 Main Street
CLARENCE, NY 14031
Tel: (716) 759-8621
C,E

Hewlett-Packard Co.
200 Cross Keys Office Park
FARPORT, NY 14450
Tel: (716) 223-9950
A,C,CM,E,M

Hewlett-Packard Co.
7641 Henry Clay Blvd.
LIVERPOOL, NY 13088
Tel: (315) 451-1820
A,C,CM,E,M

Hewlett-Packard Co.
No. 1 Pennsylvania Plaza
55th Floor
34th Street & 8th Avenue
MANHATTAN NY 10119
Tel: (212) 971-0800
C,M*

Hewlett-Packard Co.
15 Myers Corner Rd.
Hollisbrook Park, Suite 20
WAPPINGER FALLS, NY 12590
C,M,E

Hewlett-Packard Co.
250 Westchester Avenue
WHITE PLAINS, NY 10604
Tel: (914) 684-6100
C,CM,E

Hewlett-Packard Co.
3 Crossways Park West
WOODBURY, NY 11797
Tel: (516) 682-7800
A,C,CM,E,M

UNITED STATES (Cont'd)**North Carolina**

Hewlett-Packard Co.
305 Gregson Dr.
CARY, NC 27511
Tel: (919) 467-6600
C,CM,E,M,P*

Hewlett-Packard Co.
9600-H Southern Pine Blvd.
CHARLOTTE, NC 28210
Tel: (704) 527-8780
C*

Hewlett-Packard Co.
5605 Roanne Way
GREENSBORO, NC 27420
Tel: (919) 852-1800
A,C,CM,E,M,P*

Ohio

Hewlett-Packard Co.
2717 S. Arlington Road
AKRON, OH 44312
Tel: (216) 644-2270
C,E

Hewlett-Packard Co.
23200 Chagrin Blvd #100
BEACHWOOD, OH 44122
Tel: (216) 292-4677
C,P

Hewlett-Packard Co.
9920 Carver Road
CINCINNATI, OH 45242
Tel: (513) 891-9870
C,M

Hewlett-Packard Co.
16500 Sprague Road
CLEVELAND, OH 44130
Tel: (216) 243-7300
A,C,CM,E,M

Hewlett-Packard Co.
9080 Springboro Pike
MIAMSBURG, OH 45342
Tel: (513) 433-2223
A,C,CM,E*,M

Hewlett-Packard Co.
One Maritime Plaza, 5th Floor
720 Water Street
TOLEDO, OH 43604
Tel: (419) 242-2200
C

Hewlett-Packard Co.
675 Brookside Blvd.
WESTERVILLE, OH 43081
Tel: (614) 891-3344
C,CM,E*

Oklahoma

Hewlett-Packard Co.
3525 N.W. 56th St.
Suite C-100
OKLAHOMA CITY, OK 73112
Tel: (405) 946-9499
C,E*,M

Hewlett-Packard Co.
3840 S. 103rd E. Ave., 100
TULSA, OK 74146
Tel: (918) 665-3300
A**,C,E,M*,P*

Oregon

Hewlett-Packard Co.
9255 S. W. Pioneer Court
WILSONVILLE, OR 97070
Tel: (503) 682-8000
A,C,E*,M

Pennsylvania

Hewlett-Packard Co.
50 Dorchester Rd.
HARRISBURG, PA 17112
Tel: (717) 657-5900
C

Hewlett-Packard Co.
111 Zeta Drive
PITTSBURGH, PA 15238
Tel: (412) 782-0400
A,C,E,M

Hewlett-Packard Co.
2750 Monroe Boulevard
VALLEY FORGE, PA 19482
Tel: (215) 666-9000
A,C,CM,E,M

South Carolina

Hewlett-Packard Co.
Brookside Park, Suite 122
1 Harbison Way
COLUMBIA, SC 29210
Tel: (803) 732-0400
C,M

Hewlett-Packard Co.
555 N. Pleasantburg Dr.
Suite 107
GREENVILLE, SC 29607
Tel: (803) 232-8002
C

Tennessee

Hewlett-Packard Co.
One Energy Centr. 200
Pelissippi Pkwy.
KNOXVILLE, TN 37932
Tel: (615) 966-4747
A,C,M

Hewlett-Packard Co.
3070 Directors Row
Directors Square
MEMPHIS, TN 38131
Tel: (901) 346-8370
A,C,M

Hewlett-Packard Co.
220 Great Circle Road, Suite 116
NASHVILLE, TN 37228
Tel: (615) 255-1271
C,M,P*

Texas

Hewlett-Packard Co.
1826-P Kramer Lane
AUSTIN, TX 78758
Tel: (512) 835-6771
C,E,P*

Hewlett-Packard Co.
5700 Cromo Dr
EL PASO, TX 79912
Tel: (915) 833-4400
C,E*,M**

Hewlett-Packard Co.
3952 Sandshell Drive
FORT WORTH, TX 76137
Tel: (817) 232-9500
C

Hewlett-Packard Co.
10535 Harwin Drive
HOUSTON, TX 77036
Tel: (713) 776-8400
A,C,E,M,P*

Hewlett-Packard Co.
511 E. John W. Carpenter Fwy.
Royal Tech. Center 100
IRVING, TX 75062
Tel: (214) 556-1950
C,E

Hewlett-Packard Co.
109 E. Toronto, Suite 100
MCALLEN, TX 78503
Tel: (512) 630-3030
C

Hewlett-Packard Co.
930 E. Campbell Rd.
RICHARDSON, TX 75081
Tel: (214) 231-6101
A,C,CM,E,M,P*

Hewlett-Packard Co.
1020 Central Parkway South
SAN ANTONIO, TX 78216
Tel: (512) 494-9336
A,C,E,M,P*

Utah

Hewlett-Packard Co.
3530 W. 2100 South
SALT LAKE CITY, UT 84119
Tel: (801) 974-1700
A,C,E,M

Virginia

Hewlett-Packard Co.
4305 Cox Road
GLEN ALLEN, VA 23060
Tel: (804) 747-7750
A,C,E,M,P*

Hewlett-Packard Co.
Tanglewood West Bldg.
Suite 240
3959 Electric Road
ROANOKE, VA 24018
Tel: (703) 774-3444
C,E,P

Washington

Hewlett-Packard Co.
15815 S.E. 37th Street
BELLEVUE, WA 98006
Tel: (206) 643-4000
A,C,CM,E,M

Hewlett-Packard Co.
708 North Argonne Road
SPOKANE, WA 99212-2793
Tel: (509) 922-7000
C

West Virginia

Hewlett-Packard Co.
501 56th
CHARLESTON, WV 25304
Tel: (304) 925-0492
A,C,M

Wisconsin

Hewlett-Packard Co.
275 N. Corporate Dr.
BROOKFIELD, WI 53005
Tel: (414) 784-8800
A,C,E*,M

URUGUAY

Pablo Ferrando S.A.C. e I.
Avenida Italia 2877
Casilla de Correo 370
MONTEVIDEO
Tel: 80-2586
Telex: 802586
A,CM,E,M

Olympia de Uruguay S.A.
Maquinas de Oficina
Avda. del Libertador 1997
Casilla de Correos 6644
MONTEVIDEO
Tel: 91-1809, 98-3807
Telex: 6342 OROU UY
P

VENEZUELA

Hewlett-Packard de Venezuela C.A.
3A Transversal Los Ruices Norte
Edificio Segre 2 & 3
Apartado 50933
CARACAS 1071
Tel: 239-4133
Telex: 251046 HEWPACK
A,C,CM,E,M,P

Hewlett-Packard de Venezuela, C.A.
Centro Ciudad Comercial Tamanaco
Nivel C-2 (Nueva Etapa)
Local 53H05
Chua, CARACAS
Tel: 928291
P

Albis Venezolana S.R.L.
Av. Las Marias, Ota. Alix,
El Pedregal
Apartado 81025
CARACAS 1080A
Tel: 747984, 742146
Telex: 24009 ALBIS VC
A

Tecnologica Medica del Caribe, C.A.
Multicentro Empresarial del Este
Ave. Libertador
Edif. Libertador
Nucleo "C" - Oficina 51-52
CARACAS
Tel: 339867/333780
M

Hewlett-Packard de Venezuela C.A.
Residencias Tia Betty Local 1
Avenida 3 y con calle 75
MARACAIBO, Estado Zulia
Apartado 2646
Tel: (061) 75801-75805-75806-80304
Telex: 62464 HPMAR
C,E*

Hewlett-Packard de Venezuela C.A.
Urb. Lomas de Este
Torre Trebol — Piso 11
VALENCIA, Estado Carabobo
Apartado 3347
Tel: (041) 222992/223024
C,P

YUGOSLAVIA

Do Hermes
General Zdanova 4
YU-11000 BEOGRAD
Tel: 340 327, 342 641
Telex: 11433
A,C,E,P

Hermes
Titova 50
YU-61000 LJUBLJANA
Tel: 324 856, 324 858
Telex: 31583
C,E,M,P

Elektrotehna
Titova 51
YU-61000 LJUBLJANA
CM

ZAIRE

Computer & Industrial Engineering
25, Avenue de la Justice
B.P. 12797
KINSHASA, Gombe
Tel: 32063
Telex: 21552
C,P

ZAMBIA

R.J. Tilbury (Zambia) Ltd.
P.O. Box 32792
LUSAKA
Tel: 215590
Telex: 40128
E

ZIMBABWE

Field Technical Sales (Private) Limited
45, Kelvin Road North
P.O. Box 3458
HARARE
Tel: 705 231
Telex: 4-122 RH
E,P

SEPT. 1985

SALES & SUPPORT OFFICES

www.valuetronics.com By country

OPERATING AND PROGRAMMING MANUAL SUPPLEMENT

MODEL No. 81521B
SPECIAL No. # H01

This special option provides a 4 m connecting cord mounted on the HP 81521B Optical Head, instead of the standard 1 m cable.

MATERIAL LIST

Description	Part-Number	Qty	Comment
Tubing-Flexible	0890-1687	-1.20 MT	Delete
Tubing-Flexible	0890-1687	+4.20 MT	Add
Cbl Ay Plug, 1 MT	81521-61602	-1	Delete
Cbl Ay Plug, 4 MT	81521-61603	+1	Add

Note: If the unit is returned to Hewlett-Packard for any reason, please make sure that this Operating and Programming Manual Supplement is also returned with it.

Date: Sept. 1988

Page 1 of 1

Hewlett-Packard GmbH Herrenberger Strasse 130, D-7030 Boeblingen, West Germany

