

OPERATOR'S  
MANUAL

HP 7470A  
Graphics Plotter

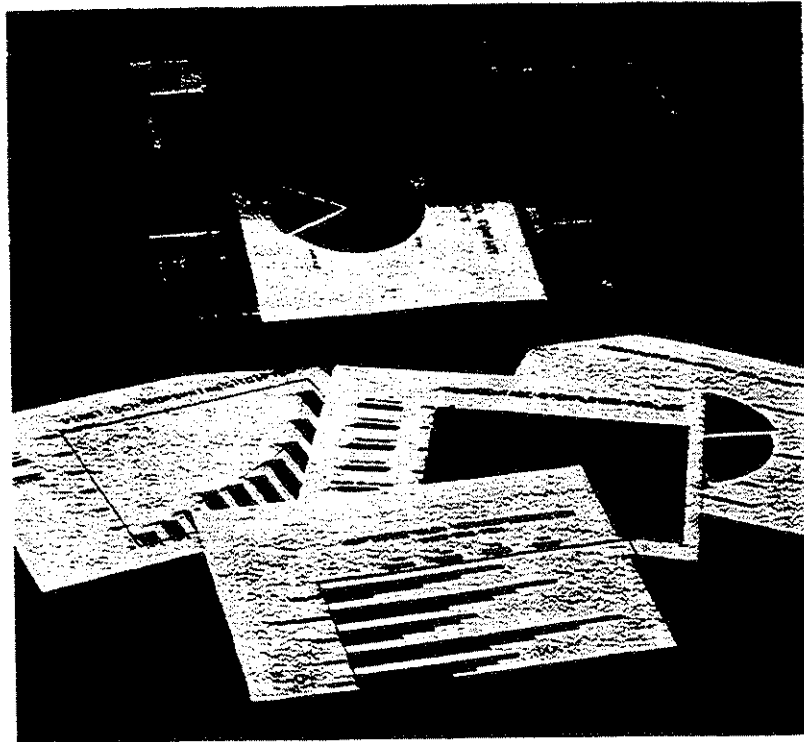

©1982, 1986 by Hewlett-Packard Company  
16399 W. Bernardo Drive, San Diego, CA 92127-1899

The United States Federal Communications Commission (in 47 CFR 15.838) has specified that the following notice be brought to the attention of users of this product.

**FEDERAL COMMUNICATIONS COMMISSION  
RADIO FREQUENCY INTERFERENCE  
STATEMENT**

"This equipment generates and uses radio frequency energy and if not installed and used properly, that is, in strict accordance with the manufacturer's instructions, may cause interference to radio and television reception. It has been type tested and found to comply with the limits for a Class B computing device in accordance with the specifications in Subpart J of Part 15 of FCC Rules, which are designed to provide reasonable protection against such interference in a residential installation. However, there is no guarantee that interference will not occur in a particular installation. If this equipment does cause interference to radio or television reception, which can be determined by turning the equipment off and on, the user is encouraged to try to correct the interference by one or more of the following measures:

- reorient the receiving antenna
- relocate the computer with respect to the receiver
- move the computer away from the receiver
- plug the computer into a different outlet so that computer and receiver are on different branch circuits.

If necessary, the user should consult the dealer or an experienced radio/television technician for additional suggestions. The user may find the following booklet prepared by the Federal Communications Commission helpful:

'How to Identify and Resolve Radio-TV Interference Problems'.

This booklet is available from the US Government Printing Office, Washington, DC 20402, Stock No. 004-000-00345-4."



The product related to this manual is no longer in production at Hewlett-Packard Co. As a service to our customers, we are supplying you with a photocopy of the original document.



## **NOTICE**

The information contained in this document is subject to change without notice.

## **PRINTING HISTORY**

**First Edition — March 1982**

**Revision to First Edition — July 1982**

**Second Edition — August 1983**

**Change Sheet to Second Edition — May 1986**

**Third Edition — August 1986**



## Limited Warranty

### One-Year Limited Hardware Warranty

Except when used as part of an HP system, Hewlett-Packard warrants your graphics peripheral hardware product against defects in materials and workmanship for a period of one year from receipt by the end user. If HP perceives notice of such defects during the warranty period, HP will either, at its option, repair or replace products which prove to be defective.

Should HP be unable to repair or replace the product within a reasonable amount of time, customers's alternative exclusive remedy shall be a refund of the purchase price upon return of the product.

If this product was purchased as part of an HP system in a coordinated shipment or as a system add-on, it is warranted against defects in material and workmanship during the same period as the HP system.

### Exclusions

The above warranty shall not apply to defects resulting from: improper or inadequate maintenance by customer; customer-supplied software or interfacing; unauthorized modification or misuse; operation outside of the environmental specifications for the product; or improper site preparation and maintenance.

### Obtaining Warranty Service

To obtain warranty service, products must be returned to a service facility designated by HP. HP may repair on-site at the option of the customer. Customer is responsible for travel charges when on-site repair is requested.

Warranty service for products purchased as part of a system will be subject to service in accordance with the system support services.

Customer shall prepay shipping charges for products returned to HP for warranty service and HP shall pay for return of the products to customer. However, customer shall pay all shipping charges, duties, and taxes for products returned to HP from another country.

### Warranty Limitations

HP makes no other warranty, either expressed or implied, with respect to this product. HP specifically disclaims the implied warranties of merchantability and fitness for a particular purpose. Some states or provinces do not allow limitations on the duration of an implied warranty, so the above limitation or exclusion may not apply to you. However, any implied warranty of merchantability or fitness is limited to the one-year duration of this written warranty.

This warranty gives you specific legal rights, and you may also have other rights which may vary from state to state, or province to province.

### Exclusive Remedies

The remedies provided herein are customer's sole and exclusive remedies. In no event shall HP be liable for any direct, indirect, special, incidental, or consequential damages, whether based on contract, tort, or any other legal theory. Some states or provinces do not allow the exclusion or limitation of incidental or consequential damages, so the above limitation or exclusion may not apply to you.

### Obtaining Service During or After Warranty

#### *During the Warranty Period*

If your hardware should fail during the warranty period, follow the test procedures in the system manuals, then bring the failed piece of equipment to an Authorized HP Personal Computer Dealer Repair Center — or send the equipment to one of the HP Field Repair Centers listed in the directory sent with your product. (HP may repair on-site at your option, in which case you are responsible for travel charges).

#### *After the Warranty Period*

If your hardware should fail after the warranty period, follow the test procedures in the system manuals, then contact an Authorized HP Personal Computer Dealer Repair Center or call your HP Sales and Service Office for details of the services available.

If you are uncertain about which unit to return, call your Authorized HP Personal Computer Dealer or a Field Repair Center for assistance.

When sending equipment to a Field Repair Center, please follow the procedures in the "Shipment" section of your operator's manual.

# Table of Contents

Introduction .....	1
Understanding Manual Conventions .....	1
Initial Inspection and Accessories Inventory .....	2
Accessories Supplied .....	2
Accessories Available .....	2
Input Power Setup .....	3
Power Options .....	3
Line Voltage Selection .....	3
Fuse Protection .....	3
Grounding Requirements .....	4
Power Cords .....	4
Operating the Plotter .....	4
Major Feature Locations .....	6
Control Functions .....	7
Setting Up the Plotter .....	15
Choosing the Correct Pen .....	15
Loading Pens .....	15
Turning the Power On .....	15
Loading Paper .....	17
The Confidence Test .....	18
Interfacing the Plotter to Your Computer .....	18
Introduction to Programming Languages .....	19
What Is a Program? .....	19
What Programming Languages Do I Use? .....	19
HP-GL (Hewlett-Packard Graphics Language) .....	22
The Plotter Coordinate System .....	22
Plotter Units .....	22
Plotting Limits .....	22
The Scaling Points P1 and P2 .....	22
Setting the Scaling Points .....	24
Preparing Equal-Sized Plots .....	24
Squeezing the Scaling Area .....	25
Symptoms and Solutions .....	27
Combining Pens and Media .....	33
Operator Maintenance .....	34
General Cleaning .....	34
Pen Stall Cleaning .....	35
Shipment .....	35



## Introduction

This manual contains general information to familiarize you with the capabilities and operation of the HP 7470A Graphics Plotter. Three options are available: Option 001 with RS-232-C/CCITT V.24 interfacing; Option 002 with the Hewlett-Packard Interface Bus (HP-IB, conforms to ANSI/IEEE 488-1978 specifications); and Option 003 with the Hewlett-Packard Interface Loop (HP-IL). All options use the Hewlett-Packard Graphics Language (HP-GL). Unless specifically noted, all information in this manual pertains to each option.

This manual explains each control and indicator and shows you how to select and load the proper pen and media combinations best suited for your applications.

Additional information is given to introduce you to programming languages and explain the plotter's coordinate system. Procedures are also included to verify correct operation of your plotter and to maintain its appearance. Suggestions to help you diagnose and correct plotting difficulties are located at the back of this manual.

## Understanding Manual Conventions

Before reading any part of this manual, you should understand the meaning of type styles and number representation used in text. Words typed in small, boldface type are either buttons, switches, or words actually found on the plotter. Numbers are typed using SI (International System of Units) standards. Numbers with more than four digits are placed in groups of three, separated by a space instead of commas, counting both to the left and right of the decimal point (54 321.123 45).

## Initial Inspection

Your plotter was thoroughly inspected before shipping and should be in good operating order. Carefully inspect the plotter and accessories for any physical damage sustained in transit. Notify the nearest HP Sales and Support Office or authorized HP dealer and file a claim with the carrier if the unit is received in a damaged condition.

Refer to the table of Accessories Supplied, and check that you have received all of the items that should accompany the plotter. If you have any difficulties with the plotter, if it is not operating properly, or if accessories are missing, contact the nearest HP Sales and Support Office or authorized HP dealer.

Retain the original packing materials and carton. If the plotter must be shipped, this will save having to order new packing materials and a carton from HP.

## Accessories Supplied

The following items are supplied with each 7470A plotter:

Item	Quantity	Part Number
Operator's Manual	1	07470-90002
Interconnection Guide	1	07470-90003
Programmer's Reference Card	1	07470-90004
Interfacing and Programming Manual	1	07470-90001
Assorted pen and media samples	—	—
*HP-IL cable, 1/2 metre	1	8120-3380

\*Supplied with Option 003 only.

## Accessories Available

The following items are available and can be purchased using the appropriate part number. For supplies information, refer to the *Supplies and Cables* brochure shipped with your plotter.

Item	Part Number
Digitizing sight	09872-60066
Eavesdrop cable (required if Option 001 plotter is connected between a terminal and computer)	17455A
Service Manual	07470-90000
Transit case	9211-3901
Vinyl carrying case (not suitable for shipping)	1540-0560

## Input Power Setup

---

### WARNING

To prevent operator injury or damage to the plotter, verify that the line voltage setting and fuse protection are correct BEFORE connecting the line power. Also ensure the line power cord is connected to a line power outlet that is provided with a protective earth ground contact.

---

### Power Options

The 7470A can be configured to operate with any of the following power sources:

Line Voltage:	100 V ~ +5%, -10%
	120 V ~ +5%, -10%
	220 V ~ +5%, -10%
	240 V ~ +5%, -10%
Line Frequency:	48 to 66 Hz, single phase
Maximum Line Current:	355 mA @ 100 V
	300 mA @ 120 V
	150 mA @ 220 V
	135 mA @ 240 V
Consumption:	25 Watts maximum

### Line Voltage Selection

The 7470A is shipped from the factory with the line voltage set to the nominal value for the area specified as the shipment's destination. The voltage selected for the plotter is identified in the recessed window on the rear panel. The line voltage can be changed by qualified service personnel only. Line voltage selection procedures are contained in the 7470A Service Manual.

### Fuse Protection

---

### WARNING

To avoid the possibility of injury, disconnect the ac power cord before installing or replacing a fuse.

---

The 7470A is factory equipped with a fuse appropriate to the factory-set line voltage. To change or inspect the line fuse, turn the fuse holder on the rear panel in the direction of the arrow (counterclockwise) until the fuse holder releases. Remove the fuse holder and insert a slo-blo type T fuse which corresponds with the voltage setting. Fuse values appear below. Place the fuse holder back into the plotter, and turn the fuse holder clockwise, while pressing in, until the lock engages and the fuse remains flush with its casing.

Voltage	U.S. Fuse	European Fuse
100 V or 120 V	0.6AT(SB)/125 V	—
220 V or 240 V	0.3AT(SB)/250 V	0.315AT(SB)/250 V

**NOTE:** Fuses and fuse caps appropriate to the plotter shipment destination are installed at the factory. U.S. fuses are  $\frac{1}{4} \times 1\frac{1}{4}$  inches and use HP 2110-0565 fuse caps. European fuses are 5 × 20 millimetres and use HP 2110-0567 fuse caps.■

## Grounding Requirements

To protect operating personnel, the plotter must be properly grounded. The plotter is equipped with a three-conductor power cable which, when connected to an appropriate power outlet, grounds the plotter. To preserve this protection feature, do not operate the plotter from a line power outlet which has no ground connection.

## Power Cords

Power cords with different plugs are available for the plotter. The cord packaged with each plotter depends upon its destination. The power cords supplied by HP have a standard female plug which mates with the power-input socket in the plotter. The polarities of the male plugs shown in the accompanying chart are matched to the line power outlets used in the indicated areas. If the plotter has the wrong power cord for the area, please contact your local HP Sales and Support Office or authorized HP dealer.



## Operating the Plotter

Default conditions for most plotting parameters are automatically established when power is applied to the plotter. These conditions are optimized to produce quality graphics in a wide range of plotting applications. Operation of the plotter is therefore simple and primarily consists of loading the pen and medium combination best suited for your application. If you want special conditions you can override the default conditions using front-panel controls or programming instructions.

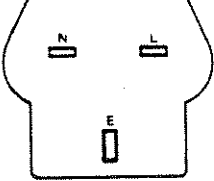
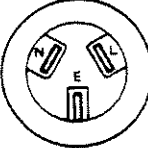
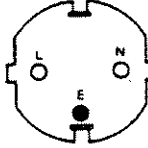

## Power Cord Configurations

Option No.

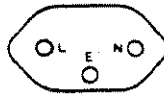
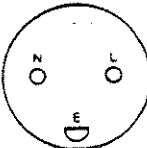
<p><b>BS 1363A</b></p> 	<p>HP Part Number 8120-1351; 250 V, 13 A, 1 <math>\phi</math> plug rating. For use in United Kingdom, Cyprus, Nigeria, Zimbabwe, Singapore.</p>	<p>900</p>
<p><b>AS C112</b></p> 	<p>HP Part Number 8120-1369; 250 V, 10 A, 1 <math>\phi</math> plug rating. For use in Australia, New Zealand.</p>	<p>901</p>
<p><b>CEE 7-VII</b></p> 	<p>HP Part Number 8120-1689; 250 V, 10/16 A, 1 <math>\phi</math> plug rating. For use in East and West Europe, Saudi Arabia, Egypt, South Africa, India.</p>	<p>902</p>
<p><b>NEMA 5-15P</b></p> 	<p>HP Part Number 8120-1378; 125 V, 15 A, 1 <math>\phi</math> plug rating. For use in Canada, Japan, Mexico, Philippines, Taiwan, UL approved in United States.</p>	<p>903</p>
<p><b>NEMA 6-15P</b></p> 	<p>HP Part Number 8120-0698; 250 V, 15 A, 1 <math>\phi</math> plug rating. For use in Canada, UL approved in United States.</p>	<p>904</p>
<p><b>SEV 1011</b></p> 	<p>HP Part Number 8120-2104; 250 V, 10 A, 1 <math>\phi</math> plug rating. For use in Switzerland.</p>	<p>906</p>
<p><b>DMCK-107</b></p> 	<p>HP Part Number 8120-2956; 250 V, 10 A, 1 <math>\phi</math> plug rating. For use in Denmark.</p>	<p>912</p>

NOTE: All plugs are viewed from connector end.

- = L Line or Active Conductor (also called "live" or "hot")
- = N Neutral or Identified Conductor
- = E Earth or Safety Ground

1-2-16-4

The following paragraphs explain major feature locations and control functions.

## Major Feature Locations

The following illustration shows the locations of the major operating features. The pen holder is shown at its power-up position near the right limit of the drawing range. A pen stall is at each end of the pen carriage arm.

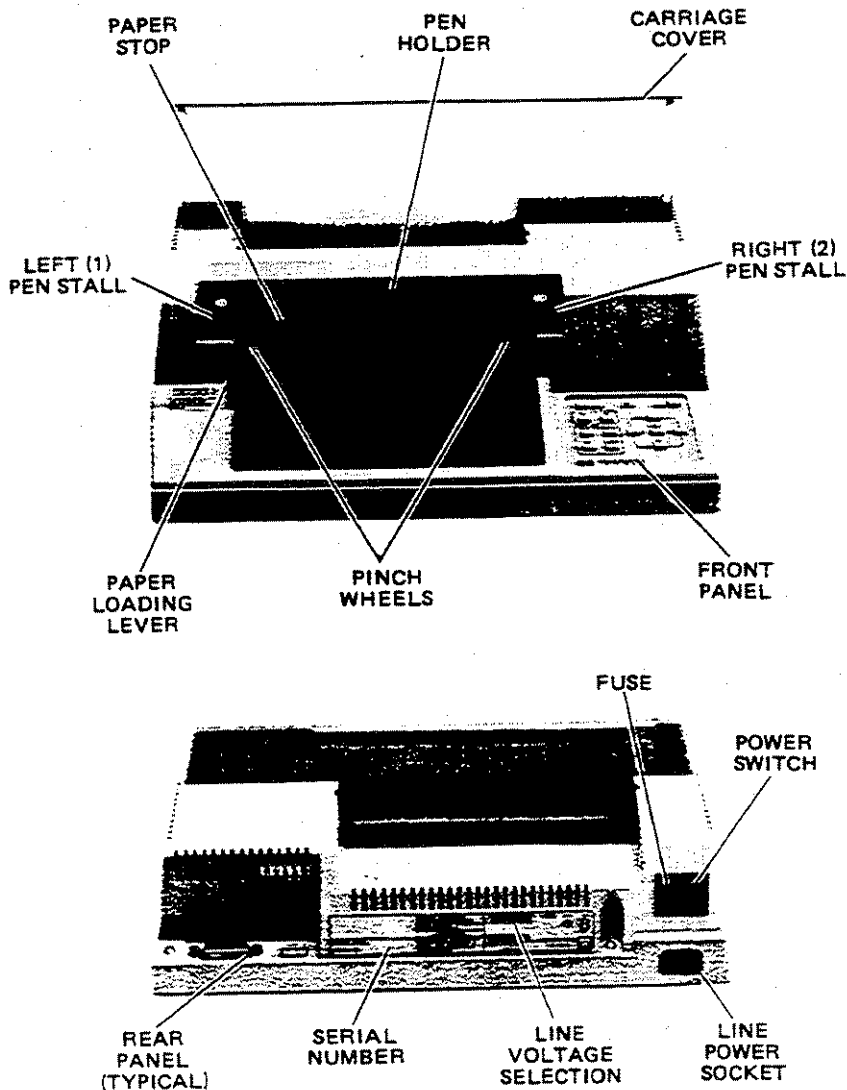

Major Feature Locations

The pinch wheels and grit-covered drive wheels that move the paper back and forth across the platen are spaced to accommodate either ANSI A or ISO A4 size media. The paper loading lever which raises and lowers the pinch wheels is located on the left side of the platen.

The operating controls and error indicator are grouped on the front panel at the right side of the plotter. Configuration and interface controls are located on the rear panel.

## Control Functions

In addition to the ~LINE power switch and paper loading lever, there are three categories of operator controls: front panel, configuration, and interface.

Front-panel controls are used to manually control pen and paper movement and to change the locations of scaling points P1 and P2. They can also be used for interaction with a running program. This interaction includes entry of digitized points, pen selection, and program suspension without loss of data. The ability to pause a running program allows pen substitution in multicolor applications. The medium is also fully extended in this state to permit viewing of the entire plotting area.

The plotter has only one configuration control. This switch limits pen movement to an area suitable for either ANSI A or ISO A4 size media. The switch is located on the rear panel and is common to all three plotter interface options.

Interface controls establish the conditions under which communication between the plotter and computer will occur.

All operator controls, including the controls on each interface option, are shown in the following illustration. A description of each control, including its function, is keyed to the illustration on page 10.

### Front Panel

1.

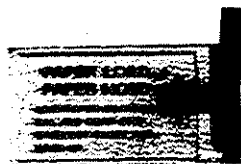

Moving the paper loading lever to the **PAPER LOAD** position turns on the **ERROR** light and raises the pinch wheels to permit loading the plotting medium. Raising the pinch wheels also returns any pen currently held in the pen holder to the pen stall from which it was selected. This avoids getting ink on the new paper and automatically caps the pen to prevent it from drying out.

**FRONT PANEL**

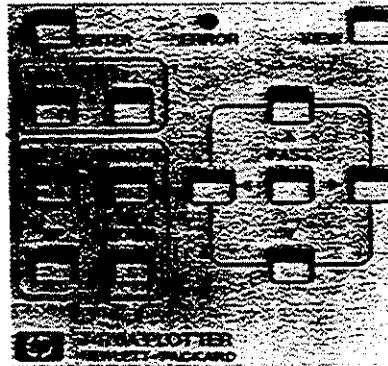
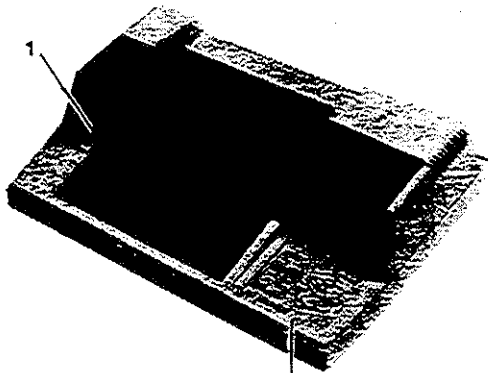

**REAR PANEL**

RS-232-C/CCITT V.24



(12-16)

HP-IB



(17-19)

HP-IL



(20, 21)

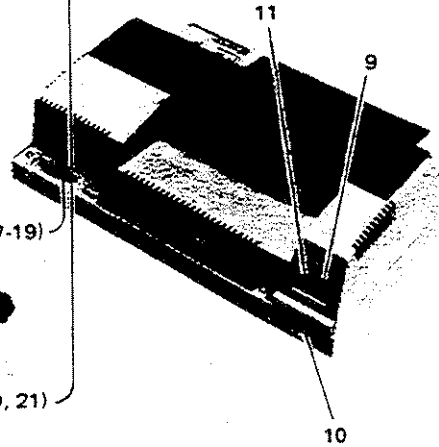

**Operator Controls**





Returning the paper loading lever to the **PAPER HOLD** position turns off the **ERROR** light and lowers the pinch wheels to secure the plotting medium. This action also cancels any pending error (**ERROR** light blinking) due to having received a move command with the pinch wheels up.

2.



This multi-purpose pushbutton is used for changing the locations of scaling points P1 or P2, storing the currently held pen, resetting the plotter to power-up default conditions, and digitizing.

The enter function is non-latching. This means the **ENTER** pushbutton must be pressed simultaneously with one of the following pushbuttons to initiate the defined action:

- a. When **ENTER** is pressed simultaneously with the **P1** or **P2** pushbutton, the current pen location becomes the new P1 or P2 scaling point.
- b. When **ENTER** is pressed simultaneously with the **LEFT** (1) or **RIGHT** (2) pushbutton, the plotter stores the pen currently held in the pen holder into the selected pen stall, if possible. The pen holder returns to its previous coordinate location.
- c. Moving the paper loading lever to the **PAPER LOAD** position and pressing **ENTER** simultaneously with the **VIEW** pushbutton resets all power-up default conditions.

The digitize function is initiated when the plotter receives the HP-GL command DP. If **ENTER** then is pressed, the actual X- and Y-coordinates and the pen status (up or down) are stored and will be sent to the computer after receipt of the HP-GL command OD. Instructions for digitizing are contained in the Interfacing and Programming Manual.

3.



Pressing **P1** or **P2** causes the plotter to raise the pen and move it to the corresponding physical point on the paper. On power-up, scaling points P1 and P2 are set to the coordinates  $P1_x = 250$ ,  $P1_y = 279$ ,  $P2_x = 10\ 250$ ,  $P2_y = 7479$  plotter units.



Pressing **P1** or **P2** simultaneously with the **ENTER** pushbutton establishes the current pen location as **P1** or **P2**.

Pressing the **LEFT(1)** pushbutton selects the pen located in the left pen stall. If the right pen is in the pen holder, it is put away before the left pen is selected. After the left pen is selected, the pen holder returns to its previous location. If a plot is in progress when the pushbutton is pressed, the plot is paused and does not resume until after the pen is selected and the pen holder returns to its previous location.

Pressing the **RIGHT(2)** pushbutton causes the same actions as described for the **LEFT(1)** pushbutton, except the right pen is selected.

Pressing the **LEFT(1)** or **RIGHT(2)** pushbutton simultaneously with the **ENTER** pushbutton stores the pen into the selected pen stall, if possible.



These pushbuttons raise or lower the pen. They can be used in conjunction with the arrow pushbuttons to draw lines or to digitize a point.

During program execution, pressing **UP** or **DOWN** is equivalent to executing an HP-GL command **PU** or **PD**. When pressed and held down, the pushbutton will override programmed pen control until released.

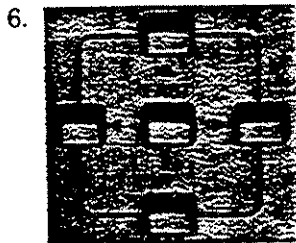

These five pushbutton switches are used to move the pen within the plotting area as follows:

- a. Pressing an arrow pushbutton moves the pen in the direction of the arrow.
- b. Pressing an arrow pushbutton together with the **FAST** pushbutton moves the pen in the direction of the arrow at four times normal speed.
- c. Pressing adjacent arrow pushbuttons moves the pen at a 45-degree diagonal between the two arrow directions.
- d. Pressing the **FAST** pushbutton pauses the program as long as the pushbutton is held down.





This multi-purpose light can be off, on, or blinking.

- a. When the light is on but not blinking, it indicates the **VIEW** pushbutton has been pressed or the paper loading lever is in the **PAPER LOAD ↑** position (pinch wheels up).
- b. When the light is blinking brightly, it indicates the plotter has detected an I/O error or an HP-GL error for which the error mask has been set. For a description of errors, refer to instructions **IM**, **OE**, and **ESC . E** in the Interfacing and Programming Manual.

**NOTE:** When the pen holder is in the pen-up position and not moving, the **ERROR** light will blink very dimly approximately every five seconds. This indicates internal calibration is being performed. ■



Pressing this latching pushbutton turns on the **ERROR** light, suspends plotting, raises the pen, and moves the paper so it is fully extended. In this state you can substitute pens and view the entire plotting area. Pressing the **VIEW** pushbutton again turns off the **ERROR** light, returns the pen to its previous coordinates and status (up or down), and plotting resumes.

### *Rear Panel*



This rocker switch controls application of ac power to the plotter (refer to Line Voltage Selection).



This is the power-input socket (refer to Power Cords).



This is the line power fuse (refer to Fuse Protection).

### **Option 001 (RS-232-C/CCITT V.24)**

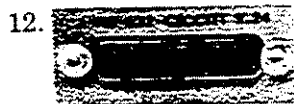

This RS-232-C/CCITT V.24 compatible, 25 pin, female type connector is used to interconnect the plotter to a host computer.

13.

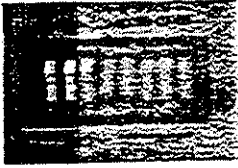

**PARITY S1** — This rocker switch controls whether parity generation and checking will occur for data transmission. If set to “0,” no parity generation or checking will occur. If set to “1,” parity generation and checking will be odd or even depending upon the setting of the S2 switch.

**PARITY S2** — This rocker switch establishes the type of parity to be used, either odd or even, when the S1 switch is set to “1.” Setting S2 to “1” establishes odd parity; “0” establishes even parity.

14.

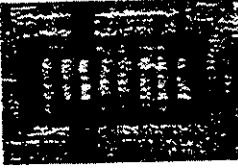

This rocker switch is used to establish either programmed “on” or programmed “off” operation status when the plotter is turned on.

Position **D** is used when the plotter is directly connected to a computer (direct connect environment). In this position, the plotter powers-up in the programmed “on” operating state. The plotter will respond to all HP-GL and escape sequence commands, except the ESC . ) or ESC . Z plotter “off” commands.

Position **Y** is used when the plotter is connected between a terminal and computer (eavesdrop operating environment). The plotter powers-up in the programmed “off” operating state. In this state, the plotter will pass information between the terminal and computer; but only responds to a plotter “on,” ESC . ( or ESC . Y command. After receipt of a plotter “on” command, the plotter will respond to all HP-GL and escape sequence commands.

**NOTE:** The plotter’s **LINE** switch must be **ON** in order to have any communication between the terminal and the computer.■

15.



This rocker switch is used to establish maximum plotting limits. The **US** position is for 8½ × 11 inch paper; **A4** is for 210 × 297 millimetre paper.

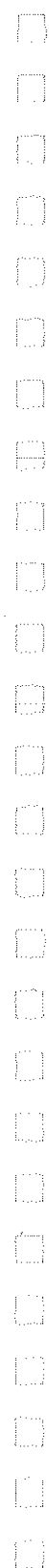

16.

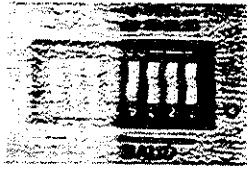

These four rocker switches are used to select a baud rate which corresponds with your computer's data transmission rate. The baud rate is selected by setting switches B1 through B4 to the appropriate binary bit positions defined below. When set to "external," the baud rate is generated by an external clock connection at pin 17 of the RS-232-C/CCITT V.24 connector.

Baud Rate	One Stop Bit				Two Stop Bits			
	B4	B3	B2	B1	B4	B3	B2	B1
External	—	—	—	—	0	0	0	0
75	—	—	—	—	0	0	0	1
110	—	—	—	—	0	0	1	0
150	0	0	1	1	—	—	—	—
200	0	1	0	0	—	—	—	—
300	0	1	0	1	1	0	1	1
600	0	1	1	0	1	1	0	0
1200	0	1	1	1	1	1	0	1
2400	1	0	0	0	1	1	1	0
4800	1	0	0	1	1	1	1	1
9600	1	0	1	0	—	—	—	—

**Option 002 (HP-IB)**

17.



This 24-pin HP-IB connector is used to interconnect the plotter to a host computer or other HP-IB device.

18.

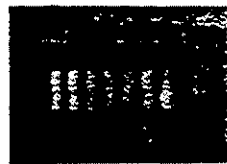

This rocker switch is used to establish maximum plotting limits. The US position is for 8½ × 11 inch paper; A4 is for 210 × 297 millimetre paper. The unlabeled switch is not used.

19.

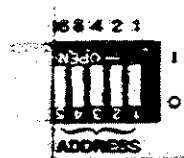

These five rocker switches are used to establish the plotter address value. The plotter address is selected by setting each switch to the appropriate binary bit position defined below. The plotter is set to an address code of 05 at the factory. This corresponds to a listen character of "%" and a talk character of "E."

The plotter is in listen-only mode when all five switches are set to "1." In this mode, the plotter does not have an address, but listens to

all data transmitted on the bus. In listen-only mode the plotter cannot be placed in a talker-active state and will not respond to a serial or parallel poll.

**NOTE:** Listen-only mode is not compatible with most software packages and plotter ROMs.■

### Address Switch Positions

Address Characters		Address Switch Settings					Address Codes		
Listen	Talk	16	8	4	2	1	Decimal	Octal	
SP	@	0	0	0	0	0	0	0	
!	A	0	0	0	0	1	1	1	
"	B	0	0	0	1	0	2	2	
#	C	0	0	0	1	1	3	3	
\$	D	0	0	1	0	0	4	4	
									← preset
&	F	0	0	1	1	0	6	6	
'	G	0	0	1	1	1	7	7	
(	H	0	1	0	0	0	8	10	
)	I	0	1	0	0	1	9	11	
*	J	0	1	0	1	0	10	12	
+	K	0	1	0	1	1	11	13	
,	L	0	1	1	0	0	12	14	
-	M	0	1	1	0	1	13	15	
.	N	0	1	1	1	0	14	16	
/	O	0	1	1	1	1	15	17	
0	P	1	0	0	0	0	16	20	
1	Q	1	0	0	0	1	17	21	
2	R	1	0	0	1	0	18	22	
3	S	1	0	0	1	1	19	23	
4	T	1	0	1	0	0	20	24	
5	U	1	0	1	0	1	21	25	
6	V	1	0	1	1	0	22	26	
7	W	1	0	1	1	1	23	27	
8	X	1	1	0	0	0	24	30	
9	Y	1	1	0	0	1	25	31	
::	Z	1	1	0	1	0	26	32	
:.	[	1	1	0	1	1	27	33	
<	\	1	1	1	0	0	28	34	
=	]	1	1	1	0	1	29	35	
>	^	1	1	1	1	0	30	36	
?	-	1	1	1	1	1	31	37	

Reserved for HP Desktop Computer Address

Sets Listen-only Mode

### Option 003 (HP-IL)

20.



These two HP-IL connectors are used to interconnect the plotter in the HP-IL loop.

21.



This rocker switch is used to establish maximum plotting limits. The US position is for 8½ × 11 inch paper; A4 is for 210 × 297 millimetre paper.

## Setting Up the Plotter

The following paragraphs describe a simple, straight-forward procedure for setting up your plotter. Included are instructions for correct pen usage, power-up initialization, loading pens, and loading paper.

### Choosing the Correct Pen

To obtain plots of the highest quality, it is important to use pens matched to your application. Two types of pens are available: one is for standard Hewlett-Packard plotting paper and one is for transparency film. The top of each pen is marked, in a color that matches the pen's ink, with a three-character code. The first character denotes the media on which the pen is designed to draw. The "P" is for paper; "T" is for transparency film. The second and third characters specify, in millimetres, the approximate line width that the pen will draw.

### Loading Pens

The pens are manually installed as follows (see figure on next page):

1. Raise the protective cover to gain access to the pen stalls.
2. Select the pen and remove the pen cap.
3. Place the pen tip in the round hole at the base of the stall, and press down and in gently until the pen snaps into place. Repeat this procedure for the second pen.
4. Lower the protective cover to prevent unintentional interruption of the plotter during operation.

### Turning the Power On

The plotter performs an initialization cycle when ac power is applied. The initialization cycle sets certain plotter functions, such as scaling

points P1 and P2, to their default conditions (conditions assumed by the plotter in the absence of an actual instruction). Apply power to the plotter as follows:

1. Using the power cord supplied, connect the plotter to a grounded (three-wire) ac outlet.

---

#### CAUTION

To prevent possible damage, ensure the plotter is properly configured for the line voltage in your area. Refer to Input Power Setup.

---

2. Set the ~LINE switch to ON. The following power-up initialization will occur:
  - a. The **ERROR** light turns on momentarily.  
**NOTE:** If the paper loading lever is in the **PAPER LOAD ↑** position, the **ERROR** light turns on momentarily; then turns on steadily when the power-up initialization cycle is completed.■
  - b. The plotter moves the pen holder to the left pen stall to initialize its location on the Y-axis and check the occupancy status of the left pen stall. If a pen is not installed in the left pen stall, the pen holder checks the occupancy status of the right pen stall. When a pen is found, or if no pens are installed, the pen holder returns to a point near the right plotting limit to complete the initialization cycle.
  - c. Default conditions are established. Refer to the Interfacing and Programming Manual for details.



Loading Pens





## Loading Paper

This plotter is designed to be used with HP paper and pens. Use of other paper may cause poor line quality. For best results, order papers listed under Accessories Available. To load paper, proceed as follows:

1. Set the **A4/US** switch to the position which corresponds with the paper size being used: **A4** for ISO A4 metric paper; **US** for ANSI A English paper.

**NOTE:** The plotter senses a change in the position of the **A4/US** switch only when default conditions are subsequently established by one of the following methods:

- power-up initialization,
  - execution of HP-GL command IN,
  - moving the paper loading lever to the **PAPER LOAD ↑** position, then simultaneously pressing **ENTER** and **VIEW** (front-panel reset).■
2. Move the paper loading lever to the **PAPER LOAD ↑** position. This raises the pinch wheels and the paper stop. It also stores and caps the pen to avoid getting ink on the new paper.
  3. Lay a sheet of paper on the platen surface so the paper is against the paper stop and the left edge of the platen.
  4. Move the paper loading lever to the **PAPER HOLD ↓** position. This lowers the pinch wheels and the paper stop to secure the paper and allow it free movement in the X-axis.

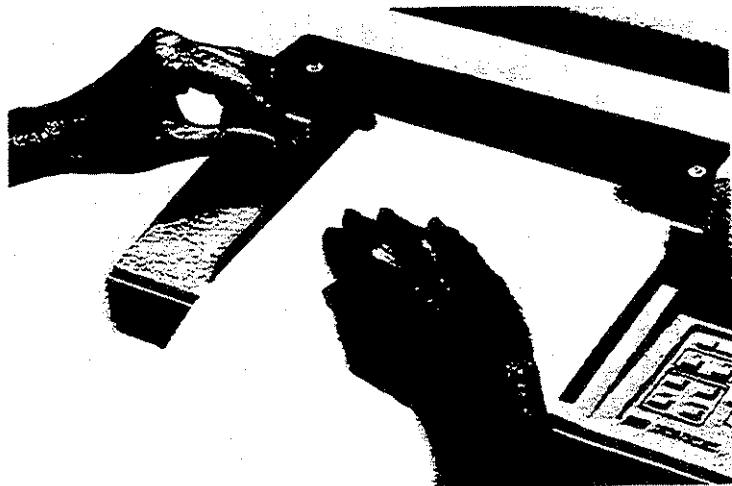

Loading Paper

## The Confidence Test

The confidence test provides you with a visual indication that the HP 7470A plotter is operating properly. This self-test checks the mechanical and electronic functions of the plotter. It does so by selecting alternate pens, moving between scaling points P1 and P2, drawing an asterisk with pen 2, and moving 79 spaces along the X-axis. Pen 2 is then stored and the pen holder returns to P1, indicating the confidence test is completed. The confidence test cannot detect every possible failure, but if the asterisk is drawn, there is a high probability that the plotter is operating properly. If the asterisk is not drawn, the plotter is malfunctioning and needs service. Refer to the Shipment paragraph for instructions on how to obtain servicing assistance.

The confidence test is initiated by holding the **PEN UP** pushbutton down while turning on the plotter. The **PEN UP** pushbutton may be released after the pen holder starts to move.

**NOTE:** The power-up initialization cycle is performed prior to the first confidence test cycle.■

The confidence test will repeat approximately every 55 seconds and can be stopped only by turning off the plotter. Each confidence test cycle automatically steps one space along the X-axis to draw the next asterisk. This process continues until 80 asterisks are drawn in the first row. The location of P1 is moved up one row as each row of asterisks is completed. P1 is returned to its original default location when the page is filled. The previously drawn asterisks are then redrawn. The delay between each confidence test cycle can be reduced to approximately 0.25 second by pressing the left arrow pushbutton. Holding the left arrow pushbutton down until a cycle is completed will return the delay time to approximately 55 seconds.

**NOTE:** Unless an intermittent problem is suspected, there is no need to continue the confidence test cycles after the first asterisk is drawn.■

## Interfacing the Plotter to Your Computer

Although interfacing the plotter to your computer is not difficult, there are far too many plotter/computer combinations to cover in this manual. The Interconnection Guide, HP Part Number 07470-90003, is furnished with your plotter to provide this information. This guide contains detailed instructions for interfacing your plotter with many commonly used computers. If your particular computer is not included, experimenting with the instructions given for a similar computer may solve the problem. A short program that you can type into your computer is included in each case to verify that communication is established between your plotter and computer.

# Introduction to Programming Languages

## What Is a Program?

A program is an organized set of instructions that tells your computer and plotter to accomplish certain tasks. There are two types of programs that you can use to generate the input data for your graphics plots: pre-packaged software programs and user-written software programs. Pre-packaged software programs are easy to use and usually do not require that you have a programming background. The manual supplied with your prepackaged software contains complete instructions for its use. If prepackaged software is not available for your application, it will be necessary to learn the programming languages that the computer and plotter understand.

## What Programming Languages Do I Use?

It is likely that your computer understands BASIC (Beginner's All-purpose Symbolic Instruction Code). BASIC is a common programming language that tells the computer what to do. Its statements are in English, are easy to use, and perform many complex operations. These operations include computation, data base management, and conditional evaluation of data to control program branching.

The BASIC on some computers including some Hewlett-Packard computers offers high-level graphics programming statements which we will call BASIC graphics statements. These statements often simplify graphics plotting and can be used in place of HP-GL (Hewlett-Packard Graphics Language) instructions. BASIC graphics statements consist of English words that are usually followed by numeric parameters. These statements are encoded by the computer and then sent to the plotter as HP-GL instructions. Each of the BASIC graphics statements is a subroutine that will often perform tasks that would require the use of several HP-GL instructions to duplicate. The following two programs which produce very similar plots illustrate the economy of the BASIC graphics statements.

**Graph plotted using HP-GL instructions.**

```
100 PRINTER IS 705
110 PRINT "IP800,500,7000,4200;SP2;"
120 PRINT "SCO,24,0,15"
130 PRINT "TL1.5,0;"
140 PRINT "SI.135,.20"
150 PRINT "PA0,0;"
160 FOR X=0 TO 24
170 PRINT "PD;PA",X,"",0;PU;XT;"
180 IF X>= 10 THEN 210
190 PRINT "CP-.33,-1;"
200 IF X<= 9 THEN 220
210 PRINT "CP-.835,-1;"
220 PRINT USING "#,K" ; "LB",X
230 PRINT " ;PA",X,"",0;"
240 NEXT X
250 PRINT "TL1,0"
260 PRINT "PA0,0;"
270 FOR Y=0 TO 15
280 PRINT "PD;PA0,"",Y,"";PU;YT;"
290 IF Y>= 10 THEN 320
300 PRINT "CP-1.833-.25;"
310 IF Y<= 9 THEN 330
320 PRINT "CP-2.5,-.25;"
330 PRINT USING "#,K" ; "LB",Y
340 PRINT " ;PA0","",Y
350 NEXT Y
360 END
```

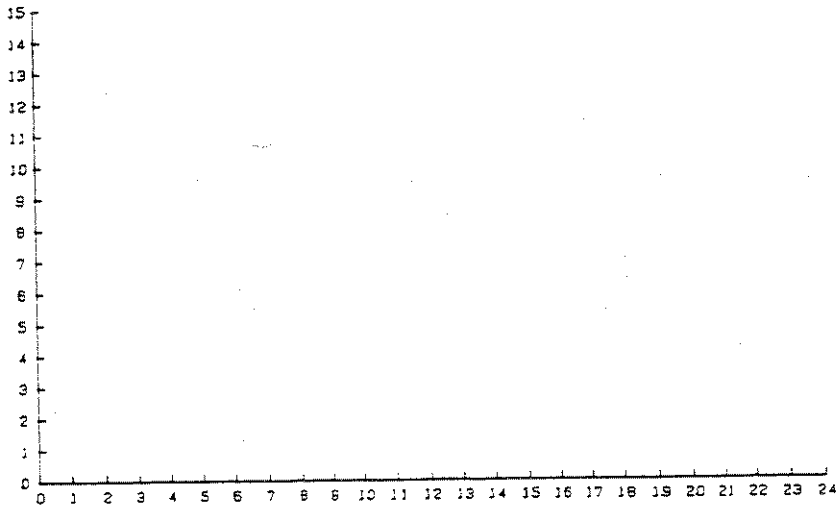

**Graph plotted using BASIC graphics statements.**

```
100 PLOTTER IS 705
110 LIMIT 0,180,0,120
120 LOCATE 10,140,10,90
130 SCALE 0,24,0,15
140 AXES 1,1,0,0
150 LORG 6
160 CSIZE 3
170 FOR X=0 TO 24
180 PLOT X,-.2
190 LABEL USING "#,K" ; X
200 NEXT X
210 FOR Y=0 TO 15
220 PLOT -.4,Y+.15
230 LABEL USING "#,K" ; Y
240 NEXT Y
250 END
```

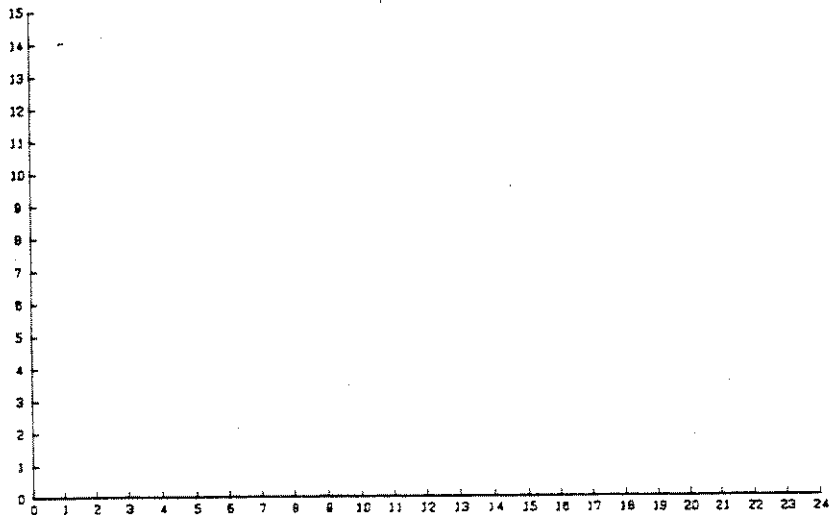

If you are new to BASIC programming and want to learn, your computer store can probably supply a BASIC programming manual. Numerous college-level courses in BASIC are also available. If you already have some familiarity with this programming language, consult your computer programming manual for complete details on how to write BASIC statements including BASIC graphics statements.

## HP-GL (Hewlett-Packard Graphics Language)

HP-GL is the graphics programming language that is actually sent to and understood by the 7470A plotter. HP-GL commands consist of two-letter mnemonics that are usually followed by numeric parameters. With the exception of certain escape sequence commands which are used for control of interface functions in an RS-232-C/CCITT V.24 environment, all data received by the plotter is interpreted as HP-GL commands. You can include HP-GL commands directly in the computer language output statements, or you can use BASIC graphics statements which the computer encodes and sends to the plotter as HP-GL commands. The HP 7470A Interfacing and Programming Manual contains complete information about handshaking and programming in HP-GL.

## The Plotter Coordinate System

The plotting area should be thought of as a Cartesian coordinate system with both the X- and Y-axes scaled into plotter units. The location of the coordinate origin (0,0 plotter units) and the orientation of the X- and Y-axes are shown in the following diagram. Plotting limits and the default locations of P1 and P2 are also shown.

### Plotter Units

A plotter unit is 0.025 mm (approximately 0.001 in.) in length and is the smallest move the plotter can make. The numeric range of plotter units is -32 768 to +32 767, and is far greater than the limits of the paper which can be used with the plotter. When the plotter is commanded to plot data which is within the above range but beyond the limits of the paper, it plots to the plotting limits, monitors the location of the off-scale data points, and resumes plotting when the data again represents points on the paper. The graphics position is defined to be this monitored position regardless of whether it is on or off the paper.

### Plotting Limits

Plotting limits determine the maximum limits of the pen's motion and the area within which P1 and P2 can be positioned. The plotting limits are determined by the position of the A4/US switch. In the A4 position, plotting limits establish a rectangular plotting area with a range of 0 to 10 900 plotter units in the X-axis and 0 to 7650 plotter units in the Y-axis. In the US position, plotting limits are in the range of 0 to 10 300 plotter units in the X-axis and 0 to 7650 plotter units in the Y-axis.

### The Scaling Points P1 and P2

On power-up, scaling points P1 and P2 are set to the coordinates  $P1_x = 250$ ,  $P1_y = 279$ ,  $P2_x = 10\,250$ , and  $P2_y = 7479$  plotter units. These

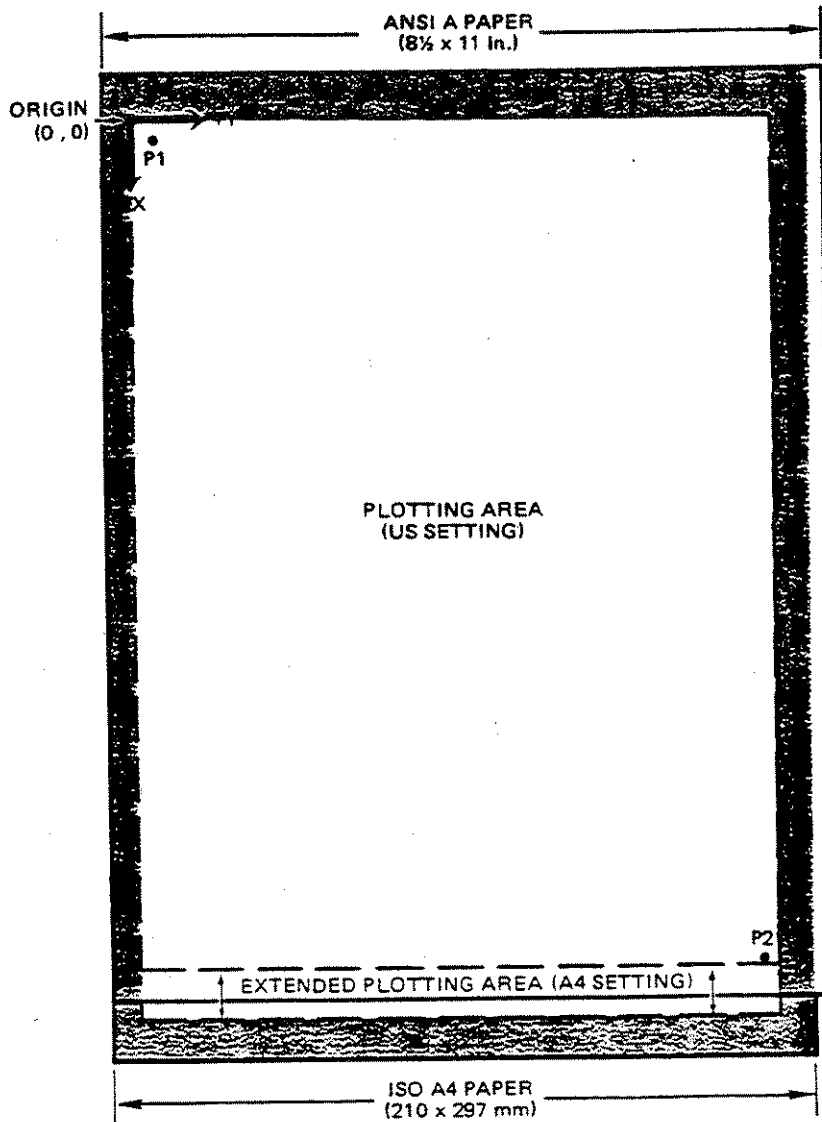

SCALING POINTS	SWITCH SETTING		PLOTTING RANGE	SWITCH SETTING	
	US	A4		US	A4
P1	X,Y = 250 , 279	X,Y = 250 , 279	X-AXIS	0 TO 10 300	0 TO 10 900
P2	X,Y = 10 250 , 7479	X,Y = 10 250 , 7479	Y-AXIS	0 TO 7650	0 TO 7650

ALL VALUES = PLOTTER UNITS

Plotter Coordinate System (Default Orientation)

locations serve different purposes, depending on the programming language being used. When programming in HP-GL, they are used in conjunction with the scaling command SC to establish a user-unit coordinate system. When programming in BASIC graphics statements, and when using some prepackaged software, they are used to establish software hard-clip plotting limits. Once the hard-clip plotting limits are defined, scaling of the plot is adjusted by the computer to fit your plot within the hard-clip plotting limits. Thus, you can draw your plot full-page size, or you can move P1 and P2 closer together to reduce the size of your plot. This feature is useful when you wish to draw more than one plot on the same page.

### Setting the Scaling Points

The locations of scaling points P1 and P2 can be changed manually from the front panel or programmatically with the HP-GL command IP. Refer to the Interfacing and Programming Manual for instructions on how to set the scaling points programmatically.

P2 can be moved without changing the position of P1. However, when P1 moves, P2 moves so that the X- and Y-distances between P1 and P2 do not change. Default positions for P1 and P2 can be reestablished by any of the following methods:

- power-up initialization,
- execution of HP-GL commands IN or IP,;
- moving the paper loading lever to the PAPER LOAD ↑ position, then simultaneously pressing ENTER and VIEW (front-panel reset).

The procedure for manually relocating P1 and P2 is as follows:

**NOTE:** Always set P1 first, since P2 moves when P1 is moved. ■

1. Using the arrow pushbuttons, position the pen at the new location chosen for P1.
2. Press ENTER simultaneously with P1 to store the new location of P1.
3. Using the arrow pushbuttons, position the pen at the location chosen for P2.
4. Press ENTER simultaneously with P2 to store the new location of P2.
5. To check the new points, press P1, then press P2. The pen should move to the new P1 point, then to the new P2 point.

### Preparing Equal-Sized Plots

Automatic positioning of P2 as P1 is moved can be used advantageously in applications such as preparing two equal-sized plots on the same page. This function is illustrated in the following diagram. The



procedure given for setting the scaling points is used to establish the first plotting area. When plotting is completed, the new position for P1 is set for the second plot. P2 moves proportionately and automatically establishes an equal-sized area for the second plot.

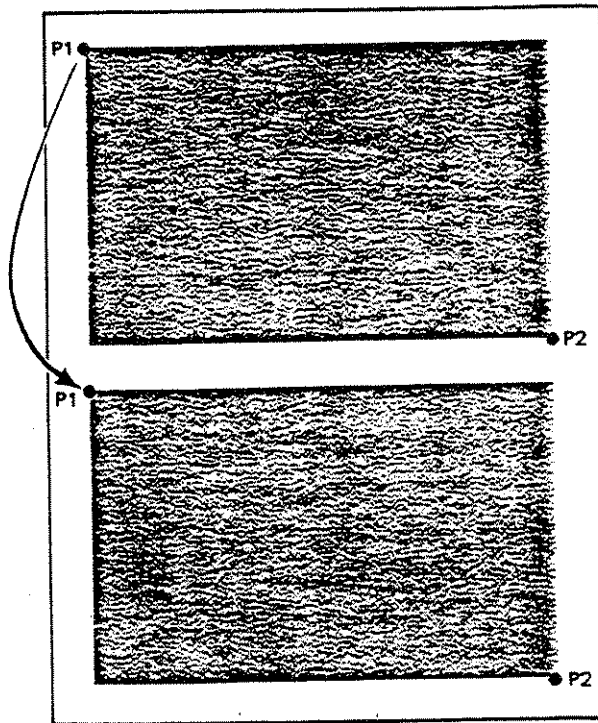

Preparing Equal-Sized Plots

### Squeezing the Scaling Area

When a scaling area is established within the plotting area, and then P1 is moved so that P2 intersects a plotting limit, a new scaling area is established at the point of intersection. This feature is illustrated as follows:

DETAIL A: Illustrates a scaling area defined by P1 and P2.

DETAIL B: Illustrates moving P1 to a new position. P2 moves proportionately until the plotting limit is reached. At this point, P2 stops moving with P1 and the distance between P1 and P2 changes.

DETAIL C: Illustrates moving P1 back to its original location. P1 and P2 maintain the relationship established in Detail B, thus producing a "squeezed" scaling area.

DETAIL "A"

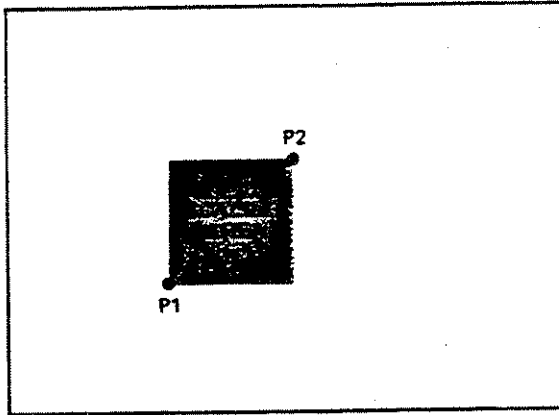

DETAIL "B"

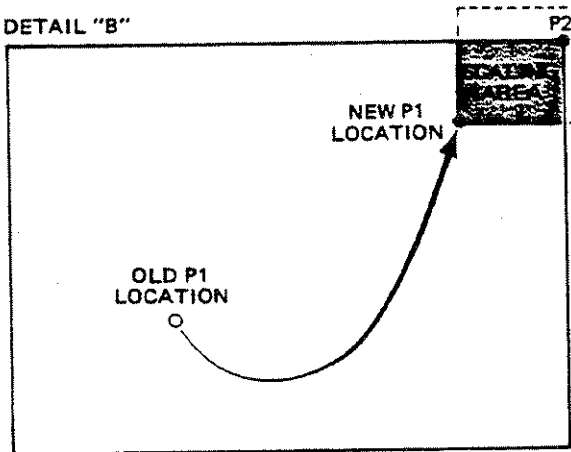

DETAIL "C"

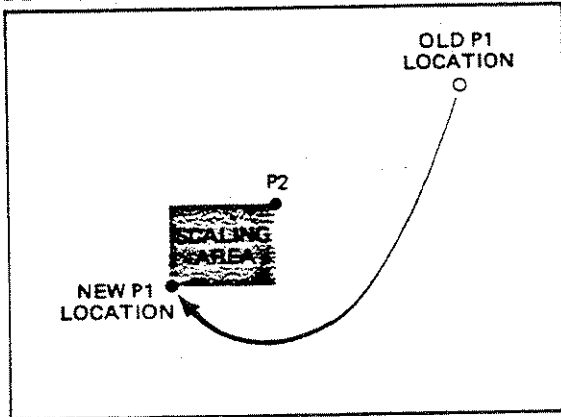

Squeezing the Scaling Area

## Symptoms and Solutions

If you follow the suggestions in this manual, you can obtain high-quality plots easily. If, however, you do have problems, the following suggestions may help you diagnose and correct the problem.

Possible Cause	Solution
<b>Plotter Does Not Respond to Commands</b>	
Front-panel controls are inoperative.	If movement of the pen holder has been obstructed, the plotter will not respond to front-panel controls or programmed commands. To correct this situation, remove the obstruction and cycle the ~LINE switch to OFF, then ON again.
<b>Plotting Does Not Occur Where Expected</b>	
P1 and P2 are positioned as set for a previous plot.	When new paper is loaded, P1 and P2 retain their previously set positions. Reset P1 and P2 or return them to their default locations. Default positions are set using HP-GL command IN or IP; by turning the plotter off, then on again, or by performing a front-panel reset.
Coordinate origin location is shifted.	If the paper is not properly positioned against the paper stop when the pinch wheels are lowered, the coordinate origin is shifted proportionately and plotting can occur off the paper.
Lines are drawn off the paper.	The A4/US switch may be set to A4 when 8½ × 11 inch paper is loaded. To correct this situation, set A4/US switch to US. Remember, the position of this switch is sensed only when the plotter is first turned on, after a front-panel reset, or when the HP-GL command IN is received.





Possible Cause	Solution
<b>Pen Appears to Skip or Drag (Continued)</b>	
<p>The plotting medium has oil on the surface.</p> <p>The plotting medium has a watermark in it.</p> <p>There is static buildup on pens and plotting medium.</p>	<p>Skin oil, or other agents that repel ink may be present on the medium surface. Correct the problem by using a new sheet of medium. Keep hands clean while working with the medium, and always handle it by the edges.</p> <p>Some brands of media contain a manufacturer's watermark. Decrease pen speed to write over the watermark.</p> <p>In low humidity, static may cause dust and particle build-up, especially when plotting on transparencies. To reduce the problem, slow the pen speed down, increase the humidity in the plotting environment, try another brand of film that emphasizes static-resistant qualities, or change to another plotting medium.</p>
<b>Pen Tip Wears Out Quickly</b>	
<p>The pen is fiber-tipped.</p>	<p>The wear is exhibited as a broadening of the line. To prolong fiber-tip pen life, use a smooth plotting medium.</p>
<b>Line Width Is Not Uniform</b>	
<p>Variations in pen speed can create variations in line width.</p>	<p>Curves and characters are a collection of many tiny line segments. The plotter stops at the beginning of each line segment that it draws, which creates a bolder line on shorter line segments than on longer line segments. Lowering the pen speed will make the line width more uniform.</p>

Possible Cause	Solution
<b>Line Width Is Too Narrow or Too Wide</b>	
<p>Fiber-tip pen may be worn down.</p> <p>Your program may not be drawing enough lines.</p>	<p>Fiber-tip pens broaden with use, producing a wider line than when they were new. If a fine line is required, use a new fiber-tip pen which maintains a constant width.</p> <p>Write a subroutine to draw multiple lines spaced so closely together that they appear to be a single line.</p>
<b>Ink Flow Is Uneven</b>	
<p>Pen is running out of ink.</p>	<p>When a pen begins to run out of ink, the ink flow generally decreases before completely stopping. Decreasing the plotter speed may provide a smoother ink flow under these conditions.</p>
<b>Ink Smears or Does Not Dry</b>	
<p>Ink and media combination is incompatible.</p>	<p>Fiber-tip pens contain ink that dries by absorption into the plotting medium. They are not suitable for use on polyester film.</p>
<b>Plotter Seems to Misregister or "Drift"</b>	
<p>Plotter has been bumped or plotting medium has been moved.</p>	<p>If the plotter is bumped during the course of a plot, it will generally continue to plot without any noticeable effect. It is possible, however, that a bump will jar the pen, causing the appearance of a misregistered line.</p>

Possible Cause	Solution
<b>Plotter Seems to Misregister or "Drift" (Continued)</b>	
<p>Climatic conditions have changed.</p> <p>Medium is unsuitable.</p>	<p>Changes in temperature and/or relative humidity during the course of a plot can cause media to stretch or shrink. This change in dimension may look like a misregistered line. To avoid the effects of environmental changes, let the plotting medium acclimate to the room in which the plotter is located before beginning to plot.</p> <p>Media that are too thick, too thin, or too slippery may not be gripped properly as they move through the wheels.</p>
<b>Writing Surface Is Rippled, Torn, or Scratched</b>	
<p>Plotting medium is too thin.</p> <p>Plotting medium is too thick.</p> <p>Plotting medium is uneven.</p> <p>Plotting medium is improperly loaded.</p>	<p>Thin or tissue-like media do not have the tensile strength to move through the wheels. Change to a heavier medium.</p> <p>Change to a lighter medium.</p> <p>It is possible that the medium is warped or otherwise uneven. If this defect is present, it may cause the pen to tear or scrape at the high places. Check the medium carefully to see if any surface aberrations can be detected. If so, replace the medium.</p> <p>Reload the sheet. Make certain the medium has square corners and is against the paper stop.</p>





Possible Cause	Solution
<b>Writing Surface Is Rippled, Torn, or Scratched (Continued)</b>	
Ink has soaked the plot.	If many closely spaced lines are drawn on chart paper without sufficient time to dry, the medium may become damp and weak. Further drawing in the same area can tear the medium. Revise the software so that the ink will have time to dry before more lines are drawn in the same area.

## Combining Pens and Media

The following table describes how to combine pens and media for best results.

	Fiber-tip Paper Pens	Fiber-tip Transparency Pens
<b>Non-Glossy Plotter Paper</b>	High quality for business graphics charts and quick check plots.	Not recommended.
<b>Glossy Plotter Paper</b>	Excellent quality for presentations, reports, and handouts. Vivid, professional results.	Good quality.
<b>Transparency Plotter Film</b>	Not recommended.	Excellent quality for overhead presentations and overlays.

## Operator Maintenance

There are no operator-serviceable parts inside the HP 7470A plotter. Maintenance which can be performed by the operator is limited to maintaining the appearance of the plotter. All other maintenance must be performed by qualified service personnel. Refer to the Shipment paragraph for instructions on how to obtain servicing assistance.

### General Cleaning

---

#### WARNING

Disconnect the plotter from the power source prior to performing any maintenance. DO NOT allow water to run onto electrical components and circuits or through openings in the enclosure as this may create a shock hazard.

---

---

#### CAUTION

Do not attempt to clean the microgrip drive wheels. Cleaning solutions may dissolve the adhesive which secures the grit particles to the wheels.

---

Thorough cleaning should be performed periodically. Cleaning intervals are determined by the type of operation, local air contamination, and climatic conditions. Cleaning procedures should include the following:

1. Blow away dust accumulation in the pen stall areas with compressed air, if available. Dust may also be removed with a lint-free cloth.
2. Clean the outer surface of the plotter with a damp sponge or cloth. Use a mild soap and water solution, if necessary. Wipe dry after cleaning.

**NOTE:** To prevent scratching, do not use abrasive cleansers on the plastic carriage cover or on the outer surface of the plotter. In addition, some "mild" detergents might cause the paint to blister because they contain chemicals that strip water-based paints. For this reason, it is recommended that you use a soft cloth dampened with a 50-50 solution of isopropyl alcohol and water. Then rinse off any residue with water and dry with a soft, lint-free cloth. ■



## **Pen Stall Cleaning**

After using overhead transparency pens, remove leftover ink from the capping hole in the pen stalls using a cotton swab. This will prevent the transfer of inks to future plots.

## **Shipment**

When the plotter is to be shipped, be sure it is packed in a protective carton. Keep the original packing materials and shipping carton for this purpose. If not available, packing materials and a carton may be ordered through your local Hewlett-Packard Sales and Support Office.

If your plotter is being returned to Hewlett-Packard for service, contact your nearest HP Field Repair Center for complete shipping instructions. In countries without Field Repair Centers, contact your HP Sales and Support Office. You can help assure effective servicing of your plotter by following these guidelines:

1. Follow the maintenance procedures outlined in this manual to verify the malfunction and, if possible, identify the defective area.
2. If you determine that repair is required, you will need to include the following items when your plotter is returned for service:
  - a. A description of the configuration exactly as it was at the time of malfunction, including the computer model number, interface, and other accessories that were in use when the malfunction occurred.
  - b. A brief description of malfunction symptoms for service personnel.
  - c. Plots or any other materials that help illustrate the problem area.
  - d. If purchased through an HP dealer, a copy of the sales slip or other proof of purchase to establish the warranty coverage period.
  - e. Serial number of your plotter (located on rear panel).
3. Include your name and address. Also include the telephone number where you may be reached during the day.
4. Do not include the power cord or other operating accessories with your plotter, unless the problem relates to an accessory.

