



**HEWLETT
PACKARD**

INSTALLATION AND VERIFICATION MANUAL

HP 70902A IF SECTION

SERIAL NUMBERS

This manual applies directly to HP 70902A IF Sections with serial numbers prefixed 2751A and below.

**COPYRIGHT © 1988 HEWLETT-PACKARD COMPANY
1212 VALLEY HOUSE DRIVE, ROHNERT PARK, CALIFORNIA 94928-4999, U.S.A.**

**Manual Part Number: 70902-90021
Microfiche Part Number: 70902-90022**

Printed: August 1988

CERTIFICATION

Hewlett-Packard Company certifies that this product met its published specifications at the time of shipment from the factory. Hewlett-Packard further certifies that its calibration measurements are traceable to the United States National Bureau of Standards, to the extent allowed by the Bureau's calibration facility, and to the calibration facilities of other International Standards Organization members.

WARRANTY

This Hewlett-Packard instrument product is warranted against defects in material and workmanship for a period of one year from date of shipment. During the warranty period, Hewlett-Packard Company will, at its option, either repair or replace products which prove to be defective.

For warranty service or repair, this product must be returned to a service facility designated by HP. Buyer shall prepay shipping charges to HP and HP shall pay shipping charges to return the product to Buyer. However, Buyer shall pay all shipping charges, duties, and taxes for products returned to HP from another country.

HP warrants that its software and firmware designated by HP for use with an instrument will execute its programming instructions when properly installed on that instrument. HP does not warrant that the operation of the instrument, or software, or firmware will be uninterrupted or error-free.

LIMITATION OF WARRANTY

The foregoing warranty shall not apply to defects resulting from improper or inadequate maintenance by Buyer, Buyer-supplied software or interfacing, unauthorized modification or misuse, operation outside of the environmental specifications for the product, or improper site preparation or maintenance.

NO OTHER WARRANTY IS EXPRESSED OR IMPLIED. HP SPECIFICALLY DISCLAIMS THE IMPLIED WARRANTIES OF MERCHANTABILITY AND FITNESS FOR A PARTICULAR PURPOSE.

EXCLUSIVE REMEDIES

THE REMEDIES PROVIDED HEREIN ARE BUYER'S SOLE AND EXCLUSIVE REMEDIES. HP SHALL NOT BE LIABLE FOR ANY DIRECT, INDIRECT, SPECIAL, INCIDENTAL, OR CONSEQUENTIAL DAMAGES, WHETHER BASED ON CONTRACT, TORT, OR ANY OTHER LEGAL THEORY.

ASSISTANCE

Product maintenance agreements and other customer assistance agreements are available for Hewlett-Packard products.

For any assistance, contact your nearest Hewlett-Packard Sales and Service Office.

HP 70000 MODULAR MEASUREMENT SYSTEM DOCUMENTATION OUTLINE

Instruments and modules of the HP 70000 Modular Measurement System are documented to varying degrees of detail. Modules that serve as masters of an instrument require operational information in addition to installation and verification information. Modules that functioning as slaves in a system require only a subset of installation and verification information.

Manuals Supplied with Module

Installation and Verification Manual

Topics covered by this manual include installation, specifications, verification of module operation, and some troubleshooting techniques. Manuals for modules that serve as instrument masters will supply information in all these areas; manuals for slave modules will contain only information needed for slave module installation and verification. Master module documentation may also include some system-level information.

Operation Manual

Operation Manuals usually pertain to multiple- and single-module instrument systems. Topics include preparation for module use, module functions, and softkey definitions.

Programming Manual

Programming Manuals also pertain to multiple- and single-module instrument systems. Programming Manual topics include programming fundamentals and definitions for remote programming commands.



Service Manual, Available Separately

Technical Reference



When available, this manual provides service information for a module, including performance verification, adjustments, troubleshooting, replaceable parts lists, replacement procedures, schematics, and component location diagrams. For ordering information, contact an HP Sales and Service Office.

SAFETY SYMBOLS

The following safety symbols are used throughout this manual and in the instrument. Familiarize yourself with each of the symbols and its meaning before operating the instrument.

Note 	Notes will be used to call attention to an important point in the text. This is not a hazard, but should not be ignored as it will provide a better understanding of the text.
Caution 	The CAUTION sign denotes a hazard. It calls attention to a procedure which, if not correctly performed or adhered to, could result in damage to or destruction of the instrument. Do not proceed beyond a CAUTION sign until the indicated conditions are fully understood and met.
Warning 	The WARNING sign denotes a hazard. It calls attention to a procedure which, if not correctly performed or adhered to, could result in injury or loss of life. Do not proceed beyond a WARNING sign until the indicated conditions are fully understood and met.

GENERAL SAFETY CONSIDERATIONS

Warning 	BEFORE THIS INSTRUMENT IS SWITCHED ON , make sure it has been properly grounded through the protective conductor of the ac power cable to a socket outlet provided with the protective earth contact. Any interruption of the protective (grounding) conductor, inside or outside the instrument, or disconnection of the protective earth terminal can result in personal injury.
Warning 	There are voltages at many points in the instrument which can, if contacted, cause personal injury. Be extremely careful. Any adjustments or service procedures that require operation of the instrument with the protective covers removed should be performed only by trained service personnel.
Caution 	BEFORE THIS INSTRUMENT IS TURNED ON , make sure its primary power circuitry has been adapted to the voltage of the ac power source. Failure to set the ac power input to the correct voltage could cause damage to the instrument when the ac power cable is plugged in.

Contents

1. General Information	
Introduction	1-1
Module Description	1-1
Modular Measurement System Terms	1-2
Functional Terms	1-2
Structural Terms	1-2
Safety Considerations	1-3
Modules Covered by Manual	1-3
Serial Numbers	1-3
Manual Updating Supplement	1-4
Initial Inspection	1-4
Accessories	1-4
Front/Rear-Panel Features	1-5
Front-Panel Status Indicators	1-5
ACT (Active green) LED	1-5
ERR (Error red) LED	1-5
Front-Panel Outputs	1-5
VIDEO 0-1V	1-5
IF 3 MHz	1-5
Module Latch	1-5
Rear-Panel Inputs and Outputs	1-6
21.4 MHz IN	1-6
VIDEO OUT	1-6
21.4 MHz OUT	1-6
LIMITED IF OUT	1-6
Mainframe/Module Interconnect	1-6
Electrostatic Discharge Information	1-8
Reducing ESD Damage	1-9
Handling of Electronic Components	1-9
Test Equipment	1-9
Static-Safe Accessories	1-10
Sales and Service Offices	1-10
Returning Instruments for Service	1-12
Packaging	1-12
Instrument Shipping Preparation Procedure.	1-12
2. Installation	
Introduction	2-1
Preparation For Use	2-1
Addressing the Module	2-2
Determining the HP-MSIB Address	2-2
Setting the HP-MSIB Address Switches	2-3

Installing the Module in the Mainframe	2-4
Module Installation	2-4
Connecting the Rear-Panel Cables	2-5
Rear-Panel Cables for HP 71100A RF Spectrum Analyzer	2-5
HP 71100A IF Section Cable Connections	2-5
Rear-Panel Cabling for HP 71210A Microwave Spectrum Analyzer	2-6
HP 71210A Dual IF Section Cable Connections	2-6
3. Specifications	
4. Verification	
Introduction	4-1
Module Self-Test	4-1
Calibration	4-1
Signal Analyzer Operation Verification	4-1
5. Troubleshooting	
Introduction	5-1
Troubleshooting Tools	5-1
Status Indicators	5-1
STATUS ACT	5-2
STATUS ERR	5-2
Module Self-Test	5-2
Error Messages	5-3
Usage/Operating Errors	5-3
Hardware Warning Errors	5-3
Hardware Broken Errors	5-3

List of Illustrations

Figure 1-1. Typical Serial Number Label	1-3
Figure 1-2. Module Front- and Rear-Panel Features	1-7
Figure 1-3. Example of a Static-Safe Work Station	1-8
Figure 1-4. Mainframe Packaging Material	1-14
Figure 1-5. Module Packaging Material	1-15
Figure 2-1. Module Address Switches	2-3
Figure 2-2. Module Installation	2-4
Figure 2-3. HP 71100A Spectrum Analyzer Rear-Panel Cables	2-5
Figure 2-4. HP 71210A Spectrum Analyzer Rear-Panel Cables	2-6

List of Tables

Table 1-1. Accessories Shipped with a Single Module	1-4
Table 1-2. Static-Safe Accessories	1-10
Table 1-3. HP Sales and Service Offices	1-11
Table 2-1. Typical Address Map	2-2
Table 2-2. HP 70902A RF Cables	2-5
Table 5-1. Error Message Grouping	5-3
Table 5-2. HP 70902A Error Messages	5-3

General Information

Introduction

The HP 70902A Installation and Verification Manual contains information needed to install and verify the HP 70902A IF Section. For information on installing and verifying HP 70000 Modular Measurement Systems, refer to the installation and verification manual for the system master (for example, HP 70900A Local Oscillator).

This manual contains the following five chapters:

- Chapter 1, General Information, describes the module and its accessories, gives electrostatic discharge and packaging information, and lists Hewlett-Packard Sales and Service Offices.
- Chapter 2, Installation, provides information for configuring and installing the module in an HP 70000 Modular Measurement System.
- Chapter 3, Specifications, lists module specifications and characteristics.
- Chapter 4, Verification, contains tests required to verify module specifications.
- Chapter 5, Troubleshooting, explains the probable cause(s) indicated by front-panel status/error LEDs, and lists the error codes that can be produced or caused by the HP 70902A module.

Module Description

The HP 70902A IF Section is a 1/8-width module, providing a resolution bandwidth of 10 Hz to 300kHz, designed for use in HP 70000 Modular Measurement Systems. The module processes a 21.4 MHz signal from a spectrum analyzer RF section or external mixer interface module. A detected video signal is produced and routed to the video processor in the local oscillator. The module contains resolution bandwidth filters, log amplifiers, detection circuitry, and video filters. The HP 70902A can be used with an HP 70903A in a single system to provide resolution bandwidths of 10 Hz to 3 MHz.

The HP 70902A is a slave module and as such is controlled by the system master (for example, HP 70900A Local Oscillator).

Modular Measurement System Terms

Understanding the following terms is essential to understanding HP-MSIB (Hewlett-Packard Modular System Interface Bus) addressing and the structural relationships among modular system devices.

Functional Terms

Modular system devices may be combined to allow them to communicate and operate as an instrument. The following terms identify the interrelationships among devices within a modular instrument.

- **Element:** Any device that communicates over the HP-MSIB (for example, HP 70902A IF Section). In contrast, the HP 70001A Mainframe coordinates all HP-MSIB communications, but does not communicate over the HP-MSIB and therefore is not an element.
- **Master:** An element that controls other elements.
- **Sub-master:** An element that simultaneously controls other elements and is controlled by other elements.
- **Slave:** An element that is controlled by another element.
- **Independent element:** An element that is neither a master or a slave (for example, HP 70206A System Graphics Display).
- **Instrument:** An element, or group of elements that performs an independent function (for example, HP 71300A Millimetre Spectrum Analyzer).

Structural Terms

Modular systems consist of hardware structures dedicated to specific functions. The structural terms used in reference to these functions are described below.

- **Mainframe:** A mainframe is the device into which plug-in modules may be installed to create an instrument such as a modular measurement system.
- **Module:** Modules are devices that plug into a mainframe. They cannot function without a mainframe.
- **Stand-Alone Instrument:** An HP-MSIB element capable of performing its functions without a mainframe (for example, HP 70206A System Graphics Display).

Safety Considerations

Before operating this module, familiarize yourself with any safety markings on the module and the safety instructions in this manual. This module has been manufactured and tested according to international safety standards. The cautions and warnings in this manual must be followed to ensure the safe operation of the module and protection of personnel. Refer to the summary of safety considerations at the front of this manual.

Modules Covered by Manual

The contents of this manual apply to HP 70902A modules with the serial-number prefix(es) listed under "Serial Numbers" on the manual title page.

Serial Numbers

Attached to the front frame of the module is a mylar serial-number label. The serial number is divided into two parts. The first four digits and letter are the serial number prefix; the last five digits are the suffix. See Figure 1-1.

The prefix is the same for all identical modules; a prefix break or change only occurs when a significant modification is made to the product. The suffix, however, is assigned sequentially and is different for each module.

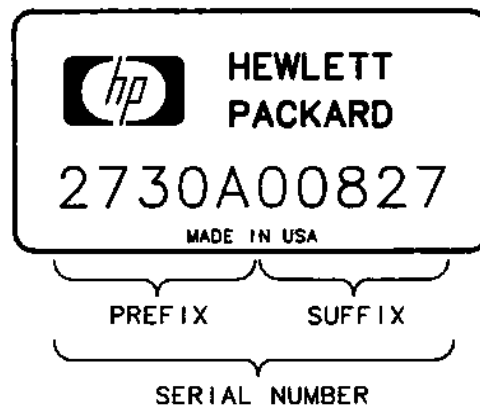

Figure 1-1. Typical Serial-Number Label

Manual Updating Supplement

A module manufactured after this manual was printed may have a serial-number prefix other than that listed under "Serial Numbers" on the manual title page. A higher serial-number prefix than stated on the title page indicate changes have been made to the module since the manual was printed.

Any changes that affect information in this manual are documented in the Manual Updating Supplement for this manual. The Manual Updating Supplement may also contain information for correcting errors in the manual. To keep the manual as current and accurate as possible, periodically request the latest Manual Updating Supplement for this manual from your nearest Hewlett-Packard Sales and Service Office.

Initial Inspection

Inspect the shipping container for damage. If the shipping container or cushioning material is damaged, it should be kept until the contents of the shipment have been checked for completeness and the module has been checked mechanically and electrically. Refer to Table 1-1 below to determine what accessories should have been shipped with the module. If the shipping contents are incomplete, or the module does not satisfy the verification procedures in Chapter 4, notify the nearest Hewlett-Packard Sales and Service Office.

Accessories

The HP 70902A may be ordered separately or as part of a preconfigured HP 70000 Modular Measurement System. When ordered separately, accessories are supplied for the most common system configurations. Table 1-1 lists cables included with the module when ordered separately. When ordered with a preconfigured HP 70000 Modular Measurement System, cables are supplied to connect the module in that configuration. Refer to the installation and verification manual for the system master for cables available to configure other module arrangements.

Table 1-1. Accessories Shipped with Single Module

Accessory	HP Part Number
Coax RF Cables:	
SMB (f) connectors, 50 Ω , 19 cm (7.5 in.)	5061-9017
SMB (f) connectors, 50 Ω , 39 cm (15.375 in.)	5061-9021

Front/Rear-Panel Features

Figure 1-2 shows the HP 70902A IF Section front- and rear-panel features.

Front-Panel Status Indicators

It is normal for both of the front-panel status LED indicators to flash on, then off, during the module self-test. Self-test occurs each time the instrument is turned on. Listed below are reasons why each status LED might light.

ACT (Active green) LED

The ACT LED active indicator of a slave module turns on when the module is making a measurement and its master has keyboard control of the display. Refer to Chapter 5 for additional detail related to ACT LED.

Note



The ACT LED of a slave module is only operative when there is a display in the system or when the instrument is performing a self-test.

ERR (Error red) LED

The ERR LED lights when there is a problem (error) related to the module. Refer to Chapter 5 for additional troubleshooting information.

Front-Panel Outputs

Note



The output levels described for both front- and rear-panels are typical and only apply if a 21.4-MHz signal, at a nominal level of -5 dBm, is applied to the 21.4-MHz input on the rear panel.

VIDEO 0-1V

This BNC (m) connector provides an auxiliary 0-1V video output.

IF 3 MHz

This BNC (m) connector provides an auxiliary 3 MHz IF signal output of approximately $+5$ dBm.

Module Latch

The module hex-nut latch secures the module in an HP 70000 Series mainframe. When the module is being installed or removed from a mainframe, an 8 mm hex-ball driver is used to turn the module latch. Refer to Chapter 2 for information on module installation.

Rear-Panel Inputs and Outputs

21.4 MHz IN

This SMB (m) input connector receives a 21.4-MHz signal, at a nominal level of -5 dBm,, from the RF section.

VIDEO OUT

This SMB (m) output connector supplies a typical 0–2V video signal to the system master (for example, HP 70900A Local Oscillator).

Note



In an HP 70000 Modular Measurement System that has two IF sections, the 21.4-MHz IN and Video OUT from the HP 70902A are cascaded through the HP 70903A IF Section before connecting to their respective RF section and system master. Refer to Chapter 2 installation.

21.4 MHz OUT

This SMB (m) connector provides a means for monitoring the RF section output by furnishing an auxiliary 21.4 MHz signal. This output signal of approximately -15 dBm is *not* acceptable as an input to another IF section (cascading). The output level is insufficient for this purpose.

LIMITED IF OUT

This SMB (m) output connector provides a nominal 2 Vp-p, 3 MHz square-wave signal for use with frequency counters.

Mainframe/Module Interconnect

This multiple-pin connector plugs into the mainframe and provides power-supply voltages and HP-MSIB connections for module communication and control.

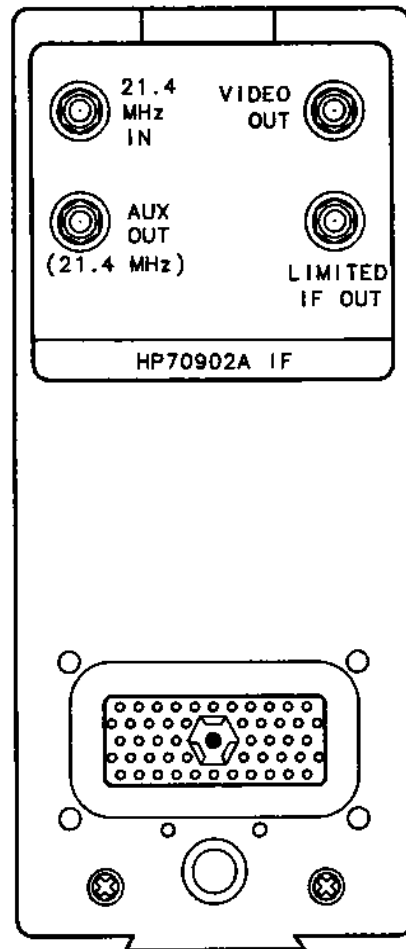
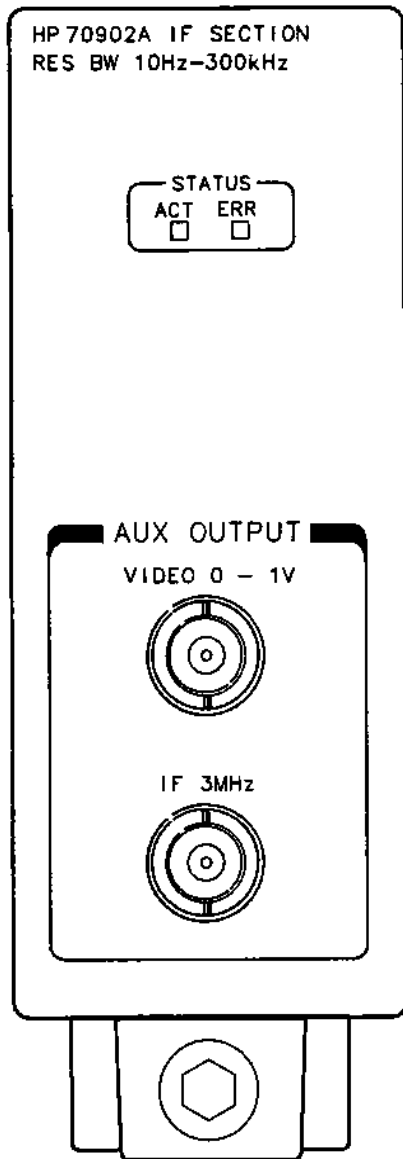

Figure 1-2. Module Front- and Rear-Panel Features

Electrostatic Discharge Information

Electrostatic discharge (ESD) can damage or destroy electronic components. All work on electronic assemblies should be performed at a static-safe work station.

Figure 1-3 shows an example of a static-safe work station using two types of ESD protection: a) conductive table-mat and wrist-strap combination, b) conductive table-mat and heel-strap combination. The two types must be used together to ensure adequate ESD protection. Refer to Table 1-2 for a list of static-safe accessories and their part numbers.

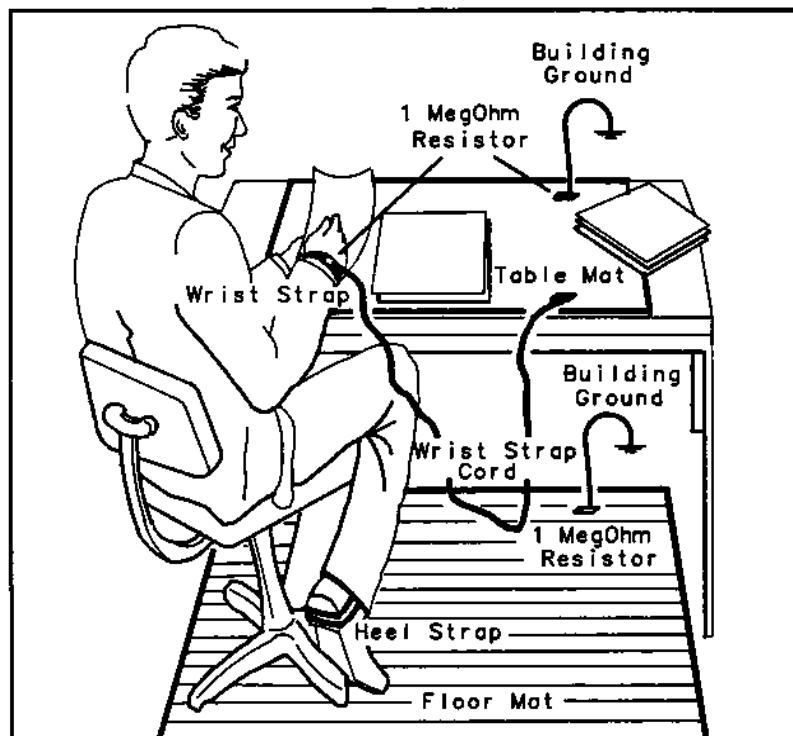

Figure 1-3. Example of a Static-Safe Work Station

Reducing ESD Damage

Handling of Electronic Components

- Perform work on these items at a static-safe work station.
- Store or transport these items in static-shielding containers.
- Use proper handling techniques.

Caution



PC board traces are easily damaged.

Do not touch traces with the bare hands.

Always handle board assemblies by the edges.

Test Equipment

- Before connecting any coaxial cable to an instrument connector for the first time each day, momentarily short the center and outer conductors of the cable together.
- Personnel should be grounded with a resistor-isolated wrist-strap before touching the center pin of any connector and before removing any assembly from the instrument.
- Be sure that all instruments are properly earth-grounded to prevent build-up of static charge.

Static-Safe Accessories

Table 1-2. Static-Safe Accessories

HP Part Number	Description
9300-0797*	set includes: 3M static control mat 0.6-m by 1.2-m (2-ft by 4-ft) and 4.6-cm (15-ft.)ground wire (The wrist-strap and wrist-strap cord are not included. They must be ordered separately.)
9300-0980*	Wrist strap cord 1.5m (5 ft)
9300-0985*	Wrist strap (large)
9300-0986*	Wrist strap (small)
9300-1169*	ESD heel strap (reusable 6 to 12 months)
9300-0793*	Shoe ground strap (one time use only)
*Can be ordered through any Hewlett-Packard Office.	
92175A **	Black, hard surface, static control mat, 1.2m by 1.5m (4 ft by 5 ft)
92175B **	Brown, soft-surface, static control mat, 2.4m by 1.2m (8 ft by 4 ft)
92175C **	Small, black, hard surface, static control mat, 1.2m by 0.9m (4 ft by 3 ft)
92175T **	Tabletop static control mat, 58 cm by 76 cm (23 in by 30 in)
92176A **	Natural color anti-static carpet, 1.8m by 1.2m (6 ft by 4 ft)
92176C **	Russet color anti-static carpet, 1.8m by 1.2m (6 ft by 4 ft)
92176B **	Natural color anti-static carpet, 2.4m by 1.2m (8 ft by 4 ft)
92176D **	Russet color anti-static carpet, 2.4m by 1.2m (8 ft by 4 ft)
**Can be ordered only from: Hewlett-Packard Company Computer Supplies Operation 1320 Kifer Road Sunnyvale, CA 94086 Phone (408) 738-8858	

Sales and Service Offices

Hewlett-Packard Sales and Service Offices provide complete support for Hewlett-Packard products. To obtain servicing information, or to order replacement parts, contact the nearest Hewlett-Packard Sales and Service Office listed in Table 1-3. In any correspondence, be sure to include the pertinent information about model numbers, serial numbers, and/or assembly part numbers.

Table 1-3. Hewlett-Packard Sales and Service Offices

IN THE UNITED STATES	IN AUSTRALIA	IN JAPAN
California Hewlett-Packard Co. P.O. Box 4230 1421 South Manhattan Ave. Fullerton, CA 92631 (714) 999-6700	Hewlett-Packard Australia Ltd. 31-41 Joseph Street Blackburn, Victoria 3130 895-2895	Yokogawa-Hewlett-Packard Ltd. 29-21 Takaido-Higashi, 3 Chome Suginami-ku Tokyo 168 (03) 331-6111
Hewlett-Packard Co. 333 Logue Ave. Mountain View, CA 94040 (415) 969-0880	IN CANADA Hewlett-Packard (Canada) Ltd. 17500 South Service Road Trans-Canada Highway Kirkland, Quebec H9J 2X8 (514) 697-4232	IN PEOPLE'S REPUBLIC OF CHINA China Hewlett-Packard, Ltd. P.O. Box 9610, Beijing 4th Floor, 2nd Watch Factory Main Bldg. Shuang Yu Shu, Bei San Huan Rd. Beijing 28-0567
Colorado Hewlett-Packard Co. 24 Inverness Place, East Englewood, CO 80112 (303) 649-5000	IN FRANCE Hewlett-Packard France F-91947 Les Ulis Cedex Orsay (6) 907-78-25	IN SINGAPORE Hewlett-Packard Singapore Pte. Ltd. #08-00 Inchcape House 450-2 Alexandra Road Alexandra P.O. Box 58 Singapore, 9115 4731788
Georgia Hewlett-Packard Co. P.O. Box 105005 2000 South Park Place Atlanta, GA 30339 (404) 955-1500	IN GERMAN FEDERAL REPUBLIC Hewlett-Packard GmbH Vertriebszentrale Frankfurt Berner Strasse 117 Postfach 560 140 D-6000 Frankfurt 56 (0611) 50-04-1	IN TAIWAN Hewlett-Packard Taiwan 8th Floor, Hewlett-Packard Building 337 Fu Hsing North Road Taipei (02) 712-0404
Illinois Hewlett-Packard Co. 5201 Tollview Drive Rolling Meadows, IL 60008 (312) 255-9800	IN GREAT BRITAIN Hewlett-Packard Ltd. King Street Lane Winnersh, Wokingham Berkshire RG11 5AR 0734 784774	IN ALL OTHER LOCATIONS Hewlett-Packard Inter-Americas 3200 Hillview Avenue Palo Alto, California 94304
New Jersey Hewlett-Packard Co. 120 W. Century Road Paramus, NJ 07653 (201) 265-5000	IN OTHER EUROPEAN COUNTRIES Hewlett-Packard (Schweiz) AG Allmend 2 CH-8967 Widen (Zurich) (0041) 57 31 21 11	
Texas Hewlett-Packard Co. 930 E. Campbell Rd. Richardson, TX 75081 (214) 231-6101		

Returning Instruments for Service

If a module is being returned to Hewlett-Packard for servicing, fill in and attach a blue service tag. Service tags are supplied at the end of this manual. Please be as specific as possible about the nature of the problem. Include copies of error messages, data related to module performance, type of system, etc., along with the module being returned.

Packaging

The original shipping containers should be used. If the original materials were not retained, identical packaging materials are available through any Hewlett-Packard office. Figures 1-5 and 1-6 illustrate the factory packaging material. When ordering packaging material to ship modules, it is necessary to order the proper number of foam inserts.

- A 3/8-width module requires no foam inserts.
- A 2/8-width module requires one foam insert.
- A 1/8-width module requires two foam inserts.

Caution



Instrument damage can result from using packaging materials other than those specified. Never use styrene pellets as packaging material. They do not adequately cushion the instrument or prevent it from shifting in the carton. They also cause instrument damage by generating static electricity.

Instrument Shipping Preparation Procedure.

1. Fill out a blue repair card (located at the end of this manual) and attach it to the instrument. Include any error messages or specific performance data related to the problem. If a blue repair tag is not available, the following information should be noted and sent with the instrument.
 - a. Type of service required
 - b. Description of the problem
 - c. Is problem constant or intermittent
 - d. Name and phone number of technical contact person
 - e. Return address
 - f. Model number of returned instrument
 - g. Full serial number of returned instrument
 - h. List of any accessories returned with instrument
2. Pack the instrument in the appropriate packaging materials. (See Figures 1-4 and 1-5.) Original shipping materials or the equivalent should be used. If the original or equivalent materials cannot be obtained, instruments can be packaged for shipment using the following instructions.

Caution



Inappropriate packaging of instruments may result in damage to the instrument during transit.

- a. Wrap the instrument in anti-static plastic to reduce the possibility of damage caused by ESD.
 - b. For instruments that weigh less than 54 kg (120 lb), use a double-walled, corrugated cardboard carton of 159 kg (350 lb) test strength.
 - c. The carton must be large enough to allow three to four inches on all sides of the instrument for packing material and strong enough to accommodate the weight of the instrument.
 - d. Surround the equipment with three to four inches of packing material, to protect the instrument and prevent it from moving in the carton.
 - e. If packing foam is not available, the best alternative is S.D.-240 Air Cap from Sealed Air Corporation (Commerce, California 90001). Air Cap looks like a plastic sheet filled with 1-1/4 air bubbles.
 - f. Use the pink (anti-static) Air Cap to reduce static electricity. Wrapping the instrument several times in this material will protect the instrument and prevent it from moving in the carton.
3. Seal the carton with strong nylon adhesive tape.
 4. Mark the carton 'FRAGILE, HANDLE WITH CARE'.
 5. Retain copies of all shipping papers.

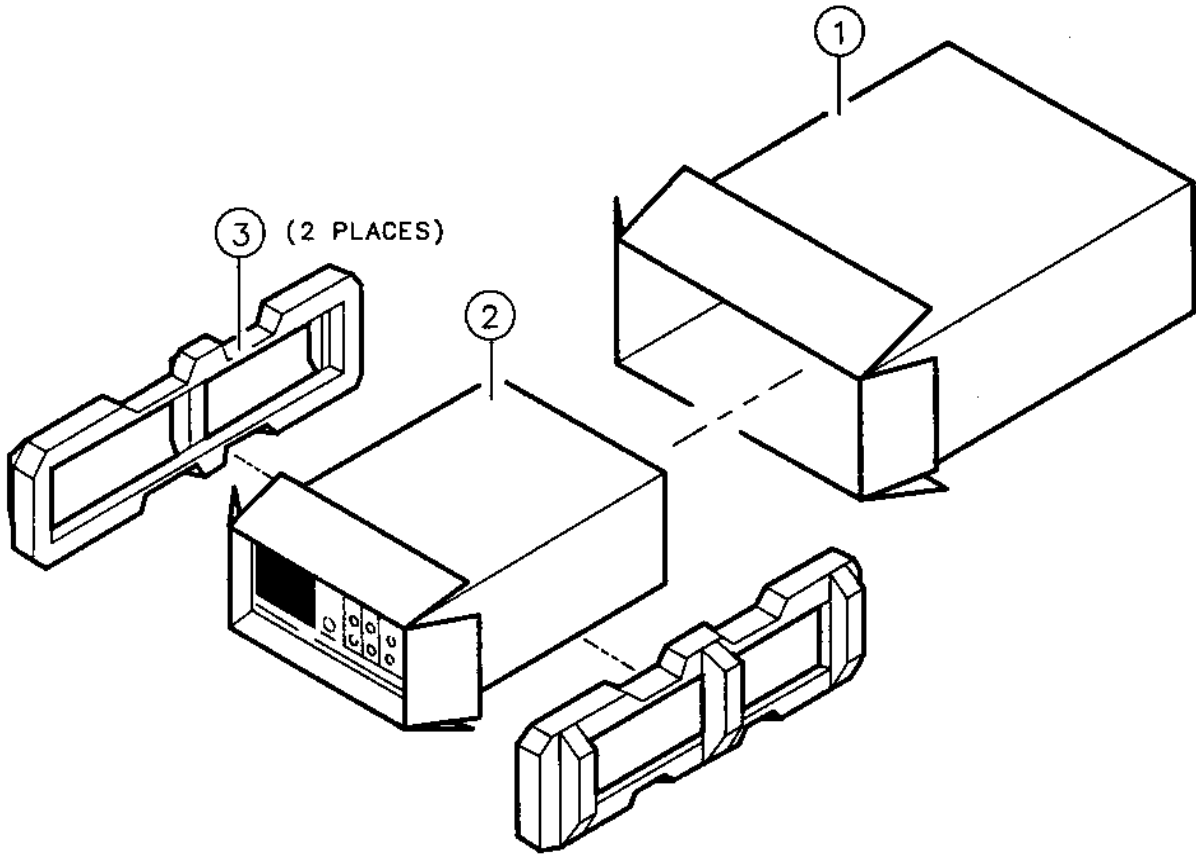

Figure 1-4. Mainframe Packaging Material

Item	HP Part Number	CD	Qty	Description
1	9211-4487	3	1	Carton-Outer
2	5180-2321	9	1	Carton-Inner
3	5180-2319	5	2	Foam Pad ¹
	5180-7829	2	2	Foam Pad ²
¹ Pad for packaging HP 70001A				
² Pad for packaging HP 70206A				

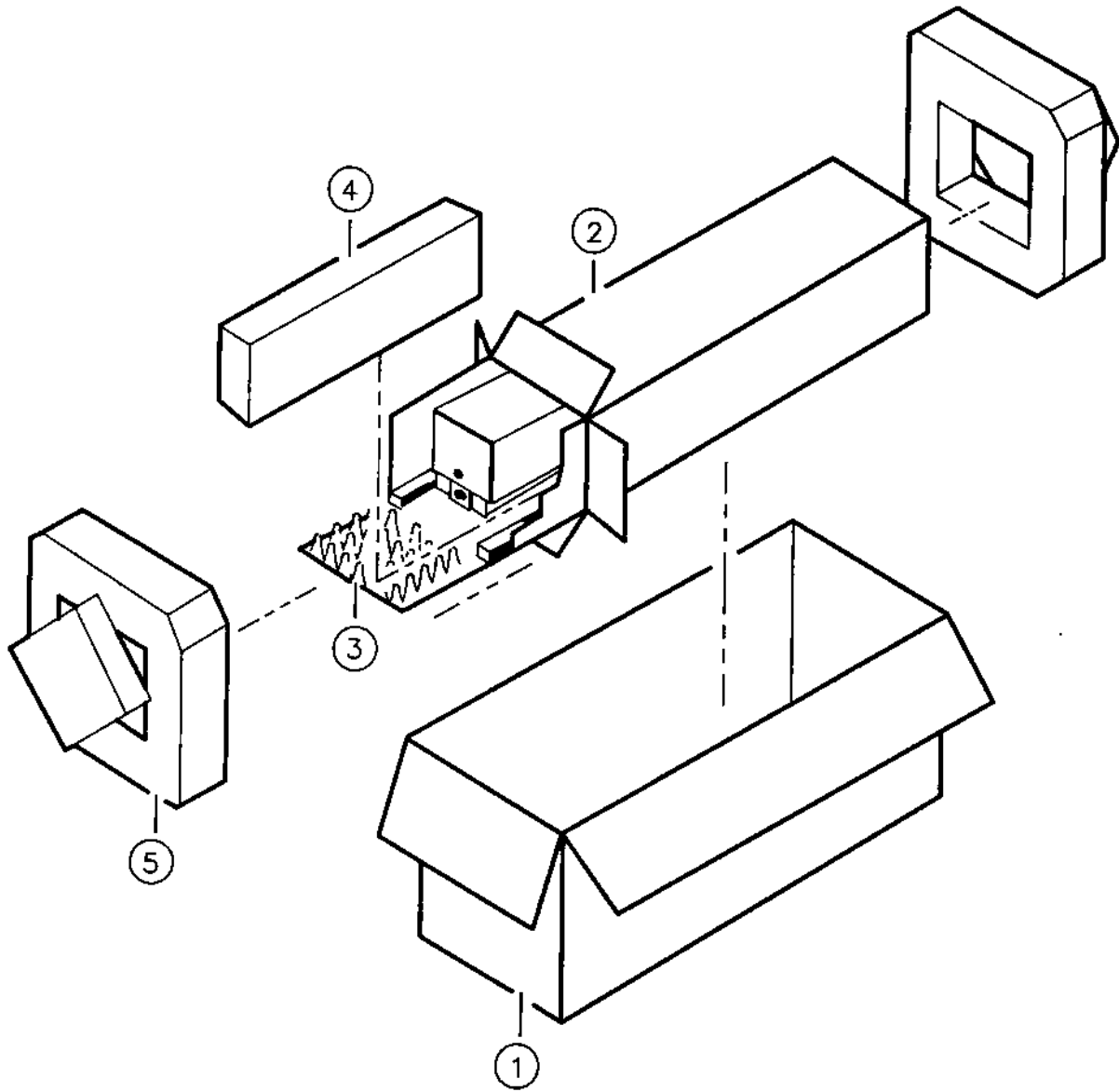

Figure 1-5. Module Packaging Material

Item	HP Part Number	CD	Qty	Description
1	9211-5181	9	1	Carton-Outer
2	9211-5119	0	1	Carton-Inner
3	5180-2369	5	1	Carton-Slider
4	4280-0493	3	2	Foam Insert
5	5180-2370	8	2	Foam Pad

Installation

Introduction

This chapter contains information needed to install the HP 70902A into an HP 70000 Series mainframe, and to configure and cable the HP 70902A for use in an HP 71100A or 71210A spectrum analyzer. These examples cover the HP 70902A cabling requirements for either a single- or dual-IF system configuration. Cabling for single- and dual-IF systems is shown in Figure 2-3 and Figure 2-4 respectively. Depending on the number of IF sections required, one of the two examples will apply when cabling the HP 70902A in other HP 70000 Series spectrum analyzers.

The information presented is general in nature. For more detailed information on spectrum analyzer configuration and HP-MSIB addressing, refer to the installation and verification manual for the system master (for example, HP 70900A Local Oscillator).

Preparation For Use

Installation of the module into an HP 70000 Modular Measurement System requires the following steps:

- Addressing the module
- Installing the module in a mainframe
- Connecting the rear-panel cables

When properly installed, the HP 70902A IF Section obtains both power and interface-bus control through the module rear-panel mainframe/module interconnect. After the module is installed, refer to Chapter 4 to ensure that the module has been properly installed and is operational.

Addressing and cabling examples in this chapter relate to both HP 71100A and HP 71210A spectrum analyzers. For more detailed information about HP 70000 Modular Measurement System configuration, cabling, and addressing, refer to the installation and verification manual for the system master (for example, HP 70900A Local Oscillator).

Addressing the Module

The HP 70902A needs an appropriate HP-MSIB (Hewlett-Packard Modular System Interface Bus) address to allow communications with the system master. The HP 70902A module HP-MSIB address is set using the module's ROW and COLUMN address switches.

Determining the HP-MSIB Address

The HP 70902A has a factory-preset HP-MSIB address of 1, 18 (row 1, column 18). Table 2-1 shows the address map for an HP 71210A Microwave Spectrum Analyzer. The addresses in this table are factory-preset for modules in this system. Refer to the installation and verification manual for the system master for instructions on how to display the instrument address map.

Table 2-1. Typical Address Map

	COLUMN	17	18	19	20
ROW	7		HP 70310A		
ROW	6				
ROW	5				
ROW	4		HP 70908A		
ROW	3				
ROW	2		HP 70903A		
ROW	1		HP 70902A		
ROW	0		HP 70900A		

The HP 70001A mainframe does not have an HP-MSIB address.
The usual address for the HP 70205A or HP 70206A display is row 0, column 4.

Note



The factory-preset addressing of a HP 70902A need not be changed if it is used with other factory-preset modules. If other modules in a system have been changed from factory-preset addresses, the HP 70902A may require re-addressing.

Setting the HP-MSIB Address Switches

A module-address change requires the following steps:

1. Locate the address switches on the right side-panel of the module. See Figure 2-1 for an example of the switches.
2. Set the address switches labeled “row” to the binary value of the module’s HP-MSIB row number. For example, if the row value is 1, set the switches to binary 001 as shown in Figure 2-1.
3. Set the five switches labeled “column” to the binary value of the module’s HP-MSIB column number. For example, if the column value is 18, set the switches to binary 10010 as shown in Figure 2-1.

Note



Changing HP-MSIB addresses requires an understanding of HP-MSIB addressing rules. For information on determining and assigning HP-MSIB addresses, refer to the installation and verification manual for the system master (for example, HP 70900A Local Oscillator).

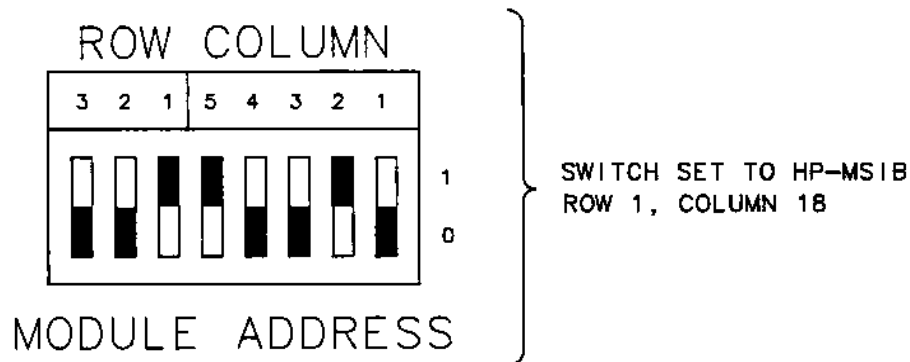

Figure 2-1. Module Address Switches

Installing the Module in the Mainframe

The HP 70902A must be installed in an HP 70000 Series mainframe. This is accomplished by following the procedure below. Figure 2-2 identifies the module and mainframe parts called out in the procedure.

Caution



To avoid blowing the mainframe line fuse or internal module fuses, the mainframe power must be turned off before connecting or disconnecting modules.

Module Installation

1. Turn the mainframe LINE switch off.
2. Open the mainframe front-panel door.
3. Slide the module into the mainframe.
4. Tighten module latch using an 8 mm hex-ball driver while pressing against module front.
5. Connect module cables.
6. Close the mainframe front-panel door.
7. Turn the mainframe LINE switch on.

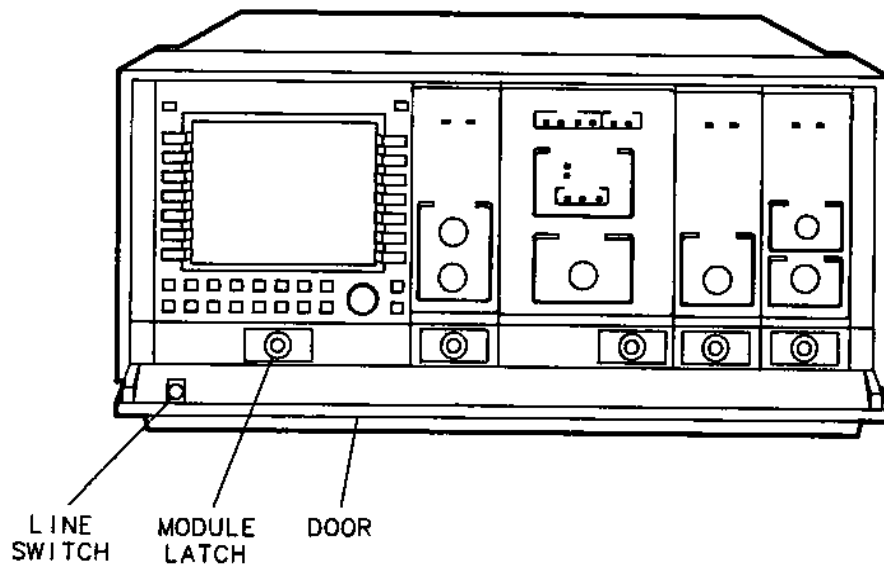

Figure 2-2. Module Installation

Connecting the Rear-Panel Cables

This section contains instructions for connecting the rear-panel cables to an HP 70902A in either an HP 71100A or an HP 71210A spectrum analyzer as examples of a single and a dual IF section system. The cables supplied with an HP 70902A module ordered separately allow it to be installed as shown in the examples. Longer cables must be ordered for other configurations. If questions arise concerning other configurations or cabling arrangements, refer to the installation verification manual for the system master.

Rear-Panel Cables for HP 71100A RF Spectrum Analyzer

Figure 2-3 illustrates typical rear-panel cable connections for an HP 71100A RF Spectrum Analyzer. This single-IF spectrum analyzer illustration includes cables normally supplied as accessories when an HP 70902A is ordered separately. Using Table 2-2 for identification and Figure 2-3 as an example, connect the IF rear-panel cables as described in the steps below.

Table 2-2. HP 70902A RF Cables

Type	Length	HP Part Number
Coax SMB (f), 50Ω	3/8 span, 19 cm (7.5 in.)	5061-9017
Coax SMB (f), 50Ω	7/8 span, 39 cm (15.375 in.)	5061-9021

HP 71100A IF Section Cable Connections

- Connect the RF Section 21.4-MHz OUT and the HP 70902A IF Section 21.4-MHz IN, using the long SMB cable.
- Connect the HP 70902A IF Section VIDEO OUT and the HP 70900A LO VIDEO IN, using the short SMB cable.

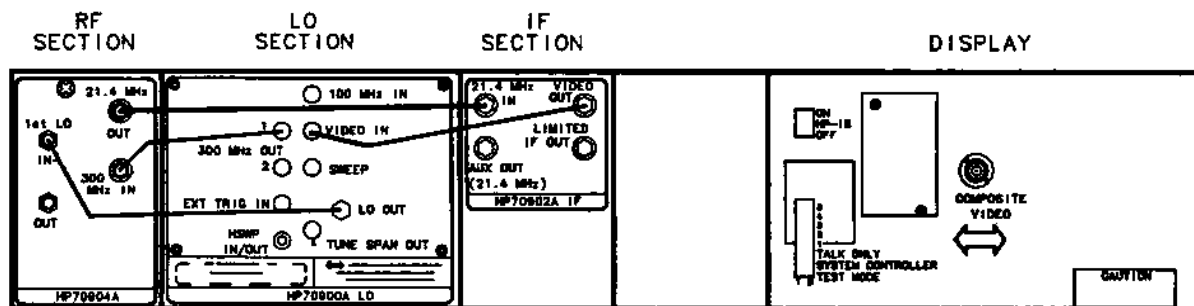

Figure 2-3. Typical HP 71100A Spectrum Analyzer Rear-Panel Cables

Rear-Panel Cabling for HP 71210A Microwave Spectrum Analyzer

Figure 2-4 depicts the rear-panel connections of an HP 71210A Microwave Spectrum Analyzer, which includes both an HP 70902A and an HP 70903A. Using Figure 2-4 as an example, connect the IF rear-panel cables as described below.

HP 71210A Dual IF Section Cable Connections

HP 70903A cable installation.

- Connect the RF Section 21.4-MHz OUTPUT and the HP 70903A IF Section 21.4-MHz INPUT.
- Connect the HP 70903A IF Section VIDEO OUT and the HP 70900A LO VIDEO IN.

HP 70902A cable installation.

- Connect the HP 70903A IF Section 21.4-MHz OUTPUT and the HP 70902A IF Section 21.4-MHz INPUT.
- Connect the HP 70902A IF Section VIDEO OUT and the HP 70903A IF Section VIDEO IN.

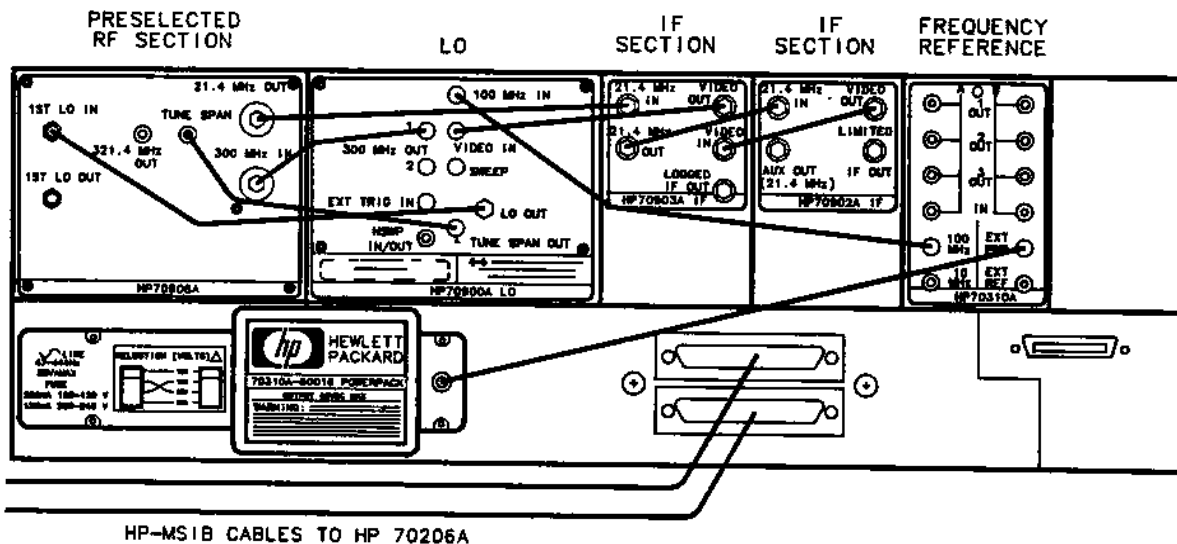

Figure 2-4. HP 71210A Microwave Spectrum Analyzer Rear-Panel Cables

Note



Do not use the HP 70902A AUX OUTPUT to connect to another IF section's 21.4-MHz IN. The power level from this auxiliary connector is 10 dB too low for this purpose.

Caution



All SMA and APC 3.5 connectors should be tightened to 5 to 8 inch-pounds. The connector mounting threads will be damaged if more than 8 inch-pounds torque is applied.

Specifications

There are no module specifications for the HP 70902A IF Section. For system-level specifications and characteristics, refer to the installation and verification manual for the system master.

3-2 Specifications

Verification

Introduction

This chapter normally contains module performance-verification tests, which evaluate the electrical performance of the module against its specifications. Since there are no module specifications for the HP 70902A IF Section, no module performance-verification tests apply.

Module Self-Test

A module self-test is performed on all modules in an HP 70000 Modular Measurement System each time the instrument is turned on. During this self-test, the ACT (Active) and ERR (Error) status indicator LEDs will blink on, then off, as the analyzer checks the operation of each module. If the LEDs stay on or continue to blink, refer to Chapter 5, "Troubleshooting".

Calibration

It is possible to check the calibration of various functions of the HP 70902A IF Section by using HP 11990A System Performance Tests. For information on calibration, refer to the installation and verification manual for the system master.

Signal Analyzer Operation Verification

It is possible to verify the electrical performance of the entire spectrum analyzer, including log fidelity and resolution bandwidth of the HP 70902A IF Section by using System Operation Verification Programs. Refer to the installation and verification manual for the system master regarding System Operation Verification Programs.

4-2 Verification

Troubleshooting

Introduction

This chapter provides information on the front-panel status indicator lights and the error messages produced by the HP 70902A IF Section. If problems are encountered, review Chapter 2 of this manual to ensure the module addressing switches are properly set, cabling is correct, and the module is securely seated in the mainframe. If problems persist, refer to the installation and verification manual for the system master for troubleshooting tools, or *HP 70902A Technical Reference* for component-level problem isolation and repair.

Troubleshooting Tools

The Modular Spectrum Analyzer has the following troubleshooting tools.

- Indicator lights
- Error Message Reporting
- Display Tests
- Analyzer Tests

The following troubleshooting programs are available for use with HP 70000 Modular Measurement Systems.

- System Diagnostics
- System Operation Verification

Refer to “Troubleshooting” in the installation and verification manual for the system master for a description of these tools and programs.

Status Indicators

There are two status-indicator LEDs located on the front panel. It is normal for both of the front-panel status LED indicators to flash on, then off, during the module self-test. Self-test occurs each time the instrument is turned on. The following pages list reasons why each status LED might light.

STATUS ACT

Note

The ACT LED of a slave module is only operative when there is a display in the system or when the instrument is performing a self-test.

The ACT LED of a slave module turns on when:

- The module is performing a function directed by manual control of the display keyboard
- The module is making a measurement and its master has keyboard control of the display.
- The instrument is in self-test mode

Refer to the installation and verification manual for the system master for additional detail related to ACT LED.

STATUS ERR

The module error indicator, the STATUS ERR light, indicates when the module has an error condition. If the module is a slave, then the error light of both the slave and its master will indicate the error condition.

- The Status ERR Indicator LED light flashes at a 1 Hz rate when communication over HP-MSIB is not satisfactorily completed.
- If the error indicator LEDs of more than one of the spectrum analyzer's modules flash at a 1 Hz rate simultaneously, refer to the installation and verification manual of the system master.
- Some errors may only be present when the spectrum analyzer sweeps and thus cause the error indicator to flash at the sweep rate.

Note

It is possible that a module may disrupt all HP-MSIB communication without its own error indicator flashing.

Caution

Do not remove the module side covers. A complete electrical alignment of the module is required when the side covers are removed. Refer to the *HP 70902A Technical Reference* for alignment procedures.

Module Self-Test

During module self-test, which occurs each time the analyzer is turned on, the ACT (Active) and ERR (error) LEDs will blink on momentarily as the analyzer activates and checks the module. If the LEDs continue to blink, or remain lit, this is an indication of a problem.

Error Messages

Spectrum-analyzer error-messages generated by an HP 70902A are listed in this section. The messages are grouped by functional category; each category has its own series of numbers. Refer to the installation and verification manual for the system master for a complete list of all system error-messages.

Table 5-1. Error Message Grouping

Type	Numbers
Usage/Operating	2000 to 2999
Hardware Warning	6000 to 6999
Hardware Broken	7000 to 7999

Usage/Operating Errors

Usage and operating errors are generated when an instrument is used incorrectly. This usually occurs during remote operations.

Hardware Warning Errors

These error codes report the status of the HP 70902A hardware. An error indicates that some of the hardware is not functioning properly. Measurement accuracy may be impaired.

Hardware Broken Errors

These error codes are generated by hardware or firmware failures within the module and are usually catastrophic to operation of the module.

Table 5-2. HP 70902A Error Messages

Error Number	Message	Meaning
2001	ILLEGAL CMD	This error occurs when the module encounters a command it does not recognize. This can be caused by the master element sending such a command, a problem internal to the module, or an open cable between the master and module. The problem can be isolated by substituting master, mainframe and/or IF Sections.
2002	ILLEGAL PARAMETER	Refer to 2001 ILLEGAL CMD.
2006	PARAMETER OUT OF RANGE	Refer to 2001 ILLEGAL CMD.
2009	PROTOCOL ERROR	Refer to 2001 ILLEGAL CMD.
6000	EAROM UNPROTECTED	Check the write-protect switch on the left side of the module. Verify it is in the PROTECT position.
7000	ROM CHECK ERROR	The programmed checksum of the ROM does not agree with the computed checksum.

5-4 Troubleshooting

Index

A

- Accessories 1-4
- ACT LED 1-5, 5-1
- Addressing
 - HP-MSIB 2-2
 - the module 2-2

C

- Cabling 2-5

E

- ERROR LED 1-5, 5-2
- Error messages 5-3
- ESD
 - heel-strap 1-8
 - protection 1-8
 - static mat;floor 1-8
 - static mat;table 1-8
 - wrist-strap 1-8

I

- Installation 2-1, 2-4

M

- Manual updating 1-4
- Module self-test 5-2

P

- Packaging
 - containers 1-12
 - damage 1-4
 - material; mainframe 1-14
 - material; modules 1-15
- PC board handling 1-9
- PC board storage 1-9
- Preparation for use 2-1

S

- Serial number
 - label 1-3
 - prefix 1-4
- Setting address switches 2-3
- Shipping
 - containers 1-12



HP MANUAL PART NUMBER 70902-90021

PRINTED IN U.S.A.