



**HEWLETT
PACKARD**

OPERATING MANUAL

HP 70900A LOCAL OSCILLATOR

MODULAR SPECTRUM ANALYZERS

**LOCAL OSCILLATOR FIRMWARE
VERSION 880901**

**DISPLAY FIRMWARE
VERSION 860625**

This manual applies directly to the following modules:

HP 70205A	Graphics Display
HP 70206A	System Graphics Display
HP 70300A	Tracking Generator (Range 20 Hz–2.9 GHz)
HP 70301A	Tracking Generator (Range 2.7–18 GHz)
HP 70310A	Precision Frequency Reference
HP 70590A	H69 MATE Test Module Adapter
HP 70600A	Preselector (Range 0–22 GHz)
HP 70601A	Preselector (Range 0–26.5 GHz)
HP 70620A	Preamplifier (Range 50 kHz–26.5 GHz)
HP 70700A	Digitizer (Rate 20 Msamples/sec)
HP 70900A	Local Oscillator
HP 70902A	IF Section (Res BW 10 Hz–300 kHz)
HP 70903A	IF Section (Res BW 100 kHz–3 MHz)
HP 70904A	RF Section (100 Hz–2.9 GHz)
HP 70905A/B	RF Section (50 kHz–22 GHz)
HP 70906A/B	RF Section (50 kHz–26.5 GHz)
HP 70907A	External Mixer Interface
HP 70908A	RF Section (RANGE 0–22 GHz)

**COPYRIGHT HEWLETT-PACKARD COMPANY 1986. ALL RIGHTS RESERVED
1212 VALLEY HOUSE DRIVE, ROHNERT PARK, CALIFORNIA 94928-4999 U.S.A.**

**Manual Part Number 5958-4233
Microfiche Part Number 5958-4234**

Printed: JAN 1986

Supplement Part Number: 70900-90141 (Rev.01SEP88) U0988

DOCUMENTATION DESCRIPTION

The following manuals are provided with the HP 71000A Modular Spectrum Analyzers.

System Support Manual

This is the service manual for the Modular Spectrum Analyzers. It provides installation procedures, specifications, troubleshooting information, and user documentation for the System Verification software.

Operating Manual

This manual is divided into three parts:

Manual Operation (Part I) tells how to use the instrument manually.

Remote Operation (Part II) explains how to program and operate the instruments remotely.

Display Operation (Part III) describes features of the graphic display. It tells how to configure the display screen, obtain hardcopy outputs, examine the addresses of modules on the HP-MSIB, and receive error reports.

Remote Language Reference

This reference lists the Modular Spectrum Analyzer remote commands. Each command is described; each description contains a syntax flow chart and a definition of the command parameters including their range.

At the back of the reference is a Keyword Summary, which lists the commands by function.





HEWLETT
PACKARD

OPERATING MANUAL

HP 71000A

SPECTRUM ANALYZER

100Hz-2.9GHz/50KHz-26.5GHz

© HEWLETT-PACKARD COMPANY 1984. ALL RIGHTS RESERVED
1212 VALLEY HOUSE DRIVE, ROHNERT PARK, CALIFORNIA, 94928, U.S.A.

Manual Part No. 5958-4233
Microfiche Part No. 5958-4234

Printed: AUGUST 1985



HP 70000 MODULAR MEASUREMENT SYSTEM DOCUMENTATION OUTLINE

Instruments and modules of the HP 70000 Modular Measurement System are documented to varying levels of detail. Modules that serve as masters of an instrument require operation information in addition to installation and verification instructions. Modules that function as slaves in a system require only a subset of installation and verification information.

MANUALS SUPPLIED WITH MODULE

Installation and Verification Manual

Topics covered by this manual include installation, specifications, verification of module operation, and some troubleshooting techniques. Manuals for modules that serve as instrument masters will supply information in all these areas; manuals for slave modules will contain only information needed for slave module installation and verification. Master module documentation may also include some system-level information.

Operating and Programming Manual

Information in this manual usually pertains to multiple- and single-module instrument systems. The manual may occupy one or two volumes. The Operating section describes manual operation of the module, with explanations of softkeys and their use. The Programming section defines commands that enable remote operation of the module, and describes remote command syntax.

SERVICE MANUAL, AVAILABLE SEPARATELY

Technical Reference

When available, this manual provides service information for a module, including performance verification, adjustments, troubleshooting, replaceable parts lists, replacement procedures, schematics, and component location diagrams. For ordering information, contact an HP Sales and Service Office.

Rev. MAY87



CONTENTS OF OPERATING MANUAL

PART I

Manual Operation

- 1. General Information**
- 2. Getting Started**
- 3. USR Hardkey**
- 4. MNU Hardkey**
- 5. Appendices**
- 6. Index**

PART II

Remote Operation

- 1. Getting Started**
- 2. Programming Fundamentals**
- 3. Advanced Programming**
- 4. Appendices**
- 5. Index**

PART III

Display Operation

- 1. Getting Started**
- 2. DSP Hardkey (Manual Display Operation)**
- 3. Remote Operation**
- 4. Appendices**
- 5. Index**

CONTENTS OF OPTIONAL MODULES

[] Tracking Generator

[]

[]

PART I

Manual Operation

CHAPTER 1

GENERAL INFORMATION

Description: This chapter describes the various instruments in the system mainframe and shows drawings of each of the modules.

Introduction1-1
Module Descriptions1-2
System Descriptions	1-12

CHAPTER 2

GETTING STARTED

Description: This chapter describes the front panel of the instrument, explains the softkey concept, and shows you how to make some typical measurements (with examples).

Introduction2-1
Front Panel Concept2-2
Softkey Controls2-7
Making Measurements2-8

CHAPTER 3

USR HARDKEY

Description: This chapter explains how to use the [USR] hardkey and how to select and change softkeys. It also shows how to go from automatic to manual coupling and back using a set of softkeys.

Introduction3-1
Using [USR] hardkey3-3
Defining Your Own Softkey Function3-3
Selecting Auto Function3-4

CHAPTER 4
MNU HARDKEY

Description: This chapter provides an overview of the MNU hardkey. In addition, it shows you how to select different functions of the spectrum analyzer.

Introduction	4-1
Frequency	4-5
Amplitude	4-19
Sweep Control	4-31
Marker	4-37
Bandwidth	4-55
Trace	4-62
Instrument Display	4-70
State	4-78
Special Function	4-80
Configuration	4-87
Calibration	4-89
Ext Mixer	4-94

APPENDICES

INDEX

CHAPTER 1

GENERAL INFORMATION

Description: This chapter describes the various instruments in the system mainframe, and shows drawings of each of the modules.

Introduction1-1
Module Descriptions1-2
HP 70001A Mainframe1-2
HP 70205A Graphics Display1-3
HP 70206A System Graphics Display1-4
HP 70900A Local Oscillator1-4
HP 70904A RF Section (100Hz - 2.9GHz)1-6
HP 70905A RF Section (50kHz - 22GHz).1-7
HP 70906A RF Section (50kHz - 26.5GHz).1-8
HP 70902A IF Section (RES BW 10Hz - 300kHz).1-8
HP 70903A IF Section (RES BW 100kHz - 3 MHz).1-8
HP 70907A External Mixer Interface	1-10
HP 70300A RF Tracking Generator.	1-11
System Descriptions	1-12
HP 71100A RF Spectrum Analyzer(100Hz-2.9GHz)	1-12
HP 71200A Microwave S.A.(50kHz-22/26.5GHz)	1-12
HP 71300A Millimeter S.A.	1-13
System Options	1-14
Support Options	1-14



Introduction

This manual describes manual, remote and display operation of the HP 71000A Modular Spectrum Analyzer Systems Series. The manual is divided into three parts. Part I (Manual Operation) tells how to use the instrument manually. Part II (Remote Operation) explains how to program and operate the instruments remotely. Part III (Display Operation) focuses on the features of the graphic displays. It shows users how to configure the display screen, obtain hardcopy outputs, examine the addresses of the modules on the HP-MSIB, and receive error reports.

All three parts are organized in chapters, sections, and subsections. For example, the MNU chapter has a section on Frequency and a subsection on Center Frequency. Part I, II, and III are differentiated by blue tabs, the chapters by white tabs, the sections by annotation at the top of the pages, and the subsections by listings in the chapter contents and the index.

This chapter, General Information, describes the HP Modular Measurement System and includes drawings of the modules. It also lists the modules in the three different systems and summarizes their specifications.

Module Descriptions

The Modular Signal Analyzer is the first product introduced as part of the HP 70000A Modular Measurement System. This modular automatic test system is built around a powerful new mainframe and may ultimately include a wide range of test instruments such as analyzers, sources, and conditioners.

The Modular Signal Analyzer product family initially consists of two displays, eight modules and a mainframe configurable as RF, microwave and millimeter wave spectrum analyzers.

Described below are the modules which are part of the Modular Measurement System.

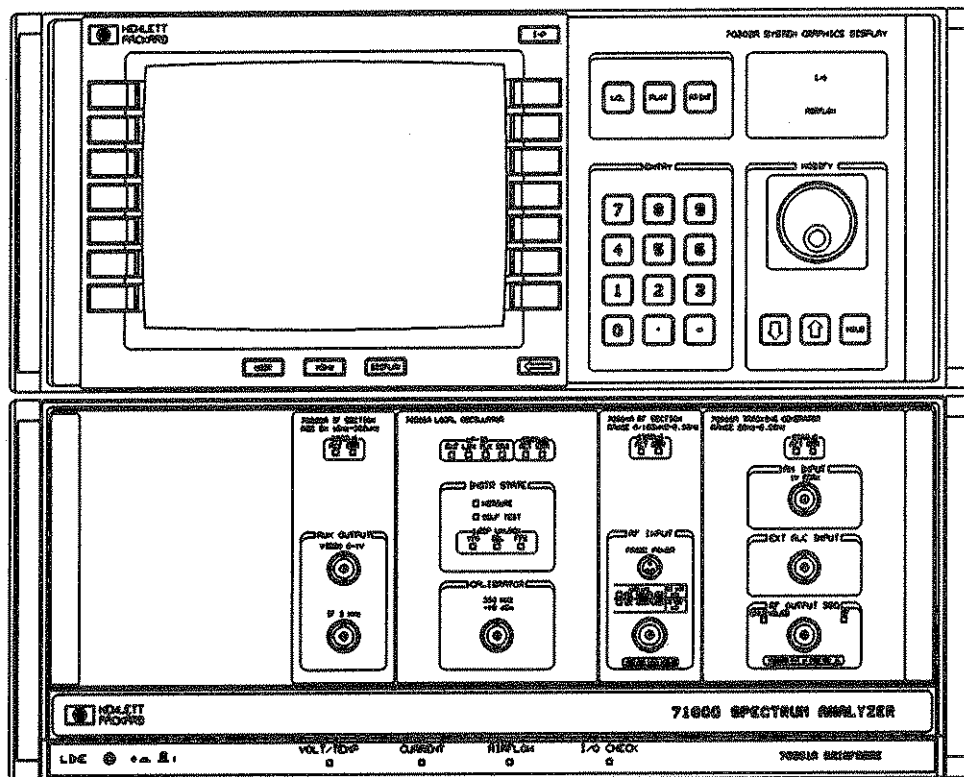

Fig. 1-1. Modular Measurement System

HP 70001A Mainframe

The HP 70000 Modular Measurement System mainframe provides the structural environment for plug-in instrument modules along with cooling, power, and digital communication bus interface. It is compatible with 1/8, 1/4, 3/8, and 1/2 width modules and has a maximum capacity of eight one-section (1/8 width) modules. External appearance is similar to System II cabinets. Rack compatibility is provided and benchtop use is facilitated with integral bails and optional handles.

Two digital buses are provided: HP-IB remote operation, and a new high performance bus called (Module System Interface Bus) for intermodule communication. The mainframe has good EMC performance (MIL-STD 461B) and has been designed to withstand the rigors of tough, industrial environments. It provides a solid, reliable base around which Modular Signal Analyzer systems may be easily configured.

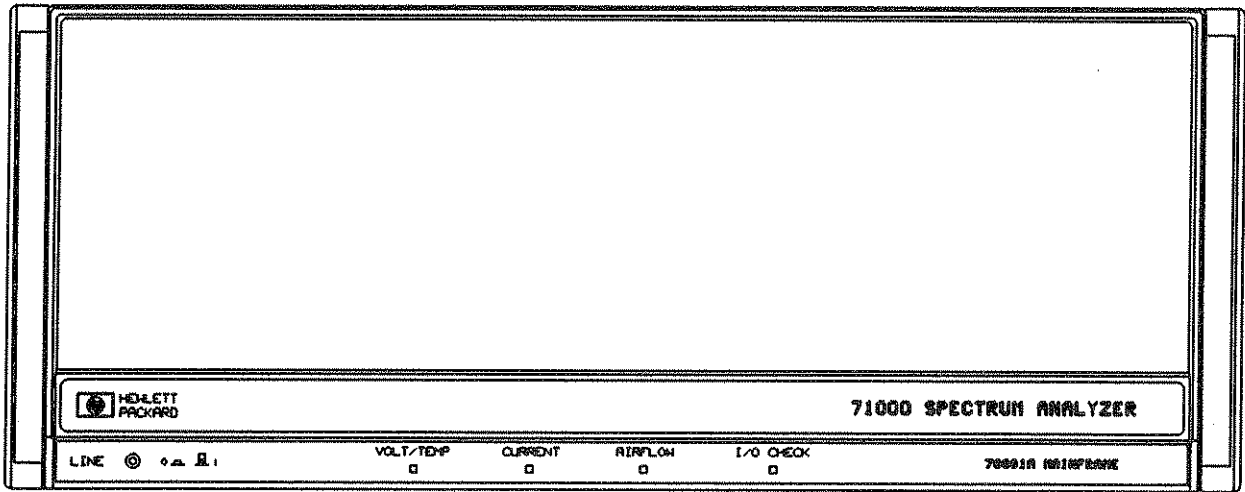

Fig. 1-2. HP 70001A Mainframe

HP 70205A Graphics Display

The Graphics Display is a 3/8 module which provides the human interface and manual control for the HP 70000 Modular Measurement System. It can display modular instrument status and measured output and has graphics, trace, text and marker capability. Controls include 14 user definable menu keys (these are referred to as Softkeys in the text), 10 data keys, 10 control keys (3 of the keys are referred to as Hardkeys in the text) and an analog control knob. Instrument control is accomplished by using the menu keys to establish an interactive front panel for the accessed instrument.

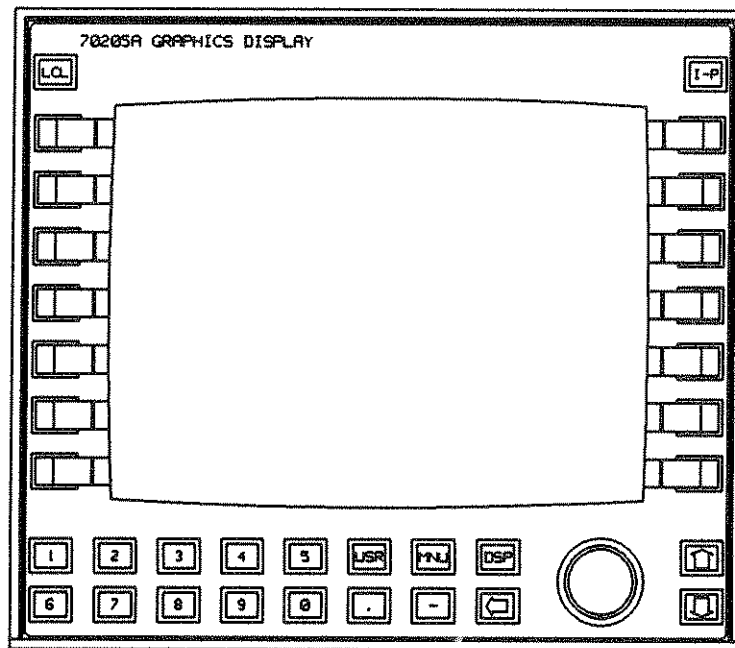

Fig. 1-3. HP 70205A Graphics Display

HP 70206A System Graphics Display

The System Graphics Display is a "stand-alone" large screen display for the HP 70000 Modular Measurement System. It uses a 9 inch raster CRT in a 7 inch, full rack System II frame and is stack compatible with the HP 70001A Mainframe and other System II instruments. It supplies the same display and manual control capability as the HP 70205A Graphic Display. Hardkeys on the HP 70205A slightly differ from the hardkeys on the larger HP 70206A. For example, on the HP 70205A the "display hardkey" is denoted by [DISPLAY] while on the HP 70206A the same hardkey is abbreviated to [DSP]. Although the key functions are identical, the abbreviated hardkey labels are used exclusively throughout this operating manual. The primary advantages of the HP 70206A are its large display size and the fact that when it is used in place of the Graphics Display, a 3/8 section of mainframe capacity is released for other modules.

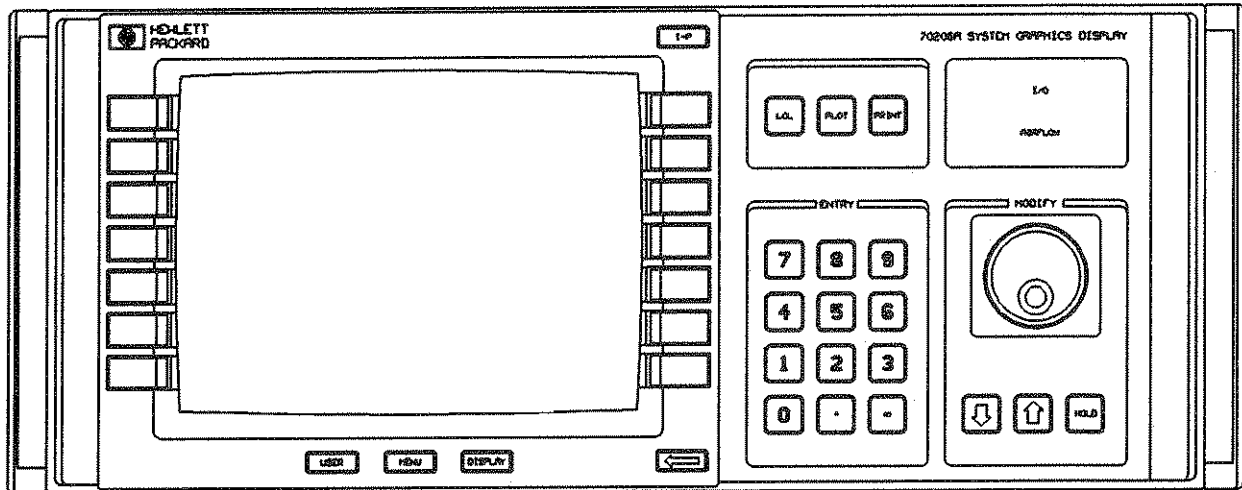

Fig. 1-4 . HP 70206A System Graphics Display

HP 70900A Local Oscillator

This 1/4 width module consists of three elements: a local oscillator (LO), a controller, and a video processor. The LO supplies a swept signal with a frequency range of 3.0 to 6.6 GHz for use by the front end modules, tracking generator, external mixer interface module or any other module or device requiring the signal. For spans ≤ 10 MHz the sweep is fully synthesized using fractional-N techniques while for spans > 10 MHz lock-and-roll tuning is used.

The video processor digitizes the video signal received from the IF module and processes this signal using normal (Rosenfell), positive peak, negative peak or sample detection.

The controller contains the system firmware which controls and coordinates measurements. Other system modules (Front Ends, IF, Tracking Generator, etc.) are slave modules which are controlled by the Local Oscillator module. Figure 1-5 shows the front and back view of the Local Oscillator module with the annotation included.

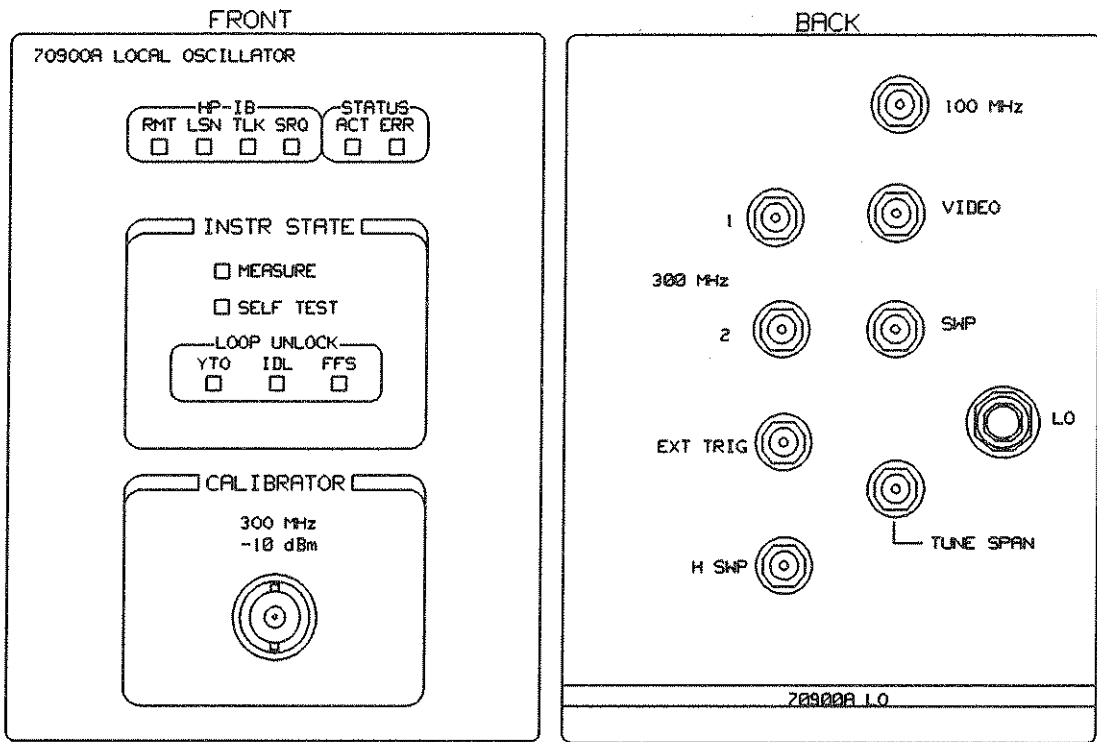

Fig. 1-5. L.O. module HP 70900A

HP 70904A RF Section (100Hz - 2.9GHz)

This 1/8 width module provides an input attenuator and converts the incoming RF signal to a 21.4 MHz IF. The RF front end (HP 70904A) has selectable input coupling with frequency ranges of 100 Hz - 2.9 GHz (DC coupled) and 100 kHz - 2.9 GHz (AC coupled). Figure 1-6 shows the front and back view of the R.F. section with the annotation included.

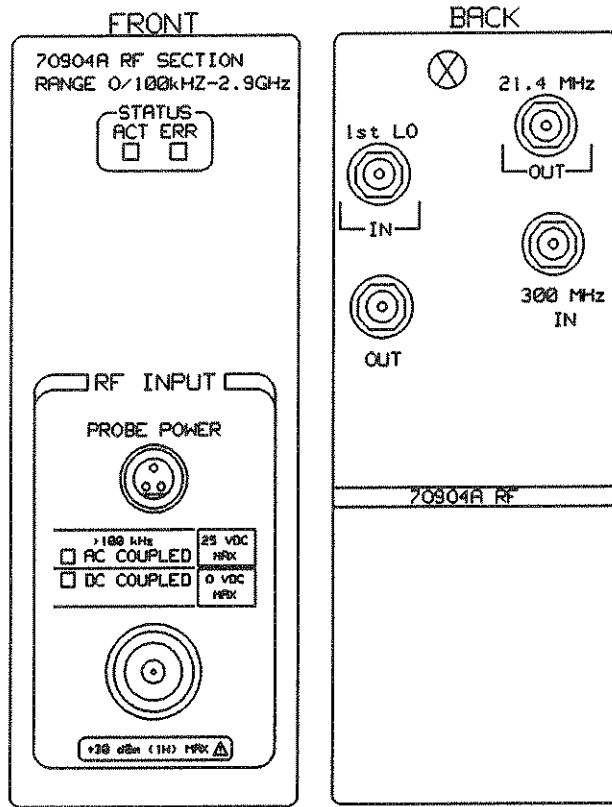

Fig. 1-6. R.F. module HP 70904A

HP 70905A RF Section (50kHz - 22GHz)

The 50 kHz - 22 GHz MW front end (HP 70905A) uses a Type N connector. Figure 1-7 shows the front and back view of the R.F. section with the annotation included.

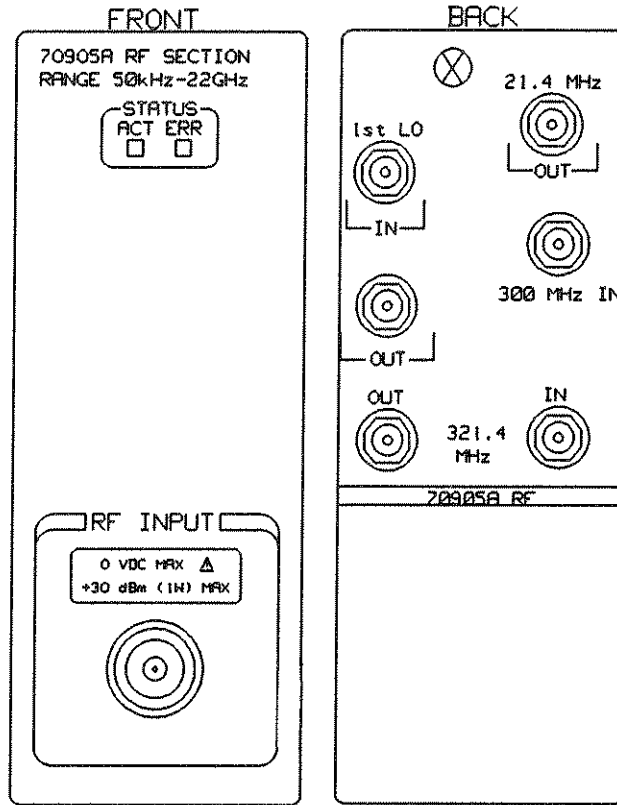

Fig. 1-7. R.F. module HP 70905A

HP 70906A RF Section (50kHz - 26.5GHz)

The 50 kHz - 26.5 GHz MW front end (HP 70906A) uses an APC-3.5 connector. Both MW front ends are unpreselected. Figure 1-9 shows the front and back view of the R.F. Section module with the annotation included.

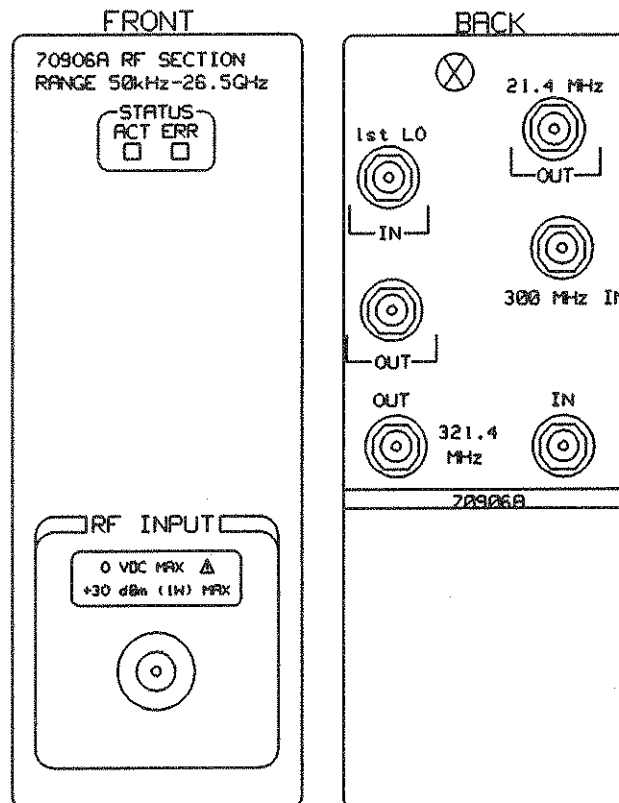

Fig. 1-9. R.F. module HP 70906A

HP 70902A IF Section (RES BW 10Hz - 300kHz)

HP 70903A IF Section (RES BW 100kHz - 3 MHz)

The 1/8 width IF modules process the 21.4 MHz signal received from the RF section or external mixer interface module. They contain resolution bandwidth filters, log amplifier, detection circuitry and video filters. Each IF module produces a detected video signal which is output to the video processor in the LO/Control module.

The HP 70902A IF contains filters ranging from 10 Hz - 300 kHz, selectable in a 1, 3, 10 sequence or in 10% increments (except from 3 kHz - 7 kHz). The HP 70903A IF offers filters from 100 kHz - 3 MHz, also selectable in a 1, 3, 10 sequence or in 10% increments (except for 3-10kHz BW). Figures 1-10 and 1-11 show the front and back views of the I.F. Section module with the annotation included.

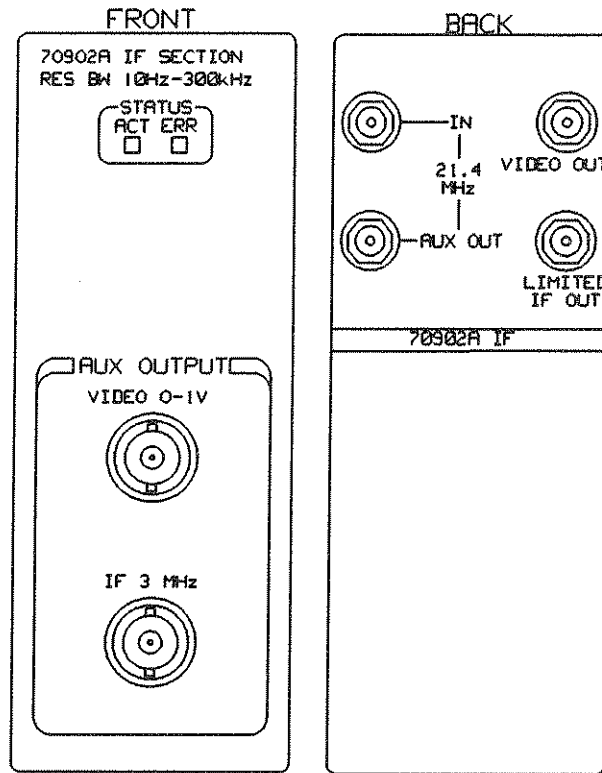

Fig. 1-10. I.F. module HP 70902A

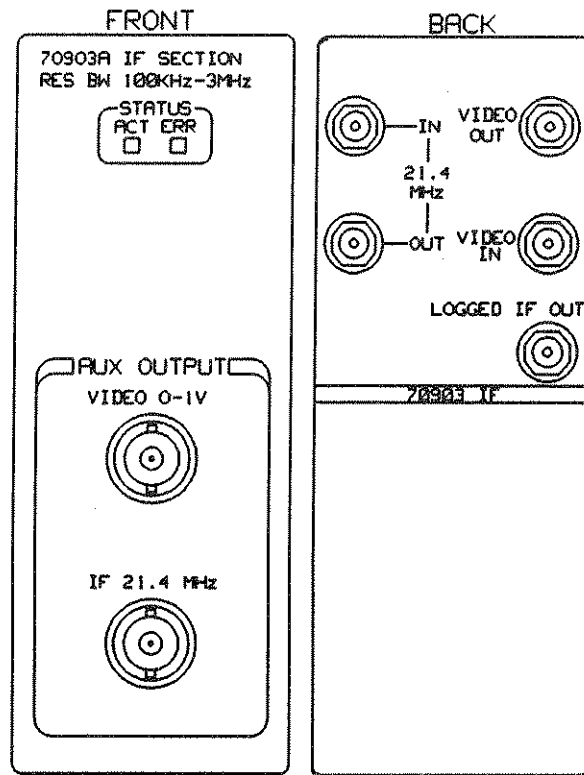

Fig. 1-11. I.F. module HP 70903A

HP 70907A External Mixer Interface

This module provides a convenient interface between external mixer and the Modular Signal Analyzer system. It contains an LO amplifier, diode bias supply, and downconversion circuitry to convert the 321.4 MHz input IF to a 21.4 MHz IF which is supplied to one of the IF modules. Modular Signal Analyzer's frequency range can be extended to 60 GHz using the HP 11970 harmonic mixer series with this module and to over 300 GHz by using mixers supplied by other manufacturers. Special applications down to 2.7 GHz can also be addressed with external mixers using this module.

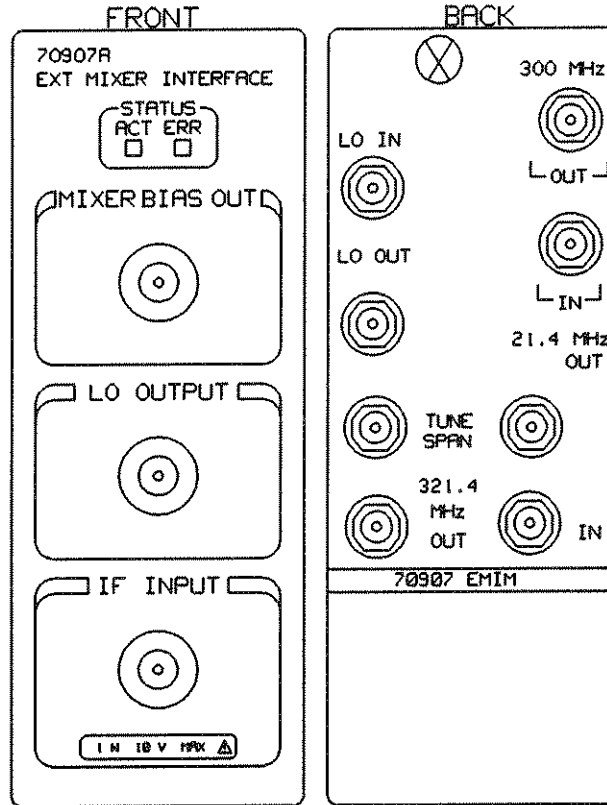

Fig. 1-12. External Mixer Interface HP 70907A

HP 70300A RF Tracking Generator

This module generates a signal which tracks the tuned frequency of the Spectrum Analyzer. Frequency range of the output is 20 Hz - 2.9 GHz with an amplitude range of -10 dBm to -20 dBm. Selection of the attenuator option increases the amplitude range to -80 dBm. A phaselocked 21.4 MHz source option allows frequency offsets of up to +/- 10 MHz. Measurement dynamic range exceeds 125 dB with the standard module and will be greater than 150 dB with an output amplifier option to be provided later. Amplitude modulation is also available and built-in firmware allows component test measurements to be made with unparalleled ease.

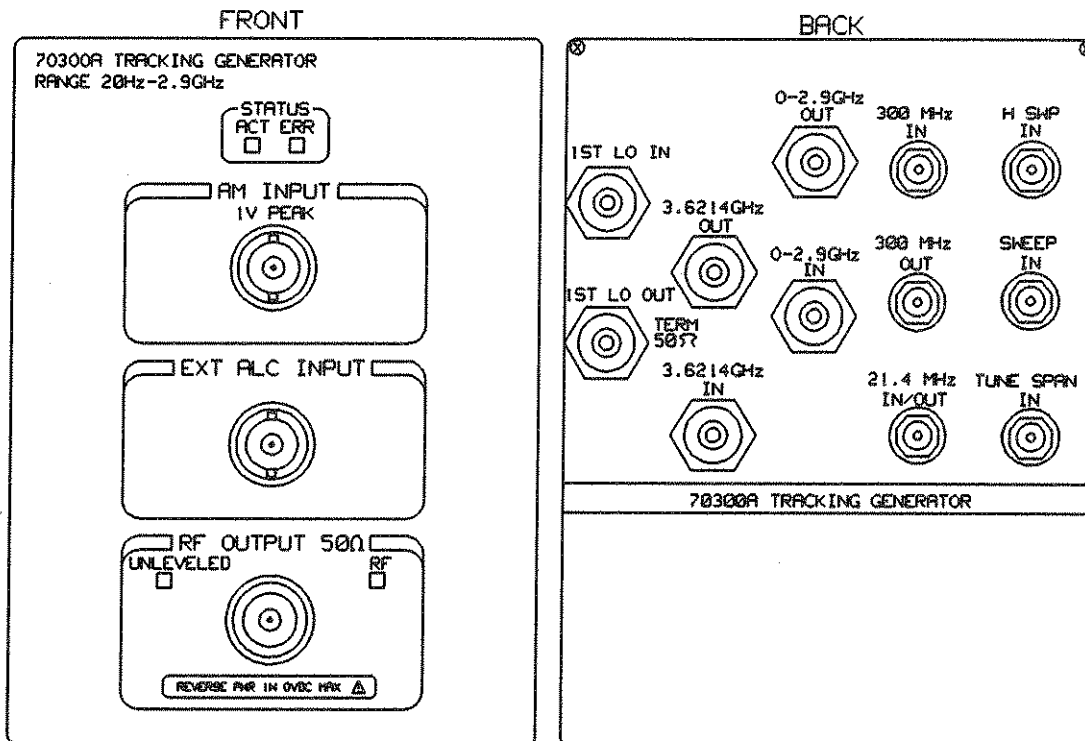

Fig. 1-12. Tracking Generator module HP 70300A

System Descriptions

Three general-purpose instrument systems will be covered in this operating manual: the HP 71100A Radio Frequency Spectrum Analyzer, the HP 71200A Microwave Spectrum Analyzer, and the HP 71300A Millimeter Wave Spectrum Analyzer. When a system is ordered, the factory will insert the required modules and blank panels into the mainframe, supply the necessary intermodule cabling, and perform a functional check on the system. A limited number of options will be available with each system to allow you the flexibility in choosing displays, IF sections, frequency ranges, and types of service. The Modular Signal Analyzer System Reference program (e.g. 71000S) will enable you to order a custom system and have it configured by the factory.

In addition to the system, you may order individual modules, blank panels, and cables from the Modular Signal Analyzer equipment list. This allows you to extend the capability of previously ordered systems, stock back-up modules, and configure your own system if one of the standard systems or the system reference program does not meet your needs. When modules are ordered individually, they will be shipped together, but will not be configured as a system and given a functional check.

These systems and options are configured and given a functional check at the factory. Required cables and blank panels are included and the System is loaded into the mainframe for shipment. A one-year return-to-HP warranty is included as a standard item with each system.

HP 71100A RF Spectrum Analyzer (100Hz-2.9GHz)

- HP 70001A Mainframe
- HP 70205A Graphics Display
- HP 70900A Local Oscillator
- HP 70902A IF Section (RES BW 10Hz-300kHz)
- HP 70904A RF Section (100Hz-2.9GHz)

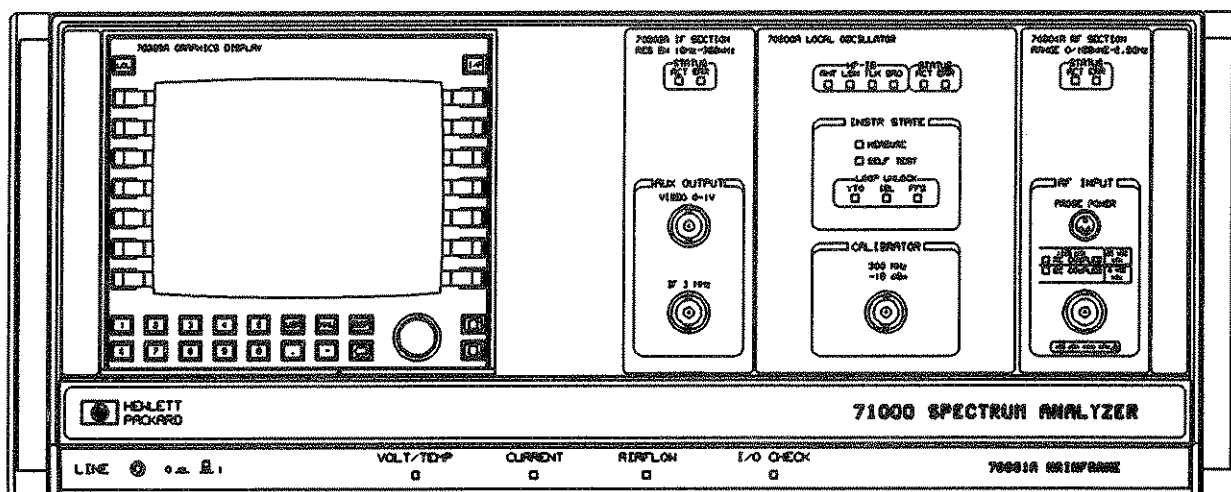

Fig. 1-13. HP 71100A Measurement System

HP 71200A Microwave S.A. (50kHz-22/26.5GHz)

- HP 70001A Mainframe
- HP 70205A Graphics Display
- HP 70900A Local Oscillator
- HP 70902A IF Section (RES BW 10Hz-300kHz)
- HP 70905A RF Section (50kHz-22GHz)

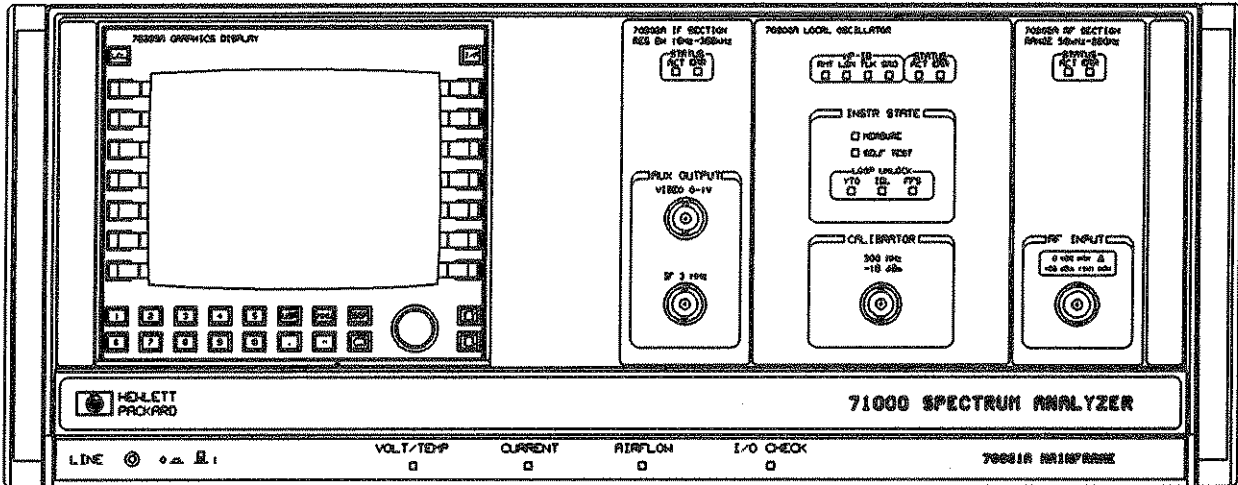

Fig. 1-14. HP 71200A Measurement System

HP 71300A Millimeter S.A.

- HP 70001A Mainframe
- HP 70205A Graphics Display
- HP 70900A Local Oscillator
- HP 70902A IF Section (RES BW 10Hz-300kHz)
- HP 70907A External Mixer Interface

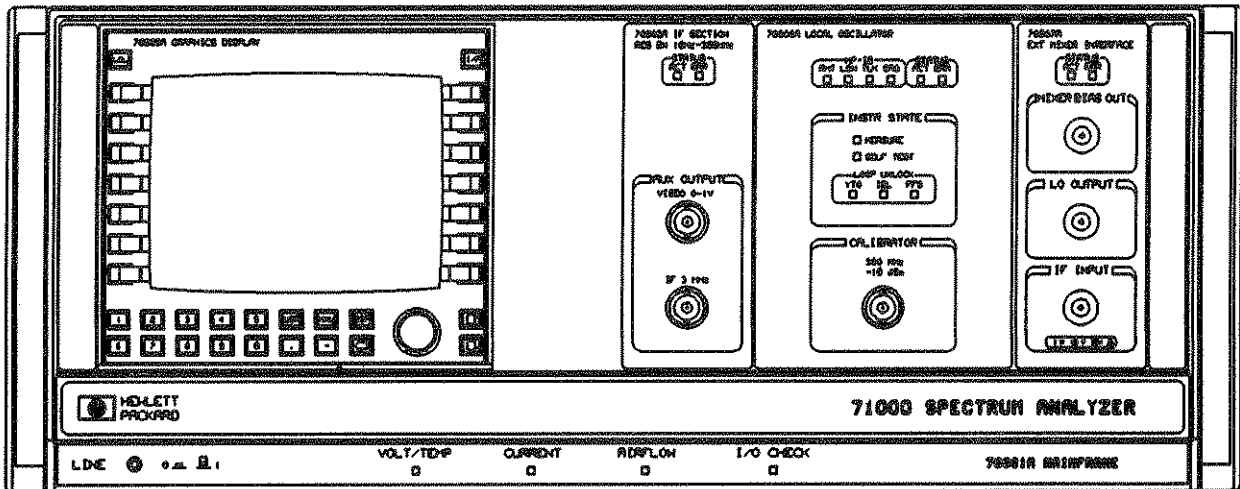

Fig. 1-15. HP 71300A Measurement System

System Options

- 001 Delete HP 70905A RF Section, add HP 70906A RF Section (50 kHz - 26.5 GHz), (applies to HP 71200A Microwave Spectrum Analyzer only)
- 002 Delete HP 70205A Graphics Display, add HP 70206A System Graphics Display (30/60 Hz Operation)
- 003 Delete HP 70205A Graphics Display, add HP 70206A System Graphics Display (50/60 Hz Operation)
- 004 Add HP 70903A IF Section (RES BW 100kHz-3MHz)
- 005 Delete HP 70902A IF Section, add HP 70903A IF Section (Res BW 100 kHz - 3 MHz)
- 908 Rack Flange Kit for mainframe or HP 70206A Display without handles
- 913 Rack Flange Kit for mainframe or HP 70206A Display with handles
- 915 Rack Mount Slide Kit for mainframe
- 910 Extra Manual

Support Options

The Option W30 provides, where available, an additional two years "Return-to-HP service support, commencing at the end of the standard one-year warranty.

- 71100 Option W30 Two (2)-Year Additional Return_to-HP Service
- 71200 Option W30 Two (2)-Year Additional Return-to-HP Service
- 71300 Option W30 Two (2)-Year Additional Return-to-HP Service

On-Site Service

On-site service for HP 71000 systems is available in some areas. Contact your HP sales representative for information on availability and terms.

CHAPTER 2
GETTING STARTED

Description: This chapter describes the front panel of the instrument, explains the softkey concept, and shows you how to make some typical measurements (with examples).

Introduction2-1
Front Panel Concept2-2
Softkey Controls2-7
Making Measurements2-8
Auto to Manual Example:2-10
Marker Examples:2-12



Introduction

This chapter is intended for both first-time and experienced spectrum analyzer users. The chapter has been partitioned into several sections and subsections. The sections describe the front panel of the instrument and the various functions of the spectrum analyzer. In addition, the sections describe how measurements are made. The subsections provide more in-depth information. At the end of this chapter are step-by-step examples for you to try.

Note: When the instrument first powers on, the set of softkeys which appears on the CRT display will contain two keys labelled ◀100/200 DIAGNST▶ and ◀71300A DIAGNST▶. See the System Support Manual for proper operation before continuing.

Front Panel Concept

The front panel of this instrument is simple and straight forward, thus allowing you to easily use this powerful instrument. When you first look at the front panel you will notice the lack of knobs and buttons. With the exception of a few "Hardkeys," softkey menus access the majority of functions. Throughout this manual, the symbol used for hardkey is [XXX]. The symbol used for softkey is ◀XXXX▶. The following section (Softkey Concept) describes the softkey functions in greater detail.

Both key types, Hardkey ([XXX]) and Softkey (◀XXX▶), are located on the displays. There are two types of displays available with this instrument: (1) the HP 70205A Graphics Display module, which plugs into the mainframe, and (2) the HP 70206A System Graphics Display, which is a large screen stand alone display. Both units serve three main functions. In their "display" function, they show information (such as traces) from the different instruments in the system. But they provide far more than the traditional functions because they can display information from several instruments at one time on a single screen, and they update this information in real time. In their "control" function, the units control the settings and actions of instruments in the system. They provide more than the traditional control function because they can control any instrument in the system. In their "utility" function, they provide a variety of valuable aids, such as system level error reporting, system level address analysis, and direct printer and plotter output.

Fig. 2-1 below shows the HP 70205A display and keys.

There are 14 softkeys, 7 on each side of the CRT display (HP 70205A). Three hardkeys ([USR], [MNU], and [DSP]) are located underneath the CRT. Press each of the hardkeys to see its top level softkey; notice the 14 top level softkeys you will use for functional operation. There are additional softkey functions associated with some of the top level softkeys.

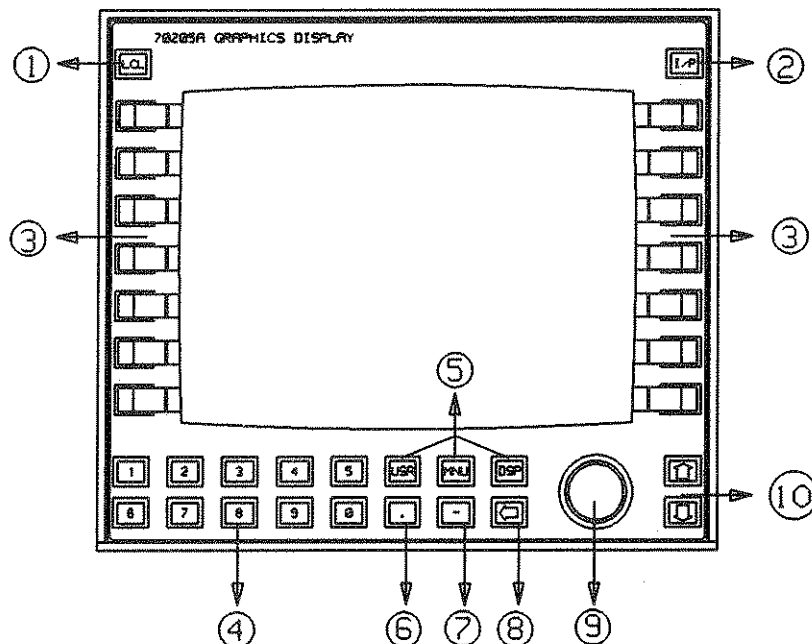

Fig.2-1. HP 70205A GRAPHICS DISPLAY

1. Local Control - This key when pressed returns the instrument to local control if it was in remote.
2. Instrument Preset - This key causes the instrument to activate all the preset conditions of the instrument.
3. Softkeys - These keys allow access to the system functions.
4. Numeric Keypad - This is the keypad for entering numeric values.
5. Hardkeys - These three keys (USR, MNU, DSP) activate the top level commands which appear on the screen next to the softkeys.
6. Decimal Pt. - This key is used for entering a decimal point when using the keypad.
7. Minus Sign - This key is used for entering negative numbers.
8. Back Space (back arrow) - This key is used to go from the lower level of softkeys to the next higher level. It is also used in programming to move the cursor to the beginning of the line.
9. Display Knob - This knob is used for changing parameter values, for selecting alpha characters and for accessing the diagnostic test.
10. Step Keys - These two keys are used for changing parameters up or down depending on which key is pressed.

Fig. 2-2 shows the location of the annotation on the CRT.

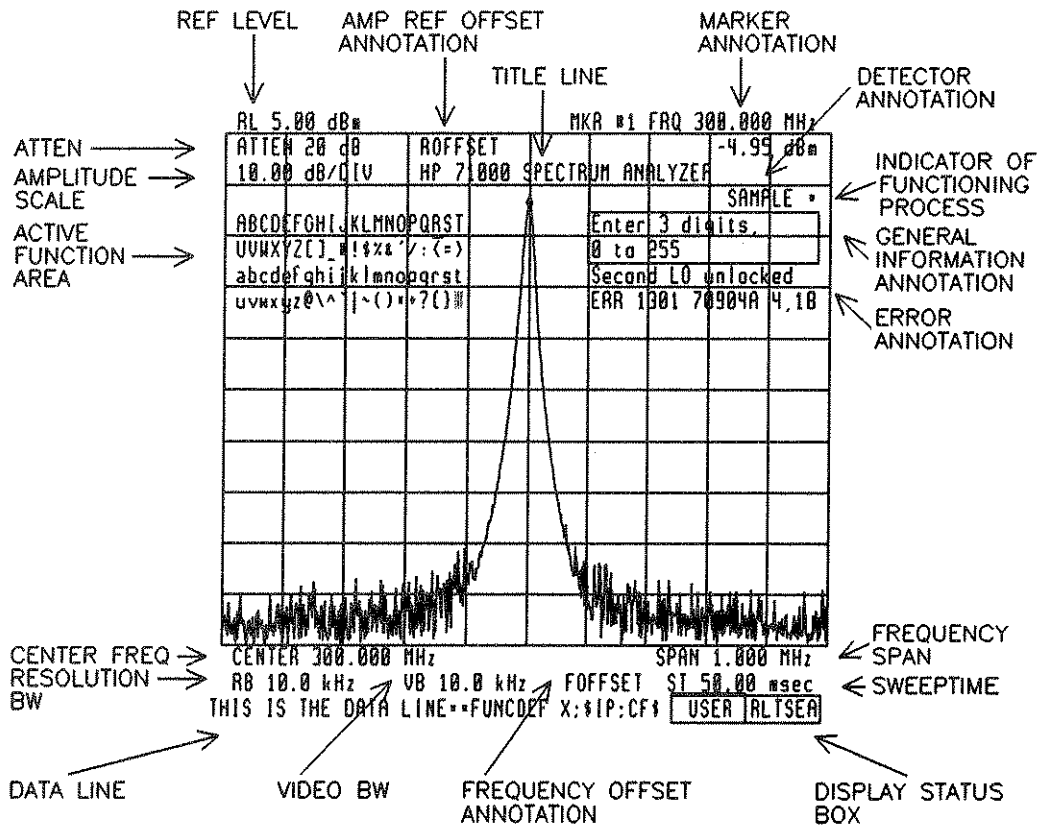

Fig.2-2. Display Annotation

Fig. 2-3 below shows the HP 70206A display and keys.

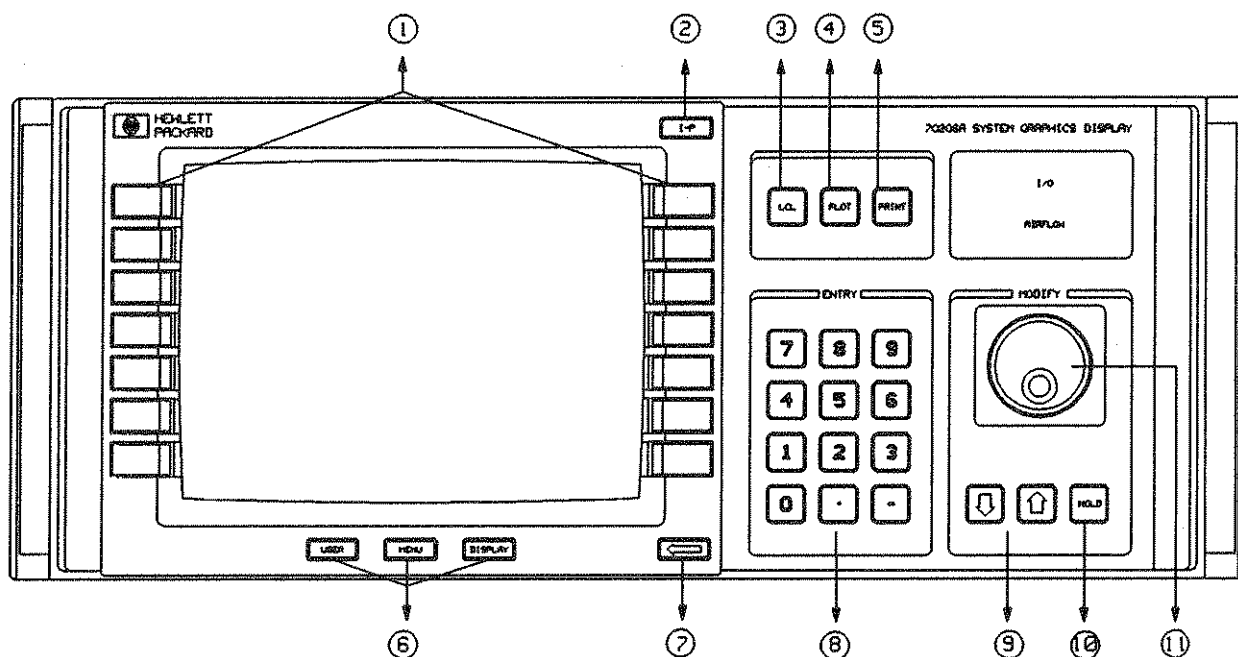

Fig. 2-3. HP 70206A SYSTEM GRAPHICS DISPLAY

1. Softkeys - These keys allow access to the system functions.
2. Instrument Preset - This key causes the instrument to activate all the preset conditions of the instrument.
3. Local Control - This key when pressed returns the instrument to local control if it was in remote.
4. Plot - This key causes the instrument to create a plot of what is on the screen.
5. Print - This key causes the instrument to print out the screen information.
6. Hardkeys - These three keys (USR, MNU, DSP) activate the top level commands which appear on the screen next to the softkeys.
7. Back Space (back arrow) - This key is used to go from the lower level of softkeys to the next higher level. It is also used in programming to move the cursor to the beginning of the line.
8. Numeric Keypad - This is the keypad for entering numeric values.
9. Step Keys - These two keys are used for changing parameters up or down depending on which key is pressed.
10. Hold - This key deactivates the function displayed in the active function area; the readout is blanked from the screen.
11. Display Knob - This knob is used for changing parameter values, for selecting alpha characters and for accessing the diagnostic test.

Fig. 2-4 shows a typical mainframe with no modules plugged in. Each of the modules were described in Chapter 1 and the display module in the previous section. The HP 70001A Mainframe is a rugged structure into which modules in varying widths can be placed. It serves two main functions. In its "life support" function, the mainframe provides power, cooling, and EMC protection for all of its modules. In its "communication" function, it manages all digital communications between modules and between mainframes. Indicators of the mainframe's condition are located on its lower part. These indicators are status LED's, and, when they are lit, report the following conditions.

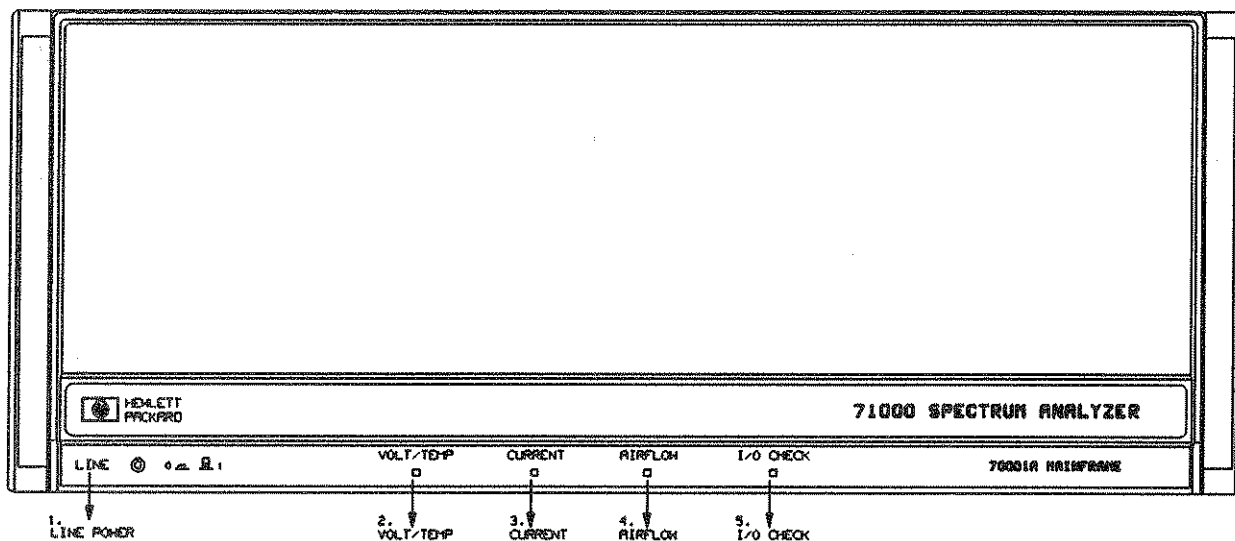

Fig. 2-4. MAINFRAME HP 70001A

1. If the power is on, the LED is lit.
2. If there is a VOLTAGE or TEMPERATURE problem, the LED is lit. (See the System Support Manual)
3. If there is a CURRENT problem, the LED is lit.
4. If there is an AIRFLOW problem, the LED is lit.
5. If there is an I/O problem, the LED is lit.

Softkey Controls

All system functions are organized into three groups which correspond to three front panel keys:

MENU USER DISPLAY

The MENU and DISPLAY keys access all spectrum analyzer and display functions, respectively. The USER key accesses a unique set of functions that are initially configured at the factory, but can be re-defined to meet special measurement needs.

All functions are activated by pressing the softkeys located around the CRT perimeter. Softkeys either activate a function or access another softkey menu.

Softkeys that activate a function are notated in capital letters only.
Softkeys that access other softkey menus are notated in lower case letters only.

**FIRMWARE VERSIONS
861015 OR LATER**

Most of the illustrations in this version of the manual show all softkeys labels in capital letters, regardless of their function.

Making Measurements

The purpose of this section is to introduce you to some of the main features of the spectrum analyzer. In addition, you will be shown how easily measurements are made with this system. Follow the step-by-step instructions through TUNE, ZOOM, and MEASURE. The softkeys to be pressed will be listed in the left column. In the right column is an explanation of the softkey you selected. The figures are samples of the displays that you will see.

Connect the Cal signal to the RF input. (The figures below were taken using a RF spectrum analyzer and could look different (wider span) on other analyzers).

SOFTKEYS:

EXPLANATION/FIGURES:

1. TUNE

SELECT ◀CENTER FREQ▶

This softkey allows you to change the center frequency of the analyzer.

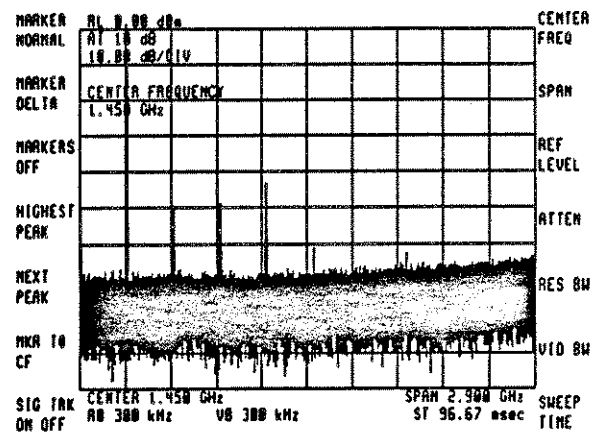

Fig. 2-5

SELECT [3], [0], [0] and ◀MHz▶

These keys select 300 MHz as the center frequency of the analyzer.

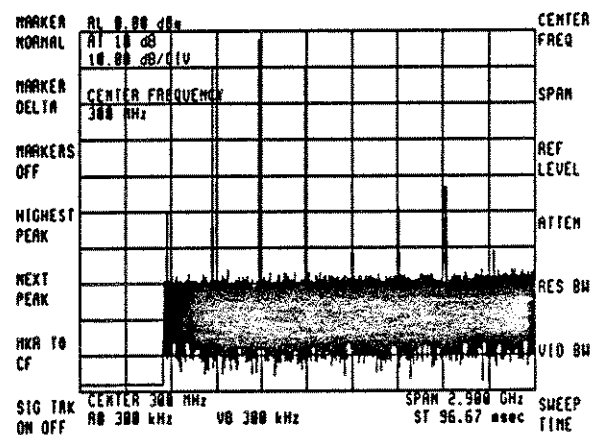

Fig. 2-6

SOFTKEYS:

EXPLANATION/FIGURES:

2. ZOOM

SELECT **◀SPAN▶**

This softkey allows you to change the span of the analyzer.

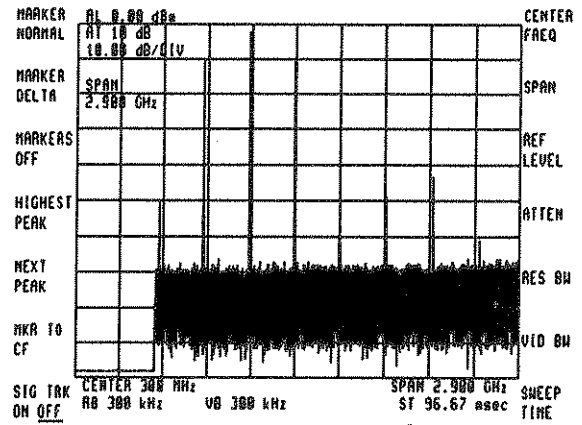

Fig. 2-7

SELECT **[1]** and **◀MHz▶**

These keys select 1 MHz as the span. In other words, the start frequency is 299.5MHz and the stop frequency is 300.5MHz.

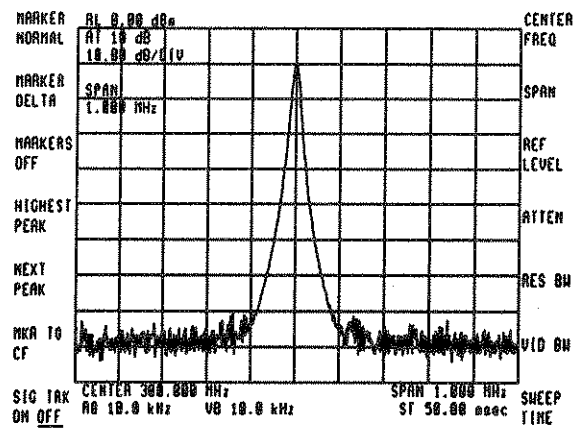

Fig. 2-8

SOFTKEYS:

EXPLANATION/FIGURES:

3. MEASURE

SELECT ◀HIGHEST PEAK▶

This softkey places a marker at the highest peak. Then the frequency and amplitude can be read directly from the annotation.

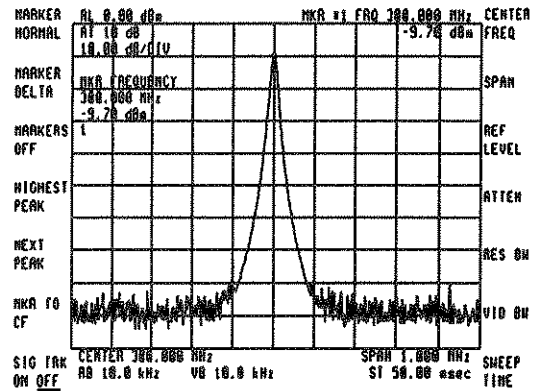

Fig. 2-9

All secondary analyzer functions (resolution bandwidth, video bandwidth, sweep time and attenuation) were automatically adjusted (coupled) to maintain a fully calibrated display. These coupled functions can also be uncoupled to allow manual operation.

Auto to Manual Example:

To manually control the different functions or to uncouple them you select the function and enter the value. Notice the asterisk beside the annotation to indicate the function is uncoupled. See the example below

Select **◀RES BW▶** and then turn the display KNOB and notice the BW changing. It changes in 10% increments.

This causes the resolution bandwidth to be fixed. It is no longer automatically determined.

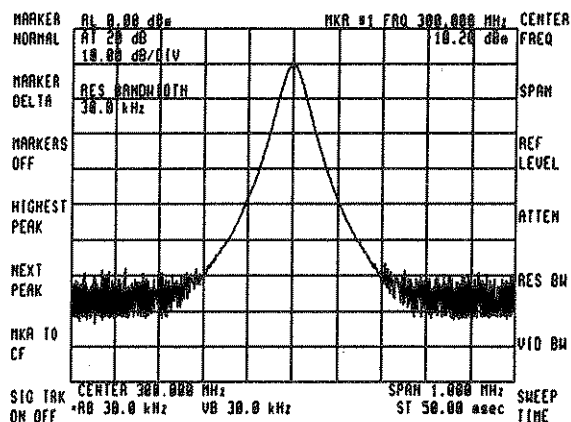

Fig. 2-10

SELECT **[1]** and then **◀AUTO▶**.

This puts the function resolution bandwidth back into the coupled mode and back to 10kHz, the preset value.

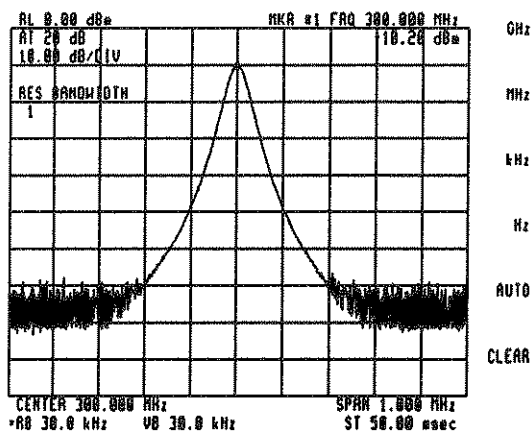

Fig. 2-11

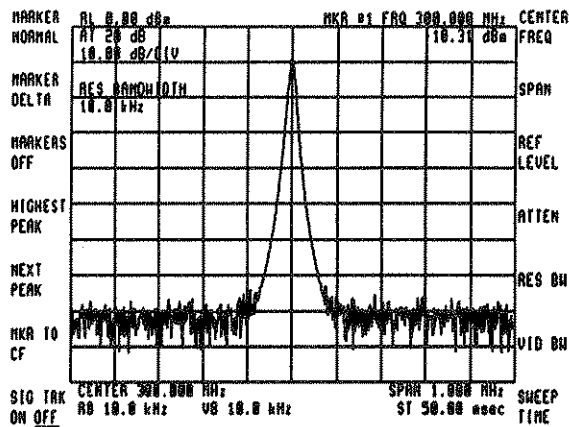

Fig. 2-12

Marker Examples:

Markers can be used to quickly identify signal frequency and amplitudes. The delta markers are available to measure signal separation or amplitude differences.

SOFTKEYS:

EXPLANATION/FIGURES:

SELECT ◀MARKERS OFF▶, ◀SPAN▶

This turns off the markers and brings span to the active function area of the analyzer.

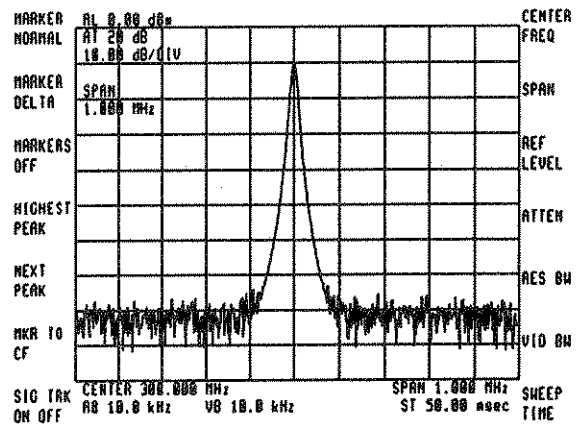

Fig. 2-13

SELECT [6], [0], [0] and ◀MHz▶

These keys select 600 MHz as the span.

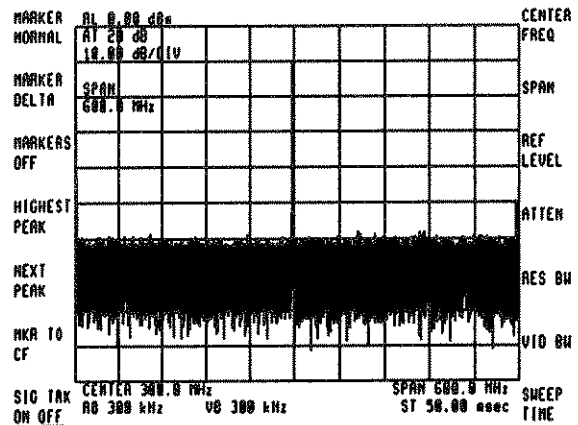

Fig. 2-14

SOFTKEYS:

SELECT ◀CENTER FREQ▶ and then [4], [5], [0] and ◀MHz▶

EXPLANATION/FIGURES:

This softkey allows you to change the center frequency of the analyzer. These keys select 450 MHz as the center frequency of the analyzer. It also shows the second harmonic of the Cal signal.

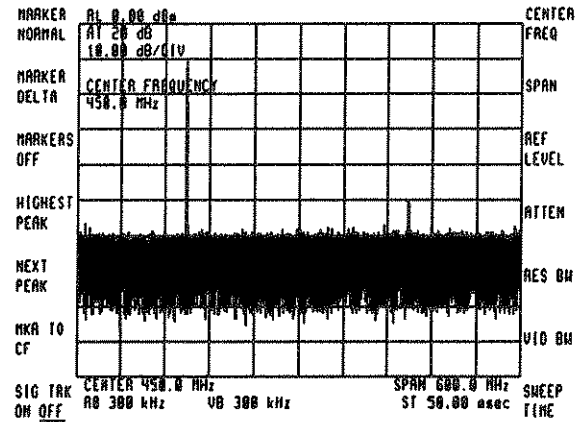

Fig. 2-15

SELECT ◀HIGHEST PEAK▶

Selecting highest peak places a marker on the highest peak signal and you can measure frequency and amplitude directly.

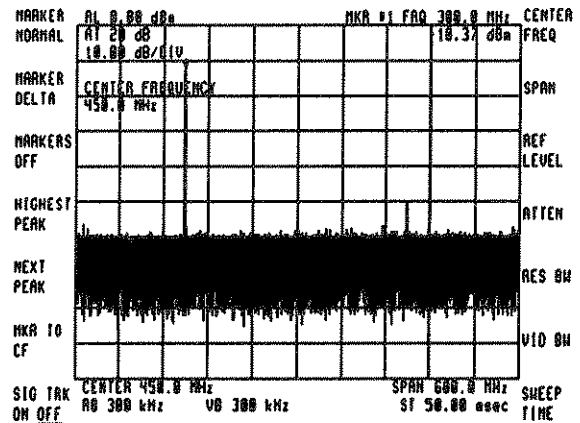

Fig. 2-16

SOFTKEYS:

EXPLANATION/FIGURES:

SELECT ◀MARKER DELTA▶

This places a second marker at the same place as the normal marker. The second marker can be moved by several methods; step keys, display knob, or key pad enter, finally, by select a marker function as below.

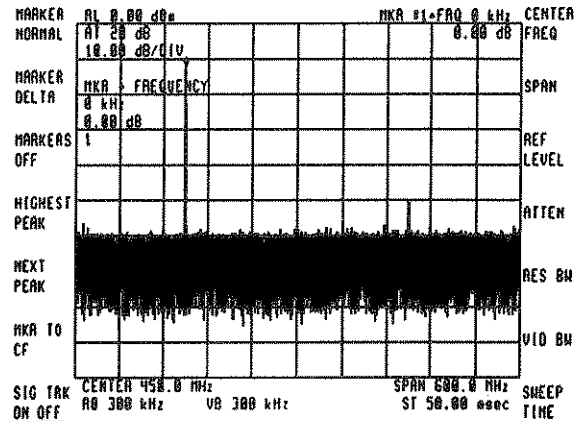

Fig. 2-17

SELECT ◀NEXT PEAK▶

This places the Delta Marker on the second harmonic of the Cal signal and the amplitude and frequency can be read from the annotation.

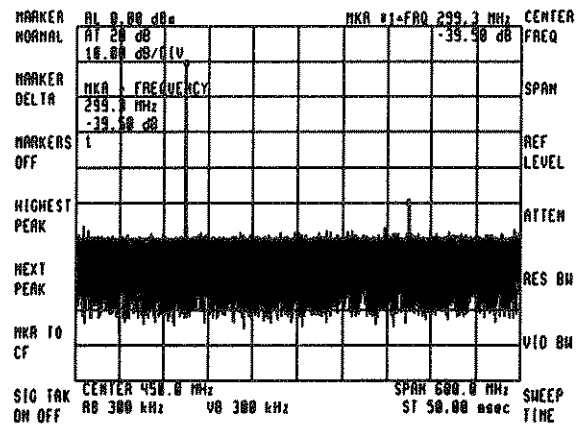

Fig. 2-18

These last examples show some of the capabilities of the markers for making fast and accurate measurements. Refer to the Marker section under MENU Hardkey for more details.

CHAPTER 3

USR HARDKEY

Description: This chapter explains how to use the [USER] hardkey and how to select and change softkeys.

Introduction	3-1
Using the [USER] Hardkey	3-4
Defining Your Own User Softkey Menu.	3-4
Saving and Recalling a [USER] Menu.. . . .	3-6
Deleting a [USER] Menu.	3-7
Selecting Auto or Manual Functions	3-8



Introduction

This chapter describes the use of the [USER] hardkey. The appearance of this menu and the name of some softkeys associated with this menu have changed with firmware version 880314. With firmware version 870501 or earlier, the softkeys associated with the [USER] hardkey appear when the instrument is first turned on, and all keys are predefined¹. With firmware version 880314 or later, the [USER] menu is not fully predefined and some of the softkey names are changed. For example, the name of the softkey used to define a user softkey has changed from <DEFINE UDK> to <DEFINE USR KEY>.

The following table summarizes the softkey name changes, and additional keys, used for defining a [USER] menu.

Table 3-1. [USER] Menu Softkey Name Changes.

Firmware Version 880314 or Later	Firmware Version 870501 or earlier
<key control>	<special functions>
<DEFINE USR KEY>	<DEFINE UDK>
<RECALL USER>	n/a
<SAVE USER>	n/a
<DISPOSE USER>	n/a

These softkeys can be found under the [USER] hardkey or under the [MENU] hardkey (press [MENU], <Misc>, <MORE>, and <key control>). Defining a user-softkey menu is described in the section "Defining Your Own User Softkey Menu" of this chapter. When a [USER] menu has been defined, it can be saved with the <SAVE USER> function. A number of softkey menus can be saved depending on the amount of user memory available. The user menus can be recalled with the <RECALL USER> function.

The [USER] menus allow the user to program quick access to the spectrum analyzer functions most often used by a user. Typical measurements (such as reading frequency and amplitude of signals) can be set up and made with this set of softkey functions.

The user-defined softkeys are changed by the user in one of two ways:

1. By using the "DEFINE USER KEY" function described in this chapter.
2. By programming the softkeys using the downloadable feature (keydef) described in Part II Remote Operation.

¹ The softkey menu associated with firmware version 870501 or earlier is available for use with firmware version 880314 or later. See the <FIRMKYS ON OFF> softkey in Chapter 4, MNU Hardkey, for more information.

Figure 3-1.1 shows the softkeys that appear when the [USER] hardkey is pressed. Figure 3-1.2 shows the predefined [USER] menu found with firmware version 870501 or earlier.

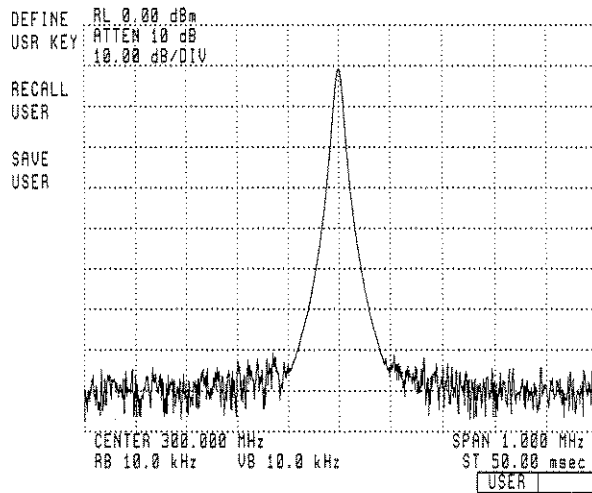

Figure 3-1.1. Top Level Menu For [USER] hardkey (firmware version 880314 or later.)

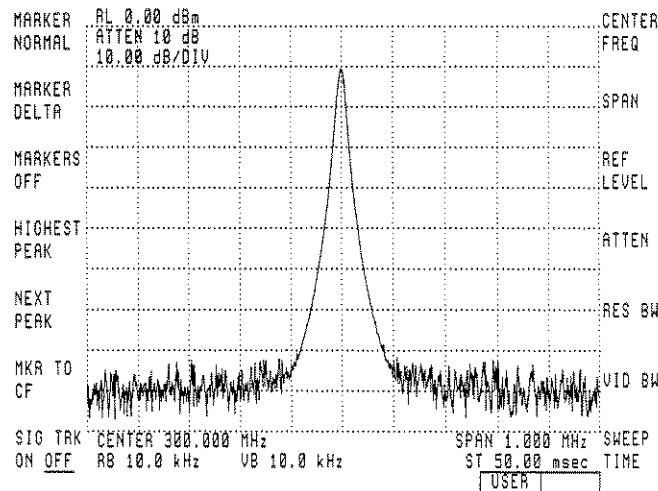

Figure 3-1.2. Top Level Menu For [USER] hardkey (firmware version 870510 or earlier.)

Figure 3-2 is a [USER] menu tree record. This figure can be used to record the user-defined softkeys for a customized [USER] menu and the user number assigned for saving and/or recalling this menu.

USER_ _____

DEFINE	*	_____
USR KEY		_____
RECALL	**	_____
USER		_____
SAVE	**	_____
USER		_____
_____		_____
_____		_____
_____		_____
_____		_____
_____		_____
_____		_____

* This key can not be redefined with firmware version 880314 or later unless first unprotected with the PROTECT command. (Refer to the HP 70900A Language Reference Manual for more information on the PROTECT command.)

** This key can be redefined. "RECALL USER" and "SAVE USER" are features of firmware version 880314 and later, see Chapter 4, MNU Hardkey, of this manual for additional information.

Figure 3-2. USER-Softkey Menu Tree Record.

Using the [USER] Hardkey

The [USER] hardkey allows programming of a user-defined menu of frequently-used spectrum analyzer functions. Fourteen softkeys are available that can be defined to meet the measurement needs of the user. The <RECALL USER> softkey allows the user to recall previously-defined [USER] menus.

Defining Your Own User Softkey Menu

To define your own softkey menu, you must use the <DEFINE USR KEY> function. To do this, select [USER], then <DEFINE USR KEY>. The example below shows how to make <START> frequency one of the "USER" softkeys.

Select [USER] and then <DEFINE USR KEY>.

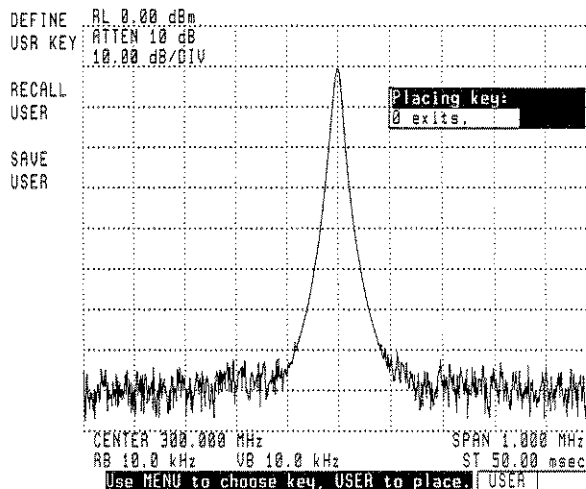

Select [MENU]. Select the firmkey <Freq>, then <START>. The annotation asks you to then select [USER] and the softkey that you want to define.

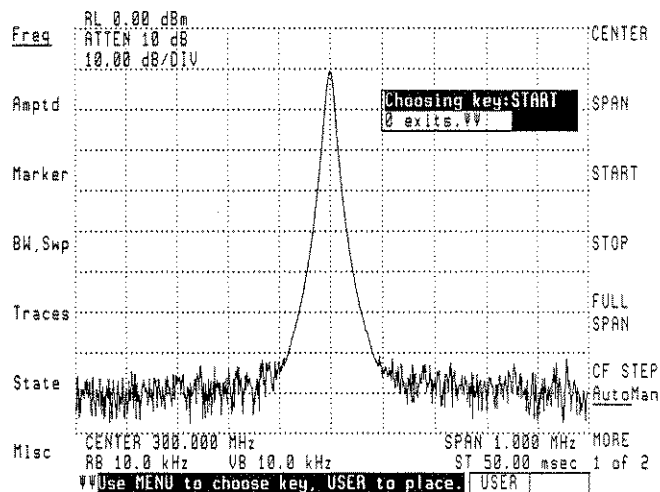

Select the top right softkey.
Notice that the softkey now
changes to **START**.

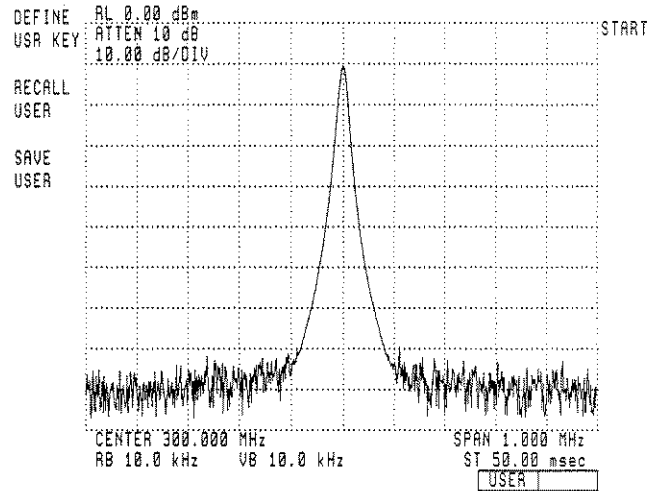

Alternate way to define a user softkey

If you are making a measurement using a softkey function under the [MENU] hardkey, and you wish to program this function under the [USER] hardkey, after you have used the function, return to the user menu and press **DEFINE USR KEY**. Note that the name of the function last used is highlighted in the box located in the upper right of the display as in the figure shown below. Now select the softkey where you want this function to be placed.

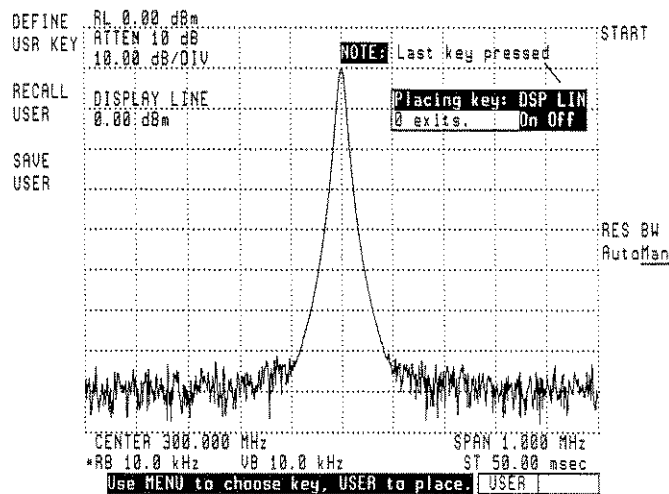

Saving and Recalling a [USER] Menu

After you have selected the softkeys and their positions in the [USER] area, this set of softkeys can be saved in user memory. Simply press **◀SAVE USER▶**, enter up to a four-digit code for the menu to be saved, and then press **◀ENTER▶**. The number of [USER] menus that can be saved will depend on the number and complexity of Downloadable Program functions (DLPs) and State Registers stored in user memory.

To recall a [USER] menu, simply press **◀RECALL USER▶**, enter the code number, and press **◀ENTER▶**. If you wish to know what code numbers have already been used or how many [USER] menus have been defined, press [MENU], **◀Misc▶**, **◀More▶**, and **◀catalog▶**. The [USER] menus are listed as "USER_xxxx", where "xxxx" is the code number assigned to the user menu.

The **◀SAVE USER▶** and **◀RECALL USER▶** softkeys can be accessed from two different areas. The first is the preset [USER] hardkey menu. The second is under the [MENU] hardkey area; press [MENU], and select **◀Misc▶**, then **◀MORE▶**, and then **◀key control▶**.

The examples below show how to save, recall, and list user-defined softkeys.

Select **◀SAVE USER▶**, then use the data entry keys to enter [1].
Press **◀ENTER▶**.

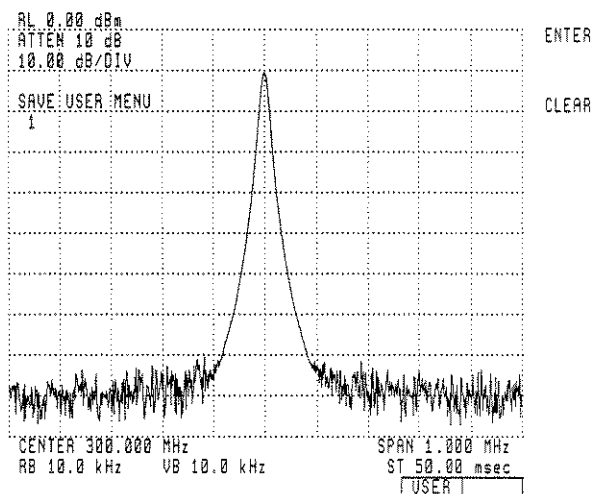

Select **◀RECALL USER▶**, then use the data entry keys to enter [1]. Press **◀ENTER▶**.

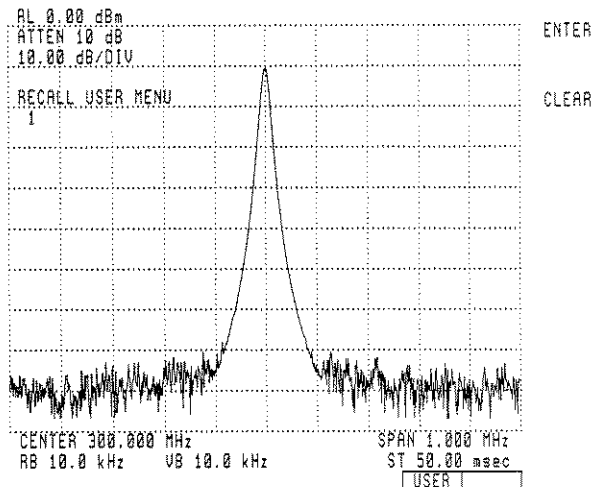

Press [MENU], **◀Misc▶**, **◀MORE▶**, and then **◀catalog▶**. The display will be similar to that shown. The previously-saved user softkey menu is listed as "USER_1".

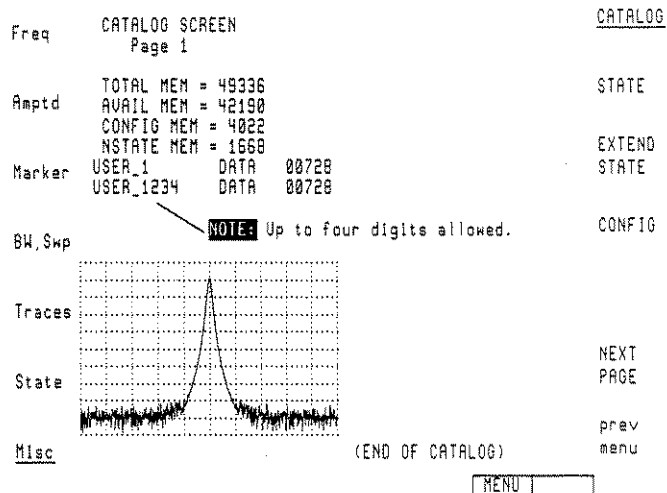

Deleting a [USER] Menu

The **◀DISPOSE USER▶** function is used to delete a previously-saved [USER] menu from memory. Use the **◀catalog▶** function to determine the user number to be deleted from memory. The example below shows how to delete a user menu from memory.

USR HARDKEY
Deleting a [USER] Menu

Press [MENU], <Misc>, <MORE>, and then <key control>. Then select <DISPOSE USER> and enter the code number of the user softkey menu to be deleted, and press <ENTER>.

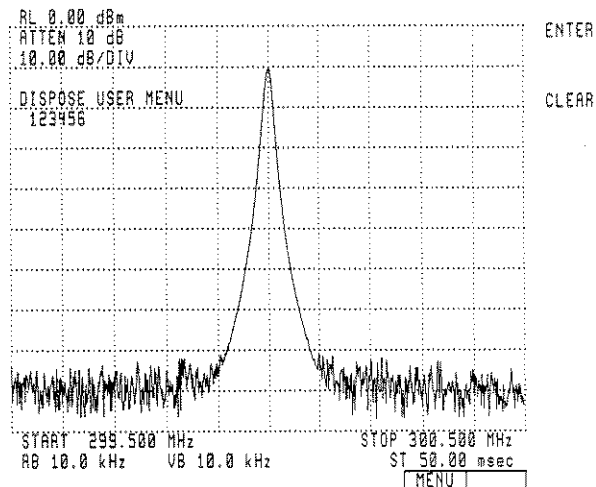

Selecting Auto or Manual Functions

With firmware version 880314 or later, returning a coupled function, such as resolution bandwidth, to its automatic state from the user menu is easy. Simply select the function as shown in the figure below and press the key a second time. Subsequent presses of the softkey switch between its manual and automatic function.

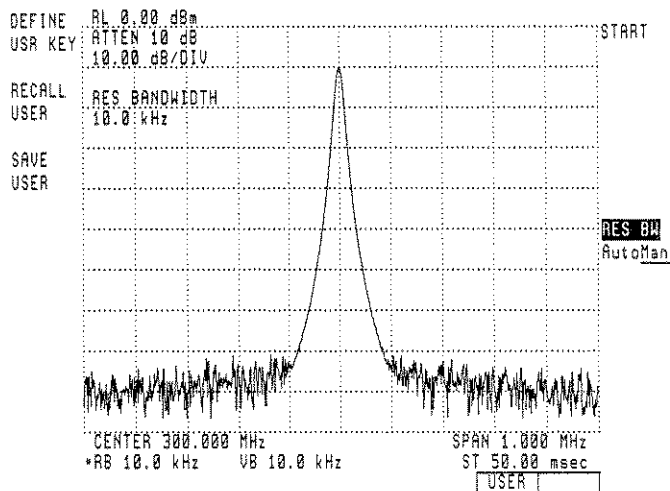

USR HARDKEY
 Selecting Auto or Manual Functions

For firmware version 870501 or earlier, to return to an auto (or coupled) function from the user menu, select the function you want and then enter any number using the numeric keypad. A set of terminator softkeys will appear, one of which is **<AUTO>**. Press this softkey and the function will return to auto if it previously had been in the manual mode.

In the example below, the resolution bandwidth softkey **<RES BW>** was selected and the number 1 was entered on the keypad.

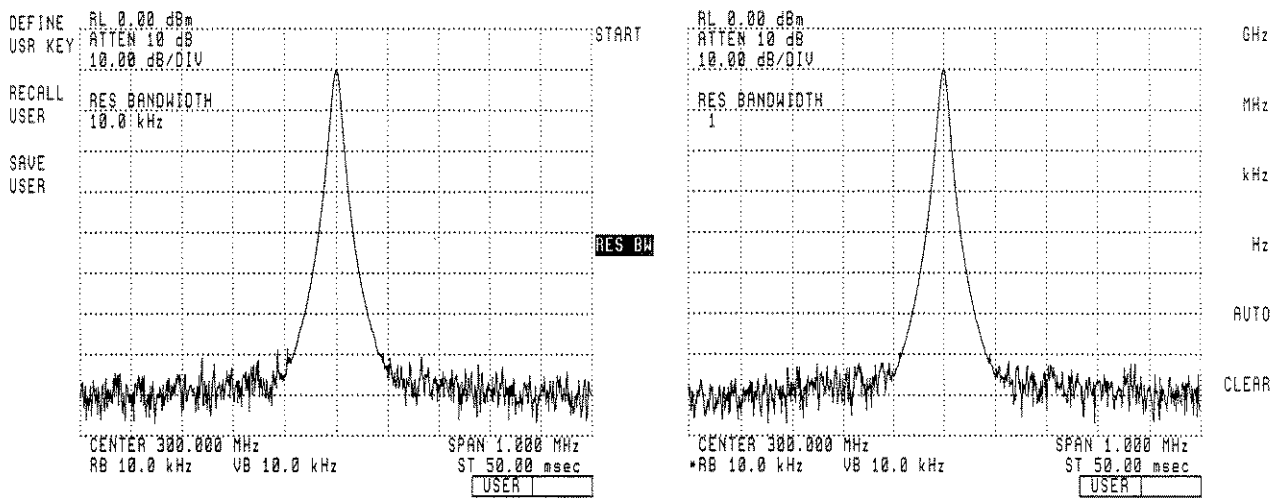



CHAPTER 4

MENU HARDKEY

Description: This chapter provides an overview of the [MENU] hardkey. In addition, it shows how to select different functions of the spectrum analyzer.

- Introduction for Firmware Version 880314 or Later. 4-0.1
 - Top-Level Firmkeys 4-0.1
 - Softkey Overview 4-0.3
 - Softkey Function Summary 4-0.4
 - Title 4-0.4
 - Save, Recall, and Dispose User 4-0.5
 - Command 4-0.5
 - Zoom to Resolution Bandwidth 4-0.7
 - Preamplifier Control 4-0.7
 - Partial Erase 4-0.8
 - Firmkeys 4-0.8
 - Limit Lines (Firmware Version 880901) 4-0.9
 - Creating Limit Lines 4-0.9
 - Limit Testing 4-0.10
 - Limit Line Softkey Function Descriptions 4-0.11
 - <AMPTD VALUE> 4-0.11
 - <BEEPER On Off> 4-0.11
 - <BLANK TRACES> 4-0.12
 - <DELETE ALL> 4-0.12
 - <DELETE SEGMENT> 4-0.12
 - <enter limit> 4-0.13
 - <edit limit> 4-0.13
 - <FREQ VALUE> 4-0.13
 - <limit lines> 4-0.13
 - <LIMITS On Off> 4-0.14
 - <RECALL LIMIT> 4-0.14
 - <RELATIV On Off> 4-0.15
 - <SAVE LIMIT> 4-0.15
 - <SELECT SEGMENT> 4-0.16
 - <TYPE> 4-0.16
 - <UPPER/LOWER> 4-0.17
- Introduction (Firmware Version 870501 or Earlier) 4-1
 - Top Level Softkeys 4-1
- Frequency 4-5
 - Center Frequency 4-5
 - Span 4-7
 - Start/Stop Frequency 4-10
 - CF Step 4-11
 - CF Step Automan 4-13
 - Full Span 4-14
 - Frequency Offset 4-14
 - Signal Ident 4-15
 - Signal ID to CF 4-15
 - Signal ID Options 4-15
 - SIG ID MAN OFF 4-15

IMAGE/SHIFT	4-16
Signal ID Amplitude Delta	4-16
Image N Start	4-16
Image N Stop	4-16
Lcl Osc Start	4-18
Lcl Osc Stop	4-18
Preselection	4-18.1
Pre-select.	4-18.1
Pre Sel Peak	4-18.1
Pre Sel DAC	4-18.1
Pre Sel Hyst	4-18.2
Pre Sel On Off	4-18.2
Frequency Limit.	4-18.2
Amplitude	4-19
Ref Lvl Postn	4-19
Ref Level	4-19
Extd Rl On Off	4-21
Atten	4-21
MAXIMUM SAFE INPUT POWER.	4-22
Zero Attenuation.	4-23
Atten Automan	4-25
Log/Div	4-25
Linear Volts	4-25
Amptd Units	4-26
Amp Ref Offset	4-27
Input Imped	4-28
Max Mxr Level	4-29
Gain Compression and Maximum Input Levels	4-30.1
Use of Maximum Mixer Level Softkey.	4-30.2
Use of the Maximum Input Level Softkey.	4-30.2
Interpreting Displayed Measurement Results.	4-30.3
Sweep Control	4-31
Continuous Sweep	4-31
Single Sweep	4-31
Sweep Time	4-32
Sweep Time Automan	4-33
Trigger Function	4-34
Vid Trg Level	4-35
Vid Hys Level	4-35
Marker.	4-37
Marker Overview	4-38
Marker Peak	4-38
Marker To	4-40
Markers Off	4-43
Normal Marker	4-43
Marker Delta	4-45
Fractional Differences.	4-46
Measurement and Readout Range	4-47
Amp Ref Left	4-48
Amp Ref Right	4-48
Active Marker	4-50
Marker Pause Time	4-50
Marker Pause On Off	4-51
Mkr Noise On Off	4-51
Sig Trk On Off	4-52
Marker Options	4-52

Marker Readout	4-53
Marker Zoom	4-53
Bandwidth	4-55
Resolution Bandwidth	4-55
Resolution Bandwidth Automan	4-57
Resolution Bandwidth Ratio	4-58
Video Bandwidth	4-58
Video Bandwidth Automan	4-59
Video Bandwidth Ratio	4-60
Trace	4-62
Trace Overview	4-62
Trace A	4-63
MAX HLD TRACE A	4-64
MIN HLD TRACE A	4-64
VIEW TRACE A.	4-64
BLANK TRACE A	4-64
TRDSPL ON OFF	4-64
LENGTH TRACE A.	4-64
Trace B	4-64
Trace C	4-64
Vid Avg	4-65
Video Average On Off	4-65
Detector	4-65
Trace Preset	4-68
A - B → A ON OFF	4-68
A - B + DL ON OFF	4-68
A + B → A	4-69
B - DL → B	4-69
A XCH B	4-69
B XCH C	4-69
Instrument Display.	4-70
Display Line	4-71
Dsp Lin ON OFF	4-71
Threshd ON OFF	4-72
Grat ON OFF	4-74
Anotatn ON OFF	4-75
Normal Display	4-75
Show State	4-75
Extend State	4-76
Show Config	4-76
Show Catalog	4-77
Next Page	4-77
State	4-78
Save State	4-78
Recall State	4-78
No. Of States	4-79
P State ON OFF	4-79
Power Up IP-Last	4-79
Special Functions	4-80
Define UDK	4-80
End UDK Def	4-82
Debug ON OFF	4-82
Debug Slow	4-83
Debug Fast	4-83
Debug Pause	4-83
Debug Cont	4-83

Debug Step	4-83
Enter Command	4-83
EXECUTE LINE.	4-84
EDIT FUNCDEF.	4-84
CLEAR TO END.	4-84
INSERT/REPLACE.	4-84
DELETE CHAR	4-85
ENTER ANYCHAR	4-85
ENTER ALPHA	4-85
Hold	4-85
Preset User Key	4-86
Analyzer Test	4-86
Configuration	4-87
Selecting an Input Port	4-87
Preset Input.	4-87
Select Input.	4-88
Activating the External IF Port	4-88
Restricting Signal Paths from Module to Module	4-88
Input Coupling	4-88
ROM Version	4-88.1
Selecting Analog-To-Digital Converter for Video Processing.	4-88.1
Preset Analog-To-Digital Converter	4-88.1
Calibration	4-89
Overview	4-89
Execute Cal	4-90
CAL ALL	4-90
CAL LOGAMP.	4-90
CAL GAIN.	4-90
CAL RES BW.	4-91
Enable Cal	4-91
Freq For Cal	4-92
Power For Cal	4-92
Cal SRC Int Ext	4-93
External Mixer.	4-94
Full Band	4-94
Lock Harmnc #	4-94
Bias ON OFF	4-94
Bias Adjust	4-95
Bias Pk, Bias Pk Min, Bias Pk Max	4-95
Bias Pk RES	4-95
Bias Pk Start	4-95
Signal ID	4-95
Conv Loss	4-95

Freq

CENTER*
SPAN
START*
STOP
FULL SPAN
CF STEP Automan
MORE 1 of 2

Amptd

REF LVL**
ATTEN Automan
LOG dB/DIV
LINEAR
units menu
CAL ALL
MORE 1 of 2

Marker

MKR NRM On Off*
DELTA*
HIGHEST PEAK
NEXT PEAK
-> CF
SIG TRK On Off
MORE 1 of 3

BW, Swp

RES BW Automan*
VID BW Automan
SWPTIME Automan*
CONT SWEEP
SINGLE SWEEP
VID AVG On Off
MORE 1 of 3

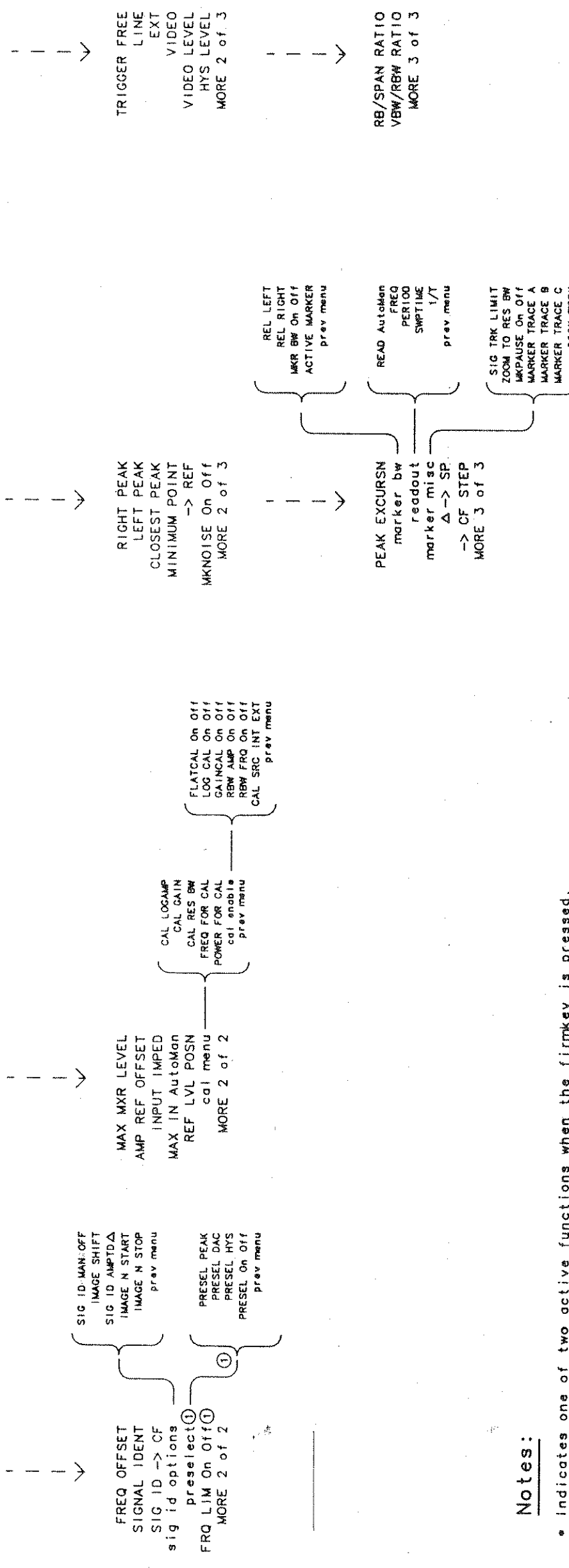

Notes:

- * Indicates one of two active functions when the firmkey is pressed.
- ** Indicates the active function when the firmkey is pressed.
- ① Available only when the appropriate module is present.
- ② When the < STORE A > softkey is selected, the < VIEW A BLANK A > softkey appears.
- ③ The < trace A B C > softkey selects the trace used for the trace functions.
- ④ Available only when downloadable programs are present and indicates the DLP name listed in the catalog.
- ⑤ These softkey functions are not available with the HP 70310A.

Traces

CLEAR WRT A
 MAX HOLD A
 MIN HOLD A
 STORE A ②
 trace A B C ③
 detectr
 MORE 1 of 3

DETECTR Automon
 NORMAL
 SAMPLE
 POS PK
 NEG PK
 GROUND
 prev menu

->A On Off
 I+DL On Off
 A+B ->A
 B-DL->B
 A XCH B
 B XCH C
 MORE 2 of 3

AVG On Off
 LIN On Off
 SHD On Off
 ACE PRESET
 lengths
 MORE 3 of 3

LENGTH A
 LENGTH B
 LENGTH C
 prev menu

State

RECALL STATE
 SAVE STATE
 ext mixer
 select input ①
 preselect ①
 track gen ①
 MORE 1 of 3

PRESEL PEAK
 PRESEL DAC
 PRESEL HYS
 PRESEL On Off
 prev menu

SRC PWR On Off
 STM RSP On Off
 traces norm
 power
 etc/track
 module
 prev menu

ADC 1 70
 ADC 2
 ADC 3
 prev menu

IN 1 70
 IN 2
 IN 3
 prev menu

ADC 1 70
 ADC 2
 ADC 3
 prev menu

PREAMP1 On Off
 PREAMP2 On Off
 PREAMP3 On Off
 prev menu

COUPLING AC-DC
 PATHLOK On Off
 POWERON IP LAST
 EXT IF On Off ①
 PARTIAL ERASE
 MORE 3 of 3

LOCK HARANG#
 LOCK M# On Off
 CONY LOSS
 bias
 fullband KADUVE
 fullband WFDGYJ
 prev menu

K 18-26.5
 A 28.5-40
 Q 33-50
 U 40-60
 V 50-75
 E 60-90
 prev menu

W 75-110
 F 90-140
 D 110-170
 G 140-220
 Y 170-260
 J 220-330
 prev menu

A-B ->A On Off
 STORE THRU ->B
 A-C ->A On Off
 STORE OPEN ->C
 AVERAGE SHRT-XC
 prev menu

SRC PWR On Off
 SRC PWR OFFSET
 BLANKING On Off
 PWR SWP On Off ⑤
 PWR STP Automon
 SRC ATN Automon
 prev menu

ALC NRB
 ALC ALT ⑤
 TRACKING PEAK
 TRACKING ADJUST
 SRC OSC INT EXT
 prev menu

AM % On Off
 AM FREQ
 AM INT EXT
 SRC OSC INT EXT
 prev menu

Misc

DSP LIN On Off
 THRESHD On Off
 TITLE
 ANOTAIN On Off
 GRAT On Off
 HOLD
 MORE 1 of 3

ENTER TITLE
 SELECT CHAR
 INSERT or ...
 SPACE
 CLEAR TO END
 prev menu

CATALOG
 STATE
 EXTEND STATE
 CONFIG
 NEXT PAGE
 prev menu

ENTER COMMAND
 SELECT CHAR
 REPLACE or ...
 EDIT FUNCDEF
 ANY CHR
 CLEAR TO END
 prev menu

RECALL USER
 SAVE USER
 DISPOSE USER
 PRESET USER
 DEFINE USR KEY
 FIRMKYS On Off
 prev menu

LCL OSC START
 LCL OSC STOP
 ANALYZR TEST
 ROM VERSION
 prev menu

DEBUG On Off
 DEBUG SLOW
 DEBUG FAST
 PAUSE
 STEP
 CONT
 prev menu

execute DLP
 catalog
 COMMAND
 key control
 limit lines
 service
 MORE 2 of 3

edit
 RECALL LIMIT
 SAVE LIMIT
 LIMITS On Off
 BEEPER On Off
 (enter) limit
 LIMITS 1 of 3

FREQ VALUE
 AMPID VALUE
 TYPE
 SELECT SEGMENT
 UPPER/LOWER
 LIMITS 2 of 3

RELATIV On Off
 DELETE ALL
 DELETE SEGMENT
 SELECT SEGMENT
 BLANK TRACES
 LIMITS 3 of 3

debug
 MORE 3 of 3

Introduction for Firmware version 880314 or Later

This chapter describes in detail the functions accessed by pressing the [MENU] key. With firmware version 880314 or later, there are seven top-level softkeys, referred to as "firmkeys", which are always displayed on the left-hand side of the display screen. The softkeys that are displayed on the right-hand side of the display screen are dependent on the firmkey selected. You will find that these seven firmkeys still contain the previous functions as before, but have now been combined for more convenient use since they are always present.

The seven top-level firmkeys appear when the instrument is first turned on, at instrument preset, or when the [MENU] key is pressed. These firmkeys always remain available for use until either the [USER] or [DISPLAY] key is pressed.

The menu structure which uses 14 softkeys in the top level (firmware version 870501 or earlier) can still be accessed via the ◀Misc▶ firmkey and pressing the ◀key control▶ softkey then the ◀FIRMKEYS On Off▶ softkey. Refer to figure 4-2, The MENU Softkeys, for a graphic representation of the menu structure for the 14 top-level softkeys.

Included in this introductory section is a Softkey Overview section which describes general concepts that pertain to the softkeys and their functions. After this section follows the Softkey Function Summary which reviews the new softkey functions that are available with firmware version 880314 or later.

For your convenience, an alphabetical listing of the available softkey functions is provided in Appendix A, Softkey Path Summary, at the end of this section. This summary also reveals under which firmkey the function resides and the key presses to access it.

Top-Level Firmkeys

Figure 4-0.1 below shows the seven top-level firmkeys available when the [MENU] key is pressed. A graphic representation of all the softkeys and their relationship to the seven top-level firmkeys is shown in the FIRMKEY MENU TREE.

Listed below is a brief summary of the softkey functions that can be found in each of the seven top-level firmkeys.

Frequency

The ◀Freq▶ firmkey allows access to softkeys that adjust frequency-related settings and signal frequency identification.

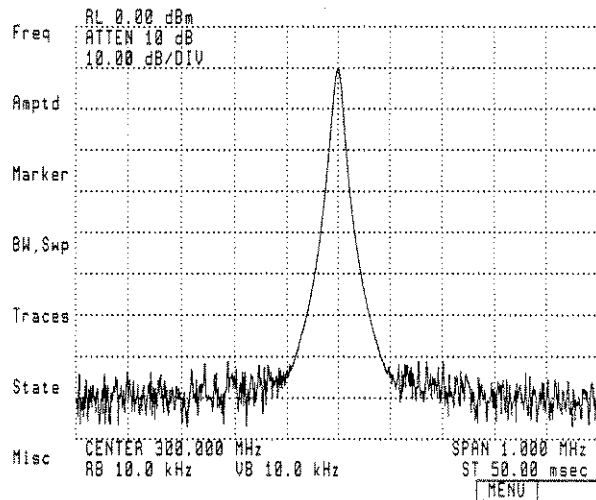

Fig.4-0.1. Seven Firmkey Top-Level Menu
(Firmware Version 880314 or Later)

Amplitude

◀Amptd▶ enables access to amplitude reference settings or attenuator settings and calibration functions.

Marker

◀Marker▶ selects marker functions and signal tracking.

Bandwidth, Sweep

◀BW, Swp▶ enables access to bandwidth settings, sweep control, and trigger mode selection.

Traces

◀Traces▶ enables trace functions used for writing, storing, and manipulating trace data, and allows selection of detector modes.

State

◀State▶ selects the functions that save and recall previously-established measurement settings. This softkey also allows access to the softkeys that control optional modules.

Miscellaneous

◀Misc▶ selects the functions that control annotation and graticule settings for the display screen and control for downloadable programming. Other miscellaneous functions such as ▶catalog▶, ▶key control▶, ▶debug▶, and ▶service▶, can also be found under this firmkey.

Softkey Overview

The new menu structure of the HP 70900A Local Oscillator is shown in figure 4-0.2. The menu structure is based on the seven top-level firmkeys, listed above, which are always displayed on the left-hand side of the display screen. Figure 4-0.2 also lists all the softkey functions available and illustrates the menu nesting levels.

Any softkey designated by lower-case letters indicates that a sub-level softkey menu exists for that particular softkey. Upper-case letters indicate that there are no further sub-level softkey menus for that particular softkey and that a function is executed when it is pressed.

Generally, a softkey that has an auto/manual selection for its function must be activated first (by pressing it), prior to switching between auto or manual with subsequent presses of the softkey.

The softkeys that have an on/off selection, in most cases, switch to the "on" position immediately when they are first activated. To select the "off" position, the softkey must be activated first, then pressed again.

When enabled, the softkey of the selected active function (e.g., ▶CENTER▶) is highlighted. When a softkey that performs an immediately-executable function (e.g., ▶FULL SPAN▶) is selected, the softkey is highlighted momentarily as the function is performed.

The back-space ([←]) key brings you back through the menu structure in the reverse sequence of the softkeys that were pressed. Up to the last ten key presses are saved.

When pressed once, the [HOLD] key deactivates the active function and blanks the annotation in the active function area of the display screen. When the [HOLD] key is pressed a second time, the softkeys on the right-hand side of the display screen are blanked.

Softkey Function Summary

There are basically six new softkey functions that are available with firmware version 880314 or later. These softkey functions are listed below. A brief functional description of each of these softkey functions immediately follows this list.

Title
Save, Recall, and Dispose User
Command
Zoom to Resolution Bandwidth
Preamplifier Control
Partial Erase

Title

The **<TITLE>** softkey can be selected under the **<Misc>** firmkey and allows you to place a title on the display screen which corresponds with the instrument state displayed. The instrument state with the corresponding title can then be saved by using the **<SAVE STATE>** softkey.

The five functions that are necessary to enter a title are described in more detail below.

ENTER TITLE

Selecting **<ENTER TITLE>** tells the analyzer to accept the title created in the data line and place it on the display screen in the title line.

SELECT CHARACTER

Using the **<SELECT CHAR>** softkey allows you to choose each character required for the title. The desired character must first be selected (by using the RPG knob) from the characters shown in the active function area. Then, by pressing the **<SELECT CHAR>** softkey, the selected character is entered into the title being created in the data line.

INSERT, DELETE, or REPLACE

The **<INSERT or ...>** softkey works in conjunction with the **<SELECT CHAR>** softkey to insert, delete, or replace a character, which is indicated by the cursor, in the data line.

CLEAR TO END

Selecting **<CLEAR TO END>** tells the analyzer to clear all the characters from the position indicated by the cursor to the end of the data line.

STEP UP [↑] and STEP DOWN [↓] KEYS

The [↑] and [↓] keys, which are located near the RPG knob, positions the cursor in the data line from left to right.

Save, Recall, and Dispose User

The **<SAVE USER>** and **<RECALL USER>** softkeys are located under the [MENU] key for the convenience of saving or recalling a "USER" softkey menu that has been defined. These softkey functions are identical to the ones located under the [USER] key. Refer to Chapter 3, USER HARDKEY, in the Manual Operation section of this manual for more information on the [USER] key.

To save a defined user-softkey menu, press **<SAVE USER>**, enter up to a four-digit code for the menu to be saved, and then press **<ENTER>**.

To recall a user menu, press **<RECALL USER>**, enter the code number of the desired menu, and then press **<ENTER>**.

The **<DISPOSE USER>** softkey is used to delete a previously-saved USER menu from memory. This softkey function resides under the **<Misc>** firmkey. However, like all the other softkey functions, the **<DISPOSE USER>** softkey can be defined as part of a USER menu. Refer to Chapter 3, USER HARDKEY, in the Manual Operation section of this manual for more information on "Defining Your Own User Softkey Menu".

These three USER softkeys (**<SAVE USER>**, **<RECALL USER>**, and **<DISPOSE USER>**) can be selected by pressing the [MENU] key, the **<Misc>** firmkey, and then the **<key control>** softkey. The **<SAVE USER>** and **<RECALL USER>** softkeys can also be found under the [USER] key.

Command

Selecting the **<COMMAND>** softkey via the **<Misc>** firmkey allows you to program the analyzer from the front panel. Below is a list of the softkey functions necessary for entering a command with a brief description of what each function does.

ENTER COMMAND

Selecting the **<ENTER COMMAND>** softkey tells the analyzer to accept the command that is typed in the data line.

SELECT CHARACTER

Using the **<SELECT CHAR>** softkey allows you to choose each character required for the command. The desired character must first be selected (by using the RPG knob) from the characters shown in the active function area. Then, by pressing the **<SELECT CHAR>** softkey, the selected character is entered into the command being created in the data line.

REPLACE, INSERT, or DELETE

The **<REPLACE or ...>** softkey works in conjunction with the **<SELECT CHAR>** softkey to replace, insert, or delete a character, which is indicated by the cursor, in the data line.

EDIT FUNCTION DEFINITION

Selecting **<EDIT FUNCDEF>** allows you the ability to edit the function definition (downloadable program). To edit an existing downloadable program (DLP), indicate the name of the DLP in the data line and press **<EDIT FUNCDEF>**. To create a new function of a DLP, press the **<EDIT FUNCDEF>** softkey with an empty data line.

ANY CHARACTER

Selecting **<ANY CHR>** allows entry of any ASCII character by entering its ASCII value in decimal.

CLEAR TO END

Selecting **<CLEAR TO END>** tells the analyzer to clear all the characters to the end of the data line under which the cursor is placed.

STEP UP [↑] and STEP DOWN [↓] KEYS

The [↑] and [↓] keys, which are located near the RPG knob, positions the cursor in the data line from left to right.

Below is a list of the equivalent Enter Command functions that can be found under the 14 top-level softkeys. More detailed descriptions of these functions and directions for using them can be found in this chapter.

Table 4-1. ◀COMMAND▶ Softkey Name Changes

Firmware Version 880314 or Later	Firmware Version 870501 or Earlier
◀ENTER COMMAND▶	◀EXECUTE LINE▶
◀SELECT CHAR▶	◀ENTER ALPHA▶
◀REPLACE or ...▶	◀INSERT/REPLACE▶
◀EDIT FUNCDEF▶	◀EDIT FUNCDEF▶
◀ANY CHR▶	◀ENTER ANY CHR▶
◀CLEAR TO END▶	◀CLEAR TO END▶

Zoom to Resolution Bandwidth

Selecting the ◀ZOOM TO RES BW▶ softkey allows you to go to zero span with a specified resolution bandwidth. To use this function, place a marker on the signal. Press the ◀ZOOM TO RES BW▶ softkey and then select a resolution bandwidth with the data entry keys. The frequency span is reduced in steps until zero span is achieved at the resolution bandwidth selected. During this process, the signal is maintained at center screen.

Using this softkey is a faster method of auto-zooming to zero span than using the ◀SIG TRK On/Off▶ (MARKER SIGNAL TRACKING) softkey, since it does not require using the narrowest resolution bandwidth filter.

The ◀ZOOM TO RES BW▶ softkey is selected via the ◀marker misc▶ softkey which resides under the ◀Marker▶ firmkey.

Preamplifier Control

The ◀preamp control▶ softkey enables you to identify, by number, each of the preamplifiers present in your system. With each preamplifier identified, you have the option of turning it on or off. The preamplifier identifying numbers are assigned by the order in which they are encountered in the local oscillator slave address area. (Refer to the HP 70900A Local Oscillator Installation and Verification Manual for detailed information on module addressing.)

The ◀preamp control▶ softkey is only available when a preamplifier module (e.g., HP 70620A) is present in your system. Therefore, the preamplifier module must be correctly addressed within the slave address area of the local oscillator.

Partial Erase

The **◀PARTIAL ERASE▶** softkey erases (from user memory) all unprotected catalog entries (e.g., DLPs and user menus), saved STATE registers, and performs an instrument preset. The serial number and calibration values of the system are not affected by this operation.

Firmkeys

The **◀FIRMKEYS On/Off▶** softkey specifies which menu structure is to be used. This softkey can be selected via the **◀key control▶** softkey which is located under the **◀Misc▶** firmkey.

The two menu structures that are available are either the seven top-level firmkeys (firmware version 880314 or later) or the 14 top-level softkeys (firmware version 870501 or earlier). Whenever this softkey is changed, press the [MENU] key or [I-P] to reset the displayed menu structure to the one selected.

When ON is selected, the seven softkeys at the left-hand side of the display screen are the top-level softkeys and are "firmkeys". These seven firmkeys are available with firmware version 880314 or later, and are always displayed to allow access to all the other softkey functions.

When OFF is selected, the menu structure is such that there are 14 top-level softkeys, seven softkeys on each side of the display screen, which allow access to all the other softkey functions.

The menu structure selected remains in effect until it is either changed or the battery fails. If the battery fails, the default menu structure that is displayed at power-up is the seven top-level firmkeys.

LIMIT LINES (Firmware Version 880901)

Limit lines, a series of line segments drawn on the display screen, represent upper and lower boundaries within which limit testing is performed on measurement data. You define the start frequency and amplitude of each segment by entering these values in a table. You also define the segment "type"--slope, flat, or point--to determine how the connections between adjoining segments are graphically represented on-screen.

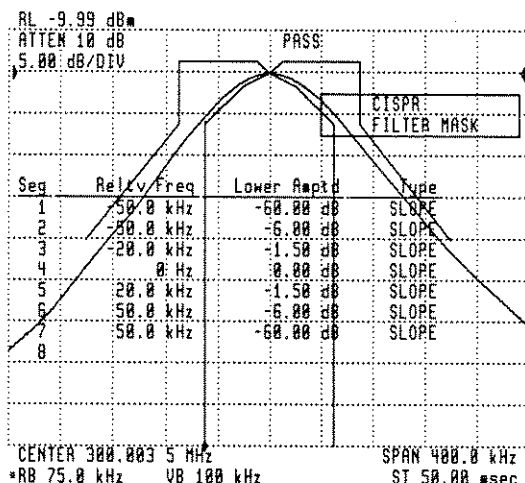

Figure 4-0.2. Limit Lines with Corresponding Table (Firmware Version 880901)

Creating Limit Lines

NOTE

You may have to change your center frequency and frequency span values so that limit lines being drawn will be displayed.

A four-column table consisting of the number, starting frequency, amplitude value, and type of segment is provided to create the limit lines. The highlighted area of the table indicates the active function and the segment parameter that can either be entered (if it's a new segment) or edited (if the segment already exists). Segments are sorted according to their frequency value as entered, thus allowing them to be created in any order. A total of 20 segments for each upper or lower limit line can be created. However, only 11 segments can be displayed in the table at one time. When more than 11 segments are created, the entire table will scroll up whenever one of the remaining segments is being entered. When editing the limit-lines table, arrows annotated alongside the uppermost and lowermost segment numbers indicate whether there are additional segments above or below the currently-displayed table.

Limit lines are saved as a pair consisting of one upper boundary and one lower boundary. A limit-line table must be created for both the upper and lower boundary. Using the **◀UPPER/LOWER▶** softkey allows you to switch between the two tables for entering or editing the limit-line tables for the current limit lines. Once the desired limit lines are drawn, the tables may be removed from the display for limit testing. As long as the **◀LIMITS On Off▶** softkey remains in the ON position, the limit lines are always displayed regardless of what other functions are being performed. The **◀RELATIV On Off▶** softkey function may also need to be enabled, depending on the center frequencies displayed. Refer to the **◀RELATIV On Off▶** softkey function description below for more information on fixed or relative frequency values.

NOTE

You may have to change center frequency or frequency span settings in order to display the segments of the limit lines as they are drawn.

When entering or editing the limit-line tables, graphic lines that correspond to the table values are drawn on the display. The lines depend on the current center frequency and frequency span settings of the analyzer. Therefore, as the limit-line tables are created, the limit lines can be viewed.

Limit Testing

Limit testing is a mechanism built into the instrument which provides a means for comparing measurement data with the limit lines. Setting the **◀LIMITS On Off▶** softkey to ON enables the limit-line testing function, which uses a PASS or FAIL error message on the display screen to indicate the status of the test. The **◀BEEPER On Off▶** softkey function can also be used in conjunction with the limit-line testing function to indicate the status of a limit test. When the beeper is enabled, a beeping sound can be heard when a failure is detected. One beep is sounded per each failed sweep.

When limit testing is enabled, the tables of the current limit lines are converted into two traces, **LIMIT_HI** and **LIMIT_LO**. The limit-line traces are identical to the current trace length and contain, for each trace data point, the proper amplitude of the limit line at that particular frequency. Interpolation techniques are used to fill in the trace data points within the line segments. During one analyzer sweep, each sweep data point is compared to its corresponding **LIMIT_HI** and **LIMIT_LO** data point to perform the limit test. If the sweep data point falls outside of either the upper or lower limit line (**LIMIT_HI** or **LIMIT_LO** trace data point respectively), then a failure is detected. Changing the frequency span, center frequency,

or any segment of the current limit-line table will cause LIMIT_HI and LIMIT_LO to be recalculated. LIMIT_HI and LIMIT_LO are automatically purged when limit testing is turned off. Therefore, LIMIT_HI and LIMIT_LO only appear as catalog items (when using the <CATALOG> softkey) when <LIMITS On Off> is turned ON.

Refer to the FIRMKEY MENU TREE at the beginning of this chapter for a graphic representation of all the softkeys available in this modular spectrum analyzer system.

Listed alphabetically below is a summary of the limit-line softkey functions.

Limit Line Softkey Function Descriptions

<AMPTD VALUE>

Limit Line Amplitude

The <AMPTD VALUE> softkey allows the amplitude value of a selected segment either to be entered or edited. Pressing <AMPTD VALUE> highlights the amplitude value in the current segment row as the active function. Then, by pressing <SELECT SEGMENT>, the desired amplitude value can be selected.

When entering the amplitude value for a new segment, the frequency value and segment type from the previous segment are automatically assumed by the new segment. Use the <FREQ VALUE> and <TYPE> softkeys to edit the frequency and segment type if required.

One of the following three methods can be used to adjust the limit-line segment amplitude: the numeric keypad, the step up/down keys, or the RPG knob. It is necessary to terminate a numeric keypad entry with one of the available terminators.

<BEEPER On Off>

Limit Line Beeper Enable

When the <BEEPER On Off> softkey is set to ON, a beep sounds whenever a limit-line test fails. One beep is sounded per each failed sweep. This feature is disabled when the softkey is set to OFF.

The sound of the beep can be heard by switching this function between ON and OFF; this sounds one beep with each press of the softkey.

◀BLANK TRACES▶

Blank All Traces

The **◀BLANK TRACES▶** softkey, which toggles between on and off, is used to blank all displayed traces on the screen. Blanking the displayed traces clears the display screen so that it is easier to view limit lines as they are drawn.

This function is only available in the Limit Lines Menu. All displayed traces automatically return when you exit the Limit Lines Menu.

◀DELETE ALL▶

Delete Current Limit Line Table

Use the **◀DELETE ALL▶** softkey to delete the upper and lower limit-line tables (and graph) for the current limit lines. This softkey function does not affect limit-line tables that have been previously saved. However, the **◀LIMITS On Off▶** softkey function is automatically disabled if it has previously been set to ON.

Refer to the **◀SAVE LIMIT▶** softkey function description for information on deleting previously saved limit lines from memory.

Refer to the **◀LIMITS On Off▶** softkey function description in this section for more information on limit-line testing.

◀DELETE SEGMENT▶

Delete Limit Line Segment

The **◀DELETE SEGMENT▶** softkey deletes the entire segment row of the current limit-line table in which an active function parameter is indicated (e.g., frequency value, amplitude value, or type of segment). When the deleted segment row is followed by additional segments, the remaining rows are automatically moved up one and the limit lines are redrawn to reflect the table values.

**<enter limit> or <edit limit>
Enter or Edit Limit Lines**

These softkeys access page 2 of the Limit Lines Menu, from which limit lines can be entered or edited.

If no limit lines currently exist, the **<enter limit>** softkey is available. If limit lines currently exist, the **<edit limit>** softkey is available. Pressing this softkey displays the current limit-lines table for editing.

NOTE

The operating error message **2011 Memory overflow** occurs if there is an inadequate amount of memory available prior to using this softkey function.

**<FREQ VALUE>
Limit Line Frequency**

The **<FREQ VALUE>** softkey allows the frequency value of a selected segment either to be entered or edited. Pressing **<FREQ VALUE>** highlights the frequency value in the current segment row as the active function. Then, by pressing **<SELECT SEGMENT>**, the desired frequency value can be selected.

When entering the frequency value for a new segment, the amplitude value and segment type from the previous segment are automatically assumed by the new segment. Use the **<AMPTD VALUE>** and **<TYPE>** softkeys to edit the amplitude and segment type if required.

One of the following three methods can be used to adjust the limit-line segment frequency: the numeric keypad, the step up/down keys, or the RPG knob. It is necessary to terminate a numeric keypad entry with one of the available terminators.

**<limit lines>
Limit Lines Menu**

The Limit Lines Menu softkey allows access to the following three pages of limit-line softkey functions.

Page 1

<RECALL LIMIT>	Recall Limit Lines
<SAVE LIMIT>	Save Limit Lines
<LIMITS On Off>	Enable Limit Line Testing
<BEEPER On Off>	Limit Line Beeper Enable
<enter limit> or <edit limit>	Enter or Edit Limit Lines

Page 2

<FREQ VALUE>	Limit Line Frequency
<AMPTD VALUE>	Limit Line Amplitude
<TYPE>	Segment Type
<SELECT SEGMENT>	Select Limit Line Segment
<UPPER/LOWER>	Upper/Lower Limit Lines

Page 3

<RELATIV On Off>	Relative Limit Lines
<DELETE ALL>	Delete Current Limit Line Table
<DELETE SEGMENT>	Delete Limit Line Segment
<SELECT SEGMENT>	Select Limit Line Segment
<BLANK TRACES>	Blank All Traces

<LIMITS On Off>
Enable Limit Line Testing

The <LIMITS On Off> softkey turns on and off the limit-line testing function set up by the upper and lower limit-lines.

NOTE

The operating error message **2011 Memory overflow** occurs if there is an inadequate amount of memory available prior to using this softkey function.

When this softkey is set to ON, a PASS or FAIL error message is displayed to indicate the status of a limit test. The softkey is also automatically enabled whenever the <edit limit> or <RECALL LIMIT> softkey functions are selected.

When OFF is selected and the table is not displayed, the current limit lines are disabled and no longer displayed.

<RECALL LIMIT>
Recall Limit Lines

NOTE

The operating error message **2011 Memory overflow** occurs if there is an inadequate amount of memory available prior to using this softkey function.

The <RECALL LIMIT> softkey returns a previously saved limit-line configuration. The numeric keypad must be used to enter the register value (a number consisting of one to four digits) that was saved via the <SAVE LIMIT> softkey.

When a previously saved limit-line configuration is recalled, the annotation "LIMIT_N" (where N is the number of the saved register) is displayed directly above the table.

◀RELATIV On Off▶
Relative Limit Lines

The **◀RELATIV On Off▶** softkey specifies whether or not all frequency and amplitude values are displayed relative to the analyzer's center frequency and reference level.

When ON is selected, the limit lines are relative only to the currently specified center frequency and reference level. For example, if limit lines are drawn in relation to a signal that has a center frequency of 100 MHz, the same limit lines can be used for a signal that has a center frequency of 300 MHz if the **◀RELATIV On Off▶** softkey is turned ON. "Reltv Freq" is also displayed in the frequency column of the limit-lines table to indicate that this function is turned on.

NOTE

Before changing the center frequency, the **◀RELATIV On Off▶** softkey must first be set to ON to retain the limit lines relative to the displayed center frequency. This is due to the frequency and amplitude value conversions occurring at the frequency at which the current limit lines are drawn.

When OFF is selected, the limit lines are "fixed" in relation to the currently specified center frequency and reference level. If another signal with a different center frequency is specified, the limit lines that were drawn around the previous signal are no longer displayed. Remember, the limit lines may be retained if the **◀RELATIV On Off▶** softkey is switched to ON.

◀SAVE LIMIT▶
Save Limit Lines

NOTE

The operating error message 2011 Memory overflow occurs if there is an inadequate amount of memory available prior to using this softkey function.

The **◀SAVE LIMIT▶** softkey stores the current limit lines in one of several registers. The numeric keypad must be used to enter the register value (a number consisting of one to four digits) in which

the limit lines are to be saved. Limit lines use a variable amount of memory, depending on the number of segments of which they are composed. Therefore, the number of registers in which limit lines may be saved depends on the memory size of each register.

Limit lines are stored as "LIMIT_N", where N is a number (consisting of one to four digits) representing the register in which the limit lines are being saved.

The **<SAVE LIMIT>** softkey must also be used when purging previously saved limit lines from memory. To do this, simply save a blank limit-line table in the same register as the limit lines that you wish to purge. For example, if you have previously saved a set of limit lines in LIMIT_10, use the **<DELETE ALL>** softkey followed by **<SAVE LIMIT>** 10 to purge LIMIT_10 from memory.

<SELECT SEGMENT>

Select Limit Line Segment

The **<SELECT SEGMENT>** softkey selects the next segment row (indicated by the highlighted area) of the limit-line table. When the bottom of the list is encountered, the next press of the softkey selects the segment at the top of the list.

Use the **<SELECT SEGMENT>** softkey in conjunction with the **<FREQ VALUE>**, **<AMPTD VALUE>**, or **<TYPE>** softkey functions to select the desired segment parameter.

<TYPE>

Segment Type

The **<TYPE>** softkey allows the selected segment to be specified as a slope, flat, or point segment. Pressing the **<TYPE>** softkey selects the "Type" column in the current segment row as the active function. Then, by pressing **<SELECT SEGMENT>**, the desired segment type can be selected. Only the segment type that is highlighted as the active function can be entered or edited.

When the **<TYPE>** softkey is pressed, a sub-level menu consisting of the three segment types is displayed: **<SLOPE>**, **<FLAT>**, and **<POINT>**. As soon as a segment type is selected, you are returned to the previous menu automatically.

When **<SLOPE>** is selected as a segment type, a sloping line is drawn as a connection to the next segment. **<FLAT>** specifies a flat line, and **<POINT>** specifies a single data point.

When entering a new segment type, the frequency and amplitude values from the previous segment are automatically assumed by the new segment. Use the <FREQ VALUE> and <AMPTD VALUE> softkeys to edit the frequency and amplitude values if required.

<UPPER/LOWER>

Upper/Lower Limit Lines

The <UPPER/LOWER> softkey selects whether the upper or lower limit-line boundary is to be displayed for entering or editing segment data.



	CENTER FREQ
	SPAN
	START FREQ
	STOP FREQ
	CF STEP
	CF STEP AUTOMAN
	FULL SPAN
PRE- SELECT	SIGNAL ID
PRE SEL PEAK	SIGNAL IDENT
PRE SEL DAC	SIG ID TO CF
PRE SEL HYST	SIG ID OPTIONS
PRE SEL ON OFF	SIG ID MAN OFF
MARKER NORMAL	IMAGE SHIFT
MARKER DELTA	SIG ID AMPTD Δ
MARKERS OFF	IMAGE N START
HIGHEST PEAK	IMAGE N STOP
NEXT PEAK	EXIT
MKR TO CF	SAVE STATE
EXIT	RECALL STATE
	MARKER NORMAL
	MARKER DELTA
	HIGHEST PEAK
	NEXT PEAK
	RIGHT PEAK
	LEFT PEAK
	CLOSEST PEAK
	EXIT
	FREQ OFFSET
	LCL OSC START
	LCL OSC STOP
	FRQ LIM ON OFF
	EXIT

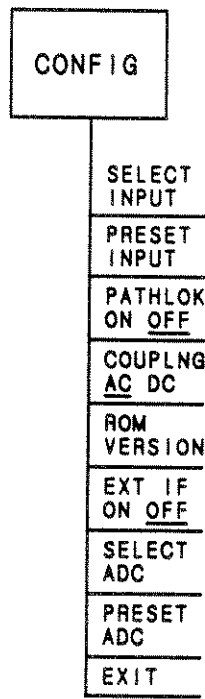

MANUAL OPERATION, FIGURE 4-2(PARTIAL). MENU SOFTKEYS (2 OF 2)

Rev. MAY87

Introduction

This chapter describes in detail the functions accessed by pressing [MNU] (hardkey). This includes the major spectrum analyzer functions.

Top Level Softkeys

Figure 4-1 shows the 14 softkeys which appear when [MNU] is pressed.

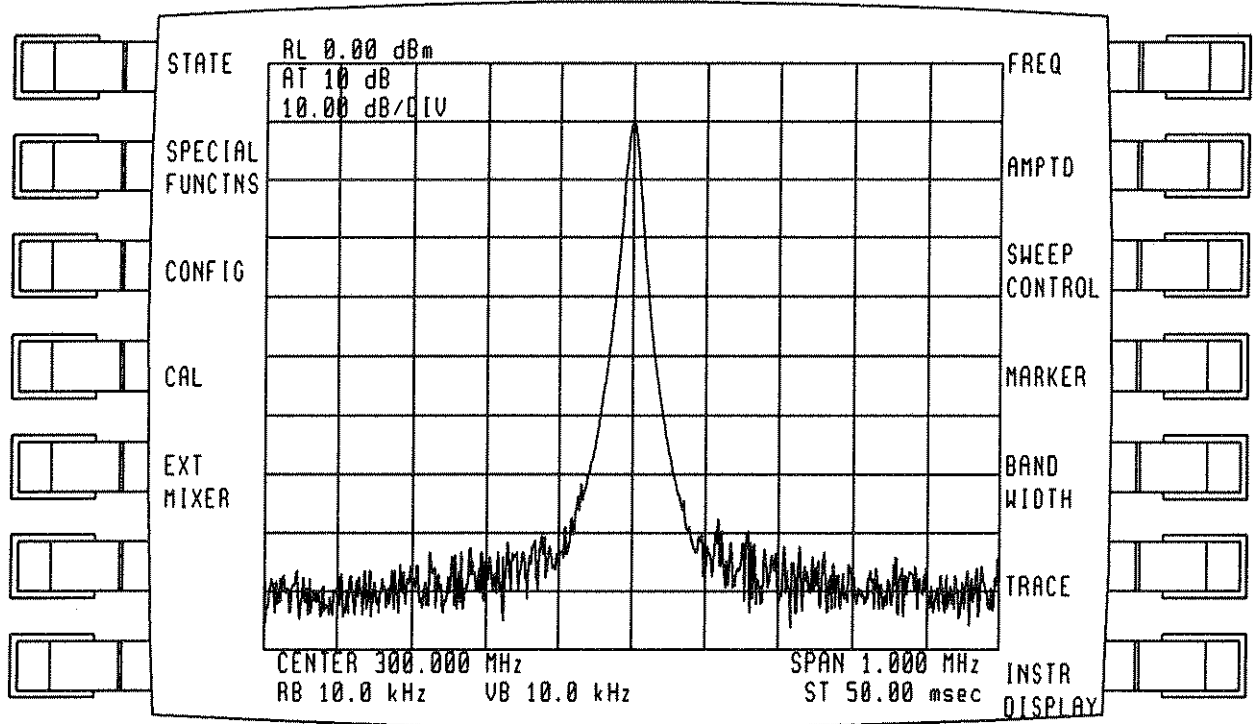

Fig.4-1. Top level menu for [MNU] hardkey

At the top of figure 4-2 is a label THE MENU SOFTKEYS, representing the [MNU] hardkey. Under this label are 14 boxes labelled FREQ, AMPL ..., EXT MIXER, representing the 14 softkeys which appear when [MNU] is pressed. If a tracking generator is in the system and activated, the softkey SOURCE will appear after EXT MIXER. Under these 14 softkeys are many branches, representing deeper levels of softkeys.



Figure 4-2. The MENU Softkeys

FREQ	AMPTD	CONTROL	MARKER	WIDTH	TRACE	DISPLAY	STATE	FUNCTNS	CONFIG	CAL	MIXER	SOURCE*
CENTER FREQ	REF LVL	CONT SWEEP	MARKER PEAK	RES BM	TRACE A	DISPLAY LINE	SAVE STATE	DEBUG ON OFF	SELECT INPUT	EXECUTE CAL	FULL BRAND	SOURCE
SPAN	POSN REF	SINGLE SWEEP	HIGHEST PEAK	RES BM AUTOMAN	CLR WRT	DSP LIN ON OFF	RECALL STATE	DEBUG SLOM	PRESET INPUT	CAL ALL	K	PMR LVL
START FREQ	EXTD RL ON OFF	SWEEP TIME	NEXT PEAK	RB/SPAN RATIO	MAX HLD	THRESHD	NO. OF STATES	DEBUG FAST	PATHLOK ON OFF	CAL LOGAMP	18-26.5	SRC RF
STOP FREQ	ATTEN	SMTIME AUTOMAN	RIGHT PEAK	VID BM	MIN HLD	THRESHD ON OFF	P STATE ON OFF	PRUSE	ON OFF	CAL GRAT	A	TRACK
CF STEP	ATTEN AUTOMAN	TRIGGER FREE	LEFT PEAK	VID BM AUTOMAN	TRACE A VIEW	ON OFF	POWERUP IP LAST	STEP	AC DC ROM	CAL GRIN	33-50	ADJUST
CF STEP AUTOMAN	LOG dB/DIV	TRIGGER VIDEO	CLOSEST PEAK	VBM/RBM RATIO	TRACE A BLANK	ON OFF	EXIT	CONT	VERSION	CAL RES BM	40-50	EXIT
FULL SPAN	LINER (VOLTS)	TRIGGER LINE	MINIMUM POINT	EXIT	TRACE A DSPL A	ANOTATN ON OFF		HOLD		ENABLE CAL	V	
SIGNAL ID	AMPTD UNITS	TRIGGER EXT	EXIT		LENGTH TRACE A	NORMAL DISPLAY		PRESET		FLATCAL ON OFF	E	
SIGNAL IDENT	A UNITS AUTOMAN	VID TRG LEVEL	MARKERS OFF		EXTEND STATE	SHOW		USER KY		LOG CAL ON OFF	75-110	
SIG ID TO CF	dBmV UNITS	VID HYS LEVEL	MARKER NORMAL		SHOW STATE	EXTEND STATE		DEFINE		LOG CAL ON OFF	F	
SIG ID OPTIONS	dBuV UNITS	EXIT	MARKER DELTA		SHOW CONFIG	SHOW		UDK		GRINGAL ON OFF	90-140	
SIG ID MAN OFF	VOLT UNITS		MARKER BM		CATALOG NEXT	CONFIG		END UDK DEF		ON OFF	D	
IMAGE SHIFT	UNITS		MARKER TRACE A		PRESET	PRESET		ENTER COMMAND		RBN CAL ON OFF	G	
SIG ID SHIFT	UNITS		MARKER TRACE B		TRACE B CLR WRT	TRACE B		EXECUTE LINE		ON OFF	140-220	
AMPTD Δ	UNITS		AMP REL LEFT		MAX HLD	A - B → A		EDIT		EXIT	Y	
IMAGE N START	UNITS		AMP REL RIGHT		MIN HLD	A - B + DL ON OFF		EXECUTE LINE		FREQ FOR CAL	170-260	
IMAGE N STOP	UNITS		MARKER TRACE C		TRACE B	A + B → A		EXECUTE LINE		POWER	J	
EXIT	UNITS		MARKER SIG TRK LIMIT		VIEW	B - DL → B		EXECUTE LINE		FOR CAL	220-330	
SAVE STATE	AMP REF OFFSET		PEAK EXCURSN		TRACE B BLANK	A XCH B		EXECUTE LINE		TO END	EXIT	
RECALL STATE	IMPED		EXCURSN		TRACE B DSPL B	B XCH C		EXECUTE LINE		REPLACE	LOCK	
MARKER NORMAL	MAX MXR LEVEL		MK READ AUTOMAN		LENGTH TRACE B	EXIT		EXECUTE LINE		DELETE	HARMNC #	
MARKER DELTA	EXIT		MK READ FREQ		TRACE B	EXIT		EXECUTE LINE		CHAR	ON OFF	
HIGHEST PEAK			MK READ PERIOD		TRACE C	EXIT		EXECUTE LINE		ENTER ANY CHR	BIAS	
NEXT PEAK			PERIOD		CLR WRT	EXIT		EXECUTE LINE		ENTER ALPHA	ON OFF	
RIGHT PEAK			MK READ SWP TIM		TRACE C	EXIT		EXECUTE LINE		;	BIAS PK	
LEFT PEAK			SWP TIM		MAX HLD	EXIT		EXECUTE LINE		ENTER ALPHA	START	
GLOSEST PEAK			MK READ I/T		TRACE C	EXIT		EXECUTE LINE		ENTER ALPHA	BIAS PK	
EXIT			EXIT		MIN HLD	EXIT		EXECUTE LINE		ENTER ALPHA	MIN	
FREQ OFFSET					VIEW	EXIT		EXECUTE LINE		ENTER ALPHA	BIAS PK	
LCL OSC					TRACE C	EXIT		EXECUTE LINE		ENTER ALPHA	MAX	
START LCL OSC					BLANK	EXIT		EXECUTE LINE		ENTER ALPHA	BIAS PK	
STOP LCL OSC					TRACE C	EXIT		EXECUTE LINE		ENTER ALPHA	RES	
EXIT					DSPL C ON OFF	EXIT		EXECUTE LINE		ENTER ALPHA	EXIT	

*Active only when tracking generator installed.

The sections in Part I are organized in the following manner:

Frequency

This section describes softkeys that change frequency settings or identify signals.

Amplitude

This section describes softkeys that change amplitude reference or attenuator settings and display scale setting functions.

Sweep Control

This section describes softkeys that change trigger mode settings or sweep time settings. It also describes softkeys that change sweep mode settings.

Marker

This section describes softkeys that use markers to make faster and more accurate measurements.

Bandwidth

This section describes softkeys that change resolution bandwidth settings.

Trace

This section describes softkeys that use the TRACE functions for writing, storing, and manipulating trace data. It also describes the softkeys used to select the detector functions.

Instrument Display

This section describes softkeys that change instrument display settings or annotation settings.

State

This section describes softkeys for saving or recalling trace displays. It also describes how to set up the spectrum analyzer's power-up state.

Special Function

This section describes softkeys you will use to select the memory display function and to re-label your own softkeys. It describes how to write, execute, and debug your own programs from the front panel. It also describes the softkeys you will use to perform an analyzer self test.

Configuration

This section describes softkeys that select the input source or the coupling mode. It also describes how to find the version of firmware in the instrument and how to lock the path of measurement into the instrument.

Calibration

This section describes softkeys used to calibrate the amplitude, the resolution, the bandwidth, the frequency, and the log amplifier. It also describes how correction features are set.

External Mixer

This section explains how to set up an external mixer using softkeys. It also describes the Bias circuitry set up.

Frequency

This section describes softkeys which change frequency settings or identify signals. Figure 4-3 shows the softkeys which appear when **◀FREQ▶** (softkey) is pressed.

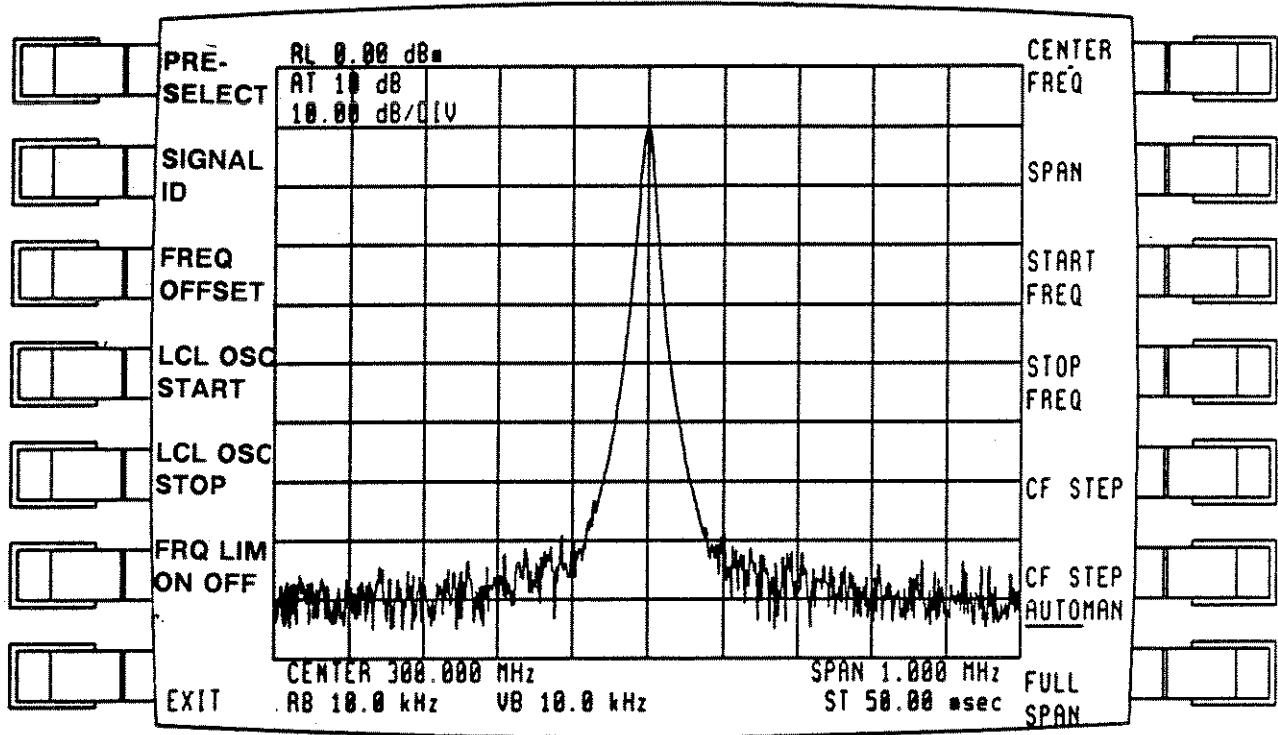
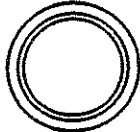



Fig.4-3. Top level menu for **◀FREQ▶**

Center Frequency

To adjust center frequency select the **◀FREQ▶** softkey and then select the **◀CENTER FREQ▶** softkey. The center frequency can be tuned continuously from 0-2.9 GHz (0-26.5 GHz for the microwave spectrum analyzer). The center frequency can be set with 1 Hz resolution. Readout resolution is for span greater than 0 it is 1 divided by trace-length times frequency of span; for span equal to 0 it is 1 divided by 10 times RBW, hence the highest readout resolution is obtained with narrow frequency spans. Data entered, however, is stored to a resolution of 1 Hz even though the center frequency readout may display less resolution.

Three methods of setting CENTER FREQUENCY are shown below:

<p>KNOB</p> 	<p>Changes the center frequency by an amount dependent on how fast or slow the knob is turned. Turning faster causes a larger change vs slow for a small change.</p>
<p>STEP KEYS</p> 	<p>Changes the center frequency by one tenth of the frequency span, i.e., by one division. ◀CF STEP▶ can be used to change this step size.</p>
<p>KEY PAD</p> 	<p>Allows direct center frequency entry. The analyzer will accept a center frequency with 1 Hz resolution. Even though the readout may show a fewer number of digits (due to wide frequency span), as the span is narrowed, the full entry will be readout. Abbreviated readouts are rounded.</p>

Example:

A signal can be tuned to the center of the display by pressing ◀CENTER FREQ▶, then turning the display knob, pressing the step keys, or using the numeric key pad. The frequency of the center of the display can be read from the active function at the center left of the display or from the center frequency annotation at the lower left of the display.

Connect CAL OUTPUT to RF INPUT, then press [I/P] for a full span display.

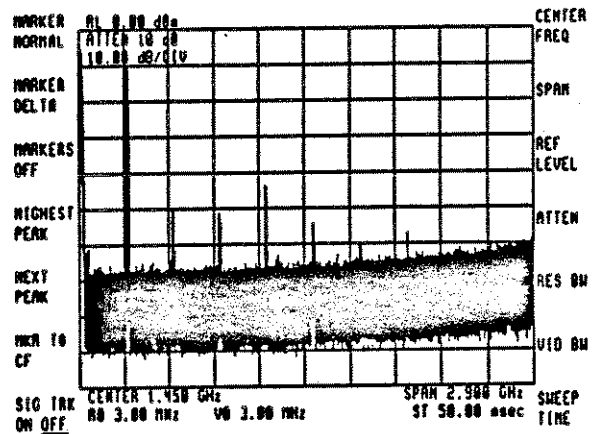

Fig.4-4. This display is for a 2.9 GHz RF section. The display will look different (wider span) for a 22 or 26.5 GHz RF section.

Select [MNU] and then select ◀FREQ▶; finally, select ◀CENTER FREQ▶. Tune signal to center of display with the knob.

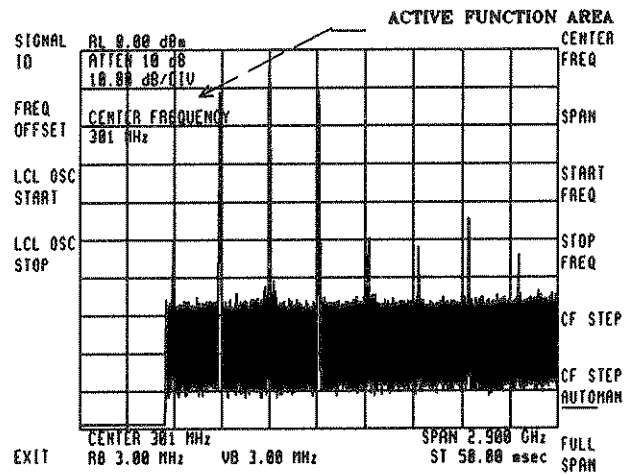

Fig.4-5



Span

The frequency span changes the total display frequency range symmetrically about the center frequency. Note that the frequency span readout refers to the total display frequency range; to determine frequency span per division, divide by 10.

As the frequency span is changed, resolution bandwidth and video bandwidth automatically change to provide a predetermined level of resolution and noise averaging respectively. Sweep time also changes automatically to maintain a calibrated display.

The analyzer's span can be adjusted from 0 to 2.9 GHz in the low band and 0 to 26.5 GHz in the microwave band. The zero span enables the analyzer to function as a fixed-tuned receiver and the zero span can display modulation waveforms in the time domain.

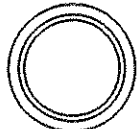
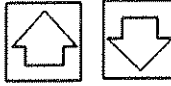
Three methods of setting SPAN are shown below:

<p>KNOB</p> 	<p>Changes the frequency span continuously.</p>
<p>STEP KEYS</p> 	<p>Changes the frequency span to the next value in a 1,2,5,10 sequence.</p>
<p>KEY PAD</p> 	<p>Enters an exact value depending on span. Resolution is read to less than 1 Hz.</p>

Example:

◀SPAN▶ to zoom-in on signals.

Connect CAL OUTPUT to RF INPUT, then press [I/P]. This selects a convenient full span display from 0 to 2.9GHz (0-26.5 GHz microwave spectrum analyzer).

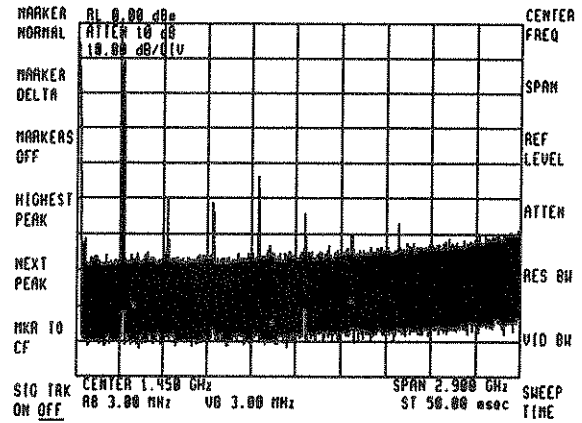

Fig. 4-6

Select [MNU] and then select ◀FREQ▶. Tune center frequency to 300 MHz by pressing ◀CENTER FREQ▶, then enter [3], [0], [0], ◀MHz▶.

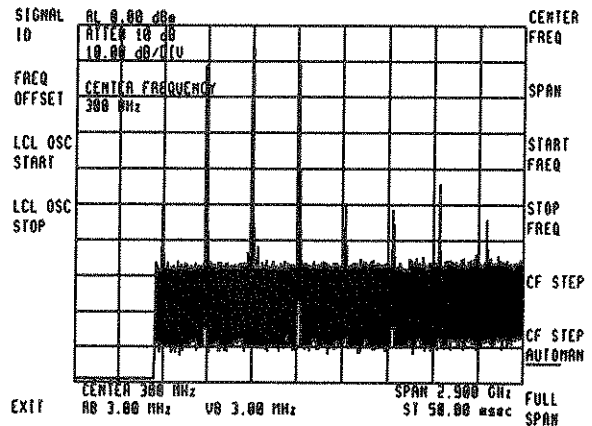

Fig. 4-7

To reduce the span press ◀SPAN▶, then select the step keys or the knob. The desired span can also be selected with the numeric keyboard. Note that narrow frequency spans provide increased center frequency resolution.

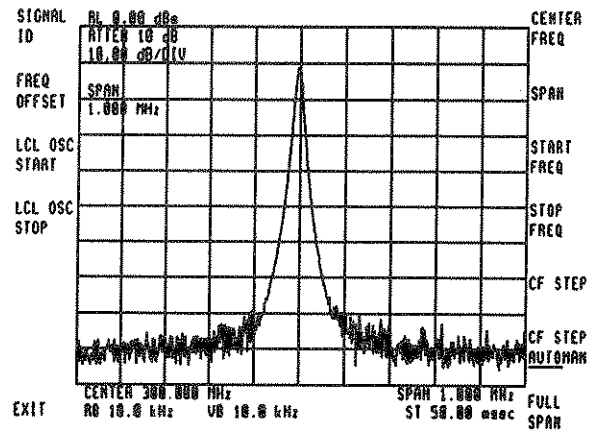

Fig. 4-8

Example:

By operating the spectrum analyzer in zero span the modulation waveform of an AM signal can be displayed in the time domain.

In the frequency domain, the analyzer can accurately determine the modulation frequency and level.

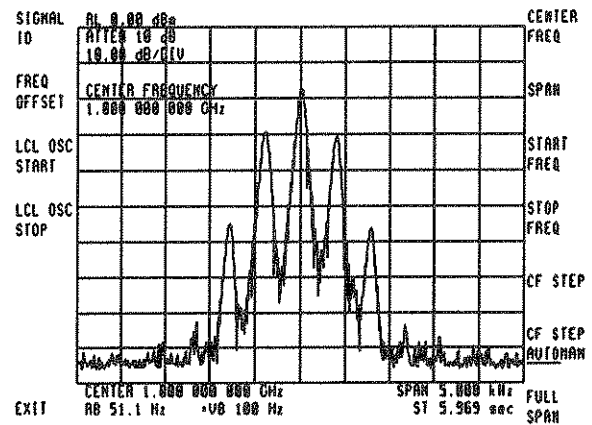

Fig. 4-9

To demodulate the AM, increase the resolution bandwidth to include both sidebands within the IF passband. Press ◀BANDWIDTH▶, then ◀RES BW▶ and then use the step keys.

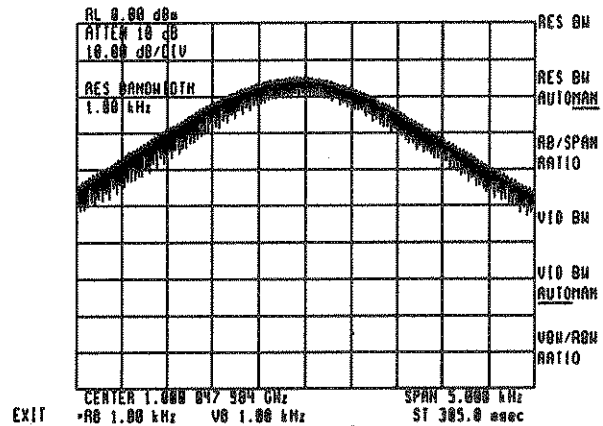

Fig. 4-10

Position the signal at the reference level and select a linear voltage display. Press ◀AMPTD▶, then ◀REF LEVEL▶, and then use the knob. Press ◀LINEAR▶.

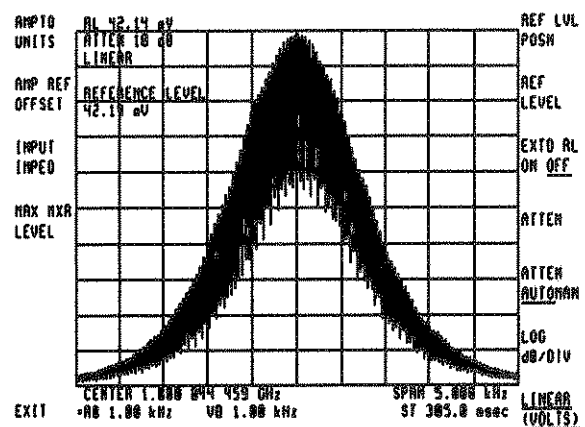

Fig. 4-11

To select zero span, press **◀FREQ▶**, **◀SPAN▶**, and then enter 0 Hz. Video Trigger can be used to trigger on the waveform. The sweep time control can be adjusted to change the horizontal scale.

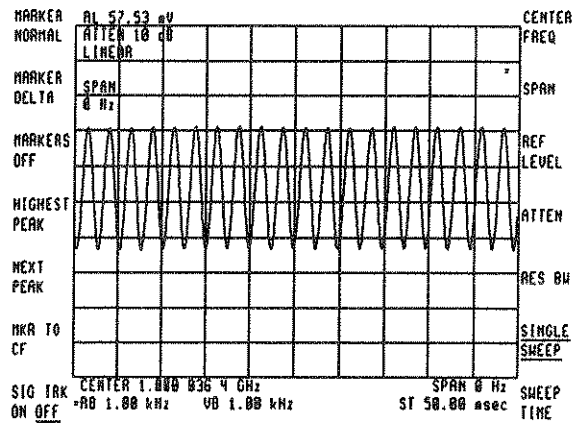

Fig. 4-12



Start/Stop Frequency

Another way to adjust the frequency range is by using **◀START FREQ▶** and **◀STOP FREQ▶** instead of **◀CENTER FREQ▶** and **◀SPAN▶**. Activating **◀START FREQ▶** or **◀STOP FREQ▶** causes both to read out in place of **◀CENTER FREQ▶** and **◀SPAN▶** on the CRT. **◀START FREQ▶** sets the left graticule frequency and **◀STOP FREQ▶** sets the right graticule frequency; both are mutually exclusive with **◀CENTER FREQ▶** and **◀SPAN▶**.

The instrument's **[I/P]** or **◀FULL SPAN▶** selects a start/stop frequency from 0-2.9 GHz (0-26.5 GHz for microwave spectrum analyzers). The maximum start/stop frequency span allowable is 26.5 GHz. The minimum span is 0 Hz (Start Freq = Stop Freq).

Start/Stop frequency readout resolution is for span greater than 0 it is 1 divided by trace-length times frequency of span; for span = 0 it is 1 divided by 10 times RBW (span= stop frequency - start frequency).

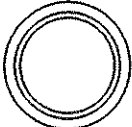
Three methods of setting START FREQ and STOP FREQ are shown below:

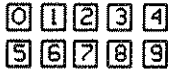
<p>KNOB</p> 	<p>Changes the start or stop frequency. The amount of change is dependent upon the rate of change of the knob. Turning faster causes a larger change vs slow for a small change.</p>
<p>STEP KEYS</p> 	<p>Changes the frequency by one tenth of the total frequency span.</p>
<p>KEY PAD</p> 	<p>Exact start or stop frequencies can be entered. The number of digits readout depends upon the frequency span.</p>

Example:

Set start/stop frequency to monitor the FM broadcast band. The input signal is from an FM antenna.

Press [I/P], [MNU], then press ◀FREQ▶, then ◀START FREQ▶, and enter [8], [8], ◀MHz▶ on the keyboard. Press ◀STOP FREQ▶ and enter [1], [0], [8], ◀MHz▶ on the keyboard.

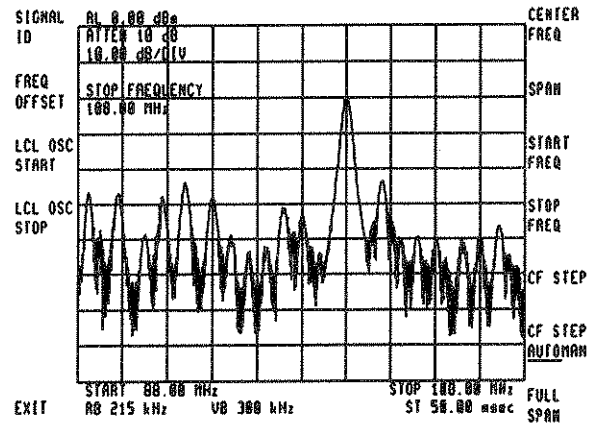

Press ◀CENTER FREQ▶. Note that horizontal scaling is unchanged although the Start/Stop frequency readouts are replaced by center frequency and span (108 - 88 = 20 MHz).

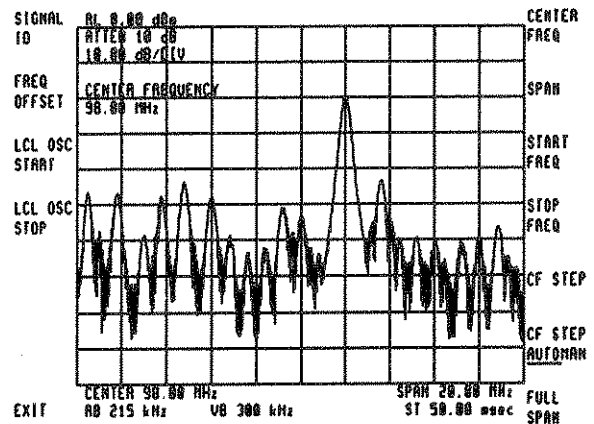

CF Step

Pressing ◀CF STEP▶ sets step size to manual, changes and stores the step size entered into a register. This also causes the underline in the ◀CF STEP AUTOMAN▶ to change from auto to manual ◀CF STEP AUTOMAN▶. (It is only changed to manual if a value is entered.) By pressing ◀CF STEP AUTOMAN▶, the analyzer will go to the auto position again. While ◀CF STEP AUTOMAN▶ is in manual, press ◀CENTER FREQ▶ and the down step key changes center frequency by the step size value stored in the register. Several functions can be used to enter step size values to the register. When a ◀CF STEP AUTOMAN▶ is auto, the center frequency steps will be 10% of the frequency span. When in AUTO, the cf-step (register) will always contain 10% of span.

The step size can be varied from 0 Hz to greater than 20 GHz with 1 Hz resolution. It is displayed with the same resolution as center frequency. See the figure below. Notice the step size is 10% (2 MHz) of the span (20 MHz).

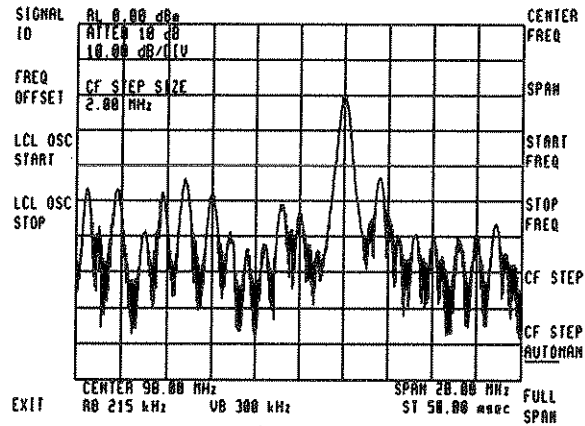
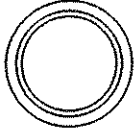



Fig. 4-15

Three methods of setting CF STEP SIZE are shown below:

<p>KNOB</p> 	<p>Changes the step size in display unit increments.</p>
<p>STEP KEYS</p> 	<p>Changes the step size to the next step value in 1, 2, 5, 10 sequence.</p>
<p>KEY PAD</p> 	<p>Selects a specific step size to a resolution equal to the current center frequency readout.</p>

Example:

Surveillance of a wide frequency span sometimes requires high resolution. One fast way to achieve this is to take the span in sequential pieces using a tailored center frequency step. This example looks from 0 Hz to 2.5 GHz in 50 MHz spans.

First set the span and center frequency. For a span of 50 MHz press **◀FREQ▶** then **◀SPAN▶** then enter 50 MHz on the keyboard. Set the center frequency to 25 MHz by pressing **◀CENTER FREQ▶** then entering 25 MHz on the keyboard.

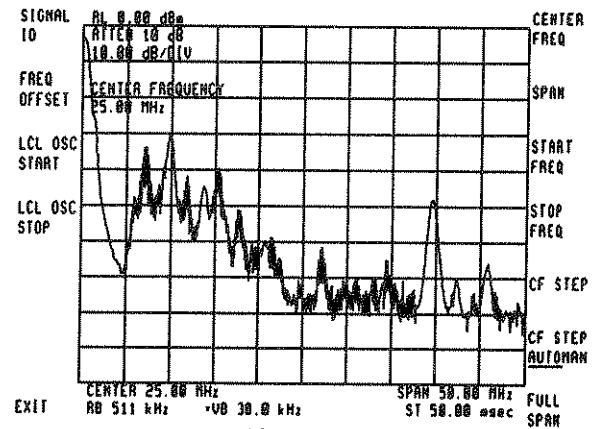

Fig. 4-16

Set the step size to 50 MHz by entering **◀CF STEP▶** then entering 50 MHz on the keyboard; reactivate center frequency with **◀CENTER FREQ▶** and step to 175 MHz.

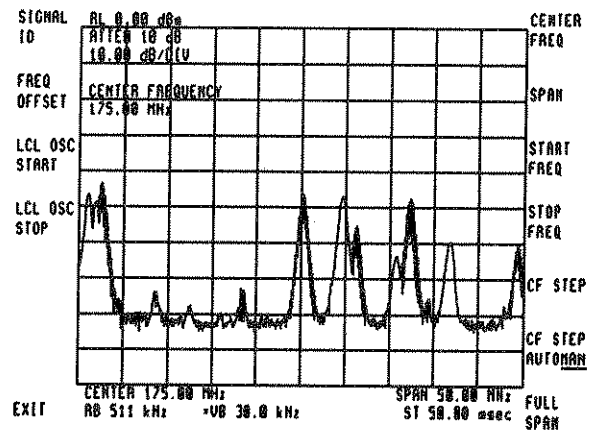

Fig. 4-17

Now each time you press the up step key you set the center frequency to the next 50 MHz span (Center frequency = 25 MHz, 75 MHz, 125 MHz, etc.). Thus, you are able to survey the spectrum span by span. Center frequency step size can also be defined by the marker (See MARKER section).

CF Step Automan

To select different step sizes press **◀CF STEP AUTOMAN▶** notice the underline changes from the auto to manual position. To go back to auto press **◀CF STEP AUTOMAN▶** and it will toggle back.

The other way to change the step size is to press **◀CF STEP▶** and then enter the change. Notice that the **◀CF STEP AUTOMAN▶** will automatically change to the manual position.

Full Span

◀FULL SPAN▶ provides a convenient starting point for making most measurements. That is, it calls for a full 0-2.9 GHz span (0-26.5 GHz for microwave spectrum analyzers), it sets the center frequency and span. Switching on line power automatically calls for an instrument preset.

[I/P] resets all the front panel functions to their preset condition.

Frequency Offset

The CRT display frequency readout can be offset. Entering an offset does not affect the trace. Press ◀FREQ OFFSET▶ and then enter the value of offset wanted.

Offset entries are added to all the frequency readouts on the CRT display including marker, start frequency, stop frequency, and others.

To eliminate an offset, activate the ◀FREQ OFFSET▶ and enter zero. An [I/P] key also sets the offsets to zero. Offsets are stored with the save functions and recalled by selecting the recall function. When an offset is entered its value is displayed on the CRT in the active function area and also at the bottom of the screen. Only a signal that FOFFSET <> 0 is turned on at the bottom of screen - its value is not displayed.

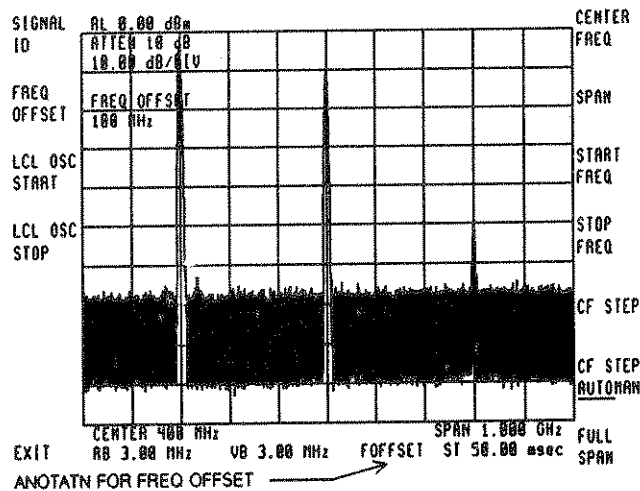

Data entry from the keyboard can be in Hz, kHz, MHz or GHz for frequency. The offset range for frequency is +/- 1000 GHz in 1 Hz steps are kept.

Example:

The 300 MHz CAL signal is used as the input signal. The frequency offset can be set positive or negative. The example below shows a negative (-50MHz) offset. The example above shows a positive 100 MHz offset.

Press **◀FREQ OFFSET▶**, then enter **[-], [5], [0], ▶MHz▶**.

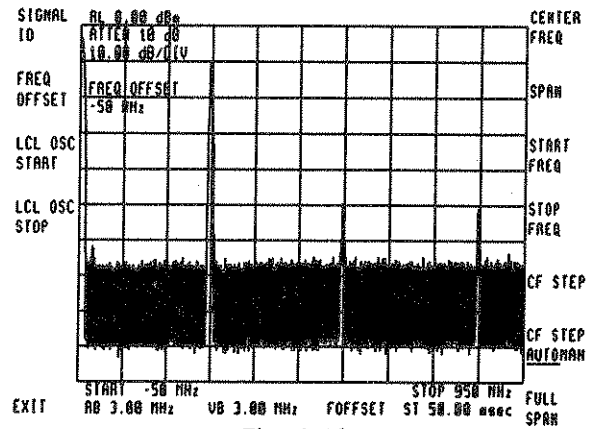

Fig. 4-19

Signal Ident

To use this function place a marker on the signal which is to be identified, and select the band (N State) of interest. (The narrower the span the higher the probability of identifying the signal). Then press **◀SIGNAL IDENT▶**. The instrument will automatically save the current state of the instrument and returns when finished. The identified signal will be indicated on the CRT display. If it can't identify the signal, this will be indicated also.

The analyzer defaults to the Automatic image mode. A detailed description can be found at the end of this section.

Signal ID to CF

Pressing **◀SIGNAL ID TO CF▶** causes the identified signal to be brought to the center frequency.

Signal ID Options

Pressing **◀SIGNAL ID OPTIONS▶** brings a new set of softkeys to the display. This set of softkeys allows the selection of manual vs automatic signal identification. It allows the selection of Image vs Shift function. The amplitude difference of the signal and image can be set. Finally, the harmonic number of start and stop can be set.

SIG ID MAN OFF

Pressing **◀SIG ID MAN OFF▶** allows the manual selection of signal indentifications. The description can be found at the end of this section.

IMAGE/SHIFT

Pressing ◀IMAGE/SHIFT▶ allows the selection of either signal identification using shift method vs image method. At the end of this section is a detailed description of these two methods.

Signal ID Amplitude delta

Pressing ◀SIG ID AMPTD DELTA▶ allows the selection of the difference in amplitude between the signal identified and the image signal. The default value is 10 dB. This softkey allows the desired value to be set. The range is from 0 dB to 300 dB.

Image N Start

Pressing ◀IMAGE N START▶ allows the selection of the start harmonic number. Selecting the correct harmonic number will reduce the time in identifying true signals.

Image N Stop

Pressing ◀IMAGE N STOP▶ allows the selection of the stop harmonic number. Selecting the correct harmonic number will reduce the time in identifying true signals.

Signal Ident

Detail description of Signal Identification function.

The analyzer provides two modes of signal identification, shift and image. Image signal identification involves searching a harmonic range for a response which has an image at twice the IF frequency. Shift signal identification involves shifting the IF frequency and the LO frequency and measuring the change in frequency of the response. For each mode, the analyzer offers both automatic and manual signal identification.

Shift Signal Identification----Automatic

The analyzer saves the current state, so that it can be recalled at the end of the signal identification process. If there is no active marker, the analyzer activates a marker and places it on the highest peak. The analyzer locates the frequency and amplitude of the response at the marker (this is the "marked" response).

Now the analyzer searches for a path from the input which uses the same mixer, but which has a different IF frequency. It tunes the analyzer so that if the marked response is a true signal, it does not move. If the marked response is a harmonic response, it shifts by N times the difference in IF frequency. The analyzer takes a sweep, and locates the shifted response. To locate the shifted response, it must appear on screen and the amplitude must be within the specified amount of the marked response set in the SIGDEL command.

If the shifted response is not found, the signal identification displays that the signal identification failed. If the shifted response is found, the difference in frequency from the marked response is divided by the IF shift to determine the harmonic number, and the true frequency of the signal is computed and displayed on the screen.

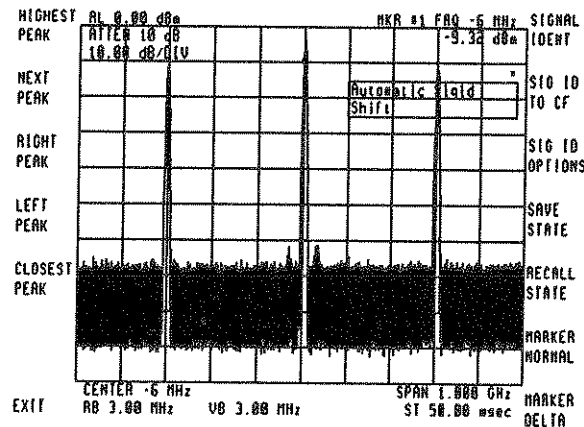

At the end of the signal identification routine, the analyzer is returned to its previous state. The SIG ID TO CF command may be used to tune the analyzer center frequency to the identified frequency (unless the signal is identified out of band and the analyzer is band locked).

Shift Signal Identification ----Manual

Manual shift signal identification works on the same principle as automatic shift signal identification, except the result is displayed differently. Instead of computing and displaying the frequency of the identified signal, the analyzer alternates sweeping between the marked response, and the shifted response, to allow you to determine the difference in frequency. During the shifted sweep, an annunciator on the display indicates that the sweep is a Manual Shift Signal Identification sweep.

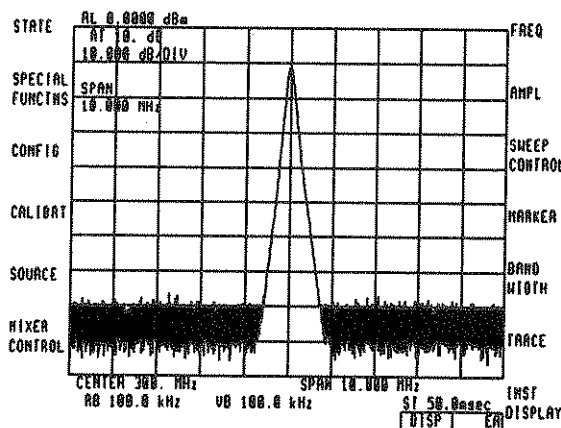

Image Signal Identification ----Automatic

To operate this mode place a marker on the response to be identified and initiate the image signal id routine. The analyzer saves the current state so that it can be recalled at the end of the signal identification process. If there is no active marker, the analyzer activates a marker and places it on the highest peak. The analyzer locates the frequency and amplitude of the response at the marker (this is the marker response).

Now the analyzer searches a range of bands for a response at any frequency, F_s , that could have produced the marked response. The range of bands may be specified by using the NSTART and NSTOP commands. For each F_s it takes a sweep, and looks for a response at F_s that is within Xdb of the marked response. You can set X by using the SIG ID AMP DELTA command. If a response is present, it looks for its image at F_s+2*IF . If the image response is present, the signal identification routines ends, displaying the frequency of the signal on the display. If the image response is not found, it checks the next F_s . After all possible frequencies have been checked, if the signal was not identified, the analyzer displays that it failed in identifying the signal.

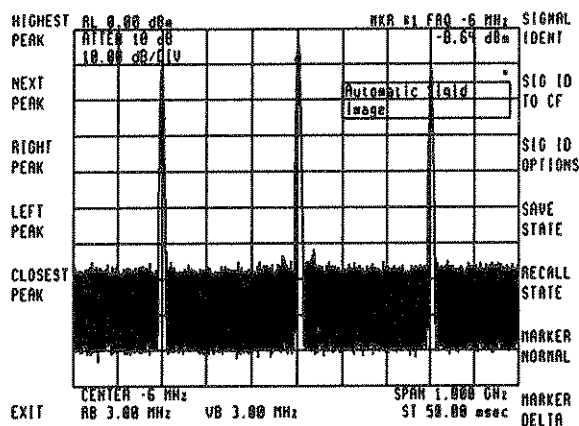

Fig.4-22

At the end of the signal identification routine, the analyzer is returned to its previous state. The SIG ID TO CF command may be used to tune the analyzer center frequency to the identified frequency (unless the signal is identified out of band and the analyzer is band locked).

Image Signal Identification ----Manual

Manual image signal identification works on the same principle as automatic image signal identification, except the result is displayed differently. Instead of searching all possible frequencies, the analyzer assumes the marked response is the signal. The analyzer alternates sweeping between the marked response and the image to allow you to compare the two.

Lcl Osc Start

Selecting ◀LCL OSC START▶ allows the selection of the local oscillator start frequency. The value can be entered on the keyboard or by using the step key or by using the display knob. In microwave analyzers the above is true if you are within a specific band.

Lcl Osc Stop

Select ◀LCL OSC STOP▶ allows the selection of the local oscillator stop frequency. The value can be entered on the keyboard or by using the step key or by using the display knob. In microwave analyzers the above is true if you are within a specific band.

PRESELECTION

Pre-Select

The preselector softkey accesses the preselector functions, which are active when a preselector is installed in the analyzer. Use them to improve amplitude accuracy. When making preselector measurements, first activate the input port on the preselector module, using the <SELECT INPUT> softkey. Be sure to recalibrate the analyzer with the <EXECUTE CAL> functions after activating a new input port. (See the Configuration and Calibration sections.)

FIRMWARE
VERSIONS
861015
OR
LATER

The preselector may not always have the same measurement range as the other modules in the analyzer. For example, the IIP 70600A preselector and HP 70906A RF section measure up to 22 GHz and 26.5 GHz, respectively. In this case, preselected measurements can be made up to 22 GHz only. To measure at higher frequencies, activate the RF section input port, recalibrate the analyzer, and reconnect the signal to the RF-section input port.

Pre Sel Peak

The preselector-peak softkey adjusts the tracking of the preselector filter to yield maximum amplitude accuracy at the active marker position. If a marker is not present, <PRE SEL PEAK> places a marker at the highest signal on screen.

FIRMWARE
VERSIONS
861015
OR
LATER

Each time the preselector is peaked, a value is stored in the preselector DAC. Up to four values can be stored, one for each of four frequency ranges:

2.7 GHz to 6.2 GHz
6.0 GHz to 12.7 GHz
12.5 GHz to 19.9 GHz
19.7 GHz to 22.0 GHz

Whenever a measurement is made, the current preselector-DAC value corresponding to the measurement range determines the preselector tracking. Press <PRE SEL PEAK> to re-peak the preselector and store a new value in the preselector DAC.

When measuring with frequency spans greater than zero, the analyzer must be swept at least once to peak the preselector. Thus, the analyzer may require several minutes to peak the preselector when measuring with slow sweep times. To execute the peaking function quickly, change the span to zero before pressing <PRE SEL PEAK>.

FIRMWARE
VERSIONS
861015
OR
LATER

Pre Sel Dac

Use the preselector-DAC softkey to enter a value into the preselector DAC. The value entered sets the DAC value for the frequency range corresponding to the frequency at the marker. If a marker is not present,

Frequency

<PRE SEL DAC> places a marker at the center of the screen.

Pre Sel Hyst

The preselector-hysteresis softkey compensates for hysteresis in the preselector filter. Use <PRE SEL HYST> when changing the center frequency by values greater than $N \times 100$ MHz when measuring ranges having spans less than $N \times 100$ MHz, where N is the number of the harmonic used for mixing. Follow this procedure:

1. Change center frequency.
2. Press <PRE SEL HYST>.
3. Sweep the measurement range once.

Pre Sel On Off

The preselector-on/off softkey bypasses the preselector and low pass filter. During normal operation, these filters are not bypassed in order to minimize the presence of distortion products and image signals. Setting <PRE SEL ON OFF> to OFF bypasses the filtering, but also improves sensitivity by 8 to 15 dB, depending on the band.

The setting of the <PRE SEL ON OFF> softkey does not affect system calibration.

**FIRMWARE
VERSIONS
861015
OR
LATER**

FREQUENCY LIMIT

The <FRQ LIM ON OFF> softkey enables measurements beyond the specified range of spectrum analyzer systems, depending on the system hardware. The <FRQ LIM ON OFF> softkey is active only when an HP 70908A RF Section is in the system and the HP 70908A input port is active. If necessary, use the configuration softkey, <SELECT INPUT>, to activate the HP 70908A input port.

Set <FRQ LIM ON OFF> to ON to limit measurements to frequencies less than or equal to 22 GHz.

Set <FRQ LIM ON OFF> to OFF to measure beyond 22 GHz with the HP 70908A RF Section. (Please note that measurements made with the HP 70908A RF Section are not specified beyond 22 GHz and no warranty is made with regard to instrument performance beyond 22 GHz.)

Amplitude

This section describes softkeys which change amplitude reference settings or attenuator settings and also display scale setting functions.

Figure 4-23 shows the softkeys which appear when **◀AMPTD▶** is pressed.

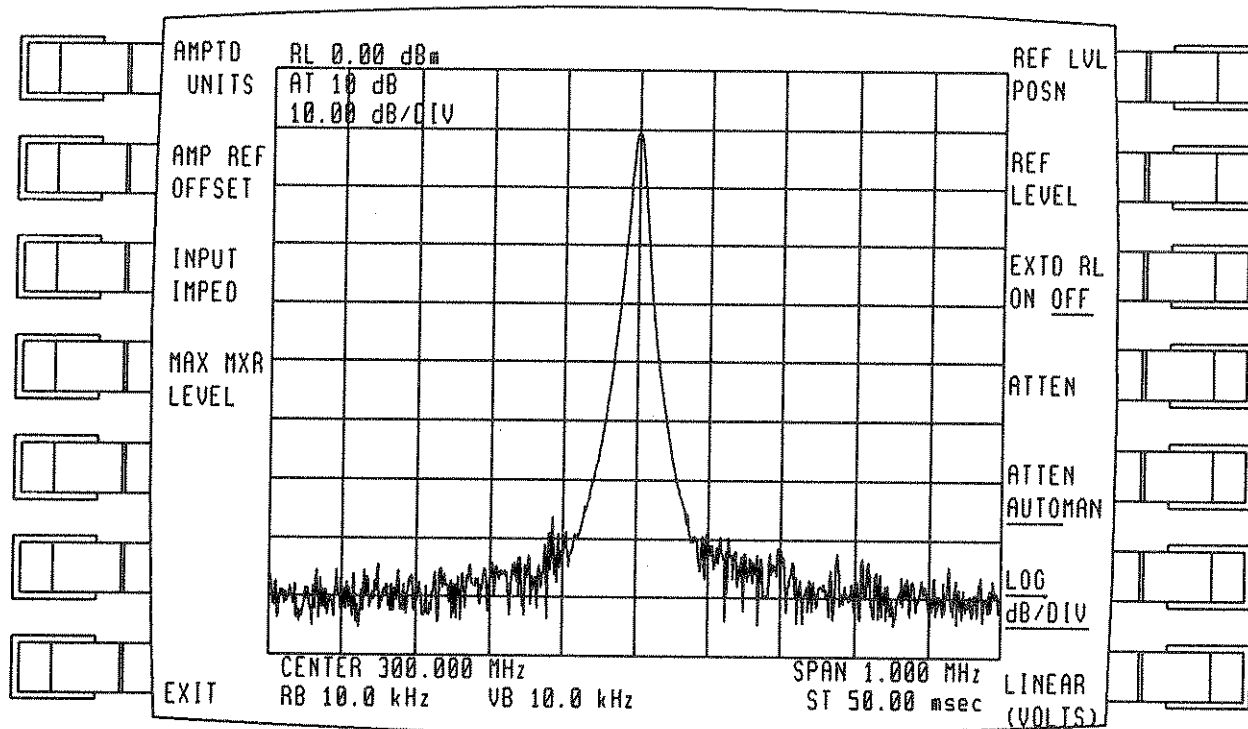

Fig.4-23. Top level menu for **◀AMPTD▶**

Ref Lvl Postn

Selecting **◀REF LVL POSTN▶** causes the analyzer to set the reference level position. The position is set in terms of graticule units from top of screen (10 = top of screen, 0 = bottom of screen). Reference level position applies only to log display scale. In linear display, top of screen is used for the reference level. The preset condition is 10. The range is 0 to 10.

The position of the reference level is indicated on the display with small arrows at the far right and far left of the screen depending on where the reference is located. If the position is changed from the default state, the arrows will appear and indicate the reference position.



Ref Level

The reference level is the amplitude value that corresponds to the reference position (typically top of screen) as set by the reference position command. Values for the reference level are limited such that a signal at the top of the screen does not exceed the maximum power limit of

the hardware input. For pulse power measurements, the EXTENDED REFERENCE LEVEL (ON/OFF) can increase the upper limit of the reference level.

When the attenuator is in the manual mode, the reference level will be set to a lower value if the attenuator setting would cause the mixer level corresponding to the top of the screen to exceed the maximum mixer level. The top of the screen level \leq ML + AT.

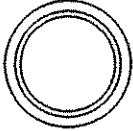
Three methods of setting REF LEVEL are shown below:

| | |
|--|---|
| <p>KNOB</p>  | <p>The amount of change is dependent on how fast or slow the knob is rotated.</p> |
| <p>STEP KEYS</p>  | <p>The step keys always step RL one division (log mode 7 dB/div the step is 7 dB, linear mode (Ref Level = 300 mV) the step would be 30 μV).</p> |
| <p>KEY PAD</p>  | <p>The key pad allows entry of exact reference levels. Digits entered beyond the displayed number of digits are deleted.</p> |

Example:

Measure the amplitude of calibration signal.

Press [I/P], [MNU], ◀FREQ▶, ◀CENTER FREQ▶, and enter [3], [0], [0], ◀MHz▶. Then press ◀SPAN▶ and enter [1], ◀MHz▶.

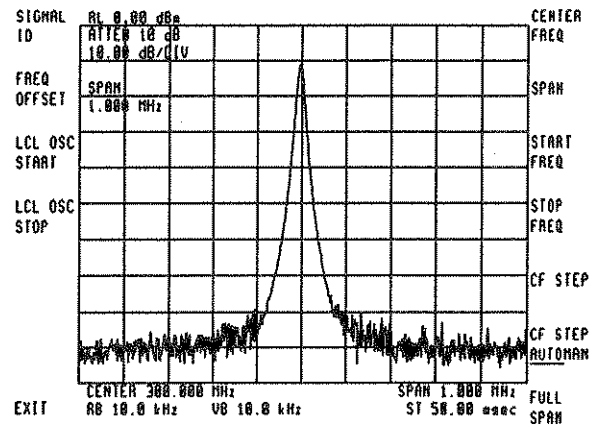

Fig. 4-24

To measure signal amplitude, press [MNU], ◀MARKER▶, ◀MARKER PEAK▶, ◀HIGHEST PEAK▶ and read the amplitude from the marker annotation.

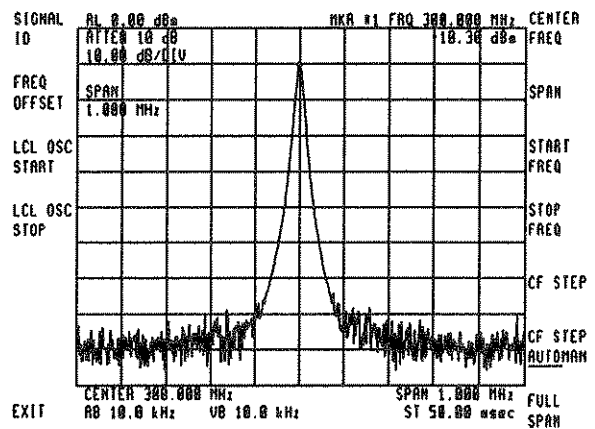

Fig. 4-25

Extd RI On Off

Selecting ◀EXTD RL ON OFF▶ allows you to extend the reference level beyond its normal continuous power limit. The maximum value for reference level is now limited such that the top of the screen value does not exceed the maximum mixer level. The preset condition is off.

When the extended reference level is on ◀EXTD RL ON OFF ▶, the minimum value for the setting is -300 dBm (as is the normal reference level). The maximum setting depends upon the values selected for the mixer level, the value of the reference position, and the display scale (LOG/LINEAR). This setting is not a function of the maximum hardware input power level (as in normal reference level) but can be extended. The instrument preset will turn this function off.

Atten

Pressing ◀ATTEN▶ allows the selection of RF input attenuation from 0 dB to 70 dB in 10 dB steps. To select a particular attenuation setting, you press ◀ATTEN▶. Notice that the ◀ATTEN AUTOMAN▶ will change to the manual position (◀ATTEN AUTOMAN▶). Next, the desired value of

attenuation is entered either by the knob, the step keys, or the keyboard. Generally the reference level does not change with attenuator settings. Notice the asterisk next to atten.

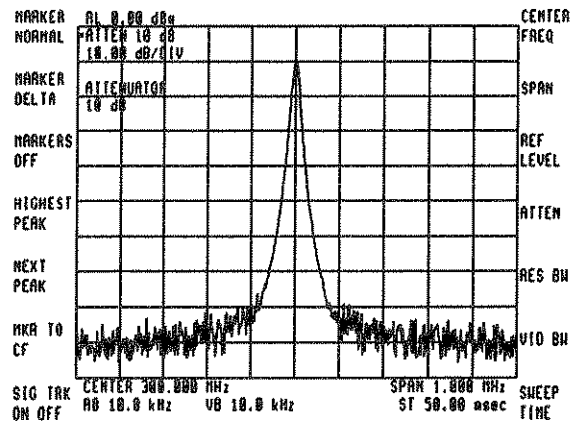

Fig. 4-26

When the RF input attenuator is in auto, the value selected assures that the level at the input mixer is less -10 dBm (the 1 dB compression point) for on-screen signals. For example, if the reference level is +28 dBm, the input attenuator will be set to 40 dBm: +28 dBm-40 dBm = -12 dBm at the mixer. The input mixer level can be changed to assure maximum dynamic range.

MAXIMUM SAFE INPUT POWER

| PARAMETER | 71100A | 71200A | 71300A |
|------------------------------------|---|--|---|
| AC AVERAGE CONTINUOUS POWER | +30dBm | +15 dBm
(0 dB Attn.)
+25 dBm
(10 dB Attn.)
+30 dBm
(>10 dB Attn.) | +20 dBm with
HP 11970 Mixers |
| PULSE POWER | 100 Watts
10 usec Pulse
≥ 20 dB Attn. | 100 Watts
10 usec Pulse
≥ 40 dB Attn. | 250 mW Peak
Pulse Power
With <1 usec
Pulse (+20 dBm
Average Power)
With HP 11970
Mixers |
| DC | 0 Volts
(DC Coupled)
+ 25 Volts
(AC Coupled) | 0 Volts | N/A |

ZERO ATTENUATION

To protect the spectrum analyzer's input mixer, 0 dB RF attenuation can be selected only from the number/units keyboard. Press ◀ATTEN▶ and enter 0 dB on the keyboard. Notice the reference level changes to -10dBm.

Determining Distortion Products

If the total power to the analyzer is overloading the input mixer, distortion products of the input signals can be displayed as real signals. The RF attenuator can be used to determine which signals, if any, are internally generated distortion products.

Using Attenuation Function

If the signal level is very close to the noise floor and the input level does not exceed the maximum power level, then 0 dB attenuation can be used to make the signal more visible (see example below). If the power level is above the maximum, then the RF input attenuator can be used.

Example: How to use the Attenuator and how to select 0 dB of attenuation.

Press [I/P] then \langle CENTER FREQ \rangle . Select 2700 MHz (for the 9th harmonic of the CAL signal). Press \langle SPAN \rangle ; enter 100 kHz on the keyboard.

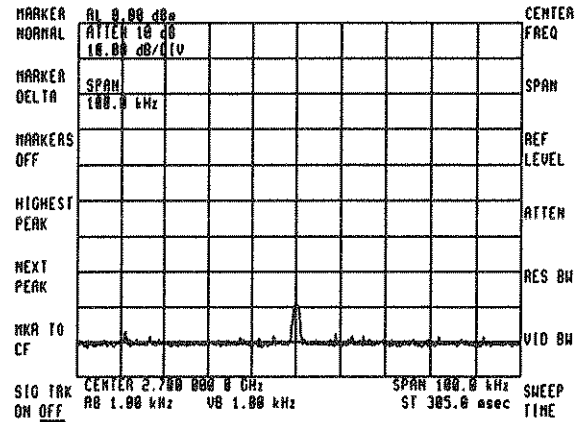

Fig. 4-27

Press \langle ATTEN \rangle . Press the up step key once to get 20 dB input attenuation. Notice the signal is closer to the noise floor.

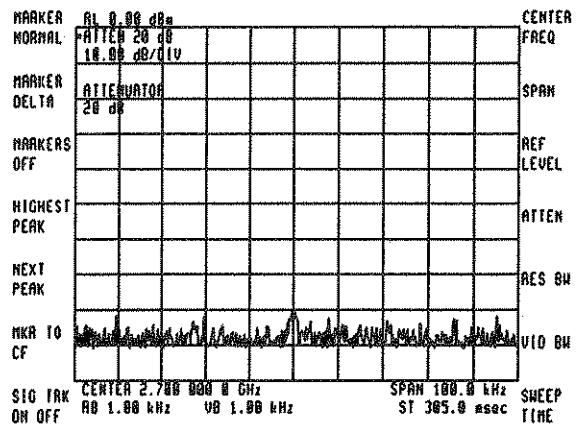

Fig. 4-28

Enter [0], \langle dB \rangle notice the signal appears more clearly above the noise floor at the same absolute power level.

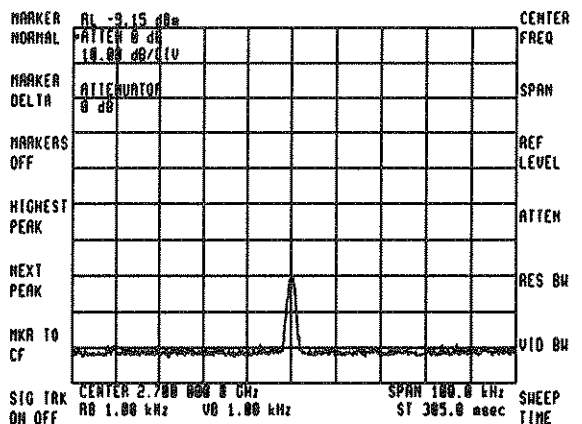

Fig. 4-29

Atten Automan

Selecting **ATTEN AUTOMAN** switches the analyzer to the manual mode of attenuation (**ATTEN AUTOMAN**). This function becomes active by entering an attenuation value. Using one of the three standard methods: step key, knob, or keyboard entry. Notice that the underline does not toggle to manual position until the entry is completed. The preset condition is Auto.

Log/Div

The scale keys **LOG DB/DIV** and **LINEAR** allow the scaling of the vertical graticule divisions in logarithmic or linear units without changing the reference level value. Pressing **LOG DB/DIV** scales the amplitude between 0.01 and 20 dB per division.

Press **I/P** then **CENTER FREQ**, **[3]**, **[0]**, **[0]**, and **MHz**. Press **MNU I**, **AMPTD**, **LOG DB/DIV**. Enter **[5]** and **DB**. Notice how the LOG SCALE dB/DIV 5.00dB appears in the active function area.

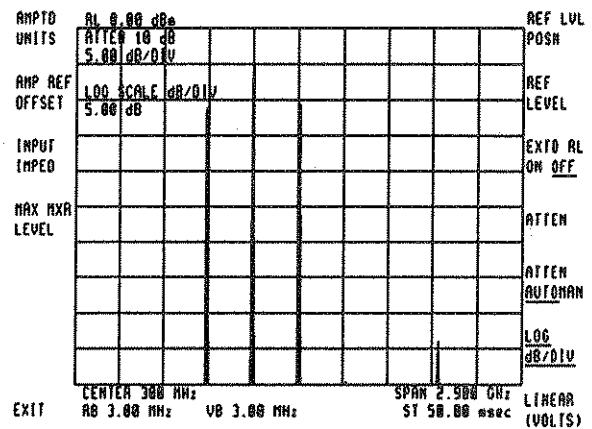

Fig. 4-30

Linear Volts

Pressing **LINEAR VOLTS** immediately scales the amplitude proportional to the input voltage. The top graticule remains the reference level; the bottom graticule becomes zero voltage. Reference level and all other amplitudes are read out in voltage. However, other units may be selected. See the Amplitude Units subsection.

If ◀LINEAR VOLTS▶ is pressed, the millivolt value will automatically be entered.

Press ◀LINEAR VOLTS▶.

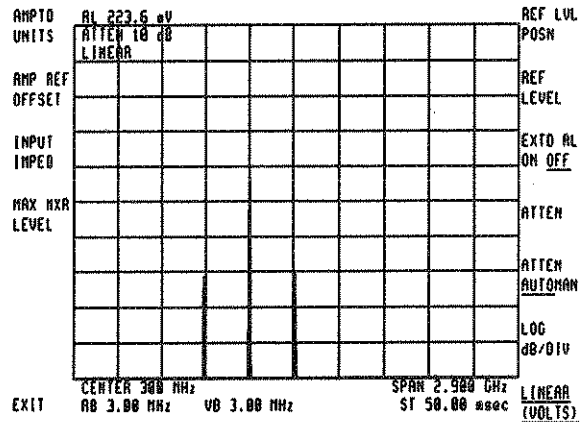
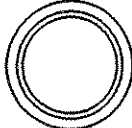

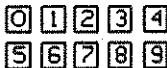

Fig. 4-31

In linear, a specific voltage per division scale can be set by entering a voltage reference level value. For example, to set the scale to 30 mV/division, press ◀REF LEVEL▶, then enter 300mV on the keyboard.

Three methods of setting the SCALE are shown below:

| | |
|--|--|
| <p>KNOB</p>  | <p>Changes scale in allowable increments which are continuously variable between .01 & 20 dB per division.</p> |
| <p>STEP KEYS</p>  | <p>Changes scale in allowable increments (0.01, 0.02, 0.05, 0.1, 0.2, 0.5, 1, 2, 5, 10 dB per division).</p> |
| <p>KEY PAD</p>  | <p>Enables direct scale selection.</p> |

Amptd Units

The choice of units is accessed by pressing ◀AMPTD UNITS▶. The following softkeys are the available choices:

1. ◀A UNITS AUTOMAN▶
2. ◀dBmV UNITS▶

3. ◀dBμV UNITS▶
4. ◀VOLT UNITS▶
5. ◀WATT UNITS▶
6. ◀dB UNITS▶
7. ◀dBm UNITS▶

The default condition, which is factory set, is ◀A UNITS AUTOMAN▶, auto unit selection and ◀dBm UNITS▶

Amp Ref Offset

The CRT display amplitude readout can be offset. Entering an offset does not affect the trace. Press ◀AMP REF OFFSET▶ and then enter the desired value.

Offset entries are added to all the amplitude readouts on the CRT display including marker, display line, and threshold, others are Ref Level, CALPWR, VTL, AMPU, MEASU.

To eliminate an offset, activate the ◀AMP REF OFFSET▶ and enter zero. An [I/P] key also sets the offsets to zero. Offsets are stored with the SAVE functions and recalled by selecting the RECALL function. See STATE section. When an offset is entered, an indicator showing that its value is <> zero is displayed on the CRT.

Press [I/P] then ◀CENTER FREQ▶ and enter [3] [0], [0], and ◀MHz▶. Press ◀SPAN▶ and enter [1], and ◀GHz▶. Press [MNU], ◀AMPTD▶, ◀AMP REF OFFSET▶ and enter [-], [1], [0], and ◀dB▶.

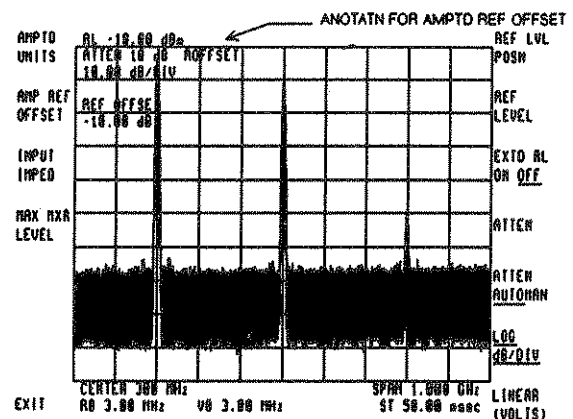

Fig. 4-32

Data entry from the keyboard can be in dB for amplitude. The amplitude offset range is greater than ±100dB in 0.01dB steps. Least significant digits will be truncated for amplitude offset entries. Notice the annotation at the top left-hand side of the display which shows that an offset has been selected.

Example:

The 300 MHz CAL signal is used as the input signal. The amplitude reference offset can be set positive or negative. The example below shows a +10dBm offset. The figure above shows a negative (-10dBm) offset.

This examples shows an Amplitude offset as a positive value.

Press ◀AMP REF OFFSET▶ then enter on keyboard 10.0 dB. Note that the original ref level of 0 dBm is now changed to 10.0 dBm also.

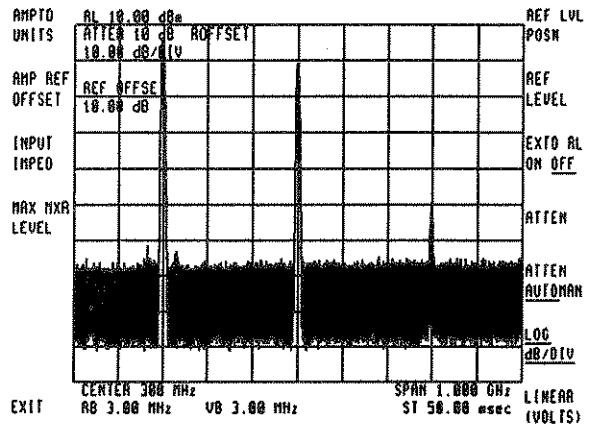
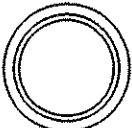
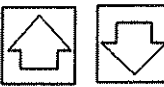



Fig. 4-33

Input Imped

The input impedance can be set by selecting the ◀INPUT IMPED▶ and then entering the desired value. The input impedance is used for power voltage conversions. This is for computational purposes only, as the actual impedance is set by hardware external to the instrument. The preset value is 50 ohms. The range of values is from 1 ohm to 100 million ohms.

The three methods of setting the INPUT IMPED is shown below:

| | |
|--|---|
| <p>KNOB</p>  | <p>Changes the INPUT IMPEDANCE continuously from 1 ohm up to 100 million ohms.</p> |
| <p>STEP KEYS</p>  | <p>Changes the INPUT IMPEDANCE to the next value in a 1,2,5,10 sequence.</p> |
| <p>KEY PAD</p>  | <p>Allows entry of exact INPUT IMPEDANCE. Digits entered beyond the displayed number of digits are deleted.</p> |

Max Mxr Level

Pressing ◀MAX MXR LEVEL▶ displays the preset value of -7dBm on the middle left-hand side of the display (active function area). This is the maximum level into the mixer. The Reference Level and Attenuator functions are coupled together and follow the equation below:

$$\text{MAXIMUM MIXER LEVEL} = \text{REFERENCE} - \text{ATTENUATION}$$

(Assuming all signals are on screen)

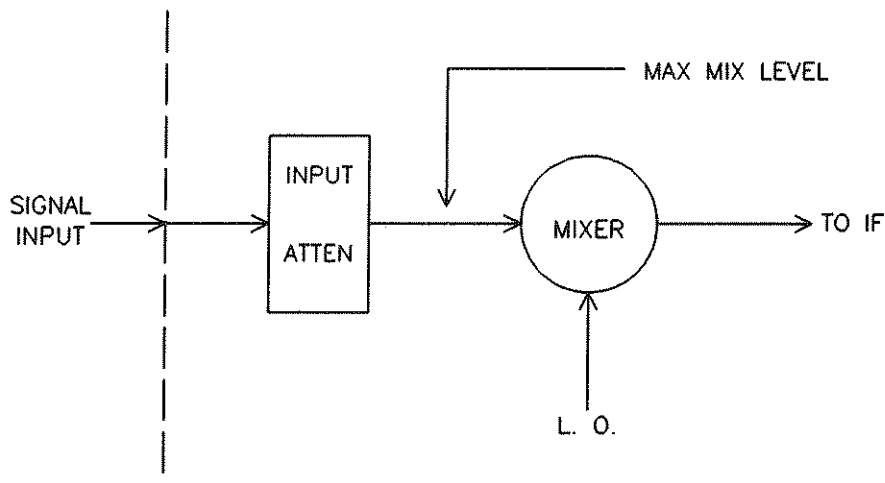

Fig.4-34.Location of Maximum Mixer Level.

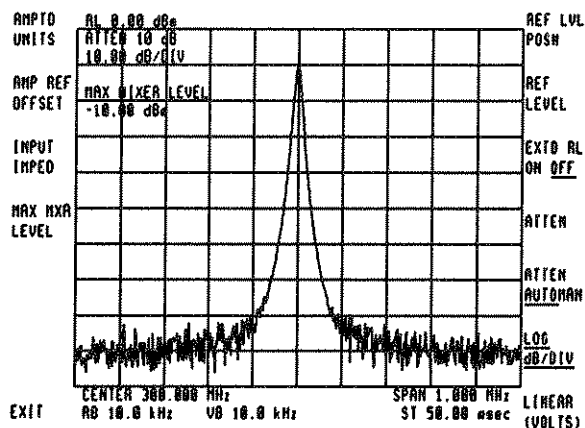
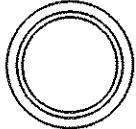





Fig.4-35

The three methods of setting MAX MXR LEVEL are shown below:

| | |
|--|---|
| KNOB
 | The setting of MAX MXR LEVEL is determined by how fast or slow the knob is turned. |
| STEP KEYS
  | One step changes the MAX MXR LEVEL in 1 vertical division of the graticule. |
| KEY PAD
 | Allows an exact value to be entered within the allowable range. -7 dBm is the maximum positive level. There is no negative restriction. |

As the analyzer's REFERENCE LEVEL is changed, the coupled input attenuator will automatically change. This feature will maintain the maximum signal level at the mixer at the value you have entered or will default to a preset value.

Gain Compression and Maximum Input Levels

The maximum-input softkey specifies a value for the maximum *expected* signal level to the *analyzer* input during a given measurement procedure. The maximum mixer level softkey specifies the maximum signal level at the *mixer* input.

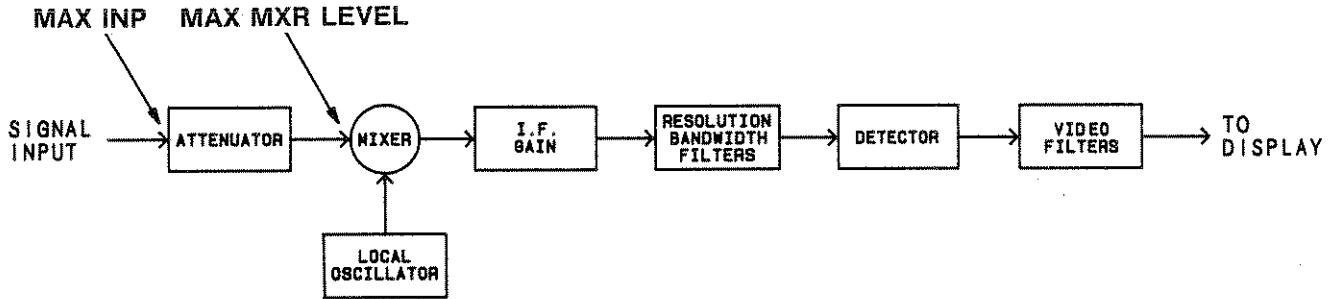

Figure 4-35a.

Together, these softkey settings control the reference level (IF gain) and input attenuation of the analyzer so that any displayed signals whose peaks are below the top graticule line, or a dashed line if it is present, have levels that do not exceed the selected maximum input level and are not affected significantly by gain compression. (Figure 4-35c.)

For example, the figure below shows how the analyzer controls the input attenuator and the IF gain circuitry when the maximum input level is set to -10 dBm and the maximum mixer level is set to -30 dBm.

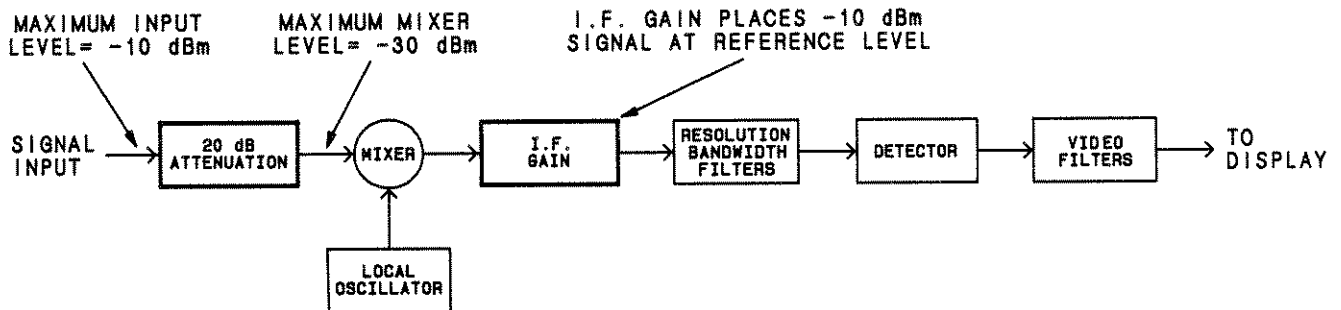

Figure 4-35b

The analyzer first activates 20 dB of input attenuation so that the mixer level never exceeds -30 dBm when the maximum input level (-10 dB) is connected to the analyzer.

$$\text{input attenuation} = \text{maximum input level} - \text{maximum mixer level}$$

$$20 \text{ dB} = -10 \text{ dBm} - (-30 \text{ dBm})$$

The analyzer then computes the IF gain necessary to position measurement results as high as possible on the analyzer screen. In most measurement procedures, this is at the top of the graticule when the displayed response equals the maximum input level setting.

maximum input - attenuation - mixer conversion loss + IF gain = maximum detected signal level

To protect the analyzer, the maximum input and maximum mixer level settings cannot effect an input attenuation less than 10 dB. Thus, when maximum input and maximum mixer level settings are both -20 dBm, input attenuation is set automatically to -10 dBm, not zero.

input attenuation = maximum input level - maximum mixer level

10 dB (cannot equal zero) = -20 dBm - (-20 dBm)

(If zero input attenuation is desired, use the ATTEN softkey.)

Use of Maximum Mixer Level Softkey ◀MAX MXR LEVEL▶

Use the maximum-mixer-level softkey to limit signal levels to the mixer in order to meet your measurement needs. Excessive signal levels into the mixer can limit the dynamic measurement range by producing spurious, false responses on the analyzer screen. Likewise, excessive levels can also cause gain compression which limits amplitude accuracy. Gain compression describes the condition where a change in spectrum analyzer response is not proportional to a change in input signal level. For example, the 1 dB gain compression point of the HP 70905A and 70906A RF modules is -7 dBm. This means that the amplitude of a -7 dBm signal at the mixer input in these modules is not reduced by more than 1 dB at the mixer output.

The maximum-mixer-level setting is reset to -7 dBm when the analyzer is turned on or when instrument preset (IP) is pressed. To improve amplitude accuracy or increase dynamic range, decrease the maximum mixer level to any value within 70 dB of the maximum input setting. Optimum dynamic range for most analyzer systems is achieved by setting the maximum mixer level to -30 or -40 dBm. Below, maximum mixer level is set to -40 dBm, which is within 70 dB of the preset value for the maximum input level, 0 dBm.

```
Press [IP]
  [MENU]
    ◀AMPTD▶
      ◀MAX MXR LEVEL▶ ◀-40▶ ◀dBm▶
```

|0 dBm - (-40 dBm)| < 70 dB

Use of the Maximum Input Level Softkey ◀MAX INP▶

Use the maximum-input-level softkey to simplify the display of normalized measurement results during tracking generator applications. Set the maximum input level to the largest signal level you anticipate measuring at the analyzer input. This ensures that the analyzer attenuation and IF gain are automatically adjusted to display normalized measurement results on the analyzer screen when the screen is calibrated in relative amplitude terms.

When the instrument is turned on, after instrument preset (IP) is pressed, or after MAX INP AUTOMAN is set to AUTO, the maximum input level setting is 0 dBm.

Interpreting Displayed Measurement Results

All displayed signals whose peaks are below the top of the graticule, or dashed line if it is present, have levels that are below the selected maximum input level. In addition, the amplitude accuracy of these responses includes the gain compression error corresponding to the mixer input level setting. Gain compression characteristics are specified for each RF module, but as a rule, gain compression is about 1 dB for mixer levels of -10 dBm.

Certain combinations of maximum input and maximum mixer level settings may cause the detected signal peak to be clipped on the analyzer screen.

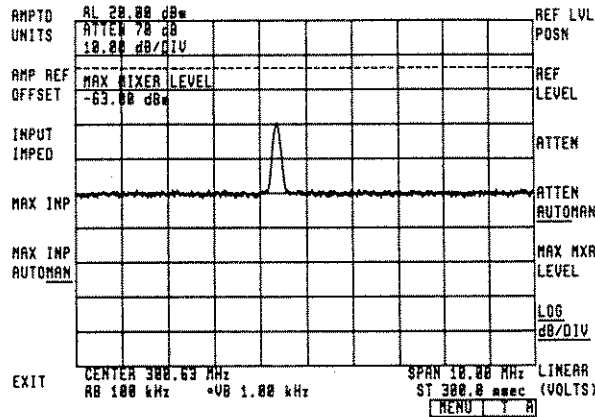

Figure 35c.



Sweep Control

This section describes softkeys which change trigger mode settings or sweep time settings. It also describes softkeys which change sweep mode settings.

Figure 4-36 shows the softkeys that appear when **◀SWEEP CONTROL▶** is pressed.

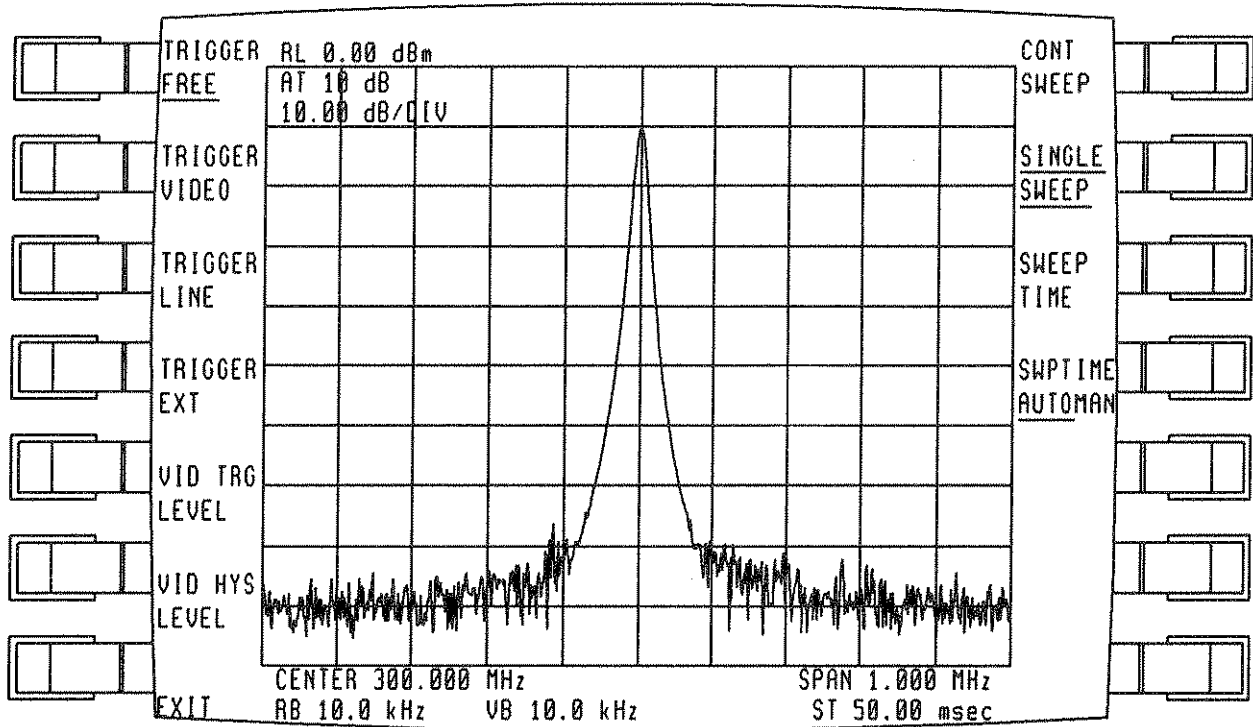

Fig.4-36. Top level menu for **◀SWEEP CONTROL▶**

Continuous Sweep

To have the display sweep continuously, press **◀CONTINUOUS SWEEP▶**. CONTINUOUS SWEEP is the preset factory setting. This function allows another sweep at the completion of the current sweep once the trigger conditions are met. Upon executing this command, the analyzer return immediately to its start frequency.

Single Sweep

For a single sweep of the display, press **◀SINGLE SWEEP▶**. To sweep again, press the soft-key again.

Sweep Time

Pressing ◀SWEEP TIME▶ sets the sweep time selection to manual and changes the rate at which the analyzer sweeps the displayed frequency or time span.

In all frequency spans, the sweep time varies continuously from 50 msec to 1000 sec. Sweep times can be made faster by changing the TRACE LENGTH to less than 800 points. (see Trace section)

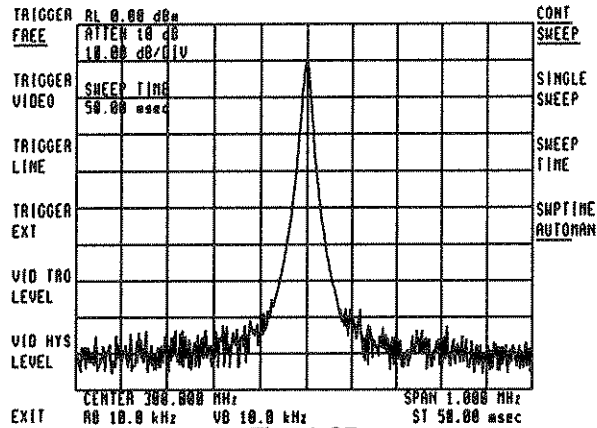

Fig. 4-37

Example:

To identify signals quickly in a very narrow frequency span (where the resolution bandwidth would be narrow) the sweep time can be temporarily reduced. (For example: speed up sweep rate.)

A frequency span of 10 kHz will have a selected resolution bandwidth of 100 Hz and a sweep time of 3 seconds.

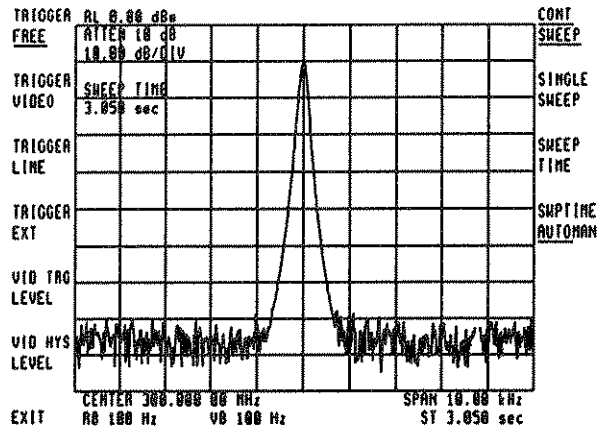

Fig. 4-38

To view quickly signals present in the span, press **◀SWEEP TIME▶** and the down step key several times. When the sweep completes its span, select **◀SWEEP TIME AUTOMAN▶** again. Note that the "Uncal" message appears automatically as the faster sweep time causes some distortion of the spectral response.

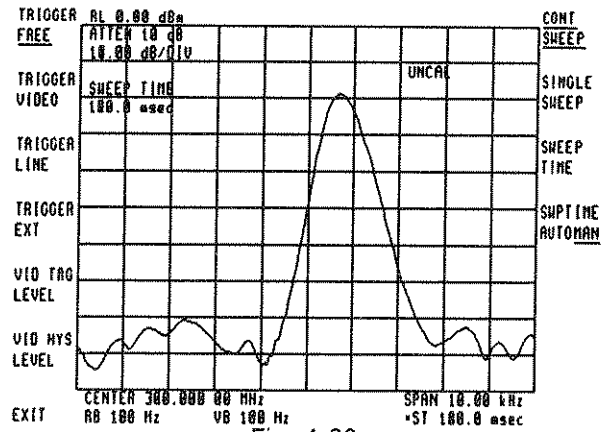

Fig. 4-39

Sweep Time Automan

To select different sweep times press **◀SWEEP TIME AUTOMAN▶** and you will notice the underline changes from the auto to manual position (**◀SWEEP TIME AUTOMAN▶**). To return to auto press **◀SWEEP TIME AUTOMAN▶** and it will toggle back.

The other way to change the sweep time is to press **◀SWEEP TIME▶** and then enter the change; you will see the **◀SWEEP TIME AUTOMAN▶** automatically change to manual position.

Trigger Function

The analyzer sweep is triggered by one of the following four modes.

- * ◀TRIGGER FREE▶ allows the next sweep to start as soon as possible after the last sweep.
- * ◀TRIGGER VIDEO▶ allows the next sweep to start if the detected RF envelope voltage rises or falls through the default level. The level can be specified or entered by the keyboard.
- * ◀TRIGGER LINE▶ triggers on the same position of the line voltage.
- * ◀TRIGGER EXT▶ allows the next sweep to start when an external voltage level passes through 1.5 volts, becoming positive.

The external trigger signal level must be between 0V and +5V.

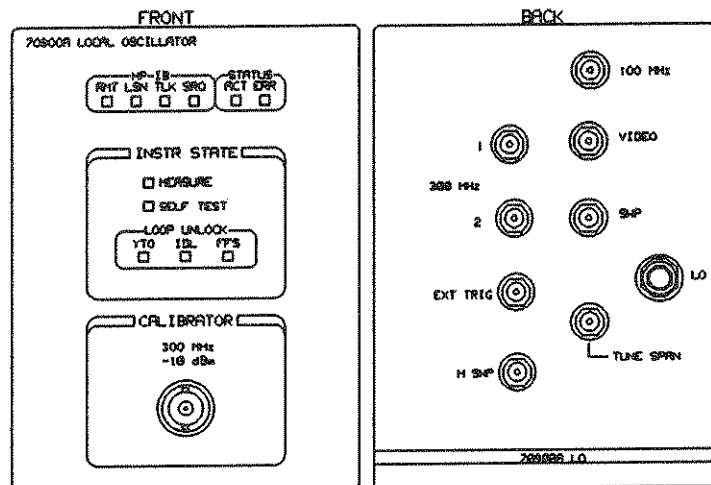

Fig. 4-40. External trigger input

An RF envelope will trigger the sweep only if it is capable of being traced on the CRT display and the resolution bandwidth and video bandwidth are wide enough to pass the modulation waveform of an input signal.

Vid Trg Level

This command is used to set the video trigger level when using the ◀TRIGGER VIDEO▶ function. The default value is -100dBm. (Bottom of the screen)

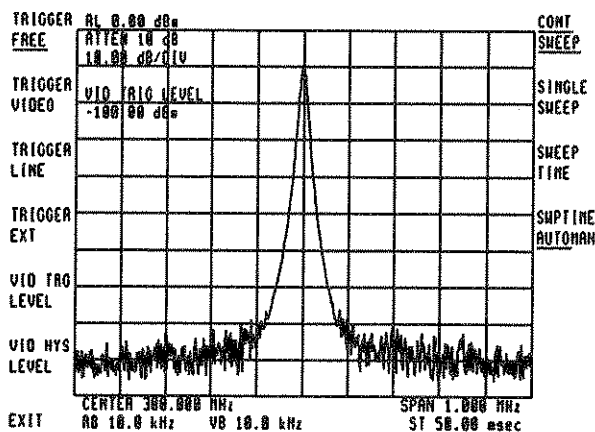
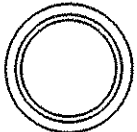



Fig. 4-41

The three methods of setting the VIDEO TRIGGER LEVEL are shown below:

| | |
|--|---|
| <p>KNOB</p>  | <p>The VID TRG LEVEL value is determined by how fast or slow the knob is rotated.</p> |
| <p>STEP KEYS</p>  | <p>One step changes the VID TRG LEVEL by 1 vertical scale division increments.</p> |
| <p>KEY PAD</p>  | <p>Allows an exact value of VID TRG LEVEL to be entered.</p> |

Vid Hys Level

The hysteresis and direction of the video trigger is specified by selecting ◀VID HYS LEVEL▶. If video trigger hysteresis is positive, the video trigger will be on the rising edge of the signal. The signal must come from below the trigger level set by the ◀VID TRY LEVEL▶ command and the magnitude specified by the ◀VID HYS LEVEL▶ command. The opposite is true for negative video trigger hysteresis; that is, the video trigger will be on the declining edge of the signal. The preset value is 3 dB and the range is ±300 dB.

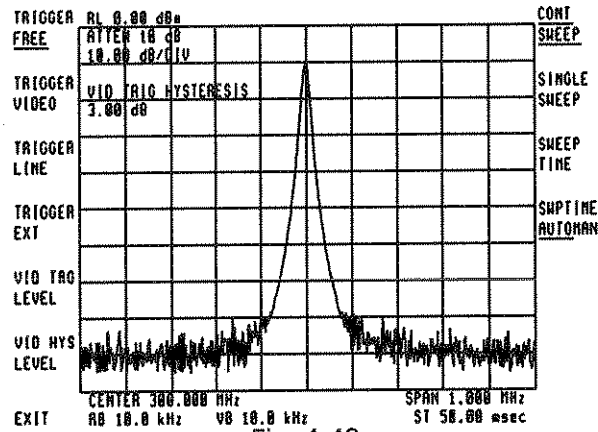
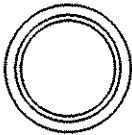



Fig. 4-42

The three methods of setting the VIDEO HYSTERESIS LEVEL are shown below:

| | |
|--|---|
| <p>KNOB</p>  | <p>The VID HYS LEVEL value is determined by how fast or slow the knob is rotated.</p> |
| <p>STEP KEYS</p>  | <p>One step changes the VID HYS LEVEL by 1 vertical scale division increments.</p> |
| <p>KEY PAD</p>  | <p>Allows an exact value of VID HYS LEVEL to be entered.</p> |

Marker

This section describes softkeys which use markers to make faster and more accurate measurements. Figure 4-43 shows the softkeys that appear when ◀MARKER▶ is pressed.

There are two categories of marker functions: marker functions which activate or disable markers and their related functions; marker functions which allow the scaling of the display frequency and amplitude using marker information.

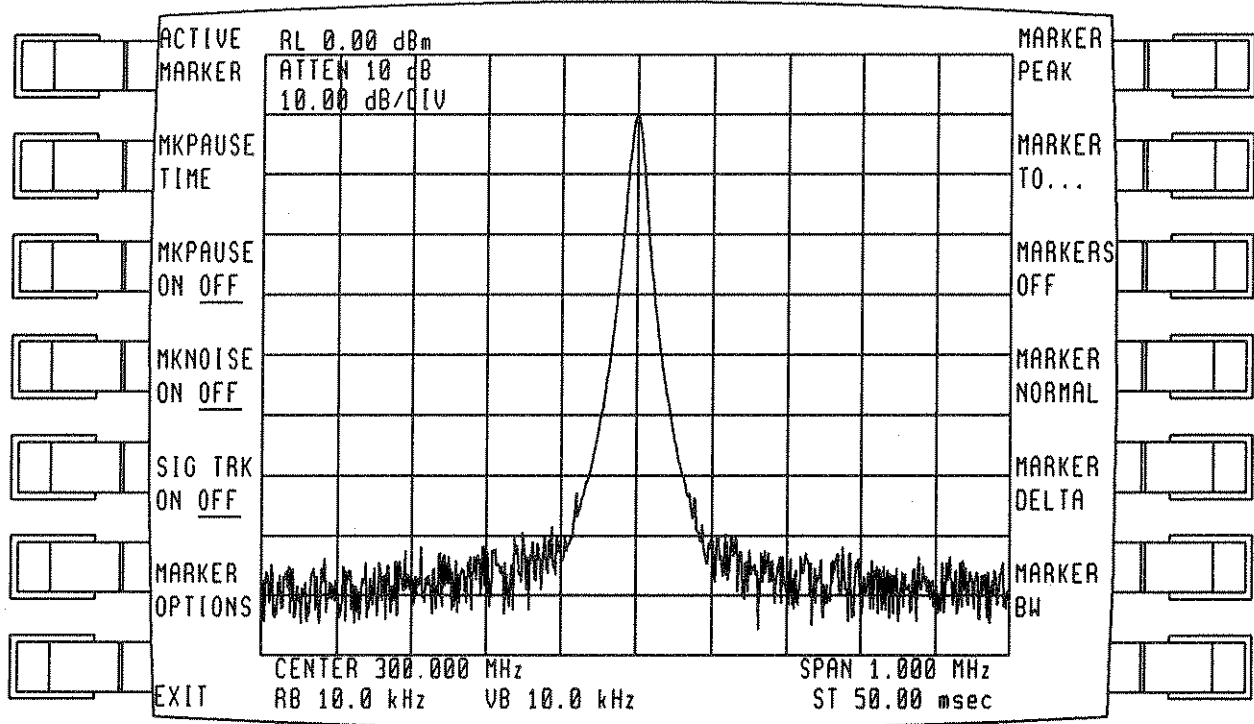

Fig.4-43. Top level menu for ◀MARKER▶

Markers are diamond shaped characters lying directly on the display trace. Up to 5 markers can be on the display at once, although only 1 can be controlled at a time; this is called the "ACTIVE" marker. It will be intensified. The horizontal position of an activated marker is controlled by the step keys, the knob, or the keyboard. The marker can be positioned at a specific frequency with the numeric keyboard.

Readout of the active marker amplitude and frequency appears in the upper right of the display. When a marker is being controlled from the front panel, its amplitude and frequency readout appears in the active function area of the graticule as well. The marker number also appears in both places.

Markers can be displayed on Trace A, Trace B and Trace C.

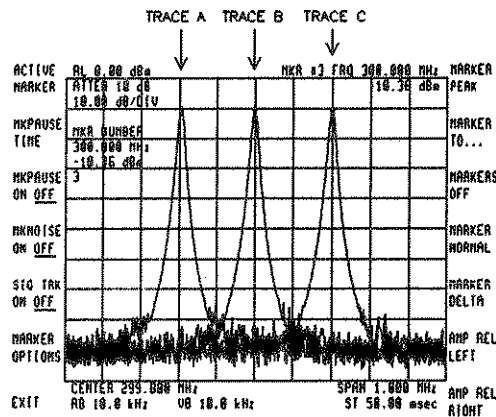

Fig. 4-44

Marker Overview

| | FUNCTION |
|--|---------------------|
| * Placing a single marker at the highest response. | ◀MARKER PEAK▶ |
| * Amplitude and frequency display. | ◀MARKER TO...▶ |
| * Direct readout of the amplitude and frequency of a point along the trace | ◀MARKER NORMAL▶ |
| * Direct readout of amplitude and frequency differences between points on the trace. | ◀MARKER DELTA▶ |
| * Direct noise level readout normalized to 1 Hz bandwidth. | ◀MKNOISE ON OFF▶ |
| * Expansion of the span about a specific frequency. | ◀MKR DELTA TO SPAN▶ |

Marker Peak

The Marker Peak function allows you to place a marker conveniently at the following positions:

1. Highest Peak
The highest peak function locates the absolute highest measured point.
2. Next Peak
The next highest peak function locates the next absolute highest measured point with respect to the point where it is at.
3. Right Peak
The right peak function locates the peak to the right of the current marker value.
4. Left Peak
The left peak function locates the peak to the left current marker value.
5. Closest Peak
The closest peak function locates the peak closest to the current marker value.
6. Minimum Point
The minimum point function locates the absolute minimum measured point.

Example:

Pressing ◀MARKER PEAK▶ and then ◀HIGHEST PEAK▶ places a single marker at the highest trace position of the trace. The active function is not changed.

Press [USR], ◀CENTER FREQ▶, and [3], [0], [0]. Press ◀MHz▶, then select ◀SPAN▶, [1], and ◀GHz▶.

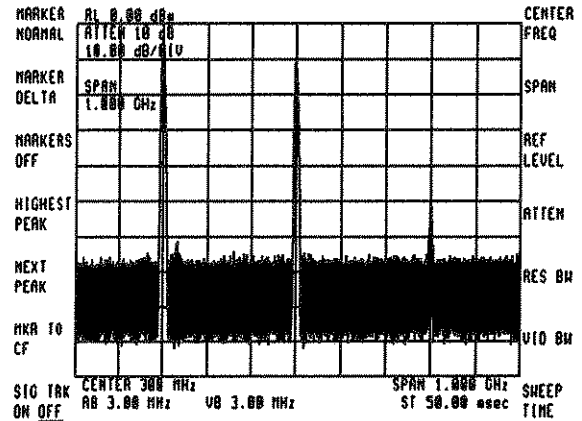

Fig. 4-45

Select [MNU], ◀MARKER▶, ◀MARKER PEAK▶; then press the ◀HIGHEST PEAK▶.

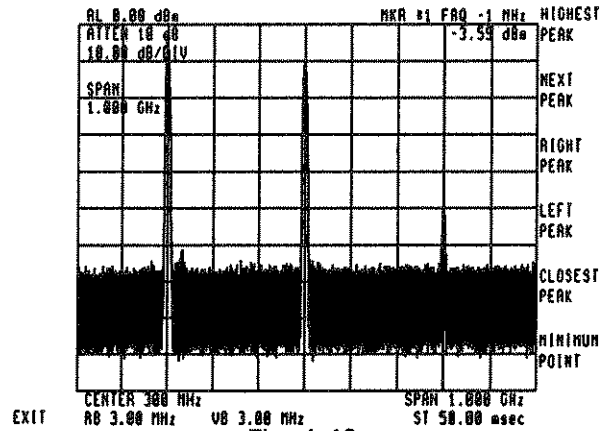

Fig. 4-46

Note that the marker seeks the maximum trace response, no matter what the cause of the response. A larger signal, or the local oscillator feedthrough, would have attracted the marker.

MARKER to Next Peak

The marker can also be placed at the next highest peaks by successively pressing ◀Next Peak▶.

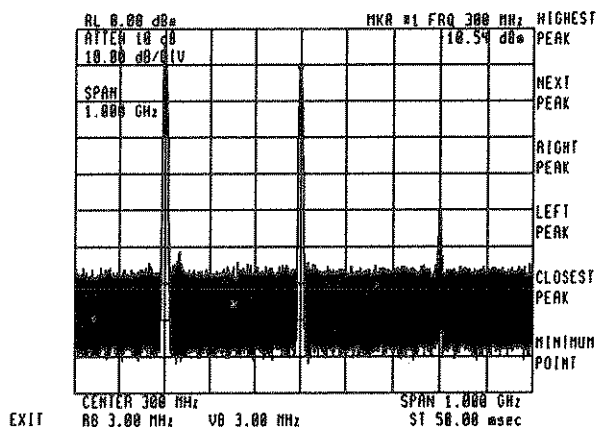

Fig. 4-47

MARKER to Minimum

The minimum trace value can be located by pressing ◀MINIMUM POINT▶.

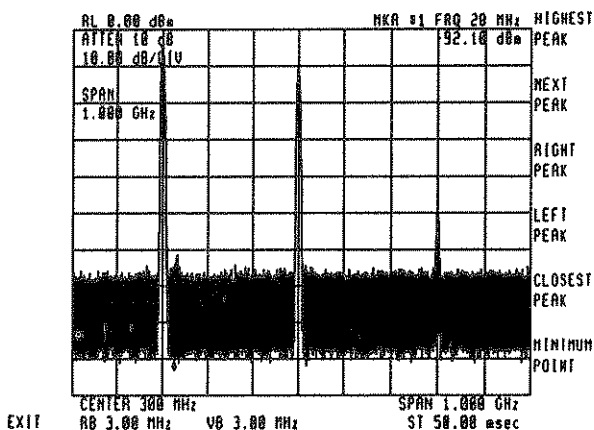

Fig. 4-48

Marker To ...

Selecting ◀MARKER TO ...▶ gives access to four helpful functions. Access a function by pressing the particular softkey associated with the function. Following a list of these functions is a detailed description of what each does.

1. ◀MKR TO CF▶ -MARKER TO CENTER FREQUENCY
2. ◀MKR TO REF LVL▶ -MARKER TO REFERENCE LEVEL
3. ◀MKR DELTA TO SPAN▶ -MARKER DELTA TO SPAN
4. ◀MKR TO CF STEP▶ -MARKER TO CENTER FREQUENCY STEP

Selecting ◀MKR TO CF▶ causes the analyzer to set the the center frequency to the frequency (absolute) of the active marker.

Selecting ◀MKR TO REF▶ causes the analyzer to set the reference level to the amplitude (absolute) of the active marker.

Selecting ◀MKR DELTA TO SPAN▶ sets the start and stop frequencies of the analyzer. If the active marker type is ◀AMP REL LEFT▶, ◀AMP REL RIGHT▶, or ◀MARKER DELTA▶, the delta reference and active marker determine the start and stop frequencies. The far left marker indicates start frequency and the far right marker indicates stop frequency. If marker delta is off, the analyzer will not operate.

Selecting ◀MKR TO CF STEP▶ assigns the value of the active to center frequency step size. If the delta function is on, the absolute difference between the delta reference and the active marker is assigned to center frequency step size.

Example:

A fast, convenient way to bring a signal to the center of the display is by using ◀MKR TO CF▶.

Activate a single marker and tune it to the desired signal by pressing ◀MARKER NORMAL▶, then use the display knob to tune to the desired signal. (Approximately 300MHz)

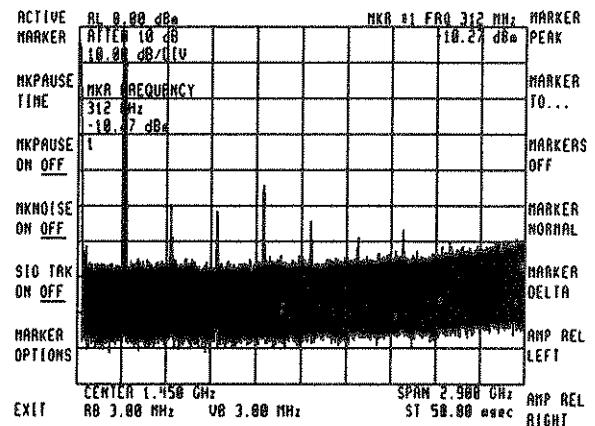

Fig. 4-49

Change the center frequency to the marker frequency by Pressing ◀MKR TO CF▶. Notice the signal with the marker now becomes the center frequency of the display.

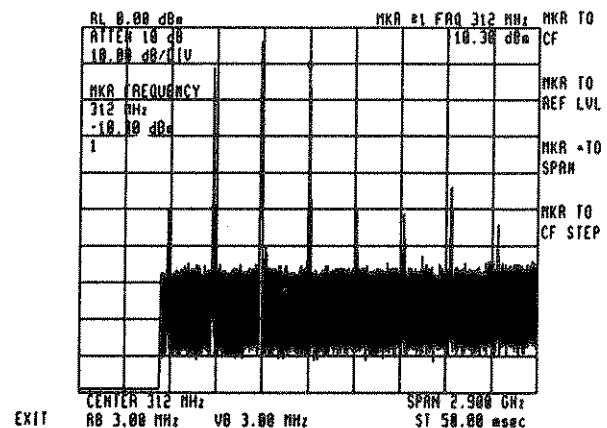

Fig. 4-50

◀MKR to CF▶ will also work if start/stop frequencies are read out.

Example:

One way to tune to a particular portion of a displayed spectrum is to use the ◀MKR DELTA TO SPAN▶ function.

Press ◀I/P▶, [MNU], ◀MARKER▶, ◀MARKER PEAK▶, ◀HIGHEST PEAK▶. Then press ◀EXIT▶ and select ◀MARKER DELTA▶. Tune the display knob to place the marker at the desired span. (approximately 1.06 GHz)

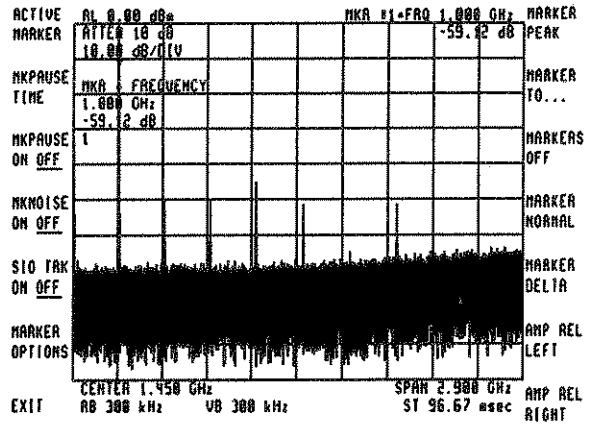

Fig. 4-51

Select ◀MARKER TO...▶ and press ◀MKR DELTA to SPAN▶. Notice the span is approximately 1 GHz and the fundamental and its two harmonics are shown.

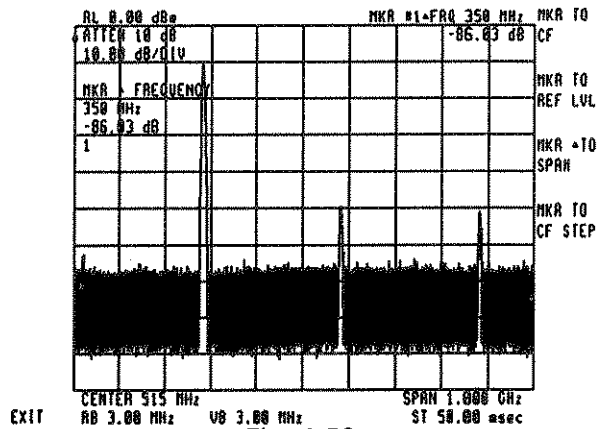

Fig. 4-52

Example:

Here is a technique for viewing a fundamental and its harmonics (or any evenly spaced portion of the spectrum) with high resolution.

Narrow the span about the fundamental to center the carrier as necessary. Place a marker on the peak.

Set the center frequency step size with ◀MKR TO CF STEP▶.

Now activate ◀center frequency▶. With each up step key, successive harmonics will be displayed.

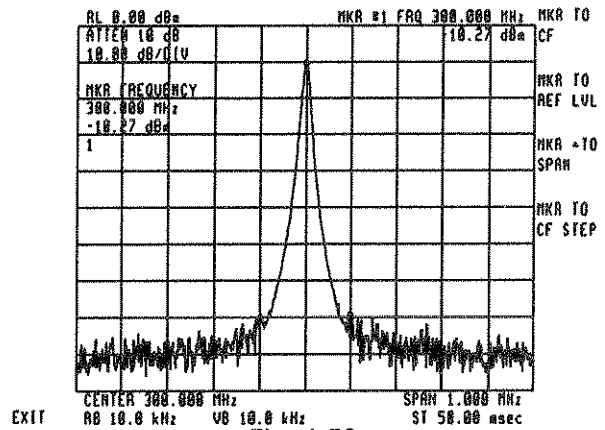
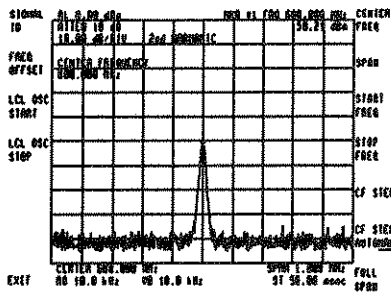
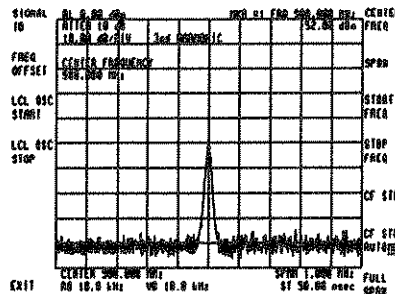

Fig. 4-53



SECOND HARMONIC



THIRD HARMONIC

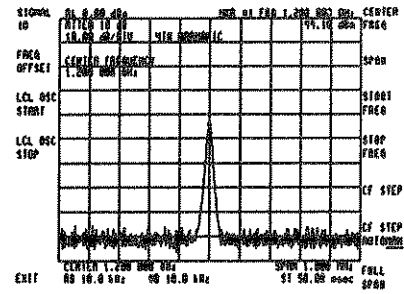

FOURTH HARMONIC

Similar stepping can be accomplished using ◀MKR TO CF STEP▶ in step size for intermodulation products or other evenly spaced signals, (such as communication channels).



Markers Off

Selecting ◀MARKERS OFF▶ disables any marker mode and blanks the marker readout from the CRT display.

Normal Marker

Selecting ◀MARKER NORMAL▶ activates a single marker at the center of the display on the trace of highest priority. Trace priority is defined in the trace section. The marker will not activate blank A, blank B, view C, or blank C on the TRACE modes.

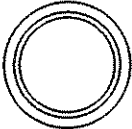
The three methods of setting MARKERS are shown below:

| | |
|--|---|
| <p>KNOB</p>  | <p>Moves the marker continuously along the trace at approximately 5 horizontal divisions each full turn. The marker moves in display unit increments.</p> |
| <p>STEP KEYS</p>  | <p>Moves the marker along the trace one tenth of the total width per step using either step key. Up arrow moves marker to the right.</p> |
| <p>KEY PAD</p>  | <p>Places the marker at the frequency entered. An out-of-range entry results in placement of the marker at a graticule edge.</p> |

Example:

Reading the frequencies and amplitudes of signals is greatly simplified using ◀MARKER NORMAL▶.

For a given display activate the single marker with ◀MARKER NORMAL▶. Tune the marker with the knob to position it at the signal peak. The frequency and amplitude is read out in two display areas.

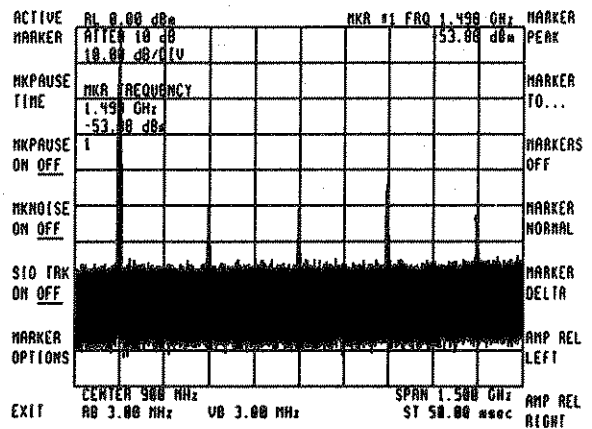

FIG. 4-54

To read the left-hand signal's parameters move the marker to the signal peak with the knob.

The signal's amplitude and frequency is read out directly.

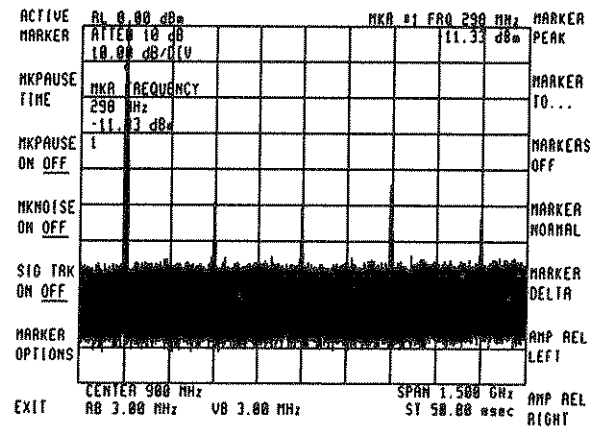

FIG. 4-55

Marker Delta

Selecting ◀MARKER DELTA▶ activates a second marker at the position of a signal marker already on the trace. (If no signal marker has been activated, ◀MARKER DELTA▶ places two markers at the center of the display.) The first marker's position is fixed. The second marker's position is under your control.

The display readout shows the difference in frequency and amplitude.

Example:

Measure the differences between two signals on the same display.

First set the marker on one of the signal peaks with ◀MARKER NORMAL▶ and the tuning knob.

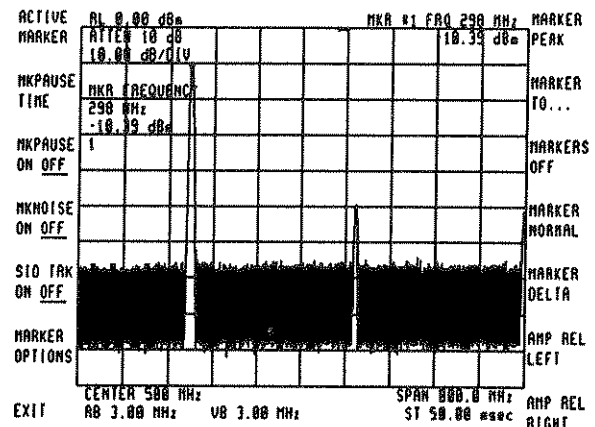

Fig. 4-56

Activate ◀MARKER DELTA▶ and move the second marker to the other signal peak with the knob. The difference between the peaks can be read off the active function area.

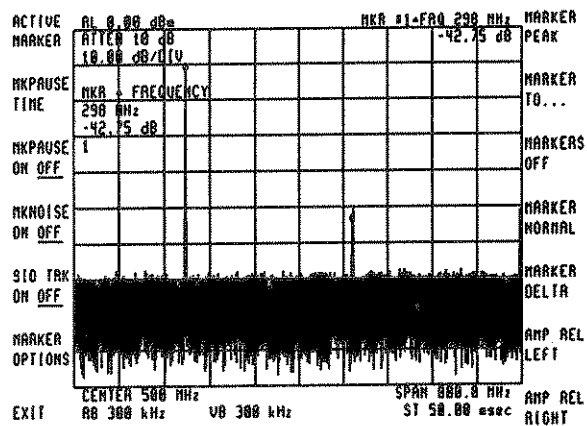

FIG. 4-57

Fractional Differences

When the reference level is calibrated in voltage, ◀MARKER DELTA▶ amplitudes are given as a fraction, the voltage ratio of two levels.

With logarithmic amplitude scale and the reference level in voltage, the fraction is based on the equation

$$\text{fraction} = 10^{-(\text{dB DIFFERENCE}/20)}$$

Since this equation yields the harmonic distortion due to a single harmonic, its distortion contribution can be read directly from the display.

Example:

Set up ◀MARKER DELTA▶ on the peaks of a fundamental (left) and its harmonic (right).

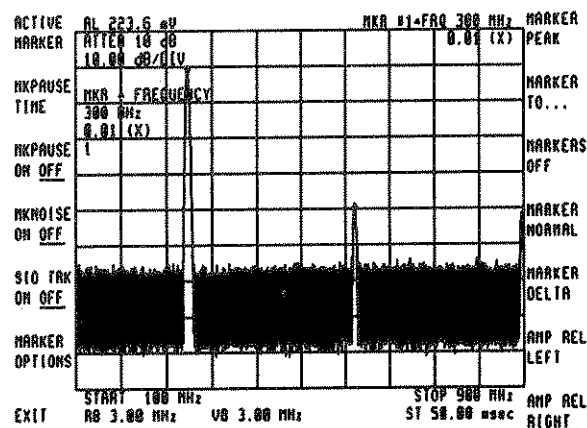

Fig. 4-58

With the display referenced and scaled as shown, the readout ".0100X" designates the fractional harmonic content. Percent is calculated as $100X(.0100)=1.0\%$.

With a linear amplitude scale and a reference level calibrated in voltage, the fractional amplitude readout is the simple linear ratio of the two markers.

Example:

To measure % AM modulation from a spectrum display, calibrate the display with the reference level in voltage and the amplitude scale in voltage.

Place the single marker on the carrier peak; ◀MARKER NORMAL▶ and the second marker on one of the sideband peaks using ◀MARKER DELTA▶ and the knob. The fractional amplitude readout gives one half the modulation index 0.18. %AM = $100 \times 2 \times 0.18 = 36\%$

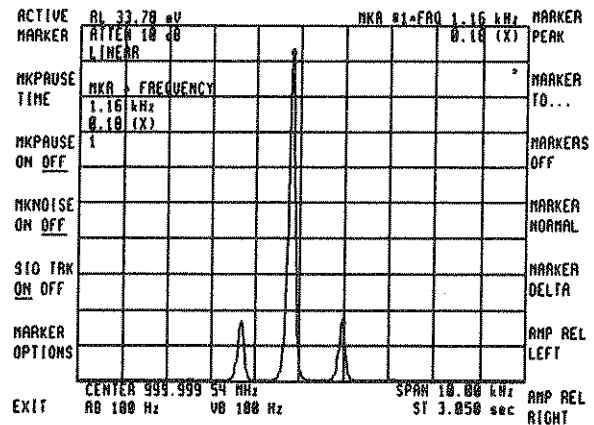

Fig. 4-59



Measurement and Readout Range

The ◀MARKER DELTA▶ function formats the amplitude readout according to the reference level's units and scale.

The frequency readout for all ◀MARKER DELTA▶ conditions has up to 4 significant digits, depending upon the portion of span measured. The amplitude readout in dB has resolution of ± 0.01 dB for linear scale. The resolution for logarithmic scale depends upon the ◀Log dB/DIV▶.

The minimum incremental change for delta frequency is 0.1% of the frequency span.

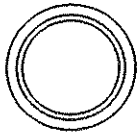
The three methods of moving MARKER DELTAS' are shown below:

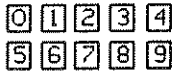
| | |
|--|---|
| <p>KNOB</p>  | <p>One full turn moves the active marker approximately one tenth of the horizontal span.</p> |
| <p>STEP KEYS</p>  | <p>One step moves the marker one tenth of the horizontal span.</p> |
| <p>KEY PAD</p>  | <p>Positive entry places marker higher in frequency than the stationary marker, negative entry places marker lower in frequency. If entries are larger than allowable, the marker will be placed on the adjacent graticule border.</p> <p>Negative frequencies can be entered using a minus sign. For example, to set a delta span of 10 MHz with the second marker positioned to the left of the first, press the minus sign and then 1, 0 MHz, -dBm, sec.</p> |

Amp Ref Left

Selecting ◀AMP REF MKR▶ results in the following: (1) If ◀MARKER NORMAL▶ is not active, this turns it on and the number 1 marker is placed at the center of the screen; otherwise, the normal marker remains in position (marker 1 is not bright). (2) Marker 2 (the active marker) is moved to a frequency to the left of marker 1 at the requested relative amplitude. This key function is useful for making -3dB and -60dB bandwidth measurements.

Amp Ref Right

Selecting ◀AMP REF RIGHT▶ is the same as ◀AMP REF LEFT▶ except marker 3, rather than marker 2, is the active marker. Also, the active marker is placed to the right, rather than to the left, of marker 1.

Example:

Measure the -60dB bandwidth of the Cal signal.

Connect Cal signal to input. Select ◀CENTER FREQ▶ and set it to 300MHz. Select ◀SPAN▶ and set it to 10KHz.

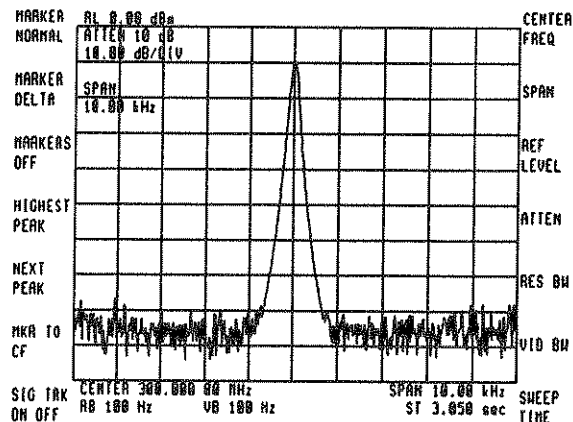

Fig. 4-60

Select [MNU], then select ◀MARKER▶ and ◀MARKER BW▶. Select ◀AMP REF LEFT▶, enter -60dB on the keyboard. Notice that marker 1 is at the center and marker 2 is at -60dB point and intensified.

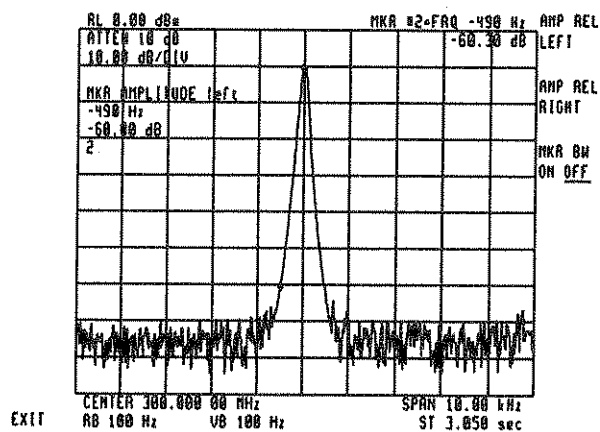

Fig. 4-61

Select ◀AMP REL RIGHT▶, enter -60dB. Notice that marker 3 is at the -60dB point and intensified.

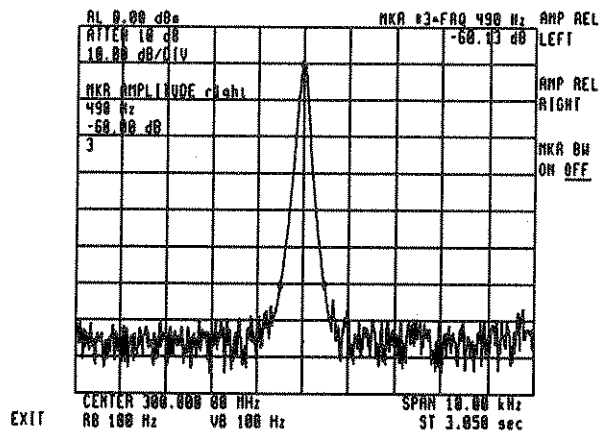

Fig. 4-62

Select ◀MKR BW ON OFF▶ and read the -60dB bandwidth from the CRT display.

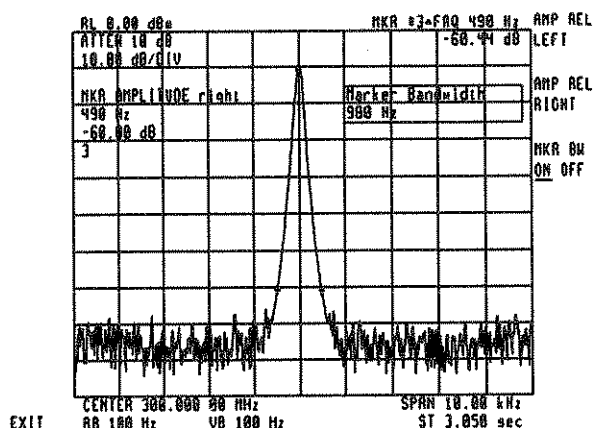

Fig. 4-63

Active Marker

Pressing ◀ACTIVE MARKER▶ activates the marker function and permits selection of one of five markers. To select a marker, use the step keys, knob, or keyboard. The marker number will appear in the upper right hand corner and also in the active function section of the display. Three things happen when you select this softkey: (1) The marker number supplied by the command becomes the active marker. (2) If the marker number was not previously set, the marker is activated using preset type (position), readout (frequency or sweep time if zero span), and trace (by default algorithm), and is placed at the center frequency. (3) The active marker is highlighted on the screen for identification.

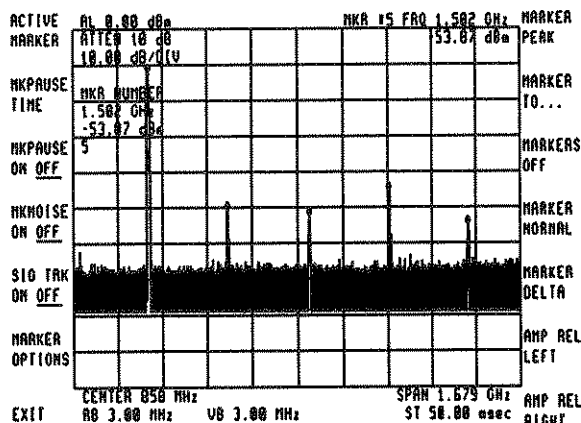
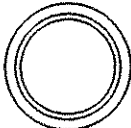

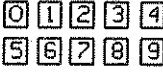

Fig. 4-64

Marker Pause Time

Selecting ◀MKPAUSE▶ causes the analyzers' sweep to stop and pause at the marker for a specified length of time. This command applies to the current active marker. A pause value of zero or turning the marker off, will terminate the pause function. The marker's preset condition is 0. The range is from 0 to 1000 seconds.

The three methods of setting MARKER PAUSE are shown below:

| | |
|--|--|
| <p>KNOB</p>  | <p>One full turn moves the active marker approximately one tenth of the horizontal span.</p> |
| <p>STEP KEYS</p>  | <p>One step moves the marker one tenth of the horizontal span.</p> |
| <p>KEY PAD</p>  | <p>Positive entries place the marker higher in frequency than the stationary marker, negative entries place the marker lower in frequency. Entries that are larger than allowable will place the marker on the adjacent graticule border.</p> <p>Negative frequencies can be entered using a minus sign. For example, to set a delta span of 10 MHz with the second marker positioned to the left of the first, press the minus sign then 1, 0 MHz, -dBm, sec.</p> |

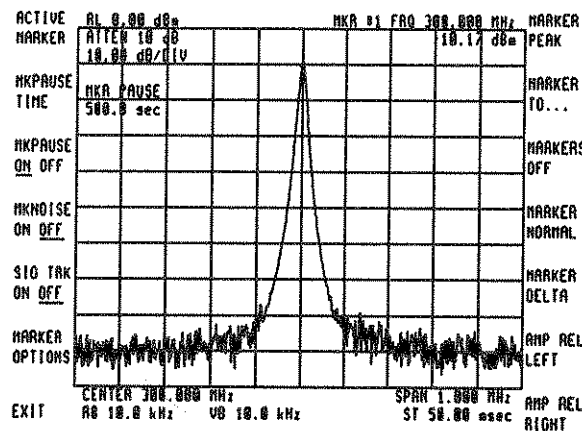

Fig. 4-65

Marker Pause On Off

Selecting ◀MKPAUSE ON OFF▶ allows you to enter a value into the analyzer to stop and pause the sweep. The function is described above in MARKER PAUSE TIME. Notice that the underline toggles back and forth when the softkey is pressed. Also, when ◀MKPAUSE TIME▶ is selected and a value entered, the function goes to the ON position.

The amount of pause time can be entered from the keyboard or with the step key (the 1, 3, 10 sequence will be in effect) or by turning the display knob to the desired value. The range is 0 to 1000 seconds.

Mkr Noise On Off

Selecting ◀MKR NOISE ON OFF▶ causes the analyzer to read out the RMS noise level of the active markers. The readout is normalized to a 1 Hz bandwidth. The noise bandwidth of the IF filters and the logging error (if log in signal path) is taken into account.

The preset condition is "off".

Sig Trk On Off

Selecting ◀SIG TRK ON OFF▶ causes the signal at the marker location to become fixed at the center of the screen. Signal tracking mode is automatically turned off for all other markers when it is turned on for the active marker. Once the signal track function is turned on, the active marker can be changed without affecting the marker that is signal tracked.

The response to a signal track query is the current status of signal track independent of which marker is the current active marker.

When signal tracking is on and span is changed, an automatic zoom is performed. The span will be reduced in steps so that the signal remains at center screen. If the instrument is in zero span then executing signal tracking has no effect.

The preset condition is off.

Marker Options

Selecting ◀MARKER OPTIONS▶ allows you access to the following functions:

1. ◀MARKER TRACE A▶
2. ◀MARKER TRACE B▶
3. ◀MARKER TRACE C▶
4. ◀SIG TRK LIMIT▶
5. ◀PEAK EXCURSN▶
6. ◀MK READ AUTO▶
7. ◀MK READ FREQ▶
8. ◀MK READ PEAK▶
9. ◀MK READ SWP TIM▶
10. ◀MK READ 1/T▶

A detailed description of each function follows:

Selecting ◀MARKER TRACE A▶ causes the analyzer to place the active marker on the A TRACE. If a marker function has not been activated, selecting ◀MARKER TRACE A▶ will have no effect. Having the markers go onto TRACE A is the preset condition.

Selecting ◀MARKER TRACE B▶ operates the same way as TRACE A except that TRACE B must be activated before the marker will appear on the screen. Notice that the underline will also appear under TRACE B when the function is activated.

Selecting ◀MARKER TRACE C▶ operates the same way as TRACE A except that TRACE C must be activated before the marker will appear on the screen. Notice that the underline will also appear under TRACE C when the function is activated.

Selecting ◀SIG TRK LIMIT▶ allows you to set the amplitude limit used by the marker track function when determining the proper signal to track. When choosing between two closely spaced signals, the signal within the amplitude limit of the previous tracked signal amplitude will be tracked. The limit is allowed plus or minus from the previous signal amplitude. The preset state is 5 dB. The minimum is 0dB and the maximum is 300dB.

Selecting ◀PEAK EXCURSN▶ allows you to select the the value of peak excursion. The value is selected in dBs, and can be entered by the standard three methods of entry (keyboard, knob, or step key). If a value of 10dB is entered, then the marker will only go to peaks which rise and fall 10 dB. (With "Normal" Detector, the noise can be peaks, if the excursion isn't set to exclude them.)

Marker Readout

The marker readout function determines the method by which the frequency or time data of the active marker will be read out. There are two basic readout types: frequency related and sweep time related. The following table describes each of the readout types.

When transitioning between different readout types, the position of the marker remains the same and the new readout type is assumed. The full range of readout possibilities is available in either zero or non-zero spans. The meaning of each readout type is explained below.

Selecting ◀MARKER READ AUTO▶ causes the analyzer to read out automatically depending on whether or not you are in zero span. In zero span the marker readout is sweep time; otherwise it reads out frequency.

Selecting ◀MK READ FREQ▶ causes the frequency value of the marker to be the center frequency of the analyzer when in zero span. If not in zero span, the frequency value of the marker is associated with its position on the frequency scale.

Selecting ◀MK READ PERIOD▶ causes the period value of the marker to be determined by 1/analyzer center frequency for the zero span. For a non-zero span condition the period value is determined by the inverse of the marker's frequency value.

Selecting ◀MK READ SWP TIM▶ causes the time value to be determined by the time point on the horizontal scale determined by sweep time.

Selecting ◀MK READ 1/T▶ causes the inverse sweep time to be determined by 1/(the TIM value).

Marker Zoom

The analyzer can automatically zoom in on a signal specified by a marker. The desired frequency span is input from the data number/units keyboard.

To activate the automatic zoom function use ◀MARKER NORMAL▶ knob to identify a specific signal. Press ◀SIG TRK ON OFF▶ and then [USR]. Press ◀SPAN▶, then the desired span with the data number and units keyboard.

When the units key is pressed, the zooming process will begin. Turn signal tracking off when auto zoom is completed.

Example:

A single carrier needs to be examined in a 200kHz span to see the sidebands. Because the SIGNAL TRACK function automatically maintains the signal on the center of the CRT, you can zoom automatically from a wide span to a narrow span for a close look at it.

Place a marker on the carrier with ◀MARKER NORMAL▶, and the knob.

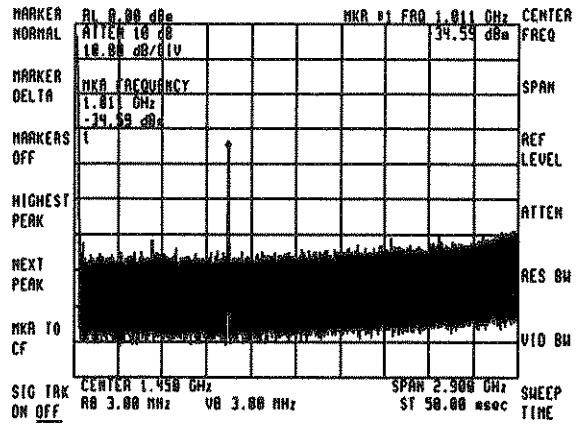

Fig. 4-66

Press ◀SIG TRK ON OFF▶, then the ◀SPAN▶. Enter the span; press [2], [0], ◀kHz▶. Auto zoom will be completed. (Turn off Signal Tracking).

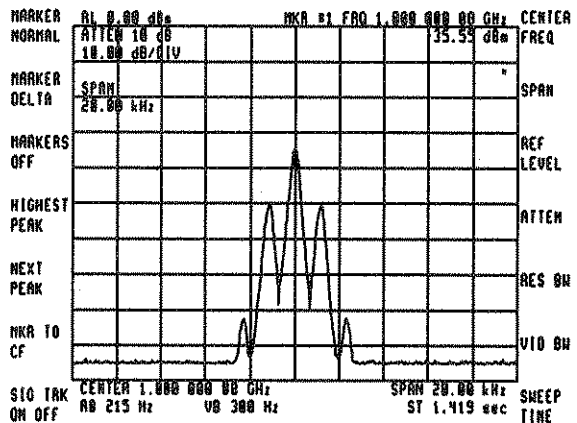

Fig. 4-67

Bandwidth

This section describes softkeys which change resolution bandwidth settings or video bandwidth settings.

Figure 4-68 shows the softkeys which appear when **◀BANDWIDTH▶** is pressed.

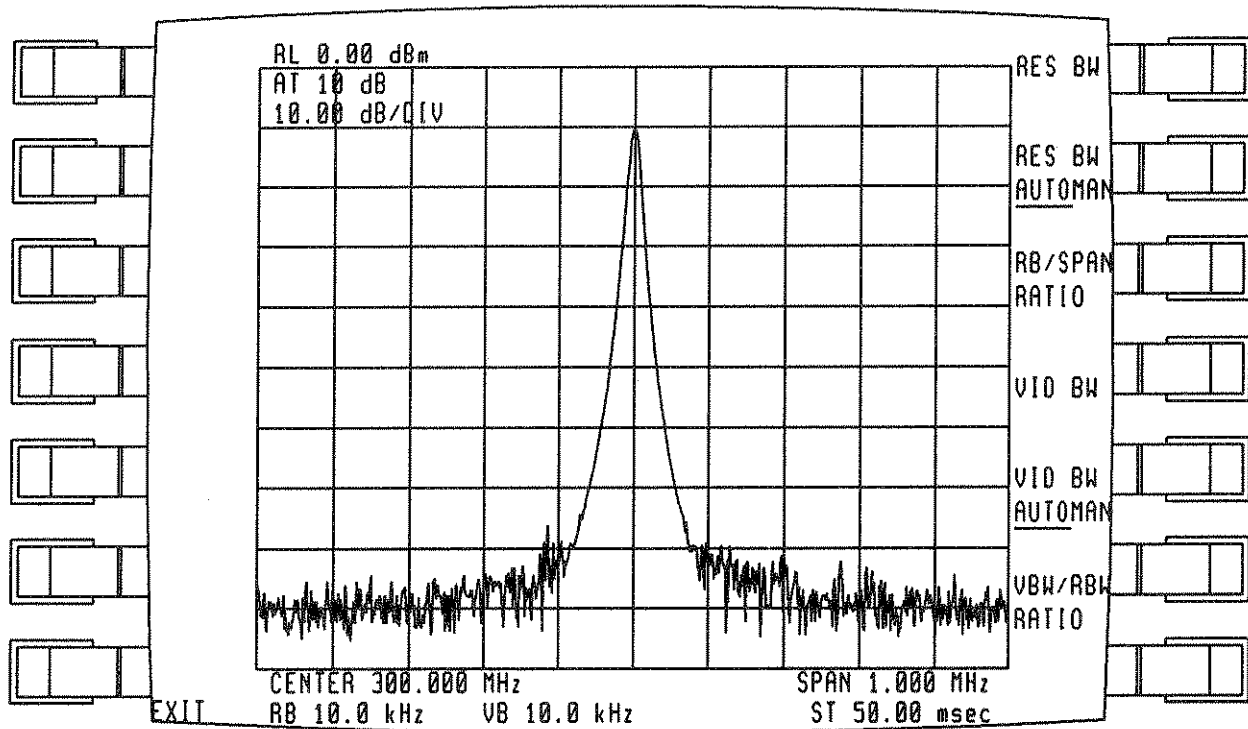

Fig.4-68. Top level menu for **◀BANDWIDTH▶**

Resolution Bandwidth

Pressing **◀RES BW▶** sets the resolution bandwidth to the manual position and changes the analyzer's IF bandwidth only when a value is actually entered. It also causes the underline in the **◀RES BW AUTOMAN▶** to change from the auto to manual position. The bandwidths that can be selected are 10Hz, 30Hz, 100Hz, 300Hz, 1kHz, 3kHz, 10kHz, 30kHz, 100kHz, 300kHz. With a 70903A IF module installed, additional 1MHz and 3MHz bandwidths are available. Bandwidths in 10% increments between the steps are available except between the 3KHz-10KHz step.

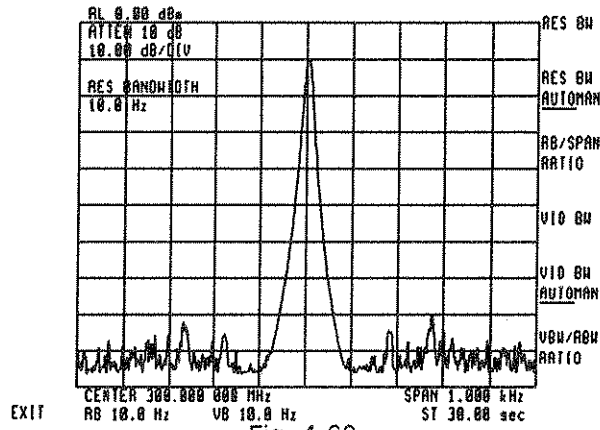
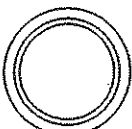



Fig. 4-69

Three methods of setting the RESOLUTION BANDWIDTH are shown below:

| | |
|--|---|
| <p>KNOB</p>  | <p>Changes the RESOLUTION BANDWIDTH continuously.</p> |
| <p>STEP KEYS</p>  | <p>Changes the RESOLUTION BANDWIDTH to the next value in a 1, 3, 10 sequence.</p> |
| <p>KEY PAD</p>  | <p>Enters an exact bandwidth value. The allowable bandwidths are dependent on the IF section. The bandwidths allowable are in increments of 10% of the 1, 3, 10 sequence of RES BW. If the entered value differs from the allowable value, the next higher value is chosen.</p> |

Example:

A measurement requiring manual resolution bandwidth selection is the zero span (time domain) observation of modulation waveforms. An example can be found in the section under SPAN.

Manual resolution bandwidth can also be used for better sensitivity over a given frequency span.

The low level intermodulation products of a signal need to be measured. With the resolution bandwidth in auto position the analyzer noise may mask the distortion products.

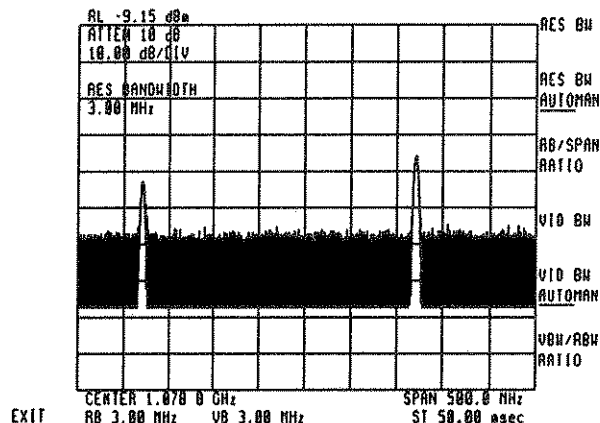

FIG. 4-70

Reduction of the noise level by 10 dB (increased sensitivity) is achieved by decreasing the bandwidth by a factor of 10. Press ◀RES BW▶ and the down step key twice. (◀THRESHOLD▶ has been activated to clarify the display).

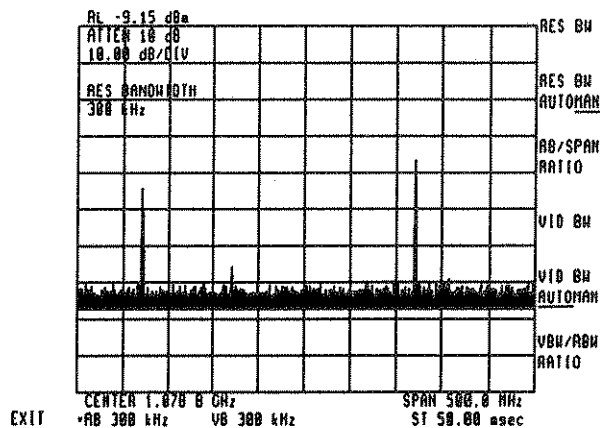

FIG. 4-71

Note: The sweep time automatically slows to maintain absolute amplitude calibration if sweep time is in the Auto position.

Resolution Bandwidth Automan



Another way of setting different resolution bandwidths is to press ◀RES BW AUTOMAN▶. The underline changes to the manual position and the function is as described in the RESOLUTION BANDWIDTH section. To go back to the auto position press ◀RES BW AUTOMAN▶ again and the analyzer will return to Auto position. (The underline toggles back to auto.)

Resolution Bandwidth Ratio

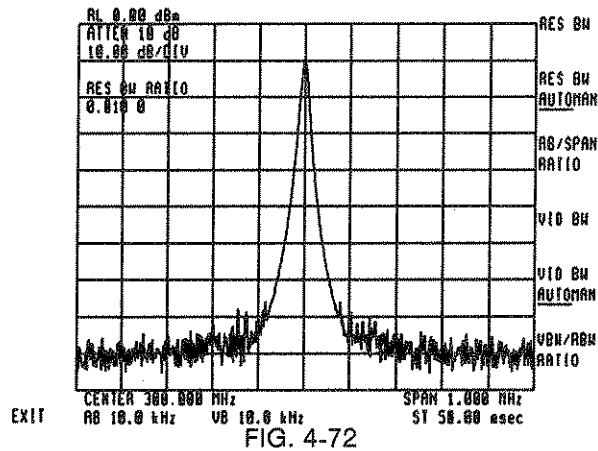
The resolution bandwidth ratio is a function of span. The preset condition of the ratio of resolution bandwidth to span is chosen to provide an aesthetically pleasing display. The ratio can be changed by pressing ◀RES BW RATIO▶ and entering a value.

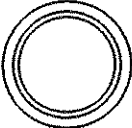

Three methods of setting the RESOLUTION BANDWIDTH RATIO are shown below:

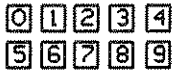
| | |
|--|---|
| <p>KNOB</p>  | <p>Changes the RESOLUTION BANDWIDTH RATIO continuously.</p> |
| <p>STEP KEYS</p>   | <p>Changes the RESOLUTION BANDWIDTH RATIO to the next value in a 1, 3, 10 sequence.</p> |
| <p>KEY PAD</p>  | <p>Enters an exact value which is allowable (any value between 10⁻¹⁰⁰ to 10⁺¹⁰⁰). The instrument will only display three significant digits. The preset value is 0.010.</p> |

Video Bandwidth

Selecting ◀VIDEO BANDWIDTH▶ allows you to set the analyzer's post-detection filter bandwidth. Video bandwidth can be automatically coupled to the resolution bandwidth. The coupling is set to manual only when a numeric value is input; or an up or down step is received.





When the video bandwidth is coupled, it follows the equation below:

$$\text{VIDEO BW} = \text{RESOLUTION BW} * \text{VIDEO BW RATIO}$$

(to the nearest value permitted by hardware)

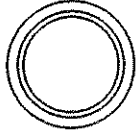
The preset condition is auto coupled. The range of video bandwidth is ± 1000 GHz or the hardware determined limit.

Three methods of setting the VIDEO BANDWIDTH are shown below:

| | |
|--|--|
| <p>KNOB</p>  | <p>Changes the VIDEO BANDWIDTH continuously.</p> |
| <p>STEP KEYS</p>   | <p>Changes the VIDEO BANDWIDTH to the next value in a 1, 3, 10 sequence.</p> |
| <p>KEY PAD</p>  | <p>Enters an exact value which is allowable (any value between ± 1000 GHz in 1, 3, 10 sequence). If a value is not allowable, it will select the next larger value.</p> |

Video Bandwidth Automan

Another way of setting different video bandwidths is to press VID BW AUTOMAN. The underline changes to the manual position and the function is as described in the VIDEO BANDWIDTH section. To go back to the Auto position press VID BW AUTOMAN. (The underline toggles back to auto.)

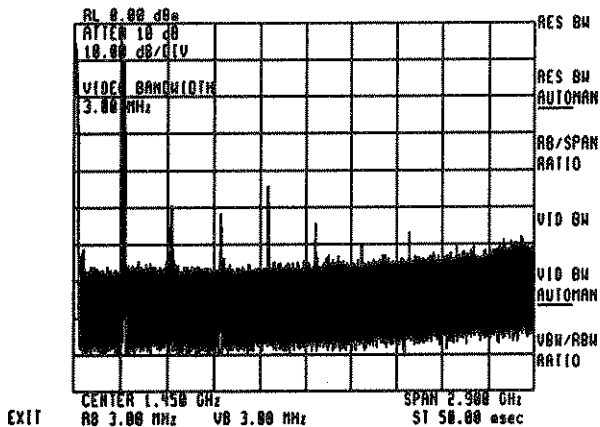

Fig. 4-73

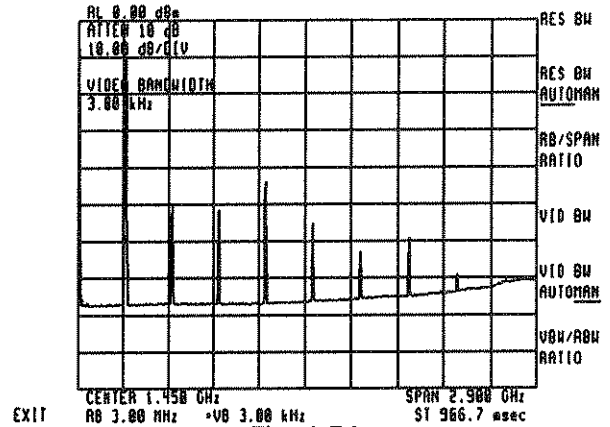
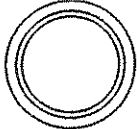
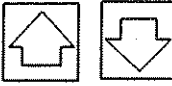
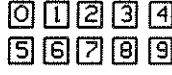

Fig. 4-74

Video Bandwidth Ratio

The video bandwidth ratio is multiplied by the resolution bandwidth to determine the automatic setting of video bandwidth. To set the value press **◀VID BW RATIO▶** and enter a value. Again, there is no manual/auto mode. The user simply changes the ratio.

Three methods of setting the VIDEO BANDWIDTH RATIO are shown below:

| | |
|--|---|
| <p>KNOB</p>  | <p>Changes the ratio in allowable increments continuously.</p> |
| <p>STEP KEYS</p>  | <p>Changes the ratio to the next value in a 1, 3, 10 sequence.</p> |
| <p>KEY PAD</p>  | <p>Enters an exact value which is allowable (any value between 10⁻¹⁰⁰ to 10⁺¹⁰⁰). The instrument will display only three significant digits. The preset value is 1.</p> |

The preset state has a ratio equal to 1.0.

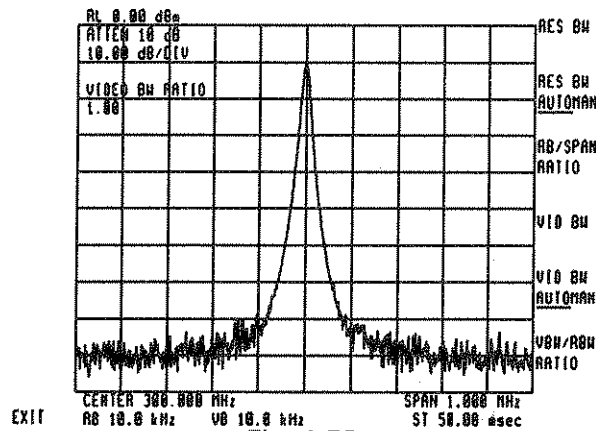

Fig. 4-75

Example:

Signal responses near the noise level of the analyzer will be visually masked by the noise. The video filter can be narrowed to smooth this noise.

A low level signal at this center frequency can just be discerned from the noise.

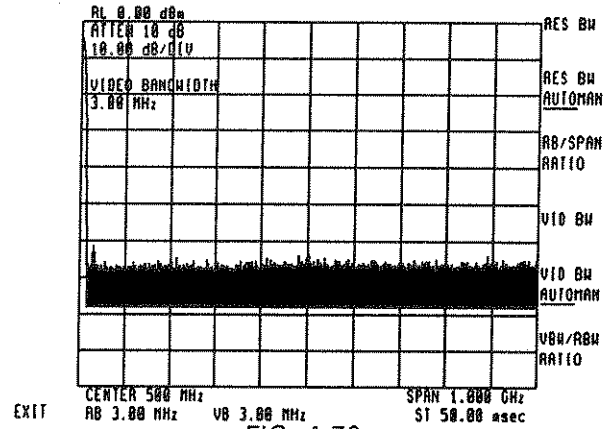

FIG. 4-76

Narrowing the video bandwidth clarifies the signal and allows for its amplitude measurement. Press **VID BW** and the step key until 3kHz is reached.

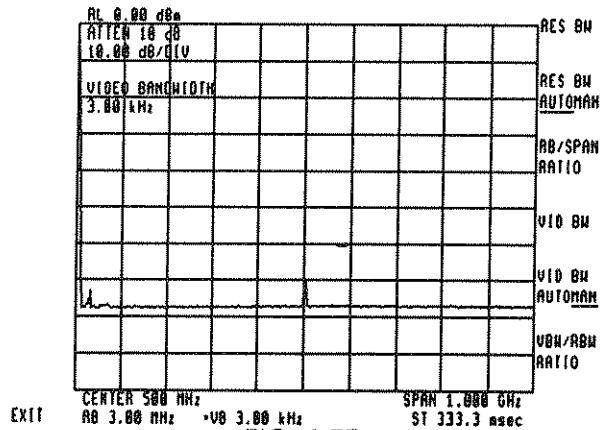

FIG. 4-77

The sweep time will increase to maintain amplitude calibration.

Note

The video bandwidth must be set wider than or equal to the resolution bandwidth when measuring pulsed RF or impulse noise levels.

Trace

This section describes softkeys which use the TRACE functions for writing, storing, and manipulating trace data. It also describes which softkeys are used to select the detector functions.

Figure 4-78 shows the softkeys which appear when **◀TRACE▶** is pressed.

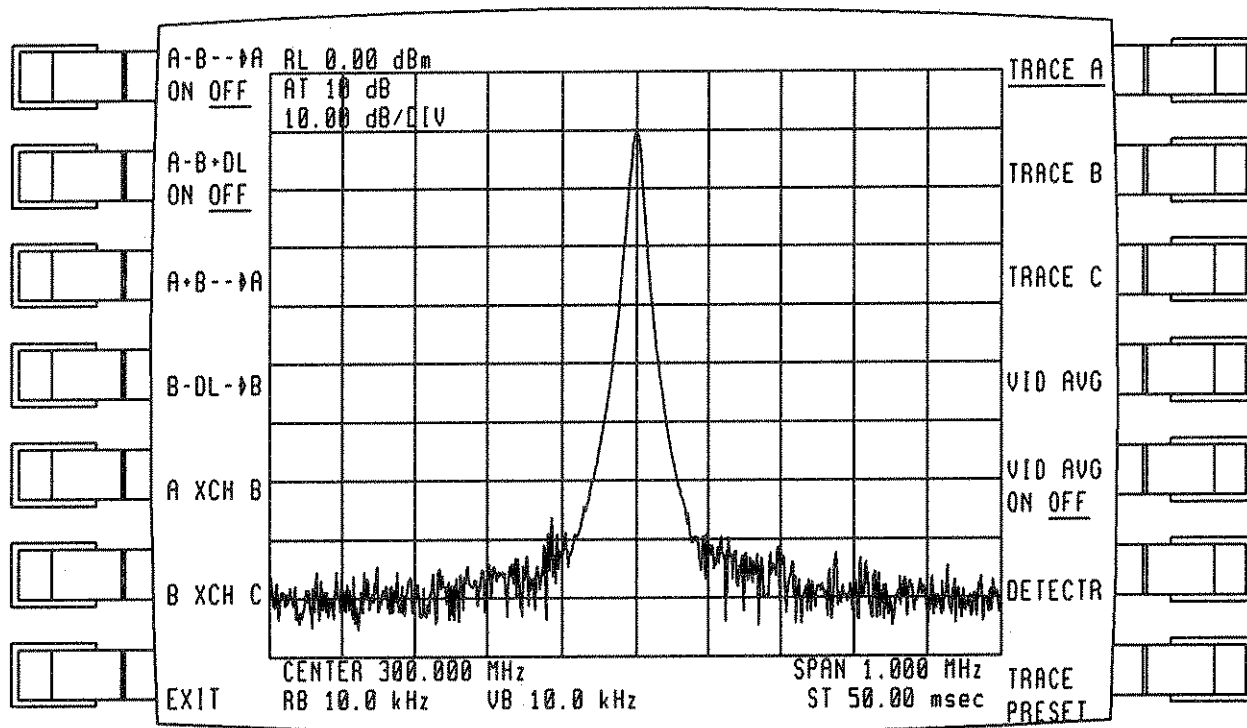

Fig.4-78. Top level menu for **◀TRACE▶**

Trace Overview

To access the trace functions, select [MNU] and **◀TRACE▶**. This menu displays the different spectrum analyzer trace functions. To select one, press the appropriate softkey. The instrument preset shows trace A being displayed. (Notice **◀TRACE A▶** is underlined.) The three traces A, B, and C can be displayed simultaneously.

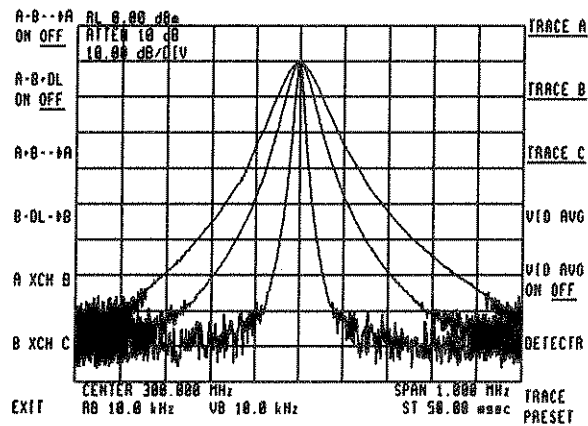

Fig. 4-79

Five mutually exclusive functions for trace A and trace B and trace C determine the manner in which the traces are displayed #6 and #7 are independently set.

Trace functions:

1. **CLEAR WRITE** - Displays the input signal response in the trace selected.
2. **MAXIMUM HOLD** - Displays and holds the maximum response of the input signal in trace selected.
3. **MINIMUM HOLD** - Displays and holds the minimum response of the input signal in trace selected.
4. **VIEW** - Stores the current trace and displays it on the CRT display.
5. **BLANK** - Stores the current trace and blanks it from the CRT display.
6. **TRACE DISPLAY ON OFF** - Displays or turns off the trace register.
7. **LENGTH OF TRACE** - Defines the number of points in a user defined or predefined trace.

Trace A

Pressing **◀TRACE A▶** allows access to all the functions for trace A display. The softkey is underlined indicating that it is active. The following describes each of the functions in detail:

CLR WRT TRACE A

The clear write function initiates a sequence of events. First, each element in the indicated trace register(A) is set to the bottom of the screen value. Then, new data from the detector is put in the trace register with each sweep. Trace display is activated for the specified trace register (A). Also, the underline will appear below this softkey.

MAX HLD TRACE A

The input data and the specified trace (A) data are examined and the maximum of the two is selected and given to the trace register specified. Display of trace (A) register is activated. The "Det" detector is set to positive peak. Also, the underline appears below this softkey.

MIN HLD TRACE A

The input data and the specified trace (A) data are examined and the smaller of the two is selected and given to the trace register specified. Display of that trace register is activated. The "Det" detector is set to negative peak. The underline appears below this softkey.

VIEW TRACE A

The indicated trace register (A) is disconnected from the input data source and is displayed. The underline appears below this softkey.

BLANK TRACE A

The Blank command disconnects the trace from the input data source. Display of trace (A) is also prevented. The underline will appear below this softkey.

TRDSPL ON OFF

The trace register indicated (A) may be displayed or turned off with this command. When the trace displays are turned off, the total sweep time can be decreased. There is no other effect on the operation of the trace or of its data. Also, the underline will toggle between the ON and OFF position.

LENGTH TRACE A

This command establishes number of points in a user-defined trace or predefined trace. The default length for predefined traces is 800 points. Any number of points may be used for a trace length. By changing the length of the predefined traces, the number of data points acquired can be changed. Since traces of varying length can be created, the following rules are used to manipulate traces of different lengths.

If two traces have different lengths, the smaller length is used for the specified span. The longer trace will acquire data only until the shorter trace is filled up. When a trace of greater length is operated on and stored in a trace of shorter length, the trace is truncated to fit. When a trace of a shorter length is operated on and stored in a trace of longer length, the last trace element is extended for operations with the longer length. For example, a single element trace would act like a display line in trace operations.

Trace B

The operations and functions are the same as those described in TRACE A.

Trace C

The operations and functions are the same as those described in TRACE A. The default trace length is 3, to save user memory.

Vid Avg

Pressing ◀VID AVG▶ sets the average counter to 100, its default value. The count is displayed on the middle left part of the screen. The counting sequence starts with the press of ◀VID AVG ON OFF▶. Pressing the ◀VID AVG▶ allows you to change the number of averages. The numeric keyboard is the only way of entering the new value. If the averaging process is working, any key that affects the data on the display (Span, Center Freq, BW, etc.) restarts the count.

Video Average on-off

Pressing ◀VID AVG ON OFF▶ causes the video average function to begin. The count sequence is displayed on the screen. Notice the underline toggles between the ON and OFF position. While the average function is working, the analyzer's function can be changed; however, the video averaging process will start over if this change alters the source data.

When video average is turned on, the detector is set to sample. If the detector is SAMPLE when video average is turned off, the detector will be set to NORMAL.

Detector

Pressing ◀DETECTR▶ allows the selection of five different modes.

*NORMAL DETECTION

*SAMPLE DETECTION

*POSITIVE PEAK DETECTION

*NEGATIVE PEAK DETECTION

*GROUND DETECTION

The detection mode specifies the input detector used to acquire measurement data. The instrument preset [I/P] is normal detection. The softkey of the activated detection mode is underlined. The following describes each of the detection modes:

◀NORMAL DETECTR▶

The normal detection algorithm selectively chooses between the positive and negative peak values to be displayed. Normal mode is selected on instrument preset.

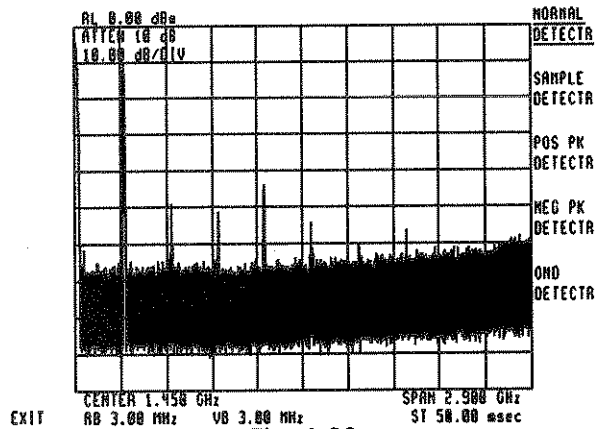

Fig. 4-80

In normal mode a detection algorithm selectively chooses between the positive and negative peak values to be displayed. The choice made depends upon the type of video signal present.

Data from the positive peak detector (signal maximums) will always be displayed in the odd addressed trace memories. If, within the time period following the storage of a value in an odd address memory, there is no change in video signal level, the positive peak detector value will be stored in the even address. In other words, the even addressed memory will also contain positive peak detection data if the signal during that time period is monotonic. Negative peak detector data (video signal minimum) will be stored in the even addressed trace memory if the signal has a point of inflection during the time period.

◀SAMPLE DETECTR▶

The instantaneous signal value of the video a/d conversion is placed in memory. Sample mode is selected automatically when video averaging from the input occurs and when a noise level marker is activated.

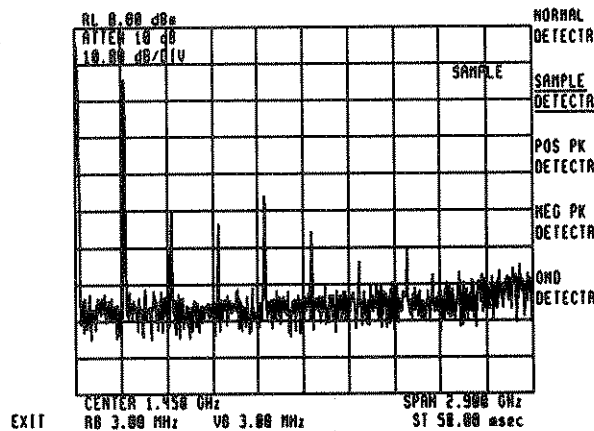

Fig. 4-81

◀POS PK DETECTR▶

The maximum signal value over the conversion period is acquired.

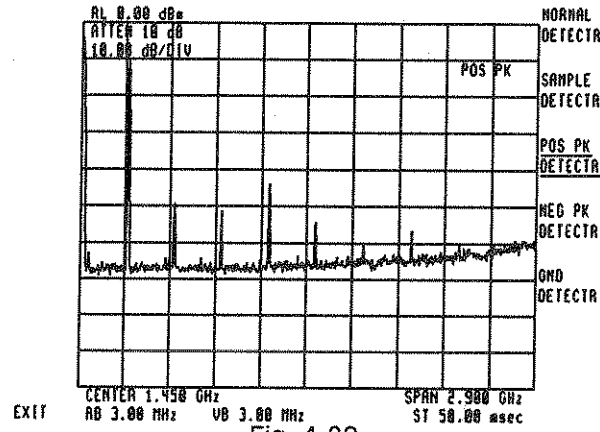

Fig. 4-82

◀NEG PK DECTECTR▶

The minimum signal value over the conversion period is acquired.

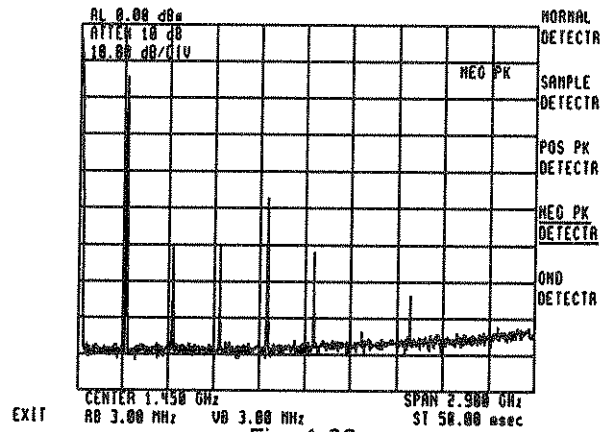

Fig. 4-83

◀GND DETECT▶

The input signal is connected to ground. This is primarily used for diagnostics.

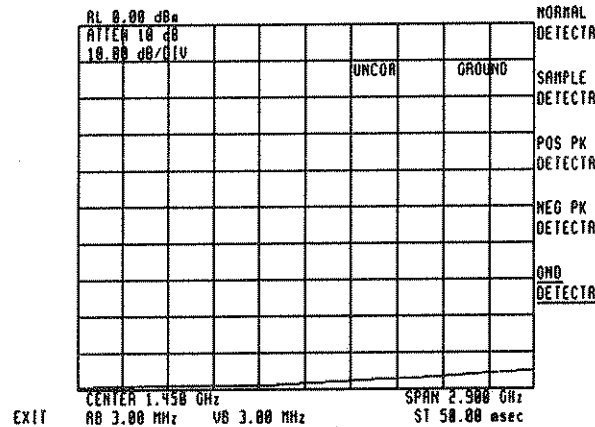

Fig. 4-84

Trace Present

With this command, the trace function can be independently preset. All trace functions are set to their preset values as follows:

1. Input to trace A.
2. Display trace A activated.
3. Zero value entered into trace A.
4. All other math and control functions off.
5. Display line off.
6. Normal detector.

A - B-->A ON OFF

Trace B is subtracted from Trace A and the result is stored in Trace A. Trace B is frozen, no longer affected by input data (writing status off). As new data is measured, the subtraction is performed as each data point is measured. The preset condition is off.

A - B + DL ON OFF

Trace B is subtracted from Trace A, the display line is added, and the result is stored in Trace A. Trace B is frozen, no longer affected by input data (writing status off). As new data is measured, the subtraction and addition is performed point by point. The preset condition is off.

A + B-->A

Trace B is added to Trace A and the result is stored in Trace A. This is done immediately and not on a repetitive basis.

B - DL-->B

The display line is subtracted from Trace B and the result is stored in Trace B. The display of Trace B is activated. Trace B is frozen, no longer being affected by the input data.

A XCH B

Trace B and Trace A are exchanged. Both Trace A and Trace B are frozen, no longer affected by the input data.

B XCH C

The Trace B is exchanged with Trace C. Both Trace B and Trace C are frozen, no longer affected by the input data.

Instrument Display

This section describes softkeys which change instrument display settings or annotation settings.

Figure 4-85 shows the softkeys which appear when ◀INST DSPLY▶ is pressed.

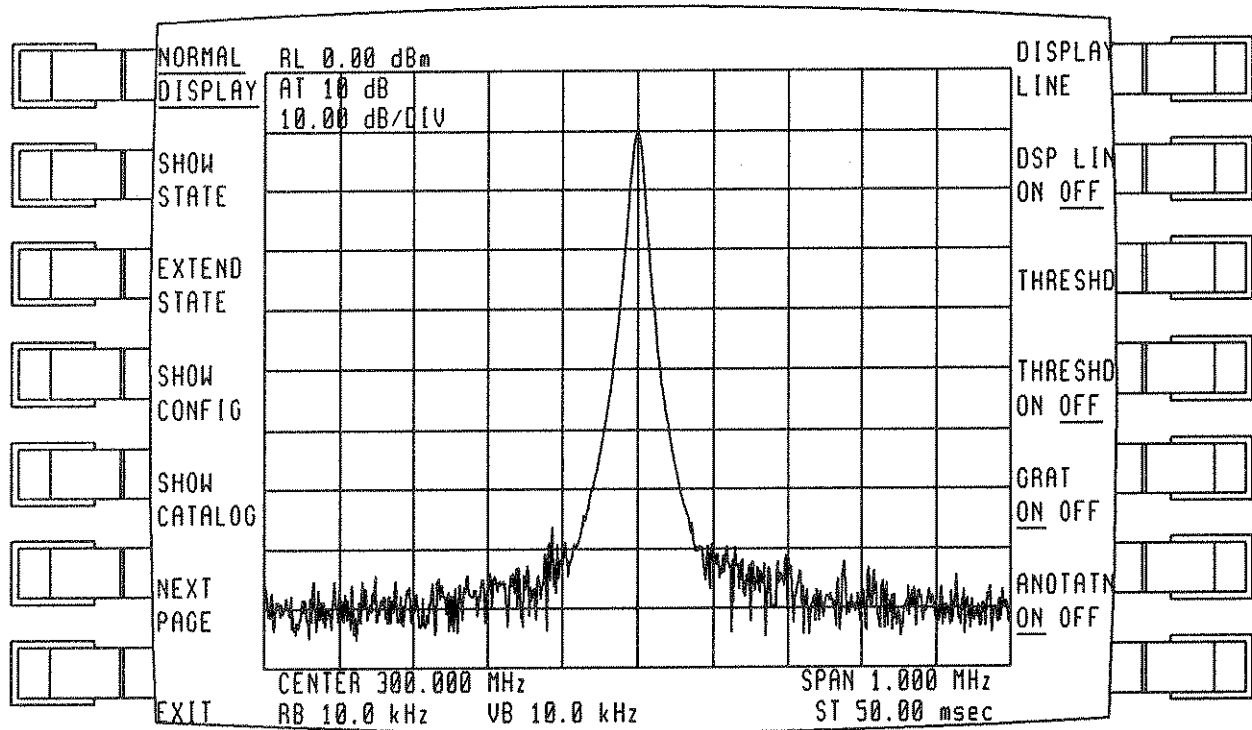

Fig.4-85. Top level menu for ◀INST DSPLY▶

Reference Line

The reference line functions, ◀DISPLAY LINE▶ and ◀THRESHD▶, place horizontal reference lines on the display. Their levels are displayed in absolute amplitude units.

DISPLAY LINE is used to:

- * measure signal levels with direct readout.
- * establish a standard for go/no go test comparisons.
- * eliminate or reduce amplitude errors due to system frequency response uncertainty.

THRESHOLD provides:

- * a base line clipper whose level is read out.
- * a minimum threshold level that can be set.

Display Line

The display line function provides a reference line in units corresponding to the vertical scale for visual and computational purposes. It may be turned on and off and can be assigned a display line level.

The display line is activated when a numeric data field is input, an up or down is entered, or an enable parameter entry is terminated. The preset condition is off.

Pressing **◀DISPLAY LINE▶** places a horizontal reference line at any level on the graticule. The line's amplitude, in reference level units, is read out on the left-hand side of the CRT display.

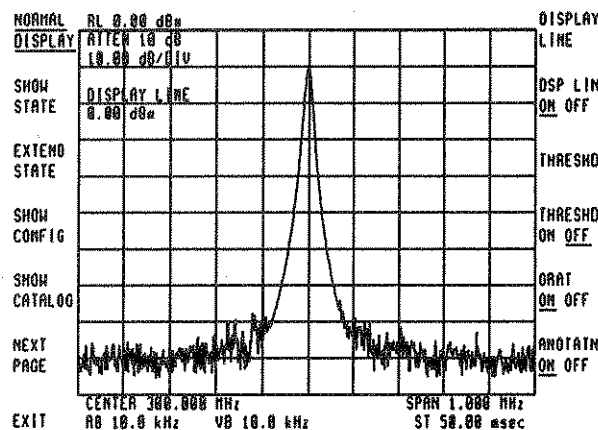

Fig. 4-86

The display line can be positioned anywhere within the graticule. When line power is activated or [I/P] is pressed the display line is placed at the reference level.

Dsp Lin ON OFF



If **◀DSP LIN ON OFF▶** is pressed, a horizontal reference line is placed on the graticule. The line can be placed at any level on the graticule. The line's amplitude, in reference level units, is read out on the left-hand side of the CRT display. The underline toggles to the ON position: this takes place when **◀DISPLAY LINE▶** is pressed.

When the OFF position is selected, the line and readout are erased from the CRT display. This does not reset the last position. If the display line is activated again before Line power ON or [I/P], it will return to its last position.

The display line position is always accessible for HP-IB and **◀B-DL->B▶**, even if it has not been activated.

The display line readout has the same number of significant digits as reference level.

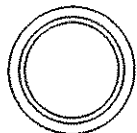
Three methods of setting DISPLAY LINE are shown below:

| | |
|--|--|
| <p>KNOB</p>  | <p>Moves the line approximately one division for each full turn. The line moves in display unit increments.</p> |
| <p>STEP KEYS</p>  | <p>Moves the line one tenth of the total amplitude scale per step.</p> |
| <p>KEY PAD</p>  | <p>Positions the line to the exact entry level. Entry may be in mV, μV, \pmdBm, \pmdBmV, or \pmdBμV, depending upon which units are selected.</p> |

Example: When the amplitude of a number of signals in the same span require a quick readout, the DISPLAY LINE can be used.

Press **◀DISPLAY LINE▶**, then with the knob place the line through the peak of a signal and read out its absolute amplitude level.

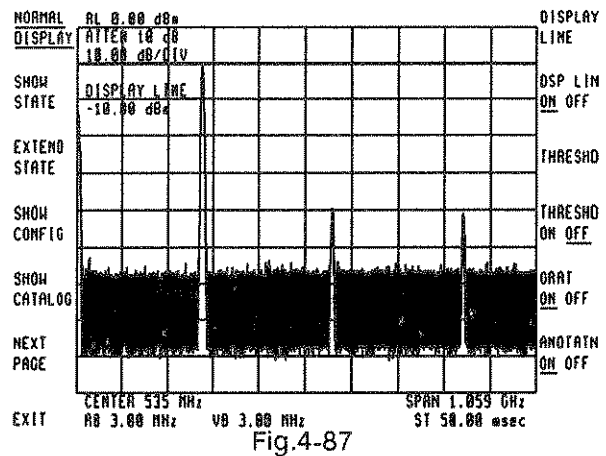

The amplitude of each signal can be read by moving the display forward to each signal.

Threshd ON OFF

The softkey **◀THRESHD ON OFF▶** moves a lower boundary to the trace. The lower boundary is similar to a base line clipper on direct writing CRT spectrum analyzers. The boundary's absolute amplitude level, in reference level units, is read out on the middle left-hand side of the CRT display.

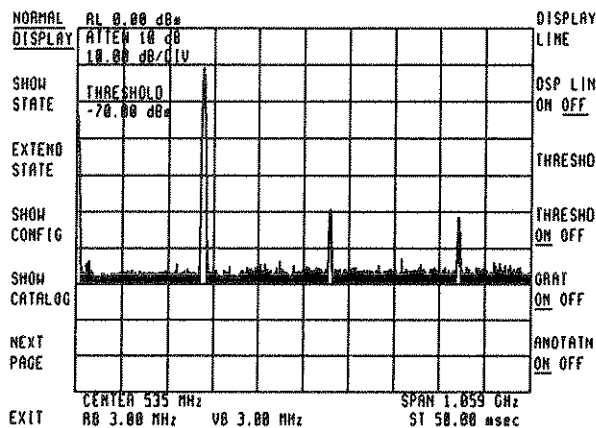

Fig.4-88



The threshold can be positioned anywhere within the graticule. It operates on Trace Clear Write, Maximum Hold, or View for Traces A, B and C simultaneously. When activated by LINE power ON or [I/P], the threshold is placed one division from the bottom graticule.

The threshold level does not influence the trace memory; that is, the threshold level is not a lower boundary for trace information stored and outputted from the trace memories through HP-IB.

toggling the ◀THRESHD ON OFF▶ changes the underline position and turns the function on and off. Selecting the off position causes the analyzer to remove the threshold boundary and readout from the CRT display but does not reset the position. If threshold is activated again before LINE power ON or [I/P] it will resume operation at its last level.

The threshold readout has the same number of significant digits as reference level. Threshold is also used as a bottom limit for marker peak functions even if it is off.

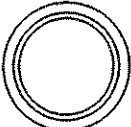
Three methods of setting THRESHOLD are shown below:

| | |
|---|--|
| <p> KNOB</p>  | <p>Moves the THRESHOLD approximately one division per rotation. The line moves in display unit increments.</p> |
| <p> STEP KEYS</p>  | <p>Moves the THRESHOLD one tenth of the total amplitude scale per step.</p> |
| <p> KEY PAD</p>  | <p>Positions the THRESHOLD to the exact entry level. Entry may be in mV, μV, ±dBm, ±dBmV, ±dBμV depending upon units selected.</p> |

Example:

The THRESHOLD can be used as a go/no go test limit.

A series of signals can be tested for a specific THRESHOLD level by placing the THRESHOLD at the test level.

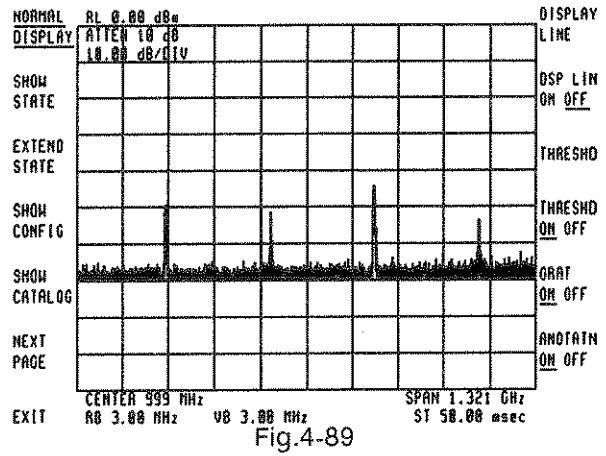

Press **THRESHD ON OFF**, then **[-]**, **[5]**, **[0]**, **[.]**, **[2]**, **dBm**. Only those signals > -55.2 dBm will be displayed.

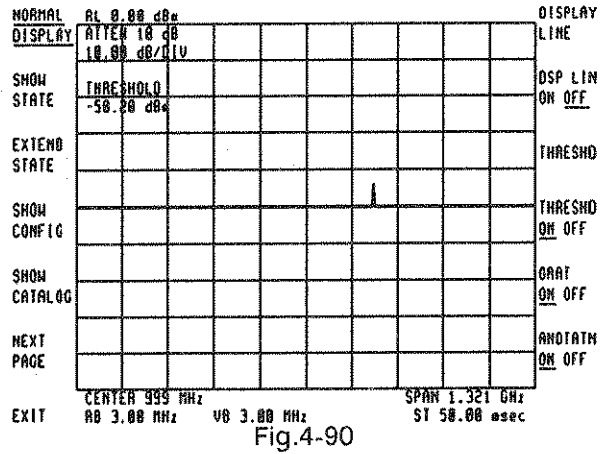

Grat ON OFF

Pressing **GRAT ON OFF** will toggle the underline and activate the function. The preset condition is with the graticule on. Pressing the softkey **GRAT ON OFF** will turn the graticule off. The graticule will disappear.

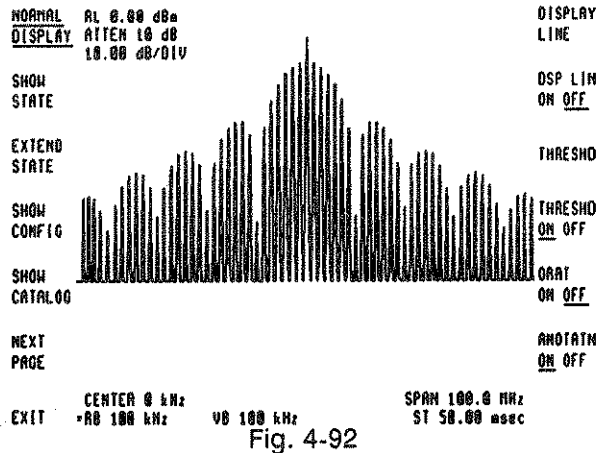
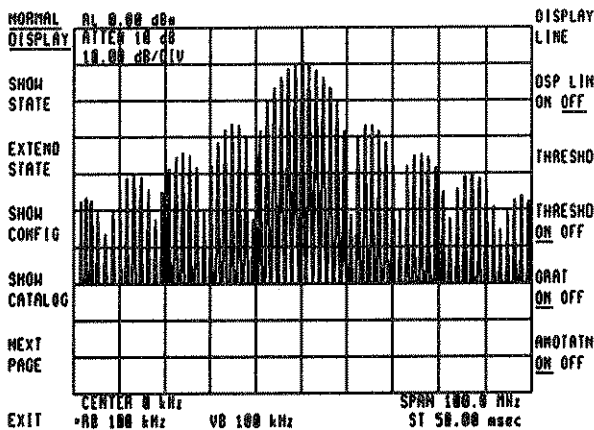

Anotatn ON OFF

Pressing **◀ANOTATN ON OFF▶** will toggle the underline and activate the function. The preset condition is with the annotation on. Pressing the softkey **◀ANOTATN ON OFF▶** will turn the annotation off.

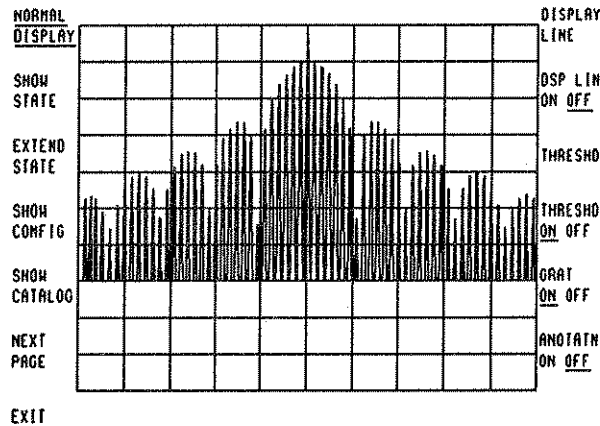

Fig. 4-93

Normal Display

Pressing **◀NORMAL DISPLAY▶** causes the measured trace data and the primary measurement parameters to be displayed. This is the preset display mode.

Show State

Pressing **◀SHOW STATE▶** causes all user- settable variables to be displayed in alphanumeric format. If more than one page of information is available, the display annotation indicates this by displaying "(more)" on the bottom of the display. The way to access this additional information is to press **◀NEXT PAGE▶**. When the last page is reached, the annotation on the display reads "end of State".

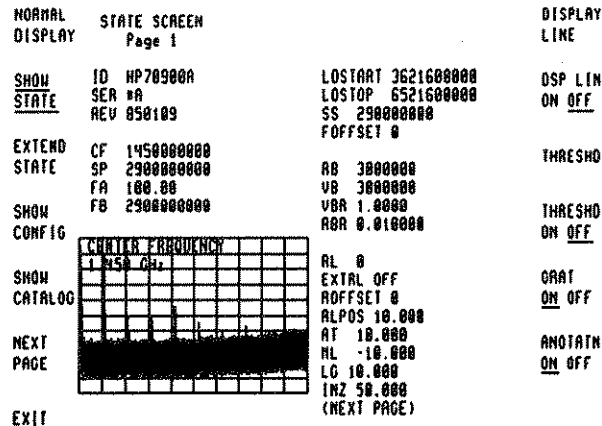

Fig. 4-94

Extend State

Pressing **◀EXTEND STATE▶** causes the analyzer to display additional state information about specific modules. If more than one page of information is available, the display annotation indicates this by displaying "(more)" on the bottom of the display. Select **◀NEXT PAGE▶** for additional information.

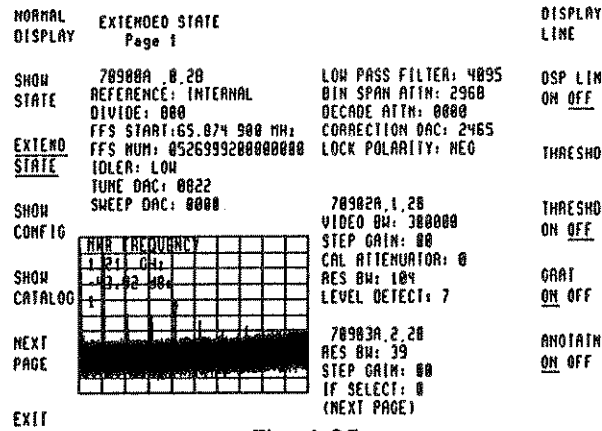

Fig. 4-95

Show Config

Pressing **◀SHOW CONFIG▶** causes the analyzer to display the instrument configuration in alphanumeric format. If more than one page of information is available, the display annotation indicates this by displaying "(more)" on the bottom of the display.

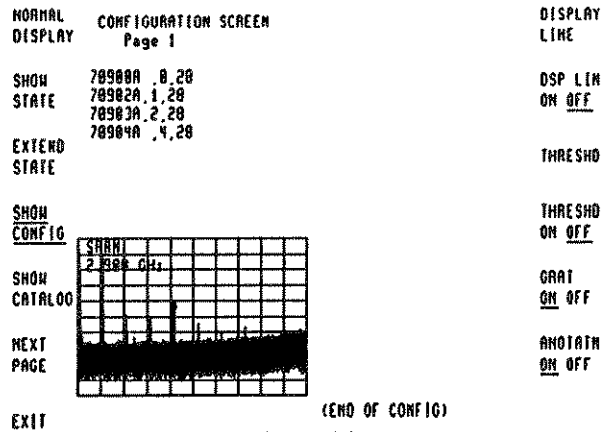

Fig. 4-96

Show Catalog

Pressing ◀SHOW CATALOG▶ brings up a catalog of all user functions, trace, and variable definitions. If more than one page of information is available, the display annotation indicates this by displaying "(more)" on the bottom of the display.

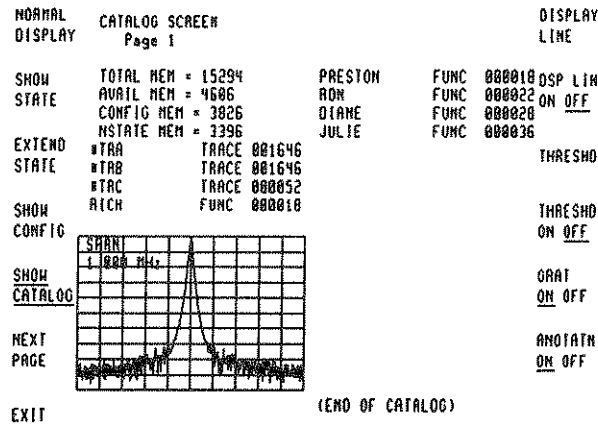

Fig. 4-97

Next Page

Pressing ◀NEXT PAGE▶ causes the analyzer to display any additional information that may not have fit on one screen. There is an annotation at the bottom of the screen just right of center, that indicates whether there is more than one page of data and also which page you are presently on.

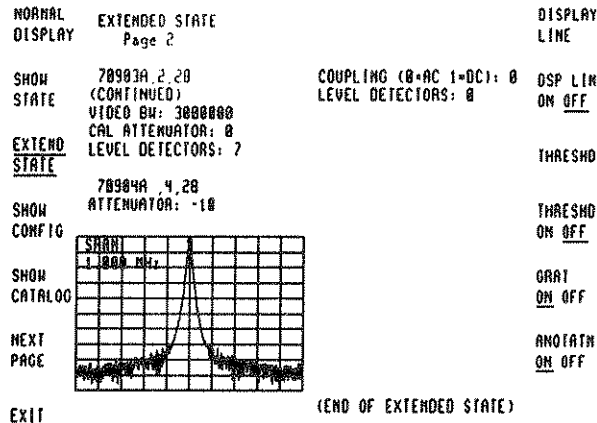

Fig. 4-98

State

This section describes softkeys for saving or recalling trace displays. It also describes how to set up the Spectrum Analyzer's power-up state.

Figure 4-99 shows the softkeys that appear when **STATE** is pressed.

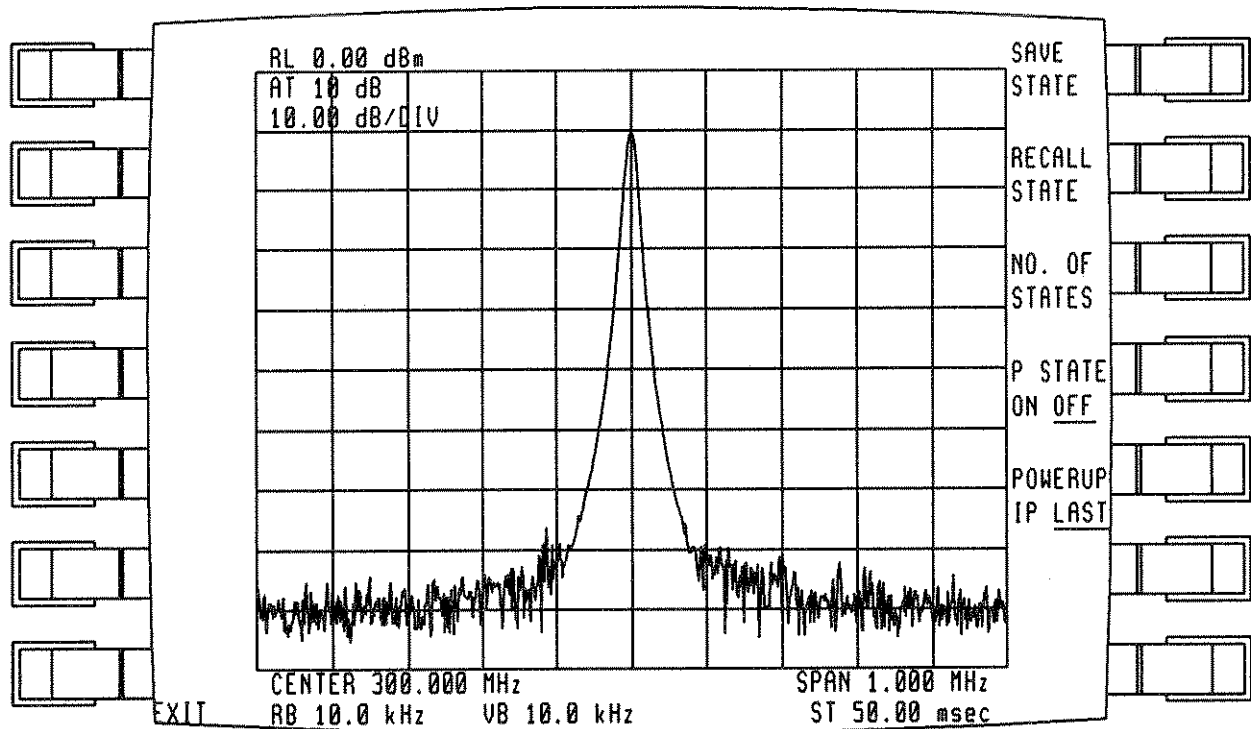

Fig.4-99. Top level menu for **STATE**

Save State

The preset state of the analyzer can be saved in one of several registers referenced by numeric values. The number of state registers is set by the [number of] STATE Registers (**STATE**) softkey.

To save a state, press **STATE** and enter a number from the keyboard. The preset number of registers is 2.

Recall State

A previously saved state may be recalled using this function. The instrument state will not be affected if a recall number is selected and that number has not been previously saved.

To recall a saved state press ◀RECALL STATE▶, then enter the number to be recalled using the numeric keypad.

No. of States

This command sets the number of state registers. Since state registers consume large amounts of user memory, this allows the user to trade off the amount of memory used versus the number of state registers needed. When a smaller number of state registers is specified, the memory for the previously used registers is reclaimed and the information stored in them is lost.

State registers are allocated starting with Number 1.

This function is not affected by instrument preset. The preset value is 2. To use this function, press ◀NO. OF STATES▶, and then enter the number.

P State on-off

This command allows the user to protect the state registers so that they will not be accidentally changed. The state registers cannot be changed if ◀P STATE ON OFF▶ is selected. The instrument preset does not change the ◀P STATE ON OFF▶ condition. The factory setting is off.

Power Up IP-Last

This command sets the instrument state when power is applied. If IP is selected, the instrument will default to the instrument preset state. If LAST is selected, the instrument will be set to the state it was in when the power was turned off.

To use the command, press ◀POWERUP IP LAST▶ and select the function wanted. By pressing ◀POWERUP IP LAST▶ the underline will toggle correspondingly to the desired function.

Special Function

This section describes softkeys you will use to select the memory display function and to relabel your own softkeys. It also describes how to write, execute, and debug your own programs from the front panel. Finally, it describes the softkey you will use to perform an analyzer self test.

Figure 4-100 shows the softkeys which appear when ◀SPECIAL FUNCTNS▶ is pressed.

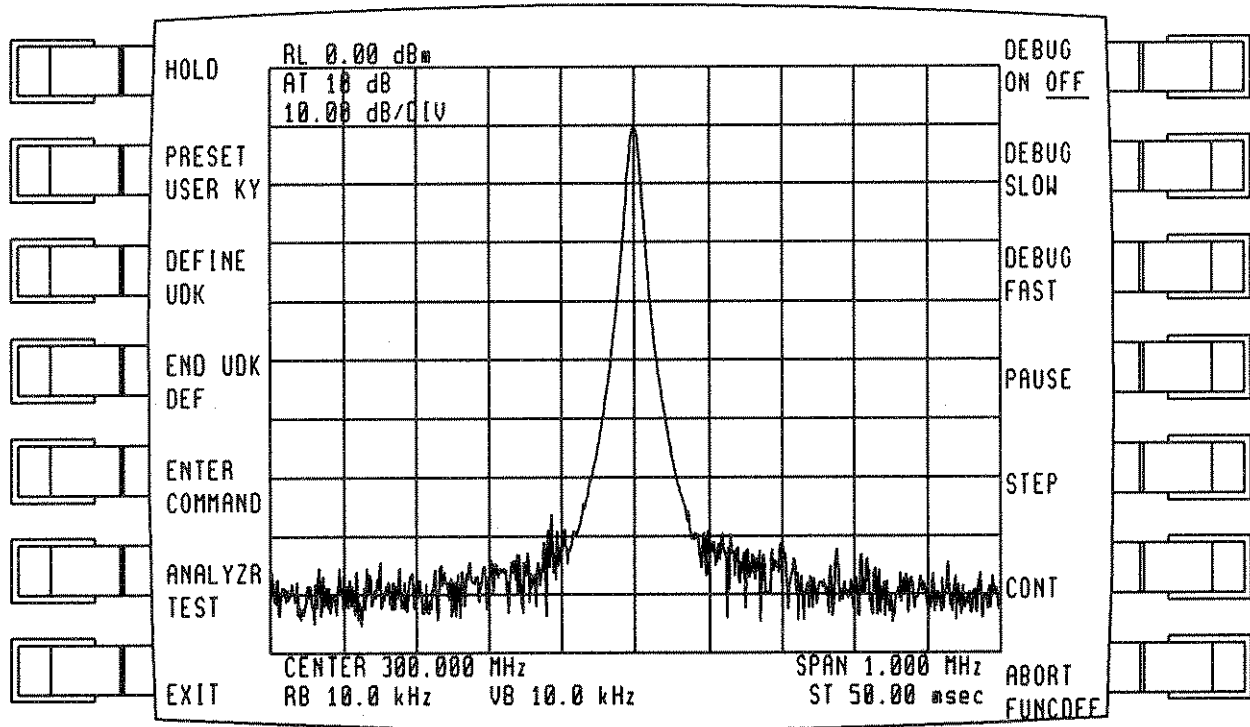

Fig.4-100. Top level menu for ◀SPECIAL FUNCTNS▶

Define UDK

Pressing ◀DEFINE UDK▶ (User Defined Key) allows you to define a softkey function. This softkey will appear when the instrument first powers up, when [I/P] is selected, or when [USR] is selected. The softkey function can become any of those functions which are located under the [MNU] hardkey.

Example:

Select Start Frequency as one of the user define softkeys.

Select [MNU] and then ◀SPECIAL FUNCTNS▶.

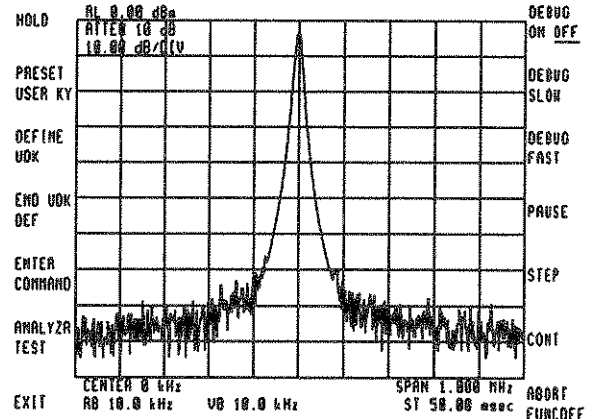

Fig. 4-101

Select ◀DEFINE UDK▶. Notice the softkeys change back to the MENU set and the annotation asks you to select the function.

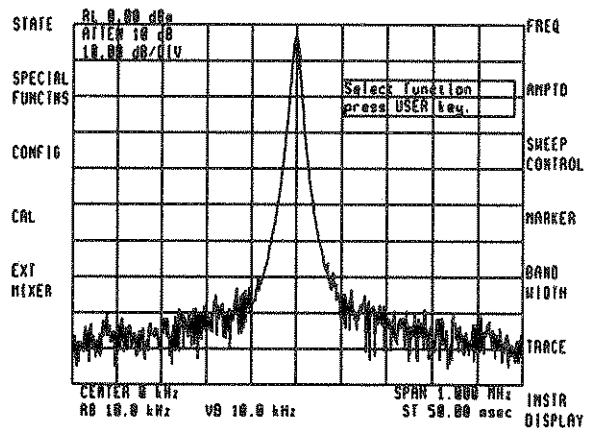

Fig. 4-102

Select **◀FREQ▶**, then select **◀START FREQ▶**. The annotation asks you to select [USR] then the softkey that you want to redefine.

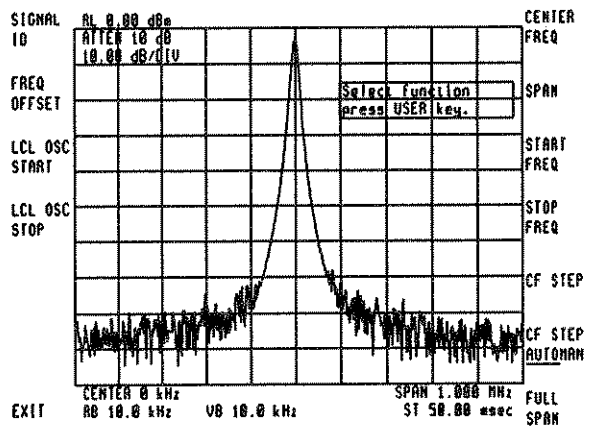

Fig. 4-103

Select **◀CENTER FREQ▶**. Notice the softkey now changes to **◀START FREQ▶** instead of **◀CENTER FREQ▶**.

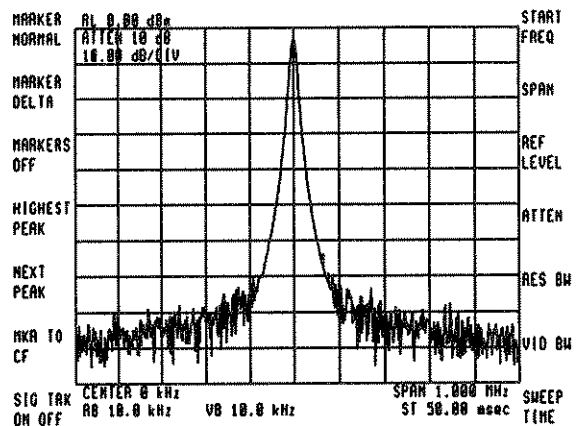

Fig. 4-104

End UDK Def

Pressing **◀END UDK DEF▶** will cause the function that defines UDK (user defined key) to end. The analyzer will go back to the SPECIAL FUNCTION menu.

Debug on-off

Selecting **◀DEBUG ON OFF▶** provides a function to aide in debugging your remote programs. When the function is ON (**◀DEBUG ON OFF▶**), the title line shows the data that is currently being processed by the instrument. In this mode, any detected error will create a pause in the program to be executed. Also, a menu is provided to single step, halt, or continue the processing of remote input. When the function is off (**◀DEBUG ON OFF▶**), the menus are blanked if the instrument goes into the remote HP-IB state. The off mode is the preset condition.

Debug Slow

Selecting ◀DEBUG SLOW▶ activates the program to process the input slowly so it can be viewed.

Debug Fast

Selecting ◀DEBUG FAST▶ activates the program to process the input at full speed.

Debug Pause

Selecting ◀DEBUG PAUSE▶ halts the processing of the remote commands.

Debug Cont

Selecting ◀DEBUG CONT▶ returns the processing of the remote commands to either fast or slow speed depending on the last setting.

Debug Step

Selecting ◀DEBUG STEP▶ causes the processing of the remote commands to accept one more character of input.

Enter Command

Selecting ◀ENTER COMMAND▶ allows you access to the functions necessary to program the analyzer from the front panel. Below you will find a list of those functions, details of what the functions are, and directions for using them.

| | |
|-------|----------------|
| ; | Execute Line |
| _ | Edit Funcdef |
| , | Clear To End |
| " | Insert/Replace |
| E | Delete Char |
| SPACE | Enter Anychar |
| EXIT | Enter Alpha |

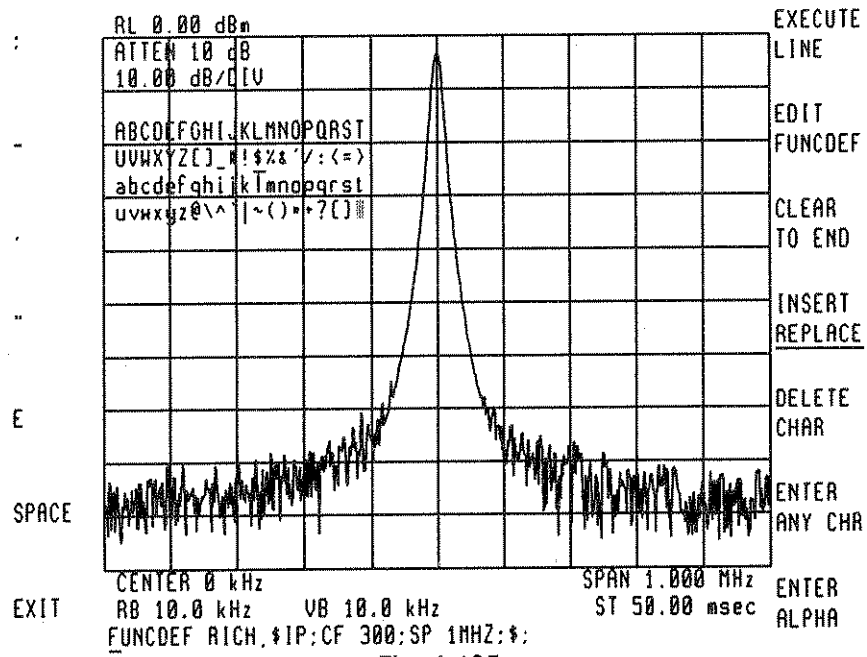

Fig. 4-105

EXECUTE LINE

Selecting ◀EXECUTE LINE▶ tells the analyzer to accept the command that is typed in on the first line. If this is I/P, for instance, the function will be executed. A maximum of 254 characters is accepted for any sequence of characters entered. For the FUNCDEF a maximum of 239 characters can be entered.

EDIT FUNCDEF

Selecting ◀EDIT FUNCDEF▶ allows you the ability to edit the function definition (downloadable program). To edit a particular FUNCDEF, where there are multiple FUNCDEF's, enter the name of the FUNCDEF and press ◀EDIT FUNCDEF▶.

CAUTION

Downloadables which come from an external CPU with more than 239 characters could be destroyed if they are edited with the ◀EDIT FUNCDEF▶ and then ◀EXECUTE LINE▶ is pressed.

CLEAR TO END

Selecting ◀CLEAR TO END▶ tells the analyzer to clear the last line entered from program memory.

INSERT/REPLACE

Selecting ◀INSERT REPLACE▶ allows you to insert or replace a character in the program line.

DELETE CHAR

Selecting ◀DELETE CHAR▶ tells the analyzer to erase the character that is under the cursor from the program memory.

ENTER ANYCHAR

Selecting ◀ENTER ANYCHR▶ allows entry of any character by entering its ASCII value in decimal.

ENTER ALPHA

Selecting ◀ENTER ALPHA▶ allows you to put any character (a - z) into the program. The display knob gives you access to the different characters. Turning the knob displays the different characters on the screen.

PROGRAMMING AIDES

Selecting ◀;▶ gives you the capability to use this delimiter in your program. This delimiter is used for terminating commands.

Example: FUNCDEF RICH, %IP;CF300;SP1MHZ;%;

Selecting ◀_▶ gives you the capability to use this underscore character in your program. This underscore is used to differentiate function names and variable names from the analyzer command set.

Example: CF_Commands --This causes the program to assign the name CF_Command and not change the center frequency of the analyzer.

Selecting ◀,▶ gives you the capability to use this delimiter in your program. This delimiter is used for separating arguments of functions.

Example: ADD VAL 1, VAL 2, VAL 3 or MOV CF,MKF

Selecting ◀"▶ gives you the capability to use this delimiter in your program. This delimiter is used for delimiting strings (text in quotes).

Example: Title "SPECTRUM ANALYZER DISPLAY"

Selecting ◀E▶ gives you the capability to use this exponent character in your program. This character is used for raising numbers to an exponential power as in "CF1E6".

Hold

Pressing ◀HOLD▶ deactivates the function displayed in the active function area; the readout is blanked from the screen. Pressing a function such as ◀CENTER FREQ▶ will reactivate the function. The function will reappear in the active function area of the screen.

Preset User Key

Selecting ◀PRESET USER KEY▶ returns the [USER] softkeys to the default softkeys (set at the factory).

Analyzer Test

Selecting ◀ANALYZER TEST▶ sends the analyzer into a self-test routine. One of the tests is to light all the indicators in the modules. Any errors are reported with the status byte. Errors can be interrogated with the error query command. On completion of analyzer test, the instrument returns to its power on state. A instrument preset may be used to stop an analyzer test.

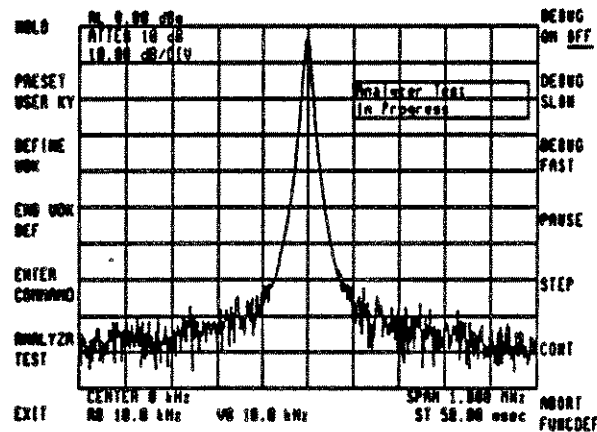

Fig. 4-106

Follow this procedure when running the self-test routine on the HP 71210A Microwave Spectrum Analyzer or on systems containing a HP 70908A RF Section with an active input port.

1. Press [IP] and allow one full sweep.
2. Press [MENU] [freq]
3. Press <1> <0> <0> [MHz]
4. Press <CENTER FREQ> <3> <0> <0> [MHz]
5. Press [MENU] <special functns>
6. Press <ANALYZR TEST>

For other systems, follow this procedure:

1. Press [MENU]
2. Press <special functns> <analyzr test>

CONFIGURATION

The configuration softkeys select the system input port and its type of coupling, AC or DC. They also control the signal path through the instrument and display the firmware version of the controlling master module, the local oscillator.

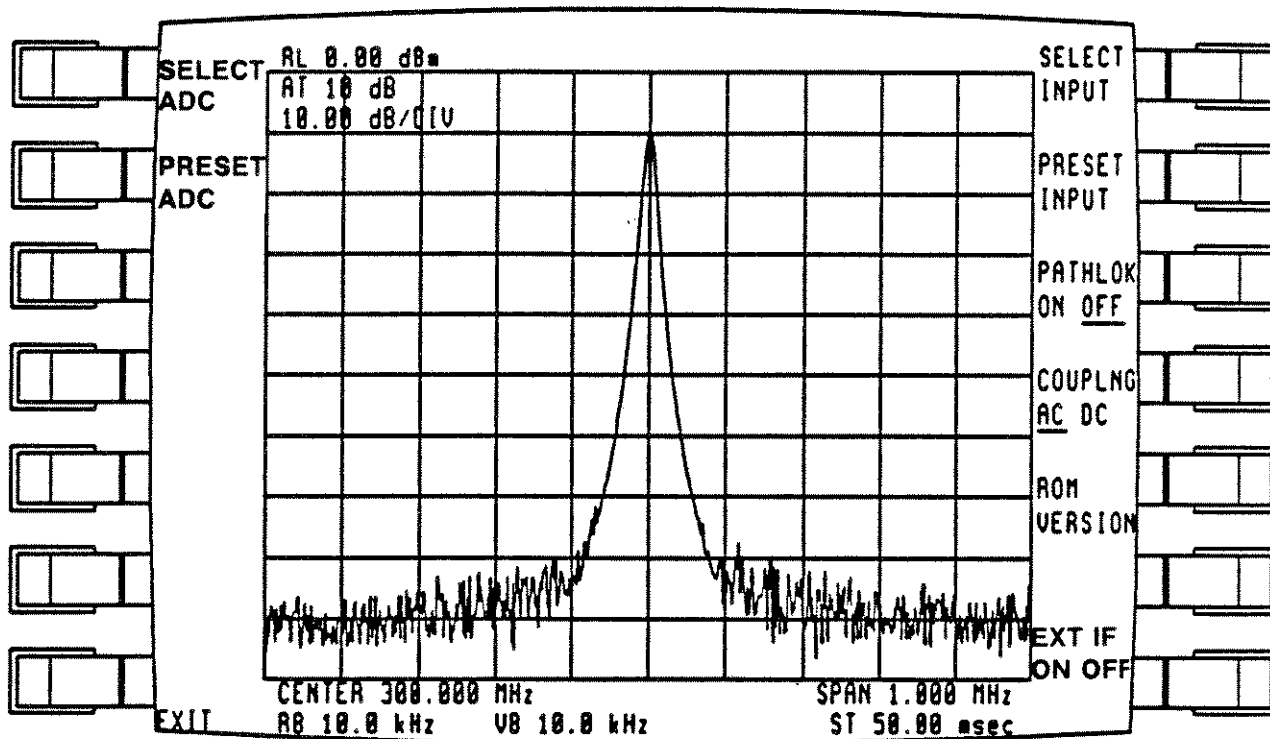

Figure 4-107. Top-level menu for <CONFIG>

SELECTING AN INPUT PORT

Preset Input

The preset-input softkey determines which input port is active when instrument preset (IP) is pressed or the analyzer is turned on. Input ports are numbered consecutively from 1, with the external-mixing-interface ports numbered first, then preselector ports, followed by RF-section ports. For example, if the following modules are combined in a system, their input ports are numbered as indicated.

| MODULE | INPUT PORT NUMBER |
|-------------------------------------|-------------------|
| HP 70907A External-Mixing-Interface | 1 |
| HP 70907A External-Mixing-Interface | 2 |
| HP 70905A RF Section | 4 |
| HP 70600A Preselector | 3 |

Select Input

The select-input softkey activates the desired input port by specifying its number. For example, to measure signals at the RF-section input port in the system described on the previous page, press

<SELECT INPUT>
<4>.

Whenever a new input port is selected for measurements, the analyzer must be recalibrated with the **<EXECUTE CAL>** functions.

Frequency-span inaccuracies are likely during tracking-generator measurements when an external-mixing-interface module and a tracking generator are contained in the same mainframe. For this reason, this configuration is not recommended for tracking-generator measurements.

**FIRMWARE
VERSIONS
851216
OR
LATER**

ACTIVATING THE EXTERNAL IF PORT

The **<EXT IF ON OFF>** softkey switches the IF signal path. During normal operation, the 321.4 MHz IF signal is routed to the next frequency converter and the IF filters in the analyzer. Set **<EXT IF ON OFF>** to ON to activate the 321.4 MHz output port on the rear panel of the HP 70908A RF section and route the 321.4 MHz IF signal to an external device. Follow this procedure:

Press **[IP]**
[MENU]
<CONFIG>
<EXT IF ON OFF>

Execute **<EXT IF OFF>** to switch off the port and route the 321.4 MHz IF signal through the analyzer.

<EXT IF ON> functions only when the input port of the HP 70908A module is active. Otherwise, an error condition occurs.

RESTRICTING SIGNAL PATHS FROM MODULE TO MODULE

Pathlock On/Off

Since the instrument is modular, the input signal can pass through different paths. For example, two signal paths are available for 300 kHz filtering when the narrow and wideband IF modules are incorporated into an analyzer system, since each of these modules has a 300 kHz bandwidth filter. If **<PATHLOCK ON OFF>** is set to ON when the 3 MHz filter is active, the signal path remains in the wideband IF module when the 300 kHz bandwidth is selected.

When a path is specified, signal inputs are limited to ports available on the path.

INPUT COUPLING

The coupling softkey activates AC or DC input coupling. Coupling options vary from system to system. When the microwave RF modules, HP models 70905A, 70905B, and 70906A, are in the analyzer, only DC

coupling is available. Their RF counterpart, HP model 70904A, offers both AC or DC coupling; instrument preset (IP) activates AC coupling.

ROM VERSION

The ROM-version softkey displays the firmware version of the local oscillator. The firmware version is coded by date: YEAR-MONTH-DAY. For example, the date code "861015" represents October 15, 1986.

SELECTING ANALOG-TO-DIGITAL CONVERTER FOR VIDEO PROCESSING

The <SELECT ADC> softkey switches between the internal and external video processing paths.

During normal operation, the video signal is routed to the analog-to-digital converter (ADC) in the local-oscillator module for processing. If the spectrum analyzer system has more than one analog-to-digital converter, <SELECT ADC> may be used to route the video signal to the desired converter for processing.

At power-up, all analog-to-digital converters in the system are assigned numbers. The local-oscillator converter is assigned to 1, and successive external converters are numbered consecutively starting with 2 in the order they are encountered in the local-oscillator slave address area.

<SELECT ADC 1> is normally active. Execute <SELECT ADC 2> when processing the video signal with an external device, such as a digitizer module that is configured as a slave module to the local-oscillator module. Use the HP 70700A Digitizer to obtain faster sweep times.

PRESET ANALOG-TO-DIGITAL CONVERTER

The <PRESET INPUT> softkey specifies whether internal or external video processing is active when the analyzer is in its preset state, such as after instrument preset (IP) or when power is applied.

<PRESET ADC 1> enables internal video processing after instrument preset. <PRESET ADC 2> (or greater) enables external video processing after instrument preset.



Calibration

This section describes softkeys used to calibrate the amplitude, the resolution, the bandwidth, the frequency, and the log amplifier. It also describes the setting of correction features.

Figure 4-108 shows the softkeys that appear when ◀CALIBRT▶ is pressed.

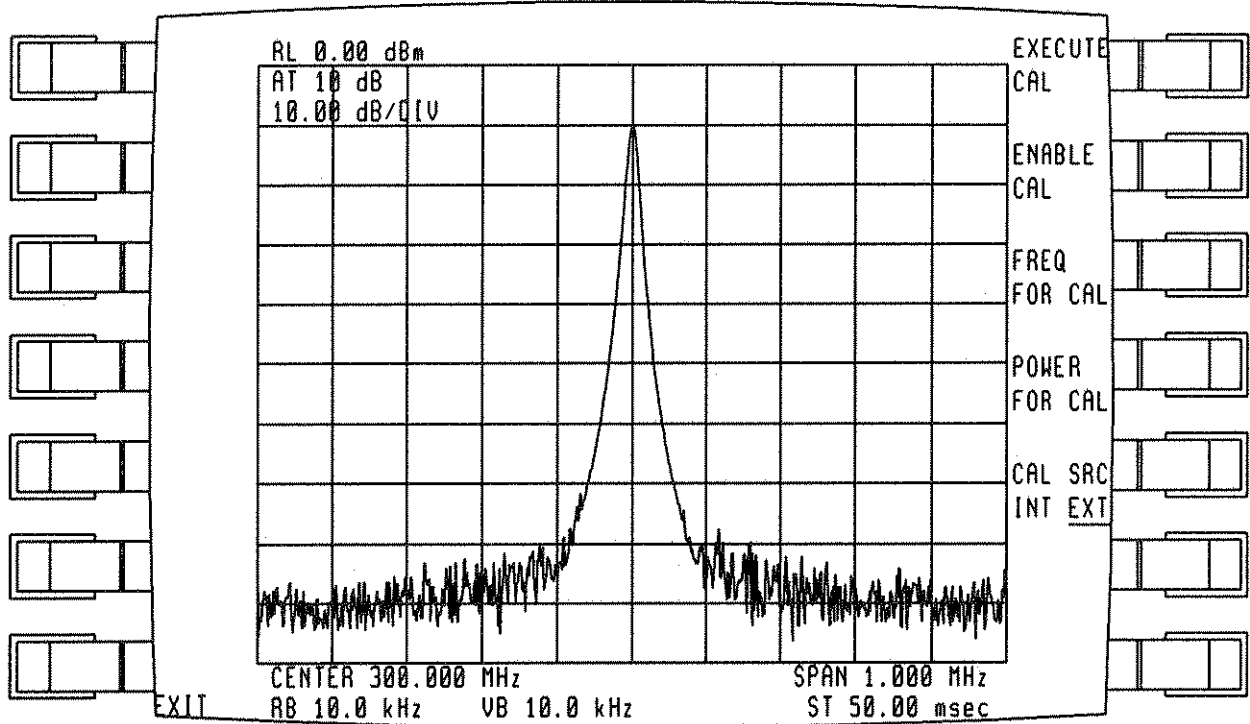

Fig.4-108. Top level menu for ◀CALIBRT▶

OVERVIEW

There are several calibration functions which can be performed by the instrument. The calibration commands found below can be accessed by selecting the particular softkey associated with the calibration function. The calibration source, calibration frequency, and calibration power can be entered with the following softkeys commands:

1. ◀CAL SRC INT EXT▶
2. ◀FREQ FOR CAL▶
3. ◀POWER FOR CAL▶

The following describes in detail what each function calibrates.

Execute Cal

To access each of the calibration functions, press ◀EXECUTE CAL▶, and the following four functions become available:

1. ◀CAL ALL▶
2. ◀CAL LOGAMP▶
3. ◀CAL GAIN▶
4. ◀CAL RES BW▶

CAL ALL

Selecting ◀CAL ALL▶ causes the analyzer to do a complete system calibration. This means the analyzer goes through all the calibration steps for cal LogAmp, Cal Gain, and Cal Res BW. The details are given below.

CAL LOGAMP

Selecting ◀CAL LOGAMP▶ causes the analyzer to initiate a calibration on the LOG AMPLIFIER fidelity. The analyzer uses the Freq For Cal set by the factory (300 MHz) or the one you have selected. The analyzer's resolution bandwidth is set depending on the IF BW, video bandwidth is set to 300 Hz, and the instrument's span is set to zero.

If the Cal signal is not connected, an error condition is indicated (illegal Cal signal). Once the calibration has started, the annotation on the screen indicates the progress of the function. Also, the calibration of each logamp if more than 1 IF is present is stepped through, and this is visible on the screen. Finally, when the calibration is completed, an indication is given on the screen and the instrument is returned to its previous state (before calibration). (If there was enough ram space to save it when cal is begun).

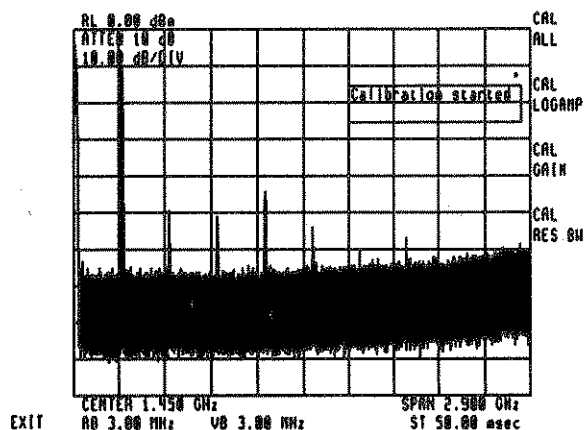

Fig. 4-109

CAL GAIN

Selecting ◀CAL GAIN▶ causes the analyzer to initiate a calibration procedure on the Attenuation and Amplification gain sections. The analyzer uses the Freq For Cal set by the factory

(300 MHz), or the one specified with the <FREQ FOR CAL> softkey.

If a calibration signal is not connected, an error condition is indicated. At the end of the routine, the analyzer is returned to the state it was in before the calibration, provided sufficient memory (RAM) is available.

NOTE

For accurate results, execute the log-fidelity calibration routine first.

Cal Res BW

Selecting <CAL RES BW> calibrates the analyzer with frequency and amplitude correction factors that compensate for irregularities in the resolution bandwidth filters.

If a calibration signal is not connected, an error condition is indicated. At the end of the routine, the analyzer is returned to the state it was in before calibration, provided sufficient memory (RAM) is available.

NOTE

For accurate results, execute the log fidelity calibration routine first.

Enable Cal

The enable calibration softkey, <ENABLE CAL>, accesses softkeys options that enable or disable calibration factors. Normally, the calibration factors are enabled.

<FLAT CAL ON OFF> disables the frequency-dependant gain correction factors.

<LOG CAL ON OFF> disables the amplitude correction factors for the logarithmic amplifiers.

<GAIN CAL ON OFF> disables the correction factors for the attenuator and linear IF gain circuitry.

<RB CAL ON OFF> disables both the amplitude and frequency correction factors to the local oscillator. During normal operation these corrections improve the amplitude and frequency accuracy of displayed measurement results by compensating for irregularities in the IF resolution bandwidth filters. The corrections may be deactivated for special applications.

<RBW AMP ON OFF> and <RBW FREQ ON OFF> disable the amplitude and frequency correction factors to the local oscillator. During normal operation these corrections improve the amplitude and frequency accuracy of displayed measurement results by compensating for irregularities in the IF resolution bandwidth filters. The corrections may be deactivated for special applications. Set <RBW FREQ ON OFF> to OFF to eliminate the frequency correction and improve the frequency accuracy of the source output, especially when using resolution bandwidths of 10 KHz or greater.

FIRMWARE
VERSIONS
851216
OR LATER

Freq For Cal

During normal operation, the -10 dBm, 300 MHz calibration signal is used to calibrate the analyzer with the <EXECUTE CAL> functions. Use the <FREQ FOR CAL> softkey to specify a different frequency for calibrating. Whenever <FREQ FOR CAL> is used, be sure that the calibration signal is the largest signal on the screen before executing the calibration functions accessed with the <EXECUTE CAL> softkey.

Power For Cal

During normal operation, the -10 dBm, 300 MHz calibration signal is used to calibrate the analyzer. Use the <POWER FOR CAL> softkey to specify a different power level for calibrating. Whenever <POWER FOR CAL> is used, be sure that the calibration signal is the largest signal on the screen before executing the calibration functions accessed with the <EXECUTE CAL> softkey.

Cal SRC Int Ext

Selecting ◀CAL SRC INT EXT▶ allows you to choose whether an internal or external calibration source will be used. An internal source is a source in the current input path that can be switched in without cables. A built-in source from another module is considered an external source.

The preset value is determined by the default input selector (Input 1).

External Mixer

This section explains how to use softkeys to setup an external mixer. It describes the setup of the Bias circuitry.

Figure 4-111 shows the softkeys that appear when ◀EXT MIXER▶ is pressed.

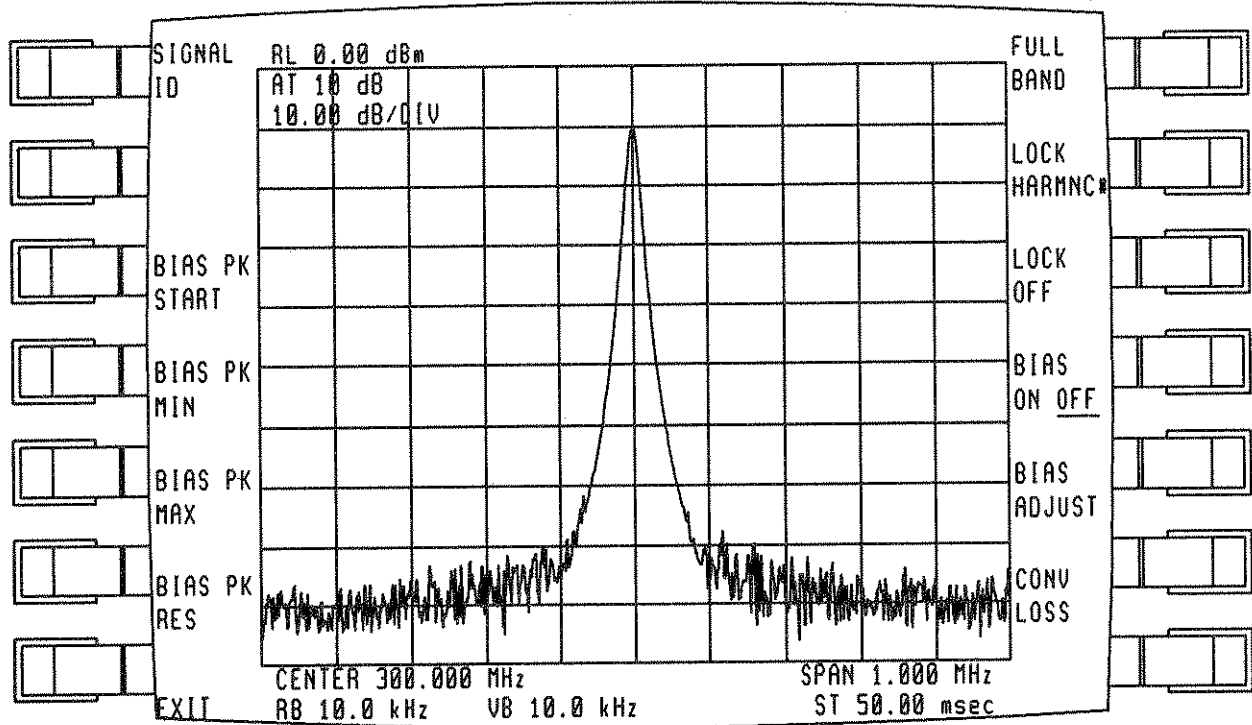

Fig.4-111. Top level menu for ◀EXT MIXER▶

Full Band

Pressing this softkey allows access to the bands K, A, Q, U, V, E, W, F, D, G, Y, and J.

Lock Harmnc

Pressing this softkey allows the selection of the harmonic number. The number is entered on the keypad.

Bias On Off

Pressing this softkey toggles the bias control on or off. The underline indicates the last state of the control. The preset condition is off.

Bias Adjust

The bias-adjust softkey activates a bias current that is specified with the numeric keypad. To deactivate the bias, set <BIAS ON OFF> to OFF.

Bias Pk, Bias Pk Min, Bias Pk Max

The bias-peak softkey automatically selects the best bias current within a particular range for the current measurement conditions. The range is set with the bias-peak-minimum and -maximum softkeys.

Bias Pk RES

The bias-peak-resolution softkey determines the number of possible bias currents within the range specified by the <BIAS PK MIN> and <BIAS PK MAX> softkeys.

Bias Pk Start

The bias-peak-start softkey peaks the conversion gain for the signal marked with the active marker. If no marker is present, <BIAS PK START> places a marker at the highest signal level on screen. To a certain extent, <BIAS PK START>, maintains the marker position, but to ensure best results use as narrow a frequency span as possible.

Signal Id

See Frequency section for details.

Conv Loss

The conversion-loss softkey offsets the reference level to compensate for amplitude losses at the active input port. One offset can be specified for each input port. If necessary, use <SELECT INPUT> to activate the desired input port before specifying its conversion-loss offset. To clear the offset, enter a conversion loss of zero.

One offset value can be stored in the analyzer for each external mixing band. Offset values must be within ± 100 dBm.

After instrument preset or power-up, an offset value of 30 dB is automatically activated for the input port of the external-mixing-interface module.

FIRMWARE
VERSIONS
861015 OR
LATER

External Mixer

The following keystrokes activate the external-mixing-interface-module input port and set its conversion loss offset:

Press **IP**

<CONFIG>

<SELECT INPUT 2>

<EXIT>

<EXT MIXER>

<CONV LOSS 10 DB>

Measurement Mode

The ◀MEASURE MODE▶ softkey accesses softkeys that tell the system the type of measurement to be made (for example, ◀SIGNAL ANALYSIS▶ or ◀STIMULS RESPONSP▶).

◀ SIGNAL ANALYSIS ▶ is the preset mode and is used for measurements of absolute amplitude over frequency. (Modes are active when underlined.)

Descriptions for the MEASUREMENT MODE softkeys are found in the manuals for the modules they control. For example, the ◀STIMULS RESPONSP▶ softkey is described in the *HP 70300A Tracking Generator Operating Manual*.

Source

The ◀SOURCE▶ softkey accesses the functions of the HP 70300A Tracking Generator. The SOURCE softkeys are described in detail in the *HP 70300A Tracking Generator Operating Manual*.

Note: If a tracking generator is not in the system, a "Hardware not present" error message will appear when many of the softkeys under ◀SOURCE▶ are pressed. Although the majority of softkeys cannot be used when the tracking generator is not in the system, some softkeys, such as ◀A - B --> A▶ and ◀A - C --> A▶, can be used. See the *HP 70300A Tracking Generator Manual* for more information.



APPENDIX A

KEYWORD SUMMARY

AMPLITUDE COMMANDS

| | |
|---------|----------------------------|
| AT | INPUT ATTENUATOR |
| AUNITS | ABSOLUTE AMPLITUDE UNITS |
| INZ | INPUT IMPEDANCE |
| LG | LOGARITHM SCALE |
| LN | LINEAR SCALE |
| ML | MIXER LEVEL |
| RL | REFERENCE LEVEL |
| RLPOS | REFERENCE LEVEL POSITION |
| ROFFSET | AMPLITUDE REFERENCE OFFSET |

BANDWIDTH COMMANDS

| | |
|-----|-----------------------|
| RB | RESOLUTION BANDWIDTH |
| RBR | RES BW TO SPAN RATIO |
| VB | VIDEO BANDWIDTH |
| VER | VIDEO BANDWIDTH RATIO |

CALIBRATION AND DIAGNOSTIC COMMANDS

| | |
|---------|-------------------------|
| AMPCOR | AMPLITUDE CORRECTION |
| CAL | CALIBRATE |
| CALCOR | CALIBRATION CORRECTION |
| CALFREQ | CALIBRATION FREQUENCY |
| CALPWR | CALIBRATION POWER |
| CALSRC | CALIBRATION SOURCE |
| DEBUG | DEBUG MODE |
| PAUSE | PAUSE COMMAND EXECUTION |

REMOTE OPERATION APPENDICES

CONFIGURATION COMMANDS

| | |
|----------|------------------------------------|
| ADC | ANALOG-TO-DIGITAL CONVERTER |
| COUPLE | INPUT COUPLING |
| EXTIF | EXTERNAL IF |
| INPUT | INPUT PORT |
| INPUTMOD | INPUT MODULE |
| MODADD | MODULE ADDRESS |
| MODID | MODULE IDENTIFICATION |
| PADC | PRESET ANALOG-TO-DIGITAL CONVERTER |
| PATHLOCK | PATH LOCK |

DISPLAY COMMANDS

| | |
|---------|---------------------|
| ANNOT | ANNOTATION ON/OFF |
| DL | DISPLAY LINE |
| DSPMODE | DISPLAY MODE |
| DSPTEXT | OUTPUT DISPLAY TEXT |
| GRAT | GRATICULE ON/OFF |
| HD | HOLD |
| IWINDOW | INSTRUMENT WINDOW |
| PLOT | PLOT DISPLAY |
| TH | THRESHOLD |

EXTERNAL MIXER COMMANDS

| | |
|---------|-----------------------|
| CNVLOSS | CONVERSION LOSS |
| FULBAND | FULL BAND |
| HNLOCK | HARMONIC NUMBER LOCK |
| MBIAS | MIXER BIAS |
| MBIASPK | MIXER BIAS PEAK |
| MBMAX | MIXER BIAS MAXIMUM |
| MBMIN | MIXER BIAS MINIMUM |
| MBRES | MIXER BIAS RESOLUTION |

FREQUENCY COMMANDS

| | |
|---------|----------------------------------|
| CF | CENTER FREQUENCY |
| FA | START FREQUENCY |
| FB | STOP FREQUENCY |
| FLIMIT | FREQUENCY LIMIT |
| FOFFSET | FREQUENCY OFFSET |
| FS | FULL SPAN |
| LOSTART | LOCAL-OSCILLATOR START FREQUENCY |
| LOSTOP | LOCAL-OSCILLATOR STOP FREQUENCY |
| SP | FREQUENCY SPAN |
| SS | CENTER-FREQUENCY STEP SIZE |

GRAPHICS COMMANDS

| | |
|---------|---------------------------|
| CLRDSP | CLEAR DISPLAY |
| DELETE | DELETE ITEM |
| DSPLY | DISPLAY VARIABLE |
| DWINDOW | DISPLAY WINDOW |
| GRAPH | GRAPH TRACE |
| GRID | DISPLAY GRID |
| IT | IDENTIFY ITEM |
| LINET | LINE TYPE |
| MK | MARKER DISPLAY |
| OP | OUTPUT DISPLAY PARAMETERS |
| OR | SET ORIGIN |
| PA | PLOT ABSOLUTE |
| PD | PEN DOWN |
| PEN | SELECT PEN |
| PR | PLOT RELATIVE |
| PU | PEN UP |
| SCALE | SCALE GRAPHICS |
| TEXT | TEXT |
| TITLE | TITLE ENTRY |
| TP | TRACE POINTER |
| VW | VIEW ITEM |

INFORMATION COMMANDS

| | |
|---------|------------------------|
| ERR | ERROR |
| ID | OUTPUT IDENTIFICATION |
| MSG | MESSAGE |
| REV | OUTPUT REVISION NUMBER |
| SER | SERIAL NUMBER |
| TEST | SELF TEST |
| TIME | TIME STAMP |
| USERERR | USER ERROR REPORT |
| USERMSG | USER MESSAGE |
| XERR | EXTENDED ERROR QUERY |

INPUT/OUTPUT COMMANDS

| | |
|---------|----------------------------|
| CLS | CLEAR STATUS BYTE |
| DONE | DONE |
| ENTER | ENTER FROM HP-IB |
| MDS | MEASUREMENT DATA SIZE |
| OUTPUT | OUTPUT TO HP-IB |
| RELHPIB | RELEASE HP-IB |
| RQS | REQUEST SERVICE CONDITIONS |
| SRQ | SERVICE REQUEST |
| STB | STATUS BYTE QUERY |
| IDF | TRACE DATA FORMAT |
| TS | TAKE SWEEP |

INSTRUMENT STATE COMMANDS

| | |
|----------|---------------------------|
| ERASE | ERASE ALL MEMORY |
| IP | INSTRUMENT PRESET |
| NSTATE | NUMBER OF STATE REGISTERS |
| POWERON | POWER ON |
| PROTECT | PROTECT USER MEMORY |
| PSTATE | PROTECT STATE |
| RCLS | RECALL STATE REGISTER |
| SAVES | SAVE STATE |
| STATE | INSTRUMENT STATE |
| USERLOCK | USER KEY LOCK |

MARKER COMMANDS

| | |
|---------|--------------------------------------|
| MKA | MARKER AMPLITUDE |
| MKACT | ACTIVE MARKER |
| MKAL | MARKER AMPLITUDE RELATIVE LEFT |
| MKAR | MARKER AMPLITUDE RELATIVE RIGHT |
| MKBW | MARKER BANDWIDTH |
| MKCF | MARKER TO CENTER FREQUENCY |
| MKD | MARKER DELTA |
| MKF | MARKER FREQUENCY |
| MKMIN | MARKER TO MINIMUM |
| MKN | MARKER NORMAL |
| MKNOISE | MARKER NOISE |
| MKOFF | MARKER OFF |
| MKP | MARKER POSITION |
| MKPAUSE | PAUSE AT MARKER |
| MKPK | MARKER PEAK SEARCH |
| MKPX | MARKER PEAK EXCURSION |
| MKREAD | MARKER READOUT |
| MKRL | MARKER TO REFERENCE LEVEL |
| MKSP | MARKER DELTA TO SPAN |
| MKSS | MARKER TO CENTER FREQUENCY STEP SIZE |
| MKT | MARKER TIME |
| MKTRACE | MARKER TRACE |
| MKTRACK | MARKER SIGNAL TRACK |
| MKTV | MARKER TRACKING VARIANCE |
| MKTYPE | MARKER TYPE |

SIGNAL IDENTIFICATION COMMANDS

| | |
|--------|--|
| IDCF | SIGNAL IDENTIFIED FREQUENCY TO CENTER FREQ |
| IDFREQ | SIGNAL IDENTIFIED FREQUENCY |
| IDMODE | SIGNAL IDENTIFICATION MODE |
| IDSTAT | SIGNAL IDENTIFICATION STATUS |
| NSTART | START HARMONIC NUMBER |
| NSTOP | STOP HARMONIC NUMBER |
| SIGDEL | SIGNAL AMPLITUDE DELTA |
| SIGID | SIGNAL IDENTIFY |

PRESELECTOR COMMANDS

| | |
|-----------|------------------------|
| PP | PRESELECTOR PEAK |
| PRSDAC | PRESELECTOR DAK |
| PRSENA BL | PRESELECTOR ENABLE |
| PRSHYST | PRESELECTOR HYSTERESIS |

SWEEP AND TRIGGER COMMANDS

| | |
|-------|--------------------------|
| CONTS | CONTINUOUS SWEEP |
| SNGLS | SINGLE SWEEP |
| ST | SWEEP TIME |
| TM | TRIGGER MODE |
| VTH | VIDEO TRIGGER HYSTERESIS |
| VTL | VIDEO TRIGGER LEVEL |

TRACE COMMANDS

| | |
|-------------|--|
| COMPRESS | COMPRESS TRACE |
| DET | DETECTION MODE |
| FFT | FAST FOURIER TRANSFORM |
| FFTKNL | FAST FOURIER TRANSFORM KERNAL |
| IFTKNL | SCALED FAST FOURIER TRANSFORM KERNAL |
| MEAN | TRACE MEAN |
| PDA | PROBABILITY DISTRIBUTION OF AMPLITUDE |
| PDF | PROBABILITY DISTRIBUTION OF FREQUENCY |
| PEAKS | TRACE PEAKS |
| PWRBW | TRACE POWER BANDWIDTH |
| RMS | TRACE ROOT MEAN SQUARE VALUE |
| SMOOTH | SMOOTH TRACE |
| STDEV | STANDARD DEVIATION OF TRACE AMPLITUDES |
| SUM | SUM OF TRACE AMPLITUDES |
| SUMSQR | SUM OF SQUARE TRACE AMPLITUDES |
| TRA/TRB/TRC | TRACE DATA INPUT/OUTPUT |
| TRCOND | TRACE CONDITIONS |
| TRPST | TRACE PRESET |
| TRSTAT | TRACE STATUS |
| TWNDOW | TRACE WINDOW |
| VARIANCE | VARIANCE OF TRACE AMPLITUDES |

TRACE MATH COMMANDS

| | |
|-------|---|
| AMB | TRACE A MINUS TRACE B |
| AMC | TRACE A MINUS TRACE C |
| AMBPL | TRACE A MINUS TRACE B PLUS DISPLAY LINE |
| APB | TRACE A PLUS TRACE B |
| AXB | TRACE A EXCHANGE TRACE B |
| BML | TRACE B MINUS DISPLAY LINE |
| ETC | MOVE TRACE B TO TRACE C |
| BXC | TRACE B EXCHANGE TRACE C |
| VAVG | VIDEO AVERAGE |

TRACE PROCESSING COMMANDS

| | |
|-------|----------------------|
| BLANK | BLANK TRACE |
| CLRW | CLEAR WRITE |
| MINH | MINIMUM HOLD |
| MXMH | MAXIMUM HOLD |
| TRDSP | TRACE DISPLAY ON/OFF |
| VIEW | VIEW TRACE |

TRACKING GENERATOR SOURCE COMMANDS

| | |
|---------|---------------------------------------|
| MEASURE | MEASUREMENT MODE |
| MIL | MAXIMUM INPUT LEVEL |
| SRCALC | SOURCE AUTOMATIC LEVEL CONTROL MODE |
| SRCAM | SOURCE AMPLITUDE MODULATION |
| SRCAMF | SOURCE AMPLITUDE MODULATION FREQUENCY |
| SRCAT | SOURCE ATTENUATOR |
| SRCBLNK | SOURCE BLANKING |
| SRCMOD | SOURCE MODULATION INPUT |
| SRCOSC | SOURCE OSCILLATOR |
| SRCPOFS | SOURCE POWER OFFSET |
| SRCPSTP | SOURCE POWER STEP |
| SRCPSWP | SOURCE POWER SWEEP |
| SRCPWR | SOURCE POWER |
| SRCTK | SOURCE TRACKING |
| SRCTKPK | SOURCE TRACK PEAK |
| STORREF | STORE REFERENCE |

UNIT CONVERSION COMMANDS

| | |
|-------|-----------------------------|
| AMPV | AMPLITUDE UNIT CONVERSION |
| FREQU | FREQUENCY UNIT CONVERSION |
| MEASU | MEASUREMENT UNIT CONVERSION |
| POSU | POSITION UNIT CONVERSION |

USER COMMAND FLOW COMMANDS

| | |
|------------------------------|-----------------------|
| ABORT | ABORT USER FUNCTIONS |
| IF/THEN/ELSIF/
ELSE/ENDIF | CONDITIONALS |
| REPEAT/UNTIL | LOOPING |
| RETURN | RETURN FROM FUNCTION |
| WAIT | WAIT A SPECIFIED TIME |

USER DEFINITION COMMANDS

| | |
|----------|-----------------------------|
| DISPOSE | DISPOSE |
| FUNCDEF | FUNCTION DEFINITION |
| KEYCLR | CLEAR USER DEFINED KEYS |
| KEYDEF | USER DEFINED KEY DEFINITION |
| KEYPST | PRESET USER DEFINED KEYS |
| MEM | MEMORY AVAILABLE |
| ONEOS | ON END OF SWEEP |
| READMENU | READ MENU INPUT |
| TRDEF | TRACE DEFINITION |
| USERKEY | USER DEFINED KEYS |
| USTATE | USER STATE INPUT/OUTPUT |
| VARDEF | VARIABLE DEFINITION |

USER OPERATOR COMMANDS

| | |
|--------|-------------|
| ABS | ABSOLUTE |
| ADD | ADDITION |
| AVG | AVERAGE |
| BIT | BIT TEST |
| CONCAT | CONCATENATE |
| DIV | DIVIDE |
| EXP | EXPONENT |
| INT | INTEGER |
| LOG | LOGARITHM |
| MIN | MINIMUM |
| MOD | MODULO |
| MOV | MOVE |
| MPY | MULTIPLY |
| MXM | MAXIMUM |
| SQR | SQUARE ROOT |
| SUB | SUBTRACT |
| XCH | EXCHANGE |



| | | | |
|--|------|--|------|
| -A- | | Define UDK | 4-80 |
| A + B-->A | 4-69 | Defining Your Own Softkey Function | 3-3 |
| A - B + DL ON OFF | 4-68 | Detector | 4-65 |
| A - B-->A ON OFF | 4-68 | Display Knob (HP 70206A Display) | 2-3 |
| A XCH B | 4-69 | Display Knob (HP 70206A Display) | 2-5 |
| Active Marker | 4-50 | Display Line | 4-71 |
| Amplitude | 4-19 | Dsp Lin On Off | 4-71 |
| Amp Ref Left | 4-48 | -E- | |
| Amp Ref Offset | 4-27 | EDIT FUNCDEF | 4-84 |
| Amp Ref Right | 4-48 | ENTER ALPHA | 4-85 |
| Amptd Units | 4-26 | ENTER ANYCHAR | 4-85 |
| Analyzer Test | 4-86 | EXECUTE LINE | 4-84 |
| Anotatn On Off | 4-75 | Enable Cal | 4-91 |
| Atten Automan | 4-25 | End UDK Def. | 4-82 |
| Atten | 4-21 | Enter Command | 4-83 |
| -B- | | Execute Cal | 4-90 |
| B - DL-->B | 4-69 | Extd RL On Off | 4-21 |
| B XCH C | 4-69 | Extend State | 4-76 |
| BLANK TRACE A | 4-64 | -F- | |
| Back Space (HP 70205A Display) | 2-3 | FLAT CAL ON OFF | 4-92 |
| Back Space (HP 70206A Display) | 2-5 | Freq For Cal | 4-92 |
| Bandwidth | 4-55 | Frequency Offset | 4-14 |
| -C- | | Frequency | 4-5 |
| Calibration | 4-89 | Front Panel Concept | 2-2 |
| CAL ALL | 4-90 | Full Span | 4-14 |
| CAL GAIN | 4-90 | -G- | |
| CAL LOGAMP | 4-90 | GAIN CAL ON OFF | 4-92 |
| CAL RES BW | 4-91 | GND DETECTR | 4-68 |
| CF Step Automan | 4-13 | -H- | |
| CF Step | 4-12 | HP 70001A Mainframe | 1-2 |
| CLEAR TO END | 4-84 | HP 70205A Graphics Display | 1-3 |
| CLR WRT TRACE A | 4-63 | HP 70206A System Graphics Display | 1-4 |
| Cal SRC Int Ext | 4-93 | HP 70300A RF Tracking Generator | 1-11 |
| Catalog (Display) | 4-70 | HP 70900A Local Oscillator | 1-4 |
| Center Frequency | 4-5 | HP 70902A IF (RES BW 10Hz - 300kHz) | 1-8 |
| Continuous Sweep | 4-31 | HP 70903A IF (RES BW 100kHz - 3 MHz) | 1-8 |
| Coupling AC-DC | 4-88 | HP 70904A RF Section (100Hz - 2.9GHz) | 1-6 |
| -D- | | HP 70905A RF Section (50kHz - 22GHz) | 1-7 |
| DELETE CHAR | 4-85 | HP 70906A RF Section (50kHz - 26.5GHz) | 1-8 |
| Display Knob (HP 70206A Display) | 2-5 | HP 70907A External Mixer Interface | 1-10 |
| Debug Cont | 4-83 | HP 71100A RF S. A.(100Hz-2.9GHz) | 1-12 |
| Debug Fast | 4-83 | HP 71200A MW S.A.(50kHz-22/26.5GHz) | 1-13 |
| Debug Pause | 4-83 | HP 71300A Millimeter S.A. | 1-13 |
| Debug Slow | 4-83 | Hardkeys (HP 70205A Display) | 2-3 |
| Debug Step | 4-83 | Hardkeys (HP 70206A Display) | 2-5 |
| Debug On Off | 4-82 | | |
| Decimal Pt (HP 70206A Display) | 2-3 | | |

| | | | |
|--|------|---|------|
| Hold (HP 70206A Display) | .2-5 | Normal Display | 4-75 |
| Hold (Spectrum Analyzer) | 4-85 | Normal Marker | 4-43 |
| -I- | | Numeric Keypad | .2-3 |
| INSERT/REPLACE | 4-84 | Numeric Keypad | .2-5 |
| Input Imped | 4-28 | -P- | |
| Instrument Preset (HP 70205A Display). | .2-3 | P State On Off | 4-79 |
| Instrument Preset (HP 70206A Display). | .2-5 | Plot (HP 70206A Display). | .2-5 |
| Instrument Display | 4-70 | POS PK DETECTR | 4-67 |
| Introduction (General Info.) | .1-1 | Print (HP 70206A Display) | .2-5 |
| Introduction (Getting Started). | .2-1 | Pathlock On Off | 4-88 |
| Introduction (USR Hardkey) | .3-1 | Power For Cal | 4-93 |
| Introduction (MNU Hardkey) | .4-1 | Power Up IP-Last | 4-79 |
| -L- | | Preset User Key | 4-86 |
| LENGTH TRACE A | 4-64 | -R- | |
| LOG CAL ON OFF | 4-92 | RB CAL ON OFF | 4-92 |
| Linear Volts | 4-25 | Recall State | 4-78 |
| Loc Osc Start | 4-18 | Ref Level. | 4-19 |
| Loc Osc Stop | 4-18 | Ref Lvl Postn. | 4-19 |
| Local Control (HP 70205A Display). | .2-3 | Resolution Bandwidth | 4-55 |
| Local Control (HP 70206A Display). | .2-5 | Resolution Bandwidth Automan | 4-57 |
| Log dB/Div | 4-25 | Resolution Bandwidth Ratio | 4-58 |
| -M- | | Rom Version | 4-88 |
| MAX HLD TRACE A | 4-64 | -S- | |
| MIN HLD TRACE A. | 4-64 | SAMPLE DETECTR | 4-66 |
| Making Measurements | .2-8 | Save State | 4-78 |
| Marker Delta | 4-45 | Select Input | 4-87 |
| Marker Options. | 4-52 | Selecting Auto Function | .3-4 |
| Marker Overview | 4-38 | Sig Trk On Off | 4-52 |
| Marker Pause Time. | 4-50 | Signal Ident | 4-16 |
| Marker Pause On Off. | 4-51 | Single Sweep. | 4-31 |
| Marker Peak | 4-38 | Softkey Controls | .2-7 |
| Marker Readout | 4-53 | Softkeys (HP 70205A Display) | .2-3 |
| Marker To | 4-40 | Softkeys (HP 70206A Display) | .2-5 |
| Marker Zoom | 4-53 | Span | 4-7 |
| Marker | 4-37 | Start/Stop Frequency. | 4-11 |
| Markers Off | 4-43 | Start/Stop Frequency. | 4-10 |
| Max Mxr Level | 4-29 | State | 4-78 |
| Minus Sign (HP 70205A Display) | .2-3 | Step Keys (HP 70205A Display) | .2-3 |
| Marker Noise On Off | 4-51 | Step Keys (HP 70206A Display) | .2-5 |
| Module Descriptions | .1-2 | Support Options | 1-14 |
| -N- | | Sweep Control | 4-31 |
| NEG PK DECTECTR | 4-67 | Sweep Time | 4-32 |
| Next Page | 4-77 | Sweep Time Automan | 4-33 |
| No. of States | 4-79 | System Descriptions | 1-12 |
| NORMAL DETECTR | 4-66 | System Options | 1-14 |

-T-

TRDSPLY ON OFF 4-64
 Threshd On Off 4-72
 Top Level Softkeys 4-1
 Trace A 4-63
 Trace B 4-64
 Trace C 4-64
 Trace Overview. 4-62
 Trace Preset 4-68
 Trace 4-62
 Trigger Function 4-34
 Tune 2-8

-V-

VIEW TRACE A. 4-64
 Video Avg 4-65
 Video Hys Level 4-35
 Video Trg Level 4-35
 Video Average On Off 4-65
 Video Bandwidth. 4-58
 Video Bandwidth Automan. 4-59
 Video Bandwidth Ratio. 4-60

-W-

WATT UNITS 4-27

-U-

Units 4-27
 Using [USR] Hardkey. 3-3

-Z-

Zoom 2-9



This part of the Operating Manual tells how to operate the HP 71000 Modular Spectrum Analyzer by remote, computer control.

Unlike the HP 71000 Language Reference manual that describes the spectrum analyzer commands in alphabetical order, the text here is organized by programming concepts in increasing levels of complexity. If you wish to duplicate manual operation of the analyzer, Chapter 2, *Programming Fundamentals*, should answer most of your programming questions. Chapter 3, *Advanced Programming*, describes techniques for computations, measurements, and graphics. Chapter 1 describes installation procedures for remote operation.



CHAPTER 1
GETTING STARTED

Installation for Remote Operation1-1
 Setup Procedure1-1
Address Switches1-2
 HP 70900A Local Oscillator Module Switches1-2
 HP 70205A and 70206A Graphics Display Switches1-2
Changing HP-IB Address at Front Panel1-4



Installation for Remote Operation

The following instructions tell how to set your equipment for remote operation and apply to standard systems and their options: HP models 71100A, 71200A, and 71300A. Examples shown only apply to units with a coaxial RF input.

Setup Procedure

Follow these steps to set up for remote control:

1. **Connect computer, spectrum analyzer, and other peripherals with HP-IB cables.** The HP-IB connector is located at the back of the mainframe.
2. **After the HP-IB cable is installed, reset all instruments connected to the bus.** Reset the spectrum analyzer by cycling power. As for resetting peripherals like plotters or printers, most of them are reset by pressing a front panel reset key. However, if you are not sure how to reset a device, switch its line power off, then on, to reset it.
3. **Check HP-IB address of the local oscillator module on the address map.** To view the map, press [DSP], then press ◀ADDRESS MAP▶. Turn the front panel knob until the local oscillator module appears in the address map.

The HP-IB address is indicated next to the local oscillator module number. The local oscillator must be in row 0 for HP-IB access. (See Figure 1-1.)

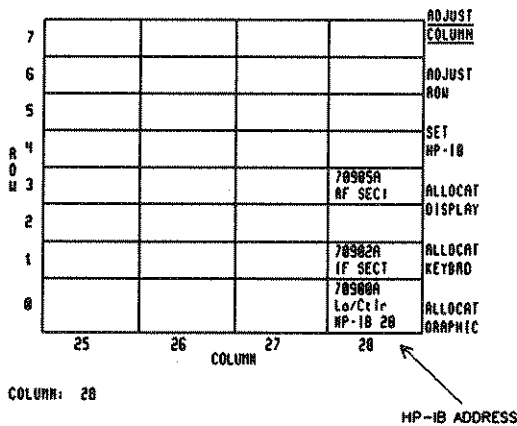

Fig. 1-1.

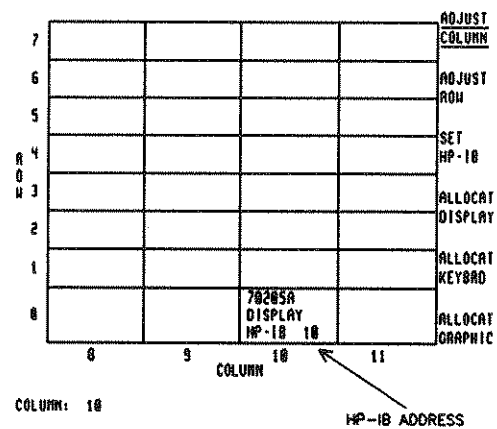

Fig. 1-2.

4. **Check system configuration on the address map.** For normal spectrum analyzer operation, the local oscillator and display modules are positioned in the bottom row, row 0, of the address map with the other modules stacked in a column above the local oscillator module. (See Figures 1-1 and 1-2.) The column may contain empty spaces between modules. The modules are positioned in this way at the factory. If this is not the case, see Part 1 for configuring instructions, or refer to **ADDRESS SWITCHES** in the following text.

Address Switches

HP-IB addresses may be set manually with address switches or may be set at the front panel.

The switches are located on the side, top cover, or rear panel of the module. Figure 1-3 shows the address switches of the different modules. The "column" switches select the HP-IB address and correspond to the column numbers on the address map.

The "row" switches of the HP70900A Local Oscillator module must be set to 0 for spectrum analyzer HP-IB control. They correspond to the row numbers on the address map. The display module does not have row switches. (Its row address is permanently set to 0.)

Note: HP-IB address 31 is illegal and should not be used.

Figure 1-3 shows how to set the address switches. The numbers in parenthesis indicate the binary value of the individual switches. The column or row address is the sum of the values in the parentheses beside each switch that is set to 1. For example, a column address of 18 is selected by setting column switches 2 and 5 to 1, and column switches 1, 3, and 4 to 0. ($18 = 0 + 2 + 0 + 0 + 16$.)

All of the modules have address switches. The other switches peculiar to the local oscillator module and the graphics display are described below.

HP 70900A Local Oscillator Module Switches

The **HP-IB** switch breaks or reconnects the module to the HP-IB bus. It must be switched on for HP-IB control.

The **SWI/MEM** (switch/memory) switch specifies how the HP-IB address is set. When set to **SWI**, the address can be changed with the address switch only. When set to **MEM**, the address can be selected with either the switch or the front panel softkeys. The **MEM** position is suggested.

The **MAS/SLA** (master/slave) switch is set to **MAS** during normal spectrum analyzer operation. The switch is set to **SLA** for some special applications that require system reconfiguration.

The **NRML/TEST** (normal/test) switch is set to **NRML**. The **TEST** setting is for diagnostic purposes.

HP 70205A and 70206A Graphics Display Switches

The **HP-IB** switch breaks or reconnects the display to the HP-IB bus. It must be on for HP-IB control.

The **TALK ONLY** switch is set to 0 (off) for normal operation. When set to 1 (on), the display can talk to the HP-IB and not require a reply.

The **SYSTEM CONTROLLER** switch is set to 0 (off) during normal operation. When set to 1 (on), the display may function as a controller on HP-IB.

The TEST MODE switch is set to 0 (off) during normal operation, and is for diagnostic purposes.

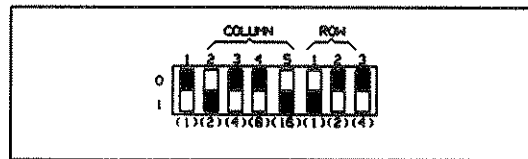
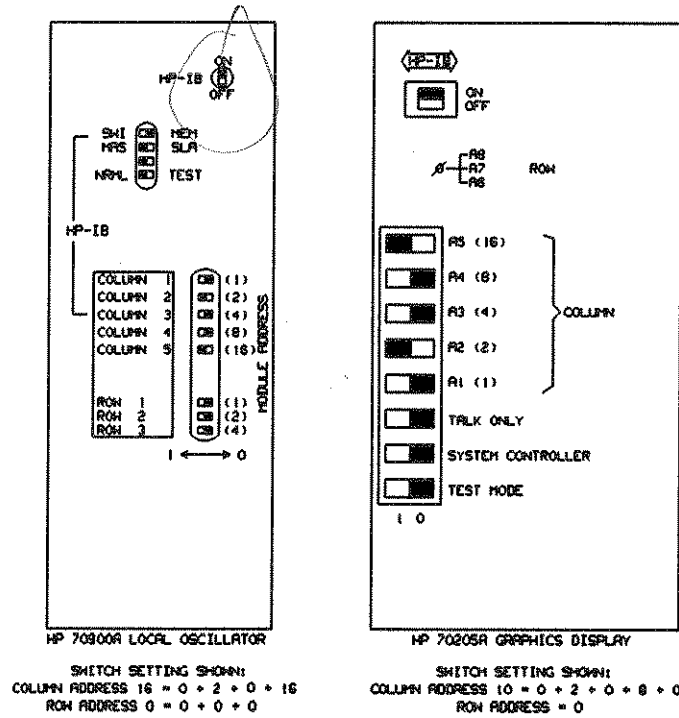

IF OR RF MODULES
 SWITCH ADDRESS SHOWN:
 COLUMN ADDRESS 16 = 0 + 2 + 0 + 0 + 16
 ROW ADDRESS 1 = 1 + 0 + 0

Fig. 1-3.

Changing HP-IB Address at Front Panel

The HP-IB address of the spectrum analyzer may be changed at the front panel when the local oscillator module switch is set to **MEM**. Use this procedure:

Press [DSP].
Press ◀ADDRESS MAP▶.

With the front panel knob, position the box around the local oscillator module.
Press ◀SET HP-IB▶.

Enter the HP-IB address on the front panel numeric keyboard.
Press ◀ENTER▶.

The HP-IB address is indicated inside the local oscillator module box on the address map. Changing the HP-IB address with the front panel keys does not affect the position of the modules on the map.

CHAPTER 2

Programming Fundamentals

| | |
|--|------|
| Introduction | 2-1 |
| Communicating with the Analyzer | 2-2 |
| Syntax Requirements | 2-3 |
| Local and Remote Control | 2-3 |
| Initial Program Considerations | 2-4 |
| Executing Remote Spectrum Analyzer Commands. | 2-6 |
| Analyzer Timing | 2-8 |
| Data Transfer from Spectrum Analyzer to Computer | 2-11 |
| Debugging Programs. | 2-14 |
| Creating Graphics | 2-15 |
| Clearing the Display | 2-15 |
| Graphics Origin and Scale | 2-16 |
| Pen and Plot Commands | 2-17 |
| Line Type and Pen Color. | 2-19 |
| Drawing Grids | 2-20 |
| Writing Text | 2-20 |
| Creating a Graphics Workspace | 2-22 |
| Printing and Plotting the Display | 2-23 |



| | | | |
|----------------|----------|-----------------------|----------------------------|
| FREQ | | CENTER FREQ | CF |
| | | SPAN | SP |
| | | START FREQ | FR |
| | | STOP FREQ | FB |
| | | CF STEP | SS |
| | | CF STEP AUTOMAN | SS AUTO
SS MAN |
| | | FULL SPAN | FS |
| PRE-SELECT | | SIGNAL ID | |
| PRE SEL PEAK | PP | SIGNAL IDENT | SIGID AUTO |
| PRE SEL DAC | PRSDAC | SIG ID TO CF | IDCF |
| PRE SEL HYST | PRSHYST | SIG ID OPTIONS | |
| PRE SEL ON OFF | PRSENABL | SIG ID MAN OFF | SIGID MAN
SIGID OFF |
| MARKER NORMAL | MKN | IMAGE SHIFT | SIGID IMAGE
SIGID SHIFT |
| MARKER DELTA | MKD | SIG ID AMPTD Δ | SIGDEL |
| MARKERS OFF | MKOFF | IMAGE N START | NSTART |
| HIGHEST PEAK | MKPK HI | IMAGE N STOP | NSTOP |
| NEXT PEAK | MKPK NP | EXIT | |
| MKR TO CF | MKCF | SAVE STATE | SAVES |
| EXIT | | RECALL STATE | RCLS |
| | | MARKER NORMAL | MKN |
| | | MARKER DELTA | MKD |
| | | HIGHEST PEAK | MKPK HI |
| | | NEXT PEAK | MKPK NP |
| | | RIGHT PEAK | MKPK NR |
| | | LEFT PEAK | MKPK NL |
| | | CLOSEST PEAK | MKPK CP |
| | | EXIT | |
| | | FREQ OFFSET | FOFFSET |
| | | LCL OSC START | LOSTART |
| | | LCL OSC STOP | LOSTOP |
| | | FRO LIM ON OFF | FLIMIT |
| | | EXIT | |

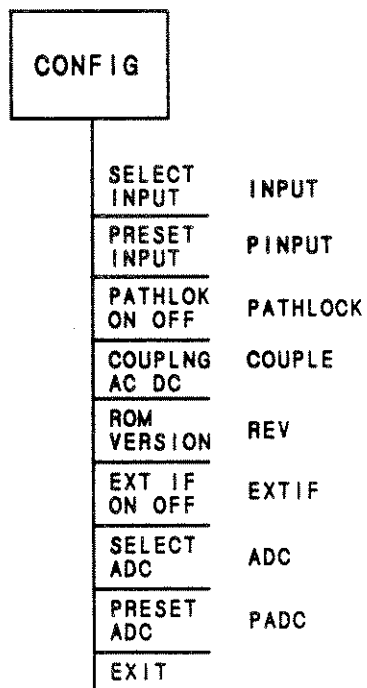

REMOTE OPERATION, FIGURE 2-1(PARTIAL). MENU SOFTKEYS AND CORRESPONDING REMOTE COMMANDS(2 OF 2)

Rev. MAY87

| FREQ | AMP/10 | CONTROL | MARKER | WIDTH | TITLE | DISPLAY | STATE |
|--------------------|----------------|--------------------------|-----------------|-----------------|-----------------|----------------|-------------|
| CENTER FREQ | REF LVL | CONT | MARKER TO . . . | RES BW | TRACE A | DISPLAY LINE | SAVE STATE |
| SPAN | POSN REF LEVEL | SNEEP SINGLE SNEEP SNEEP | CF | RES BW | CLR WRT TRACE A | LINE | RECAL STATE |
| START FREQ | EXTD RL ON OFF | ST | MKR TO REF LVL | AUTOMAN RB/SPAN | MAX HLD TRACE A | DSP LIN ON OFF | RECAL STATE |
| STOP FREQ | ATTEN | ST AUTO | MKR Δ TO | RATIO | MIN HLD TRACE A | ON OFF | STATE NO. 0 |
| CF STEP | AUTOMAN | ST MAN | MKR TO CF STEP | VID BW | MIN HLD TRACE A | THRESHD | STATE |
| CF STEP AUTOMAN | LOG | TM FREE | EXIT | VID BW AUTOMAN | VIEW TRACE A | TH ON | P STR |
| FULL SPAN | dB/DIV | TH VID | ACTIVE MARKER | VBM/RBM RATIO | BLANK TRACE A | TH OFF | POWER |
| SIGNAL ID | LINEAR (VOLTS) | TH LINE | MKPAUSE MARKER | EXIT | TROSP TRA.ON | GRAT ON | IP LA |
| SIGNAL IDENT | LINE LINE | TH EXT | MKPAUSE TIME | EXIT | TROSP TRA.OFF | GRAT OFF | EXIT |
| SIG ID | AMPTD UNITS | VTL | MKPAUSE ON OFF | EXIT | TRDEF TRA | TH ON | |
| SIG ID TO CF | A UNITS | VTH | MKNOISE ON OFF | EXIT | TRDEF TRA | TH OFF | |
| SIG ID OPTIONS | AUTOMAN | EXIT | MKNOISE ON | EXIT | TRDEF TRA | TH OFF | |
| SIG ID MAN OFF | dBm | MARKERS OFF | MKNOISE ON | EXIT | TRDEF TRA | TH OFF | |
| SIG ID IMAGE SHIFT | UNITS | MARKER NORMAL | MKTRACK ON OFF | EXIT | TRDEF TRA | TH OFF | |
| SIG ID AMPTD Δ | UNITS | MARKER DELTA | MKTRACK ON | EXIT | TRDEF TRA | TH OFF | |
| IMAGE N START | VOLT | MARKER BW | MKTRACK OFF | EXIT | TRDEF TRA | TH OFF | |
| IMAGE N STOP | UNITS | MARKER REL LEFT | MKTRACK OFF | EXIT | TRDEF TRA | TH OFF | |
| EXIT | UNITS | MARKER REL RIGHT | MKTRACK OFF | EXIT | TRDEF TRA | TH OFF | |
| SAVE STATE | EXIT | MKR BW ON OFF | MKTRACK OFF | EXIT | TRDEF TRA | TH OFF | |
| RECALL STATE | AMP REF OFFSET | EXIT | MKTRACK OFF | EXIT | TRDEF TRA | TH OFF | |
| MARKER NORMAL | INPUT IMPED | EXIT | MKTRACK OFF | EXIT | TRDEF TRA | TH OFF | |
| MARKER DELTA | IMPED | EXIT | MKTRACK OFF | EXIT | TRDEF TRA | TH OFF | |
| HIGHEST PEAK | MAX MXR LEVEL | EXIT | MKTRACK OFF | EXIT | TRDEF TRA | TH OFF | |
| NEXT PEAK | LEVEL | EXIT | MKTRACK OFF | EXIT | TRDEF TRA | TH OFF | |
| RIGHT PEAK | EXIT | EXIT | MKTRACK OFF | EXIT | TRDEF TRA | TH OFF | |
| LEFT PEAK | EXIT | EXIT | MKTRACK OFF | EXIT | TRDEF TRA | TH OFF | |
| CLOSEST PEAK | EXIT | EXIT | MKTRACK OFF | EXIT | TRDEF TRA | TH OFF | |
| EXIT | EXIT | EXIT | MKTRACK OFF | EXIT | TRDEF TRA | TH OFF | |
| FREQ OFFSET | EXIT | EXIT | MKTRACK OFF | EXIT | TRDEF TRA | TH OFF | |
| LCL OSC START | EXIT | EXIT | MKTRACK OFF | EXIT | TRDEF TRA | TH OFF | |
| LCL OSC STOP | EXIT | EXIT | MKTRACK OFF | EXIT | TRDEF TRA | TH OFF | |
| EXIT | EXIT | EXIT | MKTRACK OFF | EXIT | TRDEF TRA | TH OFF | |
| CF | RL POS | CONTS | MARKER PEAK | MKCF | CLR WRT TRACE A | VID AVG | VID AVG |
| SP | RL | SNGLS | HIGHEST PEAK | MKAL | TRACE A | ON OFF | ON OFF |
| FA | EXTD RL ON OFF | ST | NEXT PEAK | MKSP | MAX HLD TRACE A | DETECTR | DETECTR |
| FB | ATTEN | ST AUTO | RIGHT PEAK | MKSS | MIN HLD TRACE A | NORMAL | NORMAL |
| SS | AUTOMAN | ST MAN | LEFT PEAK | MKACT | MIN HLD TRACE A | DETECTR | DETECTR |
| SS AUTO | LOG | TM FREE | CLOSEST PEAK | MKACT | VIEW TRACE A | POS PK | POS PK |
| SS MAN | dB/DIV | TH VID | MINIMUM POINT | MKACT | BLANK TRACE A | NEG PK | NEG PK |
| FS | LINEAR (VOLTS) | TH LINE | POINT | MKACT | TROSP TRA.ON | DETECTR | DETECTR |
| SIGID AUTO | LINE LINE | TH EXT | EXIT | MKACT | TROSP TRA.OFF | GND | GND |
| SIGID OFF | AMPTD UNITS | VTL | MARKERS OFF | MKACT | TRDEF TRA | DETECTR | DETECTR |
| SIGID IMAGE | A UNITS | VTH | MARKER NORMAL | MKACT | EXIT | EXIT | EXIT |
| SIGID SHIFT | AUTOMAN | MARKERS OFF | MARKER DELTA | MKACT | TRACE | TRACE | TRACE |
| SIGID | UNITS | MARKER BW | MARKER REL LEFT | MKACT | PRESET | PRESET | PRESET |
| SIGID Δ | UNITS | MARKER REL RIGHT | MKR BW ON OFF | MKACT | A - B → A | A - B → A | A - B → A |
| NSTART | VOLT | MKR BW ON OFF | EXIT | MKACT | ON OFF | ON OFF | ON OFF |
| NSTOP | UNITS | EXIT | EXIT | MKACT | ON OFF | ON OFF | ON OFF |
| SAVE | UNITS | EXIT | EXIT | MKACT | A + B → A | A + B → A | A + B → A |
| RECALL | UNITS | EXIT | EXIT | MKACT | B - DL → B | B - DL → B | B - DL → B |
| STATE | UNITS | EXIT | EXIT | MKACT | A XCH B | A XCH B | A XCH B |
| MARKER | UNITS | EXIT | EXIT | MKACT | B XCH C | B XCH C | B XCH C |
| MARKER NORMAL | UNITS | EXIT | EXIT | MKACT | EXIT | EXIT | EXIT |
| MARKER DELTA | UNITS | EXIT | EXIT | MKACT | EXIT | EXIT | EXIT |
| HIGHEST PEAK | UNITS | EXIT | EXIT | MKACT | EXIT | EXIT | EXIT |
| NEXT PEAK | UNITS | EXIT | EXIT | MKACT | EXIT | EXIT | EXIT |
| RIGHT PEAK | UNITS | EXIT | EXIT | MKACT | EXIT | EXIT | EXIT |
| LEFT PEAK | UNITS | EXIT | EXIT | MKACT | EXIT | EXIT | EXIT |
| CLOSEST PEAK | UNITS | EXIT | EXIT | MKACT | EXIT | EXIT | EXIT |
| EXIT | UNITS | EXIT | EXIT | MKACT | EXIT | EXIT | EXIT |
| FREQ OFFSET | UNITS | EXIT | EXIT | MKACT | EXIT | EXIT | EXIT |
| LCL OSC START | UNITS | EXIT | EXIT | MKACT | EXIT | EXIT | EXIT |
| LCL OSC STOP | UNITS | EXIT | EXIT | MKACT | EXIT | EXIT | EXIT |
| EXIT | UNITS | EXIT | EXIT | MKACT | EXIT | EXIT | EXIT |
| CF | RL POS | CONTS | MARKER TO . . . | MKCF | CLR WRT TRACE B | VID AVG | VID AVG |
| SP | RL | SNGLS | CF | MKAL | TRACE B | ON OFF | ON OFF |
| FA | EXTD RL ON OFF | ST | MKR TO REF LVL | MKSP | MAX HLD TRACE B | DETECTR | DETECTR |
| FB | ATTEN | ST AUTO | MKR Δ TO | MKSS | MIN HLD TRACE B | NORMAL | NORMAL |
| SS | AUTOMAN | ST MAN | MKR TO CF STEP | MKACT | MIN HLD TRACE B | DETECTR | DETECTR |
| SS AUTO | LOG | TM FREE | EXIT | MKACT | VIEW TRACE B | POS PK | POS PK |
| SS MAN | dB/DIV | TH VID | ACTIVE MARKER | MKACT | BLANK TRACE B | NEG PK | NEG PK |
| FS | LINEAR (VOLTS) | TH LINE | MKPAUSE MARKER | MKACT | TROSP TRA.ON | DETECTR | DETECTR |
| SIGID AUTO | LINE LINE | TH EXT | MKPAUSE TIME | MKACT | TROSP TRA.OFF | GND | GND |
| SIGID OFF | AMPTD UNITS | VTL | MKPAUSE ON OFF | MKACT | TRDEF TRA | DETECTR | DETECTR |
| SIGID IMAGE | A UNITS | VTH | MKNOISE ON OFF | MKACT | EXIT | EXIT | EXIT |
| SIGID SHIFT | AUTOMAN | MARKERS OFF | MKNOISE ON | MKACT | TRACE | TRACE | TRACE |
| SIGID | UNITS | MARKER NORMAL | MKTRACK ON OFF | MKACT | PRESET | PRESET | PRESET |
| SIGID Δ | UNITS | MARKER DELTA | MKTRACK ON | MKACT | A - B → A | A - B → A | A - B → A |
| NSTART | VOLT | MKR BW ON OFF | MKTRACK OFF | MKACT | ON OFF | ON OFF | ON OFF |
| NSTOP | UNITS | MARKER REL LEFT | MKTRACK OFF | MKACT | ON OFF | ON OFF | ON OFF |
| SAVE | UNITS | MARKER REL RIGHT | MKTRACK OFF | MKACT | A + B → A | A + B → A | A + B → A |
| RECALL | UNITS | MKR BW ON OFF | MKTRACK OFF | MKACT | B - DL → B | B - DL → B | B - DL → B |
| STATE | UNITS | EXIT | MKTRACK OFF | MKACT | A XCH B | A XCH B | A XCH B |
| MARKER | UNITS | EXIT | MKTRACK OFF | MKACT | B XCH C | B XCH C | B XCH C |
| MARKER NORMAL | UNITS | EXIT | MKTRACK OFF | MKACT | EXIT | EXIT | EXIT |
| MARKER DELTA | UNITS | EXIT | MKTRACK OFF | MKACT | EXIT | EXIT | EXIT |
| HIGHEST PEAK | UNITS | EXIT | MKTRACK OFF | MKACT | EXIT | EXIT | EXIT |
| NEXT PEAK | UNITS | EXIT | MKTRACK OFF | MKACT | EXIT | EXIT | EXIT |
| RIGHT PEAK | UNITS | EXIT | MKTRACK OFF | MKACT | EXIT | EXIT | EXIT |
| LEFT PEAK | UNITS | EXIT | MKTRACK OFF | MKACT | EXIT | EXIT | EXIT |
| CLOSEST PEAK | UNITS | EXIT | MKTRACK OFF | MKACT | EXIT | EXIT | EXIT |
| EXIT | UNITS | EXIT | MKTRACK OFF | MKACT | EXIT | EXIT | EXIT |
| FREQ OFFSET | UNITS | EXIT | MKTRACK OFF | MKACT | EXIT | EXIT | EXIT |
| LCL OSC START | UNITS | EXIT | MKTRACK OFF | MKACT | EXIT | EXIT | EXIT |
| LCL OSC STOP | UNITS | EXIT | MKTRACK OFF | MKACT | EXIT | EXIT | EXIT |
| EXIT | UNITS | EXIT | MKTRACK OFF | MKACT | EXIT | EXIT | EXIT |
| CF | RL POS | CONTS | MARKER TO . . . | MKCF | CLR WRT TRACE C | VID AVG | VID AVG |
| SP | RL | SNGLS | CF | MKAL | TRACE C | ON OFF | ON OFF |
| FA | EXTD RL ON OFF | ST | MKR TO REF LVL | MKSP | MAX HLD TRACE C | DETECTR | DETECTR |
| FB | ATTEN | ST AUTO | MKR Δ TO | MKSS | MIN HLD TRACE C | NORMAL | NORMAL |
| SS | AUTOMAN | ST MAN | MKR TO CF STEP | MKACT | MIN HLD TRACE C | DETECTR | DETECTR |
| SS AUTO | LOG | TM FREE | EXIT | MKACT | VIEW TRACE C | POS PK | POS PK |
| SS MAN | dB/DIV | TH VID | ACTIVE MARKER | MKACT | BLANK TRACE C | NEG PK | NEG PK |
| FS | LINEAR (VOLTS) | TH LINE | MKPAUSE MARKER | MKACT | TROSP TRA.ON | DETECTR | DETECTR |
| SIGID AUTO | LINE LINE | TH EXT | MKPAUSE TIME | MKACT | TROSP TRA.OFF | GND | GND |
| SIGID OFF | AMPTD UNITS | VTL | MKPAUSE ON OFF | MKACT | TRDEF TRA | DETECTR | DETECTR |
| SIGID IMAGE | A UNITS | VTH | MKNOISE ON OFF | MKACT | EXIT | EXIT | EXIT |
| SIGID SHIFT | AUTOMAN | MARKERS OFF | MKNOISE ON | MKACT | TRACE | TRACE | TRACE |
| SIGID | UNITS | MARKER NORMAL | MKTRACK ON OFF | MKACT | PRESET | PRESET | PRESET |
| SIGID Δ | UNITS | MARKER DELTA | MKTRACK ON | MKACT | A - B → A | A - B → A | A - B → A |
| NSTART | VOLT | MKR BW ON OFF | MKTRACK OFF | MKACT | ON OFF | ON OFF | ON OFF |
| NSTOP | UNITS | MARKER REL LEFT | MKTRACK OFF | MKACT | ON OFF | ON OFF | ON OFF |
| SAVE | UNITS | MARKER REL RIGHT | MKTRACK OFF | MKACT | A + B → A | A + B → A | A + B → A |
| RECALL | UNITS | MKR BW ON OFF | MKTRACK OFF | MKACT | B - DL → B | B - DL → B | B - DL → B |
| STATE | UNITS | EXIT | MKTRACK OFF | MKACT | A XCH B | A XCH B | A XCH B |
| MARKER | UNITS | EXIT | MKTRACK OFF | MKACT | B XCH C | B XCH C | B XCH C |
| MARKER NORMAL | UNITS | EXIT | MKTRACK OFF | MKACT | EXIT | EXIT | EXIT |
| MARKER DELTA | UNITS | EXIT | MKTRACK OFF | MKACT | EXIT | EXIT | EXIT |
| HIGHEST PEAK | UNITS | EXIT | MKTRACK OFF | MKACT | EXIT | EXIT | EXIT |
| NEXT PEAK | UNITS | EXIT | MKTRACK OFF | MKACT | EXIT | EXIT | EXIT |
| RIGHT PEAK | UNITS | EXIT | MKTRACK OFF | MKACT | EXIT | EXIT | EXIT |
| LEFT PEAK | UNITS | EXIT | MKTRACK OFF | MKACT | EXIT | EXIT | EXIT |
| CLOSEST PEAK | UNITS | EXIT | MKTRACK OFF | MKACT | EXIT | EXIT | EXIT |
| EXIT | UNITS | EXIT | MKTRACK OFF | MKACT | EXIT | EXIT | EXIT |
| FREQ OFFSET | UNITS | EXIT | MKTRACK OFF | MKACT | EXIT | EXIT | EXIT |
| LCL OSC START | UNITS | EXIT | MKTRACK OFF | MKACT | EXIT | EXIT | EXIT |
| LCL OSC STOP | UNITS | EXIT | MKTRACK OFF | MKACT | EXIT | EXIT | EXIT |
| EXIT | UNITS | EXIT | MKTRACK OFF | MKACT | EXIT | EXIT | EXIT |

Introduction

This section develops some fundamental techniques for controlling the spectrum analyzer and obtaining sound measurement results. Remote operation of the spectrum analyzer is controlled with commands that largely correspond to front panel key functions. These commands are summarized in Figure 2-1. See the Appendices for a complete listing of spectrum analyzer commands, also called keywords.

At the outset of our discussion, it is important to understand how messages are communicated to the spectrum analyzer. We will discuss enter and output statements and command syntax, and inspect sample programs written in the HP BASIC language for HP series 200 computers. Topics discussed are initializing the analyzer, controlling analyzer functions, data entry, analyzer timing, data transfer to and from the computer (I/O), program debugging, and graphics.

Communicating with the Analyzer

Spectrum analyzer programs control the passage of spectrum analyzer commands and data between the analyzer and the computer on the Hewlett-Packard Interface Bus (HP-IB) using the computer *output* and *enter* statements.

An *output* statement tells the computer to send a message to the spectrum analyzer. For example, executing this output statement sets the center frequency to 300 MHz:

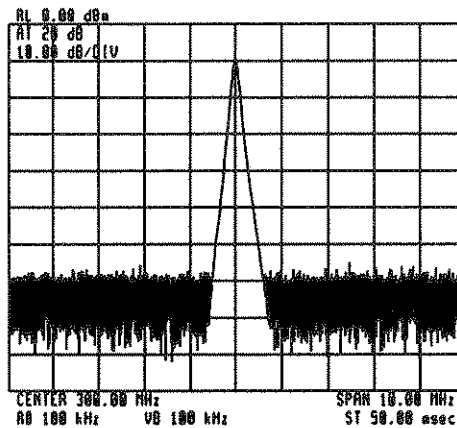
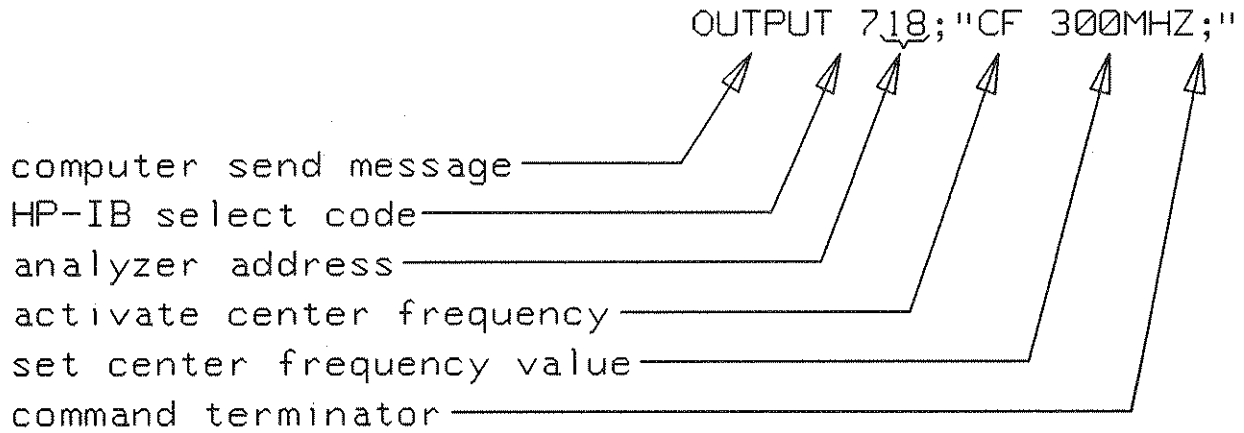

Set center frequency to 300MHz.

An *enter* statement used in conjunction with an analyzer *query* returns information to the computer. To return the center frequency value to the computer, first form a query by adding a question mark (?) to the command:

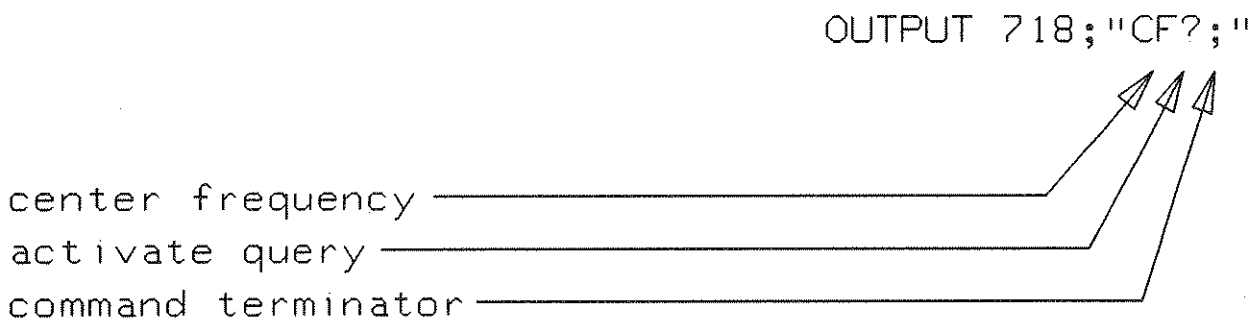

Next, use the enter statement to assign the returned value to a variable in the computer:

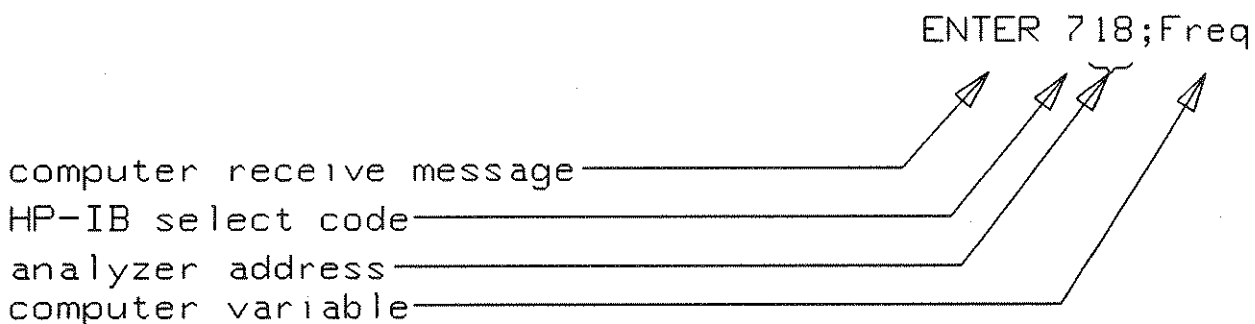

The value of the center frequency above is equated to the computer variable, Freq. The variable may be printed, stored, or used for any other computer function.

Syntax Requirements

All of the program examples in this manual show the recommended command syntax. All spectrum analyzer commands must be constructed according to specific syntactical rules which are outlined in this manual's counterpart: the HP 70900A Language Reference manual. The Language Reference lists all of the remote spectrum analyzer commands in alphabetical order and has a syntax diagram for each command.

Local and Remote Control

Whenever the analyzer is addressed, its front panel softkeys are disabled. Similarly, whenever the graphics display is addressed, its softkeys are disabled. Pressing the ◀LOCAL▶ key or executing the HP BASIC command, LOCAL, reenables the keys.

Initial Program Considerations

Programs should begin with a series of HP BASIC and spectrum analyzer commands that form a good starting point for spectrum analyzer measurements. The following example shows how to initialize the analyzer to form a good starting point.

Example: Initialize analyzer.

```
10 ASSIGN @Sa TO 718
20 CLEAR @Sa
30 OUTPUT @Sa;"IP;SNGLS;TS;"
```

The ASSIGN command is an HP BASIC command that creates an I/O path name and assigns that name to an I/O resource. In the example above, the I/O path name is "@Sa" and is assigned to the device at HP-IB address 718. (All program examples in this manual assume that a spectrum analyzer is at HP-IB address 718.)

The ASSIGN command offers several advantages when included in a spectrum analyzer program. For example, the spectrum analyzer address is easily changed in the computer program and the program can transfer data to a mass storage unit.

The CLEAR command is an HP BASIC command that resets a device on HP-IB to a known state unique to each instrument. CLEAR can reset devices on the bus singly or in unison. It is often desirable to reset only one instrument so that other instruments on the bus are not affected.

Example: Clear devices individually.

```
30 CLEAR @Sa           !Clear spectrum analyzer
40 CLEAR @Sg           !Clear signal generator
```

Example: Clear all devices at select code 7.

```
30 CLEAR 7             !Clear all devices on HP-IB at select code 7.
```

The instrument preset command, IP, sets all of the analog parameters of the spectrum analyzer and provides a good starting point for all measurement processes. Executing IP actually is the same as executing a number of spectrum analyzer commands that set the analyzer to a known state.

The single sweep and take sweep commands, SNGLS and TS, control the sweep and are discussed in Analyzer Timing.

Another useful command is CAL ALL, which calibrates the spectrum analyzer system. Below, CAL ALL calibrates with the 300 MHz calibration signal.

Example: Analyzer calibration.

(Connect calibration signal to analyzer input.)

```
10 ASSIGN @Sa TO 718           !Initialize analyzer.
20 CLEAR @Sa
30 OUTPUT @Sa;"IP;SNGLS;TS;"
40 OUTPUT @Sa;"CAL ALL;"       !Calibrate all correction factors.
```

Since CAL ALL takes up to 3 minutes depending on configuration, it is generally not performed except when the system requires calibration, such as at beginning of the day after the instrument has warmed-up.

All of the initializing commands discussed above work together to place the spectrum analyzer in a known state. Incorporate them at the beginning of spectrum analyzer programs so that repeatable measurement results are obtained. It is a good practice to also include other program information, such as program title, author, date, and revision numbers.

Executing Remote Spectrum Analyzer Commands

Remote operation is very similar to manual operation. In fact, the two measurement procedures are identical except for timing considerations which become important during remote operation. Remote measurements are executed with commands that correspond to the front panel keys. Programs for remote operation are composed as follows:

1. Measure, then list the order of keystrokes used.
2. Using Figure 2-1, find commands that correspond to keystrokes.
3. Incorporate commands into output statements.

ACTIVATING ANALYZER COMMANDS

Most spectrum analyzer commands first activate a function, then enter a number followed by a units code and a command terminator:

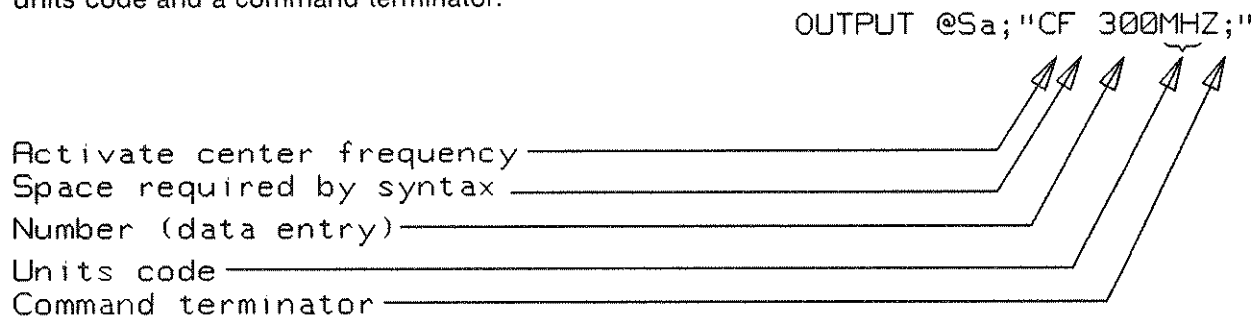

The number within the quote field must be a string of (ASCII) decimal numbers plus an optional decimal point and may be preceded by a minus or plus sign. Either fixed or floating point notation may be used. For example, "12.3E3", "12.3e3", and "12300" each enter the same number.

The number of significant digits the analyzer accepts depends upon which function is active. For example, an 11 digit entry for center frequency can be stored in the analyzer center frequency storage register. (The analyzer does not display all of the significant digits stored.)

A units code (Figure 2-2) follows a data entry. For compatibility with HP 8568 and 8566 Spectrum Analyzers, optional units codes listed in the HP 70900A Language Reference are also allowed. The preferred codes in Figure 2-2 should be used whenever possible.

| UNITS | CODE | UNITS | CODE |
|-------------------|------|------------------------------|------|
| Frequency: | | Ratio Measurement: | |
| Hertz | HZ | Decibel | DB |
| Kilohertz | KHZ | Power: | |
| Megahertz | MHZ | Watt | W |
| Gigahertz | GHZ | Milliwatt | MW |
| | | Microwatt | UW |
| Time: | | Decibels Relative To: | |
| Second | S | 1 Milliwatt (dBm) | DBM |
| Millisecond | MS | 1 Millivolt (dBmV) | DBMV |
| Microsecond | US | 1 Microvolt (dBuV) | DBUV |
| Current: | | Voltage: | |
| Amp | A | Volt | V |
| Milliamp | MA | Millivolt | MV |
| Microamp | UA | Microvolt | UV |
| Impedance: | | | |
| Ohm | OHM | | |

Fig. 2-2. Units codes.

The semicolon is the preferred command terminator. While most functions allow other command terminators, such as carriage-return, line-feed, space, or comma, use the semicolon whenever possible.

Spectrum analyzer commands may be used in conjunction with computer variables. The following program line sets the analyzer center frequency to the value of a computer variable, Freq.

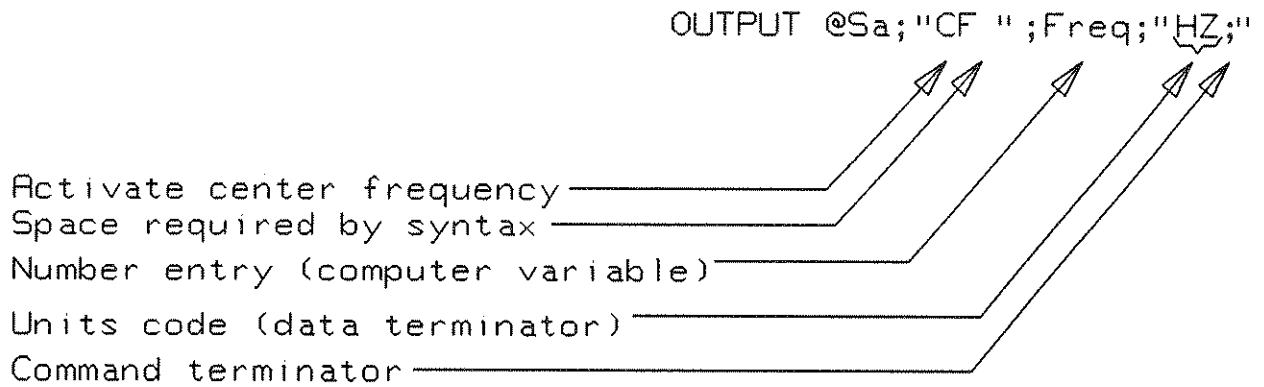

Data may also be entered from the front panel when the analyzer is in remote control. This is done by following the analyzer command with EP (enable parameter).

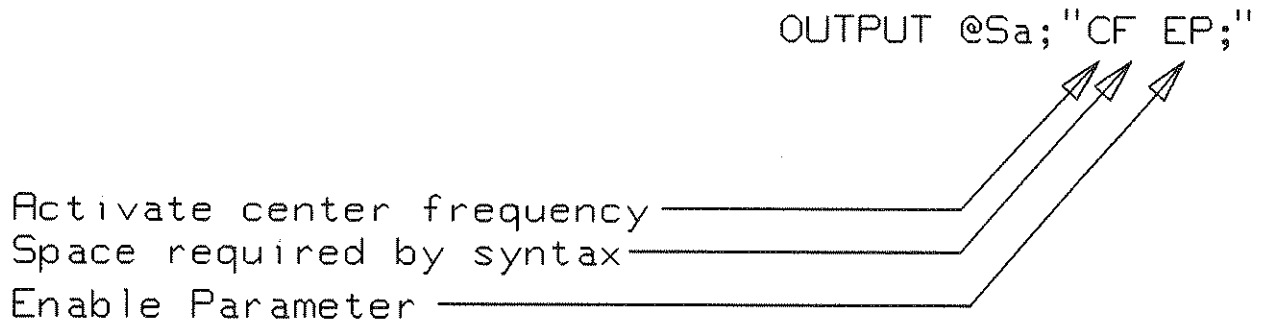

EP halts execution of analyzer commands so that values may be entered with the front panel numeric keypad, step keys, knob, or units code keys. Data may be entered from the front panel until the ◀ACCEPT VALUE▶ keys is pressed. The syntax diagrams in the Language Reference show which commands can be followed by EP.

Analyzer Timing

Most remotely controlled measurements require control of the sweep. The TS (take sweep) command initiates a sweep when the trigger conditions are met. The TM (trigger mode) command controls trigger conditions and usually is set to the free run mode (TM FREE) so that trigger conditions are always satisfied.

When TS is executed as part of a command sequence, the analyzer starts and completes one full sweep before the next analyzer command is executed. The SNGLS (single sweep) command is also used during remote control to maintain absolute control over the sweep and reduce execution time. Once SNGLS activates the single sweep mode, TS may be used to initiate a sweep only when necessary.

The TS command updates trace information. Since many remote commands process trace information, it is important to update trace information whenever the input signal or analyzer settings change. Thus, use TS to update the trace *after* the analyzer settings or input signals change, but *before* the trace information is returned to the computer or processed by other commands, like trace math or marker commands.

When developing measurement algorithms from the front panel keys, use the ◀SINGLE SWEEP▶ key to simulate the effect of the TS command updating the trace. When the single sweep mode is active, pressing ◀SINGLE SWEEP▶ is the same as executing TS via remote control.

The following examples demonstrate the significance of updating trace information with the TS command.

Example: Change analyzer settings.

(Connect calibration signal input.)

```
10 ASSIGN @Sa TO 718           !Initialize analyzer.
20 CLEAR @Sa
30 OUTPUT @Sa;"IP;"
40 OUTPUT @Sa;"SNGLS;TS;"
50 OUTPUT @Sa;"CF 300MHZ;SP 1MHZ;" !Change analyzer settings.
60 END
```

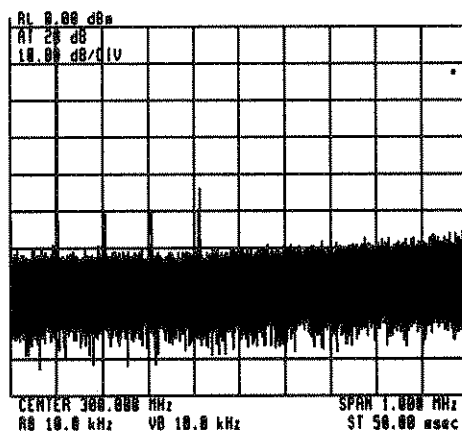

Fig. 2-3. Invalid trace information.

In the previous example, trace information does not reflect the new center frequency and spanwidth settings. To obtain valid trace information, the trace must be updated with the TS command. Here is the program again:

Example: Change analyzer settings *and* update trace.

```
(Connect calibration to analyzer input.)
10 ASSIGN @Sa TO 718                !Initialize analyzer.
20 CLEAR @Sa
30 OUTPUT @Sa;"IP;"
40 OUTPUT @Sa;"SNGLS;TS;"
50 OUTPUT @Sa;"CF 300MHZ;SP 1MHZ;"  !Change analyzer settings.
60 OUTPUT @Sa;"TS;"                 !Take a sweep to update trace.
70 END
```

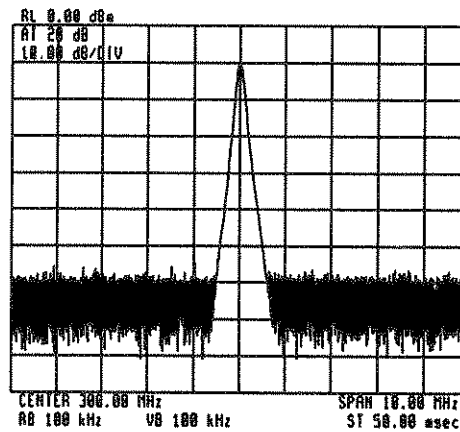

Fig. 2-4. Updated trace information.

The TS command is important in the following example that processes trace information. In the program, marker command MKPK HI examines trace information and positions a marker on the trace element with the highest amplitude level. Since the program changes the analyzer settings, the trace information must be updated with TS before MKPK HI is executed.

Example: Update trace information with TS command before executing marker commands.

```
(Connect calibration signal to analyzer input.)
10 ASSIGN @Sa TO 718                !Initialize analyzer.
20 CLEAR @Sa
30 OUTPUT @Sa;"IP;SNGLS;TS;"
40 OUTPUT @Sa;"CF 300.5MHZ;SP 10MHZ;RL -5DBM;"  !Change analyzer settings.
50 OUTPUT @Sa;"TS;"                 !Take a sweep to update trace.
60 OUTPUT @Sa;"MKPK HI;"           !Move marker to highest peak.
70 END
```

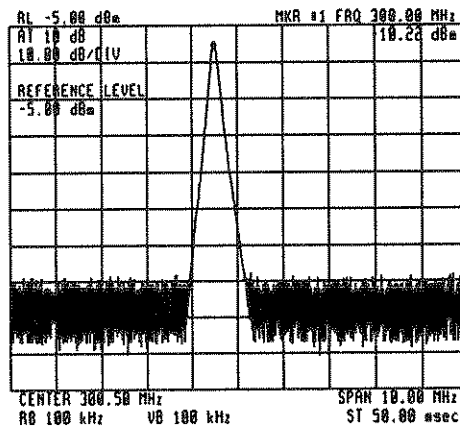

Fig. 2-5.

As the example shows, TS is executed *after* analyzer settings are changed, but *before* trace information is processed. Note that SNGLS cannot be substituted successfully for TS in the program. If this were the case, SNGLS would initiate a sweep, but MKPK HI would be executed before the completion of the sweep.

There are two commands that change the analyzer settings indirectly: MKCF and MKRL. They change the analyzer settings when moving a marker to the center frequency or reference level. If valid trace information is needed, a TS command should be executed after these commands.

In all cases, executing TS invokes at least one entire sweep. However, TS invokes more than one sweep when certain commands are active, such as video averaging (VAVG) or marker tracking (MKTRACK).

Data Transfer from Spectrum Analyzer to Computer

Data transfer varies in simplicity, but in all cases it is initiated with an analyzer *query*. When a programming command is appended with a question mark (?), it becomes a query which tells the spectrum analyzer to send data to the HP-IB bus. An enter statement follows the query to assign the value to a computer variable.

The following example shows how the value of an analyzer setting is transferred to the computer.

Example: Return analyzer center frequency to computer.

```

10 ASSIGN @Sa to 718           !Initialize analyzer.
20 CLEAR @Sa
30 OUTPUT @Sa;"IP;SNGLS;TS;"
40 OUTPUT @Sa;"CF?;"          !Return center frequency value to computer.
50 ENTER @Sa; Freq            !Assign center frequency to computer variable, Freq.
60!
70!
80!
90!
100 END

```

Values of other analyzer settings, such as span, attenuation, and resolution bandwidth are transferred similarly to the computer. The Language Reference syntax charts show which commands can be queries.

After instrument preset or power-up, the analyzer returns information as decimal values in fundamental units listed in Figure 2-6. However, trace information that has been manipulated with math commands or the MOV command may be returned in other units. (See Internal Processing in Chapter 3.)

| MEASUREMENT TYPE | FUNDAMENTAL UNIT |
|------------------|--------------------------|
| Frequency | Hertz |
| Power | dBm, dBmV, dBuV, or watt |
| Ratio | dB |
| Voltage | Volt |
| Time | Second |
| Current | Amp |
| Impedance | Ohm |

Fig. 2-6. Fundamental units.

Measurement data trace information is returned two different ways, either directly as trace information, or indirectly with the use of markers. The next example marks trace A with a marker and returns the frequency and amplitude values at the marker.

Example: Return marker frequency and amplitude to computer.

(Connect calibration signal to analyzer input.)

```
10 ASSIGN @Sa TO 718
20 CLEAR @Sa
30 OUTPUT @Sa;"IP;SNGLS;TS;"
40 OUTPUT @Sa;"CF 300MHZ;SP 100MHZ;"      !Tune to signal.
50 OUTPUT @Sa;"RL -5DBM;"                 !Set amplitude range.
60 OUTPUT @Sa;"TS;"                       !Take a sweep to update trace.
70 OUTPUT @Sa;"MKPK HI;"                  !Move marker to highest displayed peak.
80 OUTPUT @Sa;"MKF?;"                     !Return marker frequency in Hz to computer.
90 ENTER @Sa;Freq                          !Assign frequency to computer variable, Freq.
100 OUTPUT @Sa;"MKA?;"                     !Return marker amplitude to computer.
110 ENTER @Sa;Ampl                          !Assign amplitude to computer variable, Ampl.
120 Freq=Freq/1.E+6                          Convert frequency from Hz to MHz.
130 PRINT Freq,Ampl
140 END
```

Printed result: 300 -10

Note that each query is followed by a single enter statement. Also note the importance of placing the marker on the appropriate signal peak before querying marker information.

Queries do not decouple analyzer functions that are automatically coupled, such as resolution bandwidth, video bandwidth, and sweep time.

Use the TRA command to return the amplitude value of an entire trace or individual points on the trace. The following examples return the amplitude of the 400th element and all elements in trace A.

Example: Return amplitude of 400th element in trace A.

(Connect calibration signal to analyzer.)

```
10 ASSIGN @Sa TO 718
20 CLEAR @Sa
30 OUTPUT @Sa;"IP;"SNGLS;TS;"
40 OUTPUT @Sa;"CF 305MHZ;SP 100MHZ;"
50 OUTPUT @Sa;"RL -5DBM;"
60 OUTPUT @Sa;"TS;"
70 OUTPUT @Sa;"TRA[400]?;"                 !Return amplitude of 400th element in trace A.
80 ENTER @Sa;Ampl                          !Assign amplitude to controller variable, Ampl.
70 PRINT Ampl                               !Print value of Ampl on designated printer.
80 END
```

Example: Return amplitude values of all elements in trace A to computer.

(Connect calibration signal to analyzer input.)

```
10 DIM Array (1:800)           !Declare array of 800 elements, called Array.
20 ASSIGN @Sa TO 718
30 CLEAR @Sa
40 OUTPUT @Sa;"IP;SNGLS:TS;"
50 OUTPUT @Sa;"CF 305MHz;SP 100MHz;"
60 OUTPUT @Sa;"RL -5DBM;"
70 OUTPUT @Sa;"TS;"
80 OUTPUT @Sa;"TRA?;"         !Return amplitude of all points in trace A.
90 ENTER @Sa;Array (*)       !Assign trace amplitude values to array.
100!
120!
130!
140 END
```

Formats are available that return data in units other than the fundamental units, such as binary. These formats are activated with the MDS (measurement data size) and TDF (trace data format) commands, and are explained in Chapter 3.

Debugging Programs

The debug mode simplifies analysis of faulty programs. When the mode is on, spectrum analyzer commands are displayed on the data line at the bottom of the CRT as they are executed. When a faulty spectrum analyzer command is encountered, subsequent analyzer commands are not executed. The faulty command is the last command shown at the right end of the data line.

The debug mode has a fast and slow setting. Fast debugging executes the program quickly and is useful for trapping errors. Slow debugging executes the program slowly so that you can monitor the execution of each command, much like stepping through a program on a computer.

The debug mode slows execution of analyzer commands and should be turned off when not needed.

The debug mode may be turned on at the front panel or remotely via HP-IB. The DEBUG ON and DEBUG FAST commands select fast debugging. The DEBUG SLOW command selects slow debugging. The DEBUG OFF command turns off the debug mode. Enter a debug command at the beginning of the program section for analysis.

Example: Debugging spectrum analyzer programs.

(Connect calibration signal to input.)

```

10 ASSIGN @Sa TO 718           !Initialize analyzer.
20 CLEAR @Sa
30 OUTPUT @Sa;"IP;SNGLS;TS;"
40 OUTPUT @Sa;"DEBUG SLOW;"    !Activate slow debug mode.
50 OUTPUT @Sa;"CF 300MHZ;SN 100MHZ;" !Analyzer stops at illegal command.
60 OUTPUT @Sa;"TS;"
70 OUTPUT @Sa;"MKPK HI;"
80 END
    
```

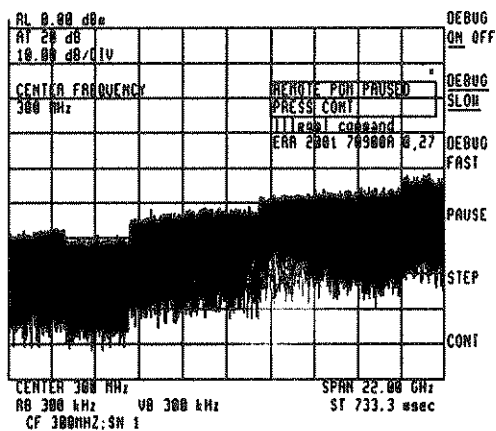

Fig. 2-7. Debug mode trapping a syntax error.

The PAUSE command is another debugging function. When executed, it suspends program operation and activates the debugging softkeys at the front panel. This way, front panel step and continue keys, «STEP» and «CONT», may be used to step through the analyzer program or resume program operation. Once program execution is halted either by command or by error during debug mode, no further remote input is possible until «CONT» or «DEBUG OFF» is pressed or a device clear is sent.

Creating Graphics

Creating custom graphics allows measurement results to be displayed the way you want. The graphics capabilities discussed in this section illustrate how to use spectrum analyzer commands to draw objects and print text anywhere on the display. Also see Chapter 3 in Part III, Display Operation.

Clearing the Display

The spectrum analyzer graphics are usually blanked before drawing graphics. Use the command sequence shown in the following example to clear the display before drawing new graphics.

Example: Clear the display.

```
70 OUTPUT @Sa;"ANNOT OFF;GRAT OFF;"
80 OUTPUT @Sa;"DL OFF;TRDSP TRA OFF;"
90 OUTPUT @Sa;"TRDSP TRB OFF;"
100 OUTPUT @Sa;"TRDSP TRC OFF;"
110 OUTPUT @Sa;"CLRDSPL;"
```

The ANNOT OFF (annotation off) command turns off all of the analyzer annotation except for the display status box and the data line (used in debug mode) on the bottom of the display. Although the graticule is generally turned off, it may be left on as part of the final graphics or you may create your own graticule with the GRID command covered later in this section.

The DL OFF command blanks the display line. The CLRDSPL (clear display) command deletes user-created graphics.

The TRDSPLY OFF (trace display off) command blanks traces A, B, or C. TRDSP also blanks the markers. Blanked traces may still be updated with a new sweep (TS), processed in math operations, or used with the markers just as though the traces were displayed. When developing measurement programs, monitor program operation with the traces displayed before using the TRDSP command.

Some of the commands in the clearing sequence (previous program example) are automatically executed with instrument preset. However, the sequence ensures that all of the graphics on the display are cleared. Thus, execute the sequence after program lines that measure or generate other graphics so that new graphics may be generated properly:

Example: Display-clearing sequence as part of a program.

```
10 ASSIGN @Sa to 718           !Initialize analyzer.
20 CLEAR @Sa
30 OUTPUT @Sa;"IP,SNGLS;TS;"
40 !
50 !                             !Do measurement here.
60 !
70 OUTPUT @Sa;"ANNOT OFF;GRAT OFF;" !Clear the display.
80 OUTPUT @Sa;"DL OFF;TRDSP TRA OFF;"
90 OUTPUT @Sa;"TRDSP TRB OFF;"
100 OUTPUT @Sa;"TRDSP TRC OFF;"
110 OUTPUT @Sa;"CLRDSP;"
120 !                             !Do graphics here.
130 !
140 !
150 END
```

The remaining program examples in this chapter assume that the analyzer has been initialized and its display has been cleared with the commands shown in the above example. Thus, subsequent program examples begin with line 120.

Graphics Origin and Scale

Graphics are drawn on a display 1024 dots wide by 384 dots high. Most graphics are drawn between the lower left position, P1, and the upper right position, P2, when the analyzer has been assigned the full screen as shown in Figure 2-8. P1 and P2 are fixed, non-movable reference points for scaling the display size. In Figure 2-8, P1 is located at the edge of the graticule, just above the data line. P2 is located at the right edge of the graticule at the top of the display. For smaller windows, P1 and P2 are changed.

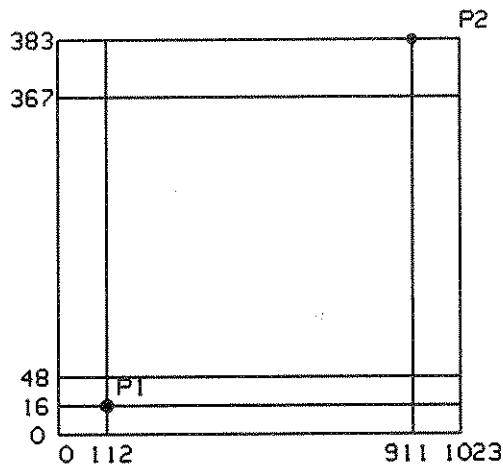

Fig. 2-8. Display Reference Positions.

P1 and P2 have preset values of 0,0 and 1000,1000. This preset coordinate system is shown in Figure 2-9.

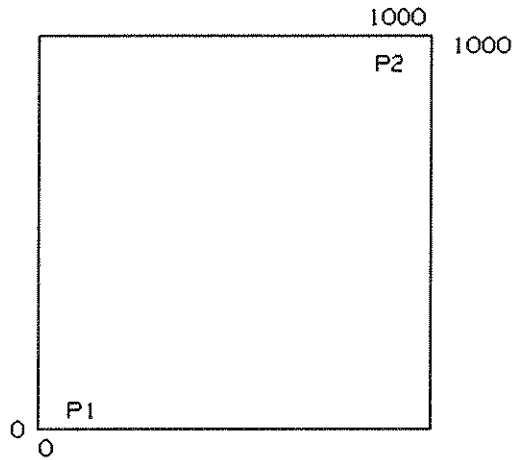

Fig. 2-9. Default display coordinates.

Pen and Plot Commands

Creating graphics is just like using a pen and paper. Graphics are drawn on the display using an imaginary pen on an electronic tablet. The PD (pen down) command allows graphics to be drawn as the pen is moved. The PU (pen up) command allows the pen to be positioned on the display without drawing unwanted lines. When the pen is up, previously drawn graphics are not erased from the display (just as with a pen and paper).

The pen is positioned on the display using plot commands and x-y coordinates. There are two ways to position the pen. The PA (plot absolute) command moves the pen to an absolute position on the display, referenced to P1 and P2. The PR (plot relative) command moves the pen to a position on the display relative to the current pen position.

Coordinates specified with the PA command move the pen to an absolute position on the display. Once PA is executed, a series of x-y coordinate pairs is specified. If several program lines are used to specify coordinate pairs, either the carriage return and line feed must be suppressed at the end of the program line or each new line must begin with a PA command since the carriage return or line feed will terminate the PA command. The following example positions the pen and then draws a rectangle using absolute coordinates.

Example:

```
(Initialize analyzer and clear the display.)
120 OUTPUT @Sa;"PU;PA 0,0;PD;"           !Position pen.
130 OUTPUT @Sa;"PA 300,0,300,200,0,200,0,0;" !Draw rectangle.
140 !
150 END
```

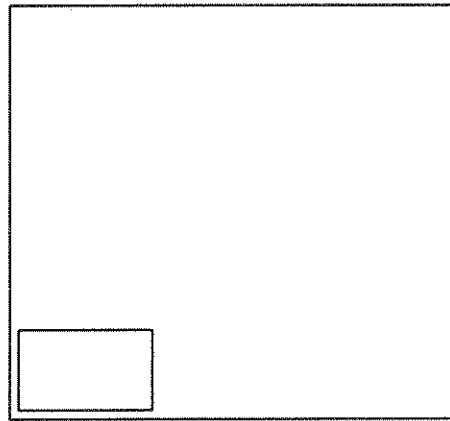

Fig. 2-10. Rectangle drawn with absolute coordinates.

Some graphics solutions are more effectively done using the PR (plot relative) command, which specifies pen movement relative to the current pen position. PR is useful when the same object appears in more than one position on the display. The PA command positions the object on the display, then PR draws the object using relative coordinates. The following example draws the same rectangle as before, this time using PR.

Example:

(Initialize analyzer and clear the display.)

```
120 OUTPUT @Sa;"PU;PA 0,0;PD;"  
130 OUTPUT @Sa;"PR 300,0,0,200,-300,0,0,-200;"  
140 !  
150 END
```

!Position pen.
!Draw rectangle.

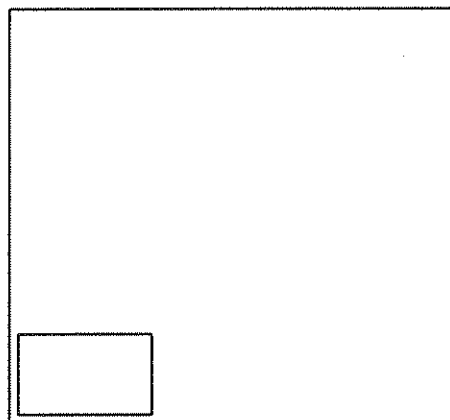

Fig. 2-11. Rectangle drawn with relative coordinates.

The next example shows how easy it is to move the rectangle to different positions on the display.

Example:

(Initialize analyzer and clear the display.)

```
120 FOR N=0 TO 600 STEP 300
130 OUTPUT @Sa;"PU;PA ";N,N;"PD;"
140 OUTPUT @Sa;"PR 300,0,0,200,-300,0,0,-200;"
150 NEXT N
160 END
```

!Position pen.
!Draw rectangle.

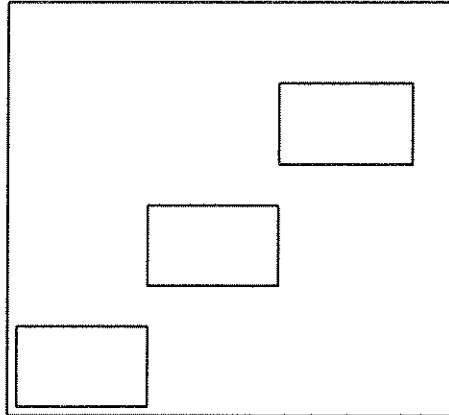

Fig. 2-12. Rectangle repositioned with absolute coordinates.

Line Type and Pen Color

The analyzer draws several different types of lines using the LINET (line type) command. Once the line type is specified, all subsequent lines are drawn with that new type. The next example shows how the line type is used to differentiate the different boxes drawn.

Example:

(Initialize analyzer and clear the display.)

```
120 FOR N=0 TO 750 STEP 150
130 L=L+1
140 OUTPUT @Sa;"LINET ";L;"
150 OUTPUT @Sa;"PU;PA ";N,N;"PD;"
160 OUTPUT @Sa;"PR 300,0,0,200,-300,0,0,-200;"
170 NEXT N
180 END
```

!Change line type.
!Position pen.
!Draw rectangle.

The analyzer also selects plotter pens with the PEN command. Once the pen is selected, all subsequent lines are drawn with that pen. The pen may be used in conjunction with the different line types.

Incorporate PEN commands into your graphics when plotted copies of the display are anticipated. For example, the following program line may be inserted into the previous program example to plot each rectangle in a different color:

```
135 OUTPUT @Sa;"PEN ";L;" !Change pen color.
```

Drawing Grids

The GRID command draws a variable size grid anywhere on the display. The size of each division and the number of divisions are specified with the GRID command. Use the PA command to position the lower left corner of the grid. LINET (line type) and PEN commands may be used to modify the grid. The following example places a 5 division by 4 division grid in the upper right quadrant of the display. (GRID does not work when DWINDOW ON is active.)

Example:

```
(Initialize analyzer and clear the display.)  
120 OUTPUT @Sa;"PU;PA 500,500;PD;"           !Position pen to center of display.  
130 OUTPUT @Sa;"GRID 100,125,5,4;"          !Draw 5x4 division grid.  
140 !  
150 END
```

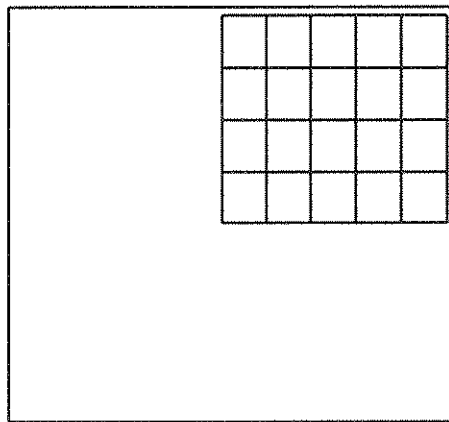

Fig. 2-13.

Writing Text

Writing messages on the display can be done whether or not the spectrum analyzer graphics have been cleared. Messages may be written using either of two commands: TITLE or TEXT.

The TITLE command is the easiest way to label spectrum analyzer displays. Use TITLE to place messages on the title line at the top of the display.

The following example shows how to form a message with the TITLE command and delimiters listed in the HP70900A Language Reference manual, such as \$, %, or @. Note that the message characters must be different than the delimiter chosen.

Example:

```
10 ASSIGN @Sa TO 718                               !Initialize analyzer.  
20 CLEAR @Sa  
30 OUTPUT @Sa;"IP;SNGLS;TS;"  
40 OUTPUT @Sa;"TITLE$YOUR MESSAGE HERES;"         !Display title.  
50 END
```

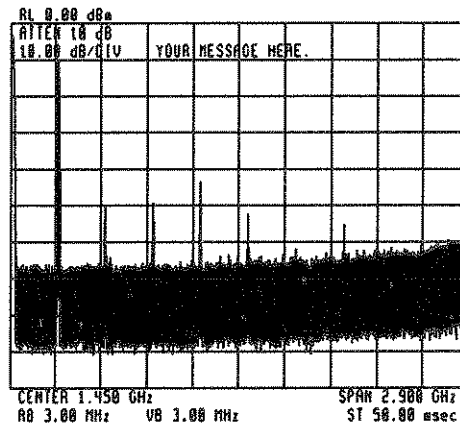

Fig. 2-14. Analyzer Title Line.

The TEXT command places messages anywhere on the display. The next example shows how TEXT is used. The PA command positions the pen, then TEXT prints a message on the display. (TEXT does not work when DWINDOW ON is active.)

Example:

```

10 ASSIGN @Sa TO 718           !Initialize analyzer.
20 CLEAR @Sa
30 OUTPUT @Sa;"IP;SNGLS;TS;"
40 !
50 OUTPUT @Sa;"PU;PA 400,700;PD;" !Position pen.
60 OUTPUT @Sa;"TEXT$YOUR MESSAGE HERE.$" !Print text.
70 !
80 END
    
```

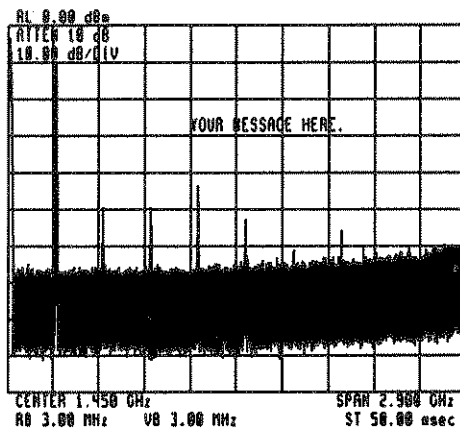

Fig. 2-15. Printing text.

Measurement data (variables) is displayed by using the DSPLY (display variable) command. DSPLY formats the data, specifying the field width and decimal places in the variable. When specifying the field width, be sure to account for the greatest number of characters that will be printed including the sign and decimal point.

The data (a variable) is positioned with the PA (plot absolute) command or it can simply follow a TEXT message. This next example uses the DSPLY and TEXT commands to display the value of the computer variable, Freq.

Example:

(Connect calibration original to analyzer)

```
10 ASSIGN @Sa TO 718 !Initialize analyzer.
20 CLEAR @Sa
30 OUTPUT @Sa;"IP;SNGLS;TS;"
40 !
50 Freq=123 !Assign value to Freq.
60 OUTPUT @Sa;"PU;PA 400,700;PD;" !Position pen.
70 OUTPUT @Sa;"TEXT$The frequency is:$;" !Print a message.
80 OUTPUT @Sa;"DSPLY ";Freq;","7,1;" !Print the value.
90 OUTPUT @Sa;"TEXT$ MHz$;" !Print a label.
100 !
110 END
```

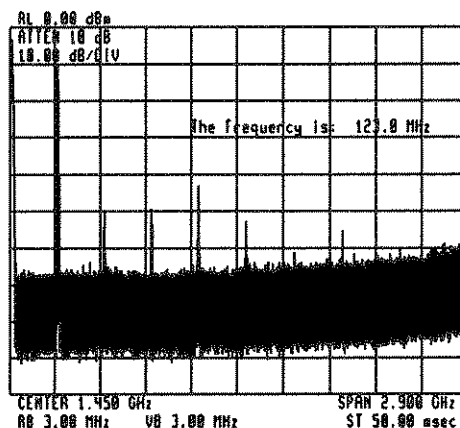

Fig. 2-16.

Use CLRDSP (clear display) to erase any user-created text from the display. ANNOT OFF does not blank text created by the TEXT command.

Creating a Graphics Workspace

A dedicated workspace for displaying messages and measurement data is easily created using the IWINDOW (instrument window) command. This command changes the size of the "window" used by the spectrum analyzer, leaving space for displaying other graphics (lines or text).

The following program uses the IWINDOW command to create a workspace at the top of the display. The program then measures the calibrator signal and two harmonics and displays the amplitudes at the top of the display. Also note how the marker amplitude (MKA) is displayed directly with the DSPLY command.

Example:

(Connect calibration signal to analyzer.)

```

10 ASSIGN @Sa TO 718           !Initialize analyzer.
20 CLEAR @Sa                   !IP clears display.
30 OUTPUT @Sa;"IP;SNGLS;TS;"
40 OUTPUT @Sa;"SP 1MHZ;"
50 !
60 OUTPUT @Sa;"IWINDOW 1000,800;" !Create workspace.
70 OUTPUT @Sa;"PU;PA 0,955;PD;"
80 OUTPUT @Sa;"TEXT$SIGNALS FOUND:$;" !Print heading.
90 !
100 FOR N=1 TO 3
110 OUTPUT @Sa;"CF ";(N*300);"MHZ;TS;" !Measure three signals.
120 OUTPUT @Sa;"MKPK HI;"           !Tune & measure signal.
130 OUTPUT @Sa;"PU;PA 20,";(955-N*45);"PD;" !Position pen.
140 OUTPUT @Sa;"DSPLY ";N,"3,0;"    !Label signal.
150 OUTPUT @Sa;"TEXT$AMPLITUDE = $;"
160 OUTPUT @Sa;"DSPLY MKA,6,1;"     !Print amplitude.
170 OUTPUT @Sa;"TEXT$ dBm$;"
180 NEXT N
190 !
200 LOCAL @Sa
210 END

```

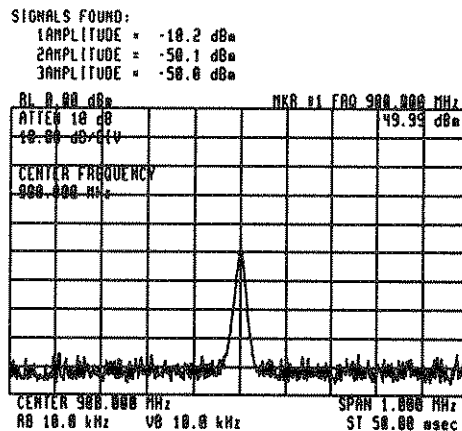

Fig. 2-17. Use IWINDOW to display measurement results.

Printing and Plotting the Display

The PLOT command reproduces the display on a plotter or printer. The softkey labels are also reproduced depending on the setting of the **KEYCOPY ON/OFF** softkey. See the Hardcopy Output section in Chapter 3, Part III.



CHAPTER 3
ADVANCED PROGRAMMING

| | |
|---|--------|
| INTRODUCTION | 3-1 |
| SECTION I. MATH FUNCTIONS, VARIABLES, AND TRACE ARRAYS | 3-3 |
| UNITS | 3-3 |
| VARIABLES AND TRACES | 3-3 |
| MATH AND MOVE COMMANDS | 3-6 |
| USING PRE-DEFINED FUNCTIONS AS OPERANDS | 3-11 |
| USER-SUPPLIED LIMIT TRACES | 3-12.1 |
| SECTION II. TRACE DATA FORMAT | 3-13 |
| FORMAT MODES | 3-13 |
| TDF P: Return Decimal Numbers in Parameter Units | 3-13 |
| TDF M: Return Decimal Numbers in Measurement Units | 3-14 |
| TDF B: Return Binary Numbers in Measurement Units | 3-14 |
| TDF A and TDF I: Return Block-Data Fields in
Measurement Units | 3-14 |
| TRANSMISSION SEQUENCE OF DATA ON THE HP-IB | 3-14 |
| CONTROLLER FORMATS | 3-15 |
| TRACE DATA FORMAT EXAMPLES | 3-16 |
| SECTION III. STORING NEW FUNCTIONS IN THE SPECTRUM ANALYZER | 3-17 |
| CREATING USER-DEFINED FUNCTIONS WITH THE FUNCDEF COMMAND | 3-17 |
| STORING FUNCTIONS IN THE ANALYZER | 3-19 |
| BRANCHING AND LOOPING | 3-21 |
| MEMORY | 3-22 |
| EXECUTING USER-DEFINED FUNCTIONS WITH SOFTKEYS | 3-23 |
| SECTION IV. ADVANCED GRAPHICS | 3-27 |
| DEFINING CRT SCALE UNITS | 3-27 |
| POSITIONING GRAPHICS ON CRT | 3-28 |
| RESIZING COORDINATE SYSTEM | 3-29 |
| ITEMS | 3-33 |
| SECTION V. CONTROLLING SYSTEM OPERATION WITH SERVICE REQUESTS | 3-37 |
| HP-IB INTERRUPT PROCESS | 3-37 |
| ANALYZER STATUS BYTE | 3-37 |
| THE REQUEST-FOR-SERVICE MASK | 3-38 |
| SERVICE REQUEST EXAMPLES | 3-39 |
| SECTION VI. ANALYZER CONTROL OF HP-IB | 3-41 |
| OUTPUT AND ENTER COMMANDS | 3-41 |
| COMPUTER CONTROL VERSUS ANALYZER CONTROL OF HP-IB | 3-41 |



INTRODUCTION

This chapter describes advanced programming techniques. Section I, *Trace Processing, Variables, and Math Functions*, is prerequisite material for the rest of the chapter.

Section I describes the kinds of units that define measurement results. It also describes how to manipulate measurement results and store them as variables and trace arrays in the spectrum analyzer memory.

Section II describes input/output techniques and optional data formats.

Section III tells how to create user-defined functions and softkey menus.

Section IV describes advanced graphics techniques.

Section V describes how to use service requests to interrupt computer operation.

Section VI tells how to use the analyzer as a system controller.



SECTION I. MATH FUNCTIONS, VARIABLES, AND TRACE ARRAYS

The spectrum analyzer processes and stores measurement results that can be displayed on the CRT or manipulated arithmetically. The analyzer contains memory (RAM) where user-defined traces and variables may be stored for future calculation or display on the CRT.

This section describes the internal processing of traces and variables and tells how to manipulate data correctly with the math commands.

UNITS

Measurement results are referenced on the display graticule according to frequency, time, and amplitude. The terms that describe measurement results are *parameter units* and *measurement units*.

Parameter Units

A *parameter unit* is a standard scientific unit. In its preset state, the analyzer returns all measurement results in parameter units. Parameter units for amplitude are as follows:

| DECIBELS | WATTS | VOLTS |
|----------|-------|-------|
| dB | W | V |
| dBm | mW | mV |
| dBmV | uW | uV |
| dBuV | | |

Use the AUNITS command to change the active amplitude units. Other parameter units are seconds, hertz, amperes, and ohms.

Measurement Units

All trace information is stored internally in *measurement units*. For logarithmic trace information, a measurement unit is one hundredth of a dBm:

$$[\text{value in dBm}] \times 100 = \text{measurement units}$$

Thus, a -10 dBm value is equal to -1000 measurement units:

$$-10 \text{ dBm} \times 100 = -1000 \text{ measurement units}$$

Measurement units apply only to entire traces and trace elements. For linear trace information, *measurement units* are defined as 0 (zero) for the bottom of the display, and 10,000 for the top of the screen (reference level).

The measurement-unit range is restricted to integers between +32,767 and -32,768. Since measurement units are restricted to integers, -10.115 dBm equals -1012 measurement units, *not* -1011.5 measurement units because decimal values are rounded to the nearest integer.

$$-10.115 \text{ dBm} \times 100 = -1012 \text{ measurement units (rounded to nearest integer)}$$

The AMPU command converts measurement-unit values to parameter unit values. The MEASU command converts parameter-unit values to measurement-unit values. These commands are discussed later in this section.

Position Units and Trace Elements

The terms that describe trace composition are defined as follows:

Point. A *point*, also called *data point* or *element*, is a fixed location on the horizontal axis of a trace. Each point contains amplitude information. The TRDEF command specifies how many data points a trace contains. However, after initiating instrument preset (IP) or trace preset (TRPST) traces A and B each contain 800 points and trace C contains 3 points.

Position Units. *Position units* describe the position of a point along the horizontal axis of a trace. The point at the left end of the trace has a position unit value of 1. The point at the right end of an 800-point trace has a position-unit value of 800.

The POSU command converts the frequency of a point on a trace to position units. The FREQU command converts a point on a trace indicated in position units to hertz, or in zero span mode, to units of time.

VARIABLES AND TRACES

The spectrum analyzer processes all information as variables and trace arrays. For example, the spectrum analyzer reserves an area in its memory called an array for trace A information. Whenever trace A is swept, the analyzer updates the array with new data. The analyzer also has space in its memory for variables. Whenever a marker is placed on a trace, the analyzer assigns the amplitude value to the variable, MKA.

The spectrum analyzer processes two kinds of variables and traces, *pre-defined* and *user-defined*. Pre-defined variables and traces, like trace A and MKA, exist permanently in the analyzer memory and their preset values are invoked after instrument preset (IP) or power-up. User-defined variables and trace arrays are created by the user, are given preset values, and remain permanently in the analyzer memory, even when power is turned off, unless they are removed with the DISPOSE command.

Variables and traces are discussed individually below.

Variables

Pre-defined variables exist permanently in the analyzer memory. The VARDEF command creates user-defined variables which can be erased from analyzer memory with the DISPOSE command. User-defined variables are from 1 to 14 characters long and are assigned values immediately after VARDEF is executed.

The programs below define a spectrum analyzer variable called FREQUENCY.

Example: Create a user-defined variable.

```
10 ASSIGN @Sa TO 718           !Initialize analyzer.
20 CLEAR @Sa
30 OUTPUT @Sa;"IP;SNGLS;TS;"
40 OUTPUT @Sa;"VARDEF FREQUENCY,0;" !Declare user-defined variable.
50 END
```

Example: Erase user-defined variable.

```
10 OUTPUT @Sa;"DISPOSE FREQUENCY;"
20 END
```

Erase variable from analyzer memory.

Traces

Traces comprise a series of data points that contain amplitude information. Three separate traces may be swept, trace A, B, or C. These are the pre-defined traces that exist permanently in the analyzer memory. The boxed text defines the terms that describe the composition of a trace.

Use the TRDEF command to change the length of these traces from 3 to 1024 data points. Use the IP command to reset the trace lengths to their preset values. Traces A, B, and C have preset lengths of 800 data points.

The following example defines the length of trace C as 1000 data points.

Example: Change trace length.

```
OUTPUT @Sa;"TRDEF TRC,1000;"
```

!Change trace length to 1000 data points.

The TRDEF command also allocates space in memory for user-defined traces. Like traces A, B, and C, their length can be 3 to 1024 data points. Unlike traces A, B, and C, user-defined traces cannot be swept. In the example below, measurement results are transferred to a user-defined trace array.

Example: Store trace A in a user-defined trace.

```
50 OUTPUT @Sa;"TRDEF TRACE_Z, 800;"
60 OUTPUT @Sa;"MOV TRACE_Z,TRA;"
70 END
```

!Create user-defined trace array.
!Copy trace A into TRACE_Z.

Use DISPOSE to erase a trace from analyzer memory.

Example: Erase trace.

```
10 OUTPUT @Sa;"DISPOSE TRACE_Z;" 20 END
```

Do not use pre-defined variable or function names as trace labels. This interrupts the trace-defining process and executes the invoked function instead. For example, substituting the label TEST for TRACE_Z in the previous example invokes the test functions.

MATH AND MOVE COMMANDS

Math and move commands are data-manipulating functions that modify data and store results in the analyzer memory.

Each of these functions modify a value, called the *operand*. The results of the modification are stored in an area of the analyzer memory, called the *destination*. Variables, traces, real numbers, or commands listed in Table 3-2 form the operand(s) of these commands. Only variables or traces can form the destination.

| | FUNCTION | DESTINATION | OPERAND | OPERAND |
|-------------|----------|-------------|---------|---------|
| OUTPUT @Sa; | "SUB | TRB, | TRA, | TRC;" |

The math and move commands comprise the user-operator, trace-math, and trace commands listed in the Language Reference. All the commands operate on an operand on a point-by-point basis.

Below, the MOV command transfers a value from the operand to the destination.

Example: Store center frequency in a user-defined variable.

```
10 ASSIGN @Sa TO 718           !Initialize analyzer.
20 CLEAR @Sa
30 OUTPUT @Sa;"IP;SNGLS;TS;"
50 OUTPUT @Sa;"VARDEF FREQUENCY,0;" !Declare user-defined variable.
60 OUTPUT @Sa;"CF 300 MHZ;"      !Set center frequency value.
70 OUTPUT @Sa;"MOV FREQUENCY, CF;" !Copy value in FREQUENCY.
80 END
```

The next example demonstrates a math command, MPY (multiply). In this example, one of the operands and the destination are formed by the pre-defined variable for center frequency, CF. The other operand is a real number (1.1).

Example: Use the multiply command to increase the center frequency by 10 percent.

```
(Connect calibration signal.)
10 ASSIGN @Sa TO 718           !Initialize analyzer
20 CLEAR @Sa
30 OUTPUT @Sa;"IP;SNGLS;TS;"
50 OUTPUT @Sa;"CF 300MHZ;SP 1MHZ;" !Change analyzer settings.
60 OUTPUT @Sa;"TS;"           !Take a sweep to update trace.
70 OUTPUT @Sa;"MPY CF,CF,1.1;" !Increase center frequency by 10%.
80 OUTPUT @Sa;"WAIT 5;"       !Program pauses for 5 seconds.
90 OUTPUT @Sa;"TS;"           !Take a sweep with new center frequency.
100 END
```

Many math applications require the creation of user-defined variables and traces, which are often used for temporary storage of intermediate results. This leaves the pre-defined variables and traces available for active measurement results. For example, in the previous example, math results are stored in CF. However, since CF always contains the center frequency value, it is updated whenever the center frequency changes. Thus, the math results from the previous example could be lost. The example below avoids this problem by storing results in a user-defined variable.

Example: Store math results in a user-defined variable.

```

10 OUTPUT @Sa;"VARDEF VAR,0;"           !Declare user-defined variable called VAR.
20 OUTPUT @Sa;"MPY VAR,CF,1.1;"         !Multiply 1.1 and CF; send result to VAR.
40 OUTPUT @Sa;"VAR?;"
50 ENTER @Sa;Value                       !Assigns value of CF to computer variable.
60 END

```

Four Rules for Trace Math

Special consideration must be exercised when using the math and move commands with trace arrays and elements. Otherwise, these data-manipulating commands may yield inaccurate results. Follow these four rules to obtain accurate results:

1. To avoid truncation of data, be sure the destination length is equal to or greater than the operand length.
2. Remember that the analyzer truncates numbers greater than +32,767 and less than -32,768 when operating with trace elements.
3. Use the MEASU command to preserve decimal values and yield parameter units.
4. To achieve the best accuracy, use a single point for the destination, such as a trace element or variable.

Let us consider the rules one at a time.

1. To avoid truncation of data, be sure the destination length is equal to or greater than the operand length. The first rule tells us some care must be taken to avoid inadvertent shortening of trace arrays. For example, when an active trace is operated on and stored in a trace of lesser length (that is, of fewer data points), or in a variable, the portion of the trace not stored is lost when it is updated with new sweep information. The example below shows how trace information may be lost when moving a trace array into a shorter trace array. Since the user-defined trace array, TRACE, is shorter than trace A, amplitude information contained in the last 400 data points is lost when trace A is updated.

Example: Move an active trace into a smaller trace array.

(Connect calibration signal to analyzer input.)

```

10 ASSIGN @Sa TO 718                     !Initialize analyzer.
20 CLEAR @Sa
30 OUTPUT @Sa;"IP;SNGLS;TS;"
50 OUTPUT @Sa;"TRDEF TRACE,400;"         !Define user-defined trace with 400 elements.
60 OUTPUT @Sa;"MOV TRACE,TRA;"          !Duplicate amplitude information of
                                         trace A in TRACE.
70 OUTPUT @Sa;"TS;"                     !Update trace A with new sweep information.
80 END

```

When a short trace or variable is operated on and stored in a trace of longer length, the last trace element is extended for operations with the longer length.

2. Remember that the analyzer truncates numbers greater than +32,767 and less than -32,768 when operating with trace elements. Math operations are restricted to the legal range of measurement units when trace arrays or elements form the destination or operand. The two following examples truncate numbers exceeding the legal range. They move the number 32,767 - *not* 100,000 - into the one hundredth element of trace A.

Example: Truncation and the Move command.

```
10 OUTPUT @Sa;"MOV TRA[100],100000;"      !Moves 32,767 into trace element.
```

Example: Truncation of multiplication results.

```
10 OUTPUT @Sa;"MPY TRA[100],1000,1000;"    !Multiplies 1000 times 1000.  
                                             Sends 32,767 to trace element.
```

3. Use the MEASU command to preserve decimal values and yield parameter units. All trace amplitude information is internally stored and manipulated in measurement units. (See UNITS in previous text.) This means a -10 dBm reference-level value is internally converted to -1000 measurement units before it is transferred to a trace element. (Recall that a measurement unit is one hundredth of a decibel.) This process is invisible to the user except in math and move functions where the operand is formed by a variable or real number, and the destination is formed by a trace array or element. In these cases, the operand and destination express numbers in different units, making a conversion necessary. Otherwise, returned data will be inaccurate by a factor of 100 and significant digits may be lost.

The examples below demonstrate how misleading results are obtained if the conversion is neglected. They emphasize that the analyzer will only transfer integer values to a trace element. Subsequent examples show how to transfer correct values.

Example: Rounding of decimal values to integers.

```
10 OUTPUT @Sa: MOV TRA[100],-10.33;"      !Moves -10, not -10.33, to trace element.
```

Example: Rounding of decimal values to integers.

```
10 OUTPUT @Sa;"MOV TRA[100],MKA;"        !Moves -10 into trace element because MKA  
                                             (marker amplitude) equals -10.33.
```

The next example shows how erroneous results are returned to the analyzer if the MEASU conversion is neglected. The example places a marker at the calibration signal peak, which is assumed to be -10 dBm. However, this -10 dBm value becomes -10 measurement units when it is transferred to a trace element with the MOV command. If the amplitude of the element were queried, its level would be -0.1 dB, instead of the correct value, -10 dB.

Example: Return of false trace amplitude level because conversion is omitted.

```
(Connect calibration signal to analyzer input.)
10 ASSIGN @Sa TO 718                !Initialize analyzer.
20 CLEAR @Sa
30 OUTPUT @Sa;"IP;SNGLS;TS;"
50 OUTPUT @Sa;"FA 50MHZ;FB 1050MHZ;" !Change analyzer settings.
60 OUTPUT @Sa;"TS;"                 !Take a sweep to update trace.
70 OUTPUT @Sa;"MKPK HI;"           !Move marker to highest signal peak.
80 OUTPUT @Sa;"MOV TRB[100],MKA;"   !Copy integer value of marker
                                     (-10) into trace B element.
                                     TRB[100] now contains -10
                                     measurement units.
90 OUTPUT @Sa;"TRB[100]?;"         !Returns -0.1 dB. (false value).
100 END
```

Below, the MEASU command preserves decimal values and returns trace amplitude values in parameter units. Note that the conversion in line 80 preserves the decimal values of the marker amplitude.

Example: Return of correct trace amplitude data using the MEASU command.

```
(Connect calibration signal to analyzer input.)
10 ASSIGN @Sa TO 718                !Initialize analyzer.
20 CLEAR @Sa
30 OUTPUT @Sa;"IP;SNGLS;TS;"
50 OUTPUT @Sa;"FA 50MHZ;FB 1050MHZ;" !Change analyzer settings.
60 OUTPUT @Sa;"TS;"                 !Take a sweep with new analyzer settings.
70 OUTPUT @Sa;"MKPK HI;"           !Move marker to highest signal peak.
80 OUTPUT @Sa;"MOV TRB[100],MEASU MKA;" !Convert marker amplitude (-10.33) to
                                     measurement units, then move value
                                     (-1033) into trace element. TRB[100]
                                     now contains -1033 measurement units.
90 OUTPUT @Sa;"TRB[100]?;"         !Returns -10.33.
100 END
```

Here is another example showing how the MEASU command is used to return correct math results. In line 90 below, MEASU converts 10 dB to 1000 measurement units. The program raises the level of trace A by 10 dB.

Example: Add 10 dB to trace A.

```
10 ASSIGN @Sa TO 718                !Initialize analyzer.
20 CLEAR @Sa
30 OUTPUT @Sa;"IP;SNGLS;TS;"
50 OUTPUT @Sa;"FA 50MHZ;FB 1050MHZ;" !Change analyzer settings.
60 OUTPUT @Sa;"TS;"                 !Take a sweep to update trace.
70 OUTPUT @Sa;"WAIT 5;"            !Program pauses for 5 seconds.
90 OUTPUT @Sa;"ADD TRA,TRA,MEASU 10;" !Add 10 dB to trace A.
100 OUTPUT @Sa;"VIEW TRA;"         !View trace A.
110 END
```

Table 3-1 is a list of the math and move commands that may require the use of the MEASU command.

Table 3-1. Math and Move Commands

| | |
|----------|--|
| ABS | Absolute. |
| ADD | Add operands, point by point. |
| AVG | Average. |
| CONCAT | Concatenate trace. |
| DIV | Divide operands, point by point, discard remainder. |
| EXP | Divide operand by scaling factor and raise to power of 10. |
| INT | Compute integer value. |
| LOG | Compute logarithm. |
| MEAN | Compute mean value of data points. |
| MIN | Retain minimum value. |
| MOD | Divide operands, point by point, retain remainder. |
| MOV | Duplicate value(s) contained in operand in destination. |
| MPY | Multiply operands, point by point. |
| MXM | Retain maximum value. |
| RMS | Compute root mean square of operand, point by point. |
| SQR | Compute square root of operand, point by point. |
| STDEV | Compute standard deviation. |
| SUB | Subtract operands, point by point. |
| SUM | Add operands, point by point. |
| SUMSQR | Add square of operands, point by point. |
| VARIANCE | Compute variance. |
| XCH | Exchange operands, point by point. |

4. To achieve the best accuracy, use a single point for the destination, such as a trace element or a variable. If the destination consists of multiple points, the math functions round the operands first, then perform the requested operation. If the destination is a single point, the math functions compute the results in floating point, and then round the results if necessary. The example below shows how the product of 2.45 and 3.45 is 6 or 8 depending on the character of the destination.

Example: Compute product using single and multiple points as destination.

```

10 ASSIGN @Sa TO 718           !Initialize analyzer.
20 CLEAR @Sa
30 OUTPUT @Sa;"IP;SNGLS;TS;"
40 OUTPUT @Sa;"TDF M;"        !Return data in measurement units to computer.
50 !                           (Data formats described in Section II.)
60 OUTPUT @Sa;"MPY TRC,2.45,3.45;" !Fills trace C array with 2 X 3, or 6.
70 OUTPUT @Sa;"TRC[1]?;"      !Returns 6 to computer.
80 OUTPUT @Sa;"MPY TRC[1],2.45,3.45;" !Loads trace element with integer value
                                of 2.45 X 3.45, or 8.
90 OUTPUT @Sa;"TRC[1]?;"      !Returns 8 to computer.
100 END

```

USING PRE-DEFINED FUNCTIONS AS OPERANDS

The commands listed in table 3-2 form a unique set of commands that must be used in one of two ways, as queries or as operands of other analyzer commands.

Table 3-2. Commands Restricted to Operands and Queries

| | |
|---|--|
| <p>AMPU
FREQU
MEAN
MEASU
MEM
PEAKS
POSU
PWRBW
REV
RMS
STB
STDEV
SUM
SUMSQR
VARIANCE</p> | <p>Amplitude unit conversion
Frequency unit conversion
Mean value of data points
Measurement unit conversion
Available memory query
Trace peaks
Position unit conversion
Power bandwidth
Revision number
Root mean square
Status byte query
Standard deviation of trace amplitudes
Sum
Sum of squared values
Variance of data points</p> |
|---|--|

Below, the POSU command is used as a query.

Example: Find marker position in position units.

(Connect calibration signal to analyzer input.)

| | |
|---|---|
| <p>10 ASSIGN @Sa TO 718
20 CLEAR @Sa
30 OUTPUT @Sa;"IP;SNGLS;TS;"
40 OUTPUT @Sa;"CF 300MHZ;SP 1MHZ;"
50 OUTPUT @Sa;"MKPK HI;"

60 OUTPUT @Sa;"POSU MKF,?;"

70 ENTER @Sa;N
80 END</p> | <p>!Initialize analyzer.

!Set analyzer settings.
!Set marker at signal peak
 (center screen).
!Convert marker frequency to
 position units.
!Return position unit value (400).</p> |
|---|---|

The commands in Table 3-2 may be used to form the operands of the commands listed in Table 3-1 only. In the next example, POSU forms the operand of the MOV command.

Example: Forming operands with other analyzer commands.

(Connect calibration signal to analyzer input.)

| | |
|------------------------------------|--|
| 10 ASSIGN @Sa TO 718 | !Initialize analyzer. |
| 20 CLEAR @Sa | |
| 30 OUTPUT @Sa;"IP;SNGLS;TS;" | |
| 40 OUTPUT @Sa;"CF 300MHZ;SP 1MHZ;" | !Set analyzer range. |
| 50 OUTPUT @Sa;"MKPK HI;" | !Set marker at signal peak
(center screen). |
| 60 OUTPUT @Sa;"VARDEF VAR,0;" | !Declare analyzer variable called VAR. |
| 70 OUTPUT @Sa;"MOV VAR,POSU MKF;" | !Convert marker frequency to position
units. Transfer value to VAR. |
| 80 OUTPUT @Sa;"VAR?;" | !Return value, 400, to computer. |
| 90 ENTER @Sa;N | |
| 100 END | |

USER-SUPPLIED LIMIT TRACES

Limit lines are normally generated from a table of line segments created by either front-panel softkeys or the LIMISEG command via a controller. When limit testing occurs, the current limit-line table is converted into two traces, LIMIT_HI and LIMIT_LO. These traces are identical in length to the current trace length and contain, for each trace data point, the proper amplitude of the limit line at that particular frequency. Interpolation techniques are used to fill in the trace data points within the line segments. During one analyzer sweep, LIMIT_HI and LIMIT_LO are used to make point-by-point comparisons to the current trace to perform the limit test.

There are some measurements that require traces LIMIT_HI and LIMIT_LO be created manually instead of converted from a table of segments by the analyzer. This is useful for limit tests in which a known reference trace (i.e., "golden device") is stored with specified positive and negative dB offsets in LIMIT_HI and LIMIT_LO. Limit testing will then compare subsequent devices to the known reference. Some measurements require limit lines that are complex, continuous curves that are difficult to create with the 20 available line segments. These complex test limits can be created by making a copy of the reference trace and specifying an upper and lower offset relative to the reference trace.

Use the following procedure to create your own LIMIT_HI and LIMIT_LO traces.

1. Delete the current limit-line table using the remote command: LIMIDEL;
2. Create both traces the same size as the current trace(s):

```
TRDEF LIMIT_HI, 800;
TRDEF LIMIT_LO, 800;
```
3. Fill the traces with the comparison data. One example is:

```
CLRW TRA;                (prepare trace A for swept data)
TS;                      (take a sweep of data)
ADD LIMIT_HI, TRA, MEASU 10 DBM;
                          (LIMIT_HI = trace A + 10 dBm)
SUB LIMIT_LO, TRA, MEASU 10 DBM;
                          (LIMIT_LO = trace B - 10 dBm)
```
4. Initiate limit testing: LIMITEST ON;

Notes

- * When using the procedure described above, both LIMIT_HI and LIMIT_LO traces must be created. Also, there can be no existing segments in the current limit-line table.
- * LIMIT_HI and LIMIT_LO, when created manually as described above, are not rescaled when frequency span, center frequency, reference level, log/division, or trace lengths change. You must recompute them yourself.
- * LIMIT_HI and LIMIT_LO traces are not automatically displayed on the screen. They can be viewed by two methods: 1) by using the MOV command to move them into traces B and C and display TRB and TRC using the VIEW command, or 2) by using the graphics commands (e.g., SCALE and GRAPH commands).
- * When you begin adding segments to the limit-line table, either by using the LIMISEG command or entering them via the front-panel, LIMIT_HI and LIMIT_LO are automatically used by the analyzer again. Therefore, the LIMIT_HI and LIMIT_LO traces that were created manually (per step 3 of the procedure above) are overwritten.

SECTION II. TRACE DATA FORMAT

The spectrum analyzer returns all output data, except trace information as decimal values. The TDF (trace data format) command formats trace amplitude information in five different ways. The output formats are summarized in Table 3-3. (Parenthetical numbers in the table are decimal values representing binary, 8-bit numbers.)

Table 3-3. Trace Data Output Formats for Amplitude Information

| Spectrum Analyzer Output | Command | Trace Element Output:
Amplitude of +10 dBm |
|---|---------|---|
| Returns ASCII decimal value. Values are in parameter units. Data output is followed by line-feed (ASCII code 10) and end-or-identify (EOI). | TDF P | +10.00 |
| Returns ASCII integer value. Values are in measurement units. Line feed (ASCII code 10) and EOI follow data output. | TDF M | +1000 |
| Returns binary value as two 8-bit bytes, the most significant byte first. Values are in measurement units. Asserts EOI with last byte. | TDF B | (3) (232) |
| Sends series of 8-bit bytes (A-block data field). Data preceded by "#" and "A" and length of data field. Data followed by line feed (ASCII code 10) and EOI. Values are in measurement units. | TDF A | (#)(A) (0) (2) (3)(232)
(number of data bytes) |
| Sends a series of 8-bit bytes (I-block data field). Data is preceded by "#" and "I." Values are in measurement units. Asserts EOI with last byte. | TDF I | (#) (I) (3) (232) |

FORMAT MODES

The trace data format (TDF) command controls the format of trace amplitude data at the analyzer HP-IB output. All the format modes return amplitude information in *measurement units* except for one, TDF P, which returns *parameter units*. (See *UNITS* in section I of this chapter.)

TDF P: Return Decimal Numbers in Parameter Units

The TDF P command transmits data as ASCII decimal values in parameter units. Instrument preset (IP) automatically activates the mode, and the AUNITS (amplitude units) command specifies the kind of parameter units. The default units are volts for linear trace information and dBm for logarithmic trace information.

A line feed (ASCII code 10) follows data output. The end-or-identify state (EOI) is asserted with line feed.

The TDF P mode is convenient because it returns parameter-unit values, but it is the slowest of the data-format modes.

TDF M: Return Decimal Numbers in Measurement Units

The TDF M command transmits data as ASCII integer values in measurement units. A line feed (ASCII code 10) follows data output. The end-or-identify state (EOI) is asserted with line feed.

The measurement-unit mode is faster than the parameter-unit mode (TDF P), but requires conversion to parameter units.

TDF B: Return Binary Numbers in Measurement Units

The TDF B command transmits data in measurement units as binary numbers. Numbers are usually transmitted as words (two 8-bit bytes). The most significant byte is sent first, followed by the least significant byte. EOI is asserted with the last byte.

Most Significant Byte
XXXXXXXX

Least Significant Byte
XXXXXXXX

The measurement data size command (MDS) may be used to consolidate the information contained in two-byte words into one byte (MDS B). However, since trace math operations often produce numbers too large to be contained in one byte, the use of bytes instead of words as the data size is not recommended, especially during trace math operations. Instrument preset (IP) selects words as the default data size.

TDF A and TDF I: Return Block-Data Fields in Measurement Units

The TDF A and TDF I commands activate the absolute and indefinite block-data format modes. Both modes return the same kind of data, binary words (MDS W) or bytes (MDS B) in block form. However, the TDF A mode precedes the data block with "# A" and a value that specifies the number of bytes in the block. TDF I precedes the data block with "# I" and asserts EOI with the last byte of data in the block. Instrument preset (IP) selects words as the default data size.

The block-data format modes are available for compliance with IEEE standards. These modes have the same limitations as the binary format mode when bytes are chosen as the measurement data size.

TRANSMISSION SEQUENCE OF DATA ON THE HP-IB BUS

Table 3-4 shows an HP-IB transmission sequence for each format mode. Each mode transmits the +10 dBm amplitude level of a trace element. Remember that even though the analyzer transmits binary or ASCII information on HP-IB, a decimal number is always returned to the Hewlett-Packard series 200 controller display. The parenthetical numbers in the table are decimal values representing binary, 8-bit numbers.

Table 3-4. HP-IB Transmission Sequence

| Format | TDF P | TDF M | TDF B | TDF A | TDF I |
|--------|----------|----------|-----------|-------------------|-----------|
| Byte 1 | 1 | 1 | (3) | # | # |
| Byte 2 | 0 | 0 | (232-EOI) | (A) | (I) |
| Byte 3 | . | 0 | | (0) | (3) |
| Byte 4 | 0 | 0 | | (2) | (232-EOI) |
| Byte 5 | 0 | 10 (EOI) | | (3) | |
| Byte 6 | 10 (EOI) | | | (232)
(10-EOI) | |

CONTROLLER FORMATS

The format of the controller must be compatible with the output format of the analyzer. The following table and programming examples illustrate this concept.

Table 3-5. Controller Formats

| Analyzer Format | Controller Format Requirements | Example Statement |
|-----------------|------------------------------------|---|
| TDF M | Free field | ENTER 718;Amplitude |
| TDF P | Free field | ENTER 718;Amplitude |
| TDF B | Binary. Read twice for each value. | ASSIGN @Sa TO 718;FORMAT OFF
ENTER @Sa USING "#,W";Z(*) |
| TDF A | | ASSIGN @Sa TO 718;FORMAT OFF
ENTER @Sa;Poundi,Num_bytes
ALLOCATE INTEGER Z(1:Num_bytes/2)
ENTER @Sa;Z(*) |
| TDF I | | ASSIGN @Sa TO 718;FORMAT OFF
ENTER @Sa;Poundi
ENTER @Sa USING "#,W";Z(*) |

TRACE DATA FORMAT EXAMPLES

Example: Parameter-unit format with decimal values (TDF P).

```
10 ASSIGN @Sa TO 718
20 OUTPUT @Sa;"TDF P;"
30 OUTPUT @Sa;"TRA[10]?;"          !Return amplitude of trace element
                                   in parameter units.
40 ENTER @Sa;N                    !Assign value (-10.33) to N.
50 END
```

Example: Measurement-unit format with integer values (TDF M).

```
10 ASSIGN @Sa TO 718
20 OUTPUT @Sa;"TDF M;"          !Activate measurement-unit format.
30 OUTPUT @Sa;"TRA[10]?;"      !Return amplitude of trace element
                                   in measurement units.
40 ENTER @Sa;N                  !Assign value (-1033) to N.
50 END
```

Example: Binary format with data size of one word (TDF B).

```
10 INTEGER Z(1:800)             !Declare integer array.
20 ASSIGN @Sa TO 718
30 ASSIGN @Sa_fast TO 718;FORMAT OFF !Assign (fast) I/O path to 718.
40 OUTPUT @Sa;"MDS W;"         !Define word as data size.
50 OUTPUT @Sa;"TDF B;"        !Activate binary data format.
60 OUTPUT @Sa;"TRA?;"        !Return amplitude of all trace
                                   elements in measurement units.
70 ENTER @Sa_fast USING "#,W";Z(*) !Load binary values into array Z. "#" specifies
                                   that line execution is terminated when last
                                   ENTER item is terminated. "W" specifies that
                                   items loaded are words (two bytes).
80 END
```

Example: Block data format with data size of one word (TDF A).

```
10 INTEGER Pounda,Num_bytes     !Declare integer array.
20 ASSIGN @Sa TO 718
30 ASSIGN @Sa_fast TO 718;FORMAT OFF !Assign (fast) I/O path to 718.
40 OUTPUT @Sa;"MDS W;"         !Declare word as data size.
50 OUTPUT @Sa;"TDF A;"        !Activate absolute block-data format
60 OUTPUT @Sa;"TRA?;"        !Return amplitude of all trace elements.
70 ENTER @Sa_fast;Pounda,Num_bytes !Assign #A to Pounda. Assign length,
                                   i.e. number of bytes in block, to
                                   Num_bytes. (Temporary variables.)
80 ALLOCATE INTEGER A(1:Num_bytes/2) !Declare array with length of Num_bytes/2.
90 ENTER Sa_fast A(*)          !Load block data into array A.
100 END
```

SECTION III. STORING NEW FUNCTIONS IN THE SPECTRUM ANALYZER

This section tells how to store series of commands in the spectrum analyzer to form new, custom-made functions called user-defined functions.

User-defined functions have many applications. They are ideal for repetitive measurements and make it possible to conduct complicated measurements with the press of a single front panel key.

When a user-defined function operates, it does not suspend HP-IB activity. Thus, the computer is free to control other devices on the bus while the analyzer measures, processes, and stores data. When the analyzer is part of a large scale measurement system, this makes more computer processing time available.

In addition, the operation of user-defined functions does not require a computer; the functions may instead be activated with the analyzer keys. This is useful in small-scale test systems, where custom soft-key menus help create a friendly user interface to simplify test procedures.

This section tells how to create user-defined functions with the define-functions command (FUNCDEF) and assign soft keys to user-defined functions. It describes how to enhance functions with the looping and conditional constructs REPEAT/UNTIL and IF/THEN/ELSE.

CREATING USER-DEFINED FUNCTIONS WITH THE FUNCDEF COMMAND

The FUNCDEF (define function) command consolidates a series of analyzer commands into one function and gives it a name. Executing the function name is the same as executing the series of commands contained in the function.

Before a function can be executed, it must be stored in the analyzer. The example below stores a user-defined function called HIGH_PEAK in the analyzer.

Example: Store function in analyzer.

(Connect calibration signal to analyzer.)

```
10 ASSIGN @Sa TO 718
```

```
20 CLEAR @Sa
```

```
30 OUTPUT @Sa;"IP;SNGLS;TS;"
```

```
40 OUTPUT @Sa;"FUNCDEF HIGH_PEAK,@"
```

!Delimiter marks beginning of command list assigned to HIGH_PEAK.

```
50 OUTPUT @Sa;"FA 50 MHZ;FB 1GHZ;"
```

```
60 OUTPUT @Sa;"TS;MKPK HI;"
```

```
70 OUTPUT @Sa;"@"
```

!Matching delimiter marks end of command list.

```
80 END
```

Once HIGH_PEAK is stored in the analyzer, it can be executed in several ways. To execute HIGH_PEAK via remote control, incorporate it into an output statement as you would any spectrum analyzer command. Like other spectrum analyzer commands, user-defined functions require a terminating semicolon:

```
10 OUTPUT @Sa;"IP;HIGH_PEAK;"
```

User-defined functions may also be executed with the front panel keys. See *Executing User-Defined Functions with Soft Keys* at the end of this section.

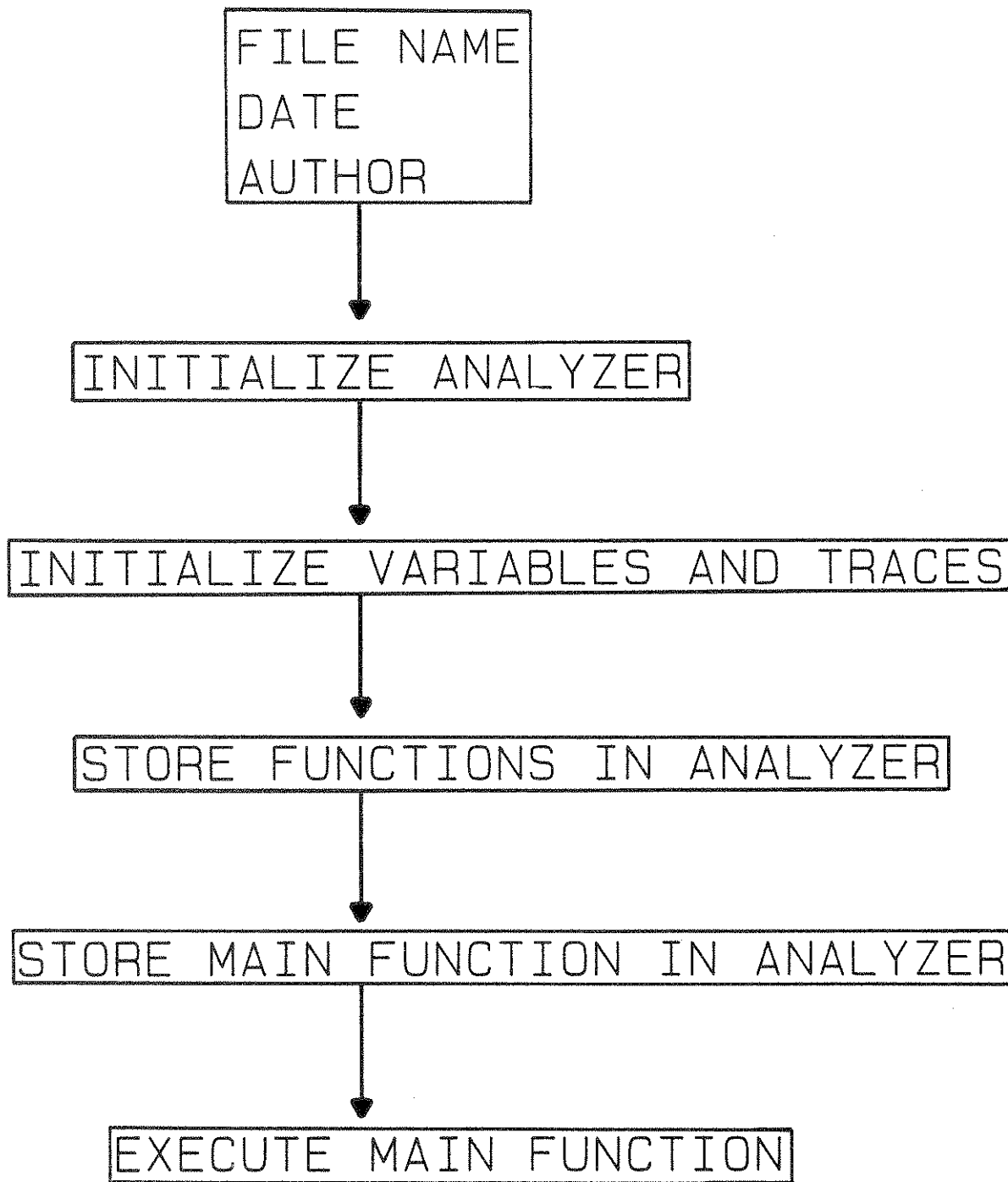

FIGURE 3-1. PROGRAM STRUCTURE

Illegal Operations

Executing a user-defined function within the FUNCDEF statement that defines it is an illegal recursion that must be avoided:

```
10 OUTPUT @Sa;"FUNCDEF SELECT_SPAN,@"
20  OUTPUT @Sa;"FA 500MHZ;FB 1GHZ;"
30  OUTPUT @Sa;"SELECT_SPAN;"
40 OUTPUT @Sa;"@";
50 END
```

Illegal recursion

It is also illegal to nest FUNCDEF commands:

```
10 OUTPUT @Sa;"FUNCDEF ONE,@"
20 OUTPUT @Sa;"FA 10MHZ;FB 10GHZ;"
30  OUTPUT @Sa;"FUNCDEF TWO,@FA 20MHZ;FB 20GHZ;@";
40 OUTPUT @Sa;"@";
```

Do not use existing function names or secondary key words as user-defined functions. This interrupts the defining process and executes the invoked function instead. For example, if the user-defined function in the previous example was called "SS" instead of "SELECT_SPAN," the analyzer step size function would be activated. Likewise, if the function was called "ALL," it would disrupt the operation of any function modified by ALL, such as DISPOSE ALL.

STORING FUNCTIONS IN THE ANALYZER

The easiest way to store new functions in the analyzer is with a computer program. Figure 3-1 illustrates an efficient program structure that simplifies the process. The model simplifies debugging and documentation and conserves analyzer memory.

In the model, the first part tells what the program does and gives other appropriate information such as the author's name, the date, and a file name if the program is stored on a disc.

The second part initializes the analyzer in order to form a good starting point for measurements. CLEAR @Sa and IP set the analyzer to a known state. DISPOSE ALL clears user-memory to maximize storage space for functions, variables, and traces.

The third part defines all user-defined variables and traces that are utilized by any of the user-defined functions. It specifies a size for each trace and a value for each variable. Always define variables and traces apart from any user-defined functions. This avoids memory overflow problems. For instance, if the initialization of several traces is made part of a function definition, analyzer memory is not allocated to the traces until the function has been executed. Thus, if available memory is checked (with the MEM? command or the ◀SHOW CATALOG▶ key) before the function has been run, the value returned accounts only for the space occupied by the function, not for the space occupied by the function *plus* the traces.

The fourth part is reserved for user-defined functions that are incorporated into and executed by a main user-defined function, which is the last part of the program. When a series of commands are consolidated in a function, they can be executed many times, even though they are stored in the analyzer only once. This conserves analyzer memory and simplifies programming.

The following example illustrates this program structure. Note that the sub-function called VIEW_SIGNAL is executed twice in the main function, SCAN.

ADVANCED PROGRAMMING
SECTION III. STORING NEW FUNCTIONS IN THE SPECTRUM ANALYZER

```
10 FILE NAME: Peaks DATE: 4/1/85 AUTHOR: Name
20 !
30 !PROGRAM DESCRIPTION:
40 !View the largest signal in two frequency ranges using a narrow
50 !spanwidth. Store the amplitude level of the largest signal of
60 !each range.
70 !
80 !Program begins here. . .
90 !
100 !INITIALIZE ANALYZER
105 !
110 ASSIGN @Sa TO 718
120 CLEAR @Sa
130 OUTPUT @Sa;"IP;SNGLS;TS;"
135 OUTPUT @Sa;"DISPOSE ALL;"
140 !
150 !INITIALIZE VARIABLES AND TRACES
160 !
170 OUTPUT @Sa;"VARDEF AMP_A,0;"
180 OUTPUT @Sa;"VARDEF AMP_B,0;"
190 !
200 !STORE SUB-FUNCTIONS IN ANALYZER
210 !
220 !Place marker on largest signal and view it with narrow spanwidth:
230 OUTPUT @Sa;"FUNCDEF VIEW_SIGNAL,@"
240 OUTPUT @Sa;"TS;MKPK HI;"
250 OUTPUT @Sa;"MKTRACK ON;TS;"
260 OUTPUT @Sa;"SP 100KHZ;"
270 OUTPUT @Sa;"@";
280 !
290 !STORE MAIN FUNCTION IN ANALYZER
292 !
295 ! Select two frequency ranges, execute VIEW_SIGNAL function and
297 ! store amplitude data in analyzer:
298 OUTPUT @Sa;"FUNCDEF SCAN,@"
300 OUTPUT @Sa;"IP;"
310 OUTPUT @Sa;"FA 50MHZ;FB 400MHZ;"
320 OUTPUT @Sa;"VIEW_SIGNAL;"
330 OUTPUT @Sa;"MOV AMP_A,MKA;"
340 !
350 OUTPUT @Sa;"WAIT 2;"
360 !
370 OUTPUT @Sa;"FA 500MHZ;FB 1 GHZ;"
380 OUTPUT @Sa;"VIEW_SIGNAL;"
390 OUTPUT @Sa;"MOV AMP_B,MKA;"
400 OUTPUT @Sa;"@";
410 !
420 !EXECUTE MAIN FUNCTION
422 !
425 OUTPUT @Sa;"SCAN;"
430 END
```

Here are some additional guidelines for writing user-defined functions:

1. Write short program lines, and document them when necessary.
2. Indent program lines to mark sub-functions and points of looping and branching.
3. Use descriptive labels for variables, functions, and traces.
4. Define all variables and traces at the beginning of the program, not within a FUNCDEF definition.
5. Use recommended syntax shown in Language Reference.

BRANCHING AND LOOPING

Use the IF/THEN/ELSE and REPEAT/UNTIL commands to add decision-making and looping capability to user-defined functions.

The example below tests the marker amplitude, MKA. If MKA is greater than -10 dBm, the amplitude is displayed.

Example: Conditional branching.

```
60 OUTPUT @Sa;"IF MKA,GT,-10DBM;THEN DSPLY MKA;"
70 OUTPUT @Sa;"ENDIF;"
```

The example below illustrates multiple conditional branching. If MKA is greater than -10 dBm or less than -30 dbm, its value is displayed. Otherwise, the message "SIGNAL WITHIN TOLERANCE" is displayed.

Example: Multiple conditional branching.

```
60 OUTPUT @Sa;"IF MKA,GT,-10DBM;THEN;DSPLY MKA;"
70 OUTPUT @Sa;"ELSIF MKA,LT,-30DBM;THEN;DSPLY MKA;"
80 OUTPUT @Sa;"ELSE TEXT $SIGNAL WITHIN TOLERANCES$;"
90 OUTPUT @Sa;"ENDIF;"
```

The next example illustrates a repeat/until loop. Repetition is controlled with a user-defined variable, N, which incrementally increases each time the loop is repeated. The example stores the amplitudes of the three largest signals in the first three elements of a trace array. In addition, N doubles as a pointer that specifies where data is stored in the trace array.

Example: Repeat/Until looping construct.

(Connect calibration signal to analyzer.)

| | |
|----------------------------------|-------------------------------------|
| 10 ASSIGN @Sa TO 718 | !Initialize analyzer. |
| 20 CLEAR @Sa | |
| 30 OUTPUT @Sa;"IP;SNGLS;TS;" | |
| 40 OUTPUT @Sa;"DISPOSE ALL;" | |
| 50 ! | |
| 60 OUTPUT @Sa;"TRDEF TR_AMP,10;" | !Define 10 element trace, TR_AMP. |
| 70 OUTPUT @Sa;"VARDEF N,0;" | !Define variable, N, as equal to 0. |
| 80 ! | |

| | |
|---|---|
| 90 OUTPUT @Sa;"MKPK HI;" | !Place marker on highest peak. |
| 100 OUTPUT @Sa;"REPEAT;" | !Begin repeat loop. |
| 110 OUTPUT @Sa;"ADD N,N,1;" | !Add 1 to N. |
| 120 OUTPUT @Sa;"MKPK NH;" | !Move marker to next highest peak. |
| 130 OUTPUT @Sa;"MOV PEAK[N],MEASU MKA;" | !Store amplitude in nth element of trace. |
| 140 OUTPUT @Sa;"UNTIL N,EQ,3;" | !Define end of repeat loop. Looping |
| 150 END | ends when N equals 3. |

MEMORY

All user-defined functions, variables, traces, and registers occupy memory in the analyzer. Items may be stored in the memory until it is full, in which case a memory-overflow message appears on the screen. A complete listing of all stored items is displayed on the analyzer screen when the following front panel keys are pressed:

```
[MENU]
<INSTR DISPLAY>
<SHOW CATALOG>
```

Variables, traces, and functions are listed by name on the screen. The number of bytes that each item occupies appears at its right. The amount of unused memory is also listed and may be queried with the MEM? command.

Items are erased from memory singly or in mass with the DISPOSE command:

Example: Erasing memory

```
10 OUTPUT @Sa;"DISPOSE HIGH_PEAK;" !Dispose of single user-defined function.
10 OUTPUT @Sa;"DISPOSE ALL;" !Dispose of all user-defined functions, variables, and traces.
```

DISPOSE erases user-defined traces, variables, functions, and soft keys, and any command lists defined with the ONEOS command. Items not erased are the contents of the state registers or traces A, B, and C.

Available analyzer memory is increased by erasing all user-defined traces, variables, functions, and trace registers, as follows:

| | |
|--------------------------------------|--|
| 10 OUTPUT @Sa;"DISPOSE ALL;" | !Disposes all user-defined variables, traces, functions, and associated soft keys. |
| 20 OUTPUT @Sa;"PSTATE OFF;NSTATE 0;" | !Disables trace-register protect mode, then clears registers. |

The amount of available memory varies with the system configuration. If memory space is critical, it may be conserved in several ways. First, erase unneeded traces, variables, and functions using DISPOSE, or reduce trace size using TRDEF. An 800 element trace occupies 1646 bytes of memory, that is, 2 bytes for each element and 46 bytes for trace overhead. Use the NSTATE command to eliminate unneeded state registers.

After DISPOSE ALL and NSTATE 0 are executed, the analyzer has at least 32 Kbytes of memory available for storage of user-defined traces, functions, and variables, and ONEOS and AMPCOR algorithms. Up to 300 user-defined traces, variables, and functions can be stored in the analyzer at one time.

Additional memory is permanently reserved for storage of all amplitude information in traces A, B, and C when they are configured at their maximum length, which is 1024 elements for each trace.

Analyzer memory is configured at the factory with a diagnostics routine. To make the memory it occupies available for other applications, follow this procedure:

*** NOTE ***

The following procedure erases *all* contents of user memory, such as user-defined traces, variables, and functions.

| | |
|----------------------------------|---|
| 10 ASSIGN @Sa TO 718 | Initialize analyzer. |
| 20 CLEAR @Sa | |
| 30 OUTPUT @Sa;"PROTECT ALL,OFF;" | Remove erasure protection. |
| 40 OUTPUT @Sa;"DISPOSE ALL;" | Purge <i>all</i> contents of user-memory. |
| 50 END | |

Use the PROTECT command to prevent unintentional disposal or modification of stored user-defined traces, variables, functions, and softkeys with the DISPOSE, TRDEF, VARDEF, FUNCDEF, and KEYDEF commands.

**FIRMWARE
VERSIONS
861015
OR
LATER**

*** NOTE ***

The protect command does not prevent memory erasure with the ERASE command. ERASE always erases all user memory, even if PROTECT has been executed.

Use the USTATE command to store the contents of the analyzer memory in a computer for future recall. When returning memory contents to the analyzer, be sure that the length of traces, A, B, and C are long enough to contain all returning amplitude information before executing USTATE.



User-defined functions may be streamlined to conserve analyzer memory. The space they occupy is reduced by inhibiting the carriage-return/line-feed (CR/LF) generated by the computer at the end of each program line. The HIGH_PEAK function is shown below with carriage-return/line-feed suppressed. Using this configuration, PEAK occupies 14% less memory space, or 30 bytes instead of 36.

Example: Suppressed carriage-return/line-feed.

(Connect calibration signal to analyzer.)

```
10 ASSIGN @Sa TO 718
20 CLEAR @Sa
30 OUTPUT @Sa;"IP;DISPOSE ALL;"
40 OUTPUT @Sa;"FUNCDEF HIGH_PEAK,@";           !Semicolon added to suppress CR/LF.
50 OUTPUT @Sa;"FA 50 MHZ;FB 1GHZ;";           !Semicolon added to suppress CR/LF.
60 OUTPUT @Sa;"TS;MKPK HI;";                 !Semicolon added to suppress CR/LF.
70 OUTPUT @Sa;"@";
80 END
```

EXECUTING USER-DEFINED FUNCTIONS WITH SOFT KEYS

User-defined functions are activated with the analyzer front panel keys in several ways. One way is with the analyzer ◀ENTER▶ key:

Press [USR]
Press ◀Special Functions▶

Press ◀ENTER COMMAND▶, then spell out the command name. For example, the HIGH_PEAK function is executed by sequentially positioning the cursor underneath the characters H-I-G-H- _P-E-A-K contained in the alphabet shown on the analyzer screen. Press ◀ENTER ALPHA▶ for each new cursor position. As each letter is entered, it appears in the *data line* at the bottom of the analyzer screen.

After HIGH_PEAK is entered into the command line, press ◀EXECUTE LINE▶.

The KEYDEF command simplifies front panel execution of user-defined functions by assigning a function to an analyzer soft key. Up to 14 soft keys can be displayed on the analyzer screen at one time. The keys are numbered 1 through 14, keys 1 and 8 occupying the upper right and left corners respectively. Below, the PEAK function is assigned to a new key, called "FIND PEAK."

Example: Assign function to softkey.

```
10 OUTPUT @Sa;"KEYDEF 7,HIGH_PEAK,$FIND PEAK$;" !Specify key number, function,
                                                and label.
```

The READMENU command facilitates the creation of soft key menus. In the next example, READMENU works with the IF/THEN/ELSE commands to build a soft key menu that activates three different frequency ranges, called bands A, B, and C. Whenever a key is pressed, the READMENU command transfers the key number to a user-defined variable. The IF/THEN/ELSE commands then test the key number and activate the associated function. The REPEAT/UNTIL commands repeat the key testing process until the exit key is pressed.

Example: Use READMENU command to build soft key menus.

```
10 ASSIGN @Sa TO 718                                !Initialize analyzer.
20 CLEAR @Sa
30 OUTPUT @Sa;"IP;DISPOSE ALL;"
32 !
35 !
40 !
50 OUTPUT @Sa;"FUNCDEF BANDA,@FA 10MHZ;FB 500MHZ;@" !Declare key functions.
60 OUTPUT @Sa;"FUNCDEF BANDB,@FA 500MHZ;FB 1GHZ;@"
70 OUTPUT @Sa;"FUNCDEF BANDC,@FA 1GHZ;FB 1.5GHZ;@"

80 !
82 !
85 !
90 OUTPUT @Sa;"VARDEF KEY,0;"                        !Declare variable for storing key number.
100 OUTPUT @Sa;"VARDEF END_LOOP,0;"                 !Declare variable for monitoring REPEAT loop.
110 !
115 !
117 !
120 OUTPUT @Sa;"REPEAT;"                            !Begin REPEAT loop.

125 ! Assign labels to soft keys 1, 2, 3, and 14. Store pressed-key number in variable, KEY:
127 !
130 OUTPUT @Sa;"READMENU KEY,1,$BAND A$,2,$BAND B$,3,$BAND C$,14,$EXIT$;"
135 !
140 OUTPUT @Sa;"IF KEY,EQ,1;THEN;BANDA;"           !Evaluate KEY to execute function.
150 OUTPUT @Sa;"ELSIF KEY,EQ,2;THEN;BANDB;"
160 OUTPUT @Sa;"ELSIF KEY,EQ,3;THEN;BANDC;"
170 OUTPUT @Sa;"ELSIF KEY,EQ,14;"                  !When key 14 is pressed, END_LOOP
180 OUTPUT @Sa;"THEN MOV END_LOOP,1;"              contains a "1" and ends loop.
190 OUTPUT @Sa;"ENDIF;"
200 OUTPUT @Sa;"UNTIL END_LOOP,EQ,1;"
210 END
```

With further use of the READMENU, KEYDEF, and FUNCDEF commands, you may assign a soft-key menu to a soft key that can be activated by yet another soft key, thus creating multi-level menus. The above example has been altered slightly in the next example to demonstrate one way of assigning a menu to another soft key. The entire program algorithm is incorporated into a user-defined function, which in turn is assigned to a single soft key (SELECT_SPAN).

Example: Use READMENU, KEYDEF, and FUNCDEF to build multi-level menus.

```

10 ASSIGN @Sa TO 718                                !Initialize analyzer.
20 CLEAR @Sa
30 OUTPUT @Sa;"IP;DISPOSE ALL;"
40 !
42 !
45 !
50 OUTPUT @Sa;"FUNCDEF BANDA,@FA 10MHZ;FB 500MHZ;@" !Declare key functions.
60 OUTPUT @Sa;"FUNCDEF BANDB,@FA 500MHZ;FB 1GHZ;@"
70 OUTPUT @Sa;"FUNCDEF BANDC,@FA 1GHZ;FB 1.5GHZ;@"

80 !
82 !
85 !
90 OUTPUT @Sa;"VARDEF KEY,0;"                       !Declare variable for storing key number.
100 OUTPUT @Sa;"VARDEF END_LOOP,0;"                 !Declare variable for monitoring REPEAT loop.

110 OUTPUT @Sa;"FUNCDEF SELECT_SPAN,@"
115 !
120 OUTPUT @Sa;"REPEAT;"                            !Begin REPEAT loop.

125 ! Assign labels to soft keys 1, 2, 3, and 14. Store pressed-key number in variable, KEY:
127 !
130 OUTPUT @Sa;"READMENU KEY,1,$BAND A$,2,$BAND B$,3,$BAND C$,14,$EXIT$;"
135 !
140 OUTPUT @Sa;"IF KEY,EQ,1;THEN;BANDA;"           !Evaluate KEY to execute function.
150 OUTPUT @Sa;"ELSIF KEY,EQ,2;THEN;BANDB;"
160 OUTPUT @Sa;"ELSIF KEY,EQ,3;THEN;BANDC;"
170 OUTPUT @Sa;"ELSIF KEY,EQ,14;"                 !When key 14 is pressed, END_LOOP
180 OUTPUT @Sa;"THEN MOV END_LOOP,1;"             contains a "1" and ends loop.
190 OUTPUT @Sa;"ENDIF;"
200 OUTPUT @Sa;"UNTIL END_LOOP,EQ,1;"
210 OUTPUT @Sa;"@"

200 OUTPUT @Sa;"KEYDEF 8,SELECT_SPAN,$SELECT SPAN$;"
210 END

```



SECTION IV. ADVANCED GRAPHICS

This section describes advanced techniques for displaying measurement results and custom graphics on the CRT.

Graphics techniques are demonstrated using program examples. Each example requires that the analyzer be initialized and its CRT cleared of all existing graphics. Program lines 10 through 100 below perform this function. If you wish to run the program examples found in this section, it is only necessary to enter lines 10 through 100 into your computer once. Enter lines after the sequence to exercise the individual examples.

```

10 ASSIGN @Sa TO 718           !Initialize analyzer.
20 CLEAR @Sa
30 OUTPUT @Sa;"IP;SNGLS;TS;"
40 !
50 OUTPUT @Sa;"ANNOT OFF;GRAT OFF;" !Clear CRT graphics.
60 OUTPUT @Sa;"TRDSP TRA OFF;"
70 OUTPUT @Sa;"TRDSP TRB OFF;"
80 OUTPUT @Sa;"TRDSP TRC OFF;"
90 OUTPUT @Sa;"DL OFF;"
100 OUTPUT @Sa;"CLRDSP;"      !Select default X-Y coordinates (0,1000,0,1000).
110 !
120 !                          !Program examples begin here.

```

When you begin writing your own graphics programs, you may wish to save lines 10 through 30, and 50 through 100 in the analyzer as user-defined functions, or in your computer as sub-routines. This way, they may be easily recalled to initialize the analyzer or to clear CRT graphics.

DEFINING CRT SCALE UNITS

All analyzer graphics are drawn on a coordinate system. For your convenience, a default coordinate system is always active whenever instrument preset (IP) or clear-display (CLRDSP) is executed. These commands set the minimum and maximum values of the X and Y coordinates to 0 and 1000. Thus, the coordinates of the lower left and upper right points, P₁ and P₂, are 0,0 and 1000,1000.

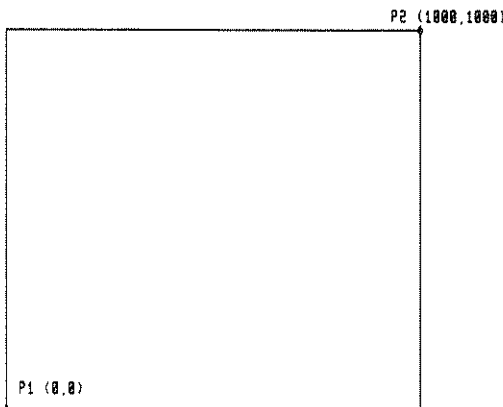

Use the SCALE command to match the scale of the CRT to the scale of the graphics you wish to display. The CRT coordinates, X and Y, may be rescaled to any values between -32,768 and +32,767. Below, SCALE changes the X and Y coordinates to new terms in decibel and degree units to illustrate an antenna pattern adjustment.

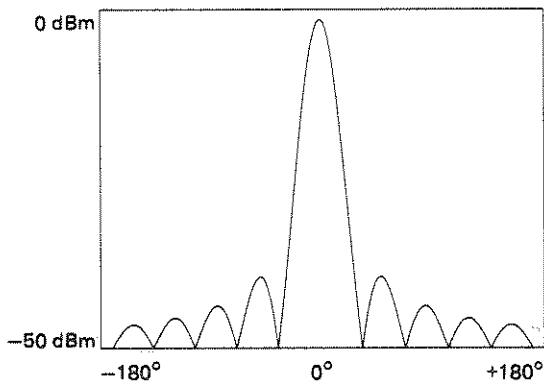

OUTPUT @Sa;"SCALE -180,180,-50,0"
 $\begin{matrix} & / & / & / & | \\ X_{min} & X_{max} & Y_{min} & Y_{max} \end{matrix}$

The SCALE command defines X-Y coordinates in integer values only. When redefining the scale, use numbers large enough to give adequate resolution. Units greater than 50 are suggested.

POSITIONING GRAPHICS ON CRT

Once graphics are "drawn," they may be repositioned with the OR (origin) command. This command *offsets* the position of graphics on the CRT relative to P1, in the current CRT scale units.

The programs below draw a box. In the first example, the box is drawn without any offset. In the second, the box is offset 500 units in the X and Y directions.

Example: Draw box without offset

```
120 OUTPUT @Sa;"PU;PA 0,0;PD;"
130 OUTPUT @Sa;"PA 0,400,400,400,400,0,0,0;"
```

!Place pen down at 0,0.
!Draw to coordinates X₁,Y₁,X₂,Y₂,
X₃,Y₃,X₄,Y₄.

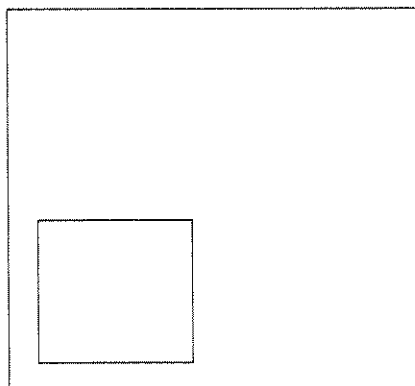

Example: Draw box with offset

```
120 OUTPUT @Sa;"OR 500,500;"
130 OUTPUT @Sa;"PU;PA 0,0;PD;"
140 OUTPUT @Sa;"PA 0,400,400,400,400,0,0,0;"
```

```
!Offset origin.
!Draw box.
```

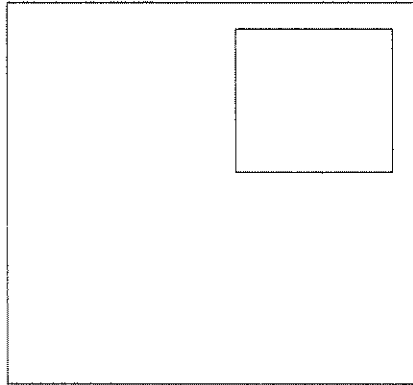

RESIZING COORDINATE SYSTEM

So far, we have examined graphics drawn on one scale that occupies the entire analyzer screen. The DWINDOW command magnifies or reduces a coordinate system. This new coordinate system can be thought of as a window for viewing measurement results or graphics which also lets you resize graphics.

DWINDOW first specifies the physical size of the window in the current scale units. (As before, current scale units are either default values of 0 to 1000 for X and Y coordinates, or are specified by the SCALE command.) DWINDOW then defines a scale for the new coordinate system *within* the window:

```
OUTPUT @Sa;"DWINDOW Length, Width, Xmin, Xmax, Ymin, Ymax;"
```

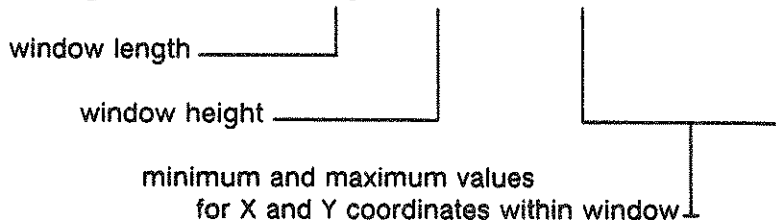

For example, the next program draws a box on the default coordinate system. Each side of the box has a length of 1000, and thus outlines the limits of the default coordinate system.

Example: Draw box.

```
120 OUTPUT @Sa;"PU;PA 0,0;PD;"  
130 OUTPUT @Sa;"PA 0,1000,1000,1000,1000,0,0,0;"
```

!Draw box.

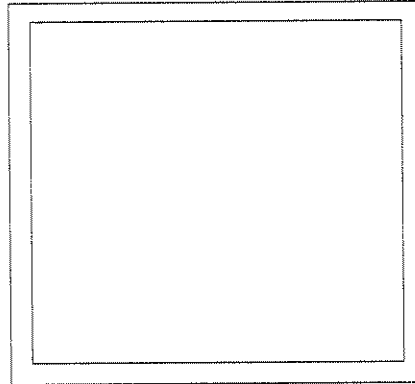

In the next program, DWINDOW orients the box in a new coordinate system, or "window." The window dimensions are 400 X 400 (current scale units) and the window X_1 - Y_1 coordinates have units from 0 to 1000. Since the sides of the box are still 1000 units long, it outlines the limits of the window.

Example: Draw box within window

```
120 OUTPUT @Sa;"DWINDOW 400,400,0,1000,0,1000;"  
130 OUTPUT @Sa;"PU;PA 0,0;PD;"  
140 OUTPUT @Sa;"PA 0,1000,1000,1000,1000,0,0,0;"
```

!Define window size and scale.

!Draw box.

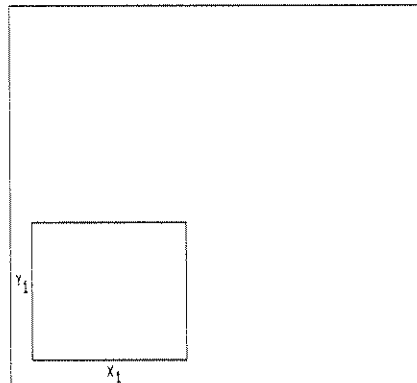

The window scale may be changed to enlarge or reduce graphics within it. Below, the same box is drawn in a window where the X_1 - Y_1 coordinates are twice as long as before. Thus, the box is half as large.

Example: Change window scale

```
120 OUTPUT @Sa;"DWINDOW 400,400,0,2000,0,2000;"  
130 OUTPUT @Sa;"PU;PA 0,0;PD;"  
140 OUTPUT @Sa;"PA 0,1000,1000,1000,1000,0,0,0;"
```

!Change window scale.
!Draw box.

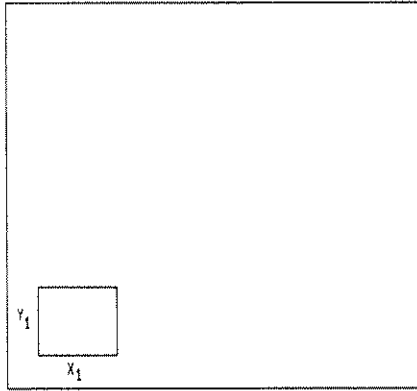

Use OR to position the window anywhere on the CRT. The OR command offsets coordinates of the window in the current scale units, as defined by the current scale units.

Example: Offset window position.

```
120 OUTPUT @Sa;"DWINDOW 400,400,0,2000,0,2000;"  
130 OUTPUT @Sa;"OR 500,500;"  
140 OUTPUT @Sa;"PU;PA 0,0;PD;"  
150 OUTPUT @Sa;"PA 0,1000,1000,1000,1000,0,0,0;"
```

!Define window size.
!Offset window position.
!Draw box.

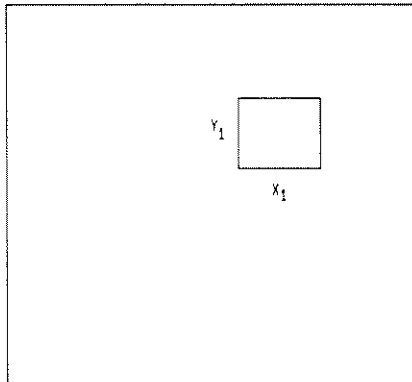

DWINDOW is especially useful for displaying traces. When traces are displayed, the window scale is set by the trace conditions:

```
OUTPUT @Sa;"DWINDOW,500,500,TRA;"
```

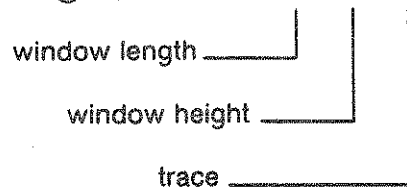

Trace A is reproduced below in a window.

Example: Draw trace within window

```
120 OUTPUT @Sa;"DWINDOW 400,400,TRA;"           !Define window size and contents.  
130 OUTPUT @Sa;"GRAPH TRA;"                     !Display trace A.  
140 OUTPUT @Sa;"DWINDOW 400,400,0,1000,0,1000;" !Draw box to outline trace.  
150 OUTPUT @Sa;"PU;PA 0,0;PD;"  
160 OUTPUT @Sa;"PA 0,1000,1000,1000,1000,0,0,0;"
```

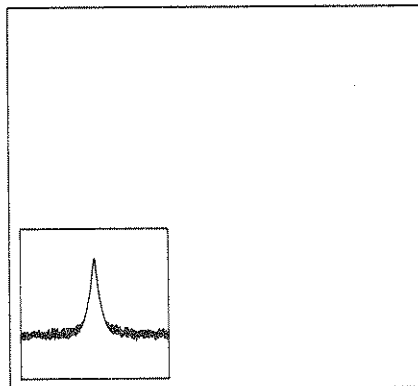

Execute DWINDOW OFF to turn a window off.

Example: Turn off window.

```
10 OUTPUT @Sa;"DWINDOW OFF;"
```

ITEMS

The item command, IT, assigns an item number from 0 to 255 to a series of graphics commands. When graphics are assigned a non-zero number, the referenced-graphics mode is activated. Executing IT 0, IP, or CLRDSP turns off the referenced-graphics mode.

In the referenced-graphics mode, referenced graphics (called *items*) may be redrawn or modified without re-executing the individual graphics commands. This is useful when a graphics item needs to be blanked and redrawn, reshaped, or repositioned at a later time. Non-referenced graphics may not be redrawn or reshaped at a later time.

All graphics items are created by assigning each one a unique, nonzero number. Once assigned, an item is automatically displayed. An item is modified by first activating it, then modifying it with one of the item-modifying commands. The details of this process are discussed below.

Assigning Item Numbers

Use the IT command to assign item numbers. Below, the points that comprise a box and a triangle are assigned:

Example: Assign triangle and box item numbers.

| | |
|---|--|
| 120 OUTPUT @Sa;"IT 1;" | !Assign box item number 1. |
| 130 OUTPUT @Sa;"PA 0,0,0,400,400,400,400,0,0,0;" | !Draw box. |
| 140 OUTPUT @Sa;"IT 2;" | !Assign triangle item number 2. |
| 150 OUTPUT @Sa;"PA 600,0;700,200,800,0,600,0;" | !Draw triangle. |

In the referenced-graphics mode, each item has its own pen, which is automatically in the down position. Thus, a pen-down command (PD) is not required. Items 1 and 2 are shown below.

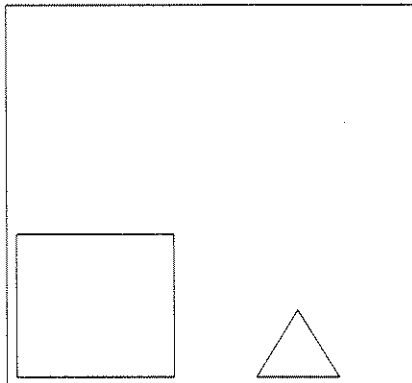

Activating and Modifying Items

An item can be redrawn or modified whenever it is active. Only one item can be active at a time. The active item is determined by the last executed IT command.

These are the commands that modify items:

VW OFF (view item off).....Blank item
VW ON (view item on).....Redraw item
OR (origin).....Offset item position
TP (pointer).....Change item shape.
DELETE.....Delete item

Below, item 1 is activated, blanked, and then redrawn. Notice that it is not necessary to re-execute the individual graphics commands assigned to the item.

Example: Blank and redraw item

```
160 OUTPUT @Sa;"WAIT 5;"  
170 OUTPUT @Sa;"IT 1;"  
180 OUTPUT @Sa;"VW OFF;"  
190 OUTPUT @Sa;"WAIT 5;"  
200 OUTPUT @Sa;"VW ON;"
```

IActivate item
IBlack item
IRedraw item.

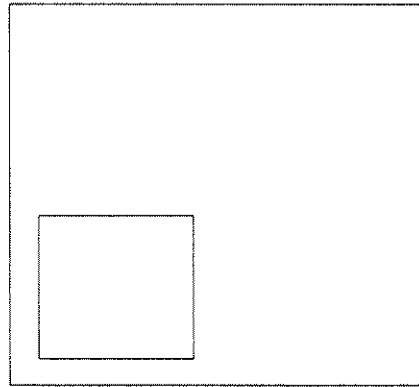
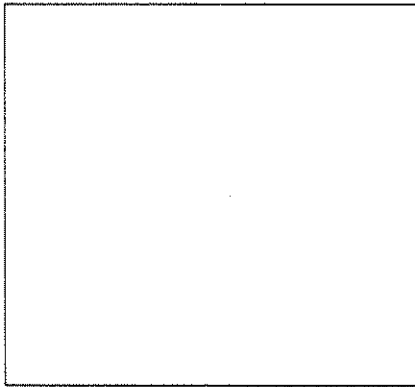

The OR command offsets item positions:

Example: Offset item.

```
160 OUTPUT @Sa;"WAIT 5;"  
170 OUTPUT @Sa;"IT 1;"  
180 OUTPUT @Sa;"OR 500,500;"
```

IActivate item 1.
IOffset item 1.

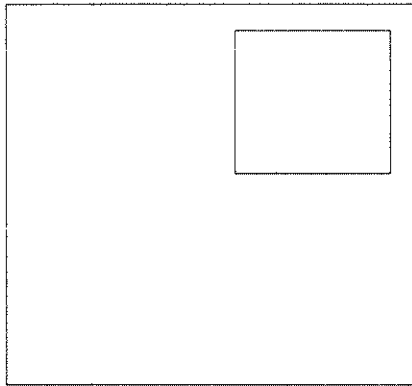

If OR is not executed with an item, its origin is assumed to be at 0,0 (OR 0,0) and no offset occurs.

The TP command modifies item shapes. The TP command may be thought of as a tablet pointer that selects a point of graphics for modification. For example, consider item 2, the triangle. It is composed of four points, numbered 0 through 3:

| #0 | #1 | #2 | #3 |
|---------|-----------|---------|---------|
| (600,0) | (700,200) | (800,0) | (600,0) |

Executing TP 1 selects point (700,200) for modification. (TP begins counting with zero.) The point value is changed with the plot absolute command (PA) that follows the TP command. In the program below, point #1 (700,200) of the triangle is modified.

Example: Modify item shape.

| | |
|------------------------------|---------------------------|
| 160 OUTPUT @Sa;"WAIT 5;" | !Activate item. |
| 170 OUTPUT @Sa;"IT 2;" | |
| 180 OUTPUT @Sa;"TP 1;" | !Select point. |
| 190 OUTPUT @Sa;"PA 300,600;" | !Specify new point value. |

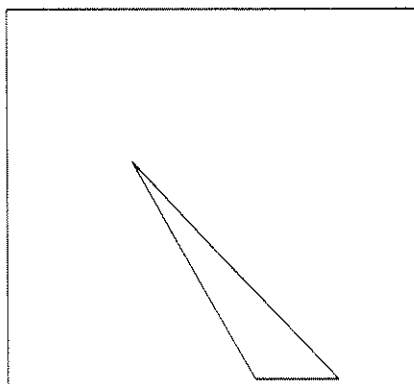

Any modifications made with OR, VW, or TP become permanent characteristics of the item unless the item is remodified or deleted with the DELETE or CLRDSP commands.

Deleting Items

The DELETE command blanks the *active* item and clears it from the analyzer memory. The CLRDSP command blanks and deletes *all* items, regardless of their state. Deleted items cannot be referenced again unless they are reassigned.

Example: Delete item.

```
160 OUTPUT @Sa;"WAIT 5;"  
170 OUTPUT @Sa;"IT 1;"           !Activate item.  
180 OUTPUT @Sa;"DELETE;"       !Delete item.
```

Example: Delete all items.

```
400 OUTPUT @Sa;"CLRDSP;"       !Delete all items.
```

Item Types

In addition to point-by-point drawing, items can be used to display text, grids, or trace information. The commands associated with these tasks are divided into groups listed below:

| TASK | COMMANDS |
|---------------------------------------|------------|
| Plot-absolute, point-by-point drawing | PA,PU,PD |
| Plot-relative, point-by-point drawing | PR,PU,PD |
| Display trace data | GRAPH |
| Draw grid | GRID |
| Display text | TEXT,DSPLY |
| Display graphics marker. | MK |

A single item can be assigned to do only one task. For example, a single item cannot draw a box and display text. In this case, two items are required: one for the box, another for the text.

SECTION V. CONTROLLING SYSTEM OPERATION WITH SERVICE REQUESTS

The programming techniques discussed so far describe communication between the analyzer and the computer, where the sequence of all data transfer is controlled by computer program. Service requests let the analyzer temporarily interrupt the normal sequence of program operation.

Service requests have many applications. They facilitate economical use of computer processing time when the analyzer is part of a large scale measurement system. For example, after the computer initiates an analyzer measurement, it can make calculations or control other devices via HP-IB while the analyzer is measuring. When the analyzer is through, it signals the computer with a service request. The service-request subprogram then determines what the computer will do next. Service requests are also used to report analyzer errors and interrupt computer processing.

HP-IB INTERRUPT PROCESS

The interrupt process begins when the analyzer "requests" attention by setting the HP-IB service request (SR) line true. The controller responds by branching to a another subroutine that is determined by the status of the instrument that requested service, which is the analyzer in this case. In this way, the computer "services" the analyzer's "request." These steps are summarized below:

1. Computer monitors HP-IB service request (SR) line.
2. Analyzer requests service by setting SR line true.
3. Computer branches to subroutine that examines analyzer state.
4. Computer branches to subroutine determined by analyzer state.

Several system-level commands are required to make the computer responsive to service requests. The HP BASIC command, ENABLE INTR (enable interrupt), tells the computer to monitor the service-request line. The on-interrupt command, ON INTR, specifies where the computer program will branch when a service request occurs. If more than one service request is possible, the serial-poll command, SPOLL, is needed to examine the nature of the service request. These HP BASIC commands are used with the HP series 200 computer.

ANALYZER STATUS BYTE

The analyzer status is summarized in the 8-bit status byte. Bits 0, 1, 2, 4, and 5 represent particular aspects of analyzer operation. These are listed in Table 3-7. The state of these bits, set (true) or cleared (false), is determined by the analyzer state.

If the service-request mode is not enabled, the bits always reflect the current analyzer state. Since bits 3 and 4 represent transient events END-OF-SWEEP and COMMAND-COMPLETE, their state is not easily detected.

If the service-request mode is enabled, all of the status-byte bits reflect the current state of the analyzer until the conditions of a service request are met. In this case, bit 6 of the status byte goes true and the bit or bits that satisfy the service-request condition remain in the true state until the status byte is interrogated by the following commands:

system-level commands

CLEAR 718 (device clear)
SPOLL (serial poll)

analyzer commands

CLS (clear status byte)
STB? (status byte query)
IP (instrument preset)

The above commands clear the status byte so that all the bits in the byte once again reflect the current status of the analyzer until another service request occurs. In this way, the process begins again.

THE REQUEST-FOR-SERVICE MASK

The service-request mode is enabled and controlled by the request-for-service command, RQS. It defines a mask which has a twofold purpose. It enables the service-request mode and specifies which of the status-byte bits may generate a service request. For example, to enable the service-request mode, a decimal number representing bit 2 is sent by using RQS.

OUTPUT 718;"RQS 4;" !Selects bit 2 to enable service-request mode.

Below, RQS specifies the ERROR-PRESENT and COMMAND-COMPLETE states (bits 5 and 4).

OUTPUT 718;"RQS 48;" !Selects bits 5 and 4 (32+16).

Once RQS is executed, a service request is generated whenever any of the selected conditions are met.

Table 3-7. Spectrum Analyzer Status Byte

| BIT NUMBER | DECIMAL EQUIVALENT | ANALYZER STATE | DESCRIPTION |
|------------|--------------------|------------------|--|
| 7 | 128 | | Unused |
| 6 | 64 | RQS | Set when any selected service condition is met. |
| 5 | 32 | ERROR PRESENT | Set when error register contains an error. |
| 4 | 16 | COMMAND COMPLETE | Set at completion of command execution. |
| 3 | 8 | | Unused |
| 2 | 4 | END OF SWEEP | Set at completion of sweep. |
| 1 | 2 | MESSAGE | Set when uncalibrated or uncorrected (UNCAL, UNCOR) messages appear. |
| 0 | 1 | TRIGGER ARMED | Set when analyzer is ready to receive a sweep trigger. |

ROM VERSIONS
861015 OR
LATER

SERVICE REQUEST EXAMPLES

The program below uses service requests to monitor measurement errors in the analyzer. If an error occurs, computer operation is interrupted and a description of the error is printed.

Example: Enable ERROR-PRESENT service request.

```

10 ASSIGN @Sa TO 718           !Initialize analyzer.
15 COM\INSTR \@Sa
20 CLEAR @Sa
30 OUTPUT @Sa;"IP;SNGLS;TS;"
40 ON INTR 7 CALL Error       !Define computer interrupt branching.
50 ENABLE INTR 7;2           !Enable computer interrupts.
60 OUTPUT @Sa;"RQS 96;"      !Enable ERROR-PRESENT service request.
70 !
90 Idle:GOTO Idle            !Monitor service request line
100 !                          while measuring. (This is where your
110 END                        measurement routine would be.)
120 !
130 SUB Error                 !Interrupt-handling subprogram.
140 COM\INST \@Sa
150 DIM Mod_num$(6),Err_text$(30)
160 OUTPUT @Sa;"XERR?;"      !Return error description.

170 ENTER @Sa USING "5(K)";Error_num,Mod_num$,Row_num,Col_num,Err_text$
180 PRINT Error_num;Mod_num$;Row_num;Col_num;Err_text$
190 SUBEND

```

The next program uses service requests to allow the computer to process data or control other instruments while the spectrum analyzer is taking a long sweep. When the sweep is completed, the analyzer generates a service request which interrupts the computer, instructing it to accept the measurement data from the analyzer.

Example: Enable END-OF-SWEEP interrupt.

```

10 OPTION BASE 1             !Define first element of array as "1."
20 ASSIGN @Sa TO 718         !Initialize analyzer
30 COM\INSTR \@Sa
40 COM Trace_a(800)
45 CLEAR @Sa
50 OUTPUT @Sa;"IP;SNGLS;TS;"
60 ON INTR 7 CALL Trace_out  !Define computer-interrupt branching.
70 ENABLE INTR 7;2           !Enable interrupts.
80 OUTPUT @Sa;"RQS 68;"      !Enable END-OF-SWEEP service request.
90 OUTPUT @Sa;"ST 100SC;"    !Set sweep time to 100 seconds.
100 OUTPUT @Sa;"TS;"         !Sweep analyzer.
110 !
130 Idle: GOTO Idle          !Monitor service request line while
140 !                          controlling other devices via HP-IB.
150 END
160 !
170 SUB Trace_out             !Trace-output subprogram
180 OPTION BASE 1
190 COM\INST \@Sa

```

```

200 COM Trace_a(800)
210 OUTPUT @Sa;"TRA?"           !Return trace data.
220 ENTER @Sa;Trace_a(*)
230 SUBEND

```

The program below allows for two types of service requests. One of them requests service when the analyzer has completed a sweep. The other requests service when an error occurs in the analyzer. When either request is generated, the computer examines the status byte using the SPOLL command to determine what caused the service request.

Example: Enable multiple service requests. Use SPOLL to examine status byte.

```

10 OPTION BASE 1
20 ASSIGN @Sa TO 718           !Initialize analyzer.
30 COM\INSTR\@Sa
40 COM Trace_a(800)
40 CLEAR @Sa
50 OUTPUT @Sa;"IP;SNGLS;TS;"
60 ON INTR 7 CALL Interrupt    !Define interrupt branching.
70 ENABLE INTR 7;2           !Enable interrupts.
80 OUTPUT @Sa;"RQS 100;"      !Enable END-OF-SWEEP and
                               ERROR-PRESENT service request.
90 OUTPUT @Sa;ST 10SC;"       !Set sweep time to 10 seconds.
100 OUTPUT @Sa;"TS;"         !Take sweep.
120 !
130 Idle: GOTO Idle          !Monitor service request line while
140 !                          processing data or controlling other
150 END                       devices.
160 !
180 SUB Interrupt             !Interrupt handling subprogram.
190 S=SPOLL(718)             !Poll the spectrum analyzer status byte.
200 IF S=68 THEN CALL Trace_out !If END-OF-SWEEP service request has
                               occurred, return trace data.
210 IF S=96 THEN CALL Error   !If ERROR-PRESENT service request has
                               occurred, return error description.
220 SUBEND
230 !
240 SUB Trace_out             !Trace output subprogram.
250 OPTION BASE 1
260 COM\INSTR\@Sa
270 COM Trace_a(800)
280 OUTPUT @Sa;"TRA?;"
290 ENTER @Sa;Trace_a(*)
300 SUBEND
310 !
320 SUB Error                 !Error handling subprogram.
330 DIM Mod_num$(6),Err_text$(30)
340 ASSIGN @Sa TO 718
350 OUTPUT @Sa;"XERR?;"
360 ENTER @Sa USING "S(K)";Error_num,Mod_num$,Row_num,Col_num, Err_text$
370 PRINT Error_num;Mod_num$;Row_num;Col_num;Err_text$
380 SUBEND

```

SECTION VI. ANALYZER CONTROL OF HP-IB

This section tells how to use the analyzer as a controller on HP-IB. As a controller, the spectrum analyzer can transfer data to, or accept data from, other HP-IB devices. This capability has many applications. For example, the analyzer can control an HP-IB switch driver in order to select the correct antenna for an EMI measurement, or the analyzer can execute a system calibration routine that controls a power meter and signal source.

OUTPUT AND ENTER COMMANDS

Use the OUTPUT command to send data to an HP-IB device. The HP-IB device is specified by its HP-IB address. Below, the spectrum analyzer sends the message "FA 1 MHZ" to a device at HP-IB address 19 (on interface 7).

Example: Analyzer sends data to HP-IB device.

```
10 OUTPUT @Sa;"OUTPUT 19,KL,$FA 1 MHZ;$;"           !Set start frequency.
```

All data is sent as free-field ASCII numbers in three different output formats, called K, KC, and KL. The K format sends data without a terminator. The KC format terminates the data with a carriage-return and line-feed. The KL format terminates data with a line-feed and END. Use the format that is compatible with the HP-IB device receiving the data.

Use the ENTER command to receive data from an HP-IB device. Below, ENTER receives a value sent by the device at HP-IB address 19 and stores the value in a user-defined variable in the analyzer.

Example: Analyzer requests data from HP-IB device.

```
10 OUTPUT @Sa;"OUTPUT 19,KL,$CF?;$;"           !Request center frequency value.
20 OUTPUT @Sa;"ENTER 19,K,NN;"                 !Receive center frequency value.
```

Three input formats for data are available: K for free-field ASCII numbers, B for bytes (8 bits), and W for words (two 8-bit bytes). Be sure to use an input format that is compatible with the output format of the HP-IB device.

In the program below, the spectrum analyzer sets the start frequency of a sweeper equal to the analyzer start frequency. The message must be sent with several output statements, since one part of the message is a string of characters and another part is a spectrum analyzer variable. Notice that a character string must be delimited.

```
10 OUTPUT @Sa;"OUTPUT 19,K,$FA$;"           !Sends letters "FA" to the sweeper.
20 OUTPUT @Sa;"OUTPUT 19,K,FA;"           !Sends current value of analyzer start frequency.
30 OUTPUT @Sa;"OUTPUT 19,KL,$HZ;$;"       !Sends letters "HZ" to the sweeper.
```

COMPUTER CONTROL VERSUS ANALYZER CONTROL OF HP-IB

The analyzer can control HP-IB only if the computer is not in control of the bus. For this reason, ENTER and OUTPUT commands are incorporated into user-defined functions that are executed by the spectrum analyzer with user-defined softkeys. (See FUNCDEF and KEYDEF commands in Section III of this chapter.)

Before the ENTER and OUTPUT functions are executed, the computer must be disconnected from HP-IB. This is accomplished by either physically disconnecting the computer from the bus, or by executing the HP-IB system level commands that release the computer from HP-IB. The HP BASIC command sequence that does this is shown below.

Example: Release computer from HP-IB.

```
10 LOCAL 7  
20 ABORT 7
```

The release HP-IB command (RELHPIB) must be included at the end of any user-defined functions containing ENTER or OUTPUT commands. This ensures that the analyzer surrenders control of HP-IB after all ENTER and OUTPUT commands have been executed.

APPENDIX A

COMMAND SUMMARY

AMPLITUDE COMMANDS

| | |
|---------|----------------------------|
| AT | Input attenuator |
| AUNITS | Absolute amplitude Units |
| INZ | Input impedance |
| LG | Logarithm scale |
| LN | Linear scale |
| ML | Mixer level |
| RL | Reference level |
| RLPOS | Reference level position |
| ROFFSET | Amplitude reference offset |

BANDWIDTH COMMANDS

| | |
|-----|---------------------------------|
| RB | Resolution bandwidth |
| RBR | Resolution-bandwidth/span ratio |
| VB | Video bandwidth |
| VBR | Video bandwidth ratio |

CALIBRATION AND DIAGNOSTIC COMMANDS

| | |
|---------|-------------------------|
| AMPCOR | Amplitude correction |
| CAL | Calibrate |
| CALCOR | Calibration correction |
| CALFREQ | Calibration frequency |
| CALPWR | Calibration power |
| CALSRC | Calibration source |
| DEBUG | Debug mode |
| PAUSE | Command execution pause |

CONFIGURATION COMMANDS

| | |
|----------|-----------------------|
| COUPLE | Input coupling |
| INPUT | Select input |
| MODID | Module identification |
| PATHLOCK | Path lock |

DISPLAY COMMANDS

| | |
|---------|---------------------|
| ANNOT | Annotation on/off |
| CONFIG | Configuration query |
| DL | Display line |
| DSPMODE | Display mode |
| GRAT | Graticule on/off |
| HD | Hold data entry |
| IWINDOW | Instrument window |
| TH | Threshold |

EXTERNAL MIXER COMMANDS

| | |
|---------|---------------------------|
| CNVLOSS | Conversion loss |
| FULBAND | Full band |
| HNLOCK | Harmonic number lock |
| MBIAS | Mixer bias |
| MBIASPK | Mixer bias peak |
| MBMAX | Mixer bias, maximum level |
| MBMIN | Mixer bias, minimum level |
| MBRES | Mixer bias resolution |

FREQUENCY COMMANDS

| | |
|---------|----------------------------------|
| CF | Center frequency |
| FA | Start frequency |
| FB | Stop frequency |
| FOFFSET | Frequency offset |
| FS | Full span |
| LOSTART | Local oscillator start frequency |
| LOSTOP | Local oscillator stop frequency |
| SP | Frequency span |
| SS | Center frequency step size |

GRAPHICS COMMANDS

| | |
|---------|------------------------------|
| CLRDSP | Clear display |
| DELETE | Delete item |
| DSPLY | Display variable |
| DWINDOW | Display window |
| GRAPH | Graph trace |
| GRID | Display grid |
| IT | Identify item |
| LINET | Line type |
| MK | Marker display |
| OP | Output display parameters |
| OR | Set origin |
| PA | Plot to absolute coordinates |
| PD | Pen down |
| PEN | Select pen |
| PR | Plot to relative coordinates |
| PU | Pen up |
| SCALE | Scale graphics |
| TEXT | Text |
| TITLE | Title entry |
| TP | Trace pointer |
| VW | View item |

INFORMATION COMMANDS

| | |
|---------|-------------------------------------|
| ERR | Error |
| ID | Identification (model number) query |
| MSG | Message query |
| REV | Revision number query |
| SER | Serial number |
| TEST | Self test |
| USERERR | User error report |
| XERR | Extended error query |

INPUT/OUTPUT COMMANDS

| | |
|---------|------------------------------------|
| DONE | Done. Previous commands completed. |
| ENTER | Enter from HP-IB |
| MDS | Measurement data size |
| OUTPUT | Output via HP-IB |
| RELHPIB | Release HP-IB |
| RQS | Request service conditions |
| SRQ | Service request |
| STB | Status byte query |
| TDF | Trace data format |
| TS | Take sweep |

INSTRUMENT STATE COMMANDS

| | |
|---------|---------------------------|
| ERASE | Erase all memory |
| IP | Instrument preset |
| NSTATE | Number of state registers |
| POWERON | Power on |
| PSTATE | Protect state |
| RCLS | Recall state register |
| SAVES | Save state |
| STATE | Instrument state |

MARKER COMMANDS

| | |
|---------|--------------------------------------|
| MKA | Marker amplitude |
| MKACT | Active marker |
| MKAL | Marker amplitude relative left |
| MKAR | Marker amplitude relative right |
| MKCF | Marker to center frequency |
| MKD | Marker delta |
| MKF | Marker frequency |
| MKMIN | Marker to minimum level |
| MKN | Marker normal |
| MKNOISE | Marker noise level |
| MKOFF | Marker off |
| MKP | Marker position |
| MKPAUSE | Pause at marker |
| MKPK | Marker peak search |
| MKPX | Marker peak excursion |
| MKREAD | Marker readout |
| MKRL | Marker to reference level |
| MKSP | Marker delta to span |
| MKSS | Marker to center frequency step size |
| MKT | Marker time |
| MKTRACE | Marker trace |
| MKTRACK | Marker signal track |
| MKTV | Marker tracking variance |
| MKTYPE | Marker type |

SIGNAL IDENTIFICATION COMMANDS

| | |
|--------|---|
| IDCF | Signal identified frequency to center frequency |
| IDFREQ | Signal identified frequency |
| IDMODE | Signal identification mode |
| IDSTAT | Signal identification status |
| NSTART | Start harmonic number |
| NSTOP | Stop harmonic number |
| SIGDEL | Signal amplitude delta |
| SIGID | Signal identify |

SWEEP AND TRIGGER COMMANDS

| | |
|-------|--------------------------|
| CONTS | Continuous sweep |
| SNGLS | Single sweep |
| ST | Sweep time |
| TM | Trigger mode |
| VTH | Video trigger hysteresis |
| VTL | Video trigger level |

TRACE COMMANDS

| | |
|-------------|--|
| COMPRESS | Compress trace |
| DET | Detection mode |
| FFT | Fast fourier transform |
| FFTKNL | Fast fourier transform kernal |
| MEAN | Trace mean |
| PDA | Probability distribution of amplitude |
| PDF | Probability distribution of frequency |
| PEAKS | Trace peaks |
| PWRBW | Trace power bandwidth |
| RMS | Trace root mean square value |
| SMOOTH | Smooth trace |
| STDEV | Standard deviation of trace amplitudes |
| SUM | Sum of trace amplitudes |
| SUMSQR | Sum of square of trace amplitudes |
| TRA/TRB/TRC | Trace data input/output |
| TRCOND | Trace conditions |
| TRDEF | Trace definition |
| TRPST | Trace preset |
| TRSTAT | Trace status |
| TWNDOW | Trace window |
| VARIANCE | Variance of trace amplitudes |

TRACE MATH COMMANDS

| | |
|-------|---|
| AMB | Trace A minus trace B |
| AMBPL | Trace A minus trace B plus display line |
| APB | Trace A plus trace B |
| AXB | Trace A exchange trace B |
| BML | Trace B minus display line |
| BXC | Trace B exchange trace C |
| VAVG | Video average |

TRACE PROCESSING COMMANDS

| | |
|-------|----------------------|
| BLANK | Blank trace |
| CLRW | clear write |
| MINH | Minimum hold |
| MXMH | Maximum hold |
| TRDSP | Trace display on/off |
| VIEW | View trace |

UNIT CONVERSION COMMANDS

| | |
|-------|-----------------------------|
| AMPU | Amplitude unit conversion |
| FREQU | Frequency unit conversion |
| MEASU | Measurement unit conversion |
| POSU | Position unit conversion |

USER COMMAND-FLOW COMMANDS

| | |
|------------------------------|----------------------|
| ABORT | Abort user functions |
| IF/THEN/ELSIF/ELSE/
ENDIF | Conditionals |
| REPEAT/UNTIL | looping |
| RETURN | Return from function |
| WAIT | Wait specified time |

USER DEFINITION COMMANDS

| | |
|----------|-----------------------------------|
| CATALOG | Catalog query |
| DISPOSE | Dispose |
| FUNCDEF | Function definition |
| KEYCLR | Clear user-defined keys |
| KEYDEF | Define user-defined key |
| KEYPST | Preset user-defined keys |
| MEM | Available memory query |
| ONEOS | Execute functions on end of sweep |
| READMENU | Read menu input |
| USERKEY | User-defined keys input/output |
| USTATE | User state input/output |
| VARDEF | Define variable |

USER OPERATOR COMMANDS

| | |
|--------|-------------|
| ABS | Absolute |
| ADD | Add |
| AVG | Average |
| BIT | Bit test |
| CONCAT | Concatenate |
| DIV | Divide |
| EXP | Exponent |
| INT | Integer |
| LOG | Logarithm |
| MIN | Minimum |
| MOD | Modulo |
| MOV | Move |
| MPY | Multiply |
| MXM | Maximum |
| SQR | Square root |
| SUB | Subtract |
| XCH | Exchange |



INDEX

| | |
|---|---|
| <p>-A-</p> <p>ANNOT. 2-15, 3-27</p> <p>Annotation</p> <p> clearing of 2-15</p> <p> creation of 2-20 -21</p> <p>Array. See Trace.</p> <p>ASSIGN I/O Path (system level command) . . 2-4</p> | <p>Enter statement 2-2,3</p> <p>ENTER 3-41</p> <p>EP 2-7</p> |
| <p>-B-</p> <p>Binary data 3-13 -15</p> <p>Block data 3-13 -15</p> <p>Branching functions 3-21 -22</p> | <p>-F-</p> <p>Flow-of-control functions. 3-21 -22</p> <p>Format. See Data; Trace data output</p> <p>FUNCDEF 3-17- 20, 25</p> <p>Fundamental unit codes 2-11</p> |
| <p>-C-</p> <p>CAL 2-14</p> <p>Calibrate analyzer 2-4</p> <p>Carriage-return/line-feed,</p> <p> suppression of 3-23</p> <p>CF 2-2,6,7,8</p> <p>CLEAR (system level command) . . . 2-4, 3-37</p> <p>CLRDSP 2-15, 3-27</p> <p>Continue 2-14</p> <p>Coordinates 2-16,17</p> <p> resizing of 3-29 -31</p> <p> window 3-29 -31</p> | <p>-G-</p> <p>GRAPH. 3-32,36</p> <p>Graphics 2-15 -20, 3-27 -36</p> <p> See also Items; Windows</p> <p> blanking of 3-34.</p> <p> initializing analyzer for 2-15 -16</p> <p> modification of; See Items.</p> <p> offset of. 3-28 -29, 31,34-5</p> <p> positioning of 3-28,31,34 -35</p> <p> resizing of 3-29 -31</p> <p> scaling of 3-29 -31</p> <p>GRAT 2-15, 3-27</p> <p>GRID 2-20, 3-36</p> <p>Grids, displaying of. 2-20</p> |
| <p>-D-</p> <p>Data. See also Trace data output; Query;</p> <p> Math functions</p> <p> entry of 2-7, 2-11 -13</p> <p> format of 2-13, 3-13 -16</p> <p> return of 2-2,11-13, 3-13 -16</p> <p>Data point 3-4</p> <p>DEBUG. 2-14</p> <p>Debugging 2-14</p> <p>DELETE 3-34, 36</p> <p>Destination 3-6</p> <p>Display, clearing of. 2-15</p> <p>Display line, clearing of. 2-15</p> <p>DISPOSE. 3-4 -5</p> <p>DL 2-15, 3-27</p> <p>Downloadables. See Arrays; Variables;</p> <p> User-defined functions</p> <p>DSPLY 2-22,23,36</p> <p>DWINDOW 3-29 -32</p> | <p>-H-</p> <p>HP-IB, analyzer control of 3-41 -42</p> |
| <p>-E-</p> <p>Element 3-4,9</p> <p> as destination in math operations. . . 3-7 -10</p> | <p>-I-</p> <p>Initialize analyzer. 2-4 -5</p> <p>Instrument preset 2-4,3-27</p> <p>I/O path 2-4</p> <p>IP 2-4, 3-27</p> <p>IT. 3-33 -36</p> <p>Item 3-33 -36</p> <p>IWINDOW 2-23</p> <p> See also Graphics.</p> |
| <p>-L-</p> <p>LINET 2-19</p> <p>Local control. 2-3</p> <p>Looping functions 3-21 -22</p> | <p>-K-</p> <p>KEYDEF 3-23 -25</p> |

INDEX

-M-

Markers 2-9 -10
 use of 2-12,3-36
 Math functions 3-6 -10
 accuracy of 3-7 -10
 measurement units and 3-7 -10
 table of 3-10
 MEASU. 3-7 -8
 rules for 3-7 -10
 Measurement units 3-13 -14
 See also Trace data output; Math functions
 definition of 3-3
 MEM 3-22
 Memory, 3-7, 22 -23
 See Variables; Arrays; User-defined functions
 Menu. See Soft keys; User-defined functions
 MK 3-36
 MKA 2-12
 MKF 2-12
 MKPK HI 3-9
 MOV 3-6 -10
 MPY 3-6,8,10

-N-

NSTATE 3-22
 Numbers 2-6
 See also Data.

-O-

Operand 3-6
 commands restricted to 3-11
 OR 3-29,31,34
 Origin 2-16
 See also Graphics, offset of.
 Output. See Trace data output; Data
 Output statement. 2-2
 OUTPUT 3-41

-P-

PA 2-17,21, 3-28,36
 Parameter units 3-3, 13-14
 Pause 2-14
 PD 2-17,21, 3-28,29,36
 with items. 3-33
 PEN 2-19
 See also Trace data output
 Pen, control of 2-17 -19
 See also PD
 Plot. 2-23

See also Graphics

Point 3-4
 Position units. 3-4
 POSU 3-11
 PR 2-18,19, 3-36
 Print 2-23
 PSTATE 3-22
 PU 2-17,21, 3-28,36
 See also PD

-Q-

Query 2-3,2-11 -13
 commands restricted to 3-11

-R-

READMENU 3-24,25
 REPEAT 3-21 -22
 RL 2-13
 RQS 3-38,39,40

-S-

SCALE 3-27,8
 Scale. 2-16 -17, 3-27 -28
 resizing of 3-28 -30
 Service requests 3-37 -40
 Significant digits 2-6
 See also Math functions, accuracy
 Soft keys 3-23 -26
 SNGLS 2-4, 3-27
 Status byte 3-37 -38
 Syntax 2-3

-T-

Take sweep
 importance of 2-8 -10
 and markers 2-9 -10
 TDF 3-13 -16
 Terminator 2-7
 for user-defined functions. 3-17
 TEXT 2-21,22,23, 3-36
 Text, displaying of 2-20 -21
 Timing 2-8 -10
 See also Service requests
 TP 3-34,35
 TRA,TRB,TRC. See Trace; Element
 Trace. 3-4 -5
 See also Element
 clearing of 2-15
 memory allocation 3-22
 trace math 3-7 -10

INDEX

truncation of 3-7 -8
Trace data output. *See also* Element;
examples of. 3-16
format types 3-13 -16
TRDEF 3-5,7
TRDSP 2-15, 3-27
TS
importance of. 2-8 -10
as initializing process 2-4, 3-27

-U-

Unit code. 2-6,2-11
Units
measurement units 3-3
parameter units 3-3
position units 3-4
scale units 3-27 -28.
User-defined functions 3-17 -25
creation of 3-17
examples of. 3-17,20
execution of 3-17, 23 -25
illegal operations 3-19
memory allocation 3-22 -23
soft keys 3-23 -25
structure of 3-18
terminator for 3-17

-V-

VARDEF 3-4,7
Variables 3-4 -5
See also Math functions
importance of. 3-7
memory allocation 3-22
VIEW 3-9
VW 3-34

-W-

WAIT 3-9
Window 2-22 -23, 3-29 -32



PART III
DISPLAY OPERATION



•



PART III

Display Operation

CHAPTER 1

GETTING STARTED

Description: This chapter highlights key features of the HP 70205A Graphics Display and the HP 70206A System Graphics Display and tells the user where to find instructions for such system-level operations as obtaining hardcopy output, configuring the display screen, examining the Hewlett-Packard Modular System Interface Bus (HP-MSIB) and the Hewlett-Packard Interface Bus (HP-IB) addresses, receiving error messages, and more.

| | |
|---|------|
| Introduction | .1-1 |
| Front Panel Concept | .1-3 |
| HP 70205A Graphics Display. | .1-4 |
| HP 70206A System Graphics Display | .1-6 |
| Softkey Concept | .1-8 |
| Top Level Softkeys. | .1-9 |
| Display Capabilities | 1-12 |

CHAPTER 2

DSP HARDKEY (MANUAL DISPLAY OPERATION)

DESCRIPTION: This chapter describes in detail the manual operation of the displays. All manually-available functions are accessed by pressing the [DSP] hardkey ([DISPLAY] hardkey on the HP 70206A). All softkeys are described and examples are included with sample outputs. In addition, a brief discussion is included on the addressing of modules on the Hewlett-Packard Interface Bus (HP-IB) and the Hewlett-Packard Modular System Interface Bus (HP-MSIB).

| | |
|-----------------------------------|-------|
| Introduction | .2-1 |
| Top Level Softkeys. | .2-1 |
| Select Instrument | .2-3 |
| Assign Keyboard | .2-5 |
| Address Map | .2-7 |
| Adjust Column/Adjust Row. | .2-11 |
| Set HP-IB | .2-12 |
| Allocate Display | .2-13 |
| Allocate Keyboard | .2-16 |
| Allocate Screen | .2-16 |
| Configure Display | .2-17 |
| Build Window | .2-18 |

| | |
|-------------------------------------|------|
| Assign Window | 2-19 |
| Purge Window | 2-23 |
| Hardset/Softset HP-IB | 2-24 |
| Help | 2-26 |
| Show Configuration | 2-27 |
| Save Config/Recall Config | 2-29 |
| Print | 2-31 |
| Plot. | 2-32 |
| Define Hardcopy | 2-33 |
| Printer Is | 2-33 |
| Plotter Is | 2-35 |
| Plotter Parameters | 2-36 |
| Keycopy ON/OFF | 2-38 |
| Expand ON/OFF | 2-40 |
| Default Values | 2-40 |
| Help | 2-41 |
| Report Errors. | 2-42 |
| Display Tests | 2-45 |
| Display Id | 2-45 |
| Knob Test | 2-46 |
| Key Test | 2-47 |
| Confidence Test | 2-47 |
| Tumble Figures | 2-48 |
| Patterns 1 - 4 | 2-48 |
| Intensity Adjust. | 2-48 |
| Help | 2-49 |

CHAPTER 3

REMOTE DISPLAY OPERATION

DESCRIPTION: This chapter discusses the remote operation of the HP 70205A Graphics Display and the HP 70206A System Graphics Display by remote control over HP-IB.

| | |
|---|------|
| Introduction | 3-1 |
| HP-IB Address | 3-2 |
| Section 1: Display Configuration. | 3-3 |
| Section 2: Simple Graphics | 3-7 |
| Section 3: Labeling the Screen | 3-19 |
| Section 4: Hardcopy Output | 3-24 |
| Section 5: Markers | 3-26 |
| Section 6: Character Sets | 3-27 |
| Section 7: Referenced Graphics | 3-31 |
| Section 8: Informational Displays | 3-36 |
| Section 9: Error Handling | 3-40 |
| Section 10: The Display as a Remotely-Controlled User Interface | 3-45 |
| Section 11: Utility Commands | 3-50 |

DISPLAY COMMAND SUMMARY

INDEX



GETTING STARTED

CHAPTER 1

GETTING STARTED

This chapter highlights important features of the HP 70205A Graphics Display and the HP 70206A System Graphics Display.

TABLE OF CONTENTS

| | |
|---|-----|
| GETTING STARTED | 1-1 |
| Tab Organization | 1-2 |
| Chapter Organization | 1-2 |
| Introduction | 1-3 |
| Front Panel Concept | 1-4 |
| HP 70205A Graphics Display | 1-5 |
| HP 70206A System Graphics Display | 1-7 |
| Softkey Concept | 1-9 |

TAB ORGANIZATION

Part III of the Operating Manual is marked by a large blue tab labeled "Display Operation." Each chapter is marked by a white tab labeled with the individual chapter title (e.g., Getting Started).

CHAPTER ORGANIZATION

Chapter 1: Getting Started

Briefly discusses capabilities and features of the two Display elements.

Chapter 2: DSP Hardkey (Manual Operation)

Discusses the manual operation of the Displays by describing the use of the softkeys under the [DISPLAY] hardkey ([DSP] on the HP 70205A). Includes step-by-step examples and a softkey menu tree diagram.

Chapter 3: Remote Display Operation

Discusses the operation of the Display using a remote controller on the Hewlett-Packard Interface Bus (HP-IB). Covers both instrument-related Display operations (windowing, labeling, output, etc.) and use of the HP 70205A and HP 70206A as stand-alone Graphics Displays.

Chapter 4: Appendices

Contains the Display Command Listings.

Chapter 5: Index

INTRODUCTION

This chapter, Getting Started, is the first chapter of Part III, Display Operation, of the Operating Manual for the HP 70000 Modular Measurement System. Part III does not cover the operation of any particular instrument in the HP 70000 System (e.g., a spectrum analyzer); instead, it covers the operation and capabilities of the Display elements—the HP 70205A Graphics Display and the HP 70206A System Graphics Display.

An HP 70000 series measuring instrument consists of a set of modules (for example, a spectrum analyzer composed of a Local Oscillator, an IF Section, and a RF section). However, such an instrument has neither a keyboard nor a screen: the measuring instrument itself is separate from the display. An HP 70000 series Display is an essential part of a **manually-operated** system and a powerful addition to a remotely operated system.

A Display provides such capabilities as:

- A screen for one or several instruments to write on.
- A keyboard to control one instrument at a time.
- System-wide error reporting.
- Hardcopy output capability without an external controller.

For a more complete description of the Display features, see the Display Capabilities section of this chapter.

FRONT PANEL CONCEPT

The Graphics Displays serve as the "Front Panel" for instruments in the HP 70000 Modular Measurement System. It is possible to use one display with multiple measurement systems, one display for a single system, or even multiple displays for the same system.

The compact HP 70205A Graphics Display and the larger HP 70206A System Graphics Display each have one screen with 14 unlabeled "softkeys" next to it (see Figure 1-3). These keys are labeled on the screen by whichever instrument owns the keyboard. Softkeys are used for all manual instrument control functions.

Notation:

Throughout this operating manual, softkey labels are denoted as **XXXX**. Fixed-label keys are referred to as "hardkeys" and are denoted as **[XXXX]**. Hardkey labels on the HP 70205A differ slightly from hardkey labels on the larger HP 70206A. For example, on the HP 70206A the Display hardkey is denoted by **[DISPLAY]** while on the HP 70205A the same hardkey is abbreviated to **[DSP]**. The key functions are identical, but the abbreviated hardkey labels are used throughout this operating manual.

Hardkeys:

For data entry, each display has a single knob and 15 labeled keys (0 – 9, decimal point, minus sign, back-space, step-up, and step-down). In most cases, data can be entered with either the numeric keypad (0 – 9), the display knob, or the stepkeys.

[I/P] (Instrument Preset)—When an instrument (such as the spectrum analyzer) owns the keyboard, pressing **[I/P]** will cause that instrument to preset many of its own operating parameters. This returns the instrument menu to the screen if the Display menu is in use, but does **not** affect operation of the display.

[USR] (User)—This key brings up from the spectrum analyzer the 14 softkeys most commonly needed by the user for instrument control. These keys are also available under the **[MNU]** (Menu) hardkey, although more than one keystroke is required to reach them. For more information on the **[USR]** hardkey, including instructions for modifying the **[USR]** keys, see the chapter entitled "USR Hardkey" in Part I.

[MNU] (Menu)—This key brings up a more general menu of softkeys for instrument control. This provides access to all softkeys shown on the Spectrum Analyzer Menu Tree Diagram (found in Chapter 4, "MNU Hardkey," in Part I). This key accesses more functions, but is less convenient, than **[USR]** for most operations. For more information, see Chapter 4 in Part I.

[DSP] (Display)—This key calls up a set of softkeys used to control the operations of the display itself. For a discussion of the functions of the display, see the "Display Capabilities" section in this chapter. For instructions on using the individual softkeys under **[DSP]**, see Chapter 2, "DSP Hardkey (Manual Operation of the Display)," in this part of the manual (Part III).

[LCL] (Local)—This key returns all modules in the system to local control from HP-IB remote.

A section in this chapter entitled "Softkey Concept" gives some examples of how to use the different softkey levels found under the **[DSP]** (Display) hardkey.

HP 70205A GRAPHICS DISPLAY

The Graphics Display is a 3/8-width module with 5 inch raster CRT which provides the human interface and manual control capability of the HP 70000 Modular Measurement System. It displays instrument status and measurement output, and it has graphics, trace, text, and marker capability. Controls include 14 user-definable menu keys (referred to as Softkeys in the text), 10 data keys (numbered 0 – 9), 10 control keys (which are referred to as Hardkeys in the text), and a control knob. Instrument control is accomplished using softkeys to establish an interactive front panel for an accessed instrument.

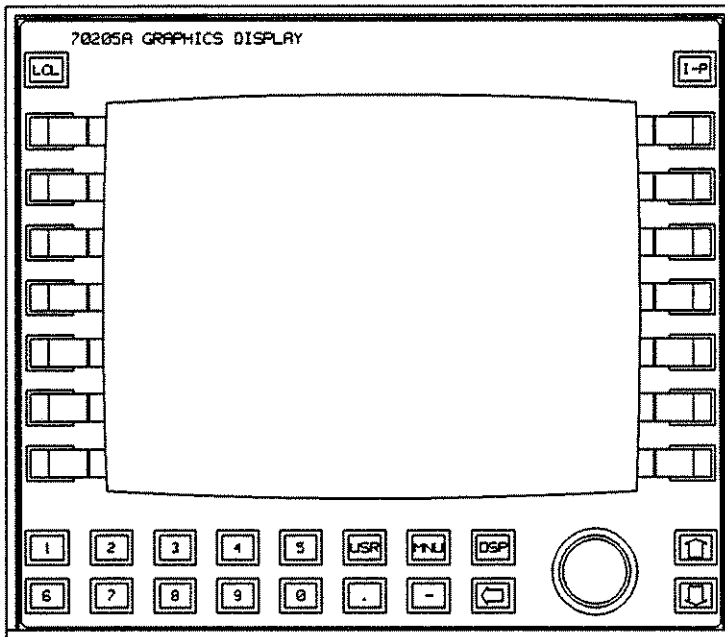

Fig. 1. HP 70205A Graphics Display

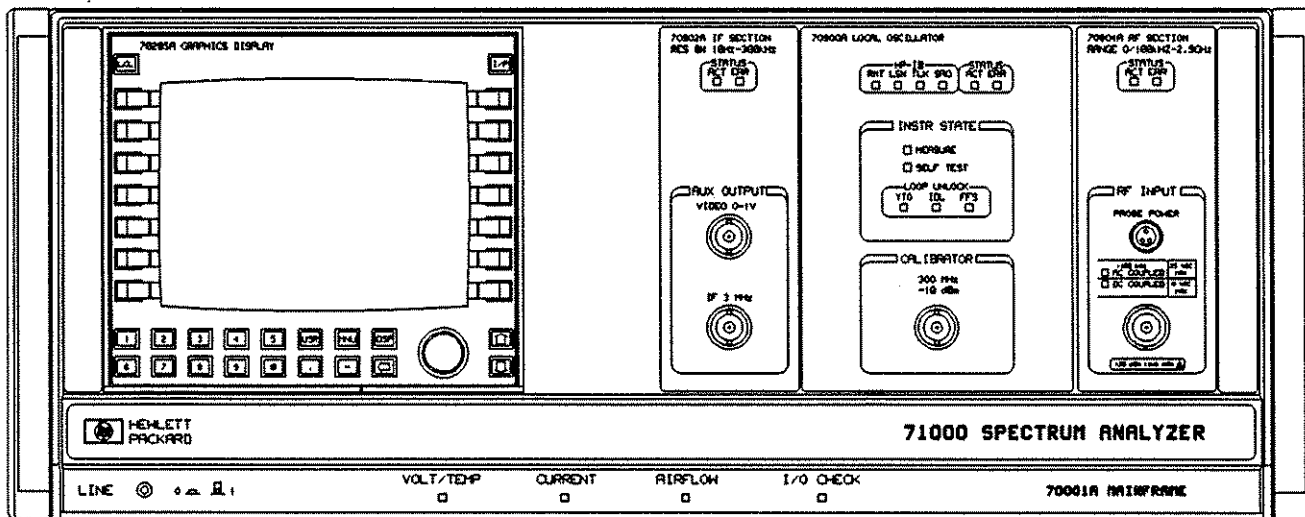

Fig. 2. HP 71100A Measurement System Including HP 70205A Graphics Display

There are 14 softkeys, 7 on each side of the CRT display. Three hardkeys ([USR], [MNU], and [DSP]), are located underneath the CRT, each providing access to a different set of softkeys. Pressing any one of these hardkeys brings up a menu of softkeys on the screen; some of these softkeys provide further access to other menus. If the display is used as a stand-alone display, the [USR] and [MNU] keys will NOT bring up a menu or softkeys. (See the Menu Tree Diagrams in Part I, Chapters 3 and 4, and Part III, Chapter 2).

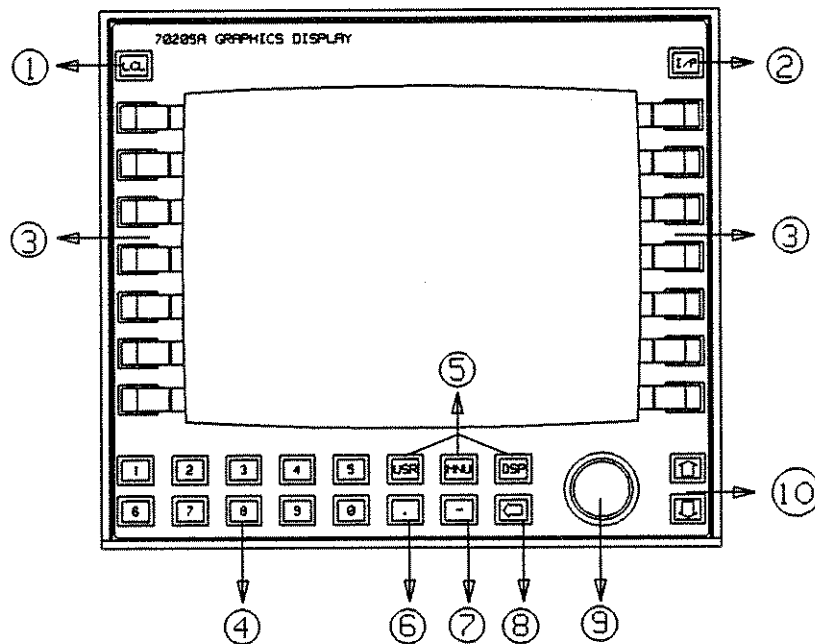

Fig. 3. HP 70205A GRAPHICS DISPLAY

1. Local Control – This key returns the instrument from remote to local control.
2. Instrument Preset – This key activates all the preset conditions of the instrument presently controlled by the keyboard.
3. Softkeys – These keys are used for most instrument and system control operations (see the "Softkey Concept" section of this Chapter).
4. Numeric Keypad – (0 – 9) This keypad enters numeric values.
5. USR, MNU, DSP Hardkeys – These are used to access three different top-level softkey menus.
6. Decimal Point. – This key enters a decimal point.
7. Minus Sign – This key is used for entering negative numbers.
8. Back Space (back arrow) – This key is used to move from a lower level of softkeys to the next higher level. It is also used in text entry to move the cursor.
9. Display Knob – This knob is used to change parameter values and to select alpha characters.
10. Step Keys – These two keys are used to change parameters up or down.

HP 70206A SYSTEM GRAPHICS DISPLAY

The System Graphics Display is a stand-alone, large-screen display for the HP 70000 Modular Measurement System. It has a 9-inch raster CRT in a 7 inch, full-rack, System II frame and is stack-compatible with the HP 70001A Mainframe and other System II instruments. It supplies the same display and manual control capability as the HP 70205A Graphics Display.

The primary advantages of the HP 70206A are its large display size and the fact that when it is used in place of the HP 70205A, 3/8 of the mainframe capacity is released for use by other modules.

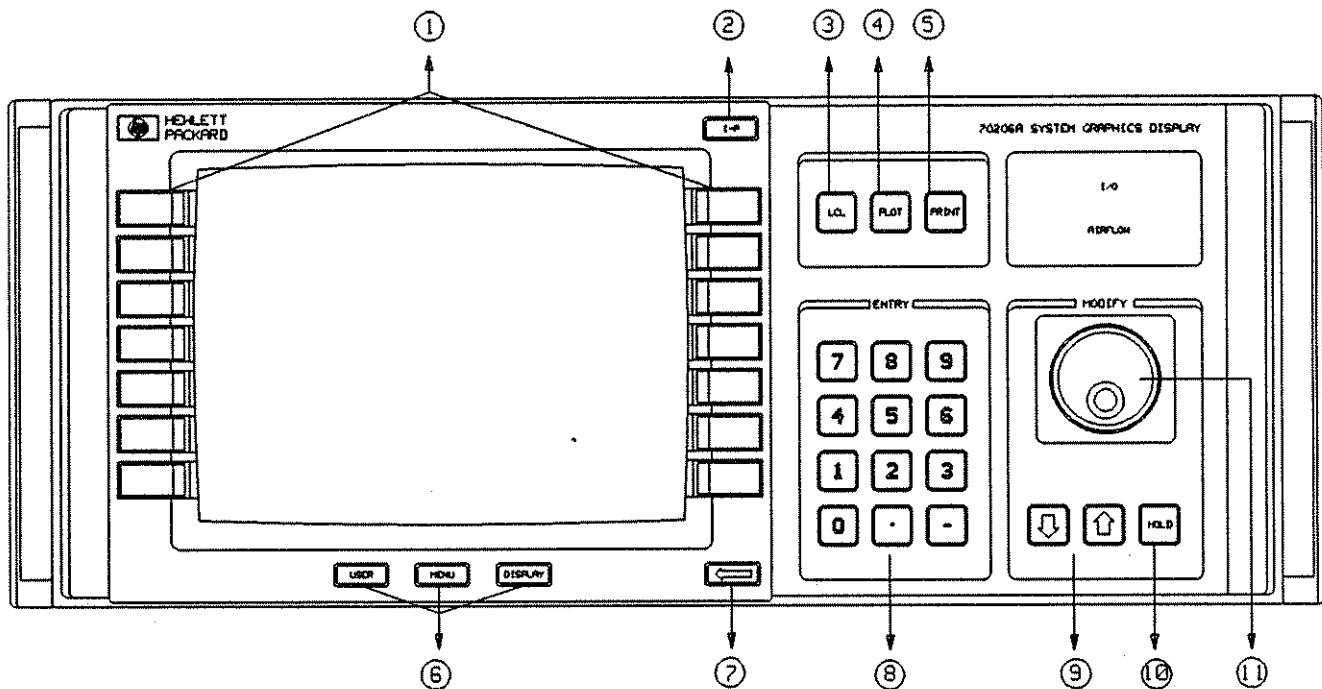

Fig. 4. HP 70206A SYSTEM GRAPHICS DISPLAY

1. Softkeys — These keys are used for most instrument and system control operations (see the "Softkey Concept" section in this chapter).
2. Instrument Preset — This key activates all the preset conditions of the instrument presently controlled by the keyboard.
3. Local Control — This key returns the instrument from remote control to local control.
4. Plot — This key starts a vector plot output of the present display screen over HP-IB (the same as the PLOT softkey).
5. Print — This key starts a raster print output of the present display screen over HP-IB. (the same as the PRINT softkey).
6. Hardkeys — These three keys (USER, MENU, DISPLAY) call the top level softkey menus to the screen. Throughout this manual these hardkeys are abbreviated to USR, MNU, and DSP.

7. Back Space (back arrow) – This key is used to move from a lower level of softkeys to the next higher level. It is also used in text entry to move the cursor.
8. Numeric Keypad – This keypad enters numeric values.
9. Step Keys – These two keys are used to change parameters up or down.
10. Hold – This key deactivates the function displayed in the active function area; the readout is blanked from the screen.
11. Display Knob – This knob is used to change parameter values, and to select alpha characters.

SOFTKEY CONCEPT

All the major functions of the spectrum analyzer and the display are accessed using softkeys. These softkeys, in turn, are accessed by three hardkeys: [USR], [MNU] and [DSP]. The [USR] and [MNU] hardkeys control functions of individual instruments in the system.

For instructions on how to use the softkeys under [USR] and [MNU], see the "USR Hardkey" and "MNU Hardkey" chapters in Part I, "Manual Operation."

The [DSP] hardkey accesses the display only and is dealt with in this portion of the operating manual, Part III "Display Operation." The hardkey [DSP] is a key that brings up the entire top level Display Menu. Softkeys in the Display Menu allow the user to:

Format and obtain hardcopy output.

```
PRINT
PLOT
define hardcopy
```

Configure the display screen into individually assignable windows.

```
config display
```

Quickly access any of several instruments in the HP 70000 Measurement System.

```
SELECT INSTR
assign keybd
```

Obtain system-wide error reports.

```
REPORT ERRORS
```

Implement several self-tests that relate specifically to the display.

```
display tests
```

Examine addresses on the HP-MSIB, the local bus for modular instruments.

```
address map
```

Alter the brightness of the display screen.

```
INTENS ADJUST
```

Review some brief key descriptions.

```
HELP
```

Clear the screen, all errors, and the HP-IB output buffer and assign the entire screen to the last module which owned the keyboard.

DISPLAY PRESET

The softkeys listed above are described in detail in Chapter 2, DSP Hardkey (Manual Operation). In addition, Chapter 2 contains practical examples of softkey usage.

DSP HARDKEY

CHAPTER 2

DSP HARDKEY

This chapter describes in detail the manual operation of the displays. All manually-available functions are accessed through softkeys by pressing the [DSP] hardkey ([DISPLAY] on the HP 70206A). Note that the 70206A also makes the PRINT and PLOT functions available on hardkeys. All softkeys are described and examples are included with sample outputs. In addition, a brief discussion is included on the addressing of modules on HP-IB and HP-MSIB.

TABLE OF CONTENTS

| | |
|---|------|
| DSP HARDKEY. | 2-1 |
| Introduction | 2-3 |
| Top Level Softkeys. | 2-3 |
| SELECT INSTR | 2-5 |
| DISPLAY PRESET. | 2-8 |
| assign keybd | 2-9 |
| address map | 2-11 |
| HP-IB, HP-MSIB, and the Address Map | 2-15 |
| ADJUST COLUMN/ADJUST ROW. | 2-16 |
| SET HP-IB | 2-18 |
| ALLOC DISPLAY | 2-20 |
| ALLOC KEYBD | 2-23 |
| ALLOC SCREEN. | 2-24 |
| config display | 2-25 |
| build window. | 2-26 |
| assign window | 2-30 |
| purge window | 2-35 |
| HARDSET/SOFTSET HP-IB. | 2-38 |
| HELP. | 2-42 |
| SHOW CONFIG | 2-43 |
| SAVE CONFIG/RECALL CONFIG | 2-47 |
| PRINT | 2-50 |
| PLOT. | 2-52 |
| define hardcopy | 2-53 |
| printer is | 2-55 |
| plotter is | 2-58 |
| plotter params | 2-59 |
| KEY/COPY ON/OFF | 2-62 |
| HI RES ON/OFF | 2-65 |
| EJECT ON/OFF | 2-66 |
| COPY IS PRT/PLT. | 2-67 |
| DEFAULT VALUES. | 2-68 |
| HELP. | 2-69 |

| | |
|--------------------------|------|
| REPORT ERRORS. | 2-70 |
| display tests | 2-75 |
| DISPLAY ID | 2-76 |
| KNOB TEST | 2-77 |
| KEY TEST | 2-78 |
| CONFID TEST | 2-79 |
| tumble figures | 2-80 |
| test pattern | 2-81 |
| INTEN ADJUST. | 2-82 |
| HELP. | 2-83 |

INTRODUCTION

This chapter describes in detail all manually accessible features of the Displays. These functions are accessed by pressing the [DSP] hardkey ([DISPLAY] on the HP 70206A).

The hardkey [DSP] is a top level key that allows the user access to the entire menu of display softkeys. Softkeys in the display menu enable the user to format and obtain hardcopy output (*PRINT*, *PLOT*, and *define hardcopy*), to configure the display screen into individually assignable windows (*config display*), and to quickly access any of several instruments in the HP 70000 Measurement System (via *SELECT INSTR* and *assign keybd*). Furthermore, system-wide error reporting is available through the display (*REPORT ERRORS*), as well as several display self-test features (under *DISPLAY TESTS*). A display preset (*DISPLAY PRESET*) is available that clears the display and gives the screen to the module which last owned the keyboard (if any).

In addition, all addressing on the HP-MSIB (the local bus for modular instruments) can be examined via the *address map* softkey. The display screen's brightness can be changed (*INTENS ADJUST*), and some brief key descriptions are available under *HELP*.

TOP LEVEL SOFTKEYS

Figure 1 shows the softkeys that appear when [DSP] is pressed.

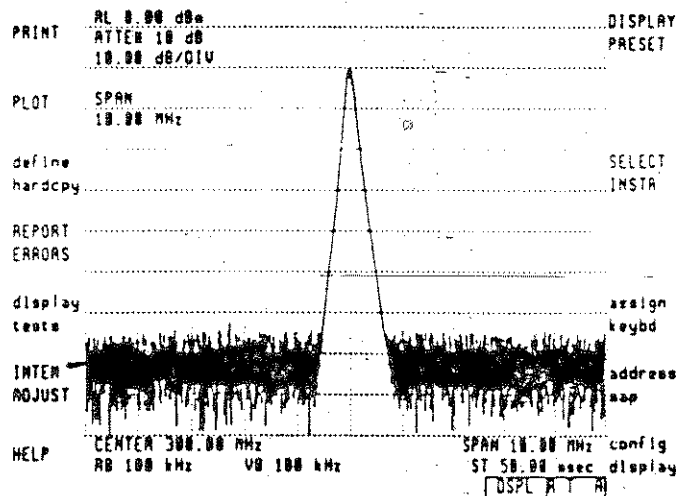

Fig. 1. Top Level Menu for the [DSP] hardkey

Figure 2 is a graphical representation of the softkeys accessed at various levels under [DSP]. The 14 boxes at the top of Figure 2 represent the softkeys shown above in Figure 1. This chapter describes the operation of all softkeys shown in the menu tree diagram, Figure 2.

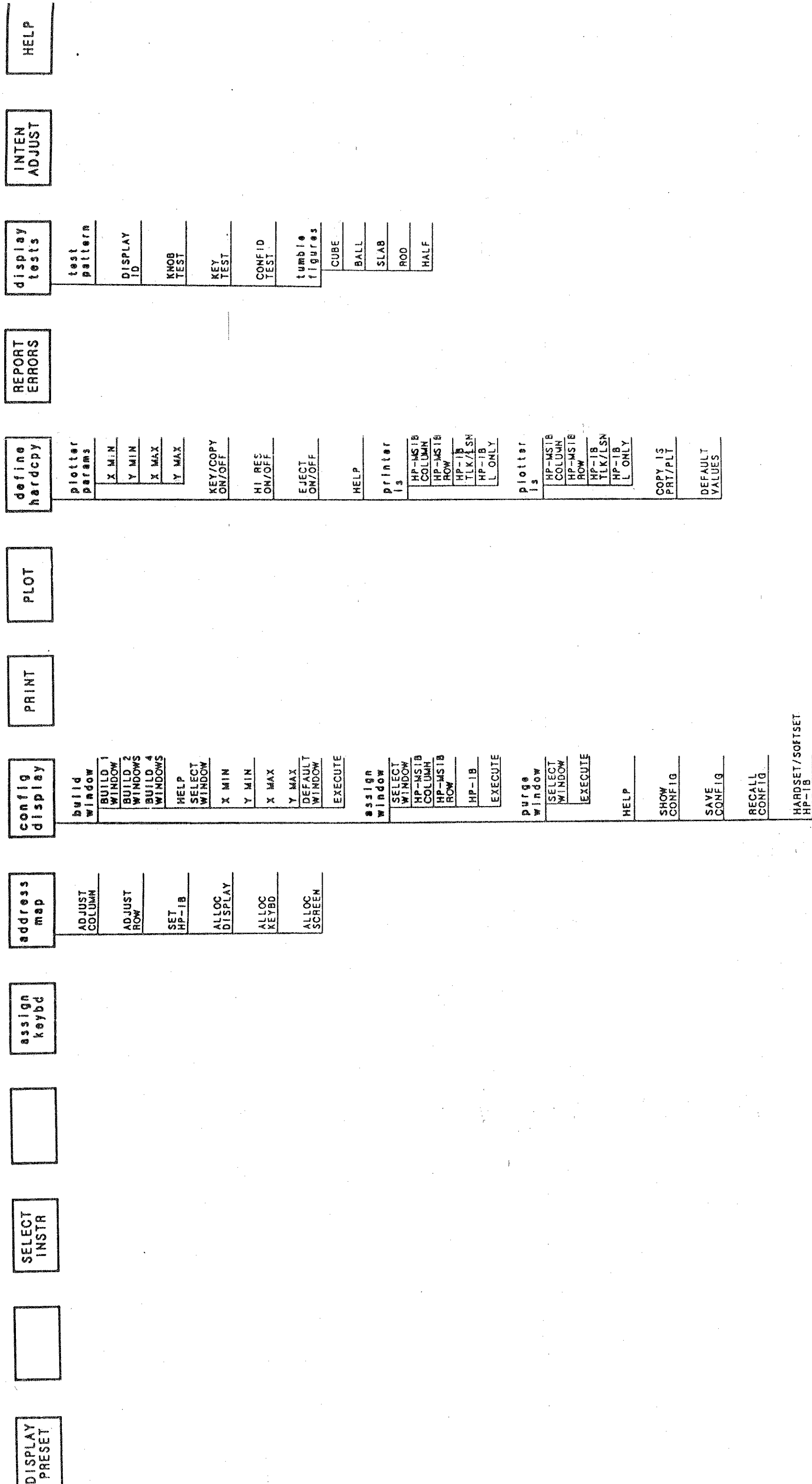

Fig. 2. The DISPLAY Soft

SELECT INSTRUMENT

The Display works by establishing links to instruments. For example, in the Spectrum Analyzer, the Display tries to establish a link with the Local Oscillator. The **SELECT INSTR** softkey establishes a link between the display and one instrument in the currently configured HP 70000 System (e.g., any of several spectrum analyzers). These links are required for data display and manual control of an instrument, since the display serves as the interface between that instrument and the user. At power-on the user is prompted to press **SELECT INST**. If during a previous session, **SELECT INST** had been pressed and the screen assigned to an instrument, the Display will automatically attempt to re-establish one link to that instrument. In that case, as soon as the link is established, the power-up prompt goes away. In most cases, this will happen so soon after the link is offered that the prompt will flash on the screen and be gone.

To establish (or re-establish) a link to an instrument, simply press [DSP] and **SELECT INSTR**. The display will look for the instrument with the lowest column address on the HP-MSIB (the HP 70000's bus) and allocate the entire screen and the 14 softkeys to that instrument. Use the step-up (or **SELECT INSTR** again) and step-down keys to select the instrument with the next highest or next lowest address.

The information displayed depends on the specific instrument selected. Since this key only establishes communication links between the display and the instrument, most settings are left unchanged. However, any previously defined display windows are erased.

This key is useful for establishing initial contact with a single instrument. To preserve existing windows, use the **assign window** softkey, available under **config display**. (These softkeys are described in detail in the CONFIG DISPLAY subsection of this chapter.)

Example: Obtaining spectrum analyzer display and keyboard control.

This example describes how the user can quickly obtain a spectrum analyzer display on the screen regardless of the current screen configuration.

It begins by breaking contact with the instrument, then re-establishes contact using the **SELECT INSTR** softkeys.

1. Press [DSP].
2. Press **DISPLAY PRESET**.
3. Press **config display**.
4. Press **purge window**.
5. Press **EXECUTE**.
6. Press [DSP]. This should result in a screen similar to Figure 3.

| | |
|----------------------|-------------------|
| PRINT | DISPLAY
PRESET |
| PLOT | |
| def line
hardcopy | SELECT
INSTR |
| REPORT
ERRORS | |
| display
tests | assign
keybd |
| INTEN
ADJUST | address
map |
| HELP | config
display |

| | | | |
|-----|---|---|---|
| DSP | L | Y | A |
|-----|---|---|---|

Fig. 3

If you press [USR], even the softkey labels disappear. No key other than [DSP], [PRINT], or [PLOT] will give a response.

[USR] does not call up any softkeys because no instrument is currently linked to the Display. All softkeys under [USR] and [MNU] are created by and responded to by an instrument (the spectrum analyzer), while all softkeys under [DSP] are generated by the Display itself.

To obtain an instrument display on the screen, press [DSP], and then **SELECT INSTR**. If using a spectrum analyzer, this should result in a display similar to Figure 4. To use the instrument now, simply press [USR] or [MNU] and use the appropriate softkeys.

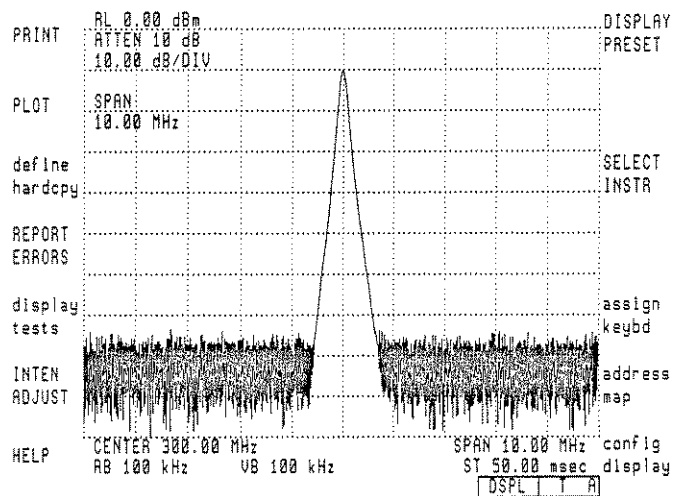

Fig. 4

DISPLAY PRESET

This key clears the screen, resets all HP-IB parameters to an initial state, and assigns the entire screen to the last module to own the keyboard (if none, the screen is left blank). It also resets the hardcopy parameters to their default values (see *define hardcopy*).

ASSIGN KEYBOARD

This softkey gives the user keyboard control over any instrument currently writing information to a window on the screen.

To use this softkey, press [DSP] and *assign keybd*, then use the step keys, the display knob, or the numeric keypad to select the window desired (i.e., the window written to by the instrument you wish to control). If it is defined, the window corresponding to the number chosen (1 through 4) will be highlighted on the screen. Next press [MNU] or [USR], and the specified instrument will respond with the appropriate softkey menu. A communication link between the keyboard and the module is established when the user leaves the [DSP] function (for instance, by pressing [MNU] or [USR]).

Example: Build two windows, one atop the other.

Use *assign keybd* to control separate spectrum analyzers, both simultaneously writing to the display. (If you have already covered *assign window* and *BUILD 2 WINDOWS*, and if you have two spectrum analyzers in your system, try this example. If not, see Configure Display later in this chapter.)

1. Press *config display*.
2. Press *build window*.
3. Press *BUILD 2 WINDOWS*.
4. Assign each to a different instrument in the system, so that the Display screen is similar to Figure 5.

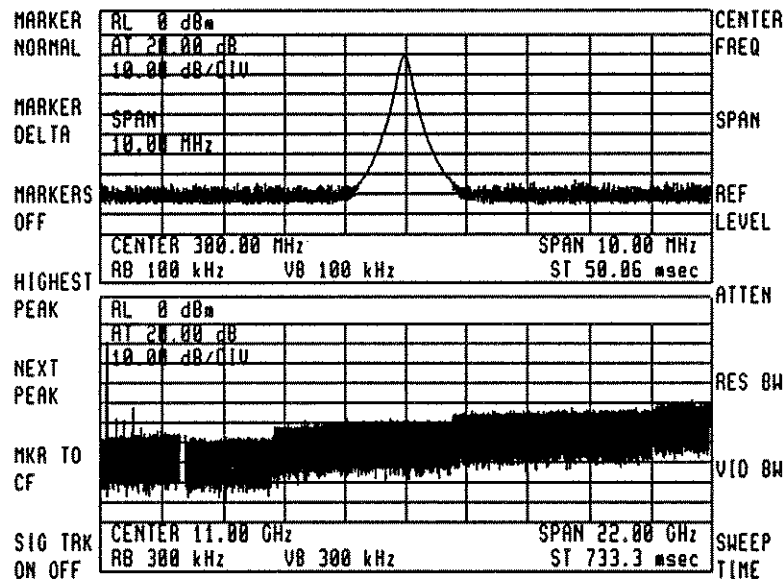

Fig. 5.

5. Press assign keybd.
6. Use the step-keys until the upper window is highlighted on the screen.
7. Press [USR].

You now have access to the basic instrument control keys of the instrument writing to the top window. In this figure, the user pressed [USR] then SPAN. Note that SPAN 10 MHZ is denoted in the upper window as the active function.

assign keybd and ALLOC KEYBD (under address map) both link the keyboard with an instrument or module. They differ in the method by which the instrument to be controlled is selected. Both link the keyboard to a module: assign keybd by selection of a window in the display, ALLOC KEYBD by moving the cursor in the address map.

ADDRESS MAP

The softkey address map allows you access to the address map. The address map is a real-time graphical representation of the HP 70000 system elements—modules and graphics displays—that are on the Hewlett-Packard Modular System Interface Bus (HP-MSIB).

NOTE

HP-MSIB is distinct from HP-IB or IEEE-488.

| | | | | |
|---|----|----|-------------------------------|------------------|
| | | | | ADJUST
COLUMN |
| 7 | | | | |
| 6 | | | | ADJUST
ROW |
| 5 | | | | |
| 4 | | | | SET
HP-IB |
| 3 | | | 70904A
RF SECT | ALLOC
DISPLAY |
| 2 | | | 70903A
IF SECT | |
| 1 | | | 70902A
IF SECT | ALLOC
KEYBD |
| 0 | | | 70900A
Lo/Ctlr
HP-IB IB | ALLOC
SCREEN |
| | 16 | 17 | 18 | 19 |

COLUMN

COLUMN: 18

Fig. 6. Typical HP 70000 Address Map Detail

The operation of individual softkeys under address map is described in the following pages. In this subsection we will briefly discuss the concept of the HP 70000 Measurement System address map, HP-MSIB, and the capabilities accessible via the address map softkey. More information about the HP-MSIB is available in the System Support Manual which is the primary user reference for addressing modules.

The HP-MSIB (Hewlett-Packard Modular System Interface Bus) has a two-dimensional addressing scheme. Each system element such as the HP 70900A Local Oscillator module or the HP 70206A System Graphics Display has a two-part bus address. The address consists of a row number and a column number; for example, "0,18" (row,column). This unique address serves as an identifier so that any element can talk with any other element on HP-MSIB, regardless of physical proximity or other bus traffic.

The address map is designed so that each element can be located by its unique address. The row address (first number) specifies the horizontal row of the grid where the element is located, and the column address specifies the vertical column. Rows have numbers 0 through 7 ("0" is at the bottom of the screen) and columns are numbered 0 through 31 ("0" at the left edge of the map). The address "0,31" is not available for use; hence, there are 255 available addresses.

Each modular measuring instrument (composed of several modules) will typically occupy all or part of a single column. (The exception to this is multi-column instruments. See the System Support Manual.) Note that the display elements (the HP 70205A and the larger HP 70206A) are not part of any measuring instrument. Each display serves as a general-purpose human-machine interface, providing a screen for the instruments and keys that enables the user to control the system. Since the displays are not part of any particular instrument, each will occupy its own column in the address map. See the figures below.

| | | | | | | |
|-------------|---|----|--------------------------------|----|----|------------------|
| R
O
W | 7 | | | | | ADJUST
COLUMN |
| | 6 | | | | | ADJUST
ROW |
| | 5 | | | | | SET
HP-18 |
| | 4 | | | | | ALLOC
DISPLAY |
| | 3 | | 70904A
RF SECT | | | ALLOC
KEYBD |
| | 2 | | 70903A
IF SECT | | | ALLOC
SCREEN |
| | 1 | | 70902A
IF SECT | | | |
| | 0 | | 70900A
Lo/Ctrlr
HP-18 18 | | | |
| | | 17 | 18 | 19 | 20 | COLUMN |

COLUMN: 18

Fig. 7. Addressing Conventions for Individual Elements. (1 of 2)

| | | | | | | |
|-------------|---|---|------------------------------|---|---|------------------|
| R
O
W | 7 | | | | | ADJUST
COLUMN |
| | 6 | | | | | ADJUST
ROW |
| | 5 | | | | | SET
HP-18 |
| | 4 | | | | | ALLOC
DISPLAY |
| | 3 | | | | | ALLOC
KEYBD |
| | 2 | | | | | ALLOC
SCREEN |
| | 1 | | | | | |
| | 0 | | 70206A
DISPLAY
HP-18 4 | | | |
| | | 3 | 4 | 5 | 6 | COLUMN |

COLUMN: 4

Fig. 8. Addressing Conventions for Individual Elements. (2 of 2)

NOTE

A more detailed description of HP-MSIB addressing conventions is given in the System Support Manual. The System Support Manual is the primary user reference for addressing modules.

HP-MSIB addresses are set only by switches located on each module or display. All elements (modules and HP 70206A displays) have adjustable column addresses. All elements except the displays have adjustable row addresses. (The displays are confined to row 0.) An appropriate element, when located in row 0, acts as a "master" to all modules above and to the right of it; this master has control as far as the column of the next master, which supersedes the first. The master module is able to control another module by ordering it to perform tasks and by controlling the flow of information to and from that module. For example, an error detected in an IF section will be reported to the master module, which will in turn report it to the user via the display. (In the Spectrum Analyzer, an example of a master module is the HP 70900A Local Oscillator.)

The modules controlled by a master are referred to as slaves. Slave modules are addressed "above" the master; that is, slaves have higher row addresses than their master. A measuring instrument such as a spectrum analyzer will typically consist of one master (local oscillator module) and several slaves (IF sections, RF "Front End" sections, tracking generators, etc.). While a master module must be located in row 0, slave modules can be addressed in any of several rows, according to these rules:

- Only one RF section (HP 70904A, HP 70905A, or HP 70906A) may be used with a single local oscillator module.
- The tracking generator (HP 70300A), if present, must have the highest row address of that column.
- If no tracking generator is present, the RF section should occupy the highest row address of that column. If a tracking generator is present, the RF section is addressed immediately below it (in the column).
- External mixer interface modules are to be addressed immediately below the RF section and/or tracking generator (in the column). Multiple external mixer interface modules should have consecutive row addresses. If neither tracking generator nor RF section is present, an external mixer interface module will have the highest row address of that column.
- The HP 70902A IF section, if present, must be closest to the local oscillator. (That is, the HP 70902A should be immediately above the HP 70900A in the address map.)
- The HP 70903A IF section, if present, should be immediately above the HP 70902A (in that column). If the HP 70902A is not present, the HP 70903A should be directly above the local oscillator.
- A single master may control only a certain number of slave modules. At present, the number is seven. For example, a modular spectrum analyzer (with a single local oscillator) could consist of that one local oscillator with two IF sections, one RF section, and four separate external mixer interface modules (each covering a separate frequency band).

The row-addressing priority for a sample system is shown below. The sample is a **relative** row-address ranking only. The individual modules do not require consecutive row addresses (i.e., there can be empty

rows between modules). Also, note that all modules need not be in the same column: they need only fall in the "slave area" of the master module (above and to the right) as described in the System Support Manual.

Highest row:

- HP 70300A Tracking Generator
- HP 70904/5/6A RF Section (one only)
- HP 70907A External Mixer Interface modules (several allowed)
- HP 70903A IF Section
- HP 70902A IF Section

Lowest row (row 0):

- HP 70900A Local Oscillator

HP-MSIB addresses must be unique. Setting two HP 70000 elements to the same address will create an error and make the system bus (HP-MSIB) inoperative. If the cursor cannot be moved about within the address map after a module has been re-addressed, check to see if two modules have the same row and column address. If the Address Map function is inoperative, removal of the modules is required. See the System Support Manual for instructions. If the HP-MSIB is inoperative at power-up all modules will indicate this by blinking their Error LED (the display blinks its "E" annunciator). To test for an inoperative HP-MSIB, cycle power and check the "E" annunciator.

HP-IB, HP-MSIB, and the ADDRESS MAP

Although HP-IB and HP-MSIB are different buses, some elements on HP-MSIB are accessible via HP-IB. Specifically, certain elements that have an HP-MSIB row address of 0 may be addressed over HP-IB with the proper configuration.

A brief discussion of HP-IB usage with HP 70000 systems will be presented here, but a more detailed coverage is given in the System Support Manual.

Between mainframes (HP 70001A), HP-IB and HP-MSIB are completely separate and are carried on separate cables. HP-IB is a parallel-connected single cable bus; HP-MSIB is a series-connected dual-cable bus. Two HP 70000 System Mainframes are connected to the same HP-IB network only if each is connected to it individually, or if there is an HP-IB cable linking the two. The 70206A also connects to the system over separate HP-IB and HP-MSIB cables.

Within a single mainframe, HP-IB and HP-MSIB connections are carried along the backplane bus and are provided at the back of each 1/8-width module slot. A mainframe has exactly one HP-IB port (one connector) and one HP-MSIB port (two connectors: one "in" and one "out"). Hence, all modules in a particular mainframe have access to both the HP-IB lines and the HP-MSIB lines.

All modules can communicate over HP-MSIB, but, as previously mentioned, only certain modules or elements can talk over HP-IB. Therefore, while every HP 70000 Series element takes up an HP-MSIB address, only the row 0 modules can occupy HP-IB addresses. Among the HP 70000 series elements that can use HP-IB are the HP 70900A Local Oscillator and the HP 70205A/ 70206A Graphics Displays.

Each system element that can talk over HP-IB can also be removed from HP-IB by positioning the "HP-IB ON/OFF" switch in the "OFF" position (some modules indicate this by putting a "NO" in the address map in place of their HP-IB address). On the HP 70205A and HP 70206A Displays, this switch is readily accessible from the back panel. On the HP 70900A Local Oscillator, the switch is located on the top of the module, along with the other HP-IB and HP-MSIB switches. Changing any of these switches on the Local Oscillator requires removal of the module from the mainframe (see the System Support Manual for more information).

The HP-IB address and the HP-MSIB address of a system element are not necessarily related. The HP-MSIB address is determined solely by the setting of the address switches on the module (see the System Support Manual). When applicable, the HP-IB address of each module defaults to the HP-MSIB column address. For example, the HP-MSIB address 0,18 has a default HP-IB address of 18. Note, however, that the HP-IB address of the local oscillator and of both displays may be set to any valid address using the SET HP-IB softkey, which is available through address map. See the SET HP-IB softkey description in this chapter for instructions.

ADJUST COLUMN/ADJUST ROW

The **ADJUST COLUMN** and **ADJUST ROW** softkeys, available directly under **address map**, allow you to move the cursor (the highlighted box) within the address map.

Example: Adjusting the column and row.

1. Press [DSP].
2. Press **address map**.
3. Press **ADJUST COLUMN**.
4. Turn the display knob until the cursor rests on the Local Oscillator module.
5. Press **ADJUST ROW**.
6. Use the step-up key to place the cursor on the RF section as in Figure 9.

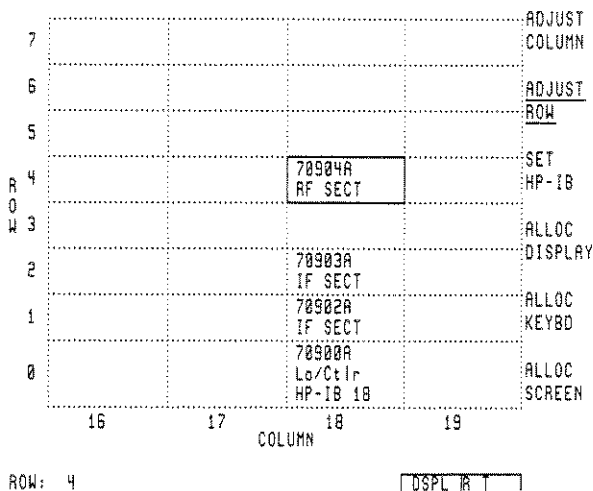

Fig. 9

The **ADJUST COLUMN** and **ADJUST ROW** softkeys accept data entry from the display knob, from the step-up and step-down keys, and from the numeric key pad. •

The module currently highlighted in the address map will have a green "ACT" light on its front panel. (The displays show an "A" in the lower right-hand status box on the screen.) This light enables you to correlate the specific physical HP 70000 System elements to their locations in the address map. Default addresses of some modules shipped from the factory are:

HP 70900A 0,18
HP 70205A 0,4
HP 70206A 0,4

SET HP-IB

The **SET HP-IB** softkey allows you to change the HP-IB address of any element currently on HP-IB if that element will permit it. The specific conditions are discussed earlier in this section.

Example: Change the HP-IB address of the display.

1. Press [DSP].
2. Press **address map**.
3. Press **ADJUST COLUMN**.
4. Turn the display knob so that the cursor box stops on the display as in Figure 10.

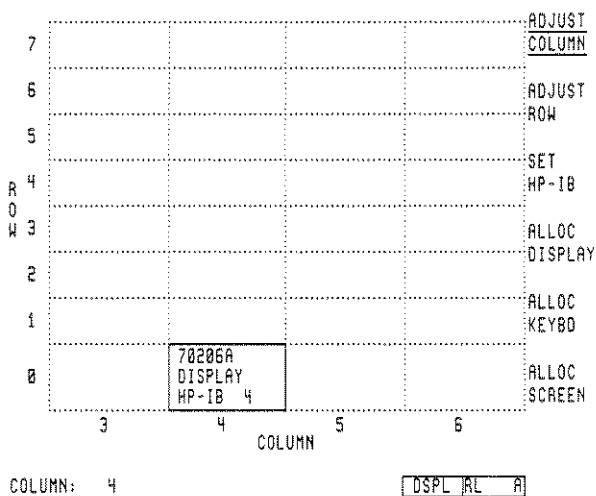

Fig. 10

5. Press **SET HP-IB**.
6. Press [2].
7. Press [0].
8. Press **ENTER**. The HP-IB address of the display should immediately change to 20 as in Figure 11.

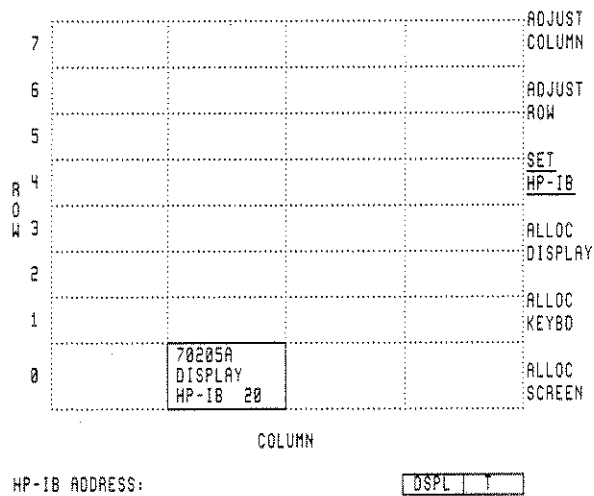

Fig. 11

Notes:

1. An HP 70000 System element can show an HP-IB address on the Address Map even though the element is disabled (by the "HP-IB" hardswitch) and cannot communicate on HP-IB. (See HP-MSIB earlier description in this section, or see the System Support Manual.) Some modules show that they are disabled by replacing their HP-IB address with the word "NO" in the address map.
2. The HP 70900A Local Oscillator module (LO) has the ability to lock its HP-IB address so it will not respond to the SET HP-IB softkey. To do this set the "SW1/MEM" switch on the LO to the "SW1" position. With this switch set to "SW1", the HP-IB address of the LO will remain identical to the HP-MSIB column address.
3. Upon power-up, the HP-IB addressing is handled differently by different elements. Displays can be configured to have a power-up HP-IB address of either the HP-MSIB column address or the most recent HP-IB address given to the display with the SET HP-IB softkey. This option (for displays only) is discussed in the HARDSET/SOFTSET HP-IB section of this chapter. The local oscillator module, however, always has a power-up HP-IB address identical to its HP-MSIB column address.

ALLOCATE DISPLAY

The softkey **ALLOC DISPLAY** is used to establish contact between the display and a specific module. It allocates the screen and softkeys to the module currently highlighted by the cursor in the address map.

Example: Allocating the display to a particular instrument.

First, break contact with the spectrum analyzer.

1. Press [DSP].
2. Press **address map**.
3. Press **ADJUST COLUMN**.
4. Use the display knob to place the cursor on an empty address, as in Figure 12. (On the display screen the cursor is the highlighted box.)

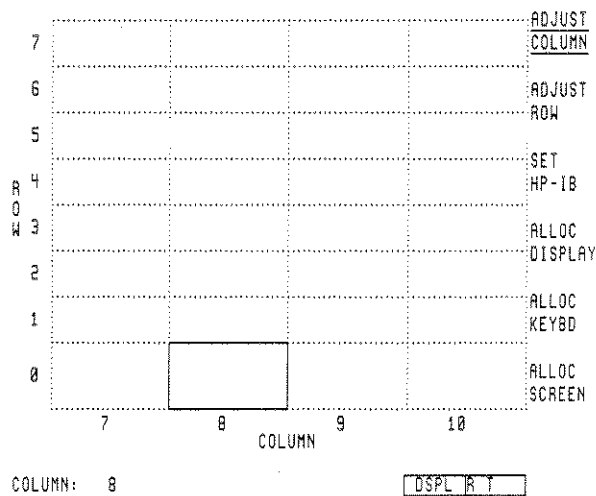

Fig. 12

5. Press **ALLOC DISPLAY**.

This breaks all links with the existing instrument and attempts to establish a link between the display and a non-existent instrument. This results in a blank screen, as in Figure 13.

| | |
|--------------------|-------------------|
| PRINT | DISPLAY
PRESET |
| PLOT | |
| define
hardcopy | SELECT
INSTR |
| REPORT
ERRORS | |
| display
tests | assign
keybd |
| INTEN
ADJUST | address
map |
| HELP | config
display |

DSPL R T A

Fig. 13

Re-establish contact with the spectrum analyzer.

1. Press address map.
2. Press ADJUST COLUMN.
3. Turn the knob to position the cursor on the local oscillator module.

| | | | | |
|---|----|--------------------------------|----|------------------|
| | | | | ADJUST
COLUMN |
| 7 | | | | |
| 6 | | | | ADJUST
ROW |
| 5 | | | | |
| 4 | | 70904A
AF SECT | | SET
HP-IB |
| 3 | | | | ALLOC
DISPLAY |
| 2 | | 70903A
IF SECT | | |
| 1 | | 70902A
IF SECT | | ALLOC
KEYBD |
| 0 | | 70900A
Lo/Ct Ir
HP-IB 18 | | ALLOC
SCREEN |
| | 16 | 17 | 18 | 19 |

COLUMN: 18

DSPL R T A

Fig. 14

4. Press **ALLOC DISPLAY**.

This should result in a screen similar to that shown in Figure 15, depending on the previous settings of the spectrum analyzer being used.

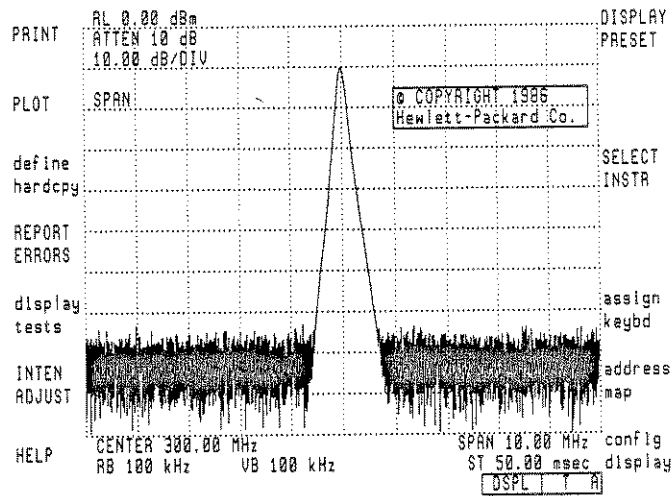

Fig. 15

In summary, **ALLOC DISPLAY** establishes contact between the Display (the user interface) and an HP 70000 module, but differs from **SELECT INSTR**. **ALLOC DISPLAY**, used in the Address Map, requires that a particular module (element) be specified. **SELECT INSTR** selects an instrument on its own. Both, however, destroy any links between the display and any other instruments. Both destroy any existing windows in the display.

ALLOCATE KEYBOARD

The **ALLOC KEYBD** softkey is used to allocate the keyboard to a specific module. The keyboard can then be used to control the instrument settings of a spectrum analyzer, such as Center Frequency and Span.

1. Press **[DSP]**.
2. Press **address map**.
3. Move the cursor to the module desired.
4. Press **ALLOC KEYBD**.

The keyboard will be linked to that module.

Notes:

1. The keyboard and the screen can be allocated separately. **ALLOC KEYBD** links the keyboard with an instrument, but does not necessarily display any trace data from that instrument. Hence, the softkeys may not correspond to the instrument display shown.
2. Only a master module such as the HP 70900A can receive the keyboard. Attempts to allocate the keyboard to slave modules will result in an error.
3. **ALLOC KEYBD** lets the user link the keyboard with any master module by way of the address map. Another softkey, **assign keyboard**, which is available directly under **[DSP]**, is generally quicker and easier to use.

ALLOCATE SCREEN

The two resources of the display, the keyboard and the screen, can be allocated separately. **ALLOC SCREEN** assigns the whole screen to a particular module, even though the keyboard may be assigned elsewhere. This allows the user to view the trace output from one instrument (on the screen) while controlling a different instrument (with the keyboard).

To use the **ALLOC SCREEN** softkey:

1. Press **addresss map**.
2. Move the cursor box to the module or instrument desired.
3. Press **ALLOC SCREEN** and the screen will be immediately allocated to that module. If the module is ready to put out trace information, the information will be immediately displayed.

NOTE

Only Master modules can be linked to the display. Therefore, use **ALLOC SCREEN only for Master Modules, such as the HP 70900 Local Oscillator module. Attempting to allocate the screen to a slave module will result in an error.**

CONFIGURE DISPLAY

config display gives the user access to a submenu of softkeys that configure the various features of the display. (See Figure 16.) These features and capabilities consist of building windows on the screen, selecting the instruments that may write to those windows, saving and recalling display configurations, and viewing stored and current configurations.

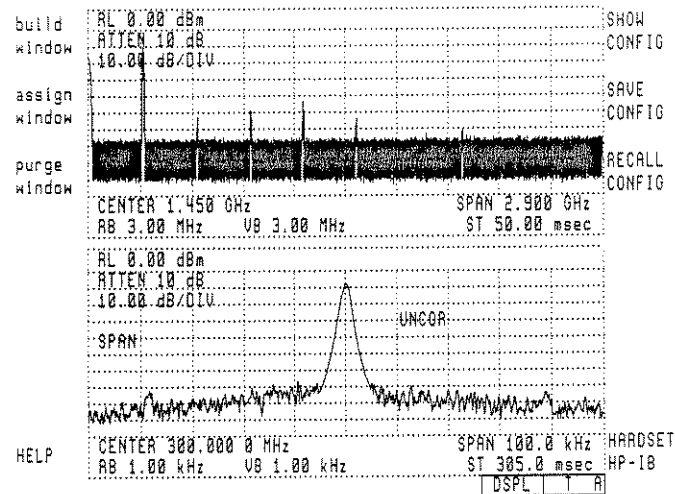

Fig. 16

The softkeys accessed by pressing *config display* include *build window*, *assign window*, *purge window*, *HELP*, *SHOW CONFIG*, *SAVE CONFIG*, *RECALL CONFIG*, and *HARDSET/SOFTSET HP-IB*. The following pages contain descriptions and examples of these softkeys. A listing and brief description of each follows:

build window allows the user to construct up to four separate windows on the screen.

assign window links windows with modules so that trace information can be displayed.

purge window removes a previously-built window.

HELP calls up some brief descriptions of the keys available under *config display*.

SHOW CONFIG displays a summary of the current and stored display screen configurations.

SAVE CONFIG, *RECALL CONFIG* saves and recalls a screen configuration to or from one of the four screen configuration registers.

HARDSET/SOFTSET HP-IB allows the user to determine the power-up HP-IB address of the Display.

BUILD WINDOW

The *build window* softkey allows the user to construct up to four separate "windows" on the screen. A window is a user-defined portion of the screen that is set aside for a single instrument to display information.

Example: Building two windows.

NOTE

The *BUILD 1 WINDOW*, *BUILD 2 WINDOWS*, and *BUILD 4 WINDOWS* softkeys perform a similar function.

1. Press [DSP].
2. Press *config display*.
3. Press *build window*.

The *build window* submenu appears with *SELECT WINDOW* automatically underlined, see Figure 17. The underline indicates that this function is active. Select a window, numbered 1 through 4, by using any data entry method (step-keys, display knob, numeric key pad, or softkey). If the key pad is used to enter the window number, the user must press *ENTER* to finish the entry.

For this example, build window #1.

NOTE

The window selected, if currently defined, is highlighted.

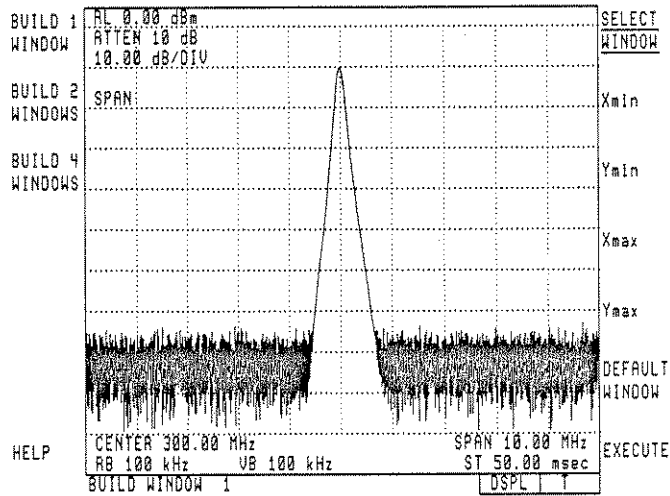

Fig. 17 Softkeys Available Under *build window*

Press *Ymax*, then turn the knob counterclockwise to bring the top line to a point just below the middle of the screen. At the bottom of the screen a Ymax value will be displayed and will change as the display knob is turned. Set Ymax at approximately 195. Press *EXECUTE*. Window #1 has now been redefined as in Figure 18.

| | |
|---------------|---------------|
| build window | SHOW CONFIG |
| assign window | SAVE CONFIG |
| purge window | RECALL CONFIG |

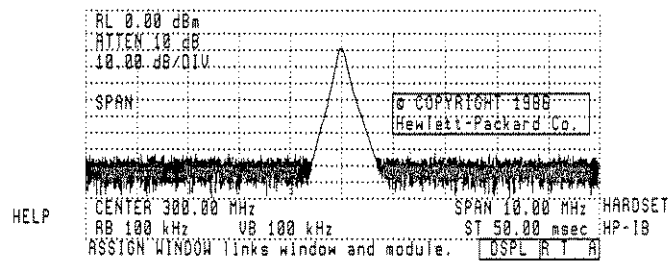

Fig. 18. Build Window #1

1. Press *build window*.
2. Press *SELECT WINDOW*.

3. Press [2].
4. Press **ENTER**.
5. Press **Ymin**.
6. Using the display knob, move the bottom line to a position just above the other window (Ymin=205).
7. Press **EXECUTE**.

Two windows are now defined as in Figure 19. Each window could be assigned to different instruments if desired. (See **assign window** description.) See the **purge window** description to remove the windows.

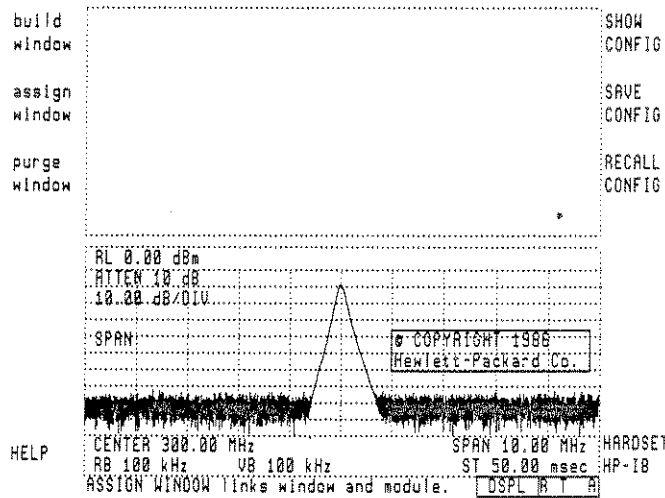

Fig. 19. Windows #1 (bottom) and #2 (top).

The values of Xmin, Ymin, Xmax, Ymax represent the distances of the lines from the origin. The origin (X = 0, Y = 0) is located at the lower-left corner of the screen. The top right corner of the screen is X = 1023, Y = 383. These dimensions are in display units (units of dots on the screen).

The standard sized window, available via **DEFAULT WINDOW**, has the following dimensions:

```
Xmin = 112
Ymin = 16
Xmax = 911
Ymax = 383
```

The default window is the window which is created by **SELECT INSTR, ALLOC DISPLAY, ALLOC SCREEN** and **DISPLAY PRESET**.

1. Any window can be changed in size or shape by re-building. Up to four windows may be defined and written to simultaneously by different instruments; thus, four different instruments can "talk" to the display simultaneously. The screen annotation usually present with one or two large windows may not appear on smaller windows.
2. The softkeys **BUILD 1 WINDOW**, **BUILD 2 WINDOWS**, and **BUILD 4 WINDOWS** can be used to construct multiple windows with a single keystroke.
3. The **DISPLAY PRESET** or **SELECT INSTR** keys will return display to a single full-screen window.

ASSIGN WINDOW

A window on the screen can be written to by any HP-MSIB master module (HP 70900A) or by an HP-IB controller. `assign window` lets the user select the instrument that will write to a chosen window. The user can select a module on HP-MSIB by using `HP-MSIB COLUMN`, `HP-MSIB ROW`, and `EXECUTE` (see following example).

Alternatively, a window may be accessed over HP-IB. To do this, press `assign window`, select the window, then press `HP-IB` and `EXECUTE`. The window will then have the HP-IB address of the display. (See `address map` to determine the HP-IB address of the display.) Only one display window at a time can be assigned to HP-IB. HP-IB can also operate without an explicitly defined window, since it automatically receives the Default window at power-up, if not assigned one (in this case, no HP-IB window shows up in `SHOW CONFIG`).

Example: Building two windows and assigning one to an instrument.

1. Clear the screen of all windows (see `purge window`).
2. Build two windows as in the `build window` example, leaving the screen with two blank, unassigned windows as in Figure 20. The lower window should be #1 and the upper window should be #2.

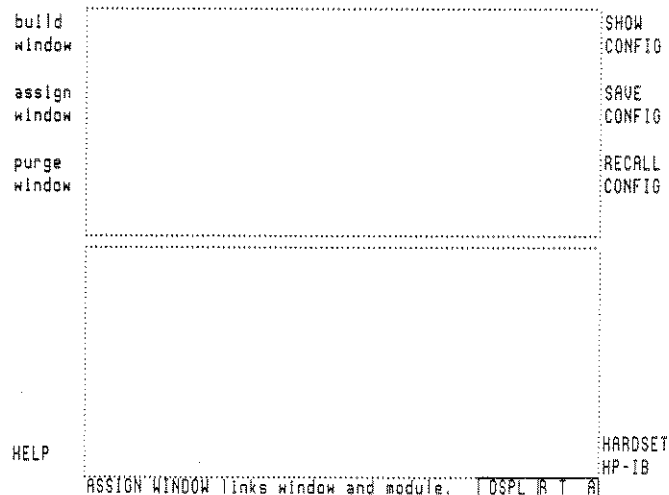

Fig. 20

3. Press `assign window`, `SELECT WINDOW`, [1], and `ENTER`. The lower window should be highlighted.
4. Press `HP-MSIB COLUMN` and turn the knob until the bottom line on the screen shows that an HP 70900A module has been found (the factory default address is 0,18) as in figure 21.

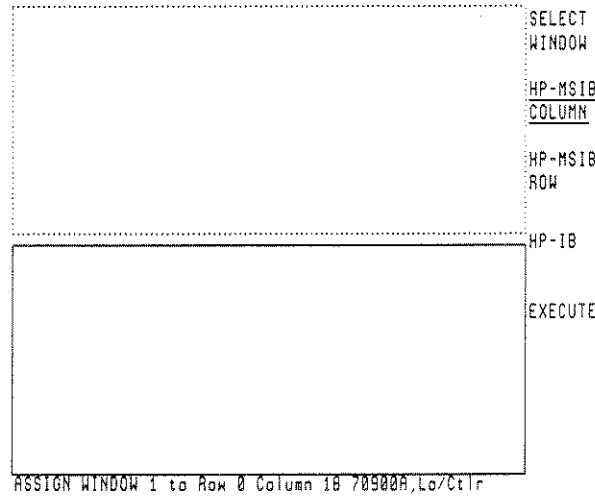

Fig. 21

5. Press **EXECUTE**. The trace output from that measurement instrument should appear in the window as in Figure 22.

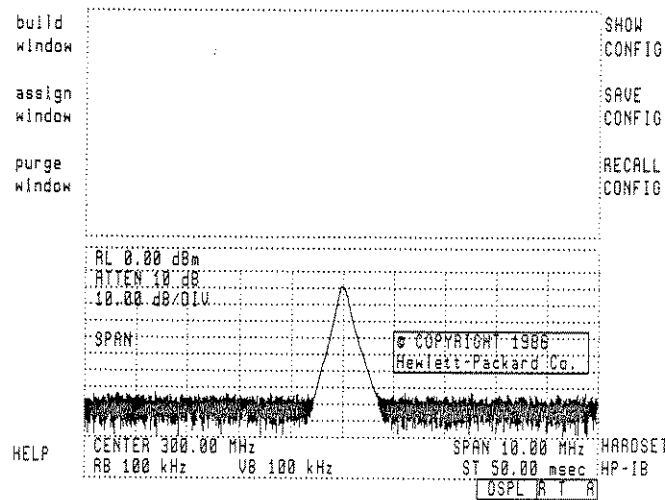

Fig. 22

The softkeys appearing now are those of the display.

To access the softkey menu for control of the measurement instrument, press [USR] or [MNU].

To control a different instrument, use **assign keybd** to link the softkeys with a master module that has a window. **assign keybd** is available directly under the [DSP] hardkey.

Example: Assigning the other window to the measurement instrument.

If your system contains only one measuring instrument, then the second window can be assigned to it. This will result in the instrument's trace information shifting to the second window, which demonstrates the flexibility of the windowing capabilities. This also demonstrates that an instrument can be re-assigned to another window from the front panel without changing any instrument settings or interrupting the sweep sequence. Note that the instrument only writes to one window at a time.

1. Press **assign window**
2. Press **SELECT WINDOW**
3. Use the step keys to select the other window (the window that is presently blank).
4. Press **HP-MSIB COLUMN**.
5. Turn the knob until the 70900A LO/Controller module is indicated at the bottom of the screen.
6. Press **EXECUTE**, and the display should shift to the other window as in Figure 23.

With only one instrument writing to the display, the instrument softkeys will be immediately available by pressing [USR] or [MNU].

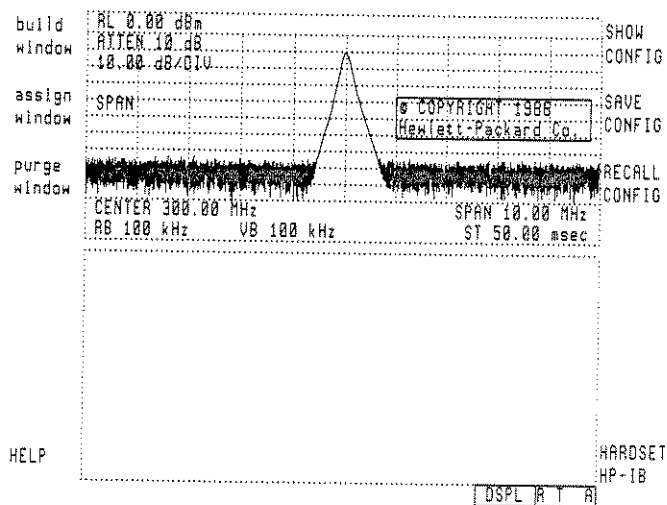

Fig. 23

Example: Assigning two windows to different measuring instruments.

If your system contains more than one instrument, assign the second window to the second instrument. This will result in each instrument writing to a separate window. The two separate traces need not be restricted to sequential updating, as with a single-instrument display. The traces are both being taken in real time by separate instruments. Only the display element is common.

Start with a two-window, one-instrument display similar to Figure 24. (See the first example in this section.)

1. Press **assign window**
2. Press **SELECT WINDOW**.
3. Use the step keys to select the window that is defined but not written to.
4. Press **HP-MSIB COLUMN**.
5. Turn the knob until the other HP 70900A LO/Controller module is indicated at the bottom of the screen.

On the front panel of each local oscillator is an "ACT" or "ACTIVE" light. The two local oscillators can be distinguished by the "ACT" light; the module indicated by the bottom line on the display screen will show "ACT" lit.

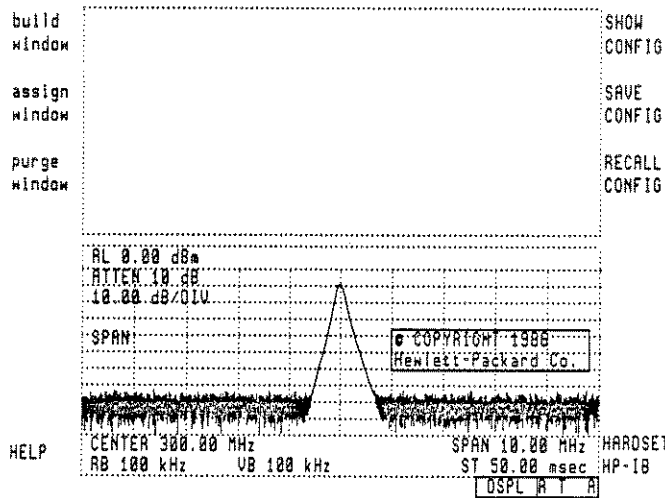

Fig. 24

Once the other HP 70900A has been indicated, press **EXECUTE** and the second instrument's trace information should appear in the other window as in Figure 25.

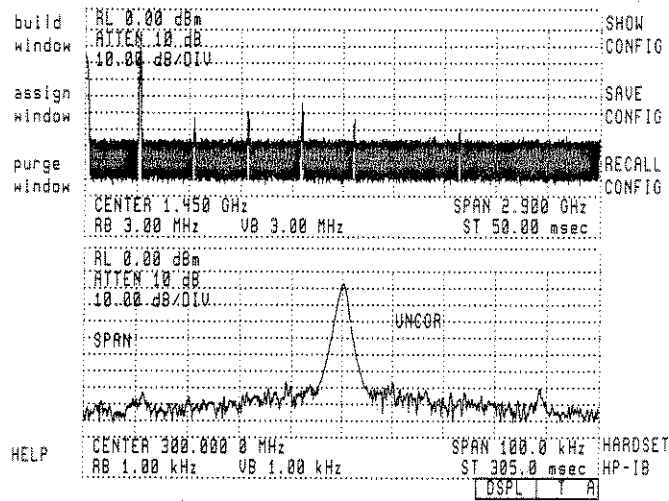

Fig. 25

The softkeys now displayed are those of the display. By pressing [USR] or [MNU], softkeys for one of the instruments will be obtained.

To control the other instrument, press *assign keybd*, use step keys to select a window, and press [USR] or [MNU]. (See the *assign keybd* description in this chapter.) *assign window* shifts the instrument's output back and forth between windows. *assign window*, however, does not disturb the link between the keyboard and an instrument. Whichever instrument has the keyboard before *assign window* is used will have it after.

PURGE WINDOW

purge window removes a previously-defined window from the screen. Upon pressing **EXECUTE**, the window is destroyed, and any link with an instrument or module is broken. Trace information displayed in the window disappears from the screen, but is not destroyed: it resides in the spectrum analyzer and may be accessed again by assigning a different window to the analyzer (see **build window** and **assign window**).

Example: Purge two windows.

Start by building two windows, as in the **build window** example (#1 on the bottom, #2 on the top). Assign window #1 to a spectrum analyzer. The resulting screen should be similar to Figure 26.

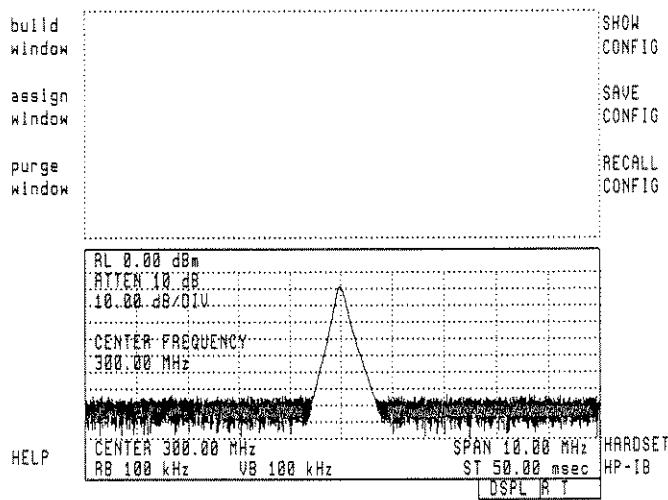
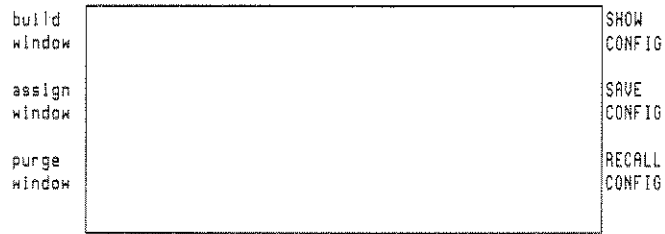

Fig. 26

1. Press **purge window**.
2. Press **SELECT WINDOW**.
3. Use the step-keys, knob, or keypad (plus **ENTER**) to select window #1 (the window with the trace displayed).
4. Press **EXECUTE**. The entire window should disappear as in Figure 27.



HELP

HARDSET
HP-1B

DISPL RT A

Fig. 27

To remove the second window:

1. Press purge window.
2. Press SELECT WINDOW.
3. Use the step-keys to select window #2.
4. Press EXECUTE and the remaining window should disappear (see Figure 28).

| | |
|------------------|------------------|
| build
window | SHOW
CONFIG |
| assign
window | SAVE
CONFIG |
| purge
window | RECALL
CONFIG |

HELP

HARDSET
HP-18

DSPL R

Fig. 28

NOTE

Windows need not be purged and rebuilt in order to change size. An existing window can be modified simply by using "BUILD WINDOW".

HARDSET/SOFTSET HP-IB

HARDSET/SOFTSET HP-IB helps select the HP-IB address that the display will have when the HP 70000 System is next turned "on." Switch the modes back and forth between HARDSET and SOFTSET by pressing the **HARDSET/SOFTSET HP-IB** softkey.

NOTE

In the HARDSET mode, the display will power-up with an HP-IB address identical to the HP-MSIB address (see "address map" description).

Example: Demonstration of HARDSET HP-IB action.

Change the HP-IB address of the display by using **SET HP-IB**. **SET HP-IB** is available via the keystroke sequence [DSP] and **address map**. (See the Address Map section within this chapter.) Make sure that the HP-IB address does not match the HP-MSIB address. (See Figure 29.)

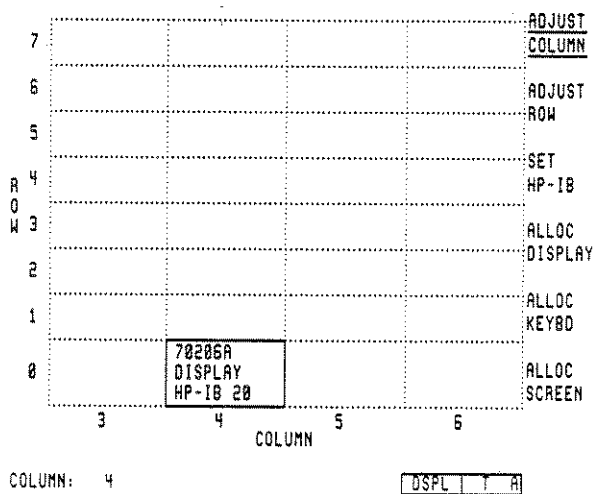

Fig. 29

1. Press [DSP].
2. Press **config display**
3. Press **HARDSET/SOFTSET HP-IB** so that the display is left in the HARDSET mode as in Figure 30.

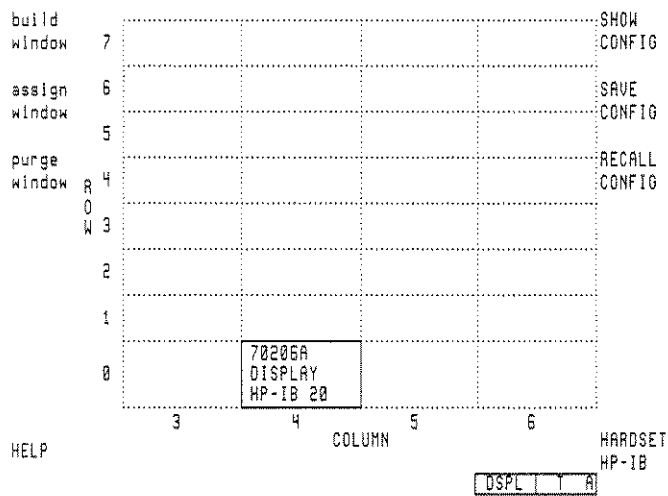

Fig. 30

Turn the system off and then on. Look at the display in the address map by pressing [DSP], ADDRESS MAP, and using the knob to move the cursor to the display.

Note that the HP-IB address is now the same as the HP-MSIB column address, as in Figure 31.

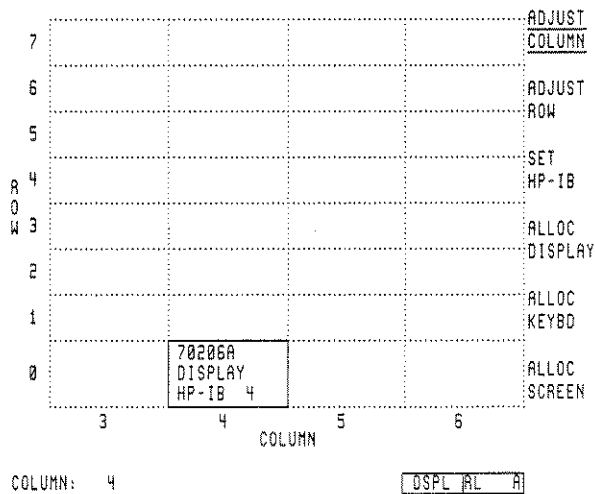

Fig. 31

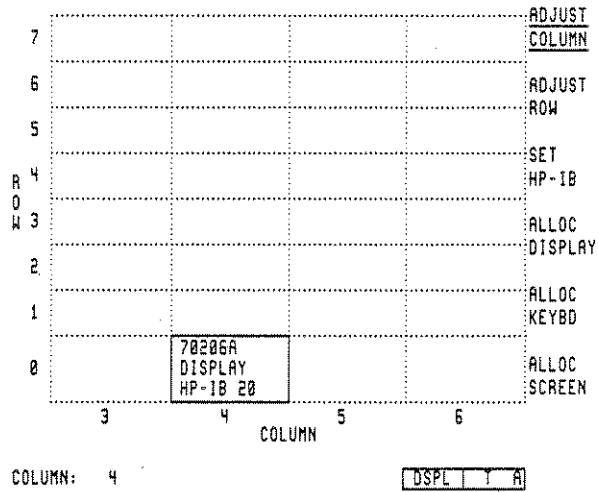

Fig. 33

NOTE

"HARDSET/SOFTSET HP-IB" affects the HP-IB address of the display ONLY, not the spectrum analyzer master module (HP 70900A). Also, this key affects the address only after the instrument has been shut off and then turned on again, and does not keep the user from changing the HP-IB address of the display or the local oscillator (by means of the "SET HP-IB" softkey).

HELP

This softkey brings up a screen that contains brief descriptions of several *config display* subkeys. (See Figure 34.)

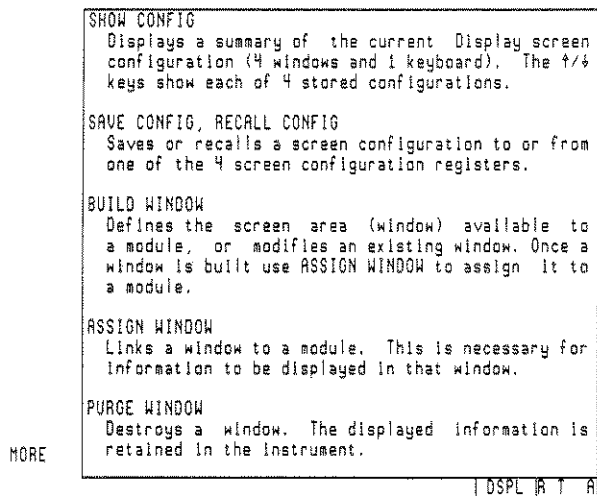

Fig. 34

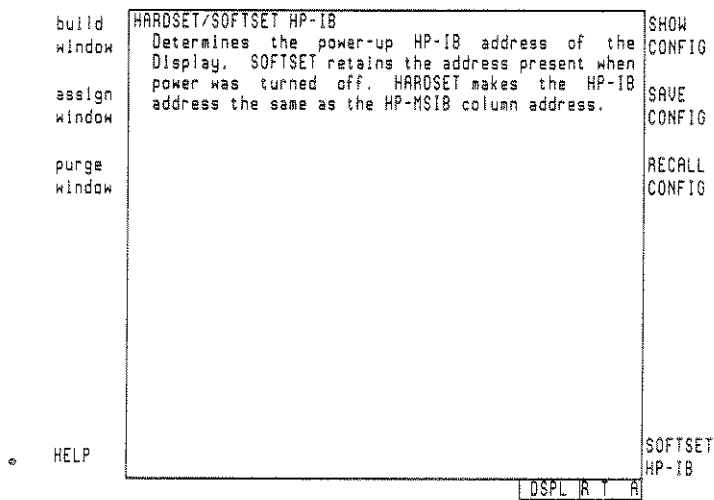

Fig. 35

SHOW CONFIGURATION

The display has six resources that it can "allocate" or "assign" to any of several HP 70000 System elements: these resources consist of a screen composed of up to four windows, plus a fifth window reserved for a controller on HP-IB, and one keyboard. The fifth window is "invisible" in that it does not show up in **SHOW CONFIG**. Press **config display**, **SHOW CONFIG** softkeys to show the following:

- Which windows are defined (1 through 4)
- What the dimensions of each window are
- The instrument or module each window is allocated to (i.e., which module can write to a given window)
- Which module the keyboard is assigned to

SHOW CONFIG not only brings up the current configuration of the display but also shows four other complete display configurations. These configurations reside in continuous-memory registers, so they will be recalled even if the power had been turned off.

(See the sections in this chapter on **SAVE CONFIG** and **RECALL CONFIG** for more information.)

Example: Viewing the Current Configuration.

1. Press [DSP].
2. Press **SHOW CONFIG**.

In figure 36, only one window is defined, and it is assigned to an HP 70900A Local Oscillator/Controller module at HP-MSIB address "0,18." The keyboard is also assigned to that module. This is the standard configuration obtained by pressing **SELECT INSTR**.

The window is of standard size; namely, it is 800 pixels wide (911-112 +1) and 368 pixels high (383-16 +1), which leaves room for softkeys. Windows 2, 3, and 4 are undefined.

```

build CURRENT CONFIGURATION
window
assign Keyboard: 78900A,Lo/Ctrl ( 0, 18)
window Xmin,Ymin: 112, 16
Xmax,Ymax: 911, 189
purge Window 2: undefined
window Window 3: undefined
Window 4: undefined
HELP
SHOW
CONFIG
SAVE
CONFIG
RECALL
CONFIG
HARDSET
HP-1B
USE ↑/↓ TO SHOW PREV/NEXT CONFIGURATION | DSP1 RL A
    
```

Fig. 36

Example: Viewing Configuration Registers 1 through 4.

There are four continuous-memory registers that store display configurations. To view these, perform the following step.

1. Press [DSP].
2. Press SHOW CONFIG (which will display the current configuration).
3. Press the step-up key. CONFIGURATION REGISTER 1 should appear as in Figure 37.
4. Press the step-up key three more times to view CONFIGURATION REGISTERS 2, 3, and 4.

```

build  CONFIGURATION REGISTER 1
window
assign Window 1: undefined
window
assign Window 2: undefined
window
assign Window 3: undefined
window
assign Window 4: undefined
window
purge
window
HELP

SOFTSET
HP-IB

SHOW
CONFIG
SAVE
CONFIG
RECALL
CONFIG
USE +/- TO SHOW PREV/NEXT CONFIGURATION DSPL L R
    
```

Fig. 37

If the Current Configuration or any of the registers contain only undefined (and unassigned) windows, try using *build window* and *assign window* to reconfigure the Display. Then use *SAVE CONFIG* to store the new configuration. Observe how the changes are shown on the CURRENT CONFIGURATION and CONFIGURATION REGISTER screens by using the *SHOW CONFIG* softkey. If multiple instruments are available on HP-MSIB, try using *assign Keybd*.

```

build  CURRENT CONFIGURATION
window
assign Window 1
window Keyboard: 70900A,Lo/Ctrl ( 0, 10)
assign Xmin,Ymin: 112, 16
window Xmax,Ymax: 911, 199
assign
window Window 2: 70900A,Lo/Ctrl ( 0, 20)
assign Xmin,Ymin: 112, 200
window Xmax,Ymax: 911, 383
assign
window Window 3: undefined
window Window 4: undefined
HELP

SOFTSET
HP-IB

SHOW
CONFIG
SAVE
CONFIG
RECALL
CONFIG
USE +/- TO SHOW PREV/NEXT CONFIGURATION DSPL R T R
    
```

Fig. 38

For example, the configuration register shown in figure 38 describes the layout of the screen shown in Figure 39. The softkeys shown in Figure 39 are for the analyzer writing to the bottom window (window #1). This can be inferred from "Keyboard" appearing below "Window 1" in the above figure. Users can

determine that window #1 is the bottom window by comparing the Ymin and Y max values for the two windows (see *build window*).

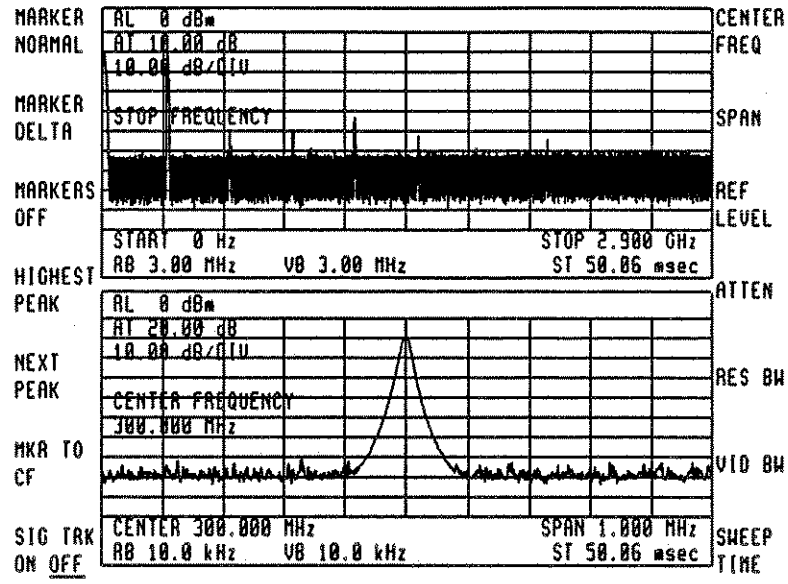

Fig. 39

SAVE CONFIG/RECALL CONFIG

SAVE CONFIG stores the complete configuration of the screen windows in a continuous-memory register. Four (4) registers are available, 1 through 4. (See **SHOW CONFIG**.)

NOTE

The Current Configuration will be retained if the power is turned off, but will be lost if a different configuration is recalled from one of the four registers.

RECALL CONFIG lets the user reconfigure the screen to a pre-saved state with only a few keystrokes.

Example: Saving a screen configuration and recalling it.

1. Configure a screen with multiple windows, as in Figure 40. (See the **build window** example.)
2. Assign an instrument (eg, a spectrum analyzer) to one window. (See the **assign window** section of this chapter.)

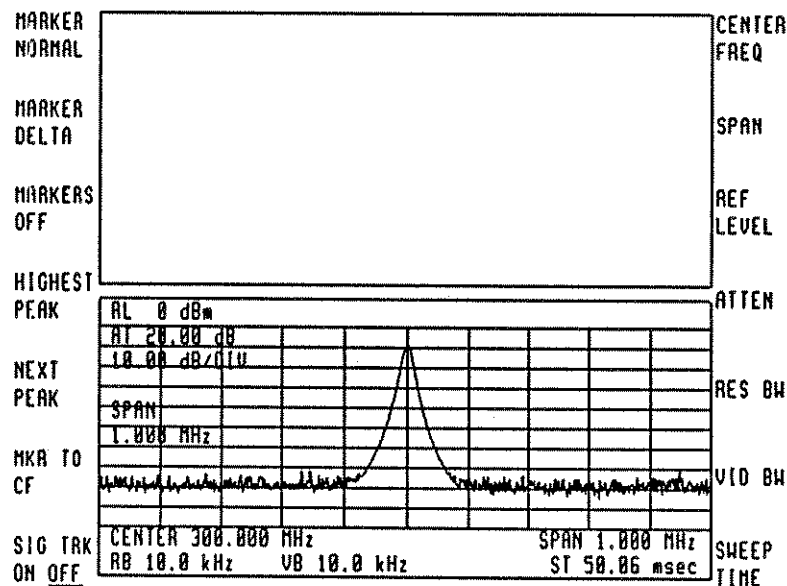

Fig. 40

To save the configuration:

3. Press [DSP].
4. Press **config display**.

5. Press **SAVE CONFIG**.
6. Press **[1]**.
7. Press **ENTER**

To change the current configuration by purging the lower window:

8. Press **config display**.
9. Press **purge window**.
10. Press **[1]**.
11. Press **ENTER**.
12. Press **EXECUTE**.

The screen should resemble Figure 41.

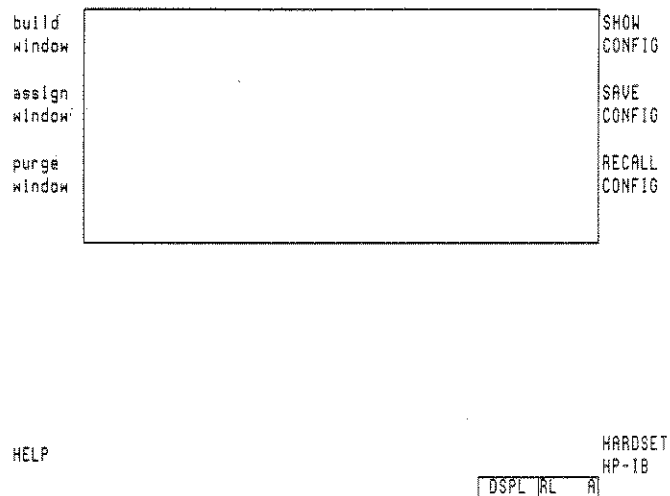

Fig. 41

To recover the original screen:

13. Press **[DSP]**.
14. Press **config display**.
15. Press **RECALL CONFIG**.
16. Press **[1]**.

17. Press **ENTER**.

The recovered configuration should look the same as the configuration that was saved.

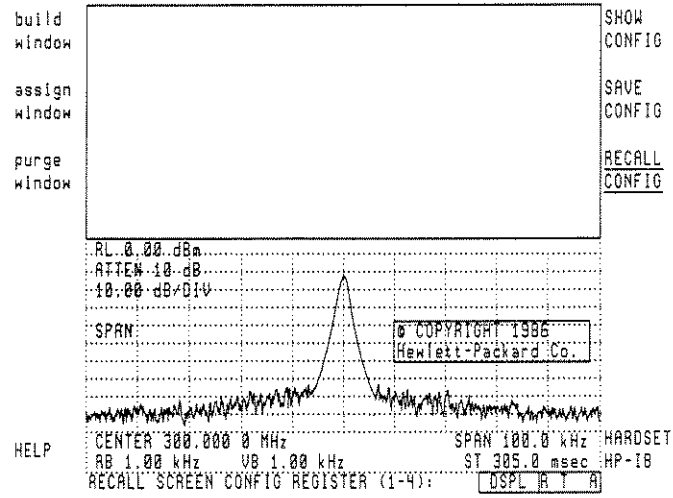

Fig. 42

PRINT

The **PRINT** softkey (or [PRINT] hardkey on the HP 70206A System Graphics Display) initiates a raster print dump of the screen (and of the instrument's softkeys if configured to do so).

Example: Print a copy of the instrument display.

NOTE

To follow this example, you may need to enter the address of your printer into the HP 70000 System and specify whether the softkeys are to be printed. (See "printer is" and "KEYCOPY ON/OFF" under "define hardcopy".)

1. Enter the address of your HP-IB printer via the **printer is** key, available under **define hardcopy**. Select **KEYCOPY ON/ OFF** if desired.
2. Obtain the instrument display you want to print by using the softkeys in the [USR] menu.
3. Press [DSP].
4. Press **PRINT** (or the [PRINT] hardkey on the HP 70206A Display). The printing process will begin immediately. It can be halted by pressing any front-panel key on the display during the print sequence. The screen will be frozen (no further sweeps taken) until the data transfer to the printer is complete.

A. To use the Display **PRINT** (or **PLOT**) operation while there is a computer on HP-IB, type the following commands on the computer keyboard.

```
SEND 7;UNT DATA  
LOCAL 7
```

The purpose of step 4A is to make the Display unaware of the computer's presence. What happens if this step is not executed is in the following paragraph.

The Display detects the presence of a computer by sensing the ATN and REN lines on HP-IB. If these lines are true, the Display **PRINT** operation is determined by the SYSTEM CONTROLLER switch. The SYSTEM CONTROLLER switch (located on the rear panel of the Display) can be set in two positions; 1 and 0. If the switch is set to 1 the Display will wait until both ATN and REN are false, then it will begin the PRINT. If the switch is set to 0 and either ATN or REN are true, the Display will not attempt to PRINT and will put the soft key labels back on the screen and go on. Do not attempt to change the SYSTEM CONTROLLER switch without turning the power to the Display off.

Notes:

1. When **PRINT** is pressed, the screen displayed will be printed.
2. The softkeys printed if **KEYCOPY ON/ OFF** is selected are the last ones displayed that were associated with the instrument, not the display element. Softkeys available under **[DSP]** are referred to as "display utility keys" and are not normally shown on hardcopy output.
3. Compatibility: the raster print dump process works with HP raster-format printers (dot-matrix) that can accept printer dumps of at least 384 lines by 512 points; for example, the HP2673A printer and the HP 2225A Thinkjet Printer have this capability. (The **HI RES ON/OFF** function, described in *define hardcopy*, requires capability of 384 lines by 1024 points.) Most of the printers that work with the HP200/300 series computers will work with the HP 70000 System.

PLOT

Pressing **PLOT** initiates a vector plot dump over HP-IB to the plotter specified under **define hardcopy**. The operation of this key is almost identical to the operation of **PRINT**, but the HP-IB output address of the plotter is set using **plotter is** rather than **printer is**.

Refer to the **PRINT** command for instructions on using this command when a computer is on HP-IB.

Note:

The HP 70205A and HP 70206A Displays require that the plotter implement HP-GL, Hewlett-Packard's Graphics Language. These displays work with plotters such as the HP 7470A, HP 7475A, and HP 7090A, and HP ColorPro.

See the **plotter is** softkey description to set the plotter parameters, including HP-IB address.

DEFINE HARDCOPY

The `define hardcopy` key allows the user access to several subkeys which are used to define parameters for hardcopy output. (See figure 45.) These parameters include:

- `COPY IS PRT/PLT` determines whether the printer or plotter will be the destination when a `CY` (copy) command is sent.
- `DEFAULT VALUES` sets the standard default values for the printer and plotter:

```
printer is: HP-IB TLK/LSN 1
plotter is: HP-IB TLK/LSN 5
COPY IS PRT/PLT: PRINTER
HI RES ON/OFF: OFF
EJECT ON/OFF: ON
KEYCOPY ON/OFF: OFF
```

- `plotter params` defines the limits used for plotter dumps when the display cannot ask the plotter what limits to use (for example, listen-only plotters).
- `KEYCOPY ON/OFF` when ON, the printer and plotter outputs will copy the softkey labels, title line, and status box. When OFF, these items will be blanked.
- `HI RES ON/OFF` When ON, the printer is set to high resolution and all 1024 display points are dumped on each line (dumps normally are 512 points per line).
- `EJECT ON/OFF` When ON, page ejects are sent at the end of dumps.

NOTE

Older plotters, such as the 9872B, will show an error when they receive the page eject command. Use `EJECT OFF` to keep this from occurring.

See subsequent key descriptions for further instructions.

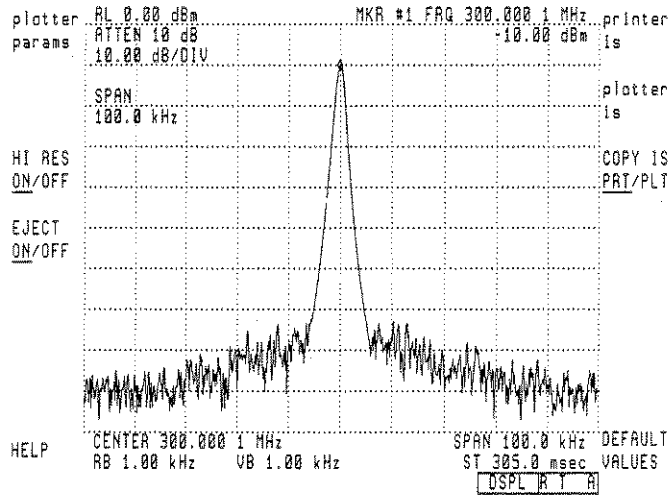

Fig. 45. Define Hardcopy Menu

PRINTER IS

printer is defines the HP-IB address and status of the output printer. The printer's address can be entered as:

- TLK/LSN or "Talk/Listen." (For example, "TLK/LSN 1" means that the display expects the printer to be in Talk/Listen Status at HP-IB address 1.)
- L ONLY or "Listen Only (sometimes called "Listen Always")." In this mode the printer is expected to be set to Listen Only on HP-IB. (For instructions, consult the operating documentation for the specific printer to be used.)

Example: Setting the expected printer address to HP-IB Talk/Listen 1.

1. Press [DSP].
2. Press **define hardcopy**.
3. Press **printer is**.
4. Press **HP-IB TLK/LSN**
5. Enter the address 1 (printers are typically addressed at "01").
6. Press **ENTER**. The printer address should now appear in the lower left corner of the screen.

Example: Setting the expected printer to Listen Only.

1. To select Listen Only press the softkey so that **HP-IB L ONLY** is underlined and "PRINTER IS HP-IB L ONLY" is shown in the lower left corner as is Figure 46.

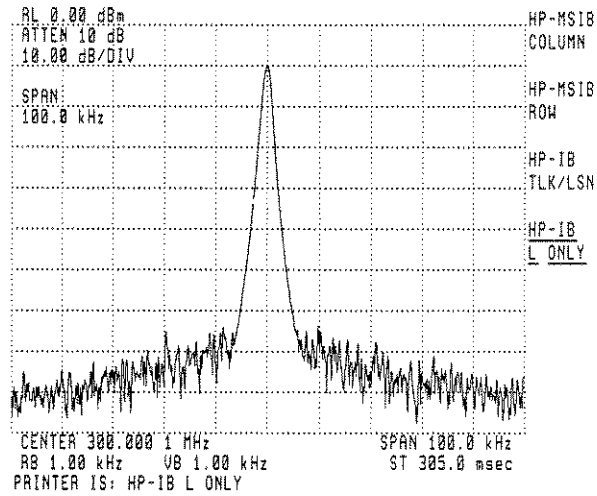

Fig. 46

Notes:

1. Switching from HP-IB L ONLY back to HP-IB TLK/LSN will change the HP-IB TLK/LSN address to 1. Check the address before you leave the printer is submenu.
2. HP-MSIB COLUMN and HP-MSIB ROW are used if an HP-MSIB print device is configured (none currently exist).
3. For a discussion of printer compatibility, see the PRINT key description.

PLOTTER IS

plotter is is used to specify the HP-IB address of the hardcopy output plotter. The operation of **plotter is** is similar to that of **printer is**. (Plotters, however, usually have an HP-IB address of 5.)

Note that a listen-only plotter cannot tell the Display what its corner points (p1,p2) are. With a listen-only plotter, the Display will always use the p1,p2 corner points stored under Plotter Params (Refer to the next section), overriding the p1,p2 set-up on the plotter.

NOTE

For a discussion on plotter compatibility see the **PLOT** softkey description.

PLOTTER PARAMETERS

`plotter params` is a softkey that allows the user to alter the physical size of hardcopy output plots to Listen Only plotters (or to TLK/LSN plotters if the output is initiated by remote control using the command "CY 1").

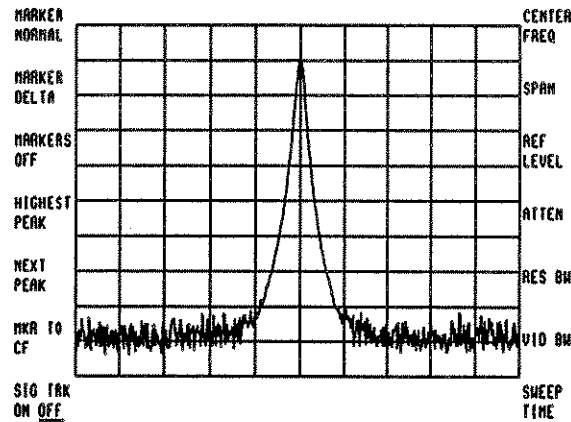

Fig. 47. Standard Plot

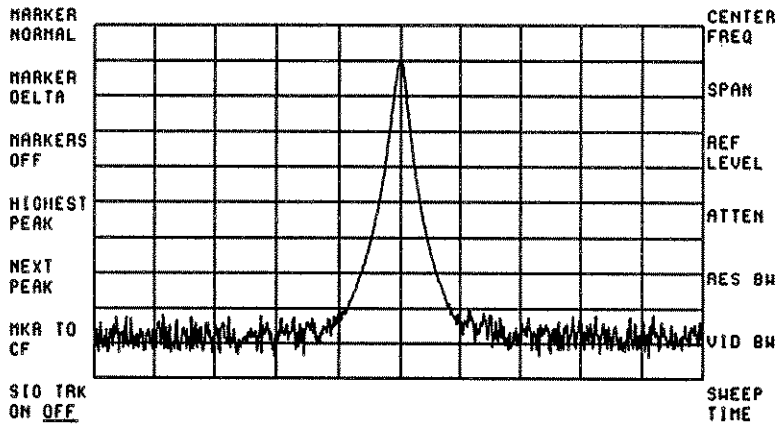

Fig. 48. Wider Plot

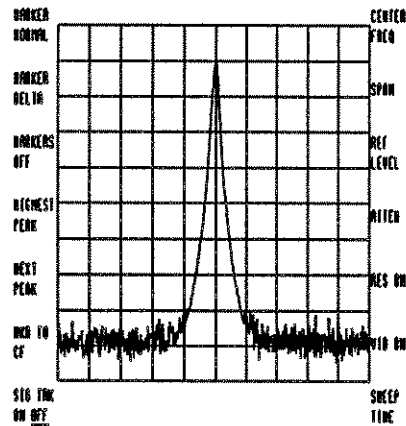

Fig. 49. Plot Increased in Height

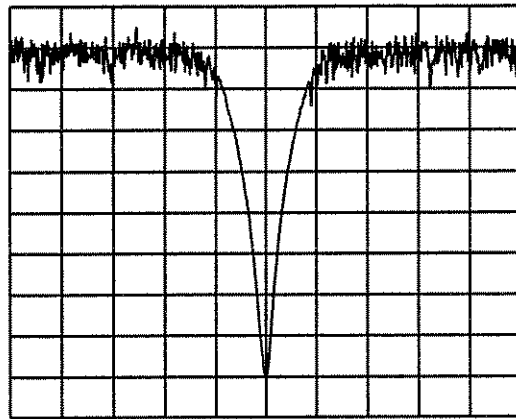

Fig. 50. Inverted Plot

On HP Plotters, the physical size and shape of output plots are determined by the locations of the Scaling Points, P1 and P2. These locations are given in Cartesian coordinates; for example, P1 = 100, 100 and P2 = 10100, 7600. The actual size of these units depends on the specific plotter used. Typical unit size is 0.025mm, or about 0.001 inch. The units are referenced from the lower left corner of the available plotting surface.

In figure 51, the default plotting area for the HP 7475A 6-Pen Graphics Plotter is outlined. P1 is the lower left corner, P2 is the upper right corner.

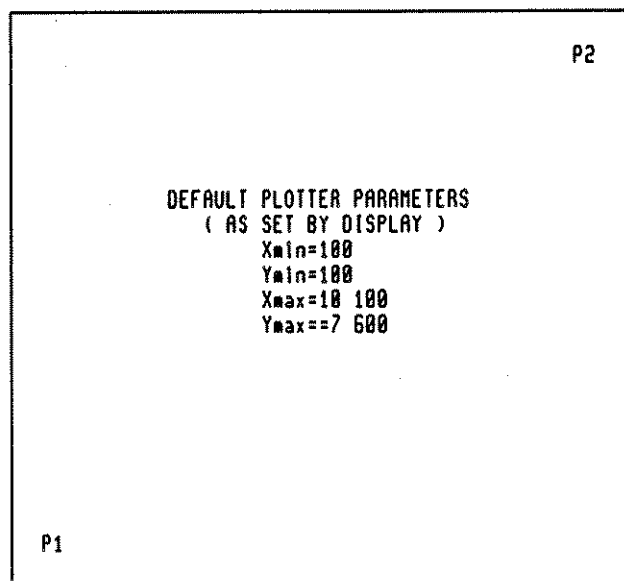

Fig. 51. Plotter Parameters as Set by HP 70205A and HP 70206A Displays

Notes:

1. To set plotter parameters to their standard default values, press [DSP], *define hardcopy*, and *DEFAULT VALUES* (see *DEFAULT VALUES* description in this chapter). Xmin, Xmax, Ymin, and Ymax will be set to the values shown in the figure above (Figure 51). These values will allow 0.5 inch margins on 8.5 by 11 inch paper.
2. The plotter parameters are stored in a continuous-memory register; they will be retained even after the power has been turned off. Turning the system off and then on will not set the plotter parameters to their default values. The default values can only be reset by using the sequence in 1 above, or by pressing *DISPLAY PRESET*.
3. Instrument Preset [I/P] does not affect the plotter parameters or any other display features.
4. Plotters may operate differently as a listener (i.e., L ONLY) or as a Talker/Listener (TLK/LSN). Consult the operating instructions for your particular plotter.

KEYCOPY ON/OFF

KEYCOPY ON/OFF enables the spectrum analyzer's softkey labels, status box, and data line to be copied as part of the hardcopy output (to either a printer or plotter).

Example: Delete softkeys from an analyzer plot.

1. With **KEYCOPY ON** and a plotter connected to the Display via HP-IB, arrange an analyzer screen to be plotted.
2. Press [DSP].
3. Press **PLOT** on the HP 70205A Display (or the [PLOT] hardkey on the HP 70206A Display). An output plot should appear as in Figure 52.

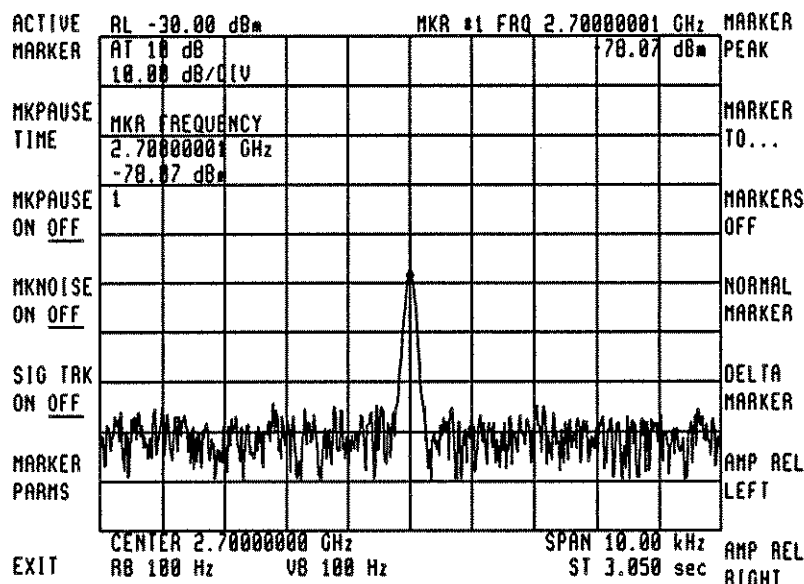

Fig. 52

To delete the keys from the hardcopy output:

1. Press [DSP].
2. Press **define hardcopy**.
3. Press **KEYCOPY ON/ OFF**.

This should result in **KEYCOPY ON/ OFF**, indicating that key labels will not be plotted.

4. Press [USR] or [DSP].

5. Press **SELECT INSTR** and arrange a instrument display for the plot.
6. Press **[DSP]**.
7. Press **PLOT** (or the **[PLOT]** hardkey on the HP 70206A).

The resulting plotter output, as in Figure 53, should contain no softkey labels.

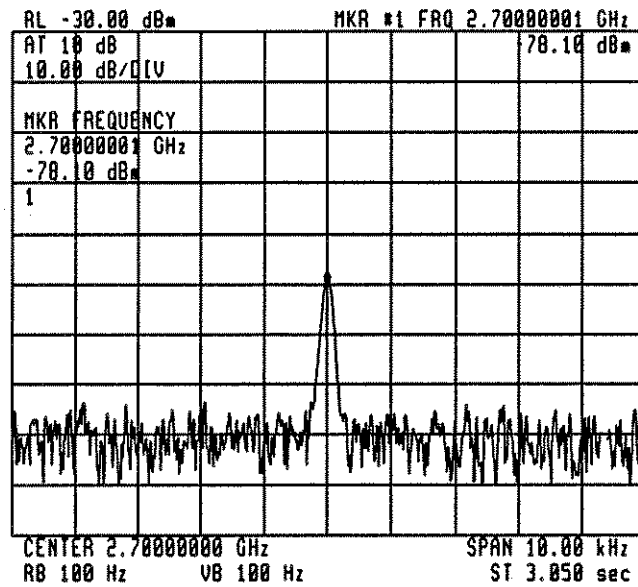
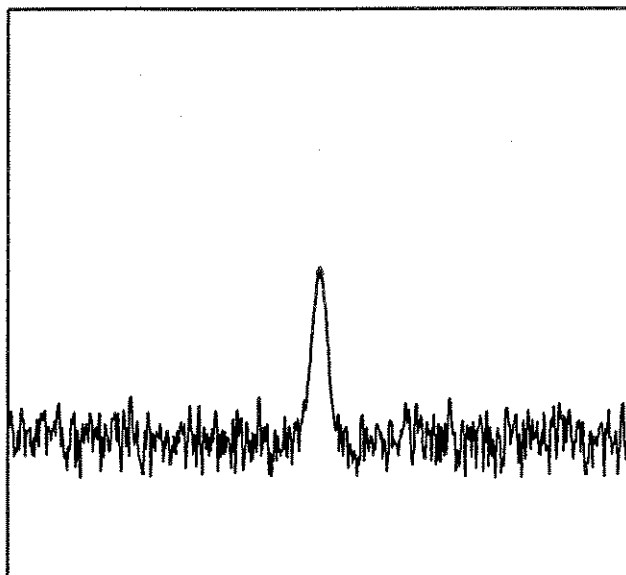

Fig. 53

Notes:

1. **KEYCOPY** affects key labels only on hardcopy output. It does not remove key labels from the screen except during the output.
2. Softkey labels accessible under [DSP] are normally not available for hardcopy output. The key labels that are printed or plotted are the most recent ones displayed by the instrument, or loaded by the ML command.
3. Annotation other than softkeys can be deleted also, but this is done by the instrument, not the display. See the sections on the [MNU] hardkey description and the **INST DISPLAY** and **ANNOT ON/OFF** softkey descriptions.



**Fig. 54. Instrument output with ANNOT ON/ OFF
and KEYCOPY ON/ OFF and GRAT ON/ OFF.**

HI RES ON/OFF

The HI RES option allows the user to obtain higher resolution printouts on certain printers.

To use the HI RES option, press **HI RES ON/ OFF** so that the key appears as **HI RES ON/ OFF**, then execute a print operation. (See **PRINT** softkey description.)

Using the HI RES option in a raster print dump, the HP 70205A and the HP 70206A Displays will put out 384 lines with 1024 points per line.

When the HI RES option is not being used, the displays will put out 384 lines of 512 points per line.

Notes:

1. The higher resolution obtainable with HI RES is available only on raster PRINT operations. HI RES does not affect PLOT operations.
2. Although the HP 2225A Thinkjet printer can, not all raster printers can accommodate 1024 points per line. Some printers, like the HP 2673A, have a line width less than 1024 points. **DO NOT** use **HI RES** with these printers.
3. When making high-resolution prints with the Thinkjet, the printing operation will be slower than usual. This is because the printer must place more dots on each line.
4. **HI RES** reprograms the printer to hold more dots per line. When done, it leaves the printer in this mode, since it has no way to know what mode the printer was in to begin with.

EJECT ON/OFF

When the EJECT ON/OFF softkey is ON a page ejects at the end of both plotter and printer dumps.

To use the EJECT ON/OFF option press [DSP], define hardcopy, then EJECT ON/OFF until the desired option is underlined.

NOTE

Many plotters do not implement a page eject feature.

COPY IS PRT/PLT

COPY IS PRT/PLT determines whether the printer or the plotter will be the destination when a COPY command (CY) is received.

To use the **COPY IS** press [DSP], *define hardcopy*, then **COPY IS PRT/PLT** until the desired device is underlined.

See the CY command description for details on the COPY command.

DEFAULT VALUES

DEFAULT VALUES automatically sets the value of several user-definable parameters for hardcopy output. These parameters and their default values are:

PRINTER IS: HP-IB Talk/Listen at address 1.
PLOTTER IS: HP-IB Talk/Listen at address 5.
COPY IS: PRINTER
PLOTTER PARAMS: Plot limits of Xmin, Ymin = 100, 100
Plot limits of Xmax, Ymax = 10100, 7600
HI RES: OFF
KEYCOPY: OFF
EJECT: ON

NOTE

The default plotter limits are those of the HP 70470A and the HP 7475A Plotters. These allow 0.5 inch margins on standard "A" size paper (8.5 by 11 inches).

HELP

The **HELP** softkey under **define hardcopy** presents a screen of brief descriptions explaining the functions available with other softkeys in the **define hardcopy** menu (see Figure 55).

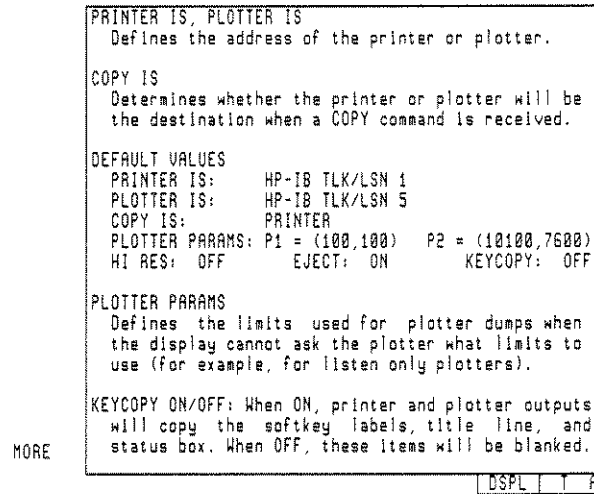

Fig. 55

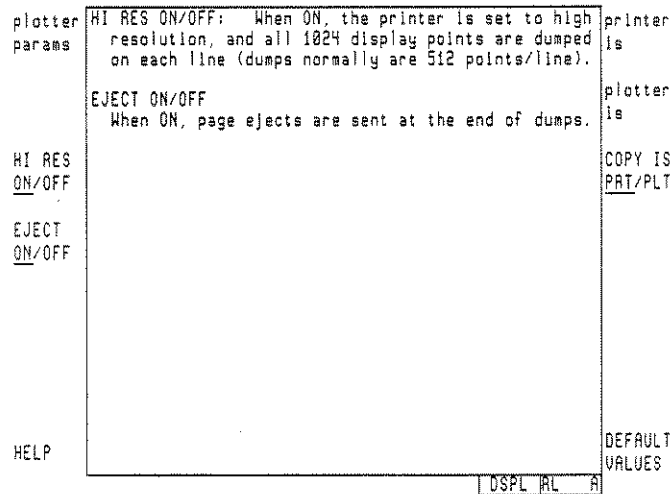

Fig. 56

REPORT ERRORS

The **REPORT ERRORS** softkey gives the user a brief description of any error that has been detected by an element on the HP-MSIB.

Example: Detecting an Illegal Command sent by HP-IB.

Begin by causing an error. Do this by connecting a computer or controller to the HP 70000 system by HP-IB and sending an illegal command. (Example: OUTPUT 718; "XX")

If the HP 70900A Local Oscillator (the Master module of the spectrum analyzer) has an HP-IB address of 18, it will detect an illegal command. An "E" will appear in the Status Box at the lower right-hand corner of the screen, as in Figure 57. Also, an error message may appear, in the upper right-hand portion of the screen.

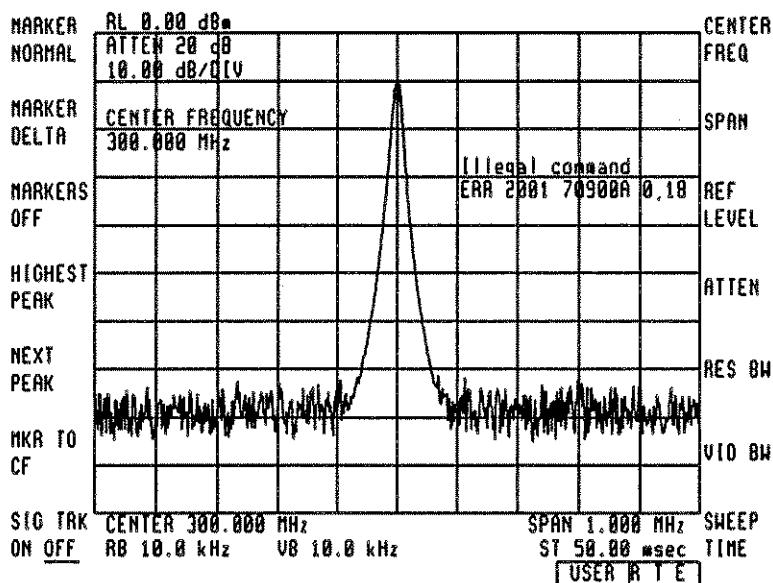

Fig. 57

The user can receive the error report by pressing [DSP], then **REPORT ERRORS**. A figure similar to Figure 58. appears, and provides the following information:

- Which module reported the error (in this case, the HP 70900A LO Module)
- What the HP-MSIB address of that module is (e.g., "0,18")
- An error identification number (e.g., 2001)
- A brief description of the error (e.g., Illegal Command)

```

PRINT  ERROR REPORT from
       70900A,Lo/Ctir (Row 0, Column 10)
PLOT   2001 70900A 0,10 Illegal command

define
hardcpy

REPORT
ERRORS

display
tests

INTEN
ADJUST

HELP
    
```

DISPLAY PRESET
 SELECT INSTR
 assign keybd
 address map
 config display

DISP L B T

Fig. 58

Most errors reported on the HP-MSIB system are transient errors such as those caused by illegal commands over HP-IB. These errors, once "reported" via **REPORT ERRORS**, are cleared from memory. Hence they cannot be reported or viewed a second time.

Other errors reported can be "hard" errors. These are caused by hardware problems such as unconnected back panel cables (see the following example) or the failure of an internal component. These problems can affect operation of the instrument, and cannot be cleared from memory until corrected.

Example: Reporting and correcting a Hardware Error.

If the back panel connection (labeled "300MHz") between the Local Oscillator module (HP 70900A) and the RF section (HP 70904, 5, 6, or 7) is removed, an error is detected by the RF Section and shown on the screen. (See Figure 59.)

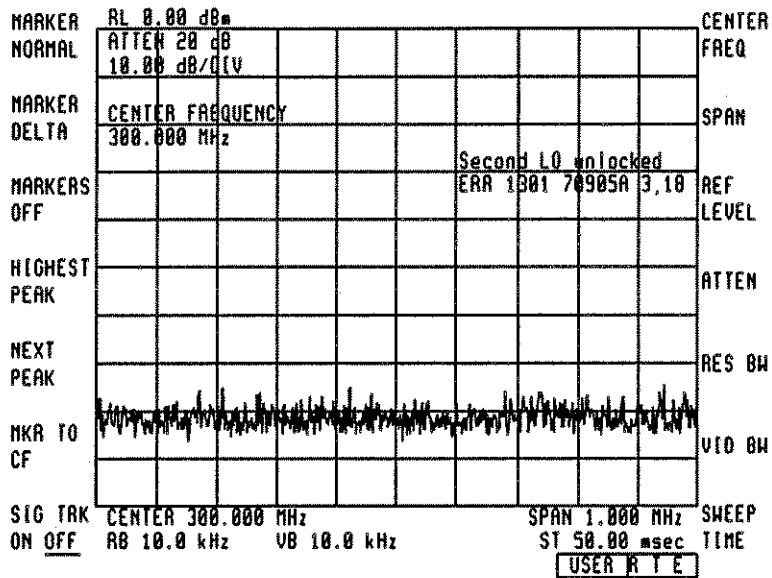

Fig. 59

If [DSP] and **REPORT ERRORS** are pressed, the error screen is shown, but the error is not cleared from memory as indicated by the presence of the "E" in the Status Box (see Figure 60.).

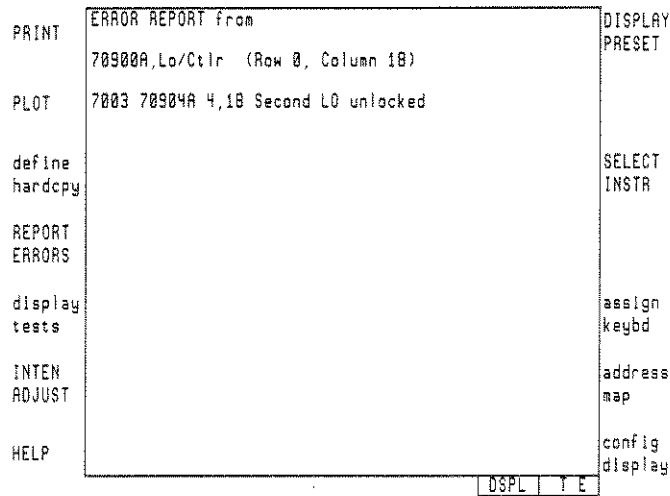

Fig. 60

Note that even if the hardware-related error is corrected at this point, it must be "reported" again to clear the system.

Thus, press **REPORT ERRORS** to clear the system and remove the "E" from the status box.

Hardware-related errors must be "reported" AFTER they have been corrected in order to clear them from memory. This has been done for the following figure.

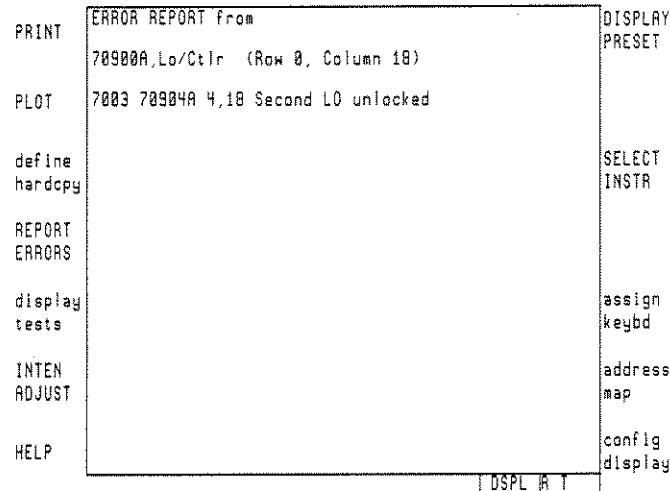

Fig. 61

Example: Clearing Error Reports from Multiple Instruments.

If a system contains multiple instruments, each instrument will independently report the errors it detects. For example, send an illegal command via HP-IB to both the display and the spectrum analyzer.

OUTPUT 704; "XX"
 OUTPUT 718; "XX"

This results in an "E" in the Status Box, just as with a single error.

After pressing [DSP] and **REPORT ERRORS**, the error detected by the module with the lowest column address is reported first (and cleared from memory if it is only a transient error).

Notice that instead of the usual softkey menu under [DSP], **MORE ERRORS** appears on the screen and the "E" remains in the status box (Figure 62.). The second error has not been reported yet.

Press **MORE ERRORS**, and the last error is reported (and cleared if it is only a transient error).

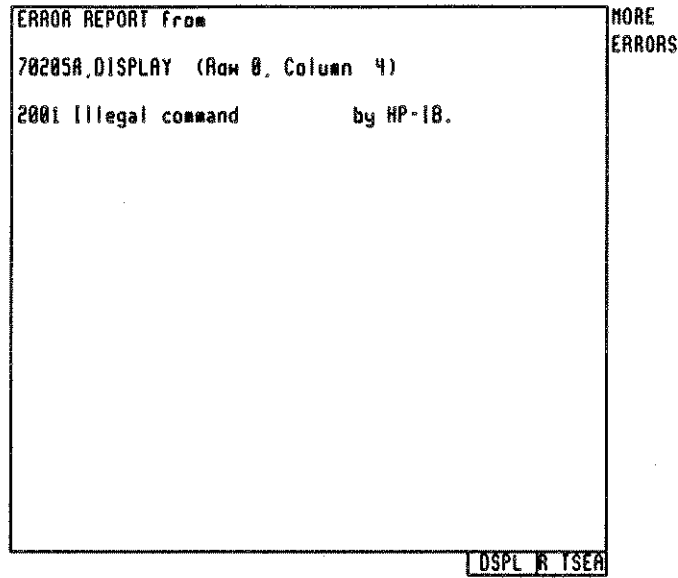

Fig. 62

NOTE

Some transient errors can be cleared by pressing [USR], [MNU], or by pressing [DSP] and REPORT ERRORS.

DISPLAY TESTS

The *display tests* softkey gives the user access to a submenu of keys that provide operational tests of the HP 70205A or HP 70206A Displays themselves, their internal operation, and the keypad and knob.

Figure 63. shows the softkey submenu that appears when *display tests* is pressed.

See the following pages for a description of each *display tests* subkey and its operation.

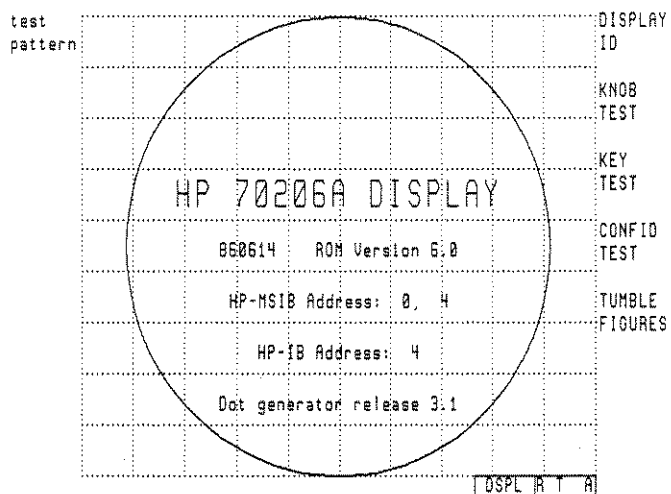

Fig. 63. Display Tests Menu

DISPLAY ID

The **DISPLAY ID** softkey brings up an identification screen similar to the figure above. This provides:

1. Basic verification of display operation.
2. Display model number (e.g., HP 70205).
3. ROM firmware version of the display.

NOTE

This does not provide the ROM version of other modules. For that information, see the appropriate section of the operating instructions for that module. For instance, the local oscillator's ROM version is available by pressing [MNU], **CONFIG**, and **ROM VERSION**.

4. HP-MSIB address (row, column) of the display.

NOTE

Both displays can only have a row address of zero. The factory-shipped default address is Row 0, Column 4 (0,4).

5. HP-IB address of display.

NOTE

This does not necessarily correspond to the HP-MSIB column address. To change the address of any HP-IB enabled module (HP 70900A or displays at present) see the operating instructions in this chapter for the **SET HP-IB** softkey, which is available under **address map**.

6. Dot Generator Release code (e.g., 3.1). (This is provided for firmware updating purposes.)

KNOB TEST

The **KNOB TEST** softkey brings up a test pattern similar to the one shown in Figure 64.

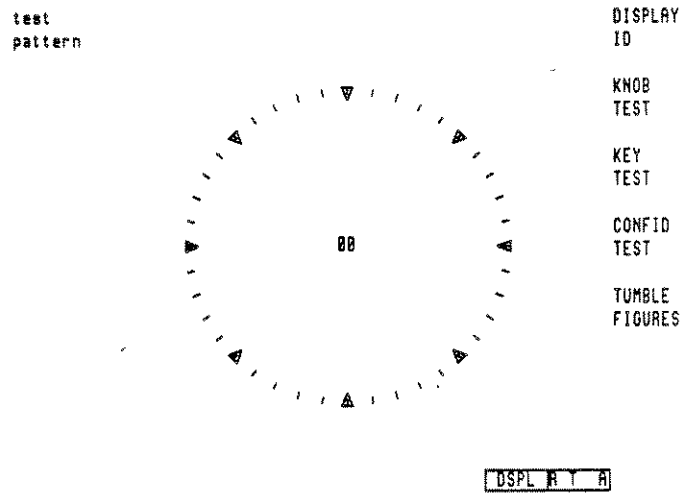

Fig 64. Knob Test Pattern

As the knob is turned, the test pattern rotates in a digital fashion. This provides a test of the mechanical and electrical operation of the Display knob. Note that the step-keys will rotate the pattern but the numeric entry keypad will not.

KEY TEST

The **KEY TEST** softkey allows the user to check the mechanical and electrical operation of every front-panel key on the Display.

Example: Use of **KEY TEST**

1. Press [DSP].
2. Press **display tests**.
3. Press **KEY TEST**.
4. Press any key on the display's front panel and it will be "echoed" on the screen if it is working properly.
5. Press the back space (back-arrow) hardkey to exit this function.

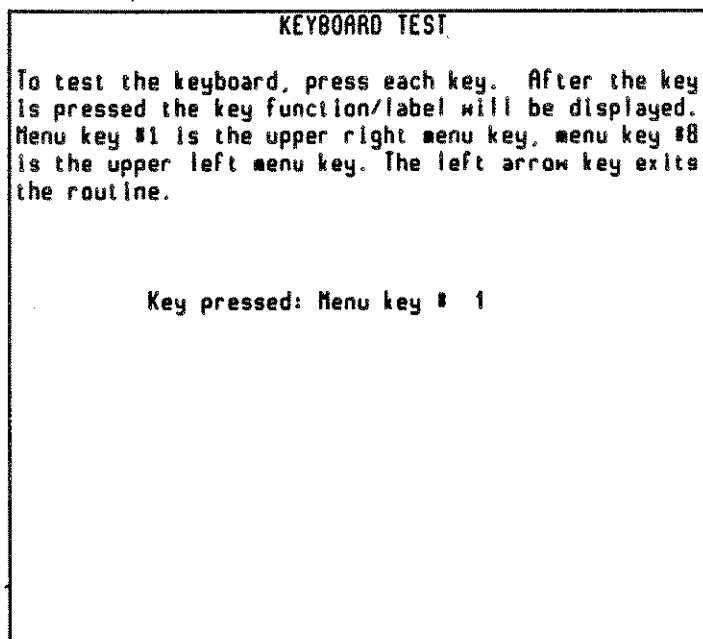

Fig. 65

CONFIDENCE TEST

The Display Confidence Test, initiated by pressing the **CONFID TEST** softkey, checks the operation of roughly 90% of the display unit. If no fault is found, "6001 confidence test passed" appears in the lower left corner of the screen. If a fault is found, "6008 confidence test failed" is shown. In either case, the "character set" remains on the display.

If an error is detected, refer to the System Support Manual.

TUMBLE FIGURES

TUMBLE FIGURES provides a menu of several keys that show rotating 3-dimensional figures.

- To change the size of the figures, turn the display knob.
- To change the speed of rotation about the three spatial axes, press three consecutive numeric keys; for example, press "999" for rapid rotation and "000" to halt rotation.
- To exit this function, press the back space (back-arrow) key.

TEST PATTERN

The softkey **test pattern** produces five test patterns used in screen alignment procedures. They are selected by pressing [DSP], **display tests**, **test pattern**, entering a number 1 to 5 on the Key-Pad, then pressing **ENTER**.

INTENSITY ADJUST

INTEN ADJUST allows the user to change the brightness of the picture on the screen. Brightness is incrementally adjustable from 0 to 19 in steps of 1. (Note: 0 is not necessarily fully off).

When a Display is turned on, it will use the most recent intensity adjustment unless it was set to less than 9. In this case the intensity will default to 9.

HELP

The **HELP** softkey under [DSP] provides two "pages" of information about the operation of the other top-level softkeys directly accessible under [DSP]. (See the figures below.)

| | | |
|------------------------|--|-------------------------|
| <p>DISP
PRESET</p> | <p>DISPLAY PRESET
Clears the display and gives the screen to the module which currently owns the keyboard (if any). Restores the DEFINE HARDCOPY menu DEFAULT VALUES.</p> <p>SELECT INSTR
Establishes link with an instrument. Displays data and allows the user to control the instrument with softkeys. Use ↑/↓ to select another instrument.</p> <p>ASSIGN KEYBD
Changes keyboard control from one instrument to another in a multi-window display. The selected window will be highlighted.</p> <p>ADDRESS MAP
Displays a matrix showing all the modules on the HP70000 Modular System Interface Bus (HP-MSIB). It shows the HP-MSIB and HP-IB addresses, allows the user to change a master module HP-IB address, and allocates Display resources to an instrument.</p> | <p>DISPL
PRESET</p> |
|------------------------|--|-------------------------|

Fig. 66. Display Help: page 1

| | | |
|----------------------------|--|---------------------------|
| <p>PRINT</p> | <p>CONFIG DISPLAY
Stores and recalls display setups; builds or purges windows; allocates the windows to specified instruments.</p> | <p>DISP
PRESET</p> |
| <p>PLOT</p> | <p>PRINT, PLOT
Performs a printer output (PRINT), or a plotter output (PLOT) to an external device. A hardcopy output may be aborted by pressing any key. The parameters for the hardcopy output are set in DEFINE HARDCPY.</p> | <p>SELECT
INSTR</p> |
| <p>define
hardcopy</p> | <p>DEFINE HARDCPY
Sets the hardcopy output parameters: printer and plotter address, plotter scale points (P1,P2), KEYCOPY, HI RES and EJECT options.</p> | <p>assign
keybd</p> |
| <p>REPORT
ERRORS</p> | <p>REPORT ERRORS
When an "E" shows in the status box, an error has been reported by a module via HP-MSIB. REPORT ERRORS shows a description of the error and clears it if the error is not hardware related.</p> | <p>address
map</p> |
| <p>display
tests</p> | | <p>config
display</p> |
| <p>INTEN
ADJUST</p> | | |
| <p>HELP</p> | | |

Fig. 67. Display Help: page 2



REMOTE OPERATION



CHAPTER 3

REMOTE DISPLAY OPERATION

This chapter discusses the remote operation of the HP 70205A Graphics Display and the HP 70206A System Graphics Display by remote computer control over HP-IB.

Table of Contents

| | |
|---|------|
| REMOTE DISPLAY OPERATION | 3-1 |
| Introduction | 3-2 |
| HP-IB Address. | 3-4 |
| Section 1: DISPLAY CONFIGURATION | 3-5 |
| Section 2: SIMPLE GRAPHICS | 3-10 |
| Pen Control | 3-11 |
| Plotting | 3-13 |
| Graphing | 3-16 |
| Scaling | 3-18 |
| Axes and Graticules | 3-21 |
| Section 3: LABELING THE SCREEN. | 3-24 |
| Making a label. | 3-25 |
| Enhancing a label | 3-28 |
| Character enhancements. | 3-29 |
| Section 4: HARDCOPY OUTPUT. | 3-31 |
| Section 5: MARKERS | 3-34 |
| Section 6: CHARACTER SETS | 3-36 |
| Section 7: REFERENCED GRAPHICS | 3-41 |
| Section 8: INFORMATIONAL DISPLAYS | 3-48 |
| Section 9: ERROR HANDLING. | 3-53 |
| Section 10: REMOTELY-CONTROLLED DISPLAY | 3-59 |
| Section 11: UTILITY COMMANDS. | 3-65 |

INTRODUCTION

Chapter 3 covers remote operation of the HP 70000 series displays. For general information on the two display models, see Chapter 1, Introduction, in this part of the Operating Manual. For instructions on manual operation see Chapter 2, DSP Hardkey (Manual Display Operation). All capabilities and commands covered in this chapter are accessible with a computing controller over HP-IB. From the point of view of remote operation, both displays (HP 70205A and HP 70206A) are essentially identical. Any differences will be described in the text.

This chapter discusses different capabilities of the display accessed through remote operation. Capabilities are accessed by one or more two-letter commands, some of which require alphanumeric parameters: e.g. "PD" (Pen Down), or "RC 4" (Recall Screen Configuration from Register #4). The complete set of these commands comprises the HP 70000 Series Graphics Language, which contains some commands from HP-GL, the Hewlett-Packard Graphics Language. HP-GL commands are identified as such in the Graphics Command Listing later in this chapter.

NOTE

Programming techniques for the HP 71000 Series spectrum analyzers are discussed in Part II, Remote Operation. The second chapter of Part II, Programming Fundamentals, contains instructions for imitating manual operation. Chapter 3, Advanced Programming, describes techniques for making computations, measurements, and graphics.

Below is a list of the sections found in this chapter (Chapter 3, of Part III) and a brief description of each:

1. **Display Configuration:** Discusses remote techniques for building and assigning windows on the screen, saving and recalling screen configurations, and interrogating the display about its present configuration. For a more detailed description of the windowing concepts, see Chapters 1 and 2 in this part of the Operating Manual.
2. **Simple Graphics:** Shows how to use the screen of the display like a plotter. Covers pen control, line-type selection, plotting, graphing, scaling of the screen or window, and drawing of axes and graticules. (HP-GL type commands)
3. **Labeling the Screen:** Demonstrates the labeling of any type of display and the manipulation of the label, including rotation, relocation, enhancement, and enlargement.
4. **Hardcopy Output:** Shows how to obtain hardcopy output of the display screen with an external device such as an HP 7470A or 7075A Plotter, or an HP 2225A Thinkjet Printer. Covers the initiation of an output operation, selection of the output device on HP-IB, and the option of including the softkey labels in the output.
5. **Markers:** Demonstrates the selection and placement of a character on the screen as a marker, either for annotation or prompting.
6. **Character Sets:** Covers the use of either the standard character set or a set of the user's creation. This capability can be used to create one or more customized characters such as special markers or logos.

7. **Referenced Graphics:** Discusses the concept and use of a new graphics capability called Referenced Graphics. With this capability, items on the screen such as axes, figures, and labels can be logically grouped together and manipulated as a single entity. The group as a whole can, for example, be moved, turned on or off, deleted, or made to blink.
8. **Informational Displays:** Discusses some of the informational screens that can be displayed, such as the Address Map, the Screen Configuration, and the Error Screen. See Chapter 2 for a further explanation of these features from the point of view of manual operation.
9. **Error Handling:** Discusses how the display can be used by a computer to report errors over HP-IB or on the screen for direct operator viewing. Modules in the HP 70000 system on HP-MSIB row 0 report all detected errors to the display.
10. **Utility Commands:** Contains examples, descriptions, and demonstrations of other capabilities of the HP 70000 Series Displays. These include direct and system-wide features such as Page Clearing, Learn Strings, and Beeping.
11. **Remotely-Controlled Display:** This section shows how softkey labels can be loaded in a computer window, how alphanumeric entries can be received, and how user operation can be simulated, all by remote control.

NOTE

This document uses brackets [XXX] to represent hardkeys and XXX to represent softkeys. It uses the HP 9000 Series 200/300 BASIC Language in all examples.

HP-IB ADDRESS

The Display is accessed remotely over HP-IB at its own address, separate from that of any instrument in the HP 70000 system. See the Address Map section in Chapter 2 for more general information on HP-IB and the display.

To find the HP-IB address of the display, press the following keys: [LCL], [DSP], and *address map*.

Turn the knob until an "A" appears in the Status Box as shown in figure 1.

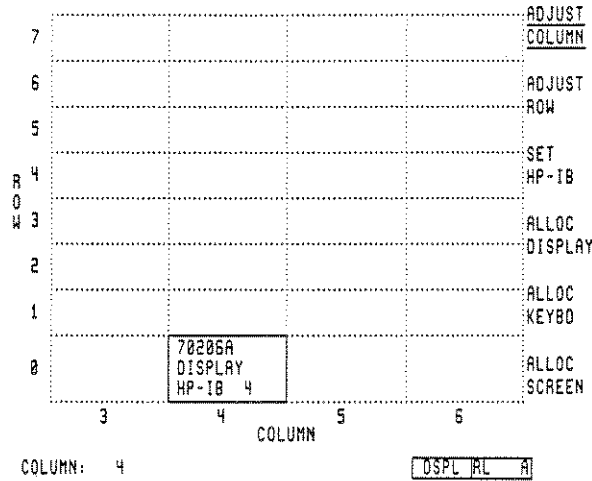

Fig 1. Address Map

This display shows an HP-IB address of 4.

The HP-IB address (also known as the device selector code) is formed by combining the HP-IB interface select code (7) from the computer with the Display HP-IB address (4 in this case) yielding 704. The display's factory-shipped HP-IB address in the example, 704, will be used throughout this chapter. If the HP-IB address of your display is different, substitute the appropriate value.

NOTE

The HP-IB Address can be determined only through manual operation.

Section 1: DISPLAY CONFIGURATION

The resources of the display can be configured either manually or remotely by the user to meet various testing needs. These resources and capabilities are discussed in general in Chapter 2, DSP Hardkey (Manual Operation of Display), under the *config display* softkey description. In brief, the resources of the display include one keyboard and up to four separate windows (numbered 1-4) on the screen. Any window can be assigned to any instrument on HP-MSIB or to a controller on HP-IB. The keyboard is typically associated with one window, although it can be independent. A fifth window, which does not appear in the *SHOW CONFIG* screen, is automatically assigned to HP-IB unless one of the windows, one to four, is already assigned to HP-IB.

The HP 70000 Series Graphics Language commands that pertain to Display Configuration are listed and described below and demonstrated in the following example. Some command descriptions assume prior definition of other commands or concepts. These other commands are described elsewhere in this chapter (see the Display Command Summary in Chapter 4 for the location) and general concepts of display operation are covered in Chapters 1 and 2.

Assign Keyboard: AK window

The AK command allows the controller to allocate the keyboard of the display to one of the four existing windows. If an instrument such as a modular spectrum analyzer is writing to that window, the keyboard can be used to control instrument settings such as Center Frequency and Span.

window # = 1 through 4

Build Window: BW Window#, X1,Y1,X2,Y2, Bus, Row, Col, Keyboard Control

BW constructs a window on the screen, assigns the window to an HP-MSIB element or to HP-IB, and determines whether the keyboard is similarly assigned or not.

Window # = 1 through 4

X1,Y1 X2,Y2: coordinates of window vertices. The smallest window allowed is 100 high by 200 wide (this appears square due to the extra horizontal resolution of the display).

Bus = 0: HP-IB (Window to be used by HP-IB controller)

Bus = 1: HP-MSIB (Window assigned to modular instrument)

Row, Col: HP-MSIB address of controlling module if window is assigned to one. These two parameters are ignored if window is used for HP-IB.

Keyboard Control = 0: Keyboard control unaffected, keyboard not necessarily associated with window.

Keyboard Control = 1: Keyboard linked with window, and can be used to control the modular instrument the window is assigned to.

Select Instrument: CI address #

CI establishes a link with an instrument. It displays data and allows the user to control the instrument with softkeys. The CI command accepts a parameter from 0 to 30 or none. It invokes a SELECT INSTRUMENT starting at that address. If a parameter is not sent, the current address plus 1 (0 if the current address is 30) is used. If there is no current address, the search starts at 0.

Address # = 0 through 30

NOTE

While the CI is proceeding, no other HP-IB traffic should take place. The computer should wait until a module is found to proceed. A sample program which does this is:

```
10 Dsp=704
20 OUTPUT Dsp;"CI";
30 REPEAT
40 UNTIL BIT (SPOLL(Dsp),4)
50 END
```

Note that CI resets all HP-IB parameters and assigns the entire screen to the module it finds.

Delete Entire Screen: DE (no parameters sent)

DE clears the entire screen of all writing, softkeys, windows, and keyboard assignments. All displayed data and current configuration information is lost. DE is useful for clearing the display before building windows.

Default Values: DF (no parameters sent)

DF sets certain display parameters to their default values. These parameters and their values are shown below. If the sender (either an HP 70900A LO Control Module or an HP-IB controller) does not have a window assigned, only the Input Mask value, the character sets, the label terminator, and preprocess mode are reset.

HP-GL Parameters: Line Type--Solid Line; Pen 1; Pen Up; Delta X=1; Standard character size; Standard and alternate character sets both 0; Input Mask (IM)=255,32,0. Label terminator: CHR\$(3); Character rotation and lettering direction: normal.

Non-HP-GL Parameters: Group 0; Item 0; Blink Off; View On; Mapping Method (MP) Anisotropic. Preprocess mode: off.

Initialize: IN (no parameters sent)

IN sets the Display to an initial power-on state. It clears data from the windows and sets default values as described by the DF command. IN does not alter window configuration, or clear errors. It does clear SRQ and the serial poll status byte.

Output P1,P2: OP (no parameters required, but response sent by display)

OP interrogates the display for the vertices, in display units, of the window that is currently assigned to HP-IB. The display responds over HP-IB with the values of X1, Y1, X2, and Y2, respectively. See the example in this section and the description of windowing in Chapter 2 under *config display*.

Output Graphics Link: OG (no parameters required, but response sent by display)

OG causes the display to output the row and column of the first module in the memory of the display which owns a window. The output consists of two integers separated by a comma. Both are -1 if no module has a window.

Recall Screen Configuration: RC register #

RC recalls the screen configuration (window sizes and assignment, and keyboard assignment) from the specified register (1 - 4). Operates similarly to the *RECALL CONFIG* softkey described in Chapter 2.

Show Configuration: SN register #

SN shows a summary of the display screen stored in registers 1 - 4, or in the current configuration (with register number = 0). A value of -1 exits the mode. SN works similarly to the *SHOW CONFIG* softkey described in Chapter 2.

NOTE

The configuration summary will remain on the screen until cleared by sending SN without an argument or by sending "SN -1."

Save Configuration: SV register #

SV saves the current screen configuration in one of four registers (1 - 4). SV works similarly to the *SAVE CONFIG* softkey described in Chapter 2.

Example: Building a Window and Finding P1,P2

Type in and run the following demonstration program on an HP-IB computing controller.

NOTE

This example, like most others in this chapter, uses the HP BASIC language and assumes an HP-IB address of 704 for the Display and 718 for an HP 71000 series Modular Spectrum Analyzer (HP-MSIB address 0,18 for the Local Oscillator/Control Module).

```

10 REMOTE 7
20 ASSIGN @Dsp TO 704
      (DISPLAY'S HP-IB ADDRESS)
30 ASSIGN @Sa TO 718
      (ANALYZER'S HP-IB ADDRESS)
40 OUTPUT @Dsp;"DE;"
      (CLEAR THE SCREEN)
50 OUTPUT @Dsp;"BW 1,112,16,911,195,0,0,1;"
      (BUILD WINDOW #1 IN BOTTOM HALF OF SCREEN,
      ASSIGN TO HP-IB)
60 OUTPUT @Dsp;"OP;"
      (INTERROGATE FOR X1,Y1,X2,Y2)
70 ENTER @Dsp;X1,Y1,X2,Y2
      (RECEIVE COORDINATES)
80 DISP X1,Y1,X2,Y2
      (CONTROLLER SHOWS 112,16,911,195)
90 PAUSE
      (PRESS "CONTINUE" ON CONTROLLER)
100 OUTPUT @Dsp;"SN0;"
      (SHOW CURRENT CONFIGURATION ON SCREEN)
110 PAUSE
      (PRESS "CONTINUE" ON CONTROLLER)
120 OUTPUT @Dsp;"SN;"
      (CLEAR SCREEN OF CONFIGURATION SUMMARY)
130 OUTPUT @Dsp;"BW2,112,205,911,383,1,0,18,1;"
      (BUILD WINDOW #2 IN TOP HALF OF SCREEN,
      ASSIGN TO ANALYZER AT HP-MSIB ADDRESS 0,18
      WITH KEYBOARD)
140 OUTPUT @Sa;"IP;TS;"
      (PRESET INSTRUMENT, TAKE SWEEP.
      TRACE DATA WILL BE DISPLAYED IN WINDOW)
150 PAUSE
      (PRESS "CONTINUE" ON CONTROLLER)
160 OUTPUT @Dsp;"SN0;"
      (SHOW NEW SCREEN CONFIGURATION)
170 END

```

```

CURRENT CONFIGURATION

Window 1
Keyboard: HP-1B
          Xmin,Ymin: 112, 16
          Xmax,Ymax: 911, 195

Window 2: undefined
Window 3: undefined
Window 4: undefined
    
```

Fig. 2. Result of SN0

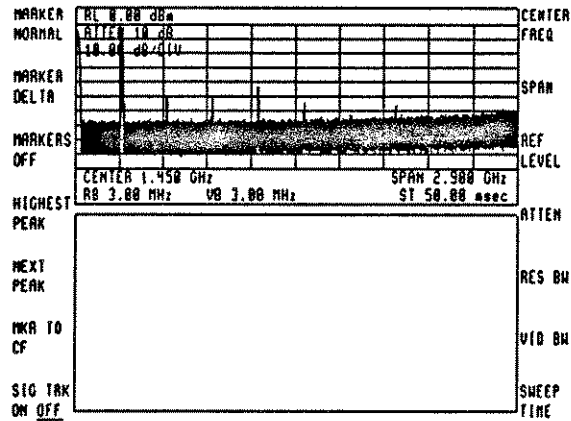

Fig. 3. Two-window screen.

Section 2: SIMPLE GRAPHICS

The HP 70000 Series Displays can be used like an HP-GL plotter by a remote controller. The user can:

- Draw simple figures on the screen using various line types.
- Plot points by their X,Y coordinates.
- Graph sequential values such as those from an array.
- Change the shape and scale of drawings.
- Draw graticules or axes with a single command.
- Initialize the window to a preset condition.

This section is divided into the following subsections that deal with various simple graphics capabilities:

Pen Control: Covers commands PD (Pen Down), PU (Pen Up), SP (Select Pen), and LT (Line Type).

Plotting: Covers commands PA (Plot Absolute) and PR (Plot Relative).

Graphing: Covers commands GA (Graph Absolute), GR (Graph Relative), and DX (Set Delta – X).

Scaling and Shape: Covers commands SC (Scale to user units) and MP (Mapping Shape).

Axes and Graticules: Covers commands AX (Create Axis) and GT (Create Graticule).

PEN CONTROL

Although the actual lines on the display screen are "drawn" by an electron beam, the term "pen" is used for graphics in two separate contexts. First, terms like "Pen Up" and "Pen Down" mean "draw with beam off" or "draw with beam on". Second, the "Select Pen" command (SP), while not affecting the lines drawn on the screen, indicates which of a plotter's ink pens is to be used for drawing, in anticipation of display-to-plotter output operations.

The pen control commands are described below and shown in the example.

Pen Up: PU (no parameters needed)

Suspends line drawing regardless of pen movement until the PD command is sent or the pen status is otherwise reset. The pen can move around but lines will not be drawn.

Pen Down: PD (no parameters needed)

Restarts the line drawing following a PU command. In non-referenced graphics, this must be done before any lines will be seen (the pen starts UP).

Select Pen: SP pen #

On a monochromatic display such as the HP 70205A or HP 70206A Graphics Displays, SP affects operation only when the display performs a plotter output operation. The actual pen selected will depend on the plotter used. "Pen #" can range from 0 to 255, with 0 as the default value.

Line Type: LT type

LT selects the type of line used for on-screen graphics. The line types are shown below. Note that some plotters may not support all line types so they may appear different when dumped to a plotter. The line-type default is a solid line.

| Type | Line | |
|------|-----------------|--------------------------|
| 0 | end points only | |
| 1 | | (one dot ON in twelve) |
| 2 | | (four dots ON in twelve) |
| 3 | | (six dots ON in twelve) |
| 4 | | |
| 5 | | |
| 6 | | (two dots ON in four) |
| 7 | | (one dot ON in four) |
| 8 | | (every other dot ON) |

NOTE

Because the display "stretches" each dot horizontally to take up two dot positions , line type 8 appears solid for horizontal lines. This phenomenon also affects the other line types to some degree.

A second parameter "length" is ignored if sent, but is included for HP-GL compatibility. The LT command allows the user to create any desired line type within a 12-dot template. These are formed by passing a "type" parameter, other than 0-8. The display will take the bottom 12 bits of the parameter and repeat them over and over as the line type.

Example

"Type" Parameter = 2048 (In binary is 100000000000, so line type will be one dot on in every 12, same as type 1.)

PLOTTING

Plotting can be thought of as moving a pen from its present position to another specified position. If the pen was down before the plot operation, a line will be drawn from the starting point to an endpoint specified in the PA or PR command. If the pen is up, no line will be drawn, but the pen will be located at the new endpoint. When a window is initialized the pen starts at coordinates X=0, Y=0, the lower-left corner of the screen. Scaling operations, described later in this chapter, do not move the pen.

NOTE

A controller writing on the screen over HP-IB may plot anywhere on the screen, and is not necessarily restricted by window size.

Plot Absolute: PA X1, Y1, ... Xn, Yn

The PA command moves the pen to a specific point on the screen, specified in the current user units (see SC command description later in this chapter), then moves it to the next specified point, and so on until it runs out of X, Y pairs.

The screen is considered to be a grid of points, any of which can be the endpoint of a PA command. Each point has an X and Y value. In the standard display units, the lower left corner of the display screen has coordinates X = 0, Y = 0, and the upper right corner has coordinates X = 1023, Y = 383. The screen can also be scaled to set the corner points to any chosen X, Y.

Example: Using the PA command to draw a box.

Execute the following program from an HP-IB controller:

```

10 ASSIGN @Dsp TO 704
    (DISPLAY'S HP-IB ADDRESS)
20 CLEAR @Dsp
30 OUTPUT @Dsp;"IN;"
40 OUTPUT @Dsp;"DE;"
    (CLEAR THE SCREEN)
50 OUTPUT @Dsp;"SC;"
    (SELECT DEFAULT DISPLAY UNITS,i.e.1023x383 UNITS)
60 OUTPUT @Dsp;"PU;PA 100,100;"
    (MOVE PEN TO LOWER LEFT CORNER)
70 OUTPUT @Dsp;"PD;"
    (PREPARE TO DRAW A BOX)
80 OUTPUT @Dsp;"PA 900,100,900,300;"
    (PLOT BOTTOM AND RIGHT SIDES OF BOX)
90 OUTPUT @Dsp;"PA 100,300,100,100;"
    (PLOT TOP AND LEFT SIDES)

```

```
100 OUTPUT @Dsp;"PA 500,200;"  
      (DRAW LINE TO CENTER OF BOX)  
110 OUTPUT @Dsp;"PU;PA 700,250;PD;PA 900,300;"  
      (DRAW BROKEN LINE TO TOP RIGHT CORNER OF BOX)  
120 END
```

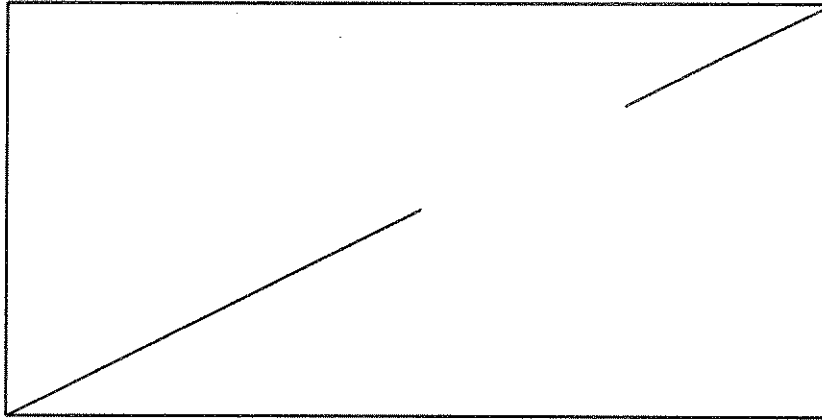

Fig. 4. Result of PA example program.

Plot Relative: PR Xincrement1, Yincrement1...Xincrementn,Yincrementn

The Plot Relative command moves the pen Xincrement units to the right and Yincrement units up from its starting position. The currently defined user units are used. See the following example for a demonstration.

Example: Relative Plotting

```

10 ASSIGN @Dsp TO 704
   (DISPLAY'S HP-IB ADDRESS)
20 CLEAR @Dsp
30 OUTPUT @Dsp;"IN;"
   (INITIALIZE DISPLAY)
40 OUTPUT @Dsp;"DE;"
   (CLEAR THE SCREEN)
50 OUTPUT @Dsp;"SC;"
   (SELECT DEFAULT DISPLAY UNITS,
    i.e.1023x383 UNITS)
60 OUTPUT @Dsp;"PU;PA 0,0;"
   (MOVE PEN TO LOWER LEFT CORNER)
70 OUTPUT @Dsp;"PD;"
   (PREPARE TO DRAW A LINE)
80 OUTPUT @Dsp;"PA 500,200;"
   (MOVE PEN TO APPROX CENTER OF SCREEN)
90 OUTPUT @Dsp;"PR 100,0;"
   (PR DRAWS A LINE 100 UNITS TO THE RIGHT)
100 OUTPUT @Dsp;"PD;PA 100,0;"
   (NOTE HOW PA COMMAND OPERATES WITH THE SAME
    COORDINATES AS PR ABOVE)
110 END

```

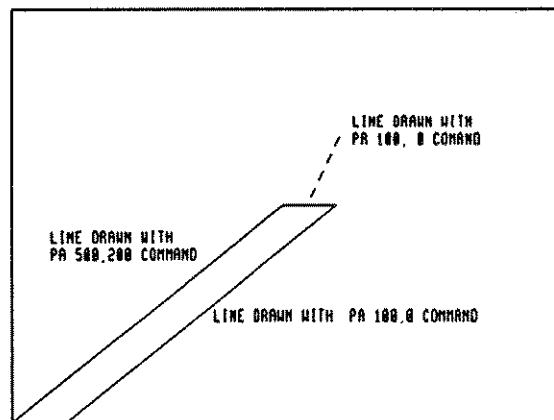

Fig. 5 Relative Plotting

GRAPHING

Graphing differs from plotting in that only one parameter is specified, namely, the ordinate or y-value, and that graphing is usually faster. The x-value (abscissa) is adjusted automatically by the display according to the DX (Set Delta-X) command.

Graph Absolute: GA Y1, Y2, . . . Yn

GA moves the pen to a new point on the screen. The X-coordinate of that point will be the present X-coordinate plus the value set by the DX command. The Y-coordinate of that point will be the Y value. Consecutive Y values can be used with a single GA command.

Set Delta-X: DX Xincrement

The DX command is used for graphing with the GA and GR commands. Each time the GA or GR command is sent, or with each successive Y value, the X-coordinate of the pen is adjusted by Xincrement units. The DX command operates with whatever units (user or display) are presently being used. See the following example.

Example: Graphing Array Contents

```

10 DIM Array(2000)
20 ASSIGN @Dsp TO 704
      (DISPLAY'S HP-IB ADDRESS)
30 CLEAR @Dsp
40 OUTPUT @Dsp;"DE;IN;"
      (CLEAR SCREEN AND INITIALIZE DISPLAY)
50 DEG
60 FOR I=0 TO 1023
70   Array(I)=200+100*SIN(4*I)
      (FILL ARRAY TO GRAPH LATER)
80 NEXT I
90 OUTPUT @Dsp;"SC;"
      (SELECT DEFAULT DISPLAY UNITS,i.e.1023x383 UNITS)
100 OUTPUT @Dsp;"PU;PA 0,0;"
      (MOVE PEN TO LOWER LEFT CORNER)
110 OUTPUT @Dsp;"PD;"
      (PREPARE TO GRAPH ARRAY CONTENTS)
120 OUTPUT @Dsp;"DX1;"
      (SET Xincrement TO 1)
130 FOR J=0 TO 511
140   OUTPUT @Dsp;"GA";ARRAY(J);"
      (GRAPH ARRAY CONTENTS)
150 NEXT J

```

```
160 OUTPUT @Dsp;"DX2;"  
      (EXPAND THE GRAPH HORIZONTALLY)  
170 FOR K=512 TO 768  
180  OUTPUT @Dsp;"GA";Array(K);"  
      (PLOT THE EXPANDED PORTION)  
190 NEXT K  
200 END
```

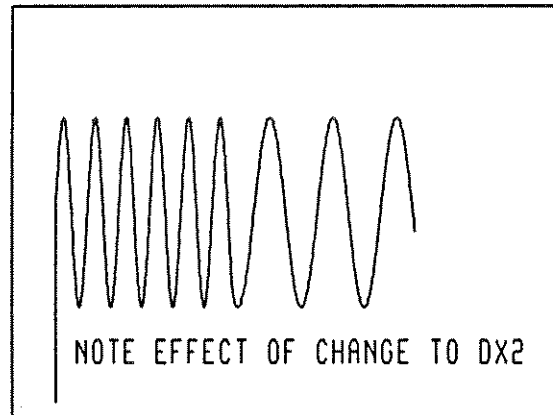

Fig 6.

Graph Relative: GR Yincrement1 . . . Yincrementn

GR uses one or several parameters to successively move the pen up or down from its present position. Yincrement is the number of units, positive or negative, that the pen will be moved vertically. The DX command sets the number of units the X coordinate will be incremented.

SCALING

Any individual window on the screen can be given arbitrary dimensions for the convenience of the user. There are two kinds of units (dimensions) used: display units and user units.

Display units are the individual physical locations that can be addressed by the display. The display screen is 1024 units wide ($x = 0$ to 1023) and 384 units high ($Y = 0$ to 383), as discussed in the *build window* softkey description in Chapter 2. Display units can be specified at any time by sending the SC command with no parameter; e.g., OUTPUT 704;"SC;"

User units are specified by the user with the SC command. These units pertain to the currently active window only, and will not affect graphics operations in other windows, even those on the same screen.

Scale to User Units: SC Xmin, Xmax, Ymin, Ymax

The SC command is used to give the window dimensions that are useful from the user's point of view. Regardless of the physical size of the window, it will subsequently have a "width" in user units of Xmax minus Xmin and a "height" of Ymax minus Ymin. Any parameters can be negative, as long as Xmax is greater than Xmin and Ymax is greater than Ymin. See the following example.

NOTE

If no window is currently being used, the SC command will apply to the entire screen

Example: Scaling to User Units (SC command).

```

10 ASSIGN @Dsp TO 704
      (DISPLAY'S HP-IB ADDRESS)
20 CLEAR @Dsp
30 OUTPUT @Dsp;"DE;IN;"
      (CLEAR THE SCREEN, INITIALIZE WINDOW)
40 OUTPUT @Dsp;"BW 1,112,16,911,383,0,0,0,1;"
      (BUILD HP-IB WINDOW)
50 OUTPUT @Dsp;"SC;"
      (USE STANDARD DISPLAY UNITS FIRST)
60 OUTPUT @Dsp;"PU;PA 0,0;PD;PA 1023,0, 1023,383, 0,383, 0,0;"
      (FRAME THE WHOLE SCREEN IN DISPLAY UNITS)
70 I=0
80 Loop: I=I+1
90 OUTPUT @Dsp;"PU;PA 112,16;PD;PA 911,16, 911,383, 112,383, 112,16;"
      (FRAME THE STANDARD WINDOW
      NOTE SPACE LEFT ON SCREEN FOR SOFTKEYS)
100 OUTPUT @Dsp;"SC 0,1000, 0,1000;"
      (SCALE THE WINDOW TO 1000 BY 1000)
110 IF I=1 THEN GOTO Loop
      (GO BACK AND FRAME THE AREA WITH VERTICES P1,P2
      OF 112,16 AND 911,383 IN THE NEW USER UNITS)
    
```

```

120 OUTPUT @Dsp;"PU;PA0,0;PD;PA1000,1000;"
      (SHOW THE "1000 BY 1000" WINDOW BY DRAWING
      DIAGONAL LINE)
130 END

```

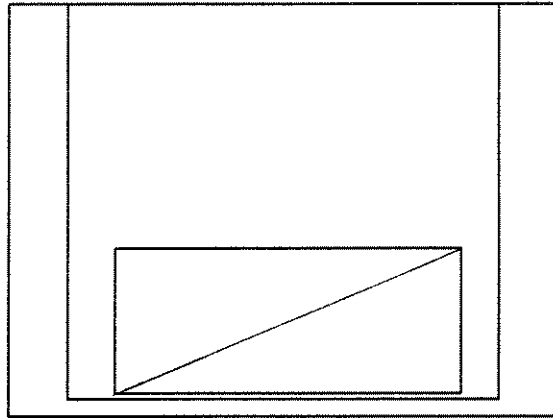

Fig. 7

Mapping Shape: MP shape

The MP command determines whether the shape of squares drawn in the active window will be square or rectangular.

Shape = 0: Squares take on aspect ratio of window
 Shape = 1: Square are square shaped

See the following example.

Example: Using Mapping Shape (MP command).

```

10 ASSIGN @Dsp TO 704
      (DISPLAY'S HP-IB ADDRESS)
20 CLEAR @Dsp
30 OUTPUT @Dsp;"DE;IN;"
      (CLEAR THE SCREEN, INITIALIZE)
40 OUTPUT @Dsp;"BW 1,112,16,911,383,0,0,0,1;"
      (BUILD HP-IB WINDOW)
50 OUTPUT @Dsp;"SC 0,1000, 0,1000;"
      (SCALE THE WINDOW TO 1000 BY 1000)
60 OUTPUT @Dsp;"PU;PA0,0;PD;PA1000.0, 1000,1000, 0,1000, 0,0;"
      (FRAME WINDOW)
70 OUTPUT @Dsp;"MP0;"
      (DEFAULT MAPPING SHAPE, i.e. oblong)
80 OUTPUT @Dsp;"GP1;IT1;OR 0,0;GT 100,100,4,4;"
      (DRAW RECTANGULAR GRATICULE)
90 OUTPUT @Dsp;"MP1;"

```

(OTHER MAPPING SHAPE, i.e. square)
100 OUTPUT @Dsp;"IT2;OR 0,500;GT 100,100,4,4;"
(DRAW SQUARE GRATICULE)
110 END

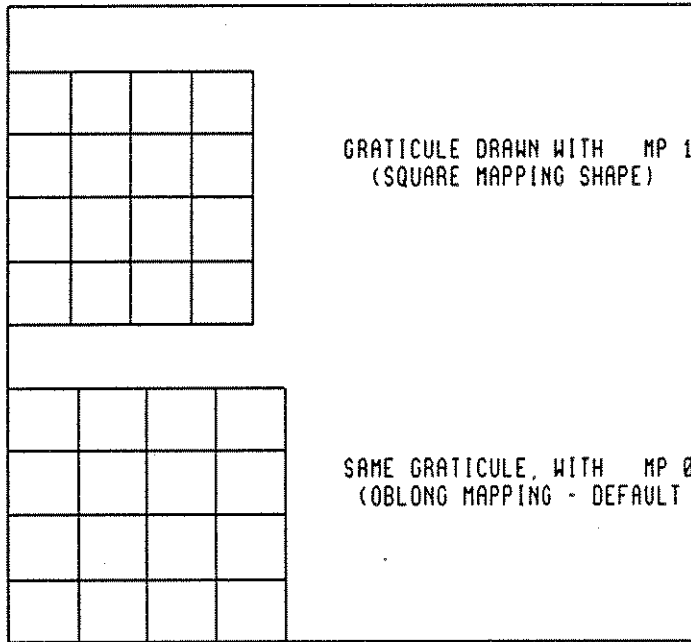

Fig. 8.

AXES AND GRATICULES

Axes or graticules can be drawn with a single command. For usage see the example below. For annotation of axes, see the section in this chapter titled "Labeling the Screen."

AX Xlength, Ylength, Xint, Yint, Xtic, Ytic, Xmaj, Ymaj, Tsize. The Axis command draws a set of axes on the screen. All parameters are optional.

Xlength, Ylength: The length of each axis in current units. (Default 800,320)

Xint, Yint: The point on each axis that is intersected by the other axis Default = 0,0).

Xtic, Ytic: The distance, in current units, between minor tic marks on each axis. The default condition displays no tic marks.

Xmaj, Ymaj: The number of minor tic spaces between each major tic mark.

Tsize: The length of a major tic mark (Default 16). Minor tic marks are half as long. The tics on both axis are the same size even if the scaling factor in X and Y are different. The X scale factor is used to calculate their size.

NOTE

When using referenced graphics (see later section), the intersection of the two axes is the point that is "referenced."

Example: Drawing a set of axes.

```

10 ASSIGN @Dsp TO 704
    (DISPLAY'S HP-IB ADDRESS)
20 CLEAR @Dsp
30 OUTPUT @Dsp;"DE;IN;"
    (CLEAR THE SCREEN, INITIALIZE)
40 OUTPUT @Dsp;"BW 1,112,16,911,383,0,0,0,1;"
    (BUILD A WINDOW FOR HP-IB)
50 OUTPUT @Dsp;"SC 0,1000,0,1000;"
    (SCALE TO 1000 USER UNITS IN X AND Y)
60 OUTPUT @Dsp;"PD;"
70 OUTPUT @Dsp;"GP1;IT1;OR200,200;"
    (REFER TO REFERENCED GRAPHICS SECTION)
80 OUTPUT @Dsp;"AX1000,1000,200,200,10,10,2,2,20;"
    (DRAW AXIS)
90 END

```

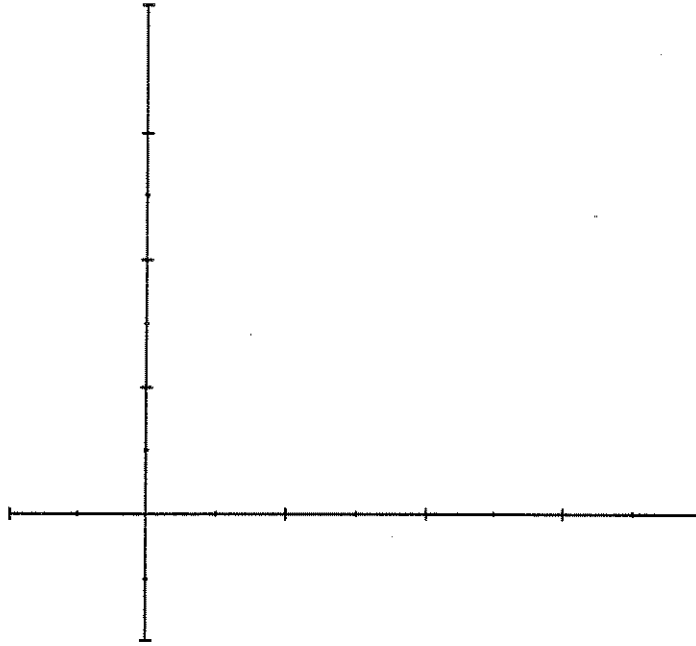

Fig. 9

Graticule: GT Boxwidth, Boxheight, #X boxes, #Y boxes

The GT command draws a graticule on the screen (see the following example). The point on a graticule referenced by the OR command (see Referenced Graphics section) is the lower left-hand corner of the graticule.

Boxwidth, Boxheight: The width and height of each box in current units.

#X boxes, #Y boxes: The number of boxes along each axis.

Example: Drawing a graticule.

```

10 ASSIGN @Dsp TO 704
20 CLEAR @Dsp
30 OUTPUT @Dsp;"DE;IN;"
40 OUTPUT @Dsp;"BW 1,112,16,911,383,0,0,0,1;"
   (BUILD A WINDOW FOR HP-IB)
50 OUTPUT @Dsp;"SC 0,1000,0,1000;"
   (SCALE TO 1000 USER UNITS IN X AND Y)
60 OUTPUT @Dsp;"PD;"
70 OUTPUT @Dsp;"GT100,100,10,10;"
   (DRAW GRATICULE, 10 BOXES BY 10 BOXES,
   EACH BOX 100 UNITS SQUARE)

80 END
    
```

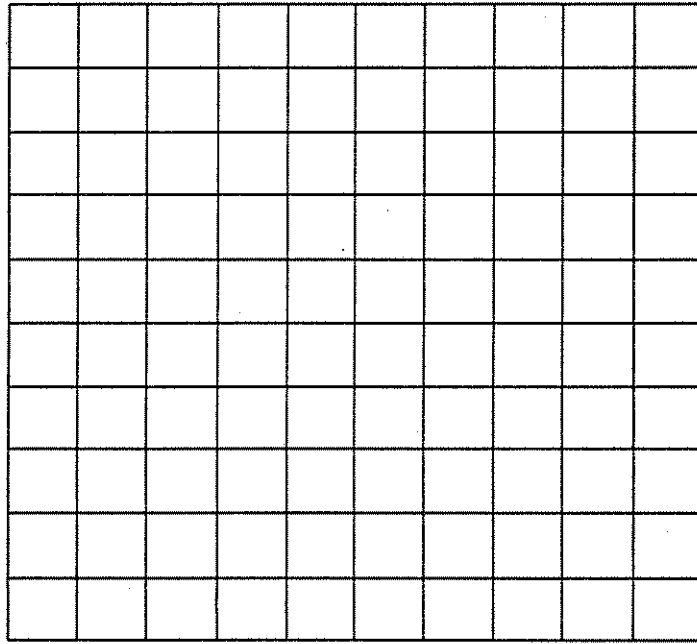



Fig. 10

Section 3: LABELING THE SCREEN

The HP 70000 Series Displays have the capability to place text labels anywhere on the screen. Labels can be used by an HP 70000 series modular instrument (e.g., the local oscillator module of a spectrum analyzer) or by an HP-IB controller.

The example below uses Referenced Graphics. Although Referenced Graphics will be covered in a later section of this chapter, notice that labels can be used either in a referenced or non-referenced mode.

The location of a non-referenced label is determined by the location of the pen. To move the pen to a specified location prior to placing the label, use the Plot Absolute (PA) command. Use the Origin (OR) command to shift the location of a referenced label.

MAKING A LABEL

Three commands are used to make a label. Configure Label (CL) defines the shape of the label (number of characters and lines), Define Terminator (DT) allows the user to define the end of a label, and Label (LB) actually places the label on the screen.

Configure Label: CL lines (24-max), characters, (68 max)

CL specifies the number of lines in the label ("lines") and the number of characters per line ("characters"). Default condition (when CL is sent with no parameters) is 1 line of 35 characters. No more than 68 characters will fit on any single line of the display.

NOTE

The CL command affects only those labels used in a referenced mode. Non-referenced labels can be written on multiple lines by sending the text in multiple OUTPUT statements, leaving out the semicolon, as in lines 140 through 160 of the following labeling example.

Define Terminator: DT Character

The DT command is used to define a character (any ASCII character) that will be used to signal the end of a label. A space cannot be sent between the DT and the Character.

Example: Correct = DT& Incorrect = DT &

The label terminator thus defined is used to terminate text in the LB, FC, and ML commands

Label: LB text <terminator>

The LB command causes the display to start placing text on the screen, according to the last CL command, until the label terminator character is received (See DT). A text string that is longer than the CL command allows will be scrolled off the display (see example).

NOTE

The defined terminator character must be sent at the end of each label. Anything received over HP-IB by the Display between the LB command and the defined terminator will be considered part of the label. See the example below for multi-line labels.

Example: Making Labels.

```

10 ASSIGN @Dsp TO 704
20 CLEAR @Dsp
30 OUTPUT @Dsp;"DE;IN;"
40 OUTPUT @Dsp;"BW 1,112,16,911,383,0,0,0,1;"
    (BUILD STANDARD WINDOW #1)
50 OUTPUT @Dsp;"SC 0,1000,0,1000;"
    (SCALE TO 1000 USER UNITS IN X AND Y)
60 OUTPUT @Dsp;"DT#;"
    (DEFINE LABEL TERMINATOR TO BE #)
70 OUTPUT @Dsp;"PU;PA700,700;"
    (MOVE PEN TO TOP RIGHT QUADRANT)
80 OUTPUT @Dsp;"LBUNREFERENCED LABEL#;"
    (DRAW AN UNREFERENCED LABEL)
90 OUTPUT @Dsp;"GP1;IT1;CL2,10;"
    (CONFIGURE A REFERENCED LABEL)
100 OUTPUT @Dsp;"OR 100,700;"
    (SHIFT ORIGIN TO TOP LEFT QUADRANT)
110 OUTPUT @Dsp;"LBREFERENCED LABEL#;"
    (DRAW THE REFERENCED, CONFIGURED LABEL)
120 OUTPUT @Dsp;"GP1;IT2;CL3,10;"
    (CONFIGURE LABEL, 3 LINES OF 10 CHARACTERS)
130 OUTPUT @Dsp;"OR 100, 300;"
    (PLACE LABEL IN LOWER LEFT QUADRANT)
140 OUTPUT @Dsp;"LBLINE 1"
150 OUTPUT @Dsp;"LINE 2"
160 OUTPUT @Dsp;"LINE 3#;"
    (DRAW A MULTI-LINE LABEL BY SENDING THE
    LINES SEPARATELY, AND ONLY USING THE TERMINATOR
    CHARACTER AT THE END)
170 OUTPUT @Dsp;"GP1;IT3;CL2,5;"
    (CONFIGURE LABEL, 2 LINES OF 5 CHARACTERS)
180 OUTPUT @Dsp;"OR 700,300;"
    (PLACE LABEL IN LOWER RIGHT QUADRANT)
190 OUTPUT @Dsp;"LBTHIS LABEL IS BY FAR TOO LONG#;"
    (NOTE HOW LABEL GETS SCROLLED ACCORDING TO CL
    COMMAND)
200 END

```

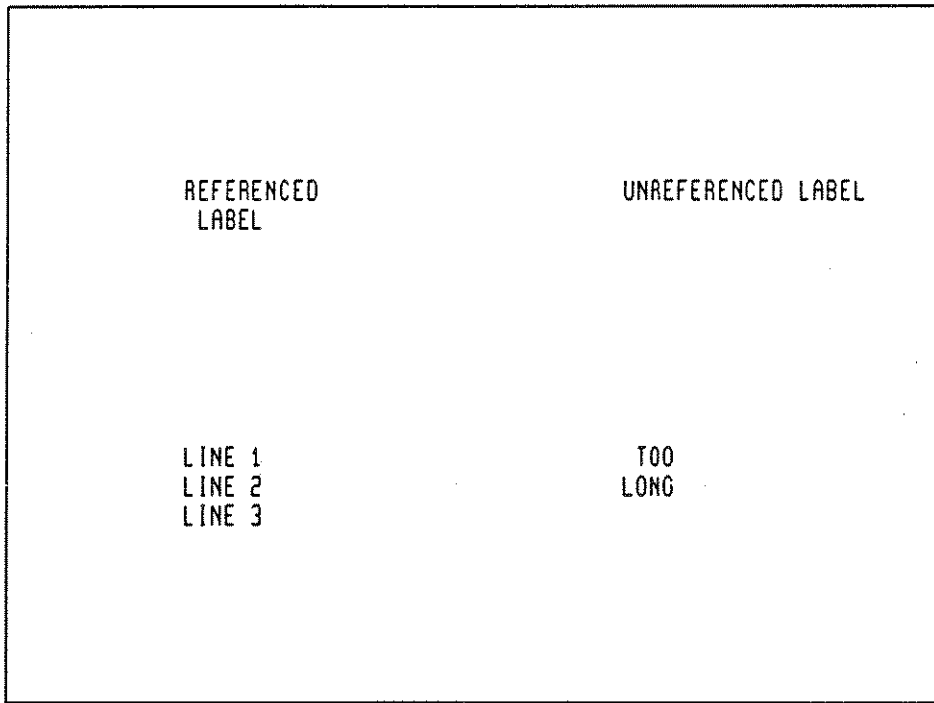

Fig. 11

ENHANCING A LABEL

Labels, uniquely among figures on the display, can be enhanced by changing the size and angle of the characters that comprise them. Four commands are used to do this: DI (Set Character Direction Absolute), SI (Set Character Size Absolute), SR (Set Character Size Relative), DR (Set Character Direction Relative).

Set Character Direction Absolute: DI run, rise

The DI command specifies the direction of all text that appears until the direction is changed or reset, or until another referenced group or item is specified.

Set Character Direction Relative: DR run, rise

The DR command specifies the direction in which characters are lettered relative to width and length of a window. Run and rise are integers and specify a percentage of the algebraic distance between P1 and P2. P1 and P2 are the lower left and upper right vertex points of the window. Run is the desired percentage of $P2x - P1x$ and the rise is the desired percentage of $P2y - P1y$. (See the DI command for lettering not affected by the choice of P1 or P2.) A DR command with a run parameter of 0 will produce vertical labeling.

Limits:

$$\text{Run} \times (P2x - P1x) < 32768$$

$$\text{Rise} \times (P2y - P1y) < 32768$$

Example:

Output@Dsp; "IN;IT1;DT#;OR 400,200;DR 10,10;LBTEST#;IT2;DT#;OR 400,100;DR 10,30;LBTEST#"

Set Character Size Absolute: SI width

The SI command sets the absolute size of characters used in labels. Width is in display units and specifies width of a cell. There are 16 discrete widths available, in multiples of 15 dots (15 is the smallest, 240 the largest).

Set Character Size Relative: SR percent

The SR command sets the size of the characters as a fixed percentage of the present window width so that character size remains proportional when P1 and P2 are changed. The same restrictions hold as for SI.

NOTE

The HP-GL commands SR and SI have another parameter for height, which the HP 70205A and HP 70206A will ignore.

CHARACTER ENHANCEMENTS

The display supports character enhancements of underlining, blinking, and inverse video. These enhancements are enabled and disabled by sending an escape sequence and an enhancement character. The escape sequence is:

<ESC> & d <enhancement character>

| FUNCTION | ENHANCEMENT | | | | | | | |
|-------------------|-------------|---|---|---|---|---|---|---|
| | @ | A | B | C | D | E | F | G |
| Enhance Character | | | | | | | | |
| Blinking | X | | | X | | X | | X |
| Inverse Video | | | X | X | | | X | X |
| Underline | | | | | X | X | X | X |
| End Enhancements | X | | | | | | | |

NOTE

These character enhancements are **ONLY** available for referenced graphics (See Section 7 in this Chapter).

Example: Character Enhancement

```

10 Dsp = 704
20 OUTPUT Dsp;"IT 1;";
25 OUTPUT Dsp;"DT#;";
30 OUTPUT Dsp;"LB";CHR$(27);"&dB";
40 OUTPUT Dsp;"Inverse Video";
50 OUTPUT Dsp;"CHR$(27);"&d@#;";
60 END
    
```

This example shows how the size and direction of labels can be altered using the DI, SI, and SR commands. The window has been scaled to X = 0 to 1000, Y = 0 to 1000.

NOTE

Each of these enhancements, when used with referenced graphics, must be specified for each item individually.

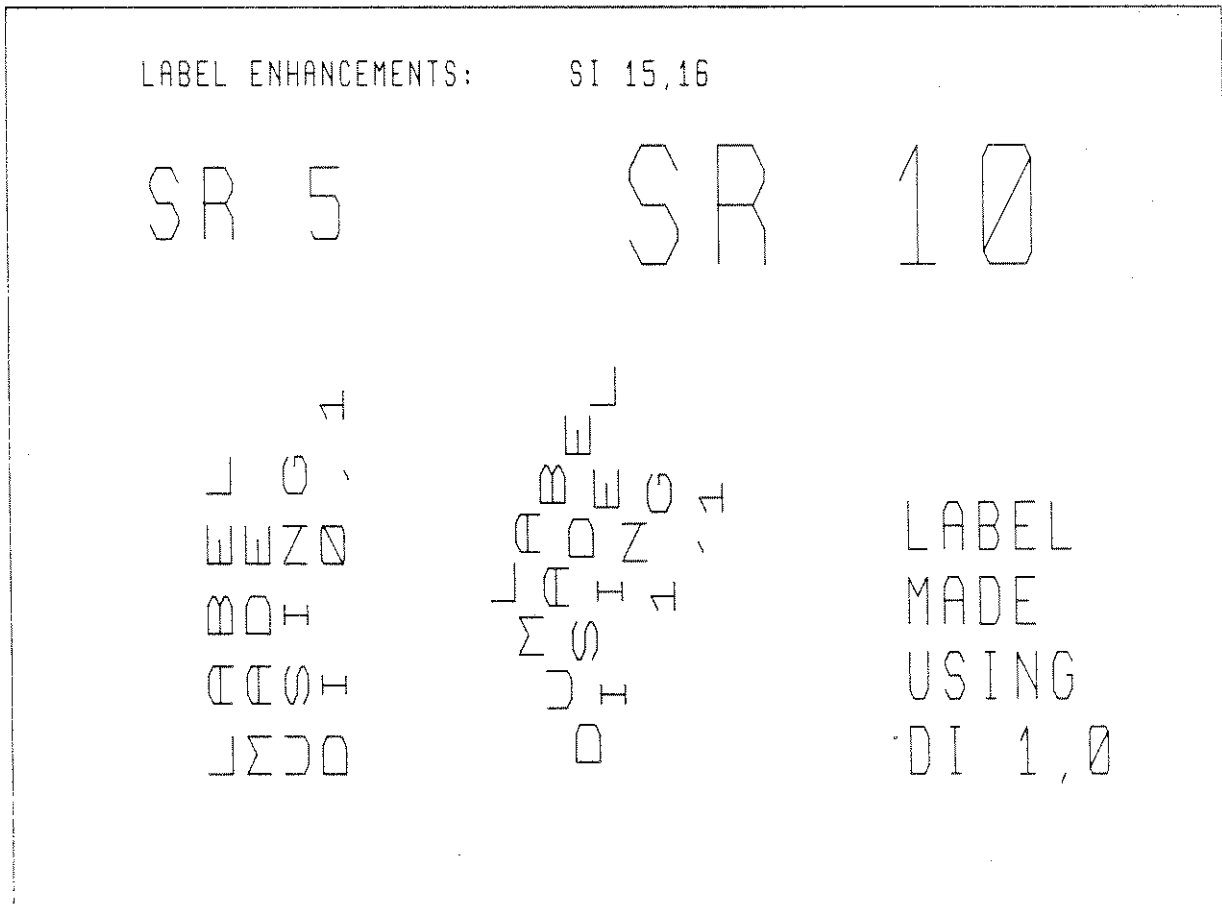

Fig. 12

Section 4: Hardcopy Output

Both of the HP 70000 Graphics Displays have the ability to provide hardcopy output directly to a printer or plotter over HP-IB without the need for an external controller or computer. Plotter operations are performed using a vector graphics plotter that is HP-GL compatible to yield high-quality output. Printer operations are performed using an HP-IB compatible raster-format graphics printer, and usually take less time than plotter outputs. For more information on output device compatibility and manual operation for obtaining output, see the notes following the PRINT and PLOT softkey descriptions in Chapter 2.

Copy: CY (parameter option)

The CY command initiates a hardcopy output operation over HP-IB to the device specified by the PI (Printer/Plotter Is) command described below, or by the COPY IS PRT/PLT key in "Parameter option" is used to select the scaling points (P1 and P2) for plotting the define hardcopy menu.

Parameter option = 0: Use P1 and P2 as set by the plotter (for TLK/LSN plotters only). If the plotter is defined as L ONLY in the menu, use P1,P2 as stored in the display via the PL command or the plotter params softkey.

Parameter option = 1: Use P1,P2 as stored in the display.

Compatibility with Display ROM version 5.0: Software, using the CY or the PLOT command in the Local Oscillator Module, which worked with Display ROM version 5.0 when the System Controller on the Display switch was NOT set should work with version 6.0 when the System Controller switch IS set. (In version 5.0 when the System Controller was set, printer/plotter dumps did not work.) Refer to the CY command example.

Eject: EJ eject #

Parameter 1 = send a form feed at the end of printer dumps and PG at the end of plotter dumps. The EJECT ON/OFF softkey performs the same function. (PG causes the 7550 Plotter to eject a page, but turns on the error light on older plotters.) The parameters and their values are listed below.

Page Eject = 1
Page does not Eject = 0
Default = 1

High Resolution: HR resolution #

HR sets the printer dump resolution to either high resolution (1024 dots) or low resolution (512 dots). The HI RES ON/OFF softkey performs the same function. The parameters and their values are shown below.

High Resolution = 1
Low Resolution = 0

KeyCopy On/Off: KC option #

The KC command allows the user to select whether or not the softkey labels will be included in the next hardcopy output. The **KEYCOPY ON/OFF** softkey performs the same function.

- option # = 0: Off — do not include softkey labels (Default)
- option # = 1: On — include softkey labels

Printer/Plotter Is: PI device type, row, col, bus

The PI command is used to specify the HP-IB address of the hardcopy output device used by CY. The device can be a printer or a plotter at any address.

- device type = 0: Printer (default)
- device type = 1: Plotter
- row, col : These specify the address of the output device. For HP-IB devices, set row = 0 and col = HP-IB address (e.g., 1 or 5, not 701 or 705).
- bus = 0: HP-IB
- bus = 1: HP-MSIB

Plotter Parameters: PL X1, Y1, X2, Y2

The PL command sets the parameters (P1 and P2 coordinates) of the output plotter for Listen Only (L ONLY) plotters and for all plotters when the output is initiated with the command "CY1." Physical size of the output is dependent on the output device.

- Default values: X1,Y1 = 100,100
- Default values: X2,Y2 = 10500,7500

NOTE

The display will not perform an output operation over HP-IB if there is also an active controller on the bus. See the last part of the following examples.

Example: Obtaining Hardcopy Output with the System Controller switch set to 0 (OFF). (Note: Do not attempt to change the position of this switch with the Display ON.) Assumes data to be dumped is already on screen.

- 100 Dsp=704
- 105 Plt=705
- 110 CLEAR Dsp

120 OUTPUT Dsp;"PI 1;";
(THIS COMMAND TELLS THE DISPLAY THAT IT IS TO
PERFORM A PLOTTER DUMP WHEN THE "CY" COMMAND
IS ISSUED. "PI 0;" WOULD RESULT IN A PRINTER
DUMP BEING PERFORMED)

130 OUTPUT Dsp;"CY0;";
(THE DISPLAY IS INSTRUCTED TO DO A HARDCOPY DUMP.
WITH THE SYSTEM CONTROLLER SWITCH SET TO 0 (OFF),
THE DISPLAY WILL WAIT TO BE INSTRUCTED TO TALK
BEFORE DOING THE OUTPUT. EVEN THOUGH WE HAVE TOLD
IT TO ASK THE PLOTTER FOR P1,P2, IT WILL NOT BECAUSE
IT IS NOT THE SYSTEM CONTROLLER. HENCE IT WILL USE
THE STORED PLOTTER PARAMS)

140 SEND 7;UNL TALK (Dsp-700) LISTEN (Plt-700) DATA
(THIS LINE INSTRUCTS THE DISPLAY TO
TALK AND THE DEVICE AT ADDRESS 705 TO LISTEN.
"DATA" CAUSES THE CONTROLLER UNASSERT THE ATN
(ATTENTION) LINE ON THE HP-IB)

150 END

Example: Obtaining Hardcopy Output with Controller switch set to 1 (ON). (Note: Do not attempt to change the position of this switch with the Display ON.)

100 Dsp=704
120 CLEAR Dsp
130 OUTPUT Dsp;"PI 1;";
160 OUTPUT Dsp;"CY0;";
(THE DISPLAY IS INSTRUCTED TO DO A HARDCOPY DUMP.
WITH THE SYSTEM CONTROLLER SWITCH SET TO 1 (ON),
THE DISPLAY LOOKS AT THE STATUS OF THE ATN AND
REN LINES, PERFORMING THE DUMP ONLY WHEN BOTH GO
FALSE)

210 SEND 7;UNT DATA
(THIS LINE INSTRUCTS ALL DEVICES ON HP-IB TO
UNTALK AND SETS ATN FALSE. NOW IT WILL USE THE
PLOTTERS P1, P2.)

230 LOCAL 7
(THIS COMMAND SETS REN FALSE – CLEARS THE
COMPUTER FROM HP-IB AT WHICH POINT THE DISPLAY
STARTS THE DUMP)

250 END

Section 5: Markers

Multiple single-character fixed-size markers can be placed on the display screen using the commands MA (Marker Attributes) and MK (Place Marker). Markers can be used in either the referenced or non-referenced modes (see "Referenced Graphics" section of this chapter).

Intensity Setting: IS

IS sets the intensity of up to a maximum of two markers. Only **referenced** markers can be intensified (see Section 7).

IS 0 = normal (0 thru 127)

IS-1 = intensified (-128 thru -1)

Example: Output 704;"IN;IT1;MK400,200;IS0;IT2;MK500,200;IS-1;"

Marker Attributes: MA character, position (no space between MA and the character).

The MA command is used to specify the character to be used as a marker.

character = any character in the currently active character set (no default value). This character will be used as the marker.

position = (0 - 4). This specifies the position on the character that serves as the reference point for the marker. (See figure below.)

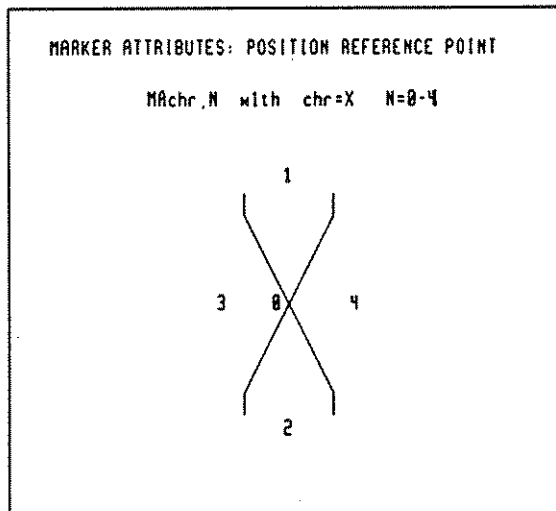

Fig. 13. Marker Reference Positions

Place Marker: MK X, Y

The MK command is used to place a marker on the screen. The coordinates X and Y give the distance from the current location (or from the origin) that the marker will be placed.

For NON-REFERENCED graphics, the marker will be placed X units to the right and Y units above the current pen position.

NOTE

Placing a marker at a point other than the current pen position (neither X nor Y at 0) does NOT affect pen position after the marker has been drawn.

For REFERENCED graphics, the marker will be placed X units to the right and Y units above the current item origin. (See section on referenced graphics.)

Section 6: Character Sets

The HP 70205A and HP 70206A Graphics Displays have the capacity to store multiple character sets. At present, two are available:

Character Set 0: US ASCII
 Character Set 30: Saved User-Defined Set

The user can create a single new character for special uses (such as a logo or marker), or create a whole new character set in a different font. Once the other character set has been defined, it can be called up at any time by the controller or instrument.

There are six commands which pertain to character sets:

CA – Designate Character Set Alternate
 CS – Designate Character Set Standard
 SA – Select Alternate Character Set
 SS – Select Standard Character Set
 SU – Save User-Defined Character
 UC – Draw User-Defined Character

Typically two Character Sets sets are available at any time, with one being used.

To choose which of the available character sets is used, either the SS (Select Standard) or SA (Select Alternate) command is used. When either of these commands is issued, the character set associated with the command (Standard or Alternate), is used when labeling (See section 3).

If a character set other than those currently associated with SS and SA is desired, then CA or CS must be used. CA associates a character set (0 or 30) with the SA command, and CS does the same for the SS command.

For Example: CS0; SS; will cause labels to use character set 0.

CS0; SS; CS30; will also cause labels to use character set 0 because no SS follows the CS30.

CS0; SS; CS30; SS will cause labels to use character set 30.

See below for details.

Designate Character Set Alternate: CA set#

The CA command specifies which character set will be used for labeling when the SA command has been sent: CA designates the set, and SA calls it into action.

set # = 0: US ASCII (Standard and default)
set # = 30: User-Defined Character Set (see SU command)

Designate Character Set Standard: CS set#

The CS command specifies which character set will be used for labeling when the SS command has been sent. The standard set is used when default conditions exist (power-on, DF, IN, DISPLAY PRESET, SELECT INSTR, DEVICE CLEAR) or when the SS (Select Standard Character Set) command is received. Set# designations are the same as for CA.

Select Alternate Character Set: SA (no parameters sent)

The SA command causes the display to begin writing labels and markers using the alternate character set specified by the CA command. It will continue to use this set until the power is turned off, the Display is initialized (DISPLAY PRESET, SELECT INSTR, Device clear, DF, IN), or the Select Standard Character Set (SS) command is used. Note that the alternate character set is used only to create labels and markers, and all commands (including the label terminator) must still be sent in the standard US ASCII character set.

Select Standard Character Set: SS (no parameters sent)

The SS command causes the display to activate the standard character set designated by the CS command. The standard character set is also activated upon power-on and by the DF, IN, DISPLAY PRESET, SELECT INSTR, and Device Clear commands.

Save User Defined Character: SU Char, pen control, xincrement, yincrement, (pen control), xincrement, yincrement, . . .

The SU command is used to save characters of your own design in character set 30. It can be used to create symbols not included in the character set of the display, to store logos, or to create your own character fonts. The ASCII name "char" denotes which position of the character set 30 the character will be saved in, and the parameters following (pen control, and x and y increments) define its shape (note no space should be sent between SU and Char).

SU defines the shape of the special character, as shown in the figure below.

The SU command does not draw the character on the screen. To do this, create a label using Character Set #30. (See descriptions of the LB, CA, and SA commands for instructions on how to do this.) The physical size of the character is determined by the SI or SR command in effect at the time it is actually drawn on the screen.

Char: The ASCII name that the newly created character is stored under in character set 30.

Pen control:

- 99 = pen down
- 99 = pen up (parameter is optional: pen is initially up)

Xincrement, Yincrement: the number of display units to move the pen in order to create the character (14 max). Very much like parameters in the PR command, these must be in successive pairs, all separated by commas and optional pen control commands. The stroke defined by a X,Y pair must be at a multiple of 45 degrees. To achieve this, the Display uses the following algorithm:

1. Either stroke = 0: stroke length that of nonzero stroke.
2. Both strokes non-zero: stroke length=X increment, stroke direction determined by sign of X and Y increment. Both positive, 45°, X>0, Y<0, -45°, both negative, -135°; X<0, Y>0, 135°

NOTE

Because of the doubled horizontal resolution, characters will actually appear shortened horizontally, and 45° angles will appear to be 63° angles.

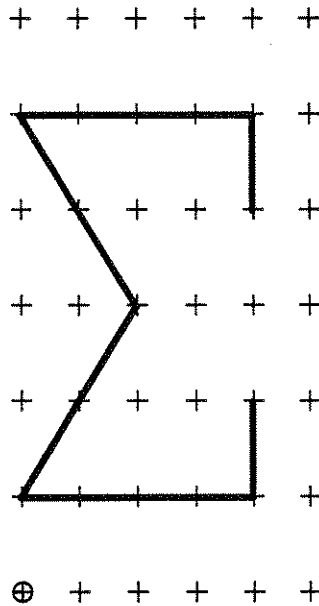

Fig. 14. Character Cell drawn by SU in example below

Draw User-Defined Character: UC pen control, xincrement, yincrement, (pen control), xincrement, yincrement, . . .

The UC command draws a character immediately but does not save it. No limits are placed on the parameters and the strokes can be at any angle (just like using PR). A pen control parameter can come between any pair of X and Y increments (+99 = pen down, -99 = pen up).

NOTE

The UC command immediately draws a user-defined character (UDC); it does not deal with a stored character set.

Example: Character Set Usage

```

10 ASSIGN @Dsp TO 704
20 CLEAR @Dsp
30 OUTPUT @Dsp;"DE;IN;"
40 OUTPUT @Dsp;"BW1,112,16,911,383,0,0,0,1;"
    (BUILD HP-IB WINDOW)
50 OUTPUT @Dsp;"SC0,1000,0,1000;"
60 OUTPUT @Dsp;"PU;PA0,0;PD;PA1000,0,1000,1000,0,1000,0,0;"
70 OUTPUT @Dsp;"CS0;"
    (DESIGNATE STANDARD CHARACTER SET TO BE 0,
    i.e., US ASCII - DEFAULT CONDITION)
80 OUTPUT @Dsp;"CA30;"
    (DESIGNATE ALTERNATE CHARACTER SET TO BE 30
    i.e., USER-CREATED SET)
90 OUTPUT @Dsp;"SS;"
    (SELECT STANDARD CHARACTER SET; START USING IT)
100 OUTPUT @Dsp;"PU;PA400,500;DT#;"
    (MOVE PEN, DEFINE TERMINATOR)
110 OUTPUT @Dsp;"LBXXXXX#;"
    (PLACE LABEL OF Xs)
120 OUTPUT @Dsp;"SUX,4,1,+99,0,1,-4,0,2,-1,-2,-1,4,0,0,1;"
    (SAVE THE USER-DEFINED CHARACTER GREEK SIGMA UNDER
    THE NAME OF "X" IN SET 30. NOTE: PLACE
    "char" DIRECTLY AFTER THE SU COMMAND WITHOUT
    A SPACE, OTHERWISE THE UDC WILL BE STORED UNDER
    THE NAME)
130 OUTPUT @Dsp;"SA;"
    (SELECT-START USING-ALTERNATE CHARACTER SET)
140 OUTPUT @Dsp;"PU;PA400,400;LBXXXXX#;"
    (PLACE USER-DEFINED CHARACTERS)
150 OUTPUT @Dsp;"PU;PA400,300;SR10;LBXXXXX#;"
    (PLACE LARGER UDCs)

```

```
160 OUTPUT @Dsp:"SR10,UC0,0,=99,6,0,0,16,-6,0,0,-16;"  
      (DRAW A 6X16 BOX USING THE UC COMMAND. NOTE THAT  
      THE PEN MOVEMENT PARAMETERS ARE INCREMENTAL,  
      IN A 6X16 CELL. NOTE SIZE OF CELL RELATIVE TO  
      THE UDCs TO THE LEFT, WHICH WERE DRAWN WITH THE  
      SAME SR COMMAND.  
170 OUTPUT @Dsp:"SS;"  
      (RE-SELECT THE STANDARD CHARACTER SET )  
180 END
```

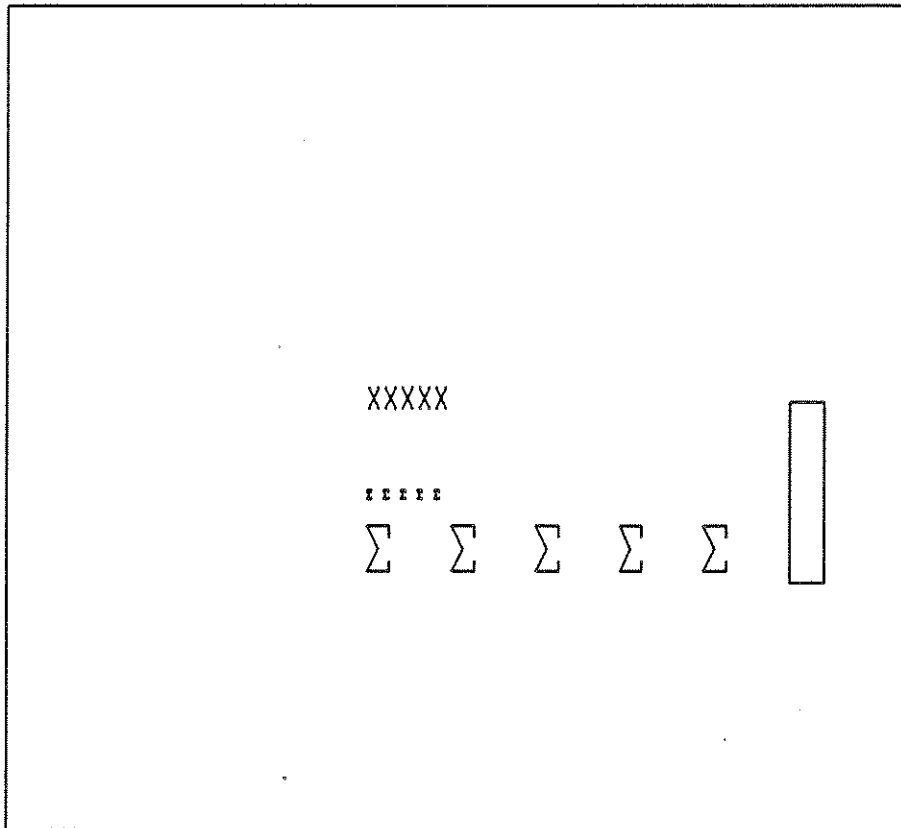

Fig. 15. Display Screen for Sample Program

Section 7: REFERENCED GRAPHICS

Many of the capabilities discussed earlier in this chapter are contained in HP-GL, the Hewlett-Packard Graphics Language. One powerful set of capabilities not included in HP-GL but available with the HP 70205A and HP 70206A Graphics Displays are those of Referenced Graphics. Referenced Graphics allow the user greater flexibility in drawing figures and labeling the screen than would be possible with a regular plotter, printer, or instrument display.

Referenced Graphics allow the user to control and manipulate an item on the screen even after it has been drawn. The object can be moved, enlarged, blanked (turned off), viewed (turned on), deleted entirely, or made to blink. Furthermore, objects can be logically grouped with other objects, and attributes can be applied to each object individually or to the group collectively.

Virtually anything that can be drawn on the screen can be used as a referenced object. All types of objects can be included in the same logical group. Examples include lines, figures, labels, graphs, axes, graticules, and markers.

Each object drawn on the screen can be used in either a referenced or a non-referenced mode. If created in non-referenced mode, the object cannot be changed after being drawn. If drawn in a referenced mode, the object is known as an "item" and has a specific number associated with it (e.g., Item 3). When multiple items must be referred to at the same time, they may be defined as belonging to a single "group." Each item, however, retains its identity by having a unique reference number (e.g., Group 2, Item 3).

The following attributes can be assigned to **Referenced Items**:

- **Blinking** — See BL command description in this section.
- **Blanking** — See VW command description in this section.
- **Pen Type** — See SP command description in section 2.
- **Origin** — See OR command description in this section.
- **Character size and Direction (labels only)** — See the DI, DR, SI and SR command descriptions in section 3.
- **Marker Character** — See section 5.
- **Line Type (plots and graphs only)** — See LT command descriptions in section 2.
- **Intensity (markers only)** — See IS command
- **Delta-X (graphs only)** — See DX command descriptions in section 2.

To determine whether an object will be drawn as referenced or non-referenced, and to refer to a referenced item once it has been drawn, use the commands Identify Item (IT) and Identify Group (GP). If

GP or IT commands are not received by the display, all objects drawn will be non-referenced. If the last IT command received was IT0 or the last GP command received was GP0, the next object drawn will be non-referenced. As previously mentioned, objects can be drawn in referenced mode (but without a group designation) simply by not sending any GP commands, causing each item's group number to default to 1. In this case, the whole concept of groups can be ignored for purposes of remote operation. The display will automatically be put in the non-referenced mode upon power-up or upon receipt of either DF or IN command (*DISPLAY PRESET* or *SELECT INSTR*). Once an IT# has been assigned an object and that object has been defined as a GRAPH, PLOT, LABEL, AXIS, MARKER, or GRATICULE, the item must be deleted with a DL command for it to be assigned to a different type of object, or an invalid parameter error will result.

Blank Ahead: BA <number of segments>

BA sets the number of line segments in a trace which will be blanked to the right of the current trace pointer. Traces are referenced plots or graphs drawn with GA, GR, PA, or PR commands. (see IT and GP) The blanking action occurs when a point is actually plotted or graphed.

Example

```
OUTPUT 704;"IN;IT1;OR 150,100;DX50;GA0,40,20,60,50,150,40,60,30,20,50,40,70,0;"
(DRAW A GRAPH)
OUTPUT 704;"BA3;"
(SET BLANK AHEAD TO 3)
OUTPUT 704;"TP5;GA150;"
(REGRAPH POINT 5, NOW NEXT THREE SEGMENTS WILL BLANK)
```

Identify Item: IT item#

The most recently received IT command for the current window determines whether the next object to be drawn or modified will be referenced or non-referenced, and, if referenced, what its item number will be. The item will be in the most recently referenced GROUP (see GP below), or GP1 if no group has been referenced.

- item# = 0: activates non-referenced mode
- item# = 0 – 50: referenced item number 1 – 50.

Identify Group: GP group#

The most recently received GP command determines the group number of all referenced items (item# not 0) drawn or referred to. Attributes that may apply to an entire group include blinking, blanking (view command), and origin.

- group# = 0: activates non-referenced mode (can be reversed by subsequent GP or IT commands)
- group# = 1: referenced group number 1 – 16

Set Origin: OR Xposition, Yposition

The OR command specifies the origin of the current entity. Both groups and items have an origin (location on the screen): the origin of a group is relative to the 0,0 point of the window (see SC command) and the origin of an item is relative to the origin of the group that contains the item.

NOTE

The physical location of a group's reference point on the screen (its origin) is determined by the OR command according to the units (scale) in effect at the time the group's origin is specified (that is, when the group or item is defined or the OR command is received). This means that the scale of the screen can be changed after the group's origin has been specified and the physical location of that origin will not be affected, that is, GP1, IT1;SC0,100,0,100 is NOT equivalent to SC0,100,0,100; GP1; IT1. Only in the latter case will the placement of the items reflect the scale factor 0,100,0,100.

If no group has been specified or if GP0 has been most recently received, the origin of the item will be located with respect to the 0,0 point of the window in current units. The origin of a group or item is implicitly set to 0,0 when the GP or IT command is sent.

NOTE

The OR command requires that parameters be sent. No default values exist for Xposition and Yposition.

The command sequence:

```
SC 0,1000,0,1000;
GP1;OR 500,500;
IT1;OR 0,0;
```

would place both the group's origin and the item's origin at the center of the window (not necessarily the center of the screen), while the sequence:

```
SC 0,1000,0,1000;
GP1;OR 500,500;
IT1;OR 500,500;
```

would place the group's origin in the center of the window (500,500) but the item's origin at the top right corner of the window (1000,1000).

NOTE

Once the origin of a group or item has been specified, it can be changed at any time. The effect of changing the origin is to immediately shift the position of the group or item on the screen.

```
GPI;OR 500,500;
IT1;OR 500,500;
::
GPI;IT1;OR 0,0;   (Resets item's origin)
GPI;OR 0,0;      (Resets group's origin)
```

Blink On/Off: BL mode

The BL command causes the currently active entity (group or item) to blink on and off.

```
mode = 0: off
mode = 1: on
```

Delete All Ref./Non-Ref. Objects: DA #

The DA command allows the user to delete (not just blank) all referenced or all non-referenced objects.

```
# = 0: Delete all non-referenced objects.
# = 1: Delete all referenced items and groups.
```

Delete Active Item or Group: DL (no parameter)

The DL command deletes (removes entirely) only the active entity (i.e., the last object or group of objects referred to by an IT or GP command).

NOTE

Be sure that the proper entity is active (e.g., send GP1;IT2;DL;, to delete only item 2 of group 1).

Pan: PN offset

The PN command is used to move an entire trace (plot or graph) horizontally in the current window. "Offset" gives the number of endpoints to shift the trace to the right (positive offset) or to the left (negative offset). Endpoints are just X-axis points or values on a plot or graph; the physical distance between endpoints depends on the scale being used (SC command) and, in the case of a graph, on the Delta-X value in force (DX command).

Trace Pointer: TP endpoint

The TP command is used to specify the next point on a trace (graph or plot) that is to be referenced. This capability can be used to only re-draw a specific portion of a trace, as shown in the figure below.

"Endpoint" is the number of x-values from the beginning of a trace that the trace pointer will point to; i.e., the next graph command will begin at that x position.

NOTE

The TP command can only be used with referenced graphics.

Example: Re-Drawing a Trace Using Trace Pointer.

```

10 ASSIGN @Dsp TO 704
20 CLEAR @Dsp
30 OUTPUT @Dsp;"DE;IN;"
40 OUTPUT @Dsp;"SC0,1000,0,1000;"
    (SCALE SCREEN TO 1000X1000)
50 OUTPUT @Dsp;"PU;PA0,0;"
60 OUTPUT @Dsp;"DX1;"
    (SET Xincrement TO 1)
70 OUTPUT @Dsp;"GPI;IT1;"
    (TRACE POINTER MAY ONLY BE USED WITH
    REFERENCED ITEMS)
80 OUTPUT @Dsp;"PD;"
90 FOR J=0 TO 900
100  OUTPUT @Dsp;"GA";J;"
    (GRAPH DIAGONAL LINE)
110 NEXT J
120 OUTPUT @Dsp;"TP450;"
    (SET TRACE POINTER TO CENTER OF LINE)
130 FOR K=450 TO 900
140  OUTPUT @Dsp;"GA";K/2;"
    (START RE-GRAPHING POINTS WITH NEW VALUES,
    STARTING WITH THE POINT SPECIFIED BY THE
    TP COMMAND)

```

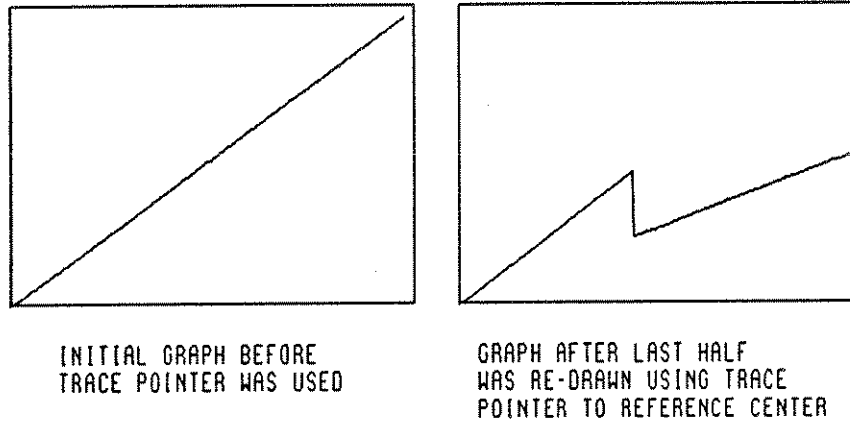

Fig. 16

View On/Off: VW mode

The VW command allows the user to view (turn on) or blank (turn off) the currently active entity (group or item). If no group or item has been specified (i.e., the window is in non-referenced mode), then all non-referenced objects are blanked.

- mode = 0: blank active entity
- mode = 1: view (unblank) active entity

For Example:

- GPI; IT1; VW0 blanks Item 1 in Group 1
- GPI; VW0; blanks all items in Group 1
- GP0, IT0; VW0 blanks all non-referenced objects

Example: Using Referenced Graphics.

```

10 ASSIGN @Dsp TO 704
20 CLEAR @Dsp
30 OUTPUT @Dsp;"DE;IN;"
40 OUTPUT @Dsp;"BW 1,112,16,911,383,0,0,0,1;"
50 OUTPUT @Dsp;"SC0,1000,0,1000;"
60 OUTPUT @Dsp;"GP1;OR0,0;
   (GROUP 1 HAS ORIGIN AT LOWER LEFT CORNER)
70 OUTPUT @Dsp;"IT1;OR250,250;"
   (ITEM 1 IN GROUP 1 HAS ORIGIN 250,250 RELATIVE TO
   ORIGIN OF GROUP 1. THAT IS, ITEM 1 HAS ORIGIN
   250,250)
80 OUTPUT @Dsp;"MAX,0;MK0,0;"
    
```



```

(PLACE A MARKER (X) AT ORIGIN OF ITEM 1, GROUP 1)
90 OUTPUT @Dsp;"GP2;OR500,500;"
    (ORIGIN OF GROUP 2 IS AT MIDDLE OF SCREEN)
100 OUTPUT @Dsp;"IT1;MAX,0;MK0,0;"
    (PLACE A MARKER (X) AT ORIGIN OF GROUP 2)
110 OUTPUT @Dsp;"IT2;OR 250,250;"
    (ITEM 2 IN GROUP 2 HAS ORIGIN 250,250 RELATIVE TO
    ORIGIN OF GROUP 2, WHICH IS AT 500,500. HENCE
    GP2,IT2 HAS ABSOLUTE ORIGIN 750,750 ON SCREEN)
120 OUTPUT @Dsp;"MAX,0;MK0,0;"
    (PLACE MARKER AT ORIGIN OF ITEM 2 IN GROUP 2)
130 OUTPUT @Dsp;"IT3,OR250,250;MAX,0;MK0,100;"
    (ITEM 3 HAS SAME ORIGIN AS ITEM 2, BUT DATA
    (X=0,Y=100) PLACES IT ABOVE ITS ORIGIN)
140 END
    
```

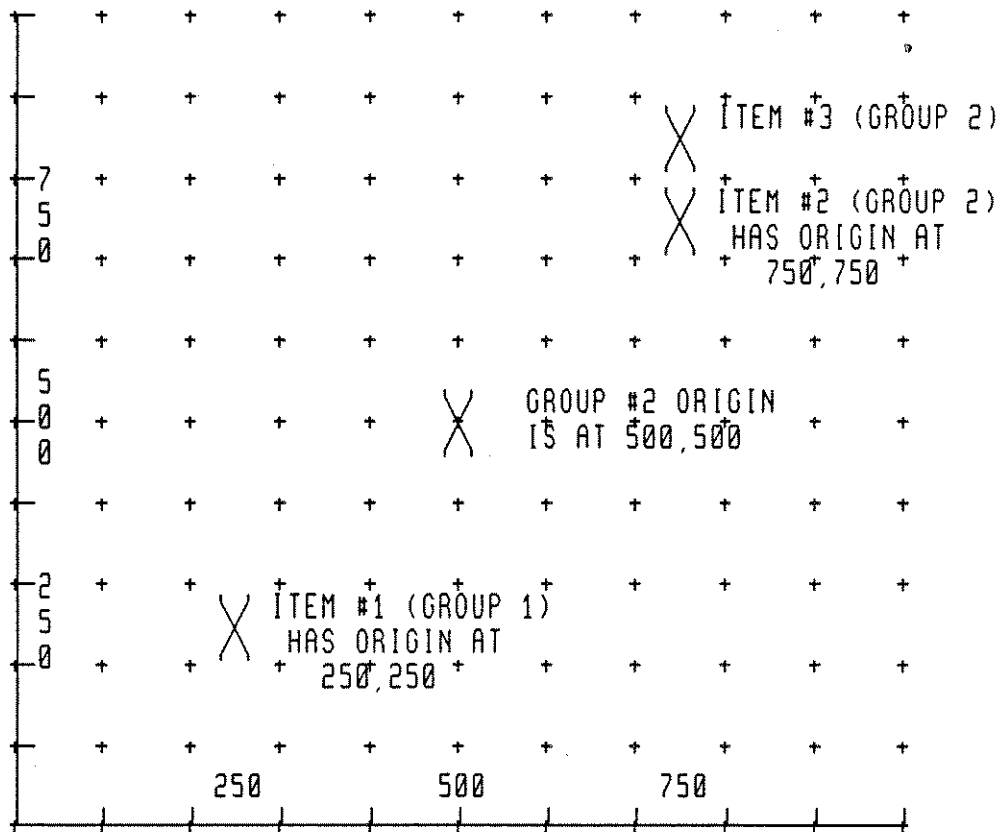

Fig. 17. Output From the Referenced Graphics Example.

Section 8: INFORMATIONAL DISPLAYS

The HP 70205A and HP 70206A Graphics Displays have the capability to provide various types of system-level information, both on the screen for viewing by the user and over HP-IB for receipt by a controller. The informational screens include the Address Map, the Error Screen, and the Screen Configuration. Each of these is described in detail in Chapter 2 of this part, "DSP Hardkey (Manual Display Operation)," and the remote commands used to access them will be covered here.

Address Map: AM row, col

This command displays the Address Map screen, with the cursor (the highlighted box) resting in the space given by "row, col." The map is removed if either "row" or "col" is -1.

Example: Checking for Spectrum Analyzer in Address Map:

OUTPUT @Dsp;"AM0,18;"

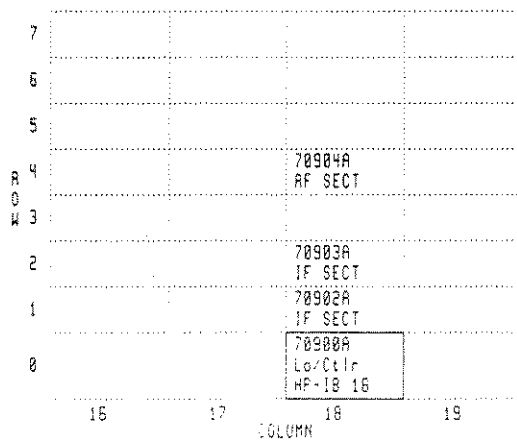

Fig. 18.

Display Status On/Off: DS statusbox, dataline

The DS command allows the user to selectively blank either or both of the two display status items: the status box and the data line box.

statusbox = 0: blank status box
 statusbox = 1: show status box

dataline = 0: blank data line box
 dataline = 1: show data line box

DS; gives statusbox on dataline box off.

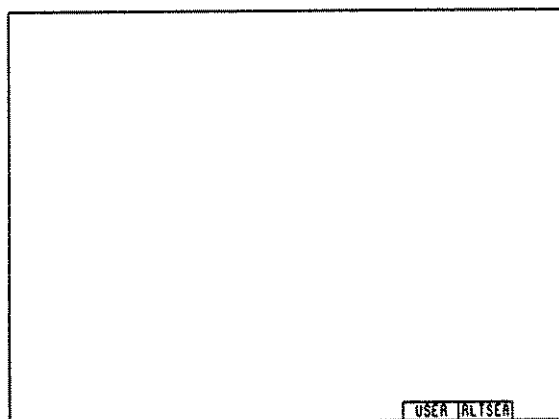

Fig. 19. Display Status Box

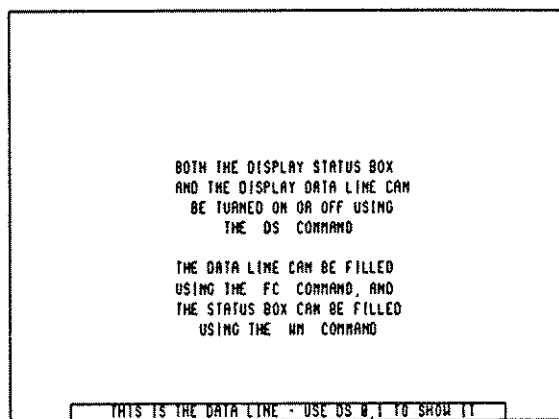

Fig. 20. Display Data Line Box

The display status box, shown in figure 20, gives status indications to the user for several aspects of the display's current operating mode. The left half of the box shows one of three indicators:

- **USER** — the softkey labels shown are those sent to the display by the master module of an instrument (e.g. HP 70900A) in response to pressing the [USER] or [USR] hardkey.
- **MENU** — the softkey labels shown are those found in the main menu of the modular instrument that has control of the keyboard. MENU appears in the status box after the [MENU] or [MNU] hardkey is pressed.
- **DSPL** — the softkey labels shown are those of the display itself. DSPL shows in the status box after the [DISPLAY] or [DSP] hardkey has been pressed.

The right half of the display status box gives any of six single-letter indicators:

- **R** — Display is in remote mode on HP-IB. The keyboard is not accessible to the user until the [LOCAL] key on the display is pressed.
- **L** — Display is in listen mode on HP-IB.
- **T** — Display is in talk mode on HP-IB.
- **S** — Display is asserting SRQ (Service Request) on HP-IB.
- **E** — Display has detected a display error on HP-IB or over HP-MSIB. (see REPORT ERRORS softkey description in chapter 2).
- **A** — Display is addressed on HP-MSIB. This means either that its address is being interrogated (e.g., the cursor box in the address map is resting on the display) or that the display itself has control of the softkeys.

Error Screen: ES column#

The ES command forces the display to show the error screen, which lists any errors currently reported on the HP-MSIB column specified. Just like the REPORT ERRORS softkey (described in Chapter 2), the ES command clears non-hardware-related errors from the memory after they have been reported.

The errors are reported from one master module at a time. Hence, if more than one master module has errors to report, multiple ES commands must be sent. Also, only as many errors as can fit on the screen at once may be reported with a single ES command.

column# : Show error report screen from module with column # specified.

column# = -1: Turn off error reporting mode (default value)

Output Identification: OI (no parameter sent, but response is generated)

The OI command causes the display to output, over HP-IB, an ASCII string that identifies the display as either an HP 70205A or HP 70206A.

Example: Interrogating Display for Identification.

```
10 OUTPUT @Dsp; "OI"
20 ENTER @Dsp;A$
30 DISP A$
40 END
```

The screen of the computer should show either "70205A" or "70206A."

Output Options: OO (no parameter sent, but response is generated)

OO is used to determine which plotter options are available. The display outputs: 0,1,0,0,0,0,0. The (1) in the second position indicates the display has pen select capability.

Output Version: OV (no parameters sent, but response is generated)

The OV command causes the display to respond over HP-IB with an ASCII string that gives the firmware version (for the display ROMs only).

Example: Finding Display Firmware Version

```
10 DIM A$[30]
20 ASSIGN @Dsp TO 704
30 OUTPUT @ Dsp;"OV;"
40 ENTER @Dsp;A$
50 DISP A$
60 END
```

The computer should display something similar to "860625 ROM Version 6.0."

Show Current Configuration: SN register#

The SN command shows a summary of the screen configuration, very much as the **SHOW CONFIG** softkey does (see Chapter 2). It lists all windows, their sizes and instrument assignments, and the allocation of the keyboard.

```
register # 0: show current screen configurations
          1 - 4: show configuration from registers 1 through 4
          -1: exit the Show Configuration function.
```

| CURRENT CONFIGURATION | | | |
|-----------------------|----------------|----------|--|
| Window 1 | | | |
| Keyboard: | 78900A,Lo/Ctrl | (0, 18) | |
| | Xmin,Ymin: | 517, 205 | |
| | Xmax,Ymax: | 911, 383 | |
| Window 2: | HP-1B | | |
| | Xmin,Ymin: | 112, 205 | |
| | Xmax,Ymax: | 507, 383 | |
| Window 3: | unassigned | | |
| | Xmin,Ymin: | 112, 16 | |
| | Xmax,Ymax: | 507, 195 | |
| Window 4: | unassigned | | |
| | Xmin,Ymin: | 517, 16 | |
| | Xmax,Ymax: | 911, 195 | |

Fig. 21

Section 9: ERROR HANDLING

Both the HP 70205A and the HP 70206A Graphics Displays can detect and report errors that occur on either HP-IB or HP-MSIB. The general procedure for reporting errors is discussed in Chapter 2 under the **REPORT ERRORS** softkey description.

Output Error String: EG (no parameters sent, but response generated)

The EG command causes the display to output an ASCII string over HP-IB describing any detected error pertains to the currently active window.

Notes:

1. EG responds only to errors detected at the display. Errors detected elsewhere but reported to the display by another master module (such as the HP 70900A) will not be indicated by the EG command.
2. EG clears errors from memory. Compatibility Note: In Display ROM version 5.0, EG did not clear errors.
3. EG only reports usage errors, not hardware errors.

Example: Receiving Error Report from Illegal Command

```
10 DIM A$ [30]
20 ASSIGN @Dsp to 704
30 OUTPUT @Dsp;"DE;IN;XX;"
   (SEND ILLEGAL COMMAND "XX" TO THE DISPLAY)
40 OUTPUT @Dsp;"EG;"
   (ASK FOR REPORT)
50 ENTER @Dsp;A$
60 DISP A$
70 END
```

This program should result in the following message on the screen of the computer (see the System Support Manual for error numbers):

2001,Illegal command

More than one error may be sent, separated by CR (Carriage Return) LF (Line Feed).

Error Screen: ES column

See the description in Section 8, Informational Displays.

NOTE

The **ES** command clears some errors from memory.

Output Error Number: OE (no parameter sent, but response generated)

The **OE** command causes the display to send ASCII numbers over HP-IB describing the errors detected that pertains to the currently active window. The error numbers sent in response are described in the System Support Manual.

Notes:

1. **OE** responds only to errors detected at the display. (see **EG** description above) The errors described by both **OE** and **EG** pertain to the currently active window; e.g., the window assigned to HP-IB.
2. **OE** clears reported errors from memory.
3. **OE** only reports usage errors, not hardware errors.

Example: Detecting a parameter out of range using **OE** command.

```
10 ASSIGN @Dsp TO 704
20 OUTPUT @Dsp;"DE;"
30 OUTPUT $Dsp;"KC5;"
40 OUTPUT @Dsp;"OE;"
50 ENTER @Dsp;A$
60 DISP A$
70 END
```

This should result in an error number of 2006, which indicates "Parameter Out of Range". If more than one error, the output will be numbers separated by commas. If no errors, 0 will be sent.

Output Status: OS (no parameter sent, but response generated)

Upon receipt of the **OS** command, the display makes available over HP-IB a status byte, which is an unsigned ASCII integer, terminated by (CR) and (LF). The status byte provides information about the active window (values 1 and 8), the keyboard (values 2, 4 and 128) and the display as a whole (value 32). This is the same status byte sent when a Serial Poll is done. After **OS** is received, the Status Byte and **SRQ** are cleared.

The display maintains a separate status byte for each window. Hence, if an HP-IB controller sends OS, the status byte pertains to the window assigned to HP-IB; if an HP-MSIB module sends OS, the status byte refers to the window assigned to that module.

Compatibility note: In ROM version 5.0 OS did not clear SRQ or the Status byte.

The decimal value of the status byte is the sum of eight different quantities:

| Quantity | Meaning |
|----------|--|
| 1 | Pen down |
| 2 | I/P key pressed |
| 4 | Knob count available |
| 8 | Window initialized |
| 16 | Ready/Not Busy (cleared during CI and CY, set at end.) |
| 32 | Error detected by the display (not by another module on HP-MSIB) |
| 64 | not used |
| 128 | Keyboard data available after OS status byte is cleared. |

Example: Receiving Status Byte

```

10 ASSIGN @Dsp TO 704
20 OUTPUT @Dsp;"IN;"
   (INITIALIZE WINDOW)
30 OUTPUT @Dsp;"OS;"
   (REQUEST STATUS BYTE)
40 ENTER @Dsp;A$
   (READ STATUS BYTE – EXPECTED VALUE OF 8)
50 OUTPUT @Dsp;PD;OS;"
   (PEN DOWN, REQUEST STATUS BYTE)
60 ENTER @Dsp;B$
   (READ STATUS BYTE – EXPECTED VALUE OF 1)
70 DISP A$,B$
   (DISPLAY BOTH STATUS BYTES, VALUES 8 AND 1)
80 END

```

Input Mask: IM Emask, Smask, Pmask

The IM command allows the user to specify the conditions under which the display will:

- Set the Error Detected value in the status byte (see the OS command description)
- Assert SRQ (Service Request) on HP-IB

The parameters Emask and Smask, sent along with the IM command, are each 8-bit numbers given in decimal notation: their value will determine under what conditions the above actions are taken. The specific value of either parameter should be the sum the values (given below) corresponding to all conditions the user determines as prerequisite to setting the Error Detected bit in the status byte, or to asserting SRQ. See the OS command description for a discussion of the status byte.

NOTE

The Pmask parameter is included for consistency with HP-GL, where it is used to determine the response to an HP-IB Parallel Poll. The HP 70205A and HP 70206A Displays, however, do not have Parallel Poll response capability, so the parameter Pmask will be accepted by display, but then ignored.

Emask parameter composition values and meanings:

| If the value of
Emask contains: | Then the Error Detected bit in
the status byte will be set if: |
|------------------------------------|---|
| 1 | 2001 — Illegal command |
| 2 | 2006 — Parm out of range |
| 4 | 2002 — Illegal parameter |
| 8 | 2011 — Memory overflowed |
| 16 | 2005 — Illegal character set |
| 32 | 2007 — Missing terminator |
| 64 | 2009 — Protocol error |
| 128 | 6008 — Confidence test failed |

For instance, Emask = 159 (128+16+8+4+2+1) sets the error value in the status byte if any error condition other than "Missing Terminator" or "Protocol error" occurs. Emask = 255 (all bits) is the default value. It will be set to this value during the following conditions:

- Power-up
- Device Clear
- DISPLAY PRESET
- SELECT INST
- DF
- IN

Smask parameter composition values and meanings:

| If the value of
Smask contains: | Then the Display will
assert SRQ on HP-IB if: |
|------------------------------------|--|
| 1 | Pen down (cleared on PU) |
| 2 | I/P key pressed (cleared upon receipt of KY) |
| 4 | Knob count available (cleared on RP) |
| 8 | Window initialized (cleared upon receipt of OS) |
| 16 | Ready/Not Busy (cleared at start of CY or CI,
set at end) |
| 32 | Error detected in display |
| 64 | Require service (for HP-IB compatibility) |
| 128 | Keyboard data is available (cleared on KY) |

NOTE

Defaults set as for Serial Mask.

Notes: See notes below for individual values.

- 1 Refers to current window only
- 2 SRQ will be asserted on HP-IB in response to keyboard action only if the display is in Remote and:

Pre-Process mode is **ON**, regardless of where the keyboard is assigned (see PP command description)

OR

Pre-Process mode is **OFF**, but the keyboard is assigned to HP-IB

- 4 See note for 2
- 8 See note for 1

16 Refers to entire display. If the value 16 is included, SRQ will be asserted if:

A copy operation has been completed (see CY)

A SELECT INSTR has been completed (see CI).

NOTE

Since CI re-initializes most Display parameters, including this mask, the Display CANNOT be set to assert SRQ at the end of a CI. The READY bit can be polled however (see example in CI command).

32 SRQ will be asserted if an error is detected at the display. This does not pertain to errors reported by the spectrum analyzer (i.e., the HP 70900A Local Oscillator/Control module). The HP 70900A can be instructed to assert SRQ in response to its own errors using the RQS command.

64 This value is included for HP-GL compatibility only. Its inclusion in Smask will have no effect.

128 See note for 2

For instance, sending IM255,32 (Smask = 32) will assert SRQ if an error is detected at the display. This is the default condition.

Section 10: REMOTELY-CONTROLLED DISPLAY

The HP 70205A and HP 70206A Graphics Displays can be used in a variety of ways as a user interface while being remotely controlled. The displays have the capability to accept alphanumeric entry from the user, to display messages, prompts, and softkeys, and to send all keyboard entries to a controller for processing before being sent to an instrument.

The commands covered in this section will be:

AE: Alpha Entry – Allows the user to directly enter general ASCII text.

FC: Fill Command Window – Allows controller to display prompts on screen.

KP: Simulate Key Pressed – Allows controller to simulate any keyboard entry.

KY: Send Keyboard Data – Allows controller to interrogate display for keyboard entry.

ML: Menu Load – Allows controller to load softkey labels.

PP: Pre-Process – Forces the display to send all keyboard entries to the controller for processing.

RG: Simulate Knob Turned – Allows controller to simulate rotating the knob.

RP: Send Knob count

Alpha entry: AE mode#

When AE is received, the display clears the data line and softkey labels, then shows a portion of the character set on the data line with one character underlined by the cursor. The user may select a character by turning the display knob to position the cursor, then pressing ENTER. As the knob is turned further, the remainder of the character set will scroll into the data line.

The data entered with this simulated keyboard is immediately sent to the element controlling the keyboard. To determine which element controls the keyboard, see the SHOW CONFIG softkey and the discussions of the BW (Build Window) and PP(Pre-Process) commands.

mode# = 0: Disable Alpha Entry mode, clear line (default condition).

mode# = 1: Enable Alpha Entry mode.

Fill Command Window: FC text <terminator>

The FC command allows the user to place a message or prompt on the data line, as shown below.

NOTE

The "text" message sent must end with the previously defined label terminator (see the DT command description).

Example:

OUTPUT @Dsp;"DS0,1;DT#;FCThis Is The Data Line#;"

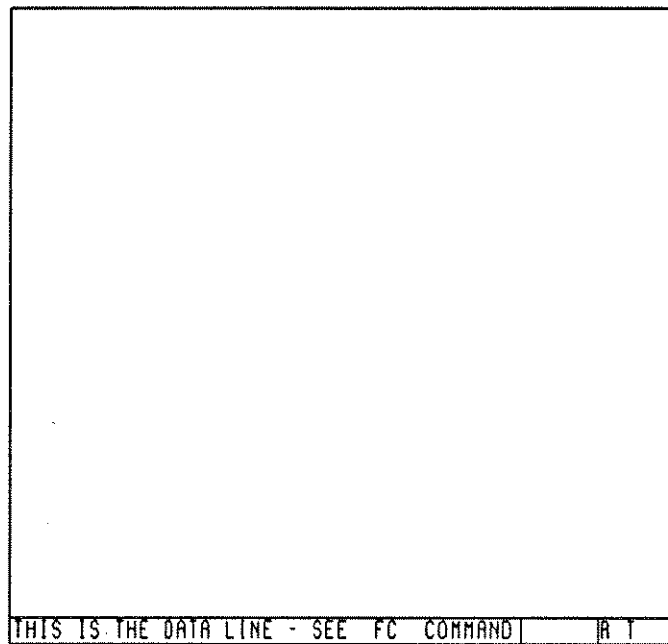

Fig. 22.

Simulate Key Pressed: KP keycode

The KP command allows the computing controller to simulate any sequence of key closures exactly as if a user had pressed the keys manually. The phantom key closure will be sent to the element controlling the keyboard. This capability works in conjunction with the PP, RG, KY, and RP commands for flexible semi-automatic operation.

The keycodes are given below. The default code is 64, the Null Key (simulates no key closure).

Note that to push keys in [DSP] menu, the display must be in LOCAL. For example to ask for the first HELP screen:

```

10 LOCAL 7
20 OUTPUT @DSP:"KP42;"
   (PRESS DSP)
30 OUTPUT @DSP: "KP30;"
   (PRESS HELP)
40 END
    
```

Compatibility Note: In ROM Version 5.0 the Display did not obey HP-IB commands in LOCAL, so KP could not be used to push [DSP] keys.

| Key Simulated | Keycode |
|----------------------------------|---------|
| Numeric 0. | 0 |
| Numeric 1. | 1 |
| Numeric 2. | 2 |
| Numeric 3. | 3 |
| Numeric 4. | 4 |
| Numeric 5. | 5 |
| Numeric 6. | 6 |
| Numeric 7. | 7 |
| Numeric 8. | 8 |
| Numeric 9. | 9 |
| Softkey 1 | 17 |
| Softkey 2 | 18 |
| Softkey 3 | 19 |
| Softkey 4 | 20 |
| Softkey 5 | 21 |
| Softkey 6 | 22 |
| Softkey 7 | 23 |
| Softkey 8 | 24 |
| Softkey 9 | 25 |
| Softkey 10. | 26 |
| Softkey 11. | 27 |
| Softkey 12. | 28 |
| Softkey 13. | 29 |
| Softkey 14. | 30 |
| Decimal Point | 32 |
| Minus Sign | 33 |
| Left Arrow | 34 |
| Down Key | 35 |
| Up Key | 36 |
| Menu [MNU]. | 37 |
| User [USR]. | 39 |
| Local. | 40 |
| Hold | 41 |
| Print | 42 |
| Display [DSP] | 43 |
| Instrument Preset [I/P]. | 46 |
| Plot | 47 |
| Null Key | 64 |

Keycodes for other ASCII characters are 256 + N, where "N" is the character's decimal value in ASCII.

NOTE

The HP 70000 element receiving the phantom key closures may not be able to process incoming key signals as quickly as a controller can send them. A WAIT statement or equivalent may be used by the controller if necessary.

Send Keyboard Data: KY responsemode

Upon receipt of the KY command, the display will output, over HP-IB, the code of the key that was last pressed. See the KP description for a listing of the keycodes.

responsemode = 0: Send keycode in ASCII (default mode).

responsemode = 1: Send keycode in binary. If no key is pressed, a 64 "null Key" will be sent.

Menu Load: ML key#, label <terminator>, key#, label <terminator>...

NOTE

Each "label" must end with the previously define label terminator (see the DT command description).

The ML command enables the controller to place softkey labels on the screen. These labels serve as prompts for the user but do not affect the value of the key when it is pressed.

The softkeys are numbered 1 thru 14, as shown in the figure below. The "label" can be one or two lines of up to seven characters; the lines are either separated by a line feed or simply scrolled over to fit the window. Note use of the label terminators.

NOTE

A LF in a menu label also performs a CR function.

Example: Loading Menu Key Labels.

```
10 ASSIGN @Dsp TO 704
20 OUTPUT @Dsp;"DE;IN;"
30 OUTPUT @Dsp;"DT%;"
   (NOTE THAT LABEL TERMINATOR MUST BE USED!)
40 OUTPUT @Dsp;"ML1,KEY #1%,7,KEY #7%;"
```



```
(LOAD KEYS #1 AND 7)
50 OUTPUT @Dsp;"ML8,KEY #8%,14,KEY #14%;"
    (LOAD KEYS #8 AND 14)
60 END
```

MLO; or ML; clears ALL menu keys.

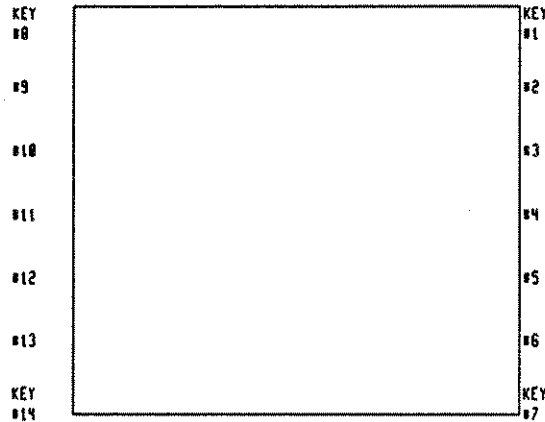

Fig. 23. Use of the Menu Load Command (ML)

Pre-Process: PP mode #

The PP command allows the user to direct that all key closures and knob data be reported directly to the controller, not to the active element (the modular instrument to which the keyboard is assigned). This allows the controller to process inputs intended for the instrument, and to send whatever key closure signals it determines are suitable using the commands KP (Simulate Key Pressed) and RG (Simulate Knob Turned).

mode # = 0: Turn off Pre-Process mode (default condition).

mode # = 1: Turn on Pre-Process mode; report keyboard entry to controller.

PP mode will only work if the Display is in Remote.

Simulate Knob Turned: RG count

The RG command, like the KP command, allows the controller to send phantom keyboard inputs to the instrument that the keyboard is assigned to. By sending either a positive or negative "count," the controller can simulate either a clockwise or counter-clockwise rotation of the knob.

Example: OUTPUT @Dsp;"RG 48;"

This simulates the clockwise rotation of the knob one full revolution.

NOTE

Depending on the element receiving the knob count, the response may not be proportional to the size of the count; e.g., RG10 may result in a larger effect than RG5;RG5.

Send Knob Data: RP responsemode

The RP command causes the display to output, over HP-IB, the count of knob rotations accumulated since the last knob count reading. The response may be sent in either ASCII or binary format.

responsemode = 0: ASCII (default condition)
responsemode = 1: Binary

Example: OUTPUT @Dsp;"RP;" ENTER @Dsp;Count

Section 11: UTILITY COMMANDS

The HP 70205A and HP 70206A Graphics Displays have several capabilities not mentioned in prior sections that deal with such things as self-testing of the display, automatically reconfiguring the screen, moving traces, and interrogating the display for available memory space. This section covers the following commands.

- BP – Output audible "beep" tone
- HF – Temporarily hold off on trace drawing
- OL – Output learn string for reconfiguration
- PG – Clear page (delete contents of only one window)
- PN – Pan trace (graph or plot) across screen
- RM – Interrogate display for remaining memory space
- TE – Initiate self-test of display
- TP – Specify trace pointer for graph updating
- WM – Load label stating which menu is in use

Beep: BP frequency, duration

The BP command causes the display to put out an audible beep. The frequency and duration are independently adjustable to any of several discrete values, as shown below.

| Frequency | Duration |
|-----------|----------|
| 444 (Hz) | .8 (mS) |
| 500 | 15 |
| 571 | 31 |
| 666 | 61 |
| 800 | 123 |
| 1000 | 246 |
| 1333 | 492 |
| 2000 | 983 |

Hold Off: HF mode#

The HF command lets the user force the display to stop drawing new figures, although more data can still be sent. Once the HF command is received with "mode #" equal to 1, the display will finish drawing all figures in the input buffer, and then stop displaying new data until the "HF0" command is received. This command can be used to present only complete traces on the screen, but will affect speed of drawing, and may affect other windows in a multi-instrument system.

- mode# = 1: Stop updating trace data.
- mode# = 0: Resume updating trace data.

Intensity Adjust: IA intensity #

IA sets the Display intensity. (in steps of 1). The parameters and their values are shown below.

Intensity # = 0 through 19

Default = 15

NOTE

An intensity setting of 0 is not guaranteed to result in a fully-off display.

Output Learn String: OL (no parameter sent but response generated)

The OL command can be used to obtain, over HP-IB, a string of ASCII characters describing the current configuration of the display screen (window definitions and assignments, but not trace data or stored configurations). This string can be stored in a controller or on a disc, and later sent back to the display, causing the display to reconfigure itself as it was prior to receiving the OL command.

Example: Reconfigure Display to Prior State.

```

10 ASSIGN @Dsp TO 704
20 DIM L$(100)
30 OUTPUT @Dsp;"DE;IN;"
40 OUTPUT @Dsp;"BW1,112,16,911,195,0,0,0,0;"
   (BUILD WINDOW #1, ASSIGN TO HP-IB)
50 OUTPUT @Dsp;"BW2,112,205,911,383,1,0,18,1;"
   (WINDOW #2,ASSIGN TO SPECTRUM ANALYZER AT 0,18)
60 OUTPUT @Dsp;"SNO;"
70 PAUSE
   (VIEW CONFIGURATION – PRESS CONTINUE)
80 OUTPUT @Dsp;"OL;"
   (ASK FOR LEARN STRING ON HP-IB)
90 ENTER @Dsp USING "%,K";L$
   (RECEIVE LEARN STRING)
100 OUTPUT @Dsp;"DE;"
   (DELETE SCREEN)
110 OUTPUT @Dsp;"SNO;"
   (SHOW BLANK CONFIGURATION ON SCREEN)
120 PAUSE
   (VIEW CONFIGURATION – PRESS "CONTINUE")
130 OUTPUT @Dsp USING "#,K";L$
   (SEND LEARN STRING – RECONFIGURE SCREEN)
140 SEND ;DATA 0 END
150 OUTPUT @Dsp;"SN0;"
   (SHOW "NEW" CONFIGURATION)
160 END

```

Page: PG (no parameters sent, no response generated over HP-IB)

The PG command erases all information displayed in the current window. While this does cause all trace data in that window to be lost, it does not alter the screen configuration as DE (Delete Screen) does, nor does it affect information contained within the other windows.

Remaining Memory: RM (no parameters sent, but response generated)

The RM command causes the display to output over HP-IB an ASCII string describing the amount of memory remaining for displayed information. The information is in the form: # blocks, block size (words).

Example: Interrogate Display for Remaining Memory.

```
10 ASSIGN @Dsp TO 704
20 OUTPUT @Dsp;"DE;IN;"
30 OUTPUT @Dsp;"RM;"
40 ENTER @Dsp;L$
50 DISP L$
60 END
```

The controller screen should respond with a number such as "96, 128" (96 blocks remaining, 128 words each).

Switch Sweep Circuits: SW sweep #

SW turns on and off the horizontal sweep of the display, which subsequently blanks the display. The sweep is turned back on if any key is pressed. The parameters and their values are shown below.

```
Sweep on = 0
Sweep off = 1
Default = 1
```

NOTE

It is not recommended that SW be used for blanking the Display due to the visible turn-on and turn-off transients.

Self Test: TE (no parameters)

The TE command initiates the self-test routine of the display. This is the same test described under the **CONFID TEST** softkey discussion in Chapter 2.

If the display fails the self test, error 6008 will be generated which will go out to OE or OG. If it passes, OE or OG will return 0.

Which Menu: WM menu

The WM command can be used to load a menu name into the left half of the display status box.

NOTE

The menu name placed on the screen by the WM command does not necessarily relate to the actual softkeys displayed.

- menu = 0: Blank the menu status box.
- menu = 1: Load menu status box with "MENU."
- menu = 2: Load menu status box with "USER."

CHAPTER 4

APPENDICES



APPENDIX A

DISPLAY COMMAND SUMMARY

The command summary below is a listing of HP 70205A and HP 70206A Display commands. The categories of commands correspond to section headings in Chapter 3, Remote Display Operation.

SECTION 1: DISPLAY CONFIGURATION

| | |
|----|-----------------------------|
| AK | ASSIGN KEYBOARD |
| BW | BUILD WINDOW |
| CI | SELECT INSTRUMENT |
| DE | DELETE ENTIRE SCREEN |
| DF | DEFAULT VALUES |
| IN | INITIALIZE |
| OG | OUTPUT GRAPHICS LINK |
| OP | OUTPUT P1, P2 |
| RC | RECALL SCREEN CONFIGURATION |
| SN | SHOW CONFIGURATION |
| SV | SAVE CONFIGURATION |

SECTION 2: SIMPLE GRAPHICS

| | |
|----|---------------------|
| AX | AXIS |
| DX | SET DELTA - X |
| GA | GRAPH ABSOLUTE |
| GR | GRAPH RELATIVE |
| GT | GRATICULE |
| LT | LINE TYPE |
| MP | MAPPING SHAPE |
| PA | PLOT ABSOLUTE |
| PD | PEN DOWN |
| PR | PLOT RELATIVE |
| PU | PEN UP |
| SC | SCALE TO USER UNITS |
| SP | SELECT PEN |

SECTION 3: LABELING THE SCREEN

| | |
|----|----------------------------------|
| CL | CONFIGURE LABEL |
| DI | SET CHARACTER DIRECTION ABSOLUTE |
| DR | SET CHARACTER DIRECTION RELATIVE |
| DT | DEFINE TERMINATOR |
| LB | LABEL |
| SI | SET CHARACTER SIZE ABSOLUTE |
| SR | SET CHARACTER SIZE RELATIVE |

SECTION 4: HARDCOPY OUTPUT

| | |
|----|--------------------|
| CY | COPY |
| EJ | EJECT |
| HR | HIGH RESOLUTION |
| KC | KEYCOPY ON/OFF |
| PI | PRINTER/PLOTTER IS |
| PL | PLOTTER PARAMETERS |

SECTION 5: MARKERS

| | |
|----|-------------------|
| IS | INTENSITY SETTING |
| MA | MARKER ATTRIBUTES |
| MK | PLACE MARKER |

SECTION 6: CHARACTER SETS

| | |
|----|-----------------------------------|
| CA | DESIGNATE CHARACTER SET ALTERNATE |
| CS | DESIGNATE CHARACTER SET STANDARD |
| SA | SELECT ALTERNATE CHARACTER SET |
| SS | SELECT STANDARD CHARACTER SET |
| SU | SAVE USER-DEFINED CHARACTER |
| UC | DRAW USER-DEFINED CHARACTER |

SECTION 7: REFERENCED GRAPHICS

| | |
|----|--|
| BA | BLANK AHEAD |
| BL | BLINK ON/OFF |
| DA | DELETE ALL REFERENCED/NON-REFERENCED OBJECTS |
| DL | DELETE ACTIVE ITEM OR GROUP |
| GP | IDENTIFY GROUP |
| IT | IDENTIFY ITEM |
| OR | SET ORIGIN |
| PN | PAN |
| TP | TRACE POINTER |
| VW | VIEW ON/OFF |

SECTION 8: INFORMATIONAL DISPLAYS

| | |
|----|-----------------------|
| AM | ADDRESS MAP |
| DS | DISPLAY STATUS ON/OFF |
| ES | ERROR SCREEN |
| OI | OUTPUT IDENTIFICATION |
| OV | OUTPUT VERSION |
| SN | SHOW CONFIGURATION |
| OO | OUTPUT OPTIONS |

SECTION 9: ERROR HANDLING

| | |
|----|---------------------|
| EG | OUTPUT ERROR STRING |
| ES | ERROR SCREEN |
| IM | INPUT MASK |
| OE | OUTPUT ERROR NUMBER |
| OS | OUTPUT STATUS |

SECTION 10: REMOTELY-CONTROLLED DISPLAY

| | |
|----|----------------------|
| AE | ALPHA ENTRY |
| FC | FILL COMMAND WINDOW |
| KP | SIMULATE KEY PRESSED |
| KY | SEND KEYBOARD DATA |
| ML | MENU LOAD |
| PP | PRE-PROCESS |
| RG | SIMULATE KNOB TURNED |
| RP | SEND KNOB DATA |

SECTION 11: UTILTITY COMMANDS

| | |
|----|---------------------|
| BP | BEEP |
| HF | HOLD OFF |
| IA | INTENSITY ADJUST |
| OL | OUTPUT LEARN STRING |
| PG | PAGE |
| RM | REMAINING MEMORY |
| SW | SWEEP CONTROL |
| TE | SELF TEST |
| WM | WHICH MENU |

APPENDIX B

HP-GL COMMANDS

Some non-HP-GL commands in the display have the same mnemonics as HP-GL commands not in the display (for example, GP).

| | |
|----|-----------------------------------|
| BP | BEEP |
| CA | DESIGNATE ALTERNATE CHARACTER SET |
| CS | DESIGNATE STANDARD CHARACTER SET |
| DF | SET DEFAULT VALUES |
| DI | SET CHARACTER DIRECTION ABSOLUTE |
| DR | SET CHARACTER DIRECTION RELATIVE |
| DT | DEFINE TERMINATOR |
| GR | GRAPH RELATIVE |
| IM | INPUT MASK |
| IN | INITIALIZE |
| LB | LABEL |
| OE | OUTPUT ERROR |
| OH | OUTPUT HARD LIMITS |
| OI | OUTPUT IDENTIFICATION |
| OO | OUTPUT OPTIONS |
| OS | OUTPUT STATUS |
| PA | PLOT ABSOLUTE |
| PD | PEN DOWN |
| PG | PAGE |
| PR | PLOT RELATIVE |
| PU | PEN UP |
| SA | SELECT ALTERNATE CHARACTER SET |
| SC | SCALE TO USER UNITS |
| SI | SET ABSOLUTE CHARACTER SIZE |
| SP | SELECT PEN |
| SR | SET RELATIVE CHARACTER SIZE |
| SS | SET STANDARD CHARACTER SET |
| UC | USER-DEFINED CHARACTER |

PART IV
TRACKING GENERATOR



HP 70300A TRACKING GENERATOR

OPERATION AND PROGRAMMING

DESCRIPTION: This part of the operating manual introduces users to the manual and remote operation of the HP 70300A Tracking Generator. Tracking generator information is divided into the four sections shown below. The material is intended for both first-time users and for those who have not used softkeys to operate a tracking generator.

| | |
|---|------|
| HP 70300A: INTRODUCTION | 1-1 |
| Module Description | 1-2 |
| Front Panel Features | 1-2 |
| Back Panel Connectors | 1-3 |
| Installation Checklist | 1-4 |
|
 | |
| TYPICAL TRACKING GENERATOR MEASUREMENTS | 1-5 |
| General Guidelines | 1-5 |
| Transmission Measurement | 1-6 |
| Reflection Measurement | 1-10 |
| Using the HP 70300A as a Source | 1-14 |
|
 | |
| TRACKING GENERATOR SOFTKEYS | 1-17 |
| Introduction | 1-17 |
| Organization of this Section | 1-17 |
| Softkey Overview | 1-18 |
| Accessing the Tracking Generator Softkeys | 1-20 |
| Moving Between Spectrum Analyzer and Tracking Generator Menus | 1-21 |
| Measure Mode | 1-22 |
| Signal Analysis Mode | 1-23 |
| Stimulus-Response Mode | 1-23 |
| Source: Calibration and Normalization | 1-25 |
| A - B --> A | 1-26 |
| A - C --> A | 1-26 |
| Store Thru -> B | 1-27 |
| Store Open -> C | 1-29 |
| Average Short -> C | 1-29 |
| Save/Recall State | 1-32 |
| Source: Power Control | 1-33 |
| Source Power | 1-34 |
| Source Power Step | 1-34 |
| Power Sweep | 1-35 |
| Source Power Offset | 1-36 |
| Source Attenuator | 1-36 |
| Source: Tracking Adjustments | 1-39 |
| Tracking Adjust | 1-40 |
| Tracking Peak (Automatic Tracking) | 1-42 |

| | |
|---|------|
| Source Options | 1-44 |
| Blanking | 1-45 |
| Automatic Level Control | 1-45 |
| Modulation | 1-47 |
| AM Percentage | 1-48 |
| AM Frequency | 1-48 |
| AM Internal/External | 1-48 |
| Source Oscillator Internal/External | 1-48 |
|
 | |
| TRACKING GENERATOR REMOTE OPERATION | 1-49 |
| Introduction | 1-49 |
| Organization of This Section | 1-49 |
| HP 71000 Documentation | 1-49 |
| Setup for Remote Operation | 1-50 |
| Suggested Equipment | 1-50 |
| HP-IB Address | 1-50 |
| Check-Out Procedure | 1-51 |
| Tracking Generator Remote Commands | 1-52 |
| Command Summary | 1-53 |
| Tracking Generator Programs | 1-54 |
| Programming Guidelines | 1-54 |
| Tracking Generator Programming Basics | 1-54 |
| Program 1: Transmission Measurement | 1-55 |
| Program 2: Reflection Measurement | 1-58 |
| Program 3: 3 dB Bandwidth | 1-61 |
| Program 4: 3 dB Bandwidth Softkey | 1-63 |
| Program 5: Dynamic Range | 1-66 |

HP 70300A: INTRODUCTION

This part of the operating manual discusses the manual and remote operation of the HP 70300A Tracking Generator.

The HP 70300A Tracking Generator is compatible with HP 70900A Local Oscillator ROM versions 851216 (December 16, 1985) and later. Systems with earlier ROM versions must be updated as described in HP 70900A Service Note (No. 70900A-1). To check your ROM version, press [MENU], ◀CONFIG▶, and ◀ROM VERSION▶.

Organization

Introduction

This section briefly describes the front- and back-panel features of the HP 70300A Tracking Generator. An installation checklist is provided to check the configuration of the tracking generator/spectrum analyzer system.

Typical Tracking Generator Measurements

This second section demonstrates three typical tracking generator measurements.

Tracking Generator Softkeys

This section discusses the manual operation of the HP 70300A Tracking Generator by describing each of the softkeys. Tracking generator softkeys are divided by function into six groups. Step-by-step examples demonstrate how the softkeys are used.

Remote Tracking Generator Measurements

The last section discusses the operation of the HP 70300A using a remote controller. The relationship between softkeys and their corresponding remote commands is described. Sample programs are provided to demonstrate tracking generator commands.

Module Description

The HP 70300A Tracking Generator Module generates a signal that precisely tracks (follows) the tuned frequency of the HP 71100A or 71200A Spectrum Analyzer. The signal present at the RF OUTPUT connector on the front panel of the tracking generator is applied to a device under test (DUT) which is connected to the RF INPUT connector on the HP 70904A, 70905A, or 70906A RF module. Thus, the spectrum analyzer/tracking generator system can be used to make stimulus-response measurements (such as transmission and reflection measurements) and the system may be used as a conventional signal source (that is, the output need not be returned to the RF INPUT). And, the system can still be used as a spectrum analyzer (the input need not come from the tracking generator).

Front Panel Features

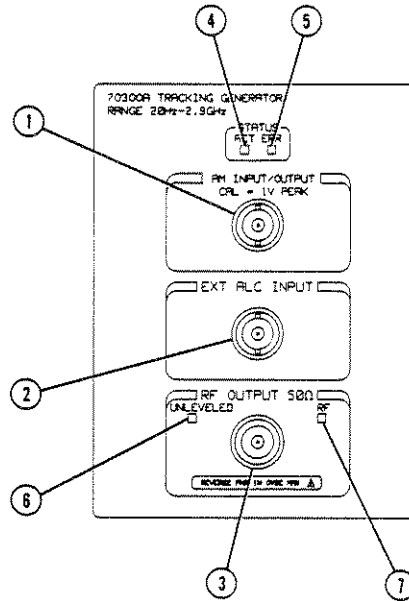

Figure 1-1.

Inputs and Outputs:

1. **AM INPUT/OUTPUT** (type BNC connector) is the input/output for amplitude modulating signals.
2. **EXT ALC INPUT** (type BNC connector) is the input for an external negative diode detector.
3. **RF OUTPUT** (type N connector) is the tracking generator RF output (usually connected through a device under test to the RF INPUT on the HP 70904A or HP 70905A RF modules.)

Indicator Lights:

4. **STATUS ACT** indicates that the HP 70300A Tracking Generator is active.
5. **STATUS ERR** indicates errors. (See System Support Manual "Troubleshooting.")
6. **UNLEVELLED** indicates that the RF OUTPUT power is unlevelled during the time the indicator is lit, possibly during part of a sweep. Unlevelling can occur if the source power (SRC PWR) or power sweep (PWR SWP) are set too high or if the normal ALC detector (ALC NRM) is used at a frequency below the normal detection range.
7. **RF** indicates that the HP 70300A Tracking Generator RF OUTPUT power is turned on. When the **◀SRC PWR ON OFF▶** softkey is on, the indicator is lit.

Back Panel Connectors

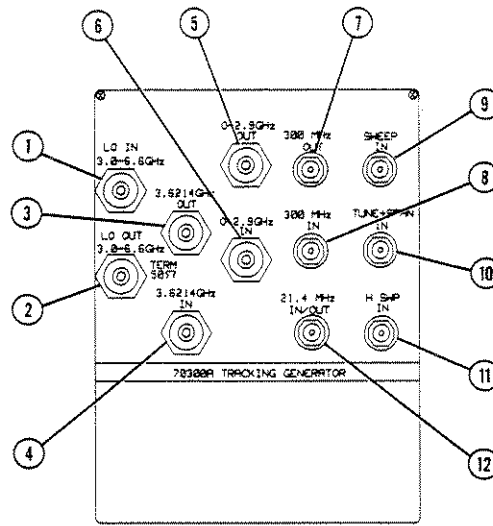

Figure 1-2.

1. LO IN 3.0-6.6 GHZ (SMA female connector) normally connected to 1st LO OUT on the HP 70904A, 70905A, or 70906A RF Module.
2. LO OUT 3.0-6.6 GHZ (SMA female connector) normally terminated (50 ohms).
3. 3.6214 GHZ OUT (SMA female connector) normally connected to 3.6214 GHZ IN.
4. 3.6214 GHZ IN (SMA female connector) normally connected to 3.6214 GHZ OUT.
5. 0-2.9 GHz OUT (SMA female connector) normally connected to 0-2.9 GHz IN.
6. 0-2.9 GHz IN (SMA female connector) normally connected to 0-2.9 GHz OUT.
7. 300 MHz OUT (SMB male connector)
8. 300 MHz IN (SMB male connector) normally connected to 300 MHz OUT on the HP 70900A Local Oscillator module.
9. SWEEP IN (SMB male connector) normally connected to SWP on the HP 70900A Local Oscillator module.
10. TUNE + SPAN IN (SMB male connector) normally connected to TUNE SPAN on the HP 70900A Local Oscillator module.
11. HSWP IN (SMB male connector) normally connected to H SWP on the HP 70900A Local Oscillator module.
12. 21.4 MHz IN/OUT (SMB male connector)

Note: The System Support Manual is the user's primary reference for system configuration.

Installation Checklist

The following instructions briefly describe how to configure the tracking generator. Use the checklist to ensure that your equipment is properly set up for operation. (Examples in this manual assume that the instrument has been correctly configured.)

For a detailed description of the HP 70300A Tracking Generator's installation, consult the System Support Manual.

1. Connect all back-panel cabling as described in the System Support Manual. If you are programming through a controller and using the HP 70206A System Graphics Display, connect it to the spectrum analyzer with an HP-IB cable.
2. After the HP-IB cable has been installed, reset all instruments connected to the bus by cycling the power. Most plotters and printers can be reset with their front-panel reset keys or by turning their power off and on again.
3. Check the HP-MSIB address by pressing [DSP] and ◀ADDRESS MAP▶. The Hewlett-Packard Modular System Interface Bus (HP-MSIB) has a two-dimensional addressing scheme. Each address consists of a row number and a column number; for example, the local oscillator is typically found at "0,18" (row,column). The local oscillator must be in row 0 for HP-MSIB access. Check this by turning the knob until the local oscillator number appears.

The HP 70300A Tracking Generator must be addressed above the RF module. Individual modules do not require consecutive row addresses. Not all modules need be in the same column; they need only fall to the right of the local oscillator.

Note: The System Support Manual is the user's primary reference for addressing modules. Additional information is available in the HP 71000 Operating Manual (see Chapter 2 of Part III, *DSP Hardkey*, under ◀ADDRESS MAP▶).

HP-MSIB addressing priority for a sample system is shown in Figure 1-3. The sample is a relative address ranking only.

| | | | | |
|---|----|--------------------------------|----|----|
| 7 | | | | |
| 6 | | 70300A
RFTrack0 | | |
| 5 | | | | |
| 4 | | 70504A
AF SECT | | |
| 3 | | | | |
| 2 | | | | |
| 1 | | 70502A
IF SECT | | |
| 0 | | 70500A
Lo/Ctrlr
HP-1B 1B | | |
| | 17 | 18 | 19 | 20 |

Figure 1-3.

TYPICAL TRACKING GENERATOR MEASUREMENTS

This section introduces you to the HP 70300A Tracking Generator by walking you through typical measurements. Three examples show how common measurements are rapidly and easily made:

1. *Transmission Measurement:* This example tests the transmission characteristics of a bandpass filter. The insertion loss of the filter is examined to determine such factors as the 3 dB bandwidth.
2. *Reflection Measurement:* This example tests the reflection characteristic of a bandpass filter. The return loss of the filter is examined.
3. *Source:* This example uses the spectrum analyzer/tracking generator as a source.

General Guidelines

1. To ensure good repeatability, connectors must be clean, in good condition, and properly tightened. If the test setup is not stable from connection to connection, the frequency response of the test setup will not be removed from the measurement of the device under test (DUT).
2. Make the open/short and thru calibrations using the same adapters and interconnect cables that will be used during measurement of the DUT. If this is impossible, use adapters with similar insertion- and return-loss characteristics.
3. To achieve greatest accuracy, do not change the frequency span or center frequency after the open/short and thru calibrations have been made. If the frequency parameters are changed, the stored reference trace and the current measurement data will pertain to different frequency ranges, and the normalization will no longer be valid. The reference level, reference level position, and vertical log scale (dB/div) can be changed after calibration.
4. If the test setup changes during the normalization process, reconnect the standards or the thru connection, and store a new reference trace.

Transmission Measurement

In this example, the HP 70300A is used to make a normalized transmission measurement. Making normalized transmission measurements involves measuring the difference between the power seen during a "thru calibration" and the power seen when a device under test (DUT) is inserted.

Normalization increases our measurement accuracy. By subtracting the thru calibration, the frequency response variations of the test setup are removed from the measurement.

When the DUT is inserted in the thru path, the transmission measurement appears on the display. By studying the insertion loss or gain of a device such as a bandpass filter, you can find the filter's center frequency, 3 dB bandwidth, average insertion loss, peak-to-peak ripple, and out-of-band attenuation.

In the example below, a normalized transmission measurement is made with a 321.4 MHz center frequency bandpass filter. The softkeys used in the example are described in the following *Softkeys* section.

Setup Procedure

Before we make the transmission measurement, the analyzer must be adjusted for this particular measurement and the device to be tested.

Turn the system on and bring it to an instrument preset state by pressing [I-P].

Connect the device between the RF OUTPUT on the tracking generator and the RF INPUT on the RF module.

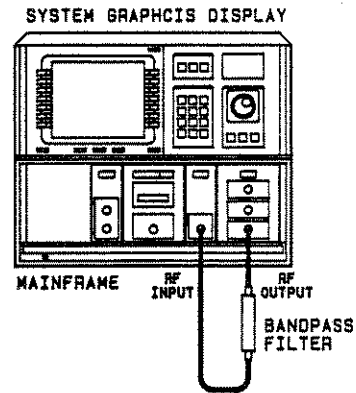

Figure 1-4. Setup Configuration

Press [MENU] and then ◀MEASURE MODE▶. Press ◀STIMULS RESPONS▶ to activate this mode.

Stimulus-response mode optimizes spectrum analyzer/tracking generator operation for transmission and reflection measurements.

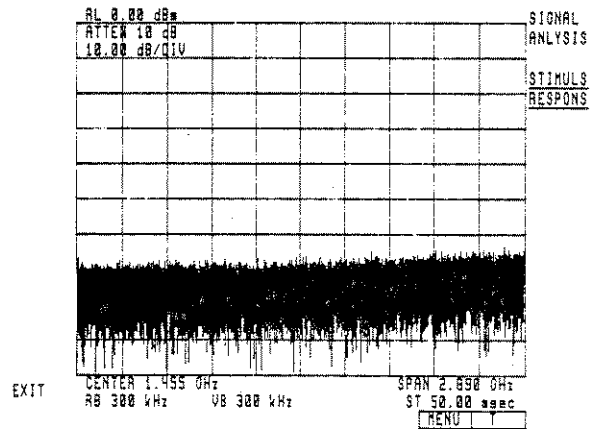

Figure 1-5.

Turn on the tracking generator by pressing **EXIT**, **SOURCE** and then **SRC PWR ON OFF**. The underline will move to the on position.

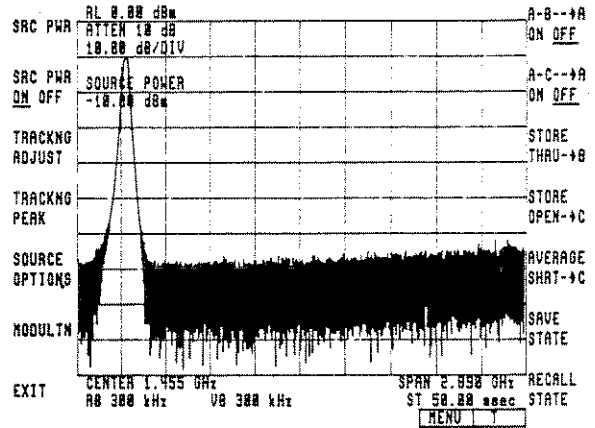

Figure 1-6.

Press **USER** and set the center frequency to 321.4 MHz: **CENTER FREQ**, 3, 2, 1, ., 4, **MHZ**.

Next set the frequency span to 500 MHz: **SPAN**, 5, 0, 0, **MHZ**.

Change the resolution bandwidth to 1 kHz: **RES BW**, 1, **KHZ**. (A resolution bandwidth is selected to optimize the dynamic range of the displayed response, yet maintain a fast sweep time.)

Note: Different DUTs will require different analyzer settings.

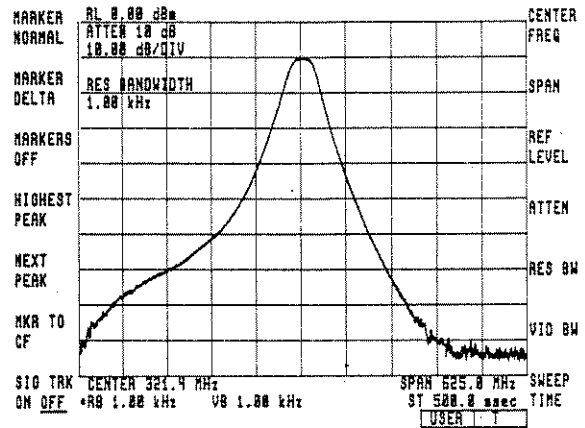

Figure 1-7.

Press the backspace (backarrow) key to return to the **SOURCE** menu. You can easily move between signal analysis and stimulus-response menus with the **USER** and backspace key.

At this point it is recommended you save the analyzer settings by pressing **SAVE STATE** and entering a register number.

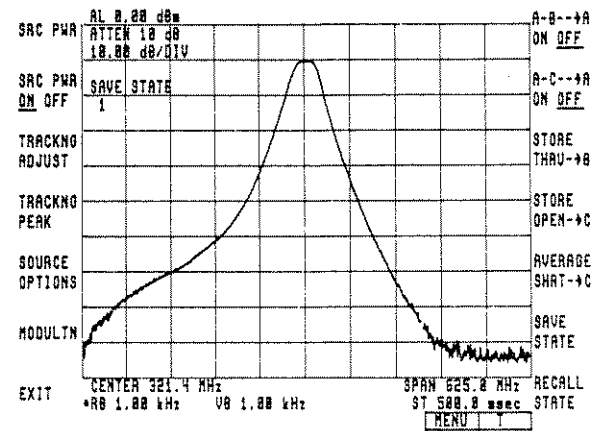

Figure 1-8.

Transmission Measurement

If the resolution bandwidth is less than 2 kHz, the automatic tracking function can be used to optimize measurements.

Disconnect the DUT and connect the RF OUTPUT of the tracking generator directly to the RF INPUT of the RF module.

Press **◀TRACKNG PEAK▶**. Wait until "Automatic Tracking Complete" appears.

If the resolution bandwidth is greater than 2 kHz, **◀TRACKNG PEAK▶** is not needed.

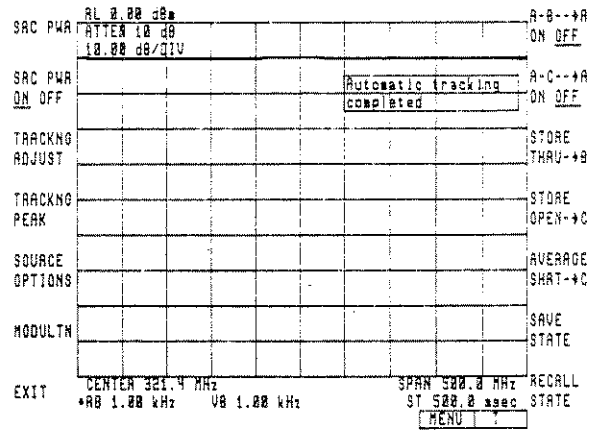

Figure 1-9.

Calibration/Normalization Procedure

Before we can measure transmission loss or gain, we must establish a thru reference.

In the last section we connected the RF OUTPUT of the tracking generator to the RF INPUT of the RF module.

This configuration is called a "thru connection" of our test setup. A thru connection is the calibration standard for 0 dB insertion loss.

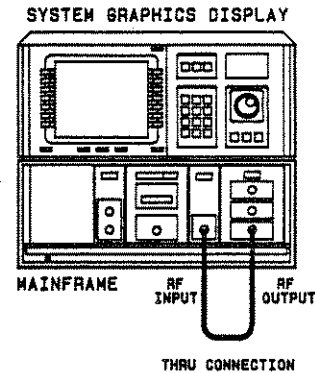

Figure 1-10. Calibration Configuration

The softkeys you will use to store the measurement standards and then to "normalize" are located along the right side of the SOURCE menu.

Wait for the trace to be completely updated.

Press **◀STORE THRU->B▶** to store your thru measurement in trace B. "Function executed" will appear on the display.

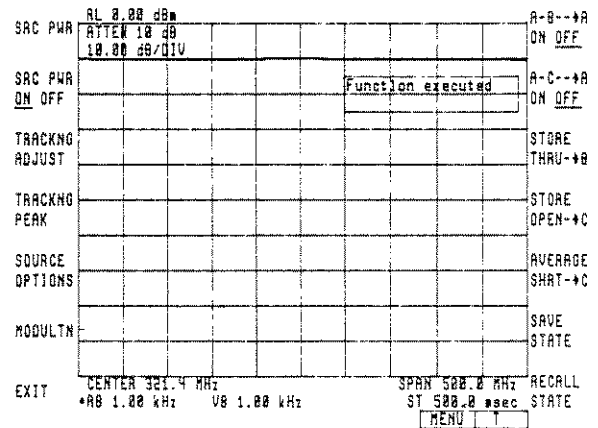

Figure 1-11.

Turn on **◀A - B -> A ON OFF▶** to subtract the thru calibration data from the measurement data and view the normalized transmission measurement. (Before the device is inserted, the 0 dB reference line will appear at the top of the display.)

Re-insert the device in the measurement path. (For this example, we test a 321.4 MHz bandpass filter.)

In stimulus-response mode, when a normalization softkey is on (A - B or A - C is on), scale units change from dBm to dB. The measurement is relative to the thru calibration.

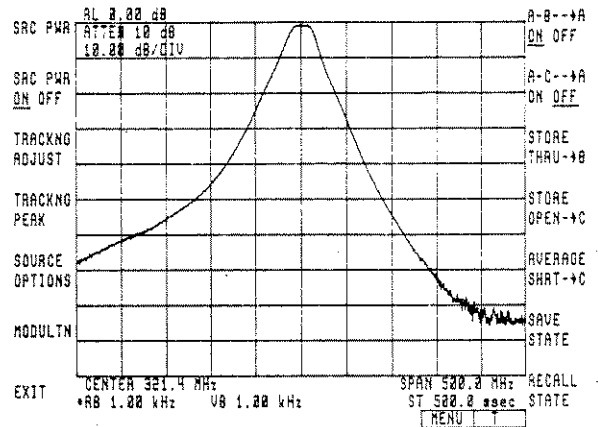

Figure 1-12.

Measurement Procedure:

3 dB Bandwidth:

One convenient method for testing the 3 dB bandwidth is shown below.

First, press [MENU], **◀MARKER▶**, and **◀MARKER BW▶**.

Select **◀AMP REF LEFT▶** and enter -3 dB. Then select **◀AMP REF RIGHT▶** and enter -3 dB. Turn on **◀MKR BW ON OFF▶** and read the -3 dB bandwidth from the CRT display.

If this measurement is made often, the bandwidth softkeys can be placed on the USER menu. (See the user-defined-key function.)

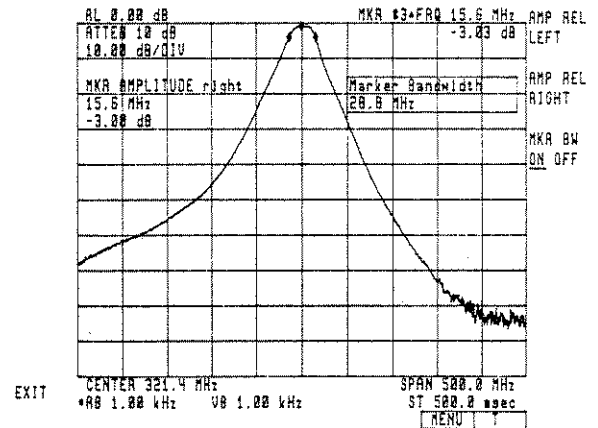

Figure 1-13.

Stop Band Attenuation:

The stop band attenuation can be measured using the marker functions.

Press the backspace key and **◀MARKER NORMAL▶**. A marker will appear on the trace and its frequency will be displayed on the screen. The marker can be moved with the knob, step keys, or keypad if desired.

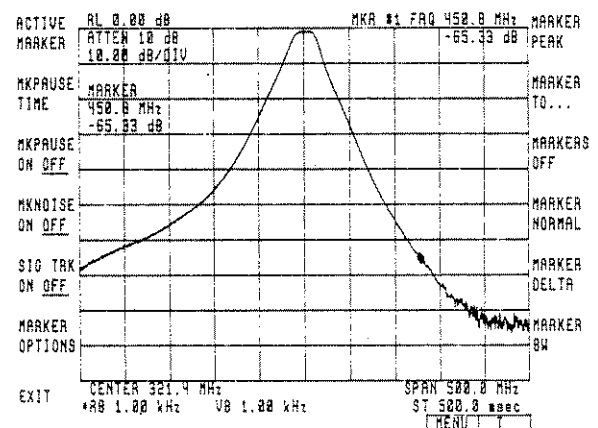

Figure 1-14.

Reflection Measurement

This example uses the HP 70300A to make a normalized scalar reflection measurement. In a typical reflection measurement sequence, a standard (such as an open or short circuit) is connected to a directional bridge or coupler and its trace is stored. Then the test device is connected in place of the standard, and the spectrum analyzer/tracking generator displays the magnitude difference between the response of the standard and the response of the test device.

A short circuit is the usual standard for reflection measurements. The short circuit reflects all incident power so that a convenient 0 dB reference line is obtained. An open circuit can also be used as the standard. But, better accuracy can be obtained by using the open/short average. First, an open circuit is connected to the test port and its frequency response is stored. Then a short is connected, and its frequency response is averaged with the response of the open. Later, the device is connected and the open/short average is subtracted from the measurement. With the open/short average, mismatch and directivity effects are reduced, producing a more accurate frequency-response reference trace than does either standard alone.

In the following example, a normalized reflection measurement is made on a 321.4 MHz bandpass filter. The tracking generator softkeys used in this example are described in the following *Softkeys* section.

Setup Procedure

Before we make the reflection measurement, the analyzer must be adjusted for this particular measurement and the device to be tested. If you have just finished the transmission measurement, skip to the TRACKING PEAK discussion (immediately prior to the calibration procedure).

Turn the system on and bring it to an instrument preset state by pressing [I-P].

Connect a directional bridge or coupler to the RF OUTPUT on the tracking generator and the RF INPUT on the RF module. Connect the device to the bridge or coupler. (Some devices will require a termination.)

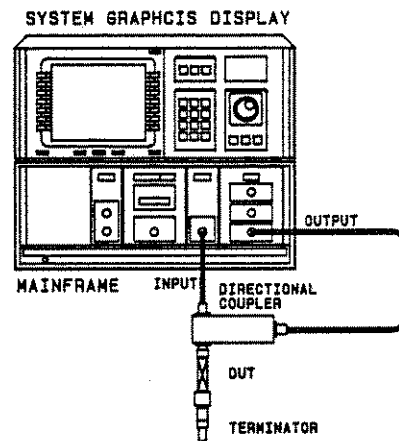

Figure 1-15. Setup Configuration

Press [MENU] and then ◀MEASURE MODE▶. Press ◀STIMULUS RESPONSE▶ to activate this mode.

Stimulus-response mode optimizes spectrum analyzer/tracking generator operation for transmission and reflection measurements.

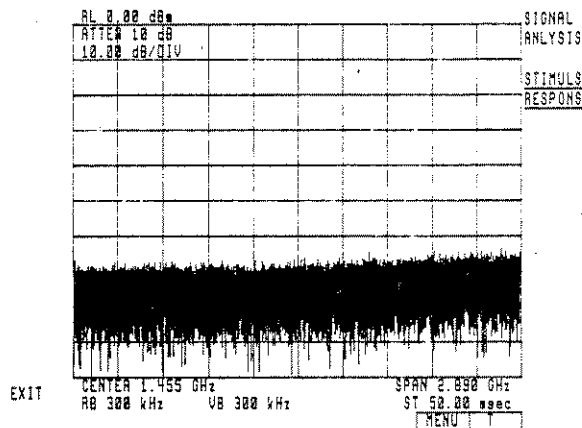

Figure 1-16.

Turn on the tracking generator by pressing ◀EXIT▶, ◀SOURCE▶ and then ◀SRC PWR ON OFF▶. The underline will move to the on position.

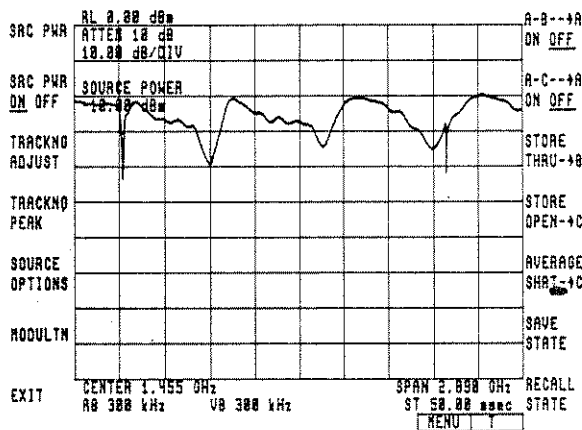

Figure 1-17.

Press [USER], and set the center frequency to 321.4 MHz: ◀CENTER FREQ▶, 3, 2, 1, ., 4, ◀MHZ▶.

Next set the frequency span to 500 MHz: ◀SPAN▶, 5, 0, 0, ◀MHZ▶.

Change the resolution bandwidth to 1 kHz: ◀RES BW▶, 1, ◀KHZ▶. (A resolution bandwidth is selected to optimize the dynamic range of the displayed response, yet maintain a fast sweeptime.)

Note: Different DUTs will require different analyzer settings.

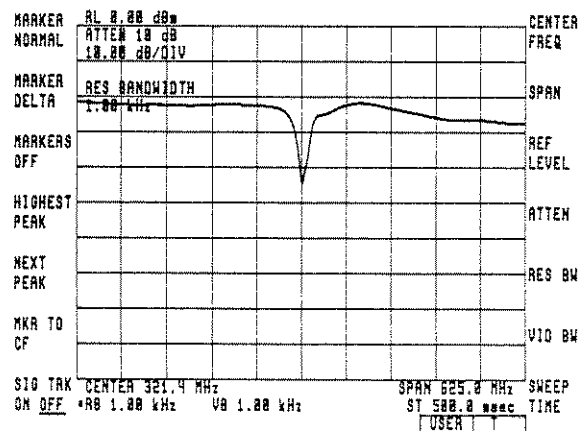

Figure 1-18.

Reflection Measurement

Press the backspace (backarrow) key to return to the SOURCE menu.

At this point it is recommended you save the analyzer settings by pressing **SAVE STATE** and entering a register number.

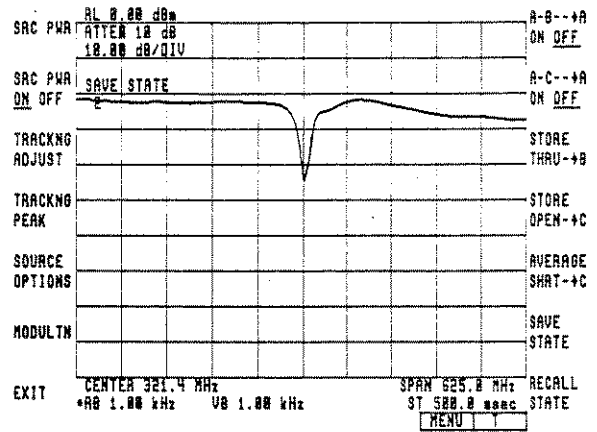

Figure 1-19.

When the resolution bandwidth is less than 2 kHz, the automatic tracking function should be used to optimize the measurement.

Disconnect the DUT from the bridge or coupler.

With the bridge or coupler connected, press **TRACKNG PEAK**. Wait until "Automatic Tracking Completed" appears.

If the resolution bandwidth is greater than 2 kHz, **TRACKNG PEAK** is not needed.

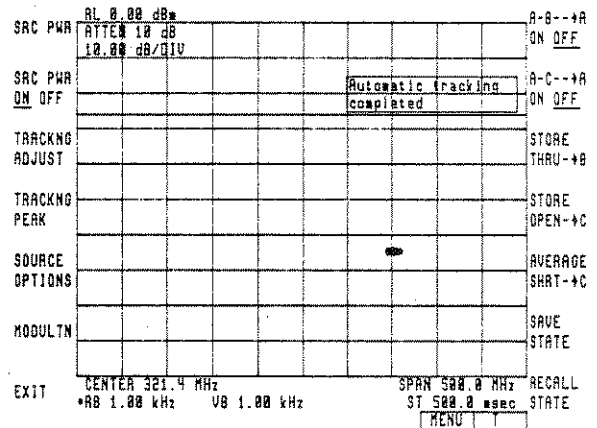

Figure 1-20.

Calibration/Normalization Procedure

Before we make our reflection measurement, we will establish an open/short reference.

In the last step we disconnected the DUT, leaving the test port on the coupler open. Now, connect an open circuit to the port.

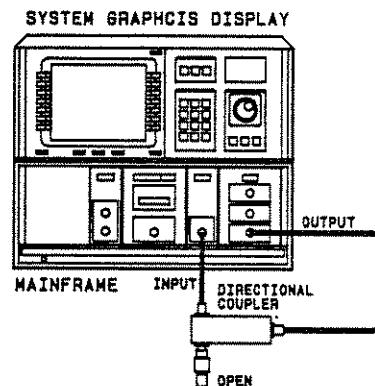

Figure 1-21. "Store open" Configuration

The softkeys used to store the open, average the short, and view the normalized trace are located along the right side of the SOURCE menu.

Connect the open circuit to the bridge or coupler (the point at which the DUT will be connected).

Wait for the trace to be completely updated.

Press **◀STORE OPEN -> C▶**. "Function executed" appears.

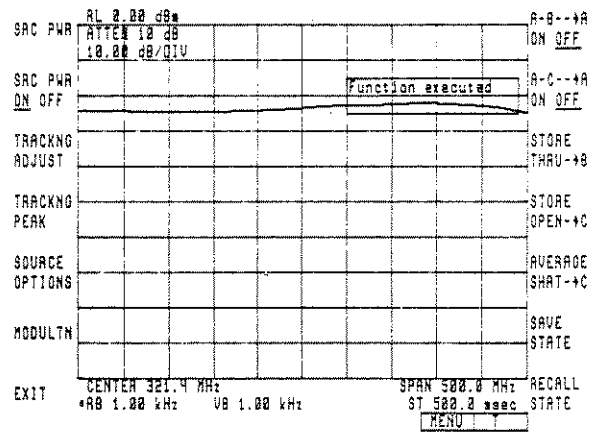

Figure 1-22.

Remove the open circuit and connect the short circuit to the bridge or coupler.

Wait for trace to be completely updated.

Press **◀AVERAGE SHRT -> C▶**. The data from trace A (the open measurement) will be averaged with trace C (the short measurement), and the result will be stored in trace C.

"Function executed" appears on the display.

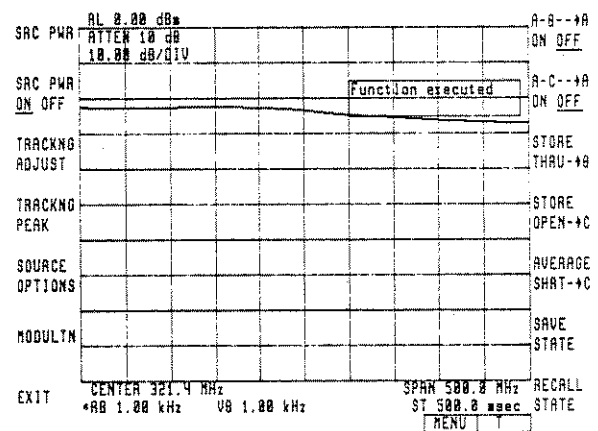

Figure 1-23.

Turn on **◀A - C --> A▶** to later subtract the open/short average from the test measurement. (Before the device is connected, a 0 dB reference line will appear at the top of the display.)

Remove the short circuit and connect the DUT to the test port. (This is the normalized reflection measurement.)

In stimulus-response mode, when a normalization softkey is on (A - B or A - C are on), scale units change from dBm to dB. The measurement is relative to the open/short average. Thus, return loss in dB is displayed.

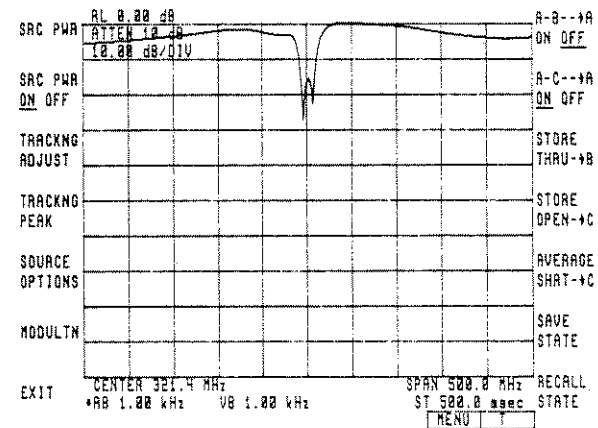

Figure 1-24.

To obtain a single CW signal, press **◀SPAN▶** and enter 0, **◀Hz▶**.

(When in zero span, use single sweep mode.)

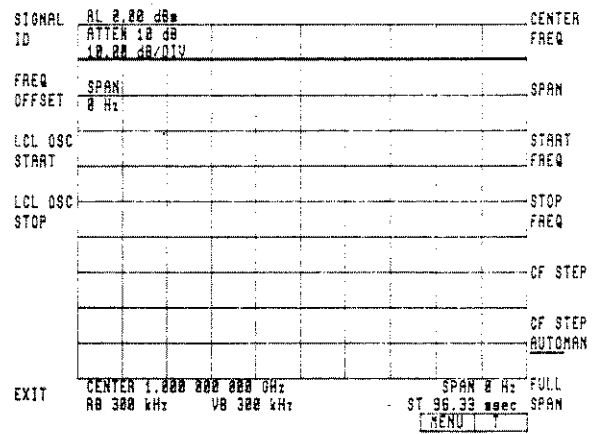

Figure 1-27.

To modulate the signal amplitude, press **[MENU]**, **◀SOURCE▶**, and **◀MODULTN▶**.

Then press **◀AM %▶** and enter the desired modulation percentage (depth).

Within the MODULATION softkey menu, internal and external modulation can be selected and an amplitude modulation frequency can be specified. These functions are described in the "Modulation" subsection of *Softkeys*.

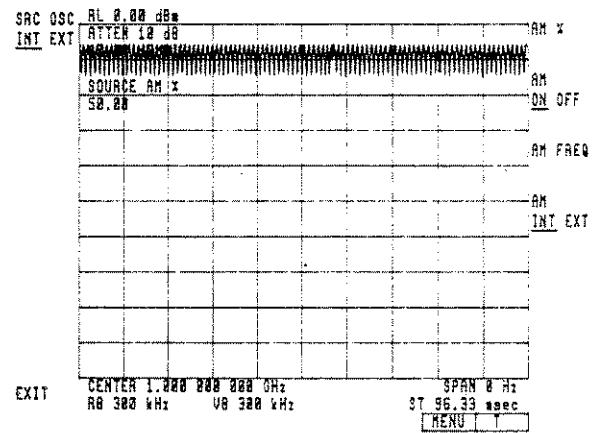

Figure 1-28.

The power of the HP 70300A can be controlled with softkeys under **◀SOURCE▶** and **◀SOURCE OPTIONS▶**. (To reach these keys from the MODULATION softkey menu, press the backspace key.)

To change the power level, press the backspace key, **◀SRC PWR▶** and then enter a value. The instrument preset power level is -10 dBm.

The control of power is discussed in the "Source: Power Control" subsection of *Softkeys*.

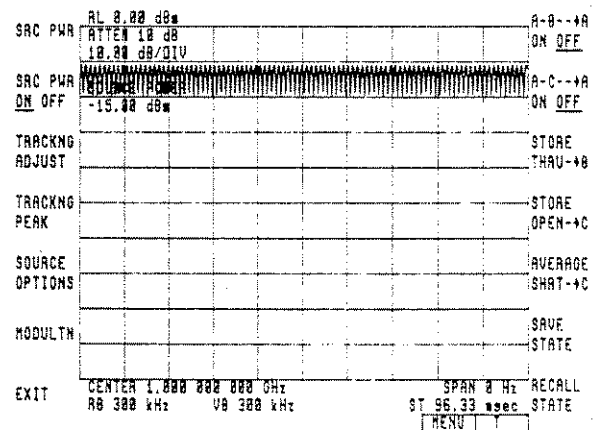

Figure 1-29.

1-16
LOCAL OSCILLATOR ROM VERSION 851216 OR LATER

TRACKING GENERATOR SOFTKEYS

Introduction

This section describes the functions of the HP 70300A Tracking Generator softkeys. Step-by-step examples demonstrate how some of these softkeys are used.

Organization of this Section

The tracking generator softkeys are divided by function into six groups. Each group is described in a subsection of *Tracking Generator Softkeys*:

Measurement Mode: Signal Analysis or Stimulus Response presents softkeys that allow you to choose the mode of instrument operation. Differences between the internal analyzer functions of the two modes are described.

Source: Calibration and Normalization describes softkeys that allow you to store calibration traces (such as open/short and thru calibrations) and softkeys that perform math functions for normalized measurements.

Source: Power Control discusses the softkeys that control the power of the HP 70300A Tracking Generator.

Source: Tracking Adjustments describes softkeys that manually or automatically adjust the output frequency of the tracking generator to maximize the amplitude of the active trace.

Source Options describes several specialized softkeys on the SOURCE OPTIONS menu. Among these keys are ◀ALC NRM▶ and ◀BLANKNG ON OFF▶.

Modulation discusses the four softkeys that control the amplitude modulation of the HP 70300A Tracking Generator.

Note: A "Hardware not present" error message will appear if tracking generator softkeys are pressed when the HP 70300A Tracking Generator is *not* in the system. (The error message will also appear, for example, if the AM frequency is changed when external modulation is used.)

Softkey Overview

All HP 70300A functions can be accessed through softkey menus. The four HP 70300A softkey menus are shown below.

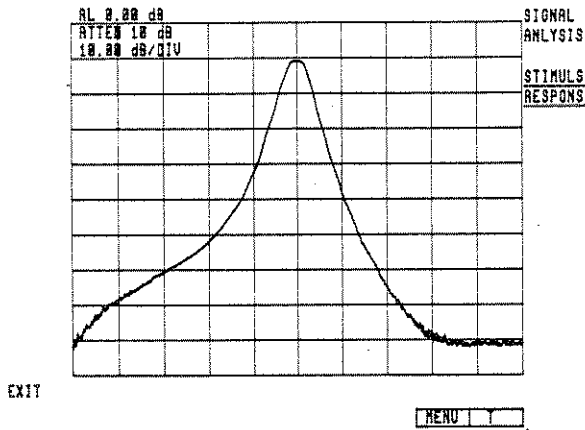

Figure 1-30. MEASURE MODE Softkey Menu

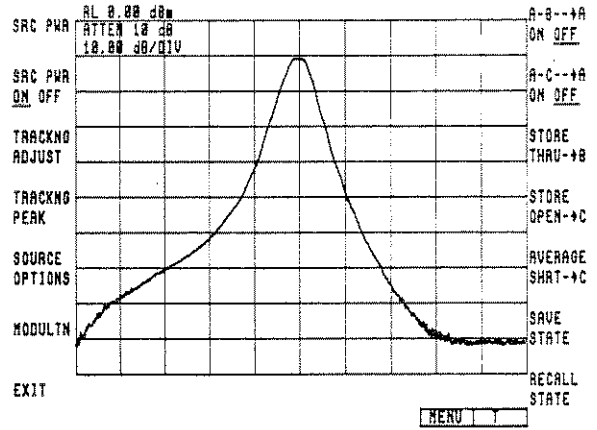

Figure 1-31. SOURCE Softkey Menu

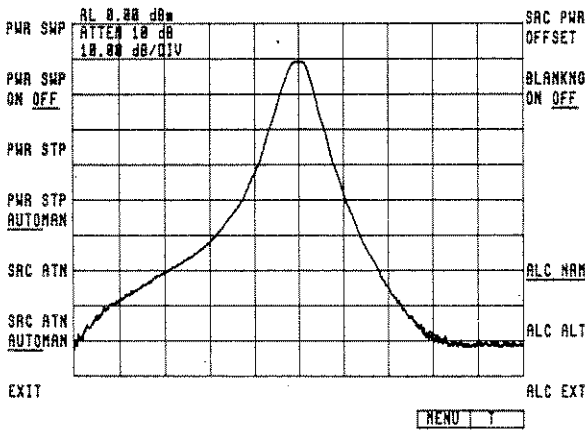

Figure 1-32. SOURCE OPTIONS Softkey Menu

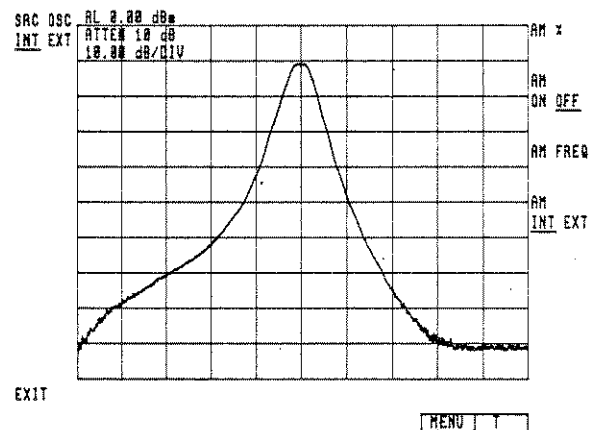

Figure 1-33. MODULATION Softkey Menu

The softkeys shown above are presented graphically in Figure 1-34. Softkeys and their corresponding remote commands are described in the *Remote Operation* section.

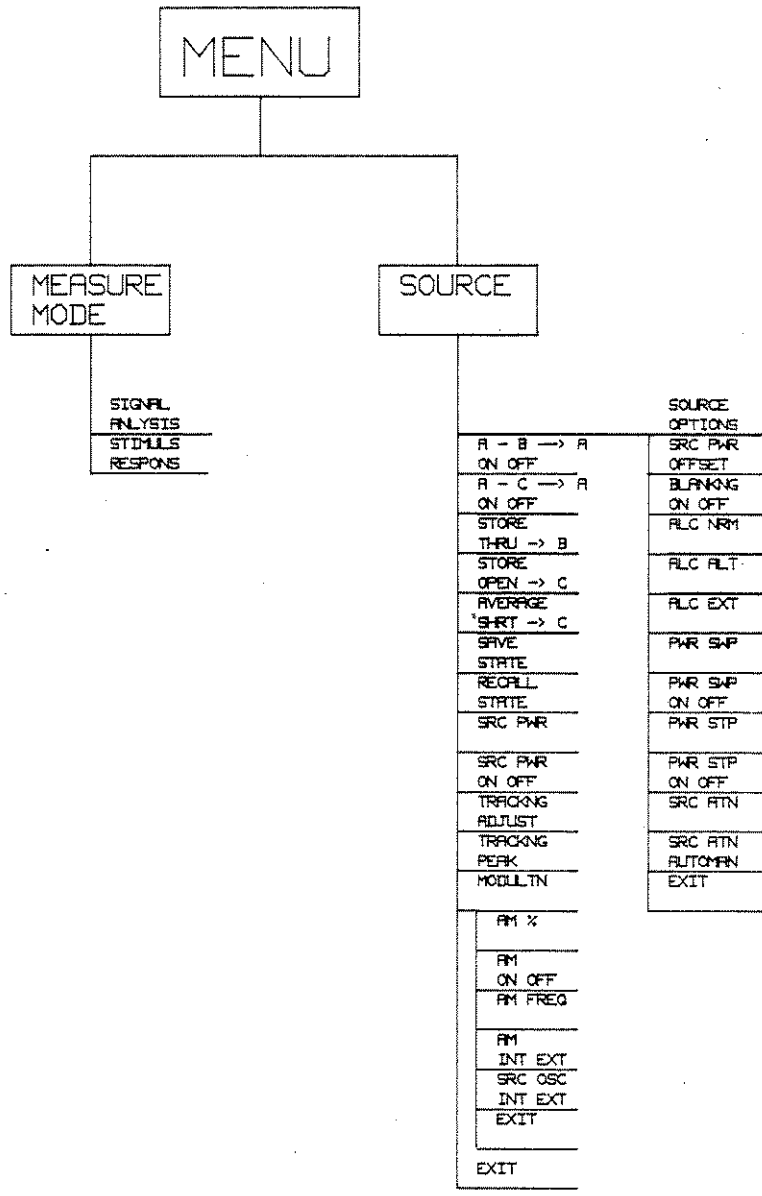

Figure 1-34. HP 70300A Tracking Generator Softkeys

Accessing the Tracking Generator Softkeys

All HP 70300A Tracking Generator functions are accessed through two keys under the [MENU] hardkey: ◀MEASURE MODE▶ and ◀SOURCE▶. These softkeys appear at the lower left side of the [MENU] screen (as shown below).

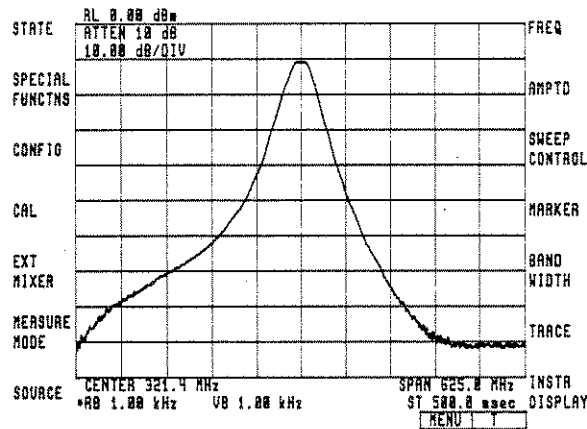

Figure 1-35. The MENU Softkeys

When ◀MEASURE MODE▶ and ◀SOURCE▶ are pressed, the softkeys shown in the previous two pages appear.

Measure Mode: With the HP 70300A Tracking Generator in your system, the system can make both signal analysis measurements and stimulus-response measurements. Press the [MENU] hardkey to access the ◀MEASURE MODE▶ softkey. The ◀MEASURE MODE▶ softkey accesses other softkeys that tell the system which measurement type will be made. These softkeys are described in the following pages.

Source: The HP 70300A Tracking Generator generates a signal that precisely tracks (follows) the tuned frequency of the spectrum analyzer. Because it produces a signal, the tracking generator is a "source." Press the [MENU] hardkey to access the ◀SOURCE▶ softkey. Almost all tracking generator functions are accessed through the ◀SOURCE▶ softkey. These softkeys will be described later in this chapter.

Moving Between Spectrum Analyzer and Tracking Generator Menus

For your convenience, the backspace and USER keys move you between spectrum analyzer and tracking generator menus. When in the tracking generator menu (accessed by the **◀SOURCE▶** softkey), you can press the [USER] key to call up the 14 most frequently used spectrum-analyzer softkeys. Use the following procedure, for example, to quickly activate a marker when using the **◀SOURCE▶** softkeys.

Press [MENU], **◀SOURCE▶**, and **◀SOURCE OPTIONS▶** to access the SOURCE OPTIONS menu.

Now press [USER] to access the USER softkeys.

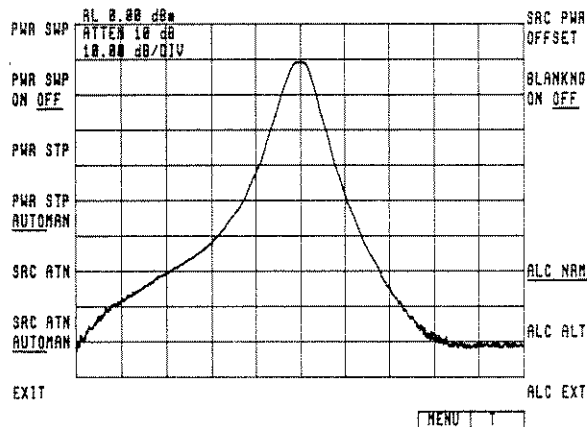

Figure 1-36.

The USER softkeys appear on the display.

Press a softkey on the USER menu, such as **◀HIGHEST PEAK▶**.

Next, press the backspace key and the **◀SOURCE OPTIONS▶** menu reappears.

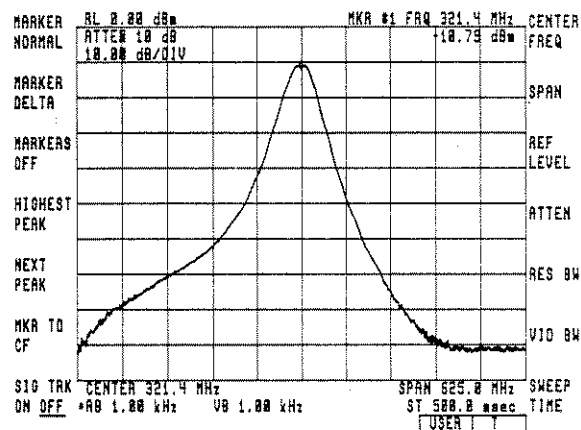

Figure 1-37.

Other functions on the USER menu, such as **◀RES BW▶** and **◀SWEEP TIME▶**, can be changed.

You can replace the softkeys found under the [USER] hardkey with softkeys of your own choosing to create a customized softkey menu. For instance, you can place the **◀MARKER BW ON OFF▶** softkey on the USER menu for making 3 dB bandwidth measurements.

The **◀DEFINE UDK▶** softkey defines softkeys. Press [MENU] and **◀SPECIAL FUNCTIONS▶** to access **◀DEFINE UDK▶**. Also see the description under **◀SPECIAL FUNCTIONS▶**.

Measure Mode

The MEASURE MODE softkeys tell the instrument whether to make signal analysis or stimulus-response measurements. Instrument settings are optimized for each particular measurement type.

When ◀MEASURE MODE▶ is pressed, ◀SIGNAL ANALYSIS▶ and ◀STIMULUS RESPONSE▶ appear. ◀MEASURE MODE▶ appears at the lower left side of the [MENU] screen as in Figure 1-38.

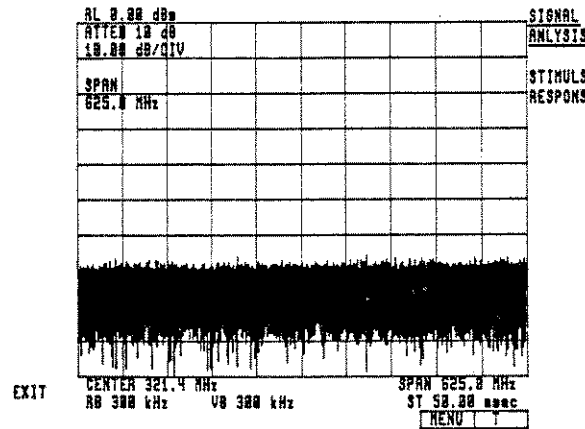

Figure 1-38. The MEASURE MODE Softkeys

Overview

There are two MEASURE MODE softkeys. (See the following pages for detailed descriptions.)

SIGNAL ANALYSIS optimizes system operation for signal analysis measurements--measurements of absolute amplitude versus frequency, where signals from external sources are examined.

STIMULUS RESPONSE optimizes system operation for stimulus-response measurements--transmission and reflection measurements, which use the HP 70300A Tracking Generator as the source.

Signal Analysis Mode

Signal analysis, the basic measurement provided by the HP spectrum analyzer system, measures absolute amplitude relative to frequency. Use signal analysis mode, for example, to survey a wide frequency span or to monitor a frequency band.

The system is instrument preset to signal analysis mode. The mode is active when **◀ SIGNAL ANALYSIS ▶** is underlined.

When **◀ SIGNAL ANALYSIS ▶** is enabled, the displayed units are dBm. (Power level in decibels is referenced to a power of one milliwatt.) This is referred to as *absolute amplitude mode*. For example, the reference level in Figure 1-39 is "RL 0.00 dBm."

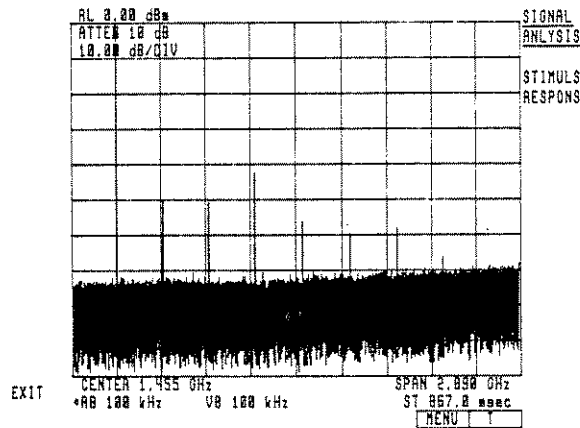

Figure 1-39.

Stimulus-Response Mode

Stimulus-response mode optimizes spectrum analyzer/tracking generator operation for stimulus-response measurements. Use stimulus-response mode to make transmission or reflection measurements on devices such as filters and amplifiers.

◀STIMULUS RESPONDS▶ is active when underlined as in Figure 1-40. When active, **◀STIMULUS RESPONDS▶** activates the stimulus-response auto sweep time (which is typically valid for devices when the system's span is less than 20 times the bandwidth of the device).

Activating **◀ STIMULUS RESPONDS ▶** and either of the math function softkeys (**◀A - B --> A▶** or **◀A - C --> A▶**), activates *relative amplitude mode*. When the system enters relative amplitude mode, the reference level is set to 0 dB and the following functions are displayed in dB units: amplitude unit conversion (AMPU), display line (DL), measurement unit conversion (MEASU), marker amplitude (MK), reference level (RL), threshold (TH), and trace data input/output (TRA/TRB/TRC). For example, the reference level in Figure 1-40 is set to "RL 0.0 dB." (For more information, see "MEASURE" in the HP 71000 Language Reference.)

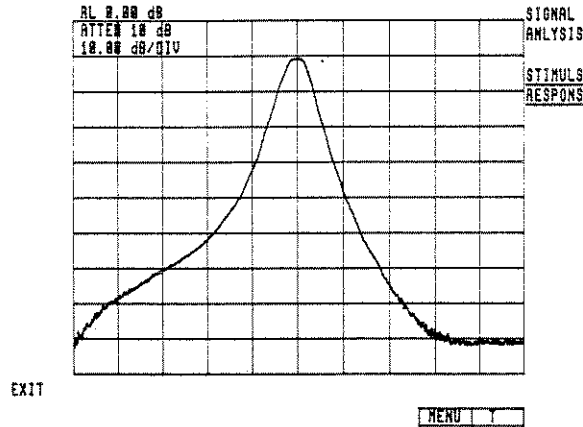

Figure 1-40.

Hints:

1. The stimulus-response AUTO sweep time differs from the signal analysis AUTO sweep time. In stimulus-response mode, AUTO sweep times are usually much faster for swept-response measurements than spectrum analyzer AUTO sweep times.

Sweep times adjust automatically when the resolution bandwidth (RES BW) or video bandwidth (VID BW) change. In the AUTO (coupled) sweep time state, the UNCAL (uncalibrated) indication will not be displayed, since the AUTO mode chooses valid sweep times.

If necessary, the sweep time can be manually increased or decreased with the ◀SWEEP TIME▶ softkey. In the MANUAL (uncoupled) state, if you change the resolution bandwidth, video bandwidth, or sweep time, the UNCAL indication may appear.

2. Linear mode is not allowed in stimulus-response mode. The analyzer automatically changes to LOG in stimulus-response mode. If told to change to linear, the analyzer returns the error message: "Linear not allowed."
3. For greater frequency accuracy when using resolution bandwidths greater than 10 kHz, turn off the resolution bandwidth frequency corrections with the ◀RBW FRQ ON OFF▶ softkey (located under ◀CAL▶ and ◀ENABLE CAL▶).

Source: Calibration and Normalization

Softkeys on the right side of the SOURCE menu allow you to make calibrated and normalized measurements and to store and retrieve instrument states. Press [MENU] and then ◀SOURCE▶ to access these softkeys.

The softkeys that appear when ◀SOURCE▶ is pressed are shown in Figure 1-41 below. Except for the ◀SAVE STATE▶ and ◀RECALL STATE▶ softkeys, the softkeys on the right side are used to increase measurement accuracy.

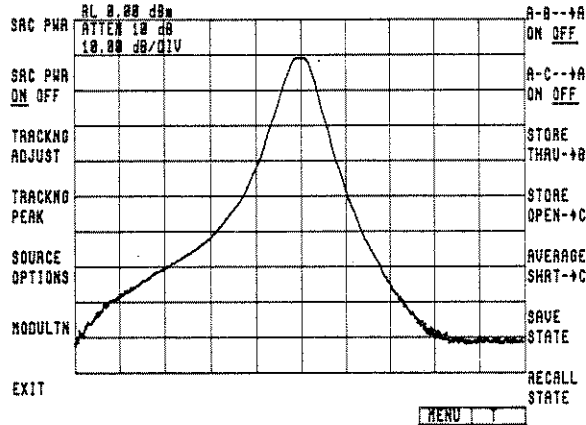

Figure 1-41. SOURCE Softkeys

Overview

The calibration and normalization softkeys are briefly described below. The function of each softkey is described in greater detail on the following pages. Examples of softkey usage are also given.

A - B --> A is used in normalization measurements to subtract trace B amplitude (the thru calibration data) from the measured data. The normalized data is displayed in trace A.

A - C --> A is used in normalization measurements to subtract trace C amplitude (the open/short calibration data) from the measured data. The normalized data is displayed in trace A.

STORE THRU -> B stores a thru measurement (thru reference) in trace B.

STORE OPEN -> C stores an open measurement (open reference) in trace C. (A short circuit response could be stored.)

AVERAGE SHRT -> C averages the short measurement with an open (previously stored in trace C) and then stores the open/short average in trace C.

SAVE STATE places analyzer settings into storage registers.

RECALL STATE retrieves previously stored analyzer settings.

Hint: The examples in *Typical Measurements* use the normalization and calibration softkeys.

A - B --> A

When $\langle A - B \rightarrow A \rangle$ is turned on, the data in trace B is subtracted from the measured data, and the resulting trace (trace A) is displayed. (That is, input minus calibration is displayed.) The $\langle A - B \rightarrow A \rangle$ math function, used in the normalization process, improves your measurements by allowing you to subtract out system errors that existed before your device was connected.

$\langle A - B \rightarrow A \rangle$ is used with $\langle \text{STORE THRU} \rightarrow B \rangle$. Activate $\langle A - B \rightarrow A \text{ ON OFF} \rangle$ to subtract the thru calibration data (trace B) from trace A. Removing the thru data from trace A sets trace A to a reference level of 0 dB. (Only one math function can be ON at one time.)

If the tracking generator is in stimulus-response mode when $\langle A - B \rightarrow A \rangle$ is turned on, relative amplitude mode is activated. In this mode, certain functions will have dB units. The active trace is relative to the thru calibration measurement; and 0 dB is established as the transmission loss of the thru. (See "Stimulus-Response Mode" for more information.)

A measurement using $\langle A - B \rightarrow A \rangle$ is shown in the $\langle \text{STORE THRU} \rightarrow B \rangle$ example later in this subsection. (Also see the Transmission Measurement example in *Typical Measurements*.)

A - C --> A

When $\langle A - C \rightarrow A \rangle$ is turned on, the data in trace C is subtracted from trace A. The resulting trace is displayed in trace A. The $\langle A - C \rightarrow A \rangle$ math function, used in the normalization process, improves your measurements by allowing you to subtract out errors that existed before your device was connected.

$\langle A - C \rightarrow A \rangle$ is used with $\langle \text{STORE OPEN} \rightarrow C \rangle$ and $\langle \text{AVERAGE SHRT} \rightarrow C \rangle$. Activate $\langle A - C \rightarrow A \text{ ON OFF} \rangle$ to subtract the average of the open and short (trace C) from trace A. Removing the open/short calibration data from trace A sets trace A to a reference level of 0 dB. (Only one math function can be ON at one time.)

If the instrument is in stimulus-response mode when $\langle A - C \rightarrow A \rangle$ is pressed, relative amplitude mode is activated. In this mode, certain functions have dB units. The active trace is relative to the open/short calibration data; and 0 dB is established as the return loss of the open/short average.

A measurement using $\langle A - C \rightarrow A \rangle$ is shown in the $\langle \text{AVERAGE SHRT} \rightarrow C \rangle$ example later in this chapter. (Also see the Reflection Measurement example in *Typical Measurements*.)

Hints:

1. Both $\langle A - B \rightarrow A \rangle$ and $\langle A - C \rightarrow A \rangle$ must be turned off to store open/short and thru calibration traces.
2. The $\langle A - B \rightarrow A \rangle$, $\langle A - C \rightarrow A \rangle$, $\langle \text{STORE THRU} \rightarrow B \rangle$, $\langle \text{STORE OPEN} \rightarrow C \rangle$, and $\langle \text{AVERAGE SHRT} \rightarrow C \rangle$ softkeys can be used for spectrum analysis measurements even if there is no tracking generator in the system.
3. One of the math functions and stimulus-response measurement mode must be active for the system to use relative amplitude mode.

Store Thru -> B

The ◀STORE THRU -> B▶ softkey is used in the normalization process for transmission measurements. Normalization improves your measurements by allowing you to subtract out system errors such as frequency response and cable losses.

Press ◀STORE THRU -> B▶ to place the data from trace A (presumably a thru trace) in trace B. "Function executed" appears on the display. If the span or the start and stop frequencies are changed after the thru has been stored, the calibration trace will no longer be valid. A new thru calibration trace must be stored. (The reference level, reference position, and vertical log scale can be changed and the trace will remain valid.)

Storing the thru connection saves correction factors that can later be subtracted out. This is sometimes referred to as "calibrating" the instrument setup.

The following example demonstrates a normalized transmission measurement. (Also see the Transmission Measurement example in *Typical Measurements*.)

Hints:

1. Pressing ◀STORE THRU -> B▶ removes any data previously stored in trace B.
2. If ◀STORE THRU -> B▶ is pressed when ◀A - B --> A▶ is on, the "Not stored; A-x ->A on" error message appears. The thru calibration trace *is not stored*. ◀A - B --> A▶ must be turned off.

Example: Measure the insertion loss or gain of a filter.

Turn on the spectrum analyzer; press [MENU] and ◀MEASURE MODE▶.

Press ◀STIMULS RESPON▶ to activate stimulus-response mode.

Stimulus-response mode optimizes spectrum analyzer/tracking generator operation for transmission and reflection measurements.

Select the center frequency, span, and other analyzer settings for your particular device under test (DUT). During setup, place the DUT between the RF OUTPUT on the tracking generator and the RF INPUT on the RF module.

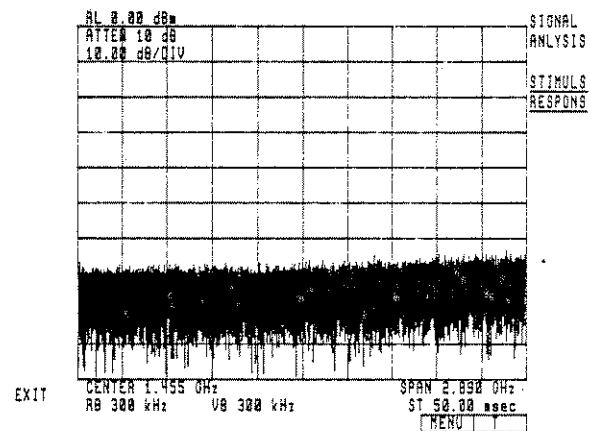

Figure 1-42.

Press [MENU], [SOURCE], and turn on [SRC PWR ON OFF]. The RF light on the tracking generator turns on.

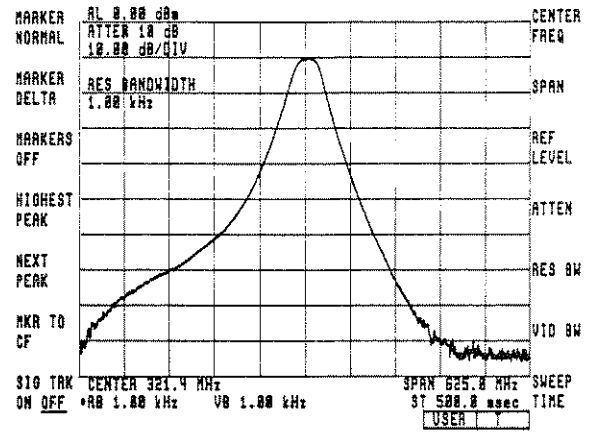

Figure 1-43.

The softkeys required for instrument calibration and normalization are located along the right side of the SOURCE menu.

Connect the RF OUTPUT on the tracking generator to the RF INPUT on the RF section.

Wait for the trace to be completely updated. (Do not store data if the "invalid" asterisk appears in the upper right corner of the display.)

Press [STORE THRU -> B]. Trace A is stored in trace B and all data previously stored in trace B is written over.

"Function executed" appears on the display.

Turn on [A - B --> A]. (The 0 dB reference will appear at the top of the display.)

Insert the DUT in the through path. Trace B is subtracted from the measured data and the normalized transmission measurement appears on the display.

To view both trace B (the calibration) and trace A (the normalized measurement) at one time, use the [VIEW TRACE B] softkey. (Press [MENU], [TRACE], and [TRACE B].)

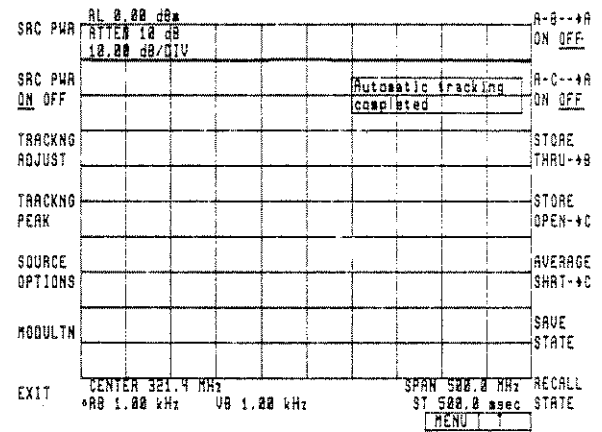

Figure 1-44.

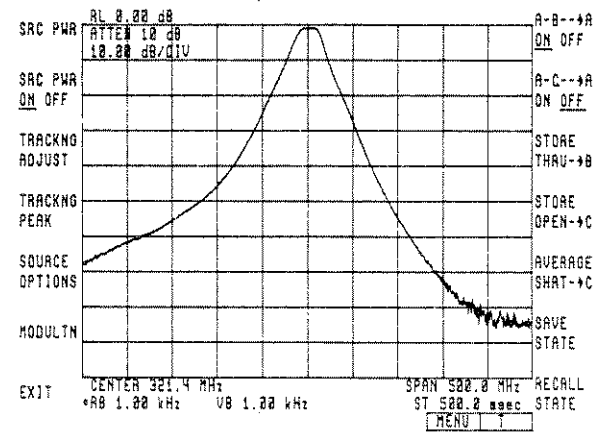

Figure 1-45.

Store Open -> C

A short circuit is the usual standard for reflection measurements. The short circuit reflects all incident power so that a convenient 0 dB reference line is obtained.

The ◀STORE OPEN -> C▶ softkey is used with the ◀AVERAGE SHRT -> C▶ and ◀A - C --> A▶ softkeys in the normalization process. The ◀STORE OPEN -> C▶ softkey stores an open calibration in trace C. Then, ◀AVERAGE SHRT -> C▶ averages a short-circuit data with the open-circuit data. Finally, device under test is inserted and ◀A - C --> A▶ is activated to subtract trace C and view the normalized trace. Normalization improves your measurements by allowing you to subtract out errors that existed before your device was connected.

Once the open is stored in trace C, "Function executed" appears on the display. If the span or the start and stop frequencies are changed after the open has been stored, the calibration trace will no longer be valid. A new open-calibration trace must be stored. (The reference level, reference level position, and vertical log scale can be changed and the trace will remain valid.)

The example under ◀AVERAGE SHRT -> C▶ demonstrates the usage of ◀STORE OPEN -> C▶. (Also see the Reflection Measurement example in *Typical Measurements*.)

Hints:

1. Press ◀STORE OPEN -> C▶ to place the data from trace A (presumably the open calibration data) in trace C. This removes any data that was previously stored in trace C.
2. If ◀AVERAGE SHRT -> C▶ is pressed before ◀STORE OPEN -> C▶, a "Not stored, open 1st" error message appears reminding you to store the open first.
3. If ◀STORE OPEN -> C▶ is pressed when ◀A - C --> A▶ is on, the "Not stored; A-x->A on" error message appears. The open calibration *is not stored*. ◀A - C --> A▶ must be in the off position.
4. Use the ◀STORE OPEN -> C▶ softkey to store a short when an open/short average is not required. In this case, connect the short and press ◀STORE OPEN -> C▶. Then connect the DUT and press ◀A - C --> A▶.

Average Short -> C

Although a short circuit is the usual standard for reflection measurements, better accuracy can be obtained with an open/short average. The open/short average reduces mismatch and directivity effects, and this produces a more accurate frequency-response reference trace.

Use the ◀AVERAGE SHRT -> C▶ softkey with the ◀STORE OPEN -> C▶ softkey to store correction information for normalized measurements. First, connect the open circuit and press ◀STORE OPEN -> C▶. Then, connect the short circuit and press ◀AVERAGE SHRT -> C▶ to average the data from trace A (the short calibration data) with trace C (the previously-stored open calibration). Once this open/short average is stored in trace C, "Function executed" appears on the display. Finally, connect the DUT and press ◀A - C --> A▶ to subtract out trace C, and view the normalized trace. (See the following example for more details.)

If the span or the start and stop frequencies are changed after the open/short average has been stored, the calibration trace will no longer be valid. A new open/short average trace must be stored.

Hints:

1. Pressing ◀AVERAGE SHRT -> C▶ removes any data that was previously stored in trace C.
2. If ◀AVERAGE SHRT -> C▶ is pressed before ◀STORE OPEN -> C▶, a "Not stored, open 1st" error message appears, reminding you to store the open first.
3. If ◀AVERAGE SHRT -> C▶ is pressed when ◀A - C --> A▶ is on, the "Not stored; A-x->A on" error message appears. The short *is not averaged*. ◀A - C --> A▶ must be turned off.

Example: Measure the return loss of a filter.

Turn on the spectrum analyzer, press [MENU], and then press ◀MEASURE MODE▶.

Next, press ◀STIMULUS RESPON▶ to activate stimulus-response mode.

Stimulus-response mode optimizes spectrum analyzer/tracking generator operation for transmission and reflection measurements.

Select the center frequency, span, and other analyzer settings for your particular DUT. The device can be connected to a directional bridge or coupler during the setup procedure.

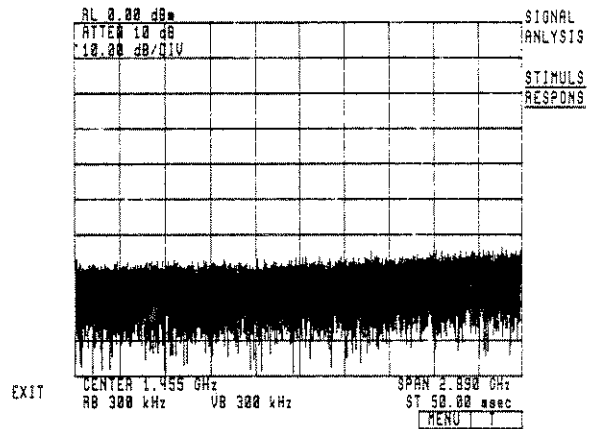

Figure 1-46.

Press ◀EXIT▶, ◀SOURCE▶, and then turn on ◀SRC PWR ON OFF▶.

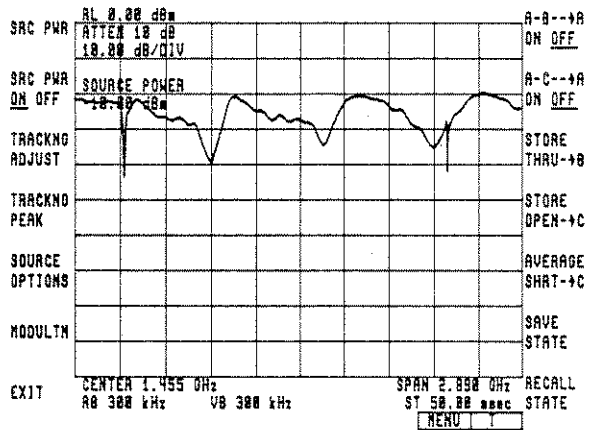

Figure 1-47.

When using bandwidths less than 2 kHz, connect your bridge or coupler from the RF OUTPUT on the tracking generator to the RF INPUT on the RF section. Press **TRACKNG PEAK** and wait until "Automatic Tracking Completed" appears. (The **TRACKNG PEAK** softkey is described later in this subsection.)

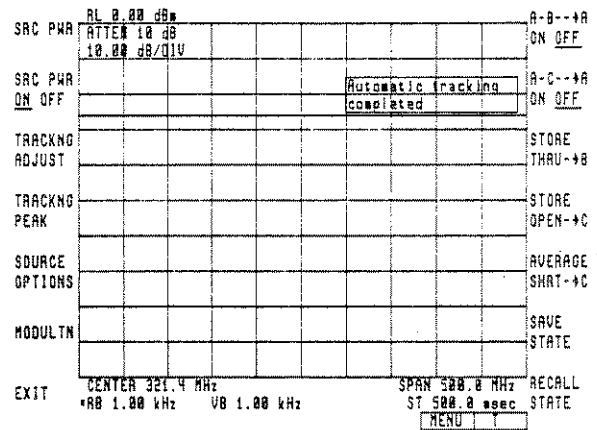

Figure 1-48.

The softkeys required for instrument calibration are located along the right side of the SOURCE MENU.

Connect an open circuit to your test coupler or bridge. (This is also shown in the Reflection Measurement example in *Typical Measurements*.)

Wait for the trace to be completely updated. (Do not store data if the "invalid" asterisk appears in the upper right corner of the display.)

Press **STORE OPEN -> C**. The trace on the display is stored in trace C. Any data previously stored in trace C is removed, and "Function executed" appears on the display.

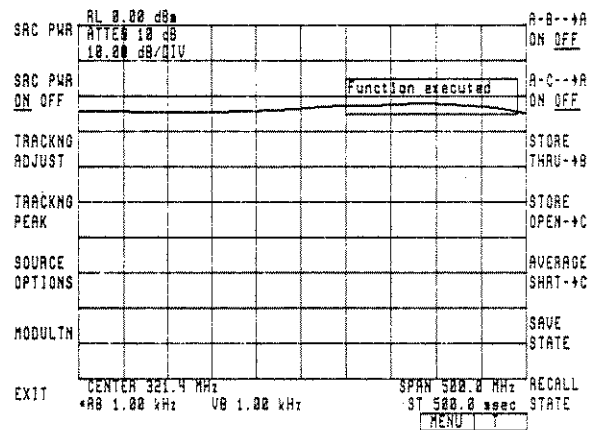

Figure 1-49.

Remove the open circuit and connect the short circuit to the test setup.

Again, wait for the trace to be completely updated.

Press **AVERAGE SHORT -> C** to average the data from trace A (the open calibration data) with trace C (the short calibration data). This open/short average is stored in trace C, and "Function executed" appears on the display.

If the span or start/stop frequencies are changed after the calibration is made, the calibration is no longer valid. A new open/short average must be made.

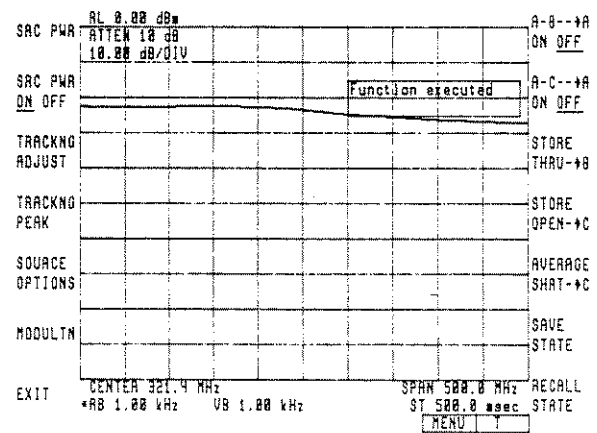

Figure 1-50.

Turn on **◀A - C --> A▶** to subtract the open/short average from the measurement data.

Remove the short circuit and connect your DUT to the test setup.

The normalized reflection measurement of the filter appears on the screen as shown in Figure 1-51.

To view both the active trace (trace A) and the stored average (trace C), press **[MENU]**, **◀TRACE▶**, **◀TRACE C▶**, and **◀VIEW TRACE C▶**.

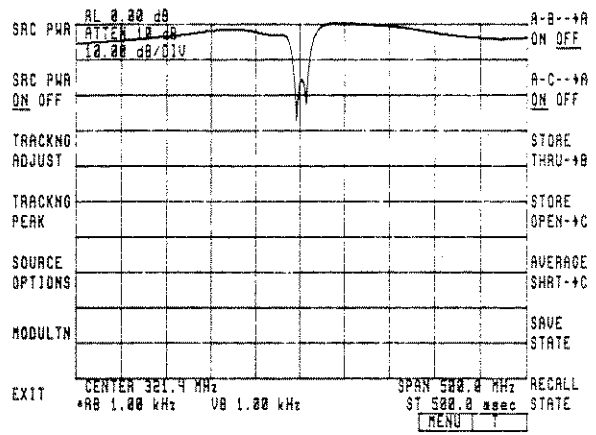

Figure 1-51.

Save/Recall State

The **◀SAVE STATE▶** and **◀RECALL STATE▶** softkeys store and retrieve operator-determined analyzer settings. With **◀SAVE STATE▶**, the current state of the analyzer is stored in one of several registers. **◀RECALL STATE▶** brings back a previously stored state. The storage registers are referenced by numeric values.

1. To save a state, press **◀STATE▶** and enter a register number with the keyboard. There are two preset registers. More state registers can be created depending upon the amount of available memory. (Press **◀INST DISPLAY▶**, **◀SHOW CONFIG▶**, and **◀SHOW CATALOG▶** to check the available memory.)

Additional registers created using **◀NO. OF STATES▶** should be protected by turning on **◀P STATE ON OFF▶**.

2. To recall a saved state, press **◀RECALL STATE▶** and enter the register number.

Additional information can be found under **◀STATE▶** in the [HP 71000 Operating Manual](#).

Hint: For convenience, you can create a save state for stimulus-response measurements. In this saved state, activate **◀ STIMULUS RESPONS ▶** mode, turn on **◀SRC PWR ON OFF▶**, and select a resolution bandwidth (for example, 1 kHz).

Source: Power Control

Nine softkeys allow you to control the HP 70300A Tracking Generator's power. These keys are located on the upper left side of the display screen on the SOURCE menu and on the SOURCE OPTIONS menu (as shown below).

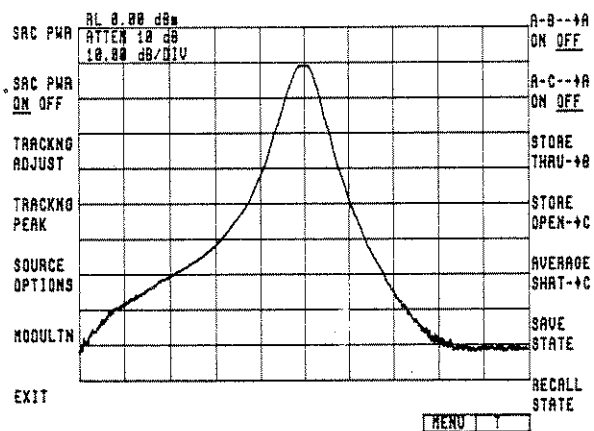

Figure 1-52. SOURCE Softkeys

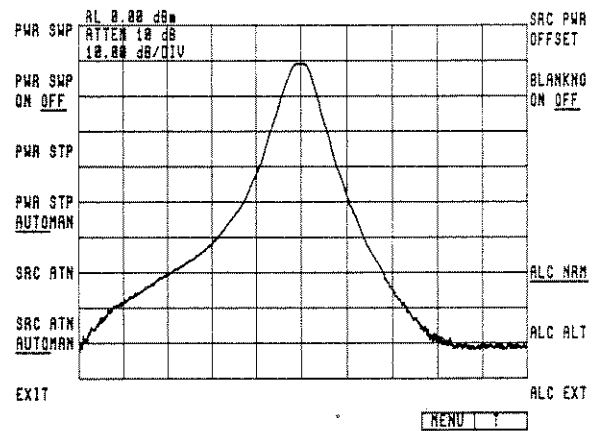

Figure 1-53. SOURCE OPTIONS Softkeys

Overview

The softkeys that control tracking-generator power are briefly described below. See the following pages for detailed descriptions.

SOURCE POWER turns the tracking generator on and changes the source power level.

SOURCE POWER ON OFF turns the source power (tracking generator RF OUTPUT) on and off.

SOURCE OPTIONS accesses the following power controls:

POWER SWEEP sets the power sweep amplitude range.

POWER SWEEP ON OFF turns the power sweep function on and off.

POWER STEP changes the step size for the source power level, power sweep, and source offset functions.

POWER STEP AUTO/MANUAL sets the step size for either automatic or manual control.

SOURCE ATTENUATOR changes source attenuation for the Option 001 HP 70300A Tracking Generator, which has a 70 dB attenuator with 10 dB steps.

SOURCE ATTENUATOR AUTO/MANUAL sets the source attenuator for either automatic or manual control.

SOURCE POWER OFFSET adds a user-determined numeric value to the source power output level readout. Offsets change the tracking generator's displayed output level, but do not change the actual signal level produced.



Source Power

The ◀SRC PWR▶ softkey sets the source power level and turns the source power on when a value is entered. The ◀SRC PWR ON OFF ▶ softkey turns the tracking generator on and off.

Press ◀SRC PWR ON OFF ▶ to turn on the RF output power of the tracking generator. The underline moves to the on position and the RF light turns on.

The instrument preset tracking generator power level is -10 dBm. The specified power level range is from -10 to -21 dBm. Entering a power level with the keypad, turns on ◀SRC PWR ON OFF▶. Otherwise, simply turn on ◀SRC PWR ON OFF▶ and the previous source power level will be activated.

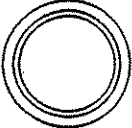
The three methods of setting the power level are shown:

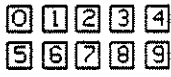
| | |
|--|--|
| <p>KNOB</p>  | <p>The source power level value is changed by knob rotation. The knob rotation speed determines the rate of change.</p> |
| <p>STEP KEYS</p>  | <p>The step keys change the power level in steps. The step size can be changed with the ◀PWR STP▶ softkey.</p> |
| <p>KEY PAD</p>  | <p>The keypad directly enters a specific power level. The specified range for the HP 70300A is from -10 to -21 dBm, but this range is increased with the Option 001 70 dB step attenuator.</p> |





Source Power Step

The ◀PWR STP▶ softkey sets the power step size for the ◀SRC PWR▶ (source power), ◀PWR SWP▶ (power sweep), and ◀SRC PWR OFFSET▶ functions.

When the ◀PWR STP AUTOMAN▶ softkey is in the AUTO position, the step size is automatically set to the value of the LOG dB/DIV. Pressing ◀PWR STP▶ and the step keys changes the step size in a 1, 2, 5, 10 step increment sequence.

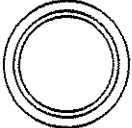
The step size can be set to a value between 0 and 300 dB. Entering a step size moves ◀PWR STP AUTOMAN▶ to the MANUAL position. Pressing ◀PWR STP AUTOMAN ▶, returns the step size to the LOG dB/DIV value.

- The three methods of setting the power step size are shown:

| | |
|--|---|
| KNOB
 | The power step size value is changed by knob rotation. The knob rotation speed determines the rate of change. |
| STEP KEYS
  | The step keys change the power step size in a 1, 2, 5, 10 increment sequence. |
| KEY PAD
 | They keypad directly enters a power step size value between 0 and 300 dB. When values other than those in the range or hardware limit are entered, "Parm out of range" appears and the closest allowed value is used. |



Power Sweep

The amplitude range of the power sweep is set with the ◀PWR SWP▶ softkey. The ◀PWR SWP ON OFF▶ softkey turns this function on and off. (Press ◀SOURCE OPTIONS▶ to access these softkeys.) This function enables the output power to be swept up.

Entering an amplitude range value, moves ◀PWR SWP ON OFF▶ to the on position. The power sweep function may also be turned on to the current amplitude range value or turned off directly.

The sweep amplitude range is instrument preset to 0 dB. The maximum power sweep allowed is limited by the output-power range of the tracking generator (for example, -10 to -21 dBm). Therefore, when sweeping from -10 to -21 dBm, the maximum calibrated sweep range is 11 dB. (First, change the source power level to -21 dBm with ◀SRC PWR▶, then change the power sweep to 11 dB.)

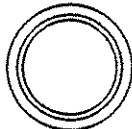
The three methods of setting the power sweep amplitude range are shown:

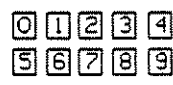
| | |
|--|--|
| KNOB
 | The knob changes the power sweep amplitude range continuously from 0 to 20 dB. |
| STEP KEYS
  | The step keys change the power sweep size in steps. Change the step size with the ◀PWR STP▶ softkey. |
| KEY PAD
 | The keypad directly enters a power sweep amplitude range between 0 and 20 dB with resolution to 0.1 dB. When an unacceptable value is entered, the instrument defaults to the closest allowed value. |

Source Power Offset



◀SRC PWR OFFSET▶ adds a user-determined value to the source power output level readout. For example, when compensating for transmission line loss, you can add an offset value to reduce the displayed power level. This does not change the actual signal level produced by the tracking generator nor affect the displayed trace.

Press ▶SOURCE OPTIONS▶ to access ▶SRC PWR OFFSET▶.

The ▶SRC PWR OFFSET▶ is instrument preset to 0 dB. Pressing ▶SRC PWR OFFSET▶ and entering a value activates this function. An offset value remains in affect until turned off. The display screen does not indicate whether source power offsets are active.

To eliminate an offset, press ▶SRC PWR OFFSET▶ and enter zero. Pressing [I-P] also sets the offset to zero. (Offsets are stored in save states and recalled.)

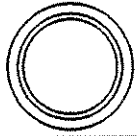
The three methods of changing the offset are shown:

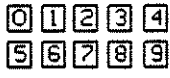
| | |
|--|--|
| <p>KNOB</p>  | <p>The source power offset value is changed by knob rotation. The knob rotation speed determines the rate of change.</p> |
| <p>STEP KEYS</p>  | <p>The step keys change the offset value in steps. Change the step increment with the ▶PWR STP▶ softkey.</p> |
| <p>KEY PAD</p>  | <p>The keypad directly enters a power offset value between ± 300 dB. If an unacceptable value is entered, the instrument defaults to the closest allowed value. Least significant digits are truncated for power offset entries. The resolution is 0.01 dB.</p> |

Source Attenuator

The ▶SRC ATN▶ and ▶SRC ATN AUTOMAN▶ softkeys change the attenuation level of the HP 70300A Option 001 70 dB Attenuator. Press ▶SOURCE OPTIONS▶ to access these softkeys.



The attenuator increases the power level range from a range of -10 to -21 dBm to a range of -10 to -91 dBm. The example that follows decreases the power level from -10 dBm to -60 dBm.

The instrument is preset with 0 dB attenuation and with AUTO source attenuation. In the AUTO state, the source attenuator is controlled automatically as required to produce the requested source output power. (For tracking generators with the attenuator, press ▶SRC PWR▶, the step keys, and observe how the attenuator changes to produce the requested source output.) For most applications, leave ▶SRC ATN AUTO MAN▶ in the AUTO state.

Under MANUAL control, attenuation in increments of 10 dB is available; however, the source power is limited for any given source attenuator setting. Pressing ▶SRC ATN▶ and entering an attenuator value, changes ▶SRC ATN AUTOMAN▶ to the MANUAL position. If you press these softkeys and the attenuator is not present, the "Hardware not present" error message appears on the screen.

The attenuator is not calibrated during the system CAL routine. Since the attenuator is not calibrated, the **◀SRC PWR OFFSET▶** softkey may be used to add an offset to the displayed power level and bring the displayed power level up to a standard.

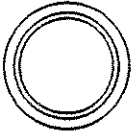
The three methods of changing the attenuation value are shown:

| | |
|--|--|
| <p>Knob</p>  | <p>The knob changes the attenuation level in 10 dB increments. If the knob is turned counterclockwise when the minimum attenuation value (0 dB) is indicated, a "Param out of range" error appears.</p> |
| <p>Step Keys</p>  | <p>The step keys change the attenuation level in 10 dB increments, from 0 to 70 dB.</p> |
| <p>Key Pad</p>  | <p>The keypad directly enters an attenuation level between 0 and 70 dB (in 10 dB increments). When an unacceptable value is entered, the instrument defaults to the closest allowed value. (For example, an entry of 16 dB would be rounded to 20 dB.)</p> |

Example: Change the source power level to -50 dBm.

Connect the RF OUTPUT on the tracking generator to the RF INPUT on the RF module.

Press [MENU], **◀MEASURE MODE▶**, and **◀STIMULS RESPNS▶**.

Press **◀EXIT▶** and **◀SOURCE▶**.

Turn on the tracking generator by pressing **◀SRC PWR ON OFF ▶**. The power level is preset to -10 dBm.

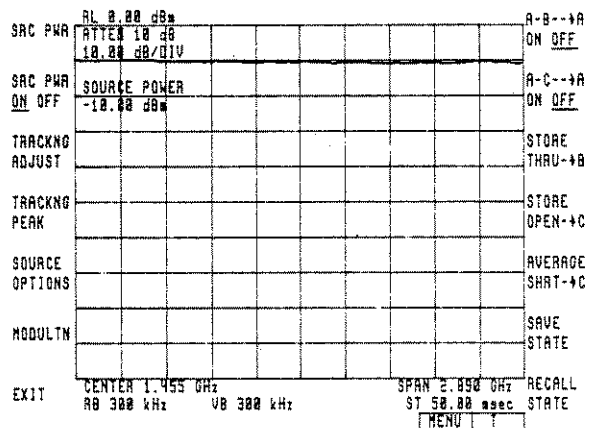

Figure 1-54.

Press **◀SOURCE OPTIONS▶** and **◀SRC ATN▶**.

Enter 40 dB.

◀SRC ATN AUTOMAN▶ moves to the manual position.

| | | | |
|---------|--------------------------|----------------|---------|
| PWR SWP | AL 0.00 dB | SRC PWR | OFFSET |
| | ATTEN 10 dB | | |
| | 10.00 dB/DIV | | |
| PWR SWP | SOURCE ATTENUATED | BLANKING | ON OFF |
| ON OFF | 40.00 dB | | |
| PWR STP | | | |
| PWR STP | | | |
| AUTOMAN | | | |
| SRC ATN | | ALC NAM | |
| SRC ATN | | ALC ALT | |
| AUTOMAN | | | |
| EXIT | CENTER 50.00 MHz | SPAN 50.00 MHz | ALC EXT |
| | *RB 1.00 kHz VB 1.00 kHz | ST 500.0 msec | |
| | | MENU | |

Figure 1-55.

Press **◀EXIT▶** and **◀SRC PWR▶**.

Use the step key to decrease the power level to -60 dBm.

Notice that with 40 dB of attenuation, the power can be decreased lower than -60 dBm.

| | | |
|---------|--------------------------|----------------|
| SRC PWR | AL 0.00 dB | A-B-->A |
| | ATTEN 10 dB | ON OFF |
| | 10.00 dB/DIV | |
| SRC PWR | SOURCE POWER | A-C-->A |
| ON OFF | -60.00 dBm | ON OFF |
| TRACKNG | | STORE |
| ADJUST | | THRU->B |
| TRACKNG | | STORE |
| PEAK | | OPEN->C |
| SOURCE | | AVERAGE |
| OPTIONS | | SHRT->C |
| MODULN | | SAVE |
| | | STATE |
| EXIT | CENTER 50.00 MHz | SPAN 50.00 MHz |
| | *RB 1.00 kHz VB 1.00 kHz | ST 500.0 msec |
| | | RECALL |
| | | STATE |
| | | MENU |

Figure 1-56.

Source: Tracking Adjustments

Two softkeys on the SOURCE softkey menu allow you to adjust the tracking. These softkeys are shown on the left side of Figure 1-57 below.

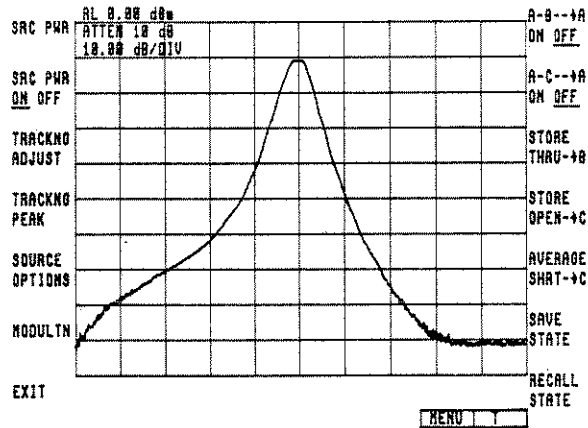

Figure 1-57. The SOURCE Softkeys

Overview

Tracking adjustments are made to maximize the amplitude of the active trace and increase frequency accuracy. During tracking, the frequency of the 21.4 MHz oscillator in the tracking generator is tuned so that the RF OUTPUT frequency precisely tracks the frequency to which the spectrum analyzer is tuned. That is, tracking tunes the 21.4 MHz oscillator of the tracking generator to the precise frequency of the IF bandwidth filter.

Due to the relative flatness of the IF bandwidths, there can be a range of frequencies that yield the same peak amplitude. Thus, each time the tracking is adjusted, the resulting adjustment values may vary.

The tracking adjustment range is ± 500 Hz. Adjustments are typically made in resolution bandwidths less than 300 Hz. Typically, at resolution bandwidths greater than 300 Hz, tracking is unnecessary. Resolution bandwidths greater than 2 kHz do not require tracking. In fact, if the resolution bandwidth is greater than 2 kHz and automatic tracking is activated, "Tracking not required" appears on the display.

TRACKING ADJUST allows you to manually adjust the output frequency of the tracking generator to maximize the amplitude of the active trace.

TRACKING PEAK automatically adjusts the output frequency of the tracking generator to maximize the amplitude of the active trace.

Tracking Adjust

The ◀TRACKNG ADJUST▶ softkey allows you to manually adjust the output frequency of the 21.4 MHz oscillator in the tracking generator. During tracking, the tracking generator is tuned to maximize the amplitude of the active trace.

The ◀TRACKNG ADJUST▶ is instrument preset to 0 Hz.



Tracking adjustments are used for resolution bandwidths less than 2 kHz; they are typically necessary for resolution bandwidths less than 300 Hz only. Resolution bandwidths greater than 2 kHz do not require ◀TRACKNG ADJUST▶.

Placing ◀SRC OSC INT EXT▶ in the external mode disables the ◀TRACKNG ADJUST▶ and ◀TRACKNG PEAK▶ softkeys. Pressing either of these tracking adjustment softkeys will produce an error message.

Once the instrument has warmed up and the tracking has been adjusted, the source tracking does not need to be re-adjusted. If the resolution bandwidth is changed, tracking adjustments should be repeated.

Use ◀TRACKNG PEAK▶ instead of ◀TRACKNG ADJUST▶ for most applications.

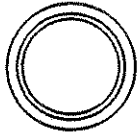
The three methods of setting the tracking adjust are shown below.

| | |
|--|--|
| <p>KNOB</p>  | <p>The knob adjusts the tracking continuously between ± 500 Hz with 1 Hz resolution.</p> |
| <p>STEP KEYS</p>  | <p>The step keys change the tracking in increments of 10 Hz between ± 500 Hz.</p> |
| <p>KEY PAD</p>  | <p>The keypad directly enters tracking adjustment values between ± 500 Hz with 1 Hz resolution.</p> |

Example: Adjust tracking to maximize the amplitude of the active trace.

Connect the RF OUTPUT on the tracking generator to the RF INPUT on the front end module. (Include connectors and adapters that will allow the DUT to be inserted easily.)

Press [MENU], ◀MEASURE MODE▶, and then ◀STIMULS RESPNS▶.

Press the backspace key and ◀SOURCE▶, and turn on ◀SRC PWR ON OFF▶.

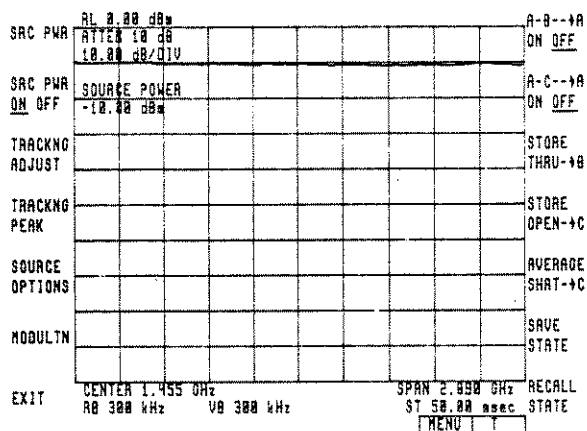

Figure 1-58.

Press [USER] and then ◀RES BW▶.

Select a narrow bandwidth to achieve higher dynamic range. For example, change the resolution bandwidth to 300 Hz. (The video bandwidth changes automatically with the resolution bandwidth.)

◀TRACKNG ADJUST▶ is used for bandwidths less than 2 kHz.

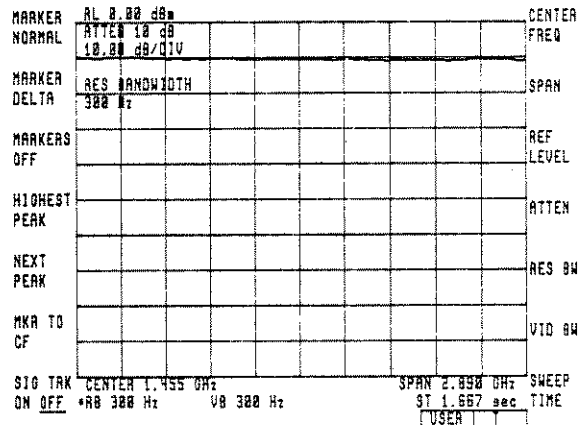

Figure 1-59.

Press the backspace key and then ◀TRACKNG ADJUST▶.

Press the step keys and observe the trace. Determine where the trace peaks, then use the knob to maximize the amplitude of the active trace.

Due to the relative flatness of the IF bandwidths, there can be a range of frequencies that yield the same peak amplitude. Thus, each time tracking is adjusted, the resulting adjustment values may vary.

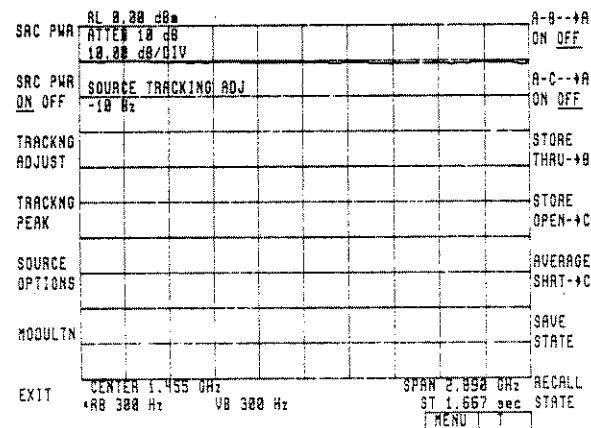

Figure 1-60.

Tracking Peak (Automatic Tracking)

The automatic tracking function, tracking peak, maximizes the amplitude of the active trace. During tracking, the frequency of the 21.4 MHz oscillator in the tracking generator is tuned so that the RF OUTPUT precisely tracks the spectrum analyzer. Automatic tracking changes analyzer settings (described below), but these settings are restored at completion.

Press ◀TRACKNG PEAK▶ and "Automatic tracking" appears on the screen. Then, the system searches for a marker. If no marker is present, automatic tracking places a marker at the center frequency. This marker is used by ◀TRACKING PEAK▶ to find the highest amplitude. The marker can be placed at another point on your trace (rather than at center frequency) by using ◀MARKER NORMAL▶. For example, the marker could be placed at a peak on the active trace and automatic tracking will move the marker to the center frequency.

Once a marker has been positioned, the system changes to zero span and reads the current resolution bandwidth value. As with ◀TRACKNG ADJUST▶, if the resolution bandwidth is greater than 2 kHz, tracking adjustments are not required and "Tracking not required" appears. (At wider bandwidths, since the adjustment range is small in comparison, tracking is not required.)

If the resolution bandwidth is less than 2 kHz, the sweep time and trace length are altered automatically to maximize the tracking adjustment speed. When the system has found the highest amplitude, "Automatic Tracking Completed" appears. At this time, your original trace length, sweep time, and span values are recalled. All markers are turned off at the completion of automatic tracking.

Hints:

1. If the RF OUTPUT is not connected to the RF INPUT, "no peak found" appears after approximately one minute. If you press [I-P] during automatic tracking, the current instrument settings will be lost unless they have been saved in a state register.

"Tracking not required" will appear if the tracking generator is turned off. Press ◀SRC PWR ON OFF▶ to turn on the tracking generator. (The underline moves to the on position.)

2. Do not press any softkeys until "Automatic Tracking Completed" appears. This message appears in approximately five seconds to one minute. If you press a softkey during tracking, that function will be executed immediately upon completion of automatic tracking.
3. Although ◀TRACKING PEAK▶ is normally used with a thru connection, you can insert a DUT in the signal path.
4. Measuring high insertion-loss devices may require adjusting the reference level prior to tracking.

Example: Use **◀TRACKING PEAK▶** to maximize the amplitude of the active trace.

Connect the RF OUTPUT on the tracking generator to the RF INPUT on the RF module.

Press [MENU], **◀MEASURE MODE▶**, and then **◀STIMULS RESPON▶**.

Set the resolution bandwidth by pressing [USER] and **◀RES BW▶**; then enter 300 Hz.

Press [MENU] and **◀SOURCE▶**, and turn on the tracking generator by pressing **◀SRC PWR ON OFF▶**. The underline toggles to the on position.

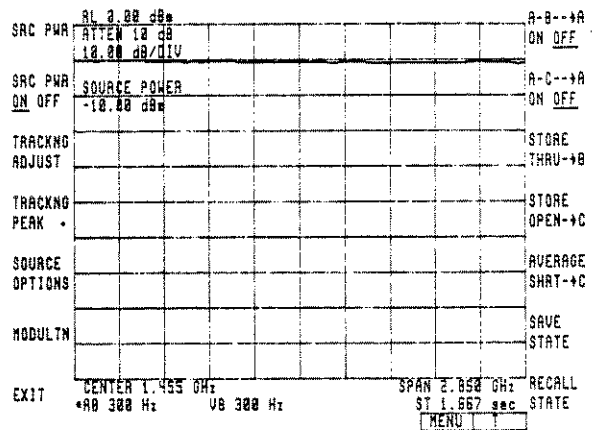

Figure 1-61.

Press **◀TRACKNG PEAK▶**.

Wait until "Automatic Tracking Completed" appears. (Automatic tracking usually takes five seconds to one minute, depending on the bandwidth and the amount the system is mistracked.) If you press a softkey during peaking, that function will be executed immediately upon completion of automatic tracking.

Due to the relative flatness of the IF bandwidths, there can be more than one frequency at which the amplitude peaks. Thus, each time automatic tracking is used, the resulting adjustment values may vary.

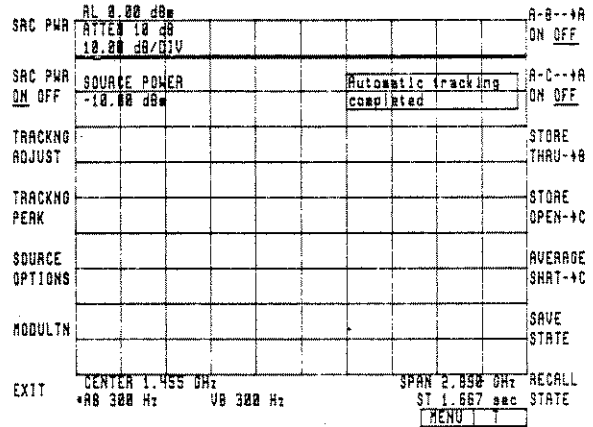

Figure 1-62.

Source Options

The **◀SOURCE OPTIONS▶** softkey calls up a variety of source softkeys as shown in Figure 1-63 below.

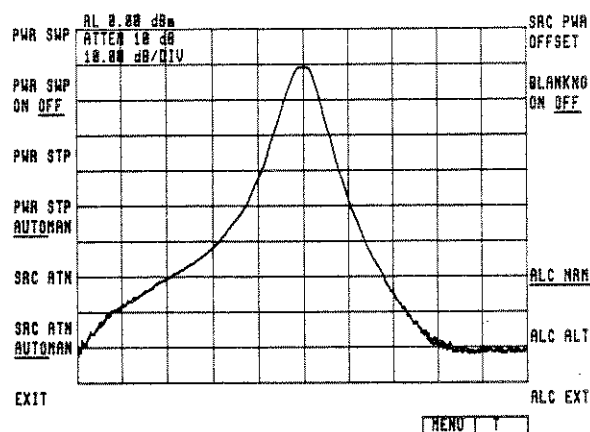

Figure 1-63. SOURCE OPTIONS Softkeys

Overview

Many of the softkeys on the SOURCE OPTIONS screen (**◀PWR SWP▶**, **◀PWR SWP AUTOMAN▶**, **◀SRC ATN▶**, **◀SRC ATN AUTOMAN▶**, and **◀SRC PWR OFFSET▶**) control the power of the tracking generator. These softkeys are described in the *Source: Power Control* section.

The remaining SOURCE OPTIONS softkeys are discussed in this section. Each of these keys is briefly described below.

BLANKING ON OFF (when on) reduces the output power of the source to a low level during retrace. *When measuring power sensitive devices, turn this function ON.*

ALC NORMAL connects the automatic level control to the normal internal detector. The normal detector is active in the instrument preset state.

ALC ALTERNATE connects the automatic level control to an alternate internal detector.

ALC EXTERNAL connects the automatic level control of the source to an external detector.

Blanking

The ◀BLANKNG ON OFF▶ softkey (when on) reduces the output power of the tracking generator. Otherwise, in certain span and center frequency combinations, a power spike of + 5 dBm can occur.

CAUTION!

When you measure devices sensitive to a power of + 5dBm, TURN BLANKING ON!

Blanking is turned OFF (◀BLANKNG ON OFF ▶) in the instrument preset state.

Automatic Level Control

The automatic level control of the source is set with three softkeys: ◀ALC NRM▶, ◀ALC ALT▶, and ◀ALC EXT▶. These softkeys are described below.

◀ALC NRM▶ connects the automatic level control to the normal internal detector. The normal detector is active in the instrument preset state. The normal internal detector at the tracking generator RF OUTPUT is normally used for measurements between 10 MHz and 2.9 GHz.

◀ALC ALT▶ connects the automatic level control to an alternate internal detector. The alternate detector at the internal 3.6 GHz amplifier is typically used for measurements between 20 Hz and 10 MHz. The alternate detector can be used above 10 MHz, but the output flatness is better with normal detection. Accurate measurements can be made with the alternate detector by normalizing. Choose the alternate detector for wideband applications (for example, 1 kHz to 100 MHz).

◀ALC EXT▶ connects the automatic level control to an external negative detector (0 to 100 millivolts). An external detector can be used, for example, to level at the output of an amplifier or splitter. With external detectors, use the "ALC EXT INPUT" connector on the front panel of the tracking generator.

Activate an ALC mode by pressing the desired softkey. The active mode is underlined. (See the following example.)

Example: Using the alternate detector.

In this example, the start frequency is set to 100 kHz and the stop frequency to 100 MHz.

If the start frequency is less than 10 MHz in normal detection mode, an "Output unlevelled" error may appear on the display, as in Figure 1-64.

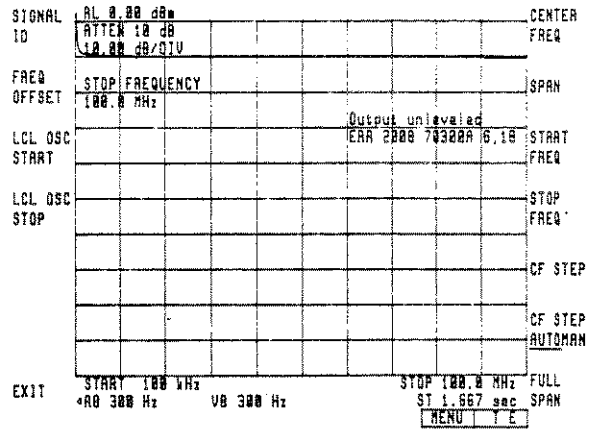

Figure 1-64.

The alternate detector can be used.

To activate this detector, press **◀SOURCE▶**, **◀SOURCE OPTIONS▶**, and **◀ALC ALT▶**.

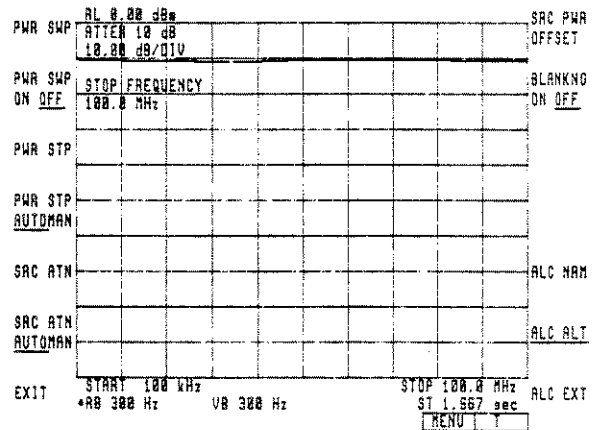

Figure 1-65.

Modulation

The MODULATION softkeys control the modulation of the tracking generator's output and select the tracking generator oscillator.

Press **◀MODULTN▶** and the MODULATION softkeys appear as shown in Figure 1-66 below.

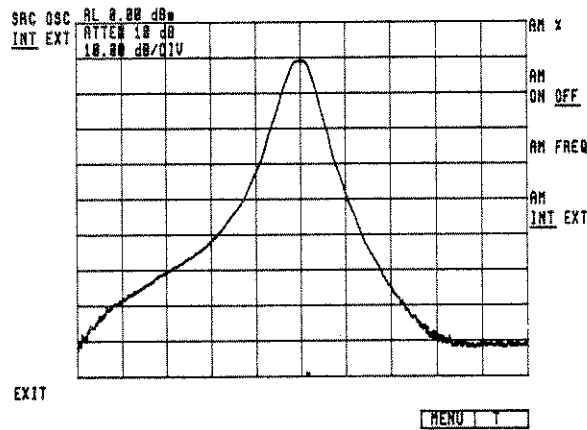

Figure 1-66. The MODULATION Softkeys

Overview

The MODULATION softkeys are briefly described below. See the following pages for detailed descriptions.

AM PERCENT sets the amplitude modulation percentage (depth).

AM ON OFF turns the amplitude modulation on and off.

AM FREQUENCY selects the internal amplitude modulation frequency: 1 kHz or 400 Hz.

AM INTERNAL/EXTERNAL selects the amplitude modulation input. External modulation and internal continuous-wave modulation are available.



SOURCE OSCILLATOR INTERNAL/EXTERNAL selects the 21.4 MHz source oscillator, either internal or external.

AM Percentage

The amplitude modulation percentage (depth) of the source is set and controlled with the ◀AM %▶ and ◀AM ON OFF▶ softkeys.

To enter a percent value, press ◀AM %▶ and use the keypad. ◀AM ON OFF▶ automatically moves to the ON position. If turned on with ◀AM ON OFF▶, the amplitude modulation is set to the current amplitude modulation depth.

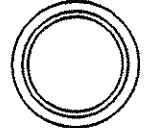
The three methods of setting the amplitude percentage (depth) are shown:

| | |
|--|---|
| <p>KNOB</p>  | <p>The knob adjusts the amplitude modulation percentages continuously between 0 and 100%.</p> |
| <p>STEP KEYS</p>  | <p>The step keys change the amplitude modulation percentage in increments of 10 %.</p> |
| <p>KEY PAD</p>  | <p>The keypad directly enters percent values between 0 and 100%. Entering any non-zero value turns amplitude modulation on.</p> |

AM Frequency

Select the internal amplitude modulation frequency with the ◀AM FREQ▶ softkey. Selections are limited to 1 kHz and 400 Hz. The instrument preset amplitude modulation frequency is 1 kHz. If you enter a frequency other than 1 kHz or 400 Hz, the instrument defaults to the nearest value.

AM Internal/External

Select the amplitude modulation input with the ◀AM INT EXT▶ softkey. The INTERNAL continuous wave modulation input is the instrument preset condition.

If frequencies other than 1 kHz or 400 Hz are needed, an EXTERNAL oscillator can be used. For example, in an AM receiver application requiring 10 kHz modulation, a function generator can be used.

Source Oscillator Internal/External

Select the 21.4 MHz source oscillator for the tracking generator with the ◀SRC OSC INT EXT▶ softkey. The INTERNAL source oscillator is active in the instrument preset state. With external source oscillation, the tracking generator output may be offset up to ± 10 MHz. A modulated external 21.4 MHz source will put modulation on the RF OUTPUT of the tracking generator. (With external oscillators, tracking adjustments are not functional.)

TRACKING GENERATOR REMOTE OPERATION

Introduction

This section, *Remote Operation*, categorizes tracking generator commands and provides some examples of their usage. (Individual tracking generator commands are described in detail in the HP 71000 Language Reference.)

Organization of This Section

Set-up for Remote Operation lists the suggested equipment for remote operation and describes the HP-IB and HP-MSIB addressing scheme. A short procedure that demonstrates communication between the analyzer and computer is provided.

Tracking Generator Remote Commands shows the relationship between the HP 70300A soft-keys and their corresponding remote commands. In addition, commands are summarized by function.

Tracking Generator Program Examples describes several tracking generator programs in order of increasing complexity. Refer to *Remote Operation* in the HP 71000 Operating Manual for an introduction to spectrum analyzer programming.

HP 71000 Documentation

Other HP 71000 documentation covers remote operation:

The HP 71000 Language Reference lists the HP 71000 Modular Spectrum Analyzer remote commands. Commands appear in alphabetical order, each with a description that contains a syntax flow chart and a definition of command parameters.

The HP 71000 Operating Manual Part II: Remote Operation introduces HP 71000 Spectrum Analyzer programming. Programming concepts are discussed in levels of increasing complexity in "Programming Fundamentals" and "Advanced Programming." Refer to *Remote Operation* for an introduction to spectrum analyzer programming.

The HP 71000 Operating Manual Part III: Display Operation describes remote operation of the HP 70205A and 70206A Displays. (See "Remote Display Operation.")

Setup for Remote Operation

Suggested Equipment

The following equipment was used to run the programs in this chapter:

- HP 71100A or HP 71200A with the HP 70206A Graphics Display
- HP 70300A
- HP 9836, 9826, 9817, 9816 Computer, or equivalent
- Cables
- Connectors
- Device for Testing (A filter is used in this chapter.)

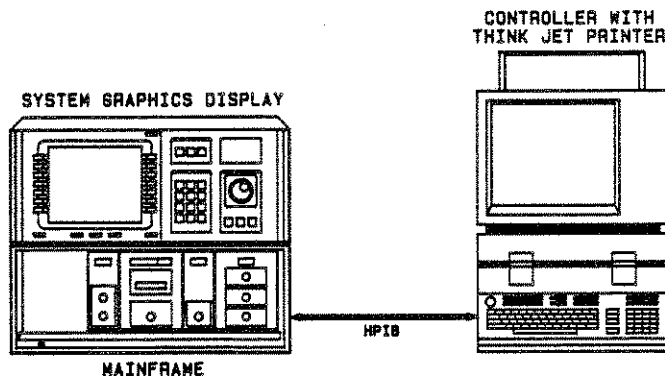

Figure 1-67. Typical Equipment Configuration for Remote Operation

HP-IB Address

For remote operation, the Hewlett-Packard Interface Bus (HP-IB) address must be set properly. Check the HP-IB address by pressing [DSP], ◀ADDRESS MAP▶, and then rotating the knob until the HP 70900A Local Oscillator (or controller) appears. The HP-IB instrument address will appear in the cursor box with the LO. (See Figure 1-68.)

The HP-IB address is formed by combining the interface select code (7) with the instrument address (18 in this case). The HP-IB address in this example, 718, will be used throughout this chapter. If the HP-IB address of your instrument is different, substitute the appropriate value in all examples.

Note: The System Support Manual is the primary user reference for addressing modules.

| | | | | |
|---|----|-------------------------------|----|----|
| 7 | | | | |
| 6 | | 70300A
AF Trck 0 | | |
| 5 | | | | |
| 4 | | 70304A
AF SECT | | |
| 3 | | | | |
| 2 | | | | |
| 1 | | 70302A
IF SECT | | |
| 0 | | 70300A
Lo/Clif
HP-IB 18 | | |
| | 17 | 18 | 19 | 20 |

COLUMN

Figure 1-68.

Check-Out Procedure

To verify that the HP-IB connections and interface are functional, perform the following procedure:

1. Press [RESET] on the computer.
2. Type "OUTPUT 718"
3. Press [EXECUTE].

If the system is functional, the RMT (remote) indicator on the local oscillator will turn on. If the light does not turn on, check the power cables and HP-IB cables.

Tracking Generator Remote Commands

Remote operation of the tracking generator is similar to manual operation. Remote measurements are executed with commands that correspond to the front panel softkeys.

The relationship between tracking generator softkeys and remote commands is shown in Figure 1-69. Since this figure contains all of the manual and remote commands, it is a helpful reference.

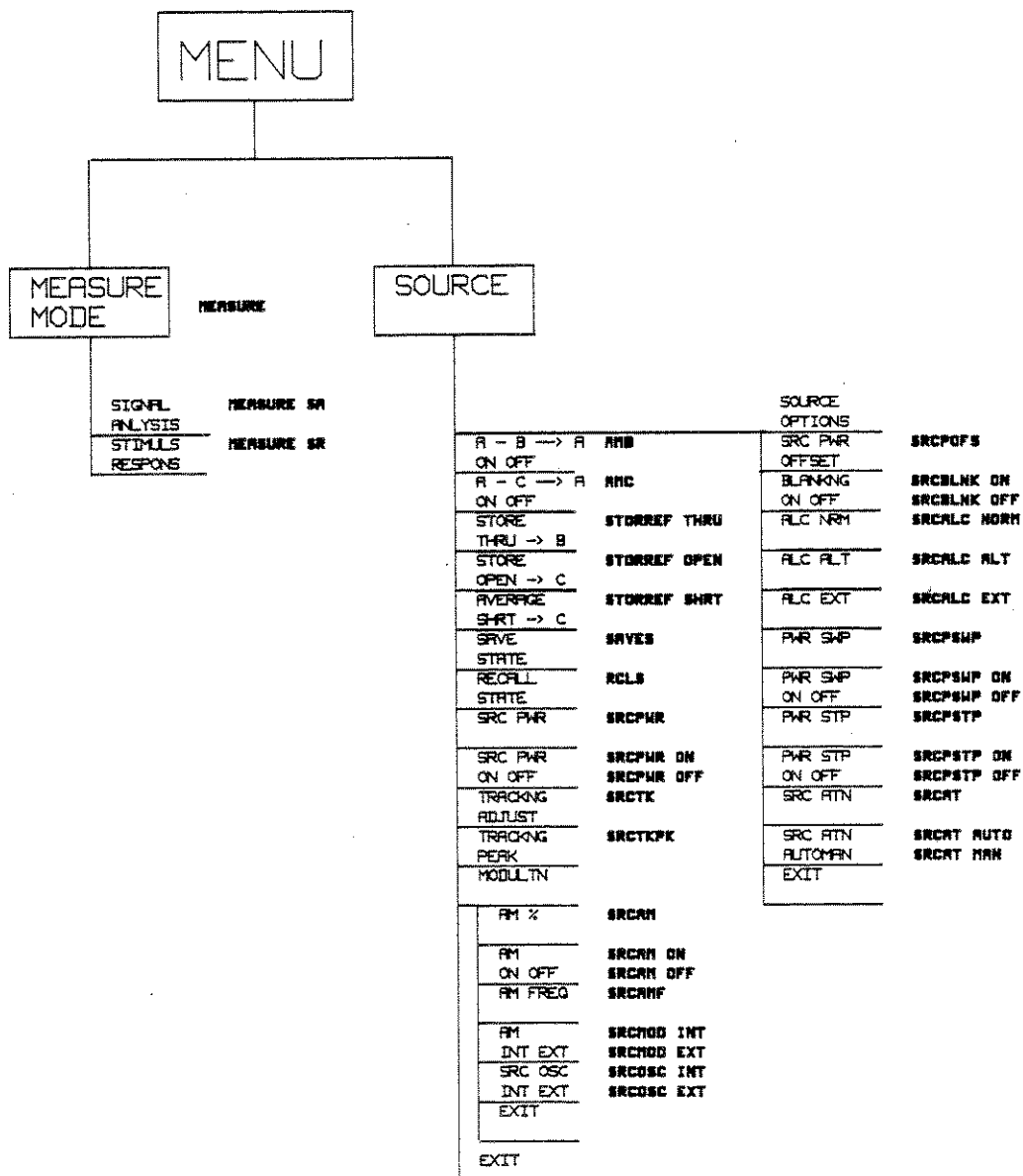

Figure 1-69. HP 70300A Softkeys and Corresponding Remote Commands

Command Summary

The command summary below categorizes the HP 70300A commands by type of function. These commands are also listed in the index. As a mnemonic aid, the majority of tracking generator commands begins with the prefix SRC (SOURCE). (A detailed description of each command is provided in the HP 71000 Language Reference which lists commands alphabetically.)

Power Level Controls

| | |
|---------|---|
| MIL | Maximum input level |
| SRCPWR | Source power level |
| SRCPOFS | Source power offset |
| SRCPSWP | Source power sweep |
| SRCPSTP | Source power step |
| SRCALC | Source automatic level control (normal, alternate, or external) |

Frequency Controls

| | |
|---------|--|
| SRCTK | Source tracking adjustment |
| SRCTKPK | Source automatic tracking peak |
| SRCOSC | Source oscillator (internal or external) |

Modulation Controls

| | |
|--------|--|
| SRCAM | Source amplitude modulation |
| SRCAMF | Source amplitude modulation frequency |
| SRCMOD | Source modulation (internal or external) |

Other controls

| | |
|----------|--|
| MEASURE | Measurement mode: spectrum analysis or stimulus response |
| STORREF | Store reference (thru, open, or short) |
| SRCBLANK | Source RF blanking |
| SRCAT | Source attenuator |

Tracking Generator Programs

This section introduces you to the commands and programming capabilities of the HP 70300A by walking you through several remote programs.

1. *Transmission Measurement* makes a normalized transmission measurement.
2. *Reflection Measurement* makes a normalized reflection measurement.
3. *3 dB Bandwidth* measures the 3 dB bandwidth of a bandpass filter.
4. *3 dB Bandwidth Softkey: Downloadable Program* discusses downloadable programs written for the 3 dB bandwidth program.
5. *Full Dynamic Range* displays 150 dB of dynamic range on the display at one time.

Programming Guidelines

1. Since remote operation imitates manual operation, review the examples in the previous *Softkeys* section.
2. Before trying the programs in this section, refer to the HP 71000 Operating Manual Remote Operation section.
3. Follow the suggestions provided in the previous section, "Setup for Remote Operation."

Tracking Generator Programming Basics

Most HP 70300A Tracking Generator programs contain several common statements. These statements address the spectrum analyzer, preset the analyzer, turn on the tracking generator, and prepare the system to make stimulus-response measurements. We can, for example, write a short program that executes only these "basic" statements.

The first line of our basic tracking generator program assigns an I/O path called @Sa to our spectrum analyzer at address 718. The HP BASIC "CLEAR" command in the second line resets the analyzer on HP-IB. The third line sets the instrument preset state. The IP command corresponds to the [I-P] key on the front of the display. Then, SNGLS activates single sweep mode to control the sweep, and a sweep is taken. (To reduce program-execution time and to ensure complete calibration-trace storage, TS is used to initiate a sweep only when a sweep is necessary. For example, TS is used before a thru trace is stored.)

Next, the tracking generator power is turned on with the SRCPWR command. (The SRCPWR command corresponds to the ◀SRC PWR ON OFF▶ softkey.) Using the MEASURE SR command, the fifth line activates stimulus-response measurement mode. (The MEASURE command corresponds to the ◀MEASURE MODE▶ softkey, and SR corresponds to ◀STIMULS RESPONDS▶.) Last, we return the instrument to local control and end the program.

```

10 ASSIGN @Sa TO 718
20 CLEAR @Sa
30 OUTPUT @Sa;"IP;SNGLS;TS;"
40 OUTPUT @Sa;"SRCPWR ON;"
50 OUTPUT @Sa;"MEASURE SR;"
60 OUTPUT @Sa;"TS;"
70 LOCAL 7
80 END

```

As you try the programs in the remainder of this section, you will recognize these basic statements. The statements are rearranged and other statements are added as the programs become more sophisticated.

Program 1: Transmission Measurement

Introduction

This program guides an operator through one method of storing thru calibration data, which is then used to make a normalized transmission measurement. The program imitates manual operation of the "Transmission Measurement" example in the *Typical Measurements* section.

Program Explanation

The first segment of the program initializes the analyzer. Line 30 addresses the spectrum analyzer at address 718. (Your instrument address may differ.) The CLEAR command on line 40 resets the analyzer on HP-IB. Then, line 50 sets the instrument preset conditions, activates single sweep mode to control the sweep, and takes a sweep. (To reduce program-execution time and ensure complete data storage, TS is used to initiate a sweep only before a trace is stored.) The DISPOSE ALL command in line 60 clears spectrum analyzer memory and CLRDSP in line 70 removes all previous user graphics from the display. (If you do not want your analyzer's memory cleared, omit the DISPOSE ALL command.)

In the second segment of the program, the VARDEF commands define KEYA and KEYB variables, which are used later (in lines 240 and 340) to create ◀CONT▶ (continue) softkeys.

The third program segment sets analyzer parameters for a stimulus-response measurement by setting the measurement mode to stimulus-response and turning on the tracking generator.

The fourth segment sets the analyzer parameters. Lines 150 and 160 set center frequency for the device under test (DUT) and narrow the span. Line 170 selects a resolution bandwidth to optimize the dynamic range of the displayed response while maintaining a fast sweep time. (Select a wider resolution bandwidth if you are using the HP 70203A IF module.) This example looks at the transmission characteristics of a 321.4 MHz bandpass filter. Different DUTs will require different analyzer settings.

The fifth program segment stores the thru calibration data. Lines 210 through 240 instruct the operator to make the thru connection. (The RF OUTPUT on the tracking generator is connected to the RF INPUT on the RF module.) Once the thru connection has been made, the operator presses ◀CONT▶ to resume program operation. Line 250 removes instructions from the display. Line 260 takes a sweep to ensure that the trace data to be stored is complete. Then, line 270 uses the STORREF (store reference) command to store the THRU calibration in trace B. Line 280 then activates the AMB (trace A minus trace B) command which later subtracts the thru calibration data from the measurement data.

The last program segment completes the transmission measurement. Lines 310 through 340 instruct the operator to insert the device into the thru path and press **◀CONT▶** to resume program operation. Then, lines 350 and 360 erase instructions from the display and take a sweep. Once the last sweep has been made, the normalized transmission measurement appears in trace A (see Figure 1-70). "Measurement complete" is written on the display and LOCAL 7 returns the instrument to local control.

Running the Program:

1. Clear the computer's memory. (In many computers, the "SCRATCH" command is used.)
2. Type in the program as shown. Modify the analyzer parameters for the DUT to be tested.
3. Press [RUN] on the computer. Follow instructions as they appear on the instrument display.
4. The normalized transmission measurement appears on the display screen.

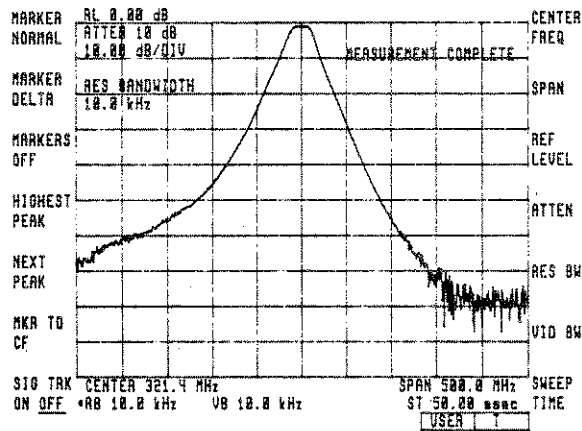

Figure 1-70. Normalized Transmission Measurement.

```

10  !TRANSMISSION MEASUREMENT FILE: TRANS
20  !THE FOLLOWING FIVE LINES INITIALIZE THE ANALYZER.
30  ASSIGN @Sa TO 718
40  CLEAR @Sa
50  OUTPUT @Sa;"IP;SNGLS;TS;"
60  OUTPUT @Sa;"DISPOSE ALL;"
70  OUTPUT @Sa;"CLRDSP;"
80  !DEFINE VARIABLE SOFTKEYS USED LATER IN THE PROGRAM.
90  OUTPUT @Sa;"VARDEF KEYA,0;"
100 OUTPUT @Sa;"VARDEF KEYB,0;"
110 !PREPARE THE INSTRUMENT FOR STIMULUS-RESPONSE MEASUREMENTS.
120 OUTPUT @Sa;"MEASURE SR;" !select stimulus-response mode
130 OUTPUT @Sa;"SRCPWR ON;" !turn on the tracking generator
140 !SET ANALYZER PARAMETERS TO MEASURE A 321.4MHZ BANDPASS FILTER.
150 OUTPUT @Sa;"CF 321.4MHZ;"
160 OUTPUT @Sa;"SP 500MHZ;"
170 OUTPUT @Sa;"RB 10KHZ;"
180 !INSTRUCT OPERATOR TO MAKE A THROUGH CONNECTION, THEN PRESS CONT.
190 !THE THROUGH IS STORED IN TRACE B WITH THE STORREF COMMAND AND THE
200 !AMB (TRACE A MINUS TRACE B) COMMAND IS ACTIVATED.
210 OUTPUT @Sa;"IT 0;OR 280,955;"
220 OUTPUT @Sa;"TEXT %CONNECT RF OUT TO RF IN, THEN"
230 OUTPUT @Sa;"PRESS CONT (NO DEVICE IN PATH)%;"
240 OUTPUT @Sa;"READMENU KEYA,1,%CONT%;"
250 OUTPUT @Sa;"CLRDSP;"
260 OUTPUT @Sa;"TS;" !update trace before storing data
270 OUTPUT @Sa;"STORREF THRU;" !store the thru calibration data
280 OUTPUT @Sa;"AMB ON;" !subtract thru trace from active
290 !INSTRUCT THE OPERATOR TO INSERT THE DEVICE, THEN PRESS CONT.
300 !THE NORMALIZED TRANSMISSION MEASUREMENT WILL APPEAR.
310 OUTPUT @Sa;"IT 0;OR 280,900;"
320 OUTPUT @Sa;"TEXT%FOR TRANSMISSION MEASUREMENT"
330 OUTPUT @Sa;"INSERT DEVICE, PRESS CONT%;"
340 OUTPUT @Sa;"READMENU KEYB,1,%CONT%;"
350 OUTPUT @Sa;"CLRDSP;"
360 OUTPUT @Sa;"TS;" !update trace to show device
370 OUTPUT @Sa;"IT 0;OR 600,860;"
380 OUTPUT @Sa;"TEXT%MEASUREMENT COMPLETE%;WAIT 1S;CLRDSP;"
390 LOCAL 7
400 END

```

Program 2: Reflection Measurement

Introduction

This program guides an operator through one method of storing reflection calibration data (an open/short average), which is then used to make a normalized, scalar-reflection measurement. The program imitates the manual operation of the `◀AVERAGE SHRT -> C▶` example in *Softkeys*.

Program Explanation

The first segment of the program initializes the analyzer. Line 30 addresses the spectrum analyzer at address 718. (Your instrument address may differ.) The CLEAR command on line 40 resets the analyzer on HP-IB. Then, line 50 sets the instrument preset conditions, activates single sweep mode to control the sweep, and takes a sweep. (To reduce program-execution time and ensure complete data storage, TS initiates a sweep only before a trace is stored.) The DISPOSE ALL command in line 60 clears spectrum analyzer memory and the CLRDSP in line 70 removes all previous user graphics from the display. (If you do not want your analyzer's memory cleared, omit the DISPOSE ALL command.)

In the second segment of the program, the VARDEF command defines KEYA, KEYB, and KEYC variables, which are used later (in lines 230, 320, and 410) to create `◀CONT▶` (continue) softkeys.

The third program segment sets analyzer parameters for a stimulus-response measurement by selecting stimulus-response measurement mode and turning on the tracking generator.

In the fourth segment, line 160 sets the center frequency for the DUT and line 170 narrows the span. A resolution bandwidth is selected in line 180 to optimize dynamic range of the displayed response, while maintaining a fast sweep time. This example tests a 321.4 MHz bandpass filter. Different DUTs will require different analyzer settings.

The fifth program segment stores the open-circuit trace data. Lines 200 through 230 instruct the operator to connect a directional bridge or coupler. Connect the bridge or coupler to the RF OUTPUT on the tracking generator and to the RF INPUT on the RF module. Then connect the open-circuit to the bridge and press `◀CONT▶` to resume program operation. Line 240 removes instructions from the display and line 250 takes a sweep to ensure that the trace data to be stored is complete. Line 260 then uses the STORREF (store reference) command to store the open-circuit trace data in trace C.

The next segment averages the short-circuit trace data with the open-circuit trace data. Lines 290 through 320 instruct the operator to connect the short-circuit to the bridge or coupler and press `◀CONT▶` to resume program operation. In lines 330 and 340, instructions are removed from the display and a sweep is taken to update the trace. Line 350 uses the STORREF command to average the open data (trace C) with the short data (trace A) and store the resulting open/short average in trace C. Then, line 360 turns on the AMC (trace A minus trace C) command, which later subtracts the OPEN/SHORT average calibration data (trace C) from measurement data (trace A) and displays the normalized measurement on trace A.

The last segment completes the reflection measurement. Lines 380 through 410 instruct the operator to connect the device to the bridge or coupler and press `◀CONT▶` to resume program operation. Again, instructions are removed from the screen and the trace is updated. On line 430 the last sweep is taken and the normalized reflection measurement appears on the display (see Figure 1-71). "Measurement complete" is written on the display and LOCAL 7 returns the instrument to local control.

Running the Program:

1. Clear the computer's memory. (In many computers, the "SCRATCH" command is used.)
2. Type in the program as shown. Modify the analyzer parameters for your device.
3. Press [RUN] on the computer. Follow instructions as they appear on the instrument display.
4. The normalized reflection measurement appears on the display screen.

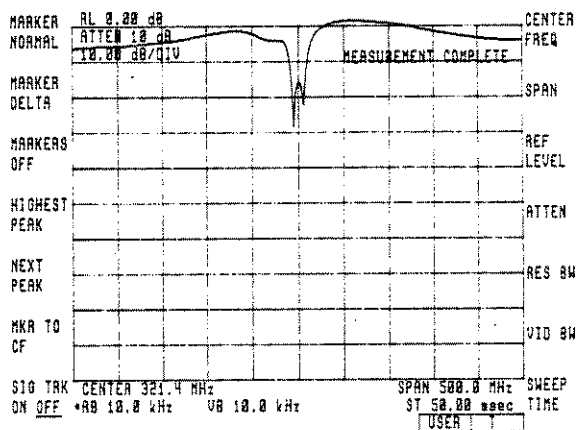

Figure 1-71.

```
10  !REFLECTION MEASUREMENT      FILE: REFL
20  !THE FOLLOWING FIVE LINES INITIALIZE THE ANALYZER.
30  ASSIGN @Sa TO 718
40  CLEAR @Sa
50  OUTPUT @Sa;"IP;SNGLS;TS;"
60  OUTPUT @Sa;"DISPOSE ALL;"
70  OUTPUT @Sa;"CLR DSP;"
80  !DEFINE VARIABLE SOFTKEYS THAT WILL BE USED IN THE PROGRAM.
90  OUTPUT @Sa;"VARDEF KEYA,0;"
100 OUTPUT @Sa;"VARDEF KEYB,0;"
110 OUTPUT @Sa;"VARDEF KEYC,0;"
120 !PREPARE THE INSTRUMENT FOR STIMULUS-RESPONSE MEASUREMENTS.
130 OUTPUT @Sa;"MEASURE SR;"           !select stimulus-response mode
140 OUTPUT @Sa;"SRCPWR ON;"           !turn on the tracking generator
150 !SET ANALYZER PARAMETERS TO MEASURE A 321.4MHZ BANDPASS FILTER.
160 OUTPUT @Sa;"CF 321.4MHZ;"
170 OUTPUT @Sa;"SP 500MHZ;"
180 OUTPUT @Sa;"RB 10KHZ;"
190 !INSTRUCT OPERATOR TO MAKE OPEN CONNECTION, CONT RESUMES OPERATION.
200 OUTPUT @Sa;"IT 0;OR 280,955;"
210 OUTPUT @Sa;"TEXT %CONNECT BRIDGE TO RF IN AND TO RF OUT"
220 OUTPUT @Sa;"CONNECT OPEN TO BRIDGE, THEN PRESS CONT%;"
230 OUTPUT @Sa;"READMENU KEYA,1,%CONT%;"
240 OUTPUT @Sa;"CLR DSP;"
250 OUTPUT @Sa;"TS;"                   !update trace before storing data
260 OUTPUT @Sa;"STORREF OPEN;"         !store the open in trace C
270 !INSTRUCT OPERATOR TO MAKE SHORT CONNECTION, CONT RESUMES OPERATION.
280 !THE AMC COMMAND (TRACE A MINUS TRACE C) IS ACTIVATED.
290 OUTPUT @Sa;"IT 0;OR 280,955;"
300 OUTPUT @Sa;"TEXT %DISCONNECT OPEN, CONNECT SHORT"
310 OUTPUT @Sa;"TO BRIDGE, PRESS CONT%;"
320 OUTPUT @Sa;"READMENU KEYB,1,%CONT%;"
330 OUTPUT @Sa;"CLR DSP;"
340 OUTPUT @Sa;"TS;"                   !update trace before storing data
350 OUTPUT @Sa;"STORREF SHORT;"        !average the short with the open
360 OUTPUT @Sa;"AMC ON;"               !subtrace trace C from active trace
370 !INSTRUCT OPERATOR TO CONNECT THE DEVICE TO BE TESTED.
380 OUTPUT @Sa;"IT 0;OR 280,900;"
390 OUTPUT @Sa;"TEXT %FOR REFLECTION MEASUREMENT"
400 OUTPUT @Sa;"CONNECT DEVICE, PRESS CONT%;"
410 OUTPUT @Sa;"READMENU KEYC,1,%CONT%;"
420 OUTPUT @Sa;"CLR DSP;"
430 OUTPUT @Sa;"TS;"                   !update trace to show device
440 OUTPUT @Sa;"IT 0;OR 600,860;"
450 OUTPUT @Sa;"TEXT%MEASUREMENT COMPLETE%;WAIT 1S;CLR DSP;"
460 LOCAL 7
470 END
```

Program 3: 3 dB Bandwidth

Introduction

The following program demonstrates one technique for finding the 3 dB bandwidth of a bandpass filter. This example modifies the transmission measurement program and adds several lines to make 3 dB bandwidth measurements.

Program Explanation

Lines 10 through 380 are copied from the transmission program and then modified as follows. First, on line 160, the span is narrowed to 50 MHz so that only the top portion of the filter is viewed. An optional sweep is taken on line 180 to update the trace. Then, on line 280, the automatic tracking peak function is added to maximize the displayed amplitude. (Automatic tracking is used for resolution bandwidths less than 2 kHz. Since we are viewing only the top of the filter and only minimal dynamic range is required, we could select a wider resolution bandwidth and omit automatic tracking.) Finally, a sweep is taken on line 280 to ensure that the trace data to be stored is complete.

The sixth segment of the program completes the transmission measurement. In lines 330 through 360 the program instructs the operator to insert the device. Once **◀CONT▶** has been pressed, line 370 erases text from the display and line 380 takes a sweep to update trace data.

The last segment makes the 3 dB bandwidth measurement. Line 400 removes all previously-set markers from the display. Then, lines 410 and 420 place markers at the right and left -3 dB points using the MKAR (marker amplitude relative right) and MKAL (marker amplitude relative left) commands. The MKBW (marker bandwidth) function is turned on in line 430. Using the amplitude markers, the bandwidth function finds the 3 dB bandwidth and presents the bandwidth value on the display. LOCAL 7 returns the instrument to local control.

Running the Program:

1. Clear the computer's memory. (In many computers, the "SCRATCH" command is used.)
2. Type in the program as shown.
3. Press [RUN] on the computer and follow instructions as they appear on the display screen.

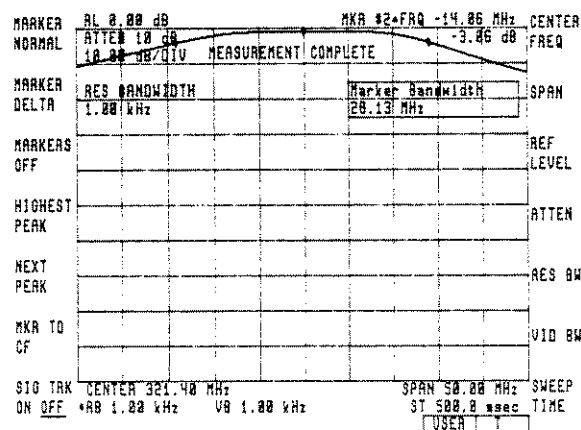

Figure 1-72.

Program 3: 3 dB Bandwidth

```

10      13 DB BANDWIDTH MEASUREMENT          FILE:  BWMEAS
20      !THE FOLLOWING FIVE LINES INITIALIZE THE ANALYZER.
30      ASSIGN @Sa TO 718
40      CLEAR @Sa
50      OUTPUT @Sa;"IF;SNGLS;TS;"
60      OUTPUT @Sa;"DISPOSE ALL;"
70      OUTPUT @Sa;"CLRDSP;"
80      !DEFINE VARIABLE SOFTKEYS USED LATER IN THE PROGRAM.
90      OUTPUT @Sa;"VARDEF KEYA,0;"
100     OUTPUT @Sa;"VARDEF KEYB,0;"
110     !PREPARE THE INSTRUMENT FOR STIMULUS-RESPONSE MEASUREMENTS.
120     OUTPUT @Sa;"MEASURE SR;"             !select stimulus-response mode
130     OUTPUT @Sa;"SRCPWR ON;"             !turn on the tracking generator
140     !SET ANALYZER PARAMETERS TO MEASURE A 321.4MHZ BANDPASS FILTER.
150     OUTPUT @Sa;"CF 321.4MHZ;"
160     OUTPUT @Sa;"SP 50MHZ;"
170     OUTPUT @Sa;"RB 1KHZ;"
180     OUTPUT @Sa;"TS;"
190     !INSTRUCT OPERATOR TO MAKE A THROUGH CONNECTION, THEN PRESS CONT.
200     !THE THROUGH IS STORED IN TRACE B WITH THE STORREF COMMAND AND THE
210     !AMB (TRACE A MINUS TRACE B) COMMAND IS ACTIVATED.
220     OUTPUT @Sa;"IT 0;OR 280,955;"
230     OUTPUT @Sa;"TEXT %CONNECT RF OUT TO RF IN, THEN"
240     OUTPUT @Sa;"PRESS CONT (NO DEVICE IN PATH)%;"
250     OUTPUT @Sa;"READMENU KEYA,1,%CONT%;"
260     OUTPUT @Sa;"CLRDSP;"
270     OUTPUT @Sa;"SRCTKPK;"              !max amplitude w/auto tracking
280     OUTPUT @Sa;"TS;"                  !update trace before storing data
290     OUTPUT @Sa;"STORREF THRU;"        !store the thru calibration data
300     OUTPUT @Sa;"AMB ON;"              !subtract thru trace from active
310     !INSTRUCT THE OPERATOR TO INSERT THE DEVICE, THEN PRESS CONT.
320     !THE NORMALIZED TRANSMISSION MEASUREMENT WILL APPEAR.
330     OUTPUT @Sa;"IT 0;OR 280,900;"
340     OUTPUT @Sa;"TEXT%FOR TRANSMISSION MEASUREMENT"
350     OUTPUT @Sa;"INSERT DEVICE, PRESS CONT%;"
360     OUTPUT @Sa;"READMENU KEYB,1,%CONT%;"
370     OUTPUT @Sa;"CLRDSP;"
380     OUTPUT @Sa;"TS;"                  !update trace to show device
390     !THE FOLLOWING SIX LINES MEASURE THE -3 DB BANDWIDTH.
400     OUTPUT @Sa;"MKOFF;"
410     OUTPUT @Sa;"MKAR -3DB;"           !set the right -3 dB point
420     OUTPUT @Sa;"MKAL -3DB;"           !set the left -3 dB point
430     OUTPUT @Sa;"MKBW ON;"            !determine the -3 dB bandwidth
440     OUTPUT @Sa;"IT 0;OR 290,875;"
450     OUTPUT @Sa;"TEXT%MEASUREMENT COMPLETE%;WAIT 1S;CLRDSP;"
460     LOCAL 7
470     END

```

Program 4: 3 dB Bandwidth Softkey

Introduction

HP 71000 spectrum analyzers give you the built-in capability to store and run programs and to control other instruments over the Hewlett-Packard Interface Bus (HP-IB). Programs written on a computer are loaded into the analyzer, which stores them in its battery-backed, continuous memory. The computer can then be disconnected, freeing it for other uses, because the spectrum analyzer alone executes the downloaded programs.

For user convenience, new softkeys can be created for downloadable programs. These softkeys replace keys on the USER menu and execute downloaded programs. Downloadable programs can be developed and softkeys can be created for the programs in this chapter. As an example, the bandwidth measurement program will be modified.

Program Explanation

The 3dB downloadable-bandwidth program operates the same as the 3dB bandwidth program. In fact, the downloadable-bandwidth program is the same as the 3dB bandwidth program with three exceptions. First, we divide the bandwidth program into a main program and a subprogram. (Breaking a program into subprograms creates smaller subunits that are more easily developed, edited, and combined.) Second, we place the 3dB bandwidth measurement routine in the subprogram and call the routine a "user-defined function." Last, we create a **◀3DB BW MEAS▶** softkey. These alterations are explained below.

The main program is similar to the other programs in this section, with the exception of the CALL command. The CALL command on line 60 transfers program execution to the Bw_meas subprogram (described below). This loads the Bw_meas subprogram into the analyzer's memory. As in earlier programs, the DISPOSE ALL command clears all analyzer memory. (If you do not want your analyzer's memory cleared, omit the DISPOSE ALL command.)

The Bw_meas subprogram, beginning on line 100, does two things: it includes the 3dB bandwidth measurement routine as a user-defined function and it creates a **◀3DB BW MEAS▶** softkey.

First, the Bw_meas subprogram uses the FUNCDEF (function definition) command on line 110 to define the bandwidth-measurement routine as a function. Two of the initialization lines from the bandwidth program are included as part of the user-defined function (lines 130 and 140). Lines 150 through 490 are copied directly from the 3 dB bandwidth program. Caret " ^ " delimiters are placed at the beginning and end of the function (lines 110 and 500). To conserve random access memory (RAM) in the analyzer, we add semicolons ";" to the end of our subprogram lines. (Semicolons suppress the carriage return/line feed.)

Then, on line 510, the subprogram creates a **◀3DB BW MEAS▶** softkey using the KEYDEF (user-defined softkey) command. The KEYDEF is followed by the number of the softkey to be defined, the user-defined function to be executed, and the softkey label. Percent sign "%" delimiters are placed around the softkey label. (Refer to "Section III: Storing New Functions" in *Advanced Programming* for detailed descriptions of the FUNCDEF and KEYDEF commands.)

Program 4: 3 dB Bandwidth Softkey

Running the Program:

1. Clear the computer's memory. (In many computers, the "SCRATCH" command is used.)
2. Type in the program as shown.
3. Press [RUN] on the computer. Press **◀3 DB MEAS▶** on the analyzer and follow directions as they appear on the display.
4. The value of the 3 dB bandwidth appears on the instrument display.

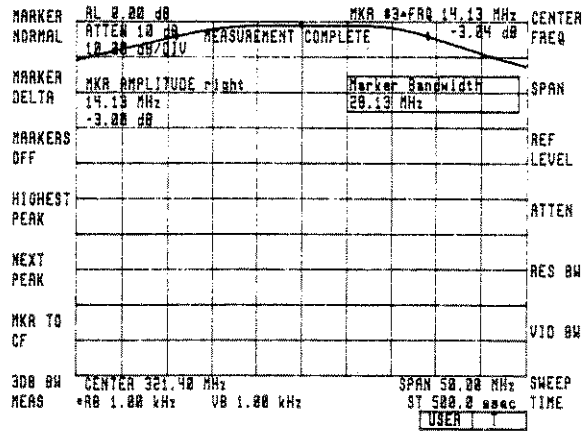

Figure 1-73. 3 dB Bandwidth with **◀3DB BW MEAS▶** Softkey

```

10 !THIS PROGRAM MAKES A -3DB BW MEASUREMENT WITH A "3DB BW MEAS" SOFTKEY
20 !FILE: BWMEAS2
30 ASSIGN @Sa TO 718
40 CLEAR @Sa
50 OUTPUT @Sa;"DISPOSE ALL;";
60 CALL Bw_meas(@Sa) !download subprogram into analyzer
70 LOCAL 7
80 END
90 !
100 Bw_meas:SUB Bw_meas(@Sa) !define the 3 dB bandwidth subprogram
110 OUTPUT @Sa;"FUNCDEF BW_MEAS,^" !create a user-defined function
120 !THE NEXT TWO LINES PRESET THE ANALYZER.
130 OUTPUT @Sa;"IP;SNGLS;TS;";
140 OUTPUT @Sa;"CLRDSP;";
150 !DEFINE VARIABLES USED LATER IN THE PROGRAM.
160 OUTPUT @Sa;"VARDEF KEYA,0;";
170 OUTPUT @Sa;"VARDEF KEYB,0;";
180 !PREPARE THE ANALYZER FOR A STIMULUS-RESPONSE MEASUREMENT.
190 OUTPUT @Sa;"MEASURE SR;";
200 OUTPUT @Sa;"SRCPWR ON;";
210 !SET ANALYZER PARAMETERS TO MEASURE A 321.4MHZ BANDPASS FILTER.
220 OUTPUT @Sa;"CF 321.4MHZ;";
230 OUTPUT @Sa;"SP 50MHZ;";
240 OUTPUT @Sa;"RB 1KHZ;";
250 OUTPUT @Sa;"TS;";
260 !INSTRUCT OPERATOR TO MAKE THROUGH CONNECTION FOR NORMALIZATION.
270 OUTPUT @Sa;"IT 0;OR 280,955;";
280 OUTPUT @Sa;"TEXT %CONNECT RF OUT TO RF IN, THEN"
290 OUTPUT @Sa;"PRESS CONT (NO DEVICE IN PATH)%;";
300 OUTPUT @Sa;"READMENU KEYA,1,%CONT%;";
310 OUTPUT @Sa;"CLRDSP;";
320 OUTPUT @Sa;"SRCTKPK;";
330 OUTPUT @Sa;"TS;";
340 OUTPUT @Sa;"STORREF THRU;";
350 OUTPUT @Sa;"AMB ON;";
360 !INSTRUCT OPERATOR TO INSERT DEVICE TO BE TESTED.
370 OUTPUT @Sa;"IT 0;OR 280,955;";
380 OUTPUT @Sa;"TEXT %FOR 3DB BANDWIDTH MEASUREMENT"
390 OUTPUT @Sa;"INSERT DEVICE, THEN PRESS CONT%;";
400 OUTPUT @Sa;"READMENU KEYB,1,%CONT%;";
410 OUTPUT @Sa;"CLRDSP;";
420 OUTPUT @Sa;"TS;";
430 !MEASURE THE -3dB BANDWIDTH.
440 OUTPUT @Sa;"MKOFF;";
450 OUTPUT @Sa;"MKAL -3DB;";
460 OUTPUT @Sa;"MKAR -3DB;";
470 OUTPUT @Sa;"MKBW ON;";
480 OUTPUT @Sa;"IT 0;OR 280,900;";
490 OUTPUT @Sa;"TEXT%MEASUREMENT COMPLETE%;WAIT 1S;CLRDSP;";
500 OUTPUT @Sa;"^;"; !end function
510 OUTPUT @Sa;"KEYDEF 14,BW_MEAS,%3DB BW MEAS%;"; !create softkey
520 SUBEND

```

Program 5: Dynamic Range

Introduction

The following program displays 150 dB of dynamic range on the display at one time. Under normal conditions, only 90 dB appear on the display, although the instrument is capable of measuring greater dynamic range. The program below increases the displayed dynamic range by manipulating the traces and trace positions. In addition, the program creates a ◀FULL RANGE▶ softkey.

Program Explanation

The following program consists of a main program and a "Full_range" subprogram. The first line of the main program addresses the instrument. The DISPOSE ALL clears analyzer memory, making the total available memory the maximum size. (If you do not want your analyzer memory cleared, omit the DISPOSE ALL command.) The CALL command transfers program execution to the Full_range subprogram (described below). This loads the Full_range subprogram into the analyzer's memory.

The Full_range subprogram, beginning on line 100, does two things: it includes the Full_range measurement routine as a user-defined function and it creates a ◀FULL RANGE▶ softkey. Line 110 uses the FUNCDEF (function definition) command, defining the Full_range-measurement routine as a function. Caret " ^ " delimiters are placed at the beginning and end of the Full_range function (lines 110 and 560).

First, the user-defined function presets the instrument, clears the display, and defines variables. The P_K_AMP, P_OS_L, and P_OS_R variables are used for data storage later in the subprogram.

Lines 200 through 260 set analyzer parameters for stimulus-response measurements and the 321.4 MHz bandpass filter to be tested. The automatic tracking peak function, activated on line 270, maximizes the amplitude of the trace. Then, lines 280 through 300 clear text from the display, remove all previously set markers, and take a sweep to ensure complete data storage.

The next section of the subprogram manipulates trace data to store the top half of the trace. The highest peak on the trace is found with the highest peak marker and is stored in the P_K_AMP (peak amplitude) variable. Next, in lines 340 through 400, amplitude markers are used to identify and store the right and left sections of the trace in the P_OS_R (right position) and P_OS_L (left position) variables. Each stored section is repositioned 75 dB above its previous location. Finally, line 410 turns off all markers.

The next section stores the bottom half of the trace. First, trace A is deactivated (not viewed) and trace B is activated (viewed). Line 450 adjusts the reference level so that the bottom half of the filter's response is displayed. A sweep is then taken to obtain trace B data (that is, the bottom half of trace A's filter response).

At this point the top and bottom halves of the filter's response have been stored. Now, in lines 470 and 480, the reference level is adjusted and trace A data is positioned relative to trace B data. Then, the log scale is adjusted to 15 dB per division, displaying 150 dB of dynamic range. (The dynamic range of the HP 70300A is limited by its specifications.)

Lines 510 through 530 place markers on the trace to find the amplitude difference between the high and low peaks. Lines 540 and 550 write "measurement complete" on the display and line 560

ends the Full_range function. Finally, the KEYDEF command is used to create a ◀FULL RANGE▶ softkey, which executes the Full_range subprogram.

Refer to "Section III: Storing New Functions" in *Advanced Programming* for detailed descriptions of the FUNCDEF and KEYDEF commands. (Also refer to the HP 71000 Language Reference for detailed command information.)

Running the Program:

1. Clear the computer's memory. (In many computers, the "SCRATCH" command is used.)
2. Type in the program as shown.
3. Press [RUN] on the computer. Insert the DUT in the thru path and press the ◀FULL RANGE▶ softkey.
4. The full dynamic range appears on the display screen.

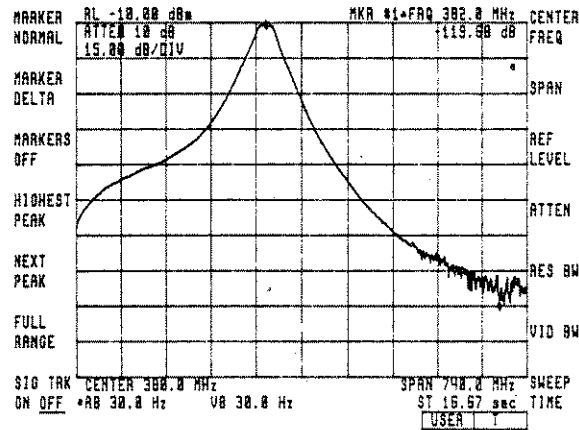

Figure 1-74. Full Dynamic Range of 321.4 MHz Bandpass Filter

Program 5: Dynamic Range

```

10  IDISPLAY 150 DB OF DYNAMIC RANGE USING A "FULL RANGE SOFTKEY."
20  IFILE: FULLR
30  ASSIGN @Sa TO 718
40  CLEAR @Sa
50  OUTPUT @Sa;"DISPOSE ALL;";
60  CALL Full_range(@Sa)           !load subprogram into analyzer
70  LOCAL 7
80  END
90  !
100 Full_range:SUB Full_range(@Sa)   !define Full_range subprogram
110  OUTPUT @Sa;"FUNCDEF FULL_RANGE,^"; !create a user-defined function
120  !PRESET ANALYZER.
130  OUTPUT @Sa;"IP;SNGLS;TS;";
140  OUTPUT @Sa;"CLRDSP;";
150  !DEFINE VARIABLES USED LATER IN SUBPROGRAM.
160  OUTPUT @Sa;"VARDEF P_K_AMP,0;";
170  OUTPUT @Sa;"VARDEF P_OS_L,0;";
180  OUTPUT @Sa;"VARDEF P_OS_R,0;";
190  !PREPARE ANALYZER FOR STIMULUS-RESPONSE MEASUREMENT.
200  OUTPUT @Sa;"MEASURE SR;";
210  OUTPUT @Sa;"SRCPWR ON;";
220  !SET ANALYZER PARAMETERS FOR DEVICE TO BE MEASURED.
230  OUTPUT @Sa;"CF 380MHZ;";
240  OUTPUT @Sa;"SP 740MHZ;";
250  OUTPUT @Sa;"RB 30HZ;";
260  OUTPUT @Sa;"TS;";
270  OUTPUT @Sa;"SRCTKPK;";
280  OUTPUT @Sa;"MSG?;";           !clear message from display
290  OUTPUT @Sa;"MKOFF ALL;";
300  OUTPUT @Sa;"TS;";
310  !DIVIDE TOP PORTION OF FILTER'S RESPONSE INTO ITS RIGHT
320  !AND LEFT HALVES AND STORE EACH HALF RELATIVE TO -75DB.
330  OUTPUT @Sa;"MKPK HI;";
340  OUTPUT @Sa;"MOV P_K_AMP,MKA;";
350  OUTPUT @Sa;"MKAL;";
360  OUTPUT @Sa;"SUB MKA,-75,P_K_AMP;";
370  OUTPUT @Sa;"MOV P_OS_L,MKP;";
380  OUTPUT @Sa;"MKAR;";
390  OUTPUT @Sa;"SUB MKA,-75,P_K_AMP;";
400  OUTPUT @Sa;"MOV P_OS_R,MKP;";
410  OUTPUT @Sa;"MKOFF ALL;";
420  !MOVE THE REFERENCE LEVEL TO VIEW THE BOTTOM PORTION OF THE
430  !FILTER'S RESPONSE, THEN ADD IT TO THE TOP HALF.
440  OUTPUT @Sa;"BLANK TRA;CLRWB TRB;";
450  OUTPUT @Sa;"RL -75DBM;";
460  OUTPUT @Sa;"TS;";
470  OUTPUT @Sa;"RL -10DBM;";
480  OUTPUT @Sa;"MOV TRB[P_OS_L,P_OS_R],TRA[P_OS_L,P_OS_R];";
490  !SET LOG SCALE TO DISPLAY FULL RANGE AND ACTIVATE MARKERS.
500  OUTPUT @Sa;"LG 15DB;";           !set scale to display full range
510  OUTPUT @Sa;"MKPK HI;";
520  OUTPUT @Sa;"MKD;";
530  OUTPUT @Sa;"MKMIN;";
540  OUTPUT @Sa;"IT 0, OR 600,860;";
550  OUTPUT @Sa;"TEXT%MEASUREMENT COMPLETE%;WAIT 1S;CLRDSP;";
560  OUTPUT @Sa;"^";           !end the function
570  OUTPUT @Sa;"KEYDEF 13,FULL_RANGE,%FULL RANGE%;"; !create softkey
580  SUBEND

```

1-68

LOCAL OSCILLATOR ROM VERSION 851216 OR LATER

INDEX

| | | |
|------------|--|--|
| -A- | <p>A - B --> A 1-26</p> <p>A - C --> A 1-26</p> <p>Accessing Tracking Generator Softkeys 1-20</p> <p>ALC ALT 1-45</p> <p>ALC EXT 1-45</p> <p>ALC NRM 1-45</p> <p>AM Frequency 1-48</p> <p>AM Internal/External 1-48</p> <p>AM Percentage 1-48</p> <p>Attenuation (Stop Band) 1-9</p> <p>Attenuator 1-36</p> <p>Automatic Tracking 1-42</p> <p>Automatic Level Control 1-45</p> <p>Average Short -> C 1-29</p> | <p>Frequency (Modulation) 1-48</p> <p>Front-Panel Features 1-2</p> <p>Funcdef (Command) 1-63</p> |
| | -H- | |
| | <p>HP-IB Address 1-50</p> | <p>Installation Checklist 1-4</p> <p>Introduction (Softkeys) 1-17</p> <p>Introduction (Remote Operation) 1-49</p> |
| | -I- | |
| -B- | <p>Back-Panel Connectors 1-3</p> <p>Backspace Key 1-21</p> <p>Bandwidth Test 1-9</p> <p>Bandwidth (Program) 1-61</p> <p>Blanking 1-45</p> | <p>Keydef (Command) 1-63</p> |
| | -L- | |
| | <p>Language Reference 1-49</p> | |
| | -M- | |
| -C- | <p>Calibration</p> <p> for Normalization 1-25</p> <p> Open 1-29</p> <p> Open/Short Average 1-29</p> <p> Through 1-27</p> <p>Check-Out Procedure 1-51</p> <p>Checklist (Installation) 1-4</p> <p>Command</p> <p> Documentation 1-49</p> <p> Summary 1-53</p> <p> With Softkeys(Figure) 1-52</p> | <p>Math Functions 1-26</p> <p>Measurement Guidelines 1-5</p> <p>Measurement Mode (Overview) 1-20</p> <p>MEASURE MODE Softkey Menu 1-18, 1-22</p> <p>MENU Softkeys 1-20</p> <p>Modes (Measurement) 1-22</p> <p>Modulation</p> <p> Internal/External 1-48</p> <p> Softkey Menu 1-18, 1-47</p> <p>Module Description 1-2</p> <p>Moving Between SA and TG Menus 1-21</p> |
| | -D- | |
| | <p>Documentation (Remote) 1-49</p> <p>Dynamic Range (Program) 1-66</p> | <p>Normalzation (Softkeys) 1-25</p> <p>Normalization (A - B) 1-26</p> <p>Normalization (A - C) 1-26</p> |
| -E- | <p>Equipment for Remote Operation 1-50</p> <p>Examples</p> <p> Programming 1-54</p> <p> Typical Measurements 1-5</p> | <p>Offset (Source Power) 1-36</p> <p>Open-Circuit (Calibration) 1-29</p> <p>Open/Short Average 1-29</p> <p>Oscillator (Source) 1-48</p> |
| | -O- | |

INDEX

-P-

| | |
|----------------------------------|------|
| Percentage (Amplitude) | 1-48 |
| Power Blanking | 1-45 |
| Power Control Softkeys | 1-33 |
| Power Sweep | 1-35 |
| Programming Guidelines | 1-54 |

-R-

| | |
|--|------|
| Rear-panel Connections | 1-3 |
| Recall State | 1-32 |
| Reflection Measurement | 1-10 |
| Reflection Measurement (Program) | 1-58 |
| Remote Language Reference | 1-49 |
| Remote Operation | 1-49 |

-S-

| | |
|---|-----------|
| Sample Measurements | 1-5 |
| Sample Programs | 1-54 |
| Save/Recall State | 1-32 |
| Setup for Remote Operation | 1-50 |
| Short (Calibration) | 1-29 |
| Signal Analysis Mode | 1-23 |
| Softkey | |
| Accessing | 1-20 |
| Overview | 1-18 |
| Softkeys and Corresponding Commands | 1-52 |
| Source (Overview) | 1-20 |
| Source Attenuator | 1-36 |
| Source Capability (Introduction) | 1-14 |
| Source | |
| Calibration and Normalization | 1-25 |
| Oscillator Internal/External | 1-48 |
| Power Control | 1-33,1-34 |
| Power Offset | 1-36 |

| | |
|--|----------------|
| Power Step | 1-34 |
| SOURCE OPTIONS Softkeys | 1-18,1-33,1-44 |
| SOURCE Softkey | 1-25,1-33,1-39 |
| SOURCE Softkey Menu | 1-18, 1-25 |
| Tracking Adjustments | 1-39 |
| State (Save/Recall) | 1-32 |
| Step Size (Src Pwr Step) | 1-34 |
| Stimulus-Response Mode | 1-23 |
| Stop Band Attenuation | 1-9 |
| Store Open -> C | 1-29 |
| Store Thru -> B | 1-27 |
| Sweep (Power) | 1-35 |
| Sweep Time (Stimulus-Response) | 1-24 |

-T-

| | |
|--|-----------|
| Through Calibration | 1-27 |
| Trace Math Functions | 1-26 |
| Tracking Adjust | 1-40 |
| Tracking Generator | |
| Programming Basics | 1-54 |
| Programs | 1-54 |
| Softkeys | 1-17,1-19 |
| Remote Commands | 1-52 |
| Remote Operation | 1-49 |
| Tracking Adjust Softkeys | 1-39 |
| Tracking Peak (Auto Tracking) | 1-42 |
| Transmission Measurement | 1-6 |
| Transmission Measurement (Program) | 1-55 |

-U-

| | |
|--|------|
| Using the HP 70300A as a Source | 1-14 |
| 3 dB Bandwidth (Program) | 1-61 |
| 3 dB Bandwidth Softkey (Program) | 1-63 |

USER MEMORY GUIDELINES

This analysis of user memory is intended for HP 70900A Local Oscillator ROM Version 860203. Future releases of Local Oscillator ROM versions and other module ROM versions may change the memory requirements of the system.

1 Predefined Usage

Some user memory is used as part of the power-up and Instrument Preset definition.

1.1 Traces

All analyzer traces are stored in user memory. This includes the default traces and all user defined traces. The equation for memory usage due to traces is

$$\text{bytes} = 46 + 2(\text{no. of trace points})$$

Using this formula a 3 point trace will occupy 52 bytes of user memory and an 800 point trace will occupy 1646 bytes of user memory.

The predefined traces and their default lengths in a non Tracking-Generator system are defined as: TRA 800 points, TRB 800 points, and TRC 3 points. This is a total of 3,344 bytes.

The predefined traces and their default lengths with a Tracking-Generator module is: TRA 800 points, TRB 800 points, and TRC 800 points. This is a total of 4,938 bytes usage.

All user defined traces use the same memory equation as the analyzers predefined traces.

1.2 Save State Registers

The analyzer's Measurement-Save-State registers take 634 bytes each. At shipment 2 state registers are defined as the default for a total memory usage of 1268 bytes. The number of state registers can be changed by the user with the `NSTATE` command. A user that does not require any state registers can change the number of registers to 0 to restore state memory to the user. Neither `IP` or power-up effects the number of save-state registers. The `ERASE` command will reset the analyzer to the original 2 Save-State condition.

1.3 IP

Instrument Preset will return all predefined traces (`TRA`, `TRB`, `TRC`) to their default lengths. This is regardless of any length the user may have set the traces to. User defined traces are not effected by Instrument Preset.

2 Commands Affecting Usage

Some analyzer commands which are memory intensive compete for memory with the user. The following is a list of those commands and a description of their requirements.

2.1 User Defined

The commands which define user memory for the user are `FUNCDEF` and `VARDEF`. A `VARDEF` command will allocate 8 bytes of memory to store an I.E.E format floating point number. A `FUNCDEF` command will allocate 1 byte per character of the defined function then round up to the nearest even number of bytes for alignment purposes. Both variable and function memory can be returned to the user with the `DISPOSE` command.

2.2 ONEOS

The On End Of Sweep command will allocate 1 byte of memory per character of the defined function then round up to the nearest even byte. Memory can be returned to the user via the `DISPOSE` command.

2.3 CAL

The calibration of the analyzer will attempt to allocate enough memory to save the instruments measurement state. If the memory is available it is allocated and after calibration the instrument is returned to the measurement state it was in immediately preceding calibration. If there is not enough user memory available to save the analyzer's measurement state the calibration will execute and the analyzer will be left in the last measurement state that the calibration process used. At the completion of **CAL** any memory allocated for calibration is released back to the user.

2.4 SIGID

The Signal Identify command will attempt to allocate enough memory to save the instruments measurement state. If the memory is available it is allocated and after **SIGID** the instrument is returned to the measurement state it was in immediately preceding **SIGID** . If there is not enough user memory available to save the analyzer's measurement state the **SIGID** will execute and the analyzer will be left in the last measurement state that the **SIGID** process used. At the completion of **SIGID** any memory allocated for **SIGID** is released back to the user.

2.5 TRDEF

User defined traces are allocated in User Memory. The memory usage equation is the same as outlined in section 1.1 . User Defined traces are not effected by IP .

2.6 FFT

The Fast Fourier Transform command creates a temporary trace in memory whose length is calculated by the equation

$$length = 2 + 1.5 * 2^{\lceil \log_2(\max(DESTlen/2, \min(SRClen, WINDOWlen)) - 1) \rceil}$$

where **DESTlen** is the destination trace length, **SRClen** is the source trace length and **WINDOWlen** is the window length. All lengths are in measurement

points. An example for a 400 point source trace transformed into a 400 point destination with a 400 point window is

$$770 = 2 + 1.5 * 2^{\lceil \log_2(\max(400/2, \min(400, 400)) - 1) \rceil}$$

This length can then be applied to the trace equation in 1.1 to yield total memory usage of 1,586 bytes.

If the necessary memory to perform an FFT is not available in User Memory space the analyzer will report an error and abort the function.

The memory used for the temporary trace is returned to User Memory after the function completes execution.

2.7 SMOOTH and PDA

The command for trace SMOOTHing and Probability Distribution of Amplitude both need to create a temporary trace in the User Memory space. These traces are the same length as the source trace argument to the command. The trace equation from 1.1 applies to convert trace length to bytes.

If the memory is not available an error will be reported by the analyzer and the command will be aborted.

The memory used for the temporary trace is returned to User Memory after the function completes execution.

2.8 REPEAT/UNTIL

The REPEAT/UNTIL loop structure needs User Memory to store the repeat loop text for execution. The amount of memory necessary is equal to the length of the loop text including the UNTIL condition text. If the length is odd it is rounded up to the next even byte.

In the event that a repeat loop is executed with insufficient memory the analyzer will report an error and terminate execution of the loop.

2.9 Function Execution

Each user defined function (FUNCDEF) and nested function (FUNCDEF calling another user defined function) requires an environment to operate in. The environment contains pointers to the function and various status flags. The environment occupies 40 bytes in user memory.

If a function attempts to execute and cannot allocate enough memory for it's environment it will report an error and terminate .

3 Module Usage

Each module that is installed in an MSA system takes away a piece of User Memory. This memory is acquired by the controller to store information on the capabilities of each module in the system. Each type of module has it's own requirements for memory usage. The more modules a system has installed in it, the more user memory is required to document the systems capabilities. The following table summarizes the user memory requirements for modules.

(The following data may vary slightly depending on module ROM version.)

RAM USAGE

| ANALYZER | MODULE | BYTES |
|---------------------------|---------------|--------|
| Total Available User Mem | | 15,430 |
| Save States (2) | | 1,268 |
| Traces (w/o Trk. Gen.) | | 3,344 |
| Traces (with Trk. Gen.) | | 4,938 |
| | 70900A LO | 1,082 |
| | 70902A HRIF | 1,222 |
| | 70903A WBIF | 1,218 |
| | 70904A RF | 682 |
| | 70905A microW | 1,476 |
| | 70907A EMIM | 830 |
| | 70300A TrkGen | 1,138 |
| | 70310A PFR | 72 |

4 Summary

User memory available is dependent on: total system memory minus system module requirements, trace defaults, and NSTATES.

IP will reset the predefined traces (TRA, TRB and TRC) to their default length.

Some analyzer commands (FFT, PDA and SMOOTH) are memory intensive and require temporary space in user memory to execute.

All user defined operations (FUNCDEF, VARDEF, REPEAT/UNTIL and ONEOS) are defined in and executed from user memory.

SYSTEM DIAGNOSTIC CAUTIONS

Your system may have been shipped with a System Diagnostics program already loaded. System Diagnostics software is a troubleshooting tool which determines if your HP 71000 System is functional.

System Diagnostics occupy user memory. To give you the most flexibility with your system, you can remove the program from user memory. If you do not have an HP Series 200 computer, make a backup copy of the System Diagnostics **BEFORE** deleting them. If you do have an HP Series 200 computer, the System Diagnostics discs are your backup.

To run or remove the diagnostics, refer to the instructions in the System Diagnostics Supplement (HP Part Number 70900-90035) or refer to the System Support Manual.

