

**User's Guide**

**HP 71500A and HP 70820A**

**Microwave Transition Analyzer**



HP Part No. 70820-90049  
Printed in USA November 1992

Edition B.0.0

**Notice**

The information contained in this document is subject to change without notice.

Hewlett-Packard makes no warranty of any kind with regard to this material, including, but not limited to, the implied warranties of merchantability and fitness for a particular purpose. Hewlett-Packard shall not be liable for errors contained herein or for incidental or consequential damages in connection with the furnishing, performance, or use of this material.

**Restricted Rights Legend.**

Use, duplication, or disclosure by the U.S. Government is subject to restrictions as set forth in subparagraph (c) (1) (ii) of the Rights in Technical Data and Computer Software clause at DFARS 252.227-7013 for DOD agencies, and subparagraphs (c) (1) and (c) (2) of the Commercial Computer Software Restricted Rights clause at FAR 52.227-19 for other agencies.

©Copyright Hewlett-Packard Company 1992

All Rights Reserved. Reproduction, adaptation, or translation without prior written permission is prohibited, except as allowed under the copyright laws.  
1400 Fountaingrove Parkway, Santa Rosa, CA 95403-1799, USA

# Contents

---

<b>1. Configuring the HP 71500A</b>	
Using a Common Frequency Reference . . . . .	1-3
To lock on the HP 70820A frequency reference . . . . .	1-4
To lock on the RF source frequency reference . . . . .	1-4
Configuring the RF Source . . . . .	1-4
To select the source type . . . . .	1-7
To enter bus used and source address . . . . .	1-9
To disable service requests . . . . .	1-10
To use secondary HP-IB addressing . . . . .	1-10
To disable source control momentarily . . . . .	1-10
Controlling the Display of Information . . . . .	1-11
To control the screen graticule . . . . .	1-11
To control split screen displays . . . . .	1-13
To position traces on split screen . . . . .	1-13
To display measurement points . . . . .	1-15
To set the number of measurement points . . . . .	1-17
To turn on screen persistence . . . . .	1-17
Using the clock . . . . .	1-19
To select United States or European format . . . . .	1-20
To show time or date . . . . .	1-20
To set the clock . . . . .	1-20
To turn the clock display off . . . . .	1-20
To display the instrument status line . . . . .	1-21
To display the internal state of the instrument . . . . .	1-23
To view the ROM version . . . . .	1-23
Getting Prints and Plots of the Display . . . . .	1-24
To get a print or plot . . . . .	1-24
To enter the plotter type and address . . . . .	1-24
To enter the printer type and address . . . . .	1-25
Changing Step Key Jumps . . . . .	1-25
To change step size: source frequency/power . . . . .	1-26
To change step size: sampler frequency . . . . .	1-26
Securing the Instrument . . . . .	1-26
To prevent display of frequency and time information . . . . .	1-27
To erase user memory registers . . . . .	1-27
To erase user instrument states . . . . .	1-27
To erase user correction data . . . . .	1-28
To erase user-created math equations . . . . .	1-29

<b>2. Performing Measurements</b>	
Using Predefined Measurement States . . . . .	2-2
Performing a Frequency and Power Measurement . . . . .	2-5
To measure frequency and power of input signals . . . . .	2-6
Performing a Vector Voltage Measurement . . . . .	2-6
To measure vector voltage transmission . . . . .	2-8
To measure vector voltage reflection . . . . .	2-9
Performing a Vector Network Measurement . . . . .	2-10
To measure vector network transmission . . . . .	2-15
To measure vector network reflection . . . . .	2-21
Performing a Scalar Network Measurement . . . . .	2-26
To measure scalar transmission and reflection . . . . .	2-28
Performing a Time and FFT Measurement . . . . .	2-34
To measure time and frequency domains . . . . .	2-35
Using Automatic Waveform Measurements . . . . .	2-36
To measure pulsed RF . . . . .	2-44
To measure delay . . . . .	2-45
To perform all measurements . . . . .	2-48
To measure rise time, fall time, and overshoot . . . . .	2-49
To measure period . . . . .	2-50
To measure frequency . . . . .	2-51
To measure width and duty cycle . . . . .	2-52
To measure pulse power . . . . .	2-53
To measure voltage . . . . .	2-54
<b>3. Performing Pulsed RF Measurements</b>	
Introducing Pulsed RF Measurements . . . . .	3-2
Controlling the Pulse Generator . . . . .	3-7
To set pulse interval and frequency . . . . .	3-9
To set pulse width and duty cycle . . . . .	3-9
To turn the RF source's pulse modulator on or off . . . . .	3-10
Selecting the Pulse Generator . . . . .	3-10
To turn on the internal pulse generator . . . . .	3-10
To select an external pulse generator . . . . .	3-11
To trigger an external pulse generator . . . . .	3-11
Selecting the Pulse Generator's Application . . . . .	3-11
To view the modulated RF . . . . .	3-11
To view the pulse generator's signal before the modulator . . . . .	3-12
To prevent coupling of pulse generator settings to measurements . . . . .	3-12
Performing Time Domain Measurements . . . . .	3-12
To perform a time domain measurement . . . . .	3-14
To perform an FFT . . . . .	3-16
To separate video feedthrough . . . . .	3-18
Performing Vector Network Measurements . . . . .	3-22
To measure vector network transmission . . . . .	3-23
To measure vector network reflection . . . . .	3-33
Performing Scalar Network Measurements . . . . .	3-45
To measure scalar network transmission/reflection . . . . .	3-48
Performing Swept Power Measurements . . . . .	3-60
To perform a swept power measurement . . . . .	3-61

<b>4. Viewing Transient and Non-Repetitive</b>	<b>Signals</b>	
Learning About Single-Shot Operation . . . . .		4-2
To enter single-shot operation . . . . .		4-4
To use single sweep triggering . . . . .		4-5
Displaying Periodic Signals Accurately . . . . .		4-6
Ensuring Maximum Bandwidth for Modulated Signals . . . . .		4-14
To ensure maximum bandwidth . . . . .		4-14
Viewing Modulated Signals in Frequency	Domain . . . . .	4-14
To center an FFT . . . . .		4-16
To change the span of an FFT . . . . .		4-17
Increasing the Number of Data Points in Single Shot . . . . .		4-17
Tutorial: Measuring Turn-On Time of a CW Source . . . . .		4-18
Step 1. Connecting the equipment . . . . .		4-18
Step 2. Setting the RF source parameters . . . . .		4-18
Step 3. Setting hardware scaling . . . . .		4-19
Step 4. Setting the trigger . . . . .		4-21
Step 5. Turning on single-shot operation . . . . .		4-21
Step 6. Displaying the turn-on time. . . . .		4-22
Step 7. Measuring waveform parameters . . . . .		4-23
Tutorial: Measuring Turn-On Time of a Pulsed RF Source . . . . .		4-23
Step 1. Connecting the equipment . . . . .		4-25
Step 2. Setting the RF source parameters . . . . .		4-25
Step 3. Setting the pulse parameters . . . . .		4-25
Step 4. Setting hardware scaling . . . . .		4-26
Step 5. Setting the trigger . . . . .		4-28
Step 6. Turning on single-shot operation . . . . .		4-30
Step 7. Displaying the turn-on time. . . . .		4-31
Tutorial: Measuring a Modulated Signal . . . . .		4-31
Step 1. Connecting the equipment . . . . .		4-31
Step 2. Setting the RF source modulation . . . . .		4-32
Step 3. Setting the trigger . . . . .		4-33
Step 4. Turning on single-shot operation . . . . .		4-34
Step 5. Formatting the trace . . . . .		4-35
Step 6. Ensuring a centered FFT . . . . .		4-37
Step 7. Formatting an FFT . . . . .		4-38
Step 8. Changing the span of the FFT . . . . .		4-39
<b>5. Controlling Time, Frequency, and Power Sweeps</b>		
Displaying Time Sweeps . . . . .		5-2
To select a time sweep . . . . .		5-4
To turn the source power on . . . . .		5-4
To set the time scale manually . . . . .		5-4
To find the input signal automatically . . . . .		5-4
To control the number of cycles displayed . . . . .		5-4
To control the scale control softkeys . . . . .		5-5
To track changes in signal frequency automatically . . . . .		5-7
To filter signal noise . . . . .		5-7
To delay the sweep . . . . .		5-8
Displaying Frequency Sweeps . . . . .		5-8
To perform a frequency sweep . . . . .		5-10
To change the sweep speed . . . . .		5-10
To control measurement settling time . . . . .		5-11
To change the frequency scale control . . . . .		5-12
Displaying Power Sweeps . . . . .		5-13
To select a power sweep . . . . .		5-15

To change the sweep speed . . . . .	5-15
To perform a power sweep . . . . .	5-16
To set measurement settling time . . . . .	5-17
Tutorial: Normalizing a Power Sweep . . . . .	5-17
Step 1. Connect the equipment . . . . .	5-18
Step 2. Set the power sweep . . . . .	5-19
Step 3. Perform a sweep . . . . .	5-20
Step 4. Scale and store the response . . . . .	5-21
Step 5. Build a normalized trace equation . . . . .	5-22
Step 6. Display the normalized response . . . . .	5-23
Performing Harmonic and Offset Sweeps . . . . .	5-23
To perform a harmonic sweep . . . . .	5-25
To perform an offset sweep . . . . .	5-25
<b>6. Using and Defining Traces</b> . . . . .	
Selecting and Defining Traces . . . . .	6-2
To select a trace . . . . .	6-4
To display a trace on screen . . . . .	6-4
Defining Trace Input . . . . .	6-4
To define the trace's input . . . . .	6-6
Building a Trace Equation . . . . .	6-7
To build a custom trace . . . . .	6-11
Formatting a Trace . . . . .	6-11
To format a trace . . . . .	6-14
Averaging Traces . . . . .	6-14
To average a trace before formatting . . . . .	6-16
To average a trace after formatting . . . . .	6-16
To restart averaging . . . . .	6-17
To turn averaging off . . . . .	6-17
Holding Traces . . . . .	6-17
To hold trace values . . . . .	6-18
To restart holding . . . . .	6-19
To turn holding off . . . . .	6-19
Smoothing Traces . . . . .	6-19
To smooth a trace . . . . .	6-20
Performing Trace Transforms . . . . .	6-21
To transform a trace . . . . .	6-25
To zoom a transformed trace . . . . .	6-25
Storing Traces . . . . .	6-25
To store a trace . . . . .	6-26
To recall a trace . . . . .	6-26
<b>7. Triggering the Sweep</b> . . . . .	
Introducing the Trigger Menu . . . . .	7-2
To select a channel for triggering . . . . .	7-4
Setting the Trigger Type . . . . .	7-4
To sweep without triggering . . . . .	7-8
To prevent triggering without a trigger condition . . . . .	7-8
To select the trigger type . . . . .	7-9
To adjust the trigger level . . . . .	7-9
To adjust the trigger phase . . . . .	7-9
To adjust the trigger hysteresis . . . . .	7-9
Setting the Trigger Source . . . . .	7-10
To trigger from input channels . . . . .	7-12
To trigger the sweep externally . . . . .	7-12

To gate a trigger externally . . . . .	7-13
Using Automatic Trigger Tracking . . . . .	7-13
To track the source power level with the trigger level . . . . .	7-13
Using Continuous or Single Sweeps . . . . .	7-14
To sweep continuously . . . . .	7-14
To trigger a single sweep . . . . .	7-14
Triggering a Group of Sweeps . . . . .	7-14
To trigger a group of averaged sweeps . . . . .	7-14
<b>8. Controlling the Amplitude Scale</b>	
Scaling a Trace . . . . .	8-2
To select a trace to scale . . . . .	8-5
To scale the response automatically . . . . .	8-5
To scale the response manually . . . . .	8-5
Changing Reference Level and Position . . . . .	8-5
To change the reference level . . . . .	8-5
To change the reference position . . . . .	8-6
Changing Hardware Scaling . . . . .	8-6
Setting the range and offset . . . . .	8-7
To turn hardware auto ranging off . . . . .	8-7
To change the hardware scale range and offset . . . . .	8-7
To couple display scaling to hardware scaling . . . . .	8-7
Adding Frequency Shifts and Time Delays . . . . .	8-8
To add frequency shifts . . . . .	8-8
To add time delays . . . . .	8-9
Smoothing FM( ), TD( ), and DIFF( ) Traces . . . . .	8-9
To smooth FM( ), TD( ), and DIFF( ) traces . . . . .	8-11
Changing Input Coupling . . . . .	8-11
To change input ac/dc coupling . . . . .	8-11
Compensating for External Attenuation . . . . .	8-11
To compensate for external attenuation . . . . .	8-11
Compensating for Internal dc Drifts . . . . .	8-12
To compensate for internal dc drifts . . . . .	8-12
<b>9. Using Markers</b>	
Selecting and Moving Markers . . . . .	9-2
To turn on a marker . . . . .	9-6
To turn off a marker . . . . .	9-6
To simultaneously move both markers . . . . .	9-6
To hold marker values as a reference . . . . .	9-7
Using Delta Markers . . . . .	9-7
To use the delta markers . . . . .	9-8
Using Markers to Move Traces . . . . .	9-8
To move marker position to center screen . . . . .	9-10
To move marker to reference position . . . . .	9-11
Automatically Searching for Peaks . . . . .	9-11
To perform an automatic search . . . . .	9-12
To track a drifting peak . . . . .	9-13
To ignore dc response in peak searches . . . . .	9-13
Using Peak Searches on FFT Traces . . . . .	9-13
To turn peak interpolation off . . . . .	9-15
Maintaining Marker Position with Changing Frequencies . . . . .	9-15
To keep cycle position constant . . . . .	9-15
Changing Marker Readouts . . . . .	9-15
To select marker amplitude units . . . . .	9-19

To select phase readout units . . . . .	9-19
To select scalar or vector readout . . . . .	9-19
<b>10. Using the Harmonic Table</b>	
Selecting the Table Source . . . . .	10-2
To display the table . . . . .	10-5
Updating the Table Data . . . . .	10-5
To use single updating . . . . .	10-5
To average table data . . . . .	10-5
Selecting Signals to List . . . . .	10-5
To automatically add signals to list . . . . .	10-7
To add signals to list manually . . . . .	10-7
To display all listed signals . . . . .	10-8
Editing the Table . . . . .	10-9
To change number of harmonics shown . . . . .	10-9
To prevent display of harmonics . . . . .	10-9
To show only magnitude or phase . . . . .	10-10
Making Relative Measurements . . . . .	10-10
To make relative measurements . . . . .	10-12
To make delta measurements . . . . .	10-12
Viewing a Trace of Table Data . . . . .	10-12
To view a trace of table data . . . . .	10-14
<b>11. Viewing Trace Histograms</b>	
Generating Histograms . . . . .	11-2
Tutorial: Creating a Vertical Histogram . . . . .	11-3
Step 1. Select the histogram type . . . . .	11-3
Step 2. Acquire the data . . . . .	11-4
Step 3. Perform statistical analysis . . . . .	11-5
Tutorial: Creating a Horizontal Histogram . . . . .	11-6
Step 1. Select the histogram type . . . . .	11-6
Step 2. Acquire the data . . . . .	11-7
Step 3. Perform statistical analysis . . . . .	11-8
<b>12. Creating Masks and Limit Lines</b>	
Creating Masks . . . . .	12-2
To create a mask . . . . .	12-3
To erase a mask . . . . .	12-3
Testing Responses . . . . .	12-4
To start testing . . . . .	12-5
Saving, Recalling, and Cataloging Masks . . . . .	12-5
To save a mask . . . . .	12-6
To recall a mask . . . . .	12-7
To catalog files in memory . . . . .	12-7
To erase a mask file . . . . .	12-8



<b>13. Entering User-Correction Filters</b>	
Learning About User Corrections . . . . .	13-2
To enter the user correction menu . . . . .	13-5
To select a channel for user corrections . . . . .	13-5
To turn user corrections on . . . . .	13-5
To delete a channel's user corrections . . . . .	13-5
Entering and Editing User Corrections . . . . .	13-6
To enter a line of data . . . . .	13-7
To edit a line of data . . . . .	13-7
To delete a line of data . . . . .	13-7
To select flat-line interpolation . . . . .	13-8
To select logarithmic slope interpolation . . . . .	13-8
To copy user correction to alternate channel . . . . .	13-8
Viewing User-Correction Data . . . . .	13-8
Setting the frequency scale for frequency sweeps . . . . .	13-8
Setting the frequency scale for time sweeps . . . . .	13-8
To view user corrections . . . . .	13-9
Tutorial: Constructing a 1.5 GHz High-Pass Filter . . . . .	13-10
Step 1. Connecting the equipment . . . . .	13-10
Step 2. Setting the source frequency and power . . . . .	13-11
Step 3. Displaying the signal . . . . .	13-12
Step 4. Creating the user-correction filter . . . . .	13-13
Step 5. Turning on user corrections . . . . .	13-14
<b>14. Calibrating the HP 70820A</b>	
Introducing the Calibration Menu . . . . .	14-2
Adding Delay to a Channel . . . . .	14-3
To delay a channel . . . . .	14-5
Calibrating the IF . . . . .	14-5
To calibrate the IF . . . . .	14-6
To view the last calibration date . . . . .	14-6
Viewing the Calibration Data . . . . .	14-7
To view IF correction data traces . . . . .	14-7
To view hardware response traces . . . . .	14-9
To view calibration data . . . . .	14-10
Performing a Self Test . . . . .	14-10
To perform the self test . . . . .	14-10
Turning Off RF Correction . . . . .	14-11
To turn off RF correction . . . . .	14-11
Controlling the Calibrator Signal . . . . .	14-11
To turn the calibrator signal on . . . . .	14-11
To change the calibrator frequency and amplitude . . . . .	14-12
<b>15. Managing Cards, Disks, and RAM</b>	
Selecting and Formatting Memory . . . . .	15-2
To use a memory card . . . . .	15-4
To use an HP-IB disk drive . . . . .	15-5
To use an internal RAM disk . . . . .	15-6
To change a memory card's battery . . . . .	15-7
Working with Files . . . . .	15-7
To duplicate a memory card . . . . .	15-9
To catalog all files . . . . .	15-10
To save a file . . . . .	15-11
To recall a file . . . . .	15-12
To erase a file . . . . .	15-12

To erase all files . . . . .	15-13
To change the prefix . . . . .	15-14
To erase a custom prefix . . . . .	15-15

**Index**

## Configuring the HP 71500A

This chapter describes how to configure an RF source, control the display, and obtain prints and plots of the display. You can also prevent access to selected information. To control the pulse generator, refer to Chapter 3, “Performing Pulsed RF Measurements.”

Browse this chapter before beginning measurements. Your first task should be ensuring that the microwave transition analyzer shares a frequency reference with and has control of an RF source. The required cable connections are shown in the following figure. Refer to the sections “Using a Common Frequency Reference” and “Configuring the RF Source” in this chapter.

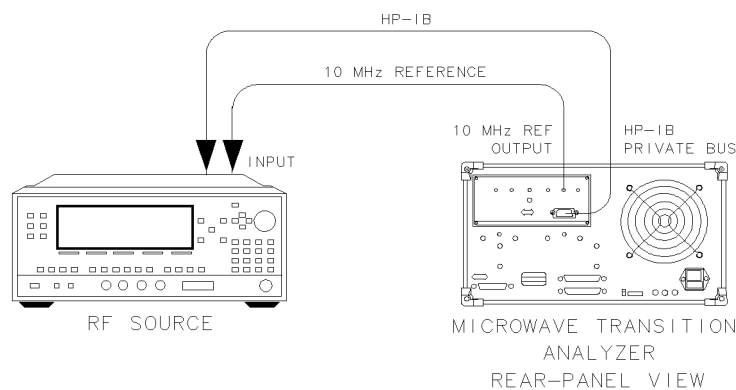

qta1a

**Cable connections for a configured system.**

Using a Common Frequency Reference .....	1-4
To lock on the HP 70820A frequency reference .....	1-5
To lock on the RF source frequency reference .....	1-5
Configuring the RF Source .....	1-6
To select the source type .....	1-8
To enter bus used and source address .....	1-10
To disable service requests .....	1-11
To use secondary HP-IB addressing .....	1-11
To disable source control momentarily .....	1-12
Controlling the Display of Information .....	1-13
To control the screen graticule .....	1-13
To control split screen displays .....	1-16
To position traces on split screen .....	1-17
To display measurement points .....	1-18
To set the number of measurement points .....	1-20
To turn on screen persistence .....	1-20
Using the clock .....	1-22
To select United States or European format .....	1-23
To show time or date .....	1-23
To set the clock .....	1-24
To turn the clock display off .....	1-24
To display the instrument status line .....	1-25
To display the internal state of the instrument .....	1-27
To view the ROM version .....	1-28
Getting Prints and Plots of the Display .....	1-29
To get a print or plot .....	1-29
To enter the plotter type and address .....	1-29
To enter the printer type and address .....	1-31
Changing Step Key Jumps .....	1-32
To change step size: source frequency/power .....	1-32
To change step size: sampler frequency .....	1-33
Securing the Instrument .....	1-34
To prevent display of frequency and time information .....	1-34
To erase user memory registers .....	1-35
To erase user instrument states .....	1-35
To erase user correction data .....	1-36
To erase user-created math equations .....	1-37

## Using a Common Frequency Reference

For most measurements, the frequency reference of the microwave transition analyzer and RF source must be shared. You can either lock the RF source to the HP 70820A's 10 MHz frequency reference or lock the HP 70820A to the RF source's frequency reference. When an external reference is used, the annotation EXT appears on the display.

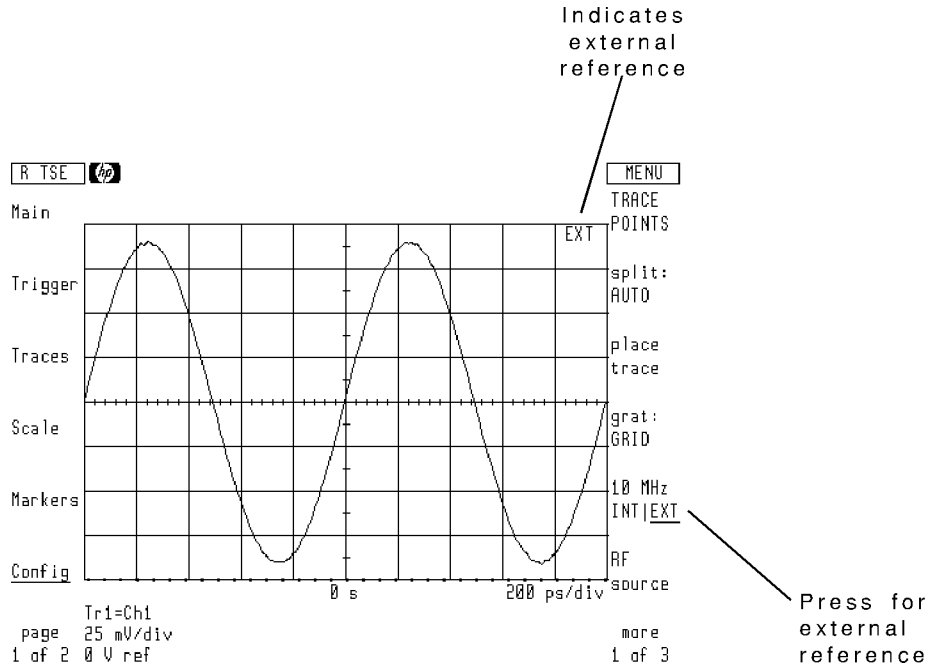

When the instrument is turned on (or the **INSTR PRESET** key is pressed), the microwave transition analyzer determines if an external reference signal is present at the rear-panel 10 MHz REF INPUT connector. If a signal is present, the external reference is automatically selected.

### **To lock on the HP 70820A frequency reference**

1. Connect the rear-panel 10 MHz REF OUTPUT connector to the RF source's reference input connector.
2. Press the **Config** softkey to enter the Configuration menu.
3. Press the **10 MHz INT|EXT** softkey so that INT is underlined.

### **To lock on the RF source frequency reference**

1. Connect the rear-panel 10 MHz REF INPUT connector to the RF source's 10 MHz reference output connector.
2. Press the **Config** softkey to enter the Configuration menu.
3. Press the **10 MHz INT|EXT** softkey so that **EXT** is underlined.

---

## **Configuring the RF Source**

The microwave transition analyzer controls the RF source's power, frequency, and other settings via commands sent over the HP-IB or HP-MSIB. To control an RF source, you must configure the microwave transition analyzer with the following information:

- The RF source's model number.
- The communication bus used (HP-IB or HP-MSIB).
- The RF source's address on the bus.

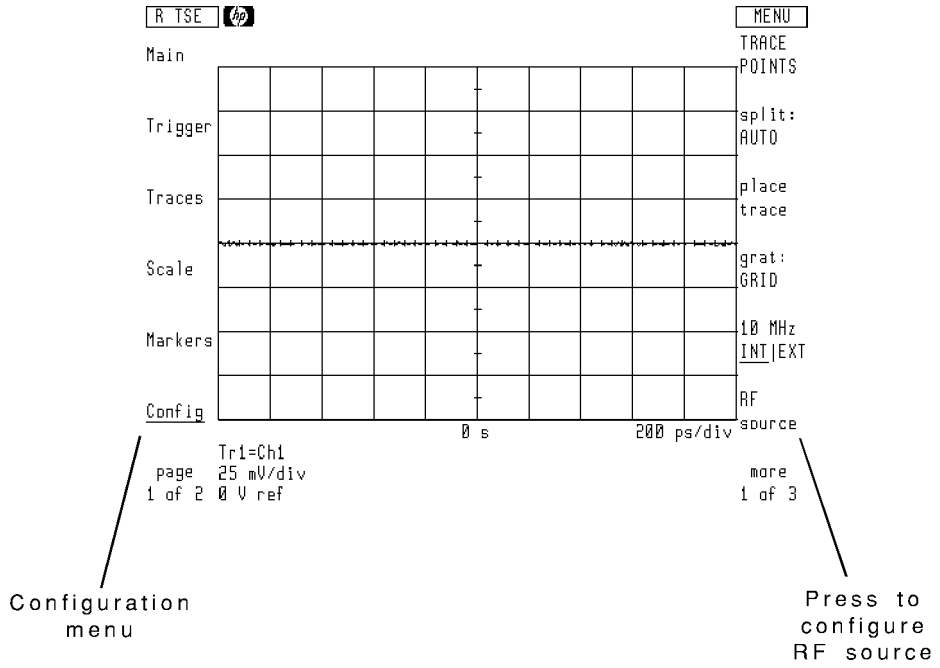

The Configuration menu's **RF source** softkey presents a menu for configuring the microwave transition analyzer with the above selections. When either the source type, bus, or address is entered, the microwave transition analyzer attempts to locate the source on the bus. If no instrument is found, an error message is displayed. If the RF source uses the HP-IB bus, be sure to use the HP-IB connector on the rear panel of the HP 70820A. Do not connect the bus to the display's HP-IB connector.

When the RF source is located, it is preset to default settings which include turning its RF output off. You can turn the RF source's power on from the microwave transition analyzer's Main menu.



## To select the source type

The microwave transition analyzer must know the model number of the RF source. Be aware that some available sources have more features than others. For example the HP 3325A/B synthesizer/level generator does not have an internal pulse modulator.

When an RF source is selected, the microwave transition analyzer searches the appropriate bus for the source at the default address. If the source is not located, an error message is displayed. Use the **HP-IB HP-MSIB** softkey to change the default bus searched. Use the **HP-IB ADDR** softkey or **HP-MSIB ROW** and **HP-MSIB COLUMN** softkeys to change the RF source's bus address used by the microwave transition analyzer.

The following is a partial list of RF sources that can be selected and controlled. Selections are made using softkeys.

- HP 8360 Series Synthesized Sweepers
- HP 3325A/B Synthesizer/Level Generator
- HP 3335A Synthesizer/Level Generator
- HP 8340A/B Synthesized Sweeper
- HP 8341B Synthesized Sweeper
- HP 8662A Synthesized Signal Generator
- HP 8672A Synthesized Signal Generator
- HP 8673A through H Synthesized Signal Generator
- HP 70320A Synthesized Signal Generator
- HP 70322A Synthesized Signal Generator
- HP 70325A Agile Signal Generator

To determine the address of the RF source, consult the RF source's manual.

1. If the RF source uses HP-IB, connect the HP-IB cable to the HP 70820A's rear-panel HP-IB connector.

---

**HP-IB connectors** Do not connect the HP-IB cable to the HP 70820A module's HP-IB connector and not the connector on the display. The display's HP-IB connector is used for remote control of the microwave transition analyzer.

---

2. If the RF source uses HP-MSIB and is located in a separate mainframe, connect the mainframes together using an HP-MSIB cable.
3. Turn the RF source on.
4. Press the **Config** softkey to enter the Configuration menu.
5. Press the **RF source** softkey.
6. Press the **RF src** softkey.
7. Press the softkey indicating the RF source you are using.

Softkey selections are provided on both sides of the display. If you don't have an RF source listed in the softkeys, press the **NONE** softkey.

## To enter bus used and source address

1. Press the **Config** softkey to enter the Configuration menu.
2. Press the **RF source** softkey.
3. Select the communication bus:
  - If the RF source is connected through the HP-IB private, press the **HP-IB HP-MSIB** softkey so that HP-IB is underlined.  
or
  - If the RF source is connected through the HP-MSIB, press the **HP-IB HP-MSIB** softkey so that HP-MSIB is underlined.
4. Enter the address:
  - If the RF source is connected through the HP-IB private, press the **HP-IB ADDR** softkey and enter the source's address.  
or
  - If the RF source is connected through the HP-MSIB, press the **HP-MSIB ROW** softkey and enter the row address for the RF source module. Press the **HP-MSIB COLUMN** softkey and enter the column address for the RF source module.

## To disable service requests

Service requests enable the microwave transition analyzer to respond to requests for help or service from the RF source. Service requests can be turned on or off from the microwave transition analyzer. Normally, you would leave service request on.

1. Press the **Config** softkey to enter the Configuration menu.
2. Press the **RF source** softkey.
3. Press the **HP-IB options** softkey.
4. To enable service requests press the **use SRQ ON|OFF** softkey so that **ON** is underlined.  
or
5. To disable service requests press the **use SRQ ON|OFF** softkey so that **OFF** is underlined.

## To use secondary HP-IB addressing

If the RF source requires extended addressing on the HP-IB, press the **HP-IB PRI|SEC** softkey so that **SEC** (secondary) is underlined. Normally, primary (**PRI**) addressing is used.

1. Press the **Config** softkey to enter the Configuration menu.
2. Press the **RF source** softkey.
3. Press the **HP-IB options** softkey.
4. Press the **HP-IB PRI|SEC** softkey so that **SEC** (secondary) is underlined.

## To disable source control momentarily

The Configuration menu provides the **src cfg ON|OFF** softkey for momentarily disabling control of the RF source. This feature allows you to use the RF source's front-panel controls for functions not supported by the microwave transition analyzer.

1. Press the **Config** softkey to enter the Configuration menu.
2. Press the **RF source** softkey.
3. Press the **src cfg ON|OFF** softkey so that **OFF** is underlined.

---

## Controlling the Display of Information

The microwave transition analyzer offers substantial control over annotation, graticules, and trace information. This allows you to customize the screen for ease of viewing.

### To control the screen graticule

You can change the type of graticule displayed. Using the Configuration menu's **grat:** softkey, you can select all graticules, the major axis graticules, the outside frame, or turn all graticules off.

1. Press the **Config** softkey to enter the Configuration menu.
2. Press the **grat:** softkey.
3. Make one of the following selections:
  - **OFF** turns all graticules and display borders off.
  - **AXES** displays only the two center vertical and horizontal graticule lines.
  - **FRAME** displays only the outside display border.
  - **GRID** displays all the graticules and borders.

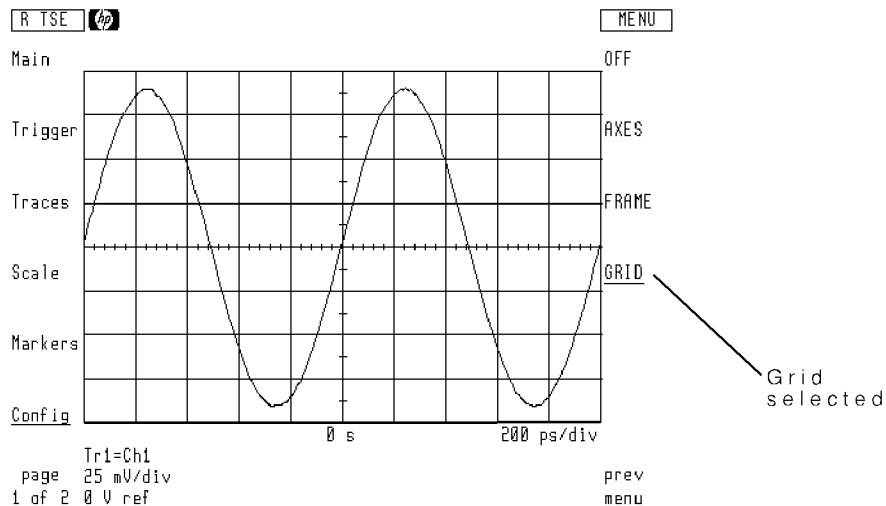

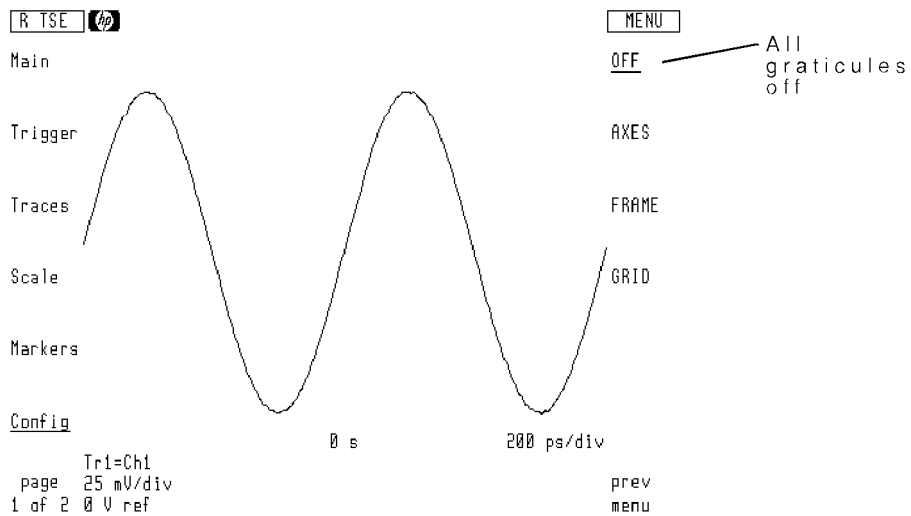
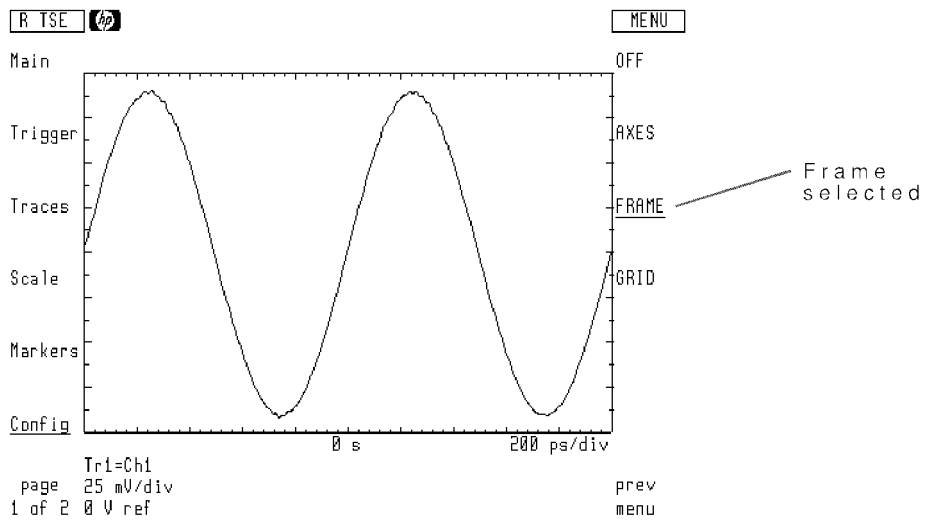
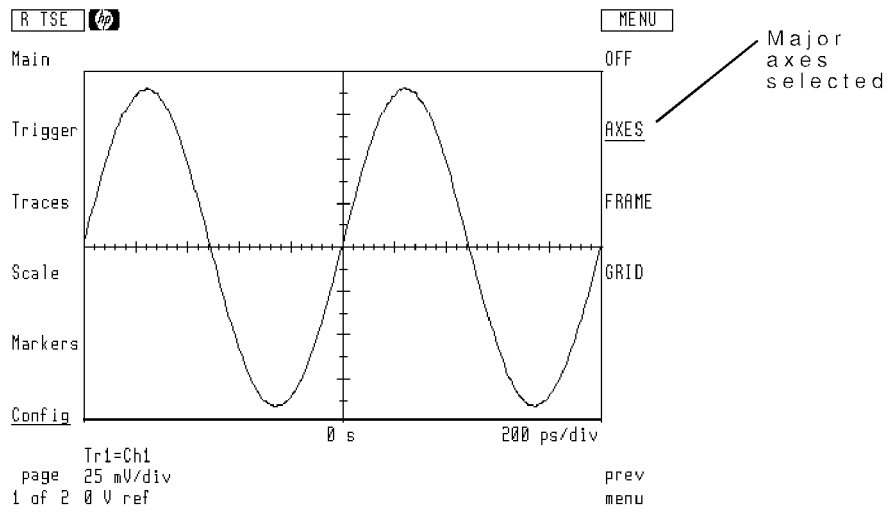

## To control split screen displays

The display can be split into two windows as shown in the following figure:

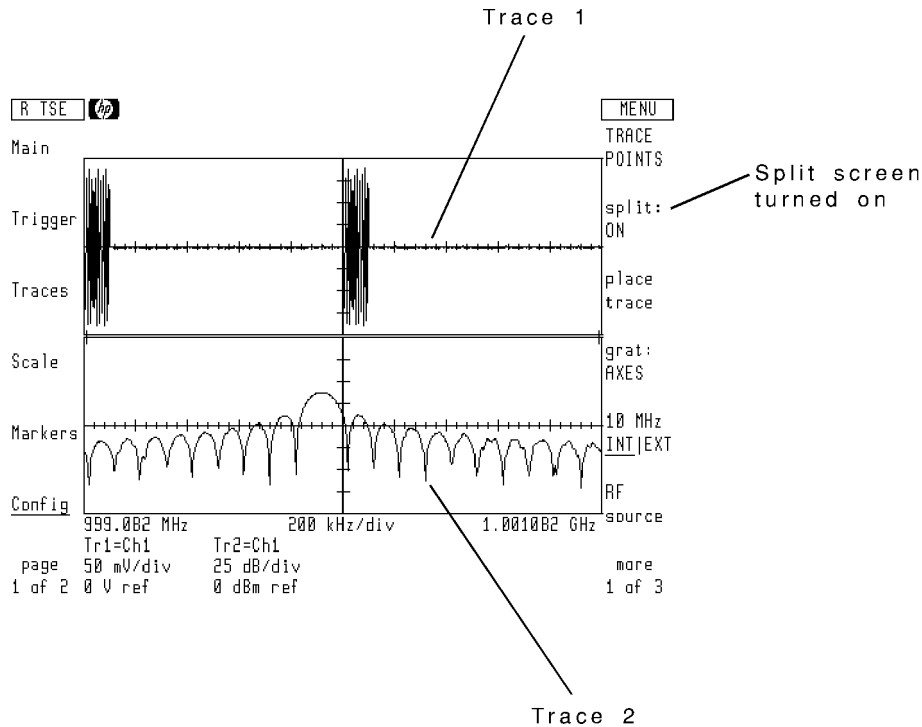

Normally, the decision to split the screen is automatically made by the microwave transition analyzer. However, you can manually control screen splitting at any time.

You control screen splitting using the `split:` softkey of the Configuration menu. Selections include ON, OFF, or AUTO. Automatic (AUTO) screen splitting is the default value used when the microwave transition analyzer is turned on.

1. Press the `Config` softkey to enter the Configuration menu.
2. Press the `split:` softkey.
3. Select one of the following: `AUTO`, `ON`, or `OFF`.

## To position traces on split screen

You can select to display each trace in either the top or bottom half of the screen. Default trace assignments are as follows:

```

trace 1 ..... top
trace 2 ..... bottom
trace 3 ..... top
trace 4 ..... bottom

```

1. Press the `Config` softkey to enter the Configuration menu.
2. Press the `place trace` softkey.

3. Press the appropriate softkey to assign any of the four traces to either the top or bottom screen window.



## To display measurement points

You can control how traces are displayed on the screen. With the default method, measurement points are connected by lines:

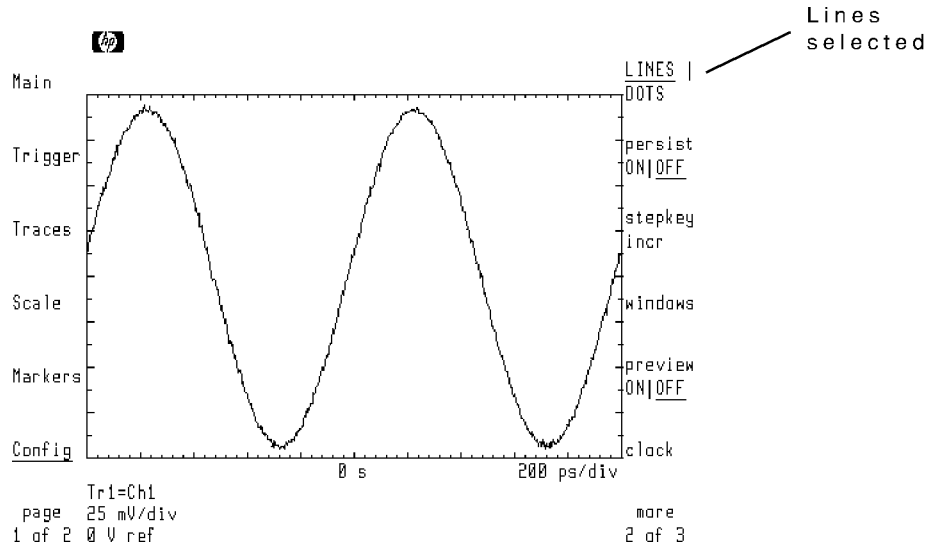

Line drawing can be turned off so that only the measurement points are displayed.

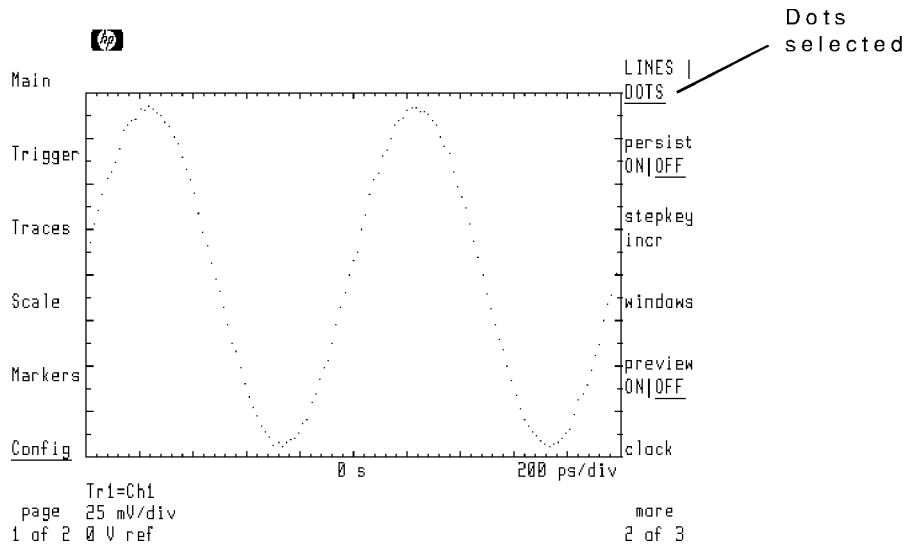

Use the Configuration menu's **LINES | DOTS** softkey to select lines or dots. If the number of measurement points used is large, there may not appear to be a difference between the two displays.

1. Press the **Config** softkey to enter the Configuration menu.
2. Press the **more 1 of 3** softkey.

3. Press the **LINES | DOTS** softkey so that **DOTS** is underlined.

## To set the number of measurement points

Each measurement is made using a set number of points. Use the Configuration menu's **TRACE POINTS** softkey to set the number of points used. With time sweeps, trace points can range from 32 to 1024. With frequency and power sweeps, trace points can range from 1 to 1024.

The higher the number of trace points, the more trace resolution. However, large values slow down measurement speeds.

1. Press the **Config** softkey to enter the Configuration menu.
2. Press the **TRACE POINTS** softkey so that it is highlighted.
3. Enter the desired measurements for the trace.

## To turn on screen persistence

Screen persistence defines how many traces are placed on the screen before the traces are erased. Once erased, the process repeats with new traces displayed on the screen. Normally, trace persistence is off, and each trace is erased before a new one is drawn. Persistence can range from 1 through infinity.

---

**Persistence** Screen persistence is only available with HP 70004 color displays. Information is stored in the display and is not available for manipulation.

---

1. Press the **Config** softkey to enter the Configuration menu.
2. Press the **more 1 of 3** softkey.
3. Press the **persist ON | OFF** softkey so that **ON** is underlined.
4. Enter the number of sweeps drawn before the screen is cleared.

## Using the clock

There are two clocks that can be displayed on the screen: the display's clock and the microwave transition analyzer's clock.

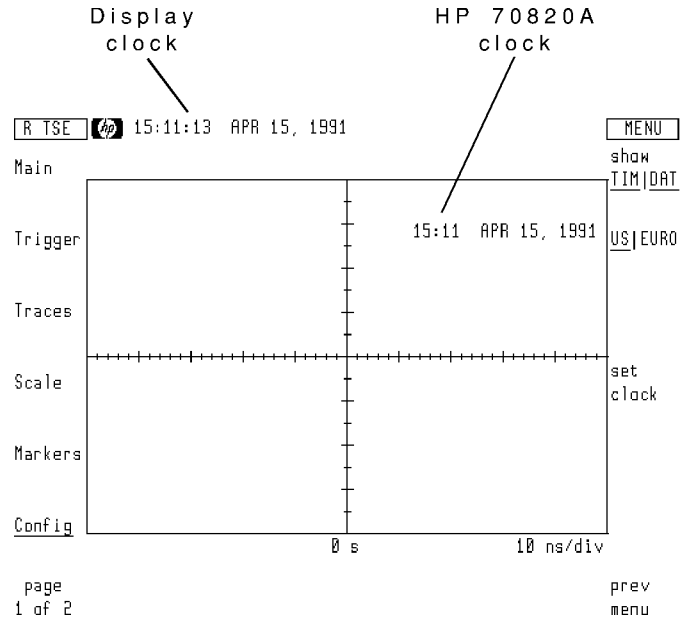

To set the display's clock (or blank its display), refer to the display's manual. To control (or blank) the microwave transition analyzer's clock, use the **clock** softkey in the Configuration menu. You can select from United States or European clock formats.

## To select United States or European format

1. Press the **Config** softkey to enter the Configuration menu.
2. Press the **more 1 of 3** softkey.
3. Press the **clock** softkey.
4. To display the clock in US format, press the **US|EURO** softkey so that **US** is underlined.
5. To display the clock in European format, press the **US|EURO** softkey so that **EURO** is underlined.

## To show time or date

1. Press the **Config** softkey to enter the Configuration menu.
2. Press the **more 1 of 3** softkey.
3. Press the **clock** softkey.
4. To display the time, press the **show TIM|DAT** softkey so that **TIM** is underlined.
5. To display the date, pressing the **show TIM|DAT** softkey so that **DAT** is underlined.
6. To display both time and date, pressing the **show TIM|DAT** softkey so that both **TIM** and **DAT** are underlined.

## To set the clock

1. Press the **Config** softkey to enter the Configuration menu.
2. Press the **more 1 of 3** softkey.
3. Press the **clock** softkey.
4. Press the **set clock** softkey.
5. Press the appropriate softkey, and enter the new value in the same format as displayed.

## To turn the clock display off

1. Press the **Config** softkey to enter the Configuration menu.
2. Press the **more 1 of 3** softkey.
3. Press the **clock** softkey.
4. Repeatedly press the **show TIM|DAT** softkey until neither **TIM** or **DAT** is underlined.

## To display the instrument status line

The display's status line shows important information concerning the microwave transition analyzer's state. To turn the status line on or off, use the **status ON|OFF** softkey in the Configuration menu .

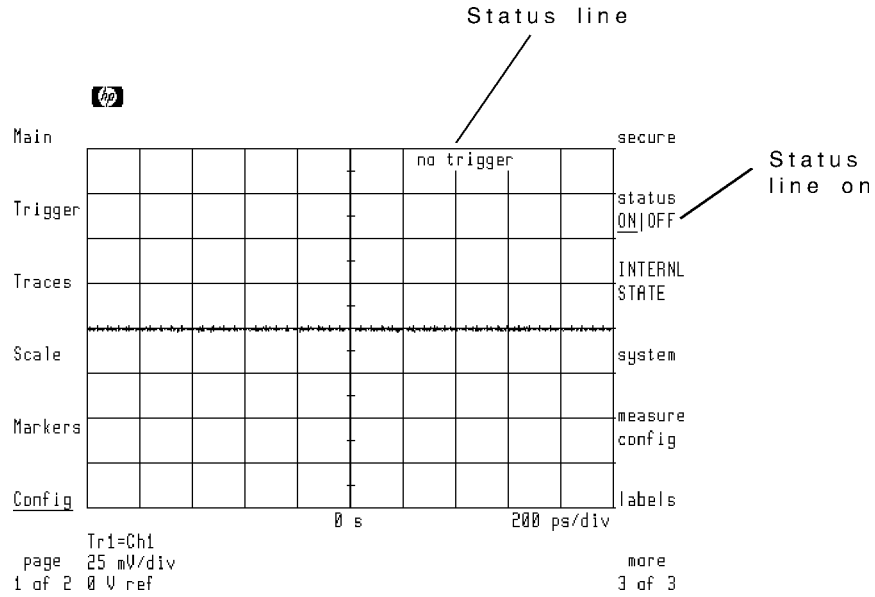

1. Press the **Config** softkey to enter the Configuration menu.
2. Press the **more 1 of 3** then **more 2 of 3** softkeys.
3. Press the **status ON|OFF** softkey so that **ON** is underlined.



## To display the internal state of the instrument

Some measurement applications require the knowledge of certain internal instrument conditions. These conditions can be listed on the display. Interpreting the data requires a detailed knowledge of the sampling techniques employed by the microwave transition analyzer. View the data by pressing the Configuration menu's **INTERNAL STATE** softkey. Pressing any key removes the displayed values.

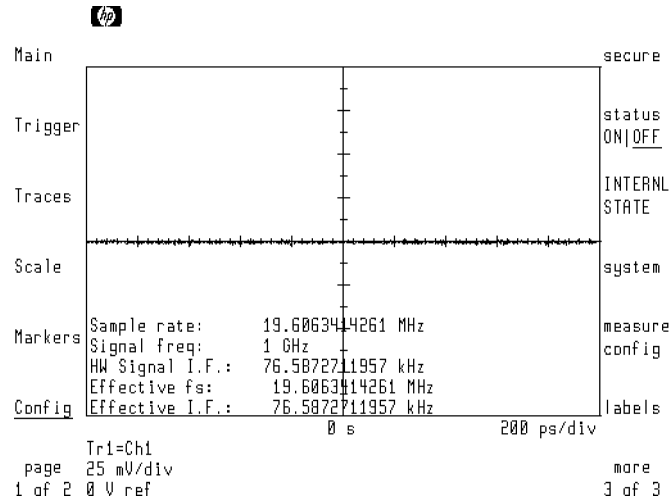

1. Press the **Config** softkey to enter the Configuration menu.
2. Press the **more 1 of 3** then **more 2 of 3** softkeys.
3. Press the **INTERNAL STATE** softkey.

## To view the ROM version

The instrument's program is stored in ROM (Read Only Memory). Knowing the ROM version can be important when communicating problems or questions with Hewlett-Packard. To view the ROM version, press the Configuration menu's **ROM VERSION** softkey.

1. Press the **Config** softkey to enter the Configuration menu.
2. Press the **more 1 of 3** then **more 2 of 3** softkey.
3. Press **system**.
4. Press the **ROM VERSION** softkey.

---

## Getting Prints and Plots of the Display

Often, it is important to get hard copies of the display using the HP 70004A display's print and plot capability. For your convenience, it is discussed here. If you need more detailed information, refer to the display's operating manual.

The display can be printed on any Hewlett-Packard graphics printer. These printers support the Hewlett-Packard PCL printer language and include the ThinkJet, PaintJet, and LaserJet printers. Plots can be made on any Hewlett-Packard HPGL plotter.

### To get a print or plot

1. Connect the printer or plotter to the display via the HP-IB.
  - Be sure to connect the HP-IB to the display's connector and not to the connector on the HP 70820A microwave transition analyzer.
2. Enter the printer or plotter address into the display.
3. Press the front-panel **(PLOT)** or **(PRINT)** keys.

### To enter the plotter type and address

This task applies to HP 70004A displays.

1. Press the front-panel **(DISPLAY)** key.
2. Press the **Hard Copy** softkey.
3. Press the **plotter address** softkey.
  - To configure the plotter in talk/listen mode on the HP-IB, use the **HP-IB TLK/LSN** softkeys to enter the plotter's address.
  - To configure the plotter in listen only mode on the HP-IB, press the **HP-IB L ONLY** softkey.
  - To configure the plotter via the HP-MSIB, enter its address using **HP-MSIB COLUMN** and **HP-MSIB ROW** softkeys.
4. Press the front-panel **←** softkey.
5. Press the **plotter config** softkey.
6. Use the softkeys along the right side of the display to enter the plotter scaling points and select pen numbers.
  - Normally, the scaling points do not need to be changed from the default values.
7. Press the front-panel **(←)** key.
8. Press the **copy options** softkey, and then press the **COPY IS PRT/PLT** softkey so that **PLT** is underlined.
9. Press the front-panel **(MENU)** key to return to the microwave transition analyzer's menu.

## To enter the printer type and address

This task applies to HP 70004A displays.

1. Press the front-panel **DISPLAY** key.
2. Press the **Hard Copy** softkey.
3. Press the **printer address** softkey.
  - To configure the printer in talk/listen mode on the HP-IB, use the **HP-IB TLK/LSN** softkeys to enter the printer's address.
  - To configure the printer in listen only mode on the HP-IB, press the **HP-IB L ONLY** softkey.
  - To configure the printer via the HP-MSIB, enter its address using **HP-MSIB COLUMN** and **HP-MSIB ROW** softkeys.
4. Press the front-panel **←** softkey.
5. Press the **printer config** softkey.
6. Use the softkeys along the right side of the display to select the type of printer used.
7. Press the front-panel **←** softkey.
8. Press the **copy options** softkey, and then press the **COPY IS PRT/PLT** softkey so that **PRT** is underlined.
9. Press the front-panel **MENU** key to return to the microwave transition analyzer's menu.

---

## Changing Step Key Jumps

The front-panel step keys (located beneath the knob) are used to change an active function by a predetermined value (step size). For example, if a 1 GHz source frequency is selected, pressing the **□** step key increases the frequency to 1.1 GHz.

You can change frequency and power step sizes for both the RF source and the microwave transition analyzer's internal sampler frequency. Normally, the default step sizes are adequate. The default step sizes are as follows:

RF source frequency .....	100 MHz
RF source power .....	1 dB
sampler frequency .....	100 kHz

The step key sizes are changed using the Configuration menu's **stepkey incr** menu.

### To change step size: source frequency/power

1. Press the `Config` softkey to enter the Configuration menu.
2. Press the `more 1 of 3` softkey.
3. Press the `stepkey incr` softkey.
4. Press the `RF src FRQ|PWR` softkey so that `FRQ` is underlined.
5. Enter the desired frequency step size.
6. Press the `RF src FRQ|PWR` softkey so that `PWR` is underlined.
7. Enter the desired power step size.

### To change step size: sampler frequency

1. Press the `Config` softkey to enter the Configuration menu.
2. Press the `more 1 of 3` softkey.
3. Press the `stepkey incr` softkey.
4. Press the `SAMPLER FREQ` softkey.
5. Enter the desired sampler frequency step size.

---

## Securing the Instrument

For security reasons, you can prevent the display of important measurement settings. Or, you may need to clear certain memory registers or states. This section indicates how this is done.

The security features are available in the `secure` menu (located in the Configuration menu). You can do any of the following:

- Prevent display of frequency and time information.
- Clear user memory registers and states.
- Clear user correction data.

If you prevent the display of frequency and time information, the only way to resume the display of these values is to press the front-panel `(INSTR PRESET)` key or cycle the line power. Of course, this resets the microwave transition analyzer to its start-up state.

Once cleared, the contents of *user* memory registers, states, and correction data are permanently erased. Predefined states that come with the microwave transition analyzer are *not* erased. For example the `FREQ & POWER` state in the States menu is stored in ROM (read-only-memory) and cannot be erased.

### **To prevent display of frequency and time information**

1. Press the **Config** softkey to enter the Configuration menu.
2. Press the **more 1 of 3** and **more 2 of 3** softkeys.
3. Press the **secure** softkey.
4. Press the **SECURE SCREEN** softkey.

### **To erase user memory registers**

1. Press the **Config** softkey to enter the Configuration menu.
2. Press the **more 1 of 3** and **more 2 of 3** softkeys.
3. Press the **secure** softkey.
4. Press the **clear memory** softkey.
5. Press the appropriate softkey to clear any one of four memory registers or all user memory.

### **To erase user instrument states**

1. Press the **Config** softkey to enter the Configuration menu.
2. Press the **more 1 of 3** and **more 2 of 3** softkeys.
3. Press the **secure** softkey.
4. Press the **clear state** softkey.
5. Press the appropriate softkey to clear any one of six user state registers or all user states memory.

## To erase user correction data

1. Press the `Config` softkey to enter the Configuration menu.
2. Press the `more 1 of 3` and `more 2 of 3` softkeys.
3. Press the `secure` softkey.
4. Press the `clear usr cor` softkey.
5. Press the appropriate softkey to clear the correction data for either input channel.

### **To erase user-created math equations**

1. Press the **Config** softkey to enter the Configuration menu.
2. Press the **more 1 of 3** and **more 2 of 3** softkeys.
3. Press the **secure** softkey.
4. Press the **CLEAR MATH EQ** softkey.





## Performing Measurements

---

The microwave transition analyzer provides six predefined measurement states and fourteen automatic waveform measurements. Predefined measurement states automatically prepare the instrument for the following six measurement types:

- frequency and power
- vector voltage
- vector network
- scalar network
- time and FFT
- pulsed time

Automatic waveform measurements perform the following common waveform analysis:

- rise and fall times
- period
- frequency
- + width and –width
- duty cycle
- delay
- peak and average pulsed power
- RMS voltage
- peak-to-peak voltage
- voltage amplitude
- overshoot

Refer to Chapter 5, “Controlling Time, Frequency, and Power Sweeps,” for details on displaying signals in the time domain.

---

**Using probes** If the device you’re measuring does not have coaxial inputs and outputs, you can use probes such as the HP 85024A high frequency probes. Two probe power jacks on the microwave transition analyzer’s front panel supply the necessary probe power.

---

Using Predefined Measurement States .....	2-4
To save a user-defined state .....	2-7
To recall a user-defined state .....	2-7
Performing a Frequency and Power Measurement .....	2-8
To measure frequency and power of input signals .....	2-9
Performing a Vector Voltage Measurement .....	2-10
To measure vector voltage transmission .....	2-11
To measure vector voltage reflection .....	2-12
Performing a Vector Network Measurement .....	2-14
To measure vector network transmission .....	2-19
To measure vector network reflection .....	2-25
Performing a Scalar Network Measurement .....	2-31
To measure scalar transmission and reflection .....	2-33
Performing a Time and FFT Measurement .....	2-40
To measure time and frequency domains .....	2-41
Using Automatic Waveform Measurements .....	2-42
To perform an automatic measurement .....	2-43
To turn off automatic measurements .....	2-43
To measure pulsed RF .....	2-50
To measure delay .....	2-51
To perform all measurements .....	2-54
To measure rise time, fall time, and overshoot .....	2-55
To measure period .....	2-56
To measure frequency .....	2-57
To measure width and duty cycle .....	2-58
To measure pulse power .....	2-59
To measure voltage .....	2-60

---

## Using Predefined Measurement States

Predefined measurement states give you instant configurations for common measurements. They reduce the number of keystrokes required for measurements. (You can also manually configure these states using the information provided in the remaining chapters.)

The predefined measurement states are located in the States menu. After pressing any state softkey, the state is invoked, and the microwave transition analyzer's Main menu is displayed. To remove a predefined state, press the front-panel **INSTR PRESET** key. This presets the instrument.

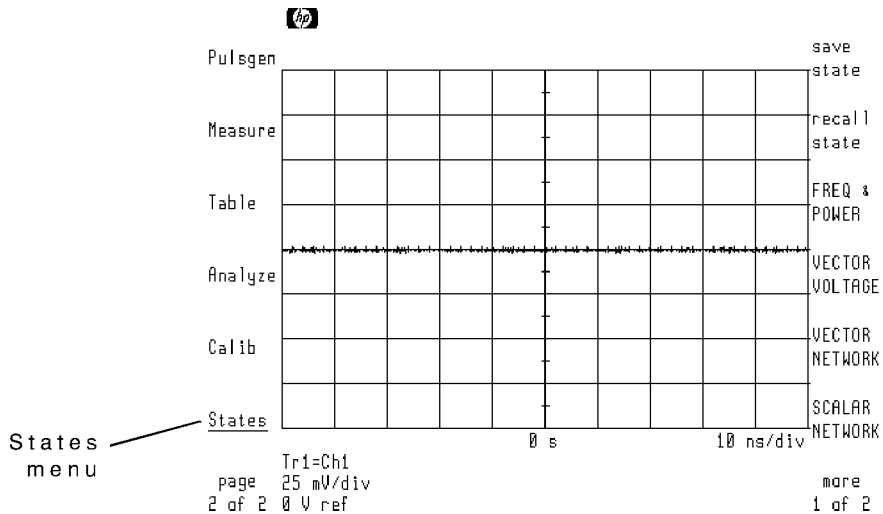

**Page 1 of the States menu**

**Pulsed RF stimulus** Chapter 3 for information on using the Pulsed Time predefined measurement state. With the exception of Pulsed Time, the predefined measurement states require the use of CW signals. They do not work when using pulsed RF stimulus. To perform these measurements using pulsed RF, refer to Chapter 3, "Performing Pulsed RF Measurements."

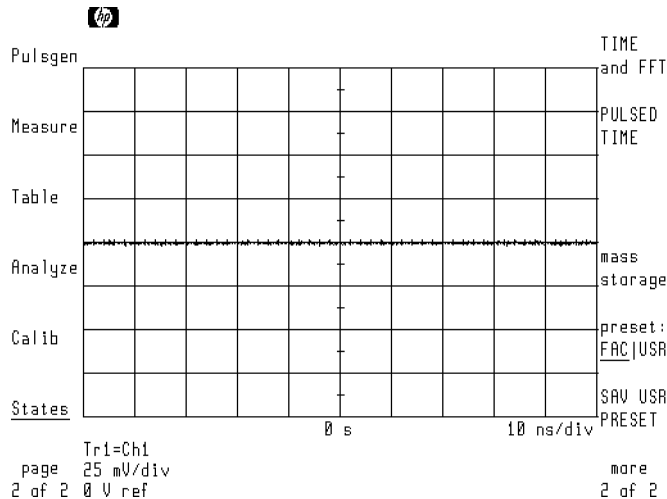

**Page 2 of the States menu**

You should know:

- Predefined measurement states automatically select either frequency or time sweeps. Chapter 5 shows you how to manually configure time, frequency, and power sweeps.
- The Frequency and Power and Vector Voltage states do not require that the RF source be controlled by the microwave transition analyzer.
- Predefined measurement states do not turn on the RF source's power or change its frequency or power levels. The only exceptions are the Scalar Network and Vector Network states.
- Using Vector Voltage, Vector Network, and Scalar Network states may require external hardware such as couplers, splitters, and switches. These must be provided by the user. There are presently no standard test sets available for Modular Measurement Systems (MMS).

### **Creating measurement states**

You can create your own custom measurement states using the States menu's **save state** and **recall state** softkeys. User-defined states reduce the set-up time required for common measurements. Up to six user-defined states can be saved and recalled. When recalled, user-defined states automatically set instrument settings to the values present when the state was saved.

Unlike predefined states, user-defined states save both RF source configuration values and settings.

**To save a user-defined state**

1. Press the **States** softkeys to enter the States menu.
2. Press the **save state** softkey.
3. Select and press a **SAVE empty #** softkey. (N represents a state register from 1 through 6.)

**To recall a user-defined state**

1. Press the **States** softkeys to enter the States menu.
2. Press the **recall state** softkey.
3. Select and press a **RECALL STATE #** softkey. (# represents a state register from 1 through 6.)

---

## Performing a Frequency and Power Measurement

The Frequency and Power state measures the frequency and power of any signal at the channel 1 input connector. The RF source does not have to be controlled by the microwave transition analyzer. This state turns all traces off and uses the table feature to display the results. To learn more about the table feature, refer to chapter 10, “Using the Harmonic Table.”

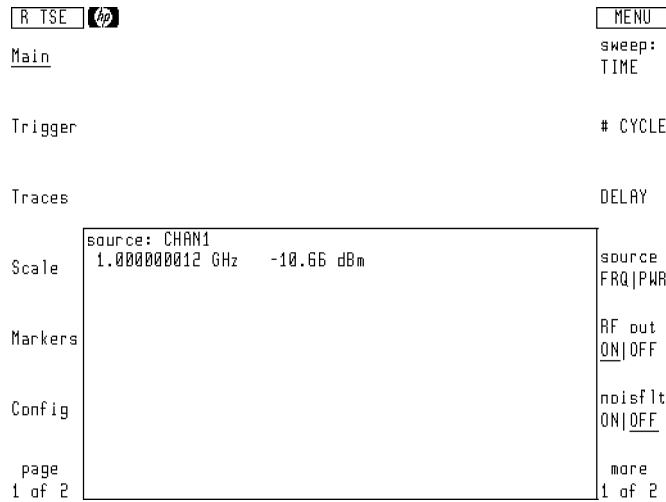

**Frequency and power measurement results**

---

**Measuring channel 2** Frequency and Power state measures the signal on channel 1. You can measure the signal on channel 2 by invoking the state, entering the Table menu, and then reassigning the table's input to channel 2.

---

### To measure frequency and power of input signals

1. Connect the input signal to channel 1.
2. Press the front-panel (INSTR PRESET) key to preset the instrument.
3. If the RF source is controlled by the microwave transition analyzer, press the RF out ON|OFF softkey so that ON is underlined.
4. Press the page 1 of 2 softkey.
5. Press the States softkey to enter the States menu.
6. Press the FREQ & POWER softkey.

---

### Performing a Vector Voltage Measurement

The Vector Voltage state configures the microwave transition analyzer for measuring the frequency, gain, and phase of a signal between channels 1 and 2. The RF source does not need to be synthesized or controlled by the microwave transition analyzer. Both transmission and reflection measurements can be made with any CW signal between 500 Hz and 40 GHz.

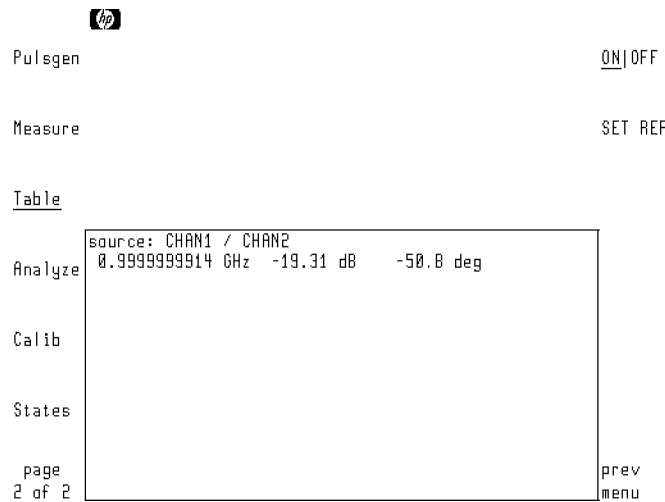

**Vector voltage measurement results**

Vector Voltage turns all traces off and uses the table feature to display the results. If the input signal frequency changes, the microwave transition analyzer detects the change in frequency and performs the measurement at the new frequency.

#### Normalizing the test setup

Before performing the measurement, the test setup should be normalized. (Normalization compensates for errors caused by the frequency response of the test setup.) The instructions in this section include steps on normalizing the test setup.

## To measure vector voltage transmission

1. The equipment should be connected as shown below. The DUT should not be connected at this time. Connect the *through* line.

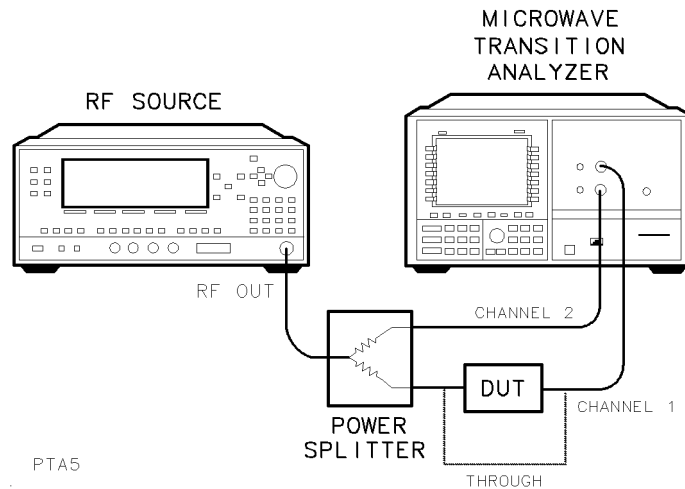

2. If the RF source is controlled by the microwave transition analyzer, press the **RF out ON|OFF** softkey so that **ON** is underlined.
3. Press the **page 1 of 2** softkey.
4. Press the **States** softkey to enter the States menu.
5. Press the **VECTOR VOLTAGE** softkey.
6. Press the **page 1 of 2** and then **Table** softkeys to enter the Table menu.
7. Press the **delta** and then **SET REF** softkeys.

This normalizes the gain and phase for relative measurements.

8. Insert the DUT into the channel 1 signal path.



## To measure vector voltage reflection

1. The equipment should be connected as shown below. The DUT should not be connected at this time. Connect an *open* to the output.

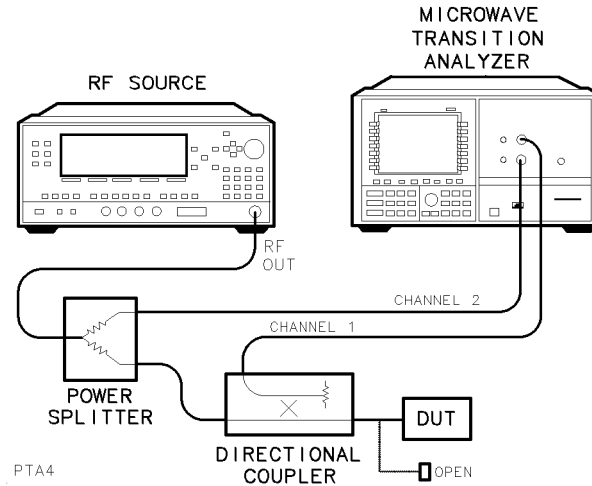

2. If the RF source is controlled by the microwave transition analyzer, press the **RF out ON|OFF** softkey so that **ON** is underlined.
3. Press the **page 1 of 2** softkey.
4. Press the **States** softkey to enter the States menu.
5. Press the **VECTOR VOLTAGE** softkey.
6. Press the **page 1 of 2** and then **Table** softkeys to enter the Table menu.
7. Press the **delta** and then **SET REF** softkeys.

This normalizes the gain and phase for relative measurements.

8. Replace the *open* with the DUT.

If the DUT is a two port device, terminate its output port with its characteristic impedance.

## Performing a Vector Network Measurement

The Vector Network state configures the microwave transition analyzer for making vector network transmission and reflection measurements from 10 Hz to 40 GHz (depending on the RF source used). The RF source must be controlled by the microwave transition analyzer.

Pressing the **VECTOR NETWORK** softkey automatically defines traces and memory registers for the following uses:

- Trace 1: active trace for saving calibrations
- Trace 2: normalized transmission response formatted as log magnitude
- Trace 3: normalized return loss (log magnitude)
- Trace 4: normalized return loss (phase)
- MEM 1: saved *through* transmission response
- MEM 2: saved *open* reflection response
- MEM 3: saved *short* reflection response

### Normalizing the test setup

The instructions in this section include steps on normalizing the test setup. (Normalization compensates for errors caused by the frequency response of the test setup.) Full vector error correction is not available.

### Measuring transmission

Transmission measurements are displayed using traces 1 and 2. After storing the *through* response in memory register 1, trace 1 can be redefined to the same definition as trace 2. Trace 2 can then be formatted to show phase instead of magnitude.

The following figure shows the transmission through a 321.4 MHz band-pass filter.

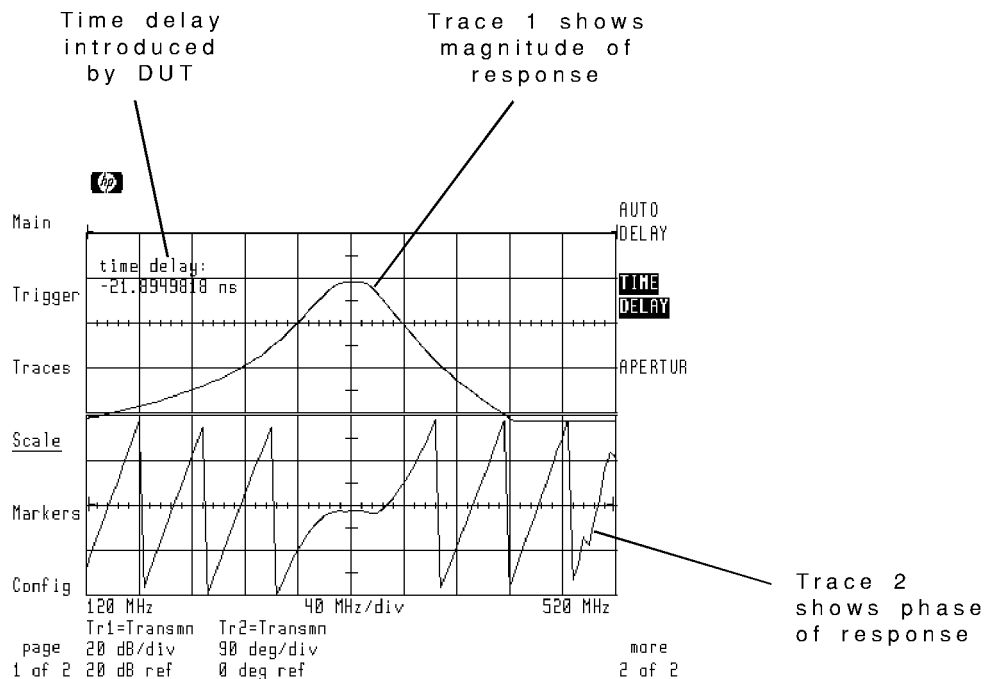

The predefined vector network state automatically sets the following trace definitions for transmission measurements:

$$\begin{aligned} \text{trace 1} &= \frac{CH1}{CH2} \\ \text{trace 2} &= \frac{\left(\frac{CH1}{CH2}\right)}{MEM1} \end{aligned}$$

where:

CH1/CH2 is the ratio of device output to input.

MEM1 is the stored *through* response on trace 1. The response is stored without the DUT in the signal path.

### Compensating for time delay

When performing transmission measurements, inserting the DUT after saving the *through* response increases the electrical length of the line. This causes the phase to wrap around on the display. Compensation can be accomplished by using the Scale menu's **AUTO DELAY** feature. (Auto delay subtracts a fixed amount of time delay from the displayed response.)

Using auto delay on devices such as cables (which have a constant delay over frequency) compensates the complete response. However, devices such as filters have a changing delay over frequency, and adding a fixed amount of delay cannot compensate the whole response. Use markers to limit the frequency range compensated for by auto slope. Press the Scale menu's **TIME DELAY** softkey to display the amount of delay removed by the auto slope function or to adjust the delay manually.

## Measuring reflection

Reflection measurements are displayed using traces 3 and 4. Trace 3 shows the normalized return loss formatted as magnitude, and trace 4 shows the normalized return loss formatted as phase. Save the *open* response in memory register 2, and the *short* response in memory register 3.

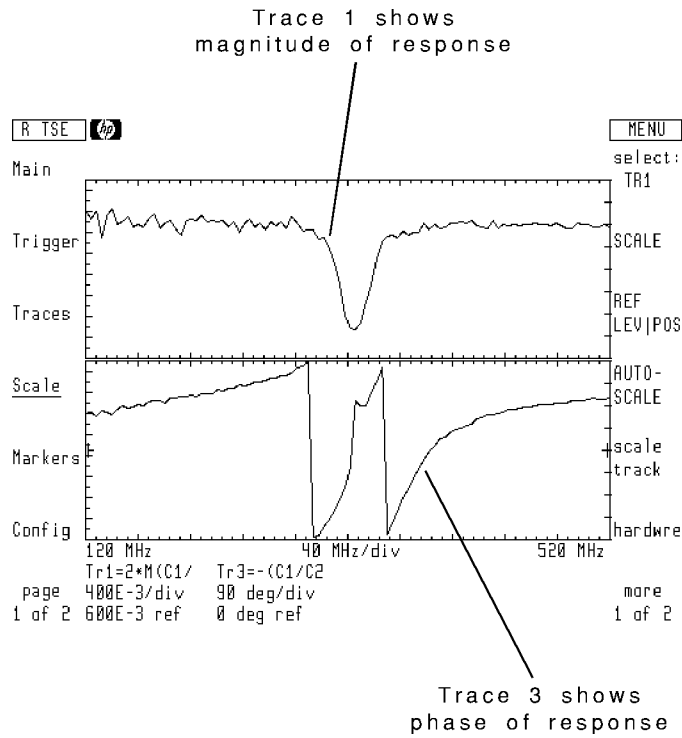

The following trace definitions are automatically set for reflection measurements:

$$\begin{aligned} \text{trace 1} &= \frac{CH1}{CH2} \\ \text{trace 3} &= \frac{2 \left[ \text{MAGN} \left( \frac{CH1}{CH2} \right) \right]}{\text{MAGN}(MEM2) + \text{MAGN}(MEM3)} \end{aligned}$$

where:

MAGN(CH1/CH2) is the magnitude of the ratio of reflected to incident waves.

(MAGN(MEM2)+MAGN(MEM3)), in conjunction with the factor 2, gives the average of the *open* and *short* calibration responses.

$$\text{trace 4} = (-1) \left[ \frac{\left( \frac{CH1}{CH2} \right)}{MEM3} \right]$$

where:

CH1/CH2 is the ratio of reflected to incident waves.

MEM3 is the stored response with the *short* load.

## To measure vector network transmission

Before beginning this procedure, configure the RF source to be controlled from the microwave transition analyzer. Refer to Chapter 1 “Configuring the HP 71500A,” for information on configuring for the RF source.

### Step 1. Connect the equipment

1. Connect the equipment as shown below with the output of the splitter connected directly to the channel 1 input. (The DUT should not be connected at this time.)

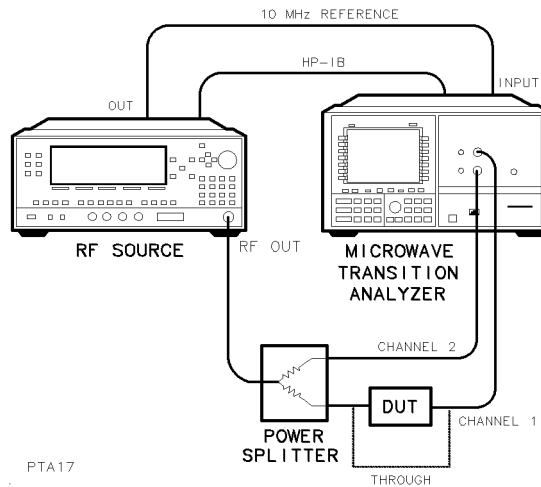

### Step 2. Invoke the autostate

1. Press the `page 1 of 2` then `States` softkeys to enter the States menu.
2. Press the `VECTOR NETWORK` softkey.
3. Press the `START` softkey, and enter the starting frequency of the sweep.
4. Press the `STOP` softkey, and enter the stop frequency of the sweep.
5. Press the `source POWER` softkey, and enter the RF source's power level.
6. Press the `RF out ON|OFF` softkey so that `ON` is underlined.

### Step 3. Save the through calibration response

1. Press the `Trigger` softkey to enter the Trigger menu.
2. Press the `SINGLE` softkey, and wait for the sweep to finish.

As the sweep is taken, a diamond moves across the bottom of the display. This indicates the frequency of the source as it is stepped from the start frequency to the stop frequency.

3. Press the `Traces` softkey to enter the Traces menu.
4. Press the `store trace` and then `TO MEM1` softkeys.

The *through* calibration response is now saved in memory register 1.



#### Step 4. Define and format the traces

1. Press the **input:** softkey. Use the front-panel knob to scroll the menu bar to the definition of trace 2. Press the **RETURN** softkey. See the following figure.

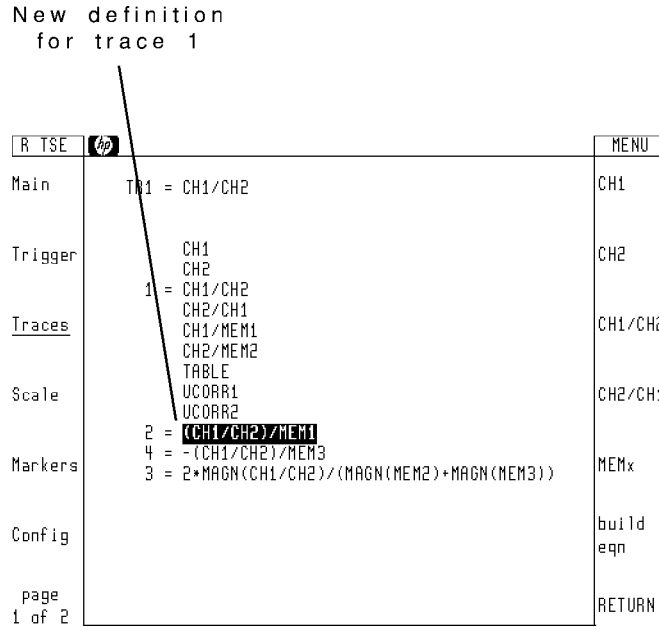

Traces 1 and 2 now have the same definition. We will format trace 1 to show the magnitude and trace 2 to show the phase.

2. Press the **select:** and then **TR2** softkeys.
3. Press the **display ON|OFF** softkey so that **ON** is underlined.
4. Press the **format:** and then **PHASE** softkeys.

Trace 2 is now formatted to show phase.

### Step 5. Display the normalized response

1. Place the DUT in the line going to channel 1.
2. Press the **Trigger** and then **SINGLE** softkeys to start a sweep. Wait for the sweep to finish.

The following figure shows what the response of a 321.4 MHz band-pass filter would look like.

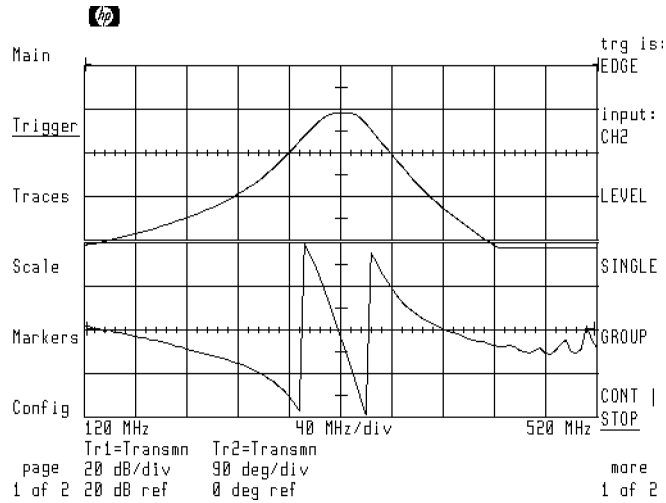

3. Use the Scale menu's **select:**, **AUTOSCALE**, and **REF LEV|POS** softkeys to position the traces as desired on the display.



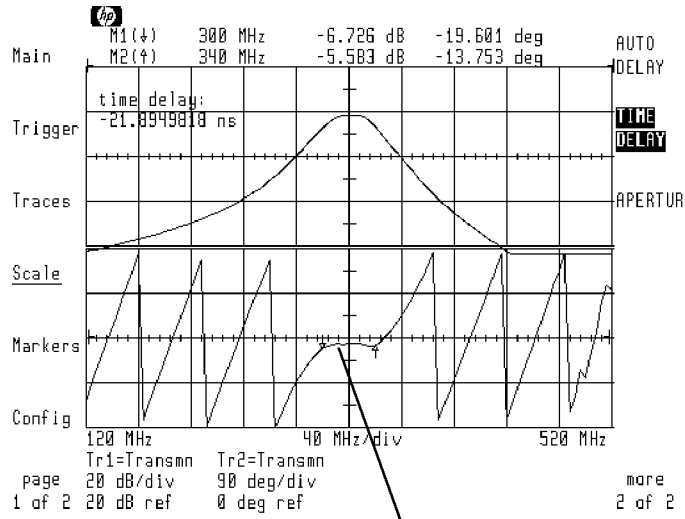

Compensated phase  
response between  
6dB points

## To measure vector network reflection

Before beginning this procedure, configure the RF source so that it is controlled from the microwave transition analyzer. Refer to Chapter 1 “Configuring the HP 71500A,” for information on configuring for the RF source.

### Step 1. Connect the equipment

1. Connect the equipment as shown below with the coupler’s output terminated with an *open*. (The DUT should not be connected at this time.) Be sure to position the directional coupler so that it couples power reflected *from* the DUT to channel 1.

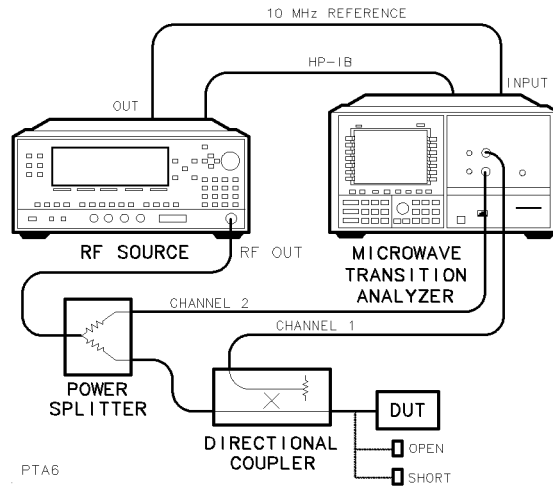

## Step 2. Invoke the autostate

1. Press **INSTR PRESET**.
2. Press the **page 1 of 2** then **States** softkeys to enter the States menu.
3. Press the **VECTOR NETWORK** softkey.
4. Press the **START** softkey, and enter the starting frequency of the sweep.
5. Press the **STOP** softkey, and enter the stop frequency of the sweep.
6. Press the **source POWER** softkey, and enter the RF source's power level.
7. Press the **RF out ON|OFF** softkey so that **ON** is underlined.

### Step 3. Save the open response

1. Press the **Trigger** softkey to enter the Trigger menu.
2. Press the **SINGLE** softkey, and wait for the sweep to finish.

As the sweep is taken, a diamond moves across the bottom of the display. This indicates the frequency of the source as it is stepped from the start frequency to the stop frequency.

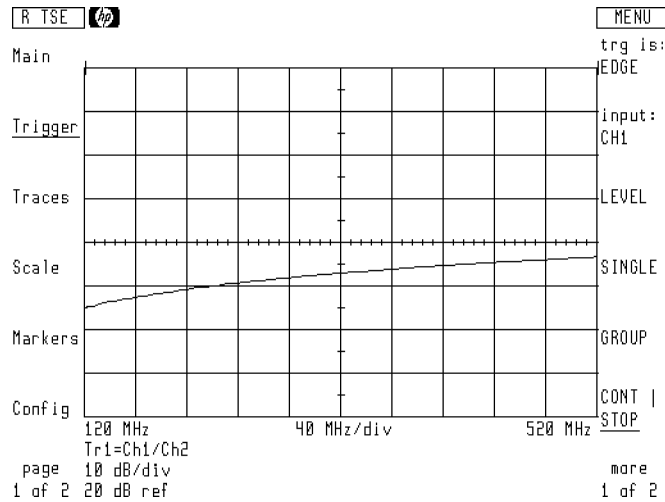

3. Press the **Traces** softkey to enter the Traces menu.
4. Press the **store trace** and then **TO MEM2** softkeys.

The *open* calibration response is now saved in memory register 2.

#### Step 4. Save the short response

1. Replace the *open* with a *short* termination.
2. Press the **Trigger** softkey to enter the Trigger menu.
3. Press the **SINGLE** softkey, and wait for the sweep to finish.
4. Press the **Traces** softkey to enter the Traces menu.
5. Press the **store trace** and then **TO MEM3** softkeys.

The *short* calibration response is now saved in memory register 3.

#### Step 5. Define and format the traces

1. Press the **display ON|OFF** softkey so that **OFF** is underlined.

Trace 1 is no longer displayed.

2. Press the **select:** and then **TR3** softkeys.
3. Press the **display ON|OFF** softkey so that **ON** is underlined.

Trace 3 is displayed and already formatted for log magnitude.

4. Press the **select:** and then **TR4** softkeys.
5. Press the **display ON|OFF** softkey so that **ON** is underlined.

Trace 4 is displayed and already formatted for phase.



### Step 6. Display the normalized response

1. Replace the *short* with the DUT. If the DUT is a two-port device, terminate its other port with its characteristic impedance.
2. Press the **Trigger** and then **SINGLE** softkeys to start a sweep.

The following figure shows what the reflection from a 321.4 MHz band-pass filter would look like.

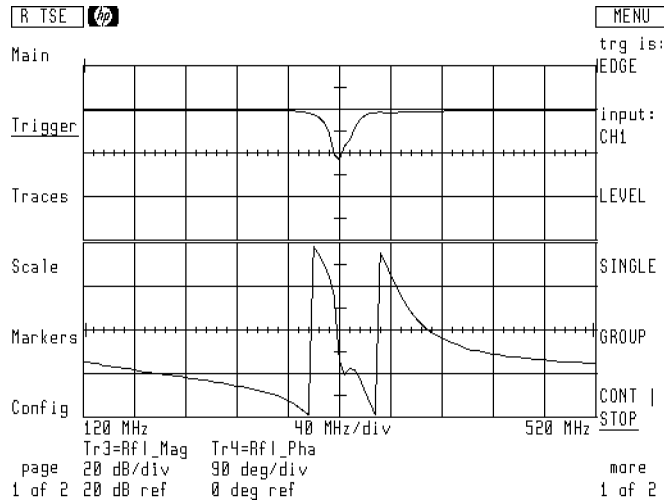

3. Use the Scale menu's **SCALE** and **REF LEV|POS** softkeys to position the traces as desired on the display. Be sure to first use the **select:** softkey to select the trace for scaling.

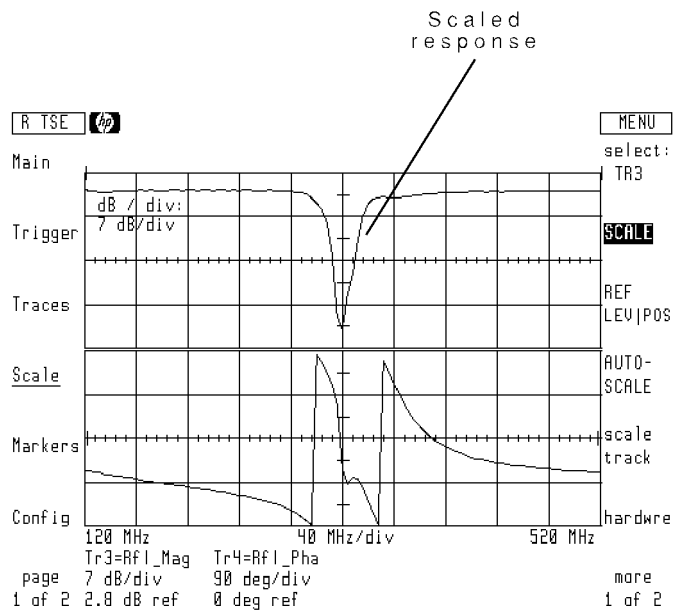

## Performing a Scalar Network Measurement

The Scalar Network state allows you to simultaneously display both transmission and reflection responses. The RF source must be controlled from the microwave transition analyzer.

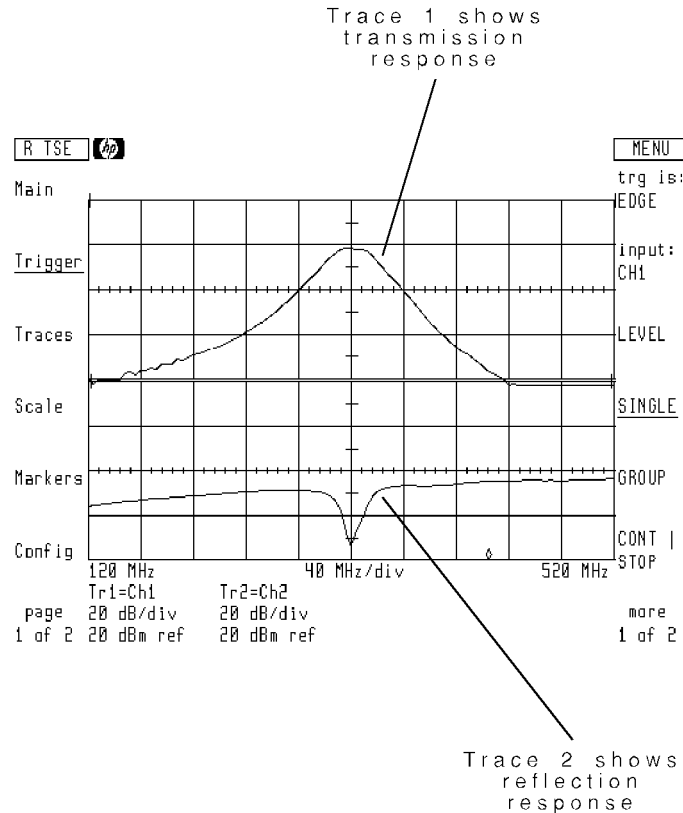

### Normalizing the test setup

The instructions in this section include steps on normalizing the test setup. Normalization compensates for errors caused by the frequency response of the test setup. Full vector error correction is not available.

### Trace definitions

Pressing the **SCALAR NETWORK** softkey automatically defines traces and memory registers for the uses listed below. However, do not turn on traces 3 and 4 until after completing normalization.

- Trace 1: trace for saving *through* normalization
- Trace 2: trace for saving *open/short* normalization
- Trace 3: normalized transmission response
- Trace 4: normalized return loss
- MEM 1: saved *through* transmission response
- MEM 2: saved *open* reflection response
- MEM 3: saved *short* reflection response

Trace 3 shows the normalized transmission, and has the trace definition listed below.

$$trace\ 3 = \frac{CH1}{MEM1}$$

where:

CH1 is the measured response at channel 1.

MEM1 is the stored *through* normalization response stored in memory register one. (The response is stored without the DUT in the signal path.)

Trace 4 shows the normalized return loss. (Channel 2 divided by an open/short average normalization.) It has the trace definition listed below.

$$trace\ 4 = \frac{2(MAGN(CH2))}{MAGN(MEM2) + MAGN(MEM3)}$$

where:

MAGN(CH2) is the log magnitude of the reflected signal.

(MAGN(MEM2)+MAGN(MEM3)), in conjunction with the factor 2, gives the average of the *open* and *short* calibration responses.

## To measure scalar transmission and reflection

Before beginning this procedure, configure the RF source to be controlled from the microwave transition analyzer. Refer to Chapter 1, “Configuring the HP 71500A,” for information on configuring for the RF source.

### Step 1. Connect the equipment

1. Connect the equipment as shown below. Connect the output of the directional coupler directly to channel 1. Do not connect the DUT, *open*, or *short* connections at this time.

Be sure to position the directional coupler so that it couples power reflected *from* the DUT to channel 2. The equipment setup is ready for a transmission normalization using a *through* line.

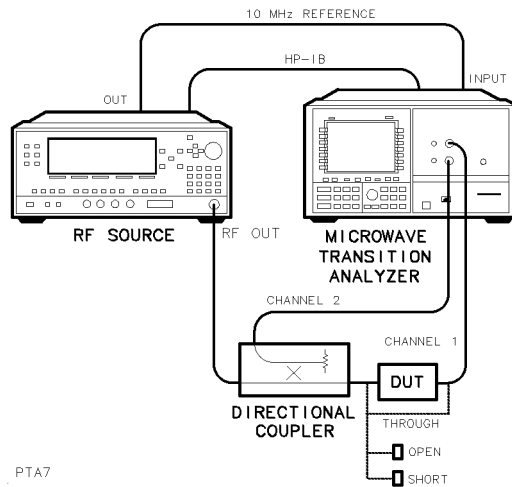

## Step 2. Invoke the autostate

1. Press the `page 1 of 2` and then `States` softkeys to enter the States menu.
2. Press the `SCALAR NETWORK` softkey.

The microwave transition analyzer sweeps the frequency of the RF source.

3. Press the `START` softkey, and enter the starting frequency of the desired sweep.
4. Press the `STOP` softkey, and enter the stop frequency of the sweep.
5. Press the `source POWER` softkey, and enter the power level of the sweep.
6. Press the `RF out ON|OFF` softkey so that `ON` is underlined.

### Step 3. Save the through response

1. Press the **Trigger** softkey to enter the Trigger menu.
2. Press the **SINGLE** softkey to trigger single sweeps.

As the sweep is taken, a diamond moves across the bottom of the display. This indicates the frequency of the source as it is stepped from the start frequency to the stop frequency.

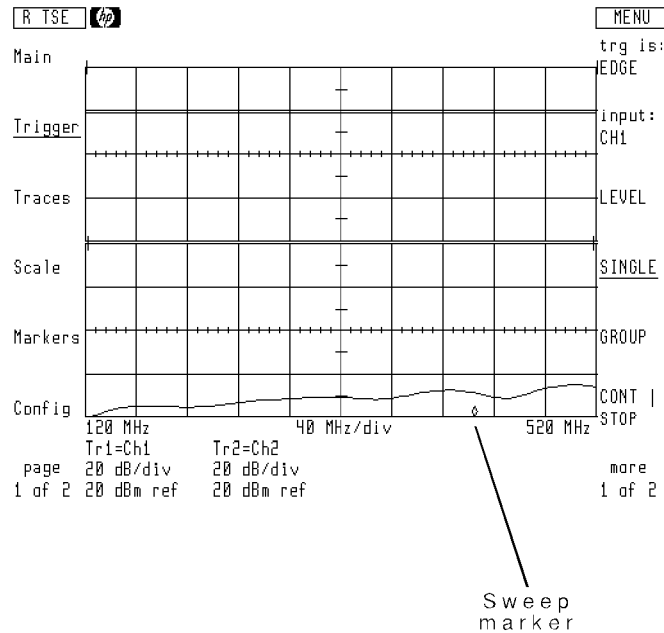

3. Press the **Traces** softkey to enter the Traces menu.
4. Press the **store trace** and then **TO MEM1** softkeys.

The transmission *through* calibration is now saved in memory register 1.

#### Step 4. Save the open response

1. Disconnect the channel 1 cable at the directional coupler, and connect an *open* to the coupler's output.

See the dotted line in the test setup figure. The reflection response will now be saved for normalization.

2. Press the **Trigger** and then **SINGLE** softkeys. Wait for the trace to complete.
3. Press the **Traces** and then **select:** softkeys. Press **TR2**.
4. Press the **store trace** and then **T0 MEM2** softkeys.

#### Step 5. Save the short response

1. Remove the *open*, and replace it with a *short*.
2. Press the **Trigger** and then **SINGLE** softkeys. Wait for the trace to complete.
3. Press the **Traces** and then **store trace** softkeys. Press the **T0 MEM3** softkey.
4. Remove the *short*, and connect the coupler's output, through the DUT, to channel 1.

### Step 6. Define the traces

1. Press the **Traces**, **select**, and then **TR1** softkeys.
2. Press the **display ON|OFF** softkey so that **OFF** is underlined.
3. Press the **select** and then **TR2** softkeys.
4. Press the **display ON|OFF** softkey so that **OFF** is underlined.
5. Press the **select** and then **TR3** softkeys.
6. Press the **display ON|OFF** softkey so that **ON** is underlined.
7. Press the **select** and then **TR4** softkeys.
8. Press the **display ON|OFF** softkey so that **ON** is underlined.



### Step 7. Display the normalized response

1. Press the **Trigger** and then **SINGLE** softkeys. Wait for the trace to complete.

The normalized transmission and reflection responses are now displayed.

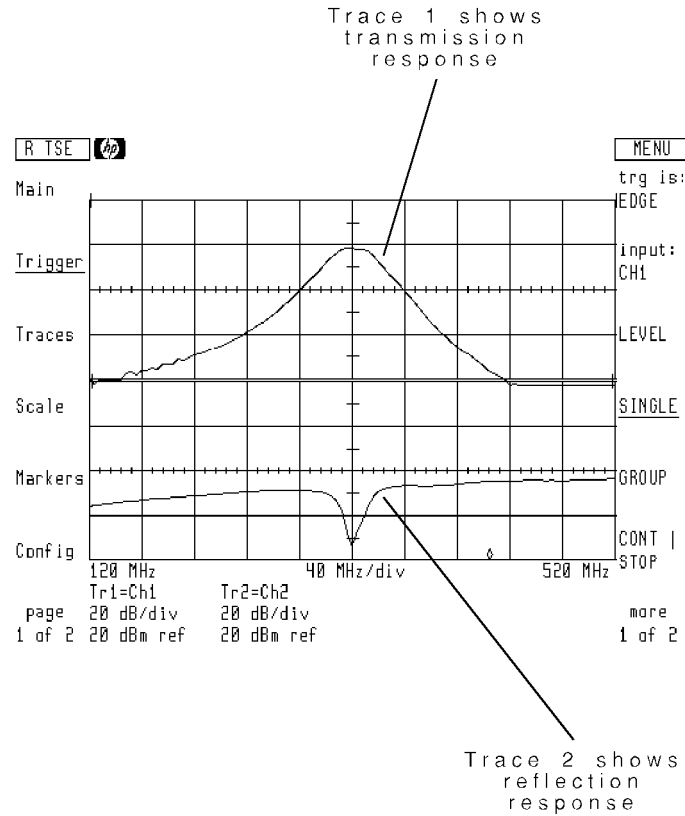

2. Press the **Scale** softkey to enter the Scale menu.
3. Use the **SCALE** and **REF LEV|POS** softkey to scale trace 4 as desired.
4. Press the **Traces**, **select:**, and then **TR3** softkeys.

- Use the Scale menu's **SCALE** and **REF LEV|POS** softkey to scale trace 3 as desired.

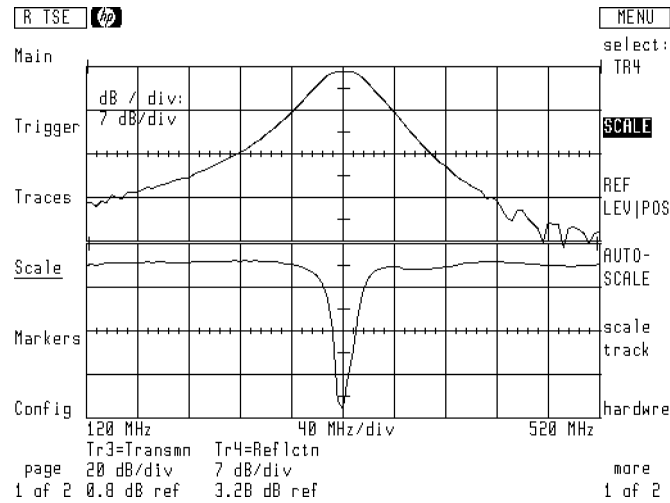

## Performing a Time and FFT Measurement

The Time and FFT state automatically sets the microwave transition analyzer's settings for viewing signals in both time and frequency domains:

- The screen is split.
- Traces 1 and 2 are assigned to channel 1.
- Trace 1 is formatted for time domain.
- Trace 2 is formatted for frequency domain.

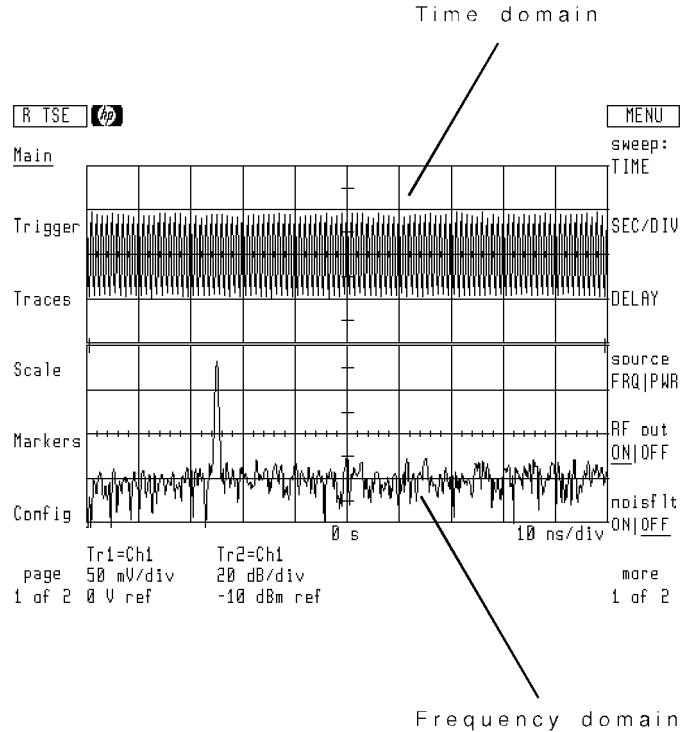

### CW signal

After using the TIME and FFT state, refer to the following sections in this manual to learn how to control the displayed information:

- Chapter 5 to control the time scale
- Chapter 7 to learn about trigger controls
- Chapter 6 to control the trace transform displayed on trace 2

### To measure time and frequency domains

In order to use this state feature, the RF source must be controlled by the microwave transition analyzer.

1. Configure the RF source to be controlled from the microwave transition analyzer. Refer to Chapter 1, “Configuring the HP 71500A.”
2. Connect the input signal to channel 1.
3. Press the left-side **Main** softkey to enter the Main menu.
4. Press the **source FRQ|PWR** softkey so that **FRQ** is underlined. Enter the frequency of the RF source.
5. Press the **source FRQ|PWR** softkey so that **PWR** is underlined. Enter the power of the RF source.
6. Press the **RF out ON|OFF** softkey so that **ON** is underlined.
7. Press the **page 1 of 2** and then **States** softkeys to enter the States menu.

8. Press the **more 1 of 2** and then **TIME** and **FFT** softkeys.

The display is automatically formatted for a split screen. Trace 2 is formatted for an FFT (fast fourier transform).

9. Use the Main menu's **SEC/DIV** softkey to set the horizontal time scale as desired.

## Using Automatic Waveform Measurements

Automatic waveform measurements are selected and controlled using the Measure menu. You can use automatic waveform measurements with CW and pulsed RF signals.

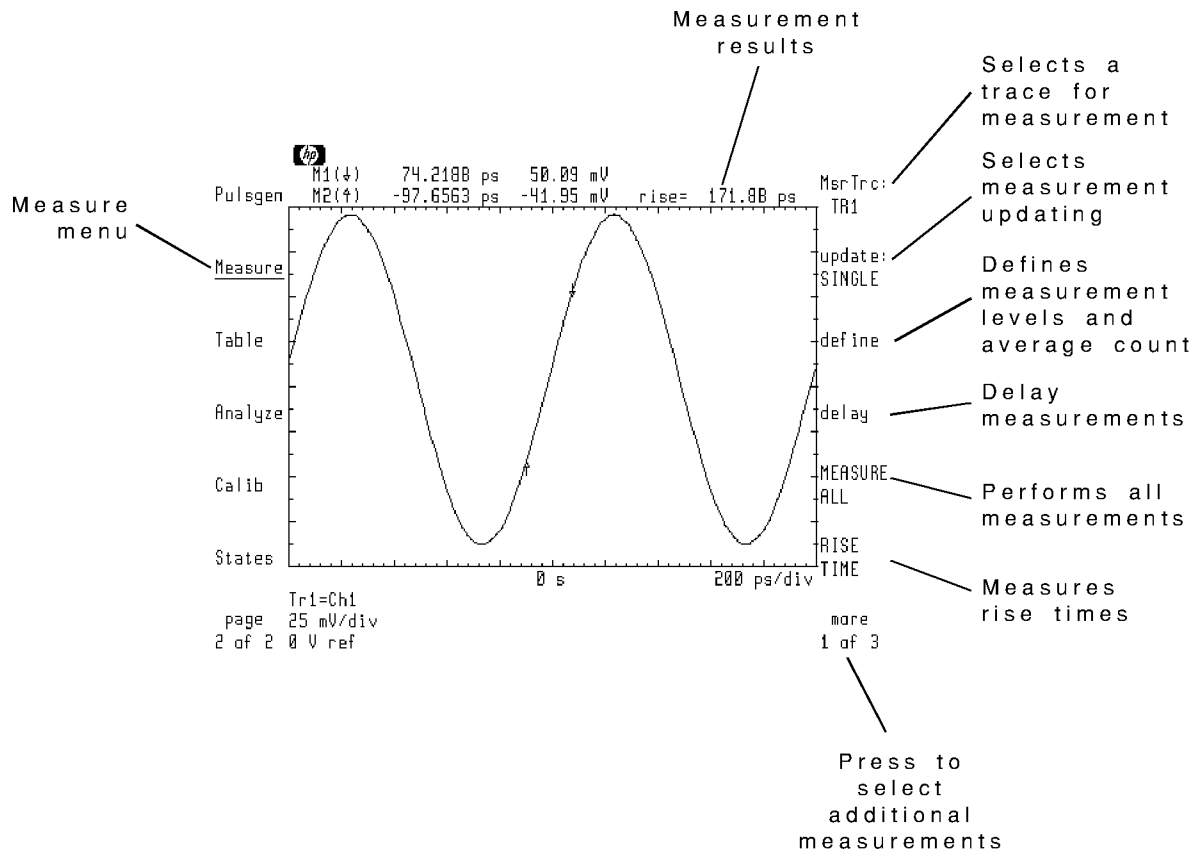

Page 1 of the Measure menu

The Measure menu offers softkeys to perform the following automatic waveform measurements:

- delay
- rise time and fall time
- period
- frequency
- + width and –width
- duty cycle
- peak and average pulsed power
- RMS voltage
- peak-to-peak voltage
- voltage amplitude
- overshoot

Before you select an automatic measurement, you must first choose a trace for measuring. Any displayed trace can be selected. Use the **MsrTrc:** softkey to select the trace.

#### **To perform an automatic measurement**

1. Press the **Measure** softkey to enter the Measure menu.
2. Press the **MsrTrc:** softkey, and select a displayed trace to perform measurements on.

If only one trace is displayed, it is automatically selected.

3. Press the softkey for the desired measurement.

The measurement is performed once. To change to continuous or averaged measurements, press the **update:** softkey.

#### **To turn off automatic measurements**

1. Press the **Measure** softkey to enter the Measure menu.
2. Press the **update:** softkey.
3. Press the **OFF** softkey.

## Updating measurements

Normally, when a measurement is selected, a single measurement is performed on the selected trace. However, using the `update:` softkey, you can select continuous or averaged measurements. With continuous or averaged measurements, the microwave transition analyzer takes a new measurement with each sweep.

With average measurement updating, the automatic measurements use a moving average as shown in the following formula.

$$\text{new average} = \frac{(N - 1)(\text{old average}) + \text{new value}}{N}$$

where:

N is the number of averages

The default number of averages used is 16. You change the number of averages using the `MEASURE AVERAGE` softkey. Press the `define` softkey to locate `MEASURE AVERAGE`.

**To change measurement updating**

1. Press the left-side **Measure** softkey to enter the Measure menu.
2. Press the **update:** softkey.
3. Press one of the following softkeys:
  - **SINGLE** to select single updating.
  - **CONT** to select continuous updating.
  - **AVERAGE** to select averaged updating.

**To change number of measurement averages**

1. Press the left-side **Measure** softkey to enter the Measure menu.
2. Press the **define** softkey.
3. Press the **MEASURE AVERAGE** softkey, and enter the desired average.
4. Press the **prev menu** softkey.

## Defining measurement levels

Measurements such as rise time, fall time, amplitude, and overshoot are derived from top and base waveform voltages. You can define:

- the method of determining top and base voltages, and
- the measurement threshold levels to perform the measurement

Normally, the threshold level is expressed as a percentage of top and base voltages.

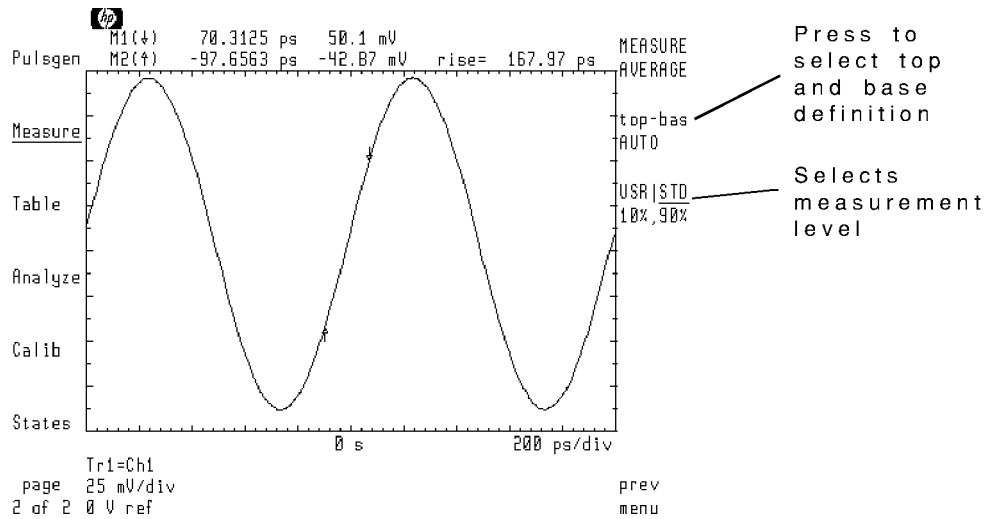

## The define menu



Three methods are available for determining top and base voltages: PEAK, CENTROID, and AUTOMATIC. In the default condition, the microwave transition analyzer automatically selects either peak or centroid based on the instrument state. The following figure shows a rise time measurement based on peak top-and-base voltages.

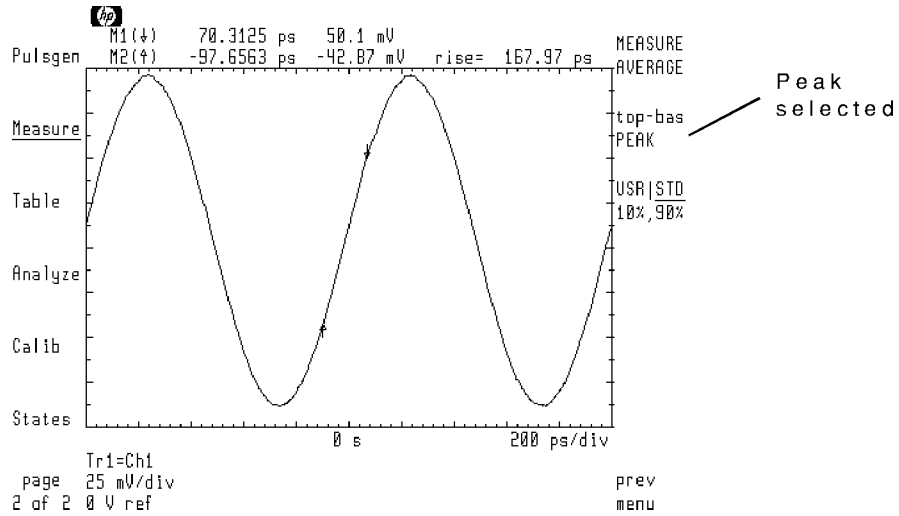

Displayed markers indicate the threshold where the measurement is performed. In the figure above, notice that the markers are located at the standard 10 percent and 90 percent levels.

This next figure shows the identical measurement based on a centroid top and base. Observe the change in marker levels and measurement results.

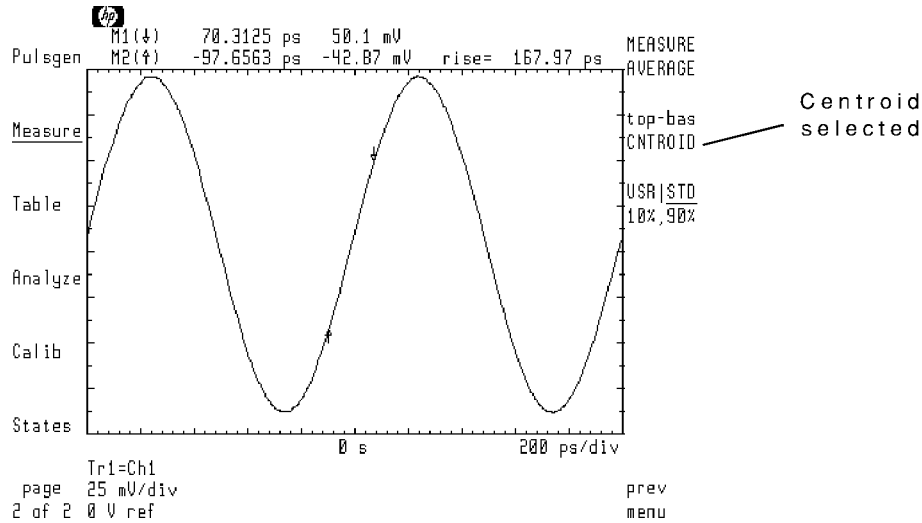

---

## Top and base voltage calculations

PEAK, CNTRD, and AUTO calculations are based on histogram data. PEAK sets the TOP equal to the portion of the histogram above the center value ( $\frac{V_{min} + V_{max}}{2}$ ) that contains the most data points. BASE is set to the portion of the histogram below the center value that contains the most data points. The absolute maximum or minimum values are used if the derived top and base is less than 5 percent of the total number of points in the waveform.

CNTRD sets the TOP equal to the weighted average of data from the center value to  $V_{max}$ . BASE is set to the weighted average of data from the center value to  $V_{min}$ .

AUTO is the same as PEAK except that if the derived TOP and BASE is less than 5 percent of the total number of points in the waveform, the centroid values are used.

---

If the **USR|STD** softkey is pressed, two additional softkeys appear for entering the lower and upper thresholds.

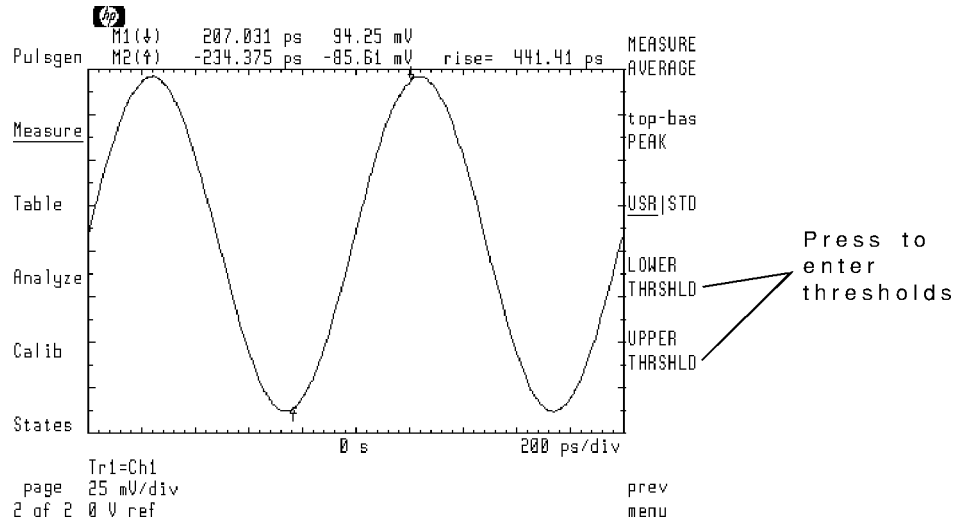

**Lower threshold = 1%, upper threshold = 99%, top-bas = PEAK**

### **To measure pulsed RF**

When measuring pulsed RF signals, the measured trace must be formatted as MAGN (am magnitude) or LOGMAG data. If it is not, the measurements attempt to measure the carrier. Refer to Chapter 6, “Using and Defining Traces,” for information on formatting traces.

## To measure delay

The **delay** softkey presents a menu that allows you to measure the time delay between any two points. To measure the delay, you place reference and measurement markers at any position on any displayed trace.

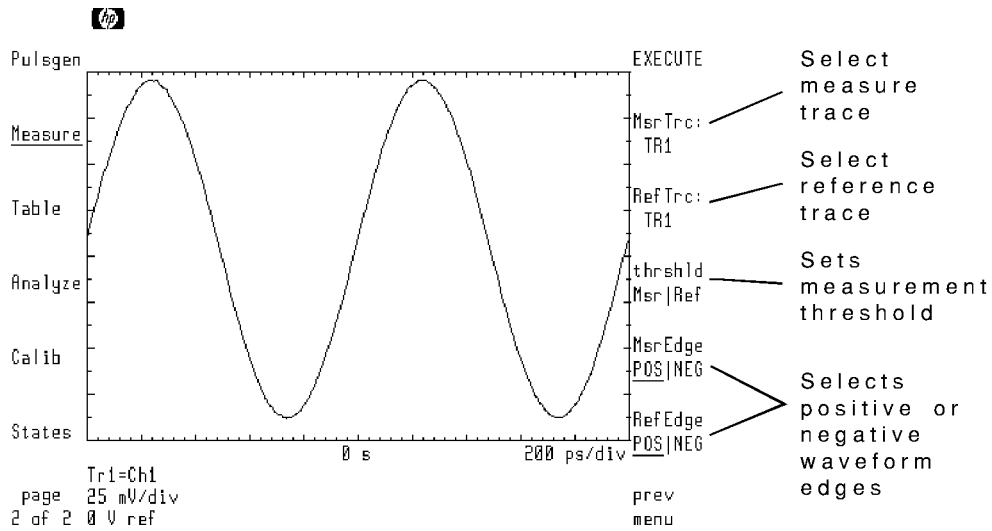

**Delay menu**

Once the measurement conditions are set, press the EXECUTE softkey to measure the delay.

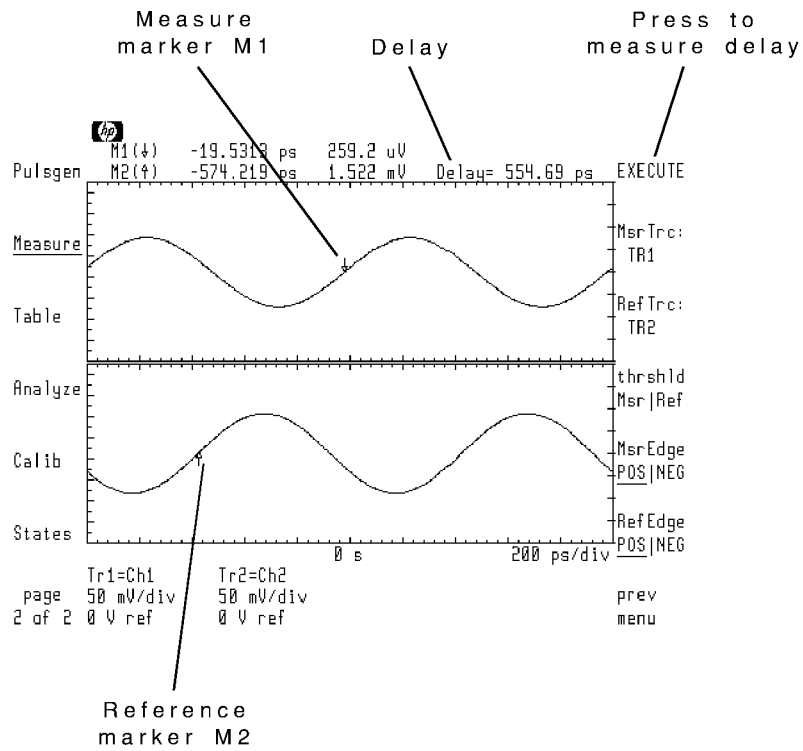

1. Press the left-side **Measure** softkey to enter the Measure menu.
2. Press the **delay** softkey.
3. Press the **RefTrc:** softkey and select the reference trace.
4. Press the **MsrTrc:** softkey and select the measurement trace.
5. Use the **thrshld Msr|Ref** softkey to enter measurement threshold voltages.

Normally, the default 50 percent points can be used.

6. Use the **MsrEdge POS|NEG** and **RefEdge POS|NEG** softkeys to select either measurements on either positive or negative waveform edges.

If multiple edges are on the screen, use the front-panel knob to select to move the marker to the desired edge.

7. Press the **EXECUTE** softkey to measure the time delay between the reference trace and the measured trace.

## To perform all measurements

- Press the **MEASURE ALL** softkey.

All automatic measurements are performed with the results displayed in a table. If the measurement is undefined for the displayed waveform type, the table indicates invalid data.

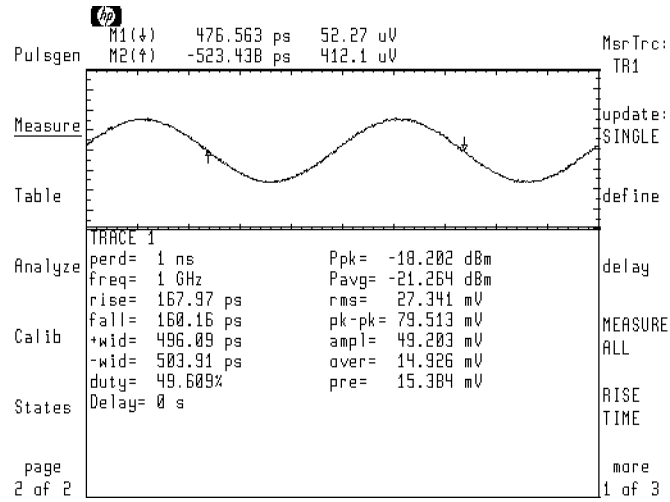



## To measure rise time, fall time, and overshoot

- Press the **RISE TIME** softkey to measure the rise time of a trace.
- Press the **FALL TIME** softkey to measure the fall time of a trace.
- Press the **OVER-SHOOT** softkey to measure overshoot.

Use the Measure menu's **define** softkey to set the amplitude levels for these measurements. The default measurement levels are shown in the following figure.

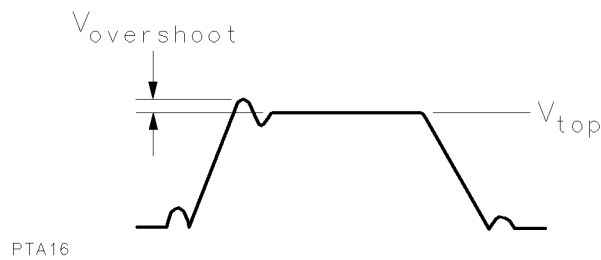
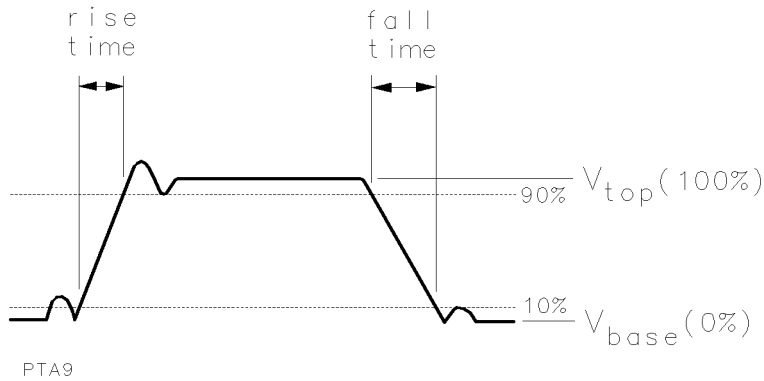

## To measure period

- Press the **PERIOD** softkey to measure the period of a trace.

There must be at least two positive (or negative) edges on screen to make the period measurement. This softkey is located on page 2 of the Measure menu.

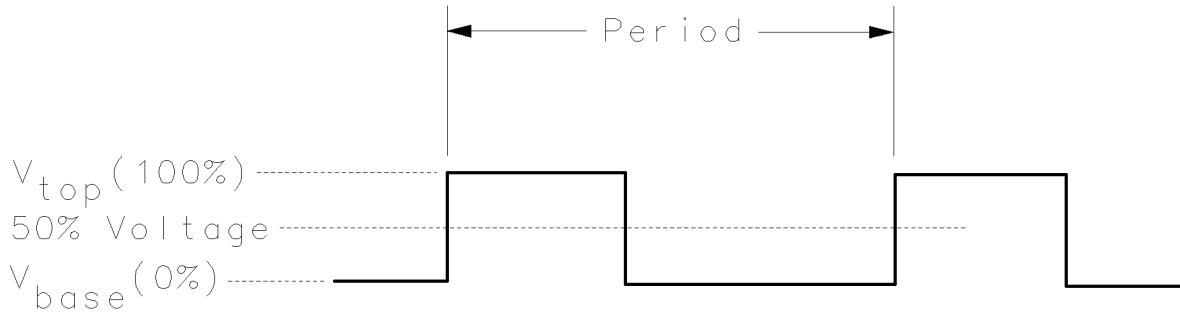

PTA10

## To measure frequency

- Press the **FREQ** softkey to measure the frequency of a trace.

There must be at least two positive (or negative) edges on screen to make the frequency measurement.

## To measure width and duty cycle

- Press the **+WIDTH** and **-WIDTH** softkeys to measure trace widths as defined in the following figure.
- Press the **DUTY CYCLE** softkey to measure the duty cycle of a trace.

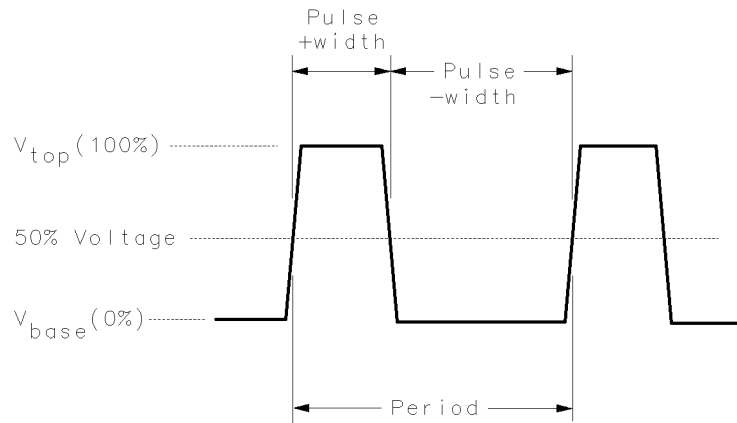

PTA11

$$\text{duty cycle} = 100 \left( \frac{+width}{period} \right)$$

## To measure pulse power

- Press the **PK PWR (pulse)** softkey to measure the peak power of a pulse.
- Press the **AVG PWR (pulse)** softkey to measure the average power of a pulse.

When measuring pulsed RF signals, the measured trace must be formatted as MAGN (am magnitude) or LOGMAG data. To measure average power, at least two positive (or negative) edges must be displayed.

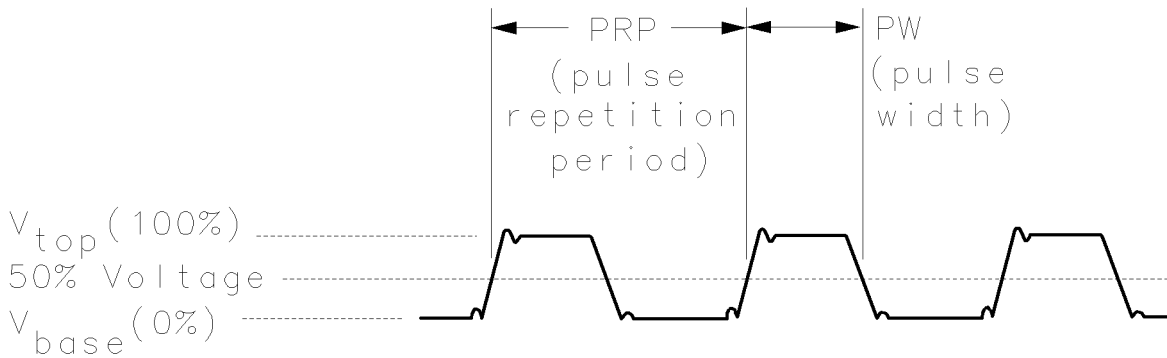

$$\text{peak power} = \frac{\sum dtP_i}{PW}$$
$$\text{average power} = \frac{\sum P_i}{N}$$

where:

dt equals time per point

$P_i$  equals  $\frac{V_i^2}{50\Omega}$

PW equals the pulse width

N equals number of points in 1 cycle

## To measure voltage

- Press the **RMS** softkey to measure the RMS voltage of a trace.
- Press the **PK-PK** softkey to measure the peak-to-peak voltage of a trace. The Measure menu's **define** softkeys do not affect this measurement.

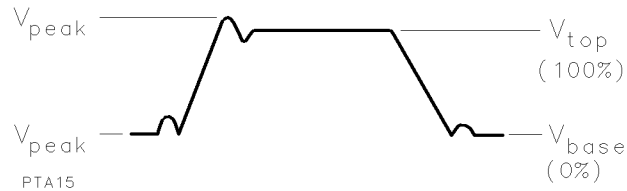

- Press the **AMPL=TOP-BAS** softkey to measure the voltage amplitude from the top of the waveform to the base of the waveform.

Use the Measure menu's **define** softkey to set either peak or centroid measurements. Threshold levels do not affect the measurement.

There must be at least two positive (or negative) edges on screen to make this measurement.

## Performing Pulsed RF Measurements

---

This chapter shows you how to perform the following measurement tasks using pulsed RF stimulus:

- pulsed time and FFT measurements
- vector network measurements
- scalar network measurements
- swept power measurements

You do not need to read the section “Controlling the Pulse Generator” in this chapter before attempting to perform the measurements. However, quickly browse through this section to gain an understanding of pulse generator control.

Introducing Pulsed RF Measurements .....	3-4
Controlling the Pulse Generator .....	3-9
To set pulse interval and frequency .....	3-10
To set pulse width and duty cycle .....	3-10
To turn the RF source's pulse modulator on or off .....	3-11
Selecting the Pulse Generator .....	3-12
To turn on the internal pulse generator .....	3-12
To select an external pulse generator .....	3-13
To trigger an external pulse generator .....	3-13
Selecting the Pulse Generator's Application .....	3-14
To view the modulated RF .....	3-14
To view the pulse generator's signal before the modulator .....	3-15
To prevent coupling of pulse generator settings to measurements .....	3-15
Performing Time Domain Measurements .....	3-16
To perform a time domain measurement .....	3-18
To perform an FFT .....	3-21
To separate video feedthrough .....	3-23
Performing Vector Network Measurements .....	3-29
To measure vector network transmission .....	3-30
To measure vector network reflection .....	3-40
Performing Scalar Network Measurements .....	3-53
To measure scalar network transmission/reflection .....	3-56
Performing Swept Power Measurements .....	3-69
To perform a swept power measurement .....	3-70

## Introducing Pulsed RF Measurements

The information in this introduction is critical to successful pulsed RF measurements. Take the time to carefully read this material.

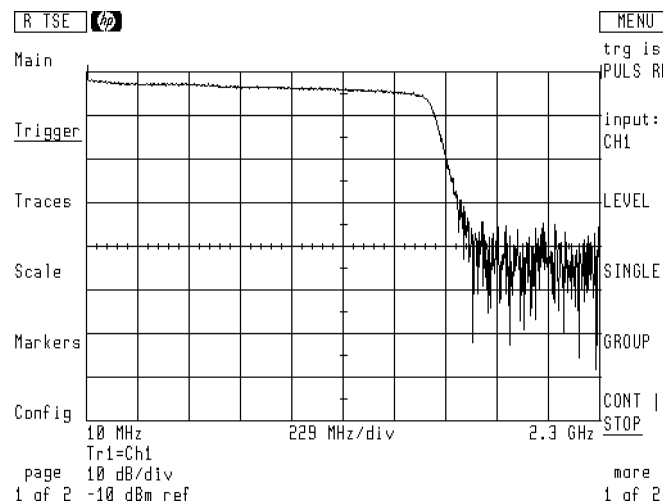

**A pulsed RF sweep of a low-pass filter**



---

**Harmonic and offset sweeps** are presently not available when using pulsed RF stimulus.

---

---

**Autoranging** No autoranging of the input channels is performed when using frequency or power sweeps with pulsed RF stimulus.

---

**Dynamic range** Dynamic range is approximately 60 dB when using frequency or power sweeps with pulsed RF stimulus.

---

**Triggering problems** Some modulators may not trigger correctly when using the HP 70820A internal pulse generator's output. Because the input impedance of modulators varies widely, mismatches between the HP 70820A's rear-panel MOD OUTPUT connector and the modulator's input connector can cause trigger problems. Long connecting cables can aggravate this problem. To fix this problem, insert an HP 10100C 50  $\Omega$  Feedthrough between the MOD OUTPUT connector and the modulator's input connector. (The HP 10100C is normally shipped with the HP 70820A.)

---

## Representing pulses on screen

In the time domain, with real trace formatting, the microwave transition analyzer displays RF pulses by showing the RF carrier. This graphical representation of the carrier is displayed for visual effect only. It is usually an aliased representation of the carrier waveform and is not accurate with the time scale.

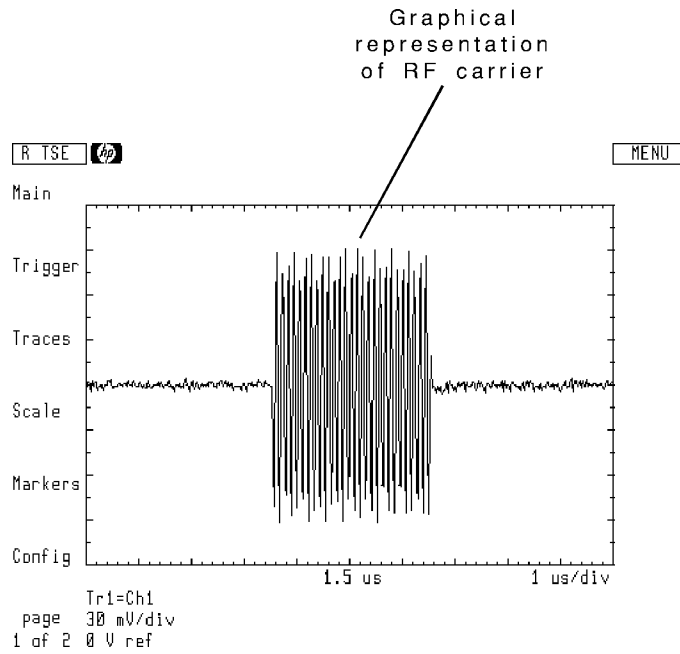

### Establishing the measurement point

When using pulsed RF stimulus with vector network, scalar network, and swept power measurements, you must first set the measurement point on the desired portion of the pulse envelope. Tutorials in this chapter include instructions on establishing the measurement point.

Establishing the measurement point is done by placing the microwave transition analyzer in time sweep mode and then adding a time delay between the trigger point and the measurement point. After establishing the measurement point, the microwave transition analyzer is switched to a frequency or power sweep, and the measurement is made.

The following figure shows the measurement point delayed to the center of the pulse. Both time and frequency domains are shown. Adding the delay allows you to measure the response at any point on the pulse envelope.

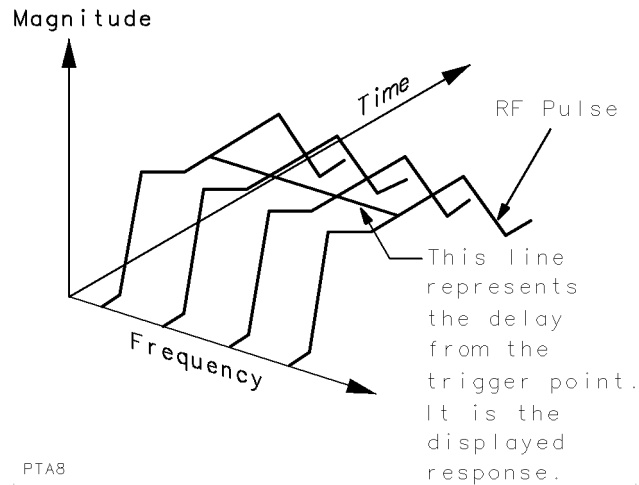

**RF pulses shown in time and frequency domains**

During a frequency or power sweep, the microwave transition analyzer first establishes a trigger on the input signal. Then, the sweep is started and measurements are taken at a delayed time from the trigger point. The frequency used to establish the trigger point does not have to be within the range swept while testing.

The following figure shows the measurement point (center screen) delayed from the trigger point. The trigger point is on the leading edge of the pulse.

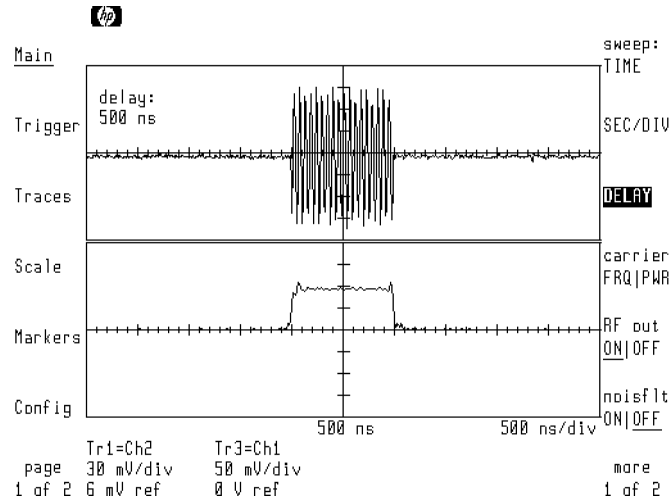

**Trigger delayed into pulse**

## Controlling the Pulse Generator

The microwave transition analyzer greatly simplifies pulsed RF measurements. This is especially true if it is controlling an RF source with a built-in RF modulator. You can either use the microwave transition analyzer's internal pulse generator or supply your own.

Use the **Pulsgen** menu to control the pulse generator. In configured systems, the RF source's pulse modulator can be turned on or off from this menu.

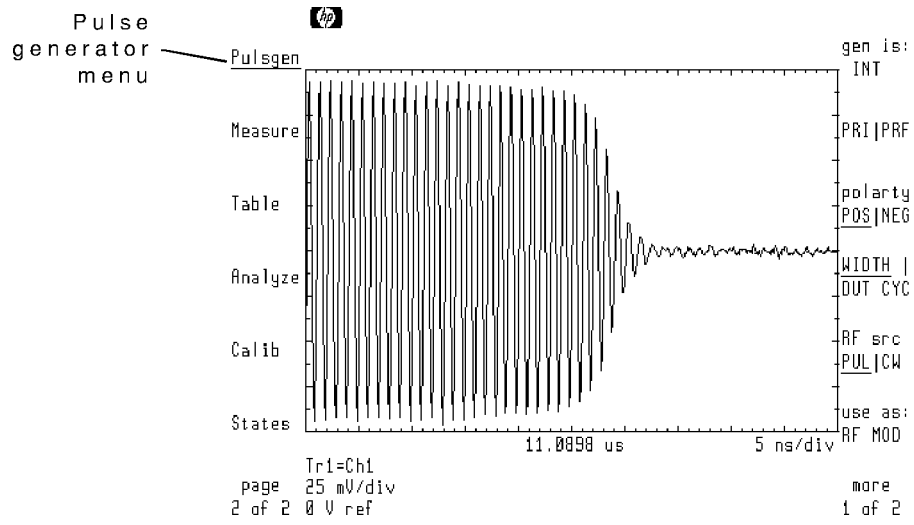

Instrument preset sets the pulse parameters to the following settings:

PRI (pulse repetition interval) .....	100 $\mu$ s
PRF (pulse repetition frequency) .....	10 kHz
Pulse width .....	10 $\mu$ s
Pulse duty cycle .....	10%
Pulse polarity .....	positive

### To set pulse interval and frequency

1. Press the **Pulsgen** softkey to enter the pulse generator menu.
2. Press the **PRI|PRF** softkey so that **PRI** is highlighted for entering the pulse interval or **PRF** is highlighted for entering the pulse frequency.

Repeatedly pressing the softkey toggles between viewing the pulse interval and frequency.

3. Enter the pulse repetition interval or frequency.

### To set pulse width and duty cycle

1. Press the **Pulsgen** softkey to enter the pulse generator menu.
2. Press the **WIDTH | DUT CYC** softkey so that **WIDTH** is highlighted for entering the pulse width or **DUT CYC** is highlighted for entering the pulse duty cycle.

Repeatedly pressing the softkey toggles between viewing the pulse width and duty cycle.

3. Enter the pulse width or duty cycle.

### **To turn the RF source's pulse modulator on or off**

1. Press the **Puls**gen softkey to enter the pulse generator menu.
2. Press the **RF src PUL|CW** softkey to turn the source modulator on or off.

When **PUL** is underlined, the synthesizer's modulator is turned on.

When **CW** is underlined, the synthesizer's modulator is turned off.

---

## **Selecting the Pulse Generator**

You can use either the internal pulse generator or an external pulse generator. The internal pulse generator's output is available at the HP 70820A module's rear-panel MOD OUTPUT connector. Connect this output to the RF source's modulation input connector.

The internal pulse generator can be used as a trigger source for an external pulse generator.

When an external pulse generator is used, the microwave transition analyzer needs to know the pulse repetition interval or frequency. It uses this information to configure certain internal instrument settings. The pulse repetition interval and frequency should be entered using the **Puls**gen menu.

An external pulse generator should be phase locked. When using non-synthesized sources such as the HP 8116A pulse/function generator, externally trigger the source from the HP 70820A.

In configured systems, the RF source's pulse modulator is turned on or off from the microwave transition analyzer.

### **To turn on the internal pulse generator**

1. Press the **Puls**gen softkey to enter the pulse generator menu.
2. Press the **gen is:** softkey.
3. Press the **INT** softkey.



## To select an external pulse generator

1. Press the **Pulsgen** softkey to enter the pulse generator menu.
2. Press the **gen is:** softkey.
3. Press the **MANUAL** softkey.

This selection turns the internal pulse generator off. However, the pulse repetition interval or frequency entered in the **Pulsgen** menu are still needed for proper operation.

## To trigger an external pulse generator

1. Connect the HP 70820A Microwave Transition Analyzer's rear-panel MOD OUTPUT connector to the pulse generator's trigger input.
2. Press the **Pulsgen** softkey to enter the pulse generator menu.
3. Press the **gen is:** softkey.
4. Press the **INT** softkey to turn on the internal pulse generator.

---

## Selecting the Pulse Generator's Application

You can select the application for the pulse generator. When you select the internal pulse generator, the microwave transition analyzer couples pulse modulator settings into the instrument's measurements. You can prevent this measurement coupling by selecting **STANDALONE** in the **use as:** softkey.

Normally, you'll be controlling the pulse generator and viewing the pulsed RF signal. However, you can set the microwave transition analyzer to observe the pulse generator's signal before the modulator by selecting **BASEBND TRIGGER**.

## To view the modulated RF

1. Press the **Pulsgen** softkey to enter the pulse generator menu.
2. Press the **use as:** softkey.
3. Press the **RF MOD** softkey.

The **RF MOD** selection informs the microwave transition analyzer to use the pulse modulation settings in internal measurement calculations.

### **To view the pulse generator's signal before the modulator**

1. Press the **PulsGen** softkey to enter the pulse generator menu.
2. Press the **use as:** softkey.
3. Press the **BASEBND TRIGGER** softkey.

### **To prevent coupling of pulse generator settings to measurements**

1. Press the **PulsGen** softkey to enter the pulse generator menu.
2. Press the **use as:** softkey.
3. Press the **STAND- ALONE** softkey.

---

## **Performing Time Domain Measurements**

The Pulsed Time predefined measurement state automatically configures the microwave transition analyzer for viewing pulsed RF signals. The following instrument conditions are set:

- The screen is split
- Traces 1 and 3 are assigned to channel 1
- Trace 1 is formatted for real response
- Trace 3 is formatted for magnitude response
- Time scale is set for the pulse interval

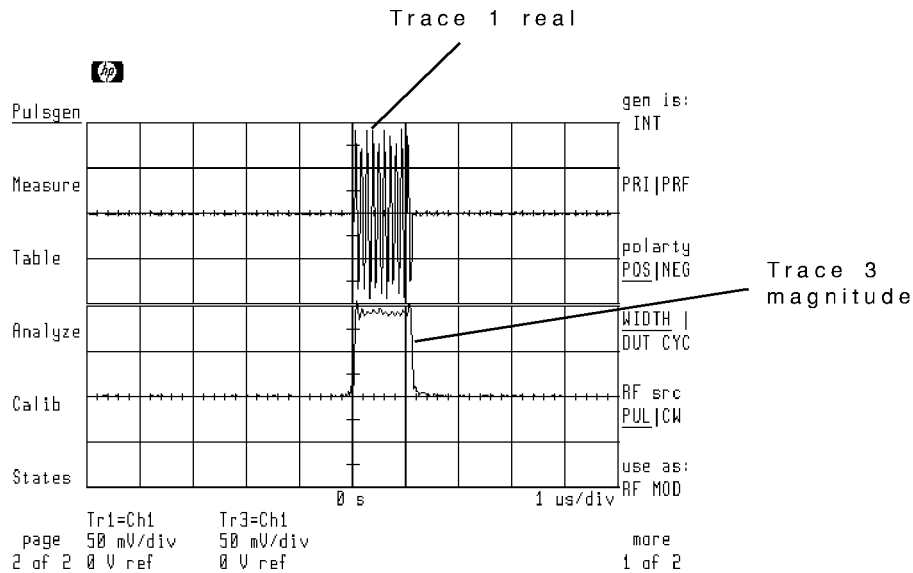

After invoking the Pulsed Time state, you must turn on the RF source's RF output and pulse modulator. In configured systems, use the Main menu's **RF out ON|OFF** softkey to turn on the RF source's power. Use the Pulsgen menu's **RF src PUL|CW** softkey to turn the RF source's modulator on.

### Measuring pulse parameters

You can characterize pulsed RF signals using the automatic waveform measurements described at the end of Chapter 2, "Performing Measurements." Measurements include rise time, fall time, duty cycle, and pulse width.

## To perform a time domain measurement

In this procedure, the RF source must be controlled by the microwave transition analyzer. The microwave transition analyzer's internal pulse generator is modulating the RF source.

1. Configure the RF source to be controlled from the microwave transition analyzer. Refer to Chapter 1, "Configuring the HP 71500A."
2. Connect the equipment as shown below.

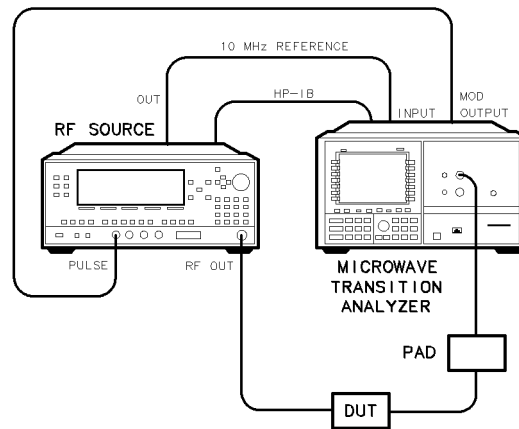

PTA25

3. Press the left-side **States** softkey to enter the States menu.
4. Press the **more 1 of 2** and then **PULSED TIME** softkeys.
5. Press the **carrier FRQ|PWR** softkey so that **FRQ** is highlighted. Enter the desired frequency of the RF source.
6. Press the **carrier FRQ|PWR** softkey so that **PWR** is highlighted. Enter the desired power of the RF source.
7. Press the **RF out ON|OFF** softkey so that **ON** is underlined.

The RF source's frequency and power levels are now set, and its RF output is turned on.

8. Press the **page 1 of 2** and **Pulsgen** softkeys.
9. Press the **RF src PUL|CW** softkey so that **PUL** is underlined.

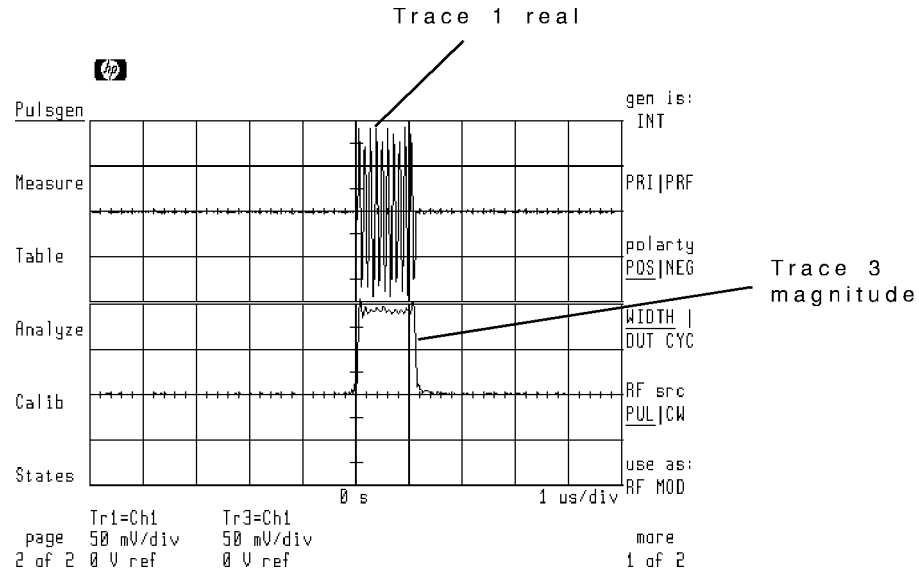

10. If the signal is not displayed or is unstable, perform the following steps:
  - a. Press the left-side **page 2 of 2** softkey.
  - b. Press **Trigger** and then **LEVEL**.
  - c. Use the front-panel knob to adjust the trigger level for a stable display.
  - d. Press the left-side **page 1 of 2** softkey.
11. Use the **WIDTH | DUT CYC** softkey to enter the desired pulse width and duty cycle.
12. Use the **PRI|PRF** softkey to enter the desired pulse interval or pulse repetition frequency.
13. If the display is unstable, press the **page 2 of 2**, **Trigger**, and then **LEVEL** softkeys, and using the front-panel knob, position the trigger level for a stable display.

## To perform an FFT

This task uses the Pulsed Time predefined measurement state to view an RF pulse. The displayed trace is formatted for an FFT. It is assumed that the microwave transition analyzer's internal pulse generator is modulating the RF source.

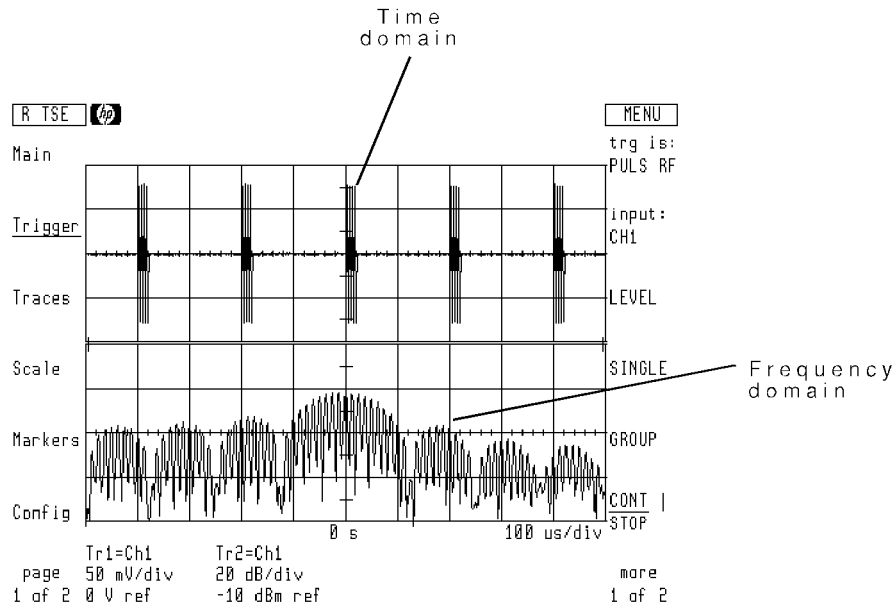

1. Perform the steps listed in the previous section “To perform a time domain measurement.”
2. Press the `Traces` softkeys to enter the Traces menu.
3. Press the `select:` and then `TR3` softkeys.
4. Press the `format:` softkey.
5. Press the `xfrm to FRQ|OFF` softkey so that `FRQ` is underlined.

For information on controlling the FFT, refer to “Performing trace transforms” in Chapter 6, “Using and Defining Traces.”

## To separate video feedthrough

The microwave transition analyzer allows you to remove video feedthrough from a pulsed RF signal without using external filtering. An internal digital filter is used to separate the video feedthrough from the carrier. The video feedthrough and pulsed RF signal can then be displayed independently.

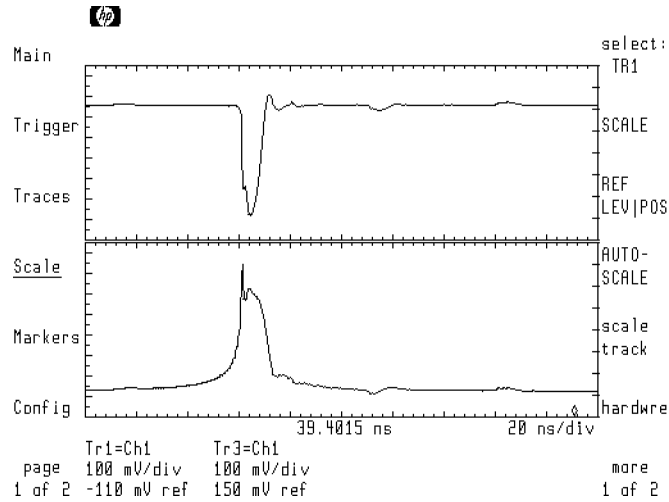

**Video feedthrough**



In this procedure, the RF source must be controlled by the microwave transition analyzer.

1. Connect the equipment as shown below.

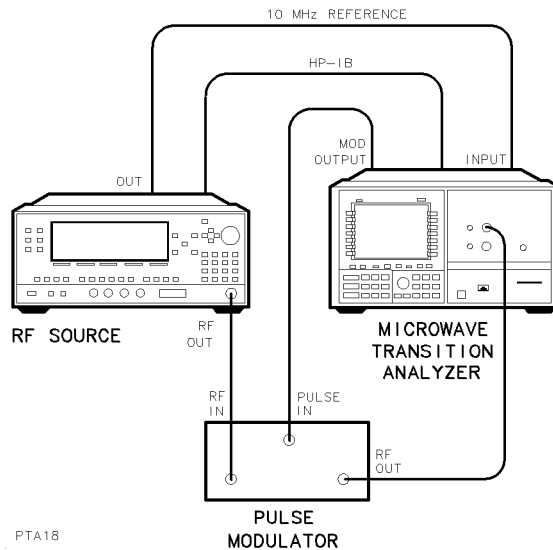

2. Press the left-side **States** softkeys to enter the States menu.
3. Press the **more 1 of 2** and then **PULSED TIME** softkeys.
4. Press the **carrier FRQ|PWR** softkey so that **FRQ** is highlighted, and enter frequency of the RF source.
5. Press the **carrier FRQ|PWR** softkey so that **PWR** is highlighted. Enter the power of the RF source.
6. Press the **RF out ON|OFF** softkey so that **ON** is underlined.  
The RF source's RF output is turned on.
7. Press the **page 1 of 2** and then **Pulsgen** softkeys.
8. If the pulse modulator used is in the RF source, press the **RF src PUL|CW** softkey so that **PUL** is underlined.
9. If the pulse modulator is external and requires negative pulses, press **polarity POS|NEG** so that **NEG** is underlined.
10. Use the **WIDTH | DUT CYC** softkey to change the pulse width and duty cycle as desired.
11. Use the **PRI|PRF** softkey to change the pulse interval and pulse repetition frequency as desired.
12. Press the **page 2 of 2** softkey.
13. If a stable pulse is not displayed on the screen, enter the Trigger menu, and adjust the trigger **LEVEL**.

- Press the **Scale** softkey to enter the Scale menu, and press the **AUTOSCALE** softkey to scale the response.

Notice that the Pulsed Time state has defined trace 1 as the REAL response and trace 3 as the MAGN (magnitude) response.

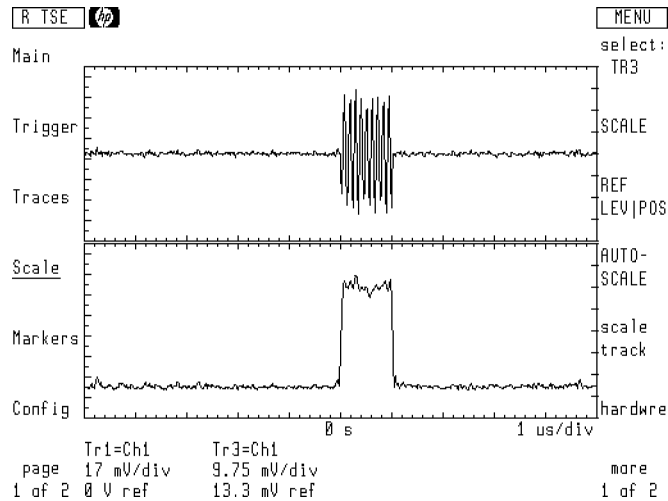

- Press the **select:** and then **TR3** softkeys.
- Press the **AUTOSCALE** softkey.
- Press the **Main** softkey to enter the Main menu.
- Use the front-panel knob to adjust the time scale so that the leading edge of the pulse is displayed.

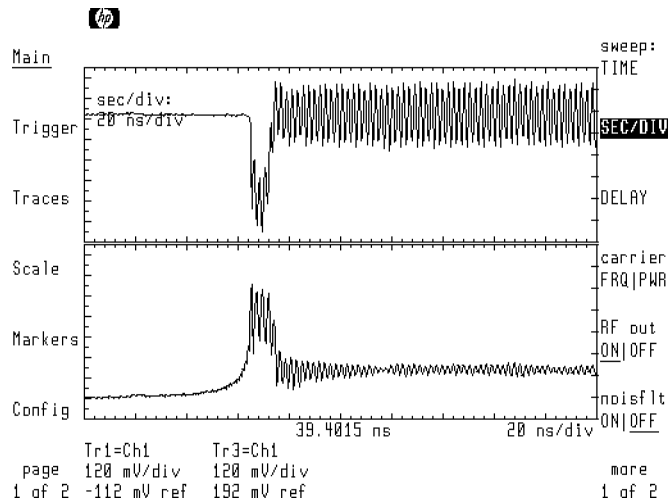

- If necessary, use the **DELAY** softkey to center the pulse on screen.

20. Press the `noisflt ON|OFF` softkey so that `ON` is underlined. The RF without the video feedthrough is now displayed.

An internal digital filter separates the video feedthrough from the displayed RF. You can use the front-panel knob to change the amount of filtering.

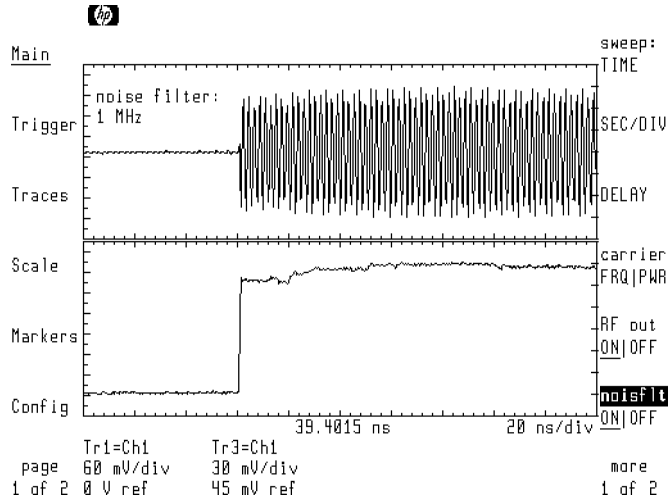

21. Press the `more 1 of 2` and then `sweep options` softkeys.
22. Press the `CH1 = VID|RF` so that `VID` is underlined. The video feedthrough without the RF is displayed.

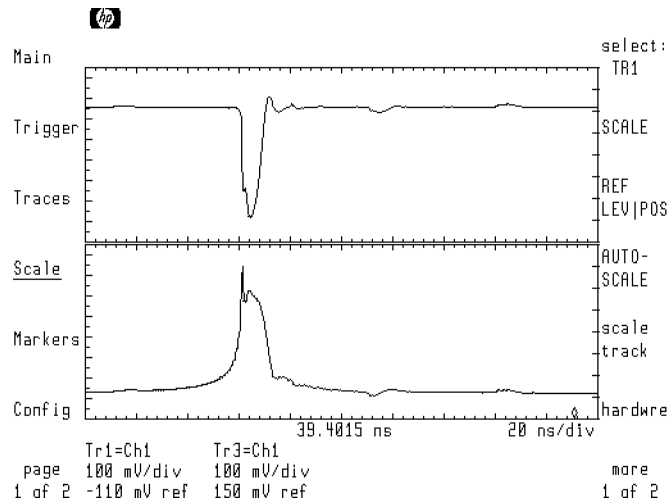

23. As an example of using an automatic waveform measurement, do the following steps:
- Press the `page 1 of 2` and then `Measure` softkeys to enter the Measure menu.
  - Press the `more 1 of 3` and then `more 2 of 3` softkeys.
  - Press the `PK-PK` softkey to measure the peak-to-peak amplitude of the video feedthrough.

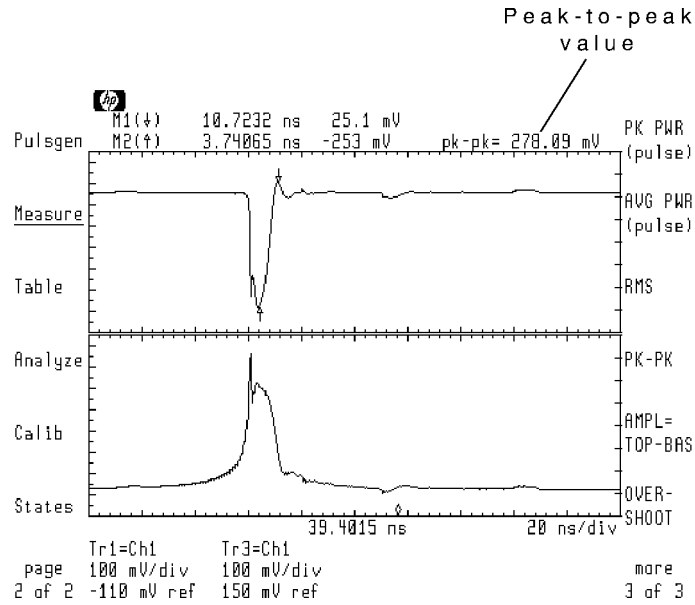

---

## Performing Vector Network Measurements

Depending on the RF source used, vector network measurements from 500 kHz to 40 GHz can be performed. This section shows you how to perform both transmission and reflection measurements. The instructions include normalization. Full vector error correction is not available.

---

**Autoranging** Channel autoranging is not available when performing frequency sweeps using pulsed RF stimulus.

---

## To measure vector network transmission

This procedure displays transmission measurements using traces 1 and 3. Traces 1 and 3 use the same input definitions with trace 1 formatted in log magnitude and trace 3 formatted in phase. The calibration *through* response is stored in memory register 1.

The following trace definitions are used for transmission measurements:

$$\begin{aligned} \text{calibration response} &= \frac{CH1}{CH2} \\ \text{normalized transmission} &= \frac{\left(\frac{CH1}{CH2}\right)}{MEM1} \end{aligned}$$

where:

CH1/CH2 is the ratio of device output to input.

MEM1 is the *through* response stored without the DUT in the signal path.

### Compensating for time delay

When performing transmission measurements, inserting the DUT after saving the *through* response increases the electrical length of the line. This causes the phase to wrap around on the display. Compensation can be accomplished by using the Scale menu's **AUTO DELAY** feature. (Auto delay subtracts a fixed amount of time delay from the displayed response.)

Using auto delay on devices such as cables (which have a constant delay over frequency) compensates the complete response. However, devices such as filters have a changing delay over frequency, and adding a fixed amount of delay cannot compensate the whole response. Use markers to limit the frequency range compensated for by auto delay. Press the Scale menu's **TIME DELAY** softkey to display the amount of delay removed by the auto delay function or to adjust the delay manually.

The figures in this vector network transmission example show the response of a 321 MHz bandpass filter.

**Step 1. Connect the equipment**

1. Connect the equipment as shown below with the output of the splitter connected directly to the channel 1 input. (The DUT should not be connected at this time.)

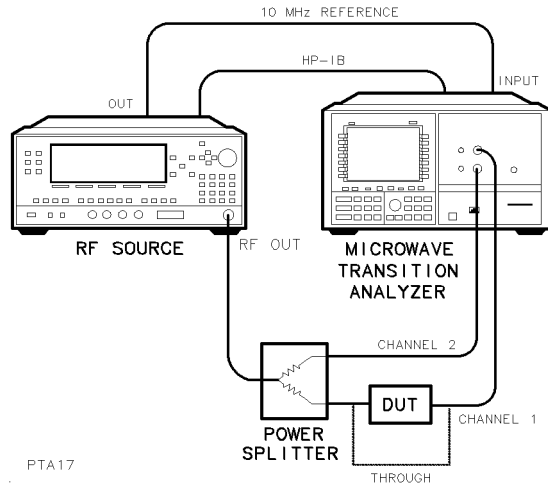

PTA17

## Step 2. Establish the measurement point

This step establishes a measurement point on the pulse envelope. Triggering is taken off the channel 2 input. Be sure to configure the RF source to be controlled from the microwave transition analyzer. Refer to Chapter 1, “Configuring the HP 71500A.”

1. Press the left-side **States** softkey to enter the States menu.

The **States** softkey is located on the second page of left-hand softkeys. (Press **page 1 of 2**.)

2. Press the **more 1 of 2** and then **PULSED TIME** softkeys.
3. Press the **carrier FRQ|PWR** softkey so that **FRQ** is highlighted.

4. Enter the RF source frequency.

With frequency sweeps, this frequency does not have to be within the planned sweep range. When sweeping, the microwave transition analyzer first establishes a trigger at this frequency and power, and then begins its sweep.

5. Press the **carrier FRQ|PWR** softkey so that **PWR** is highlighted. Enter the power of the RF source.
6. Press the **RF out ON|OFF** softkey so that **ON** is underlined.

The RF source's power is turned on.

7. Press the **Traces** softkey to enter the Traces menu.
8. Press the **input:** and then **CH2** softkeys.
9. Press the **Trigger** softkey to enter the Trigger menu.
10. Press the **input:** and then **CH2** softkeys.

The microwave transition analyzer is now triggering off the channel 2 input. This gives a stable trigger source.

11. Press the **page 1 of 2** and then **PulsGen** softkeys.
12. Press the **RF src PUL|CW** softkey so that **PUL** is underlined.

This turns on the RF source's pulse modulator.

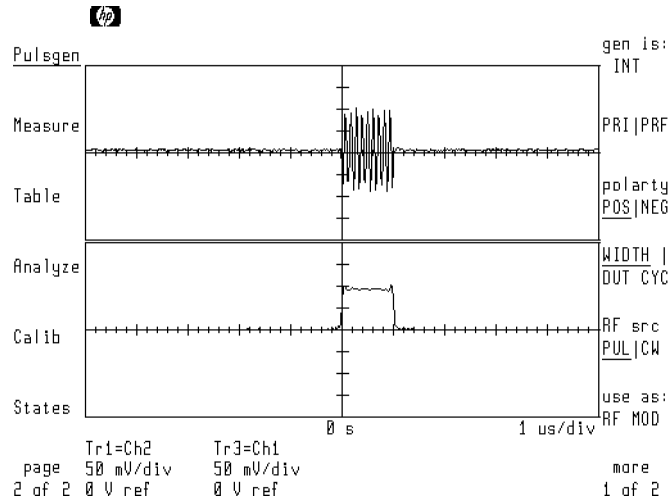

13. Use the **WIDTH | DUT|CYC** softkey to change the pulse width or duty cycle as desired.
14. Use the **PRI|PRF** softkey to change the pulse interval or pulse repetition frequency as desired.
15. Press the **page 2 of 2** softkey.
16. Press the **Scale** and then **AUTOSCALE** softkeys.
17. Press the **Main** softkey, and, if necessary, change the time scale to view the pulse envelope.
18. Press the **DELAY** softkey.

The measurement point used in the sweep is represented at center screen.

19. Enter the time delay to place the measurement point (center screen) at the desired position on the pulse envelope.

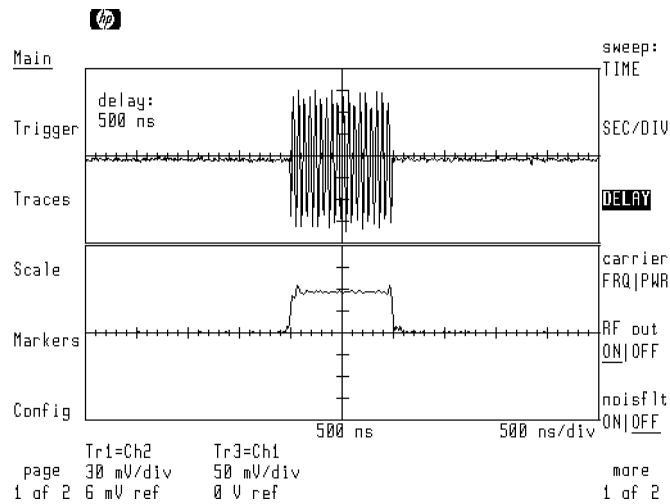



20. Press the **Config** softkey to enter the Configuration menu.

21. Press the **TRACE POINTS** softkey, and enter 100 points.

This speeds up the sweeps in preparation for the frequency sweep. Because the number of measurement points is reduced, horizontal resolution is reduced.

### Step 3. Set the sweep parameters

1. Press the **Trigger** softkey to enter the Trigger menu, and press the **SINGLE** softkey.

The microwave transition analyzer is now in single sweep mode. This reduces the time needed to change post-processing data such as amplitude scaling.

2. Press the **Main** softkey to enter the Main menu.
3. Press the **sweep:** and then **FREQ** softkeys.

The microwave transition analyzer is now in frequency sweep mode.

4. Press the **START STOP** softkey so that **START** is highlighted. Enter the start frequency.
5. Press the **START STOP** softkey so that **STOP** is highlighted. Enter the stop frequency.

#### Step 4. Save the through response

1. Press the **Traces** softkey to enter the Traces menu.
2. Press the **input:**, **CH1/CH2** softkeys.

Trace 1 is now defined as the ratio of device output to input.

3. Press the **Trigger** softkey to enter the Trigger menu.
4. Press the **SINGLE** softkey.

A small diamond shaped marker begins to move across the bottom of the screen. This indicates the frequency of the source as it is stepped from the start frequency to the stop frequency.

5. After the sweep has completed, the display should be similar to the following figure.

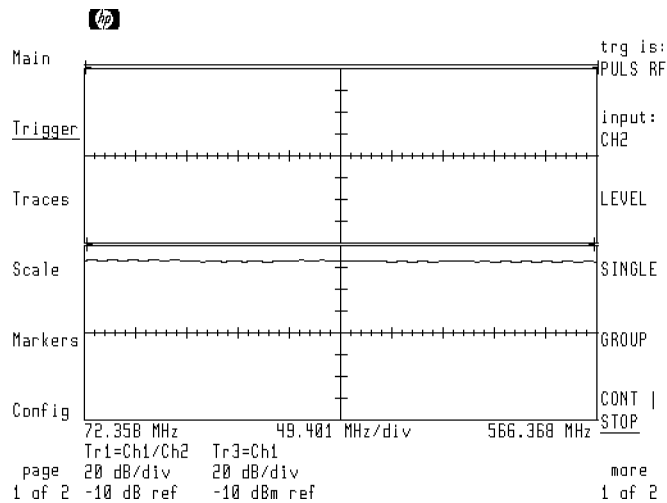

6. Press the **Traces** softkey to enter the Traces menu.
7. Press the **store trace** and then **TO MEM1** softkeys.

The *through* calibration response is now saved in memory register 1.

### Step 5. Redefine the traces

1. Press the **input:** softkey. Use the front-panel knob to scroll the menu bar to the (CH1/CH2)/MEM1 definition as shown in the following figure.

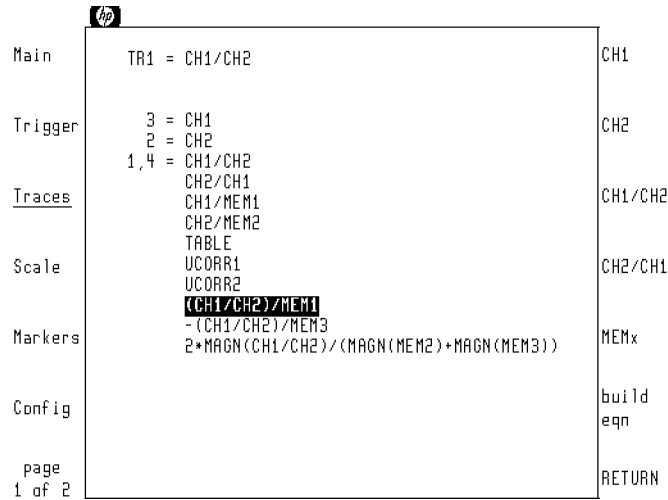

2. Press the **RETURN** softkey.

Trace 1 is now defined to show the normalized transmission response.

3. Press the **select:** and then **TR3** softkeys.
4. Press the **input:** softkey. Use the front-panel knob to scroll the menu bar to the (CH1/CH2)/MEM1 definition. This is the same definition used for trace 1.
5. Press the **RETURN** softkey.
6. Press the **format:**, **PHASE**, and then **prev menu** softkeys.

Trace 3 now is now defined to show the normalized transmission response formatted in phase.

### **Step 6. Adjust channel 1 range**

1. Place the DUT in the path to the channel 1 input.
2. Press the **Scale** softkey to enter the Scale menu.
3. Press the **hardwre** softkey.
4. Press the **RANGE | OFFSET** softkey so that **RANGE** is highlighted.
5. Set the range of channel 1 for the maximum anticipated input level.

Because the microwave transition analyzer is performing a pulsed RF frequency sweep, the range of channel 1 must be set manually.

### Step 7. Display the transmission response

1. Press the **Trigger** and then **SINGLE** softkeys.

When the sweep is completed, the transmission response is displayed.

2. Press the **Scale** and then **AUTOSCALE** softkeys to scale trace 3.
3. Press the **select:**, **TR1**, and then **AUTOSCALE** softkeys to scale trace 1.

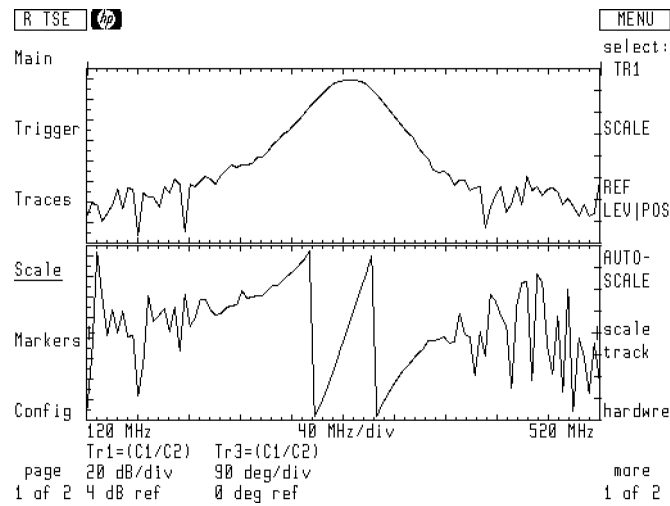

**Transmission response of a bandpass filter**

## To measure vector network reflection

The reflection tutorial displays reflection measurements using traces 1 and 3. Trace 1 shows the normalized return loss formatted as magnitude. Trace 3 shows the normalized return loss formatted as phase. Save the calibration *open* response in memory register 2, and the *short* response in memory register 3.

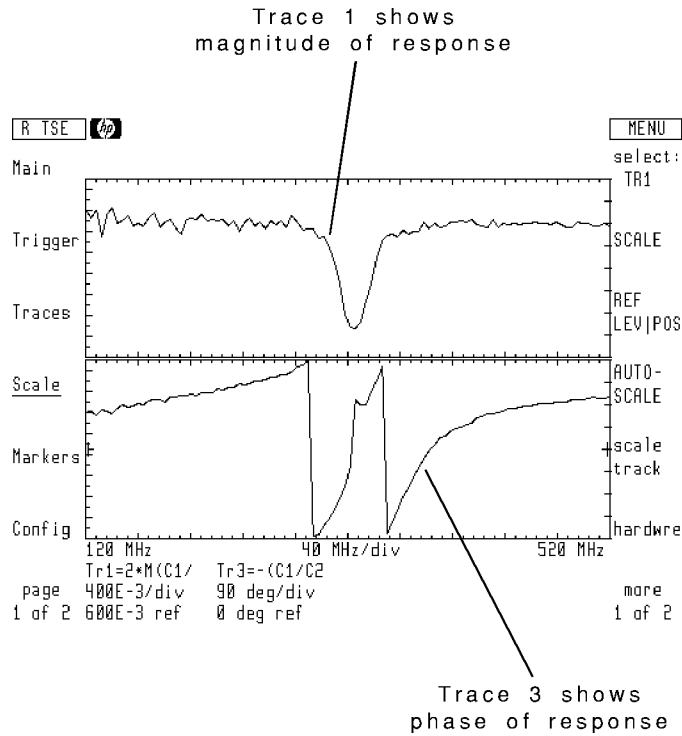

The following trace definitions is used for the calibration data:

$$\text{calibration response} = \frac{CH1}{CH2}$$

The normalized reflection response formatted as magnitude:

$$\text{normalized reflection} = \frac{2 \left[ \text{MAGN} \left( \frac{CH1}{CH2} \right) \right]}{\text{MAGN}(MEM2) + \text{MAGN}(MEM3)}$$

where:

MAGN(CH1/CH2) is magnitude of the ratio of reflected to incident waves.

(MAGN(MEM2)+MAGN(MEM3)), in conjunction with the factor 2, gives the average of the *open* and *short* calibration responses.

The normalized reflection response formatted as phase:

$$\text{normalized reflection} = (-1) \left[ \frac{\left( \frac{CH1}{CH2} \right)}{MEM3} \right]$$

where:

CH1/CH2 is the ratio of reflected to incident waves.

MEM3 is the stored response with the *short* load.



Before beginning this procedure, be sure to configure the RF source to be controlled from the microwave transition analyzer. Refer to Chapter 1, "Configuring the HP 71500A." The figures in this example show the response of a 321 MHz bandpass filter.

### Step 1. Connect the equipment

1. Connect the equipment as shown below with the coupler's output terminated with an *open*. (The DUT should not be connected at this time.)

Be sure to position the directional coupler so that it couples power reflected *from* the DUT to channel 1. The equipment setup is ready for a transmission normalization using a *open*.

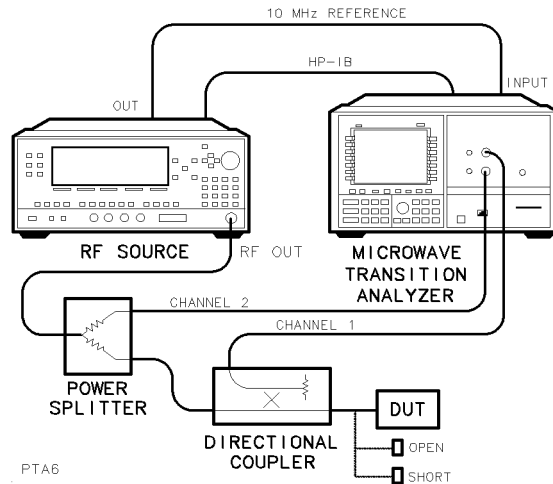

## Step 2. Establish the measurement point

This step establishes a measurement point on the pulse envelope. Triggering is taken off the channel 2 input.

1. Press the left-side **States** softkey to enter the States menu.

The **States** softkey is located on the second page of left-hand softkeys. (Press **page 1 of 2**.)

2. Press the **more 1 of 2** and then **PULSED TIME** softkeys.
3. Press the **carrier FRQ|PWR** softkey so that **FRQ** is highlighted.
4. Enter the RF source frequency.

With frequency sweeps, this frequency does not have to be within the planned sweep range. When sweeping, the microwave transition analyzer first establishes a trigger at this frequency and power, and then begins its sweep.

5. Press the **carrier FRQ|PWR** softkey so that **PWR** is highlighted. Enter the desired RF source output power.
6. Press the **RF out ON|OFF** softkey so that **ON** is underlined.

The RF source's output is turned on.

7. Press the **Traces** softkey to enter the Traces menu.
8. Press the **input:** and then **CH2** softkeys.
9. Press the **Trigger** softkey to enter the Trigger menu.
10. Press the **input:** and then **CH2** softkeys.

The microwave transition analyzer is now triggering off the channel 2 input. This gives a stable trigger source.

11. Press the **page 1 of 2** and then **Pulsgen** softkeys.
12. Press the **RF src PUL|CW** softkey so that **PUL** is underlined.

This turns on the RF source's pulse modulator.

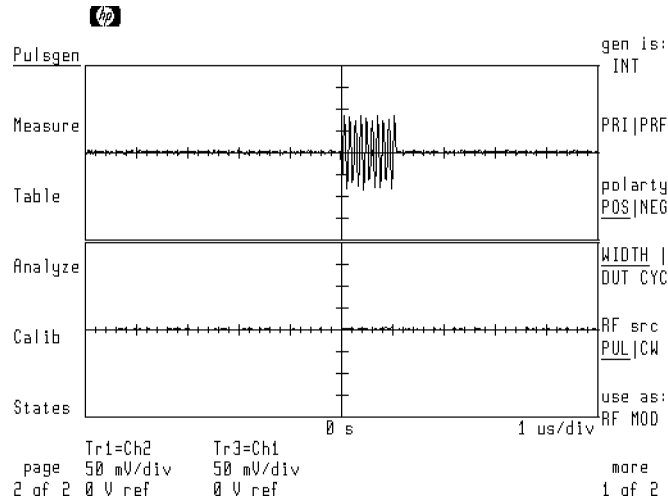

13. Use the **WIDTH | DUT CYC** softkey to change the pulse width or duty cycle as desired.
14. Use the **PRI|PRF** softkey to change the pulse interval or pulse repetition frequency as desired.
15. Press the left-side **page 2 of 2** softkey.
16. Press the **Scale** and then **AUTOSCALE** softkeys.
17. Press the **Main** softkey, and, if necessary, change the time scale to view the pulse envelope.
18. Press the **DELAY** softkey.

The measurement point used in the sweep is represented at center screen.

19. Enter the time delay to place the measurement point (center screen) at the desired position on the pulse envelope.

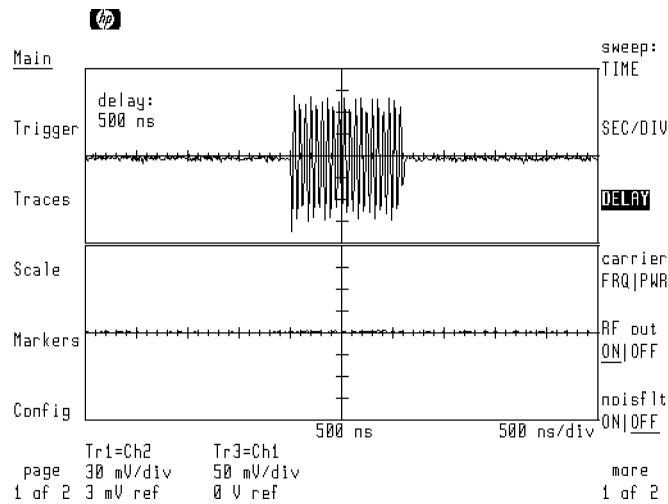

20. Press the **Config** softkey to enter the Configuration menu.

21. Press the **TRACE POINTS** softkey, and enter 100 points.

This speeds up the sweeps in preparation for the frequency sweep. Because the number of measurement points is reduced, horizontal resolution decreases.

### Step 3. Set the sweep parameters

1. Press the **Trigger** softkey to enter the Trigger menu, and press the **SINGLE** softkey.

The microwave transition analyzer is now in single sweep mode. This reduces the time needed to change post-processing data such as amplitude scaling.

2. Press the **Main** softkey to enter the Main menu.
3. Press the **sweep:** and then **FREQ** softkeys.

The microwave transition analyzer is now in frequency sweep mode.

4. Press the **START STOP** softkey so that **START** is highlighted. Enter the start frequency.
5. Press the **START STOP** softkey so that **STOP** is highlighted. Enter the stop frequency.

#### Step 4. Save the open calibration

1. Press the **Traces** softkey to enter the Traces menu.
2. Press the **input:** and then **CH1/CH2** softkeys.

Trace 1 is now defined as the ratio of device output to input.

3. Press the **Trigger** softkey to enter the Trigger menu, and press the **SINGLE** softkey.
4. After the sweep has completed, the display should look similar to the following figure.

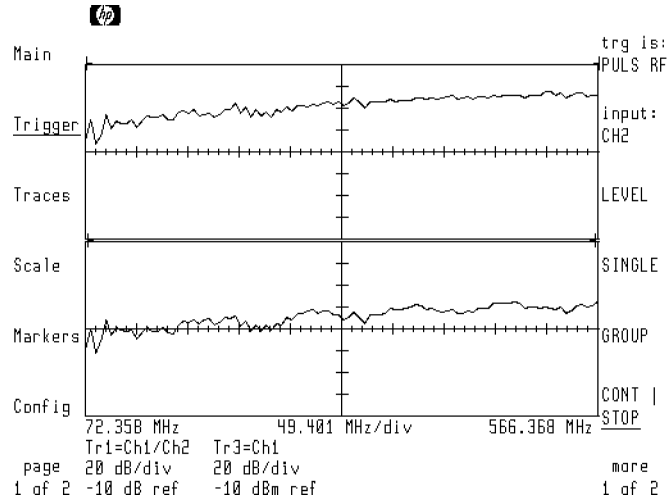

5. Press the **Traces** softkey to enter the Traces menu.
6. Press the **store trace** and then **TO MEM2** softkeys.

The *open* calibration response is now saved in memory register 2.

### Step 5. Save the short calibration

1. Replace the *open* with a *short* termination.
2. Press the **Trigger** softkey to enter the Trigger menu.
3. Press the **SINGLE** softkey, and wait for the sweep to finish.
4. Press the **Traces** softkey to enter the Traces menu.
5. Press the **store trace** and then **TO MEM3** softkeys.

The *short* calibration response is now saved in memory register 3.

## Step 6. Define traces for normalized reflection

1. Press the **input:** softkey. Use the front-panel knob to scroll the menu bar to the  $2 * \text{MAGN}(\text{CH1}/\text{CH2}) / (\text{MAGN}(\text{MEM2}) + \text{MAGN}(\text{MEM3}))$  definition as shown in the following figure.

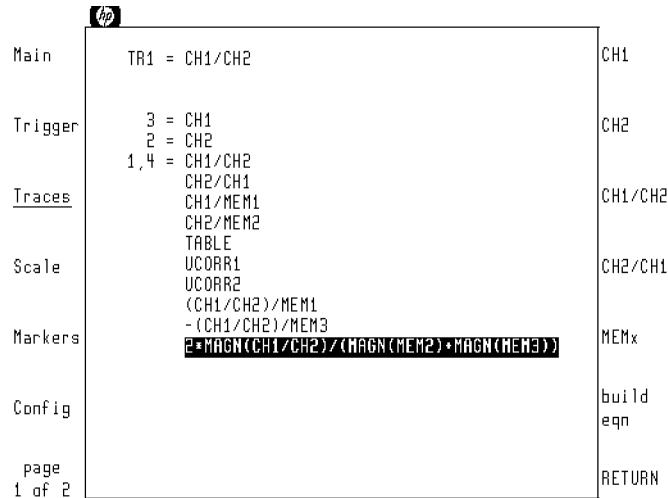

2. Press the **RETURN** softkey.

Trace 1 is now ready to display the normalized reflection response formatted as log magnitude.

3. Press the **select:** and then **TR3** softkeys.
4. Press the **input:** softkey. Use the front-panel knob to scroll the menu bar to the  $-(\text{CH1}/\text{CH2})/\text{MEM3}$  definition.

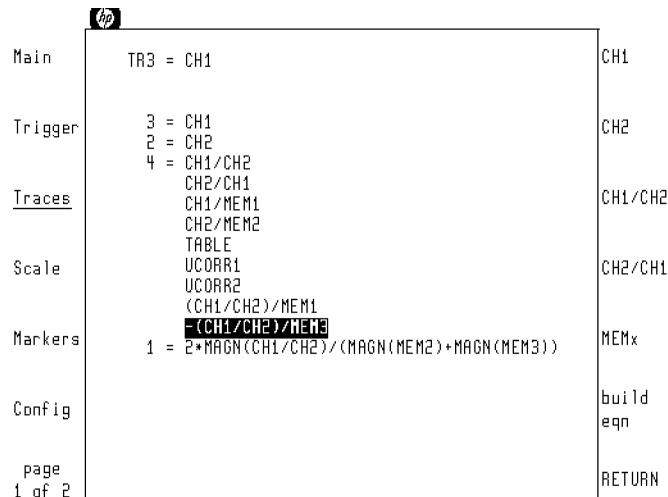

5. Press the **RETURN** softkey.
6. Press the **format:**, **PHASE**, and then **prev menu** softkeys.



Trace 3 is now ready to display the normalized reflection response formatted as phase.

### Step 7. Adjust channel 1 range

1. Replace the *short* with the DUT. If the DUT is a two port device, terminate its other port with its characteristic impedance.
2. Press the **Scale** softkey to enter the Scale menu.
3. Press the **hardwre** softkey.
4. Press the **RANGE | OFFSET** softkey so that **RANGE** is highlighted.
5. Set the range of channel 1 for the maximum anticipated input level.

Because the microwave transition analyzer is performing a pulsed RF frequency sweep, the range of channel 1 must be set manually.

### Step 8. Display the reflection response

6. Press the **Trigger** and then **SINGLE** softkeys to start a sweep.
7. Press the **Scale** and then **AUTOSCALE** softkeys.
8. Press **select:** and then **TR1** softkeys.
9. Press the **AUTOSCALE** softkey.

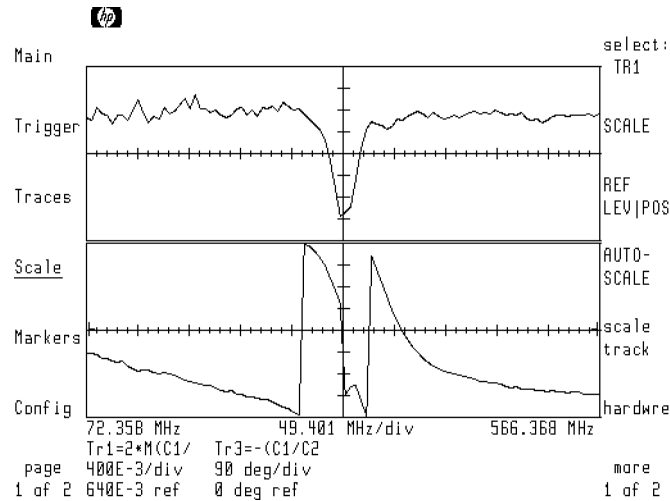

**Reflection response of a bandpass filter**

---

## Performing Scalar Network Measurements

Simultaneous scalar transmission/reflection measurements involve the added difficulty of establishing a stable trigger source. This section shows how to use external triggering to perform this measurement. If you do not need to view the transmission and reflections responses simultaneously, perform a vector network measurement as explained in the previous section. (When performing the vector network measurement, do not format any trace for phase information.)

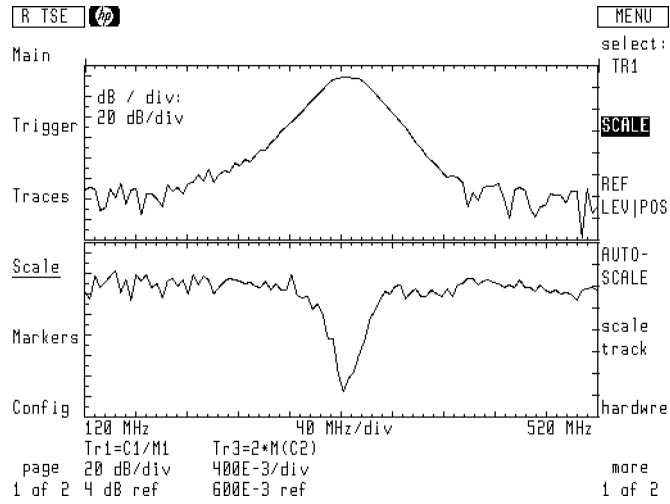

**Transmission and reflection of a bandpass filter**

---

**External triggering** triggering is limited due to up to 300 ns of absolute external trigger accuracy with  $\pm 50$  ns of trigger jitter. This poses minimal problems when measuring pulses with relatively wide pulse widths. However, measurements become inaccurate when measuring pulses with widths shorter than approximately 10  $\mu$ s. In this case you must use internal triggering.

---

### **Autorangeing**

Channel autorangeing is not available when performing frequency sweeps using pulsed RF stimulus. In the following procedures, the measurement point is established in a time sweep so channel 1 is correctly ranged during normalization. However channel 2 cannot autorange. Channel 2's range must be set manually.

### **Internal triggering**

If you want to use internal triggering, you must ensure that the trigger is always established in the pass band of the DUT. This is because the amplitude of the trigger signal is dependent on the response of the DUT. Product notes for the microwave transition analyzer cover simultaneous scalar transmission/reflection measurements in detail.

## Trace definitions

The procedures in this section define traces and memory registers for the uses listed below.

- Trace 1: trace for saving *through*, *open*, and *short* normalizations
- Trace 1: normalized transmission response
- Trace 3: normalized return loss
- MEM 1: saved *through* transmission response
- MEM 2: saved *open* reflection response
- MEM 3: saved *short* reflection response

The normalized transmission trace has the following definition:

$$\text{trace 1} = \frac{CH1}{MEM1}$$

where:

CH1 is the measured response at channel 1.

MEM1 is the stored *through* normalization response stored in memory register one. (The response is stored without the DUT in the signal path.)

The normalized reflection trace (channel 2 divided by an open/short average normalization) has the following definition:

$$\text{trace 3} = \frac{2(MAGN(CH2))}{MAGN(MEM2) + MAGN(MEM3)}$$

where:

MAGN(CH2) is the log magnitude of the reflected signal.

(MAGN(MEM2)+MAGN(MEM3)), in conjunction with the factor 2, gives the average of the *open* and *short* calibration responses.

## To measure scalar network transmission/reflection

Before beginning this procedure, configure the RF source to be controlled from the microwave transition analyzer. Refer to Chapter 1, "Configuring the HP 71500A." The figures in this example show the response of a 321 MHz bandpass filter.

### Step 1. Connect the equipment

1. Connect the equipment as shown below. Connect the output of the directional coupler directly to channel 1. Do not connect the DUT, *open*, or *short* connections at this time.

Be sure to position the directional coupler so that it couples power reflected *from* the DUT to channel 2. The equipment setup is ready for a transmission normalization using a *through* line. The HP 70820A rear-panel MOD OUTPUT provides the signal for external triggering.

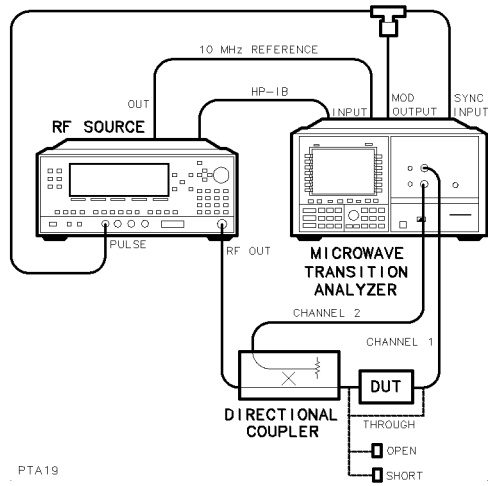

PTA19

## Step 2. Establish the measurement point

1. Press the left-side **States** softkeys to enter the States menu.

The **States** softkey is located on the second page of left-hand softkeys. (Press **page 1 of 2**.)

2. Press the **more 1 of 2** and then **PULSED TIME** softkeys.
3. Press the **carrier FRQ|PWR** softkey so that **FRQ** is highlighted.
4. Enter the RF source frequency.

This trigger frequency does not have to be within the planned sweep range. When sweeping, the microwave transition analyzer first establishes a trigger at this frequency and power, and then begins its sweep.

5. Press the **carrier FRQ|PWR** softkey so that **PWR** is highlighted. Enter the power of the RF source.
6. Press the **RF out ON|OFF** softkey so that **ON** is underlined.

The RF source's power is turned on.

7. Press the **Trigger** softkey to enter the Trigger menu.
8. Press the **input:** and then **EXT FORCE** softkeys.

The microwave transition analyzer is now triggering off the rear-panel SYNC INPUT.

9. Press the **page 1 of 2** and then **Pulsgen** softkeys.
10. Press the **RF src PUL|CW** softkey so that **PUL** is underlined.

This turns on the RF source's pulse modulator.

11. Use the **PRI|FRQ** softkey to increase the pulse interval to accommodate a pulse width greater than 10  $\mu$ s.
12. Use the **WIDTH | DUT CYC** softkey to change the pulse width or duty cycle as desired.

---

**Pulse widths** When using external triggering, the pulse width must be greater than 10  $\mu$ s.

---



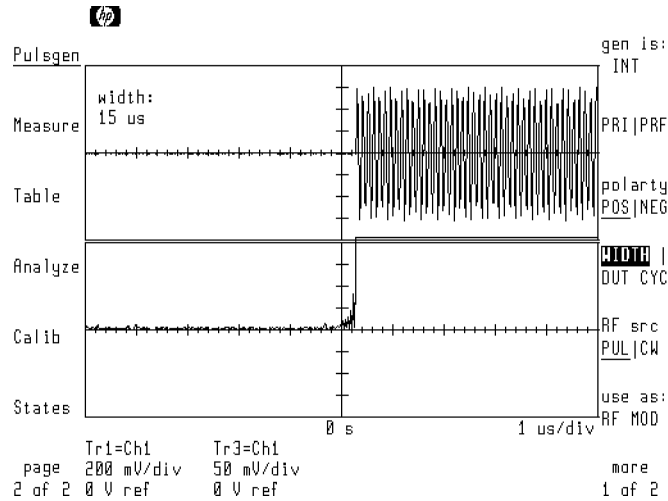

13. Press the **page 2 of 2** softkey.
14. Press the **Scale** and then **AUTO- SCALE** softkeys.
15. Press the **Main** softkey, and, if necessary, change the time scale to view the pulse envelope.
16. Press the **DELAY** softkey.

The measurement point used in the sweep is represented at center screen.

17. Enter the time delay to place the measurement point (center screen) at the desired position on the pulse envelope.

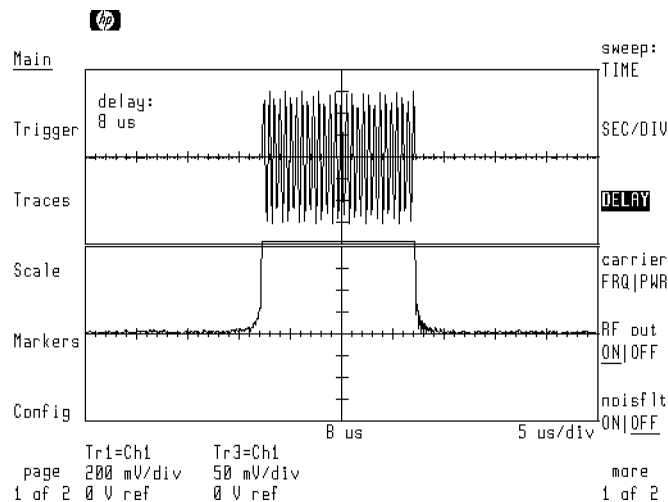

18. Press the **Config** softkey to enter the Configuration menu.
19. Press the **TRACE POINTS** softkey, and enter 100 points.

This speeds up the sweeps in preparation for the frequency sweep. Because the number of measurement points is reduced, measurement resolution decreases.

### Step 3. Set the sweep parameters

1. Press the **Trigger** softkey to enter the Trigger menu, and press the **SINGLE** softkey.

The microwave transition analyzer is now in single sweep mode. This reduces the time needed to change post-processing data such as amplitude scaling.

2. Press the **Main** softkey to enter the Main menu.

3. Press the **sweep:** and then **FREQ** softkeys.

The microwave transition analyzer is now in frequency sweep mode.

4. Press the **START STOP** softkey so that **START** is highlighted. Enter the start frequency.

5. Press the **START STOP** softkey so that **STOP** is highlighted. Enter the stop frequency.

#### Step 4. Save the through response

1. Press the **Trigger** softkey to enter the Trigger menu, and press the **SINGLE** softkey.

As the sweep is taken, a diamond moves across the bottom of the display. This indicates the frequency of the source as it is stepped from the start frequency to the stop frequency.

2. After the sweep has completed, the display should look similar to the following figure.

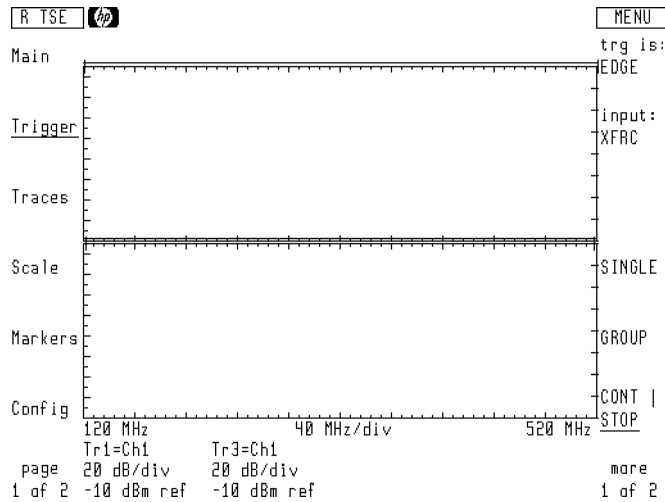

3. Press the **Traces** softkey to enter the Traces menu.
4. Press the **store trace** and then **TO MEM1** softkeys.

The transmission *through* calibration is now saved in memory register 1.

### **Step 5. Set the range of channel 2**

1. Press the **Scale** softkey to enter the Scale menu.
2. Press the **hardwre** softkey, and observe the hardware range setting for channel 1.
3. Press the **CH1|CH2** softkey so that **CH2** is underlined.
4. Enter a hardware range for channel 2 that is equal to the range observed for channel 1.

The microwave transition analyzer is unable to automatically range the input channels during frequency sweeps of pulsed RF.

### Step 6. Save the open response

1. Disconnect the channel 1 cable at the directional coupler, and connect an *open* to the coupler's output.

The reflection response will now be saved for normalization.

2. Press the **Traces** softkey.
3. Press the **input:** and then **CH2** softkeys.
4. Press the **Trigger** and then **SINGLE** softkeys. Wait for the trace to complete. The resulting trace should look similar to the following figure.

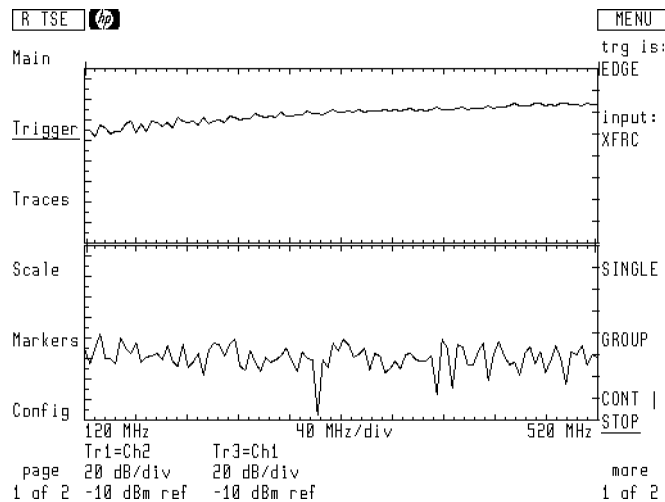

5. Press the **Traces** softkey.
6. Press the **store trace** and then **TO MEM2** softkeys.

**Step 7. Save the short response**

1. Remove the *open*, and replace it with a *short*.
2. Press the **Trigger** and then **SINGLE** softkeys. Wait for the trace to be completed.
3. Press the **Traces** and then **store trace** softkeys. Press the **TO MEM3** softkey.

**Step 8. Adjust channel 1 range**

1. Remove the *short*, and connect the coupler's output, through the DUT, to channel 1.
2. Press the **Scale** softkey to enter the Scale menu.
3. Press the **hardwre** softkey.
4. Press the **RANGE |OFFSET** softkey so that **RANGE** is highlighted.
5. Set the range of channel 1 for the maximum anticipated input level.

Because the microwave transition analyzer is performing a frequency sweep, the range of channel 1 must be set manually.

### Step 9. Define normalized traces

1. Press the **Traces** softkey to enter the Traces menu.
2. Press the **input:** softkey and scroll the menu bar to the following trace definition:

CH1/MEM1

R TSE		MENU
Main	TR1 = CH2	CH1
Trigger	3 = CH1 1,2 = CH2 4 = CH1/CH2	CH2
<u>Traces</u>	CH2/CH1 <b>CH1/MEM1</b>	CH1/CH2
Scale	CH2/MEM2 TABLE	CH2/CH1
Markers	UCORR1 UCORR2 (CH1/CH2)/MEM1 -(CH1/CH2)/MEM3 2*MAGN(CH1/CH2)/(MAGN(MEM2)+MAGN(MEM3))	MEMx
Config		build eqn
page 1 of 2		RETURN

3. Press the **RETURN** softkey.
4. Press the **select:** and then **TR3** softkeys.

The following steps define a new trace equation for trace 3. Because the required trace is not listed, the procedure modifies an existing equation.

5. Press the **input:** softkey. Use the front-panel knob to scroll the menu bar to the following trace definition:

$2 * \text{MAGN}(\text{CH1} / \text{CH2}) / (\text{MAGN}(\text{MEM2}) + \text{MAGN}(\text{MEM3}))$

R TSE		MENU
Main	TR3 = CH1	CH1
Trigger	3 = CH1 2 = CH2 4 = CH1/CH2	CH2
<u>Traces</u>	CH2/CH1 1 = CH1/MEM1	CH1/CH2
Scale	CH2/MEM2 TABLE	CH2/CH1
Markers	UCORR1 UCORR2 (CH1/CH2)/MEM1 -(CH1/CH2)/MEM3 <b>2*MAGN(CH1/CH2)/(MAGN(MEM2)+MAGN(MEM3))</b>	MEMx
Config		build eqn
page 1 of 2		RETURN



- Press the **build eqn** softkey.
- Use the front-panel knob to scroll the equation line cursor to the position shown in the following figure.

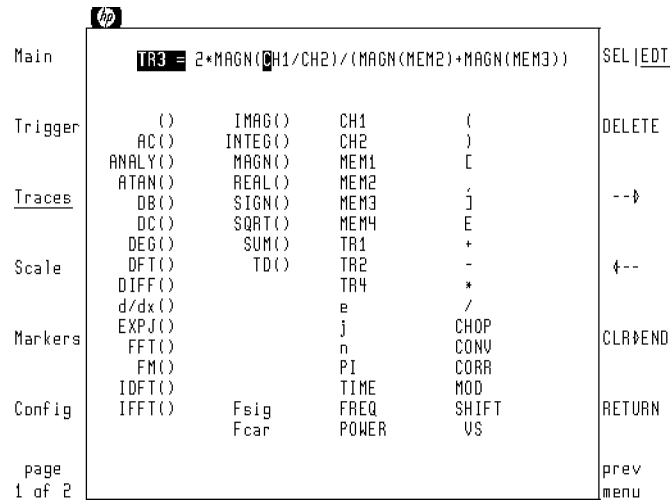

- Press the **DELETE** softkey four times to erase **CH1/**.
- Press the **RETURN** softkey.

Trace 3 is now ready to display the normalized reflection response formatted as log magnitude.

### Step 10. Display the transmission/reflection response

1. Press the **Trigger** and then **SINGLE** softkeys to start a sweep.
2. Wait for the sweep to complete.
3. Press the **Scale** softkey to enter the Scale menu.
4. Press the **AUTOSCALE** softkey.
5. Press the **select:** and then **TR1** softkeys.
6. Press the **AUTOSCALE** softkey.

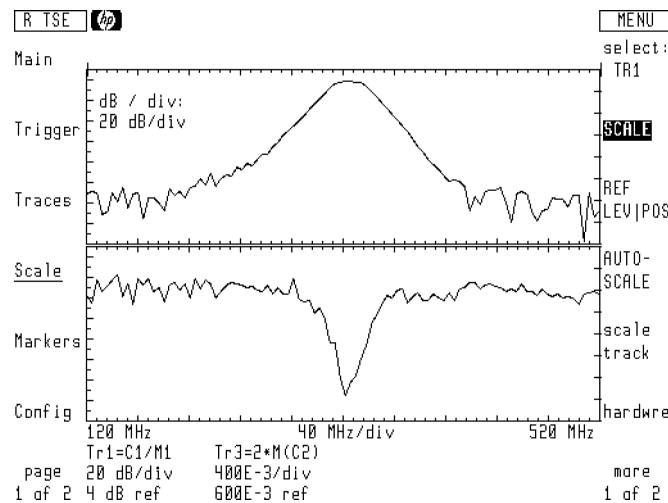

---

## Performing Swept Power Measurements

The technique used to perform pulsed RF power sweeps and CW power sweeps is similar. A difference occurs in the first few steps where a trigger point is first established using a time sweep. The following figure shows the equipment setup for a typical swept power measurement using pulsed RF stimulus.

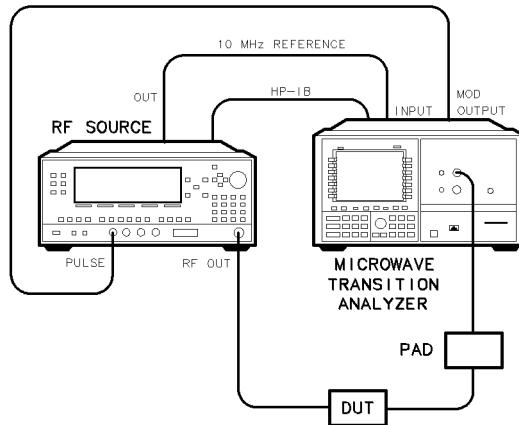

PTA25

---

**Caution** Total input signal power to the HP 71500A's front-panel channel inputs must not exceed +16 dBm. Because there is no RF input attenuator, power in excess of +16 dBm may damage the instrument. The largest measurable power level before signal compression is 0 dBm.

---

**Protection from excessive power** When performing power sweeps, place a pad at the front-panel channel inputs to protect them from excessive power.

---

**Autorangeing** Channel autorangeing is not available when performing power sweeps using pulsed RF stimulus.

---

### To perform a swept power measurement

The example figures in this procedure were taken using a 0 to 3 GHz limiter. A 1 GHz frequency was used with the power sweeping from 0 to +15 dBm.

#### Step 1. Connect the equipment

1. Configure the RF source to be controlled from the microwave transition analyzer. Refer to Chapter 1, "Configuring the HP 71500A."
2. Connect the test setup as shown in the following figure.

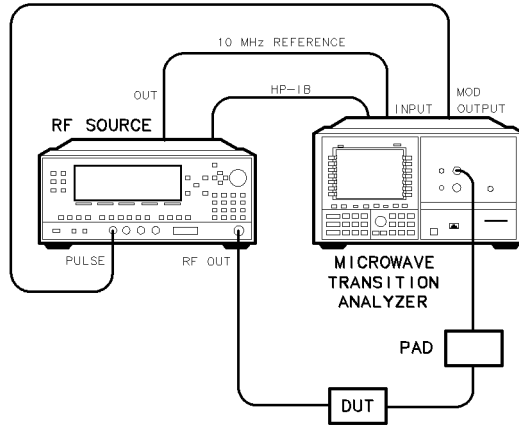

PTA25

## Step 2. Establish the measurement point

1. Press the left-side **States** softkeys to enter the States menu.

The **States** softkey is located on the second page of left-hand softkeys. (Press **page 1 of 2**.)

2. Press the **more 1 of 2** and then **PULSED TIME** softkeys.
3. Press the **carrier FRQ|PWR** softkey so that **FRQ** is highlighted.
4. Enter the desired frequency for the RF source.
5. Press the **carrier FRQ|PWR** softkey so that **PWR** is highlighted. Enter the power of the RF source.

The power does not have to be within the planned power sweep range.

6. Press the **RF out ON|OFF** softkey so that **ON** is underlined.

The RF source's output is turned on.

7. Press the **Traces** softkey to enter the Traces menu.
8. Press the **select:** and then **TR3** softkeys.
9. Press the **display ON|OFF** softkey so that **OFF** is underlined.
10. Press the left-side **page 1 of 2** and then **Pulsgen** softkeys.
11. Press the **RF src PUL|CW** softkey so that **PUL** is underlined.

This turns on the RF source's pulse modulator.

12. If the signal is not displayed or is unstable, perform the following steps:

Press the left-side **page 2 of 2** softkey.

Press **Trigger** and then **LEVEL**.

Use the front-panel knob to adjust the trigger level for a stable display.

Press the left-side **page 1 of 2** softkey.

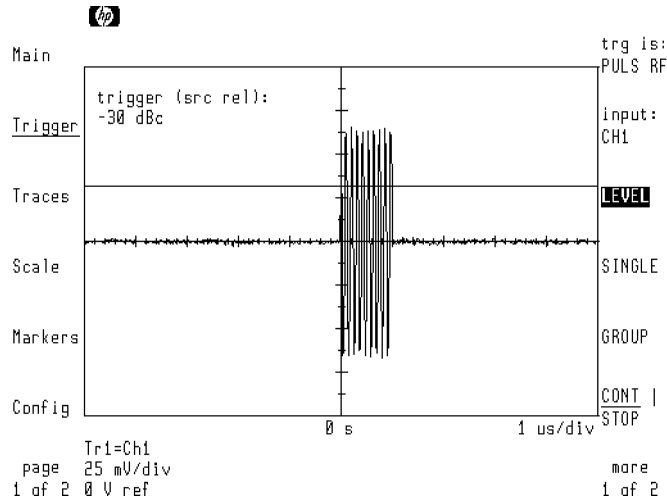

13. Use the **WIDTH | DUT CYC** softkey to change the pulse width or duty cycle as desired.
14. Use the **PRI | PRF** softkey to change the pulse interval or pulse repetition frequency as desired.
15. Press the left-side **page 2 of 2** then **Main**.
16. If necessary, change the time scale to view the pulse envelope.
17. Press the Main menu's **DELAY** softkey.

The measurement point used in the frequency sweep is represented at center screen.

18. Enter the time delay to place the measurement point (center screen) at the desired position on the pulse envelope.

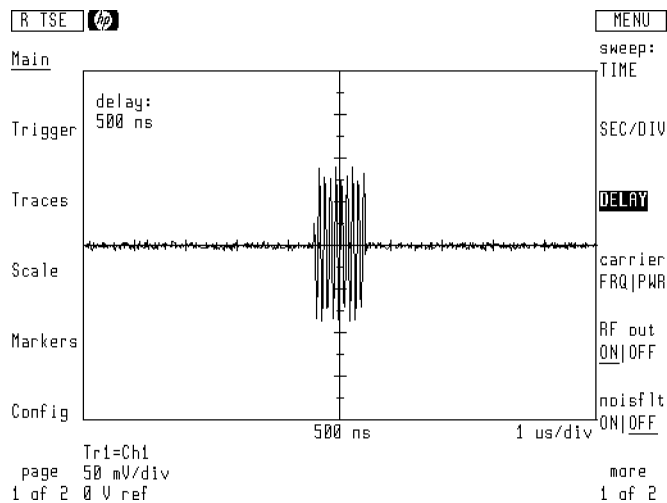

19. Press the **Config** softkey to enter the Configuration menu.
20. Press the **TRACE POINTS** softkey, and enter 100 points.

This speeds up the sweeps in preparation for the frequency sweep. Because the number of measurement points is reduced, measurement resolution decreases.

### **Step 3. Set the sweep parameters**

1. Press the **Main** softkey to enter the Main menu.
2. Press the **sweep:** softkey, and select **POWER**.
3. Press the **START STOP** softkey so that **START** is highlighted. Enter the start power.
4. Press the **START STOP** softkey so that **STOP** is highlighted. Enter the stop power.



#### **Step 4. Set the range of channel 1**

1. Press the **Scale** softkey to enter the Scale menu.
2. Press the **hardwre** softkey. The Channel 1 range is the active function.
3. Press **RANGE | OFFSET** so that **RANGE** is highlighted.
4. Use the keypad to enter the maximum power level that will be applied to channel 1.

This manually sets the Channel 1 range and is necessary because autoranging is disabled during power sweeps using pulsed RF.

### Step 5. Display the power sweep

1. Press the **Trigger** softkey to enter the Trigger menu, and press the **SINGLE** softkey.

The microwave transition analyzer is now in single sweep mode. This reduces the time needed to change post-processing data such as amplitude scaling. A small diamond shaped marker begins to move across the bottom of the screen. This indicates that a power sweep has started, and measurements are being taken.

2. After the sweep has completed, the power response is displayed.

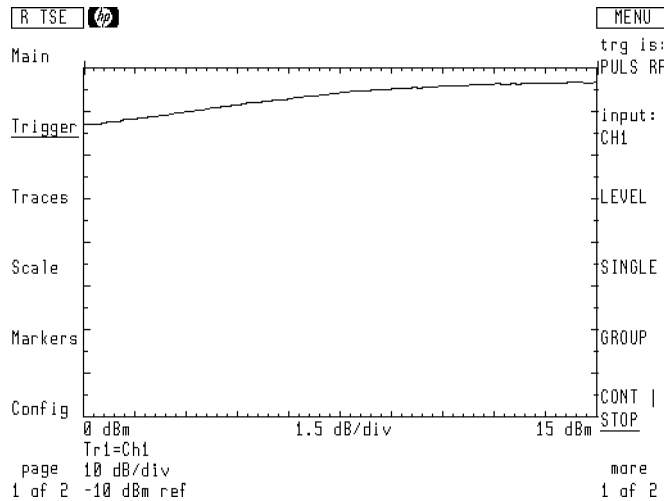

3. Press the **Scale** softkey to enter the Scale menu.
4. Press the **select:** and then **TR1** softkeys.
5. Press the **AUTO-SCALE** softkey to automatically scale the response.
6. The following figure shows the power sweep of the limiter from 0 to +15 dBm.

Because the microwave transition analyzer is in single sweep mode, the scale and reference level changes are immediately displayed.

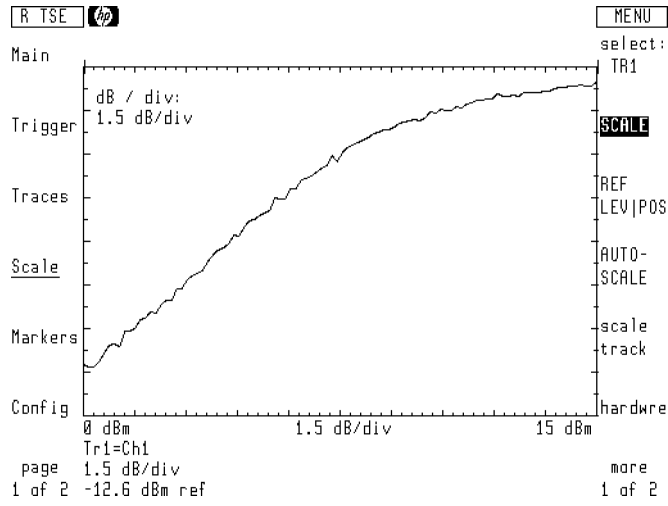



## Viewing Transient and Non-Repetitive Signals

Single-shot operation of the microwave transition analyzer enables you to view non-repetitive and transient signals. Up to 10 MHz of bandwidth can be viewed anywhere between 0 to 40 GHz. Examples of using single shot operation include measuring a pulse modulator's turn-on characteristics and the settling times of phase lock loops. Single-shot operation is accessed through the Main menu's `single shot` softkey.

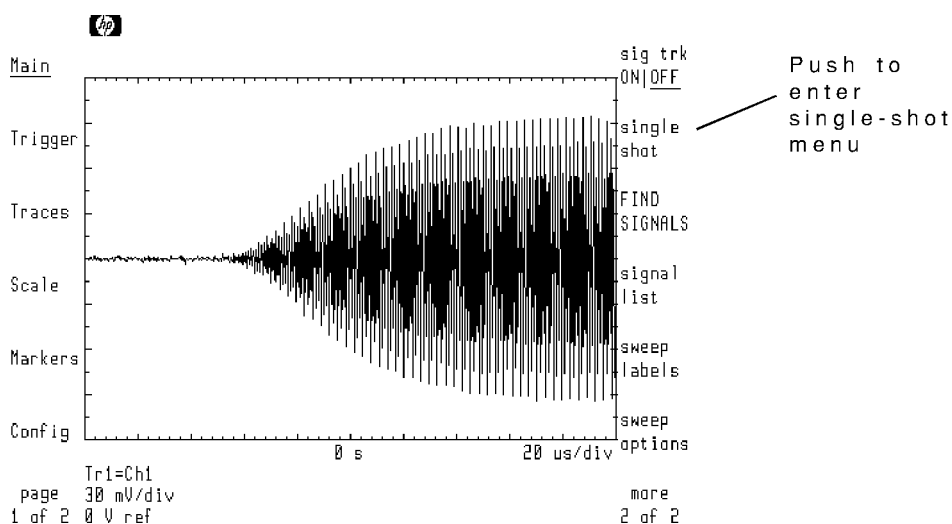

Start-up of a CW oscillator

Learning About Single-Shot Operation .....	4-4
To enter single-shot operation .....	4-6
To use single sweep triggering .....	4-7
Displaying Periodic Signals Accurately .....	4-8
Ensuring Maximum Bandwidth for Modulated Signals .....	4-17
To ensure maximum bandwidth .....	4-17
Viewing Modulated Signals in Frequency Domain .....	4-18
To center an FFT .....	4-19
To change the span of an FFT .....	4-19
Increasing the Number of Data Points in Single Shot .....	4-21
Tutorial: Measuring Turn-On Time of a CW Source .....	4-22
Tutorial: Measuring Turn-On Time of a Pulsed RF Source .....	4-30
Tutorial: Measuring a Modulated Signal .....	4-41

## Learning About Single-Shot Operation

During normal operation, the microwave transition analyzer precisely controls measurement conditions to display repetitive input signals. With single-shot operation you manually control measurement conditions to capture transient or non-repetitive signals. Try the examples in this chapter to gain experience with making these measurements. Proficient use of single-shot operation requires a thorough understanding of sampling techniques.

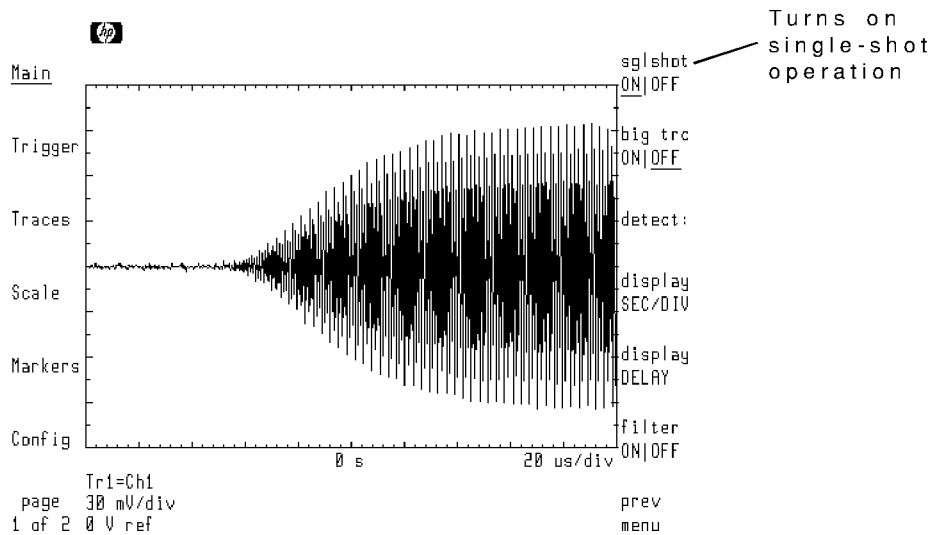

Single-shot menu

Interpreting displayed results requires a basic understanding of the measurement relationships described in this section. To enter single-shot operation, you must place the microwave transition analyzer in a time sweep, and then press the Main menu's **single shot** and then **sglshot ON/OFF** softkeys. In addition, enter the signal frequency using the Main menu's **signal FREQ** softkey. You must also set the following conditions:

RF source control ..... off  
trigger condition ..... required for sweep  
sample rate ..... manually set  
(maximum 20 MHz)

Both internal and external triggering can be used. During single-shot operation, use the Main menu's delay feature to view pre-trigger data.

---

**You should know** maximum alias bandwidth in single-shot operation is 10 MHz (with a 20 MHz sampling rate). As you reduce the sampling rate, the alias free bandwidth decreases.

The minimum rise time that can be displayed is approximately 200 ns. The minimum pulse width is approximately 500 ns.

---

## To enter single-shot operation

The following steps place the microwave transition analyzer in single-shot operation. However, additional steps are required if the microwave transition analyzer is placed in single sweep mode. This is because single sweep mode may prevent proper autoranging of the input channels. Consequently, each channel's hardware range must be manually set. Refer to the tutorials in this chapter for more detailed examples of using single-shot operation.

1. Press the front-panel **(INSTR PRESET)** key to preset the microwave transition analyzer.
2. Connect the input signal to the microwave transition analyzer's front-panel RF INPUT 1 connector.
3. If a signal is displayed, press left-side **Scale** softkey, and then press the **AUTOSCALE** softkey.
4. Press the left-side **Main** softkey to enter the Main menu.
5. Some applications may require you to press the **signal FREQ** softkey, and enter the frequency of the input signal.
6. Press the **more 1 of 2** softkey.
7. Press **single shot**.
8. Press the **sglshot ON|OFF** softkey so that **ON** is underlined.

If the input signal frequency is close to or greater than half the sampler frequency, the time scale will not be accurate for measuring waveform parameters. The sampler frequency is displayed in the upper-left corner of the display.



## To use single sweep triggering

1. Place the microwave transition analyzer in single-shot operation.
2. Press the **hardwre** softkey.
3. Press the **autorng ON|OFF** softkey so that **OFF** is underlined.
4. Determine the maximum input signal level, and enter this level as the **RANGE** value for channel 1.

Autoranging for channel 1 is turned off and set to the proper levels.

5. Enter the Trigger menu and select the trigger input and levels as desired.
6. Press the **SINGLE** softkey.
7. Press the **more 1 of 2** softkey.
8. Press the **AUTO | TRIG'D** softkey so that **TRIG'D** is underlined.

This prevents the microwave transition analyzer from sweeping without a trigger condition.

9. Press the left-side **Scale** softkey to enter the Scale menu.

---

## Displaying Periodic Signals Accurately

When a trace is triggered, the microwave transition analyzer performs a set number of measurements. Each measurement is separated by an equal amount of time. The time between measurements is equal to the period of the sampling rate. The following equation shows this relationship between total time span, number of measurements, and sampling period:

$$time\ span = (measurements)(sampling\ period)$$

where:

$$sampling\ period = \frac{1}{sampling\ frequency}$$

Depending on the signal and sampler frequencies used, displayed carrier and baseband waveforms may be aliased as described in the following three sections:

- Signals less than the sampler frequency
- Signals equal to (or harmonic of) the sampler frequency
- Signals greater than the sampler frequency

Although the carrier may be aliased, the modulation waveform can still be accurately displayed. This remains true as long as the modulation bandwidth is narrow enough and positioned correctly. Single-shot operation can be used to display up to 10 MHz of bandwidth anywhere between 0 and 40 GHz.

---

**Softkeys used** Use the Configure menu's **TRACE POINTS** softkey to set the number of measurements. Use the Main menu's **sglshot ON|OFF** softkey to set the sampling rate. The maximum sampling rate is 20 MHz. The fastest sweep time available, while still maintaining acceptable measurement resolution, is approximately 5  $\mu$ s per division.

---

### Signals less than the sampler frequency

To ensure an adequate number of measurement points to reconstruct the input signal, the sampling rate should be at least ten times the input signal's frequency. This gives at least ten measurements per cycle. Of course, this is not a fixed rule. Using less than ten times the input frequency reduces measurement resolution.

$$f_{\text{sampler}} = 10 f_{\text{signal}}$$

where:

$f_{\text{sampler}}$  is the sampler frequency.

$f_{\text{signal}}$  is the frequency of the input signal.

Since the maximum sampling frequency of the microwave transition analyzer is 20 MHz, we could accurately display input signals up to approximately 2 MHz. Depending on the type of input signal being measured, more or less measurement resolution may be needed. The following figure shows how a 20 MHz sampling frequency with a 2 MHz input signal gives 10 measurements for each cycle.

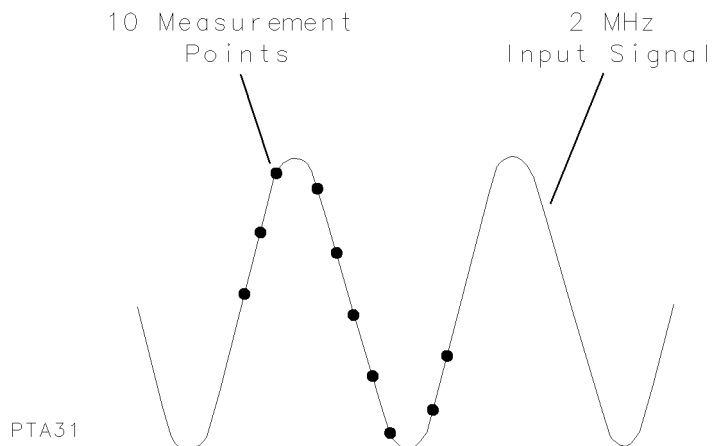

The following figure shows the microwave transition analyzer measuring a 2 MHz signal. With a sampling frequency of 20 MHz, this gives 10 measurements per cycle. Thirty-two trace points (measurement points) are used allowing slightly more than three cycles to be shown on screen. Use the Configure menu's TRACE POINTS softkey to change the number of measurement points used. Notice that with 10 measurement points per cycle, the sine wave not accurately represented on the screen.

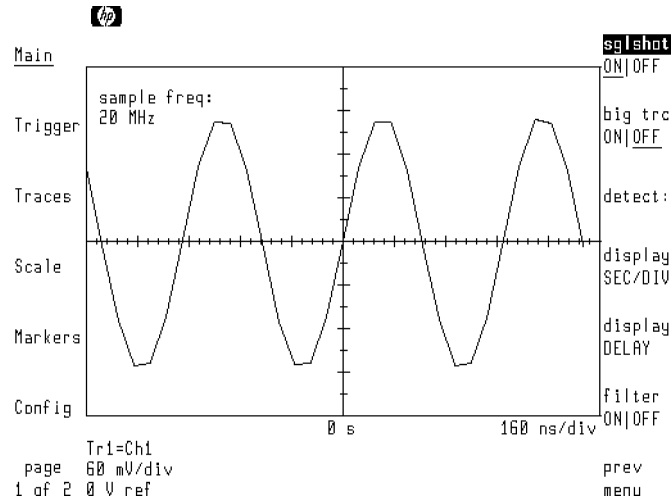

**Source frequency: 2 MHz, sampler frequency: 20 MHz**

The number of measurements made for each cycle of input signal can be calculated as follows:

$$\text{measurements per cycle} = \frac{f_{\text{sampler}}}{f_{\text{signal}}}$$

where:

$f_{\text{sampler}}$  is the sampler frequency.

$f_{\text{signal}}$  is the frequency of the input signal.

The following figure shows the same measurement as above except that the input signal is now at 10 MHz. Notice the 32 measurement points. With only 2 measurement points per cycle, the displayed representation of the waveform is severely distorted.

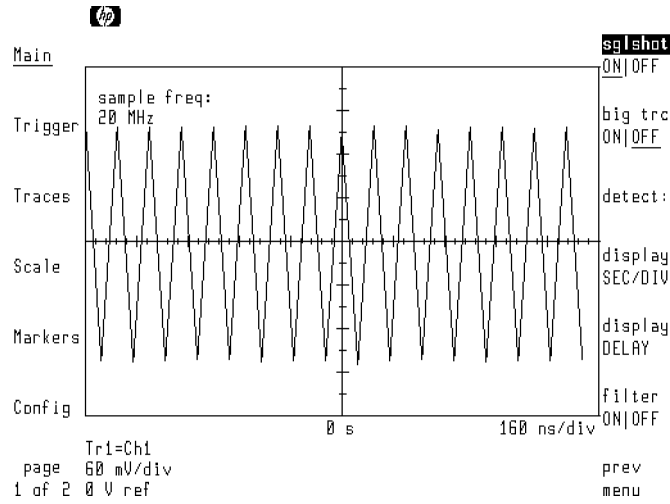

**Source frequency: 10 MHz, sampler frequency: 20 MHz**

The number of cycles displayed can be determined by the following formula:

$$\text{displayed cycles} = \text{measurement points} \left( \frac{f_{\text{signal}}}{f_{\text{sampler}}} \right)$$

### Signals equal to (or harmonic of) the sampler frequency

Input signals cannot be displayed if they are equal to the sampler frequency or a harmonic of the sampler frequency. This is due to the fact that each measurement point occurs on the same portion of each input cycle. The input signal is aliased to dc.

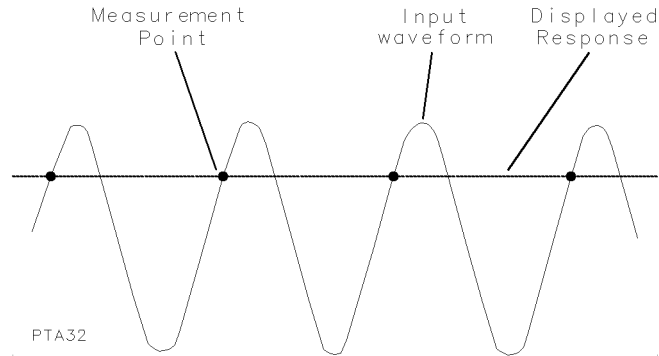

If a modulation envelope is harmonically related to the sampler frequency, the measurement points occur on the same portion of the modulation envelope but does not occur on the same location of the carrier signal. This condition is illustrated in the following figure. This too results in a distorted waveform.

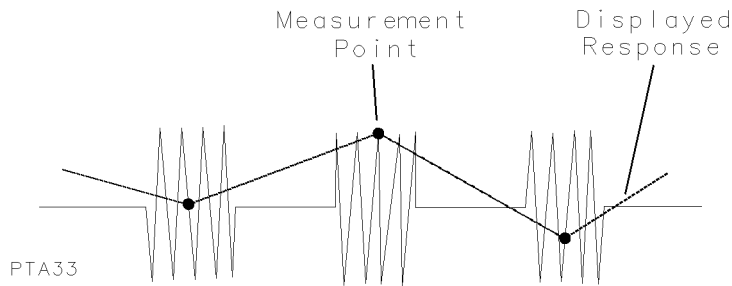

The following figure shows a 40 MHz input signal displayed using a sampler frequency of 20 MHz. With only one measurement every two cycles, the input signal is aliased to dc.

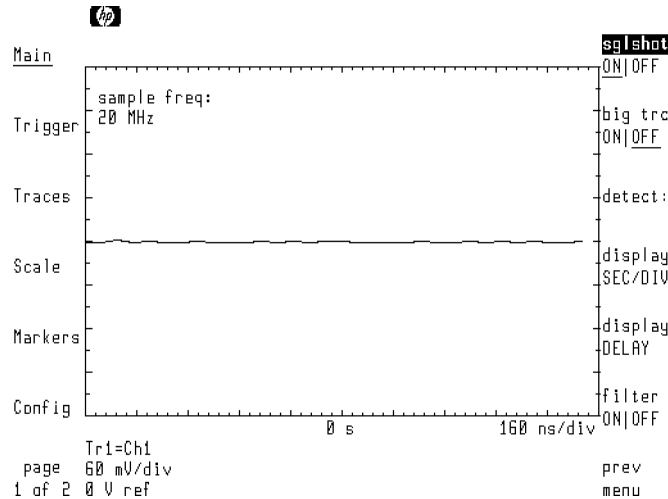

**Source frequency: 40 MHz, sampler frequency: 20 MHz**

The simplest method of preventing a conflict between the sampling and RF source frequencies is to enter the RF source's frequency to six or seven significant digits. Avoid entering multiples of 2 or 10. For example, enter 1.234567 GHz. This setting greatly reduces the possibility of a harmonic relationship.

You can also enter a new sampling frequency. When the single-shot operation is turned on using the `sglshot ON|OFF` softkey, the sampling frequency is shown in the upper-left corner of the display. With the softkey activated, enter a new sampler frequency.

### Signals greater than the sampler frequency

When the input signal frequency is higher than the sampler frequency, measurements occur less than once per cycle. In practice, hundreds or even thousands of cycles can separate measurements. This results in an aliased displayed waveform that does not accurately show the input signal. However amplitude information is valid.

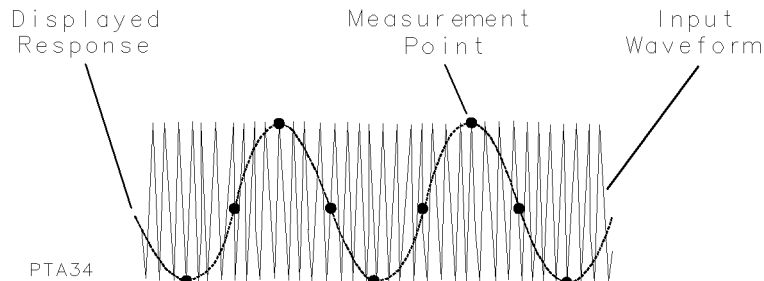

The following figure shows a 1 GHz CW source turning on. The time scale accurately shows the time required for the oscillator to produce consistent amplitude cycles. However, if one displayed cycle were measured, it would indicate an input signal of approximately 134 KHz. This is far below the real input signal of 1 GHz.

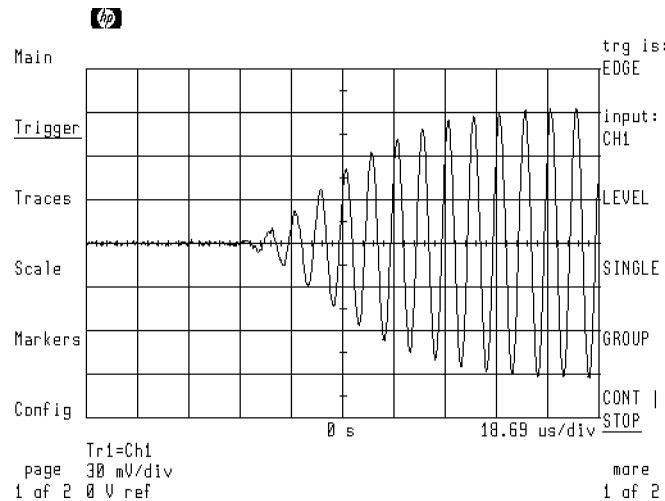

**Source frequency: 1 GHz**

If the trace is formatted as magnitude (MAGN) instead of real (REAL), the rise time of the envelope can be measured as shown in the following figure.



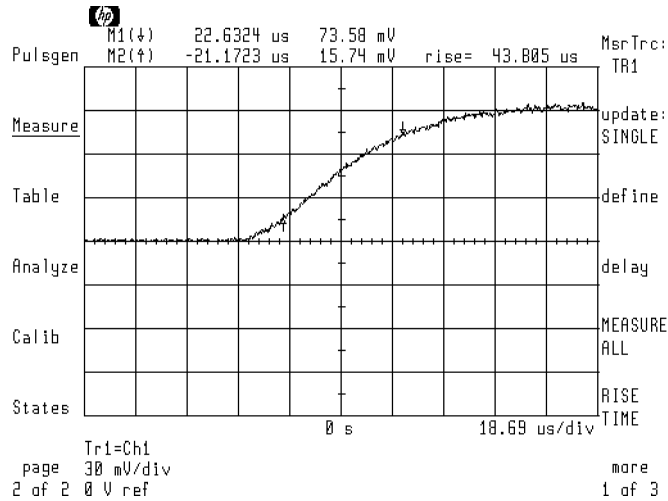

---

**10 MHz bandwidth** the maximum bandwidth is 10 MHz, modulated signals with bandwidths greater than 10 MHz will be distorted. For example, if the turn on time of a CW source is extremely fast, it may exceed the bandwidth limit and be distorted. Distortion can also occur if modulated signals are not properly centered in the microwave transition analyzer's IF. Refer to "Ensuring Maximum Bandwidth for Modulated Signals" in this chapter.

---

---

## Ensuring Maximum Bandwidth for Modulated Signals

Distortion can occur if modulated signals are not properly centered in the microwave transition analyzer's IF. With proper centering, the maximum bandwidth is 10 MHz. If the signal is not centered in the IF, the effective bandwidth is reduced. The following procedure centers the signal in the IF by adjusting the sampling frequency.

### To ensure maximum bandwidth

1. Place the microwave transition analyzer in single-shot operation.
2. Press the left-side **Main** softkey to enter the Main menu.
3. Press the **more 1 of 2** softkey.
4. Press the **sweep labels** softkey.
5. Press the **# CYCLE DELAY** softkey.
6. Press the left-side **Config** softkey to enter the Configure menu.
7. The **TRACE POINTS** softkey should be highlighted. Read the trace points value displayed in the upper-left corner of the display.
8. Divide the trace points by four and record the result on the following line. The result should be 128.      trace points/4 \_\_\_\_\_
9. Press the left-side **Main** softkey to enter the Main menu.
10. The **# of CYCLE** softkey should be active. Subtract 2 or 3 from the number entered in the previous step, and enter the resulting number as the number of cycles.

Subtracting 2 or 3 from the recorded value prevents harmonics mixing on top of each other.

---

## Viewing Modulated Signals in Frequency Domain

Single-shot operation can be used to display modulated signals in the frequency domain. The trace is formatted with an FFT, and the carrier is centered in the FFT as described in this section. Refer to the tutorial located at the end of this chapter for an example of measuring modulated signals.

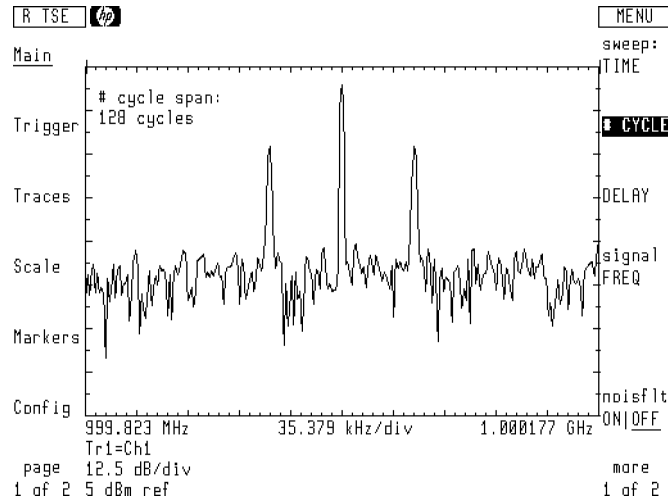

**50 kHz amplitude modulation on 1 GHz carrier**

The FFT's frequency span can be adjusted to zoom in on the displayed modulation. The maximum bandwidth is 10 MHz. Any signal within  $\pm 5$  MHz of the carrier is accurately shown. All signals outside the bandwidth are folded in and displayed.

During an FFT, the frequency scale (displayed beneath the displayed FFT) may not be accurate and is subject to user interpretation.

## To center an FFT

1. Place the microwave transition analyzer in the single-shot mode.
2. Press the left-side **Main** softkey to enter the Main menu.
3. Press the **more 1 of 2** and then **sweep labels** softkeys.
4. Press the **# CYCLE DELAY** softkey.
5. Press the left-side **Config** softkey to enter the Configure menu.
6. The **TRACE POINTS** softkey should be highlighted. Read the trace points value displayed in the upper-left corner of the display.
7. Divide the trace points by four and record the result on the following line:  
trace points/4 \_\_\_\_\_
8. Press the left-side **Main** softkey to enter the Main menu.
9. The **# of CYCLE** softkey should be active. Subtract 2 or 3 from the number entered in the previous step, and enter the resulting number as the number of cycles.  
Subtracting 2 or 3 from the recorded value prevents harmonics mixing on top of each other.

## To change the span of an FFT

1. Place the microwave transition analyzer in the single-shot mode and center the FFT as shown in the above procedure.
2. Press the left-side **Main** softkey to enter the Main menu.
3. Press the **more 1 of 2** and then **single shot**.
4. Press **sglshot ON|OFF** so that **ON** is underlined.
5. Use the front-panel knob to change the comb tooth value shown in the upper-left corner of the display.

Increasing the comb tooth value decreases the viewed frequency span.

---

## Increasing the Number of Data Points in Single Shot

Normally, single-shot operation provides up to 1024 measurement data points. The **big trc ON|OFF** softkey allows you to acquire up to 250,000 measurement data points. This gives you the ability to capture data that span relatively large amounts of time. Once the data is captured, use the **display SEC/DIV** and **display DELAY** softkeys to display selected portions of the captured data. **OFF** softkey|

You can selectively filter and detect portions of the data after a measurement is performed. Acquiring additional data points is not required. Use the **filter ON|OFF** softkey to apply software filtering to the data. With the filter on, turn the front-panel knob to adjust the amount of filtering.

### Detecting the data

Use the **detect:** softkey to select from the following six methods of data detection:

- Sample detection: Use to uniformly space the data.
- Maximum detection: Use when decimating (keeping 1 of N points) for each N points to keep the point with maximum value.
- Maximum detection: Use when decimating (keeping 1 of N points) for each N points to keep the point with minimum value.
- AM detection: Returns the amplitude demodulation of the data.
- FM detection: Returns the frequency demodulation of the data.
- PM detection: Returns the phase demodulation of the data.

---

## Tutorial: Measuring Turn-On Time of a CW Source

In this tutorial, the time required for a CW source to start up at 1 GHz is measured. Because the period of the signal is less than  $5 \mu\text{s}$ , the displayed graphical representation of the carrier is an aliased representation of the carrier waveform and is not accurate with the time scale. Also, because the signal's start-up time does not require a bandwidth greater than 10 MHz, the displayed envelope can be accurately measured.

### Step 1. Connecting the equipment

1. Connect the equipment as shown below.

Notice that the RF source is not controlled by the microwave transition analyzer and does not have to share a common time base.

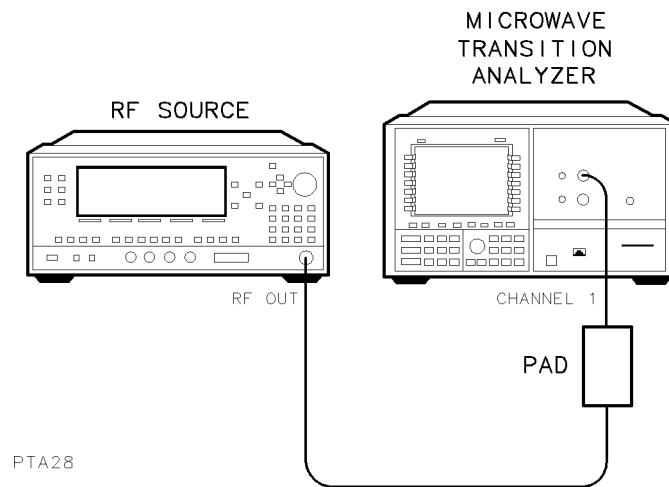

2. Press the front-panel **INSTR PRESET** key to preset the microwave transition analyzer.
3. Press the left-side **Config** softkey to enter the Configuration menu.
4. Press the **RF source** and then **RF src:** softkeys.
5. Press the **NONE** softkey.

This disables control of the RF source by the microwave transition analyzer.

### Step 2. Setting the RF source parameters

1. Set the source's frequency to 1 GHz.
2. Set the source's power to  $-10 \text{ dBm}$ .
3. Turn on the RF source. The microwave transition analyzer's display should be similar to the following figure.

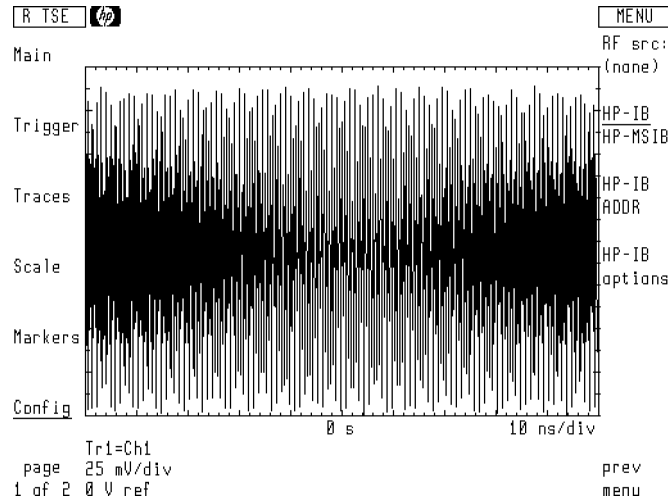

### Step 3. Setting hardware scaling

Because this measurement uses a single sweep, the autoranging feature may not be able to properly set the hardware range. These steps turn hardware autoranging off. The hardware range is then manually set for each channel. The range for channel 2 must be set even though no signal is input to the channel.

1. Press the left-side **Scale** softkey to enter the Scale menu.
2. Press the **AUTOSCALE** softkey to perform automatic software scaling on the displayed signal.
3. Press the **hardwre** softkey.
4. Press the **autorng ON|OFF** softkey so that **OFF** is underlined.

The display may look similar to the following figure. Different sampler frequencies result in different looking aliased waveforms. At some sampler frequencies, the waveform may actually be aliased to dc. The sampler frequency can be adjusted later in this tutorial. Because the signal is input before single sweep mode is turned on, the range for channel 1 is properly set.

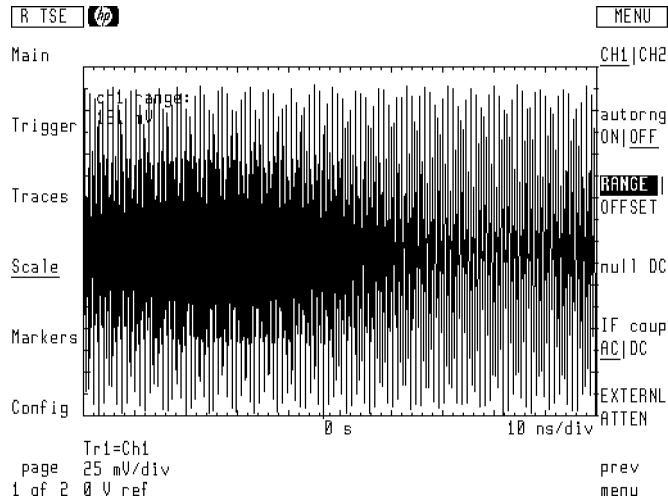

5. Record the channel 1 range (shown in the upper-left corner of the display) on the following line:

CH1 hardware range \_\_\_\_\_

6. Press the **CH1|CH2** softkey so that **CH2** is underlined.

7. The **RANGE** softkey should be highlighted. Enter the channel 2 range that is equal to the range previously shown for channel 1.



## Step 4. Setting the trigger

1. Press the left-side **Trigger** softkey to enter the Trigger menu.
2. Press the **LEVEL** softkey, and use the front-panel knob to enter the desired trigger level.

Set the trigger level for a stable display. The trigger level should be set above any noise.

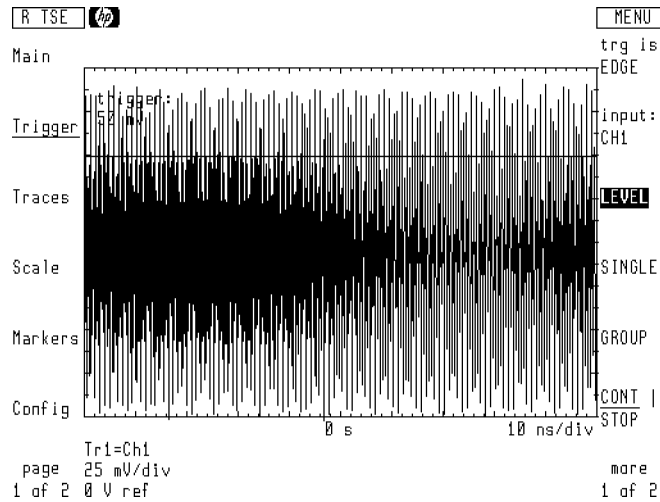

3. Press the **more 1 of 2** softkey.
4. Press the **AUTO | TRIG'D** softkey so that **TRIG'D** is underlined.

This ensures that sweeps will be triggered only if the proper trigger conditions are met.

## Step 5. Turning on single-shot operation

1. Press the left-side **Main** softkey to enter the Main menu.
2. Press the **more 1 of 2** softkey.
3. Press **single shot** to enter the single-shot menu.
4. Press the **sglshot ON|OFF** softkey so that **ON** is underlined.
5. Press **prev menu**.
6. Press the **more 2 of 2** softkey.
7. Press the **signal FREQ** softkey, and enter the frequency of the input signal.
8. Press the **SEC/DIV** softkey, and enter the desired time span. For example, enter 200  $\mu$ s per division.

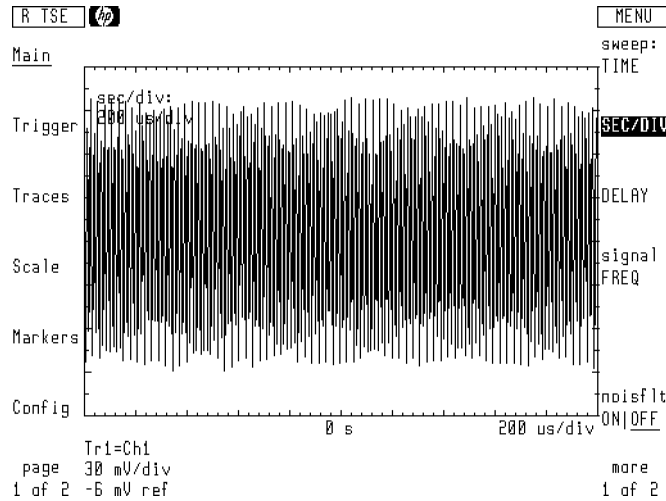

### Step 6. Displaying the turn-on time.

1. Turn the RF source output off.
2. Press the left-side **Trigger** softkey to enter the Trigger menu.
3. Press the **SINGLE** softkey.

The microwave transition analyzer stops sweeping and waits for a trigger.

4. Turn the RF source output on. The display should show the turn on of the source.

If the proper signal is not displayed, proceed to the next step to adjust the time scale. Also, check that the triggering is not occurring on signal noise.

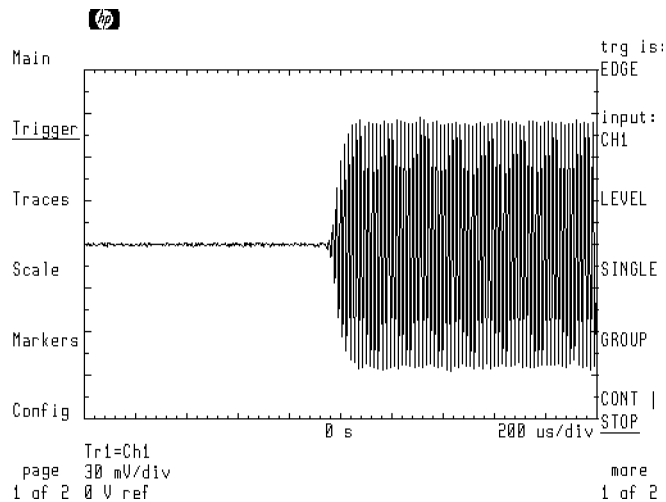

5. To capture the desired data, repeat the above steps after making the following changes:
  - Use the Main menu's **DELAY** softkey to delay the data captured from the trigger point.
  - Use the Main menu's **SEC/DIV** softkey to change the horizontal scale.

## Step 7. Measuring waveform parameters

1. Press the left-side **Traces** softkey to enter the Traces menu.
2. Press the **format:** and then **MAGN** softkey.
3. Press the left-side **page 1 of 2** softkey.
4. Press the left-side **Measure** softkey to enter the Measure menu.
5. To measure the rise time, press the **RISE TIME** softkey. In this application, the rise time measures the time required for the RF source to produce an output at the proper amplitude.

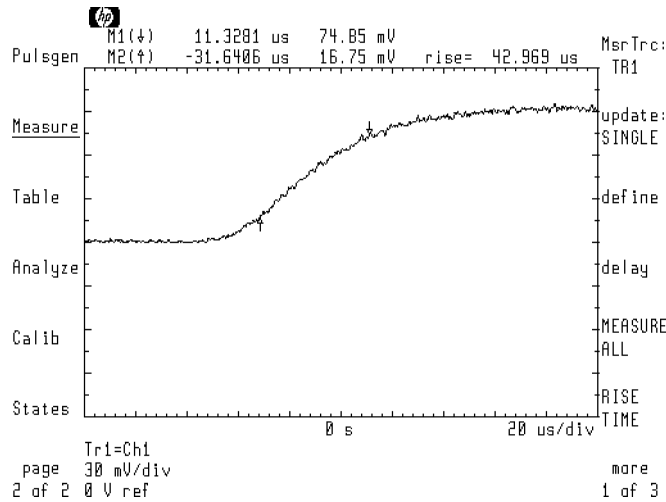

---

## Tutorial: Measuring Turn-On Time of a Pulsed RF Source

In this tutorial the turn-on time of a pulsed RF source is measured. The microwave transition analyzer's internal pulse generator is used to modulate the source.

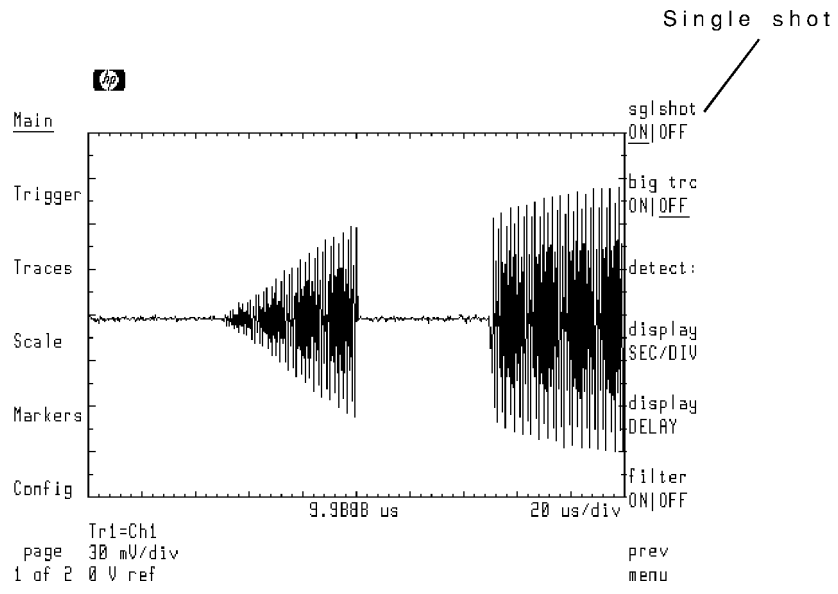

## Step 1. Connecting the equipment

1. Connect the equipment as shown below.

Notice that while the RF source is not controlled by the microwave transition analyzer, it still shares a common time base. Remember that the bandwidth of the pulses must be less than 10 MHz.

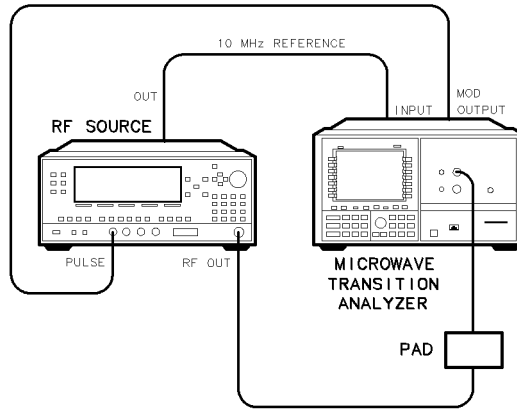

PTA29

2. Press the front-panel **(INSTR PRESET)** key to preset the microwave transition analyzer.
3. Press the left-side **Config** softkey to enter the Configuration menu.
4. Press the **RF source** and then **RF src:** softkeys.
5. Press the **NONE** softkey.

## Step 2. Setting the RF source parameters

1. Set the source's frequency to 1 GHz.
2. Set the source's power to  $-10$  dBm.
3. Turn on the RF source's output.
4. Turn off the RF source's pulse modulator.

## Step 3. Setting the pulse parameters

1. Press the left-side **page 1 of 2** and then **Pulsgen** softkeys to enter the Pulse Generator menu.
2. Press the **gen is:** and then **INT** softkeys.

This selects and turns on the microwave transition analyzer's internal pulse generator.

3. The default pulse repetition frequency is 10 kHz. Press the **WIDTH | DUTY CYC** softkey so that **DUTY CYC** is highlighted.

4. Enter a 50% duty cycle. The CW signal should be visible on the display as shown in the following figure.

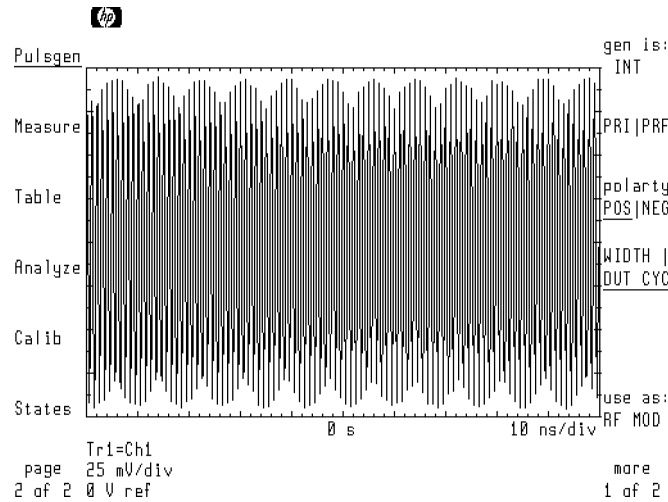

#### Step 4. Setting hardware scaling

Because this measurement uses a single sweep, the autoranging feature may not be able to properly set the hardware range. These steps turn hardware autoranging off. The hardware range is then manually set for each channel. The range for channel 2 must be set even though no signal is input to the channel.

1. Press the left-side **page 2 of 2** and then the **Scale** softkeys.
2. Press the **AUTOSCALE** softkey.

This step simply adjusts the vertical scale for more convenient viewing.

3. Press the **hardwre** softkey.
4. Press the **autorng ON|OFF** softkey so that **OFF** is underlined.

The display should look similar to the following figure. Because the signal is input to the microwave transition analyzer before single sweep mode is turned on, the range for channel 1 is properly set.

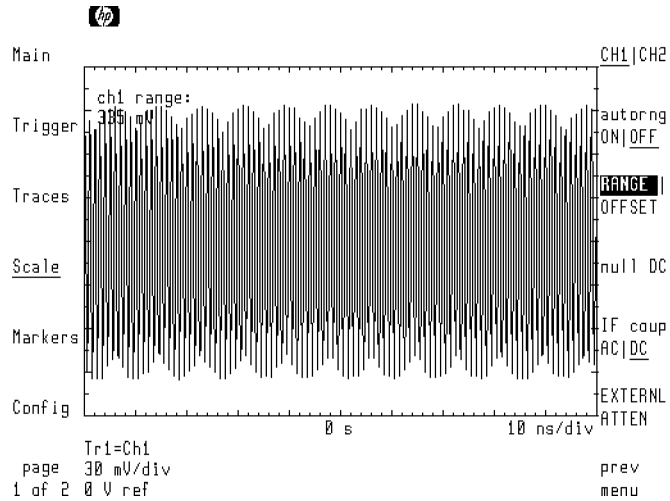

5. Record the channel 1 range shown in the upper-left corner of the display.

CH1 hardware range \_\_\_\_\_

6. Press the CH1|CH2 softkey so that CH2 is underlined.

7. The RANGE softkey should be highlighted. Enter the range for channel 2 that is equal to the range recorded for channel 1.

## Step 5. Setting the trigger

1. Turn on the RF source's pulse modulator.
2. Press the left-side **Trigger** softkey to enter the Trigger menu.
3. Press the **LEVEL** softkey, and use the front-panel knob to enter the desired trigger level.

Set the trigger level above any noise. Because pulsed RF triggering is not used, the triggering may not be stable.

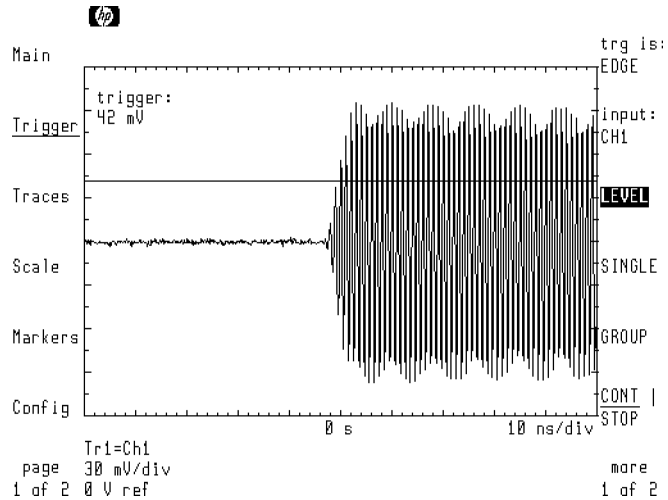

4. Press the **more 1 of 2** softkey.



5. Press the AUTO | TRIG'D softkey so that TRIG'D is underlined.

This ensures that sweeps will only be triggered if the proper trigger conditions are met.

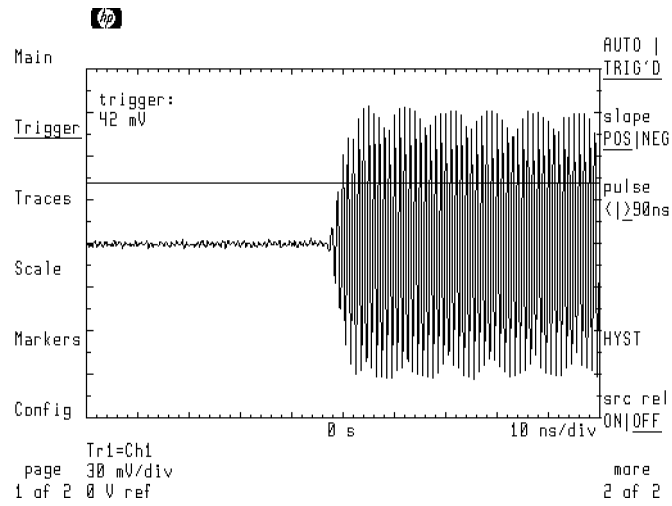

## Step 6. Turning on single-shot operation

1. Press the left-side **Main** softkey to enter the Main menu.
2. Press the **carrier FREQ** softkey, and enter the frequency of the carrier signal.
3. Press the **more 1 of 2** softkey.
4. Press the **single shot** softkey to enter the single shot menu.
5. Press the **sglshot ON|OFF** softkey so that **ON** is underlined.
6. Press **prev menu**.
7. Press the **more 2 of 2** softkey.
8. Press the **SEC/DIV** softkey, and enter the desired time span. For example, enter 200  $\mu$ s per division.

If the displayed waveform is distorted, you may need to use the **sglshot ON|OFF** softkey to adjust the sampler frequency.

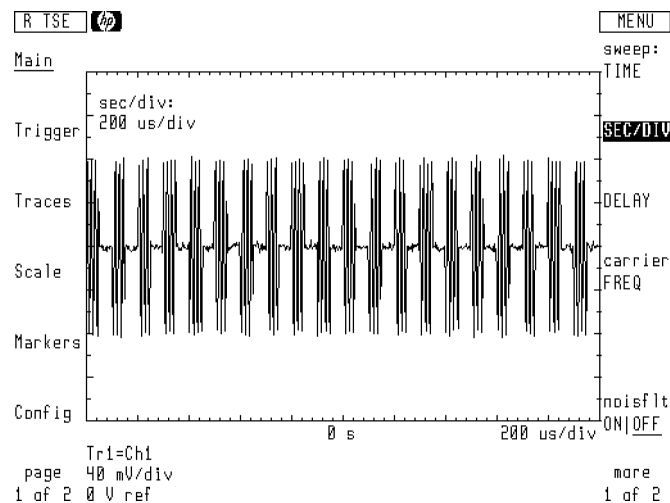

## Step 7. Displaying the turn-on time.

1. Turn the RF source off.
2. Press the left-side **Trigger** softkey to enter the Trigger menu.
3. Press the **SINGLE** softkey.

The microwave transition analyzer stops sweeping and waits for a trigger.

4. Turn the RF source on. The display should show the turn on of the source.

If the proper signal is not displayed, proceed to the next step to adjust the time scale. Also, check that the triggering is not occurring on signal noise.

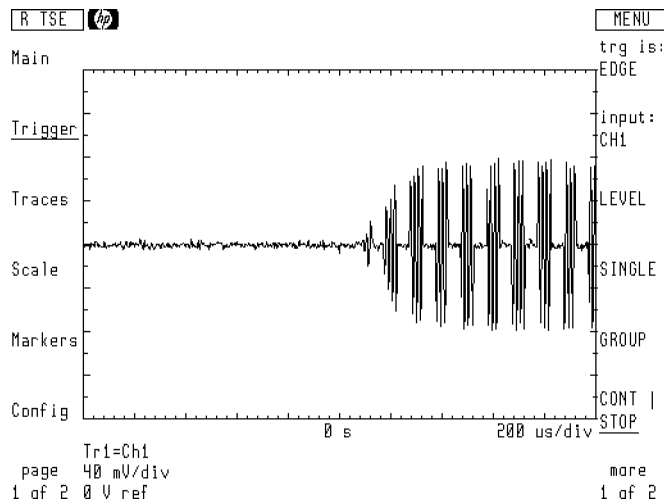

5. To capture the desired data, repeat the above steps after making the following changes:
  - Use the Main menu's **DELAY** softkey to delay the data captured from the trigger point.
  - Use the Main menu's **SEC/DIV** softkey to change the horizontal scale.

---

## Tutorial: Measuring a Modulated Signal

This tutorial measures a 1 GHz carrier with 50 kHz amplitude modulation. An FFT is performed showing the signal in the frequency domain.

### Step 1. Connecting the equipment

1. Connect the equipment as shown below.

Notice that the RF source is not controlled by the microwave transition analyzer and does not have to share a common time base.

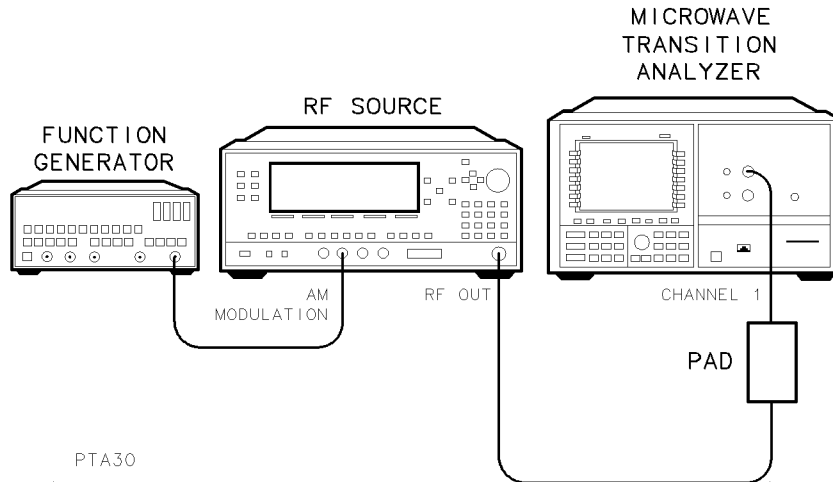

2. Press the front-panel **INSTR PRESET** key to preset the microwave transition analyzer.
3. Press the left-side **Config** softkey to enter the Configuration menu.
4. Press the **RF source** and then **RF src:** softkeys.
5. Press the **NONE** softkey.

This disables control of the RF source by the microwave transition analyzer.

## Step 2. Setting the RF source modulation

1. Set the source's frequency to 1 GHz.
2. Set the source's power to  $-10$  dBm.
3. Set the function generator for a 50 kHz sine wave output at 700 mV amplitude. Turn on the function generator.
4. Turn on the RF source output.
5. Press the left-side **Scale** softkey to enter the Scale menu.
6. Press the **scale track** and then **CONT AUTOSCL** softkeys. The microwave transition analyzer's display should be similar to the following figure.

The microwave transition analyzer will continuously adjust the vertical scale for the most convenient viewing of the input signal.



## Step 4. Turning on single-shot operation

1. Press the left-side **Main** softkey to enter the Main menu.
2. Press the **signal FREQ** softkey, and enter the frequency of the 1 GHz carrier.

This step ensures a correct frequency scale for the FFT performed later in this tutorial.

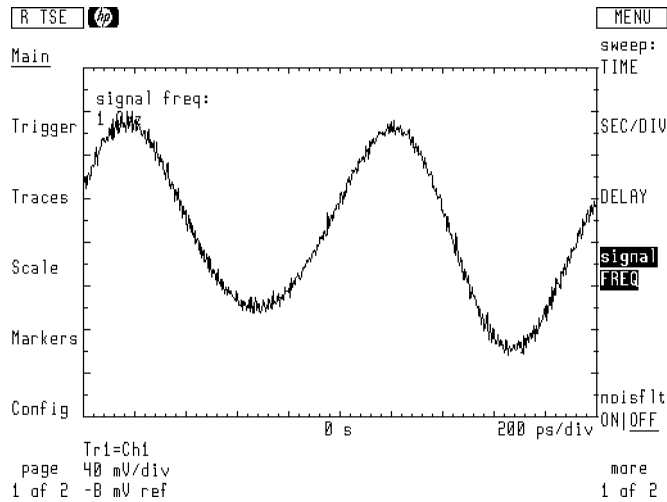

3. Press the **more 1 of 2** softkey.
4. Press **single shot**.
5. Press the **sglshot ON/OFF** softkey so that **ON** is underlined.

## Step 5. Formatting the trace

1. Press the left-side **Traces** softkey.
2. Press the **format:** and then **MAGN** softkeys to format the trace to show the magnitude response. The am modulation should be visible as shown in the following figure.

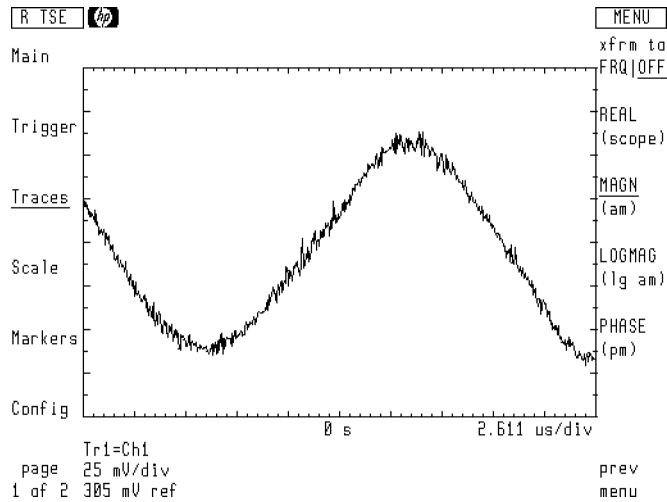

3. Press the **PHASE** softkey to format the trace to show phase.
4. Press the left-side **Scale** softkey to enter the Scale menu.
5. Press the **more 1 of 2** and then **AUTO SHIFT** softkeys. The following figure shows the resulting display of incidental FM.

The auto shift function compensates for the linear phase of the carrier.

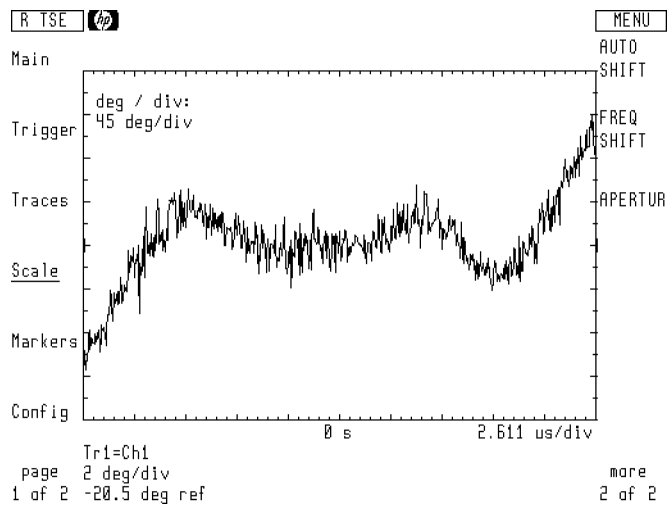

6. Press the **FREQ SHIFT** softkey, and enter a value of 0 Hz.

This step removes the shift added by the **AUTO SHIFT** softkey.

7. Press the left-side **Traces** softkey.
8. Press the **format:** and then **REAL** softkey.



## Step 6. Ensuring a centered FFT

1. Press the left-side **Main** softkey to enter the Main menu.
2. Press the **more 1 of 2** softkey.
3. Press the **sweep labels** softkey.
4. Press the **# CYCLE DELAY** softkey.
5. Press the left-side **Config** softkey to enter the Configure menu.
6. The **TRACE POINTS** softkey should be highlighted. Read the trace points value displayed in the upper-left corner of the display.
7. Divide the trace points by four and record the result on the following line. The result should be 128.

trace points/4 \_\_\_\_\_

8. Press the left-side **Main** softkey to enter the Main menu.
9. The **# of CYCLE** softkey should be active. Enter the number recorded above.



## Step 8. Changing the span of the FFT

1. Press the left-side **Main** softkey to enter the Main menu.
2. Press the **more 1 of 2** softkey and then **single shot**.
3. Press the **sglshot ON|OFF** softkey so that it is highlighted.
4. Use the front-panel knob to change the comb tooth value shown in the upper-left corner of the display.

Increasing the comb tooth value decreases the viewed frequency span.

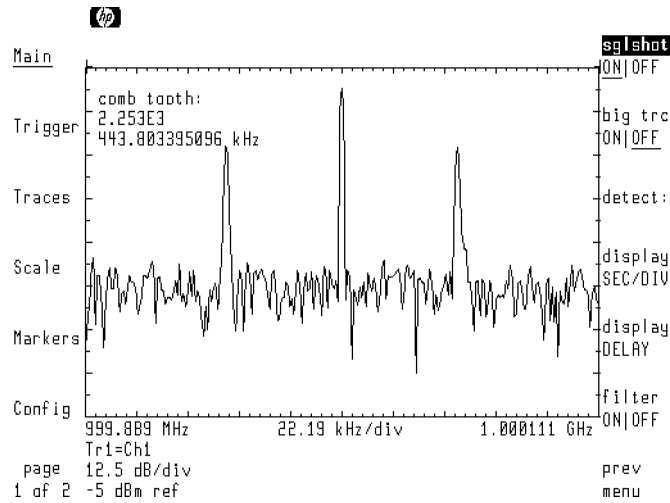



## Controlling Time, Frequency, and Power Sweeps

---

This chapter explains how to manually control time, frequency, and power sweeps. Although you'll learn about controlling sweeps, many of the measurement setups are easier to perform using the predefined measurement states presented in Chapter 2, "Performing Measurements."

The microwave transition analyzer's sweep modes give you the ability to perform swept time, frequency, or power measurements using continuous wave (CW) or pulsed RF signals. Use the Main menu to select and control the sweep type.

Displaying Time Sweeps .....	5-4
To select a time sweep .....	5-6
To turn the source power on .....	5-6
To set the time scale manually .....	5-6
To find the input signal automatically .....	5-7
To control the number of cycles displayed .....	5-7
To control the scale control softkeys .....	5-8
To track changes in signal frequency automatically .....	5-10
To filter signal noise .....	5-10
To delay the sweep .....	5-11
Displaying Frequency Sweeps .....	5-12
To perform a frequency sweep .....	5-14
To change the sweep speed .....	5-14
To control measurement settling time .....	5-15
To change the frequency scale control .....	5-16
Displaying Power Sweeps .....	5-18
To select a power sweep .....	5-20
To change the sweep speed .....	5-20
To perform a power sweep .....	5-21
To set measurement settling time .....	5-23
Tutorial: Normalizing a Power Sweep .....	5-24
Performing Harmonic and Offset Sweeps .....	5-31
To perform a harmonic sweep .....	5-32
To perform an offset sweep .....	5-32

## Displaying Time Sweeps

Time sweeps enable the viewing of CW, pulsed RF, and other types of modulation signals. Select time sweeps using the Main menu's **sweep:** softkey. The time scale can be manually set using the Main menu's **SEC/DIV** softkey.

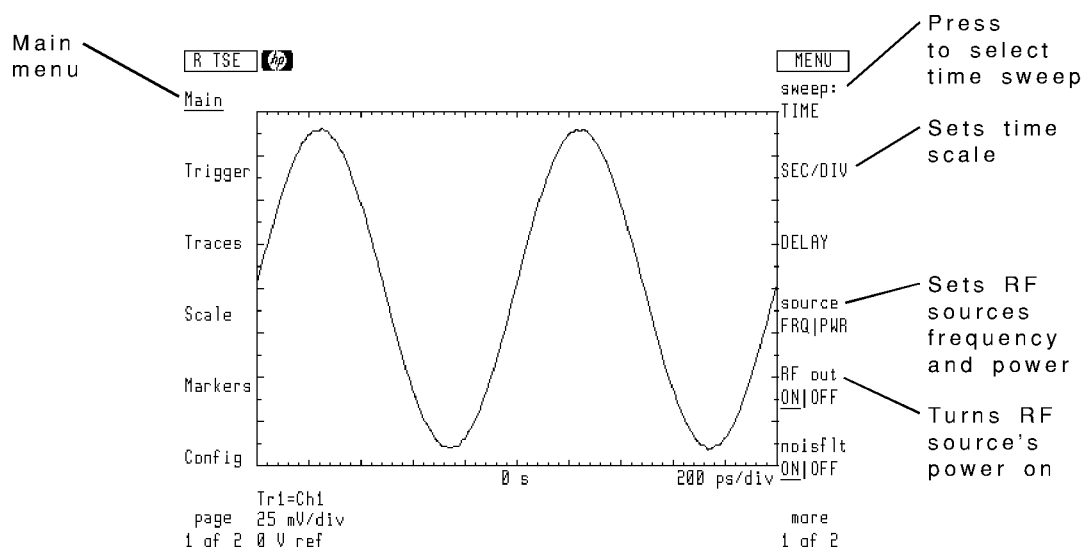

Page 1 of Main menu

If the RF source is not controlled by the microwave transition analyzer, use the Main menu's **FIND SIGNALS** softkey to automatically acquire the source frequency and set the time scale.

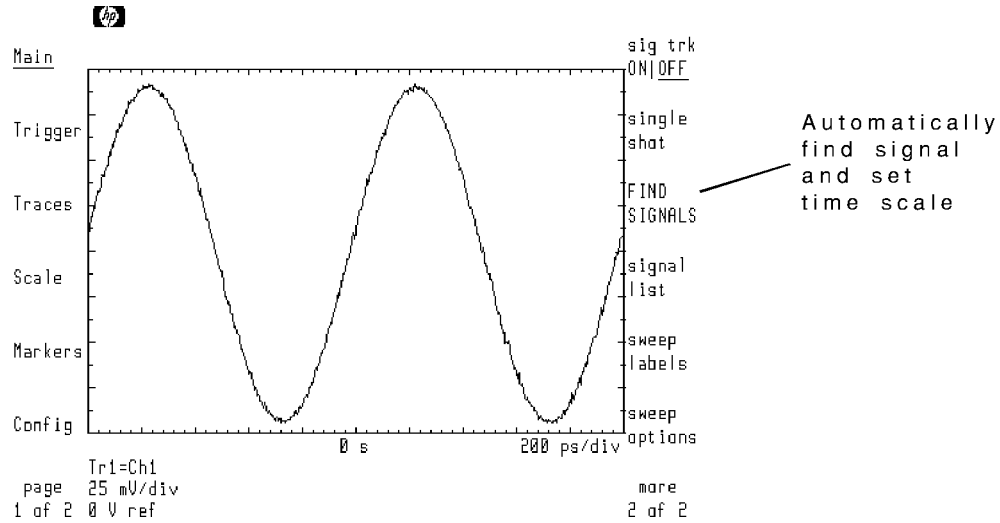

### Page 2 of Main menu

When viewing pulsed RF, you must additionally set the trigger type to pulsed RF, and set the horizontal seconds-per-division scale for viewing the PRI (pulse repetition interval). If a CW signal appears on screen, it is likely that the time scale is too short to view a pulse. You are looking at the carrier.

---

**Product notes** For information on measuring modulated signals, refer to the product notes available for the microwave transition analyzer.

---

### To select a time sweep

1. Press the **Main** softkey to enter the main menu.
2. Press the **sweep:** softkey.
3. Press the **TIME** softkey to select time sweeps (time domain).

### To turn the source power on

1. Press the **Main** softkey to enter the main menu.
2. Press the **source FRQ|PWR** softkey so that **PWR** is underlined.
3. Enter the power level of the RF source.
4. Press the **RF out ON|OFF** softkey so **ON** is underlined.

### To set the time scale manually

1. Press the **Main** softkey to enter the Main menu.
2. Press the **SEC/DIV** softkey.
3. Use the front-panel knob or key pad to enter the desired seconds per division.

### To find the input signal automatically

This feature is provided for applications where the RF source is not controlled by the microwave transition analyzer.

1. Press the **Main** softkey to enter the Main menu.
2. Press the **more 1 of 2** softkey.
3. Press the **FIND SIGNALS** softkey.

### To control the number of cycles displayed

You can control the number of cycles displayed. If the frequency of the input signal changes, the number of cycles displayed remains constant.

1. Press the **Main** softkey to enter the Main menu.
2. If the **# CYCLE** softkey is not displayed, do the following:
  - a. Press the **more 1 of 2** softkey.
  - b. Press the **sweep labels** softkey, and then press the **# CYCLE DELAY** softkey.
  - c. Press the **more 2 of 2** softkey.
3. Press the **# CYCLE** softkey, and enter the number of cycles you want to view.



## To control the scale control softkeys

You can select the two Main menu sweep control softkeys shown in the following figure.

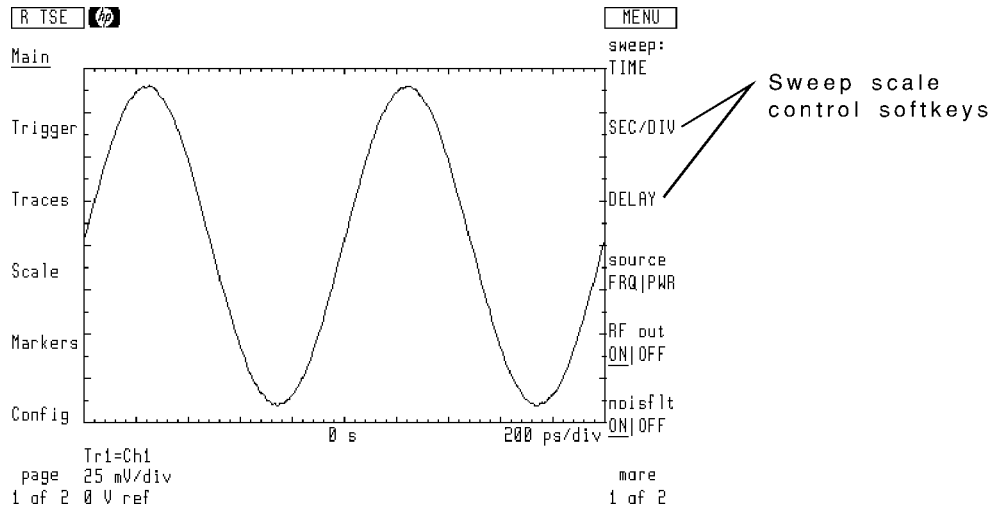

These softkeys can be changed to any of the following choices:

- CENTER and SPAN
- START and STOP
- SEC/DIV and DELAY
- # CYCLE and DELAY

1. Press the **Main** softkey to enter the Main menu.
2. Press the **more 1 of 2** softkey.
3. Press the **sweep labels** softkey.

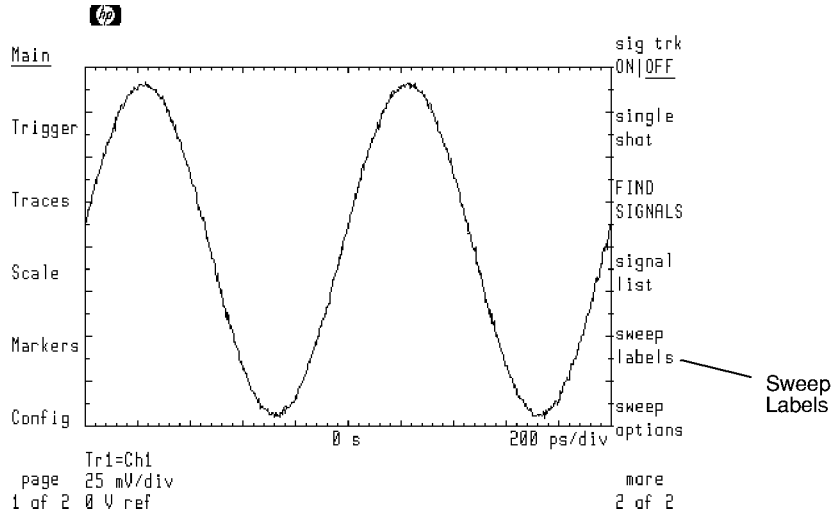

4. Press the softkey corresponding to the desired control.

## To track changes in signal frequency automatically

With signal tracking on, the microwave transition analyzer automatically re-acquires the input signal if the signal drifts in frequency.

1. Press the **Main** softkey to enter the Main menu.
2. Press the **more 1 of 2** softkey.
3. Press the **sig trk ON|OFF** softkey so that **ON** is underlined.

## To filter signal noise

Signal noise can be reduced by using the microwave transition analyzer's internal 100 kHz filter.

1. Press the **Main** softkey to enter the Main menu.
2. Press the **noisflt ON|OFF** softkey so that **ON** is underlined.

## To delay the sweep

Delay time can be added to shift the display. This can be useful when compensating for delay between the trigger event and the desired portion of the measured signal. The center of the screen represents the reference point which is at *delay* seconds from the trigger point.

---

**Delaying individual channels** “Calibrating the HP 70820A,” for information on adding delays individually to the input channels.

---

1. Press the **Main** softkey to enter the Main menu.
2. Press the **DELAY** softkey.
3. Enter the amount of delay time desired.

---

## Displaying Frequency Sweeps

The microwave transition analyzer performs frequency sweeps with both CW and pulsed RF signals. Frequency sweeps require that the RF source be controlled by the microwave transition analyzer. This is because the frequency of the RF source must track the frequency of the microwave transition analyzer as it steps through the frequency range.

Select frequency sweeps from the Main menu's **sweep:** softkey.

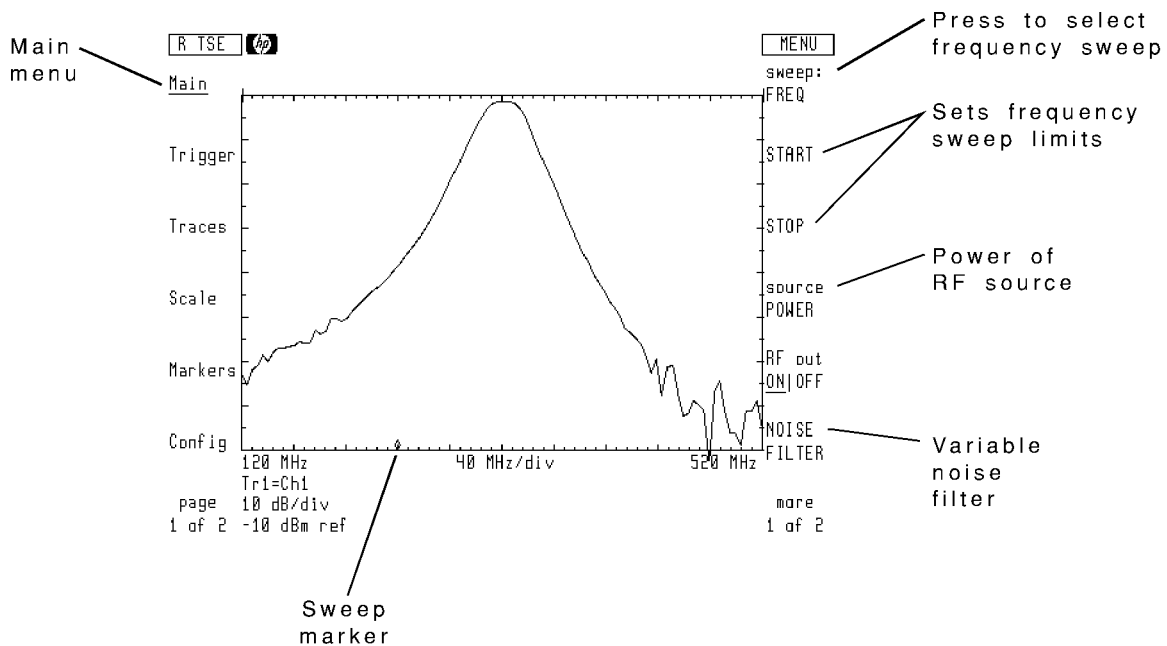

The displayed trace is updated after each sweep. During the sweep, a small diamond appears at the bottom of the display showing the measurement points.

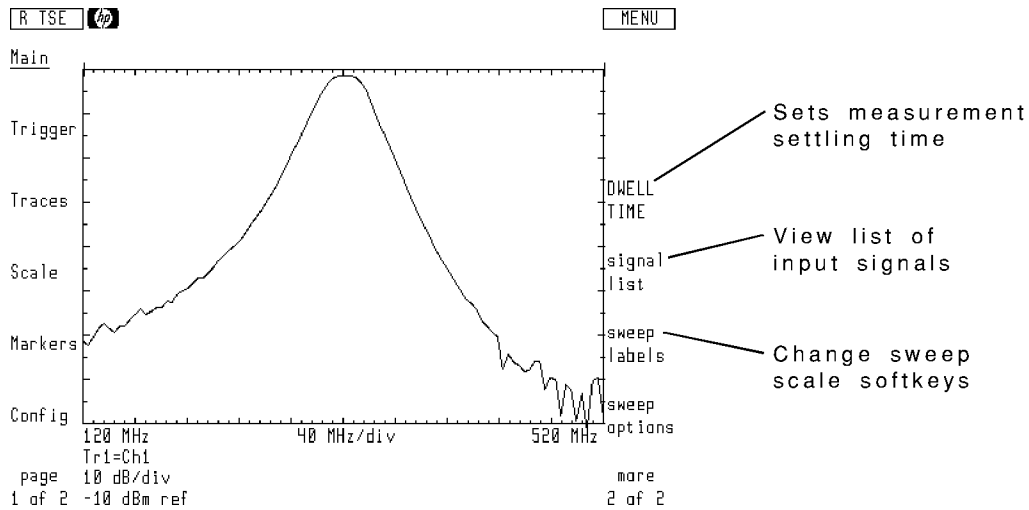

**Page 2 of Main menu**

The sweep speed is affected by the number of measurement points in a sweep. These are known as trace points. The smaller the number of trace points, the faster the sweeps. However, faster sweeps reduce frequency resolution. Set the number of trace points using the Configuration menu's **TRACE POINTS** softkey.

Signal noise can be reduced by using the microwave transition analyzer's variable-width digital filter. Press the Main menu's **NOISE FILTER** softkey to access the filter, and use the front-panel controls to change the filter.

### **To perform a frequency sweep**

1. Press the front-panel **(INSTR PRESET)** key.
2. Determine the frequency range that you want to sweep.
3. Press the **sweep:** softkey, and select **FREQ**.
4. Press the **START** softkey, and enter the start frequency.
5. Press the **STOP** softkey, and enter the stop frequency.
6. Press the **source POWER** softkey, and set the power level of the RF source.
7. Press the **RF out ON|OFF** softkey so that **ON** is underlined.

A small diamond shaped marker begins to move across the bottom of the screen. This indicates that a frequency sweep has started.

8. After the sweep has completed, the frequency response is displayed.

### **To change the sweep speed**

1. Press the **Config** softkey to enter the Configuration menu.
2. Press the **TRACE POINTS** softkey so that it is highlighted.
3. Enter the desired number of measurements for the trace.

## To control measurement settling time

The microwave transition analyzer waits for a specific amount of time between setting the RF source at a new frequency and making a measurement. This is known as the dwell time and ensures that the output signal has time to stabilize before making any measurements at the new frequency.

1. Press the **Main** softkey to enter the Main menu.
2. Press the **more 1 of 2** softkey.
3. Press the **DWELL TIME** softkey, and enter the amount of settling time required.

## To change the frequency scale control

You can select the two Main menu sweep control softkeys shown in the following figure.

These softkeys can be changed to any of the following choices using the Main menu's **sweep labels** softkey:

- **CENTER** and **SPAN**
- **START** and **STOP**

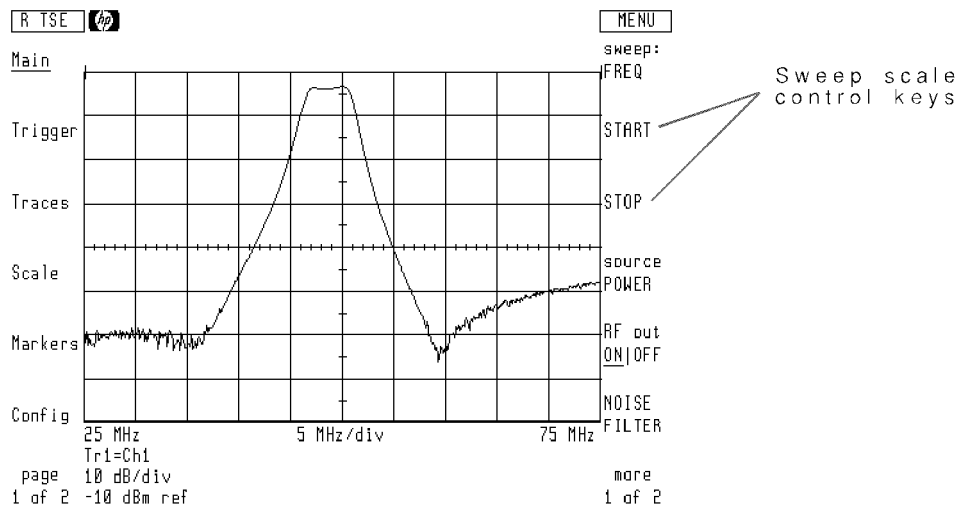



1. Press the **Main** softkey to enter the Main menu.
2. Press the **more 1 of 2** softkey.
3. Press the **sweep labels** softkey.
4. Press the softkey corresponding to the desired control.

## Displaying Power Sweeps

Power sweeps enable the characterization of CW and pulsed RF signals with respect to power.

The microwave transition analyzer performs power sweeps with both CW and pulsed RF signals. Power sweeps require that the RF source be controlled by the microwave transition analyzer. This is because the power of the RF source must track the measurement points of the microwave transition analyzer. The following figures show a 1 GHz CW power sweep of a 0 to 3 GHz limiter.

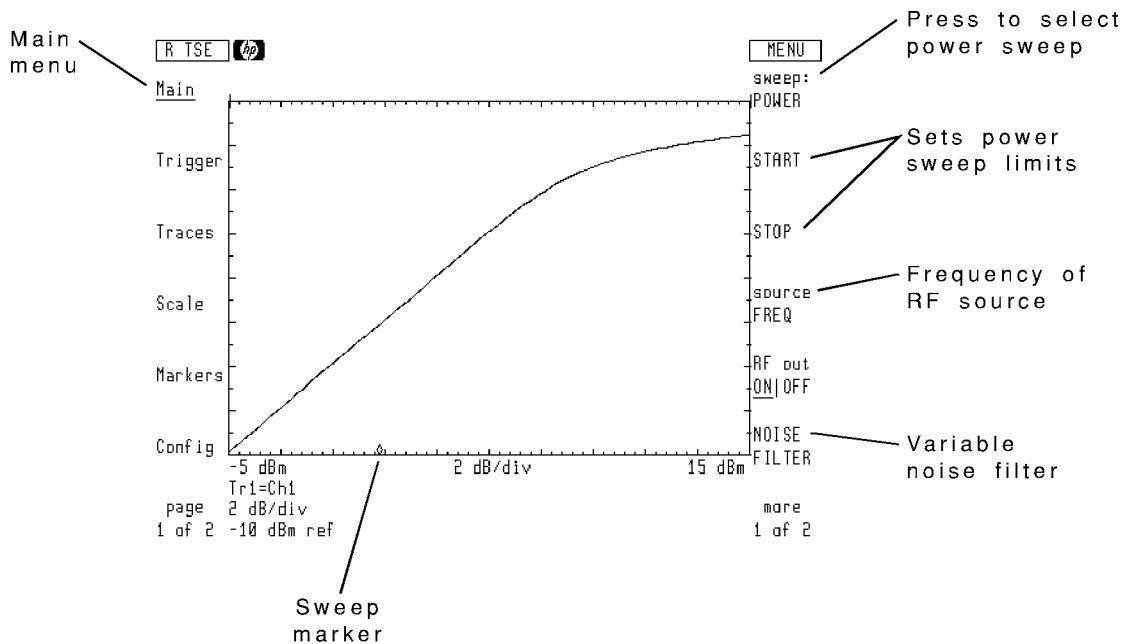

Page 1 of Main menu

The displayed trace is updated after each sweep. During the sweep, a small diamond appears at the bottom of the display showing the measurement points.

The sweep speed is affected by the number of measurement points in a sweep. These are known as trace points. The smaller the number of trace points, the faster the sweeps. However, faster sweeps reduce power resolution. Set the number of trace points using the Configuration menu's **TRACE POINTS** softkey.

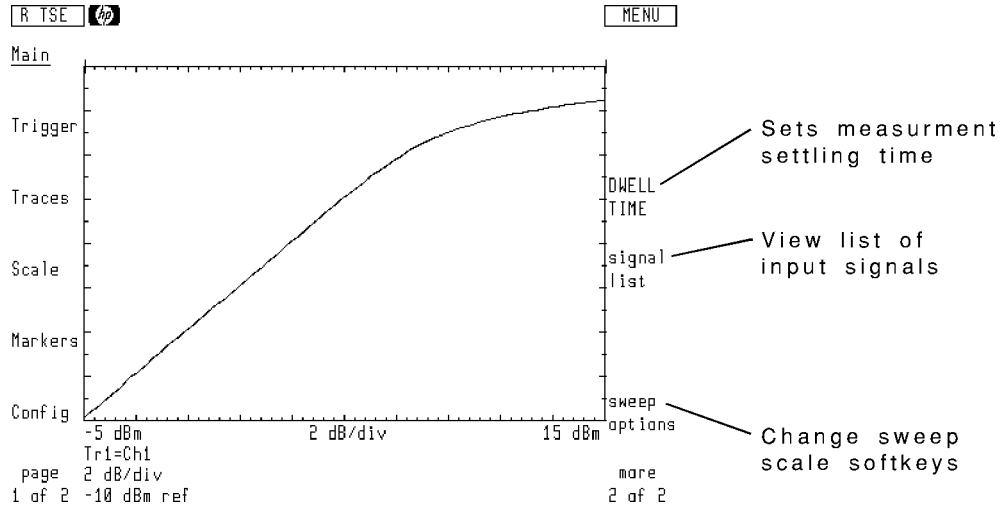

**Page 2 of Main menu**

Signal noise can be reduced by using the microwave transition analyzer's variable-width digital filter. Press the Main menu's **NOISE FILTER** softkey to access the filter, use the front-panel knob to change the filter.

### **To select a power sweep**

1. Press the **Main** softkey to enter the main menu.
2. Press the **sweep:** softkey.

The current sweep mode is displayed in the softkey label.

3. Press the **POWER** softkey to select power sweeps.

### **To change the sweep speed**

1. Press the **Config** softkey to enter the Configuration menu.
2. Press the **TRACE POINTS** softkey so that it is highlighted.
3. Enter the desired measurements for the trace.

## To perform a power sweep

**Caution** Total input signal power to the HP 70820A's front-panel channel inputs must not exceed +16 dBm. Because there is no RF input attenuator, power in excess of +16 dBm may damage the instrument. The largest measurable power level before signal compression is 0 dBm.

**Excessive power** When performing power sweeps, if needed, place a pad at the front-panel channel inputs to protect them from excessive power.

The following example figure was taken using a 0 to 3 GHz limiter. A 1 GHz frequency was used with the power sweeping from -5 to +15 dBm.

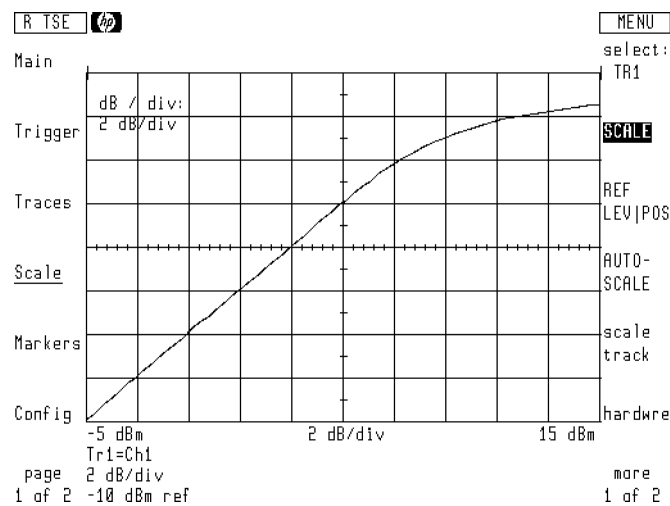

1. Press the front-panel **(INSTR PRESET)** key.
2. Connect the output of the RF source to the microwave transition analyzer's channel 1 input. Place the device you're testing in the signal path.
3. Determine the power range that you want to sweep.
4. Press the **Main** softkey to enter the Main menu.
5. Press the **sweep:** softkey, and select **POWER**.
6. Press the **START** softkey, and enter the start power.
7. Press the **STOP** softkey, and enter the stop power.
8. Press the **source FREQ** softkey, and set the frequency of the RF source.
9. Press the **RF out ON|OFF** softkey so that **ON** is underlined.

A small diamond shaped marker begins to move across the bottom of the screen. This indicates that a power sweep has started.

10. Press the **Config** softkey to enter the Configure menu. Enter 64 trace points to reduce the sweep time.

11. Press the **Trigger** softkey to enter the Trigger menu, and press the **SINGLE** softkey.

The microwave transition analyzer is now in single sweep mode.

12. Press the **Scale** softkey to enter the Scale menu.

13. Change the scale and reference level so that a full screen display is shown. In this example, the limiting action of the limiter from  $-5$  to  $+15$  dBm is clearly shown.

To change the scale, press **SCALE** so that it is highlighted. To change the reference level, press **REF LEV|POS** so that **LEV** is highlighted.

### To set measurement settling time

The microwave transition analyzer waits for a specific amount of time between setting the RF source at a new power level and making a measurement. This is known as the dwell time and ensures that the output signal has time to stabilize before making any measurements at the new setting.

1. Press the **Main** softkey to enter the Main menu.

2. Press the **more 1 of 2** softkey.

3. Press the **DWELL TIME** softkey, and enter the amount of settling time required.

---

## Tutorial: Normalizing a Power Sweep

This example builds a custom trace definition to normalize a power sweep. Refer to Chapter 6, “Using and Defining Traces,” for more information on trace definitions. The figures were taken sweeping the input power to a 0 to 3 GHz limiter. The RF source was set to the following settings:

frequency .....	1 GHz
start power .....	$-5$ dBm
stop power .....	$+15$ dBm

---

**Caution** Total input signal power to the HP 71500A’s front-panel channel inputs must not exceed  $+16$  dBm. Because there is no RF input attenuator, power in excess of  $+16$  dBm may damage the instrument.

---

**Excessive power** When performing power sweeps, use a pad at the front-panel channel inputs to protect the microwave transition analyzer from excessive power.

---

## Step 1. Connect the equipment

1. Press the front-panel **(INSTR PRESET)** key.
2. Connect the output of the RF source to the microwave transition analyzer's channel 1 input through a pad.

These first steps configure the sweep and normalize the display for the power sweep.

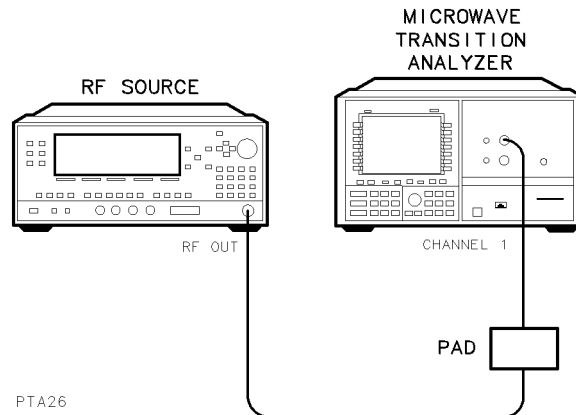

## Step 2. Set the power sweep

1. Determine the power range that you want to sweep.
2. Press the Main menu's **sweep:** softkey, and select POWER.
3. Press the **START** softkey, and enter the start power.
4. Press the **STOP** softkey, and enter the stop power.
5. Press the **source FREQ** softkey, and enter the frequency of the RF source.
6. Press the **RF out ON|OFF** softkey so that **ON** is underlined.

A small diamond shaped marker begins to move across the bottom of the screen. This indicates that a power sweep has started.

### Step 3. Perform a sweep

1. Press the **Config** softkey to enter the Configuration menu.
2. Press the **TRACE POINTS** softkey and enter 100 points.

This decreases the time required to complete a sweep.

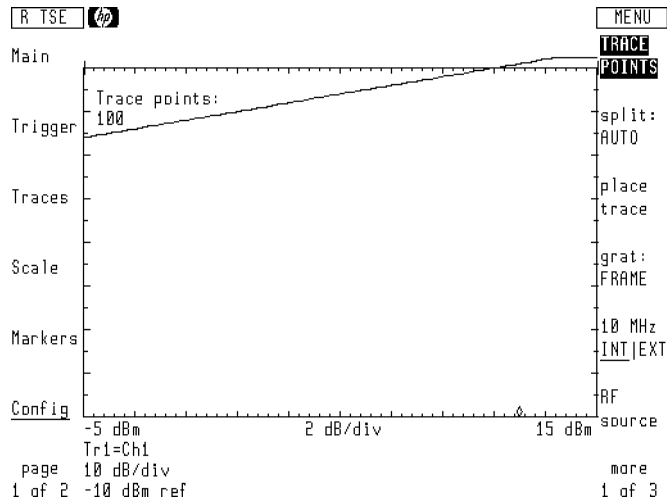

3. Press the **Trigger** softkey to enter the Trigger menu, and press the **SINGLE** softkey.  
The microwave transition analyzer is now in single sweep mode.
4. Wait for the sweep to complete.



### Step 4. Scale and store the response

1. Press the **Scale** softkey to enter the Scale menu.
2. Change the scale and reference level so that the display is similar to the following figure.

To activate the scale, press **SCALE** so that it is highlighted. To activate the reference level, press **REF LEV|POS** so that LEV is highlighted.

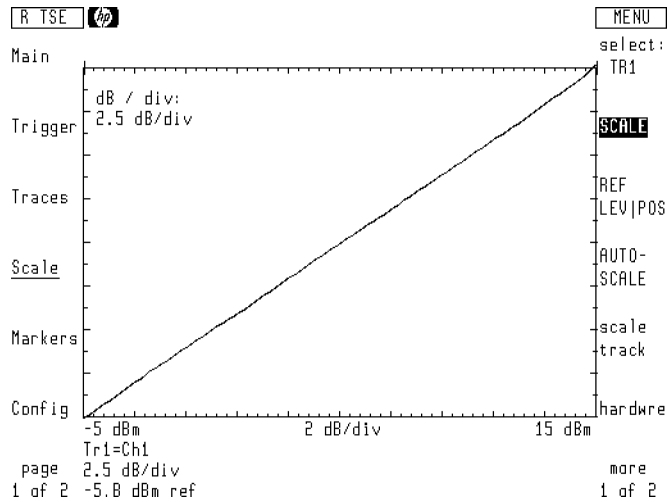

3. Press the **Traces** softkey to enter the Trace menu.
4. Press the **store trace** and then **TO MEM1** softkey.

## Step 5. Build a normalized trace equation

1. Press the **input:** softkeys
2. Use the front-panel knob to scroll the menu bar to the CH1/MEM1 definition as shown in the following figure.

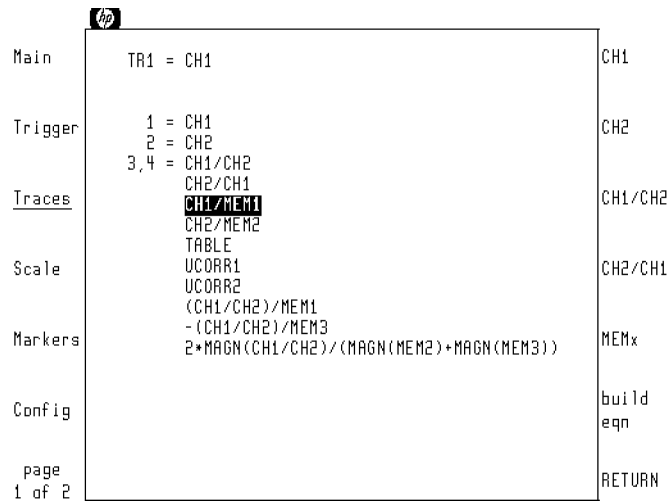

3. Press the **RETURN** softkey.
4. Press the **Scale** softkey to enter the Scale menu.
5. Press the **SCALE** softkey so that it is highlighted, and enter a scale of 1 dB per division.

The actual scale you enter depends on your application.

## Step 6. Display the normalized response

1. Place the device you want to test in the signal path between the RF source's output and the pad.
2. Press the **Trigger** softkey to enter the Trigger menu, and press the **SINGLE** softkey.
3. The normalized response of the device being tested is now displayed.

In this example the limiting action of the limiter from -5 to +15 dBm is clearly shown. You could use a marker to locate the 1 dB compression point.

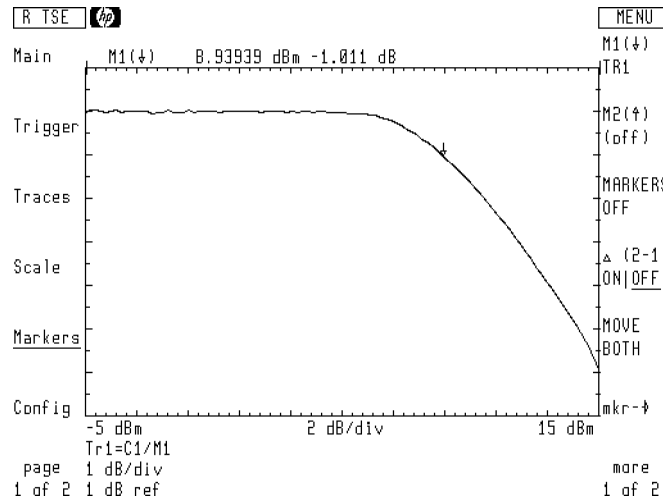

---

## Performing Harmonic and Offset Sweeps

---

**Pulsed RF** Harmonic and offset frequency sweeps are not available when using pulsed RF stimulus.

---

During CW frequency and power sweeps, the microwave transition analyzer normally sets its RF input frequency according to the following equation:

$$RF\ input = RF\ Source\ Frequency$$

However, the microwave transition analyzer offers additional control over its input frequency which includes harmonics and offsets. This allows you to modify the measured frequency range. It does *not* change the output frequency of the RF source instrument.

$$RF\ input = (harmonic)(RF\ Source\ Freq.) + Offset$$

### Offset term

The offset term allows you to measure a frequency offset from the RF source frequency. You can use it to compensate for frequency translations caused by mixers.

Use the Main menu's **sweep options** and then **freq offset** softkeys to enter an offset.

### Harmonic factor

The harmonic factor allows you to view the response of harmonics of the frequency sweep. It sets the input frequency of the microwave transition analyzer to a multiple of the RF source's output frequency. This is useful in characterizing distortion in nonlinear devices. For example, you could step the input to an amplifier from 10 MHz to 20 MHz and measure its second harmonic output from 20 MHz to 40 MHz.

The microwave transition analyzer allows for fractional harmonic settings:

$$RF \text{ input} = \left( \frac{\text{numerator}}{\text{denominator}} \right) (RF \text{ Source Freq.}) + \text{Offset}$$

Use the `sweep options` softkeys `f mult numer.` and `f mult denom.` softkeys to enter the harmonic factor. (The `sweep options` softkey is located in the Main menu.)

### To perform a harmonic sweep

1. Configure a frequency sweep as explained earlier in this section.
2. Press the Main menu's `more 1 of 2` softkey.
3. Press the `sweep options` softkey.
4. Press the `f mult numer.` softkey, and enter the factor required for the RF input.

If the factor is not a whole number, press the `f mult denom.` softkey, and enter the factor's denominator.

### To perform an offset sweep

1. Configure a frequency sweep as explained earlier in this section.
2. Press the Main menu's `more 1 of 2` softkey.
3. Press the `sweep options` softkey.
4. Press the `freq offset` softkey, and then enter the required frequency offset.



## Using and Defining Traces

---

The microwave transition analyzer has four traces: TR1, TR2, TR3, and TR4. You decide which traces are displayed, the source of their input data, and their format. (When first turned on, the microwave transition analyzer only displays trace 1. Traces 2, 3, and 4 are blanked.) Use the Traces menu to define, format, and display traces.

Selecting and Defining Traces .....	6-4
To select a trace .....	6-5
To display a trace on screen .....	6-5
Defining Trace Input .....	6-6
To define the trace's input .....	6-7
Building a Trace Equation .....	6-8
To build a custom trace .....	6-12
Formatting a Trace .....	6-13
To format a trace .....	6-15
Averaging Traces .....	6-16
To average a trace before formatting .....	6-17
To average a trace after formatting .....	6-17
To restart averaging .....	6-18
To turn averaging off .....	6-18
Holding Traces .....	6-19
To hold trace values .....	6-20
To restart holding .....	6-20
To turn holding off .....	6-21
Smoothing Traces .....	6-22
To smooth a trace .....	6-23
Performing Trace Transforms .....	6-24
To transform a trace .....	6-28
To zoom a transformed trace .....	6-28
Storing Traces .....	6-29
To store a trace .....	6-30
To recall a trace .....	6-30

---

## Selecting and Defining Traces

Traces TR1, TR2, TR3, and TR4 are controlled from the Traces menu. Press the left-side **Traces** softkey to access the menu. The microwave transition analyzer uses a unique color to identify each trace. Whenever the display is split into two windows, traces are automatically assigned either the top or bottom window. Use the Configure menu to change the trace window assignments. Refer to Chapter 2, "Performing Measurements," for a discussion of window trace assignments.



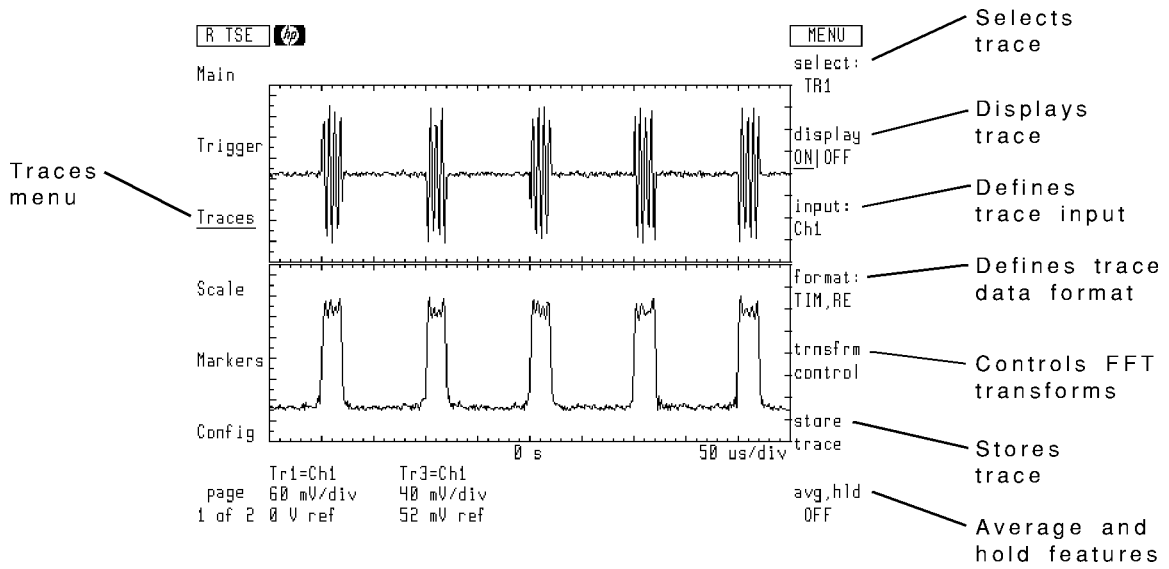

### Traces menu

Upon power-on, the default trace input definitions are as follows:

- Trace 1: input channel 1
- Trace 2: input channel 2
- Trace 3:  $\frac{\text{channel 1}}{\text{channel 2}}$
- Trace 4:  $\frac{\text{channel 2}}{\text{channel 1}}$

Annotation at the bottom of the display shows each displayed trace's input definition, color, and amplitude scale (reference level and vertical scale).

Trace operations act on the currently selected trace. To select a trace, use the Traces menu's `select:` softkey. After selecting a trace, turn it on or off using the `display ON|OFF` softkey. Traces can be saved and then recalled at a later time.

### To select a trace

1. Press the `Traces` softkey to enter the Traces menu.
2. Press the `select:` softkey.
3. Press a softkey to select trace 1, 2, 3, or 4.

### To display a trace on screen

1. Press the `Traces` softkey to enter the Traces menu.
2. Press the `select:` softkey, and select the trace as the active trace.
3. Press the `display ON|OFF` softkey so that `ON` is underlined.

---

## Defining Trace Input

The `input:` softkey allows you to select the source of input data for the currently active trace. In addition, the display shows the current definition for each of the four traces.

Main	TR1 = CH1	CH1
Trigger	1 = CH1 2 = CH2 3,4 = CH1/CH2	CH2
Traces	CH2/CH1 CH1/MEM1 CH2/MEM2 TABLE	CH1/CH2
Scale	UCORR1 UCORR2 (CH1/CH2)/MEM1	CH2/CH1
Markers	-(CH1/CH2)/MEM3 2*MAGN(CH1/CH2)/(MAGN(MEM2)+MAGN(MEM3))	MEMx
Config		build eqn
page 1 of 2		RETURN

Selecting user correction data UCORR1 and UCORR2 assigns a trace to user-correction data. For information on user corrections, refer to Chapter 12, “Creating Masks and Limit Lines.”

Selecting TABLE enables you to graphically view the harmonic table. Refer to Chapter 10, “Using the Harmonic Table,” for information on building and using harmonic tables.

## To define the trace's input

1. Press the **Traces** softkey to enter the Traces menu.
2. Press the **select:** softkey, and select the active trace.
3. Press the **input:** softkey.
4. Select the trace input by pressing an appropriate softkey. Or, scroll the menu bar to a selection using the front-panel knob and then press the **RETURN** softkey. Selections include the following:
  - a. **CH1 CH2**: input channels 1 or 2
  - b. **CH1/CH2 CH2/CH1**: ratio of input channels
  - c. **MEMX**: one of four memory registers
  - d. **TABLE**: the harmonic table
  - e. **UCORR1 UCORR2**: user correction data
  - f. **build eqn**: custom trace definition

# Building a Trace Equation

Selecting **build eqn** for a trace input presents a menu for building custom trace definitions.

```
hp
Main      TR1 = CH1
Trigger   1 = CH1
          2 = CH2
          3,4 = CH1/CH2
Traces    CH2/CH1
          CH1/MEM1
          CH2/MEM2
          TABLE
Scale     UCORR1
          UCORR2
          (CH1/CH2)/MEM1
Markers   -(CH1/CH2)/MEM3
          2*MAGN(CH1/CH2)/(MAGN(MEM2)+MAGN(MEM3))
Config    build eqn
          RETURN
page 1 of 2
```

Build equation

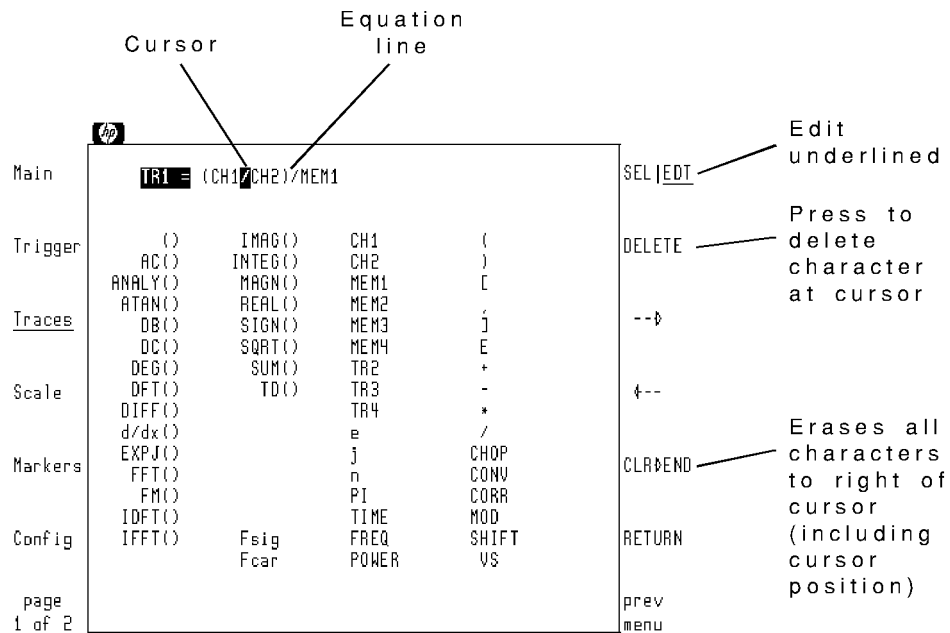

### Build equation menu

When **SEL/EDT** is pressed so that **EDT** is underlined, you can edit the equation line. The **→** and **←** softkeys move the equation line cursor in either select or edit mode.

When **SEL/EDT** is pressed so that **SEL** is underlined, you can select an operation or operand to add to the equation. Selections are added at the cursor. Press the **RETURN** softkey to enter the finished equation. Press **prev menu** to return to the Traces menu without making any changes.

hp

Main TR1 = (CH1/CH2)/

Trigger

Traces

Scale

Markers

Config

page 1 of 2

(	IMAG()	CH1	(
AC()	INTEG()	CH2	)
ANALY()	MAGN()	MEM1	[
ATAN()	REAL()	<u>MEM2</u>	]
DB()	SIGN()	MEM3	-
DC()	SQRT()	MEM4	E
DEG()	SUM()	TR2	+
DFT()	TD()	TR3	-
DIFF()		TR4	*
d/dx()		e	/
EXPJ()		j	CHOP
FFT()		n	CONV
FM()		PI	CORR
IDFT()		TIME	MOD
IFFT()	Fsig	FREQ	SHIFT
	Fcar	POWER	VS

SEL|EDT

INSERT

-->

←--

CLR|END

RETURN

prev menu

Select underlined

Adds selected item to equation

Selected operand to add

### Selecting an operation or operand

## Equation Operands

Mnemonic	Definition	Mnemonic	Definition
CH1	channel 1	e	2.718 or NeX = N(10 <sup>x</sup> )
CH2	channel 2	E	NEX = N(10 <sup>x</sup> ) or 2.718
TR1	trace 1	j	$\sqrt{-1}$
TR2	trace 2	n	create a dimensionless index array corresponding
TR3	trace 3		to trace points across screen
TR4	trace 4	PI	$\pi$
MEM1	memory register 1	TIME	create trace point's time value
MEM2	memory register 2	FREQ	create trace point's frequency value
MEM3	memory register 3	POWER	create trace point's power value
MEM4	memory register 4		

## Equation Operators

Mnemonic	Definition	Mnemonic	Definition
+	addition	FFT()	fast Fourier transform
-	subtraction	F <sub>car</sub>	returns current carrier frequency
*	multiplication	F <sub>sig</sub>	returns current signal frequency
/	division	FM()	frequency demodulation (difference between aperture endpoints of phase component of time trace)
[ ]	trace subrange	IDFT()	inverse discrete Fourier transform
AC()	ac component	IFFT()	inverse fast Fourier transform
ANALY()	analytic representation	IMAG()	imaginary part
ATAN()	arctangent	INTEG()	integration
CHOP	force small magnitudes to 0	MAGN()	magnitude (am demodulation)
CONST	change domain to constant	MOD	modulo
CONV	convolution	REAL()	real part
CORR	correlation	SHIFT	performs frequency, time, or phase shift
DB()	20 * log(magnitude)	SIGN	returns polarity of signal
DC()	dc component	SQRT()	square root
DEG()	degrees (phase demodulation)	SUM()	summation
DIFF()	difference between aperture endpoints	TD()	time delay (difference between aperture endpoints of phase component of frequency trace)
DFT()	discrete Fourier transform	VS	versus
d/dx()	derivative		
EXPJ()	$e^{j2\pi}$		



## To build a custom trace

1. Select the trace that you want to build a custom trace definition for.
2. Press the **input:** and then **build eqn** softkeys.
3. Press the **CLR→END** softkey to erase the current trace definition.
4. Press the **SEL|EDT** softkey so that **SEL** is underlined.
5. Use the front-panel knob to scroll the menu bar to the first operator of the trace equation.  
Numbers can be entered directly from the front panel.
6. Press the **INSERT** softkey to add the operator to the trace equation.
7. Continue to add operators and operands to complete the trace equation. Then, press the **RETURN** softkey to assign the equation to the selected trace.

The equation can be edited at any time by first pressing the **SEL|EDT** softkey so that **EDT** is underlined.

---

## Formatting a Trace

Once you've selected and defined a trace, it is ready for formatting. Press the **format:** softkey to view the formatting options shown in the following figure. Each trace represents the same input at channel 1 in a different format. (The graticules are turned off to allow easier viewing of the traces.)

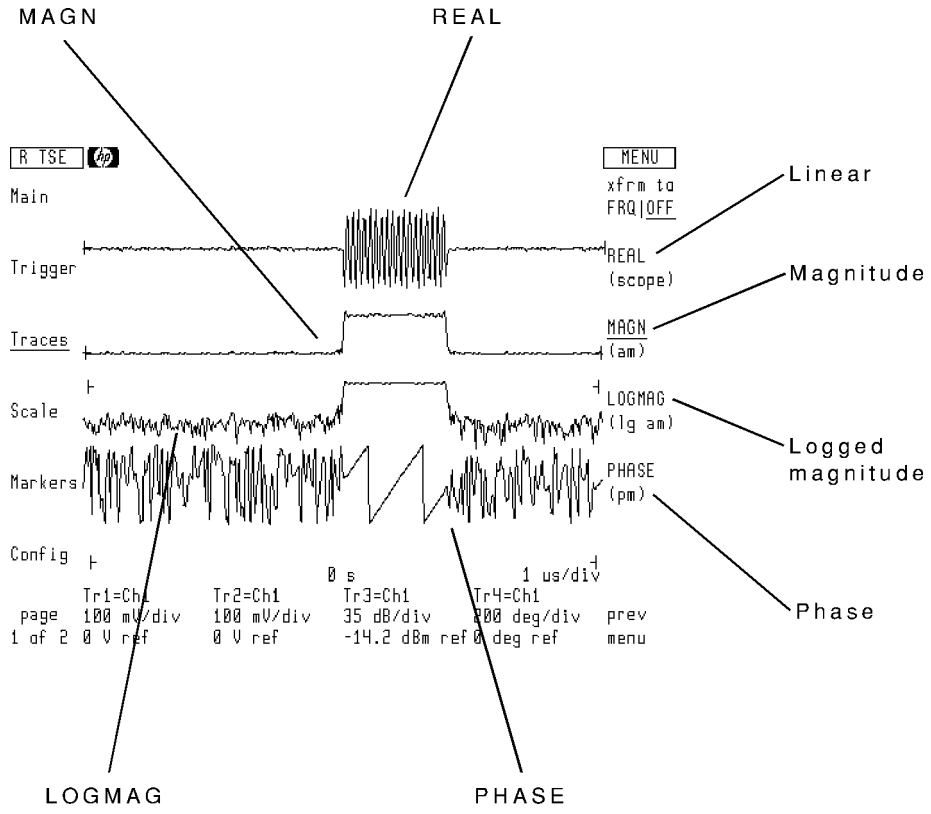

The top softkey allows you to perform fast Fourier transforms. For time sweeps, the softkey reads `xfrm to FRQ|OFF`. Pressing the softkey so that `FRQ` is underlined mathematically transforms the trace data to the frequency domain.

For frequency and power sweeps, the top softkey reads `xfrm to TIM|OFF`. Pressing the softkey so that `TIM` is underlined mathematically transforms the trace data to the time domain.

The following figure shows an FFT of trace 1 in the previous figure. For information on controlling the transform, refer to “Performing Trace Transforms” in this chapter.

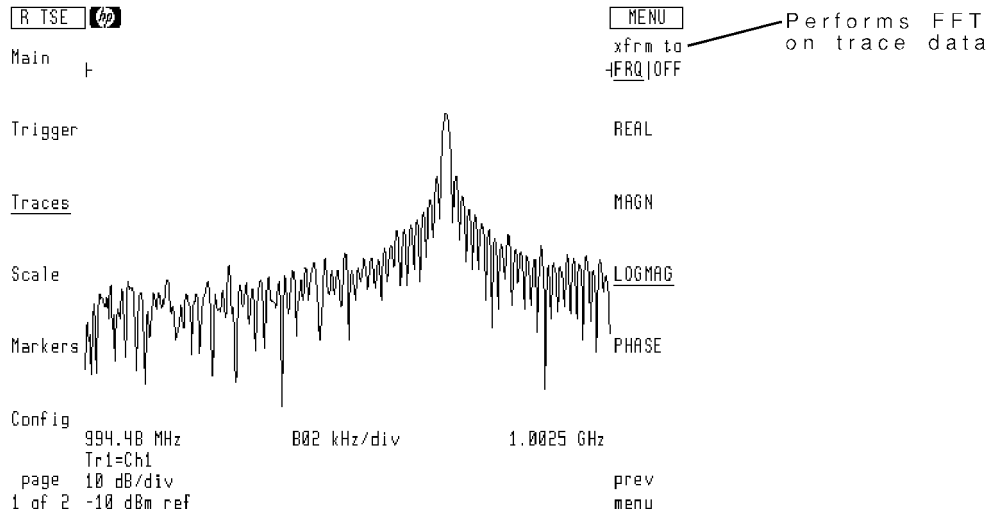

## To format a trace

1. Select the trace that you want to format.
2. Press the `format:` softkey.
3. Press and select one of the following:
  - `REAL` for a linear display.
  - `MAGN` for an am demodulated display.
  - `LOGMAG` for a logarithmic am demodulated display.
  - `PHASE` for phase display.
  - `xfrm` to `FRQ|OFF` to perform a fast Fourier transform of time sweeps.
  - `xfrm` to `TIM|OFF` to transform a frequency or power sweep to the time domain.

---

## Averaging Traces

Traces can be averaged using the microwave transition analyzer's averaging feature. Press the `avg,hld` softkey to access trace averaging. Two types of averages are available: format and vector. Select format averaging to average scalar data. Select vector averaging to average complex vector data.

A default value of 16 traces is averaged. (You can use the front-panel keys to change the number of traces averaged.) Averaging can be restarted at any time by pressing the `RESTART ALL TRC` softkey.

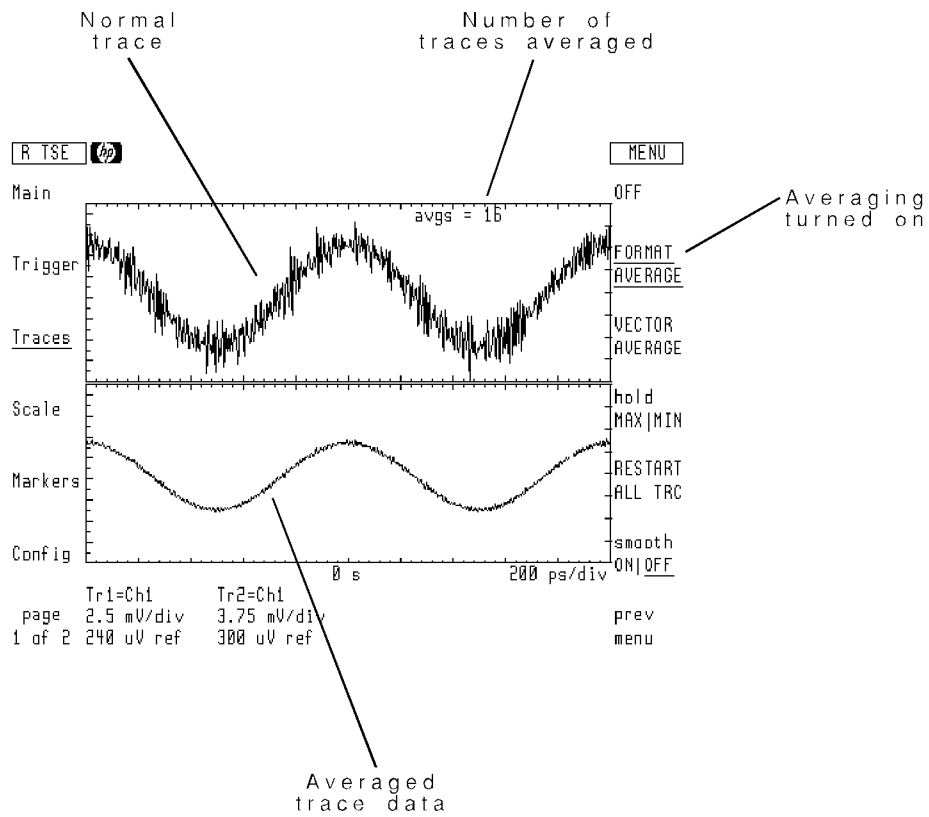

### **To average a trace before formatting**

1. Press the **Traces:** softkey to enter the Traces menu, and the **select:** softkey to select a trace.
2. Press a softkey to select a trace 1, 2, 3, or 4.
3. Press the **avg,hld** softkey.
4. Press the **VECTOR AVERAGE** softkey.
5. Enter the number of sweeps used in averaging the displayed trace.

### **To average a trace after formatting**

1. Press the **Traces:** softkey to enter the Traces menu, and the **select:** softkey to select a trace.
2. Press a softkey to select a trace 1, 2, 3, or 4.
3. Press the **avg,hld** softkey.
4. Press the **FORMAT AVERAGE** softkey.
5. Enter the number of sweeps used in averaging the displayed trace.

Trace averaging is performed on the trace data after it has been formatted for display. The default number of trace averages is sixteen.

### **To restart averaging**

1. Press the `Traces:` softkey to enter the Traces menu.
2. Press the `avg,hld` softkey.
3. Press the `RESTART ALL TRC` softkey.

This feature restarts averaging for all traces including the active trace.

### **To turn averaging off**

1. Press the `Traces:` softkey to enter the Traces menu, and the `select:` softkey to select a trace.
2. Press the `avg,hld` softkey.
3. Press the `OFF` softkey.

---

## **Holding Traces**

The microwave transition analyzer offers a trace holding feature. Holding processes a trace so that only the maximum or minimum values are displayed. Press the `avg,hld` softkey to access trace holding.

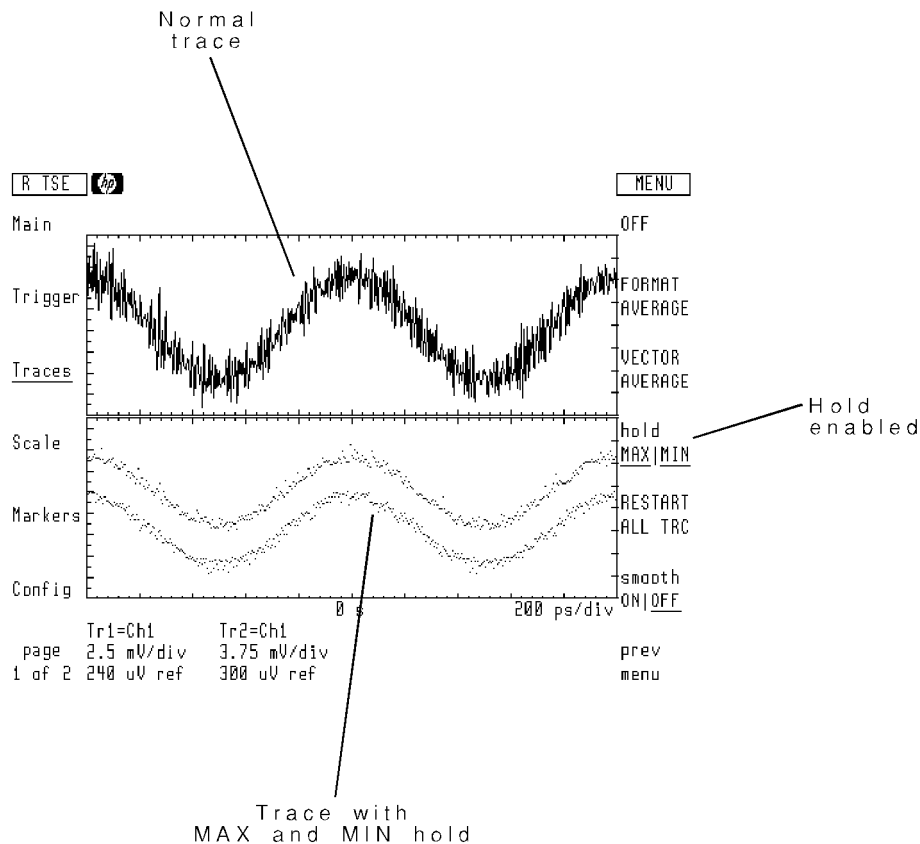

Values held for each trace remain displayed until holding is turned off or restarted. Use the `hold MAX|MIN` softkey to turn holding on. Press the softkey to underline the type of holding: MAX, MIN or MAX|MIN.

Holding can be restarted at any time by pressing the `RESTART ALL TRC` softkey.

### To hold trace values

1. Press the `Traces:` softkey to enter the Traces menu, and the `select:` softkey to select a trace.
2. Press the `avg,hld` softkey.
3. To hold minimum values, press the `hold MAX|MIN` softkey so that `MIN` is underlined.
4. To hold maximum values, press the `hold MAX|MIN` softkey so that `MAX` is underlined.
5. To hold minimum and maximum values, press the `hold MAX|MIN` softkey so that both `MAX` and `MIN` are underlined.



### To restart holding

1. Press the **Traces:** softkey to enter the Traces menu.
2. Press the **avg,hld** softkey.
3. Press the **RESTART ALL TRC** softkey.

This feature restarts holding for all traces including the active trace.

### To turn holding off

1. Press the **Traces:** softkey to enter the Traces menu, and the **select:** softkey to select a trace.
2. Press the **avg,hld** softkey.
3. Press the **OFF** softkey.

---

## Smoothing Traces

The microwave transition analyzer offers a trace smoothing feature.

Smoothing uses median averaging of adjacent measurement points to smooth the trace. The number of measurement points used is referred to as the *smoothing width*. Press the **avg,hld** softkey to access trace holding.

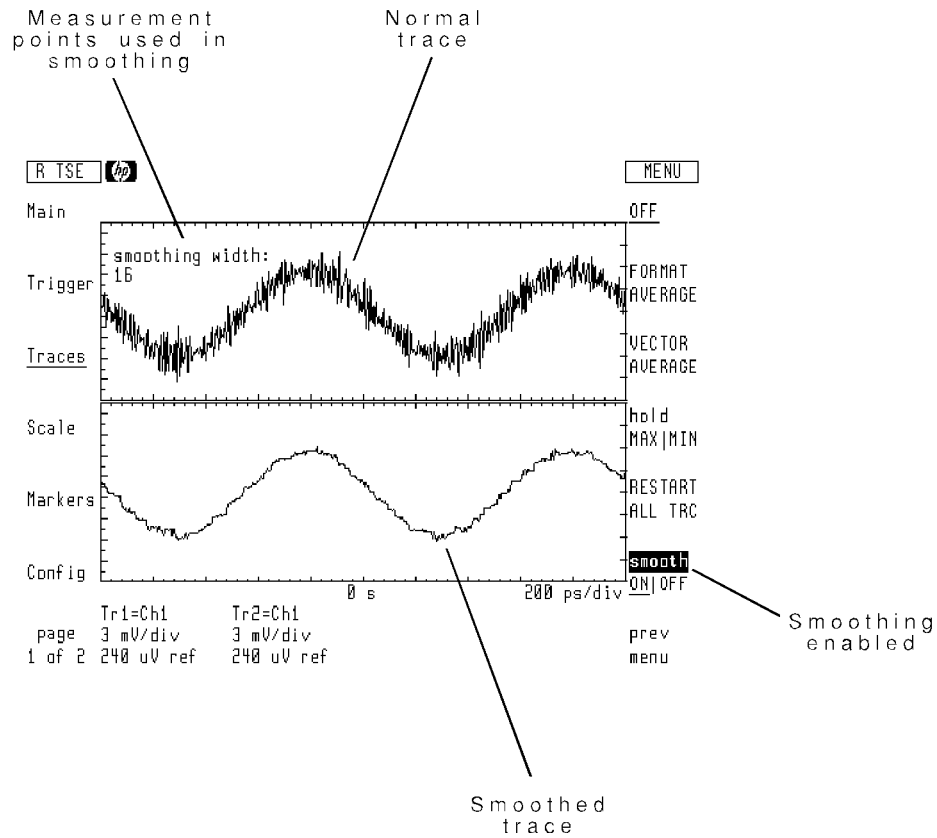

Smoothing can be restarted at any time by pressing the **RESTART ALL TRC** softkey.

### To smooth a trace

1. Press the **Traces:** softkey to enter the Traces menu, and the **select:** softkey to select a trace.
2. Press the **avg,hld** softkey.
3. Press the **smooth ON|OFF** softkey so that **ON** is underlined, and use the front-panel knob to adjust the smoothing width.

## Performing Trace Transforms

This section tells you how to transform data from time sweeps to the frequency domain and how to transform data from frequency sweeps to the time domain. Traces can be individually transformed using the `xfrm to FRQ|OFF` and `xfrm to TIM|OFF` softkeys located under the Traces menu's `format:` softkey. The following figure shows a time sweep with trace 2 formatted by a transform to the frequency domain. (Both traces display a 1 GHz signal at channel 1.)

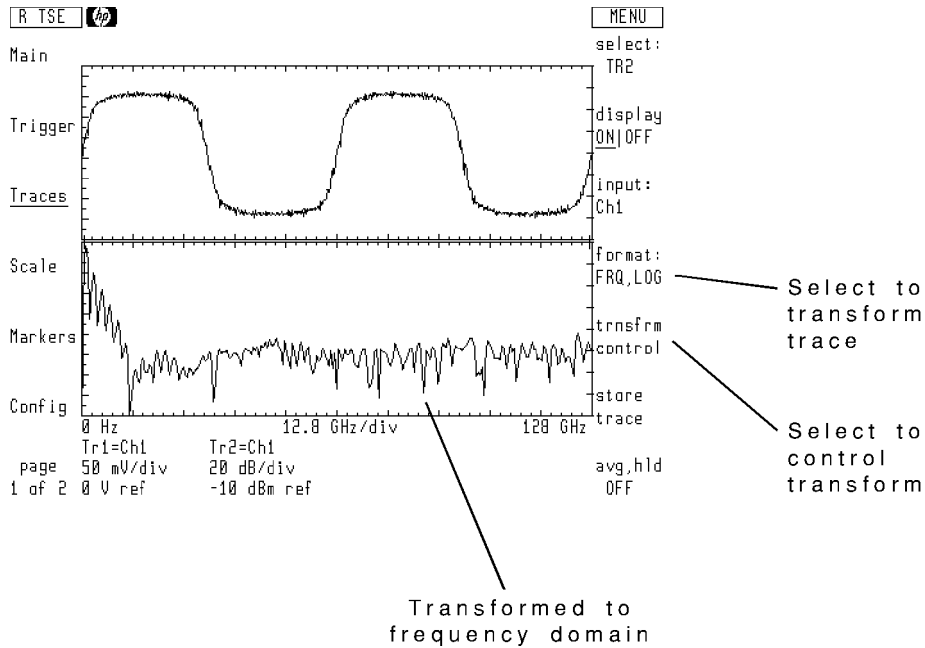

### Setting a frequency transform's stop frequency

When transforming time-domain signals to the frequency domain, the frequency scale of the transformed trace is related to the sweep time. The start frequency is set to 0 Hz. The stop frequency is determined by the seconds-per-division setting. To set the stop frequency, use the following formula to determine the seconds-per-division setting, and then set the sweep time using the Main menu's **SEC/DIV** softkey.

$$\text{seconds/division} = \frac{\text{trace length}}{20 F_{\text{stop}}}$$

where:

- trace length is determined or adjusted by pressing **TRACE POINTS** in the Configuration menu.
- $F_{\text{stop}}$  equals the desired stop frequency in hertz.

For example, to set the stop frequency to 10 GHz with 512 trace points, set the time scale to 2.56 ns per division.

## Zooming a transform

By selecting the `trnsfrm control` softkey, the frequency span of a transformed trace can be temporarily reduced and the stop and start frequencies changed. This is known as *zooming* the transform. The following figure shows trace 2 from the previous figure after the `zoom ON|OFF` softkey has been pressed.

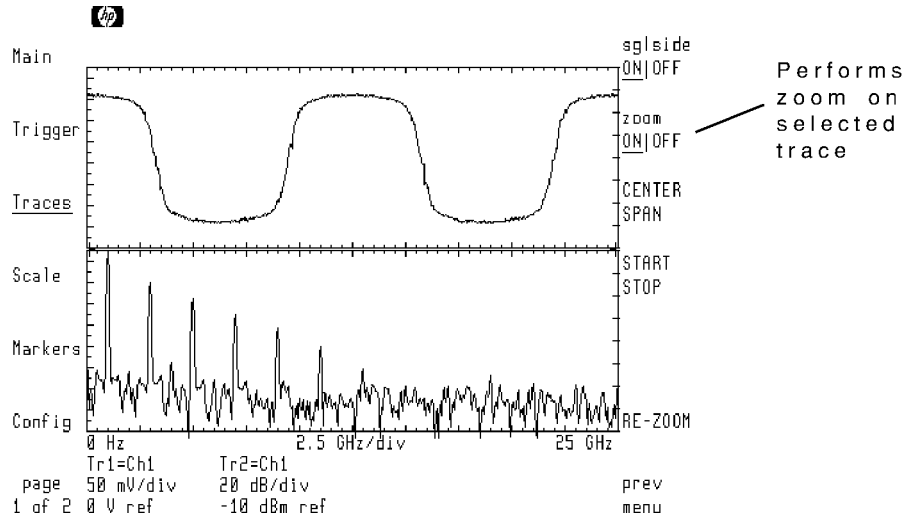

By using the **CENTER SPAN** and **START STOP** softkeys, the you can change the display of the transform. For example, the stop frequency on the following transform is now 10 GHz.

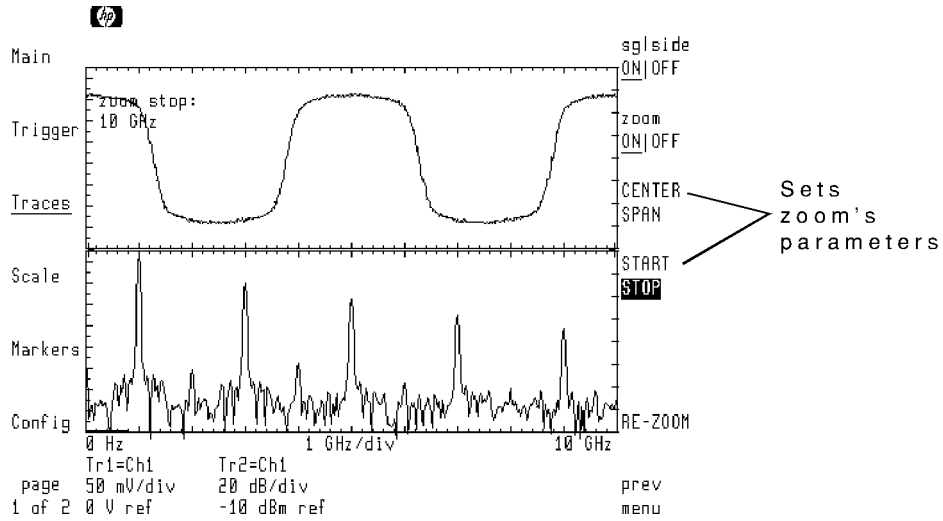

## To transform a trace

1. Press the **Traces:** softkey to enter the Traces menu, and the **select:** softkey to select a trace.
2. Press the **format:** softkey.
3. To transform time sweeps to the frequency domain, press the **xfrm to FRQ|OFF** softkey so that **FRQ** is underlined.
4. To transform frequency sweeps to the time domain, press the **xfrm to TIM|OFF** softkey so that **TIM** is underlined.

## To zoom a transformed trace

1. Press the **Traces:** softkey to enter the Traces menu.
2. Press the **select:** softkey, and select the desired trace.
3. Press the **trnsfrm control** softkey.
4. Use either the **CENTER SPAN** or **START STOP** softkeys to change the frequency limits of the zoomed transform.
5. Press the **zoom ON|OFF** softkey so that **ON** is underlined.

The selected trace is now zoomed.

---

## Storing Traces

Traces can be stored in one of four memory registers labeled MEM1, MEM2, MEM3, and MEM4. Press the **store trace** softkey, and use softkeys shown in the following figure to select a memory register.

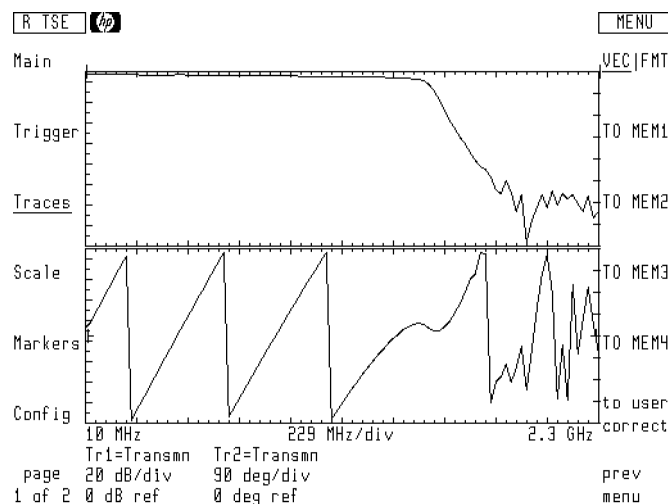

The **VEC|FMT** softkey allows you to select the type of trace data to save. Choices are either complex data, **VEC**, or scalar data, **FMT**. For traces that have smoothing, averaging, or holding, select **FMT**.

The softkey **to user correct** saves trace data for special calibration functions. If you are saving a trace for user corrections, be sure to select **VEC** to save complex data. Refer to Chapter 12, “Creating Masks and Limit Lines,” for more information on user shaping.

View stored traces by assigning the appropriate memory register as the input to a trace or as part of a trace definition equation.

### **To store a trace**

1. Press the **Traces:** softkey to enter the Traces menu, and the **select:** softkey to select a trace.
2. Press the **store trace** softkey.
3. If the trace has smoothing, averaging, or holding, press the **VEC|FMT** softkey so that **FMT** is underlined.
4. Press the softkey corresponding to memory register 1, 2, 3, or 4.

The trace is stored. Any previously stored data in the memory register is lost.

### **To recall a trace**

1. Press the Traces menu's **input:** softkey
2. Assign the memory register to a trace.



## Triggering the Sweep

---

Time, frequency, and power sweeps start when a specified trigger event occurs. You can select the type of trigger event and its source. The microwave transition analyzer can trigger continuous sweeps, single sweeps, and a group of averaged sweeps.

Introducing the Trigger Menu .....	7-4
To select a channel for triggering .....	7-5
Setting the Trigger Type .....	7-6
To sweep without triggering .....	7-9
To prevent triggering without a trigger condition .....	7-9
To select the trigger type .....	7-10
To adjust the trigger level .....	7-10
To adjust the trigger phase .....	7-11
To adjust the trigger hysteresis .....	7-11
Setting the Trigger Source .....	7-12
To trigger from input channels .....	7-14
To trigger the sweep externally .....	7-14
To gate a trigger externally .....	7-15
Using Automatic Trigger Tracking .....	7-16
To track the source power level with the trigger level .....	7-16
Using Continuous or Single Sweeps .....	7-17
To sweep continuously .....	7-17
To trigger a single sweep .....	7-17
Triggering a Group of Sweeps .....	7-18
To trigger a group of averaged sweeps .....	7-18

---

## Introducing the Trigger Menu

The Trigger menu provides the control of sweep triggering. Unless noted, all the softkeys listed in this chapter are located in the Trigger menu.

Controlling the trigger involves the following:

- Setting the trigger type
- Setting the trigger source
- Setting the trigger level or angle
- Selecting continuous or single sweep triggering

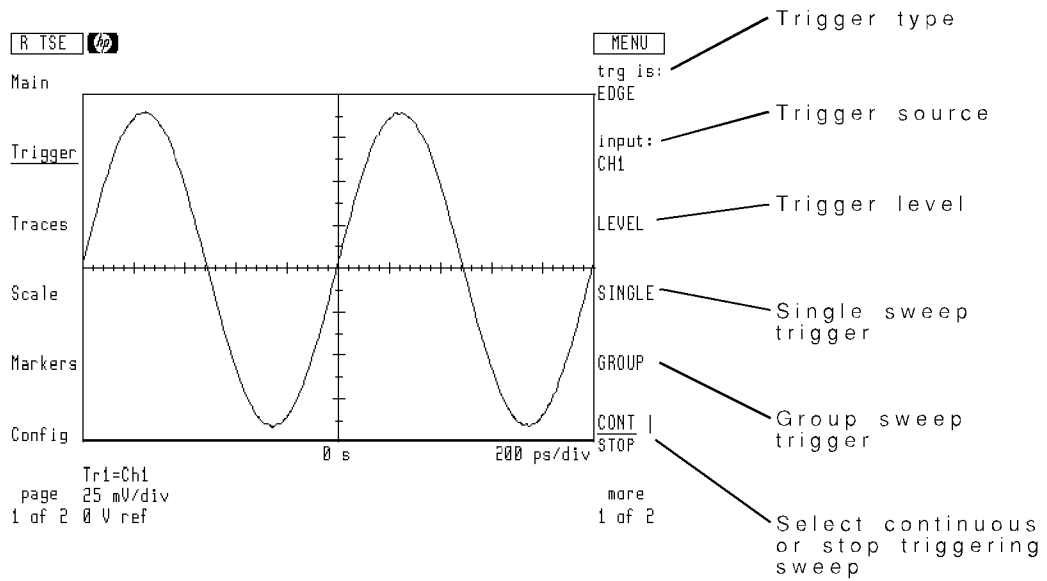

**Page 1 of the Trigger menu**

## To select a channel for triggering

1. Press the **Trigger** softkey to enter the Trigger menu.
2. Press the **input:** softkey.
3. Press **CH1** to select channel 1 or press **CH2** to select channel 2.

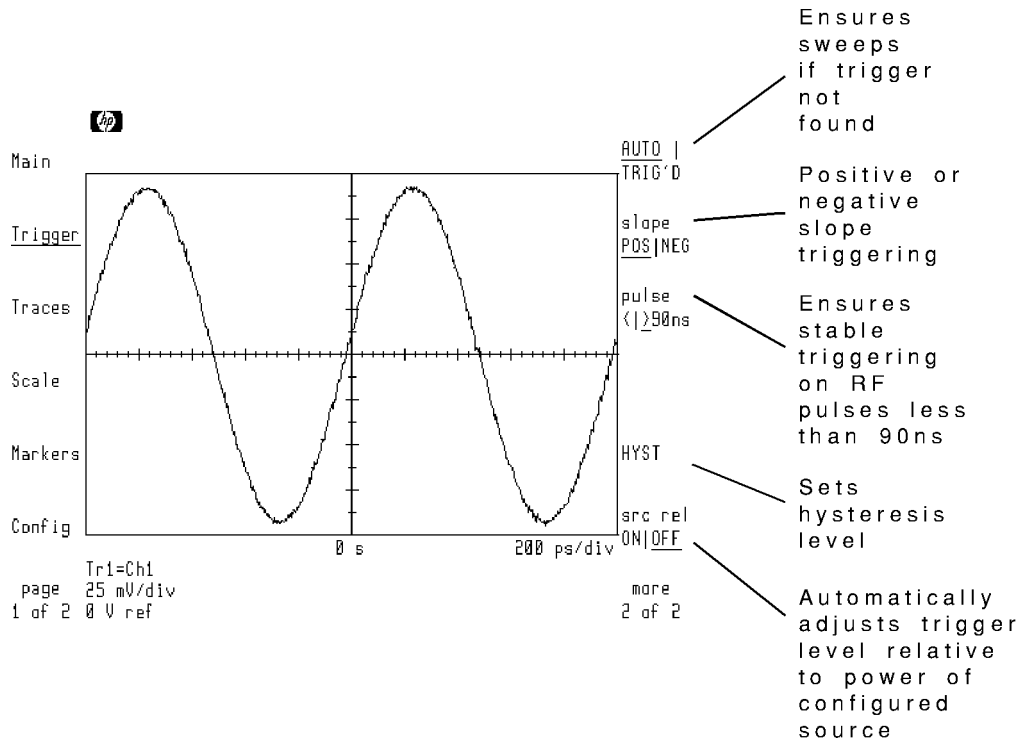

Page 2 of the Trigger menu

## Setting the Trigger Type

The microwave transition analyzer uses freerun, edge, phase, or pulsed RF triggering. Use the **trg is:** softkey to select the trigger type.

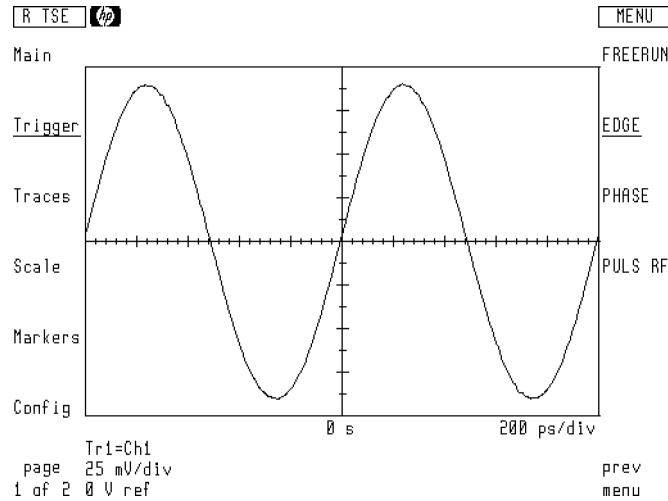

### Trigger types

If the trigger conditions are *not* met during edge, pulsed RF, or phase triggering, the microwave transition analyzer automatically starts a new sweep after a time-out period. To disable this feature and only allow triggered sweeps, press the AUTO | TRIG'D softkey so that TRIG'D is underlined.

With freerun triggering, the microwave transition analyzer sweeps continually without the need for any internal or external trigger. The trigger source input is not used in freerun triggering.

## Edge triggering

Edge triggering occurs on the signal's edge. You define either positive or negative edge triggering using the **slope POS|NEG** softkey. The default setting is positive. If the trigger source is channel 1 or channel 2, use the **LEVEL** softkey to specify the signal amplitude at which triggering occurs. The default level is 0 volts. Use **HYST** to adjust the hysteresis. The hysteresis value is a percentage of the hardware scaling range. The default value is 10 percent.

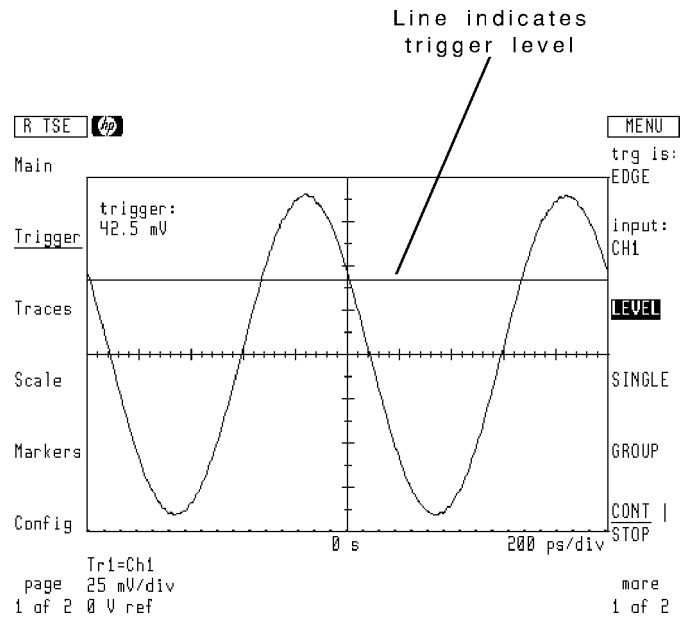

## Phase triggering

Phase triggering enables triggering on low-level signals where the signal-to-noise ratio makes edge triggering impractical. The microwave transition analyzer performs an FFT on the trace data and then triggers on a particular phase of the input signal.

Use the **ANGLE** softkey to specify the phase angle at which triggering occurs. The default angle is 0 degrees.

## Pulsed RF triggering

Pulsed RF triggering ensures stable triggering on the envelope of pulsed RF signals. Triggering is limited to positive edges only. If the trigger source is channel 1 or channel 2, use the **LEVEL** softkey to specify the signal amplitude at which triggering occurs. The default level is 0 volts. Use **HYST** to adjust the hysteresis. The hysteresis value is a percentage of the hardware scaling range. The default value is 10 percent.

If the input signal is pulsed RF with a pulse width less than 90 nanoseconds, press the **pulse <|>90ns** softkey so that **<** is underlined.

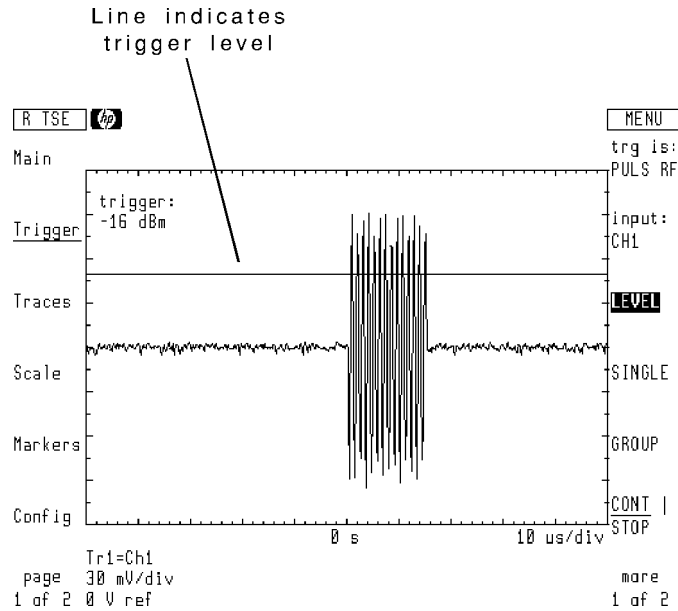

### **To sweep without triggering**

1. Press the **Trigger** softkey to enter the Trigger menu.
2. Press the **trg is** softkey.
3. Press the **FREERUN** softkey.

### **To prevent triggering without a trigger condition**

1. Press the **Trigger** softkey to enter the Trigger menu.
2. Press the **more 1 of 2** softkey.
3. Press the **AUTO | TRIG'D** softkey so that **TRIG'D** is underlined.



## To select the trigger type

1. Press the **Trigger** softkey to enter the Trigger menu.
2. Press the **trg is:** softkey.
3. Select from one of the following:
  - Press the **EDGE** softkey for edge triggering.
  - Press the **PHASE** softkey for phase triggering.
  - Press the **PULS RF** softkey for pulsed RF triggering.

If the pulse width is less than 90 nanoseconds, press the **more 1 of 2** and then **pulse <|>90ns** softkey so that **<** is underlined.

## To adjust the trigger level

The **LEVEL** softkey is displayed for edge and pulsed RF triggering. It is not available for freerun or phase triggering. The default trigger level is zero volts.

1. Press the **Trigger** softkey to enter the Trigger menu.
2. Press the **LEVEL** softkey.
3. Enter the desired trigger level.

A line appears on the display indicating the trigger level.

## To adjust the trigger phase

The **ANGLE** softkey is displayed for phase triggering. The default trigger angle is 0 degrees.

1. Press the **Trigger** softkey to enter the Trigger menu.
2. Press the **ANGLE** softkey.
3. Enter the desired trigger angle.

## To adjust the trigger hysteresis

1. Press the **Trigger** softkey to enter the Trigger menu.
2. Press **more 1 of 2**.
3. Press the **HYST** softkey.
4. Enter the desired hysteresis as a percentage of the hardware scaling voltage range.

To determine the hardware range, press the left-side **Scale** softkey followed by **hardwr**.

Press **RANGE|OFFSET** so that **RANGE** is highlighted and read the value displayed on the screen.

## Setting the Trigger Source

The **input:** softkey is used to select the trigger source. Triggers can originate from channel 1, channel 2, or from an external signal connected to the rear-panel SYNC INPUT connector.

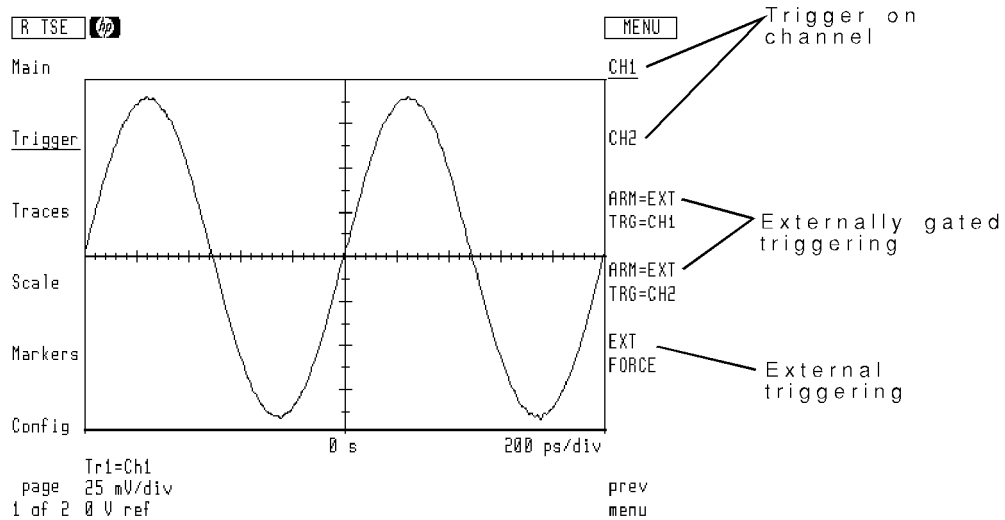

Use the **EXT FORCE** softkey to select external triggering. With external triggering, sweeps are triggered when the signal at the rear-panel SYNC INPUT connector transitions TTL logic levels. To select either positive or negative transitions, use the **slope POS|NEG** softkey located on page 2 of the Trigger menu.

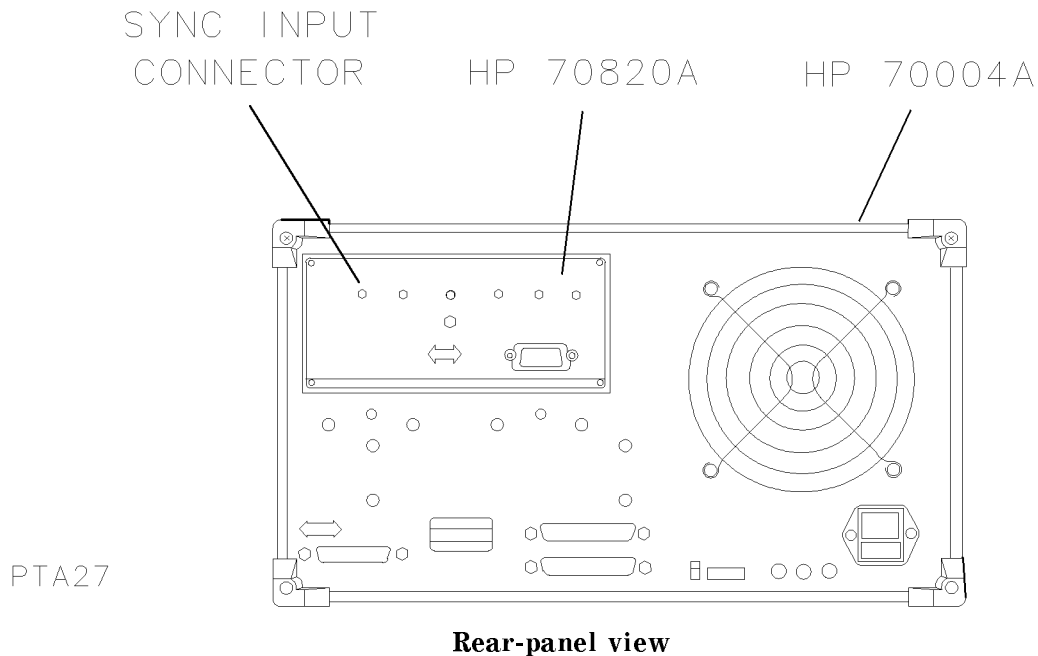

---

**Accuracy** External triggering accuracy is <300 ns with up to  $\pm 50$  ns of jitter. The trigger point may be unstable with time spans of less than 1 microsecond.

---

You can externally gate the triggering that occurs on channel 1 or channel 2. Although the source of triggering is the selected channel, triggering occurs only when *both* of the following conditions are true:

- The rear-panel SYNC INPUT becomes logic 1 (TTL level).
- The channel signal satisfies the trigger conditions.

Use the `ARM=EXT TRG=CH1` and `ARM=EXT TRG=CH2` softkeys to select external gating.

## To trigger from input channels

1. Press the **Trigger** softkey to enter the Trigger menu.
2. Press **input:** softkey.
3. Press **CH1** to trigger from channel 1, or press **CH2** to trigger from channel 2.

## To trigger the sweep externally

1. Press the **Trigger** softkey to enter the Trigger menu.
2. Press the **input:** softkey.
3. Press the **EXT FORCE** softkey.
4. Press the **more 1 of 2** softkey.
5. If you want to trigger sweeps only when an external trigger is applied, press the **AUTO | TRIG'D** softkey so that **TRIG'D** is underlined.

With **AUTO** selected, the microwave transition analyzer automatically triggers sweeps in the absence of any external trigger.

6. Connect the trigger signal from an external source to the HP 70820A's rear-panel SYNC INPUT connector.

Edge and freerun triggering are available for use with **EXT FORCE**.

## To gate a trigger externally

1. Press the **Trigger** softkey to enter the Trigger menu.
2. Press the **input:** softkey.
3. To externally gate channel 1, press the **ARM=EXT TRG=CH1** softkey.
4. To externally gate channel 2, press the **ARM=EXT TRG=CH2** softkey.
5. Press the **more 1 of 2** softkey.
6. If you want to trigger sweeps only when an external gating signal is applied, press the **AUTO | TRIG'D** softkey so that **TRIG'D** is underlined.

With **AUTO** selected, the microwave transition analyzer automatically triggers sweeps in the absence of any external trigger after a timeout.

7. Connect the trigger signal from an external source to the HP 70820A's rear-panel SYNC input.

---

## Using Automatic Trigger Tracking

The microwave transition analyzer's trigger level can be set to automatically track the source output power level. If the power level changes, the trigger level automatically adjusts to the new power or voltage level (dBc or %). Use to **src rel ON|OFF** softkey to turn automatic trigger tracking on.

### To track the source power level with the trigger level

1. Press the **Trigger** softkey to enter the Trigger menu.
2. Press the **more 1 of 2** softkey.
3. Press the **src rel ON|OFF** softkey so that **ON** is underlined.

If the input power level changes, the trigger level automatically adjusts to the new level.

---

## Using Continuous or Single Sweeps

Normally, the microwave transition analyzer continuously triggers successive sweeps. However, single sweep triggering is available. Use the **CONT | STOP** softkey to select continuous or single sweep. Press the **SINGLE** softkey whenever a new single sweep is needed.

- **SINGLE** selects single sweeps
- **CONT** selects continuous sweeps
- **STOP** stops a measurement currently in progress

### To sweep continuously

1. Press the **Trigger** softkey to enter the Trigger menu.
2. Press the **CONT | STOP** softkey so that **CONT** is underlined.

### To trigger a single sweep

1. Press the **Trigger** softkey to enter the Trigger menu.
2. Press the **SINGLE** softkey to trigger each sweep.

---

## Triggering a Group of Sweeps

Group triggering allows you to trigger a group of averaged traces. Each time the **GROUP** softkey is pressed, the microwave transition analyzer resets the average and then sweeps and averages the number of traces specified. Use the **FORMAT AVERAGE** or **VECTOR AVERAGE** softkeys to change the number of traces grouped. (These softkeys are located under the Traces menu's **avg,hld** softkey.) The default number of averaged traces is 16.

To turn grouping format off, press the Traces menu's **avg,hld** and then **OFF** softkeys.

### To trigger a group of averaged sweeps

1. Press the **Traces** softkey to enter the Traces menu.
2. Press the **avg,hld** softkey.
3. Press the **FORMAT AVERAGE** or **VECTOR AVERAGE** softkey, and enter the number of sweeps to be averaged
4. Press the **Trigger** softkey to enter the Trigger menu.
5. To trigger a group of averaged sweeps, press the **GROUP** softkey.

The microwave transmission analyzer's sweep is stopped. Each time **GROUP** is pressed, the required number of sweeps are taken and averaged.

## Controlling the Amplitude Scale

---

Use the Scale menu to control and change the amplitude scale. You can set a different scale for each of the four available traces. Two kinds of scaling are available: display and hardware. Display scaling adjusts the scale by mathematically changing the measured trace data. Hardware scaling actually adjusts the gain of internal circuits.

Scaling a Trace .....	8-4
To select a trace to scale .....	8-6
To scale the response automatically .....	8-6
To scale the response manually .....	8-6
Changing Reference Level and Position .....	8-7
To change the reference level .....	8-7
To change the reference position .....	8-7
Changing Hardware Scaling .....	8-8
Setting the range and offset .....	8-9
To turn hardware auto ranging off .....	8-9
To change the hardware scale range and offset .....	8-9
To couple display scaling to hardware scaling .....	8-10
Adding Frequency Shifts and Time Delays .....	8-11
To add frequency shifts .....	8-12
To add time delays .....	8-12
Smoothing FM( ), TD( ), and DIFF( ) Traces .....	8-13
To smooth FM( ), TD( ), and DIFF( ) traces .....	8-15
Changing Input Coupling .....	8-16
To change input ac/dc coupling .....	8-16
Compensating for External Attenuation .....	8-17
To compensate for external attenuation .....	8-17
Compensating for Internal dc Drifts .....	8-18
To compensate for internal dc drifts .....	8-19

---

## Scaling a Trace

The amplitude scale is controlled from the Scale menu. Press the left-side **Scale** softkey to enter the menu. (Use the Traces menu's **display ON|OFF** softkey to display the trace.) If the selected trace is not displayed, only the Scale menu's **hardwre** softkey is available.



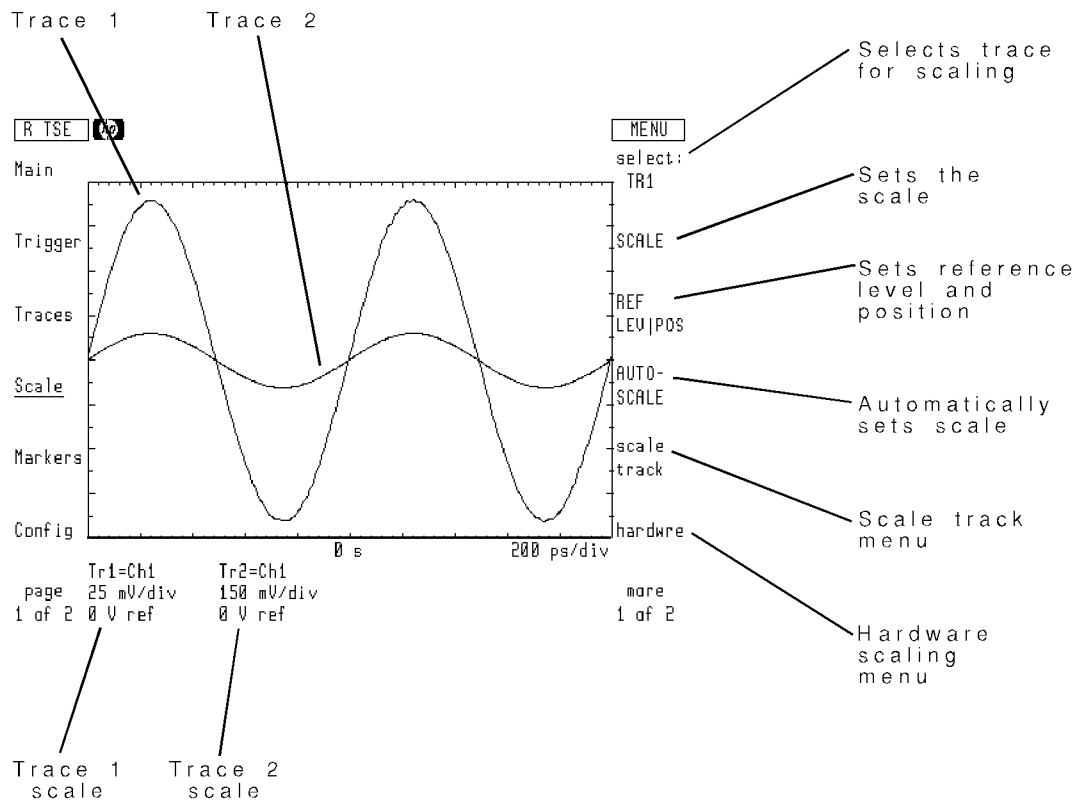

### Page 1 of the Scale menu

Use the `select:` softkey to choose the trace for scaling. `SCALE`, `REF LEV|POS`, and `AUTOSCALE` all affect display scaling. Use the `hardware` softkey to access the hardware scaling menu.

Pressing the `AUTOSCALE` softkey causes the microwave transition analyzer to automatically adjust the scale and reference level. (To continuously autoscale, after every sweep, press `scale track` and then the `CONT AUTOSCL` softkey.

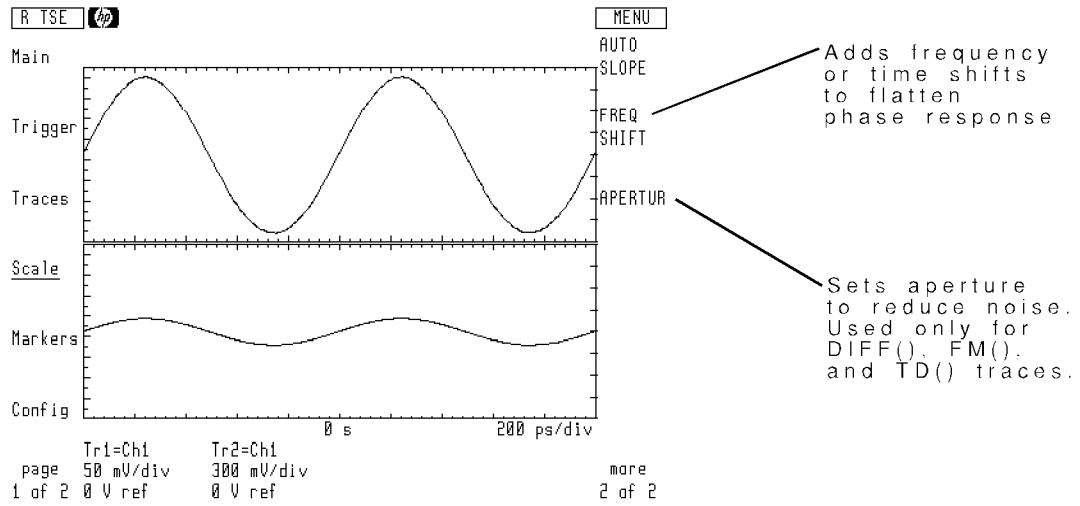

**Page 2 of the Scale menu**

### **To select a trace to scale**

1. Press the **Scale** softkey to enter the Scale menu.
2. Press the **select:** softkey.
3. Press the softkey for the desired trace.

If the selected trace is not displayed, only the Scale menu's **hardwre** softkey is available. Use the Traces menu's **display ON|OFF** softkey to display the trace.

### **To scale the response automatically**

1. Press the **Scale** softkey to enter the Scale menu.
2. Press the **select:** softkey and select the desired trace.
3. Press the **AUTOSCALE** softkey.

### **To scale the response manually**

1. Press the **Scale** softkey to enter the Scale menu.
2. Press the **select:** softkey and select the desired trace.
3. Press the **SCALE** softkey.
4. Enter the desired amplitude scale.

---

## **Changing Reference Level and Position**

Use the **REF LEV|POS** softkey to change the reference level and reference position. The reference level is the amplitude value at the reference position. Enter the reference position as a percentage of the vertical display. The top of the screen is 100 percent. The bottom of the screen is 0 percent.

### **To change the reference level**

1. Press the **Scale** softkey to enter the Scale menu.
2. Press the **select:** softkey and select the desired trace.
3. Press the **REF LEV|POS** softkey so that **LEV** is highlighted.
4. Enter the desired reference level.

## To change the reference position

1. Press the **Scale** softkey to enter the Scale menu.
2. Press the **select:** softkey and select the desired trace.
3. Press the **REF LEV|POS** softkey so that **POS** is highlighted.
4. Enter the desired reference position.

A 0 percent entry places the reference position at the bottom of the screen. A 100 percent entry places the reference position at the top of the screen.

---

## Changing Hardware Scaling

Two kinds of scaling are available: display and hardware. Display scaling adjusts the scale by mathematically changing the measured trace data. Hardware scaling actually adjusts the gain of internal circuits. **SCALE**, **REF LEV|POS**, and **AUTOSCALE** all affect display scaling. Use the **hardwre** softkey to access the hardware scaling menu.

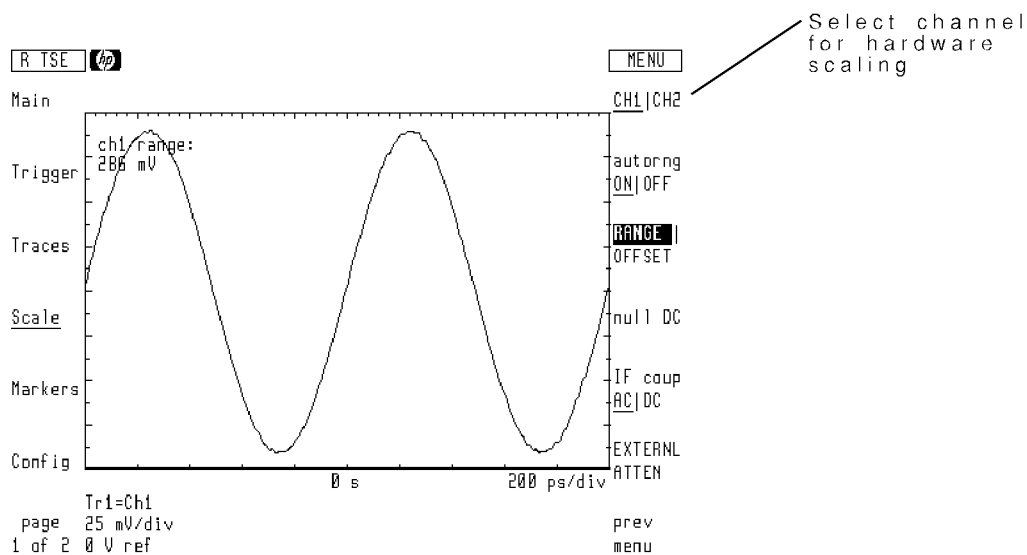

### Hardware scaling menu

Hardware scaling can be set separately for each of the two input channels. Use the **CH1|CH2** softkey to select a channel when changing hardware scaling.

## Setting the range and offset

In its default operating mode, the microwave transition analyzer automatically selects the proper hardware range and offset for the two channels. This is called automatic ranging. The hardware range determines the maximum input level before signal clipping occurs. Both range and offset can be added manually.

### To turn hardware auto ranging off

1. Press the `Scale` softkey to enter the Scale menu.
2. Press the `hardwre` softkey.
3. Press the `CH1|CH2` softkey to select the channel.  
The selected channel will be underlined.
4. Press the `autornrg ON|OFF` softkey so that `OFF` is underlined.

### To change the hardware scale range and offset

1. Press the `Scale` softkey to enter the Scale menu.
  2. Press the `hardwre` softkey.
  3. Press the `CH1|CH2` softkey to select the channel.  
The selected channel will be underlined.
  4. Press the `RANGE | OFFSET` softkey so that `RANGE` is underlined.
  5. Enter the desired range for the maximum input signal.
  6. Press the `RANGE | OFFSET` softkey so that `OFFSET` is underlined.
  7. Enter the desired offset value.
- Adjusting `RANGE` or `OFFSET` turns hardware autoranging off.

### To couple display scaling to hardware scaling

Using display scaling functions (for example `SCALE`, `REF LEV|POS`, and `AUTOSCALE`) never changes the hardware scaling. However, display scaling can be coupled to hardware scaling. Hardware coupling sets the display scaling to the same values as the hardware scaling. This feature is particularly useful when autoranging is turned off. Hardware coupling is only available for traces that are assigned to an input channel.

1. Press the `Scale` softkey to enter the Scale menu.
2. Press the `scale track` softkey.
3. Press the `COUP HW ON|OFF` softkey so that `ON` is underlined.

## Adding Frequency Shifts and Time Delays

During certain measurements, it is advantageous to add frequency shifts or time delays to flatten the displayed response. This is particularly true when measuring phase. For time sweeps, the **FREQ SHIFT** softkey allows you to enter frequency shifts. (If the microwave transition analyzer is performing a frequency sweep, this softkey reads **TIME DELAY** and is used for adding time shifts.)

As shown in this figure, if delta markers are on the screen, they define the limits of the range for compensation.

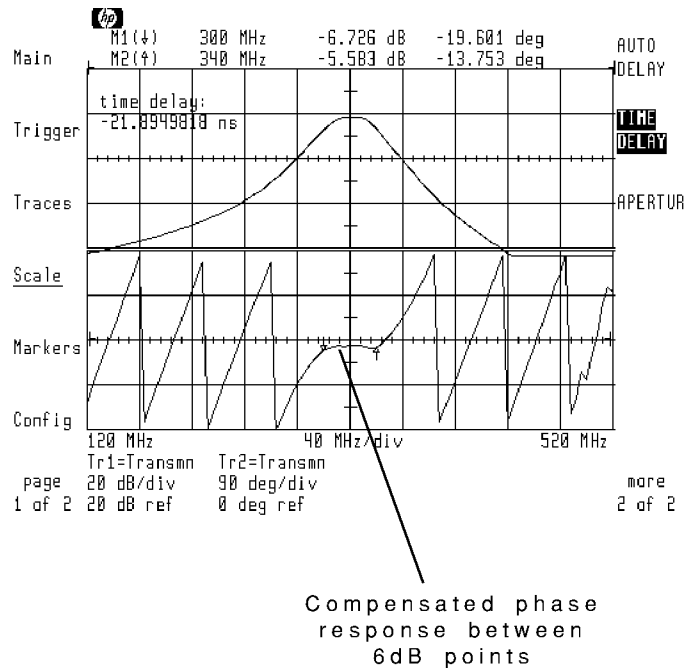

An example of using a time delay is in vector-network phase measurements. You can add a time delay to compensate for the different electrical lengths of the normalization and DUT paths.

### To add frequency shifts

1. Press the **Scale** softkey to enter the Scale menu.
2. Press the **more 1 of 2** softkey.
3. Press the **FREQ SHIFT** softkey, and enter the amount of frequency shift.
4. To add frequency shift automatically, press the **AUTO SHIFT** softkey.

## To add time delays

1. Press the **Scale** softkey to enter the Scale menu.
2. Press the **more 1 of 2** softkey.
3. Press the **TIME DELAY** softkey, and enter the amount of time delay.
4. To add time delay automatically, press the **AUTO DELAY** softkey.

---

## Smoothing FM( ), TD( ), and DIFF( ) Traces

If the trace is defined as FM( ), TD( ), or DIFF( ) you can use aperture smoothing on the displayed response. Aperture smoothing uses an average filter available only for FM( ), TD( ), or DIFF( ) traces. (In contrast, normal smoothing uses a median filter available for all traces.) Refer to Chapter 6, "Using and Defining Traces," for information on smoothing and defining traces.) The following figures show aperture smoothing on demodulated FM. Trace 1 displays the modulated carrier in the frequency domain. Trace 2 displays the demodulated FM in the time domain. The first figure uses an aperture of 1 which results in no smoothing.

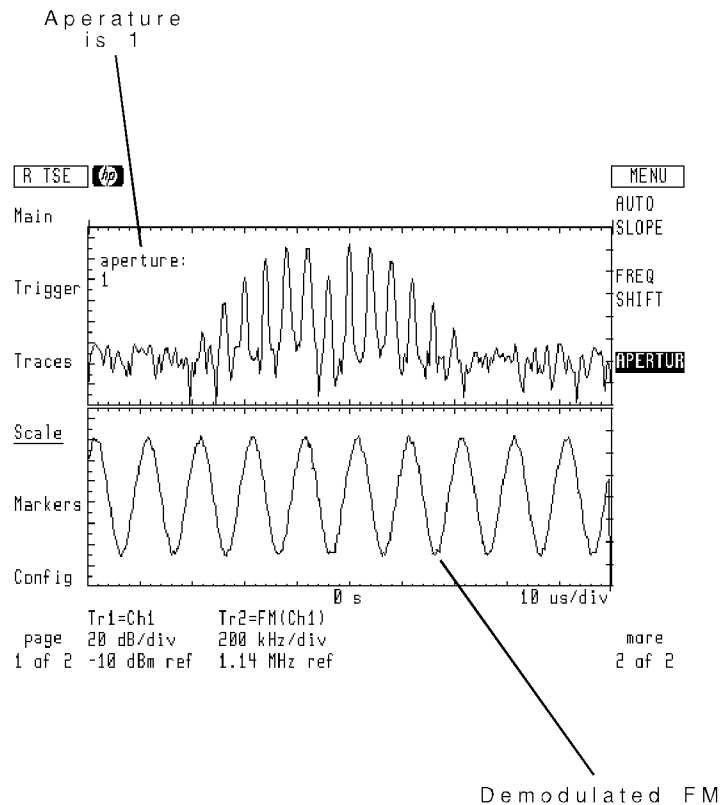

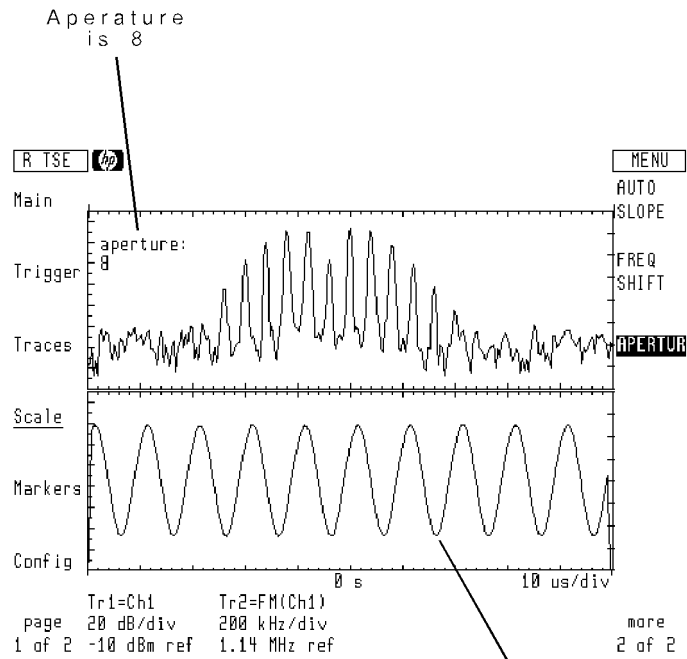

---

**Note** Aperture has *no effect* on traces not defined with FM(), TD(), or DIFF().

---



### To smooth FM( ), TD( ), and DIFF( ) traces

1. Press the `Scale` softkey to enter the Scale menu.
2. Press the `more 1 of 2` softkey.
3. Press the `APERTUR` softkey.
4. Enter the number of measurement points to be smoothed.

---

## Changing Input Coupling

Both ac and dc hardware coupling can be used to couple the input signal to the microwave transition analyzer's input circuits. The default is dc coupling. To change the coupling, press the Scale menu's `hardwre` and then `IF coup AC|DC` softkeys.

---

**Caution** The maximum input power levels apply to both ac and dc coupling. The front-panel inputs are *always* dc coupled. With ac hardware coupling, any dc is removed after the sampler circuitry.

---

### To change input ac/dc coupling

1. Press the `Scale` softkey to enter the Scale menu.
2. Press the `hardwre` softkey.
3. To select ac coupling, press the `IF coup AC|DC` softkey so that `AC` is underlined.
4. To select dc coupling, press the `IF coup AC|DC` softkey so that `DC` is underlined.

---

## Compensating for External Attenuation

External attenuation between the signal source and the microwave transition analyzer's input connectors can be compensated. Compensation moves the input reference plane to the attenuator's input. The trigger level range, hardware input range, and display scaling are all scaled accordingly.

### To compensate for external attenuation

1. Press the `Scale` softkey to enter the Scale menu.
2. Press the `hardwre` softkey.
3. Press the `EXTERNL ATTEN` softkey.
4. Enter the amount of attenuation.

## Compensating for Internal dc Drifts

Temperature changes can cause slight dc drifts in the microwave transition analyzer's gain and filter circuits. This causes offsets on displayed traces as shown in the following figure. To correct for internal dc drifts, use the functions located under the **hardwre** then **null DC** softkeys.

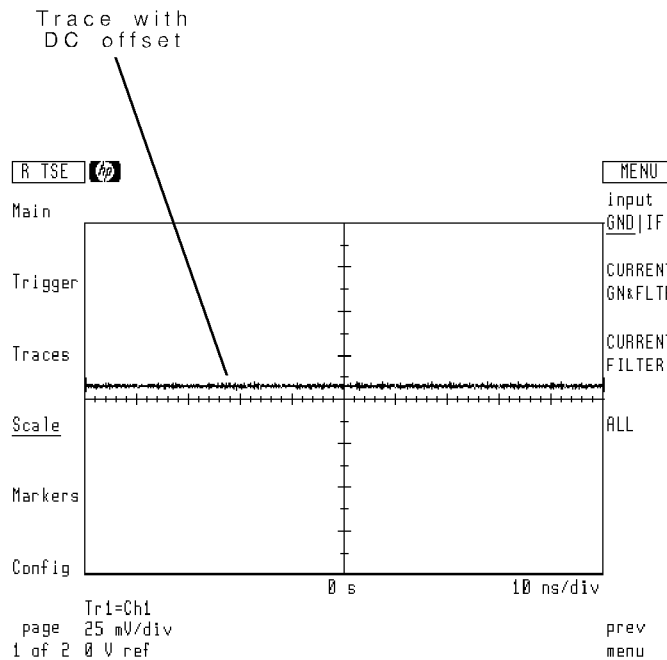

Due to the time required to null the dc, three compensation routines are provided: **CURRENT GN&FLTR**, **CURRENT FILTER**, and **ALL**. You must first select an input for the routine, and then select a routine.

**CURRENT GN&FLTR** is the fastest compensation routine. It compensates for dc drifts caused by the currently used internal gain and filter circuits. The **CURRENT FILTER** routine compensates for dc drifts caused by all the internal gain stages for the currently used filter circuits. The **ALL** routine requires the most time (about five minutes). It compensates for dc drifts caused by all the internal gain and filter circuits.

### To compensate for internal dc drifts

1. Press the **Scale** softkey to enter the Scale menu.
2. Press the **hardwre** softkey.
3. Press the **CH1|CH2** and select the channel that needs dc drift compensation.
4. Press the **null DC** softkey.

5. Select the input:

- For the most accurate compensation, press the `input GND|IF` softkey so that `IF` is underlined. Then, remove any cables to the front-panel channel inputs that have dc on them.
- If you do not want to remove any front-panel cables, press the `input GND|IF` softkey so that `GND` is underlined.

6. Press one of the following softkeys to select a compensation routine:

- `CURRENT GN&FLTR` to compensate the currently used gain and filter circuits.
- `CURRENT FILTER` to compensate all the gain circuits for the currently used filter circuit.
- `ALL` to compensate all internal gain and filter circuits.



## Using Markers

---

The microwave transition analyzer has two markers, M1 and M2, for measuring absolute and relative trace values. Markers can be displayed on any trace. They can even be used to compare two separate traces. Use the Markers menu to access and control markers.

Selecting and Moving Markers .....	9-4
To turn on a marker .....	9-7
To turn off a marker .....	9-7
To simultaneously move both markers .....	9-7
To hold marker values as a reference .....	9-8
Using Delta Markers .....	9-9
To use the delta markers .....	9-10
Using Markers to Move Traces .....	9-11
To move marker position to center screen .....	9-13
To move marker to reference position .....	9-14
Automatically Searching for Peaks .....	9-15
To perform an automatic search .....	9-16
To track a drifting peak .....	9-17
To ignore dc response in peak searches .....	9-17
Using Peak Searches on FFT Traces .....	9-18
To turn peak interpolation off .....	9-19
Maintaining Marker Position with Changing Frequencies .....	9-20
To keep cycle position constant .....	9-20
Changing Marker Readouts .....	9-21
To select marker amplitude units .....	9-24
To select phase readout units .....	9-24
To select scalar or vector readout .....	9-25

---

## Selecting and Moving Markers

Use the Markers menu to access and control markers. Pressing a marker softkey, **M1(↑)** or **M2(↑)**, turns the marker on. Pressing the softkey again moves the marker to the next trace (provided another trace is displayed). Markers cannot be selectively turned off. To turn a marker off, you must turn all the markers off using the **MARKERS OFF** softkey.

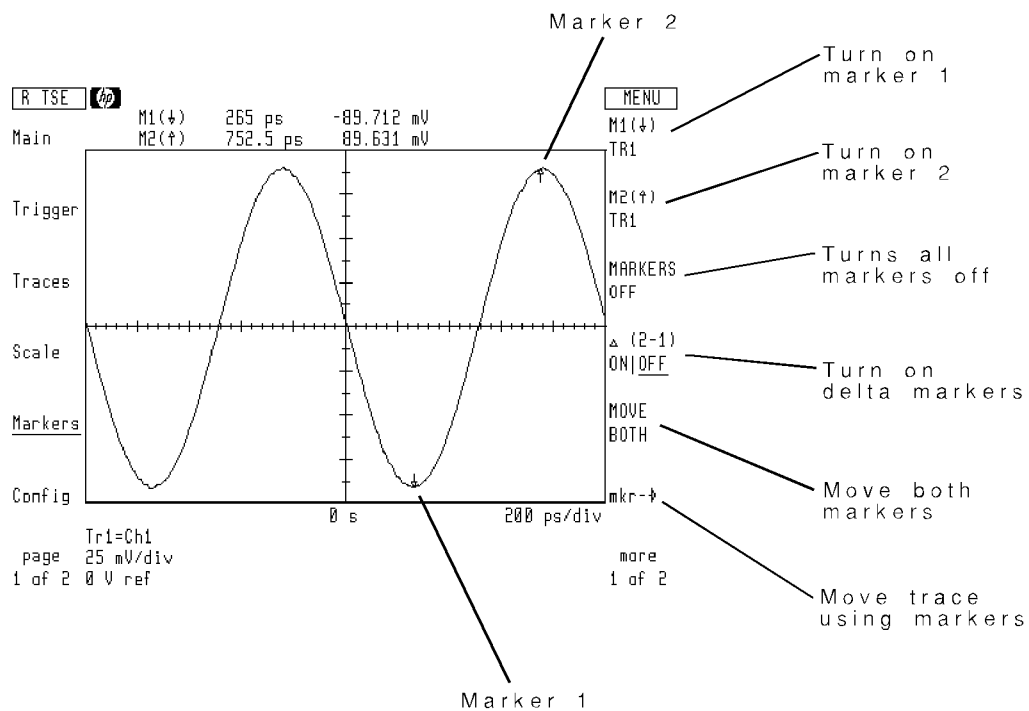

### Page 1 of the Markers menu

A highlighted softkey indicates an active marker. Use the front-panel knob to move the active marker along a trace. If both markers are displayed, you can move both simultaneously by first pressing the **MOVE BOTH** softkey. The relative marker positions do not change. To temporarily hold marker values as references, press the **mkr hld ON|OFF** softkey so that **ON** is underlined. For delta measurements, the softkey label reads **ref hld ON|OFF**.

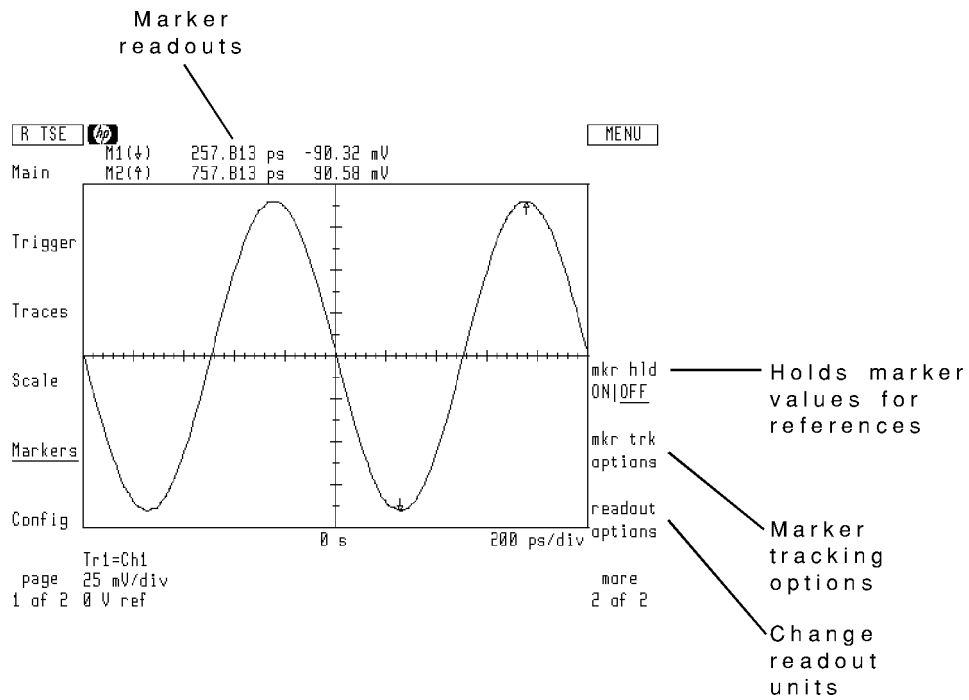

**Page 2 of the Markers menu**



Marker positions can be protected from accidental changes due to unintentional turning of the front-panel knob. To protect them, press the front-panel **(HOLD)** key.

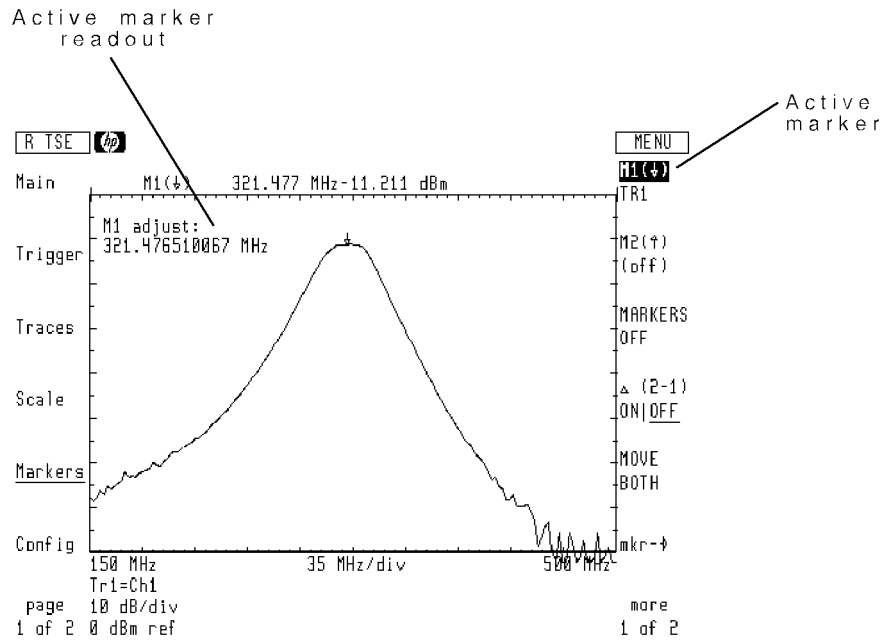

### **To turn on a marker**

1. Press the **Markers** softkey to enter the Markers menu.
2. To turn on Marker 1, press the **M1(↓)** softkey.

If more than one trace is displayed, successive pressing of the marker key moves the marker to the next trace.

3. To turn on Marker 2, press the **M2(↑)** softkey.

### **To turn off a marker**

1. Press the **Markers** softkey to enter the Markers menu.
2. Press the **MARKERS OFF** softkey.

### **To simultaneously move both markers**

1. Press the **Markers** softkey to enter the Markers menu.
2. Press the **MOVE BOTH** softkey.

## To hold marker values as a reference

1. Press the **Markers** softkey to enter the Markers menu.
2. Press the **more 1 of 2** softkey.
3. Press the **mkr hld ON|OFF** softkey so that **ON** is underlined.

---

## Using Delta Markers

Delta markers allow you to measure relative values between any two trace points. For example, you can measure the peak-to-peak amplitude of a sine wave. You can even compare points on two separate traces.

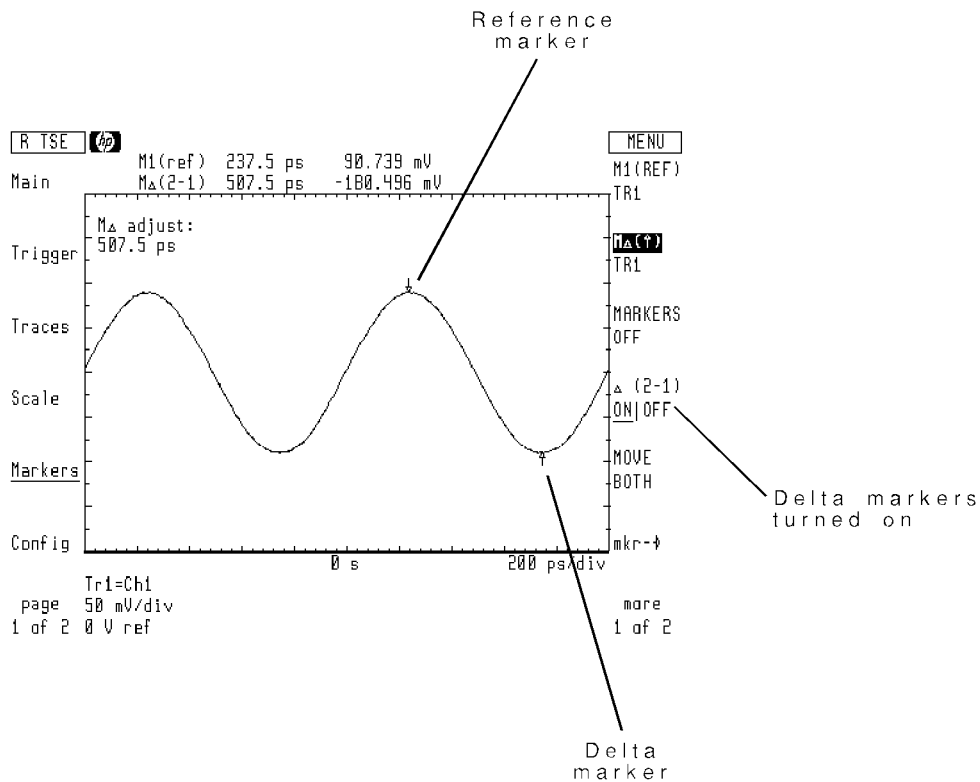

The top of the display shows marker values for both reference and delta markers. This includes amplitude and horizontal (time, frequency, or power) values. Reference marker values are absolute. Delta marker values are relative to the reference marker.

Delta markers can be changed to normal markers at any time by pressing the  **$\Delta$  (2-1) ON|OFF** softkey so that **OFF** is underlined.

## To use the delta markers

1. Press the **Markers** softkey to enter the Markers menu.
2. Press the **Δ (2-1) ON|OFF** softkey so that **ON** is underlined. The reference marker is activated.  
If more than one trace is displayed, successive pressing of **M1(REF)** moves the reference marker to the next trace. Successive presses of **MΔ(↑)** moves the delta marker to the next trace.
3. Use the front-panel knob to place the reference marker at the desired trace position.
4. Press the **MΔ(↑)** softkey to activate the delta marker.
5. Use the front-panel knob to place the delta marker at the desired trace position.

---

## Using Markers to Move Traces

Markers can be used to move a waveform to either the center screen or to the reference level. The **mk $\rightarrow$**  softkey leads to a menu of softkeys used for this purpose.

Press **to REF LEV** to move the waveform at the marker to the reference level. Press **to CENTER** to move the waveform at the marker to center screen. In single sweep mode, pressing **to CENTER** does not change the displayed waveform until a new sweep is triggered.

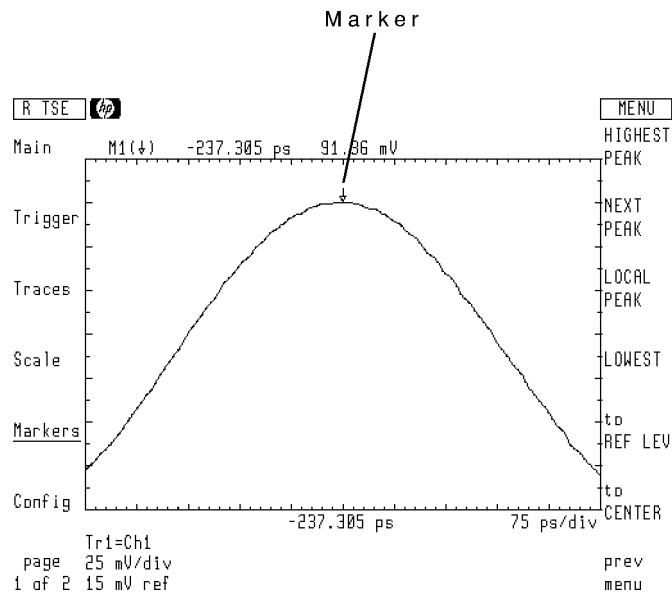

**Trace after **to CENTER** pressed**

Pressing the **to CENTER** softkey during power sweeps has no effect. (This protects input circuits from accidental damage due to high power levels.)

Using the **to REF LEV** softkey sets the reference level equal to the amplitude at the marker. This is the same as manually setting these parameters using the Scale menu's **REF LEV|POS** softkey.

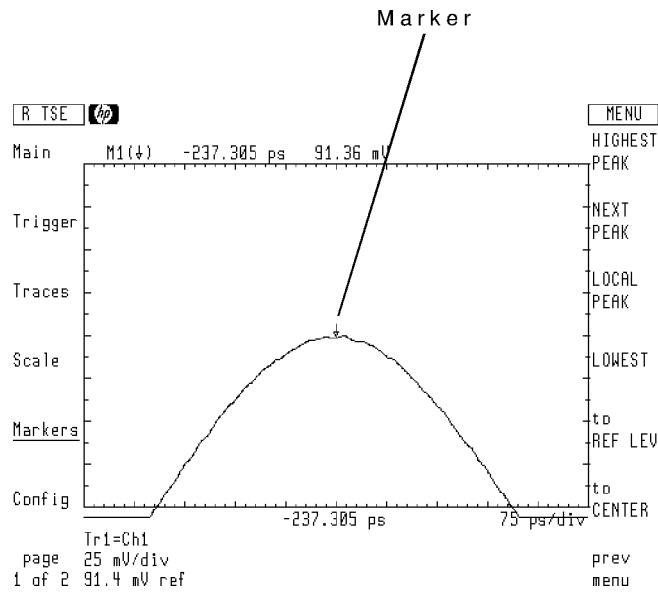

**Trace after **to REF LEV** pressed**

## To move marker position to center screen

1. Press the **Markers** softkey to enter the Markers menu.
2. Press the **M1()** softkey to turn on Marker 1.

If more than one trace is displayed, continue pressing the marker key until the marker moves to the desired trace.

3. Using the front-panel knob, place the marker at the trace position to be moved to the center screen.
4. Press the **mk $\rightarrow$**  softkey.
5. Press the **to CENTER** softkey.

---

**Single sweeps** If the microwave transition analyzer is in single sweep, the displayed response will not change until a new sweep is triggered. This is because **to CENTER** changes the measurement setup and not the measurement data.

---

## To move marker to reference position

1. Press the **Markers** softkey to enter the Markers menu.
2. Press the **M1(1)** softkey to turn on Marker 1.

If more than one trace is displayed, continue pressing the marker key until the marker moves to the desired trace.

3. Using the front-panel knob, place the marker at the trace position to be moved to the reference position.
4. Press the **mk $\rightarrow$**  softkey.
5. Press the **to REF LEV** softkey.

---

## Automatically Searching for Peaks

Located under the Marker menu's **mk $\rightarrow$**  softkey is a set of marker peak functions. Use these functions to automatically place markers on the following waveform positions:

- highest peak
- next highest peak
- nearest identifiable peak
- lowest peak

When used with the **to REF LEV** and **to CENTER** softkeys, these marker features provide a convenient method of centering waveforms on the screen.

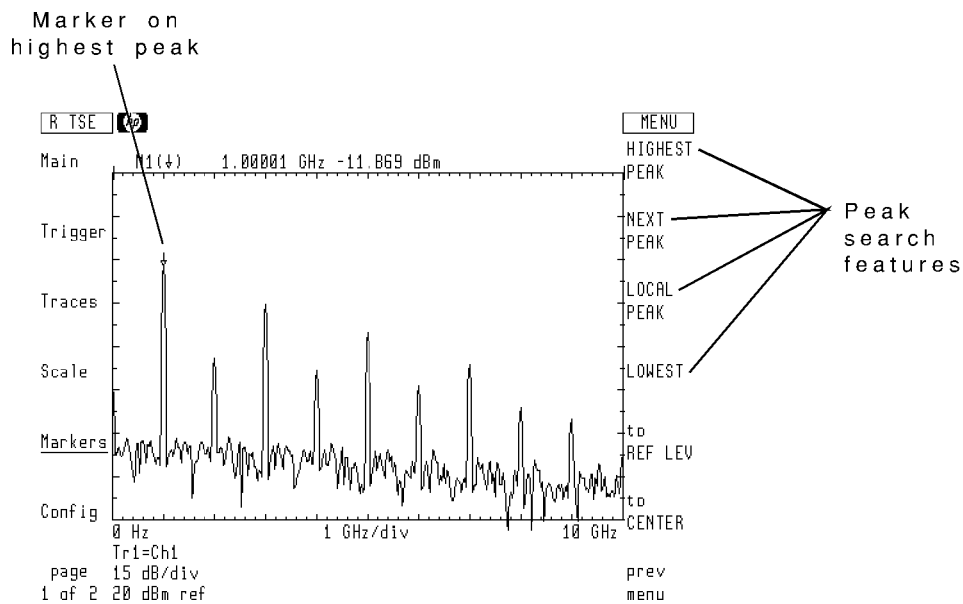

You can set the microwave transition analyzer to automatically perform a peak search after every sweep. This ensures that the marker always indicates the highest peak.

Normally, peak searches consider any response at dc (0 Hz) as a valid peak. However, peak searches can be configured to keep dc from being located as a peak.

### **To perform an automatic search**

1. Press the **Markers** softkey to enter the Markers menu.
2. Turn on either marker 1 or marker 2.
3. Press the **mkf** softkey.
  - Press the **HIGHEST PEAK** softkey to place the marker on the highest peak of the displayed waveform.
  - Press the **NEXT PEAK** softkey to place the marker to the next highest displayed peak.
  - Press the **LOWEST** softkey to place the marker on the lowest trace point.
  - Press the **LOCAL PEAK** softkey to place the marker on the nearest identifiable peak.



### To track a drifting peak

1. Place the active marker on the displayed peak.
2. Press the Marker menu's `mkr trk options` softkey.

Locate this softkey on page 2 of the Marker menu.

3. Press the `pk trk ON|OFF` softkey so that `ON` is underlined.

### To ignore dc response in peak searches

1. Press the `Markers` softkey to enter the Markers menu.
2. Press the `more 1 of 2` softkey.
3. Press the `mkr trk options` softkey.
4. Press the `pk DC ON|OFF` softkey so that `OFF` is underlined.

---

## Using Peak Searches on FFT Traces

Traces formatted using a fast Fourier transform (FFT) have limited ability to resolve signals. Because of this, the microwave transition analyzer applies a peak interpolation routine to determine a peak's approximate frequency and power level. For CW signals, this interpolation greatly improves both amplitude and frequency accuracy. However, for non-CW signals you may wish to disable peak interpolation.

The `HIGHEST PEAK`, `NEXT PEAK`, `LOWEST`, and `LOCAL PEAK` softkeys all use peak interpolation (if turned on) to determine signal peaks.

The following two figures show marker readout values on the same FFT trace. Notice how the amplitude values vary depending on peak interpolation.

Marker readouts at interpolated peak

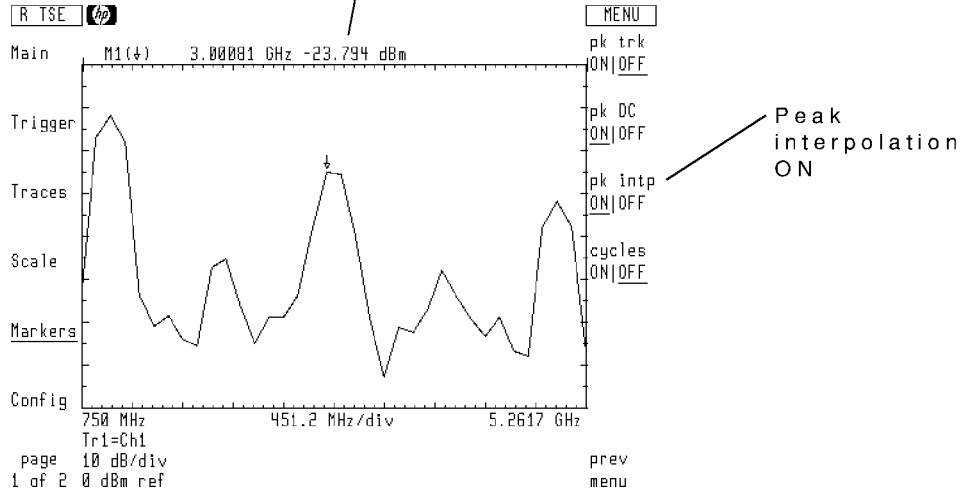

Marker peak readouts with peak interpolation on

Marker readout without peak interpolation

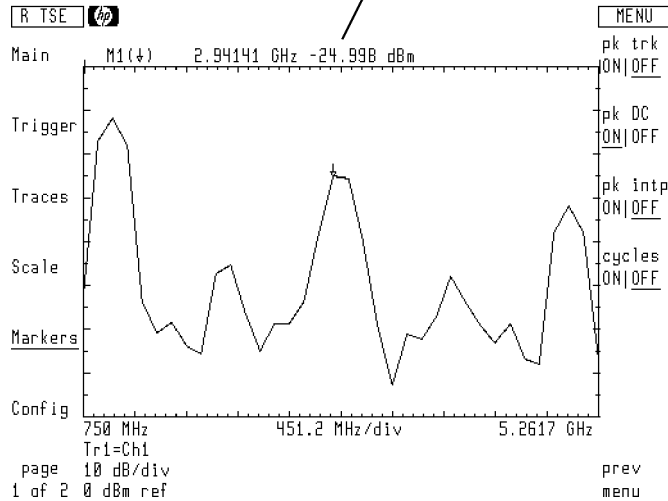

Marker peak readouts with peak interpolation off

### **To turn peak interpolation off**

1. Press the **Markers** softkey to enter the Markers menu.
2. Press the **more 1 of 2** softkey.
3. Press the **mkr trk options** softkey.
4. Press the **pk intp ON|OFF** softkey so that **OFF** is underlined.

---

### **Maintaining Marker Position with Changing Frequencies**

This feature is useful with CW signals viewed in the time domain (time sweeps). Normally, if the input frequency changes, markers remain placed at a constant time offset from the trigger position (time delay). This means that a marker placed at the peak of a signal at one frequency may be displayed at the start of a cycle at another frequency. However, you can change this so that the marker remains positioned at a constant position on the cycle.

### **To keep cycle position constant**

1. Press the **Markers** softkey to enter the Markers menu.
2. Press the **more 1 of 2** softkey.
3. Press the **mkr trk options**.
4. Press the **cycles ON|OFF** softkey so that **ON** is underlined.

---

### **Changing Marker Readouts**

Selections from the **readout options** softkey allow you to change the units used for marker amplitude and phase. Marker readouts can also be defined as either scalar or vector (includes phase information).

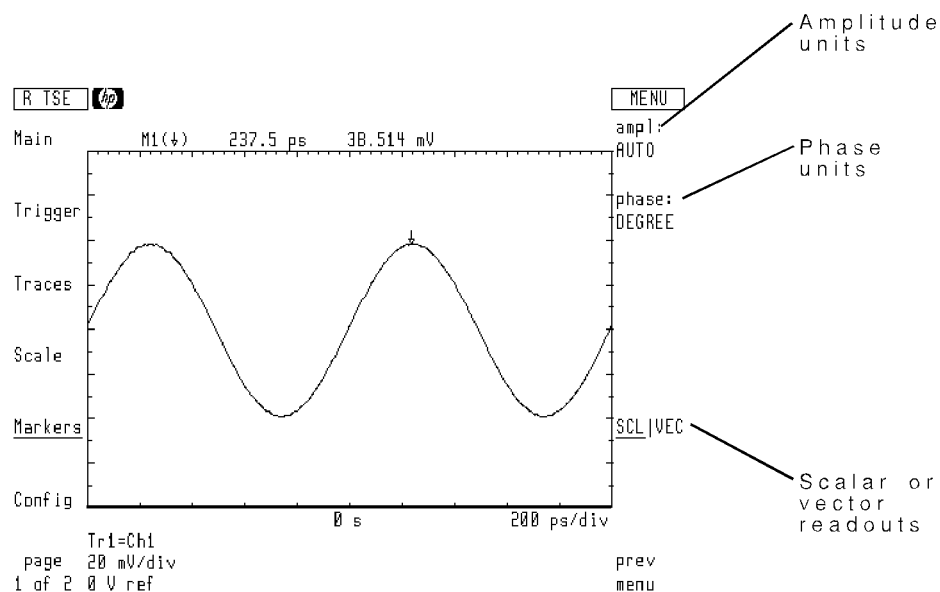

Using the **ampl:** softkey, select the units or **AUTO** readouts. Auto readout enables the microwave transition analyzer to automatically select the proper units based on the displayed amplitude scale.

Using the **phase:** softkey, select readouts in either degrees or radians.

The **SCL|VEC** softkey allows you to choose between displaying only scalar data corresponding to the trace format (amplitude or phase) or both amplitude and phase (vector or complex amplitude) values.

The following figure shows a vector network measurement of the transmission through a low-pass filter. Scalar, **SCL**, markers have been selected.

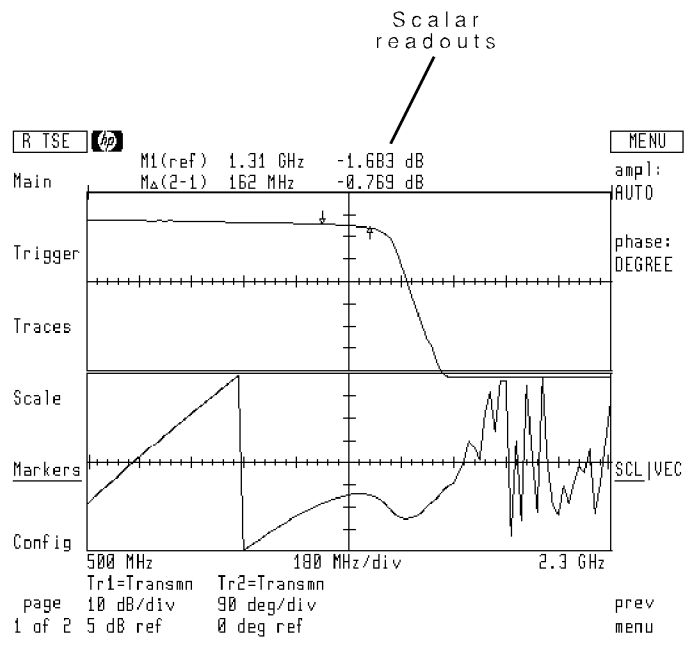

With vector, **VEC**, markers selected, the phase measurements are added to the readouts. Notice that the phase units are in degrees. This could easily be changed to radians using the **phase:** softkey.

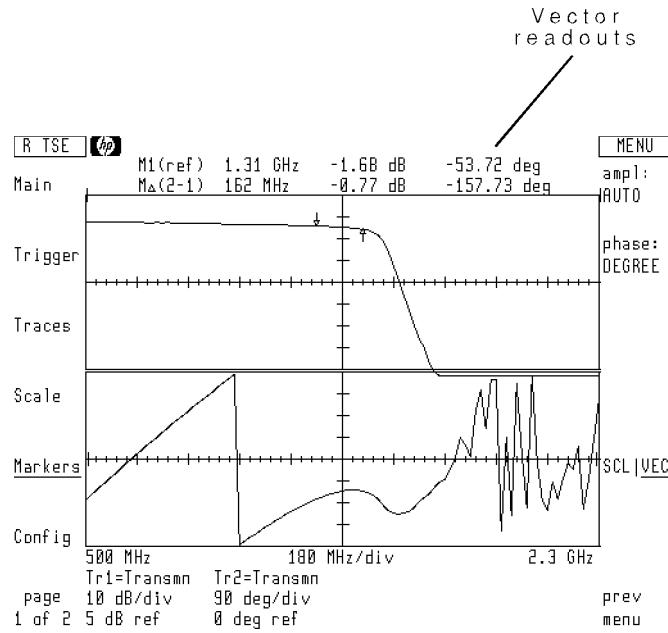

### To select marker amplitude units

1. Press the **Markers** softkey to enter the Markers menu.
2. Press the **more 1 of 2** softkey.
3. Press the **readout options** softkey.
4. Press the **ampl** softkey.
  - Press the **LINEAR** softkey for marker readout values in volts.
  - Press the **LOG** softkey for marker readout values in decibels.
  - Press the **AUTO** softkey to let the microwave transition analyzer automatically select either linear or log amplitude units.

### To select phase readout units

1. Press the **Markers** softkey to enter the Markers menu.
2. Press the **more 1 of 2** softkey.
3. Press the **readout options** softkey.
4. Press the **phase** softkey.

The current phase readout units are displayed in the softkey label.

  - Press the **RADIAN** softkey for marker readout values in radians.
  - Press the **DEGREE** softkey for marker readout values in degrees.

### To select scalar or vector readout

1. Press the **Markers** softkey to enter the Markers menu.
2. Press the **more 1 of 2** softkey.
3. Press the **readout options** softkey.
  - To view marker magnitudes only, press the **SCL|VEC** softkey so that **SCL** is underlined.
  - To view both magnitude and phase, press the **SCL|VEC** softkey so that **VEC** is underlined.





## Using the Harmonic Table

---

The microwave transition analyzer's harmonic table automatically lists input signals and their harmonics. The table allows you to quantify the relationship between a fundamental and its harmonics. Because the table can be assigned to a trace, the effects of reducing a signal's harmonic content can be viewed.

Using the harmonic table requires three basic steps:

1. selecting the table source
2. selecting signals to list
3. viewing table data

Selecting the Table Source .....	10-4
To display the table .....	10-6
Updating the Table Data .....	10-7
To use single updating .....	10-7
To average table data .....	10-7
Selecting Signals to List .....	10-8
To automatically add signals to list .....	10-10
To add signals to list manually .....	10-10
To display all listed signals .....	10-12
Editing the Table .....	10-14
To change number of harmonics shown .....	10-14
To prevent display of harmonics .....	10-14
To show only magnitude or phase .....	10-15
Making Relative Measurements .....	10-16
To make relative measurements .....	10-18
To make delta measurements .....	10-18
Viewing a Trace of Table Data .....	10-19
To view a trace of table data .....	10-21

---

## Selecting the Table Source

Use the Table menu to display and control the harmonic table. Press the **input:** softkey to display the table and select the table's input from channel 1, channel 2, or a ratio of the two channels. The table is placed in the lower half of the screen. The screen's upper half remains dedicated to showing the normal display. The normal display area can be controlled as usual and does not need to be related to the table.

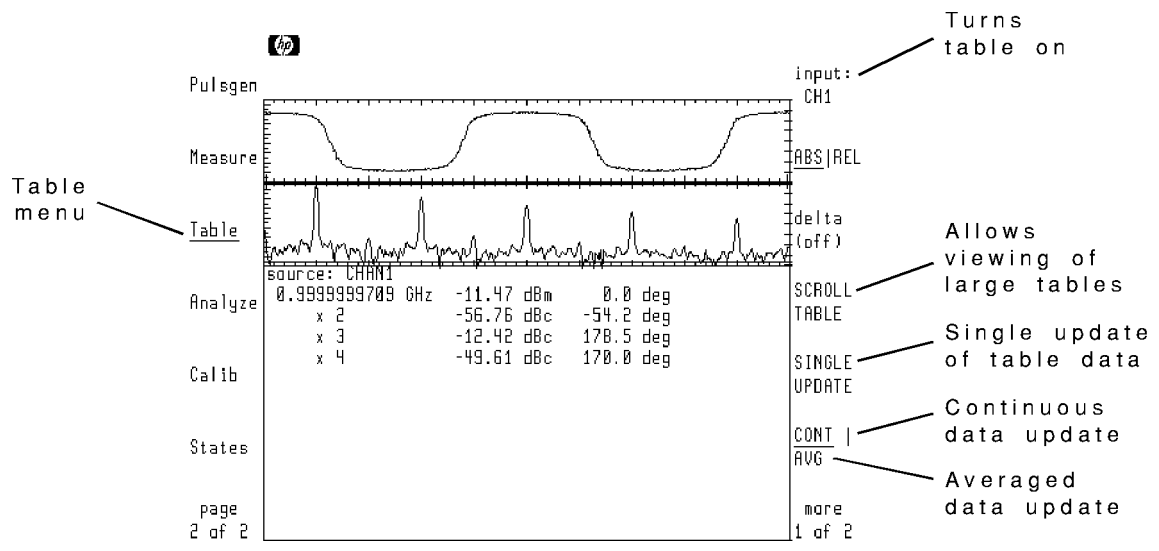

Page 1 of Table Menu

The source frequency entered in the microwave transition analyzer's Main menu is the default signal listed in the table. Additional signal frequencies can be listed as explained later in this chapter. Sometimes, the table contains more entries than can fit in the display area. Use the **SCROLL TABLE** softkey to scroll the table data so that any hidden data can be viewed.

Drifting signals can be tracked automatically using signal tracking. With signal tracking turned on, the microwave transition analyzer continuously reacquires the input signal for the table. Normally, signal tracking is turned off.

Use the **filter ON|OFF** softkey to filter input signals. The microwave transition analyzer filters the signal using an internal 100 kHz filter.

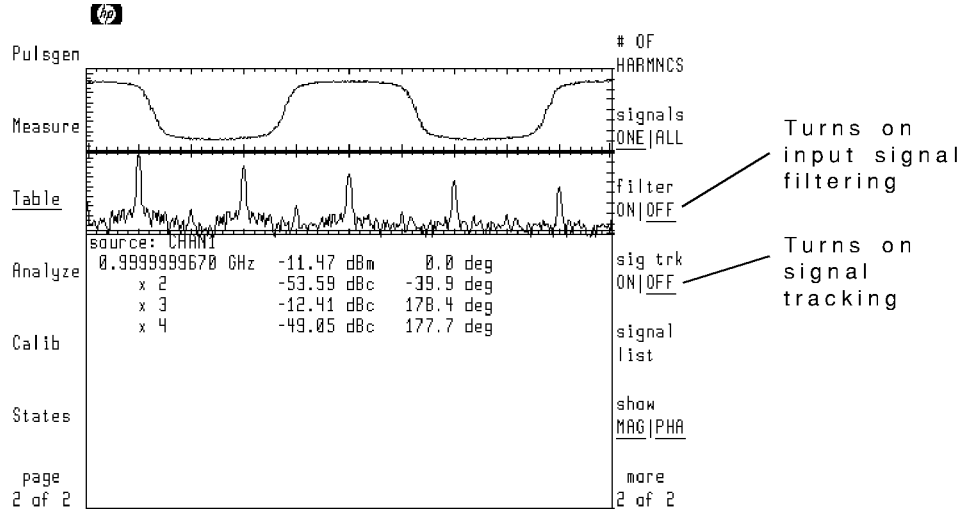

**Page 2 of Table Menu**

## To display the table

1. Press the left-side **Table** softkey to enter the Table menu.
2. Press the **input:** softkey.
3. Select the signal source for the table.

---

## Updating the Table Data

Normally, the microwave transition analyzer updates the table's data with each sweep. This is the continuous update mode. However, you can choose to update the table only when the **SINGLE UPDATE** softkey is pressed. Averaged data is also available. With table averaging, a set number of traces are averaged for each update of the table's data. The default number is 16 traces averaged.

### To use single updating

1. Display a table.
2. Press the Table menu's **SINGLE UPDATE** softkey so that it is underlined.

Press this softkey whenever new table data is desired.

### To average table data

1. Display a table.
2. Press the Table menu's **CONT | AVG** softkey so that **AVG** is highlighted.
3. Enter the number of trace sweeps to average for table input.

---

## Selecting Signals to List

The harmonic table has a signal list associated with it. The signal list records each signal that can be shown in the table. You can edit the signal list to add, delete, and change signals for the table. Using the signal list allows you to do the following:

- Automatically find the five largest input signals.
- Control a configured RF source's frequency from the table menu.
- Place multiple signals in the table.

The following figure shows the signal list and its menu. (The trace has been turned off to make viewing the list easier.)

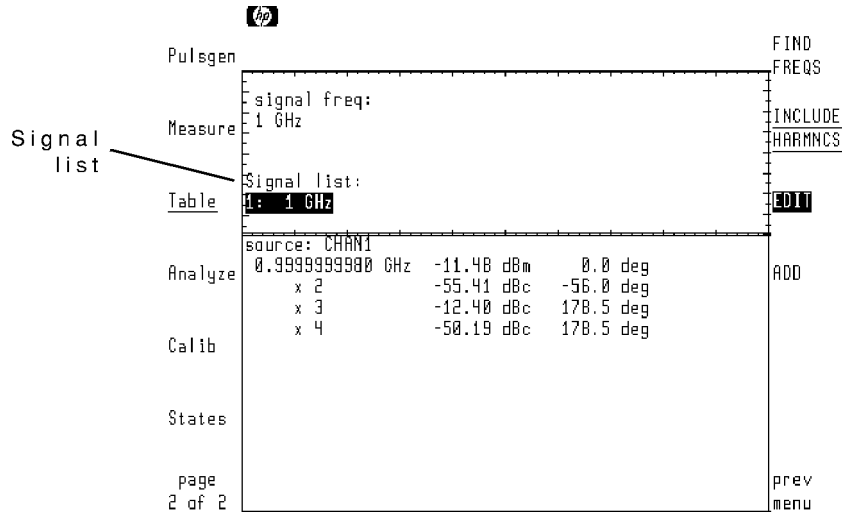

**Removing the signal list** To remove the signal list from the display at any time by pressing the Table menu's **input**: softkey and selecting **OFF**.

To view the signal list, press the **signal list** softkey located on page 2 of the Table menu. The signal list always contains at least one signal: the signal selected in the microwave transition analyzer's Main menu. If the RF source is controlled by the microwave transition analyzer, the RF source's frequency is automatically set to the selected signal list entry.

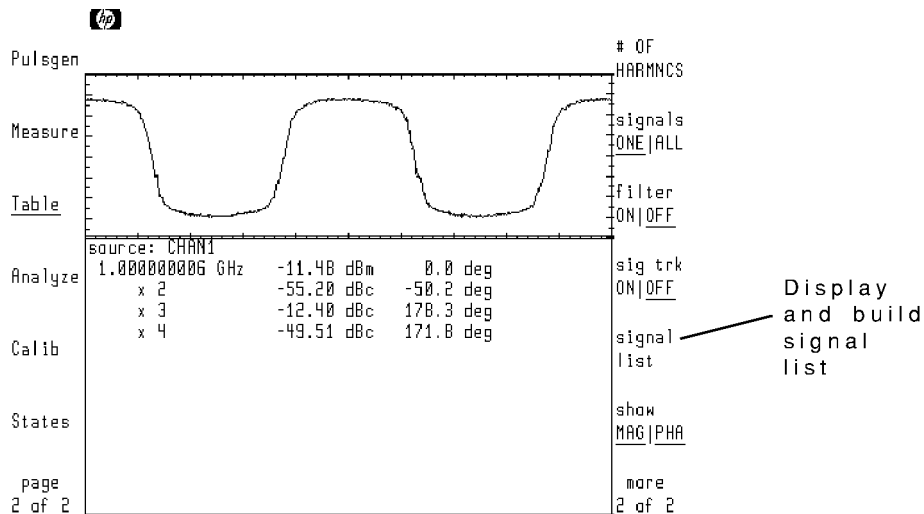

## To automatically add signals to list

When the **FIND FREQS** softkey is pressed, the microwave transition analyzer automatically locates the five largest signals. These signal and their harmonics are then added to the signal list. You can then view any or all of the signals in the harmonic table.

1. Turn on the harmonic table, and enter page 2 of the Table menu.
2. Press the **signal list** softkey.
3. Press the **FIND FREQS** softkey.

## To add signals to list manually

Up to five signals can be placed in the signal list. When the **ADD** softkey is pressed, a default frequency is added to the list. (If the RF source is controlled by the microwave transition analyzer, it will also be set to this frequency.) Use the front-panel knob to change the default frequency to the desired frequency.

The following figure shows a signal added to the signal list. Notice that the added signal is automatically highlighted and selected for editing. Also, two new softkeys appear for editing.

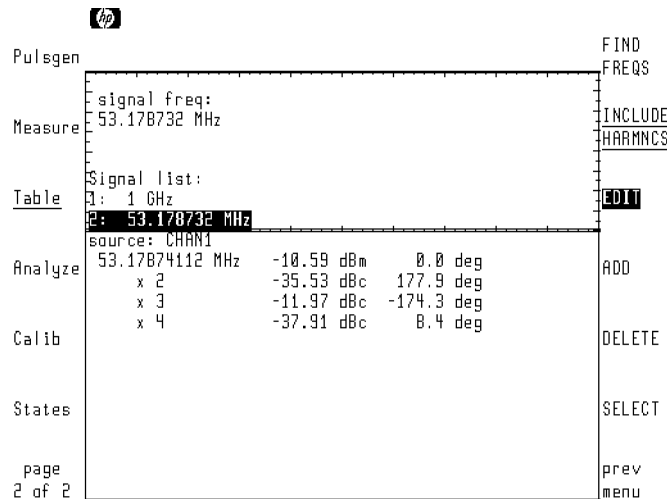

The harmonic table shows the selected signal and its harmonics. Repeatedly pressing the **SELECT** softkey moves the menu bar to the different signal list entries.

1. Turn on the harmonic table, and enter page 2 of the Table menu.
2. Press the **signal list** softkey.
3. Press the **ADD** softkey.

A new entry at a default frequency is added to the list.

4. Use the front-panel knob to change the new entry to the desired frequency.

## To display all listed signals

Normally, only the selected signal-list entry is shown in the harmonic table. However, you can include all the entries in the table by using the `signals ONE|ALL` softkey. See the following figure. Because this figure was taken in a system where the RF source was controlled by the microwave transition analyzer, only the selected 1 GHz signal shows any amplitude. The source is tuned to 1 GHz. (The 3.75 GHz and 4.89 GHz signals are only measuring noise.) However, the signal-list menu could be used to set the RF source to 3.75 GHz or 4.89 GHz. Or, if the device-under-test were a mixer, additional output signals could be measured.

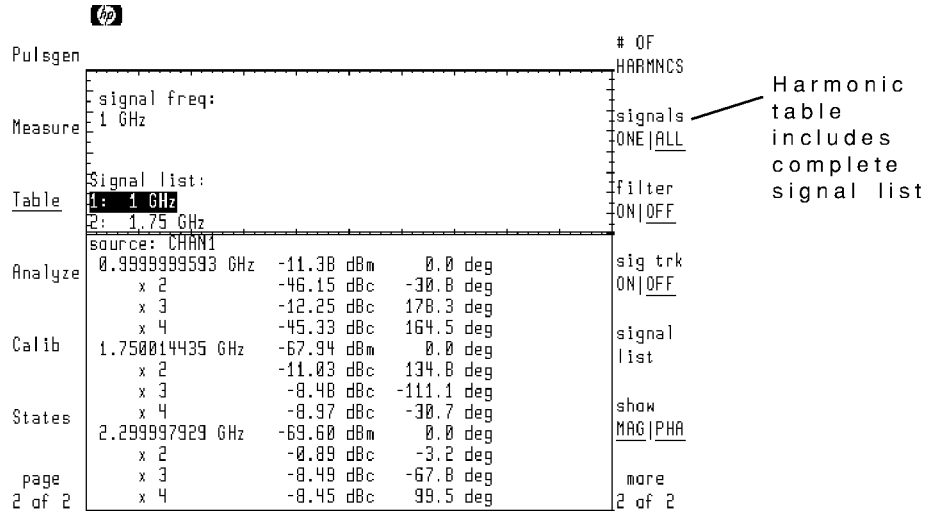



1. Turn on the harmonic table, and enter page 2 of the Table menu.
2. Press the `signals ONE|ALL` softkey so that `ALL` is underlined.

---

## Editing the Table

The harmonic table normally lists four harmonics for each signal. However, you can change the table to list as many as sixteen harmonics. You can also prevent the display of magnitude or phase in the table.

### To change number of harmonics shown

1. Enter page 2 of the Table menu.
2. Press the `# OF HARMNCS` softkey.
3. Enter the number of harmonics to include in the table.

### To prevent display of harmonics

1. Enter page 2 of the Table menu.
2. Press the `signal list` softkey.
3. Press the `INCLUDE HARMNCS` softkey so that the softkey text is not underlined.

## To show only magnitude or phase

1. Enter page 2 of the Table menu.
2. To include only magnitude values in the table, press the **show MAG|PHA** softkey so that only **MAG** is underlined.
3. To include only phase values in the table, press the **show MAG|PHA** softkey so that only **PHA** is underlined.
4. To blank the table data, press the **show MAG|PHA** softkey so that neither **MAG** or **PHA** is underlined.

---

## Making Relative Measurements

When first turned on, the harmonic table lists the absolute magnitude and phase values of each signal and harmonic. Relative table values are shown using the **ABS|REL** softkey. A displayed highlighted bar indicates which table entry is the reference. All others entries are measured relative to the reference. Use the front-panel knob to move the reference. The following figure shows the third harmonic used as the reference.

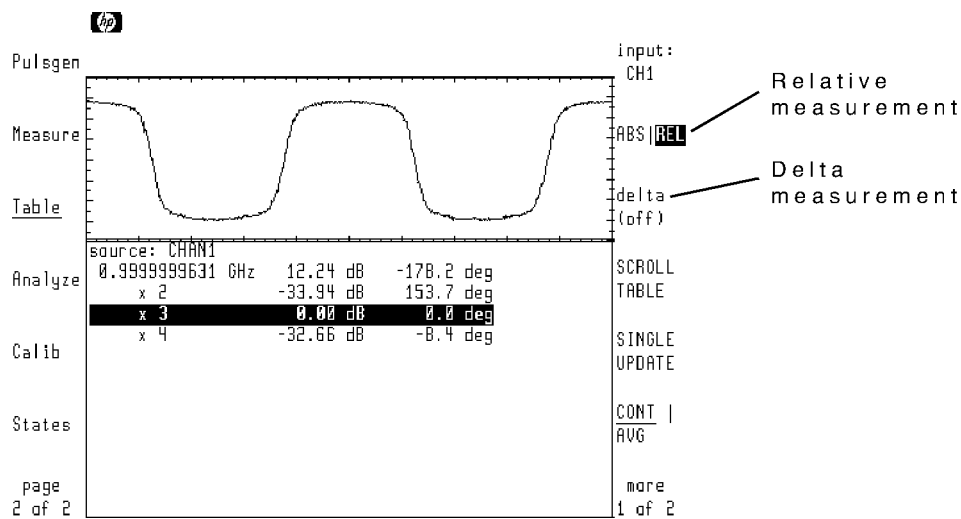

The harmonic table provides a **delta** feature for measuring signal changes with time. After the reference values for magnitude and phase are set, all subsequent table updates show the deviation from the reference values.

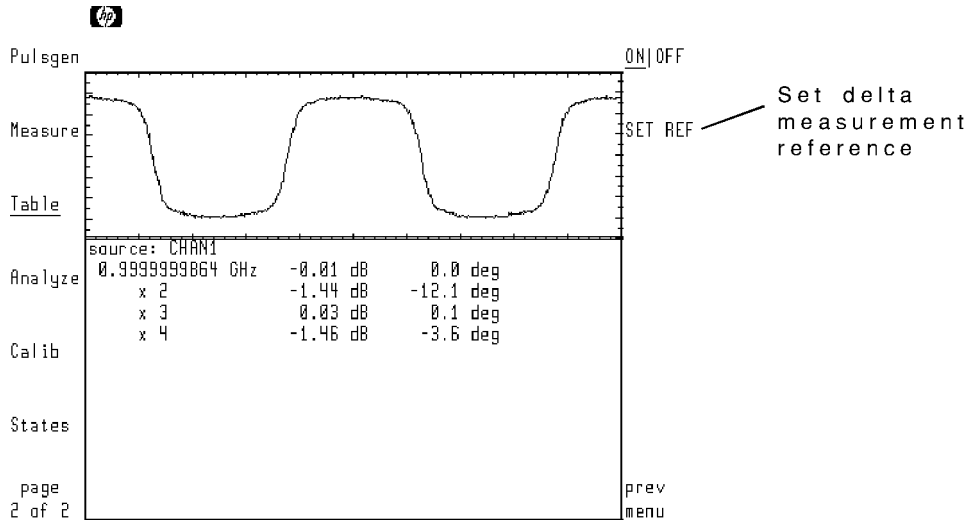

## To make relative measurements

1. Enter page 1 of the Table menu.
2. Press the **ABS|REL** softkey so that **REL** is highlighted.
3. Use the front-panel knob to scroll the displayed bar to the reference signal.

## To make delta measurements

1. Enter page 1 of the Table menu.
2. Press the **delta** softkey.
3. Press the **SET REF** softkey.

To turn off the delta measurement, press the **ON|OFF** softkey so that **OFF** is underlined.

---

## Viewing a Trace of Table Data

Using the Traces menu, you can assign the harmonic table as the input to a trace. The displayed trace is constructed using only the data listed in the table. The following figure shows the table data displayed as a trace. Trace 1 shows the harmonic-rich input directly from channel 1. Trace 2 shows the table with only the fundamental signal from channel 1 listed. Notice that the trace is a sine wave because the harmonic content has been removed.

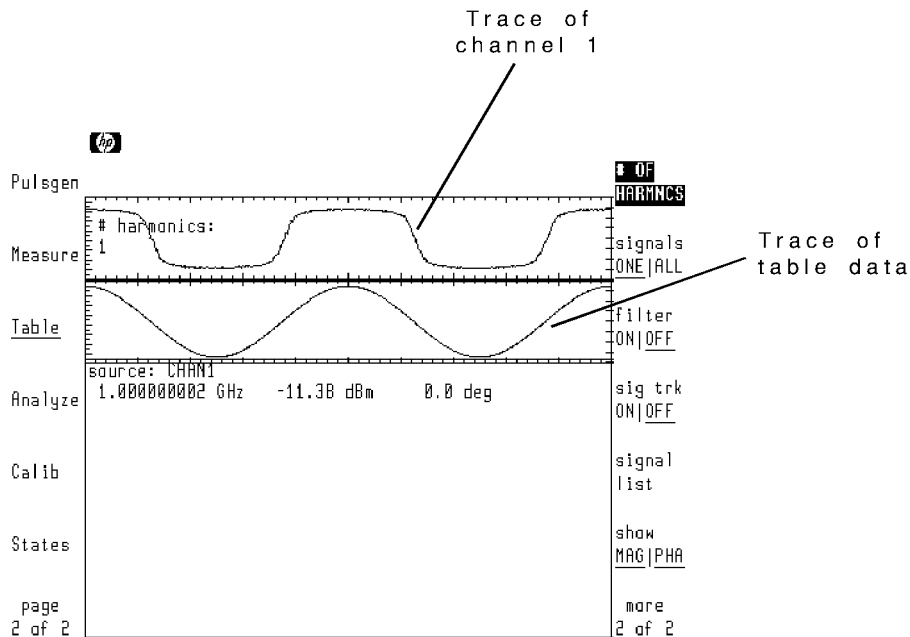

As harmonics are added to the table, the displayed table trace more closely resembles the input at channel 1.

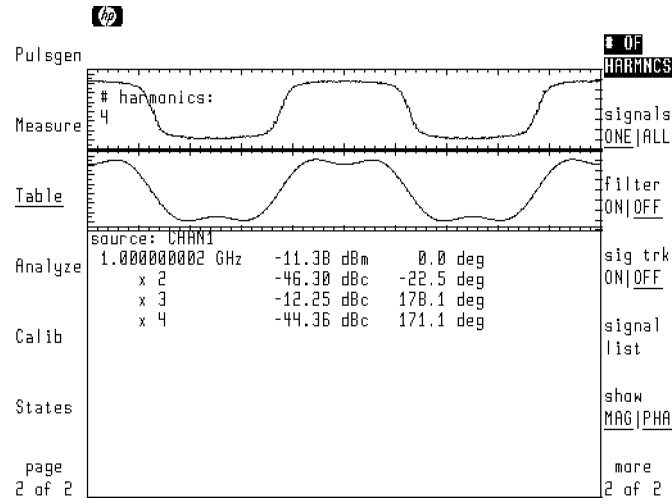

---

**Phase relationships** Comparing a harmonic-table trace with other traces, the phase relationship between the traces may be off by 90 degrees. To correct this discrepancy, select phase triggering for the microwave transition analyzer.

---

## To view a trace of table data

1. Press the left-side **Table** softkey to enter the Table menu.
2. Press the **input:** softkey.
3. Select the signal source for the table.
4. Press the left-side **page 2 of 2** softkey.
5. Press the **Traces** softkey to enter the Traces menu.
6. Select a trace, and then press the **input:** softkey.
7. Use the front-panel knob to scroll the highlight bar to the **TABLE** entry.

Table selected

R TSE	Ap	MENU
Main	TR1 = CH1	CH1
Trigger	1 = CH1 2 = CH2 3,4 = CH1/CH2	CH2
<u>Traces</u>	CH2/CH1 CH1/MEM1 CH2/MEM2	CH1/CH2
Scale	<b>TABLE</b> UCORR1 UCORR2 (CH1/CH2)/MEM1 -(CH1/CH2)/MEM3	CH2/CH1
Markers	2*MAGN(CH1/CH2)/(MAGN(MEM2)+MAGN(MEM3)) 2*MAGN(CH2)/(MAGN(MEM2)+MAGN(MEM3))	MEMx
Config		build eqn
page 1 of 2		RETURN

8. Press the **RETURN** softkey.

## Viewing Trace Histograms

---

The microwave transition analyzer can perform statistical analysis on any displayed trace. After creating a vertical or horizontal histogram of the trace data, the display shows mean and standard deviation values.

Generating Histograms ..... 11-4  
 Tutorial: Creating a Vertical Histogram ..... 11-6  
 Tutorial: Creating a Horizontal Histogram ..... 11-11

## Generating Histograms

Automatic histogram analysis is performed using the Histogram menu. (Press the left-side **Analyze** softkey and then **Histogram** to enter the menu.) The microwave transition analyzer performs vertical or horizontal histograms on any single trace.

You can control the number of samples taken, the window for valid data samples, and the sample bounds for calculating mean and standard deviations.

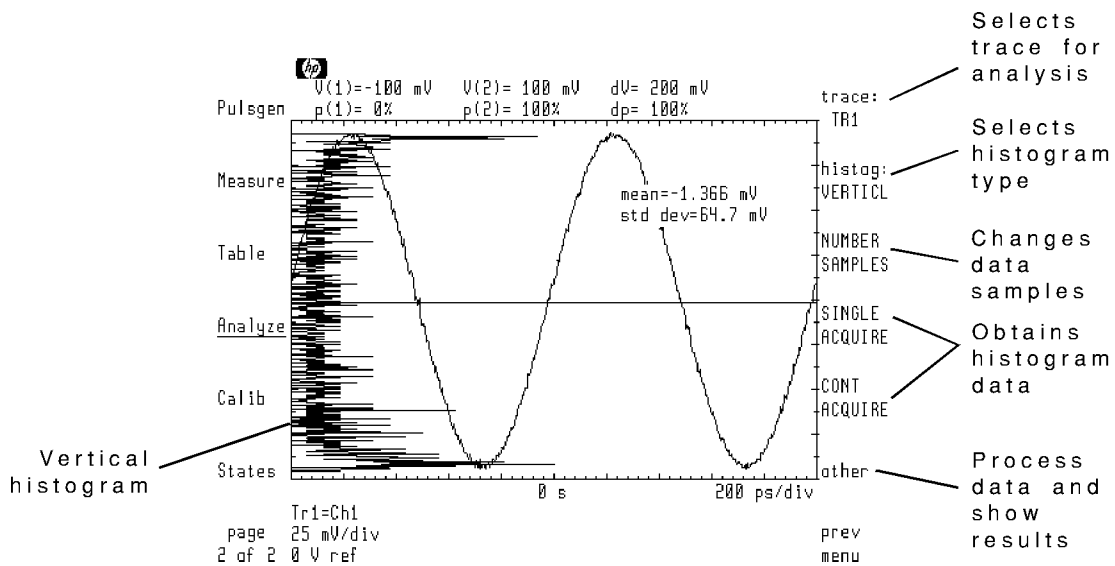

Page 1 of Histogram menu



When generating histograms, you must perform the following basic steps:

1. Select a trace.
2. Select histogram type.
3. Enter the number of samples.
4. Set limits for acquired data.
5. Acquire the data.
6. Establish limits for statistical analysis.
7. View the mean and standard deviation.

Histogram data can be acquired once using the **SINGLE ACQUIRE** softkey or continuously updated using the **CONT ACQUIRE** softkey.

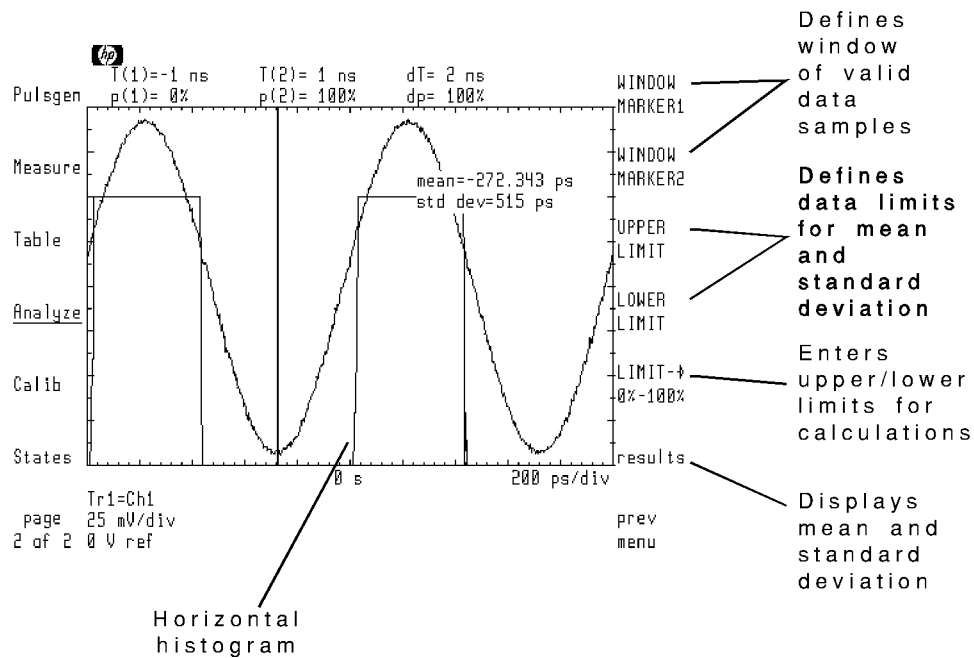

Page 2 of Histogram menu

## Tutorial: Creating a Vertical Histogram

This tutorial creates a vertical histogram on data taken from sine wave. However, the procedure works for any type of waveform.

### Step 1. Select the histogram type

1. Display a trace to perform statistical analysis on.
2. Press the left-side **page 1 of 2** and then **Analyze** softkeys.
3. Press **histogm** to enter the Histogram menu.
4. Press the **trace:** softkey, and select the trace to perform statistical analysis on.
5. Press the **histog:** softkey.

- Press the **VERTICAL HISTOGRAM** softkey so that the softkey text is underlined.

## Step 2. Acquire the data

- Press **other**.
- Use the **WINDOW MARKER1** and **WINDOW MARKER2** softkeys to define a window for taking histogram data.

Notice that the values at the marker positions are indicated at the top of the display.

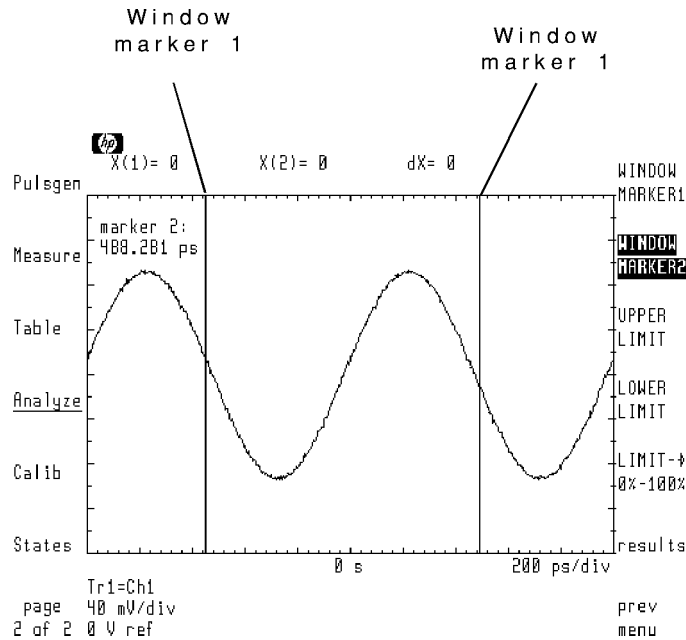

- Press **prev menu** and then **NUMBER SAMPLES** softkeys. If desired, change the number of samples taken for the histogram.

The default number of samples taken is 1000.

- Press the **SINGLE ACQUIRE** softkey to draw the vertical histogram.

Data will be acquired once. To continually acquire and update the histogram, press **CONT ACQUIRE** instead.

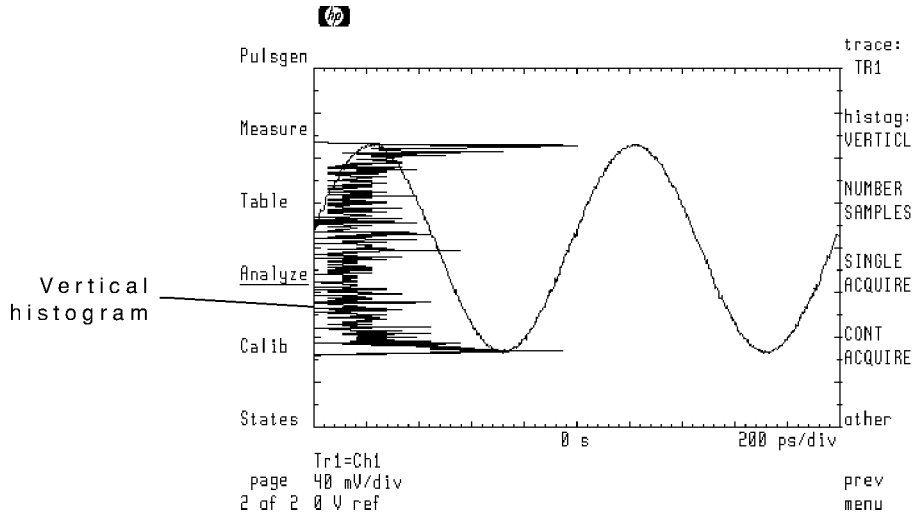

### Step 3. Perform statistical analysis

1. Press **other**.
2. The range of sample points used to calculate the mean and standard deviation is the full screen. If you desire to change these limits, perform the following:
  - a. Use the **UPPER LIMIT** and **LOWER LIMIT** softkeys to enter the new limits.

Notice that the values at the limit-line positions are indicated at the top of the display.

- b. Press the **LIMIT → 0%-100%** softkey to enter the new upper limit and lower limit values for the calculations.

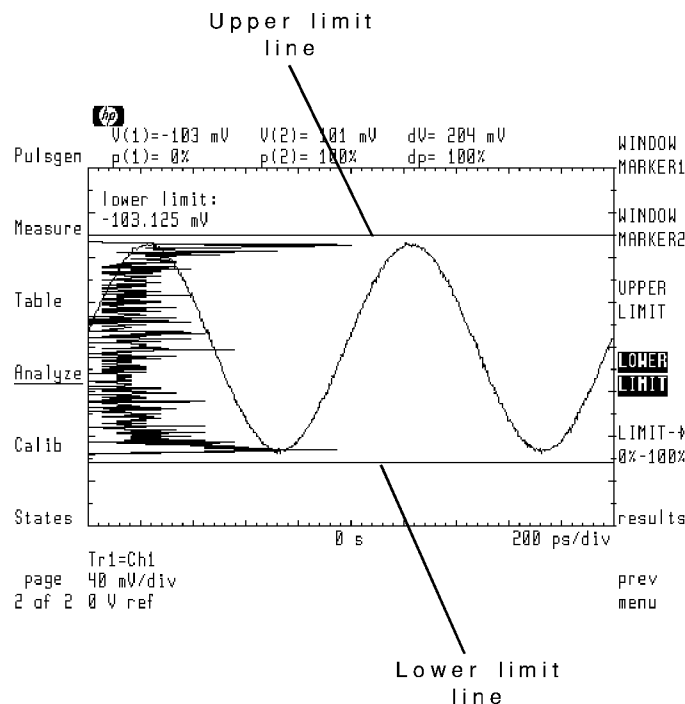

3. Press the **results** softkey.
4. Press the **MEAN** softkey to display a line indicating the location of the mean. The mean and standard deviation values are also indicated.
5. Press the **STD DEV** softkey to display a line indicating the location of the standard deviation.

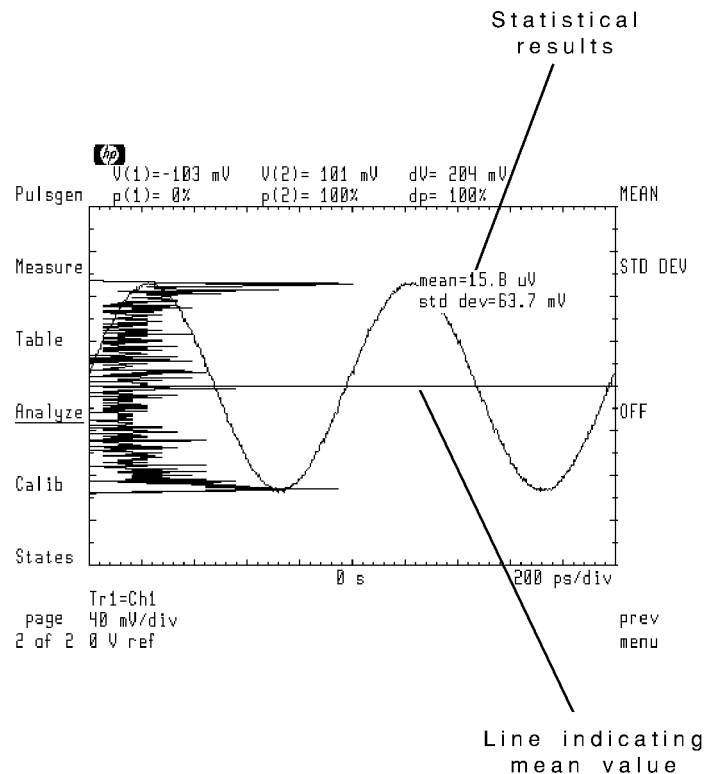

---

## Tutorial: Creating a Horizontal Histogram

This tutorial creates a horizontal histogram on data taken from sine wave. However, the procedure works for any type of waveform.

### Step 1. Select the histogram type

1. Display a trace to perform statistical analysis on.
2. Press the left-side **page 1 of 2** and then **Analyze** softkeys.
3. Press **histogm** to enter the Histogram menu.
4. Press the **trace:** softkey, and select the trace to perform statistical analysis on.
5. Press the **histog:** softkey.
6. Press the **HORZNTL HISTOGM** softkey so that the softkey text is underlined.

## Step 2. Acquire the data

1. Press **other**.
2. Use the **WINDOW MARKER1** and **WINDOW MARKER2** softkeys to define a window for taking histogram data.

Notice that the values at the marker positions are indicated at the top of the display.

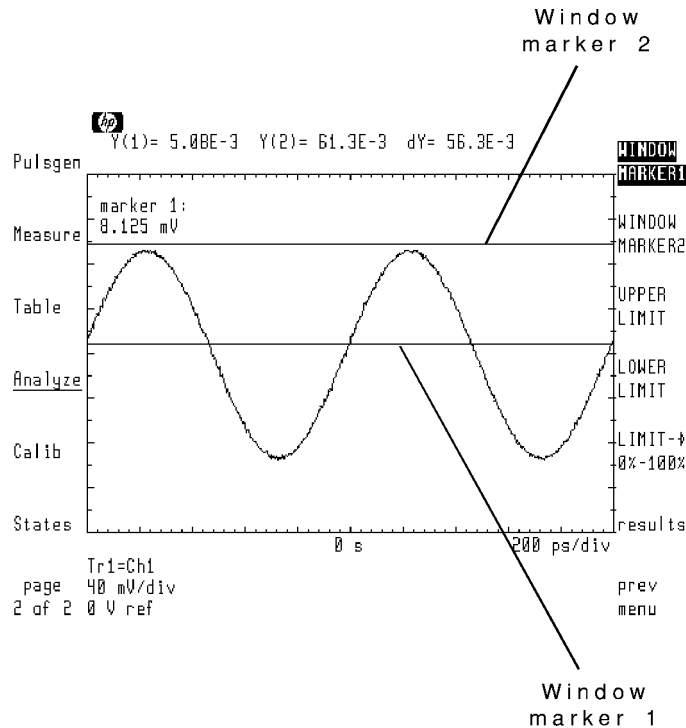

3. Press the **prev menu** and then **NUMBER SAMPLES** softkeys. If desired, change the number of samples taken for the histogram.

The default number of samples taken is 1000.

4. Press the **SINGLE ACQUIRE** softkey to draw the vertical histogram.

Data will be acquired once. To continuously acquire and update the histogram, press **CONT ACQUIRE** instead.

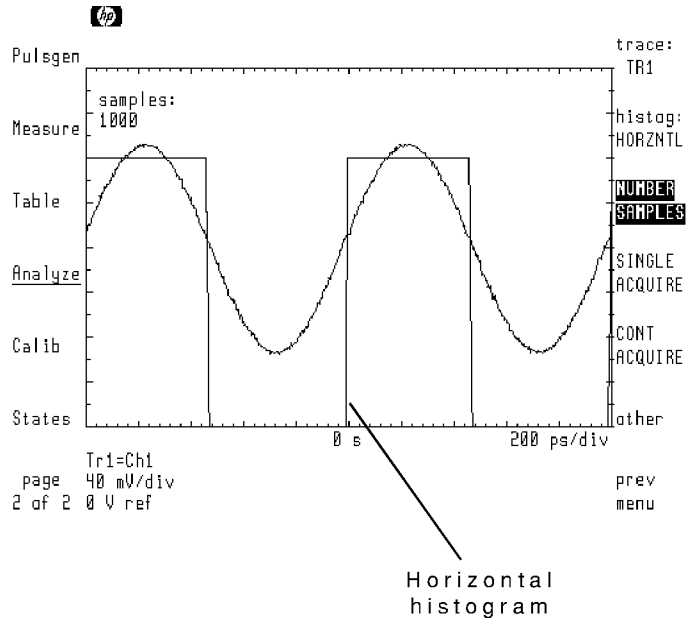

### Step 3. Perform statistical analysis

1. Press **other**.
2. Use the **UPPER LIMIT** and **LOWER LIMIT** softkeys to indicate the range of sample points used to calculate the mean and standard deviation.

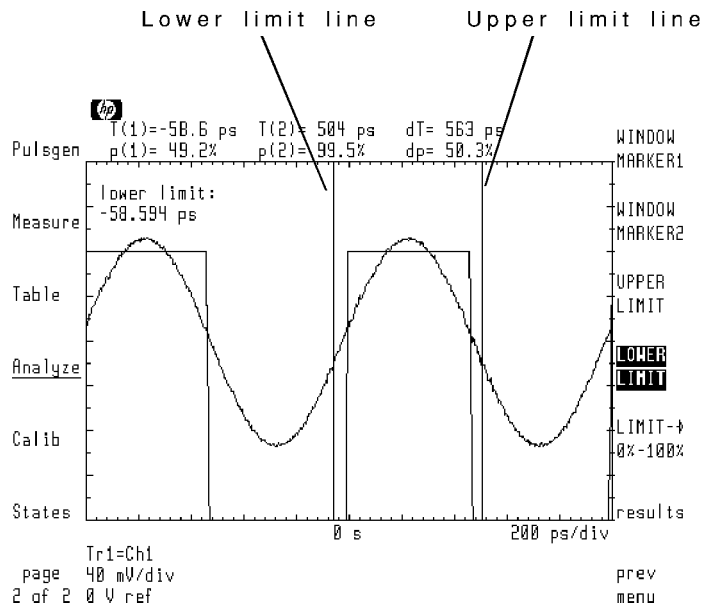

3. Press the **LIMIT→ 0%-100%** softkey to enter the upper limit and lower limit values for the calculations.
4. Press the **results** softkey.

5. Press the **MEAN** softkey to display a line indicating the location of the mean. The mean and standard deviation values are also indicated.
6. Press the **STD DEV** softkey to display a line indicating the location of the standard deviation.

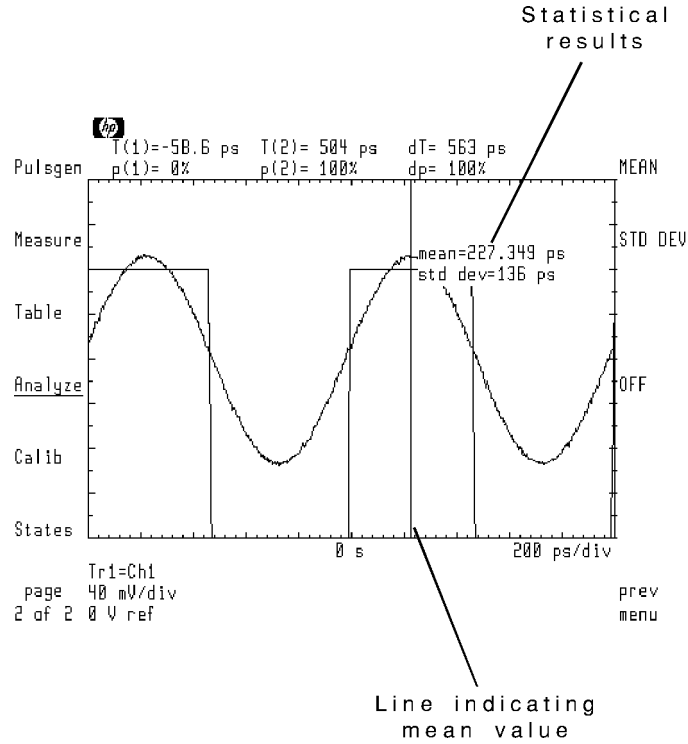





## Creating Masks and Limit Lines

Masks and limit lines allow you to test the shape (wavelength and amplitude) of a displayed response. Masks are closed polygon shapes. Limit lines are lines. Traces or measurement points that penetrate a mask or cross a limit line result in testing errors.

Because you can perform repetitive testing of response shapes, masks and limit lines are ideal for pass/fail testing on production lines. You create, save, recall, and edit limit lines using the **masks, limits** menu. Access this menu using the left-side **Analyze** softkey.

Since masks and limit lines are treated similarly, in this chapter, most references to masks applies equally to limit lines.

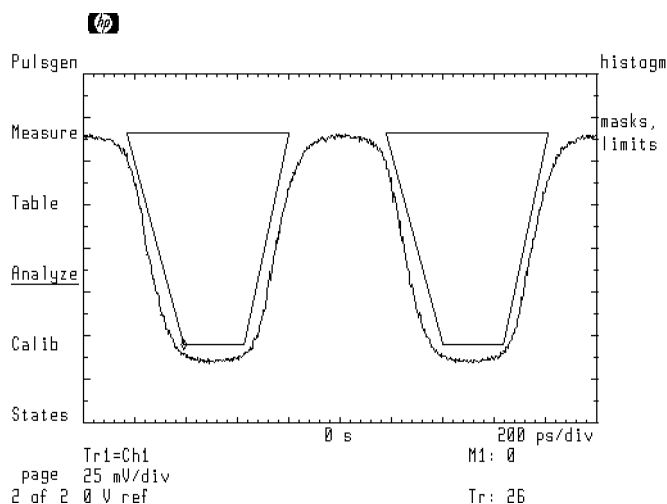

**Two masks displayed on screen.**

Creating Masks .....	12-4
To create a mask .....	12-5
To erase a mask .....	12-6
Testing Responses .....	12-7
To start testing .....	12-8
Saving, Recalling, and Cataloging Masks .....	12-9
To save a mask .....	12-10
To recall a mask .....	12-11
To catalog files in memory .....	12-11
To erase a mask file .....	12-12

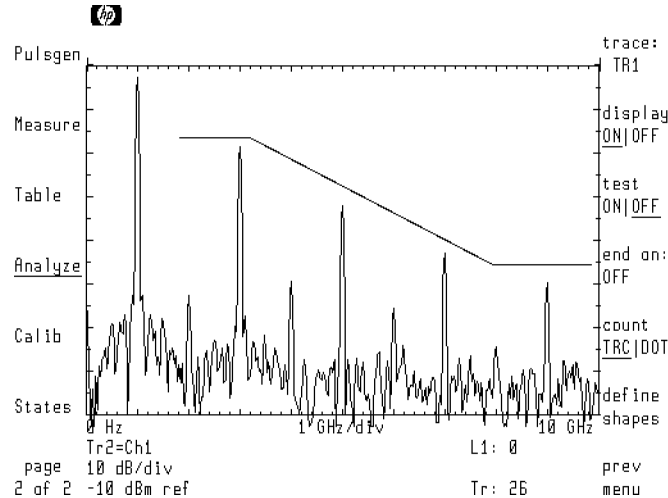

**A limit line displayed on screen.**

## Creating Masks

The microwave transition analyzer allows you to create and display up to eight limit lines and masks at one time. Five default mask shapes are provided for your use:

1. hexagon
2. square
3. equilateral triangle
4. inverted equilateral triangle
5. flat line

You can stretch, shrink, or move any mask. Its also easy to add additional points or delete unneeded points from any shape. Both limit lines and masks can establish either upper or lower limits for a response. Most menus contain a **SELECT** softkey for selecting which mask to apply the editing functions.

## To create a mask

1. Press the left-side **Analyze** softkey.
2. Press **masks, limits** and then **define shapes**.
3. Press **default shapes** and select the shape that most closely matches the mask you need.
4. Press **edit**.
5. To move a point perform the following steps:
  - a. Press the **↑** and **↓** keys to select the point.
  - b. Press **move X|Y** to select the direction.
  - c. Rotate the front-panel knob to move the point. (Or, use the numeric keypad.)
6. To add a point perform the following steps:
  - a. Press the **↑** and **↓** keys to select a point.
  - b. Press **ADD POINT** to add a point at the location of the currently selected point.
  - c. Press **move X|Y** to select the direction for moving the new point.
  - d. Rotate the front-panel knob to move the point.
7. To delete a point perform the following steps:
  - a. Press the **↑** and **↓** keys to select the point.
  - b. Press **DELETE POINT**.
8. Press **prev menu**.
9. Use the **scale X|Y** and **offset X|Y** softkeys to stretch, reduce, or move the mask.
10. Press the **type:** softkey and select the type of testing imposed by the mask.

## To erase a mask

1. Press the left-side **Analyze** softkey.
2. Press **masks, limits** and then **define shapes**.
3. Press **edit**.
4. Press **SELECT**, and enter the number of the mask or limit line you need to erase.
5. Press **delete shapes**.
6. Press **DELETE CURRENT** to erase the mask.
7. You can erase all masks and limit lines by pressing **DELETE ALL**.

## Testing Responses

Once you've created a mask or limit line, set the following conditions for testing:

- Trace to which testing is applied.
- Violations defined as traces or measurement points.
- Testing ends after a set number of errors.
- Testing ends after a set number of traces.

Use the `test ON|OFF` softkey to start testing. Testing stops whenever one of the following events occurs:

- A set number of trace sweeps.
- A set number of violations.
- `test ON|OFF` is set to `OFF`.

Numbers displayed at the bottom of the screen indicate the number of mask violations and trace sweeps that have occurred. The following figure shows a response that has violated a limit line three times on three sweeps.

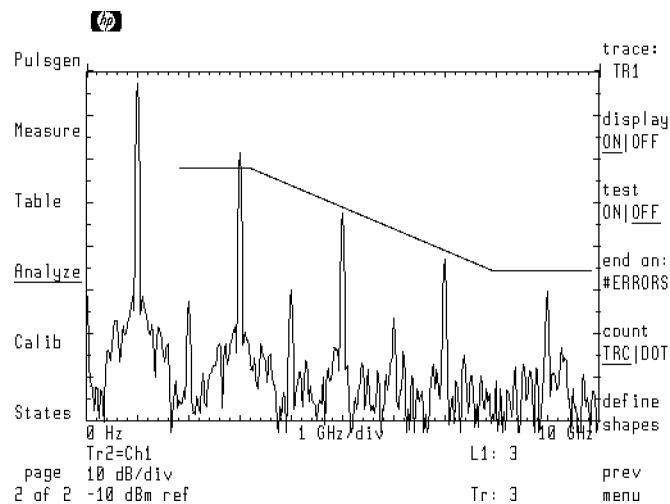

## To start testing

1. Create a mask.
2. Press the left-side **Analyze** softkey.
3. Press **masks, limits**.
4. Press **trace:**, and select the trace for testing.
5. Use the **count TRC|DOT** softkey to indicate whether traces (**TRC**) or measurement point (**DOT**) violations are counted as errors.
6. Press **end on:**.
7. If you want testing to stop after a set number of errors, press **#Errors ON|OFF** so that **ON** is underlined. Enter the desired number of errors.
8. If you want testing to stop after a set number of traces, press **#Traces ON|OFF** so that **ON** is underlined. Enter the desired number of traces.
9. Press **test ON|OFF** so that **ON** is underlined to begin testing.

---

## Saving, Recalling, and Cataloging Masks

Masks can be saved in files and recalled for later use. Use the States menu's **mass storage** feature to save, recall, and catalog mask files. Each file has a file name that consists of the prefix *m\_* followed by a custom name that you enter. The prefix identifies the file as a mask or limit line.

Although eight masks can be displayed at one time, only mask 1 is nonvolatile. All other masks are erased by turning the power off. Pressing (**INSTR PRESET**) does not erase the masks.

```
msi: HP-MSIB
PREV PAGE
NEXT PAGE
LOAD FILE
save
more
prev
menu

Pulsgen
Measure
Table
Analyze
Calib
States
page
2 of 2

Prefix:
MSI: HP-MSIB,4 Page 1
m_Shape_1 ASCII 2560
m_Shape_2 ASCII 2560
(end of catalog)
```

Catalog of files in memory.

## To save a mask

1. Create a mask.
2. Press the left-side **States** softkey.
3. Press **more 1 of 2**, and then **mass storage**.
4. If the mass-storage device needs to be selected, refer to chapter 15.
5. Press **save**, **save misc**, and then **SAV MSK LIM**.
6. Use the softkeys, knob, numeric keypad, and step keys to create a file name.
7. Press **ENTER LINE** to save the file.

---

## Entering a filename without a keyboard

- Press **SELECT CHAR** to enter a character at the character-select cursor.
  - Press the numeric keypad to enter numbers or a minus sign.
  - The **INSERT** or **. . .** softkey determines the action of the **SELECT CHAR** softkey. Choices are **INSERT** a character, **REPLACE** an existing character, or **DELETE** a character.
  - Press the **↓** and **↑** keys (beneath the front-panel knob) to move the command-entry cursor.
  - Use the **CLEAR TO END** softkey to remove characters from the command-entry cursor to the end of the command.
-

### **To recall a mask**

1. Press the left-side **States** softkey.
2. Press **more 1 of 2**, and then **mass storage**.
3. If the mass-storage device needs to be selected, refer to chapter 15.
4. Rotate the front-panel knob to select (highlight) the desired file.
5. Press **LOAD FILE**.

### **To catalog files in memory**

1. Press the left-side **States** softkey.
2. Press **more 1 of 2**, and then **mass storage**.
3. If the mass-storage device needs to be selected, refer to chapter 15.

### **To erase a mask file**

1. Press the left-side **States** softkey.
2. Press **more 1 of 2**, and then **mass storage**.
3. If the mass-storage device needs to be selected, refer to chapter 15.
4. Press **more**.
5. Rotate the front-panel knob to select (highlight) the desired file.
6. Press **PURGE FILE** to erase the file.



## Entering User-Correction Filters

---

User-correction filters provide a convenient method for filtering input signals. Some of the applications for user-correction filters include the following:

- Filtering input signals to simulate the effects of circuit design.
- Compensating for frequency and phase response of external probes.
- Compensating for frequency and phase response of external test setups.

Learning About User Corrections .....	13-4
To enter the user correction menu .....	13-7
To select a channel for user corrections .....	13-7
To turn user corrections on .....	13-7
To delete a channel's user corrections .....	13-8
Entering and Editing User Corrections .....	13-9
To enter a line of data .....	13-11
To edit a line of data .....	13-11
To delete a line of data .....	13-11
To select flat-line interpolation .....	13-12
To select logarithmic slope interpolation .....	13-12
To copy user correction to alternate channel .....	13-12
Viewing User-Correction Data .....	13-13
Setting the frequency scale for frequency sweeps .....	13-13
Setting the frequency scale for time sweeps .....	13-13
To view user corrections .....	13-14
Tutorial: Constructing a 1.5 GHz High-Pass Filter .....	13-17

---

## Learning About User Corrections

To apply user corrections, enter the User Correction menu. (This menu is reached from the Calibration menu as shown in the following figure.) The microwave transition analyzer maintains two separate user-correction memories: one for channel 1 and one for channel 2. The following figure shows a square wave whose fundamental has been removed using a user-correction filter. Refer to the tutorial at the end of this chapter for producing this figure.

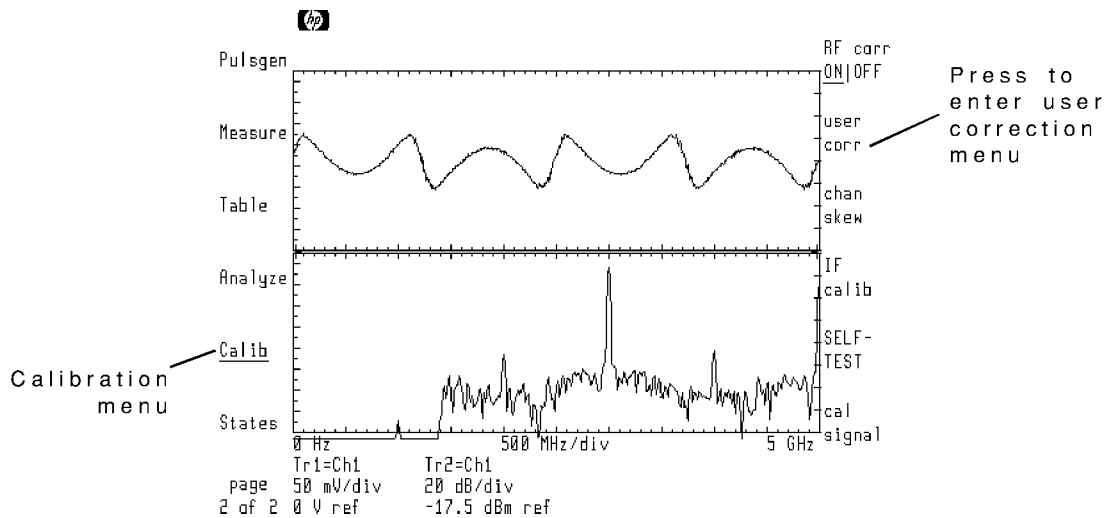

After entering the User Correction menu, the microwave transition analyzer displays user-correction data in the lower half of the screen. The screen's upper half remains dedicated to showing the normal display. The normal display area is controlled as usual. Displayed traces can even be assigned to show the user correction data.

The following figure shows the User Correction menu with a 2 GHz bandpass filter entered. The displayed trace has been assigned to the data providing a graphical representation of the filter. To learn how to assign a trace to user corrections, refer to "Viewing User-Correction Data" in this chapter.

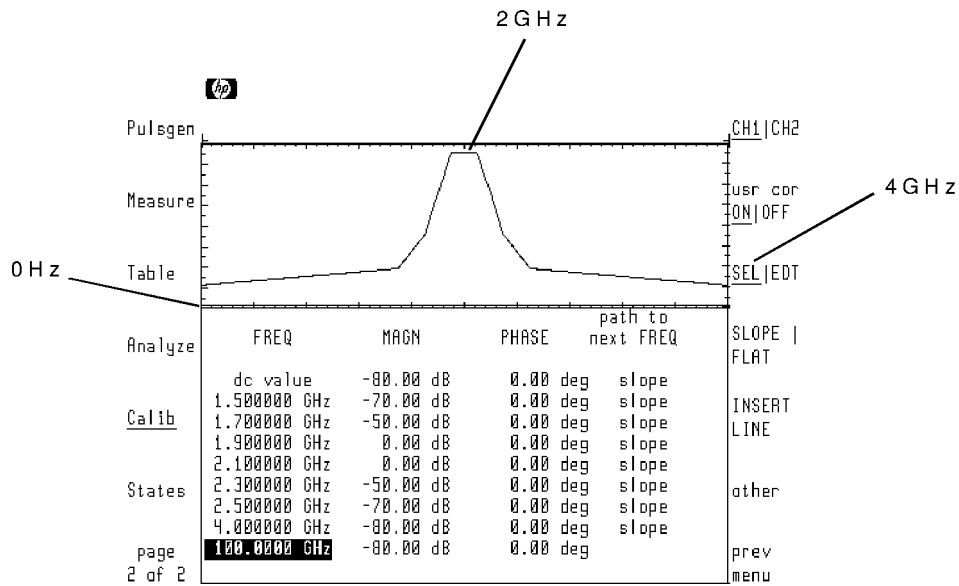

User Correction menu

User corrections always contain at least two default lines of data as shown below. While these two lines of data cannot be removed, you can modify their magnitude or phase values. New lines of data are easily added. Each line of data consists of FREQUENCY, MAGNITUDE, PHASE, and path to next FREQ fields. The path to next FREQ field determines how data is interpolated between two adjacent user correction frequency points. The path to the next user correction point can be a linear slope (this is the default), log slope, or flat line.

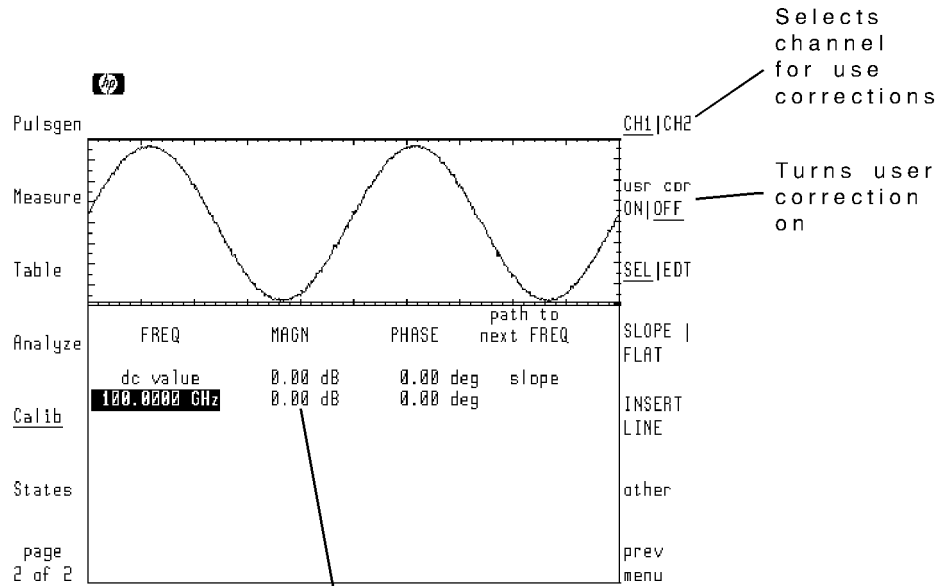

Default user correction data  
**Default data**

You enter user correction data using one of the following two methods:

- manually using front-panel keys *or*
- storing the results of a sweep to user correction memory

### **To enter the user correction menu**

1. Press the left-side **Calib** softkey to enter the Calibration menu.
2. Press the **user corr** softkey to enter the User Correction menu.

### **To select a channel for user corrections**

1. Enter the User Correction menu.
2. To select channel 1, press the **CH1|CH2** softkey to underline **CH1**.
3. To select channel 2, press the **CH1|CH2** softkey to underline **CH2**.

### **To turn user corrections on**

1. Enter the User Correction menu.
2. Press the **usr cor ON|OFF** softkey so that **ON** is underlined.

### **To delete a channel's user corrections**

1. Enter the User Correction menu.
2. Use the **CH1|CH2** softkey to select the channel.
3. Press the **other** softkey.
4. Press the **DELETE ALL** softkey.
5. Press the **CONFIRM DEL ALL** softkey to delete all corrections, or press the **ABORT DEL ALL** to abort the deletion process.

## Entering and Editing User Corrections

The User Correction menu provides softkeys for entering and editing lines of user-correction data. To view user-correction data graphically at the same time it is created, refer to “Viewing User-Correction Data” in this chapter.

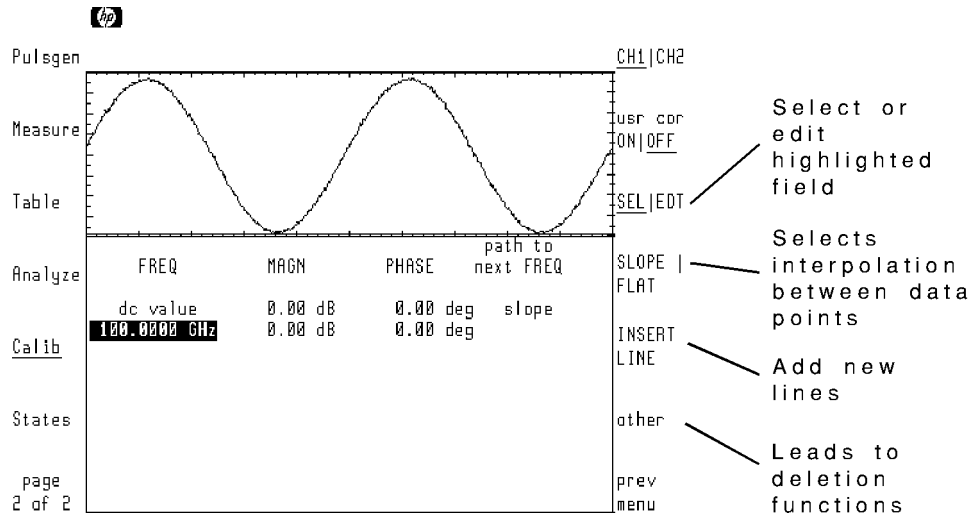

The **SEL|EDT** softkey determines whether the front-panel knob and arrow keys select a field for editing or change the current field’s data. New lines can be entered between the first and last lines.

The microwave transition analyzer interpolates the data between two adjacent lines. The choices of interpolation are slope and flat line. The **slope LOG|LIN** softkey (press **other** in the User Correction menu), determines whether slopes are linear or logarithmic. The following two figures show the effect of slope and flat interpolation. The trace graphically shows the filter. With the exception of the path to next FREQ, the data in each filter is identical.

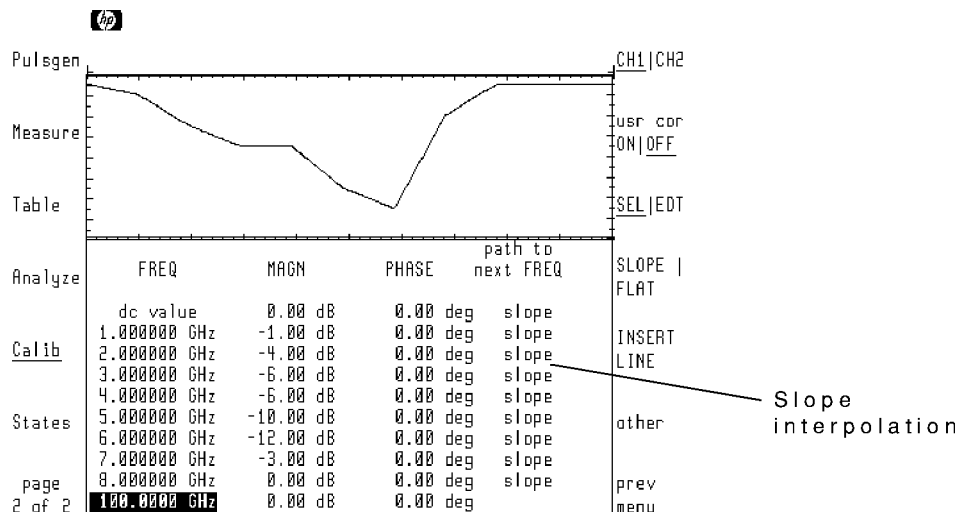

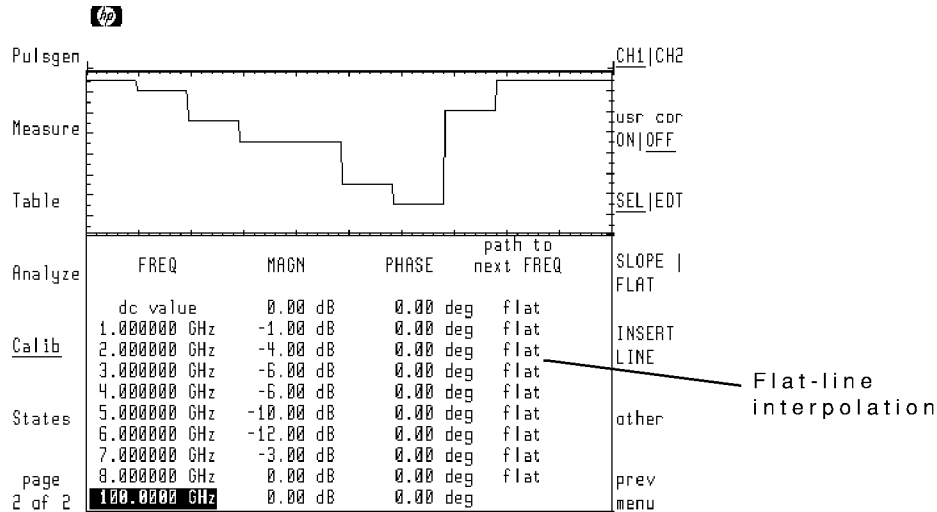

### To enter a line of data

1. In the User Corrections menu, press the **SEL|EDT** softkey so that **SEL** is underlined.
2. New lines are added just above the highlighted line. Use the front-panel knob or arrow keys to highlight any field of the line following the desired position for the new line.
3. Press the **INSERT LINE** softkey.

### To edit a line of data

1. In the User Corrections menu, use the front-panel knob or arrow keys to highlight a field in the line.
2. Press the **SEL|EDT** softkey so that **EDT** is underlined.
3. Use the front-panel knob, step keys, or numeric keypad to change the displayed value.

If you are editing the path to next FREQ field, press the **SLOPE | FLAT** softkey to change the value.

### To delete a line of data

1. In the User Corrections menu, press the **SEL|EDT** softkey so that **SEL** is underlined.
2. Use the front-panel knob or arrow keys to highlight any field in the line you wish to delete.
3. Press the **other** softkey.
4. Press the **DELETE LINE** softkey.

### To select flat-line interpolation

1. In the User Corrections menu, press the `SEL|EDT` softkey so that `SEL` is underlined.
2. Use the front-panel knob or arrow keys to highlight the desired path to next `FREQ` field.
3. Press the `SLOPE | FLAT` softkey so that `FLAT` is underlined.

### To select logarithmic slope interpolation

1. In the User Corrections menu, press the `other` softkey.
2. Press the `slope LOG|LIN` softkey so that `LOG` is underlined.

### To copy user correction to alternate channel

1. In the User Corrections menu, press the `other` softkey.
2. Press the `copy to CH2` softkey.

If channel 2 data is selected the softkey reads `copy to CH1`.

---

## Viewing User-Correction Data

This section explains how to assign user-correction data to a trace. This allows you to view the data graphically. Graphically displaying the data is especially helpful when you are designing a custom filter. When a trace is assigned to user correction data, the display's horizontal axis automatically changes to frequency. The technique used to control the frequency scale depends on the microwave transition analyzer's sweep mode.

### Setting the frequency scale for frequency sweeps

When using a frequency sweep, the frequency scales of the microwave transition analyzer and the user-correction trace are identical. The start and stop frequencies are the same. This includes any frequency offset.

### Setting the frequency scale for time sweeps

When the microwave transition analyzer is performing time sweeps, the frequency scale of any user-correction trace is related to the sweep time. The start frequency is set to 0 Hz. The stop frequency is determined by the seconds-per-division setting. To set the stop frequency, use the following formula to determine the seconds-per-division setting, then set the sweep time using the Main menu's `SEC/DIV` softkey.

$$\text{seconds/division} = \frac{\text{trace length}}{20 F_{\text{stop}}}$$

where:

trace length is determined by pressing `TRACE POINTS` in the Configuration menu.

$F_{\text{stop}}$  equals the desired stop frequency in hertz.



For example, to set the stop frequency to 10 GHz with 512 trace points, set the time scale to 2.56 ns per division.

It should be noted that this formula also determines the frequency scale of any time domain trace that has been formatted to the frequency domain using an FFT. The advantage of using a trace formatted using an FFT is that the displayed upper frequency limit can be higher than the available range of many RF sources.

### To view user corrections

1. Press the left-side **Traces** softkey to enter the Traces menu.
2. Select a trace, and then press the **input:** softkey.
3. Use the front-panel knob to scroll the menu bar to **UCORR1** as shown in the following figure.

**UCORR1** sets the trace to user-correction data for channel 1. **UCORR2** sets the trace to user-correction data for channel 2.

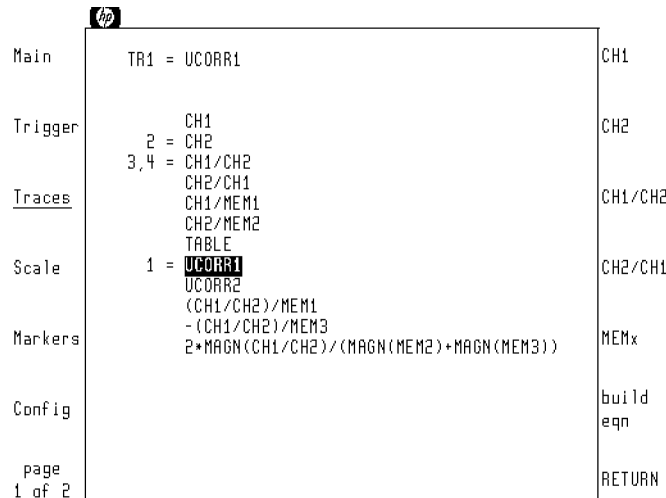

4. Press the **RETURN** softkey.
5. Press the left-side **Main** softkey to enter the Main menu.
6. Set the frequency scale of the user-correction trace:
  - If the microwave transition analyzer is set for a frequency sweep, use the Main menu's **START** and **STOP** softkeys.
  - If the microwave transition analyzer is set for a time sweep, press the Main menu's **SEC/DIV** softkey, and enter the sweep time to set the stop frequency. The formula to determine the sweep time is provided at the beginning of this section.
7. Press the left-side **Scale** softkey to enter the Scale menu.
8. Press the **REF LEV|POS** softkey, and set the reference level to correctly position the trace on screen.

9. If needed, press the **SCALE** softkey, and change the vertical amplitude scale.
10. Press the left-side **Calib** softkey.
11. Press the **user corr** softkey.

The user correction data is now displayed graphically above the data.

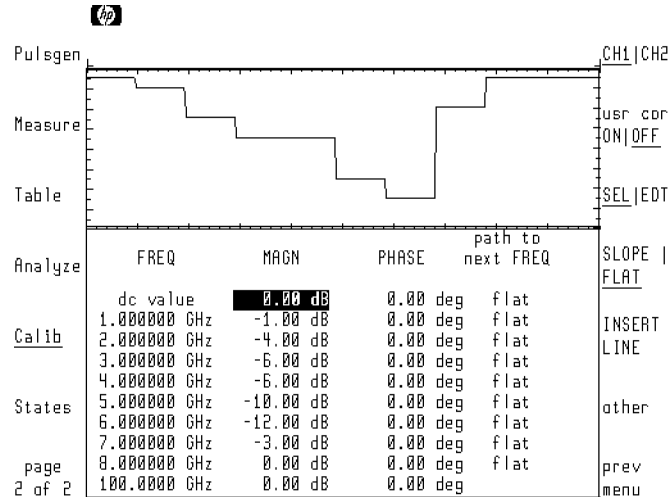

## Tutorial: Constructing a 1.5 GHz High-Pass Filter

This procedure builds a 1.5 GHz high-pass “brick wall” filter using channel 1 user-correction data. The filter will be used to remove the fundamental from a 1 GHz square wave. Only the harmonics will remain. The tutorial formats trace 1 for the time domain and trace 2 for the frequency domain.

The square wave used in this procedure is produced by overdriving a limiter. The pad protects the microwave transition analyzer from high power levels. If you use a different signal source, be sure to change the power and frequency settings used in this procedure. The following Hewlett-Packard part numbers are used:

limiter ..... 5086-7746  
 20 dB pad ..... HP 33340C

### Step 1. Connecting the equipment

1. Connect the equipment as shown below.

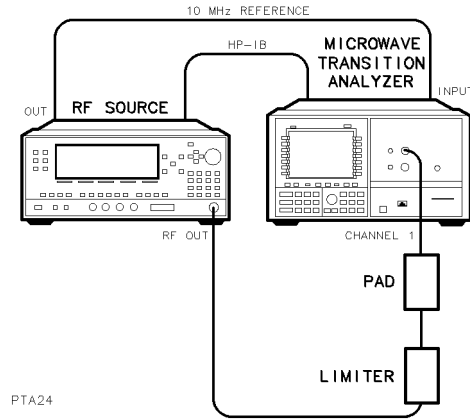

2. Press the front-panel **INSTR PRESET** key.

## Step 2. Setting the source frequency and power

1. Press the **Main** softkey to enter the Main menu.
2. Press the **source FRQ|PWR** softkey twice so that **FRQ** is highlighted.
3. Enter a source frequency of 1 GHz.
4. Press the **source FRQ|PWR** softkey twice so that **PWR** is highlighted.
5. Enter a source power of 13 dBm.

---

**Caution** Do not place greater than 16 dBm of power to the HP 70820A's channel 1 input. Be sure a pad is placed between the limiter and the channel 1 input connector.

---

6. Press the **RF out ON|OFF** softkey so that **ON** is underlined. The display should look similar to the following figure.

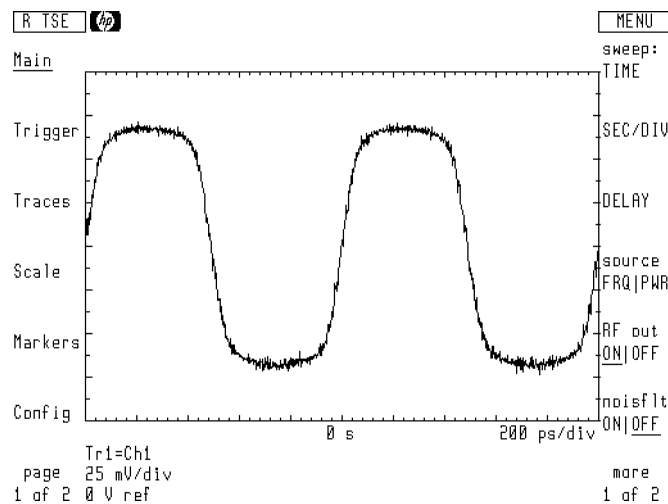

### Step 3. Displaying the signal

1. Press the left-side **Traces** softkey to enter the Traces menu.
2. Press the **select:** and then **TR2** softkeys.
3. Press the **input:** and then **CH1** softkeys.
4. Press the **format:** softkey.
5. Press the **xfrm to FRQ|OFF** softkey so that **FRQ** is underlined.

Traces 1 and 2 both represent the input at channel 1. Trace 2 is formatted in the frequency domain.

6. Press the **prev menu** softkey.
7. Press the **trnsfrm control**.
8. Press the **START STOP** softkey so that **STOP** is underlined. Enter a stop frequency of 5 GHz.
9. Press the **zoom ON|OFF** softkey so that **ON** is underlined. The display should look similar to the following figure.

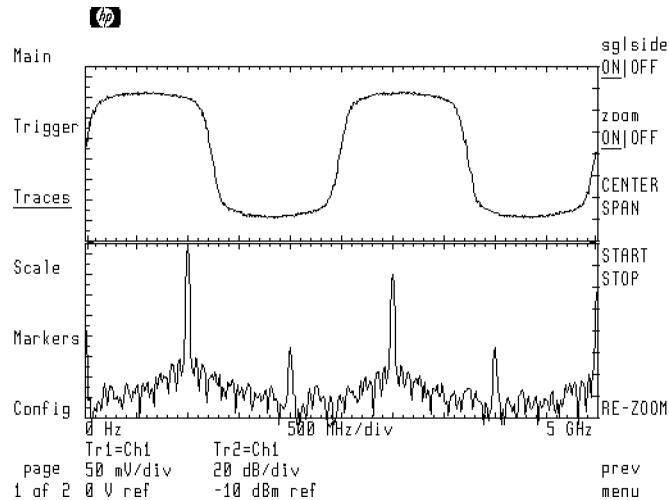

## Step 4. Creating the user-correction filter

1. Press the left-side `page 1 of 2` softkey.
2. Press the `Calib` and then `user corr` softkeys to enter the User-Correction menu.
3. Enter the user-correction data so that the display looks like the following figure. Be sure the path to next `FREQ` field is changed from `slope` to `flat`.

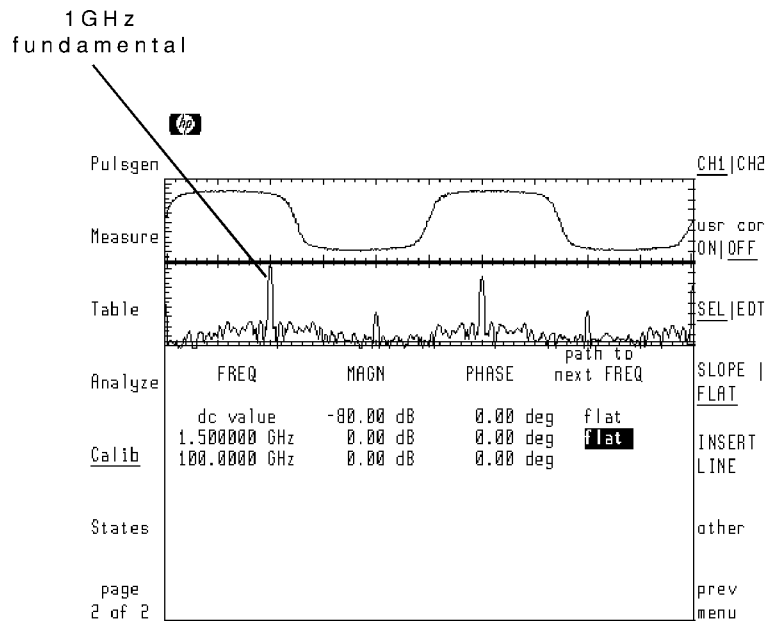

## Step 5. Turning on user corrections

1. Press **other**.
2. Press **action MPY|DIV** so that **MPY** is underlined.
3. Press **prev menu**.
4. Turn on user corrections by pressing the **usr cor ON|OFF** softkey so that **ON** is underlined.

The following figure shows the input signal in both time and frequency domains with the 1 GHz fundamental filtered out.

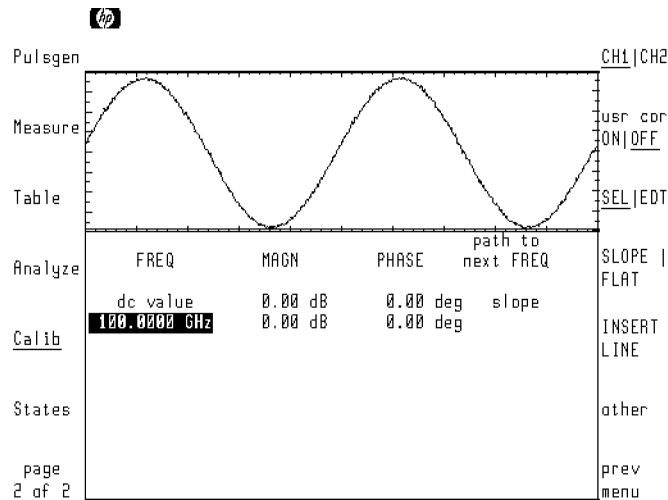

5. To remove the user-correction data, press the front-panel **(HOLD)** key.

## Calibrating the HP 70820A

---

Using the Calibration menu, you can perform the following tasks:

- Add delay to a channel.
- Initiate an instrument self-test routine.
- Turn off RF correction.
- Calibrate the IF.
- Verify the calibrator signal.

Introducing the Calibration Menu .....	14-4
Adding Delay to a Channel .....	14-6
To delay a channel .....	14-8
Calibrating the IF .....	14-9
To calibrate the IF .....	14-10
To view the last calibration date .....	14-11
Viewing the Calibration Data .....	14-12
To view IF correction data traces .....	14-12
To view hardware response traces .....	14-14
To view calibration data .....	14-16
Performing a Self Test .....	14-17
To perform the self test .....	14-17
Turning Off RF Correction .....	14-18
To turn off RF correction .....	14-18
Controlling the Calibrator Signal .....	14-19
To turn the calibrator signal on .....	14-20
To change the calibrator frequency and amplitude .....	14-20

---

## Introducing the Calibration Menu

The features documented in this chapter are located in the Calibration menu. The automatic IF calibrations documented in this chapter ensure accurate measurements using the microwave transition analyzer. RF correction data resides in nonvolatile instrument memory and does not need to be changed unless repairs have been made.

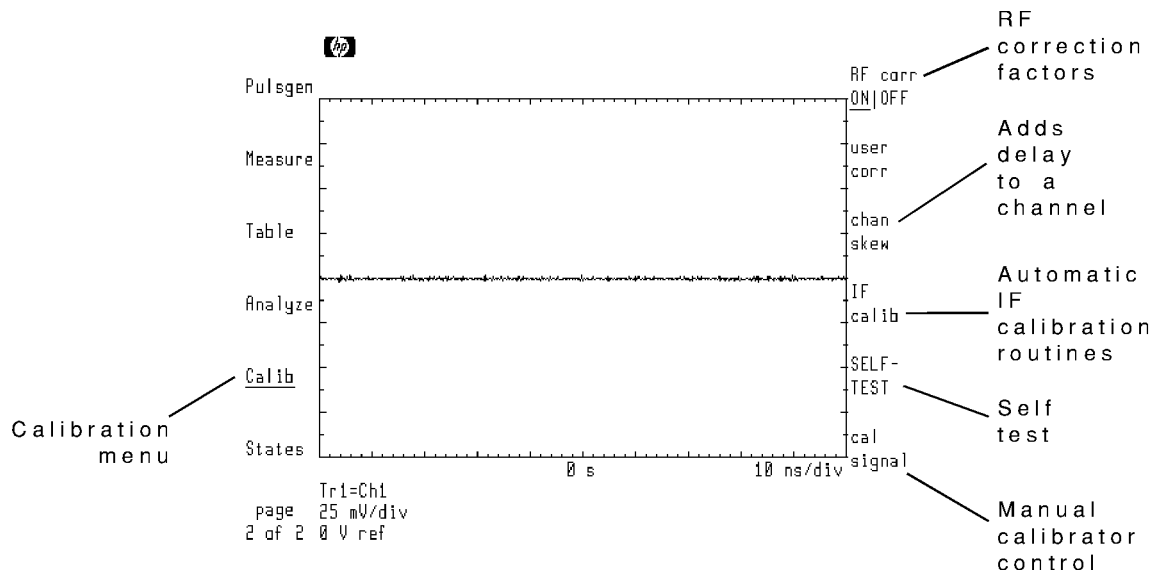

**The Calibration menu**



---

**User correction** Calibration menu's **user corr** softkey features are documented in Chapter 12, "Creating Masks and Limit Lines."

---

## Adding Delay to a Channel

Significant delays can occur between the signals on channel 1 and channel 2 when the electrical lengths of external cabling varies. This results in a phase offset between the two channels. The microwave transition analyzer offers the capability to add delay to either channel 1 or channel 2.

The following figure shows added delay on channel 2.

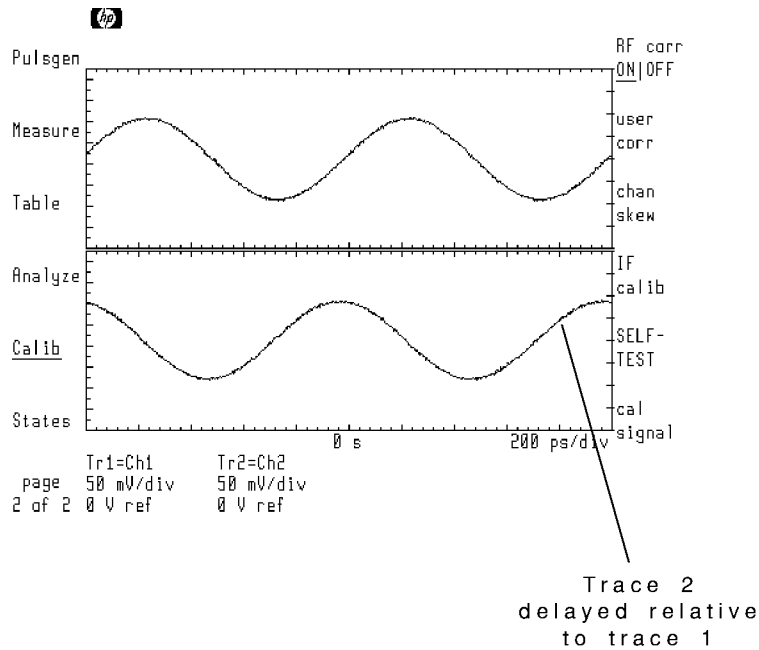

Use the **AUTO SKEW** softkey to automatically compensate the delay on channel 2. Automatic skewing assumes two equal phase signals input to channels 1 and 2. If measurements are to be performed at multiple frequencies, it is recommended that the **AUTO SKEW** function be performed first at a low frequency and then at higher frequencies to ensure better resolution.

Delay can be manually compensated using the **CHAN2 SKEW** softkey. For convenience, the **SEC/DIV** softkey is provided so that the time scale can be changed.

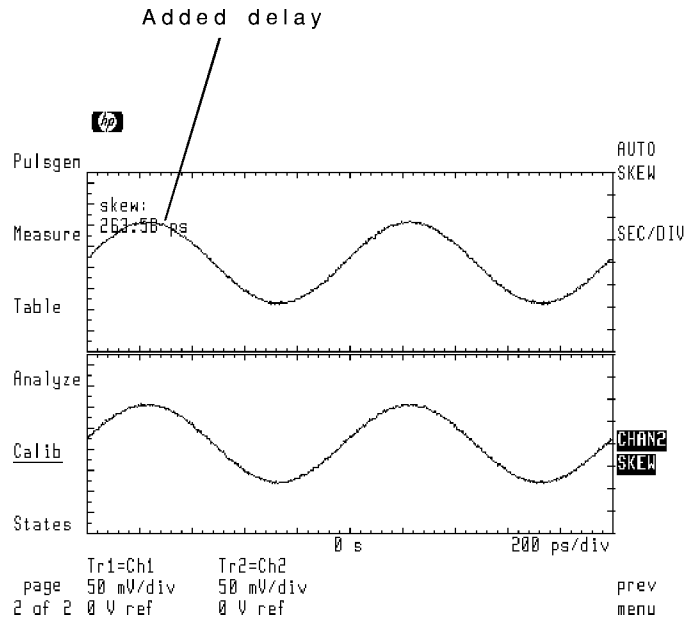

**Trace 2 delay compensated**

## To delay a channel

1. Press the left-side **Calib** softkey to enter the Calibration menu.
2. Press the **chan skew** softkey.
3. Press **AUTO SKEW** to automatically compensate channel 2.

---

## Calibrating the IF

The microwave transition analyzer provides separate automatic IF calibration routines for channel 1 and channel 2. Each requires approximately 30 minutes to run. For optimum performance, you should perform the calibrations when at least one of the following is true:

- The temperature has changed  $\pm 5$  °C since the last calibration was performed.
- More than one week has passed since the last calibration.
- Before any critical measurement.

---

**Warmup time** Allow the microwave transition analyzer to warm up for at least one hour before performing a calibration.

---

## To calibrate the IF

1. Connect a low-loss cable between the front-panel CALIBRATOR OUTPUT and Channel 1 connectors.

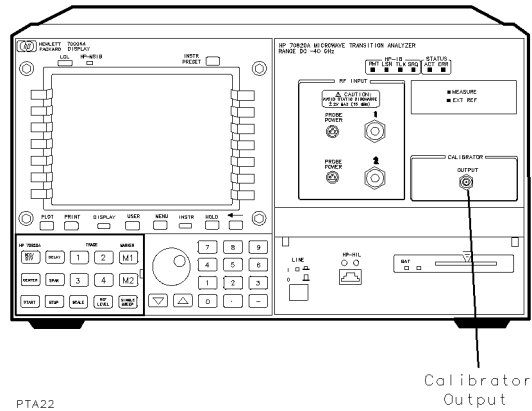

2. Press the left-side **Calib** softkey to enter the Calibration menu.
3. Press the **IF calib** softkey.
4. Press the **CAL CH1** softkey.
5. Press the **CAL CH1** softkey.

The calibration routine takes about 30 minutes to complete.

6. Disconnect the cable from Channel 1, and connect it to the Channel 2 connector.
7. Repeat the above procedure for Channel 2.

## To view the last calibration date

1. Turn any displayed traces off to make viewing the calibration date easier.
2. Press the left-side **Calib** softkey to enter the Calibration menu.
3. Press the **IF calib** softkey.
4. Press the **cal debug** softkey.
5. Press the **show** softkey.
6. Press the **CH1 CAL INFO** softkey to view when Channel 1 was last calibrated.
7. Press the **CH2 CAL INFO** softkey to view when Channel 2 was last calibrated.

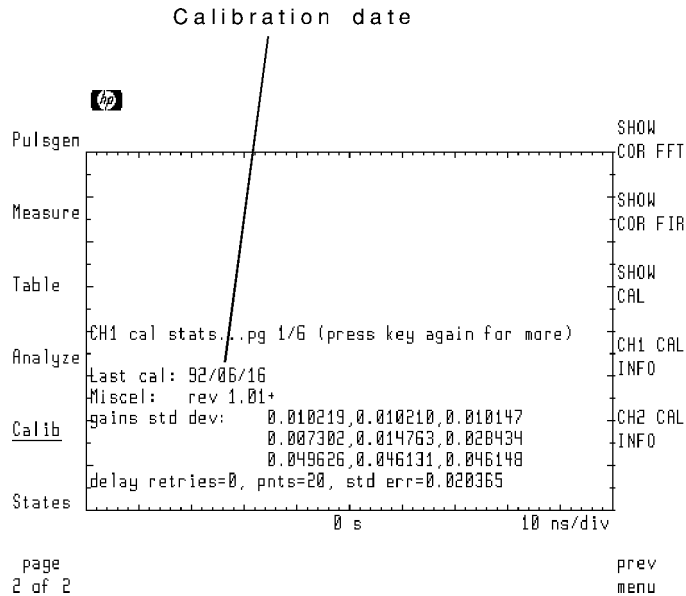

## Viewing the Calibration Data

The ability to view the IF calibration data is mainly intended for service purposes. However, the procedures in this section show you how to view the data.

### To view IF correction data traces

1. Press the left-side **Traces** softkey to enter the Traces menu.
2. Turn on both trace 1 and trace 2. Set the input to trace 1 as Channel 1. Set the input to trace 2 to Channel 2.
3. Press the left-side **page 1 of 2** softkey.
4. Press the left-side **Calib** softkey to enter the Calibration menu.
5. Press the **IF calib**, **cal debug**, and then **show** softkeys.
6. Press the **SHOW COR FFT** or **SHOW COR FIR** softkeys to display the IF correction data for each channel.
7. Press the left-side **page 2 of 2** softkey.
8. Press the left-side **Scale** softkey to enter the Scale menu.
9. Select trace 1, and press the **AUTOSCALE** softkey. Select trace 2, and press the **AUTOSCALE** softkey.

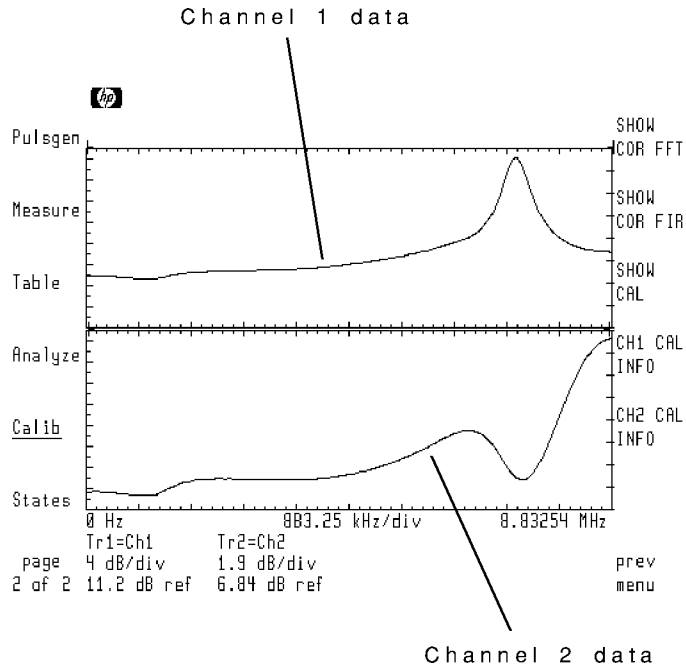

## To view hardware response traces

1. Press the left-side **Traces** softkey to enter the Traces menu.
2. Turn on both trace 1 and trace 2. Set the input to trace 1 as Channel 1. Set the input to trace 2 to Channel 2.
3. Press the left-side **page 1 of 2** softkey.
4. Press the left-side **Calib** softkey to enter the Calibration menu.
5. Press the **IF calib**, **cal debug**, and then **show** softkeys.
6. Press the **SHOW CAL** softkey to display the 100 kHz filter response of stage 0.
7. Press the left-side **page 2 of 2** softkey.
8. Press the left-side **Scale** softkey to enter the Scale menu.
9. Select trace 1, and press the **AUTOSCALE** softkey. Select trace 2, and press the **AUTOSCALE** softkey.
10. Press the left-side **page 1 of 2** softkey to re-enter the Calibration menu.
11. Press the **SHOW CAL** softkey.
12. Use the front-panel step keys to scroll through the various hardware responses.

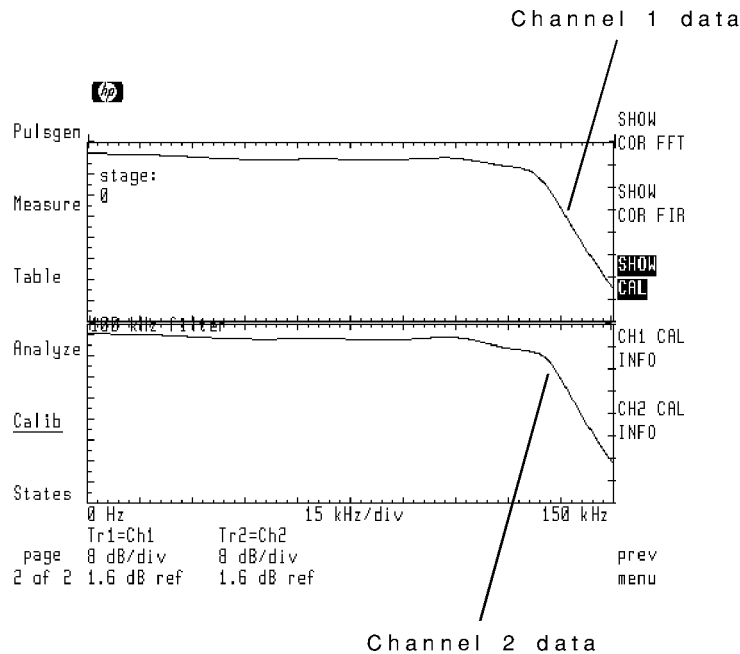

## To view calibration data

1. Turn all displayed traces off.

This makes viewing the calibration data easier.

2. Press the left-side **Calib** softkey to enter the Calibration menu.
3. Press the **IF calib**, **cal debug**, and then **show** softkeys.
4. Press the **CH1 CAL INFO** softkey to view the data for Channel 1. Or, press the **CH2 CAL INFO** softkey to view the data for Channel 2.

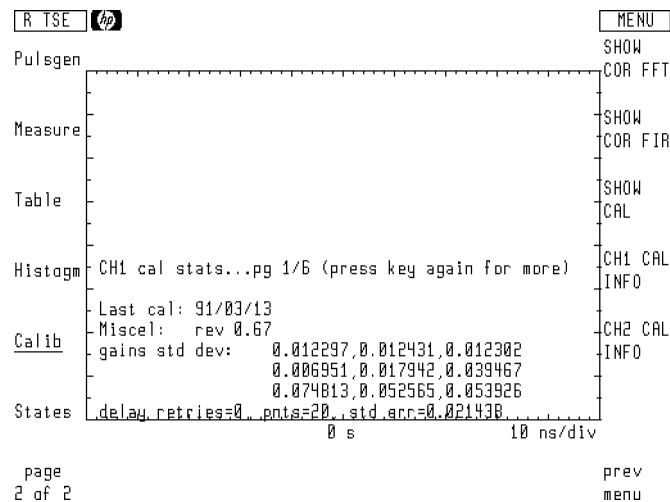

5. Repeatedly press the **CH1 CAL INFO** or **CH2 CAL INFO** softkey to view additional pages of information.

---

## Performing a Self Test

You can initiate an automatic self-test routine that checks the internal condition of all major circuits. The self test takes approximately 30 seconds to run. (This routine automatically runs whenever the microwave transition analyzer is turned on.)

### To perform the self test

1. Press the left-side **Calib** softkey to enter the Calibration menu.
2. Press the **SELF- TEST** softkey.



---

## Turning Off RF Correction

The microwave transition analyzer applies RF correction factors to all measurements. These correction factors are loaded at the factory into nonvolatile memory. You can prevent the use of RF correction factors during measurements.

### To turn off RF correction

1. Press the left-side **Calib** softkey to enter the Calibration menu.
2. Press the **RF corr ON|OFF** softkey so that **OFF** is underlined.

---

## Controlling the Calibrator Signal

For verification purposes, the Calibrator Output signal can be manually controlled. This includes changing its amplitude and frequency. The signal has the following characteristics:

shape	..... square wave
frequency	..... 156 Hz to 5 MHz
amplitude	..... 5 positions

The signal's amplitude can be set to one of five positions: 0 through 4. Zero represents the smallest available amplitude. Four represents the largest amplitude. These settings do not correlate to any specific amplitude and may vary between instruments.

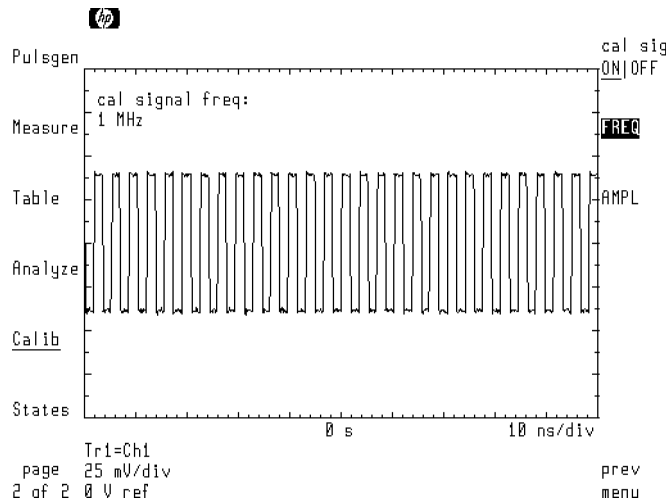

### To turn the calibrator signal on

1. Press the left-side **Calib** softkey to enter the Calibration menu.
2. Press the **cal signal** softkey.
3. Press the **cal sig ON|OFF** softkey so that **ON** is underlined.

## To change the calibrator frequency and amplitude

1. Press the left-side **Calib** softkey to enter the Calibration menu.
2. Press the **cal signal** softkey.
3. Press the **FREQ** softkey, and enter a frequency between 156 Hz and 5 MHz.
4. Press the **AMPL** softkey, and enter an amplitude setting between 0 and 4.

## Managing Cards, Disks, and RAM

---

The microwave transition analyzer has the ability to store data as files on the following media:

- Memory cards
- HP-IB Disk drive
- Internal random-access memory (RAM) disk

Learning how to manage this memory is essential to obtaining the most benefit from your microwave transition analyzer. Memory cards are inserted into the front-panel card slot. RAM disks can be used as temporary storage for copying the contents of one memory card to another memory card.

The following list shows the types of data that can be saved as files:

- Traces
- Measurement states
- Histograms
- Masks
- Limit lines
- Calibrations
- User corrections
- User menus
- Downloadable programs (DLPs)

Selecting and Formatting Memory .....	15-4
To use a memory card .....	15-6
To use an HP-IB disk drive .....	15-7
To use an internal RAM disk .....	15-8
To change a memory card's battery .....	15-9
Working with Files .....	15-10
To duplicate a memory card .....	15-12
To catalog all files .....	15-13
To save a file .....	15-14
To recall a file .....	15-15
To erase a file .....	15-15
To erase all files .....	15-16
To change the prefix .....	15-17
To erase a custom prefix .....	15-18

---

## Selecting and Formatting Memory

When first turned on, the microwave transition analyzer automatically selects the memory card as the mass-storage device. You can format memory and save, recall, erase, and list (catalog) files using the mass-storage menu located in the States menu.

### Memory cards

Memory cards must be formatted before use. Formatting erases any previously stored files and initializes memory for storing data. RAM memory cards have a built-in battery to retain memory data. Data stored in the card remain as long as the card's battery has sufficient power. You should change the battery every two years using the procedure in this section.

On new cards, a special code is stamped on the card's side indicating the date it was installed. The first digit tells the year, and the next two digits the month. The third digit indicates the week. For example, 10C3 indicates the battery was installed during the third week of October in 1991.

---

**Error Message: catalog open failed** If you insert a card in the front-panel card slot, and you attempt to catalog a memory card, the microwave transition analyzer displays the message `catalog open failed`. Place a card in the card slot, and retry the operation.

---

### RAM disks

RAM disks offer a convenient method of duplicating memory cards. Refer to "To duplicate a memory card" in this section. Up to 16 internal RAM disks can be created. (These are numbered 0 through 15.) The default size of each RAM disk is 32 kilobytes.

Use Instrument BASIC's INITIALIZE statement to create each disk. The following example creates RAM disk zero:

```
INITIALIZE ":MEMORY,0,0",128
```

The second integer, 0, determines the RAM disk number. The value 128 represents the size of the RAM disk in sectors. Each sector consists of 256 bytes. So, a value of 128 sectors creates a RAM disk of 32 kilobytes. A value of 512 sectors creates a RAM disk of 128 kilobytes.

Use the following command to create RAM disk 1 with a size of 128 kilobytes:

```
INITIALIZE ":MEMORY,0,1",512
```

---

**RAM is volatile** Because internal RAM is volatile, all RAM disks are deleted when the power is turned off. When this happens, all files are lost and each RAM disk must be recreated.

---

### HP-IB Disk Drives

Measurement data and files can be saved on an external HP-IB disk drive. The disc drive must be a 3.5 inch, CS80 compatible, such as an HP 9122. To use the drive, you must connect it and enter its HP-IB address using (DISPLAY) menu softkeys. The procedure in this section shows you how to do this. You'll need to know the disk drive's HP-IB address, unit number, and volume number. The HP-IB address is represented by a digit from 1 through 7. The unit number indicates an individual slot in the disk drive. Although unit numbers can range from 0 through 9, they are typically 0 or 1. The volume number is used for hard disk drives. For reading diskettes, the volume number should be 0.

## To use a memory card

1. Locate the arrow printed on one end of the card.
2. Insert the card with the arrow facing up into the front-panel card slot. The card's arrow should match the arrow printed above the card slot.
3. Press **DISPLAY** and then the left-side **Mass Storage** softkey.
4. Press **msi** and then **MEMORY CARD**.
5. Press **MENU** and then the left-side **States** softkey.
6. Press **more 1 of 2**, **mass storage**, and then **msi:**.
7. Press **HP-MSIB CARD**.

If 6218 catalog open failed is displayed, the card is not in the front-panel card slot. The HP-MSIB address for the card is the same address as the display's HPIB address and is normally set to 4. If the address is not correct, enter the correct address using the numeric keypad.

---

**Caution** The following steps erase any files on the card.

---

8. If the memory card is new and needs to be formatted, perform the following steps:
  - a. Press **prev menu**, **more**, and then **FORMAT**.
  - b. Press **FORMAT as LIF** to use the LIF format or press **FORMAT as DOS** to use the DOS format.

## To use an HP-IB disk drive

1. Connect the HP-IB disk drive to the HP 70004A Color Display using an HP-IB cable.
2. Determine or set the HP-IB address of the disk drive. Refer to the disk drive's user's manual for information on determining the disk drive's address.
3. Press **DISPLAY** and then the left-side **Mass Storage** softkey.
4. Press **msi** and then **HP-IB disk**.
5. Press **HP-IB ADDRESS**, and enter the disk drive's HP-IB address.

This value is between 1 and 7.

6. Press **UNIT NUMBER**, and enter the disk drive's unit number.

This number is typically a 0 or 1. Zero usually indicates the disk drive's left side slot.

7. Press **VOLUME NUMBER**, and enter the disk drive's volume number.

The volume number should be left at the default value of zero for floppy disk drives.

8. Press **MENU** and then the left-side **States** softkey.
9. Press **more 1 of 2**, **mass storage**, and then **msi:**.
10. Press **HP-MSIB CARD**.

Although card is selected, the display's **HP-IB disk** softkey pressed in step 4 redirected communications to the HP-IB disk drive.

## To use an internal RAM disk

1. Press **(USER)** to invoke Instrument BASIC.
2. Enter an INITIALIZE statement to create a RAM disk. For example, enter the following BASIC statement:

```
INITIALIZE ":MEMORY,0,0",128
```

3. Press **(MENU)** and then the left-side **page 1 of 2** and **States** softkeys.
4. Press **more 1 of 2** and then **mass storage**.
5. Press **msi:** and then **MEMORY** to select the internal RAM disk.

The RAM disk number is shown on the screen. You can use the front-panel knob to change the RAM disk number.



## To change a memory card's battery

The memory card's battery is a lithium commercial CMOS type, part number CR 2016.

---

**Caution** The memory card should be installed when the battery is removed. If the battery is removed while the card is not installed, all data in the card will be lost. Store memory-card files on another device before changing the battery, when extra care is appropriate.

---

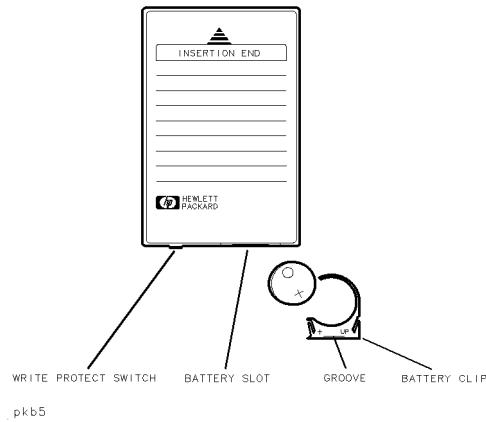

1. Install the memory card into the HP 70004A Display.
2. On the front edge of the card, locate the groove of the battery clip.
3. Gently pry the battery clip out of the card. The battery fits inside the clip.
4. Replace the battery, making sure the plus (+) sign on the battery is on the same side as the plus sign on the clip.
5. Insert the battery clip into the memory card, holding the clip as oriented in the following figure. (Face the open edge of the clip toward the memory card's write-protect switch.)
6. Write the on the card the date that the battery was replaced.

---

## Working with Files

Files are identified by a prefix and a name. The microwave transition analyzer assigns a prefix according to the type of data as shown in the following table. You enter the file name. When cataloged, the file listings show the file's data type and size in bytes.

### File Prefixes

File Type	File Prefix
Calibration data	c_
Histograms	h_
Instrument registers	r_
Instrument state	s_
Mask/Limit line	m_
Program	d_
Trace	t_
User corrections	a_
(USER) menu	k_

You can create additional prefix text for your file names. The text, appended to the standard prefixes, allows you to indicate files that have similar data. For example, the following figure shows a catalog of two mask files. Each file has an additional prefix of Shape. The additional prefix is appended regardless of the type of file you are saving.

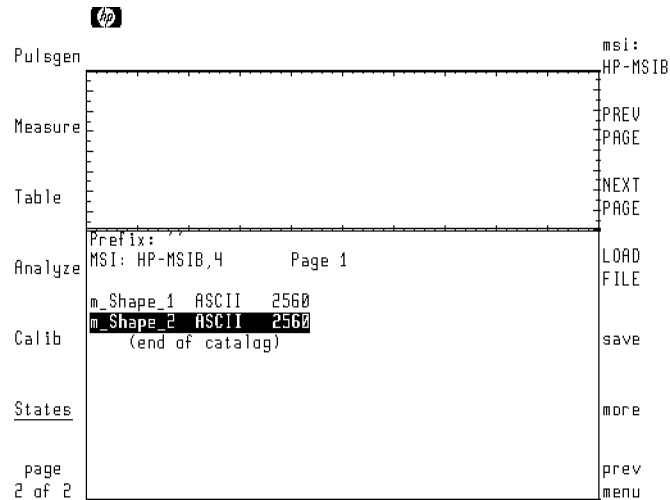

The total length of your file name can not exceed 10 characters for LIF and 8 characters for DOS. This includes prefix and file name.

## To duplicate a memory card

Instrument BASIC provides the ability to mass copy all the files from one memory card to another memory card. This allows you to easily reproduce copies without having to copy file one at a time. Use the following steps:

1. Refer to “To use a memory card” in this chapter to select the memory card for use.
2. Insert the memory card with the files into the front-panel card slot.
3. Press **(USER)**.
4. Use a keyboard to enter the following Instrument BASIC commands. These commands initialize a RAM disc and copy the files from the card to the RAM disk. If you don't have a keyboard, Instrument BASIC has an editor for creating these commands. Refer to the *HP 71500 Series Instrument BASIC User's Guide*.

```
INITIALIZE ":MEMORY,0,0"  
WILDCARDS DOS  
COPY "*" TO ":MEMORY,0,0"
```

5. Remove the card from the card slot and insert a blank formatted card in the slot.
6. Issue the following Instrument BASIC command to copy the files from the RAM disk to the new card:

```
COPY "*:MEMORY,0,0" TO ":EXTERNAL,904"
```

## To catalog all files

Use this procedure to catalog default memory. To select default memory, refer to “Selecting and Formatting Memory” in this chapter.

1. If you plan to catalog the files on a memory card, insert the card in the front-panel card slot.
2. Press the left-side **States** softkey.
3. Press **more 1 of 2** and then **mass storage**.

Remember to insert the card before cataloging a memory card. If **6218 catalog open failed** is displayed, the card is missing. The HP-MSIB address for the card is the same address as the display's HPIB address and is normally set to 4. If the address is not correct, enter the correct address using the numeric keypad.

## To save a file

Use this procedure to save a file in the default memory. To select default memory, refer to “Selecting and Formatting Memory” in this chapter.

1. Press the left-side **States** softkey.
2. Press **more 1 of 2**, **mass storage**, **save**, and then perform one of the following:
  - If your saving an instrument state, user-correction, or histogram, press the appropriate softkey.
  - If your saving a trace, press **save trace**. Select the trace and then use the **VEC|FMT** softkey to determine if the trace data is saved as complex data (VEC) or scalar data (FMT). Press **save**.
  - If your saving a channel calibration, mask, limit line, user-defined key, all recall registers, press **save misc** and then the appropriate softkey.
3. Enter the desired file name.
4. Press **ENTER LINE** to save the file.

---

### Entering a filename without a keyboard

- Press **SELECT CHAR** to enter a character at the character-select cursor.
  - Press the numeric keypad to enter numbers or a minus sign.
  - The **INSERT** or **. . .** softkey determines the action of the **SELECT CHAR** softkey. Choices are INSERT a character, REPLACE an existing character, or DELETE a character.
  - Press the **(↓)** and **(↑)** keys (beneath the front-panel knob) to move the command-entry cursor.
  - Use the **CLEAR TO END** softkey to remove characters from the command-entry cursor to the end of the command.
-

### **To recall a file**

Use this procedure to recall a file from the default memory. To select default memory, refer to “Selecting and Formatting Memory” in this chapter.

1. Press the left-side **States** softkey.
2. Press **more 1 of 2**, and then **mass storage**.
3. Rotate the front-panel knob to select (highlight) the desired file.
4. Press **LOAD FILE**.

### **To erase a file**

Use this procedure to erase a file in the default memory. To select default memory, refer to “Selecting and Formatting Memory” in this chapter.

1. Press the left-side **States** softkey.
2. Press **more 1 of 2**, and then **mass storage**.
3. Press **more**.
4. Rotate the front-panel knob to select (highlight) the desired file.
5. Press **PURGE FILE** to erase the file.

## To erase all files

---

**Caution** This procedure erases all files in default memory.

---

1. Press the left-side **States** softkey.
2. Press **more 1 of 2**, and then **mass storage**.
3. Press **more**.
4. Press **FORMAT** to erase all files in default memory.

## To change the prefix

1. Press the left-side **States** softkey.
2. Press **more 1 of 2**, and then **mass storage**.
3. Press **more**.
4. Press **CHANGE PREFIX**, and enter the desired text.
5. Press **ENTER LINE** to enter the prefix.

---

## Entering the prefix without a keyboard

- Press **SELECT CHAR** to enter a character at the character-select cursor.
  - Press the numeric keypad to enter numbers or a minus sign.
  - The **INSERT** or **. . .** softkey determines the action of the **SELECT CHAR** softkey. Choices are **INSERT** a character, **REPLACE** an existing character, or **DELETE** a character.
  - Press the **↓** and **↑** keys (beneath the front-panel knob) to move the command-entry cursor.
  - Use the **CLEAR TO END** softkey to remove characters from the command-entry cursor to the end of the command.
-



### To erase a custom prefix

1. Press the left-side **States** softkey.
2. Press **more 1 of 2**, and then **mass storage**.
3. Press **more**.
4. Press **CHANGE PREFIX**, and enter the desired text.
5. Repeatedly press the **⇩** step key until the cursor is located at the start of the custom text.
6. Press **CLEAR TO END**.
7. Press **ENTER LINE**.



# Index

---

## Special characters

\*, 6-10  
+, 6-10  
/, 6-10

## 1

10 MHz REF INPUT, 1-4  
10 MHz REF OUTPUT, 1-4

## A

ABORT DEL ALL, 13-5  
ABS REL, 10-10  
AC(), 6-10  
address, 1-4, 1-9  
aliasing, 3-5  
ampl, 9-16  
amplitude corrections, 12-1  
amplitude scale, 8-1  
AMPL=TOP-BAS, 2-54  
ANALY(), 6-10  
analytc ON OFF, 4-3  
Analyze softkey, 11-2, 12-1  
ANGLE, 7-6  
APERTUR, 8-11  
aperture smoothing, 8-9  
ARM=EXT TRG=CH1, 7-11  
ARM=EXT TRG=CH2, 7-11  
ATAN(), 6-10  
AUTO DELAY, 2-12, 3-23  
automatic measurements, 2-36  
automatic waveform measurements, 2-1  
autoranging, 3-4  
autorng ON OFF, 8-7  
AUTOSCALE, 8-3  
AUTO SKEW, 14-4  
AUTO TRIG'D, 7-5, 7-8  
average, 2-38  
AVERAGE, 2-39  
average power, 2-53  
avg,hld, 6-14, 7-14  
avg hld, 6-16  
AVG PWR, 2-53  
AXES, 1-11

## B

bandwidth  
    single shot mode, 4-13  
    single shot operation, 4-3  
BASE, 2-42  
BASEBND TRIGGER, 3-11, 3-12  
battery  
    card, 15-2  
    changing in card, 15-7  
big trc ON, 4-17  
build eqn, 6-7  
bus, 1-9

## C

cables, 3-4  
CAL CH1, 14-6  
CAL CH2, 14-6  
cal debug, 14-6  
Calib, 14-2  
calibrating  
    delay, 14-3  
    IF, 14-5  
    signal, 14-11  
calibration, 14-1  
    date, 14-6  
    viewing, 14-7  
    warm-up time, 14-5  
CALIBRATOR OUTPUT, 14-11  
cal signal, 14-11  
cal sig ON OFF, 14-11  
card  
    battery, 15-2  
    changing battery, 15-7  
    write-protect switch, 15-4  
carrier FRQ PWR, 3-14  
cataloging memory, 15-10  
catalog open failed, 15-2, 15-4  
CENTER, 5-5  
CENTER SPAN, 5-12, 6-24  
centroid, 2-42  
CH1, 6-10  
CH1 CAL INFO, 14-6  
CH1 = VID RF, 3-21  
CH2, 6-10  
CH2 CAL INFO, 14-6  
CHAN2 SKEW, 14-4

- changing file prefixes, 15-14
- chan skew, 14-5
- CLEAR MATH EQ, 1-29
- clear memory, 1-27
- clear state, 1-27
- CLEAR TO END softkey, 12-6, 15-11, 15-14
- clear usr cor, 1-28
- clock, 1-19
- CLR→END, 6-11
- communication bus, 1-4
- Config, 1-4
- configuration, 1-1
- configure
  - plotter, 1-24
  - printer, 1-25
  - pulse generator, 3-7
  - RF source, 1-4
- CONFIRM DEL ALL, 13-5
- CONT, 2-39, 7-14
- CONT ACQUIRE, 11-3
- CONT AUTOSCL, 8-3
- CONT AVG, 10-5
- CONV, 6-10
- copy to CH1, 13-8
- copy to CH2, 13-8
- CORR, 6-10
- COUP HW ON OFF, 8-7
- creating a RAM disk, 15-2
- CURRENT FILTER, 8-12
- CURRENT GN&FLTR, 8-12
- # CYCLE, 5-4, 5-5
- cycles ON OFF, 9-15

## D

- DB(), 6-10
- DC(), 6-10
- DC drift, 8-12
- d/dx(), 6-10
- default memory, 15-2
- DEG(), 6-10
- delay, 2-45, 14-3
- DELAY, 5-5, 5-8
- DELETE ALL, 13-5
- DELETE LINE, 13-7
- DELETE or ... softkey, 12-6, 15-11, 15-14
- delta markers, 9-7
- DFT(), 6-10
- DIFF( ), 8-9
- DIFF(), 6-10
- disabling service requests, 1-10
- disabling source control, 1-10
- disk drive
  - type, 15-3
- disk drive addressing, 15-3
- disk drives, 15-1

- display
  - clock, 1-19
  - instrument state, 1-23
  - persistence, 1-17
  - security, 1-26
  - status line, 1-21
- display DELAY softkey, 4-17
- display ON OFF, 6-4, 8-5
- display scaling, 8-1, 8-3
- display SEC/DIV softkey, 4-17
- down-loadable programs, 15-7
- duplicating memory cards, 15-2
- duty cycle, 2-52, 3-9
- DWELL TIME, 5-11, 5-17
- dynamic range, 3-4

## E

- e, 6-10
- E, 6-10
- EDGE, 7-5
- EXECUTE, 2-46, 2-47
- EXPJ(), 6-10
- EXT, 1-3
- external attenuation, 8-11
- external disk drive
  - addressing, 15-3
  - connecting, 15-3
- external triggering, 7-10
- EXTERNL ATTEN, 8-11
- EXT FORCE, 7-10

## F

- fall time, 2-49
- FALL TIME, 2-49
- fast Fourier transform, 4-14
- FFT(), 6-10
- file
  - cataloging, 15-10
  - recalling, 15-12
  - saving, 15-11
- files
  - erasing, 15-12
  - erasing all files, 15-13
  - modifying names, 15-14
  - name, 15-7
  - prefix, 15-7
- filtering noise, 5-7
- filter ON OFF, 10-4
- filter ON OFF softkey, 4-17
- FIND FREQS, 10-7
- FIND SIGNALS, 5-3, 5-4
- FM, 8-9
- FM( ), 8-9
- FM(), 6-10
- f mult denom., 5-25

f mult numer., 5-25  
FORMAT AVERAGE, 6-16, 7-14  
FORMAT softkey, 15-13  
FRAME, 1-11  
FREERUN, 7-5, 7-8  
FREQ, 2-51, 5-8, 6-10  
freq offset, 5-23  
FREQ & POWER, 2-5, 2-6  
FREQ SHIFT, 8-8  
frequency, 2-51  
frequency modulation, 8-9  
frequency reference, 1-3  
frequency shift, 8-8  
frequency sweeps, 5-1, 5-8

## G

gen is, 3-10  
grat, 1-11  
graticule, 1-11  
GROUP, 7-14

## H

Hard Copy, 1-24  
hardware scaling, 8-1, 8-3  
hardwre, 8-2, 8-5  
harmonics, 10-1  
harmonic sweeps, 5-23  
harmonic table, 10-1  
    editing, 10-9  
    phase relationships, 10-13  
    removing, 10-6  
    signal list, 10-5  
    trace of, 10-12  
HIGHEST PEAK, 9-12  
high frequency probes, 2-1  
Histogram softkey, 11-1  
histograms  
    generating, 11-2  
    horizontal, 11-6  
    vertical, 11-3  
Histograms, 11-1  
HOLD, 9-5  
hold MAX MIN, 6-18  
HORZNTL HISTOGM, 11-6  
HP 10100C, 3-4  
HP-IB connector, 1-6, 1-8  
HP-IB disk drives, 15-1  
HPIB DISK softkey, 15-3  
HP-IB HP-MSIB, 1-7  
HP-IB PRI SEC, 1-10  
HP-MSIB, 1-4  
HP-MSIB CARD softkey, 15-4  
HP-MSIB COLUMN, 1-7  
HP-MSIB ROW, 1-7  
hysteresis, 7-9

HYST softkey, 7-9

## I

IDFT(), 6-10  
IF calib, 14-6  
IF coup AC DC, 8-11  
IFFT(), 6-10  
IMAG(), 6-10  
INCLUDE HARMNCS, 10-9  
input coupling, 8-11  
INSERT LINE, 13-7  
INSERT or . . . softkey, 12-6, 15-11, 15-14  
INSTR PRESET, 1-4, 1-26, 3-9  
INT, 3-10  
INTEG(), 6-10  
INTERNAL STATE, 1-23  
invalid, 2-48

## J

j, 6-10

## L

LEVEL, 7-6  
limit lines, 12-1, 15-7  
    creating, 12-2  
    recalling, 12-5  
    saving, 12-5  
LIMIT→ 0%-100%, 11-5  
LINES DOTS, 1-15  
LOAD FILE softkey, 12-7, 15-12  
LOCAL PEAK, 9-12  
LOGMAG, 2-44, 6-14  
LOWER LIMIT, 11-5, 11-8  
LOWEST, 9-12

## M

M1(↓), 9-2  
M2(↑), 9-2  
MAGN, 2-44, 6-14  
MAGN(), 6-10  
MANUAL, 3-11  
markers, 9-1  
    cycle position, 9-15  
    DC response, 9-12  
    delta, 9-7  
    highest peak, 9-11  
    lowest peak, 9-11  
    moving traces, 9-8  
    nearest identifiable peak, 9-11  
    next highest peak, 9-11  
    peak interpolation, 9-13  
    readouts, 9-15  
Markers, 9-6  
MARKERS OFF, 9-2, 9-6  
masks, 12-1, 15-7

- creating, 12-2
- recalling, 12-7
- saving, 12-6
- mass storage softkey, 15-6, 15-10
- maximum input power, 8-11
- MEAN, 11-6, 11-9
- MEASURE ALL, 2-48
- MEASURE AVERAGE, 2-38
- measurement points, 1-17, 4-6
  - displaying, 1-15
  - establishing, 3-6
  - sweep indicator, 5-9
- measurements
  - automatic, 2-1, 2-36
  - average, 2-38
  - average power, 2-53
  - CW turn-on time, 4-18
  - duty cycle, 2-52
  - fall time, 2-49
  - freq & power, 2-5
  - frequency, 2-51
  - measure all, 2-48
  - modulated signal, 2-34, 4-31
  - overshoot, 2-49
  - peak power, 2-53
  - period, 2-50
  - predefined, 2-1, 2-2
  - pulsed RF turn-on time, 4-23
  - PULSED TIME, 3-12
  - rise time, 2-49
  - scalar network, 2-26, 3-1, 3-45, 3-48
  - settling time, 5-11, 5-17
  - swept power, 3-1, 3-60, 3-61
  - time and fft, 3-1
  - TIME and FFT, 2-34
  - updating, 2-38
  - vector network, 2-10, 3-1, 3-22, 3-24, 3-35
  - vector voltage, 2-6
  - video feedthrough, 3-18
  - voltage, 2-54
  - width, 2-52
- MEM1, 6-10
- MEM2, 6-10
- MEM3, 6-10
- MEM4, 6-10
- memory
  - cataloging, 15-10
  - connecting external disk drive, 15-3
  - default, 15-2
  - erasing all files, 15-13
  - erasing files, 15-12
  - formatting, 15-2
  - HP-IB disk drives, 15-1
  - memory cards, 15-1
  - RAM disks, 15-1

- selecting, 15-1
- memory card
  - battery, 15-2
  - changing battery, 15-7
  - write-protect switch, 15-4
- memory cards, 15-1
- MEMX, 6-6
  - , 6-10
- mkr hld ON OFF, 9-3
- mkr→, 9-8, 9-12
- MOD, 6-10
- model number, 1-4
- MOD OUTPUT, 3-4, 3-10
- modulated signals, 4-14
- modulator, 3-4, 3-10
- MOVE BOTH, 9-3, 9-6
- MsrEdge POS NEG, 2-47
- MsrTrc, 2-37, 2-47

**N**

- n, 6-10
- NEXT PEAK, 9-12
- noise, 5-7
- noisflt ON OFF, 5-7
- non-repetitive signals, 4-2
- null DC, 8-12
- NUMBER SAMPLES, 11-4, 11-7

**O**

- # of CYCLE, 4-14, 4-16
- offset sweeps, 5-23
- # OF HARMNCS, 10-9
- overshoot, 2-49
- OVER SHOOT, 2-49

**P**

- pass/fail testing, 12-1
- path to next FREQ, 13-4
- peak power, 2-53
- PERIOD, 2-50
- persistence, 1-17
- persist ON OFF, 1-18
- PHASE, 6-14, 7-5
- PI, 6-10
- pk DC ON OFF, 9-13
- pk intp ON OFF, 9-15
- PK-PK, 2-54
- PK PWR, 2-53
- pk trk ON OFF, 9-13
- place trace, 1-13
- plots, 1-24
- plotter address, 1-24
- power
  - maximum input, 8-11
- POWER, 5-13, 6-10

power sweeps, 5-1, 5-13  
 predefined measurement states, 2-1, 2-2  
 printer address, 1-25  
 prints, 1-24  
 PRI PRF, 3-9  
 PROBE POWER, 2-1  
 probes, 2-1  
 pulse < >90ns, 7-7  
 pulsed RF, 2-44, 3-1  
     default settings, 3-9  
     FFT, 3-16  
     power, 2-53  
     time domain, 3-14  
     video feedthrough, 3-18  
 PULSED TIME, 3-12  
 pulse generator, 3-7, 3-10, 3-11  
 pulse width, 3-9  
 Pulsgen, 3-7, 3-9  
 PULS RF, 7-5  
 PURGE FILE softkey, 12-8, 15-12

**R**

RAM disk, 15-2  
     creating, 15-2  
 RAM disks, 15-1  
 RANGE OFFSET, 8-7  
 readout options, 9-15, 9-19  
 REAL, 6-14  
 REAL(), 6-10  
 recalling  
     limit lines, 12-5  
     masks, 12-7  
     user-defined states, 2-5  
 recall state, 2-4, 2-5  
 recall trace, 6-26  
 RefEdge POS NEG, 2-47  
 ref hld ON OFF, 9-3  
 reflection  
     scalar network, 3-48  
     vector network, 2-21, 3-35  
     vector voltage, 2-9  
 REF LEV POS, 8-3, 8-5  
 RefTrc, 2-47  
 REPLACE or ... softkey, 12-6, 15-11, 15-14  
 RESTART ALL TRC, 6-14, 6-17  
 results, 11-6  
 RF correction, 14-11  
 RF corr ON OFF, 14-11  
 RF MOD, 3-11  
 RF out ON OFF, 3-13, 5-4  
 RF source, 1-6, 1-7  
     address, 1-4  
     control, 1-4, 1-10  
     frequency step, 1-25  
     model number, 1-4

    power step, 1-25  
     selecting, 1-8  
     type, 1-7  
 RF src PUL CW, 3-10, 3-13, 3-14  
 rise time, 2-49  
 RISE TIME, 2-49  
 RMS, 2-54  
 ROM VERSION, 1-23  
 ROM VERSION softkey, 1-23

**S**

sampler  
     frequency, 1-25  
 SAMPLER FREQ, 1-26  
 sampling, 4-2  
 sampling frequency, 4-6  
 sampling rate, 1-23  
 SAVE empty #, 2-5  
 save state, 2-4, 2-5  
 saving  
     limit lines, 12-5  
     masks, 12-6  
 scalar measurements, 2-28  
 scalar network, 3-1, 3-45, 3-48  
 SCALAR NETWORK, 2-26, 2-29  
 scale, 8-1  
     automatic, 8-3  
     offset, 8-7  
     range, 8-7  
 SCALE, 8-3  
 scale track, 8-3, 8-7  
 SCROLL TABLE, 10-4  
 SEC/DIV, 5-2, 5-4, 5-5  
 secondary addressing, 1-10  
 secure, 1-26  
 SECURE SCREEN, 1-27  
 security, 1-26  
 SELECT, 10-7  
 SEL/EDT, 6-8  
 SELF- TEST, 14-10  
 self-test routine, 14-1, 14-10  
 service requests, 1-10  
 set clock, 1-20  
 SET REF, 2-8, 2-9  
 settling time, 5-11  
 sglshot ON OFF, 4-3, 4-4  
 SHOW COR FFT, 14-7  
 SHOW COR FIR, 14-7  
 show MAG PHA, 10-10  
 show TIM DAT, 1-20  
 signal drift, 10-4  
 signal FREQ, 4-3, 4-4  
 signal list, 10-4, 10-5, 10-6  
     adding to, 10-7  
 signals ONE All, 10-8

- signal tracking, 5-7
- sig trk ON OFF, 5-7
- SINGLE, 2-39, 7-14
- SINGLE ACQUIRE, 11-3
- single shot, 4-1
  - data detection, 4-17
  - increasing data points, 4-17
- SINGLE UPDATE, 10-5
- SLOPE FLAT, 13-8
- slope LOG LIN, 13-6, 13-8
- slope POS NEG, 7-6, 7-10
- smooth ON OFF, 6-20, 7-14
- source control, 1-10
- source FRQ PWR, 5-4
- SPAN, 5-5
- split, 1-13
- split screen, 1-13
- SQRT(), 6-10
- src cfg ON OFF, 1-10
- src rel ON OFF, 7-13
- STAND- ALONE, 3-12
- STANDALONE, 3-11
- standard deviation, 11-2
- START, 5-5
- START STOP, 5-12, 6-24
- states, 2-1, 15-7
- States, 2-4, 2-5
- status line, 1-21
- status ON OFF, 1-21
- STD DEV, 11-6, 11-9
- stepkey incr, 1-25
- step keys, 1-25
- STOP, 5-5, 7-14
- store trace, 6-26
- SUM(), 6-10
- sweep, 5-2, 5-4
  - continuous, 7-14
  - frequency, 5-8
  - harmonic, 5-23
  - offset, 5-23
  - power, 5-13
  - single, 7-14
  - speed, 1-17, 5-9, 5-14
  - time, 5-2
  - triggering, 7-1
- sweep delay, 5-8
- sweep labels, 5-5, 5-12
- sweep options, 5-25
- sweeps, 5-1
- sweep speed, 1-17
- sweep types, 2-4
- swept power, 3-1, 3-60, 3-61
- SYNC INPUT, 7-10, 7-11

## T

- table, 10-1
- Table, 10-5
- TABLE, 6-6
- TD(), 8-9
- TD(), 6-10
- threshold, 2-40
- thrshld Msr Ref, 2-47
- time, 1-19
- TIME, 5-4, 6-10
- time and FFT, 3-1
- TIME and FFT, 2-34, 2-36
- time delay, 3-23
- TIME DELAY, 2-12, 3-23, 8-8
- time sweeps, 5-1, 5-2
- to CENTER, 9-8
- TOP, 2-42
- to REF LEV, 9-8
- TR1, 6-10
- TR2, 6-10
- TR3, 6-10
- TR4, 6-10
- trace
  - assignments, 1-13
  - averaging, 6-14
  - equations, 6-7
  - format, 6-11
  - holding, 6-17
  - position, 1-13
  - recalling, 6-26
  - smoothing, 6-19
  - storing, 6-26
- TRACE POINTS, 1-17, 4-6
- traces, 6-1, 15-7
  - displaying, 1-15
- trace transforms, 6-21
- transient, 4-2
- transmission
  - scalar, 2-28
  - scalar network, 3-48
  - vector network, 2-15, 3-24
- trg is, 7-4
- trigger, 3-4
  - automatic tracking, 7-13
  - external, 7-10
  - external accuracy, 7-11
  - group, 7-14
  - type, 7-4
- Trigger, 7-4
- triggering, 7-1
- trnsfrm control, 6-23



## U

UCORR1, 13-9  
UCORR2, 13-9  
Δ (2-1) ON OFF, 9-7  
unstable display, 3-4  
update, 2-37, 2-38  
UPPER LIMIT, 11-5, 11-8  
user corr, 13-1  
user-correction filters, 13-1  
user corrections  
    clearing, 1-28  
    copying, 13-8  
    deleting, 13-5  
    viewing, 13-8  
user-defined states, 2-4  
    recalling, 2-5  
    saving, 2-5  
user menus, 15-7  
use SRQ ON OFF, 1-10  
US EURO, 1-20  
usr cor ON OFF, 13-5  
USR STD, 2-43

## V

VEC FMT, 6-26  
VECTOR AVERAGE, 6-16, 7-14  
vector network, 3-1, 3-22, 3-24, 3-35

VECTOR NETWORK, 2-10, 2-16, 2-22  
vector network reflection, 2-21  
vector network transmission, 2-15  
vector voltage, 2-9  
VECTOR VOLTAGE, 2-6, 2-8  
vector voltage transmission, 2-8  
VERTICAL HISTOGRAM, 11-3  
video feedthrough, 3-18  
voltage, 2-54  
VS, 6-10

## W

warm-up time, 14-5  
width, 2-52  
WIDTH DUT CYC, 3-9  
WINDOW MARKER1, 11-4, 11-7  
WINDOW MARKER2, 11-4, 11-7  
windows, 1-13  
write-protect switch  
    card, 15-4

## X

xfrm to FRQ OFF, 3-17, 6-13, 6-14, 6-21  
xfrm to TIM OFF, 6-13, 6-14, 6-21

## Z

zoom ON OFF, 6-23

