

DC POWER SUPPLY  
SCR-1P SERIES, MODEL 6443B  
SERIAL NUMBER PREFIX 6G

June, 1966  
Ⓢ Stock No. 06443-90001

# TABLE OF CONTENTS

Section	Title	Page
I	GENERAL INFORMATION . . . . .	1-1
	1-1. Description . . . . .	1-1
	1-2. General . . . . .	1-1
	1-4. Overload Protection . . . . .	1-1
	1-7. Cooling . . . . .	1-1
	1-9. Monitoring . . . . .	1-1
	1-11. Output Terminals . . . . .	1-1
	1-13. Instrument Identification . . . . .	1-2
II	INSTALLATION . . . . .	2-1
	2-1. Initial Inspection . . . . .	2-1
	2-2. General . . . . .	2-1
	2-4. Mechanical Check . . . . .	2-1
	2-6. Electrical Check . . . . .	2-1
	2-8. Installation Data . . . . .	2-1
	2-9. General . . . . .	2-1
	2-11. Location . . . . .	2-1
	2-13. Power Requirements . . . . .	2-2
	2-15. Power Cable . . . . .	2-2
	2-18. Repackaging for Shipment. . . . .	2-2
III	OPERATING INSTRUCTIONS. . . . .	3-1
	3-1. Controls and Indicators . . . . .	3-1
	3-3. Operation . . . . .	3-1
	3-4. General . . . . .	3-1
	3-6. Normal . . . . .	3-1
	3-10. Connecting Load. . . . .	3-2
	3-14. Remote Sensing . . . . .	3-2
	3-17. Remote Programming . . . . .	3-3
	3-26. Parallel . . . . .	3-5
	3-30. Series . . . . .	3-5
	3-35. Auto-Tracking . . . . .	3-6
	3-38. Operating Considerations. . . . .	3-7
	3-39. Pulse Loading . . . . .	3-7
	3-41. Output Capacitance . . . . .	3-7
	3-44. Negative Voltage Loading . . . . .	3-7
	3-46. Negative Current Loading . . . . .	3-7

Table 1-1. Specifications

INPUT:	105-125 vac, 57 to 63 cps, single phase, 6.5 amperes, 400 watts max.
RATED OUTPUT:	Constant Voltage: 0 to 120 vdc. Constant Current: 0 to 2.5 amperes dc
LINE REGULATION:	Constant Voltage: Less than 60 mv for 105-125 vac input change. Constant Current: Less than 25 ma for 105-125 vac input change.
LOAD REGULATION:	Constant Voltage: Less than 120 mv for 0 to 2.5 ampere load change. Constant Current: Less than 25 ma for 0 to 120 vdc load change.
RIPPLE AND NOISE:	240 mvrms
OPERATING TEMPERATURE RANGE:	0°C to 50°C
STORAGE TEMPERATURE RANGE:	-20°C to 71°C
TEMPERATURE COEFFICIENT:	Constant Voltage: 0.05% plus 30 mv per degree centigrade. Constant Current: 8 ma per degree centigrade.
OUTPUT STABILITY: (after 30-minute warm-up)	Constant Voltage: 0.15% plus 90 mv for 8 hours at constant temperature. Constant Current: 25 ma for 8 hours at constant temperature.
REMOTE PROGRAMMING:	Constant Voltage: 300 ohms per volt $\pm 1\%$ Constant Current: 100 ohms per ampere
TYPICAL OUTPUT IMPEDANCE:	Less than 0.1 ohm from dc to 0.5 cps Less than 2.0 ohm from 0.5 cps to 100 cps Less than .5 ohm from 100 cps to 1kc Less than 4.0 ohm from 1kc to 100 kc
OUTPUT INDUCTANCE:	2.0 microhenry

Table 1-1. Specifications (cont.)

TRANSIENT RECOVERY TIME:

In constant voltage operation, less than 300 milliseconds is required for output voltage recovery to within 600 millivolts of the nominal output voltage following a load change equal to one half the maximum current rating of the power supply. Nominal output voltage is defined as the mean between the no-load and full-load voltages. The transient amplitude is less than 4.0 volt per ampere for any load change between 20% and 100% of rated output current. (Excluding the initial spike of approximately 100 microseconds duration which is significant only for load rise times faster than 0.2 ampere per microsecond.)

SIZE AND WEIGHT:

Height	Width	Depth	Weight
3-1/2 in.	19 in.	17-1/2 in.	31 lb.

FINISH:

Light gray front panel with dark gray case.

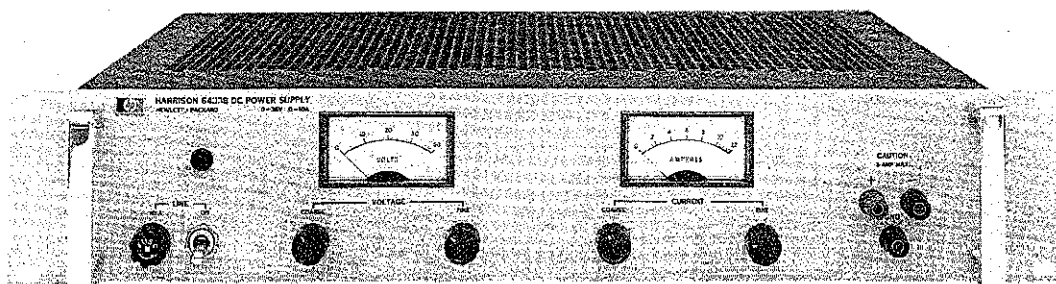

Figure 1-1. Model 6443B DC Power Supply

and either the positive or the negative terminal may be connected to the chassis via a separate ground terminal located adjacent to the output terminals. The power supply is insulated to permit operation up to 300 vdc off ground.

### 1-13. INSTRUMENT IDENTIFICATION

1-14. Harrison Laboratories power supplies are identified by a three-part designation. The first part is the model number; the second part is the serial number; and the third part is the manufacturing code letter. This manual applies to all Model 6443A power supplies with the same manufacturing code letter given in the title page. Change sheets will be supplied with the manual to make it apply to Model 6443A power supplies with different manufacturing code letters.

SECTION II  
INSTALLATION

2-1. INITIAL INSPECTION

2-2. GENERAL

2-3. Before shipment, the power supply was inspected and found free of mechanical and electrical defects. If damage to the shipping carton is evident, ask that the carrier's agent be present when the power supply is unpacked. As soon as the power supply is unpacked, inspect it for any damage that may have occurred in transit. Also check the cushioning material for signs of severe stress (may be indication of internal damage). Save all packing materials until the inspection is completed. If damage is found, proceed as instructed in the Claim for Damage in Shipment notice on the back of the front cover of this manual.

2-4. MECHANICAL CHECK

2-5. Check that there are no broken knobs or connectors, that the external surface is not scratched or dented, that the meter faces are not damaged, and that all controls move freely. Any external damage may be an indication of internal damage.

2-6. ELECTRICAL CHECK

2-7. Check that the straps on the terminal strip at the rear of the power supply are secure and that the strapping pattern is in accord with figure 3-2. Check the electrical performance of the power supply as soon as possible after receipt. A performance check that is suitable for incoming inspection is given in paragraphs 5-7 through 5-22.

2-8. INSTALLATION DATA

2-9. GENERAL

2-10. The power supply is shipped ready for bench or relay rack (19 inch) operation.

2-11. LOCATION

2-12. Because the power supply is cooled by convection, there must be enough space along the sides and rear of the power supply to permit free flow of cooling air. The power supply should be located in an area where the ambient temperature does not exceed 50°C.

## 2-13. POWER REQUIREMENTS

2-14. The power supply is operated from a 105 to 125 volt (115 volts nominal), 57 to 63 cps, single phase power source. At 115 volts, 60 cps, the full load requirement is 400 watts at 6 amperes.

## 2-15. POWER CABLE

2-16. To protect operating personnel, the National Electrical Manufacturers Association (NEMA) recommends that the instrument panel and cabinet be grounded. This instrument is equipped with a three-conductor power cable. The third conductor is the ground conductor and when the cable is plugged into an appropriate receptacle, the instrument is grounded. The offset pin on the power cable three-prong connector is the ground connection.

2-17. To preserve the protection feature when operating the instrument from a two-contact outlet, use a three-prong to two-prong adaptor and connect the green lead on the adaptor to ground.

## 2-18. REPACKAGING FOR SHIPMENT

2-19. To insure safe shipment of the instrument, it is recommended that the package designed for the instrument be used. The original packaging material is reusable. If it is not available, contact your Hewlett-Packard field office for packing materials and information. A packing carton part number is included in the parts list.

2-20. Attach a tag to the instrument which specifies the owner, model number, full serial number, and service required, or a brief description of the trouble.



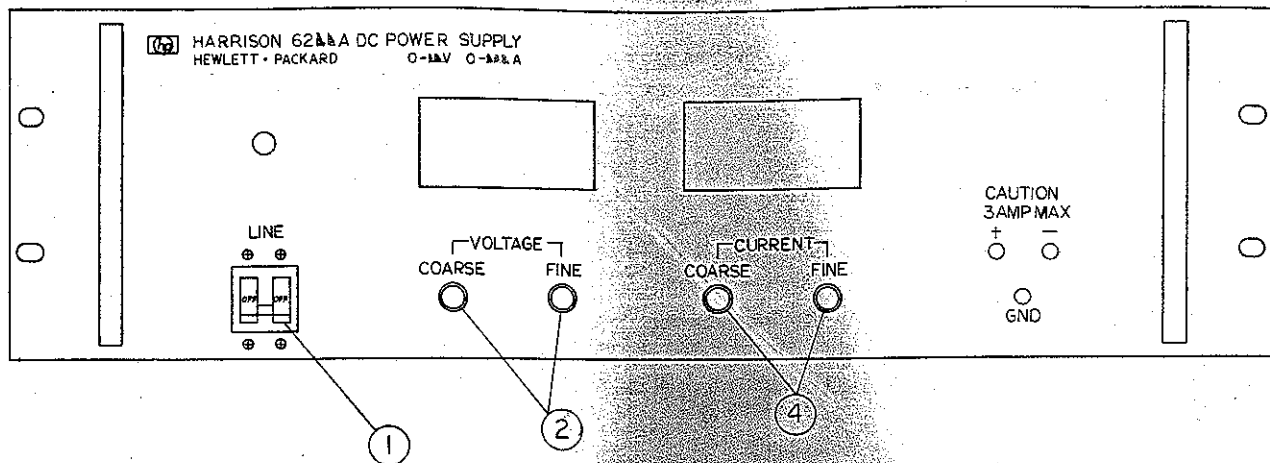

1. TURN AC POWER ON.
2. ADJUST COARSE AND FINE VOLTAGE CONTROLS UNTIL THE VOLTAGE ON THE OUTPUT VOLTAGE METER IS OF DESIRED VALUE.
3. SHORT CIRCUIT THE OUTPUT TERMINALS (AT REAR OF POWER SUPPLY)
4. ADJUST COARSE AND FINE CURRENT CONTROLS UNTIL THE CURRENT ON THE OUTPUT CURRENT METER IS OF DESIRED VALUE.
5. REMOVE SHORT AND CONNECT LOAD.

OPERATING PROCEDURE  
FIG 3-1



## SECTION III

### OPERATING INSTRUCTIONS

#### 3-1. CONTROLS AND INDICATORS

3-2. The controls and indicators are illustrated in figure 3-1.

#### 3-3. OPERATION

#### 3-4. GENERAL

3-5. The power supply is designed so that its mode of operation can be selected by making strapping connections between particular terminals on the terminal strip at the rear of the power supply. The terminal designations are stenciled in white on the power supply and are adjacent to their respective terminals. The strapping patterns illustrated in this section show neither terminal grounded. The operator can ground either terminal or operate the power supply up to 300 vdc off ground (floating).

#### 3-6. NORMAL

3-7. GENERAL. The power supply is normally shipped with its rear terminal strapping connections arranged for constant voltage/constant current, local sensing, local programming, single unit mode of operation. This strapping pattern is illustrated in figure 3-2. The operator selects either a constant voltage or a constant current output using the front panel controls (local programming, no strapping changes are necessary).

3-8. CONSTANT VOLTAGE. To select a constant voltage output, proceed as follows:

a. Turn-on power supply and adjust VOLTAGE controls for desired output voltage (output terminals open).

b. Short output terminals and adjust CURRENT controls for maximum output current allowable (current limit), as determined by load conditions. If a load change causes the current limit to be exceeded, the power supply will automatically cross-over to constant current output at the preset current limit and the output voltage will drop proportionately. In setting the current limit, allowance must be made for high peak currents which can cause unwanted cross-over (refer to para. 3-40).

3-9. CONSTANT CURRENT. To select a constant current output, proceed as follows:

a. Short output terminals and adjust CURRENT controls for desired output current.

b. Open output terminals and adjust VOLTAGE controls for maximum output voltage allowable (voltage limit), as determined by load conditions. If a load change causes the voltage limit to be exceeded, the power supply will automatically crossover to constant voltage output at the preset voltage limit and the output current will drop proportionately. In setting the voltage limit, allowance must be made for high peak voltages which can cause unwanted crossover. (Refer to para. 3-40.)

### 3-10. CONNECTING LOAD

3-11. Two pairs of output terminals are provided on the terminal strip at the left rear side (facing rear) of the power supply. Either pair of terminals or both may be used. The terminals are marked + and -. A separate ground terminal is located adjacent to the output terminals. The positive or negative output terminal may be grounded, or neither grounded (floating operation; permitted to 300 vdc off ground).

3-12. Each load should be connected to the power supply output terminals using separate pairs of connecting wires. This will minimize mutual coupling effects between loads and will retain full advantage of the low output impedance of the power supply. Each pair of connecting wires should be as short as possible and twisted or shielded to reduce noise pickup. (If shield is used, connect one end to power supply ground terminal and leave the other end unconnected.)

3-13. If load considerations require that the output power distribution terminals be remotely located from the power supply, then the power supply output terminals should be connected to the remote distribution terminals via a pair of twisted or shielded wires and each load separately connected to the remote distribution terminals. For this case, remote sensing should be used (para. 3-14).

#### NOTE

It is recommended that the voltage drop in the connecting wires not exceed 2 volts. If a larger drop must be tolerated, please consult a Hewlett-Packard field representative.

### 3-14. REMOTE SENSING

3-15. Remote sensing is used to ameliorate the degradation of regulation which will occur at the load when the voltage drop in the connecting wires is appreciable. The use of remote distribution terminals (para. 3-13) is an example where remote sensing may be required. Due to the voltage drop in the load leads, it may be necessary to slightly increase the current limit in constant voltage operation.

## CAUTION

Turn-off power supply before rearranging strapping pattern at the power supply rear terminal strip. If the -S terminal is opened while the power supply is on, the output voltage and current may exceed their maximum ratings and result in damage to the load. The power supply will not be damaged.

### 3-16. Proceed as follows:

a. Turn-off power supply and arrange rear terminal strapping pattern as shown in figure 3-3. The sensing wires will carry less than 10 ma and need not be as heavy as the load wires. It is recommended that sensing and load wires be twisted and shielded. (If shield is used, connect one end to power supply negative terminal and leave the other end unconnected.)

## CAUTION

Observe polarity when connecting the sensing leads to the load.

b. In order to maintain low ac output impedance, a capacitor with a minimum rating of 4,000 $\mu$ fd and 150 vdcw should be connected across the load using short leads. This capacitor must have high-frequency characteristics as good or better than C17 has (see parts list).

c. Turn-on power supply.

### 3-17. REMOTE PROGRAMMING

3-18. GENERAL. The constant voltage and constant current outputs may be programmed (controlled) from a remote location. The front-panel controls are disabled in the following instructions. Changes in the rear terminal strapping arrangement are necessary. The wires connecting the programming terminals of the power supply to the remote programming device should be twisted or shielded to reduce noise pick-up. (if shield is used, connect one end to power supply ground terminal and leave the other end unconnected.) Remote sensing (para. 3-14) may be used simultaneously with remote programming. However, the strapping patterns shown in figures 3-4, 3-5, and 3-6 employ only local sensing and do not show the load connections.

## CAUTION

Turn-off power supply before rearranging strapping pattern at the power supply rear terminal strip. If the current programming terminals are opened while the power supply is on, the output current will exceed its maximum rating and may result in damage to the load. The power supply will not be damaged. The constant voltage programming terminals have a zener diode connected internally across them to limit the programming voltage and thus prevent excessive output voltage.

3-19. **CONSTANT VOLTAGE.** In the constant voltage mode of operation, either a resistance or voltage source can be used for remote programming. For resistance programming, the programming coefficient (fixed by the programming current) is 300 ohms per volt (output voltage increases 1 volt for each 300 ohms in series with programming terminals). The programming current is adjusted to within 1% of 3.33ma at the factory. If greater programming accuracy is required, change R39 (shunt). The programming resistance should be a stable, low noise, low-temperature (less than 30 ppm per °C) resistor with a power rating at least 10 times its actual dissipation.

3-20. The output voltage of the power supply should be 0 +20 mv, -100 mv when the programming resistance is zero ohms. This tolerance can be improved by changing R6. For further information on improving this tolerance, refer to paragraph 5-63 and to H-Lab Tech Letter #1.

3-21. If the resistance programming device is controlled by a switch, make-before-break contacts should be used in order to avoid momentary opening of the programming terminals. To connect the remote programming resistance, arrange rear terminal strapping pattern as shown in figure 3-4. The front-panel VOLTAGE controls are disabled when the strap between A6 and A7 is removed.

3-22. If a voltage source is used as the remote programming device, the output voltage of the power supply will vary in a 1 to 1 ratio with the programming voltage. The load on the voltage source will not exceed 25 microamperes. To connect the programming voltage, arrange rear terminal strapping pattern as shown in figure 3-5.

3-23. **CONSTANT CURRENT.** In constant current operation, resistance programming is used. The resistance programming coefficient (fixed by the programming current) is 100ohms per ampere (output current increases 1 ampere for each 100 ohms in series with programming terminals). The programming current is adjusted to within approximately 10% of 4 ma at the factory. If greater programming accuracy is required, change R41 (shunt). The programming resistance should be a stable, low noise, low-temperature (less than 30 ppm per °C) resistor with a power rating at least 10 times its actual dissipation.



3-24. The output current of the power supply should be  $0 \pm 25\text{ ma}$ ,  $-50\text{ ma}$  when the programming resistance is zero ohms. This tolerance can be improved by changing R20. For further information on improving this tolerance, refer to paragraph 5-67 and to H-Lab Tech Letter #1.

3-25. If the resistance programming device is controlled by a switch, make-before-break contacts should be used to avoid momentary opening of the programming terminals. To connect the remote programming resistance, arrange rear terminal strapping as shown in figure 3-6. The front-panel CURRENT controls are disabled when the strap between A1 and A2 is removed.

### 3-26. PARALLEL

3-27. GENERAL. Two or more power supplies can be connected in parallel to obtain a total output current greater than that available from one power supply. The total output current is the sum of the output currents of the individual power supplies. Each power supply can be turned-on or off separately. Remote sensing (para. 3-14) and programming (para. 3-17) can be used; however, the strapping patterns shown in figures 3-7 and 3-8 employ only local sensing and programming.

3-28. NORMAL. The strapping pattern for normal parallel operation of two power supplies is shown in figure 3-7. The output current controls of each power supply can be separately set. The output voltage controls of one power supply (master) should be set to the desired output voltage; the other power supply (slave) should be set for a slightly larger output voltage. The master will act as a constant voltage source; the slave will act as a constant current source, dropping its output voltage to equal the master's.

3-29. AUTO-PARALLEL. The strapping patterns for auto-parallel operation of two and three power supplies are shown in figures 3-8A and B, respectively. Auto-parallel operation permits equal current sharing under all load conditions, and allows complete control of output current from one master power supply. The output current of each slave is approximately equal to the master's. Because the output current controls of each slave is operative, they should be set to maximum to avoid having the slave revert to constant current operation; this would occur if the master output current setting exceeded the slave's.

### 3-30. SERIES

3-31. GENERAL. Two or more power supplies can be connected in series to obtain a total output voltage higher than that available from one power supply. The total output voltage is the sum of the output voltages of the individual power supplies. A single load can be connected across the series-connected power supplies or a separate load can be connected across each power supply. The power supply has a reverse polarity diode connected internally across the output terminals to protect the power supply against reverse polarity voltage if the load is short-circuited or if one power supply is turned off while its series partners are on.



3-32. The output current controls of each power supply are operative and the current limit is equal to the lowest control setting. If any output current controls are set too low with respect to the total output voltage, the series power supplies will automatically crossover to constant current operation and the output voltage will drop. Remote sensing (para. 3-14) and programming (para. 3-17) can be used; however, the strapping patterns shown in figures 3-9 and 3-10 employ only local sensing and programming.

3-33. NORMAL. The strapping pattern for normal series operation of two power supplies is shown in figure 3-9. The output voltage controls of each power supply must be adjusted to obtain the total output voltage.

3-34. AUTO-SERIES. The strapping patterns for auto-series operation of two and three power supplies are shown in figures 3-10A and B, respectively. Auto-series operation permits control of the output voltage of several power supplies (slaves) from one master power supply. The master must be the most negative power supply of the series. To obtain positive and negative voltages, the + terminal of the master may be grounded. For a given position of the slave output voltage controls, the total output voltage is determined by the master output voltage controls. The output voltage controls of a slave determines the percentage of the total output voltage that the slave will contribute. Turn-on and turn-off of the series is controlled by the master. In order to maintain the temperature coefficient and stability specifications of the power supply, the external resistors shown in figures 3-10A and B, should be stable, low-noise, low-temperature (less than 30 ppm per °C) resistors. The value of these resistors is determined by multiplying the output voltage of the applicable slave by the programming coefficient (300 ohms/volt).

### 3-35. AUTO-TRACKING

3-36. The strapping patterns for auto-tracking operation of two and three power supplies are shown in figures 3-11A and B, respectively. Automatic tracking operation permits the output voltages of two or more power supplies to be referenced to a common buss; one of the power supplies (master) controls the magnitude of the output voltage of the others (slaves) for a given position of the slave output voltage controls. The master must be the most negative power supply in the group. The output voltage of a slave is a percentage of the master output voltage. The output voltage controls of a slave determines this percentage. Turn-on and turn-off of the power supplies is controlled by the master. Remote sensing (para. 3-14) and programming (para. 3-17) can be used; however, the strapping patterns shown in figure 3-4 employ only local sensing and programming.

3-37. The value of the external resistor shown in figure 3-11 is determined by dividing the voltage difference between the master and the applicable slave by the programming current (nominally 3.33ma; refer to para. 3-19) Finer adjustment of the slave output voltage can be accomplished using the slave output voltage controls. In order to maintain the temperature coefficient and stability specifications of the power supply, the external resistors should be stable, low-noise, low-temperature (less than 30 ppm per °C) resistor.

### 3-38. OPERATING CONSIDERATIONS

#### 3-39. PULSE LOADING

3-40. The power supply will automatically cross over from constant voltage to constant current operation, or the reverse, in response to an increase (over the preset limit) in the output current or voltage, respectively. Although the preset limit may be set higher than the average output current or voltage, high peak currents or voltages (as occur in pulse loading) may exceed the preset limit and cause crossover to occur. To avoid this unwanted crossover, the preset limit must be set for the peak requirement and not the average.

#### 3-41. OUTPUT CAPACITANCE

3-42. There are capacitors (internal) across the output terminals of the power supply. These capacitors help to supply high-current pulses of short duration during constant voltage operation. Any capacitance added externally will improve the pulse current capability, but will decrease the safety provided by the constant current circuit. A high-current pulse may damage load components before the average output current is large enough to cause the constant current circuit to operate.

3-43. The effects of the output capacitors during constant current operation are as follows:

a. The output impedance of the power supply decreases with increasing frequency.

b. The rise time of the output voltage is increased.

c. A large surge current causing a high power dissipation in the load occurs when the load impedance is reduced rapidly.

#### 3-44. NEGATIVE VOLTAGE LOADING

3-45. A diode is connected across the output terminals. Under normal operating conditions, the diode is reverse biased (anode connected to negative terminal). If a negative voltage is applied to the output terminals (positive voltage applied to negative terminal), the diode will conduct, shunting current across the output terminals and limiting the voltage to the forward voltage drop of the diode. This diode protects the filter and output electrolytic capacitors.

#### 3-46. NEGATIVE CURRENT LOADING

3-47. Certain types of loads may cause current to flow into the power supply in the direction opposite to the output current. If the reverse current exceeds 0.02 ampere, preloading will be necessary. For example; if the load delivers 1 ampere to the power supply with the power supply output voltage at 18 vdc, a resistor equal to

18 ohms (18v/1a) should be connected across the output terminals. Thus, the 18 ohm resistor shunts the reverse current across the power supply. For more information on preloading, refer to paragraph C4 in the H-Lab Application Manual.

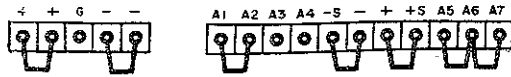

FIGURE 3-2. NORMAL STRAPPING PATTERN

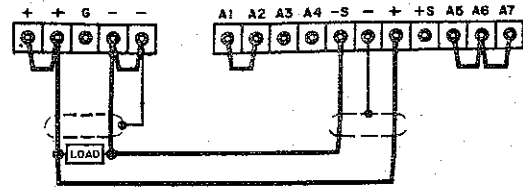

FIGURE 3-3. REMOTE SENSING STRAPPING PATTERN

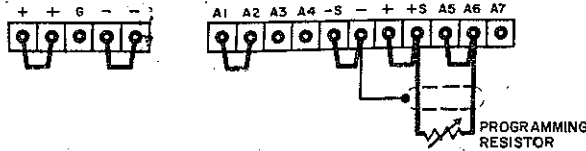

FIGURE 3-4. REMOTE RESISTANCE PROGRAMMING (CONSTANT VOLTAGE) STRAPPING PATTERN

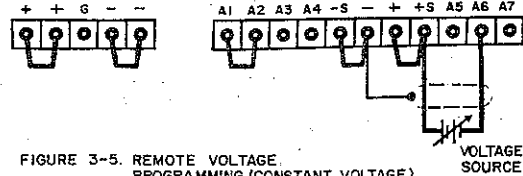

FIGURE 3-5. REMOTE VOLTAGE PROGRAMMING (CONSTANT VOLTAGE) STRAPPING PATTERN

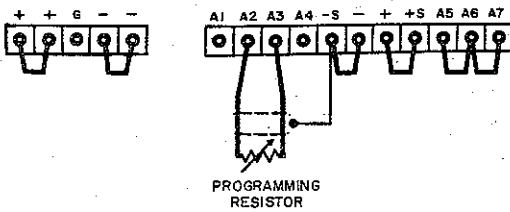

FIGURE 3-6. REMOTE RESISTANCE PROGRAMMING (CONSTANT CURRENT) STRAPPING PATTERN

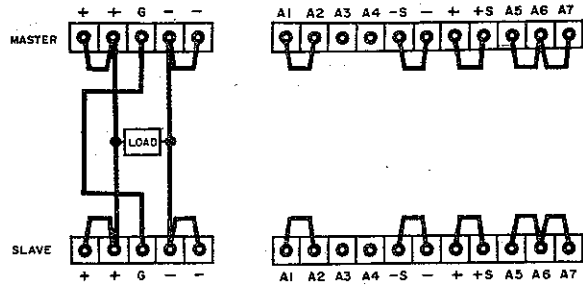
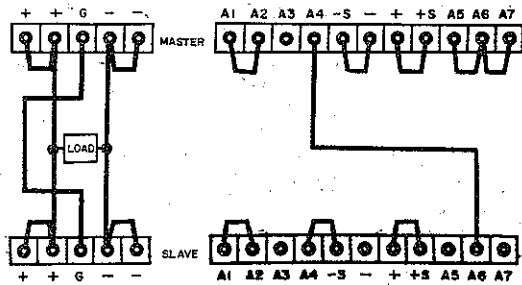
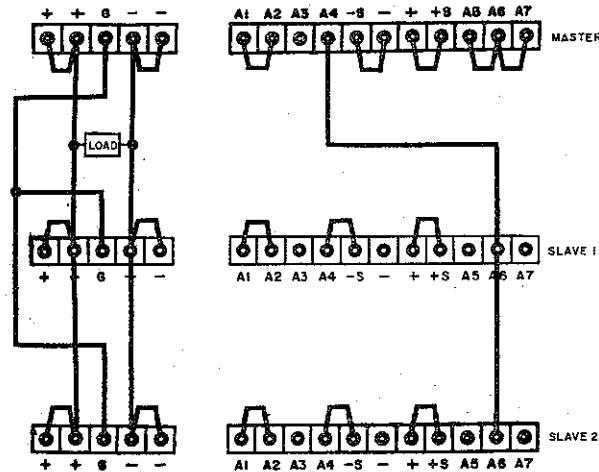

FIGURE 3-7 NORMAL PARALLEL STRAPPING PATTERN



A. TWO POWER SUPPLIES



B. THREE POWER SUPPLIES

FIGURE 3-8. AUTO-PARALLEL STRAPPING PATTERN



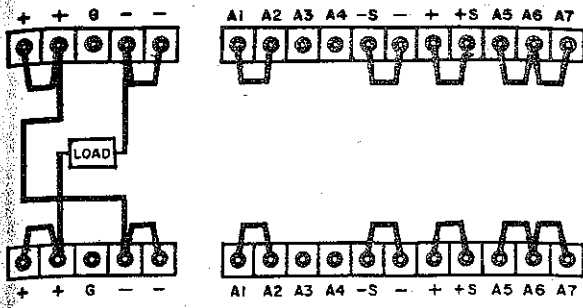
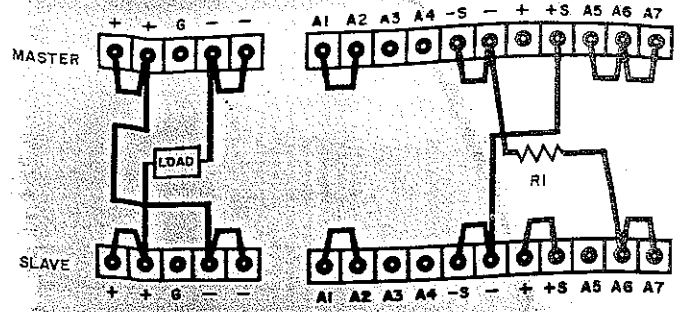
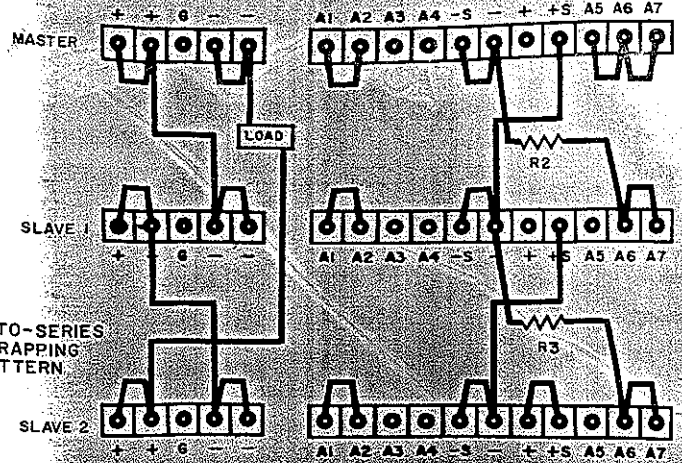

FIGURE 3-9. NORMAL SERIES STRAPPING PATTERN



A. TWO POWER SUPPLIES



B. THREE POWER SUPPLIES

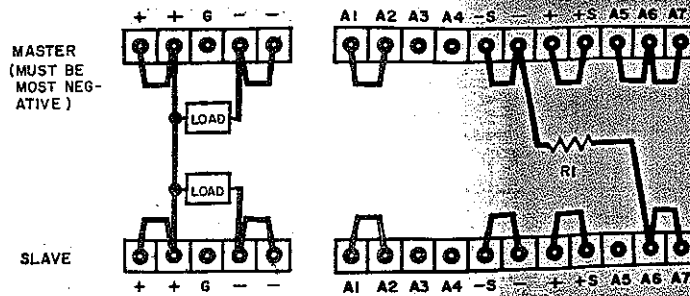

A. TWO POWER SUPPLIES

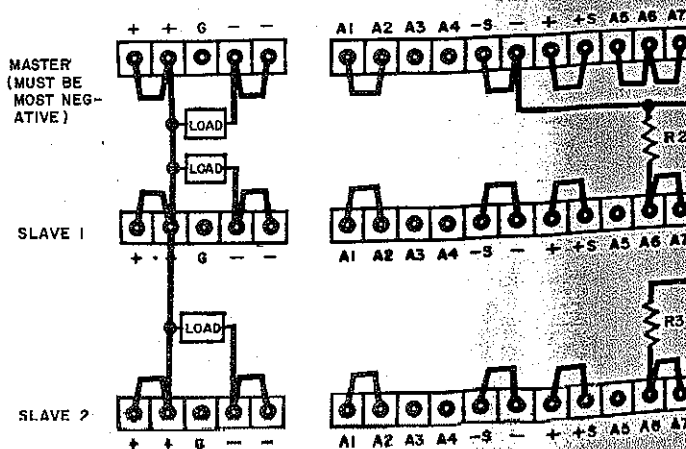

B. THREE POWER SUPPLIES

FIGURE 3-11. AUTO-TRACKING STRAPPING PATTERN

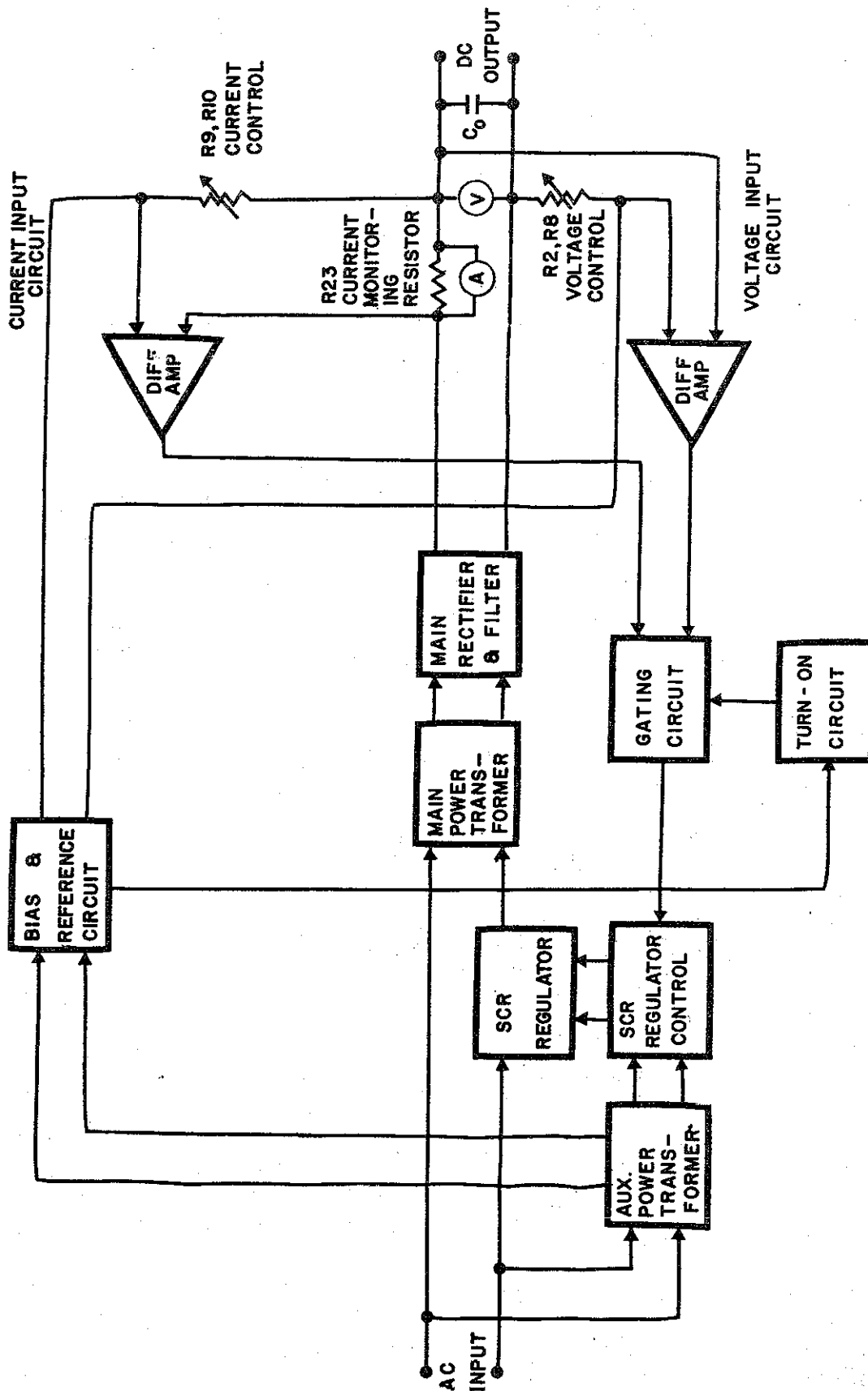

FIGURE 4-1. BLOCK DIAGRAM