

OPERATING AND SERVICE MANUAL

MODEL 6438B

DC POWER SUPPLY

MANUFACTURING CODE 6B

February, 1966.

Table 1-1. Specifications

INPUT:	105-125 vac, 57 to 63 cps, single phase, 6.5 amperes, 400 watts max.
RATED OUTPUT:	Constant Voltage: 0 to 60 vdc. Constant Current: 0 to 5 amperes dc
LINE REGULATION:	Constant Voltage: Less than 30 mv for 105-125 vac input change. Constant Current: Less than 50 ma for 105-125 vac input change.
LOAD REGULATION:	Constant Voltage: Less than 60 mv for 0 to 5 ampere load change. Constant Current: Less than 50 ma for 0 to 60vdc load change.
RIPPLE AND NOISE:	120 mvrms
OPERATING TEMPERATURE RANGE:	0°C to 50°C
STORAGE TEMPERATURE RANGE:	-20°C to 71°C
TEMPERATURE COEFFICIENT:	Constant Voltage: 0.05% plus 15 mv per degree centigrade Constant Current: 15 ma per degree centigrade.
OUTPUT STABILITY: (after 30-minute warm-up)	Constant Voltage: 0.15% plus 45 mv for 8 hours at constant temperature. Constant Current: 50 ma for 8 hours at constant temperature.
REMOTE PROGRAMMING:	Constant Voltage: 300 ohms per volt $\pm 1\%$ Constant Current: 50 ohms per ampere
TYPICAL OUTPUT IMPEDANCE:	Less than 0.02 ohm from dc to 0.5 cps Less than 0.5 ohm from 0.5 cps to 100 cps Less than 0.1 ohm from 100 cps to 1kc Less than 1.0 ohm from 1kc to 100 kc
OUTPUT INDUCTANCE:	1.0 microhenry

Table 1-1. Specifications (cont.)

TRANSIENT RECOVERY TIME:

In constant voltage operation, less than 300 milliseconds is required for output voltage recovery to within 300 millivolts of the nominal output voltage following a load change equal to one half the maximum current rating of the power supply. Nominal output voltage is defined as the mean between the no-load and full-load voltages. The transient amplitude is less than 1.0 volt per ampere for any load change between 20% and 100% of rated output current. (Excluding the initial spike of approximately 100 microseconds duration which is significant only for load rise times faster than 0.1 ampere per microsecond.)

SIZE AND WEIGHT:

Height	Width	Depth	Weight
3-1/2 in.	19 in.	17-1/2 in.	31 lb.

FINISH:

Light gray front panel with dark gray case.

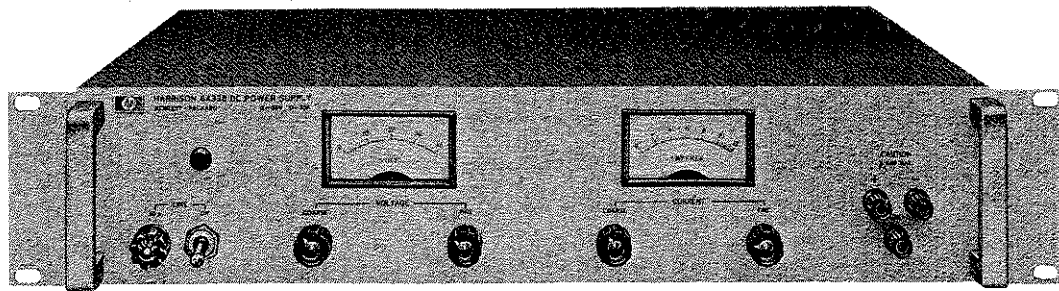

Figure 1-1. Model 6438B DC Power Supply

## SECTION I

### GENERAL INFORMATION

#### 1-1. DESCRIPTION

#### 1-2. GENERAL

1-3. The H-Lab Model 6438A DC Power Supply (fig. 1-1) is a completely solid-state, compact, well-regulated, constant voltage/constant current dc power supply suitable for either bench or relay rack operation. A three-wire five-foot power cord is provided. The output is continuously variable between 0 and 60vdc, and between 0 and 5 amperes. Detailed specifications are given in table 1-1.

#### 1-4. OVERLOAD PROTECTION

1-5. A crossover feature protects both power supply and load in constant voltage operation. Automatic crossover circuitry switches the power supply from constant voltage to constant current operation if the output current exceeds a preset limit. This crossover circuitry also protects the load from overvoltage during constant current operation by automatically switching the power supply into constant voltage operation. The user can adjust the crossover point via the front panel controls (para. 3-8 and 3-9).

1-6. The power supply is protected from reverse voltage (positive voltage applied to negative terminal) by a diode that shunts current across the output terminals when this condition exists. The ac input is fused. A double-pole on/off switch opens both power leads in the off position.

#### 1-7. COOLING

1-8. Convection cooling is used. No fan is required. The power supply has no moving parts (except meter movement).

#### 1-9. MONITORING

1-10. Two front-panel meters are provided for monitoring output voltage and current. The voltmeter has a 0 to 64 volt range and the ammeter has a 0 to 6 ampere range. Each meter has a 2% accuracy at full scale.

#### 1-11. OUTPUT TERMINALS

1-12. Output power is available via a terminal strip on the rear panel. The rear panel terminal strip also enables the power supply to be connected for different modes of operation (para. 3-3). The output terminals are isolated from the chassis

and either the positive or the negative terminal may be connected to the chassis via a separate ground terminal located adjacent to the output terminals. The power supply is insulated to permit operation up to 300 vdc off ground.

### 1-13. INSTRUMENT IDENTIFICATION

1-14. Harrison Laboratories power supplies are identified by a three-part designation. The first part is the model number; the second part is the serial number; and the third part is the manufacturing code letter. This manual applies to all Model 6438A power supplies with the same manufacturing code letter given in the title page. Change sheets will be supplied with the manual to make it apply to Model 6438A power supplies with different manufacturing code letters.

SECTION II  
INSTALLATION

2-1. INITIAL INSPECTION

2-2. GENERAL

2-3. Before shipment, the power supply was inspected and found free of mechanical and electrical defects. If damage to the shipping carton is evident, ask that the carrier's agent be present when the power supply is unpacked. As soon as the power supply is unpacked, inspect it for any damage that may have occurred in transit. Also check the cushioning material for signs of severe stress (may be indication of internal damage). Save all packing materials until the inspection is completed. If damage is found, proceed as instructed in the Claim for Damage in Shipment notice on the back of the front cover of this manual.

2-4. MECHANICAL CHECK

2-5. Check that there are no broken knobs or connectors, that the external surface is not scratched or dented, that the meter faces are not damaged, and that all controls move freely. Any external damage may be an indication of internal damage.

2-6. ELECTRICAL CHECK

2-7. Check that the straps on the terminal strip at the rear of the power supply are secure and that the strapping pattern is in accord with figure 3-2. Check the electrical performance of the power supply as soon as possible after receipt. A performance check that is suitable for incoming inspection is given in paragraphs 5-7 through 5-22.

2-8. INSTALLATION DATA

2-9. GENERAL

2-10. The power supply is shipped ready for bench or relay rack (19 inch) operation.

2-11. LOCATION

2-12. Because the power supply is cooled by convection, there must be enough space along the sides and rear of the power supply to permit free flow of cooling air. The power supply should be located in an area where the ambient temperature does not exceed 50°C.

## 2-13. POWER REQUIREMENTS

2-14. The power supply is operated from a 105 to 125 volt (115 volts nominal), 57 to 63 cps, single phase power source. At 115 volts, 60 cps, the full load requirement is 400 watts at 6 amperes.

## 2-15. POWER CABLE

2-16. To protect operating personnel, the National Electrical Manufacturers Association (NEMA) recommends that the instrument panel and cabinet be grounded. This instrument is equipped with a three-conductor power cable. The third conductor is the ground conductor and when the cable is plugged into an appropriate receptacle, the instrument is grounded. The offset pin on the power cable three-prong connector is the ground connection.

2-17. To preserve the protection feature when operating the instrument from a two-contact outlet, use a three-prong to two-prong adaptor and connect the green lead on the adaptor to ground.

## 2-18. REPACKAGING FOR SHIPMENT

2-19. To insure safe shipment of the instrument, it is recommended that the package designed for the instrument be used. The original packaging material is reusable. If it is not available, contact your Hewlett-Packard field office for packing materials and information. A packing carton part number is included in the parts list.

2-20. Attach a tag to the instrument which specifies the owner, model number, full serial number, and service required, or a brief description of the trouble.

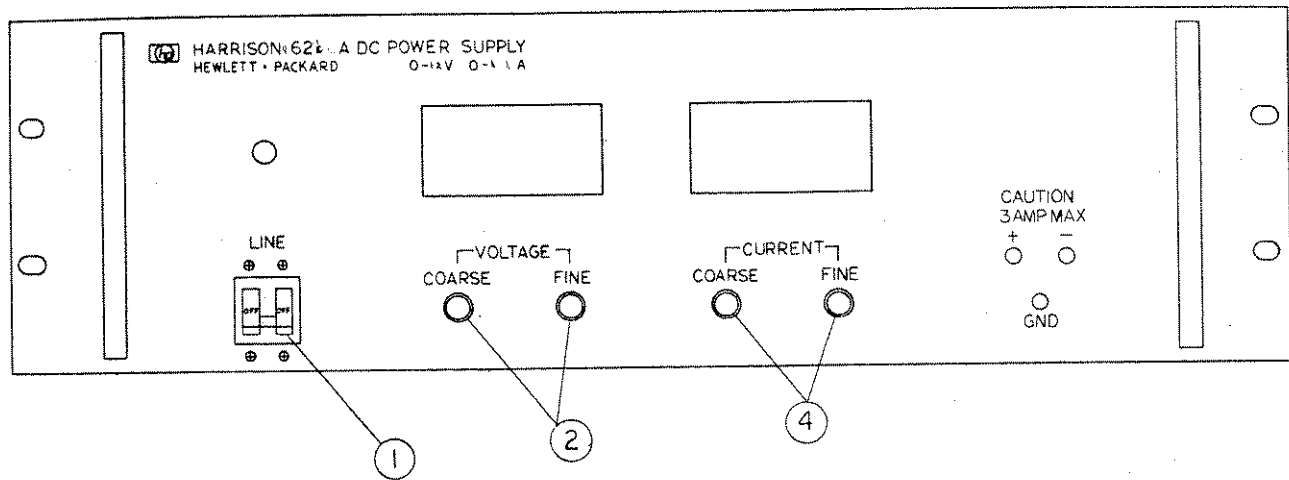

1. TURN AC POWER ON.
2. ADJUST COARSE AND FINE VOLTAGE CONTROLS UNTIL THE VOLTAGE ON THE OUTPUT VOLTAGE METER IS OF DESIRED VALUE.
3. SHORT CIRCUIT THE OUTPUT TERMINALS (AT REAR OF POWER SUPPLY)
4. ADJUST COARSE AND FINE CURRENT CONTROLS UNTIL THE CURRENT ON THE OUTPUT CURRENT METER IS OF DESIRED VALUE.
5. REMOVE SHORT AND CONNECT LOAD.

OPERATING PROCEDURE  
FIG 3-1



SECTION III  
OPERATING INSTRUCTIONS

3-1. CONTROLS AND INDICATORS

3-2. The controls and indicators are illustrated in figure 3-1.

3-3. OPERATION

3-4. GENERAL

3-5. The power supply is designed so that its mode of operation can be selected by making strapping connections between particular terminals on the terminal strip at the rear of the power supply. The terminal designations are stenciled in white on the power supply and are adjacent to their respective terminals. The strapping patterns illustrated in this section show neither terminal grounded. The operator can ground either terminal or operate the power supply up to 300 vdc off ground (floating).

3-6. NORMAL

3-7. GENERAL. The power supply is normally shipped with its rear terminal strapping connections arranged for constant voltage/constant current, local sensing, local programming, single unit mode of operation. This strapping pattern is illustrated in figure 3-2. The operator selects either a constant voltage or a constant current output using the front panel controls (local programming, no strapping changes are necessary).

3-8. CONSTANT VOLTAGE. To select a constant voltage output, proceed as follows:

a. Turn-on power supply and adjust VOLTAGE controls for desired output voltage (output terminals open).

b. Short output terminals and adjust CURRENT controls for maximum output current allowable (current limit), as determined by load conditions. If a load change causes the current limit to be exceeded, the power supply will automatically cross-over to constant current output at the preset current limit and the output voltage will drop proportionately. In setting the current limit, allowance must be made for high peak currents which can cause unwanted cross-over (refer to para. 3-40).

3-9. CONSTANT CURRENT. To select a constant current output, proceed as follows:

a. Short output terminals and adjust CURRENT controls for desired output current.

b. Open output terminals and adjust VOLTAGE controls for maximum output voltage allowable (voltage limit), as determined by load conditions. If a load change causes the voltage limit to be exceeded, the power supply will automatically crossover to constant voltage output at the preset voltage limit and the output current will drop proportionately. In setting the voltage limit, allowance must be made for high peak voltages which can cause unwanted crossover. (Refer to para. 3-40.)

### 3-10. CONNECTING LOAD

3-11. Two pairs of output terminals are provided on the terminal strip at the left rear side (facing rear) of the power supply. Either pair of terminals or both may be used. The terminals are marked + and -. A separate ground terminal is located adjacent to the output terminals. The positive or negative output terminal may be grounded, or neither grounded (floating operation; permitted to 300 vdc off ground).

3-12. Each load should be connected to the power supply output terminals using separate pairs of connecting wires. This will minimize mutual coupling effects between loads and will retain full advantage of the low output impedance of the power supply. Each pair of connecting wires should be as short as possible and twisted or shielded to reduce noise pickup. (If shield is used, connect one end to power supply ground terminal and leave the other end unconnected.)

3-13. If load considerations require that the output power distribution terminals be remotely located from the power supply, then the power supply output terminals should be connected to the remote distribution terminals via a pair of twisted or shielded wires and each load separately connected to the remote distribution terminals. For this case, remote sensing should be used (para. 3-14).

#### NOTE

It is recommended that the voltage drop in the connecting wires not exceed 2 volts. If a larger drop must be tolerated, please consult a Hewlett-Packard field representative.

### 3-14. REMOTE SENSING

3-15. Remote sensing is used to ameliorate the degradation of regulation which will occur at the load when the voltage drop in the connecting wires is appreciable. The use of remote distribution terminals (para. 3-13) is an example where remote sensing may be required. Due to the voltage drop in the load leads, it may be necessary to slightly increase the current limit in constant voltage operation.

## CAUTION

Turn-off power supply before rearranging strapping pattern at the power supply rear terminal strip. If the -S terminal is opened while the power supply is on, the output voltage and current may exceed their maximum ratings and result in damage to the load. The power supply will not be damaged.

3-16. Proceed as follows:

a. Turn-off power supply and arrange rear terminal strapping pattern as shown in figure 3-3. The sensing wires will carry less than 10 ma and need not be as heavy as the load wires. It is recommended that sensing and load wires be twisted and shielded. (If shield is used, connect one end to power supply negative terminal and leave the other end unconnected.)

## CAUTION

Observe polarity when connecting the sensing leads to the load.

b. In order to maintain low ac output impedance, a capacitor with a minimum rating of 20,000 $\mu$ fd and 25 vdcw should be connected across the load using short leads. This capacitor must have high-frequency characteristics as good or better than C17 has (see parts list).

c. Turn-on power supply.

3-17. REMOTE PROGRAMMING

3-18. GENERAL. The constant voltage and constant current outputs may be programmed (controlled) from a remote location. The front-panel controls are disabled in the following instructions. Changes in the rear terminal strapping arrangement are necessary. The wires connecting the programming terminals of the power supply to the remote programming device should be twisted or shielded to reduce noise pick-up. (if shield is used, connect one end to power supply ground terminal and leave the other end unconnected.) Remote sensing (para. 3-14) may be used simultaneously with remote programming. However, the strapping patterns shown in figures 3-4, 3-5, and 3-6 employ only local sensing and do not show the load connections.

## CAUTION

Turn-off power supply before rearranging strapping pattern at the power supply rear terminal strip. If the current programming terminals are opened while the power supply is on, the output current will exceed its maximum rating and may result in damage to the load. The power supply will not be damaged. The constant voltage programming terminals have a zener diode connected internally across them to limit the programming voltage and thus prevent excessive output voltage.

3-19. **CONSTANT VOLTAGE.** In the constant voltage mode of operation, either a resistance or voltage source can be used for remote programming. For resistance programming, the programming coefficient (fixed by the programming current) is 300 ohms per volt (output voltage increases 1 volt for each 300 ohms in series with programming terminals). The programming current is adjusted to within 1% of 3.33ma at the factory. If greater programming accuracy is required, change R39 (shunt). The programming resistance should be a stable, low noise, low-temperature (less than 30 ppm per °C) resistor with a power rating at least 10 times its actual dissipation.

3-20. The output voltage of the power supply should be  $0 \pm 20$  mv,  $-100$  mv when the programming resistance is zero ohms. This tolerance can be improved by changing R6. For further information on improving this tolerance, refer to paragraph 5-63 and to H-Lab Tech Letter #1.

3-21. If the resistance programming device is controlled by a switch, make-before-break contacts should be used in order to avoid momentary opening of the programming terminals. To connect the remote programming resistance, arrange rear terminal strapping pattern as shown in figure 3-4. The front-panel VOLTAGE controls are disabled when the strap between A6 and A7 is removed.

3-22. If a voltage source is used as the remote programming device, the output voltage of the power supply will vary in a 1 to 1 ratio with the programming voltage. The load on the voltage source will not exceed 25 microamperes. To connect the programming voltage, arrange rear terminal strapping pattern as shown in figure 3-5.

3-23. **CONSTANT CURRENT.** In constant current operation, resistance programming is used. The resistance programming coefficient (fixed by the programming current) is 50 ohms per ampere (output current increases 1 ampere for each 50 ohms in series with programming terminals). The programming current is adjusted to within approximately 10% of 4 ma at the factory. If greater programming accuracy is required, change R41 (shunt). The programming resistance should be a stable, low noise, low-temperature (less than 30 ppm per °C) resistor with a power rating at least 10 times its actual dissipation.

3-24. The output current of the power supply should be  $0 \pm 25\text{ma}$ ,  $-50\text{ ma}$  when the programming resistance is zero ohms. This tolerance can be improved by changing R20. For further information on improving this tolerance, refer to paragraph 5-67 and to H-Lab Tech Letter #1.

3-25. If the resistance programming device is controlled by a switch, make-before-break contacts should be used to avoid momentary opening of the programming terminals. To connect the remote programming resistance, arrange rear terminal strapping as shown in figure 3-6. The front-panel CURRENT controls are disabled when the strap between A1 and A2 is removed.

### 3-26. PARALLEL

3-27. GENERAL. Two or more power supplies can be connected in parallel to obtain a total output current greater than that available from one power supply. The total output current is the sum of the output currents of the individual power supplies. Each power supply can be turned-on or off separately. Remote sensing (para. 3-14) and programming (para. 3-17) can be used; however, the strapping patterns shown in figures 3-7 and 3-8 employ only local sensing and programming.

3-28. NORMAL. The strapping pattern for normal parallel operation of two power supplies is shown in figure 3-7. The output current controls of each power supply can be separately set. The output voltage controls of one power supply (master) should be set to the desired output voltage; the other power supply (slave) should be set for a slightly larger output voltage. The master will act as a constant voltage source; the slave will act as a constant current source, dropping its output voltage to equal the master's.

3-29. AUTO-PARALLEL. The strapping patterns for auto-parallel operation of two and three power supplies are shown in figures 3-8A and B, respectively. Auto-parallel operation permits equal current sharing under all load conditions, and allows complete control of output current from one master power supply. The output current of each slave is approximately equal to the master's. Because the output current controls of each slave is operative, they should be set to maximum to avoid having the slave revert to constant current operation; this would occur if the master output current setting exceeded the slave's.

### 3-30. SERIES

3-31. GENERAL. Two or more power supplies can be connected in series to obtain a total output voltage higher than that available from one power supply. The total output voltage is the sum of the output voltages of the individual power supplies. A single load can be connected across the series-connected power supplies or a separate load can be connected across each power supply. The power supply has a reverse polarity diode connected internally across the output terminals to protect the power supply against reverse polarity voltage if the load is short-circuited or if one power supply is turned off while its series partners are on.



3-32. The output current controls of each power supply are operative and the current limit is equal to the lowest control setting. If any output current controls are set too low with respect to the total output voltage, the series power supplies will automatically crossover to constant current operation and the output voltage will drop. Remote sensing (para. 3-14) and programming (para. 3-17) can be used; however, the strapping patterns shown in figures 3-9 and 3-10 employ only local sensing and programming.

3-33. NORMAL. The strapping pattern for normal series operation of two power supplies is shown in figure 3-9. The output voltage controls of each power supply must be adjusted to obtain the total output voltage.

3-34. AUTO-SERIES. The strapping patterns for auto-series operation of two and three power supplies are shown in figures 3-10A and B, respectively. Auto-series operation permits control of the output voltage of several power supplies (slaves) from one master power supply. The master must be the most negative power supply of the series. To obtain positive and negative voltages, the + terminal of the master may be grounded. For a given position of the slave output voltage controls, the total output voltage is determined by the master output voltage controls. The output voltage controls of a slave determines the percentage of the total output voltage that the slave will contribute. Turn-on and turn-off of the series is controlled by the master. In order to maintain the temperature coefficient and stability specifications of the power supply, the external resistors shown in figures 3-10A and B, should be stable, low-noise, low-temperature (less than 30 ppm per °C) resistors. The value of these resistors is determined by multiplying the output voltage of the applicable slave by the programming coefficient (300 ohms/volt).

### 3-35. AUTO-TRACKING

3-36. The strapping patterns for auto-tracking operation of two and three power supplies are shown in figures 3-11A and B, respectively. Automatic tracking operation permits the output voltages of two or more power supplies to be referenced to a common buss; one of the power supplies (master) controls the magnitude of the output voltage of the others (slaves) for a given position of the slave output voltage controls. The master must be the most negative power supply in the group. The output voltage of a slave is a percentage of the master output voltage. The output voltage controls of a slave determines this percentage. Turn-on and turn-off of the power supplies is controlled by the master. Remote sensing (para. 3-14) and programming (para. 3-17) can be used; however, the strapping patterns shown in figure 3-4 employ only local sensing and programming.

3-37. The value of the external resistor shown in figure 3-11 is determined by dividing the voltage difference between the master and the applicable slave by the programming current (nominally 3.33 ma; refer to para. 3-19). Finer adjustment of the slave output voltage can be accomplished using the slave output voltage controls. In order to maintain the temperature coefficient and stability specifications of the power supply, the external resistors should be stable, low-noise, low-temperature (less than 30 ppm per °C) resistor.

### 3-38. OPERATING CONSIDERATIONS

#### 3-39. PULSE LOADING

3-40. The power supply will automatically cross over from constant voltage to constant current operation, or the reverse, in response to an increase (over the preset limit) in the output current or voltage, respectively. Although the preset limit may be set higher than the average output current or voltage, high peak currents or voltages (as occur in pulse loading) may exceed the preset limit and cause crossover to occur. To avoid this unwanted crossover, the preset limit must be set for the peak requirement and not the average.

#### 3-41. OUTPUT CAPACITANCE

3-42. There are capacitors (internal) across the output terminals of the power supply. These capacitors help to supply high-current pulses of short duration during constant voltage operation. Any capacitance added externally will improve the pulse current capability, but will decrease the safety provided by the constant current circuit. A high-current pulse may damage load components before the average output current is large enough to cause the constant current circuit to operate.

3-43. The effects of the output capacitors during constant current operation are as follows:

- a. The output impedance of the power supply decreases with increasing frequency.
- b. The rise time of the output voltage is increased.
- c. A large surge current causing a high power dissipation in the load occurs when the load impedance is reduced rapidly.

#### 3-44. NEGATIVE VOLTAGE LOADING

3-45. A diode is connected across the output terminals. Under normal operating conditions, the diode is reverse biased (anode connected to negative terminal). If a negative voltage is applied to the output terminals (positive voltage applied to negative terminal), the diode will conduct, shunting current across the output terminals and limiting the voltage to the forward voltage drop of the diode. This diode protects the filter and output electrolytic capacitors.

#### 3-46. NEGATIVE CURRENT LOADING

3-47. Certain types of loads may cause current to flow into the power supply in the direction opposite to the output current. If the reverse current exceeds 0.05 ampere, preloading will be necessary. For example; if the load delivers 1 ampere to the power supply with the power supply output voltage at 18 vdc, a resistor equal to

18 ohms (18v/1a) should be connected across the output terminals. Thus, the 18 ohm resistor shunts the reverse current across the power supply. For more information on preloading, refer to paragraph C4 in the H-Lab Application Manual.

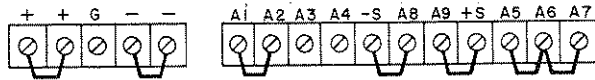

Figure 3-2.  
Normal Strapping Pattern

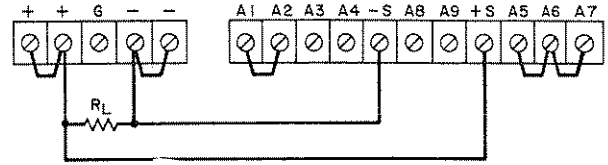

Figure 3-3.  
Remote Sensing

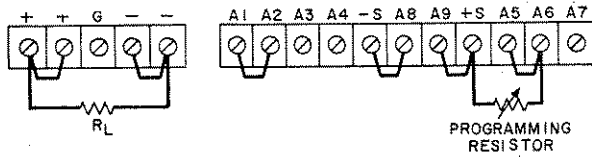

Figure 3-4.  
Remote Resistance Programming  
(Constant Voltage)

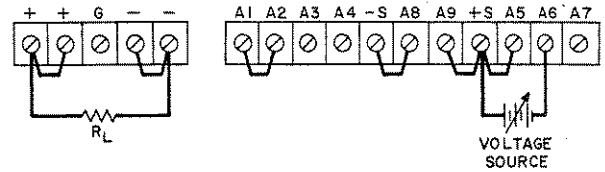

Figure 3-5.  
Remote Voltage Programming  
(Constant Current)

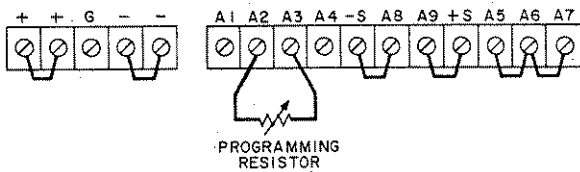

Figure 3-6.  
Remote Resistance Programming  
(Constant Current)

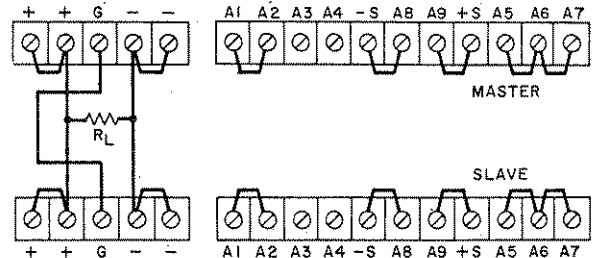
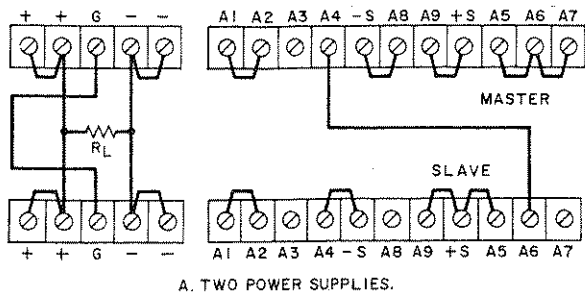
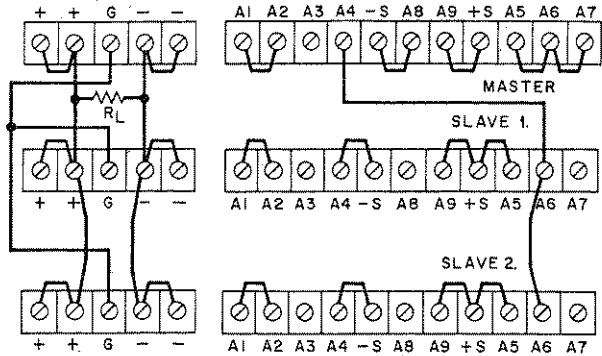

Figure 3-7.  
Normal Parallel Operation





A. TWO POWER SUPPLIES.



B. THREE POWER SUPPLIES.

Figure 3-8.  
Auto-Parallel Operation

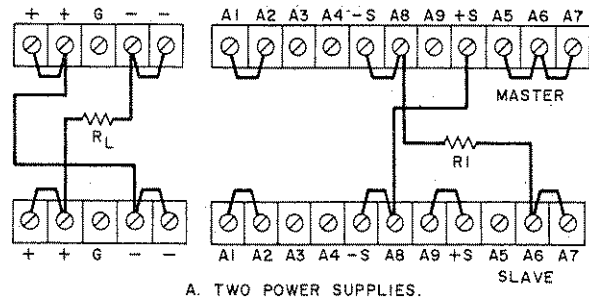

A. TWO POWER SUPPLIES.

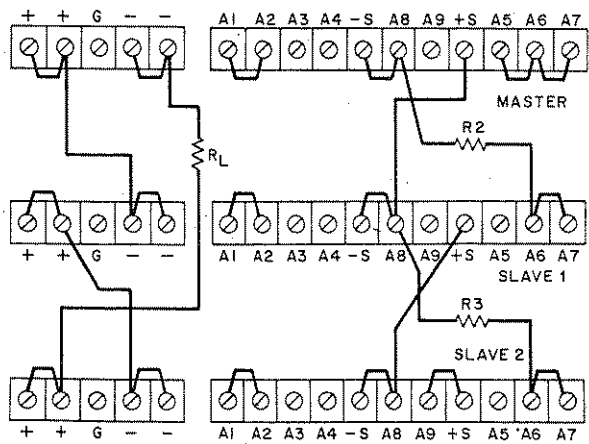

B. THREE POWER SUPPLIES.

Figure 3-10.  
Auto-Series Operation

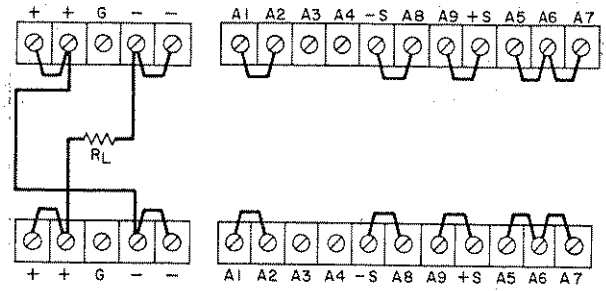
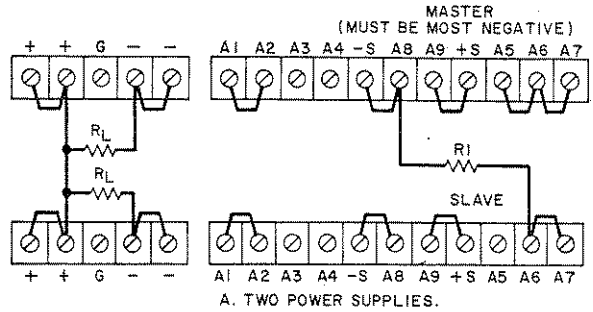
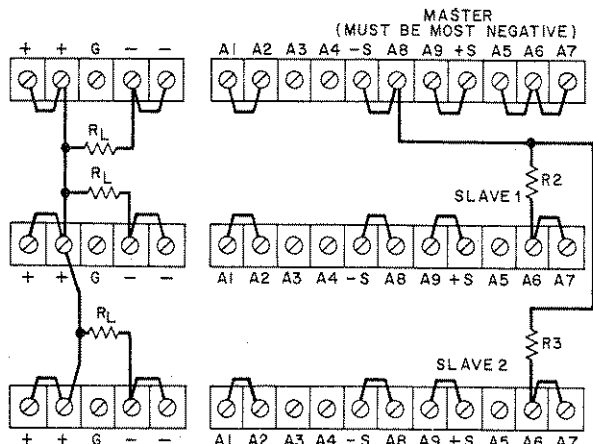

Figure 3-9.  
Normal Series Operation



A. TWO POWER SUPPLIES.



B. THREE POWER SUPPLIES.

Figure 3-11.  
Auto-Tracking Operation

MANUAL CHANGES

Model 6438B DC Power Supply  
Manual HP Part No. 06438-90001

Make all corrections in the manual according to errata below, then check the following table for your power supply serial number and enter any listed change(s) in the manual.

SERIAL		MAKE CHANGES
Prefix	Number	
ALL	-	Errata
6B	0101 - 0130	1, 2
6F	0131 - 0740	2
0C	0741 - 0770	1, 2, 3
0C	0771 - 0800	1, 2, 3, 4
0J	0801 - 0840	1 thru 5
0J	0841 - 0880	1 thru 6
1142A	0881 - 0900	1 thru 7
1142A	0901 - 0920	1 thru 8
1142A	0921 - 0960	1 thru 9
1142A	0961 - 1555	1 thru 10
1706A	1556-1695	1 thru 12
1839A	1696 - 1795	1-13
1934A	1796-up	1 - 14

ERRATA:

On Figures 3-2 through 3-11, change the - and + terminals on the right hand terminal board to A8 and A9, respectively.

On Figure 3-3, the +S terminal on the right hand terminal board should be connected to the + side of the load. Delete present connection from + (A9) terminal to this point.

Q10: Change to 2N2907A, Sprague, 56289, HP Part No. 1853-0099.

In replaceable parts table, add HP Part No. 0160-0493 for capacitor C1.

Add the following note to the specification table (1-1) and Paragraph 2-14: "The minimum ac power line protection capacity required for SCR firing surges is 10 amperes when operated from a 115Vac line."

In Figure 3-3, remove the lead connected from the load to (+) on the right hand terminal strip and connect it instead to (+S).

In Table 1-1, substitute the following paragraph for the entire Transient Recovery Time Specification:

**TRANSIENT RECOVERY TIME:** Less than 200 milliseconds is required for output voltage recovery to within 300 millivolts of the nominal output voltage following a load change from full load to half load or half load to full load. Excluding the initial spike of approximately 100µsec (significant only with load rise times faster than 0.1 amps/µsec), the transient amplitude is less than 1.0 volt/amp for load change between 20% and 100% of rated output current.

CHANGE 1:

In the replaceable parts table and on the schematic

(where applicable) make the following changes:

F2: Delete reference.

Q1, 2, 3, 4, 6, 8, 9: Should be HP Part No. 1854-0071.

R21: Should be 43 ohms.

R22: Should be 2k, ½W.

R24: Should be 68.1k, ¼W.

On the schematic, remove C12 from AC line and connect to ACC line (anode of CR18).

CHANGE 2:

On the Title Page, change Serial Number Prefix from "6B" to "6F."

Throughout the manual change model from "6438A" to "6438B."

In Table 1-1 and in the applicable portions of the specification checks in Section V, make the following changes:

**TEMP. COEFFICIENT:** Change constant voltage temperature coefficient to 0.03% plus 10mV.

**OUTPUT STABILITY:** Change constant voltage output stability to 0.10% plus 30mV.

**TRANSIENT RECOVERY:** Change to "less than 200 milliseconds is required for output voltage recovery to within 300 millivolts ---."

Add to Paragraph 1-12 and 3-11 "The +, -, and GND jacks on the front panel can be used for loads of less than 3 amperes and for applications not requiring remote programming, remote sensing, auto-parallel, auto-series, and auto-tracking."

Change Paragraph 1-14 to read "Hewlett-Packard power supplies are identified by a three-part designation. The first part is the model number, the second part is the manufacturing number/letter code, and the third part is the serial number. This manual applies to all Model 6438B power supplies with the same Serial Number Prefix given in the title page. Change sheets are included in the manual to update it to reflect the latest engineering changes."

CHANGE 3:

On the Title Page, change the serial number prefix from "6F" to "0C."

In the replaceable parts list and on the schematic diagram, make the following changes:

Change CR17 and CR18 to 35A, 400prv SCR, HP Part No. 1884-0058.

Change R32 to 12k, ±5%, ½W, HP Part No. 0686-1235.

Change R21 to 100Ω, ±5%, 2W, HP Part No. 0698-3620.

Change R17 from selected to 3.9k, ±5%, ½W, HP Part No. 0686-3925.

CHANGE 4:

In the replaceable parts table, add Terminal Strip, HP Part No. 0360-0417.

CHANGE 5:

On the Title Page, change the serial number prefix from "0C" to "0J." On the schematic diagram and in the replaceable parts table, add diode CR24, 200prv, 250mW, HP Part No. 1901-0033. The diode's cathode is connected to the base of Q8 and and its anode to the cathode of CR26 (at the junction of R20 and R23).

CHANGE 6:

The following changes are made to allow the power supply to operate with Option 27 (208Vac input) or Option 28 (230Vac input).

In the replaceable parts table and on the schematic, make the following changes:

- C7: Add C7, 1 $\mu$ F, 35V, HP Part No. 0180-0291.
- C10 and C12: Change to .047 $\mu$ F, 600V, HP Part No. 0160-0005.
- C11: Change to .22 $\mu$ F, 600V, HP Part No. 0160-2461.
- C26: Change to .22 $\mu$ F, 800V, HP Part No. 0160-2453.
- C28: Change to 1 $\mu$ F, 200V, HP Part No. 0160-2465.
- R3 and R13: Change to 47.5k  $\pm$ 1%, 1/8W, HP Part No. 0757-0457.
- R15: Change to 150k  $\pm$ 5%, 1/2W, HP Part No. 0686-1545.
- R17: Change to 3.9k  $\pm$ 5%, 1/2W, HP Part No. 0686-3925.
- R21: Change to 390 $\Omega$   $\pm$ 5%, 2W, HP Part No. 0698-3633.
- R49: Add R49 2k  $\pm$ 5%, 1/2W, HP Part No. 0686-2025.
- R56: Change to 270 $\Omega$   $\pm$ 5%, 1/2W, HP Part No. 0686-2715.
- T1: Change to HP Part No. 06438-80091.
- T2: Change to HP Part No. 9100-2195.
- T3: Change to HP Part No. 5080-7176.

On the schematic, the wiring of T1 and T2 and associated parts has been changed as shown opposite.

On the schematic:

In the SCR Regulator Control Circuit: Remove R56 (connected between C28 at the junction of R50, CR41-CR43) and replace with a short circuit. Reconnect new R56 (changed to 270 $\Omega$ ) in series with the junction of CR41-CR43 (anodes) and the junction of C28, R50, CR44, and CR46.

In the Constant Voltage Input Circuit: Add C7 (1 $\mu$ F, 35V) in parallel with R18.

In the Constant Current Input Circuit: Remove jumper and substitute R49 (2k) in its place.

208Vac (Option 27) and 230Vac (Option 28) operation.

If Option 27 or 28 is installed, change all references in the manual from 115Vac operation to the appropriate line input.

In Chapter 2, add the following paragraph:

2-21. CONNECTIONS FOR 208/230 VOLT OPERATION (Option 27 and 28 respectively)

T1 is rewired as follows:

Connection between terminals 1 and 3 is removed.  
Connection between terminals 2 and 5 is removed.  
Terminal 2 is connected to terminal 3.

For 208V (Option 27) only, the AC input connection to terminal 5 is removed and connected to terminal 4.

T2 is rewired:

The AC input connection to the "115V" terminal is removed and connected to the "208V" or "230V" terminal as applicable.

F1: Changed to 6 amps, HP Part No. 2110-0056.

In the replaceable parts table and on the schematic:

F1: Change to 6 amps, HP Part No. 2110-0056.

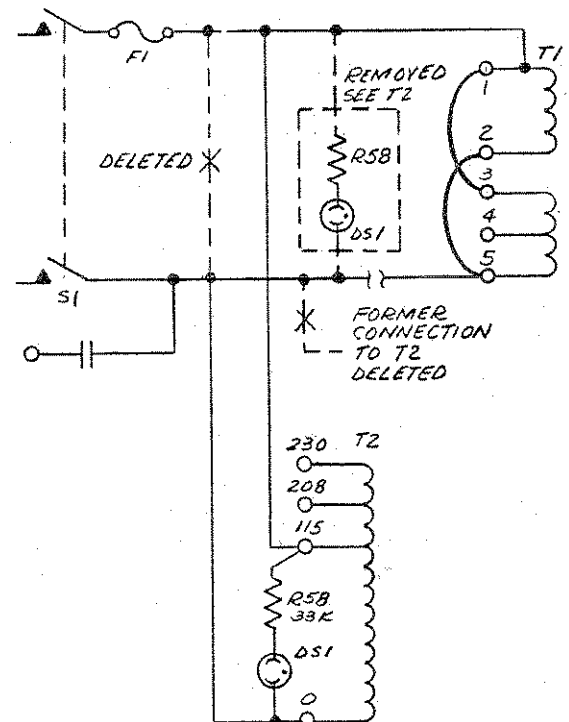

CHANGE 7:

The Serial Prefix of this unit has been changed to 1142A. This is the only change.

ERRATA:

The constant current resistance programming coefficient has been changed from 50 ohms/amp to 60 ohms/amp. In addition, the programming tolerance is now  $\pm 20\%$ . Make the following changes to reflect these new specifications:

- Table 1-1: Change Remote Programming, Constant Current to 60 ohms per ampere  $\pm 20\%$ .
- Page 3-4, Paragraph 3-23, Line 3 now reads: "current) is 60 ohms per ampere...for each 60 ohms...". Line 5 now reads: "...approximately 20% of 3.33mA at the...".
- Page 5-15, Paragraph 5-65: Step b: Change resistance to 300 ohms, 0.1%, 1/2W resistor.
- Step e (Page 5-16): Adjust resistance box until voltmeter indicates  $50 \pm 10.0\text{mVdc}$ .

CHANGE 8:

The standard colors for this instrument are now mint gray (for front and rear panels) and olive gray (for all top, bottom, side, and other external surfaces). Option X95 designates use of the former color scheme of light gray and blue gray. Option A85 designates use of a light gray front panel with olive gray used for all other external surfaces. New part numbers are shown at bottom.

CHANGE 9:

In the replaceable parts table and on the schematic, change Resistor R46 to  $10\text{M}\Omega \pm 5\%$ , 1/2W, HP Part No. 0686-1065.

On Page 5-16, Paragraph 5-67, Step e and the NOTE: Change the reference to R20 to Read "R6."

In the replaceable parts table and on the schematic, make the following changes:

- R16: Change to  $910\Omega \pm 5\%$  1/2W, HP Part No. 0686-9115.
  - R17: Delete R17.
  - R40: Change to  $3.01\text{k}\Omega \pm 1\%$  1/4W, HP Part No. 0757-0339.
  - R59: Add R59, Var WW  $500\Omega \pm 5\%$ , HP Part No. 2100-0898.
- R59 is added in the Q4 Gating Circuit as follows:

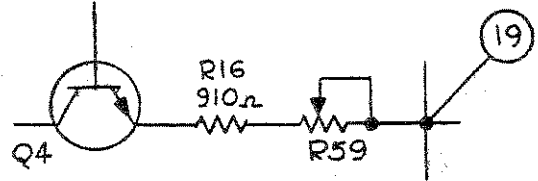

R59 allows the Gating circuit clamp voltage to be adjusted in order to prevent half-cycle operation. In the factory, R59 is adjusted as follows: with supply set for full output voltage and current rating at low line, adjust R59 for a forward bias across CR9 of 150mV to 200mV.

ERRATA:

In Table 1-1 and paragraph 5-33, change the Output Impedance specification to read as follows: Output Impedance (Typical): Approximated by a 20 milliohm resistance in series with a 1 microhenry inductance.

Change the part number of pilot light DS1 to 1450-0566. This new light is more reliable than the former one.

CHANGE 11:

The front binding posts have been changed to a type with better designed insulation. Delete the two types of posts listed on page 6-6 and add: black binding post, HP Part No. 1510-0107 (qty. 1); and red binding post, HP Part No. 1510-0091, (qty. 2).

DESCRIPTION	HP PART NO.		
	STANDARD	OPTION A85	OPTION X95
Front Panel, Lettered	06438-60003	06438-60001	←
Chassis, Rear	06438-00002	←	06438-00001
Cover	5000-9483	←	5000-6045
Welding Assembly Chassis	5060-7971	←	5060-6115
Heat Sink	5020-8449	←	5020-5526

CHANGE 12:

This change replaces SCR s CR17 and CR18 with a new type, HP Part No. 1884-0219, and adds a MOV varistor designated RV1 across the load side of the line switch. The part number of the varistor is 0837-0117.

ERRATA:

Add three 3/8 32 nylon hex nuts, HP Part No. 2950-0144, to the parts list. These hex nuts mount the new binding posts added by Change 11.

The blue-gray meter bezel has been replaced by a black one, HP Part No. 4040-0414.

Change the part number of R59 (added to the gating circuit by Change 10) to 2100-1772. The resistor has not been changed; just its part number has.

CHANGE 13:

Change zener VR3 to 9V, HP Part No. 1902-0785.  
Change resistor R35 to 2.87K $\Omega$ , 1%, HP Part No. 0698-3151.

Change resistor R37 to 1.3K, 1%, HP Part No. 0757-0735.

▶CHANGE 14:

On page 6-6, add Bracket - P.C. Board, HP Part No. 5000-3175.

▶ERRATA:

For all instruments delivered on or after July 1, 1978, change the HP Part No. for fuseholder ~~from~~ 1400-0084 to fuseholder body 2100-0564 and fuseholder carrier 2100-0565. Change the HP Part No. for fuseholder nut ~~from~~ 2950-0038 to 2110-0569. If old fuseholder must be replaced for any reason, replace complete fuseholder and nut with new fuseholder parts. Do not replace new parts with old parts.