



THERMISTOR MOUNT

478A

HP Model 478A Thermistor Mount

GENERAL INFORMATION

1. INTRODUCTION.

2. The HP Model 478A Coaxial Thermistor Mount is designed for use with HP Model 431 and 432 Power Meters to measure microwave power from $1 \mu\text{W}$ to 10 mW. Design of the mount minimizes adverse effects from environmental temperature changes during measurement. For increased measurement accuracy, Effective Efficiency and Calibration Factor are measured for each mount, and at selected frequencies across the operating range; the results are marked on the label of the instrument (see Paragraph 31). The Model 478A can be used over the 10-MHz to 10-GHz frequency range. Through-

out the range, the mount terminates the coaxial input in a 50-ohm impedance, and has a SWR of not more than 1.75 without external tuning.

3. Each mount contains two seriespairs of thermistors, which are matched to cancel the effects of drift with ambient temperature change. Thermal stability is accomplished by mounting the leads of all four thermistors on a common thermal conductor to ensure a common thermal environment. This conductor is thermally insulated from the main body of the mount so the thermal noise or shocks applied externally to the mount, such as those from handling the mount manually, cannot significantly penetrate to disturb the thermistor. This thermal immunity enables the thermistors to be used in the

MARCH 1976

HEWLETT  PACKARD

Table 1. Specifications

Frequency Range: 478A: 10 MHz to 10 GHz				
Mount Calibration: Calibration Factor and Effective Efficiency furnished at six frequencies between 10 MHz and 10 GHz.				
Impedance: 50 ohms.				
Maximum Reflection Coefficient:				
10 to 25 MHz: 0.273 (1.75 SWR, 11.3 dB return loss).				
25 MHz to 7 GHz: 0.13 (1.3 SWR, 17.7 dB return loss).				
7 to 10 GHz: 0.2 (1.5 SWR, 14 dB return loss).				
Operating Resistance: 200 ohms.				
Power Range with Model 431 and 432A: 1 μ W to 10 mW.				
Maximum Peak Power: 200W.				
Maximum Average Power: 30 mW.				
Maximum Energy per Pulse: 10 W \cdot μ s for a PRF \geq 1 kHz; 5 W \cdot μ s for a PRF <1 kHz.				
Elements: Field-replaceable, thermally balanced thermistor assembly. Thermistor assembly field adjustable so that full "zero-set" capability can be restored in the event of inadvertent overload (mount calibration no longer valid).				
RF Connector: Type-N male, compatible with female connectors whose dimensions conform to MIL-C-71 or MIL-C-39012. Brass connector.				
Output Connector: Mates with 431 and 432 cables.				
Weight: Net, 5 oz (140 g). Shipping, 1 lb (450 g).				
Uncertainty of Calibration Factor and Effective Efficiency Data for 478A				
Sum of Uncertainties (%)			Probable Uncertainties (%)	
Freq. (GHz)	Cal. Factor	Effective Efficiency	Cal. Factor	Effective Efficiency
1.0	2.3	2.3	1.1	1.1
3.0	2.8	3.1	1.6	1.6
5.0	3.6	3.5	2.1	2.1
7.0	3.7	4.1	2.1	2.1
8.2	2.8	3.5	1.3	1.3
9.8	2.8	3.1	1.3	1.3
12.4	6.3	4.6	2.1	1.6
15.0	6.3	4.6	2.1	1.6
18.0	6.3	4.8	2.1	1.6
*Includes uncertainty of reference standard and transfer uncertainty. Directly traceable to NBS. In addition to the listed uncertainties, add the following for the indicated 431 ranges: \pm 0.3%; 0.1 mW, \pm 0.7%; 0.03 mW, \pm 1.5%; 0.01 mW. When using the 432 Power Meter no additional uncertainties are encountered.				

measurement of microwave power down to the micro-watt region.

4. INCOMING INSPECTION.

5. Inspect the Model 478A upon receipt for mechanical damage. Also check it electrically; if the mount was subjected to severe mechanical shock during shipment, the match between the thermistors may be affected. To check thermistor match, proceed as described in Paragraph 58.

6. If any damage is found, inform the carrier and your nearest HP Sales and Service Office immediately.

OPERATION

7. PRECAUTIONS.

8. MECHANICAL SHOCK.

9. DO NOT DROP OR SUBJECT TO SEVERE MECHANICAL SHOCK. SHOCK MAY DESTROY THE MATCH BETWEEN THERMISTORS AND INCREASE SUSCEPTIBILITY TO DRIFT.

10. BIASING THERMISTORS.

CAUTION

Before connecting the Model 478A to the 431 or 432 Power Meters, set the MOUNT RES switch to 200-ohm position. CONNECTING A 200-OHM MOUNT TO A POWER METER SET FOR A 100-OHM MOUNT CAN RESULT IN THERMISTOR DAMAGE.

11. MAXIMUM INPUT.

12. The Model 478A/431 and 478A/432 combinations respond to the average RF power applied. The maximum signal applied to the thermistor mount should not exceed the limitations for 1) average power, 2) pulse energy and 3) peak pulse power. Excessive input can permanently damage the Model 478A by altering the match between the RF and compensation thermistors (resulting in excessive drift or zero shift) or cause error in indicated power.

13. AVERAGE POWER. The 478A/431 and 478A/432 combinations can measure average power up to 10 mW. To measure power in excess of 10 mW, insert a calibrated directional coupler such as one of the HP Model 770 series or 790 series between the mount and the source. UNDER NO CIRCUMSTANCES APPLY MORE THAN 30 mW AVERAGE POWER TO THE MOUNT.

14. PULSE ENERGY AND PEAK POWER FOR 478A/432 COMBINATION. For pulses shorter than 250 μ s, energy per pulse must not exceed 10 W- μ s and peak power should never exceed 200 watts. (For example, a 40 mW, 250 μ s pulse contains 10 W- μ s of energy.) Pulses longer than 250 μ s are allowed to contain more energy but peak power must not exceed 200W. Figures 1 and 2 interpret these limits in graphical form. (For lack of space, the mount nameplate lists only a 5 W- μ s

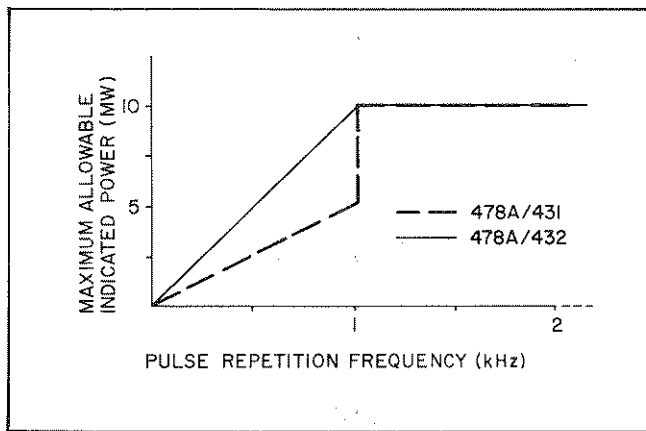

Figure 1. Maximum Power Meter Reading vs PRF for Pulses Shorter than 250 μ s

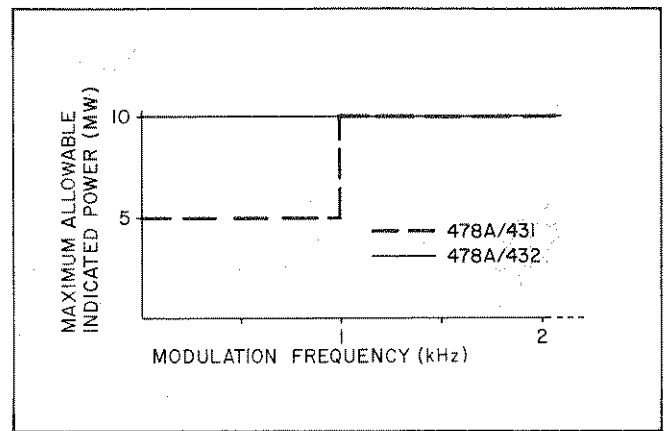

Figure 3. Maximum Power Meter Reading vs Square and Sine-Wave Frequency

limit, a rating which applies to the 478A/431 combination.)

15. PULSE ENERGY AND PEAK POWER FOR 478A/431 COMBINATION. The limitations of this combination are basically the same as the 478A/432 with the exception that at pulse repetition rates less than 1 kHz, energy per pulse must not exceed 5 W- μ s and peak power must not exceed 10 mW. These limits are also interpreted in Figures 1 and 2.

16. Square-wave modulation is a special case of pulse modulation, and maximum power-meter reading versus square-wave frequency is illustrated in Figure 3. This figure also holds for sine-wave modulation.

17. In the discussions above, the primary consideration is maximum power or energy. However, for modulation frequencies less than 100 Hz, the low repetition frequency itself causes errors in indicated power. These errors may be as large as two percent regardless of range or reading.

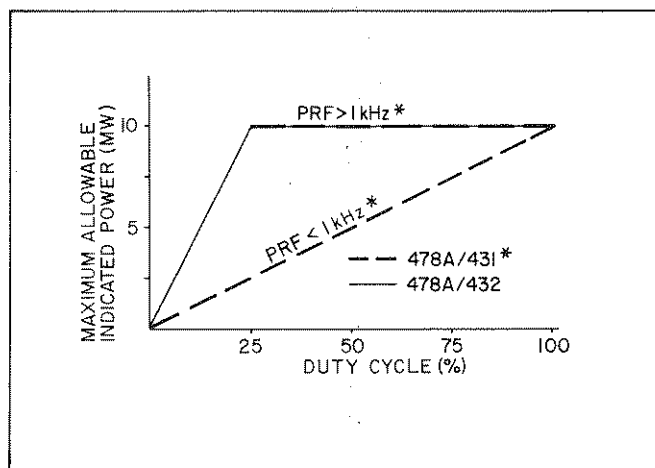

Figure 2. Maximum Power Meter Readings vs Duty Cycle for Pulses Longer than 250 μ s

18. When RF is switched by pulse-gating (coaxial solid state switches), consideration must be given to the RF energy contained in the switching pulse itself. This energy must be added to actual RF pulse power when estimating the RF power dissipated in the thermistor mount. PIN diode modulators of HP Model 8741A/8716A Modulators and 8614A/8616A Signal Generators, however, are not subject to this consideration because output filtering prevents transmission of modulating signals.

19. DRIFT PRECAUTION.

20. Thermistors are inherently temperature-sensitive devices. A cold thermistor mount connected to a warm piece of equipment, or vice versa, produces rapid drift. FOR MINIMUM DRIFT ON SENSITIVE RANGES, MAKE SURE THAT THE MOUNT AND THE EQUIPMENT CONNECTED TO IT ARE AT NEARLY THE SAME TEMPERATURE BEFORE MAKING A MEASUREMENT.

21. ZERO-SET.

22. It is necessary to electrically zero-set the Model 431/432 Power Meter before making a power measurement. To preserve the same zero reference throughout the measurement, maintain the same thermal environment when RF power is applied. Two recommended set-ups for 431 zero-set up are presented in Paragraphs 23 and 25. The recommended set-up for zero-set in the 432 is shown in Paragraph 30.

23. RF POWER TURNED OFF FOR ZERO-SET.

24. There is minimum zero drift when the zero is set with the RF system connected to the thermistor mount and the RF power switch off or greatly attenuated by the generator attenuator. The methods used to switch off RF output in HP signal generators are listed in Table 2. After allowing time for the mount to stabilize thoroughly, follow zero-set procedures in the 431 or 432 Power Meter manual and then turn on the RF source.

Table 2. Methods of Switching Off RF Output of Various HP Signal Generators

HP Generator	Frequency Range	Procedure to Switch Off RF Output
Model 606	50 kHz to 65 MHz	Increase the generator output attenuation 30 or more dB
Model 8614A/8616A Model 614/616 Model 618/620	800 to 2400 MHz/1800 to 4500 MHz 800 to 2100 MHz/1800 to 4200 MHz 3.8 to 7.6 GHz/7 to 11 GHz	Release RF pushbutton Set modulation selector to OFF Set modulation selector to OFF
Model 608 Model 682/687	10 to 480 MHz/10 to 420 MHz 1 to 2 GHz/12.4 to 18.0 GHz	Set MOD SELECTOR to PULSE, but do not apply modulation signal to modulation input terminal
Model 612	450 to 1230 MHz	Set MODSELECTOR to PULSE 2, but do not apply modulation signal to modulation input terminal
Model 690, 8690 Series	1 to 20 GHz	Set LINE to STANDBY

25. THERMISTOR MOUNT DISCONNECTED FOR ZERO-SET.
26. 478A/431. When it is inconvenient to turn off the RF power in the RF system, connect the Model 478A mount to the RF system and set RANGE on the Model 431 Power Meter for an approximate midscale reading. When the reading no longer drifts, disconnect the

Note

In the proximity of a high RF field, shield the disconnected thermistor mount from possible stray RF pick-up during the zero-set.

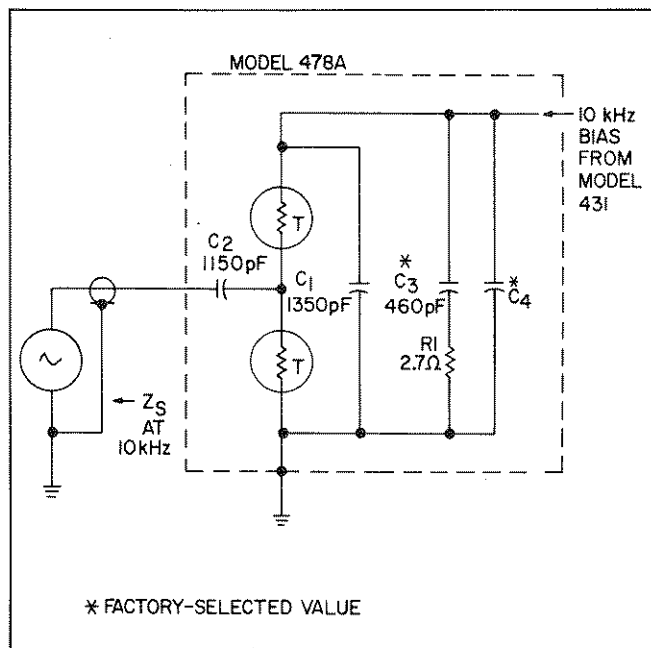

Figure 4. Source Impedance Shunting One RF Thermistor Mount

mount from the source, terminate the mount, if necessary, as described in Paragraph 27, and then zero-set the power meter. Immediately reconnect the mount to the RF source for the power measurement.

27. With the Model 478A mount connected to the RF system, the source impedance shunts one of the RF thermistors (see Figure 4); when the Model 478A mount is disconnected, the source impedance is removed. Unless source impedance is high, this variation in impedance affects the RF bridge 10-kHz feedback loop in the power meter, and the zero-level setting obtained with the source disconnected is no longer zero for the measurement. This error can be eliminated by terminating the mount in an impedance which approximately matches the generator impedance at 10 kHz; the termination should be connected while the mount is disconnected (see Paragraph 26) from the source. For example, if the impedance presented by the RF system to 10 kHz is low (1K ohm or less) terminate the thermistor mount in a 50-ohm resistor or a short. On the other hand, if the impedance of the RF system at 10 kHz is high (100K ohms or more) leave the thermistor mount unterminated during zero-set.

28. Note that some 10-kHz bias signal is coupled into the RF transmission system by C2 (Figure 5). If the RF source output impedance at 10 kHz is 15K ohms or greater, 10-kHz bias voltage is typically 1.3 V RMS and could equal 1.5 V RMS. For an RF source output impedance of 50 ohms at 10 kHz, bias signal voltage is typically 5 mV RMS.

29. The presence of this 10-kHz bias signal may affect solid state RF sources and RF voltmeter measurements. To minimize or eliminate these effects, use an additional blocking capacitor at the Model 478A or a high-pass filter at the RF source output.

30. 478A/432. When it is inconvenient to turn the RF power off while using the 478A/432 combination simply remove the mount from the source, and using the COARSE and FINE ZERO, zero the 432.

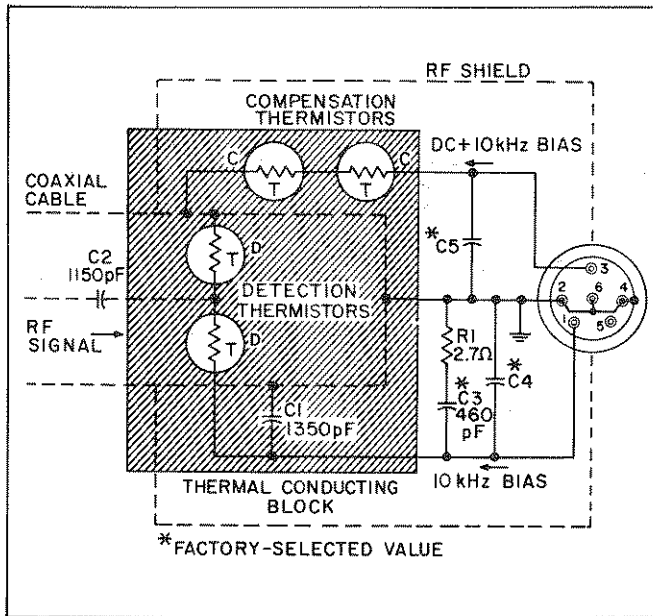

Figure 5. Schematic Diagram of a Model 478A Thermistor Mount when Connected to a 431 Power Meter

31. MOUNT CALIBRATION DATA.

32. The calibration points imprinted on the label of each 478A allow power measurements to be made with increased accuracy. Values of Calibration Factor and Effective Efficiency are given at six frequencies between 10 MHz and 10 GHz. The mounts are tested on a swept-frequency basis to assure accurate interpolation between calibration points. Calibration Factor and Effective Efficiency values are traceable to the National Bureau of Standards to the extent allowed by the Bureau's calibration facilities.

33. CALIBRATION FACTOR. Calibration Factor is the ratio of substituted audio or dc power in a thermistor mount to the microwave RF power incident upon the mount.

$$\text{Calibration Factor} = \frac{P_{dc} \text{ Substituted}}{P_{\mu\text{wave}} \text{ Incident}}$$

34. Calibration Factor is a figure of merit assigned to a thermistor mount to correct for the following sources of error: 1) RF reflected by the mount due to mismatch, 2) RF loss caused by absorption within the mount but not in the detection thermistor elements, and 3) dc-to-microwave power substitution error. Calibration Factor is applied as a correction factor to all measurements made without a tuner. When these factors and thermoelectric effect (refer to Paragraph 39) are taken into consideration, the power indicated is the power that would be delivered by the RF source to the characteristic impedance of the transmission line. The total SWR in the transmission line determines a region of uncertainty about the measured power. This subject is discussed in Application Note 64, available from any Hewlett-Packard Sales and Service Office.

35. EFFECTIVE EFFICIENCY. Effective Efficiency is the ratio of substituted audio or dc power in a thermistor mount to the microwave RF power dissipated within the mount.

$$\text{Effective Efficiency} = \frac{P_{dc} \text{ Substituted}}{P_{\mu\text{wave}} \text{ Dissipated}}$$

36. Effective Efficiency corrects for power absorbed in parts of the mount other than the detection thermistor elements and dc-to-microwave power substitution error in the thermistor mount. Effective Efficiency is applied as a correction factor when a tuner is used to match the thermistor mount to the transmission line or RF source. In this case, all of the RF power incident upon the mount is absorbed in the mount. Since all power is absorbed in the mount, measurement uncertainty due to mount SWR is eliminated; however, losses in the tuner must be considered.

37. CALIBRATION DATA APPLICATION.

38. When the 478A is used with the Model 431 or 432 Power Meters, Calibration Factor or Effective Efficiency corrections can be made by setting a front panel switch. With the proper setting, the 431 or 432 compensates for the Calibration Factor or Effective Efficiency in the 478A. If the 478A is used with a power meter other than the 431 or 432, Calibration Factor or Effective Efficiency corrections can be made by dividing the measured power by the Calibration Factor or Effective Efficiency value respectively.

39. THERMOELECTRIC EFFECT.

40. Mount calibration uncertainties given in Table 1 include inaccuracies caused by thermoelectric effect error. Calibration Factor uncertainty of $\pm 1.5\%$ and Effective Efficiency uncertainty of $\pm 2.5\%$ can be maintained on the three lowest power ranges of the Model 431 series Power Meters by correcting for the measurement error introduced by thermoelectric effect. An error correction procedure is given in Paragraph 44.

41. A mild thermocouple exists at each point of contact where the connecting wires join to the thermistor elements. Each thermocouple creates a dc voltage. Thus, two thermocouple voltages of opposite relative polarity are formed, one at each junction to each thermistor element.

42. Ideally, each thermocouple voltage would be equal in magnitude so that they cancel with no resultant effect on the accuracy of power measurement. In practice however, each point of contact does not have identical thermocouple characteristics, and in addition, the temperatures at each junction may not be the same. These differences cause an incomplete cancellation of the thermoelectric voltages, resulting in a voltage that causes a thermoelectric effect error. The magnitude of the error is important when making dc substitution measurements on the 0.1 mW, 0.03 mW and 0.01 mW ranges with one of the Model 431 series Power Meters. On other ranges, the effect is negligible. Maximum error introduced by thermoelectric effect is about 0.3 μW and is typically 0.1 μW on the 0.01 mW range.

43. THERMOELECTRIC EFFECT ERROR CORRECTION FOR 478A/431 COMBINATION.

44. Use the following technique to correct for thermoelectric effect error.

- a. Measure power.
- b. Connect a HP Model 8402 Power Meter Calibrator to the power meter DC CALIBRATION AND SUBSTITUTION connector.
- c. Zero and null power meter.
- d. By dc substitution (refer to procedure in 431 Manual), duplicate power measurement made in step a. Calculate and record substituted power as P₁.
- e. Reverse connection polarity between the calibrator and power meter.
- f. Re-zero and re-null power meter, if necessary.
- g. By dc substitution, duplicate lower measurement made in step a. Calculate and record substituted power as P₂.
- h. Calculate arithmetic mean of the two substitution powers P₁ and P₂. This mean power includes a correction for thermoelectric effect error.

$$\text{Power} = \frac{P_1 + P_2}{2}$$

45. THERMOELECTRIC ERROR FOR 478A/432 COMBINATION.

46. The thermoelectric errors present in the 431 are minimized in the 432 since the thermoelectric voltage is negligible compared with the dc voltage used to bias the thermistor bridges.

OPERATING PRINCIPLES

47. CIRCUIT DESCRIPTION.

48. Two matched series thermistors are mounted on a common thermal conducting block, represented by the shaded rectangle in Figure 5. One pair, marked "D" for detection, is mounted between the end of a coaxial cable and cylindrical cavity. These thermistors are exposed to incoming RF power which heats them, lowering their resistance. The other pair, marked "C" for compensation and situated immediately outside the cavity, is completely shielded from RF. With the 478A attached to the 431 Power Meter, the detection thermistors are part of the metering circuit.

49. With the 478A attached to the 432 Power Meter the detection thermistors are part of the RF bridge and the compensation thermistors are part of the compensation bridge. Since the two pairs of thermistors show the same thermal environment, any change in temperature which affects the RF bridge simultaneously affects the metering bridge; this allows the power meter circuit to compensate for changes in temperature and thus minimize drift.

50. During 431/478A operation, sufficient amounts of dc and 10 kHz bias currents are supplied from the 431 Power Meter to heat the thermistors until their resistances are reduced to approximately 200Ω per series pair. Capacitor C1 offers high impedance to 10 kHz, but is practically a short to RF. This causes "D" to appear series connected to 10 kHz, but parallel connected to RF. In this manner, "D" appears to the audio bridge of the 431 Power Meter as a 200Ω resistance, but terminates the coaxial cable in 50Ω. Capacitor C2 blocks any dc and audio power that may be present in the incoming signal, and passes only RF power.

51. During 432 operation (see Figure 6) sufficient amounts of dc current are supplied from 432 Power Meter to heat the thermistors until their resistances are reduced to approximately 200Ω per series pair. Capacitor C1 is practically a short to RF. This causes "D" to appear series connected to the dc bridge, parallel connected to RF. In this manner, "D" appears to the dc bridge in the 432 Power Meter as a 200Ω resistance that terminates the coaxial cable into 50Ω. Capacitor C2 blocks any dc and audio power that may be present in the incoming signal and passes only RF power.

52. 431 POWER METER DETECTION.

53. Under normal operation, the total power supplied to heat thermistor pair "D" (see Figure 5) consists of 1) RF signal, 2) 10 kHz bias, 3) heat from the environment. The total power supplied to heat thermistor pair "C" consists of: 1) dc bias, 2) an equal amount of 10 kHz bias, and 3) heat from the same environment. As "D" and "C" are matched thermally, the total amounts of heat applied to reduce their series resistance equally must be equal.

54. 432 POWER DETECTION.

55. Under normal operation the total power applied to heat thermistor pair "D" (see Figure 6) consists of: 1) RF signal and 2) heat from the environment. The total power supplied to heat thermistor "C" consists of: 1) dc bias and 2) heat from the same environment. As "D" and "C" are matched thermally, the total amounts of heat applied to reduce their series resistance equally must be equal.

MAINTENANCE

56. MECHANICAL SHOCK.

57. The Model 478A is a precision instrument. Avoid dropping or other mechanical shocks. Such shocks can destroy the match between the thermistors.

58. CHECK ON THERMISTOR MATCH.

59. Match between the thermistors may be checked by comparing the thermistor resistances under simulated operating conditions. Equipment required is indicated in Figure 6. Make connections to the connector at the rear of the thermistor mount; pins are shown in Figure 6. Note that the small battery in series with the HP Model 3440 Digital Voltmeter is connected in opposition

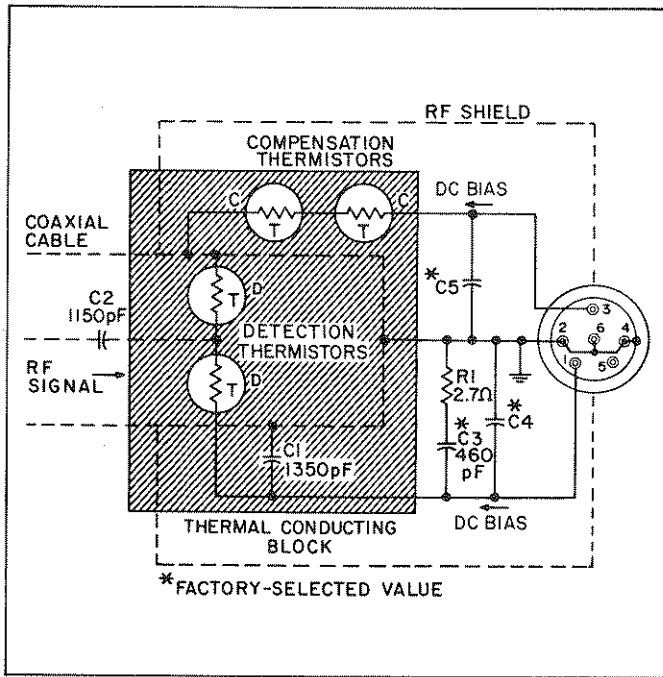

Figure 6. Schematic Diagram of a Model 478A Thermistor Mount when Connected to a 432 Power Meter

WARNING

Under no conditions should the mount be required to carry a current higher than 14 mA.

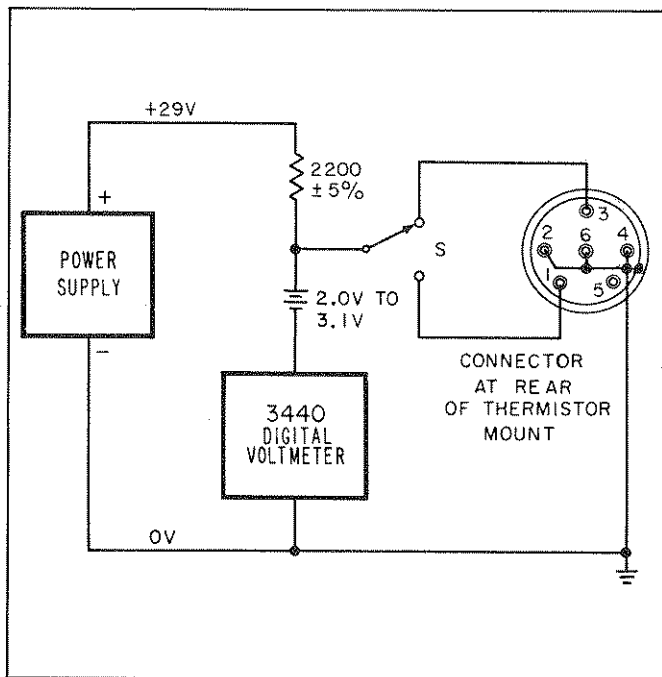

Figure 7. Check on Model 478A Thermistor Resistance Match

to the power supply. The value of this bucking voltage should be such that voltmeter resolution down to 0.001 volt is obtained. Take readings with switch S connected to pin 1 and then to pin 3. Thermistor match is satisfactory if the two readings do not differ by more than 0.030 volt. Nonoperating mounts with readings as high as 0.150 volt can probably be repaired as outlined in the succeeding paragraphs.

60. REPAIR.

61. Exceeding the cw or pulse power limit of the Model 478A Thermistor Mount may result in damage such that the mount will no longer zero on the Model 431 or 432 Power Meter.

62. Before adjusting the mount in any way, make sure that the mount is the cause of the problem. An open or short indication, using the checks in Paragraphs 59 or 64, means that the mount is not repairable by the procedures outlined in the following paragraphs. However, the mount may be nonoperative but still repairable. Test for this by using the procedures in Paragraph 58, or by connecting the mount to a Model 431 or 432 Power Meter and a cable which is known to be good. A faulty cable will not have continuity through the respective connector pins or may have poor contact in the mount connector. Poor contact will show as an intermittancy or a great deal of noise (visible on the 431 or 432 Meter) when the cable is gently flexed near the connector end.

Note

The following procedures are set down for the 431/478A combination. The same procedures can be used for the 432 except for the ZERO/VERNIER control. These controls on the 431 are replaced by the COARSE ZERO and FINE ZERO control on the 432.

63. The major difference between the 478A/431 and 478A/432 combination is that the 478A/432 combination does not use 10 kHz as a biasing factor in the thermistor. All biasing factors in the 432 are from dc sources therefore, lowering the thermoelectric effect.

64. To troubleshoot a damaged mount, proceed as follows:

- a. Connect mount to Model 431.
- b. Set: MOUNT RES 200 ohm
RANGE 10 mW
POWER ON
- c. Rotate ZERO from one limit to the other.

65. If meter remains pegged upscale, the thermistor elements have been damaged. However, it may be possible to recompensate the thermistors per Paragraphs 68 and 69 and return the mount to operation; otherwise they must be replaced. In either case, the Effective Efficiency and Calibration Factor data on the nameplate are no longer valid (see Paragraph 77).

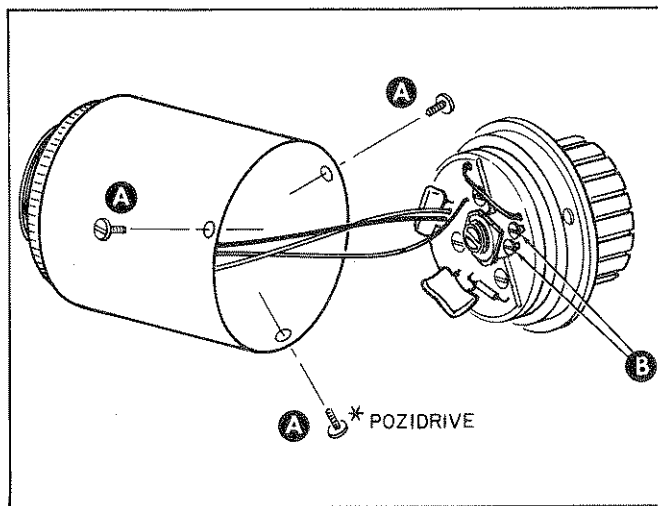

Figure 8. Thermistor Compensation

66. If meter remains pegged downscale, measure resistance between pins 1 and 2, and pins 3 and 4. The resistance should measure between 1000 and 5000 ohms. An open or shorted reading indicates the need for replacement of the thermistors.

67. If the resistance reading is satisfactory, it may be possible to recompensate the mount and return it to service. The drift with temperature changes will be higher because of the damage to the thermistors, but it will be possible to zero the meter and to make measurements. The Effective Efficiency and Calibration Factor indicated on the label will no longer be valid (see Paragraph 77). There are two adjusting screws inside the instrument which permit recompensation within limits. Most instruments with serials lower than 7663 do not have the adjusting screws at the time of manufacture, but are modified if the instrument was sent in for repair after March 1964.

68. Refer to Figure 8 and proceed as follows:

- a. Remove the three screws (A).
- b. Slide instrument out of its cover.
- c. Plug cover into Model 431.
- d. Set: MOUNT RES 200 ohm
POWER ON

69. If meter is pegged downscale:

- a. Set RANGE to 10 mW.
- b. Set ZERO and VERNIER to mid-range.
- c. Turn screws (B) clockwise, 1/8 turn alternately.

CAUTION

If there is a sudden jump in meter indication when advancing either screw, back off 1/8 turn, and do not advance that screw further. Check resistance as in Paragraph 66. If either screw bottoms, do not apply force. Thermistor replacement (Paragraph 71) is indicated.

d. When meter pointer rises, trim to zero with each adjusting screw.

e. Replace cover and three screws (A). The instrument is now operative.

Note

Make sure the three screws in the body of the thermistor mount are tight when the mount is put together; this insures quiet operation.

70. If meter is pegged upscale:

- a. Set ZERO and VERNIER to mid-range.
- b. Set RANGE to highest position which will not peg the meter.
- c. Turn one of the screws (B) counterclockwise to obtain a meter reading half that observed in step b.
- d. Turn the other screw (B) counterclockwise to zero the meter. If it is impossible to zero the meter, replace the thermistors (Paragraph 71).
- e. Replace cover and three screws (A). The instrument is now operative.

71. THERMISTOR ASSEMBLY REPLACEMENT PROCEDURE.

Note

After replacement of the thermistor assembly, the Effective Efficiency and Calibration Factor indicated on the label of the mount are no longer valid (see Paragraph 77).

72. The procedure consists of removing the damaged thermistor assembly, the printed circuit assembly and replacing them with pretested assemblies included in

Table 3. Replaceable Parts

HP Part Number	Qty	Description
0520-0136	3	Screw, 2-56 x 5/8, RDHD
0520-0173	3	Screw, 2-56 x 3/16, PNHD
1251-0153	1	Receptacle Connector
1251-1281	1	Nut, Knurled
1460-0977	1	Spring, Compressor
2190-0014	3	Internal Lock Washer No. 2
2190-0036	1	Washer Lock . 818 ID
08491-2009	1	Sliding Contact
00478-60002	1	Thermistor Assembly (includes 478A-65A and components)
00478-60003	1	Connector Assembly
00478-00001	1	Terminal Shield
478A-54A	3	Insulator Bushing

Thermistor Assembly Replacement Kit, HP Stock No. 00478-60002 (see Table 3).

73. The replacement assemblies are pretested at the factory. However, since the operation of the thermistor mount depends on proper installation of the assembly, it may be desirable to check the SWR and efficiency following replacement. The efficiency may be checked by comparing against a known mount. The SWR is checked at 9 GHz and 10 GHz. SWR should be approximately equal at 9 and 10 GHz, and should be 1.5 or less.

Note

In the field, replaceable thermistor assembly connection of the RF thermistors to the Type N center conductor is made by a bellows. If the bellows does not contact the center conductor, SWR will be about 2.0 at 10 GHz. The bellows may be lengthened slightly with a pair of tweezers.

74. The following special tools may be required for the completion of this procedure:

- a. One small screwdriver, 0.070 tip, suitable for removing a 00-90 x 1/8 screw.
- b. One pair of tweezers.

75. REMOVAL PROCEDURE.

a. Remove three 2-56 x 3/16 screws holding terminal shield (Figure 9). Move terminal shield aside.

CAUTION

Do not break wires connecting printed circuit assembly to receptacle connector.

b. Loosen locknut and remove 5/16-32 setscrew from thermistor assembly.

c. Disconnect the three wires between the printed circuit assembly and the receptacle connector from the printed circuit assembly.

d. In early thermistor assemblies there is a 00-90 x 1/8 screw used to connect the RF Thermistors to the Type N center conductor. Remove this screw, if present, using small screwdriver and tweezers.

e. Remove the three 2-56 x 5/8 inch screws holding printed circuit and thermistor assemblies to the RF connector assembly.

f. Remove printed circuit and thermistor assemblies.

g. Remove the three insulator bushings from thermistor assembly. This completes the removal of the damaged assembly.

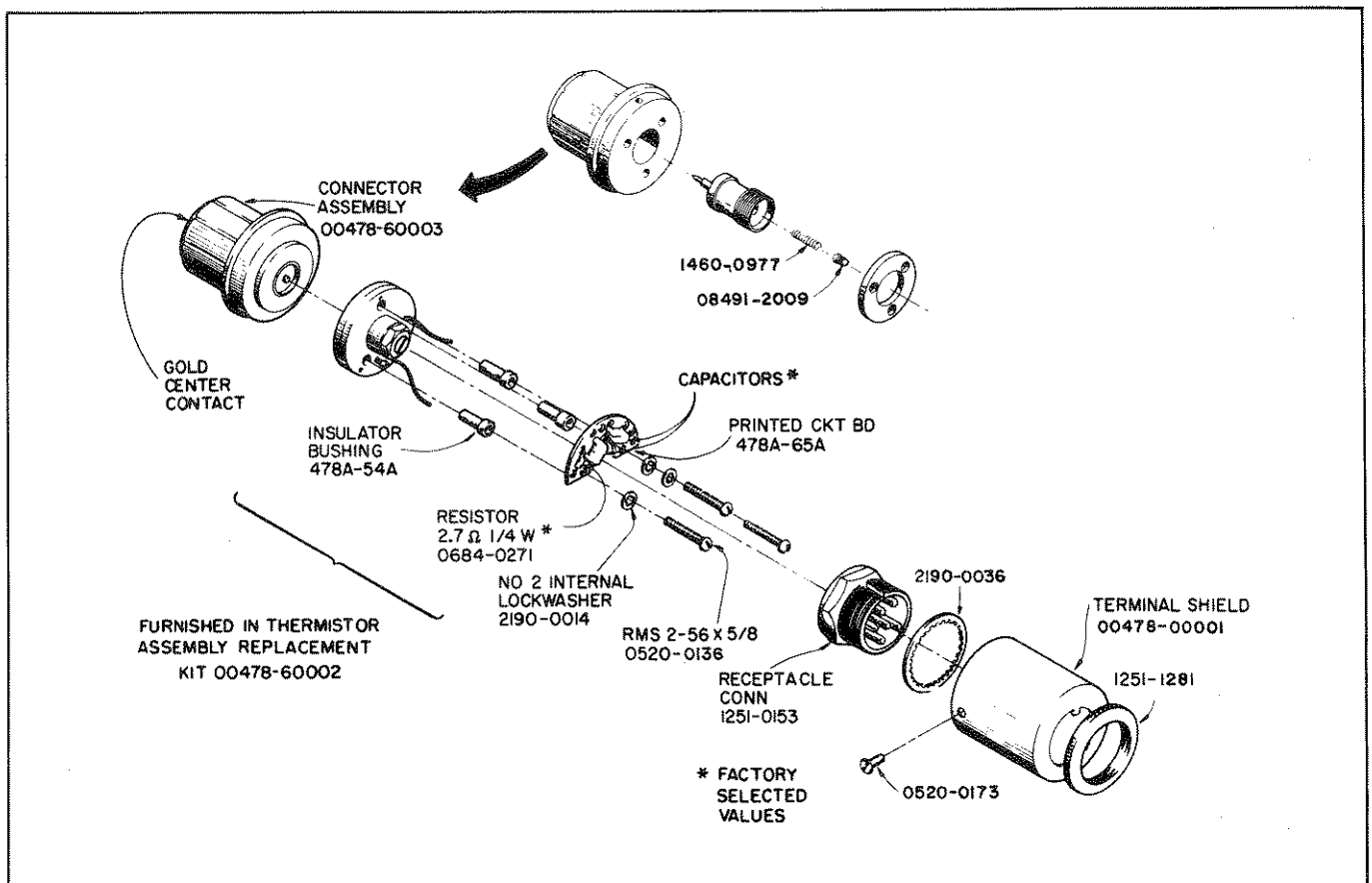

Figure 9. Model 478A Thermistor Mount Assembly

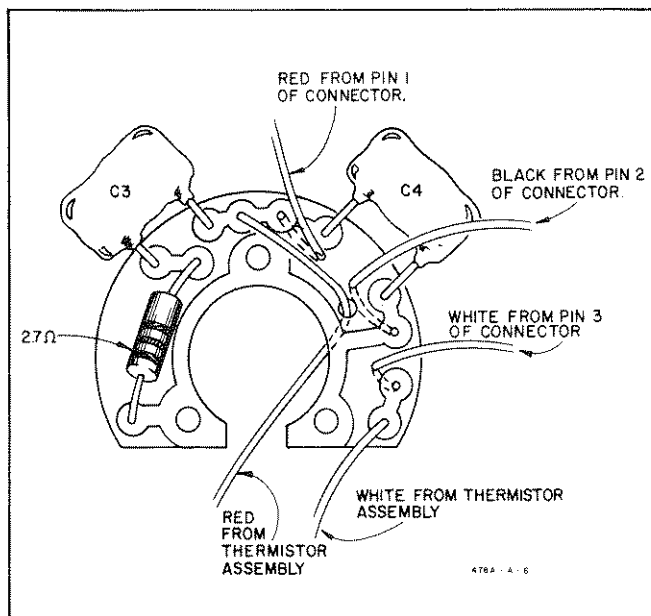

Figure 10. HP Model 478A Printed Circuit Assy
Wiring

76. INSTALLATION PROCEDURE.

a. Referring to Figure 10, connect the three wires from receptacle connector to printed circuit assembly.

Note

For strain relief, the wires should go through the holes indicated and connect from the bottom of the printed circuit assembly.

b. Install the three insulator bushings in the thermistor assembly.

c. Pass the red wire from the thermistor assembly through the hole indicated in Figure 10. Do not connect to printed circuit assembly at this time.

d. Mount thermistor and printed circuit assemblies on RF connector assembly. Use three 2-56 x 5/8 inch screws and lockwashers. Screws must be tightened firmly to insure proper bellows contact with the Type N center conductor.

Note

Printed circuit assembly must be positioned so it does not cover compensating screws.

e. Connect red and white wires from thermistor assembly to printed circuit assembly.

f. Connect thermistor mount to a HP Model 431. Check for proper null and zero.

g. If desired, check SWR and efficiency. The Mount SWR has been adjusted at the factory to be about equal at 9 GHz and 10 GHz and less than 1.5. The adjustment is made with the 5/16-23 setscrew which is secured by a locknut. The setscrew should not be moved unless SWR is being recalibrated. Efficiency may be checked by comparing to a known good mount.

CAUTION

To prevent pulling wires out of terminal connector, secure terminal shield with one 2-56 x 3/16 inch screw while making checks.

h. When any testing or recalibration is completed, secure terminal shield with three 2-56 x 3/16 inch screws. This completes the Installation Procedure.

77. RECALIBRATION. If recalibration of the mount is desired, the instrument may be sent to the factory for repair and recalibration. Any Hewlett-Packard Sales and Service Office will arrange for such repair.

CERTIFICATION

The Hewlett-Packard Company certifies that this instrument was thoroughly tested and inspected and found to meet its published specifications when it was shipped from the factory. The Hewlett-Packard Company further certifies that its calibration measurements are traceable to the U.S. National Bureau of Standards to the extent allowed by the Bureau's calibration facility.

WARRANTY AND ASSISTANCE

All Hewlett-Packard products are warranted against defects in materials and workmanship. This warranty applies for one year from the date of delivery, or, in the case of certain major components listed in the operating manual, for the specified period. We will repair or replace products which prove to be defective during the warranty period provided they are returned to Hewlett-Packard. No other warranty is expressed or implied. We are not liable for consequential damages.

Service contracts or customer assistance agreements are available for Hewlett-Packard products that require maintenance and repair on-site.

For any assistance, contact your nearest Hewlett-Packard Sales and Service Office. Addresses are provided at the back of this manual.

HEWLETT-PACKARD SALES AND SERVICE OFFICES

To obtain servicing information and order replacement parts, contact the nearest Hewlett-Packard Sales and Service Office in HP Catalog, or contact the nearest regional office.

IN THE UNITED STATES:

CALIFORNIA

3939 Lankershim Blvd.
North Hollywood 91604

GEORGIA

P.O. Box 28234
450 Interstate North
Atlanta 30328

ILLINOIS

5500 Howard Street
Skokie 60076

NEW JERSEY

W. 120 Century Road
Paramus 07652

IN CANADA:

QUEBEC

Hewlett-Packard (Canada) Ltd.
275 Hymus Blvd.
Pointe Claire

IN EUROPE:

SWITZERLAND

HEWPAK S.A.
54 Route des Acacias
1211 Geneva 24

IN AFRICA, ASIA AND AUSTRALIA:

Hewlett-Packard Export Marketing
3200 Hillview Ave.
Palo Alto, California 94304

IN CENTRAL AND SOUTH AMERICA:

Hewlett-Packard Inter-Americas
3200 Hillview Ave.
Palo Alto, California 94304