Operating and Service Manual

HP 435B Power Meter

(Including Options 001, 002, 003, and 004)

SERIAL NUMBERS

Attached to the rear panel of the instrument is a serial number plate. The serial number is in the form: 0000A00000. The first four digits and the letter are the serial number prefix. The last five digits are the suffix. The prefix is the same for identical instruments; it changes only when a configuration change is made to the instrument. The suffix, however, is assigned sequentially and is different for each instrument.

This manual applies directly to instruments with serial numbers prefixed 2342A and 2342U.

With changes described in Chapter 7, this manual also applies to instruments with serial numbers prefixed 2005A, 2041U, 2238A, 2441U and above.

For additional important information about serial numbers, see "Instruments Covered By Manual" in Chapter 1.



HP Part No. 00435-90055

© HEWLETT-PACKARD COMPANY 1980, 1983, 1984, 1991
1501 Page Mill Road, Palo Alto, California
Printed in UK

NOTICE

The information contained in this document is subject to change without notice.

HEWLETT-PACKARD MAKES NO WARRANTY OF ANY KIND WITH REGARD TO THIS MANUAL, INCLUDING, BUT NOT LIMITED TO, THE IMPLIED WARRANTIES OF MERCHANTABILITY AND FITNESS FOR A PARTICULAR PURPOSE. Hewlett-Packard shall not be liable for errors contained herein or direct, indirect, special, incidental or consequential damages in connection with the furnishing, performance, or use of this material.

WARRANTY

A copy of the specific warranty terms applicable to your Hewlett-Packard product and replacement parts can be obtained from your local Sales and Service Office.

Herstellerbescheinigung

Hiermit wird bescheinigt, daß dieses Gerät/System in Übereinstimmung mit den Bestimmungen von Postverordnung 1046/84 funktentstört ist.

Der Deutschen Bundespost wurde das Inverkehrbringen dieses Gerätes/System angezeigt und die Berechtigung zur Überprüfung der Serie auf Einhaltung der Bestimmungen eingeräumt.

Zusatzinformation für Meß- und Testgeräte:

Werden Meß- und Testgeräte mit ungeschirmten Kabeln und/oder in offenen Meßaufbauten verwendet so ist vom Betreiber sicherzustellen, daß die Funkentstörbedingungen unter Betriebsbedingungen an seiner Grundstücksgrenze eingehalten werden.

Manufacturer's Declaration

This is to certify that this equipment is in accordance with the Radio Interference Requirements of Directive FTZ 1046/1984. The German Bundespost was notified that this equipment was put into circulation, and has been granted the right to check the equipment type for compliance with these requirements.

Note: If test and measurement equipment is operated with unshielded cables and/or used for measurements in open setups, the user must ensure that under these operating conditions, the radio frequency interference limits are met at the border of his premises.

Contents

1. General Information	
Introduction	1-1
Instruments Covered by Manual	1-1
Manual Changes Supplement	1-1
Replaceable Parts	1-1
Description	1-3
Options	1-6
Battery	1-6
Input-Output Options	1-6
Accessories Supplied	1-6
Equipment Required But Not Supplied	1-6
Equipment Available	1-6
Recommended Test Equipment	1-7
Safety Considerations	1-7
2. Installation	
Introduction	2-1
Initial Inspection	2-1
Preparation for Use	2-1
Storage and Shipment	2-8
3. Operation	
Introduction	3-1
Panel Features	3-1
Operator's Checks	3-1
Operating Instructions	3-1
Power Measurement Accuracy	3-2
Operator's Maintenance	3-5
Operator's Checks	3-8
Operating Instructions	3-10
Specified Uncertainty Calculation	3-12
Calculating Measurement Uncertainty	3-13
Calculating Measurement Uncertainty (Uncertainty in dB Known)	3-16

4. Performance Tests	
Introduction	4-1
Equipment Required	4-1
Test Record	4-1
Performance Tests	4-1
Power Reference Level Test	4-2
Zero Carryover Test	4-5
Instrumentation Accuracy Test with Calibrator	4-7
Calibration Factor Test	4-9
5. Adjustments	
Introduction	5-1
Safety Considerations	5-1
Equipment Required	5-2
Factory Selected Components	5-2
Adjustment Locations	5-2
Power Reference Oscillator Level Adjustment	5-3
Typical Calculations	5-5
Multivibrator Adjustment	5-6
Power Meter Adjustments with 50Ω Power Sensor	5-8
Power Meter Adjustments with Calibrator	5-11
6. Replaceable Parts	
Introduction	6-1
Abbreviations	6-1
Replaceable Parts List	6-1
Factory Selected Parts (*)	6-2
Ordering Instructions	6-2
Parts Provisioning	6-2
7. Manual Changes	
Introduction	7-1
Manual Changes	7-1
Manual Change Instructions	7-1
8. Service	
Introduction	8-1
Safety Considerations	8-1
Service Sheets	8-2
Recommended Test Equipment	8-4
Repair	8-4
General Service Information	8-4
Service Sheet 1	8-11
Service Sheet 2	8-17
Service Sheet 3	8-27
Service Sheet 4	8-35
Service Sheet 5	8-41

Figures

1-1. HP 435B Power Meter and Accessories Supplied	1-2
2-1. Changing Range Switch Scale	2-2
2-2. Line Voltage Selection	2-3
2-3. Power Cables and Line (Mains) Plug Options	2-4
2-4. Battery Installation	2-6
2-5. Power Meter with Battery Installed	2-7
3-1. Front Panel Controls, Connectors and Indicators	3-6
3-2. Rear Panel Controls, Connectors and Indicators	3-7
3-3. Worst Case Effects of Specified and Mismatch Uncertainties (Values From Examples on Page 3-12 and 3-14)	3-15
4-1. Power Reference Level Test Setup	4-2
4-2. Zero Carryover Test Setup	4-5
4-3. Instrumentation Accuracy Test Setup with Calibrator	4-7
4-4. Calibration Factor Test Setup	4-9
5-1. Power Reference Oscillator Level Adjustment Setup	5-3
5-2. Multivibrator Adjustment Setup	5-6
5-3. 220 Hz Zero Crossover	5-7
5-4. Power Meter Adjustment Setup with 50Ω Power Sensor	5-8
5-5. Power Meter Adjustment Setup with Calibrator	5-11
8-1. A4 Assembly Extended for Service	8-3
8-2. Non-Inverting Amplifier (Gain = 1)	8-7
8-3. Non-inverting Amplifier (Gain = $1 + R_1/R_2$)	8-7
8-4. Inverting Amplifier (Gain = $-R_1/R_2$)	8-7
8-5. Schematic Diagram Notes	8-8
8-6. Troubleshooting Block Diagram	8-15
8-7. Multivibrator/Detector Waveforms	8-23
8-8. A5 Mother Board Component Locations	8-23
8-9. P/O Assembly (AC Ampl/Sync Detector) Component Locations	8-25
8-10. P/O A4 Assembly (AC Ampl/Sync Detector) Schematic Diagram	8-25
8-11. A1 Switch Assembly Component Locations	8-31
8-12. P/O A4 Assembly (DC Ampl/Auto Zero) Component Locations	8-33
8-13. P/O Assembly (DC Ampl/Auto Zero) Schematic Diagram	8-33
8-14. P/O A4 Assembly (Power Supply) Component Locations	8-39
8-15. P/O A4 Assembly (Power Supply) Schematic Diagram	8-39

8-16. A3 Power Reference Assembly Component Locations	8-45
8-17. A3 Power Reference Assembly Schematic Diagram	8-45
8-18. HP 435B Front and Rear Panel Views	8-47
8-19. HP 435B Top and Bottom Views	8-48
8-20. HP 435B Right and Left Views	8-49

Tables

1-1. Specifications	1-4
1-2. Recommended Test Equipment	1-8
4-1. Performance Test Record (1 of 2)	4-11
5-1. Factory Selected Components	5-2
7-1. Manual Changes by Serial Number	7-1
8-1. Etched Circuit Soldering Equipment	8-5
8-2. Assembly, Chassis and Adjustable Components Locations	8-43

Safety Considerations

This product and related documentation must be reviewed for familiarization with safety markings and instructions before operation.

This product is a Safety Class I instrument (provided with a protective earth terminal).

Before Applying Power

Verify that the product is set to match the available line voltage and the correct fuse is installed.

Safety Earth Ground

An uninterruptible safety earth ground must be provided from the main power source to the product input wiring terminals, power cord, or supplied power cord set.

Warning



Any interruption of the protective (grounding) conductor (inside or outside the instrument) or disconnecting the protective earth terminal will cause a potential shock hazard that could result in personal injury. (Grounding one conductor of a two conductor outlet is not sufficient protection.) In addition, verify that a common ground exists between the unit under test and this instrument prior to energizing either unit.

Whenever it is likely that the protection has been impaired, the instrument must be made inoperative and be secured against any unintended operation.

If this instrument is to be energized via an autotransformer (for voltage reduction) make sure the common terminal is connected to neutral (that is, the grounded side of the mains supply).

Servicing instructions are for use by service-trained personnel only. To avoid dangerous electric shock, do not perform any servicing unless qualified to do so.

Adjustments described in the manual are performed with power supplied to the instrument while protective covers are removed. Energy available at many points may, if contacted, result in personal injury.

Capacitors inside the instrument may still be charged even if the instrument has been disconnected from its source of supply.

For continued protection against fire hazard, replace the line fuse(s) only with 250V fuse(s) of the same current rating and type (for example, normal blow, time delay, etc.). Do not use repaired fuses or short circuited fuseholders.

Safety Symbols



Instruction manual symbol: The product will be marked with this symbol when it is necessary for the user to refer to the instruction manual (see Table of Contents for page references).



Indicates hazardous voltages.



Indicates earth (ground) terminal.

Warning



The **WARNING** sign denotes a hazard. It calls attention to a procedure, practice, or the like, which, if not correctly performed or adhered to, could result in personal injury. Do not proceed beyond a **WARNING** sign until the indicated conditions are fully understood and met.

Caution



The **CAUTION** sign denotes a hazard. It calls attention to an operating procedure, practice, or the like, which, if not correctly performed or adhered to, could result in damage to or destruction of part or all of the product. Do not proceed beyond a **CAUTION** sign until the indicated conditions are fully understood and met.

General Information

Introduction

This manual provides information for the installation, operation, testing, adjustment and maintenance of the HP 435B Power Meter.

Figure 1-1 shows the power meter with accessories supplied.

An operating manual is shipped with the instrument. This is simply a copy of the first three sections of this manual. The operating manual should be kept with the instrument for use by the operator. Additional copies of the operating manual may be ordered separately through your nearest Hewlett-Packard office. The part number is listed on the title page of this manual.

Instrument specifications are listed in Table 1-1. These specifications are the performance standards or limits against which the instrument may be tested.

Instruments Covered by Manual

Options 001, 002, 003 and 004 of the power meter are documented in this manual. The differences are noted in the appropriate location such as Options in Chapter 1, the Replaceable Parts List, and the schematic diagrams.

This instrument has a two-part serial number. The first four digits and the letter comprise the serial number prefix. The last five digits form the sequential suffix that is unique to each instrument. The contents of this manual apply directly to instruments having the same serial number prefix(es) listed under "SERIAL NUMBERS" on the title page.

Manual Changes Supplement

An instrument manufactured after the printing of a manual may have a serial number prefix *not listed* on the title page. Unlisted serial number prefixes indicate that the manual for such an instrument has been amended with a distinctive yellow *Manual Changes* supplement containing updated technical information.

In addition to updated information, *Manual Changes* supplements may also provide corrections to errors in manuals. *Manual Changes* supplements are keyed to a manual's print date and part number, both of which appear on the title page.

Replaceable Parts

In the U.S.A., it is better to order directly from the HP Parts Center. Contact your nearest HP sales office for more information. Also, your nearest HP office can supply toll-free telephone numbers for ordering parts and supplies.

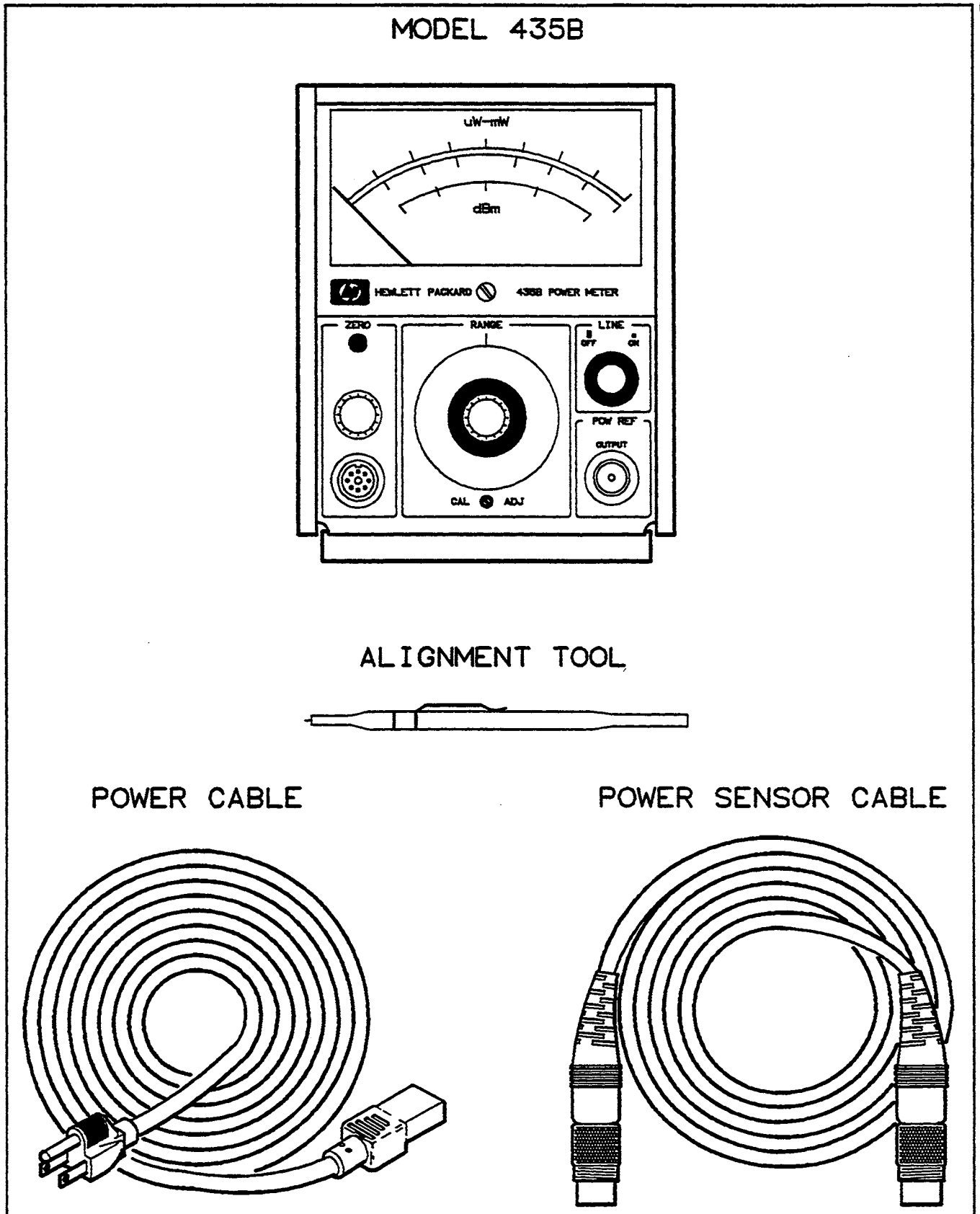

Figure 1-1. HP 435B Power Meter and Accessories Supplied

Description

The power meter and a compatible power sensor are interconnected with the power sensor cable to form a power measurement system. The system power level range, frequency response, and load impedance are dependent on the power sensor.

Accuracy of the power measurement system is ensured by the following power meter characteristics:

- a. An internal automatic zeroing circuit which removes error due to the ambient temperature output of the power sensor's power sensing device.
- b. A calibration factor-adjustment which accounts for error due to the frequency response of the power sensing device.
- c. An internal calibration reference which has an output of $1 \text{ mW} \pm 0.7\% (50\Omega)$.

Table 1-1. Specifications

FREQUENCY	
Frequency Range:	100 kHz to 26.5 GHz (depending on power sensor used).
POWER	
Power Range:	(Meter calibrated in watts and dBm.)
With HP 8481B or 8482B sensors:	44 dB with 9 full scale ranges of 5, 10, 15, 20, 25, 30, 35, 40 and 45 dBm (1 mW to 25W).
With HP 8481H or 8482H sensors:	45 dB with 9 full scale ranges of -5, 0, 5, 10, 15, 20, 25, 30 and 35 dBm (30 μ W to 3W).
With HP 8481A, 8482A, 8483A or 8485A sensors:	50 dB with 10 full scale ranges of -25, -20, -15, -10, -5, 0, 5, 10, 15 and 20 dBm (3 μ W to 100 mW).
With HP 8484A sensor:	50 dB with 10 full scale ranges of -65, -60, -55, -50, -45, -40, -35, -30, -25 and -20 dBm (300 pW to 10 μ W).
ACCURACY	
Instrumentation ¹ :	$\pm 1\%$ of full scale on all ranges.
Zero:	Automatic, operated by front-panel switch.
Zero Set:	$\pm 0.5\%$ of full scale on most sensitive range, typical.
Zero Carryover:	$\pm 0.5\%$ of full scale when zeroed on the most sensitive range.
Noise:	(Typical, at constant temperature, peak change over any one-minute interval.)
HP 8484A	20 pW
HP 8481A, 8482A, 8483A, 8485A	40 nW
HP 8481H, 8482H	4 μ W
HP 8481B, 8482B	40 μ W
Drift:	(1 hour, typical, at constant temperature after 24-hour warm-up)
HP 8484A	40 pW
HP 8481A, 8482A, 8483A, 8485A	15 nW
HP 8481H, 8482H	1.5 μ W
HP 8481B, 8482B	15 μ W

¹ Includes sensor non-linearity. Add +2, -4% on top two ranges when using the HP 8481A, 8482A, 8483A and 8485A power sensors; add $\pm 4.0\%$ on the top two ranges when using the HP 8481H and 8482H power sensors.

Table 1-1. Specifications (continued)

Power Reference:	Internal 50 MHz oscillator with Type N Female connector on front panel (or rear panel, Option 003 only).
Power output:	1.00 mW Factory set to $\pm 0.7\%$ traceable to the National Bureau of Standards.
Accuracy:	$\pm 1.2\%$ worst case ($\pm 0.9\%$ rss) for one year (0 to 55°C)
Response Time:	(0 to 99% of reading, five time constants.)
Range 1 (most sensitive)	<10.0 seconds
Range 2	<3.8 seconds
Range 3	<1.3 seconds
Ranges 4-10	<500 milliseconds Typical, measured at recorder output.
Cal Factor:	16-position switch normalizes meter reading to account for calibration factor or effective efficiency. Range 85% to 100% in 1% steps.
Cal Adjustment:	Front panel adjustment provides capability to adjust gain of meter to match power sensor in use.
Recorder Output:	Proportional to indicated power with 1 volt corresponding to full scale; 1 k Ω output impedance; BNC connector.
RF Blanking Output:	Provides a contact closure to ground when autozero mode is engaged.
Power Consumption:	100, 120, 220, or 240V +5%, -10% 100 and 120 volts, 48 to 66 Hz and 360-440 Hz 220 and 240 volts, 48 to 66 Hz 20 VA maximum
Weight:	Net, 2.7 kg (5.9 lbs)
Dimensions:	155 mm high ($6\frac{3}{32}$ inches) 130 mm wide ($5\frac{1}{8}$ inches) 279 mm deep (11 inches)

Options

Battery

The HP 435B Power Meter, Option 001 is supplied with a rechargeable battery that provides up to 16 hours continuous operation from a full charge.

If the power meter was purchased without the battery option, it may be ordered in kit form under HP part number 00435-60012. The kit includes the battery, the battery clamp, a 6-32 by $\frac{1}{2}$ inch pan head machine screw and installation instructions.

Input-Output Options

Option 002

A rear panel input connector is connected in parallel with the front panel input connector.

Option 003

A rear panel input connector is connected in parallel with the front panel input connector. A rear panel POWER REF OUTPUT connector replaces the standard front panel connector.

Option 004

The 1.5 meter (5 ft.) power sensor cable is not shipped with the power meter.

Accessories Supplied

The accessories supplied with the power meter are shown in Figure 1-1.

- a. The HP 11730A, 1.5 meter (5-foot) power sensor cable is used to couple the power sensor to the power meter. The 1.5 meter cable is omitted when Option 004 is ordered.
- b. The line power cable may be supplied in several configurations. Refer to the paragraph entitled "Power Cable" in Chapter 2.

Equipment Required But Not Supplied

To form a complete RF power measurement system a power sensor such as the HP 8481A must be connected to the power meter via the power sensor cable.

Equipment Available

The HP 11683A Range Calibrator is recommended for performance testing, adjusting and troubleshooting the power meter. The power meter's range-to-range accuracy and auto-zero operation can easily be verified with the calibrator. It also has the capability of supplying a full-scale test signal for each range.

An extender board (HP part number 5060-0630) may be used to place the A4 assembly printed circuit board in a position that allows easy access to test points and components.

The following table lists the power sensor cable accessories and their lengths that are available for use with the power meter. Order option 004 if the standard 1.5 meter cable is not desired with a cable accessory.

Power Sensor Cable Accessory	Cable Length
HP 11730B	3.1m (10 ft)
HP 11730C	6.1m (20 ft)
HP 11730D	15.2m (50 ft)
HP 11730E	30.5m (100 ft)
HP 11730F	61.0m (200 ft)

Recommended Test Equipment

The test equipment shown in Table 1-2 is recommended for use during performance testing, adjustments and troubleshooting. To ensure optimum performance of the power meter, the specifications of a substitute instrument must equal or exceed the critical specifications shown in the table.

Safety Considerations

The power meter is a Safety Class I instrument (provided with a protective earth terminal). This instrument has been designed according to international safety standards and has been supplied in safe condition.

Table 1-2. Recommended Test Equipment

Instrument Type	Critical Specifications	Suggested Model	Use ¹
Digital Voltmeter	Function: DC, Resistance Ranges: Resistance: 200 Ω Vdc: 100 mV, 1000 mV, 10V, 100V 10 MΩ input impedance 5½ digit resolution Accuracy: ±0.05% of reading ±0.028% of range	HP 3455A	P, A, T
Frequency Counter	Frequency Range: 200 Hz – 50 MHz Sensitivity: 100 mVrms Accuracy: 0.01%	HP 5314A	A
Oscilloscope	Bandwidth: dc to 50 MHz Vertical sensitivity: 0.2 V/division Horizontal sensitivity: 1 ms/division	HP 1740A	P, A, T
Power Meter	Range: capability to measure 1 mW Transfer Accuracy (input to output): ±0.2%	HP 432A	P,A
Power Sensor	Range: capability to measure 1 mW	HP 8481A/H or HP 8482A/H	P, A
Range Calibrator		HP 11683A	
Thermistor Mount	SWR: 1.05 at 50 MHz Accuracy: ±0.5% at 50 MHz	HP 478A - H75 or 478A - H76 ²	P, A

1 P = Performance Tests; A = Adjustments; T = Troubleshooting.

2 Traceable to NIST.

Installation

Introduction

This section includes information on the initial inspection, preparation for use, and storage and shipment instructions for the power meter.

Initial Inspection

Warning



To avoid hazardous electrical shock, do not perform electrical tests when there are signs of shipping damage to any portion of the outer enclosure (covers and panels).

Inspect the shipping container for damage. If the shipping container or cushioning material is damaged, it should be kept until the contents of the shipment have been checked for completeness and the instrument has been checked mechanically and electrically. The contents of the shipment should be as shown in Figure 1-1. Procedures for checking electrical performance are given in Chapter 4. If the contents are incomplete, if there is mechanical damage or defect, or if the instrument does not pass the electrical performance tests, notify the nearest Hewlett-Packard office. If the shipping container is damaged, or the cushioning material shows signs of stress, notify the carrier as well as the Hewlett-Packard office. Keep the shipping materials for the carrier's inspection.

Preparation for Use

Meter Zeroing

With the LINE switch set to OFF, the meter pointer should be positioned directly over zero. If necessary, insert a screwdriver into the mechanical meter zero control (beneath the meter) and align the pointer with zero. Back the adjustment off slightly. The backlash in the control ensures against a meter indication error caused by jarring the instrument.

Range Switch Scale Selection

The RANGE switch has three scales on two removable rings which correspond to the measurement capabilities of compatible power sensors. The range scales are 3 W to 0.3 mW (+35 to -5 dBm), 100 mW to 3 μ W (+20 to -25 dBm) and 10 μ W to 0.3 nW (-20 to -65 dBm). Each scale listed indicates the maximum and minimum full scale meter readings.

To select the correct RANGE switch knob assembly scale (see Figure 2-1):

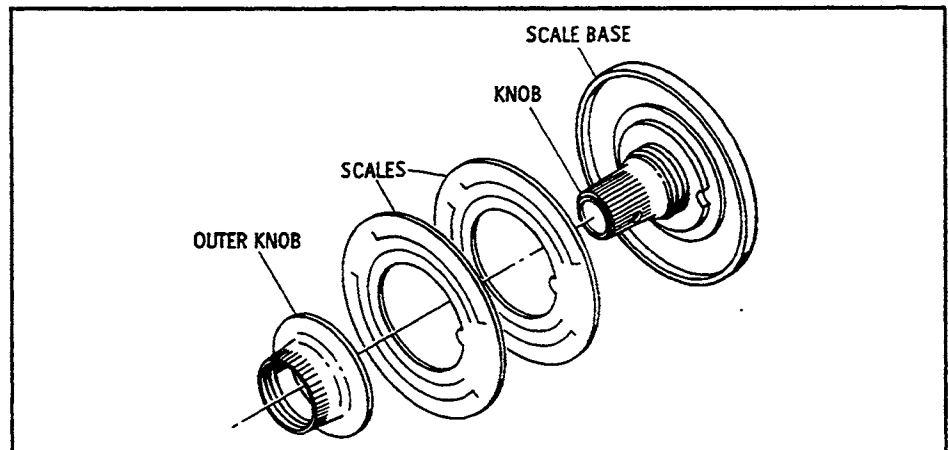

Figure 2-1. Changing Range Switch Scale

- a. Unscrew the outer (black) knob by turning it counterclockwise. Then, remove the outer knob.
- b. Remove the two scale rings.
- c. Determine which of the three scales is to be used.
- d. Place the other scale ring on the knob assembly.
- e. Place the selected ring on the knob assembly with the selected scale out.
- f. Line up the tabs of the scale rings with the slot in the knob assembly.
- g. Hold the scale rings in place with your fingers. Thread the outer knob onto the knob assembly. Lightly tighten the knob.

Note



For the following HP instruments (8484A, 8481D, 8485D, and 8487D) ring replacement, order HP part no. 0350-0148. For HP instrument (8482B), order HP part no. 0350-0153.

Power Requirements

The power meter requires a power source with an output of 100, 120, 220, or 240 Vac +5%, -10% single phase, 100 and 120 volts, 48 to 66 Hz and 360 to 440 Hz, 220 and 240 volts, 48 to 66 Hz. Power consumption is 20 VA maximum.

Warning



If this instrument is to be energized via an external autotransformer, make sure the autotransformer common terminal is connected to the earth terminal of the power source.

Line Voltage Selection

Caution



BEFORE SWITCHING ON THIS INSTRUMENT, make sure the instrument is set to the voltage of the power source.

Figure 2-2 provides instructions for line voltage and fuse selection. The line voltage selection card and proper fuse are factory installed for 120 Vac operation.

Fuses may be ordered as:

Fuse	HP Part Number
0.1 A, 250 V slow blow (100/120 Vac)	2110-0234
0.062 A, 250 V slow blow (220/240 Vac)	2110-0311

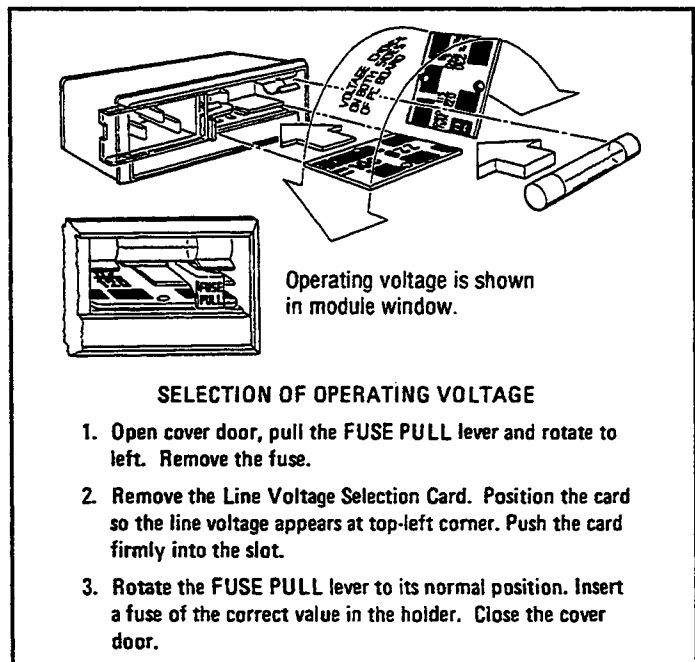

Figure 2-2. Line Voltage Selection

Warning



To avoid the possibility of hazardous electrical shock, do not operate this instrument at line voltages greater than 126.5 Vac with line frequencies greater than 66 Hz (leakage currents at these line settings may exceed 3.5 mA).

Power Cable

In accordance with international safety standards, this instrument is equipped with a three-wire power cable. When connected to an appropriate ac power receptacle, this cable grounds the instrument cabinet. The type of power cable plug shipped with each instrument depends on the country of destination. Refer to Figure 2-3 for the part numbers of the power cable plugs available.

Warning



BEFORE SWITCHING ON THIS INSTRUMENT, the protective earth terminals of this instrument must be connected to the protective conductor of the (Mains) power cord. The Mains plug shall only be inserted in a socket outlet provided with a protective earth contact. The protective action must not be negated by the use of an extension cord (power cable) without a protective conductor (grounding).

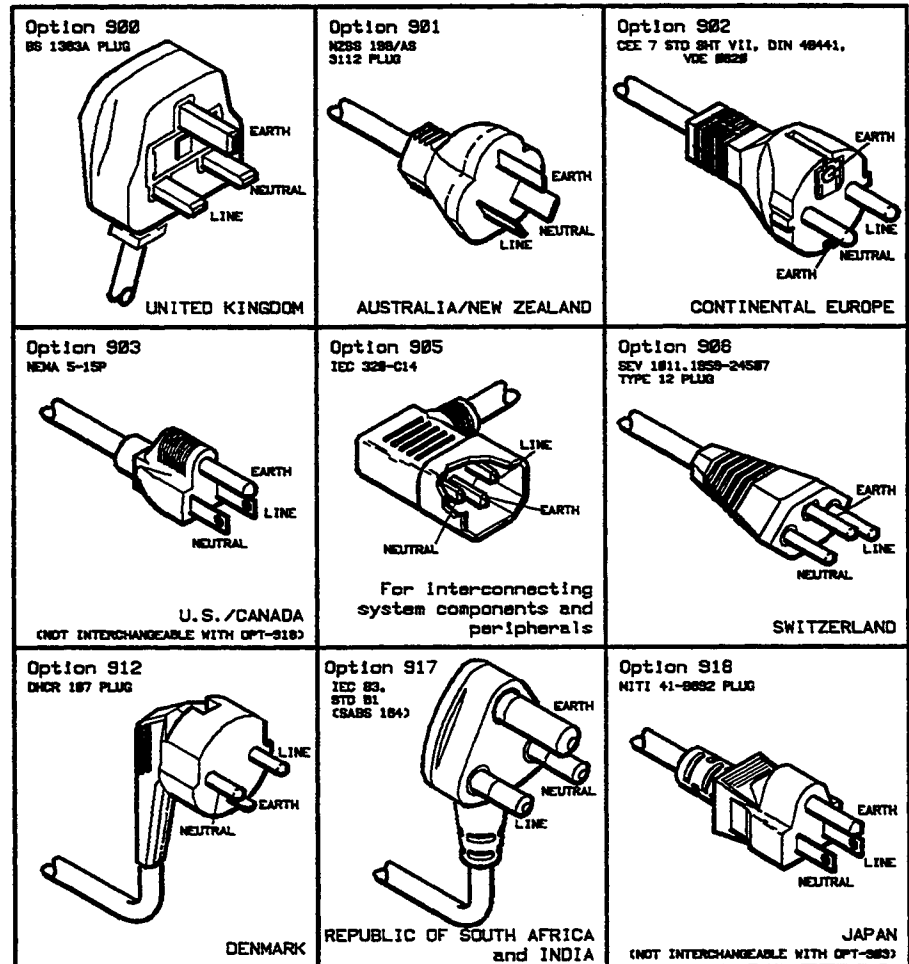

Figure 2-3. Power Cables and Line (Mains) Plug Options

Interconnections

The power meter and a power sensor are integral parts of this measurement system. Before measurements can be performed, the power meter and sensor must be connected together with the power sensor cable. (The cable is supplied with the power meter.)

The power sensor cable couples the dc supply and sampling gate drive from the power meter to the power sensor and the 220 Hz ac output signal from the power sensor to the power meter.

Caution

The maximum voltage which may be safely coupled to the power meter input from the power sensor is 18 mVrms.

Operating Environment

The operating environment should be within the following limitations:

Temperature 0 to 55°C
Humidity <95% relative at 40°C
Altitude 4570 meters (15 000 feet)

Bench Operation

The instrument cabinet has plastic feet and a foldaway tilt stand for convenience in bench operation. (The plastic feet are shaped to ensure self aligning of the instruments when stacked.) The tilt stand raises the front of the instrument for easier viewing of the control panel.

Rack Mounting

Instruments that are narrower than full rackwidth may be rack-mounted using Hewlett-Packard adapter frames or combining cases.

Adaptor Frames. Hewlett-Packard accessory adaptor frames are an economical means of rack mounting instruments that are narrower than full rack-width. A set of spacer clamps, supplied with each adaptor frame, permits instruments of different dimensions to be combined and rack mounted as a unit. Accessory blank panels are available for filling unused spaces.

Combining Cases. HP 1051A and 1052A Combining Cases are metal enclosures that allow combinations of one-third and one-half rack-width instruments to be assembled for use on a workbench or for mounting in a rack of standard 19-inch spacing. Each case includes a set of partitions for positioning and retaining instruments and a rack mounting kit. No tools are required for installing the partitions. For bench use the cases have the same convenient features as full rackwidth instruments, (for example, fold-away tilt stands and specially designed feet for easier instrument stacking). Accessories available for the combining cases include blank filler panels and snap-on full width control panel covers.

Battery Operation

To operate the power meter on battery power, the battery must be installed and charged, the line power cable must be disconnected, and the LINE switch must be ON.

**Battery Installation.****Warning**

This task should be performed only by service trained persons who are aware of the potential shock hazard of working on an instrument with protective covers removed.

To avoid hazardous electrical shock, the line (Mains) power cable should be disconnected before attempting to install the battery.

Do not short the battery terminals. This may result in overheating which can cause burns or increase risk of fire.

Do not incinerate or mutilate the battery. It might burst or release toxic materials causing personal injury.

The battery is installed in the power meter as follows (see Figure 2-4):

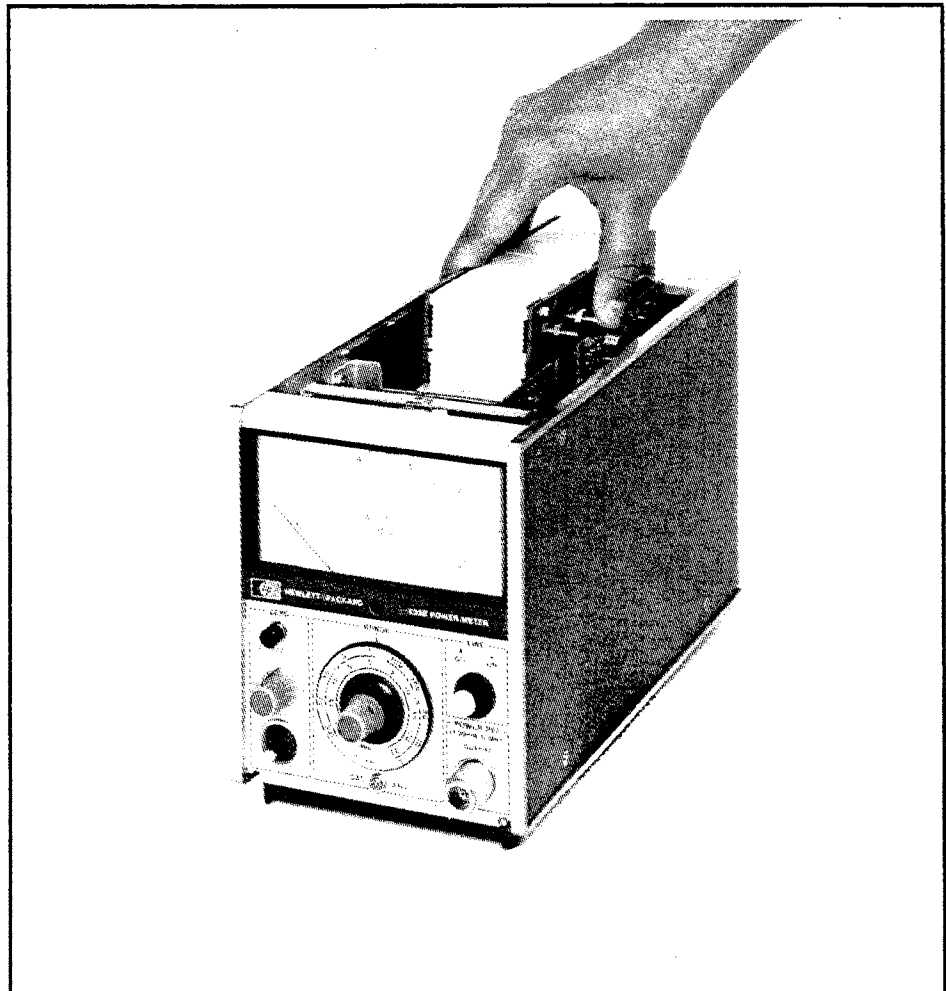

Figure 2-4. Battery Installation

- a. Remove the top cover.
- b. Hold the battery above the power meter, parallel to printed circuit board A4. The battery terminal lugs must face the circuit board.
- c. Loosen the lugs. Move the battery down into place and guide the lugs into the slots on the circuit board. The battery should now rest on the aluminum deck.
- d. Place the battery clamp over the battery and secure it. The two prongs fit into slots on the rear panel and the $\frac{6}{32}$ by $\frac{1}{2}$ inch pan head machine screw holds the forward end of the clamp in place.
- e. Tighten the battery terminal lugs by hand.

Figure 2-5 shows the power meter with battery installed.

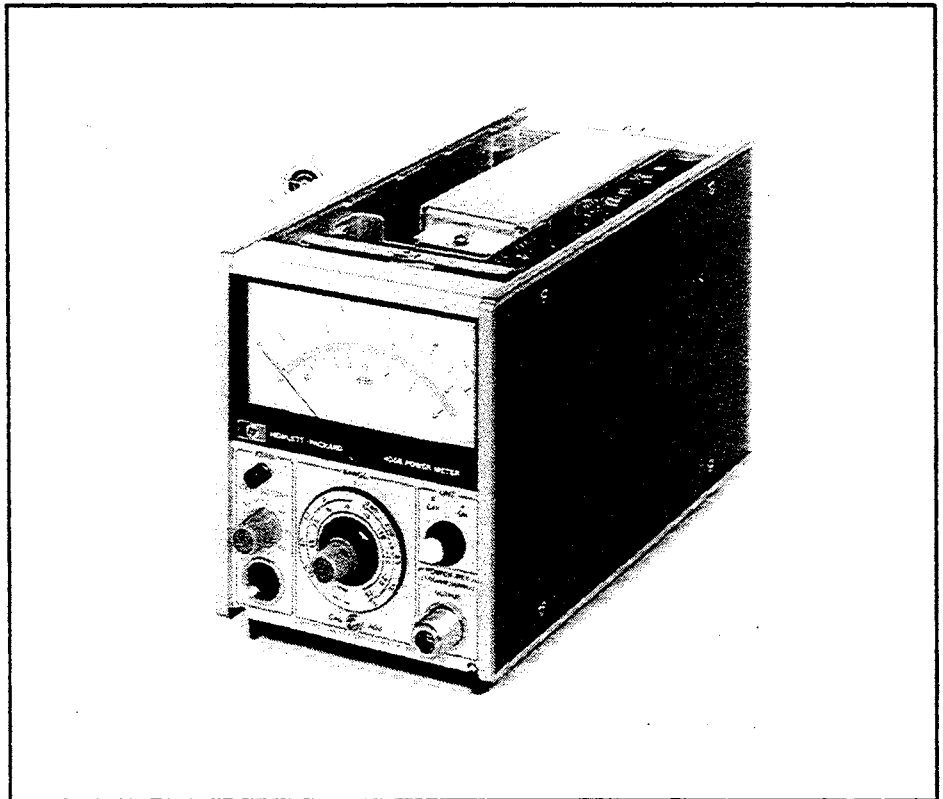

Figure 2-5. Power Meter with Battery Installed

Battery Charging. The battery is being charged if the battery has been installed, the line power cable is connected to the available line power, and the LINE switch is ON. In the fully charged condition, (24-hour charge time), the battery will supply power for a minimum of 16 hours.

Storage and Shipment

Environment

The instrument should be stored in a clean, dry environment. The following environmental limitations apply to both storage and shipment:

Temperature -55 to +75°C
Humidity <95% relative at 40°C
Altitude <15 300 meters (50 000 feet)

Packaging

Tagging for Service. If the instrument is being returned to Hewlett-Packard for service, please complete one of the blue repair tags located at the end of this manual and attach it to the instrument.

Original Packaging. Containers and materials identical to those used in factory packaging are available through Hewlett-Packard offices. If the instrument is being returned to Hewlett-Packard for servicing, attach a tag indicating the type of service required, return address, model number and full serial number. Mark the container FRAGILE to ensure careful handling. Refer to the instrument by model number and full serial number in any correspondence.

Other Packaging. The following general instructions should be used for re-packaging with commercially available materials:

- a. Wrap the instrument in heavy paper or plastic. (If shipping to a Hewlett-Packard office or service center, attach a tag indicating the type of service required, return address, model number and full serial number.)
- b. Use a strong shipping container. A doublewall carton made of 2.4 MPa (350 pound) test material is adequate.
- c. Use a layer of shock-absorbing material 70 to 100 mm (3 to 4 inches) thick around all sides of the instrument to provide firm cushioning and prevent movement inside the container. Protect the control panel with cardboard.
- d. Seal the shipping container securely.
- e. Mark the shipping container FRAGILE to ensure careful handling.
- f. In any correspondence, refer to the instrument by model number and full serial number.

Operation

Introduction

This section provides complete operating instructions for the power meter. The instructions cover:

- panel features
- operator's checks
- operating instructions
- power measurement accuracy
- operator's maintenance

Panel Features

Front and rear panel features of the power meter are described in Figure 3-1 and Figure 3-2. These figures contain a detailed description of the controls, indicators and connectors.

Operator's Checks

Note



If the instrument does not operate properly and is being returned to Hewlett-Packard for service, please complete one of the blue repair tags located at the end of this manual and attach it to the instrument.

Upon receipt of the instrument, or to check the power meter for an indication of normal operation, follow the operational procedures in the "Operator's Checks" section. These checks are designed to familiarize the operator with the power meter and to provide an understanding of the operating capabilities.

Operating Instructions

General operating instructions are listed in the "Operating Instructions" section. The instructions will familiarize the operator with the basic practices used when operating the power meter.

Warning



Any interruption of the protective (grounding) conductor (inside or outside the instrument) or disconnecting the protective earth terminal is likely to make this instrument dangerous. Intentional interruption is prohibited.

Power Measurement Accuracy

A power measurement is never free from error or uncertainty. Any RF system has RF losses, mismatch losses, mismatch uncertainty, instrumentation uncertainty and calibration uncertainty. Measurement errors as high as 50% are not only possible, they are highly likely unless the error sources are understood and, as much as possible, eliminated.

Sources of Error and Measurement Uncertainty

RF Losses. Some of the RF power that enters the power sensor is not dissipated in the power sensing elements. This RF loss is caused by dissipation in the walls of waveguide power sensors, in the center conductor of coaxial power sensors, in the dielectric of capacitors, connections within the sensor and radiation losses.

Mismatch. The result of mismatched impedances between the device under test and the power sensor is that some of the power fed to the sensor is reflected before it is dissipated in the load. Mismatches affect the measurement in two ways. First, the initial reflection is a simple loss and is called mismatch loss. Second, the power reflected from the sensor mismatch travels back up the transmission line until it reaches the source. There, most of it is dissipated in the source impedance, but some of it is re-reflected by the source mismatch. The re-reflected power returns to the power sensor and adds to, or subtracts from, the incident power. For all practical purposes, the effect the re-reflected power has upon the power measurement is unpredictable. This effect is called mismatch uncertainty.

Instrumentation Uncertainty. Instrumentation uncertainty describes the ability of the metering circuits to accurately measure the dc output from the power sensor's power sensing device. In the power meter, this error is less than $\pm 1\%$ ¹. It is important to realize, however, that a 1% meter does not automatically give 1% overall measurement accuracy.

Power Reference Uncertainty. The uncertainty of the output level of the power reference oscillator is $\pm 0.7\%$. This reference is normally used to calibrate the system and is, therefore, a part of the system's total measurement uncertainty.

Cal Factor Switch Resolution Error. The resolution of the CAL FACTOR switch contributes a significant error to the total measurement because the switch has 1% steps. The maximum error possible in each position is $\pm 0.5\%$.

¹ Refer to Instrument accuracy specification in Chapter 1 when using the top two ranges.

Corrections for Error

Calibration Factor and Effective Efficiency. The two correction factors basic to power meters are calibration factor and effective efficiency. Effective efficiency is the correction factor for RF losses within the power sensor. Calibration factor takes into account the effective efficiency and mismatch losses.

Calibration factor is expressed as a percentage with 100% meaning the power sensor has no losses. Normally the calibration factor will be 100% at 50 MHz, the operating frequency of the internal reference oscillator.

The power sensors used with the power meter have individually calibrated calibration factor curves placed on their covers. To correct for RF and mismatch losses, simply find the power sensor's calibration factor at the measurement frequency from the curve or the table that is supplied with the power sensor, and set the CAL FACTOR switch to this value.

The CAL FACTOR switch resolution error of $\pm 0.5\%$ may be reduced by one of the following methods:

1. Set the CAL FACTOR switch to the nearest positions above and below the correction factor given on the table. Interpolating between the power levels measured provides the corrected power level.
2. Leave the CAL FACTOR switch on 100% after calibration. Then, make the measurement and record the reading. Use the reflection coefficient, magnitude and phase angle, if such a table is supplied with the power sensor, to calculate the corrected power level.

Calculating Worst Case Uncertainty

Worst case uncertainty is the sum of the specified uncertainties and mismatch uncertainty. Uncertainty calculation is outlined in the following two subsections. Examples are worked out in the "Specified Uncertainty Calculation" section and the "Calculating Measurement Uncertainty" section. For a more complete explanation of measurement uncertainty refer to HP application note AN-64-1 "Fundamentals of RF and Microwave Power Measurement".

Specified Uncertainties. The specified uncertainties which account for part of the total power measurement uncertainty are:

- a. Instrumentation $\pm 1\%$ ¹ or ± 0.05 dB.
- b. Power reference $\pm 0.7\%$ or ± 0.03 dB.
- c. CAL FACTOR switch resolution, 0 to $\pm 0.5\%$ (depending on Cal Factor).
- d. Zero set, $\pm 0.5\%$ of full scale of lowest range which is 15 nW.
- e. Zero Carryover, $\pm 0.5\%$.
- f. Noise and Drift, depends on the range and type of sensor.
- g. Calibration factor uncertainty, which depends on sensor type, is listed in the sensor manual.

The "Specified Uncertainty Calculation" section gives an example of specified uncertainty calculation.

Calculating Mismatch Uncertainty. Mismatch uncertainty is the result of the source mismatch interacting with the power sensor mismatch. The magnitude of uncertainty is related to the magnitudes of the source and power sensor reflection coefficients, which can be calculated from SWR. The "Calculating Measurement Uncertainty" section shows how the calculations are made and Figure 3-3 illustrates mismatch uncertainty and total calculated uncertainty for two cases. In the first case, the power sensor's SWR = 1.5, and in the second case, the power sensor's SWR = 1.25. In both cases the source has an SWR of 2.0. The example shows the effect on power measurement accuracy a poorly matched power sensor will have as compared to one with low mismatch.

A faster, easier way to find mismatch uncertainty is to use the HP Mismatch Error (uncertainty) Limits/Reflectometer Calculator. The calculator may be obtained, on request, from your nearest Hewlett-Packard office by using HP part number 5952-0948.

The method of calculating measurement uncertainty from the uncertainty in dB is shown in the "Calculating Measurement Uncertainty (Uncertainty in dB Known)" section. This method would be used when the initial uncertainty calculations were made with the Mismatch Error/Reflectometer Calculator.

¹ Refer to Instrument accuracy specification in Chapter 1 when using the top two ranges.

Operator's Maintenance

The only maintenance responsibilities the operator should normally perform are primary power fuse replacement, LINE switch lamp replacement and rechargeable battery replacement.

Battery replacement is the only operation that requires tools. A Pozidrive screwdriver is needed to remove the battery clamp.

Fuses

The primary power fuse is found within the A6 Power Module Assembly on the power meter's rear panel. For instructions on how to change the fuse, refer to the paragraph entitled Line Voltage Selection in Chapter 2.

Caution

Make sure that only fuses with the required rated current and of the specified type (slow blow, time delay, etc.) are used for replacement. The use of repaired fuses and the short-circuiting of fuse-holders must be avoided.

Lamp Replacement

The lamp is contained in a plastic lens which doubles for a pushbutton on the LINE switch. When the power meter LINE switch is ON and is being operated by the available line power, the lamp should be illuminated. If the lamp is defective, remove the lens by pulling it straight out. Order lamp (HP part number 3131-0434) CD6 and replace the old pushbutton-lamp assembly with the new one. To replace the assembly, align the pins with the notch in the receptacle and push straight in.

Battery Replacement

If the meter indicates that the battery is discharged by a full downscale reading, and after charging the battery still will only power the power meter for a short period of time, the battery is probably defective. The replacement battery, BT1 (HP part number 1420-0096), may be ordered through the nearest Hewlett-Packard office. Refer to Battery Installation in Chapter 2.

Warning

This task should be performed only by service trained persons who are aware of the potential shock hazard of working on an instrument with protective covers removed.

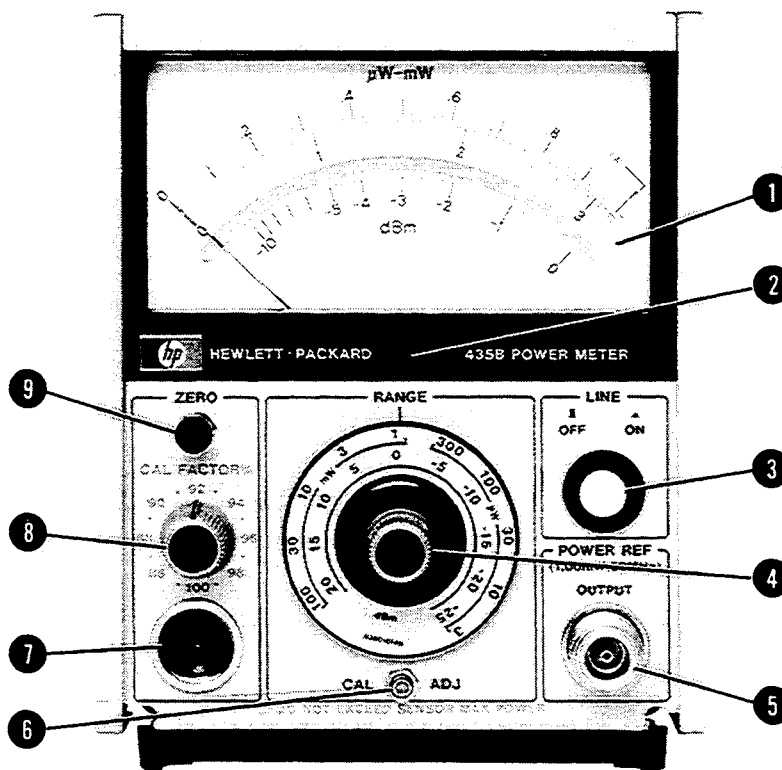

- 1 **Meter.** Normally indicates average RF power in dBm or Watts. During battery operation the meter continuously indicates battery condition. A normal reading indicates the battery is charged; a full down-scale reading indicates the battery is discharged or is defective.
- 2 **Meter Zero.** Mechanical adjustment used to zero the meter when the LINE switch is OFF.
- 3 **LINE Switch.** Connects line or battery power to the Power Meter circuits when the LINE switch is ON. During battery operation, the lamp contained within the LINE switch will not be illuminated when the INSTRUMENT is ON.
- 4 **RANGE Switch.** Selects desired power range; keyed to meter full-scale deflection; has three removable scales which are changed to match the range of the power sensor.
- 5 **POWER REF OUTPUT.** RF output of 1.00 mW \pm 0.70% into 50 Ω at 50 MHz from an internal reference oscillator. Available for system calibration.
- 6 **CAL ADJ.** Screwdriver adjustment for calibrating any power sensor and Power Meter as a system, to a known standard.
- 7 **Input Connector.** Input from the power sensor via the power sensor cable.
- 8 **CAL FACTOR Switch.** Changes the gain of the Power Meter amplifier circuits to compensate for mismatch losses and effective efficiency of the power sensor.
- 9 **ZERO Switch.** The ZERO switch activates a feedback circuit, which automatically zeros the meter pointer, and a rear panel RF blanking signal.

Figure 3-1. Front Panel Controls, Connectors and Indicators

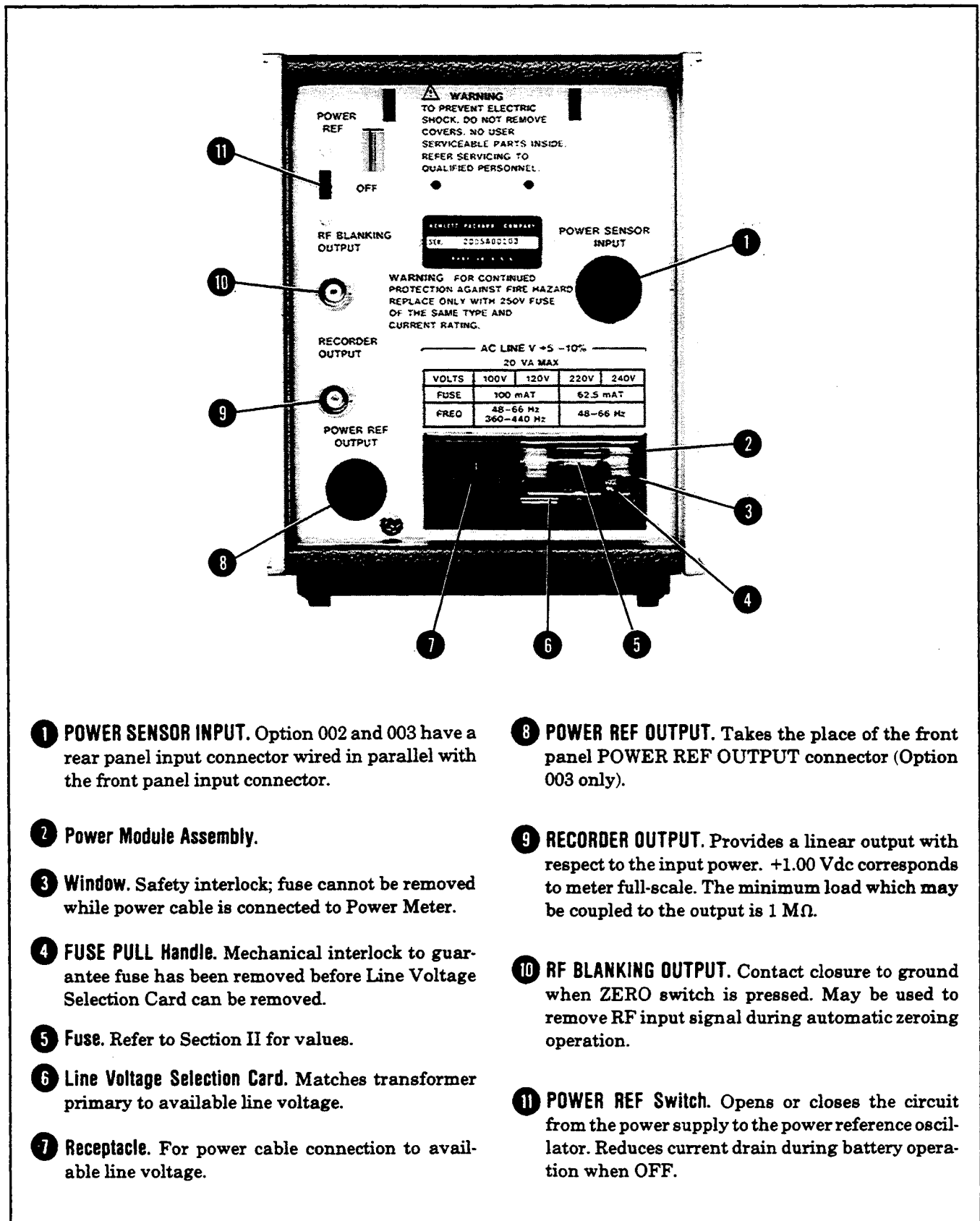

Figure 3-2. Rear Panel Controls, Connectors and Indicators

Operator's Checks

1. BEFORE SWITCHING ON THIS INSTRUMENT, check that the power transformer primary is matched to the available line voltage, the correct fuse is installed and the safety precautions are taken. See "Power Requirements", "Line Voltage Selection", "Power Cable" and associated warnings and cautions in Chapter 2.

Warning



BEFORE CONNECTING LINE POWER TO THIS INSTRUMENT, ensure that all devices connected to this instrument are connected to the protective (earth) ground.

BEFORE SWITCHING ON THIS INSTRUMENT, ensure that the line power (Mains) plug is connected to a three-conductor line power outlet that has a protective (earth) ground. (Grounding one conductor of a two-conductor outlet is not sufficient.)

Caution



Do not twist the body of the power sensor when connecting or disconnecting it. This can cause major damage to the power sensor.

2. Set the meter indication to zero with the mechanical meter zero control. Back the control off slightly.
3. Connect the power sensor to the power meter with the power sensor cable.
4. Connect the power cable to the power outlet and power module receptacles. Set the LINE switch to ON; the lamp within the switch lens should be illuminated.
5. Change the power meter's RANGE switch scale so it corresponds to the range of the power sensor. Refer to "Range Switch Scale Selection" in Chapter 2.
6. Set the power meter Controls as follows:
 - RANGE switch position . fully ccw
 - CAL FACTOR switch . . 100%
 - POWER REF switch . . . OFF
7. Press the ZERO switch and verify that the meter pointer moves to "0" (zero) and the RF BLANKING OUTPUT is shorted to ground.
8. Set the RANGE switch to the position indicated in the following table. Then, connect the power sensor (and adapter or attenuator as required) to the POWER REF OUTPUT and set the rear panel POWER REF switch to (ON). Verify that the meter reads approximately the same as indicated in the table.

Power Sensor	RANGE Switch Position	Meter Indication
HP 8481B and 8482B (remove attenuator)	3 W	1 w
HP 8481A, 8482A, 8481H, 8482H	3 mW	1 mW
HP 8485A (HP 1250-1250 Adapter required)	3 mW	1 mW
HP 8483A (HP 1250-0597 Mechanical Adapter required)	3 mW	0.96 mW
HP 8484A (HP 11708A Reference Attenuator required)	3 μ W	1 μ W

9. Step the CAL FACTOR switch through its range noting a small increase in meter reading with each successive step. Reset the CAL FACTOR switch to 100%.
10. Set the RANGE switch to the position indicated in the table below. Then, adjust the CAL ADJ control for a full-scale meter reading for 50 Ω power sensors and a 96% of full scale meter reading for 75 Ω power sensors.

Power Sensor	RANGE Switch Position
HP 8481B and 8482B (remove attenuator)	1 W
HP 8481A, 8482A, 8481H, 8482H	1 mW
HP 8485A (HP 1250-1250 Adapter required)	1 mW
HP 8483A (HP 1250-0597 Mechanical Adapter required)	1 mW
HP 8484A (HP 11708A Reference Attenuator required)	1 μ W

11. Check at the rear panel RECORDER OUTPUT jack for an output of \approx 1 Vdc.
12. To check operation using battery power, disconnect the power cable from the rear power panel module receptacle and set the LINE switch to ON (the lamp within the switch will lens not be illuminated). When a power measurement is made, a normal upscale reading indicates normal operation; a full down-scale reading indicates the battery is discharged.

Operating Instructions

1. BEFORE SWITCHING ON THIS INSTRUMENT, check that the power transformer primary is matched to the available line voltage, the correct fuse is installed and safety precautions are taken. See "Power Requirement", "Line Voltage Selection", "Power Cable" and associated warnings and cautions in Chapter 2.

Warning



BEFORE CONNECTING LINE POWER TO THE INSTRUMENT, ensure that all devices connected to this instrument are connected to the protective (earth) ground.

BEFORE SWITCHING ON THIS INSTRUMENT, ensure that the line power (Mains) plug is connected to a three-conductor line power outlet that has a protective (earth) ground. (Grounding one conductor of a two-conductor outlet is not sufficient.)

Caution



Do not twist the body of the power sensor when connecting or disconnecting it. This can cause major damage to the sensor.

2. Set the meter indication to zero with the mechanical meter zero control. Back the control off slightly.
3. Connect the power sensor to the power meter with the power sensor cable.
4. Connect the power cable to the power outlet and power module receptacles. Set the LINE switch to ON; the lamp within the switch lens should be lit.
5. Change the power meter's RANGE switch scale so it corresponds to the range of the power sensor. Refer to the paragraph entitled Range Switch Scale Selection in Chapter 2.
6. Set the power meter switches as follows:

RANGE position	fully ccw
CAL FACTOR	100%
POWER REF	OFF
7. Press the ZERO switch, allow 5 seconds for the zeroing operation to take place, and release the switch.
8. Set the RANGE switch to the position indicated in the following table. Then, connect the power sensor (and adapter or attenuator as required) to the POWER REF OUTPUT and set the rear panel POWER REF switch to (ON). For 50Ω power sensors, adjust the CAL ADJ control for a full-scale reading; the meter pointer should be aligned with the CAL mark (full-scale reading) on the meter face. For 75Ω power sensors, adjust the CAL ADJ control for a 96% of full scale reading; the meter pointer should be aligned with the 0.96 mark on the meter face.

Power Sensor	RANGE Switch Position
HP 8481B and 8482B (remove attenuator)	1 W
HP 8481A, 8482A, 8481H, 8482H	1 mW
HP 8485A (HP 1250-1250 Adapter required)	1 mW
HP 8483A (HP 1250-0597 Mechanical Adapter required)	1 mW
HP 8484A (HP 11708A Reference Attenuator required)	1 μ W

9. Disconnect the power sensor from the POWER REF OUTPUT and set the POWER REF switch to OFF.
10. Locate the calibration curve on the power sensor cover. find the CAL FACTOR for the measurement frequency; set the CAL FACTOR for the measurement frequency; set the CAL FACTOR switch accordingly.
11. Set the RANGE switch so that full scale is greater than the power level to be measured.
12. Connect the power sensor to the RF source. Read the power level in dBm or watts on the panel meter.

Caution



See "Operating Precautions" in the power sensor Operating and Service manuals for maximum power levels which may be safely coupled to this system. Levels which exceed the limits may damage the power sensor, power meter, or both.



Note



When the battery is being used as the power supply for the power meter, an automatic test circuit continually monitors battery condition. When the battery voltage is above a predetermined level, the meter indicates the correct power level. When the voltage drops below the threshold level, the meter reading is full downscale.

Specified Uncertainty Calculation

Conditions:

- Range — 1 mW
- Meter Reading — 0.7 mW
- Sensor — HP 8481A
- Frequency — 1 GHz
- CAL FACTOR — 99.5%

(FS) ¹ Instrumentation Uncertainty	= ±1.0%	= ±0.01 mW	= ±0.06 dB
(R) ² Power Reference Uncertainty	= ±0.7%	= ±0.0049 mW	= ±0.03 dB
(R) CAL FACTOR Switch Resolution Uncertainty	= ±0.5%	= ±0.0035 mW	= ±0.02 dB
(R) Zero Set Uncertainty	= ±0.002%	= ±0.000015 mW	= ±0.00009 dB
(FS) Zero Carryover Uncertainty	= ±0.5%	= ±0.005 mW	= ±0.03 dB
(R) Noise	= ±.006%	= ±0.00004 mW	= ±0.00025 dB
(R) Drift	= ±.002%	= ±0.000015 mW	= ±0.00009 dB
(R) Cal Factor Uncertainty	= ±2.70%	= ±0.019 mW	= ±0.12 dB

±0.0425 mW

1 FS = % of full scale

2 R = % of reading

$$\begin{aligned}
 \text{Total Specified Uncertainties} &= \pm 0.0425 \text{ mW} \\
 &= \frac{0.0425}{0.07} (100) \\
 &= \pm 6.07\% \\
 &= 10 \log \frac{0.7425}{0.7} \\
 &= \pm 0.26 \text{ dB}
 \end{aligned}$$

Calculating Measurement Uncertainty

1. Calculate the reflection coefficient from the given SWR.

$$\rho = \frac{SWR - 1}{SWR + 1}$$

Power Sensor #1 SWR = 1.5	Power Sensor #2 SWR = 1.25	Power Source SWR = 2.0
$\rho_1 = \frac{1.5-1}{1.5+1}$	$\rho_2 = \frac{1.25-1}{1.25+1}$	$\rho_s = \frac{2.0-1}{2.0+1}$
$= \frac{0.5}{2.5}$	$= \frac{0.25}{2.25}$	$= \frac{1.0}{3.0}$
$= 0.2$	$= 0.111$	$= 0.333$

2. Calculate the relative power and percentage power mismatch uncertainties from the reflection coefficients. An initial reference level of 1 is assumed.

Relative Power Uncertainty

$$PU = [1 \pm (\rho_n \rho_s)]^2$$

$$\begin{aligned} PU_1 &= \{1 \pm [(0.2)(0.333)]\}^2 & PU_2 &= \{1 \pm [(0.111)(0.333)]\}^2 \\ &= \{1 \pm 0.067\}^2 & &= \{1 \pm 0.037\}^2 \\ &= \{1.067\}^2 \text{ and } \{0.933\}^2 & &= \{1.037\}^2 \text{ and } \{0.963\}^2 \\ &= 1.138 \text{ and } 0.871 & &= 1.075 \text{ and } 0.927 \end{aligned}$$

Percentage Power Uncertainty

$$\%PU = (PU - 1) 100\%$$

$$\begin{aligned} PU_1 &= (1.138 - 1) 100\% & \text{and} & & (0.871 - 1) 100\% \\ &= (0.138) 100\% & \text{and} & & (-0.129) 100\% \\ &= 13.8\% & \text{and} & & -12.9\% \\ \\ PU_2 &= (1.075 - 1) 100\% & \text{and} & & (0.927 - 1) 100\% \\ &= (0.075) 100\% & \text{and} & & (-0.073) 100\% \\ &= 7.5\% & \text{and} & & -7.3\% \end{aligned}$$

3. Calculate the Measurement Uncertainty in dB.

Measurement Uncertainty in dB

$$MU = 10 \left[\log_{10} \left(\frac{P_1}{P_0} \right) \right] \text{ dB}$$

$\begin{aligned} MU_1 &= \left[10 \log \left(\frac{1.138}{1} \right) \right] \\ &= 10 [0.056] \\ &= +0.56 \text{ dB} \end{aligned}$	and	$\begin{aligned} &10 \left[\log \left(\frac{0.871}{1} \right) \right] \\ &10 [-0.060] \\ &-0.6 \text{ dB} \end{aligned}$
---	-----	--

$\begin{aligned} MU_2 &= \left[10 \log \left(\frac{1.075}{1} \right) \right] \\ &= 10 [0.031] \\ &= +0.31 \text{ dB} \end{aligned}$	and	$\begin{aligned} &10 \left[\log \left(\frac{0.927}{1} \right) \right] \\ &10 [-0.033] \\ &-0.33 \text{ dB} \end{aligned}$
---	-----	---

INDICATED POWER VERSUS RANGE OF ACTUAL POWER

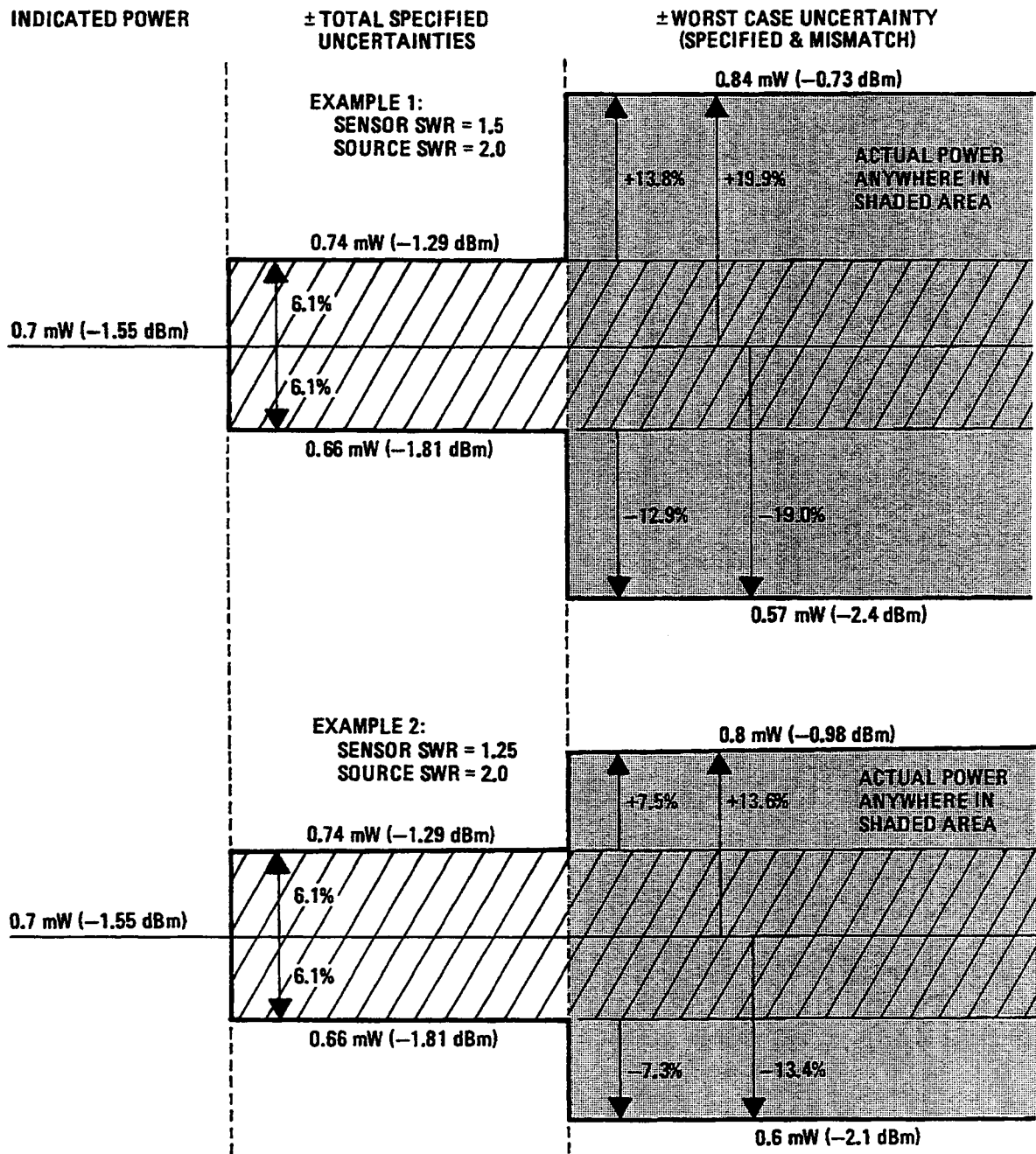

Figure 3-3.
 Worst Case Effects of Specified and Mismatch Uncertainties
 (Values From Examples on Page 3-12 and 3-14)

Calculating Measurement Uncertainty (Uncertainty in dB Known)

1. For this example the known values are: source SWR, 2.2 and power sensor SWR, 1.16. From the Mismatch Error Calculator the mismatch uncertainty is found to be +0.24, -0.25 dB.
2. Add the results from the "Specified Uncertainty Calculation" section, (± 0.26 dB). The total measurement uncertainty is +0.50, -0.51 dB.
3. Calculate the relative measurement uncertainty from the following formula:

$$\text{dB} = 10 \log \left(\frac{P_1}{P_0} \right)$$

$$\frac{\text{dB}}{10} = \log \left(\frac{P_1}{P_0} \right)$$

$$\frac{P_1}{P_0} = \log^{-1} \left(\frac{\text{dB}}{10} \right)$$

$$\begin{aligned} \text{MU} = P_1 &= \log^{-1} \left(\frac{\text{dB}}{10} \right) \\ &= \log^{-1} \left(\frac{0.50}{10} \right) &= \log^{-1} \left(\frac{-0.51}{10} \right) \\ &= 1.122 &= 0.889 \end{aligned}$$

4. Calculate the percentage Measurement Uncertainty.

Percentage Measurement Uncertainty

$$\% \text{MU} = (P_1 - P_0) 100$$

$$\begin{aligned} \% \text{MU} &= (1.22 - 1) 100 &= (0.889 - 1) 100 \\ &= +12.2\% &= -11.1\% \end{aligned}$$

Performance Tests

Introduction

The procedures in this section test the electrical performance of the power meter using the specifications of Table 1-1 as performance standards. All tests can be performed without access to the interior of the instrument. A simpler operational test is included in Chapter 3 under “Operator’s Checks.”

Equipment Required

Equipment required for the performance tests is listed in Table 1-2, Recommended Test Equipment. Any equipment that satisfies the critical specifications given in the table may be substituted for the recommended model(s).

Test Record

Results of the performance tests may be recorded on the test record at the end of the test procedures. The test record lists all of the tested specifications and their acceptable limits. Test results recorded at incoming inspection can be used for comparison in periodic maintenance, troubleshooting and after repairs or adjustments.

Performance Tests

The performance tests given in this section are suitable for incoming inspection, troubleshooting or preventive maintenance. During any performance test, all shields and connecting hardware must be in place. Perform the tests in the order given and record the data on the test card and/or in the data spaces provided at the end of each procedure.

Note



The power meter must have a half-hour warmup and the line voltage must be within +5%, -10% of nominal if the performance tests are to be considered valid.

Each test is arranged so that the specification is written as it appears in Table 1-1. Next, a description of the test and any special instructions or problem areas are included. Each test that requires test equipment has a setup drawing and a list of the required equipment. The initial steps of each procedure give control settings required for that particular test.

Power Reference Level Test

Specification Internal 50 MHz oscillator with Type-N Female connector on front panel (or rear panel, Option 003 only). Power output: 1.00 mW. Factory set to $\pm 0.7\%$ traceable to the National Bureau of Standards. Accuracy: $\pm 1.2\%$ worst case ($\pm 0.9\%$ rss) for one year (0 to 55°C).

Description The power reference oscillator output is factory adjusted to 1 mW $\pm 0.7\%$. To achieve this accuracy, Hewlett-Packard employs a special measurement system accurate to 0.5% (traceable to the National Bureau of Standards) and allows for a transfer error of $\pm 0.2\%$ in making the adjustment. If an equivalent measurement system is employed for verification, the power reference oscillator output can be verified to 1 mW $\pm 1.9\%$ ($\pm 1.2\%$ accuracy $\pm 0.5\%$ verification system error $\pm 0.2\%$ transfer error = 1.9% maximum error). The power reference oscillator can be set to $\pm 0.7\%$ using the same equipment and following the adjustment procedure in Chapter 5. To ensure maximum accuracy in verifying the power reference oscillator output, the following procedure provides step-by-step instructions for using specified Hewlett-Packard test instruments of known capability. If equivalent test instruments are used, signal acquisition criteria may vary and reference should be made to the manufacturer's guidelines for operating the instruments.

Note



The power meter may be returned to the nearest Hewlett-Packard office to have the power reference oscillator checked and/or adjusted. Refer to Chapter 2, "Packaging."

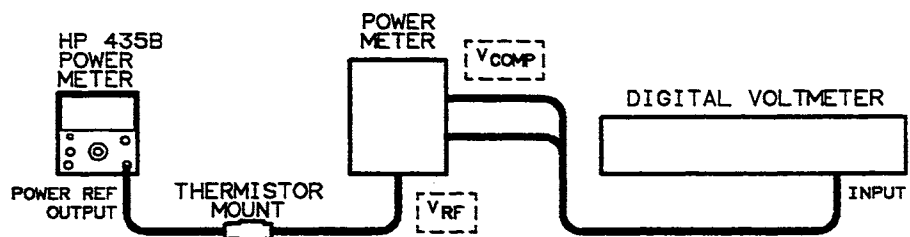

Figure 4-1. Power Reference Level Test Setup

Equipment	Power meter	HP 432A
	Thermistor mount	HP 478A-H75/H76
	Digital voltmeter	HP 3455A

Procedure

1. Set up the DVM to measure resistance. Connect the DVM between the V_{RF} connector on the rear panel of the power meter and pin 1 of the thermistor mount end of the power meter interconnect cable.
2. Round off the DVM indication to two decimal places and record this value as the internal bridge resistance (R) of the power meter (approximately 200 ohms).
3. Connect the HP 432A Power Meter to the HP 435B Power Meter as shown in Figure 4-1.
4. Set the HP 432A Power Meter LINE switch to ON (in) and the POWER REF switch to OFF. Then, wait thirty minutes for the HP 432A Power Meter thermistor mount to stabilize before proceeding to the next step.
5. Set the HP 432A Power Meter RANGE switch to COARSE ZERO and adjust the front-panel COARSE ZERO control to obtain a zero meter indication.
6. Fine zero the HP 432A Power Meter on the most sensitive range, then set the HP 432A Power Meter RANGE switch to 1 mW.

Note

Check that DVM input leads are isolated from chassis ground when performing the next step.

7. Set up the DVM to measure microvolts and connect the positive and negative input leads, respectively, to the V_{COMP} and V_{RF} connectors on the rear panel of the HP 432A Power Meter.
8. Observe the indication on the DVM. If less than 400 microvolts, proceed to the next step. If 400 microvolts or greater, press and hold the power meter FINE ZERO switch and adjust the COARSE ZERO control so that the DVM indicates 200 microvolts or less. Then, release the FINE ZERO switch and proceed to the next step.
9. Round off the DVM indication to the nearest microvolt and record this value as V_0 .
10. Set the HP 435B Power Meter POWER REF switch to ON (in) and record the indications observed on the DVM as V_1 .
11. Disconnect the DVM negative input lead from the V_{RF} connector on the HP 432A Power Meter and reconnect it to the HP 432A Power Meter chassis ground. Record the new indication observed on the DVM as V_{COMP} .
12. Calculate the power reference oscillator output level (P_{RF}) from the following formula:

$$P_{RF} = \frac{2V_{COMP}(V_1 - V_0) + V_0^2 - V_1^2}{4R(CALIBRATION FACTOR)}$$

Where:

P_{RF} = power reference oscillator output level

V_{COMP} = previously recorded value

V₁ = previously recorded value

V₀ = previously recorded value

R = previously recorded value

CALIBRATION FACTOR = value for thermistor mount at
50 MHz (traceable to the National
Bureau of Standards)

13. Verify that the P_{RF} is within the following limits:

Min.	Actual	Max.
0.988 mW	_____	1.012 mW

Zero Carryover Test

Specification $\pm 0.5\%$ of full scale when zeroed in the most sensitive range.

Description After the power meter is initially zeroed, the change in the meter reading is monitored at the RECORDER OUTPUT as the instrument is stepped through its ranges. The meter readings take into account noise and drift because zero carryover and the noise drift readings cannot be separated. Refer to Table 5-1 if the results are not within the limits.

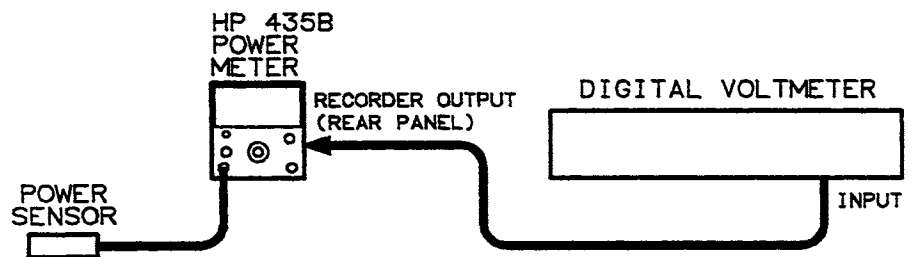

Figure 4-2. Zero Carryover Test Setup

Equipment Digital voltmeter HP 3455A
Power sensor HP 8481A/H or 8482A/H

- Procedure**
1. Set the DVM RANGE control to 100 mVdc.
 2. Set the power meter switches as follows:
 - CAL FACTOR 100%
 - RANGE position fully ccw
 - POWER REF (rear panel) .. OFF
 3. Connect the equipment shown in Figure 4-2.
 4. Press the front panel ZERO switch and wait for the meter indicator's position to stabilize. Verify that the DVM reads 0 ± 1.0 mVdc. Release the ZERO switch.
 5. Verify that the RECORDER OUTPUT falls within the limits shown on the table for each range. Record the readings.

RANGE Switch Position	Results			RANGE Switch Position	Results		
	Min.	Actual	Max.		Min.	Actual	Max.
	mVdc	mVdc	mVdc		mVdc	mVdc	mVdc
fully ccw	-15	_____	+15	5 steps cw	-5	_____	+5
1 step cw	-17	_____	+17	6 steps cw	-5	_____	+5
2 steps cw	-14	_____	+14	7 steps cw	-5	_____	+5
3 steps cw	-11	_____	+11	8 steps cw	-5	_____	+5
4 steps cw	-8	_____	+8	fully cw	-5	_____	+5

Instrumentation Accuracy Test with Calibrator

Specification $\pm 1\%$ of full scale on all ranges.

Description Instrumentation accuracy is verified by coupling a full-scale reference input from the HP 11683A Calibrator to the power meter on each range. Verify that the RECORDER OUTPUT level is within $\pm 1\%$ plus noise and drift.

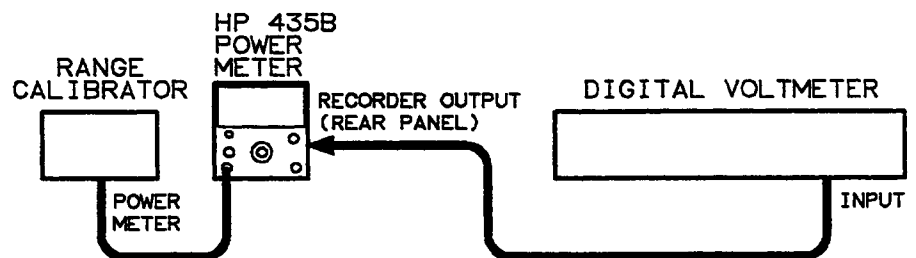

Figure 4-3. Instrumentation Accuracy Test Setup with Calibrator

Equipment
 Digital voltmeter HP 3455A
 Range calibrator HP 11683A

- Procedure**
1. Set the range calibrator RANGE switch to 1mW, the FUNCTION switch to CALIBRATE and the POLARITY switch to NORMAL.
 2. Set the power meter RANGE switch 5 steps from the fully ccw position.
 3. Set the DVM RANGE switch to 1000 mvdc.
 4. Connect the equipment as shown in Figure 4-3.
 5. Adjust the front panel CAL ADJ control to provide a reading of 1000 ± 2 mVdc.

Caution



To avoid damage to the meter, set the range calibrator's FUNCTION control to STANDBY while changing the RANGE control settings on the power meter and range calibrator.

6. Set the power meter RANGE switch to each possible position in turn. Set the range calibrator RANGE switch to the same position and verify that the DVM reading, which includes noise and drift, is within the limits shown in the following table.

RANGE Switch Position	Results			RANGE Switch Position	Results		
	Min.	Actual	Max.		Min.	Actual	Max.
fully ccw	mVdc +975	mVdc _____	mVdc +1025	5 steps cw	mVdc +998	mVdc _____	mVdc +1002
1 step cw	+978	_____	+1022	6 steps cw	+990	_____	+1010
2 steps cw	+981	_____	+1019	7 steps cw	+990	_____	+1010
3 steps cw	+984	_____	+1016	8 steps cw	+990	_____	+1010
4 steps cw	+987	_____	+1013	fully cw	+990	_____	+1010

Calibration Factor Test

Specification A 16-position switch normalizes meter reading to account for calibration factor or effective efficiency. Range 85% to 100% in 1% steps.

Description After the power meter is zeroed on the most sensitive range, a 1 mW input level is applied to the power meter and the CAL ADJ control is set to obtain a 1.000 mW indication. Then the CAL FACTOR switch is stepped through its 16 positions and the meter is monitored to ensure that the proper indication is obtained for each position.

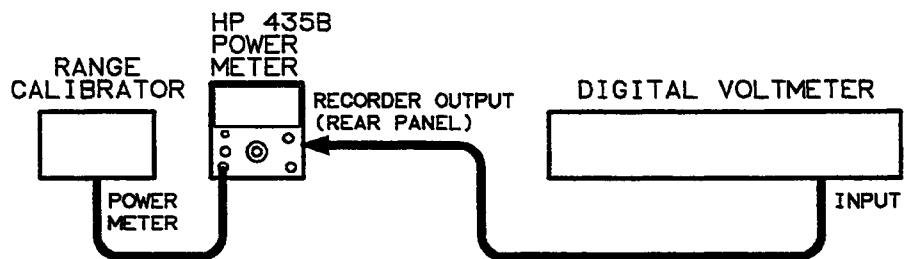

Figure 4-4. Calibration Factor Test Setup

Equipment

Digital voltmeter	HP 3455A
Range calibrator	HP 11683A

- Procedure**
1. Set the range calibrator RANGE switch to 1 mW, the FUNCTION switch to CALIBRATE and the POLARITY switch to NORMAL.
 2. Set the power meter RANGE switch 5 steps from the fully ccw position.
 3. Set the DVM RANGE switch to Vdc.
 4. Connect the equipment as shown in Figure 4-4.
 5. Set the front panel CAL ADJ control to provide a reading of 1000 ± 2 mVdc on the DVM.
 6. Set the CAL FACTOR switch to each position and verify that the indications observed at each position are within the limits specified in the following table.

RANGE Switch Position	Results			RANGE Switch Position	Results		
	Min.	Actual	Max.		Min.	Actual	Max.
	Vdc	Vdc	Vdc		Vdc	Vdc	Vdc
100	0.994	_____	1.006	92	1.081	_____	1.093
99	1.004	_____	1.016	91	1.093	_____	1.105
98	1.014	_____	1.026	90	1.105	_____	1.117
97	1.025	_____	1.037	89	1.118	_____	1.130
96	1.036	_____	1.048	88	1.130	_____	1.142
95	1.047	_____	1.059	87	1.143	_____	1.155
94	1.058	_____	1.070	86	1.157	_____	1.169
93	1.069	_____	1.081	85	1.170	_____	1.182

Table 4-1. Performance Test Record (1 of 2)

Hewlett-Packard Company

Tested by _____

HP 435B Power Meter

Date _____

Serial Number _____

Test Description	Results		
	Min.	Actual	Max.
Power Reference Accuracy 1 mw	mW 0.988	mW _____	mwW 1.012
Zero Carryover	mVdc	mVdc	mVdc
fully ccw	-15	_____	+15
1 step cw	-17	_____	+17
2 steps cw	-14	_____	+14
3 steps cw	-11	_____	+11
4 steps cw	-8	_____	+8
5 steps cw	-5	_____	+5
6 steps cw	-5	_____	+5
7 steps cw	-5	_____	+5
8 steps cw	-5	_____	+5
fully cw	-5	_____	+5
Instrumentation Accuracy	mVdc	mVdc	mVdc
fully ccw	+975	_____	+1025
1 step cw	+978	_____	+1022
2 steps cw	+981	_____	+1019
3 steps cw	+984	_____	+1016
4 steps cw	+987	_____	+1013
5 steps cw	+998	_____	+1002
6 steps cw	+990	_____	+1010
7 steps cw	+990	_____	+1010
8 steps cw	+990	_____	+1010
fully cw	+990	_____	+1010
Calibration Factor	Vdc	Vdc	Vdc
100	0.994	_____	1.006
99	1.004	_____	1.016
98	1.014	_____	1.026
97	1.025	_____	1.037

Test Description	Results		
	Min.	Actual	Max.
Calibration Factor (cont'd)	Vdc	Vdc	Vdc
96	1.036	_____	1.048
95	1.047	_____	1.059
94	1.058	_____	1.070
93	1.069	_____	1.081
92	1.081	_____	1.093
91	1.093	_____	1.105
90	1.105	_____	1.117
89	1.118	_____	1.130
88	1.130	_____	1.142
87	1.143	_____	1.155
86	1.157	_____	1.169
85	1.170	_____	1.182

Adjustments

Introduction

This section describes the adjustments which will return the power meter to peak operating condition after repairs are completed.

If the adjustments are to be considered valid, the power meter must have a half hour warmup and the line voltage must be within +5 to -10% of nominal.

The adjustment procedure titled "Power Meter Adjustments with 50 Ω Power Sensor" is to be performed only when the HP 11683A Range Calibrator is *not* available.

Safety Considerations

Although this instrument has been designed in accordance with international safety standards, this manual contains information, cautions and warnings which must be followed to avoid personal injury and damage to the instrument (see Chapters 2 and 3). Service and adjustments should be performed only by qualified service personnel.

Warning



Any interruption of the protective (grounding) conductor (inside or outside the instrument) or disconnection of the protective earth terminal is likely to make the instrument dangerous. Intentional interruption is prohibited.

Any adjustment, maintenance and repair of the opened instrument under voltage should be avoided as much as possible and, when inevitable, should be carried out only by a skilled person who is aware of the hazard involved.

Capacitors inside the instrument may still be charged even if the instrument has been disconnected from its source of supply.

Make sure that only fuses with the required rated current and of the specified type (slow blow, time delay, etc.) are used for replacement. The use of repaired fuses and the short-circuiting of fuseholders must be avoided.

Whenever it is likely that the protection offered by fuses has been impaired, the instrument must be made inoperative and be secured against any unintended operation.

Adjustments described herein are performed with power supplied to the instrument while protective covers are removed. Energy available at many points may, if contacted, result in personal injury.

Equipment Required

The test equipment required for the adjustment procedures is listed in Table 1-2, "Recommended Test Equipment". The critical specifications of substitute test instruments must meet or exceed the standards listed in the table if the power meter is to meet the specifications in Table 1-1, "Specifications".

Factory Selected Components

Factory selected components are indicated on the schematic and replaceable parts list with an asterisk (*) immediately following the reference designator. The nominal value of the component is listed. Table 5-1 lists the parts by reference designator and provides an explanation of how the component is selected, the normal value range and a reference to the appropriate service sheet. The *Manual Changes* supplement will update any changes to factory selected component information.

Adjustment Locations

All the adjustments for the power meter are contained on the A4 assembly except the front panel CAL ADJ control and POWER REF OUTPUT level control. The last foldout in this manual contains a table which cross-references all pictorial and schematic locations of the adjustment controls. The accompanying figure shows the locations of the adjustable controls, assemblies and chassis-mounted parts.

Table 5-1. Factory Selected Components

Reference Designator	Basis of Selection	Range of Values	Service Sheet
A3R5	A3R5 is selected for a power reference output of 1 mW (into 50Ω) if this value is outside the adjustment range of LEVEL ADJ A3R4.	7.1 to 7.5 kΩ	5
A4R12, C14	See "Multivibrator Adjustment"	0.0082 to 0.01 μF	2
A4R12, R16	A4R12 and R16 are selected for correct zero carryover between ranges. See "Zero Carryover Test" for the limits for each range.	3.16 to 4.64 kΩ	2
A4R66	A4R66 is selected for a full-scale reading (100 mW) with an accurate 10 mW input after completing "Power Meter Adjustments with Calibrator." Hewlett-Packard recommends using an HP 11683A Calibrator to achieve the needed accuracy for selecting this resistor. The DVM reading at the power meter's RECORDER OUTPUT will be 1000 ±3 mVdc with the correct resistor in place.	150 to 250 kΩ	2
A4VR1, VR2	A4VR1 and VR2 are selected to achieve accuracy on the top two ranges when the accuracy on other ranges is within specifications. See "Instrumentation Accuracy Test with Calibrator" for the limits for each range.	2.37 to 2.61 V	2

Power Reference Oscillator Level Adjustment

Reference Service Sheet 5.

Description The power reference oscillator output is factory-adjusted to 1 mW $\pm 0.7\%$ using a special measurement system accurate to 0.5% (traceable to the National Institute of Standards and Technology [NIST]) and allowing for a 0.2% transfer error. To ensure maximum accuracy in readjusting the power reference oscillator, the following procedure provides step-by-step instructions for using specified Hewlett-Packard instruments of known capability. If equivalent instruments are used, signal acquisition criteria may vary and reference should be made to the manufacturer's guidelines for operating the equipment.

Note  The power meter may be returned to the nearest HP office to have the power reference oscillator checked and/or adjusted. Refer to Chapter 2, Packaging.

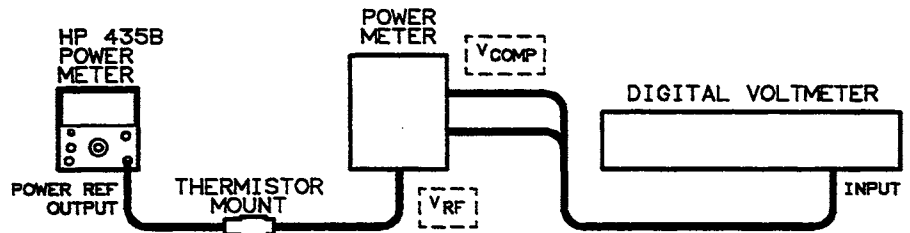

Figure 5-1. Power Reference Oscillator Level Adjustment Setup

Equipment

Power meter	HP 432A
Thermistor mount	HP 478A-H75
Digital voltmeter (DVM)	HP 3455A

- Procedure**
1. Set up the DVM to measure resistance and connect the DVM between the V_{RF} connector on the rear panel of the HP 432A and pin 1 on the thermistor mount end of the HP 432A interconnect cable.
 2. Round off the DVM indication to two decimal places and record this value as the internal bridge resistance (R) of the HP 432A (approximately 200 ohms).
 3. Connect the HP 432A to the HP 435B Power Meter as shown in Figure 5-1.
 4. Set the HP 435B Power Meter LINE switch to ON (in) and the POWER REF switch to OFF. Then, wait thirty minutes for the HP 432A thermistor mount to stabilize before proceeding to the next step.

5. Set the HP 432A RANGE switch to COARSE ZERO and adjust the front-panel COARSE ZERO control to obtain a zero meter indication.
6. Fine zero the HP 432A on the most sensitive range, then set the HP 432A RANGE switch to 1 mW.

Note

Ensure that the DVM input leads are isolated from chassis ground when performing the next step.

7. Set up the DVM to measure microvolts and connect the positive and negative input leads, respectively, to the V_{COMP} and V_{RF} connectors on the rear panel of the HP 432A.
8. Observe the indication on the DVM. If less than 400 microvolts, proceed to the next step. If 400 microvolts or greater, press and hold the HP 432A **FINE ZERO** switch and adjust the COARSE ZERO control so that the DVM indicates 200 microvolts or less. Then release the **FINE ZERO** switch and proceed to the next step.
9. Round off the DVM indication to the nearest microvolt and record this value as V_0 .
10. Disconnect the DVM negative input lead from the V_{RF} connector on the HP 432A and reconnect it to chassis ground.
11. Set the power meter POWER REF switch to ON and record the indication observed on the DVM as V_{COMP} .
12. Disconnect the DVM negative input lead from chassis ground and reconnect it to the V_{RF} connector on the rear panel of the HP 432A. The DVM is now set up to measure V_1 , which represents the power reference oscillator output level.
13. Calculate the value of V_1 equal to 1 milliwatt from the following equation:

$$V_1 - V_0 \} =$$

$$V_{COMP} - \sqrt{(V_{COMP})^2 - (10^{-3})(4R)(EFFECTIVE\ EFFICIENCY)}$$

Where:

V_0 = previously recorded value

V_{COMP} = previously recorded value

10^{-3} = 1 milliwatt

R = previously recorded value

EFFECTIVE

EFFICIENCY = value for thermistor mount at 50 MHz (traceable to the National Institute of Standards and Technology [NIST]).

14. Remove the HP 435B Power Meter top cover and adjust LEVEL ADJ potentiometer A3R4 so that the DVM indicates the calculated value of V_1 .

Typical Calculations

1. Accuracy

DVM Measurements:

(HP 3455A—90 days, 23°C ±5°C)	(V _{COMP})	±0.018%
	(V ₁ - V ₀)	±0.023%
	(R)	±0.03%

Math Assumptions:

EFFECTIVE EFFICIENCY CAL(NIST): ±0.01%

MISMATCH UNCERTAINTY:

(Source & Mount SWR ≤1.05)	±0.1%
	≤±0.7%

2. Math Assumptions:

$$P_{RF} = \frac{2V_{COMP}(V_1 - V_0) + V_0^2 - V_1^2}{(4R)(EFFECTIVE\ EFFICIENCY)}$$

Assume: $V_0^2 - V_1^2 = -(V_1 - V_0)^2$

Since: $-(V_1 - V_0)^2 = -V_1^2 + 2V_1V_0 - V_0^2$, and

we want: $V_0^2 - V_1^2$, then

the error is: $(-V_1^2 + 2V_1V_0 - V_0^2) - (V_0^2 - V_1^2) =$

$$-2V_0^2 + 2V_1V_0 = 2V_0(V_1 - V_0)$$

if $2V_0(V_1 - V_0) \ll 2V_{COMP}(V_1 - V_0)$ i.e., $V_0 \ll V_{COMP}$, error is negligible

$V_{COMP} \sim 4$ volts. If $V_0 < 400 \mu V$, error is $< 0.01\%$.

(typically V_0 can be set to $< 50 \mu V$.)

3. Derivation of Formula for $V_1 - V_0$:

$$P_{RF} = \frac{2V_{COMP}(V_1 - V_0) + V_0^2 - V_1^2}{(4R)(EFFECTIVE\ EFFICIENCY)}$$

Desired $P_{RF} = 1 \text{ MW} = 10^{-3}$

Therefore:

$$10^{-3} = \frac{2V_{COMP}(V_1 - V_0) + V_0^2 - V_1^2}{(4R)(EFFECTIVE\ EFFICIENCY)}$$

Let $(4R)(EFFECTIVE\ EFFICIENCY)(10^{-3}) = K$

Substitute $-(V_1 - V_0)^2$ for $V_0^2 - V_1^2$ (see Math Assumptions under Accuracy)

Then $0 = (V_1 - V_0)^2 - 2V_{COMP}(V_1 - V_0) + K$ or

$$V_1 - V_0 = V_{COMP} - \sqrt{(V_{COMP})^2 - K}$$

Multivibrator Adjustment

Reference Service Sheet 2.

Description FREQ potentiometer A4R76 is adjusted to set the reference frequency of the multivibrator which drives the phase detector and the FET power sensor.

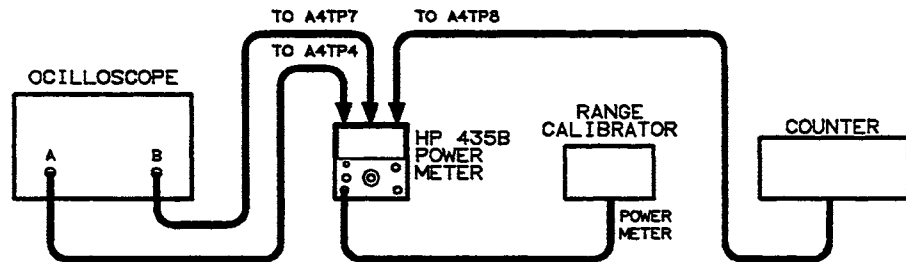

Figure 5-2. Multivibrator Adjustment Setup

Equipment

Range calibrator	HP 11683A
Counter	HP 5314A
Oscilloscope	HP 1740A

- Procedure**
1. a. power meter switch settings:

CAL FACTOR	100%
POWER REF	OFF
LINE	ON
 - b. Range Calibrator switch settings:

FUNCTION	CALIBRATE
POLARITY	NORMAL
LINE	ON
 - c. Oscilloscope switch settings:

CH. A	0.05 V/Div. AC coupled
CH. B	0.2 V/Div.
TIME	0.5 ms/Div.
Display	Chopped — Ch. B trigger
 2. Connect the equipment as shown in Figure 5-2.
 3. Adjust oscilloscope position controls to superimpose waveforms. Establish a horizontal grid line as dc average of the TP4 waveform by turning the HP 11683A MODE to STANDBY and positioning the Channel A trace on the line. Set the HP 11683A back to CALIBRATE. Turn the oscilloscope horizontal MAGNIFIER to $\times 10$ so that time calibration will be $50 \mu\text{s}/\text{div}$. See Figure 5-3.

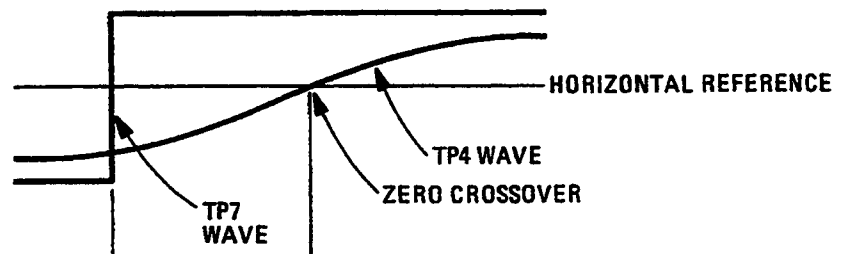

Figure 5-3. 220 Hz Zero Crossover

4. Adjust A4R76 so that the zero crossover lags the square wave by $150 \pm 10 \mu\text{s}$.
5. Check that the counter measures $220 \pm 12 \text{ Hz}$ at TP8. If necessary, adjust A4R76 for a compromise between frequency and phase.
6. If the conditions of steps 4 and 5 cannot be met, change A4C11* or A4C14* as follows:
 - a. If the frequency at TP8 is too high, change C14* to $0.01 \mu\text{F}$.
 - b. If the frequency at TP8 is too low, change C11* to $0.0082 \mu\text{F}$.
 - c. Repeat steps 4 and 5.

Power Meter Adjustments with 50Ω Power Sensor

Note



This adjustment should only be performed when the HP 11683A Range Calibrator is *not* available.

If the adjustments are to be considered valid, the power meter must have a half hour warmup and the line voltage must be within +5 to -10% of nominal.

Reference

Service Sheets 2 and 3.

Description

1. The balance control is centered to remove the dc offset introduced by the auto zero circuit.
2. The dc offset control removes any dc voltage introduced by the dc amplifier.
3. The CAL ADJ control is used to set a level of +1.00 Vdc at the rear panel RECORDER OUTPUT jack with a full scale input.
4. The meter control sets the meter reading to full scale when the RECORDER OUTPUT level is +1.00 Vdc.
5. The auto zero offset adjustment removes any dc voltage introduced by the auto zero circuits when the **ZERO** switch is pressed.
6. The balance control centers the auto zero circuits output voltage range. The auto zero output is forced to its negative extreme and the balance control sets the RECORDER OUTPUT voltage below center-range (+1.00 Vdc) by one-half the total range.

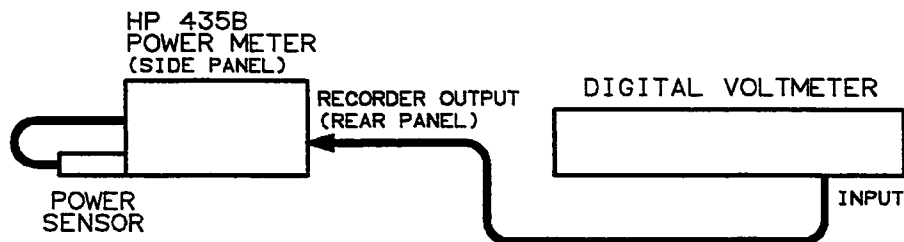

Figure 5-4. Power Meter Adjustment Setup with 50Ω Power Sensor

Equipment

Digital voltmeter HP 3455A
 Power sensor HP 8481A/H or HP 8482A/H

Procedure

1. Set the LINE switch to OFF, wait a few seconds, and adjust the mechanical meter zero control for a meter reading of zero.
2. Set the DVM RANGE switch to 1 Vdc.
3. Set the power meter CAL FACTOR switch to 100%.
4. Remove the right side cover of the power meter and connect the equipment as shown in Figure 5-4.
5. Set the LINE switch to (ON).

Note



Before proceeding with the adjustment, connect the input of a frequency counter (such as the HP 5314A) to TP7 or TP8 and verify that the multivibrator frequency is 220 ± 12 Hz. If the frequency is incorrect, perform the "Multivibrator Adjustment".

6. Center the power meter balance control A4R46.
7. Set the power meter RANGE switch fully cw and adjust A4R32, dc offset control, for a DVM reading of 0 ± 0.2 mVdc.
8. Set the RANGE switch to the position indicated in the table below; set the rear panel POWER REF switch to (ON).

Power Sensor	RANGE Switch Position
HP 8481B and 8482B (remove attenuator)	1W
HP 8481A, 8482A, 8481H, 8482H	1mW
HP 8485A (HP 1250-1250 Adapter required)	1mW
HP 8484A (HP 11708A Reference Attenuator required)	1 μ W

9. Adjust the front panel CAL ADJ control to read 1.000 ± 0.001 Vdc on the DVM.
10. Adjust A4R35, meter control, to give a full-scale meter reading.
11. Set the rear panel POWER REF switch to OFF; set the RANGE switch to the position indicated in the table below.

Power Sensor	RANGE Switch Position
HP 8481B and 8482B (remove attenuator)	3W
HP 8481A, 8482A, 8481H, 8482H	3mW
HP 8485A (HP 1250-1250 Adapter required)	3mW
HP 8484A (HP 11708A Reference Attenuator required)	3 μ W

12. Press the front panel **ZERO** switch, hold it in, and adjust the auto zero offset control A4R42 for a DVM reading of 0 ± 1 mVdc.
13. Set the RANGE switch to the position indicated in the table below; set the rear panel POWER REF switch to (ON).

Power Sensor	RANGE Switch Position
HP 8481B, 8482B, (remove attenuator)	1W
HP 8481A, 8482A, 8481H, 8482H	1 mW
HP 8485A (HP 1250-1250 Adapter required)	1 mW
HP 8484A (HP 11708A Reference Attenuator required)	1 μ W

14. Press the **ZERO** switch. Hold it in, and adjust the balance adjustment, A4R46, until the DVM reading is 961 ± 1 mVdc.

Power Meter Adjustments with Calibrator

Note



If the adjustments are to be considered valid, the power meter must have a half-hour warmup and the line voltage must be within +5 to -10% of nominal.

Reference

Service Sheets 2 and 3.

Description

1. The balance control is centered to remove the dc offset introduced by the auto zero circuits.
2. The dc offset control removes any dc voltage introduced by the dc amplifier.
3. The CAL ADJ control is used to set a level of +1.00 Vdc at rear panel RECORDER OUTPUT jack with a full scale input from the HP 11683A Range Calibrator.
4. The meter control sets the meter reading to full scale when the RECORDER OUTPUT level is +1.00 Vdc.
5. The auto zero offset adjustment removes any dc voltage that is introduced by the auto zero circuits while the ZERO switch is pressed.
6. The balance control centers the auto zero circuit's output voltage range. The auto zero output is forced to its negative extreme. The balance control sets the RECORDER OUTPUT voltage below the center (+1.00 Vdc) by one-half the total possible voltage swing.

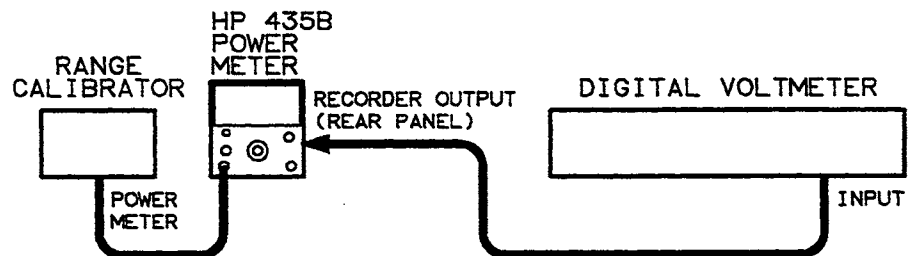

Figure 5-5. Power Meter Adjustment Setup with Calibrator

Equipment

Digital voltmeter HP 3455A
 Range calibrator HP 11683A (ONLY)

Procedure

1. Set the power meter LINE switch to OFF and adjust the mechanical meter zero control for a meter reading of zero.
2. Set the power meter switches as follows:
CAL FACTOR 100%
RANGE position fully cw
POWER REF OFF
3. Set the range calibrator switches as follows:
RANGE 1 mW
FUNCTION STANDBY
POLARITY NORMAL
4. Set the DVM RANGE switch to Vdc.
5. Remove the right side cover of the power meter, connect the equipment as shown in Figure 5-5 and set the LINE switch to ON.

Note

Before proceeding with the adjustment, connect the input of a frequency counter (such as the HP 5314A) to TP7 or TP8 and verify that the multivibrator frequency is 220 ± 12 Hz. If the frequency is incorrect, perform the "Multivibrator Adjustment."

6. Center the power meter balance control, A4R46.
7. Adjust A4R32 dc offset control for a DVM reading of 0 ± 0.2 mVdc.
8. Set the power meter RANGE switch 5 turns from the fully ccw position.
9. Set the range calibrator FUNCTION switch to CALIBRATE.
10. Adjust the power meter front panel CAL ADJ control for a DVM reading of 1000 ± 1 mVdc.
11. Adjust the meter control A4R35 for a full-scale meter reading.
12. Set the range calibrator FUNCTION switch to STANDBY.
13. Set the power meter RANGE switch fully ccw, press and hold the **ZERO** switch, and adjust A4R42 auto zero offset control for a DVM reading of 0 ± 1 mVdc.
14. Set the power meter RANGE switch 5 turns from the fully ccw position; set the range calibrator's FUNCTION switch to CALIBRATE.
15. Press and hold the power meter **ZERO** switch and adjust the A4R46 balance control for a DVM reading of 961 ± 3 mVdc.

Replaceable Parts

Introduction

This section contains information for ordering replacement parts for the power meter. Table 6-1 lists abbreviations used in the parts list and throughout the manual. Table 6-2 lists all replaceable parts in reference designator order. Table 6-3 contains the names and addresses that correspond to the manufacturer's code number.

Abbreviations

Table 6-1 gives a list of abbreviations used in the parts list, schematics and throughout the manual. In some cases, two forms of the abbreviations are given, one all capital letters and one partial or no capitals. This occurs because the abbreviations in the parts list are always all capitals. However, in the schematics and other parts of the manual, other abbreviation forms are used with both lower case and upper case letters.

Replaceable Parts List

Table 6-2 is the list of replaceable parts and is organized as follows:

- a. Electrical assemblies and their components in alpha-numeric order by reference designation.
- b. Chassis-mounted parts in alpha-numeric order by reference designation.
- c. Miscellaneous parts.
- d. Illustrated parts breakdown.

The information given for each part consists of the following:

- a. The Hewlett-Packard part number.
- b. The part number check digit (CD).
- c. The total quantity (Qty) used in the instrument.
- d. The description of the part.
- e. Typical manufacturer of the part in a five-digit code.
- f. The manufacturer's number for the part.

The total quantity for each part is given only once; at the first appearance of the part number in the list.

Factory Selected Parts (*)

Parts marked with an asterisk (*) are factory selected parts. The value listed in the parts list is the nominal value. Refer to Chapter 5 for information on determining what value to use for replacement.

Ordering Instructions

To order a part listed in the replaceable parts table, quote the Hewlett-Packard part number, indicate quantity required and address the order to the nearest Hewlett-Packard office.

To order a part that is not listed in the replaceable parts table, include the instrument model number, instrument serial number, the description and function of the part, and the number of parts required. Address the order to the nearest Hewlett-Packard office.

Note

Within the USA it is better to order directly from the HP Parts Center in Roseville, California. Ask your nearest HP office for information and forms for the "Direct Mail Order System." Your nearest HP office can also supply telephone numbers for ordering parts and supplies. A list of HP Sales and Service offices is printed inside the back cover of this manual.

Parts Provisioning

Stocking spare parts for an instrument is often done to insure quick return to service after a malfunction occurs. Hewlett-Packard has a "Spare Parts Kit" available for this purpose. The kit consists of selected replaceable assemblies and components for this instrument. The contents of the kit and the "Recommended Spares" list are based on failure reports and repair data, and parts support for one year. A complimentary "Recommended Spares" list for this instrument may be obtained on request, and the "Spare Parts Kit" may be ordered through your nearest Hewlett-Packard office.

Table 6-1. Reference Designations and Abbreviations (1 of 2)

REFERENCE DESIGNATIONS

A assembly	B miscellaneous electrical part	P electrical connector (movable portion); plug	V electron tube
AT attenuator; isolator; termination	F fuse	Q transistor; SCR; triode thyristor	VR voltage regulator; breakdown diode
B fan; motor	FL filter	R resistor	W ... cable; transmission path; wire
BT battery	H hardware	RT thermistor	X socket
C capacitor	HY circulator	S switch	Y crystal unit (piezoelectric or quartz)
CP coupler	J electrical connector (stationary portion); jack	T transformer	Z .. tuned cavity; tuned circuit
CR diode; diode thyristor; varactor	K relay	TB terminal board	
DC directional coupler	L coil; inductor	TC thermocouple	
DL delay line	M meter	TP test point	
DS ... annunciator; signaling device (audible or visual); lamp; LED	MP . miscellaneous mechanical part	U integrated circuit; microcircuit	

ABBREVIATIONS

A ampere	cm centimetre	HET heterodyne	MEG meg (10 ⁶) (used in Parts List)
ac alternating current	D/A digital-to-analog	HEX hexagonal	MET FLM metal film
ACCESS accessory	dB decibel	HD head	MET OX metallic oxide
ADJ adjustment	dBm decibel referred to 1 mW	HDW hardware	MF medium frequency; microfarad (used in Parts List)
A/D analog-to-digital	dc direct current	HF high frequency	MFR manufacturer
AF audio frequency	deg degree (temperature interval or difference)	HG mercury	mg milligram
AFC automatic frequency control	° degree (plane angle)	HI high	MHz megahertz
AGC .. automatic gain control	°C degree Celsius (centigrade)	HP Hewlett-Packard	mH millihenry
AL aluminum	°F degree Fahrenheit	HPF high-pass filter	mho mho
ALC .. automatic level control	°K degree Kelvin	HR .. hour (used in Parts List)	MIN minimum
AM amplitude modulation	DEPC deposited carbon	HV high voltage	min minute (time)
AMPL amplifier	DET detector	Hz Hertz ' minute (plane angle)
APC . automatic phase control	diam diameter	IC integrated circuit	MINAT miniature
ASSY assembly	DIA .. diameter (used in Parts List)	ID inside diameter	mm millimetre
AUX auxiliary	DIFF AMPL differential amplifier	IF ... intermediate frequency	MOD modulator
avg average	div division	IMP impregnated	MOM momentary
AWG ... American wire gauge	DPDT double-pole, double-throw	IN inch	MOS metal-oxide semiconductor
BAL balance	DR drive	INCD incandescent	ms millisecond
BCD ... binary coded decimal	DSB double sideband	INCL include(s)	MTG mounting
BD board	DTL ... diode transistor logic	INP input	MTR meter (indicating device)
BE CU beryllium copper	DVM digital voltmeter	INS insulation	mV millivolt
BFO .. beat frequency oscillator	ECL emitter coupled logic	INT internal	mVac millivolt, ac
BH binder head	EMF electromotive force	kg kilogram	mVdc millivolt, dc
BKDN breakdown	EDP electronic data processing	kHz kilohertz	mVpk millivolt, peak
BP bandpass	ELECT electrolytic	kΩ kilohm	mVp-p millivolt, peak-to-peak
BPF bandpass filter	ENCAP encapsulated	kV kilovolt	mVrms millivolt, rms
BRS brass	EXT external	lb pound	mW milliwatt
BWO backward-wave oscillator	F farad	LC inductance-capacitance	MUX multiplex
CAL calibrate	F/F flip-flop	LED light-emitting diode	MY mylar
ccw counterclockwise	FE flat head	LF low frequency	μA microampere
CER ceramic	FIL H fillister head	LG long	μF microfarad
CHAN channel	FM frequency modulation	LE left hand	μH microhenry
cm centimeter	FP front panel	LIM limit	μmho micromho
CMO cabinet mount only	FREQ frequency	LIN linear taper (used in Parts List)	μs microsecond
COAX coaxial	FXD fixed	LK WASH lock washer	μV microvolt
COEF coefficient	g gram	LO low; local oscillator	μVac microvolt, ac
COM common	GE germanium	LOG .. logarithmic taper (used in Parts List)	μVdc microvolt, dc
COMP composition	GHZ gigahertz	log logarithmic	μVpk microvolt, peak
COMPL complete	GL glass	LPF low pass filter	μVp-p microvolt, peak-to-peak
CONN connector	GRD ground(ed)	LV low voltage	μVrms microvolt, rms
CP cadmium plate	H henry	m metre (distance)	μW microwatt
CRT cathode-ray tube	h hour	mA milliamper	
CTL complementary transistor logic		MAX maximum	
CW continuous wave		MΩ megohm	
cw clockwise			

NOTE

All abbreviations in the Parts List appear in uppercase.

Table 6-1. Reference Designations and Abbreviations (2 of 2)

ABBREVIATIONS (cont'd)

nA nanoampere	PIV peak inverse voltage	R&P rack and panel	TV television
NC no connection	pk peak	RWV . reverse working voltage	TVI television interference
N/C normally closed	PL phase lock	S scattering parameter	TWT traveling wave tube
NE neon	PLO phase lock oscillator	s second (time)	U micro (10 ⁻⁶)
NEG negative	PM phase modulation	... " ... second (plane angle)	(used in Parts List)
nF nanofarad	PNP positive-negative-positive	S-B slow-blow (fuse)	UF . microfarad (used in Parts
NI PL nickel plate	P/O part of	(used in Parts List)	List)
N/O normally open	POLY polystyrene	SCR silicon controlled rectifier;	UHF ultra-high frequency
NOM nominal	PORC porcelain	screw	UNREG unregulated
NORM normal	POS positive; position(s) (used	SE selenium	V volt
NPN negative-positive-negative	in Parts List)	SECT sections	VA voltampere
NPO negative-positive	POSN position	SEMICON semiconductor	Vac volts, ac
zero (zero temperature	POT potentiometer	SHF super-high frequency	VAR variable
coefficient)	p-p peak-to-peak	SI silicon	VCO voltage-controlled
NRFR .. not recommended for	PP peak-to-peak (used in Parts	SIL silver	oscillator
field replacement	List)	SL slide	Vdc volts, dc
NSR not separately	PPM pulse-position	SNR signal-to-noise ratio	VDCW volts, dc, working
replaceable	modulation	SPDT single-pole,	(used in Parts List)
ns nanosecond	PREAMPL preamplifier	double-throw	V(F) volts, filtered
nW nanowatt	PRF pulse-repetition frequency	SPG spring	VFO variable-frequency
OBD order by description	PRR pulse repetition rate	SR split ring	oscillator
OD outside diameter	ps picosecond	SPST single-pole, single-throw	VHF very-high frequency
OH oval head	PT point	SSB single sideband	Vpk volts, peak
OP AMPL operational	PTM .. pulse-time modulation	SST stainless steel	Vp-p volts, peak-to-peak
amplifier	PWM . pulse-width modulation	STL steel	Vrms volts, rms
OPT option	PWV ... peak working voltage	SQ square	VSWR . voltage standing-wave
OSC oscillator	RC ... resistance-capacitance	SWR standing-wave ratio	ratio
OX oxide	RECT rectifier	SYNC synchronize	VTO . voltage-tuned oscillator
oz ounce	REF reference	T timed (slow-blow fuse)	VTVM vacuum-tube voltmeter
Ω ohm	REG regulated	TA tantalum	V(X) volts, switched
P ... peak (used in Parts List)	REPL replaceable	TC temperature compensating	W watt
PAM pulse-amplitude	RF radio frequency	TD time delay	W/ with
modulation	RFI radio frequency	TERM terminal	WIV .. working inverse voltage
PC printed circuit	interference	TFT thin-film transistor	WW wirewound
PCM .. pulse-code modulation;	RH ... round head; right hand	TGL toggle	W/O without
pulse-count modulation	RLC ... resistance-inductance-	THD thread	YIG yttrium-iron-garnet
PDM pulse-duration	capacitance	THRU through	Z _o ... characteristic impedance
modulation	RMO rack mount only	TI titanium	
pF picofarad	rms root-mean-square	TOL tolerance	
PH BRZ phosphor bronze	RND round	TRIM trimmer	
PHL Phillips	RAM .. random-access memory	TSTR transistor	
PIN positive-intrinsic-	ROM read-only memory	TTL transistor-transistor logic	
negative			

MULTIPLIERS

Abbreviation	Prefix	Multiple
T	tera	10 ¹²
G	giga	10 ⁹
M	mega	10 ⁶
k	kilo	10 ³
da	deka	10
d	deci	10 ⁻¹
c	centi	10 ⁻²
m	milli	10 ⁻³
μ	micro	10 ⁻⁶
n	nano	10 ⁻⁹
p	pico	10 ⁻¹²
f	femto	10 ⁻¹⁵
a	atto	10 ⁻¹⁸

NOTE

All abbreviations in the Parts List appear in uppercase.

Table 6-2. Replaceable Parts

Reference Designation	HP Part No.	C D	Qty	Description	Mfr Code	Manufacturer Part Number
A1	00435-60035	8	1	BD AY SWITCH	28480	00435-60035
A1C1	0180-0374	3	1	CAP-FXD 10uF +10% 20 V TA	04200	150D106X9020B2-DYS
A1C2	0180-0229	7	1	CAP-FXD 33uF +10% 10 V TA	04200	150D336X9010B2-DYS
A1C3	0180-1746	5	1	CAP-FXD 15uF +10% 20 V TA	04200	150D156X9020B2-DYS
A1C4	0180-1704	5	1	CAP-FXD 47uF +10% 6 V TA	04200	150D476X9006B2-DYS
A1J1	1200-1204	5	1	SOCKET-IC-DIP 14-CONT DIP DIP-SLDR	01380	2-641609-2
A1R1	0757-0346	2	1	RESISTOR 10 +1% .125W TF TC=0+-100	05524	CMF-55-1, T-1
A1R2	0757-0346	2	1	RESISTOR 10 +1% .125W TF TC=0+-100	05524	CMF-55-1, T-1
A1R3	0757-0346	2	1	RESISTOR 10 +1% .125W TF TC=0+-100	05524	CMF-55-1, T-1
A1R4	0757-0346	2	1	RESISTOR 10 +1% .125W TF TC=0+-100	05524	CMF-55-1, T-1
A1R5	0757-0346	2	1	RESISTOR 10 +1% .125W TF TC=0+-100	05524	CMF-55-1, T-1
A1R6	0757-0346	2	1	RESISTOR 10 +1% .125W TF TC=0+-100	05524	CMF-55-1, T-1
A1R7	0757-0346	2	1	RESISTOR 10 +1% .125W TF TC=0+-100	05524	CMF-55-1, T-1
A1R8	0757-0346	2	1	RESISTOR 10 +1% .125W TF TC=0+-100	05524	CMF-55-1, T-1
A1R9	0757-0346	2	1	RESISTOR 10 +1% .125W TF TC=0+-100	05524	CMF-55-1, T-1
A1R10	0757-0346	2	1	RESISTOR 10 +1% .125W TF TC=0+-100	05524	CMF-55-1, T-1
A1R11	0757-0346	2	1	RESISTOR 10 +1% .125W TF TC=0+-100	05524	CMF-55-1, T-1
A1R12	0757-0346	2	1	RESISTOR 10 +1% .125W TF TC=0+-100	05524	CMF-55-1, T-1
A1R13	0757-0346	2	1	RESISTOR 10 +1% .125W TF TC=0+-100	05524	CMF-55-1, T-1
A1R14	0757-0346	2	1	RESISTOR 10 +1% .125W TF TC=0+-100	05524	CMF-55-1, T-1
A1R15	0757-0346	2	1	RESISTOR 10 +1% .125W TF TC=0+-100	05524	CMF-55-1, T-1
A1R16	0757-0279	0	1	RESISTOR 3.16K +1% .125W TF TC=0+-100	05524	CMF-55-1, T-1
A1R17	0757-0280	3	1	RESISTOR 1K +1% .125W TF TC=0+-100	05524	CMF-55-1, T-1
A1R18	0757-0279	0	1	RESISTOR 3.16K +1% .125W TF TC=0+-100	05524	CMF-55-1, T-1
A1R19	0757-0279	0	1	RESISTOR 3.16K +1% .125W TF TC=0+-100	05524	CMF-55-1, T-1
A1S1	3100-1618	5	1	SWITCH-ROTARY 0.812 STRUT CTR SPCG; 10	04757	525321-418
A1S2	3100-1617	4	1	SWITCH-ROTARY 1.562 STRUT CTR SPCG; 16	04757	5-12784-433
A3	00435-60003	0	1	OSC AY 50MHZ	28480	00435-60003
A3C1	0160-3879	7	1	CAP-FXD 0.01uF +20% 100 V CER X7R	02010	SR201C103MAAH
A3C2	0160-3036	8	1	CAP-FXD 5000pF +80% -20% 0 V CER X5V	03746	54-713-011-X5V-502Z
A3C3	0160-3036	8	1	CAP-FXD 5000pF +80% -20% 0 V CER X5V	03746	54-713-011-X5V-502Z
A3C4	0160-3879	7	1	CAP-FXD 0.01uF +20% 100 V CER X7R	02010	SR201C103MAAH
A3C5	0160-3879	7	1	CAP-FXD 0.01uF +20% 100 V CER X7R	02010	SR201C103MAAH
A3C6	0160-2027	5	1	CAP-FXD 300pF +5% 500 V MICA	02367	CD15FD301JO3
A3C7	0160-3070	0	1	CAP-FXD 100pF +5% 300 V MICA	02367	CD15FD101JO3
A3C9	0160-2255	1	1	CAP-FXD 8.2pF +3.05% 500 V CER C0G	09538	301-000-COH0-829C
A3C10	0160-3878	6	1	CAP-FXD 1000pF +20% 100 V CER X7R	02010	SR201C102MAAH
A3C11	0160-0179	4	1	CAP-FXD 33pF +5% 300 V MICA	02367	CD15ED330JO3
A3C12	0160-3879	7	1	CAP-FXD 0.01uF +20% 100 V CER X7R	02010	SR201C103MAAH
A3C13	0160-7088	8	1	CAP-FXD 36pF +2% 300 V GL	02010	TY06-360G
A3C14	0160-7087	7	1	CAP-FXD 200pF +2% 300 V GL	02010	CY06C201G
A3CR1	1901-0518	8	1	DIODE-SCHOTTKY SM SIG	02062	5082-5509

Table 6-2. Replaceable Parts (continued)

Reference Designation	HP Part No.	C D	Qty	Description	Mfr Code	Manufacturer Part Number
A3CR2	1901-0518	8	1	DIODE-SCHOTTKY SM SIG	02062	5082-5509
A3J1	1250-1220	0	1	CONNECTOR-RF SMC M PC 50-OHM	05769	050-051-0109-220
A3Q1	1854-0247	9	1	TRANSISTOR NPN SI TO-39 PD=1W FT=800MHZ	02037	
A3R2	0757-0421	4	1	RESISTOR 825 +-1% .125W TF TC=0+-100	05524	CMF-55-1, T-1
A3R4	2100-3109	2	1	RESISTOR-TRMR 2K 10% TKF SIDE-ADJ 17-TRN	04568	89PR2K
A3R13	0698-0083	8	1	RESISTOR 1.96K +-1% .125W TF TC=0+-100	05524	CMF-55-1, T-1
A3R15	0698-3445	2	1	RESISTOR 348 +-1% .125W TF TC=0+-100	05524	CMF-55-1, T-1
A3TP1	1251-0600	0	1	CONNECTOR-SGL CONT PIN 1.14-MM-BSC-SZ SQ	03418	16-06-0034
A3TP2	1251-0600	0	1	CONNECTOR-SGL CONT PIN 1.14-MM-BSC-SZ SQ	03418	16-06-0034
A3U1	1826-0013	8	1	IC OP AMP LOW-NOISE 8 PIN TO-99	03285	AD741CH
A3U2	1820-0223	0	1	IC OP AMP GP 8 PIN TO-99	03406	LM301AH
A4	00435-60047	2	1	PWR METER BD AY	28480	00435-60047
A4	0757-0279	0	1	RESISTOR 3.16K +-1% .125W TF TC=0+-100	05524	CMF-55-1, T-1
A4	8150-0014	3		WIRE 22AWG BL 300V PVC 7X30 105C	06900	
A4A1	00435-60010	9	1	BD AY ZERO CKT	28480	00435-60010
A4C1	0180-2206	4	1	CAP-FXD 60uF +-10% 6 V TA	04200	150D606X9006B2-DYS
A4C2	0180-0228	6	1	CAP-FXD 22uF +-10% 15 V TA	04200	150D226X9015B2-DYS
A4C3	0160-2055	9	1	CAP-FXD 0.01uF +80% -20% 100 V CER Y5V	09538	805-504 Y5V 103Z
A4C4	0160-3439	5	1	CAP-FXD 0.039uF +-5% 200 V POLYE-MET	05176	HEW-249
A4C5	0160-0160	3	1	CAP-FXD 8200pF +-10% 200 V POLYE-FL	05176	HEW238T
A4C6	0180-0228	6	1	CAP-FXD 22uF +-10% 15 V TA	04200	150D226X9015B2-DYS
A4C7	0170-0040	9	1	CAP-FXD 0.047uF +-10% 200 V POLYE-FL	05176	HEW238T
A4C8	0160-3439	5	1	CAP-FXD 0.039uF +-5% 200 V POLYC-MET	05176	HEW-249
A4C9	0180-0197	8	1	CAP-FXD 2.2uF +-10% 20 V TA	04200	150D225X9020A2-DYS
A4C10	0180-0197	8	1	CAP-FXD 2.2uF +-10% 20 V TA	04200	150D225X9020A2-DYS
A4C11	0160-0161	4	1	CAP-FXD 0.01uF +-10% 200 V POLYE-FL	05176	HEW238T
A4C12	0180-0116	1	1	CAP-FXD 6.8uF +-10% 35 V TA	04200	150D685X9035B2-DYS
A4C13	0180-0116	1	1	CAP-FXD 6.8uF +-10% 35 V TA	04200	150D685X9035B2-DYS
A4C14	0160-0161	4	1	CAP-FXD 0.01uF +-10% 200 V POLYE-FL	05176	HEW238T
A4C15	0170-0040	9	1	CAP-FXD 0.047uF +-10% 200 V POLYE-FL	05176	HEW238T
A4C16	0180-0374	3	1	CAP-FXD 10uF +-10% 20 V TA	04200	150D106X9020B2-DYS
A4C17	0180-0197	8	1	CAP-FXD 2.2uF +-10% 20 V TA	04200	150D225X9020A2-DYS
A4C18	0180-0373	2	1	CAP-FXD 0.68uF +-10% 35 V TA	04200	150D684X9035A2-DYS
A4C19	0180-0116	1	1	CAP-FXD 6.8uF +-10% 35 V TA	04200	150D685X9035B2-DYS
A4C20	0180-0116	1	1	CAP-FXD 6.8uF +-10% 35 V TA	04200	150D685X9035B2-DYS
A4C21	0160-3456	6	1	CAP-FXD 1000pF +-10% 1 kV CER X5E	09538	808-542 X5E 102K
A4C22	0180-1997	8	1	CAP-FXD 20uF +50% -10% 150 V AL-ELCTLT	04200	30D206F150DH2-DSM
A4C23	0180-0197	8	1	CAP-FXD 2.2uF +-10% 20 V TA	04200	150D225X9020A2-DYS
A4C24	0180-0374	3	1	CAP-FXD 10uF +-10% 20 V TA	04200	150D106X9020B2-DYS
A4C25	0160-2290	4	1	CAP-FXD 0.15uF +-10% 80 V POLYE-FL	05176	HEW-238T
A4C26	0160-2204	0	1	CAP-FXD 100pF +-5% 300 V MICA	02367	CD15FD101JO3
A4C28	0180-1794	3	1	CAP-FXD 22uF +-10% 35 V TA	04200	150D226X9035R2-DYS
A4C29	0180-1794	3	1	CAP-FXD 22uF +-10% 35 V TA	04200	150D226X9035R2-DYS
A4C30	0180-0228	6	1	CAP-FXD 22uF +-10% 15 V TA	04200	150D226X9015B2-DYS

Table 6-2. Replaceable Parts (continued)

Reference Designation	HP Part No.	C D	Qty	Description	Mfr Code	Manufacturer Part Number
A4C39	0180-0291	3	1	CAP-FXD 1uF +10% 35 V TA	04200	150D105X9035A2-DYS
A4CR1	1901-0996	6	1	DIODE-SCHOTTKY SM SIG	12395	
A4CR2	1901-0996	6	1	DIODE-SCHOTTKY SM SIG	12395	
A4CR3	1901-0033	2	1	DIODE-GEN PRP 180V 200MA DO-35	03406	
A4CR4	1901-0033	2	1	DIODE-GEN PRP 180V 200MA DO-35	03406	
A4CR5	1906-0256	1	1	DIODE-FW BRDG 200V 1.5A	04504	W02M
A4CR6	1901-0033	2	1	DIODE-GEN PRP 180V 200MA DO-35	03406	
A4CR7	1901-0033	2	1	DIODE-GEN PRP 180V 200MA DO-35	03406	
A4CR8	1901-0328	8	1	DIODE-PWR RECT 400V 1A 6US	02664	
A4CR9	1901-0033	2	1	DIODE-GEN PRP 180V 200MA DO-35	03406	
A4CR10	1901-0328	8	1	DIODE-PWR RECT 400V 1A 6US	02664	
A4CR11	1901-0033	2	1	DIODE-GEN PRP 180V 200MA DO-35	03406	
A4CR12	1901-0033	2	1	DIODE-GEN PRP 180V 200MA DO-35	03406	
A4CR13	1901-0328	8	1	DIODE-PWR RECT 400V 1A 6US	02664	
A4K1	0490-0916	6	1	RELAY-REED 1A 500MA 100VDC 5VDC-COIL	02744	R-6966-1
A4MP1	1205-0280	5	1	HEAT SINK TO-66-CS	05792	LAIC66A2CB
A4MP2	1205-0280	5	1	HEAT SINK TO-66-CS	05792	LAIC66A2CB
A4Q1	1853-0020	4	1	TRANSISTOR PNP SI PD=300MW FT=150MHZ	02037	
A4Q2	1853-0020	4	1	TRANSISTOR PNP SI PD=300MW FT=150MHZ	02037	
A4Q3	1854-0810	2	1	TRANSISTOR NPN SI PD=625MW FT=200MHZ	02037	
A4Q4	1854-0810	2	1	TRANSISTOR NPN SI PD=625MW FT=200MHZ	02037	
A4Q5	1854-0810	2	1	TRANSISTOR NPN SI PD=625MW FT=200MHZ	02037	
A4Q6	1855-0020	8	1	TRANSISTOR J-FET N-CHAN D-MODE TO-18 SI	02883	FN1962
A4Q7	1855-0020	8	1	TRANSISTOR J-FET N-CHAN D-MODE TO-18 SI	02883	FN1962
A4Q10	1853-0012	4	1	TRANSISTOR PNP 2N2904A SI TO-39 PD=600MW	02037	2N2904A
A4Q11	1853-0012	4	1	TRANSISTOR PNP 2N2904A SI TO-39 PD=600MW	02037	2N2904A
A4Q12	1854-0072	8	1	TRANSISTOR NPN 2N3054 SI TO-66 PD=25W	02037	2N3054
A4Q13	1853-0052	2	1	TRANSISTOR PNP 2N3740 SI TO-66 PD=25W	02037	2N3740
A4Q14	1854-0810	2	1	TRANSISTOR NPN SI PD=625MW FT=200MHZ	02037	
A4Q15	1854-0810	2	1	TRANSISTOR NPN SI PD=625MW FT=200MHZ	02037	
A4Q16	1854-0090	0	1	TRANSISTOR NPN SI TO-39 PD=1W FT=100MHZ	02037	
A4Q17	1853-0038	4	1	TRANSISTOR PNP SI TO-39 PD=1W FT=100MHZ	02037	
A4Q18	1853-0020	4	1	TRANSISTOR PNP SI PD=300MW FT=150MHZ	02037	
A4Q20	1884-0073	2	1	THYRISTOR-SCR VRRM=100	02037	
A4R1	0698-3160	8	1	RESISTOR 31.6K +1% .125W TF TC=0+100	05524	CMF-55-1, T-1
A4R2	0698-3156	2	1	RESISTOR 14.7K +1% .125W TF TC=0+100	05524	CMF-55-1, T-1
A4R3	0757-0288	1	1	RESISTOR 9.09K +1% .125W TF TC=0+100	05524	CMF-55-1, T-1
A4R4	0698-3438	3	1	RESISTOR 147 +1% .125W TF TC=0+100	05524	CMF-55-1, T-1
A4R5	0698-3152	8	1	RESISTOR 3.48K +1% .125W TF TC=0+100	05524	CMF-55-1, T-1
A4R6	0757-0459	8	1	RESISTOR 56.2K +1% .125W TF TC=0+100	05524	CMF-55-1, T-1
A4R7	0757-0465	6	1	RESISTOR 100K +1% .125W TF TC=0+100	05524	CMF-55-1, T-1
A4R8	0757-0444	1	1	RESISTOR 12.1K +1% .125W TF TC=0+100	05524	CMF-55-1, T-1
A4R9	0757-0442	9	1	RESISTOR 10K +1% .125W TF TC=0+100	05524	CMF-55-1, T-1
A4R10	0698-3159	5	1	RESISTOR 26.1K +1% .125W TF TC=0+100	05524	CMF-55-1, T-1
A4R11	0698-3159	5	1	RESISTOR 26.1K +1% .125W TF TC=0+100	05524	CMF-55-1, T-1

Table 6-2. Replaceable Parts (continued)

Reference Designation	HP Part No.	C D	Qty	Description	Mfr Code	Manufacturer Part Number
A4R13	0757-0442	9	1	RESISTOR 10K +1% .125W TF TC=0+100	05524	CMF-55-1, T-1
A4R14	0698-3446	3	1	RESISTOR 383 +1% .125W TF TC=0+100	05524	CMF-55-1, T-1
A4R15	0757-0461	2	1	RESISTOR 68.1K +1% .125W TF TC=0+100	05524	CMF-55-1, T-1
A4R17	0757-0461	2	1	RESISTOR 68.1K +1% .125W TF TC=0+100	05524	CMF-55-1, T-1
A4R18	0757-0442	9	1	RESISTOR 10K +1% .125W TF TC=0+100	05524	CMF-55-1, T-1
A4R19	0811-3214	5	1	RESISTOR 31.62 +0.1% .05W PN TC=0+10	03123	140
A4R20	0811-2284	7	1	RESISTOR 1K +0.1% .05W PN TC=0+10	01854	R342
A4R21	0757-0290	5	1	RESISTOR 6.19K +1% .125W TF TC=0+100	05524	CMF-55-1, T-1
A4R22	0698-3450	9	1	RESISTOR 42.2K +1% .125W TF TC=0+100	05524	CMF-55-1, T-1
A4R23	0757-0278	9	1	RESISTOR 1.78K +1% .125W TF TC=0+100	05524	CMF-55-1, T-1
A4R24	0757-0438	3	1	RESISTOR 5.11K +1% .125W TF TC=0+100	05524	CMF-55-1, T-1
A4R25	0698-3162	0	1	RESISTOR 46.4K +1% .125W TF TC=0+100	05524	CMF-55-1, T-1
A4R26	0757-0280	3	1	RESISTOR 1K +1% .125W TF TC=0+100	05524	CMF-55-1, T-1
A4R27	0698-3450	9	1	RESISTOR 42.2K +1% .125W TF TC=0+100	05524	CMF-55-1, T-1
A4R28	0757-0278	9	1	RESISTOR 1.78K +1% .125W TF TC=0+100	05524	CMF-55-1, T-1
A4R29	0757-0442	9	1	RESISTOR 10K +1% .125W TF TC=0+100	05524	CMF-55-1, T-1
A4R30	0757-0442	9	1	RESISTOR 10K +1% .125W TF TC=0+100	05524	CMF-55-1, T-1
A4R31	0698-3158	4	1	RESISTOR 23.7K +1% .125W TF TC=0+100	05524	CMF-55-1, T-1
A4R32	2100-1738	9	1	RESISTOR-TRMR 10K 10% TKF TOP-ADJ 1-TRN	04568	82PR10K
A4R33	0698-8300	8	1	RESISTOR 840 +1% .125W TF TC=0+100	05524	CMF-55-1, T-1
A4R34	0757-0280	3	1	RESISTOR 1K +1% .125W TF TC=0+100	05524	CMF-55-1, T-1
A4R35	2100-2061	3	1	RESISTOR-TRMR 200 10% TKF TOP-ADJ 1-TRN	04568	82PR200
A4R36	0757-0419	0	1	RESISTOR 681 +1% .125W TF TC=0+100	05524	CMF-55-1, T-1
A4R37	0757-0399	5	1	RESISTOR 82.5 +1% .125W TF TC=0+100	05524	CMF-55-1, T-1
A4R38	0698-3154	0	1	RESISTOR 4.22K +1% .125W TF TC=0+100	05524	CMF-55-1, T-1
A4R39	0698-3150	6	1	RESISTOR 2.37K +1% .125W TF TC=0+100	05524	CMF-55-1, T-1
A4R42	2100-1738	9	1	RESISTOR-TRMR 10K 10% TKF TOP-ADJ 1-TRN	04568	82PR10K
A4R43	0683-2265	1	1	RESISTOR 22M +5% .25W CC TC=-900/+1200	01607	CB2265
A4R44	0698-3160	8	1	RESISTOR 31.6K +1% .125W TF TC=0+100	05524	CMF-55-1, T-1
A4R45	0757-0467	8	1	RESISTOR 121K +1% .125W TF TC=0+100	05524	CMF-55-1, T-1
A4R46	2100-2031	7	1	RESISTOR-TRMR 50K 10% TKF TOP-ADJ 1-TRN	04568	82PR50K
A4R47	0757-0841	2	1	RESISTOR 12.1K +1% .5W TF TC=0+100	05524	CMF-65-2
A4R48	0757-1000	7	1	RESISTOR 51.1 +1% .5W TF TC=0+100	05524	CMF-65-2
A4R49	0683-0685	5	1	RESISTOR 6.8 +5% .25W CF TC=0-400	00746	R-25J
A4R50	0757-0465	6	1	RESISTOR 100K +1% .125W TF TC=0+100	05524	CMF-55-1, T-1
A4R51	0757-0465	6	1	RESISTOR 100K +1% .125W TF TC=0+100	05524	CMF-55-1, T-1
A4R52	0698-3157	3	1	RESISTOR 19.6K +1% .125W TF TC=0+100	05524	CMF-55-1, T-1
A4R53	0757-0279	0	1	RESISTOR 3.16K +1% .125W TF TC=0+100	05524	CMF-55-1, T-1
A4R54	0698-3159	5	1	RESISTOR 26.1K +1% .125W TF TC=0+100	05524	CMF-55-1, T-1
A4R55	0683-1555	0	1	RESISTOR 1.5M +5% .25W CF TC=0-900	00746	R-25J
A4R56	0757-0442	9	1	RESISTOR 10K +1% .125W TF TC=0+100	05524	CMF-55-1, T-1
A4R57	0757-0441	8	1	RESISTOR 8.25K +1% .125W TF TC=0+100	05524	CMF-55-1, T-1
A4R58	0757-0428	1	1	RESISTOR 1.62K +1% .125W TF TC=0+100	05524	CMF-55-1, T-1
A4R59	0698-3155	1	1	RESISTOR 4.64K +1% .125W TF TC=0+100	05524	CMF-55-1, T-1
A4R60	0698-3162	0	1	RESISTOR 46.4K +1% .125W TF TC=0+100	05524	CMF-55-1, T-1

Table 6-2. Replaceable Parts (continued)

Reference Designation	HP Part No.	C D	Qty	Description	Mfr Code	Manufacturer Part Number
A4R61	0757-1094	9	1	RESISTOR 1.47K +1% .125W TF TC=0+100	05524	CMF-55-1, T-1
A4R62	0698-3449	6	1	RESISTOR 28.7K +1% .125W TF TC=0+100	05524	CMF-55-1, T-1
A4R63	0757-0442	9	1	RESISTOR 10K +1% .125W TF TC=0+100	05524	CMF-55-1, T-1
A4R64	0757-0442	9	1	RESISTOR 10K +1% .125W TF TC=0+100	05524	CMF-55-1, T-1
A4R65	0757-0403	2	1	RESISTOR 121 +1% .125W TF TC=0+100	05524	CMF-55-1, T-1
A4R67	0698-0084	9	1	RESISTOR 2.15K +1% .125W TF TC=0+100	05524	CMF-55-1, T-1
A4R68	0698-0083	8	1	RESISTOR 1.96K +1% .125W TF TC=0+100	05524	CMF-55-1, T-1
A4R69	0683-3355	2	1	RESISTOR 3.3M +5% .25W CC TC=-900/+1100	01607	CB3355
A4R70	0757-0279	0	1	RESISTOR 3.16K +1% .125W TF TC=0+100	05524	CMF-55-1, T-1
A4R71	0757-0442	9	1	RESISTOR 10K +1% .125W TF TC=0+100	05524	CMF-55-1, T-1
A4R72	0698-3160	8	1	RESISTOR 31.6K +1% .125W TF TC=0+100	05524	CMF-55-1, T-1
A4R73	0757-0274	5	1	RESISTOR 1.21K +1% .125W TF TC=0+100	05524	CMF-55-1, T-1
A4R74	0698-3440	7	1	RESISTOR 196 +1% .125W TF TC=0+100	05524	CMF-55-1, T-1
A4R75	0698-3158	4	1	RESISTOR 23.7K +1% .125W TF TC=0+100	05524	CMF-55-1, T-1
A4R76	2100-1738	9	1	RESISTOR-TRMR 10K 10% TKF TOP-ADJ 1-TRN	04568	82PR10K
A4R77	0757-0401	0	1	RESISTOR 100 +1% .125W TF TC=0+100	05524	CMF-55-1, T-1
A4R78	0757-0442	9	1	RESISTOR 10K +1% .125W TF TC=0+100	05524	CMF-55-1, T-1
A4R79	0757-0442	9	1	RESISTOR 10K +1% .125W TF TC=0+100	05524	CMF-55-1, T-1
A4R80	0698-3442	9	1	RESISTOR 237 +1% .125W TF TC=0+100	05524	CMF-55-1, T-1
A4R81	0757-0428	1	1	RESISTOR 1.62K +-1% .125W TF TC=0+100	05524	CMF-55-1, T-1
A4R82	0757-0428	1	1	RESISTOR 1.62K +1% .125W TF TC=0+100	05524	CMF-55-1, T-1
A4RT1	0839-0011	2	1	THERMISTOR DISC 100-OHM TC=-3.8%/C-DEG	05098	21E23
A4U1	1826-0013	8	1	IC OP AMP LOW-NOISE 8 PIN TO-99	03285	AD741CH
A4U2	1826-0013	8	1	IC OP AMP LOW-NOISE 8 PIN TO-99	03285	AD741CH
A4U3	1826-0013	8	1	IC OP AMP LOW-NOISE 8 PIN TO-99	03285	AD741CH
A4U4	1826-0139	9	1	IC OP AMP GP DUAL 8 PIN DIP-P	02037	MC1458P1
A4U5	1826-0271	0	1	IC OP AMP GP 8 PIN DIP-P	03406	LM741CN
A4U6	1826-0271	0	1	IC OP AMP GP 8 PIN DIP-P	03406	LM741CN
A4U7	1826-0915	9	1	IC OP AMP LOW-BIAS-H-IMPED 8 PIN DIP-C	02037	MC34001BU
A4VR3	1902-0041	4	1	DIODE-ZNR 5.11V 5% DO-35 PD=.4W	02037	
A4VR4	1902-3182	0	1	DIODE-ZNR 12.1V 5% DO-35 PD=.4W	02037	
A4VR5	1902-0184	6	1	DIODE-ZNR 16.2V 5% DO-35 PD=.4W	02037	
A4VR6	1902-3416	3	1	DIODE-ZNR 90.9V 5% DO-7 PD=.4W TC=+.082%	02688	
A4W1	00435-60013	2	1	CABLE JUMPER	28480	00435-60013
A5	00435-60034	7	1	BD AY MOTHER	28480	00435-60034
A5	8120-3230	8	1	FLAT RIBBON ASSY 28-AWG 14-COND 54-MM-LG	07775	
A5C1	0180-0374	3	1	CAP-FXD 10uF +-10% 20 V TA	04200	150D106X9020B2-DYS
A5J2	1252-3610	0	1	CONN-POST TYPE .156-PIN-SPCG 10-CONT	03418	26-61-0100
A5J3	1252-3610	0	1	CONN-POST TYPE .156-PIN-SPCG 10-CONT	03418	26-61-0100
A5R1	0811-3202	1	1	RESISTOR 30.615K +-0.1% .05W PN TC=0+10	03123	140
A5R2	0811-3203	2	1	RESISTOR 968 +-0.1% .05W PN TC=0+10	03123	140
A5R3	0811-3204	3	1	RESISTOR 21.616K +-0.1% .05W PN TC=0+10	03123	140
A5R4	0811-3205	4	1	RESISTOR 6.836K +-0.1% .05W PN TC=0+10	03123	140
A5R5	0811-3206	5	1	RESISTOR 2.162K +-0.1% .05W PN TC=0+10	03123	140

Table 6-2. Replaceable Parts (continued)

Reference Designation	HP Part No.	C	D	Qty	Description	Mfr Code	Manufacturer Part Number
A5R6	1810-0206	8		1	NETWORK-RES 8-SIP 10.0K OHM X 7	02483	750-81
A5R7	0757-0442	9		1	RESISTOR 10K +1% .125W TF TC=0+-100	05524	CMF-55-1, T-1
A5R8	0757-0442	9		1	RESISTOR 10K +1% .125W TF TC=0+-100	05524	CMF-55-1, T-1
A5U1	1826-1018	5		1	ANALOG SWITCH 4 SPST 16 -DIP-P	02883	DG201ACJ
A5U2	1826-1018	5		1	ANALOG SWITCH 4 SPST 16 -DIP-P	02883	DG201ACJ
A5VR1	1902-3082	9		1	DIODE-ZNR 4.64V 5% DO-35 PD=.4W	02037	
A5XA4	1251-8115	8		1	CONNECTOR-PC EDGE 22-CONT/ROW 2-ROWS	04068	252-22-50-123
BT1	1420-0096	7		1	BATTERY 28.8V 1.2A-HR NI-CD POST	55857	402656
C1	0160-4851	7		1	CAP-FXD 0.022uF +-20% 0 V PPR-MET		PME265-MB522
F1	2110-0234	9		1	FUSE .1A 250V TD 1.25X.25 UL (FOR 100,200 VAC OPERATION)	71400	MDL 1/10
F1	2100-0311	2		1	(FOR 200,240 VAC OPERATION)	28480	2100-0311
J1					NSR, PART OF W1, SEE MP4 AND MP5		
J2					NSR, PART OF W1, SEE MP3 AND MP6		
J3	1250-0118	3		1	CONNECTOR-RF BNC FEM SGL-HOLE-FR 50-OHM	24931	28JR128-1
J4	1250-0118	3		1	CONNECTOR-RF BNC FEM SGL-HOLE-FR 50-OHM	24931	28JR128-1
J5					NSR, PART OF W1, SEE MP4 AND MP5		
J6					NSR, PART OF W1, SEE MP3 AND MP6		
M1	1120-0696	9		1	METER 4.50-IN; 1MA FSD; LINEAR; TAUT	28480	
MP1	0370-1099	4		1	KNOB-BASE-PTR 1/2 JGK .25-IN-ID	28480	
MP2	00435-60030	3		1	KNOB ASSY	28480	00435-60030
MP3	0590-0505	1		1	NUT-KNRLD-R 5/8-24-THD .125-IN-THK (USED WITH J2)	3D855	TD-801
MP6	2190-0036	7		1	WASHER-LK INTL T 13/16 IN .818-IN-ID (USED WITH J2 AND J6)	78189	1233-03
MP7	00435-00024	9		1	COVER-TOP	28480	00435-00024
MP8	00435-00017	0		1	PANEL REAR	28480	00435-00017
MP9	5000-8565	5		1	COVER SIDE 6X11	28480	5000-8565
MP10	00435-00023	8		1	COVER-BOTTOM	28480	00435-00023
MP11	00435-00015	8		1	PANEL FRONT	28480	00435-00015
MP12	00435-00019	4		1	NO PART NUMBER FOUND	28480	00435-00019
MP13	5020-7633	0		1	NO PART NUMBER FOUND	28480	
MP14	00435-00016	9		1	DECK SWITCH	28480	00435-00016
MP15	0403-0131	4		1	GUIDE-PC BD GRA POLYC .062-IN-BD-THKNS		
MP16	5060-0703	3		1	FRAME AY 6X11 SM	28480	5060-0703
MP17	00435-00018	1		1	DECK-CHASSIS PWR	28480	00435-00018
MP18	5060-0727	1		1	FOOT AY 3RD MOD	28480	5060-0727
MP19	6960-0024	0		1	PLUG-HOLE TR-HD FOR .688-D-HOLE NYL (EXCEPT OPTION 002 AND 003)	28520	2673 (BLACK)
MP20	1490-0031	7		1	TILT STAND 2.236-IN-W 4.438-IN-OA-LG SST	91260	
MP21	5040-0700	8		1	HINGE	28480	5040-0700
MP22	6960-0027	3		1	PLUG-HOLE TR-HD FOR .625-D-HOLE NYL	28520	2663 (BLACK)

Table 6-2. Replaceable Parts (continued)

Reference Designation	HP Part No.	C	Qty	Description	Mfr Code	Manufacturer Part Number
MP23	2360-0192	7	1	SCREW-MACH 6-32 .25-IN-LG 100 DEG	93907	
MP24	2360-0194	9	1	SCREW-MACH 6-32 .312-IN-LG 100 DEG	93907	
MP25	7120-1254	1	1	NAMEPLATE .312-IN-WD .54-IN-LG ABS	22670	
MP26	2360-0116	5	1	SCREW-MACH 6-32 .312-IN-LG 82 DEG	93907	
MP27	2360-0120	1	1	SCREW-MACH 6-32 .438-IN-LG 82 DEG	93907	

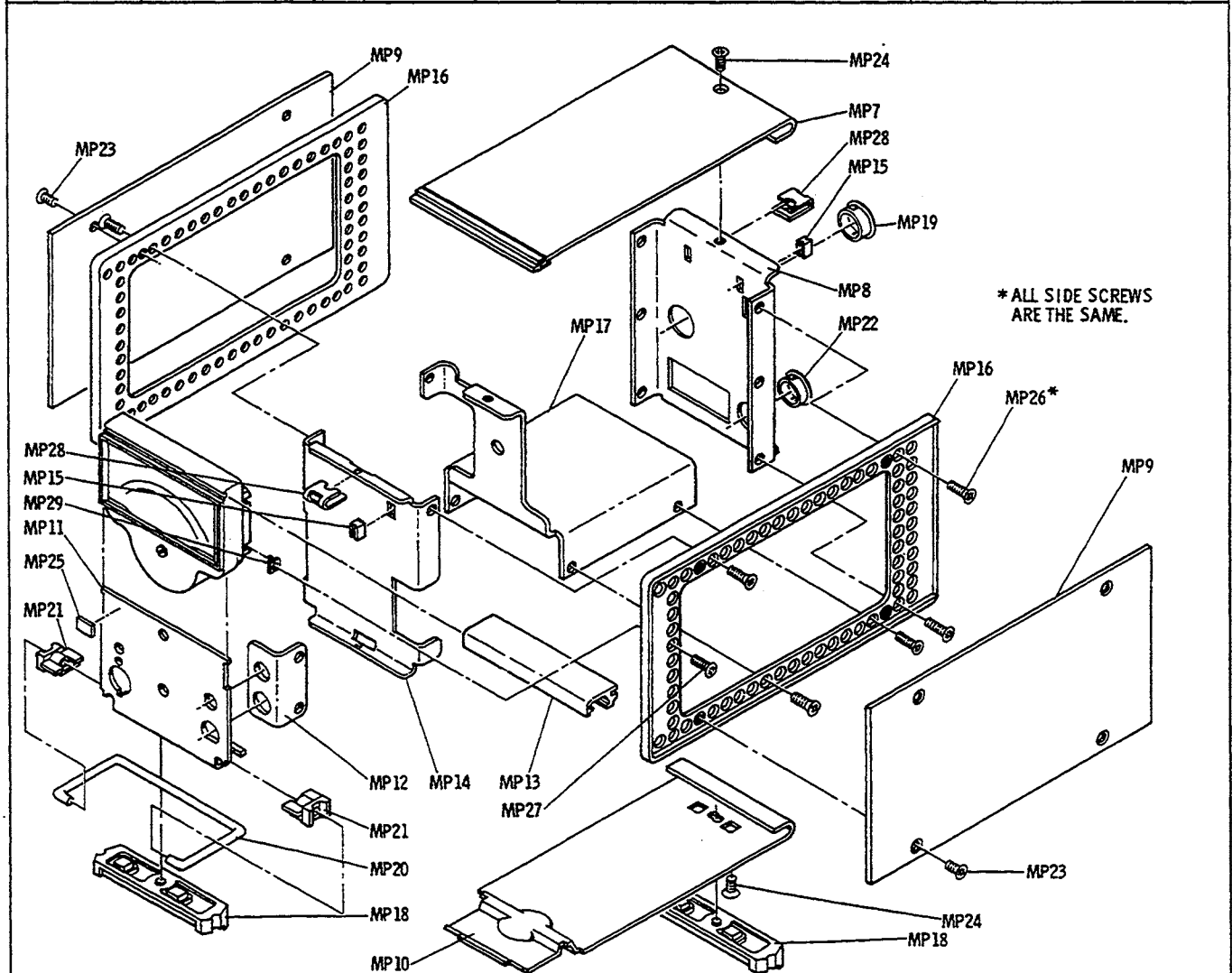

Figure 6-1. Cabinet Parts, Exploded View

MP28	0590-0052	3	1	NUT-SHMET-J-TP 6-32-THD .5-WD STL	78553	C-8020-632-3B
MP29	0590-0039	6	1	NUT-SHMET 6-32-THD .28-WD STL	78553	C-6800-632-3B
MP30	0360-1859	3	1	TERMINAL-SLDR LUG PL-MTG FOR-#5-SCR	86928	
MP31	00435-00009	0	1	CLAMP BATTERY (OPTION 001 ONLY)	28480	00435-00009
MP31A	2360-0115	4	2	SCREW-MACH 6-32 .312-IN-LG PAN-HD-POZI	93907	
MP32	7120-3738	0	1	LABEL-WARNING .62-IN-WD 1-IN-LG AL	22670	

Table 6-2. Replaceable Parts (continued)

Reference Designation	HP Part No.	C D	Qty	Description	Mfr Code	Manufacturer Part Number
MP33	00432-00011	1	1	NO PART NUMBER FOUND	28480	00432-00011
MP33A	2360-0116	5	2	SCREW-MACH 6-32 .312-IN-LG 82 DEG	93907	
MP34	3050-1167	2	1	WASHER-SPR CRVD NO. 10 .2-IN-ID	92830	U190-0090-S
MP35	00432-90010	9	1	NO PART NUMBER FOUND	28480	00432-90010
MP36	00432-90011	0	1	NO PART NUMBER FOUND	28480	00432-90011
MP37	00432-90023	4	1	NO PART NUMBER FOUND	28480	00432-90023
P2	1251-3437	7	1		28480	1251-3437
	1251-3966	7	15	CONTACT-CONN U/W-POST-TYPE FEM CRP	27264	08-56-0107
P3	1251-3437	7	1		28480	1251-3437
	1251-3966	7	15	CONTACT-CONN U/W-POST-TYPE FEM CRP	27264	08-56-0107
P10	1250-0665	5	1	CONNECTOR-RF SMC FEM UNMTD 50-OHM (PART OF W3 OR W9)	98291	50-328-0129-22
R1	2100-3797	4	1	RESISTOR-TRMR 10K 10% TKF SIDE-ADJ	32997	3059J-DM3-103M
R2	0757-0459	8	1	RESISTOR 56.2K +-1% .125W TF TC=0+-100	91637	CMF-55-1
S1	3101-2359		1	NO PART NUMBER FOUND	28480	
S2	3101-2055	8	1	SWITCH-PB SPDTMOM .02A 20 VAC	09353	8125-ZBE
	3131-0439	1	1	CAP-PUSHBUTTON BLACK; .316 IN DIA; .25	09353	8018-2
S3	3101-0415	0	1	SWITCH-SL DPDT MINTR .5A 125VAC/DC (POWER REF, SWITCH)	28480	3101-0415
T1	9100-0424	5	1	XFMR-PWR 100/120/220/240V		
	2360-0115	4	1	SCREW-MACH 6-32 .312-IN-LG PAN-HD-POZI	93907	
W1	00435-60037	0	1	CONN AY-RF INPUT (INCL J1)	28480	00435-60037
	00436-20014	0	2	WASHR MOUNT CONN	28480	00436-20014
	1251-3362	7	2	NUT-AUDIO CONN		91-T-422-6-9
W2	00435-60045	0	1	SWITCH AY PRI PW (INCLUDES R2 AND S1)	28480	00435-60045
W3	00436-60029	1	1	CBL REF OSC STD	28480	00436-60029
W4	11730A	4	1	SENSOR CBL 5 FT	28480	11730A
W5	0120-1378	3	1	NO PART NUMBER FOUND	28480	0120-1378
W6	00435-60039	2	1	CONNECT AY-RF IN	28480	00435-60039
W6A	1251-3362	7	1	NUT-AUDIO CONN		91-T-422-6-9
W6B	00436-20014	0	1	WASHR MOUNT CONN	28480	00436-20014
W9	00436-60029	1	1	CBL REF OSC STD (INCL. J6 & P1; OPT. 003 ONLY)	28480	00436-60029

Table 6-3. Code List of Manufacturers

Mfr Code	Manufacturer Name	Address	Zip Code
00000	ANY SATISFACTORY SUPPLIER		
01121	ALLEN-BRADLEX CO	MILWAUKEE, WI	53204
01295	TEXAS INSTR INC SEMICONDUCTOR CMPNT DIV	DALLAS, TX	75222
02111	SPECTROL ELECTRONICS CORP	CITY OF IND, CA	91745
03508	GE CO SEMICONDUCTOR PROD DEPT	AUBURN, NY	13201
04713	MOTOROLA SEMICONDUCTOR PRODUCTS	PHOENIX, AZ	85008
06665	PRECISION MONOLITHICS INC	SANTA CLARA, CA	95050
14140	EDISON ELEK DIV MCGRAW-EDISON	MANCHESTER, NH	03130
17856	SILICONIX INC	SANTA CLARA, CA	95054
19701	MEPCO/ELECTRA CORP	MINERAL WELLS, TX	76067
20940	MICRO-OHM CORP	EL MONTE, CA	91731
24046	TRANSITRON ELECTRONIC CORP	WAKEFIELD, MA	01880
24546	CORNING GLASS WORKS (BRADFORD)	BRADFORD, PA	16701
28480	HEWLETT-PACKARD CO CORPORATE HQ	PALO ALTO, CA	94304
3L585	RCA CORP SOLID STATE DIV	SOMERVILLE, NJ	
32997	BOURNS INC TRIMPOT PROD DIV	RIVERSIDE, CA	92507
56289	SPRAGUE ELECTRIC CO	NORTH ADAMS, MA	01247
71400	BUSSMAN MFG DIV OF MCGRAW-EDISON CO	ST LOUIS, MO	63107
73138	BECKMAN INSTRUMENTS INC HELIPOT DIV	FULLERTON, CA	92634



Manual Changes

Introduction

This chapter contains instructions for backdating this manual for HP 435B Power Meters that have serial number prefixes that are lower than the prefix listed on the title page.

Manual Changes

To adapt this manual to your instrument, refer to Table 7-1 and make all of the manual changes listed opposite your instrument's serial number or prefix.

If your instrument's serial number or prefix is not listed on the title page of this manual or in Table 7-1, it may be documented in a yellow MANUAL CHANGES supplement. For additional important information about serial number coverage, refer to INSTRUMENTS COVERED BY MANUAL in Chapter 1.

Table 7-1. Manual Changes by Serial Number

Serial Prefix or Number	Make Manual Changes
2005A, 2041U	B, A
2238A	B

Manual Change Instructions

Change A

Table 6-2. Add the following capacitors:

A4C31-33,40-47 and 50	0160-3879 CD7 CAPACITOR-FXD.01 μ F \pm 20% 100 VDC CER 28480 0160-3879.
A4C34-37, 48-49	0160-3877 CD5 CAPACITOR-FXD 100 pF \pm 20% 200 VDC CER 28480 0160-3877.
A4C38	0160-4306 CD7 CAPACITOR-FXD 100 pF \pm 10% 100 VDC CER 51959 0805C 101K3P.

Service Sheet 2 (schematic). On the J1 and J5 Connector Assemblies (leftside of service sheet) add a capacitor from each pin (C, D, E, L) to ground.

Add the following capacitors on the A4 Assembly (left side of schematic):

C31	0.01, μ F between pins 5 and 6 of U4B.
C32	0.01 μ F from pin 3 of U1 to -12 volts.
C33	0.1 μ F from pin 4 of U1 to 12 volts.
C38	100 μ F between pins 2 and 3 of U1.
C50	0.01,4F from pin 7 of U1 to ground 1.

Add the following capacitors on the A4 Assembly (center of schematic):

C36	100 pF between pins 3 and 2 of U2.
C42	0.01 μ F from pin 7 of U2 to ground 3.
C43	0.01 μ F from pin 7 of U3 to ground 3.
C44	0.01 μ F from pin 4 of U2 to ground 3.
C45	0.01 μ F from pin 4 of U3 to ground 3.
C48	100 μ F between pins 2 and 3 of U3.

Add the following capacitors on the A4 Assembly (right side of schematic):

C34	100 pF between the drain (D) and source (S) of Q7.
C35	100 pF from the source (S) of Q7 to ground 2.
C40	0.01 μ F from pin 8 of U4A to ground 1.
C41	0.01 μ F from pin 4 fo U4A to ground 1.
C49	100 pF between pins 2 and 3 of U4A.

Service Sheet 3 (schematic). Add the following capacitors on the A4 Assembly (center of schematic):

C37	100 pF between pins 2 and 3 of U5.
C46	0.01 μ F from pin 7 of U5 to ground.
C47	0.01 μ F from pin 4 of U5 to ground.

Change B

Page 1-6, Input-Output Options. Change the description for Option 003 to the following: a rear panel input connector replaces the standard front panel input connector; a rear panel POWER REF OUTPUT connector replaces the standard front panel connector.

Page 3-7, Figure 3-2. The description of the POWER SENSOR INPUT should read as follows: Option 002 has a rear panel input connector wired in parallel with the front panel input connector. In Option 003 this connector replaces the input front panel connector.

Table 6-2. A4CR1, 2 was originally 1901-0895. However the part listed in the table is the recommended replacement, therefore, no manual change is suggested.

A4R20 was originally 0811-3218. However the part listed in the table is the recommended replacement, therefore, no manual change is suggested.

Under the description for W1 add the following: Omitted on Option 003.

Service Sheet 2 (schematic). To the left of J1 (left side of schematic) add the following: (Omit J1 and W1 on Option 003 only).



Service

Introduction

Service information is provided in this chapter. General service information relates to troubleshooting. Repair information relates to performance testing and adjustments after repairs are made. Each service sheet includes principles of operation and troubleshooting information, a component location diagram and a schematic diagram.

The last foldout in the manual shows the location of each assembly, chassis mounted component and adjustable component.

Safety Considerations

Although this instrument has been designed in accordance with international safety standards, this manual contains information, cautions and warnings which must be followed to avoid personal injury and damage to the instrument (see Chapters 2, 3, and 5). Service and adjustments should be performed only by qualified service personnel.

Warning



Any interruption of the protective (grounding) conductor (inside or outside the instrument) or disconnection of the protective earth terminal is likely to make the instrument dangerous. Intentional interruption is prohibited.

The maintenance described in this chapter is performed with power supplied to the instrument and with the protective covers removed. Such maintenance should be performed only by service-trained personnel who are aware of the hazards involved (for example, fire and electrical shock). Where maintenance can be performed without power supplied, the power should be removed.

Capacitors inside the instrument may still be charged even if the instrument has been disconnected from its source of supply.

For continued protection against fire hazard, replace the line fuse only with a 250 V fuse of the same current rating and type (for example, slow blow, time delay, etc.). Do not use repaired fuses or short circuited fuseholders.

Whenever it is likely that this protection has been impaired, the instrument must be made inoperative and be secured against any unintended operation.

The service information is often used with power supplied and protective covers removed from the instrument. Energy available at manypoints may, if contacted, result in personal injury.

Service Sheets

Each service sheet normally includes principles of operation and troubleshooting information, a component location diagram and a schematic, all of which apply to a specific portion of circuitry within the instrument.

Service Sheet 1 includes an overview of the instrument operation, troubleshooting on an assembly or stage level and a troubleshooting block diagram. The block diagram also serves as an “index” for the other service sheets.

The Schematic Diagram Notes, Figure 8-5, aid in interpreting the schematics.

Principles of Operation

The operation of the circuitry shown by the schematic diagram is explained in the Principles of Operation. This information is outlined by using assembly and stage names. These names also separate circuit areas on the schematic diagrams.

Troubleshooting

This information is in the form of hints and suggestions about problems that may be encountered while troubleshooting the power meter. The troubleshooting information is located on the service sheet following the Principles of Operation.

On Service Sheet 1, a malfunction is isolated to an assembly or stage. After turning to the appropriate service sheet, troubleshooting continues on a stage and component level.

DC voltages and, in some cases, ac voltages and waveforms are included on the schematics. Test points are physically located on printed circuit boards and have assigned reference designators and symbols on the schematics. The waveforms and voltages refer to the test points and other important circuit junctions.

A circuit board extender, which provides easy access for troubleshooting, is shown in Figure 8-1. The extender may be ordered through your nearest HP office. See “Equipment Available” in Chapter 1.

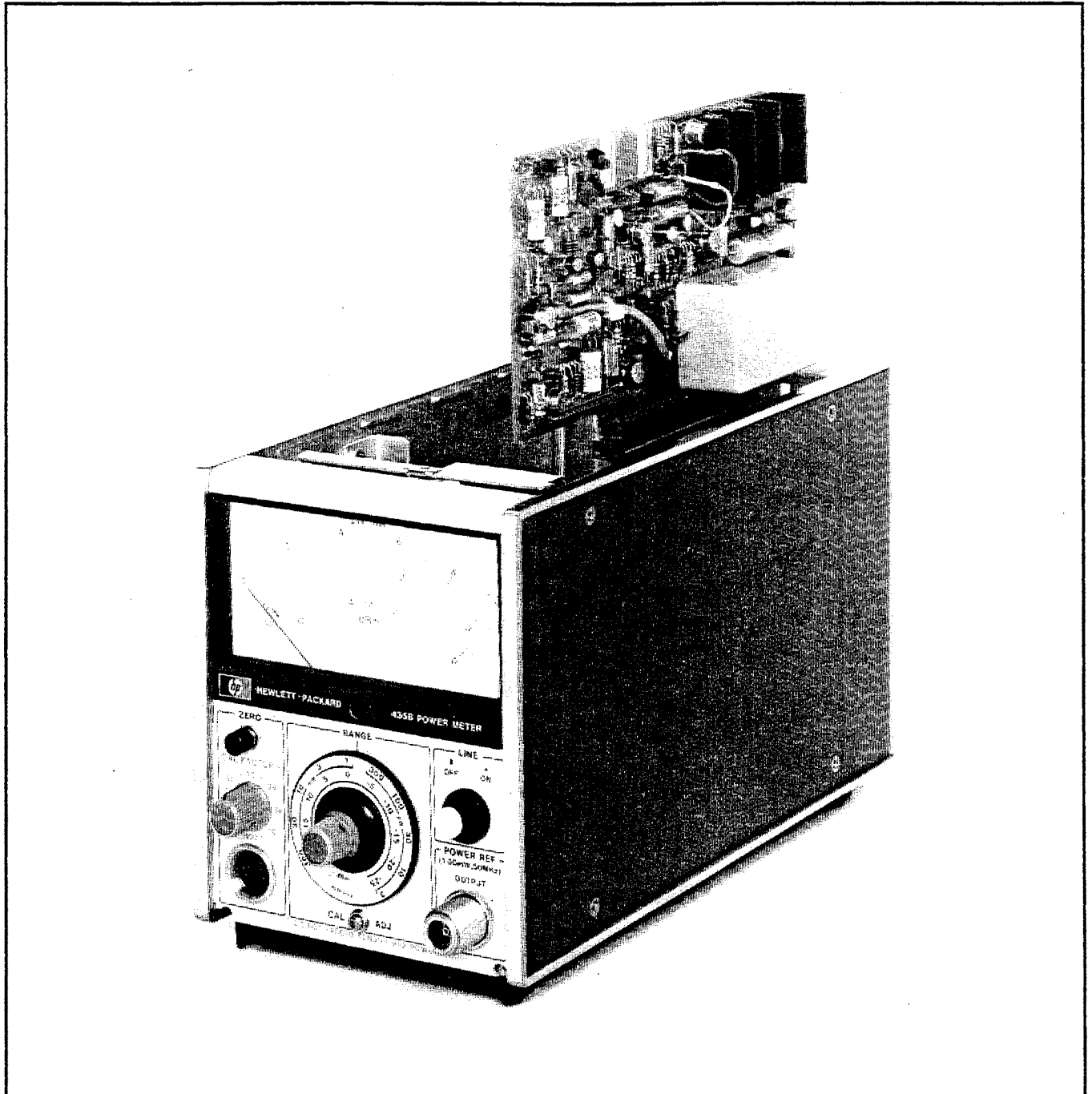

Figure 8-1. A4 Assembly Extended for Service

Recommended Test Equipment

Equipment recommended in Table 1-2 should be used for testing and troubleshooting the power meter to ensure that it is operating within the specifications listed in Table 1-1. Test equipment that meets or exceeds the critical specifications listed may be used in place of recommended equipment.

Repair

After repairing any circuitry within the power meter perform the adjustments in Chapter 5.

Perform the tests in Chapter 7 to ensure that the instrument is operating within the specified limits.

Note

If the A3 Power Reference Assembly is repaired, see the “Power Reference Output Test” in Chapter 4 for instructions on setting the power output level.

General Service Information**Etched Circuit Boards**

The etched circuit boards used in Hewlett-Packard equipment are the plated-through type consisting of metallic conductors bonded to both sides of an insulating material. The metallic conductors are extended through the component holes or interconnect holes by a plating process. Soldering can be performed on either side of the board with equally good results. Table 8-1 lists recommended tools and materials for use in repairing etched circuit boards. Following are recommendations and precautions pertinent to etched circuit repair work.

- a. Avoid unnecessary component substitution; it can result in damage to the circuit board and adjacent components.
- b. Do not use a high power soldering iron on etched circuit boards. Excessive heat may lift a conductor or damage the board or a component.

Caution

Do not use a sharp metal object such as an awl or twist drill to remove solder from component mounting holes. Sharp objects may damage the plated-through conductor.

- c. Use a suction device or wooden toothpick to remove solder from component mounting holes.
- d. After soldering, remove excess flux from the soldered areas and apply a protective coating to prevent contamination and corrosion.

Table 8-1. Etched Circuit Soldering Equipment

Item	Use	Specification	Item Recommended
Soldering tool	Soldering, unsoldering.	Wattage rating: $47\frac{1}{2}$ - $56\frac{1}{2}$ Tip Temp: 850 - 900° F	Ungar No. 776 handle with Ungar ¹ No. 4037 Heating Unit
Soldering tip ¹	Soldering, unsoldering.	Shape ¹ : pointed	Ungar ¹ No. PL111
De-soldering Aid	To remove molten solder from connection.	Suction device	Soldapult by Edsyn Co. Arleta, California
Rosin (flux)	Remove excess flux from soldered area before application of protective coating.	Must not dissolve etched circuit base board material or conductor bonding agent.	Freon, Acetone, Lacquer Thinner, Isopropyl Alcohol (100% dry)
Solder	Component replacement, circuit board repair, wiring.	Rosin (flux) core, high tin content (60/40 tin/lead), 18 gauge (SWG) preferred	
Protective Coating	Contamination, corrosion protection.	Good electrical insulation, corrosion-prevention properties	Silicone Resin such as GE DRI-FILM ²

1 For working on etched boards; for general purpose work, use Ungar No. 1237 Heating Unit (37.5W, tip temperature of 750-800 degrees) and Ungar No. PLI 13, 1/8-inch chisel tip.

2 General Electric Co., Silicone Products Dept., Waterford, New York, U.S.A.

Component Replacement

The following procedures are recommended when component replacement is necessary:

- a. Remove defective component from board.
- b. If component was unsoldered, remove solder from mounting holes with a suction device or a wooden toothpick.
- c. Shape leads of replacement component to match mounting hole spacing.

Note



Although not recommended when both sides of the circuit board are accessible, axial lead components such as resistors and tubular capacitors can be replaced without unsoldering. Clip leads near body or defective component, remove component and straighten leads left in board. Wrap leads of replacement component one turn around original leads. Solder wrapped connection and clip off excess lead.

- d. Insert component leads into mounting holes and position component as original was positioned. Do not force leads into mounting holes; sharp lead ends may damage the plated-through conductor.

Operational Amplifiers

The source of gain in an operational amplifier can be characterized as an ideal, differential voltage amplifier having low output impedance, high input impedance, and very high differential gain. The output of an operational amplifier is proportional to the difference in the voltages applied to the two input terminals. In use, the amplifier output drives the input voltage difference close to zero through a feedback path.

When troubleshooting an operational amplifier circuit, measure the voltages at the two inputs; the difference between these voltages should be less than 10 mV.

Note



This troubleshooting procedure will not work for operational amplifiers which are configured as comparators.

A difference voltage much greater than 10 mV indicates trouble in the amplifier or its external circuitry. Usually, this difference will be several volts and one of the inputs will be very close to one of the supply voltages (for example, +12 V or -12 V).

Next, check the amplifier's output voltage. It will probably also be close to one of the supply voltages (for example, ground, +12 V, or -12 V). Check to see that the output conforms to the inputs. For example, if the inverting input is more positive than the noninverting input, the output should be negative; if the non-inverting input is more positive than the inverting input, the output should be positive. If the output conforms to the inputs, check the amplifier's external circuitry. If the amplifier's output does not conform to its inputs, it is probably defective.

Figure 8-2, Figure 8-3, and Figure 8-4 show typical operational amplifier configurations. Figure 8-2 shows a noninverting buffer amplifier with a gain of 1. Figure 8-3 is a non-inverting amplifier with gain determined by R1 and R2. Figure 8-4 is an inverting amplifier with a gain determined by R1 and R2.

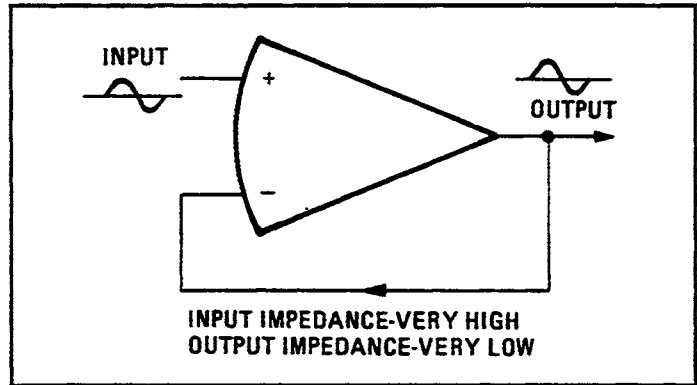

Figure 8-2. Non-Inverting Amplifier (Gain = 1)

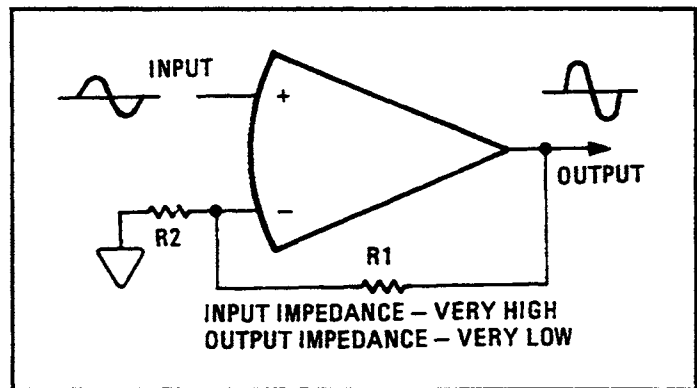

Figure 8-3. Non-inverting Amplifier (Gain = $1 + R_1/R_2$)

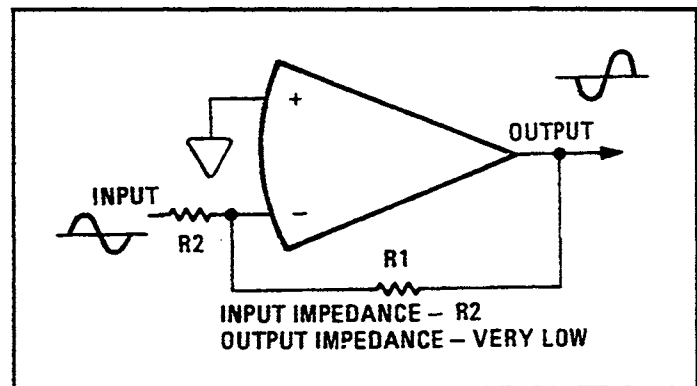

Figure 8-4. Inverting Amplifier (Gain = $-R_1/R_2$)

SCHEMATIC DIAGRAM NOTES
SWITCH DESIGNATIONS

EXAMPLE: A3S1AR(2-1/2)

A3S1 = SWITCH S1 WITHIN
ASSEMBLY A3

A = 1ST WAFER FROM
FRONT (A=1ST, ETC)

R = REAR OF WAFER
(F=FRONT)

(2-1/2) = TERMINAL LOCATION
(2-1/2) (VIEWED FROM
FRONT)

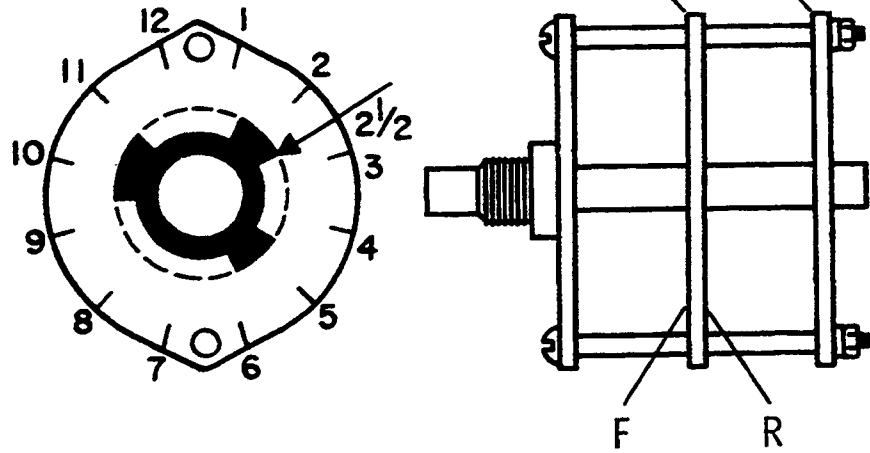





Figure 8-5. Schematic Diagram Notes (1 of 3)

SCHEMATIC DIAGRAM NOTES

- *

Asterisk denotes a factory-selected value. Value shown is typical. Part might be omitted.
- 

Tool-aided adjustment.
- 

Manual control.
- 

Encloses front-panel designation.
- 

Encloses rear-panel designation.
- 

Circuit assembly borderline.
- 

Other assembly borderline. Also used to indicate mechanical interconnection (ganging).
- 

Heavy line with arrows indicates path and direction of main signal.
- 

Heavy dashed line with arrows indicates path and direction of main feedback.
- 

Wiper moves toward CW with clockwise rotation of control (as viewed from shaft or knob).
- 

Numbered Test point.
Measurement aid provided.
- 

Lettered Test point.
No measurement aid provided.
- 

Encloses wire color code. Code used is the same as the resistor color code. First number identifies the base color, second number identifies the wider stripe, third number identifies the narrower stripe. Eg., **947** denotes white base, yellow wide stripe, violet narrow stripe.
- 

A direct conducting connection to the earth, or a conducting connection to a structure that has a similar function (e.g., the frame of an air, sea or land vehicle).
- 

A conducting connection to a chassis or frame.
- 

Common connections. All like-designated points are connected.
- 

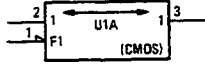
Letter = off-page connection.
Number = Service Sheet number for off-page connection.
- 

Bilateral switch — acts as an on/off switch to analog signals when the input marked F is active.

Figure 8-5. Schematic Diagram Notes (2 of 3)

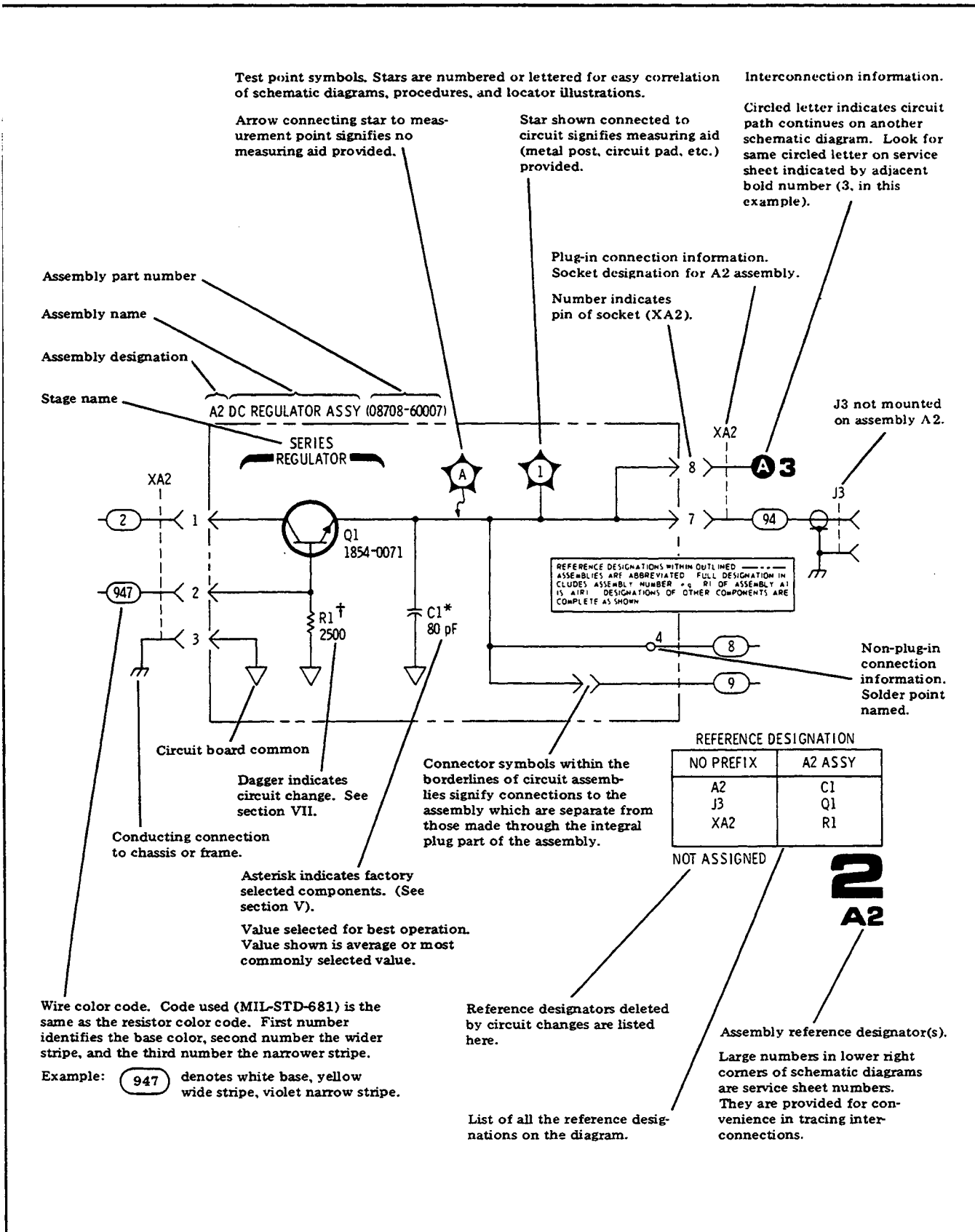

Figure 8-5. Schematic Diagram Notes (3 of 3)

Service Sheet 1

Principles of Operation

General

The power meter and a compatible power sensor are used to measure RF power levels. For example, the power range of the HP 8481A is from -35 to $+20$ dBm ($\cong 0.3 \mu\text{W}$ to 100 mW) into 50Ω the frequency range is from 10 MHz to 18 GHz .

Power Sensor

The power sensing device dissipates the input RF energy into 50 ohms and produces a dc voltage proportional to the power level. This dc voltage is sampled creating an ac signal which is coupled to the input amplifier for amplification.

AC Amplifiers/Range Switch

The ac signal is amplified by the power sensor's input amplifier and the power meter's first, second and third amplifiers. The RANGE switch attenuators, which are placed between the first and second amplifiers and the second and third amplifiers, are used to set the range-to-range gain of the power meter amplifiers.

DC Circuits

The synchronous detector converts the ac signal back to dc. The output is coupled to the dc amplifier via a low pass filter network. The dc amplifier drives the meter, the servo amplifier and possibly an external device through the RECORDER OUTPUT jack.

Servo Amplifier/Auto Zero

The servo amplifier amplifies the dc amplifier output. When the front panel **ZERO** switch is pressed, the servo amplifier output is connected to the auto zero circuits completing the automatic zeroing feedback loop. The auto zero dc output voltage (error signal) is added to the ambient temperature output of the power sensor's power sensing device. The polarity of the error signal and the feedback loop gain force the dc amplifier output to ground potential after five seconds. When the **ZERO** switch is released, the auto zero circuits hold the error signal constant.

Power Reference Assembly

The A3 Power Reference Assembly contains a 50 MHz oscillator with an ALC loop capable of providing an exceptionally stable output level. The calibrated output is $1 \text{ mW} \pm 0.70\%$ at $50 \pm 5 \text{ MHz}$.

Power Supply

The power supply is a 24 V series regulator with a shunt regulator coupled across the output. The shunt regulator places ground potential midway between the 24 V potential difference thus providing supply outputs of +12 and -12 Vdc. The battery charging and test circuits are automatically operative with the battery installed.

Troubleshooting

General

Before beginning to troubleshoot the power meter, remove the cover from the right side of the instrument and measure the power supply voltages at TP9 and TP10.

When a malfunctioning component is isolated to an assembly or stage, refer to the appropriate service sheet for component level troubleshooting.

Block Diagram Troubleshooting Conditions

The waveforms and voltages shown are normal when operating under the following conditions.

Note



To exhibit the correct waveforms in the RANGE positions shown, the power sensor (as part of the measurement system) must measure power from -35 to +20 dBm (50 Ω).

a. Power Meter and Sensor

Set the power meter as follows:

RANGE..... 1 mW
 CAL FACTOR..... 100%
 POWER REF(rear panel) . . ON

Connect the power sensor to the power meter's POWER REF OUTPUT jack.

b. Power Meter and HP 11683A Range Calibrator

Set the power meter as follows:

RANGE..... 1 mW
 CAL FACTOR..... 100%

Set the range calibrator as follows:

RANGE..... 1 mW
 POLARITY..... NORMAL
 FUNCTION STANDBY

Connect the range calibrator to the power meter with the power sensor cable. Set the range calibrate FUNCTION switch to CALIBRATE.

AC Amplifiers

If the waveform and/or voltage at TP1 is incorrect, it must be determined if the circuit malfunction is in the power meter, the power sensor or the cable. Substitution will quickly isolate the defective instrument. If a spare cable and power sensor or range calibrator is not available, refer to the troubleshooting information for the first amplifier on Service Sheet 2. Also, check the multivibrator output (TP7 and TP8) of the power meter.

Miscellaneous

Voltages at TP4, 5, 6 and 12 are correct as shown for full-scale meter readings on any range.

With a full scale input, on 1 mW range only, pressing the front panel **ZERO** switch should produce a meter reading of about 0.96. If the reading is incorrect, refer to Chapter 5 and perform the adjustments. If the problem still exists, refer to auto zero circuit troubleshooting on Service Sheet 3. A noise problem evident as meter vibration may be due to defective components illustrated on Service Sheets 2, 3, or 4.



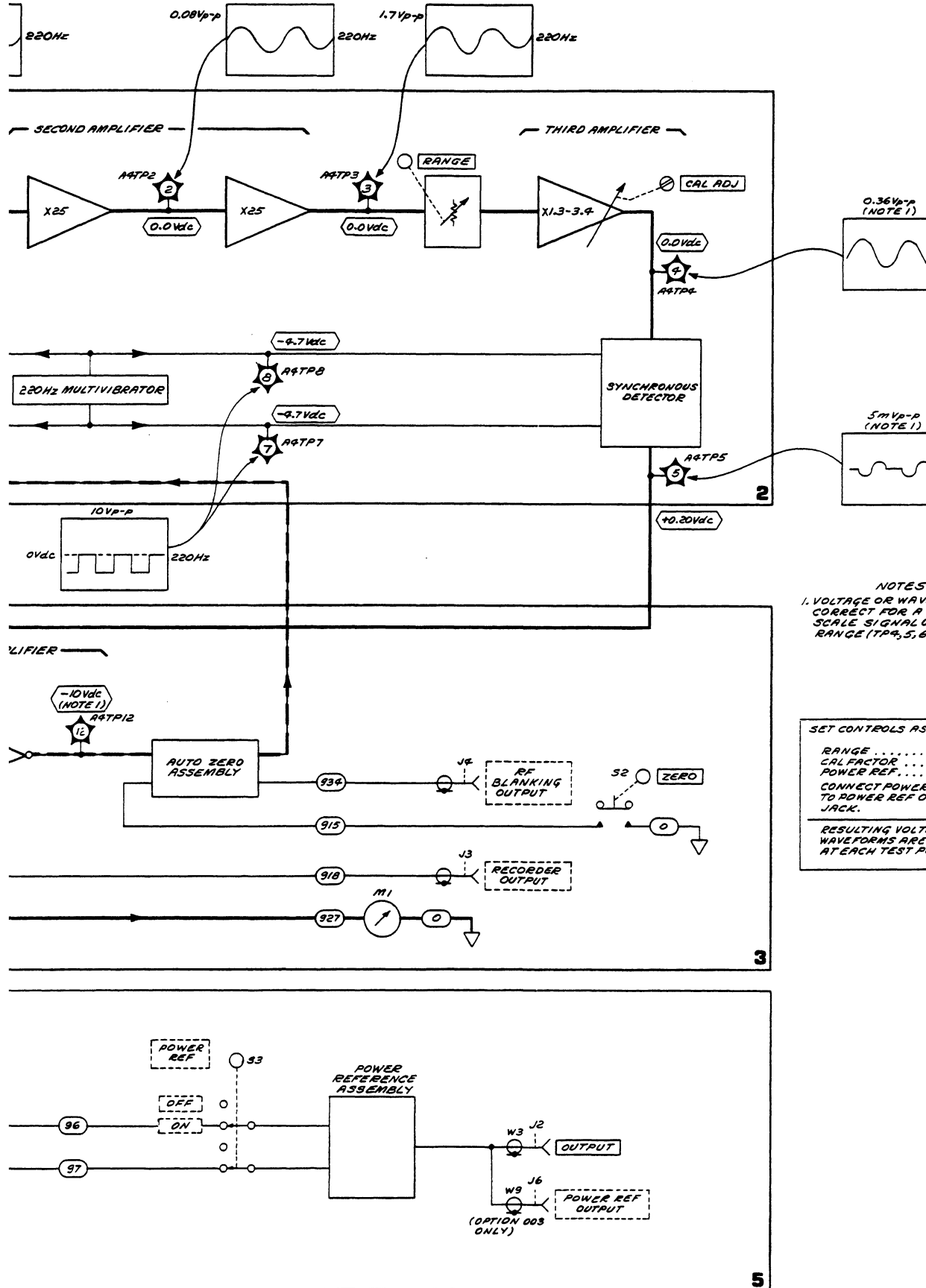

Figure 8-6. Troubleshooting Block D

Service Sheet 2

Principles of Operation

General

The RF input power coupled to the power sensor is dissipated by the load impedance of the power sensing device. The dc output of the power sensing device is converted to a 220 Hz ac signal by a sampling gate (chopper) circuit. The ac signal, which is proportional to the RF input, is amplified by tuned ac amplifiers in the power sensor and power meter. The synchronous detector converts the amplified 220 Hz ac signal back to a dc level which is also proportional to the RF input.

The RANGE switch attenuator networks attenuate the ac signal for higher power inputs. This allows equal measurement resolution for high and low power levels. The synchronous detector and a sampling gate circuit (in the power sensor) are driven in phase by the 220 Hz multivibrator.

A4U4B is connected as a voltage follower between the input signal ground and signal ground. This circuit ensures a minimum voltage difference exists between the grounds thereby eliminating the possibility of unreliable readings. High current flow, through the ground return of cables which are greater than 5 feet long, causes the voltage difference.

First Amplifier

The first amplifier of the power meter and the power sensor's amplifier stage form a low-noise high-gain hybrid operational amplifier (refer to the figure below). The ac gain is approximately 750; dc bias is set by A4R1, R2, R6, R10 and R11.

Diodes A4CR1, CR2, VR1 and VR2 and their associated components are part of a shaping network which compensates for the non-linear output of the power sensor's power sensing device. At RF inputs near the maximum power input (100 mW for the HP 8481A), the power sensing device is slightly more efficient and the hybrid amplifier's gain is reduced slightly to provide an overall response that is linear.

The combination of A4C5, R8 and R9 is one of three RC networks in the ac amplifiers which determine the high frequency cutoff (240 Hz) of the 220 \pm 20 Hz bandpass. A4C1, C6 and C30 are line noise filters.

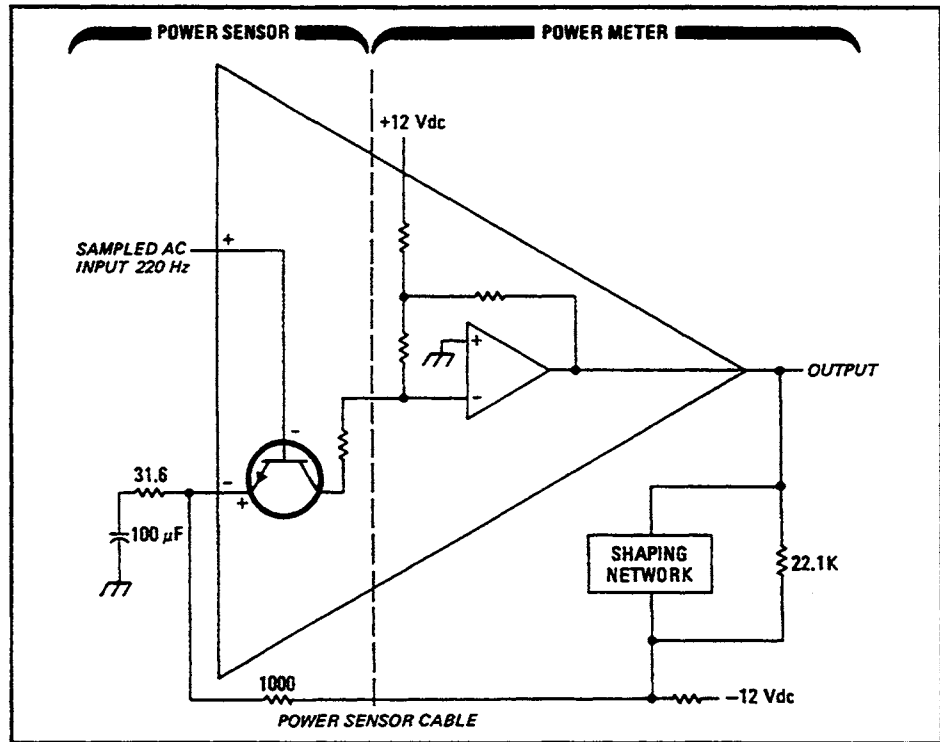

Hybrid Operational Amplifier

Range Switch

The RANGE switch and associated components on the A4 and A5 assemblies form two separate attenuator networks and a low pass filter (the filter is shown and discussed on Service Sheet 3).

With higher power RF inputs, relatively high voltages are coupled to the attenuator inputs. The higher the voltage the more it is attenuated, thus allowing for greater sensitivity needed for low power measurements while providing the needed resolution for each range. The various levels of attenuation permit ten usable range positions from 3 μ W to 100 mW (full scale). The following table shows the individual and combined effect of the attenuators on the ac signal.

The bandpass of the ac amplifiers in the power meter is approximately 220 \pm 20 Hz. The lower cutoff frequency (200 Hz) is fixed by the combination of A4C7 with A5R1, A5R2 and A4R19; also A4R15 with A5R3, A5R4, A5R5 and A4R20.

RANGE Switch Position	Attenuation		
	Network #1 (A5R1, R2 and A4R19)	Network #2 (A5R3, R4, R5 and A4R20)	Total
3 μ W	$\div 1$	$\div 1$	$\div 1$
10 μ W	$\div 1$	$\div 10$	$\div 10^{1/2}$
30 μ W	$\div 1$	$\div 100$	$\div 10$
100 μ W	$\div 1$	$\div 1000$	$\div 10^{3/2}$
300 μ W	$\div 1000$	$\div 10$	$\div 10^2$
1 mW	$\div 1000$	$\div 100$	$\div 10^{5/2}$
3 mW	$\div 1000$	$\div 1000$	$\div 10^3$
10 mW	$\div 1000$	$\div 10$	$\div 10^{7/2}$
30 mW	$\div 1000$	$\div 100$	$\div 10^4$
100 mW	$\div 1000$	$\div 1000$	$\div 10^{9/2}$

Second Amplifier

A4U2 and U3 and associated components are operational amplifiers with voltage gains of about 25 each. Gain for A4U2 is determined by A4R22 and R23; for A4U3 by A4R27 and R28. Bias current is provided for A4U3 by A4R25.

The tuned amplifiers upper bandpass limit (240 Hz) is set by the parallel RC networks of A4C11 and R22, A4C14 and R27 and parallel RC network in the first amplifier.

Third Amplifier

A4U4A and its associated components form an operational amplifier stage with variable voltage gain from 1.3 to 3.4. The front panel CAL ADJ gain control is set to compensate for differences in sensitivity of individual power sensors. The gain is determined by A4R24, R21 and the CAL ADJ control R1.

Synchronous Detector

The phase shift of the 220 Hz signal through the tuned amplifiers is approximately zero. Because the phase shift is minimal, error introduced into the system is also minimal. This ensures that the detector output is proportional to the RF power input level.

The synchronous detector, like the sampling gate circuit in the power sensor, is driven by the 220 Hz multivibrator drive signal. When A4Q6 is biased on, the equivalent sampling gate FET (which is connected to ground) is also on. Therefore, a negative going signal is coupled to the ac amplifiers. Because there is no phase inversion of the signal throughout the ac amplifiers, the output of the third amplifier is

also the negative going portion of the distorted sinusoidal waveform. During this half cycle current flows from ground through A4Q6 and R26 to charge C12 and C13. A positive voltage is stored on the positive terminal of C13. When the 220 Hz drive signal turns A4Q6 off and Q7 on, the third amplifier output is the positive going portion of the distorted sinusoidal waveform. This positive going signal is superimposed on the voltage across C12 and C13 such that the peak voltage is about twice the peak voltage of the third amplifier output. This voltage charges A4C16 through R26 and Q7. The dc output voltage is coupled across a dc pass filter to the dc amplifier.

Troubleshooting

General

Before attempting to troubleshoot the circuits represented by this schematic, verify that the power supply is operating properly. The voltage on TP9 should be +12 Vdc; on TP10, -12 Vdc.

The important characteristics of the waveforms shown on this schematic are the frequency and peak-to-peak voltage. If the shape of the waveform varies slightly, the performance of the system will not be degraded. Measuring and recording dc voltages and comparing them with the normal levels shown on the schematics may help to isolate defective components. See "General Service Information" in Chapter 8 for information on operational amplifier circuits.

The waveforms and voltages shown on the schematic are normal when operating under the following conditions.

Note



To exhibit the correct waveforms in the RANGE switch positions indicated, the power sensor (as part of the measurement system) must measure power from -35 to +20 dBm into a 50Ω load.

a. Power Meter and Sensor

Set the power meter as follows:

RANGE 1 mW
 CAL FACTOR 100%
 POWER REF (rear panel) .. ON

Connect the power sensor to the power meter's POWER REF OUTPUT jack.

b. Power Meter and HP 11683A Range Calibrator

Set the power meter as follows:

RANGE 1 mW
 CAL FACTOR 100%

Set the range calibrator as follows:

RANGE 1 mW
 POLARITY NORMAL
 FUNCTION STANDBY

Connect the range calibrator to the power meter with the power sensor cable. Set the range calibrator FUNCTION switch to CALIBRATE.

First Amplifier

To troubleshoot the hybrid operational amplifier effectively, consider the complete amplifier as shown on the schematic on the opposite foldout and the power sensor's schematic.

The bias levels may be used most effectively to isolate the problem to the power meter. If the dc voltage at TP1 is correct but the ac voltage is incorrect, a defective component probably exists in the power sensor before the signal is input to the hybrid amplifier.

An ac voltage coupled with a positive voltage ($\cong +3$ Vdc) at A4U1 pin 2 would indicate a defect in the power sensor's hybrid amplifier input or the interconnect cable. If the voltage at pin 2 is about 0.0 Vdc, the defective component is probably in the power meter's first amplifier.

A positive voltage at TP1 indicates the malfunction is probably in the power meter's first amplifier.

Note



Do not overlook the possibility that a problem can exist in the auto zero circuits shown on Service Sheet 3.

An increased noise level may be caused by C1, C6 or C30 line noise filters.

Range-to-range inaccuracy between the 100 mW range and another range may be due to a shaping circuit defect.

Range Switch

Range-to-range inaccuracy which is caused by the RANGE switch attenuators can easily be isolated by performing one of the "Instrumentation Accuracy Performance Tests" (refer to Chapter 4).

Third Amplifier

Adjust the CAL ADJ control from its present setting to the ccw stop. Then adjust the control to the cw stop. The meter reading will normally change by ± 2 dB (> 4 dB from stop to stop). The ac voltage at TP4 will change from the nominal setting to approximately -35% (ccw stop) and $+70\%$ (cw stop).

Synchronous Detector

The phase change of the 220 Hz signal between the power sensor's sampling gate and the synchronous detector cannot be measured directly because the detector output is dc rather than ac. However, the phase difference at TP4 (the input to the detector circuit) can be measured. Because the phase change between TP4 and the detector is known, the phase relationship between the drive signal (TP7) and the TP4 signal indicates the total phase shift through the ac amplifiers. This is the step-by-step procedure for checking phase shift.

- a. Set the power meter and (if used) the range calibrator controls as shown in the general troubleshooting information above.
- b. Connect the oscilloscope's vertical inputs to the 220 Hz drive (TP7) through a divide-by-ten probe (Channel B) and to TP4 through a one-to-one probe (Channel A).
- c. Set the oscilloscope controls as follows: Channel A sensitivity to 0.05V/division with ac coupling, Channel B sensitivity to 0.2V/division, horizontal sweep to 0.5 ms/division and the display mode to Channel A and B, chopped with triggering from B.
- d. Adjust the vertical position controls until both traces are symmetrical with respect to the horizontal center line (see the typical waveform below).
- e. Set the time base magnifier control to $\times 10$. The horizontal scale is now 50 μs /division (see the expanded waveform below).
- f. Set the power meter's rear panel POWER REF switch to OFF or set the range calibrator's FUNCTION switch to STANDBY. With the oscilloscope's Channel A position control, set the trace representing a zero input at TP4 to the grid horizontal center line.
- g. Set the power meter's POWER REF switch to (ON) or set the range calibrator's FUNCTION switch to CALIBRATE. The zero crossing of the Channel A (TP4) trace should lag the drive signal by 150 $\pm 75\mu\text{s}$.

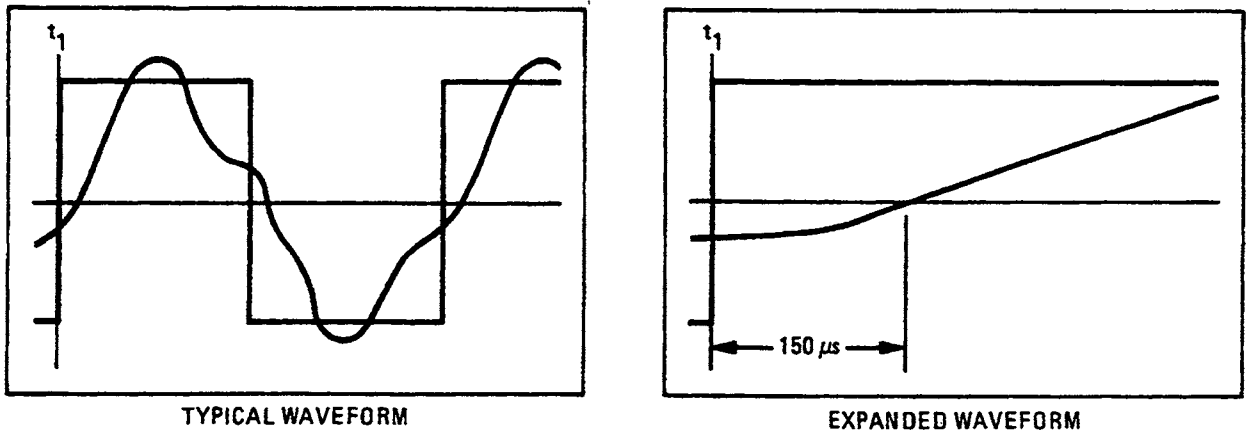

Figure 8-7. Multivibrator/Dectector Waveforms

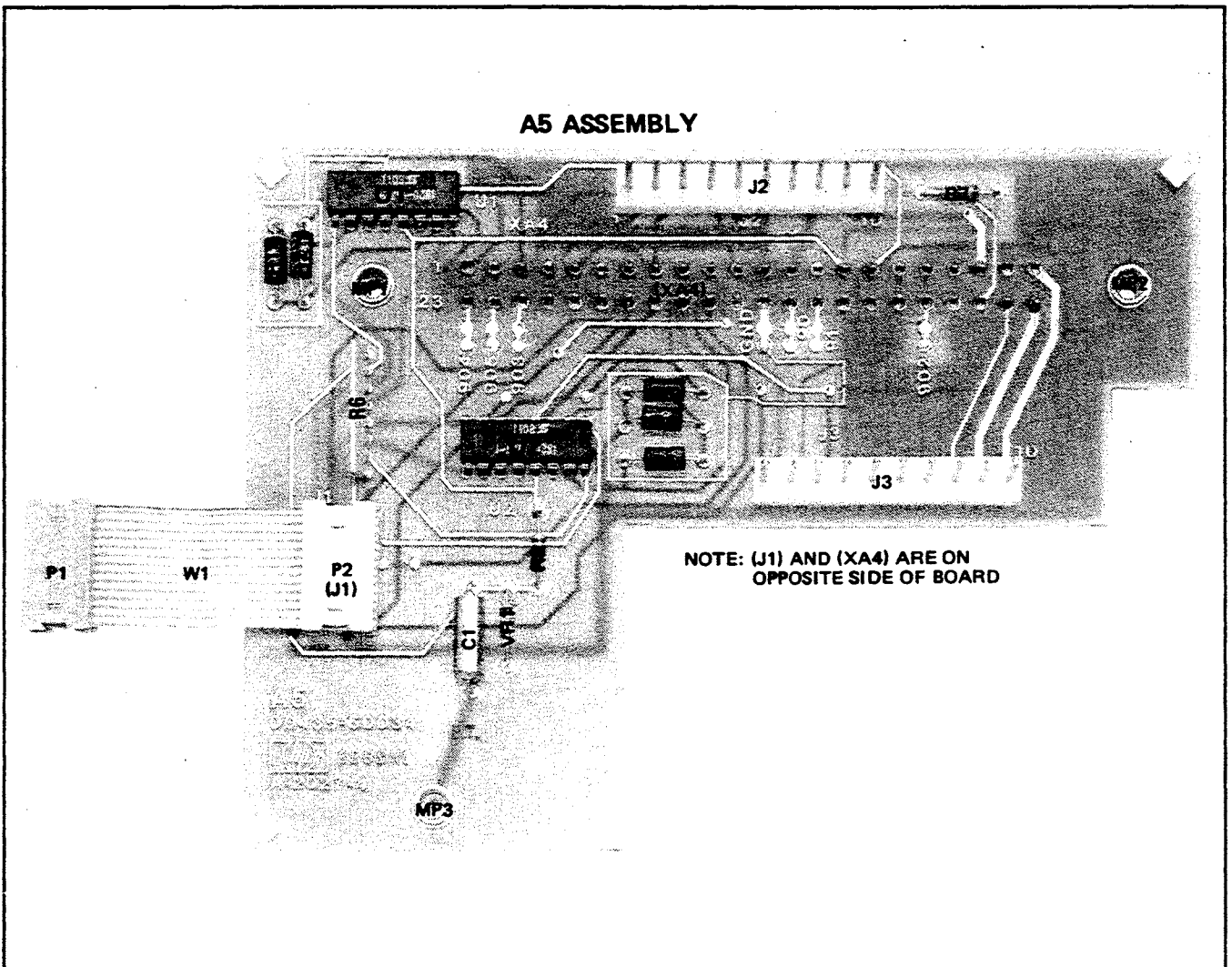

Figure 8-8. A5 Mother Board Component Locations



Service Sheet 3

Principles of Operation

General

The input from the synchronous detector passes through a low pass filter before it is amplified by the dc amplifier. The output drives the meter, the servo amplifier, and may also be coupled through the RECORDER OUTPUT jack to drive an external device such as an x-y recorder. The gain of the dc amplifier is set by the CAL FACTOR switch.

The servo amplifier generates an error voltage if the dc amplifier output is not ground potential. Without an RF input coupled to the power sensor, the dc amplifier output is very close to 0 Vdc. When the **ZERO** switch is pressed, the servo amplifier error offset voltage is coupled to the auto zero circuits. The error voltage is processed, attenuated and coupled across the power sensor's power sensing device output as a zeroing correction voltage. This correction voltage is of equal dc level but opposite polarity to the output of the power sensing device (no RF input). With the corrected input voltage, the dc amplifier output is exactly zero. When the **ZERO** switch is released, the servo amplifier output voltage is stored within the auto zero circuits and the correction voltage remains coupled across the output of the power sensing device. (See the auto zero feedback diagram that follows.)

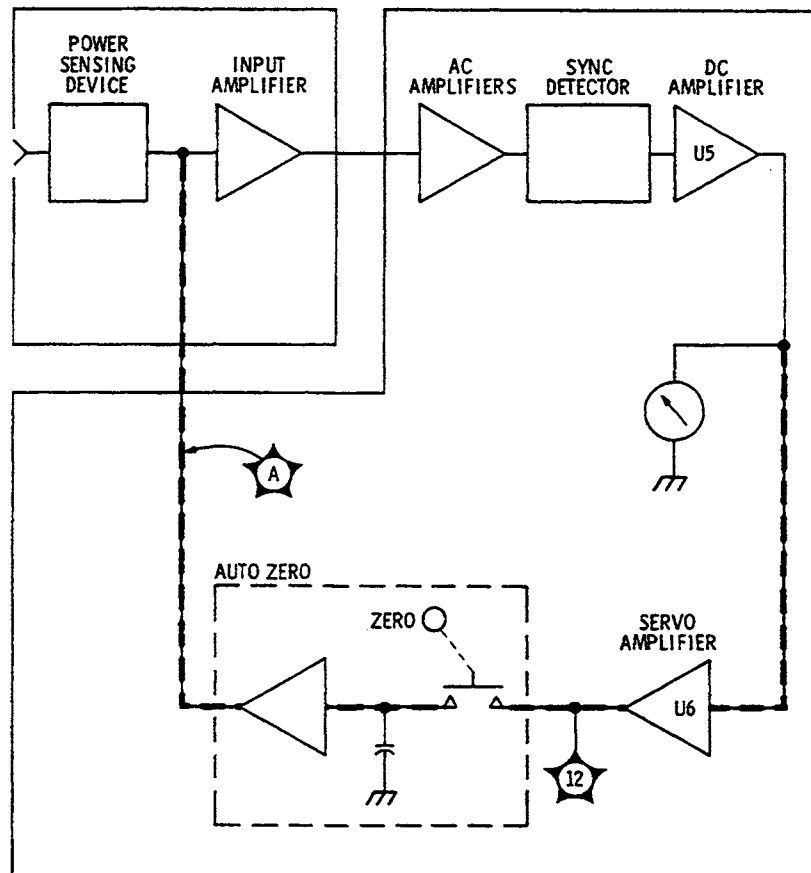

Auto Zero Feedback Path

DC Amplifier

The input to the dc amplifier is filtered by a two-stage low pass filter: A4R29 and C17, and R30 and C18. On the three most sensitive ranges additional filtering is introduced by components which are mounted on the A1 Switch Assembly.

The dc offset control A4R32 is set to eliminate any dc offset voltage introduced by the dc amplifier. The gain of the dc amplifier is controlled by A4R38, A4R33 and A1R1-15. The gain is variable from approximately 5.3 to 6.2 in 15 one-percent steps as determined by the CAL FACTOR switch. The CAL FACTOR switch setting is dependent on the frequency response of the power sensing device. (See the chart on the power sensor case).

The dc amplifier drives the meter, servo amplifier and an external instrument through the rear panel RECORDER OUTPUT jack. The meter control, A4R35, is used to calibrate the meter with a known input. Thermistor A4RT1 compensates for changes in sensitivity of the meter due to temperature. Diodes CR11 and CR12 at the output of the dc amplifier, U5, prevent the meter needle from being damaged if excess power is applied to the meter.

Servo Amplifier

The dc amplifier output is coupled to A4R39, the servo amplifier input. Because of the high dc gain ($\cong 7000$), a small dc output from the dc amplifier U5, produces a large error voltage at the servo amplifier U6 output. When the **ZERO** switch is pressed, this error voltage is coupled to the auto zero circuit.

Capacitor A4C21 with R43 gives the servo amplifier the characteristics of a low pass filter. The auto zero offset control A4R42 is set to remove any dc offset voltage introduced by the servo amplifier.

Auto Zero Circuit

When the front panel **ZERO** switch S2 is pressed, A4Q17 is turned on, the collector voltage goes positive which places a dc voltage across relays A4K1 and A4A1K1. The RF BLANKING OUTPUT is now coupled to ground by A4K1 and the servo amplifier error voltage is coupled to A4A1Q1 and A4A1C1 by A4A1K1.

The error voltage from the servo amplifier biases Q1 which produces an equivalent error voltage at Q1 source. This voltage is attenuated by A4A1R2, A4A1R4 and A4R74. The voltage is further attenuated in the power sensor and is coupled across the ambient temperature dc output of the power sensing device as a correction voltage. The algebraic sum of the dc voltages is amplified and coupled back to the auto zero input. Because the feedback loop is a negative path, the correction voltage across the power sensing device output begins to change and continues to do so until it is the same level but opposite polarity as the power sensing device output. The input to the power meter circuits goes to zero which means the dc amplifier output is also zero. When the **ZERO** switch is released, relay A4A1K1 opens and the final servo amplifier error voltage is stored on A4A1C1 at the high impedance input to A4A1Q1. The correction voltage across the power sensing device remains constant as long as the error voltage remains on C1.

Diodes A4CR4 and A4A1CR1 reduce voltage spikes caused by switching the relays. A4R69 also reduces switching transients in the feedback path.

The voltage which appears at the source of A4A1Q1 is coupled to A4U6 pin 2 through A4R44, C20 and C19. This voltage tends to keep the servo amplifier output constant when the **ZERO** switch is first pressed. It damps the violent change which tries to occur because of the high gain of the servo amplifier, so the initial change occurs slowly.

A4A1R1 establishes an RC time constant (1 s) with A4A1C1 which averages out the thermal noise during the zeroing operation.

The special construction of the A4A1 assembly and the high gate impedance of A4A1Q1 reduce leakage from A4A1C1 and thus increases the correction voltage storage time.

A4A1R2, R3, R4, C2, C3 and C4 are part of a frequency response network which keeps the auto zero feedback loop from oscillating during the zeroing sequence.

A4R46, R45 and A4A1R4 form a voltage divider. The balance control A4R46 removes the dc offset introduced by the auto zero circuit so its effective range is centered at 0 Vdc.

Troubleshooting

General

Before attempting to troubleshoot these circuits, verify that the power supply is operating properly. The voltage on TP9 should be +12 Vdc; on TP10, -12 Vdc.

If the dc offset controls A4R32, R42 or R46 are incorrectly adjusted, the auto zero circuits may not respond properly. See the adjustment procedures in Chapter 5.

Noise problems may be due to defective components in the low pass filter (especially the three most sensitive ranges) or the servo amplifier which is an active low pass filter. A noise problem in the servo amplifier will be evident only during the zeroing sequence.

DC Amplifier and Servo Amplifier

Measure the dc input and output voltages. Verify that the amplifier outputs respond properly to the inputs. For troubleshooting operational amplifiers see "General Service Information" in Chapter 8. A servo amplifier problem will be evident only during the zeroing sequence.

Auto Zero Assembly

The normal value range of the offset error voltage at TPA is -14 to +14 mVdc. The power sensing device normally exhibits a slightly positive output due to ambient temperature, so the normal correction voltage is slightly negative. At ambient temperature it is about -4 mVdc.

The voltage measured at TPB will provide an indication of how long the charge is retained on A4A1C1. The voltage should remain virtually unchanged (± 1 mVdc) for 24 hours.

If any component on the A4A1 assembly is found to be defective, the entire assembly must be replaced.

A1 SWITCH ASSEMBLY

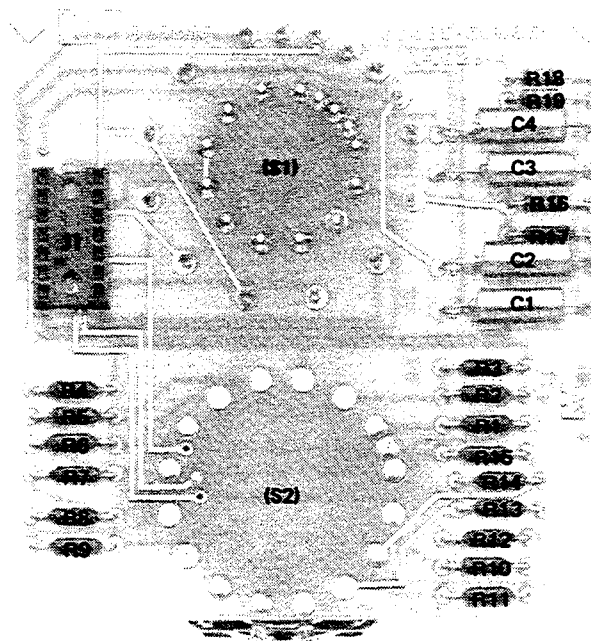

NOTE: (S1) AND (S2) ARE ON
OPPOSITE OF BOARD

Figure 8-11. A1 Switch Assembly Component Locations

-32 This Page Intentionally Left Blank

Service Sheet 4

Principles of Operation

General

Power sources for the power meter are line (Mains) power or the rechargeable battery. If the battery is being used as a power source, it will receive a charging current any time the line voltage is coupled to the instrument and the LINE switch is set to ON. When the line voltage is disconnected, the battery automatically becomes the power source.

Caution



A voltmeter or oscilloscope that is used to measure the 24 V output across the +12 V terminals must have a floating ground input.

The 12 V shunt regulator establishes a reference ground at the half voltage point of the 24 V series regulator output and thus establishes the +12 and -12 Vdc outputs with respect to ground.

Over Voltage Protection Circuit

The over voltage protection circuit consists of capacitor C39, thyristor Q20, resistors R81 and R82, and zener diode VR6. The function of this circuit is to prevent component damage in the power supply due to power line transients, wrong voltages being applied to the power module (A6) or the shorting of Q13's collector to ground.

24 V Series Regulator

Note



The explanation of the 24 V series regulator is based on the assumption that TP9 is the reference ground and the regulator output is -24 Vdc at TP10.

A reference voltage of -12 Vdc is established on the base of Q11 by VR4. Because Q10 and Q11 are a differential amplifier pair a difference in voltage between the base of Q11 and the base of Q10, half the 24 V output (refer to the note above), produces an error output on the collector of Q11. This error voltage is coupled to Q16, the regulator driver, and from there to Q13, the series regulator. If, for example, the output voltage suddenly decreased to -23 volts, the current through Q11 would increase and the collector voltage would become less negative. Current flow through Q16 increases and the collector voltage goes more negative. The emitter voltage of Q13 follows the collector voltage of Q16 and approaches -24 V. As the output voltage becomes more negative, the Q10 base voltage also becomes more negative until it equals the base voltage of Q11. At this instant, the output voltage is -24 Vdc and the circuit action (voltage change) ceases.

Regulating action of the 24 V supply is started by CR9, R58 and R60. When the LINE switch is set to ON, current begins to flow through

R60 and VR4. As the voltage increases across VR4, current begins to flow through Q11 which biases Q13 and Q16 on. The regulator output begins to increase in a negative direction. The output voltage biases CR9 which, in turn, causes the voltage across VR4 to increase. The resulting rapid increase in voltage on the base of Q11 keeps it ahead of that on the base of Q10. When the Q11 base voltage stabilizes at -12 Vdc, the lower voltage on Q10 keeps the output level increasing until it approaches -24 Vdc. At this point the base voltages of Q10 and Q11 become equal, the differential amplifier's error output goes to zero, and the output is stabilized at -24 V.

C25 and R61 form a low pass filter which reduces the high gain of the circuit at high frequencies and prevents unwanted oscillations. R59 and C24 form a noise filter for the zener diode.

The input voltage to the 24 V regulator may be as high as 70 Vdc from the line voltage or as low as 26 Vdc from the battery.

12 V Shunt Regulator

U7 is connected as a voltage follower circuit. Chassis ground is coupled to the inverting input of U7 and the non-inverting input is coupled across half the 24 V series regulator output by a voltage divider R63 and R64. If the voltage input to pin 3 tries to shift toward $+12$ or -12 Vdc, the output from U7 would bring the voltage at U7 pin 3 back to ground potential.

Battery Test

Note



The battery test circuit is in operation any time the LINE switch is set to ON. The only time the meter indication is meaningful however, is when the battery is supplying power.

When the battery is supplying power for the power meter circuits, and the battery is defective or discharged, the battery test circuit removes the positive ($+12$ Vdc) supply voltage from the DC Amplifier (A4U5). This causes a full downscale meter indication.

The test circuit measures a percentage of the voltage difference between the -12 V output and the negative battery terminal. As this voltage difference decreases to approximately 3 Vdc, Q14 begins to turn off. The collector voltage begins to go positive and the change is transmitted through R51 and VR5 to Q18. As Q18 begins to turn off, its collector goes more negative. A negative going transient is coupled through R55 to the base of Q14 which speeds up the turn-off time. The positive supply voltage is removed from the collector of Q18 and also the dc amplifier. As the battery voltage is further reduced, the series regulated output begins to decrease faster than the battery voltage and, eventually, the three volt threshold voltage is exceeded. Q14 is then biased on, but, because the battery voltage is less than 20 Vdc, the knee voltage of VR5 cannot be reached. Therefore, VR5 does not conduct and Q18 remains biased off.

Battery Charger

If a battery has been placed in the power meter as a secondary power source, it is being charged whenever the line voltage is coupled to the instrument and the LINE switch is ON. With ac line (Mains) power supplying energy, VR3 is turned on, which biases Q12 for a charging current of approximately 90 mA. This current is supplied through CR6 to the battery BT1. CR7 is reverse biased while the battery is being charged.

When the line voltage is removed, CR7 is forward biased by the current flowing to the power meter circuits from the battery. CR6 is turned off and no current flows through the charging circuit.

Current Limiter

If the current flow through the 24 V regulator were to suddenly increase to approximately 90 mA, Q15 would turn on and draw the drive current away from Q16. Consequently, the current flow to Q13 would disappear and the regulator output would be reduced.

Troubleshooting

Set the LINE switch to OFF and remove A4P1 (red wire) from A4J1 and A4P2 (blue wire) from A4J2. This disconnects the load from the power supply. If the supply voltages are now correct, the malfunction is not in the power supply.

If, after removing the load, the output voltages measured are less than normal but of equal and opposite polarity, the malfunction is probably in the series regulator circuits.

Voltages shown in parenthesis are for battery operation only.



Service Sheet 5

Principles of Operation

General

The A3 assembly provides a 50 ± 5 MHz output at $1 \text{ mW} \pm 0.7\%$. The oscillator output is held constant by an ALC loop made up of a peak detector CR2 and comparator U2. The comparator reference input is from a very stable +5V power supply composed of U1, VR1, VR2, Q2, and their associated components. The LEVEL ADJ control R4 sets the comparator reference which controls the oscillator feedback level, thereby controlling the A3 assembly POWER REFERENCE OUTPUT level.

50 MHz Oscillator

The oscillator circuit is made up of common emitter amplifier Q1 and its associated components. Resistors R10, R11, R12 and R13 bias Q1 for an emitter current of approximately 5 mA. The π -network tuned circuit (C9, L2, C10 and C11) determines the operating frequency. The amplifier ac gain is set by the operating circuit impedance across the tuned circuit and the emitter resistor R15 (which is ac coupled to ground by C12). The positive feedback required to sustain oscillation is satisfied in this circuit. Phase shift of 180° is a characteristic of both common-emitter transistor amplifiers and π -network tuned circuits. This feedback is coupled through C9 and C10, back to the base of Q1.

ALC Loop

At the positive peak of each cycle, current momentarily flows from the feedback loop through peak detector diode CR2 to C7. The resultant stored charge is coupled, as a dc input voltage, to pin 3 of U2. The detector output is compared to a very stable reference input by comparator U2. Any difference between the comparator's input voltages produces an error voltage at the dc output. The comparator output is coupled to a reactance voltage divider, capacitor C9 and varactor CR3. As the error output voltage goes more positive the capacitive reactance of CR3 decreases, which reduces the oscillator feedback. Conversely, a more negative output voltage will increase the feedback. For example, if the oscillator output were to suddenly increase, the detector output would become more positive. The comparator output would become more positive, a lower CR3 reactance would decrease the feedback to Q1 which forces the oscillator output level back to its original level. If the R4 LEVEL ADJ control were adjusted for a more positive reference voltage, the comparator output would go more negative, the feedback would increase, allowing the oscillator output to increase. Therefore, the peak detector output would increase until it equaled the comparator reference level input. This would establish a higher leveled-output signal from the oscillator. Frequency shaping components R8, R10, R11 and C8 determine the upper limit of frequency response of the ALC loop which prevents spurious oscillations.

+5V Power Supply

A3VR2 provides a reference voltage of -6.2 Vdc to the power supply reference amplifier A3U1. The gain of the reference amplifier is set by R3, R4 and R5 and is approximately -0.8 with R4 centered. The very stable output is coupled through CR1 as the reference voltage input to comparator U2. Diode CR1 temperature compensates CR2.

Troubleshooting

General

Before trying to troubleshoot the A3 assembly, verify the presence of $+12$ Vdc and -12 Vdc on the circuit board.

If a defect in the A3 assembly is isolated and repaired, the correct output level (1 mW $\pm 0.7\%$) must be set by a very accurate power measurement system. Hewlett-Packard employs a special system, accurate to $\pm 0.5\%$ and traceable to the National Bureau of Standards. When setting the power level, a transfer error of $\pm 0.2\%$ is introduced making the total error $\pm 0.7\%$. If a system this accurate is available it may be used to set the proper output level. Otherwise, Hewlett-Packard recommends returning the power meter so it can be reset at the factory. Contact your nearest Hewlett-Packard office for more information.

50 MHz Oscillator

Malfunctions of the oscillator circuits will occur as a wrong output frequency or as an abnormal output level. The voltage at TP2 will indicate if the ALC loop is trying to compensate for an incorrect output level.

Modulation of the 50 MHz signal or spurious signals, which are part of the output, may be caused by defects in R8, R10, R11 or C8 in the ALC loop.

ALC Loop and Power Supply

Problems in the ALC loop and power supply circuits may be quickly isolated by measuring dc voltages at the inputs and outputs of the integrated circuits. For more information on troubleshooting integrated circuits, see "General Service Information" in Chapter 8.

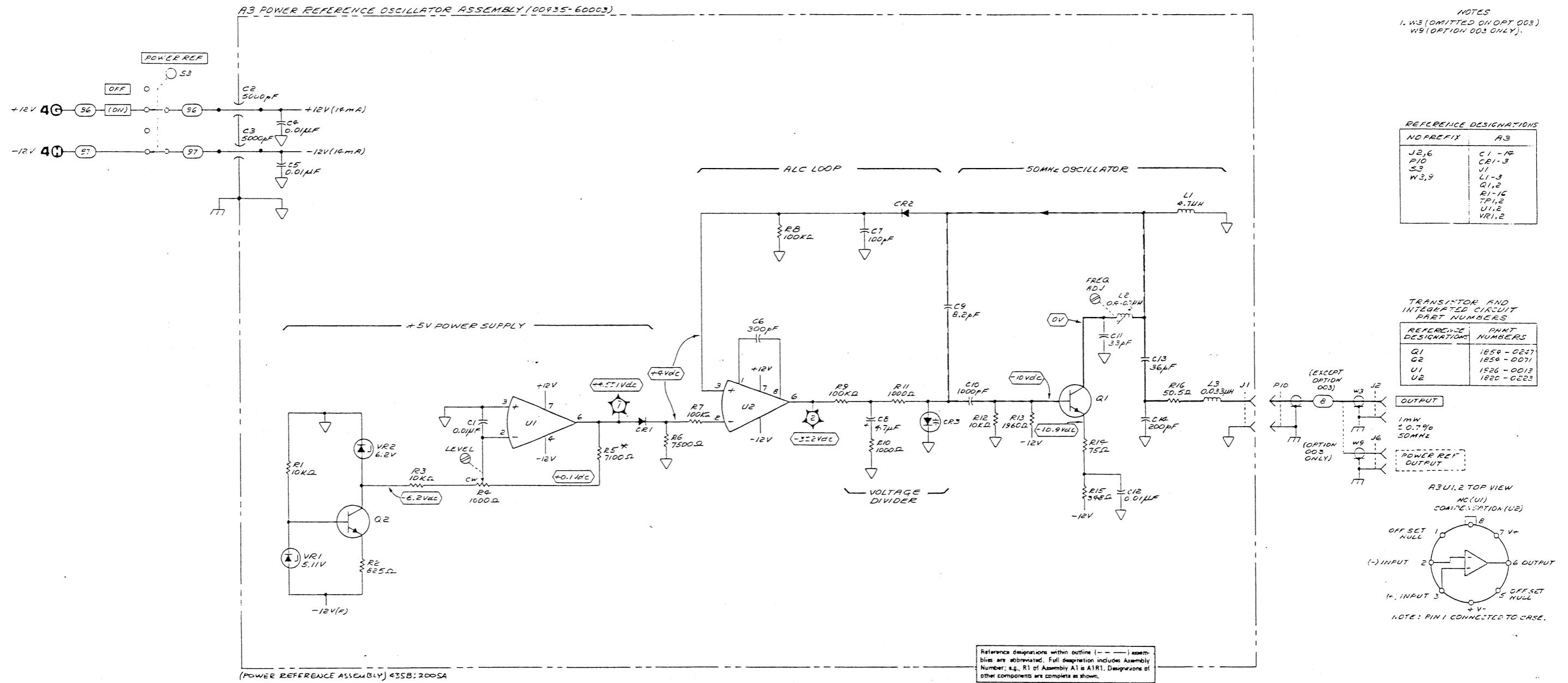
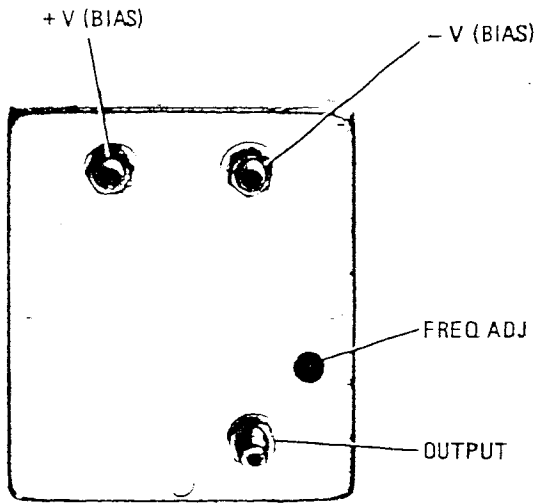
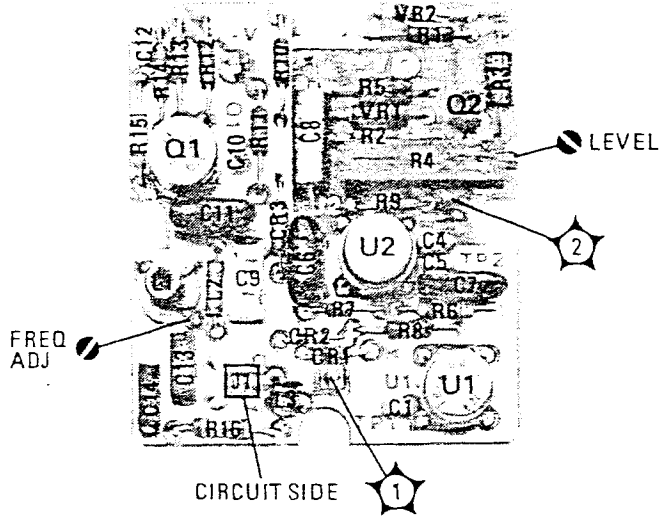
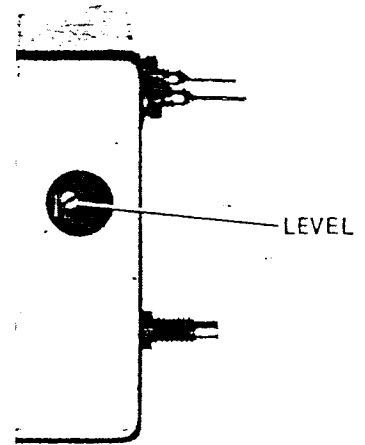

Figure 8-17. A3 Power Reference Assembly Schematic Diagram
 8-43/8-44

A3 ASSEMBLY



A3 REFERENCE OSCILLATOR COVER
(FRONT VIEW)



A3 REFERENCE OSCILLATOR COVER
(SIDE VIEW)

Figure 8-16. A3 Power Reference Assembly Component Locations

Table 8-2. Assembly, Chassis and Adjustable Components Locations

Assembly or Component Reference Designator	Service Sheet	Figure	Remarks
A1 Assembly	2, 3	8-11, 18	8-18 Bottom View
A3 Assembly	5	8-16, 18	
A3R4 LEVEL ADJ	5	8-18	8-18 Top View
A4 Assembly	2, 3, 4	8-9, 12, 14, 18	
A4R32 DC OFFSET	3	8-12, 18	8-18 Right Side View
A4R35 METER	3	8-12, 18	8-18 Right Side View
A4R42 AUTO ZERO OFFSET	3	8-12, 18	8-18 Right Side View
A4R46 BALANCE	3	8-12, 18	8-18 Right Side View
A4R76 220 Hz	2	8-9, 18	8-18 Right Side View
A4A1	3	8-12, 18	8-18 Right Side View
A5 Assembly	2, 3, 4	8-8, 18	8-18 Bottom View
A5XA4	2, 3, 4	8-18	8-18 Left Side View
A6 Assembly	4	8-18	8-18 Top View
C1	4	8-18	8-18 Bottom View
F1	4	8-18	8-18 Rear Panel View
J1	2	8-18	8-18 Front Panel View
J2	5	8-18	8-18 Front Panel View
J3	3	8-18	8-18 Rear Panel View
J4	3	8-18	8-18 Rear Panel View
J5	2	8-18	8-18 Rear Panel View (Options 002 and 003 only)
J6	5	8-18	8-18 Rear Panel View (Option 003 only)
M1	3	8-18	8-18 Front Panel View
P2	2, 3, 4	8-18	8-18 Bottom View
P3	3, 4	8-18	8-18 Bottom View
P10	5	8-18	8-18 Top View
R1 CAL FACTOR ADJ 2	8-18		8-18 Front Panel View
R2	4	—	Connected to S1 inside safety cover
S1 LINE	4	8-18	8-18 Front Panel View
S2 ZERO	3	8-18	8-18 Front Panel View
S3 POWER REF	5	8-18	8-18 Rear Panel View

Table 8-2. Assembly, Chassis and Adjustable Components Locations (continued)

Assembly or Component Reference Designator	Service Sheet	Figure	Remarks
T1	4	8-18	8-18 Bottom View
W1	2	8-18	Cable connecting J1 to A5 Assembly
W2	4	8-18	Cable connecting S1 to power module
W3	5	8-18	Cable connecting J2 to A3 Assembly
W4	2	—	Power sensor cable
W5	4	—	Line (Mains) power cable
W6	2	—	Cable connecting J5 to A5 Assembly (Options 002 and 003 only)
W9	5	—	Cable connecting J6 to A3 Assembly (Option 003 only)

FRONT PANEL VIEW

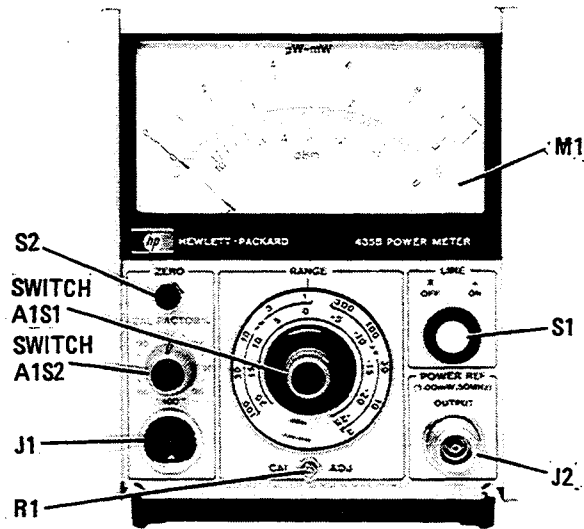

REAR PANEL VIEW

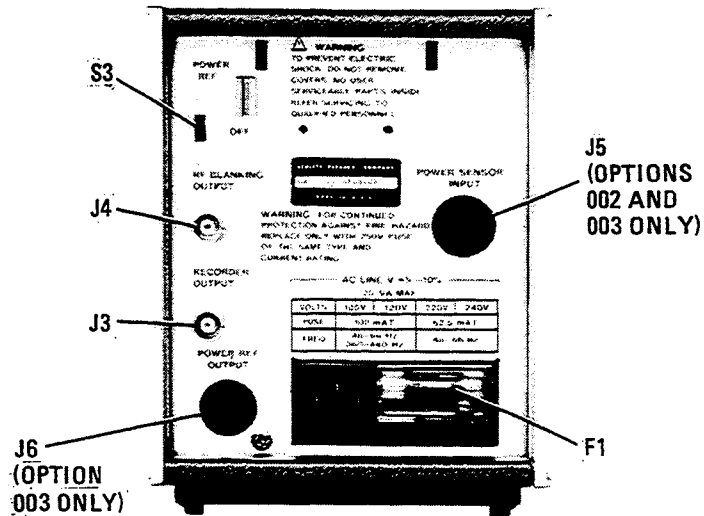
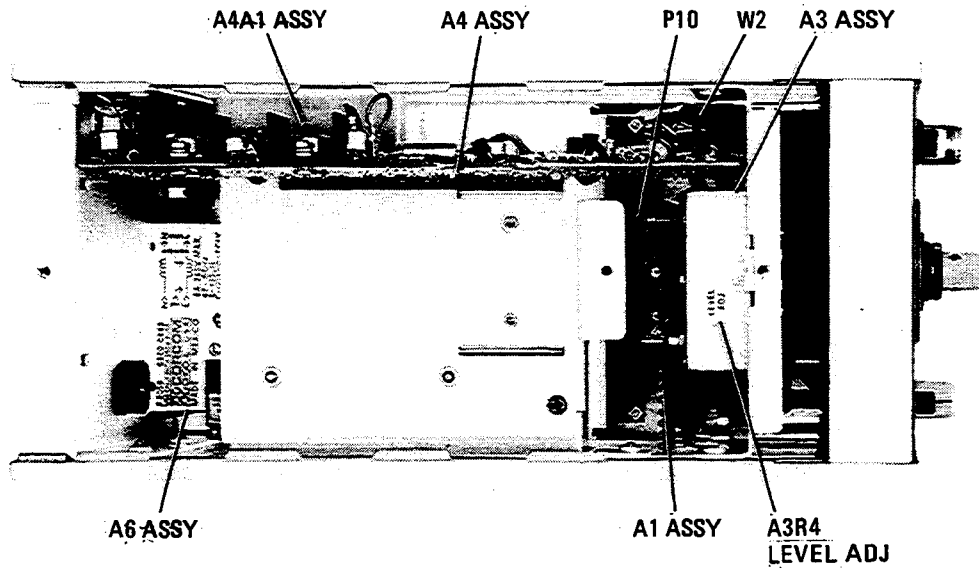

Figure 8-18. HP 435B Front and Rear Panel Views

TOP VIEW



BOTTOM VIEW

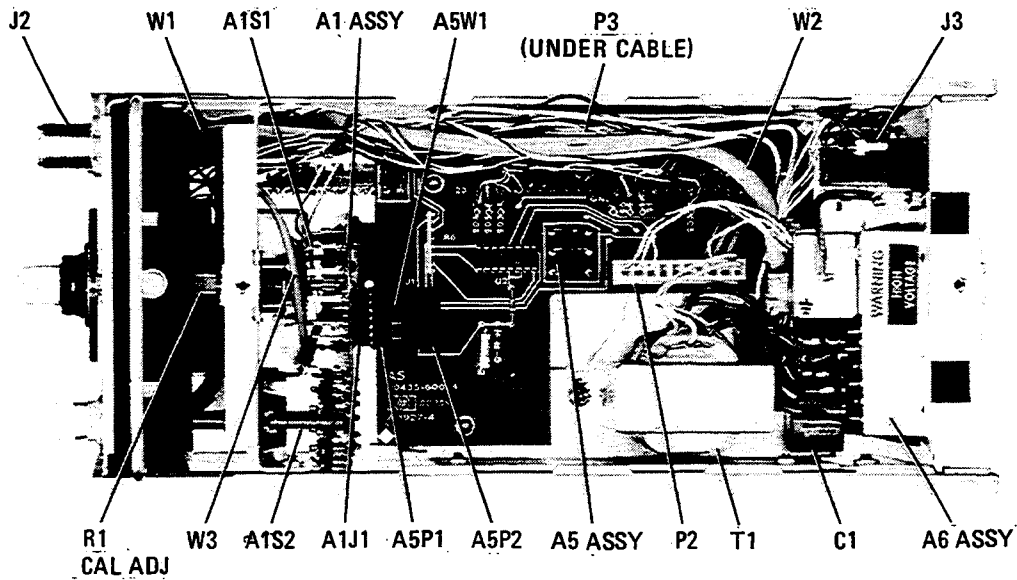

Figure 8-19. HP 435B Top and Bottom Views

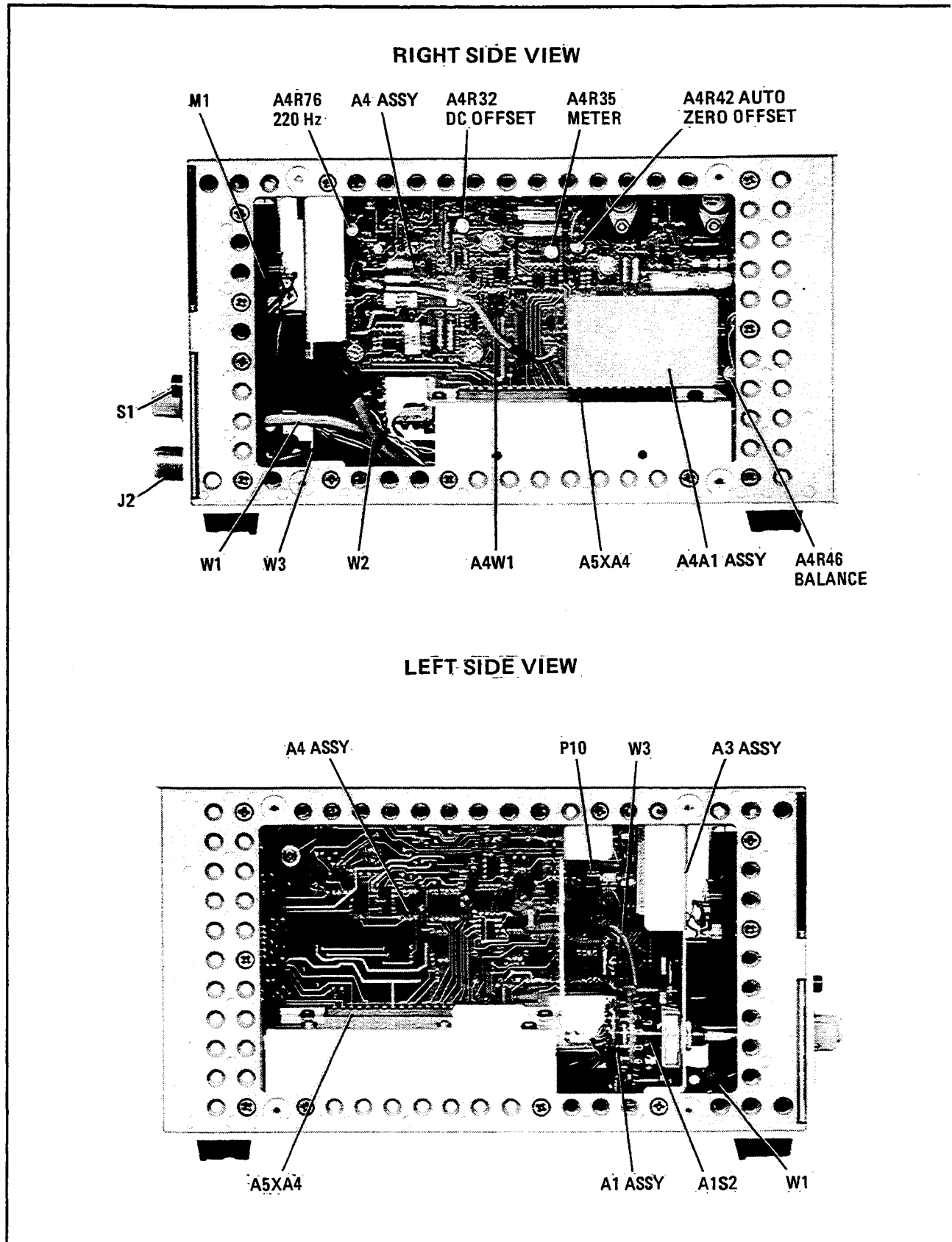

Figure 8-20. HP 435B Right and Left Side Views

REGIONAL SALES AND SUPPORT OFFICES

For information relating to Sales or Support of Hewlett-Packard products, first contact your local Hewlett-Packard office listed in the white pages of your telephone directory. If none is listed locally, contact Hewlett-Packard at one of the offices listed below to obtain the address or phone number of the Sales or Support office nearest you.

The format for telephone numbers is listed as: (country code/area code or city code) local number. For example, at European Operations HQ, the main site number is listed as: (41/22)780.8111; 41 is the country code, 22 is the city code, and 780.8111 is the local number.

EUROPEAN MULTICOUNTRY

(Scandinavia, Middle East,
Africa, Eastern Europe)

Hewlett-Packard S.A.
150, route du Nant-d'Avril
P.O. Box 1217 Meyrin
2/Geneva
Switzerland
Tel: (41/22)780.8111
Fax: (41/22)780.8609

FRANCE

Hewlett-Packard France
Parc d'Activite du Bois Briard
2, avenue du Lac
91040 Evry Ce'dex
France
Tel: (33/1)69 91 80 00
Fax: (33/1)69 91 84 32

GERMANY

Hewlett-Packard GmbH
Herrenberger Strasse 130
D-7030 Boblingen
West Germany
Tel: (49/7031)14-0
Fax: (49/7031)14-2999

ITALY

Hewlett-Packard Italiana
S.p.A.
Via Giuseppe di Vittorio, 9
20063 Cernusco sul Naviglio,
Milan
Italy
Tel: (39/2)921 001
Fax: (39/2)921 044 73

UNITED KINGDOM

Hewlett-Packard Ltd.
Nine Mile Ride
Wokingham, Berkshire RG11
3LL
England
Tel: (44/344)773100
Fax: (44/344)763526

AUSTRALASIA REGION

Hewlett-Packard Australia Ltd.
31-41 Joseph Street
Blackburn, Victoria 3130
Australia
Tel: (61/3)895-2895
Fax: (61/3)898-7831

CANADA

Hewlett-Packard (Canada)
Ltd.
6877 Goreway Drive
Mississauga, Ontario L4V 1M8
Canada
Tel: (1/416)678-9430
Fax: (1/416)678-9421

FAR EAST REGION

Hewlett-Packard Asia Ltd.
22nd Floor
West Tower, Bond Centre
89 Queensway, Central
Hong Kong
Tel: (852)848-7777
Fax: (852)868-4997

JAPAN

Yokogawa-Hewlett-Packard
Ltd.
3-29-21, Takaido-Higashi
Suginami-Ku, Tokyo 168
Japan
Tel: (81/3)331-6111
Fax: (81/3)331-6631

LATIN AMERICA REGION

HP Mexico, S.A. de C.V.
Monte Pelvoux No. 111
Fracc. Lomas de Virreyes
11000 Distrito Federal
Mexico
Tel: (52/5)202 01 55
Fax: (52/5)540 42 08

EASTERN U.S.A. REGION

Hewlett-Packard Company
4 Choke Cherry Road
Rockville, MD 20850, USA
Tel: (1/301)670-4300
Fax: (1/301)670-4531

MIDWEST U.S.A. REGION

Hewlett-Packard Company
5201 Tollview Drive
Rolling Meadows, IL 60008,
USA
Tel: (1/708)255-9800
Fax: (1/708)259-4995

SOUTHERN U.S.A. REGION

Hewlett-Packard Company
2015 South Park Place
Atlanta, GA 30339, USA
Tel: (1/404)955-1500
Fax: (1/404)980-7669

WESTERN U.S.A. REGION

Hewlett-Packard Company
5161 Lankershim Blvd.
N. Hollywood, CA 91601-
3794,
USA
Tel: (1/818)505-5600
Fax: (1/818)505-5875

OTHER INTERNATIONAL AREAS

Hewlett-Packard Company
3495 Deer Creek Road
Palo Alto, CA 94304-1316,
USA
Tel: (1/415)857-5027
Fax: (1/415)857-7045

1990