

---

HP 4284A PRECISION LCR METER  
**OPERATION MANUAL**

(Including Option 001, 002, 006, 201, 202, 301)

**SERIAL NUMBERS**

This manual applies directly to instruments with the serial number prefix of 2940J02283,02285 and above, and whose ROM-based firmware is version 01.20. For additional important information about serial numbers, read "Serial Number" in Chapter 9 of this Operation Manual.



HP Part No. 04284-90040  
Printed in JAPAN August 1998

Sixth Edition

---

## Notice

The information contained in this document is subject to change without notice.

This document contains proprietary information which is protected by copyright. All rights are reserved. No part of this document may be photocopied, reproduced, or translated to another language without the prior written consent of the Hewlett-Packard Company.

Hewlett-Packard Japan, LTD.  
Kobe Instrument Division  
1-3-2, Murotani, Nishi-ku, Kobe-shi,  
Hyogo, 651-2241 Japan

© Copyright 1988,1991,1994,1996,1998 Hewlett-Packard Japan, LTD.

## CAUTIONS ON OPERATION

### 1. UNKNOWN (MEASUREMENT) TERMINALS

Do **NOT** apply DC voltage or current to the UNKNOWN terminals. Doing so will damage the HP 4284A. Before you measure a capacitor, be sure the capacitor is fully discharged.

### 2. MEMORY CARD

Use HP-specified memory cards containing 4284A-specific data only. If other memory cards are used, the HP 4284A may be damaged. Non 4284A-specific data contained on a memory card is not guaranteed, and data may be lost.

To insert a memory card into the MEMORY card slot, hold the memory card with the label facing upward and with the contacts at the slot opening. Insert the card into the slot until it "clicks" in place.

To remove a memory card from the HP 4284A, press the UNLOCK button and remove the card.

Do **NOT** remove a memory card while LOADING or STORING data. Doing so may damage the memory card and any data stored in the memory card may be lost.

Store memory cards in their furnished card cases when not in use. The card case protects memory cards from contamination and electrostatic discharge. Also, store memory cards under the following environmental conditions.

Storage Temperature Range: -30 °C to +70 °C

Storage Humidity Range: 30% to 85% (@ +50 °C)

Do **NOT** shock or stress memory cards.

When storing or moving your HP 4284A, be sure the memory card slot is empty (no memory card inserted).

Do **NOT** touch the connector contact surface of a memory card and do **NOT** use chemical liquids to clean the contacts.

### 3. HANDLER INTERFACE BOARD (OPTION 201)

If the +5V internal voltage (pin 16, 17 or 18 of the handler interface connector) is not output, a fuse on the handler interface board (A32F1) has blown and must be replaced. Two replacement fuses are furnished with the 4285A option 201. Additional fuses are available from Hewlett-Packard. Order PN 2110-0046.

To replace A32F1, perform the following procedure.

1. To remove the handler interface board (A32), perform procedure 1 through 7 on page 10-26.
2. Remove A32F1 (indicated in Figure A) from socket and carefully insert the new fuse.
3. Replace the handler interface board, top shield plate, rear feet, and top cover.

If the handler interface continues not to output +5V after A32F1 has been replaced, contact the nearest Hewlett-Packard office.

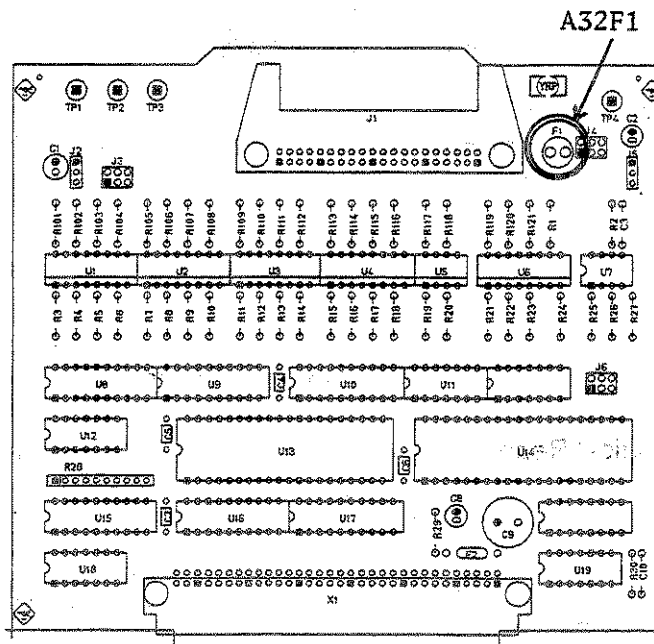

Figure A. Handler Interface Board

# DECLARATION OF CONFORMITY

according to ISO/IEC Guide 22 and EN 45014

**Manufacturer's Name:** Hewlett-Packard Japan, Ltd.

**Manufacturer's Address:** 1-3-2, Murotani, Nishi-ku, Kobe-shi, Hyogo, 651-22 Japan

**declares, that the product**

**Product Name:** Precision LCR Meter

**Model Number:** HP 4284A

**Product Options:** This declaration covers all options of the above product.

conforms with the protection requirements of European Council Directive 89/336/EEC on the approximation of the laws of the member states relating to electromagnetic compatibility. Against EMC test specifications EN 55011:1991 (Group 1, Class A) and EN 50082-1:1992.

**As detailed in:** Electromagnetic Compatibility (EMC)  
Technical Construction File (TCF)  
No. 96-3355-001-TCF

**Assessed by:** Dti Appointed Competent Body  
EMC Test Centre, GEC-Marconi Avionics Ltd.,  
Donibristle Industrial Park, Dunfermline, Fife KY11 5LB  
Scotland, United Kingdom

**Technical Report No.:** 4122/1300/CBC, dated 25,09,1996

## Supplementary Information:

The individual components of the product meet relevant international safety standards.  
IEC 1010-1:1990+A1 / EN 61010-1:1993

LEDs in this product are Class 1 in accordance with IEC 825-1.

The product herewith complies with the requirements of the Low Voltage Directive 73/23/EEC and the amending Directive 93/68/EEC.

Kobe, November 01, 1996

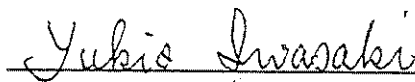

Yukio Iwasaki / Quality Manager

European Contact: Your local Hewlett-Packard Sales and Service Office or Hewlett-Packard GmbH, Department HQ-TRE, Herrenberger Straße 130, D-71034 Böblingen (FAX:+49-7031-14-3143)

---

## Herstellerbescheinigung

### GERÄUSCHEMISSION

LpA < 70 dB  
am Arbeitsplatz  
normaler Betrieb  
nach DIN 45635 T. 19

---

## Manufacturer's Declaration

### ACOUSTIC NOISE EMISSION

LpA < 70 dB  
operator position  
normal operation  
per ISO 7779

---

## Manual Printing History

The manual printing date and part number indicate its current edition. The printing date changes when a new edition is printed. (Minor corrections and updates which are incorporated at reprint do not cause the date to change.) The manual part number changes when extensive technical changes are incorporated.

December 1988 ..... First Edition  
April 1991 ..... Second Edition  
December 1991 ..... Third Edition  
March 1994 ..... Fourth Edition  
December 1996 ..... Fifth Edition  
August 1998 ..... Sixth Edition

---

## Safety Summary

The following general safety precautions must be observed during all phases of operation, service, and repair of this instrument. Failure to comply with these precautions or with specific *WARNINGS* elsewhere in this manual may impair the protection provided by the equipment. In addition it violates safety standards of design, manufacture, and intended use of the instrument.

*The Hewlett-Packard Company assumes no liability for the customer's failure to comply with these requirements.*

---

### Note



HP 4284A complies with INSTALLATION CATEGORY II and POLLUTION DEGREE 2 in IEC1010-1. HP 4284A is INDOOR USE product.

---

### Note



LEDs in this product are Class 1 in accordance with IEC825-1.  
**CLASS 1 LED PRODUCT**

---

## Ground The Instrument

To avoid electric shock hazard, the instrument chassis and cabinet must be connected to a safety earth ground by the supplied power cable with earth blade.

## DO NOT Operate In An Explosive Atmosphere

Do not operate the instrument in the presence of flammable gasses or fumes. Operation of any electrical instrument in such an environment constitutes a definite safety hazard.

## Keep Away From Live Circuits

Operating personnel must not remove instrument covers. Component replacement and internal adjustments must be made by qualified maintenance personnel. Do not replace components with the power cable connected. Under certain conditions, dangerous voltages may exist even with the power cable removed. To avoid injuries, always disconnect power and discharge circuits before touching them.

## DO NOT Service Or Adjust Alone

Do not attempt internal service or adjustment unless another person, capable of rendering first aid and resuscitation, is present.

## DO NOT Substitute Parts Or Modify Instrument

Because of the danger of introducing additional hazards, do not install substitute parts or perform unauthorized modifications to the instrument. Return the instrument to a Hewlett-Packard Sales and Service Office for service and repair to ensure that safety features are maintained.



## Dangerous Procedure Warnings

Warnings, such as the example below, precede potentially dangerous procedures throughout this manual. Instructions contained in the warnings must be followed.

### Warning



---

**Dangerous voltages, capable of causing death, are present in this instrument. Use extreme caution when handling, testing, and adjusting this instrument.**

---

### Safety Symbols

General definitions of safety symbols used on equipment or in manuals are listed below.



Instruction manual symbol: the product is marked with this symbol when it is necessary for the user to refer to the instruction manual.



Alternating current.



Direct current.



On (Supply).



Off (Supply).



In position of push-button switch.



Out position of push-button switch.



Frame (or chassis) terminal. A connection to the frame (chassis) of the equipment which normally include all exposed metal structures.

### Warning



This **Warning** sign denotes a hazard. It calls attention to a procedure, practice, condition or the like, which, if not correctly performed or adhered to, could result in injury or death to personnel.

### Caution



This **Caution** sign denotes a hazard. It calls attention to a procedure, practice, condition or the like, which, if not correctly performed or adhered to, could result in damage to or destruction of part or all of the product.

### Note



**Note** denotes important information. It calls attention to a procedure, practice, condition or the like, which is essential to highlight.



Affixed to product containing static sensitive devices use anti-static handling procedures to prevent electrostatic discharge damage to component.

---

## How To Use This Manual

This manual, the Operation Manual for the HP 4284A Precision LCR Meter, contains ten chapters plus appendixes, organized for the convenience of the first time user. After you receive your HP 4284A, begin with Chapter 1.

- |   |   |
|---|---|
| <b>Chapter 1<br/>Getting Started</b>                  | Chapter 1 provides unpacking, initial inspection, and preparation information necessary for you to know before you apply AC power.  |
| <b>Chapter 2<br/>Overview</b>                         | Chapter 2 provides information including a product overview and a tour of the front panel, which will help you to quickly learn how to operate the HP 4284A.                |
| <b>Chapter 3<br/>DISPLAY FORMAT</b>                   | Chapter 3 provides detailed information for the display format and measurement function, corresponding to <b>DISPLAY FORMAT</b> menu key.                                   |
| <b>Chapter 4<br/>MEAS SETUP</b>                       | Chapter 4 provides detailed information for the measurement condition setup, corresponding to <b>MEAS SETUP</b> menu key.   |
| <b>Chapter 5<br/>CATALOG/SYSTEM<br/>CONFIGURATION</b> | Chapter 5 provides detailed information for the internal/external memory and system configuration catalog of the HP 4284A, corresponding to <b>CATALOG/SYSTEM</b> menu key. |
| <b>Chapter 6<br/>Measurement Basics</b>               | Chapter 6 provides the basic measurement procedure with the general impedance theory and measurement techniques, and practical measurement examples.                        |
| <b>Chapter 7<br/>Remote Control</b>                   | Chapter 7 provides information to control the HP 4284A using the HP-IB interface.   |
| <b>Chapter 8<br/>Command Reference</b>                | Chapter 8 provides detailed information for each of the HP 4284A HP-IB commands.  |
| <b>Chapter 9<br/>General Information</b>              | Chapter 9 provides the specifications, rack mount/handle kit installation, and other general information on the HP 4284A.   |
| <b>Chapter 10<br/>Performance Test</b>                | Chapter 10 provides the performance tests for the HP 4284A used for incoming inspection and verification that your instrument is completely calibrated.                     |

HP 4284A  
Precision LCR Meter  
Operation Manual



HP 4284A  
Precision LCR Meter

Operation Manual

MANUAL IDENTIFICATION

Model Number: HP 4284A  
Date Printed: August 1998  
Part Number: 04284-90040

This supplement contains information for correcting manual errors and for adapting the manual to newer instruments that contains improvements or modifications not documented in the existing manual.

To use this supplement

1. Make all ERRATA corrections
2. Make all appropriate serial-number-related changes listed below

SERIAL PREFIX OR NUMBER CHANGES	MAKE MANUAL
ALL	1

◆ New Item

SERIAL PREFIX OR NUMBER CHANGES	MAKE MANUAL

ERRATA

CHANGES 1

CHANGE 1 contains the information needed to adapt the HP 4284A's manual.

MODEL 4284A PRECISION LCR METER OPTION 201 HANDLER INTERFACE  
OPERATION NOTE

Page 2-6 Signal Line Used for List Sweep Comparator Function.

Change the description as follows:

- Comparison Output Signals:  
/BIN1 - /BIN9 and /AUX\_BIN indicate IN/OUT judgements for each sweep point (refer to Figure 2-4). /OUT\_OF\_BINS indicates pass/fail judgement (one or more failed judgements of Steps 1 to 10 occurred during a single sweep)

NOTE

Manual change supplement are revised as often as necessary to keep manuals as current and accurate as possible. Hewlett-Packard recommends that you periodically request the latest edition of this supplement. Free copies are available from all HP offices. When requesting copies, quote the manual identification information from your supplement, or the model number and print date from the title page of the manual.

**Page 2-7 Table 2-2. Contact Assignments for List Sweep Comparator Function**

Change a part of the table 2-2 as follows:

Pin No.	Signal Name	Description
1	/BIN1	Failed (out of limit) at sweep Point 1
2	/BIN2	Failed (out of limit) at sweep Point 2
3	/BIN3	Failed (out of limit) at sweep Point 3
4	/BIN4	Failed (out of limit) at sweep Point 4
5	/BIN5	Failed (out of limit) at sweep Point 5
6	/BIN6	Failed (out of limit) at sweep Point 6
7	/BIN7	Failed (out of limit) at sweep Point 7
8	/BIN8	Failed (out of limit) at sweep Point 8
9	/BIN9	Failed (out of limit) at sweep Point 9
11	/AUX_BIN	Failed (out of limit) at sweep Point 10
10	/OUT_OF_BINS	/OUT_OF_BINS is asserted when one or more fail judgements of Step 1 to 10 occur in a single sweep.

**Page 2-8 Figure 2-4. Signal Area Example. (For The List Sweep Comparator Function)**

Change the figure as follows:

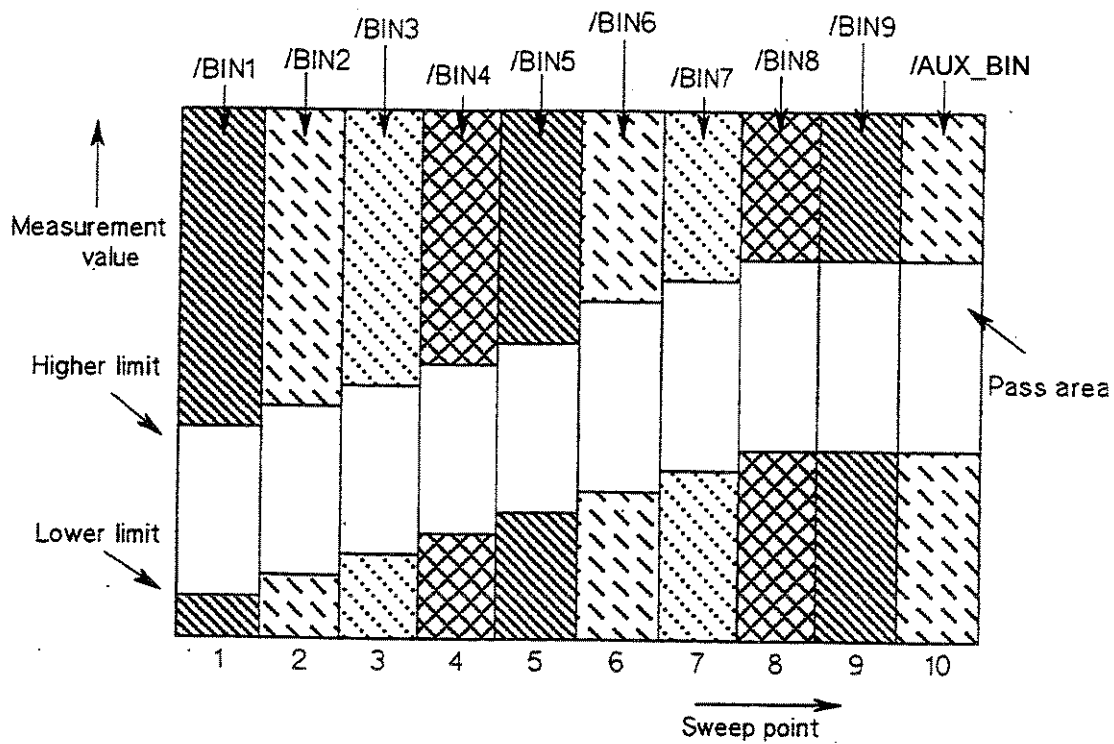

**HP 4284A  
Precision LCR Meter**

**Operation Manual**

**MANUAL IDENTIFICATION**

Model Number: HP 4284A  
Date Printed: December 1996  
Part Number: 04284-90020

This supplement contains information for correcting manual errors and for adapting the manual to newer instruments that contains improvements or modifications not documented in the existing manual.

To use this supplement

1. Make all ERRATA corrections
2. Make all appropriate serial-number-related changes listed below

SERIAL PREFIX OR NUMBER	MAKE MANUAL CHANGES
All	I

◆ New Item

SERIAL PREFIX OR NUMBER	MAKE MANUAL CHANGES

**ERRATA**

**CHANGES 1**

CHANGE 1 contains the information needed to adapt the HP 4284A's manual.

Changed the company name from YOKOGAWA-HEWLETT-PACKARD, LTD., or its abbreviation YHP to Hewlett-Packard Japan, Ltd.

**NOTE**

Manual change supplement are revised as often as necessary to keep manuals as current and accurate as possible. Hewlett-Packard recommends that you periodically request the latest edition of this supplement. Free copies are available from all HP offices. When requesting copies, quote the manual identification information from your supplement, or the model number and print date from the title page of the manual.



## The pink sheet titled "CAUTION ON OPERATION"

Change the page title as follows.



**CAUTION ON OPERATION**

### 3.HANDLER INTERFACE BOARD (OPTION 201)

Add the following information.

Fuse: Non Time Delay 0.5A 125V

If you need this fuse,contact your nearest Hewlett-Packard Sales and Service Office.

### Page 10-26 PROCEDURE: 1 and Warning

Change the procedure 1 and warning as follows:

1. Disconnect the power cable from the HP 4284A and allow 1 minute for the internal capacitors to discharge.

#### **WARNING**

**Dangerous energy/voltage exists when the HP 4284A is in operation,and for a time after it is powered down. Allow 1 minute for the internal capacitors to discharge.**

### Page 10-27

Add the following CAUTION after the procedure 7.

#### **CAUTION**

**The interface board contains electronic components that can be damaged by static electricity through electrostatic discharge(ESD).To prevent ESD damage,maintain frequent contact with any bare sheet metal surface on the chassis. A grounding wrist strap (or similar device) is useful for this purpose. Handle the board carefully at all times. Avoid touching electronic components or circuit paths.**

### Page 10-30

Add the following CAUTION after the procedure 3.

#### **CAUTION**

**The interface board contains electronic components that can be damaged by static electricity through electrostatic discharge(ESD).To prevent ESD damage,maintain frequent contact with any bare sheet metal surface on the chassis. A grounding wrist strap (or similar device) is useful for this purpose. Handle the board carefully at all times. Avoid touching electronic components or circuit paths.**



## Page 10-34

Add the following CAUTION after the procedure 3.

### CAUTION

The interface board contains electronic components that can be damaged by static electricity through electrostatic discharge(ESD).To prevent ESD damage,maintain frequent contact with any bare sheet metal surface on the chassis. A grounding wrist strap (or similar device) is useful for this purpose. Handle the board carefully at all times. Avoid touching electronic components or circuit paths.

## Page 10-35 PROCEDURE:8.

Change the procedure 8 as follows:

8.Replace the top shield plate,rear feet,and top cover. Turn the HP 4284A ON.

## Page 10-36 PROCEDURE:16.

Change the procedure 16 as follows:

16.Remove the top cover,top shield plate and expose the scanner interface board. Set SW1 and SW2 on the scanner interface board to their settings before this test.

## Page 10-37 PROCEDURE: 1 and Warning

Change the procedure 1 and warning as follows:

1. Disconnect the power cable from the HP 4284A and allow 1 minute for the internal capacitors to discharge.

### WARNING

Dangerous energy/voltage exists when the HP 4284A is in operation,and for a time after it is powered down. Allow 1 minute for the internal capacitors to discharge.

## Page E-1

Change the Write Protection Procedure 1 and warning as follows:

1. Turn the HP 4284A off and remove the power cord.Allow 1 minute for the internal capacitors to discharge.

Warning



---

Dangerous voltage may be present in the 4284A even through the power switch is off. Be sure to wait 1 minutes for the internal capacitors to discharge.

---

## MODEL 4284A PRECISION LCR METER OPTION 201 HANDLER INTERFACE OPERATION NOTE

### Page 2-16 Procedure 1 and Warning

Change the procedure 1 and warning as follows:

1. Disconnect the power cable from the HP 4284A and allow 1 minute for the internal capacitors to discharge.

#### **WARNING**

Dangerous energy/voltage exists when the HP 4284A is in operation, and for a time after it is powered down. Allow 1 minute for the internal capacitors to discharge.

### Page 2-17

Add the following CAUTION after the procedure 7.

#### **CAUTION**

The interface board contains electronic components that can be damaged by static electricity through electrostatic discharge (ESD). To prevent ESD damage, maintain frequent contact with any bare sheet metal surface on the chassis. A grounding wrist strap (or similar device) is useful for this purpose. Handle the board carefully at all times. Avoid touching electronic components or circuit paths.

## MODEL 4284A PRECISION LCR METER OPTION 202 HANDLER INTERFACE OPERATION NOTE

### Page 3-4 Procedure 1 and Warning

Change the procedure 1 and warning as follows:

1. Disconnect the HP 4284A's power cord and allow 1 minute for the internal supply filter capacitors to discharge.

#### **WARNING**

Dangerous energy/voltage exists when the HP 4284A is in operation, and for a time after it is powered down. Allow 1 minute for the internal capacitors to discharge.

### Page 3-4

Add the following CAUTION after the procedure 6.

#### **CAUTION**

The interface board contains electronic components that can be damaged by static electricity through electrostatic discharge (ESD). To prevent ESD damage, maintain frequent contact with any bare sheet metal surface on the chassis. A grounding wrist strap (or similar device) is useful for this purpose. Handle the board carefully at all times. Avoid touching electronic components or circuit paths.

## MODEL 4284A PRECISION LCR METER OPTION 301 SCANNER INTERFACE OPERATION NOTE

### Page 2-11 PROCEDURE 1 and Warning

Change the procedure 1 and warning as follows:

1. Disconnect the power cable from the HP 4284A and allow 1 minute for the internal capacitors to discharge.

#### **WARNING**

**Dangerous energy/voltage exists when the HP 4284A is in operation, and for a time after it is powered down. Allow 1 minute for the internal capacitors to discharge.**

### Page 2-12

Add the following CAUTION after the procedure 7.

#### **CAUTION**

**The interface board contains electronic components that can be damaged by static electricity through electrostatic discharge (ESD). To prevent ESD damage, maintain frequent contact with any bare sheet metal surface on the chassis. A grounding wrist strap (or similar device) is useful for this purpose. Handle the board carefully at all times. Avoid touching electronic components or circuit paths.**



**Appendix A  
Manual Changes**

Appendix A contains Manual Changes and provides information for using this manual with an HP 4284A manufactured before the printing date of the manual.

**Appendix B  
Error and Warning  
Messages**

Appendix B lists the HP 4284A's error and warning messages with brief descriptions and solutions and the system messages.

**Appendix C  
Initial Settings and  
System Memory**

Appendix C lists the HP 4284A's initial settings and functions whose status is stored in internal system memory.

**Appendix D  
Correction Data**

Appendix D provides information about the relationship between the test frequency and the correction data.

**Appendix E  
Write Protection**

Appendix E provides the procedure for write protecting all of the stored data in the HP 4284A's memory card and internal EEPROM memory.

**Appendix F  
Test Frequency Points**

Appendix F lists all available test frequency points from 1 kHz to 1 MHz.

**Appendix G  
Transient States  
Caused by  
Measurement Condition  
Changes**

Appendix G describes the measurement condition changes which cause the transient states, and lists the delay times required for various transient states.

---

**Typeface  
Conventions**

**Bold**

Boldface type is used when a term is defined. For example: **icons** are symbols.

*Italics*

Italic type is used for emphasis and for titles of manuals and other publications.

Italic type is also used for keyboard entries when a name or a variable must be typed in place of the words in italics. For example: copy *filename* means to type the word copy, to type a space, and then to type the name of a file such as file1.

Computer

Computer font is used for on-screen prompts and messages.

**HARDKEYS**

Labeled keys on the instrument front panel are enclosed in .

## **SOFTKEYS**

Softkeys located to the right of the Liquid Crystal Display (LCD) are enclosed in .

---

## **Certification**

Hewlett-Packard Company certifies that this product met its published specifications at the time of shipment from the factory. Hewlett-Packard further certifies that its calibration measurements are traceable to the United States National Institute of Standards and Technology (NIST), to the extent allowed by the Institute's calibration facility, or to the calibration facilities of other International Standards Organization members.

---

## **Warranty**

This Hewlett-Packard instrument product is warranted against defects in material and workmanship for a period of one year from the date of shipment, except that in the case of certain components listed in "Components not Covered by Warranty" in Chapter 9 of this manual, the warranty shall be for the specified period. During the warranty period, Hewlett-Packard Company will, at its option, either repair or replace products which prove to be defective.

For warranty service or repair, this product must be returned to a service facility designated by HP. Buyer shall prepay shipping charges to HP and HP shall pay shipping charges to return the product to Buyer. However, Buyer shall pay all shipping charges, duties, and taxes for products returned to HP from another country.

HP warrants that its software and firmware designated by HP for use with an instrument will execute its programming instruction when properly installed on that instrument. HP does not warrant that the operation of the instrument, or software, or firmware will be uninterrupted or error free.

---

## **Limitation of Warranty**

The foregoing warranty shall not apply to defects resulting from improper or inadequate maintenance by Buyer, Buyer-supplied software or interfacing, unauthorized modification or misuse, operation outside of the environmental specifications for the product, or improper site preparation or maintenance.

*No other warranty is expressed or implied. HP specifically disclaims the implied warranties of merchantability and fitness for a particular purpose.*

---

## **Exclusive Remedies**

*The remedies provided herein are buyer's sole and exclusive remedies. HP shall not be liable for any direct, indirect, special, incidental, or consequential damages, whether based on contract, tort, or any other legal theory.*

---

## **Assistance**

Product maintenance agreements and other customer assistance agreements are available for Hewlett-Packard products.

For any assistance, contact your nearest Hewlett-Packard Sales and Service Office. Addresses are provided at the back of this manual.





# Contents

---

<b>1. Installation and Set Up Guide</b>	
Incoming Inspection . . . . .	1-1
Power Requirements . . . . .	1-2
Power Cable . . . . .	1-2
Line Voltage and Fuse Selection . . . . .	1-4
Line Voltage Selection . . . . .	1-4
⚠ Fuse Selection . . . . .	1-4
Operation Environment . . . . .	1-5
Electromagnetic Compatibility . . . . .	1-5
Ventilation Requirements . . . . .	1-6
Instruction for Cleaning . . . . .	1-6
Rack/Handle Installation . . . . .	1-6
Option 907 Handle Kit . . . . .	1-7
Installing the Handle . . . . .	1-7
Option 908 Rack Flange Kit . . . . .	1-7
Mounting the Rack . . . . .	1-7
Option 909 Rack Flange & Handle Kit . . . . .	1-8
Mounting the Handle and Rack . . . . .	1-8
<b>2. Overview</b>	
Introduction . . . . .	2-1
Product Introduction . . . . .	2-1
A Tour of the Front Panel . . . . .	2-2
(1) LINE On/Off . . . . .	2-2
(2) LCD . . . . .	2-2
(3) SOFTKEYs . . . . .	2-2
(4) MENU Keys . . . . .	2-2
(5) CURSOR Keys . . . . .	2-3
(6) ENTRY Keys . . . . .	2-3
(7) HP-IB Status Indicators . . . . .	2-3
(8) <b>LCL</b> Key . . . . .	2-3
(9) <b>TRIGGER</b> Key . . . . .	2-3
(10) MEMORY Card Slot and UNLOCK Button . . . . .	2-3
(11) <b>DC BIAS</b> Key . . . . .	2-3
(12) CONTRAST Control Knob . . . . .	2-4
(13) ⚠ UNKNOWN Terminals . . . . .	2-4
(14) FRAME Terminal . . . . .	2-4
A Tour of the Rear Panel . . . . .	2-4
(1) HP-IB Interface Connector . . . . .	2-5
(2) Interface Connectors . . . . .	2-5

(3) INT DC BIAS MONITOR Connector . . . . .	2-5
(4) EXT TRIGGER Connector . . . . .	2-5
(5) ~LINE Input Receptacle . . . . .	2-6
(6)  ~LINE Fuse Holder . . . . .	2-6
(7) ~LINE VOLTAGE SELECTOR . . . . .	2-6
Display . . . . .	2-7
Display Area Definition . . . . .	2-7
Display Page Area . . . . .	2-7
System Menu Field . . . . .	2-7
Comment Line Area . . . . .	2-7
Softkey Area . . . . .	2-8
Measurement Data/Conditions Area . . . . .	2-8
Input Line Area . . . . .	2-8
System Message Area . . . . .	2-8
MENU keys and Display Page . . . . .	2-9
DISPLAY FORMAT MENU key . . . . .	2-9
MEAS SETUP MENU key . . . . .	2-9
CATALOG/SYSTEM menu key . . . . .	2-10
Summary of Pages . . . . .	2-11
MEAS DISPLAY (under <b>DISPLAY FORMAT</b> ) . . . . .	2-11
BIN No. DISPLAY (under <b>DISPLAY FORMAT</b> ) . . . . .	2-11
BIN COUNT DISPLAY (under <b>DISPLAY FORMAT</b> ) . . . . .	2-11
LIST SWEEP DISPLAY (under <b>DISPLAY FORMAT</b> ) . . . . .	2-11
MEAS SETUP (under <b>MEAS SETUP</b> ) . . . . .	2-11
CORRECTION (under <b>MEAS SETUP</b> ) . . . . .	2-11
LIMIT TABLE SETUP (under <b>MEAS SETUP</b> ) . . . . .	2-12
LIST SWEEP SETUP (under <b>MEAS SETUP</b> ) . . . . .	2-12
CATALOG (under <b>CATALOG/SYSTEM</b> ) . . . . .	2-12
SYSTEM CONFIG (under <b>CATALOG/SYSTEM</b> ) . . . . .	2-12
SELF TEST (under <b>CATALOG/SYSTEM</b> ) . . . . .	2-12
Basic Operation . . . . .	2-16

### 3. DISPLAY FORMAT Menu

Introduction . . . . .	3-1
MEAS DISPLAY Page . . . . .	3-1
Measurement Function . . . . .	3-4
Description . . . . .	3-4
Front Panel Operation for Setting the Measurement Function . . . . .	3-5
Measurement Range . . . . .	3-6
Description . . . . .	3-6
Front Panel Operation for Setting the Measurement Range . . . . .	3-9
Test Frequency . . . . .	3-10
Description . . . . .	3-10
Front Panel Operation for Setting the Test Frequency . . . . .	3-11
Oscillator Level . . . . .	3-12
Description . . . . .	3-12

Front Panel Operation for Setting the Oscillator Level . . . . .	3-13
DC Bias . . . . .	3-14
Description . . . . .	3-14
Front Panel Operation for Setting the DC Bias . . . . .	3-16
Integration Time . . . . .	3-17
Description . . . . .	3-17
Front Panel Operation for Setting the Integration Time . . . . .	3-17
System Menu . . . . .	3-18
Load/Store Function . . . . .	3-18
Fixed Decimal Point Function . . . . .	3-20
Printer Function . . . . .	3-20
Keylock Function . . . . .	3-23
BIN No. DISPLAY Page . . . . .	3-23
Comparator Function ON/OFF . . . . .	3-25
Description . . . . .	3-25
Front Panel Operation for Setting the Comparator Function to ON or OFF . . . . .	3-25
System Menu . . . . .	3-25
Load/Store Function . . . . .	3-25
Printer Function . . . . .	3-26
Keylock Function . . . . .	3-27
BIN COUNT DISPLAY Page . . . . .	3-28
System Menu . . . . .	3-30
Counter Function . . . . .	3-30
Load/Store Function . . . . .	3-30
Printer Function . . . . .	3-31
Keylock Function . . . . .	3-32
LIST SWEEP DISPLAY Page . . . . .	3-32
Sweep Mode . . . . .	3-34
Front Panel Operation for Setting the Sweep Mode of the List Sweep Measurement . . . . .	3-35
System Menu . . . . .	3-35
Load/Store Function . . . . .	3-35
Printer Function . . . . .	3-36
Keylock Function . . . . .	3-37
4. MEAS SETUP Menu . . . . .	
Introduction . . . . .	4-1
MEAS SETUP page . . . . .	4-1
Comment . . . . .	4-4
Description . . . . .	4-4
Front Panel Operation for Entering a Comment Number . . . . .	4-4
Trigger Mode . . . . .	4-4
Description . . . . .	4-4
Front Panel Operation for Setting the Trigger Mode . . . . .	4-5
Automatic Level Control Function . . . . .	4-6
Description . . . . .	4-6

Front Panel Operation for Setting the Automatic Level Control Function . . . . .	4-9
High Power Mode . . . . .	4-9
Description (Refer to Appendix G.) . . . . .	4-9
Front Panel Operation for Setting the High Power Mode . . . . .	4-9
Bias Current Isolation Function . . . . .	4-10
Description (Refer to Appendix G.) . . . . .	4-10
Front Panel Operation for Setting the Bias Current Isolation Function . . . . .	4-10
Averaging Rate . . . . .	4-11
Description . . . . .	4-11
Front Panel Operation for Setting the Averaging Rate . . . . .	4-11
Delay Time . . . . .	4-11
Description (Refer to Appendix G.) . . . . .	4-11
Front Panel Operation for Setting the Delay Time . . . . .	4-11
Level Monitor Function . . . . .	4-12
Description . . . . .	4-12
Front Panel Operation for Setting the Level Monitor Function . . . . .	4-12
Deviation Measurement Function . . . . .	4-12
Description . . . . .	4-12
Front Panel Operation for the Deviation Measurement Function . . . . .	4-13
System Menu . . . . .	4-14
Load/Store Function . . . . .	4-14
Clear Setup Function . . . . .	4-15
Printer Function . . . . .	4-16
SYSTEM RESET Function . . . . .	4-16
CORRECTION Page . . . . .	4-18
OPEN Correction . . . . .	4-21
Description . . . . .	4-21
Front Panel Operation for the Open Correction . . . . .	4-22
SHORT Correction . . . . .	4-23
Description . . . . .	4-23
Front Panel Operation for the Short Correction . . . . .	4-24
LOAD Correction . . . . .	4-24
Description . . . . .	4-24
Front Panel Operation for the OPEN/SHORT/LOAD Correction . . . . .	4-25
Measurement Function for the Standard . . . . .	4-28
Description . . . . .	4-28
Front Panel Operation for Setting the Standard's Measurement Function . . . . .	4-29
Single/Multi Correction Mode Selection . . . . .	4-31
Description . . . . .	4-31
Front Panel Operation for Setting the Correction Mode to the Multi Correction Mode . . . . .	4-31
Cable Length Selection . . . . .	4-32
Description . . . . .	4-32

Front Panel For Selecting the Cable Length . . .	4-32
System Menu . . . . .	4-32
Printer Function . . . . .	4-33
LIMIT TABLE SETUP Page . . . . .	4-33
Swap Parameter Function . . . . .	4-36
Description . . . . .	4-36
Front Panel Operation for Swapping the Primary Parameter for the Secondary Parameter . . .	4-37
Limit Mode for Comparator . . . . .	4-37
Description . . . . .	4-37
Front Panel Operation for Setting the Limit Mode for the Comparator . . . . .	4-38
Nominal Value for Tolerance Mode . . . . .	4-39
Description . . . . .	4-39
Front Panel Operation for Setting the Nominal Value . . . . .	4-39
Comparator Function ON/OFF . . . . .	4-40
Description . . . . .	4-40
Front Panel Operation for Setting the Comparator Function to ON or OFF . . . . .	4-40
Auxiliary Bin ON/OFF . . . . .	4-41
Description . . . . .	4-41
Front Panel Operation for Setting the AUX BIN to ON or OFF . . . . .	4-42
Low/High Limits . . . . .	4-43
Description . . . . .	4-43
Front Panel Operation for Setting the Low/High Limits . . . . .	4-44
System Menu . . . . .	4-45
Load/Store Function . . . . .	4-46
Clear Table Function . . . . .	4-46
Printer Function . . . . .	4-47
LIST SWEEP SETUP Page . . . . .	4-48
Sweep Mode . . . . .	4-50
Description . . . . .	4-50
Front Panel Operation for Setting the List Sweep Measurement Mode . . . . .	4-51
List Sweep Parameter . . . . .	4-51
Description . . . . .	4-51
Front Panel Operation for Setting the List Sweep Parameter . . . . .	4-51
Sweep Points and Limit Mode . . . . .	4-52
Description . . . . .	4-52
Front Panel Operation for Setting the Sweep Points . . . . .	4-53
System Menu . . . . .	4-54
Load/Store Function . . . . .	4-54
Clear Table Function . . . . .	4-54
Printer Function . . . . .	4-55

<b>5. Catalog/System Configuration</b>	
Introduction . . . . .	5-1
CATALOG Page . . . . .	5-1
System Menu . . . . .	5-3
Media Specifying . . . . .	5-3
Load/Store Function . . . . .	5-3
Printer Function . . . . .	5-4
Purge Function . . . . .	5-4
SYSTEM CONFIG Page . . . . .	5-5
Beeper Function ON/OFF . . . . .	5-7
Description . . . . .	5-7
How to Set the Beeper to ON or OFF . . . . .	5-7
HP-IB Setting . . . . .	5-8
Description . . . . .	5-8
How to Set the HP-IB Address . . . . .	5-8
How to Set the Talk Only Mode . . . . .	5-8
Handler Interface Setting . . . . .	5-8
Description . . . . .	5-8
How to Set the Handler Interface to ON or OFF . . . . .	5-9
Scanner Interface Setting . . . . .	5-9
Description . . . . .	5-9
How to Set the Scanner Interface to ON or OFF . . . . .	5-9
System Menu . . . . .	5-10
Printer Function . . . . .	5-10
SELF TEST Page . . . . .	5-11
Memory Card R/W Test . . . . .	5-13
Description . . . . .	5-13
How to Perform the Memory Card R/W Test . . . . .	5-13
LED Display Test . . . . .	5-14
Description . . . . .	5-14
How to Perform the LED Display Test . . . . .	5-14
LCD Display Test . . . . .	5-14
Description . . . . .	5-14
How to Perform the LCD Display Test . . . . .	5-14
Handler I/F Test . . . . .	5-14
Description . . . . .	5-14
Scanner I/F EEPROM R/W Test . . . . .	5-15
Description . . . . .	5-15
How to Perform the Scanner I/F EEPROM R/W Test . . . . .	5-15
Scanner I/F I/O Test . . . . .	5-16
Description . . . . .	5-16
Bias Current I/F I/O Test . . . . .	5-16
Description . . . . .	5-16

<b>6. Measurement Procedure and Examples</b>	
Introduction . . . . .	6-1
Basic Measurement Procedure . . . . .	6-1
Impedance Parameters . . . . .	6-2
Parallel/Series Circuit Mode . . . . .	6-5
Selecting Circuit Mode of Capacitance . . . . .	6-5
Small Capacitance (modeled by (a) in Figure 6-3)	6-5
Large Capacitance (modeled by (b) in Figure 6-3)	6-5
Selecting Circuit Mode of Inductance . . . . .	6-6
Large Inductance (modeled by (a) in Figure 6-4)	6-6
Small Inductance (modeled by (b) in Figure 6-4)	6-6
Signal Level . . . . .	6-7
Signal Level Across The DUT . . . . .	6-7
Oscillator Level Setting . . . . .	6-8
Signal Level Setting Selection Example for	
Inductance Measurements . . . . .	6-8
Four-Terminal Pair Configuration . . . . .	6-9
Measurement Contacts . . . . .	6-10
Capacitance To Ground . . . . .	6-11
Contact Resistance . . . . .	6-12
Extending Test Leads . . . . .	6-13
Guarding For Low Capacitance Measurements . . . . .	6-15
Shielding . . . . .	6-15
Correction Functions . . . . .	6-16
Performing OPEN Correction . . . . .	6-19
Performing SHORT Correction . . . . .	6-19
Performing LOAD Correction . . . . .	6-20
Preparing the Standard . . . . .	6-20
Reference Values of the LOAD Standard . . . . .	6-20
Using the Pre-Measured Device for the LOAD . . . . .	6-21
Parasitics Incident to DUT Connection . . . . .	6-22
Characteristics Example . . . . .	6-23
Capacitor Measurements . . . . .	6-24
Inductance Measurements . . . . .	6-27
If the HP 4284A does NOT Measure Correctly . . . . .	6-32
<b>7. Remote Control</b>	
Introduction . . . . .	7-1
Hewlett-Packard Interface Bus (HP-IB) . . . . .	7-1
HP-IB Connection . . . . .	7-1
HP-IB Capability . . . . .	7-3
HP-IB Addressing . . . . .	7-4
HP-IB Bus Capability . . . . .	7-4
ABORT I/O (IFC) . . . . .	7-4
CLEAR LOCKOUT/SET LOCAL . . . . .	7-4
DEVICE CLEAR (SDC or DCL) . . . . .	7-4
LOCAL (GTL) . . . . .	7-4
LOCAL LOCKOUT (LLO) . . . . .	7-5
REMOTE . . . . .	7-5
SPOLL . . . . .	7-5
SERVICE REQUEST . . . . .	7-5

TRIGGER (GET) . . . . .	7-5
Standard Commands for Programmable Instruments(SCPI) . . . . .	7-6
Data Transfer . . . . .	7-7
ASCII Format . . . . .	7-7
Binary Format . . . . .	7-9
Floating Point Format . . . . .	7-10
Trigger System . . . . .	7-12
Data Buffer Memory . . . . .	7-16
Status Byte . . . . .	7-20
Enabling the Status Byte . . . . .	7-22
Operation Status Register Group . . . . .	7-23
Standard Operation Status Condition Register . . . . .	7-24
Standard Operation Status Event Register . . . . .	7-25
Standard Operation Status Event Enable Register . . . . .	7-26
Standard Event Status Register . . . . .	7-27
Enabling the Event Status Register . . . . .	7-30
Sample Programs . . . . .	7-31
Control Settings . . . . .	7-31
MEAS SETUP page . . . . .	7-32
CORRECTION page . . . . .	7-33
LIMIT TABLE SETUP page . . . . .	7-34
LIST SWEEP SETUP page . . . . .	7-35
Data Transfer Examples . . . . .	7-36
ASCII Format . . . . .	7-36
BINARY Format . . . . .	7-38

## 8. Command Reference

Introduction . . . . .	8-1
Notation Conventions and Definitions . . . . .	8-1
Command Structure . . . . .	8-2
Command Abbreviations . . . . .	8-4
Header and Parameters . . . . .	8-5
NR1 . . . . .	8-6
NR2 . . . . .	8-6
NR3 . . . . .	8-6
Terminators . . . . .	8-8
Program Message Terminators . . . . .	8-8
Response Message Terminators . . . . .	8-8
Command Reference . . . . .	8-9
DISPlay Subsystem . . . . .	8-10
:PAGE . . . . .	8-11
:LINE . . . . .	8-12
FREQuency Subsystem . . . . .	8-13
VOLTage Subsystem . . . . .	8-14
CURRent Subsystem . . . . .	8-15
AMPLitude Subsystem . . . . .	8-16
OUTPut Subsystem . . . . .	8-17
:High POWER . . . . .	8-17
:DC:ISOLation . . . . .	8-18
BIAS Subsystem . . . . .	8-19



:STATe . . . . .	8-20
:VOLTage . . . . .	8-21
:CURRent . . . . .	8-22
FUNCTION Subsystem . . . . .	8-23
:IMPedance[:TYPE] . . . . .	8-24
:IMPedance:RANGe . . . . .	8-25
:IMPedance:RANGe :AUTO . . . . .	8-26
:Source MONitor:VAC . . . . .	8-27
:Source MONitor:IAC . . . . .	8-28
:DEV<n>:MODE . . . . .	8-29
:DEV<n>:REFerence . . . . .	8-30
:DEV<n> :REFerence:FILL . . . . .	8-30
LIST Subsystem . . . . .	8-31
:FREQuency . . . . .	8-32
:VOLTage . . . . .	8-33
:CURRent . . . . .	8-34
:BIAS:VOLTage . . . . .	8-35
:BIAS:CURRent . . . . .	8-36
:MODE . . . . .	8-37
:BAND<n> . . . . .	8-38
APERTure Subsystem . . . . .	8-39
TRIGger Subsystem . . . . .	8-40
:IMMediate . . . . .	8-40
:SOURce . . . . .	8-41
:DELay . . . . .	8-42
INITiate Subsystem . . . . .	8-43
[:IMMediate] . . . . .	8-43
:CONTinuous . . . . .	8-44
FETCh? Subsystem . . . . .	8-45
[:IMP]? . . . . .	8-45
:Source MONitor:VAC? . . . . .	8-46
:Source MONitor:IAC? . . . . .	8-46
ABORt Subsystem . . . . .	8-47
FORMat Subsystem . . . . .	8-48
MEMory Subsystem . . . . .	8-49
:DIM . . . . .	8-49
:FILL . . . . .	8-49
:CLEar . . . . .	8-50
:READ? . . . . .	8-50
CORRection Subsystem . . . . .	8-51
:LENGth . . . . .	8-52
:METHod . . . . .	8-53
:OPEN . . . . .	8-53
:OPEN:STATe . . . . .	8-54
:SHORT . . . . .	8-54
:SHORT:STATe . . . . .	8-55
:LOAD:STATe . . . . .	8-56
:LOAD:TYPE . . . . .	8-57
:SPOT<n>:STATe . . . . .	8-58
:SPOT<n>:FREQuency . . . . .	8-59
:SPOT<n>:OPEN . . . . .	8-60

:SPOT<n>:SHORT . . . . .	8-60
:SPOT<n>:LOAD . . . . .	8-61
:SPOT<n>:LOAD :STANdard . . . . .	8-62
:USE . . . . .	8-63
:USE:DATA? . . . . .	8-64
COMParator Subsystem . . . . .	8-65
[:STATe] . . . . .	8-66
:MODE . . . . .	8-67
:TOLerance:NOMinal . . . . .	8-68
:TOLerance:BIN<n> . . . . .	8-69
:SEQuence:BIN . . . . .	8-70
:Secondary LIMit . . . . .	8-71
:Auxiliary BIN . . . . .	8-72
:SWAP . . . . .	8-73
:BIN:CLEar . . . . .	8-73
:BIN:COUNt[:STATe] . . . . .	8-74
:BIN:COUNt:DATA? . . . . .	8-75
:BIN:COUNt:CLEar . . . . .	8-75
Mass MEMOry Subsystem . . . . .	8-76
:LOAD:STATe . . . . .	8-76
:STORe:STATe . . . . .	8-76
SYSTem:ERRor? . . . . .	8-77
STATus Subsystem . . . . .	8-78
:OPERation[:EVENT]? . . . . .	8-79
:OPERation:CONDition? . . . . .	8-80
:OPERation:ENABle . . . . .	8-81
Common Commands . . . . .	8-82
*CLS . . . . .	8-82
*ESE . . . . .	8-83
*ESR? . . . . .	8-84
*SRE . . . . .	8-85
*STB? . . . . .	8-86
*IDN? . . . . .	8-87
*OPC . . . . .	8-88
*WAI . . . . .	8-88
*RST . . . . .	8-89
*TST? . . . . .	8-89
*TRG . . . . .	8-90
*LRN? . . . . .	8-91
*OPT? . . . . .	8-92

**9. General Information**

Introduction . . . . .	9-1
Components not Covered by Warranty . . . . .	9-1
Serial Number . . . . .	9-1
Specifications . . . . .	9-2
Measurement Functions . . . . .	9-2
Measurement Parameters . . . . .	9-2
Combinations . . . . .	9-2
Mathematical Functions . . . . .	9-3
Equivalent Measurement Circuit . . . . .	9-3

Ranging . . . . .	9-3
Trigger . . . . .	9-3
Delay Time . . . . .	9-3
Measurement terminals . . . . .	9-3
Test Cable Length . . . . .	9-3
Standard . . . . .	9-3
With Option 006 . . . . .	9-3
Integration Time . . . . .	9-3
Averaging . . . . .	9-3
Test Signal . . . . .	9-3
Frequency . . . . .	9-3
Accuracy . . . . .	9-3
Signal Modes . . . . .	9-3
Normal . . . . .	9-3
Constant . . . . .	9-3
Signal Level . . . . .	9-4
Output Impedance . . . . .	9-4
Test Signal Level Monitor . . . . .	9-4
Display Range . . . . .	9-5
Absolute Measurement Accuracy . . . . .	9-5
Z ,  Y , L, C, R, X, G and B Accuracy . . . . .	9-5
D accuracy . . . . .	9-5
Q Accuracy . . . . .	9-5
$\theta$ Accuracy . . . . .	9-6
G Accuracy . . . . .	9-6
R <sub>p</sub> Accuracy . . . . .	9-6
R <sub>s</sub> Accuracy . . . . .	9-6
Relative Measurement Accuracy . . . . .	9-7
Z ,  Y , L, C, R, X, G and B Accuracy . . . . .	9-8
D accuracy . . . . .	9-9
Q Accuracy . . . . .	9-9
$\theta$ Accuracy . . . . .	9-9
G Accuracy . . . . .	9-9
R <sub>p</sub> Accuracy . . . . .	9-9
R <sub>s</sub> Accuracy . . . . .	9-10
Example of C-D Accuracy Calculation . . . . .	9-11
Measurement Conditions . . . . .	9-11
Specification Charts and Tables . . . . .	9-12
HP 4284A Calibration Accuracy . . . . .	9-16
Correction Functions . . . . .	9-17
Zero Open . . . . .	9-17
Zero Short . . . . .	9-17
Load . . . . .	9-17
List Sweep . . . . .	9-17
Comparator Function . . . . .	9-17
Sorting Modes . . . . .	9-17
Bin Count . . . . .	9-17
List Sweep Comparator . . . . .	9-17
DC Bias . . . . .	9-17
Setting Accuracy . . . . .	9-17
Other Functions . . . . .	9-18

Store/Load . . . . .	9-18
HP-IB . . . . .	9-18
Interface Functions . . . . .	9-18
Self Test . . . . .	9-18
Options . . . . .	9-18
Option 001 (Power Amp/DC Bias) . . . . .	9-18
Test Signal Level . . . . .	9-18
Output Impedance . . . . .	9-18
Test Signal Level Monitor . . . . .	9-19
DC Bias Level . . . . .	9-19
Bias Current Isolation Function . . . . .	9-20
DC Bias Monitor Terminal . . . . .	9-20
Other Options . . . . .	9-20
Furnished Accessories . . . . .	9-20
Power Requirements . . . . .	9-20
Line Voltage . . . . .	9-20
Line Frequency . . . . .	9-20
Power Consumption . . . . .	9-20
Operating Environment . . . . .	9-21
Temperature . . . . .	9-21
Humidity . . . . .	9-21
Altitude . . . . .	9-21
Dimensions . . . . .	9-21
Weight . . . . .	9-21
Display . . . . .	9-21
Capable of Displaying . . . . .	9-21
Number of Display Digits . . . . .	9-21
Supplemental Performance Characteristics . . . . .	9-21
Stability . . . . .	9-21
Temperature Coefficient . . . . .	9-22
Settling Time . . . . .	9-22
Frequency ( $f_m$ ) . . . . .	9-22
Test Signal Level . . . . .	9-22
Measurement Range . . . . .	9-22
Input Protection . . . . .	9-22
Measurement Time . . . . .	9-23
Display Time . . . . .	9-23
HP-IB Data Output Time . . . . .	9-23
DC Bias (1.5 V/2 V) . . . . .	9-24
Option 001 (Power Amp/DC Bias) . . . . .	9-24
DC Bias Voltage . . . . .	9-24
DC Bias Current . . . . .	9-24
Relative Measurement Accuracy with Bias Current Isolation . . . . .	9-24
Calculation Example . . . . .	9-25
Measurement Conditions . . . . .	9-25
DC Bias Settling Time . . . . .	9-26
Rack/Handle Installation . . . . .	9-27
Storage and Repacking . . . . .	9-28
Environment . . . . .	9-28
Original Packaging . . . . .	9-28

Other Packaging . . . . .	9-28
<b>10. Performance Tests</b>	
Introduction . . . . .	10-1
Test Equipment . . . . .	10-1
Performance Test Record . . . . .	10-2
Calibration Cycle . . . . .	10-2
System Reset . . . . .	10-4
Procedure . . . . .	10-4
Test Frequency Accuracy Test . . . . .	10-5
Equipment . . . . .	10-5
Procedure: . . . . .	10-5
Test Signal Level/Level-Monitor Accuracy Test . . . . .	10-6
Equipment: . . . . .	10-6
Procedure: . . . . .	10-7
DC Bias Level Accuracy Test . . . . .	10-9
Equipment: . . . . .	10-9
Procedure: . . . . .	10-10
Impedance Measurement Accuracy Test . . . . .	10-12
Equipment: . . . . .	10-12
Procedure: . . . . .	10-12
Store and Load Function Test . . . . .	10-20
Equipment: . . . . .	10-20
Procedure: . . . . .	10-20
HP-IB Interface Test . . . . .	10-21
Equipment: . . . . .	10-21
Procedure: . . . . .	10-21
Bias Current Interface Function Test (Option 002 only) . . . . .	10-23
Equipment: . . . . .	10-23
Procedure: . . . . .	10-23
Handler Interface Function Test (Option 201 only) . . . . .	10-26
Equipment: . . . . .	10-26
Procedure: . . . . .	10-26
Handler Interface Function Test (Option 202 only) . . . . .	10-30
Equipment: . . . . .	10-30
Procedure: . . . . .	10-30
Scanner Interface Function Test (Option 301 only) . . . . .	10-33
Equipment: . . . . .	10-33
Procedure: . . . . .	10-33
Supplying DC Power to the Simulator . . . . .	10-36
Procedure: . . . . .	10-36
Performance Test Record . . . . .	10-37
Test Signal Frequency Accuracy Test . . . . .	10-37
Test Signal Level/Level-Monitor Accuracy Test . . . . .	10-37
Multimeter Reading (Signal Frequency: 1.25 kHz, Hi-PW: OFF) . . . . .	10-37
Level Monitor Reading (Signal Frequency: 1.25 kHz, Hi-PW: OFF) . . . . .	10-37
Multimeter Reading (Signal Frequency: 960 kHz, Hi PW: OFF) . . . . .	10-38

Multimeter Reading (Signal Frequency: 1.25 kHz, Hi PW: ON) Option 001 ONLY . . . . .	10-38
Level Monitor Reading (Signal Frequency: 1.25 kHz, Hi-PW: ON) Option 001 ONLY . . . . .	10-38
Multimeter Reading (Signal Frequency: 960 kHz, Hi PW: ON) Option 001 ONLY . . . . .	10-39
Level Monitor Reading (Signal Frequency: 960 kHz, Hi-PW: ON) Option 001 ONLY . . . . .	10-39
DC Bias Voltage Accuracy Test . . . . .	10-40
Hi-PW OFF . . . . .	10-40
Hi-PW ON (Option 001 only) . . . . .	10-40
Impedance Measurement Accuracy Test . . . . .	10-41
10 pF Standard . . . . .	10-41
OSC Level: 510 mV . . . . .	10-41
OSC Level: 20 mV . . . . .	10-41
OSC Level: 5.1 V (Option 001 only) . . . . .	10-42
100 pF Standard . . . . .	10-42
OSC Level: 510 mV . . . . .	10-42
OSC Level: 20 mV . . . . .	10-42
OSC Level: 5.1 V (Option 001 only) . . . . .	10-42
1000 pF Standard . . . . .	10-43
OSC Level: 510 mV . . . . .	10-43
OSC Level: 20 mV . . . . .	10-43
OSC Level: 5.1 V (Option 001 only) . . . . .	10-43
0.01 $\mu$ F Standard . . . . .	10-44
OSC Level: 510 mV . . . . .	10-44
OSC Level: 20 mV . . . . .	10-44
OSC Level: 5.1 V (Option 001 only) . . . . .	10-44
0.1 $\mu$ F Standard . . . . .	10-44
OSC Level :510 mV . . . . .	10-44
OSC Level: 20 mV . . . . .	10-44
OSC Level: 5.1 V (Option 001 only) . . . . .	10-44
1 $\mu$ F Standard . . . . .	10-45
OSC Level :510 mV . . . . .	10-45
OSC Level: 20 mV . . . . .	10-45
OSC Level: 5.1 V (Option 001 only) . . . . .	10-45
100 $\Omega$ Standard . . . . .	10-45
OSC Level :510 mV . . . . .	10-45
OSC Level: 20 mV . . . . .	10-45
OSC Level: 5.1 V (Option 001 only) . . . . .	10-45
1k $\Omega$ Standard . . . . .	10-46
OSC Level :510 mV . . . . .	10-46
OSC Level: 20 mV . . . . .	10-46
1 m Cable Length Operation . . . . .	10-46
2 m Cable Length Operation (Option 006 only) . . . . .	10-46
4 m Cable Length Operation (Option 006 only) . . . . .	10-46
Store and Load Function Test . . . . .	10-46
HP-IB Interface Test . . . . .	10-46
Bias Current Interface Function Test (Option 002 only) . . . . .	10-46

<b>A. Manual Changes</b>	
Introduction . . . . .	A-1
Manual Changes . . . . .	A-1
CHANGE1 . . . . .	A-2
CHANGE2 . . . . .	A-2
<b>B. Error and Warning Messages</b>	
Introduction . . . . .	B-1
Error Messages . . . . .	B-1
Operation Errors . . . . .	B-1
HP-IB Errors . . . . .	B-1
Sample Program to Detect the Error . . . . .	B-2
Operation Errors . . . . .	B-3
HP-IB Errors . . . . .	B-9
System Message . . . . .	B-11
Warning Messages . . . . .	B-11
Instruction Messages . . . . .	B-12
<b>C. Initial Settings and System Memory</b>	
Introduction . . . . .	C-1
<b>D. Correction Data</b>	
Introduction . . . . .	D-1
Test Frequency and Correction Frequency . . . . .	D-1
Single Channel Correction Mode . . . . .	D-2
Multi Channel Correction Mode . . . . .	D-3
CORRECTION FUNCTION SETTING . . . . .	D-4
<b>E. Write Protection</b>	
Introduction . . . . .	E-1
Write Protection Procedure . . . . .	E-1
<b>F. Test Frequency Point</b>	
Introduction . . . . .	F-1
Frequency Points . . . . .	F-1
<b>G. Transient States Caused by Measurement Condition Changes</b>	
Introduction . . . . .	G-1
Changing the Test Frequency . . . . .	G-2
Changing the Measurement Range . . . . .	G-3
CHANGING THE DC BIAS VOLTAGE . . . . .	G-6
Short Circuit Recovery . . . . .	G-8

**Index**

## Figures

---

1-1. Power Cable Supplied . . . . .	1-3
1-2. Line Voltage Selector . . . . .	1-4
1-3. Rack Mount Kits Installation . . . . .	1-7
2-1. Front Panel Overview . . . . .	2-2
2-2. Rear Panel Overview . . . . .	2-5
2-3. Display Area Definition . . . . .	2-7
2-4. MENU keys . . . . .	2-9
2-5. Display Pages (1/3) . . . . .	2-13
2-6. CURSOR Keys and Field Operation Example . . . . .	2-16
2-7. Softkey Selection Example . . . . .	2-17
3-1. Available Fields on the MEAS DISPLAY Page . . . . .	3-2
3-2. Available Softkeys on the MEAS DISPLAY Page . . . . .	3-3
3-3. Effective Measuring Range for Each Measurement Range . . . . .	3-7
3-4. Effective Measuring Range (Oscillator Level $\leq$ 2V or $\leq$ 20 mA) . . . . .	3-8
3-5. Effective Measuring Range (Oscillator Level $>$ 2V or $>$ 20 mA) . . . . .	3-9
3-6. DC BIAS Current . . . . .	3-15
3-7. DC BIAS Monitor Circuits . . . . .	3-16
3-8. MEAS DISPLAY Page Example . . . . .	3-21
3-9. Available Fields on the BIN No. DISPLAY Page . . . . .	3-24
3-10. Available Softkeys on the BIN No. DISPLAY Page . . . . .	3-24
3-11. BIN No. DISPLAY Page Example . . . . .	3-27
3-12. Available Fields on the BIN COUNT DISPLAY Page . . . . .	3-29
3-13. Available Softkeys on the BIN COUNT DISPLAY Page . . . . .	3-29
3-14. BIN COUNT DISPLAY Page Example . . . . .	3-31
3-15. Available Fields on the LIST SWEEP DISPLAY Page . . . . .	3-33
3-16. Available Softkeys on the LIST SWEEP DISPLAY Page . . . . .	3-34
3-17. SEQ Mode and STEP Mode . . . . .	3-34
3-18. LIST SWEEP DISPLAY Page Example . . . . .	3-36
4-1. Available Fields on the MEAS SETUP Page . . . . .	4-2
4-2. Available Softkeys on the MEAS SETUP Page . . . . .	4-3
4-3. External Trigger Pulse . . . . .	4-5
4-4. Feedback Circuit . . . . .	4-7
4-5. Available Operating Area for the ALC Function . . . . .	4-8
4-6. MEAS SETUP page After Clearing the Setup . . . . .	4-15
4-7. MEAS SETUP page Example . . . . .	4-16
4-8. Available Fields on the CORRECTION Page . . . . .	4-19



4-9. Available Softkeys on the CORRECTION Page . . . . .	4-20
4-10. Stray Admittance . . . . .	4-21
4-11. OPEN/SHORT Correction Using The Interpolation Method . . . . .	4-22
4-12. Residual Impedance . . . . .	4-23
4-13. OPEN/SHORT/LOAD Correction . . . . .	4-25
4-14. CORRECTION Page Example . . . . .	4-33
4-15. Available Fields on the LIMIT TABLE SETUP Page . . . . .	4-35
4-16. Available Softkeys on the LIMIT TABLE SETUP Page . . . . .	4-36
4-17. Swap Parameter Function . . . . .	4-37
4-18. Tolerance Mode and Sequential Mode . . . . .	4-38
4-19. Limit Table Using the Sequential Mode . . . . .	4-45
4-20. LIMIT TABLE SETUP Page Example . . . . .	4-47
4-21. Available Fields on the LIST SWEEP SETUP Page . . . . .	4-49
4-22. Available Softkeys on the LIST SWEEP SETUP Page . . . . .	4-50
4-23. SEQ mode and STEP mode . . . . .	4-51
4-24. List Sweep Settings . . . . .	4-52
4-25. LIST SWEEP SETUP Page Example . . . . .	4-55
5-1. Available Fields on the CATALOG Page . . . . .	5-2
5-2. Available Softkeys on the CATALOG Page . . . . .	5-2
5-3. CATALOG Page Example . . . . .	5-4
5-4. Available Fields on the SYSTEM CONFIG Page . . . . .	5-6
5-5. Available Softkeys on the SYSTEM CONFIG Page . . . . .	5-7
5-6. SYSTEM CONFIG page Example . . . . .	5-10
5-7. Available Fields on the SELF TEST Page . . . . .	5-12
5-8. Available Softkeys on the SELF TEST Page . . . . .	5-12
6-1. Definition of Impedance . . . . .	6-3
6-2. Vector Representation of Admittance . . . . .	6-4
6-3. Capacitance Circuit Mode Selection . . . . .	6-6
6-4. Inductance Circuit Mode Selection . . . . .	6-7
6-5. Simplified Model of Signal Level and DUT . . . . .	6-8
6-6. Four-Terminal Pair Measurement Principle . . . . .	6-9
6-7. Measurement Contacts . . . . .	6-10
6-8. Model of Capacitance to Ground . . . . .	6-11
6-9. Reducing Capacitance to Ground . . . . .	6-12
6-10. Contact Resistance . . . . .	6-13
6-11. Extending The Four-Terminal Pair Test Leads . . . . .	6-13
6-12. Measurement Contacts for Test Leads Extension . . . . .	6-14
6-13. Example DUT Guard Plate Connection . . . . .	6-15
6-14. Guard Shield . . . . .	6-15
6-15. Sample Shorting Plate . . . . .	6-19
6-16. Shorting Plate Connection . . . . .	6-20
6-17. Parasitic Impedance Model (Using the HP 16047A/C/D) . . . . .	6-22
6-18. Typical Characteristics of Components . . . . .	6-23
6-19. Connecting the HP 16047A . . . . .	6-25
6-20. Connecting A Shorting Bar . . . . .	6-26
6-21. Connecting DUT . . . . .	6-26
6-22. Measurement Results of A 470 pF Capacitor . . . . .	6-27

6-23. Connecting the HP 16047A . . . . .	6-29
6-24. Connecting A Shorting Bar . . . . .	6-30
6-25. Connecting DUT . . . . .	6-30
6-26. Measurement Results of The Magnetic-Cored Inductor . . . . .	6-31
7-1. HP-IB Connector Signal/Pin Configuration . . . . .	7-2
7-2. Typical HP-IB System Interconnection . . . . .	7-3
7-3. Functional Layers Diagram . . . . .	7-6
7-4. ASCII Format 1 . . . . .	7-7
7-5. ASCII Format 2 (List Sweep) . . . . .	7-9
7-6. BINARY Format 1 . . . . .	7-10
7-7. Binary Data Format For List Sweep Measurement . . . . .	7-11
7-8. Trigger State Diagram . . . . .	7-12
7-9. INITiate Subsystem Commands and Trigger System . . . . .	7-12
7-10. Trigger System and Trigger Commands . . . . .	7-13
7-11. TRIGger:IMMediate Command Sample Program . . . . .	7-14
7-12. *TRG or GET Command Sample Program . . . . .	7-14
7-13. Triggering System and Data Transfer . . . . .	7-15
7-14. Buffered Data Transfer Sample Program and Description . . . . .	7-16
7-15. ASCII Format (Buffer Memory) . . . . .	7-18
7-16. BINARY Format (Buffer Memory) . . . . .	7-18
7-17. Status Byte Register . . . . .	7-20
7-18. Operation Status Register Structure . . . . .	7-23
7-19. Standard Event Status Register . . . . .	7-28
7-20. MEAS SETUP Page . . . . .	7-32
7-21. CORRECTION page . . . . .	7-33
7-22. LIMIT TABLE SETUP page . . . . .	7-34
7-23. LIST SWEEP SETUP . . . . .	7-35
7-24. Sample Program (Comparator) Using ASCII Format . . . . .	7-36
7-25. Sample Program (Buffer Memory) Using ASCII Format . . . . .	7-37
7-26. Sample Program (List Sweep) Using ASCII Format . . . . .	7-37
7-27. Sample Program (Comparator) Using BINARY Format . . . . .	7-38
7-28. Sample Program (Buffer Memory) Using BINARY Format . . . . .	7-39
7-29. Sample Program (List Sweep) Using BINARY Format . . . . .	7-39
8-1. Command Tree Example . . . . .	8-2
8-2. Command Header and Parameters . . . . .	8-5
8-3. DISPlay Subsystem Command Tree . . . . .	8-10
8-4. OUTPut Subsystem Command Tree . . . . .	8-17
8-5. BIAS Subsystem Command Tree . . . . .	8-19
8-6. FUNction Subsystem Command Tree . . . . .	8-23
8-7. LIST Subsystem Command Tree . . . . .	8-31
8-8. TRIGger Subsystem Command Tree . . . . .	8-40
8-9. INITiate Subsystem Command Tree . . . . .	8-43
8-10. FETCh? Subsystem Command Tree . . . . .	8-45
8-11. MEMory Subsystem Command Tree . . . . .	8-49
8-12. CORRection Subsystem Command Tree . . . . .	8-51

8-13. COMParator Subsystem Command Tree . . . . .	8-65
8-14. Mass MEMory Subsystem Command Tree . . . . .	8-76
8-15. STATus Subsystem Command Tree . . . . .	8-78
9-1. Serial Number Plate . . . . .	9-1
9-2. Test Signal Voltage and Test Frequency upper Limits to apply measurement accuracy to 2 m and 4 m Cable Length Operation. . . . .	9-7
9-3. Test Signal Voltage and DC Bias Voltage Upper Limits Apply for Measurement Accuracy. . . . .	9-8
9-4. Basic Accuracy A (1 of 2) . . . . .	9-12
9-5. Basic Accuracy A (2 of 2) . . . . .	9-13
9-6. Temperature Factor $K_e$ . . . . .	9-15
9-7. Maximum Capacitance Voltage . . . . .	9-22
9-8. Measurement Time . . . . .	9-26
9-9. Rack Mount Kits Installation . . . . .	9-27
10-1. Test Frequency Accuracy Test Setup . . . . .	10-5
10-2. Test Signal Level Accuracy Test Setup Using an Interface Box . . . . .	10-6
10-3. Test Signal Level Accuracy Test Setup Without an Interface Box . . . . .	10-6
10-4. DC Bias Level Accuracy Test Setup Using an Interface Box . . . . .	10-9
10-5. DC Bias Level Accuracy Test Setup Without an Interface Box . . . . .	10-9
10-6. Impedance Measurement Accuracy Test Setup . . . . .	10-12
10-7. Correction Page Setup . . . . .	10-13
10-8. HP-IB Interface Test Setup . . . . .	10-21
10-9. Bias Interface Simulator . . . . .	10-23
10-10. Bias Current Interface Function Test Setup . . . . .	10-24
10-11. Bias Current Interface Function Test . . . . .	10-25
10-12. Interface Board Locations . . . . .	10-26
10-13. Jumper Settings . . . . .	10-27
10-14. Jumper Settings . . . . .	10-28
10-15. Handler Interface Function Test Set UP . . . . .	10-28
10-16. Handler Interface Function Check . . . . .	10-29
10-17. Jumper Settings . . . . .	10-31
10-18. Handler Interface Function Test Set up . . . . .	10-31
10-19. Handler Interface Function Check . . . . .	10-32
10-20. SW1 and SW2 settings . . . . .	10-34
10-21. Scanner Simulator Connections . . . . .	10-34
10-22. A7 Board Location . . . . .	10-36
E-1. A7 Digital Board Location . . . . .	E-2
E-2. Write Protection Switch . . . . .	E-3
G-1. Required Delay Time After Changing the Measurement Range (1) . . . . .	G-3
G-2. Required Delay Time After Changing the Measurement Range (2) . . . . .	G-4
G-3. Required Delay Times After Changing the Measurement Range (3) . . . . .	G-5
G-4. Required Delay Times After Changing the DC Bias (1) . . . . .	G-6

G-5. Required Delay Time After Changing the DC Bias (2) . . . . .	G-7
G-6. Required Delay Times For Short Circuit Recovery (1)	G-8
G-7. Required Delay Times For Short Circuit Recovery (2)	G-9
G-8. Short Circuit Recovery Delay Times (3) . . . . .	G-10

## Tables

---

1-1. HP 4284A Contents . . . . .	1-2
1-2. Line Voltage Selection . . . . .	1-4
1-3. Fuse Selection . . . . .	1-4
1-4. Rack Mount Kits . . . . .	1-6
3-1. Measurement Function . . . . .	3-5
3-2. Oscillator Level and Resolution (Std.) . . . . .	3-12
3-3. Oscillator Level and Resolution (Opt.001) . . . . .	3-13
3-4. DC bias and Resolution (Opt.001) . . . . .	3-14
3-5. DC Bias and Oscillator level Setting limits . . . . .	3-15
4-1. Maximum DC Bias Current . . . . .	4-10
6-1. Parallel/Series Circuit Mode . . . . .	6-5
6-2. Correction Functions . . . . .	6-16
7-1. HP-IB Interconnect Cables . . . . .	7-2
7-2. HP-IB Interface Capability . . . . .	7-3
7-3. Data Format and Data Transfer Time . . . . .	7-19
7-4. Status Byte Assignments . . . . .	7-21
7-5. Standard Operation Status Condition Register Assignments . . . . .	7-24
7-6. Standard Operation Status Event Register Assignments . . . . .	7-25
7-7. Standard Event Status Register Assignments . . . . .	7-29
8-1. Multiplier Mnemonics . . . . .	8-7
8-2. Suffix Units and Available Commands . . . . .	8-7
9-1. Impedance Proportional Factors $K_a$ and $K_b$ . . . . .	9-14
9-2. Cable Length Factor $K_{aa}$ . . . . .	9-14
9-3. Cable Length Factor $K_{bb}$ . . . . .	9-15
9-4. Calibration Interpolation Factor $K_c$ . . . . .	9-15
9-5. Preset Calibration Frequencies . . . . .	9-15
9-6. Cable Length Factor $K_d$ . . . . .	9-15
9-7. Coefficient Related to Test Frequency and Measurement Range . . . . .	9-25
9-8. Rack Mount Kits . . . . .	9-27
10-1. Recommended Test Equipment . . . . .	10-3
10-2. Test Frequency Test limits . . . . .	10-5
10-3. Test Signal Level/Level-Monitor Test Limits (Hi-PW OFF) . . . . .	10-8
10-4. Test Signal Level/Level-Monitor Test Limits (Hi-PW ON) . . . . .	10-8
10-5. DC Bias Level Test Limits (Hi-PW OFF) . . . . .	10-10
10-6. DC Bias Level Test Limits (Hi-PW ON) . . . . .	10-11
10-7. Impedance Measurement Accuracy Test Limits (1 of 2) . . . . .	10-14

10-7. Impedance Measurement Accuracy Test Limits (2 of 2) . . . . .	10-15
10-8. Impedance Measurement Accuracy Test Limits . . . . .	10-16
10-9. Impedance Measurement Accuracy Test Limits for 1 m Cable Length Operation . . . . .	10-17
10-10. Impedance Measurement Accuracy Test Limits for 2 m and 4 m Cable Length Operation . . . . .	10-19
A-1. Manual Changes by Serial Number . . . . .	A-1
A-2. Manual Changes by Firmware's Version . . . . .	A-1
D-1. Correction Data Selecting Rule for SINGLE Mode . . . . .	D-2
D-2. Correction Data Selecting Rule for MULTI Mode . . . . .	D-3
G-1. Measurement Condition Changes . . . . .	G-1

## Installation and Set Up Guide

---

This chapter provides the information necessary for performing an incoming inspection and setting up the HP 4284A. The main topics in this chapter are:

- Incoming Inspection
- Power requirements
- Line Voltage and Fuse Selection
- Operation Environment
- Electromagnetic Compatibility
- Ventilation Requirements
- Instruction for Cleaning
- Rack/Handle Installation

---

### Incoming Inspection

#### Warning



---

**To avoid hazardous electrical shock, do not turn on the HP 4284A when there are signs of shipping damage to any portion of the outer enclosure (for example, covers, panel, or display)**

---

Inspect the shipping container for damage. If the shipping container or cushioning material is damaged, it should be kept until the contents of the shipment have been checked for completeness and the HP 4284A has been checked mechanically and electrically. The contents of the shipment should be as listed in Table 1-1. If the contents are incomplete, if there is mechanical damage or defect, or if the analyzer does not pass the power-on selftests, notify the nearest Hewlett-Packard office. If the shipping container is damaged, or the cushioning material shows signs of unusual stress, notify the carrier as well as the Hewlett-Packard office. Keep the shipping materials for the carrier's inspection.

**Table 1-1. HP 4284A Contents**

Description	Qty.	HP Part Number
<b>HP 4284A</b>		
Power cable <sup>1</sup>	1	—
Operation Manual	1	04284-90020
<b>Option 004 Memory Card</b>		
Memory Card	1	04278-89001
<b>Option 201 Fuse</b>		
Fuse	2	2110-0046
<b>Option 907 Handle Kit</b>		
Handle kit	1	5061-9690
<b>Option 908 Rack Flange Kit</b>		
Rack Flange Kit	1	5061-9678
<b>Option 909 Rack Flange &amp; Handle Kit</b>		
Rack Flange & Handle Kit	1	5061-9684

<sup>1</sup> Power Cable depends on where the instrument is used, see "Power Cable".

## Power Requirements

The HP 4284A requires the following power source:

Voltage : 90 to 132 Vac, 198 to 252 Vac

Frequency : 47 to 66 Hz

Power : 200 VA maximum

## Power Cable

In accordance with international safety standards, this instrument is equipped with a three-wire power cable. When connected to an appropriate ac power outlet, this cable grounds the instrument frame.

The type of power cable shipped with each instrument depends on the country of destination. Refer to Figure 1-1 for the part numbers of the power cables available.

## Warning



**For protection from electrical shock, the power cable ground must not be defeated.**

**The power plug must be plugged into an outlet that provides a protective earth ground connection.**



<p><b>OPTION 900</b></p>  <p>Plug : BS 1363A, 250V Cable : HP 8120-1351</p>	<p><b>OPTION 901</b></p>  <p>Plug : NZSS 198/AS C112, 250V Cable : HP 8120-1369</p>
<p><b>OPTION 902</b></p>  <p>Plug : CEE-VII, 250V Cable : HP 8120-1689</p>	<p><b>OPTION 903</b></p>  <p>Plug : NEMA 5-15P, 125V, 15A Cable : HP 8120-1378</p>
<p><b>OPTION 904</b></p>  <p>Plug : NEMA 6-15P, 250V, 15A Cable : HP 8120-0698</p>	<p><b>OPTION 906</b></p>  <p>Plug : SEV 1011.1959-24507 Type 12, 250V Cable : HP 8120-2104</p>
<p><b>OPTION 912</b></p>  <p>Plug : DHCR 107, 220V Cable : HP 8120-2956</p>	<p><b>OPTION 917</b></p>  <p>Plug : SABS 164, 250V Cable : HP 8120-4211</p>
<p><b>OPTION 918</b></p>  <p>Plug : JIS C 8303, 125V, 15A Cable : HP 8120-4753</p>	<p><b>OPTION 922</b></p>  <p>Plug : GB 1002, 250V Cable : HP 8120-8376</p>
<p><b>NOTE:</b> Each option number includes a 'family' of cords and connectors of various materials and plug body configurations (straight, 90° etc.).</p>	

Figure 1-1. Power Cable Supplied

## Line Voltage and Fuse Selection

Figure 1-2 illustrates the line voltage selection switch and fuseholder on the instrument's rear panel.

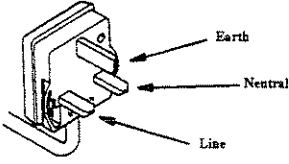
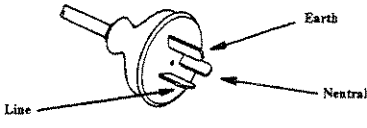
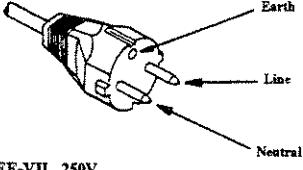
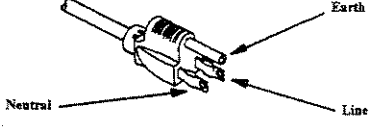
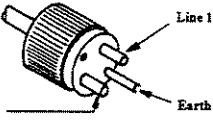
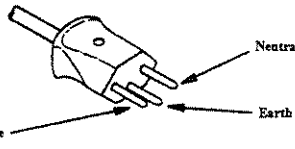
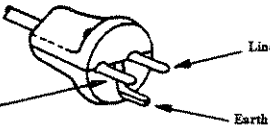
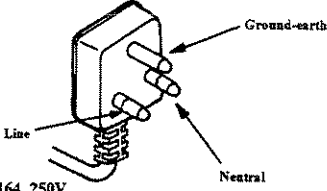
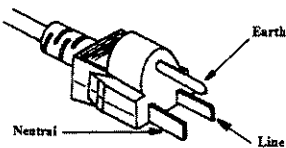
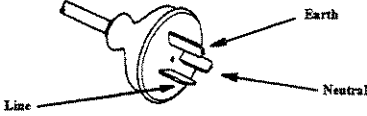
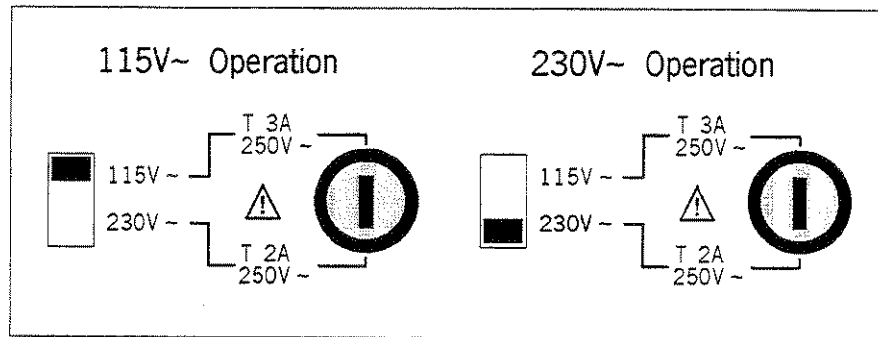

Figure 1-2. Line Voltage Selector

### Caution



Before connecting the instrument to the power source, make sure that the correct fuse has been installed and the Line Voltage Selection Switch is correctly set.

### Line Voltage Selection

Select the proper voltage selector according to the Table 1-2.

Table 1-2. Line Voltage Selection

Voltage Selector	Line Voltage
115 V~	90-132 V, 47-66 Hz
230 V~	198-252 V, 47-66 Hz



### Fuse Selection

Select proper fuse according to the Table 1-3. Current ratings for the fuse are printed under the fuseholder on the rear panel, and are listed, along with the fuse's HP part number, in Table 1-3.

Table 1-3. Fuse Selection

Operating Voltage	Fuse Rating/Type	Fuse Part Number
115 V~	3A 250Vac UL/CSA type Time Delay	2110-0381
230 V~	2A 250Vac UL/CSA type Time Delay	2110-0303

If you need this fuse, contact your nearest Hewlett-Packard Sales and Service Office.

To remove the fuse, turn the fuse holder counterclockwise until the fuse pops out.

**Caution**

Use the proper fuse for the line voltage selected. Use only fuses with the required current rating and of the specified type as replacements. DO NOT use a mended fuse or short-circuit the fuse-holder in order to by-pass a blown fuse. Find out what caused the fuse to blow!

---

**Operation Environment**

The HP 4284A must be operated under within the following environment conditions, and sufficient space must be kept behind the HP 4284A to avoid obstructing the air flow of the cooling fans.

Temperature: 0°C to 55°C

Humidity: less than 95% RH at 40°C

**Note**

The HP 4284A must be protected from temperature extremes which could cause condensation within the instrument.

---

**Electromagnetic Compatibility**

This product has been designed and tested to the requirements of the Electromagnetic Compatibility (EMC) Directive 89/336/EEC. To use a properly shielded cable or shielded coaxial cable (such as those recommended in the General Information and the Performance Test) to connect each of the ports to their respective controllers, peripherals, equipments or devices may ensure to meet the requirements.

---

## Ventilation Requirements

To ensure adequate ventilation, make sure that there is adequate clearance around the HP 4284A.

---

## Instruction for Cleaning

To prevent electrical shock, disconnect the HP 4284A power cable from the receptacle before cleaning. Use a dry cloth or a cloth slightly dipped in water to clean the casing. Do not attempt to clean the HP 4284A internally.

---

## Rack/Handle Installation

The analyzer can be rack mounted and used as a component in a measurement system. Figure 1-3 shows how to rack mount the HP 4284A.

**Table 1-4. Rack Mount Kits**

Option	Description	HP Part Number
907	Handle Kit	5061-9690
908	Rack Flange Kit	5061-9678
909	Rack Flange & Handle Kit	5061-9684

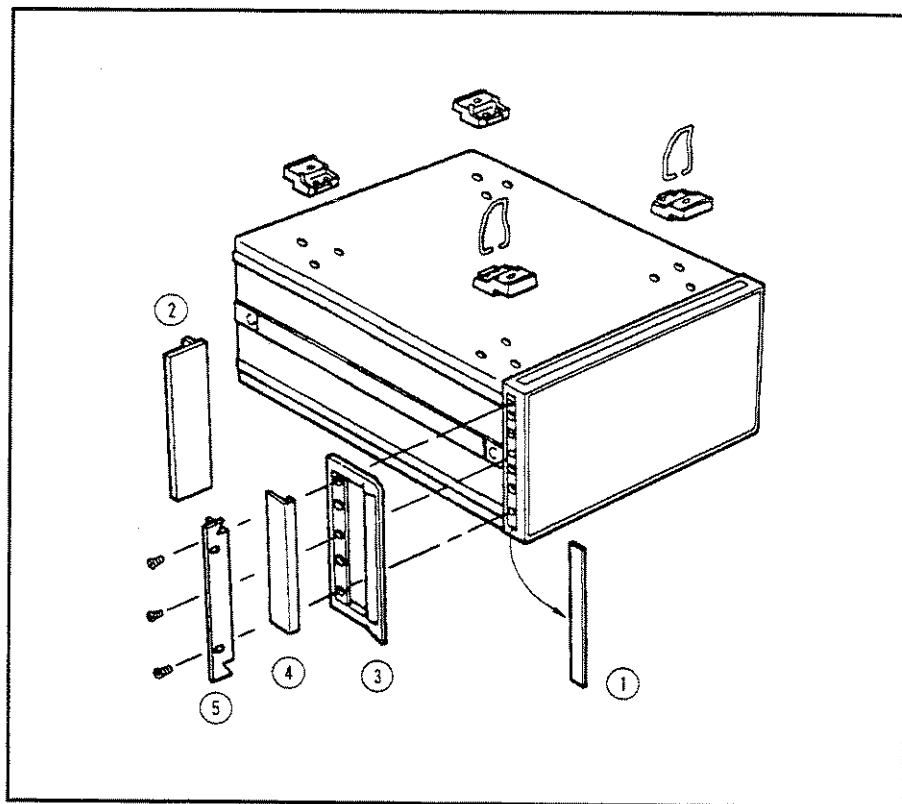

**Figure 1-3. Rack Mount Kits Installation**

### Option 907 Handle Kit

Option 907 is a handle kit containing a pair of handles and the necessary hardware to attach them to the instrument.

#### Installing the Handle

1. Remove the adhesive-backed trim strips ① from the left and right front sides of the HP 4284A. (Refer to Figure 1-3.)
2. Attach the front handles ② to the sides using the screws provided.
3. Attach the trim strips ③ to the handles.

### Option 908 Rack Flange Kit

Option 908 is a rack flange kit containing a pair of flanges and the necessary hardware to mount them to the instrument in an equipment rack with 482.6 mm (19 inches) horizontal spacing.

#### Mounting the Rack

1. Remove the adhesive-backed trim strips ① from the left and right front sides of the HP 4284A. (Refer to Figure 1-3.)
2. Attach the rack mount flange ④ to the left and right front sides of the HP 4284A using the screws provided.
3. Remove all four feet ⑤ (lift bar on the inner side of the foot, and slide the foot toward the bar.)

## **Option 909 Rack Flange & Handle Kit**

Option 909 is a rack mount kit containing a pair of flanges and the necessary hardware to mount them to an instrument which has handles attached, in an equipment rack with 482.6 mm (19 inches) spacing.

### **Mounting the Handle and Rack**

1. Remove the adhesive-backed trim strips 1 from the left and right front sides of the HP 4284A.
2. Attach the front handle 3 and the rack mount flange 5 together on the left and right front sides of the HP 4284A using the screws provided.
3. Remove all four feet (lift bar on the inner side of the foot, and slide the foot toward the bar).

## Overview

---

### Introduction

This Chapter provides the information you will need to know before operating the Hewlett-Packard Model 4284A Precision LCR Meter. Before using the HP 4284A, read through this Chapter so you can quickly and efficiently learn the HP 4284A's operation.

---

### Product Introduction

The HP 4284A is a general purpose LCR meter for incoming inspection of components, quality control, and laboratory use. The HP 4284A is used for evaluating LCR components, materials, and semiconductor devices over a wide range of frequencies (20 Hz to 1 MHz) and test signal levels (5 mV to 2 V<sub>rms</sub>, 50  $\mu$ A to 20 mA<sub>rms</sub>). With Option 001 the HP 4284A's test signal level range spans 5 mV to 20 V<sub>rms</sub>, and 50  $\mu$ A to 100 mA<sub>rms</sub>.

The HP 4284A offers C-D measurements with a basic accuracy of  $\pm 0.05\%$  (C),  $\pm 0.0005$  (D) at all test frequencies with six digit resolution (the dissipation factor resolution is 0.000001) on every range.

With its built-in comparator, the HP 4284A can output comparison/decision results for sorting components into a maximum of ten bins. By using the handler interface and scanner interface options, the HP 4284A can easily be combined with a component handler, a scanner, and a system controller to fully automate component testing, sorting, and quality control data processing.

The HP 4284A's new list sweep function permits entry of up to ten frequencies, test signal levels, or bias level points to be automatically measured.

The HP-IB interface is a standard interface on the HP 4284A and can be used to build an automatic test system to completely characterize new components and materials, and to fully automatic production line testing.

The HP 4284A with Option 002 can apply a 0 to 20A (Maximum 40A : When two HP 4284As are paralleled.) DC current bias to the DUT (Device Under Test). So, high current biased impedance measurement of coils or transformers can be performed easy, fast and safe.

## A Tour of the Front Panel

Figure 2-1 shows the brief description of each key on the HP 4284A's front panel.

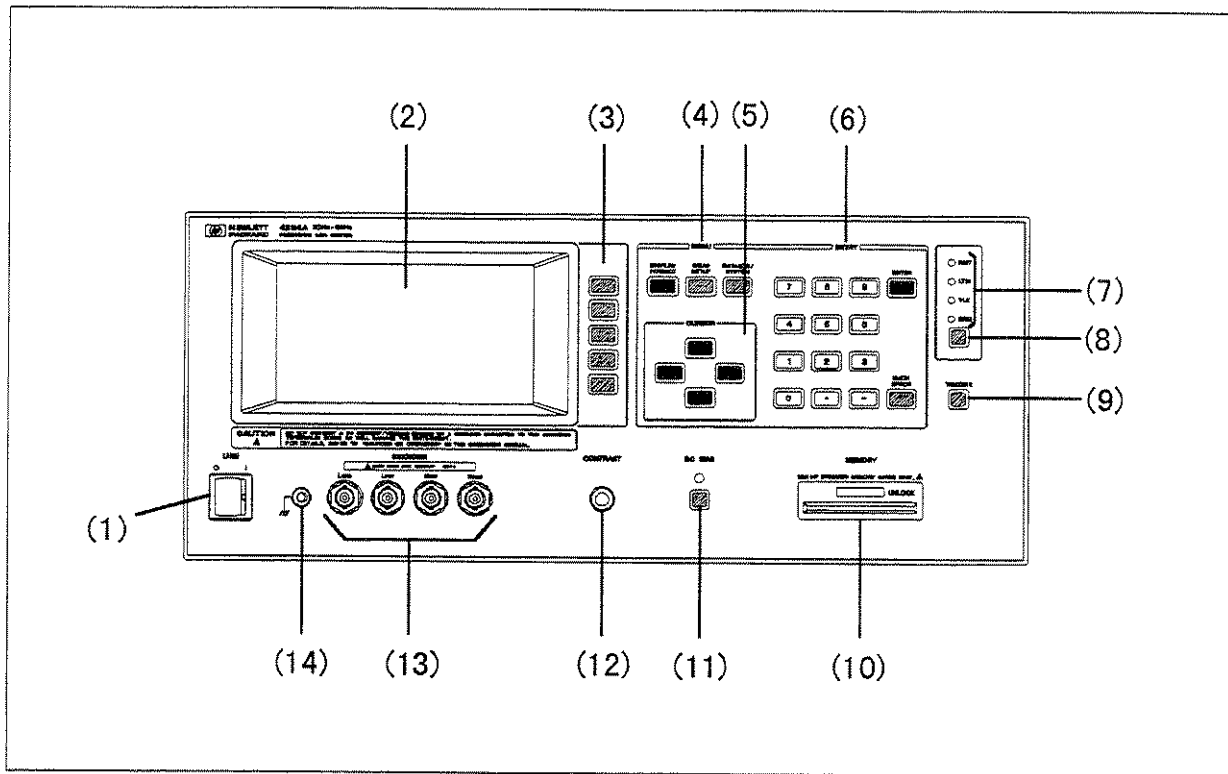

L1002001

**Figure 2-1. Front Panel Overview**

### (1) LINE On/Off

Power on/off switch. In the "ON" position all operating voltages are applied to the instrument. In the "OFF" position NO operating voltages are applied to the instrument.

### (2) LCD

The Liquid Crystal Display (LCD) displays measurement results, test conditions, etc.

### (3) SOFTKEYs

Five softkeys are used to select control and parameter functions. Each softkey has a softkey label along its left side.

### (4) MENU Keys

Menu selection keys. There are three menu keys, **DISPLAY FORMAT**, **MEAS SETUP**, and **CATALOG/SYSTEM**. The menu keys are used to access the corresponding selection of instrument controls.



### (5) CURSOR Keys

The CURSOR keys are used to move the field select cursor from field to field on the LCD display page. When the cursor is moved to a field, the field changes to an inverse video image of the original field. The cursor can only be moved from field to field.

### (6) ENTRY Keys

The ENTRY keys are used to enter numeric data into the HP 4284A. The ENTRY keys are composed of the digits 0 to 9, a period  $\cdot$ , a minus sign  $-$ , **ENTER**, and **BACK SPACE** keys. **ENTER** terminates numeric input data and enters the displayed value on the Input Line (second line from the bottom of the LCD screen). **BACK SPACE** deletes one last character of the input value.

### (7) HP-IB Status Indicators

The HP-IB status indicators consist of the RMT (remote), TLK (talk), LTN (listen), and SRQ (service request) indicators. These indicators are used to show the HP 4284A's HP-IB status when it is interfaced to a controller via HP-IB.

### (8) **LCL** Key

This is the Local (LCL) key which sets the HP 4284A to local (front-panel) control, if it was in REMOTE and if the HP-IB controller had not invoked a local lockout. **LCL** is the only front-panel key that is active when the HP 4284A is in REMOTE state.

### (9) **TRIGGER** Key

This is the TRIGGER key used to manually trigger the HP 4284A when it is set to the Manual Trigger mode.

### (10) MEMORY Card Slot and UNLOCK Button

The MEMORY card slot is where you insert the memory cards. The UNLOCK button is used to eject a memory card.

### (11) **DC BIAS** Key

This is **DC BIAS** used to enable the DC bias output. **DC BIAS** is a toggle type switch, and the DC BIAS ON/OFF LED indicator is located above **DC BIAS**. When **DC BIAS** is set to ON, the DC BIAS ON/OFF LED indicator is ON. When **DC BIAS** is set to OFF, the DC BIAS ON/OFF LED indicator is OFF. If **DC BIAS** is set to OFF, even though the DC bias is set to ON according to the LCD display, the DC bias isn't output.

**(12) CONTRAST Control Knob**

This knob is used to adjust the LCD's CONTRAST.

**(13)  UNKNOWN Terminals**

These are the UNKNOWN Terminals used to connect a four-terminal pair test fixture or test leads for measuring the device under test. Available four terminal-pair test fixtures or test leads are refer to the Accessories Selection Guide For Impedance Measurements (Catalog number 5963-6834E).

**INSTALLATION CATEGORY I**

---

**Caution**



 Do not apply DC voltage or current to the UNKNOWN terminals. Doing so will damage the HP 4284A. Before you measure a capacitor, be sure the capacitor is fully discharged.

---

**(14) FRAME Terminal**

This is the FRAME Terminal which is tied to the instrument's chassis and which can be used for measurements that require guarding.

**A Tour of the Rear Panel**

Figure 2-2 shows a brief description of the HP 4284A's rear panel.

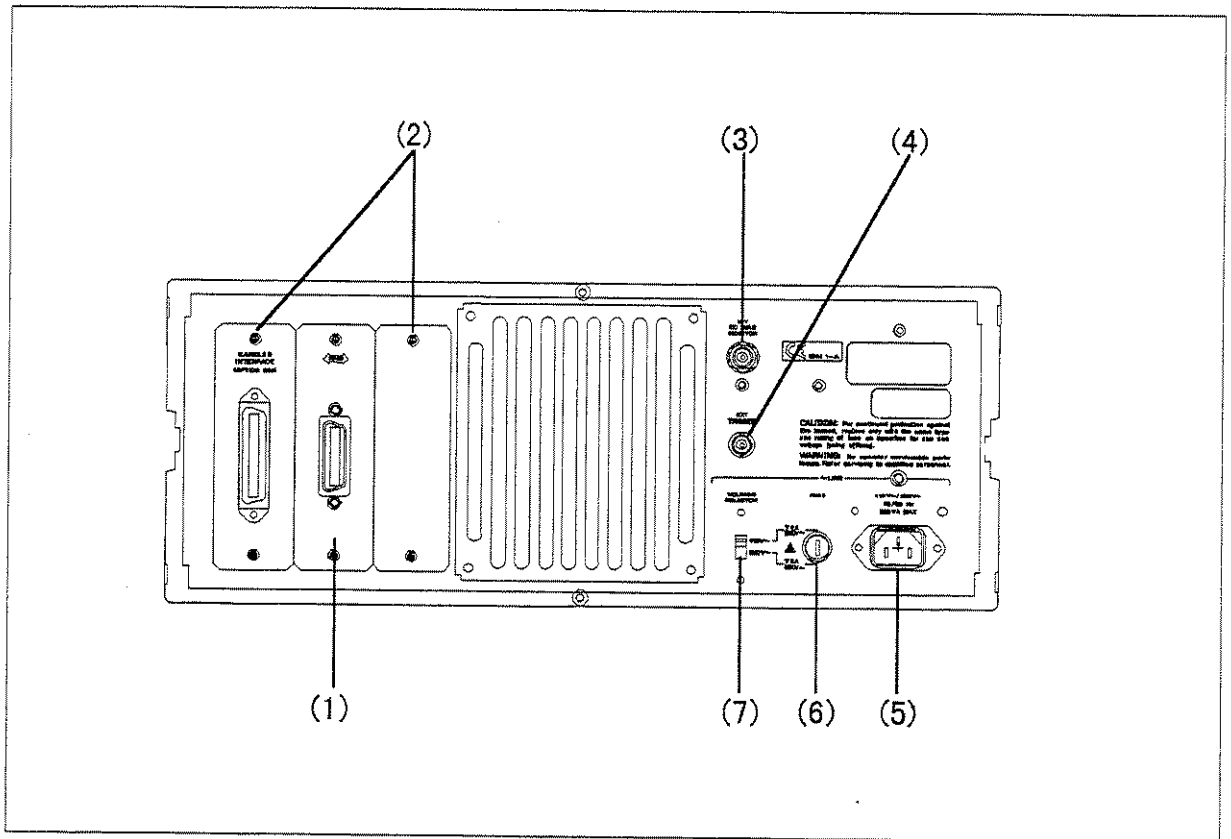

**Figure 2-2. Rear Panel Overview**

**(1) HP-IB Interface Connector**

This is the HP-IB interface connector used when operating on the Hewlett-Packard Interface Bus.

**(2) Interface Connectors**

When interface options are installed, the interface connectors will be installed as shown. When the HP 4284A is not equipped with an interface option, blank covers are installed.

**(3) INT DC BIAS MONITOR Connector**

This BNC connector is the internal DC BIAS monitor connector used for monitoring the DC bias voltage applied to the device under test. This connector is installed only when Option 001 is installed.

**(4) EXT TRIGGER Connector**

This BNC connector is the external trigger connector used to input the positive-going TTL pulse signal to trigger the HP 4284A. (The trigger mode must be set to EXTERNAL.)

**(5) ~LINE Input Receptacle**

AC power cord receptacle.

**(6)  ~LINE Fuse Holder**

Fuse holder for the HP 4284A's line fuse. Refer to CHAPTER 1 to determine the correct line fuse rating.

**(7) ~LINE VOLTAGE SELECTOR**

The switch used to match the HP 4284A to the AC operating voltage being used. Refer to CHAPTER 1 to determine the correct operating voltage.

## Display

The following paragraphs define the display areas and fields, and describes the LCD's display pages.

### Display Area Definition

The HP 4284A uses a 40 character by 16 line Liquid Crystal Display (LCD), and the display area on the LCD is divided into the areas shown in Figure 2-3.

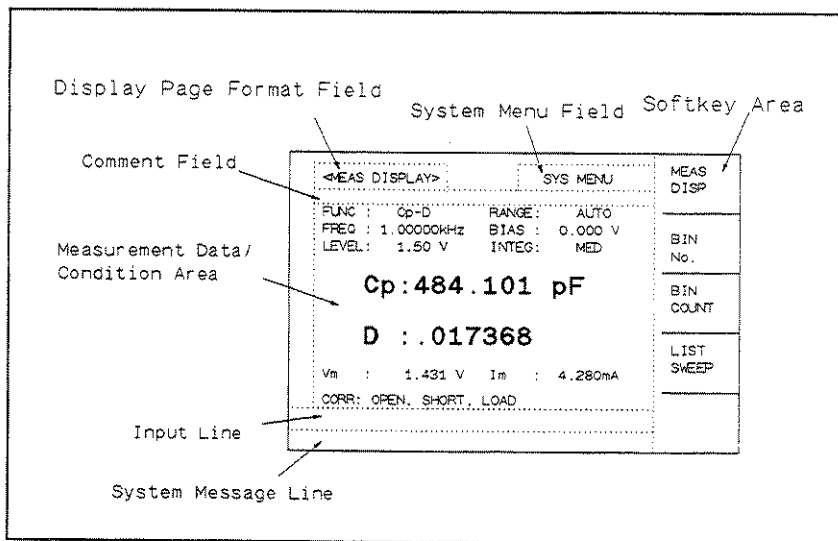

Figure 2-3. Display Area Definition

### Display Page Area

This is the display page area. This area identifies the current display page.

### System Menu Field

The system menu area is always displayed on all pages (except for the *SELF TEST* page) as the *SYS MENU* field. When the cursor is set on the *SYS MENU* field, common system functions which are not displayed on the display pages (for example, *LOAD/STORE* function), or controls which cannot be set on a display page's fields, are made available.

### Comment Line Area

The comment line area is used to display comment messages sent via the HP-IB bus using the *DISPlay:LINE* command or entered on the *MEAS SETUP* page using the 0 to 9, (period), (minus) keys. Up to 30 characters can be displayed. The comment line area is displayed on the following pages.

- *MEAS DISPLAY*
- *BIN No. DISPLAY*
- *LIST SWEEP DISPLAY*
- *MEAS SETUP*

- *LIST SWEEP SETUP*
- *SYSTEM CONFIG*

### **Softkey Area**

The last six character positions of each line are reserved for softkey labels. The softkeys displayed correspond to the field at the cursor's position on the LCD.

### **Measurement Data/Conditions Area**

This area is where measurement results and measurement conditions are displayed.

### **Note**



---

Under certain conditions one of the following messages may be displayed instead of the measurement results.

- “UNBAL”: This message is displayed when the impedance of the device exceeds the range of the analog measurement circuit's capability.
- “ADC ERR”: This message is displayed when the A/D converter in the measurement circuit is not functioning.
- “-----”: This message is displayed and is called “overflow” when the analog measurement circuit can measure the device, but the data format used will not hold the calculated results.
- “INFINITY”: This message is displayed when an attempt is made to divide by zero during parameter calculation. For example, if you set the  $\Delta$  % measurement function without setting the reference value, this message will be displayed.
- 

### **Input Line Area**

This area is the input line where numeric input data entered with the front panel keys is displayed.

### **System Message Area**

This area is where system messages, comments, and error messages are displayed.

## MENU keys and Display Page

The HP 4284A has three MENU keys which are used to define the LCD display pages.

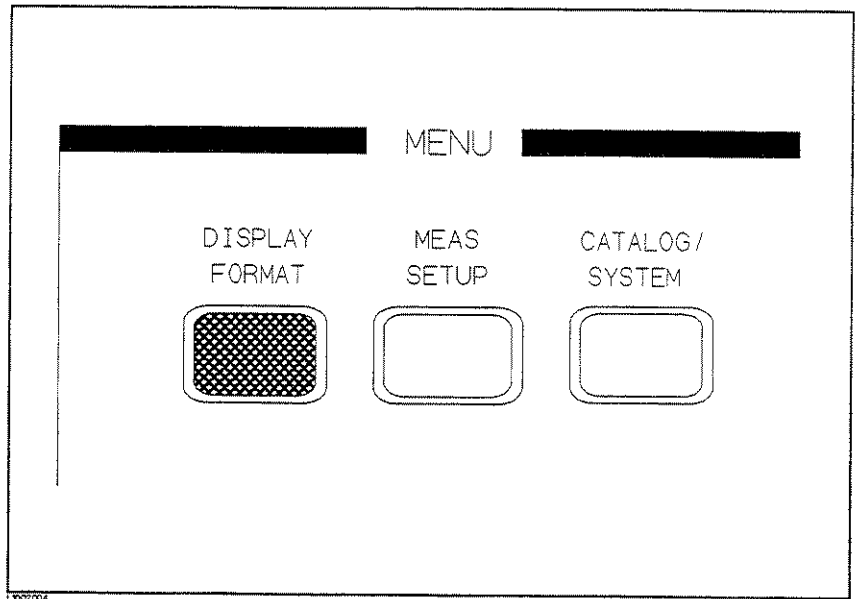

Figure 2-4. MENU keys

Each MENU key has three or four display pages as follows.

### DISPLAY FORMAT MENU key

This MENU key has the following four pages.

- *MEAS DISPLAY*
- *BIN No. DISPLAY*
- *BIN COUNT DISPLAY*
- *LIST SWEEP DISPLAY*

These display pages are used for displaying the measurement results, and displaying the sorting results. Some controls for each display page can be set from the display page. Only from the above display pages can the HP 4284A measure a device under test. When **DISPLAY FORMAT** is pressed, the *MEAS DISPLAY* page will be displayed on the LCD screen, and the softkeys used to select the other three pages are displayed. The cursor will be positioned at the *MEAS DISPLAY* field. The power-on default display page is the *MEAS DISPLAY* page. For more information under **DISPLAY FORMAT**, refer to Chapter 3.

### MEAS SETUP MENU key

This MENU key has the following four pages.

- *MEAS SETUP*
- *CORRECTION*
- *LIMIT TABLE SETUP*

### ■ *LIST SWEEP SETUP*

These display pages are used for setting the measurement conditions (including the correction function), or setting the bin sorting limits. When one of these display pages are being displayed, the HP 4284A cannot perform measurement, and also cannot perform bin sorting judgments. (The HP 4284A can only measure a device under test and can perform the bin judgments from the display pages under **DISPLAY FORMAT**.) When **MEAS SETUP** is pressed, the *MEAS SETUP* page must be displayed, and the softkeys used to select the other three pages are displayed. The cursor will be positioned at the *MEAS SETUP* field. For more information about **MEAS SETUP**, refer to Chapter 3.

### **CATALOG/SYSTEM menu key**

This MENU key has the following three pages.

- *CATALOG*
- *SYSTEM CONFIGURATION*
- *SELF TEST*

These display pages are used for operating conditions other than main measurement control. When **CATALOG/SYSTEM** is pressed, the *CATALOG* page will be displayed, and the softkeys used to select the other two pages are displayed. The cursor will be positioned at the *CATALOG* field. For more information about **CATALOG/SYSTEM**, refer to Chapter 5.

Starting from the next paragraph, a summary for each display page will be given.



## Summary of Pages

Figure 2-5 shows all display pages. Each summary of each page is shown below.

### **MEAS DISPLAY (under DISPLAY FORMAT)**

This display page provides the measurement result information, and control settings are entered from this page. The HP 4284A measures the device under test from this page, and displays the measurement results in large characters.

### **BIN No. DISPLAY (under DISPLAY FORMAT)**

This display page provides the bin sorting result information, the measurement results, and comparator function on/off settings. The HP 4284A measures the device under test from this page. The bin number is displayed in large characters, and the measurement results are displayed in normal characters.

### **BIN COUNT DISPLAY (under DISPLAY FORMAT)**

This display page provides the limit table's conditions, and the comparator's bin counter results. The HP 4284A can measure the device under test from this page, but the measurement results will not be displayed.

### **LIST SWEEP DISPLAY (under DISPLAY FORMAT)**

This display page provides the list sweep measurement results, and the sweep mode step/seq selection. The HP 4284A measures the device under test according to the list sweep conditions in the LIST SWEEP SETUP page. An asterisk (\*) shows the current measuring point in the list sweep points. The list sweep point cannot be set from this page. You must use the *LIST SWEEP SETUP* (in MEAS SETUP) page to set the list sweep points.

### **MEAS SETUP (under MEAS SETUP)**

This display page provides all of the measurement control settings. The HP 4284A cannot perform a measurement from this page, and the measurement result can not be displayed on this page. When you measure the device under test using the control settings on this page, use one of the display pages from DISPLAY FORMAT.

### **CORRECTION (under MEAS SETUP)**

This display page provides the correction function. The correction function must be used to measure the device under test accurately. The HP 4284A cannot measure the device under test from this page, and the measurement results will not be displayed. When you measure a device under test, use one of the display pages from DISPLAY FORMAT.

#### **LIMIT TABLE SETUP (under MEAS SETUP)**

This display page provides the limit table settings for bin sorting. The HP 4284A cannot perform a measurement from this page, and the comparison results can not be displayed. When you want to see the comparison results, either the *BIN No. DISPLAY* page (under DISPLAY FORMAT) or the *BIN COUNT DISPLAY* page (under DISPLAY FORMAT) must be used.

#### **LIST SWEEP SETUP (under MEAS SETUP)**

This display page provides the control settings for the List Sweep measurement function. The HP 4284A cannot measure the device under test from this page, and the list sweep measurement results can not be displayed from this page. When you measure the device under test using the control settings on the *LIST SWEEP SETUP* page, the *LIST SWEEP DISPLAY* page (in DISPLAY FORMAT) must be used.

#### **CATALOG (under CATALOG/SYSTEM)**

This display page provides the catalog of the stored contents in internal memory or a from the memory card.

#### **SYSTEM CONFIG (under CATALOG/SYSTEM)**

This display page provides the operation of either the HP-IB interface or the HP 4284A's options, and will also tell you the option installation information.

#### **SELF TEST (under CATALOG/SYSTEM)**

This display page provides the HP 4284A's self test utilities and the the Performance Test given in Chapter 10.

# DISPLAY FORMAT MENU

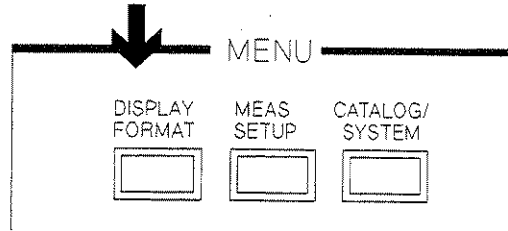

## MEAS DISPLAY page

<MEAS DISPLAY>		SYS MENU	MEAS DISP
FUNC : Cp-D	RANGE: AUTO		
FREQ : 1.00000kHz	BIAS : 0.000 V		
LEVEL: 1.500 V	INTEG: MED		
<b>Cp : 484.101 pF</b>			
<b>D : .017368</b>			
Vm : 1.431 V	Im : 4.280mA		
CORR: OPEN, SHORT, LOAD		CBL: 0m	
		BIN No.	
		BIN COUNT	
		LIST SWEEP	

## BIN No. DISPLAY page

<BIN No.DISPLAY>		SYS MENU	MEAS DISP
FUNC : Cp-D	RANGE: AUTO		
FREQ : 1.00000kHz	BIAS : 1.5000 V		
LEVEL: 1.00 V	INTEG: MED		
	COMP : ON		
<b>BIN 1</b>			
Cp : 123.456 pF	D : 0.12345		
CORR: OPEN, SHORT, LOAD		CBL: 0m	
		BIN No.	
		BIN COUNT	
		LIST SWEEP	

## BIN COUNT DISPLAY page

<BIN COUNT DISPLAY>		SYS MENU	MEAS DISP
FUNC : Cp-D	NOM : 100.000 pF		
BIN	LOW[ % ]	HIGH[ % ]	COUNT
1	- 0.010	+ 0.010	0
2	- 0.020	+ 0.020	0
3	- 0.030	+ 0.030	0
4	- 0.040	+ 0.040	5
5	- 0.050	+ 0.050	9999
6	- 0.060	+ 0.060	80
7	- 0.070	+ 0.070	5
8	- 0.080	+ 0.080	0
9	- 0.090	+ 0.090	0
2nd	+ .000000	+ .000005 [ ]	
REJ CNT	AUX: 999999	OUT: 999999	
		BIN No.	
		BIN COUNT	
		LIST SWEEP	

## LIST SWEEP DISPLAY page

<LIST SWEEP DISPLAY>		SYS MENU	MEAS DISP
MODE :	SEQ		
FREQ(Hz)	Cp[ F ]	D[ ]	CMP
1.00000k	123.453p	0.00001	L
2.00000k	123.456p	0.00002	L
5.00000k	123.456p	0.00003	
10.0000k	123.457p	0.00004	
20.0000k	123.458p	0.00005	H
50.0000k	123.459p	0.00006	
100.000k	123.550p	0.00007	
200.000k	123.551p	0.00008	H
500.000k	123.552p	0.00009	H
1.00000M	123.553p	0.00010	H
			BIN No.
			BIN COUNT
			LIST SWEEP

L1002005

Figure 2-5. Display Pages (1/3)

# MEAS SETUP MENU

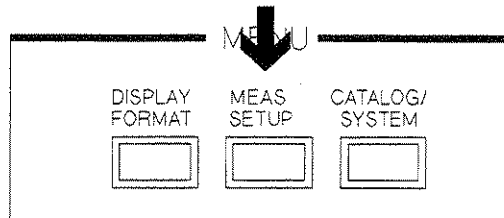

## MEAS SETUP page

<MEAS SETUP>		SYS MENU	MEAS SETUP
FUNC : Cp-D	RANGE: AUTO		
FREQ : 1.00000kHz	BIAS : 1.5000 V		
LEVEL : * 1.00 V	INTEG: MED		
TRIG : INT	AVG : 4		
ALC : ON	Vm : ON		
HI-PW: ON	Im : ON		
DCI :ISO ON	DELAY: 0 ms		
DEV A: ΔABS	REF A: 123.456 pF		
B: ΔABS	B: 0.00005		

## CORRECTION Page

<CORRECTION>		SYS MENU	MEAS SETUP
OPEN : ON	CABLE: 1 m		
SHORT: ON	MODE : MULTI		
LOAD : ON	CH No.: 10		
	FUNC : Cp-D		
FREQ01 : 1.00000kHz			
REF A: 100.000pF	B: 0.00010		
MEA A: 100.001pF	B: 0.00011		
FREQ02 : 10.0000kHz			
REF A: 100.020pF	B: 0.00012		
MEA A: 100.021pF	B: 0.00013		
FREQ03 : 100.000kHz			
REF A: 100.040pF	B: 0.00014		
MEA A: 100.041pF	B: 0.00015		

## LIMIT TABLE SETUP page

<LIMIT TABLE SETUP>		SYS MENU	MEAS SETUP
FUNC : Cp-D	NOM : 100.000 pF		
MODE : %	AUX: OFF	COMP: ON	
BIN	LOW	HIGH	
1	- 0.010 %	+ 0.010 %	
2	- 0.020 %	+ 0.020 %	
3	- 0.030 %	+ 0.030 %	
4	- 0.040 %	+ 0.040 %	
5	- 0.050 %	+ 0.050 %	
6	- 0.060 %	+ 0.060 %	
7	- 0.070 %	+ 0.070 %	
8	- 0.080 %	+ 0.080 %	
9	- 0.090 %	+ 0.090 %	
2nd	+ .000000	+ .000005	

## LIST SWEEP SETUP page

<LIST SWEEP SETUP>		SYS MENU	MEAS SETUP
MODE : SEQ			
FREQ(Hz)	LMT	LOW	HIGH
1.00000k	A	123.456p	124.567p
2.00000k	A	123.456p	124.567p
5.00000k	A	123.456p	124.567p
10.0000k	A	123.456p	124.567p
20.0000k	A	123.456p	124.567p
50.0000k	A	123.456p	124.567p
100.000k	A	123.456p	124.567p
200.000k	A	123.456p	124.567p
500.000k	A	123.456p	124.567p
1.00000M	A	123.456p	124.567p

L1002006

Figure 2-5. Display Pages (2/3)

# CATALOG/SYSTEM MENU

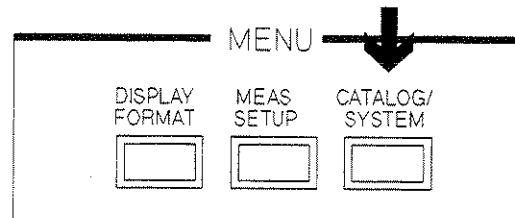

## CATALOG page

<CATALOG>		SYS MENU	CATA-LOG
MEDIA: CARD			
No.	S	COMMENT	
10	1	Cp-D Measurements (1kHz)	SYSTEM CONFIG
11	1	0160-123B	
12	1	Device A	
13	0		
14	0		
15	0		
16	0		
17	0		SELF TEST
18	X	(Data for 4285A)	
19	X	(Data for 4265A)	

## SYSTEM CONFIG page

<SYSTEM CONFIG>		SYS MENU	CATA-LOG
BEEPER	:	ON	
HP-IB I/F	:	INSTALLED	SYSTEM CONFIG
HP-IB ADDRESS	:	17	
TALK ONLY	:	OFF	
DC BIAS	(#001):	INSTALLED	
ACCESSORY I/F	(#002):	INSTALLED	
CONFIG	:	I BIAS	SELF TEST
HANDLER I/F	(#201):	INSTALLED	
	:	ON	
SCANNER I/F	(#301):	INSTALLED	
	:	ON	

## SELF TEST page

<SELF TEST>		CATA-LOG
No.	TEST MENU	
1	Memory card R/W test	SYSTEM CONFIG
2	LED display test	
3	LCD display test	
4	Handler I/F test	
5	Scanner I/F EEPROM R/W test	
6	Scanner I/F I/O test	
7	Bias Current I/F I/O test	SELF TEST

L1002007

Figure 2-5. Display Pages (3/3)

## Basic Operation

The HP 4284A's basic operation is described in the following paragraphs.

- Display the desired display page using both the MENU keys and the softkeys. (Refer to Figure 2-5.)
- Move the cursor to the field to be used using the CURSOR arrow keys. The cursor will be an inverse video marker, and the field is the area to which you can set the cursor.

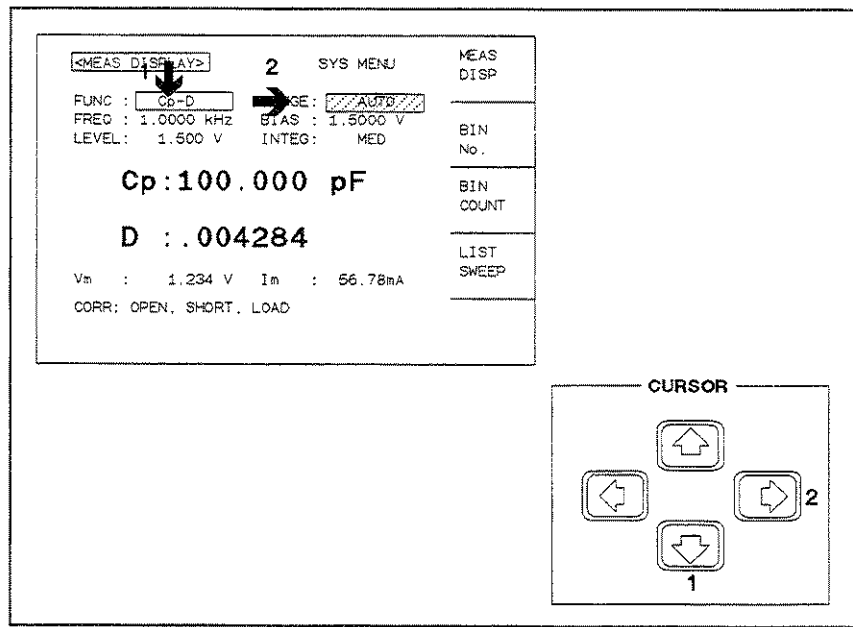

Figure 2-6. CURSOR Keys and Field Operation Example

- The softkeys corresponding to the field pointed to by the cursor will be displayed. Select and press a softkey. The numeric entry keys and **ENTER** are used to enter numeric data.

When one of the numeric entry keys is pressed, the softkeys will change to the available unit softkeys. You can use these unit softkeys instead of **ENTER**. When **ENTER** is used, the numeric data is entered with Hz, V, or A as the default unit depending on the cursor field selected, e.g., test frequency's unit will be Hz, etc.

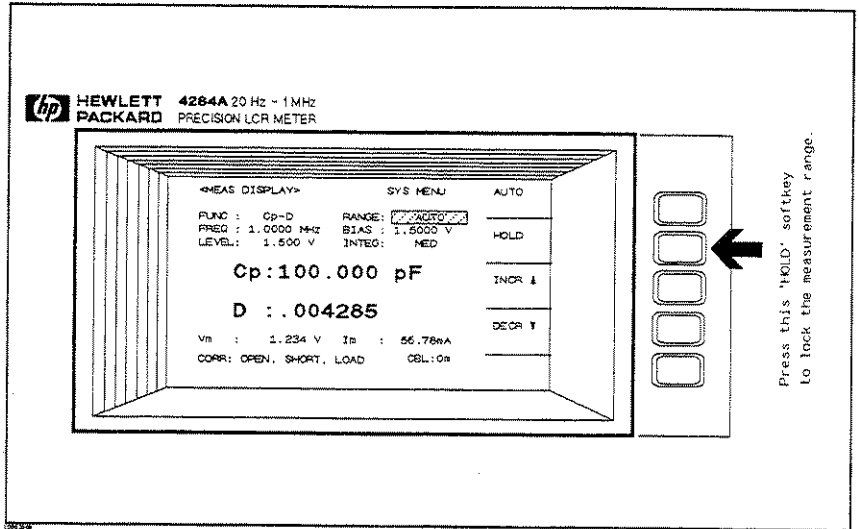

Figure 2-7. Softkey Selection Example





## DISPLAY FORMAT Menu

### Introduction

This Chapter provides information about the function of each page of **DISPLAY FORMAT**. The following four display pages can be called from **DISPLAY FORMAT**.

- *MEAS DISPLAY*
- *BIN No. DISPLAY*
- *BIN COUNT DISPLAY*
- *LIST SWEEP DISPLAY*

This Chapter describes the functions on each page in the order of the preceding list.

### MEAS DISPLAY Page

When you press **DISPLAY FORMAT**, the *MEAS DISPLAY* page will be displayed. On this *MEAS DISPLAY* page, the measurement results are displayed in large characters, and the following measurement controls can be set from this page. (The field in parenthesis is used to set the control function.)

- Measurement Function (*FUNC*)
- Measurement Range (*RANGE*)
- Test Frequency (*FREQ*)
- Oscillator Level (*LEVEL*)
- DC Bias (*BIAS*)
- Integration Time (*INTEG*)
- System Menu (*SYS MENU*)

There are eight fields on this page: *MEAS DISPLAY*, *FUNC*, *RANGE*, *FREQ*, *LEVEL*, *BIAS*, *INTEG*, and *SYS MENU*. Each control function is described in the following paragraphs.

This page also provides the following information in monitor areas on the displayed page. These conditions can be set from the *MEAS SETUP* page or *CORRECTION* page. (For more detail of the following information, refer to Chapter 4.)

- Oscillator Level Voltage/Current Monitor value ( $V_m$ ,  $I_m$ )
- OPEN, SHORT, LOAD on/off setting conditions (*CORR*)
- Channel Number (*CH*) when the scanner interface is used.

The available fields and the softkeys which correspond to the fields on this page are shown in Figure 3-1 and Figure 3-2 respectively.

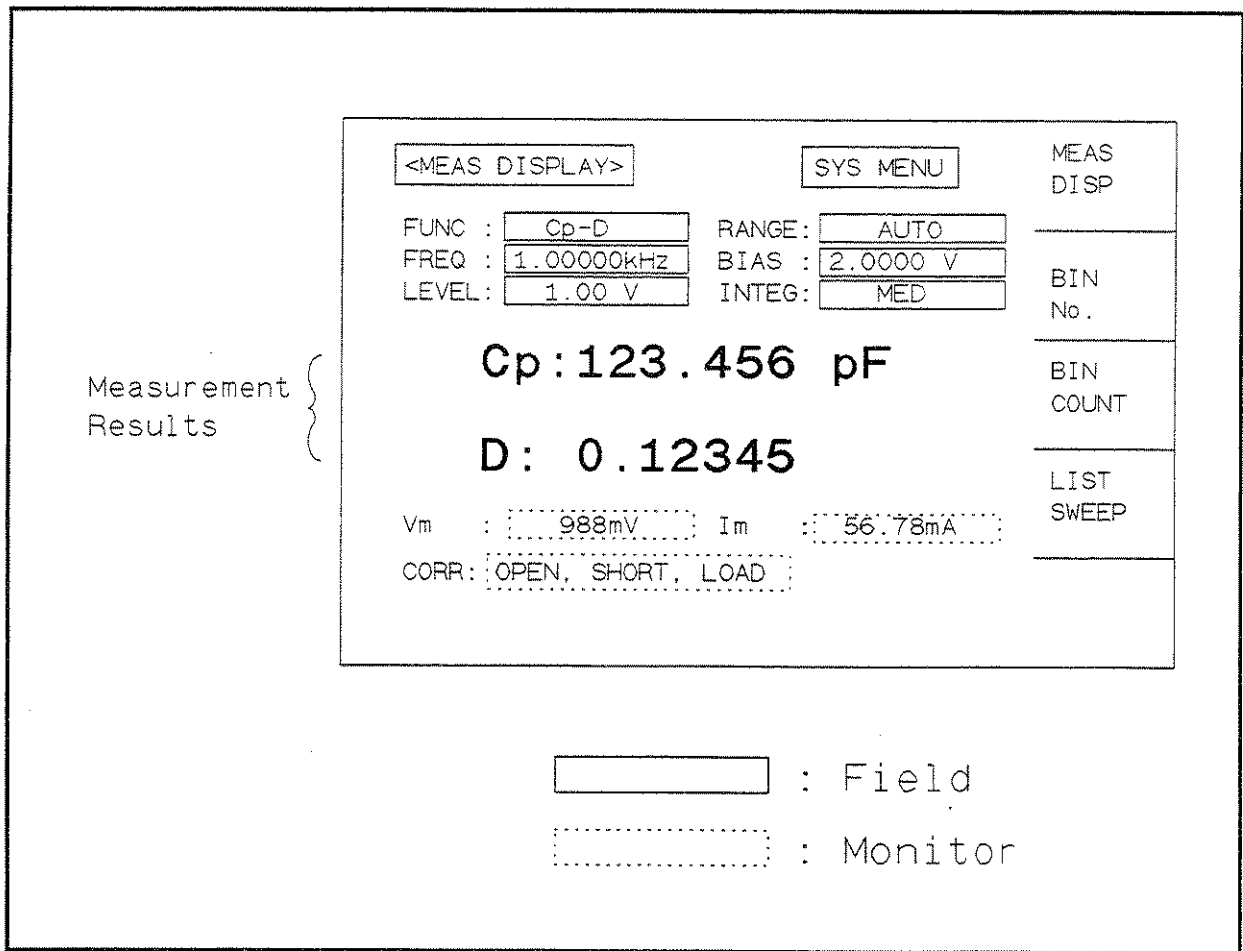

L1003001

Figure 3-1. Available Fields on the MEAS DISPLAY Page

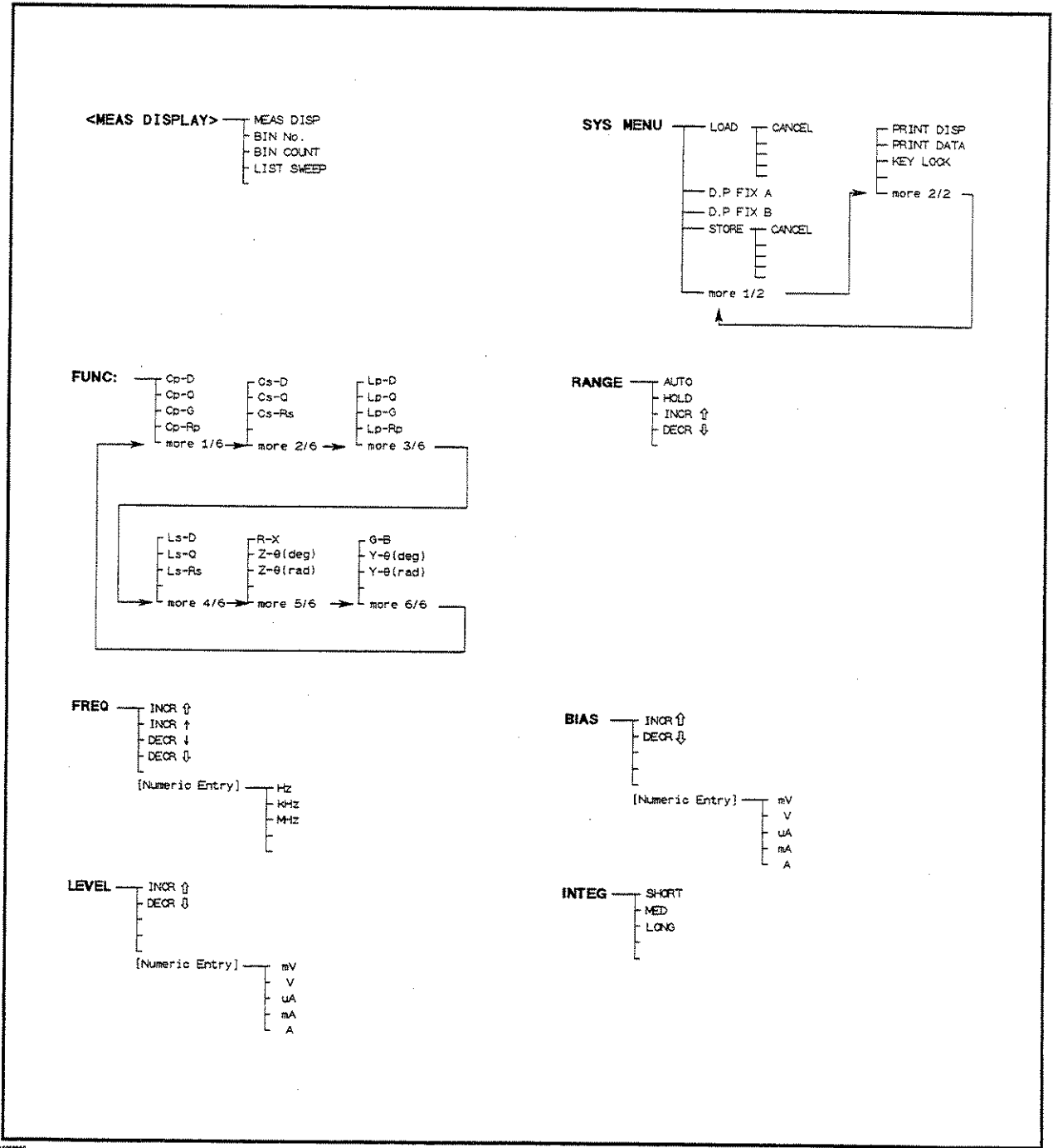

1303302

Figure 3-2. Available Softkeys on the MEAS DISPLAY Page

## Measurement Function

### Description

The HP 4284A measures two components of the complex impedance (parameters) at the same time in a measurement cycle. The measurement parameters are listed as follows.

#### ■ Primary Parameters

Z	(absolute value of impedance)
Y	(absolute value of admittance)
L	(inductance)
C	(capacitance)
R	(resistance)
G	(conductance)

#### ■ Secondary Parameters

D	(dissipation factor)
Q	(quality factor)
$R_s$	(ESR (equivalent series resistance))
$R_p$	(equivalent parallel resistance)
X	(reactance)
B	(susceptance)
$\theta$	(phase angle)

The primary parameter measurement result is located on the upper line as two large character lines on this page, and the secondary parameter measurement result is located on the lower line as two large character lines on this page.

The combinations of primary and secondary parameters, including the equivalent parallel and serial combinations, are listed in Table 3-1.

**Table 3-1. Measurement Function**

Primary Parameter	Serial Mode	Parallel Mode
Z	Z- $\theta$ (rad) Z- $\theta$ (deg)	
Y		Y- $\theta$ (rad) Y- $\theta$ (deg)
C	C <sub>s</sub> -D C <sub>s</sub> -Q C <sub>s</sub> -R <sub>s</sub>	C <sub>p</sub> -D C <sub>p</sub> -Q C <sub>p</sub> -G C <sub>p</sub> -R <sub>p</sub>
L	L <sub>s</sub> -D L <sub>s</sub> -Q L <sub>s</sub> -R <sub>s</sub>	L <sub>p</sub> -D L <sub>p</sub> -Q L <sub>p</sub> -G L <sub>p</sub> -R <sub>p</sub>
R	R-X	
G		G-B

**Front Panel Operation for Setting the Measurement Function**

Perform the following steps to set the measurement function.

- Use the CURSOR arrow keys to move the cursor to the *FUNC* field. The following softkeys will be displayed.
  - Cp-D
  - Cp-Q
  - Cp-G
  - Cp-Rp
  - more 1/6
- Select and press a softkey to set the measurement function. If the softkey you want is not displayed, press **more 1/6** to display the following set of softkeys.
  - Cs-D
  - Cs-Q
  - Cs-Rs
  - more 2/6
- Select and press a softkey to set the measurement function. If the softkey you want is not displayed, press **more 2/6** to display the following set of softkeys.
  - Lp-D
  - Lp-G

- **Lp-G**
  - **Lp-Rp**
  - **more 3/6**
4. Select and press a softkey to set the measurement function. If the softkey you want is not displayed, press **more 3/6** to display the following set of softkeys.
- **Ls-D**
  - **Ls-Q**
  - **Ls-Rs>**
  - **more 4/6**
5. Select and press a softkey to set the measurement function. If the softkey you want is not displayed, press **more 4/6** to display the following set of softkeys.
- **R-X**
  - **Z- $\theta$  (deg)**
  - **Z- $\theta$  (rad)**
  - **more 5/6**
6. Select and press a softkey to set the measurement function. If the softkey you want is not displayed, press **more 5/6** to display the following set of softkeys.
- **G-B**
  - **Y- $\theta$  (deg)**
  - **Y- $\theta$  (rad)**
  - **more 6/6**
7. Select and press a softkey to set the measurement function. When **more 6/6** is pressed, the softkeys shown in step 1 will be displayed. Retry steps 1 through 7 if you missed the function you were looking for.

## Measurement Range

### Description

The HP 4284A has eight measurement ranges: 10 $\Omega$ , 100 $\Omega$ , 300 $\Omega$ , 1 k $\Omega$ , 3 k $\Omega$ , 10 k $\Omega$ , 30 k $\Omega$ , and 100 k $\Omega$ . When Option 001 is installed, the HP 4284A has nine measurement ranges: 1 $\Omega$ , 10 $\Omega$ , 100 $\Omega$ , 300 $\Omega$ , 1 k $\Omega$ , 3 k $\Omega$ , 10 k $\Omega$ , 30 k $\Omega$ , and 100 k $\Omega$ . The measurement range is selected according to the DUT's impedance even if measurement parameter is capacitance or inductance.

Figure 3-3 shows the display range and effective measuring range for each measurement range while in the impedance mode ( $|Z|$ , R, X). For example, 50 k $\Omega$  DUT impedance can be measured using from

the 100  $\Omega$  to the 30 k $\Omega$  range, but the HP 4284A's measurement accuracy specification is only met by using the 30 k $\Omega$  range. If this DUT is measured by the 100 k $\Omega$  range, UNBAL will be displayed.

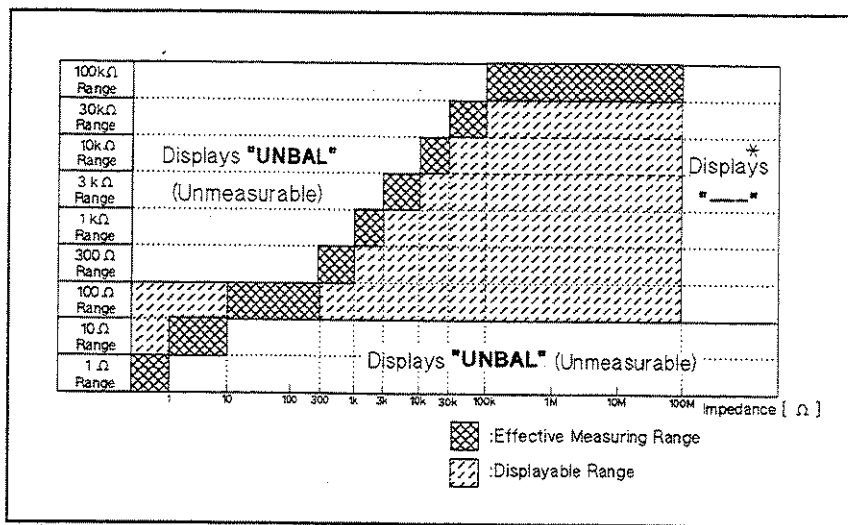
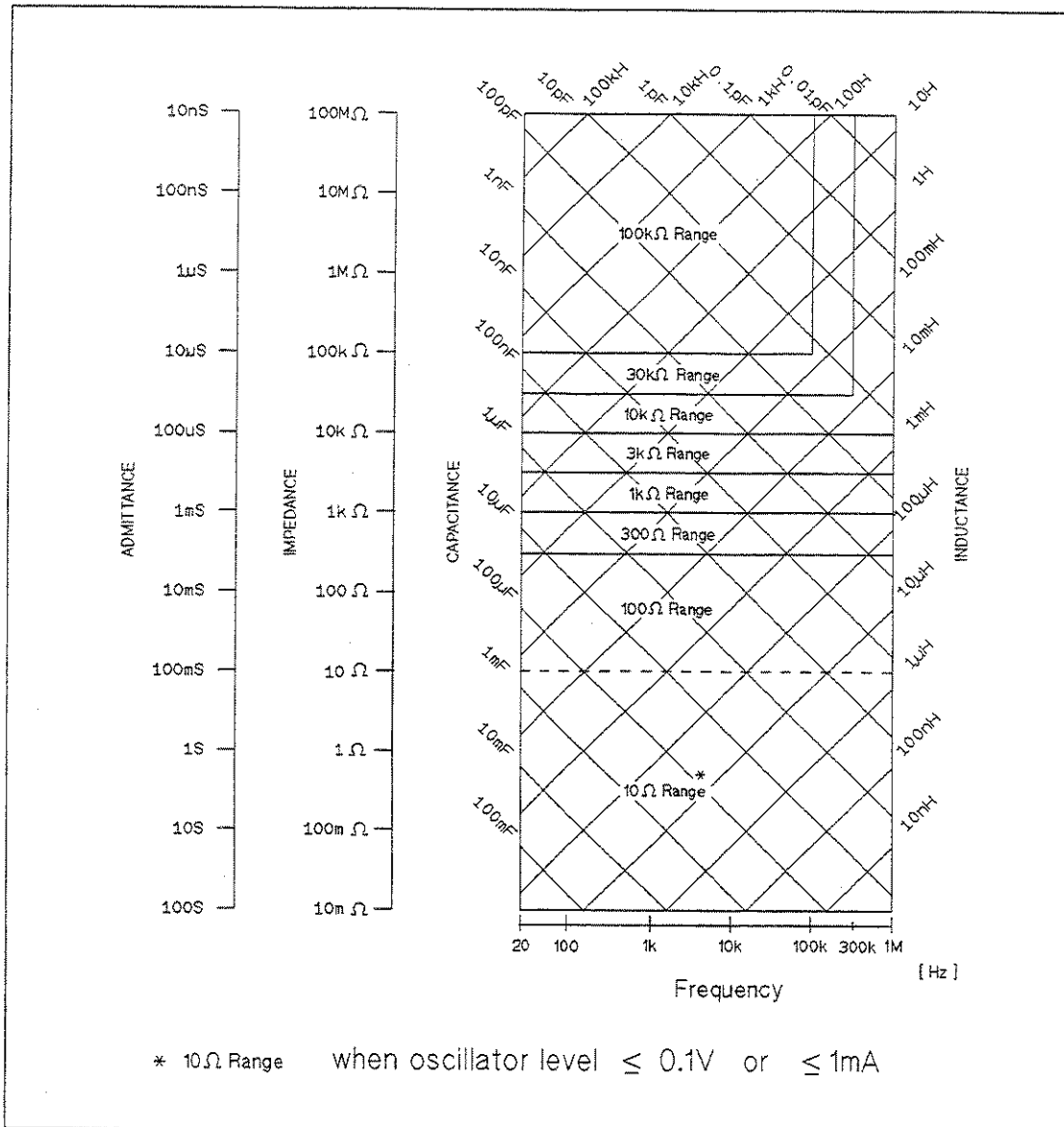

Figure 3-3. Effective Measuring Range for Each Measurement Range

Figure 3-4 and Figure 3-5 show the effective measuring range of each measurement range, in which the HP 4284A's measurement accuracy meets its specification. When the measurement range is set manually, the optimum measurement range should be selected by matching the DUT's impedance to the effective measuring range shown in Figure 3-4 and Figure 3-5. When the measurement range is set to AUTO, the optimum measurement range is automatically selected according to the impedance of each DUT.



L100300A

**Figure 3-4.**  
**Effective Measuring Range**  
**(Oscillator Level  $\leq 2V$  or  $\leq 20 mA$ )**



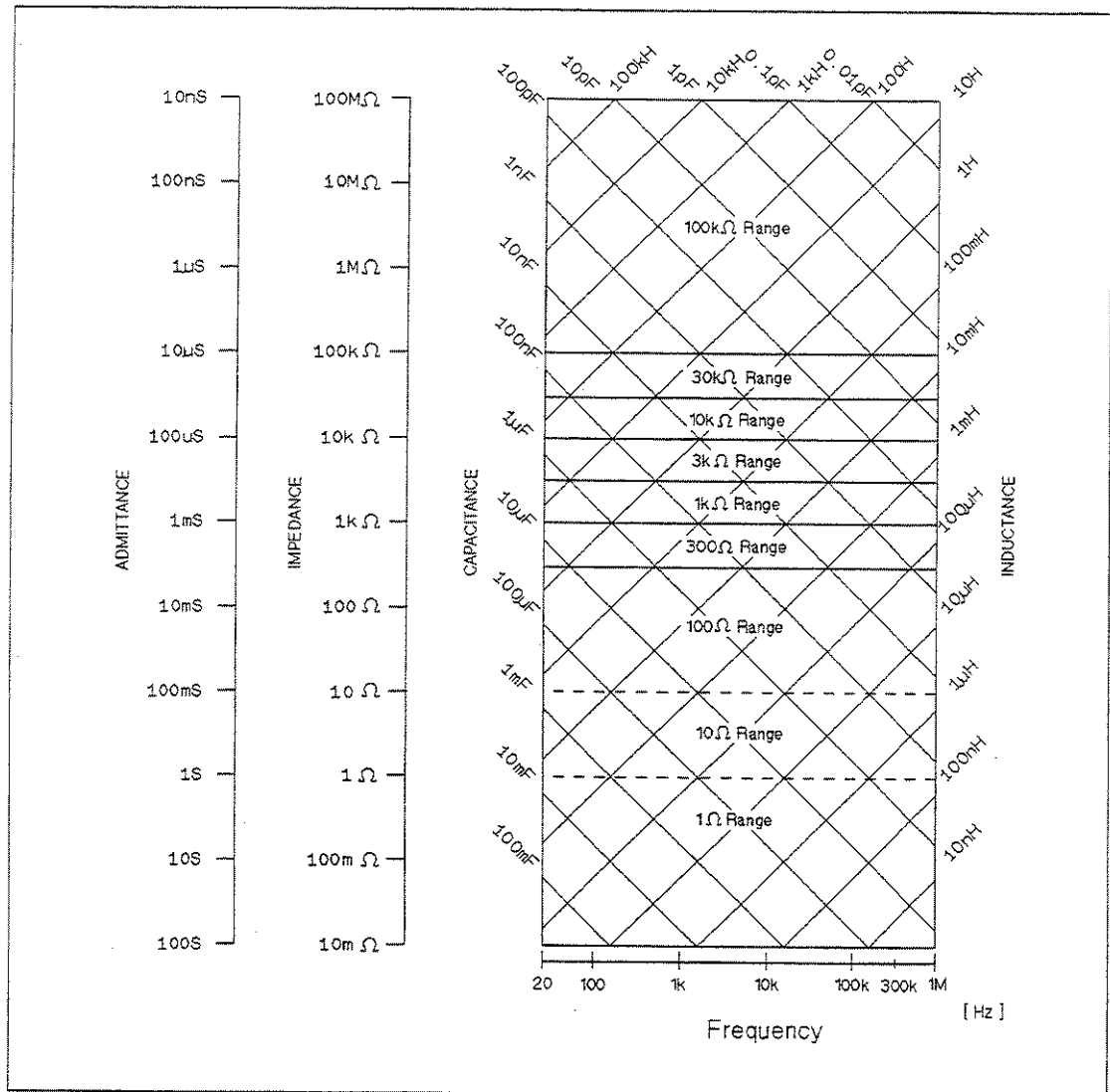

L100300B

**Figure 3-5.**  
**Effective Measuring Range**  
**(Oscillator Level > 2V or > 20 mA)**

**Note**



The measurement range is limited by the test frequency setting when the oscillator level is equal to 2 V or less than 2 V. When the measurement range and the test frequency are set under the above conditions, the test frequency must be set first, and then the measurement range. If you set the measurement range first and then frequency, the resulting measurement range may not be the one you wanted to set.

**Front Panel Operation for Setting the Measurement Range**

Perform the following procedure to set the measurement range.

1. Move the cursor to the *RANGE* field using the *CURSOR* keys.  
 The following softkeys will be displayed.

**AUTO** This softkey is used to set the measurement range to AUTO.

**HOLD** This softkey is used to change the measurement range from the AUTO mode to the HOLD mode. When the measurement range is set to the HOLD mode, the impedance range is fixed at the current range setting, and the impedance range is displayed in the *RANGE* field.

**INCR** ↑ This softkey is used to increment the measurement range in the HOLD (fixed range) mode.

**DECR** ↓ This softkey is used to decrement the measurement range in the HOLD (fixed range) mode.

2. Use the softkeys to set the measurement range.

## Test Frequency

### Description

The HP 4284A operates from 20 Hz to 1 MHz with 8610 frequency steps in between. All of test frequency points (F) are calculated values using the following formula. (All available frequency points above 1 kHz are shown in Appendix F.)

$$F = \frac{m}{n} \quad [\text{kHz}]$$

Where,

Frequency [F]	m	n
20 Hz ≤ F ≤ 5 kHz (8467 points)	60, 62.5, and 75	13 to 3750 (integer)
5 kHz < F ≤ 10 kHz (34 points)	120, 125, and 150	13 to 29 (integer)
10 kHz < F ≤ 20 kHz (34 points)	240, 250, and 300	13 to 29 (integer)
20 kHz < F ≤ 250 kHz (63 points)	480, 500 and 600	2 to 29 (integer)
250 kHz < F ≤ 500 kHz (6 points)	960, 1000 and 1200	2, 3, and 4
500 kHz < F ≤ 1 MHz (6 points)	1920, 2000 and 2400	2, 3, and 4

When numeric data is entered, the nearest available frequency point is automatically set.

## Front Panel Operation for Setting the Test Frequency

There are two ways to set the test frequency. One is to use the softkeys, and the other is to use the numeric entry keys. Perform the following steps to set the test frequency.

1. Move the CURSOR to the *FREQ* field. The following softkeys will be displayed.

- **INCR ↑**

This softkey is the coarse frequency increment softkey used to increment the test frequency to the next sequentially higher tenfold value after 20 Hz. The frequency points set using this softkey are as follows.

20 Hz    100 Hz    1 kHz    10 kHz    100 kHz    1 MHz

- **INCR ↓**

This softkey is the fine frequency increment softkey used to increment the current test frequency to the next sequentially higher frequency point. There are 10 frequency points between successive decade values. The sequential frequency points which can be set using this softkey are as follows.

20 Hz	100 Hz	1 kHz	10 kHz	100 kHz	1 MHz
25 Hz	120 Hz	1.2 kHz	12 kHz	120 kHz	
30 Hz	150 Hz	1.5 kHz	15 kHz	150 kHz	
40 Hz	200 Hz	2 kHz	20 kHz	200 kHz	
50 Hz	250 Hz	2.5 kHz	25 kHz	250 kHz	
60 Hz	300 Hz	3 kHz	30 kHz	300 kHz	
80 Hz	400 Hz	4 kHz	40 kHz	400 kHz	
	500 Hz	5 kHz	50 kHz	500 kHz	
	600 Hz	6 kHz	60 kHz	600 kHz	
	800 Hz	8 kHz	80 kHz	800 kHz	

- **DECR ↓**

This softkey is the fine frequency decrement softkey used to decrease the test frequency to the next sequentially lower frequency point. There are ten frequency points between successive decade values. The frequency points set using this softkey are the same values as set using **INCR ↓**.

- **DECR ↑**

This softkey is the coarse frequency decrement softkey which is used to decrement the test frequency to the next sequentially lower tenth value. The frequency points set using this softkey are the same as the frequency points set using **INCR ↓**.

2. Select and set the test frequency using either the softkeys or the numeric entry keys. When the test frequency is entered using the numeric entry keys, the softkey labels are changed to the available

units (**Hz**, **KHz**, and **MHz**), and so you can use these softkeys instead of **ENTER** to enter the units and enter the data. When **ENTER** is used, the numeric data is entered with Hz as the default unit.

## Oscillator Level

### Description

The HP 4284A's oscillator level can be set as the effective value (RMS value) of a sine wave of the test frequency from the HP 4284A's internal oscillator. You can set either the oscillator voltage level or the oscillator current level. The output impedance is 100Ω.

### Note



The set value of the oscillator current level is the value set when the measurement contacts (UNKNOWN Terminals) are shorted together.

The set value of the oscillator voltage level is the value set when the measurement contacts (UNKNOWN Terminals) are opened.

When the Option 001 (power amplifier/DC-bias) isn't installed, the oscillator voltage level can be set from 0 V<sub>rms</sub> to 2 V<sub>rms</sub> with a resolution as listed in Table 3-2, or the oscillator current level can be set from 0 A<sub>rms</sub> to 20 mA<sub>rms</sub> with a resolution as listed in Table 3-2.

**Table 3-2. Oscillator Level and Resolution (Std.)**

Mode	Oscillator Level	Resolution
Voltage	0 V <sub>rms</sub>	
	5 mV <sub>rms</sub> to 200 mV <sub>rms</sub>	1 mV <sub>rms</sub>
	210 mV <sub>rms</sub> to 2 V <sub>rms</sub>	10 mV <sub>rms</sub>
Level	0 A <sub>rms</sub>	
	50 μA <sub>rms</sub> to 2 mA <sub>rms</sub>	10 μA <sub>rms</sub>
	2.1 mA <sub>rms</sub> to 20 mA <sub>rms</sub>	100 μA <sub>rms</sub>

When the option 001 (power amplifier/DC-bias) is installed, the oscillator voltage level can be set from 0 V<sub>rms</sub> to 20 V<sub>rms</sub> with a resolution as listed in Table 3-3, or the oscillator current level can be set from 0 A<sub>rms</sub> to 200 mA<sub>rms</sub> with a resolution as listed in Table 3-3.

### Note



It is possible to make the option 001 valid or invalid from the *MEAS SETUP* page. When the option 001 function is used, the high power mode must be set to ON in the *MEAS SETUP* page. (For more information, refer to Chapter 4.)

**Table 3-3. Oscillator Level and Resolution (Opt.001)**

Mode	Oscillator Level	Resolution
Voltage	0 V <sub>rms</sub>	
	5 mV <sub>rms</sub> to 200 mV <sub>rms</sub>	1 mV <sub>rms</sub>
	210 mV <sub>rms</sub> to 2 V <sub>rms</sub>	10 mV <sub>rms</sub>
	2.1 V <sub>rms</sub> to 20 V <sub>rms</sub>	100 mV <sub>rms</sub>
Level	0 A <sub>rms</sub>	
	50 μA <sub>rms</sub> to 2 mA <sub>rms</sub>	10 μA <sub>rms</sub>
	2.1 mA <sub>rms</sub> to 20 mA <sub>rms</sub>	100 μA <sub>rms</sub>
	21 mA <sub>rms</sub> to 200 mA <sub>rms</sub>	1 mA <sub>rms</sub>

The HP 4284A can measure a device using a constant voltage or current level by using the automatic level control function. (The automatic level control function (*ALC* field) can be set to ON from the *MEAS SETUP* page.) When a constant voltage or current level measurement is performed, the asterisk mark (\*) is located at the head of the oscillator level value. For more information about the automatic level control function, refer to Chapter 4.

#### Front Panel Operation for Setting the Oscillator Level

There are two ways to set the oscillator level. One is to use the softkeys, and the other is to use the numeric entry keys. Perform the following steps to set the oscillator level.

1. Move the cursor to the *LEVEL* field. The following softkeys will be displayed.
  - **INCR** ↑
  - Press this softkey to increase the oscillator's output level.
  - **DECR** ↓
  - Press this softkey to decrease the oscillator's output level.
2. Select and set the oscillator level using either the softkeys or the numeric entry keys. When the oscillator level is entered using the numeric entry keys, the softkey labels are changed to the available units labels (**mV**, **V**, **μA**, **mA**, and **A**), and you can use these softkeys to enter the units and enter the data instead of **ENTER**. When **ENTER** is used, the numeric data is entered with V or A as the default unit.

**Note**



When you want to change the oscillator level from voltage to current, or from current to voltage, the numeric entry keys and units' softkeys must be used.

## DC Bias

### Description

The HP 4284A has internal dc bias voltage selections of 0 V, 1.5 V, and 2.0 V.

When option 001 is installed, the dc bias voltage can be set from 0 V to  $\pm 40$  V with a resolution as listed in Table 3-4, or the DC bias current can be set from 0 A to  $\pm 100$  mA with a resolution as listed in Table 3-4.

### Note



Option 001 can be made valid or invalid from the *MEAS SETUP* page. When the option 001 function is used, the high power mode must be set to ON from the *MEAS SETUP* page. (For more information, refer to Chapter 4.)

**Table 3-4. DC bias and Resolution (Opt.001)**

Mode	DC Bias Level	Resolution
Voltage	$\pm$ (0 V to 4 V)	1 mV
	$\pm$ (4.002 V to 8 V)	2 mV
	$\pm$ (8.005 V to 20 V)	5 mV
	$\pm$ (20.01 V to 40 V)	10 mV
Current	$\pm$ (0 A to 40 mA)	10 $\mu$ A
	$\pm$ (40.02 mA to 80 mA)	20 $\mu$ A
	$\pm$ (80.05 mA to 100 mA)	50 $\mu$ A

### Note



The setting value of the dc bias current is the value set when the measurement contacts (UNKNOWN Terminals) are shorted. (Refer to Figure 3-6.) When a DUT is connected to the measurement contacts, the setting current value is different from the actual current through the DUT. To determine the bias current through a device, refer to BIAS CURRENT ISOLATION FUNCTION, Chapter 4.

The setting value of the DC bias voltage is the value set when the measurement contacts (UNKNOWN Terminals) are opened.

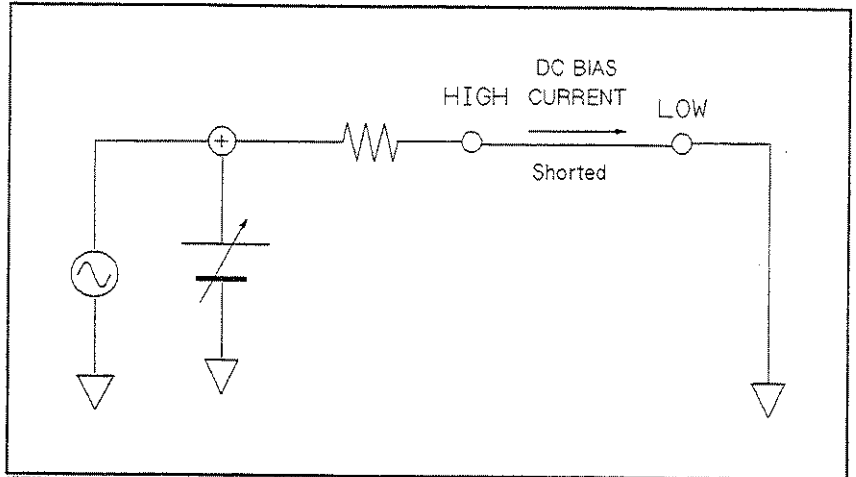

Figure 3-6. DC BIAS Current

**Note**



The DC bias will be output after setting **DC BIAS** on the front panel to ON. **DC BIAS** is used to enable the dc bias output. **DC BIAS** is a toggle type switch, and the DC BIAS on/off LED indicator is located above **DC BIAS**. When **DC BIAS** is set to ON, the DC BIAS on/off LED indicator is ON. When **DC BIAS** is set to OFF, the DC BIAS on/off LED indicator is OFF. If **DC BIAS** is set to OFF, even though the dc bias is set to ON according to the LCD display, the set dc bias isn't output.

**Note**



When both the dc bias and the oscillator level are set under the following conditions, the amount of the dc bias plus the oscillator level is limited as listed in Table 3-5.

- Option 001 is installed.
- The high power mode (Hi-PW) is set to ON.
- **DC BIAS** on the front panel is set to ON.

Table 3-5. DC Bias and Oscillator level Setting limits

DC Bias Setting	Osc Level Setting	Limit
$V_{dc}(V)$	$V_{osc}(V_{rms})$	$V_{osc} \times \sqrt{2} \times 1.1 + V_{dc} \times 1.002 < 42 V$
$V_{dc}(V)$	$I_{osc}(A_{rms})$	$I_{osc} \times \sqrt{2} \times 110 + V_{dc} \times 1.002 < 42 V$
$I_{dc}(A)$	$V_{osc}(V_{rms})$	$V_{osc} \times \sqrt{2} \times 1.1 + I_{dc} \times 100.2 < 42 V$
$I_{dc}(A)$	$I_{osc}(A_{rms})$	$I_{osc} \times (\sqrt{2} / \pi) \times 1.1 + I_{dc} \times 1.01 < 0.11 A$

When Option 001 is installed, the DC bias voltage across the DUT can be monitored at the INT DC BIAS MONITOR connector on the rear panel. See Figure 3-7. There are resistors (approximately 9.9

k $\Omega$ ) in series between the INT DC BIAS MONITOR connector and the H<sub>CUR</sub> Terminal. So if you use a dc voltmeter to find the actual DC bias voltage, use the following formula to calculate it.

$$V_{dc} = \left(1 + \frac{9.9k}{R_{in}}\right) \times V_m - V_{low}$$

Where,

- $V_{dc}$  : Actual DC bias voltage  
 $R_{in}$  : Input Resistor of the DC voltage meter  
 $V_m$  : Actual monitor value at the INT DC BIAS MONITOR connector  
 $V_{low}$  : Residual voltage at the LOW Terminal (Typical: 2 mV, Max.: 6 mV (DC:ISO ON), 20 mV (DC:ISO OFF))

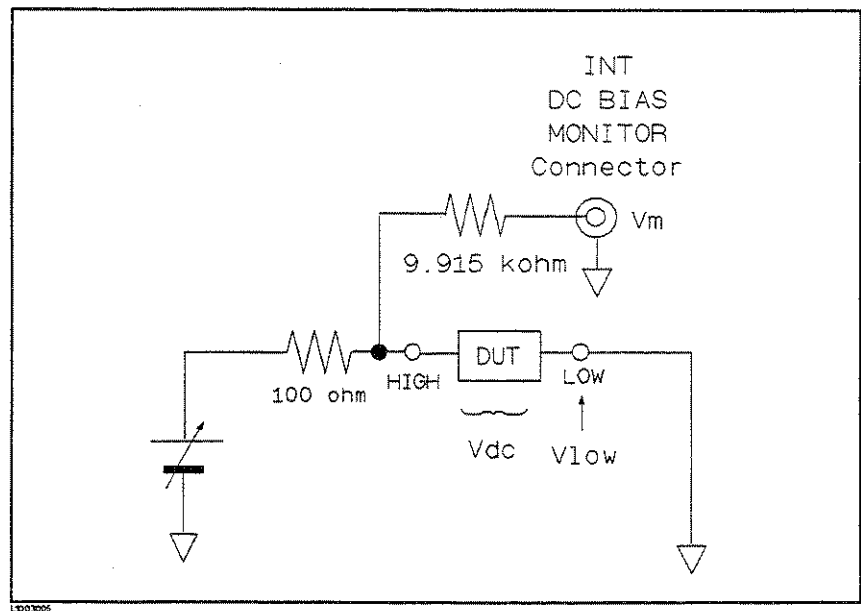

Figure 3-7. DC BIAS Monitor Circuits

#### Front Panel Operation for Setting the DC Bias

There are two ways to set the DC bias, one is to use the softkeys, and the other is to use the numeric entry keys. Perform the following steps to set the DC bias.

1. Move the cursor to the *BIAS* field. The following softkeys will be displayed.
  - a. **INCR ↑**  
Press this softkey to increase the DC bias level.
  - b. **DECR ↓**  
Press this softkey to decrease the DC bias level.



2. Set the dc bias to your desired bias using either the softkeys or the numeric entry keys. When the dc bias is entered using the numeric entry keys, the softkey labels are changed to the available units (**mV**, **V**, **μA**, **mA**, and **A**), and so you can use these softkeys instead of **ENTER**. When **ENTER** is used, the numeric data is entered with V or A as the default unit.

### Note



When you want to change the DC bias from voltage to current or from current to voltage, you must use the numeric entry keys and the units' softkeys.

3. Set **DC BIAS** on the front panel to ON to output the dc bias.

## Integration Time

### Description

The HP 4284A's measurement time is determined by the following.

- Integration Time (A/D conversion)
- Averaging Rate (number of measurement averaged)
- Delay Time (time delay between the trigger and the start of the measurement)
- Measurement result's display time

On this page, only the Integration Time in the above items can be set, the other settings except for the measurement result's display time can be set from the *MEAS SETUP* page.

The HP 4284A uses an integrating A/D converter in the internal circuits to convert the analog signal to a digital signal. The Integration Time is the time required to perform an A/D conversion. Generally, a longer conversion time will result in more stable and accurate measurement results. **SHORT**, **MEDIUM**, or **LONG** integration times can be selected. The measurement time of each integration time is shown in "Measurement Time" in Chapter 9.

### Front Panel Operation for Setting the Integration Time

Perform the following steps to set the integration time.

1. Move the cursor to the *INTEG* field. The following softkeys will be displayed.
  - **SHORT**
  - **MED**
  - **LONG**
2. Use the preceding softkeys to select and set the integration time.

## System Menu

The system menu allows you to perform the following functions.

- Load/Store
- Decimal fixed point
- Printer
- Keylock

This paragraph describes each function in the order listed above.

### Load/Store Function

The HP 4284A uses two types of non-volatile memory: the internal EEPROM and an external memory card for storing and retrieving a maximum of 20 sets of instrument control settings. The following data will be stored in non-volatile memory as one record.

- Control settings on the *MEAS SETUP* page.
  - Measurement Function
  - Test Frequency
  - Measurement Range
  - Oscillator Level
  - DC Bias
  - Integration Time
  - Averaging Rate
  - Delay Time
  - Trigger Mode
  - ALC on/off
  - Hi-PW mode on/off
  - V Monitor on/off
  - I Monitor on/off
  - Deviation Measurement A/B ( $\Delta$ ABS/ $\Delta$ %/off)
  - Deviation Measurement A/B Reference Value
  - Bias Current Isolation on/off
- Control settings on the *LIMIT TABLE* page.
  - Measurement Function (Swap Parameter)
  - Nominal Value
  - Limit Mode for the Primary Parameter
  - Auxiliary Bin on/off
  - Comparator Function on/off
  - Low/High Limits for Each Bin
- Control setting on the *BIN COUNT DISPLAY* page.
  - Bin Count Capability on/off
- Control settings on the *LIST SWEEP SETUP* page.
  - Sweep Mode
  - All Sweep Points
  - All Low/High Limits including the limit mode (A or B)
- Comment Line
- Display page format

**Note**



---

**DC BIAS** ON/OFF condition on the front panel cannot be stored in non-volatile memory.

---

When the memory card is inserted into the MEMORY card slot and the HP 4284A is turned on, the HP 4284A's Auto Load function will load the control settings stored in record number 10. If there are no control settings stored in record number 10, the power-on default settings will be used, the same ones loaded without the memory card.

**Note**



---

The following items are stored in internal nonvolatile memory without using the load/store function.

---

- Control settings on the *CORRECTION* page.
  - OPEN, SHORT, LOAD correction on/off
  - OPEN, SHORT correction data for all test frequencies.
  - OPEN, SHORT, LOAD correction data at **FREQ 1**, **FREQ 2**, **FREQ 3**. (OPEN correction data at each frequency, SHORT correction data at each frequency, and LOAD correction reference data and actual data at each frequency.)
- Control settings on the *SYSTEM CONFIG* page.
  - Beeper on/off
  - HP-IB address
  - Talk Only on/off
  - Handler I/F on/off
  - Scanner I/F on/off

Perform the following steps to store the control settings to the internal non-volatile memory or to the external memory card.

1. Select and set all control settings on the *MEAS DISPLAY* page.
2. Move the cursor to the *SYS MENU* field.
3. Insert a memory card in the MEMORY card slot, if you are going to store the data to the memory card.
4. Press **STORE**. The message **Enter record number to STORE** will be displayed on the system message line.
5. Enter a record number using the numeric entry keys and **ENTER** to store the current control settings. Then when the record is stored in the internal EEPROM, the record number can be set from 0 to 9. When the record is stored in the memory card, record numbers from 10 to 19 can be set used.

Perform the following steps to load the control settings from the internal non-volatile memory or from an external memory card.

1. Move the cursor to the *SYS MENU* field.
2. Insert the memory card into the MEMORY card slot, if you are going to use a memory card.

3. Press **LOAD**. The message Enter record number to LOAD will be displayed on the system message line.
4. Enter record number you want to load using the numeric entry keys and **ENTER**.

### Fixed Decimal Point Function

The HP 4284A displays the measurement data using a six digit floating point display format. The fixed decimal point function is used to display the measurement data using a fixed point display format. This function can also be used to change the number of digits displayed.

Perform the following steps to use the fixed decimal point function.

1. Move the cursor to the *SYS MENU* field.
2. Press **D.P. FIX A** to fix the decimal point for the main parameter's data. The **▲** mark will be displayed at the decimal fixed point. Each time **D.P. FIX A** is pressed, the last digit is dropped, the value is rounded off.
3. Press **D.P. FIX B** to fix the decimal point for the sub parameter's data. The **▲** mark will be displayed at the decimal fixed point. Each time **D.P. FIX B** is pressed, the value is rounded off giving one less digit.

### Note



---

In the following cases the fixed decimal point function is automatically disabled.

- The measurement function is changed.
  - When the deviation measurement (which is set on the *MEAS SETUP* page) is performed, the deviation measurement function ( $\Delta$ ABS,  $\Delta$ %, OFF) is changed.
- 

### Printer Function

The HP 4284A's printer function is used to make a hardcopy of the displayed information (except for the softkey labels) or the measurement results without the need of an external controller. The HP 4284A must be set to the HP-IB talker mode, and the printer must be set to the HP-IB listener mode. There are two print modes: the PRINT DISPLAY mode and the PRINT DATA mode.

#### ■ PRINT DISPLAY mode

The print display mode is used to print out all of information on the displayed page by sending ASCII character strings to a printer. An example is shown Figure 3-8.

```

<MEAS DISPLAY>          SYS MENU

FUNC : Cp-D            RANGE:  AUTO
FREQ :1.00000MHz     BIAS :  1.000 V
LEVEL:  1.00 V      INTEG:  MED

      Cp :  99 . 9929 p F

      D  :  . 000071

Vm  :  1.009 V      Im  :  633.9uA
CORR: OPEN,SHORT,LOAD  CH:  0

```

Figure 3-8. MEAS DISPLAY Page Example

**Note**



The following characters are not recognized by the printer, so the character in [ ] on the same line will be printed instead.

- $\Omega$  → [ ] (space)
- $\theta$  → [0]
- $\Delta$  → [d]
- $\mu$  → [E]
- ▶ → [V]

■ PRINT DATA mode

The print data mode is used to print out the measurement results using the following format. This format is the same as the ASCII format used for data transfer via HP-IB. For details, refer to Chapter 7.

<DATA A>,<DATA B>,<STATUS>,<BIN No.><CR><LF>

<DATA A> ::= The measurement results of the main parameter (|Z|, |Y|, C, L, R, G).  
12 ASCII characters (SN.NNNNNESNN)

<DATA B> ::= The measurement results of the sub parameter ( $\theta$ , D, Q, G,  $R_s$ , X, B). 12 ASCII characters (SN.NNNNNESNN)

<STATUS> ::= 0: Normal Measurement.  
1: Analog Bridge is unbalanced.  
2: A/D converter not working.  
3: Signal source is overloaded.  
4: ALC unable to regulate.

<BIN No.> ::= 0: OUT OF BINS  
1: BIN 1  
2: BIN 2

3: BIN 3  
:  
8: BIN 8  
9: BIN 9  
10: AUX BIN

**Note**



BIN number data is valid only when the comparator function is set to ON. When the comparator function is set to OFF, the BIN number data isn't output as shown below.

<DATA A>,<DATA B>,<STATUS><CR><LF>

In the talk only mode, the HP 4284A waits for the completion of the handshake before starting the next measurement. The measurement cycle of the HP 4284A depends on the printer's speed.

When the <STATUS> is 1 or 2 the measurement data is 9.9E37.  
When the <STATUS> is 0, 3, or 4 the actual measurement data are output.

Use the PRINT DISP mode and perform the following steps to print out all of information on the display page except for the softkey labels.

1. Connect the HP 4284A to the printer using an HP-IB cable.
2. Set the printer to the listen only mode.
3. Set the talk only mode to ON from the *SYSTEM CONFIG* page.
4. Press *DISPLAY FORMAT* to display the *MEAS DISPLAY* page.
5. Move the cursor to the *SYS MENU* field.
6. Press **more 1/2**.
7. Press **PRINT DISP**.

Use the PRINT DATA mode and perform the following steps to print out the measurement results to the printer.

- Connect the HP 4284A to the printer using an HP-IB cable.
- Set the printer to the listen only mode.
- Set the talk only mode to ON from the *SYSTEM CONFIG* page.
- Press **DISPLAY FORMAT** to display the *MEAS DISPLAY* page.
- Move the cursor to the *SYS MENU*.
- Press **more 1/2**.
- Press **PRINT DATA**. The marker will appear at the side of **PRINT DATA**. The measurement results are sent out to the printer on subsequent measurements.

## Keylock Function

The HP 4284A has keyboard lock-out capability that disables all front panel operation except for the power LINE switch, CONTRAST knob, **TRIGGER** key, and **KEYLOCK**. This is useful when you don't want the control settings changed, for example, if the HP 4284A is performing bin sorting for a large number of capacitors.

Perform the following steps to disable all front panel operation on the *MEAS DISPLAY* page.

1. Move the cursor to the *SYS MENU* field.
2. Press **more 1/2**.
3. Press **KEY LOCK** (which is a toggle type softkey). The key mark will be shown on the left side of **KEY LOCK**, and the Keys Locked message will be displayed on the system message line.
4. Press **KEY LOCK** again, when you want to enable all front panel keys again.

## BIN No. DISPLAY Page

When you press **DISPLAY FORMAT**, and **BIN No.**, the *BIN No. DISPLAY* page will be displayed. The bin sorting results are displayed in large characters and the measurement results are displayed in normal characters on the *BIN No. DISPLAY* page, and the following measurement controls can be set from the *BIN No. DISPLAY* page. (The field in parenthesis is used when this control is set.)

- Comparator Function ON/OFF (*COMP*)
- System Menu (*SYS MENU*)

There are three fields on this page: *<BIN No. DISPLAY>*, *COMP*, and *SYS MENU* fields.

Each control is described in the following paragraphs.

This page also provides the following information in the monitor areas (each monitor area looks like a field, but is not). These conditions can be set from the *MEAS SETUP* page, and most conditions can be set from the *MEAS DISPLAY* page.

- Measurement Function (*FUNC*)
- Measurement Range (*RANGE*)
- Test Frequency (*FREQ*)
- Oscillator Level (*LEVEL*)
- DC Bias (*BIAS*)
- Integration Time (*INTEG*)
- OPEN, SHORT, LOAD on/off setting conditions (*CORR*)

The available fields and the softkeys which correspond to each field on this page are shown in Figure 3-9 and Figure 3-10.

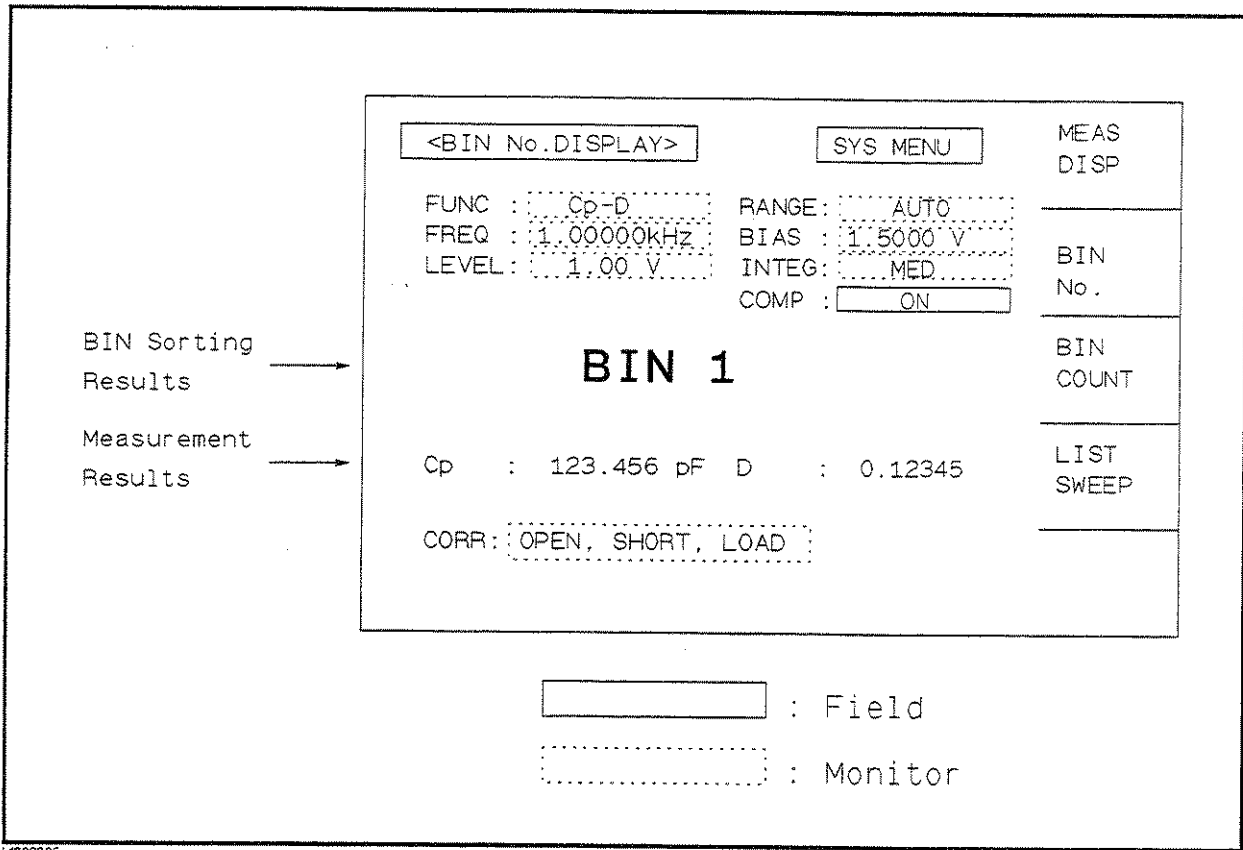

L1003006

Figure 3-9. Available Fields on the BIN No. DISPLAY Page

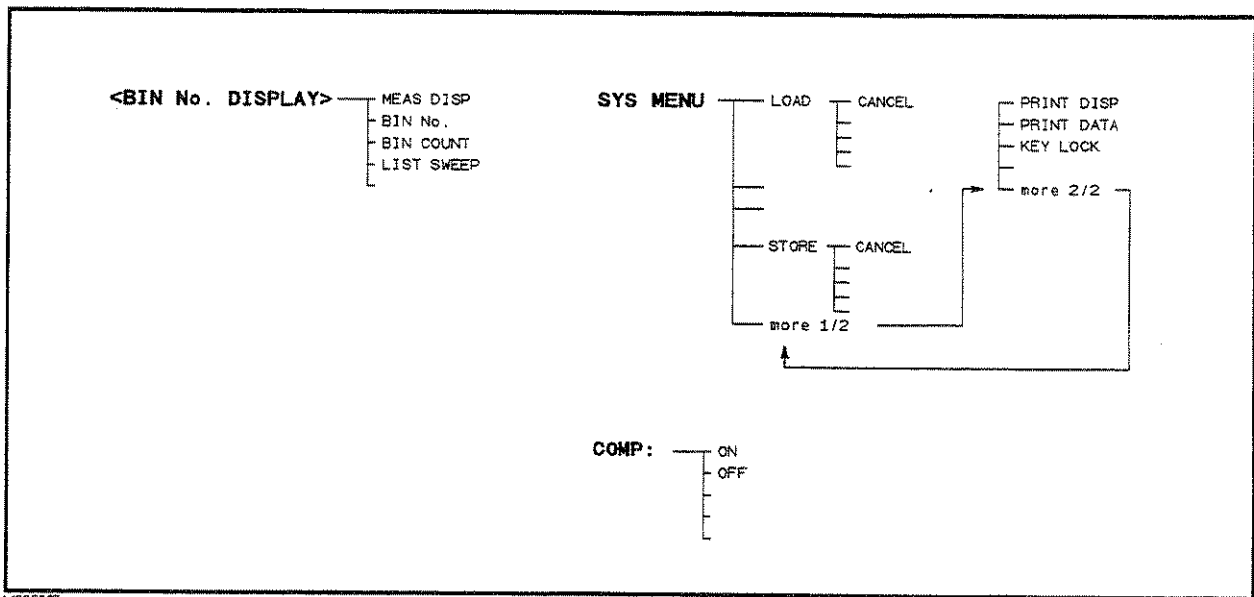

L1003507

Figure 3-10. Available Softkeys on the BIN No. DISPLAY Page



## Comparator Function ON/OFF

### Description

The HP 4284A's built-in comparator can sort devices into a maximum of ten bins (BIN 1 to BIN 9 and the OUT OF BINS bin) using a maximum of nine pairs of primary limits and one pair of secondary parameter limits. Also, a device whose primary parameter is within limits, but whose secondary parameter measurement result is not within limits can be sorted into an AUXiliary BIN. The comparator function is especially useful when using the HP 4284A with a component handler (handler interface option is installed). These limit settings for bin sorting are only set on the *LIMIT TABLE* page under **MEAS SETUP** (refer to the Chapter 4). So this *COMP* field allows you to only set the comparator function to ON or OFF.

### Front Panel Operation for Setting the Comparator Function to ON or OFF

Perform the following steps to set the comparator function to ON or OFF.

1. Move the cursor to the *COMP* field. The following softkeys will be displayed.
  - **ON**
  - **OFF**
2. Use the softkeys to set the comparator function to ON or OFF.

## System Menu

The system menu on this page allows you to use the following functions.

- Load/Store
- Printer
- Keylock

These functions are the same as the functions on the system menu on the *MEAS DISPLAY* page (Refer to page 3-19, "System Menu"). So only the procedure for each function is given in the following paragraphs.

### Load/Store Function

Perform the following steps to store the control settings to the internal non-volatile memory or the external memory card or load the control settings from the internal non-volatile memory or the external memory card.

1. Set all controls.
2. ON the *BIN No. DISPLAY* page move the cursor to the *SYS MENU* field using the CURSOR keys.

3. If you are going to store the settings on a memory card, insert a memory card to the MEMORY card slot.
4. Press **STORE** when you want to use the STORE function. The message Enter record number to STORE will be displayed on the system message line.

Press **LOAD** when you want to use the LOAD function. Then the Enter record number to LOAD will be displayed on the system message line.

5. Use the numeric entry keys and **ENTER** to enter the record number at which the current control settings will be STORED to or LOADED from.

### Printer Function

Perform the following steps to print out the displayed page or the measurement data using the PRINT DISP mode or PRINT DATA mode.

1. Connect the HP 4284A to the printer using an HP-IB cable
2. Set the printer to the listen only mode.
3. Set the talk only mode to ON on the *SYSTEM CONFIG* page.
4. Press **DISPLAY FORMAT**, and press **BIN No.** to display the *BIN No. DISPLAY* page.
5. Move the cursor to the *SYS MENU* field.
6. Press **more 1/2**.
7. Press **PRINT DISP** when you want to print out the displayed page. The displayed page is printed out as shown in Figure 3-8.

Press **PRINT DATA** when you want to print out the measurement data. The marker will appear beside **PRINT DATA**. The measurement results are printed out on subsequent measurements.

```
<BIN No. DISPLAY>      SYS MENU

FUNC : Cp-D           RANGE:  AUTO
FREQ :1.00000MHz     BIAS :  1.000 V
LEVEL:  1.00 V       INTEG:  MED
                                COMP :   ON

      B I N   6

      Cp: 99.9609pF  D : .000387

CORR: OPEN,SHORT,LOAD  CH: 0
```

Figure 3-11. BIN No. DISPLAY Page Example

**Keylock Function**

Perform the following steps from the *BIN No. DISPLAY* page to disable all front panel operation.

1. Move the cursor to the *SYS MENU* field.
2. Press **more 1/2**.
3. Press **KEY LOCK** (which is a toggle type softkey). The key mark will be shown on the left side of **KEY LOCK**, and the Keys locked message will be displayed on the system message line.
4. Press **KEY LOCK** again to enable all front panel keys.

---

## **BIN COUNT DISPLAY Page**

When you press **DISPLAY FORMAT** and **BIN COUNT**, the *BIN COUNT DISPLAY* page will be displayed. On the *BIN COUNT DISPLAY* page, the comparator's count results are displayed, and the following measurement controls can be set.

- System Menu (*SYS MENU*)

So there are two fields on this page: *<BIN COUNT DISPLAY>* and *SYS MENU* fields.

The system menu is described in the following paragraphs.

This page also provides the following information in monitor areas (the monitor areas look like fields, but they are not). These conditions can be set from the *LIMIT TABLE* page. (For more details on the following controls, refer to Chapter 4.)

- Nominal Value
- Measurement Function
- Bin Sorting Low/High Limits

The available fields and the softkeys which corresponded to each field on this page are shown in Figure 3-12 and Figure 3-13.

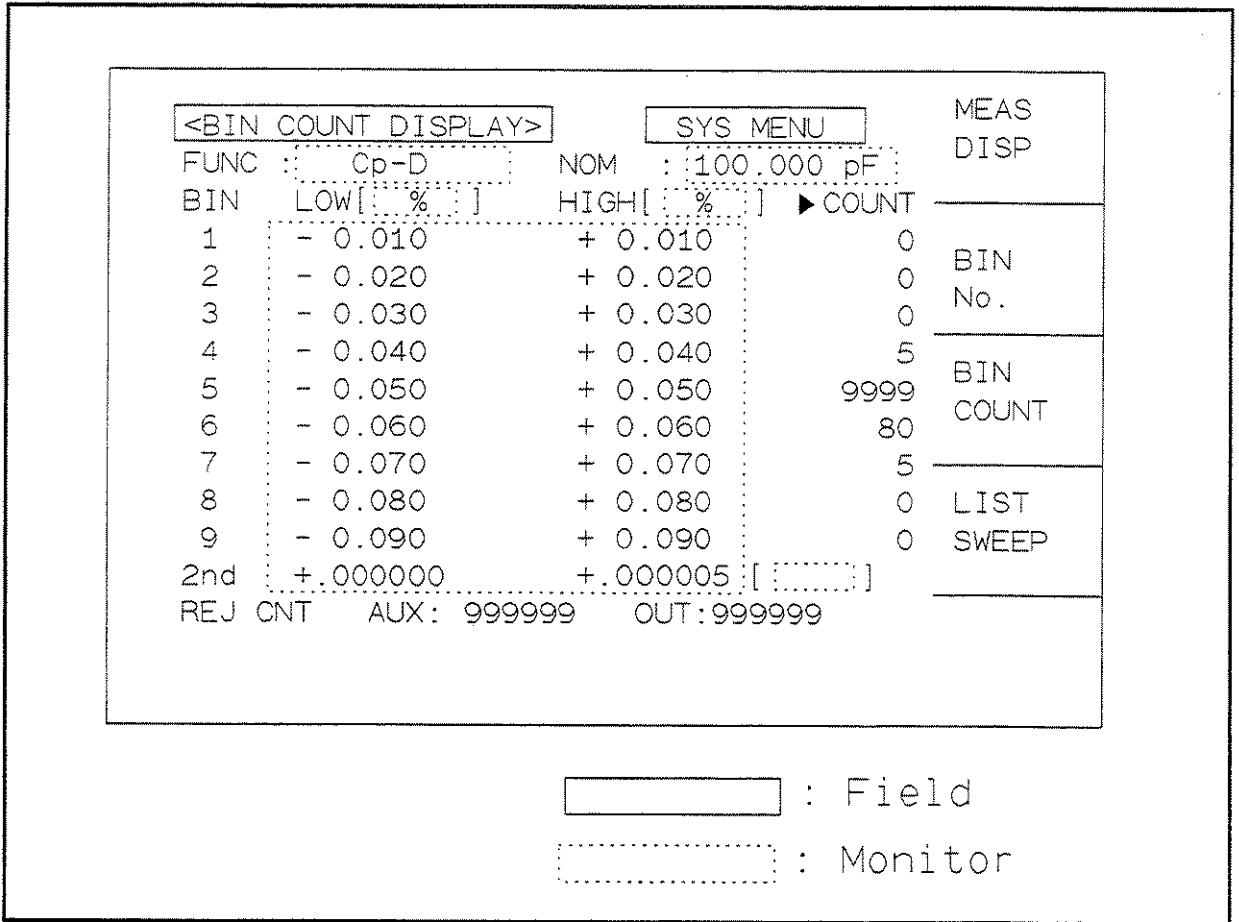

L1003008

Figure 3-12. Available Fields on the BIN COUNT DISPLAY Page

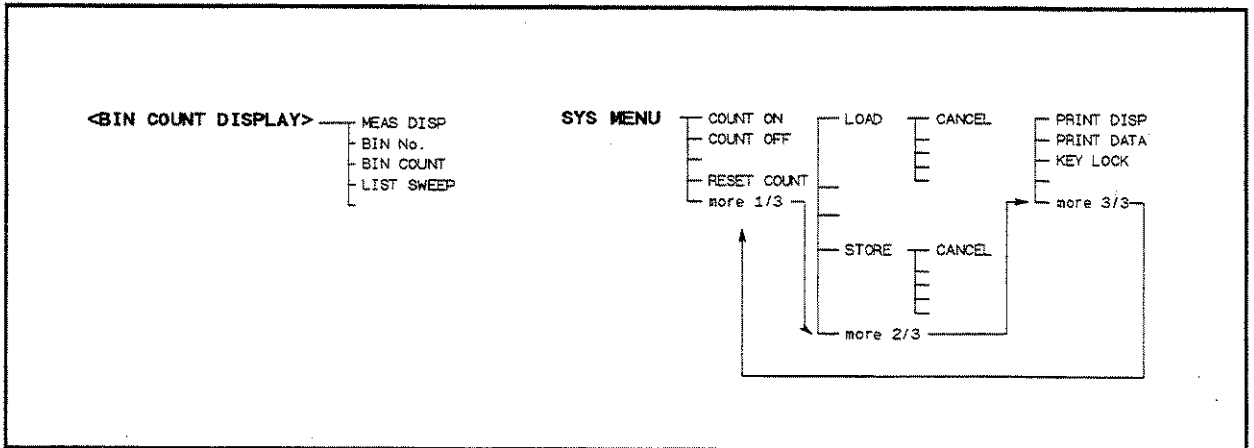

L1003009

Figure 3-13. Available Softkeys on the BIN COUNT DISPLAY Page

## System Menu

The system menu on this page allows you to perform the following functions.

- Counter ON/OFF
- Load/Store
- Printer
- Keylock

These functions, except for the counter function, are the same as the functions displayed on the system menu of the *MEAS DISPLAY* page. (Refer to page 3-19, "System Menu") So in the case of the counter function, the description and setting procedures are described in the following paragraphs, for the other functions, only the procedure is described.

### Counter Function

The HP 4284A has bin counting capability. When many devices are being sorted into bins using the comparator function, the number of devices sorted into each bin is counted. The maximum count is 999999, the overflow message "----" will be displayed when this value is exceeded. The bin counter will still be operating, so you can only get the count data via HP-IB.

Perform the following steps to set the counter function to ON or OFF from the *BIN COUNT DISPLAY* page.

- Move the cursor to *SYS MENU* field on the *BIN COUNT DISPLAY* page.
- Press **COUNT ON** to set the counter function to ON. An arrow will be displayed at the left of COUNT.
- Press **COUNT OFF** when you want to set the counter function to OFF. The arrow will disappear.
- Press **RESET COUNT** when all counts are reset to zero. The message **RESET COUNT, do you proceed?** will be displayed on the system message line, and **YES** and **NO** will be displayed. Press **YES**.

### Load/Store Function

Perform the following steps to store the current control settings to the internal non-volatile memory or the external memory card, and to load the control settings from the internal non-volatile memory or the external memory card.

1. Set all controls.
2. Move the cursor to the *SYS MENU* field on the *BIN COUNT DISPLAY* page.
3. Insert a memory card into the MEMORY card slot, if you are going to store or load the settings to or from a memory card.
4. Press **more 1/3**.

5. Press **STORE** when you want to use the STORE function. The message Enter record number to STORE will be displayed on the system message line.

Press **LOAD** when you want to use the LOAD function. Then the Enter record number to LOAD will be displayed on the system message line.

6. Use the numeric entry keys and **ENTER** to enter the record number at which the current control settings will be STORED to or LOADED from.

### Printer Function

Use the PRINT DISP or PRINT DATA mode and perform the following steps to print out the display page or the measurement data.

1. Connect the HP 4284A to the printer using an HP-IB cable.
2. Set the printer to the listen only mode.
3. Set the talk only mode to ON on the *SYSTEM CONFIG* page.
4. Press **DISPLAY FORMAT**, and press **BIN COUNT** to display the *BIN COUNT DISPLAY* page.
5. Move the cursor to the *SYS MENU* field.
6. Press **more 1/3** and then press **more 2/3**.
7. Press **PRINT DISP** when you want to print out the displayed page. Figure 3-10 shows a sample print out of the display page.

Press **PRINT DATA** when you want to print out the measurement results. The marker will appear beside **PRINT DATA**. The measurement results are printed out on subsequent measurements.

<BIN COUNT DISPLAY>			SYS MENU
FUNC :	Cp-D	NOM :	100.000pF
BIN	LOW [ % ]	HIGH [ % ]	>COUNT
1	- 0.001	+ 0.001	0
2	- 0.003	+ 0.003	0
3	- 0.005	+ 0.005	0
4	- 0.010	+ 0.010	0
5	- 0.030	+ 0.030	0
6	- 0.050	+ 0.050	76
7	- 0.100	+ 0.100	0
8	- 0.500	+ 0.500	0
9	- 1.000	+ 1.000	1
2nd	+.000000	+.000300	[ ]
REJ CNT	AUX: 12	OUT: 38	

Figure 3-14. BIN COUNT DISPLAY Page Example

### Keylock Function

Perform the following steps to disable all front panel operations on the *BIN COUNT DISPLAY* page.

- Move the cursor to the *SYS MENU* field.
- Press **more 1/3**, and press **more 2/3**.
- Press **KEY LOCK** (a toggle type softkey). The key mark will be displayed on the left side of **KEY LOCK**, and the message Keys Locked will be displayed on the system message line.
- Press **KEY LOCK** again, if you want to enable the front panel keys.

---

## LIST SWEEP DISPLAY Page

The HP 4284A's LIST SWEEP function permits entry of up to ten frequencies, signal levels, or DC bias levels, and the measurement limits on the *LIST SWEEP SETUP* page under the *MEAS SETUP* page. These points are automatically swept and the measurement results are compared to the limits set. When you press **DISPLAY FORMAT** and **LIST SWEEP**, the *LIST SWEEP DISPLAY* page will be displayed. On the *LIST SWEEP DISPLAY* page, the sweep points are swept and the measurement results are compared to the limits. During a sweep, an asterisk mark (\*) will appear on the left side of the current measuring list sweep point. The following measurement controls can be set from this page. (Each field in parenthesis is used when that control is set.)

- Sweep Mode of the List sweep Measurement (*MODE*)
- System Menu (*SYS MENU*)

So there are three fields on this page: *<LIST SWEEP DISPLAY>*, *MODE*, and *SYS MENU* fields.

The system menu is described in the following paragraphs.

The list sweep point can not be set from this page, but can only be set from the *LIST SWEEP SETUP* page.

The available fields and the softkeys which corresponded to each field on this page are shown in Figure 3-15 and Figure 3-16.



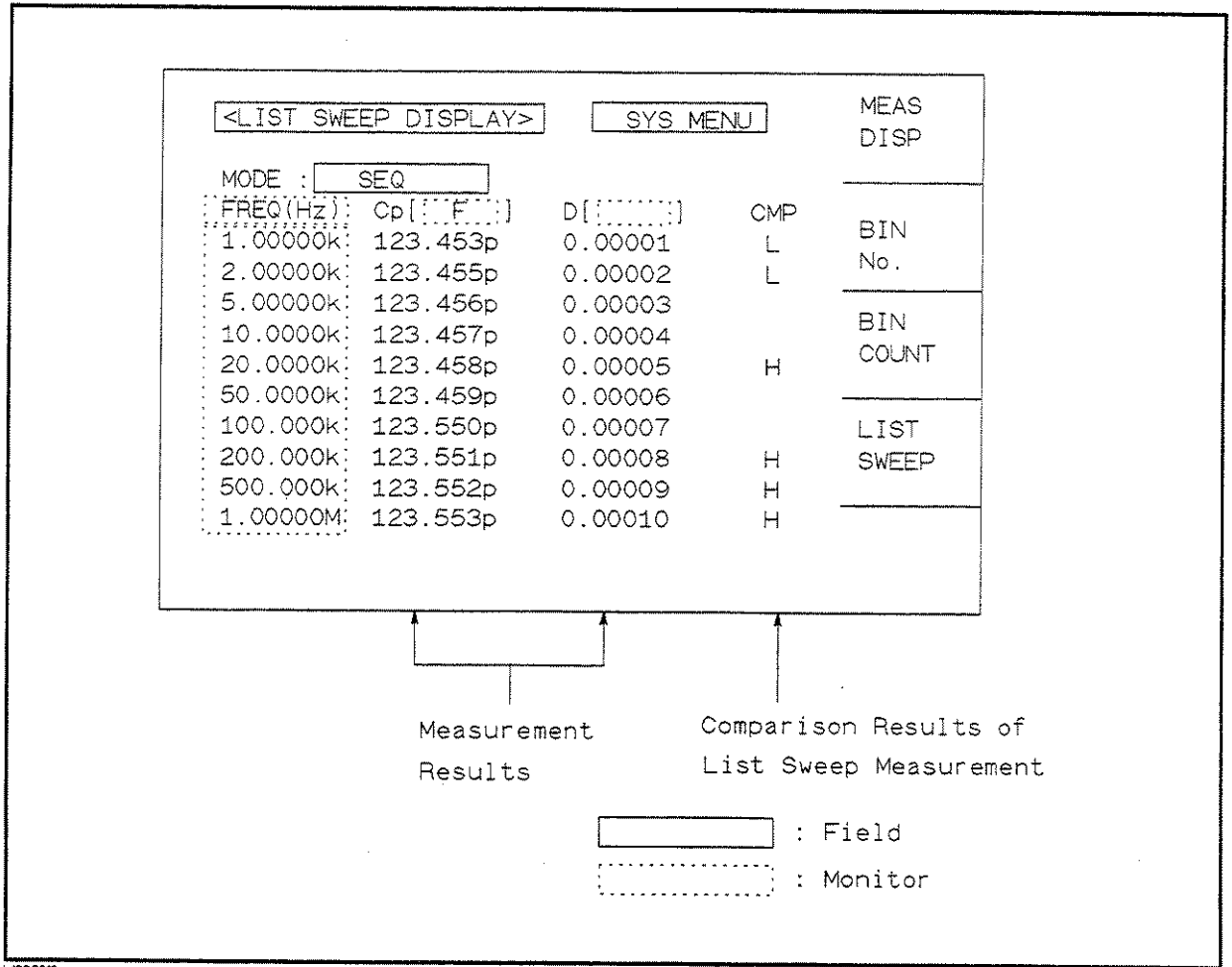

L1003010

Figure 3-15. Available Fields on the LIST SWEEP DISPLAY Page

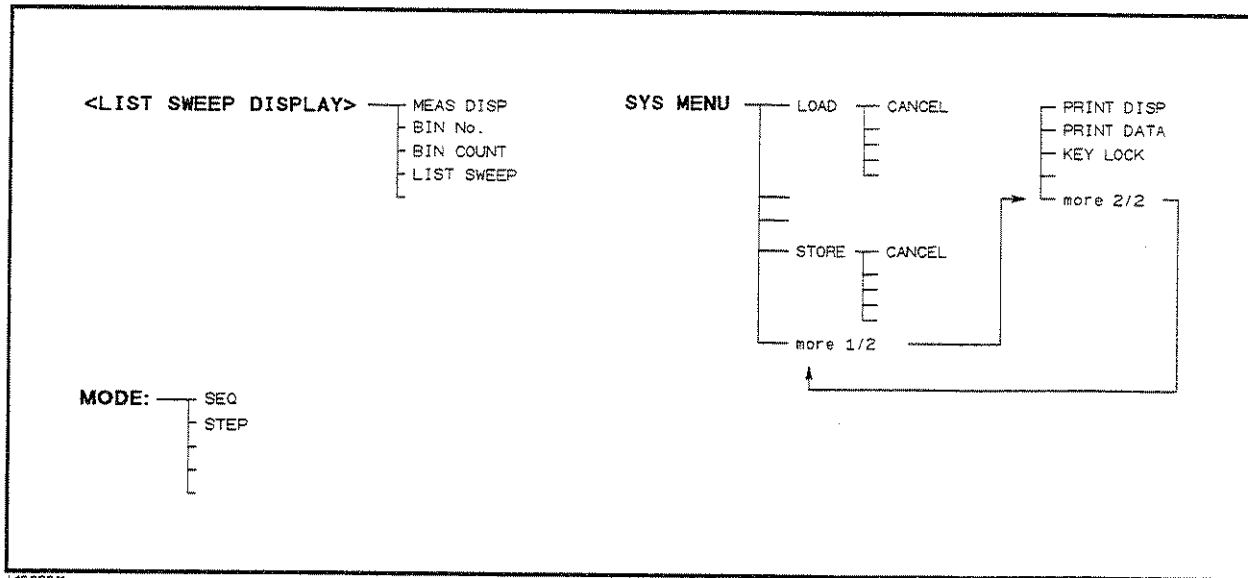

Figure 3-16. Available Softkeys on the LIST SWEEP DISPLAY Page

**Sweep Mode** The HP 4284A's List Sweep Measurement function permits up to 10 test frequencies, oscillator levels, or DC bias points to be automatically measured. There are two measurement modes for list sweep measurements: sequential (SEQ) mode and step (STEP) mode. In the case of SEQ mode, when the HP 4284A is triggered once, all sweep points are automatically swept. In the case of the STEP mode, each time the HP 4284A is triggered the sweep point is swept by one step.

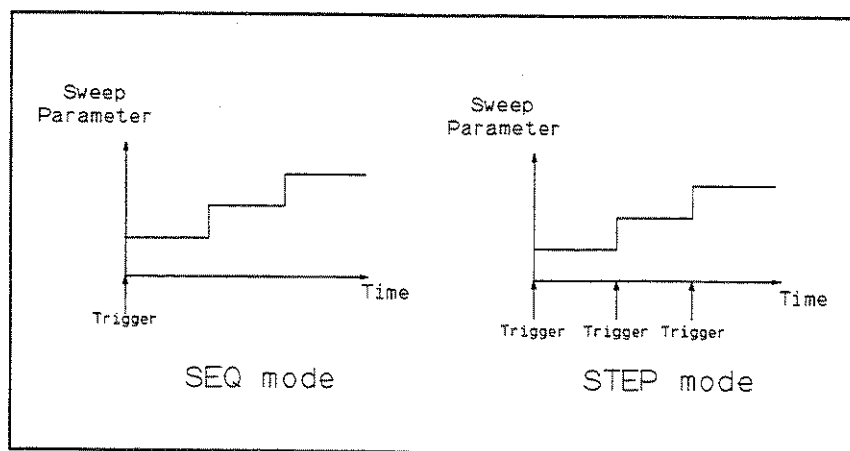

Figure 3-17. SEQ Mode and STEP Mode

**Note**



When two or more sweep points are the same, and are adjacent the HP 4284A measures the device once, and then the measurement result is compared to limits set for each sweep point.

### Front Panel Operation for Setting the Sweep Mode of the List Sweep Measurement

Perform the following steps to set the list sweep measurement mode to the SEQ or STEP modes.

1. Move the cursor to the *MODE* field. The following softkeys will be displayed.
  - SEQ
  - STEP
2. Use the softkeys to select and set the list sweep measurement mode (SEQ or STEP mode).

### System Menu

The system menu on this page allows you to perform the following functions.

- Load/Store
- Printer
- Keylock

These functions are the same as the functions of the system menu on the *MEAS DISPLAY* page. (Refer to "System Menu" on page 3-19) So only the procedure is given for each function.

#### Load/Store Function

Perform the following steps to store the control settings in the internal non-volatile memory or in an external memory card.

1. Set all controls.
2. Move the cursor to the *SYS MENU* field.
3. Insert a memory card to the MEMORY card slot, if you are going to store the settings in a memory card.
4. Press **STORE**. The message Enter record number to STORE will be displayed on the system message line.
5. Use the entry keys and **ENTER** to enter the record number where the current control setting are to be stored. When the data is to be stored in the internal EEPROM, record numbers 0 to 9 are used, and when the record is stored in a memory card, record numbers 10 to 19 are used.

Perform the following steps to load the control settings from the internal non-volatile memory or from an external memory card.

1. Move the cursor to the *SYS MENU* field.
2. Insert the appropriate memory card into the MEMORY card slot, if you are going to load the settings from a memory card.
3. Press **LOAD**. The message Enter record number to LOAD will be displayed on the system message line.

4. Enter the record number using the numeric entry keys and **ENTER**.

#### Printer Function

Perform the following steps to print out the display page or to list sweep measurement results using the PRINT DISP mode or PRINT DATA mode.

1. Connect the HP 4284A to the printer using an HP-IB cable.
2. Set the printer to the listen only mode.
3. Set the talk only mode to ON from the SYSTEM CONFIG page.
4. Press **DISPLAY FORMAT**, and press **LIST SWEEP** to display the *LIST SWEEP DISPLAY* page.
5. Move the cursor to the *SYS MENU* field.
6. Press **more 1/2**.
7. Press **PRINT DISP** to print out the display page. The displayed page will be printed out as shown in Figure 3-18.

<LIST SWEEP DISPLAY>		SYS MENU	
MODE : SEQ			
FREQ [Hz]	Cp [ F ]	D [ ]	CMP
1.00000k	99.6257p	.008338	L
2.00000k	99.8398p	.003280	L
3.00000k	99.8841p	.002077	L
4.00000k	99.9033p	.001570	
5.00000k	99.9187p	.001228	
6.00000k	100.021p	.000936	
6.94444k	100.016p	.000787	
8.00000k	100.002p	.000691	
8.92857k	100.015p	.000646	
10.0000k	100.014p	.000810	

Figure 3-18. LIST SWEEP DISPLAY Page Example

Press **PRINT DATA** to print out the measurement results. A marker will appear beside **PRINT DATA**. The measurement results will be printed out on subsequent measurements according to the following data format. (This format is as same as the ASCII format of the data transfer via HP-IB. For more details, refer to Chapter 7.)

<DATA A>,<DATA B>,<STATUS>,<IN/OUT><CR><LF>

<DATA A>::= The measurement results of the main parameter (|Z|, |Y|, C, L, R, G).  
12 ASCII characters (SN.NNNNESNN)

<DATA B>::= Measurement results of the sub parameter ( $\theta$ , D, Q, G, Rs, X, B).  
12 ASCII characters (SN.NNNNNESNN)

<STATUS>::= 0: Normal Measurement.  
1: Analog Bridge is unbalance.  
2: A/D converter doesn't work.  
3: Signal source overload.  
4: ALC unable to regulate.

<IN/OUT>::= -1: LOW  
0: IN  
1: HIGH

#### Note



When the sequential sweep mode is used, the above formats are repeated at each sweep point.

When the <STATUS> is 1 or 2, 9.9E37 is output as the measurement data. When the <STATUS> is 0, 3, or 4, the actual measurement results are output.

#### Keylock Function

Perform the following steps from the *LIST SWEEP DISPLAY* page to disable all front panel operation.

1. Move the cursor to the *SYS MENU* field.
2. Press **more 1/2**.
3. Press **KEY LOCK** (a toggle type softkey). A key symbol will be displayed on the left side of **KEY LOCK**, and the Keys locked message will be displayed on the system message line.
4. Press **KEY LOCK** again, if you want to enable all front panel keys.



## MEAS SETUP Menu

---

### Introduction

This Chapter provides information for each page's function under **MEAS SETUP**. **MEAS SETUP** have four display pages as listed below.

- *MEAS SETUP*
- *CORRECTION*
- *LIMIT TABLE SETUP*
- *LIST SWEEP SETUP*

This Chapter describes each function of each page in the order of the preceding list.

---

### MEAS SETUP page

When you press **MEAS SETUP**, the *MEAS SETUP* page will be displayed. On this *MEAS SETUP* page, all of the following measurement control functions can be set. (Each field in parenthesis is used when each control is set.)

- Comment Line (*comment line*)
- Measurement Function (*FUNC*)
- Measurement Range (*RANGE*)
- Test Frequency (*FREQ*)
- Oscillator Level (*LEVEL*)
- DC Bias (*BIAS*)
- Integration Time (*INTEG*)
- Trigger Mode (*TRIG*)
- Automatic Level Control (*ALC*)
- High Power Mode ON/OFF (*Hi-PW*)
- Bias Current Isolation Mode ON/OFF (*DCI:ISO*)
- Averaging Rate (*AVG*)
- Voltage Level Monitor ON/OFF (*Vm*)
- Current Level Monitor ON/OFF (*Im*)
- Delay Time (*DELAY*)
- System Menu (*SYS MENU*)
- Deviation Measurement A Mode (*DEV A*)
- Deviation Measurement B Mode (*(DEV) B*)
- Reference Value for the Deviation Measurement A (*REF A*)
- Reference Value for the Deviation Measurement B (*(REF) B*)

Some fields on the *MEAS SETUP* page are the same as the fields on the *MEAS DISPLAY* page as follows. So, these fields are not described in this Chapter, and the other functions on the *MEAS SETUP* page are described in the following paragraphs.

- Measurement Function (*FUNC*)
- Measurement Range (*RANGE*)
- Test Frequency (*FREQ*)
- Oscillator Level (*LEVEL*)
- DC Bias (*BIAS*)
- Integration Time (*INTEG*)

The available fields and the softkeys which corresponded to each field on this page are shown in Figure 4-1 and Figure 4-2.

<b>&lt;MEAS SETUP&gt;</b>		<b>SYS MENU</b>	<b>MEAS SETUP</b>
FUNC :	Cp-D	RANGE :	AUTO
FREQ :	1.00000kHz	BIAS :	1.5000 V
LEVEL :	* 1.00 V	INTEG :	MED
TRIG :	INT	AVG :	4
ALC :	ON	Vm :	ON
Hi-PW :	ON	Im :	ON
DCI :	ISO ON	DELAY :	0 ms
DEV A :	ΔABS	REF A :	123.456 pF
B :	ΔABS	B :	0.00005
			<b>CORREC TION</b>
			<b>LIMIT TABLE</b>
			<b>LIST SETUP</b>
<div style="border: 1px solid black; display: inline-block; width: 50px; height: 15px; vertical-align: middle;"></div> : Field			

L1004001

**Figure 4-1. Available Fields on the MEAS SETUP Page**



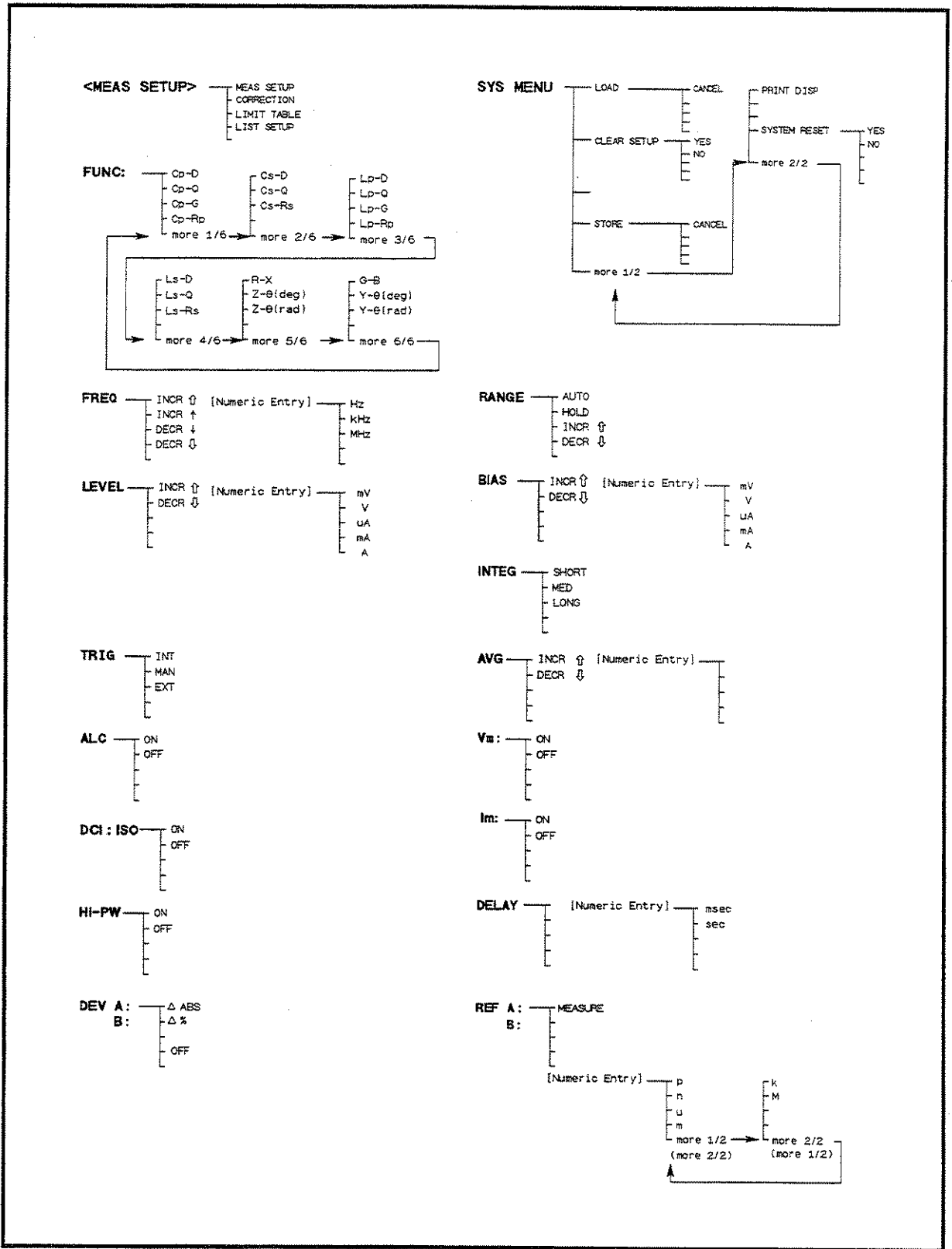

L1004002

Figure 4-2. Available Softkeys on the MEAS SETUP Page

## Comment

### Description

You can enter a comment using the numeric entry keys (**0** to **9**, **-** (minus), **.** (period)) on the comment line field. This comment line is stored to the internal non-volatile memory or to the external memory card with the HP 4284A control settings. Also this comment line is loaded from the internal non-volatile memory or from the external memory card with the control settings. A comment can be up to 30 characters long.

## Note



---

When you want to enter the ASCII characters on the comment line, only the **DISPlay:LINE HP-IB** command must be sent via HP-IB.

---

### Front Panel Operation for Entering a Comment Number

Perform the following steps to enter a comment.

1. Move the cursor to the comment line field.
2. Enter the comment using the numeric entry keys, then press **ENTER**.

## Trigger Mode

### Description

The HP 4284A has four trigger modes: **INT**ernal, **EXT**ernal, **MAN**ual, and **BUS**.

When the trigger mode is set to **INT** trigger mode, the HP 4284A continuously repeats measurements on any display page under **DISPLAY FORMAT**.

When the trigger mode is set to **MAN** trigger mode, the HP 4284A performs a single measurement on any display page under **DISPLAY FORMAT** every time **TRIGGER** on the front panel is pressed.

When the trigger mode is set to **EXT** trigger mode, the HP 4284A performs a single measurement on any display page under **DISPLAY FORMAT** every time a positive going TTL pulse is applied to the **EXT TRIGGER** connector on the rear panel. External triggering can be also be achieved by momentarily switching the center conductor of the **EXT TRIGGER** connector to chassis ground (center conductor circuit contains a pull-up resistor). Figure 4-3 shows the required TTL pulse.

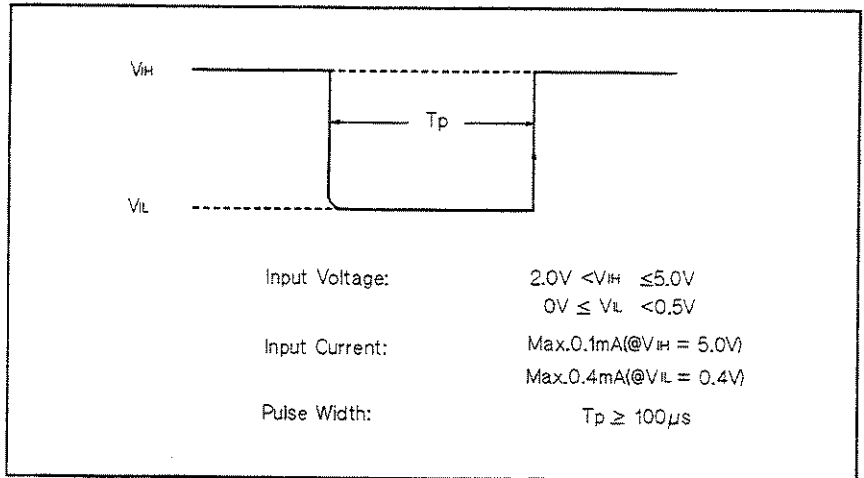

**Figure 4-3. External Trigger Pulse**

**Note**



The HP 4284A ignores triggers that are applied while a measurement is in progress. Trigger the HP 4284A after the measurement is completed.

Select the EXT trigger mode when the HP 4284A is triggered via an optional interface.

When the trigger mode is set to BUS trigger mode, the HP 4284A performs a single measurement every time the TRIGGER command is sent to the HP 4284A via HP-IB. Then the BUS trigger mode cannot be set on the front panel.

**Front Panel Operation for Setting the Trigger Mode**

Perform the following steps to set the trigger mode except for in the BUS TRIG mode. To set the trigger mode in the BUS TRIG mode, the TRIGger:SOURCE BUS command should be sent via HP-IB.

1. Move the cursor to the *TRIG* field. The following softkeys will be displayed.

- TRF
- MAN
- EXT

2. Set the trigger mode using the softkeys.

## Automatic Level Control Function

### Description

The automatic level control (ALC) function regulates the actual test level (voltage across the DUT, or current through the DUT) to your desired level. So by using this function, the test signal voltage or current level at the DUT can be held constant.

When the automatic level control function is used, the oscillator level settings are limited as follows.

- When Option 001 is not installed, or the high power mode is set to OFF

Voltage Level:  $10 \text{ mV}_{\text{rms}}$  to  $1 \text{ V}_{\text{rms}}$

Current Level:  $100 \mu\text{A}_{\text{rms}}$  to  $10 \text{ mA}_{\text{rms}}$

- When the high power mode is set to ON

Voltage Level:  $10 \text{ mV}_{\text{rms}}$  to  $10 \text{ V}_{\text{rms}}$

Current Level:  $100 \mu\text{A}_{\text{rms}}$  to  $100 \text{ mA}_{\text{rms}}$

### Note



When the ALC function is active, if the oscillator level setting exceeds the above limits, the ALC function is automatically set to OFF and the setting value is entered as a normal oscillator level.

### Note



The automatic level control is achieved using feedback with the level monitor function as shown in Figure 4-4. The feedback operation performs a level measurement/OSC level adjustment 2 to 6 times per measurement. (The time required ( $n$  in the following formula) depends on the device being tested. The more non-linear the device is, the greater the time required.) When the ALC function can't regulate the level using 6 output level measurement/adjustment cycles (when a device has non-linear characteristics, the ALC function may stop before the 6 output level measurement/adjustment cycles), the ALC function stops, and a warning message **ALC unable to regulate** is displayed, and sets the oscillator level to equal your setting value, open-loop, the output level will be the same as when ALC is set to OFF. The time required for the ALC function to operate is calculated using the following formula.

$(\text{meas.time (SHORT)} + \text{approx. } 115 \text{ msec.}) \times n$

Where,  $n = 2$  (min.)

$n = 6$  (max.)

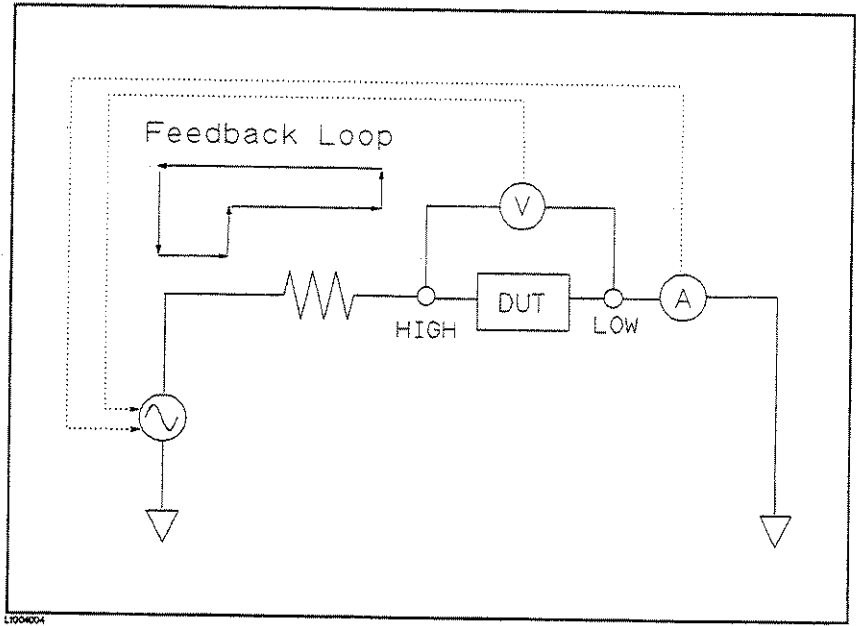

**Figure 4-4. Feedback Circuit**

The available operation range for the ALC function is shown in Figure 4-5. The solid line shows the operation range for a resistor as the DUT, and the dotted line shows the operation range for a capacitor or inductor as the DUT.

The uncertainty of the limitation of the operating range is:

Hi-PW mode: off  $\pm 13\%$

Hi-PW mode: on  $\pm 16\%$

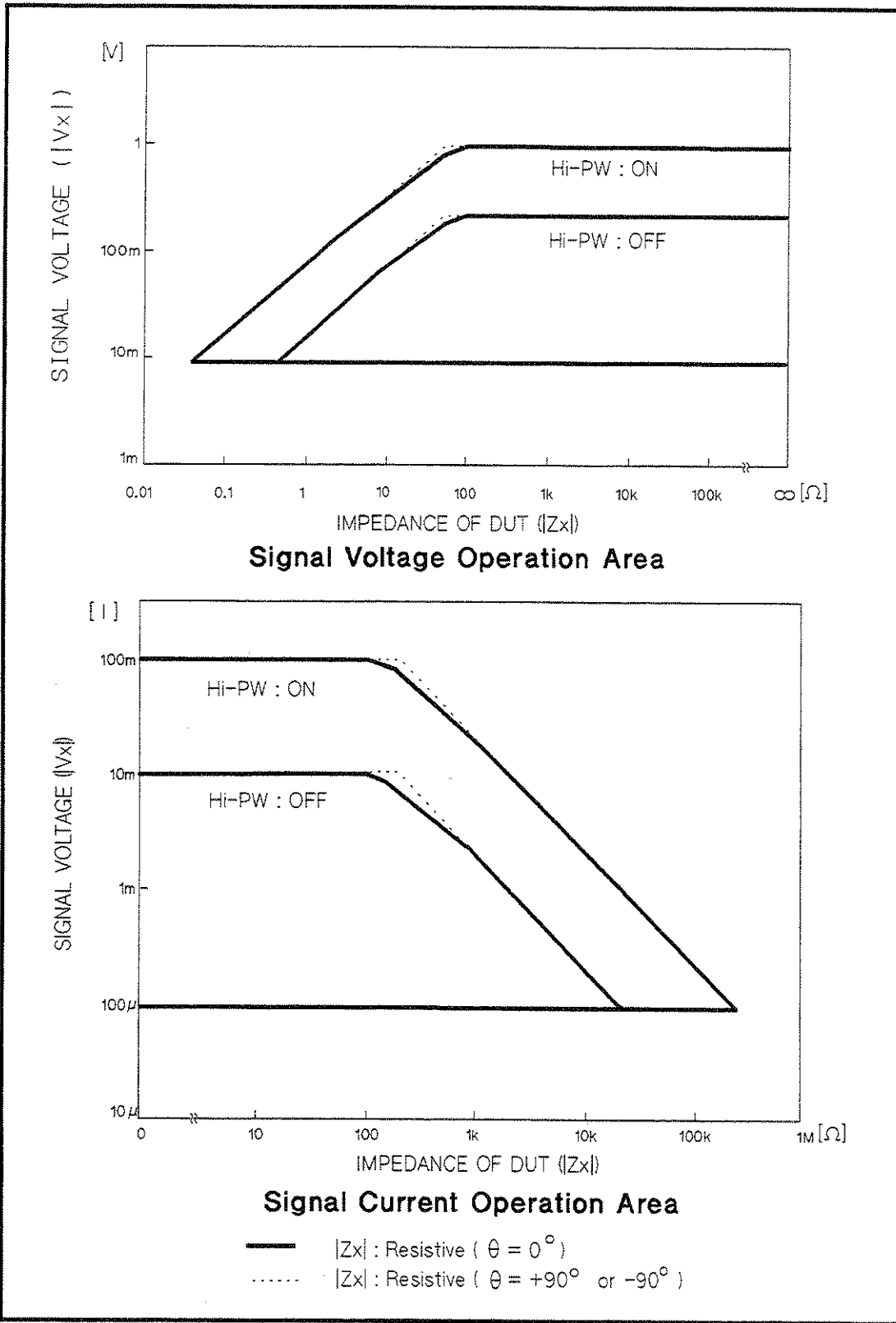

L100400A

Figure 4-5. Available Operating Area for the ALC Function

### Front Panel Operation for Setting the Automatic Level Control Function

Perform the following steps to set the automatic level control function to ON or OFF.

1. Move the cursor to the *ALC* field. The following softkeys will be displayed.
  - **ON**
  - **OFF**
2. Press **ON** to set the automatic level control function to ON. Press **OFF** to set the automatic level control function OFF.

### High Power Mode

#### Description (Refer to Appendix G.)

When Option 001 (Power Amplifier/DC Bias) is installed, the oscillator level can be set from the 5 mV<sub>rms</sub> to 20 V<sub>rms</sub>, and from 50  $\mu$ A<sub>rms</sub> to 200 mA<sub>rms</sub>, and also the dc bias can be set up to  $\pm 40$  V. The *Hi-PW* field allows you to make Option 001 valid or invalid. So if the high power mode is set to OFF, the oscillator level or the dc bias controls are the same as the oscillator level or the dc bias controls of an HP 4284A without Option 001.

#### Note



When Option 001 is installed, the power-on default setting of the high power mode is ON.

When the low test signal level measurement is performed without using dc bias, the measurement value at the high power mode: OFF may be more stable than the measurement value at the high power mode: ON.

#### Note



When the HP 42841A is connected to the HP 4284A, the high power mode is set to OFF, and Option 001 is disabled.

### Front Panel Operation for Setting the High Power Mode

Perform the following steps to set the high power mode to ON or OFF when Option 001 is installed.

1. Move the cursor to the *Hi-PW* field. The following softkeys will be displayed.
  - **ON**
  - **OFF**
2. Press **ON** to set the high power mode to ON. Press **OFF** to set the high power mode to OFF.

## Bias Current Isolation Function

### Description (Refer to Appendix G.)

When Option 001 (Power Amplifier/DC Bias) is installed, the dc bias can be set up to  $\pm 40$  V. The dc bias current through the device under test can be calculated using the following formula.

$$I_{dc} = \frac{V_s}{100 + R_{dc}} = \frac{I_s \times 100}{100 + R_{dc}}$$

Where,  $I_{dc}$ : Actual Bias Current [A]

$R_{dc}$ : DUT's DC resistance [ $\Omega$ ]

$V_s$ : Setting Value of the dc bias [V]

$I_s$ : Setting Value of the dc bias [A]

This bias current isolation function prevents the DC current from affecting the measurement input circuit. The *DCI:ISO* field allows you to set the bias current isolation function to ON or OFF. When the bias current isolation function is set to ON, the bias current through the device can be up to 100 mA. When the bias current isolation function is set to OFF, the current through the device can be set to the values listed in Table 4-1. When the current through a device exceeds the values listed in Table 4-1, normal measurement can't be performed.

**Table 4-1. Maximum DC Bias Current**

Measurement Range	100 $\Omega$	300 $\Omega$	1 k $\Omega$	3 k $\Omega$	10 k $\Omega$	30 k $\Omega$	100 k $\Omega$
Max. current	2 mA	2 mA	1 mA	300 $\mu$ A	100 $\mu$ A	30 $\mu$ A	10 $\mu$ A

### Note



The bias current isolation function influences the measurement accuracy. (Refer to "Relative Measurement Accuracy with Bias Current Isolation" in Chapter 9.) So when measuring a high impedance device at low frequency with low bias current, the bias current isolation function should be set to OFF.

### Front Panel Operation for Setting the Bias Current Isolation Function

Perform the following steps to set the bias current isolation function to ON or OFF when high power mode is set to ON.

1. Move the cursor to the *DCI:ISO* field. The following softkeys will be displayed.
  - **ON**
  - **OFF**



2. Press **ON** to set the bias current isolation function to ON. Press **OFF** to set the bias current isolation function to OFF.

## Averaging Rate

### Description

The HP 4284A's averaging rate function arithmetically averages the results of two or more A/D conversions. (The A/D conversion time can be set in the *INTEG* field.) The number of conversions averaged can be set from 1 to 256, in steps of 1.

### Front Panel Operation for Setting the Averaging Rate

Perform the following steps to set the averaging rate.

1. Move the cursor to the *AVG* field. The following softkeys will be displayed.
  - **INCR** ↑  
This softkey is used to increment the averaging rate. (1, 2, 4, 8, 16, 32, 64, 128, and 256)
  - **DECR** ↓  
This softkey is used to decrement the averaging rate. (1, 2, 4, 8, 16, 32, 64, 128, and 256)
2. Use the softkeys to set the averaging rate, or enter the averaging rate using the numeric entry keys, and **ENTER**.

## Delay Time

### Description (Refer to Appendix G.)

The HP 4284A's delay time function allows you to set a trigger delay so the HP 4284A will delay the start of the measurement after it is triggered. (When the list sweep measurement is performed, the HP 4284A will delay the start of the measurement at each sweep point using the trigger delay time.) The trigger delay time can be set from 0 s to 60 s in 1 ms steps. This function is useful if a component handler triggers the HP 4284A before stable contact is made with the device under test (DUT).

### Front Panel Operation for Setting the Delay Time

Perform the following steps to set the delay time.

1. Move the cursor to the *DELAY* field.
2. Enter the delay time using the numeric entry keys. When one of the numeric entry keys is pressed, the following unit softkeys will be displayed, these can be used instead of **ENTER**.
  - **msec**
  - **sec**

## Level Monitor Function

### Description

The level monitor function allows you to monitor the actual voltage level across the device under test or the actual current level through the device under test. The voltage monitor value is only displayed on the *MEAS DISPLAY* page at  $V_m$  monitor area. The current monitor value is only displayed on the *MEAS DISPLAY* page at  $I_m$  monitor area.

### Note



The correction function interacts with the level monitor function. So the monitor value may be changed by the correction data change or the OPEN/SHORT/LOAD correction ON/OFF condition change.

### Front Panel Operation for Setting the Level Monitor Function

Perform the following steps to set the level monitor function to ON or OFF.

1. Move the cursor to the  $V_m$  field. The following softkeys will be displayed.
  - **ON**
  - **OFF**
2. Press **ON** to set the voltage level monitor function to ON. Press **OFF** to set the voltage level monitor function to off.
3. Move the cursor to the  $I_m$  field. The following softkeys will be displayed.
  - **ON**
  - **OFF**
4. Press **ON** to set the current level monitor function to ON. Press **OFF** to set the current level monitor function to OFF.

## Deviation Measurement Function

### Description

The deviation measurement function allows you to display the deviation value instead of the actual measurement value. The deviation value is the value calculated by taking the difference between the actual measurement value and a previously stored reference value. This function is useful when the change of a component's value versus changes in temperature, frequency, bias, etc. are being observed. Deviation measurements can be made for either or both primary parameter and/or secondary parameter measurements. There are two types of deviation measurements.

- $\Delta$ ABS (Delta ABSolute) deviation measurement

The difference between the measured value of the DUT and a previously stored reference value are displayed. The formula used to calculate the deviation is as follows.

$$\Delta\text{ABS} = X - Y$$

Where, X: The measured value of the DUT  
Y: The stored reference value

■  $\Delta\%$  (Delta percent) deviation measurement

The difference between the measured value of the DUT and a previously stored reference value are displayed as a percentage of the reference value. The formula used to calculate the percent deviation is as follows.

$$\Delta\% = (X - Y) / Y \times 100 [\%]$$

Where, X: The measured value of the DUT  
Y: The stored reference value

### Front Panel Operation for the Deviation Measurement Function

Perform the following steps to execute the deviation measurement function.

1. Move the cursor to the *REF A* field to enter the reference value for the primary parameter. The following softkey will be displayed.

■ **MEA-SURE**

When the device which has a reference value is connected, pressing this **MEA-SURE**, the HP 4284A measures the device, and the measurement results are entered as a reference value for REF A and REF B values.

2. Enter the reference value for the primary parameter using **MEA-SURE** or the numeric entry keys.
3. Move the cursor to the (*REF*) *B* field to enter the reference value for the secondary parameter. The following softkey will be displayed.

■ **MEA-SURE**

When the device is to be used as the reference value is connected, **MEA-SURE** is pressed, the HP 4284A measures the device, and the measurement results are entered as a reference value for REF A and REF B values.

4. Enter the reference value for the secondary parameter using **MEA-SURE** or the numeric entry keys. If the reference values for A and B are entered using **MEA-SURE** in step 2, skip this step.
5. Move the cursor to the *DEV A* field. The following softkeys will be displayed.

- $\Delta$  ABS
  - $\Delta$  %
  - OFF
6. Select and press a softkey to select the deviation mode for the primary parameter.
  7. Move the cursor to the (DEV) B field. The following softkeys will be displayed.
    - $\Delta$  ABS
    - $\Delta$  %
    - OFF
  8. Select and press a softkey to select the deviation mode for the secondary parameter.

## System Menu

The system menu on this page allows you to perform the following control functions.

- Load/Store
- Clear Setup
- Printer
- System Reset

These functions, except for the clear setup function and system reset function, are the same as the functions on the system menu on the *MEAS DISPLAY* page. (The description of each function is given on page 3-19, system menu.) So in the case of the clear setup function and the system reset function, the description and setting procedure are given, while in the case of the other functions, only the procedure is given.

### Load/Store Function

Perform the following steps on the *MEAS SETUP* page to store the control settings to the internal non-volatile memory or the external memory card, or to load the control settings from the internal non-volatile memory or the external memory card.

1. Set all controls.
2. Move the cursor to the *SYS MENU* field on the *MEAS SETUP* page.
3. If you are using a memory card insert the memory card into the MEMORY card slot.
4. Press **STORE** when you want to use the store function. The message Enter record number to STORE will be displayed on the system message line.

Press **LOAD** when you want to use the load function. The message Enter record number to LOAD will be displayed on the system message line.

5. Enter the record number using the numeric entry keys and **ENTER** to store the current control settings, or load the control settings.

### Clear Setup Function

This function allows you to set all of the operation on the *MEAS SETUP* page to the power on default settings. The control settings on the other pages are not initialized. Figure 4-6 shows the *MEAS SETUP* page after performing the clear setup function.

Hi-PW : ON (When Option 001 is installed)

<MEAS SETUP>	SYS MENU	LOAD
FUNC : Cp-D	RANGE: AUTO	CLEAR SETUP
FREQ : 1.00000KHz	BIAS : 0.000 V	
LEVEL: 1.00 V	INTEG: MED	
TRIG : INT	AVG : 1	STORE
ALC : OFF	Vm : ON	
Hi-PW: OFF	Im : ON	
DCI : ISO OFF	DELAY: 0 ms	more 1/2
DEV A: OFF	REF A: 0.00000 F	
B: OFF	B: 0.00000	

Figure 4-6. MEAS SETUP page After Clearing the Setup

Perform the following steps to set only all of the operations on the *MEAS SETUP* page to the power on default settings.

1. Move the cursor to the *SYS MENU* field.
2. Press **CLEAR SETUP**. The message Clearing setup. Are you sure? will be displayed, and the following softkeys will be displayed.
  - **YES**
  - **NO**
3. Press **YES** to set all of the control settings on the *MEAS SETUP* page to the power-on default settings.

### Printer Function

Perform the following steps to print out the display page using the PRINT DISP mode.

1. Connect a printer to the HP 4284A using an HP-IB cable.
2. Set the printer to the Listen Only mode.
3. Set the Talk Only mode to ON from the *SYSTEM CONFIG* page.
4. Press **MEAS SETUP** to display the *MEAS SETUP* page.
5. Move the cursor to the *SYS MENU* field.
6. Press **more 1/2**.
7. Press **PRINT DISP**. The display page will be printed out to the printer as shown below.

<MEAS DISPLAY>		SYS MENU	
FUNC :	Cp-D	RANGE:	AUTO
FREQ :	1.00000kHz	BIAS :	0.000 V
LEVEL:	1.00 V	INTEG:	MED
TRIG :	INT	AVG :	1
ALC :	OFF	Vm :	ON
Hi-Pw:	ON	Im :	ON
DCI :	ISO ON	DELAY:	0ms
DEV A:	dABS	REF A:	10.0000pF
B:	dABS	B:	500.000u

Figure 4-7. MEAS SETUP page Example

### SYSTEM RESET Function

This function allows you to set all of the control settings to the power-on default values. (For more detail information about the default settings, refer to Appendix C.)

Perform the following steps to execute the SYSTEM RESET function.

1. Move the cursor to the *SYS MENU* field on the *MEAS SETUP* page.
2. Press **more 1/2**.
3. Press **SYSTEM RESET**. The message *Resetting system, Are you sure?* will be displayed, and the following softkeys will be displayed.
  - **YES**
  - **NO**

4. Press **YES** to reset the HP 4284A.

## CORRECTION Page

When you press **MEAS SETUP**, and **CORRECTION**, the *CORRECTION* page will be displayed. On the *CORRECTION* page, the OPEN, SHORT, LOAD correction for correcting the stray admittance, the residual impedance, and the other errors can be performed, and also the cable length can be selected. The correction function has two kinds of correction methods. In one method the open and short correction can be performed at all of the frequency points using the interpolation method, and in the other method the open, short, and load correction can be performed at the frequency points you specify.

The following operations can be performed from this page. The field is in parenthesis.

- OPEN Correction (*OPEN*)
- SHORT Correction (*SHORT*)
- LOAD Correction (*LOAD*)
- Cable Length Selection (*CABLE*)
- Multi/Single Correction Mode Selection (*MODE*)
- Measurement Function for LOAD Correction (*FUNC*)
- Frequency 1, 2, 3 for OPEN, SHORT, LOAD Correction (*FREQ1*, *FREQ2*, and *FREQ3*)
- Reference Values (A, B) at each three frequencies for LOAD Correction (*REF A, B*)
- Cable Length Selection (*CABLE*)
- System Menu (*SYS MENU*)

There are seventeen available fields on this page: *<CORRECTION>*, *SYS MENU*, *OPEN*, *SHORT*, *LOAD*, *CABLE*, *MODE*, *FUNC*, *FREQ1*, *REF A, B*, *FREQ2*, *REF A, B*, *FREQ3*, *REF A, B*, and *B*.

These controls are described in the following paragraphs.

This page also provides the following monitor information (the monitor area looks like a field, but it is not).

- Actual Measurement Values for LOAD Correction
- Channel Number on the MULTI Correction Mode

The actual measurement values for LOAD Correction can be measured from the *FREQ1*, *FREQ2*, or *FREQ3* fields on this page, and the channel number can be set using the scanner interface connector or HP-IB.

The available fields and the softkeys which are corresponded with each field on this page are shown in Figure 4-8 and Figure 4-9.



<b>&lt;CORRECTION&gt;</b>		<b>SYS MENU</b>		MEAS SETUP
OPEN :	<input type="text" value="ON"/>	CABLE :	<input type="text" value="0 m"/>	
SHORT :	<input type="text" value="ON"/>	MODE :	<input type="text" value="MULTI"/>	
LOAD :	<input type="text" value="ON"/>	CH No :	<input type="text" value="100"/>	CORREC TION
		FUNC :	<input type="text" value="Cp-D"/>	
FREQ1 :	<input type="text" value="1.00000kHz"/>			LIMIT TABLE
REF A :	<input type="text" value="100.000pF"/>	B :	<input type="text" value="0.00010"/>	
MEA A :	<input type="text" value="100.001pF"/>	B :	<input type="text" value="0.00011"/>	
FREQ2 :	<input type="text" value="10.0000kHz"/>			
REF A :	<input type="text" value="100.020pF"/>	B :	<input type="text" value="0.00012"/>	
MEA A :	<input type="text" value="100.021pF"/>	B :	<input type="text" value="0.00013"/>	
FREQ3 :	<input type="text" value="100.000kHz"/>			LIST SETUP
REF A :	<input type="text" value="100.040pF"/>	B :	<input type="text" value="0.00014"/>	
MEA A :	<input type="text" value="100.041pF"/>	B :	<input type="text" value="0.00015"/>	

: Field  
 : Monitor

L1004006

**Figure 4-8. Available Fields on the CORRECTION Page**

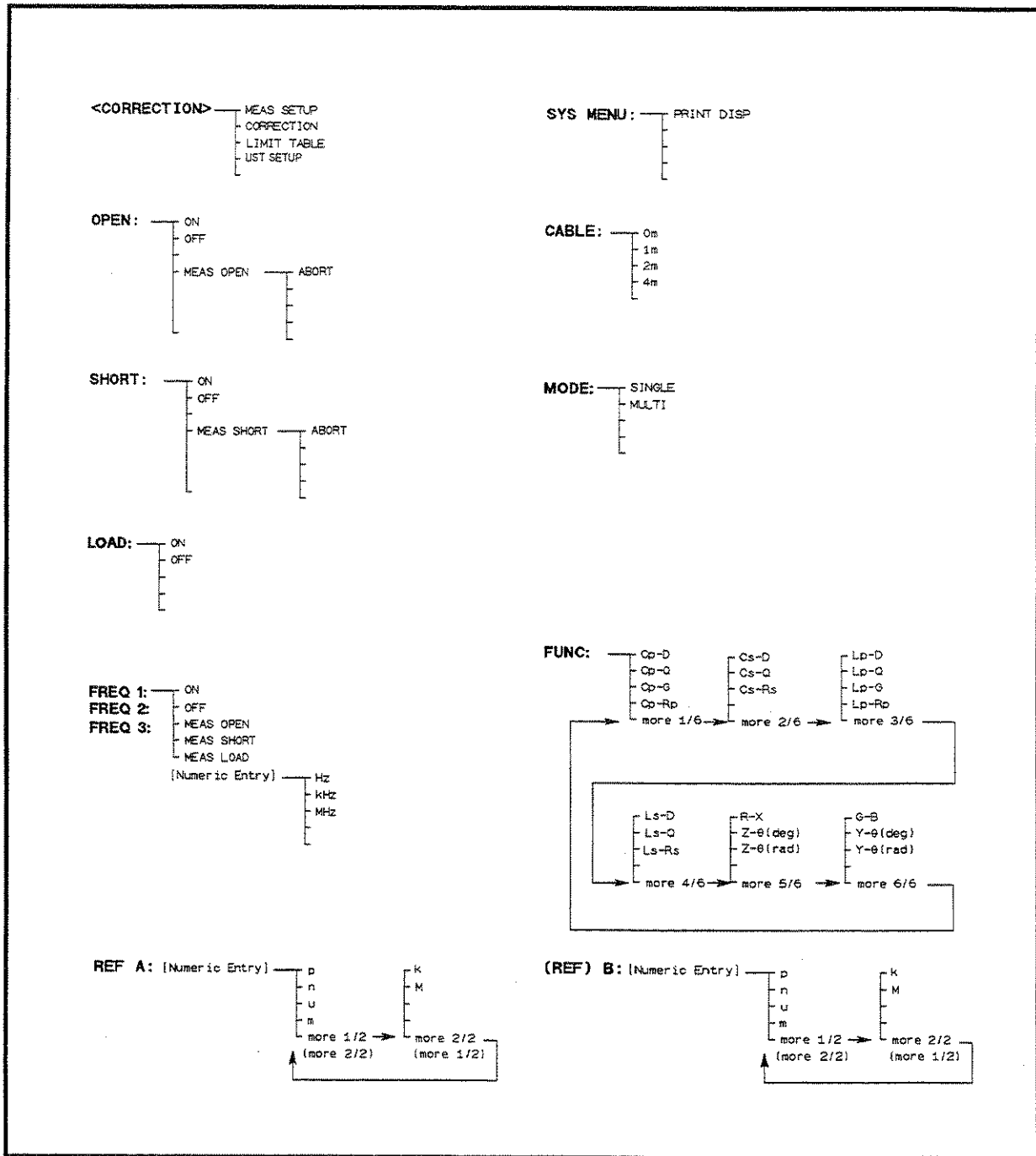

L1004007

Figure 4-9. Available Softkeys on the CORRECTION Page

## OPEN Correction

### Description

The HP 4284A's OPEN correction capability cancels errors due to the stray admittance (G, B) in parallel with the device under test (Refer to Figure 4-10).

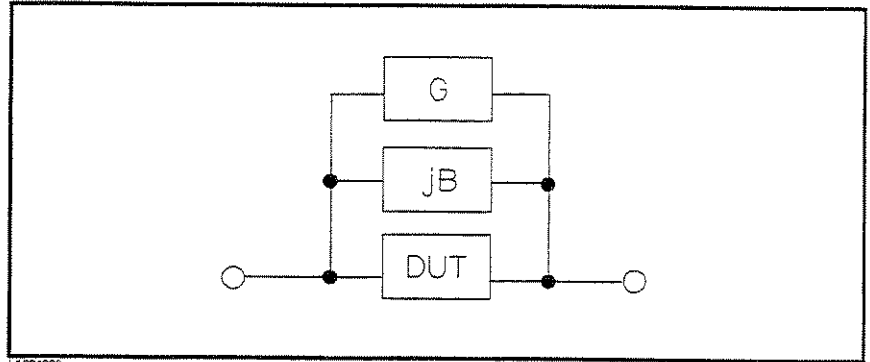

Figure 4-10. Stray Admittance

The HP 4284A uses two kinds of OPEN correction data as follows.

- The OPEN correction data is taken at all 48 preset frequency points, independent of the test frequency you set. Except for those 48 frequency points, the OPEN correction data for each measurement point over the specified range is calculated using the interpolation method (Refer to Figure 4-11 in the next page). The following is a list of the 48 preset frequency points.

20 Hz	100 Hz	1 kHz	10 kHz	100 kHz	1 MHz
25 Hz	120 Hz	1.2 kHz	12 kHz	120 kHz	
30 Hz	150 Hz	1.5 kHz	15 kHz	150 kHz	
40 Hz	200 Hz	2 kHz	20 kHz	200 kHz	
50 Hz	250 Hz	2.5 kHz	25 kHz	250 kHz	
60 Hz	300 Hz	3 kHz	30 kHz	300 kHz	
80 Hz	400 Hz	4 kHz	40 kHz	400 kHz	
	500 Hz	5 kHz	50 kHz	500 kHz	
	600 Hz	6 kHz	60 kHz	600 kHz	
	800 Hz	8 kHz	80 kHz	800 kHz	

To take the OPEN correction data at the preset frequencies, **MEAS OPEN** displayed when the cursor is moved to the *OPEN* field, is used.

- The OPEN correction data which is taken at the frequency points you specify allows you to set up to three frequency points in the *FREQ1*, *FREQ2*, and *FREQ3* fields. To take the OPEN correction data at the frequency points you specify, **MEAS OPEN** displayed when the cursor is moved to the *FREQ1*, *FREQ2*, or *FREQ3* field, is used.

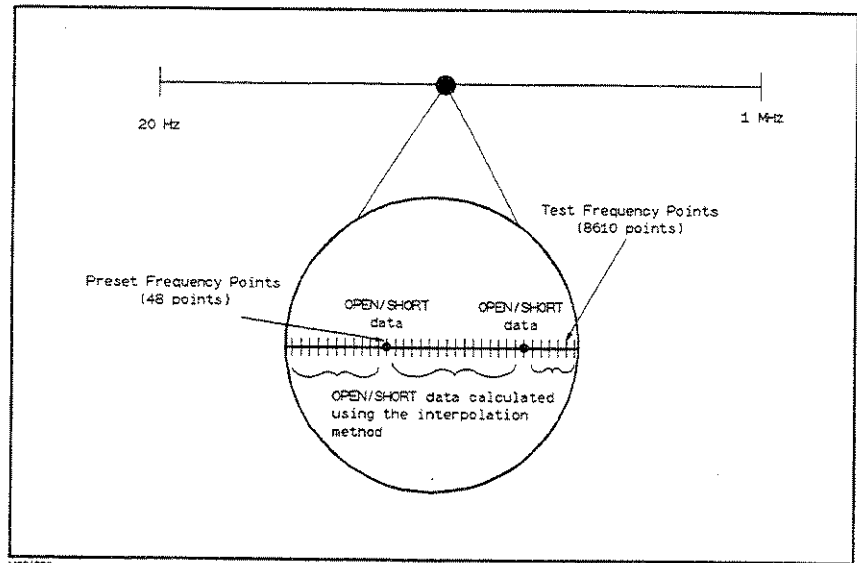

**Figure 4-11. OPEN/SHORT Correction Using The Interpolation Method**

#### Front Panel Operation for the Open Correction

There are two procedures: OPEN correction using the interpolation method, and OPEN correction at the frequency points you specify.

Perform the following steps to execute the OPEN correction at all frequency points using the interpolation method. When you want to execute the OPEN correction at a single frequency point, refer to "LOAD Correction".

1. Move the cursor to the *OPEN* field. The following softkeys will be displayed.
  - **ON**
  - **DEF**
  - **MEAS OPEN**
2. Connect your test fixture to the UNKNOWN Terminals without connecting the device under test.
3. Press **MEAS OPEN**. The HP 4284A will measure the OPEN admittance (capacitance, and inductance) at the preset frequency points. The time required to measure the open correction data is approximately 90 s. During the OPEN correction measurement, the following softkey is available.
  - **ABORT**

This softkey is used to stop an OPEN correction data measurement. The previous OPEN correction data will still be stored.
4. Press **ON** to perform the OPEN correction calculations on subsequent measurements using the OPEN interpolation

correction data when the *FREQ1*, *FREQ2*, and *FREQ3* fields are set to OFF.

When the *FREQ1*, *FREQ2*, and *FREQ3* fields are set to ON, and the test frequency is equal to *FREQ1/2/3*, the OPEN correction data at *FREQ1/2/3* is used. (Refer to APPENDIX D.)

5. Press **OFF** not to perform the OPEN correction calculations on subsequent measurements.

## SHORT Correction

### Description

The HP 4284A's SHORT correction capability corrects for the residual impedance (R, X) in serial with the device under test (Refer to Figure 4-12).

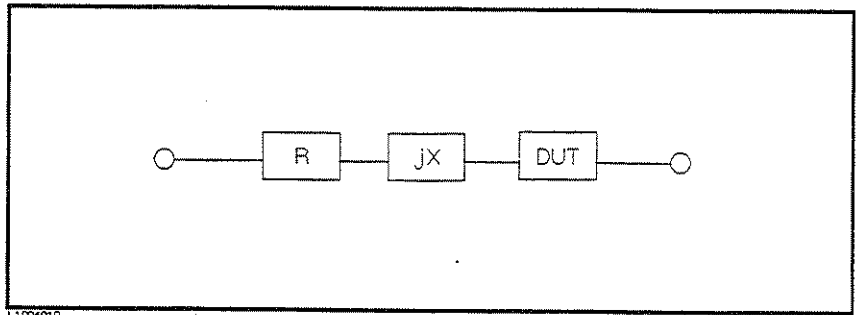

Figure 4-12. Residual Impedance

The HP 4284A uses the following two kinds of SHORT correction data.

- The SHORT correction data is taken at all 48 preset frequency points independent of the test frequency(ies) you set, and the SHORT correction data for each measurement point other than those present frequency points are calculated using the interpolation method(Refer to Figure 4-11). All preset frequency points (48 frequency points) are as same as the preset frequencies for the OPEN correction using the interpolation method.

To take the SHORT correction data at the preset frequency points, **MEAS SHORT**, which is displayed when the cursor is moved to the *SHORT* field, is used.

- The SHORT correction data which is taken at the frequency points you specify. You can set up to three frequency points in the *FREQ1*, *FREQ2*, and *FREQ3* fields.

To take the SHORT correction data at the frequency points you specify, **MEAS SHORT**, which is displayed when the cursor is moved to the *FREQ1*, *FREQ2*, or *FREQ3* field, is used.

### Front Panel Operation for the Short Correction

There are two procedures: SHORT correction at all frequency points, and SHORT correction at user specified frequency points.

Perform the following steps to execute the SHORT correction for all frequency points. When you want to execute the short correction at the user specified frequency points, refer to "LOAD Correction".

1. Move the cursor to the *SHORT* field. The following softkeys will be displayed.

- **ON**
- **OFF**
- **MEAS SHORT**

2. Connect the test fixture to the UNKNOWN Terminals, and short the measurement contacts together.

Press **MEAS SHORT**. The HP 4284A will measure the short impedance (inductance and resistance) at the preset frequency points. The time required to measure the short correction data is approximately 90 s. During the SHORT correction measure cycle, the following softkey is available.

- **ABORT**

This softkey is used to stop the short correction data measurement. The previous SHORT correction data is still stored.

3. Press **ON** to perform SHORT correction calculations on subsequent measurements when the *FREQ1*, *FREQ2*, and *FREQ3* fields are set to OFF.

When the *FREQ1*, *FREQ2*, and *FREQ3* fields are set to ON, and the test frequency is equal to *FREQ1/2/3*, the SHORT correction data at *FREQ1/2/3* is used. (Refer to Appendix D.)

4. Press **OFF** to halt SHORT correction calculations on subsequent measurements.

### LOAD Correction

#### Description

The HP 4284A's LOAD correction capability corrects for the other errors by using the transmission coefficient derived from the relationship between a standard's (premeasured) reference value to the actual measurement value at the frequency points you specify (up to three frequency points). So, OPEN/ SHORT/LOAD corrections can be performed at the frequency points you specify (Refer to Figure 4-13). The three frequency points can be set in the *FREQ1*, *FREQ2*, and *FREQ3* fields. The standard's reference values are set in the *REF A*, and *B* fields. Before entering the standard's reference values, the measurement function for the standard must

be set in the *FUNC* field. The standard's value can be measured using **MEAS LOAD**, which is displayed when the cursor is moved to the *FREQ1*, *FREQ2*, or *FREQ3* fields.

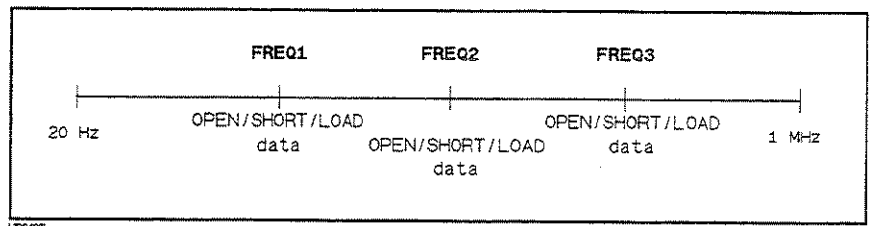

Figure 4-13. OPEN/SHORT/LOAD Correction

#### Front Panel Operation for the OPEN/SHORT/LOAD Correction

Perform the following steps to perform the OPEN/SHORT/LOAD correction at the frequency points you want to specify.

1. Move the cursor to the *FREQ1*, *FREQ2*, or *FREQ3* field to specify the frequency for the OPEN/SHORT/LOAD correction. The following softkeys will be displayed.
  - **ON**  
This softkey is used to make the OPEN/SHORT/LOAD correction data at the *FREQ1*, *FREQ2*, or *FREQ3* frequency point valid.
  - **OFF**  
This softkey is used to make the OPEN/SHORT/LOAD correction data at the *FREQ1*, *FREQ2*, or *FREQ3* frequency point invalid.
  - **MEAS OPEN**  
This softkey is used to perform an OPEN correction measurement at the *FREQ1*, *FREQ2*, or *FREQ3* frequency points.
  - **MEAS SHORT**  
This softkey is used to perform a SHORT correction measurement at the *FREQ1*, *FREQ2*, or *FREQ3* frequency points.
  - **MEAS LOAD**  
This softkey is used to perform a LOAD correction measurement at the *FREQ1*, *FREQ2*, or *FREQ3* frequency points.
2. Press **ON** to show the previous frequency for the OPEN/SHORT/LOAD correction.
3. Enter the frequency using the numeric entry keys. When pressing one of the numeric entry keys, the softkey labels are changed to

the available units (**Hz**, **KHz**, and **MHz**), so you can use these softkeys to enter the unit and terminate the entry without hitting **ENTER**. (When **ENTER** is used, the numeric data is entered with Hz.)

4. Connect the test fixture to the UNKNOWN Terminals.

—*OPEN correction*—

5. Leave the connection contacts open.
6. Press **MEAS OPEN**. The HP 4284A performs an OPEN correction measurement at the frequency points you specified. After which, the OPEN correction measurement data are displayed on the system message line.
7. Move the cursor to the *OPEN* field.
8. Press **DN** to perform the OPEN correction calculations for subsequent measurements at the specified frequency points.

—*SHORT correction*—

9. Move the cursor to the *FREQ1*, *FREQ2*, or *FREQ3* field at which you specified the frequency.
10. Short the connection contacts together.
11. Press **MEAS SHORT**. The HP 4284A will perform a SHORT correction measurement, and display the SHORT correction data on the system message line.
12. Move the cursor to the *SHORT* field.
13. Press **DN** to perform the SHORT correction calculations for subsequent measurements at the specified frequency points.

—*LOAD correction*—

14. Prepare the standard for measurement.
15. Move the cursor to the *FUNC* field.
16. Set the measurement function for your standard. (Refer to the next paragraph (Measurement function for the standard.))
17. Move the cursor to the *REF A* field of your specified frequency.
18. Enter the premeasured value of your standard's primary parameter using the numeric entry keys and the unit softkeys.
19. Move the cursor to the *B* field on the right side of your set *REF A* field.
20. Enter your standard's premeasured secondary parameter value using the numeric entry keys and the unit softkeys.
21. Move the cursor to the *FREQ1*, *FREQ2* or *FREQ3* field at which you specified the frequency.
22. Connect the standard to the measurement contacts.



23. Press **MEAS LGAD**. The HP 4284A will perform a LOAD correction measurement, and display the LOAD correction data on the system message line.
24. Move the cursor to the *LOAD* field.
25. Press **ON** to enable the LOAD correction calculations for subsequent measurements at the specified frequency points.

**Note**



The relationship between the *CORRECTION* page and OPEN/SHORT/LOAD correction function are as follows.

<CORRECTION>		SYS MENU	MEAS SETUP
①	OPEN : ON	CABLE : 1 m	
	SHORT : ON	MODE : SINGLE	
	LOAD : ON	CH No. : ---	CORREC TION
		FUNC : Cp-D	
	FREQ1 : 1.00000kHz		LIMIT TABLE
	REF A : 100.000pF	B : 0.00010	
	MEA A : 100.001pF	B : 0.00011	
②	FREQ2 : 10.0000kHz		LIST SETUP
	REF A : 100.020pF	B : 0.00012	
	MEA A : 100.021pF	B : 0.00013	
	FREQ3 : 100.000kHz		
	REF A : 100.040pF	B : 0.00014	
	MEA A : 100.041pF	B : 0.00015	

L1004912

① This area is used as follows.

- To perform the OPEN/SHORT/LOAD correction calculations using either the OPEN/SHORT interpolation correction data or the OPEN/SHORT/LOAD correction data at the spot frequency you specify. This correction data selection depends on the test frequency.
- To obtain the OPEN/SHORT interpolation correction data.

② This area is used as follows.

- To obtain the OPEN/SHORT/LOAD correction data at the spot frequencies you specify (FREQ1, FREQ2, or FREQ3).
- To make the OPEN/SHORT/LOAD correction data at the spot frequencies you specify (FREQ1, FREQ2, or FREQ3) valid or invalid.

The correction data used depends on the test frequency as follows. (For more detail, refer to APPENDIX D.)

Correction Mode	Test Frequency $\neq$ <i>FREQ1-3</i>		Test Frequency $=$ <i>FREQ1-3</i>	
	<i>FREQ1-3</i> OFF	<i>FREQ1-3</i> ON	<i>FREQ1-3</i> OFF	<i>FREQ1-3</i> ON
OPEN: ON	INTPOL	INTPOL	INTPOL	SPOT
SHORT: ON	INTPOL	INTPOL	INTPOL	SPOT
LOAD: ON	×	×	×	SPOT

SPOT: The correction data for the frequency points you specified is used.

INTPOL: Interpolation correction data is used.

×: Correction isn't performed even if the correction function is set to ON in the *OPEN*, *SHORT*, or *LOAD* fields.

When the frequency you specify is equal to a frequency already specified, the following correction data is used.

- Test Frequency = *FREQ1* = *FREQ2*

Correction data: Data at *FREQ1*

- Test Frequency = *FREQ2* = *FREQ3*

Correction data: Data at *FREQ2*

- Test Frequency = *FREQ1* = *FREQ2* = *FREQ3*

Correction data: Data at *FREQ1*

## Measurement Function for the Standard

### Description

When the LOAD correction is performed, the reference (pre-measured) value of the standard must be entered. The reference value should be the premeasured value of the following measurement functions.

$C_p$ -D	$L_p$ -D	R-X
$C_p$ -Q	$L_p$ -Q	Z- $\theta$ (deg)
$C_p$ -G	$L_p$ -G	Z- $\theta$ (rad)
$C_p$ - $R_p$	$L_p$ - $R_p$	G-B
$C_s$ -D	$L_s$ -D	Y- $\theta$ (deg)
$C_s$ -Q	$L_s$ -Q	Y- $\theta$ (rad)
$C_s$ - $R_s$	$L_s$ - $R_s$	

The LOAD correction corrects the errors using the transmission coefficient derived from the relationship between the standard's reference value and the actual raw measurement value. The above function is used only for calculating the transmission coefficient.

## Front Panel Operation for Setting the Standard's Measurement Function

Perform the following steps to set the measurement function for the standard.

1. Move the cursor to the *FUNC* field. The following softkeys will be displayed.
  - Cp-D
  - Cp-Q
  - Cp-G
  - Cp-Rp
  - more 1/6
2. Select and press a softkey to set the measurement function. If the measurement function softkey you want isn't displayed, press **more 1/6**. The following softkeys will be displayed.
  - Cs-D
  - Cs-Q
  - Cs-Rs
  - more 2/6
3. Select and press a softkey to set the measurement function. If the measurement function softkey you want isn't displayed, press **more 2/6**. The following softkeys will be displayed.
  - Lp-D
  - Lp-Q
  - Lp-G
  - Lp-Rp
  - more 3/6
4. Select and press a softkey to set the measurement function. If the measurement function softkey you want isn't displayed, press **more 3/6**. The following softkeys will be displayed.
  - Ls-D
  - Ls-Q
  - Ls-Rs
  - more 4/6
5. Select and press a softkey to set the measurement function. If the measurement function softkey you want isn't displayed, press **more 4/6**. The following softkeys will be displayed.
  - R-X

- Z- $\theta$  (deg)
- Z- $\theta$  (rad)
- more 5/6

6. Select and press a softkey to set the measurement function. If the measurement function softkey isn't displayed, press **more 5/6**. The following softkeys will be displayed.

- G-B
- Y- $\theta$  (deg)
- Y- $\theta$  (rad)
- more 6/6

7. Select and press a softkey to set the measurement function.

## Single/Multi Correction Mode Selection

### Description

When the Option 301 (Scanner Interface) is installed, the HP 4284A can store up to 128 sets of OPEN, SHORT, LOAD correction measurement data, and one LOAD correction reference data for each of the three test frequencies (FREQ1, FREQ2, and FREQ3), and this correction mode is the MULTI correction mode. (The normal correction mode is the SINGLE correction mode.)

### Note



When the MULTI correction mode is used, the OPEN/SHORT correction using the interpolation method cannot be performed. (Only the OPEN/SHORT/LOAD correction at the frequencies you specify can be performed.)

The FREQ1, FREQ2, and FREQ3 frequency points are dependent on the correction mode (SINGLE, MULTI).

This *MODE* field allows you to select the single correction mode or the multi correction mode. For more information about the multi correction mode, refer to Chapter 3, option 301. scanner interface operation note.

In the case of the multi correction mode, the channel number for selecting the correction data is displayed at the *CH No.* monitor area.

### Front Panel Operation for Setting the Correction Mode to the Multi Correction Mode

1. Press **CATALOG/SYSTEM**, and **SYSTEM CONFIG** to display the *SYSTEM CONFIG* page.
2. Move the cursor to the *SCANNER INTERFACE SETTING* field.
3. Press **ON** to make the scanner interface function valid.
4. Press **MEAS SETUP**, and **CORRECTION** to return to the *CORRECTION* page.
5. Move the cursor to the *MODE* field. The following softkeys will be displayed.
  - **SINGLE**
  - **MULTI**
6. Press **MULTI** to select the multi correction mode. If you want to set the single correction mode, press **SINGLE**.

## Cable Length Selection

### Description

The HP 4284A has two reference planes—to the UNKNOWN Terminals (0m), and to the end of the HP 16048A/B test leads (1m). When Option 006 (2m/4m Cable Length Operation) is installed, the HP 4284A has four reference planes—to the UNKNOWN Terminals (0m), to the end of the HP 16048A/B Test Leads (1m), to the end of the HP 16048D test leads (2m), and to the end of the HP 16048E test leads (4m). Measurement accuracy is specified at these points.

When you select 0m, the four outer conductors of the  $H_{POT}$ ,  $H_{CUR}$ ,  $L_{POT}$ , and  $L_{CUR}$  test leads must be tied together at the UNKNOWN terminals.

When you select 1m, the four outer conductors of the  $H_{POT}$ ,  $H_{CUR}$ ,  $L_{POT}$ , and  $L_{CUR}$  test leads must be tied together at the end of the HP 16048A/B 1m leads.

When you select 2m, the four outer conductors of the test leads must be tied together at the end of the HP 16048D 2m test leads.

When you select 4m, the four outer conductors of the  $H_{POT}$ ,  $H_{CUR}$ ,  $L_{POT}$ , and  $L_{CUR}$  test leads must be tied together at the end of the HP 16048E 4m test leads.

In other words, the four-terminal pair configuration must be terminated for the cable length selected. When an HP 16048A/B/D/E test leads are used, use the furnished terminal plate at the end of the cable for easy configuration.

### Front Panel For Selecting the Cable Length

Perform the following steps to select the cable length.

1. Move the cursor to the *CABLE* field. The following softkeys will be displayed.

- 0 m
- 1 m
- 2 m
- 4 m

2. Select and press a softkey to select the cable length.

## System Menu

The system menu on this page allows you to perform the following control functions.

- Printer

This function is the same as the functions on the system menu on the *MEAS DISPLAY* page. (A description of this function is given in "System Menu" in Chapter 3.) So only the procedure is given in the following paragraphs.

## Printer Function

Perform the following steps to print out the information of the *CORRECTION* page using the PRINT DISP mode.

1. Connect the HP 4284A to the printer using an HP-IB cable.
2. Set the printer to the Listen Only mode.
3. Set the Talk Only mode to ON from the *SYSTEM CONFIG* page.
4. Press **MEAS SETUP**, and **CORRECTION** to display the *CORRECTION* page.
5. Move the cursor to the *SYS MENU* field.
6. Press **PRINT DISP** to print out the display page. The display page is printed out to the printer as shown in Figure 4-14.

<CORRECTION>	SYS MENU
OPEN : ON	CABLE : 0 m
SHORT: ON	MODE : MULTI
LOAD : ON	CH No. : 0
	FUNC : Cp-D
FREQ1 : 1.00000kHz	
REF A: 100.000pF	B: .000000
MEA A: 99.6222pF	B: .008178
FREQ2 : 2.00000kHz	
REF A: 100.000pF	B: .000000
MEA A: 99.8350pF	B: .003234
FREQ2 : 1.00000MHz	
REF A: 100.000pF	B: .000003
MEA A: 99.9439pF	B: .000266

Figure 4-14. *CORRECTION* Page Example

## LIMIT TABLE SETUP Page

When you press **MEAS SETUP**, and **LIMIT TABLE**, the *LIMIT TABLE SETUP* page will be displayed. The *LIMIT TABLE SETUP* page allows you to set the HP 4284A's comparator. The HP 4284A's built-in comparator can sort devices into a maximum of ten bins (BIN 1 to BIN 9 and one OUT OF BINS) using a maximum of nine pairs of primary limits and one pair of secondary parameter limits. Also, devices whose primary parameter is within limits, but whose secondary parameter measurement result not within limits, can be sorted into an AUXiliary BIN. The comparator function is especially useful when using the HP 4284A with a component handler (handler interface option is installed). These limit settings for bin sorting are only set on this *LIMIT TABLE SETUP* page.

- Measurement Function (*FUNC*)
- Comparator Function's Limit Mode (*MODE*)

- Nominal Value for tolerance mode (*NOMINAL*)
- Auxiliary bin ON/OFF (*AUX*)
- Comparator Function ON/OFF (*COMP*)
- Low Limit Value of each bin (*LOW*)
- High Limit Value of each bin (*HIGH*)

Each function is described in the following paragraphs.

The available fields and the softkeys which correspond to the fields on this page are shown in Figure 4-15 and Figure 4-16.



<LIMIT TABLE SETUP>
SYS MENU

FUNC : Cp-D

MODE : %

NOM : 100.000 pF

AUX: OFF

COMP: ON

BIN	LOW	HIGH
1	- 0.010 %	+ 0.010 %
2	- 0.020 %	+ 0.020 %
3	- 0.030 %	+ 0.030 %
4	- 0.040 %	+ 0.040 %
5	- 0.050 %	+ 0.050 %
6	- 0.060 %	+ 0.060 %
7	- 0.070 %	+ 0.070 %
8	- 0.080 %	+ 0.080 %
9	- 0.090 %	+ 0.090 %
2nd	+ .000000	+ .000005

MEAS SETUP

---

CORREC TION

---

LIMIT TABLE

---

LIST SETUP

: Field

L1004013

**Figure 4-15. Available Fields on the LIMIT TABLE SETUP Page**

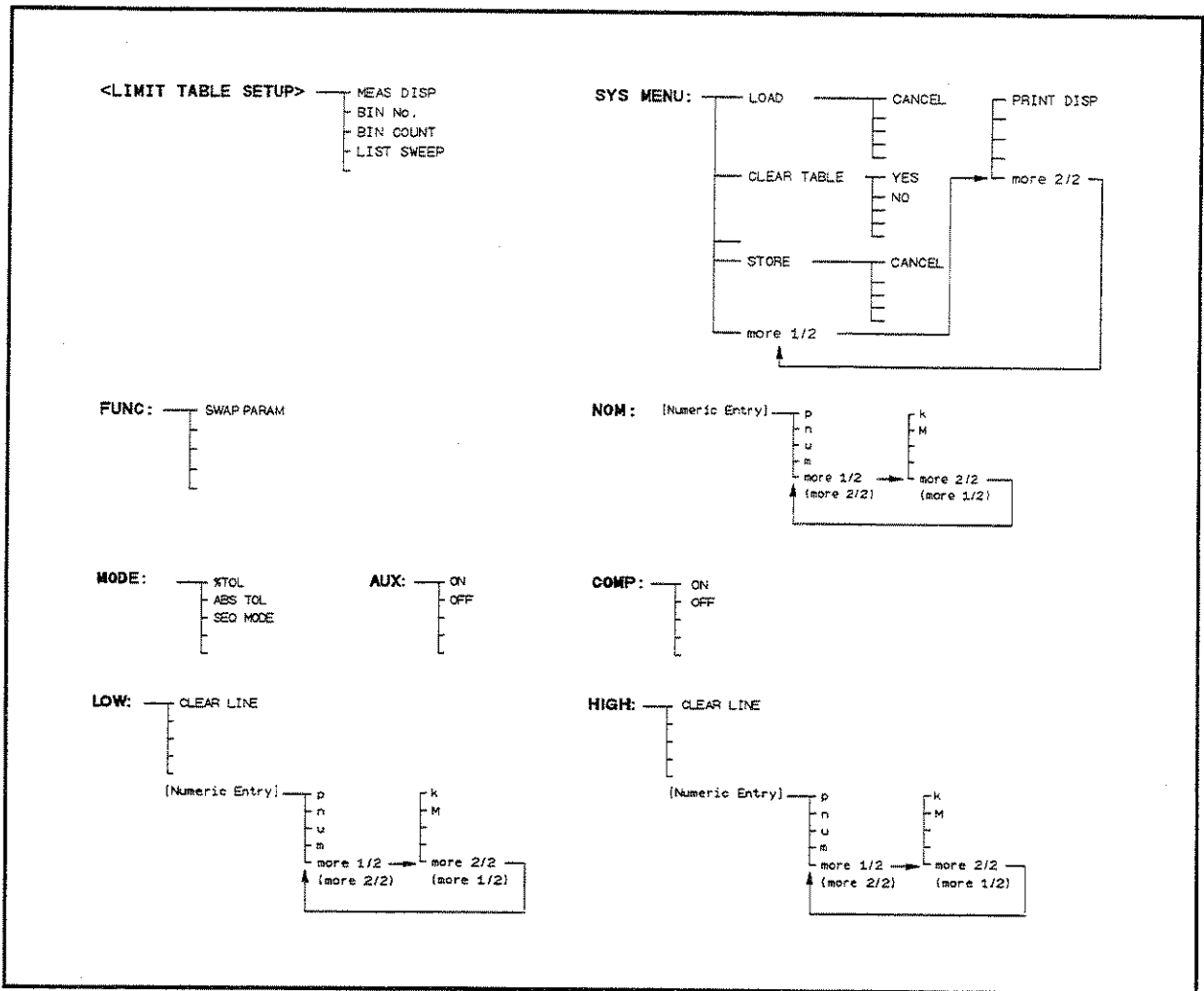

L1004014

Figure 4-16. Available Softkeys on the LIMIT TABLE SETUP Page

### Swap Parameter Function

#### Description

The swap parameter function is used to swap the primary parameter for the secondary parameter in the *FUNC* field. For example, when the measurement function is  $C_p$ -D, the swap parameter function sets the measurement function to D- $C_p$ . (Refer to Figure 4-17) Then the comparison limits for D are a maximum of nine pairs of comparison limits, and the comparison limits for  $C_p$  are now one pair.

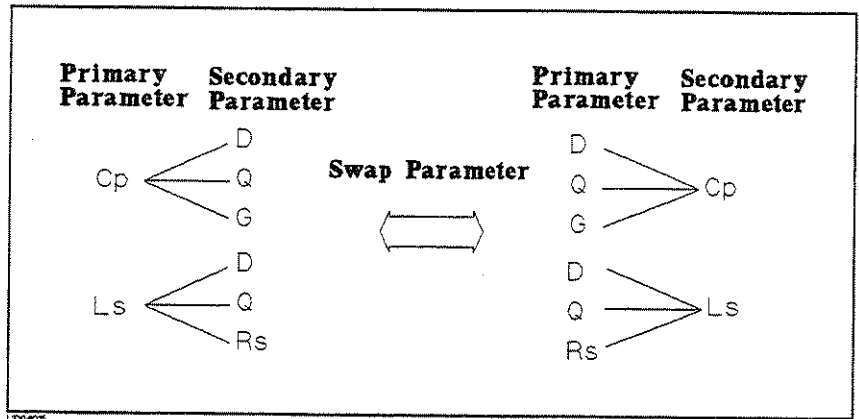

Figure 4-17. Swap Parameter Function

### Front Panel Operation for Swapping the Primary Parameter for the Secondary Parameter

Perform the following steps to swap the primary parameter for the secondary parameter.

1. Move the cursor to the *FUNC* field. The following softkey will be displayed.
  - **SWAP PARAM**
2. Press **SWAP PARAM** to swap the primary parameter for the secondary parameter.
3. Press **SWAP PARAM** again to return the measurement function to the previous combination.

### Limit Mode for Comparator

#### Description

There are two methods for specifying primary parameter limits, as follows. (Refer to Figure 4-18)

- **Tolerance Mode** The tolerance mode specifies comparison limits by the deviation from the specified nominal value. (The nominal value is specified at *NOM* field.) There are two methods used to specify the tolerance mode limits, the ratio in percent and by parameter value.
- **Sequential Mode** The sequential mode specifies comparison limits as the absolute measurement value. The limits must be set in order from the smallest value to the largest value.

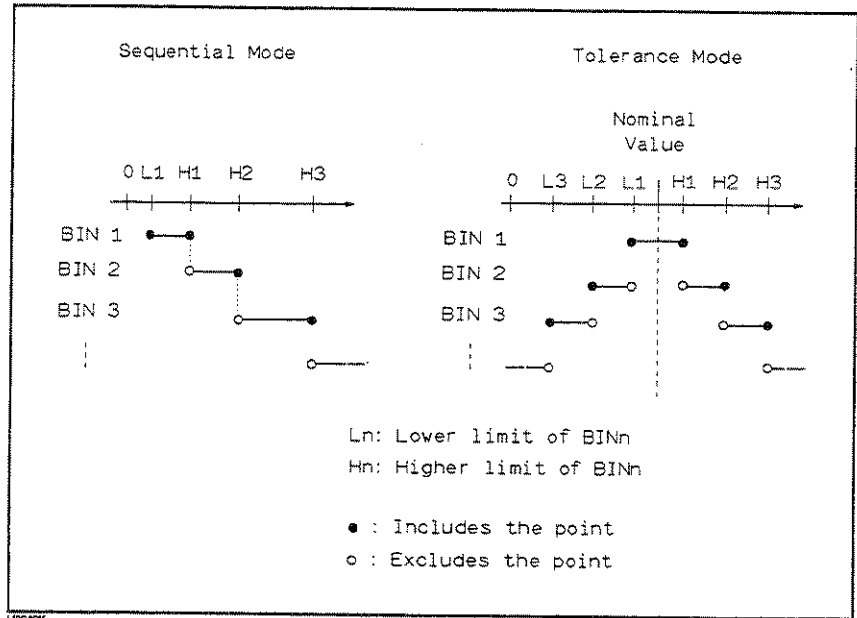

Figure 4-18. Tolerance Mode and Sequential Mode

**Note**



The limit values for tolerance mode sorting must be placed in the order of the narrower limits to the wider limits. If BIN 1 has the widest limits, all of the DUTs will be sorted into BIN 1.

In tolerance mode sorting, the lower limit doesn't have to be less than the nominal value, and the upper limit doesn't have to be greater than the nominal value. As you can see in the following illustration, there can be openings and there can be duplications.

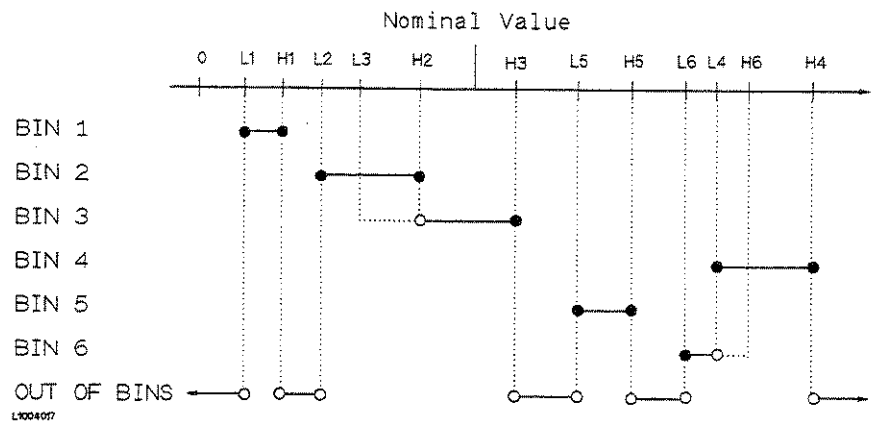

**Front Panel Operation for Setting the Limit Mode for the Comparator**

Perform the following steps to set the limit mode for the comparator.

1. Move the cursor to the *MODE* field. Then the following softkeys will be displayed.

- **% TOL**

This softkey is used to set the limit mode to the tolerance mode (the ratio in percent).

- **ABS TOL**

This softkey is used to set the limit mode to the tolerance mode (parameter value).

- **SEQ**

This softkey is used to set the limit mode to the sequential mode.

2. Select and set the limit mode using the softkeys.

### Nominal Value for Tolerance Mode

#### Description

When the tolerance mode is used as a limit mode for the primary parameter, the nominal value must be set. The nominal value can be set within the range of the following measurement range of the primary parameter.

#### Primary Parameter and Display Range

Parameter	Range
Z , R, X	0.01 mΩ to 99.9999 MΩ
Y , G, B	0.01 nS to 99.9999 S
C	0.01 fF to 9.99999 F
L	0.01 nH to 99.9999 kH
D	0.000001 to 9.99999
Q	0.01 to 99999.9
$\theta$	-180.000 ° to 180.000 °

When the limit mode for the primary parameter is the sequential mode, the nominal value can be set, but this has no meaning in the sequential mode.

#### Front Panel Operation for Setting the Nominal Value

Perform the following steps to set the nominal value.

1. Move the cursor to the *NOM* field.
2. Enter the nominal value using the numeric entry keys. When the numeric data is entered, the suffix softkeys (**p**, **n**, **μ**, **m**, **k**, **M**) can be used instead of **ENTER**.

## Comparator Function ON/OFF

### Description

The HP 4284A's built-in comparator can sort devices into a maximum of ten bins (BIN 1 to BIN 9 and the OUT OF BINS bin) using a maximum of nine pairs of primary limits and one pair of secondary parameter limits. Also, a device whose primary parameter is within limits, but whose secondary parameter measurement result is not within limits can be sorted into the AUXiliary BIN. The comparator function is especially useful when using the HP 4284A with a component handler (handler interface option is installed).

### Front Panel Operation for Setting the Comparator Function to ON or OFF

Perform the following steps to set the comparator function to ON or OFF.

1. Move the cursor to the *COMP* field. The following softkeys will be displayed.
  - **ON**
  - **OFF**
2. Use the softkeys to set the comparator function to ON or OFF.

## Auxiliary Bin ON/OFF

### Description

When the secondary parameters affect the sorting results, the limits for the secondary parameter can be set in *2nd LOW/HIGH* fields. So there are three patterns for the sorting area of the secondary parameter.

- When the secondary parameter limits are not specified on the *LIMIT TABLE SETUP* page.

Devices will be sorted according to primary parameter comparison results.

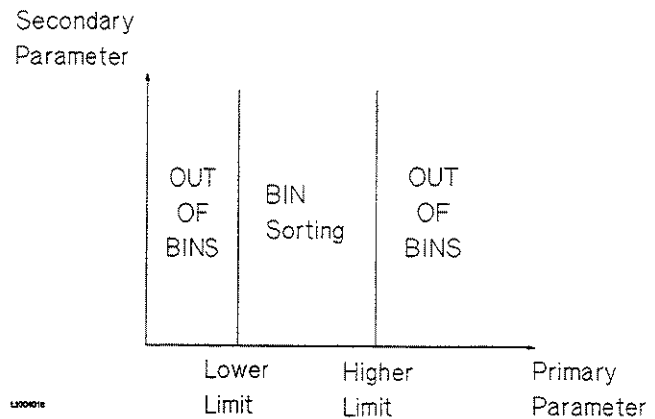

- When the secondary parameter limits are set and AUX BIN are set to OFF.

Only devices with secondary limits are sorted by the primary parameter result. Devices not within the secondary parameter limits are sorted OUT OF BINS even if the device's primary parameter is within limits.

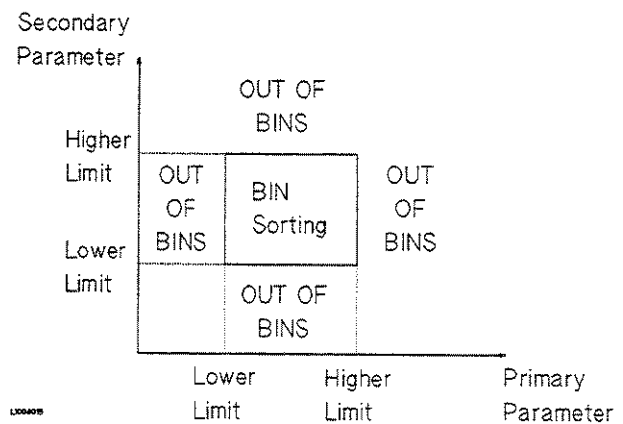

- When the secondary parameter limits are set and AUX BIN are set to ON.

Devices whose primary parameter is not within limits are sorted OUT OF BINS. Devices whose primary parameter is within limits, but whose secondary parameter is out of limits are sorted into the AUX BINS.

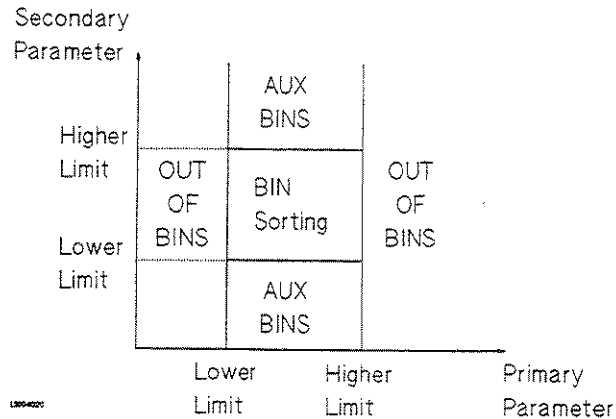

**Note**



When only the lower limit of the secondary parameter is set and the AUX BIN are set to ON, the devices whose primary parameter is within limits, but whose secondary parameter is equal to or below the lower limit are sorted into the AUX BIN. Also when only the higher limit of the secondary parameter is set and the AUX BIN are set to ON, the devices whose primary parameter is within limits, but whose secondary parameter is equal or above the higher limit are sorted into the AUX BIN. (See below.)

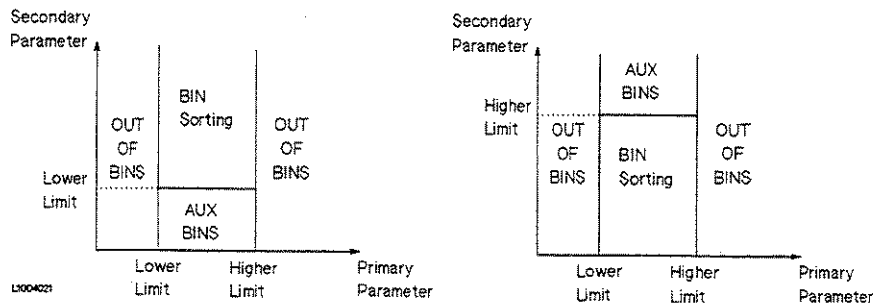

The AUX field allows you to set the AUX BIN to ON or OFF.

**Front Panel Operation for Setting the AUX BIN to ON or OFF**

Perform the following steps to set the AUX BIN to ON or OFF.

1. Move the cursor to the *AUX* field. The following softkeys will be displayed.



- **ON**
- **OFF**

2. Select and press a softkey to set AUX BIN to ON or OFF.

## Low/High Limits

### Description

The HP 4284A's built-in comparator can sort devices into a maximum of ten bins (BIN 1 to BIN 9, and OUT OF BINS) using a maximum of nine pairs of primary parameter limits and one pair of secondary parameter limits. These primary parameter low/high limits can be set in the *BIN 1* to *BIN 9 LOW/HIGH* fields, and the secondary parameter low/high limits can be set in the *2nd LOW/HIGH* fields.

### Note



Do NOT enter a value which is lower than the LOW limit into the HIGH limit in the tolerance sorting mode. If you do, the warning message **Warning, Improper high/low limits** will be displayed (this isn't an error), and the HP 4284A will not sort a DUT into the BINS you specify.

The limit values for sequential mode sorting can be set without setting the lower/higher limits of BIN1. For example,

- BIN 1: Low Limit (L1) only
- BIN 2: High Limit (H2)
- BIN 3: High Limit (H3)

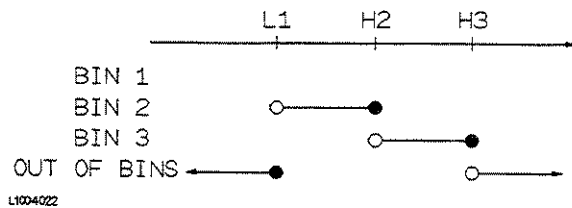

- BIN 1: High Limit (H1) only
- BIN 2: High Limit (H2)
- BIN 3: High Limit (H3)

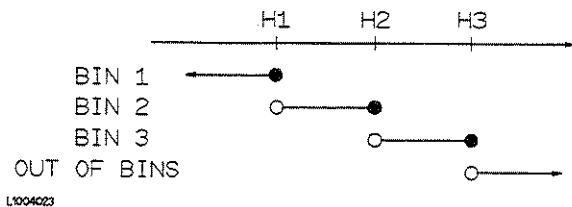

- BIN 2: High Limit (H2)
- BIN 3: High Limit (H3)

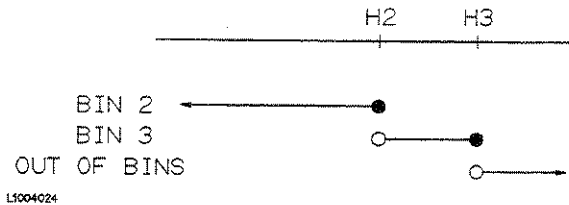

### Front Panel Operation for Setting the Low/High Limits

Perform the following steps to set the bin sorting limits.

1. Set the measurement function for the comparator function, the nominal value, and the the limit mode for the primary parameter.
2. Move the cursor to the *SYS MENU* field, and perform the clear table function.
3. Move the cursor to the *BIN 1 LOW* field. When you use the tolerance mode, perform steps 4 through 7. When you use the sequential mode, perform steps 8 through 12.

—*Tolerance Mode is used*—

4. Enter the limit value of the BIN 1 at *BIN 1 LOW* field using the numeric entry keys. When one of the numeric entry keys is pressed, the suffix softkeys (**p**, **n**, **μ**, **m**, **k**, and **M**) are available, and so you can use these softkeys to enter the unit and terminate the entry without hitting **ENTER**. When the limit value of BIN 1 is entered in the *BIN 1 LOW* field, the BIN 1 low limit becomes - (absolute input value), and the BIN 1 high limit becomes + (absolute input value).
5. The cursor will be automatically moved to the *BIN 2 LOW* field. Repeat step 4 until the limits of the BIN 9 is entered. After that, the cursor will be moved to the *2nd LOW* field.
6. Enter the low limit value of the secondary parameter. After that, the cursor will be automatically moved to the *2nd HIGH* field.
7. Enter the high limit value of the secondary parameter. Then the entry example using the tolerance mode is shown in Figure 4-16.

—*Sequential Mode is used*—

8. Enter the low limit of the BIN 1 using the numeric entry keys. When the one of the numeric entry keys is pressed, the suffix soft-keys (**p**, **n**, **μ**, **m**, **k**, and **M**) are available, so you can use

these softkeys to enter the unit and terminate the entry without hitting **ENTER**.

9. The cursor will be automatically moved to the *BIN 1 HIGH* field after entering the low limit of the BIN 1. Enter the high limit of the BIN 1.
10. The cursor will be automatically moved to the *BIN 2 HIGH* field. Because the BIN 2 low limit value is as same as the BIN 1 high limit value. Enter the high limit of the BIN 2.
11. Repeat step 5 until the BIN 9 limits are entered. After entering the BIN 9 high limit, the cursor will be automatically moved to the *2nd LOW* field. Enter the low limit value of the secondary parameter.
12. The cursor will be automatically moved to the *2nd HIGH* field. Enter the high limit value of the secondary parameter. The entry example using the sequential mode is shown below.

<LIMIT TABLE SETUP>			SYS MENU	MEAS SETUP
FUNC :	Cp-D	NOM :	100.000 pF	
MODE :	SEQ	AUX: ON	COMP: ON	
BIN	LOW	HIGH		CORREC TION
1	+100.000pF	+110.000pF		
2		+120.000pF		
3		+130.000pF		LIMIT TABLE
4		+140.000pF		
5		+150.000pF		
6		+160.000pF		LIST SETUP
7		+170.000pF		
8		+180.000pF		
9		+190.000pF		
2nd	+ 0.000	+ 0.005		

**Figure 4-19. Limit Table Using the Sequential Mode**

### System Menu

The system menu on this page allows you to perform the following control functions.

- Load/Store
- Clear Table
- Printer

These functions, except for the clear table function, are the same as the functions in the system menu on the *MEAS DISPLAY* page. (A description of each function is given in "System Menu" in Chapter 3.) So, in the case of the clear table function, the description and procedure are given, and in the case of the other functions, only the procedure is given.

### Load/Store Function

Perform the following steps on the *LIMIT TABLE SETUP* page to Load/Store the control settings to the internal non-volatile memory or to the external memory card.

1. Set all controls.
2. Move the cursor to the *SYS MENU* field on the *LIMIT TABLE SETUP* page.
3. Insert the memory card to the MEMORY card slot, if you are using a memory card.
4. Press **STORE** when you want to use the store function. The message Enter record number to STORE will be displayed on the system message line.

Press **LOAD** when you want to use the load function. The message Enter record number to LOAD will be displayed on the system message line.

5. Enter the record number using the numeric entry keys and **ENTER** to store the current control settings, or load the control settings.

### Clear Table Function

This function allows you to clear all of the limit values. So, when you change the limit mode, this function must be used.

Perform the following steps to clear all of bin sorting limits on the *LIMIT TABLE SETUP* page.

1. Move the cursor to the *SYS MENU* field.
2. Press **CLEAR TABLE**. The message Clearing table, Are you sure? will be displayed, and the following softkeys will be displayed.
  - **YES**
  - **NO**
3. Press **YES** to clear all of the bin sorting limits.

### Printer Function

Perform the following steps to print out the display page using the PRINT DISP mode.

1. Connect the HP 4284A to the printer using the HP-IB cable.
2. Set the printer to the Listen Only mode.
3. Set the talk only mode to ON on the *SYSTEM CONFIG* page.
4. Press **MEAS SETUP** and **LIMIT TABLE** to display the *LIMIT TABLE SETUP* page.
5. Move the cursor to the *SYS MENU* field.
6. Press **more 1/2**.
7. Press **PRINT DISP**. The display page is printed out to the printer as shown in Figure 4-20.

<LIMIT TABLE SETUP>		SYS MENU	
FUNC: Cp-D		NOM: 100.000pF	
MODE: %		AUX: ON COMP: ON	
BIN	LOW		HIGH
1	- 0.001 %	+	0.001 %
2	- 0.002 %	+	0.002 %
3	- 0.005 %	+	0.005 %
4	- 0.010 %	+	0.010 %
5	- 0.020 %	+	0.020 %
6	- 0.050 %	+	0.050 %
7	- 0.100 %	+	0.100 %
8	- 0.200 %	+	0.200 %
9	- 0.500 %	+	0.500 %
2nd	+.000000		+.000010

Figure 4-20. LIMIT TABLE SETUP Page Example

## LIST SWEEP SETUP Page

When you press **MEAS SETUP** and **LIST SETUP**, the *LIST SWEEP SETUP* page will be displayed. The HP 4284A has a list sweep measurement function which permits up to ten test frequencies, oscillator levels, or DC bias points to be automatically measured. On the *LIST SWEEP SETUP* page, the following control settings of the list sweep measurement can be set. (Each field in parenthesis is used when that control is set.)

- Sweep Mode (*MODE*)
- Sweep Parameter Selection (*FREQ[Hz]*, *LEVEL[V]*, *LEVEL[A]*, *BIAS[V]*, or *BIAS[A]*)
- Sweep Point Settings (*sweep point*)
- Limit Parameter Selection (*LMT*)
- Low/High Limit Values (*LOW*, *HIGH*)

There are following fields on this page: *<LIST SWEEP SETUP>*, *MODE*, *FREQ [Hz]* (*LEVEL [V]*, *LEVEL [A]*, *BIAS [V]*, or *BIAS [A]*), *LMT*, *LOW/HIGH*, *SYS MENU*, and sweep points.

These functions are described in the following paragraphs.

The available fields and softkeys which corresponded to the fields on this page are shown in Figure 4-21 and Figure 4-22.

<LIST SWEEP SETUP>
SYS MENU
MEAS SETUP

MODE : SEQ

FREQ (Hz)	LMT	LOW	HIGH	
1.00000k	A	123.456p	124.567p	CORRECTION
2.00000k	A	123.456p	124.567p	
5.00000k	A	123.456p	124.567p	LIMIT TABLE
10.0000k	A	123.456p	124.567p	
20.0000k	A	123.456p	124.567p	LIST SETUP
50.0000k	A	123.456p	124.567p	
100.000k	A	123.456p	124.567p	
200.000k	A	123.456p	124.567p	
500.000k	A	123.456p	124.567p	
1.00000M	A	123.456p	124.567p	

: Field

L1004026

Figure 4-21. Available Fields on the LIST SWEEP SETUP Page





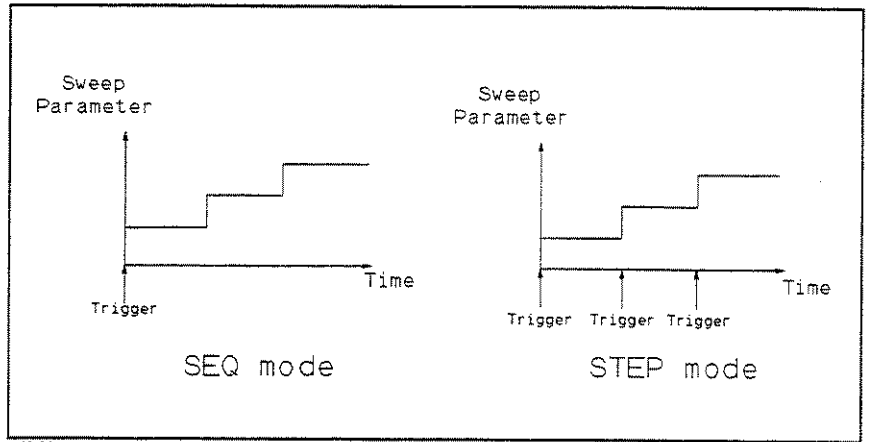

Figure 4-23. SEQ mode and STEP mode

**Note**



When two or more sweep points are the same, and are adjacent the HP 4284A measures the device once, and then the measurement result is compared to limits set for each sweep point.

**Front Panel Operation for Setting the List Sweep Measurement Mode**

Perform the following steps to set the list sweep measurement mode to the sequential mode, or to the step mode.

1. Move the cursor to the *MODE* field. The following softkeys will be displayed.

- SEQ
- STEP

2. Select and press a softkey to set the list sweep measurement mode.

**List Sweep Parameter**

**Description**

The sweep point parameter for the list sweep measurement can be set to the test frequency, oscillator level, and DC bias. This field allows you to set the parameter of the list sweep measurement.

**Front Panel Operation for Setting the List Sweep Parameter**

Perform the following steps to set the list sweep parameter.

1. Move the cursor to the *FREQ [Hz]* (*LEVEL [V]*, *LEVEL [A]*, *BIAS [V]*, or *BIAS [A]*) field. The following softkeys will be displayed.

- FREQ [Hz]
- LEVEL [V]
- LEVEL [A]
- BIAS [V]

■ **BIAS [A]**

2. Select and press a softkey to set the list sweep measurement sweep parameter.

**Sweep Points and Limit Mode**

**Description**

The list sweep function permits entry of up to 10 points and measurement limits. Figure 4-24 shows the available fields for setting the sweep points, the limit parameter, and the high/low limit values.

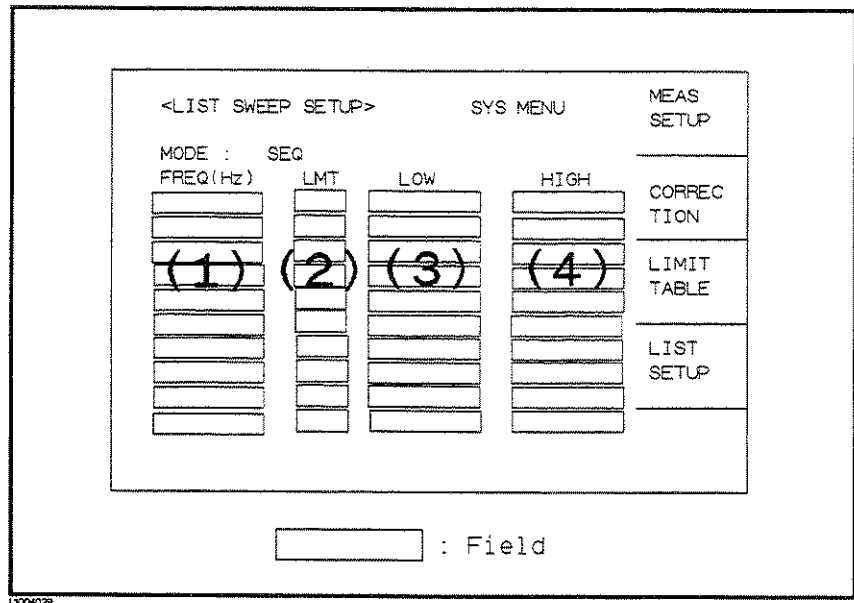

**Figure 4-24. List Sweep Settings**

**Note**



When only the low limits of the sweep points are set, the devices whose selected parameter's data are equal, or are above the low limits are sorted as IN. When only the high limits of the sweep points are set, the devices whose selected parameter's data are equal, or are below the high limits are sorted as IN.

**Note**



The comparison results are always IN when the parameter selection for the limit function is performed, but the low/high limit values aren't entered.

**Note**



The comparison results is always LOW under the following conditions (which are equal to the condition at <STATUS> ≠ 0 in the data format.)

- Analog Bridge is unbalanced.
- A/D converter isn't working.
- Signal source is overloaded.
- ALC is unable to regulate.

## Note



---

Do NOT enter a value which is lower than the LOW limit into the HIGH limit. If you do, the warning message **Warning, Improper high/low limits** will be displayed (this isn't an error). The comparison results are as follows.

- Measurement results < LOW limit  
Result: LOW
  - Measurement results  $\geq$  LOW limit  
Result: HIGH
- 

### Front Panel Operation for Setting the Sweep Points

Perform the following steps to set the sweep points and measurement limits.

1. Move the cursor to the *sweep parameter* field and set the sweep parameter.
2. Move the cursor to the *sweep point* field.
3. Enter the sweep point using the numeric entry keys. When the one of the numeric entry keys is pressed, the unit softkeys ( **$\mu$** , **m**, **k**, and **M**) are available, so you can use these softkeys to enter the unit and terminate the entry without hitting **ENTER**.
4. The cursor will move automatically to the *LMT* field after you enter a sweep point. The following softkeys will be displayed.
  - **LIMIT DATA A**  
This softkey is used to set the limit parameter to the primary parameter of the measurement function. When this softkey is pressed, the cursor will automatically move to the *LOW* field.
  - **LIMIT DATA B**  
This softkey is used to set the limit parameter to the secondary parameter of the measurement function. When this softkey is pressed, the cursor will move automatically to the *LOW* field.
  - **OFF**  
This softkey is used to set the list sweep measurement's limit function to OFF for the sweep point. When this softkey is pressed, the cursor will move automatically to the next sweep point field.
5. Press the softkey to set the limit parameter.
6. The cursor will move automatically to the *LOW* field. (If you pressed **OFF** in the previous step, the cursor will move automatically to the next sweep point field.) Enter the low limit value.
7. The cursor will move automatically to the *HIGH* field. Enter the high limit value using the numeric entry keys. After entering the

high limit value, the cursor will move automatically to the next sweep point field. Repeat steps 3 through 7.

## System Menu

The system menu on this page allows you to perform the following control functions.

- Load/Store
- Clear Table
- Printer

These functions, except for the clear table function, are the same as the functions in the system menu on the *MEAS DISPLAY* page. (A description of each function is given in "System Menu" in Chapter 3 on page 3-19.) So in the case of the clear table function, the description and procedure are given, and in the case of the other functions, only the procedure is given.

### Load/Store Function

Perform the following steps on the *LIST SWEEP SETUP* page to Load/Store the control settings from/to internal non-volatile memory or an external memory card.

1. Set all controls.
2. Move the cursor to the *SYS MENU* field on the *LIST SWEEP SETUP* page.
3. If you are using a memory card insert the memory card to the MEMORY card slot.
4. Press **STORE** when you want to use the store function. The message Enter record number to STORE will be displayed on the system message line.

Press **LOAD** when you want to use the load function. The message Enter record number to LOAD will be displayed on the system message line.

5. Enter the record number using the numeric entry keys and **ENTER** to Load/Store the current control settings.

### Clear Table Function

This function allows you to clear all of the list sweep points and limits. When you change from the current sweep parameter to the other sweep parameter, this function must be used.

Perform the following steps to set only all of the operations on the *LIST SWEEP SETUP* page to the power on default settings.

1. Move the CURSOR to the *SYS MENU* field.
2. Press **CLEAR TABLE**. Then the message Clearing table, Are you sure? will be displayed, and the following softkeys will be displayed.

- YES
- NO

3. Press **YES** to clear all of the list sweep points and limits.

### Printer Function

Perform the following steps to print out the display page using the PRINT DISP mode.

1. Connect the HP 4284A to the printer using an HP-IB cable.
2. Set the printer to the Listen Only mode.
3. Set the talk only mode to ON on the *SYSTEM CONFIG* page.
4. Press **MEAS SETUP** and **LIST SETUP** to display the *LIST SWEEP SETUP* page.
5. Move the cursor to the *SYS MENU* field.
6. Press **more 1/2**.
7. Press **PRINT DISP**. The display page is printed out to the printer as shown in Figure 4-25.

<LIST SWEEP SETUP>		SYS MENU	
MODE : SEQ			
FREQ [Hz]	LMT	LOW	HIGH
1.00000k	A	100.000p	100.030p
2.00000k	A	100.000p	100.030p
5.00000k	A	100.000p	100.030p
10.0000k	A	100.000p	100.030p
20.0000k	A	100.000p	100.030p
50.0000k	A	100.000p	100.030p
100.000k	A	100.000p	100.030p
200.000k	A	100.000p	100.030p
500.000k	A	100.000p	100.030p
1.00000M	A	100.000p	100.030p

Figure 4-25. LIST SWEEP SETUP Page Example



## Catalog/System Configuration

---

### Introduction

This chapter provides information on the function of each page of **CATALOG/SYSTEM**. The following three pages can be called from **CATALOG/SYSTEM**.

- *CATALOG*
- *SYSTEM CONFIG*
- *SELF TEST*

This chapter describes the functions on each page in the order of the preceding list of display pages.

---

### CATALOG Page

When you press **CATALOG/SYSTEM**, the *CATALOG* page will be displayed. On this *CATALOG* page, the catalog of the HP 4284A's internal memory (EEPROM) or the external memory card which is inserted into the front panel MEMORY card slot, and the following control functions can be set from this page. (The field in parenthesis is used to set the control function.)

- System Menu (*SYS MENU*)

There are two fields on this page: *<CATALOG>* and *SYS MENU* fields.

The available fields and the softkeys which corresponded to each field on this page are shown in Figure 5-1 and Figure 5-2.

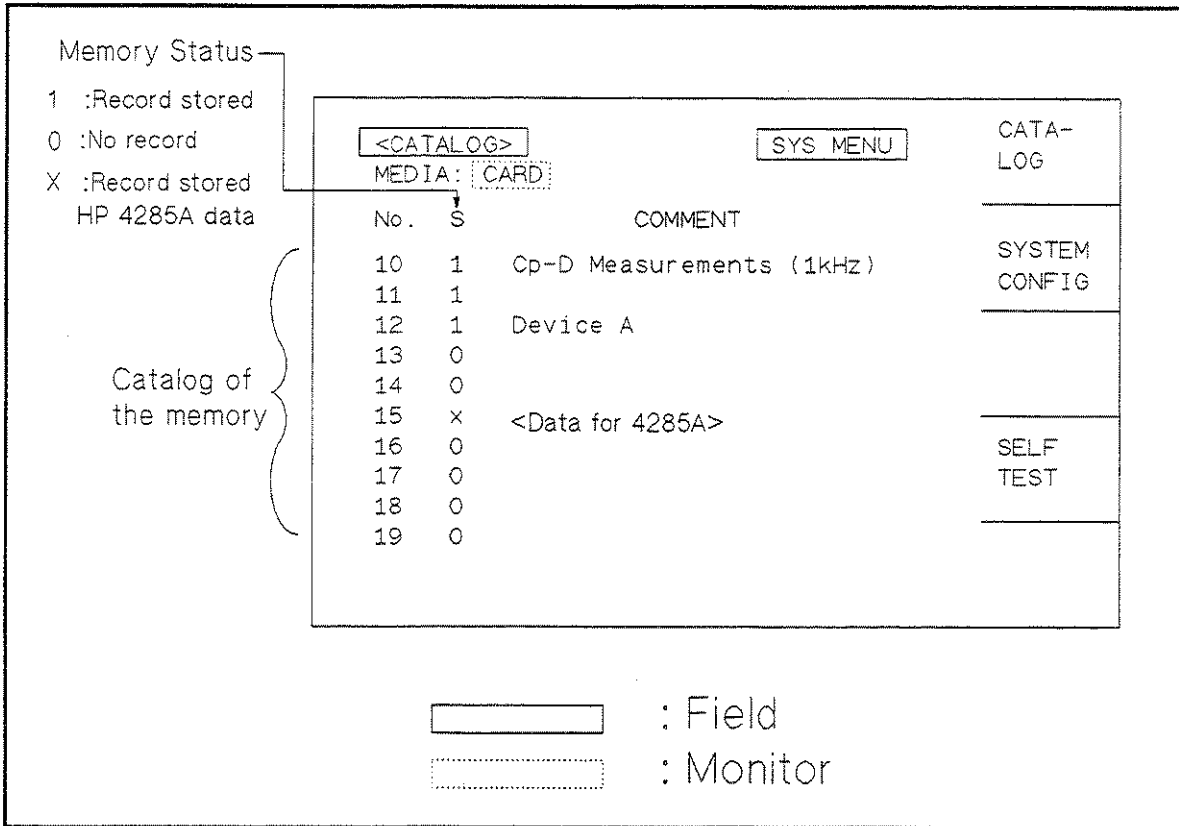

L1005001

Figure 5-1. Available Fields on the CATALOG Page

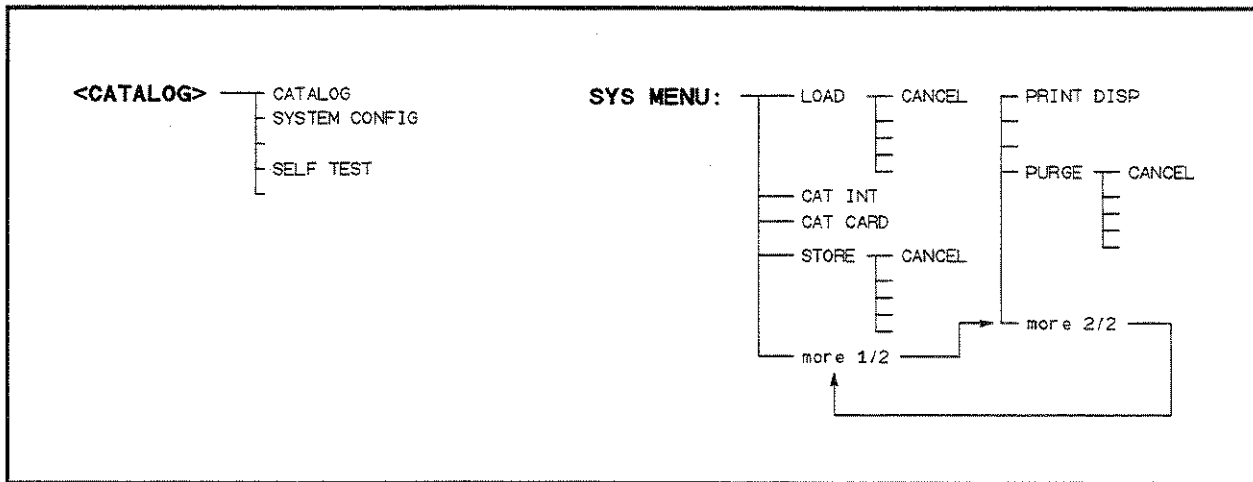

L1005002

Figure 5-2. Available Softkeys on the CATALOG Page



## System Menu

The system menu on this page allows you to perform the following functions.

- Load/Store
- Media Specifying
- Printer
- Purge

The load/store function is the same as the functions displayed on the system menu of the *MEAS DISPLAY* page. And the printer function is the same as the function of **PRINT DISP** of the system menu on the *MEAS DISPLAY* page. (The description of each function is given in "System Menu" in Chapter 3.) So in the case of the **MEDIA SPECIFYING** and the **PURGE** functions, the description and setting procedures are described in the following paragraphs, only the procedure is described for the other functions.

### Media Specifying

On the *CATALOG* page, the catalog of the HP 4284A's internal memory (EEPROM) or the external memory card which are inserted into the **MEMORY** card slot on the front panel are displayed, with memory status (records stored or no record in the memory) and the comments (displayed on the comment line) for each settings.

To specify the media of memory to be displayed the catalog, **CAT INT** or **CAT CARD** can be used.

Perform the following steps to specify the media of memory.

1. Move the cursor to the *SYS MENU* field using the **CURSOR** arrow keys. The following softkeys will be displayed in the softkey label area.
  - **CAT INT**
  - **CAT CARD**
2. Select the memory media, using **CAT INT** for the internal memory, or **CAT CARD** for the memory card.

### Load/Store Function

Perform the following steps to store the current control settings to the internal non-volatile memory or to the external memory card, or to load the control settings from the internal non-volatile memory or from the external memory card.

1. Set all controls.
2. Move the cursor to the *SYS MENU* field on the *CATALOG* page.
3. Insert the memory card into the **MEMORY** card slot, if you are going to store or load the settings to or from a memory card.

4. Press **STORE** when you want to use the STORE function. The message Enter record number to STORE will be displayed on the system message line.

Press **LOAD** when you want to use the LOAD function. The message Enter record number to LOAD will be displayed on the system message line.

5. Use the numeric entry keys and **ENTER** to enter the record number at which the current control settings will be STORED to or LOADED from.

### Printer Function

Perform the following steps to print out the displayed page using the PRINT DISP mode.

1. Connect the HP 4284A to the printer using an HP-IB cable.
2. Set the printer to the Listen Only mode.
3. Set the Talk Only mode to ON from the *SYSTEM CONFIG* page.
4. Press **CATALOG/SYSTEM** to display the *CATALOG* page.
5. Move the cursor to the *SYS MENU* field.
6. Press **more 1/2**.
7. Press **PRINT DISP** to print out the displayed page. The displayed page is printed out as shown in Figure 5-3.

<CATALOG>		SYS MENU	
MEDIA : CARD			
No.	S	COMMENT	
10	1	470pF Ceramic Capacitor	
11	1		
12	1	Magnetic Head test	
13	1	9140-401	
14	0		
15	0		
16	0		
17	0		
18	0		
19	0		

Figure 5-3. CATALOG Page Example

### Purge Function

Perform the following steps to purge the control settings from the internal non-volatile memory or from the external memory card.

1. Move the cursor to the *SYS MENU* field on the *CATALOG* page.

2. Insert the memory card into the MEMORY card slot, if you are going to purge the settings from a memory card.
3. Press **more 1/2**, and **PURGE**. The message Enter record number to PURGE will be displayed on the system message line.
4. Use the numeric entry keys and **ENTER** to enter the record number at which the control settings will be PURGED.

---

## SYSTEM CONFIG Page

When you press **CATALOG/SYSTEM** and **SYSTEM CONFIG**, the *SYSTEM CONFIG* page will be displayed. On this *SYSTEM CONFIG* page, the status of HP-IB interface and the options are displayed, and the following control functions can be set from this page. (The field in parenthesis is used to set the control function.)

- Beeper function ON/OFF (*BEEPER*)
- HP-IB address (*HP-IB ADDRESS*)
- HP-IB talk only mode ON/OFF (*TALK ONLY*)
- Handler Interface (Option 201 or 202) ON/OFF (*HANDLER I/F*)
- Scanner Interface (Option 301) ON/OFF (*SCANNER I/F*)
- System Menu (*SYS MENU*)

So there are seven fields on this page: *<SYSTEM CONFIG>*, *BEEPER*, *HP-IB ADDRESS*, *TALK ONLY*, *HANDLER I/F*, *SCANNER I/F*, and *SYS MENU* fields.

Each control function is described in the following paragraphs.

This page also the following information as a monitor. These conditions is set depending on the status of the options installed in the instrument.

- HP-IB interface installed/not installed (*HP-IB I/F*)
- Power Amplifier (Option 001) installed /not installed (*POWER AMP (#001)*)
- Bias current interface (Option 002) installed /not installed (*I BIAS I/F (#002)*)
- 2m/4m cable operation (Option 006) installed /not installed (*2m/4m CABLE (#006)*)
- Handler Interface (Option 201 or 202) installed /not installed (*HANDLER I/F (#201 or #202)*)
- Scanner Interface (Option 301) installed /not installed (*SCANNER I/F (#301)*)

The available fields and the softkeys which correspond to each field on this page are shown in Figure 5-4 and Figure 5-5.

<input type="button" value=" &lt;SYSTEM CONFIG &gt;"/>		<input type="button" value=" SYS MENU"/>	CATA-LOG
BEEPER	:	<input type="text" value=" ON"/>	SYSTEM CONFIG
HP-IB I/F	:	<input type="text" value=" INSTALLED"/>	
HP-IB ADDRESS	:	<input type="text" value=" 17"/>	
TALK ONLY	:	<input type="text" value=" OFF"/>	
POWER AMP (#001)	:	<input type="text" value=" INSTALLED"/>	SELF TEST
I BIAS I/F (#002)	:	<input type="text" value=" INSTALLED"/>	
2m/4m CABLE (#006)	:	<input type="text" value=" INSTALLED"/>	
HANDLER I/F (#201)	:	<input type="text" value=" INSTALLED"/>	
	:	<input type="text" value=" ON"/>	
SCANNER I/F (#301)	:	<input type="text" value=" INSTALLED"/>	
	:	<input type="text" value=" ON"/>	

<input type="text"/>	:	Field
<input type="text"/>	:	Monitor

L1005003

Figure 5-4. Available Fields on the SYSTEM CONFIG Page

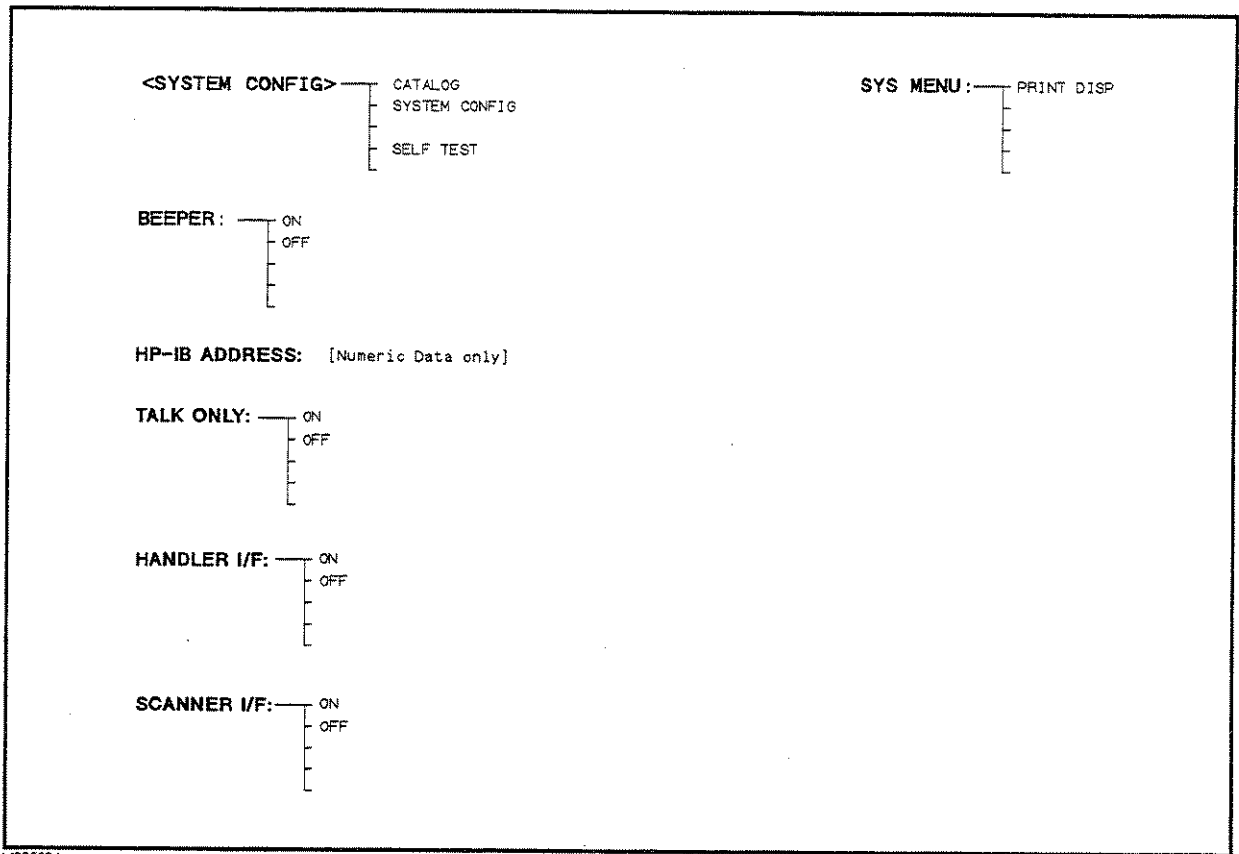

Figure 5-5. Available Softkeys on the SYSTEM CONFIG Page

**Beeper Function  
ON/OFF**

**Description**

The HP 4284A has a beeper which it beeps if any of the following conditions occur.

- ADCERR is displayed.
- An error has occurred.
- Warning message is displayed.
- Correction data measurement at 48 preset frequencies is completed.
- Comparison judgment Result is out of bin.
- Failed sweep comparison judgment.
- Key lock ON/OFF is switched.

**How to Set the Beeper to ON or OFF**

Perform the following steps to set the beeper function to ON or OFF.

1. Move the cursor to the *BEEPER* field on the *SYSTEM CONFIG* page. The following softkeys will be displayed in the softkey label area.

- ON
- OFF

2. Use the softkeys to set the beeper function to the ON or OFF.

## HP-IB Setting

### Description

All HP 4284As except those with Option 109 Delete HP-IB Interface are equipped with an HP-IB interface so they can be controlled via the HP-IB bus. The HP 4284A can be linked to other instruments and computers to form an automated measurement system. The status of the HP-IB interface installed/not installed is monitored on this *SYSTEM CONFIG* page (*HP-IB I/F*).

The HP-IB address and the Talk Only mode can be set on this page.

### How to Set the HP-IB Address

Perform the following steps to set HP-IB address.

1. Move the cursor to the HP-IB ADDRESS field on the *SYSTEM CONFIG* page.
2. Enter the HP-IB address using the numeric entry keys, and press **ENTER**.

### How to Set the Talk Only Mode

Perform the following steps to set the HP 4284A to the Talk Only mode (ON). To set the HP 4284A to the addressable mode, perform the following steps to set the Talk Only mode to OFF.

1. Move the cursor to the *TALK ONLY* field on the *SYSTEM CONFIG* page. The following softkeys will be displayed in the softkey label area.
  - ON
  - OFF
2. Use the softkeys to set the Talk Only mode to ON (Talk only), or to OFF (addressable).

## Handler Interface Setting

### Description

When the HP 4284A is equipped with an Option 201 or 202 Handler Interface, the 36-pin Amphenol connector on the rear panel is used to interface between the HP 4284A and the handler to pass control input/output signals and the comparator function bin judgment results. Refer to the HP 4284A Option 201 or 202 Operation Note.

The status of the handler interface installed/not installed is monitored on this *SYSTEM CONFIG* page (*HANDLER I/F (#201 or #202)*).

#### How to Set the Handler Interface to ON or OFF

When the handler interface is set to ON, the handler interface signals through the interface connector are enabled. Perform the following steps to set the handler interface signal input/output to ON or OFF.

1. Move the cursor to the *HANDLER I/F (#201)* field (or the *HANDLER I/F (#202)* field) on the *SYSTEM CONFIG* page. The following softkeys will be displayed in the softkey label area.

- **ON**

- **OFF**

2. Use the softkeys to set the handler interface function to ON or OFF.

### Scanner Interface Setting

#### Description

When the HP 4284A is equipped with the Option 301 Scanner Interface, the multi channel correction function can be used. The 14-pin Amphenol connector on the rear panel is used to interface between the HP 4284A and the scanner to pass control output signals and channel selection signals for multi channel correction. Refer to the HP 4284A Option 301 Operation Note.

The status of the scanner interface installed/not installed is monitored on this *SYSTEM CONFIG* page (*SCANNER I/F (#301)*).

#### How to Set the Scanner Interface to ON or OFF

When the scanner interface is set to ON, the scanner interface signals through the interface connector are enabled. Perform the following steps to set the handler interface to ON or OFF.

#### Note



---

To set the correction mode to MULTI, this procedure must be performed, even if the multi channel correction function is used without the interface connector on the rear panel, for example in the case of controlling a scanner and the HP 4284A via HP-IB.

---

1. Move the cursor to the *SCANNER I/F (#301)* field on the *SYSTEM CONFIG* page. The following softkeys will be displayed in the softkey label area.

- **ON**

- **OFF**

2. Use the softkeys to set the scanner interface function to ON or OFF.

## System Menu

The system menu on this page allows you to perform the following functions.

### ■ Printer

The printer function is the same as the function of **PRINT DISP** of the system menu on the *MEAS DISPLAY* page. (The description of the function is given in "System Menu" in Chapter 4.) So only the setting procedures for this function are described in the following paragraphs.

### Printer Function

Perform the following steps to print out the displayed page or the measurement data using the **PRINT DISP** mode.

1. Connect the HP 4284A to the printer using an HP-IB cable.
2. Set the printer to the Listen Only mode.
3. Set the Talk Only mode to ON from the *SYSTEM CONFIG* page.
4. Move the cursor to the *SYS MENU* field.
5. Press **PRINT DISP** to print out the displayed page. The displayed page is printed out as shown in Figure 5-6.

<SYSTEM CONFIG>	SYS MENU
BEEPER	: OFF
HP-IB I/F	: INSTALLED
HP-IB ADDRESS	: 17
TALK ONLY	: ON
POWER AMP (#001)	: INSTALLED
I BIAS I/F (#002)	: NOT INSTALLED
2m/4m CABLE (#006)	: NOT INSTALLED
HANDLER I/F (#201)	: INSTALLED
	: ON
SCANNER I/F (#301)	: INSTALLED
	: ON

Figure 5-6. *SYSTEM CONFIG* page Example



## SELF TEST Page

When you press **CATALOG/SYSTEM** and **SELF TEST**, the *SELF TEST* page will be displayed. This *SELF TEST* page is for service use. You can check the HP 4284A's digital functions using the self test functions listed on this page. The following self tests are included in this page. (Each number in parenthesis is used when each test is selected.)

- Memory Card Read/Write Test (*No.1*)
- LED Display Test (*No.2*)
- LCD Display Test (*No.3*)
- Handler Interface Test (*No.4*)
- Scanner Interface EEPROM Read/Write Test (*No.5*)
- Scanner Interface Input/Output Test (*No.6*)
- Bias Current Interface Input/Output Test (*No.7*)

There are two fields on this page, *<SELF TEST>*, and *TEST MENU*.

Each test is described in the following paragraphs.

The available fields and the softkeys which corresponded to the field on this page are shown in Figure 5-7 and Figure 5-8.

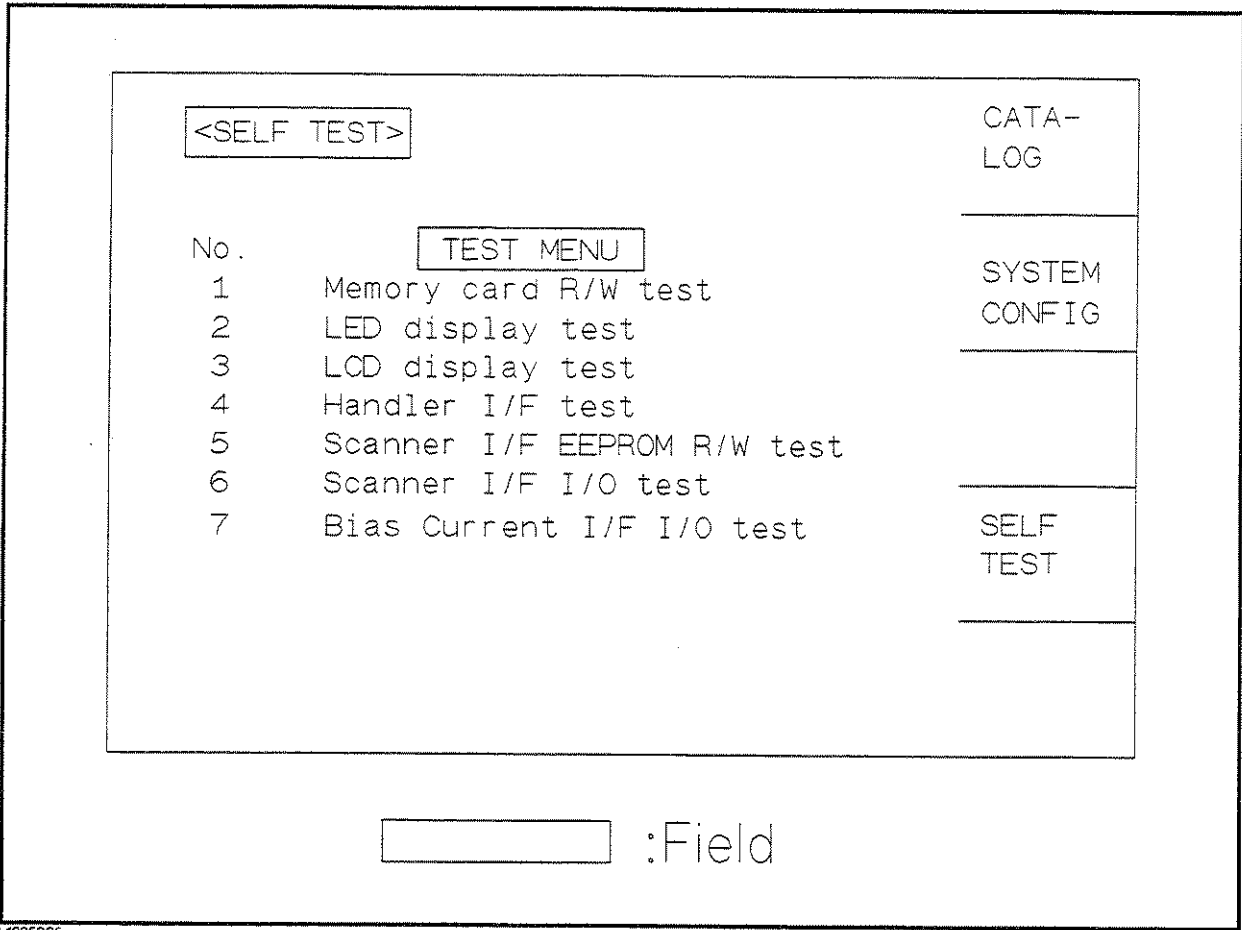

L1005005

Figure 5-7. Available Fields on the SELF TEST Page

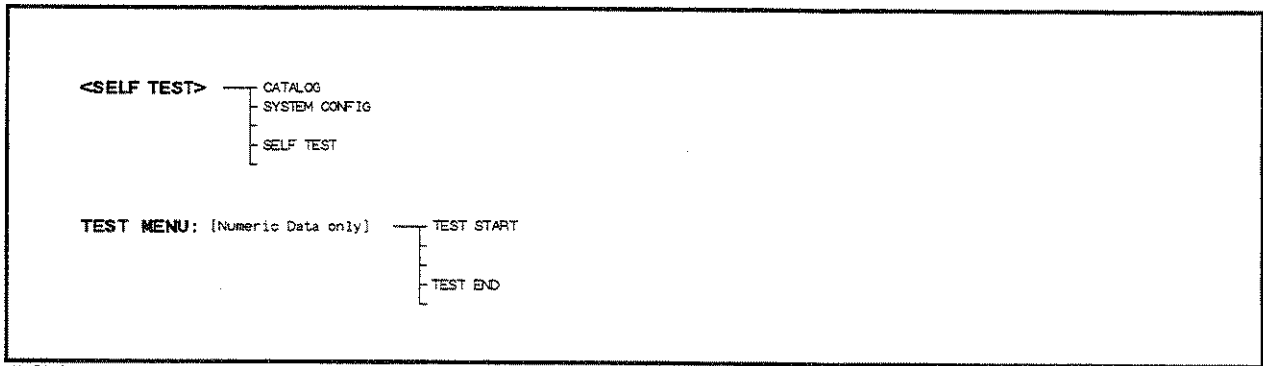

L1005005

Figure 5-8. Available Softkeys on the SELF TEST Page

## Memory Card R/W Test

### Description

This test is used to check the read and write functions of the memory card. When this test is started, a bit pattern is written to the lower address of the memory card, then pattern is read back and checked. This write pattern check is repeated from the low to high memory addresses.

### How to Perform the Memory Card R/W Test

Perform the following steps to perform the memory card R/W test.

1. Move the cursor to the *TEST MENU* field on the *SELF TEST* page.
2. Press **1** and **ENTER**, to select test number 1. The **▶ MEMORY CARD R/W TEST** screen will be displayed, and the following information indicating the address of the memory card is displayed.

*START ADRS (HEX)=* : Start address as a hexadecimal expression

*END ADRS (HEX)=* : End address as a hexadecimal expression

*TEST ADRS (HEX)=* : Current testing address as a hexadecimal expression

3. Insert a memory card into the MEMORY card slot on the front panel.

#### Note



When this test is performed, data stored on the memory card is retained.

#### Caution



While this test is in progress, DO NOT remove the memory card, and DO NOT turn the HP 4284A OFF. If you do the data stored on the memory card may be lost.

4. Press **TEST START** to start the test.

#### Note



To abort the test, press **TEST END**.

If the test failed, the test is aborted and *TEST ADRS (HEX)=* on the display shows the address at which the test failed. Retry the test from step 1.

If the test passed, **Test completed.** will be displayed on the system message line.

5. Press **TEST END** to exit from the **▶ MEMORY CARD R/W TEST** display.

## LED Display Test

### Description

This test checks the five LEDs on the front panel. When this test is started, five LED indicators, *RMT*, *LTN*, *TLK*, *SRQ* and *DC BIAS*, will be toggled ON and OFF once per second.

### How to Perform the LED Display Test

Use the following steps to perform the LED display test.

1. Move the cursor to the *TEST MENU* field on the *SELF TEST* page.
2. Press **2** and **ENTER** to select test number 2. The **▶LED DISPLAY TEST** screen will be displayed.
3. Press **TEST START** to start the test. The five LED indicators, *RMT*, *LTN*, *TLK*, *SRQ* and *DC BIAS*, will be toggled ON and OFF once per second.
4. Press **TEST END** to stop the test and to exit from the **▶LED DISPLAY TEST** screen.

## LCD Display Test

### Description

This test checks the front panel LCD. When this test is started, all LCD characters used are displayed and toggled between the normal and inverse modes once per second.

### How to Perform the LCD Display Test

Perform the following steps to perform the LCD display test.

1. Move the cursor to the *TEST MENU* field on the *SELF TEST* page.
2. Press **3** and **ENTER**, to set the test number to 3. The **▶LCD DISPLAY TEST** screen and all LCD characters will be displayed.
3. Press **TEST START** to start the test. The display will toggle between the normal and inverse modes once per second.
4. Press **TEST END** to stop the test and to exit from the **▶LCD DISPLAY TEST** screen.

## Handler I/F Test

### Description

This test checks the output signals of the Option 201 or 202 Handler Interface. When this test is started, each of the handler output signals is sequentially asserted for one second, until all output signals have been asserted, then the sequence is repeated until **TEST END** is pressed. This test using the Handler Simulator (HP PN 04278-65001) is described on *CHAPTER 10, PERFORMANCE TEST*.

## Scanner I/F EEPROM R/W Test

### Description

This test checks the read and write functions of EEPROM for the Option 301 Scanner Interface. When this test is started, a bit pattern is written to the lower address of the EEPROM, then the write pattern is checked by reading back the bit pattern. This write pattern check is repeated from low to high EEPROM addresses.

### How to Perform the Scanner I/F EEPROM R/W Test

Perform the following steps to perform the scanner interface EEPROM R/W test.

1. Move the cursor to the *TEST MENU* field on the *SELF TEST* page.
2. Press **5** and **ENTER**, to set the test number to 5. The *▶SCANNER I/F EEPROM R/W TEST* screen will be displayed, and the following messages indicating the address of the scanner interface EEPROM are displayed.

*START ADRS (HEX)=* : Start address as a hexadecimal expression

*END ADRS (HEX)=* : End address as a hexadecimal expression

*TEST ADRS (HEX)=* : Current testing address as a hexadecimal expression

### Note



The Data stored in the EEPROM is retained when this test is performed.

3. Press **TEST START** to start the test.

### Note



To abort the test, press **TEST END**.

If the test failed, the test is aborted and *TEST ADRS (HEX)=* on the display will show the address at which the test failed. Restart from step 1.

If the test passed, the message *Test completed.* will be displayed on the system message line.

4. Press **TEST END** to exit from the *▶SCANNER I/F EEPROM R/W TEST* screen.

## Scanner I/F I/O Test

### Description

This test checks the input/output signals of the Option 301 Scanner Interface. When the test is started, two scanner output signals (/INDEX and /EOM) are asserted alternately, and the input signals (CH No. and /CH\_VALID) are read when only the status of these signals is switched. This sequence is repeated until **TEST END** is pressed. This test uses the Scanner Simulator (HP PN 04278-65301) described on *CHAPTER 10, PERFORMANCE TEST*.

## Bias Current I/F I/O Test

### Description

This test checks the input/output signals of the Option 002 Bias Current Interface. When the test is started, the /CS\_0 and /CS\_1 output signals are alternately asserted, and ADDRESS and DO0 to DO7 output signals are changed in ascending order. Input signals DI0 to DI15 are read when only the status of these signals is switched. This sequence is repeated until **TEST END** is pressed. This test uses the Bias Current Interface Simulator (HP PN 42841-65001) described on Chapter 10.

## Measurement Procedure and Examples

---

### Introduction

This Chapter provides basic measurement procedures, basic L, C, and R measurement theory, and measurement hints. After the descriptions of basic measurement procedures, practical measurement examples are given using the HP 4284A.

### Basic Measurement Procedure

The following description shows the basic procedures used to measure the impedance of capacitors, inductors, resistors and other components. Follow the procedure to perform impedance measurements, referring to the paragraphs noted on right side of each step.

<b>Procedure</b>	<b>Reference Paragraph</b>
Start	
Setup the HP 4284A measurement conditions.	<ul style="list-style-type: none"> <li>■ IMPEDANCE PARAMETERS</li> <li>■ PARALLEL/SERIES CIRCUIT MODE</li> <li>■ SIGNAL LEVEL</li> </ul>
Connect the test fixture to the HP 4284A.	<ul style="list-style-type: none"> <li>■ FOUR-TERMINAL PAIR CONFIGURATION</li> <li>■ MEASUREMENT CONTACTS</li> </ul>
Setup the correction function.	<ul style="list-style-type: none"> <li>■ CORRECTION FUNCTION</li> </ul>
Connect DUT to the test fixture.	<ul style="list-style-type: none"> <li>■ PARASITICS INCIDENT TO DUT CONNECTION</li> </ul>
Perform measurement.	<ul style="list-style-type: none"> <li>■ CHARACTERISTICS EXAMPLES</li> </ul>

## Impedance Parameters

All circuit components, resistors, capacitors or inductors, have parasitic components lurking in the shadows waiting for the unwary, for example unwanted resistance in capacitors, unwanted capacitance in inductors, and unwanted inductance in resistors. Thus simple components should be modeled as complex impedances, for in fact that is what they are!

Figure 6-1 (A) shows the impedance definitions and (B) shows vector representation of impedance. Impedance,  $Z$  is the total opposition that a circuit or device offers to the flow of alternating current at a given frequency.  $Z$  contains a real and an imaginary part, and it is expressed in rectangular form as Resistance and Reactance, or in polar form as magnitude of Impedance and Phase as follows.

$$Z = R + jX = |Z| \angle \theta$$

$$|Z| = \sqrt{R^2 + X^2}$$

$$\theta = \arctan \left( \frac{|X|}{R} \right)$$

$$R = R_s$$

Where,

- Z : Impedance [  $\Omega$  ]
- R : Resistance [  $\Omega$  ]
- X : Reactance [  $\Omega$  ]
- |Z| : Magnitude of Impedance [  $\Omega$  ]
- $\theta$  : Phase of Impedance [deg or rad]
- $R_s$  : Series Resistance [  $\Omega$  ]



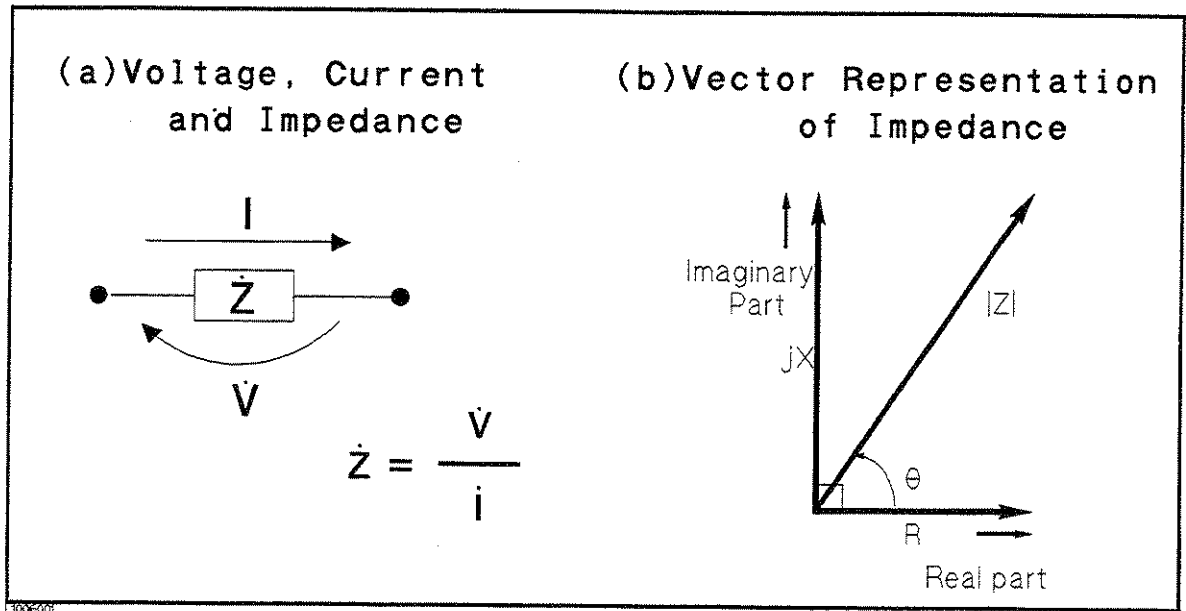

Figure 6-1. Definition of Impedance

The following parameters can be used to represent the reactance.

$$X = 2\pi fL$$

Where,

$f$  : Frequency [Hz]

$L$  : Inductance [H]

In addition to these parameters, the Quality Factor ( $Q$ ) and Dissipation Factor ( $D$ ) are used to describe the quality of components.

$$Q = \frac{1}{D} = \frac{|X|}{R}$$

Where,

$Q$  : Quality Factor

$D$  : Dissipation Factor

In some case, the reciprocal of impedance (Admittance),  $Y$  is used. Figure 6-2 shows the vector representation of admittance. As  $Z$  (Impedance),  $Y$  contains a real and an imaginary part, and is expressed in rectangular form as Conductance and Susceptance, or in polar form as magnitude of Admittance and Phase. The following are expressions for Admittance.

$$Y = \frac{1}{Z}$$

$$Y = G + jB = |Y| \angle \phi$$

$$|Y| = \sqrt{G^2 + B^2} = \frac{1}{|Z|}$$

$$\phi = \arctan\left(\frac{|B|}{G}\right) = -\theta$$

$$B = 2\pi fC$$

$$Q = \frac{1}{D} = \frac{|B|}{G}$$

$$G = \frac{1}{R_p}$$

Where,

- Y : Admittance [ S ]
- G : Conductance [ S ]
- B : Susceptance [ S ]
- |Y| : Magnitude of Admittance [ S ]
- $\phi$  : Phase of Admittance [deg or rad]
- C : Capacitance [ F ]
- $R_p$  : Parallel Resistance [  $\Omega$  ]

**Note**



The  $|Y|$ - $\theta$  measurement function of the HP 4284A can obtain the  $|Y|$  and  $\phi$  parameters given in the above equations.

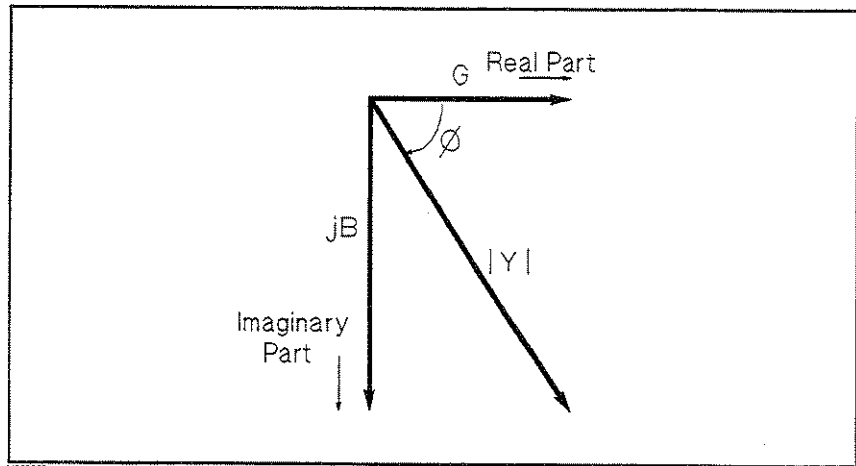

**Figure 6-2. Vector Representation of Admittance**

## Parallel/Series Circuit Mode

To measure L, C, or R, there are two equivalent circuit models, the parallel and series modes as shown in Table 6-1, and the HP 4284A can select the mode by setting the FUNC ( $C_p$ ,  $C_s$ ,  $L_p$  or  $L_s$ ) on the *MEAS SETUP* page. To determine which mode is best, consider the relative impedance magnitude of the reactance and  $R_s$  and  $R_p$ .

**Table 6-1. Parallel/Series Circuit Mode**

Circuit Mode	Measurement Function	Definition of D, Q and G
$C_p$ mode	$C_p$ -D $C_p$ -Q $C_p$ -G $C_p$ - $R_p$	$D = \frac{1}{2\pi f C_p R_p} = \frac{1}{Q}$ $G = \frac{1}{R_p}$
$C_s$ mode	$C_s$ -D $C_s$ -Q $C_s$ - $R_s$	$D = 2\pi f C_s R_s = \frac{1}{Q}$
$L_p$ mode	$L_p$ -D $L_p$ -Q $L_p$ -G $L_p$ - $R_p$	$Q = \frac{R_p}{2\pi f L_p} = \frac{1}{D}$ $G = \frac{1}{R_p}$
$L_s$ mode	$L_s$ -D $L_s$ -Q $L_s$ - $R_s$	$Q = \frac{2\pi f L_s}{R_s} = \frac{1}{D}$

### Selecting Circuit Mode of Capacitance

The following description gives some practical guide lines for selecting the capacitance measurement circuit mode.

#### Small Capacitance (modeled by (a) in Figure 6-3)

Small capacitance yields large reactance, which implies that the effect of the parallel resistance ( $R_p$ ) has relatively more significance than that of series resistance ( $R_s$ ). The low value of resistance represented by  $R_s$  has negligible significance compared with the capacitive reactance, so the parallel circuit mode ( $C_p$ -D or  $C_p$ -G) should be used.

#### Large Capacitance (modeled by (b) in Figure 6-3)

When the converse is true and the measurement involves a large value of capacitance (low impedance),  $R_s$  has relatively more significance than  $R_p$ , so the series circuit mode ( $C_s$ -D or  $C_s$ -Q) should be used.

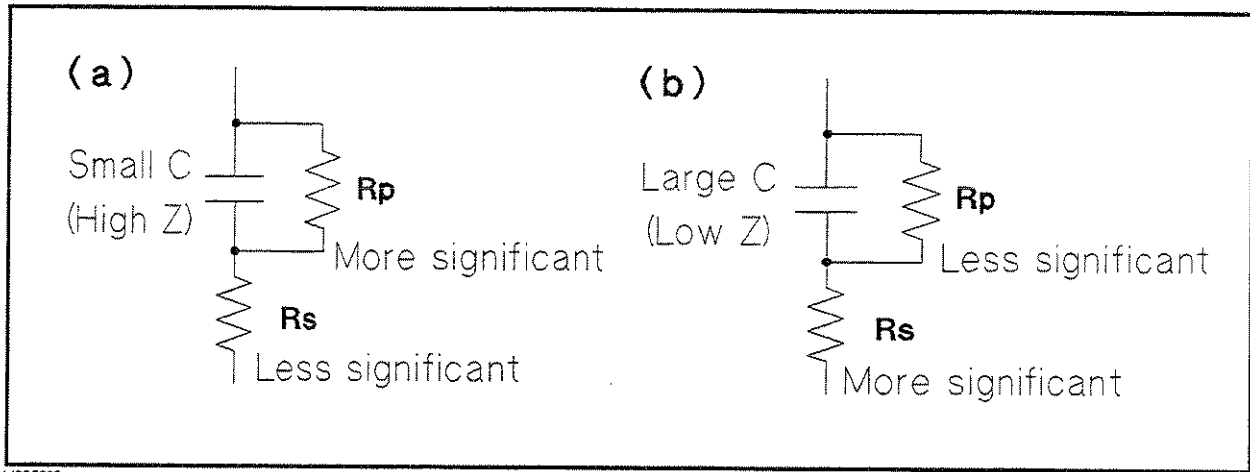

L1006003

**Figure 6-3. Capacitance Circuit Mode Selection**

The following is a rule of thumb for selecting the circuit mode according to the impedance of the capacitor.

- Above approx. 10 k $\Omega$  : use parallel circuit mode
- Below approx. 10  $\Omega$  : use series circuit mode
- Between above values : follow the manufacturer's recommendation

For example, to measure a 20  $\mu\text{F}$  capacitor at 1 kHz (impedance will be approximately 8  $\Omega$ ), the  $C_s$ -D or  $C_s$ -Q function is suitable.

### Selecting Circuit Mode of Inductance

The following description gives some practical guide lines for selecting the inductance measurement circuit mode.

#### Large Inductance (modeled by (a) in Figure 6-4)

The reactance at a given frequency is relatively large (compared with that of a small inductance), so the parallel resistance becomes more significant than the series component. So, a measurement in the parallel equivalent circuit mode ( $L_p$ -D,  $L_p$ -Q or  $L_p$ -G) is more suitable.

#### Small Inductance (modeled by (b) in Figure 6-4)

Conversely, for low values of inductance the reactance becomes relatively small (compared with that of a large inductance) so the series resistance component is more significant. So, the series equivalent circuit mode ( $L_s$ -D or  $L_s$ -Q) is the appropriate choice.

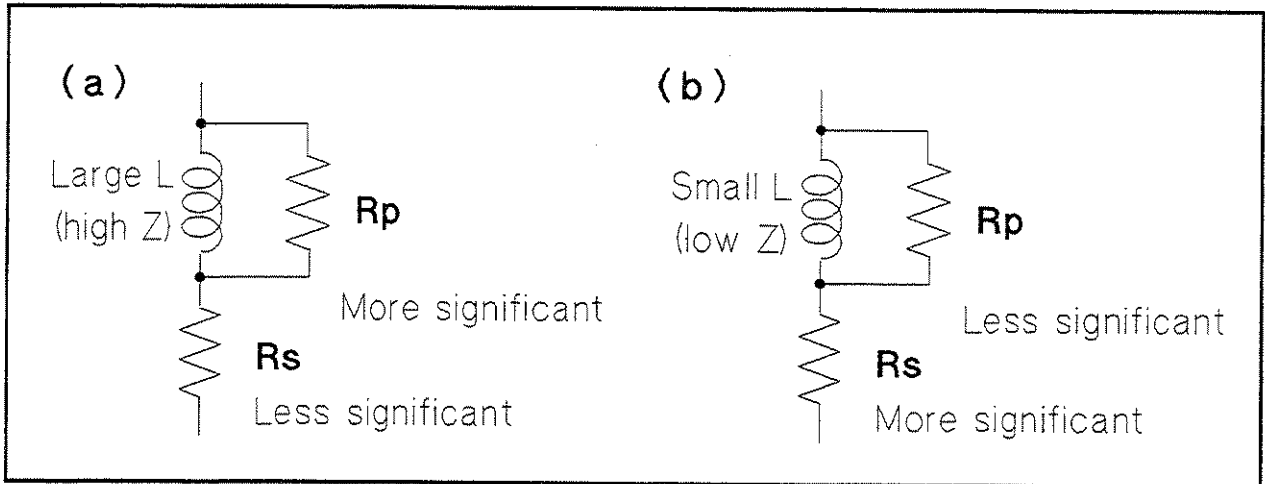

**Figure 6-4. Inductance Circuit Mode Selection**

The following is a rule of thumb for selecting the circuit mode according to the impedance of the inductor.

- Below approx.  $10 \Omega$  : use series circuit mode
- Above approx.  $10 \text{ k}\Omega$  : use parallel circuit mode
- Between above values : follow the manufacturer's recommendation

For example, to measure a  $1 \text{ mH}$  inductor at the  $1 \text{ kHz}$  (impedance may be approximately  $6.3 \Omega$ ),  $L_s$ -D or  $L_s$ -Q function is suitable.

## Signal Level

Most components have impedance characteristics that are dependent on the applied signal level. So, the oscillator level setting should be set appropriate for the DUT.

### Signal Level Across The DUT

Figure 6-5 shows a simplified model of the HP 4284A and a DUT. The signal level across the DUT depends on the oscillator level, the source resistance of the HP 4284A, and the impedance of the DUT, as follows.

$$|V_m| = \frac{|Z_x|}{|R_{so} + Z_x|} \times |V_{osc}|$$

$$|I_m| = \frac{|V_{osc}|}{|R_{so} + Z_x|}$$

Where,

$|V_{osc}|$  : oscillator voltage level of the HP 4284A,  
 $R_{so}$  : Source resistor of the HP 4284A ( $= 100 \Omega$ ),  
 $|V_m|$  : Signal voltage level applied on DUT,  
 $|I_m|$  : Signal current level flowed in DUT,  
 $|Z_x|$  : Impedance of DUT.

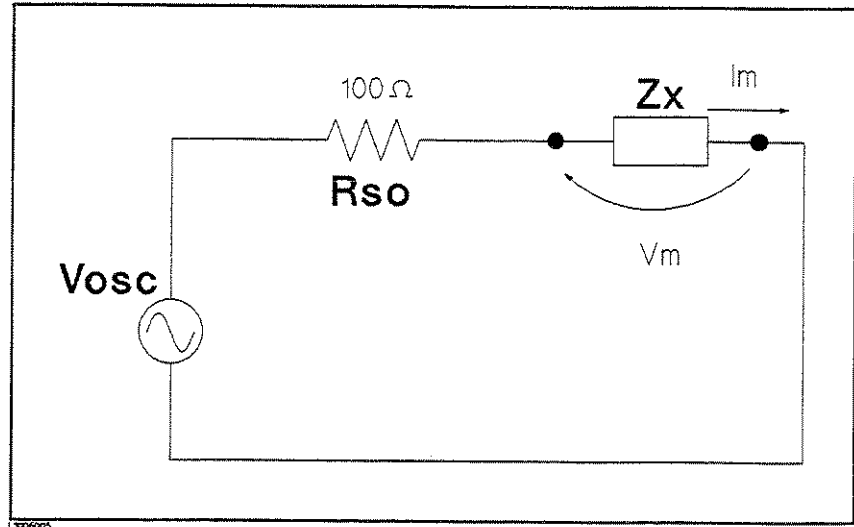

Figure 6-5. Simplified Model of Signal Level and DUT

### Oscillator Level Setting

The HP 4284A's oscillator level ( $V_{osc}$  in Figure 6-5) can be set to the appropriate value in the voltage or current mode. Using the ALC (automatic level control) function, the signal level set is the same as the applied level across the DUT ( $V_m$  or  $I_m$  in Figure 6-5). So the signal level setting mode can be selected in the following four ways.

- Oscillator level set as voltage and ALC set to OFF:  
The open terminal voltage is set to the entered voltage value in the *LEVEL* field.
- Oscillator level set as current and ALC set to OFF:  
The short terminal current is set to the entered current value in the *LEVEL* field.
- Oscillator level set as voltage and ALC set to ON:  
The signal level across the DUT is set to the entered voltage value in the *LEVEL* field.
- Oscillator level set as current and ALC set to ON:  
The signal level across the DUT is set to the entered current value in the *LEVEL* field.

For more information for the ALC function, refer to Chapter 4, Automatic Level Control Function.

### Note



By using the level monitor function ( $V_m$  and  $I_m$  on the *MEAS DISPLAY* page), the actual signal level across the DUT ( $V_m$  and  $I_m$  in Figure 6-5) can be monitored.

### Signal Level Setting Selection Example for Inductance Measurements

An inductor's inductance value may differ widely depending on the current through the inductor due to the permeability of its core material. Inductance measurements under constant current signal levels allows you to extract the frequency characteristics of the inductor isolated from its signal level characteristics.

To make constant current level measurements, set appropriate oscillator level in current value, and set ALC to ON. The signal current level through the inductor will be constant.

## Four-Terminal Pair Configuration

Generally, any mutual inductance, interference of the measurement signals, and unwanted residual factors in the connection method incidental to ordinary termination methods will have significant effects on the measurements, especially at a high frequency. The HP 4284A employs the four-terminal pair measurement configuration which permits easy, stable, and accurate measurements and avoids the measurement limitations inherent to such factors.

Figure 6-6 shows the four-terminal pair measurement principle. The *UNKNOWN* terminals consists of four coaxial connectors.

- H<sub>CUR</sub> : High current
- H<sub>POT</sub> : High potential
- L<sub>POT</sub> : Low potential
- L<sub>CUR</sub> : Low current

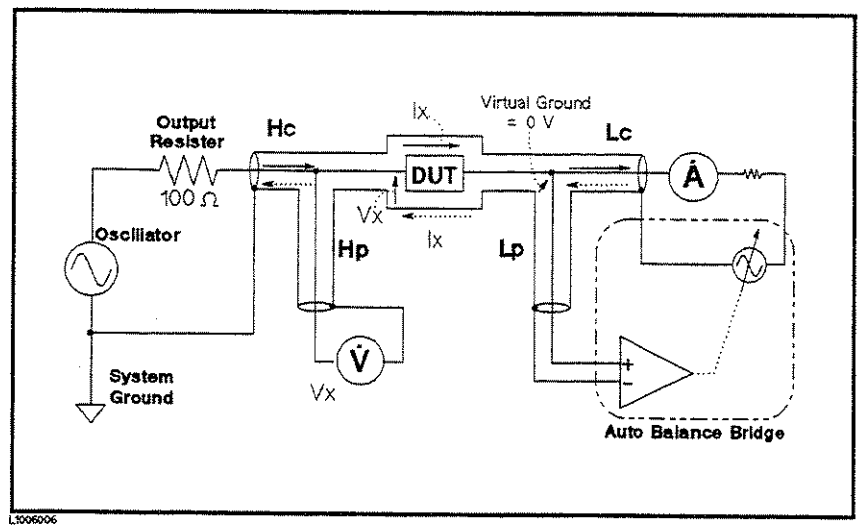

Figure 6-6. Four-Terminal Pair Measurement Principle

The four-terminal pair measurement method has the advantage in both low and high impedance measurements. The outer shield conductors work as the return path for the measurement signal current (they are not grounded). The same current flows through both the center conductors and outer shield conductors (in opposite directions), but no external magnetic fields are generated around the conductors (the magnetic fields produced by the inner and outer currents completely cancel each other). Because the measurement signal current does not develop an inductive magnetic field, test leads

do not contribute additional errors due to self or mutual inductance between the individual leads.

## Measurement Contacts

This paragraph gives general notes and techniques for using the four-terminal pair configuration efficiently. To realize accurate measurements using the four-terminal pair measurement technique, the following are required to make measurement contacts (the number labels in the following description corresponds to the numbers in Figure 6-7).

1. The signal path between the HP 4284A and DUT should be as short as possible.
2. To construct the four-terminal pair measurement circuit configuration, the outer shields of  $H_{CUR}$  and  $H_{POT}$ ,  $L_{CUR}$  and  $L_{POT}$  terminals must be respectively connected together at the point as near as possible to the point at which the DUT will be connected.
3. Keep connections between the point at which the shielding ends and DUT as short as possible.

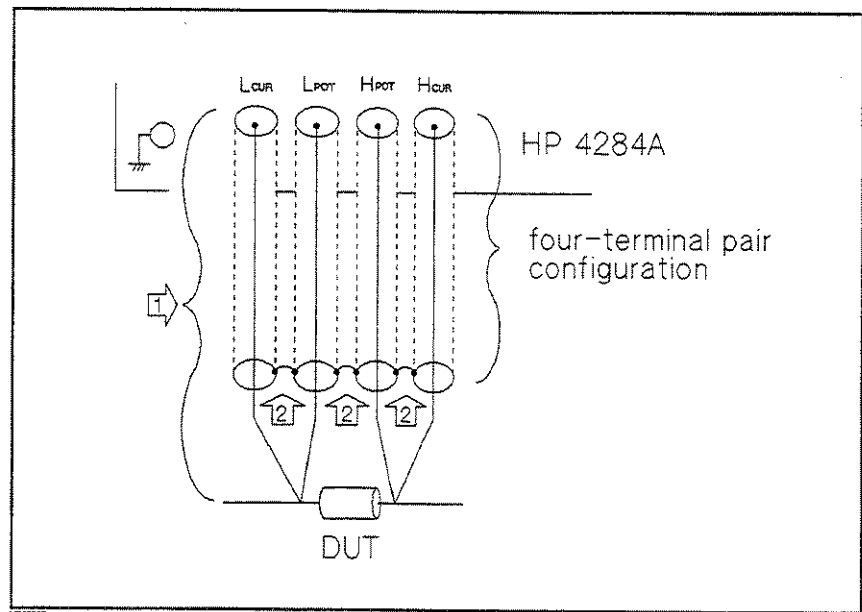

Figure 6-7. Measurement Contacts

The following paragraphs will give you some techniques for using the four-terminal pair configuration effectively and efficiently.



## Capacitance To Ground

To measure capacitors of 10 pF or less, the stray capacitance (when the conductors are grounded, this is capacitance to ground), between the measurement contacts and the conductors near the capacitor will influence the measurement, as shown in Figure 6-8.

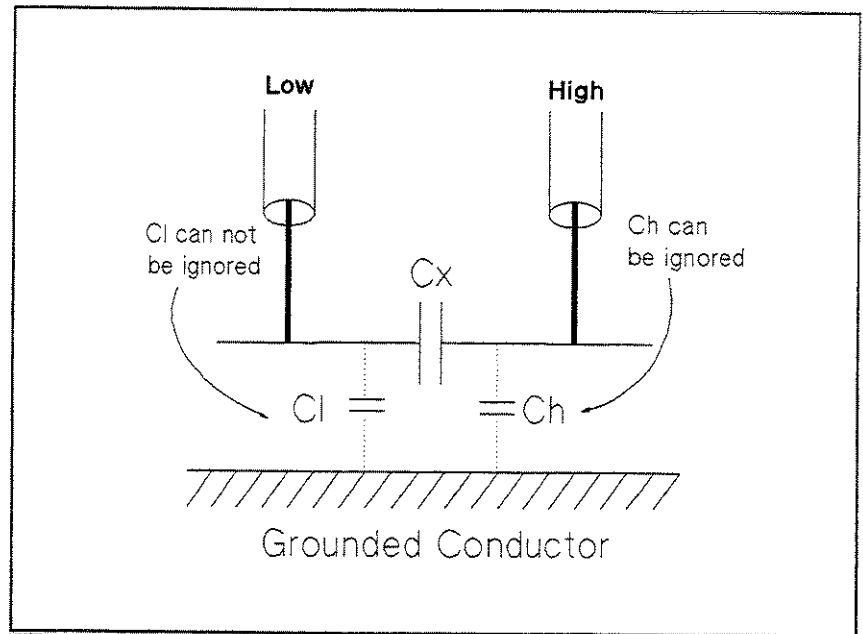

**Figure 6-8. Model of Capacitance to Ground**

To minimize the stray capacitance of the test leads, the center conductor of the test leads should be kept as short as possible, as shown in Figure 6-9 (A). If four-terminal pair connections are close to the point where contact is made with the DUT, interconnect the shields of the measurement terminals to the conductor to reduce the influence of the stray capacitance to ground, as shown in Figure 6-9 (B).

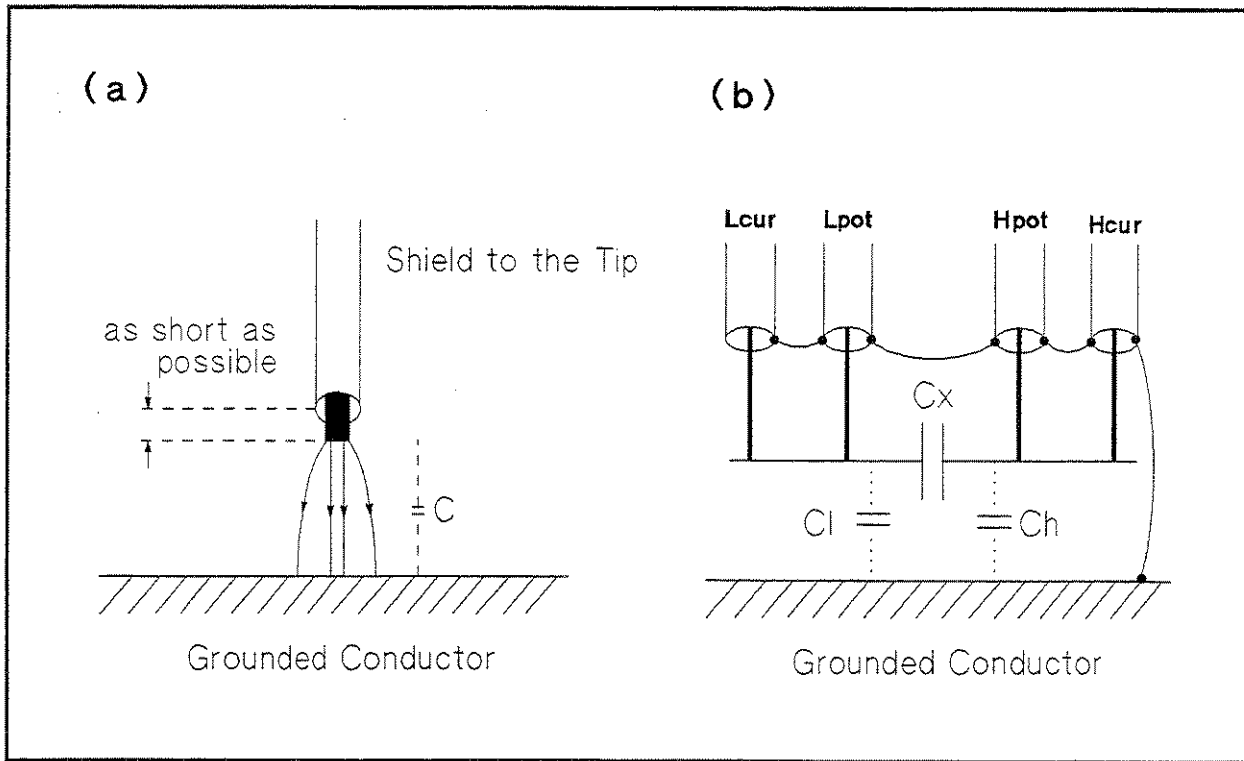

**Figure 6-9. Reducing Capacitance to Ground**

**Contact Resistance**

Contact resistance between the contacting terminals and the DUT causes measurement error when measuring large values of capacitance, especially in D (dissipation factor) measurements.

When measuring large capacitance values, the four-terminal measurement contacts have the advantage of less measurement error as compared to the two terminal method. Select a test fixture which can hold the DUT tight to stabilize the connection.

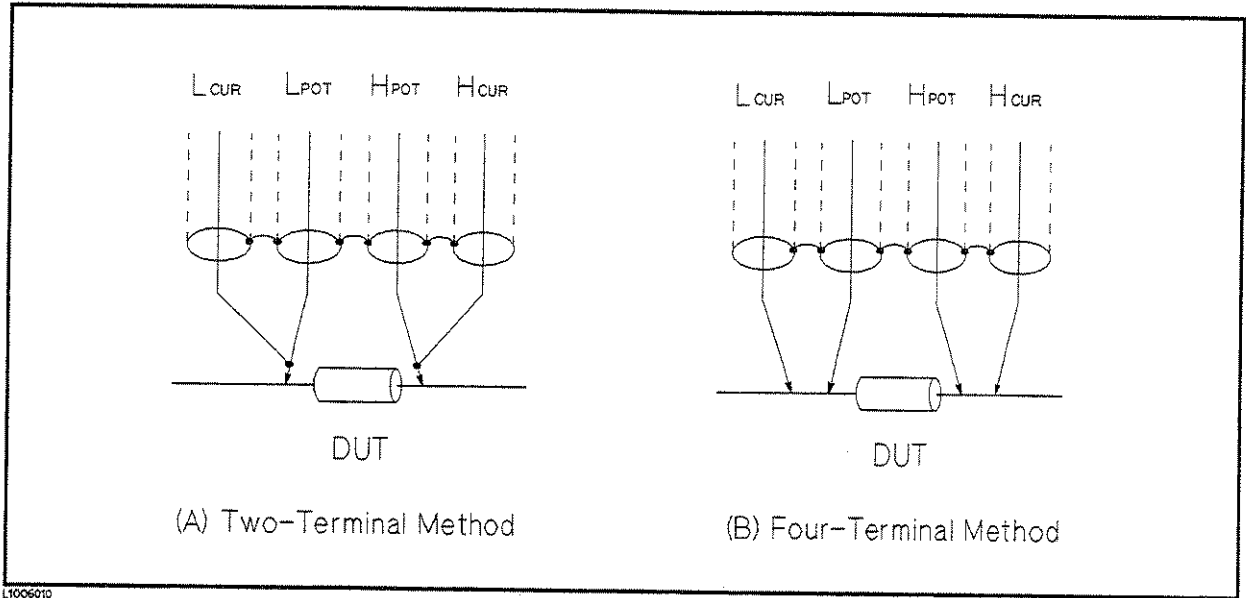

Figure 6-10. Contact Resistance

**Extending Test Leads**

When extending the four-terminal pair test leads to the contacts of DUT, make the contacts as shown in Figure 6-11. If the measurement contact cannot be made using the four-terminal pair configuration, use one of the connection methods shown in Figure 6-12, to make the measurement contact.

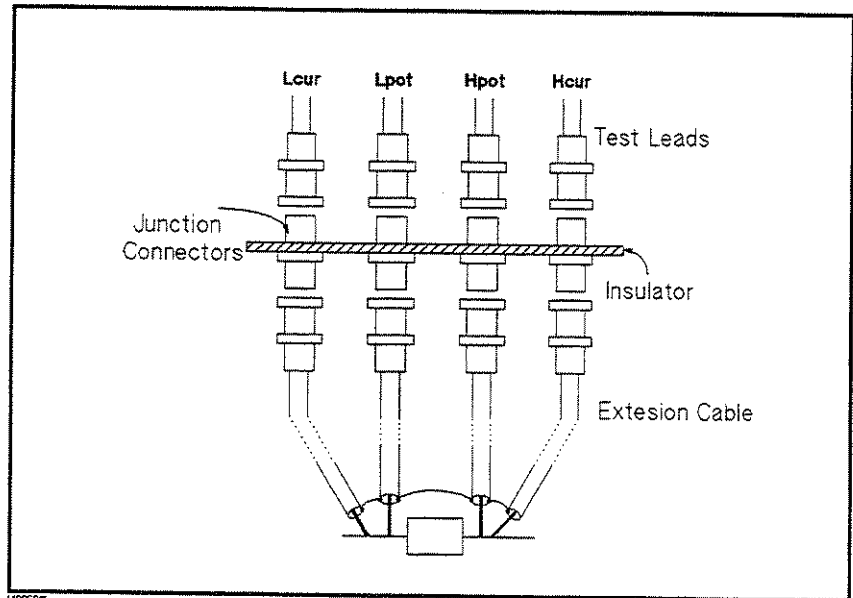
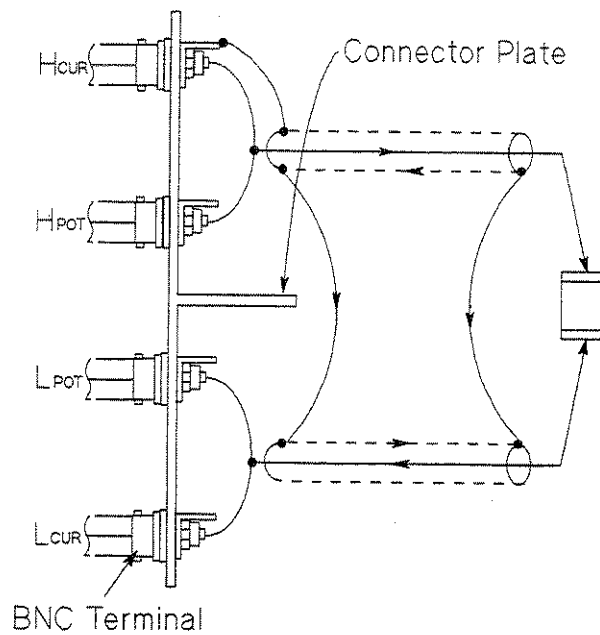
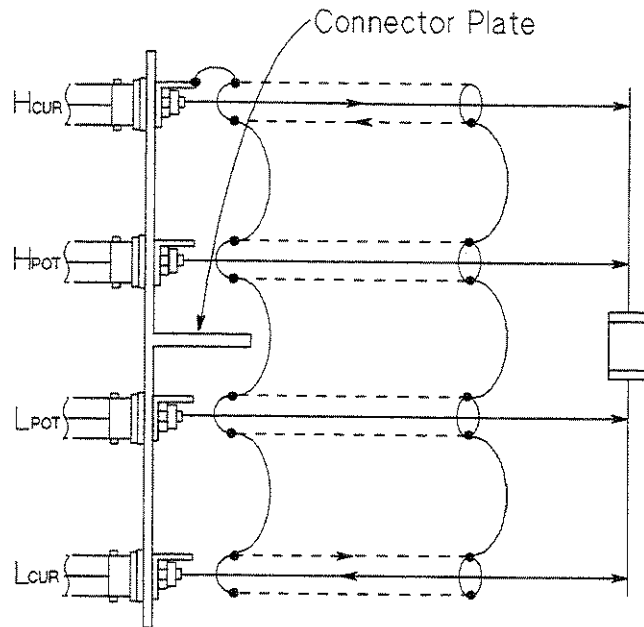

Figure 6-11. Extending The Four-Terminal Pair Test Leads

### Shielded Two-Terminal Connection



### Five-Terminal Connection



L1006012

Figure 6-12. Measurement Contacts for Test Leads Extension

### Guarding For Low Capacitance Measurements

Use a guard plate to minimize measurement errors caused by stray capacitance when measuring low capacitance values, such as low capacitance chip capacitors. Figure 6-13 shows an example of measurement contacts using a guard plate in the four-terminal pair measurement configuration.

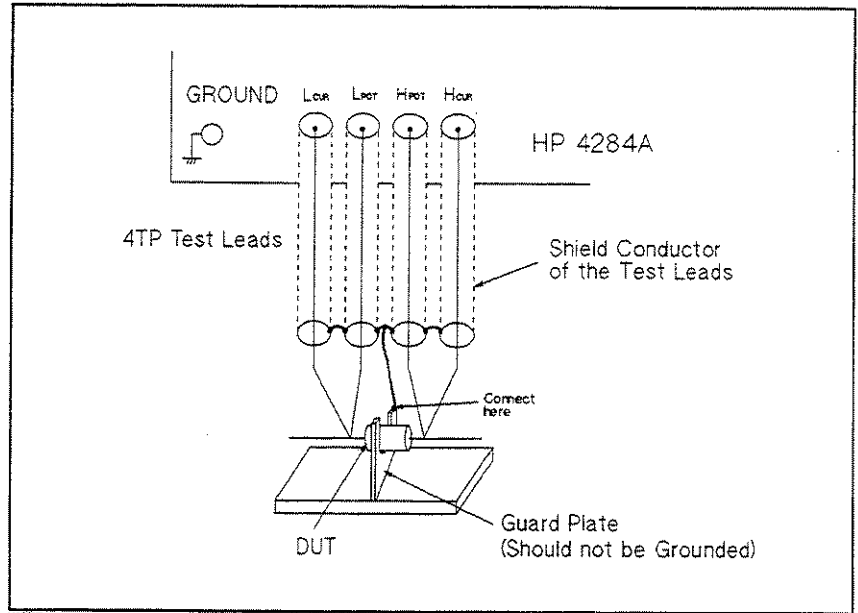

Figure 6-13. Example DUT Guard Plate Connection

### Shielding

Shielding minimizes the effects of electrical noise picked up by the test leads. So provide a shield plate and connect it to the outer shield conductors of the four-terminal pair test leads as shown in Figure 6-14.

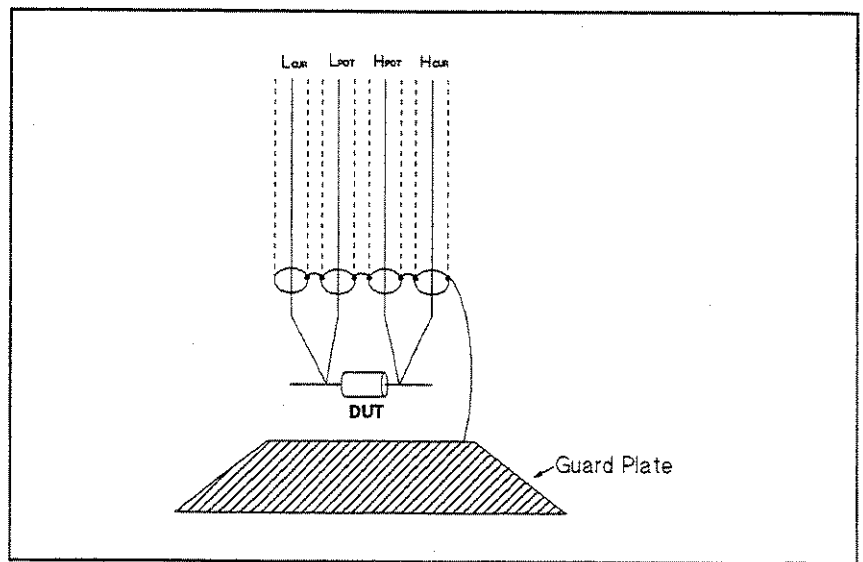

Figure 6-14. Guard Shield

## Correction Functions

The HP 4284A has powerful correction functions, Cable Length correction, and OPEN, SHORT, and LOAD corrections. These correction functions are used to correct additional error due to the test fixture and the test leads. Table 6-2 lists the Correction functions with a brief description.

**Table 6-2. Correction Functions**

Correction Selection	Description	Typical Usage
Cable Length Correction	Correct phase shift error due to the 1 or 2 m test Leads.	<ul style="list-style-type: none"><li>• Measurements using the HP 16048A/D</li></ul>
OPEN Correction	Correct for stray admittance due to the test fixture.	<ul style="list-style-type: none"><li>• High impedance measurements</li></ul>
SHORT Correction	Correct for residual impedance due to test fixture.	<ul style="list-style-type: none"><li>• Low impedance measurements</li></ul>
OPEN/SHORT Correction	Correct the stray admittance and residual impedance due to the test fixture.	<ul style="list-style-type: none"><li>• Precise measurements</li></ul>
OPEN/SHORT/LOAD Correction	Correct any error due to the test fixture and test leads by using the standard.	<ul style="list-style-type: none"><li>• Measurements to be referenced to a standard</li><li>• Measurements using a test fixture that has complicated impedance characteristics</li></ul> <p>For example, the HP 4284A combined with the scanner.</p>

- Simple measurements using an HP supplied direct connecting test fixture

In this case, **LOAD** correction is not required, **OPEN/SHORT** correction is enough to correct the residual errors.

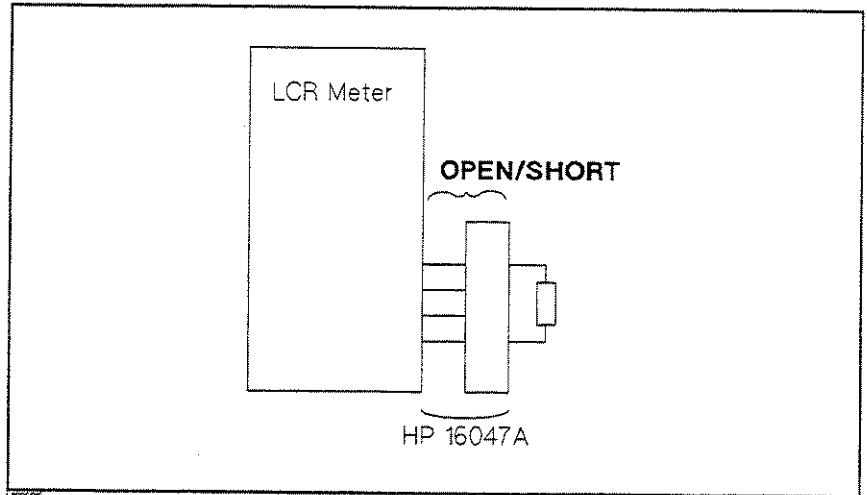

- Measurements using HP test leads and a test fixture.

In this case, **CABLE LENGTH** and **OPEN/SHORT** correction is used. Of course **CABLE CORRECTION** must be performed completely described in "Cable Length Selection" in Chapter 4.

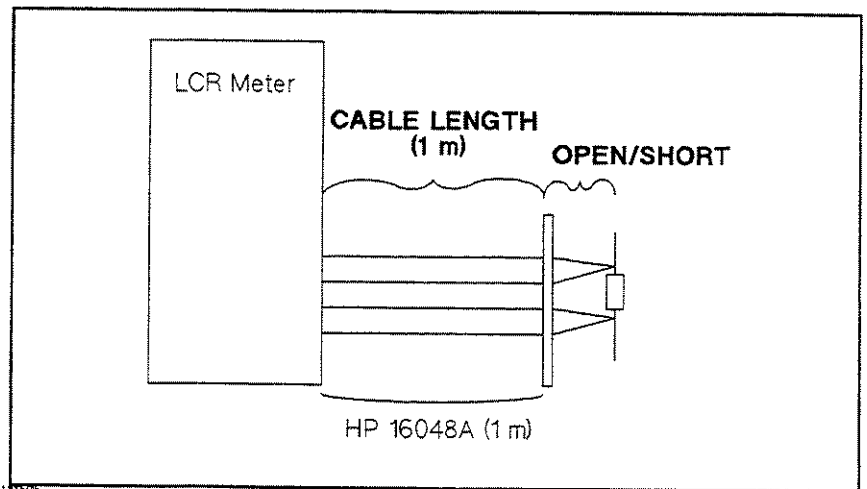

- Precise measurements to be referenced to a working standard.

Use the working standard as the LOAD reference DUT and perform the OPEN/SHORT/LOAD correction.

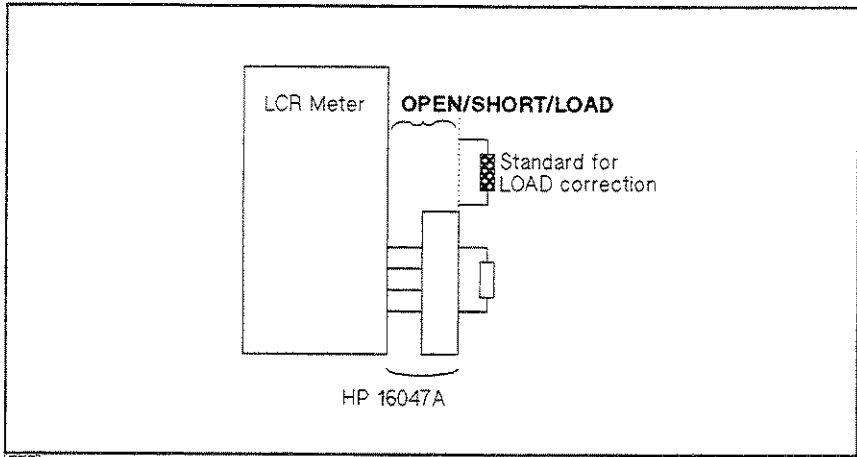

- Measurements using a test fixture that has complicated impedance characteristics.

In this case, use the OPEN/SHORT/LOAD correction. When you combine a scanner, the HP 4284A with Option 301 scanner interface provides powerful error correction functions for up to three sets of OPEN/SHORT/LOAD correction data for 128 channels.

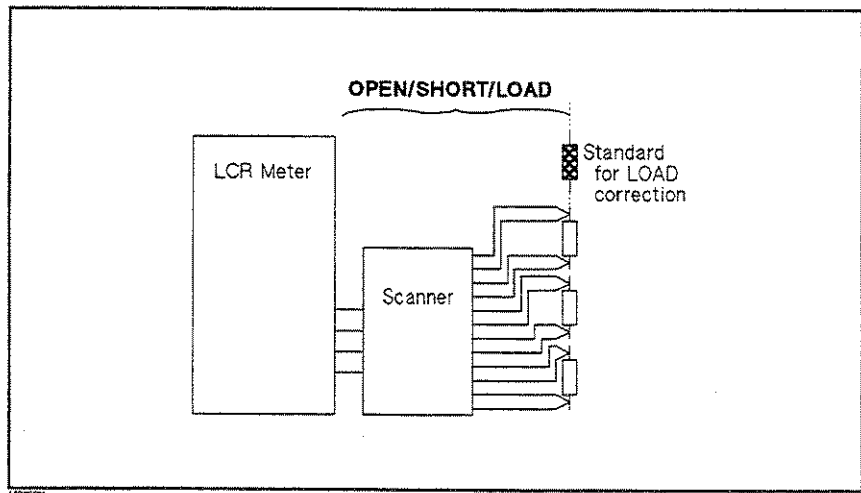



### Performing OPEN Correction

To perform an OPEN correction data measurement, set up an OPEN condition, nothing is connected to the test fixture. When the OPEN measurement is being performed, don't touch or move your hands near the test fixture.

### Performing SHORT Correction

To perform a SHORT correction data measurement, set up a SHORT condition, using a shorting bar to short between high terminal and low terminal of the *UNKNOWN* terminals.

Figure 6-15 shows a sample shorting bar (HP Part Number 5000-4226) for the HP 16047A/C/D test fixtures.

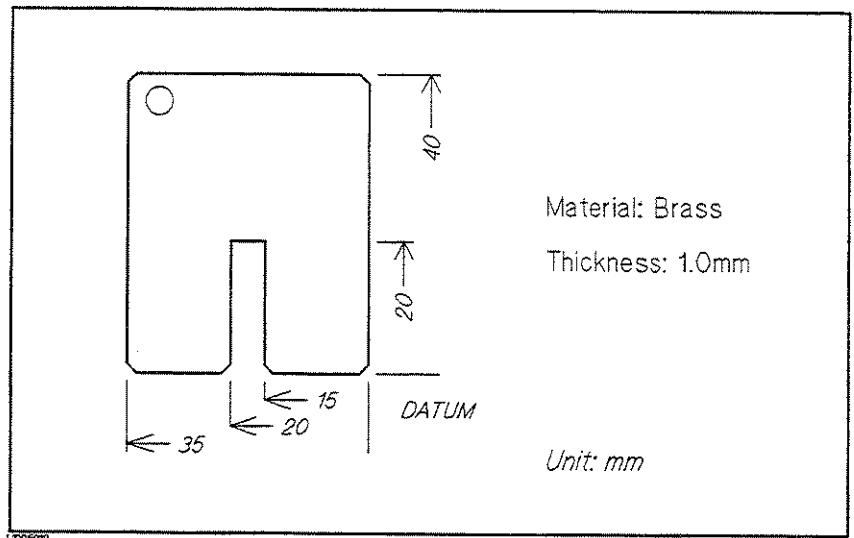

**Figure 6-15. Sample Shorting Plate**

The shorting bar should have very low residual impedance, so a high conductivity metal plate that is not easily corroded, is recommended for the shorting plate. (It must be clean.)

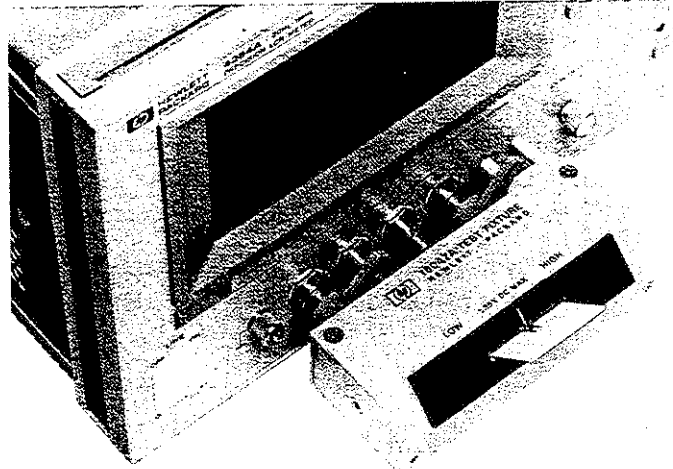

Inserting a shorting plate into the HP 16047A.

**Figure 6-16. Shorting Plate Connection**

### **Performing LOAD Correction**

To perform LOAD correction data measurement, connect the LOAD standard to the measurement contacts.

#### **Preparing the Standard**

It is necessary to prepare the working standard, such as a standard resistor and standard capacitor. It is recommended that you select a standard whose impedance is as close as possible to DUT's impedance. The following are recommendations for selecting standards.

- For capacitance measurements:

A standard capacitor whose capacitance is nearly equal to the DUT capacitance is recommended.

- For resistance measurements:

A standard resistor whose resistance is nearly equal to DUT's resistance is recommended.

- For inductance measurements:

A standard inductor whose inductance is nearly equal to DUT's inductance is recommended.

#### **Reference Values of the LOAD Standard**

Enter specified reference values of the standard as the *REF A* and *REF B* values using the appropriate function on the *CORRECTION* page. For example, When using a standard capacitor which has a specified parallel capacitance and D values, enter the specified

parallel capacitance value as the *REF A* value and the specified D value as the *REF B* value with  $C_p$ -D function.

**Note**



---

If the REF A and REF B values are entered with the  $C_p$ -D function, measurements with other functions (such as the  $|Z|-\theta$  function) can be performed.

---

**Using the Pre-Measured Device for the LOAD**

Even if you have no standard which has specified reference values, you can perform a LOAD correction using a device such as a general purpose capacitor or resistor. The pre-measured values of a device are used for the *REF A* and *REF B* values. Follow the procedure shown in below to use a device for the LOAD standard.

1. Prepare a device, whose impedance is as close as possible to the DUT's impedance, for the LOAD standard.
2. If the device has BNC connectors constructed in the four-terminal pair configuration, measure the device directly, do not use a test fixture (connect it directly to the HP 4284A).

If the device does not have four-terminal pair measurement terminals, measure the device using a direct coupling test fixture (such as the HP 16047A/C/D).

3. On the *CORRECTION* page, enter the measured values obtained in step 2 as the *REF A* and *REF B* values with the function used in step 2.

## Parasitics Incident to DUT Connection

You should consider that some parasitics remain in measurement path even after performing corrections, as follows.

Figure 6-16 shows parasitic impedance model after corrections performed using the HP 16047A/C/D test fixture. In this case, to minimize the influence of parasitics on measurement the values, insert DUT completely into the test fixture (keep the leads of the DUT as short as possible).

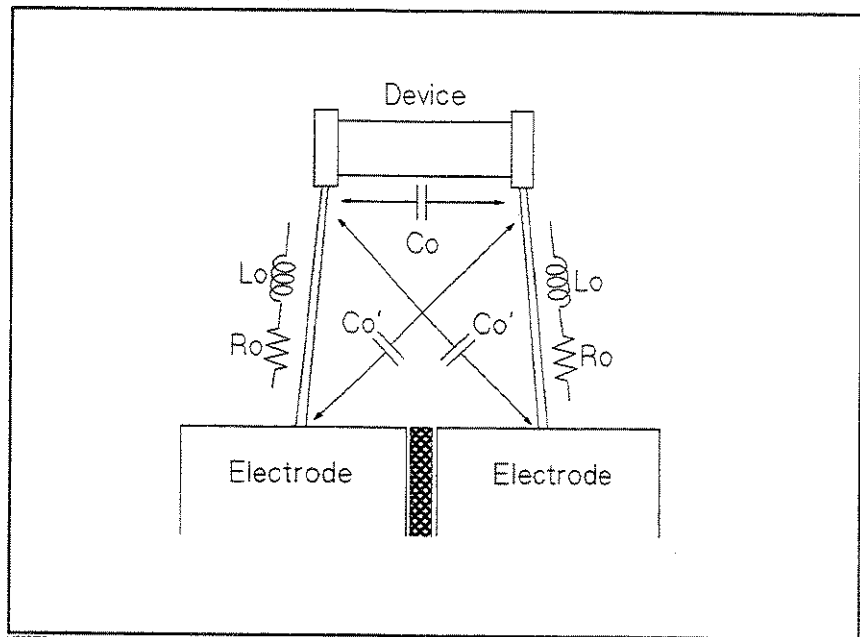

Figure 6-17. Parasitic Impedance Model (Using the HP 16047A/C/D)

$L_o$ : Residual inductance in DUT lead  
 $R_o$ : Lead resistance in DUT lead  
 $C_o$ : Stray capacitance

## Characteristics Example

Figure 6-18 shows typical characteristics of various components. As can be seen in the figure, a component may have different effective parameter values dependent upon its operating conditions. The measured values most useful in actual applications are obtained from precise measurement under the actual operating conditions.

DUT	Characteristics Example	Measurement Functions
Large C		Cs-Rs, Cs-D, Cs-Q, R-X, $ Z -\theta$
Small C		Cp-D, Cp-G, G-B, $ Y -\theta$
Large L		Lp-Rp, Lp-D, Lp-Q, G-B, $ Y -\theta$
Small L		Ls-Rs, Ls-D, Ls-Q, R-X, $ Z -\theta$
Large R		Cp-Rp, G-B, $ Y -\theta$
Small R		Ls-Rs, R-X, $ Z -\theta$

L1006021

Figure 6-18. Typical Characteristics of Components

## Capacitor Measurements

This paragraph describes practical example of measuring a 470 pF ceramic capacitor.

The basic procedure flow to perform this measurement is the same as the *BASIC MEASUREMENT PROCEDURE* described previously. In this example a 470 pF ceramic capacitor will be measured under the following conditions.

Sample (DUT) : 470 pF ceramic capacitor (HP Part Number 0160-3335)

Measurement  
Conditions

Function : C<sub>p</sub>-D  
Frequency : 1 MHz  
Test Signal Level : 1.5 V

### Caution



 Do not apply DC voltage or current to the UNKNOWN terminals. Doing so will damage the HP 4284A. Before you measure a capacitor, be sure the capacitor is fully discharged.

1. Turn the HP 4284A ON.
2. Setup the HP 4284A's measurement conditions by filling in the fields on the *MEAS DISPLAY* page.

Set *FREQ* field to 1 MHz, and *LEVEL* field to 1.5 V. (The other functions, including the measurement function are left as the default settings.)

- a. Move the cursor to the *FREQ* field. The current measurement frequency, 1.00000kHz, is displayed in this field.
- b. Press **1**. 1 will be displayed on the system message line, and the softkey labels will change to the available units (**Hz**, **kHz**, and **MHz**). Press **MHz**. 1.00000MHz is now displayed in the *FREQ* field.

### Note



The FREQUENCY can be changed using **INCR** and **DECR** displayed when the CURSOR moved to the *FREQ* field.

- c. Move the cursor to the *LEVEL* field. The current test signal level, 1.00V, is displayed in this field.
- d. Press **1**, **0**, **5**. 1.5 will be displayed on the system message line, and the softkey labels are changed to the available units (**mV**, **V**, **µA**, **mA** and **A**). Press **V**. 1.50V is now displayed in the *LEVEL* field.

### Note



The OSC LEVEL can be changed using with **INCR** and **DECR** displayed when the cursor is moved to the *LEVEL* field.

### Note



These measurement conditions can also be set from the *MEAS SETUP* page which is displayed when **MEAS SETUP** is pressed. The set up operation from the *MEAS SETUP* page is the same as in the preceding steps 1 to 4.

3. Connect the test fixture to the HP 4284A.

The HP 16047A Direct Couple Test Fixture (general purpose) is used for this measurement.

Connect the HP 16047A to the HP 4284A's UNKNOWN terminals, as shown in Figure 6-19.

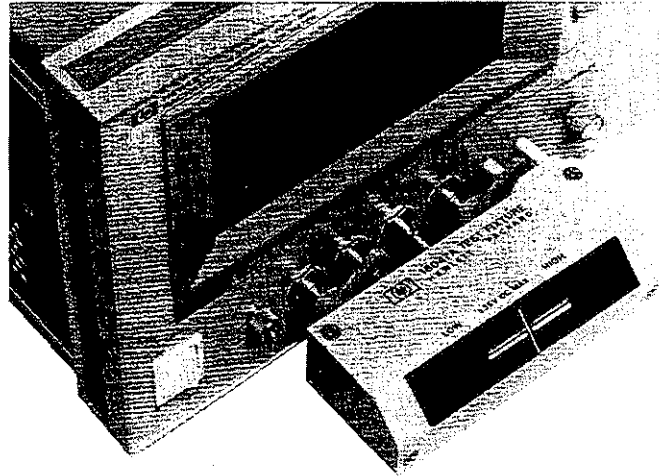

Figure 6-19. Connecting the HP 16047A

4. Perform the correction.

To compensate for the HP 16047A's residuals and strays, an OPEN/SHORT correction is required.

- a. Leave the HP 16047A in an OPEN condition as shown in Figure 6-17.
- b. Press **MEAS SETUP**, and **CORRECTION**. The *CORRECTION* page will now be displayed.
- c. Move the cursor to the *OPEN* field. **ON**, **OFF** and **MEAS OPEN** will be displayed.
- d. Press **MEAS OPEN** to perform the OPEN correction data measurement. Wait until the message *OPEN measurement completed.* is displayed on the system message line.
- e. Press **ON** to set the OPEN correction function to ON.
- f. Connect a shorting bar to the HP 16047A to set up the SHORT condition as shown in Figure 6-20.

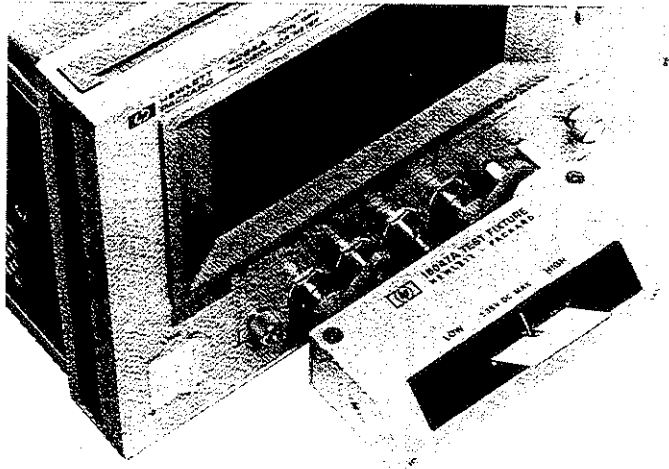

Figure 6-20. Connecting A Shorting Bar

- g. Move the cursor to the *SHORT* field. **ON**, **OFF** and **MEAS SHORT** will be displayed.
  - h. Press **MEAS SHORT** to perform the SHORT correction data measurement. Wait until the message *SHORT measurement completed.* is displayed on the system message line.
  - i. Press **ON** to set the SHORT correction function to ON.
5. Connect DUT to the test fixture.

Insert the DUT into the HP 16047A's measurement contacts deeply as shown in Figure 6-21.

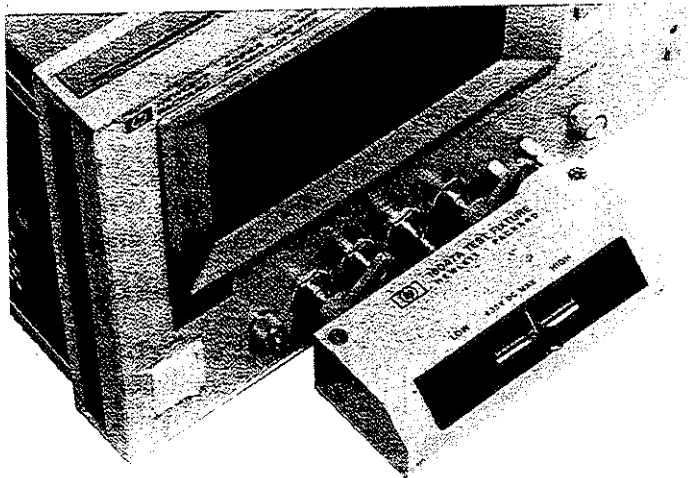

Figure 6-21. Connecting DUT

6. Perform the measurement.



Press **DISPLAY FORMAT**.

Measurements are performed continuously by the internal trigger, and the capacitors measured  $C_p$  and  $D$  values are displayed as large characters as shown in Figure 6-22.

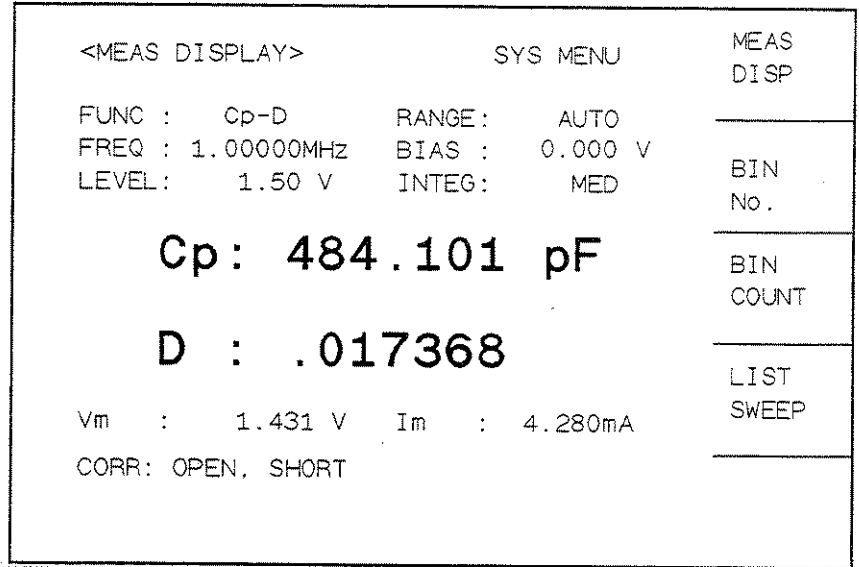

**Figure 6-22. Measurement Results of A 470 pF Capacitor**

## Inductance Measurements

This paragraph describes a practical example of measuring a 64  $\mu\text{H}$  magnetic-core inductor.

The basic procedure flow to perform this measurement is the same as for the BASIC MEASUREMENT PROCEDURE described previously. A 64  $\mu\text{H}$  magnetic-core inductor will be measured under the following conditions.

Sample (DUT) : 64  $\mu\text{H}$  magnetic-core inductor  
(HP Part Number 9140-1401)

Measurement Conditions

Function :  $L_s-R_s$   
Frequency : 100 kHz  
Test Signal Level : 10 mA (constant)

1. Turn the HP 4284A ON.
2. Setup the HP 4284A measurement conditions by filling the fields on the *MEAS DISPLAY* page.

Set FUNC to  $L_s-R_s$ , FREQ to 100 kHz, and LEVEL to 10 mA constant. (The other functions will be left as the default settings.)

- a. Move the cursor to the *FUNC* field. The Current measurement function, *C<sub>p</sub>-D*, is displayed in this field, and *C<sub>p</sub>-D*, *C<sub>p</sub>-Q*, *C<sub>p</sub>-G*, *C<sub>p</sub>-Rp* and *more 1/6* are displayed.
- b. Press *more 1/6*. *C<sub>s</sub>-D*, *C<sub>s</sub>-Q*, *C<sub>s</sub>-Rs* and *more 2/6* will be displayed.
- c. Press *more 2/6*. *L<sub>p</sub>-D*, *L<sub>p</sub>-Q*, *L<sub>p</sub>-G*, *L<sub>p</sub>-Rp* and *more 3/6* will be displayed.
- d. Press *more 3/6*. *L<sub>s</sub>-D*, *L<sub>s</sub>-Q*, *L<sub>s</sub>-Rs* and *more 4/6* will be displayed.
- e. Press *L<sub>s</sub>-Rs* to select the *L<sub>s</sub>-R<sub>s</sub>* measurement function.
- f. Move the cursor to the *FREQ* field. The current measurement frequency, 1.00000kHz, will be displayed in this field.
- g. Press **1**, **0**, **0**. 100 will be displayed on the system message line, and the softkey labels will change to the available units (**Hz**, **kHz**, and **MHz**). Press **kHz**. 100.000 kHz is displayed on the *FREQ* field.

**Note**



*FREQ* can be changed using **INCR** and **DECR** displayed when the **CURSOR** is moved to the *FREQ* field.

- h. Move the cursor to the *LEVEL* field. The current test signal level, 1.00V, will be displayed in this field.
- i. Press **1**, and **0**. 10 will be displayed on the system message line, and the softkey labels are changed to the available units (**mV**, **V**, **µA**, **mA** and **A**). Press **mA**. 10.0mA is displayed on the *LEVEL* field.

**Note**



These measurement conditions can also be set from the *MEAS SETUP* page displayed when **MEAS SETUP** is pressed. The setting operation on the *MEAS SETUP* page is same as in the preceding steps (a) to (i).

- j. Press **MEAS SETUP**. The *MEAS SETUP* page is displayed.
  - k. Move the **CURSOR** to the *ALC* field. The current status of the *ALC* function, **OFF**, is displayed on this field, and **ON** and **OFF** are displayed.
  - l. Press **ON** to set the test signal current level to be constant.
3. Connect the test fixture to the HP 4284A.

The HP 16047A Direct Couple Test Fixture (general purpose) is used for this measurement.

Connect the HP 16047A to the HP 4284A's UNKNOWN terminals, as shown in Figure 6-23.

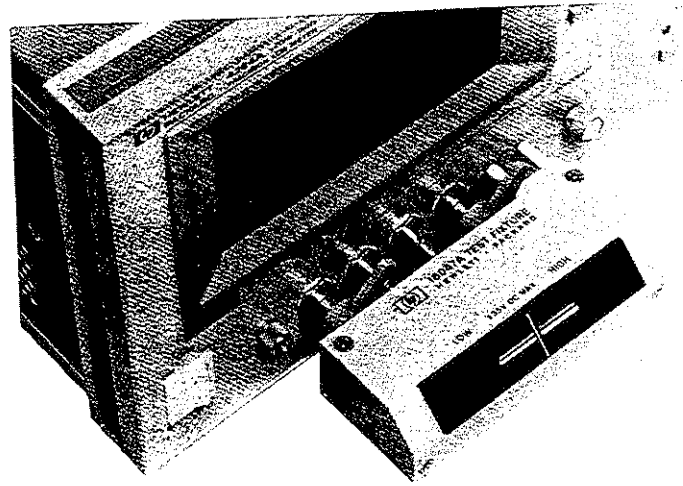

Figure 6-23. Connecting the HP 16047A

4. Perform the correction.

To compensate the HP 16047A's residuals and strays, an OPEN/SHORT correction is required.

- a. Leave the HP 16047A in an OPEN condition as shown in Figure 6-21.
- b. Press **MEAS SETUP**, and **CORRECTION**. The *CORRECTION* page will be displayed.
- c. Move the cursor to the *OPEN* field. **ON**, **OFF** and **MEAS OPEN** will be displayed.
- d. Press **MEAS OPEN** to perform the OPEN correction data measurement. Wait until the message *OPEN measurement completed.* is displayed on the system message line.
- e. Press **ON** to set the OPEN correction function to ON.
- f. Connect a shorting bar to the HP 16047A to set up the SHORT condition as shown in Figure 6-24.

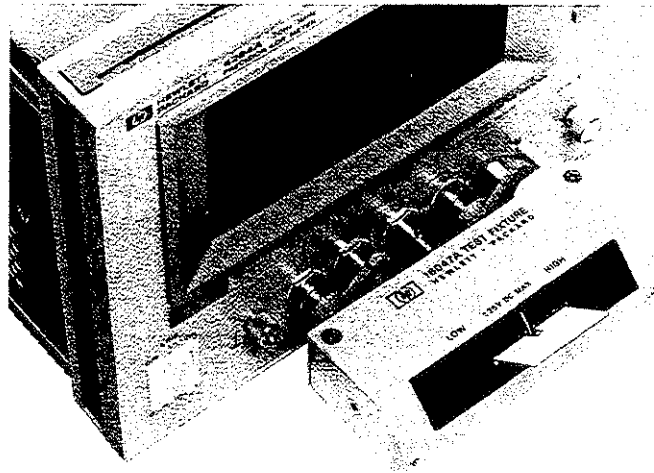

Figure 6-24. Connecting A Shorting Bar

- g. Move the cursor to the *SHORT* field. **ON**, **OFF** and **MEAS SHORT** will be displayed.
  - h. Press **MEAS SHORT** to perform the SHORT correction data measurement. Wait until the message *SHORT measurement completed.* is displayed on the system message line.
  - i. Press **ON** to set the SHORT correction function to ON.
5. Connect the DUT to the test fixture.

Insert the DUT into the HP 16047A's measurement contacts deeply, as shown in Figure 6-25.

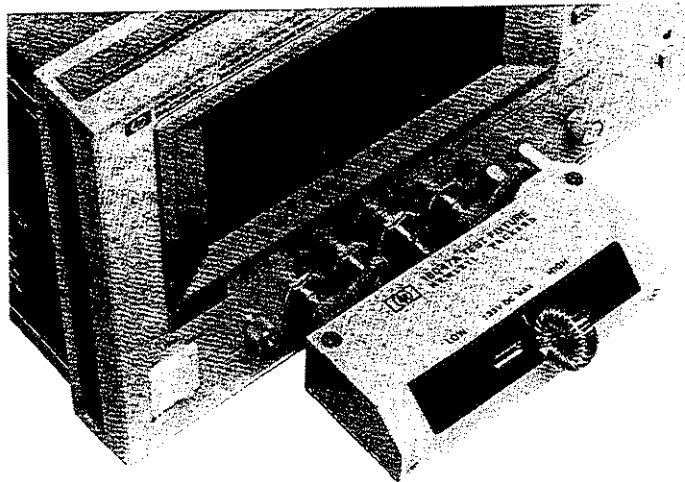
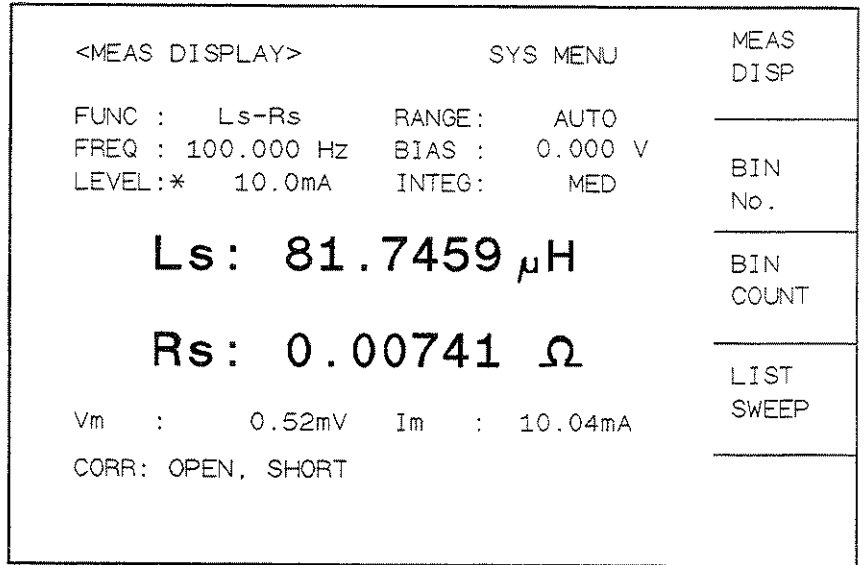

Figure 6-25. Connecting DUT

6. Perform the measurement.

Press **DISPLAY FORMAT**.

Measurements are performed continuously by the internal trigger, and the measured  $L_s$  and  $R_s$  values of the magnetic-cored inductor are displayed in large characters as shown in Figure 6-26.



**Figure 6-26. Measurement Results of The Magnetic-Cored Inductor**

## If the HP 4284A does NOT Measure Correctly

The HP 4284A is working correctly but its measurement results seem strange. For example:

- The HP 4284A does not measure at all.
- Measurement value is strange.
- Measurement value is strange at a specific frequency point or points.

These situations may be caused by the incorrect correction data. If you come upon these situations, use the following procedure to check the instrument.

1. Turn correction OFF.
  - a. Press **MEAS SETUP**, **CORRECTION**.
  - b. Move the cursor to the *OPEN* field and press **OFF**.
  - c. Move the cursor to the *SHORT* field and press **OFF**.
  - d. Move the cursor to the *LOAD* field and press **OFF**.
  - e. Press **DISPLAY FORMAT** and confirm *CORR*: turns OFF.

<MEAS DISPLAY>		SYS MENU	MEAS DISP
FUNC :	Cp-D	RANGE :	AUTO
FREQ :	1.00000KHZ	BIAS :	0.000 V
LEVEL :	1.50 V	INTEG :	MED
<b>Cp:484.101 pF</b>			BIN No.
<b>D : .017368</b>			BIN COUNT
Vm :	1.431 V	Im :	4.280mA
CORR : OFF			LIST SWEEP

MCS0513S

2. Measure the DUT again. If the HP 4284A now measures properly then the correction data may have been improperly obtained or saved. Carefully perform the correction procedure again and measure the DUT.

For more information on the correction procedure, refer to chapter 4, "CORRECTION Page".

## Remote Control

---

### Introduction

This chapter provides the following information to remotely control the HP 4284A via the Hewlett-Packard Interface Bus (HP-IB).

- Reference information for programming the HP 4284A
- Introduction to the Standard Commands for Programmable Instruments (SCPI)
- Tutorial information for the SCPI programmer

---

### Hewlett-Packard Interface Bus (HP-IB)

HP-IB is Hewlett-Packard's implementation of IEEE standard 488.1-1987. And IEEE standard 488.1-1987 is identical to the original IEEE standard 488-1978.

#### HP-IB Connection

When configuring an HP-IB system, the following restrictions must be adhered to.

- The total length of cable in one bus system must be less than or equal to two meters times the number of devices connected on the bus (the HP-IB controller counts as one device) and the total length of cable must not exceed 20 meters.
- A maximum of 15 devices can be connected on one bus system.
- There are no restrictions on how the cables are connected together. However, it is recommended that no more than four piggyback connectors be stacked together on any one device. The resulting structure could exert enough force on the connector mounting to damage it.

For example, a system containing six devices can be connected together with cables that have a total length of less than or equal to 12 meters (six devices  $\times$  2m/device = 12 meters). The individual length of cable may be distributed in any manner desired as long as the total length does not exceed the allowed maximum. If more than ten devices are to be connected together, cables shorter than two meters must be used between some of the devices to keep the total cable length less than 20 meters.

Figure 7-1 shows an HP-IB interface connector. The HP 4284A uses all of the available HP-IB lines; therefore, damage to any connector pin will adversely affect its HP-IB operation.

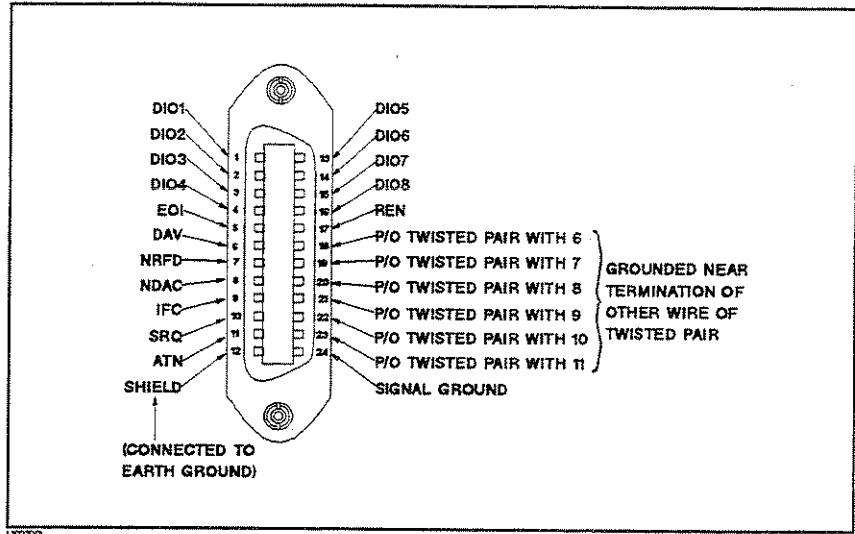

Figure 7-1. HP-IB Connector Signal/Pin Configuration

Table 7-1. HP-IB Interconnect Cables

HP Part Number	Length
10833A	1 m (3.3 ft)
10833B	2 m (6.6 ft)
10833C	4 m (13.2 ft)
10833D	0.5 m (1.6 ft)



Typical HP-IB system interconnection is shown in Figure 7-2. The HP-IB connector is firmly fastened using two bolts to keep it from working loose during use.

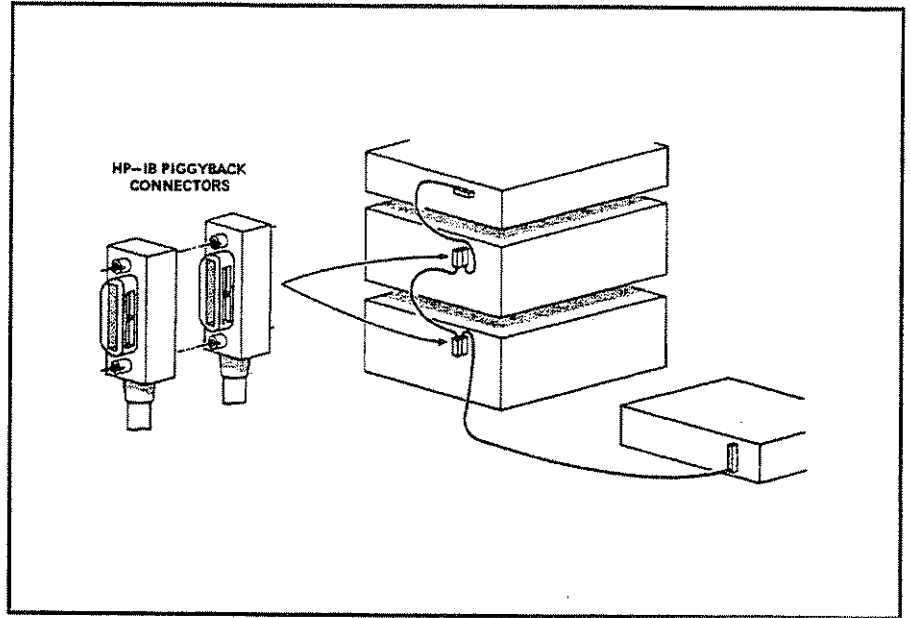

Figure 7-2. Typical HP-IB System Interconnection

### HP-IB Capability

Table 7-2 lists the HP 4284A's HP-IB capabilities and functions. These functions provide the means for an instrument to receive, process, and transmit, commands, data, and status over the HP-IB bus.

Table 7-2. HP-IB Interface Capability

Code	Function
SH1	Complete Source Handshake capability
AH1	Complete Acceptor Handshake capability
T5	Basic Talker; serial poll; unaddressed if MLA; Talk-Only
L4	Basic Listener; unaddressed if MTA; no Listen Only
SR1	Service Request capability
RL1	Remote/Local capability
DC1	Device Clear capability
DT1	Device Trigger capability
C0	No Controller capability
E1	Drivers are open-collector

## HP-IB Addressing

The HP 4284A's HP-IB address is stored in non-volatile memory and can be set to any address from 0 to 30 by front panel key entry in the *SYSTEM CONFIG* page. When the HP 4284A is shipped from the factory the default HP-IB address is 17. For more information, refer to "How to Set the HP-IB Address" in Chapter 5.

## HP-IB Bus Capability

The HP 4284A will respond to the following bus commands which are given as HP 9000 series 200/300 BASIC statements.

### ABORT I/O (IFC)

ABORT I/O (IFC control line TRUE) halts all bus activity and deselects the HP 4284A.

For example:

```
ABORT 7
```

### CLEAR LOCKOUT/SET LOCAL

CLEAR LOCKOUT/SET LOCAL (REN control line false) releases devices on the bus from the lockout mode and returns them to local (front panel) control. The difference between CLEAR LOCKOUT/SET LOCAL, and LOCAL is in the addressing method used.

For example:

```
LOCAL 7
```

### DEVICE CLEAR (SDC or DCL)

This command can be used with an address to clear a particular device (SDC : selected device clear) or used without an address (DCL : clears all devices). The HP 4284A will initialize the following items only when it receives this command. Then the:

- Input buffer is cleared
- Output data buffer is cleared
- Bit 4 (MAV bit) of the status byte is set to "0"

For example:

```
CLEAR 7
```

### LOCAL (GTL)

LOCAL returns control of a listening device to front panel control.

For example:

```
LOCAL 717
```

### LOCAL LOCKOUT (LLO)

LOCAL LOCKOUT disables the LOCAL operation (HP 4284A : Pressing **LCL**) of all devices on the bus. After this command is sent you will be unable to operate the HP 4284A from the front panel. Execute the LOCAL command to undo LOCAL LOCKOUT.

For example:

```
LOCAL LOCKOUT 7
```

### REMOTE

REMOTE sets the HP 4284A to the remote mode. When this command is sent, front panel with the exception of **LCL** will be disabled.

For example:

```
REMOTE 717
```

### SROLL

SROLL is the serial polling command. SROLL is used to place the status byte of the addressed instrument on the bus. The eight bits of the status byte can be masked off and read to determine the HP 4284A's operating state.

For example:

```
Var=SROLL(717)
```

### SERVICE REQUEST

The HP 4284A can send an SRQ (Service Request) control signal when it requires the controller to perform a task. An SRQ can be thought of as an interrupt which informs the controller that information is ready to be transmitted, or that an error condition exists in the instrument. When the HP 4284A sends an SRQ it also sets Bit 6 of the status byte. Bit 6 is the RQS (Request Service) bit, sometimes referred to as the *status bit* in connection with polling. When the HP 4284A is serially polled, it clears the RQS bit and the SRQ line, one of the five management control lines of the system interface. Any bit in the status byte can initiate an SRQ. The status byte may be masked by the user to determine which bits caused the HP 4284A to set the SRQ line. For more information on the status byte, refer to "Status Byte".

### TRIGGER (GET)

Enables the HP 4284A to the TRIGGER bus command. This command may be sent to a selected device or to all devices addressed as listeners on the HP-IB bus. The HP 4284A must first be addressed as a listener, second the trigger mode is set to the BUS trigger mode before the trigger message is sent.

For example:

## Standard Commands for Programmable Instruments(SCPI)

Standard Commands for Programmable Instrument(SCPI) is the new universal command set adopted by Hewlett-Packard for test and measurement instrumentation by extending IEEE 488.2-1987. (SCPI is equal to TMSL, Test and Measurement Systems Language, which developed by Hewlett-Packard.) This language uses standard HP-IB hardware and will be used in many future Hewlett-Packard Products. SCPI uses easy to learn, self explanatory commands, and is flexible for both beginners and expert programmers. Detailed SCPI command descriptions are given in Chapter 8.

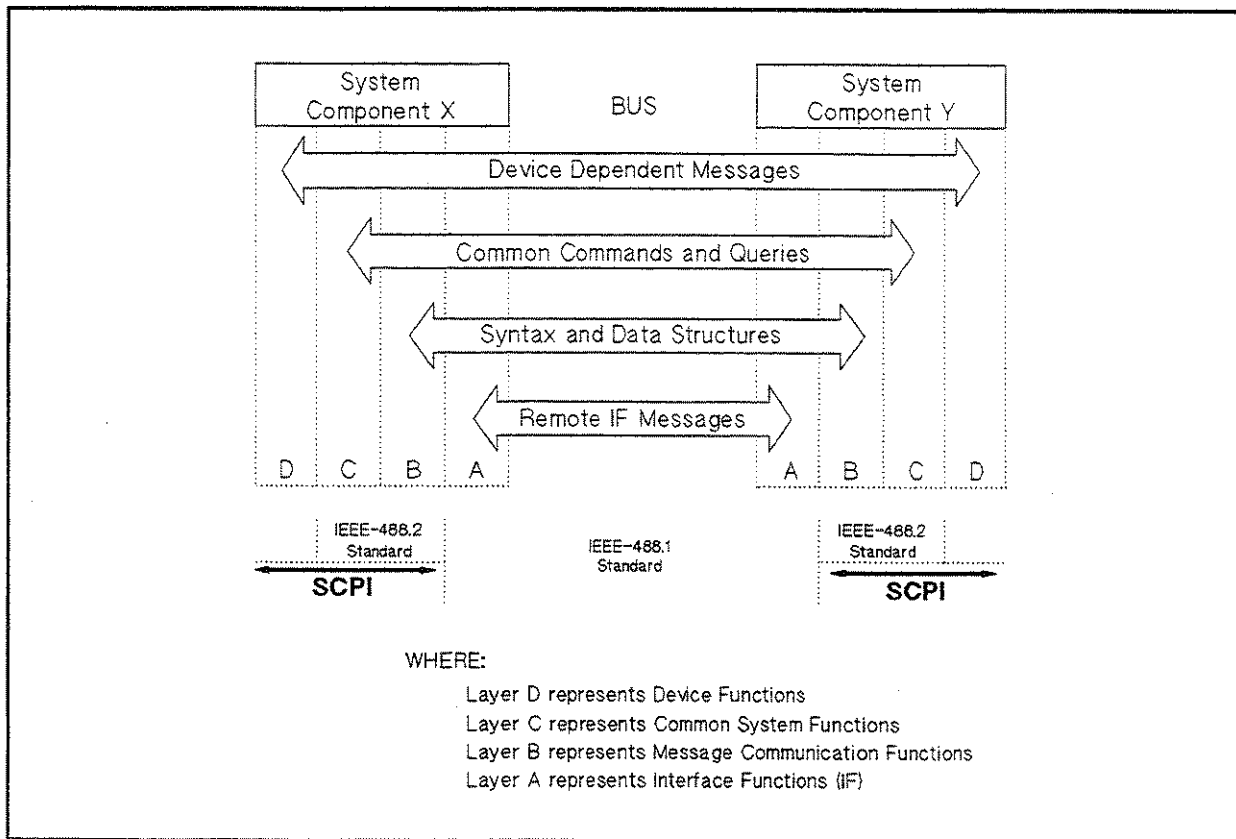

Figure 7-3. Functional Layers Diagram

## Data Transfer

The HP 4284A offers two data formats for HP-IB data transfer to the controller, ASCII and BINARY. The data transfer rates for these data formats are different.

### ASCII Format

The ASCII data format is the default output format. When the `FORMat:DATA ASCII` command is executed, the HP 4284A transfers data in the ASCII format. The ASCII data output format on the `MEAS DISPLAY`, `BIN No. DISPLAY`, or `BIN COUNT DISPLAY` page is described in Figure 7-4.

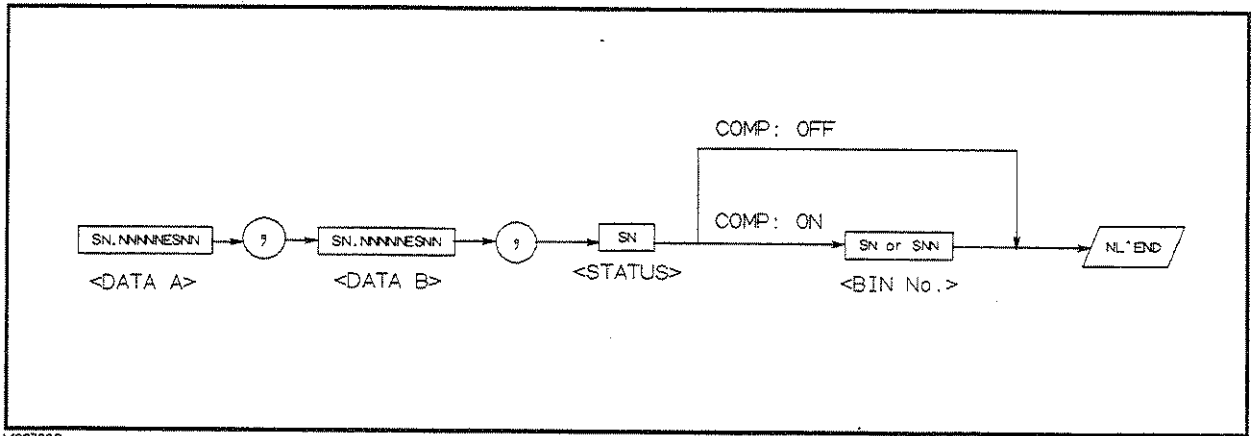

Figure 7-4. ASCII Format 1

The `<DATA A>`, `<DATA B>`, `<STATUS>`, and `<BIN No.>` formats are as follows.

■ `<DATA A>` and `<DATA B>` format:

The data output formats for `<DATA A>` (primary parameter's measurement data), and `<DATA B>` (secondary parameter's measurement data) uses the 12 ASCII character fixed length format as follows.

SN.NNNNESNN

(S: +/-, N: 0 to 9, E: Exponent Sign)

■ `<STATUS>` Format:

The `<STATUS>` data shows the measurement status when getting the measurement data as follows.

Status	Description
-1	No data (in the data buffer memory)
0	Normal measurement data.
+1	Analog bridge is unbalanced.
+2	A/D converter is not working.
+3	Signal source overloaded.
+4	ALC unable to regulate.

The data output formats for <STATUS> uses the 2 ASCII character fixed length format as follows.

SN (S: +/–, N: 0 to 4)

**Note**



When the <STATUS> is –1, 1, or 2, the measurement data is 9.9E37. When the <STATUS> is 0, 3, or 4, the actual measurement data is output.

■ <BIN No.> Format:

The <BIN No.> data shows the bin sorting results as follows.

Data	Sorting Results
0	OUT_OF_BINS
+1	BIN 1
+2	BIN 2
+3	BIN 3
+4	BIN 4
+5	BIN 5
+6	BIN 6
+7	BIN 7
+8	BIN 8
+9	BIN 9
+10	AUX_BIN

The <BIN No.> data is output with the measurement data only when the comparator function is set to ON.

The data output formats for <BIN No.> uses a 2 or 3 ASCII character data length format as follows.

SN or SNN (S: +/–, N: 0 to 9)

The ASCII data output format on the *LIST SWEEP DISPLAY* page is described in Figure 7-5. The data loop is repeated for the number of the sweep points.

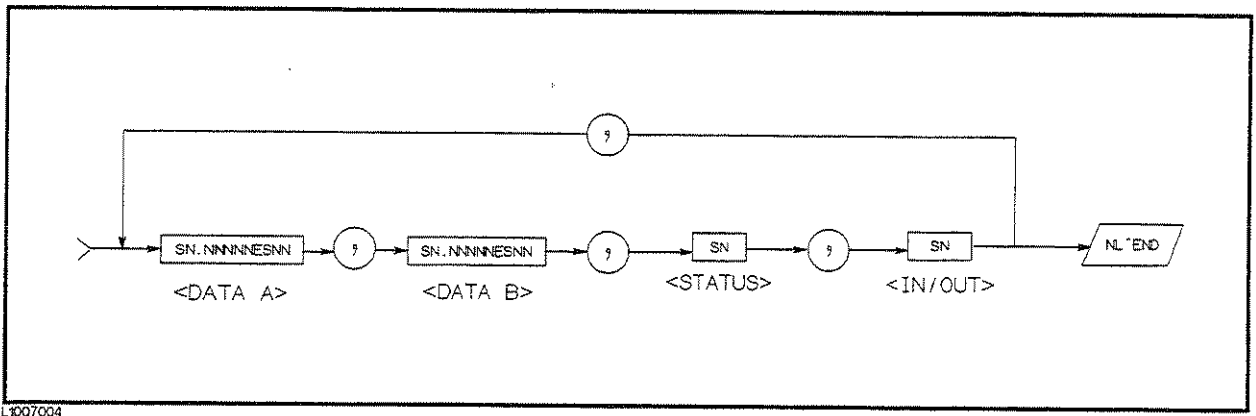

L1007004

**Figure 7-5. ASCII Format 2 (List Sweep)**

The <DATA A>, <DATA B>, <STATUS> formats are the same as the formats on the MEAS DISPLAY, BIN No. DISPLAY, or BIN COUNT DISPLAY page. So the only the <IN/OUT> format will be described.

■ <IN/OUT> format:

The <IN/OUT> data shows the result of the list sweep's comparator function.

Data	Result
-1	LOW
0	IN
+1	HIGH

When the comparator function of the list sweep measurement isn't used, the <IN/OUT> data output result is 0 (zero).

The data output formats for <IN/OUT> use the 2 ASCII character fixed length format as follows.

SN (S: +/-, N: 0 to 1)

**Binary Format**

When the FORMat:DATA REAL,64 command is executed the HP 4284A transfers data in the BINARY format. The BINARY format is the 64-bit floating point binary format specified in IEEE Standard 754-1985. This is the same data format used by the HP Technical computers, such as the HP 9000 series 200/300 computers. The BINARY data output format on the MEAS DISPLAY, BIN No. DISPLAY, or BIN COUNT DISPLAY page is shown in Figure 7-6.

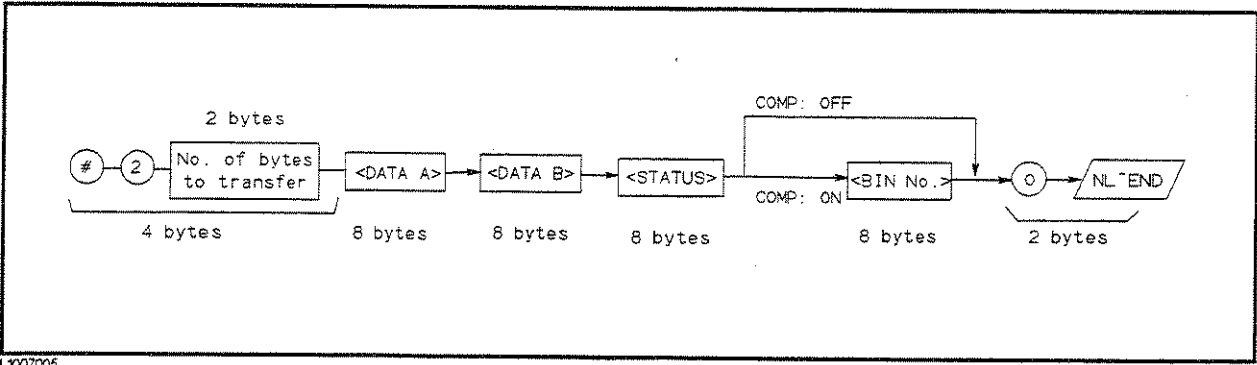

L1007005

Figure 7-6. BINARY Format 1

This data field is initiated by a unique code, the number sign (#). A second byte, (2), designates the number of the bytes for the “No. of the bytes transfer”. “No. of the bytes transfer” designates the data byte length. The last byte is zero (0), and has no meaning. The response message terminator is, the EOI line is asserted while the New Line (Line Feed) character (10 decimal) is being sent on the bus.

### Floating Point Format

Each data format of the <DATA A>, <DATA B>, <STATUS>, and <BIN No.> are common formats (8 bytes, IEEE 754 floating point format) as follows. The meaning of each data is the same as the meaning of each data in the ASCII format.

#### IEEE 754 Floating Point Format

Bit No.	7	6	5	4	3	2	1	0
First byte sent	S	E <sub>msb</sub>	E	E	E	E	E	E
Second byte sent	E	E	E	E <sub>lsb</sub>	F <sub>msb</sub>	F	F	F
Third – seventh byte sent	F	F	F	F	F	F	F	F
⋮	⋮	⋮	⋮	⋮	⋮	⋮	⋮	⋮
Last byte sent	F	F	F	F	F	F	F	F <sub>lsb</sub>

Where,

- E<sub>msb</sub> : is the most significant bit of the exponent.
- E<sub>lsb</sub> : is the least significant bit of the exponent.
- F<sub>msb</sub> : is the most significant bit of the fractional part.
- F<sub>lsb</sub> : is the least significant bit of the fractional part.
- S : is the sign bit.
- E : is an exponent bit.
- F : is a fraction bit.

The real number RN represented in floating point format are provided using the following formula. (EXP: Exponent part of number, f: Fractional part of number)

- When  $0 < e < 1111111111$  (2047)



$$RN = (-1)^S \times 2^{(EXP-1023)} \times (1 + f/2^{52})$$

- When  $e = 0$

$$RN = (-1)^S \times 2^{-1022} \times (f/2^{52})$$

- When  $e = 0, f = 0,$

$$RN = 0$$

For example,

$$S = 1$$

$$EXP = 0111111111 \text{ (1023 decimal)}$$

$$f = 1000\ 00000000\ 00000000\ 00000000\ 00000000\ 00000000\ 00000000\ 00000000\ (2^{51})$$

$$RN = (-1)^1 \times 2^{(1023-1023)} \times \left(1 + \frac{2^{51}}{2^{52}}\right)$$

$$= -1 \times 1 \times 1.5$$

$$= -1.5$$

When the list sweep measurement is performed, the binary data format is as follows. <DATA A>, <DATA B>, <STATUS>, and <IN/OUT> are repeated as many times as there are sweep points. Each data format is the same as the 8-byte data format described in the "Floating Point Format". The meaning of each data is the same as each data in the ASCII format.

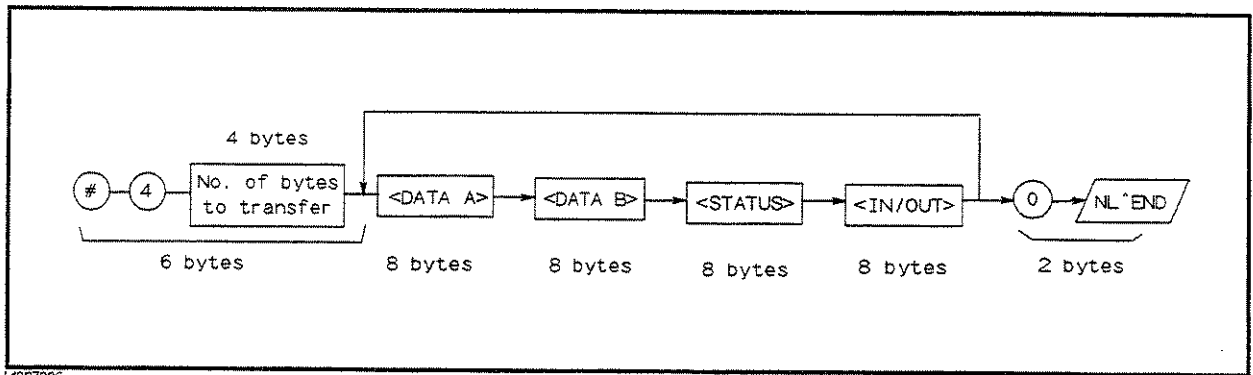

Figure 7-7. Binary Data Format For List Sweep Measurement

## Trigger System

Figure 7-8 shows the HP 4284A trigger state diagram when in REMOTE.

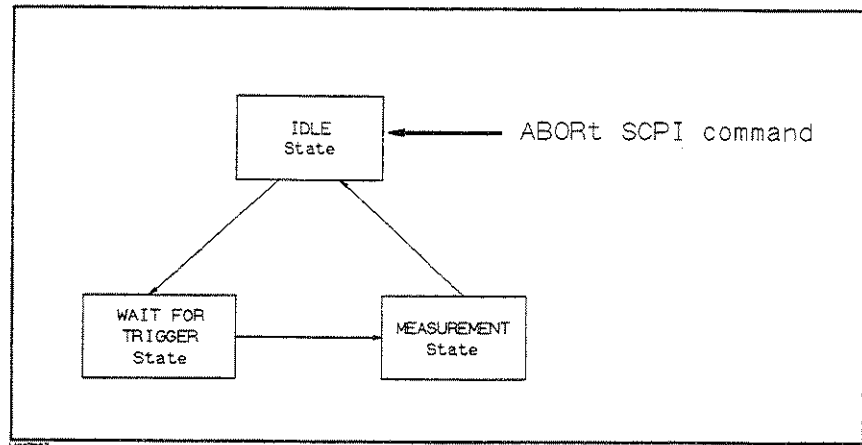

Figure 7-8. Trigger State Diagram

Each HP-IB trigger state is described in the following paragraphs.

### ■ IDLE state

During the IDLE state, the measurement data can be read by a controller via HP-IB using the FETCh? query. To change the IDLE state to the WAIT FOR TRIGGER state, the INITiate subsystem command must be used as shown in Figure 7-9.

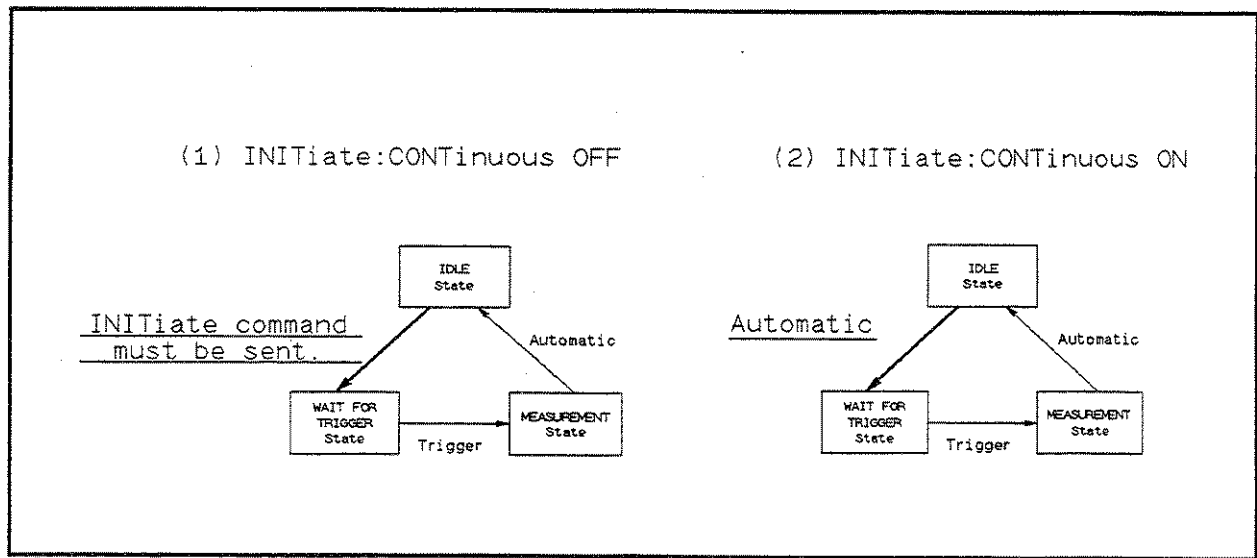

Figure 7-9. INITiate Subsystem Commands and Trigger System

There are the following two conditions for the INITiate subsystem commands.

1. INITiate:CONTInuous OFF condition

In this condition, the INITiate:IMMediate command must be sent via HP-IB to change the IDLE state to the WAIT FOR TRIGGER state after reading the measurement data by a controller.

2. INITiate:CONTInuous ON condition

In this condition, the IDLE state is automatically changed to the WAIT FOR TRIGGER state without using the INITiate:IMMediate command after reading the measurement data by a controller.

**Note**



When the ABORt command is sent under any state, the HP 4284A state is forced to the IDLE state. In this condition there are no data stored in the HP 4284A. If the FETCh? query is sent in this case, an error (error message -230: "Data corrupt or stale") will occur.

■ WAITING FOR TRIGGER state

In this state, the HP 4284A can accept a trigger command while in the remote condition. When the trigger command is sent to the HP 4284A, the state is automatically changed to the MEASUREMENT state.

There are three kinds of the trigger commands: \*TRG common command, Group Execution Trigger (GET) bus command, and TRIGger:IMMediate SCPI command. These commands are divided into two types in this trigger system. (Refer to Figure 7-10.)

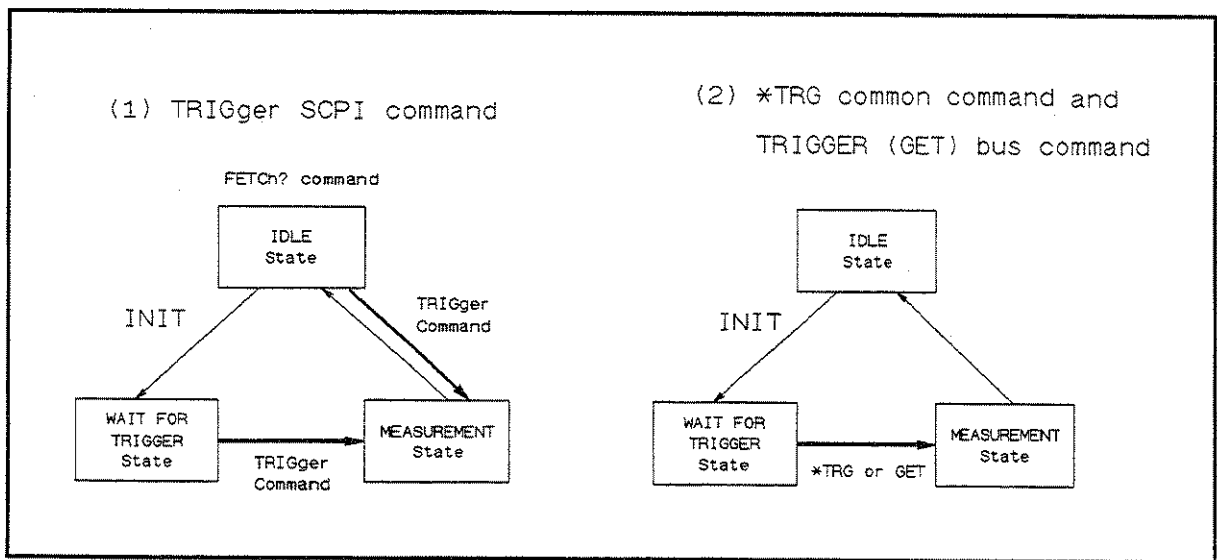

**Figure 7-10. Trigger System and Trigger Commands**

1. TRIGger:IMMediate SCPI command

Either the WAIT FOR TRIGGER state or the IDLE state, the HP 4284A is triggered by sending the TRIGger:IMMediate

command. When the measurement results can be read by a controller under the IDLE state, the FETCh? command must be used.

2. \*TRG common command or Group Execution Trigger (GET) bus command

In the WAIT FOR TRIGGER state, the HP 4284A is triggered by sending the \*TRG common command or GET bus command, and the measurement results in one trigger sequence can be read without sending the FETCh? command under the IDLE state. Thus,

“\*TRG” = “TRIGger:IMMediate;:FETCh?”

Figure 7-11 and Figure 7-12 shows the difference between the TRIGger:IMMediate command and \*TRG or GET command by using the sample programs.

```
10    ASSIGN @Meter TO 717
20    REMOTE @Meter
30    OUTPUT @Meter;"*RST;*CLS"
40    OUTPUT @Meter;"TRIG:SOUR BUS"
50    OUTPUT @Meter;"ABORT;:INIT"
60    OUTPUT @Meter;"TRIGGER:IMMEDIATE"
70    OUTPUT @Meter;"FETCh?"
80    ENTER @Meter;A,B,C
90    PRINT A,B,C
100   END
```

**Figure 7-11. TRIGger:IMMediate Command Sample Program**

```
10    ASSIGN @Meter TO 717
20    REMOTE @Meter
30    OUTPUT @Meter;"*RST;*CLS"
40    OUTPUT @Meter;"TRIG:SOUR BUS"
50    OUTPUT @Meter;"ABORT;:INIT"
60    OUTPUT @Meter;"*TRG"
70    ENTER @Meter;A,B,C
80    PRINT A,B,C
90    END
```

**Figure 7-12. \*TRG or GET Command Sample Program**

**Note**



When the HP 4284A is set to the EXT TRIG mode, and is triggered via the EXT TRIGGER connector or an optional interface under the remote condition, this trigger signal has the same effect as the TRIGger:IMMediate SCPI command.

■ MEASUREMENT state

In this state, DUT measurement is being performed. After the DUT measurement is completed, trigger state automatically changes to the IDLE state.

**Note**



The HP 4284A can only measure a DUT on one page of the *MEAS DISPLAY*, *BIN No. DISPLAY*, *BIN COUNT DISPLAY*, and *LIST SWEEP DISPLAY* pages under **DISPLAY FORMAT** even if the HP 4284A is in remote.

A typical flowchart of data transfer using the trigger system is shown below.

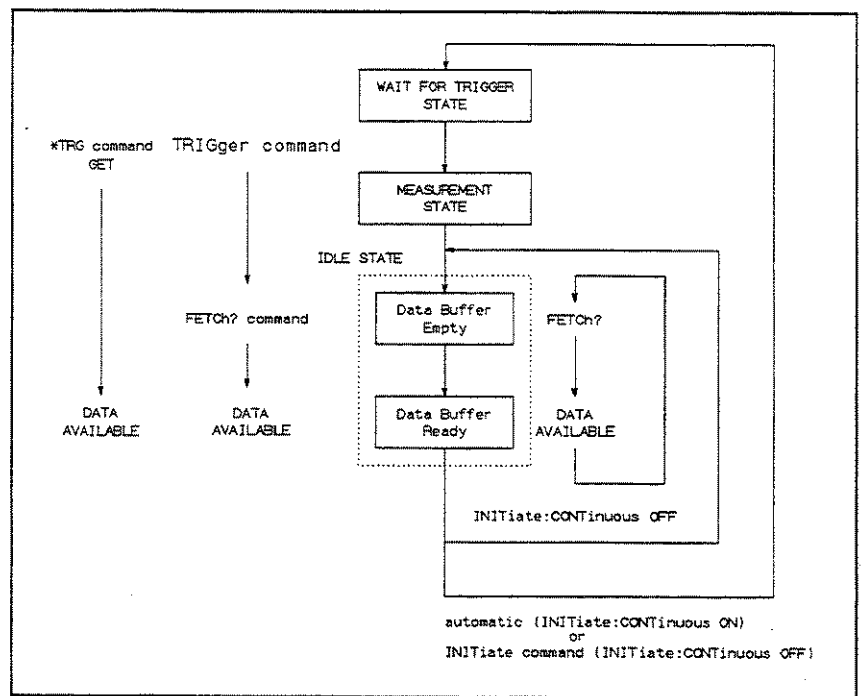

Figure 7-13. Triggering System and Data Transfer

## Data Buffer Memory

The HP 4284A has data buffer memory capability. The data buffer memory can hold up to 128 sets of measurement results, and all buffered measurement results are transferred at once to the controller using the `MEMORY:READ? DBUF` command as shown in Figure 7-14. So the overall data transmission time will be greatly reduced.

```

10  OPTION BASE 1
20  DIM D(5,4)
30  ASSIGN @Meter TO 717
40  REMOTE @Meter
50  OUTPUT @Meter;"*RST;*CLS"
60  OUTPUT @Meter;"FORM ASCII"
70  OUTPUT @Meter;"TRIG:SOUR BUS"
80  OUTPUT @Meter;"DISP:PAGE MEAS"
90  OUTPUT @Meter;"MEM:DIM DBUF,5"
100 OUTPUT @Meter;"MEM:FILL DBUF"
110 FOR I=1 TO 5
120   OUTPUT @Meter;"TRIGGER:IMMEDIATE"
130 NEXT I
140 OUTPUT @Meter;"MEM:READ? DBUF"
150 ENTER @Meter;D(*)
160 PRINT D(*)
170 OUTPUT @Meter;"MEM:CLE DBUF"
180 END

```

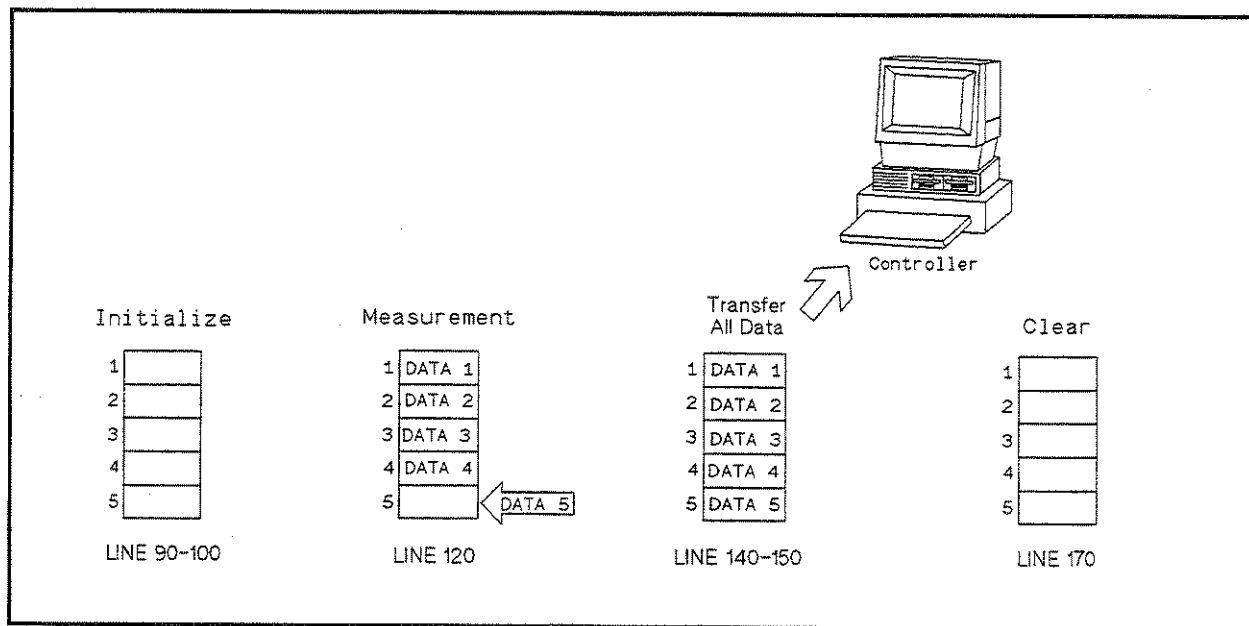

Figure 7-14. Buffered Data Transfer Sample Program and Description

## Note



When the data buffer memory is used, use the following rules.

- The measurement data after sending the `MEMory:FILL DBUF` command to use the data buffer memory capabilities are stored into the data buffer memory in the order measured.
- When triggering the HP 4284A using the `TRIGger:IMMEDIATE` command, the measurement results are entered only into the data buffer memory. So you don't have to clear the output buffer. When triggering using the `*TRG` or Group Execution Trigger (`GET`) command, the measurement results are entered into both the data buffer memory and the output buffer. So the output buffer must be cleared every time the HP 4284A's controller reads the measurement results. If you don't, error (-410, "Query INTERRUPTED") will occur.
- When the number of sets of measurement data exceeds the capacity of the buffer memory, all of the overflowed measurement data are lost, error 90: "Data Memory Overflow" occurs, and bit 3 of the standard event status register is set to 1. If you enter new data into the data buffer memory, the data buffer memory should first be cleared using the `MEMory:CLear DBUF` command.
- When the number of sets of measurement data is less than the capacity of the buffer memory, the following data, instead of the actual measurement data, are input to the unused portion of the data buffer memory.

```
<DATA A>:          9.9E37
<DATA B>:          9.9E37
<STATUS>:          -1
<BIN No.> or <IN/OUT>:  0
```

- When the data buffer memory capabilities are used during a list sweep measurement, the measurement result of one sweep point is stored as one set of measurement data. So when two or more sweep points are the same, and are adjacent, the HP 4284A measures the device once, but the number of data sets stored is equal to the number of sweep points.
- When the limit function of the list sweep measurement is set to OFF at a sweep point, `<IN/OUT>` is 0. Also when the comparator function is set to OFF, the `<BIN No.>` is 0.

---

There are two formats returned by `MEMory:READ? DBUF` query, ASCII and BINARY. Each format is described below. (The sample programs using the data buffer memory (returned format: ASCII and BINARY) are shown later in this chapter.)

### ■ ASCII Format

When the ASCII format is selected as a data format, the returned format is as follows. The `<DATA A>`, `<DATA B>`, `<STATUS>`,

<BIN No.>, or <IN/OUT> data format and meaning are the same as the ASCII data format described in "ASCII Format".

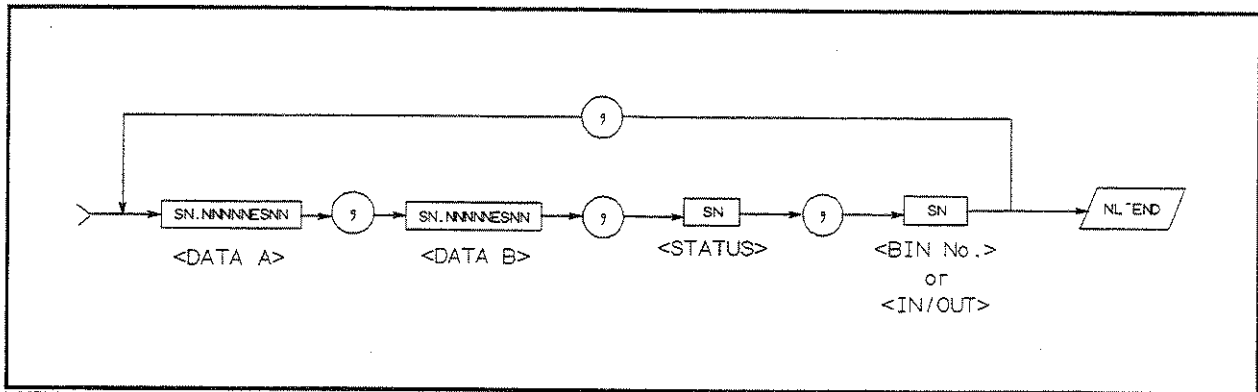

L1007012

Figure 7-15. ASCII Format (Buffer Memory)

■ BINARY Format

When the BINARY format is selected as the data format, the returned format is as follows. The <DATA A>, <DATA B>, <STATUS>, <BIN No.>, or <IN/OUT> data format and meaning are the same as the BINARY data format described in "Binary Format".

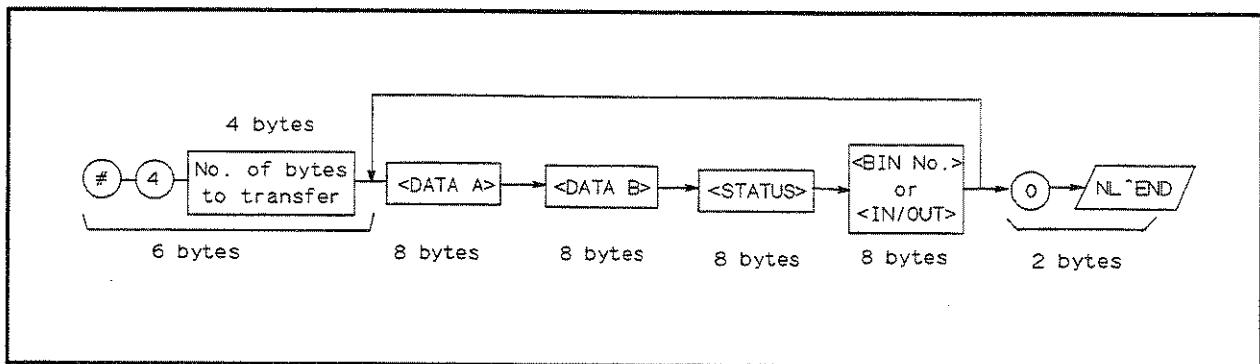

L1007013

Figure 7-16. BINARY Format (Buffer Memory)



Each data format has a different data transfer rate. Table 7-3 shows the typical time required from sending the FETCh? command or the MEM:READ? DBUF command to enter the data using the ENTER command with an HP 9000 series 300 computer.

**Table 7-3. Data Format and Data Transfer Time**

<b>Format</b>	<b>Data Type</b>	<b>Time</b>
ASCII	Data without BIN No.	10 ms
	Data with BIN No.	11 ms
	List Sweep Data (10 points)	75 ms
	Data Buffer Memory (128 sets of data)	960 ms
BINARY	Data without BIN No.	8 ms
	Data with BIN No.	8.8 ms
	List Sweep Data (10 points)	34 ms
	Data Buffer Memory (128 sets of data)	406 ms

## Status Byte

The status byte register contains an 8-bit word that the HP 4284A places on the HP-IB bus when it is serially polled.

The value of each bit indicates the status of an internal HP 4284A function, and two bits of the status byte are used as the summary bits of the registers (Refer to Figure 7-17). Bits are set to "1" and reset to "0".

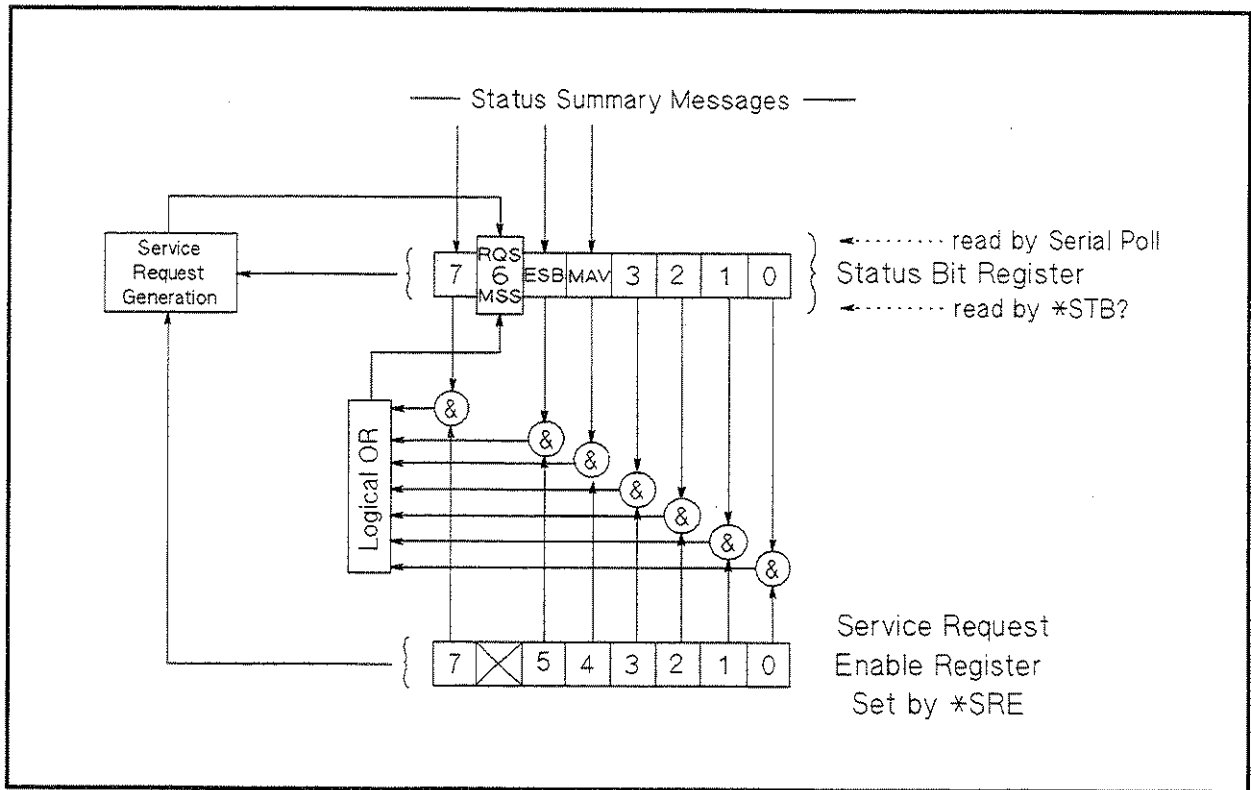

**Figure 7-17. Status Byte Register**

The individual bit assignments of the status byte and its bit weights are given in Table 7-4. When you read the status byte using HP-IB serial polling, the value is the sum of the total bit weights of all the high bits at the time you read the byte. After serial polling the status byte, only bit 6 (RQS) is cleared.

**Table 7-4. Status Byte Assignments**

Bit No.	Bit Weight	Description
7	128	<p>Operation Status Event Register Summary Bit</p> <p>This bit is set to "1" when one or more enabled bits of the operation status event register (discussed later in this chapter) has been set to "1". This bit is cleared when all bits of the operation status register are set to 0. (This bit isn't cleared by serial-polling.)</p>
6	64	<p>Bit 6 serves two functions RQS/MSS depending on how it is read.</p> <ul style="list-style-type: none"> <li>• RQS (Request Service) Bit</li> </ul> <p>If bit 6 is read in the serial polling process, it is treated as the RQS bit and is reset during the serial polling process.</p> <ul style="list-style-type: none"> <li>• MSS (Master Summary) Bit</li> </ul> <p>If bit 6 is read using the *STB? (status byte) query, it is treated as the MSS bit, and its value is not changed by the executing the *STB? query.</p> <p>To understand this operation think of the RQS and MSS bits as two inputs to a multiplexer (MUX) and the output of the MUX being bit 6 of the status byte register.</p> <p>During the serial polling operation the MUX path selected is from the service request generation circuit to bit 6, so bit 6 represents the RQS bit.</p> <p>During execution of the *STB? query the MUX path selected is from the master summary bit generation circuit to bit 6, so bit 6 represents the MSS bit.</p> <p>To clear the MSS bit, all bits of the original registers corresponding to the enabled summary bit in the status byte and the output buffer of the HP 4284A must be cleared. When you read the status byte including the MSS bit instead of the RQS bit, the *STB? query must be used. *STB? query clears neither the MSS bit nor the RQS bit.</p>
5	32	<p>Standard Event Status Register Summary Bit</p> <p>This bit is set to "1" when any enabled bits of the standard event status register (discussed later in this section) has been set to "1". This bit is cleared when all bits of the standard event status register are set to 0. (This bit isn't cleared by serial-polling.)</p>
4	16	<p>MAV (Message Available) Bit</p> <p>This bit is set to "1" whenever the HP 4284A has data available to output. This bit is cleared when the available data is read. (This bit isn't cleared by serial-polling.)</p>
3	8	always 0 (zero)
2	4	always 0 (zero)
1	2	always 0 (zero)
0	1	always 0 (zero)

## Enabling the Status Byte

A service request (SRQ) will be generated when any enable bit in the status byte register is set to "1". So to enable/disable any bits of the status byte register, you can set bits in the service request enable register. These bits correspond to bits in the status byte. When a bit is set in the service request enable register it enables that bit in the status byte to request service. To set bits in the service request enable register, the \*SRE command is used. The syntax of the \*SRE command is :

**\*SRE<n>**

Where, <n> : decimal number (0 to 255)

For example,

If <n> is equal to 34 (00100010 in binary), bit 1 and bit 5 are enabled, as follows.

Bit No. of Status Byte	MSB		LSB					
	7	6	5	4	3	2	1	0
Bit Pattern for *SRE command	0	0	1	0	0	0	1	0

In this case, when either bit 1 or bit 5 of the status byte is set to "1", a service request is generated.

The default setting is \*SRE 0 (all bits of the status byte are disabled).

Bit 6 (RQS) is non-maskable, and bits 0 to 3 are always 0 (zero). Thus, it is meaningless to mask these bits. (The \*SRE command's bit pattern for masking bit 6 is ignored, and the \*SRE command's bit pattern for masking bits 0 to 3 are accepted, but is meaningless.)

## Operation Status Register Group

The operation status register group provides operation status reporting by summarizing multiple events into a summary message (bit 7) of the status byte. The structure of the operation status register group is shown in Figure 7-18. The operation status register group consists of the standard operation status condition register, the standard operation status event register, and the standard operation status event enable register.

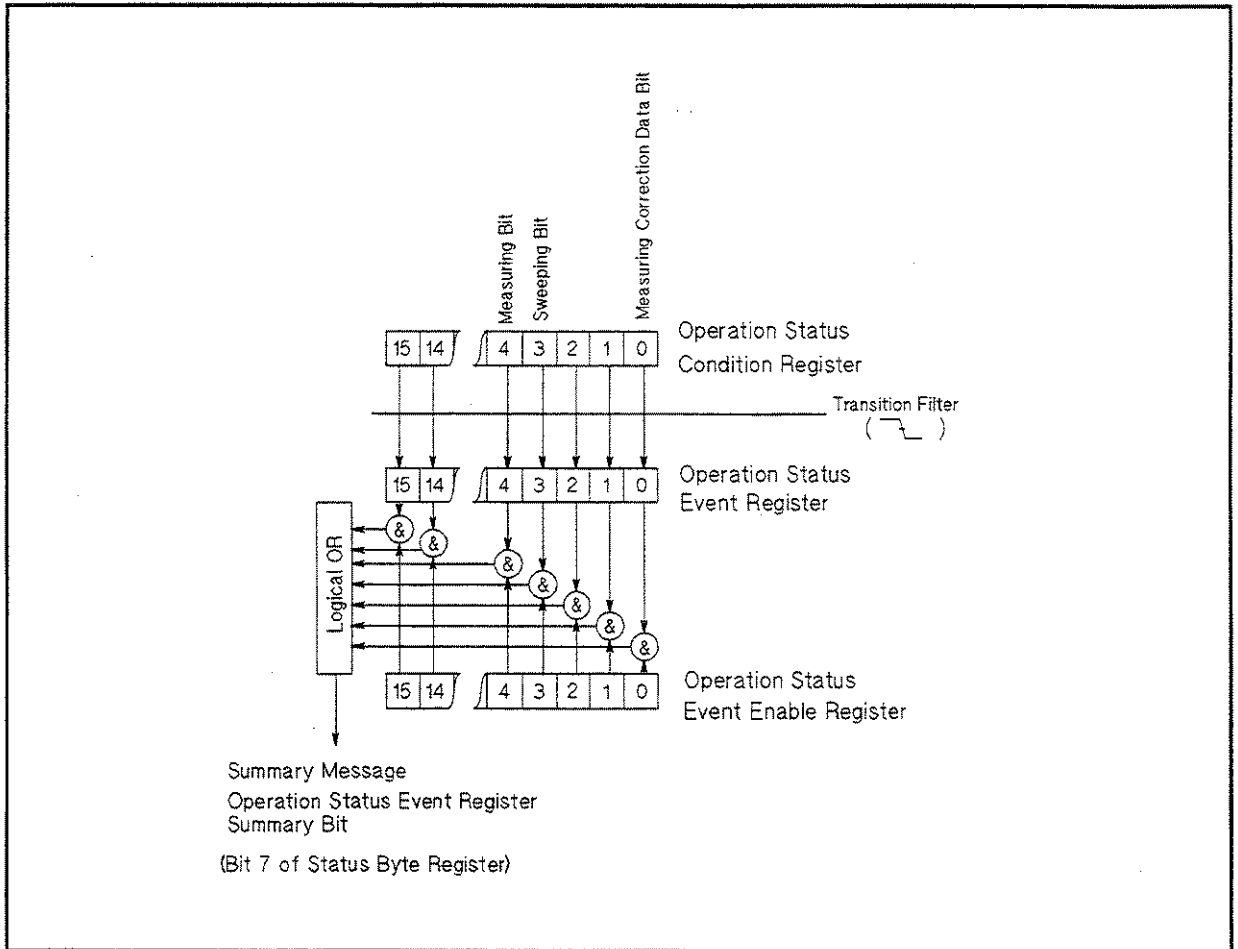

Figure 7-18. Operation Status Register Structure

### Standard Operation Status Condition Register

The standard operation status condition register consists of 16-bits, and reflects these states in its condition bits. So each time the HP 4284A's condition is changed, its condition bit is changed from "0" to "1", or from "1" to "0". Each bit of the standard operation status condition register is shown below.

**Table 7-5.**  
**Standard Operation Status Condition Register**  
**Assignments**

Bit No.	Bit Weight	Description
15 - 5		always 0 (zero)
4	16	Measuring Bit 0 : Measurement not in progress 1 : Measurement in progress
3	8	Sweeping Bit 0 : List sweep measurement not in progress 1 : List sweep measurement in progress
2	4	always 0 (zero)
1	2	always 0 (zero)
0	1	Measuring Correction Data Bit 0 : Correction data measurement not in progress 1 : Correction data measurement in progress

When you read the contents of the standard operation status condition register using the `STATUS:OPERation:CONDition?` query, the standard operation status condition register isn't cleared. To clear the standard operation status condition register, the device's condition state should only be changed by setting all bits to 0.

### Standard Operation Status Event Register

The standard operation status event register consists of 16-bit registers, and each event bit in the event register corresponds to a condition bit in the standard operation status condition register. Each event bit is set to "1" when its corresponding bit in the condition register makes a "1" to "0" transition only, a negative transition filter is used.

**Table 7-6.**  
**Standard Operation Status Event Register Assignments**

Bit No.	Bit Weight	Description
15 - 5		always 0 (zero)
4	16	Measurement Complete Bit  This bit is set to "1" when a single point measurement is completed.
3	8	List Sweep Measurement Complete Bit  This bit is set to "1" when a last sweep point measurement of the list sweep measurement is completed.
2	4	always 0 (zero)
1	2	always 0 (zero)
0	1	Correction Data Measurement Complete Bit  This bit is set to "1" when the OPEN, SHORT, or LOAD correction data measurement is completed.

When you read the contents of the operation status event register using the `STATUS:OPERation:EVENT?` query, the operation status event register is cleared, and bit 7 of the status byte is set to "0".

### Standard Operation Status Event Enable Register

A operation status summary bit (bit 7 of the status byte) will be set when any enable bit in the operation status event register is set to "1". To enable/disable any bits of the operation status event register, the standard operation event enable register is used. The standard operation event enable register is the same length as the standard operation event register. When a bit is set in the operation status event register it enables the corresponding bit in the operation event register to request service. To set any bit in the operation status event enable register, The `STATUS:OPERation:ENABLE` command is used. The syntax of the `STATUS:OPERation:ENABLE` command is:

`STATUS:OPERation:ENABLE<n>`

Where, `<n>` : decimal number (0 to 65535)

For example,

If `<n>` is equal to 8 (0000000000001000 in binary), bit 3 is enabled, as follows.

Bit No. of Event Register	MSB															LSB	
	15	14	13	12	11	10	9	8	7	6	5	4	3	2	1	0	
Event Enable Register	0	0	0	0	0	0	0	0	0	0	0	0	1	0	0	0	

In this case, when either bit 3 of the operation status event register is set to "1", the operation status summary bit (bit 7 of the status byte) is set to "1".

The default setting is `STATUS:OPERation:ENABLE 0` (all bits of the operation status event register are disabled).

Bit 1, bit 2, and bits 5 to 15 are always 0 (zero). Thus, it is meaningless to mask these bits.



## Standard Event Status Register

The standard event status register contains the 16-bits of the operation status report which is defined in IEEE 488.2-1987 as shown in Figure 7-19. If one or more enable bits of the standard event status register is set to "1", bit 5 (standard event status register summary bit) of the status byte is set to "1". Each bit of the standard event status register is shown on the next page.

When each error bit (bit 2, bit 3, bit 4, and bit 5) of the standard event status register is set to "1", an error message with the following error numbers is input to the error queue. For details, refer to Appendix B.

Bit No.	Error No.
5 (Command Error)	-100 to -178
4 (Execution Error)	-211 to -230
3 (Device Specific Error)	10 to 101, -310, -311
2 (Query Error)	-400 to -440

When you read the contents of the standard event status register using the \*ESR? command, the standard event status register is cleared, and bit 5 of the status byte is set to "0".

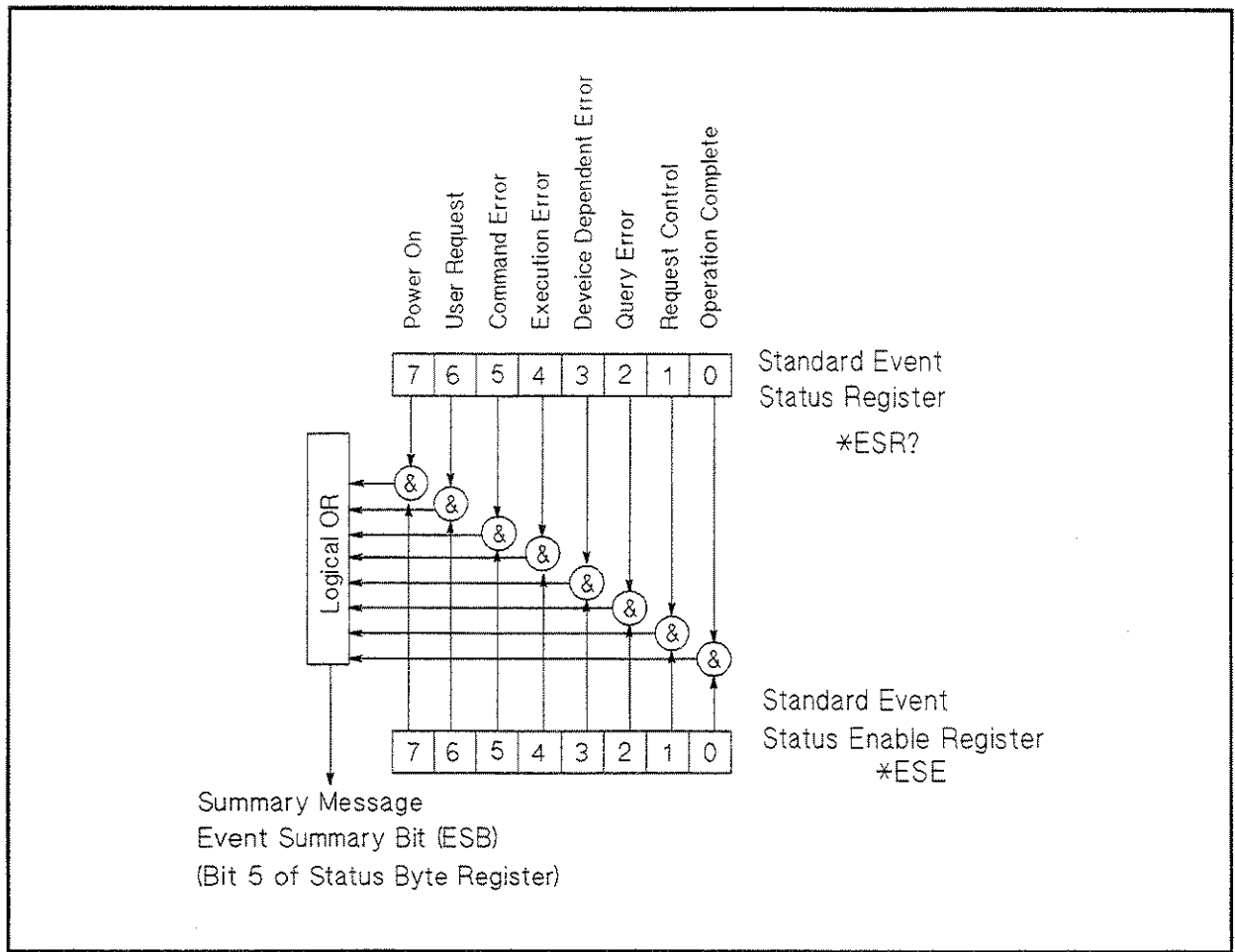

L1007016

**Figure 7-19. Standard Event Status Register**

**Table 7-7. Standard Event Status Register Assignments**

Bit No.	Bit Weight	Description
7	128	<p>Power On (PON) Bit</p> <p>This bit is set to "1" when the HP 4284A's power supply has been turned OFF and then ON since the last time this register was read.</p>
6	64	<p>User Request (URQ) Bit</p> <p>always 0 (zero)</p>
5	32	<p>Command Error (CME) Bit</p> <p>This bit is set to "1" if the following the command errors occur. An IEEE 488.2 syntax error occurred. The device received a Group Execute Trigger (GET) inside a program message.</p>
4	16	<p>Execution Error (EXE) Bit</p> <p>This bit is set to "1" when a parameter following a header of a HP-IB command was evaluated by the HP 4284A as being outside of its legal input range or is otherwise inconsistent with the HP 4284A's capabilities.</p>
3	8	<p>Device Specific Error (DDE) Bit</p> <p>This bit is set to "1" when a device dependent error (except for the command error, query error, and execution error) has occurred.</p>
2	4	<p>Query Error (QYE) Bit</p> <p>This bit is set to "1" when reading data from the output buffer and no data was present, or when the data was lost.</p>
1	2	<p>Request Control (RQC) Bit</p> <p>always 0 (zero)</p>
0	1	<p>Operation Complete (OPC) Bit</p> <p>This bit is set to "1" when the HP 4284A has completed all selected pending operations before sending the *OPC command.</p>

## Enabling the Event Status Register

An event status register summary bit (bit 6 of the status byte) will be set to "1" when any enable bit in the standard event status register is set to "1". To enable/disable any bits of the standard event status register, you can set the bits in the standard event status enable register. These bits correspond to bits in the standard event status enable register. When a bit is set in the standard event status enable register it enables the corresponding bit in the standard event status register and sets bit 6 of the status byte (event status register summary bit) to "1". To set any bit in the standard event status enable register, the \*ESE command is used. The syntax of the \*ESE command is:

\*ESE<n>

Where, <n> : decimal number (0 to 255)

For example,

If <n> is equal to 34 (00100010), bit 1 and bit 5 are enabled, as follows.

Bit No. of Event Status Register	MSB	LSB
	7	6 5 4 3 2 1 0
Bit Pattern for *ESE command	0 0 1 0 0 0 1 0	

When either bit 1 or 5 of the standard event status register is set to "1", the event status register summary bit (bit 6 of the status byte) is set to "1".

The default setting is \*ESE 0 (all bits of the standard event status byte are disabled).

Bits 1 and 6 of the event status register are always 0 (zero). Thus masking these bits has no meaning.

## Sample Programs

This paragraph provides some HP BASIC sample programs for control set and data transfer.

### Control Settings

The HP 4284A has four control setting pages under **MEAS SETUP** as follows.

- *MEAS SETUP*
- *CORRECTION*
- *LIMIT TABLE SETUP*
- *LIST SWEEP SETUP*

So, the control settings on each page should be set. The sample programs are shown in the order of the preceding list starting on the next page.

#### Note



In case of the front panel operation, the available control settings depends on the display page. But in the case of HP-IB operation, all of control settings can be set without concern to the page being displayed.

#### Note



When the HP 4284A measures a DUT, one of the following pages under **DISPLAY FORMAT** must be used even if the HP 4284A is in the remote condition.

- *MEAS DISPLAY*
- *BIN No. DISPLAY*
- *BIN COUNT DISPLAY*
- *LIST SWEEP DISPLAY*

## MEAS SETUP page

This sample program sets all of the setting controls on the *MEAS SETUP* page.

```
10  ASSIGN @Meter TO 717
20  REMOTE @Meter
30  OUTPUT @Meter;"DISP:PAGE MSET"
40  OUTPUT @Meter;"DISP:LINE ""Control Example""
50  OUTPUT @Meter;"FUNC:IMP ZTD"
60  OUTPUT @Meter;"FREQ 1MHZ"
70  OUTPUT @Meter;"VOLT 1V"
80  OUTPUT @Meter;"TRIG:SOUR BUS"
90  OUTPUT @Meter;"AMPL:ALC ON"
100 OUTPUT @Meter;"OUTP:HPOW ON"
110 OUTPUT @Meter;"OUTP:DC:ISOL ON"
120 OUTPUT @Meter;"FUNC:IMP:RANG 10KOHM"
130 OUTPUT @Meter;"BIAS:VOLT 5"
140 OUTPUT @Meter;"APER LONG,4"
150 OUTPUT @Meter;"FUNC:SMON:VAC ON"
160 OUTPUT @Meter;"FUNC:SMON:IAC ON"
170 OUTPUT @Meter;"TRIG:DEL 5"
180 OUTPUT @Meter;"FUNC:DEV1:MODE ABS"
190 OUTPUT @Meter;"FUNC:DEV2:MODE ABS"
200 OUTPUT @Meter;"FUNC:DEV1:REF 10000"
210 OUTPUT @Meter;"FUNC:DEV2:REF 1"
220  END
```

Figure 7-20. MEAS SETUP Page

## CORRECTION page

This sample program sets the setting controls on the *CORRECTION* page after the correction data have already been stored.

```
10  ASSIGN @Meter TO 717
20  REMOTE @Meter
30  OUTPUT @Meter;"DISP:PAGE CSET"
40  OUTPUT @Meter;"CORR:OPEN STAT ON"
50  OUTPUT @Meter;"CORR:SHOR:STAT ON"
60  OUTPUT @Meter;"CORR:LOAD:STAT ON"
70  OUTPUT @Meter;"CORR:LENG 1"
80  OUTPUT @Meter;"CORR:METH MULT"
90  OUTPUT @Meter;"CORR:USE 10"
100 OUTPUT @Meter;"CORR:LOAD:TYPE CPD"
110 OUTPUT @Meter;"SPOT1:STAT ON"
120 OUTPUT @Meter;"SPOT2:STAT ON"
130 OUTPUT @Meter;"SPOT3:STAT ON"
140  END
```

Figure 7-21. CORRECTION page

## LIMIT TABLE SETUP page

This sample program sets all of the setting controls on the *LIMIT TABLE SETUP* page.

```
10  ASSIGN @Meter TO 717
20  REMOTE @Meter
30  OUTPUT @Meter;"DISP:PAGE LTAB"
40  OUTPUT @Meter;"FUNC:IMP CPD"
50  OUTPUT @Meter;"COMP:TOL:NOM 10E-12"
60  OUTPUT @Meter;"COMP ON"
70  OUTPUT @Meter;"COMP:ABIN ON"
80  OUTPUT @Meter;"COMP:MODE PTOL"
90  OUTPUT @Meter;"COMP:TOL:BIN1 -1,1"
100 OUTPUT @Meter;"COMP:TOL:BIN2 -2,2"
110 OUTPUT @Meter;"COMP:TOL:BIN3 -3,3"
120 OUTPUT @Meter;"COMP:TOL:BIN4 -4,4"
130 OUTPUT @Meter;"COMP:TOL:BIN5 -5,5"
140 OUTPUT @Meter;"COMP:TOL:BIN6 -6,6"
150 OUTPUT @Meter;"COMP:TOL:BIN7 -7,7"
160 OUTPUT @Meter;"COMP:TOL:BIN8 -8,8"
170 OUTPUT @Meter;"COMP:TOL:BIN9 -9,9"
180 OUTPUT @Meter;"COMP:SLIM 0,0.00005"
190  END
```

Figure 7-22. LIMIT TABLE SETUP page



## LIST SWEEP SETUP page

This sample program sets all of the setting controls on the *LIST SWEEP SETUP* page.

```
10  ASSIGN @Meter TO 717
20  REMOTE @Meter
30  OUTPUT @Meter;"DISP:PAGE LSET"
40  OUTPUT @Meter;"LIST:MODE SEQ"
50  OUTPUT @Meter;"LIST:FREQ 1KHZ,2KHZ,5KHZ,10KHZ,20KHZ,50KHZ,100KHZ,200KHZ,500KHZ,1MHZ"
60  OUTPUT @Meter;"LIST:BAND1 A,100,200"
70  OUTPUT @Meter;"LIST:BAND2 A,100,200"
80  OUTPUT @Meter;"LIST:BAND3 A,100,200"
90  OUTPUT @Meter;"LIST:BAND4 A,100,200"
100 OUTPUT @Meter;"LIST:BAND5 A,100,200"
110 OUTPUT @Meter;"LIST:BAND6 A,100,200"
120 OUTPUT @Meter;"LIST:BAND7 A,100,200"
130 OUTPUT @Meter;"LIST:BAND8 A,100,200"
140 OUTPUT @Meter;"LIST:BAND9 A,100,200"
150 OUTPUT @Meter;"LIST:BAND10 A,100,200"
160  END
```

Figure 7-23. LIST SWEEP SETUP

## Data Transfer Examples

The HP 4284A has two data transfer formats, ASCII and BINARY. This paragraph includes sample programs for each.

### ASCII Format

The sample programs using the ASCII data format are in the following three patterns.

- Measurement data transfer when the comparator function of the limit table is set to ON. (Figure 7-24)
- Measurement data transfer using the buffer memory function when the comparator function of the limit table is set to ON. (Figure 7-25)
- Measurement data transfer when the list sweep measurement is performed. (Figure 7-26)

```
10  ASSIGN @Meter TO 717
20  REMOTE @Meter
30  OUTPUT @Meter;"*RST;*CLS"          !\
40  OUTPUT @Meter;"FORM ASCII"        ! Setup
50  OUTPUT @Meter;"TRIG:SOUR BUS"     ! Measurement
60  OUTPUT @Meter;"COMP ON"           ! Condition
70  OUTPUT @Meter;"INIT:CONT ON"     !/
80  FOR I=0 TO 9
90      TRIGGER @Meter                 ! Perform measurement
100     ENTER @Meter;A,B,C,D           ! Transfer data to controller
110     PRINT A,B,C,D                 ! Print measurement result
120  NEXT I
130  END
```

Figure 7-24. Sample Program (Comparator) Using ASCII Format

```

10 DIM D(127,3)
20 ASSIGN @Meter TO 717
30 REMOTE @Meter
40 OUTPUT @Meter;"*RST;*CLS"           !\
50 OUTPUT @Meter;"FORM ASCII"         ! Setup
60 OUTPUT @Meter;"MEM:DIM DBUF,128"   ! Measurement
70 OUTPUT @Meter;"TRIG:SOUR BUS"      ! Condition
80 OUTPUT @Meter;"COMP ON"            !/
90 OUTPUT @Meter;"MEM:FILL DBUF"      ! Enable the buffer memory
100 FOR I=0 TO 127
110   OUTPUT @Meter;"TRIGGER"          ! Perform measurement 128 times
120 NEXT I
130 OUTPUT @Meter;"MEM:READ? DBUF"    !\
140 ENTER @Meter;D(*)                 !/Transfer the measurement result
150 PRINT D(*)                         ! Display the measurement result
160 OUTPUT @Meter;"MEM:CLE DBUF"      ! Disable the buffer memory
170 END

```

Figure 7-25. Sample Program (Buffer Memory) Using ASCII Format

```

10 DIM D(6,3)
20 ASSIGN @Meter TO 717
30 REMOTE @Meter
40 OUTPUT @Meter;"*RST;*CLS"           !\
50 OUTPUT @Meter;"FORM ASCII"         ! |
60 OUTPUT @Meter;"TRIG:SOUR BUS"      ! |
70 OUTPUT @Meter;"LIST:MODE SEQ"      ! |
80 OUTPUT @Meter;"LIST:FREQ 1KHZ,2KHZ,5KHZ,10KHZ,20KHZ,50KHZ,100KHZ"
90 OUTPUT @Meter;"LIST:BAND1 A,100,200"! Setup
100 OUTPUT @Meter;"LIST:BAND2 A,100,200"! Measurement
110 OUTPUT @Meter;"LIST:BAND3 A,100,200"! Condition
120 OUTPUT @Meter;"LIST:BAND4 A,100,200"! |
130 OUTPUT @Meter;"LIST:BAND5 A,100,200"! |
140 OUTPUT @Meter;"LIST:BAND6 A,100,200"! |
150 OUTPUT @Meter;"LIST:BAND7 A,100,200"! |
160 OUTPUT @Meter;"DISP:PAGE LIST"    ! |
170 OUTPUT @Meter;"INIT:CONT ON"      !/
180 TRIGGER @Meter                     ! Perform measurement
190 ENTER @Meter;D(*)                 ! Transfer measurement data
200 PRINT D(*)                         ! Display measurement data
210 END

```

Figure 7-26. Sample Program (List Sweep) Using ASCII Format

## BINARY Format

The sample programs using the BINARY data format are in the following three patterns. (The contents of the sample programs are same as the contents of the ASCII format's sample programs.)

- Measurement data transfer when the comparator function of the limit table is set to ON. (Figure 7-27)
- Measurement data transfer using the buffer memory function when the comparator function of the limit table is set to ON. (Figure 7-28)
- Measurement data transfer when the list sweep measurement is performed. (Figure 7-29)

```
10  INTEGER Header_1,Header_2,Term
20  ASSIGN @Meter TO 717;FORMAT ON
30  ASSIGN @Binary TO 717;FORMAT OFF
40  REMOTE @Meter
50  OUTPUT @Meter;"*RST;*CLS"           !\
60  OUTPUT @Meter;"FORM REAL,64"       ! Setup
70  OUTPUT @Meter;"TRIG:SOUR BUS"      ! Measurement
80  OUTPUT @Meter;"COMP ON"           ! Condition
90  OUTPUT @Meter;"INIT:CONT ON"      !/
100 FOR I=0 TO 9
110   TRIGGER @Meter                   ! Perform measurement
120   ENTER @Binary;Header_1,Header_2,A,B,C,D,Term! Transfer data
130   PRINT A,B,C,D                   ! Display measurement result
140 NEXT I
150 END
```

Figure 7-27. Sample Program (Comparator) Using BINARY Format

```

10  INTEGER Header_1,Header_2,Header_3,Term
20  DIM D(127,3)
30  ASSIGN @Meter TO 717;FORMAT ON
40  ASSIGN @Binary TO 717;FORMAT OFF
50  REMOTE @Meter
60  OUTPUT @Meter;"*RST;*CLS"          !\
70  OUTPUT @Meter;"FORM REAL,64"      ! Setup
80  OUTPUT @Meter;"MEM:DIM DBUF,128"  ! Measurement
90  OUTPUT @Meter;"TRIG:SOUR BUS"     ! Condition
100 OUTPUT @Meter;"COMP ON"           !/
110 OUTPUT @Meter;"MEM:FILL DBUF"     ! Enable the buffer memory
120 FOR I=0 TO 127
130   OUTPUT @Meter;"TRIGGER"         ! Perform the measurement 128 times
140 NEXT I
150 OUTPUT @Meter;"MEM:READ? DBUF"    ! Transfer data
160 ENTER @Binary;Header_1,Header_2,Header_3,D(*),Term
170 PRINT D(*)                        ! Display the measurement result
180 OUTPUT @Meter;"MEM:CLE DBUF"     ! Disable the buffer memory
190  END

```

Figure 7-28. Sample Program (Buffer Memory) Using BINARY Format

```

10  INTEGER Header_1,Header_2,Header_3,Term
20  DIM D(6,3)
30  ASSIGN @Meter TO 717;FORMAT ON
40  ASSIGN @Binary TO 717;FORMAT OFF
50  REMOTE @Meter
60  OUTPUT @Meter;"*RST;*CLS"          !\
70  OUTPUT @Meter;"FORM REAL,64"      ! |
80  OUTPUT @Meter;"TRIG:SOUR BUS"     ! |
90  OUTPUT @Meter;"LIST:MODE SEQ"     ! |
100 OUTPUT @Meter;"LIST:FREQ 1KHZ,2KHZ,5KHZ,10KHZ,20KHZ,50KHZ,100KHZ"
110 OUTPUT @Meter;"LIST:BAND1 A,100,200"! Setup
120 OUTPUT @Meter;"LIST:BAND2 A,100,200"! List
130 OUTPUT @Meter;"LIST:BAND3 A,100,200"! Sweep
140 OUTPUT @Meter;"LIST:BAND4 A,100,200"! Table
150 OUTPUT @Meter;"LIST:BAND5 A,100,200"! |
160 OUTPUT @Meter;"LIST:BAND6 A,100,200"! |
170 OUTPUT @Meter;"LIST:BAND7 A,100,200"! |
180 OUTPUT @Meter;"DISP:PAGE LIST"    ! |
190 OUTPUT @Meter;"INIT:CONT ON"      !/
200 TRIGGER @Meter                    ! Perform measurement
210 ENTER @Binary;Header_1,Header_2,Header_3,D(*),Term! Transfer measurement data
220 PRINT D(*)                        ! Display measurement data
230  END

```

Figure 7-29. Sample Program (List Sweep) Using BINARY Format



## Command Reference

---

### Introduction

This chapter provides descriptions of all the HP 4284A's available HP-IB commands which correspond to Standard Commands for Programmable Instruments(SCPI) command sets, listed in functional subsystem order. Use this chapter as a reference. Each command description contains the following paragraphs:

<b>Field</b>	A field name corresponding to a SCPI command.
<b>Command Syntax</b>	The way you must type in the command, including all of the required and optional parameters.
<b>Query Syntax</b>	The way you must type in the query, including all of the required and optional parameters.
<b>Query Response</b>	HP 4284A's response data format.
<b>Example</b>	A case serving as a typical model for the more common uses of the command.

### Notation Conventions and Definitions

The following conventions and definitions are used in this chapter to describe HP-IB operation.

- < > Angular brackets enclose words or characters that are used to symbolize a program code parameter or an HP-IB command.
- [ ] Square brackets indicates that the enclosed items are optional. The square brackets with the asterisk (for example, [*<value>* \*]) means the enclosed item (*<value>*) repeats until the maximum counted number.
- { } When several items are enclosed by braces, one and only one of these elements may be selected.

The following definitions are used:

- <NL^END> Terminators (the EOI line is asserted by New Line or ASCII Line Feed character (decimal 10))
- White space Single ASCII character (0-9, 11-32 decimal)  
For example, Carriage Return (13 decimal) or Space (32 decimal)

## Command Structure

The HP 4284A commands are divided into two types: HP-IB common commands and SCPI commands. The HP-IB common commands are defined in IEEE std. 488.2-1987, and these commands are common for all devices. The SCPI commands are used to control all of the HP 4284A's functions. The SCPI commands are tree structured three levels deep. (The highest level commands are called the subsystem commands in this manual.) So the lower level commands are legal only when the subsystem commands have been selected. A colon (:) is used to separate the higher level commands and the lower level commands. See Figure 8-1 for a sample.

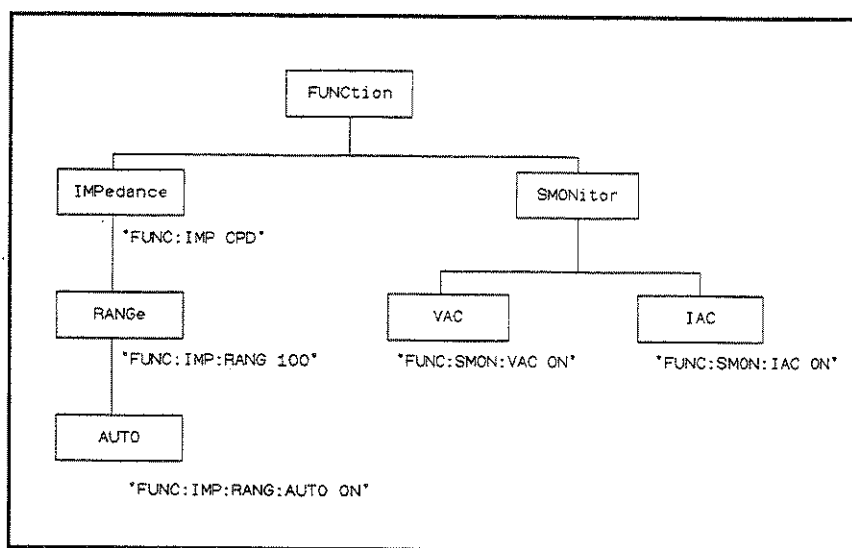

Figure 8-1. Command Tree Example



The basic rules of the command tree are as follows.

- Letter case (upper and lower) is ignored.

For example,

`FUNC:IMP CPD = func:imp CpD = FuNc:IMp cPd`

- Spaces (␣ used to indicate a space) must not be placed before and/or after the colon (:).

For example,

(wrong) `FUNCL␣:␣LIMP CPD` → (right) `FUNC:IMP CPD`

- The command can be completely spelled out or in abbreviated. (The rules for command abbreviation are described later in this section)

For example,

`FUNCTION:IMPEDANCE CPD = FUNC:IMP CPD`

- The command header should be followed by a question mark (?) to generate a query for that command.

For example,

`FUNC:IMP?`

The semicolon (;) can be used as a separator to execute multiple commands on a single line. The multiple command rules are as follows.

- Commands at the same level and in the same subsystem command group can be separated by a semicolon (;) on a multiple command line.

For example,

`FUNC:SMON:VAC ON;IAC ON`

- To restart commands from the highest level, a semicolon (;) must be used as the separator, and then a leading colon (:), which shows that the restarted command is a command at the top of the command tree, must follow.

For example,

`FUNC:IMP CPD;:FUNC:SMON:VAC ON`

- The HP-IB common commands can restart only after a semicolon on a multiple command line.

For example,

`FUNC:IMP CPD;*SRE 32`

- The HP-IB common commands keeps the previous commands level in a multiple command line.

For example,

`FUNC:IMP CPD;*SRE 32;SMON:VAC ON;IAC ON`

---

## Command Abbreviations

Every command and character parameter has at least two forms, a short form and a long form. In some cases they will be the same. The short form is obtained using the following rules.

- If the long form has four characters or less, the long form and short form are the same.
- If the long form has more than 4 characters,
  - If the 4th character is a vowel, the short form is the first 3 characters of the long form.
  - If the 4th character is not a vowel, the short form is the first 4 characters.

For example:

BIAS abbreviates to BIAS.  
TRIGger abbreviates to TRIG.  
LEVel abbreviates to LEV.  
FREQuency abbreviates to FREQ.

- If the long form mnemonic is defined as a phrase rather than a single word, then the long form mnemonic is the first character of the first word(s) followed by the entire last word. The above rules, when the long form mnemonic is a single word, are then applied to the resulting long form mnemonic to obtain the short form.

For example:

Percent TOLerance abbreviates to PTOL. (The long form is PTOLERANCE.)

### Note



---

The HP 4284A accepts the three forms of the same SCPI commands: all upper case, all lower case, and mixed upper and lower case.

---

## Header and Parameters

The HP-IB control commands consists of a command header and parameters. (See the following.)

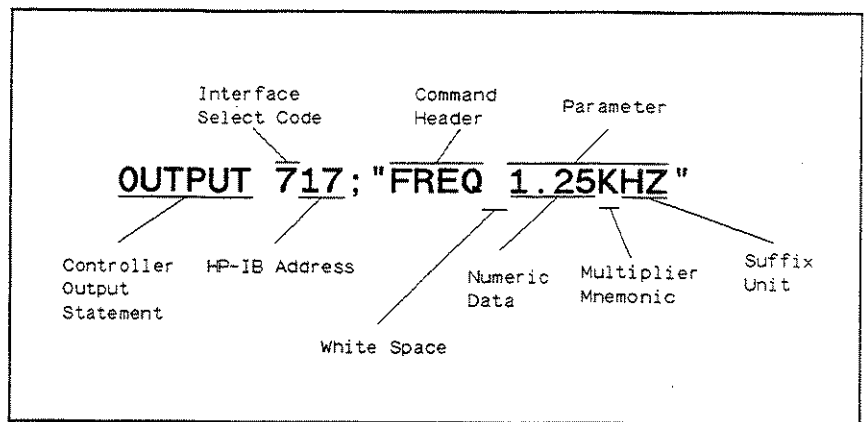

Figure 8-2. Command Header and Parameters

Headers can be of the long form or the short form. The long form allows easier understanding of the program code and the short form allows more efficient use of the computer. Parameters may be of two types as follows.

- Character Data and String Data

Character data consists of ASCII characters. The abbreviation rules are the same as the rules for command headers. String data consists of ASCII characters enclosed by double quotes (" ").

- Numeric Data

Integer (NR1), fixed point (NR2), or floating point (NR3). These three numeric data types are defined in IEEE 488.2-1988. (Refer to the syntax diagrams on the next page.) The available range for numeric data is  $\pm 9.9E37$ .

NR1

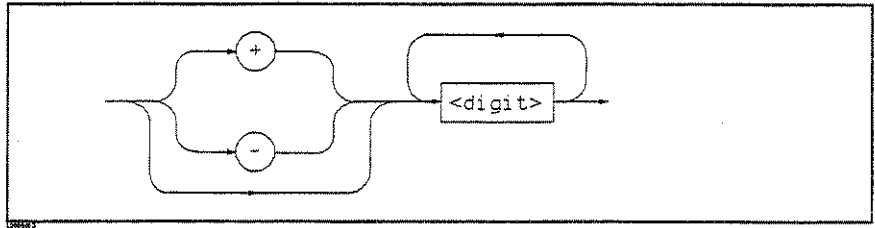

For example, 123  
+123  
-12345

NR2

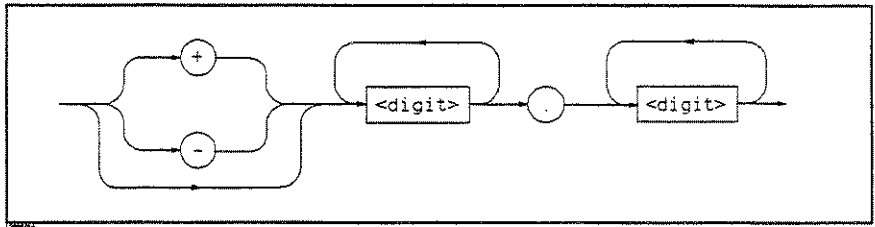

For example, 12.3  
+1.234  
-123.4

NR3

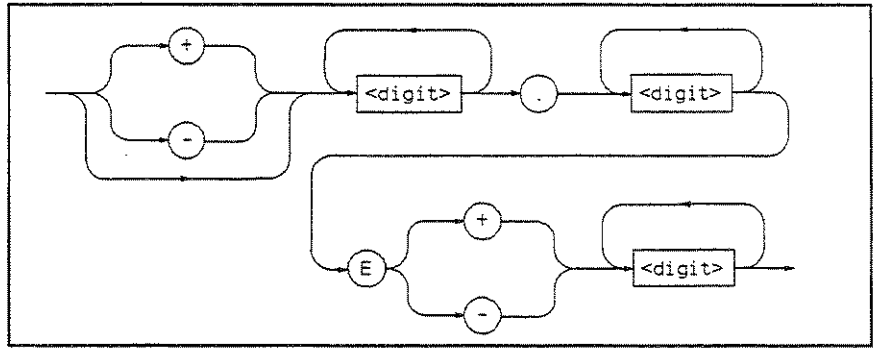

For example, 1.23E+5  
123.4E-56

When numeric data is used as a parameter, the suffix multiplier mnemonics and suffix units (The suffix multiplier must be used with the suffix unit.) can be used for some commands as follows.

**Table 8-1. Multiplier Mnemonics**

Definition	Mnemonic
1E18 (EXA)	EX
1E15 (PETA)	PE
1E12 (TERA)	T
1E9 (GIGA)	G
1E6 (MEGA)	MA <sup>1</sup>
1E3 (KILO)	K
1E-3 (MILLI)	M
1E-6 (MICRO)	U
1E-9 (NANO)	N
1E-12 (PICO)	P
1E-15 (FEMTO)	F
1E-18 (ATTO)	A

<sup>1</sup>: M or MA is available only when the suffix unit is HZ.

**Table 8-2. Suffix Units and Available Commands**

Suffix Unit	Available Command
HZ	FREQuency LIST:FREQuency CORRection:SPOT<n>:FREQuency
V	VOLTage BIAS:VOLTage LIST:VOLTage LIST:BIAS:VOLTage
A	CURRent BIAS:CURRent LIST:CURRent LIST:BIAS:CURRent
OHM	FUNcTion:IMPedance:RANGe
M	CORRection:LENGth
S	TRIGger:DELay

The header separator is placed between the header and its parameter. This is one white space which is defined as a single ASCII character in the range 0 through 9 or 11 through 32 decimal. This includes the ASCII space (32 decimal) code.

## Terminators

There are two kinds of the terminators: program message terminators and response message terminators.

### Program Message Terminators

The HP 4284A responds to the input data message when it is in the remote mode (REN control line true) and is addressed to listen. The input data message contain a string of HP-IB commands and terminators. The HP-IB commands are executed after the terminators are received. The terminators defined as follows.

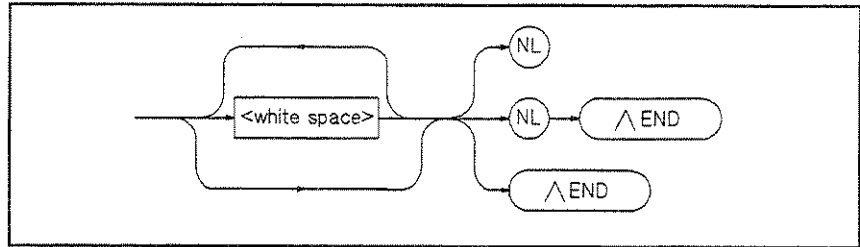

**White Space** Single ASCII character (0 to 9, 11 to 32 decimal)  
For example, Carriage Return (13 decimal) or Space (32 decimal)

**NL** New Line (Line Feed (10 decimal))  
**^END** EOI is asserted with the last byte is sent.

### Response Message Terminators

The HP 4284A can send an output data message when it is in the local or remote modes, when it is addressed to talk, or in the talk-only mode. The data message contains the message returned by the query command and the terminators. Terminators defined as follows.

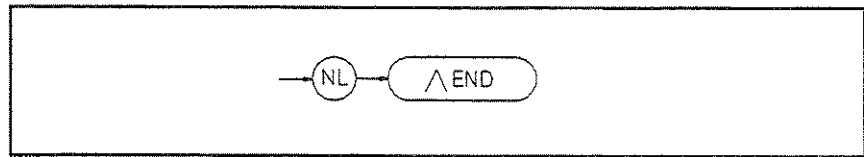

The EOI line is asserted while the New Line or Line Freed character (10 decimal) is being sent on the bus.

## Command Reference

All commands in this reference are fully explained and listed in the following functional command order.

### HP 4284A Subsystem Commands

- DISPlay
- FREQuency
- VOLTagE
- CURRent
- AMPLitude
- OUTPut
- BIAS
- FUNCTion
- LIST
- APERTure
- TRIGger
- INITiate
- FETCh?
- ABORT
- FORMat
- MEMory
- CORRection
- COMParator
- Mass MEMory
- SYSTem
- STATus

### HP-IB Common Commands

- \*CLS
- \*ESE
- \*ESR?
- \*SRE
- \*STB?
- \*IDN?
- \*OPC?
- \*WAI
- \*RST
- \*TST?
- \*TRG
- \*LRN?
- \*OPT?

The explanation of each subsystem command is patterned as follows.

1. Subsystem command name
2. Command Tree (Subsystem command only)
3. Compound Command Name
4. Command Description
5. Command Syntax
6. Example Using The Above Command Syntax
7. Query Syntax
8. Query Response
9. Example Using The Above Query Syntax

## DISPlay Subsystem

The DISPlay subsystem command group sets the display page, and enters ASCII characters on the comment line. Figure 8-3 shows the command tree of the DISPlay subsystem command group.

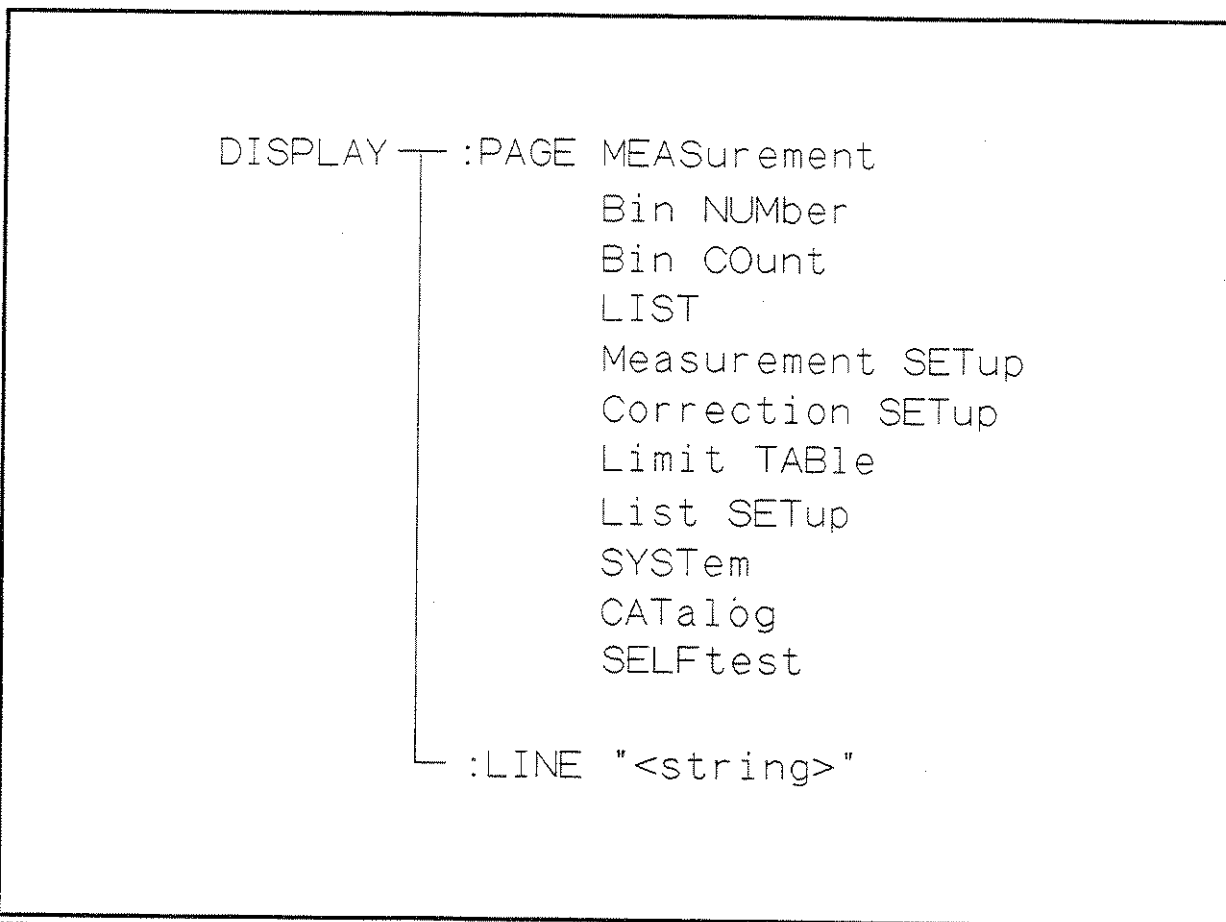

Figure 8-3. DISPlay Subsystem Command Tree



**:PAGE**

The :PAGE command sets the display page. The :PAGE? query returns the abbreviated page name currently displayed on the LCD screen.

**Command Syntax**

DISPlay:PAGE <page name>

Where, <page name> is:

MEASurement	Sets display page to <i>MEAS DISPLAY</i>
BNumber	Sets display page to <i>BIN No.DISPLAY</i>
BCOunt	Sets display page to <i>BIN COUNT DISPLAY</i>
LIST	Sets display page to <i>LIST SWEEP DISPLAY</i>
MSEtup	Sets display page to <i>MEAS SETUP</i>
CSEtup	Sets display page to <i>CORRECTION</i>
LTAbLe	Sets display page to <i>LIMIT TABLE SETUP</i>
LSEtup	Sets display page to <i>LIST SWEEP SETUP</i>
CATalog	Sets display page to <i>CATALOG</i>
SYSTem	Sets display page to <i>SYSTEM CONFIG</i>
SELF	Sets display page to <i>SELF TEST</i>

**Example**

```
OUTPUT 717;"DISP:PAGE BCO" ! Set to the BIN COUNT DISPLAY
```

**Query Syntax**

DISPlay:PAGE?

**Query Response**

Returned data format is :

<page name><NL~END>

Where,

<page name> Return the abbreviated name of the current display page as shown in the preceding list.

**Example**

```
10 OUTPUT 717;"DISP:PAGE?"
20 ENTER 717;A$
30 PRINT A$
40 END
```

**:LINE**

The :LINE command enters an arbitrary comment line of up to 30 ASCII characters in the comment field. The :LINE? query returns the comment line characters.

**Command Syntax**

DISPlay:LINE "<string>"

Where, <string> is ASCII character string (maximum of 30 characters)

**Example**

OUTPUT 717;"DISP:LINE ""This is a comment.""

**Query Syntax**

DISPlay:LINE?

**Query Response**

Returned data format is :

<string><NL^END>

**Example**

```
10 OUTPUT 717;"DISP:LINE?"
20 ENTER 717;A$
30 PRINT A$
40 END
```

## FREQUENCY Subsystem

The FREQUENCY command sets the oscillator frequency. The FREQUENCY? query returns the current test frequency setting.

### Command Syntax

$$\text{FREQUENCY}[:\text{CW}] \left\{ \begin{array}{l} \langle \text{value} \rangle \\ \text{MIN} \\ \text{MAX} \end{array} \right\}$$

Where,

$\langle \text{value} \rangle$  is the NR1, NR2, or NR3 format  
 MIN Sets to the minimum value (20 Hz)  
 MAX Sets to the maximum value (1 MHz)

### Note



A suffix multiplier and a suffix unit, HZ (hertz), can be used with this command. Either MAHZ and MHZ can be used as the suffix multiplier for MHz (1E6 Hz).

### Example

OUTPUT 717;"FREQ 1KHZ" ! Set to 1 kHz

OUTPUT 717;"FREQ MIN" ! Set to 20 Hz

OUTPUT 717;"FREQ MAX" ! Set to 1 MHz

### Query Syntax

$$\text{FREQUENCY}[:\text{CW}]? \left[ \begin{array}{l} \text{MIN} \\ \text{MAX} \end{array} \right]$$

### Query Response

Returned Format is :

$\langle \text{NR3} \rangle \langle \text{NL} \rangle \langle \text{END} \rangle$

### Example

```
10 OUTPUT 717;"FREQ? MIN"
20 ENTER 717;A
30 PRINT A
40 END
```

## VOLTage Subsystem

The VOLTage command sets the oscillator's output voltage level. The VOLTage? query returns the current oscillator voltage level.

### Command Syntax

$$\text{VOLTage}[:\text{LEVel}] \left\{ \begin{array}{l} \langle \text{value} \rangle \\ \text{MIN} \\ \text{MAX} \end{array} \right\}$$

Where,

$\langle \text{value} \rangle$  is the NR1, NR2, or NR3 format

MIN Sets or returns to the minimum oscillator voltage level (5mV)

MAX Sets or returns to the maximum oscillator voltage level (When Hi-PW mode is OFF: 2V  
When Hi-PW mode is ON : 20V)

### Note



A suffix multiplier and a suffix unit, V (volt), can be used with this command. If this query is received when the oscillator level set to a current level, error -230 Data corrupt or stale will occur.

### Example

```
OUTPUT 717;"VOLT 100 MV" ! Set to 100 mV
```

```
OUTPUT 717;"VOLT MIN" ! Set to 5 mV
```

```
OUTPUT 717;"VOLT MAX" ! Set to 2 V  
(the HP 4284A standard configuration)
```

### Query Syntax

$$\text{VOLTage}[:\text{LEVel}]? \left[ \begin{array}{l} \text{MIN} \\ \text{MAX} \end{array} \right]$$

### Query Response

Returned format is :

```
<NR3><NL^END>
```

### Example

```
10 OUTPUT 717;"VOLT? MIN"  
20 ENTER 717;A  
30 PRINT A  
40 END
```

## CURRent Subsystem

The CURRent command sets the oscillator's output current level. The CURRent? query returns the current oscillator current level.

### Command Syntax

$$\text{CURRent} [ :LEVel ] \left\{ \begin{array}{l} \langle \text{value} \rangle \\ \text{MIN} \\ \text{MAX} \end{array} \right\}$$

Where,

$\langle \text{value} \rangle$  is the NR1, NR2 or NR3 format

MIN Sets or returns the minimum oscillator current level (50 $\mu$ A)

MAX Sets or returns the maximum oscillator current level (When Hi-PW mode is OFF: 20mA  
When Hi-PW mode is ON :200mA)  
In case of ALC ON, this command sets to ALC OFF and sets the maximum oscillator current level.

### Note



A suffix multiplier and a suffix unit, A (ampere), can be used with this command. If this query is received when the oscillator level set to a current level, error -230 Data corrupt or stale will occur.

### Example

```
OUTPUT 717;"CURR 10MA" ! Set to 10 mA
```

```
OUTPUT 717;"CURR MAX" ! Set to 20 mA
(the HP 4284A standard configuration)
```

### Query Syntax

$$\text{CURRent} [ :LEVel ] ? \left[ \begin{array}{l} \text{MIN} \\ \text{MAX} \end{array} \right]$$

### Query Response

Returned format is :

$\langle \text{NR3} \rangle \langle \text{NL} \rangle \text{END}$

### Example

```
10 OUTPUT 717;"CURR? MIN"
20 ENTER 717;A
30 PRINT A
40 END
```

## AMPLitude Subsystem

The AMPLitude command sets the Automatic Level Control (ALC) to ON or OFF. The AMPLitude? query returns the current ALC ON/OFF state.

### Command Syntax

$$\text{AMPLitude:ALC} \left\{ \begin{array}{l} \text{ON} \\ \text{OFF} \\ 1 \\ 0 \end{array} \right\}$$

Where,

1 (decimal 49) When the function is ON  
0 (decimal 48) When the function is OFF

### Example

```
OUTPUT 717;"AMPL:ALC ON"
```

### Query Syntax

```
AMPLitude:ALC?
```

### Query Response

Returned format is :

```
<NR1><NL^END>
```

### Example

```
10 OUTPUT 717;"AMPL:ALC?"  
20 ENTER 717;A  
30 PRINT A  
40 END
```

## OUTPut Subsystem

The OUTPut subsystem command sets the DC bias monitor function. Figure 8-4 shows the command tree of the OUTPut subsystem group.

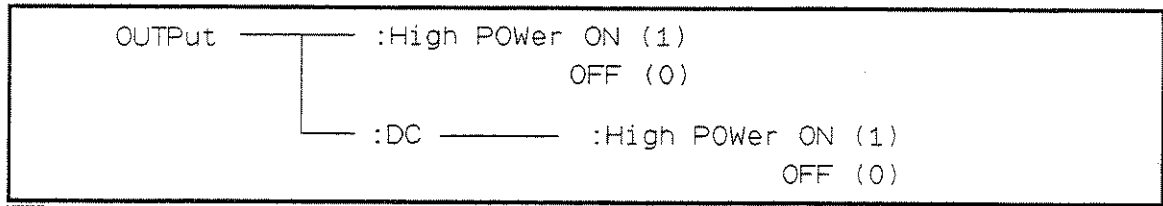

Figure 8-4. OUTPut Subsystem Command Tree

## :High POWER

The :High POWER command sets the high power mode to ON or OFF, which means that Option 001(Power Amplifier/DC Bias) is valid or invalid when Option 001 is installed. The :High POWER? query returns the current high power mode setting. Refer to Appendix G.

### Command Syntax

OUTPut:HPOWER  $\left\{ \begin{array}{l} \text{ON} \\ \text{OFF} \\ 1 \\ 0 \end{array} \right\}$

Where,

1 (decimal 49) When the function is ON  
0 (decimal 48) When the function is OFF

### Example

OUTPUT 717;"OUTP:HPOW ON"

OUTPUT 717;"OUTP:HPOW 0"

### Query Syntax

OUTPut:HPOWER?

### Query Response

Returned format is :

<NR1><NL^END>

### Example

```

10 OUTPUT 717;"OUTP:HPOW?"
20 ENTER 717:A
30 PRINT A
40 END
  
```

## :DC:ISOLation

The :DC:ISOLation command sets the bias current isolation to ON or OFF. The :DC:ISOLation? query returns the current setting of the bias current isolation function. Refer to Appendix G.

### Command Syntax

$$\text{OUTPut:DC:ISOLation} \left\{ \begin{array}{l} \text{ON} \\ \text{OFF} \\ 1 \\ 0 \end{array} \right\}$$

Where,

1 (decimal 49) When the function is ON

0 (decimal 48) When the function is OFF

### Example

```
OUTPUT 717;"OUTP:DC:ISOL ON"
```

```
OUTPUT 717;"OUTP:DC:ISOL 0"
```

### Query Syntax

```
OUTPut:DC:ISOLation?
```

### Query Response

Returned format is :

```
<NR1><NL^END>
```

### Example

```
10 OUTPUT 717;"OUTP:DC:ISOL?"
```

```
20 ENTER 717:A
```

```
30 PRINT A
```

```
40 END
```



## BIAS Subsystem

The BIAS subsystem command group sets the DC BIAS switch to ON or OFF, and sets the DC bias voltage value or the DC bias current value. Figure 8-5 shows the command tree of the BIAS subsystem command group. Refer to Appendix G.

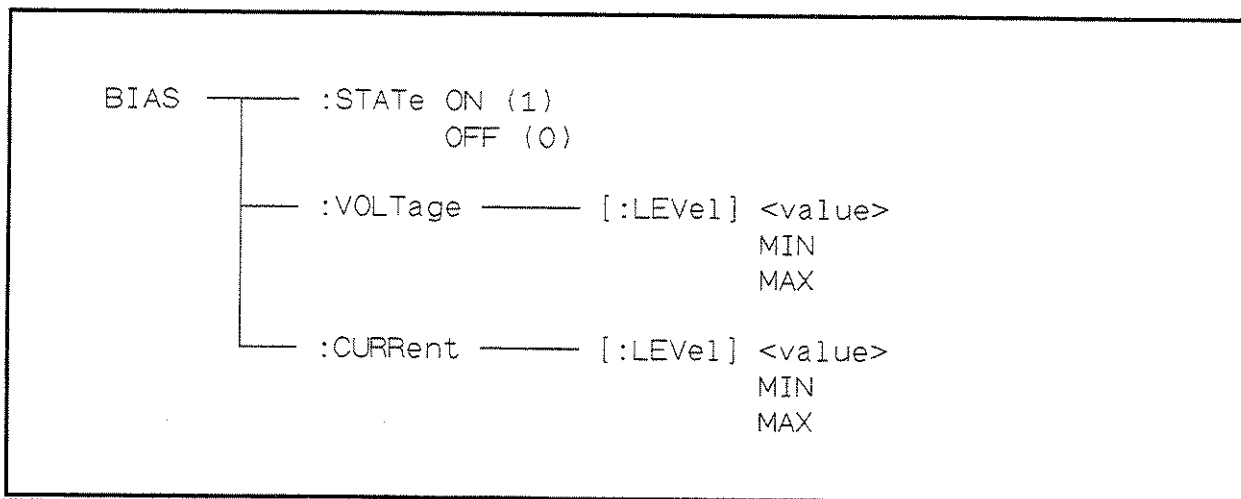

Figure 8-5. BIAS Subsystem Command Tree

**:STATe**

The :STATe command turns the DC BIAS switch to ON or OFF. Setting BIAS:VOLTage or BIAS:CURREnt do not implicitly turn this ON. The :STATe? query returns the current DC BIAS switch ON/OFF state. \*RST default value is OFF. And when Instrument control settings are loaded from the internal memory or memory card, this switch is set to OFF.

**Command Syntax**

$$\text{BIAS:STATe} \left\{ \begin{array}{l} \text{ON} \\ \text{OFF} \\ 1 \\ 0 \end{array} \right\}$$

Where,

- 1 (decimal 49) When the switch is ON
- 0 (decimal 48) When the switch is OFF

**Example**

OUTPUT 717;"BIAS:STAT 1"

**Query Syntax**

BIAS:STATe?

**Query Response**

Returned format is :

<NR1><NL^END>

**Example**

```
10 OUTPUT 717;"BIAS:STAT?"
20 ENTER 717;A
30 PRINT A
40 END
```

**:VOLTage**

The :VOLTage command sets the DC bias voltage. Setting BIAS:VOLTage does not implicitly turn the DC bias ON. The :VOLTage? query returns the current DC bias voltage setting value. Refer to Appendix G.

**Command Syntax**

$$\text{BIAS:VOLTage[:LEVel]} \left\{ \begin{array}{l} \langle \text{value} \rangle \\ \text{MIN} \\ \text{MAX} \end{array} \right\}$$

Where,

*<value>* is the NR1, NR2, or NR3 format  
 MIN Sets to the minimum DC bias voltage level (0V)  
 MAX Sets to the maximum DC bias voltage level  
 (When Hi-PW mode is OFF: 2V  
 When Hi-PW mode is ON : 40V)

**Example**

```
OUTPUT 717;"BIAS:VOLT 1.5V"
```

**Query Syntax**

$$\text{BIAS:VOLTage[:LEVel]}? \left[ \begin{array}{l} \text{MIN} \\ \text{MAX} \end{array} \right]$$
**Query Response**

Returned format is :

```
<NR3><NL~END>
```

**Example**

```
10 OUTPUT 717;"BIAS:VOLT? MAX"
20 ENTER 717;A
30 PRINT A
40 END
```

**Note**

A suffix multiplier and a suffix unit, V (volt), can be used with this command. If this query is received when the DC bias level is set to a current level, error -230 Data corrupt or stale will occur.

**:CURRent**

The :CURRent command sets the DC bias current. Setting BIAS:CURRent does not implicitly turn the DC bias ON. The :CURRent? query returns the current DC bias current setting value. This command is effective when the Option 001 DC Bias is installed or the HP 42841A and the HP 42842A/B are combined.

**Command Syntax**

BIAS:CURRent[:LEVel] { *<value>* }  
   MIN  
   MAX

Where,

*<value>* NR1, NR2, or NR3 format  
 MIN Sets or returns the minimum DC bias current level (0V)  
 MAX Sets or returns the maximum DC bias current level  
 (When Hi-PW mode is ON: 100mA)

**Note**



A suffix multiplier and a suffix unit, A (ampere), can be used with this command. If this query is received when the DC bias level is set to a current level, error -230 Data corrupt or stale will occur.

**Example**

OUTPUT 717;"BIAS:CURR 10MA"

**Query Syntax**

BIAS:CURRent[:LEVel]? [MIN]  
   MAX

**Query Response**

Returned format is :

<NR3><NL^END>

**Example**

10 OUTPUT 717;"BIAS:CURR?"  
 20 ENTER 717;A  
 30 PRINT A  
 40 END

# FUNCTION Subsystem

The FUNCTION subsystem command group sets the measurement function, the measurement range, monitor ON/OFF control, and the deviation measurement control. Figure 8-6 shows the command tree of the FUNCTION subsystem command group.

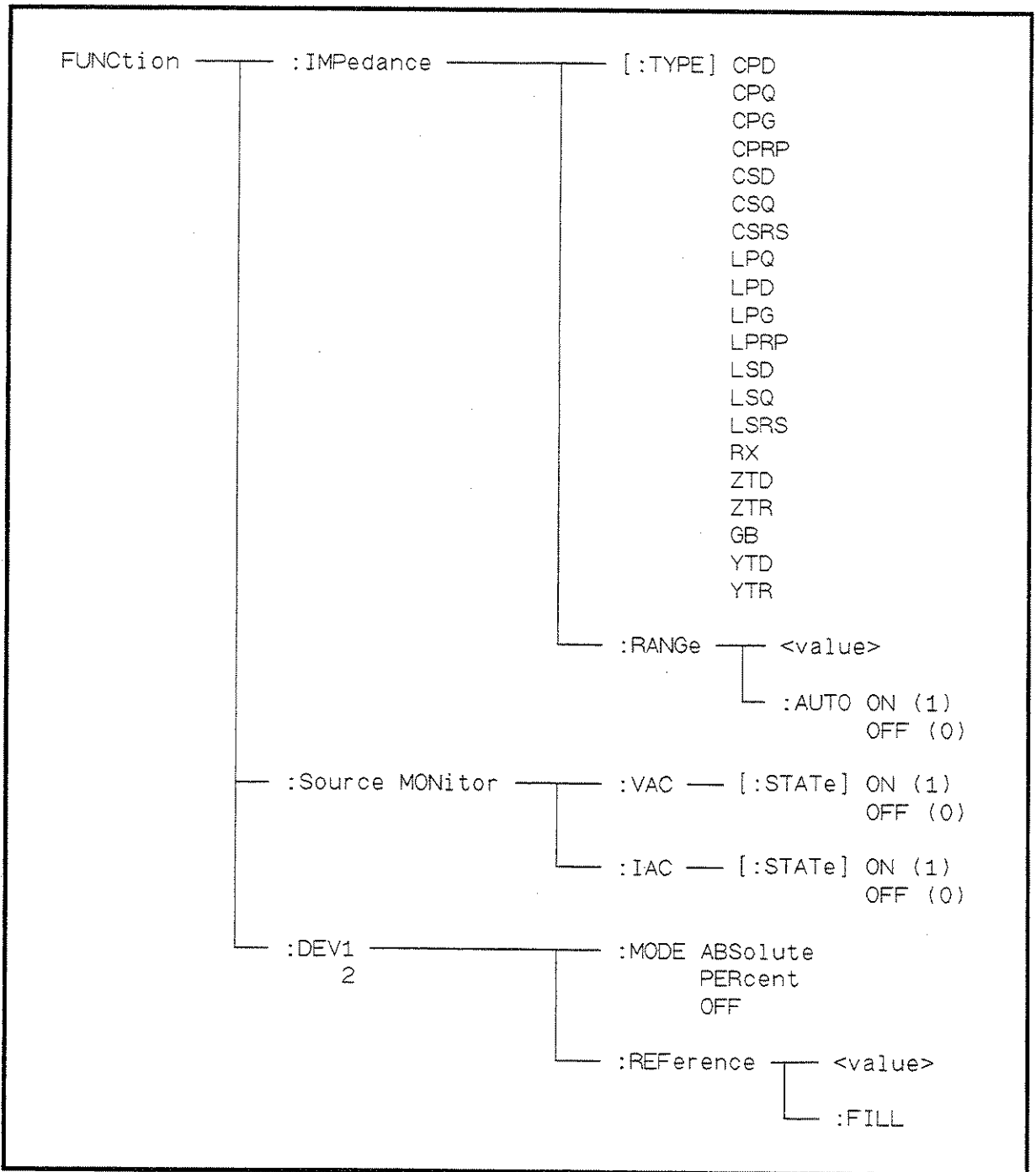

L200901

Figure 8-6. FUNCTION Subsystem Command Tree

**:IMPedance[:TYPE]**

The :IMPedance command sets the measurement function. The :IMPedance? query returns the current measurement function.

**Command Syntax**

FUNCTION:IMPedance[:TYPE] <function>

Where, <function> is:

CPD	Sets function to $C_p$ -D	LPRP	Sets function to $L_p$ - $R_p$
CPQ	Sets function to $C_p$ -Q	LSD	Sets function to $L_s$ -D
CPG	Sets function to $C_p$ -G	LSQ	Sets function to $L_s$ -Q
CPRP	Sets function to $C_p$ - $R_p$	LSRS	Sets function to $L_s$ - $R_s$
CSD	Sets function to $C_s$ -D	RX	Sets function to R-X
CSQ	Sets function to $C_s$ -Q	ZTD	Sets function to Z- $\theta$ (deg)
CSRS	Sets function to $C_s$ - $R_s$	ZTR	Sets function to Z- $\theta$ (rad)
LPQ	Sets function to $L_p$ -Q	GB	Sets function to G-B
LPD	Sets function to $L_p$ -D	YTD	Sets function to Y- $\theta$ (deg)
LPG	Sets function to $L_p$ -G	YTR	Sets function to Y- $\theta$ (rad)

**Example**

OUTPUT 717;"FUNC:IMP GB" ! Set to the G-B function

**Query Syntax**

FUNCTION:IMPedance[:TYPE]?

**Query Response**

Returned format is :

<function><NL^END>

**Example**

```
10 OUTPUT 717;"FUNC:IMP?"
20 ENTER 717;A$
30 PRINT A$
40 END
```

**:IMPedance:RANGe**

The :IMPedance:RANGe command sets the measurement range. Any value can be used as the setting value. The HP 4284A selects an appropriate measurement range for the setting value. The :IMPedance:RANGe? query returns the current measurement range even if the measurement range is set to AUTO. Refer to Appendix G.

**Command Syntax**

FUNCTION:IMPedance:RANGe <value>

Where, <value> is the impedance value of DUT in the NR1, NR2, or NR3 format

**Note**



A suffix multiplier and a suffix unit, OHM, can be used with this command. If this command is received while auto range is ON, the auto range function is automatically set to OFF and the range will be held at the range dictated by the received command.

**Example**

OUTPUT 717;"FUNC:IMP:RANG 5KOHM"

**Query Syntax**

FUNCTION:IMPedance:RANGe?

**Query Response**

Returned format is :

<value><NL^END>

Where, <value> is

1 <sup>1</sup>	10	100
300	1000	3000
10000	30000	100000

1 When Option 001 is installed

**Example**

```
10 OUTPUT 717;"FUNC:IMP:RANG?"
20 ENTER 717;A
30 PRINT A
40 END
```

**:IMPedance:RANGe  
:AUTO**

The :IMPedance:RANGe:AUTO command sets the auto range to ON or OFF. The :IMPedance:RANGe:AUTO? query returns the current auto range ON/OFF condition.

**Command Syntax**

FUNcTion:IMPedance:RANGe:AUTO  $\left\{ \begin{array}{l} \text{ON} \\ \text{OFF} \\ 1 \\ 0 \end{array} \right\}$

Where,

1 (decimal 49) When the function is ON

0 (decimal 48) When the function is OFF

**Example**

OUTPUT 717;"FUNC:IMP:RANG:AUTO ON"

OUTPUT 717;"FUNC:IMP:RANG:AUTO 1"

**Query Syntax**

FUNcTion:IMPedance:RANGe:AUTO?

**Query Response**

Returned format is :

<NR1><NL^END>

**Example**

10 OUTPUT 717;"FUNC:IMP:RANG:AUTO?"

20 ENTER 717;A

30 PRINT A

40 END



**:Source  
MONitor:VAC**

The :Source MONitor:VAC command sets the voltage level monitor to ON or OFF. The :Source MONitor:VAC? query returns the voltage level monitor ON/OFF condition.

**Command Syntax**

$$\text{FUNction:SMONitor:VAC[:STATe]} \left\{ \begin{array}{l} \text{ON} \\ \text{OFF} \\ 1 \\ 0 \end{array} \right\}$$

Where,

- 1 (decimal 49) When the switch is ON
- 0 (decimal 48) When the switch is OFF

**Example**

```
OUTPUT 717;"FUNC:SMON:VAC ON"
OUTPUT 717;"FUNC:SMON:VAC 1"
```

**Query Syntax**

```
FUNction:SMONitor:VAC[:STATe]?
```

**Query Response**

Returned format is :

```
<NR1><NL^END>
```

**Example**

```
10 OUTPUT 717;"FUNC:SMON:VAC?"
20 ENTER 717;A
30 PRINT A
40 END
```

**:Source MONitor:IAC**

The :Source MONitor:IAC command sets the current level monitor to ON or OFF. The :Source MONitor:IAC? query returns the current ON/OFF condition of the current level monitor.

**Command Syntax**

`FUNCTION:SMONitor:IAC[:STATe]`  $\left. \begin{array}{l} \text{ON} \\ \text{OFF} \\ 1 \\ 0 \end{array} \right\}$

Where,

- 1 (decimal 49) When the switch is ON
- 0 (decimal 48) When the switch is OFF

**Example**

OUTPUT 717;"FUNC:SMON:IAC 1"

**Query Syntax**

`FUNCTION:SMONitor:IAC[:STATe]?`

**Query Response**

Returned format is :

<NR1><NL^END>

**Example**

10 OUTPUT 717;"FUNC:SMON:IAC?"  
20 ENTER 717;A  
30 PRINT A  
40 END

**:DEV<n>:MODE**

The :DEV<n>:MODE command sets the deviation measurement mode. The :DEV<n>:MODE? query returns the current setting of the deviation measurement mode.

**Command Syntax**

$$\text{FUNction:DEV<n>:MODE} \left\{ \begin{array}{l} \text{ABSolute} \\ \text{PERCent} \\ \text{OFF} \end{array} \right\}$$

Where,

ABSolute    Δ ABSolute deviation mode  
 PERCent    Δ % deviation mode  
 OFF        Turn the deviation measurement mode OFF

<n> is :

- 1 (decimal 49) Deviation mode setting for primary parameter
- 2 (decimal 50) Deviation mode setting for secondary parameter

**Example**

OUTPUT 717;"FUNC:DEV1:MODE ABS"

OUTPUT 717;"FUNC:DEV2:MODE OFF"

**Query Syntax**

FUNction:DEV<n>:MODE?

**Query Response**

Returned format is :

$$\left\{ \begin{array}{l} \text{ABS} \\ \text{PERC} \\ \text{OFF} \end{array} \right\} \langle \text{NL} \sim \text{END} \rangle$$
**Example**

```
10 OUTPUT 717;"FUNC:DEV1:MODE?"
20 ENTER 717;A$
30 PRINT A$
40 END
```

**:DEV<n>:REFeRence**

The :DEV<n>:REFeRence command sets the reference value for deviation measurement. The :DEV<n>:REFeRence? query returns the current reference values.

**Command Syntax**

FUNCTION:DEV<n>:REFeRence<value>

Where,

<value> is the NR1, NR2, or NR3 format

<n> is :

- 1 (decimal 49) Reference value setting for primary parameter
- 2 (decimal 50) Reference value setting for secondary parameter

**Example**

OUTPUT 717;"FUNC:DEV1:REF 10"

OUTPUT 717;"FUNC:DEV2:REF 2E-3"

**Query Syntax**

FUNCTION:DEV<n>:REFeRence?

**Query Response**

Returned format is :

<NR3><NL^END>

**Example**

```
10 OUTPUT 717;"FUNC:DEV1:REF?"
20 ENTER 717;A
30 PRINT A
40 END
```

---

**:DEV<n>  
:REFeRence:FILL**

The :DEV<n>:REFeRence:FILL command executes a single measurement and enters two measured values (the primary and secondary parameters) into each of the reference values for the deviation measurement.

**Command Syntax**

FUNCTION:DEV<n>:REFeRence:FILL

Where, <n> is

- 1 or 2 (Both reference values are measured simultaneously.)

**Example**

OUTPUT 717;"FUNC:DEV1:REF:FILL"

## LIST Subsystem

The LIST subsystem command group sets the List Sweep measurement function, including the sweep point settings, the sweep mode and limit values for the limit function. Figure 8-7 shows the command tree of the LIST subsystem command group.

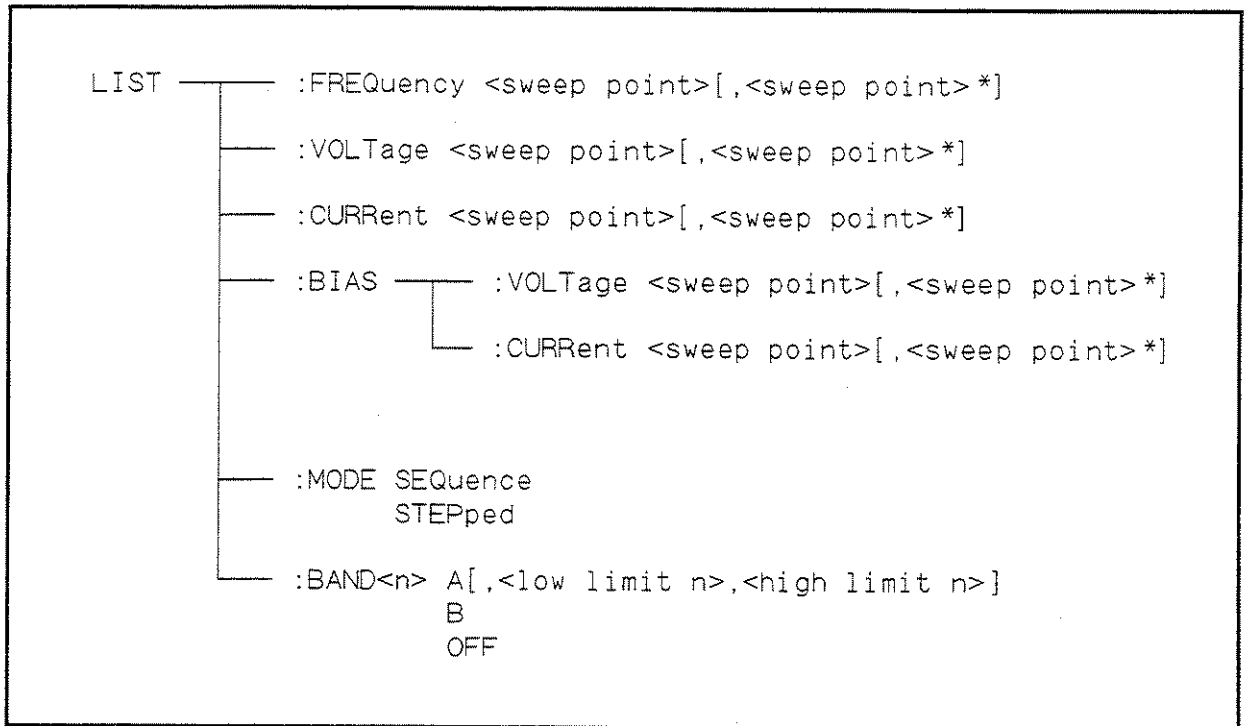

Figure 8-7. LIST Subsystem Command Tree

**:FREQUENCY**

The :FREQUENCY command clears the previous List Sweep point table, and sets the frequency sweep points. The :FREQUENCY? query returns the current settings of the frequency sweep points.

**Command Syntax**

```
LIST:FREQUENCY <value> [,<value>*]
```

\*Repeat Max. 10 sweep points

Where,

<value> is the NR1, NR2, or NR3 format

**Example**

```
OUTPUT 717;"LIST:FREQ 1E3,2E3,3E3,4E3"
!Set 1kHz to point 1, ..., 4kHz to point 4
```

**Note**

A suffix multiplier and a suffix unit, HZ (hertz), can be used with this command. Either MAHZ and MHZ can be used as the suffix multiplier for MHz (1E6 Hz).

**Query Syntax**

```
LIST:FREQUENCY?
```

**Query Response**

Returned format is :

```
<NR3> [,<NR3>*] <NL^END>
```

**Example**

```
10 DIM A$[100]
20 OUTPUT 717;"LIST:FREQ?"
30 ENTER 717;A$
40 PRINT A$
50 END
```

**Note**

If this query is received when the List Sweep parameter is set to anything other than frequency, error -230 Data corrupt or stale will occur.

**:VOLTage**

The :VOLTage command clears the previous list sweep point table, and sets the oscillator voltage level sweep points. The :VOLTage? query returns the current settings of the voltage sweep points.

**Command Syntax**

```
LIST:VOLTage <value> [ , <value> *]
```

\*Max. 10 sweep points

Where,

<value> is the NR1, NR2, or NR3 format

**Example**

```
OUTPUT 717;"LIST:VOLT 1.5" !Set 1.5V to point 1
OUTPUT 717;"LIST:VOLT 1E-2,2E-2,3E-2,4E-2"
! Set 10 mV to point 1, .... 40 mV to point 4
```

**Note**

A suffix multiplier and a suffix unit, V (voltage), can be used with this command.

**Query Syntax**

```
LIST:VOLTage?
```

**Query Response**

Returned format is :

```
<NR3> [ , <NR3> *] <NL~END>
```

**Example**

```
10 DIM A$[100]
20 OUTPUT 717;"LIST:VOLT?"
30 ENTER 717;A$
40 PRINT A$
50 END
```

**Note**

If this query is received when the List Sweep parameter is set to anything other than voltage, error -230 Data corrupt or stale will occur.

---

**:CURRent**

The :CURRent command clears the previous list sweep point table, and sets the oscillator current level sweep points. The :CURRent? query returns the current settings of current sweep points.

**Command Syntax**

```
LIST:CURRent <value> [ , <value> * ]
```

\*Max. 10 sweep points

Where,

<value> is the NR1, NR2, or NR3 format

**Example**

```
OUTPUT 717;"LIST:CURR 100mA" !Set 100mA to point 1
OUTPUT 717;"LIST:CURR 1E-2,2E-2,3E-2,4E-2"
! Set 10 mA to point 1, ... 40 mA to point 4
```

**Note**

---

A suffix multiplier and a suffix unit, A (ampere), can be used with this command.

---

**Query Syntax**

```
LIST:CURRent?
```

**Query Response**

Returned format is :

```
<NR3> [ , <NR3> * ] <NL^END>
```

**Example**

```
10 DIM A$[100]
20 OUTPUT 717;"LIST:CURR?"
30 ENTER 717;A$
40 PRINT A$
50 END
```

**Note**

---

If this query is received when the List Sweep parameter is set to anything other than current, error -230 Data corrupt or stale will occur.

---



**:BIAS:VOLTage**

The :BIAS:VOLTage command clears the previous List Sweep point table, and sets the DC bias voltage level sweep points. The :BIAS:VOLTage? query returns the current settings of the DC voltage sweep points. Refer to Appendix G

**Command Syntax**

```
LIST:BIAS:VOLTage <value> [ ,<value>*]
```

\*Max. 10 sweep points

Where,

<value> is the NR1, NR2, or NR3 format

**Example**

```
OUTPUT 717;"LIST:BIAS:VOLT 1.5V" !Set 1.5V to point 1
OUTPUT 717;"LIST:BIAS:VOLT 2E-1,4E-1,6E-1,8E-1"
! Set 200 mV to point 1, ... 800 mV to point 4
```

**Note**

A suffix multiplier and a suffix unit, V (voltage), can be used with this command.

**Query Syntax**

```
LIST:BIAS:VOLTage?
```

**Query Response**

Returned format is :

```
<NR3> [ ,<NR3>*] <NL~END>
```

**Example**

```
10 DIM A$[100]
20 OUTPUT 717;"LIST:BIAS:VOLT?"
30 ENTER 717;A$
40 PRINT A$
50 END
```

**Note**

If this query is received when the List Sweep parameter is set to anything other than bias voltage, error -230 Data corrupt or stale will occur.

**:BIAS:CURRent**

The :BIAS:CURRent command clears the previous List Sweep point table, and sets the DC bias current level sweep points. The :BIAS:CURRent? query returns the current settings of the DC current sweep points.

**Command Syntax**

```
LIST:BIAS:CURRent <value> [ , <value> * ]
```

\*Max. 10 sweep points

Where,

<value> is the NR1, NR2, or NR3 format

**Example**

```
OUTPUT 717;"LIST:BIAS:CURR 100MA" !Set 100mA to point 1
OUTPUT 717;"LIST:BIAS:CURR 1E-2,2E-2,3E-2,4E-2"
! Set 10 mA to point 1, ... 40 mA to point 4
```

**Note**

A suffix multiplier and a suffix unit, A (ampere), can be used with this command.

**Query Syntax**

```
LIST:BIAS:CURRent?
```

**Query Response**

Returned format is :

```
<NR3> [ , <NR3> * ] <NL~END>
```

**Example**

```
10 DIM A$[100]
20 OUTPUT 717;"LIST:BIAS:CURR?"
30 ENTER 717;A$
40 PRINT A$
50 END
```

**Note**

If this query is received when the List Sweep parameter is set to anything other than bias current, error -230 Data corrupt or stale will occur.



**:BAND<n>**

The :BAND<n> command sets the limit values of the limit function for the list sweep measurement. The :BAND<n>? query returns the current limit value settings.

**Command Syntax**

LIST:BAND<n><parameter> [ ,<low limit n> ,<high limit n> ]

Where,

- <n> 1 to 10 (NR1) : Sweep point number
- <parameter> is : A Limit setting enable for primary parameter
- B Limit setting enable for secondary parameter
- OFF Limit setting disable
- <low limit n> NR1, NR2, or NR3 format : low limit for sweep point<n>
- <high limit n> NR1, NR2, or NR3 format : high limit for sweep point<n>

**Example**

OUTPUT 717;"LIST:BAND1 A,10,20"

OUTPUT 717;"LIST:BAND3 OFF"

**Query Syntax**

LIST:BAND<n>?

**Query Response**

Returned format is :

<parameter> ,<low limit n> ,<high limit n>

**Example**

```
10 DIM A$[30]
20 OUTPUT 717;"LIST:BAND3?"
30 ENTER 717;A$
40 PRINT A$
50 END
```

## APERTure Subsystem

The APERTure command sets the integration time of the A/D converter and the averaging rate. The APERTure? query returns the current integration time and the averaging rate settings.

### Command Syntax

$$\text{APERTure} \left\{ \begin{array}{l} \text{SHORT} \\ \text{MEDIUM} \\ \text{LONG} \end{array} \right\} [ , < \text{value} > ]$$

Where,

SHORT      Short integration time  
 MEDIUM    Medium integration time  
 LONG       Long integration time  
 <value>   1 to 128 (NR1) : Averaging rate

### Example

```
OUTPUT 717;"APER SHOR"
```

```
OUTPUT 717;"APER MED,64"
```

### Query Syntax

```
APERTure?
```

### Query Response

Returned format is :

$$\left\{ \begin{array}{l} \text{SHOR} \\ \text{MED} \\ \text{LONG} \end{array} \right\} , < \text{NR1} > < \text{NL} \text{^} \text{END} >$$

### Example

```
10 OUTPUT 717;"APER?"
20 ENTER 717;A$
30 PRINT A$
40 END
```

## TRIGger Subsystem

The TRIGger subsystem command group is used to enable a measurement or a sweep measurement, and to set the trigger mode and the trigger delay time. Figure 8-8 shows the command tree of the TRIGger subsystem command group.

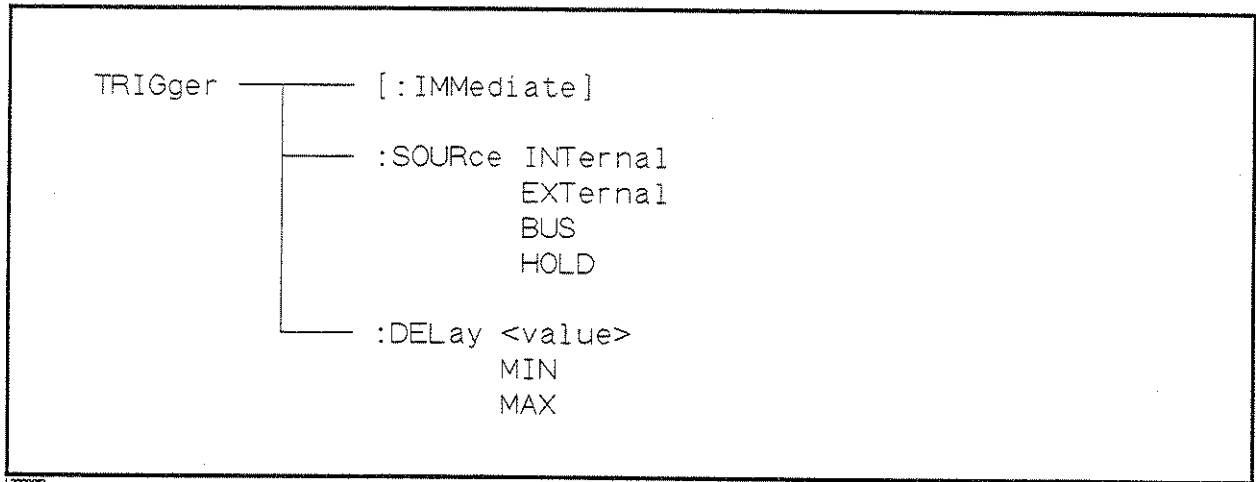

Figure 8-8. TRIGger Subsystem Command Tree

## :IMMediate

The :IMMediate command causes the trigger to execute a measurement or a sweep measurement, regardless of the trigger state. Refer to “Trigger System” in Chapter 7, for details.

**Command Syntax**      TRIGger[:IMMediate]

**Example**

```
OUTPUT 717;"TRIG"
OUTPUT 717;"TRIG:IMM"
```

**:SOURce**

The :SOURce command sets the trigger mode. The :SOURce? query returns the current trigger mode.

**Command Syntax**

$$\text{TRIGger:SOURce} \left\{ \begin{array}{l} \text{INTernal} \\ \text{EXTernal} \\ \text{BUS} \\ \text{HOLD} \end{array} \right\}$$

Where,

INTernal Internal trigger mode  
 EXTernal External trigger mode  
 BUS Bus trigger mode  
 HOLD Trigger hold (Manual trigger mode)

**Example**

OUTPUT 717;"TRIG:SOUR BUS"

**Query Syntax**

TRIGger:SOURce?

**Query Response**

Returned format is :

$$\left\{ \begin{array}{l} \text{INT} \\ \text{EXT} \\ \text{BUS} \\ \text{HOLD} \end{array} \right\} \langle \text{NL} \sim \text{END} \rangle$$
**Example**

10 OUTPUT 717;"TRIG:SOUR?"  
 20 ENTER 717;A\$  
 30 PRINT A\$  
 40 END

**:DElay**

The :DElay command sets the trigger delay time. The :DElay? query returns the current delay time.

**Command Syntax**

TRIGger:DElay { *<value>* }  
                   { MIN }  
                   { MAX }

Where,

*<value>* is the NR1, NR2, or NR3 format; 0 to 60 [s] in 1 ms resolution

MIN Sets the minimum delay value (0 s)

MAX Sets the maximum delay value (60 s)

**Example**

OUTPUT 717;"TRIG:DEL 5S" ! Set delay time to 5 s

OUTPUT 717;"TRIG:DEL MIN" ! Set delay time to 0 s

**Note**



A suffix multiplier and a suffix unit, S (second), can be used with this command.

---

**Query Syntax**

TRIGger:DElay? [ MIN ]  
                   [ MAX ]

**Query Response**

Returned Format is :

<NR3><NL^END>

**Example**

```
10 OUTPUT 717;"TRIG:DEL?"
20 ENTER 717;A
30 PRINT A
40 END
```



## INITiate Subsystem

The INITiate subsystem command group controls initiation of the triggering system. Figure 8-9 shows the command tree of the INITiate subsystem command group.

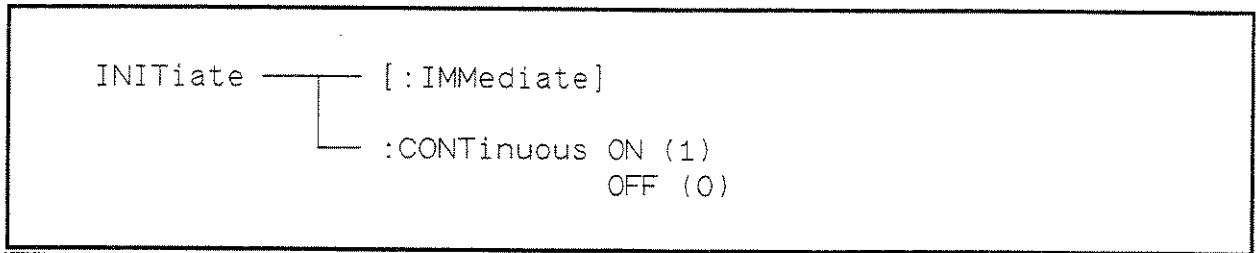

Figure 8-9. INITiate Subsystem Command Tree

### [:IMMediate]

The [:IMMediate] command changes the trigger state to the IDLE STATE to the WAIT FOR TRIGGER STATE for one trigger sequence. For details, refer to “Trigger System” in Chapter 7.

**Command Syntax**      INITiate[IMMediate]

**Example**

```

OUTPUT 717;"INIT"

OUTPUT 717;"INIT:IMM"
  
```

## :CONTInuous

The :CONTInuous command sets the trigger system to the CONTInuous ON or OFF condition. In the CONTInuous ON condition, after reading the measurement data by a controller, the IDLE STATE is automatically set to the WAIT FOR TRIGGER STATE. For details refer to "Trigger System" in Chapter 7. The :CONTInuous? query responds the current condition of the CONTInuous ON or OFF.

### Command Syntax

INITiate:CONTInuous  $\left\{ \begin{array}{l} \text{ON} \\ \text{OFF} \\ 1 \\ 0 \end{array} \right\}$

Where,

- 1 (decimal 49) When the function is ON
- 0 (decimal 48) When the function is OFF

### Example

OUTPUT 717;"INIT:CONT ON"

### Query Syntax

INITiate:CONTInuous?

### Query Response

Returned format is :

<NR1><NL^END>

### Example

```
10 OUTPUT 717;"INIT:CONT?"
20 ENTER 717;A
30 PRINT A
40 END
```

## FETCh? Subsystem

The FETCh? subsystem command group is a sensor-only command which retrieves the measurement data taken by measurement(s) initiated by a trigger, and places the data into the HP 4284A's output buffer.

Figure 8-10 shows the command tree of the FETCh? subsystem command group.

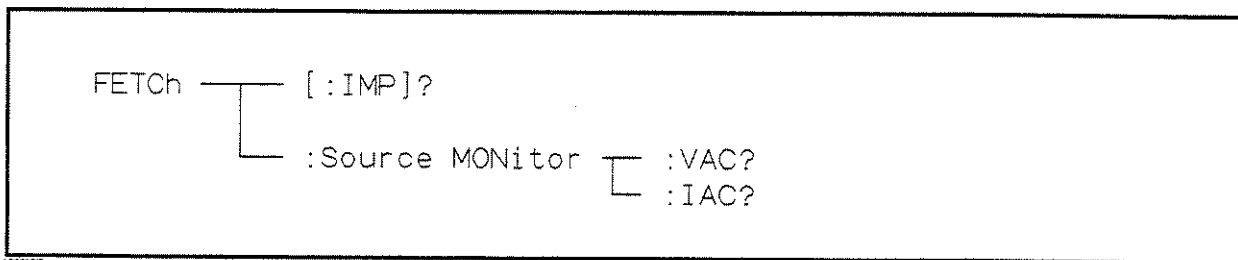

Figure 8-10. FETCh? Subsystem Command Tree

## [:IMP]?

The [:IMP]? query sets the latest measurement data of the primary and secondary parameters into the HP 4284A's output buffer. For the returned format, refer to "Data Transfer" in Chapter 7.

### Query Syntax

FETCh[:IMP]?

### Example

```

10 OUTPUT 717;"TRIG:SOUR BUS"
20 OUTPUT 717;"TRIG"
30 OUTPUT 717;"FETC?"
40 ENTER 717;A,B,C
50 PRINT A,B,C
60 END
  
```

**:Source MONitor:VAC?**

The :Source MONitor:VAC? query sets the latest measured voltage monitor data into the HP 4284A's output buffer.

**Query Syntax**            FETCh:SMONitor:VAC?

**Query Response**        Returned format is :

<NR3><NL^END>.

**Example**

```
10 OUTPUT 717;"TRIG:SOUR BUS"
20 OUTPUT 717;"TRIG"
30 OUTPUT 717;"FETC:SMON:VAC?"
40 ENTER 717;A
50 PRINT A
60 END
```

**Note**



---

If this query is received when the voltage level monitor is set to OFF, returned data is 9.9E37.

---

---

**:Source MONitor:IAC?**

The :Source MONitor:IAC? query sets the latest measured current monitor data into the HP 4284A's output buffer.

**Query Syntax**            FETCh:SMONitor:IAC?

**Query Response**        Returned format is :

<NR3><NL^END>.

**Example**

```
10 OUTPUT 717;"TRIG:SOUR BUS"
20 TRIGGER 717
30 OUTPUT 717;"FETC:SMON:IAC?"
40 ENTER 717;A
50 PRINT A
60 END
```

**Note**



---

If this query is received when the current level monitor is set to OFF, returned data is 9.9E37.

---

---

## ABORt Subsystem

The ABORt command sets the trigger system to reset, and the trigger state is in the IDLE STATE on the state diagram. For detail, refer to "Trigger System" in Chapter 7.

### Command Syntax

ABORt

### Example

OUTPUT 717;"ABOR"

---

## FORMat Subsystem

The FORMat command sets the data output format. For details, refer to "Data Transfer" in Chapter 7. The FORMat? query returns the current data format setting.

### Command Syntax

$$\text{FORMat}[:\text{DATA}] \left\{ \begin{array}{l} \text{ASCii} \\ \text{REAL}[,64] \end{array} \right\}$$

Where,

ASCii is set by the ASCII data format

REAL[,64] is set by the IEEE-64 bit floating point data format

### Example

```
OUTPUT 717;"FORM REAL"
```

### Query Syntax

```
FORMat[:DATA]?
```

### Query Response

Returned data format is :

$$\left\{ \begin{array}{l} \text{ASC} \\ \text{REAL},64 \end{array} \right\} \langle \text{NL} \text{^} \text{END} \rangle$$

### Example

```
10 OUTPUT 717;"FORM?"
20 ENTER 717;A$
30 PRINT A$
40 END
```

## MEMory Subsystem

The MEMory subsystem command group controls the HP 4284A's data buffer. Figure 8-11 shows the command tree of the MEMory subsystem command group.

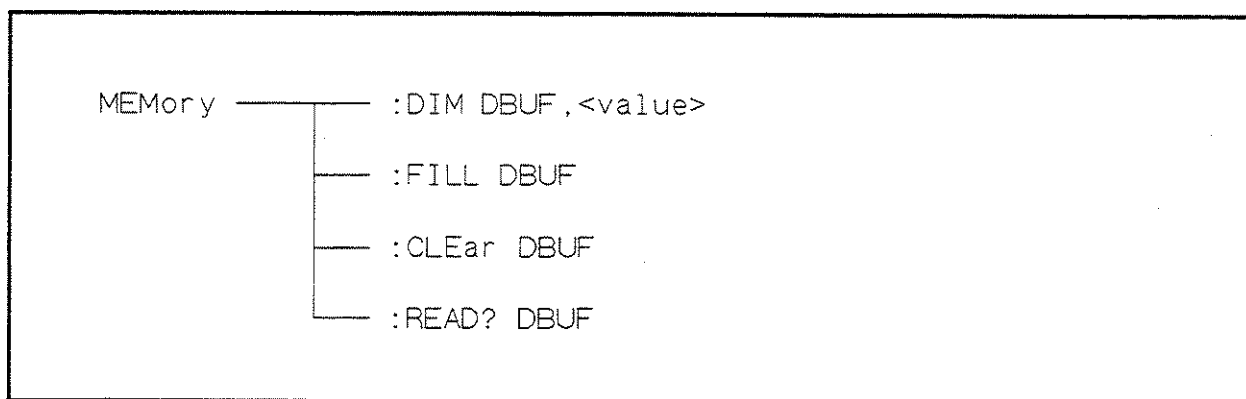

Figure 8-11. MEMory Subsystem Command Tree

### :DIM

The :DIM command clears the data buffer memory, and sets the size of the data buffer memory. For details, refer to "Data Transfer" in Chapter 7.

#### Command Syntax

MEMory: DIM DBUF, <value>

Where,

<value> 1 to 128 (NR1) : Number of data sets

#### Example

OUTPUT 717; "MEM: DIM DBUF, 3"

! Specify the DBUF size for 3 sets of measurement data

### :FILL

The :FILL command enables the data buffer memory to store the measurement data. After execution of the :FILL command, all measurement data will be stored in the data buffer memory. For details, refer to "Data Transfer" in Chapter 7.

#### Command Syntax

MEMory: FILL DBUF

#### Example

OUTPUT 717; "MEM: FILL DBUF"

**:CLEar**

The :CLEar command clears the data buffer memory. After execution of this command, measurement data will not be stored in the data buffer memory until execution of the :FILL command. For details, refer to "Data Transfer" in Chapter 7.

**Command Syntax**

MEMory:CLEar DBUF

**Example**

OUTPUT 717;"MEM:CLE DBUF"

---

**:READ?**

The :READ? query places the data in the data buffer memory into the output buffer. If the data buffer memory is not filled to the specified size (specified by the :DIM command), the data locations in which data is not stored will be set to -1 (no data). For details of the returned data format, refer to "Data Transfer" in Chapter 7.

**Query Syntax**

MEMory:READ? DBUF

**Example**

OUTPUT 717;"MEM:READ? DBUF"



## CORRection Subsystem

The CORRection subsystem command group sets the correction function, including the cable length correction settings, and the OPEN/SHORT/LOAD correction settings. Figure 8-12 shows the command tree of the CORRection subsystem command group.

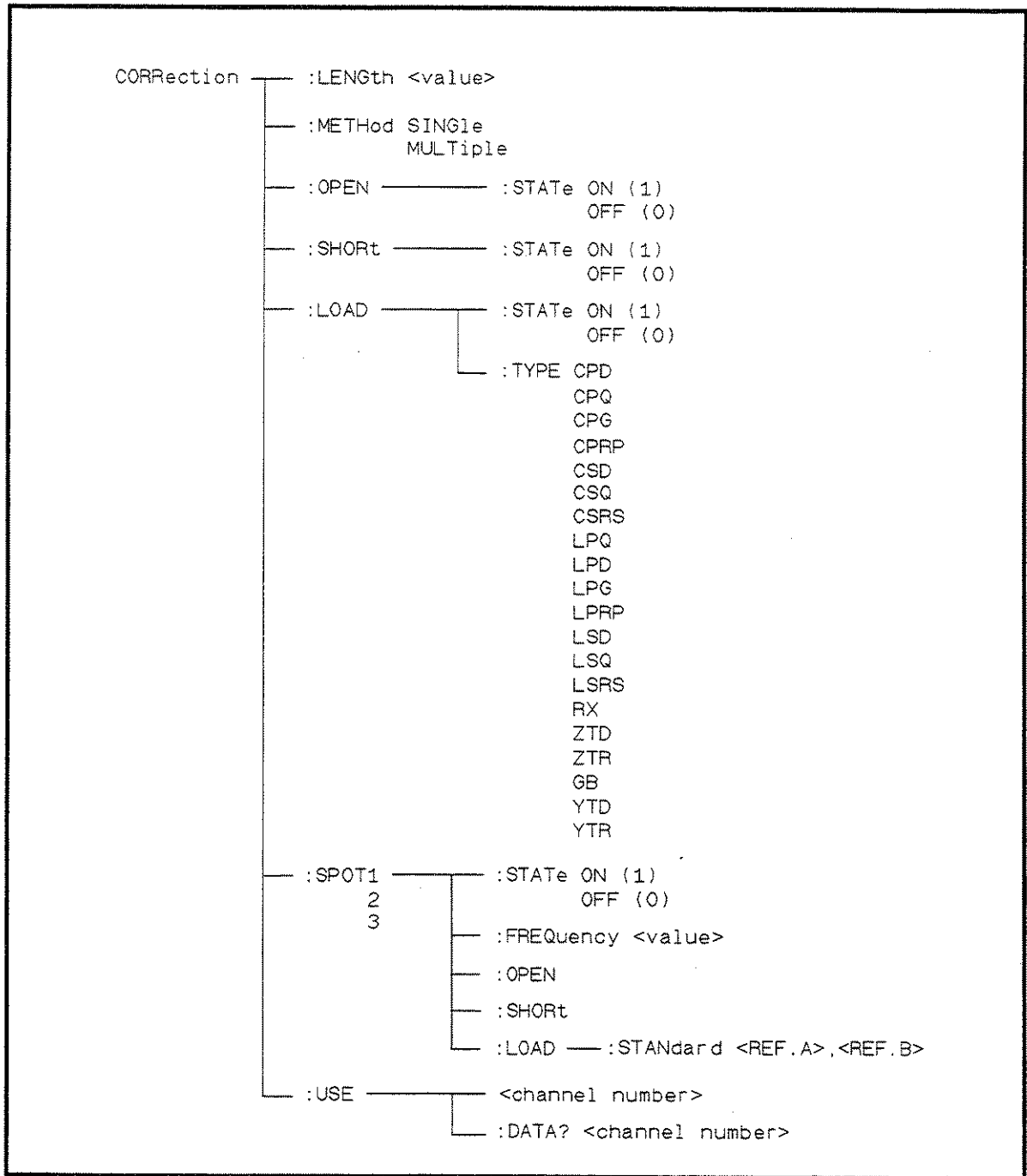

Figure 8-12. CORRection Subsystem Command Tree

## :LENGth

The :LENGth command sets the cable length correction setting. The :LENGth? query returns the current settings of the cable length correction.

### Command Syntax

CORRection:LENGth <value>

Where,

<value> 0, 1, or 2 is Cable length in [m]

---

### Note



A suffix with a suffix unit, M (meter), can be used with this command.

---

### Example

OUTPUT 717;"CORR:LENG 1M"

### Query Syntax

CORRection:LENGth?

### Query Response

Returned format is :

<NR1><NL^END>

### Example

```
10 OUTPUT 717;"CORR:LENG?"
20 ENTER 717;A
30 PRINT A
40 END
```

**:METHOD**

The :METHOD command sets the correction mode. The :METHOD? query returns the current settings of the correction mode.

**Command Syntax**

```
CORRection:METHOD { SINGLE }
                  { MULTI }
```

Where,

SINGLE Sets or returns the single channel correction mode  
 MULTI Sets or returns the multi channel correction mode

**Example**

```
OUTPUT 717;"CORR:METH MULT"
```

**Query Syntax**

```
CORRection:METHOD?
```

**Query Response**

Returned format is :

```
{ SING }
{ MULT } <NL^END>
```

**Example**

```
10 OUTPUT 717;"CORR:METH?"
20 ENTER 717;A$
30 PRINT A$
40 END
```

**:OPEN**

The :OPEN command executes 51 presettled OPEN correction data measurement points.

**Command Syntax**

```
CORRection:OPEN
```

**Example**

```
OUTPUT 717;"CORR:OPEN"
```

**:OPEN:STATe**

The :OPEN:STATe command sets the OPEN correction function to ON or OFF. The :OPEN:STATe? query returns the current ON/OFF condition of the OPEN correction.

**Command Syntax**

CORRection:OPEN:STATe  $\left\{ \begin{array}{l} \text{ON} \\ \text{OFF} \\ 1 \\ 0 \end{array} \right\}$

Where,

1 (decimal 49) When the function is ON  
0 (decimal 48) When the function is OFF

**Example**

OUTPUT 717;"CORR:OPEN:STAT ON"

**Query Syntax**

CORRection:OPEN:STATe?

**Query Response**

Returned format is :

<NR1><NL~END>

**Example**

10 OUTPUT 717;"CORR:OPEN:STAT?"  
20 ENTER 717;A  
30 PRINT A  
40 END

---

**:SHORT**

The :SHORT command executes 51 presettled SHORT correction data measurement points.

**Command Syntax**

CORRection:SHORT

**Example**

OUTPUT 717;"CORR:SHOR"

**:SHORT:STATE**

The :SHORT:STATE command sets the SHORT correction function to ON or OFF. The :SHORT:STATE? query responds the current ON/OFF condition of the SHORT correction.

**Command Syntax**

$$\text{CORRection:SHORT:STATE} \left\{ \begin{array}{l} \text{ON} \\ \text{OFF} \\ 1 \\ 0 \end{array} \right\}$$

Where,

1 (decimal 49) When the function is ON  
 0 (decimal 48) When the function is OFF

**Example**

OUTPUT 717;"CORR:SHOR:STAT ON"

**Query Syntax**

CORRection:SHORT:STATE?

**Query Response**

Returned format is :

<NR1><NL^END>

**Example**

10 OUTPUT 717;"CORR:SHOR:STAT?"  
 20 ENTER 717;A  
 30 PRINT A  
 40 END

## :LOAD:STATE

The :LOAD:STATE command sets the LOAD correction function to ON or OFF. The :LOAD:STATE? query responds the current ON/OFF condition of the LOAD correction.

### Command Syntax

$$\text{CORRection:LOAD:STATE} \left\{ \begin{array}{l} \text{ON} \\ \text{OFF} \\ 1 \\ 0 \end{array} \right\}$$

Where,

1 (decimal 49) When the function is ON  
0 (decimal 48) When the function is OFF

### Example

OUTPUT 717;"CORR:LOAD:STAT ON"

### Query Syntax

CORRection:LOAD:STATE?

### Query Response

Returned format is :

<NR1><NL^END>

### Example

10 OUTPUT 717;"CORR:LOAD:STAT?"  
20 ENTER 717;A  
30 PRINT A  
40 END

**:LOAD:TYPE**

The :LOAD:TYPE command sets the function of the reference values for the load correction. The :LOAD:TYPE? query responds the current function of the reference values.

**Command Syntax**

CORRection:LOAD:TYPE <function>

Where, <function> is:

CPD	Sets function to $C_p$ -D	LPRP	Sets function to $L_p$ - $R_p$
CPQ	Sets function to $C_p$ -Q	LSD	Sets function to $L_s$ -D
CPG	Sets function to $C_p$ -G	LSQ	Sets function to $L_s$ -Q
GPRP	Sets function to $C_p$ - $R_p$	LSRS	Sets function to $L_s$ - $R_s$
CSD	Sets function to $C_s$ -D	RX	Sets function to R-X
CSQ	Sets function to $C_s$ -Q	ZTD	Sets function to Z- $\theta$ (deg)
CSRS	Sets function to $C_s$ - $R_s$	ZTR	Sets function to Z- $\theta$ (rad)
LPQ	Sets function to $L_p$ -Q	GB	Sets function to G-B
LPD	Sets function to $L_p$ -D	YTD	Sets function to Y- $\theta$ (deg)
LPG	Sets function to $L_p$ -G	YTR	Sets function to Y- $\theta$ (rad)

**Example**

OUTPUT 717;"CORR:LOAD:TYPE CPD"

**Query Syntax**

CORRection:LOAD:TYPE?

**Query Response**

Returned format is :

<function><NL^END>

<function> returns the current function of the reference value, using the abbreviations listed above.

**Example**

```
10 OUTPUT 717;"CORR:LOAD:TYPE?"
20 ENTER 717;A$
30 PRINT A$
40 END
```

## :SPOT<n>:STATe

The :SPOT<n>:STATe command sets the specified frequency point correction (FREQ1, FREQ2 or FREQ3) to ON or OFF. The :SPOT<n>:STATe? query responds the current ON/OFF setting of the specified frequency point correction.

### Command Syntax

$$\text{CORRection:SPOT}\langle n \rangle\text{:STATe} \left\{ \begin{array}{l} \text{ON} \\ \text{OFF} \\ 1 \\ 0 \end{array} \right\}$$

Where,

1 (decimal 49) When the function is ON  
0 (decimal 48) When the function is OFF

<n> is:

1 State setting for FREQ1 point  
2 State setting for FREQ2 point  
3 State setting for FREQ3 point

### Example

```
OUTPUT 717;"CORR:SPOT1:STAT ON"
```

### Query Syntax

```
CORRection:SPOT<n>:STATe?
```

### Query Response

Returned format is :

```
<NR1><NL^END>
```

### Example

```
10 OUTPUT 717;"CORR:SPOT1:STAT?"  
20 ENTER 717;A  
30 PRINT A  
40 END
```



**:SPOT<n>:FREQUENCY** The :SPOT<n>:FREQUENCY command sets the frequency points (FREQ1, FREQ2 or FREQ3) for the specified frequency point correction. The :SPOT<n>:FREQUENCY? query returns the current settings of the frequency points ( FREQ1, FREQ2 or FREQ3).

**Command Syntax**

CORRection:SPOT<n>:FREQUENCY <value>

Where,

<value> is the NR1, NR2, or NR3 format

<n> is:

- 1 Frequency setting for FREQ1 point
- 2 Frequency setting for FREQ2 point
- 3 Frequency setting for FREQ3 point

**Example**

OUTPUT 717;"CORR:SPOT1:FREQ 2KHZ"! Set 2 kHz to FREQ1

**Note**

A suffix multiplier and a suffix unit, HZ (hertz), can be used with this command. Either MAHZ and MHZ can be used as the suffix multiplier for MHz (1E6 Hz).

**Query Syntax**

CORRection:SPOT<n>:FREQUENCY?

**Query Response**

Returned format is :

<NR3><NL^END>

**Example**

```
10 OUTPUT 717;"CORR:SPOT1:FREQ?"
20 ENTER 717;A
30 PRINT A
40 END
```

**Note**

If this query is received when the List Sweep parameter is set to anything other than frequency, error -230 Data corrupt or stale will occur.

**:SPOT<n>:OPEN**

The :SPOT<n>:OPEN command executes the OPEN correction data measurement for the specified frequency point (FREQ1, FREQ2 or FREQ3) correction.

**Command Syntax**

CORRection:SPOT<n>:OPEN

Where,  
<n> is :

- 1 State setting for FREQ1 point
- 2 State setting for FREQ2 point
- 3 State setting for FREQ3 point

**Example**

OUTPUT 717;"CORR:SPOT1:OPEN"

---

**:SPOT<n>:SHORT**

The :SPOT<n>:SHORT command executes the SHORT correction data measurement for the specified frequency point (FREQ1, FREQ2 or FREQ3) correction.

**Command Syntax**

CORRection:SPOT<n>:SHORT

Where, <n> is:

- 1 State setting for FREQ1 point
- 2 State setting for FREQ2 point
- 3 State setting for FREQ3 point

**Example**

OUTPUT 717;"CORR:SPOT1:SHOR"

**:SPOT<n>:LOAD**

The :SPOT<n>:LOAD command executes the LOAD correction data measurement for the specified frequency point (FREQ1, FREQ2 or FREQ3) correction.

**Command Syntax**

CORRection:SPOT<n>:LOAD

Where,  
<n> is :

- 1 State setting for FREQ1 point
- 2 State setting for FREQ2 point
- 3 State setting for FREQ3 point

**Example**

OUTPUT 717;"CORR:SPOT1:LOAD"

**:SPOT<n>:LOAD  
:STANdard**

The :SPOT<n>:LOAD:STANdard command sets the reference values of the standard at the specified frequency point (FREQ1, FREQ2 or FREQ3). The :SPOT<n>:LOAD:STANdard? query returns the current settings of the reference values for FREQ1, FREQ2 or FREQ3.

**Command Syntax**

CORRection:SPOT<n>:LOAD:STANdard <REF.A>,<REF.B>

Where,

- <n>
- 1 Setting for FREQ1 point
  - 2 Setting for FREQ2 point
  - 3 Setting for FREQ3 point

<REF.A> is the NR1, NR2, or NR3 format :  
Primary parameter's reference value of the standard  
<REF.B> is the NR1, NR2, or NR3 format :  
Secondary parameter's reference value of the standard

**Example**

OUTPUT 717;"CORR:SPOT1:LOAD:STAN 100.7,0.0002"

**Query Syntax**

CORRection:SPOT<n>:LOAD:STANdard?

**Query Response**

Returned format is :

<NR3>,<NR3><NL^END>

**Example**

10 OUTPUT 717;"CORR:SPOT1:LOAD:STAN?"  
20 ENTER 717;A,B  
30 PRINT A,B  
40 END

**:USE**

The :USE command sets the channel number to be used for multi channel correction. The :USE? query returns the current settings of the channel selected.

**Command Syntax**

CORRection:USE <channel number>

Where, <channel number> is : 1 to 127 (NR1, NR2, or NR3) :  
channel number

**Example**

OUTPUT 717;"CORR:USE 10" ! Set to channel number 10

**Query Syntax**

CORRection:USE?

**Query Response**

Returned format is :

<channel number><NL^END>

**Example**

```
10 OUTPUT 717;"CORR:USE?"
20 ENTER 717;A
30 PRINT A
40 END
```

## :USE:DATA?

The :USE:DATA? query returns the OPEN/SHORT/LOAD correction measurement data at FREQ1, FREQ2 or FREQ3.

### Query Syntax

CORrection:USE:DATA? <channel number>

Where, <channel number> is : 1 to 127 (NR1)

### Query Response

Returned format is :

<open1 A>, <open1 B>, <short1 A>, <short1 B>, <load1 A>, <load1 B>,  
<open2 A>, <open2 B>, <short2 A>, <short2 B>, <load2 A>, <load2 B>,  
<open3 A>, <open3 B>, <short3 A>, <short3 B>, <load3 A>, <load3 B>,

Where,

<open1/2/3 A> NR3 format : primary OPEN correction data at FREQ1/2/3.  
<open1/2/3 B> NR3 format : secondary OPEN correction data at FREQ1/2/3.  
<short1/2/3 A> NR3 format : primary SHORT correction data at FREQ1/2/3.  
<short1/2/3 B> NR3 format : secondary SHORT correction data at FREQ1/2/3.  
<load1/2/3 A> NR3 format : primary LOAD correction data at FREQ1/2/3.  
<load1/2/3 B> NR3 format : secondary LOAD correction data at FREQ1/2/3.

### Example

```
10 OPTION BASE 1
20 DIM A(18)
30 OUTPUT 717;"CORR:USE:DATA? 89"
40 ENTER 717;A(*)
50 PRINT A(*)
60 END
```

## COMParator Subsystem

The COMParator subsystem command group sets the comparator function, including its ON/OFF setting, limit mode, and limit values. Figure 8-13 shows the command tree of the COMParator subsystem command group.

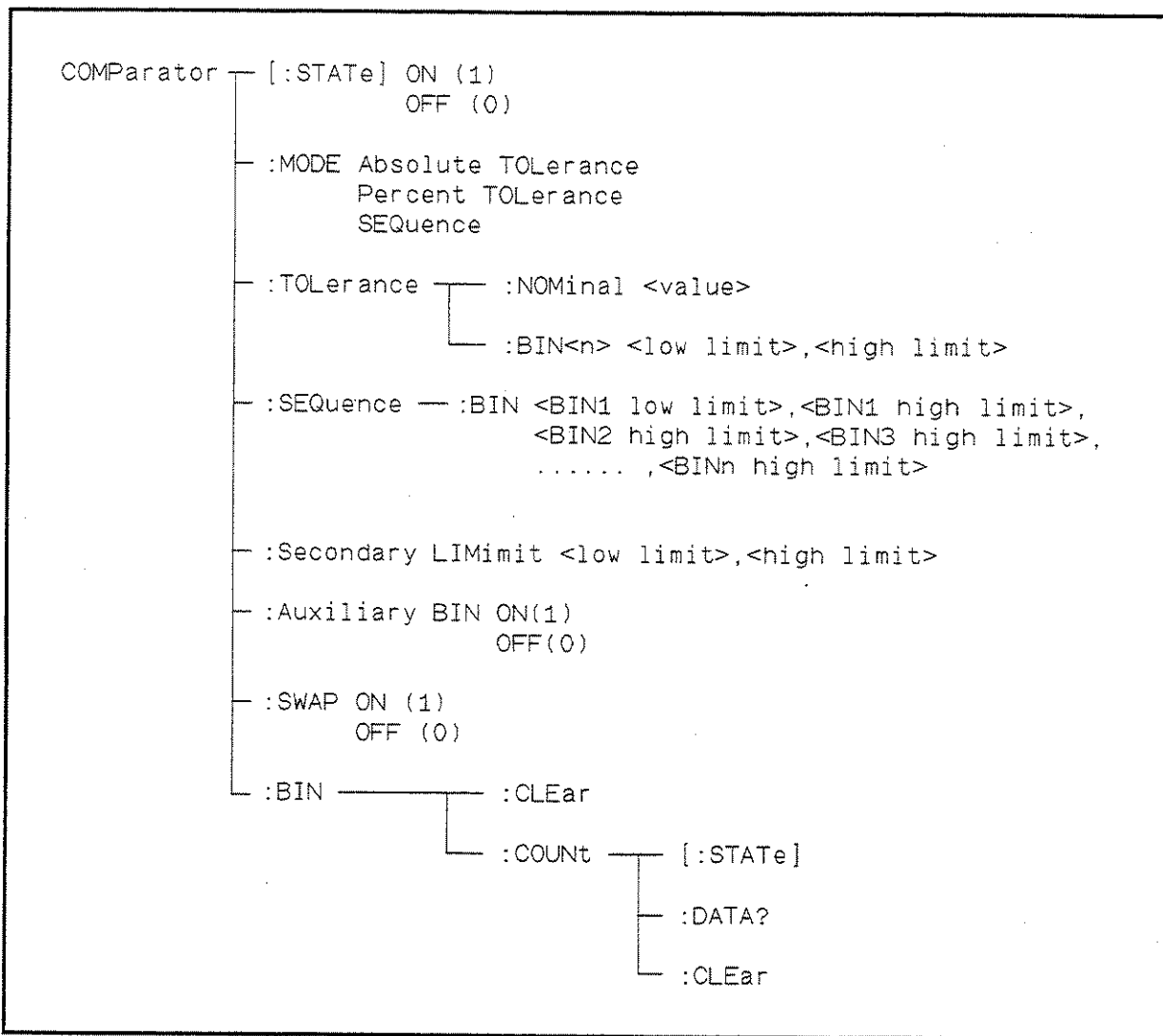

Figure 8-13. COMParator Subsystem Command Tree

**[:STATE]**

The [:STATE] command sets the comparator function to ON or OFF. The [:STATE]? query responds the current ON/OFF condition of comparator function.

**Command Syntax**

$$\text{COMParator}[:\text{STATE}] \left\{ \begin{array}{l} \text{ON} \\ \text{OFF} \\ 1 \\ 0 \end{array} \right\}$$

Where,

- 1 (decimal 49) When the function is ON
- 0 (decimal 48) When the function is OFF

**Example**

OUTPUT 717;"COMP ON"

**Query Syntax**

COMParator[:STATE]?

**Query Response**

Returned format is :

<NR1><NL^END>

**Example**

```
10 OUTPUT 717;"COMP?"
20 ENTER 717;A
30 PRINT A
40 END
```



**:MODE**

The :MODE command sets the limit mode of the comparator function. The :MODE? query returns the current settings of the limit mode.

**Command Syntax**

COMParator:MODE { ATOLerance  
PTOLerance  
SEQuence }

Where,

ATOLerance Set the absolute tolerance mode (parameter value)  
PTOLerance Set the percent tolerance mode (the ratio in percent)  
SEQuence Set the sequential mode

**Example**

OUTPUT 717;"COMP:MODE ATOL"

**Query Syntax**

COMParator:MODE?

**Query Response**

Returned format is:

{ ATOL  
PTOL } <NL~END>  
SEQ }

**Example**

10 OUTPUT 717;"COMP:MODE?"  
20 ENTER 717;A\$  
30 PRINT A\$  
40 END

**:TOLerance:NOMinal**

The :TOLerance:NOMinal command sets the nominal value for the tolerance mode of the comparator function. This can be set only when the limit mode is set to the tolerance mode. The :TOLerance:NOMinal? query returns the current settings of the nominal value for the tolerance mode.

**Command Syntax**

COMPARATOR:TOLerance:NOMinal <value>

Where,

<value> is the NR1, NR2, or NR3 format : nominal value

**Example**

OUTPUT 717;"COMP:TOL:NOM 100E-12"

**Query Syntax**

COMPARATOR:TOLerance:NOMinal?

**Query Response**

Returned Format is :

<NR3><NL^END>

**Example**

```
10 OUTPUT 717;"CORR:TOL:NOM?"
20 ENTER 717;A
30 PRINT A
40 END
```

**:TOLerance:BIN<n>**

The :TOLerance:BIN<n> command sets the low/high limit values of each BIN for the comparator function tolerance mode. These limits can be set only when the limit mode is set to the tolerance mode. The :TOLerance:BIN<n> query returns the current settings of the low/high limit values of each of the BINs.

**Command Syntax**

COMPARATOR:TOLerance:BIN<n> <low limit>,<high limit>

Where,

<n> 1 to 9 (NR1) : BIN number  
 <low limit> NR1, NR2, or NR3 format : low limit value  
 <high limit> NR1, NR2, or NR3 format : high limit value

**Note**

The low limit value should be lower than the high limit value. If the low limit value is set higher than the high limit, a warning message is displayed when this command is received (an error does not occur).

**Example**

OUTPUT 717;"COMP:TOL:BIN1 -5,5"

OUTPUT 717;"COMP:TOL:BIN2 -10,10"

**Query Syntax**

COMPARATOR:TOLerance:BIN<n>?

**Query Resopnse**

Returned Format is :

<low limit>,<high limit><NL^END>

**Example**

10 OUTPUT 717;"COMP:TOL:BIN1?"  
 20 ENTER 717;A,B  
 30 PRINT A,B  
 40 END

**:SEQuence:BIN**

The :SEQuence:BIN command sets the low/high limit values of the BINs for the sequence mode of the comparator function. These limits can be set only when the limit mode is set to the sequence mode. The :SEQuence:BIN query returns the current settings of the low/high limit values of the BINs.

**Command Syntax**

COMParator:SEQuence:BIN <BIN1 low limit>,<BIN1 high limit>,<BIN2 high limit>,... , <BINn high limit>

Where,

- <BIN1 low limit> NR1, NR2, or NR3 format : low limit value for BIN1
- <BIN1 high limit> NR1, NR2, or NR3 format : high limit value for BIN1
- <BINn high limit> NR1, NR2, or NR3 format : high limit value for BINn (n : max. 9 )

**Note**



The low limit value should be lower than the high limit value.

**Example**

OUTPUT 717;"COMP:SEQ:BIN 10,20,30,40,50"

**Query Syntax**

COMParator:SEQuence:BIN?

**Query Response**

Returned Format is :

<BIN1 low limit>,<BIN1 high limit>,<BIN2 high limit>,... , <BINn high limit><NL^END>

**Example**

```
10 DIM A$[200]
20 OUTPUT 717;"COMP:SEQ:BIN?"
30 ENTER 717;A$
40 PRINT A$
50 END
```

## :Secondary LIMit

The :Secondary LIMit command sets the low/high limit values for the comparator function secondary parameter. The :Secondary LIMit? query returns the current settings of the secondary parameter low/high limit values.

### Command Syntax

COMParator:SLIMit <low limit>,<high limit>

Where,

<low limit> is the NR1, NR2, or NR3 format : low limit value  
<high limit> is the NR1, NR2, or NR3 format : high limit value

### Note



The low limit value should be lower than the high limit value. If the low limit value is set higher than the high limit, a warning message is displayed when this command is received (an error does not occur).

### Example

OUTPUT 717;"COMP:SLIM 0.001,0.002"

### Query Syntax

COMParator:SLIMit?

### Query Response

Returned Format is:

<NR3>,<NR3><NL^END>

### Example

```
10 OUTPUT 717;"COMP:SLIM?"
20 ENTER 717;A,B
30 PRINT A,B
40 END
```

## :Auxiliary BIN

The :Auxiliary BIN command sets the auxiliary BIN counting function of the comparator to ON or OFF. The :Auxiliary BIN query responds the current ON/OFF condition of the auxiliary BIN counting function.

### Command Syntax

COMParator:Auxiliary BIN  $\left\{ \begin{array}{l} \text{ON} \\ \text{OFF} \\ 1 \\ 0 \end{array} \right\}$

Where,

0 (decimal 48) When the function is OFF

1 (decimal 49) When the function is ON

### Example

OUTPUT 717;"COMP:ABIN ON"

### Query Syntax

COMParator:Auxiliary BIN?

### Query Response

Returned Format is :

<NR1><NL^END>

### Example

```
10 OUTPUT 717;"COMP:ABIN?"
20 ENTER 717;A
30 PRINT A
40 END
```

**:SWAP**

The :SWAP command sets the swap parameter function to ON (9 BIN settings for secondary parameter) or OFF (9 BIN settings for primary parameter). The :SWAP? query responds the current ON/OFF condition of the auxiliary BIN counting function.

**Command Syntax**

$$\text{COMParator:SWAP} \left\{ \begin{array}{l} \text{ON} \\ \text{OFF} \\ 1 \\ 0 \end{array} \right\}$$

Where,

0 (decimal 48) When the function is OFF

1 (decimal 49) When the function is ON

**Example**

OUTPUT 717;"COMP:SWAP ON"

**Query Syntax**

COMParator:SWAP?

**Query Response**

Returned Format is :

<NR1><NL^END>

**Example**

```
10 OUTPUT 717;"COMP:SWAP?"
20 ENTER 717;A
30 PRINT A
40 END
```

**:BIN:CLEAr**

The :BIN:CLEAr command clears all of the limit value settings.

**Command Syntax**

COMParator:BIN:CLEAr

**Example**

OUTPUT 717;"COMP:BIN:CLE"

**:BIN:COUNT[:STATe]**

The :BIN:COUNT[:STATe] command sets the BIN count function to ON or OFF. The :BIN:COUNT[:STATe]? query responds with the current ON/OFF condition of the BIN count function.

**Command Syntax**

COMParator:BIN:COUNT[:STATe]  $\left\{ \begin{array}{l} \text{ON} \\ \text{OFF} \\ 1 \\ 0 \end{array} \right\}$

Where,

- 0 (decimal 48) When the function is OFF
- 1 (decimal 49) When the function is ON

**Example**

OUTPUT 717;"COMP:BIN:COUN ON"

**Query Syntax**

COMParator:BIN:COUNT[:STATe]?

**Query Response**

Returned Format is :

<NR1><NL^END>

**Example**

10 OUTPUT 717;"COMP:BIN:COUN?"  
20 ENTER 717;A  
30 PRINT A  
40 END



**:BIN:COUNT:DATA?**

The :BIN:COUNT:DATA? query returns the comparator BIN count results.

**Query Syntax**

COMPARATOR:BIN:COUNT:DATA?

**Query Response**

Returned Format is :

<BIN1 count>, <BIN2 count>, ... , <BIN9 count>, <OUT OF BIN count>, <AUX BIN count><NL^END>

Where,

<BIN1-9 count>

NR1 format : count result of BIN1-9

<OUT OF BINS count>

NR1 format : count result of OUT OF BINS

<AUX BIN count>

NR1 format : count result of AUX BIN

**Example**

```
10 OPTION BASE 1
20 DIM A(11)
30 OUTPUT 717;"COMP:BIN:COUN:DATA?"
40 ENTER 717;A(*)
50 PRINT A(*)
60 END
```

**:BIN:COUNT:CLEAr**

The :BIN:COUNT:CLEAr command clears all BIN counts.

**Command Syntax**

COMPARATOR:BIN:COUNT:CLEAr

**Example**

```
OUTPUT 717;"COMP:BIN:COUN:CLE"
```

---

## Mass MEMORY Subsystem

The Mass MEMORY subsystem command group loads or stores setting data from/to the internal EEPROM and the external memory card. Figure 8-14 shows the command tree of the Mass MEMORY subsystem command group.

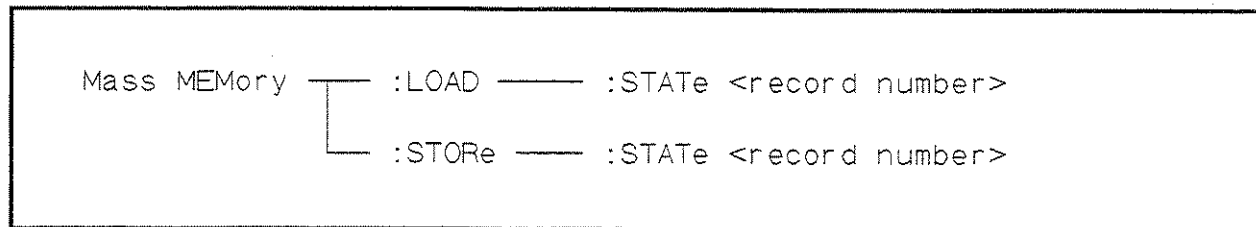

Figure 8-14. Mass MEMORY Subsystem Command Tree

---

### :LOAD:STATE

The :LOAD:STATE command loads the setting data from the internal EEPROM or a memory card.

#### Command Syntax

MMEMoRY:LOAD:STATE <value>

Where,

<value> 0 to 9 (NR1) : record number for internal EEPROM  
10 to 19 (NR1) : record number for memory card

#### Example

OUTPUT 717;"MMEM:LOAD:STAT 10"

---

### :STORE:STATE

The :STORE:STATE command stores the setting data to the internal EEPROM or to the memory card.

#### Command Syntax

MMEMoRY:STORE:STATE <value>

Where,

<value> 0 to 9 (NR1) : record number for EEPROM  
10 to 19 (NR1) : record number for memory card

#### Example

OUTPUT 717;"MMEM:STOR:STAT 5"

## SYSTem:ERRor?

The SYSTem:ERRor? query returns the existing error numbers with the error messages for the errors in the HP 4284A's error queue.

The HP 4284A's error queue stores errors generated by the HP 4284A. As errors are generated, they are placed in the error queue which stores up to five errors. This is a first in, first out queue (FIFO).

If the error queue overflows, the last error in the queue is replaced with error -350, "Too many errors". Anytime the queue overflows, the least recent errors remain in the queue, and the most recent errors are discarded.

When all errors have been read from the queue, further SYSTem:ERRor? queries will return error 0, "no errors". Reading an error from the queue removes that error from the queue, opening a position in the queue for a new error, if one is subsequently generated.

### Query Syntax

SYSTem:ERRor?

### Query Response

Returned Format is :

*<number>*, "*<message>*"

Where,

*<number>* NR1 format : error number  
For details, refer to Appendix B.  
*<message>* ASCII string : error message  
For details, refer to Appendix B.

### Example

```
10 DIM A$[50]
20 FOR I=1 to 5
30  OUTPUT 717;"SYST:ERR?"
40  ENTER 717;A$
50  PRINT A$
60 NEXT I
70 END
```

## STATUS Subsystem

The STATUS subsystem command group sets the Operation Status Registers which report events which are part of the HP 4284A's normal operation, including measuring and sweeping. Figure 8-15 shows the command tree of the STATUS subsystem command group.

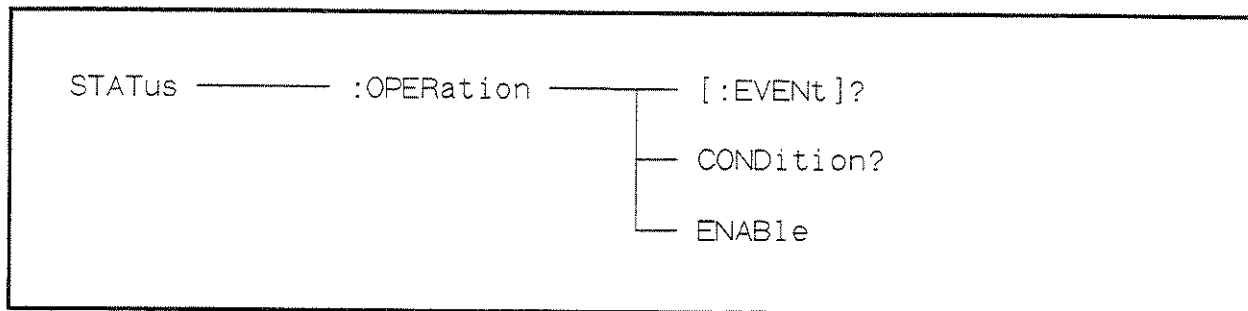

Figure 8-15. STATUS Subsystem Command Tree

**:OPERa-  
tion[:EVENT]?**

The :OPERation[:EVENT]? query returns the contents of the standard operation status event register. Reading the event register using this query has the effect of clearing its contents, but has no effect on the operation status condition register.

**Query Syntax**                    STATus:OPERation[:EVENT]?

**Query Response**                Returned Format is :

*<value>*<NL^END>

Where,

*<value>*                NR1 format : decimal expression of the contents of the operation status event register

The definition of each bit of the operation status event register is as follows.

Bit No.	Description
15 - 5	Always 0 (zero)
4	Measurement Complete Bit
3	List Sweep Measurement Complete Bit
2, 1	Always 0 (zero)
0	Correction Data Measurement Complete Bit

**Example**                    10 OUTPUT 717;"STAT:OPER?"  
                                   20 ENTER 717;A  
                                   30 PRINT A  
                                   40 END

## :OPERation:CONDition?

The :OPERation:CONDition? query returns the contents of the standard operation status condition register. Reading a condition register using this query does not clear its contents.

### Query Syntax

STATus:OPERation:CONDition?

### Query Response

Returned Format is :

<value><NL^END>

Where,

<value> NR1 format : decimal expression of the contents of the operation status condition register

The definition of each bit in the operation status condition register is as follows.

Bit No.	Description
15 - 5	Always 0 (zero)
4	Measuring Bit
3	Sweeping Bit
2, 1	Always 0 (zero)
0	Measuring Correction Data Bit

### Example

```
10 OUTPUT 717;"STAT:OPER:COND?"
20 ENTER 717;A
30 PRINT A
40 END
```

**:OPERation:ENABLE**

The :OPERation:ENABLE command sets the enable bits of the standard operation status event register that allows true conditions in the event register to be reported in the summary bit of the status byte register. The :OPERation:ENABLE? query returns the current setting of the enable bits of the operation status event register.

**Command Syntax**

STATus:OPERation:ENABLE <value>

Where,

<value> NR1 format : decimal expression of enable bits of the operation status event register

The definition of each bit in the operation status event register is as follows.

Bit No.	Description
15 - 5	Always 0 (zero)
4	Measurement Complete Bit
3	List Sweep Measurement Complete Bit
2, 1	Always 0 (zero)
0	Correction Data Measurement Complete Bit

**Example**

OUTPUT 717;"STAT:OPER:ENAB 16"! Bit 4 enable

**Query Syntax**

STATus:OPERation:ENABLE?

**Query Response**

Returned Format is:

<value><NL^END>

**Example**

```
10 OUTPUT 717;"STAT:OPER:ENAB?"
20 ENTER 717;A
30 PRINT A
40 END
```

---

## Common Commands

The HP-IB Common commands are defined as IEEE 488.2-1987, and are noninstrument specific HP-IB commands. A common command consists of an asterisk (\*) and a header. The HP 4284A acceptable HP-IB common commands are as follows.

### HP-IB Common Commands

- \*CLS
- \*ESE
- \*ESR?
- \*SRE
- \*STB?
- \*IDN?
- \*OPC?
- \*WAI
- \*RST
- \*TST?
- \*TRG
- \*LRN?
- \*OPT?

---

## \*CLS

The \*CLS command (clear status command) clears the status byte register, the event register of the standard operation status register structure, and the standard event status register. It also clears the error queue (refer to the description of the `SYSTEM:ERROR?` query).

### Command Syntax

\*CLS

### Example

OUTPUT 717; "\*CLS"



## \*ESE

The \*ESE command (standard Event Status Enable command) sets the enable bits of the standard event status register. The \*ESE? query returns the current setting of the enable bits of the event status register.

### Command Syntax

\*ESE <value>

Where,

<value> NR1 format : decimal expression of enable bits of the operation status register

The definition of each bit in the event status register is as follows.

Bit No.	Description
7	Power On (PON) Bit
6	User Request (URQ) Bit
5	Command Error (CME) Bit
4	Execution Error (EXE) Bit
3	Device Dependent Error (DDE) Bit
2	Query Error (QYE) Bit
1	Request Control (RQC) Bit
0	Operation Complete (OPC) Bit

### Example

```
OUTPUT 717;"*ESE 36"! Bit 2 and 5 enabled
```

### Query Syntax

```
*ESE?
```

### Query Response

Returned format is :

```
<value><NL^END>
```

### Example

```
10 OUTPUT 717;"*ESE?"
20 ENTER 717;A
30 PRINT A
40 END
```

## \*ESR?

The \*ESR? query returns the contents of the standard event status register. Using the \*ESR query command to read the standard event status register clears its contents.

### Query Syntax

\*ESR?

### Query Response

Returned format is :

<value><NL^END>

Where,

<value> NR1 format : decimal expression of the contents of the event status register

The definition of each bit of the event status register is as follows.

Bit No.	Description
7	Power On (PON) Bit
6	User Request (URQ) Bit
5	Command Error (CME) Bit
4	Execution Error (EXE) Bit
3	Device Dependent Error (DDE) Bit
2	Query Error (QYE) Bit
1	Request Control (RQC) Bit
0	Operation Complete (OPC) Bit

### Example

```
10 OUTPUT 717;"*ESR?"
20 ENTER 717;A
30 PRINT A
40 END
```

## \*SRE

The \*SRE command (Service Request Enable command) sets the enable bits of the status byte register. The \*SRE? query returns the current setting of the status byte register.

### Command Syntax

\*SRE <value>

Where,

<value> NR1 format : decimal expression of enable bits of the status byte register

The definition of each bit of the status byte register is as follows.

Bit No.	Description
7	Operation Status Register Summary Bit
6	RQS (Request Service) Bit
5	Standard Event Status Register Summary Bit
4	MAV (Message Available) Bit
3 - 0	Always 0 (zero)

### Example

```
OUTPUT 717;"*SRE 32"! Bit 5 enabled
```

### Query Syntax

```
*SRE?
```

### Query Response

Returned format is :

```
<value><NL^END>
```

### Example

```
10 OUTPUT 717;"*SRE?"  
20 ENTER 717;A  
30 PRINT A  
40 END
```

## \*STB?

The \*STB? query reads the status byte by reading the master summary status (MSS) bit. These bits represent the contents of the status byte register. Execution of the \*STB query command has no effect on the contents of the status byte register.

### Query Syntax

\*STB?

### Query Response

Returned format is :

<value><NL^END>

Where,

<value> NR1 format : decimal expression of the contents of the status byte register

The definition of each bit of the status byte is as follows.

Bit No.	Description
7	Operation Status Register Summary Bit
6	RQS (Request Service) Bit
5	Standard Event Status Register Summary Bit
4	MAV (Message Available) Bit
3 - 0	Always 0 (zero)

### Example

```
10 OUTPUT 717;"*STB?"
20 ENTER 717;A
30 PRINT A
40 END
```

**\*IDN?**

The \*IDN? query returns the HP 4284A ID.

**Query Syntax**

\*IDN?

**Query Response**

Returned format is :

<manufacturer>,<model>,<serial no.>,<firmware><NL^END>

Where,

<manufacturer> HEWLETT-PACKARD  
 <model> 4284A  
 <serial number> 0 (not available)  
 <firmware> REVdd.dd  
 (dd.dd : ROM firmware revision number)

**Example**

```
10 DIM A$[30]
20 OUTPUT 717;"*IDN?"
20 ENTER 717;A$
30 PRINT A$
40 END
```

**Note**

This string data is an arbitrary ASCII response. So, this command should not be sent before a normal query in a program message. (For example, \*IDN?;FREQ? can not accepted, FREQ?;\*IDN? should be sent.)

**\*IDN?**

---

**\*OPC**

The \*OPC command (operation complete command) tells the HP 4284A to set bit 0 (OPC bit) in the standard event status register when it completes all pending operations. The \*OPC? command tells the HP 4284A to place an ASCII "1" (decimal 49) in the HP 4284A's output buffer when it completes all pending operations.

**Command Syntax**        \*OPC

**Example**

```
OUTPUT 717;"*OPC" ! Set the HP 4284A to set OPC bit
! when the operation executed by previous command is completed.
```

**Query Syntax**        \*OPC?

**Query Response**    Returned format is :

```
1<NL^END>
```

Where,

```
1     1 (ASCII, decimal 49)
```

**Example**

```
10 OUTPUT 717;"CORR:OPEN" ! Perform OPEN correction measurement
20 OUTPUT 717;"*OPC?"     ! Wait for OPEN correction
30 ENTER 717;A            !     measurement completed
40 END
```

---

**\*WAI**

The \*WAI command (the wait to continue command) makes the HP 4284A wait until all previously sent commands are completed. The HP 4284A then continues executing the commands that follow the \*WAI command.

**Command Syntax**        \*WAI

**Example**                OUTPUT 717;"\*WAI"

---

## \*RST

The \*RST command (reset command) sets the HP 4284A to its initial settings. The initial settings set by the \*RST command are given in Appendix C. When the HP 4284A receives a \*RST command, it aborts all pending operations, and forgets about any previously received \*OPC commands and \*OPC? queries.

### Command Syntax

\*RST

### Example

OUTPUT 717; "\*RST"

---

## \*TST?

The \*TST? query (self-test query) causes the device to execute an internal self-test and reports whether or not it detected any errors. In the case of the HP 4284A, the response to this query is always "0" (no error).

### Query Syntax

\*TST?

### Query Response

Returned format is :

0<NL^END>

Where,

0 0 (NR1 format)

### Example

```
10 OUTPUT 717; "*TST?"
20 ENTER 717;A
30 END
```

---

## **\*TRG**

The \*TRG command (trigger command) performs the same function as the Group Execute Trigger command (refer to "Trigger System" in Chapter 7). This command also moves the primary and secondary parameter measurement data into the HP 4284A's output buffer.

### **Command Syntax**

\*TRG

### **Example**

```
10 OUTPUT 717;"*TRG"  
20 ENTER 717;A,B,C  
30 PRINT A,B,C  
40 END
```



## \*LRN?

The \*LRN? query (learn device setup query) tells the HP 4284A to send a response that contains all the necessary commands to set the HP 4284A to its present state. The response can later be sent back to the HP 4284A to place it in this state. This provides the user with a means of setting up a device manually and then reading the device setting and storing the information for later use.

### Query Syntax

\*LRN?

### Query Response

Returned format is :

```
:FREQ <NR3>;:VOLT (or CURR) <NR3>;
:AMPL:ALC {0|1};:OUTP:HPOW {0|1};DC:ISOL {0|1};
:BIAS:VOLT (or CURR) <NR3>;:STAT {0|1};
:CORR:LENG <NR1>;METH {SING|MULT};
:CORR:OPEN:STAT {0|1};:CORR:SHOR:STAT {0|1};
:CORR:LOAD:STAT {0|1};TYPE <function>;
:CORR:SPOT1:STAT {0|1};FREQ <NR3>; LOAD:STAN <REF.A>,<REF.B>;
:CORR:SPOT2:STAT {0|1};FREQ <NR3>; LOAD:STAN <REF.A>,<REF.B>;
:CORR:SPOT3:STAT {0|1};FREQ <NR3>; LOAD:STAN <REF.A>,<REF.B>;
:CORR:USE <NR1>;
:FUNC:IMP:TYPE <function>;RANG <NR3>;RANG:AUTO {0|1};
:FUNC:SMDN:VAC:STAT {0|1};FUNC:SMDN:IAC:STAT {0|1};
:FUNC:DEV1:MODE {ABS|PERC|OFF};REF <NR3>;
:FUNC:DEV2:MODE {ABS|PERC|OFF};REF <NR3>;
:APER {SHOR|MED|LONG},<NR1>;
:TRIG:SOUR {INT|EXT|BUS|HOLD};DEL <NR3>;
:DISP:PAGE <page name>;LINE "<string>";
:FORM {ASC|REAL,64};
:COMP:STAT {0|1};MODE {ATOL|PTOL|SEQ};TOL:NOM <NR3>;
(BIN1 <low>,<high>;BIN2 <low>,<high>, ... ;) or
(:COMP:SEQ:BIN <BIN1 low>,<BIN2 high>,<BIN3 high>,...;)
[:COMP:SLIM <low>,<high>;]
:COMP:ABIN {0|1};SWAP {0|1};BIN:COUN {0|1};
:LIST:FREQ (VOLT, CURR, BIAS:VOLT, or BIAS:CURR) <NR3>[,<NR3>*];
:LIST:MODE {SEQ|STEP};
BAND1 <parameter>,<low>,<high>;
BAND2 <parameter>,<low>,<high>;
;;
BAND<n> <parameter>,<low>,<high>
```

For details, refer to each command reference page.

### Example

```
10 DIM A$[1000]
20 OUTPUT 717;"*LRN?"
30 ENTER 717;A$
40 !
50 OUTPUT 717;A$
60 END
```

---

## \*OPT?

The \*OPT? query (OPTion identification query) tells the HP 4284A to identify the options installed in the system interface.

### Query Syntax

\*OPT?

### Query Response

Returned format is :

*<power amp>, <I bias I/F>, <2m/4m cable>, <handler I/F>, <scanner I/F><NL~END>*

Where,

*<power amp>* is : 001 (ASCII) : Option 001 is installed  
0 (ASCII) : Option 001 is not installed  
*<I bias I/F>* is : 002 (ASCII) : Option 002 is installed  
0 (ASCII) : Option 002 is not installed  
*<2m/4m cable>* is : 006 (ASCII) : Option 006 is installed  
0 (ASCII) : Option 006 is not installed  
*<handler I/F>* is : 201 (ASCII) : Option 201 is installed  
202 (ASCII) : Option 202 is installed  
0 (ASCII) : Option 201 and 202 are not installed  
*<scanner I/F>* is : 301 (ASCII) : Option 301 is installed  
0 (ASCII) : Option 301 is not installed

### Note



This string data is the arbitrary ASCII response. So this command should not be sent before a normal query in a program message. (For example, \*OPT?;FREQ? can not accepted, FREQ?;\*OPT? should be sent.)

---

### Example

```
10 OUTPUT 717;"*OPT?"
20 ENTER 717;A$
30 END
```

## General Information

---

### Introduction

This chapter describes specifications, supplemental performance characteristics, storage/repackaging, and other general information about the HP 4284A.

### Components not Covered by Warranty

The memory card is not covered under the HP 4284A's warranty. If the memory card becomes defective even within the warranty period of the HP 4284A, the memory card must be paid for by the user.

### Serial Number

Hewlett-Packard uses a two-section, nine character serial number which is stamped on the serial number plate (Figure 9-1) attached to the instrument's rear panel. The first four digits and a letter are the serial number prefix, and the last five digits are the suffix. The letter placed between the two sections identifies the country where the instrument was manufactured. The prefix is the same for all identical instruments; it changes only when a change is made to the instrument. The suffix, however, is assigned sequentially and is different for each instrument. The contents of this manual apply to instruments with the serial number prefix(es) listed under the serial numbers on the title page.

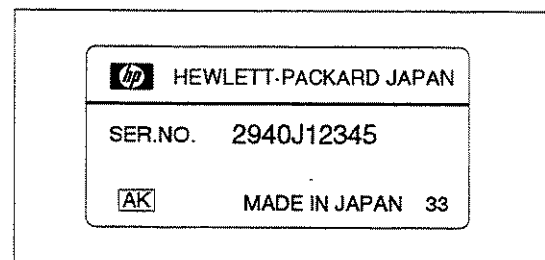

**Figure 9-1. Serial Number Plate**

An instrument manufactured after the printing of this manual may have a serial number prefix that is not listed on the title page. This unlisted serial number prefix indicates the instrument is different from those described in this manual. The manual for this new instrument may be accompanied by a yellow Manual

Change supplement or have a different manual part number. This sheet contains "change information" that explains how to adapt the manual to the newer instrument.

In addition to change information, the supplement may contain information for correcting errors (Errata) in the manual. To keep this manual as current and accurate as possible, Hewlett-Packard recommends that you periodically request the latest Manual Changes supplement. The supplement for this manual is identified by this manual's printing date and its part number, both of which appear on the manual's title page. Complimentary copies of the supplement are available from Hewlett-Packard. If the serial prefix or number of an instrument is lower than that on the title page of this manual, see *Appendix A, MANUAL CHANGES*.

For information concerning, a serial number prefix that is not listed on the title page or in the Manual Change supplement, contact the nearest Hewlett-Packard office.

## Specifications

The complete HP 4284A specifications are listed below. These specifications are the performance standards or limits against which the instrument is tested. When shipped from the factory, the HP 4284A meets the specifications listed in this section. The specification test procedures are covered in Chapter 10.

## Measurement Functions

### Measurement Parameters

- |Z| : Absolute value of impedance
- |Y| : Absolute value of admittance
- L : Inductance
- C : Capacitance
- R : Resistance
- G : Conductance
- D : Dissipation factor
- Q : Quality factor
- R<sub>s</sub> : Equivalent series resistance
- R<sub>p</sub> : Parallel resistance
- X : Reactance
- B : Susceptance
- θ : Phase angle

### Combinations

Z ,  Y	L, C	R	G
θ(deg), θ(rad)	D, Q, R <sub>s</sub> , R <sub>p</sub> , G	X	B

### **Mathematical Functions**

The deviation and the percent of deviation of measurement values from a programmable reference value.

### **Equivalent Measurement Circuit**

Parallel and Series

### **Ranging**

Auto and Manual (Hold/Up/Down)

### **Trigger**

Internal, External, BUS (HP-IB), and Manual.

### **Delay Time**

Programmable delay from the trigger command to the start of the measurement, 0 to 60.000 sec. in 1 msec. steps.

### **Measurement terminals**

Four-terminal pair

### **Test Cable Length**

**Standard.** 0 m and 1 m selectable

**With Option 006.** 0 m, 1 m, 2 m and 4 m selectable

### **Integration Time**

Short, Medium and Long (See Supplemental Performance Characteristics for the measurement time.)

### **Averaging**

1 to 256, programmable

## **Test Signal**

### **Frequency**

20 Hz to 1 MHz, 8610 selectable frequencies (refer to Appendix F for selectable frequencies.)

**Accuracy.**  $\pm 0.01\%$

### **Signal Modes**

**Normal.** Programs selected voltage or current at the measurement terminals when they are opened or shorted, respectively.

**Constant.** Maintains selected voltage or current at the device under test independent of changes in the device's impedance.

## Signal Level

	Mode	Range	Setting Accuracy
Voltage	Non-constant	5 mV <sub>rms</sub> to 2 V <sub>rms</sub>	±(10% + 1 mV <sub>rms</sub> )
	Constant <sup>1</sup>	10 mV <sub>rms</sub> to 1 V <sub>rms</sub>	±(6% + 1 mV <sub>rms</sub> )
Current	Non-constant	50 μA <sub>rms</sub> to 20 mA <sub>rms</sub>	±(10% + 10 μA <sub>rms</sub> )
	Constant <sup>1</sup>	100 μA <sub>rms</sub> to 10 mA <sub>rms</sub>	±(6% + 10 μA <sub>rms</sub> )

1 Automatic Level Control Function is set to ON.

## Output Impedance

100 Ω, ±3%

## Test Signal Level Monitor

Mode	Range	Accuracy
Voltage <sup>1</sup>	5 mV <sub>rms</sub> to 2 V <sub>rms</sub>	±(3% of reading + 0.5 mV <sub>rms</sub> )
	0.01 mV <sub>rms</sub> to 5 mV <sub>rms</sub>	±(11% of reading + 0.1 mV <sub>rms</sub> )
Current <sup>2</sup>	50 μA <sub>rms</sub> to 20 mA <sub>rms</sub>	±(3% of reading + 5 μA <sub>rms</sub> )
	0.001 μA <sub>rms</sub> to 50 μA <sub>rms</sub>	±(11% of reading + 1 μA <sub>rms</sub> )

1 Add the impedance measurement accuracy [%] to the voltage level monitor accuracy when the DUT's impedance is < 100 Ω.

2 Add the impedance measurement accuracy [%] to the current level monitor accuracy when the DUT's impedance is ≥ 100 Ω.

Accuracies apply when test cable length is 0 m or 1 m. additional error when test cable length is 2 m or 4 m is given as:

$$f_m \times \frac{L}{2} \quad [\%]$$

Where,  $f_m$  is test frequency [MHz],  
 $L$  is test cable length [m].

Example DUT's impedance : 50 Ω  
 Test signal level : 0.1 V<sub>rms</sub>  
 Measurement accuracy : 0.1 %

Then, Voltage level monitor accuracy is  
 ±(3.1 % of reading+0.5 mV<sub>rms</sub>)

## Display Range

Parameter	Range
Z , R, X	0.01 mΩ to 99.9999 MΩ
Y , G, B	0.01 nS to 99.9999 S
C	0.01 fF to 9.99999 F
L	0.01 nH to 99.9999 kH
D	0.000001 to 9.99999
Q	0.01 to 99999.9
$\theta$	-180.000 ° to 180.000 °
$\Delta$	-999.999% to 999.999%

## Absolute Measurement Accuracy

Absolute measurement accuracy is given as the sum of the relative measurement accuracy plus the calibration accuracy.

### |Z|, |Y|, L, C, R, X, G and B Accuracy

|Z|, |Y|, L, C, R, X, G and B accuracy is given as,

$$A_e + A_{cal} \quad [\%]$$

Where,  $A_e$  is the relative accuracy,  
 $A_{cal}$  is the calibration accuracy.

L, C, X and B accuracies apply when  $D_x$  (measured D value)  $\leq 0.1$ .  
 R and G accuracies apply when  $Q_x$  (measured Q value)  $\leq 0.1$ .  
 G accuracy described in this paragraph applies to the G-B combination only.

### D accuracy

D accuracy is given as,

$$D_e + \theta_{cal}$$

Where,  $D_e$  is the relative D accuracy,  
 $\theta_{cal}$  is the calibration accuracy [radian].

Accuracy applies when  $D_x$  (measured D value)  $\leq 0.1$ .

### Q Accuracy

Q accuracy is given as,

$$\pm \frac{Q_x^2 \times D_a}{1 \mp Q_x \times D_a}$$

Where,  $Q_x$  is the measured Q value,  
 $D_a$  is the absolute D accuracy.

Accuracy applies when  $Q_x \times D_a < 1$ .

### **$\theta$ Accuracy**

$\theta$  accuracy is given as,

$$\theta_e + \theta_{cal} \quad [deg]$$

Where,  $\theta_e$  is the relative  $\theta$  accuracy [deg],  
 $\theta_{cal}$  is the calibration accuracy [deg].

### **G Accuracy**

When  $D_x$  (measured D value)  $\leq 0.1$ .

G accuracy is given as,

$$B_x \times D_a \quad [S]$$

$$B_x = 2\pi f C_x = \frac{1}{2\pi f L_x}$$

Where,  $B_x$  is the measured B value [S],  
 $C_x$  is the measured C value [F],  
 $L_x$  is the measured L value [H],  
 $D_a$  is the absolute D accuracy,  
 $f$  is the test frequency [Hz].

G accuracy described in this paragraph applies to the C<sub>p</sub>-G and L<sub>p</sub>-G combinations only.

### **R<sub>p</sub> Accuracy**

When  $D_x$  (measured D value)  $\leq 0.1$

R<sub>p</sub> accuracy is given as,

$$\pm \frac{R_{px} \times D_a}{D_x \mp D_a} \quad [\Omega]$$

Where,  $R_{px}$  is the measured R<sub>p</sub> value [ $\Omega$ ],  
 $D_x$  is the measured D value,  
 $D_a$  is the absolute D accuracy.

### **R<sub>s</sub> Accuracy**

When  $D_x$  (measured D value)  $\leq 0.1$

R<sub>s</sub> accuracy is given as,

$$X_x \times D_a \quad [\Omega]$$

$$X_x = 2\pi f L_x = \frac{1}{2\pi f C_x}$$

Where,  $X_x$  is the measured X value [ $\Omega$ ],  
 $C_x$  is the measured C value [F],  
 $L_x$  is the measured L value [H],  
 $D_a$  is the absolute D accuracy,  
 $f$  is the test frequency [Hz].



## Relative Measurement Accuracy

Relative measurement accuracy includes stability, temperature coefficient, linearity, repeatability and calibration interpolation error. Relative measurement accuracy is specified when all of the following conditions are satisfied:

1. Warm-up time :  $\geq 30$  minutes
2. Test cable length : 0 m, 1 m, 2 m or 4 m (HP 16048 A/B/D/E)  
For 2 m or 4 m cable length operation, test signal voltage and test frequency are set according to Figure A. (2 m and 4 m cable can be used only when Option 006 is installed.)
3. OPEN and SHORT corrections have been performed.
4. Bias current isolation : OFF  
(For accuracy with bias current isolation, refer to supplemental performance characteristics.)
5. Test signal voltage and DC bias voltage are set according to Figure B.
6. The optimum measurement range is selected by matching the DUT's impedance to the effective measuring range shown in Table 3-1-1, page 3-7. (For example, if the DUT's impedance is 50 k $\Omega$ , the optimum range is the 30 k $\Omega$  range.)

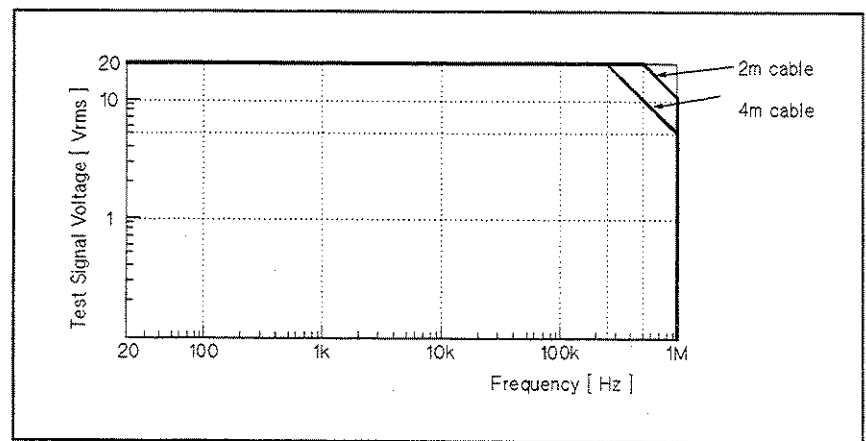
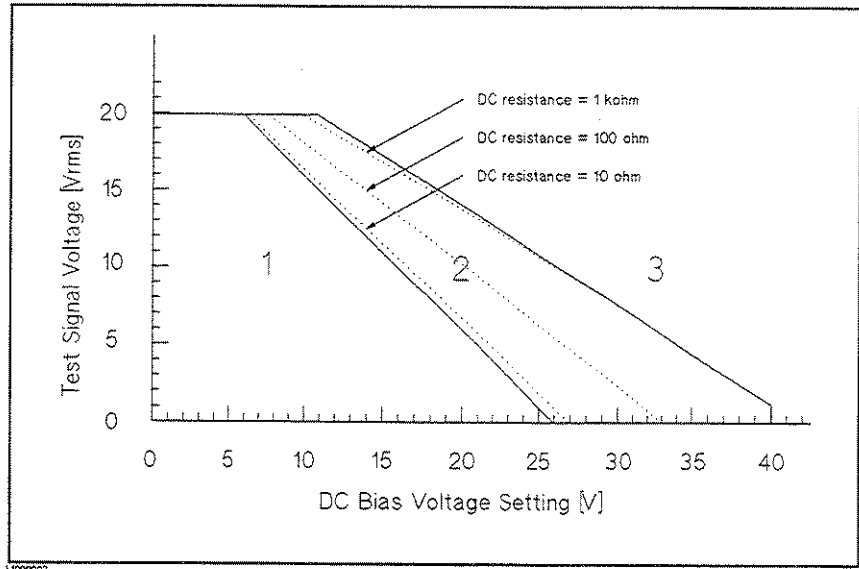

Figure 9-2.

Test Signal Voltage and Test Frequency upper Limits to apply measurement accuracy to 2 m and 4 m Cable Length Operation.



**Figure 9-3.**  
**Test Signal Voltage and DC Bias Voltage Upper Limits Apply for Measurement Accuracy.**

Range 1: Measurement accuracy can apply.

Range 2: The limits applied for measurement accuracy differ according to DUT's DC resistance. Three dotted lines show the upper limits when the DC resistance is 10  $\Omega$ , 100  $\Omega$  and 1 k $\Omega$ .

#### **|Z|, |Y|, L, C, R, X, G and B Accuracy**

|Z|, |Y|, L, C, R, X, G and B accuracy  $A_e$  is given as

$$A_e = \pm[A + (K_a + K_{aa} + K_b \times K_{bb} + K_c) \times 100 + K_d] \times K_e \quad [\%]$$

- $A$ : Basic Accuracy (Refer to Figure C and D.)
- $K_a$ : Impedance Proportional Factor (Refer to Table A.)
- $K_{aa}$ : Cable Length Factor (Refer to Table B.)
- $K_b$ : Impedance Proportional Factor (Refer to Table A.)
- $K_{bb}$ : Cable Length Factor (Refer to Table C.)
- $K_c$ : Calibration Interpolation Factor (Refer to Table D.)
- $K_d$ : Cable Length Factor (Refer to Table E.)
- $K_e$ : Temperature Factor (Refer to Table F.)

L, C, X and B accuracies apply when  $D_x$  (measured D value)  $\leq 0.1$ .

R and G accuracies apply when  $Q_x$  (measured Q value)  $\leq 0.1$ .

When  $D_x \geq 0.1$ , multiply  $A_e$  by  $\sqrt{1 + D_x^2}$  for L, C, X and B accuracies.

When  $Q_x \geq 0.1$ , multiply  $A_e$  by  $\sqrt{1 + Q_x^2}$  for R and G accuracies.

G accuracy described in this paragraph applies to the G-B combination only.

#### **D accuracy**

D accuracy  $D_e$  is given as,

$$D_e = \pm \frac{A_e}{100}$$

Accuracy applies when  $D_x$  (measured D value)  $\leq 0.1$ .

When  $D_x > 0.1$ , multiply  $D_e$  by  $(1 + D_x)$ .

#### **Q Accuracy**

Q accuracy is given as,

$$\pm \frac{Q_x^2 \times D_e}{1 \mp Q_x \times D_e}$$

Where,  $Q_x$  is the measured Q value,  
 $D_e$  is the relative D accuracy.

Accuracy applies when  $Q_x \times D_e < 1$ .

#### **$\theta$ Accuracy**

$\theta$  accuracy is given as,

$$\frac{180}{\pi} \times \frac{A_e}{100} \quad [deg]$$

#### **G Accuracy**

When  $D_x$  (measured D value)  $\leq 0.1$ .

G accuracy is given as,

$$B_x \times D_e \quad [S]$$
$$B_x = 2\pi f C_x = \frac{1}{2\pi f L_x}$$

Where,  $B_x$  is the measured B value [S],  
 $C_x$  is the measured C value [F],  
 $L_x$  is the measured L value [H],  
 $D_e$  is the relative D accuracy,  
 $f$  is the test frequency [Hz].

G accuracy described in this paragraph applies to the C<sub>p</sub>-G and L<sub>p</sub>-G combinations only.

#### **R<sub>p</sub> Accuracy**

When  $D_x$  (measured D value)  $\leq 0.1$

R<sub>p</sub> accuracy is given as,

$$\pm \frac{R_{px} \times D_e}{D_x \mp D_e} \quad [\Omega]$$

Where,  $R_{px}$  is the measured  $R_p$  value  $[\Omega]$ ,  
 $D_x$  is the measured D value,  
 $D_e$  is the relative D accuracy.

### **R<sub>s</sub> Accuracy**

When  $D_x$  (measured D value)  $\leq 0.1$

$R_s$  accuracy is given as,

$$X_x \times D_e \quad [\Omega]$$

$$X_x = 2\pi f L_x = \frac{1}{2\pi f C_x}$$

Where,  $X_x$  is the measured X value  $[\Omega]$ ,  
 $C_x$  is the measured C value  $[F]$ ,  
 $L_x$  is the measured L value  $[H]$ ,  
 $D_e$  is the relative D accuracy,  
 $f$  is the test frequency  $[Hz]$ .

**Example of C-D  
Accuracy Calculation**

**Measurement Conditions**

Frequency :	1 kHz
C measured :	100 nF
Test Signal Voltage :	1 V <sub>rms</sub>
Integration Time :	MEDIUM
Cable Length :	0 m

Then,

$$A = 0.05$$

$$\begin{aligned} |Z_m| &= \frac{1}{2\pi \times 1 \times 10^3 \times 100 \times 10^{-9}} \\ &= 1590 \quad [\Omega] \end{aligned}$$

$$\begin{aligned} K_a &= \frac{1 \times 10^{-3}}{1590} \left( 1 + \frac{200}{1000} \right) \\ &= 7.5 \times 10^{-7} \end{aligned}$$

$$\begin{aligned} K_b &= 1590 \times 1 \times 10^{-9} \left( 1 + \frac{70}{1000} \right) \\ &= 1.70 \times 10^{-6} \end{aligned}$$

$$K_c = 0$$

Therefore,

$$\begin{aligned} C_{\text{accuracy}} &= \pm [0.05 + (7.5 \times 10^{-7} + 1.70 \times 10^{-6}) \times 100] \\ &\approx \pm 0.05 \quad [\%] \end{aligned}$$

$$\begin{aligned} D_{\text{accuracy}} &= \pm \frac{0.05}{100} \\ &= \pm 0.0005 \end{aligned}$$

## Specification Charts and Tables

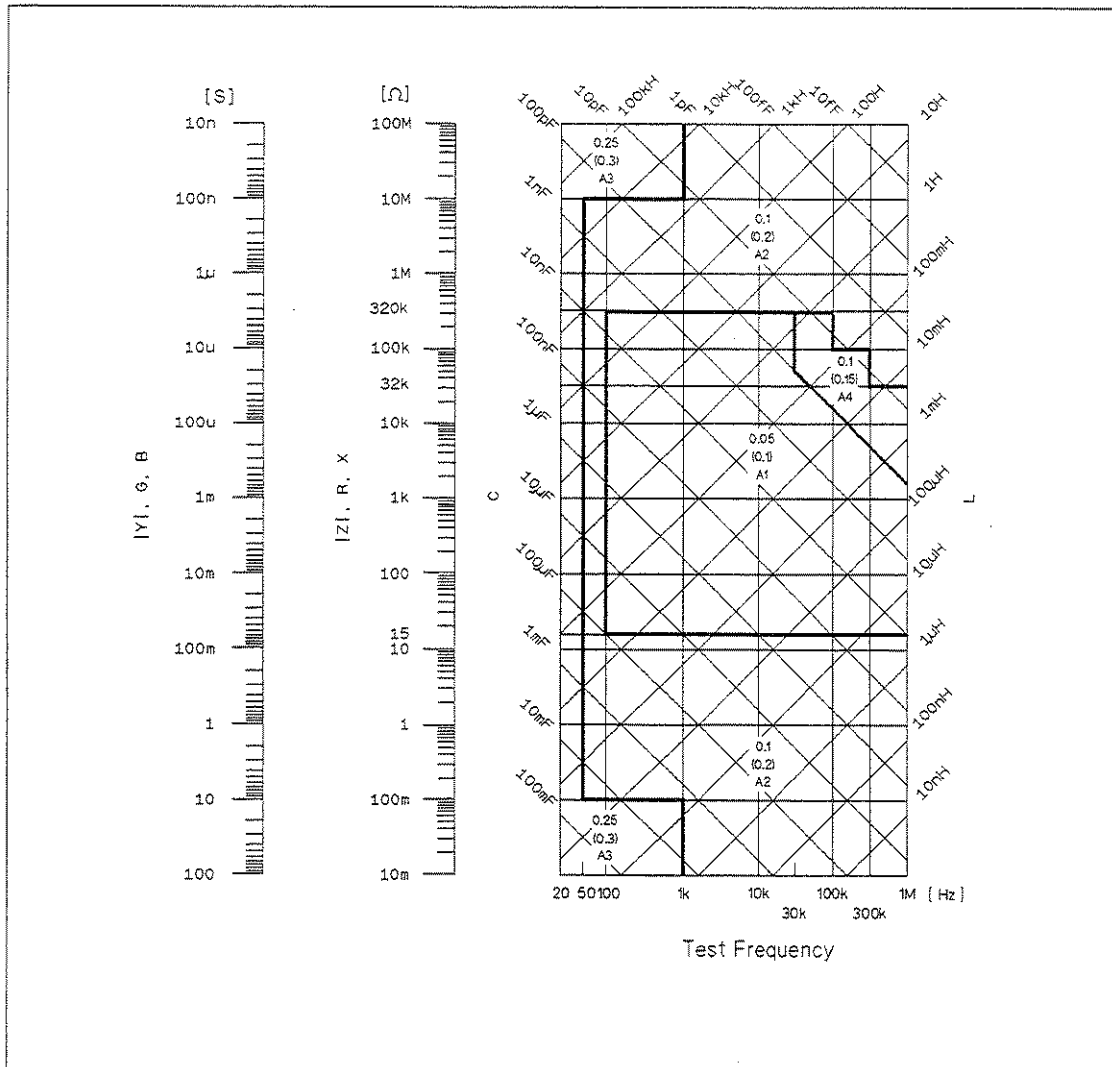

L1009011.gal

**Figure 9-4. Basic Accuracy A (1 of 2)**

On boundary line apply the better value.

Example of how to find the A value.

0.05— A value when  $0.3 V_{\text{rms}} \leq V_s \leq 1 V_{\text{rms}}$  and integration time is MEDIUM and LONG.

(0.1)— A value when  $0.3 V_{\text{rms}} \leq V_s \leq 1 V_{\text{rms}}$  and integration time is SHORT.

A<sub>1</sub>— A value when  $V_s < 0.3 V_{\text{rms}}$  or  $V_s > 1 V_{\text{rms}}$ . To find the value of A<sub>1</sub>, A<sub>2</sub>, A<sub>3</sub> and A<sub>4</sub> refer to Figure 9-5.

Where,  $V_s$ : Test Signal Voltage

The following table lists the value of  $A_1$ ,  $A_2$ ,  $A_3$ , and  $A_4$ . When  $Atl$  is indicated find the  $Atl$  value using the following graph.

		Test Signal Voltage								
		5m	12m	0.1	0.15	0.3	1	2	5	20 [Vrms]
MEDIUM/ LONG		$A_1=Atl$ $A_2=Atl$ $A_3=Atl$ $A_4=Atl$	$A_1=Atl$ $A_2=Atl$ $A_3=0.25$ $A_4=Atl$ *	$A_1=Atl$ $A_2=Atl$ $A_3=0.25$ $A_4=Atl$	$A_1=Atl$ $A_2=0.1$ $A_3=0.25$ $A_4=0.1$	$A_1=Atl$ $A_2=Atl$ $A_3=0.25$ $A_4=0.1$	$A_1=Atl$ $A_2=Atl$ $A_3=0.25$ $A_4=Atl$	$A_1=Atl$ $A_2=Atl$ $A_3=0.25$ $A_4=Atl$	$A_1=Atl$ $A_2=Atl$ $A_3=0.25$ $A_4=Atl$ **	$A_1=Atl$ $A_2=Atl$ $A_3=0.25$ $A_4=Atl$ **
SHORT		$A_1=Atl$ $A_2=Atl$ $A_3=Atl$ $A_4=Atl$	$A_1=Atl$ $A_2=Atl$ $A_3=0.3$ $A_4=Atl$	$A_1=Atl$ $A_2=0.2$ $A_3=0.3$ $A_4=0.5 \times Atl + 0.1$	$A_1=Atl$ $A_2=0.2$ $A_3=0.3$ $A_4=0.5 \times Atl + 0.1$	$A_1=Atl$ $A_2=Atl$ $A_3=0.3$ $A_4=Atl$	$A_1=Atl$ $A_2=Atl$ $A_3=0.3$ $A_4=Atl$	$A_1=Atl$ $A_2=Atl$ $A_3=0.3$ $A_4=Atl$	$A_1=Atl$ $A_2=Atl$ $A_3=0.3$ $A_4=Atl$ **	$A_1=Atl$ $A_2=Atl$ $A_3=0.3$ $A_4=Atl$ **

\*: Multiply the A values as follows, when the test frequency is less than 300 Hz.

100 Hz  $\leq f_m < 300$  Hz: Multiply the A values by 2.  $f_m < 100$  Hz: Multiply the A values by 2.5.

\*\* : Add 0.15 to the A values when all of the following measurement conditions are satisfied.

Test Frequency : 300 kHz  $< f_m \leq 1$  MHz

Test Signal Voltage : 5 V<sub>rms</sub>  $< V_s \leq 20$  V<sub>rms</sub>

DUT : Inductor,  $|Z_m| < 200 \Omega$  ( $|Z_m|$  : impedance of DUT)

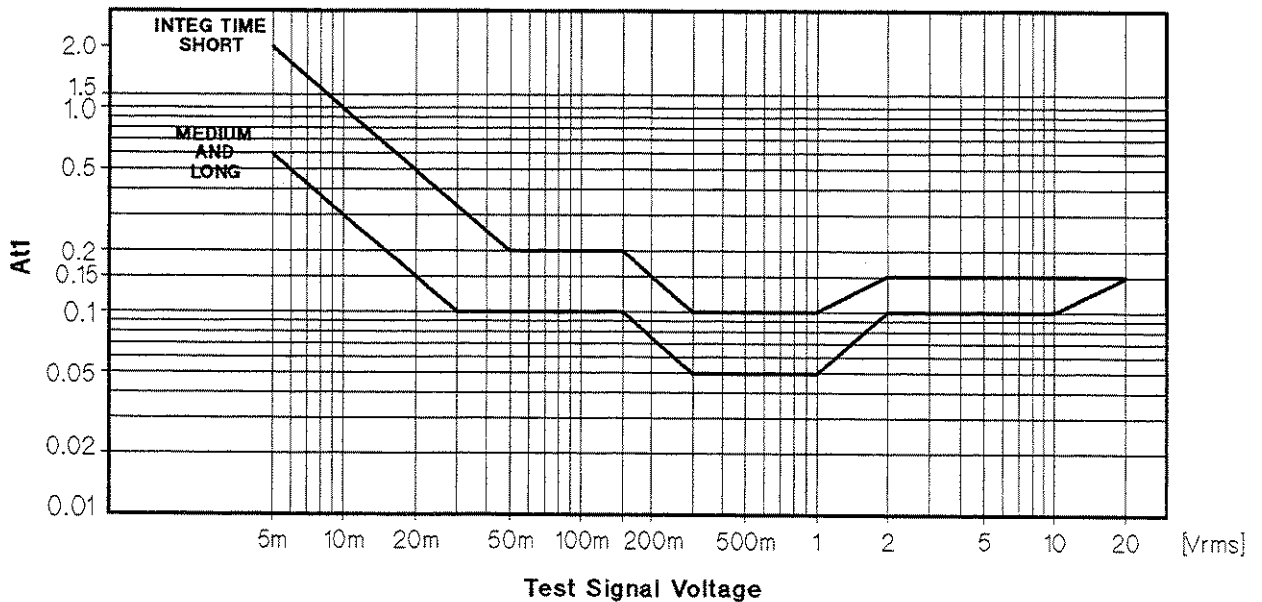

Figure 9-5. Basic Accuracy A (2 of 2)

$K_a$  and  $K_b$  values are the incremental factors in low impedance and high impedance measurements, respectively.  $K_a$  is practically negligible for impedances above 500  $\Omega$ , and  $K_b$  is also negligible for impedances below 500  $\Omega$ .

**Table 9-1. Impedance Proportional Factors  $K_a$  and  $K_b$**

Integ-time	Frequency	$K_a$	$K_b$
MEDIUM LONG	$f_m < 100$ Hz	$\left(\frac{1 \times 10^{-3}}{ Z_m }\right) \left(1 + \frac{200}{V_s}\right) \left(1 + \sqrt{\frac{100}{f_m}}\right)$	$ Z_m  (1 \times 10^{-9}) \left(1 + \frac{70}{V_s}\right) \left(1 + \sqrt{\frac{100}{f_m}}\right)$
	$100$ Hz $\leq f_m \leq 100$ kHz	$\left(\frac{1 \times 10^{-3}}{ Z_m }\right) \left(1 + \frac{200}{V_s}\right)$	$ Z_m  (1 \times 10^{-9}) \left(1 + \frac{70}{V_s}\right)$
	$100$ kHz $< f_m \leq 300$ kHz	$\left(\frac{1 \times 10^{-3}}{ Z_m }\right) \left(2 + \frac{200}{V_s}\right)$	$ Z_m  (3 \times 10^{-9}) \left(1 + \frac{70}{V_s}\right)$
	$300$ kHz $< f_m \leq 1$ MHz	$\left(\frac{1 \times 10^{-3}}{ Z_m }\right) \left(3 + \frac{200}{V_s} + \frac{V_s^2}{10^8}\right)$	$ Z_m  (10 \times 10^{-9}) \left(1 + \frac{70}{V_s}\right)$
SHORT	$f_m < 100$ Hz	$\left(\frac{2.5 \times 10^{-3}}{ Z_m }\right) \left(1 + \frac{400}{V_s}\right) \left(1 + \sqrt{\frac{100}{f_m}}\right)$	$ Z_m  (2 \times 10^{-9}) \left(1 + \frac{100}{V_s}\right) \left(1 + \sqrt{\frac{100}{f_m}}\right)$
	$100$ Hz $\leq f_m \leq 100$ kHz	$\left(\frac{2.5 \times 10^{-3}}{ Z_m }\right) \left(1 + \frac{400}{V_s}\right)$	$ Z_m  (2 \times 10^{-9}) \left(1 + \frac{100}{V_s}\right)$
	$100$ kHz $< f_m \leq 300$ kHz	$\left(\frac{2.5 \times 10^{-3}}{ Z_m }\right) \left(2 + \frac{400}{V_s}\right)$	$ Z_m  (6 \times 10^{-9}) \left(1 + \frac{100}{V_s}\right)$
	$300$ kHz $< f_m \leq 1$ MHz	$\left(\frac{2.5 \times 10^{-3}}{ Z_m }\right) \left(3 + \frac{400}{V_s} + \frac{V_s^2}{10^8}\right)$	$ Z_m  (20 \times 10^{-9}) \left(1 + \frac{100}{V_s}\right)$

$f_m$  : Test Frequency [Hz]  
 $|Z_m|$  : Impedance of DUT [ $\Omega$ ]  
 $V_s$  : Test Signal Voltage [mV<sub>rms</sub>]

$K_{aa}$  is practically negligible for impedances above 500  $\Omega$ .

**Table 9-2. Cable Length Factor  $K_{aa}$**

Test Signal voltage	Cable Length			
	0 m	1 m	2 m	4 m
$\leq 2$ V <sub>rms</sub>	0	0	$\frac{K_a}{2}$	$K_a$
$> 2$ V <sub>rms</sub>	0	$\frac{2 \times 10^{-3} \times f_m^2}{ Z_m }$	$\frac{(1+5 \times f_m^2) \times 10^{-3}}{ Z_m }$	$\frac{(2+10 \times f_m^2) \times 10^{-3}}{ Z_m }$

$f_m$  : Test Frequency [MHz]  
 $|Z_m|$  : Impedance of DUT [ $\Omega$ ]  
 $K_a$  : Impedance Proportional Factor



**Table 9-3. Cable Length Factor  $K_{bb}$**

Frequency	Cable Length			
	0 m	1 m	2 m	4 m
$f_m \leq 100$ kHz	1	$1+5 \times f_m$	$1+10 \times f_m$	$1+20 \times f_m$
$100$ kHz $< f_m \leq 300$ kHz	1	$1+2 \times f_m$	$1+4 \times f_m$	$1+8 \times f_m$
$300$ kHz $< f_m \leq 1$ MHz	1	$1+0.5 \times f_m$	$1+1 \times f_m$	$1+2 \times f_m$

$f_m$  : Test Frequency [MHz]

**Table 9-4. Calibration Interpolation Factor  $K_c$**

Test Frequency	$K_c$
Direct Calibration Frequencies	0
Other Frequencies	0.0003

Direct Calibration Frequencies are the following 48 frequencies.

**Table 9-5. Preset Calibration Frequencies**

	20	25	30	40	50	60	80	[Hz]		
100	120	150	200	250	300	400	500	600	800	[Hz]
1	1.2	1.5	2	2.5	3	4	5	6	8	[kHz]
10	12	15	20	25	30	40	50	60	80	[kHz]
100	120	150	200	250	300	400	500	600	800	[kHz]
1										[MHz]

**Table 9-6. Cable Length Factor  $K_d$**

Test Signal level	Cable Length		
	1 m	2 m	4 m
$\leq 2$ V <sub>rms</sub>	$2.5 \times 10^{-4}(1+50 \times f_m)$	$5 \times 10^{-4}(1+50 \times f_m)$	$1 \times 10^{-3}(1+50 \times f_m)$
$> 2$ V <sub>rms</sub>	$2.5 \times 10^{-3}(1+16 \times f_m)$	$5 \times 10^{-3}(1+16 \times f_m)$	$1 \times 10^{-2}(1+16 \times f_m)$

$f_m$  : Test Frequency [MHz]

Temperature (°C)	5	8	18	28	38	45
$K_e$		4	2	1	2	4

**Figure 9-6. Temperature Factor  $K_e$**

# HP 4284A Calibration Accuracy

Calibration accuracy is shown in the following figure.

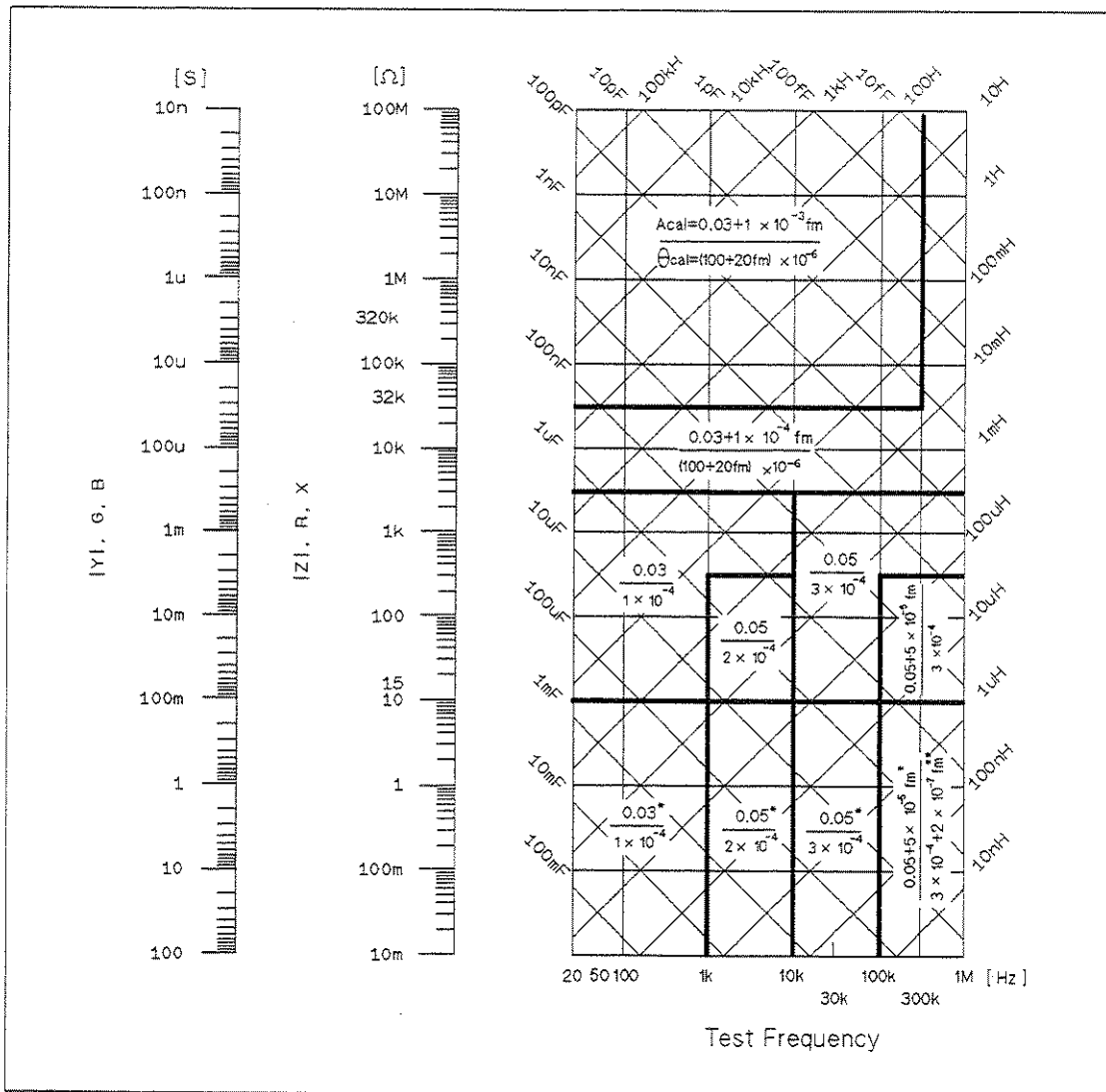

L1009013

$f_m$  : test frequency [kHz]

On boundary line apply the better value.

Upper value ( $A_{cal}$ ) is |Z|, |Y|, L, C, R, X, G and B calibration accuracy [%].

Lower value ( $\theta_{cal}$ ) is phase calibration accuracy in radians.

\*  $A_{cal} = 0.1\%$  when Hi-PW mode is ON.

\*\*  $A_{cal} = (300 + f_m) \times 10^{-6}$  [rad] when Hi-PW mode is ON.

Phase calibration accuracy in degree,  $\theta_{cal}$  [deg], is given as,

$$\theta_{cal} [deg] = \frac{180}{\pi \times \theta_{cal}} [rad]$$

## **Correction Functions**

### **Zero Open**

Eliminates measurement errors due to parasitic stray impedances of the test fixture.

### **Zero Short**

Eliminates measurement errors due to parasitic residual impedances of the test fixture.

### **Load**

Improves the measurement accuracy by using a working standard (calibrated device) as a reference.

## **List Sweep**

A maximum of 10 frequencies or test signal levels can be programmed. Single or sequential test can be performed. When Option 001 is installed, DC bias voltages can also be programmed.

## **Comparator Function**

Ten bin sorting for the primary measurement parameter, and IN/OUT decision output for the secondary measurement parameter.

### **Sorting Modes**

Sequential mode

Sorting into unnested bins with absolute upper and lower limits.

Tolerance Mode

Sorting into nested bins with absolute or percent limits.

### **Bin Count**

0 to 999999

### **List Sweep Comparator**

HIGH/IN/LOW decision output for each point in the list sweep table.

## **DC Bias**

0 V, 1.5 V, and 2 V selectable

### **Setting Accuracy**

±5% (1.5 V, 2 V)

## Other Functions

### Store/Load

Ten instrument control settings, including comparator limits and list sweep programs, can be stored and loaded from and into the internal non-volatile memory. Ten additional settings can also be stored and loaded from each removable Memory Card.

### HP-IB

All control settings, measured values, comparator limits, list sweep program. ASCII and 64-bit binary data format. HP-IB buffer memory can store measured values for a maximum of 128 measurements and output packed data over the HP-IB bus. Complies with IEEE-488.1 and 488.2. The programming language is SCPI.

**Interface Functions.** SH1, AH1, T5, L4, SR1, RL1, DC1, DT1, C0, E1

### Self Test

Softkey controllable. Provides a means to confirm proper operation.

## Options

### Option 001 (Power Amp/DC Bias)

Increases test signal level and adds the variable dc bias voltage function.

### Test Signal Level

	Mode	Range	Setting Accuracy
Voltage	Non-constant	5 mV to 20 Vrms	$\pm(10\%+1 \text{ mV})$
	Constant <sup>1</sup>	10 mV to 10 Vrms	$\pm(10\%+1 \text{ mV})$
Current	Non-constant	50 $\mu\text{A}$ to 200 mArms	$\pm(10\%+10 \mu\text{A})$
	Constant <sup>1</sup>	100 $\mu\text{A}$ to 100 mArms	$\pm(10\%+10 \mu\text{A})$

<sup>1</sup> Automatic Level Control Function is set to ON.

### Output Impedance

100  $\Omega$ ,  $\pm 6\%$

### Test Signal Level Monitor

Mode	Range	Accuracy
Voltage <sup>1</sup>	> 2 V <sub>rms</sub>	±(3% of reading + 5 mV)
	5 mV to 2 V <sub>rms</sub>	±(3% of reading + 0.5 mV)
	0.01 mV to 5 mV <sub>rms</sub>	±(11% of reading + 0.1 mV)
Current <sup>2</sup>	> 20 mA <sub>rms</sub>	±(3% of reading + 50 µA)
	50 µA to 20 mA <sub>rms</sub>	±(3% of reading + 5 µA)
	0.001 µA to 50 µA <sub>rms</sub>	±(11% of reading + 1 µA)

1 Add the impedance measurement accuracy [%] to the voltage level monitor accuracy when the DUT's impedance is < 100 Ω.

2 Add the impedance measurement accuracy [%] to the current level monitor accuracy when the DUT's impedance is ≥ 100 Ω.

Accuracies apply when test cable length is 0 m or 1 m. Additional error for 2 m or 4 m test cable length is given as:

$$f_m \times \frac{L}{2} \quad [\%]$$

Where,

$f_m$  is test frequency [MHz],

$L$  is test cable length [m].

### DC Bias Level

The following DC bias level accuracy is specified for an ambient temperature range of 23°C±5°C. Multiply the temperature induced setting error listed in Table F for the temperature range of 0°C to 55°C.

#### Test Signal Level ≤ 2 V<sub>rms</sub>

Voltage Range	Resolution	Setting Accuracy
±(0.000 to 4.000) V	1 mV	±(0.1% of setting + 1 mV)
±(4.002 to 8.000) V	2 mV	±(0.1% of setting + 2 mV)
±(8.005 to 20.000) V	5 mV	±(0.1% of setting + 5 mV)
±(20.01 to 40.00) V	10 mV	±(0.1% of setting + 10 mV)

#### Test Signal Level > 2 V<sub>rms</sub>

Voltage Range	Resolution	Setting Accuracy
±(0.000 to 4.000) V	1 mV	±(0.1% of setting + 3 mV)
±(4.002 to 8.000) V	2 mV	±(0.1% of setting + 4 mV)
±(8.005 to 20.000) V	5 mV	±(0.1% of setting + 7 mV)
±(20.01 to 40.00) V	10 mV	±(0.1% of setting + 12 mV)

Setting accuracies apply when the bias current isolation function is set to OFF. When the bias current isolation function is set to ON, add  $\pm 20$  mV to each accuracy value (DC bias current  $\leq 1 \mu\text{A}$ ).

#### **Bias Current Isolation Function**

A maximum DC bias current of 100 mA (typical value) can be applied to the DUT.

#### **DC Bias Monitor Terminal**

Rear panel BNC connector

#### **Other Options**

Option 002	Bias Current Interface Allows the HP 4284A to control the HP 42841A Bias Current Source.
Option 006	2 m/4 m Cable Length Operation
Option 008	Add Operation Manual (Japanese)
Option 009	Delete operation manual
Option 109	Delete HP-IB Interface
Option 201	Handler Interface
Option 202	Handler Interface
Option 301	Scanner Interface
Option 907	Front Handle Kit
Option 908	Rack Mount Kit
Option 909	Rack Flange and Handle Kit
Option 910	Extra Operation Manual
Option W30	3 Year Extended Warranty

#### **Furnished Accessories**

Operation Manual	HP Part Number 04284-90000
Memory Card	HP Part Number 04278-89001
Power Cable	Depends on the country where the HP 4284A is being used. Refer to Page 1-6, Figure 1-3
Fuse	Only for Option 201, HP Part Number 2110-0046, 2ea.

#### **Power Requirements**

##### **Line Voltage**

90 to 132 Vac, 198 to 252 Vac

##### **Line Frequency**

47 to 66 Hz

##### **Power Consumption**

200 VA max.

## Operating Environment

### Temperature

0°C to 55°C

### Humidity

≤ 95% R.H. at 40°C

### Altitude

0m to 2000m

**Dimensions** 426(W) by 177(H) by 498(D) (mm)

**Weight** Approximately 15 kg (33 lb., standard)

**Display** LCD dot-matrix display.

### Capable of Displaying

Measured values

Control settings

Comparator limits and decisions

List sweep tables

Self test message and annunciations

### Number of Display Digits

6-digits, maximum display count 999999

---

## Supplemental Performance Characteristics

The HP 4284A supplemental performance characteristics are listed starting from page 9-26. Supplemental performance characteristics are not specifications but are typical characteristics included as supplemental information for the operator.

**Stability** MEDIUM integration time and operating temperature at 23°C ±5°C]  
|Z|, |Y|, L, C, R < 0.01% / day  
D < 0.0001 / day

## Temperature Coefficient

MEDIUM integration time and operating temperature at 23°C ±5°C

Test Signal Level	Z ,  Y , L, C, R	D
≥ 20 mV <sub>rms</sub>	< 0.0025%/°C	< 0.000025/°C
< 20 mV <sub>rms</sub>	< 0.0075%/°C	< 0.000075/°C

## Settling Time

### Frequency (f<sub>m</sub>)

- < 70 ms (f<sub>m</sub> ≥ 1 kHz)
- < 120 ms (100 Hz ≤ f<sub>m</sub> < 1 kHz)
- < 160 ms (f<sub>m</sub> < 100 Hz)

### Test Signal Level

- < 120 ms

### Measurement Range

- < 50 ms/range shift (f<sub>m</sub> ≥ 1 kHz)

## Input Protection

Internal circuit protection, when a charged capacitor is connected to the UNKNOWN terminals.

The maximum capacitor voltage is:

$$V_{max} = \sqrt{\frac{1}{C}} \quad [V]$$

Where,  $V_{max} \leq 200$  V,  
 $C$  is in Farads.

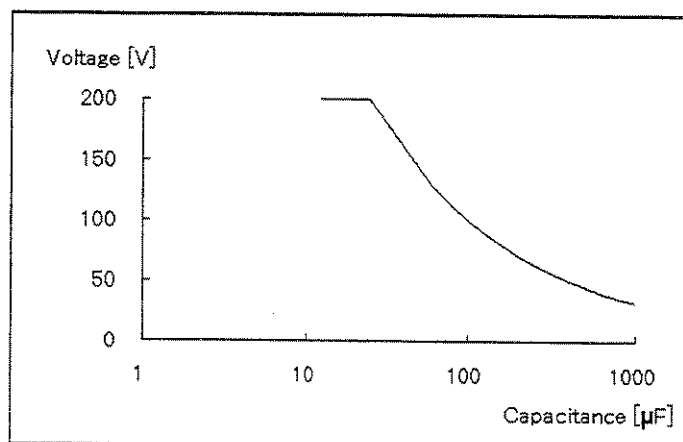

Figure 9-7. Maximum Capacitance Voltage



## Measurement Time

Typical measurement times from the trigger to the output of EOM at the Handler Interface. (EOM: End of Measurement)

Integ. Time	Test Frequency			
	100 Hz	1 kHz	10 kHz	1 MHz
SHORT	270 ms	40 ms	30 ms	30 ms
MEDIUM	400 ms	190 ms	180 ms	180 ms
LONG	1040 ms	830 ms	820 ms	820 ms

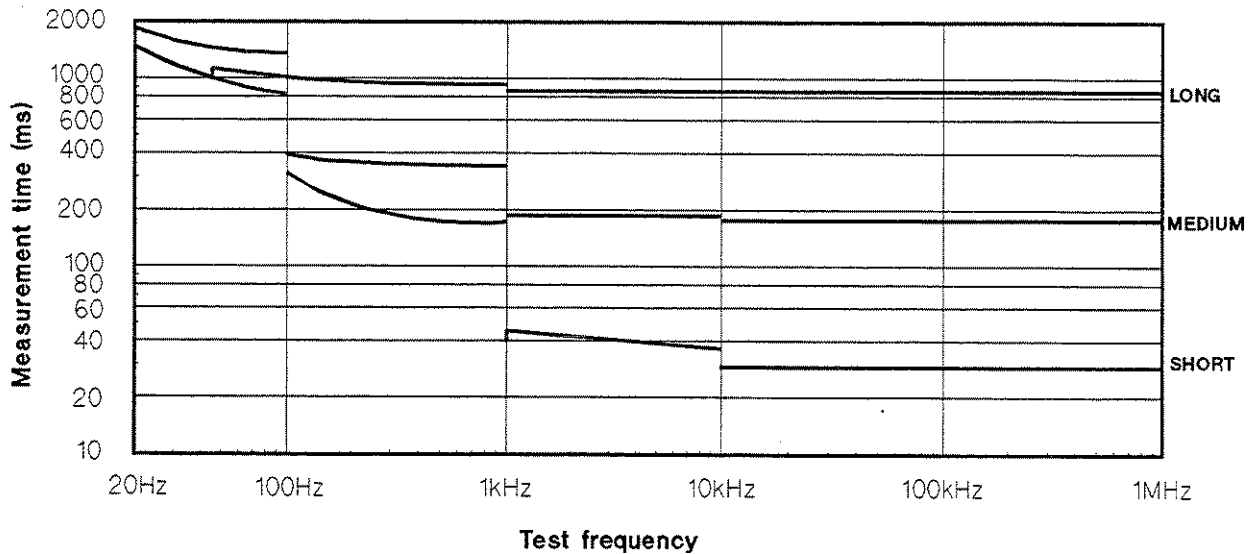

## Display Time

Display time for each display format is given as

MEAS DISPLAY page	approx. 8 ms
BIN No. DISPLAY page	approx. 5 ms
BIN COUNT DISPLAY page	approx. 0.5 ms

## HP-IB Data Output Time

Internal HP-IB data processing time from EOM output to measurement data output on HP-IB lines (excluding display time).

Approx. 10 ms

**DC Bias (1.5 V/2 V)** Output Current: 20 mA max.

**Option 001 (Power Amp/DC Bias)**

**DC Bias Voltage**

DC Bias voltage applied to DUT ( $V_{dut}$ ) is given as,

$$V_{dut} = V_b - 100 \times I_b \quad [V]$$

Where,  $V_b$  is DC bias setting voltage [V],  
 $I_b$  is DC bias current [A].

**DC Bias Current**

DC bias current applied to DUT ( $I_{dut}$ ) is given as,

$$I_{dut} = \frac{V_b}{100 + R_{dc}} \quad [A]$$

Where,  $V_b$  is DC bias setting voltage [V],  
 $R_{dc}$  is the DUT's DC resistance [ $\Omega$ ].

Maximum DC bias current when the normal measurement can be performed is as follows.

Measurement Range	10 $\Omega$	100 $\Omega$	300 $\Omega$	1 k $\Omega$	3 k $\Omega$	10 k $\Omega$	30 k $\Omega$	100 k $\Omega$	
Bias Current Isolation	On	100 mA							
	Off	2 mA	2 mA	2 mA	1 mA	300 $\mu$ A	100 $\mu$ A	30 $\mu$ A	10 $\mu$ A

**Relative Measurement Accuracy with Bias Current Isolation**

When the bias current isolation function is set to ON, add the display fluctuation (N) given in the following equation to the Ae of relative measurement accuracy (Refer to "relative measurement accuracy" of specification).

The following equation is specified when all of the following conditions are satisfied.

- DUT impedance  $\geq 100 \Omega$
- Test signal level setting  $\leq 1 V_{rms}$
- DC bias current  $\geq 1 mA$
- Integration time : MEDIUM

$$N = P \times \frac{\text{DUT}_{\text{impedance}} [\Omega]}{\text{Measurement Range} [\Omega]} \times \frac{\text{DC}_{\text{bias current}} [\text{mA}]}{\text{Test signal level} [V_{rms}]} \times \frac{1}{\sqrt{n}} \times 10^{-4} \quad [\%]$$

Where, P is the coefficient listed on Table A,  
n is the number of averaging.

When the DC bias current is less than 1 mA, apply N value at 1 mA.  
 When integration time is set to SHORT, multiply N value by 5.  
 When integration time is set to LONG, multiply N value by 0.5.

**Table 9-7.**  
**Coefficient Related to Test Frequency and Measurement Range**

Meas. Range	Test Frequency $f_m$ [Hz]			
	$20 < f_m < 100$	$100 < f_m < 1 \text{ k}$	$1 \text{ k} < f_m < 10 \text{ k}$	$10 \text{ k} < f_m < 1 \text{ M}$
100 $\Omega$	0.75	0.225	0.045	0.015
300 $\Omega$	2.5	0.75	0.15	0.05
1 k $\Omega$	7.5	2.25	0.45	0.15
3 k $\Omega$	25	7.5	1.5	0.5
10 k $\Omega$	75	22.5	4.5	1.5
30 k $\Omega$	250	75	15	5
100 k $\Omega$	750	225	45	15

### Calculation Example

#### Measurement Conditions

DUT : 100 pF  
 Test signal level : 20 mV<sub>rms</sub>  
 Test frequency : 10 kHz  
 Integration time : MEDIUM

Then, DUT's impedance =  $1/(2\pi \times 10^4 \times 100 \times 10^{-12}) = 159 \text{ k}\Omega$   
 Measurement range is 100 k $\Omega$   
 DC bias current  $\ll 1 \text{ mA}$   
 P = 15 (according to Table A)

$A_e$  of relative measurement accuracy without bias current isolation is  $\pm 0.22$  [%]. (Refer to "relative measurement accuracy" of specification.)

$$\text{Then, } N = 15 \times (159 \times 10^3) / (100 \times 10^3) \times 1 / (20 \times 10^{-3}) \times 10^{-4} = 0.12 \text{ [%]}$$

Therefore, Relative Capacitance measurement accuracy is:

$$\pm(0.22 + 0.12) = \pm 0.34 \text{ [%]}$$

## DC Bias Settling Time

When DC bias is set to ON, add the settling time listed in the following table to the measurement time. This settling time does not include the DUT charge time.

Test Frequency ( $f_m$ )	Bias Current Isolation	
	ON	OFF
$20 \text{ Hz} \leq f_m < 1 \text{ kHz}$	210 ms	20 ms
$1 \text{ kHz} \leq f_m < 10 \text{ kHz}$	70 ms	
$10 \text{ kHz} \leq f_m \leq 1 \text{ MHz}$	30 ms	

Sum of DC bias settling time plus DUT (capacitor) charge time is shown in the following figure.

	Bias Source	Bias Current Isolation	Test Frequency ( $f_m$ )
①	Standard	On/Off	$20 \text{ Hz} \leq f_m \leq 1 \text{ MHz}$
②	Option 001	Off	$20 \text{ Hz} \leq f_m \leq 1 \text{ MHz}$
③		On	$10 \text{ kHz} \leq f_m \leq 1 \text{ MHz}$
④			$1 \text{ kHz} \leq f_m < 10 \text{ kHz}$
⑤			$20 \text{ Hz} \leq f_m < 1 \text{ kHz}$

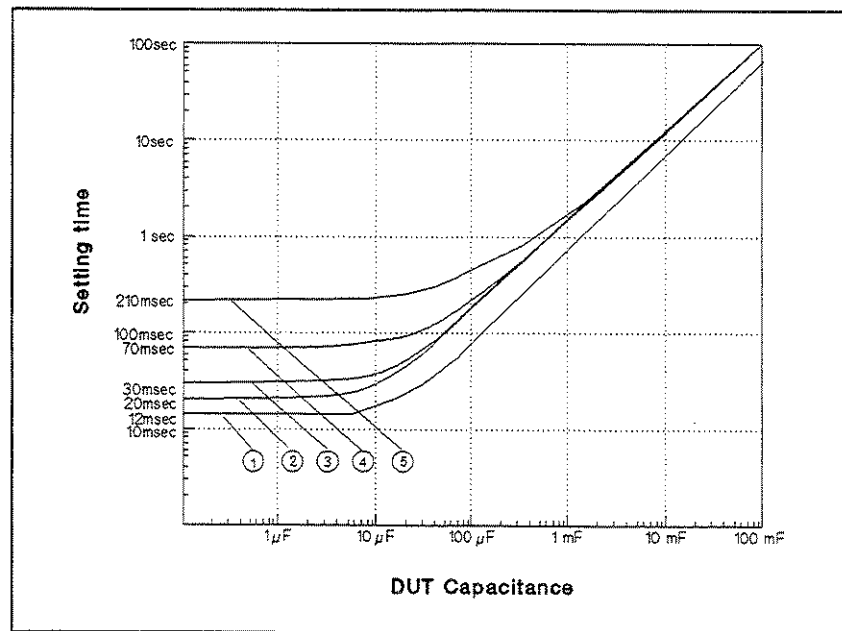

Figure 9-7. Measurement Time

## Rack/Handle Installation

The HP 4284A can be rack mounted and used as a component of a measurement system. Following figure shows how to rack mount the HP 4284A.

Table 9-8. Rack Mount Kits

Option	Description	Kit Part Number
907	Handle Kit	HP Part Number 5061-9690
908	Rack Flange Kit	HP Part Number 5061-9678
909	Rack Flange & Handle Kit	HP Part Number 5061-9684

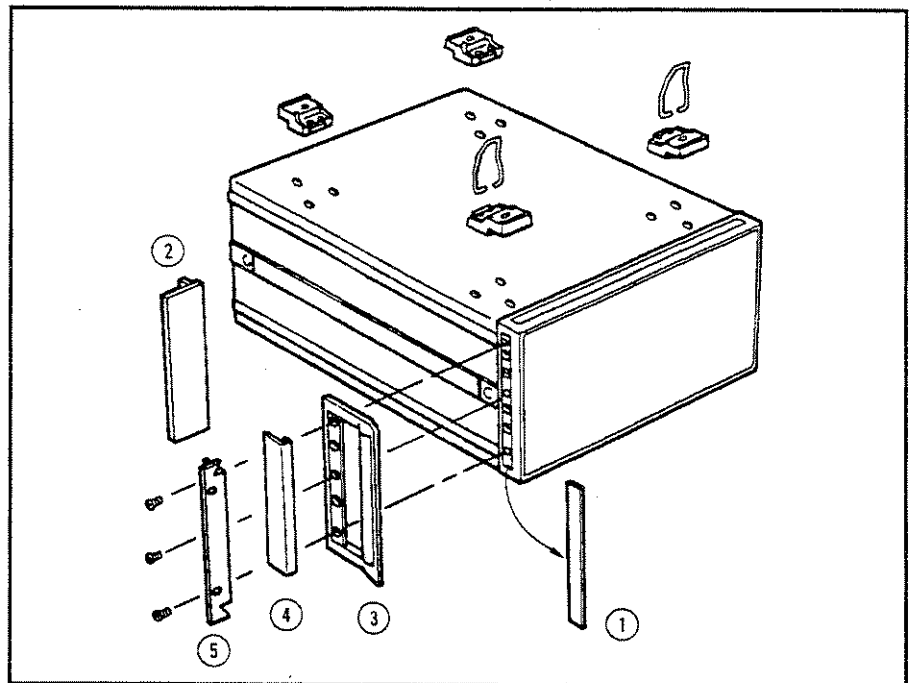

Figure 9-8. Rack Mount Kits Installation

1. Remove the adhesive-backed trim strips ① from the left and right front sides of the HP 4284A.
2. **HANDLE INSTALLATION:** Attach the front handles ③ to the sides using the screws provided and attach the trim strip ④ to the handle.
3. **RACK MOUNTING:** Attach the rack mount flange ② to the left and right front sides of the HP 4284A using the screws provided.
4. **HANDLE AND RACK MOUNTING:** Attach the front handle ③ and the rack mount flange ⑤ together on the left and right front sides of the HP 4284A using the screws provided.

5. When rack mounting the HP 4284A (3 and 4 above), remove all four feet (lift bar on the inner side of the foot, and slide the foot toward the bar).

---

## Storage and Repacking

This paragraph describes the environment for storing or shipping the HP 4284A, and how to repackage the HP 4284A for shipment when necessary.

### Environment

The HP 4284A should be stored in a clean, dry environment. The following environmental limitations apply for both storage and shipment.

Temperature:  $-20^{\circ}\text{C}$  to  $60^{\circ}\text{C}$

Humidity:  $\leq 95\%$  RH (at  $40^{\circ}\text{C}$ )

To prevent condensation from taking place on the inside of the HP 4284A, protect the instrument against temperature extremes.

### Original Packaging

Containers and packing materials identical to those used in factory packaging are available through your closest Hewlett-Packard sales office. If the instrument is being returned to Hewlett-Packard for servicing, attach a tag indicating the service required, the return address, the model number, and the full serial number. Mark the container *FRAGILE* to help ensure careful handling. In any correspondence, refer to the instrument by model number and its full serial number.

### Other Packaging

The following general instructions should be used when repacking with commercially available materials:

1. Wrap the HP 4284A in heavy paper or plastic. When shipping to a Hewlett-Packard sales office or service center, attach a tag indicating the service required, return address, model number, and the full serial number.
2. Use a strong shipping container. A double-walled carton made of at least 350 pound test material is adequate.
3. Use enough shock absorbing material (3 to 4 inch layer) around all sides of the instrument to provide a firm cushion and to prevent movement inside the container. Use cardboard to protect the front panel.
4. Securely seal the shipping container.
5. Mark the shipping container *FRAGILE* to help ensure careful handling.
6. In any correspondence, refer to the HP 4284A by model number and by its full serial number.

**Caution**



---

The memory card should be removed, before packing the HP 4284A.

---





## Performance Tests

---

### Introduction

This chapter provides the test procedures to verify that the HP 4284A meets the specifications listed in Chapter 9. All tests can be performed without accessing the indicator of the instruments. Performance tests are used to perform incoming inspection and to verify that the HP 4284A is within its performance specification after troubleshooting or adjustment have been performed. If the performance tests indicate that the HP 4284A is not within specifications, check your test setup, then proceed to Adjustment or Troubleshooting as required.

---

**Note**

Allow the HP 4284A to warm up a minimum of 30 minutes before starting any of the performance tests.

---

**Note**

The performance tests are valid only when performed in an ambient temperature of  $23\text{ }^{\circ}\text{C} \pm 5\text{ }^{\circ}\text{C}$ .

---

---

### Test Equipment

Table 10-1 lists the test equipment required to perform the tests described in this chapter. Use only calibrated test instruments when performance testing the HP 4284A. If the recommended equipment with specifications equal to or surpassing those of the recommended equipment may be used.

---

**Note**

Components used as standards must be (1) calibrated using an instrument whose specifications are traceable to the National Bureau of Standard (NBS) or an equivalent standards group, or (2) calibrated directly by an authorized calibration organization, such as NBS. The calibration cycle depends on the stability specification of each component.

---

---

## Performance Test Record

Record the results of each performance test in the Performance Test Record located at the end of this chapter. The performance record lists each test, parameters tested, and acceptable tolerance limits. Keep a record of past performance test results for comparison purposes to help indicate any possible areas of developing trouble.

### Note



---

The test limits indicated in each performance test do not take into account the measurement errors induced by the test equipment used. Be sure to consider this when determining whether or not the HP 4284A meets its indicated specifications.

---

---

## Calibration Cycle

The HP 4284A requires periodic performance verification. How often you verify performance depends on the operating and environmental conditions. Check the HP 4284A using the performance tests described in this chapter at least once a year. To minimize instrument down-time and to ensure optimum operation, perform preventive maintenance and calibration at least twice a year.

**Table 10-1. Recommended Test Equipment**

Equipment	Requirements	Recommended Model
Electronic Counter	Frequency: 20 Hz to 1 MHz Accuracy: <<0.01%	HP 5334B
RMS Voltmeter	Frequency: 20 Hz to 1 MHz Voltage Range: 5 mV <sub>rms</sub> to 20 V <sub>rms</sub> Accuracy: <<3.0%	HP 3458A
DC Voltmeter	Voltage range: -40 V to 40 V Accuracy: <<0.1%	HP 3458A
Standard Capacitor	No substitute	HP16380A HP 16380C
Standard Resister	No Substitute	HP 16074A
DC Power Source	+5 V, 0.1 A	HP 6214C
Adapter	BNC(f) to BNC(f) Tee, BNC(m)(f)(f) BNC(f) to Dual Banana	HP PN 1250-0080 HP PN 1250-0781 HP PN 1251-2277
Cable	BNC(m)-to-BNC(m), 30 cm	HP PN 8120-1838
Test Leads	2 BNC(m) to 3 alligator clips 4 BNC(m), Cable Length 1 m 4 BNC(m), Cable Length 2 m 4 BNC(m), Cable Length 4 m	HP PN 8120-1661 HP 16048A HP 16048D HP 16048E
HP-IB Cable	HP-IB cable, 1 m	HP 10388A
Computer	HP Technical Computer	HP 9000 Series 200 Model 226
Memory Card	(furnished accessory)	HP PN 04278-89001
Bias IF Simulator	No substitute	HP PN 42841-65001
Handler Simulator	No substitute	HP PN 04278-65001
Scanner Simulator	No substitute	HP PN 04278-65301
Simulator Cable	No substitute	HP PN 04278-61635
Bias IF Cable	GP-IO Cable	HP PN 42841-61640

---

## System Reset

By using **SYSTEM RESET** function the HP 4284A can be set easily for the performance test. **SYSTEM RESET** can be performed using the following procedure.

### Procedure

1. Press **MEAS SETUP** to display **MEAS SETUP** page.
2. Use **CURSOR** keys to move the cursor to the **SYS MENU** field.
3. Press **more 1/2** softkey to display **SYSTEM RESET**.
4. Press **SYSTEM RESET**.
5. Press **YES** to perform a **SYSTEM RESET**.

## Test Frequency Accuracy Test

This test verifies that the accuracy of the HP 4284A's test frequency is within  $\pm 0.01\%$ .

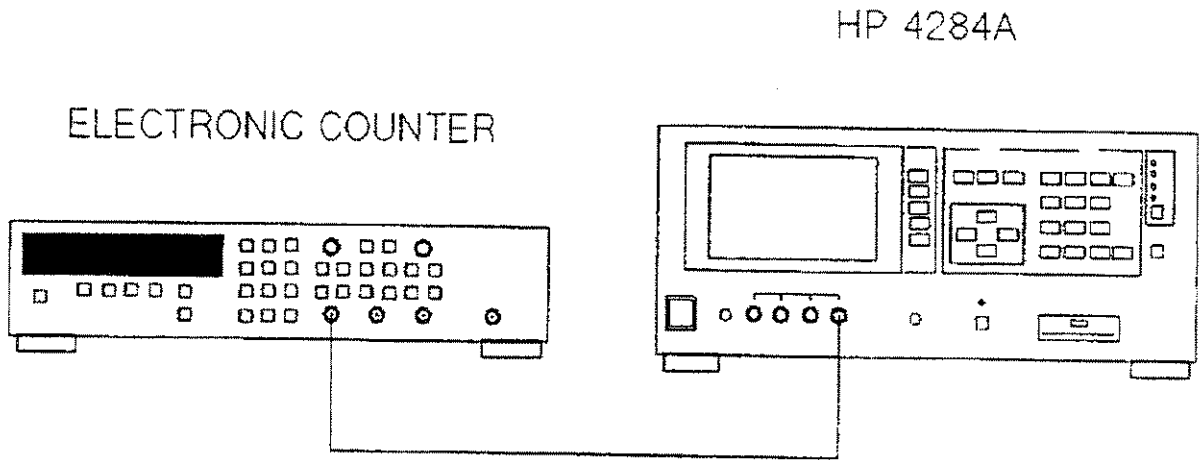

BNC(m)-BNC(m) Cable 30 cm  
**Figure 10-1. Test Frequency Accuracy Test Setup**

**Equipment** Electronic Counter HP 5334B  
 BNC(m)-to-BNC(m) Cable, 30 cm HP PN 8120-1838

- Procedure:**
1. Set up the equipment as shown in Figure 10-1.
  2. Perform a SYSTEM RESET as described in "System Reset".
  3. Set the Test Frequency in accordance with Table 10-2, and confirm that the counter readings are within the test limits given in the table.

**Table 10-2. Test Frequency Test limits**

Test Frequency	Test Limits
1 kHz	0.9999 kHz to 1.0001 kHz
8 kHz	7.9992 kHz to 8.0008 kHz
20 kHz	19.998 kHz to 20.002 kHz
80 kHz	79.992 kHz to 80.008 kHz
400 kHz	399.96 kHz to 400.04 kHz
1 MHz	0.9999 MHz to 1.0001 MHz

## Test Signal Level/Level-Monitor Accuracy Test

This test verifies the HP 4284A's test signal level, and test signal level monitor accuracy.

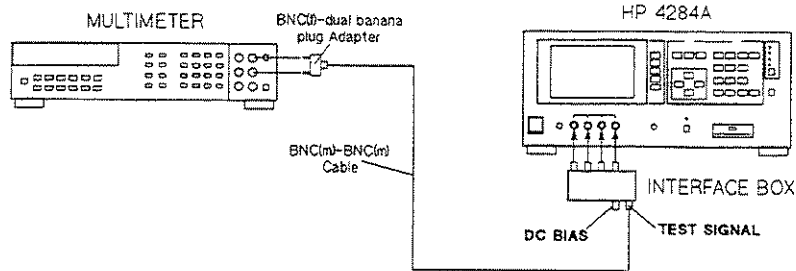

Figure 10-2. Test Signal Level Accuracy Test Setup Using an Interface Box

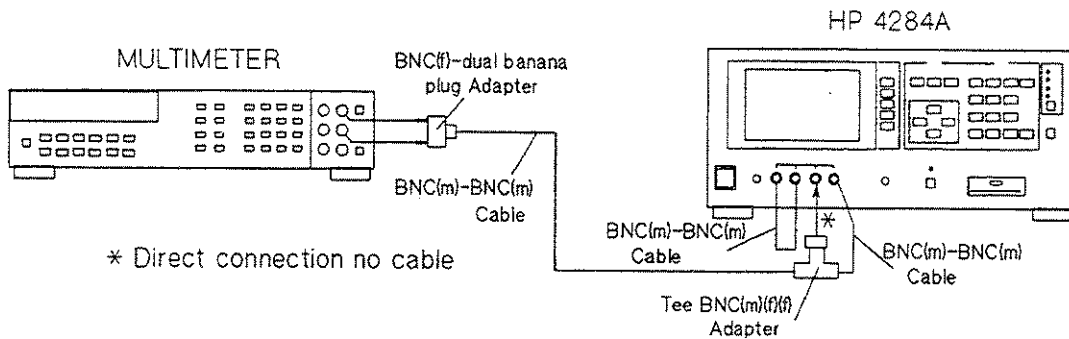

Figure 10-3. Test Signal Level Accuracy Test Setup Without an Interface Box

### Note



The BNC to BNC cables used in this test should be shorter than 30 cm.

### Equipment:

Interface Box	HP PN 04284-65007
Multimeter	HP 3458A
Cable BNC(m)-to-BNC(m) 30 cm	HP PN 8120-1838
BNC(f) to dual banana plug Adapter	HP PN 1251-2277

**Procedure:**

1. Set up the equipment as shown in Figure 10-2.

**Note**



If the Interface Box is not available, use the following cables and adapters as a substitute. Figure 10-3 shows the test setup without the interface box.

---

BNC(m) to BNC(m) Cable, 30 cm	HP PN 8120-1838 2ea.
Tee, BNC(m)(f)(f) Adapter	HP PN 1250-0781

---

2. Set the multimeter to ACV.
3. Perform a SYSTEM RESET as described in "System Reset".
4. Set HP 4284A's controls as follows:
  - Test Frequency: 1.25 kHz
  - High Power Option: OFF
5. Display the **MEAS DISPLAY** page.
6. Set the Oscillator Level in accordance with Table 10-3, and confirm that the Multimeter reading and the Level Monitor reading are within the test limits given in the table.
7. Set the Test Frequency to 960 kHz and perform step 6.

**Note**



Steps 8 through 11 should be performed only when the HP 4284A is equipped with Option 001.

- 
8. Set the controls of the HP 4284A as follows:
    - Test Frequency: 1.25 kHz
    - High Power Option: ON
  9. Display the **MEAS DISPLAY** page.
  10. Set the Oscillator Level in accordance with Table 10-4, and confirm that the Multimeter reading and the Level Monitor reading are within the test limits given in Table 10-3.
  11. Set the Test Frequency to 960 kHz and perform step 10.

**Table 10-3.**  
**Test Signal Level/Level-Monitor Test Limits (Hi-PW OFF)**

Test Signal Level	Test Limits	
	Multimeter Reading	Level Monitor Reading
5 mV	5 mV $\pm$ 1.5 mV	M.R. $\pm$ (3%+0.5 mV)
10 mV	10 mV $\pm$ 2 mV	M.R. $\pm$ (3%+0.5 mV)
20 mV	20 mV $\pm$ 3 mV	M.R. $\pm$ (3%+0.5 mV)
50 mV	50 mV $\pm$ 6 mV	M.R. $\pm$ (3%+0.5 mV)
100 mV	100 mV $\pm$ 11 mV	M.R. $\pm$ (3%+0.5 mV)
200 mV	200 mV $\pm$ 21 mV	M.R. $\pm$ (3%+0.5 mV)
250 mV	250 mV $\pm$ 26 mV	M.R. $\pm$ (3%+0.5 mV)
500 mV	500 mV $\pm$ 51 mV	M.R. $\pm$ (3%+0.5 mV)
1 V	1 V $\pm$ 101 mV	M.R. $\pm$ (3%+0.5 mV)
2 V	2 V $\pm$ 201 mV	M.R. $\pm$ (3%+0.5 mV)

M.R. is the Multimeter Reading for the HP 4284A's output signal level.

**Table 10-4.**  
**Test Signal Level/Level-Monitor Test Limits (Hi-PW ON)**

Test Signal Level	Test Limits	
	Multimeter Reading	Level Monitor Reading
10 mV	10 mV $\pm$ 2 mV	M.R. $\pm$ (3%+0.5 mV)
1 V	1 V $\pm$ 0.11 V	M.R. $\pm$ (3%+0.5 mV)
2.5 V	2.5 V $\pm$ 0.26 V	M.R. $\pm$ (3%+5 mV)
20 V	20 V $\pm$ 2.01 V	M.R. $\pm$ (3%+5 mV)

M.R. is the Multimeter Reading for the HP 4284A's output signal level.



## DC Bias Level Accuracy Test

This test verifies the accuracy of the HP 4284A's internal dc bias level.

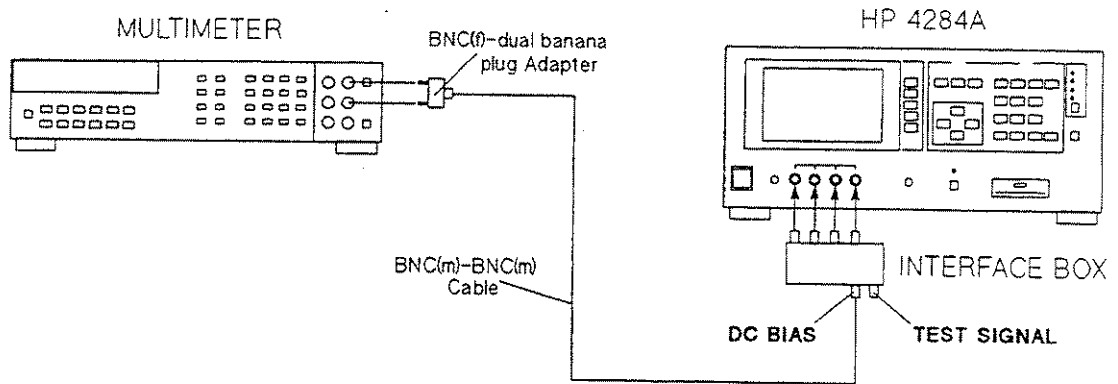
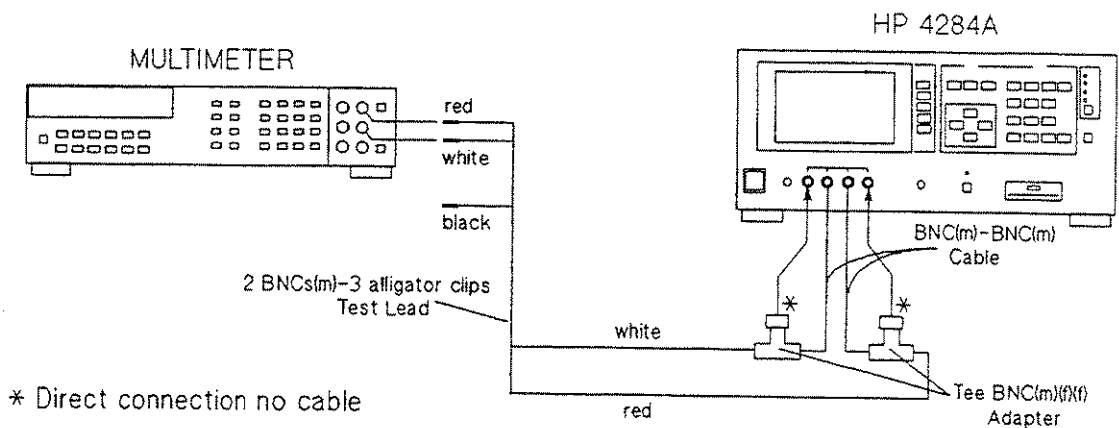

Figure 10-4. DC Bias Level Accuracy Test Setup Using an Interface Box



\* Direct connection no cable

Figure 10-5. DC Bias Level Accuracy Test Setup Without an Interface Box

<b>Equipment:</b>	Interface Box	HP PN 04284-65007
	Multimeter	HP 3458A
	Cable BNC(m)-to-BNC(m) 30 cm	HP PN 8120-1838
	BNC(f) to dual banana plug Adapter	HP PN 1251-2277

**Procedure:** 1. Connect the equipment as shown in Figure 10-4.

**Note**



if the Interface Box is not available, use the following cables and adapters as a substitute. Figure 10-5 shows the test setup without the interface box. The center conductors of  $H_{CUR}$  and  $H_{POT}$  are connected to the Hi-input of the multimeter. The center conductors of the  $L_{CUR}$  and  $L_{POT}$  are connected to Lo-input of the multimeter.

Cable BNC(m)-to-BNC(m) 30 cm	HP PN 8120-1838 2 ea.
Test Lead 2 BNCs(m) to	HP PN 8120-1661
3 alligator clips	
Tee, BNC(m)(f)(f) Adapter	HP PN 1250-0781 2 ea.

2. Set the multimeter to DCV.
3. Perform a SYSTEM RESET as described in "System Reset".
4. Set HP 4284A's controls as follows:

Test Signal level: 0 mV  
High Power Option: OFF  
DC Bias: ON

**Note**



The High Power Mode cannot be changed when the DC Bias is set to ON.

Set the DC Bias voltage in accordance with Table 10-5, and confirm that the Multimeter readings are within the test limits given in Table 10-5.

**Table 10-5. DC Bias Level Test Limits (Hi-PW OFF)**

Bias Level	Test Limits
1.5 V	1.425 V to 1.575 V
2 V	1.9 V to 2.1 V

**Note**



Steps 6 through 7 should be performed only when the HP 4284A is equipped with Option 001.

5. set the HP 4284A's controls as follows:

Test Signal Level: 0 mV  
High Power Option: ON  
DC Bias: ON

6. Set the DC Bias Level in accordance with Table 10-6, and confirm that the Multimeter readings are within the test limits given in Table 10-6.

**Table 10-6. DC Bias Level Test Limits (Hi-PW ON)**

Bias Level	Test Limits
0 V	0.0010 V to -0.0010 V
0.1 V	0.0989 V to 0.1011 V
2 V	1.9970 V to 2.0030 V
6 V	5.9920 V to 6.0080 V
14 V	13.981 V to 14.019 V
30 V	29.960 V to 30.040 V
40 V	39.950 V to 40.050 V
-0.1 V	-0.1011 V to -0.0989 V
-2 V	-2.0030 V to -1.9970 V
-6 V	-6.0080 V to -5.9920 V
-14 V	-14.019 V to -13.981 V
-30 V	-30.040 V to -29.960 V
-40 V	-40.050 V to -39.950 V

# Impedance Measurement Accuracy Test

This test verifies the HP 4284A's impedance measurement accuracy.

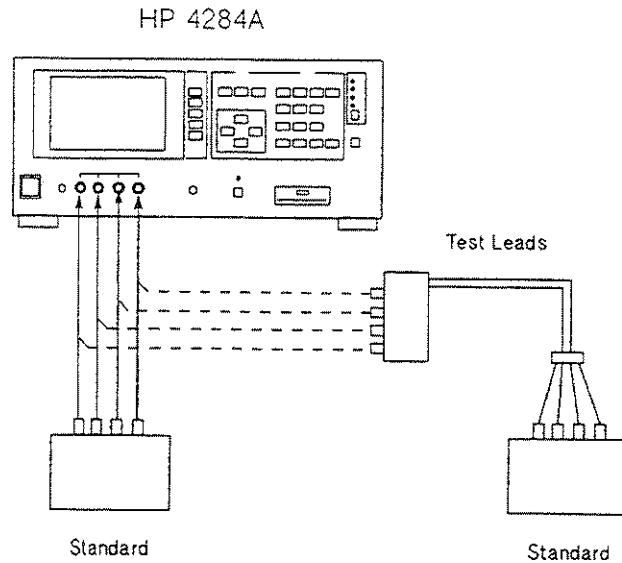

**Figure 10-6. Impedance Measurement Accuracy Test Setup**

<b>Equipment:</b>	10 pF Standard Capacitor	HP 16382A
	100 pF Standard Capacitor	HP 16383A HP 16380A
	1000 pF Standard Capacitor	HP 16384A
	0.01 $\mu$ F Standard Capacitor	HP 16385A
	0.1 $\mu$ F Standard Capacitor	HP 16386A HP 16380C
	1 $\mu$ F Standard Capacity	HP 16387A
	Calibration R-L Standard	HP 16074A
	Adapter BNC(f) to BNC(f)	HP PN 1250-0080 4 ea.
	Test Leads (1 m)	HP 16048A
	Test Leads (2 m)	HP 16048D (Option 006 only)
Test Leads (4 m)	HP 16048E (Option 006 only)	

- Procedure:**
1. Perform a SYSTEM RESET as described on in "System Reset".
  2. Press the **MEAS SETUP** MENU key and the **CORRECTION** softkey to display the **CORRECTION** page.
  3. Set the **CORRECTION** page as shown in Figure 10-7.

## CORRECTION page

<b>&lt;CORRECTION&gt;</b>		<b>SYS MENU</b>	MEAS SETUP
OPEN :	ON	CABLE :	0 m
SHORT :	ON	MODE :	SINGLE
LOAD :	OFF	CH No. :	.....
		FUNC :	CP-D *
FREQ1 :	OFF	B :	.....
REF A :	.....	B :	.....
MEA A :	.....		
FREQ2 :	OFF	B :	.....
REF A :	.....	B :	.....
MEA A :	.....		
FREQ3 :	OFF	B :	.....
REF A :	.....	B :	.....
MEA A :	.....		
			CORREC TION
			LIMIT TABLE
			LIST SETUP

: Field      \* : Any Setting  
 : Monitor

**Figure 10-7. Correction Page Setup**

**Note**



It takes approx. 90 s each to store the **OPEN CORRECTION** data and the **SHORT CORRECTION** data.

4. Connect the OPEN termination to the HP 4284A's UNKNOWN terminals.
5. Move the cursor to the **OPEN** field.
6. Press the **MEAS OPEN** softkey to store the open correction data.
7. Connect the SHORT termination to the HP 4284A's UNKNOWN terminals.
8. Move the cursor to the **SHORT** field.
9. Press the **MEAS SHORT** softkey to store the short correction data.
10. Set the HP 4284A to the Manual Trigger mode.
11. Perform Steps 12 through 14 for the all standards and settings listed in Table 10-7.

**Note**



Test signal level is set to 5.1 V only when the HP 4284A is equipped with Option 001

12. Connect the Standard to the HP 4284A's UNKNOWN terminals.
13. Press the **TRIGGER** key.
14. Confirm that the HP 4284A's reading is within the test limits in Table 10-7.

**Table 10-7. Impedance Measurement Accuracy Test Limits (1 of 2)**

Setting			Test Limits (Cp, D)		
Signal Level	Test Frequency		10 pF Standard	100 pF Standard	1000 pF Standard
510 mV	20 Hz	Cp			C.V. $\pm 32.09$ pF
		D			$\pm 0.00319$
	125 Hz	Cp		C.V. $\pm 1.759$ pF	C.V. $\pm 3.05$ pF
		D		$\pm 0.01739$	$\pm 0.00286$
	1 kHz	Cp		C.V. $\pm 0.312$ pF	C.V. $\pm 1.00$ pF
		D		$\pm 0.00293$	$\pm 0.00081$
	12.5 kHz	Cp	C.V. $\pm 0.0318$ pF	C.V. $\pm 0.137$ pF	C.V. $\pm 1.13$ pF
		D	$\pm 0.0031$	$\pm 0.00130$	$\pm 0.00095$
	48 kHz	Cp	C.V. $\pm 0.0246$ pF	C.V. $\pm 0.162$ pF	C.V. $\pm 1.16$ pF
		D	$\pm 0.0028$	$\pm 0.0190$	$\pm 0.00103$
	96 kHz	Cp	C.V. $\pm 0.0275$ pF	C.V. $\pm 0.122$ pF	C.V. $\pm 1.31$ pF
		D	$\pm 0.0035$	$\pm 0.00116$	$\pm 0.00111$
	1 MHz	Cp	C.V. $\pm 0.0249$ pF	C.V. $\pm 0.102$ pF	C.V. <sup>1</sup> $\pm 1.53$ pF
		D	$\pm 0.0038$	$\pm 0.00082$	$\pm 0.00083$
20 mV	1 kHz	Cp		C.V. $\pm 0.898$ pF	C.V. $\pm 2.53$ pF
	1 MHz	Cp	C.V. $\pm 0.0402$ pF	C.V. $\pm 0.208$ pF	C.V. <sup>1</sup> $\pm 2.59$ pF
5.1 V*	1 kHz	Cp		C.V. $\pm 0.293$ pF	C.V. $\pm 1.48$ pF
	1 MHz	Cp	C.V. $\pm 0.0297$ pF	C.V. $\pm 0.152$ pF	C.V. <sup>1</sup> $\pm 2.03$ pF

C.V.: Standard's calibration value at 1 kHz.

C.V.<sup>1</sup>: C.V. multiplied by 1.0003

\*Option 001 only

**Table 10-7. Impedance Measurement Accuracy Test Limits (2 of 2)**

Setting		Test Limits (Cp)		
Signal Level	Test Frequency	0.01 $\mu$ F Standard	0.1 $\mu$ F Standard	1 $\mu$ F Standard
510 mV	1 kHz	C.V. $\pm$ 0.0082 nF	C.V. $\pm$ 0.081 nF	C.V. $\pm$ 0.81 nF
20 mV	1 kHz	C.V. $\pm$ 0.0188 nF	C.V. $\pm$ 0.182 nF	C.V. $\pm$ 1.87 nF
5.1 V*	1 kHz	C.V. $\pm$ 0.0132 nF	C.V. $\pm$ 0.131 nF	C.V. $\pm$ 1.31 nF

C.V.: Standard's calibration value at 1 kHz.

C.V.<sup>1</sup>: C.V. multiplied by 1.0005

C.V.<sup>2</sup>: C.V. multiplied by 1.0002

\*Option 001 only

15. Set the measurement function to **R-X**.
16. Perform Steps 17 through 19 for all the standards and settings listed in Table 10-8.
17. Connect the Standard to the HP 4284A's **UNKNOWN** terminals.
18. Press the **TRIGGER** key.
19. Confirm that the HP 4284A's readings are within the test limits listed in Table 10-8.

**Table 10-8.  
Impedance Measurement Accuracy Test Limits**

Setting		Test Limits (R)	
Signal Level	Test Frequency	100 $\Omega$ Standard	1 k $\Omega$ Standard*
510 mV	20 Hz	C.V. $\pm 0.285 \Omega$	C.V. $\pm 2.81 \Omega$
	125 Hz	C.V. $\pm 0.112 \Omega$	C.V. $\pm 1.11 \Omega$
	1 kHz	C.V. $\pm 0.082 \Omega$	C.V. $\pm 0.81 \Omega$
	12.5 kHz	C.V. $\pm 0.132 \Omega$	C.V. $\pm 1.31 \Omega$
	48 kHz	C.V. $\pm 0.132 \Omega$	C.V. $\pm 1.31 \Omega$
	96 kHz	C.V. $\pm 0.132 \Omega$	C.V. $\pm 1.31 \Omega$
	1 MHz	C.V. $\pm 0.154 \Omega$	C.V. $\pm 1.02 \Omega$
20 mV	20 Hz	C.V. $\pm 0.691 \Omega$	C.V. $\pm 6.60 \Omega$
	1 kHz	C.V. $\pm 0.191 \Omega$	C.V. $\pm 1.82 \Omega$
	1 MHz	C.V. $\pm 0.264 \Omega$	C.V. $\pm 2.06 \Omega$
5.1 V**	20 Hz	C.V. $\pm 0.284 \Omega$	C.V. $\pm 2.81 \Omega$
	1 kHz	C.V. $\pm 0.131 \Omega$	C.V. $\pm 1.31 \Omega$
	1 MHz	C.V. $\pm 0.204 \Omega$	C.V. $\pm 1.52 \Omega$

C.V.: Standard's calibration value at DC.

\*1 k $\Omega$  standard should be measured on the 300  $\Omega$  range.

\*\*Option 001 only

20. Connect the 1 m Test Leads (HP 16048A) to the UNKNOWN terminals.
21. Press the **MEAS SETUP** MENU key and the **CORRECTION** softkey to display the **CORRECTION** page.
22. Set the **CABLE** length selection switch to 1 m.
23. Store the **OPEN CORRECTION** data and the **SHORT CORRECTION** data referring to Steps 4 through 9. In this procedure the OPEN termination and the SHORT termination should be connected to the 1 m Test Leads (HP 16048A).
24. Set the HP 4284A to the manual trigger mode.
25. Set the measurement function to **Cp-D**.
26. Connect the 1000 pF standard to the 1 m Test Leads (HP 16048A)
27. Perform Step 28 through 29 for all the test frequencies listed in Table 10-9.



28. Press the **TRIGGER** key.
29. Confirm that HP 4284A's reading is within the test limits in Table 10-9.

**Table 10-9.**  
**Impedance Measurement Accuracy Test Limits for 1 m Cable Length Operation**

Setting		Test Limits (Cp)
Signal Level	Test Frequency	
510 mV	20 Hz	C.V. $\pm 32.10$ pF
	125 Hz	C.V. $\pm 3.06$ pF
	1 kHz	C.V. $\pm 1.00$ pF
	12.5 kHz	C.V. $\pm 1.14$ pF
	48 kHz	C.V. $\pm 1.17$ pF
	96 kHz	C.V. $\pm 1.32$ pF
	1 MHz	C.V. <sup>1</sup> $\pm 1.66$ pF
20 mV	1 kHz	C.V. $\pm 2.54$ pF
	1 MHz	C.V. <sup>1</sup> $\pm 2.72$ pF
5.1 V*	20 Hz	C.V. $\pm 28.94$ pF
	1 kHz	C.V. $\pm 1.50$ pF
	1 MHz	C.V. <sup>1</sup> $\pm 2.47$ pF

C.V.: Standard's calibration value at DC.

C.V.<sup>1</sup>: C.V. multiplied by 1.0003

\*Option 001 only

**Note**



Steps 30 through 49 should be performed only when the HP 4284A is equipped with Option 006.

30. Connect the 2 m Test Leads (HP 16048D) to the UNKNOWN terminals.
31. Press the **MEAS SETUP** MENU key and the **CORRECTION** softkey to display the **CORRECTION** page.
32. Set the **CABLE** to 2 m.
33. Store the **OPEN CORRECTION** data and the **SHORT CORRECTION** data referring to Step 4 through 9. In this procedure the OPEN termination and the SHORT termination should be connected to the 2 m Test Leads (HP 16048D).
34. Set the HP 4284A to the Manual Trigger mode.
35. Set the measurement function to **Cp-D**.
36. Connect the 1000 pF standard to the 2 m Test Leads (HP 16048D).
37. Perform Steps 38 through 39 for all the test frequencies listed in Table 10-10.
38. Press the **TRIGGER** key.
39. Confirm that the HP 4284A's reading is within the test limits in Table 10-10.
40. Connect the 4 m Test Leads (HP 16048E) to the UNKNOWN terminals.
41. Press the **MEAS SETUP** MENU key and the **CORRECTION** softkey to display the **CORRECTION** page.
42. Set the **CABLE** to 4 m.
43. Store the **OPEN CORRECTION** data and the **SHORT CORRECTION** data referring to steps 4 through 9. In this procedure the OPEN termination and the SHORT termination should be connected to the 4 m Test Leads (HP 16048E).
44. Set the HP 4284A to the Manual Trigger mode.
45. Set the measurement function to **Cp-D**.
46. Connect the 1000 pF standard to the 4 m Test Leads (HP 16048E).
47. Perform Steps 48 through 49 for all the test frequencies listed in Table 10-10.
48. Press the **TRIGGER** key.
49. Confirm that the HP 4284A's reading is within the test limits listed in Table 10-10.

**Table 10-10.**  
**Impedance Measurement Accuracy Test Limits for 2 m**  
**and 4 m Cable Length Operation**

Setting		Test Limits (Cp)	
Signal Level	Test Frequency	2 m Cable	4 m Cable
510 mV	20 Hz	C.V. $\pm 32.10$ pF	C.V. $\pm 32.11$ pF
	125 Hz	C.V. $\pm 3.06$ pF	C.V. $\pm 3.07$ pF
	1 kHz	C.V. $\pm 1.00$ pF	C.V. $\pm 1.01$ pF
	12.5 kHz	C.V. $\pm 1.14$ pF	C.V. $\pm 1.15$ pF
	48 kHz	C.V. $\pm 1.18$ pF	C.V. $\pm 1.19$ pF
	96 kHz	C.V. $\pm 1.34$ pF	C.V. $\pm 1.37$ pF
	1 MHz	C.V. <sup>1</sup> $\pm 1.80$ pF	C.V. <sup>1</sup> $\pm 2.06$ pF
20 mV	1 kHz	C.V. $\pm 2.54$ pF	C.V. $\pm 2.56$ pF
	1 MHz	C.V. <sup>1</sup> $\pm 2.90$ pF	C.V. <sup>1</sup> $\pm 3.20$ pF
5.1 V*	20 Hz	C.V. $\pm 28.97$ pF	C.V. $\pm 29.02$ pF
	1 kHz	C.V. $\pm 1.53$ pF	C.V. $\pm 1.58$ pF
	1 MHz	C.V. <sup>1</sup> $\pm 2.92$ pF	C.V. <sup>1</sup> $\pm 3.81$ pF

C.V.: Standard's calibration value at DC.

C.V.<sup>1</sup>: C.V. multiplied by 1.0003

\* Option 001 only

---

## Store and Load Function Test

This test verifies the HP 4284A's ability to store information to, and load information from a memory card.

**Equipment:** Memory Card                      HP PN 04278-89001

- Procedure:**
1. Perform a SYSTEM RESET as described in "System Reset".
  2. Insert a memory card into the MEMORY card slot.
  3. Display the MEAS SETUP page.

**Note**



---

This test should be performed from the MEAS SETUP page.

---

4. Change the measurement function from Cp-D to Cp-G in the FUNC field.
5. Use the CURSOR arrow keys to move the cursor to the SYS MENU field.
6. Press the STORE softkey to store the HP 4284A's control settings to the memory card as data record-number 10.
7. Press the CLEAR SETUP softkey to clear the set up, and then confirm that FUNC is set to Cp-D.
8. Press the LOAD softkey to load data record-number 10 from the memory card.
9. Confirm that the measurement function is set to Cp-G.

## HP-IB Interface Test

This test verifies the HP 4284A'S HP-IB function.

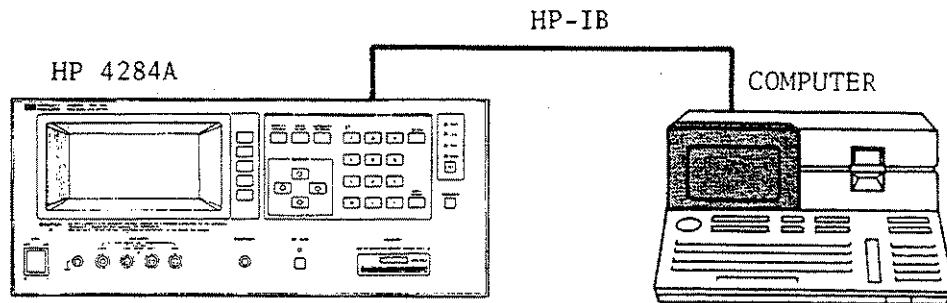

Figure 10-8. HP-IB Interface Test Setup

**Equipment:** Personal Technical Computer HP 9000 Series 200 Model 226  
HP-IB Cable HP 10833A

- Procedure:**
1. Set the HP 4284A's HP-IB address to 17.
  2. Set up the equipment as shown in Figure 10-8. Use the computer's interface Select Code (7).
  3. Load BASIC and input the following program, but do not RUN the program yet.

```
10 DIM A$[38]
20 OUTPUT 717;"*IDN?"
30 ENTER 717;A$
40 PRINT AS
50 OUTPUT 717;"*SRE328"
60 OUTPUT 717;"ABC"
70 PRINT SPOLL(717)
80 END
```

4. Press the computer's STEP key three times to single step to line 20.
5. Confirm that the **LTN** and **RMT** lamps are ON and that the softkey label page cannot be changed by pressing the **MENU** keys.
6. Press the **LCL** key on the HP 4284A.
7. Confirm that the **LTN** lamp stays ON, the **RMT** lamp is OFF, and the softkey label page can be changed by pressing the **MENU** keys.
8. Press the computer's STEP key to execute line 30 and confirm that the **TLK** lamp is ON.
9. Step to line 40 and confirm that the following message is displayed on the computer.

```
"HEWLETT-PACKARD, 4284A, 0, REV01.01 "
```

10. Step to line 60, and confirm that the **SRQ**, **LTN**, and **RMT** lamps are ON.
11. Step to line 80 and confirm that the status byte value displayed on the computer is greater than 95.

## Bias Current Interface Function Test (Option 002 only)

This test verifies the bias current interface functions.

**Equipment:** Bias Interface Simulator HP PN 42841-65001  
 Bias Interface Cable HP PN 42841-61640  
 DC Power Supply HP 6214C

**Procedure:** 1. Set all switches of S1 and S2 on the bias interface simulator to '1' as shown in Figure 10-9.

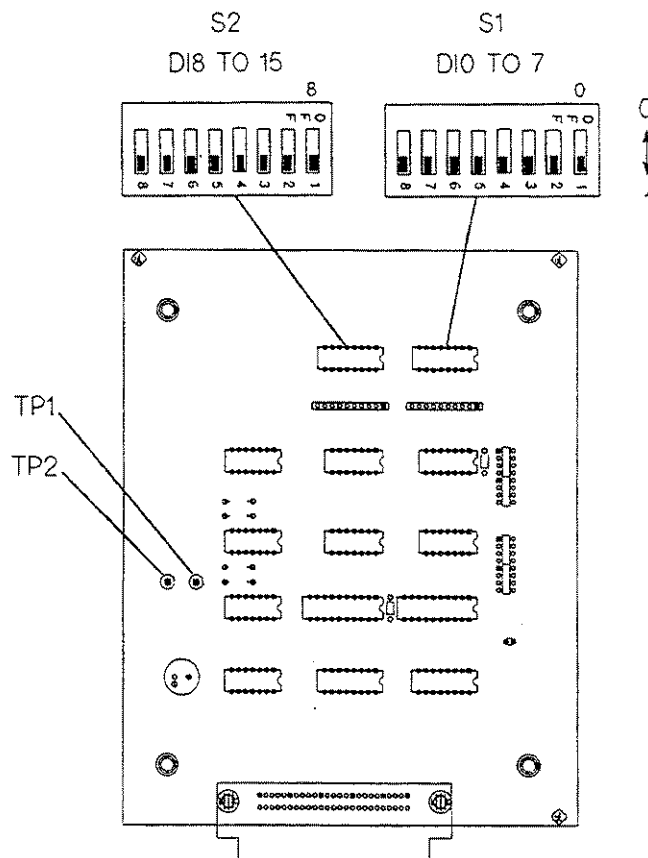

**Figure 10-9. Bias Interface Simulator**

2. Set DC power supply output voltage +5 V. Connect TP2(GND) on the bias interface simulator to '-' terminal of the power supply. Then connect TP1(Vcc) on the simulator to '+' terminal of the power supply. (refer to Figure 10-9 and Figure 10-10)

**Note**

DC power for the bias interface simulator can be supplied from the HP 4284A instead of from an external DC power supply. For further details, see “Supplying DC Power to the Simulator”.

- Interconnect the bias interface simulator and bias interface connector on the rear panel of the HP 4284A with the bias interface cable as shown in Figure 10-10.

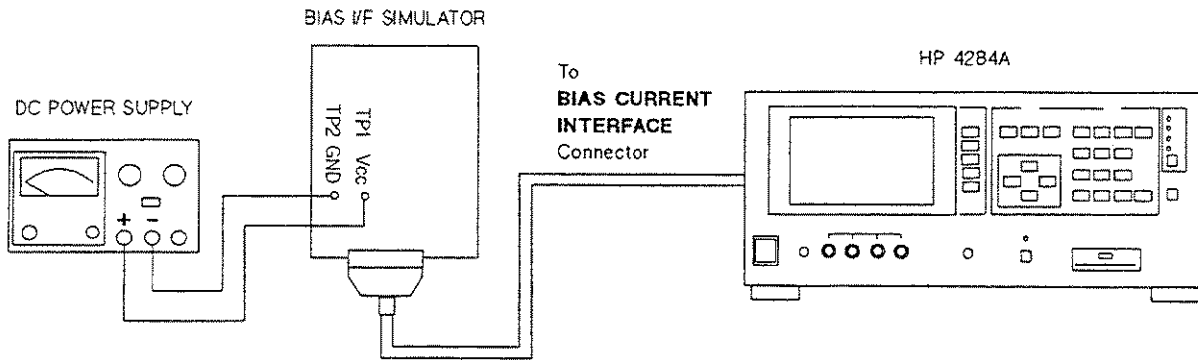

**Figure 10-10. Bias Current Interface Function Test Setup**

- Turn the HP 4284A ON.
- Press the **CATALOG/SYSTEM** MENU key.
- Press the **SELF TEST** softkey to display the **SELF TEST** page.
- Use the **CURSOR** arrow keys to move the cursor to the **TEST MENU** field.
- Press the **7** and the **ENTER** keys to select the **Bias Current I/F I/O** test.

**Note**

Check the settings of S1 and S2 described in the step 1, if the HP 4284A's LCD displays “E74:Illegal test setup”.

- Confirm the /RESET LED on the bias interface simulator turns ON.
- Confirm CS0 and CS1 LEDs on the simulator turn ON as the HP 4284A's output signal is displayed on the LCD. (Refer to Figure 10-11).
- Confirm that ADRS1-ADRS6 LEDs on the simulator turn ON in accordance with the hexadecimal number displayed on the LCD. One of the 6 LEDs turns ON in sequence as shown in Figure 10-11.
- Confirm that DO0-DO7 LEDs on the simulator turn ON in accordance with the hexadecimal number displayed on the LCD. One of the 8 LEDs turns ON in sequence as shown in Figure 10-11.



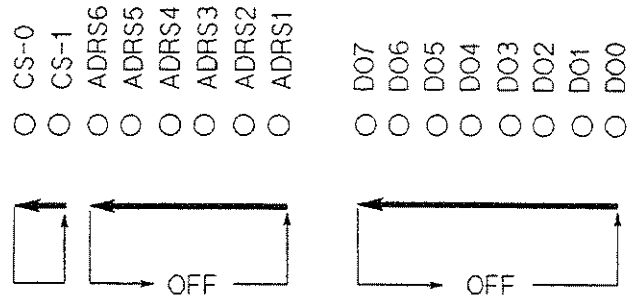

**Figure 10-11. Bias Current Interface Function Test**

13. Confirm that “DI0 TO 7” and “DI8 TO 15” on the LCD of the HP 4284A display hexadecimal number “FF”.
14. Set switches S1 and S2 on the bias interface simulator to '0'. Then confirm that hexadecimal number “00” is displayed by “DI0 TO 7” and “DI8 TO 15”.

**Note**



The states of S1(DI0 TO 7) and S2(DI1 TO 8) are displayed as a hexadecimal number on the HP 4284A's LCD.

15. Press the **TEST END** softkey.

**Caution**



Do not execute any SELF TEST except for the Bias Current I/F I/O Test or the HP 4284A will become inoperative.

## Handler Interface Function Test (Option 201 only)

Perform this test only when troubleshooting the Option 201 Handler Interface Board.

This test verifies the handler interface functions.

**Equipment:** Handler Simulator      HP PN 04278-65001

**Procedure:** 1. Disconnect the power cable from the HP 4284A and allow 1 minute for the internal capacitors to discharge.

### Warning



**Dangerous energy/voltage exists when the HP 4284A is in operation, and for a time after it is powered down. Allow 1 minutes for the internal capacitors to discharge.**

2. Disconnect the two rear feet which lock the top cover and rear panel together.
3. Fully loosen the top cover retaining screws located on the rear of the top cover.
4. Slide the top cover toward rear and lift it off. The top shield plate will be visible.
5. Remove the top shield plate to expose the PC boards.
6. Disconnect a flat cable from the handler interface board which has an ORANGE and a BLACK, or an ORANGE and a RED extractors. See Figure 10-12.

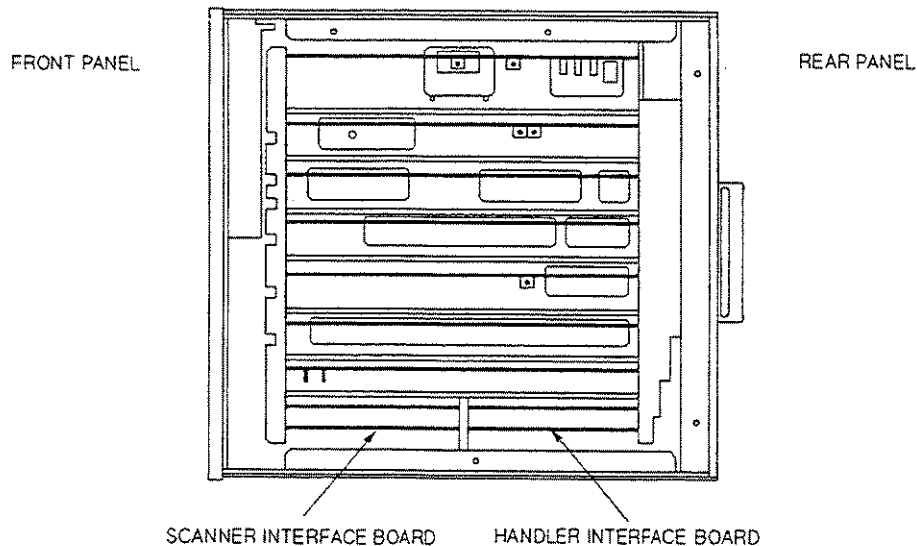

**Figure 10-12. Interface Board Locations**

7. Remove the handler interface board.

**Caution**



The interface board contains electronic components that can be damaged by static electricity through electrostatic discharge(ESD). To prevent ESD damage, maintain frequent contact with any bare sheet metal surface on the chassis. A grounding wrist strap (or similar device) is useful for this purpose. Handle the board carefully at all times. Avoid touching electronic components or circuit paths.

**Note**



Before performing step 8, note the jumper settings in order to return them to the same settings at the end of this function test.

8. Set the jumpers on the handler interface board to the same settings as when the board is shipped from the factory. Configure the interface board according the color of the extractors, see step (1) for ORANGE and BLACK extractors and step (2) for ORANGE and RED extractors.

(1) ORANGE and BLACK (See Figure 10-13.)

OPEN (remove): W1, W2, W3, W5, W6, W8, W9, W10, and R101 thru R121

SHORT: W4, W7, and W11

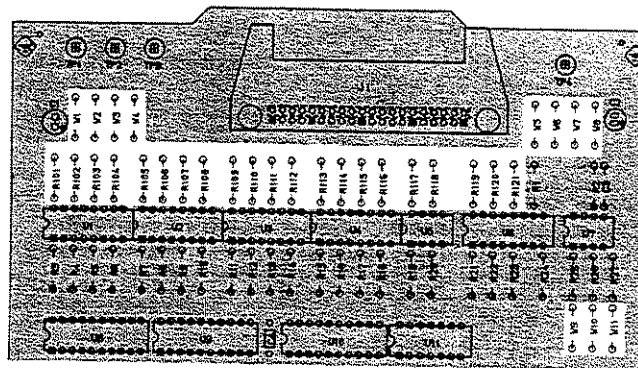

**Figure 10-13. Jumper Settings**

(2) ORANGE and RED (See Figure 10-14.)

SET: All Jumper Switches to position "N"

OPEN (remove): R101 thru R121

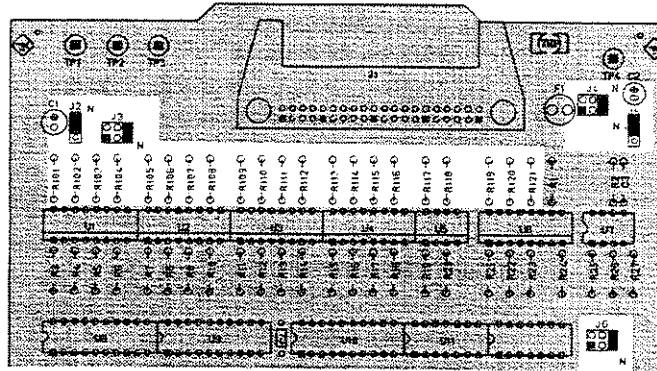

Figure 10-14. Jumper Settings

9. Replace the handler interface board, top shield plate, rear feet, and the top cover.
10. Turn the HP 4284A ON.
11. Connect the handler interface connector on the HP 4284A's rear panel to the handler simulator as shown in Figure 10-14.
12. Press the **CATALOG/SYSTEM** MENU key.
13. Press the **SELF TEST** softkey to display the **SELF TEST** page.

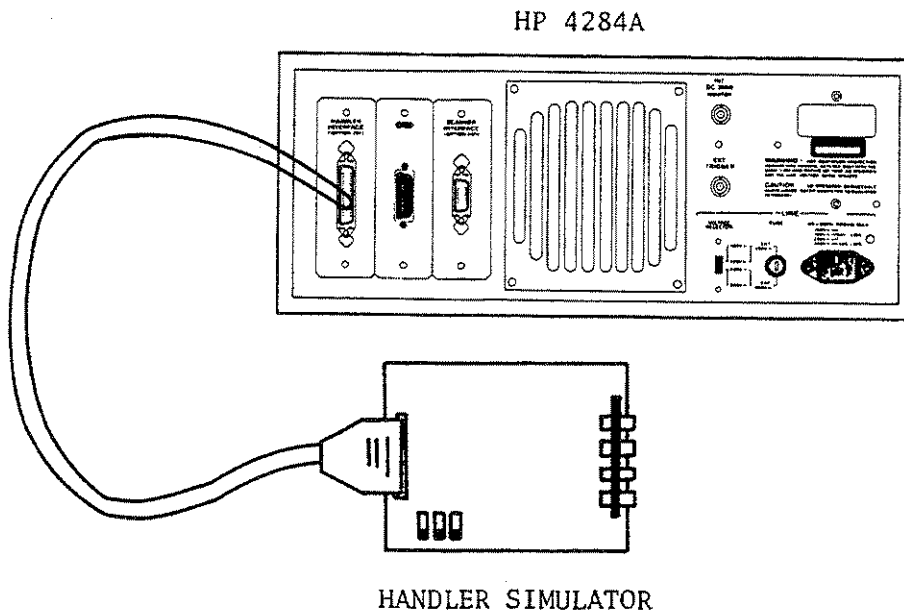
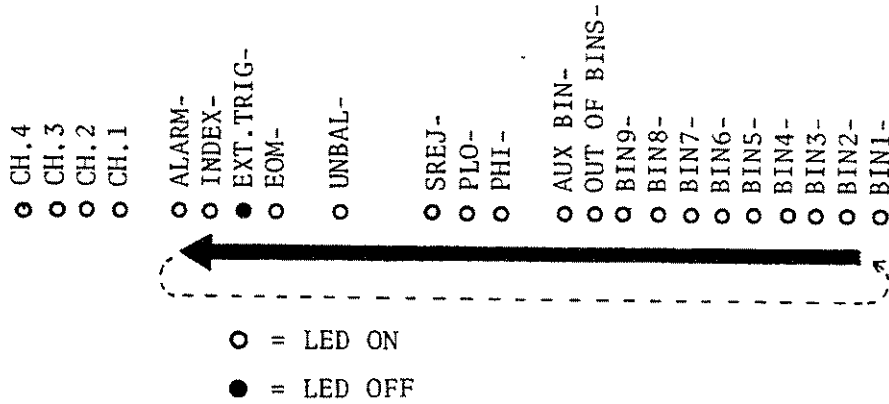

Figure 10-15. Handler Interface Function Test Set UP

14. Use the **CURSOR** arrow keys to move the cursor to the **TEST MENU** field.
15. Press the **4** and the **ENTER** keys to select the Handler I/F test.
16. Press the **TEST START** softkey.
17. Confirm that the LEDs on the handler simulator turn ON in accordance with the HP 4284A's output signals displayed on the LCD. The LEDs turns ON light in the sequence shown in Figure 10-15.



**Figure 10-16. Handler Interface Function Check**

18. Press the **TEST END** softkey.

**Caution**



Do not execute any SELF TEST except for the Bias Current I/F I/O Test or the HP 4284A will become inoperative. The remaining SELF TEST are for serviceuse only.

19. Return the jumper settings on the handler interface board to their original settings.

---

## Handler Interface Function Test (Option 202 only)

Perform this test only when troubleshooting the Option 202 handler interface board.

This test verifies the Option 202 handler interface functions. When this test is performed the following LEDs WILL NOT turn ON because the signals they represent are not used by the Option 202 handler interface board.

**PHI-, PLO-, SREJ-, UNBAL- and ALARM-**

**Equipment:** Handler Simulator                      HP PN 04278-65001  
Cable    HP PN 04278-61635

- Procedure:**
1. Perform steps 1 through 5 described "Procedure:".
  2. Disconnect the flat cable from the handler interface board. The handler interface board has brown and an orange extractors and its location is shown in Figure 10-12.
  3. Remove the handler interface board.

**Caution**



---

The interface board contains electronic components that can be damaged by static electricity through electrostatic discharge(ESD). To prevent ESD damage, maintain frequent contact with any bare sheet metal surface on the chassis. A grounding wrist strap (or similar device) is useful for this purpose. Handle the board carefully at all times. Avoid touching electronic components or circuit paths.

---

**Note**



---

Before performing step 4, note the jumper settings in order to return them to the same setting at the end of this function test.

---

4. Set the jumpers on the handler interface board the same settings as when the board is shipped from the factory referring to Figure 10-16.

OPEN	W1, W4, W5, W7, W8, W11, W12
SHORT	W2, W3, W6, W9, W10, W13
OPEN (remove)	R101 thru R113

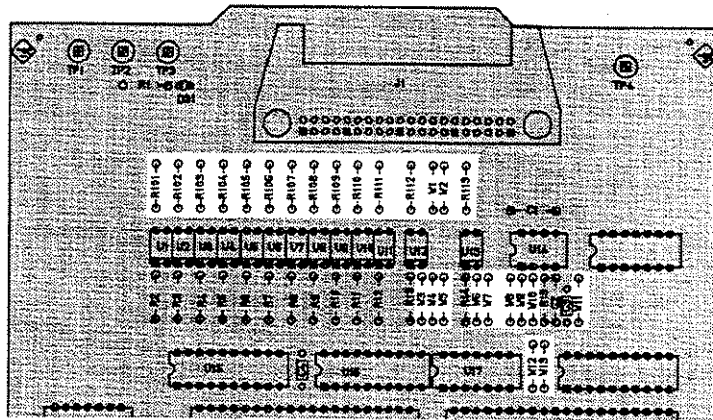

Figure 10-17. Jumper Settings

5. Replace the handler interface board, top shield board, rear feet, and the top cover.
6. Turn the HP 4284A ON.
7. Connect the handler interface connector on the HP 4284A's rear panel with the handler simulator as shown in Figure 10-17.

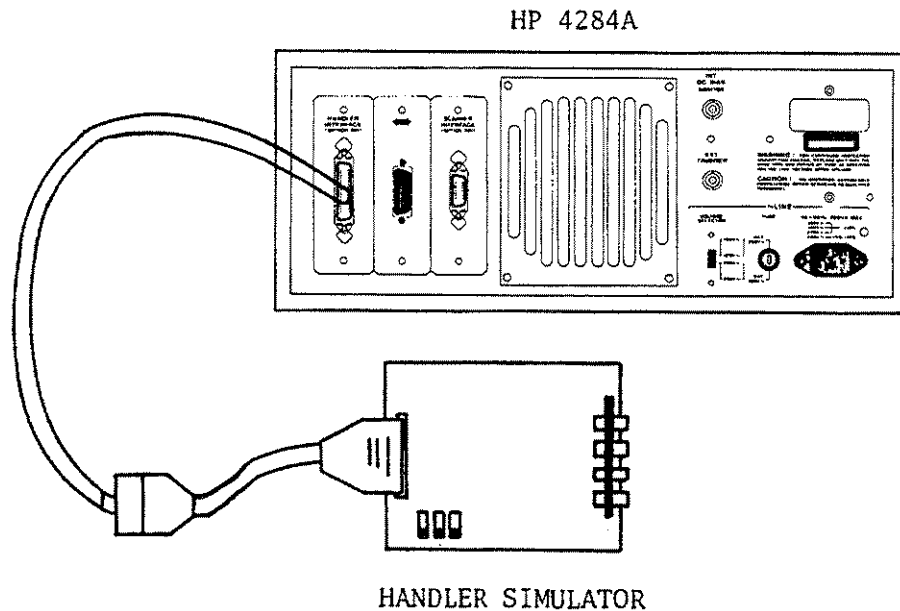
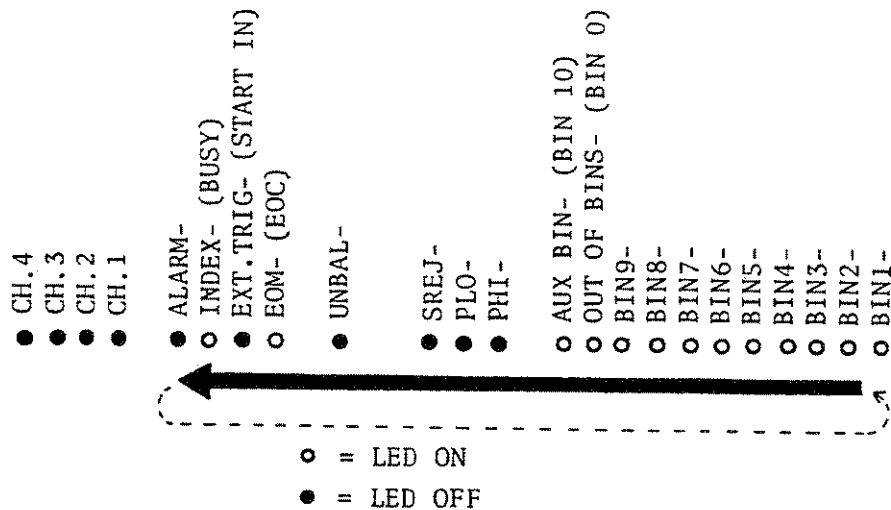

Figure 10-18. Handler Interface Function Test Set up

8. Press the **CATALOG/SYSTEM** MENU key.
9. Press the **SELF TEST** softkey to display the SELF TEST page.

10. Move the cursor to the **TEST MENU** field.
11. Press the **4** and **ENTER** keys to select the Handler I/F test.
12. Press the **TEST START** softkey.
13. Confirm that the LEDs on the handler simulator board turn ON in accordance with the HP 4284A's output signals displayed on the LCD. The LEDs should turn ON in the sequence shown in Figure 10-18.



**Figure 10-19. Handler Interface Function Check**

14. Press the **TEST END** softkey.

**Caution**



Do not execute any SELF TEST except for the Bias Current I/F I/O Test or the HP 4284A will become inoperative. The remaining SELF TEST are for serviceuse only.

15. Return the jumper settings on the handler interface board to the original settings.



---

## Scanner Interface Function Test (Option 301 only)

Perform this test only when troubleshooting the Option 301 scanner interface board.

This test verifies the scanner interface function.

**Equipment:** Scanner Simulator      HP PN 04278-65301  
DC Power Supply      HP 6414C  
Test Leads

- Procedure:**
1. Perform steps 1 through 5 described "Procedure:".
  2. Disconnect the flat cable from the scanner interface board. The scanner interface board has black and yellow extractors and its location is shown in Figure 10-12.
  3. Remove the scanner interface board.

**Caution**



---

The interface board contains electronic components that can be damaged by static electricity through electrostatic discharge(ESD). To prevent ESD damage, maintain frequent contact with any bare sheet metal surface on the chassis. A grounding wrist strap (or similar device) is useful for this purpose. Handle the board carefully at all times. Avoid touching electronic components or circuit paths.

---

4. Set SW1 and SW2 on the scanner interface board to the same settings as when the board is shipped from the factory referring to Figure 10-19.

**Note**



---

Before performing step 4, note the switch settings in order to return to the same settings at the end of this function test.

---

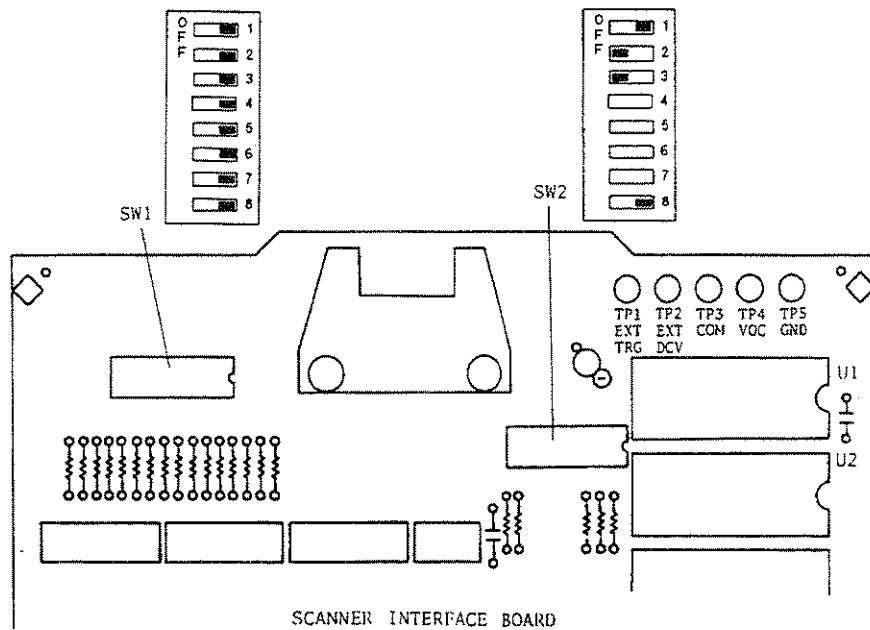

**Figure 10-20. SW1 and SW2 settings**

5. Replace the scanner interface board and reconnect the flat cable.
6. Set DC power supply output voltage +5 V. Connect TP2(GND) on the bias interface simulator to '-' terminal of the power supply. Then connect TP1 (Vcc) on the simulator to '+' terminal of the power supply. (refer to Figure 10-20)

**Note**



DC power for the bias interface simulator can be supplied from the HP 4284A instead of an external DC power supply. For further details, see "Supplying DC Power to the Simulator".

7. Connect the scanner simulator to the scanner interface connector on the HP 4284A's rear panel as shown in Figure 10-20.

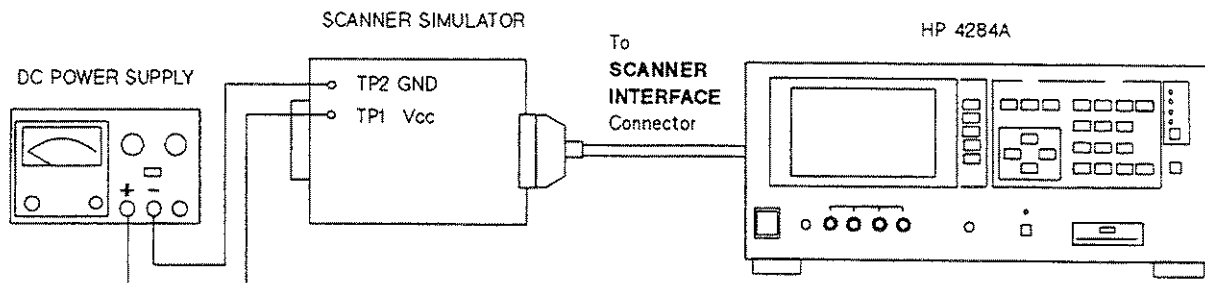

**Figure 10-21. Scanner Simulator Connections**

8. Replace the top shield plate, rear feet, and top cover. Turn the HP 4284A ON.

9. Press the **CATALOG/SYSTEM** MENU key.
10. Press the **SELF TEST** softkey to display the **SELF TEST** page.
11. Use the **CURSOR** arrow keys to move the cursor to the **TEST MENU** field.
12. Press the 6 and **ENTER** keys to select the Scanner I/F I/O test.
13. Press the **TEST START** softkey.
14. Confirm that LEDs on the scanner simulator board turn ON in accordance with the HP 4284A settings displayed in the LCD.
15. Press the **TEST END** softkey.

**Caution**



---

Do not execute any SELF TEST except for the Bias Current I/F I/O Test or the HP 4284A will become inoperative. The remaining SELF TEST are for serviceuse only.

---

16. Remove the top cover, top shield plate and expose the scanner interface board. Set SW1 and SW2 on the scanner interface board to their settings before this test.
17. Replace the top shield plate, rear feet, and top cover.

## Supplying DC Power to the Simulator

This paragraph shows the procedure supplying +5 V DC to the Bias Interface Simulator or the Scanner Simulator from the HP 4284A interior.

### Procedure:

1. Disconnect the power cable from the HP 4284A and allow 1 minutes for the internal capacitors to discharge.

### Warning



**Dangerous energy/voltage exists when the HP 4284A is in operation, and for a time after it is powered down. Allow 1 minutes for the internal capacitors to discharge.**

2. Disconnect the two rear feet which lock the top cover and rear panel together.
3. Fully loosen the top cover retaining screws located on the rear of the top cover.
4. Slide the top cover towards the rear and lift it off. The top shield plate will be visible.

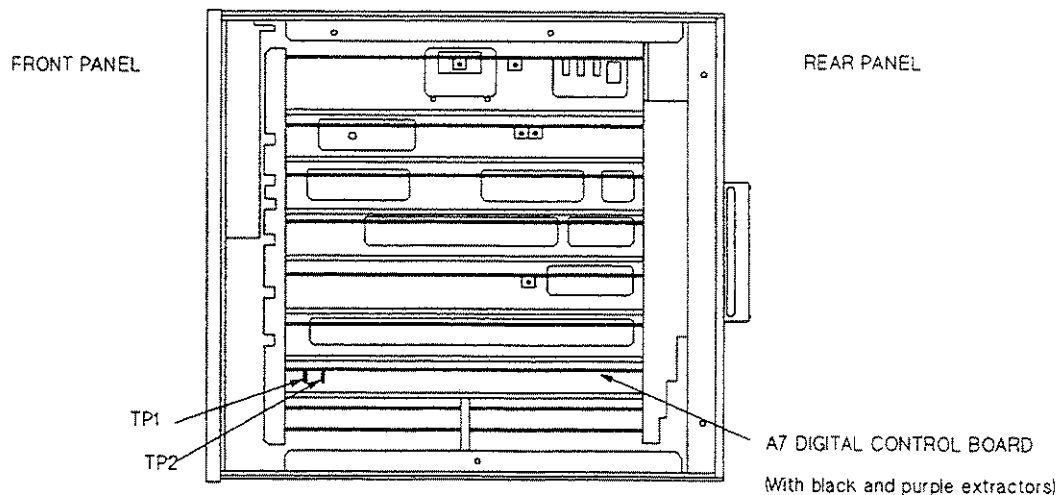

**Figure 10-22. A7 Board Location**

5. Connect TP2 (GND) on the A7 digital control board to the TP2 (GND) on the simulator board. Then connect TP1 on the A7 board to TP1 (5 V or Vcc) on the simulator board. Figure 10-21 shows the location of TP1 and TP2 on the A7 board.

# Performance Test Record

Hewlett-Packard HP 4284A

Tested by \_\_\_\_\_

Precision LCR Meter

Date \_\_\_\_\_

Serial No. \_\_\_\_\_

## Test Signal Frequency

### Accuracy Test

FREQUENCY		1 kHz	8 kHz	20 kHz	80 kHz	400 kHz	1 MHz
RESULT	PASS	[ ]	[ ]	[ ]	[ ]	[ ]	[ ]
	FAIL	[ ]	[ ]	[ ]	[ ]	[ ]	[ ]

## Test Signal Level/Level-Monitor Accuracy Test

### Multimeter Reading (Signal Frequency: 1.25 kHz, Hi-PW: OFF)

PASS [ ]      FAIL [ ]

### Level Monitor Reading (Signal Frequency: 1.25 kHz, Hi-PW: OFF)

OSC LEVEL	MULTIMETER READING	MINIMUM ( $0.97 \times \text{M.R.} - 0.5 \text{ mV}$ )	ACTUAL	MAXIMUM ( $1.03 \times \text{M.R.} + 0.5 \text{ mV}$ )
5 mV	_____	_____	_____	_____
10 mV	_____	_____	_____	_____
20 mV	_____	_____	_____	_____
50 mV	_____	_____	_____	_____
100 mV	_____	_____	_____	_____
200 mV	_____	_____	_____	_____
250 mV	_____	_____	_____	_____
500 mV	_____	_____	_____	_____
1 V	_____	_____	_____	_____
2 V	_____	_____	_____	_____

M.R. is the Multimeter Reading for the HP 4284A's test signal level.

**Multimeter Reading**  
**(Signal Frequency: 960 kHz, Hi PW: OFF)**

PASS [ ]                      FAIL [ ]

OSC LEVEL	MULTIMETER READING	MINIMUM ( $0.97 \times \text{M.R.} - 0.5 \text{ mV}$ )	ACTUAL	MAXIMUM ( $1.03 \times \text{M.R.} + 0.5 \text{ mV}$ )
5 mV	_____	_____	_____	_____
10 mV	_____	_____	_____	_____
20 mV	_____	_____	_____	_____
50 mV	_____	_____	_____	_____
100 mV	_____	_____	_____	_____
200 mV	_____	_____	_____	_____
250 mV	_____	_____	_____	_____
500 mV	_____	_____	_____	_____
1 V	_____	_____	_____	_____
2 V	_____	_____	_____	_____

M.R. is the Multimeter Reading for the HP 4284A's test signal level.

**Multimeter Reading**  
**(Signal Frequency: 1.25 kHz, Hi PW: ON)**  
**Option 001 ONLY**

PASS [ ]                      FAIL [ ]

**Level Monitor Reading**  
**(Signal Frequency: 1.25 kHz, Hi-PW: ON)**  
**Option 001 ONLY**

OSC LEVEL	MULTIMETER READING	MINIMUM ( $0.97 \times \text{M.R.} - 0.5 \text{ mV}$ )	ACTUAL	MAXIMUM ( $1.03 \times \text{M.R.} + 0.5 \text{ mV}$ )
10 mV	_____	( $0.97 \times \text{M.R.} - 0.5 \text{ mV}$ ) _____	_____	( $1.03 \times \text{M.R.} + 0.5 \text{ mV}$ ) _____
1 V	_____	( $0.97 \times \text{M.R.} - 0.5 \text{ mV}$ ) _____	_____	( $1.03 \times \text{M.R.} + 0.5 \text{ mV}$ ) _____
2.5 V	_____	( $0.97 \times \text{M.R.} - 5 \text{ mV}$ ) _____	_____	( $1.03 \times \text{M.R.} + 5 \text{ mV}$ ) _____
20 V	_____	( $0.97 \times \text{M.R.} - 5 \text{ mV}$ ) _____	_____	( $1.03 \times \text{M.R.} + 5 \text{ mV}$ ) _____

**Multimeter Reading**  
 (Signal Frequency: 960 kHz, Hi PW: ON)  
 Option 001 ONLY

PASS [ ]                      FAIL [ ]

**Level Monitor Reading**  
 (Signal Frequency: 960 kHz, Hi-PW: ON)  
 Option 001 ONLY

OSC LEVEL	MULTIMETER READING	MINIMUM ( $0.97 \times \text{M.R.} - 0.5 \text{ mV}$ )	ACTUAL	MAXIMUM ( $1.03 \times \text{M.R.} + 0.5 \text{ mV}$ )
10 mV	_____	( $0.97 \times \text{M.R.} - 0.5 \text{ mV}$ )	_____	( $1.03 \times \text{M.R.} + 0.5 \text{ mV}$ )
1 V	_____	( $0.97 \times \text{M.R.} - 0.5 \text{ mV}$ )	_____	( $1.03 \times \text{M.R.} + 0.5 \text{ mV}$ )
2.5 V	_____	( $0.97 \times \text{M.R.} - 5 \text{ mV}$ )	_____	( $1.03 \times \text{M.R.} + 5 \text{ mV}$ )
20 V	_____	( $0.97 \times \text{M.R.} - 5 \text{ mV}$ )	_____	( $1.03 \times \text{M.R.} + 5 \text{ mV}$ )

**DC Bias Voltage  
Accuracy Test**

Hi-PW OFF

PASS [ ]

FAIL [ ]

Hi-PW ON (Option 001 only)

BIAS VOLTAGE	MINIMUM	ACTUAL	MAXIMUM
0 V	-0.0010 V	_____	0.0010 V
0.1 V	0.0989 V	_____	0.1011 V
2 V	1.9970 V	_____	2.0030 V
6 V	5.9920 V	_____	6.0080 V
14 V	13.981 V	_____	14.019 V
30 V	29.960 V	_____	30.040 V
40 V	39.950 V	_____	40.050 V
-0.1 V	-0.1011 V	_____	-0.0989 V
-2 V	-2.0030 V	_____	-1.9970 V
-6 V	-6.0080 V	_____	-5.9920 V
-14 V	-14.012 V	_____	-13.988 V
-30 V	-30.040 V	_____	-29.960 V
-40 V	-30.040 V	_____	-29.960 V
-40 V	-40.050 V	_____	-39.950 V



**Impedance  
Measurement Accuracy  
Test**

**10 pF Standard**

C.V.: \_\_\_\_\_ (Cal. Value at 1 kHz)

**OSC Level: 510 mV**

SIGNAL FREQUENCY		MINIMUM	ACTUAL	MAXIMUM
12.5 kHz	Cp	C.V. -0.0318 pF	_____	C.V. +0.0318 pF
	D	-0.0031	_____	0.0031
48 kHz	Cp	C.V. -0.0246 pF	_____	C.V. +0.0246 pF
	D	-0.0028	_____	0.0028
96 kHz	Cp	C.V. -0.0275 pF	_____	C.V. +0.0275 pF
	D	-0.0035	_____	0.0035
1 MHz	Cp	C.V. -0.0249 pF	_____	C.V. +0.0249 pF
	D	-0.0038	_____	0.0038

**OSC Level: 20 mV**

PASS [ ]                      FAIL [ ]

**OSC Level: 5.1 V (Option 001 only)**

PASS [ ]                      FAIL [ ]

**100 pF Standard**    C.V.: \_\_\_\_\_ (Cal. Value at 1 kHz)

**OSC Level: 510 mV**

SIGNAL FREQUENCY		MINIMUM	ACTUAL	MAXIMUM
125 Hz	Cp	C.V. -1.7595 pF	_____	C.V. +1.759 pF
	D	-0.01739	_____	0.01739
1 kHz	Cp	C.V. -0.312 pF	_____	C.V. +0.312 pF
	D	-0.00293	_____	0.00293
12.5 kHz	Cp	C.V. -0.137 pF	_____	C.V. +0.137 pF
	D	-0.00130	_____	0.00130
48 kHz	Cp	C.V. -0.162 pF	_____	C.V. +0.162 pF
	D	-0.0190	_____	0.0190
96 kHz	Cp	C.V. -0.122 pF	_____	C.V. +0.122 pF
	D	-0.00116	_____	0.00116
1 MHz	Cp	C.V. -0.102 pF	_____	C.V. +0.102 pF
	D	-0.00082	_____	0.00082

**OSC Level: 20 mV**

PASS [ ]                      FAIL [ ]

**OSC Level: 5.1 V (Option 001 only)**

PASS [ ]                      FAIL [ ]

1000 pF Standard C.V.: \_\_\_\_\_ (Cal. Value at 1kHz)

OSC Level: 510 mV

SIGNAL FREQUENCY		MINIMUM	ACTUAL	MAXIMUM
20 Hz	Cp	C.V. -32.09 pF	_____	C.V. +32.09 pF
	D	-0.00319	_____	0.00319
125 Hz	Cp	C.V. -3.05 pF	_____	C.V. +3.05 pF
	D	-0.00286	_____	0.00286
1 kHz	Cp	C.V. -1.00 pF	_____	C.V. +1.00 pF
	D	-0.00081	_____	0.00081
12.5 kHz	Cp	C.V. -1.13 pF	_____	C.V. +1.13 pF
	D	-0.00095	_____	0.00095
48 kHz	Cp	C.V. -1.16 pF	_____	C.V. +1.16 pF
	D	-0.00103	_____	0.00103
96 kHz	Cp	C.V. -1.31 pF	_____	C.V. +1.31 pF
	D	-0.00111	_____	0.00111
1 MHz	Cp	C.V. <sup>1</sup> -1.53 pF	_____	C.V. <sup>1</sup> +1.53 pF
	D	-0.00083	_____	0.00083

C.V.<sup>1</sup>: 1.0003 × C.V.

OSC Level: 20 mV

PASS [ ]                      FAIL [ ]

OSC Level: 5.1 V (Option 001 only)

PASS [ ]                      FAIL [ ]

**0.01  $\mu$ F Standard** C.V.: \_\_\_\_\_ (Cal. Value at 1 kHz)

**OSC Level: 510 mV**

SIGNAL FREQUENCY		MINIMUM	ACTUAL	MAXIMUM
20 Hz	Cp	$C.V.^1 \times 0.0573$ nF	_____	$C.V.^1 + 0.0573$ nF
125 Hz	Cp	$C.V.^2 \times 0.0125$ nF	_____	$C.V. + 0.0125$ nF
1 kHz	Cp	$C.V. \times 0.0082$ nF	_____	$C.V. + 0.0082$ nF

$C.V.^1: 1.0005 \times C.V.$   
 $C.V.^2: 1.0002 \times C.V.$

**OSC Level: 20 mV**

PASS [ ]                      FAIL [ ]

**OSC Level: 5.1 V (Option 001 only)**

PASS [ ]                      FAIL [ ]

**0.1  $\mu$ F Standard** C.V.: \_\_\_\_\_ (Cal. Value at 1 kHz)

**OSC Level :510 mV**

SIGNAL FREQUENCY		MINIMUM	ACTUAL	MAXIMUM
20 Hz	Cp	$C.V.^1 - 0.310$ nF	_____	$C.V.^1 + 0.310$ nF
125 Hz	Cp	$C.V.^2 - 0.112$ nF	_____	$C.V. + 0.112$ nF
1 kHz	Cp	$C.V. - 0.081$ nF	_____	$C.V. + 0.081$ nF

$C.V.^1: 1.0005 \times C.V.$   
 $C.V.^2: 1.0002 \times C.V.$

**OSC Level: 20 mV**

PASS [ ]                      FAIL [ ]

**OSC Level: 5.1 V (Option 001 only)**

PASS [ ]                      FAIL [ ]

**1  $\mu$ F Standard** C.V.: \_\_\_\_\_ (Cal.Value at 1 kHz)

**OSC Level :510 mV**

SIGNAL FREQUENCY		MINIMUM	ACTUAL	MAXIMUM
20 Hz	Cp	C.V. <sup>1</sup> -2.83 nF	_____	C.V. <sup>1</sup> +2.83 nF
125 Hz	Cp	C.V. <sup>2</sup> -1.11 nF	_____	C.V. +1.11 nF
1 kHz	Cp	C.V. -0.081 nF	_____	C.V. +0.081 nF

C.V.<sup>1</sup>: 1.0005×C.V

C.V.<sup>2</sup>: 1.0002×C.V.

**OSC Level: 20 mV**

PASS [ ]                      FAIL [ ]

**OSC Level: 5.1 V (Option 001 only)**

PASS [ ]                      FAIL [ ]

**100  $\Omega$  Standard** C.V.: \_\_\_\_\_ (Cal.Value at 1 DC)

**OSC Level :510 mV**

SIGNAL FREQUENCY		MINIMUM	ACTUAL	MAXIMUM
20 Hz	R	C.V. -0.285 $\Omega$	_____	C.V. +0.285 $\Omega$
125 Hz	R	C.V. -0.112 $\Omega$	_____	C.V. +0.112 $\Omega$
1 kHz	R	C.V. -0.082 $\Omega$	_____	C.V. +0.082 $\Omega$
12.5 kHz	R	C.V. -0.132 $\Omega$	_____	C.V. +0.132 $\Omega$
48 kHz	R	C.V. -0.132 $\Omega$	_____	C.V. +0.132 $\Omega$
96 kHz	R	C.V. -0.132 $\Omega$	_____	C.V. +0.132 $\Omega$
1 MHz	R	C.V. -0.154 $\Omega$	_____	C.V. +0.154 $\Omega$

**OSC Level: 20 mV**

PASS [ ]                      FAIL [ ]

**OSC Level: 5.1 V (Option 001 only)**

PASS [ ]                      FAIL [ ]

**1k  $\Omega$  Standard** C.V.: \_\_\_\_\_ (Cal.Value at 1 kHz)

**OSC Level :510 mV**

SIGNAL FREQUENCY		MINIMUM	ACTUAL	MAXIMUM
20 Hz	R	C.V. -2.81 $\Omega$	_____	C.V. +2.81 $\Omega$
125 Hz	R	C.V. -1.11 $\Omega$	_____	C.V. +1.11 $\Omega$
1 kHz	R	C.V. -0.81 $\Omega$	_____	C.V. +0.81 $\Omega$
12.5 kHz	R	C.V. -1.31 $\Omega$	_____	C.V. +1.31 $\Omega$
48 kHz	R	C.V. -1.31 $\Omega$	_____	C.V. +1.31 $\Omega$
96 kHz	R	C.V. -1.31 $\Omega$	_____	C.V. +1.31 $\Omega$
1 MHz	R	C.V. -1.02 $\Omega$	_____	C.V. +1.02 $\Omega$

**OSC Level: 20 mV**

	PASS [ ]	FAIL [ ]
<b>1 m Cable Length Operation</b>	PASS [ ]	FAIL [ ]
<b>2 m Cable Length Operation (Option 006 only)</b>	PASS [ ]	FAIL [ ]
<b>4 m Cable Length Operation (Option 006 only)</b>	PASS [ ]	FAIL [ ]
<b>Store and Load Function Test</b>	PASS [ ]	FAIL [ ]
<b>HP-IB Interface Test</b>	PASS [ ]	FAIL [ ]
<b>Bias Current Interface Function Test (Option 002 only)</b>	PASS [ ]	FAIL [ ]

## Manual Changes

### Introduction

This appendix contains the information required to adapt this manual to earlier versions or configurations of the HP 4284A than the current printing date of this manual. The information in this manual applies directly to HP 4284A Precision LCR Meter whose serial number prefix is listed on the title page of this manual.

### Manual Changes

To adapt this manual to your HP 4284A, refer to Table A-1 and Table A-2, and make all of the manual changes listed opposite your instrument's serial number and ROM-based firmware's version.

Instruments manufactured after the printing of this manual may be different than those documented in this manual. Later instrument versions will be documented in a manual changes supplement that will accompany the manual shipped with that instrument. If your instrument serial number is not listed on the title page of this manual or in Table A-1, it may be documented in a *yellow MANUAL CHANGES* supplement.

Refer to the description of the \*IDN? query in “\*IDN?” in Chapter 8 for confirmation of the ROM-based firmware's version. For additional information on serial number coverage, refer to “Serial Number” in Chapter 9.

**Table A-1. Manual Changes by Serial Number**

Serial Prefix or Number	Make Manual Changes
2940J02282 and below	1
2940J02284	1
2940J08389 and below	2

**Table A-2. Manual Changes by Firmware's Version**

Version	Make Manual Changes
1.11 and below	1

---

**CHANGE1**

HP 4284A Operation Manual :Page 5-2, Figure 5-1. CATALOG Page  
Add the following description.

**Caution**

Memory card for HP 4285A is compatible to HP 4284A. However, HP 4284A ignores the HP 4285A's data record status and displays Memory Status 0 (Which means "NO record"). To prevent overriding the HP 4285A's data, check the card's Memory Status using HP 4285A before storing the HP 4284A's data.

---

---

**CHANGE2**

HP 4284A Operation Manual :Page 1-2, Table 1-1. HP 4284A Contents

Change the following table.

**Table 1-1. HP 4284A Contents**

Description	Qty.	HP Part Number
<b>HP 4284A</b>		
Power cable <sup>1</sup>	1	—
Memory Card	1	04278-89001
Operation Manual	1	04284-90020
<b>Option 201 Fuse</b>		
Fuse	2	2110-0046
<b>Option 907 Handle Kit</b>		
Handle kit	1	5061-9690
<b>Option 908 Rack Flange Kit</b>		
Rack Flange Kit	1	5061-9678
<b>Option 909 Rack Flange &amp; Handle Kit</b>		
Rack Flange & Handle Kit	1	5061-9684

<sup>1</sup> Power Cable depends on where the instrument is used, see "Power Cable" in Chapter 1.



## Error and Warning Messages

---

### Introduction

This appendix lists the HP 4284A's error and warning messages with brief descriptions and solutions, and lists the system messages in alphabetical order.

---

### Error Messages

The HP 4284A displays error messages on the System Message Line when a measurement error occurs or when an illegal operation is attempted. There are two categories of errors as follows.

#### Operation Errors

These errors occur while attempting an improper operation. If one of these errors occur, the HP 4284A displays the error number and a message on its system message line. There are two kinds of errors in this category.

- **Device-Specific Error** (error numbers 1 to 32767, -300 to -399)  
These errors will set the Device-Specific Error bit (bit 3) in the Event Status Register.
- **Execution Error** (error numbers -200 to -299)  
These errors will set the Execution Error bit (bit 4) in the Event Status Register.

#### HP-IB Errors

These errors occur when the HP 4284A received an improper command via HP-IB. If one of these errors occur, the HP 4284A displays the warning message, HP-IB error occurred on the system message line, check the command syntax. There are two kinds of errors in this category.

- **Command Error** (error numbers -100 to -199)  
These errors will set the Command Error bit (bit 5) in the Event Status Register.
- **Query Error** (error numbers -400 to -499)  
These errors will set the Query Error bit (bit 2) in the Event Status Register.

## Sample Program to Detect the Error

When you write an HP-IB control program for the HP 4284A, the following sample program is a useful debugging tool (using the HP 4284A status bytes and the SYST:ERRor? query) for detecting the errors.

```
100  OUTPUT 717;"*ESE 60"           ! Event Status Resister enable
110                                     ! (error bits enable)
120  OUTPUT 717;"*SRE 32"           ! Status Byte Resister enable
130                                     ! (Event Status Summary bit enable)
140  ON INTR 7,2 CALL Errors
150  ENABLE INTR 7;2

      :

500  SUB Errors
510    DIM Err$[50]
520    Sp=SPOLL(717)
530    IF BIT(Sp,5) THEN
540      OUTPUT 717;"*ESR?"           ! Clear the Event Status Resister
550      ENTER 717;Esr
560      PRINT "Event Status Resister =";Esr
570      LOOP
580      OUTPUT 717;"SYST:ERR?"! Error No. & message query
590      ENTER 717;Err$
600      EXIT IF VAL(Err$)=0         ! Exit if no error
610      PRINT Err$
620    END LOOP
630  END IF
640  ENABLE INTR 7;2
650  SUBEND
```

The following is a list of the HP 4284A's error numbers and messages.

### Operation Errors

Error No.	Displayed Message	• Description
		→ Solution
<b>Device-Specific Error</b>		
10	Exceeded AC+DC limit	• AC+DC level exceeds 42V or 110mA peak.
		→ Reduce the LEVEL or BIAS setting.
11	ALC disabled	• LEVEL setting is out of the ALC's available level range.
		→ Change LEVEL to be within the ALC's available level range.
12	power AMP opt not installed	• Illegal operation, Hi-PW mode set to ON when Option 001 is not installed.
		→ Install Option 001.
13	Can't change Hi-PW mode	• Illegal operation, Hi-PW mode set to ON when the DC BIAS is set to ON.
		→ Set BIAS to OFF(DC BIAS indicator is not ON)first, then set the Hi-PW mode to ON.
		• Illegal operation, Hi-PW mode set to OFF when the LEVEL is more than 2V/20mA, or the BIAS is more than 2V.
		→ Reduce the LEVEL or BIAS, or set the Hi-PW mode to ON.
		• Illegal operation, Hi-PW mode set to ON when the HP 42841A is connected.
→ Disconnect the HP 42841A.		
14	V bias disabled	• Illegal operation, set to DC voltage bias when the HP 4284A, HP 42841A, and HP 42842A/B are interconnected.
		→ Disconnect the HP 42842A/B from the HP 42841A, or change BIAS to a current value.
15	I bias not available	• Illegal operation, set to DC current bias when the HP 4284A is in the standard configuration.
		→ Set BIAS to a voltage value.
16	Measurement aborted	• REF data Measurement aborted.
		→ Re-measure.

Error No.	Displayed Message	• Description
		→ Solution
17	Can't change DCI Isolation	• Illegal operation, DCI set to ISO ON when the Hi-PW is OFF.
		→ Set DCI to ISO OFF.
		• Illegal operation, DCI setting changed when the DC BIAS is set to ON.
		→ Set DC BIAS OFF.
20	DC bias unit powered down	• Illegal operation, set to DC current bias when an inoperative HP 42841A is connected to the HP 4284A.
		→ Turn the HP 42841A on.
21	Fixture circuit defective	• Back-emf protection circuit of the HP 42842A/B is defective.
		→ Contact your nearest Hewlett-Packard office.
22	Fixture over temperature	• Temperature of the HP 42842A/B bias current test fixture exceeded its limit.
		→ Turn the DC BIAS off to let the HP 42842A/B cool down.
23	Fixture OPEN det. defective	• Fixture cover open detection wire is open.
		→ Contact your nearest Hewlett-Packard office.
24	Fixture cover open	• The cover of the HP 42842A/B is open.
		→ Close the cover of the HP 42842A/B.
25	DC bias I source overload	• The DC bias source current is overloaded.
		→ If this message is displayed all the time when measuring a DUT which conforms to specifications, contact your nearest Hewlett-Packard office.
26	DC bias I sink overload	• The DC bias sink current is overloaded.
		→ If this message is displayed all the time when measuring a DUT which conforms to specifications, contact your nearest Hewlett-Packard office.
40	Scanner I/F disabled	• Illegal operation, MULTI channel correction mode set or CORRection:USE command is sent via HP-IB when the SCANNER I/F is not installed or to OFF.
		→ Install the SCANNER I/F and set it to ON.

Error No.	Displayed Message	Description
		Solution
41	Measurement aborted	• Correction data measurement aborted.
		→ Re-measure.
42	2m/4m opt. not installed	• Illegal operation, 2m/4m CABLE length set when Option 006 is not installed.
		→ Install Option 006, or set 0m CABLE length and use the OPEN/SHORT/LOAD correction function.
43	Measurement failed	• Measurement error(for example, bridge unbalance) occurred during the correction data measurement.
		→ Confirm measurement condition and measurement contacts, then re-measure.
44	Correction data protected	• Correction data write protected by DIP switch A7SW3. (Refer to Appendix E)
		→ Set bit 6 of DIP switch A7SW3 to the OFF position, and retry.
45	Valid in single mode only	• Illegal operation, OPEN/SHORT correction data (for 48 frequency points) measured when the MULTI channel correction mode is set.
		→ Set to SINGLE mode first, or perform OPEN/SHORT data measurements at FREQ1-3.
46	Correction memory error	• Correction data write error.
		→ Contact your nearest Hewlett-Packard office.
50	Clear the table first	• Illegal operation, MODE of the LIMIT TABLE changed when the table exists.
		→ Clear the table first.
51	Inconsistent limit setting	• Illegal operation, COMPArator:SEQuence command sent when the TOLerance mode is set, or the COMPArator:TOLerance command was sent when the SEQuence mode is set.
		→ Set TOLerance or SEQuence mode appropriately.
60	No values in sweep list	• Illegal operation, LIST SWEEP measurement performed when no sweep point settings exist in the LIST SWEEP SETUP.
		→ Set sweep points in the LIST SWEEP SETUP first.

Error No.	Displayed Message	• Description
		→ Solution
61	Clear the table first	• Illegal operation, the sweep parameter of the LIST SWEEP SETUP is changed when the sweep list for other parameter exists.
		→ Clear the existing list first.
62	Bias off, Turn bias on	• Illegal operation, DC bias sweep was attempted while the DC BIAS is OFF.
		→ Press <b>DC BIAS</b> to set DC bias to on.
70	Handler I/F not installed	• Illegal operation, HANDLER I/F set to ON when Option 201 or 202 was not installed.
		→ Install Option 201 or 202.
		• Illegal operation, HANDLER I/F test was performed when Option 201 or 202 were not installed.
		→ Install Option 201 or 202.
71	Scanner I/F not installed	• Illegal operation, SCANNER I/F set to ON when Option 301 was not installed.
		→ Install Option 301.
		• Illegal operation, Scanner I/F EEPROM R/W test or Scanner I/F I/O test were performed when Option 301 was not installed.
		→ Install Option 301.
72	HP-IB I/F not installed	• Illegal operation, HP-IB interface used when Option 109 was installed.
		→ Install the HP-IB interface.
73	I BIAS I/F not installed	• Illegal operation, BIAS Current I/F I/O test performed when Option 002 is not installed.
		→ Install the Option 002 Bias Current interface.
74	Illegal test setup	• Illegal operation, ACCESSORY CONTROL I/F test performed when the HP 4284A and the HP 42841A are connected with the accessory control interface cable.
		→ Disconnect the interface cable from the HP 42841A.
80	Setup data protected	• Setup data write protected by DIP switch A7SW3. (Refer to Appendix E.)
		→ Set bit 5 of DIP switch A7SW3 to the OFF position.

Error No.	Displayed Message	Description
		Solution
81	No memory card	<ul style="list-style-type: none"> <li>Illegal operation, attempted to store data in record No. 10 to 19 when a memory card was not inserted.</li> </ul>
		<ul style="list-style-type: none"> <li>→ Insert a memory card, or store to record No.0 to 9 (internal memory)</li> </ul>
82	Store failed	<ul style="list-style-type: none"> <li>Memory card hardware failure (storing function) occurred.</li> </ul>
		<ul style="list-style-type: none"> <li>→ Use another memory card.</li> </ul>
		<ul style="list-style-type: none"> <li>Internal EEPROM hardware failure (storing function) occurred.</li> </ul>
		<ul style="list-style-type: none"> <li>→ Contact your nearest Hewlett-Packard office.</li> </ul>
83	No data to load	<ul style="list-style-type: none"> <li>Memory card is not inserted.</li> </ul>
		<ul style="list-style-type: none"> <li>→ Insert the memory card completely.</li> </ul>
		<ul style="list-style-type: none"> <li>No setup data to load in the record number entered.</li> </ul>
		<ul style="list-style-type: none"> <li>→ Confirm the CATALOG, and retry.</li> </ul>
84	Load failed	<ul style="list-style-type: none"> <li>Memory card hardware failure (loading function) occurred.</li> </ul>
		<ul style="list-style-type: none"> <li>→ Use another memory card.</li> </ul>
		<ul style="list-style-type: none"> <li>Internal EEPROM hardware failure (loading function) occurred.</li> </ul>
		<ul style="list-style-type: none"> <li>→ Contact your nearest Hewlett-Packard office.</li> </ul>
90	Data buffer overflow	<ul style="list-style-type: none"> <li>The amount of data to be stored into the data buffer memory (DBUF) exceeded the defined data buffer size.</li> </ul>
		<ul style="list-style-type: none"> <li>→ Re-define the data buffer memory size, or clear DBUF.</li> </ul>
100	Printer down	<ul style="list-style-type: none"> <li>Data sent to the output buffer when a printer was not connected to the HP 4284A with an HP-IB cable or the printer was turned OFF.</li> </ul>
		<ul style="list-style-type: none"> <li>→ Connect a printer to the HP 4284A with an HP-IB cable, or turn the printer ON.</li> </ul>
		<ul style="list-style-type: none"> <li>Printing speed of printer cannot keep up with the HP 4284A's data output transfer rate.</li> </ul>
		<ul style="list-style-type: none"> <li>→ Set the HP 4284A's DELAY time appropriately or replace the printer with a higher speed printer that can match the HP 4284A's data transfer rate.</li> </ul>
101	TALK ONLY disabled	<ul style="list-style-type: none"> <li>Data sent to the output buffer when the HP 4284A is addressable.</li> </ul>
		<ul style="list-style-type: none"> <li>→ Set the HP 4284A to the talk only mode, and set the printer to the listen only mode.</li> </ul>

Error No.	Displayed Message	Description
		Solution
-310	System error	• Severe error.
		→ Contact your nearest Hewlett-Packard office.
-311	Memory error	• Severe error.
		→ Contact your nearest Hewlett-Packard office.
<b>Execution Error</b>		
-211	Trigger ignored	• The HP 4284A Triggered before the previous trigger was executed.
		→ Widen the time interval between triggers.
-222	Data out of range	• Data is out of the setting range.
		→ Enter a value within the available setting range.
-230	Data corrupt or stale	• FETCH? query received after the ABORT or the *RST command was received, or after the power on reset was performed.
		→ Send the FETCH? query during idle state and when the data is valid (after a measurement is performed).
		• FETCH? query received after INITiate command was received, and a trigger was not received.
		→ Send the FETCH? command after the trigger is received.
		• FETCH? query received after the trigger was received in the list sweep mode and the table was not setup.
		→ Setup the list sweep table.
		• Setting value query (for example, VOLTage?, BIAS:CURRENT?, LIST:VOLTage?) received when the setting mode is mismatched.
→ Send a setting value query command which matches the current setting mode.		



## HP-IB Errors

Error No.	Error Message String	Description
<b>Command Error</b>		
-100	Command error	• Improper command.
-101	Invalid character	• Invalid character was received.
-102	Syntax error	• Unrecognized command or data type was received.
-103	Invalid message unit separator	• The message unit separator (for example, “;”, “,”) is improper.
-104	Data type error	• Improper data type used (for example, string data was expected, but numeric data was received).
-105	GET not allowed	• GET is not allowed inside a program message.
-108	Parameter not allowed	• Too many parameters for the command received.
-109	Missing parameter	• A command with improper number of parameters received.
-112	Program mnemonic too long	• Program mnemonic is too long (maximum length is 12 characters).
-113	Undefined header	• Undefined header or an unrecognized command was received (operation not allowed).
-121	Invalid character in number	• Invalid character in numeric data.
-123	Numeric overflow	• Numeric data value was too large (exponent magnitude >32k).
-124	Too many digits	• Numeric data length was too long (more than 255 digits received).
-128	Numeric data not allowed	• Numeric data not allowed for this operation.
-131	Invalid suffix	• Units are unrecognized, or the units are not appropriate.
-138	Suffix not allowed	• A suffix is not allowed for this operation.
-141	Invalid character data	• Bad character data or unrecognized character data was received.
-144	Character data too long	• Character data is too long (maximum length is 12 characters).
-148	Character data not allowed	• Character data not allowed for this operation.
-150	String data error	• String data is improper.

<b>Error No.</b>	<b>Error Message String</b>	<b>Description</b>
-151	Invalid string data	<ul style="list-style-type: none"> <li>Invalid string data was received (for example, END received before close quote).</li> </ul>
-158	String data not allowed	<ul style="list-style-type: none"> <li>String data is not allowed.</li> </ul>
-160	Block data error	<ul style="list-style-type: none"> <li>Block data is improper.</li> </ul>
-161	Invalid block data	<ul style="list-style-type: none"> <li>Invalid block data was received (for example, END received before length satisfied).</li> </ul>
-168	Block data not allowed	<ul style="list-style-type: none"> <li>Block data is not allowed.</li> </ul>
-170	Expression error	<ul style="list-style-type: none"> <li>Expression is improper.</li> </ul>
-171	Invalid expression	<ul style="list-style-type: none"> <li>Invalid expression was received (for example, illegal character in expression).</li> </ul>
-178	Expression data not allowed	<ul style="list-style-type: none"> <li>Expression data is not allowed.</li> </ul>
<b>Query Error</b>		
-400	Query error	<ul style="list-style-type: none"> <li>Query is improper.</li> </ul>
-410	Query INTERRUPTED	<ul style="list-style-type: none"> <li>Query is followed by DAB or GET before the response was completed.</li> </ul>
-420	Query UNTERMINATED	<ul style="list-style-type: none"> <li>Addressed to talk, incomplete program message received.</li> </ul>
-430	Query DEADLOCKED	<ul style="list-style-type: none"> <li>Input buffer and output buffer are full; cannot continue.</li> </ul>
-440	Query UNTERMINATED error after indefinite response	<ul style="list-style-type: none"> <li>The query which requests arbitrary data response (*IDN? and *OPT? queries) is sent before usual queries in a program message. (for example, FREQ?;*IDN? was expected, but *IDN?;FREQ? is recieved.)</li> </ul>

## System Message

System messages are displayed on the System Message Line to provide operation instructions for the user, and to report on the HP 4284A's status. There are two categories of system messages, warning messages and instruction messages.

### Warning Messages

The HP 4284A displays warning messages on the System Message Line when an inappropriate operation is attempted, or when the setting is changed automatically due to an inappropriate operation. The warning operation should not set an error bit. The following list describes the HP 4284A's warning messages.

Warning Message	Description
Warning, 1 I bias unit	When the HP 4284A finds one current bias unit connected, this message is displayed.
Warning, 2 I bias unit	When the HP 4284A finds two current bias units connected, this message is displayed.
Warning, ALC turned off	When the LEVEL setting is out of the ALC's available range, the ALC function is automatically turned OFF. Set the LEVEL to be within the ALC's available range, and then set ALC to ON.
Warning, ALC unable to regulate	When the LEVEL setting is inappropriate for use with the ALC function, the ALC function will not work, the operation will be the same as if the ALC function is turned OFF. (The data status is set to 4.) Set the LEVEL appropriate for the device.
Warning, Correction not effective	When the MULTI correction mode is used and the measurement frequency is not equal to <i>FREQ1-3</i> (correction frequency), correction will not be performed.
Warning, Deviation measurement ON	The deviation measurement is set to ON when the display page is changed to the <i>BIN No. DISPLAY</i> , <i>BIN COUNT DISPLAY</i> , or <i>LIMIT TABLE SETUP</i> page.
Warning, I bias unit disconnected	This message is displayed when the status is changed after the current bias unit is disconnected.
Warning, Improper high/low limits	The high limit value is less than the low limit value of the limit table.
Warning, Level changed for ALC	When the ALC is turned on and the LEVEL setting is out of the ALC's available range, the LEVEL setting is changed to be within the ALC's available range.
Warning, Signal source overload	When the signal source is overloaded, the measurement data is not guaranteed to be valid. (The data status is set to 3.) Reduce the LEVEL.
Warning, DCI Isolation turned off	When Hi-PW mode is set to OFF and DCI ISO ON is set, DCI is automatically set to ISO OFF.

## Instruction Messages

The following is a list of the instruction messages in alphabetical order.

- A Auto load completed
- C Clearing setup. Are you sure?  
Clearing table. Are you sure?
- E Enter comment  
Enter record number to LOAD  
Enter record number to PURGE  
Enter record number to STORE  
Enter REF value or select MEASURE  
Enter test number  
Enter V or I value  
Enter value  
Enter value or INCR/DECR  
Enter value or select
- F Fixed decimal point mode  
Frequency changed, re-measure
- H HP-IB error occurred
- K Keys locked
- L LOAD measurement completed  
LOAD measurement in progress
- O OPEN measurement completed  
OPEN measurement in progress
- P Press ENTER  
Press ENTER or select a unit  
Press ENTER or select CANCEL
- R Resetting count. Are you sure?  
Resetting system. Are you sure?
- S Saving correction data  
SHORT measurement completed  
SHORT measurement in progress  
Storing ...
- U Use softkeys to select

## Initial Settings and System Memory

---

### Introduction

This appendix lists the HP 4284A's initial settings and functions whose status is stored in system memory.

There are three ways to initialize the HP 4284A:

- **POWER ON**  
Turn the LINE ON/OFF switch ON.
- **\*RST**  
Press **SYSTEM RESET** in the *SYS MENU* field of *MEAS SETUP* page, or send the \*RST common command via HP-IB.
- **DEVICE CLEAR**  
Send the device clear bus command (SDC:selected device clear or DCL:clears all devices) via HP-IB.

The following list indicates the differences between the three initialization methods on the functions to be initialized. Functions whose status are stored in internal system memory are indicated by "Sys. Memory" on the "POWER ON" column in the following list.

Functions		Initialize Method		
		Power ON	*RST	Device Clear
<b>Settings</b>				
MEAS SETUP	<i>FUNC</i>	Cp-D	Cp-D	Not Affected
	<i>FREQ</i>	1 kHz	1 kHz	Not Affected
	<i>LEVEL</i>	1 V	1 V	Not Affected
	<i>RANGE</i>	AUTO	AUTO	Not Affected
	<i>BIAS</i>	0 V	0 V	Not Affected
	<b>DC BIAS</b> (On/Off)	OFF	OFF	Not Affected
	<i>INTEG</i>	MED	MED	Not Affected
	<i>TRIG</i>	INT	INT	Not Affected
	<i>ALC</i>	OFF	OFF	Not Affected
	<i>Hi-POW</i> (Opt.001 installed)	ON	ON	Not affected
	<i>Hi-POW</i> (Opt.001 not installed)	OFF	OFF	Not affected
	<i>DCI</i>	ISO OFF	ISO OFF	Not affected
	<i>AVG</i>	1	1	Not Affected
	<i>Vm</i>	ON	ON	Not Affected
	<i>Im</i>	ON	ON	Not Affected
	<i>DELAY</i>	0 s	0 s	Not Affected
	<i>DEV A</i>	OFF	OFF	Not Affected
	<i>REF A</i>	0	0	Not Affected
	<i>DEV B</i>	OFF	OFF	Not Affected
	<i>REF B</i>	0	0	Not Affected

Functions		Initialize Method		
		Power ON	*RST	Device Clear
CORRECTION	<i>OPEN</i>	Sys. Memory	Not Affected	Not Affected
	<i>SHORT</i>	Sys. Memory	Not Affected	Not Affected
	<i>LOAD</i>	Sys. Memory	Not Affected	Not Affected
	<i>CABLE</i>	Sys. Memory	Not Affected	Not Affected
	<i>MODE</i>	Sys. Memory	Not Affected	Not Affected
	<i>CH No.</i>	Sys. Memory	Not Affected	Not Affected
	<i>FUNC</i>	Sys. Memory	Not Affected	Not Affected
	<i>FREQ1 - 3</i>	Sys. Memory	Not Affected	Not Affected
	<i>REFA</i>	Sys. Memory	Not Affected	Not Affected
<i>REFB</i>	Sys. Memory	Not Affected	Not Affected	
LIMIT TABLE SETUP	<i>NOM</i>	0	0	Not Affected
	<i>MODE</i>	%	%	Not Affected
	<i>AUX</i>	OFF	OFF	Not Affected
	<i>COMP</i>	OFF	OFF	Not Affected
	<i>BIN 1 - 9 LOW</i>	Cleared	Cleared	Not Affected
	<i>BIN 1 - 9 HIGH</i>	Cleared	Cleared	Not Affected
	<i>2nd LOW</i>	Cleared	Cleared	Not Affected
	<i>2nd HIGH</i>	Cleared	Cleared	Not Affected
BIN COUNT	<i>COUNT ON/OFF</i>	OFF	OFF	Not Affected
LIST SWEEP SETUP	<i>MODE</i>	SEQ	SEQ	Not Affected
	<i>sweep parameter</i>	FREQ [Hz]	FREQ [Hz]	Not Affected
	<i>sweep points</i>	Cleared	Cleared	Not Affected
SYSTEM CONFIG	<i>BEEPER</i>	Sys. Memory	Not Affected	Not Affected
	<i>HP-IB ADDRESS</i>	Sys. Memory	Not Affected	Not Affected
	<i>TALK ONLY</i>	Sys. Memory	Not Affected	Not Affected
	<i>HANDLER I/F</i>	Sys. Memory	Not Affected	Not Affected
	<i>SCANNER I/F</i>	Sys. Memory	Not Affected	Not Affected
<b>Display Control</b>				
	<display page>	<i>MEAS DISPLAY</i>	<i>MEAS DISPLAY</i>	Not Affected
	<i>D.P. FIX A</i>	OFF	OFF	Not Affected
	<i>D.P. FIX B</i>	OFF	OFF	Not Affected
<b>Measurement Data</b>				
	Measurement Data	Cleared	Cleared	Not Affected
	List Sweep Data	Cleared	Cleared	Not Affected
	V / I Monitor Data	Cleared	Cleared	Not Affected
	BIN Count Data	Cleared	Cleared	Not Affected

Functions		Initialize Method		
		Power ON	*RST	Device Clear
<b>HP-IB</b>				
	Data Buffer Memory	Cleared	Cleared	Not Affected
	Data Format	ASCII	ASCII	Not Affected
	Input Buffer	Cleared	Not Affected	Cleared
	Output Buffer	Cleared	Not Affected	Cleared
	Error Queue	Cleared	Not Affected	Not Affected
Status Byte <sup>1</sup>	Bit 7	0	Not Affected	Not Affected
	Bit 6	0	Not Affected	Not Affected
	Bit 5	0	Not Affected	Not Affected
	Bit 4	0	Not Affected	0
	Enable Resister	0	Not Affected	Not Affected
Operation Status Register <sup>1</sup>	Bit 4	0	0	Not Affected
	Bit 3	0	0	Not Affected
	Bit 0	0	0	Not Affected
	Enable Resister	0	Not Affected	Not Affected
Standard Event Status Register <sup>1</sup>	Bit 7	1	Not Affected	Not Affected
	Bit 6	0	Not Affected	Not Affected
	Bit 5	0	Not Affected	Not Affected
	Bit 4	0	Not Affected	Not Affected
	Bit 3	0	Not Affected	Not Affected
	Bit 2	0	Not Affected	Not Affected
	Bit 0	0	Not Affected	Not Affected
	Enable Resister	0	Not Affected	Not Affected
<b>Others</b>				
	<i>comment</i>	Cleared	Cleared	Not Affected
	<i>KEY LOCK</i>	OFF	OFF	Not Affected

<sup>1</sup> Any other bits described in this table are not used. (always 0)



## **Correction Data**

---

### **Introduction**

This appendix provides information about the relationship between the test frequency and the correction data.

---

### **Test Frequency and Correction Frequency**

There are two types of correction data for the OPEN/SHORT/LOAD correction, interpolation correction data, and spot frequency (FREQ1, FREQ2, and FREQ3) correction data. These correction data are selected automatically depending on the correction mode and the test frequency. The details for interpolation correction data are described in SECTION 4, OPEN correction, SHORT correction, and for spot frequency correction data in SECTION 4, LOAD correction.

The relationship between the test frequency and the correction data for the single/multi correction modes are described on the following page.

## Single Channel Correction Mode

When the correction mode is set to SINGLE, the OPEN/SHORT interpolation correction data or the FREQ1/FREQ2/FREQ3 correction data are selected automatically, depending on the test frequency and the settings of the OPEN, SHORT, LOAD, FREQ1, FREQ2 and FREQ3 fields. Table D-1 shows the correction data selection rules for the SINGLE mode and corresponding test frequencies.

**Table D-1. Correction Data Selecting Rule for SINGLE Mode**

Test Frequency	FRQ1/2/3 setting	OPEN		SHORT		LOAD	
		ON	OFF	ON	OFF	ON	OFF
Test Freq= FRQ1	FRQ1:ON	FRQ1 OPEN data	Not performed	FRQ1 SHORT data	Not performed	FREQ1 LOAD data	Not performed
	FRQ1:OFF	OPEN data	Not performed	SHORT data	Not performed	Not performed	Not performed
Test Freq= FRQ2	FRQ2:ON	FRQ2 OPEN data	Not performed	FRQ2 SHORT data	Not performed	FRQ2 LOAD data	Not performed
	FRQ2:OFF	OPEN data	Not performed	SHORT data	Not performed	Not performed	Not performed
Test Freq= FRQ3	FRQ3:ON	FRQ3 OPEN data	Not performed	FRQ3 SHORT data	Not performed	FRQ3 LOAD data	Not performed
	FRQ3:OFF	OPEN data	Not performed	SHORT data	Not performed	Not performed	Not performed
Test Freq≠ FRQ1/2/3	FRQ1:ON FREQ2:ON FRQ3:ON	OPEN data	Not performed	SHORT data	Not performed	Not performed	Not performed
	FRQ1:OFF FRQ2:OFF FRQ3:OFF	OPEN data	Not performed	SHORT data	Not performed	Not performed	Not performed

Test Freq : Test frequency  
 OPEN data : OPEN interpolation correction data  
 SHORT data : SHORT interpolation correction data  
 FREQ1/2/3 OPEN data : OPEN correction data at FREQ1/2/3 frequency  
 FREQ1/2/3 SHORT data : SHORT correction data at FREQ1/2/3 frequency  
 FREQ1/2/3 LOAD data : LOAD correction data at FREQ1/2/3 frequency

## Multi Channel Correction Mode

To use the multi channel correction mode, Option 301 Scanner Interface must be installed, and the scanner interface function should be set to ON from the SYSTEM CONFIG page. When the correction mode is set to MULTI, only FREQ1/FREQ2/FREQ3 correction data is used for correction. If the settings of the FREQ1, FREQ2 and FREQ3 fields are OFF (even the OPEN, SHORT and LOAD fields are ON), correction will not be performed. Table D-2 shows the correction data selection rules for MULTI mode and corresponding test frequencies.

**Table D-2. Correction Data Selecting Rule for MULTI Mode**

Test Frequency	FRQ1/2/3 setting	OPEN		SHORT		LOAD	
		ON	OFF	ON	OFF	ON	OFF
Test Freq= FRQ1	FRQ1:ON	FRQ1 OPEN data	Not performed	FRQ1 SHORT data	Not performed	FRQ1 LOAD data	Not performed
	FRQ1:OFF	Not performed	Not performed	Not performed	Not performed	Not performed	Not performed
Test Freq= FRQ2	FRQ2:ON	FRQ2 OPEN data	Not performed	FRQ2 SHORT data	Not performed	FRQ2 LOAD data	Not performed
	FRQ2:OFF	Not performed	Not performed	Not performed	Not performed	Not performed	Not performed
Test Freq= FRQ3	FRQ3:ON	FRQ3 OPEN data	Not performed	FRQ3 SHORT data	Not performed	FRQ3 LOAD data	Not performed
	FRQ3:OFF	Not performed	Not performed	Not performed	Not performed	Not performed	Not performed
Test Freq≠ FRQ1/2/3	FRQ1:ON FRQ2:ON FRQ3:ON	Not performed	Not performed	Not performed	Not performed	Not performed	Not performed
	FRQ1:OFF FRQ2:OFF FRQ3:OFF	Not performed	Not performed	Not performed	Not performed	Not performed	Not performed

Test Freq : Test frequency  
 OPEN data : OPEN interpolation correction data  
 SHORT data : SHORT interpolation correction data  
 FREQ1/2/3 OPEN data : OPEN correction data at FREQ1/2/3 frequency  
 FREQ1/2/3 SHORT data : SHORT correction data at FREQ1/2/3 frequency  
 FREQ1/2/3 LOAD data : LOAD correction data at FREQ1/2/3 frequency

# CORRECTION FUNCTION SETTING

To set the correction function or to obtain the correction data, use the following summary of the correction function setting fields with their HP-IB commands (given in the short form). (A) through (F) shown in the figure correspond to the description of each field.

## CORRECTION Page

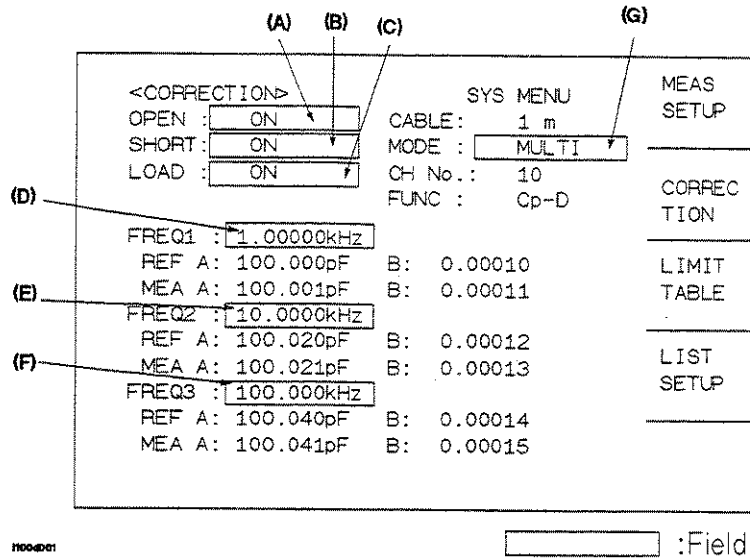

Field	Softkey	Command	Description	
(A)	OPEN	ON	CORR:OPEN:STAT ON	: Performs OPEN correction using OPEN data or FREQ1/2/3 OPEN data.
		OFF	CORR:OPEN:STAT OFF	: Not perform OPEN correction.
	MEAS OPEN		CORR:OPEN	: Obtains OPEN interpolation data
(B)	SHORT	ON	CORR:SHOR:STAT ON	: Performs SHORT correction using SHORT data or FREQ1/2/3 SHORT data.
		OFF	CORR:SHOR:STAT OFF	: Not perform SHORT correction.
	MEAS		CORR:SHOR	: Obtains SHORT interpolation SHORT data.
(C)	LOAD	ON	CORR:LOAD:STAT ON	: Performs LOAD correction using FREQ1/2/3 LOAD data.
		OFF	CORR:LOAD:STAT OFF	: Not perform LOAD correction.

Field	Softkey	Command	Description
(D)	FREQ1	ON	CORR:SPOT1:STAT ON : Use FREQ1 OPEN/SHORT/LOAD data.
		OFF	CORR:SPOT1:STAT OFF : Not use FREQ1 OPEN/SHORT/LOAD data.
	MEAS OPEN	CORR:SPOT1:OPEN	: Obtains FREQ1 OPEN data.
	MEAS SHORT	CORR:SPOT1:SHOR	: Obtains FREQ1 SHORT data.
	MEAS	CORR:SPOT1:LOAD	: Obtains FREQ1 LOAD data.
(E)	FREQ2	ON	CORR:SPOT2:STAT ON : Use FREQ2 OPEN/SHORT/LOAD data.
		OFF	CORR:SPOT2:STAT OFF : Not use FREQ2 OPEN/SHORT/LOAD data.
	MEAS OPEN	CORR:SPOT2:OPEN	: Obtains FREQ2 OPEN data.
	MEAS SHORT	CORR:SPOT2:SHOR	: Obtains FREQ2 SHORT data.
	MEAS LOAD	CORR:SPOT2:LOAD	: Obtains FREQ2 SHORT data.
(F)	FREQ3	ON	CORR:SPOT3:STAT ON : Use FREQ3 OPEN/SHORT/LOAD data.
		OFF	CORR:SPOT3:STAT OFF : Not use FREQ3 OPEN/SHORT/LOAD data.
	MEAS OPEN	CORR:SPOT3:OPEN	: Obtains FREQ3 OPEN data.
	MEAS	CORR:SPOT3:SHOR	: Obtains FREQ3 SHORT data.
	MEAS LOAD	CORR:SPOT3:LOAD	: Obtains FREQ3 LOAD data.
(G)	MODE	SINGLE	CORR:METH:SING : Sets the single channel correction mode.
		MULTI	CORR:METH:MULT : Sets the multi channel correction mode



## Write Protection

---

### Introduction

The HP 4284A is equipped with an internally mounted write-protect switch. This switch has two write protection features. One feature disables the STORE function for write protecting all of the stored data in the memory card and EEPROM internal memory, and the other feature prevents changing any of the previous correction settings on the *CORRECTION* page. This feature is useful when you want to retain specific HP 4284A control settings for everyday use, for example, on a production line where it is not necessary to store any information on a memory card, thereby making it impossible to accidentally erase or overwrite the stored data in the memory card or the EEPROM internal memory, and also making it impossible to accidentally erase or overwrite the correction settings.

---

### Write Protection Procedure

The procedure for setting the write protection switch to ON is as follows.

1. Turn the HP 4284A off and remove the power cord. Allow a few minutes for the internal capacitors to discharge.

#### Warning



**Dangerous voltage may be present in the HP 4284A even through the power switch is off. Be sure to wait a few minutes for the internal capacitors to discharge.**

---

2. Remove the two feet at the back of the top cover.
3. Fully loosen the screw that secures the top cover.
4. Pull the top cover towards the rear of the HP 4284A and lift up to remove.
5. Loosen the five screws that secure the top shield plate (Larger one).
6. Slide the top shield forward then lift it off.
7. Remove the A7 board. Figure E-1 shows the A7 board's location.

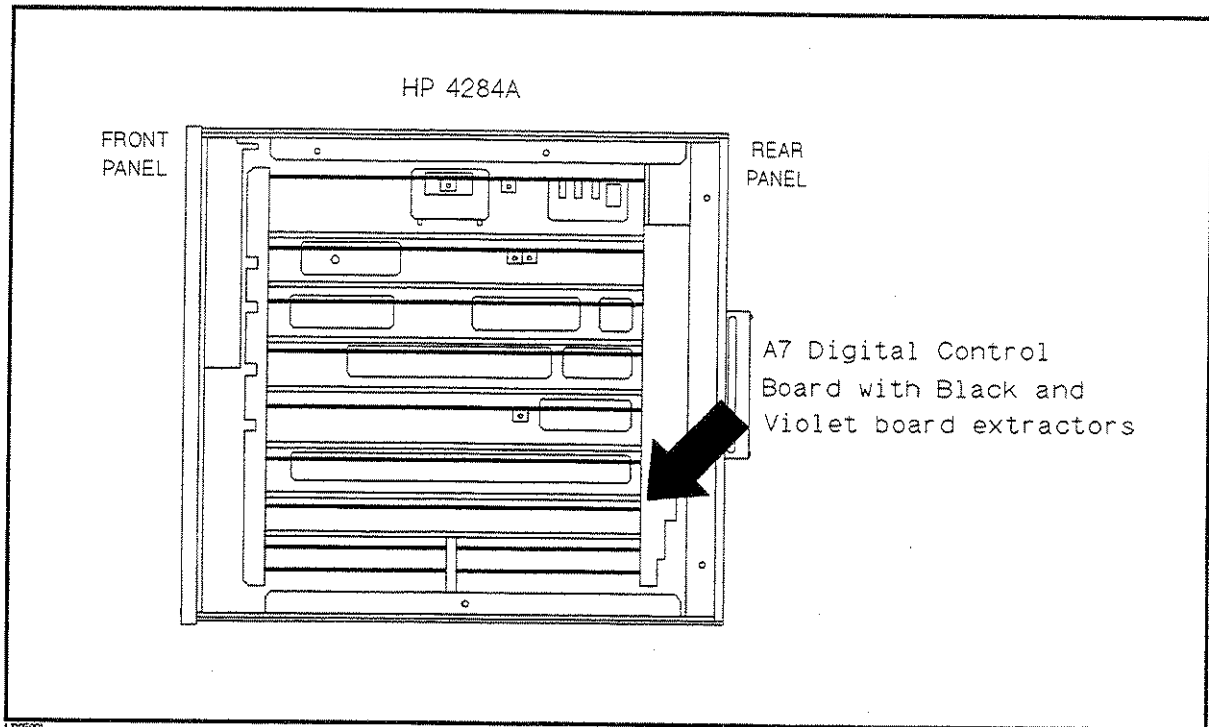

**Figure E-1. A7 Digital Board Location**

**Caution**



Semiconductor components are installed on the A7 board. When handling the A7 board, be aware that electrostatic discharge can damage these components.

8. Set A7S3-6 to the right-most position (ON) to disable HP 4284A's STORE function. Set A7S3-6 to the left-most position (OFF) to enable storing. Refer to Figure E-2.
9. Set A7S3-7 to the right-most position (ON) to disable to change all of the correction settings on the *CORRECTION* page. Set A7S3-7 to the left-most position (OFF) to enable to change all of the correction settings on the *CORRECTION* page. Refer to Figure E-2.



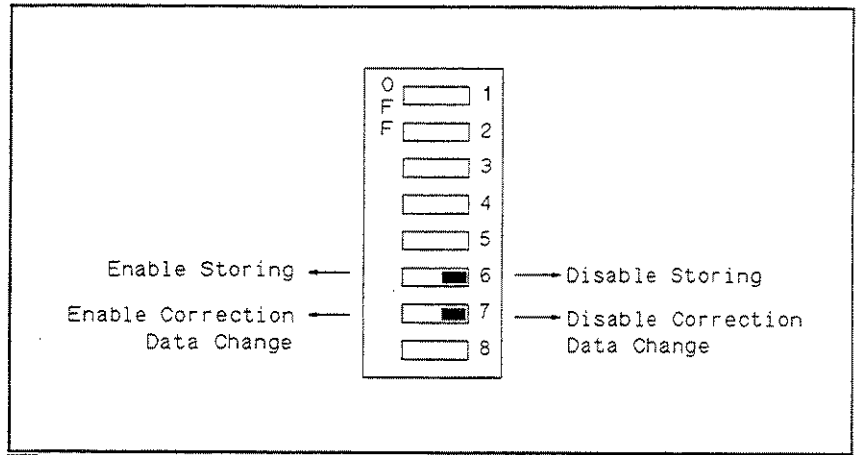

**Figure E-2. Write Protection Switch**

**Note**



Do not change any of the other switch settings on the A7 board.

10. Install the configured A7 board into the HP 4284A.
11. Replace the top shield plate, top cover, and rear feet.



## Test Frequency Point

---

### Introduction

This appendix lists all available test frequency points from 1 kHz to 1 MHz.

---

### Frequency Points

The available test frequency points from 1 kHz to 1 MHz are as listed from the next page.

The available test frequency points below 1 kHz (20 Hz to 1 kHz) can be calculated using the following formula.

$$F(Hz) = \frac{m}{n}$$

Where,

m = 6000, 6250, or 7500

n = 13 to 3750 (Integer)

1.00000 MHz	29.4118 kHz	10.4348 kHz	3.40909 kHz
960.000 kHz	28.5714 kHz	10.4167 kHz	3.33333 kHz
800.000 kHz	28.2353 kHz	10.3448 kHz	3.28947 kHz
666.667 kHz	27.7778 kHz	10.0000 kHz	3.26087 kHz
640.000 kHz	27.2727 kHz	9.61538 kHz	3.15789 kHz
600.000 kHz	26.6667 kHz	9.37500 kHz	3.12500 kHz
500.000 kHz	26.3158 kHz	9.23077 kHz	3.00000 kHz
480.000 kHz	26.0870 kHz	8.92857 kHz	2.97619 kHz
400.000 kHz	25.2632 kHz	8.82352 kHz	2.88462 kHz
333.333 kHz	25.0000 kHz	8.57243 kHz	2.85714 kHz
320.000 kHz	24.0000 kHz	8.33333 kHz	2.84091 kHz
300.000 kHz	23.8095 kHz	8.00000 kHz	2.77778 kHz
250.000 kHz	23.0769 kHz	7.89474 kHz	2.72727 kHz
240.000 kHz	22.8571 kHz	7.81250 kHz	2.71739 kHz
200.000 kHz	22.7272 kHz	7.50000 kHz	2.67857 kHz
166.667 kHz	22.2222 kHz	7.35294 kHz	2.60870 kHz
160.000 kHz	21.8182 kHz	7.14286 kHz	2.60417 kHz
150.000 kHz	21.7391 kHz	7.05882 kHz	2.58621 kHz
125.000 kHz	21.4286 kHz	6.94444 kHz	2.50000 kHz
120.000 kHz	20.8696 kHz	6.81818 kHz	2.41935 kHz
100.000 kHz	20.8333 kHz	6.66666 kHz	2.40385 kHz
96.0000 kHz	20.6897 kHz	6.57895 kHz	2.40000 kHz
85.7143 kHz	20.0000 kHz	6.52174 kHz	2.34375 kHz
83.3333 kHz	19.2308 kHz	6.31579 kHz	2.31481 kHz
80.0000 kHz	18.7500 kHz	6.25000 kHz	2.30769 kHz
75.0000 kHz	18.4615 kHz	6.00000 kHz	2.27273 kHz
72.4286 kHz	17.8571 kHz	5.95238 kHz	2.23214 kHz
68.5714 kHz	17.6471 kHz	5.76923 kHz	2.22222 kHz
66.6666 kHz	17.1429 kHz	5.71429 kHz	2.20588 kHz
62.5000 kHz	16.6667 kHz	5.68182 kHz	2.15517 kHz
60.0000 kHz	16.0000 kHz	5.55556 kHz	2.14286 kHz
55.5556 kHz	15.7895 kHz	5.45455 kHz	2.08333 kHz
54.5455 kHz	15.6250 kHz	5.43478 kHz	2.06897 kHz
53.3333 kHz	15.0000 kHz	5.35714 kHz	2.02703 kHz
50.0000 kHz	14.7059 kHz	5.21739 kHz	2.01613 kHz
48.0000 kHz	14.2857 kHz	5.20833 kHz	2.00000 kHz
46.1538 kHz	14.1176 kHz	5.17241 kHz	1.97368 kHz
45.4545 kHz	13.8889 kHz	5.00000 kHz	1.95313 kHz
43.6364 kHz	13.6364 kHz	4.80769 kHz	1.93548 kHz
42.8571 kHz	13.3333 kHz	4.68750 kHz	1.92308 kHz
41.6667 kHz	13.1579 kHz	4.61538 kHz	1.89394 kHz
40.0000 kHz	13.0435 kHz	4.46429 kHz	1.87500 kHz
38.4615 kHz	12.6316 kHz	4.41176 kHz	1.83824 kHz
37.5000 kHz	12.5000 kHz	4.28571 kHz	1.82927 kHz
36.9231 kHz	12.0000 kHz	4.16667 kHz	1.81818 kHz
35.7143 kHz	11.9048 kHz	4.00000 kHz	1.78571 kHz
35.2941 kHz	11.5385 kHz	3.94737 kHz	1.76471 kHz
34.2857 kHz	11.4286 kHz	3.90625 kHz	1.74419 kHz
33.3333 kHz	11.3636 kHz	3.75000 kHz	1.73611 kHz
32.0000 kHz	11.1111 kHz	3.67647 kHz	1.71429 kHz
31.5789 kHz	10.9091 kHz	3.57143 kHz	1.70455 kHz
31.2500 kHz	10.8696 kHz	3.52942 kHz	1.68919 kHz
30.0000 kHz	10.7143 kHz	3.47222 kHz	1.66667 kHz

**F-2 Test Frequency Point**

1.64474 kHz	1.09090 kHz
1.63043 kHz	1.08696 kHz
1.62612 kHz	1.07759 kHz
1.60256 kHz	1.07143 kHz
1.59574 kHz	1.05932 kHz
1.57895 kHz	1.05634 kHz
1.56250 kHz	1.05263 kHz
1.53846 kHz	1.04167 kHz
1.53061 kHz	1.03448 kHz
1.52439 kHz	1.02740 kHz
1.50000 kHz	1.02459 kHz
1.48810 kHz	1.01695 kHz
1.47059 kHz	1.01351 kHz
1.46341 kHz	1.00806 kHz
1.45349 kHz	1.00000 kHz
1.44231 kHz	
1.42857 kHz	
1.42045 kHz	
1.41509 kHz	
1.39535 kHz	
1.38889 kHz	
1.36364 kHz	
1.35870 kHz	
1.33929 kHz	
1.32979 kHz	
1.31579 kHz	
1.30435 kHz	
1.30208 kHz	
1.29310 kHz	
1.27660 kHz	
1.27551 kHz	
1.27119 kHz	
1.25000 kHz	
1.22951 kHz	
1.22549 kHz	
1.22449 kHz	
1.20968 kHz	
1.20192 kHz	
1.20000 kHz	
1.19048 kHz	
1.17925 kHz	
1.17647 kHz	
1.17188 kHz	
1.15741 kHz	
1.15385 kHz	
1.13637 kHz	
1.13208 kHz	
1.11940 kHz	
1.11607 kHz	
1.11111 kHz	
1.10294 kHz	
1.09649 kHz	



## Transient States Caused by Measurement Condition Changes

### Introduction

The HP 4284A's internal circuit may enter a transient state due to changes in measurement conditions. In a transient state, the HP 4284A will not meet its specifications. So in this case, a delay time (DELAY field) must be inserted into the measurement cycle until the HP 4284A is no longer in a transient state. This appendix describes the measurement condition changes which cause the transient states, and lists the delay times required for various transient states. (Refer to Table G-1.)

**Table G-1. Measurement Condition Changes**

Change in measurement condition	DC BIAS: OFF	DC BIAS: ON	
		DCI ISO: OFF	DCI ISO: ON
Frequency	1		
Meas. Range	2-(1) <sup>1</sup>	2-(2) <sup>1</sup>	2-(3) <sup>1</sup>
DC Bias Voltage		3-(1) <sup>1</sup>	3-(2) <sup>1</sup>
Short-circuit Recovery		4-(1)	4-(2)

<sup>1</sup> Test Frequency  $f < 1\text{kHz}$  only

## Changing the Test Frequency

When the test frequency is changed from range A to range C, the minimum required delay time is 50 ms. Delay times of greater than 150 ms aren't required.

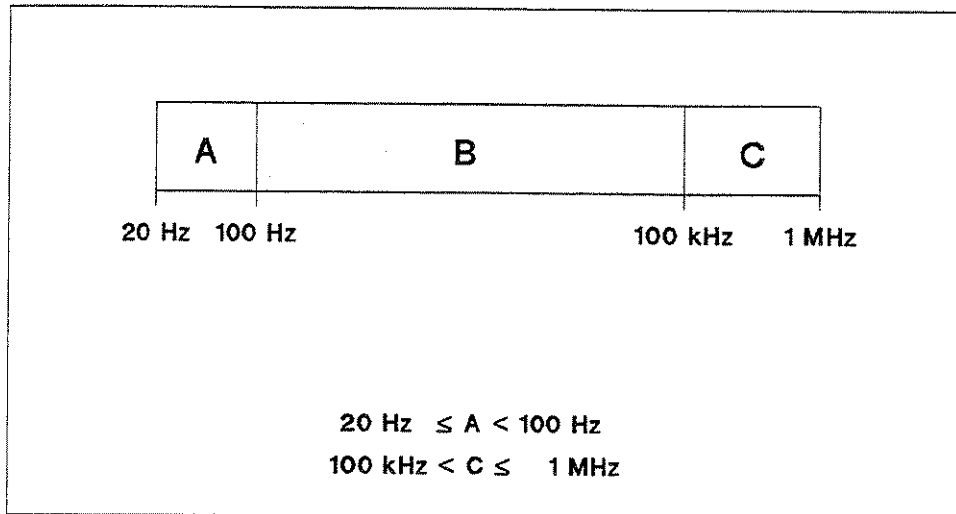

L1001001

### Note



A delay time isn't necessary for range changes other than a range A to C change.



## Changing the Measurement Range

When the measurement range frequency is set below 1 kHz, use the appropriate delay time as shown below.

1. After changing the measurement range under the following conditions use the delay times shown in Figure G-1.

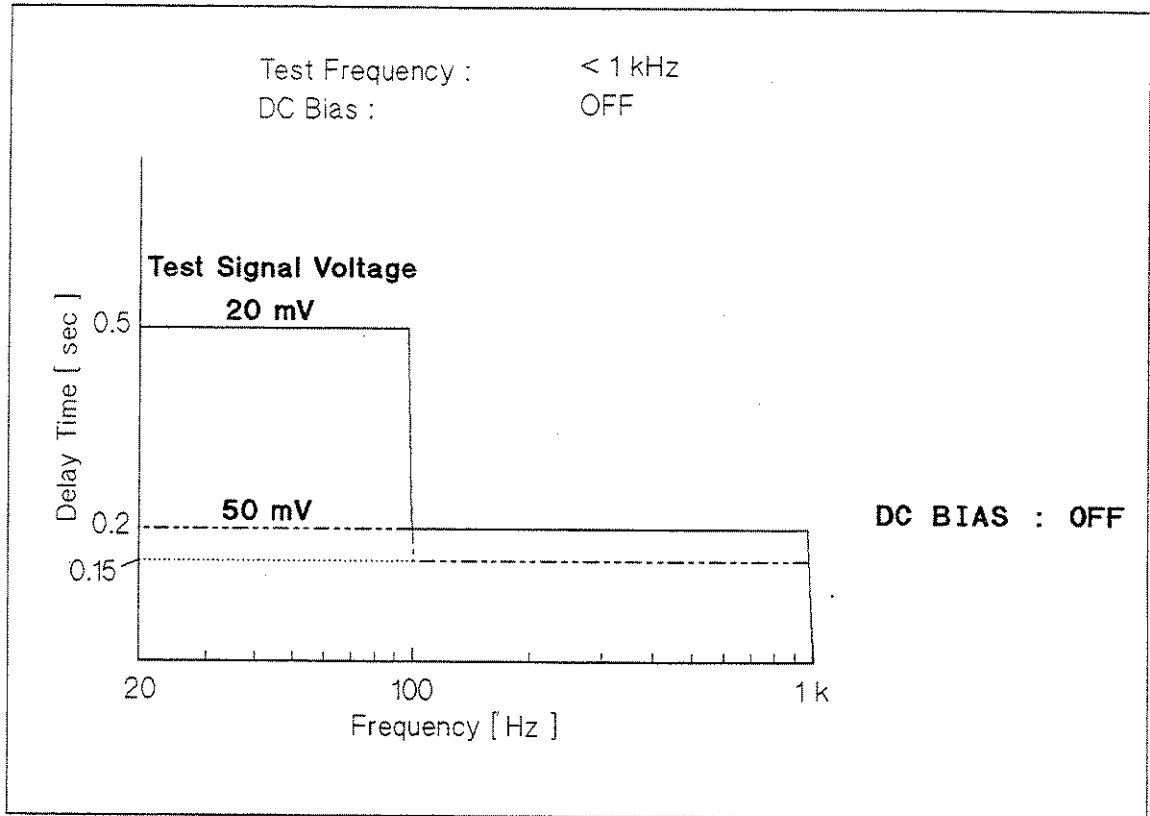

L1001002

**Figure G-1. Required Delay Time After Changing the Measurement Range (1)**

### Note



A delay time is not required when the test signal voltage is U100 mVrms.

2. After changing the measurement range under the following conditions, use the appropriate delay times as shown in Figure G-2.

Test Frequency : < 1 kHz  
DC Bias : ON  
Bias Current Isolation : OFF

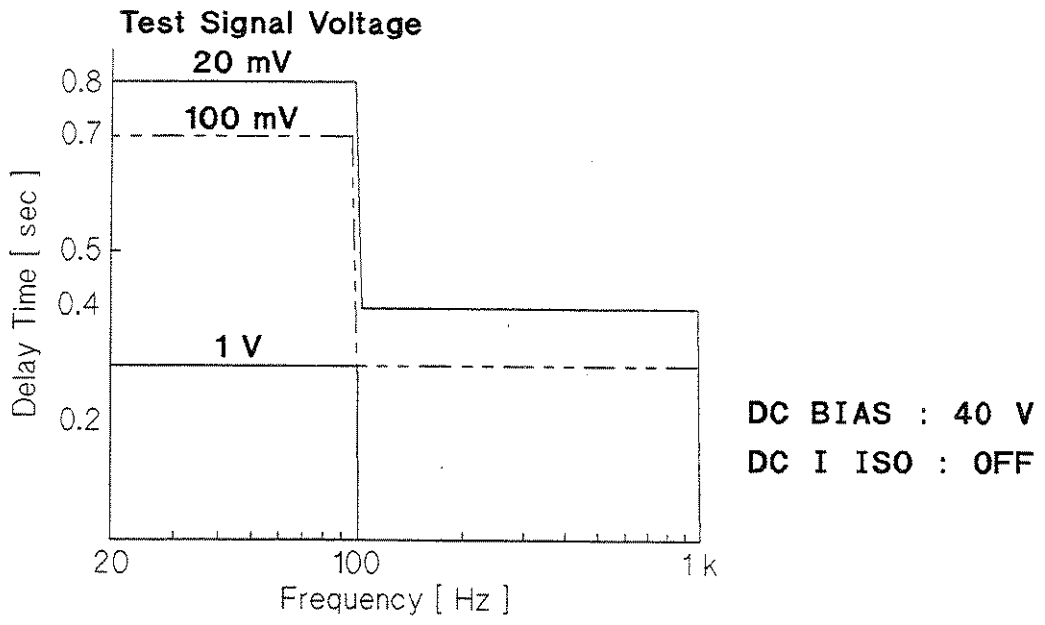

L1001003

Figure G-2. Required Delay Time After Changing the Measurement Range (2)

3. After changing the measurement range under the following conditions, use the appropriate delay times as shown in Figure G-3.

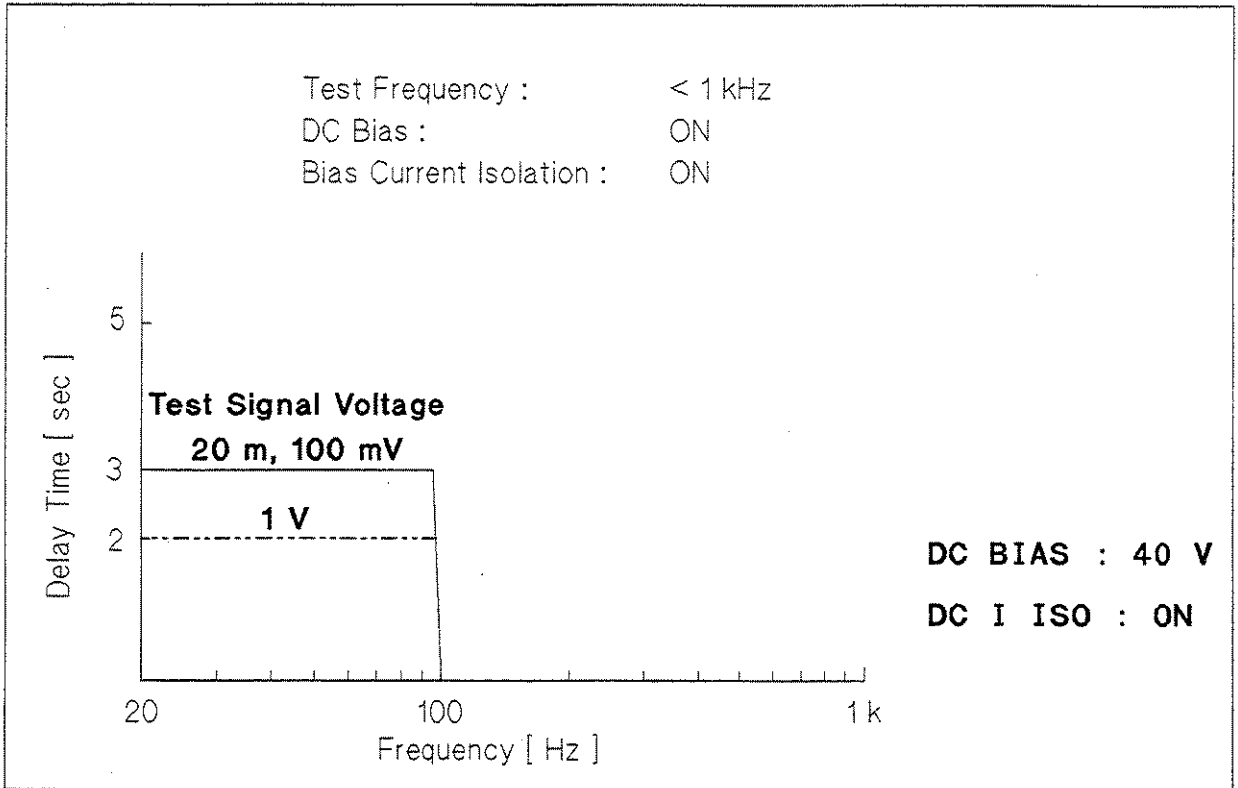

**Figure G-3. Required Delay Times After Changing the Measurement Range (3)**

**Note**



When the test signal voltage is > 1 Vrms, the wait time is the same as used for 1 Vrms.

## CHANGING THE DC BIAS VOLTAGE

When the dc bias voltage is changed at frequencies below 1 kHz, the delay wait time must be set as shown below.

1. After changing the measurement range under the following conditions, use the appropriate delay times as shown in Figure G-4.

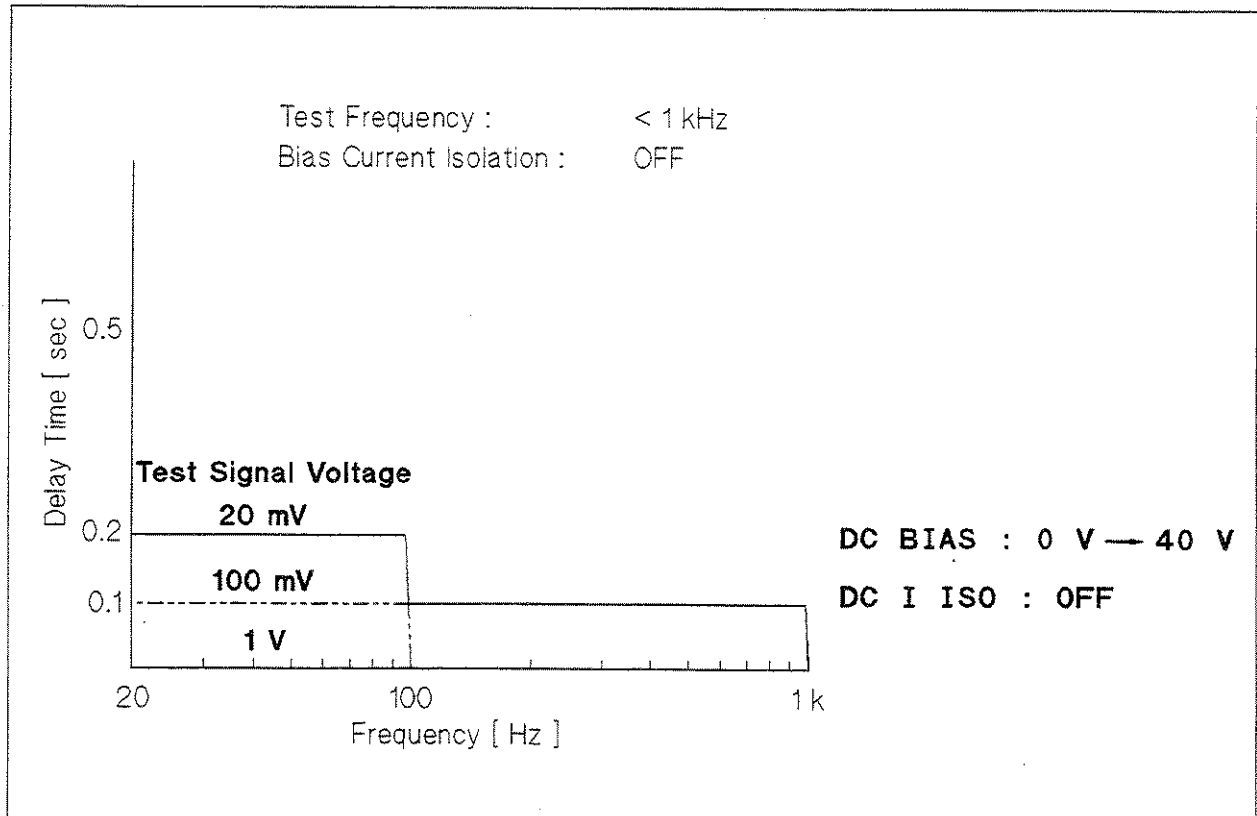

L100I005

**Figure G-4. Required Delay Times After Changing the DC Bias (1)**

### Note



A delay is unnecessary When the test signal voltage is  $\geq 500$  mVrms.

2. After changing the dc bias voltage under the following conditions, use the appropriate delay times as shown in Figure G-5.

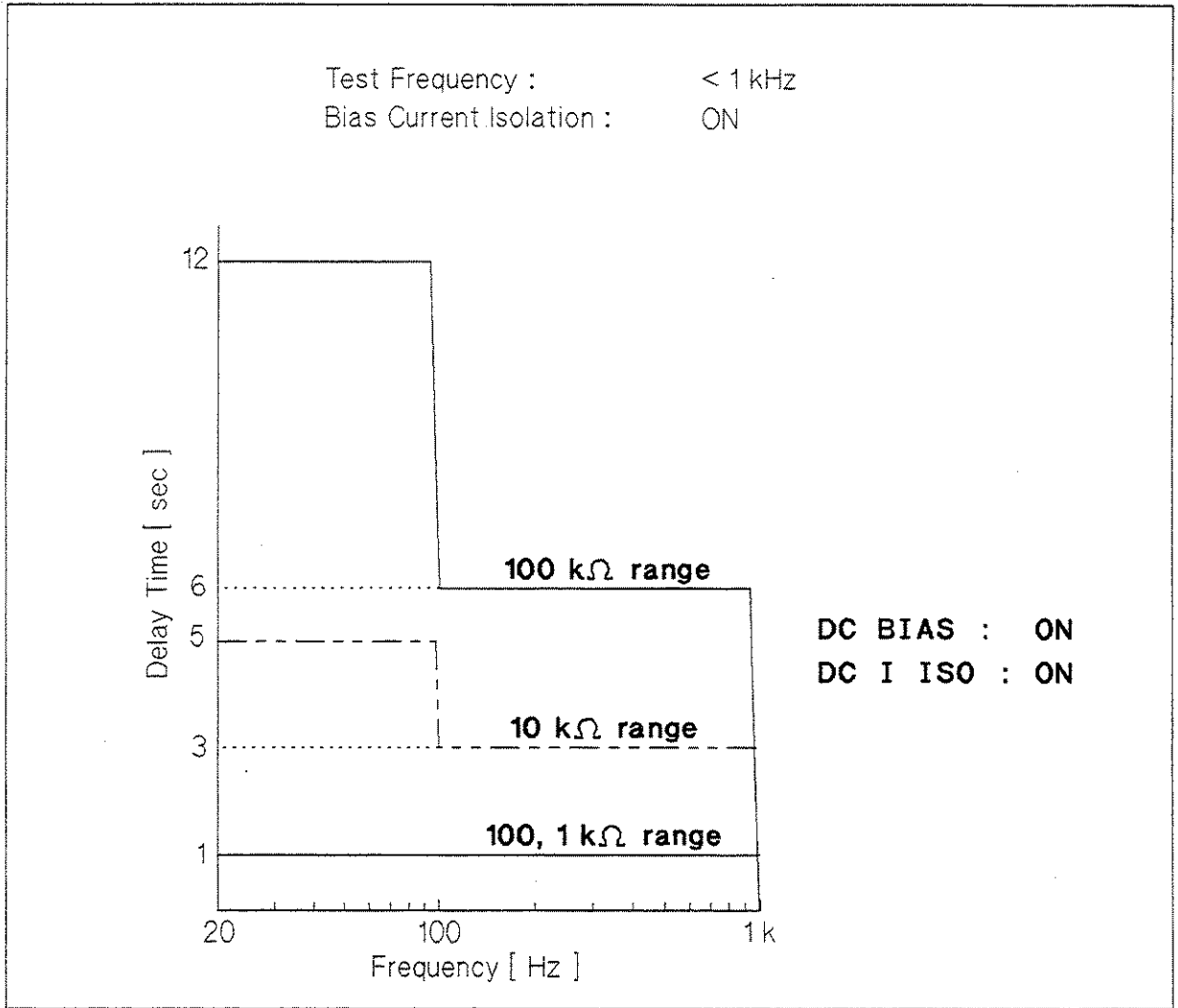
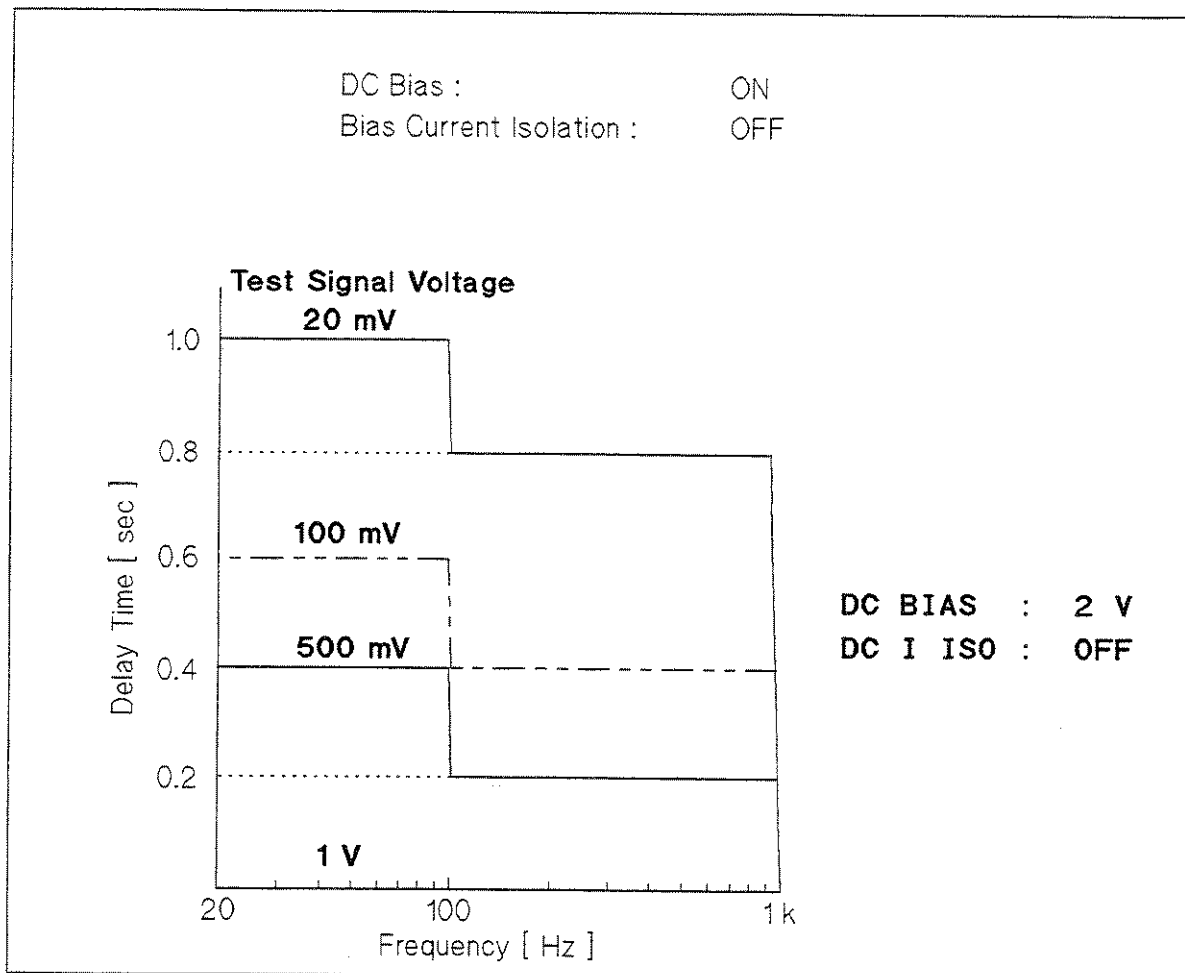

Figure G-5. Required Delay Time After Changing the DC Bias (2)

## Short Circuit Recovery

When the DUT is changed after the HP 4284A has been unbalanced by a shorted (or low impedance) DUT, use a delay time as shown below to recover from the short circuit.

1. To recover from a short circuit condition under the following conditions, use the appropriate delay times as shown in Figure G-6 and Figure G-7.



L1001007

**Figure G-6. Required Delay Times For Short Circuit Recovery (1)**

### Note



A delay time is unnecessary when the test signal voltage is  $\geq 1V_{rms}$ , a delay time is unnecessary.

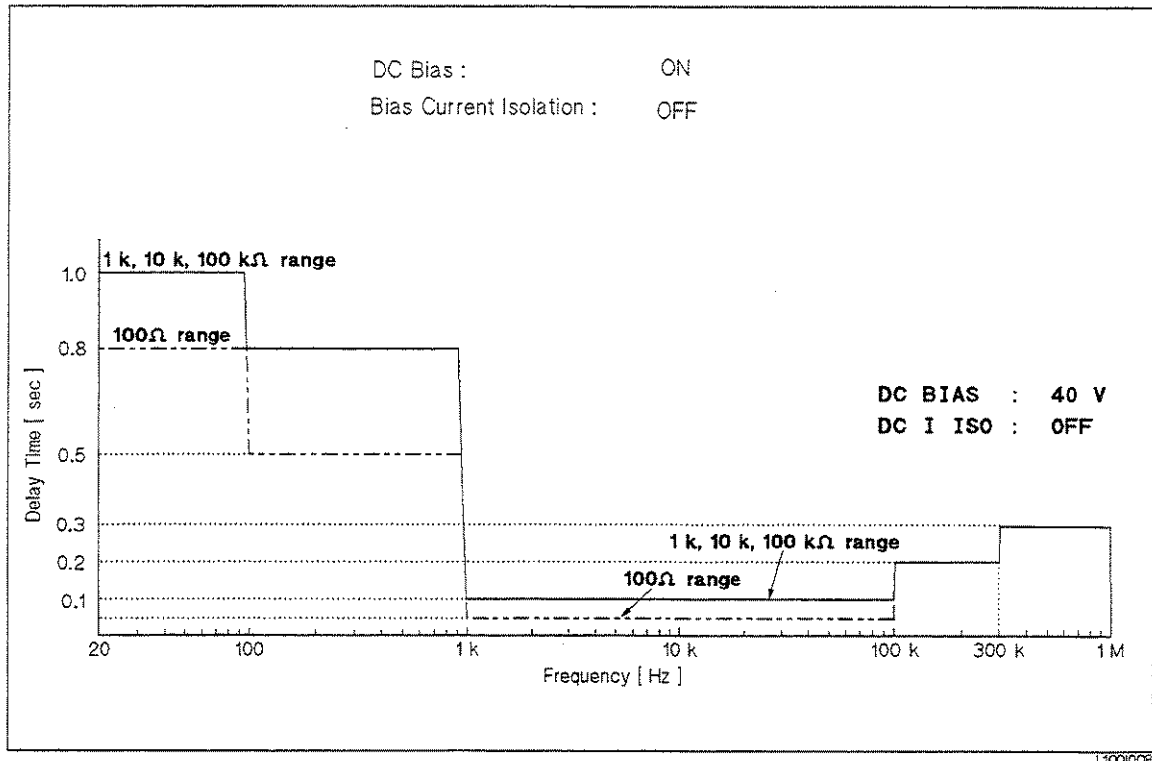

**Figure G-7. Required Delay Times For Short Circuit Recovery (2)**

2. Use the delay times shown in Figure G-8 to recover from a short circuit under the following conditions.

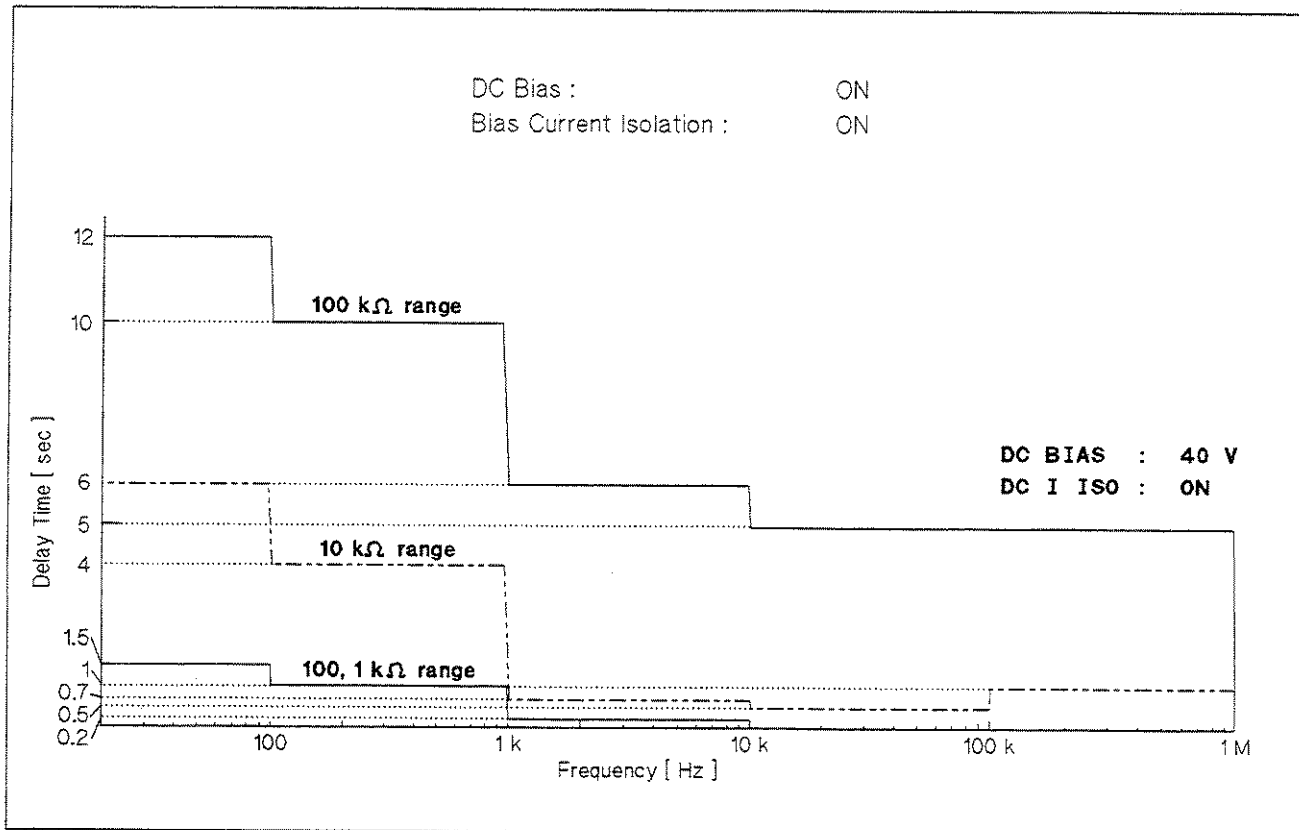

**Figure G-8. Short Circuit Recovery Delay Times (3)**

**G-10 Transient States Caused by Measurement Condition Changes**



# Index

---

**Special characters** -----, 2-8  
:, 8-2

- A**
  - ABORT I/O (IFC), 7-4
  - ABORt Subsystem, 8-47
  - Accuracy
    - DC Bias, 9-17
    - Measurement. *See* Measurement Accuracy
    - Test Signal, 9-3
  - ADC ERR, 2-8
  - ALC
    - Command, 8-16
    - Function, 4-6
  - AMPLitude Subsystem, 8-16
  - APERTure Subsystem, 8-39
  - ASCII Format, 7-7
    - (Data Buffer Memory), 7-17
    - Examples, 7-36
  - Assistance, ix
  - Automatic Level Control. *See* ALC
  - AUXiliary Bin, 4-41
  - Averaging Rate, 8-39
  
- B**
  - BEEPER* Field, 5-7
  - Beeping Condition, 5-7
  - Bias Current I/F I/O Test, 5-16
  - Bias Current Interface Function Test, 10-23
  - BIAS Subsystem, 8-19
  - BINARY Format, 7-9
    - (Data Buffer Memory), 7-18
    - Examples, 7-38
  - BIN COUNT DISPLAY* Page, 2-11, **3-28**
  - BIN No. DISPLAY* Page, 2-11, **3-23**
  
- C**
  - Cable Length Correction , 8-51
  - Calibration Cycle, 10-2
  - CATALOG* Page, 2-12, 5-1
  - CATALOG/SYSTEM** Menu, 5-1
  - Certification, viii
  - Character Data, 8-5
  - cleaning , 1-6
  - CLEAR LOCKOUT, 7-4
  - Clear Status Command, 8-82
  - \*CLS Command, 8-82

Command  
   Abbreviations, 8-4  
   ABORt Subsystem, 8-47  
   AMPLitude Subsystem, 8-16  
   APERture Subsystem, 8-39  
   BIAS Subsystem, 8-19  
   \*CLS, 8-82  
   COMParator Subsystem, 8-65  
   CORRection Subsystem, 8-51  
   CURRent Subsystem, 8-15  
   DISPlay Subsystem, 8-10  
   Error , B-1  
   \*ESE, 8-83  
   FETCh? Subsystem, 8-45  
   FORMat Subsystem, 8-48  
   FREQuency Subsystem, 8-13  
   FUNctIon Subsystem, 8-23  
   Header, 8-5  
   INITiate Subsystem, 8-43  
   LIST Subsystem, 8-31  
   Mass MEMory Subsystem, 8-76  
   MEMory Subsystem, 8-49  
   \*OPC, 8-88  
   OUTPut Subsystem, 8-17  
   Reference, 8-1, 8-9  
   \*RST, 8-89  
   \*SRE, 8-85  
   STATus Subsystem, 8-78  
   Structure, 8-2  
   SYSTem:ERRor? Query, 8-77  
   \*TRG, 8-90  
   TRIGger Subsystem, 8-40  
   VOLTage Subsystem, 8-14  
   \*WAI, 8-88  
 Command Error (CME) Bit, 7-29  
 Comment Field, 2-7  
 Comment Input, 8-12  
 Common Commands, 7-6, 8-82  
 COMParator Subsystem, 8-65  
 CONTRAST Control Knob, 2-4  
 Control Setting Examples, 7-31  
 Correction Data Measurement Complete Bit, 7-25, 8-79, 8-81  
 Correction Functions, 6-16  
 CORRECTION Page, 2-11, 4-18  
 CORRection Subsystem, 8-51  
 C<sub>p</sub>. See Parallel/Series Circuit Mode  
 C<sub>s</sub>. See Parallel/Series Circuit Mode  
 CURRent Subsystem, 8-15  
 CURSOR Keys, 2-3, 2-16

- D**
  - Data Buffer, 8-49
    - Memory, 7-16
  - Data Output Format, 8-48
  - Data Transfer, 7-7
    - Examples, 7-36
    - Rate, 7-19
  - DC Bias, 3-14, 9-17, 9-24, 9-26
    - Command, 8-17, 8-19
    - DC BIAS** Key, 2-3
  - DC Bias Level Accuracy Test, 10-9
  - DCL (Device Clear), 7-4
  - DEV A* Field. *See* Deviation, *DEV A* Field
  - (DEV) B* Field. *See* Deviation, *(DEV) B* Field
  - Deviation, 4-12
    - DEV A* Field, 4-13
    - (DEV) B* Field, 4-14
    - REF A* Field, 4-13
    - (REF) B* Field, 4-13
    - Reference value, 4-12
  - DEVICE CLEAR (SDC or DCL), 7-4
  - Device Dependent Messages, 7-6
  - Device-Specific Error , B-1
  - Device Specific Error (DDE) Bit, 7-29
  - Display Area Definition, 2-7
  - DISPLAY FORMAT** Menu, 3-1
  - Display Pages, 2-9
  - DISPlay Subsystem, 8-10
- E**
  - Electromagnetic Compatibility, 1-5
  - ENTRY Keys, 2-3
  - Equivalent Circuit. *See* Parallel/Series Circuit Mode
  - Error
    - Handling, B-2
    - Messages, B-1
  - \*ESE Command, 8-83
  - \*ESR? Query, 8-84
  - Exclusive Remedies, ix
  - Execution Error, B-1
  - Execution Error (EXE) Bit, 7-29
  - External Memory Card, 8-76
  - EXT TRIGGER Connector, 2-5
- F**
  - FETCh? Subsystem, 8-45
  - FORMat Subsystem, 8-48
  - Four-Terminal Pair Measurement, 6-9
  - FRAME Terminal, 2-4
  - FREQuency Subsystem, 8-13
  - Front Panel, 2-2
  - FUNCTion Subsystem, 8-23
  - Fuse Selection, 1-4

- G**
  - General Information, 9-1
  - Group Execute Trigger (GET), 7-5
  - GTL, 7-4
  
- H**
  - handle , 1-6
  - HANDLER I/F (#201)/(#202) Field*, 5-8
  - Handler I/F Test, 5-14
  - Handler Interface Function Test
    - Option 201, 10-26
    - Option 202, 10-30
  - Header, 8-5
  - Hewlett-Packard Interface Bus (HP-IB), 7-1
  - How To Use This Manual, vi
  - HP-IB
    - Addressing, 7-4
    - Bus Capability, 7-4
    - Command. *See* Command
    - Common Commands, 8-2, **8-82**
    - Connection, 7-1
    - Connector Signal/Pin, 7-2
    - Errors, B-1
    - Interconnect Cables, 7-2
    - Interface Capability, 7-3
    - Interface Connector, 2-5
    - Status Indicator, 2-3
    - Typical Interconnection, 7-3
    - HP-IB ADDRESS Field*, 5-8
    - HP-IB Interface Test, 10-21
  
- I**
  - IDLE state, 7-12
  - \*IDN? Query, 8-87
  - IEEE
    - 488.2 Common Commands, 7-6, **8-82**
    - 754 Floating Point Format, 7-10
    - standard 488.1-1987, 7-1
    - standard 488-1978, 7-1
    - standard 488.2-1987, 8-2
  - IFC, 7-4
  - Impedance Measurement Accuracy Test, 10-12
  - incoming inspection , 1-1
  - INFINITY, 2-8
  - Initial Settings, C-1
  - INITiate Subsystem, 8-43
  - Input Line Area, 2-8
  - installation , 1-1
  - INT DC BIAS MONITOR BNC Connector, 2-5
  - Integration Time, 8-39
  - Interface Connectors, 2-5
  - Internal Memory (EEPROM), 5-3
    - HP-IB Command, 8-76
  - Interpolation, 4-21

**L** LCD Display Test, 5-14  
 LCD Panel, 2-2  
**LCL** Key, 2-3  
 Learn Device Setup Query, 8-91  
 LED Display Test, 5-14  
 Level-Monitor Accuracy Test, 10-6  
 Limitation of Warranty, ix  
*LIMIT TABLE SETUP* Page, 2-12  
 LINE Fuse Holder, 2-6  
 LINE Input Receptacle, 2-6  
 LINE On/Off Switch, 2-2  
 Line Voltage, 1-4  
 Line Voltage and Fuse Selection, 1-4  
 LINE VOLTAGE SELECTOR, 2-6  
 Liquid Crystal Display, 2-2  
     Area Definition, 2-7  
 LIST Subsystem, 8-31  
*LIST SWEEP DISPLAY* Page, 2-11, **3-32**  
 List Sweep Measurement Complete Bit, 7-25, 8-79, 8-81  
 List Sweep Measurement Function, 8-31  
*LIST SWEEP SETUP* Page, 2-12, **4-48**  
 Load Function  
     (*BIN COUNT DISPLAY* Page), 3-30  
     (*BIN No. DISPLAY* Page), 3-25  
     (*CATALOG* Page), 5-3  
     (*LIMIT TABLE SETUP* Page), 4-46  
     (*LIST SWEEP DISPLAY* Page), 3-35  
     (*LIST SWEEP SETUP* Page), 4-54  
     (*MEAS DISPLAY* Page), 3-18  
     (*MEAS SETUP* Page), 4-14  
 Load Function Test, 10-20  
 LOCAL, 7-4  
 LOCAL LOCKOUT (LLO), 7-5  
 L<sub>p</sub>. See Parallel/Series Circuit Mode  
 \*LRN? Query, 8-91  
 L<sub>s</sub>. See Parallel/Series Circuit Mode

**M** Manual Changes, A-1  
 Manual Printing History, iii  
 Mass MEMORY Subsystem, 8-76  
 MAV (Message Available) Bit, 7-21  
*MEAS DISPLAY* Page, 2-11, **3-1**  
**MEAS SETUP** Menu, 4-1  
*MEAS SETUP* Page, 2-11, **4-1**  
 Measurement  
     Functions, 8-23  
     Procedure, 6-1  
 Measurement Accuracy  
     Absolute, 9-5  
     Relative, 9-7  
 Measurement Complete Bit, 7-25, 8-79, 8-81  
 MEASUREMENT state, 7-15  
 Measuring Bit, 7-24, 8-80  
 Measuring Correction Data Bit, 7-24, 8-80

Media Monitor Area, 5-3  
Media Type, 5-3  
Memory  
    LOAD. *See* Load  
    PURGE. *See* Purge  
    STORE. *See* Store  
Memory Card, 5-3  
Memory Card R/W Test, 5-13  
MEMORY Card Slot, 2-3  
MEMory Subsystem, 8-49  
MENU Keys, 2-2, 2-9  
MSS (Master Summary) Bit, 7-21  
Multiple Command Rules, 8-3

**N** Notation Conventions, 8-1  
NR1 Format, 8-6  
NR2 Format, 8-6  
NR3 Format, 8-6  
Numeric Data, 8-5

**O** \*OPC Command, 8-88  
OPEN/SHORT/LOAD Correction, 8-51  
Operation Complete Command, 8-88  
Operation Complete (OPC) Bit, 7-29  
Operation Environment, 1-5  
Operation Errors, B-1  
Operation Status Registers Group, 7-23, 8-78  
Operation Status Summary Bit, 7-26  
Option, 9-18  
Option 001 Power Amp/DC Bias, 9-18  
Option 201 Handler Interface, 5-8  
Option 202 Handler Interface, 5-8  
Option 301 Scanner Interface, 5-9  
OPTion Identification Query, 8-92  
\*OPT? Query, 8-92  
Oscillator  
    Level, 3-12  
Oscillator  
    Automatic Level Control(ALC), 4-6  
OUTPut Subsystem, 8-17

**P** Parallel/Series Circuit Mode, 6-5  
Parameters, 8-5  
Performance Test Record, 10-2, 10-37  
Performance Tests, 10-1  
Power Cable, 1-2  
Power On (PON) Bit, 7-29  
Power Requirements, 1-2  
Print Out  
    (*BIN COUNT DISPLAY* Page), 3-31  
    (*BIN No. DISPLAY* Page), 3-26  
    (*CATALOG* Page), 5-4  
    (*CORRECTION* Page), 4-33  
    (*LIMIT TABLE SETUP* Page), 4-47

(*LIST SWEEP DISPLAY* Page), 3-36  
(*LIST SWEEP SETUP* Page), 4-55  
(*MEAS DISPLAY* Page), 3-20  
(*MEAS SETUP* Page), 4-16  
(*SYSTEM CONFIG* Page), 5-10  
Program Message Terminators, 8-8  
Purge  
(*CATALOG* Page), 5-4

**Q** Query  
\*ESR?, 8-84  
\*IDN?, 8-87  
\*LRN?, 8-91  
\*OPT?, 8-92  
\*STB?, 8-86  
\*TST?, 8-89  
Query Error , B-1  
Query Error (QYE) Bit, 7-29

**R** rack , 1-6  
Rear Panel, 2-4  
*REF A* Field. *See* Deviation, *REF A* Field  
(*REF*) *B* Field. *See* Deviation, (*REF*) *B* Field  
Reference value. *See* Deviation, Reference value  
REMOTE, 7-5  
Remote Control, 7-1  
Reset  
Command, 8-89  
Response Message Terminators, 8-8  
*R<sub>p</sub>*. *See* Parallel/Series Circuit Mode  
RQS (Request Service) Bit, 7-5, 7-21  
*R<sub>s</sub>*. *See* Parallel/Series Circuit Mode  
\*RST Command, 8-89

**S** Safety  
Summary, iv  
Symbols, v  
Sample Programs, 7-31  
*SCANNER I/F (#301)* Field, 5-9  
Scanner I/F EEPROM R/W Test, 5-15  
Scanner I/F I/O Test, 5-16  
Scanner Interface Function Test, 10-33  
SCPI  
Basic Rules, 8-3  
SCPI Command. *See* Standard Commands for Programmable Instruments (SCPI)  
SDC (Selected Device Clear), 7-4  
*SELF TEST* Page, 2-12, 5-11  
Self-test Query, 8-89  
Sequential mode, 4-37  
Serial Number, 9-1  
Serial Polling, 7-5  
Series Circuit Mode. *See* Parallel/Series Circuit Mode

Service Request Enable Command, 8-85  
 SERVICE REQUEST (SRQ), 7-5  
 SET LOCAL, 7-4  
 Softkey Area, 2-8  
 Softkey Label, 2-8  
 SOFTKEYS, 2-2  
 Specifications, 9-2  
 SPOLL, 7-5  
 \*SRE Command, 8-85  
 Standard Commands for Programmable Instruments (SCPI), 7-6, 8-2  
 Standard Event Status Enable Command, 8-83  
 Standard Event Status Register, 7-27  
 Standard Event Status Register Summary Bit, 7-21  
 Standard Operation Status Condition Register, 7-24  
 Standard Operation Status Event Enable Register, 7-26  
 Standard Operation Status Event Register, 7-25  
 Status Byte, 7-20  
 Status Indicator, 2-3  
 STATus Subsystem, 8-78  
 \*STB? Query, 8-86  
 Store Function  
     (*BIN COUNT DISPLAY* Page), 3-30  
     (*BIN No. DISPLAY* Page), 3-25  
     (*CATALOG* Page), 5-3  
     (*LIMIT TABLE SETUP* Page), 4-46  
     (*LIST SWEEP DISPLAY* Page), 3-35  
     (*LIST SWEEP SETUP* Page), 4-54  
     (*MEAS DISPLAY* Page), 3-18  
     (*MEAS SETUP* Page), 4-14  
 Store Function Test, 10-20  
 String Data, 8-5  
 Suffix  
     Multiplier, 8-6  
     Units, 8-6  
 Summary of Pages, 2-11  
 Supplying DC Power to the Simulator, 10-36  
 Sweeping Bit, 7-24, 8-80  
 SYS MENU Field, 2-7. *See also* System Menu  
 SYSTEM CONFIG Page, 2-12, 5-5  
 SYSTem:ERRor? Query, 8-77  
 System Memory, C-1  
 System Menu, **3-18**  
     (*BIN COUNT DISPLAY* Page), 3-30  
     (*BIN No. DISPLAY* Page), 3-25  
     (*CATALOG* Page), 5-3  
     (*CORRECTION* Page), 4-32  
     (*LIMIT TABLE SETUP* Page), 4-45  
     (*LIST SWEEP DISPLAY* Page), 3-35  
     (*LIST SWEEP SETUP* Page), 4-54  
     (*MEAS DISPLAY* Page), 3-18  
     (*MEAS SETUP* Page), 4-14  
     (*SYSTEM CONFIG* Page), 5-10  
 System Menu Field. *See* SYS MENU Field  
 System Message Area, 2-8  
 System Messages, B-11



System Reset, 10-4. *See also* Reset, Function

- T** *TALK ONLY* Field, 5-8  
Terminators, 8-8  
test and Measurement System Language (TMSL) Command. *See* Standard Commands for Programmable Instruments (SCPI)  
Test Equipment, 10-1  
Test Frequency Accuracy Test, 10-5  
Test Signal Level Accuracy Test, 10-6  
TMSL Command. *See* Standard Commands for Programmable Instruments (SCPI)  
Tolerance mode, 4-37  
\*TRG Command, 8-90  
Trigger  
    Command, 8-90  
    System, 7-12  
TRIGGER, 7-5  
**TRIGGER** Key, 2-3  
TRIGger Subsystem, 8-40  
\*TST? Query, 8-89  
Typeface Conventions, vii
- U** UNBAL, 2-8  
UNKNOWN Terminals, 2-4  
UNLOCK Button, 2-3
- V** ventilation requirement, 1-6  
VOLTage Subsystem, 8-14
- W** \*WAI Command, 8-88  
WAITING FOR TRIGGER state, 7-13  
Warning  
    Messages, B-1, B-11  
Warranty, viii  
White Space, 8-7  
Write Protection, E-1



**MODEL 4284A  
PRECISION LCR METER  
OPTION 201  
HANDLER INTERFACE**

© COPYRIGHT: YOKOGAWA-HEWLETT-PACKARD, LTD. 1988  
9-1, TAKAKURA-CHO, HACHIOJI-SHI, TOKYO, JAPAN

Printed: December 1988



# TABLE OF CONTENTS

---

## SECTION 1:

### GENERAL INFORMATION

INTRODUCTION	1-1
DESCRIPTION	1-1
SPECIFICATIONS	1-1

---

## SECTION 2:

### OPERATION

INTRODUCTION	2-1
SIGNAL LINE DEFINITION	2-1
Signal Line Used for Comparator Function	2-1
Signal Line Used for List Sweep	
Comparator Function	2-6
ELECTRICAL CHARACTERISTICS	2-10
DC Isolated Outputs (Opto-coupled)	2-10
DC Isolated Inputs (Opto-coupled)	2-12
SETTING UP THE HANDLER INTERFACE BOARD	2-14
Procedure	2-16
OPERATION	2-23
Setting Procedure For Comparator	
Function	2-23
Setting Procedure For List Sweep	
Comparator Function	2-24

**GENERAL INFORMATION**

---

**INTRODUCTION**

This operation note provides the information necessary to use the HP 4284A Precision LCR Meter Option 201 Handler Interface. Refer to the HP 4284A Operation Manual for specific HP 4284A operating procedures.

---

**DESCRIPTION**

The HP 4284A Option 201 is a Handler Interface which outputs signals to indicate measurement completed, bin sorting judgments of the comparator function, and Go/No-Go judgments of the list sweep comparator function. The Option 201 Handler Interface also has an input for an external trigger signal and a keylock signal. Using these signals, the HP 4284A can easily be combined with a component handler and a system controller to fully automate component testing, sorting, and quality control data processing to increase production efficiency.

---

**SPECIFICATIONS**

Table 1-1 lists the HP 4284A Option 201 Handler Interface specifications only. All other specifications are the same as those for a standard HP 4284A.

Table 1-1. Specifications

Output signal:	Negative true, open collector, opto-isolated.
Decision Output:	
Comparator Function:	Bin number, out of bins, and rejection status.
List Sweep Comparator Function:	IN/OUT at each sweep point and pass/fail for the result of sequential comparisons.
Index:	Analog measurement complete.
Measurement Complete:	Full measurement complete.
Alarm:	Notification that a momentary power failure was detected.
Input Signal:	Opto-isolated.
Keylock:	Front panel keyboard lockout
External Trigger:	Pulse width $\geq 1 \mu\text{s}$

## OPERATION

---

### INTRODUCTION

This section provides information, including a description of the interface signal lines and their electrical characteristics, necessary to use the Option 201 Handler Interface.

---

### SIGNAL LINE DEFINITION

The handler interface uses three types of signals: comparison output, control input, and control output. The signal lines for the Comparator Function and the List Sweep Comparator Function are defined differently for comparison output signals and control input signals. The following are signal definitions of the handler interface when used with the Comparator Function and the List Sweep Comparator Function.

#### Signal Line Used for Comparator Function

The signal definitions for the Comparator Function are as follows.

- Comparison Output Signals:

/BIN1 - /BIN9, /AUX\_BIN, /OUT\_OF\_BINS, /PHI (primary parameter high reject signal), /PLO (primary parameter low reject signal), /SREJ (secondary parameter reject signal), /UNBAL (bridge unbalanced signal). See Figure 2-1.

- Control Output Signals:

/INDEX (analog measurement completed signal), /EOM (End Of Measure and comparison data valid signal) and /ALARM (instrument failure signal).

- Control Input Signal:

/EXT\_TRIG (External trigger signal) and /KEY\_LOCK (key entry disable signal)

The contact assignments and a brief description of each are given in Table 2-1 and Figure 2-2. The timing diagram is shown in Figure 2-3.

#### NOTE

The / (back slash) in the signal name means that the signal is asserted when LOW.

Table 2-1. Contact Assignments for Comparator Function (sheet 1 of 2)

Pin No.	Signal Name	Description
1 2 3 4 5 6 7 8 9 10 11	/BIN1 /BIN2 /BIN3 /BIN4 /BIN5 /BIN6 /BIN7 /BIN8 /BIN9 /OUT_OF_BINS /AUX_BIN	Sorting judgments. All /BIN_ signal outputs are open collector.
12 13	/EXT_TRIG /EXT_TRIG	External Trigger: HP 4284A is triggered on the rising edge of a pulse applied to this pin when the trigger mode is set to EXT_TRIG.
14 15	EXT.DCV2 EXT.DCV2	External DC voltage 2: DC voltage supply pins for DC Isolated inputs (/EXT_TRIG, /KEY_LOCK) and DC Isolated outputs (/ALARM, /INDEX, /EOM). Setting of internal jumpers must be changed when using an internal voltage supply.
16 17 18	+5V +5V +5V	Internal voltage supply (max. 0.5A). Exceeding 0.5A will cause the fuse to blow on the handler interface board, and the internal voltage will no longer be output (refer to the pink page at the front of this manual).
19	/PHI	Primary Parameter High Reject: The measurement value is greater than the high limit value of BIN1 - BIN9. (See Figure 2-1)
20	/PLO	Primary Parameter Low Reject: The measurement value is less than the low limit value of BIN1 - BIN9. (See Figure 2-1)
21	/SREJ	Secondary Parameter Reject: The measurement value is not within the range of the secondary parameter limit. (See Figure 2-1)
22 23	NC NC	No Connection No Connection



Table 2-1. Contact Assignments for Comparator Function (sheet 2 of 2)

Pin No.	Signal Name	Description
24	/UNBAL	Unbalance: The bridge is unbalanced.
25	/KEYLOCK	When this line is asserted, all of the HP 4284A's front panel key functions are disabled.
26	NC	No Connection
27 28	EXT.DCV1 EXT.DCV1	External DC Voltage 1: DC voltage supply pins for DC isolated open collector outputs, /BIN1 - /BIN9, /AUX_BIN, /OUT_OF_BINS, /PHI, /PLO, /SREJ, /UNBAL. The setting of internal jumpers must be changed when using the internal voltage supply.
29	/ALARM	/ALARM is asserted when a POWER FAILURE occurs.
30	/INDEX	/INDEX signal is asserted when an analog measurement is complete and the HP 4284A is ready for the next DUT to be connected to the <b>UNKNOWN</b> terminals. The measurement data, however, is not valid until /EOM is asserted. (See Figure 2-3).
31	/EOM	End Of Measurement: This signal is asserted when the measurement data and comparison results are valid. (See Figure 2-3)
32 33	COM2 COM2	Common for EXT.DCV2
34 35 36	COM1 COM1 COM1	Common for EXT.DCV1

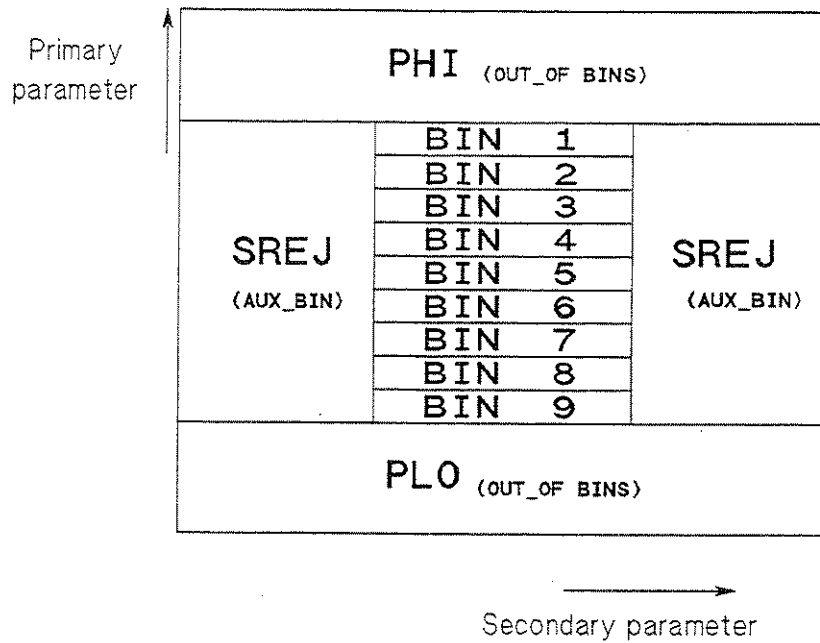

Figure 2-1. /PHI, /PLO, /SREJ Signal's Area Example  
( For The Comparator Function )

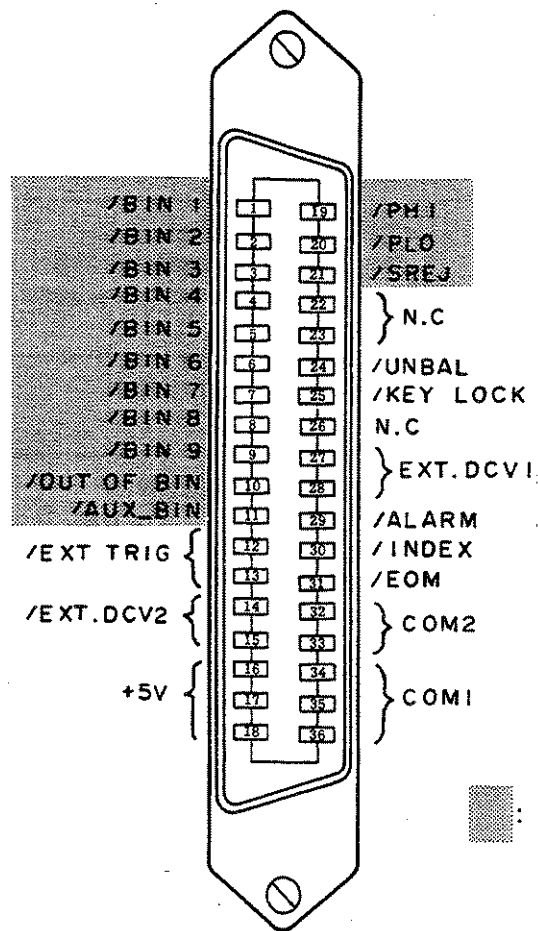
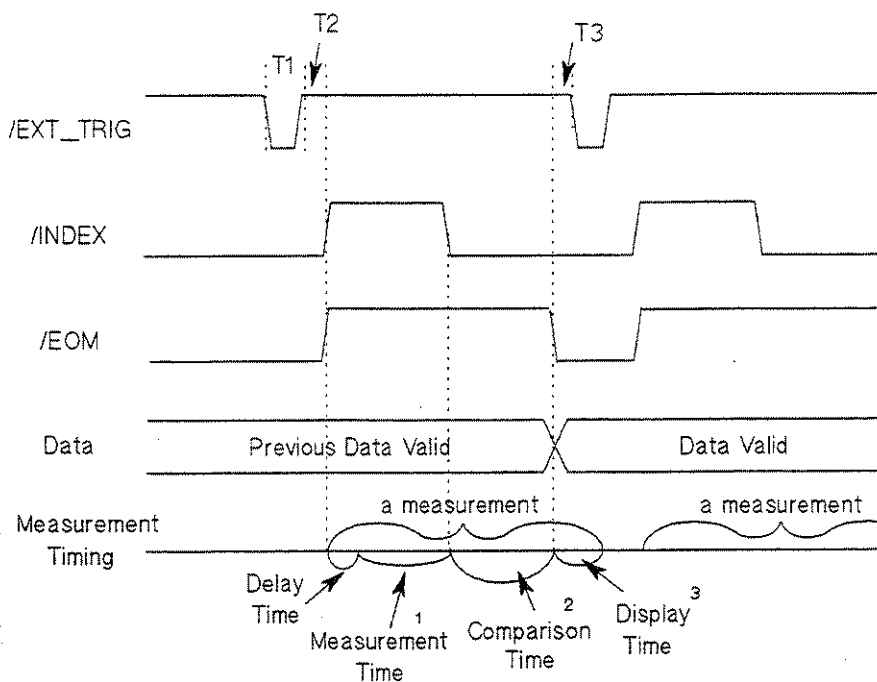

Figure 2-2. Pin Assignment For Handler Interface Connector



Time	Minimum Value	Maximum Value
T1 Trigger Pulse Width	1 $\mu$ s	---
T2 Measurement Start Delay Time	200 $\mu$ s	Display Time <sup>3</sup> + 200 $\mu$ s
T3 Trigger Wait Time After /EOM Output	0 $\mu$ s	---

<sup>1</sup> Refer to the HP 4284A Operation Manual.

<sup>2</sup> Typical comparison time is approximately 1 ms.

<sup>3</sup> Typical display time for each display format is as follows.

<b>MEAS DISPLAY</b> page	approx. 8 ms
<b>BIN No.DISPLAY</b> page	approx. 5 ms
<b>BIN COUNT DISPLAY</b> page	approx. 0.5 ms

Figure 2-3. Timing Diagram

**Signal Line  
Used for List Sweep  
Comparator  
Function**

Signal definition used for the list sweep comparator function is different from that used for the comparator function. Signal definition used for the list sweep comparator function is as follows.

- **Comparison Output Signals:**

/BIN1 - /BIN9 and /OUT\_OF BINS indicate IN/OUT judgments for each sweep point (refer to Figure 2-4). /AUX\_BIN indicates pass/fail judgment (one or more failed judgments of Steps 1 to 10 occurred during a single sweep).

These signals are output when the sweep measurement is completed.

- **Control Output Signals:**

/INDEX (analog measurement completed signal) and /EOM (end of measurement signal). The timing when /INDEX and /EOM are asserted is as follows: (different from that used for the comparator function).

- **In the SEQ sweep mode:**

/INDEX is asserted when the last step of an analog measurement of a sweep measurement is completed. /EOM is asserted when all of the comparison results are valid after a sweep measurement.

- **In the STEP sweep mode:**

/INDEX is asserted after each step of analog measurement in a sweep measurement is completed. /EOM is asserted after each step measurement, including comparison time, is completed.

The contact assignments and a brief description of signals used for the list sweep function are given in Table 2-2 and Figure 2-2 (pin assignments for the list sweep comparator function are the same as for the comparator function). The timing diagram is shown in Figure 2-5.

**NOTE**

The / (back slash) in the signal name means that the signal is asserted when LOW.

Table 2-2. Contact Assignments for List Sweep Comparator Function

Pin No.	Signal Name	Description
1	/BIN1	Failed (out of limit) at sweep Point 1
2	/BIN2	Failed (out of limit) at sweep Point 2
3	/BIN3	Failed (out of limit) at sweep Point 3
4	/BIN4	Failed (out of limit) at sweep Point 4
5	/BIN5	Failed (out of limit) at sweep Point 5
6	/BIN6	Failed (out of limit) at sweep Point 6
7	/BIN7	Failed (out of limit) at sweep Point 7
8	/BIN8	Failed (out of limit) at sweep Point 8
9	/BIN9	Failed (out of limit) at sweep Point 9
10	/OUT_OF_BINS	Failed (out of limit) at sweep Point 10
11	/AUX_BIN	/AUX_BIN is asserted when one or more fail judgments of Steps 1 to 10 occur in a single sweep.
19 - 21	N.U.	Not Used (Off state, HIGH level)
30	/INDEX	<p>In the SEQ sweep mode: /INDEX is asserted when an analog measurement of the last sweep step is completed, and the HP 4284A is ready for the next DUT to be connected to the <b>UNKNOWN</b> terminals. The measurement data, however, is not valid until /EOM is asserted. (See Figure 2-5.)</p> <p>In the STEP sweep mode: /INDEX is asserted when each analog measurement is complete and the HP 4284A is ready for the next sweep step. The measurement data, however, is not valid until /EOM is asserted. (See Figure 2-5.)</p>
31	/EOM	<p>End Of Measurement:</p> <p>In the SEQ sweep mode: /EOM is asserted when the measurement data and comparison results are valid after the last step measurement is completed. (See Figure 2-5.)</p> <p>In the STEP sweep mode: /EOM is asserted when each step measurement, including the comparison times, is completed and the measurement data is valid. The comparison results are valid after the /EOM signal of the last sweep point is asserted. (See Figure 2-5.)</p>
12 - 18, 22 - 29, 32 - 36		Same as the assignments for the comparator function (Refer to Table 2-1).

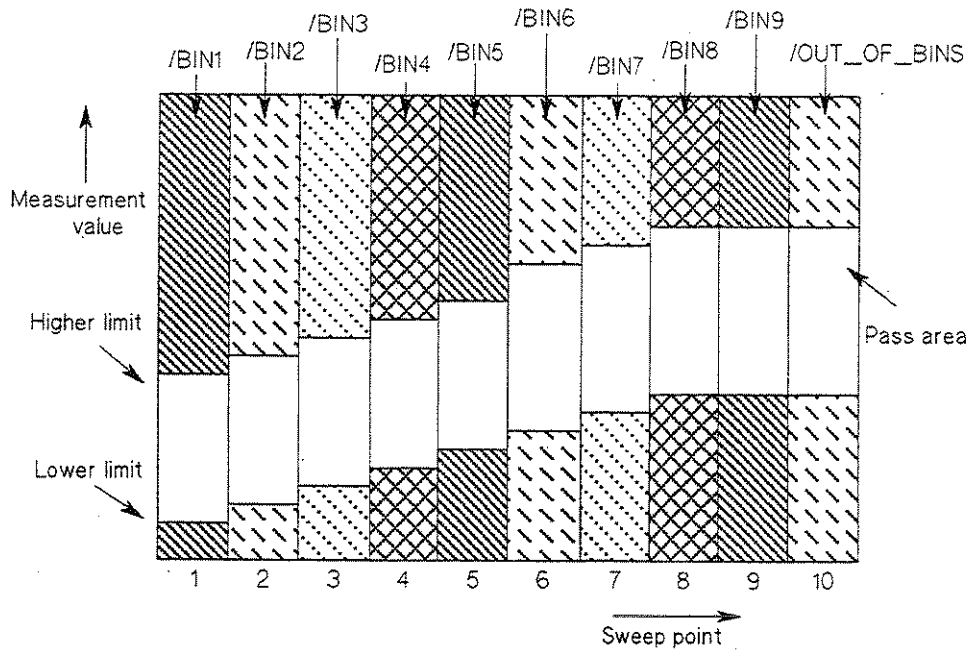
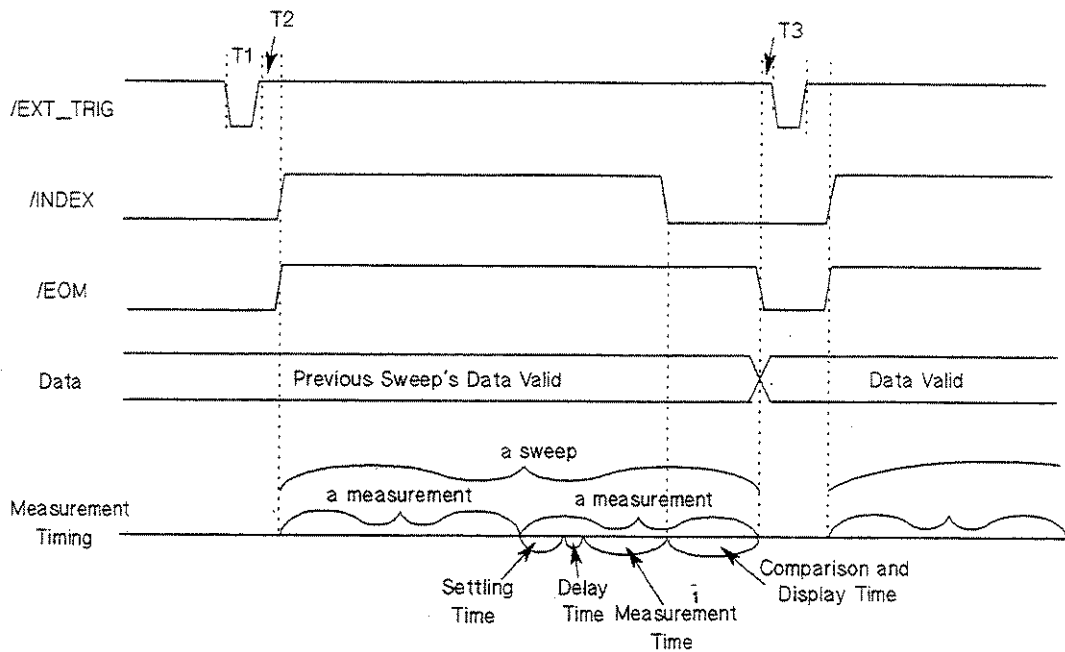
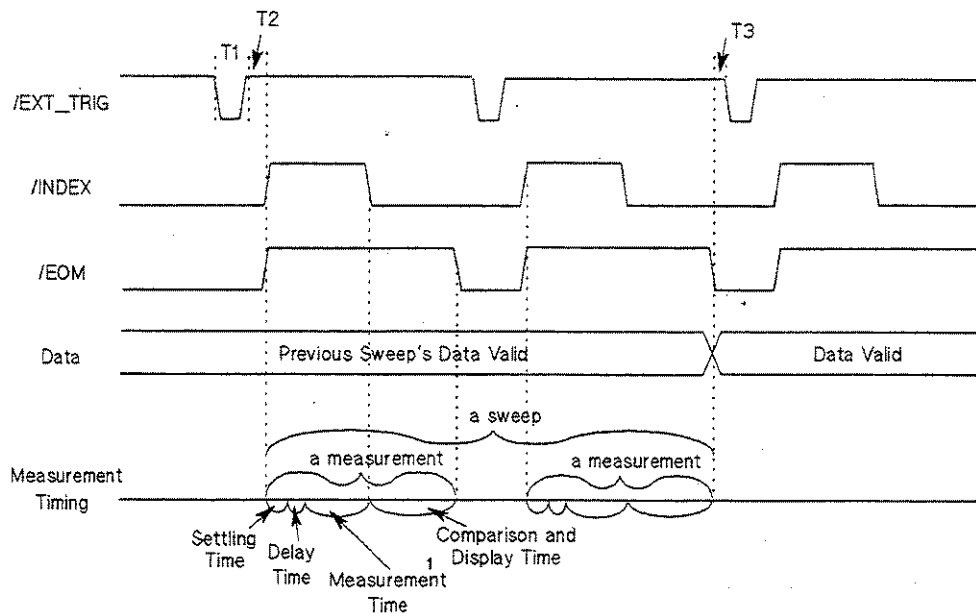

Figure 2-4. Signal Area Example  
 ( For The List Sweep Comparator Function )

**SEQ Sweep Mode:**



**STEP Sweep Mode:**



**NOTE**

Setting Time includes Correction Data Switching Time. Comparison and Display Time is approx. 4.5 ms. Refer to Figure 2-3 for information of T1, T2, T3.

Figure 2-5. Timing Diagram

## ELECTRICAL CHARACTERISTICS

As mentioned in the previous paragraph, the meaning of some of the signals is different for the the comparator function and the list sweep comparator function. However, the electrical characteristics of these signals are identical for the two operations. The following descriptions apply to both the comparator function and the list sweep comparator function.

### DC Isolated Outputs (Opto-coupled)

Each DC output (pins 1 through 11, pins 19 through 24, pins 29 through 31) is isolated using an open collector output optocoupler. The output voltage of each line is set by a pull-up resistor on the handler interface board. The pull-up resistors can be connected to the internally supplied voltages (+5 V and +12 V), or to an externally applied voltage (EXT.DCV.1: +5 V to +24 V, EXT.DCV.2: +5 V to +15 V) by setting jumpers (refer to page 2-15, **SETTING UP THE HANDLER INTERFACE BOARD**).

The electrical characteristics of the DC isolated outputs are divided into two types, (See Table 2-3).

Since the power source for the Comparison Output and Control Output signals are different, two circuit commons (COM1, COM2) are made available.

Table 2-3. DC Isolated Output Electrical Characteristics

Output Signals	Voltage Output Rating		Maximum Current	Circuit Common
	Low	High		
Comparison Signals /BIN1 - /BIN9 /AUX_BIN /OUT_OF_BINS /PHI /PLO /UNBAL	≤0.5 V	+5 V - +24 V	6 mA	Internal pull-up voltage: HP 4284A circuit common  External voltage (EXT.DCV.1): COM1
Control Signals /INDEX /EOM /ALARM	≤0.5 V	+5 V - +15 V	5 mA	Internal pull-up voltage: HP 4284A circuit common  External voltage (EXT.DCV.2): COM2

A simplified diagram of the output signals is shown in Figure 2-6 (Comparison Signals) and Figure 2-7 (Control Signals).



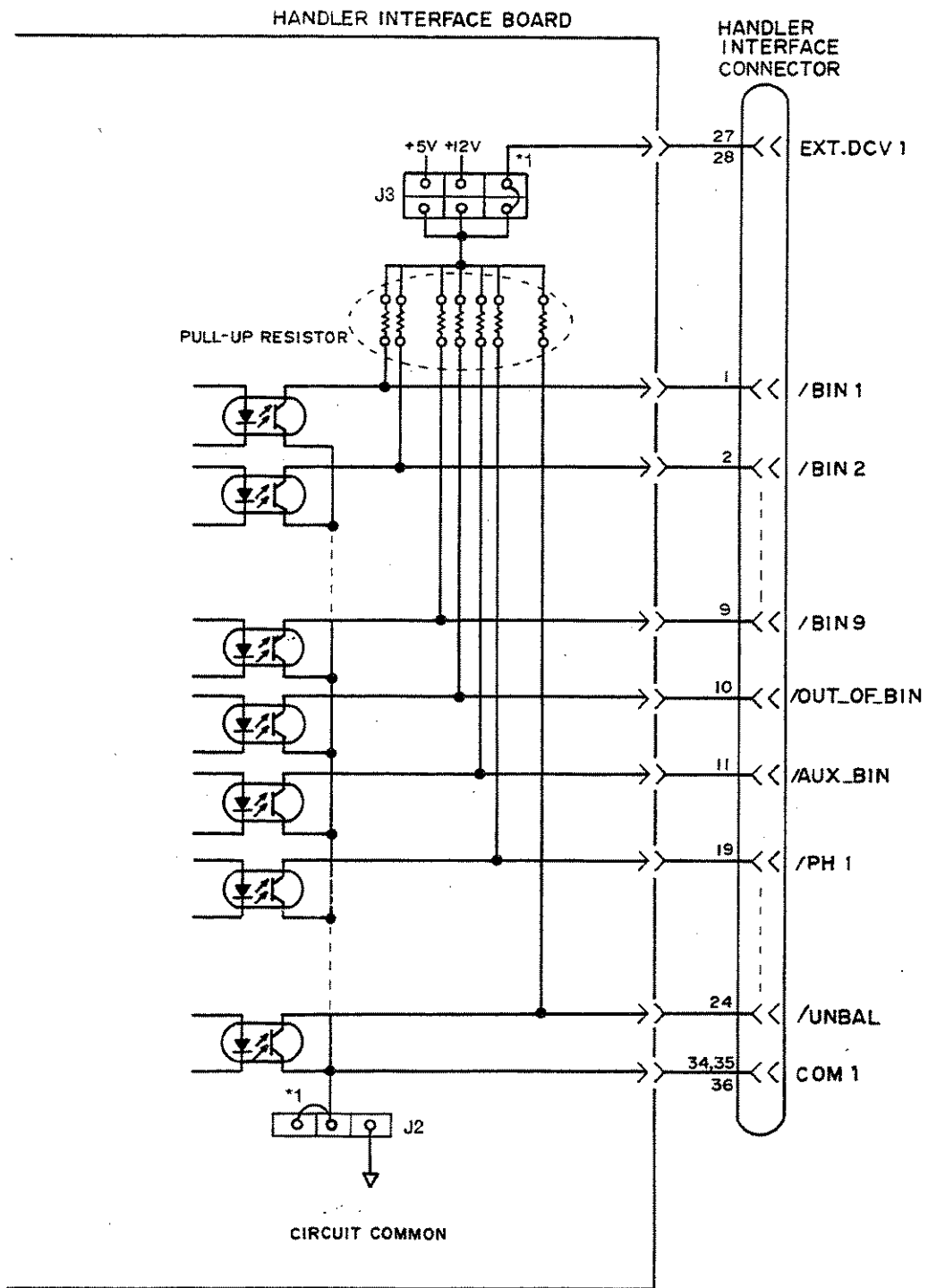

<sup>1</sup> Factory shipped jumper setting

Figure 2-6. Simplified Diagram of The Comparison Output Signals

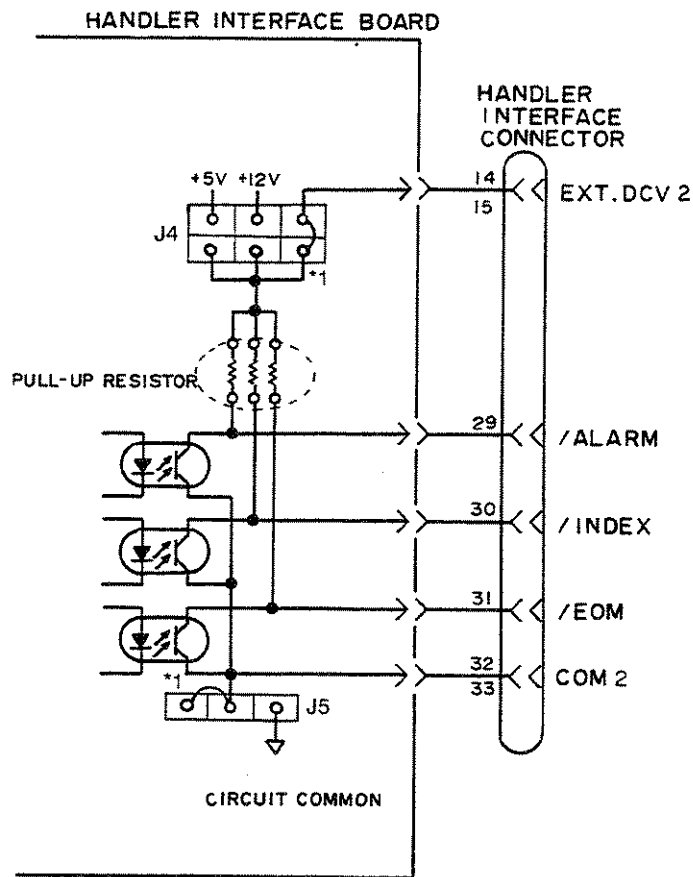

<sup>1</sup> Factory shipped jumper setting

Figure 2-7. Simplified Diagram of The Control Output Signals

### DC Isolated Input (Optocoupled)

The electrical characteristics of the DC isolated input are divided into two types.

#### 1. /EXT\_TRIG

The /EXT\_TRIG signal (pins 12 and 13) is connected to the cathode of the LED in an optocoupler. The HP 4284A is triggered on the rising edge of the /EXT\_TRIG pulse. The anode of the LED can be powered from the internal 5 V and 12 V supplies, or by an external voltage source (EXT.DCV2).

### NOTE

To limit the trigger current, jumper J6 must be selected considering the optocoupler anode voltage being used. See page 2-15, **SETTING UP THE HANDLER INTERFACE BOARD.**

## 2. /KEY\_LOCK

The /KEY\_LOCK signal (pin 25) is connected to the cathode of the LED in an optocoupler. All of the HP 4284A's front panel keys are disabled when the /KEY\_LOCK signal is asserted. The LED's anode can be connected to the internal 5V or 12V supplies, or can be connected to an external voltage source (EXT.DCV2), which is connected to pin 15 or 16 on the handler interface connector.

The OFF state voltage (high level) of the /KEY\_LOCK (pin 25) and /EXT\_TRIG (pins 12, 13) signals depends on the pull-up voltage selected using jumper J4.

A diagram for the input signals is shown in Figure 2-8.

The electrical characteristics of the signals are listed in Table 2-4.

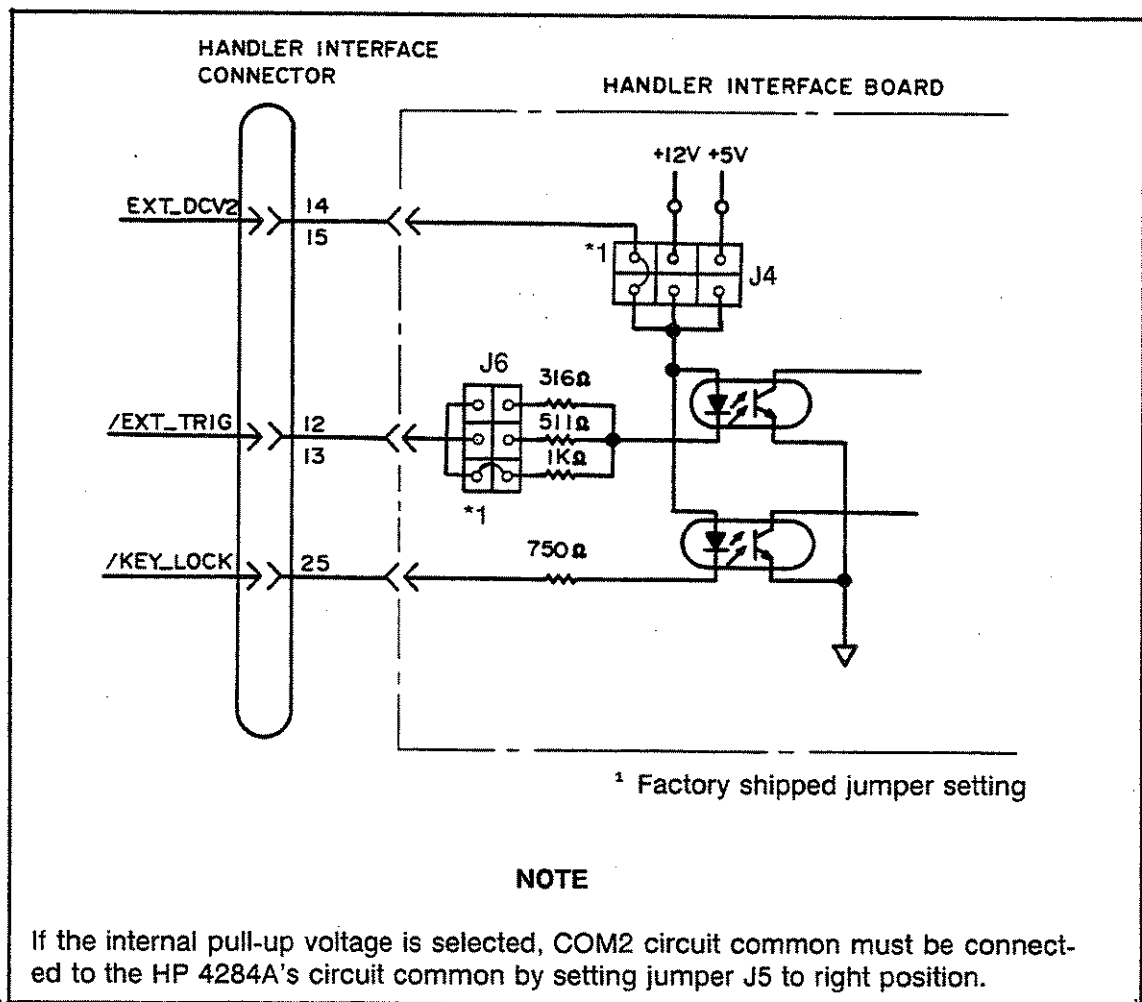

Figure 2-8. Handler Interface Input Signal Diagram

Table 2-4. Typical Electrical Characteristics

Signal	Input Voltage		Input Current (Low) Pull-up Voltage			Circuit Common
	LOW	HIGH	+5V	+12V	+15V	
/EXT_TRIG	≤1V	5V~15V	11.1mA	10.5mA	13.5mA	Internal Pull-up Voltage: HP 4284A circuit common External Pull-up Voltage: COM2
/KEY_LOCK	≤1V	5V~15V	5.2mA	14.5mA	18.5mA	Internal Pull-up Voltage: HP 4284A circuit common External Pull-up Voltage: COM2

**SETTING UP  
THE HANDLER  
INTERFACE  
BOARD**

Jumpers on the Handler Interface board must be set to select the signal outputs (Open collector, Internal voltage outputs, or External voltage outputs). A description of each of the five jumpers (J2 - J6), is given in Table 2-5, and their locations are shown in Figure 2-9.

Table 2-5. Internal Jumper Settings

Jumper		Description	Signals
No.	Position		
J2	Upper(N)	DC Isolated outputs are isolated.	/BIN1 - /BIN9 /AUX_BIN /OUT_OF_BINS /PHI - /UNBAL
	Lower	DC Isolated outputs are not isolated. COM1 is connected to the 4284A circuit common.	
J3	Right(N)	The open collector outputs are pulled up to the /EXT.DCV1(5V-24V).	
	Center	The open collector outputs are pulled up to the internal 12V.	
	Left	The open collector outputs are pulled up to the internal 5V.	
J4	Right(N)	The open collector outputs are pulled up to the EXT.DCV2(5V-15V).	
	Center	The open collector outputs are pulled up to the internal +12V.	
	Left	The open collector outputs are pulled up to the internal +5V.	
J5	Upper(N)	DC Isolated outputs are isolated.	
	Lower	DC Isolated outputs are not isolated. COM2 is connected to 4284A circuit common.	
J6	Right(N)	Trigger current limiting resistor is 1k $\Omega$ . This position should be set when EXT.DCV2 is between 9V to 15V or J4 is set to the center position.	/EXT_TRIG
	Center	Trigger current limiting resistor is 511 $\Omega$ . This position should be set when EXT.DCV2 is between 6V to 9V.	
	Left	Trigger current limiting resistor is 316 $\Omega$ . This position should be set when EXT.DCV2 is between 5V to 6V or J4 is set to left position.	

\* When shipped from the factory, each jumper is set to the (N) position (marked "N" on the handler interface board).

## NOTE

When the internal 5V (pin 16-18) of the handler interface connector is used by the handler, either jumper J2 or J5 must be set to lower position, and either COM1 or COM2 must be used as the +5 V common.

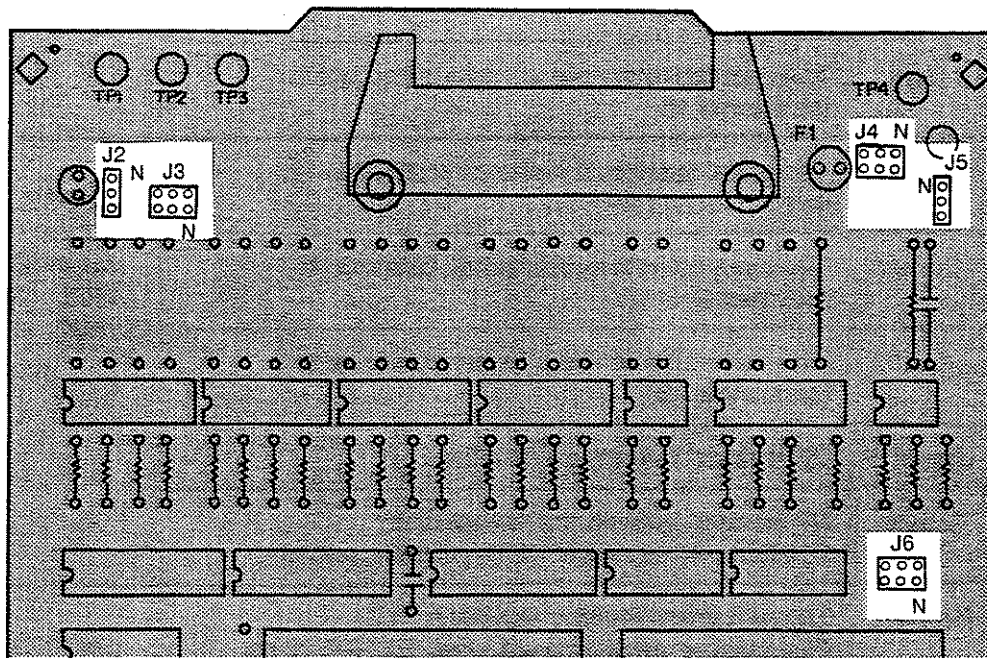

Figure 2-9. Jumper Locations

### Procedure

To set up the jumpers and pull-up resistors, perform the following steps.

1. Disconnect the power cable from the HP 4284A and allow enough time (a few minutes), for the internal capacitors to discharge.

### WARNING

**DANGEROUS ENERGY/VOLTAGE EXISTS WHEN THE HP 4284A IS IN OPERATION AND JUST AFTER IT IS POWERED DOWN. ALLOW A FEW MINUTES FOR THE INTERNAL CAPACITORS TO DISCHARGE.**

2. Disconnect the two rear feet which lock the top cover and rear panel together.
3. Fully loosen the top cover retaining screws located on the rear of the top cover.
4. Slide the top cover towards the rear and lift it off. The top shield plate will be visible.
5. Remove the top shield plate to expose the PC boards.
6. Disconnect the flat cable connected to the handler interface board.

**NOTE**

The handler interface board has the red and orange extractors. See Figure 2-10.

7. Reinstall the handler interface board.

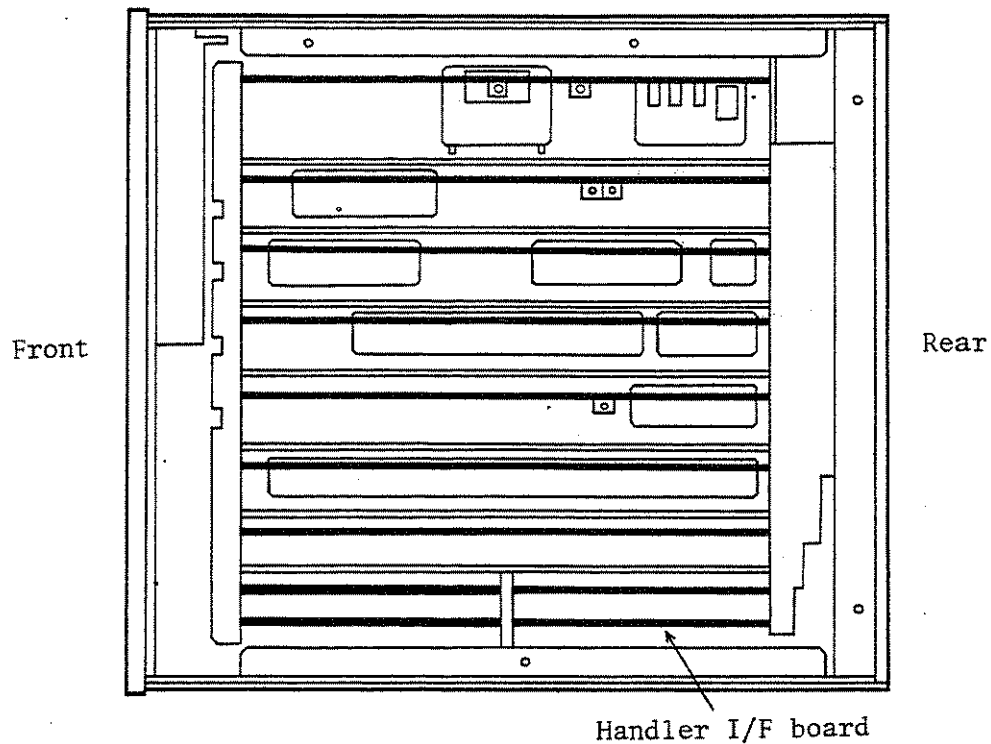
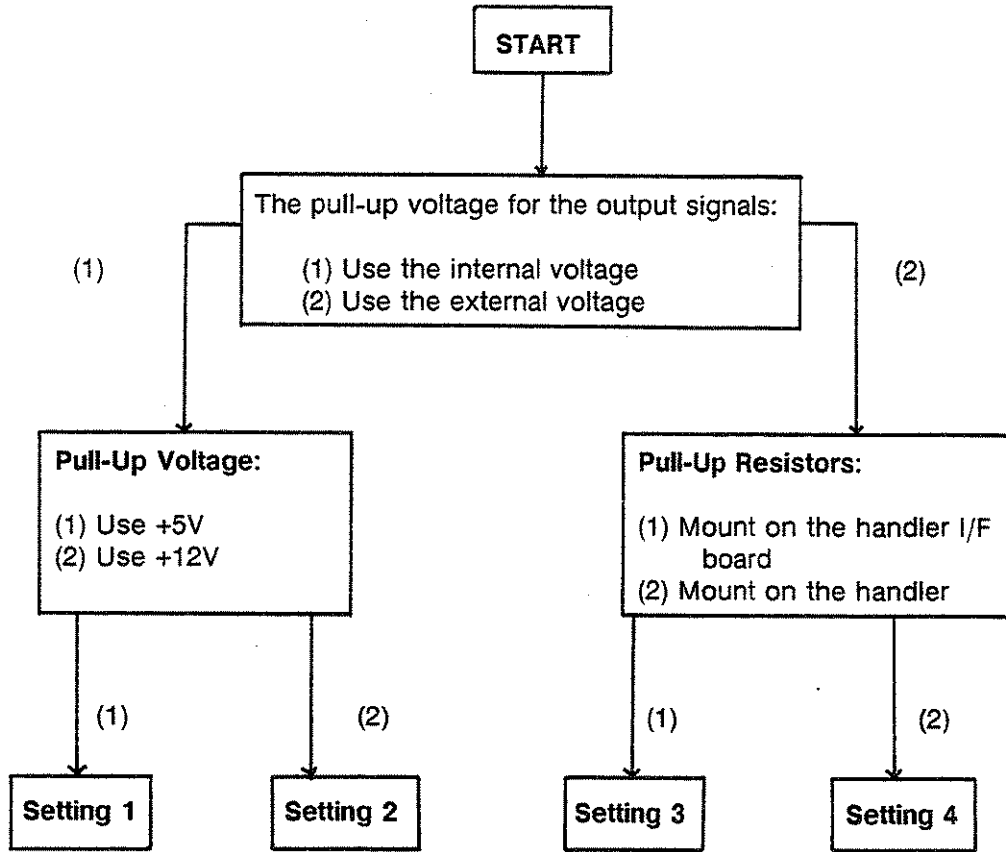

Figure 2-10. Handler Interface Board Locations

8. Use the following flow chart to set the jumpers for the comparison output signals.



9. Install jumpers according to Table 2-6, (See Figure 2-11).

10. Mount the pull-up resistors for the comparison output signals when pull-up resistors are called for in Table 2-6.

Table 2-6. Jumper Setting (1)

Setting Number	Jumper Setting		Circuit Common	Pull-up resistor	Pull-up voltage
	J2	J3			
1	Lower	Left	4284A's COM	Required	Internal+5V
2	Lower	Center	4284A's COM	Required	Internal+12V
3	Upper(N)	Right(N)	COM1	Required	EXT.DCV.1 (5V-24V)
4	Upper(N)	-	COM1	Not required	-



**NOTE**

Use the following equation to determine the value of the pull-up resistors.

$$R[k\Omega] \approx \frac{V_p[V]}{3}$$

Where,

V<sub>p</sub>: Pull-up voltage

R: Pull-up resistor

The typical pull-up resistor values are:

Pull-Up Voltage	Pull-Up Resistor	HP Part Number
5 V	1.78kΩ	PN 0757-0278
12 V	3.16kΩ	PN 0698-3154
24 V	8.25kΩ	PN 0757-0441

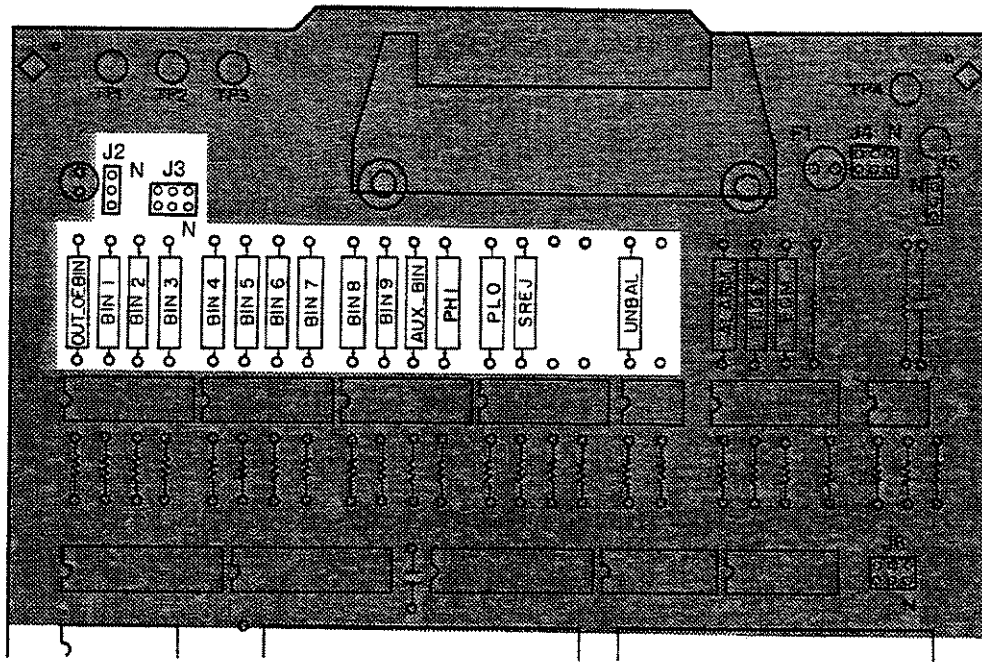

Figure 2-11. How to Set Up the Handler Interface Board (1)

11. Follow the flow chart in step 8 to set up the jumpers for the control output signals.

12. Set the jumpers in accordance to Table 2-7, (See Figure 2-12).

Table 2-7. Jumper Settings (2)

Setting Number	Jumper Setting		Circuit Common	Pull-up resistor	Pull-up voltage
	J4	J5			
1	Left	Lower	4284A's COM	Required	Internal+5V
2	Center	Lower	4284A's COM	Required	Internal+12V
3	Right(N)	Upper(N)	COM2	Required	EXT.DCV.2 (5V~15V)
4	- <sup>1</sup>	Upper(N)	COM2	Not required	-

<sup>1</sup> When input signals are used, J4 is set to the Right(N) position, (a pull-up resistor is not required).

13. Mount the pull-up resistors for the control output signals when pull-up resistors are called out in Table 2-7.

**NOTE**

Use the following equation to determine the pull-up resistor values.

$$R[k\Omega] = \frac{Vp[V]}{2.5}$$

Where,  
 Vp: Pull-up voltage  
 R: Pull-up resistor

The typical pull-up resistor values are:

Pull-Up Voltage	Pull-Up Resistor	HP Part Number
5 V	1.78kΩ	PN 0757-0278
9 V	3.16kΩ	PN 0757-0279
12 V	4.22kΩ	PN 0698-3154
15 V	5.11kΩ	PN 0757-0438

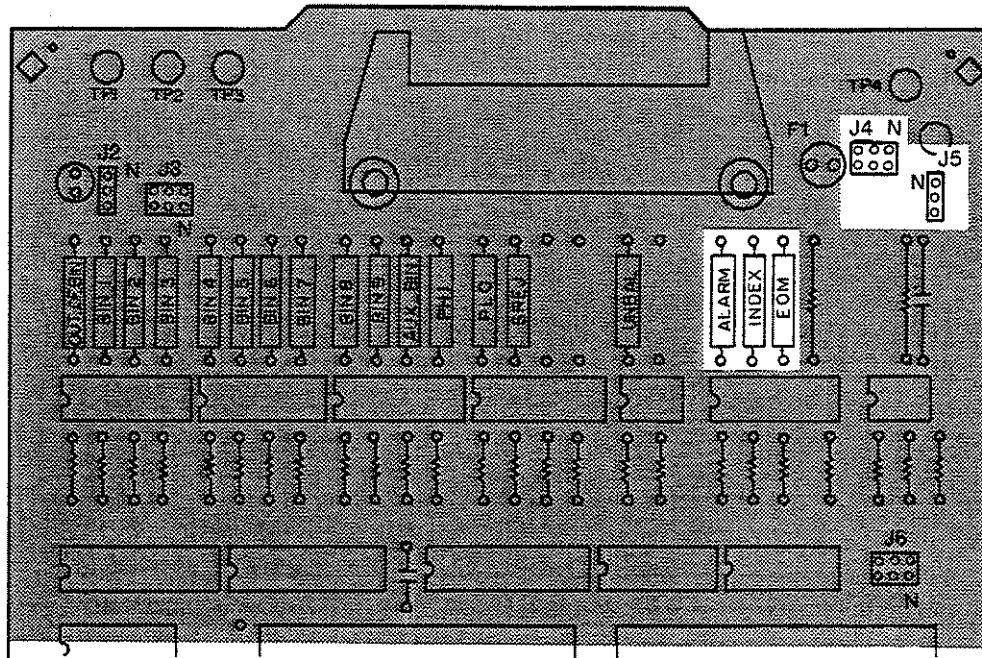

Figure 2-12. How to Set Up the Handler Interface Board (2)

14. Install the jumpers for the input signals according to Table 2-8 (See Figure 2-13).

**NOTE**

The drive voltage of the input signals uses the pull-up voltage for the control signals.

Table 2-8. Jumper Settings (3)

Drive Voltage	Jumper Setting	Circuit Common
	J6	
Internal +5V	Left	4284A's circuit common
Internal +12V	Right(N)	4284A's circuit common
EXT.DCV.2 (5-6V)	Left	COM2
EXT.DCV.2 (6-9V)	Center	COM2
EXT.DCV.2 (9-15V)	Right(N)	COM2

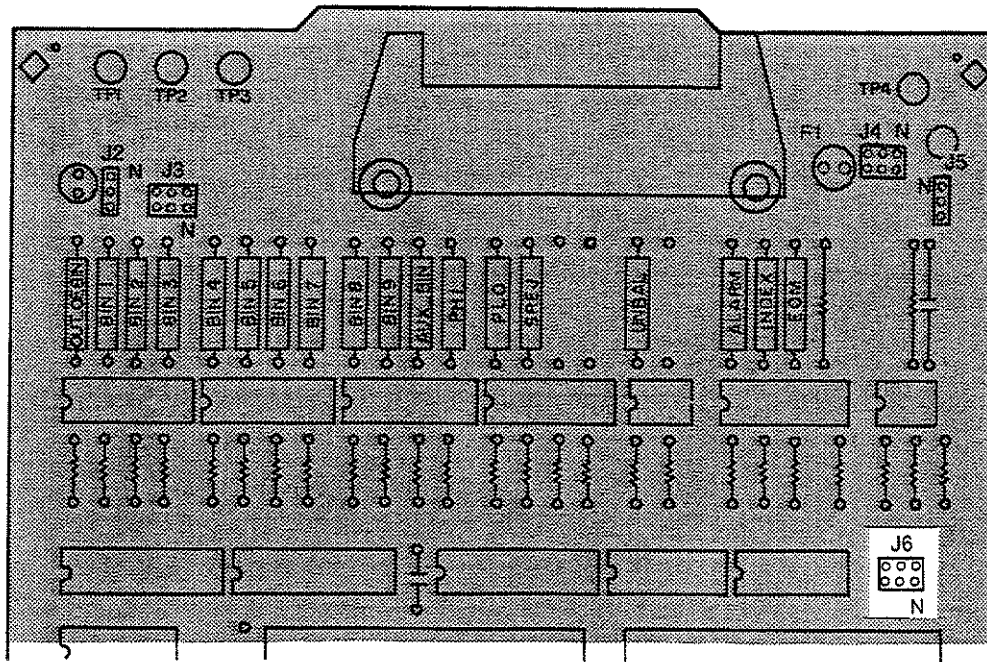

Figure 2-13. How to Set Up the Handler Interface Board (3)

15. Replace the handler interface board, top shield plate, rear feet, and top cover.

## OPERATION

To use the handler interface, after setting up the handler interface board, setup the limit table for using the comparator function or the list sweep setup table for using the list sweep comparator function. Then set the handler interface to be enable to output/input the signals. The following procedures are for using the handler interface with the comparator function or the list sweep comparator function.

### Setting Procedure For Comparator Function

The following operation procedures are for using the handler interface with the comparator function.

1. Press the **MEAS SETUP MENU** key, and the **'LIMIT TABLE'** softkey. The **LIMIT TABLE SETUP** page is displayed.
2. Setup a limit table for bin sorting (refer to the HP 4284A Operation Manual for details).
3. Use the **CURSOR** arrow keys to move the cursor to the **COMP** field. The following softkeys will be displayed in the softkey label area.
  - **'ON'**
  - **'OFF'**
4. Press the **'ON'** softkey. The comparator function is enabled.
5. Press the **CATALOG/SYSTEM MENU** key, and the **'SYSTEM CONFIG'** softkey. The **SYSTEM CONFIG** page is displayed.
6. Use the **CURSOR** arrow keys to move the cursor to the **HANDLER I/F (#201)** field. The following softkeys will be displayed in the softkey label area.
  - **'ON'**
  - **'OFF'**
7. Press the **'ON'** softkey. The handler interface can be used to output/input the signals.
8. Press the **DISPLAY FORMAT MENU** key. To perform a measurement, select the **'MEAS DISP'**, **'BIN No.'**, or **'BIN COUNT'** softkey.

#### NOTE

The comparator function ON/OFF can be set on the **BIN No. DISPLAY** page.

**Setting procedure  
For List Sweep  
Comparator  
Function**

The following operation procedures are for using the handler interface with the list sweep comparator function.

1. Press the **MEAS SETUP MENU** key, and the **'LIST SETUP'** softkey. The **LIST SWEEP SETUP** page will be displayed.
2. Setup a list table including sweep steps and high/low limits for the list sweep measurement (refer to the HP 4284A Operation Manual for details).
3. Press the **CATALOG/SYSTEM MENU** key, and the **'SYSTEM CONFIG'** softkey. The **SYSTEM CONFIG** page will be displayed.
4. Use the **CURSOR** arrow keys to move the cursor to the **HANDLER I/F (#201)** field. The following softkeys will be displayed in the softkey label area.
  - **'ON'**
  - **'OFF'**
5. Press the **'ON'** softkey. Then the handler interface can be used to output/input the signals.
6. Press the **DISPLAY FORMAT MENU** key. To perform list sweep measurements, select the **'LIST SWEEP'** softkey.

**MODEL 4284A**  
**PRECISION LCR METER**  
**OPTION 202**  
**HANDLER INTERFACE**

© COPYRIGHT: YOKOGAWA-HEWLETT-PACKARD, LTD., 1988  
9-1, TAKAKURA-CHO, HACHIOJI-SHI, TOKYO, JAPAN

Printed: December 1988



**HEWLETT  
PACKARD**

# TABLE OF CONTENTS

---

## SECTION 1:

### GENERAL INFORMATION

INTRODUCTION	1-1
DESCRIPTION	1-1
SPECIFICATIONS	1-1

---

## SECTION 2:

### OPERATION

INTRODUCTION	2-1
SIGNAL LINE DEFINITION	2-1
Signal Line Used for Comparator Function	2-1
Signal Line Used for List Sweep	
Comparator Function	2-5
ELECTRICAL CHARACTERISTICS	2-9
DC Isolated Outputs	2-9
DC Isolated Inputs	2-12
OPERATION	2-14
Setting Procedure For Comparator Function	2-14
Setting Procedure For List Sweep	
Comparator Function	2-15

---

## SECTION 3:

### SETTING UP THE HANDLER INTERFACE BOARD

INTRODUCTION	3-1
GENERAL CONFIGURATION	3-1
General Configuration Procedure	3-3
CONFIGURATION EXAMPLES	3-7
Standard Configuration	3-7
Palomar Model M16	3-9
Palomar Model M11	3-11
Q-Corporation RTR2	3-13
Isumeca 83	3-15
EA Model M015	3-17



**GENERAL INFORMATION**

---

**INTRODUCTION**

This operation note provides the information necessary to use the HP 4284A precision LCR Meter Option 202 Handler Interface. Refer to the HP 4284A Operation Manual for HP 4284A specific operating procedures.

---

**DESCRIPTION**

The Option 202 Handler Interface can be configured to physically and electrically interface the HP 4284A to the following component handlers:

- Palomar Model M16 Handler
- Palomar Model M11 Handler
- Q-Corporation RTR2 Handler
- Isumeca 83 Handler
- EA Model M015 Handler

The HP 4284A Option 202 is a Handler Interface to output signals, including a measurement completed signal, and bin sort judgments of the comparator function, or Go/No-Go judgments of the list sweep comparator function, and to input external trigger signal and keylock signal. By using these signals, the HP 4284A can easily be combined with any of the component handlers listed above, and a system controller to fully automate LCR component testing, sorting, and quality control data processing to increase production efficiency.

---

**SPECIFICATIONS**

Table 1-1 lists the HP 4284A Option 202 Handler Interface specifications only. Other specifications are the same as for a standard HP 4284A.

Table 1-1. Specifications

Output signal:	Opto-isolated and Open collector with internal pull-up resistor (to + 5 V), or external pull-up resistor and pull-up supply voltage (+ 24 V, 80 mA maximum).
Decision Output:	
Comparator Function:	Bin number
List Sweep Comparator Function:	
	IN/OUT at each sweep point and pass/fail for the result of sequential comparisons.
EOC:	End of conversion A/D output.
BUSY:	HP 4284A is busy with conversion or calculation.
Input Signal:	Opto-isolated or TTL. Opto-isolated input is a current input (5 mA to 60 mA). TTL input is a schmitt-trigger input (hysteresis = 0.8 V) with an internal 1 K $\Omega$ pull-up resistor.
START IN:	Input trigger to start a measurement. Minimum required pulse width is $\geq 5 \mu\text{s}$ with W11 installed.

**OPERATION**

---

**INTRODUCTION**

This section provides information necessary to use the Option 202 Handler Interface, including descriptions of the interface signal lines and their electrical characteristics.

---

**SIGNAL LINE DEFINITION**

The handler Interface uses three types of signals, comparison output, control input and control output. The signal lines for the Comparator Function and the List Sweep Comparator Function are defined differently for comparison output and control output signals. The following defines the the signals when the handler interface Comparator Function and the List Sweep Comparator Function are used.

**Signal Line Used for Comparator Function**

The signal definitions used for the Comparator Function are as follows.

- Comparison Output Signals:

BIN1 - BIN10. See Figure 2-1.

- Control Input Signal:

START IN ( Triggers the HP 4284A to start a measurement.)

- Control Output Signals:

**EOC:**

An opto-isolated signal output by the HP 4284A to tell the handler when the end of conversion occurs. At the End Of Conversion the HP 4284A enters the correction, calculation and comparison phase and the handler is free to position the next DUT for testing.

**BUSY:**

An opto-isolated signal output by the HP 4284A telling the Handler that the HP 4284A is busy performing a measurement, comparison, or calculation.

## NOTE

The assertion level of the following signals is selected by the jumper settings W3 through W13. Refer to **SECTION 3** for jumper setting details.

The contact assignments and a brief description of each signal used for the comparator function are given in Table 2-1 and Figure 2-2. The timing diagram is shown in Figure 2-3.

Table 2-1. Pin Assignments For Comparator Function

Pin No.	Signal Name	Description
1	Common	Isolated Common
2	BIN0	Bin sorting results Opto-Isolated open collector output
3	BIN1	
4	BIN2	
5	BIN3	
6	BIN4	
7	BIN5	
8	BIN6	
9	BIN7	
10	BIN8	
11	BIN9	
12	+ 5V OUT	+5 V for external use.
13	System Ground	Instrument Logic Ground
14	START IN	Trigger Input ( Signal from Handler )
15	EOC	End of Conversion A/D output
16	BIN10	Bin 10 Sorting result (same as BIN0 - 9)
17		+5 V output when jumper W1 is installed
18	BUSY	BUSY ( conversion, calculation ) output
19 - 36		No Connection

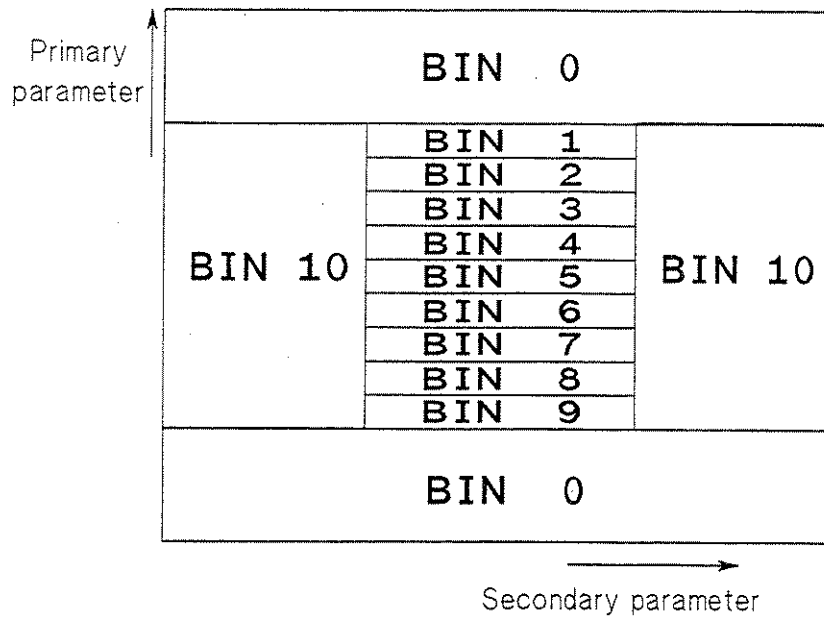

Figure 2-1. BIN0 - BIN10 Limit Map  
( For The Comparator Function )

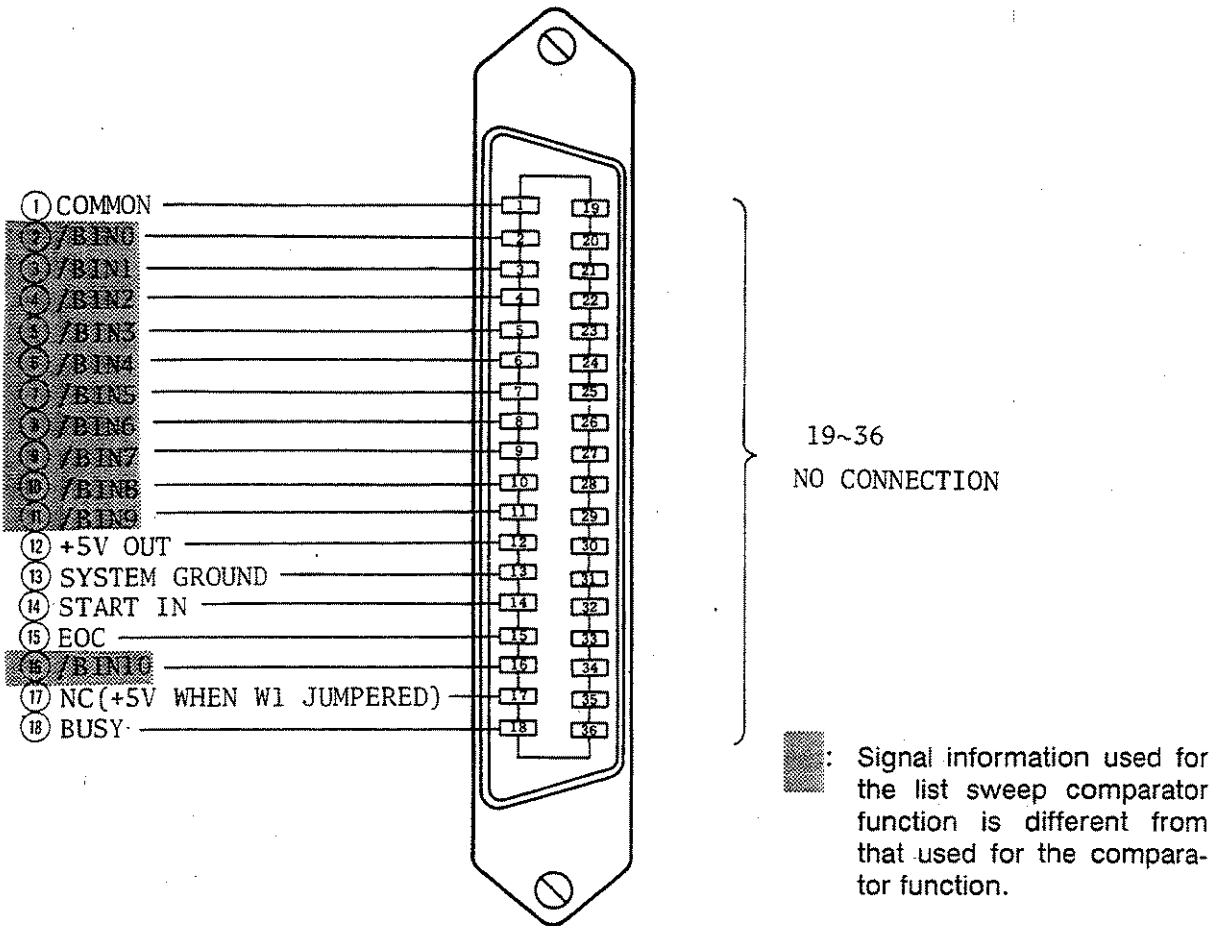
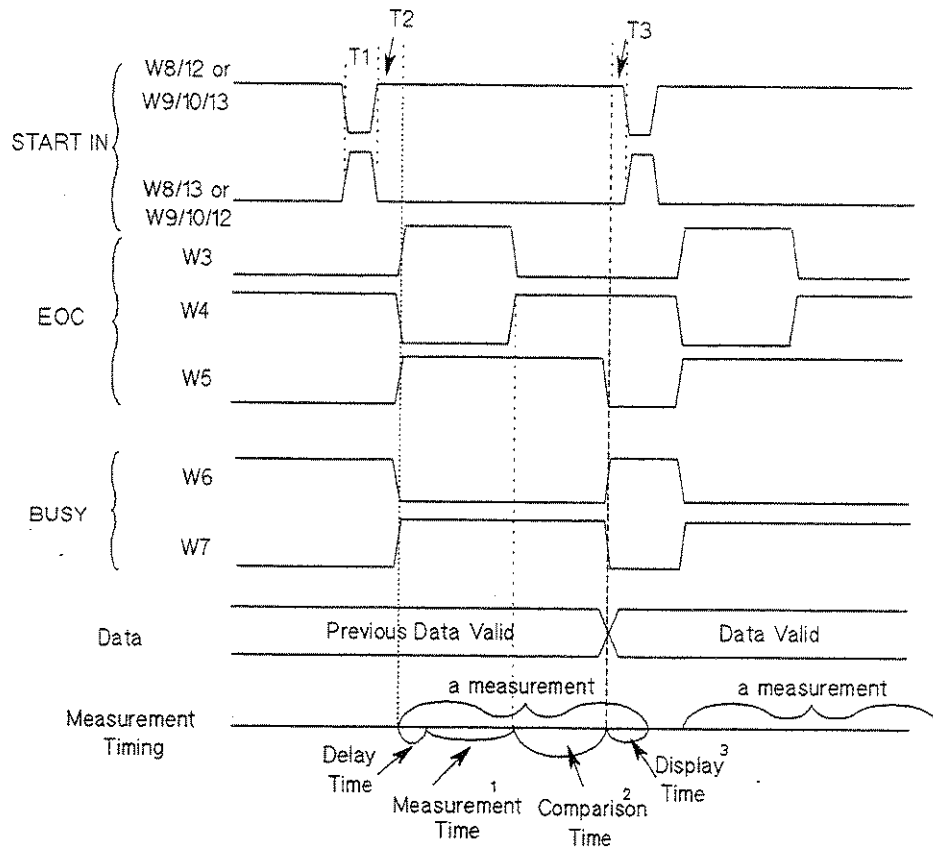

Figure 2-2. Handler Interface Connector Pin Assignments



Time	Description	Min.	Max.
T1	Trigger Pulse Width	5 $\mu$ s or 50 $\mu$ s <sup>4</sup>	---
T2	Measurement Delay Time	200 $\mu$ s	Display Time <sup>3</sup> + 200 $\mu$ s
T3	Trigger Wait Time after EOC is output	0 s	---

<sup>1</sup> Refer to the HP 4284A Operation Manual.

<sup>2</sup> Typical comparison time is approximately 1 ms.

<sup>3</sup> Typical display time for each display format is as follows.

<b>MEAS DISPLAY</b> page	approx. 8 ms
<b>BIN No.DISPLAY</b> page	approx. 5 ms
<b>BIN COUNT DISPLAY</b> page	approx. 0.5 ms

<sup>4</sup> Trigger pulse width is selected by installing or leaving open jumper W11 on the Handler Interface Board.

Figure 2-3. Timing Diagram ( For The Comparator Function )

## Signal Line Used for List Sweep Comparator Function

The signal definitions for the list sweep comparator function are different from the definitions for the comparator function. The List Sweep Comparator function signal definitions are as follows.

- Comparison Output Signals:

BIN1 - BIN10 indicate IN/OUT judgments at each sweep point (refer to Figure 2-4). BIN0 indicates pass/fail judgment (one or more fail judgments of Step 1 to Step 10 occurred during a single sweep).

These signals are output when a sweep measurement is completed.

- Control Output Signals:

EOC (analog measurement completed signal) and BUSY (end of measurement signal). The timing when EOC and BUSY are asserted is as follows (different from the timing used for the comparator function).

- In the SEQ sweep mode:

EOC is asserted when last step analog measurement of the sweep measurement is completed, and BUSY is asserted when the all of comparison results are valid after a sweep measurement.

- In the STEP sweep mode:

EOC is asserted when each step analog measurement of the sweep measurement is completed, and BUSY is asserted when each step measurement including comparing time is completed.

The contact assignments and a brief description of signals used for the list sweep function are given in Table 2-2 and Figure 2-2 (pin assignments for the list sweep comparator function is same to for the comparator function). The timing diagram is shown in Figure 2-5.

### NOTE

The assertion level of the following signals is selected by the jumper settings W3 through W13. Refer to **SECTION 3** for jumper setting details.

Table 2-2. List Sweep Comparator Function Pin Assignments

Pin No.	Signal Name	Description
2	BIN0	Is asserted when one or more fail judgments of Step 1 to Step 10 occur.
3	BIN1	Failed (out of limit) at sweep Point 1
4	BIN2	Failed (out of limit) at sweep Point 2
5	BIN3	Failed (out of limit) at sweep Point 3
6	BIN4	Failed (out of limit) at sweep Point 4
7	BIN5	Failed (out of limit) at sweep Point 5
8	BIN6	Failed (out of limit) at sweep Point 6
9	BIN7	Failed (out of limit) at sweep Point 7
10	BIN8	Failed (out of limit) at sweep Point 8
11	BIN9	Failed (out of limit) at sweep Point 9
15	EOC	<p>In the SEQ sweep mode: EOC is asserted when a analog measurement of last sweep step is complete and the HP 4284A is ready for the next DUT to be connected to the <b>UNKNOWN</b> terminals. The measurement data, however, is not valid until the BUSY line is asserted. (See Figure 2-5.)</p> <p>In the STEP sweep mode: EOC is asserted when each analog measurement is complete and the HP 4284A is ready for the next sweep step. The measurement data, however, is not valid until the BUSY line is asserted. (See Figure 2-5.)</p>
16	BIN10	Failed (out of limit) at sweep Point 10
18	BUSY	<p>BUSY ( conversion, calculation ) output</p> <p>In the SEQ sweep mode: This signal is asserted when the measurement data and comparison results are valid after the last step measurement is completed. (See Figure 2-5.)</p> <p>In the STEP sweep mode: This signal is asserted when each step measurement including comparison time is completed and the measurement data is valid. The comparison results are valid after BUSY is asserted after the last sweep point. (See Figure 2-5.)</p>
1, 12 - 14, 17, 19 - 36		Same assignments as for the comparator function (refer to Table 2-1).



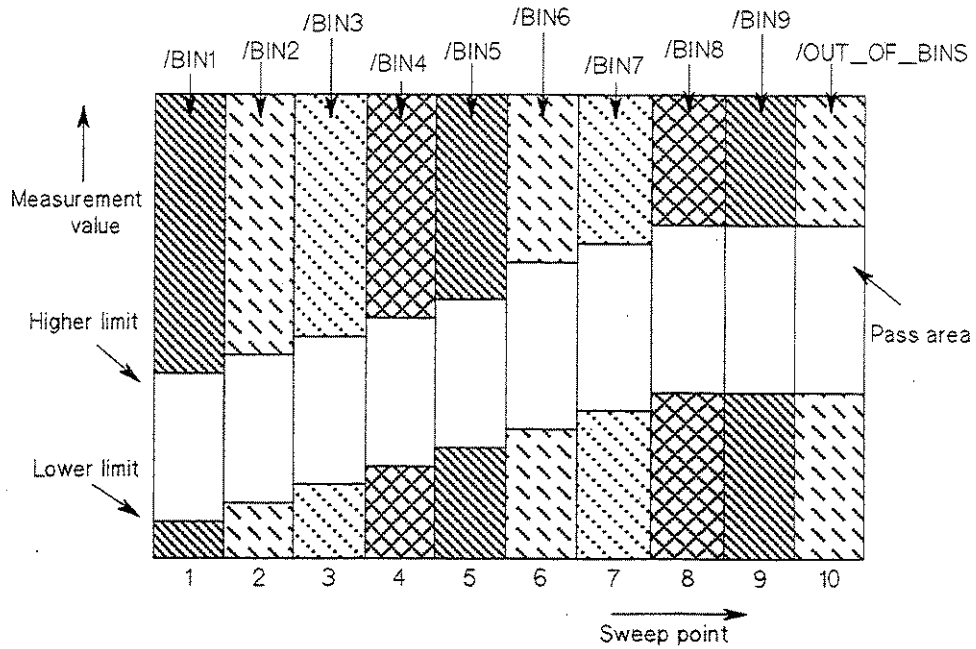

Figure 2-4. Signal Area Example  
( For The List Sweep Comparator Function )

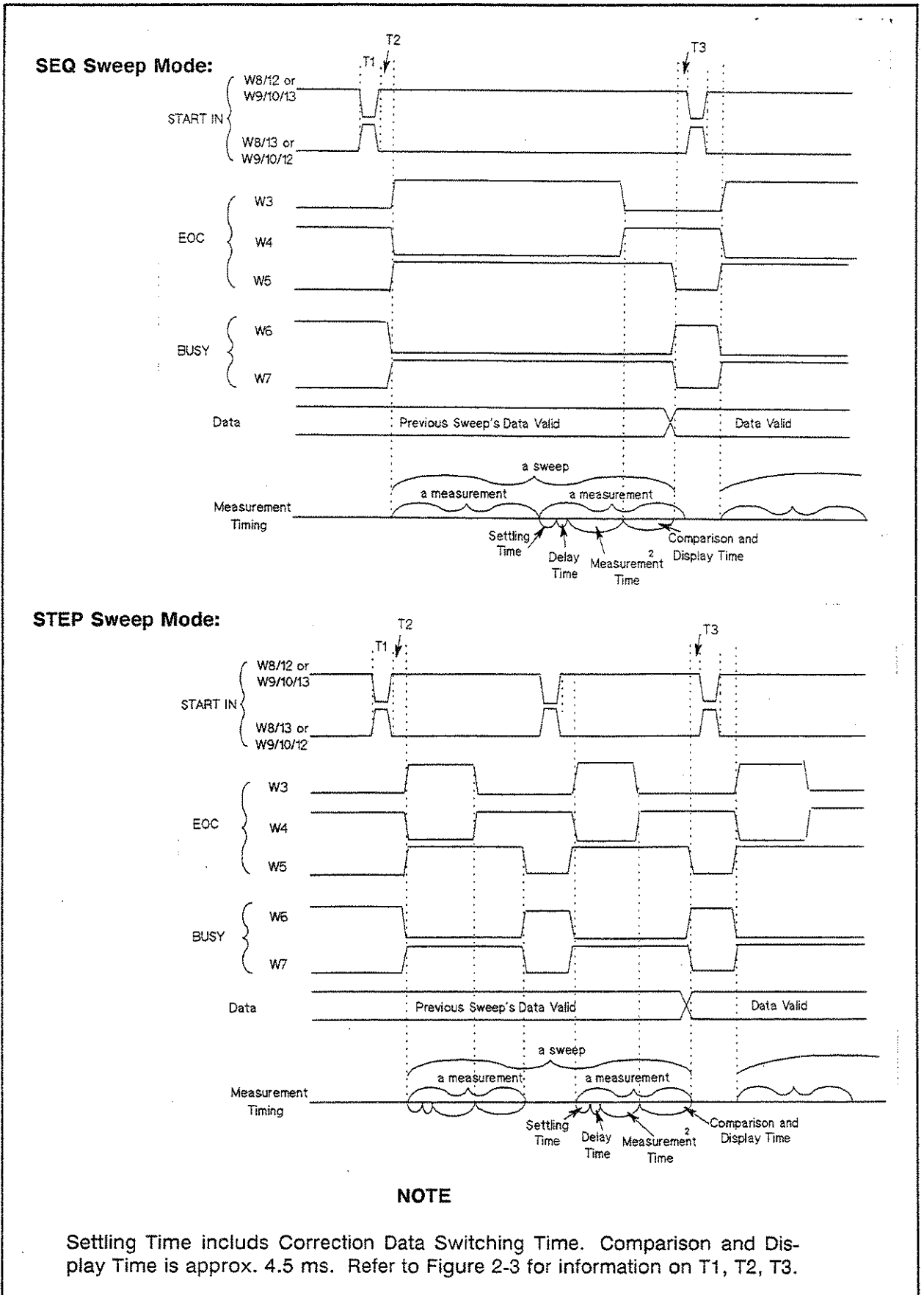

Figure 2-5. Timing Diagram for The List Sweep Comparator Function

## ELECTRICAL

**CHARACTERISTICS** As mentioned in a previous paragraph, some of the signal's represent different information when used for the comparator function and for the list sweep comparator function. However, the electrical characteristics of these signals are completely the same between the two operations. The following description applies when using both the comparator function and the list sweep comparator function.

### Opto-Isolated Outputs

The outputs from the HP 4284A are Opto-Isolated for added interfacing flexibility and to increase reliability by reducing noise pickup. Provisions have been made for mounting pull-up resistors connected to +5 V on board for systems using TTL logic levels, otherwise the supply voltage ( 24 V maximum ), and the pull-up resistors are located in the handler ( the combination of the pull-up resistor and the pull-up supply voltage used must result in a current through the opto-isolator of less than 80 mA ). The opto-isolator common supply path can be connected to or isolated from the HP 4284A's system ground with jumper W2. Installing jumper W2 connects the opto-isolator common to the HP 4284A's system ground.

Table 2-3. Electrical DC Characteristics of Opto-Isolated Outputs

Output Signals	Voltage Output Level		Maximum Current
	Low	High	
Binning Signals BIN0 - BIN10	$\leq 0.5 \text{ V}$	5 - 24 V <sup>1</sup>	80 mA
Control Signals EOC	$\leq 0.5 \text{ V}$	5 - 24 V <sup>1</sup>	80 mA
BUSY	$\leq 0.5 \text{ V}$	5 - 24 V <sup>1</sup>	80 mA

<sup>1</sup> Depends on the value of pull-up voltage used. The pull-up voltage on the handler interface board is +5 V, and up to 24 V can be used from an external source ( from the handler ).

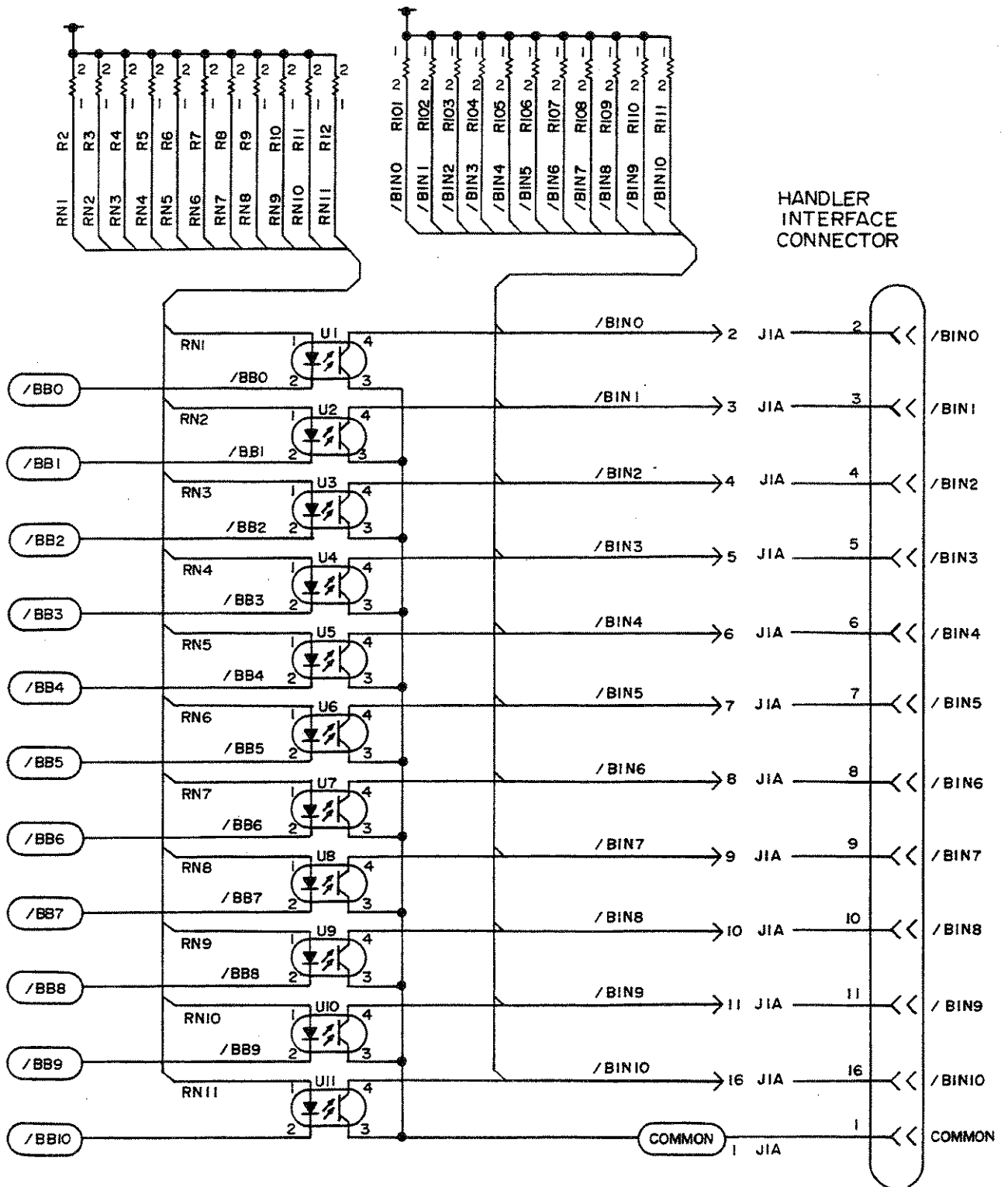

Figure 2-6. Simplified Binning Output Schematic

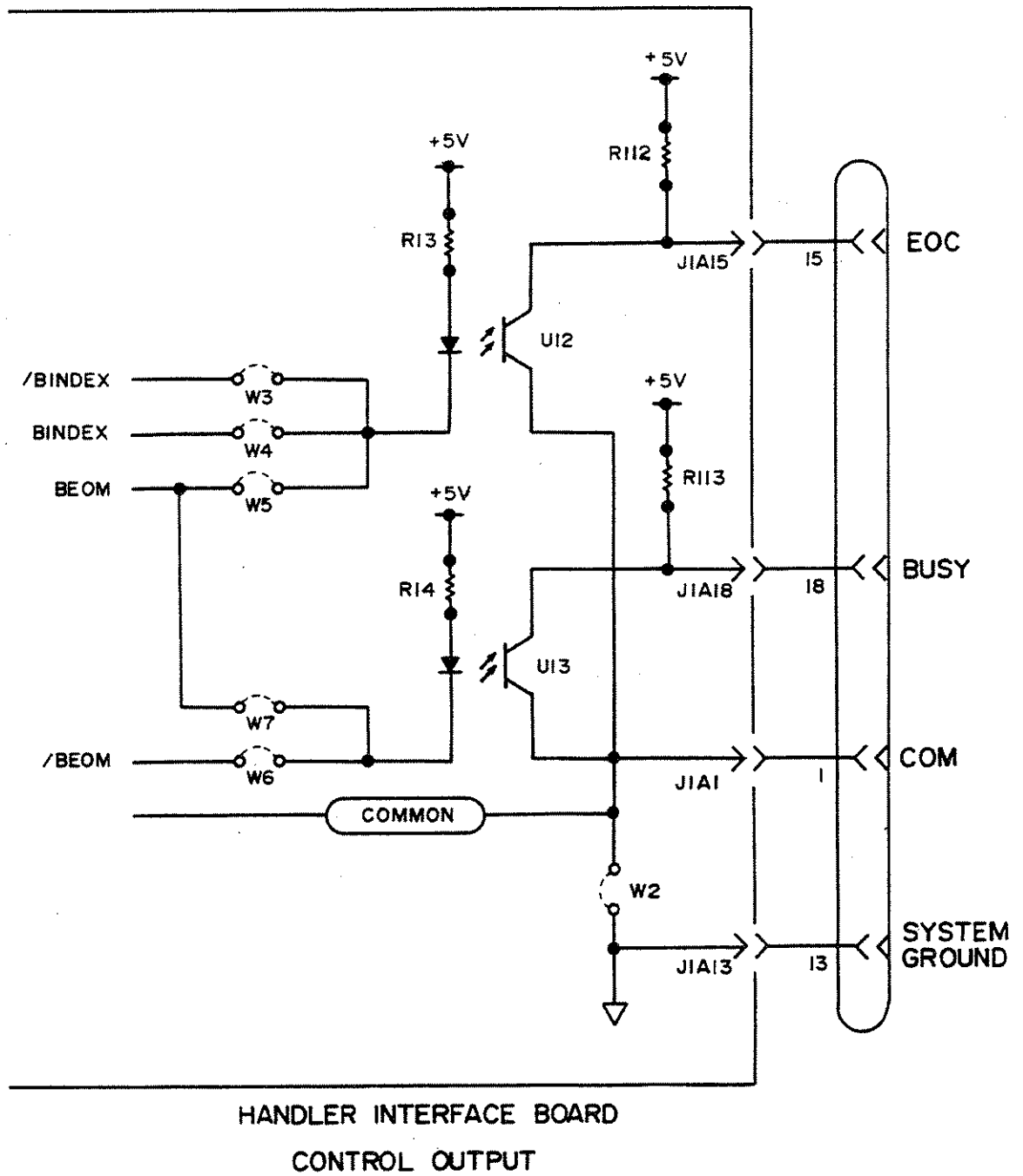

Figure 2-7. Simplified Control Output Schematic

### Opto-Isolated Input

The START IN input trigger signal can be opto-isolated by installing jumpers W9 and W10 while leaving jumper position W8 open. When this input is used as an opto-isolated input, it is current driven and requires 5 - 60 mA for proper operation. For TTL level trigger input signals, install jumper W8 and leave jumper positions W9 and W10 open.

Table 2-4. Typical Input Electrical Characteristics

Input Signal	Input Electrical Characteristics			
	Input Current		Input Voltage	
START IN (Opto-Isolated)	Low	High	2.0 V (Input Current= 5 mA)	
	0 - 250 $\mu$ A	5 - 60 mA <sup>2</sup>		
	Input Threshold Voltage		Input Current	
START IN <sup>1</sup> (TTL Level)	Low	High	Low	High
	0.8 V	1.6 V	-0.4 mA	20 $\mu$ A

<sup>1</sup> Schmitt-Trigger input, hysteresis = 0.8 V.

<sup>2</sup> Do not use less than 5 mA, the opto-isolator LED requires a minimum of 5 mA for proper operation.

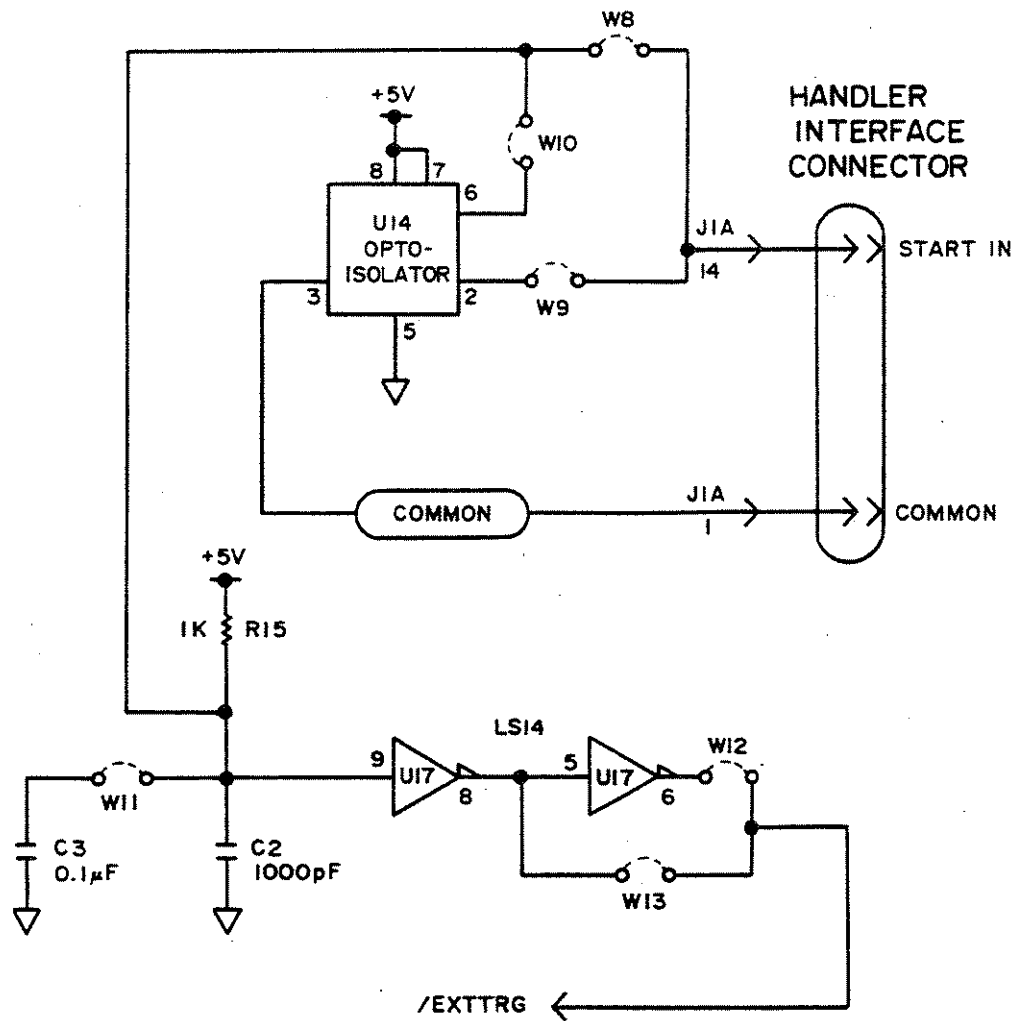

Figure 2-8. Handler Interface Input Schematic

---

## OPERATION

To use the handler interface, setup the comparator function or the list sweep comparator function, and set the handler interface to be enable to output/input signals. The followings are procedure to use the handler interface with the comparator function or the list sweep comparator function.

### Setting Procedure For Comparator Function

The followings are operation procedure to use the handler interface with the comparator function.

1. Setup the Handler Interface Board consists of installing jumpers and pull-up resistors as required for the handler. See **SECTION 3, SETTING UP THE HANDLER INTERFACE BOARD**.
2. Turn the HP 4284A ON.
3. Setup for the appropriate measurement conditions.
4. Press the **MEAS SETUP MENU** key, and the '**LIMIT TABLE**' softkey. The **LIMIT TABLE SETUP** page is displayed.
5. Setup a limit table for bin sorting (refer to the HP 4284A Operation Manual for details).
6. Move the cursor to the **COMP** field using the **CURSOR** arrow key. Then the following softkeys will be displayed on the softkey label area.
  - '**ON**' softkey
  - '**OFF**' softkey
7. Press the '**ON**' softkey to enable the comparator function.
8. Press the **CATALOG/SYSTEM MENU** key, and the '**SYSTEM CONFIG**' softkey. The **SYSTEM CONFIG** page is displayed.
9. Move the cursor to the **HANDLER I/F (#202)** field using the **CURSOR** arrow key. Then the following softkeys will be displayed on the softkey label area.
  - '**ON**' softkey
  - '**OFF**' softkey
10. Press the '**ON**' softkey. Then the handler interface can be used to output/input the signals.
11. Press the **DISPLAY FORMAT MENU** key. To perform measurement, select the '**MEAS DISP**', '**BIN No.**', or '**BIN COUNT**' softkey.



## NOTE

The Comparator function ON/OFF can be set on the **BIN No. DISPLAY** page.

### Setting procedure For List Sweep Comparator Function

The following are operation procedures for using handler interface with the list sweep comparator function.

1. Setup the Handler Interface Board consists of installing jumpers and pull-up resistors as required for the handler. See **SECTION 3, SETTING UP THE HANDLER INTERFACE BOARD**.
2. Turn the HP 4284A ON.
3. Setup for the appropriate measurement conditions.
4. Press the **MEAS SETUP MENU** key, and the **'LIST SETUP'** softkey. The **LIST SWEEP SETUP** page is displayed.
5. Setup a list table including sweep steps and high/low limits for the list sweep measurement (refer to the HP 4284A Operation Manual for details).
6. Press the **CATALOG/SYSTEM MENU** key, and the **'SYSTEM CONFIG'** softkey. The **SYSTEM CONFIG** page is displayed.
7. Move the cursor to the **HANDLER I/F (#202)** field using the **CURSOR** arrow key. Then the following softkeys will be displayed on the softkey label area.
  - **'ON'** softkey
  - **'OFF'** softkey
8. Press the **'ON'** softkey. Then the handler interface can be used to output/input the signals.
9. Press the **DISPLAY FORMAT MENU** key. To perform list sweep measurements, select the **'LIST SWEEP'** softkey.

## NOTES

## SETTING UP THE HANDLER INTERFACE BOARD

**INTRODUCTION**

This section provides information on how to setup the handler interface board to interface your handler. Setting up the handler interface board consists of installing jumpers and pull-up resistors as required.

**GENERAL CONFIGURATION**

Table 3-1 lists the jumpers and pull-up resistors to install for various handlers on the market, and Table 3-2 lists jumper definitions.

Table 3-1. Internal Jumper Settings

Handler	EOC	BUSY	START IN	+5, GND	Note
(standard)	W4	W6	W9, 10, 13		Default jumpers installed at the factory
PALOMAR M16	W5	W6	W8, 13	W1, 2	Mount 1.78 K $\Omega$ pull-up resistors at locations R101 - R113 for BIN 0 - BIN 10, EOC, and BUSY.
PALOMAR M11	W4	W6	W8, 12	W1, 2	MOUNT 1.78 K $\Omega$ pull-up resistors at locations R101 - R113 for BIN 0 - BIN 10, EOC, and BUSY.
Q Model RTR2	W4	W6	W9, 10, 13	W1, 2	
ISUMECA	W4	W6	W9, 10, 11 and W13		
EA Model 015	W4	W6	W9, 10, 12		

Table 3-2. Jumper Definitions

Jumper	Definition When Installed
W1	+5 V is supplied at pin 17.
W2	<b>COMMON</b> is connected to the system ground. When +5 V from the handler interface is used, this jumper must be installed.
W3	<b>EOC</b> is asserted <b>LOW</b> when the measurement is completed and the HP 4284A is ready for the next DUT.
W4	<b>EOC</b> is asserted <b>HIGH</b> when the measurement is completed and the HP 4284A is ready for the next DUT.
W5	<b>EOC</b> is asserted <b>LOW</b> while the measurement data and comparison results are invalid.
W6	<b>BUSY</b> is asserted <b>HIGH</b> while the measurement data and comparison results are invalid.
W7	<b>BUSY</b> is asserted <b>LOW</b> while the measurement data and comparison results are invalid.
W8	Sets the <b>START IN</b> input to operate at TTL levels. W9 and W10 must be left open.
W9, W10	Opto-isolates the <b>START IN</b> input, both W9 and W10 must have jumpers installed and W8 must be left open.
W11	Adds a 0.1 $\mu$ F capacitor to filter out noise on the <b>START IN</b> input.
W12	Sets the HP 4284A to trigger on the <b>falling edge</b> of the <b>START IN</b> input signal ( <b>Opto-Isolator</b> ).  Sets the HP 4284A to trigger on the <b>raising edge</b> of the <b>START IN</b> input signal ( <b>TTL</b> ).
W13	Sets the HP 4284A to trigger on the <b>raising edge</b> of the <b>START IN</b> input ( <b>Opto-Isolator</b> ).  Sets the HP 4284A to trigger on the <b>falling edge</b> of the <b>START IN</b> input signal ( <b>TTL</b> ).

## General Configuration Procedure

If you are using one of the handlers listed below perform steps 1 through 6 of the following general configuration procedure, and then go to page 3-7, **CONFIGURATION EXAMPLES** for your handler and install the pull-up resistors and jumpers as directed. Use the complete procedure to configure the Option 202 Handler Interface Board for a handler that is not listed.

- Palomar Model M16
- Palomar Model M11
- Q-Corporation RTR2
- Isumeca 83
- EA Model M015

Figure 3-1 shows the location of the handler interface board in the HP 4284A, Figure 3-2 shows the locations of the pull-up resistors on the handler interface board, and Figure 3-3 shows the locations of the handler interface jumpers.

1. Disconnect the HP 4284A's power cord and allow enough time ( a few minutes ) for the internal supply filter capacitors to discharge.

**WARNING**

**DANGEROUS ENERGY/VOLTAGE EXISTS WHEN 4284A IS IN OPERATION AND JUST AFTER IT IS POWERED DOWN. ALLOW A FEW MINUTES FOR THE INTERNAL CAPACITORS TO DISCHARGE.**

2. Disconnect the two rear feet which lock the top cover and rear panel together.
3. Fully loosen the top cover retaining screws located at the rear of the top panel.
4. Slide the top cover towards the rear and lift it off to expose the top shield plate.
5. Remove the top shield plate to gain access to the PC boards.
6. Disconnect the flat cable connected to the handler interface board which has Brown and Orange extractors, as shown in Figure 3-1.

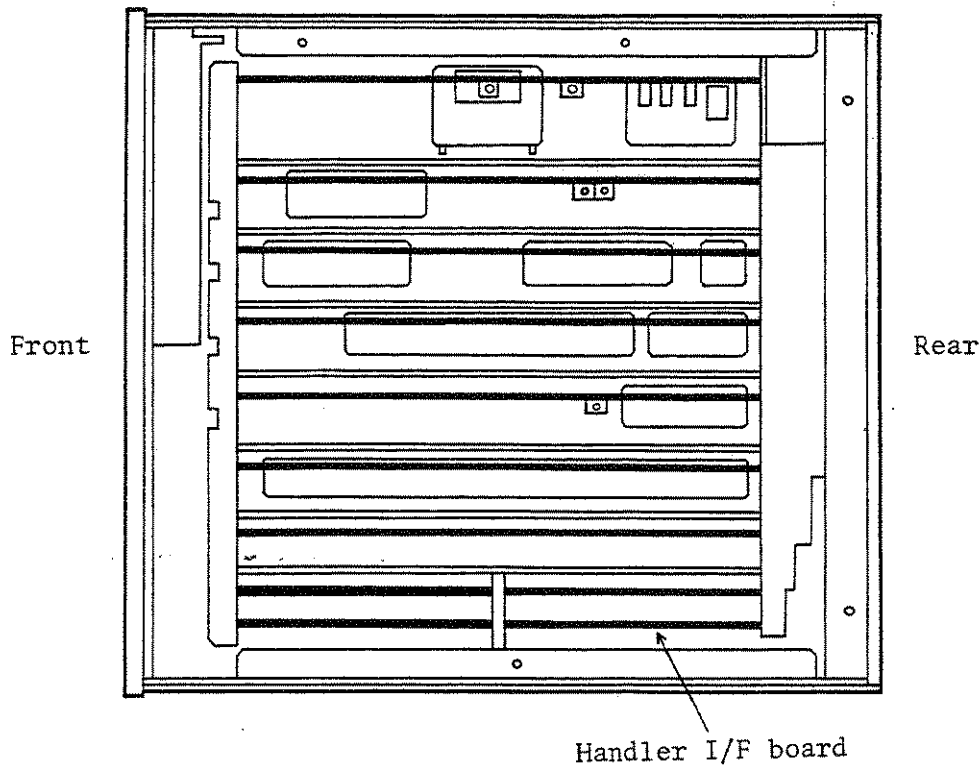

Figure 3-1. Handler Interface Board Location

### 3-4 SETTING UP THE HANDLER INTERFACE BOARD

7. If the comparison output signals are TTL levels signals and if these signals are not pulled up by the handler, determine the pull-up resistor value ( 1.78 K $\Omega$  is recommended ) and referring to Figure 3-2 for the locations of the BIN pull-up resistors, install the pull-up resistors.
8. If the control outputs ( EOC, BUSY ) are to be TTL level signals and if these signals are not pulled up by the handler, determine the pull-up resistor value ( 1.78 K $\Omega$  is recommended ) and referring to Figure 3-2 for the locations of R112 ( EOC ) and R113 ( BUSY ), install the pull-up resistors.

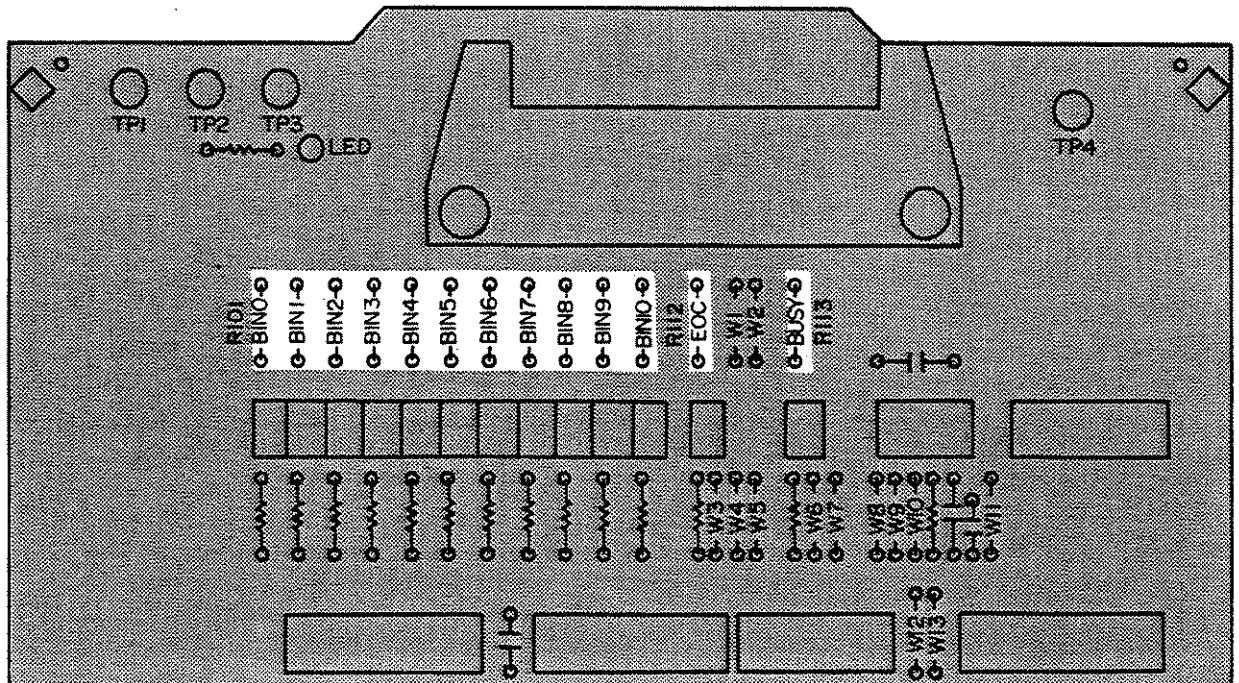

Figure 3-2. Pull-Up Resistor Locations

9. Refer to Table 3-2 to determine which jumpers to install to configure the EOC and BUSY outputs.
10. Use Figure 3-3 to locate the location of the required jumpers and install the jumpers.
11. Refer to Table 3-2 to determine the jumpers required to configure the START IN input.
12. Use Figure 3-3 to find the location of the required jumpers and install the jumpers.

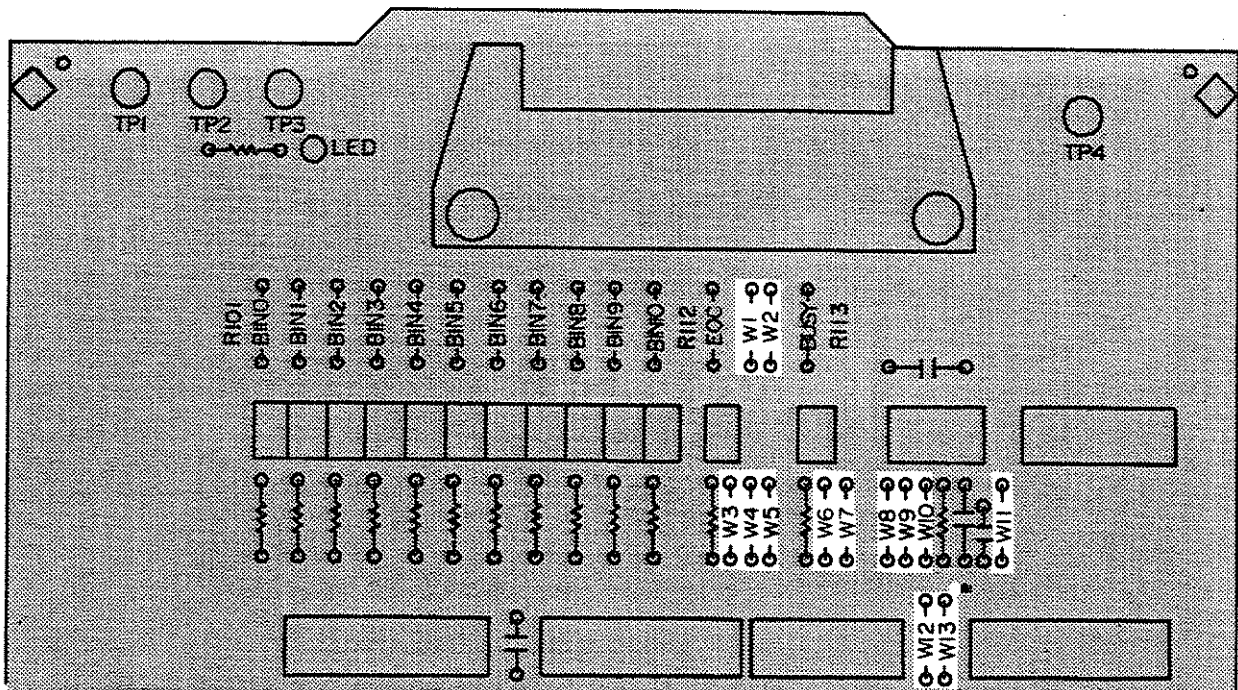

Figure 3-3. Configuration Jumper Locations

13. Install the configured handler interface board into the HP 4284A.
14. Replace the top shield plate, rear feet, and top cover.



## CONFIGURATION EXAMPLES

Setup example information consisting of handler interface board configuration, timing diagrams, list of signals used, logic levels used, and other special information pertaining to the handler under discussion will now be given. Setup examples are given for the following handlers:

- Standard Configuration (default setting)
- Palomar Model M16
- Palomar Model M11
- Q-Corporation RTR2
- Isumeca 83
- EA Model M015

### Standard Configuration

The default setting is the standard configuration of the Option 202 handler interface board as it is shipped from the factory. The timing for the default setup is shown in Figure 3-4 for reference.

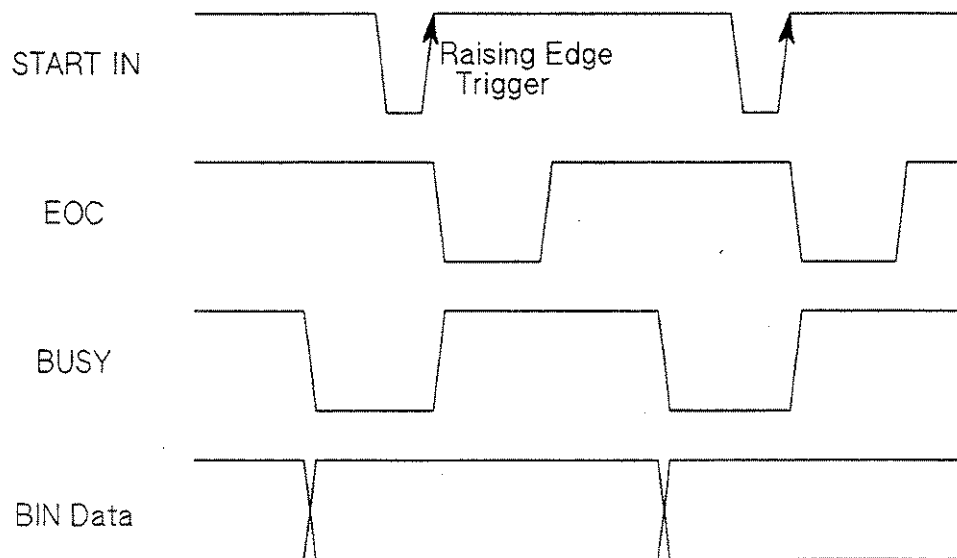

Figure 3-4. Timing for Standard Configuration  
(Used with The Comparator Function)

### Standard Configuration Procedure:

1. Perform steps 1 through 6 of the **General Configuration Procedure** on page 3-3.
2. Configure the following interface signals by installing the jumpers as shown in Figure 3-5.

**START IN**    Install jumper at W9, W10 and W13  
**BUSY**        Install jumper at W6  
**EOC**         Install jumper at W4

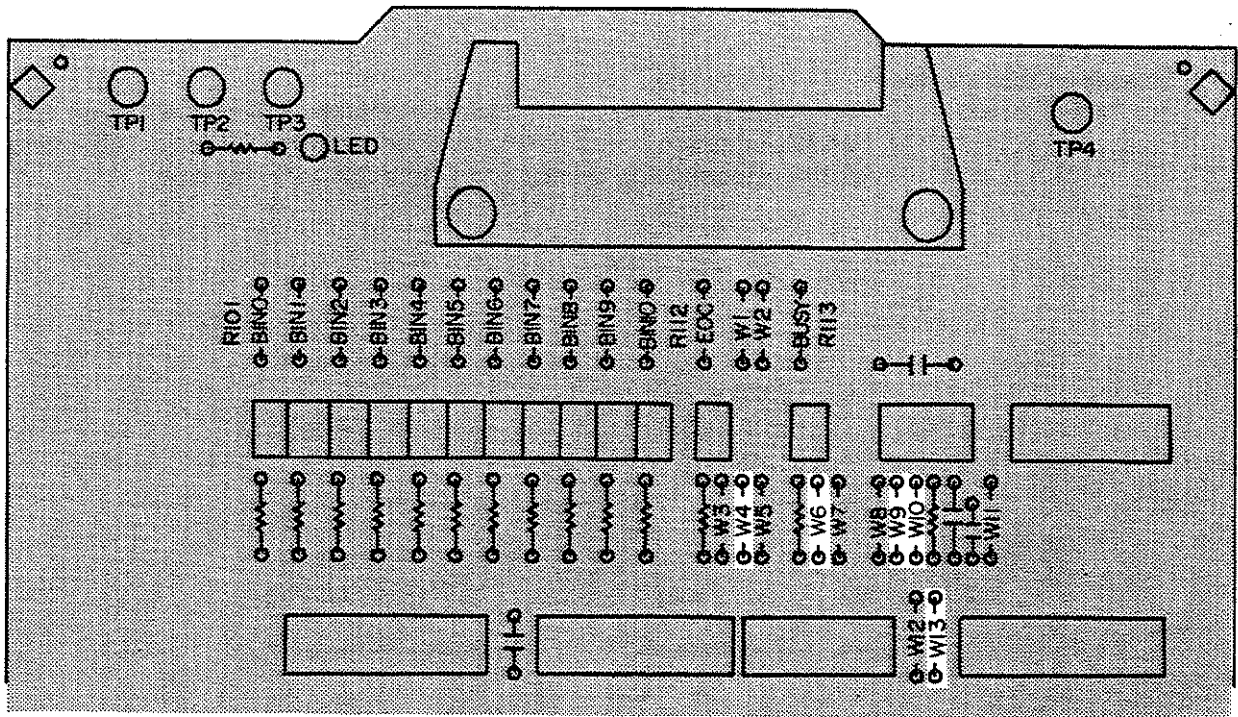

Figure 3-5. Jumper and Pull-Up Resistor Locations for Standard Configuration

3. Install the configured handler interface board into the HP 4284A.
4. Replace the top shield plate, rear feet, and top cover.

**Palomar Model M16**

The Palomar M16 timing diagram is shown in Figure 3-6 for reference.

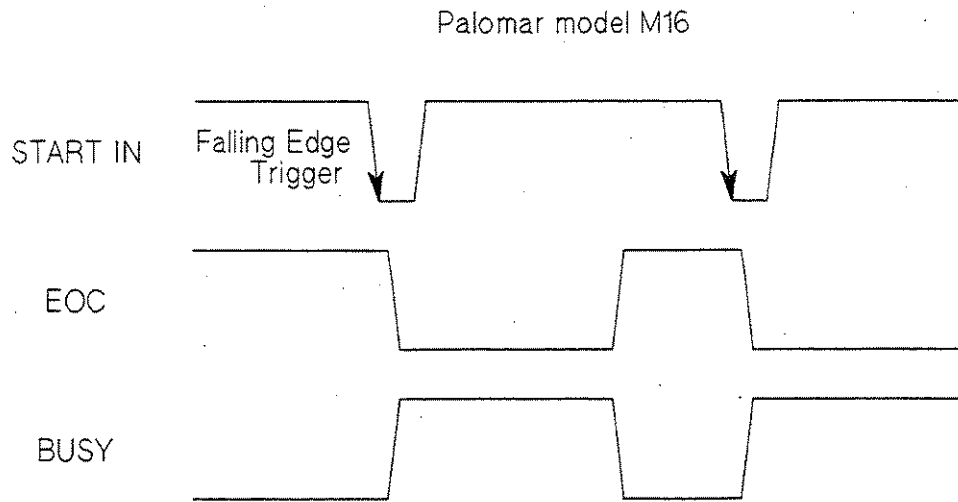

Figure 3-6. Palomar M16 Timing  
(Used with The Comparator Function)

### Palomar M16 Configuration Procedure:

1. Perform steps 1 through 6 of the **General Configuration Procedure** on page 3-3.
2. Configure the following interface signals by installing the jumpers as shown in Figure 3-7.

**START IN**    Install jumper at W8 and W13  
**BUSY**        Install jumper at W6  
**EOC**         Install jumper at W5

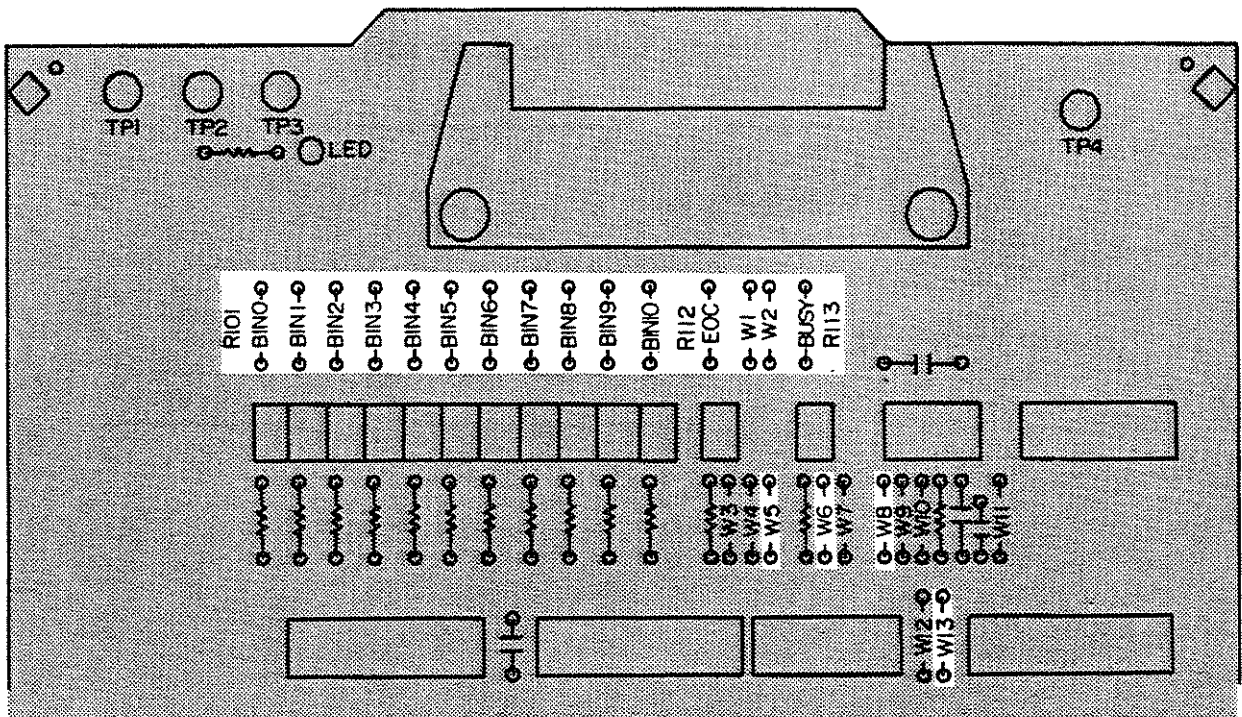

Figure 3-7. Palomar M16 Jumper and Pull-Up Resistor Locations

3. All I/O signals are TTL level so you must install all pull-up resistors to +5 V (install pull-up resistors R101 - R113). Refer to Figure 3-7 for the pull-up resistor locations.
4. Bring +5 V out through pins 12 and 17 of the handler interface rear panel connector (install a jumper at W1 for +5 V and at W2 for the COMMON connection). Refer to Figure 3-7 for the locations of W1 and W2.
5. Install the configured handler interface board into the HP 4284A.
6. Replace the top shield plate, rear feet, and top cover.

**Palomar Model M11**

The Palomar M11 timing diagram is shown in Figure 3-8 for reference.

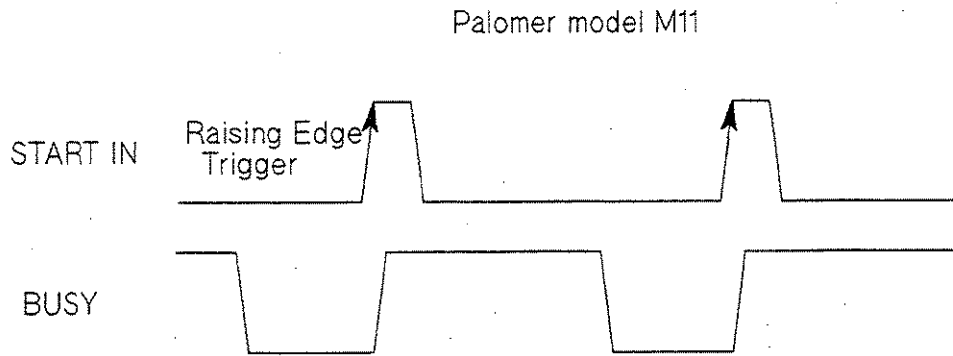

Figure 3-8. Palomar M11 I/O Timing  
(Used with The Comparator Function)

### Palomar M11 Configuration Procedure:

1. Perform steps 1 through 6 of the **General Configuration Procedure** on page 3-3.
2. Configure the following interface signals by installing the jumpers as shown in Figure 3-9.

<b>START IN</b>	Install jumper at W8 and W12
<b>BUSY</b>	Install jumper at W6
<b>EOC</b>	Install jumper at W4

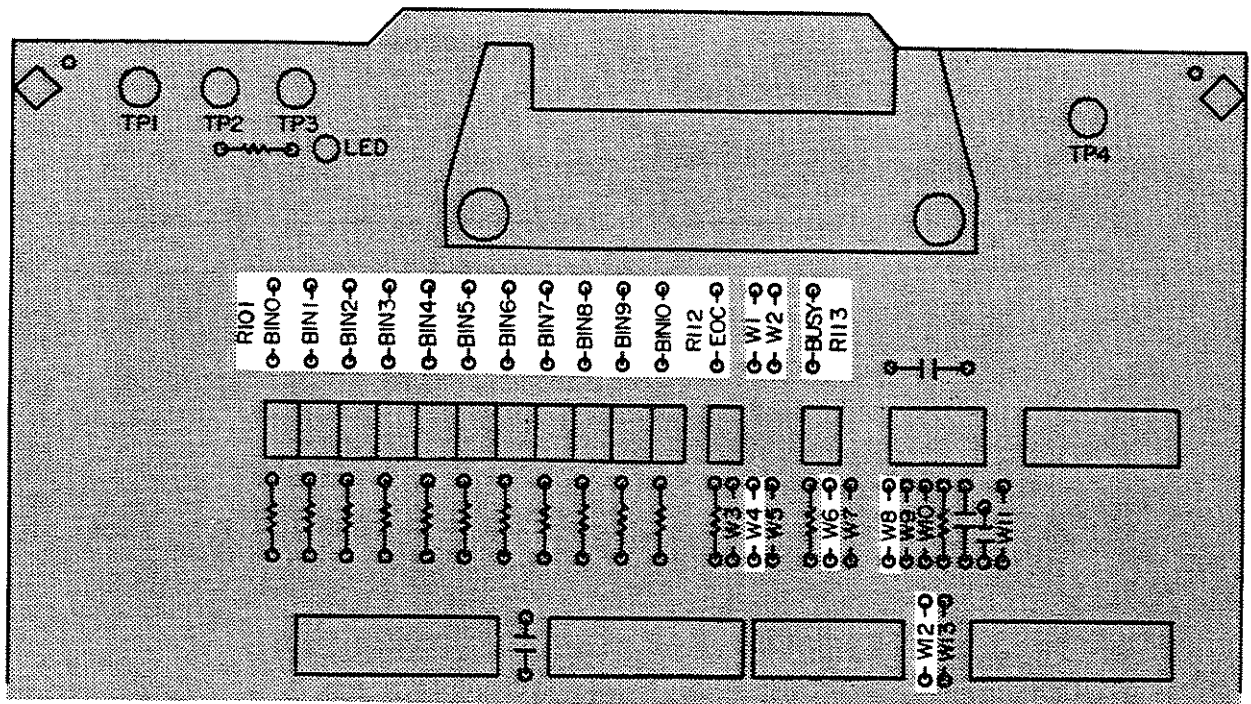

Figure 3-9. Palomar M11 Jumper and Pull-up Resistor Locations

3. All I/O signals are TTL level so you must install all pull-up resistors to +5 V (install pull-up resistors R101 - R113). Refer to Figure 3-9 for the pull-up resistor locations.
4. Bring + 5V out through pins 12 and 17 of the handler interface rear panel connector (install a jumper at W1 for +5 V and at W2 for the COMMON connection). Refer to Figure 3-9 for the locations of W1 and W2.
5. Install the configured handler interface board into the HP 4284A.
6. Replace the top shield plate, rear feet, and top cover.

**Q-Corporation RTR2** The RTR2 timing diagram is shown in Figure 3-10 for reference.

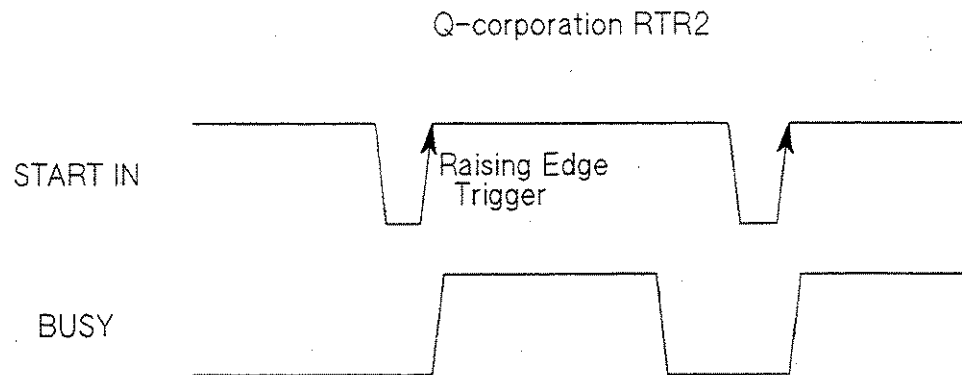

Figure 3-10. RTR2 I/O Timing  
(Used with The Comparator Function)

### Q-Corporation RTR2 Configuration Procedure:

1. Perform steps 1 through 6 of the **General Configuration Procedure** on page 3-3.
2. Configure the following interface signals by installing the jumpers as shown in Figure 3-11.

**START IN**    Install jumper at W9, W10, and W13  
**BUSY**        Install jumper at W6  
**EOC**         Install jumper at W4

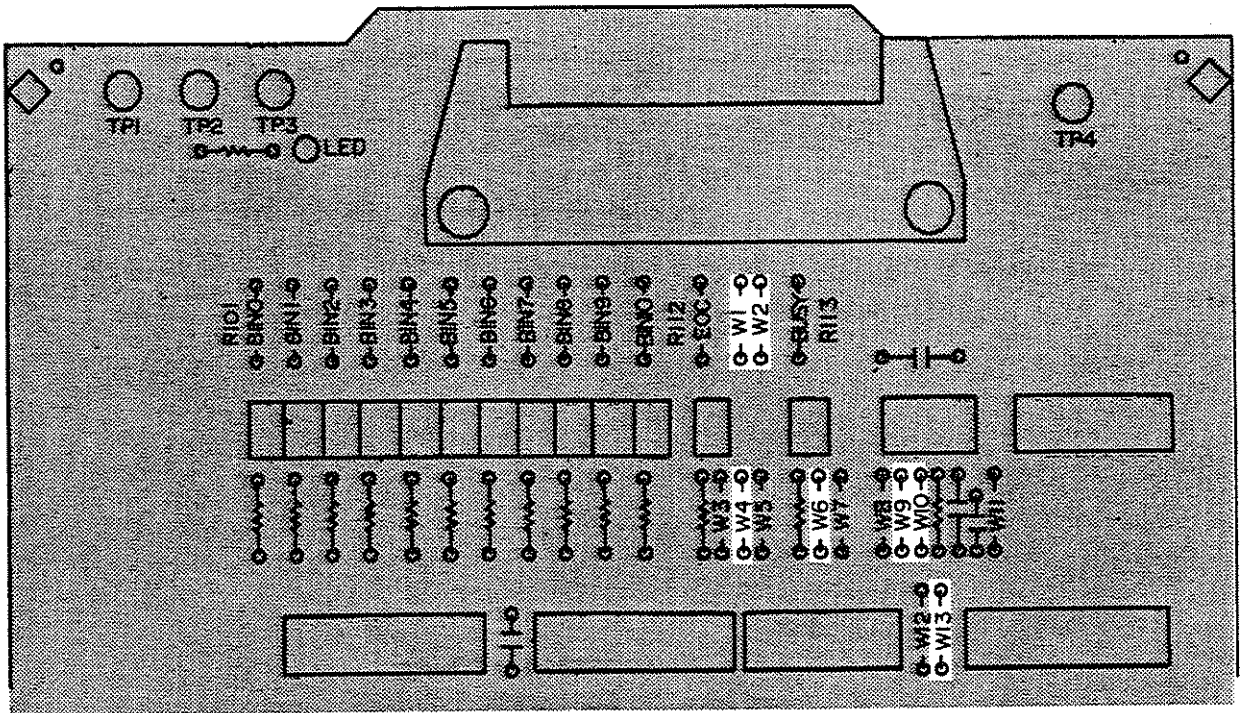

Figure 3-11. RTR2 Jumper and Pull-Up Resistor Locations

3. Bring +5 V out through pins 12 and 17 of the handler interface rear panel connector ( install a jumper at W1 for +5 V and at W2 for the COMMON connection ). Refer to Figure 3-11 for the locations of W1 and W2.
4. Install the configured handler interface board into the HP 4284A.
5. Replace the top shield plate, rear feet, and top cover.



Isumeca 83

The Isumeca 83 timing diagram is shown in Figure 3-12 for reference.

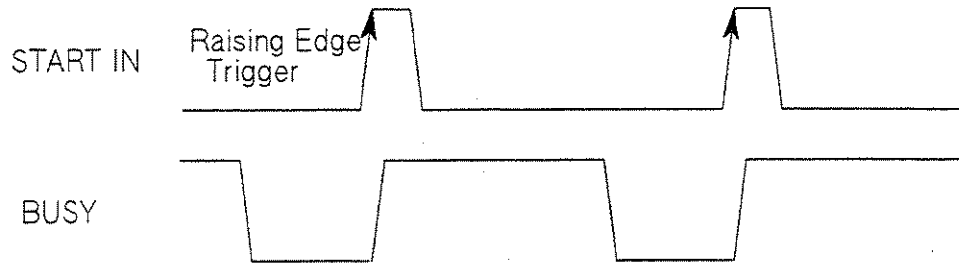

Figure 3-12. Isumeca 83 I/O Timing  
(Used with The Comparator Function)

### Isumeca 83 Configuration Procedure:

1. Perform steps 1 through 6 of the **General Configuration Procedure** on page 3-3.
2. Configure the following interface signals by installing the jumpers as shown in Figure 3-13.

<b>START IN</b>	Install jumper at W9, W10, W11, and W13
<b>BUSY</b>	Install jumper at W6
<b>EOC</b>	Install jumper at W4

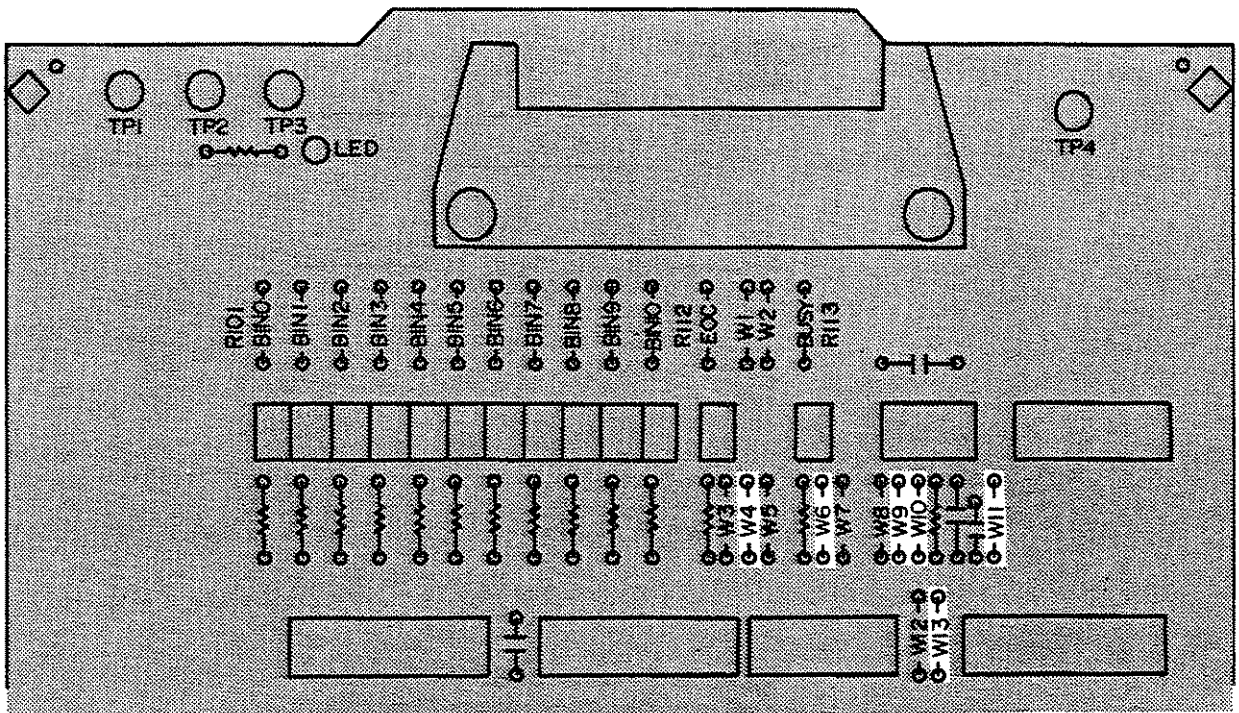

Figure 3-13. Isumeca 83 Jumper and Pull-Up Resistor Locations

3. Install the configured handler interface board into the HP 4284A.
4. Replace the top shield plate, rear feet, and top cover.

**EA Model M015**

The M015 timing diagram is shown in Figure 3-14 for reference.

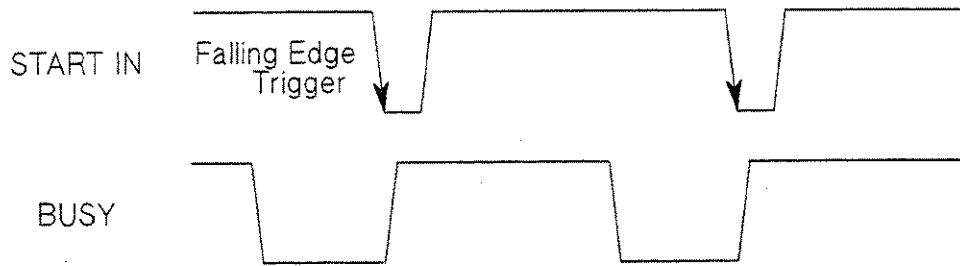

Figure 3-14. EA M015 I/O Timing  
(Used with The Comparator Function)

**EA Model M015 Configuration Procedure:**

1. Perform steps 1 through 6 of the **General Configuration Procedure** on page 3-3.
2. Configure the following interface signals by installing the jumpers as shown in Figure 3-15.

**START IN**    Install jumper at W9, W10, and W12  
**BUSY**        Install jumper at W6  
**EOC**         Install jumper at W4

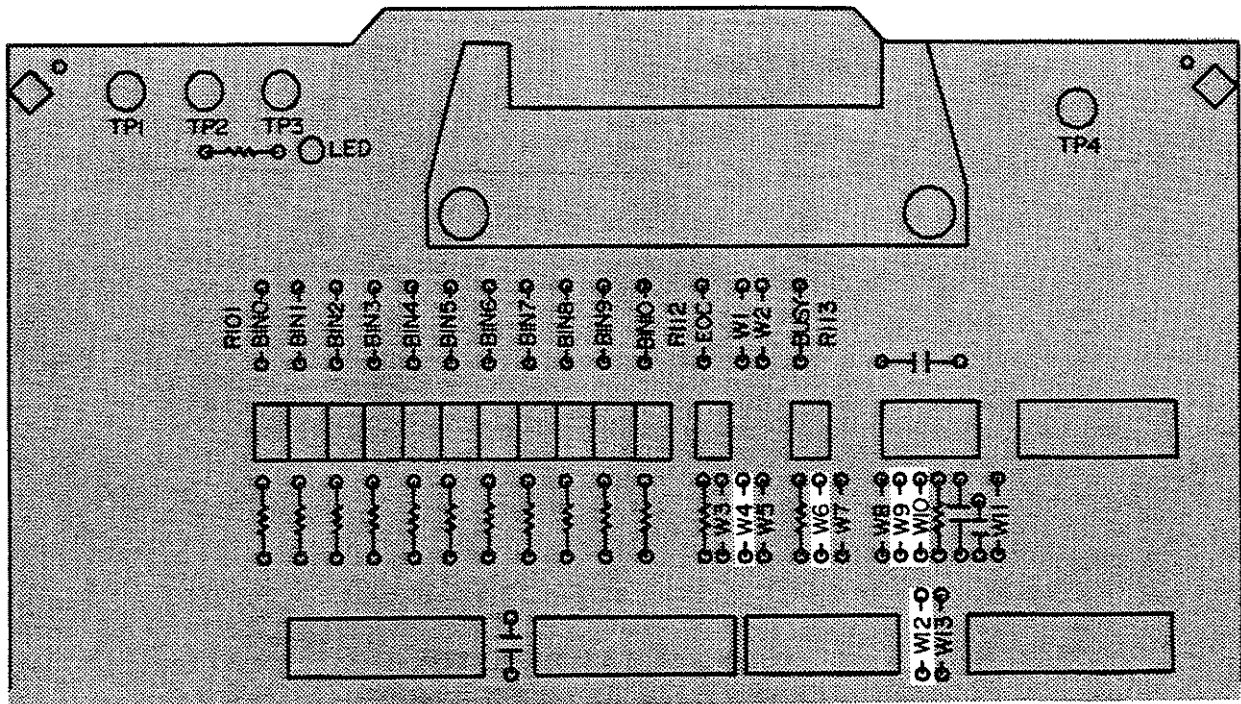

Figure 3-15. EA M015 Jumper and Pull-Up Resistor Locations

3. Install the configured handler interface board into the HP 4284A.
4. Replace the top shield plate, rear feet, and top cover.

**MODEL 4284A**  
**PRECISION LCR METER**  
**OPTION 301**  
**SCANNER INTERFACE**

© COPYRIGHT: YOKOGAWA-HEWLETT-PACKARD, LTD., 1988  
9-1, TAKAKURA-CHO, HACHIOJI-SHI, TOKYO, JAPAN

Printed: December 1988



# TABLE OF CONTENTS

---

## SECTION 1:

### GENERAL INFORMATION

INTRODUCTION	1-1
DESCRIPTION	1-1
SPECIFICATIONS	1-2

---

## SECTION 2:

### INTERFACE SIGNAL DEFINITION

INTRODUCTION	2-1
SCANNER INTERFACE SIGNAL INPUT/OUTPUT CONNECTOR	2-1
Channel Selection Input Signals	2-1
Control Output Signals	2-1
Control Input Signals	2-2
ELECTRICAL CHARACTERISTICS	2-8
Channel Selection Input Signals (Optocoupled)	2-8
External Trigger Input Signals (Optocoupled)	2-8
Control Output Signals (Optocoupled)	2-10
SETTING UP THE SCANNER INTERFACE BOARD	2-11

---

## SECTION 3:

### OPERATION

INTRODUCTION	3-1
BASIC PROCEDURE	3-1
ACTIVATING SCANNER INTERFACE	3-3
CORRECTION MODE	3-4
TEST FREQUENCY AND REFERENCE VALUE ENTRY	3-5
CORRECTION DATA SELECTION	3-6
Channel Selection Using Interface Connector	3-6
Channel Selection Using HP-IB	3-7
Monitoring Current Channel	3-7
CORRECTION DATA MEASUREMENTS	3-8
ACTIVATING THE CORRECTION FUNCTION	3-9
CORRECTION DATA CONFIRMATION	3-10

## GENERAL INFORMATION

### INTRODUCTION

This operation note provides the information necessary to use the HP 4284A Precision LCR Meter Option 301 Scanner Interface. Refer to the HP 4284A Operation Manual for specific HP 4284A operating procedures.

### DESCRIPTION

When the HP 4284A is used with the Option 301 Scanner Interface, up to 128 sets of correction measurement data (OPEN, SHORT and LOAD) for up to 3 user defined frequencies can be stored and used. These 128 sets of correction data can be used for each measurement using the multi correction function (modeled in Figure 1-1). The HP 4284A can correct for stray admittance, residual impedance, and other errors for each channel from the calibration plane (depends on the CABLE LENGTH selected) to the connection contacts at the device.

Option 301 uses an Amphenol 14-pin connector to interface between the HP 4284A and the scanner. Therefore an Option 301 HP 4284A can accurately measure impedance values without any degradation of repeatability, or differences between channels. Timing synchronization is also provided.

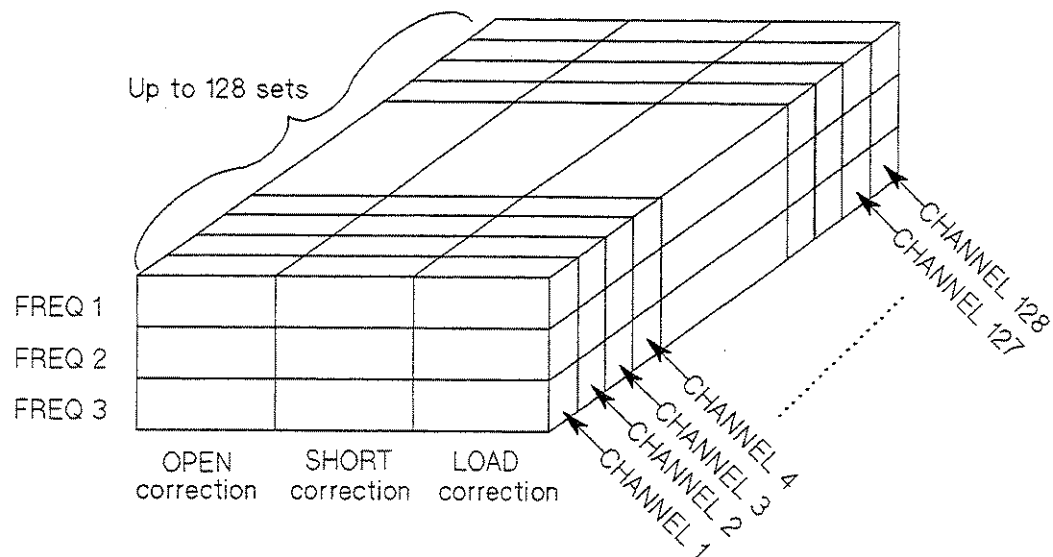

Figure 1-1. Multi Correction Data Memory Model

## SPECIFICATIONS

Table 1-1 and 1-2 list the HP 4284A Option 301 specifications and supplemental performance characteristics. Other specifications are the same as those for a standard HP 4284A.

Table 1-1. Specifications

Interface Connector:	Amphenol 14-pin connector
Maximum Number of Channels:	128
Output signal:	
/INDEX:	Analog measurement complete (1 bit).
/EOM:	Full measurement complete (1 bit).
Input Signal:	
/CH0 to /CH7:	8-bit parallel input signals for selecting the channel.
/CH_VALID:	Signal valid or invalid for /CH0 to /CH7
EXT_TRIG:	External trigger signal (1 bit).
Multi-Channel Correction:	The multi channel correction function can store OPEN, SHORT, LOAD correction data for each channel independently and correct each channel. The correction data at 3 test frequencies can be taken and stored in non-volatile memory.



Table 1-2. Supplemental Performance Characteristics

Electrical Characteristics:

(1) Input Signal Characteristics: Opto-isolated, negative true

Signal Name	Input Voltage Rate		External Pull-up Voltage	Input Current
	High	Low		
CH0 to CH7 /CH_VALID	Pull-up Voltage	≤1 V	5 to 15 V	5 to 20 mA
EXT_TRIG	Pull-up Voltage	≤1 V	5 to 15 V	6.3 to 15 mA

(2) Output Signal Characteristics: Opto-isolated, negative true

Signal Name	External Pull-Up Voltage	Maximum Current
/INDEX, /EOM	Max. 15 V	6 mA

Measurement Time:

Correction Data Switching Time:

Measurement frequency is equal to FREQ 1 <sup>1</sup> :	approx. 3.6 ms
Measurement frequency is equal to FREQ 2 <sup>1</sup> :	approx. 4.0 ms
Measurement frequency is equal to FREQ 3 <sup>1</sup> :	approx. 4.8 ms
Measurement frequency is not equal to FREQ 1/2/3 <sup>1</sup> (correction not performed):	approx. 3.0 ms

When multi-channel correction is performed, correction data switching times are added to the measurement time.

<sup>1</sup>: Correction frequency

## NOTES

## INTERFACE SIGNAL DEFINITION

---

### INTRODUCTION

This section provides information necessary to use the Option 301 Scanner Interface, including description of the interface signal lines and their electrical characteristics.

---

### SCANNER INTERFACE SIGNAL INPUT/OUTPUT CONNECTOR

The scanner interface I/O connector, a standard 14-contact female Amphenol connector, is mounted on the HP 4284A's rear panel for interconnection between the HP 4284A and your scanner. The scanner interface I/O signals are divided into three types as follows.

#### Channel Selection Input Signals

These signals are used to select the correction data which corresponds to the channel number of the scanner.

- /CH0 to /CH7      Channel Selection ( 8-bit binary input )
- /CH\_VALID        Channel Valid

#### Control Output Signals

These signals are used to control the timing between the HP 4284A and the scanner.

- /INDEX            Analog measurement complete
- /EOM             End of measurement (measurement data valid)

Assertion timing for /INDEX and /EOM is different for normal measurements and sweep measurements.

#### [Normal Measurement Timing]

/INDEX is asserted when an analog measurement is complete and the HP 4284A is ready for the next DUT to be connected to the UNKNOWN terminals. /EOM is asserted when the measurement data and the comparison results are valid. (See Figure 2-2)

**[List Sweep Measurement Timing]**

- In the SEQ mode:  
/INDEX is asserted when the last analog measurement of a sweep measurement is completed, and /EOM is asserted when the measurement results are valid after a sweep measurement is completed.
- In the STEP mode:  
/INDEX is asserted when each analog measurement of a sweep measurement is completed, and /EOM is asserted when each step measurement, including comparison time, is completed.

**Control Input Signal**

This signal triggers the HP 4284A on the rising edge of a pulse when the trigger mode is set to the EXT\_TRIG.

- EXT\_TRIG      External Trigger

**NOTE**

The / ( back slash ) in the signal name means that the signal is asserted when low.

The scanner interface I/O connector pin assignments are shown in Figure 2-1, and the contact assignments and a brief description of each are given in Table 2-1.

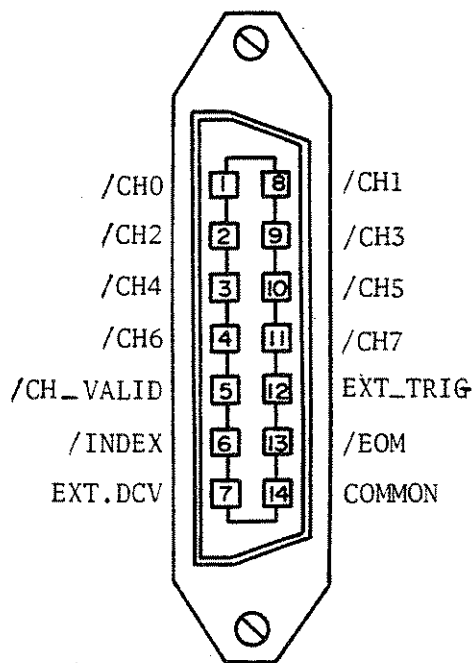

Figure 2-1. Control Assignments

**2-2 INTERFACE SIGNAL DEFINITION**

Table 2-1. Contact Assignments

Pin No.	Signal Name	Description
1 2 3 4	/CH0 /CH2 /CH4 /CH6	Channel Selection Signals ( Input )
5	/CH_VALID	Channel Valid Signal ( Input Signal ). This signal makes the channel selection signals valid or invalid.
6	/INDEX <sup>1</sup>	Analog Measurement Complete Signal (Output). /INDEX is asserted when a measurement is completed and the HP 4284A is ready for the next DUT to be connected to the <b>UNKNOWN</b> terminals. The measurement data is not valid until /EOM is asserted.
7	EXT.DCV	External DC voltage.
8 9 10 11	/CH1 /CH3 /CH5 /CH7	Channel Selection Signal (Input)
12	EXT.TRIG	External Trigger Signal (Input).
13	/EOM <sup>1</sup>	End of Measurement Signal (Output). This signal is asserted when the measurement is completed and the measurement data and comparison results are valid.
14	COMMON	Common for EXT.DCV.

<sup>1</sup> Assertion timing for these signals is different for normal measurements and list sweep measurements. Refer to Figure 2-3.

The scanner system will operate more efficiently when the input/output control signals are used as follows.

1. Set the scanner channel CHANNEL 0, the first scanner channel.
2. Set the channel selection signals (/CH0 to /CH7) and the channel valid signal (/CH\_VALID ) to compensate CHANNEL 0.
3. Trigger the HP 4284A with a trigger pulse input through the scanner input/output connector on the rear panel. The HP 4284A will acknowledge the channel number as CHANNEL 0, and then measure the device connected to scanner channel 0 using the correction data for channel 0.
4. Disassert /CH\_VALID after disasserting /INDEX.
5. Set the scanner channel, channel selection signals, and the channel valid signal to the next channel to be measured when /INDEX is asserted
6. After /EOM is asserted the HP 4284A is ready to make the next measurement.
7. Repeat steps 4 through 6.

The timing chart for the preceding procedure is shown in Figure 2-2.

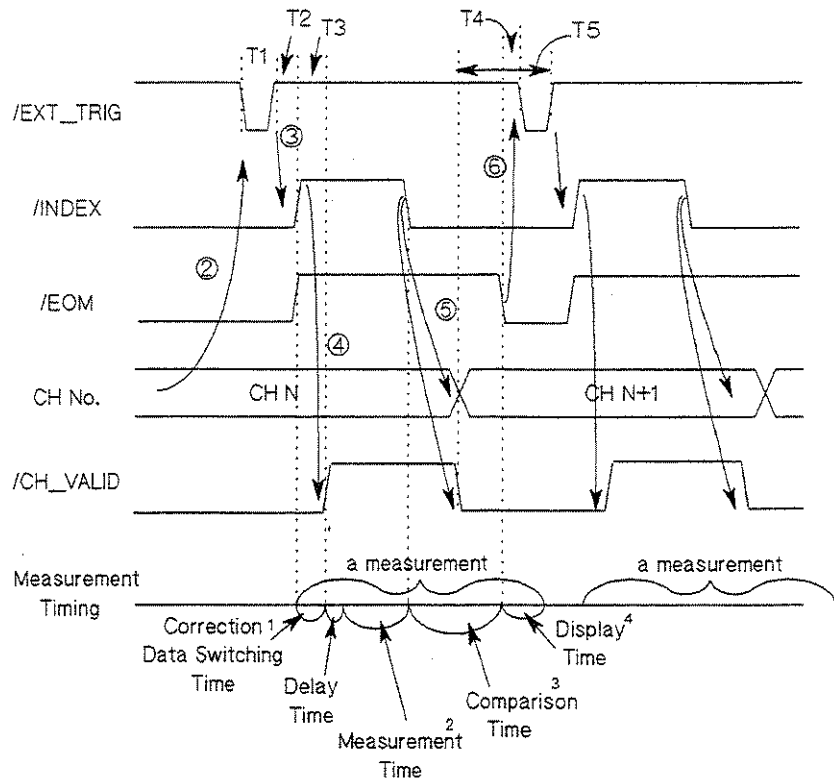

Time	Description	Minimum	Maximum
T1	Trigger Pulse Width	1 $\mu$ s	--
T2	Measurement Start Delay Time	200 $\mu$ s	Display Time <sup>4</sup> + 200 $\mu$ s
T3	/CH_VALID Wait Time After Measurement Start	0 ns	--
T4	Wait Time After /EOM Output	0 $\mu$ s	--
T5	/CH_VALID Pulse Width	50 $\mu$ s	--

<sup>1</sup> Refer to Table 1-2.

<sup>2</sup> Refer to the HP 4284A Operation Manual.

<sup>3</sup> Typical comparison time is approximately 1 ms.

<sup>4</sup> Typical display time for each display format is as follows.

MEAS DISPLAY page	approx. 8 ms
BIN No.DISPLAY page	approx. 5 ms
BIN COUNT DISPLAY page	approx. 0.5 ms

Figure 2-2. Timing Chart (for Normal Measurements)

**SEQ Sweep Mode:**

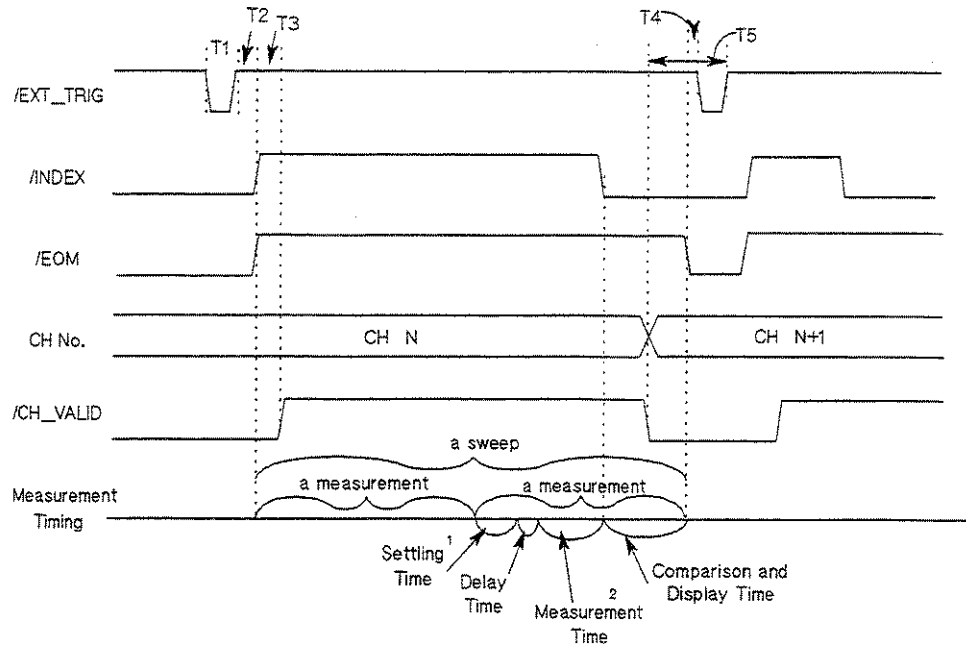

**STEP Sweep Mode:**

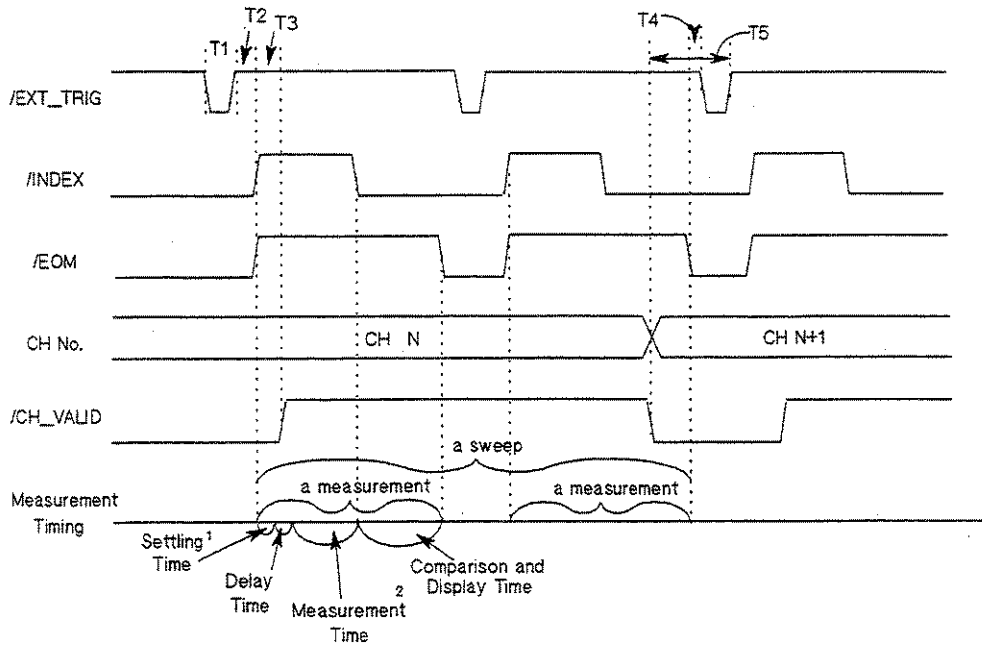

**NOTE**

Settling Time includes Correction Data Switching Time (refer to Table 1-2). Comparison and Display Time is approx. 4.5 ms. Refer to Figure 2-2 for information on T1, T2, T3, T4 and T5.

Figure 2-3. Timing Diagram (for List Sweep Measurements)



The scanner system setup for the preceding procedure is shown in Figure 2-4.

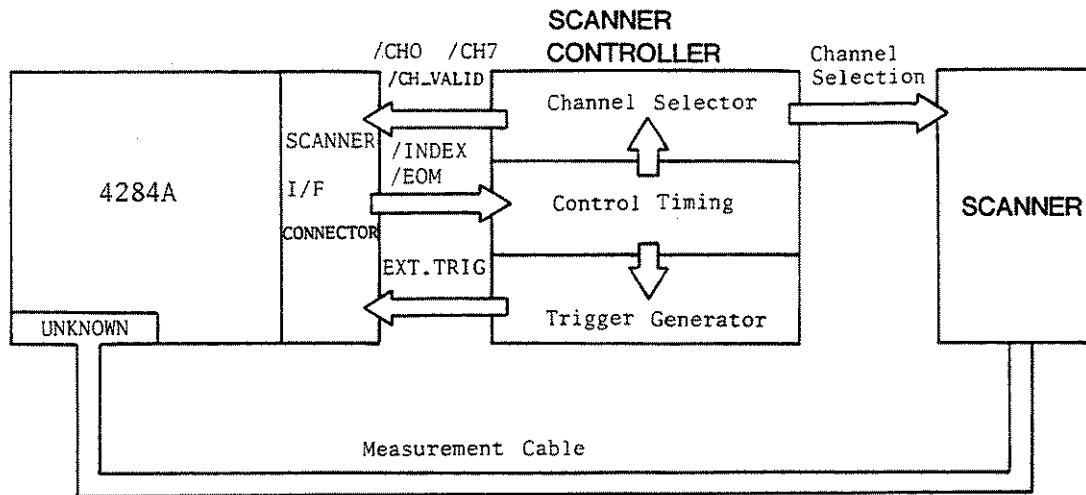

Figure 2-4. Scanner System Example

## ELECTRICAL

**CHARACTERISTICS** The electrical characteristics of the I/O signals are as follows.

### Channel Selection

#### Input Signals ( Optocoupled )

The /CH0 to /CH7 and /CH\_VALID signals are optocoupled to isolate inputs at dc. Each signal is connected to the cathode of an LED in the optocoupler which is current driven, requiring 5 mA to 20 mA for proper operation. The OFF state voltage (high level) of each signal depends on the pull-up voltage (EXT.DCV) used. EXT.DCV can be set from 5 V to 15 V. The selector switches must be set according to the value of EXT.DCV used (Refer to Table 2-2).

### External Trigger

#### Input Signals ( Optocoupled )

The EXT\_TRIG signal is optocoupled to dc isolate the input. This signal is connected to the cathode of an LED in an optocoupler which is current driven, requiring 6.3 mA to 15 mA for proper operation. The OFF state voltage (high level) of each signal depends on the pull-up voltage (EXT.DCV) used. EXT.DCV can be set from 5 V to 15 V. The bit selector switches must be set according to the value of EXT.DCV used (Refer to Table 2-2).

Table 2-2. Electrical Characteristics

Input Signal	Voltage Input Rating		Maximum Current
	LOW	HIGH	
/CH0 to /CH7 /CH_VALID	≤1 V	5 V to 15 V	5 mA to 20 mA
EXT_TRIG	≤1 V	5 V to 15 V	6.3 mA to 15 mA

A diagram of the input signals is shown in Figure 2-5.

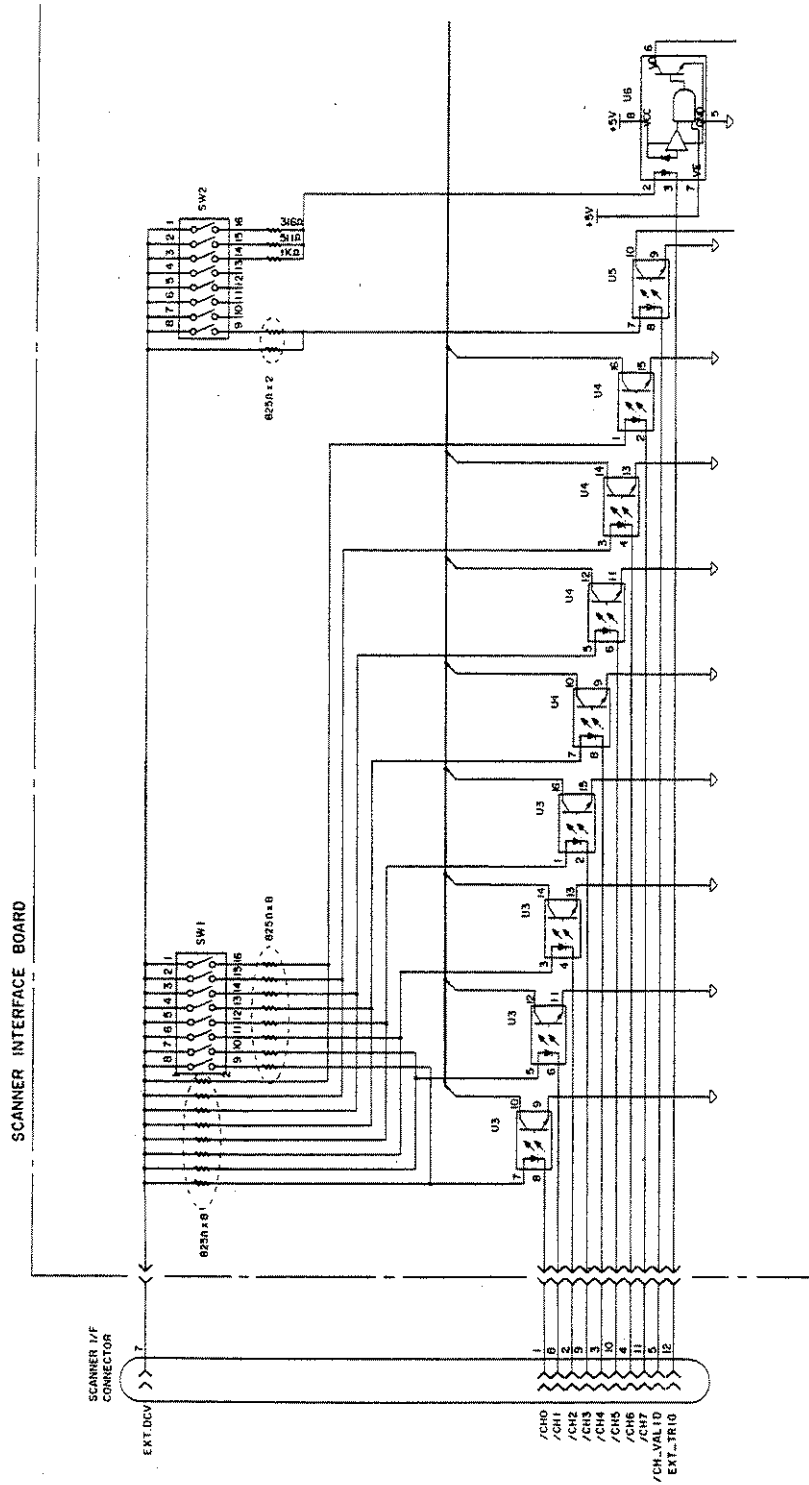

Figure 2-5. Simple Diagram of the Inputs Signals

**Control Output  
Signals  
( Optocoupled )**

The /INDEX and /EOM signals have optocoupled open collector outputs. The combination of pull-up resistor and pull-up voltage must result in a current through the optocoupler of less than 6 mA (Refer to Table 2-3).

Table 2-3. Output Signal Electrical Characteristics

Signal Name	External Pull-up Voltage	Maximum Current
/INDEX /EOM	15 V max.	6 mA

A schematic of the /INDEX and /EOM output circuits is shown in Figure 2-6.

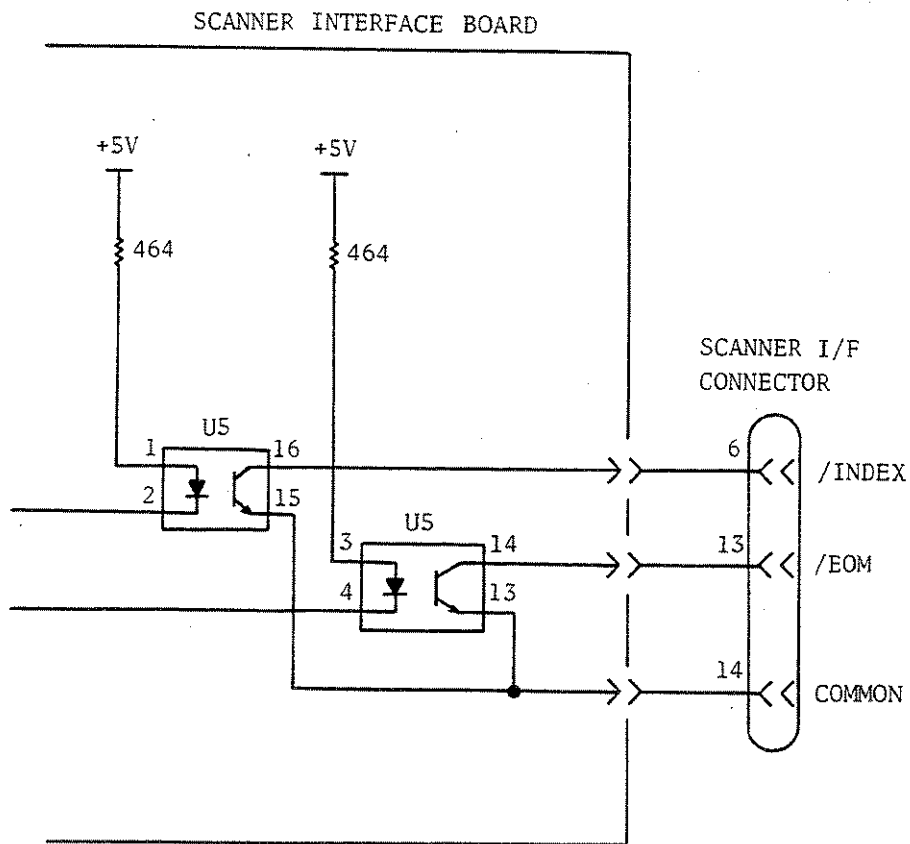

Figure 2-6. Simplified Diagram of the Output Circuits

---

## SETTING UP THE SCANNER INTERFACE BOARD

When you use the rear panel scanner I/O connector, you must set two switches on the scanner interface board according to the external dc voltage (EXT\_DCV) used. Perform the following steps.

1. Disconnect the power cable from the HP 4284A and allow enough time (a few minutes) for the internal capacitors to discharge.

### **WARNING**

**DANGEROUS ENERGY/VOLTAGE EXISTS WHEN THE HP 4284A IS IN OPERATION AND JUST AFTER IT IS POWERED DOWN. ALLOW A FEW MINUTES FOR THE INTERNAL CAPACITORS TO DISCHARGE.**

2. Disconnect the two rear feet which lock the top cover and rear panel together.
3. Fully loosen the top cover retaining screws located on the rear of the top cover.
4. Slide the top cover towards the rear and lift it off. The top shield plate will be visible.
5. Remove the top shield plate to expose the PC boards.
6. Disconnect the flat cable connected to the scanner interface.

### **NOTE**

The scanner interface board is the one with the **BLACK** and **YELLOW** extractors ( See Figure 2-7 ).

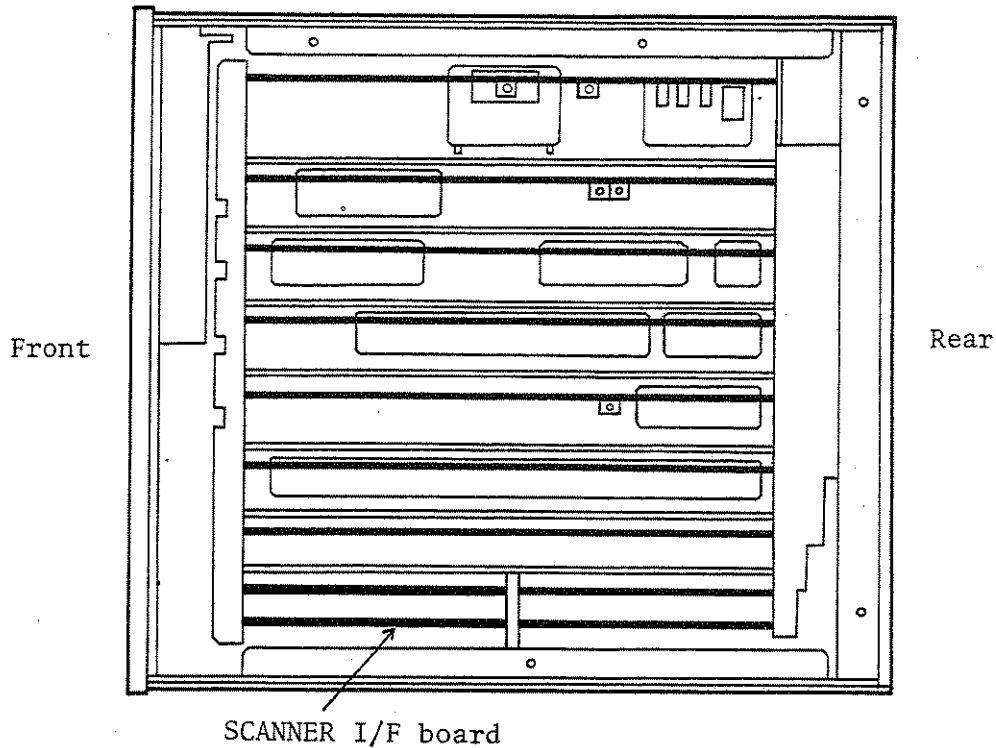

Figure 2-7. Scanner Interface Board Location

7. Remove the scanner interface board.
8. Set switches SW1 and SW2 according to Table 2-4. The location switches SW1 and SW2 are shown in Figure 2-8.
9. Replace the scanner interface board, top shield plate, rear feet, and top cover.

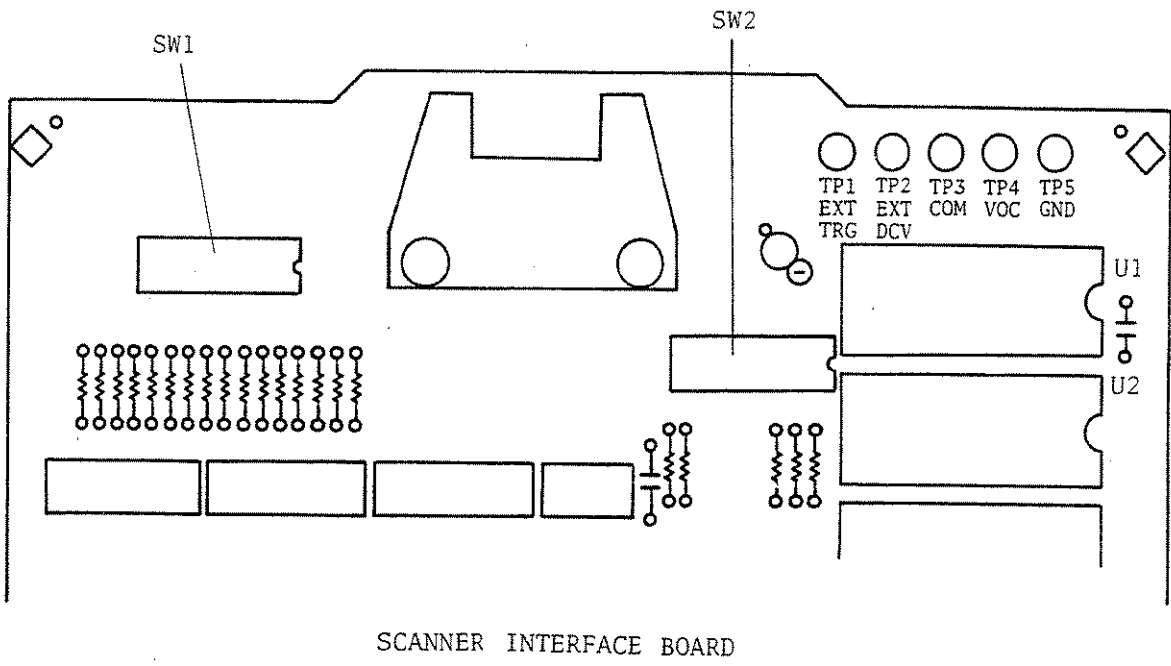
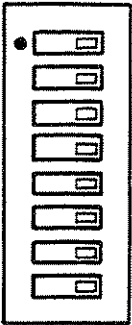

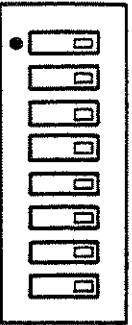
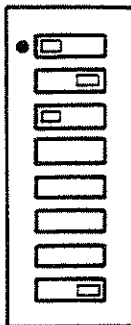
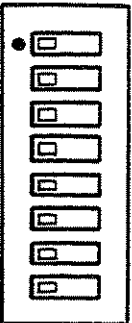
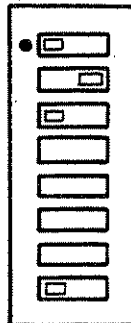
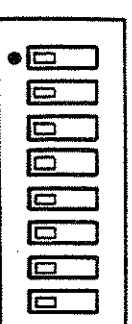
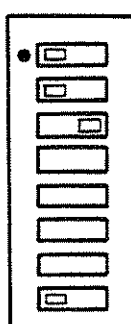

Figure 2-8. SW1 and SW2 Switch Locations

Table 2-4. SW1 and SW2 Settings

EXT_DCV	SW1	SW2
<p>5 to 6 V Factory shipped Setting</p>	 <p>OFF → ON</p>	 <p>OFF → ON</p>
<p>6 to 8 V</p>	 <p>OFF → ON</p>	 <p>OFF → ON</p>
<p>8 to 9 V</p>	 <p>OFF → ON</p>	 <p>OFF → ON</p>
<p>9 to 15 V</p>	 <p>OFF → ON</p>	 <p>OFF → ON</p>



**OPERATION**

---

**INTRODUCTION**

This section provides information necessary for the HP 4284A to operate using the Option 301 Scanner Interface.

---

**BASIC  
PROCEDURE**

Figure 3-1 shows a sample procedure to use the scanner interface. Follow this flow chart, referring to the following paragraphs describe details.

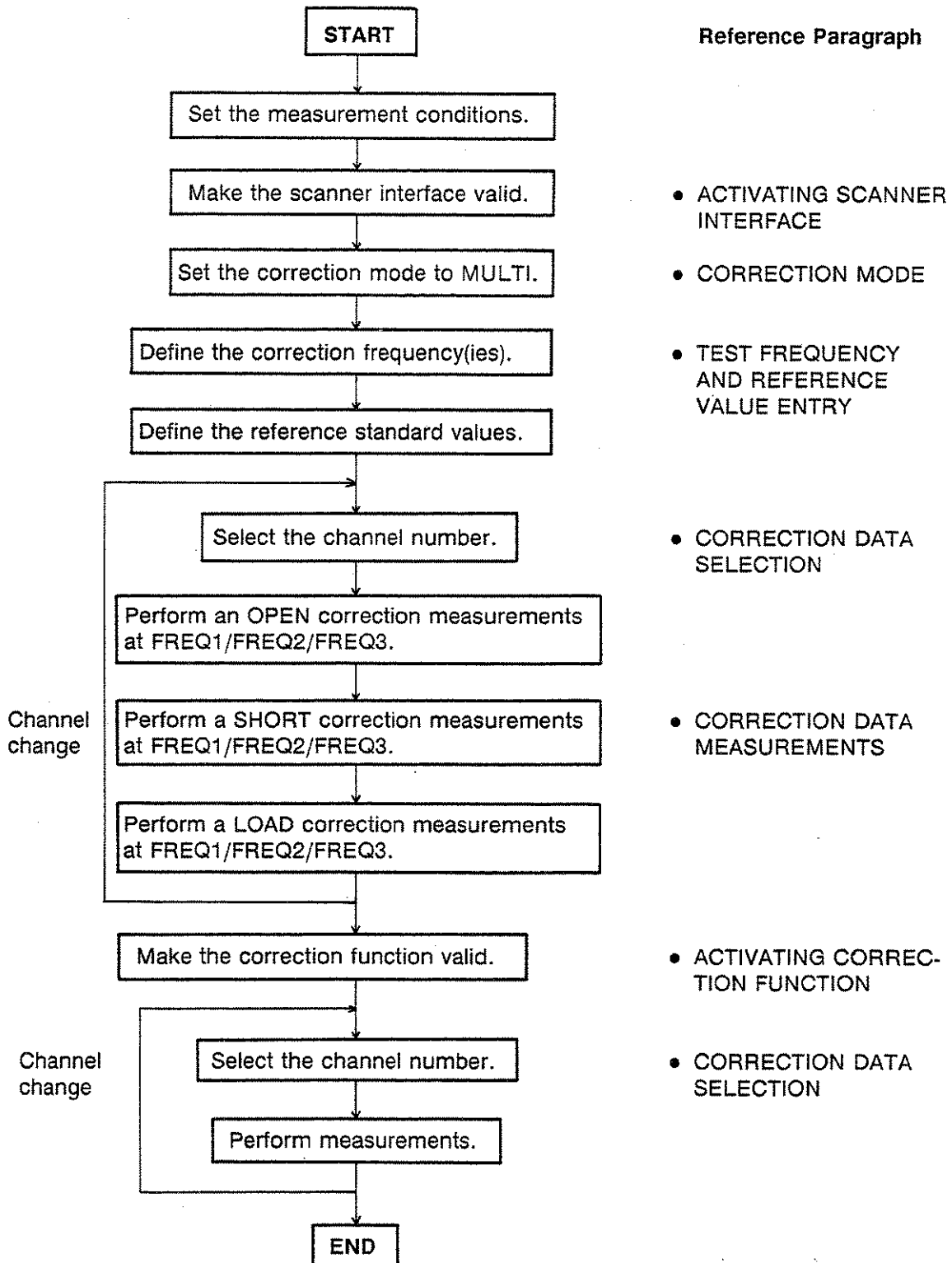

Figure 3-1. Basic Procedure

---

## ACTIVATING SCANNER INTERFACE

Make the scanner interface valid to perform multi channel correction, and to input/output signals through the interface connector on the HP 4284A's rear panel.

### NOTE

To use the multi correction function, this procedure must be performed, even if the multi correction function is used without the interface connector on the rear panel, for example in the case of controlling a scanner and the HP 4284A via HP-IB.

1. Press the **CATALOG/SYSTEM MENU** key, and the **'SYSTEM CONFIG'** softkey. The **SYSTEM CONFIG** page is displayed.
2. Use the **CURSOR** arrow keys to move the cursor to the **SCANNER I/F (#301)** field. The following softkeys will be displayed in the softkey label area.
  - **'ON'**
  - **'OFF'**
3. Press the **'ON'** softkey. The scanner interface is now valid to output/input signals.

---

## **CORRECTION MODE**

To use the multi correction function, set the correction mode to **MULTI** as follows.

### **NOTE**

Before setting the multi correction function, it is necessary to set the scanner interface to ON.

1. Press the **MEAS SETUP MENU** key, and the '**CORRECTION**' softkey. The **CORRECTION** page is displayed.
2. Use the **CURSOR** arrow keys to move the cursor to the **MODE** field. The following softkeys will be displayed on the softkey label area.
  - '**SINGLE**'
  - '**MULTI**'
3. Press the '**MULTI**' softkey to use the multi channel correction function.

## TEST FREQUENCY AND REFERENCE VALUE ENTRY

The correction data can be stored at three test frequencies. These test frequencies are defined and monitored on the **CORRECTION** page.

Also on this page, the reference values (**REF A** and **REF B**) of the standards used for LOAD correction are defined at three frequencies. The reference values can be stored with appropriate function (**FUNC**). For example, to use the standard capacitor which has reference parallel capacitance and D values, the reference values should be stored with Cp-D function. Also the function of reference values can be stored on the **CORRECTION** page.

### NOTE

The function of the standard on the **CORRECTION** page can be defined independently of the measurement function set on the **MEAS SETUP** page. For example, if the reference values are defined as the Cp-D function (entered with capacitance value and D value), the  $Z-\theta$  parameter can be measured with performing the correction.

The following is the setting procedure.

1. Press the **MEAS SETUP MENU** key, and the '**CORRECTION**' softkey. The **CORRECTION** page will be displayed.
2. Move the cursor to the **FUNC** field.
3. Use the softkeys to select the function to be used for entering the reference values.
4. Move the cursor to the **FREQ1** field.
5. If the **FREQ1** is set to OFF, press the '**ON**' softkey to use the **FREQ1** correction data.
6. Enter the frequency value for the **FREQ1** correction.
7. Move the cursor to the **REF A** field under the **FREQ1** field.
8. Enter the reference value of the primary parameter at **FREQ1**.
9. Move the cursor to **B** field on right side of **REF A** field.
10. Enter reference value of the secondary parameter at the **FREQ1**.
11. If necessary, move the cursor to the **FREQ2** field, and repeat steps 4 to 10 at the second correction frequency.

12. If necessary, move the cursor to the **FREQ3** field, and repeat steps 4 to 10 at the third correction frequency.

**NOTE**

If measurement frequency is not equal to the correction frequency, correction (including OPEN, SHORT and LOAD correction) will not be performed. So in this case, the HP 4284A displays the raw measurement value including additional error due to the test fixture's residuals.

**CORRECTION  
DATA  
SELECTION**

The correction data for each scanner channel is stored in the internal memory, and each set of correction data is assigned a channel number. To select correction data, the channel number must be set using the /CH0 to /CH7 signals, and the /CH\_VALID signal on the rear panel connector, or the **CORREction:USE** command via HP-IB.

**Channel Selection  
Using Interface  
Connector**

The channel number (correction data selection) can be selected with the channel selection signals (/CH0 to /CH7) and the channel valid signal (/CH\_VALID). The /CH0 to /CH7 signals are the 8-bit binary signals. /CH0 is the LSB, and /CH7 is the MSB.

For example,

/CH0	/CH1	/CH2	/CH3	/CH4	/CH5	/CH6	/CH7	CHANNEL No.
1	0	0	0	0	0	0	0	1
0	1	0	0	0	0	0	0	2
0	0	1	0	0	0	0	0	4
0	0	0	1	0	0	0	0	8
0	0	0	0	1	0	0	0	16
0	0	0	0	0	1	0	0	32
0	0	0	0	0	0	1	0	64
1	1	1	1	1	1	1	0	127

1: LOW  
0: HIGH

If /CH\_VALID is set to HIGH when the channel number is set using the /CH0 to /CH7 signals, the HP 4284A cannot acknowledge the channel number, and the HP 4284A will use the currently specified correction data.

## NOTE

In case of the channel number selection using the interface connector: when the HP 4284A is triggered, or when the HP 4284A starts a correction data measurement ( for example: when the 'MEAS OPEN' softkey is pressed ), the HP 4284A acknowledges the channel number. So if /CH0 to /CH7 signal and /CH\_VALID signal are sent, the HP 4284A will not set the channel number until it is triggered or until it starts a correction data measurement.

### Channel Selection Using HP-IB

The channel number used to select the correction data can be set using the **CORRection:USE** command via HP-IB. The syntax of this command is:

**CORRection:USE <channel number>**

where,

<channel number> : 0 to 127 (integer)

For example, the sample program for the channel number=20 is as follows.

```
10  OUTPUT 717;"CORR:METH MULT" ! Set the multi compen.  
    mode  
20  OUTPUT 717;"CORR:USE 20" ! Set the CH. No to 20  
30  END
```

## NOTE

In case of the channel number selection using the **CORRection:USE** command, the HP 4284A acknowledges the channel number when the HP 4284A receives this command. So if the "**CORRection:USE 10**" command is sent via HP-IB, the HP 4284A will set the channel number when the HP 4284A will receive the command.

### Monitoring Current Channel

You can monitor current channel number selected for correction on the **CORRECTION** page and the **MEAS DISPLAY** page. 'CH No.:' on these pages indicates current channel selected for correction.

---

## **CORRECTION DATA MEASUREMENTS**

It is necessary to perform correction data measurements, OPEN, SHORT and LOAD data measurements at 3 test frequencies, for each channel.

The following is a sample procedure for performing correction measurements for a channel. Repeat the following procedure for each scanner channel to be used.

1. Select the scanner channel.
2. Set the HP 4284A's channel number equal to that selected in step 1.
3. Press the **MEAS SETUP MENU** key, and the '**CORRECTION**' softkey. The **CORRECTION** page will be displayed.

### **[OPEN Correction]**

4. Open the measurement contacts of the selected scanner channel.
5. Move the cursor to the **FREQ1** field, and press the '**MEAS OPEN**' softkey to measure OPEN condition at the **FREQ1**. Wait for the end of OPEN correction measurement.
6. If necessary, repeat step 5 for the **FREQ2** and **FREQ3** fields.

### **[SHORT Correction]**

7. Short the measurement contacts of the selected scanner channel.
8. Move the cursor to the **FREQ1** field, and press the '**MEAS SHORT**' softkey to measure the SHORT condition at the **FREQ1**. Wait for the end of SHORT correction measurement.
9. If necessary, repeat step 8 for the **FREQ2** and **FREQ3** fields.

### **[LOAD Correction]**

10. Connect the standard for the **FREQ1** correction to the measurement contacts of the selected scanner channel.
11. Move the cursor to the **FREQ1** field, and press the '**MEAS LOAD**' softkey to measure the standard at the **FREQ1**. Wait for the end of LOAD correction measurement.



12. If necessary, repeat steps 10 and 11 for the **FREQ2** and **FREQ3** corrections.
13. Change the scanner's and the HP 4284A's channel, and repeat steps 4 through 12 until this procedure has been performed for all scanner channels.

---

## **ACTIVATING THE CORRECTION FUNCTION**

To set the correction function to ON, performing the correction using the correction data, set as follows.

1. Press the **MEAS SETUP MENU** key, and the '**CORRECTION**' softkey. The **CORRECTION** page will be displayed.
2. Confirm the correction frequencies (**FREQ1**, **FREQ2** and **FREQ3**) to be used are set to ON (frequency and reference values are displayed, the "**OFF**" will not be displayed).
3. Move the cursor to the **OPEN** field.
4. Press the '**ON**' softkey to set the **OPEN** correction function to ON.
5. Move the cursor to the **SHORT** field.
6. Press the '**ON**' softkey to set the **SHORT** correction function to ON.
7. Move the cursor to the **LOAD** field.
8. Press the '**ON**' softkey to set the **LOAD** correction function to ON.

## **CORRECTION DATA CONFIRMATION**

To confirm the measurement data for each channel correction, read the data via HP-IB using the following query.

The syntax of which is:

**CORRection:USE:DATA? <channel number>**

Where,

**<channel number>** : 0 to 127 (integer)

Query response :

<open1 A>,<open1 B>,<short1 A>,<short1 B>,  
<load1 A>,<load1 B>,<open2 A>,<open2 B>,  
<short2 A>,<short2 B>,<load2 A>,<load2 B>,  
<open3 A>,<open3 B>,<short3 A>,<short3 B>,  
<load3 A>,<load3 B><NL^END>

where,

<open1/2/3 A> : Primary parameter measurement data of OPEN correction at FREQ 1/2/3.  
<open1/2/3 B> : Secondary parameter measurement data of OPEN correction at FREQ 1/2/3.  
<short1/2/3 A> : Primary parameter measurement data of SHORT correction at FREQ 1/2/3.  
<short1/2/3 B> : Secondary parameter measurement data of SHORT correction at FREQ 1/2/3.  
<load1/2/3 A> : Primary parameter measurement data of LOAD correction at FREQ 1/2/3.  
<load1/2/3 B> : Secondary parameter measurement data of LOAD correction at FREQ 1/2/3.  
<NL^END> : Terminators (the EOI line is asserted while the New Line or ASCII Line Feed character is being sent on the bus).

In addition to the query, the following queries are useful to confirm status of the multi channel correction mode.

- **CORRection:SPOT{1|2|3}:STATE?** query  
::= returns ON/OFF condition of FREQ1, FREQ2 or FREQ3 correction.
- **CORRection:SPOT{1|2|3}:FREQuency?** query  
::= returns the correction frequency of FREQ1, FREQ2 or FREQ3.

- **CORRection:SPOT{1|2|3};LOAD:STANdard?** query  
 ::= returns the reference values of the standard for  
 FREQ1, FREQ2 or FREQ3.

Refer to **SECTION 8, COMMAND REFERENCE** of the HP 4284A  
**OPERATION MANUAL** for details.

The following procedure and sample program are a guide to  
 reading the correction frequency, reference values for LOAD  
 correction, and a channel's correction data via HP-IB.

1. Set the HP 4284A's HP-IB address to 17.
2. Load BASIC and input the following program. (This  
 program can be used with HP 9000 series 200 or 300  
 computers).

```

10  OPTION BASE 1
20  DIM State(3),Freq(3),Ref_a(3),Ref_b(3),Corr_data(3,6)
30  OUTPUT 717;"CORR:METH MULT"! Set MULTI correction mode
40  !
50  FOR I=1 TO 3
60  OUTPUT 717;"CORR:SPOT"&VAL$(I)&":STAT?;FREQ?"!Status & freq.queries
70  ENTER 717;State(I),Freq(I)
80  OUTPUT 717;"CORR:SPOT"&VAL$(I)&":LOAD:STAN?"!Reference value query
90  ENTER 717;Ref_a(I),Ref_b(I)
100 NEXT I
110 !
120 OUTPUT 717;"CORR:USE:DATA? 10"!Correction measurement data query
130 ENTER 717;Corr_data(*)
140 !
150 FOR I=1 TO 3
160 PRINT "FREQ"&VAL$(I)&"=";Freq(I);"Hz :";State(I)
170 PRINT " REF  :",Ref_a(I),";";Ref_b(I)
180 PRINT " MEAS DATA"
190 PRINT " OPEN A:",Corr_data(I,1),"B:";Corr_data(I,2)
200 PRINT " SHORT A:",Corr_data(I,3),"B:";Corr_data(I,4)
210 PRINT " LOAD A:",Corr_data(I,5),"B:";Corr_data(I,6)
220 PRINT
230 NEXT I
240 END

```

#### NOTE

In this example channel 10 is selected.

3. RUN the program. The correction data for channel 10 will be displayed on the computer as follows.

```
FREQ1= 1000 Hz : 1
REF : 1909.4 ; -1.59117E+6
MEAS DATA
OPEN A: .0993735 B: -9.36068E-5
SHORT A: .012764 B: .00328798
LOAD A: 2611.29 B: -368124
```

```
FREQ2= 2000 Hz : 1
REF : 1989.23 ; -795690
MEAS DATA
OPEN A: .0993439 B: -9.16435E-5
SHORT A: .0750794 B: .00345303
LOAD A: 8663.75 B: -864755
```

```
FREQ3= 5000 Hz : 1
REF : 19.7139 ; -70407
MEAS DATA
OPEN A: .0993221 B: -.000113075
SHORT A: .0244617 B: .00475126
LOAD A: 617.902 B: -73157.1
```

#### NOTE

On the HP 4284A's LCD you can monitor the correction data only for the LOAD correction (MEA A/B of the FREQ1/2/3) of the indicated channel (CH No.) on the **CORRECTION** page.