



OPERATION MANUAL

MODEL HP 4278A
1kHz/1MHz CAPACITANCE METER

(Including Options 001,002,
003,101,201,202 and 301)

SERIAL NUMBERS

This manual applies to instruments whose serial number is 2830J01160 and above, and whose ROM-based firmware is version 3.02.

With the changes described in Appendix A, this manual also applies to instruments whose serial number is 2830J01159 and below, and whose ROM-based firmware is version 3.01 and below.

For additional information concerning serial numbers, refer to INSTRUMENTS COVERED BY MANUAL in Section 5 of this Operation Manual.

© COPYRIGHT: YOKOGAWA-HEWLETT-PACKARD,LTD.,1987
9-1, TAKAKURA-CHO, HACHIOJI-SHI, TOKYO, JAPAN

Manual Part Number: 04278-90000
Microfiche Part Number: 04278-90050

Printed: APR. 1989

CERTIFICATION

Hewlett-Packard Company certifies that this product met its published specifications at the time of shipment from the factory. Hewlett-Packard further certifies that its calibration measurements are traceable to the United States National Bureau of Standards, to the extent allowed by the Bureau's calibration facility, or to the calibration facilities of other International Standards Organization members.

WARRANTY

This Hewlett-Packard instrument product is warranted against defects in material and workmanship for a period of one year from date of shipment, except that in the case of certain components listed in Section 1 of this manual, the warranty shall be for the specified period. During the warranty period, Hewlett-Packard Company will, at its option, either repair or replace products which prove to be defective.

For warranty service or repair, this product must be returned to a service facility designated by HP. Buyer shall prepay shipping charges to HP and HP shall pay shipping charges to return the product to Buyer. However, Buyer shall pay all shipping charges, duties, and taxes for products returned to HP from another country.

HP warrants that its software and firmware designated by HP for use with an instrument will execute its programming instructions when properly installed on that instrument. HP does not warrant that the operation of the instrument, or software, or firmware will be uninterrupted or error free.

LIMITATION OF WARRANTY

The foregoing warranty shall not apply to defects resulting from improper or inadequate maintenance by Buyer, Buyer-supplied software or interfacing, unauthorized modification or misuse, operation outside of the environment specifications for the product, or improper site preparation or maintenance.

NO OTHER WARRANTY IS EXPRESSED OR IMPLIED. HP SPECIFICALLY DISCLAIMS THE IMPLIED WARRANTIES OF MERCHANTABILITY AND FITNESS FOR A PARTICULAR PURPOSE.

EXCLUSIVE REMEDIES

THE REMEDIES PROVIDED HEREIN ARE BUYER'S SOLE AND EXCLUSIVE REMEDIES. HP SHALL NOT BE LIABLE FOR ANY DIRECT, INDIRECT, SPECIAL, INCIDENTAL, OR CONSEQUENTIAL DAMAGES, WHETHER BASED ON CONTRACT, TORT, OR ANY OTHER LEGAL THEORY.

ASSISTANCE

Product maintenance agreements and other customer assistance agreements are available for Hewlett-Packard products.

For any assistance, contact your nearest Hewlett-Packard Sales and Service Office. Addresses are provided at the back of this manual.

SAFETY SUMMARY

The following general safety precautions must be observed during all phases of operation, service, and repair of this instrument. Failure to comply with these precautions or with specific warnings given elsewhere in this manual violates safety standards of design, manufacture, and intended use of the instrument. Hewlett-Packard Company assumes no liability for the customer's failure to comply with these requirements.

GROUND THE INSTRUMENT

To minimize shock hazard, the instrument chassis and cabinet must be connected to an electrical ground. The instrument is equipped with a three-conductor ac power cable. The power cable must either be plugged into an approved three-contact electrical outlet or used with a three-contact to two-contact adapter with the grounding wire (green) firmly connected to an electrical ground (safety ground) at the power outlet. The power jack and the mating plug of the power cable meet International Electrotechnical Commission (IEC) safety standards.

DO NOT OPERATE IN AN EXPLOSIVE ATMOSPHERE

Do not operate the instrument in the presence of flammable gases or fumes. Operation of any electrical instrument in such an environment constitutes a definite safety hazard.

KEEP AWAY FROM LIVE CIRCUITS

Operating personnel must not remove instrument covers. Component replacement and internal adjustments must be made by qualified maintenance personnel. Do not replace components with power cable connected. Under certain conditions, dangerous voltages may exist even with the power cable removed. To avoid injuries, always disconnect power and discharge circuits before touching them.

DO NOT SERVICE OR ADJUST ALONE

Do not attempt internal service or adjustment unless another person, capable of rendering first aid and resuscitation, is present.

DO NOT SUBSTITUTE PARTS OR MODIFY INSTRUMENT

Because of the danger of introducing additional hazards, do not install substitute parts or perform any unauthorized modification to the instrument. Return the instrument to a Hewlett-Packard Sales and Service Office for service and repair to ensure that safety features are maintained.

DANGEROUS PROCEDURE WARNINGS

Warnings, such as the example below, precede potentially dangerous procedures throughout this manual. Instructions contained in the warnings must be followed.

WARNING

Dangerous voltages, capable of causing death, are present in this instrument. Use extreme caution when handling, testing, and adjusting.

SAFETY SYMBOLS

General Definitions of Safety Symbols Used On Equipment or In Manuals.



Instruction manual symbol: the product will be marked with this symbol when it is necessary for the user to refer to the instruction manual in order to protect against damage to the instrument.



Indicates dangerous voltage (terminals fed from the interior by voltage exceeding 1000 volts must be so marked).

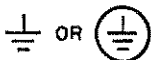

Protective conductor terminal. For protection against electrical shock in case of a fault. Used with field wiring terminals to indicate the terminal which must be connected to ground before operating equipment.



Low-noise or noiseless, clean ground (earth) terminal. Used for a signal common, as well as providing protection against electrical shock in case of fault. A terminal marked with this symbol must be connected to ground in the manner described in the installation (operating) manual, and before operating the equipment.

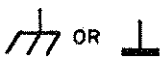

Frame or chassis terminal. A connection to the frame (chassis) of the equipment which normally includes all exposed metal structures.



Alternating current (power line).



Direct current (power line).



Alternating or direct current (power line).

WARNING

A **WARNING** denotes a hazard. It calls attention to a procedure, practice, condition or the like, which, if not correctly performed or adhered to, could result in injury or death to personnel.

CAUTION

The **CAUTION** sign denotes a hazard. It calls attention to an operating procedure, practice, condition or the like, which, if not correctly performed or adhered to, could result in damage to or destruction of part or all of the product.

Note

A **Note** denotes important information. It calls attention to a procedure, practice, condition or the like, which is essential to highlight.

HOW TO USE THIS MANUAL

The HP 4278A Operation Manual provides the information required to operate and test the 4278A. To adjust and repair the 4278A, the Maintenance Manual (PN 04278-90100) is required and must be ordered separately.

This Operation Manual contains six sections plus several appendixes, organized for the convenience of the first time user. After you receive your HP 4278A, begin with Section 1. If you are a first time user of an already installed 4278A, begin with Section 2.

Section 1, Receiving and Getting Ready To Use Your HP 4278A :

Section 1 includes unpacking, initial inspection, and preparation information necessary before you apply AC power. Do NOT connect the power cable before reading this section.

Section 2, Familiarizing Yourself with the HP 4278A :

Section 2 includes examples of basic operation. Use this section to obtain "hands-on" experience by following the examples given.

Section 3, Functions and Features :

Section 3 provides detailed 4278A function explanations. Read Section 2 before proceeding with this section.

Section 4, Interface Options :

Section 4 includes 4278A interface operation and interconnection information necessary for designing a test system.

Section 5, General Information :

Section 5 provides 4278A features, capabilities, specifications, accessories, options, option installation, and repacking information.

Section 6, Performance Tests :

Section 6 provides information for checking whether your 4278A is within the specifications given in Section 5. This section is also for initial 4278A inspection, periodic performance testing, and performance testing after repairs.

Appendix A, Backdating Changes :

Appendix A includes information for modifying this manual to instruments manufactured before the print date of this manual.

Appendix B, Softkey Tree :

Appendix B provides a listing of the 4278A's softkeys.

Appendix C, Display Messages :

Appendix C lists the 4278A's Comments and Error Messages.

Appendix D, Possible Problems and Their Solutions :

Appendix D lists several general problems that you may encounter, and tells you what to do if they occur.

CAUTIONS ON OPERATION

1. UNKNOWN (MEASUREMENT) TERMINALS

Do NOT apply DC voltage or current to the UNKNOWN terminals. Doing so will damage the 4278A. Before you measure a capacitor, be sure the capacitor is fully discharged.

2. MEMORY CARD

Use HP-specified memory cards containing 4278A-specific data only. If other memory cards are used, the 4278A may be damaged. Non 4278A-specific data contained on a memory card is not guaranteed, and data may be lost.

To insert a memory card into the **MEMORY** card slot, hold the memory card with the label facing upward and with the contacts at the slot opening. Insert the card into the slot until it "clicks" in place.

To remove a memory card from the 4278A, press the **UNLOCK** button and remove the card.

Do NOT remove a memory card while **LOADING** or **STORING** data. Doing so may damage the memory card and any data stored in the memory card may be lost.

Store memory cards in their furnished card cases when not in use. The card case protects memory cards from contamination and electrostatic discharge. Also, store memory cards under the following environmental conditions.

Storage Temperature Range: -30°C to +70°C

Storage Humidity Range: 30% to 85% (@+50°C)

Do NOT shock or stress memory cards.

When storing or moving your 4278A, be sure the memory card slot is empty (no memory card inserted).

Do NOT touch the connector contact surface of a memory card and do NOT use chemical liquids to clean the contacts.

3. HANDLER INTERFACE BOARD (OPTION 201)

If the +5V internal voltage (pin 16, 17 or 18 of the handler interface connector) is not output, a fuse on the handler interface board (A32F1) has blown and must be replaced. Two replacement fuses are furnished with the 4278A option 201. Additional fuses are available from Hewlett-Packard. Order PN 2110-0046.

To replace A32F1, perform the following procedure.

1. To remove the handler interface board (A32), perform procedure 1 through 7 on page 6-21.
2. Remove A32F1 (indicated in Figure A) from socket and carefully insert the new fuse.
3. Replace the handler interface board, top shield plate, rear feet, and top cover.

If the handler interface continues not to output +5V after A32F1 has been replaced, contact the nearest Hewlett-Packard office.

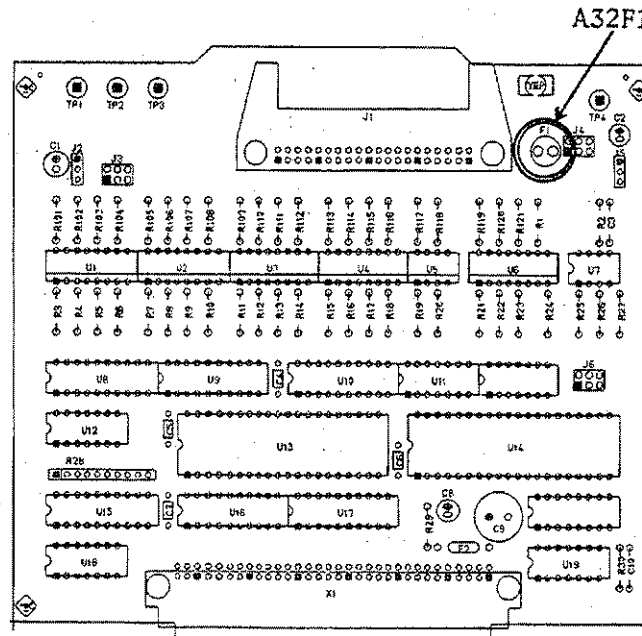

Figure A. Handler Interface Board

CONTENTS

HOW TO USE THIS MANUAL	ii
SECTION 1, RECEIVING AND GETTING READY TO USE YOUR HP 4278A	1-1
SECTION 2, FAMILIARIZING YOURSELF WITH THE HP 4278A	2-1
SECTION 3, FUNCTIONS AND FEATURES OF THE HP 4278A	3-1
SECTION 4, INTERFACES (OPTIONS)	4-1
SECTION 5, GENERAL INFORMATION	5-1
SECTION 6, PERFORMANCE TESTS	6-1
APPENDIXES	
A, BACKDATING CHANGES	
B, SOFTKEY TREE	
C, DISPLAY MESSAGES	
D, POSSIBLE PROBLEMS AND THEIR SOLUTIONS	

HP 4278A INTRODUCTION

Introduction

The HP 4278A 1kHz/1MHz Capacitance Meter is designed for capacitance and loss factor (D, Q, ESR, and G) measurements on capacitor production lines, in quality assurance departments, and in incoming/outgoing inspection.

Accurate

The 4278A's capacitance measurement accuracy is $\pm 0.05\%$ (at 1MHz) and $\pm 0.07\%$ (at 1kHz) with 6 digit resolution in all measurement ranges, --- 1pF to 2048pF (at 1MHz) and 100pF to 100 μ F (at 1kHz). Dissipation factor (D) accuracy is ± 0.0002 (at 1MHz) and ± 0.0005 (at 1kHz) with 10ppm resolution, without degrading measurement speed. The test signal level can be selected from 0.1V to 1.0V in 0.1V steps.

High Speed

The 4278A can perform measurements as quickly as 6.5ms per measurement. Minimize production test times by using the 4278A's built-in comparator with the Option 201 handler interface.

Built-in Comparator

The 4278A's built-in comparator allows you to sort comparison/decision results into a maximum of 10 bins. By using the interface options, the 4278A can easily be combined with a component handler and a system controller to fully automate capacitor testing, sorting, and quality control data processing, resulting in increased production efficiency.

Error Correction

The 4278A's zero offset capability compensates measurement results for the residual impedance and stray admittance of handlers and test fixtures. Also, the 4278A's standard compensation function allows you to compensate for complex measurement errors that may be induced at the point of test device connection.

Menu Driven Operation

The 4278A's menu driven software uses five softkeys located to the right of the LCD. Softkey labels can be selected by using the **MENU**, **PREV**, and **NEXT** softkey control keys.

Recallable Control Settings

The 4278A's control settings (measurement conditions and comparator settings) can be stored and recalled easily by using the memory card feature. This feature allows you to store control settings for a test on a memory card (one card per test), then simply insert the memory card and press the **LOAD** key.

MANUAL CHANGES

HP 4278A

1kHz/1MHz CAPACITANCE METER

MANUAL IDENTIFICATION

Model Number: HP 4278A
 Date Printed: APR. 1989
 Part Number: 04278-90000

This supplement contains information for correcting manual errors and for adapting the manual to newer instruments that contain improvements or modifications not documented in the existing manual.

To use this supplement

1. Make all ERRATA corrections
2. Make all appropriate serial-number-related changes listed below

SERIAL PREFIX OR NUMBER	MAKE MANUAL CHANGES	SERIAL PREFIX OR NUMBER	MAKE MANUAL CHANGES
2936J and above	1		

► New Item

► **CHANGE 1**

1. This contains the information needed to adapt HP 4278A's manual to instruments with firmware Version 3.10.

- Replace the following pages of your manual with attached pages in this supplement. (An underlined page number indicates a changed page.)

3- <u>13</u> /14	3-17/ <u>18</u>	3- <u>21</u> /22	3-23/24
4- <u>23</u> /24	4-25/ <u>26</u>	4- <u>49</u> /50	4- <u>57</u> /58
4- <u>59</u> /60	4- <u>71</u> /72	6-7/ <u>8</u>	6- <u>13</u> /14
B- <u>3</u> /4			

NOTE

Manual change supplements are revised as often as necessary to keep manuals as current and accurate as possible. Hewlett-Packard recommends that you periodically request the latest edition of this supplement. Free copies are available from all HP offices. When requesting copies, quote the manual identification information from your supplement, or the model number and print date from the title page of the manual.

- Page 4-1, 4-2. OPTION 101 HP-IB INTERFACE

Add description of the **CREJ** command as follows.

CREJ

SOFTKEY LABEL: LOW C LIMIT (in 'COMPARATOR')

The **CREJ** command sets the Low C Limit mode.

SYNTAX:

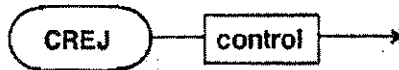

PARAMETER:

The control parameter choices are:

Control Parameter	Description
0	Set Low C Limit mode to OFF.
1	Set Low C Limit to 1% of the measurement range
2	Set Low C Limit to 2% of the measurement range
3	Set Low C Limit to 3% of the measurement range
4	Set Low C Limit to 4% of the measurement range
5	Set Low C Limit to 5% of the measurement range
6	Set Low C Limit to 6% of the measurement range

The default setting is CREJ0.

EXAMPLE:

OUTPUT 717;"CREJ1"! Set NPP BIN to sort capacitors whose value are below 1% of the current measurement range.

2. This contains the information needed to adapt HP 4278A's manual to instruments with A32 handler interface board (PN 04278-66532) of Option 201 Handler Interface.

- Replace the following pages of your manual with the attached pages in this supplement. (An underlined page number indicates a changed page.)

<u>Pink page</u>	1-1/2	4-71/72	4-75/76
4-77/78	4-79/80	4-81/82	4-83/84
4-85/86	4-87/88	5-5/6	6-21/22
6-23/24			

3. This contains the information needed to adapt HP 4278A's manual to instruments with A33 handler interface board (PN 04278-66533) of Option 202 Handler Interface.

- Replace the **PERFORMANCE TEST RECORD** of pages 6-31 thru 6-34 with attached those of pages (i) thru (iv).
- Replace the following pages of your manual with the attached pages in this supplement. (An underlined page number indicates a changed page.)

4-89/90	4-91/92	4-93/94	4-97/98
4-99/100	4-101/102	4-105/106	4-107/108
4-109/110	4-111/112	4-113/114	4-115/116
5-5/6	6-25/26	6-27/28	6-29/30
6-31/32 (Add page)			

Vertical line of text on the right edge of the page, possibly a page number or margin indicator.

SECTION 1

RECEIVING AND GETTING READY TO USE YOUR HP 4278A

1-1. INTRODUCTION	1-1
1-2. INITIAL INSPECTION	1-2
1-3. PREPARATION FOR USE	1-2
1-3-1. POWER REQUIREMENTS	1-2
1-3-2. LINE VOLTAGE AND FUSE SELECTION	1-2
1-3-3. POWER CABLE	1-3

1
2
3
4
5
6
7
8
9
10
11
12
13
14
15
16
17
18
19
20
21
22
23
24
25
26
27
28
29
30
31
32
33
34
35
36
37
38
39
40
41
42
43
44
45
46
47
48
49
50
51
52
53
54
55
56
57
58
59
60
61
62
63
64
65
66
67
68
69
70
71
72
73
74
75
76
77
78
79
80
81
82
83
84
85
86
87
88
89
90
91
92
93
94
95
96
97
98
99
100

SECTION 1

RECEIVING AND GETTING READY TO USE YOUR HP 4278A

1-1. INTRODUCTION

This section covers the receiving and setting up of your HP 4278A. Figure 1-1 shows the HP 4278A and its furnished accessories.

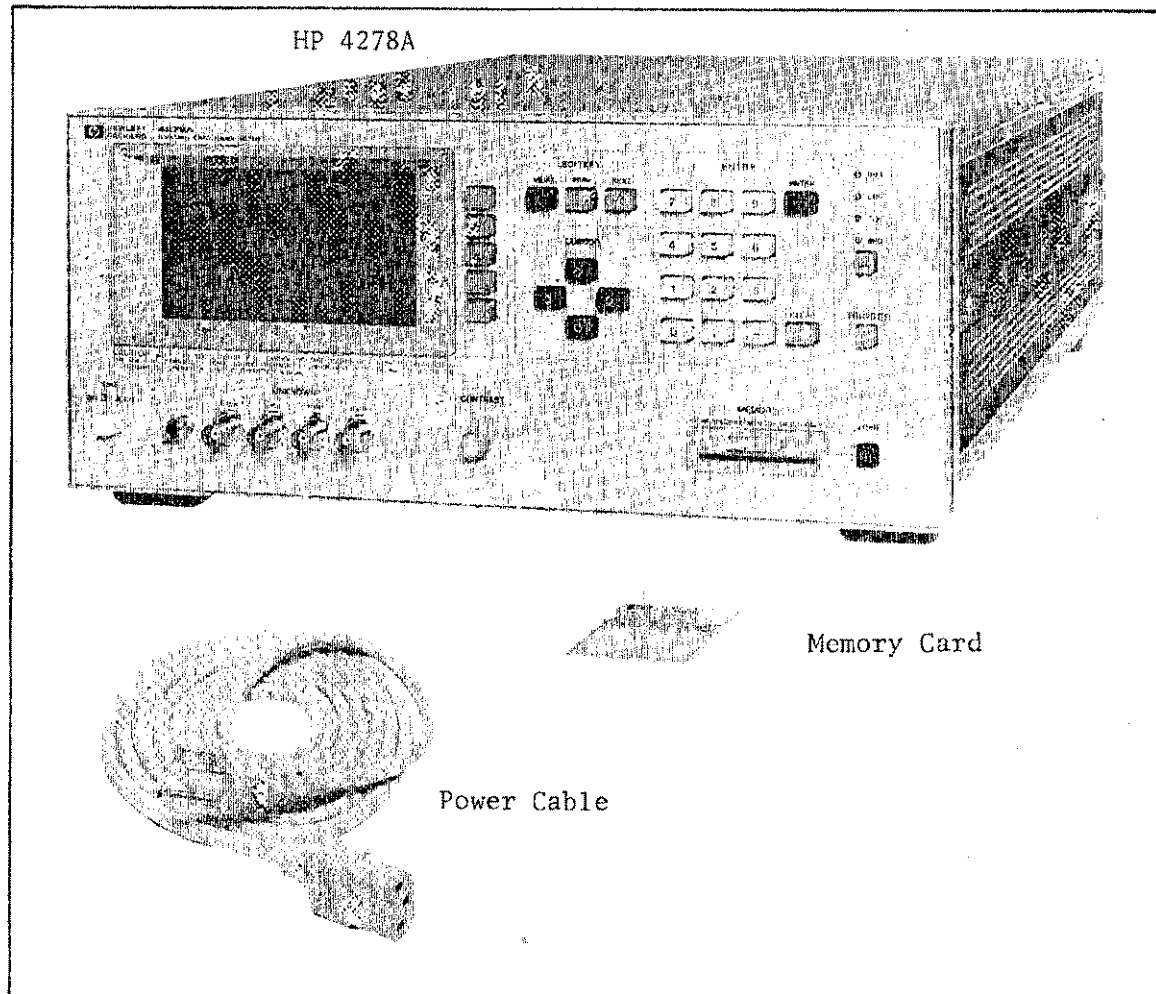

Figure 1-1. HP 4278A and Furnished Accessories

1-2. INITIAL INSPECTION

When shipped from the factory, the 4278A meets all of the specifications listed in Section 5. When you receive your 4278A, inspect the shipping container for damage. If the shipping container or cushioning material is damaged, it should be kept until the shipment has been checked for completeness, and the instrument has been verified mechanically and electrically. The shipping container should contain everything shown in Figure 1-1. The procedures for checking electrical performance are given in Section 6. If the shipment is incomplete, if the instrument is damaged in any way, or if the instrument does not pass the Performance Tests outlined in Section 6, notify the carrier and Hewlett-Packard. Keep the shipping materials for the carrier's inspection. The HP sales office will arrange for repair or replacement without waiting for the claim to be settled.

1-3. PREPARATION FOR USE

1-3-1. POWER REQUIREMENTS

The 4278A requires a power source of 100, 120, 220V AC $\pm 10\%$, or 240VAC $+5\%$ -10% , 48 to 66Hz, single phase; power consumption is 200VA, maximum.

WARNING

THIS IS A SAFETY CLASS 1 PRODUCT (PROVIDED WITH A PROTECTIVE EARTH TERMINAL). A NONINTERRUPTABLE SAFETY EARTH GROUND MUST BE PROVIDED FROM THE MAIN POWER SOURCE TO THE 4278A'S POWER INPUT TERMINALS, POWER CORD, OR FURNISHED POWER CORD SET. IF THE SAFETY EARTH GROUND BECOMES IMPAIRED, DISCONNECT THE 4278A AND SECURE IT AGAINST ANY OPERATION. IF YOUR 4278A IS TO BE ENERGIZED VIA AN AUTOTRANSFORMER FOR VOLTAGE REDUCTION, MAKE SURE THE COMMON TERMINAL IS CONNECTED TO THE EARTH TERMINAL OF THE POWER SOURCE.

1-3-2. LINE VOLTAGE AND FUSE SELECTION

CAUTION

BEFORE CONNECTING THE INSTRUMENT TO THE POWER SOURCE, MAKE SURE THE CORRECT FUSE IS INSTALLED AND THE LINE VOLTAGE SELECTION SWITCH IS SET TO THE CORRECT VOLTAGE.

Figure 1-2 shows the line voltage selector switch and the fuse holder, and provides instructions for line voltage and fuse selection. Fuse current ratings are printed on the rear panel and are listed, along with the fuse's HP part number, in Figure 1-2.

CAUTION

USE ONLY THE CORRECT FUSE FOR THE LINE VOLTAGE SELECTED. MAKE SURE THAT ONLY FUSES WITH THE REQUIRED CURRENT RATING AND OF THE SPECIFIED TYPE ARE USED AS REPLACEMENTS. NEVER USE A MENDED FUSE AND NEVER SHORT-CIRCUIT THE FUSE HOLDER.

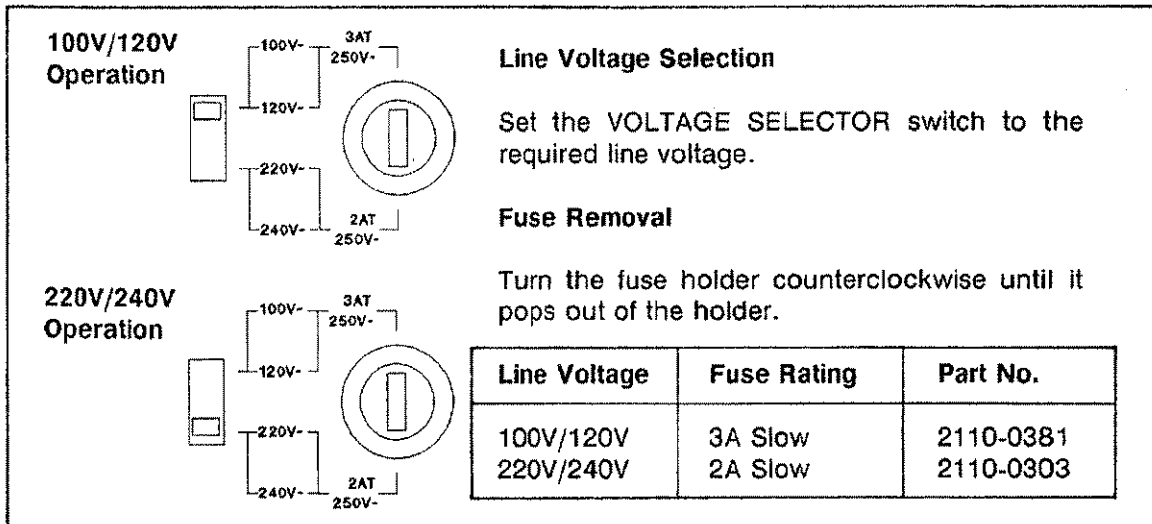

Figure 1-2. Line Voltage and Fuse Selection

1-3-3. POWER CABLE

To protect operating personnel, the National Electrical Manufacturer's Association (NEMA) recommends that the instrument panel and cabinet be grounded. The 4278A is equipped with a three-conductor power cable that, when plugged into an appropriate AC power receptacle, grounds the instrument. The offset pin on the power cable is ground.

To preserve the protection feature when operating the instrument from a two contact outlet, use a three-prong to two-prong adapter (HP PN 1251-8196) and connect the green pigtail on the adapter to the power-line ground.

CAUTION

THE POWER PLUG MUST BE PLUGGED INTO AN OUTLET THAT PROVIDES A PROTECTIVE EARTH CONNECTION. DO NOT USE AN EXTENSION CORD OR POWER CABLE THAT DOES NOT HAVE A PROTECTIVE GROUND.

Figure 1-3 shows the available power cords used in various countries. Also shown is the standard power cord furnished with the instrument. HP part numbers, applicable standards for power plugs, electrical characteristics, and the countries using each power cord are listed in Figure 1-3. For assistance in selecting the correct power cable, contact the nearest Hewlett-Packard sales office.

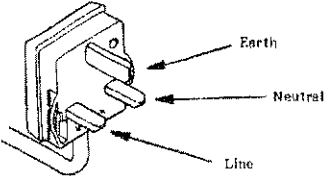
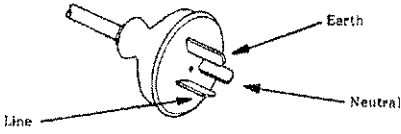
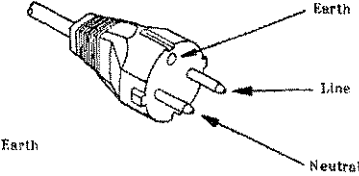
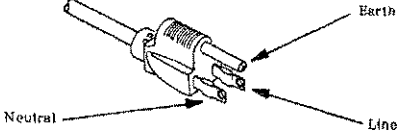
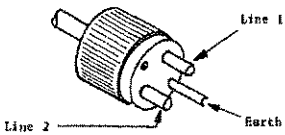
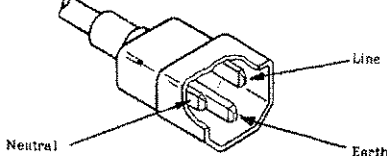
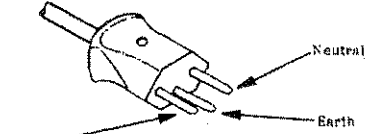
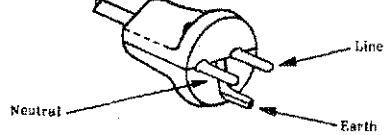
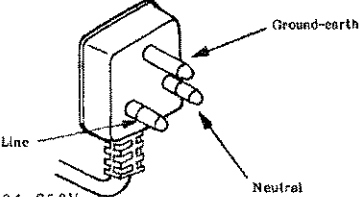
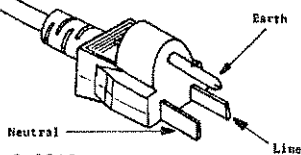
<p>OPTION 900 United Kingdom</p>  <p>Plug : BS 1363A, 250V Cable : HP 8120-1351</p>	<p>OPTION 901 Australia/New Zealand</p>  <p>Plug : NZSS 198/AS C112, 250V Cable : HP 8120-1369</p>
<p>OPTION 902 European Continent</p>  <p>Plug : CEE-VII, 250V Cable : HP 8120-1689</p>	<p>OPTION 903 U.S./Canada</p>  <p>Plug : NEMA 5-15P, 125V, 15A Cable : HP 8120-1378</p>
<p>OPTION 904 U.S./Canada</p>  <p>Plug : NEMA 6-15P, 250V, 15A Cable : HP 8120-0698</p>	<p>OPTION 905* Any country</p>  <p>Plug : CEE 22-VI, 250V Cable : HP 8120-1396</p>
<p>OPTION 906 Switzerland</p>  <p>Plug : SEV 1011.1959-24507 Type 12, 250V Cable : HP 8120-2104</p>	<p>OPTION 912 Denmark</p>  <p>Plug : DHCR 107, 220V Cable : HP 8120-2956</p>
<p>OPTION 917 India/Republic of S.Africa</p>  <p>Plug : SABS 164, 250V Cable : HP 8120-4211</p>	<p>OPTION 918 Japan</p>  <p>Plug : JIS C 8303, 125V, 15A Cable : HP 8120-4753</p>

NOTE: Each option number includes a 'family' of cords and connectors of various materials and plug body configurations (straight, 90° etc.).

* Plug option 905 is frequently used for interconnecting system components and peripherals.

Figure 1-3. Available (furnished) Power Cables

SECTION 2

FAMILIARIZING YOURSELF WITH THE HP 4278A

2-1. INTRODUCTION	2-1
2-2. PANEL FEATURES	2-1
2-3. BASIC OPERATION	2-5
2-3-1. MEASURING CERAMIC CAPACITORS	2-5
2-3-2. STANDARDS COMPENSATION	2-9
2-3-3. USING THE COMPARATOR FUNCTION	2-10
2-3-4. SELECTING DISPLAY FORMATS	2-12
2-3-5. STORING AND AUTO LOADING CONTROL SETTINGS	2-13

1
2
3
4
5
6
7
8
9
10
11
12
13
14
15
16
17
18
19
20
21
22
23
24
25
26
27
28
29
30
31
32
33
34
35
36
37
38
39
40
41
42
43
44
45
46
47
48
49
50
51
52
53
54
55
56
57
58
59
60
61
62
63
64
65
66
67
68
69
70
71
72
73
74
75
76
77
78
79
80
81
82
83
84
85
86
87
88
89
90
91
92
93
94
95
96
97
98
99
100

SECTION 2

FAMILIARIZING YOURSELF WITH THE HP 4278A

2-1. INTRODUCTION

This section provides basic operating information in the form of practice exercises for first time HP 4278A users. Read this section before operating your HP 4278A.

The **WARNINGS**, **CAUTIONS**, and **NOTES** given throughout this document must be carefully followed to ensure the operator's safety and the serviceability of the 4278A.

WARNING

BEFORE TURNING THE 4278A ON, BE SURE ALL PROTECTIVE EARTH TERMINALS, EXTENSION CORDS, AUTO-TRANSFORMERS, AND DEVICES CONNECTED TO THE 4278A ARE CONNECTED TO EARTH GROUND. ANY INTERRUPTION OF EARTH GROUND CONSTITUTES A SHOCK HAZARD WHICH MAY RESULT IN PERSONAL INJURY.

ONLY FUSES WITH THE REQUIRED CURRENT RATING AND OF THE SPECIFIED TYPE CAN BE USED. DO NOT USE A SUBSTITUTE FOR THE PROPER FUSE AND NEVER SHORT CIRCUIT THE FUSE-HOLDER. DOING SO CONSTITUTES A SHOCK AND FIRE HAZARD.

CAUTION

Before you turn your 4278A on, be sure to set the voltage selector to the line voltage to be used, or the instrument will be damaged.

2-2. PANEL FEATURES

Figures 2-1 and 2-2 identify and briefly describe the purpose of each key, indicator, and connector on the front and rear panels of the 4278A. Section 3 provides a detailed description of each 4278A control.

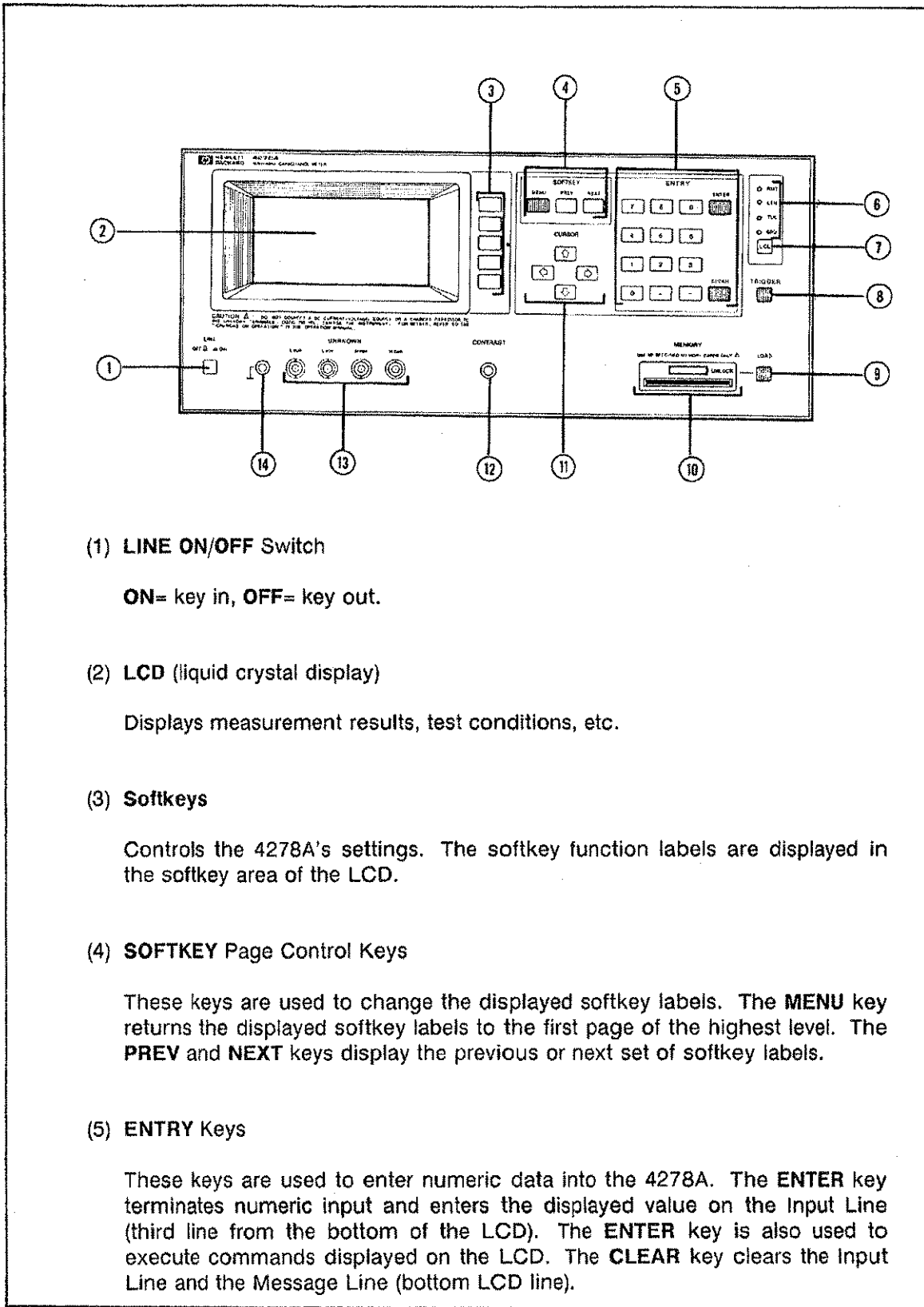

(1) **LINE ON/OFF** Switch

ON= key in, **OFF**= key out.

(2) **LCD** (liquid crystal display)

Displays measurement results, test conditions, etc.

(3) **Softkeys**

Controls the 4278A's settings. The softkey function labels are displayed in the softkey area of the LCD.

(4) **SOFTKEY** Page Control Keys

These keys are used to change the displayed softkey labels. The **MENU** key returns the displayed softkey labels to the first page of the highest level. The **PREV** and **NEXT** keys display the previous or next set of softkey labels.

(5) **ENTRY** Keys

These keys are used to enter numeric data into the 4278A. The **ENTER** key terminates numeric input and enters the displayed value on the Input Line (third line from the bottom of the LCD). The **ENTER** key is also used to execute commands displayed on the LCD. The **CLEAR** key clears the Input Line and the Message Line (bottom LCD line).

Figure 2-1. Front Panel Features (Sheet 1 of 2)

(6) **HP-IB Status Indicators**

These indicators--**RMT** (remote), **TLK** (talk), **LTN** (listen), and **SRQ** (service request)--show the 4278A's status when interfaced to a controller via HP-IB. These four indicators are valid only when the 4278A is equipped with an HP-IB interface option.

(7) **LCL** (local) Key

This key sets the 4278A to local control if an HP-IB Option is installed.

(8) **TRIGGER** Key

This key triggers the 4278A when the 4278A is set to the **MANual TRIGger** mode.

(9) **LOAD** Key

The **LOAD** key loads control setting data from an installed memory card.

(10) **MEMORY** Card Slot and **UNLOCK** Button

The **MEMORY** card slot is for inserting memory cards. To eject a memory card, press the **UNLOCK** button and remove the memory card.

(11) **CURSOR** keys

These four arrow keys move the cursor on the LCD in the direction of the arrow.

(12) **CONTRAST** Adjust Control

This knob controls the contrast of the LCD.

(13) **UNKNOWN** Terminals

These terminals are for connecting four terminal-pair test fixtures or test leads.

(14) **Guard** Terminal

This terminal is tied to the instrument's chassis and can be used for measurements that require guarding.

Figure 2-1. Front Panel Features (Sheet 2 of 2)

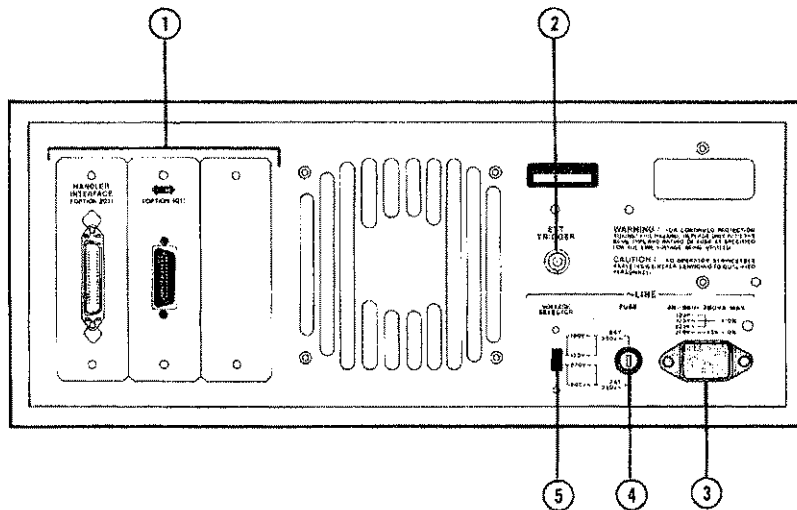

This illustration shows the 4278A's rear panel with Options 101 and 201 installed.

(1) **Interface Connectors** (Optional)

When interface options are installed, the interface connectors will be installed as shown. On 4278A's not equipped with an interface option, blank covers are installed.

(2) **EXT TRIGGER** Connector

A positive-going TTL pulse applied at this connector triggers the 4278A if the trigger mode is set to **EXT**ernal.

(3) **~ LINE** Input Receptacle

AC power cord receptacle.

(4) **~ LINE** Fuse Holder

The 4278A's line fuse is installed in this fuse holder. Refer to Section 1 for correct fuse ratings.

(5) **~ LINE VOLTAGE SELECTOR**

This switch sets the appropriate AC operating voltage.

Figure 2-2. Rear Panel Features

2-3. BASIC OPERATION

The following paragraphs describe how to perform a basic capacitance measurement when using a test fixture, and is intended for first time 4278A users. This procedure may not apply to your specific application, but will help you understand the 4278A's operation.

2-3-1. MEASURING CERAMIC CAPACITORS

This example shows how to measure a 4700pF ceramic capacitor (HP PN 0160-4298) using a direct-coupled HP 16047A test fixture. Prepare a test fixture and capacitor, not necessarily those used here, then perform the following procedure.

1. Connect a direct-coupled test fixture to the 4278A's **UNKNOWN** terminals as shown in Figure 2-3.

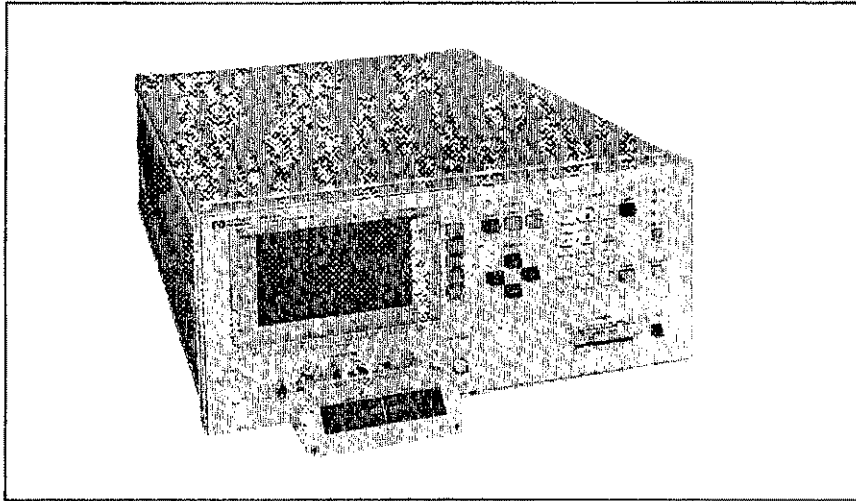

Figure 2-3. Test Fixture Connection

2. Without a memory card installed, turn the 4278A on.
3. When measurement results are displayed, adjust the **CONTRAST** knob for LCD clarity.

Selecting and Setting Measurement Parameters

4. Press the '**MEAS PARMTR**' softkey. The marker (▶) shows that **Cp-D** is the presently selected measurement parameter.



NOTE

In this manual, displayed 4278A softkey labels are indicated in **bold** text and are enclosed in single quotes: e.g., '**MEAS PARMTR**' softkey.

5. The 1/2 in the lower right-hand corner of the display indicates two pages of softkey labels, and that page one is now displayed. Press the **PREV** or **NEXT** key to display additional softkey label pages.
6. To select a measurement parameter, press the corresponding softkey. The ► marker will be displayed next to the parameter you selected. Press the '**Cp-G**' softkey.
7. Press the '**return**' softkey. The initial softkey label page will be displayed.

Setting the Test Signal

8. Press the '**SIGNAL SOURCE**' softkey. From this page, you can set the frequency and voltage of the test signal.
9. Press the '**FREQ**' softkey. Confirm that **1kHz** is the presently set frequency (default setting), and that **1kHz** is displayed in the **FREQ :** field (top line of the LCD). Press the '**return**' softkey.
10. Press the '**OSC (V)=**' softkey. The Input Line (third line from the bottom of the LCD) displays "OSC LVL=_1.0V", and the **OSC LVL :** field (second line from the top) also displays the the set test signal voltage.

For practice, change the test signal voltage to 0.9V by pressing the **.9** numeric **ENTRY** keys, and by pressing the **ENTER** key. Confirm that "OSC LVL=_0.9V" is displayed on the Input Line and in the **OSC LVL :** field. You can also edit the test signal voltage by using the ( or ) **CURSOR** keys to position the cursor under the digit you wish to change and by entering the desired value.

11. Press the '**return**' softkey.

Setting Measurement Conditions

12. Press the '**HI-ACC MODE**' softkey. Confirm that **OFF @1MHz** is selected (default setting). Because the high accuracy mode is valid for 1MHz measurements only, do not change the high accuracy mode setting. Press the '**return**' softkey.
13. Press the '**MEAS RANGE**' softkey. Confirm that **AUTO** is selected (default setting) and is displayed in the **RANGE :** field (fourth line from the top of the LCD). Press the '**return**' softkey.
14. Press the '**MEAS TIME**' softkey, then press the '**INTEG TIME**' softkey. Confirm that **LONG** is selected (default setting) and is displayed in the **INTEG :** field (top LCD line). Press the '**return**' softkey.

15. Press the '**AVG RATE**' softkey. The averaging rate is displayed in the **AVG :** field (second line from the top of the LCD). Each time you press the '**UP**' softkey, the averaging rate doubles (to a maximum averaging rate of 256), and inversely so by pressing the '**DOWN**' softkey. Set the averaging rate to 1. Press the '**return**' softkey.
16. Press the '**DELAY (ms)=**' softkey. This allows you to set the delay time from the input of a trigger to the start of a measurement. The Input Line displays the set delay time, and the delay time is also displayed in the **DELAY :** field (third line from the top of the LCD). For this example, leave the delay time set to 0ms as it is now. Press the '**return**' softkey.
17. Press the **NEXT** key to display the second page of softkey labels (2/4).
18. Press the '**TRIG MODE**' softkey, then press the '**MAN TRIG**' softkey to set the manual trigger mode. The selected trigger mode is displayed in the **TRIG :** field (fourth line from the bottom of the LCD).
19. Press the **TRIGGER** key. Note that a single measurement is performed each time you press the **TRIGGER** key. Press the '**return**' softkey.
20. Press the '**CABLE LENGTH**' softkey. Confirm that 0m is selected (default setting) and is displayed in the **CABLE :** field (fourth line from the bottom of the LCD). Press the '**return**' softkey.

Compensating for Test Fixtures

21. Press the '**COMPEN**' softkey.
22. With the fixture's terminals open (nothing connected), press the '**OPEN COMPEN**' softkey, and observe the display. The message "Open offset compen. completed" will be displayed on the Message Line (the bottom line of the LCD), and the open admittance data will be displayed on the Monitor Line (second line from the bottom).
23. Press the **TRIGGER** key and confirm that the measurement result is the same (or almost the same) as the open admittance data.
24. Press the '**OPEN ON**' softkey, then press the **TRIGGER** key. The measurement result is compensated for, in accordance with the open admittance data, and is close to zero in value. Press the **NEXT** key.
25. Connect a shorting bar to the test fixture as shown in Figure 2-4.

NOTE

The recommended shorting bar is described in the operation note for each test fixture.

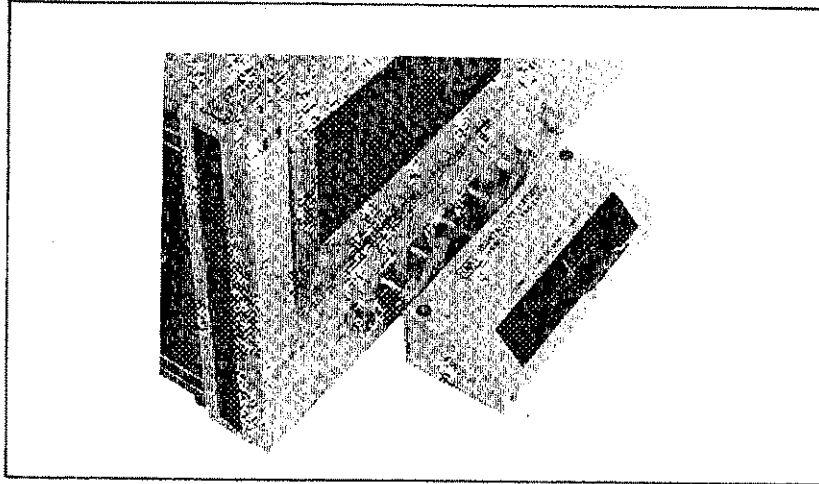

Figure 2-4. Shorting Bar Connection

26. Press the **'SHORT COMPEN'** softkey, and observe the display. The message "Short offset compen. completed" will be displayed on the Message Line, and the short compensation impedance data will be displayed on the Monitor Line.
27. Press the **'SHORT ON'** and **'return'** softkeys.
28. Remove the shorting bar and connect a ceramic capacitor as shown in Figure 2-5.

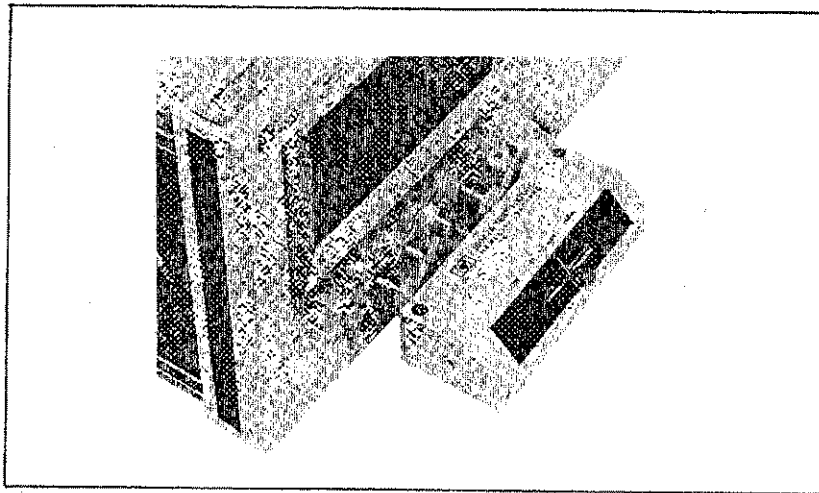

Figure 2-5. Ceramic Capacitor Connection

29. Press the **TRIGGER** key. The ceramic capacitor's capacitance and conductance measurement results will be displayed.
30. To continue with the next practice exercise, leave the 4278A's control settings as they are now, and proceed.

2-3-2. STANDARDS COMPENSATION

To compensate the 4278A for performing measurements against a working standard, confirm that softkey label page 2/4 is displayed in the lower right-hand corner of the LCD, and perform the following procedure.

Assuming that you used the capacitor mentioned at the beginning of the previous procedure, your measurement result should be approximately 4.7nF. Let's further assume that you measured this capacitor as 4.8nF using another capacitance meter, and that this reading is your working standard. The 4278A allows you to perform standards compensation to match the 4278A's reading to that of your working standard. Perform the following procedure without changing the measurement settings established in the previous procedure.

NOTE

When standards compensation is performed, 4278A capacitance measurement results are referenced to the working standard, so 4278A measurement accuracy is not applicable.

1. Press the **'COMPEN'** softkey, then press the **PREV** key twice.
2. Press the **'STD PARMTR'** and **'C-G'** softkeys. Press the **'return'** softkey.

NOTE

In this example, assume that the working standard's **Cp-G** measurement values are 4.8nF and 0 μ S.

3. Press the **'STD ENTRY'** softkey. Press the **'C='** softkey and press the **4.8** numeric keys. Press the **'nF'** softkey, then the **ENTER** key to enter the reference capacitance.
4. Press the **'G='** softkey and enter the conductance reference value (0 μ S) as in step 3 above. Press the **'return'** softkey.
5. Press the **PREV** key and **'STD COMPEN'** softkey, and observe the display. The message "Std. compensation completed" will be displayed on the Message Line and the working standard's measurement result will be displayed on the Monitor Line.
6. Press the **'STD ON'** softkey and the **TRIGGER** key. The measurement result will be very close to 4.8nF.
7. To continue with the next practice exercise, leave the 4278A's control settings as they are now, and proceed.

2-3-3. USING THE COMPARATOR FUNCTION

The following procedure will give you practice using the 4278A's comparator function. Perform this procedure without changing the measurement settings established in the previous procedure.

1. Press the **MENU** key to reset the softkey labels to the initial page.
2. Press the **NEXT** key twice.
3. Press the '**COMPARATOR**' and '**LIMIT TABLE**' softkeys to display the limit table.
4. Press the '**CLEAR LIMIT**' softkey and the **ENTER** key to initialize the limit table.
5. Press the '**CHANGE PARMTR**' softkey. Press the '**Cp-G**' softkey, then press the 'return' softkey.
6. Observe the upper-left corner of the display and press the '**REVERS PARMTR**' softkey. Note that each time you press the '**REVERS PARMTR**' softkey, the primary and secondary parameters switch positions. Reset the displayed parameters to **Cp-G**.
7. Press the '**LIMIT MODE**' softkey. This allows you to select from three sorting methods. For this example, leave the sorting method set to **% TOL**, as it is now. Basically, the **% TOL** method sorts capacitors into plus and minus percentages from a **NOMINAL** value that must be input by you. Refer to Section 3 for details. Press the 'return' softkey.
8. Confirm that the cursor is in the **Nom :** field (top LCD line). Enter the **NOMINAL** capacitance value (in this case, 4.8nF) using the numeric **ENTRY** keys, the '**nF**' softkey, and the **ENTER** key.
9. The cursor automatically moves to the **BIN 1** row of the limit table. Press the **1** key, then press the **ENTER** key. The **LOW** and the **HIGH** limits of **BIN 1** will be set to -1% and +1%, respectively, and the cursor moves to the **BIN 2** row.
10. Set **BIN 2** to $\pm 2\%$, **BIN 3** to $\pm 5\%$, **BIN 4** to $\pm 10\%$, **BIN 5** to $\pm 20\%$, and **BIN 6** to $\pm 50\%$ in the same manner.
11. Confirm that the limit table is as shown in Figure 2-6, then press the '**exit LIMIT**' softkey.

Cp-G	Nom :	4.8 nF		
BIN	LOW	HIGH	COUNT	CLEAR
1	-1%	+1%	0	LIMIT
2	-2%	+2%	0	-----
3	-5%	+5%	0	CHANGE
4	-10%	+10%	0	PARMTR
5	-20%	+20%	0	-----
6	-50%	+50%	0	REVERS
7			0	PARMTR
8			0	-----
9			0	LIMIT
2nd				MODE
Rej cnt		OUT:	0	-----
G REF=0 μS				exit
C m: 4.70000 nF		G m: 0.20000 μS		LIMIT
				1/3

Figure 2-6. Limit Table Display

NOTE

Disregard any information displayed on the Input, Monitor, and Message Lines (bottom three LCD lines) when confirming the Limit Table.

12. Press the 'COMPTR ON' softkey. The **COMPTR :** field (fifth line from the top of the LCD) will display that the comparator is set to on. Press the 'return' softkey.
13. To continue with the next practice exercise, leave the 4278A's control settings as they are now, and proceed.

2-3-4. SELECTING DISPLAY FORMATS

You can select from four 4278A display formats. To observe the available display formats, confirm that softkey page 3/4 is displayed in the lower-right hand corner of the LCD, and perform the following procedure.

1. Press the **'DISPLY PAGE'** softkey, and the four available format selections will be displayed.
2. Press the **'SORT PAGE'** softkey. This format displays bin sorting results.
3. Press the **TRIGGER** key and observe the display. The bin number selected and the capacitance and conductance measurement values for the capacitance measurement you just performed will be displayed.
4. Press the **'LIMIT PAGE'** softkey, and the Limit Table will be displayed. From this format, you can establish comparator limits, as explained in paragraph 2-3-3 (the preceding procedure).
5. Press the **'return'**, **'COMPARATOR'**, and **'COUNT'** softkeys.
6. Press the **'COUNT ON'** softkey. Observe the COUNT column (right-most column) of the Limit Table, and perform a measurement by pressing the **TRIGGER** key. The count number for the bin a capacitor is sorted to, depending on measurement results, will increase by one for each measurement performed. This allows you to keep track of how many capacitors are sorted to each bin.
7. Press the **'RESET COUNT'** softkey. Note that all bin counts are reset to zero.
8. Press the **'return'** softkey twice, then press the **'DISPLAY PAGE'** softkey.
9. Press the **'STATUS PAGE'** softkey and observe the display. This page displays the present compensation data status.
10. Press the **'MEAS PAGE'** and **'return'** softkeys.
11. Press the **'DISPLY CONTRL'** softkey.
12. Press the **'No. of DIGIT'** softkey. This page allows you to select the number of display digits, and, therefore, displayed measurement resolution. Press the **TRIGGER** key and note that measurement results are displayed to six digits. You can control the number of displayed digits by pressing the corresponding softkey.
13. Press the **'6 DIGITS'** and **'return'** softkeys.
14. Press the **'DISPLY VALUE'** softkey. Because **MEAS VALUE** is selected (default setting), capacitance measurement values are displayed as **Cp**.

15. Press the **'TOL VALUE'** softkey. Observe the display and press the **TRIGGER** key. The difference (in percent) between the measurement value and the **NOMINAL** value established on the Limit Table is displayed as **Cp**.
16. Press the **'MEAS VALUE'** softkey, and press the **'return'** softkey twice.
17. Press the **'VALUE MONITR'** softkey. The marker (▶), displayed at the **'STD'** softkey label, indicates the 4278A's monitor function is operating. This monitor function automatically turns on whenever a compensation data measurement is performed. In this example, the last compensation measurement was the working standard's measurement, so the **STD** monitor is on, and the working standard's measurement results are displayed on the Monitor Line.
18. Press the **'MONITR OFF'** softkey to clear the Monitor Line.
19. Press the **CLEAR** key to clear the Input and Message Lines.
21. Press the **'return'** softkey and the **NEXT** key.
20. To continue with the next practice exercise, leave the 4278A's control settings as they are now, and proceed.

2-3-5. STORING AND AUTO LOADING CONTROL SETTINGS

To store control settings on a memory card and to show the 4278A's auto loading feature, perform the following procedure. Confirm that softkey label page 4/4 is displayed in the lower right-hand corner of the LCD.

1. Insert a memory card into the **MEMORY** card slot until the card locks in place.
2. Press the **'MEMORY CARD'** softkey, the **'STORE'** softkey, and the **ENTER** key.
3. The present control settings will be stored in the memory card and the message "Storing completed" will be displayed on the Message Line.
4. Press the **'return'** softkey, then press the **'KEY LOCK'** softkey.
5. Press the **'LOCK'** softkey. Confirm that all the front panel keys are disabled, except for the **'UNLOCK'** softkey.
6. Press the **'UNLOCK'** softkey.
7. Turn the 4278A off.
8. With the memory card inserted, turn the 4278A on. Observe the display and note that the message "Auto load completed" is momentarily displayed on the Message Line. The control settings you stored in the memory card are now established.

NOTES

1
2
3
4
5
6
7
8
9
10
11
12
13
14
15
16
17
18
19
20
21
22
23
24
25
26
27
28
29
30
31
32
33
34
35
36
37
38
39
40
41
42
43
44
45
46
47
48
49
50
51
52
53
54
55
56
57
58
59
60
61
62
63
64
65
66
67
68
69
70
71
72
73
74
75
76
77
78
79
80
81
82
83
84
85
86
87
88
89
90
91
92
93
94
95
96
97
98
99
100

SECTION 3

FUNCTIONS AND FEATURES

3-1. INTRODUCTION	3-1
3-2. MEASUREMENT FUNCTIONS	3-1
3-2-1. 1kHz MEASUREMENTS	3-1
3-2-2. 1MHz NORMAL MEASUREMENTS	3-2
3-2-3. 1MHz HIGH ACCURACY MEASUREMENTS	3-2
3-3. MEASUREMENT PARAMETERS	3-4
3-3-1. PARAMETERS	3-4
3-3-2. PARAMETER RELATIONSHIPS	3-4
3-4. TEST SIGNAL	3-5
3-5. MEASUREMENT TIME	3-5
3-5-1. INTEGRATION TIME	3-5
3-5-2. AVERAGING	3-5
3-5-3. DELAY TIME	3-5
3-6. DISPLAY	3-7
3-6-1. DISPLAY FIELD DEFINITIONS	3-7
3-6-2. MEASUREMENT PAGE FORMAT	3-8
3-6-3. SORTING PAGE FORMAT	3-9
3-6-4. STATUS PAGE FORMAT	3-10
3-6-5. LIMIT PAGE FORMAT	3-11
3-6-6. DISPLAY DIGITS	3-11
3-6-7. DISPLAY VALUE SELECTION	3-11
3-6-8. NON-NUMERIC DISPLAY	3-12
3-7. TREE STRUCTURE OF THE SOFTKEY LABELS	3-12
3-8. DEFAULT SETTINGS AT POWER-ON	3-13

3-9. NONVOLATILE MEMORY	3-14
3-9-1. INTERNAL MEMORY	3-14
3-9-2. MEMORY CARD	3-14
3-9-3. MEMORY CARD ID COMMENTS	3-15
3-3-4. WRITE PROTECTION	3-15
3-10. COMPARATOR	3-18
3-10-1. LIMIT PARAMETERS	3-18
3-10-2. LIMIT MODES	3-18
3-10-3. SECONDARY PARAMETER AND AUX BIN	3-20
3-10-4. BIN COUNTER	3-21
3-11. CABLE LENGTH SELECTION	3-21
3-12. COMPENSATION	3-22
3-12-1. OPEN COMPENSATION	3-22
3-12-2. SHORT COMPENSATION	3-22
3-12-3. STANDARD COMPENSATION	3-22
3-12-4. TEMPERATURE COMPENSATION	3-22
3-13. DISPLAY OFFSET	3-23
3-14. VALUE MONITOR	3-23
3-15. TRIGGER MODE	3-23
3-16. KEYBOARD LOCK-OUT	3-24
3-17. SERVICE FUNCTIONS	3-24

SECTION 3

FUNCTIONS AND FEATURES

3-1. INTRODUCTION

This section provides information about the functions and features of the HP 4278A 1kHz/1MHz Capacitance Meter. Read Section 2 before reading this section. Information unique to the Option Interfaces is described in Section 4.

3-2. MEASUREMENT FUNCTIONS

The HP 4278A's measurement functions are classified by frequency into 1kHz, 1MHz normal, and 1MHz high accuracy measurement modes.

3-2-1. 1kHz MEASUREMENTS

The 4278A's 1kHz measurement function has seven measurement ranges -- 100pF, 1nF, 10nF, 100nF, 1 μ F, 10 μ F, and 100 μ F. Table 3-1 lists the maximum measurement values for each of the measurement parameters. Table 3-1 also includes information on the data display format (position of the decimal point and unit). Maximum **D** and **Q** values are 9.99999 and 99999.9, respectively, and the display format for **D** and **Q** is fixed for all ranges.

Table 3-1. 1kHz Measurement Ranges

Range	Cp/Cs	G	Rs (ESR)
100pF	200.000pF	0.62831 μ S	9.99999M Ω
1nF	2.00000nF	06.2831 μ S	999.999k Ω
10nF	20.0000nF	062.831 μ S	99.9999k Ω
100nF	200.000nF	0.62831mS	9.99999k Ω
1 μ F	2.00000 μ F	06.2831mS	999.999 Ω
10 μ F	20.0000 μ F	062.831mS	99.9999 Ω
100 μ F	200.000 μ F	0.62831S	9.99999 Ω

Leading zeros preceding the one's digit are place holders and will not be displayed. Measurement results which are greater than the values listed in the preceding table may be displayed.

When the number of display digits is set to less than six digits (4 or 5) the remaining digits will not be displayed.

3-2-2. 1MHz NORMAL MEASUREMENTS

The 4278A's 1MHz normal measurement function has eleven measurement ranges -- 1pF, 2pF, 4pF, 8pF, 16pF, 32pF, 64pF, 128pF, 256pF, 512pF, and 1024pF. Table 3-2 lists the maximum measurement values for each of the measurement parameters. The maximum values for **D** and **Q** are 9.99999 and 99999.9, respectively, and the display format of **D** and **Q** is fixed for all ranges.

Table 3-2. 1MHz Normal Measurement Ranges

Range	Cp/Cs	G	Rs (ESR)
1pF	1.25000pF	6.28319μS	999.999kΩ
2pF	2.50000pF	12.5664μS	999.999kΩ
4pF	5.00000pF	25.1327μS	99.9999kΩ
8pF	10.0000pF	50.2655μS	99.9999kΩ
16pF	20.0000pF	100.531μS	99.9999kΩ
32pF	40.0000pF	201.062μS	9.99999kΩ
64pF	80.0000pF	402.124μS	9.99999kΩ
128pF	160.000pF	0.80425mS	9.99999kΩ
256pF	320.000pF	1.60850mS	999.999Ω
512pF	640.000pF	3.21699mS	999.999Ω
1024pF	1.28000nF	6.43398mS	999.999Ω

NOTE

Leading zeros preceding the one's digit are place holders and will not be displayed. Measurement results which are greater than the values listed in the preceding table may be displayed.

When the number of display digits is set to less than six digits (4 or 5) the remaining digits will not be displayed.

The maximum length of test leads which can be used for 1MHz measurements is 2.5m.

3-2-3. 1MHz HIGH ACCURACY MEASUREMENTS

The 4278A's measurement range in the 1MHz High Accuracy measurement mode is determined differently than it is for the other measurement modes. You can set the measurement range, up to 2048pF, from the front panel, and can measure capacitance within the measurement range you set, ±30%. The measurement range is determined by the sum of the capacitance value you enter and the open capacitance.

For example, if the open capacitance is 0.3pF and you enter 47pF as the range value, the measurement range will be set to 47.3pF and you will be able to measure capacitance from 32.81pF to 61.19pF.

$$(100\% - 30\%) \times 47.3\text{pF} - 0.3\text{pF} = 32.81\text{pF}$$

$$(100\% + 30\%) \times 47.3\text{pF} - 0.3\text{pF} = 61.19\text{pF}$$

NOTE

Open capacitance is regarded as 0pF if the Open Compensation function is set to OFF when you enter the range value. Refer to paragraph 3-12-1 for details on Open Compensation.

If the sum of the entered capacitance and open capacitance is < 2pF, the 4278A measures capacitance at the range value, ±0.6pF.

Maximum **D** and **Q** values are 0.050000 and 99999.9, respectively, and the data format for **D** and **Q** is fixed for all ranges.

Maximum conductance **G**, can be derived by using the following equation.

$$G_{max} = 0.05 \times 2\pi \times 1\text{MHz} \times (C_p \text{ of the capacitor under test})$$

Maximum **Rs** (ESR) value can be derived by using the following equation.

$$R_{max} = 0.05 / (2\pi \times 1\text{MHz} \times (C_s \text{ of the capacitor under test}))$$

Table 3-3 shows the relationship between the range value and the data format (decimal point positioning and units).

Table 3-3. 1MHz High Accuracy Measurement Display Ranges

Range Value	Cp/Cs	G	Rs (ESR)
0.00pF to 2.00pF	D.DDDDDpF	D.DDDDDμS	DDD.DDDkΩ
2.01pF to 4.00pF	D.DDDDDpF	D.DDDDDμS	DD.DDDkΩ
4.01pF to 16.00pF	DD.DDDDPF	D.DDDDDμS	DD.DDDkΩ
16.01pF to 64.00pF	DD.DDDDPF	DD.DDDμS	D.DDDkΩ
64.01pF to 128.0pF	DDD.DDDpF	DD.DDDμS	D.DDDkΩ
128.1pF to 512.0pF	DDD.DDDpF	DDD.DDDμS	DDD.DDDΩ
512.1pF to 1024pF	D.DDDDDnF	DDD.DDDμS	DDD.DDDΩ
1024pF to 2048pF	D.DDDDDnF	D.DDDDDmS	DDD.DDDΩ

"D" in the table indicates one decimal digit.

NOTE

The maximum length of test leads which can be used for 1MHz measurements is 2.5m.

3-3. MEASUREMENT PARAMETERS

The 4278A's measurement parameters and their relationships are described in the following paragraph.

3-3-1. PARAMETERS

The 4278A measures parallel capacitance C_p or series capacitance C_s , and one of the following parameters: Dissipation Factor D , Quality Factor Q , Conductance G in parallel with C_p , and Equivalent Series Resistance R_s in series with C_s . The measurement parameter combinations which can be selected are C_p - D , C_p - Q , C_p - G , C_s - D , C_s - Q , and C_s - R_s .

NOTE

The 4278A displays equivalent series resistance as R_s .

3-3-2. PARAMETER RELATIONSHIPS

D and Q are not dependent on the equivalent circuit model, so D in C_p - D and C_s - D are equal, and Q in C_p - Q and C_s - Q are equal. The following equations show the relationship between C_p and C_s , and between G and R_s . C_p and C_s are equal for the ideal capacitor, where $D=0$. C_s will be greater than C_p if D is greater than 1. Figure 3-1 shows the relationships among measurement parameters.

$$C_s = (D^2 + 1)C_p$$

$$1/ESR = ((1/D^2) + 1)G$$

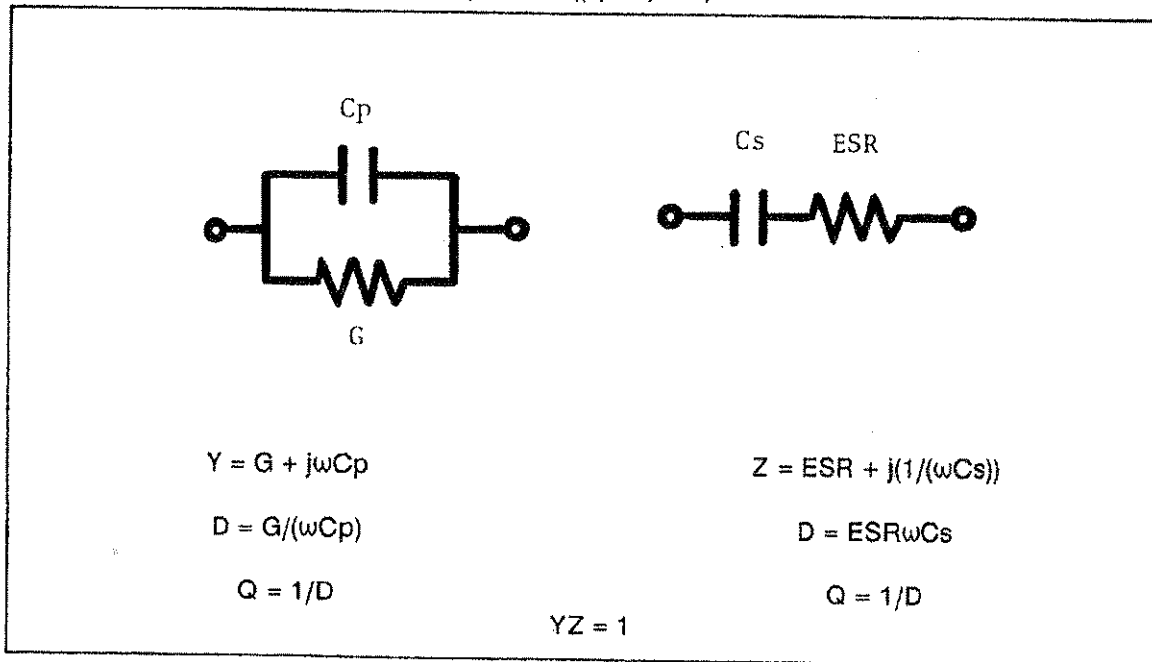

Figure 3-1. Measurement Parameter Relationships

3-4. TEST SIGNAL

A 1kHz and 1MHz sine wave signal is used as the 4278A's test signal. The test signal voltage can be set from 0.1Vrms to 1.0Vrms in 0.1V steps.

Test signal output impedance is very low, so the 4278A applies a constant test signal voltage to the capacitor under test. This holds true for all measurement ranges except the 100 μ F range at 1kHz: The low impedance of capacitors with values greater than 20 μ F tends to degrade the test signal voltage.

3-5. MEASUREMENT TIME

The measurement time starts from the moment the measurement is triggered until the 4278A is ready to start the next measurement. The 4278A's measurement time is determined by INTEG TIME (A-D conversion time) setting, the AVG RATE (number of averaging) setting, the DELAY TIME (time delay between the trigger and the start of the measurement) setting, and the DISPLY PAGE (display format) selection. Figure 3-2 shows measurement times.

3-5-1. INTEGRATION TIME

When a capacitor is connected and the 4278A is triggered, the 4278A's analog measurement circuit generates a voltage proportional to the measurement results. Integration time (INTEG TIME) is the time required to convert the analog output voltage of the measurement circuit into a digital value. Generally, greater conversion times result in more stable measurements and more accurate measurement results. SHORT, MEDIUM, or LONG integration times can be selected.

3-5-2. AVERAGING

The 4278A's averaging function arithmetically averages the results of two or more A-D conversions. The number of conversions averaged can be set to 1, 2, 4, 8, 16, 32, 64, 128, or 256.

3-5-3. DELAY TIME

The 4278A's delay time function allows you to set a trigger delay so the 4278A will delay the start of the measurement when a trigger is received. The trigger delay time can be set from 0ms to 1000ms in 1ms steps. This function is useful if a component handler triggers the 4278A before stable contact is made with the test capacitor.

When averaging is set to 1:

TRIGGER



When averaging is set to more than 2:

TRIGGER



DELAY TIME: Settable from 0ms to 1000ms in 1ms steps

Settling Time: approx. 1ms

Wait Time: approx. 4ms

INTEG TIME		Data Processing Time
SHORT	1.7ms	approx. 4ms
MED	5.4ms	approx. 4ms
LONG	13.6ms	approx. 6ms

Display Page Format	Display Time
MEAS PAGE	approx. 5.0ms
LIMIT PAGE	approx. 2.0ms
SORT PAGE	approx. 2.4ms
STATUS PAGE	0

Figure 3-2. Measurement Times

NOTE

The 4278A does not require additional recovery time if a measurement is performed on a shorted or an open capacitor. The analog measurement circuits will recover within the allotted settling time, ensuring measurement accuracy on succeeding measurements.

To obtain the highest measurement speed, set the display format to the **STATUS PAGE** format.

3-6. DISPLAY

The following paragraphs define the display fields and describe the display formats and data displayed on the LCD.

3-6-1. DISPLAY FIELD DEFINITIONS

The 4278A has a 40 character by 16 line LCD display.

The last six character spaces of each line are reserved for the softkey labels. This entire area is referred to as the SOFTKEY field.

The lowest line of the softkey field displays the MORE field. This field indicates the number of softkey pages available, and which softkey label page is presently displayed. For example, if four levels of softkey label pages are available, and the first softkey label page is displayed, 1/4 will be displayed, indicating page one of four pages. Pressing the PREV or NEXT keys will display the previous or next set of softkey labels.

The row to the left of the softkey area is the MARKER field. A marker (▶) will be displayed beside the selected softkey label.

The 4278A's settings and measurement results are displayed on the rest of the display--33 characters wide, from the left-hand side of the LCD. The first five lines from the top is the STATUS field. The fields for measurement frequency (FREQ : 1kHz or 1MHz), test signal voltage (OSC LVL :), setting of the 1MHz high accuracy mode (HI ACC : on or off), measurement range (RANGE :), A-D conversion time settings (INTEG TIME : SHORT, MEDIUM or LONG), number of measurements to be averaged (AVG :), delay time (DELAY :), and comparator setting (COMPTR : on or off) are displayed in the status area.

The next seven lines comprise the MEASUREMENT DATA field. Measurement results are displayed in this field. The top and bottom of lines of the measurement data field are not used.

The line immediately below the measurement data field is also part of the STATUS field. The trigger mode (TRIG : INT, MAN, or EXT) and cable length settings (CABLE : 0m, 1m, or 2m) are displayed on this line.

The next line is the INPUT LINE (third line from the bottom of the LCD), and numeric data input using the front panel keys will be displayed on this line.

The second line from the bottom of the LCD is the MONITOR LINE, and compensation data will be displayed on this line.

The bottom LCD line is the MESSAGE LINE, and comments and error messages will be displayed here.

Figure 3-3 shows the display fields.

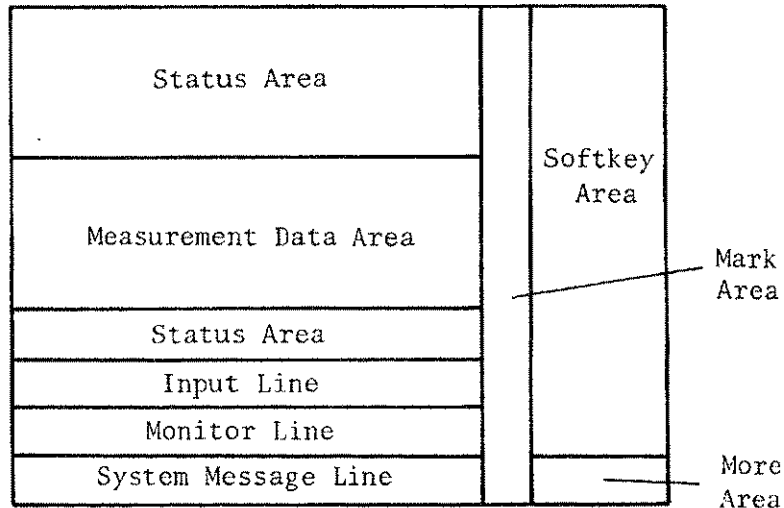

Figure 3-3. Display Fields

3-6-2. MEASUREMENT PAGE FORMAT

On this page, measurement results are displayed in the measurement data field in large characters, as shown in Figure 3-4. The time required to display each measurement result is approximately 5ms. This format is useful when manually performing capacitor measurements.

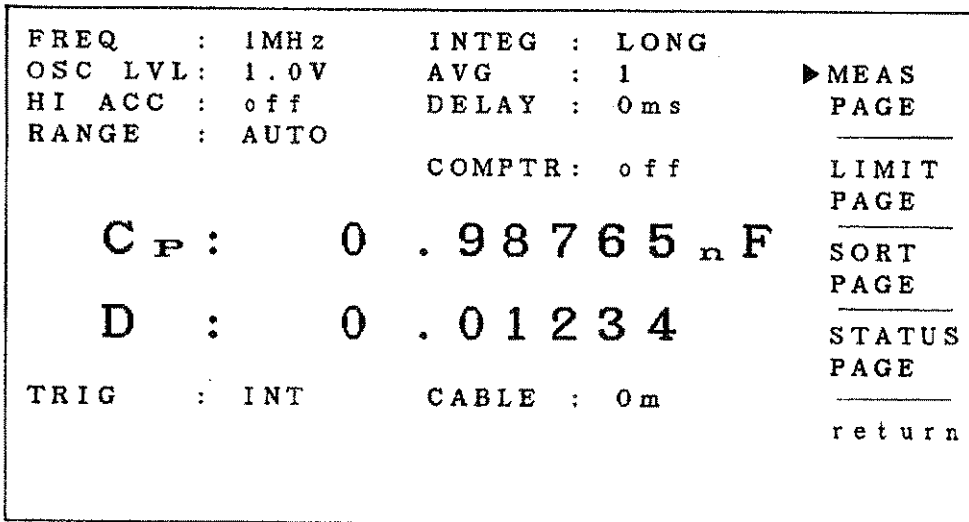

Figure 3-4. Measurement Page Format

3-6-3. SORTING PAGE FORMAT

On the SORTING page, comparison results (bin numbers) are displayed in the measurement data field in large characters, and measurement results are displayed in normal characters, as shown in Figure 3-5. The time required to display each measurement result is approximately 2.4ms. This format is useful when manually sorting capacitors to bins.

FREQ	:	1MHz	INTEG	:	LONG	
OSC LVL	:	1.0V	AVG	:	1	MEAS
HI ACC	:	off	DELAY	:	0ms	PAGE
RANGE	:	AUTO				
			COMPTR	:	off	LIMIT
						PAGE
		B I N				▶ SORT
			1			PAGE
		Cp: 0.98765nF	D : 0.01234			
						STATUS
						PAGE
TRIG	:	INT	CABLE	:	0m	return

Figure 3-5. Sorting Page Format

3-6-4. STATUS PAGE FORMAT

Open compensation admittance data, short compensation impedance data, working standard reference data, working standard actual measurement data for standards compensation, and display offset data are displayed in the measurement data field of this page. This format does not display the results of each measurement, so the time required to display measurement results is saved. This format is useful when the 4278A is used in an automatic capacitor test system.

FREQ	:	1MHz	INTEG	:	LONG	
OSC LVL	:	1.0V	AVG	:	1	MEAS
HI ACC	:	off	DELAY	:	0ms	PAGE
RANGE	:	AUTO				
			COMPTR	:	off	LIMIT
						PAGE
OPEN		Cp: 0.01234 pF	G:		0.00123 μS	
SHORT		Ls: 0.01234 μH	R:		0.01234 Ω	SORT
REF		C: 1000.00 pF	D:		0.00398	PAGE
MEAS		C: 999.990 pF	D:		0.00410	
OFS		A: 0 pF	B:		0	▶ STATUS
						PAGE
TRIG	:	INT	CABLE	:	0m	
						return

Figure 3-6. Status Page Format

3-6-5. LIMIT PAGE FORMAT

The Limit Table for the comparator function is displayed on the LIMIT page, but measurement results will not be displayed. This format takes an additional 2ms (approximately) to display each measurement result if the comparator and the comparator's counter function are set to ON. This format is useful when the 4278A is combined with an automatic component handler.

Cp - D	Nom :	1 0 0 0 p F		
BIN	LOW	HIGH	COUNT	MEAS
1	- 1%	+ 1%	0	PAGE
2	- 2%	+ 2%	0	_____
3	- 3%	+ 3%	0	▶ LIMIT
4	- 4%	+ 4%	0	PAGE
5	- 5%	+ 5%	0	_____
6	- 6%	+ 6%	0	SORT
7	- 7%	+ 7%	0	PAGE
8	- 8%	+ 8%	0	_____
9	- 9%	+ 9%	0	STATUS
2nd	0	. 0 0 5		PAGE
Rej cnt	AUX :	0 OUT :	0	_____
				return

Figure 3-7. Limit Page Format

3-6-6. DISPLAY DIGITS

Measurement results can be displayed with a maximum of six digits of display resolution, and values to ± 999999 . Decimal point positioning (data format) is fixed, depending on the measurement range. If you do not require the last one or two display digits, you can set display digit resolution to four or five digits.

3-6-7. DISPLAY VALUE SELECTION

When the comparator is set to off, the displayed measurement parameter is determined by the measurement parameter setting.

When the comparator is set to on, the displayed measurement parameter is determined by the limit parameter set in the comparator's Limit Table.

When the comparator is on, one of the tolerance limit modes is selected, and the nominal value for tolerance sorting is set in the limit table, the measurement value can be displayed by the ratio of difference in percent. This selection is performed using the 'MEAS VALUE' and 'TOL VALUE' softkeys under the 'DISPLY CONTROL' softkey.

3-6-8. NON-NUMERIC DISPLAY

The 4278A may display "UNBAL" or "-----" in the place of the numeric measurement data. When the impedance (or the admittance) of the capacitor exceeds the range of the analog measurement circuit's capability, "UNBAL" will be displayed. When the analog measurement circuit can measure the capacitor, but the data format (the number of display digits) is not enough for the calculated result, "-----" will be displayed and is called overflow.

3-7. TREE STRUCTURE OF THE SOFTKEY LABELS

The 4278A's softkeys are nested to a maximum of four levels.

When you press a softkey which has lower levels of softkeys, the softkey labels automatically change to the next lower level. When you press the 'return' softkey, the softkey labels change to the next higher level. When you press a softkey which doesn't have lower levels of softkeys, the function of the softkey will be selected or a function will be executed.

When two or more softkey pages are available, the order of the softkey page and the number of the same level softkey pages, divided by a slash (/) are displayed. By pressing the PREV or NEXT key, the softkey page and the softkey order number will be changed. When you press the MENU key, the softkey page is returned to the first softkey page.

NOTE

When editing the comparator function limit table or when performing the self test, the MENU key cannot be used. Press the 'exit LIMIT' or the 'exit TEST' softkey first.

The 4278A's softkey tree is shown in Appendix B.

3-8. DEFAULT SETTINGS AT POWER-ON

When the 4278A is turned on without a memory card inserted, the 4278A's control settings are automatically set as listed in the following table. If a memory card is inserted, the 4278A's controls are set to the settings that were stored in the memory card using the auto-load function.

Measurement Parameter	Cp-D
Test Signal Frequency	1kHz (1MHz, if supplied with option 002)
1MHz High Accuracy Mode	OFF (Normal)
Measurement Range	AUTO
Integration Time	LONG
Averaging Time	1
Trigger mode	INT
Cable Length	0m
Open Compensation	OFF
Short Compensation	OFF
Standard Compensation	OFF
Standard Parameter	C-D
Display Offset A	OFF
Display Offset B	OFF
Comparator	OFF
Limit Parameter	Cp-D
Limit Mode	Percent Tolerance
Auxiliary Bin	OFF
Bin Count	OFF
Display Page Format	Measurement Page
Number of Display Digit	6 Digits
Display Value	Measurement Value (not deviation in percent)
Value Monitor	OFF
Keyboard Lockout	UNLOCK

Settings with numeric data are as follows.

Test Signal Level	1.0Vrms
Measurement Range (1MHz High Accuracy)	256pF
Delay Time	0ms
Nominal Value (Comparator Function)	0 μ F
HP-IB Address	17 ¹

¹ The 4278A's HP-IB address is stored in internal nonvolatile memory. If you change the address, the address you set will be retained. The 4278A's HP-IB address is set to 17 when shipped from the factory, and it may be reset to 17 if the 4278A is repaired.

3-9. NONVOLATILE MEMORY

The 4278A uses two types of non-volatile memory: the internal EEPROM and the external memory card.

3-9-1. INTERNAL MEMORY

The following data is stored in the 4278A's internal EEPROM.

- Stray admittance data for OPEN compensation (**Cp-G**)
- Residual impedance data for SHORT compensation (**Ls-R**)
- Working standard reference data for STD compensation
- Working standard actual measurement data for STD compensation
- Offset capacitance value for OFFSET A
- OFFSET B parameter and value
- HP-IB settings (Addressable/Talk only and Address)

NOTE

The contents of the EEPROM may change if the 4278A is repaired.

3-9-2. MEMORY CARD

The memory card is an EEPROM card that is approximately the size of a credit card. The following single set of instrument setup data can be stored in a memory card. Memory card data will be automatically recalled if the the memory card is inserted when the 4278A is turned on, and when a memory card is inserted and the **LOAD** key on the front panel is pressed.

- Measurement Parameter (MEAS PARMTR) selection
- Test Signal FREQUENCY selection
- High ACCuracy Mode setting (ON or OFF)
- Test Signal Voltage (OSC LVL)
- 1kHz MEASurement RANGE Selection
- 1MHz MEASurement RANGE Selection
- 1MHz High Accuracy MEASurement RANGE Value
- INTEGration TIME
- Averaging Time (AVG RATE)
- Trigger DELAY TIME
- Trigger Mode
- CABLE LENGTH Selection
- OPEN COMPENsation (ON or OFF)
- SHORT COMPENsation (ON or OFF)
- STAnDard COMPENsation (ON or OFF)
- Display OFFSET (ON or OFF)
- All Comparator Settings (except for count data)
- DISPLAy PAGE Format
- Number of Display Digits
- Display Value (MEAS or TOL)
- Value Monitor Selection
- Memory Card ID Comment ¹

¹ Refer to Paragraph 3-9-3.

NOTE

If a power failure occurs, the 4278A will reset to the default settings. If you require control settings other than the default settings, store them in a memory card and load them into the 4278A as required. Make a backup copy for memory cards containing important data. Keep one as a master and one for normal use.

3-9-3. MEMORY CARD ID COMMENTS

You can store an ID number on the memory card. When you press the 'STORE' softkey, "COMMENT=" will be displayed on the Input Line. Enter an ID number using the numeric keys, then press ENTER. The usable characters are zero to nine, the minus sign (-), and the period (.). ID numbers up to ten characters can be stored in the memory card.

When the LOAD key is pressed with the card inserted, the ID number will be displayed on the Message Line.

3-9-4. WRITE PROTECTION

The 4278A is equipped with a memory card write-protect switch, mounted internally. This feature disables the 4278A's STORE function, and is useful if you want to retain specific 4278A control settings for everyday use, e.g., on a production line where it is not necessary to store any information on a memory card, thereby making it impossible to accidentally erase or overwrite memory card data. The procedure for setting the write protection switch to ON is as follows.

1. Turn the 4278A off and remove the power cable. Allow a few minutes for the internal capacitors to discharge.

WARNING

DANGEROUS VOLTAGE MAY BE PRESENT IN THE 4278A EVEN THOUGH THE POWER SWITCH IS OFF. BE SURE TO WAIT A FEW MINUTES FOR THE INTERNAL CAPACITORS TO DISCHARGE.

2. Remove the two feet at the back of the top cover.
3. Fully loosen the screw that secures the top cover.
4. Pull the top cover towards the rear of the 4278A and lift up to remove.
5. Loosen the five screws that secure the top shield plate (larger one).
6. Slide the top shield plate forward then lift it off.
7. Remove the A7 board. Figure 3-8 shows the A7 board's location.

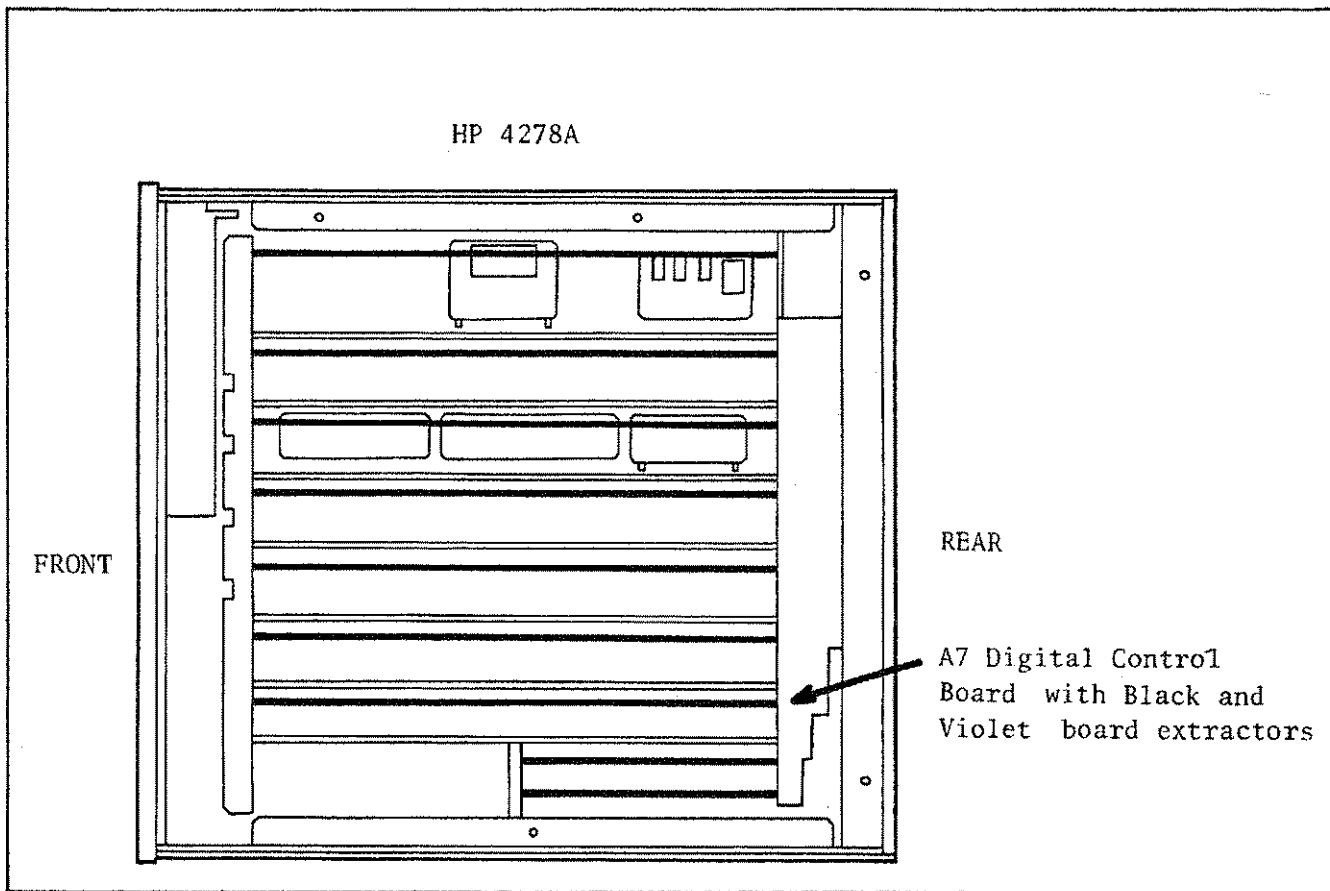

Figure 3-8. A7 Digital Control Board Location

CAUTION

Semiconductor components are installed on the A7 board. When handling the A7 board, be aware that electro-static discharge may damage these components.

- Set A7S3-6 to the right-most position (ON) to disable the 4278A's STORE function (to write-protect memory cards). Set A7S3-6 to the left-most position (OFF) to enable storing. Refer to Figure 3-9.

NOTE

Do not change any of the other switch settings on the A7 board.

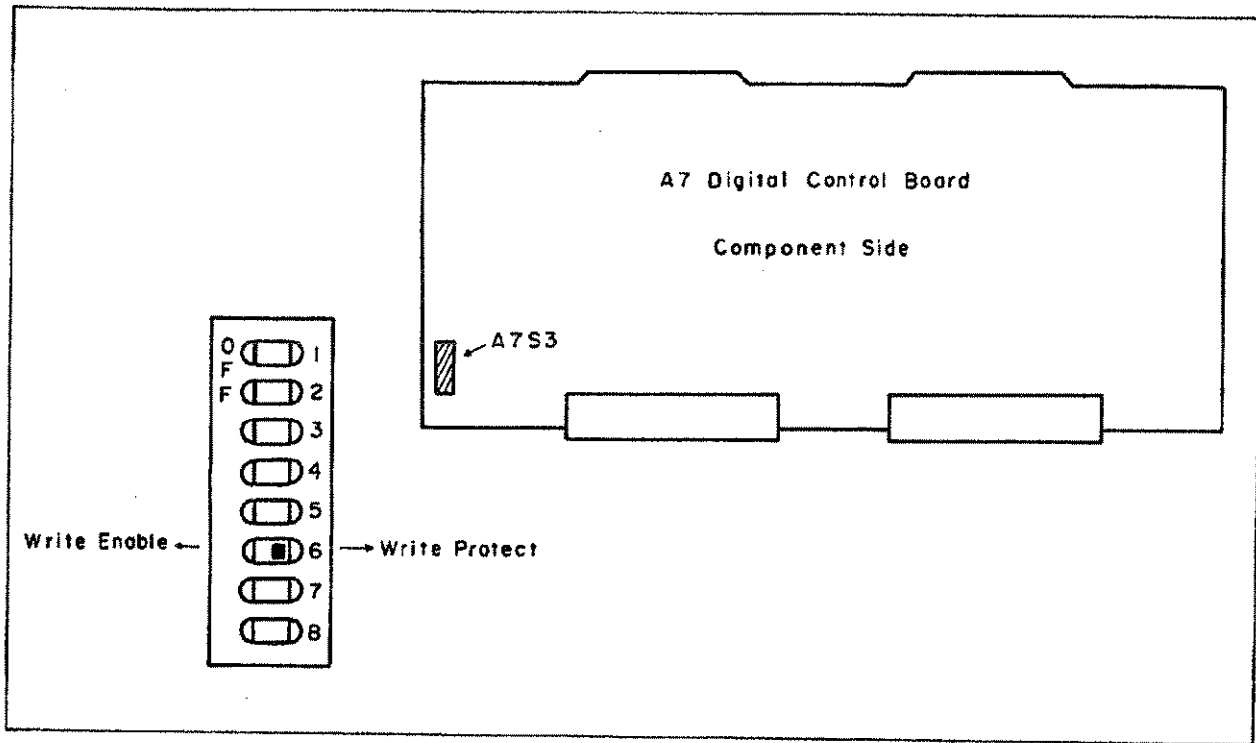

Figure 3-9. Write Protect Switch

3-10. COMPARATOR

The 4278A's built-in comparator can sort capacitors into a maximum of ten bins (Bin 1 to Bin 9 and one Out of Bins bin) using a maximum of nine pairs of primary parameter limits and one pair of secondary parameter limits. Also, capacitors whose primary parameter measurement result is within limits, but whose secondary parameter measurement result not within limits, can be sorted into an AUXiliary BIN. The comparator function is especially useful when using the 4278A with a component handler (handler interface option is installed).

3-10-1. LIMIT PARAMETERS

Limit parameters are pairs of measurement parameters for bin sorting comparisons. Limit parameters are established on the limit table and are independent from the set MEASUREMENT PARAMETER. The first limit parameter is the Primary Parameter, for which a maximum of nine pairs of comparison limits can be set. The last limit parameter is the Secondary Parameter, for which one pair of comparison limits can be set. Usually, Cp or Cs is set as the Primary Parameter, and either D, Q, G, or ESR is set as the secondary parameter. When the 'REVRES PARMTR' softkey is pressed, the primary and secondary parameters switch positions. Figure 3-10 shows the limit parameters.

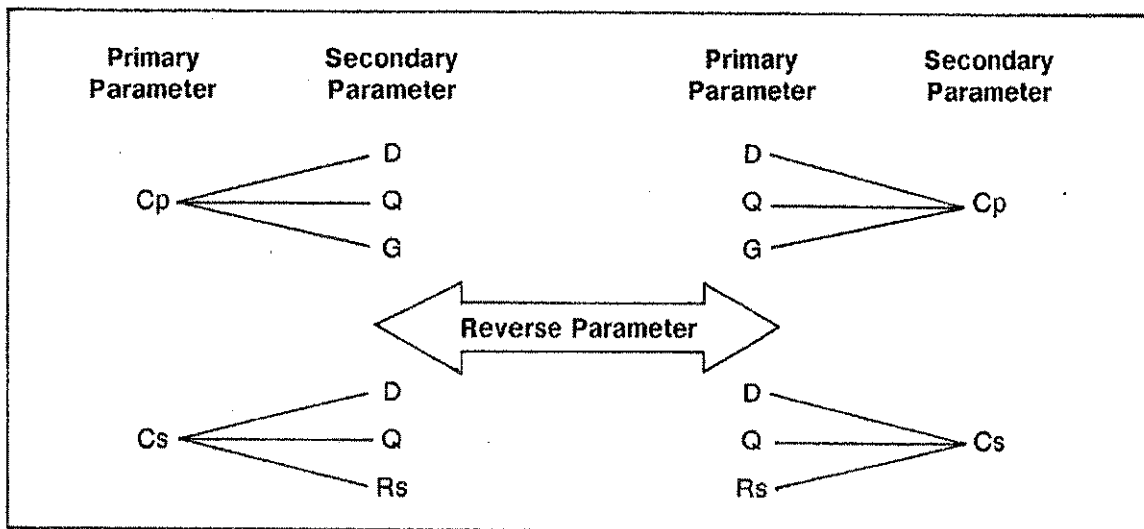

Figure 3-10. Limit Parameters

3-10-2. LIMIT MODES

There are two methods for specifying primary parameter limits, as follows.

Tolerance Mode: Specifies comparison limits by the deviation from the specified nominal value.

Sequential Mode: Specifies comparison limits as the absolute measurement value. The limits must be set from smallest value to largest value.

There are two methods used to specify the Tolerance Mode limits, the ratio in percent and by parameter value. Refer to Figure 3-11.

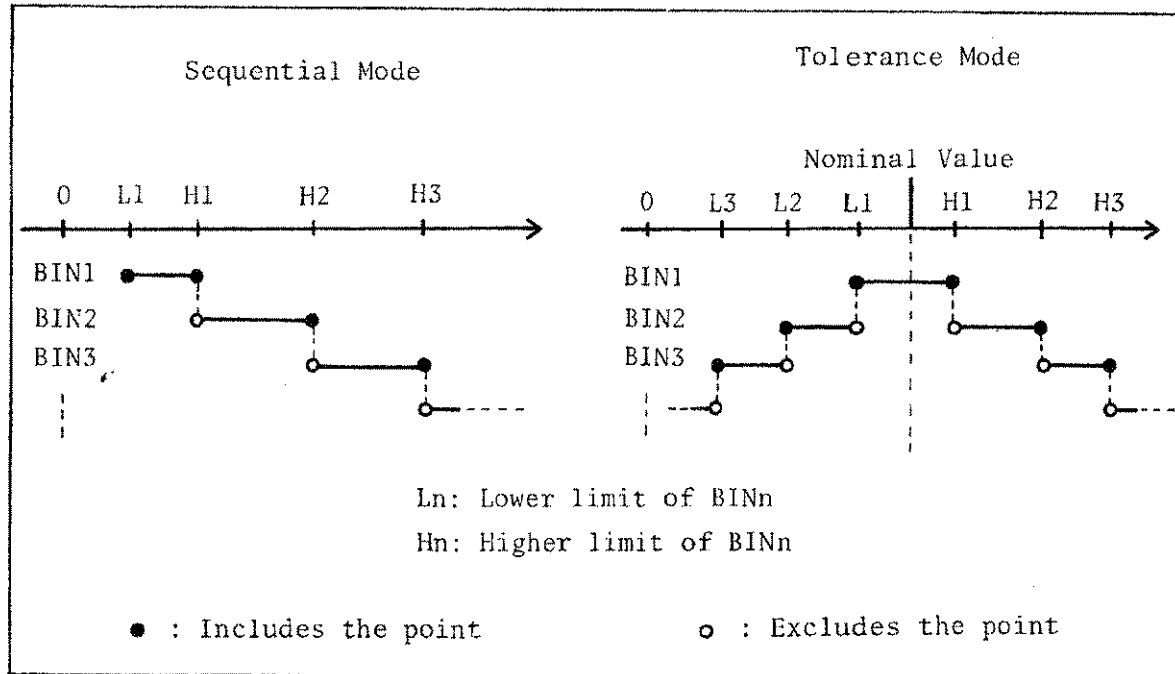
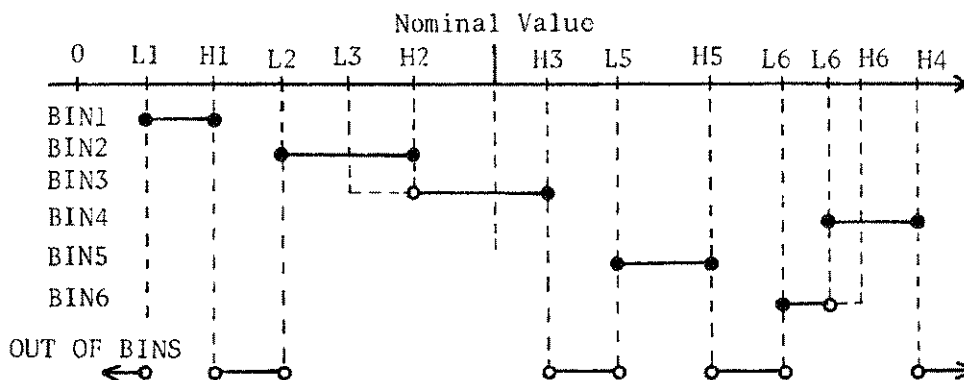

Figure 3-11. Limit Modes

NOTE

1. The limit values for Sequential Mode sorting must be placed in the order of the lower limits to the upper limits. If the reverse order is used, all of the comparison results will cause the components to be sorted OUT OF BINS, and no error message will be displayed.
2. The limit values for Tolerance Mode sorting must be placed in the order of the narrower limits to the wider limits. If BIN 1 has the widest limits, all of the capacitors will be sorted into bin 1.
3. In tolerance mode sorting, the lower limit doesn't have to be less than the nominal value, and the upper limit doesn't have to be greater than the nominal value. As you can see in the following illustration, there can be openings and there can be duplications.



3-10-3. SECONDARY PARAMETER AND AUX BIN

How the secondary parameters affect the sorting results, and how the auxiliary bin works are described in this paragraph.

When the secondary parameter limits are not specified in the limit table:

Capacitors will be sorted according to primary parameter comparison results.

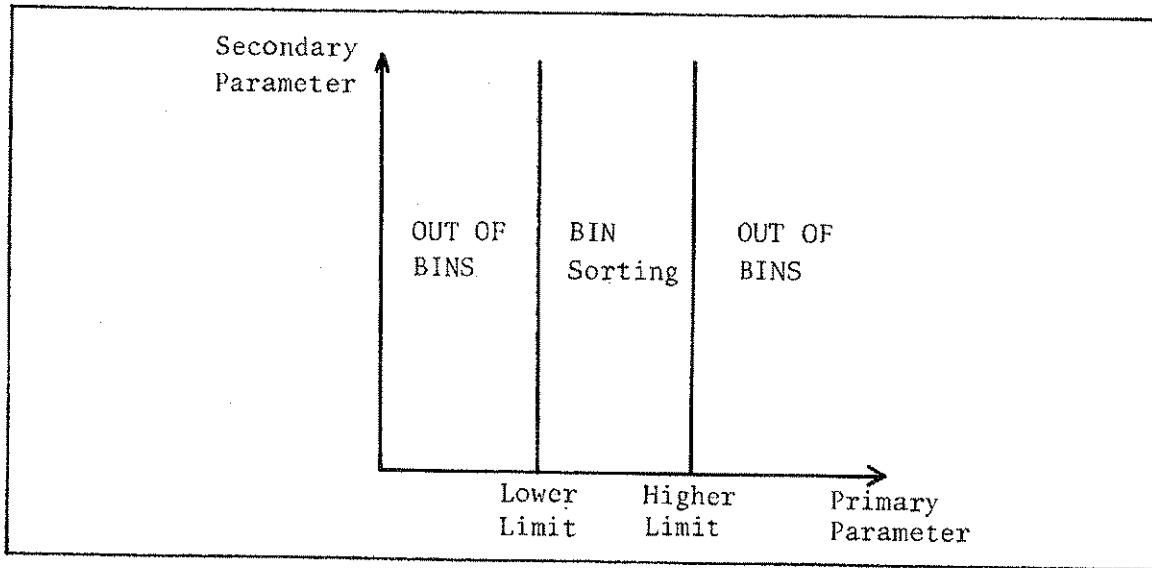

Figure 3-12. Primary Parameter Only

When the secondary parameter limits are set and AUX BIN are set to off:

Only capacitors within the secondary limits are sorted by the primary parameter result. Capacitors not within the secondary parameter limits are sorted OUT OF BINS even if the capacitor's primary parameter is within limits.

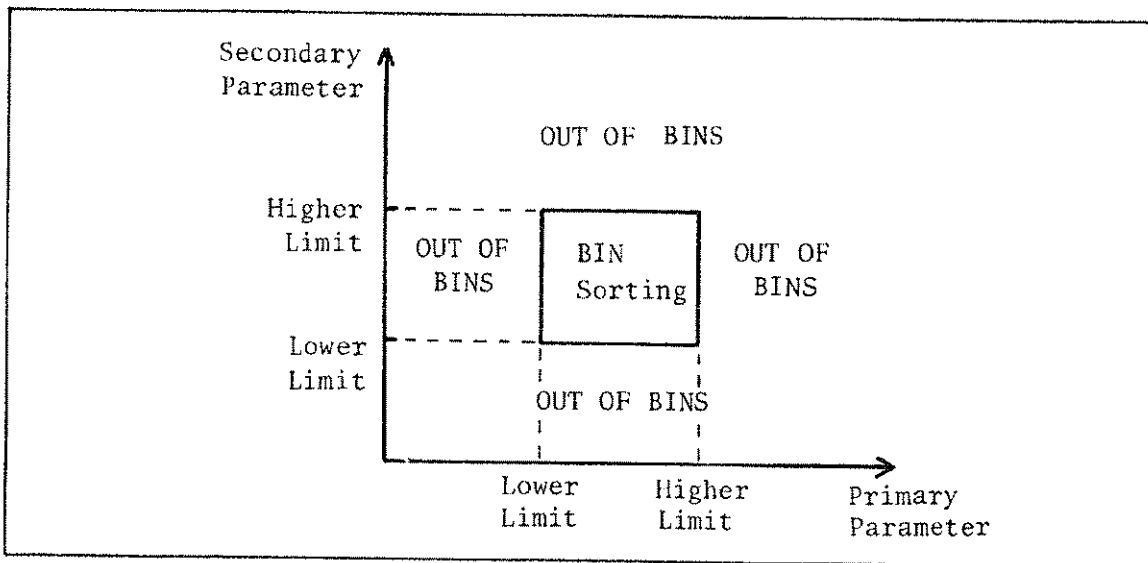

Figure 3-13. With Secondary Parameter

When the secondary parameter limits are set and the AUX BIN are set to on:

Capacitors whose primary parameter is not within limits are sorted as OUT OF BINS. Capacitors whose primary parameter is within limits, but whose secondary parameter is out of limits are sorted into the AUX BIN.

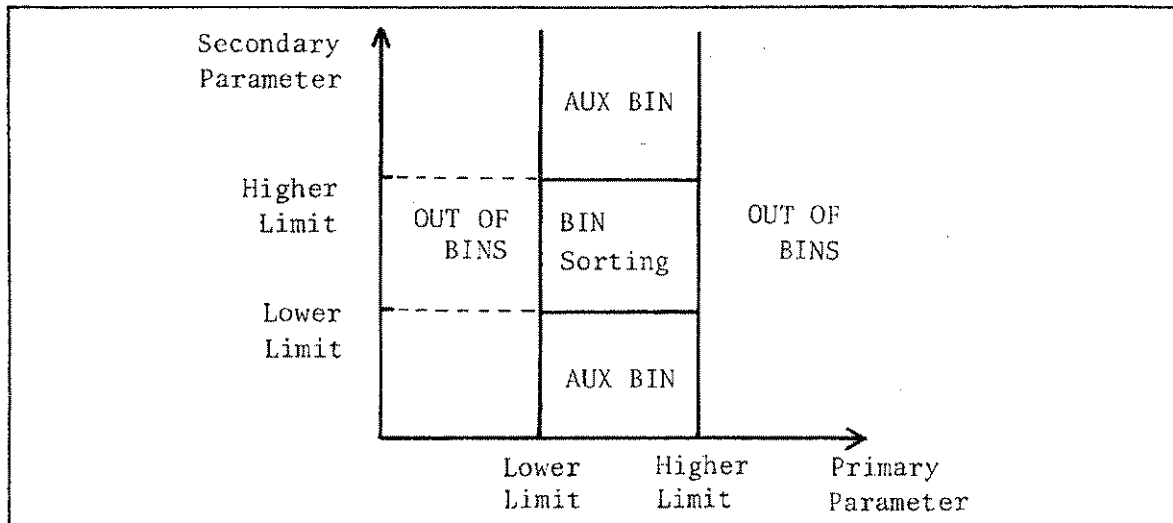

Figure 3-14. AUX BIN

3-10-4. BIN COUNTER

The 4278A has bin counting capability, the number of capacitors sorted into each bin is counted. The maximum count is 999999, and resets to zero when this value is exceeded. When the 'RESET COUNT' softkey is pressed, all counts will be reset to zero.

3-11. CABLE LENGTH SELECTION

The 4278A has three planes of calibration -- at the UNKNOWN terminal (0m), to the end of the HP 16048A/B test leads (1m), and to the end of the HP 16048D test leads (2m). Measurement accuracy is specified at these three points. Select the cable length which corresponds to the length of cables you are using.

When you select 0m, the four outer conductors of the HCUR, HPOT, LPOT, and LCUR leads must be tied together at the UNKNOWN terminals. When you select 1m, the four outer conductors of the HCUR, HPOT, LPOT, and LCUR leads must be tied together at the end of the 1m leads. When you select 2m, the four outer conductors of the HCUR, HPOT, LPOT, and LCUR leads must be tied together at the end of the 2m leads. In other words, the four-terminal pair configuration must be terminated for the cable length selected. When an HP 16048A/B/D test leads are used, use the furnished terminal plate at the end of the cable for easy configuration.

NOTE

The maximum length of the test leads which can be used for 1MHz measurements is 2.5m.

3-12. COMPENSATION

The 4278A has four compensation functions -- Open, Short, Standard, and Temperature.

3-12-1. OPEN COMPENSATION

The open compensation capability compensates for the stray admittance existing from the calibration plane (depends on the CABLE LENGTH selection) to the connection contacts for the capacitor. First, without connecting a capacitor, press the **'OPEN COMPEN'** softkey to measure the open admittance (capacitance and conductance), then press the **'OPEN ON'** softkey to enable compensation calculations on subsequent measurements. The open admittance data is dependent on the frequency setting for the test signal. This data is stored in nonvolatile memory.

3-12-2. SHORT COMPENSATION

The short compensation function compensates for the residual impedance existing from the calibration plane (depends on the CABLE LENGTH selection) to the connection contacts for the capacitor. First, short the capacitor contacts together, then press the **'SHORT COMPEN'** softkey to make a short impedance (inductance and resistance) measurement, then press the **'SHORT ON'** softkey to enable the compensation calculation. The short impedance data is dependent on the frequency setting for the test signal. This data is stored in nonvolatile memory.

3-12-3. STANDARD COMPENSATION

The standard compensation function is used to compensate for other errors by using the transmission coefficient derived from the relationship between the working standard's (pre-measured) reference value and the actual (uncompensated) measurement value. First enter the working standard's (pre-measured) reference value. The reference value should be premeasured value of the **Cp-D** or **Cp-G** parameter. To make this selection press the **'STD PARMTR'** softkey and either the **'C-D'** softkey (for **Cp-D** parameter) or the **'C-G'** softkey (for the **Cp-G** parameter). Then connect the working standard as the DUT and press the **'STD COMPEN'** softkey. Then press the **'STD ON'** softkey to execute the compensation calculation. The working standard's reference data and its measurement data are dependent on frequency setting of the test signal. These data are stored in nonvolatile memory.

3-12-4. TEMPERATURE COMPENSATION

The temperature compensation function is used to minimize the temperature induced measurement error of the analog measurement circuit. When you press the **'TEMP COMPEN'** softkey, the 4278A measures the key offset voltages in the measurement circuit and compensates the measurement value on subsequent measurements. The compensation data is stored in volatile memory, so once you turn the 4278A off, the temperature compensation data will be reset. Press the **'TEMP COMPEN'** softkey when you are making accurate measurements.

3-13. DISPLAY OFFSET

The 4278A also has a display value offset function that adds or subtracts a constant value to/from the measurement result. Offset A subtracts a pre-entered value from the capacitance measurement result. Offset B subtracts a pre-entered value from one of the following parameters **D**, **Q**, **G**, and **ESR (Rs)**. The pre-entered Offset B value is dependent on the parameter. For example, assume that you have entered the offset B value when the **Cp-D** parameter is selected and offset B is on. If the measurement parameter is changed to a parameter other than **Cp-D** or **Cs-D**, the offset B function is automatically turned off, because the second parameter (**D**) does not match.

3-14. VALUE MONITOR

The 4278A has a value monitor function which can be used to monitor open capacitance and conductance for open compensation, short inductance, and resistance for short compensation, reference value (pre-measured) of a working standard, actual measurement value of a working standard, display offset values, and nominal value for tolerance mode sorting. When a compensation measurement is made, the monitor will be automatically turned on.

3-15. TRIGGER MODE

The 4278A has three trigger modes -- **INT**ernal, **EXT**ernal, and **MAN**ual.

INT TRIG:

The 4278A continuously repeats measurements except during special operations, e.g., editing the limit table.

MAN TRIG:

The 4278A performs a single measurement every time the **TRIGGER** key on the front panel is pressed.

EXT TRIG:

The 4278A performs a single measurement every time a positive going TTL pulse is applied to the **EXT TRIGGER** connector on the rear panel. External triggering can also be achieved by momentarily switching the center conductor of the **EXT TRIGGER** connector to chassis ground (center conductor circuit contains a pull-up resistor) . Figure 3-15 shows the required TTL pulse.

NOTE

The 4278A ignores triggers that are applied while a measurement is in progress. Trigger the 4278A after the measurement is completed.

Select the **EXT TRIG** mode when the 4278A is triggered via an optional interface.

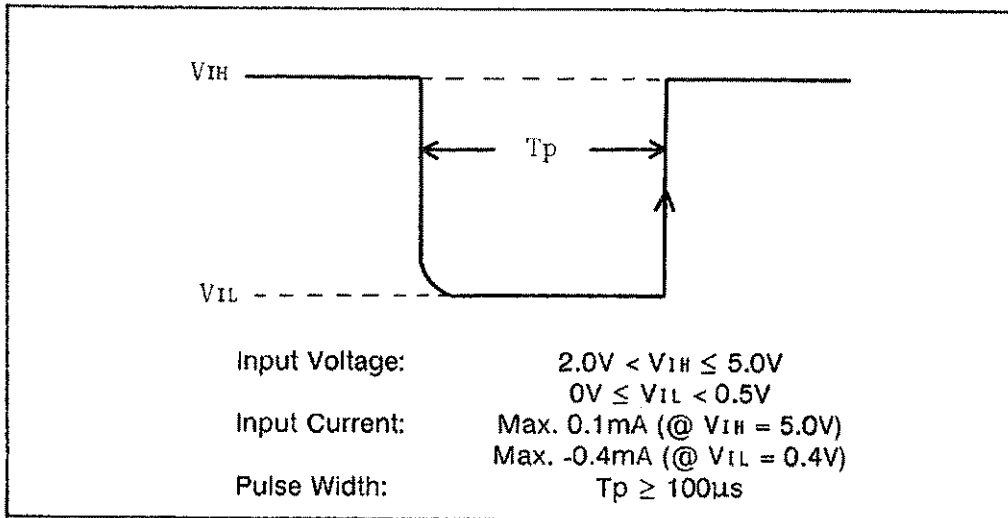

Figure 3-15. External Trigger Pulse

3-16. KEYBOARD LOCK-OUT

The 4278A has keyboard lock-out capability that disables all front panel operation except for the power **LINE** switch, **CONTRAST** knob, and 'UNLOCK' softkey. This is useful when you don't want the control settings changed, for example, if the 4278A is performing bin sorting for a large number of capacitors.

3-17. SERVICE FUNCTIONS

The 4278A has special service functions for checking operation, troubleshooting, and performing calibration. For detailed information on the service functions, refer to the 4278A's Maintenance Manual (PN 04278-90100).

SECTION 4

INTERFACE OPTIONS

4-1. INTRODUCTION

This section provides information on using interface Options 101, HP-IB interface, and 102, Handler interface.

4-2. OPTION 101 HP-IB INTERFACE

4-2-1. HP-IB INTERFACE

You can use the HP 4278A's installed option 101 can be controlled via the easy to use, high performance HP-IB bus which links the 4278A to other instruments, desktop computers, and minicomputers to form an automated measurement system. HP-IB is Hewlett-Packard's implementation of IEEE Standard 488-1978, IEEE Standard 728-1982, Digital Interface for Programmable Instrumentation.

4-2-2. HP-IB CONNECTION

With the HP-IB interface system, up to 15 HP-IB compatible instruments can be interconnected (see Figure 4-1). The HP 10833 HP-IB cables have back to back male-female connectors on each end so several cables can be connected to a single source without using special adapters or switch boxes. System components and devices can be connected in virtually any configuration as long as a path exists between each device and the controller. If too many connectors are stacked together, their weight can produce sufficient leverage to damage the connector mounting. Be sure that each connector is screwed firmly in place to keep it from working loose during use. The HP 4278A uses all of the available HP-IB lines; therefore, damage to any connector pin will adversely affect HP-IB operation. See Figure 4-2.

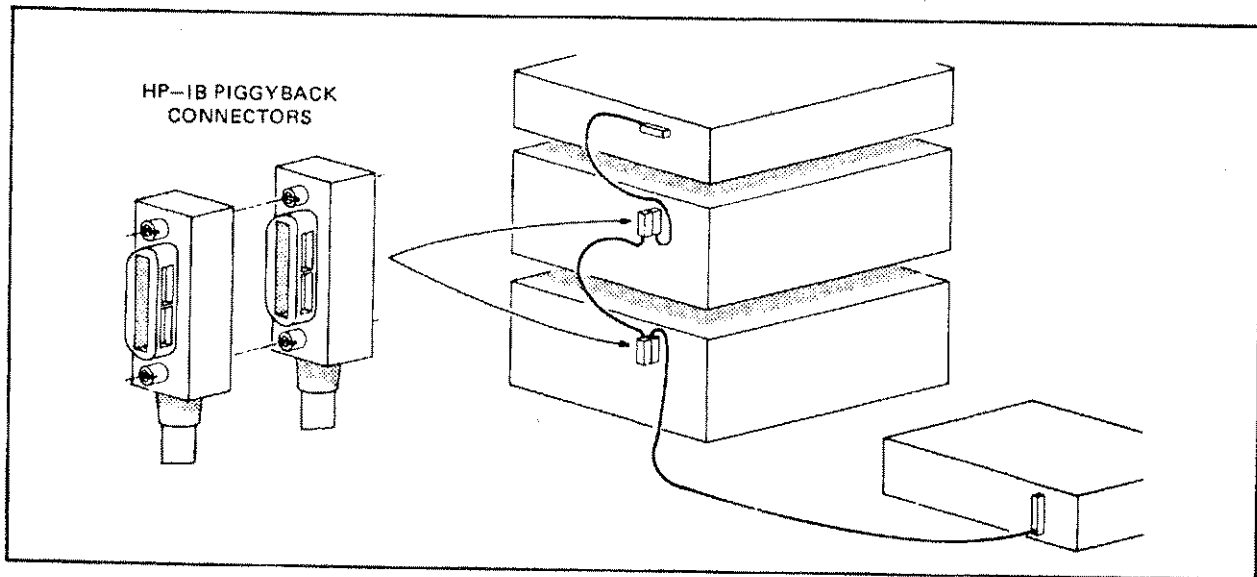

Figure 4-1. Typical HP-IB System Interconnection

CAUTION

THE 4278A'S OPTION 101 CONTAINS METRIC THREADED HP-IB CABLE MOUNTING STUDS. THE METRIC VERSION OF THE HP 10833A, B, C, OR D HP-IB CABLE FASTENERS ARE DISTINGUISHED FROM THE ENGLISH VERSION BY COLOR. ENGLISH THREADED FASTENERS ARE SILVER; METRIC THREADED FASTENERS BLACK. DO NOT ATTEMPT TO MATE SILVER AND BLACK FASTENERS TO EACH OTHER. IF YOU DO, THE THREADS OF EITHER OR BOTH WILL BE DAMAGED.

SECTION 4

INTERFACE OPTIONS

4-1. INTRODUCTION	4-1
4-2. OPTION 101 HP-IB INTERFACE	4-1
4-2-1. HP-IB INTERFACE	4-1
4-2-2. HP-IB CONNECTION	4-1
4-2-3. HP 4278A'S HP-IB CAPABILITY	4-4
4-2-4. HP-IB DEFINITION	4-5
4-2-5. HP-IB BUS COMMANDS	4-6
4-2-6. 4278A DEVICE DEPENDENT COMMANDS	4-8
4-2-7. DATA FORMAT AND DATA TRANSFER	4-59
4-2-8. STATUS BYTE	4-63
4-2-9. SAMPLE PROGRAM	4-65
4-3. OPTION 201 HANDLER INTERFACE	4-70
4-3-1. DESCRIPTION	4-70
4-3-2. SIGNAL LINE DEFINITION	4-70
4-3-3. ELECTRICAL CHARACTERISTICS	4-75
4-3-4. SETTING UP THE HANDLER INTERFACE BOARD	4-79
4-4. OPTION 202 HANDLER INTERFACE	4-88
4-4-1. DESCRIPTION	4-88
4-4-2. INTERFACE SIGNAL DEFINITIONS	4-89
4-4-3. ELECTRICAL CHARACTERISTICS AND TIMING	4-93
4-4-4. CONFIGURING THE OPTION 202 HANDLER INTERFACE BOARD	4-98
4-4-5. CONFIGURATION EXAMPLES	4-104

4-5. OPTION 301 SCANNER INTERFACE	4-117
4-5-1. DESCRIPTION	4-117
4-5-2. SCANNER INTERFACE SIGNAL INPUT/OUTPUT CONNECTOR	4-117
4-5-3. SIGNAL ELECTRICAL CHARACTERISTICS	4-123
4-5-4. SETTING UP THE SCANNER INTERFACE BOARD	4-126
4-5-5. OPERATION	4-130

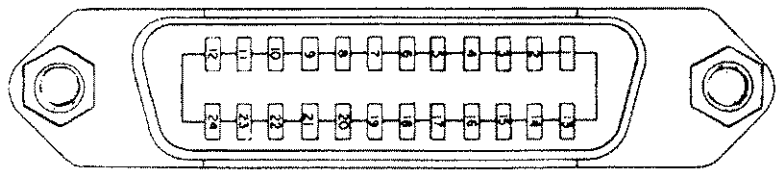

PIN	LINE	HP-IB Interconnect Cables	
1	D101		
2	D102		
3	D103		
4	D104		
13	D105		
14	D106		
15	D107		
16	D108		
5	EOI		
17	REN		
6	DAV		
7	NRF D		
8	NDAC		
9	IFC		
10	SRQ		
11	ATN		
12	SHIELD-CHASSIS GROUND		
18	P/O TWISTED PAIR WITH PIN 6	} THESE PINS ARE INTERNALLY GROUNDED	
19	P/O TWISTED PAIR WITH PIN 7		
20	P/O TWISTED PAIR WITH PIN 8		
21	P/O TWISTED PAIR WITH PIN 9		
22	P/O TWISTED PAIR WITH PIN 10		
23	P/O TWISTED PAIR WITH PIN 11		
24	ISOLATED DIGITAL GROUND		

Part Number	Length
10833A	1 m (3.3 ft)
10833B	2 m (6.6 ft)
10833C	4 m (13.2 ft)
10833D	0.5 m (1.6 ft)

Figure 4-2. HP-IB Interfacing

4-2-3. HP 4278A'S HP-IB CAPABILITY

Table 4-1 lists the 4278A's IEEE Standard 488-1978, HP-IB capabilities and functions. These functions provide the means for an instrument to receive, process, and to transmit, commands, data, and status over the HP-IB bus.

Table 4-1. HP-IB Interface Capability

CODE	FUNCTION
SH1	Complete Source Handshake capability
AH1	Complete Acceptor Handshake capability
T5	Basic Talker; serial poll; unaddressed if MLA; Talk-Only
L4	Basic Listener; unaddressed if MTA; no Listen Only
SR1	Complete Service Request capability
RL1	Complete Remote/Local capability
DC1	Complete Device Clear capability
DT1	Complete Device Trigger capability
C0	No Controller capability
E1	Drivers are open-collector

4-2-4. HP-IB DEFINITION

The HP-IB definition settings (addressable/talk only and HP-IB address number) are stored in nonvolatile memory.

Addressable Mode:

The HP-IB address of the 4278A can be set from 0 to 30. The address set at the factory is 17. The procedure for setting the HP-IB address is as follows.

1. Press the **MENU** and the **PREV** keys.
2. Press the '**HP-IB DEFINE**' and the '**ADRSABLE**' softkeys.
3. Press the '**HP-IB ADRS=**' softkey. "ADDRESS= (current address)" will be displayed.
4. Enter the desired address using the front-panel numeric keys, and then press the **ENTER** key.

NOTE

To see the current set HP-IB address, press the '**HP-IB ADRS=**' softkey and it will be displayed on the input line.

Talk Only Mode:

The 4278A is set to the HP-IB talker mode, and outputs the measurement data to the bus. When connected with a Listen-Only printer, an automatic measurement data recording system can be built without using an HP-IB controller. The output data is restricted to ASCII characters. The output data format is shown below. Refer to paragraph 4-2-7 for details.

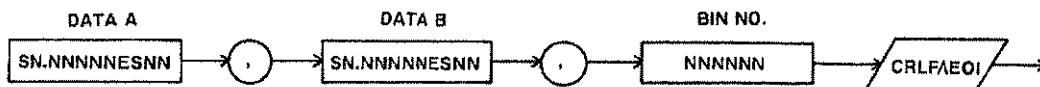

(N: 0 to 9, S: + or -)

NOTE

BIN number data is valid only when the comparator function is set to on. When the comparator function is set to off, the bin data is always zero.

In the talk-only mode, the 4278A doesn't wait for the handshake to be completed before starting next measurement. If the printer is slow and doesn't print properly, use the trigger delay function to reduce the 4278A's measurement speed.

4-2-5. HP-IB BUS COMMANDS

The 4278A will respond to the following bus commands. HP 200 series BASIC statements are used in the description that follows.

1. ABORT I/O (IFC):

ABORT I/O halts all bus activity and causes the 4278A to become deselected.

ABORT 7

2. CLEAR LOCKOUT/SET LOCAL:

CLEAR LOCKOUT/SET LOCAL removes devices on the bus from the lockout mode and returns them to local (front panel) control. The difference between this and **LOCAL** is in the addressing method.

LOCAL 7

3. DEVICE CLEAR (SDC or DCL):

This command may be addressed (**SDC**: selected device clear) or unaddressed (**DCL**: clears all devices). The 4278A will initialize itself when this command is received. It is good programming practice to begin a program with this command.

CLEAR 7:clears all devices on port 7

CLEAR 717:clears the instrument addressed at 17

4. LOCAL (GTL):

LOCAL returns control of a listening device to front panel control.

LOCAL 717

5. LOCAL LOCKOUT (LLO):

LOCAL LOCKOUT disables the **LOCAL** key of all devices on the bus. After this command is sent you will be unable to operate the 4278A from the front panel. Execute the **LOCAL** command to undo **LOCAL LOCKOUT**.

LOCAL LOCKOUT 7

6. REMOTE:

This command is used to set the 4278A to remote. When this command is sent except for the **LCL** key the front panel will be disabled. If **LOCAL LOCKOUT** is active then the front panel **LCL** key will also be disabled.

REMOTE 7: sets all devices on the port 7 to remote

REMOTE 717: sets the instrument addressed at 17 to remote.

7. SERIAL POLL:

This command places the status byte on the bus. The eight bits of the status byte shows the 4278A's operating state. See paragraph 4-2-8 for more information on the status byte.

Var=SPOLL(717): the instrument addressed at 17 is serially polled.

8. SERVICE REQUEST:

The 4278A is capable of generating a **SRQ** (Service Request) control signal when it requires the controller to take action. A **SRQ** can be thought of as an interrupt which informs the controller that information is ready to be transmitted, and an error condition exists in the instrument. When the 4278A issues an **SRQ** it also sets Bit 6 of the status byte. Bit 6 is the **RQS** (Request Service) bit, sometimes referred to as the "status bit" in connection with polling. When the 4278A is serially polled, it will clear the **RQS** bit and the **SRQ** line, which is one of the five management control lines of the system interface. Any bit in the status byte can initiate an **SRQ**. The status byte may be masked by the user to determine which bits caused the 4278A to set the **SRQ** line. See paragraph 4-2-8 for more information on the status byte.

9. TRIGGER(GET):

Enables the 4278A to respond to a **TRIGGER** bus command. This command may be sent to a selected device or to all devices addressed as listeners on the HP-IB bus. The 4278A must be addressed to listen before the trigger message is sent. Refer to Bit 2 of the status byte in paragraph 4-2-8 for information on proper triggering techniques.

SEND 7; UNL MTA LISTEN 17

TRIGGER 7

UNL=UNLISTEN: unaddresses all listeners

MTA=MY TALK ADDRESS: sets the controller to talk

LISTEN: sets the instrument addressed as 17 to listen

NOTE

1. The 4278A does not have Parallel Poll capability.
2. See "**BASIC Interfacing Techniques for HP 200 Computers**" for a further description of HP-IB bus commands.

4-2-6. 4278A DEVICE DEPENDENT COMMANDS

Device dependent commands are used with Option 101 that are only used for the 4278A.

This section consists of three parts:

1. Command Index:

All commands in the command index are listed in alphabetical order.

2. Command Reference:

Each command is fully explained in the command reference.

3. Command Functional Order:

In the command functional order list, all commands are listed in their functional order. This is convenient when you are writing a program.

INDEX

-A-

AOFF0	OFFSET A OFF	4-14
AOFF1	OFFSET A ON	4-14
AUX0	Auxiliary BIN OFF	4-14
AUX1	Auxiliary BIN ON	4-14
AVE=	Averaging Rate	4-15

-B-

BIN1=	LOW/HIGH Limit of BIN1 on the tolerance mode	4-15
BIN2=	LOW/HIGH Limit of BIN2 on the tolerance mode	4-15
BIN3=	LOW/HIGH Limit of BIN3 on the tolerance mode	4-15
BIN4=	LOW/HIGH Limit of BIN4 on the tolerance mode	4-15
BIN5=	LOW/HIGH Limit of BIN5 on the tolerance mode	4-15
BIN6=	LOW/HIGH Limit of BIN6 on the tolerance mode	4-15
BIN7=	LOW/HIGH Limit of BIN7 on the tolerance mode	4-15
BIN8=	LOW/HIGH Limit of BIN8 on the tolerance mode	4-15
BIN9=	LOW/HIGH Limit of BIN9 on the tolerance mode	4-15
BLIM=	Boundary Limit on the sequential mode	4-16
BOFF0	OFFSET B OFF	4-16
BOFF1	OFFSET B ON	4-16

-C-

CABL0	Cable Length (0m)	4-17
CABL1	Cable Length (1m)	4-17
CABL2	Cable Length (2m)	4-17
CCOU?	BIN Count Query of the selected channel	4-18
CLIM	Clear All Limits	4-19
CNO=	Channel number selection	4-19
CNT0	BIN Count OFF	4-20
CNT1	BIN Count ON	4-20
COMP0	Comparator OFF	4-20
COMP1	Comparator ON	4-20
COUN?	BIN Count Query	4-21
CSTD=	Reference data (C) of the working std. capacitor	4-22

-D-

DATA?	DATA OUTPUT query	4-22
DBIN0	Data Output (exclude the BIN number)	4-23
DBIN1	Data Output (include the BIN number)	4-23
DDIG4	Display Digit (4 digits)	4-24
DDIG5	Display Digit (5 digits)	4-24
DDIG6	Display Digit (6 digits)	4-24
DEND	Data Output Continuous End	4-24
DFMT1	Data Transfer Format (ASCII Mode)	4-25
DFMT2	Data Transfer Format (BINARY 64bit Mode)	4-25
DPAG1	Display Page (MEASUREMENT PAGE)	4-27
DPAG2	Display Page (LIMIT PAGE)	4-27
DPAG3	Display Page (SORT PAGE)	4-27
DPAG4	Display Page (STATUS PAGE)	4-27
DST	Data Output Continuous Start	4-28
DSTD=	Reference data (D) of the working std. capacitor	4-28
DTIM=	Delay Time	4-29

DVAL1	Display Value (Measurement Value)	4-29
DVAL2	Display Value (Tolerance Value)	4-29
-E-		
ERR?	Error Message Query	4-30
-F-		
FREQ1	Measurement Frequency (1kHz)	4-30
FREQ2	Measurement Frequency (1MHz)	4-30
-G-		
GSTD=	Reference data (G) of the working std. capacitor	4-31
-H-		
HIAC0	High Accuracy Mode OFF at 1MHz	4-31
HIAC1	High Accuracy Mode ON at 1MHz	4-31
-I-		
ITIM1	Integration Time (SHORT)	4-32
ITIM2	Integration Time (MEDIUM)	4-32
ITIM3	Integration Time (LONG)	4-32
-J-		
-K-		
-L-		
LMOD1	Limit Mode (% Tolerance Mode)	4-32
LMOD2	Limit Mode (Absolute Tolerance Mode)	4-32
LMOD3	Limit Mode (Sequential Mode)	4-32
LOAD	Load from the memory card	4-33
LPAR1	Limit Parameter (Cp-D)	4-33
LPAR2	Limit Parameter (Cp-Q)	4-33
LPAR3	Limit Parameter (Cp-G)	4-33
LPAR4	Limit Parameter (Cs-D)	4-33
LPAR5	Limit Parameter (Cs-Q)	4-33
LPAR6	Limit Parameter (Cs-Rs)	4-33
-M-		
MCOM0	MULTI-COMPEN mode OFF	4-34
MCOM1	MULTI-COMPEN mode ON	4-34
MPAR1	Measurement Parameter (Cp-D)	4-34
MPAR2	Measurement Parameter (Cp-Q)	4-34
MPAR3	Measurement Parameter (Cp-G)	4-34
MPAR4	Measurement Parameter (Cs-D)	4-34
MPAR5	Measurement Parameter (Cs-Q)	4-34
MPAR6	Measurement Parameter (Cs-Rs)	4-34

-N-

NOM= Nominal Value on the tolerance mode 4-35

-O-

OFFA= OFFSET A Data 4-35
OFFB= OFFSET B Data 4-36
OPEN0 OPEN Compensation OFF 4-36
OPEN1 OPEN Compensation ON 4-36
OPM? OPEN Compensation Measured Value Query 4-37
OSC= OSC LEVEL (V) 4-37

-P-

-Q-

-R-

RA0 AUTO RANGE at 1kHz 4-38
RA1 100pF at 1kHz 4-38
RA2 1nF at 1kHz 4-38
RA3 10nF at 1kHz 4-38
RA4 100nF at 1kHz 4-38
RA5 1 μ F at 1kHz 4-38
RA6 10 μ F at 1kHz 4-38
RA7 100 μ F at 1kHz 4-38
RB0 AUTO RANGE at 1MHz 4-39
RB1 1pF at 1MHz 4-39
RB2 2pF at 1MHz 4-39
RB3 4pF at 1MHz 4-39
RB4 8pF at 1MHz 4-39
RB5 16pF at 1MHz 4-39
RB6 32pF at 1MHz 4-39
RB7 64pF at 1MHz 4-39
RB8 128pF at 1MHz 4-39
RB9 256pF at 1MHz 4-39
RB10 512pF at 1MHz 4-39
RB11 1024pF at 1MHz 4-39
RC= Range Value at 1MHz High Accuracy Mode 4-40
RCNT Count Reset 4-40
REVP0 Reverse Parameter OFF 4-41
REVP1 Reverse Parameter ON 4-41

-S-

SHM? SHORT Compensation Measured Value Query 4-41
SHOR0 SHORT Calibration OFF 4-42
SHOR1 SHORT Calibration ON 4-42
SLIM= LOW/HIGH Limit of Secondary Parameter 4-42
SPAR1 Standard Parameter (C-D) 4-43
SPAR2 Standard Parameter (C-G) 4-43
STD0 STANDARD Compensation OFF 4-43
STD1 STANDARD Compensation ON 4-43
STM? STANDARD Compensation Measured Value Query 4-44
STOR Store the 4278A's controls to the memory card 4-44
STR? STANDARD Compensation Reference Value Query 4-45

-T-

TRIG1	Trigger Mode (Internal)	4-45
TRIG2	Trigger Mode (External)	4-45
TRIG3	Trigger Mode (Manual)	4-45

-U-

-V-

VMON0	Value Monitor OFF	4-46
VMON1	Value Monitor (OPEN Measurement Value)	4-46
VMON2	Value Monitor (SHORT Measurement Value)	4-46
VMON3	Value Monitor (STANDARD Measurement Value)	4-46
VMON4	Value Monitor (STANDARD Reference Value)	4-46
VMON5	Value Monitor (OFFSET Reference Value)	4-46
VMON6	Value Monitor (Limit Nominal Value)	4-46

-W-

-X-

XOP	Measure OPEN Compensation data	4-47
XSH	Measure SHORT Compensation data	4-47
XSTD	Measure STANDARD Compensation data	4-47
XTMP	Execute Temperature Compensation	4-47

-Y-

-Z-

-OTHERS-

*CLS	Clear Status Byte	4-48
*IDN?	Identification Query	4-48
*LRN?	Learn Device Setup Query	4-49
*OPT?	Option Identification Query	4-50
*RST	Reset the instrument	4-50
*SRE	Mask the status byte	4-51
*SRE?	*SRE resistor (masking number) Query	4-52
*STB?	Read the status resistor	4-52
*TRG	Trigger command	4-52

COMMAND REFERENCE

All commands listed in this reference are fully explained and listed in alphabetical order. The explanation of each command is patterned as follows:

1. Command Name
2. Softkey Name corresponding to the command
3. Command Description
4. Syntax
5. Control Setting
6. Example (BASIC language for HP 9000 series 200)

To use each command effectively, refer to this command reference.

AOFF

SOFTKEY LABEL: OFFSET A ON/OFF (in 'COMPEN')

The AOFF command makes the offset A data valid or invalid.

SYNTAX:



PARAMETER:

The control parameter choices are:

Control Parameter	Description
0	Make offset A data invalid.
1	Make offset A data valid.

The default setting is AOFF0.

FOR EXAMPLE:

OUTPUT 717;"AOFF1"! Make offset A data valid

AUX

SOFTKEY LABEL: AUX BN ON/OFF (in 'COMPARATOR')

The AUX command makes AUX_BIN valid or invalid.

SYNTAX:



PARAMETER:

The control parameter choices are:

Control Parameter	Description
0	Make AUX_BIN invalid.
1	Make AUX_BIN valid.

The default setting is AUX0.

FOR EXAMPLE:

OUTPUT 717;"AUX1"! Make AUX_BIN valid

AVE= **SOFTKEY LABEL:** AVG RATE <UP/DOWN> (in 'MEAS TIME')

The **AVE=** command sets the averaging rate.

SYNTAX:

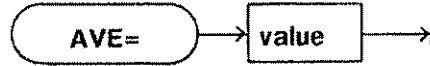

VALUE:

You can use one of the following nine averaging rates.

1, 2, 4, 8, 16, 32, 64, 128, and 256

The default setting is **AVE=1**.

EXAMPLE:

OUTPUT 717;"AVE=4" ! Set the averaging rate to 4.

BINn= **SOFTKEY LABEL:** NOT ASSIGNED

The **BINn=** command sets the low/high limit of BINn(n: 1~9) in the tolerance mode.

SYNTAX:

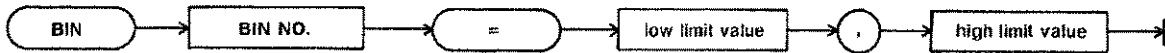

VALUE:

Both the low limit and high limit must be set. This command cannot use either a unit (for example: F), or a suffix (for example: p (pico)) with the limit value.

IMPORTANT POINTS:

Unit is % when the limit mode to % TOL MODE.

EXAMPLE:

1) In the absolute tolerance mode:

OUTPUT 717;"BIN1=10E-12,12E-12"
! Set the BIN1 limit to 10pF~12pF.

2) In % tolerance mode;

OUTPUT 717;"BIN2=-10,10"
! Set the BIN2 limit to -10%~10%.

BLIM=**SOFTKEY LABEL:** NOT ASSIGNED

The **BLIM=** command sets the limit values in the sequential mode.

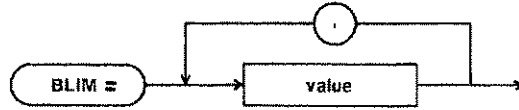
SYNTAX:**VALUE:**

You can not use units (for example: F), or suffixs (for example: p (pico)), with the limit value.

EXAMPLE:

```
OUTPUT 717;"BLIM=10E-12,12E-12,14E-12"
! Set the limit values of BIN1 to 10pF~12pF and
! set the limit values of BIN2 to 12pF~14pF.
```

BOFF**SOFTKEY LABEL:** OFFSET B ON/OFF (in 'OFFSET')

The **BOFF** command makes **OFFSET B** data valid or invalid.

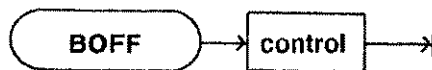
SYNTAX:**PARAMETER:**

The control parameter choices are:

Control Parameter	Description
0	Make offset B data invalid.
1	Make offset B data valid.

The default setting is **BOFF0**.

FOR EXAMPLE:

```
OUTPUT 717;"BOFF1"! Makes offset B data valid.
```

CABL

SOFTKEY LABEL: 0m/1m/2m (in 'CABLE LENGTH')

The **CABL** command sets the cable length.

SYNTAX:

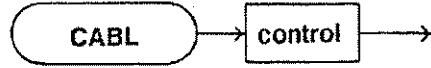

PARAMETER:

The control parameter choices are:

Control Parameter	Description
0	Set the cable length to 0m.
1	Set the cable length to 1m.
2	Set the cable length to 2m.

The default setting is CABL0.

EXAMPLE:

OUTPUT 717;"CABL1"! Set the cable length to 1m.

CCOU?

SOFTKEY LABEL: NOT ASSIGNED

CCOU? returns the BIN counts of the selected channel. This command can only be used when the option 301 scanner interface is installed.

SYNTAX:

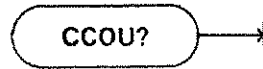

COUNT OUTPUTS (ASCII FORMAT ONLY):

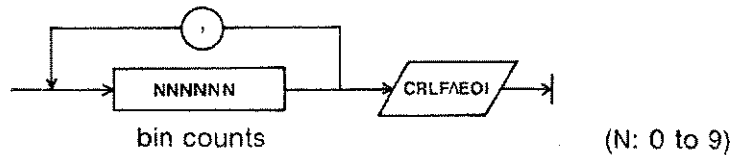

The bin counts are output in the following order:

- | | | | |
|---------|---------|---------|-----------------|
| 1. BIN1 | 4. BIN4 | 7. BIN7 | 10. OUT_OF_BINS |
| 2. BIN2 | 5. BIN5 | 8. BIN8 | 11. AUX_BIN |
| 3. BIN3 | 6. BIN6 | 9. BIN9 | |

IMPORTANT POINTS:

The 4278A acknowledges the channel number on receiving a trigger command (including the trigger command for compensation). When you use the trigger command for the selected channel, you must set the bin count function to **OFF**. If you don't, the measurement resulting from the trigger command for the selected channel will be treated as valid data, and the returned bin count data will include the count of the measurement result due to the trigger command used to select the channel.

EXAMPLE: The following program sets the compensation data to 3, and enters and displays channel 3's bin count.

```
10 DIM Cnt(10)
20 OUTPUT 717;"MCOM1" ! Set the multi compen mode to ON
30 OUTPUT 717;"COMP1" ! Set the compensation to ON
40 OUTPUT 717;"CNT0" ! Set the bin count to OFF
50 OUTPUT 717;"CNO=3" ! Set the compen. data no. to 3
60 OUTPUT 717;"*TRG" ! Set the channel
70 WAIT .1 ! Waiting the channel setting
70 OUTPUT 717;"CCOU?" ! Enter the bin counts
80 ENTER 717;Cnt(*) ! Enter the bin counts
90 PRINT Cnt(*) ! Print the bin counts
100 END
```

CLIM

SOFTKEY LABEL: CLEAR LIMIT (in 'COMPARATOR')

The CLIM command clears all limit values in the limit table.

SYNTAX:



EXAMPLE:

OUTPUT 717;"CLIM"! Clear all limits

CNO=

SOFTKEY LABEL: NOT ASSIGNED

CNO= sets the channel number. CNO= can only be used when the Option 301 scanner interface is installed.

SYNTAX:



VALUE:

0 to 255

IMPORTANT POINT:

The 4278A acknowledges the channel number when the 4278A is triggered or when the 4278A starts a compensation measurement. If CNO= is only sent via HP-IB, the 4278A does not acknowledge the channel number set by CNO=. To set the channel number, first send the CNO= command, and then trigger the 4278A, or start a compensation measurement. Running the following example program selects and triggers the measurement at channel 10

EXAMPLE:

```
10 OUTPUT 717;"MCOM1" ! Set the MULTI_COMPEN mode
20 OUTPUT 717;"CNO=10" ! Set the compen. data no. to 10.
30 OUTPUT 717;"*TRG" ! Trigger the 4278A to set the channel
40 END
```

CNT

SOFTKEY LABEL: COUNT ON/OFF (in 'COMPARATOR')

The **CNT** command sets BIN count to ON or OFF.

SYNTAX:

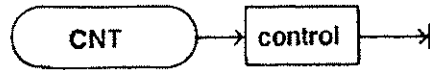

PARAMETER:

The control parameter choices are:

Control Parameter	Description
0	Set BIN count to OFF.
1	Set BIN count to ON.

The default setting is CNT0.

EXAMPLE:

OUTPUT 717;"CNT1"! Set BIN count to ON.

COMP

SOFTKEY LABEL: COMPTR ON/OFF (in 'COMPARATOR')

The **COMP** command makes the comparator valid or invalid.

SYNTAX:

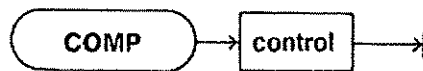

PARAMETER:

The control parameter choices are:

Control Parameter	Description
0	Make the comparator invalid.
1	Make the comparator valid.

The default setting is COMP0.

EXAMPLE:

OUTPUT 717;"COMP1"! Make the comparator valid.

COUN?

SOFTKEY LABEL: NOT ASSIGNED

The **COUN?** command returns all BIN counts.

SYNTAX:



COUNT NUMBER OUTPUTS (ASCII FORMAT ONLY):

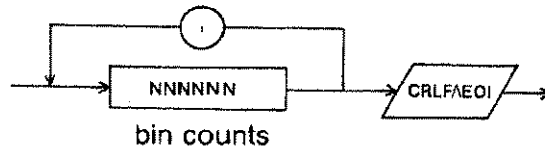

(N: 0 to 9)

The count outputs are in the following order:

1. BIN1
2. BIN2
3. BIN3
4. BIN4
5. BIN5
6. BIN6
7. BIN7
8. BIN8
9. BIN9
10. OUT_OF_BINS
11. AUX_BIN

EXAMPLE:

```
10 DIM Cnt(10)
20 OUTPUT 717;"COUN?"! Return the BIN count.
30 ENTER 717;Cnt(*)! Enter the BIN count.
60 PRINT Cnt(*)! Display the BIN count.
70 END
```

When you run the above program, BIN counts are returned and displayed.

CSTD=

SOFTKEY LABEL: C= (in 'COMPEN')

The **CSTD=** command sets the standard compensation reference value (C).

SYNTAX:

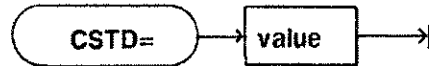

VALUE:

You cannot use units (F) or suffixes (for example: p (pico)), with the reference value.

IMPORTANT POINTS:

Unit is F.

EXAMPLE:

OUTPUT 717;"CSTD=10.2E-12"! Set the CSTD to 10.2pF

DATA?

SOFTKEY LABEL: NOT ASSIGNED

The **DATA?** command returns the measurement values. The data output format is selected by **DFMT** command.

SYNTAX:

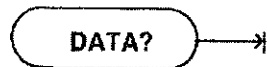

IMPORTANT POINTS:

When "UNBAL" is displayed on the LCD, the output data returned is 2.00000E20. When "-----" is displayed on the LCD, the output data returned is the measured value.

EXAMPLE:

```
10 OUTPUT 717;"TRIG2"!Set the trigger mode to EXT_TRIG
20 OUTPUT 717;"*TRG"! Trigger the 4278A.
30 WAIT .1 ! Wait for the end of the measurement.
40 OUTPUT 717;"DATA?"! Return the data.
50 ENTER 717;C,D! Enter the data
60 DISP C,D! Display the data.
70 END
```

When you run the above program, the 4278A is triggered, a measurement taken and measurement data displayed.

DBIN

SOFTKEY LABEL: NOT ASSIGNED

The **DBIN** command selects the data with BIN NO or the data without BIN NO when the **DATA?** command returns the data.

SYNTAX:

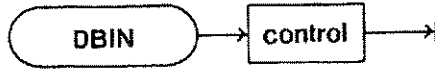

PARAMETER:

The control parameter choices are:

Control Parameter	Description
0	Set to return the data without the BIN NO.
1	Set to return the data with the BIN NO.

The default setting is DBIN0.

- (1) Data output is as follows when returning the data without the BIN NO.



- (2) Data output is as follows when returning the data with the BIN NO.

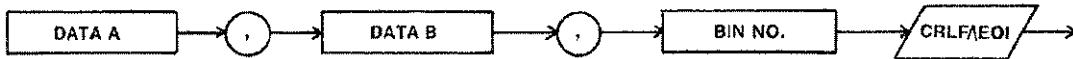

BIN NO. returns the INTEGER variable (0-10) as follows:

BIN Number	BIN Name
0	OUT_OF_BINS
1	BIN1
2	BIN2
3	BIN3
4	BIN4
5	BIN5
6	BIN6
7	BIN7
8	BIN8
9	BIN9
10	AUX_BIN

EXAMPLE:

OUTPUT 717;"DBIN1"! Set to return the data with BIN NO.

DDIG

SOFTKEY LABEL: 4/5/6 DIGITS (in 'DISPLY CONTRL')

The **DDIG** command sets the number of digits displayed.

SYNTAX:

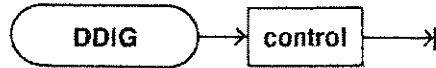

PARAMETER:

The control parameter choices are:

Control Parameter	Description
4	Set the 4 display digits
5	Set the 5 display digits
6	Set the 6 display digits

The default setting is DDIG6.

EXAMPLE:

OUTPUT 717;"DDIG4"! Set the 4 display digits.

DEND

SOFTKEY LABEL: NOT ASSIGNED

The **DEND** command ends the data continuous output mode.

SYNTAX:

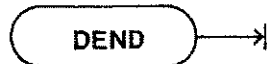

IMPORTANT POINTS:

When "UNBAL" is displayed on the LCD, the output data returned is 2.00000E20. When "----" is displayed on the LCD, the output data returned is the measured value.

EXAMPLE:

```
10 OUTPUT 717;"TRIG2"! Set the TRIG_MODE to EXT_TRIG
20 OUTPUT 717;"DST"! Start the data continuous mode
30 FOR I=1 to 10
40   OUTPUT 717;"*TRG"! Trigger the 4278A
50   ENTER 717;C,D! Read the 4278A's data
60   PRINT C,D! Display the readings
70 NEXT I
80 OUTPUT 717;"DEND"! End the data continuous mode
90 END
```

When you run the above program, data is returned and displayed ten times.

DFMT

SOFTKEY LABEL: NOT ASSIGNED

The DFMT command sets the data output format.

SYNTAX:

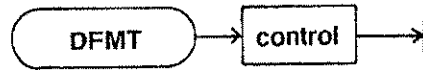

PARAMETER:

The control parameter choices are:

Control Parameter	Description
1	Set the data output format to ASCII format
2	Set the data output format to BINARY format

The default setting is DFMT1.

DIFFERENCE OF ASCII FORMAT AND BINARY FORMAT:

The difference between the ASCII and BINARY formats is as follows:

ASCII format

- (1) When the data without a BIN no. are returned:

With a fixed length of 12 ASCII characters to display the 32-bit floating point numbers that are used for the data A and B as follows:

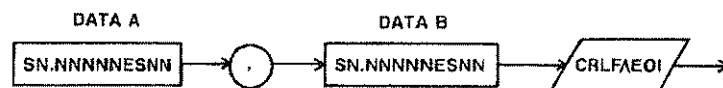

- (2) When the data with BIN NO are returned:

A fixed length of 12 characters to display 32-bit floating point numbers that are used for the data A and B, and a fixed length of 6 characters that are used to display 16-bit integer numbers that are used for the BIN number as follows:

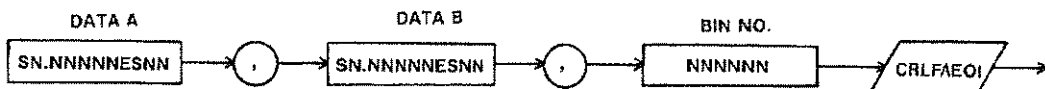

(S: + or -, N: 0 to 9)

DFMT
(cont.)

BIN NO returns an INTEGER variable (0-10) as follows:

BIN Number	BIN Name
0	OUT_OF_BINS
1	BIN1
2	BIN2
3	BIN3
4	BIN4
5	BIN5
6	BIN6
7	BIN7
8	BIN8
9	BIN9
10	AUX_BIN

BINARY format

The BINARY format is a 64-bit floating point binary number specified in IEEE Standard 728-1982. This is the same data format used by the HP Series 200 computers. The syntax diagram used for the BINARY format is shown below:

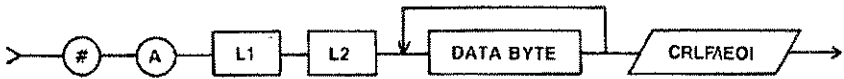

This is a block data field initiated by a unique code, the number, (#)sign. A second byte, (A), designates the data type. L1 and L2 is the block (L1: high byte, L2: low byte). The count includes all data bytes and the terminator, CR/LF (2 bytes), if they are used.

Data byte (8 bytes) for BINARY format is represented as follows:

```

S E E E E E E E E E E E M F F F F F F F F F F F F F F F F F F
F F F F F F F F F F F F F F F F F F F F F F F F F F F F L
  
```

Where:

- S is the sign bit of the fractional part
- E is the exponent part
- M is the most significant bit of the fractional part.
- F is an intermediate fractional bit
- L is the least significant fractional bit

DFMT
(cont.)

- (1) When data is returned without the BIN NO, the data byte loop is repeated twice.
- (2) When data is returned with the BIN NO, the data byte loop is repeated three times.

EXAMPLE:

OUTPUT 717;"DFMT2"! Set to BINARY format.

DPAG

SOFTKEY LABEL: MEAS/LIMIT/SORT/STATUS PAGE (in 'DISPLY PAGE')

The **DPAG** command sets the display page format.

SYNTAX:

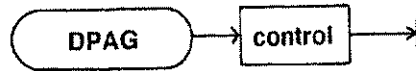

PARAMETER:

The control parameter choices are:

Control Parameter	Description
1	Set the display format to MEAS PAGE.
2	Set the display format to LIMIT PAGE.
3	Set the display format to SORT PAGE.
4	Set the display format to STATUS PAGE.

The default setting is DPAG1.

EXAMPLE:

OUTPUT 717;"DPAG2"!Set to the LIMIT PAGE.

DST

SOFTKEY LABEL: NOT ASSIGNED

The DST command starts the data continuous output mode.

SYNTAX: 

IMPORTANT POINTS:

When "UNBAL" is displayed on the LCD, the output data returned is 2.00000E20. When "-----" is displayed on the LCD, the output data returned is the measured value.

EXAMPLE:

```
10 OUTPUT 717;"TRIG2"! Set the TRIG_MODE to EXT_TRIG
20 OUTPUT 717;"DST"! Start the data continuous mode
30 FOR I=1 to 10
40   OUTPUT 717;"*TRG"! Trigger the 4278A
50   ENTER 717;C,D! Read the 4278A's data
60   PRINT C,D! Display the readings
70 NEXT I
80 OUTPUT 717;"DEND"! End the data continuous mode
90 END
```

When you run the above program data is returned and displayed ten times.

DSTD=

SOFTKEY LABEL: D= (in 'COMPEN')

The DSTD= command sets the standard compensation reference value (D).

SYNTAX:



VALUE:

You can not use a suffix (for example: m (milli)), with the reference value.

EXAMPLE:

```
OUTPUT 717;"DSTD=0.0002"! Set the DSTD to 0.0002
```

DTIM=**SOFTKEY LABEL:** DELAY(ms)= (in 'MEAS TIME')The **DTIM** command sets the delay time.**SYNTAX:****VALUE:**

You can not use a suffix (for example: m (milli)), or a unit (s) with the delay time value.

IMPORTANT POINTS:

Unit is ms, and the setting range is 0~1000ms.

EXAMPLE:

OUTPUT 717;"DTIM=360"! Set the delay time to 360ms.

DVAL**SOFTKEY LABEL:** MEAS/TOL VALUE (in 'DISPLY CONTRL')

This command selects either the MEAS VALUE display mode or the TOL VALUE display mode.

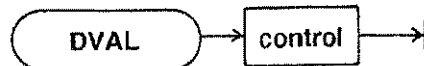
SYNTAX:**PARAMETER:**

The control parameter choices are:

Control Parameter	Description
1	Set the display mode to MEAS VALUE.
2	Set the display mode to TOL VALUE.

The default setting is DVAL1.

IMPORTANT POINTS:The **DVAL2** command can not be used when the limit mode is set to the **SEQ MODE**.**EXAMPLE:**

OUTPUT 717;"DVAL2"! Set the display mode to TOL VALUE.

ERR?

SOFTKEY LABEL: NOT ASSIGNED

The ERR? command returns the error message number.

SYNTAX:



IMPORTANT POINTS:

When the error does not occur, 0 (zero) is returned.

EXAMPLE: (Returns and displays the error number.)

```
10  OUTPUT 717;"ERR?"! Return the error number
20  ENTER 717;A ! Read the error number
30  DISP A ! Display the error number
40  END
```

FREQ

SOFTKEY LABEL: 1kHz/1MHz (in 'SIGNAL SOURCE')

The FREQ command is used to set the test frequency.

SYNTAX:



PARAMETER:

The control parameter choices are:

Control Parameter	Description
1	Set the test frequency to 1kHz.
2	Set the test frequency to 1MHz.

The default setting is FREQ1.

EXAMPLE:

```
OUTPUT 717;"FREQ2"! Set the test frequency to 1MHz
```

GSTD=

SOFTKEY LABEL: G= (in 'COMPEN')

The **GSTD=** command is used to set the standard compensation reference value (G).

SYNTAX:

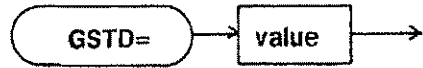

VALUE:

You cannot use a unit (S) or a suffix (for example: p (pico)), with the reference value.

IMPORTANT POINTS:

Unit is S.

EXAMPLE:

OUTPUT 717;"GSTD=10E-3"! Set the GSTD to 10mS

HIAC

SOFTKEY LABEL: OFF/ON @1MHz (in 'HI ACC MODE')

The **HIAC** command is used to set the HI ACC MODE for 1MHz measurements.

SYNTAX:

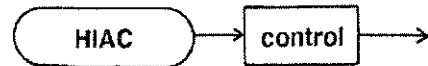

PARAMETER:

The control parameter choices are:

Control Parameter	Description
0	Set the HI ACC MODE to OFF.
1	Set the HI ACC MODE to ON.

The default setting is HIAC0.

IMPORTANT POINTS:

When the **HIAC** command is sent at 1kHz, this command is ignored.

EXAMPLE:

OUTPUT 717;"HIAC1"! Set the HI ACC MODE to ON

ITIM

SOFTKEY LABEL: SHORT/MED/LONG (in 'MEAS TIME')

The **ITIM** command sets the integration time.

SYNTAX:



PARAMETER:

The control parameter choices are:

Control Parameter	Description
1	Set the integration time to SHORT .
2	Set the integration time to MED .
3	Set the integration time to LONG .

The default setting is **ITIM3**.

EXAMPLE:

OUTPUT 717;"ITIM2"! Set the INTEG.TIME to MED

LMOD

SOFTKEY LABEL: % TOL/ABS TOL/SEQ MODE (in 'COMPARATOR')

The **LMOD** command is used to set the limit mode.

SYNTAX:



PARAMETER:

The control parameter choices are:

Control Parameter	Description
1	Set the limit mode to % TOL MODE .
2	Set the limit mode to ABS TOL MODE .
3	Set the limit mode to SEQ MODE .

The default setting is **LMOD1**.

EXAMPLE:

OUTPUT 717;"LMOD2"! Set the limit mode to ABS TOL MODE.

LOAD

SOFTKEY LABEL: NOT ASSIGNED

The **LOAD** command loads the setting conditions from the memory card.

SYNTAX:



EXAMPLE:

OUTPUT 717;"LOAD"! Load from the memory card.

LPAR

SOFTKEY LABEL: Cp-D/Cp-Q/Cp-G/Cs-D/Cs-Q/Cs-Rs (in 'COMPARATOR')

The **LPAR** command sets the limit parameter.

SYNTAX:

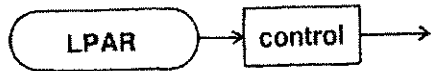

PARAMETER:

The control parameter choices are:

Control Parameter	Description
1	Set the limit parameter to Cp-D .
2	Set the limit parameter to Cp-Q .
3	Set the limit parameter to Cp-G .
4	Set the limit parameter to Cs-D .
5	Set the limit parameter to Cs-Q .
6	Set the limit parameter to Cs-Rs .

The default setting is **LPAR1**.

EXAMPLE:

OUTPUT 717;"LPAR2"! Set the limit parameter to Cp-Q.

MCOM

SOFTKEY LABEL: ON/OFF (in 'MULTI COMPEN')

MCOM toggles the multi compensation mode **ON** and **OFF**. This command can only be used when the Option 301 scanner interface is installed.

SYNTAX:

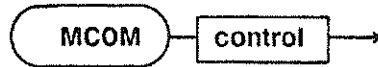

PARAMETER:

The control parameter choices are:

Control Parameter	Description
0	Set the MULTI_COMPEN mode to OFF .
1	Set the MULTI_COMPEN mode to ON .

The default setting is **MCOM0**.

EXAMPLE:

OUTPUT 717;"MCOM1" ! Set the **MULTI_COMPEN** mode to **ON**

MPAR

SOFTKEY LABEL: Cp-D/Cp-Q/Cp-G/Cs-D/Cs-Q/Cs-Rs
(in 'MEAS PARAMTR')

The **MPAR** command sets the measurement parameter.

SYNTAX:



PARAMETER:

The control parameter choices are:

Control Parameter	Description
1	Set the measurement parameter to Cp-D .
2	Set the measurement parameter to Cp-Q .
3	Set the measurement parameter to Cp-G .
4	Set the measurement parameter to Cs-D .
5	Set the measurement parameter to Cs-Q .
6	Set the measurement parameter to Cs-Rs .

The default setting is **MPAR1**.

EXAMPLE:

OUTPUT 717;"MPAR3"! Set the meas. parameter to **Cp-G**.

NOM=

SOFTKEY LABEL: NOT ASSIGNED

The **NOM=** command is used to set the nominal value in the tolerance mode.

SYNTAX:

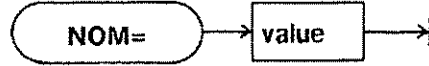

VALUE:

You cannot use units (for example: F), or a suffix (for example: p (pico), with the nominal value.

EXAMPLE:

```
OUTPUT 717;"NOM=10E-12"  
! Set the nominal value to 10pF.
```

OFFA=

SOFTKEY LABEL: OFS A= (in 'OFFSET')

The **OFFA=** command is used to set the offset A data.

SYNTAX:

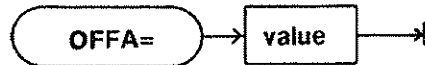

VALUE:

You cannot use units (for example: F), or suffixes (for example: p (pico)), with offset A data.

IMPORTANT POINTS:

Unit is F.

EXAMPLE:

```
OUTPUT 717;"OFFA=10E-12"!Set the offset A data to 10pF
```

OFFB=

SOFTKEY LABEL: OFS B= (in 'OFFSET')

The **OFFB=** command is used to set the offset B data.

SYNTAX:

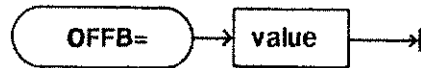

VALUE:

You cannot use units (for example: S), or suffixes (for example: p (pico)), with offset B data.

IMPORTANT POINTS:

The Offset B data unit depends on the measurement parameter when this command is sent.

EXAMPLE:

OUTPUT 717;"OFFB=0.0001"!Set the offset B data to 0.0001

OPEN

SOFTKEY LABEL: OPEN ON/OFF (in 'COMPEN')

The **OPEN** command makes open compensation data valid or invalid.

SYNTAX:

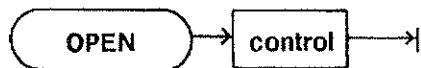

PARAMETER:

The control parameter choices are:

Control Parameter	Description
0	Make the open compen. data invalid.
1	Make the open compen. data valid.

The default setting is **OPEN0**.

EXAMPLE:

OUTPUT 717;"OPEN1"! Make the open compen. data valid

OPM?

SOFTKEY LABEL: NOT ASSIGNED

OPM? returns the open compensation measurement data (ASCII format only). Running the following example program returns and displays the open measurement data.

SYNTAX:

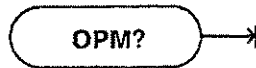

EXAMPLE:

```
10 OUTPUT 717;"OPM?" ! Return the open meas. data
20 ENTER 717;C,G ! Read the open meas. data
40 PRINT C,G ! Display the open meas. data
50 END
```

OSC=

SOFTKEY LABEL: OSC (V)= (in 'SIGNAL SOURCE')

The **OSC=** command sets the **OSC LEVEL**.

SYNTAX:



VALUE:

You cannot use units (V) or suffixes (for example: m(milli)), with the **OSC LEVEL**. The default setting is **OSC=1.0(V)**.

IMPORTANT POINTS:

The Unit is V. The **OSC LEVEL** can be set from 0.1V to 1.0V in 0.1 steps.

EXAMPLE:

```
OUTPUT 717;"OSC=0.3"!Set the OSC level to 0.3V
```

RA

SOFTKEY LABEL: AUTO/100pF/1nF/10nF/100nF/1 μ F/10 μ F/100 μ F
(in 'MEAS RANGE')

The RA command sets the measurement range to 1kHz.

SYNTAX:



PARAMETER:

The control parameter choices are:

Control Parameter	Description
0	Set the measurement range to AUTO.
1	Set the measurement range to 100pF.
2	Set the measurement range to 1nF.
3	Set the measurement range to 10nF.
4	Set the measurement range to 100nF.
5	Set the measurement range to 1 μ F.
6	Set the measurement range to 10 μ F.
7	Set the measurement range to 100 μ F.

The default setting is RA0.

EXAMPLE:

OUTPUT 717;"RA1"!Set the meas. range to 100pF.

RB

SOFTKEY LABEL: AUTO/1pF/2pF/4pF/8pF/16pF/32pF/64pF/128pF/256pF/
512pF/1024pF (in 'MEAS RANGE')

The **RB** command sets the measurement range to 1MHz (HI ACC
MODE: OFF).

SYNTAX:



PARAMETER:

The control parameter choices are:

Control Parameter	Description
0	Set the measurement range to AUTO.
1	Set the measurement range to 1pF.
2	Set the measurement range to 2pF.
3	Set the measurement range to 4pF.
4	Set the measurement range to 8pF.
5	Set the measurement range to 16pF.
6	Set the measurement range to 32pF.
7	Set the measurement range to 64pF.
8	Set the measurement range to 128pF.
9	Set the measurement range to 256pF.
10	Set the measurement range to 512pF.
11	Set the measurement range to 1024pF.

The default setting is **RB0**.

EXAMPLE:

OUTPUT 717;"RB1" | Set the measurement range to 1pF.

RC=

SOFTKEY LABEL: RANGE(pF)= (in 'MEAS RANGE')

The RC= command sets the measurement range to 1MHz (HI ACC MODE: ON).

SYNTAX:

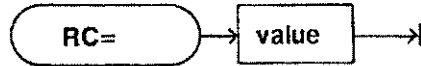

VALUE:

You cannot use unites (F), or suffixes (for example: m (milli)), with the measurement range. The default setting is RC=2.56E-10(256pF).

IMPORTANT POINTS:

The unit is F. The measurement range can be set from 0pF to 2048pF.

EXAMPLE:

OUTPUT 717;"RC=2048E-12"!Set the measurement range to 2048pF

RCNT

SOFTKEY LABEL: RESET COUNT (in 'COMPARATOR')

The RCNT command resets the BIN counts.

SYNTAX:

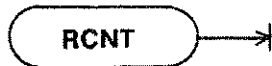

EXAMPLE:

OUTPUT 717;"RCNT"! Reset the BIN counts.

REVP

SOFTKEY LABEL: REVERS PARMTR (in 'COMPARATOR')

The REVP command can be used to reverse the limit parameters.

SYNTAX:

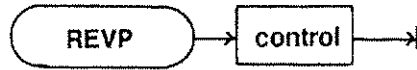

PARAMETER:

The control parameter choices are:

Control Parameter	Description
0	Set the original limit parameter.
1	Reverse the limit parameter.

The default setting is REVP0.

EXAMPLE:

OUTPUT 717;"REVP1"! Reverse the limit parameter

SHM?

SOFTKEY LABEL: NOT ASSIGNED

SHM? returns the short compensation measurement data (ASCII format only). Running the following example program returns and displays the short measurement data.

SYNTAX:

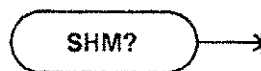

EXAMPLE:

```
10 OUTPUT 717;"SHM?" ! Return the short meas. data
20 ENTER 717;L,R ! Read the short meas. data
40 PRINT L,R ! Display the short meas. data
50 END
```

SHOR

SOFTKEY LABEL: SHORT ON/OFF (in 'COMPEN')

The **SHOR** command makes the short compensation data valid or invalid.

SYNTAX:

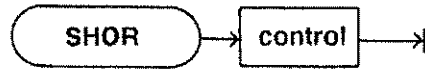

PARAMETER:

The control parameter choices are:

Control Parameter	Description
0	Make the short compen. data invalid.
1	Make the short compen. data valid.

The default setting is SHOR0.

EXAMPLE:

OUTPUT 717;"SHOR1"! Make the short compen. data valid

SLIM=

SOFTKEY LABEL: NOT ASSIGNED

The **SLIM=** command sets the high/low limit of the secondary parameter.

SYNTAX:



VALUE:

You cannot use units (for example: F), or suffixes (for example: m (milli)), with the limit value.

IMPORTANT POINTS:

The unit of the secondary parameter depends on the limit parameter when the command is sent.

EXAMPLE:

OUTPUT 717;"SLIM=0.0001,0.0002"
! Set the limit of sec.para to 0.0001-0.0002.

SPAR

SOFTKEY LABEL: C-D/C-G (in 'COMPEN')

The **SPAR** command sets the parameter for standard compensation.

SYNTAX:

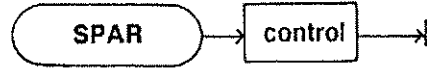

PARAMETER:

The control parameter choices are:

Control Parameter	Description
1	Set the parameter to C-D.
2	Set the parameter to C-G.

The default setting is **SPAR1**.

EXAMPLE:

OUTPUT 717;"SPAR2"! Set the parameter to **C-G**.

STD

SOFTKEY LABEL: STD ON/OFF (in 'COMPEN')

The **STD** command makes the standard compensation data valid or invalid.

SYNTAX:

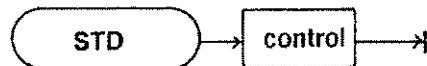

PARAMETER:

The control parameter choices are:

Control Parameter	Description
0	Make the std. compen. data invalid.
1	Make the std. compen. data valid.

The default setting is **STD0**.

EXAMPLE:

OUTPUT 717;"STD1"! Make the std. compen. data valid.

STM?

SOFTKEY LABEL: NOT ASSIGNED

STM? returns the standard compensation measurement data (ASCII format only). Running the following example program returns and displays the standard measurement data.

SYNTAX:

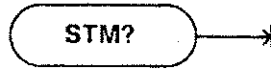

EXAMPLE:

```
10  OUTPUT 717;"STM?" ! Return the STD meas. data
20  ENTER 717;C,D ! Read the STD meas. data
40  PRINT C,D ! Display the STD meas. data
50  END
```

STOR

SOFTKEY LABEL: STORE (in 'MEMORY CARD')

The **STOR** command stores the setting conditions to the memory card.

SYNTAX:

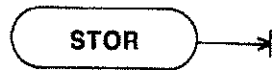

EXAMPLE:

```
OUTPUT 717;"STOR"! Store to the memory card.
```

STR?

SOFTKEY LABEL: NOT ASSIGNED

STR? returns the standard compensation reference data (ASCII format only). Running the following example program returns and displays the standard reference data.

SYNTAX:

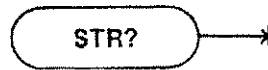

EXAMPLE:

```
10 OUTPUT 717;"STR?" ! Return the Standard ref. data
20 ENTER 717;C,D ! Read the standard ref. data
40 PRINT C,D ! Display the standard ref. data
50 END
```

TRIG

SOFTKEY LABEL: INT/EXT/MAN TRIG (in 'TRIG MODE')

The TRIG command is used to set the trigger mode.

SYNTAX:

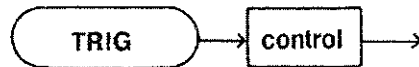

PARAMETER:

The control parameter choices are:

Control Parameter	Description
1	Set the trigger mode to INT TRIG.
2	Set the trigger mode to EXT TRIG.
3	Set the trigger mode to MAN TRIG.

The default setting is TRIG1.

EXAMPLE:

```
OUTPUT 717;"TRIG2"! Set the trigger mode to EXT TRIG.
```

VMON

SOFTKEY LABEL: MONITR OFF/OPEN/SHORT/STD/STD REF/OFFSET/
LIMIT NOM (in 'VALUE MONITR')

The **VMON** command selects the monitor display on the monitor line.

SYNTAX:



PARAMETER:

The control parameter choices are:

Control Parameter	Description
1	Set the monitor display to OFF.
2	Set the monitor display to OPEN data.
3	Set the monitor display to SHORT data.
4	Set the monitor display to STD meas data.
5	Set the monitor display to STD ref data.
6	Set the monitor display to offset data.
7	Set the monitor display to nominal value.

The default setting is **VMON1**.

EXAMPLE:

OUTPUT 717;"VMON2"! Set the monitor display to OPEN data

XOP**SOFTKEY LABEL: OPEN COMPEN** (in 'COMPEN')

The XOP command is used to get the open measurement data.

SYNTAX:**EXAMPLE:**

OUTPUT 717;"XOP"! Measure the open data.

XSH**SOFTKEY LABEL: SHORT COMPEN** (in 'COMPEN')

The XSH command gets the short measurement data.

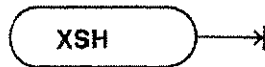
SYNTAX:**EXAMPLE:**

OUTPUT 717;"XSH"! Measure the short data.

XSTD**SOFTKEY LABEL: STD COMPEN** (in 'COMPEN')

The XSTD command gets the std measurement data.

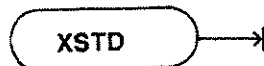
SYNTAX:**EXAMPLE:**

OUTPUT 717;"XSTD"! Measure the std measurement data.

XTMP**SOFTKEY LABEL: TEMP COMPEN** (in 'COMPEN')

This XTMP command minimizes error that may occur in the analog measurement circuit due to temperature change.

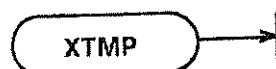
SYNTAX:**EXAMPLE:**

OUTPUT 717;"XTMP"! Minimize temperature induced error

*CLS

SOFTKEY LABEL: NOT ASSIGNED

The *CLS command clears the status byte.

SYNTAX:

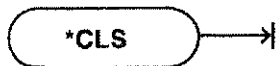

EXAMPLE:

OUTPUT 717;"*CLS"! Clear the status byte.

*IDN?

SOFTKEY LABEL: NOT ASSIGNED

The *IDN? command returns both the instrument's model name and the ROM version number as follows:

HEWLETPACKARD,4278A,0000A00000,REVn.nn

Where:

REVn.nn is ROM version number.

SYNTAX:

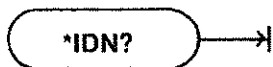

EXAMPLE:

```
10 DIM A${38}
20 OUTPUT 717;"*IDN?"! Returns the identification
30 ENTER 717;A$! Read the identification
40 PRINT A$! Display the identification
50 END
```

When you run the above program, the instrument's identification is returned and displayed.

*LRN?

SOFTKEY LABEL: NOT ASSIGNED

The *LRN? command returns the 4278A's current status.

SYNTAX:



RETURN FORMAT:

The current instrument's conditions are returned as follows:

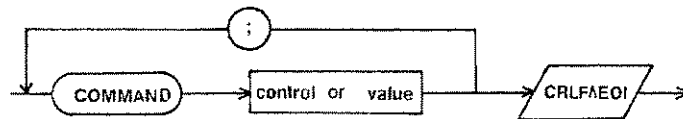

The order of the returned commands is as follows:

Order	Command	Order	Command	Order	Command
1	MPAR	15	SPAR	27	CNT
2	FREQ	16	CSTD=	28	LPAR
3	OSC=	17 ¹	DSTD=	29	REVP
4	HIAC		or	30	LMOD
5	RA		GSTD=	31	AUX
6	RB	18	AOFF	32 ²	NOM=
7	RC=	19	OFFA=		BINn=
8	ITIM	20	BOFF		or
9	AVE=	21	OFFB=		BLIM
10	DTIM	22	DPAG	33	SLIM
11	CABL	23	DDIG	34	TRIG
12	OPEN	24	DVAL	35	DFMT
13	SHOR	25	VMON	36	DBIN
14	STD	26	COMP		

¹ The returned command depends on the setting parameter of STD compensation when the *LRN? command is sent.

² The returned commands depend on the limit mode when *LRN? command is sent.

EXAMPLE:

```
10 DIM Lrn$(750)
20 OUTPUT 717;"*LRN?"! Returns the current conditions
30 ENTER 717;Lrn$! Read the current conditions
40 PRINT Lrn$! Display the current conditions
50 END
```

When you run the preceding program, the current instrument's conditions are returned and displayed.

*LRN? (cont.)

NOTE

All commands returned by *LRN? command can be used as multiple commands by using semicolon (;).

For example: OUTPUT 717;"FREQ2;HIAC1;AVE=4"

*OPT?

SOFTKEY LABEL: NOT ASSIGNED

The *OPT? command returns all option numbers as follows (ASCII format only).

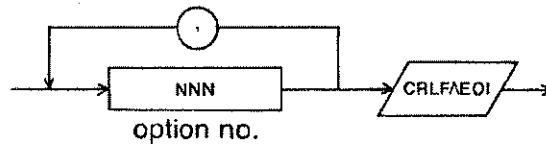

(N: 0 to 9)

SYNTAX:

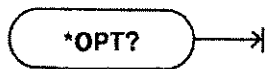

EXAMPLE:

```
10 DIM Opt$[50]
20 OUTPUT 717;"*OPT?"! Returns all option numbers
30 ENTER 717;Opt$! Read all option numbers
40 PRINT Opt$! Display all option numbers
50 END
```

When you run the above program, all option numbers are returned and displayed.

*RST

SOFTKEY LABEL: NOT ASSIGNED

The *RST command resets the 4278A. But the interface function remains (for example: HP-IB remote condition remains).

SYNTAX:

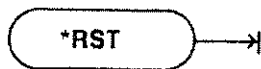

EXAMPLE:

```
OUTPUT 717;"*RST"! Reset the instrument
```

***SRE**

SOFTKEY LABEL: NOT ASSIGNED

The ***SRE** command masks the **SRQ** (Service Request).

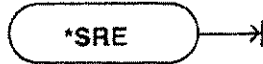
SYNTAX:**VALUE:**

In the default instrument state the setting is ***SRE0** (all zeros: all bits masked). ***SRE** ranges from ***SRE0** to ***SRE255**. The ***SRE** command must be set in accordance with the following table.

Status Bit	"0"	"1"
B7 (always 0)	-	-
B6 (RQS)	Not maskable	
B5 (Error)	Mask B5	enable B5 SRQ
B4 (Always 0)	-	-
B3 (End status)	Mask B3	enable B3 SRQ
B2 (Ignore trigger)	Mask B2	enable B2 SRQ
B1 (End of Conversion)	Mask B1	enable B1 SRQ
B0 (Meas. complete)	Mask B0	enable B0 SRQ

For example:

*SRE	Description
*SRE1	Enable B0 for SRQ
*SRE2	Enable B1 for SRQ
*SRE3	Enable B0 and B1 for SRQ
*SRE4	Enable B2 for SRQ
*SRE8	Enable B3 for SRQ
*SRE32	Enable B5 for SRQ
*SRE45	Enable B0, B2, B3, B5 for SRQ

EXAMPLE:

OUTPUT 717;""RSE1"! Enable B0 for SRQ.

***SRE?**

SOFTKEY LABEL: NOT ASSIGNED

The *SRE? command returns the input value of the *SRE command.

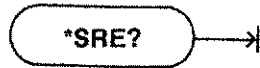
SYNTAX:

EXAMPLE: (Returns and displays the input value of the *SRE command.)

```

10  OUTPUT 717;"*SRE?"! Returns the *SRE's input value
30  ENTER 717;A! Read the *SRE's input value
40  DISP A! Display *SRE's input value
50  END

```

***STB?**

SOFTKEY LABEL: NOT ASSIGNED

The *STB? command returns the status byte without clearing the status byte.

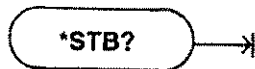
SYNTAX:

EXAMPLE: (Returns and displays the status byte.)

```

10  OUTPUT 717;"*STB?"! Returns the status byte
30  ENTER 717;A! Read the status byte
40  DISP A! Display the status byte
50  END

```

***TRG**

SOFTKEY LABEL: NOT ASSIGNED

The *TRG command triggers the instrument when the trigger mode is set to EXT_TRIG.

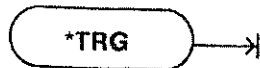
SYNTAX:

EXAMPLE: Triggers the 4278A once.

```

10  OUTPUT 717;"TRIG2"! Set TRIG MODE to EXT TRIG.
20  OUTPUT 717;"*TRG"! Trigger the instrument
30  END

```

COMMAND FUNCTIONAL ORDER

This list covers all commands in their functional order as follows:

1. MEASUREMENT
2. COMPENSATION
3. OFFSET
4. DISPLAY
5. COMPARATOR
6. LIMIT TABLE
7. MEMORY CARD
8. DATA OUTPUT
9. SELF TEST
10. OTHERS

NOTE

@ indicates a selected command as power-on default setting.

1. MEASUREMENT

Function		Code
Measurement Parameter:	Cp-D	MPAR1 @
	Cp-Q	MPAR2
	Cp-G	MPAR3
	Cs-D	MPAR4
	Cs-Q	MPAR5
	Cs-Rs	MPAR6
Frequency:	1kHz	FREQ1 @
	1MHz	FREQ2
High Accuracy Mode:	OFF	HIAC0 @
	ON	HIAC1
Trigger:	Internal	TRIG1 @
	External	TRIG2
	Manual	TRIG3
OSC LEVEL:		OSC=
Range:	AUTO RANGE at 1kHz	RA0 @
	100pF at 1kHz	RA1
	1nF at 1kHz	RA2
	10nF at 1kHz	RA3
	100nF at 1kHz	RA4
	1μF at 1kHz	RA5
	10μF at 1kHz	RA6
	100μF at 1kHz	RA7
	AUTO RANGE at 1MHz	RB0 @
	1pF at 1MHz	RB1
	2pF at 1MHz	RB2
	4pF at 1MHz	RB3
	8pF at 1MHz	RB4
	16pF at 1MHz	RB5
32pF at 1MHz	RB6	
64pF at 1MHz	RB7	
128pF at 1MHz	RB8	
256pF at 1MHz	RB9	
512pF at 1MHz	RB10	
1024pF at 1MHz	RB11	
Range at 1MHz HI-ACC mode)	RC=	
Integration Time:	SHORT	ITIM1
	MEDIUM	ITIM2
	LONG	ITIM3 @
Average Rate:		AVE=
Delay Time:		DTIM=
Cable Length:	0m	CABL0 @
	1m	CABL1
	2m	CABL2

2. COMPENSATION

Function		Code
OPEN:	OPEN OFF	OPEN0 @
	OPEN ON	OPEN1
	OPEN MEAS	XOP
	OPEN MEAS Query	OPM?
SHORT:	SHORT OFF	SHOR0 @
	SHORT ON	SHOR1
	SHORT MEAS	XSH
	SHORT MEAS Query	SHM?
STANDARD:	STD OFF	STD0 @
	STD ON	STD1
	STD MEAS	XSTD
	STD MEAS Query	STM?
	STD Parameter (C-D)	SPAR1 @
	STD Parameter (C-G)	SPAR2
	Reference Value (C)	CSTD=
	Reference Value (D)	DSTD=
	Reference Value (G)	GSTD=
Reference Value Query	STR?	
Temperature Compensation:		XTMP
Multi Compensation:	MULTI-COMPEN MODE OFF	MCOM0 @
	MULTI-COMPEN MODE ON	MCOM1
	Channel Number Selection	CNO=

3. OFFSET

Function		Code
OFFSET A:	OFF	AOFF0 @
	ON	AOFF1
	Input data	OFFA=
OFFSET B:	OFF	BOFF0 @
	ON	BOFF1
	Input data	OFFB=

4. DISPLAY

Function		Code
Display Page:	Measurement Page	DPAG1 @
	Limit Page	DPAG2
	Sort Page	DPAG3
	Status Page	DPAG4
Display Digit:	4 digits	DDIG4
	5 digits	DDIG5
	6 digits	DDIG6 @

4. DISPLAY (cont.)	Function	Code
	Display Value:	Measurement Value Tolerance Value
		DVAL1 @ DVAL2
	Value Monitor:	Monitor OFF OPEN MEAS Value SHORT MEAS Value STD MEAS Value STD Reference Data OFFSET Data Limit Nominal Value
		VMON0 @ VMON1 VMON2 VMON3 VMON4 VMON5 VMON6

5. COMPA

Function	Code
Comparator:	OFF ON
	COMP0 @ COMP1
BIN Count:	OFF ON
	CNT0 @ CNT1
BIN Count Query:	COUN?
BIN Count Query of Selected Channel:	CCOU?

6. LIMIT TABLE

Function	Code
Clear All Limits:	CLIM
Limit Parameter:	Cp-D Cp-Q Cp-G Cs-D Cs-Q Cs-Rs
	LPAR1 @ LPAR2 LPAR3 LPAR4 LPAR5 LPAR6
Reverse Parameter:	OFF ON
	REVP0 @ REVP1
Limit Mode:	% Tolerance Mode Absolute Tolerance Mode Sequential Mode
	LMOD1 @ LMOD2 LMOD3
Limit Value:	Nominal Value BIN1 Limits in TOL MODE BIN2 Limits in TOL MODE BIN3 Limits in TOL MODE BIN4 Limits in TOL MODE BIN5 Limits in TOL MODE BIN6 Limits in TOL MODE BIN7 Limits in TOL MODE BIN8 Limits in TOL MODE BIN9 Limits in TOL MODE
	NOM= BIN1= BIN2= BIN3= BIN4= BIN5= BIN6= BIN7= BIN8= BIN9=

6. LIMIT TABLE

(cont.)

Boundary Limits in Sequential MODE	BLIM=
Limits of Secondary Parameter	SLIM=

7. MEMORY CARD

Function	Code
Store to Memory Card:	STOR
Load from Memory Card:	LOAD

8. DATA OUTPUT

Function		Code
DATA Query:		DATA?
DATA Format:	ASCII format BINARY format	DFMT1 @ DFMT2
BIN DATA Output:	DATA without BIN No. DATA with BIN No.	DBIN0 @ DBIN1
DATA Continuously Output:	Start continuous mode End continuous mode	DST DEND

9. SELF TEST

Function	Code
Enter Self Test:	TENT
Test NO.:	TNO=
Self Test Start:	TST
Self Test Abort:	TAB
Test Data Query:	TDA?
Self Test End:	TEND

10. OTHERS

Function	Code
Clear Status Byte:	*CLS
Identification Query:	*IDN?
Learn Device Setup Query:	*LRN?
Option Identification Query:	*OPT?
Reset the instrument:	*RST
Masking Status Byte:	*SRE
Masking Resister Query:	*SRE?
Read Status Byte:	*STB?
Trigger:	*TRG
Error Number Query:	ERR?

4-2-7. DATA FORMAT AND DATA TRANSFER

The 4278A offers two data formats, ASCII and BINARY, to transfer data to the controller over the HP-IB bus. The data transfer rate for each data format is different.

1. ASCII Format:

ASCII Format is the default data output format. When DFMT1 is active the 4278A transfers data using the ASCII format.

NOTE

When "UNBAL" is displayed on the LCD, the output data returned is 2.00000E20.
When "-----" is displayed on the LCD, the output data returned is the measured value.

There are two ASCII formats, measurement data without a BIN number, and measurement data with a BIN number.

(1) Measurement data without the a number:

This output data format uses a fixed length, 25 ASCII characters, as shown below.

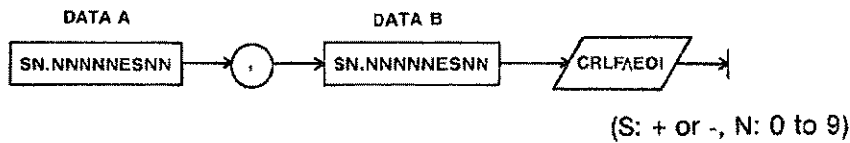

(2) Measurement data with a BIN number:

This output data format uses a fixed length, 32 ASCII characters, as shown below.

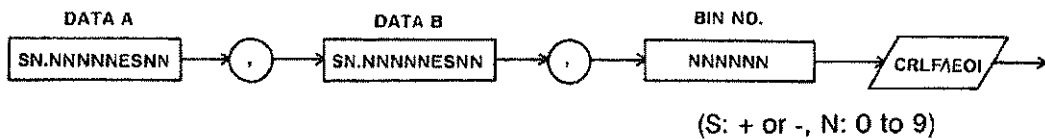

The BIN number is returned as an integer (0~10) as follows.

BIN number	BIN Name
0	OUT_OF_BINS
1	BIN1
2	BIN2
3	BIN3
4	BIN4
5	BIN5
6	BIN6
7	BIN7
8	BIN8
9	BIN9
10	AUX_BIN

2. BINARY Format (IEEE 64 BIT Format):

The BINARY format is the 64-bit floating point binary number as specified in IEEE Standard 728-1982. This is the same data format used by the HP Series 200 computers.

NOTE

When "UNBAL" is displayed on the LCD, the output data returned is $\geq 2.00000E20$.
When "-----" is displayed on the LCD, the output data returned is the measured value.

The syntax diagrams used for the BINARY Format are shown below.

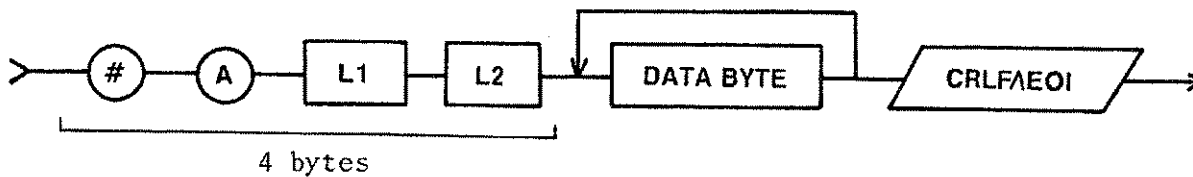

This data field is initiated by a unique code, the number sign (#). A second byte, (A), designates the data type. L1 and L2 are the block (L1: high byte, L2: low byte). The count includes all data bytes and the terminator, CR/LF (2 bytes), if they are used.

Data byte (8 bytes) for BINARY type is represented as follows.

```
S E E E E E E E E E E M F F F F F F F F F F F F F F F F F F
F F F F F F F F F F F F F F F F F F F F F F F F F F F F L
```

Where:

- S is the sign bit of the fractional part
- E is the exponent part
- M is the most significant bit of the fractional part
- F is an intermediate fractional bit
- L is the least significant fractional bit

Real Numbers (RN) can be defined as follows.

1) If Exponent part ≥ 1 then

$$RN = (-1)^S \times 2^{(\text{Exponent part} - 1023)} \times (1.\text{Fractional part})$$

2) If Exponent part = 0 then

$$RN = (-1)^S \times 2^{-1022} \times (0.\text{Fractional part})$$

3) If Exponent part=0 and Fractional part=0 then

$$RN=0$$

For example:

a) If the sign bit=0, the exponent part=all ones (1023) and the fractional part=all ones this format represents $\sim +2.0$.

b) BINARY 64-bit data

```
0 1 1 1 1 1 1 1 1 1 1 1 0 0 0 0 0 0 0 0 0 0 0 0 0 0 0 0 0 0 0 0 0 0
0 0 0 0 0 0 0 0 0 0 0 0 0 0 0 0 0 0 0 0 0 0 0 0 0 0 0 0 0 0 0 0 0 0
```

represents +1.5.

There are two BINARY formats, measurement data without a BIN number and measurement data with a BIN number.

(1) Measurement data without a BIN number:

The data byte loop is repeated twice, (for data A and data B)

(1) Measurement data with a BIN number:

The data byte loop is repeated three times, (for data A, data B, and the BIN number)

As described previously, each data format has a different data transfer rate. Table 4-2 lists typical data transfer rates.

Table 4-2. Typical Data Transfer Rate

1. Data transfer rate using the **ENTER** command with an HP 9000 Series 300 model 310 computer.

Format	Data Type	Transfer Rate
ASCII	Data without BIN NO.	approx. 7.8ms
	Data with BIN NO.	approx. 8.5ms
BINARY	Data without BIN NO.	approx. 4.8ms
	Data with BIN NO.	approx. 5.2ms

2. Data transfer rate using the **TRANSFER** command with an HP 9000 Series 300 model 310 computer.

Format	Data Type	Transfer Rate
ASCII	Data without BIN NO.	approx. 4.3ms
	Data with BIN NO.	approx. 4.3ms
BINARY	Data without BIN NO.	approx. 4.2ms
	Data with BIN NO.	approx. 4.2ms

4-2-8. STATUS BYTE

The status byte register is an 8-bit word that the 4278A places on the HP-IB bus when it is serially polled.

The value of each bit indicates the status of an internal 4278A function. Bits are set to "1" and reset to "0". The individual bit assignments of the status byte are shown below.

Table 4-3. Status Byte Assignments

BIT	Information	Description
0(LSB)	0/1	Measurement Complete
1	0/1	End of Conversion
2	0/1	Ignore Trigger
3	0/1	End Status
4	0	always 0 (zero)
5	0/1	Error
6	0/1	RQS (Request Service)
7(MSB)	0	always 0 (zero)

A description for each bit follows:

BIT 0 (Measurement Complete):

Bit 0 is set when a measurement is completed.

BIT 1 (End of Conversion):

Bit 1 is set when an analog measurement is completed (the measurement data does not become valid simultaneously with the setting of bit 1).

BIT 2 (Ignore Trigger):

Bit 2 is set under the following conditions.

1. When the instrument is set to the External Trigger Mode, the external trigger signal is received during previous measurement and data output.
2. When the instrument is set to the Manual Trigger Mode, the **TRIGGER** key on the front panel is pressed during previous measurement and data output.

BIT 3 (End Status):

Bit 3 is set when the following operations are completed.

1. End of open/short/standard compensation measurement
2. End of the self test
3. End of the EEPROM operation

BIT 4 (always 0):

Bit 4 is always set to 0 (zero).

BIT 5 (Error):

Bit 5 reflects the logical OR of all error conditions in the instrument. The error conditions include all HP-IB, all hardware, and operation errors.

BIT 6 (RQS (Request Service)):

Bit 6 is set when the instrument pulls the SRQ line low. This bit is cleared when a serial-poll is performed and is non-maskable.

BIT 7 (always 0):

Bit 7 is always 0 (zero).

NOTE

1. The status byte is cleared, set to 0 (zero), when the *CLS command is used, or when it is serially polled while bit 6 of the status byte is set to 1.
2. The status byte can be read by sending the *STB? query common command. The status byte will not be cleared by this command.

NOTE

Masking the Status Byte

A service request will be generated when any unmasked bit in the status byte is set. The SRQ mask may be loaded by sending an *SRE command followed by an ASCII mask byte. In the default instrument state the setting is *SRE0 (all zero: all bits masked). *SRE ranges from *SRE0 to *SRE255.

For example:	*SRE1	Enable B0 for SRQ
	*SRE2	Enable B1 for SRQ
	*SRE3	Enable B0 and B1 for SRQ
	*SRE4	Enable B2 for SRQ
	*SRE8	Enable B3 for SRQ
	*SRE32	Enable B5 for SRQ
	*SRE45	Enable B0, B2, B3, B5 for SRQ

4-2-9. SAMPLE PROGRAM

This paragraph contains sample programs that can be run either on the HP 9000 Series 200 (BASIC) or HP 1000 (FORTRAN).

Sample Program 1 (For the HP 9000 Series 200)

This sample program demonstrates the ASCII format data transfer.

```
10  ASSIGN @Hp4278a TO 717
20  REMOTE @Hp4278a
30  OUTPUT @Hp4278a;"*RST"
40  OUTPUT @Hp4278a;"TRIG2"
50  OUTPUT @Hp4278a;"*SRE1"
60  OUTPUT @Hp4278a;"DFMT1"
70  OUTPUT @Hp4278a;"DBIN1"
80  OUTPUT @Hp4278a;"COMP1"
90  ON INTR 7 GOTO Meas_end
100 FOR I=1 TO 100
110  ENABLE INTR 7;2
120  OUTPUT @Hp4278a;"*TRG"
130  Waiting:GOTO Waiting
140  Meas_end:DISABLE INTR 7
150  S=SPOLL(@Hp4278a)
160  OUTPUT @Hp4278a;"DATA?"
170  ENTER @Hp4278a;C,D,B
180  PRINT C,D,B
190  NEXT I
200  END
```

4278A control setting

Measurement

Data transfer and display

A description of each program line follows:

- lines
- 10: Assign address 717 to the HP 4278A.
 - 20: Put the HP 4278A into the REMOTE mode.
 - 30: Initialize the 4278A.
 - 40: Set the trigger mode to EXT_TRIG.
 - 50: Enable BO for SRQ.
 - 60: Set the data output format to ASCII.
 - 70: Set the data output with BIN number.
 - 80: Set the comparator to ON.
 - 90: Go to the Meas_end label line, on receiving an SRQ interrupt.
 - 100: Repeat until the loop counter passes a specific value.
 - 110: Enable the interrupt.
 - 120: Trigger the HP4278A.
 - 130: Wait for the end of the measurement.
 - 140: Disable the interrupt.
 - 150: Clear the status byte.
 - 160: Read the data with a BIN number.
 - 170: Enter the data with a BIN number.
 - 180: Display the data with a BIN number.
 - 190: Repeat until the loop counter is greater than the specified value.
 - 200: End the program.

Sample Program 2 (For the HP 1000)

This sample program uses the HP 1000 to run the same as sample program 1. The LU number is 25.

```
FTN7X,L
PROGRAM SVC
DIMENSION NAME(4),IPARM(5)
CHARACTER CDATA*32
DATA NAME/5,'SVC  '/
IDLU=25
CALL RMOTE(IDLU)
WRITE (IDLU,('*RST'))
WRITE (IDLU,('TRIG2'))
WRITE (IDLU,('*SRE1'))
WRITE (IDLU,('DFMT1'))
WRITE (IDLU,('DBIN1'))
WRITE (IDLU,('COMP1'))
CALL SRQ (IDLU,1,NAME)
DO I=1,100
    WRITE (IDLU,('*TRG'))
    CALL EXEC (6,0,1)
    CALL RMPAR (IPARM)
    CALL STATS (IDLU,ISTATUS)
    WRITE (IDLU,('DATA?'))
    READ (IDLU,200) CDATA
    WRITE (1,200) CDATA
    FORMAT(A32)
200 ENDDO
CALL SRQ (IDLU,1,0)
END
```

Sample Program 3 (for the HP 9000 series 200)

This sample program demonstrates the BINARY format data transfer.

```
10  INTEGER Header_1,Header_2
20  ASSIGN @Hp4278a TO 717;FORMAT ON
30  ASSIGN @Binary TO 717;FORMAT OFF
40  REMOTE @Hp4278a
50  OUTPUT @Hp4278a;"*RST"
60  OUTPUT @Hp4278a;"TRIG2"
70  OUTPUT @Hp4278a;"*SRE1"
80  OUTPUT @Hp4278a;"DFMT2"
90  OUTPUT @Hp4278a;"DBIN1"
100 OUTPUT @Hp4278a;"COMP1"
110 ON INTR 7 GOTO Meas_end
120 FOR I=1 TO 100
130   ENABLE INTR 7;2
140   OUTPUT @Hp4278a;"*TRG"
150   Waiting:GOTO Waiting
160   Meas_end:DISABLE INTR 7
170   S=SPOLL(@Hp4278a)
180   OUTPUT @Hp4278a;"DATA?"
190   ENTER @Binary;Header_1,Header_2,C,D,B
200   PRINT C,D,B
210 NEXT I
220 END
```

4278A control setting

Measurement

Data transfer and display

A description of each program line follows:

- lines
- 10: Declare Header_1 and Header_2 as INTEGER variables.
 - 20: Assign address 717 to the 4278A and set it to ASCII.
 - 30: Assign address 717 to the 4278A and set it to BINARY.
 - 40: Put the 4278A into the REMOTE mode.
 - 50: Initialize the 4278A.
 - 60: Set the trigger mode to EXT_TRIG.
 - 70: Enable B0 for SRQ.
 - 80: Set the data output format to BINARY.
 - 90: Set the data with BIN number.
 - 100: Set the comparator to ON.
 - 110: Go to the "Meas_end" label line on receiving an SRQ interrupt.
 - 120: Repeat until the loop counter is > the specified value.
 - 130: Enable the interrupt.
 - 140: Trigger the 4278A.
 - 150: Wait for the end of the measurement.
 - 160: Disable the interrupt.
 - 170: Clear the status byte.
 - 180: Read the data.
 - 190: Enter the data.
 - 200: Display the data with the BIN number.
 - 210: Repeat until the loop counter is greater than the specified value.
 - 220: End the program.

Sample Program 4 (For the HP 9000 series 200)

This sample program demonstrates setting up the 4278A and storing the 4278A's settings to the memory card.

```
10  ASSIGN @Hp4278a TO 717
20  REMOTE @Hp4278a
30  OUTPUT @Hp4278a; "*RST"
40  OUTPUT @Hp4278a; "FREQ2"
50  OUTPUT @Hp4278a; "HIAC1"
60  OUTPUT @Hp4278a; "RC=1E-12"
70  OUTPUT @Hp4278a; "ITIM3"
80  OUTPUT @Hp4278a; "DTIM=5"
90  OUTPUT @Hp4278a; "CABL2"
100 OUTPUT @Hp4278a; "CLIM"
110 OUTPUT @Hp4278a; "LMOD1"
120 OUTPUT @Hp4278a; "AUX1"
130 OUTPUT @Hp4278a; "NOM=1E-12"
140 OUTPUT @Hp4278a; "BIN1=-0.01,0.01"
150 OUTPUT @Hp4278a; "BIN2=-0.02,0.02"
160 OUTPUT @Hp4278a; "BIN3=-0.03,0.03"
170 OUTPUT @Hp4278a; "BIN4=-0.04,0.04"
180 OUTPUT @Hp4278a; "BIN5=-0.05,0.05"
190 OUTPUT @Hp4278a; "BIN6=-0.10,0.10"
200 OUTPUT @Hp4278a; "BIN7=-0.20,0.20"
210 OUTPUT @Hp4278a; "BIN8=-0.50,0.50"
220 OUTPUT @Hp4278a; "BIN9=-1.00,1.00"
230 OUTPUT @Hp4278a; "SLIM=0,0.0002"
240 OUTPUT @Hp4278a; "COMP1"
250 OUTPUT @Hp4278a; "CNT1"
260 OUTPUT @Hp4278a; "TRIG2"
270 OUTPUT @Hp4278a; "STOR"
280  END
```

A description of each program line follows:

Lines 10: Assign Hp_4278a to 717.
20: Remote the 4278A.
30: Initialize the 4278A.
40: Set the test frequency to 1MHz.
50: Set the HI ACC mode to ON.
60: Set the measurement range to 1pF.
70: Set the integration time to LONG.
80: Set the delay time to 5ms.
90: Set the cable length to 2m.
100: Clear the limit table.
110: Set the limit mode to % tolerance mode.
120: Set the AUX_BIN to ON.
130: Set the nominal value to 1pF.
140: Set the limit value of BIN1 to $\pm 0.01\%$.
:
220: Set the limit value of BIN9 to $\pm 1.00\%$.
230: Set the limit value of AUX_BIN to 0 ~ 0.0002.
240: Set the comparator to ON.
250: Set the BIN count to ON.
260: Set the trigger mode to EXT_TRIG.
270: Store the 4278A's setting to the memory card.
280: End this program.

Sample Program 5 (For the HP 1000)

This sample program uses the HP 1000 to run the same program as sample program 4. LU number is 25.

FTN.7X,L

```
PROGRAM SVC3
IDLU=25
CALL RMOTE(IDLU)
WRITE(IDLU,('*RST'))
WRITE(IDLU,('FREQ2'))
WRITE(IDLU,('HIAC1'))
WRITE(IDLU,('RC=1E-12'))
WRITE(IDLU,('ITIM3'))
WRITE(IDLU,('DTIM=5'))
WRITE(IDLU,('CABL2'))
WRITE(IDLU,('CLIM'))
WRITE(IDLU,('LMOD1'))
WRITE(IDLU,('AUX1'))
WRITE(IDLU,('NOM=1E-12'))
WRITE(IDLU,('BIN1=-0.01,0.01'))
WRITE(IDLU,('BIN2=-0.02,0.02'))
WRITE(IDLU,('BIN3=-0.03,0.03'))
WRITE(IDLU,('BIN4=-0.04,0.04'))
WRITE(IDLU,('BIN5=-0.05,0.05'))
WRITE(IDLU,('BIN6=-0.10,0.10'))
WRITE(IDLU,('BIN7=-0.20,0.20'))
WRITE(IDLU,('BIN8=-0.50,0.50'))
WRITE(IDLU,('BIN9=-1.00,1.00'))
WRITE(IDLU,('SLIM=0,0.002'))
WRITE(IDLU,('COMP1'))
WRITE(IDLU,('CNT1'))
WRITE(IDLU,('TRIG2'))
WRITE(IDLU,('STOR'))
END
```

4-3. OPTION 201 HANDLER INTERFACE

4-3-1. DESCRIPTION

When Handler Interface Option 201 is used, the HP 4278A can easily be combined with a component handler and a system controller to fully automate capacitor testing, sorting, and quality control data processing to increase production efficiency.

4-3-2. SIGNAL LINE DEFINITION

The handler interface signals are divided into the three types as follows.

Comparison Output Signals:

/BIN1~/BIN9, /AUX_BIN, /OUT_OF_BINS, /PHI (primary parameter high reject signal), /PLO (primary parameter low reject signal), /SREJ (secondary parameter reject signal), /UNBAL (bridge unbalanced signal)

Control Output Signals:

/INDEX (Measurement completed signal), /EOM (comparison data valid signal) and /ALARM (instrument failure signal)

Control Input Signals:

/EXT_TRIG (External trigger signal) and /KEY_LOCK (key entry disable signal)

This handler interface signal input/output connector, a standard 36-contact female Amphe-nol connector, is mounted on the 4278A's rear panel. The contact assignments and a brief description of each signal are given in Table 4-4 and Figure 4-4. The timing diagram is shown in Figure 4-5.

NOTE

The / (back slash) in the signal name means that the signal is asserted when low.

Table 4-4. Contact Assignments (sheet 1 of 2)

Pin No.	Signal Name	Description
1	/BIN1	Sort judgements. Each signal's output is open collector.
2	/BIN2	
3	/BIN3	
4	/BIN4	
5	/BIN5	
6	/BIN6	
7	/BIN7	
8	/BIN8	
9	/BIN9	
10	/OUT_OF_BINS	
11	/AUX_BIN	
12	/EXT_TRIG	External Trigger: 4278A is triggered on the rising edge of a pulse applied to this pin when the trigger mode is set to EXT_TRIG.
13	/EXT_TRIG	
14	EXT.DCV2	External DC voltage 2: DC voltage supply pins for DC Isolated inputs (/EXT_TRIG, /KEY_LOCK) and DC Isolated outputs (/ALARM, /INDEX, /EOM). Setting of internal jumpers must be changed when using an internal voltage supply.
15	EXT.DCV2	
16	+5V	Internal voltage supply
17	+5V	
18	+5V	
19	/PHI	Primary Parameter High Reject: The measurement value is greater than the high limit value of BIN1 ~ BIN9. (See Figure 4-3)
20	/PLO	Primary Parameter Low Reject: The measurement value is less than the low limit value of BIN1 ~ BIN9. (See Figure 4-3)
21	/SREJ	Secondary Parameter Reject: The measurement value is not within the range of the secondary parameter limit. (See Figure 4-3)
22	NC	No Connection
23	NC	No Connection

Table 4-4. Contact Assignments (sheet 2 of 2)

Pin No.	Signal Name	Description
24	/UNBAL	Unbalance: The bridge is unbalanced.
25	/KEYLOCK	When this line is asserted, all of the 4278A's front panel keys are disabled.
26	NC	No Connection
27	EXT.DCV1	External DC Voltage 1:
28	EXT.DCV1	DC voltage supply pins for DC isolated open collector outputs, /BIN1 - /BIN9, /AUX_BIN, /OUT_OF_BINS, /PHI, /PLO, /SREJ, /UNBAL. The setting of internal jumpers must be changed when using the internal voltage supply.
29	/ALARM	This signal is asserted LOW when a SELF TEST FAIL, POWER FAIL, or SPECIFIC CIRCUIT FAIL occurs. When a POWER FAIL only occurs the /ALARM signal is asserted low during the POWER FAIL.
30	/INDEX	The /INDEX signal is asserted when a measurement is complete and the 4278A is ready for the next DUT to be connected to the UNKNOWN terminals. Measurement data, however, is not valid until the /EOM signal is asserted. (See Figure 4-5).
31	/EOM	End of measurement: This signal is asserted when the measurement data and comparison results are valid. (See Figure 4-5)
32	COM2	Common for EXT.DCV2
33	COM2	
34	COM1	Common for EXT.DCV1
35	COM1	
36	COM1	
	COM1	

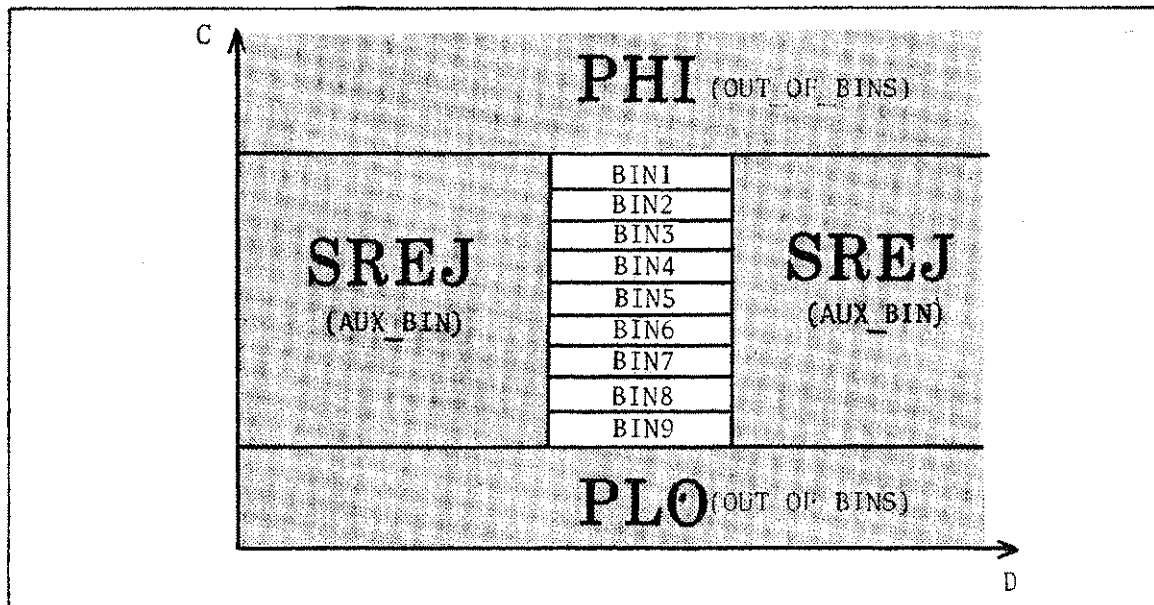

Figure 4-3. /PHI, /PLO, /SREJ Signal's Area Example

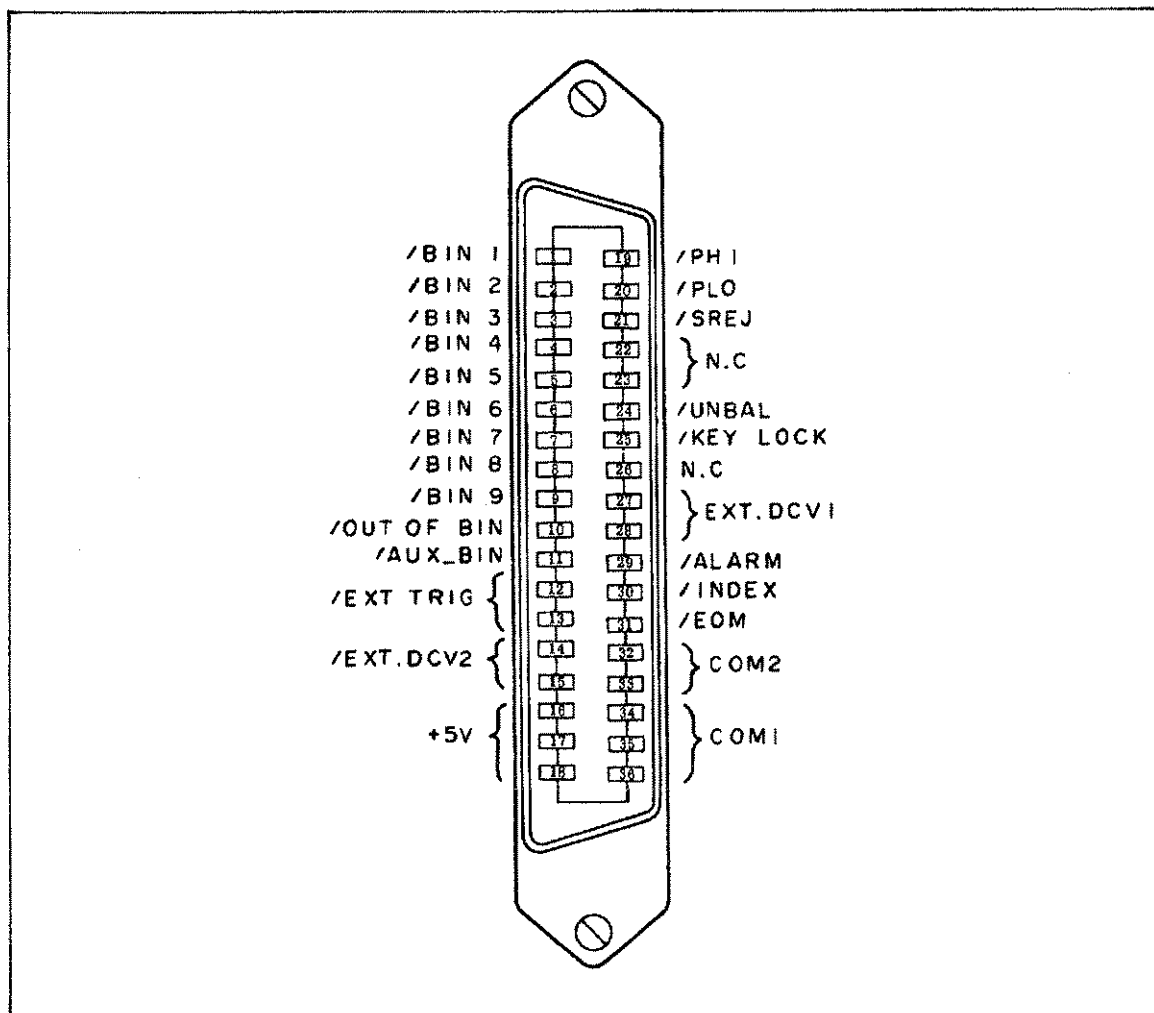
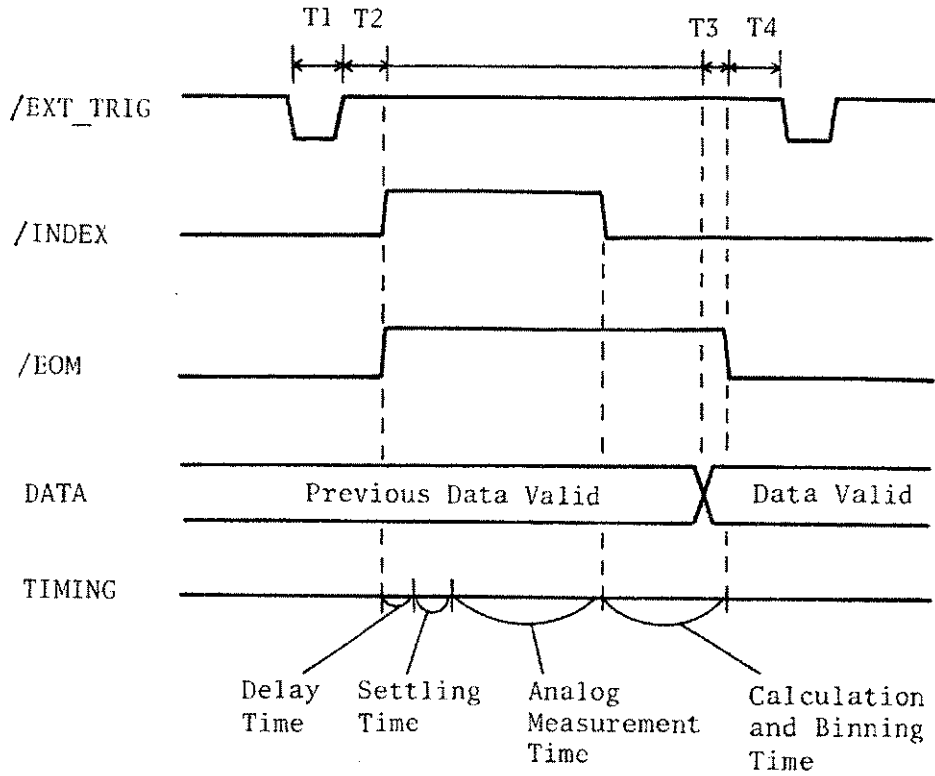

Figure 4-4. Pin Assignment For Handler Interface Connector



Time		Minimum Value	Maximum Value
T1	Trigger Pulse Width	1μs	---
T2	Measurement Start Delay Time	---	Display Time ² +200μs
T3	/EOM Delay Time After Data Output	1μs	---
T4	Trigger Wait Time After /EOM Output	0μs	---

¹ The settling time is changed by setting the delay time.

² The display time for each display format is as follows:

MEAS TIME	4ms
LIMIT PAGE	0ms
SORT PAGE	2ms
STATUS PAGE	0ms

Figure 4-5. Timing Diagram

4-3-3. ELECTRICAL CHARACTERISTICS

DC Isolated Outputs (Optocoupled):

Each DC output (pins 1 through 11, pins 19 through 24, pins 29 through 31), is isolated by using an open collector optocoupler. The output voltage of each line is set by mounting a pull-up resistor on the handler interface board. The pull-up resistor can be connected to the internally supplied voltages (+5V and +12V), or to an external voltage (EXT.DCV.1: +5V - +24V, EXT.DCV.2: +5V - +15V) by the setting jumpers, (refer to paragraph 4-4-4).

The electrical characteristics of the DC isolated outputs are divided into two types, (See Table 4-5).

Since the power source for the Comparison output and Control output signals are different, two circuit commons (COM1, COM2) are available.

Table 4-5. DC Isolated Output Electrical Characteristics

Output Signals	Voltage Output Rating		Maximum Current	Circuit Common
	Low	High		
Comparison Signals /BIN1~/BIN9 /AUX_BIN /OUT_OF_BINS /PHI /PLO /UNBAL	≤0.5V	5V~24V	6mA	Internal pull-up voltage: 4278A circuit common External voltage (EXT.DCV.1): COM1
Control Signals /INDEX /EOM /ARARM	≤0.5V	5V~15V	5mA	Internal pull-up voltage: 4278A circuit common External voltage (EXT.DCV.2): COM2

The simple diagram of the output signals is as shown in Figure 4-6 (Comparison Signals) and Figure 4-7 (Control Signals).

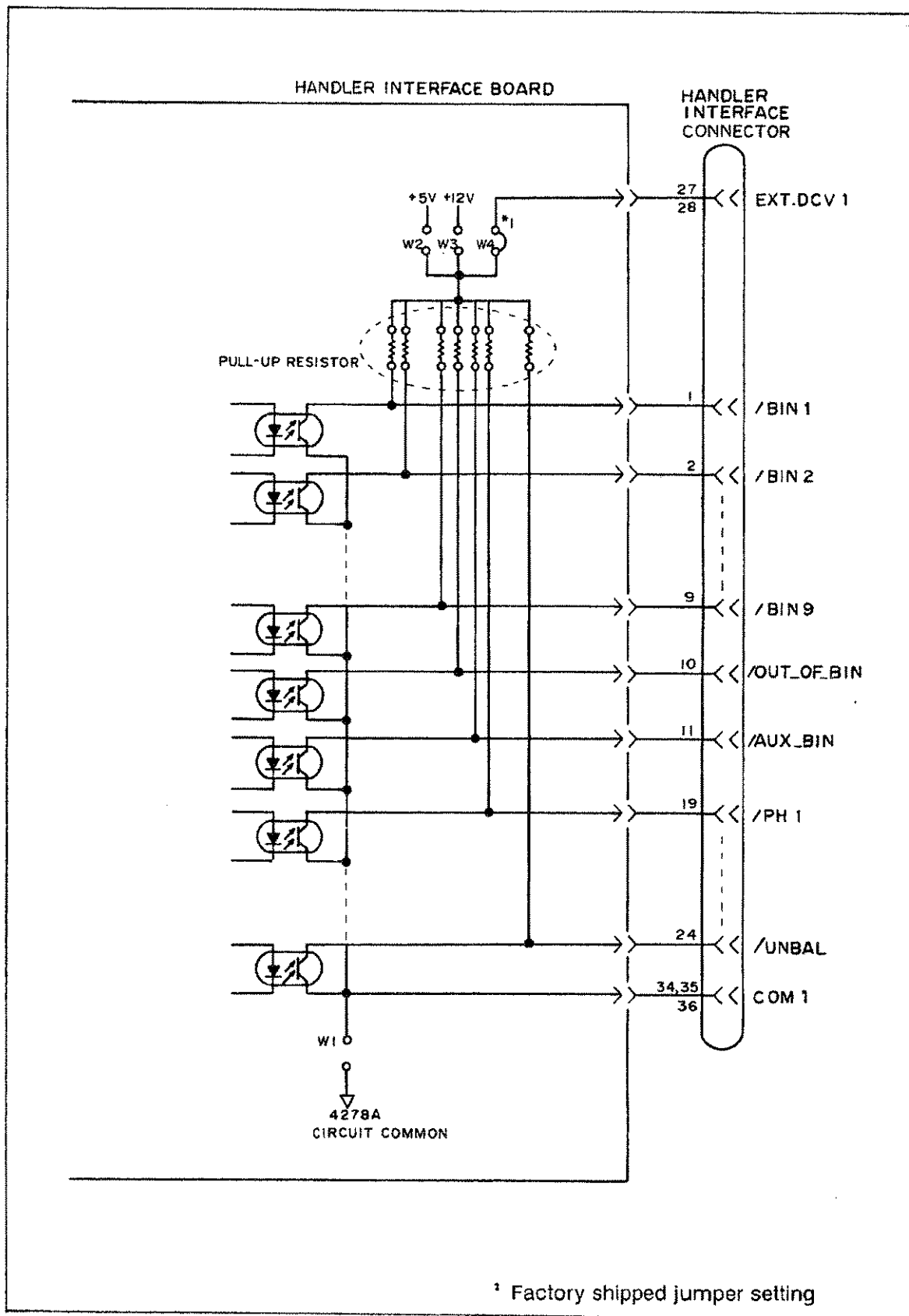

Figure 4-6. Simple Diagram of The Comparison Output Signals

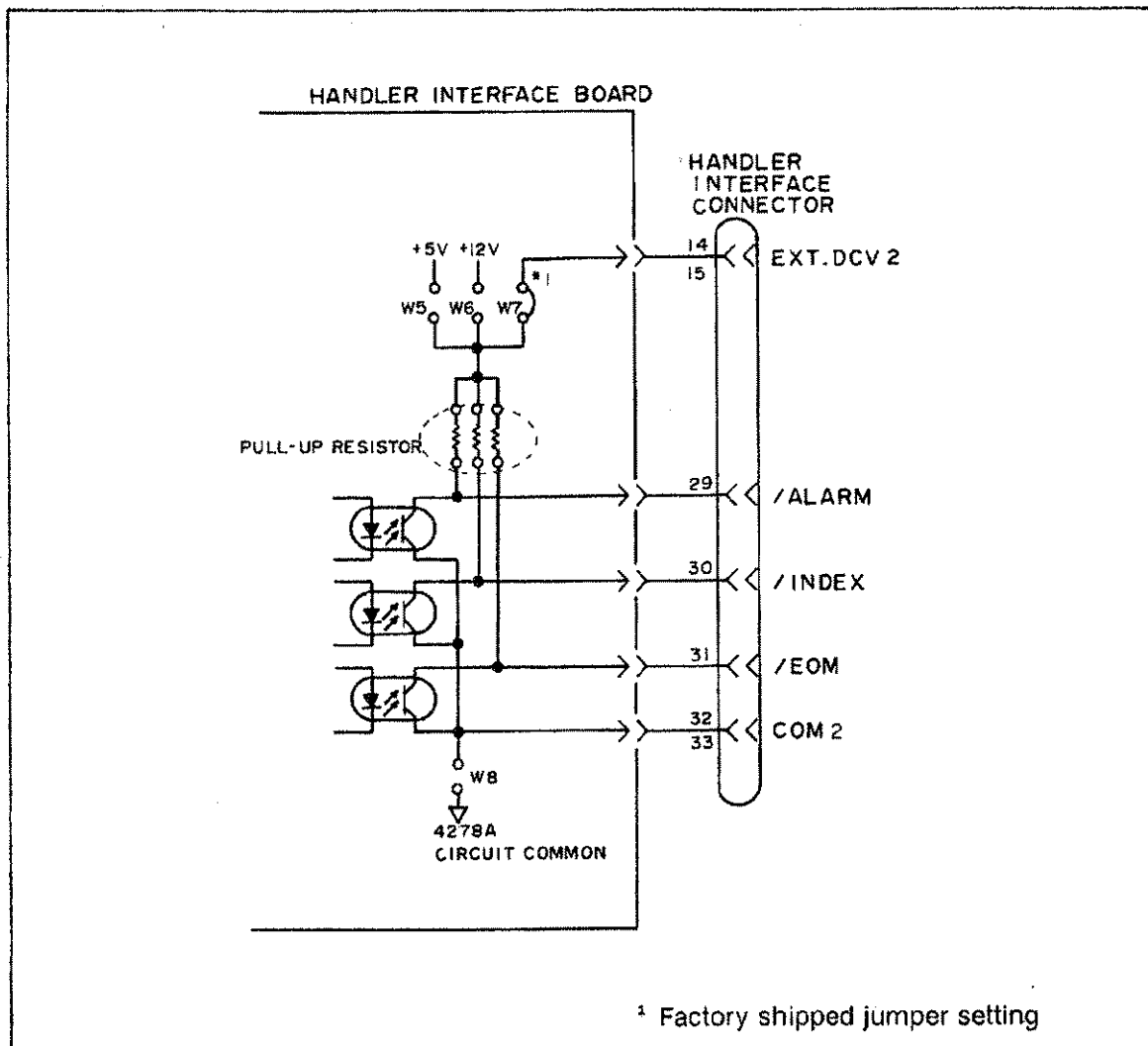

Figure 4-7. Simple Diagram of The Control Output Signals

DC Isolated Input (Optocoupled):

The electrical characteristics of the DC isolated input is divided into two types.

1. /EXT_TRIG

The /EXT_TRIG signal (pin 12 and 13) is connected to the cathode of an LED in the optocoupler. The 4278A is triggered on the rising edge of the /EXT_TRIG pulse. The anode of the LED can be powered using the internal 5V and 12V supplies, or by an external voltage source (EXT.DCV2).

NOTE

To limit the trigger current, the jumper (W9, W10, and W11) must be selected considering the optocoupler anode voltage being used. See paragraph 4-3-4.

2. /KEY_LOCK

The /KEY_LOCK signal (pin 25) is connected to the cathode of the LED in an optocoupler. All of the 4278A's front panel keys are disable when the /KEY_LOCK signal is asserted. The anode of the LED can be powered using the internal 5V and 12V supplies, or by using an external voltage source (EXT.DCV2), which is connected to pin 15 or 16 on the handler interface connector.

The off state voltage (high level) of the /KEY_LOCK (pin25) and /EXT_TRIG (pin12, 13) signals depends on the pull-up voltage selected using jumpers (W5, W6, and W7).

A diagram for the input signals is shown in Figure 4-8.

The electrical characteristics of the signals are listed in Table 4-6.

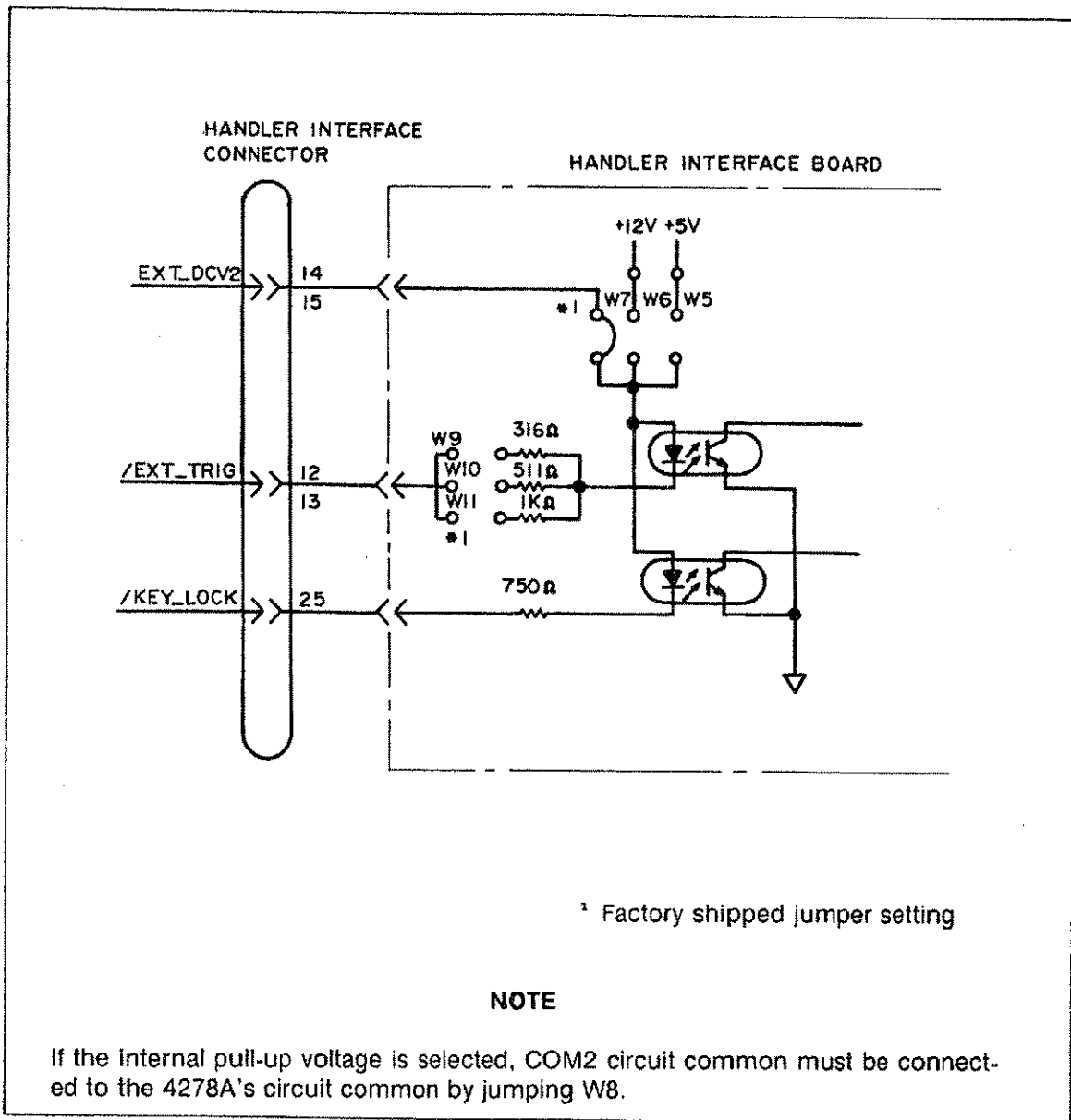

Figure 4-8. Handler Interface Input Signal Diagram

Table 4-6. Typical Electrical Characteristics

Signal	Input Voltage		Input Current (Low) Pull-up Voltage			Circuit Common
	LOW	HIGH	5V	12V	15V	
/EXT_TRIG	≤1V	5V~15V	11.1mA	10.5mA	13.5mA	Internal pull-up Voltage: 4278A circuit common External pull-up Voltage: COM2
/KEY_LOCK	≤1V	5V~15V	5.2mA	14.5mA	18.5mA	Internal pull-up Voltage: 4278A circuit common External pull-up Voltage: COM2

4-3-4. SETTING UP THE HANDLER INTERFACE BOARD

In selecting the signal outputs (Open collector, Internal voltage outputs, or External voltage outputs), jumpers on the handler interface board must be set. A description of each of the eleven jumpers (W1 ~ W11), is given in Table 4-7, and their location is shown in Figure 4-9.

Table 4-7. Internal Jumper Settings

Jumper No.	Shorted Jumper	Signals
W1	DC Isolated outputs are not isolated. COM1 is connected to 4278A circuit common. (When W1 is open DC Isolated outputs are isolated.)	/BIN1 ~ /BIN9 /AUX_BIN /OUT_OF_BINS /PHI ~ /UNBAL
W2 ¹	The open collector outputs are pulled up to the internal 5V.	
W3	The open collector outputs are pulled up to the internal 12V.	
W4	The open collector outputs are pulled up to the /EXT.DCV1(5V~24V).	
W5 ²	The open collector outputs are pulled up to the internal +5V.	/INDEX /EOM /ALARM /EXT_TRIG /KEY_LOCK
W6	The open collector outputs are pulled up to the internal +12V.	
W7	The open collector outputs are pulled up to the EXT.DCV2(5V~15V).	
W8	DC Isolated outputs are not isolated. COM2 is connected to 4278A circuit common. (When W8 is open DC Isolated outputs are isolated).	
W9 ³	Trigger current limiting resistor is 316Ω. W9 should be shorted when EXT.DCV2 is between 5V to 6V or W5 is jumped.	/EXT_TRIG
W10	Trigger current limiting resistor is 511Ω. W10 should be jumped when EXT.DCV2 is between 6V to 9V.	
W11	Trigger current limiting resistor is 1kΩ. W11 should be shorted when EXT.DCV2 is between 9V to 15V or W6 is jumped.	

¹ W2, W3, and W4 must be left open, or only one of them can be jumped at a time. When the instrument is shipped from the factory, W4 is jumped.

² W5, W6, and W7 must be left open, or one only one of them can be jumped at a time. When the instrument is shipped from the factory, W7 is jumped.

³ W9, W10, or W11 must be jumped. When the 4278A is shipped from the factory W11 is jumped.

NOTE

When the internal 5V (pin 16-18) of the handler interface connector is used by the handler, either W1 or W8 must be jumped, and either COM1 or COM2 must be used as the +5V common.

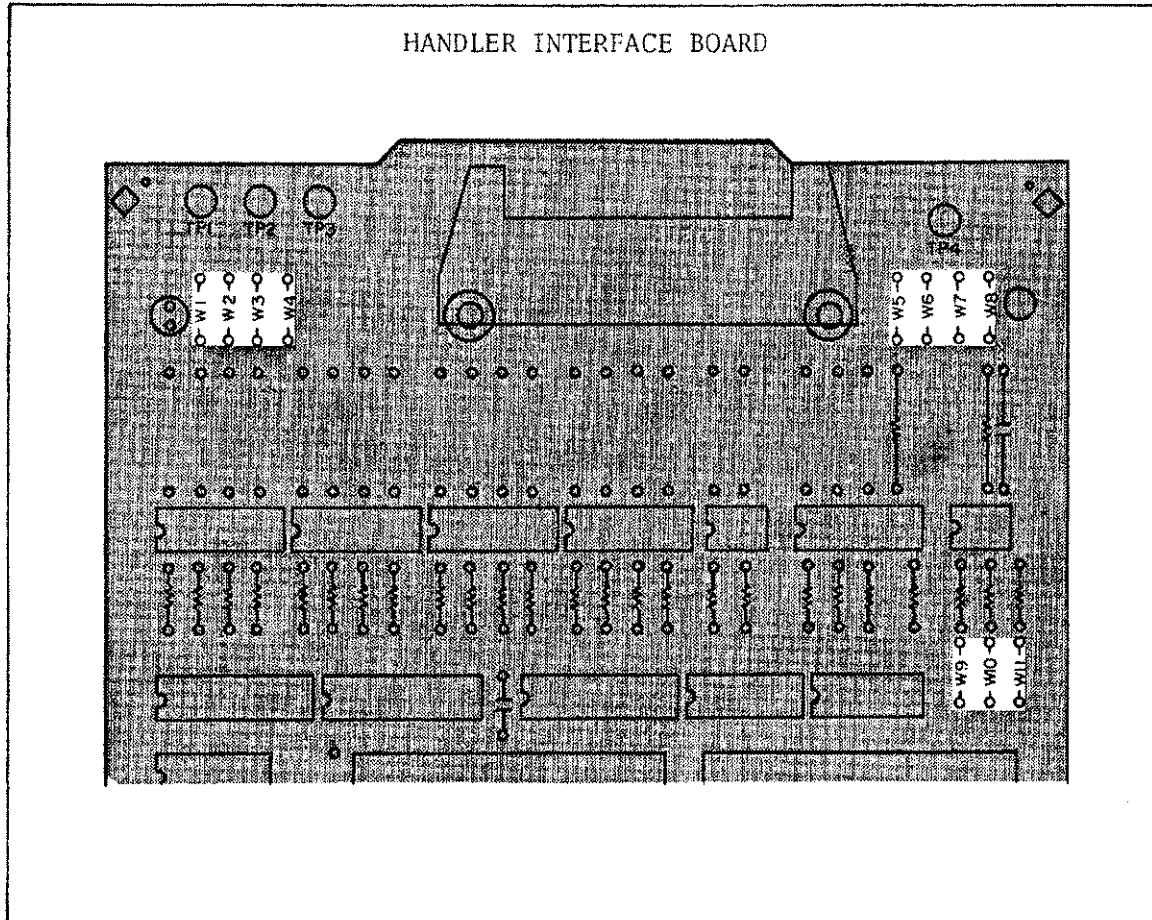

Figure 4-9. Jumper Locations

To set up the jumpers and pull-up resistors, perform the following steps.

Procedure:

1. Disconnect the power cable from the 4278A and allow time (a few minutes), for internal capacitors to discharge.

WARNING

DANGEROUS ENERGY/VOLTAGE EXISTS WHEN 4278A IS IN OPERATION AND JUST AFTER IT IS POWERED DOWN. ALLOW A FEW MINUTES FOR THE INTERNAL CAPACITORS TO DISCHARGE.

2. Disconnect the two rear feet which lock the top cover and rear panel together.
3. Fully loosen the top cover retaining screws located on the rear of the top cover.
4. Slide the top cover towards the rear and lift it off. The top shield plate will be visible.
5. Remove the top shield plate to expose the PC boards.
6. Disconnect the flat cable connected to the handler interface board.

NOTE

The handler interface board is the one with the black and orange extractors. See Figure 4-10.

7. Reinstall the handler interface board.

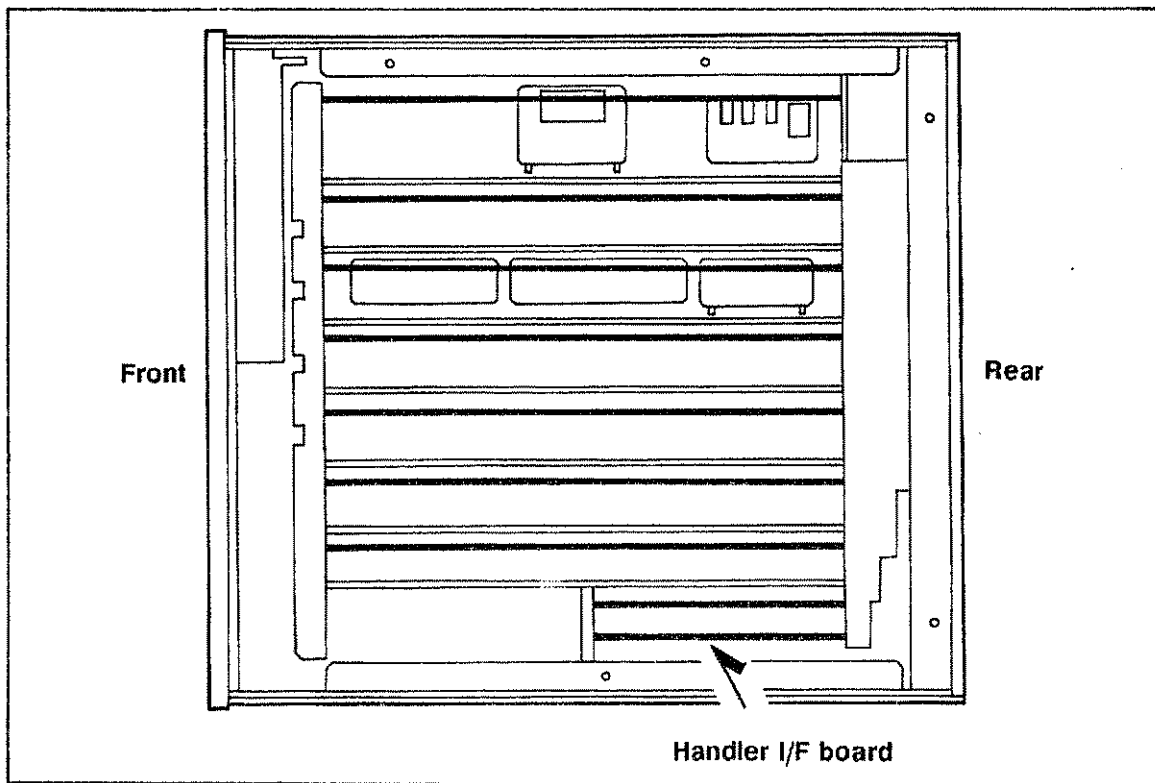
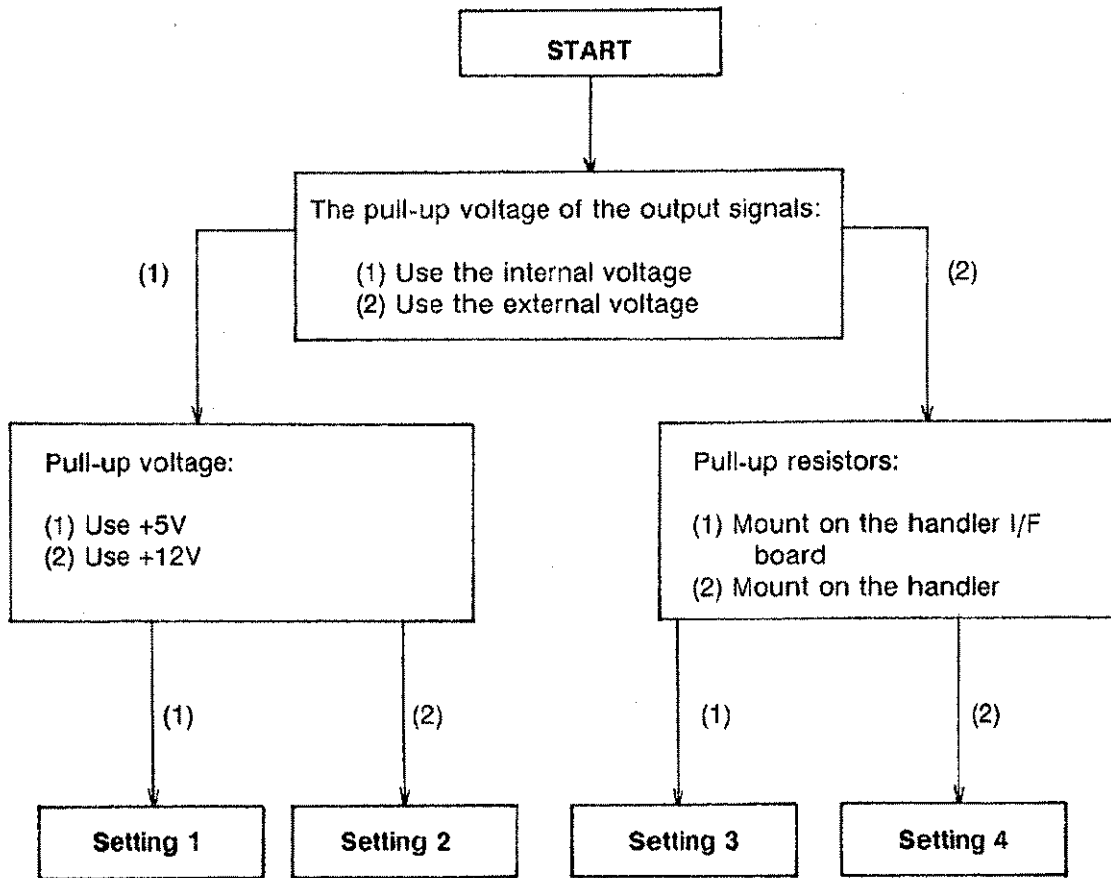

Figure 4-10. Handler Interface Board Locations

8. To set the jumpers for the comparison output signals, follow the following flow chart.



9. Set the jumpers in accordance to Table 4-8, (See Figure 4-11).

10. Mount the pull-up resistors for the comparison output signals when pull-up resistors are called for in Table 4-8.

Table 4-8. Jumper Setting 1

Setting Number	Jumper Setting				Circuit Common	Pull-up resistor	Pull-up voltage
	W1	W2	W3	W4			
1	S	S	O	O	4278A's COM	Required	Internal+5V
2	S	O	S	O	4278A's COM	Required	Internal+12V
3	O	O	O	S	COM1	Required	EXT.DCV.1 (5V~24V)
4	O	O	O	O	COM1	Not required	-

O: OPEN
S: SHORT

NOTE

Use the following equation to determine the value of the pull-up resistors.

$$R[k\Omega] = \frac{V_p[V]}{3}$$

Where,
 V_p: Pull-up voltage
 R: Pull-up resistor

The typical pull-up resistors are as follows:

Pull-up voltage	Pull-up resistor	HP Part number
5V	1.78kΩ	PN0757-0278
12V	3.16kΩ	PN0698-3154
24V	8.25kΩ	PN0757-0441

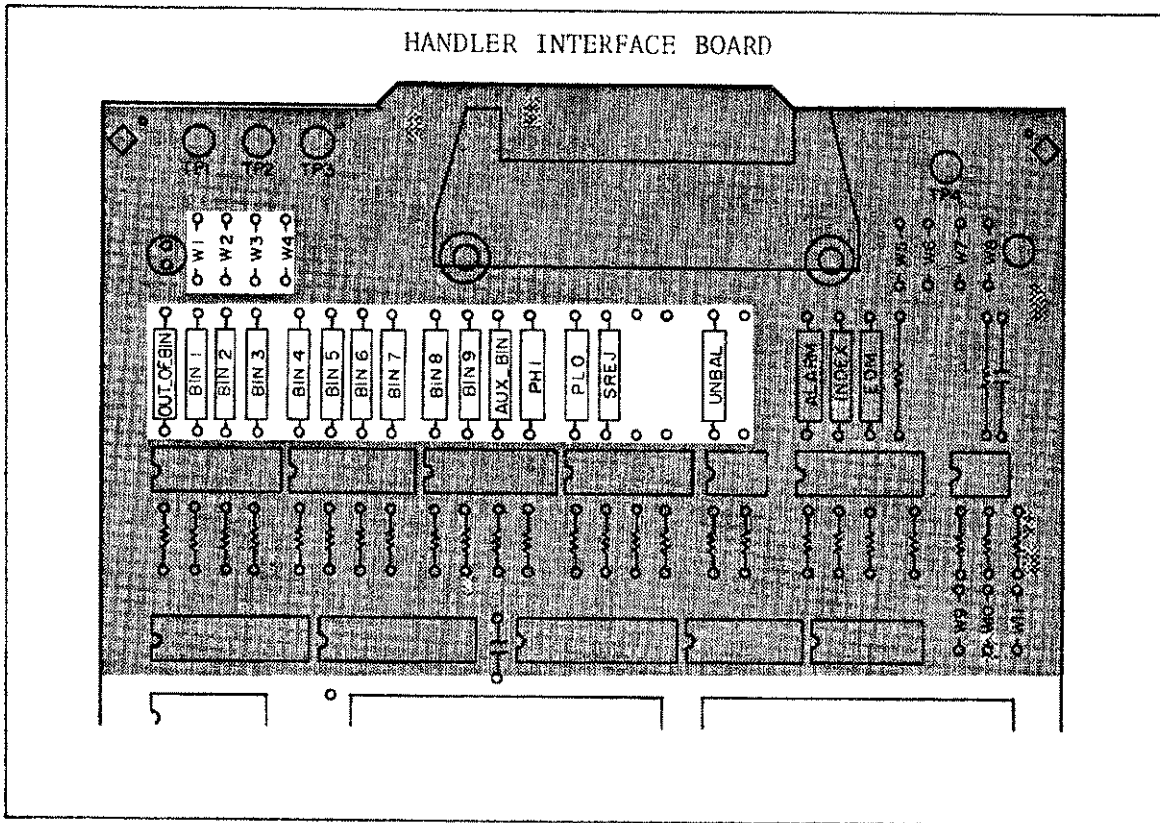

Figure 4-11. How to Set Up the Handler Interface Board 1

12. To set up the jumpers for the control output signals, follow the flow chart given in step 8.
13. Set the jumpers in accordance to Table 4-9, (See Figure 4-12).

Table 4-9. Jumper Settings 2

Setting Number	Jumper Setting				Circuit Common	Pull-up resistor	Pull-up voltage
	W5	W6	W7	W8			
1	S	O	O	S	4278A's COM	Required	Internal+5V
2	O	S	O	S	4278A's COM	Required	Internal+12V
3	O	O	S	O	COM2	Required	EXT.DCV.2 (5V-15V)
4 ¹	O	O	O	O	COM2	Not required	-

O: OPEN
S: SHORT

¹ When input signals are used, only W7 is jumped, (a pull-up resistor is not required).

14. Mount the pull-up resistors for the control output signals when the pull-up resistors are required in Table 4-9.

NOTE

Use the following equation to determine the value of the pull-up resistors.

$$R[k\Omega] \approx \frac{Vp[v]}{2.5}$$

Where,
Vp: Pull-up voltage
R: Pull-up resistor

The typical pull-up resistors are as follows:

Pull-up voltage	Pull-up resistor	HP Part number
5V	1.78kΩ	PN0757-0278
9V	3.16kΩ	PN0757-0279
12V	4.22kΩ	PN0698-3154
15V	5.11kΩ	PN0757-0438

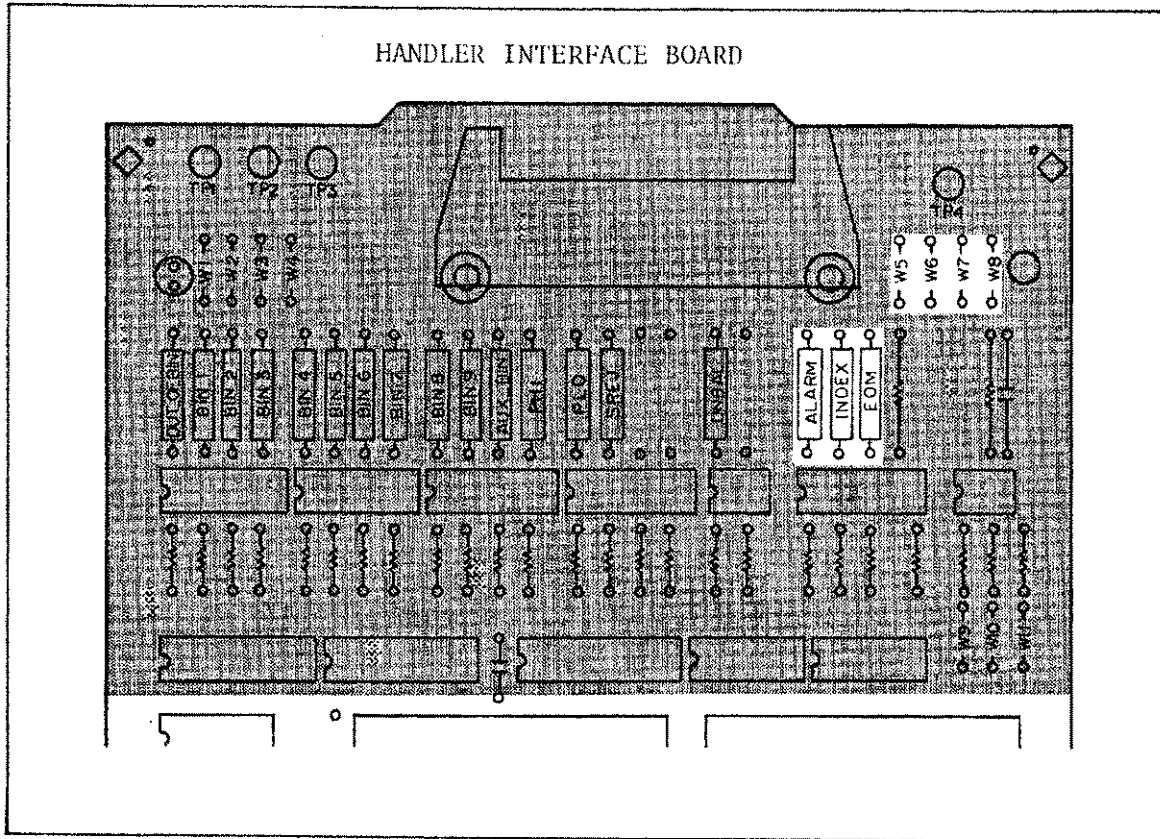

Figure 4-12. How to Set Up the Handler Interface Board 2

15. Set the jumpers for the input signals in accordance with Table 4-10 (See Figure 4-13).

NOTE

The drive voltage of the input signals uses the pull-up voltage for the control signals.

Table 4-10. Jumper Settings 3

Drive Voltage	Jumper Setting			Circuit Common
	W9	W10	W11	
Internal +5V	S	O	O	4278A's circuit common
Internal +12V	O	O	S	4278A's circuit common
EXT.DCV.2 (5-6V)	S	O	O	COM2
EXT.DCV.2 (6-9V)	O	S	O	COM2
EXT.DCV.2 (9-15V)	O	O	S	COM2

O: OPEN
S: SHORT

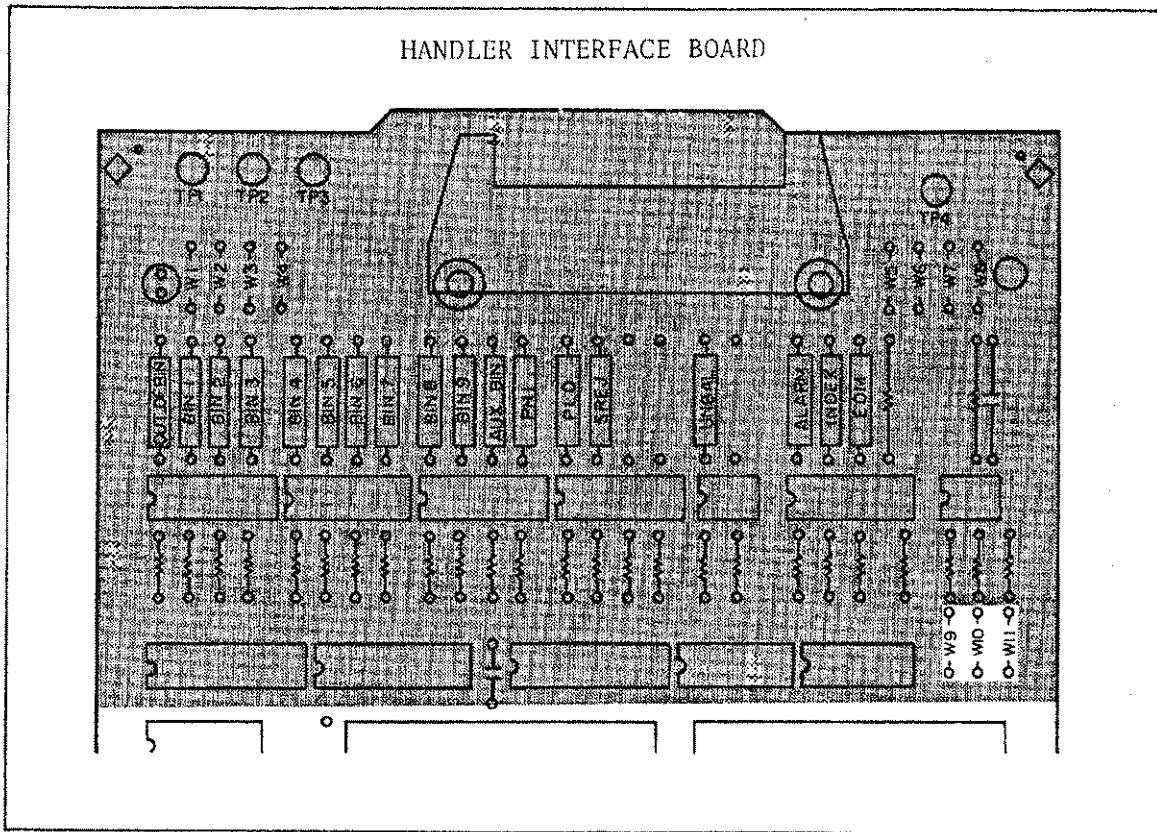

Figure 4-13. How to Set Up the Handler Interface Board 3

16. Replace the handler interface board, top shield plate, rear feet, and top cover.

4-4. OPTION 202 HANDLER INTERFACE

4-4-1. OPTION 202 DESCRIPTION

The Option 202 Handler Interface can be configured to physically and electrically interface the HP 4278A to the following handlers:

- Palomar Model M16 Handler
- Palomar Model M11 Handler
- Q-Corporation RTR2 Handler
- Isumeca 83 Handler
- EA Model M015 Handler

By configuring the Option 202 Handler Interface Board (determining and installing the jumpers as required for your handler, see Table 4-14).

4-4-2. INTERFACE SIGNAL DEFINITIONS

Option 202 uses three types of handler interface signals, control input, control outputs, and binning results. The following describes the function of, and gives the pin assignments for the Option 202 Handler Interface I/O signals.

NOTE

A back slash " / ", in front of the signal name means the signal is asserted when it is **LOW**.

Control Input:

The control input signal is:

START IN Trigger signal sent to the 4278A to start a measurement. Rising and falling edge triggering signals are handled by installing jumper **W12** or **W13** on the Option 202 Handler Interface board.

Control Output:

The control output signals are:

EOC An opto-isolated signal output by the 4278A to tell the handler when the end of conversion occurs. At the End Of Conversion the 4278A enters the compensation, calculation and comparison phase and the handler is free to ready the next DUT for testing. The assertion level for **EOC** is selected by installing jumper **W3**, **W4**, or **W5** on the Option 202 Handler Interface board.

BUSY An opto-isolated signal output by the 4278 telling the Handler that the 4278A is busy performing a measurement, comparison, or calculation. The assertion level of **BUSY** is controlled by installing **W6** or **W7** on the Option 202 Handler Interface board.

Binning Result Output:

/BIN0 ~ /BIN10 Output signals from the 4278A telling the handler the comparison results. The handler sorts the capacitors based on this information.

Table 4-11. Pin Assignments

Pin No.	Signal Name	Description
1	Common	Isolated Common
2	Bin 0	Bin sorting results Opto-Isolated open collector output
3	Bin 1	
4	Bin 2	
5	Bin 3	
6	Bin 4	
7	Bin 5	
8	Bin 6	
9	Bin 7	
10	Bin 8	
11	Bin 9	
12	+ 5V OUT	+ 5V for external use.
13	System Ground	Instrument Logic Ground
14	START IN	Trigger Input (Signal from Handler)
15	EOC	End of Conversion A/D output
16	Bin 10	Bin 10 Sorting result (same as BIN 0 - 9)
17		+ 5V output when jumper W1 is installed
18	BUSY	BUSY (conversion, calculation) output
19 - 36		No Connection

BIN0: OUT_OF_BINS

BIN10: AUX_BIN

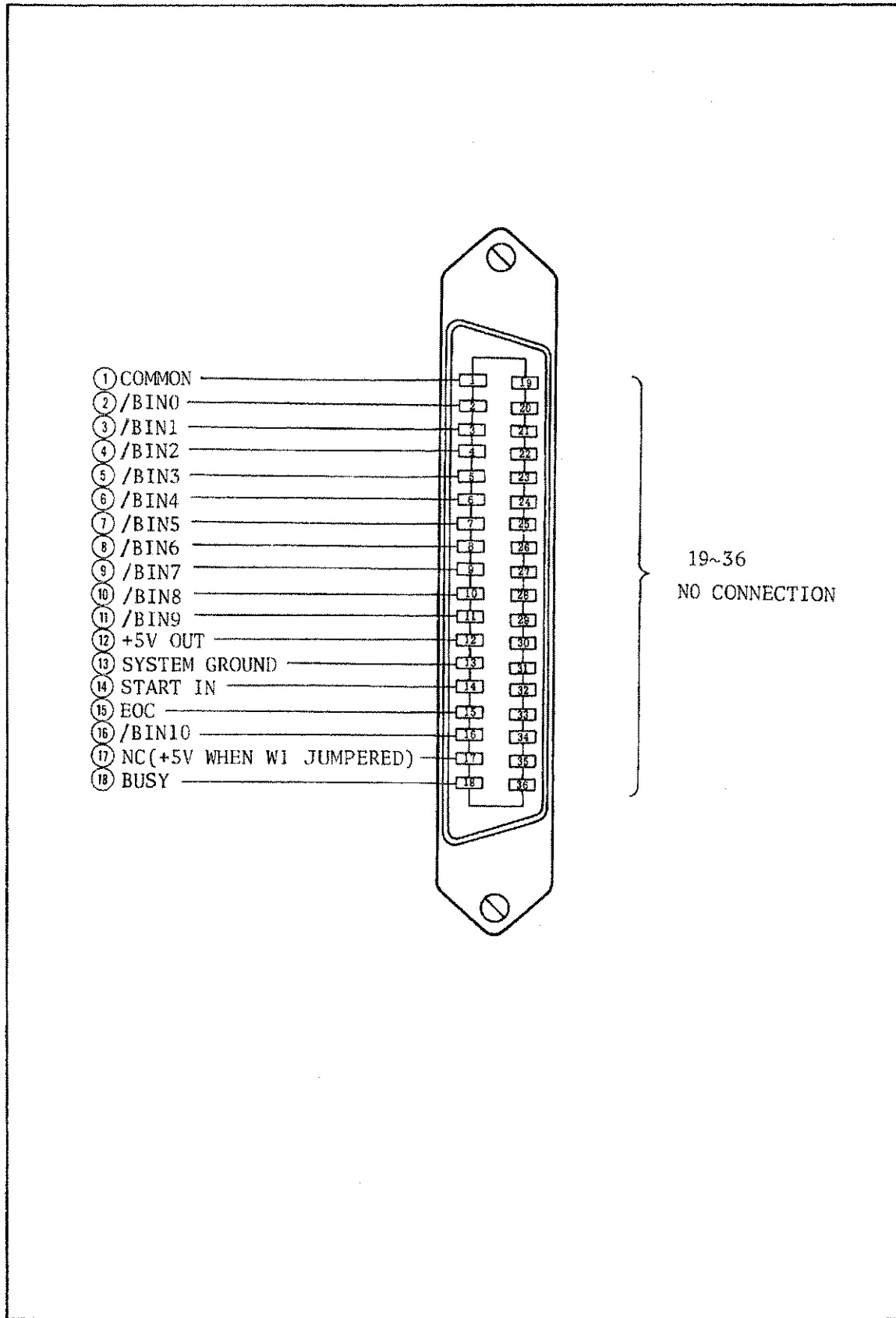
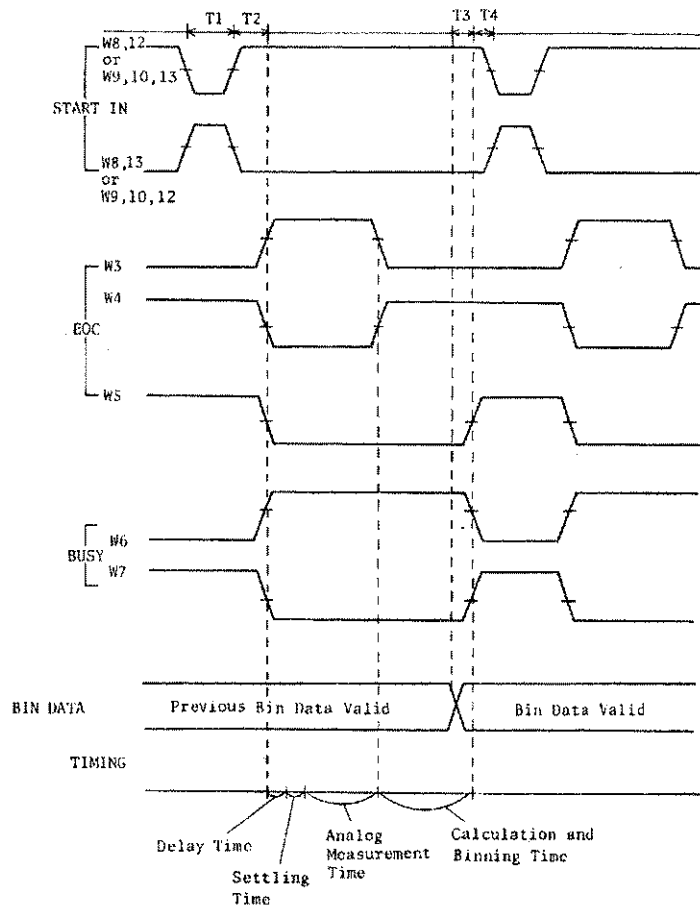

Figure 4-14. Handler Interface Connector Pin Assignments



Time	Description	Min.	Max.
T1	Trigger Pulse Width	5 μ s (W11 Open) 50 μ s (W11 Installed)	
T2	Measurement Delay Time		Display Time + 200 μ s
T3	EOC Delay Time after Comparison Data output	1 μ s	
T4	Trigger Wait Time after EOC output	0 μ s	

NOTE

The wait time before settling varies with the delay time selected. When the delay time is set to 0 sec. then the wait time is 0 sec.

Figure 4-15. Timing Diagram

4-4-3. ELECTRICAL CHARACTERISTICS AND TIMING

Opto-Isolated Input:

The **START IN** input trigger signal can be opto-isolated by installing jumpers **W9** and **W10** while leaving jumper position **W8** open. When this input is used as an opto-isolated input it is current driven and requires 5 ~ 60mA for proper operation. For TTL level trigger input signals, install jumper **W8** and leave jumper positions **W9** and **W10** open.

Opto-Isolated Outputs:

The outputs from the 4278A are Opto-Isolated for added interfacing flexibility and to increase reliability through reduced noise pickup. Provisions have been made for mounting pull-up resistors connected to + 5V on board for systems using TTL logic levels, otherwise the supply voltage (**24V maximum**), and the pull-up resistors are located in the handler (the combination of pull-up resistor and pull-up supply voltage used must result in a current through the opto-isolator of **less than 80mA**). The opto-isolator common supply path can be connected to or isolated from the 4278A's system ground with jumper **W2**. Installing jumper **W2** connects the opto-isolator common to the 4278A's system ground.

Table 4-12. Electrical DC Characteristics of Opto-Isolated Outputs

Output Signals	Voltage Output Level		Maximum Current
	Low	High	
Binning Signals /BIN0 ~ /BIN10	≤ 0.5V	5 ~ 24V ¹	80mA
Control Signals			
EOC	≤ 0.5V	5 ~ 24V ¹	80mA
BUSY	≤ 0.5V	5 ~ 24V ¹	80mA

¹ Depends on the value of pull-up voltage used. The pull-up voltage on the handler interface board is + 5V, and up to 24V can be used from an external source (from the handler).

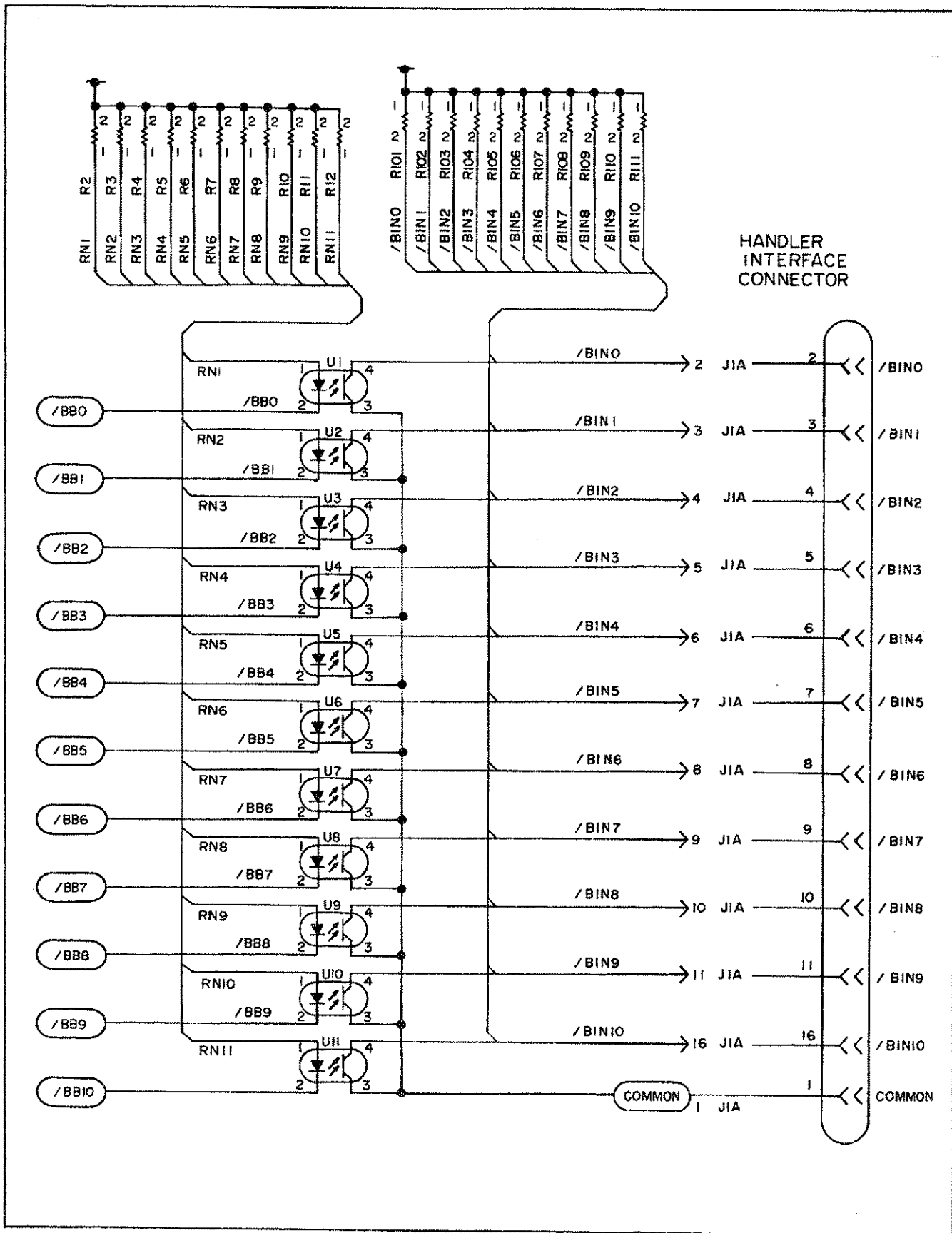

Figure 4-16. Simplified Binning Output Schematic

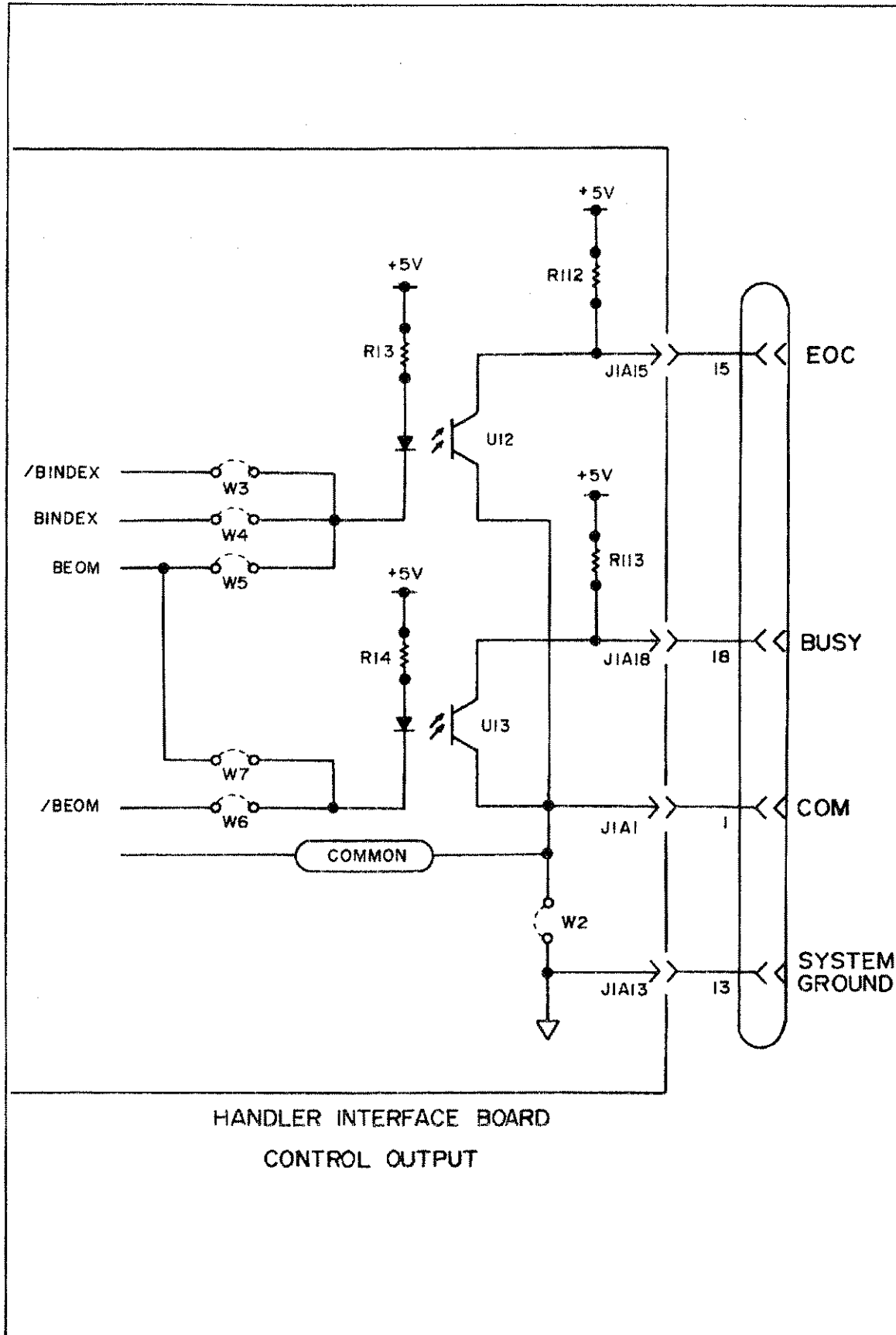

Figure 4-17. Simplified Control Output Schematic

Opto-isolated Inputs:

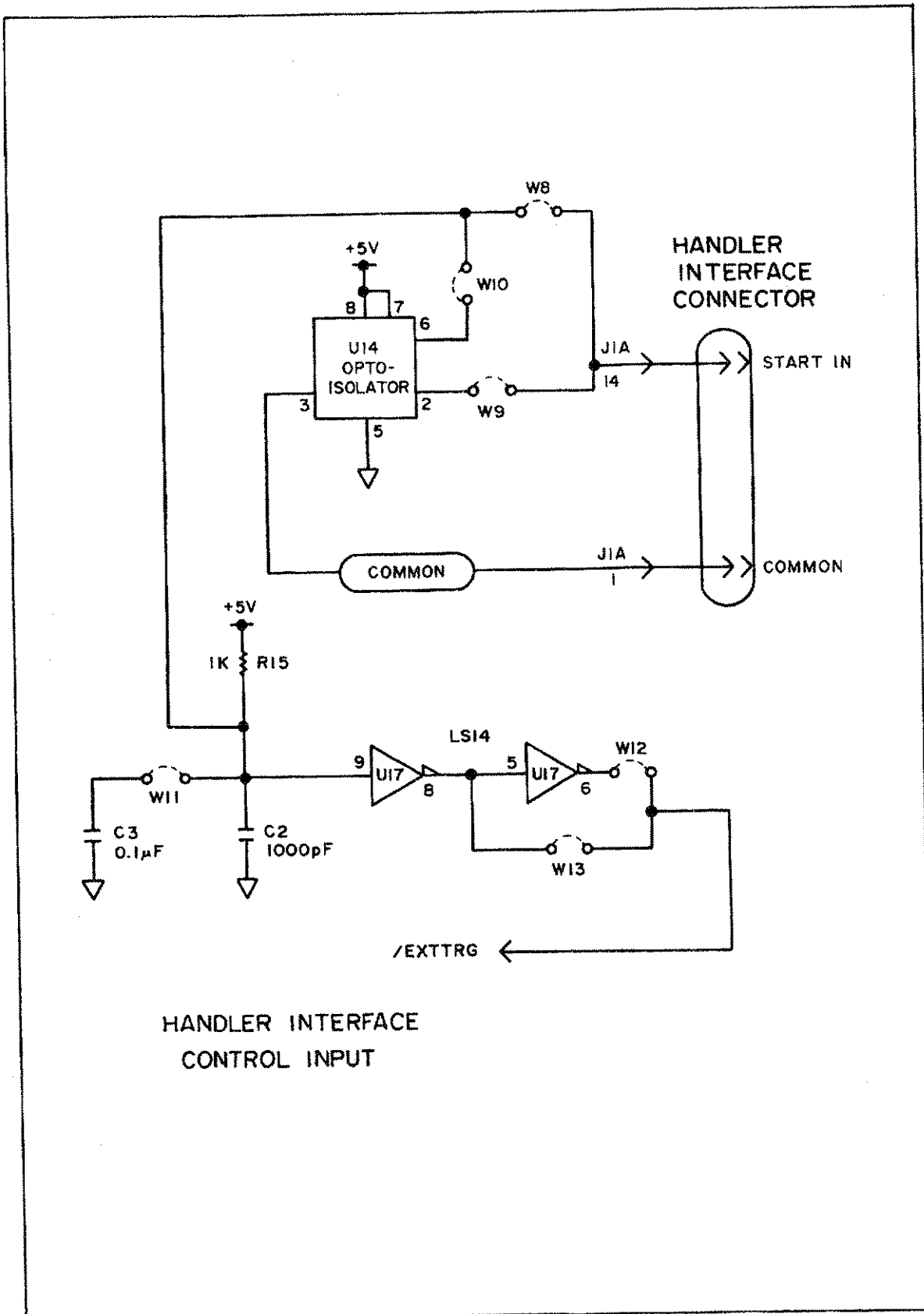

Figure 4-18. Handler Interface Input Schematic

Table 4-13. Typical Input Electrical Characteristics

Input Signal	Input Current	
	Low	High
START IN (Opto-Isolated)	0 ~ 250 μ A	5 ~ 60mA ²
	Input Voltage	
	2.0V (Input Current= 5mA)	
START IN (TTL Level) ¹	Input Threshold Voltage	
	Low	High
	0.8V	1.6V
	Input Current	
	Low	High
	-0.4mA	20 μ A

¹ Schmitt-Trigger input, hysteresis = 0.8V.

² Do not use less than 5mA, opto-isolator must have 5mA minimum for proper operation.

4-4-4. CONFIGURING THE OPTION 202 HANDLER INTERFACE BOARD

Setting up the Option 202 Handler Interface board consists of installing jumpers and pull-up resistors as required. Table 4-14 lists the jumpers and pull-up resistors to install for various handlers on the market. Figure 4-20 shows the locations of the handler interface jumpers, Figure 4-21 shows the locations of the pull-up resistors on the handler interface board, and Figure 4-22 shows the location of the handler interface board in the 4278A.

Table 4-14. Internal Jumper Settings

Handler	EOC	BUSY	START IN	+5, GND	Note
Default	W4	W6	W9, 10, 13		Default jumpers installed at the factory
PALOMAR M16	W5	W6	W8, 13	W1, 2	Mount 1.78K Ω pull-up resistors at locations R101 ~ R113 for BIN 0 ~ BIN 10 , EOC , and BUSY .
PALOMAR M11	W4	W6	W8, 12	W1, 2	MOUNT 1.78K Ω pull-up resistors at locations R101 ~ R113 for BIN 0 ~ BIN 10 , EOC , and BUSY .
Q Model RTR2	W4	W6	W9, 10, 13	W1, 2	
ISUMECA	W4	W6	W9, 10, 11 and W13		
EA Model 015	W4	W6	W9, 10, 12		

Table 4-15. Jumper Definitions

Jumper	Definition When Installed
W1	+5V is supplied to pin 17.
W2	COMMON is connected to the system ground. When + 5V from the handler interface is used, this jumper must be installed.
W3	EOC is asserted LOW when the measurement is completed and the 4278A is ready for the next DUT.
W4	EOC is asserted HIGH when the measurement is completed and the 4278A is ready for the next DUT.
W5	EOC is asserted LOW while the measurement data and comparison results are invalid.
W6	BUSY is asserted HIGH while the measurement data and comparison results are invalid.
W7	BUSY is asserted LOW while the measurement data and comparison results are invalid.
W8	Sets the START IN input to operate at TTL levels. W9 and W10 must be left open.
W9, W10	Opto-isolates the START IN input, both W9 and W10 must have jumpers installed and W8 must be left open.
W11	Adds a 0.1 μ F capacitor to filter out noise on the START IN input.
W12	Sets the 4278A to trigger on the falling edge of the START IN input signal (Opto-Isolator).
	Sets the 4278A to trigger on the raising edge of the START IN input signal (TTL).
W13	Sets the 4278A to trigger on the raising edge of the START IN input (Opto-Isolator).
	Sets the 4278A to trigger on the falling edge of the START IN input signal (TTL).

If you are using one of the handlers listed in paragraph 4-4-5 perform steps 1 through 6 of the following general configuration procedure, and then go to the setup example for your handler and install the pull-up resistors and jumpers as directed. Use the following procedure to configure the Option 202 Handler Interface Board for a handler not listed in paragraph 4-4-5. The general timing diagram is shown in Figure 4-19.

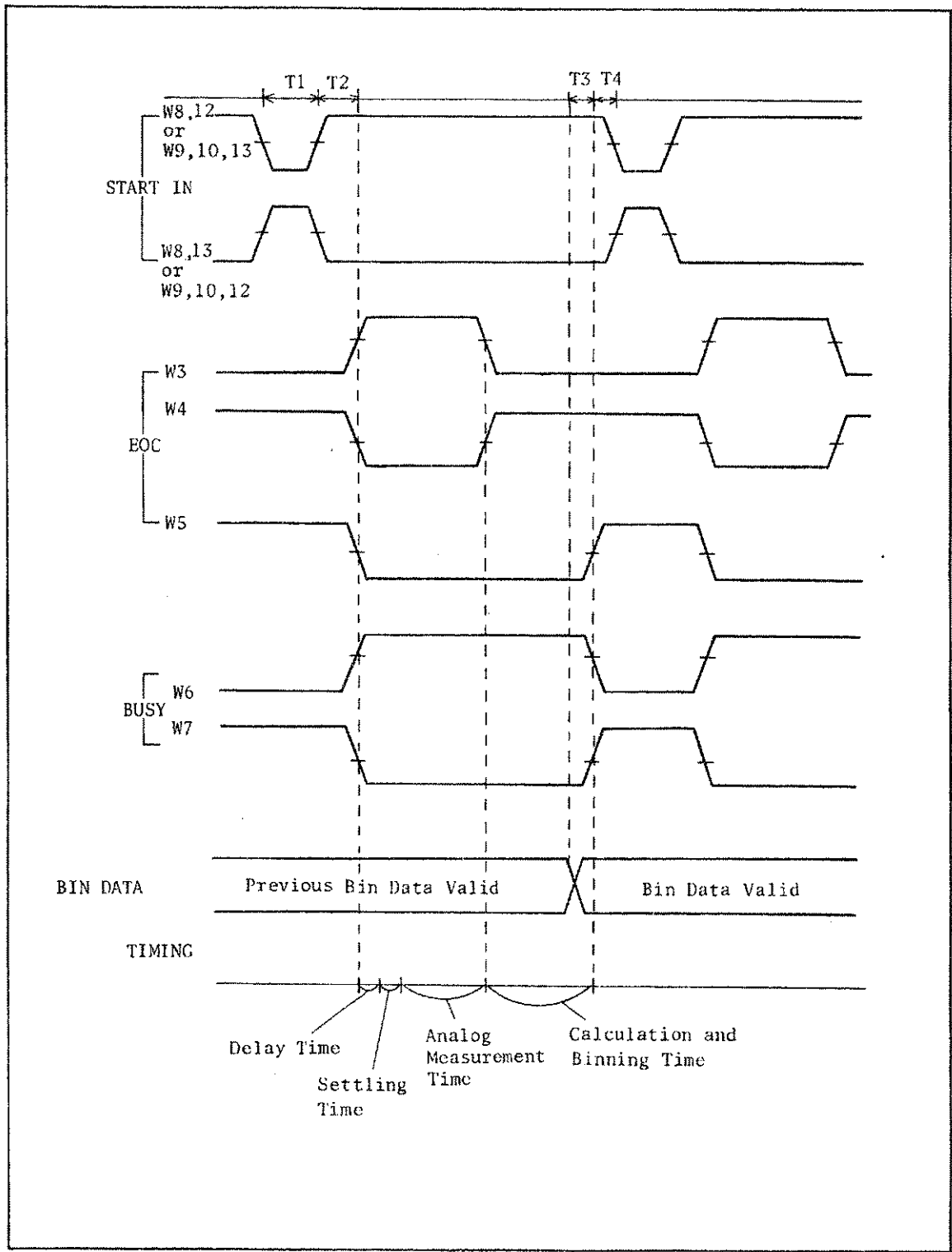

Figure 4-19. General Timing Diagram

General Configuration Procedure:

1. Disconnect the 4278A's power cord and allow enough time (a few minutes) for the internal supply filter capacitors to discharge.
2. Disconnect the two rear feet which lock the top cover and rear panel together.
3. Fully loosen the top cover retaining screws located at the rear of the top panel.
4. Slide the top cover towards the rear and lift it off to expose the top shield plate.
5. Remove the top shield plate to gain access to the PC boards.
6. Disconnect the flat cable connected to the handler interface board.

NOTE

The handler interface has **Brown** and **Orange** extractors. Refer to Figure 4-22 for the location of the handler interface board.

7. If the comparison output signals are TTL levels signals and these signals are not pulled up by the handler, determine the pull-up resistor value (1.78K is recommended) and referring to Figure 4-21 for the locations of the BIN pull-up resistors, install the pull-up resistors.
8. If the control outputs (**EOC**, **BUSY**) are to be TTL level signals and these signals are not pulled up by the handler, determine the pull-up resistor value (1.78K is recommended) and referring to Figure 4-21 for the locations of **R112** (**EOC**) and **R113** (**BUSY**) install the pull-up resistors.
9. Refer to Table 4-15 to determine which jumpers to install to configure the **EOC** and **BUSY** outputs.
10. Use Figure 4-20 to locate the location of the required jumpers and install the jumpers.
11. Refer to Table 4-15 to determine the jumpers required to configure the **START IN** input.
12. Use Figure 4-20 to find the location of the required jumpers and install the jumpers.
13. Install the configured handler interface board into the 4278A.
14. Replace the top shield plate, rear feet, and top cover.

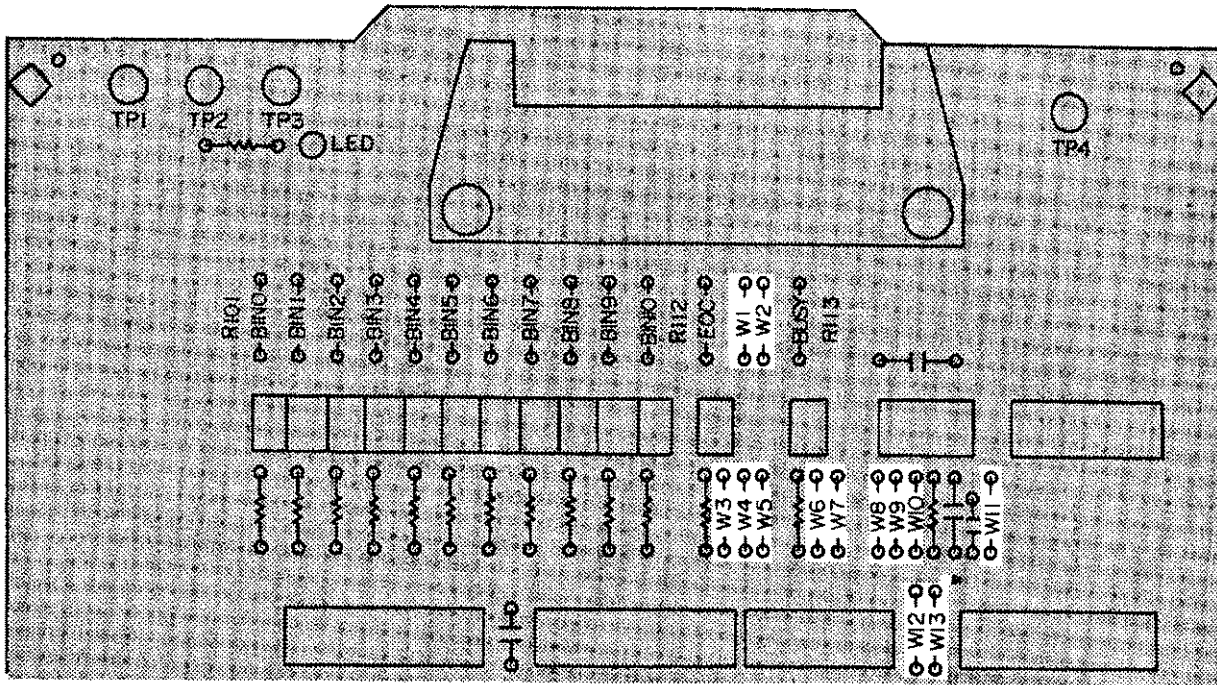

Figure 4-20. Configuration Jumper Locations

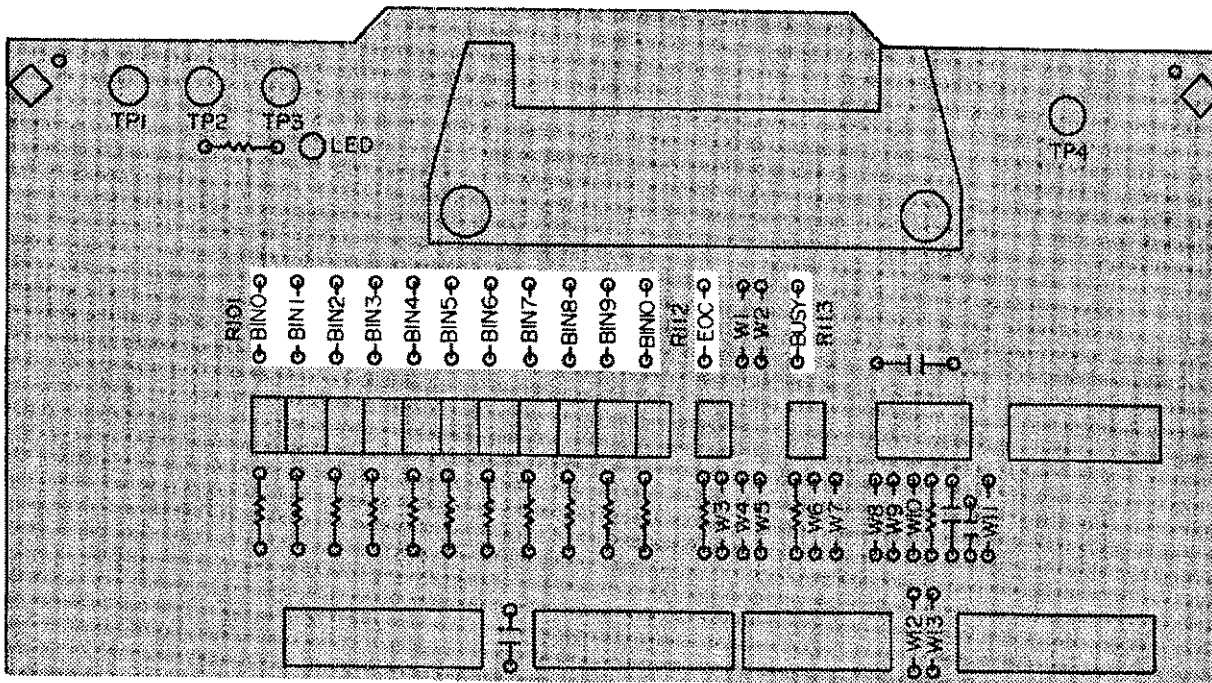

Figure 4-21. Pull-Up Resistor Locations

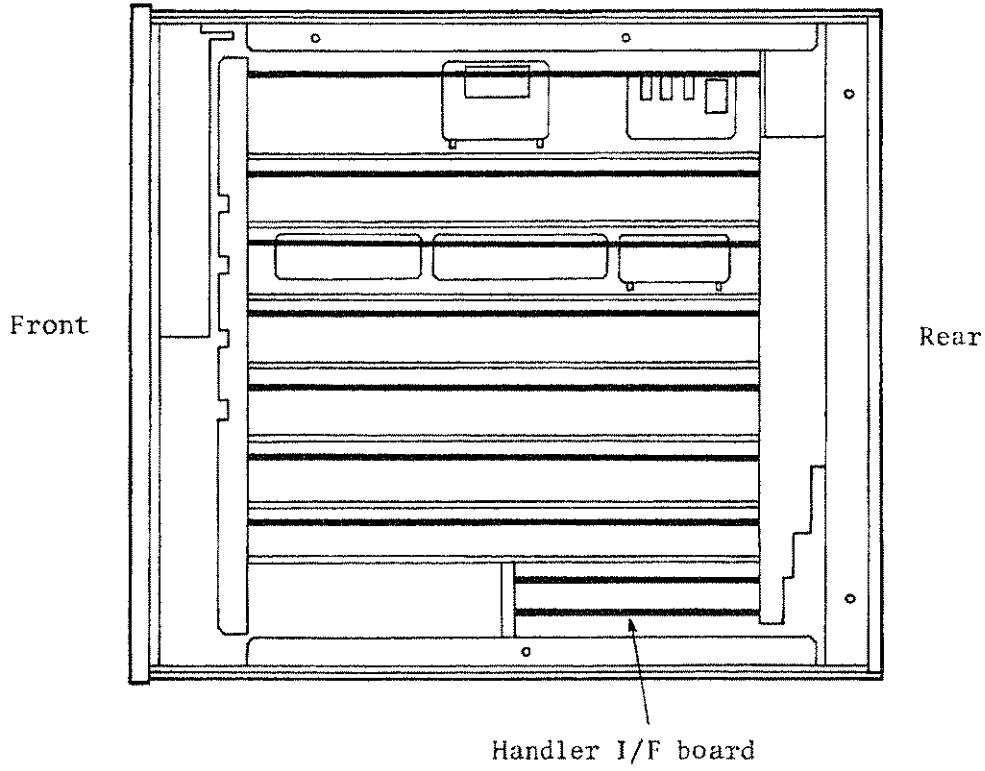

Figure 4-22. Handler Interface Board Location

4-4-5. CONFIGURATION EXAMPLES

Setup example information consisting of handler interface board configuration, timing diagrams, list of signals used, logic levels used, and other special information pertaining to the handler under discussion will now be given. Setup examples are given for the following handlers:

- Default Configuration **4-105**
- Palomar Model M16 **4-107**
- Palomar Model M11 **4-109**
- Q-Corporation RTR2 **4-111**
- Isumeca 83 **4-113**
- EA Model M015 **4-115**

• **DEFAULT CONFIGURATION**

The Standard setting is the configuration of the Option 202 handler interface board as it is shipped from the factory. The timing for the default setup is shown in Figure 4-23 for reference.

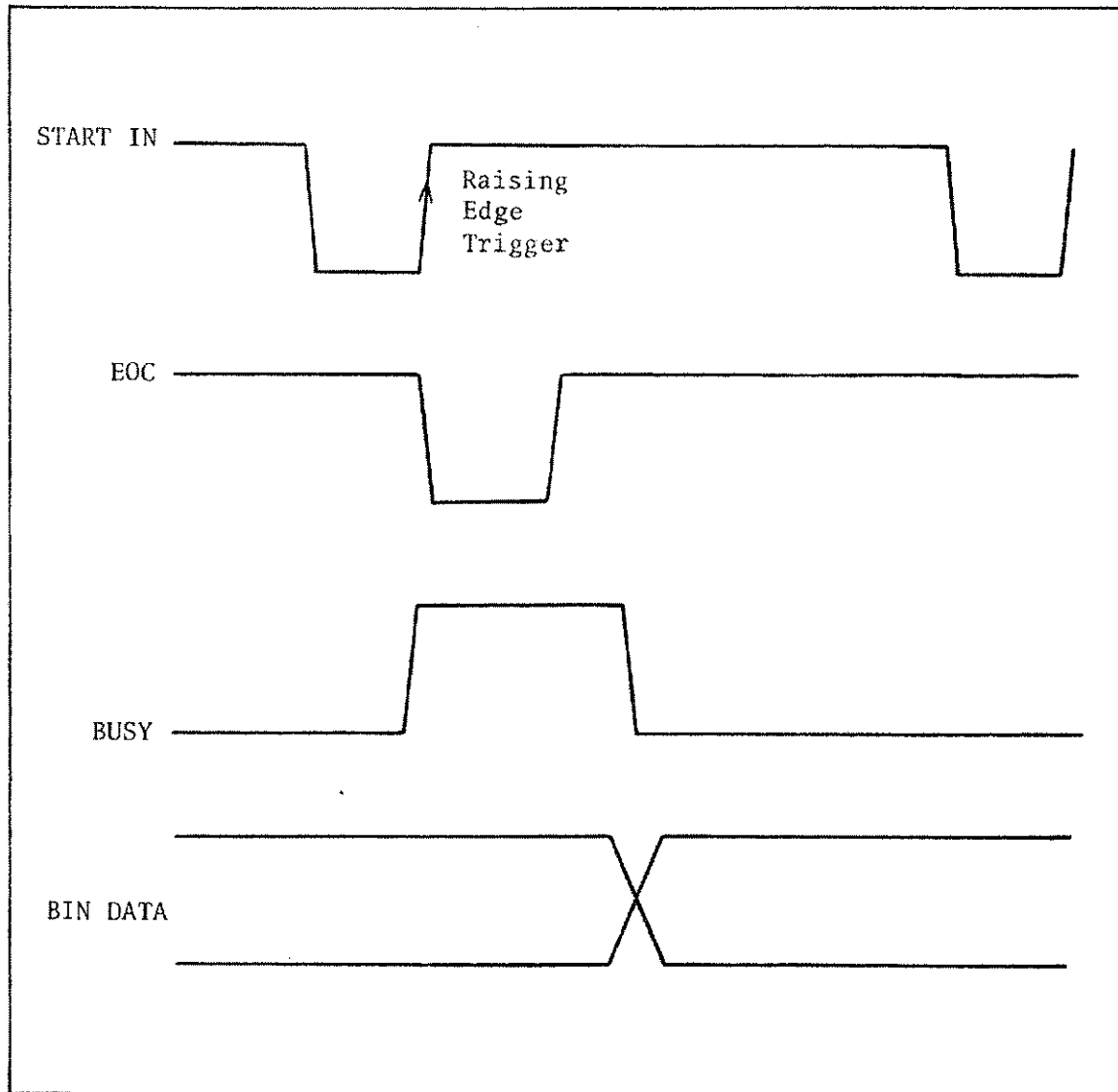

Figure 4-23. Timing for Default Setup

Standard Configuration:

1. Configure the following interface signals by installing the jumpers as shown in Figure 4-24.

START IN Install jumper at W9, W10 and W13

BUSY Install jumper at W6

EOC Install jumper at W4

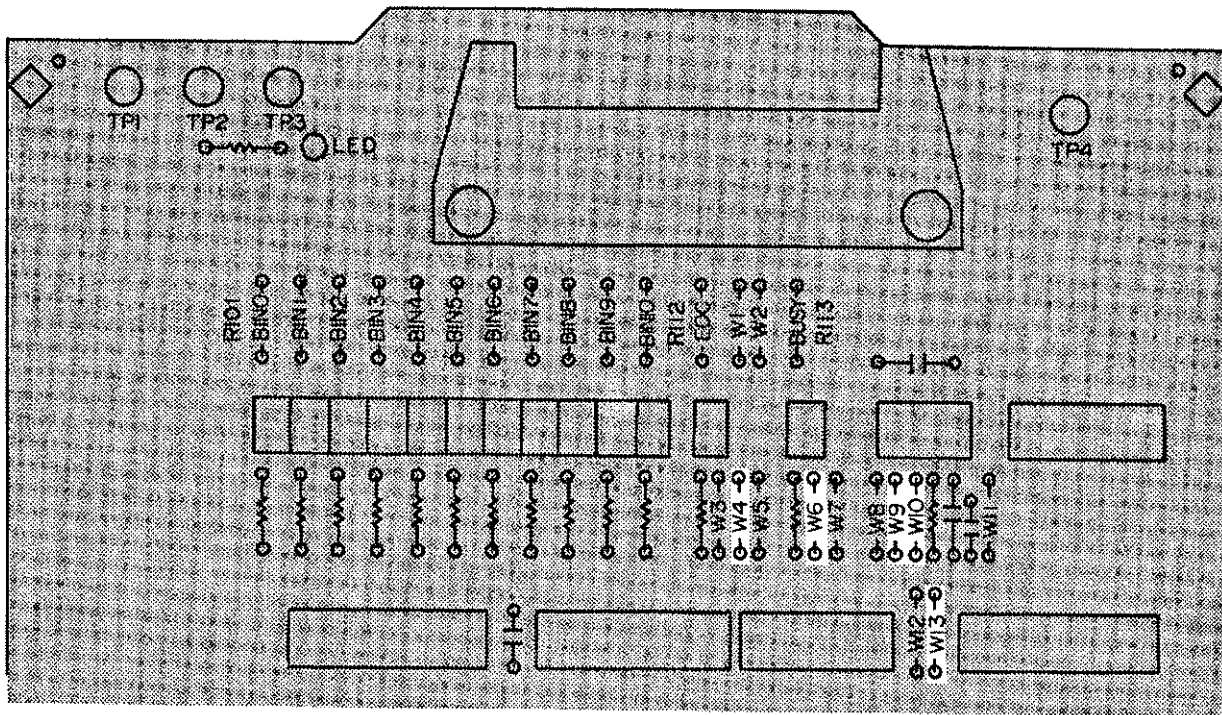

Figure 4-24. Default Jumper and Pull-Up Resistor Locations

2. Install the configured handler interface board into the 4278A.
3. Replace the top shield plate, rear feet, and top cover.

• PALOMAR MODEL M16

Have you performed steps 1 through 6 of the general procedure given in paragraph 4-4-4 ? If not, do so now, then return to this procedure. The Palomar M16 timing diagram is shown in Figure 4-25 for reference.

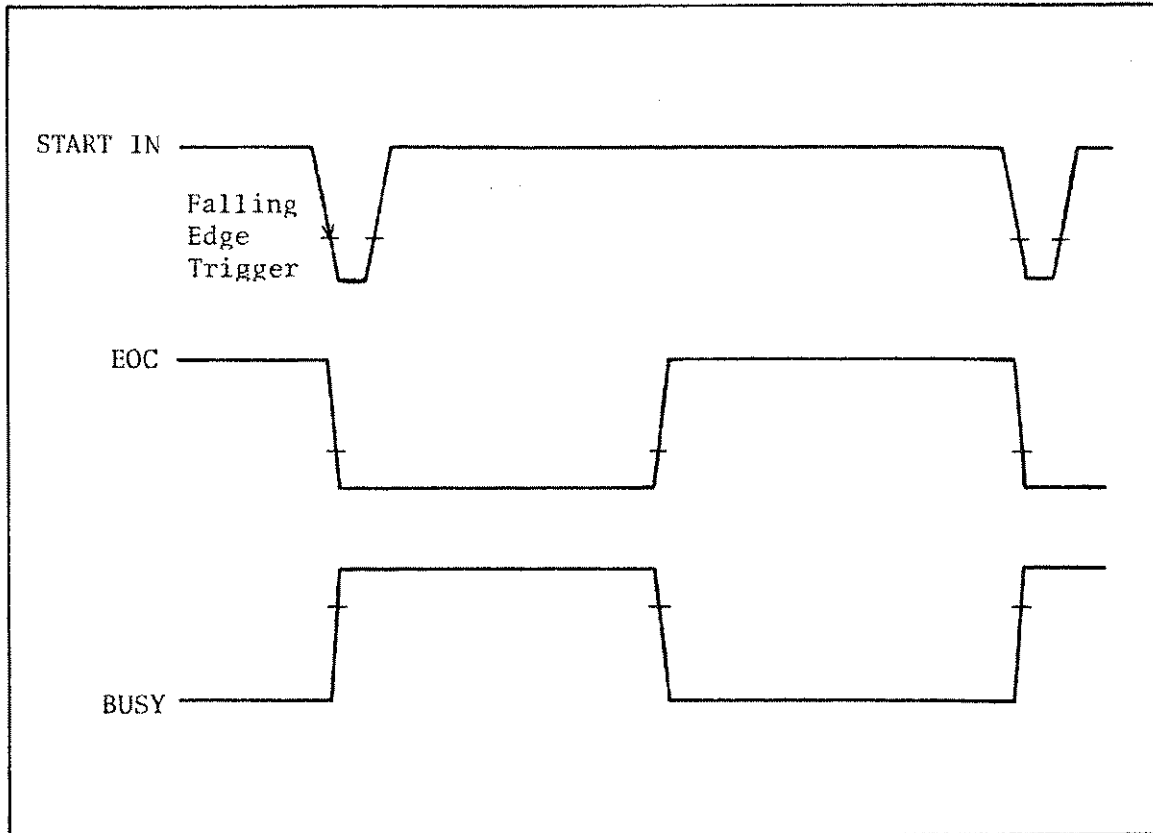

Figure 4-25. Palomar M16 Timing

Palomar M16 Configuration Procedure:

1. Configure the following interface signals by installing the jumpers as shown in Figure 4-26.

START IN Install jumper at W8 and W13

BUSY Install jumper at W6

EOC Install jumper at W5

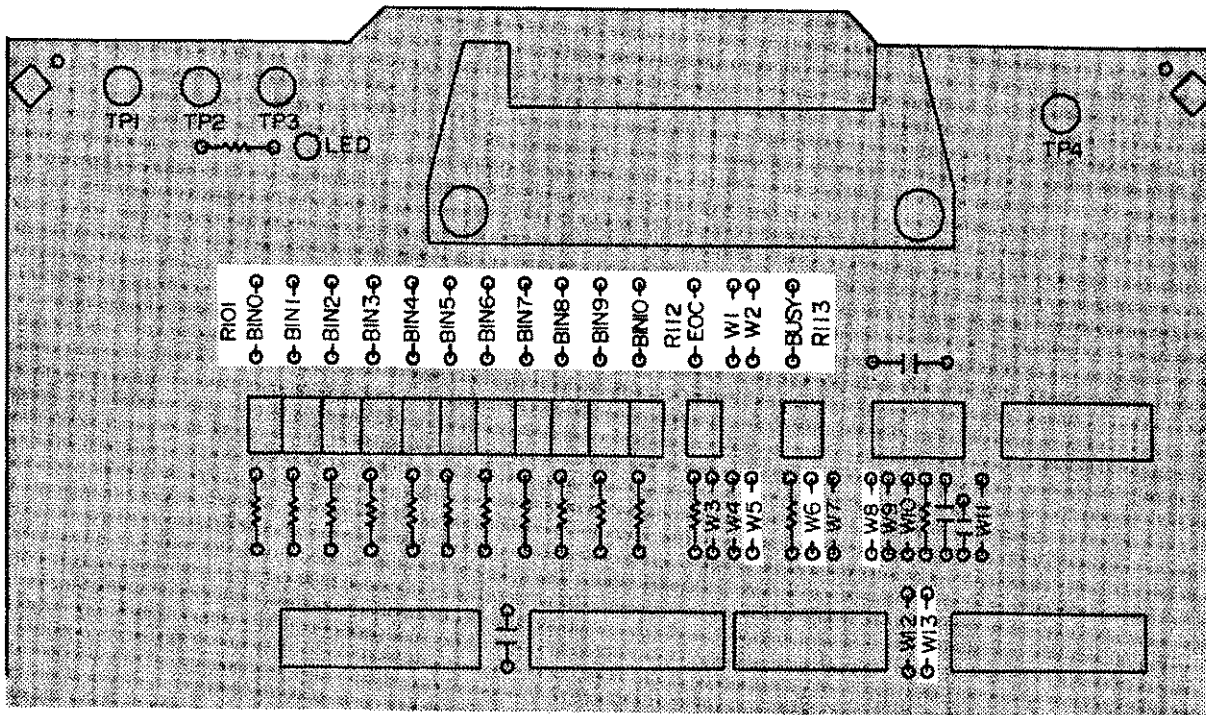

Figure 4-26. Palomar M16 Jumper and Pull-Up Resistor Locations

2. All I/O signals are TTL level so you must install all pull-up resistors to + 5V (install pull-up resistors **R101 ~ R113**). Refer to Figure 4-26 for the pull-up resistor locations.
3. Bring + 5V out through pins 12 and 17 of the handler interface rear panel connector (install a jumper at W1 for + 5V and at W2 for the **COMMON** connection). Refer to Figure 4-26 for the locations of W1 and W2.
4. Install the configured handler interface board into the 4278A.
5. Replace the top shield plate, rear feet, and top cover.

• PALOMAR MODEL M11

Have you performed steps 1 through 6 of the general procedure given in paragraph 4-4-4? If not, do so now, then return and continue with this procedure. The Palomar M11 timing diagram is shown in Figure 4-27 for reference.

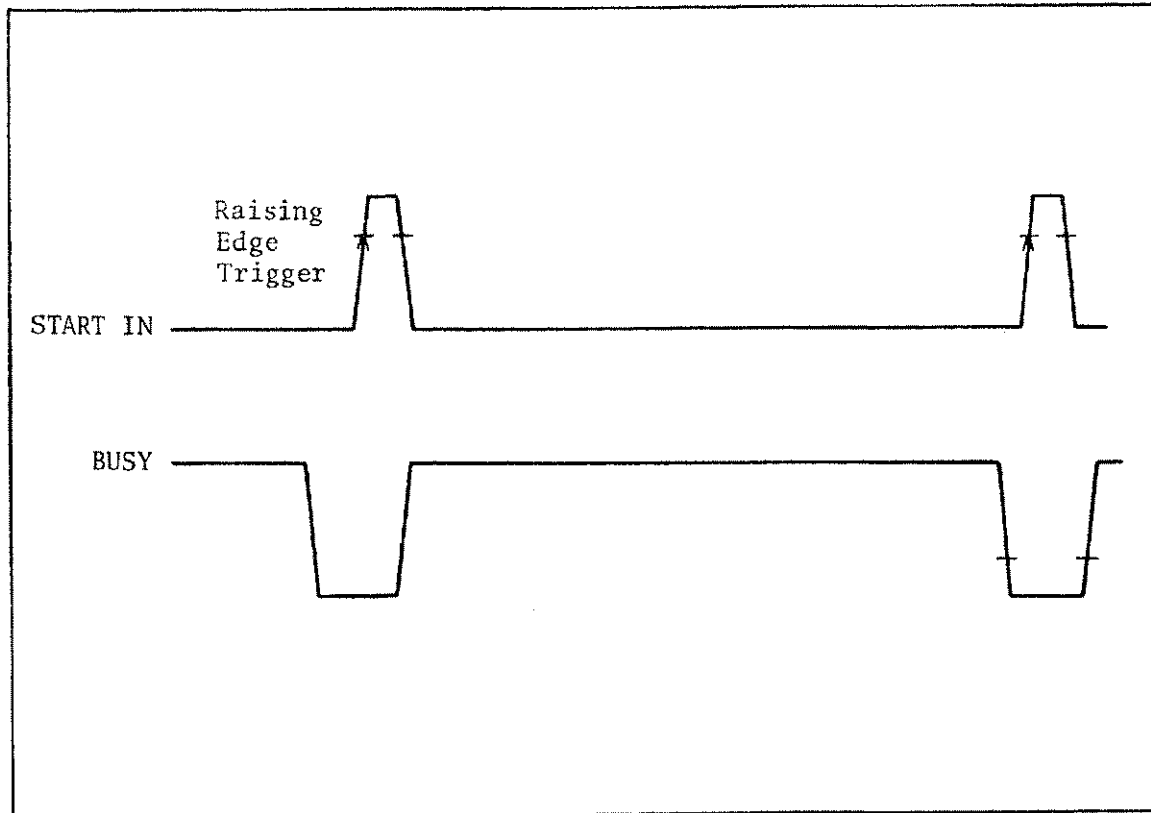

Figure 4-27. Palomar M11 I/O Timing

Palomar M11 Configuration Procedure:

1. Configure the following interface signals by installing the jumpers as shown in Figure 4-28.

START IN Install jumper at **W8** and **W12**

BUSY Install jumper at **W6**

EOC Install jumper at **W4**

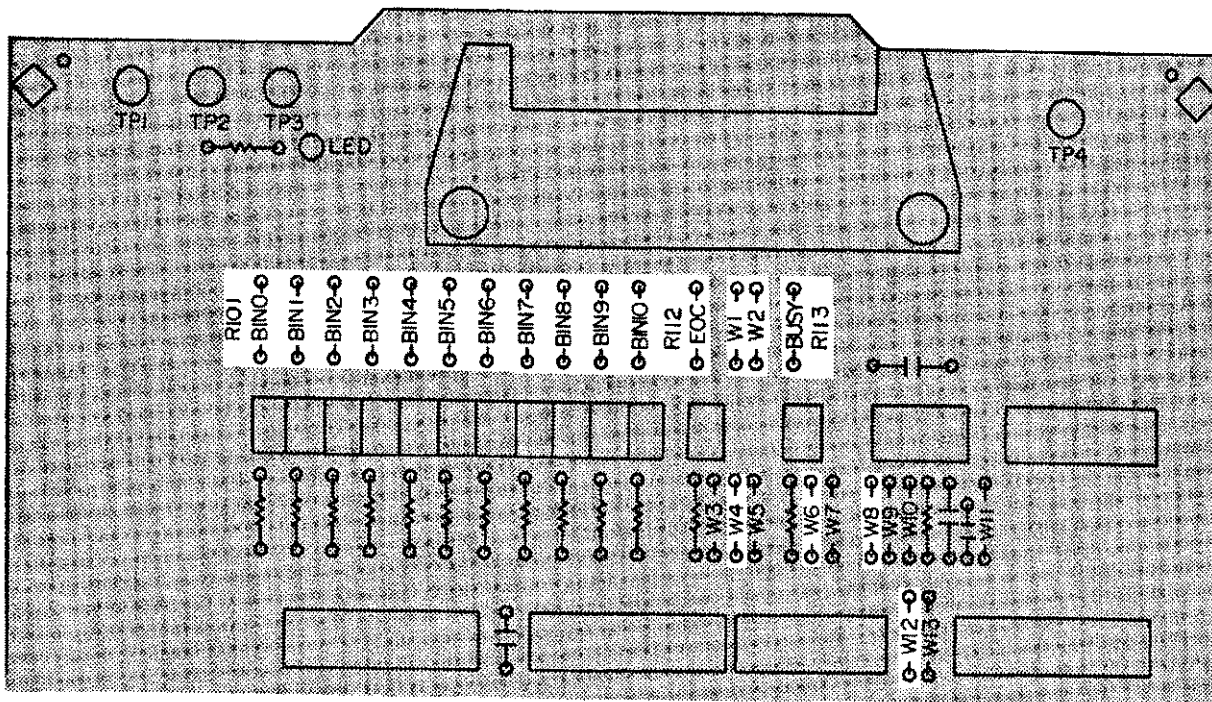

Figure 4-28. Palomar M11 Jumper and Pull-up Resistor Locations

2. All I/O signals are TTL level so you must install all pull-up resistors to + 5V (install pull-up resistors **R101 ~ R113**). Refer to Figure 4-28 for the pull-up resistor locations.
3. Bring + 5V out through pins 12 and 17 of the handler interface rear panel connector (install a jumper at **W1** for + 5V and at **W2** for the **COMMON** connection). Refer to Figure 4-28 for the locations of **W1** and **W2**.
4. Install the configured handler interface board into the 4278A.
5. Replace the top shield plate, rear feet, and top cover.

• Q-CORPORATION RTR2

Have you performed steps 1 through 6 of the general procedure given in paragraph 4-4-4 ? If not, do so now, then return and continue with this procedure. The RTR2 timing diagram is shown in Figure 4-29 for reference.

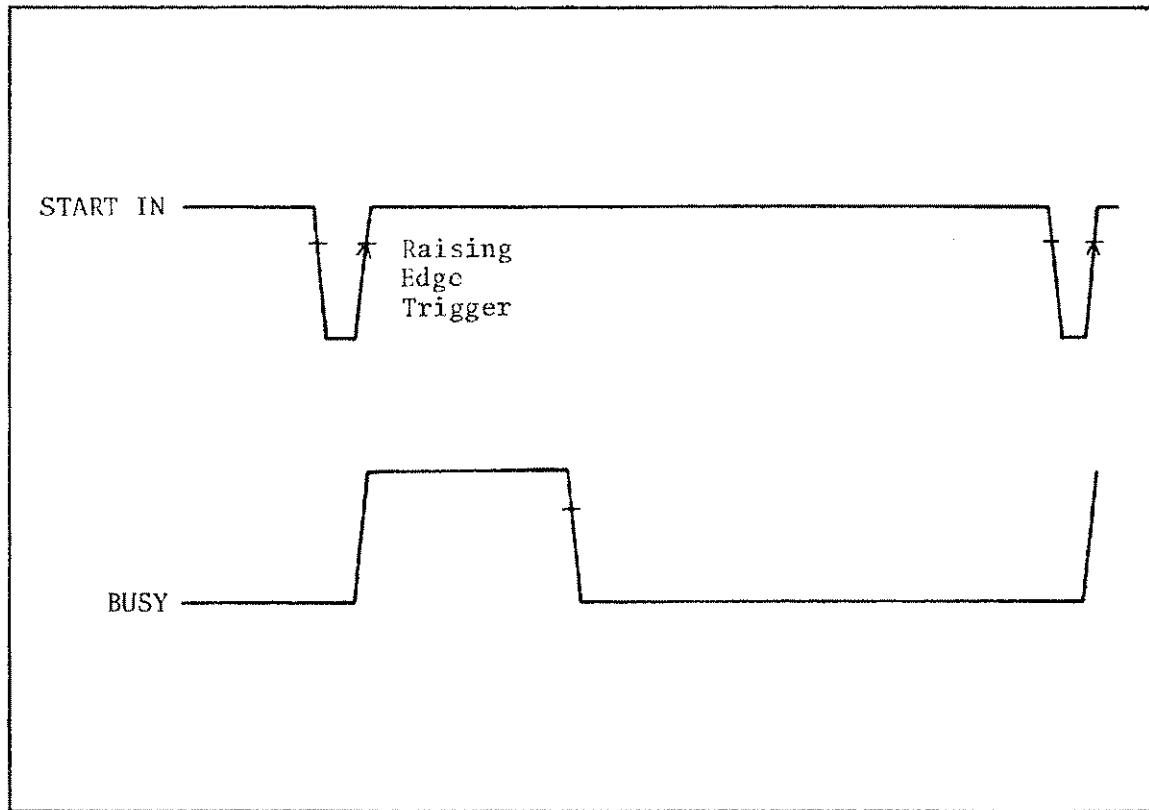

Figure 4-29. RTR2 I/O Timing

Q-Corporation RTR2 Configuration Procedure:

1. Configure the following interface signals by installing the jumpers as shown in Figure 4-30.

START IN Install jumper at W9, W10, and W13

BUSY Install jumper at W6

EOC Install jumper at W4

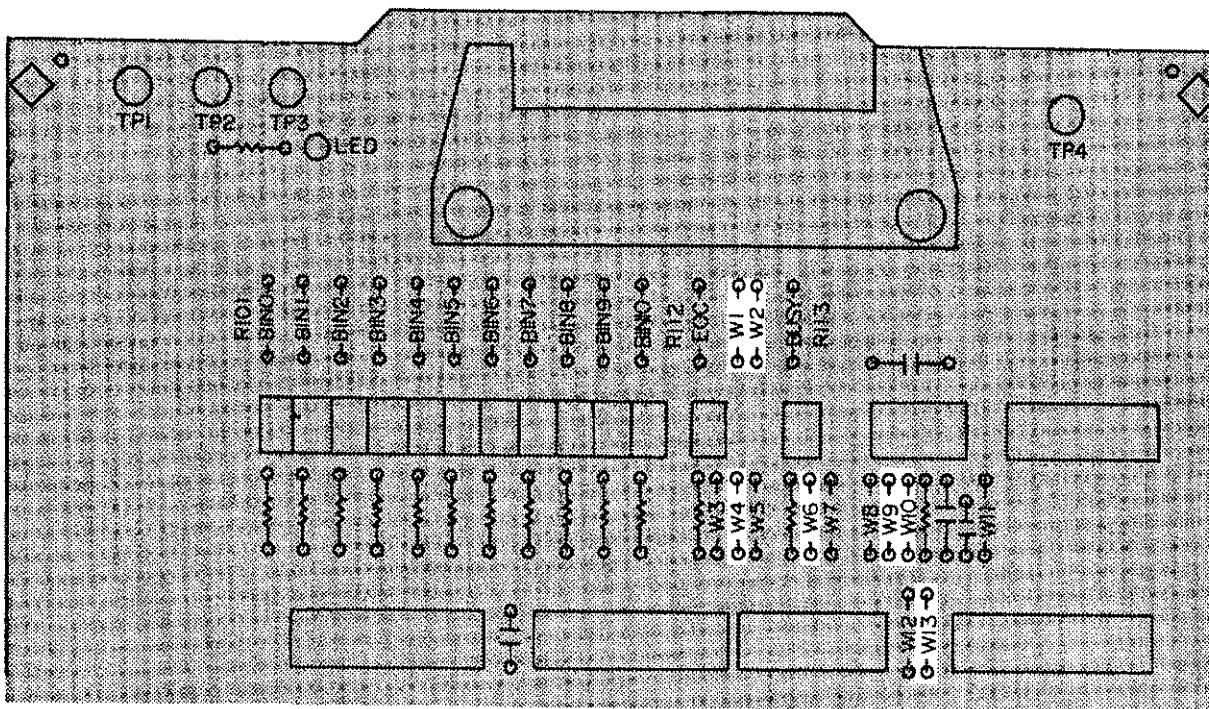

Figure 4-30. RTR2 Jumper and Pull-Up Resistor Locations

2. Bring + 5V out through pins 12 and 17 of the handler interface rear panel connector (install a jumper at W1 for + 5V and at W2 for the **COMMON** connection). Refer to Figure 4-30 for the locations of W1 and W2.
3. Install the configured handler interface board into the 4278A.
4. Replace the top shield plate, rear feet, and top cover.

• ISUMECA 83

Have you performed steps 1 through 6 of the general procedure given in paragraph 4-4-4 ? If not, do so now, then return and continue with this procedure. The Isumeca 83 timing diagram is shown in Figure 4-31 for reference.

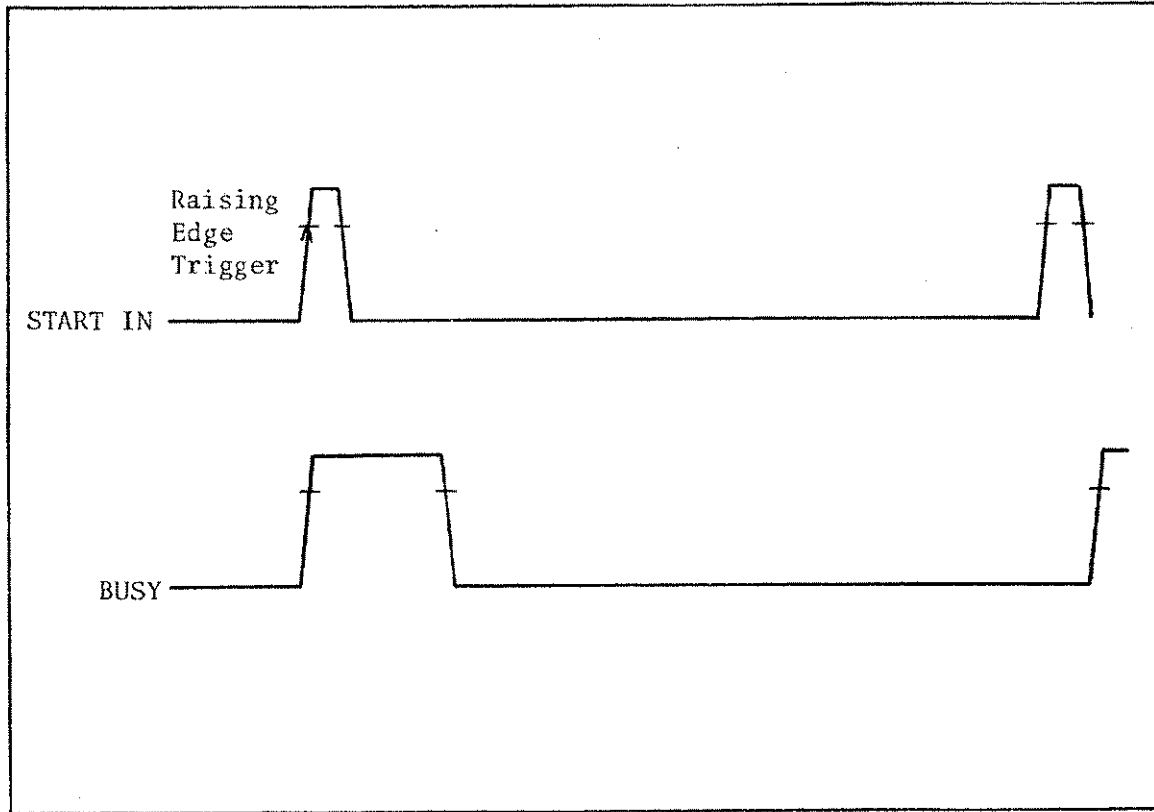

Figure 4-31. Isumeca 83 I/O Timing

Isumeca 83 Configuration Procedure:

1. Configure the following interface signals by installing the jumpers as shown in Figure 4-32.

START IN Install jumper at W9, W10, W11, and W13

BUSY Install jumper at W6

EOC Install jumper at W4

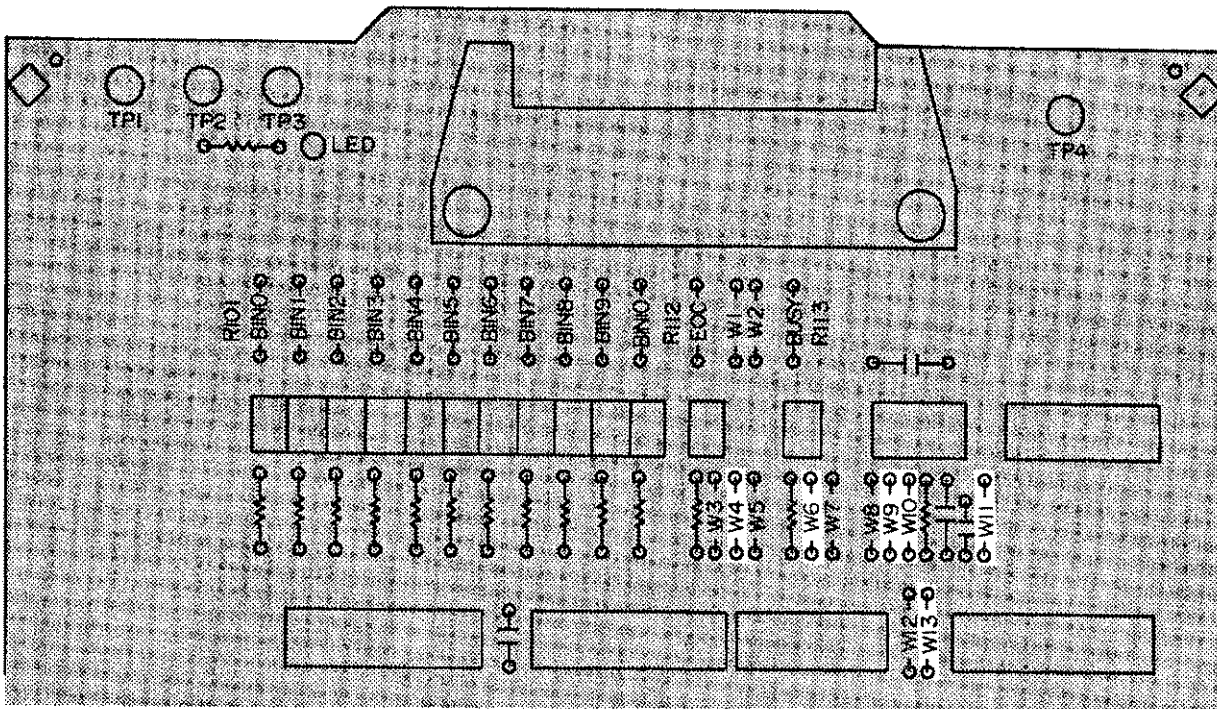

Figure 4-32. Isumeca 83 Jumper and Pull-Up Resistor Locations

2. Install the configured handler interface board into the 4278A.
3. Replace the top shield plate, rear feet, and top cover.

• EA MODEL M015

Have you performed steps 1 through 6 of the general procedure given in paragraph 4-4-4 ? If not, do so now, then return and continue with this procedure. The M015 timing diagram is shown in Figure 4-33 for reference.

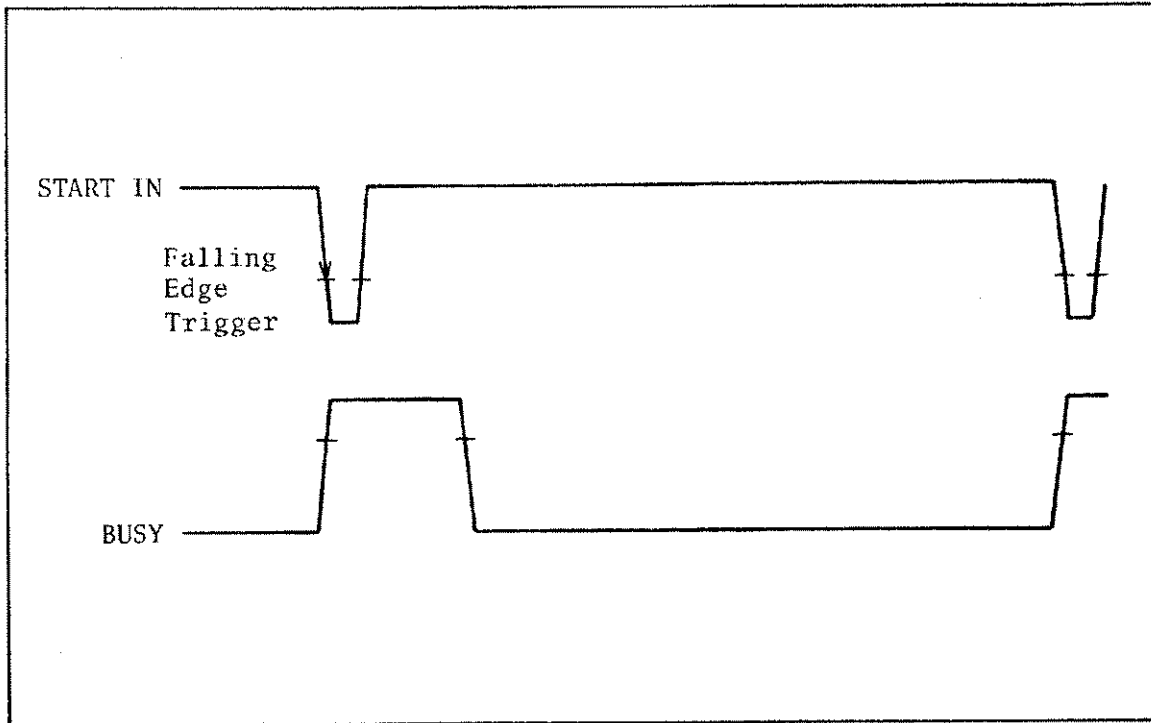

Figure 4-33. EA M015 I/O Timing

EA MODEL M015 Configuration Procedure:

1. Configure the following interface signals by installing the jumpers as shown in Figure 4-34.

START IN Install jumper at W9, W10, and W12

BUSY Install jumper at W6

EOC Install jumper at W4

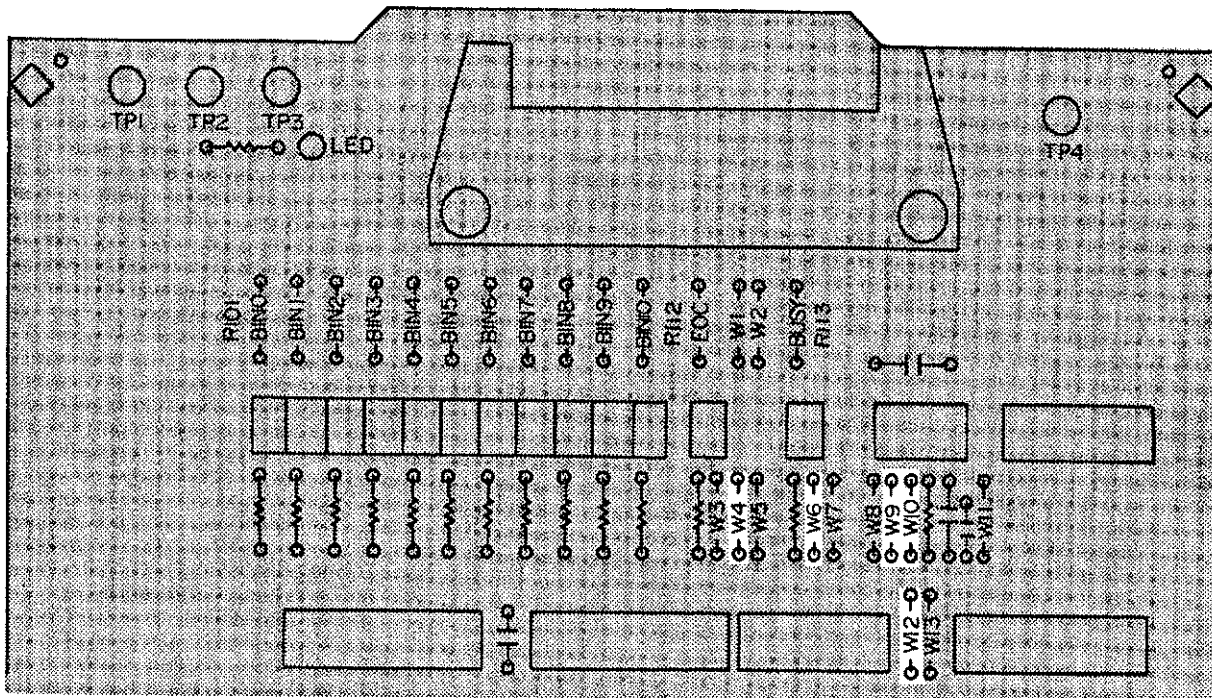

Figure 4-34. EA M015 Jumper and Pull-Up Resistor Locations

2. Install the configured handler interface board into the 4278A.
3. Replace the top shield plate, rear feet, and top cover.

4-5. OPTION 301 SCANNER INTERFACE

4-5-1. DESCRIPTION

The 4278A with the Option 301 Scanner Interface can have up to 256 sets of the compensation measurement data (OPEN, SHORT, STANDARD), and any of these 256 sets of compensation data can be used for each measurement. (The compensation data is frequency dependent). The 4278A can compensate for stray admittance, residual impedance, and other errors for each channel from the calibration plane (depends on the CABLE LENGTH selected) to the connection contacts for the capacitor. Therefore the 4278A with the Option 301 can accurately measure capacitance and dissipation factor values without any degradation on repeatability, or difference between channels. Timing synchronization is also provided.

The 4278A when equipped with Option 101 HP-IB interface and Option 301 scanner interface, store in sequential measurement order up to 500 sets of data (measurement results and comparison results), and transfer the stored data to the controller all at once using the **DATA?** command. This technique greatly reduces the data transmission time via HP-IB data transfer.

4-5-2. SCANNER INTERFACE SIGNAL INPUT/OUTPUT CONNECTOR

The scanner interface I/O connector, a standard 14-contact female Amphenol connector, is mounted on the 4278A's rear panel for interconnection between the 4278A and your scanner. The scanner interface I/O signals are divided into three types as follows.

Channel Selection Input Signals:

These signals are used to select the compensation data which corresponds to a channel number of the scanner.

/CH0 to /CH7	Channel Selection (8-bit binary input)
/CH_VALID	Channel Valid

Control Output Signals:

These signals are used to control the timing between the 4278A and the scanner.

/INDEX	Measurement Complete
/EOM	Comparison Data Valid

Control Input Signal:

This signal triggers the 4278A on the rising edge of a pulse when the trigger mode is set to the EXT_TRIG mode.

EXT_TRIG	External Trigger
-----------------	------------------

NOTE

The / (back slash) in the signal name means that the signal is asserted when low.

The scanner interface I/O connector pin assignments are shown in Figure 4-35, and the contact assignments and a brief description of each are given in Table 4-16.

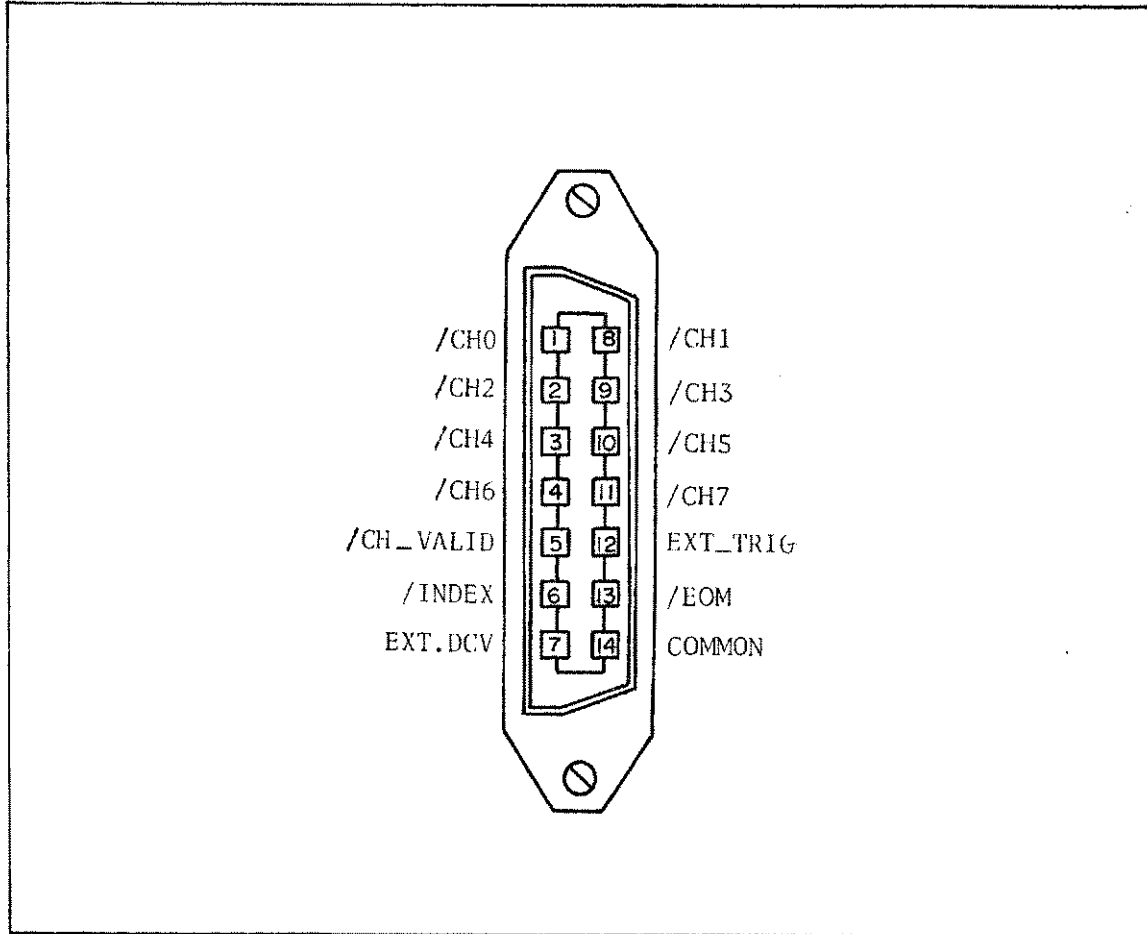

Figure 4-35. Control Assignments

Table 4-16. Contact Assignments

Pin No.	Signal Name	Description
1	/CH0	Channel Selection Signals (Input)
2	/CH2	
3	/CH4	
4	/CH6	
5	/CH_VALID	Channel Valid Signal (Input Signal). This signal makes the channel selection signals valid or invalid.
6	/INDEX	Measurement Complete Signal (Output). /INDEX is asserted when a measurement is completed and the 4278A is ready for the next DUT to be connected to the UNKNOWN terminals. The measurement data is not valid until /EOM is asserted.
7	EXT.DCV	External DC voltage.
8	/CH1	Channel Selection Signal (Input)
9	/CH3	
10	/CH5	
11	/CH7	
12	EXT.TRIG	External Trigger Signal (Input).
13	/EOM	End of Measurement Signal (Output). This signal is asserted when the measurement data and comparison results are valid.
14	COMMON	Common for EXT.DCV.

When the input/output control signals are used as follows, the scanner system will operate more efficiently.

1. Set the scanner channel **CHANNEL 0**, the first scanner channel.
2. Set the channel selection signals (**/CH0** to **/CH7**) and the channel valid signal (**/CH_VALID**) to compensate **CHANNEL 0**.
3. Trigger the 4278A by supplying a trigger pulse through the scanner input/output connector on the rear panel. The 4278A will acknowledge the channel number as **CHANNEL 0**, and then measure the capacitor connected to scanner channel 0 using the compensation data for channel 0.
4. Disassert **/CH_VALID** after **/INDEX** goes **HIGH**.
5. Set the scanner channel, channel selection signals, and the channel valid signal to the next channel to be measured when **/INDEX** goes **LOW**.
6. After **/EOM** goes **LOW** trigger the 4278A to make the measurement.
7. Repeat steps 4 through 6.

The timing chart for the preceding procedure is shown in Figure 4-36.

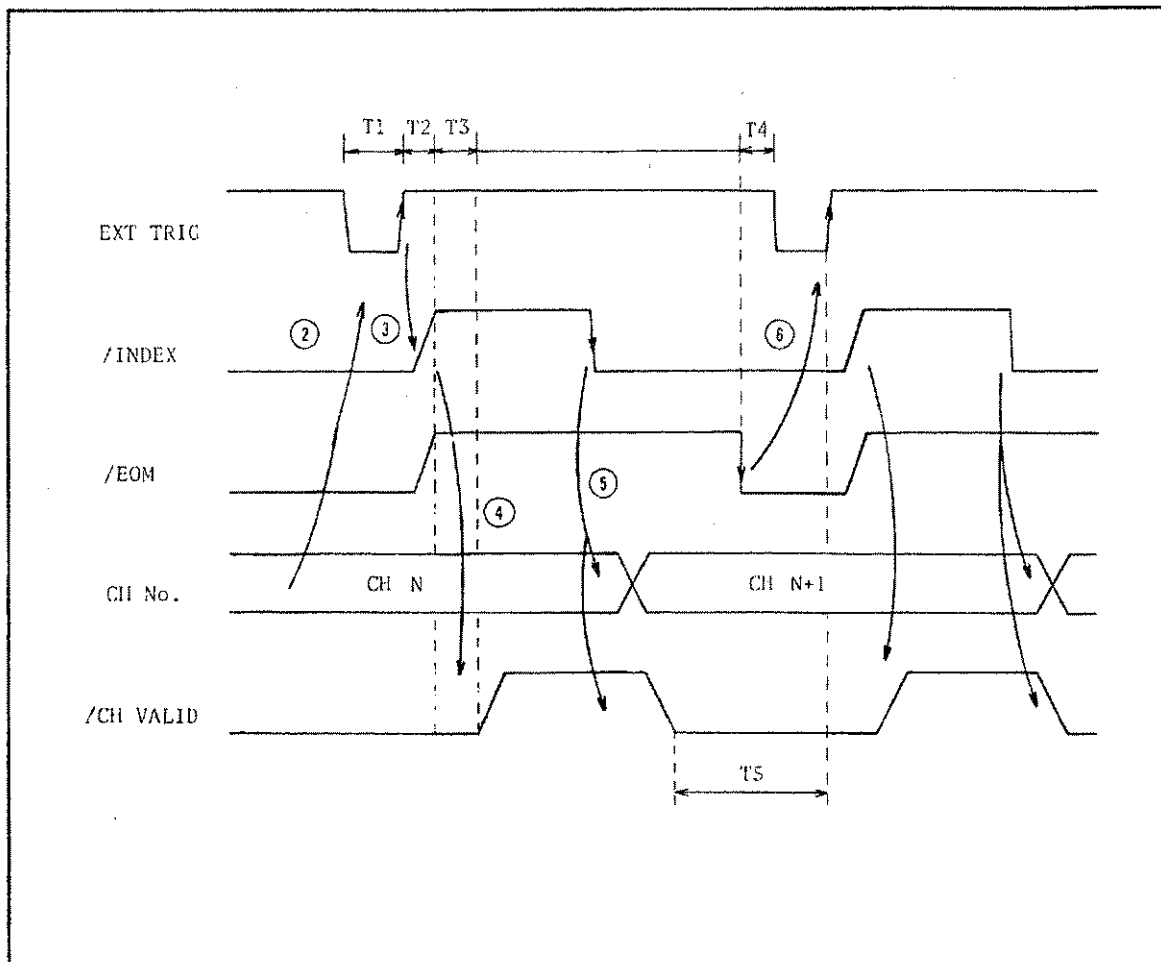

Time	Description	Minimum	Maximum
T1	Trigger Pulse Width	1 μ s	--
T2	Measurement Start Delay Time	--	Display Time + 200 μ s
T3	/CH_VALID Wait Time After Measurement Start	0ns	--
T4	Wait Time After /EOM Output	0 μ s	--
T5	/CH_VALID Pulse Width	50 μ s	--

Figure 4-36. Timing Chart

The scanner system setup for the preceding procedure is shown in Figure 4-37.

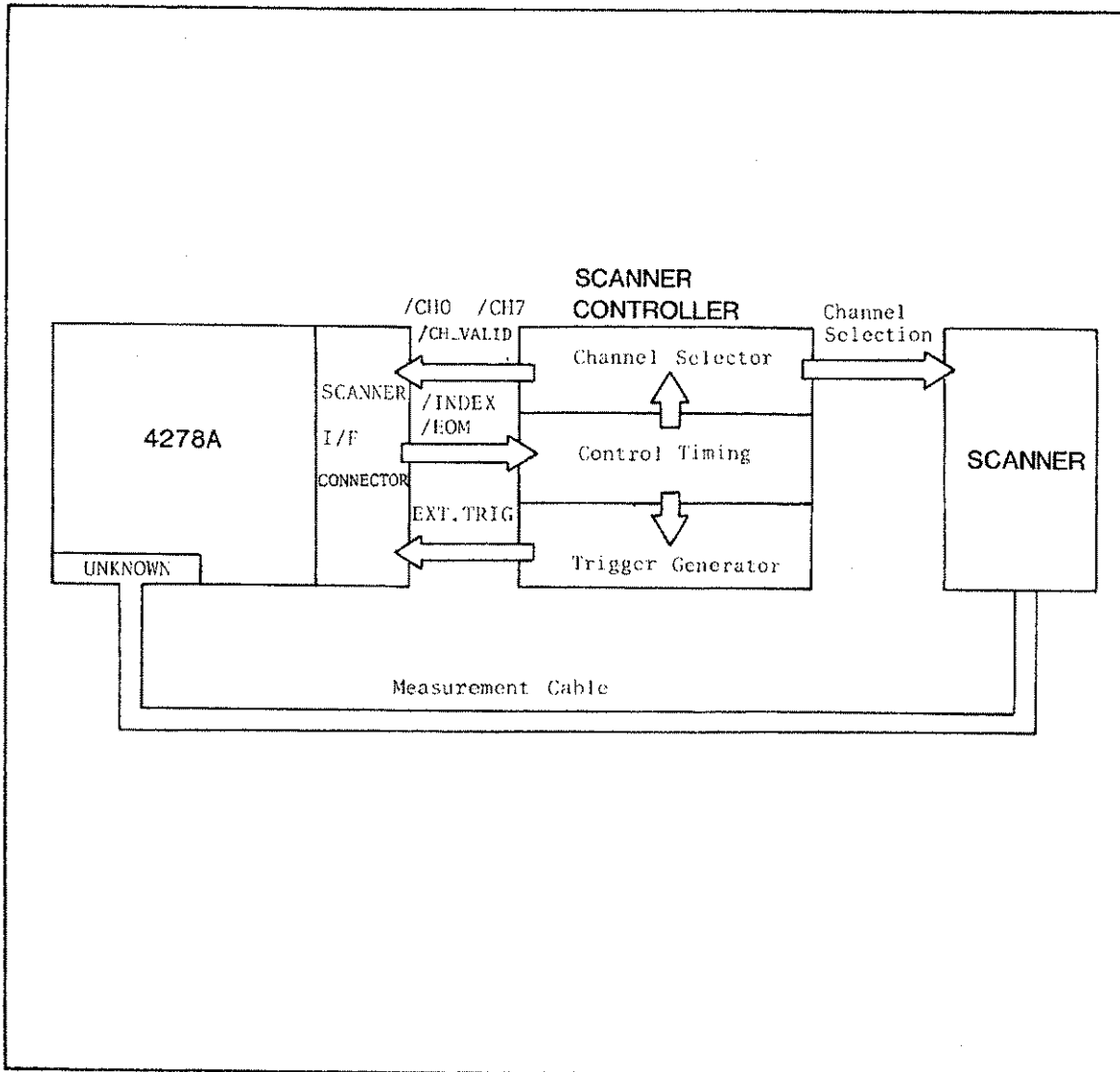

Figure 4-37. Scanner System Example

4-5-3. SIGNAL ELECTRICAL CHARACTERISTICS

The electrical characteristics of the I/O signals are as follows.

Channel Selection Input Signals (Optocoupled):

The /CH0 to /CH7 and /CH_VALID signals are optocoupled to isolate inputs at dc. Each signal is connected to the cathode of an LED in the optocoupler which is current driven and requires 5 mA to 20 mA for proper operation. The off state voltage (high level) of each signal depends on the pull-up voltage (EXT.DCV) used. EXT.DCV can be set from 5 V to 15 V. The selector switches must be set according to the EXT.DCV used (Refer to Table 4-17).

External Trigger Input Signals (Optocoupled):

The EXT_TRIG signal is an optocoupled dc isolated input. This signal is connected to the cathode of an LED in an optocoupler which is current driven and requires 6.3 mA to 15 mA for proper operation. The off state voltage (high level) of each signal depends on the pull-up voltage (EXT.DCV) used. EXT.DCV can be set from 5 V to 15 V. The bit selector switches must be set according to the EXT.DCV used (Refer to Table 4-17).

Table 4-17. Electrical Characteristics

Input Signal	Voltage Input Rating		Maximum Current
	LOW	HIGH	
/CH0 to /CH7 /CH_VALID	≤1 V	5 V to 15 V	5 mA to 20 mA
EXT_TRIG	≤1 V	5 V to 15 V	6.3 mA to 15 mA

A diagram of the input signals is shown in Figure 4-38.

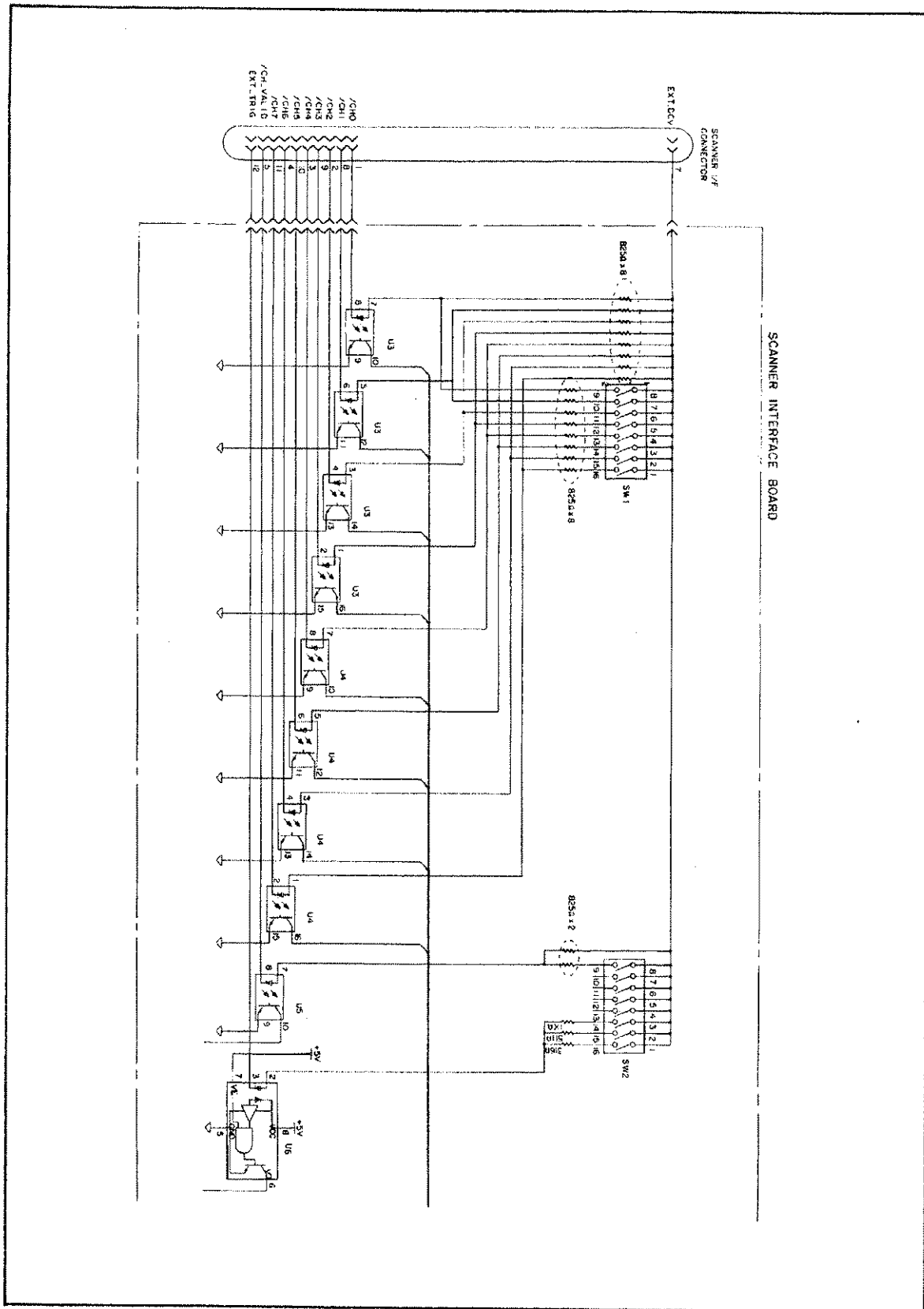

Figure 4-38. Simple Diagram of the Inputs Signals

Control Output Signals (Optocoupled):

The **/INDEX** and **/EOM** signals have open collector outputs. Each output optocoupled. The combination of pull up resistor and pull-up voltage must result in a current through the optocoupler of less than 6 mA (Refer to Table 4-18).

Table 4-18. Output Signal Electrical Characteristics

Signal Name	External Pull-up Voltage	Maximum Current
/INDEX /EOM	15 V max.	6 mA

A schematic of the **/INDEX** and **/EOM** output circuits are shown in Figure 4-39.

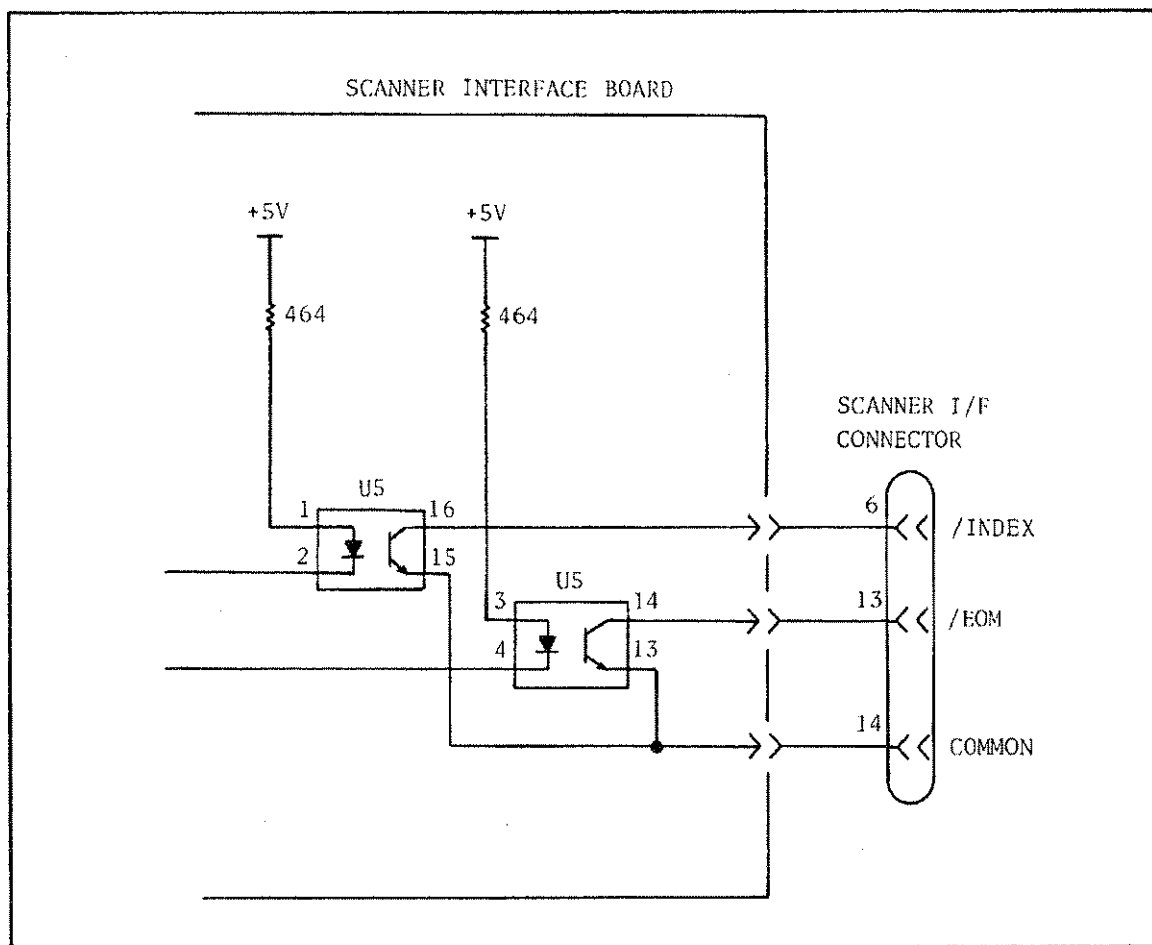

Figure 4-39. Simplified Diagram of the Output Circuits

4-5-4. SETTING UP THE SCANNER INTERFACE BOARD

When you use the rear panel scanner I/O connector two switches on the scanner interface board must be set according to the external dc voltage (EXT_DCV) used. Perform the following steps.

PROCEDURE:

1. Disconnect the power cable from the 4278A and allow time (a few minutes) for the internal capacitors to discharge.

WARNING

DANGEROUS ENERGY/VOLTAGE EXISTS WHEN THE 4278A IS IN OPERATION AND JUST AFTER IT IS POWERED DOWN. ALLOW A FEW MINUTES FOR THE INTERNAL CAPACITORS TO DISCHARGE.

2. Disconnect the two rear feet which lock the top cover and rear panel together.
3. Fully loosen the top cover retaining screws located on the rear of the top cover.
4. Slide the top cover towards the rear and lift it off. The top shield plate will be visible.
5. Remove the top shield plate to expose the PC boards.
6. Disconnect the flat cable connected to the scanner interface.

NOTE

The scanner interface board is the one with the **BLACK** and **YELLOW** extractors (See Figure 4-40).

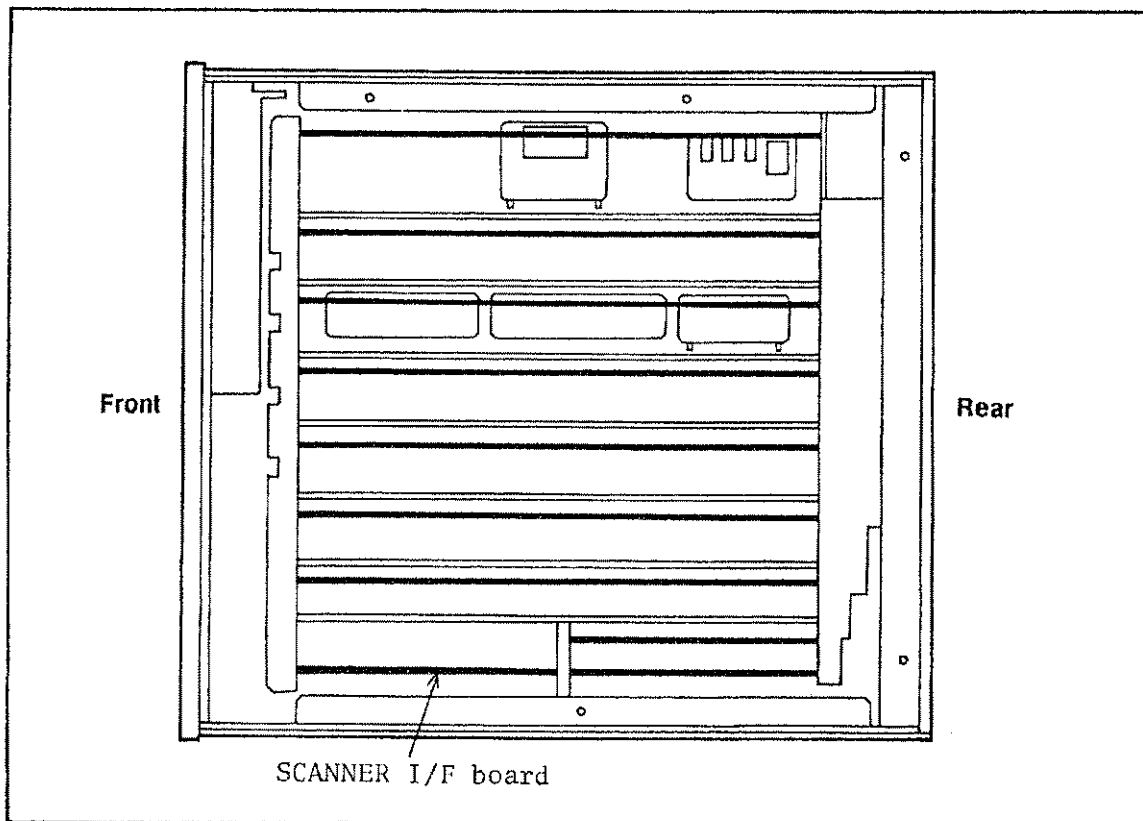

Figure 4-40. Scanner Interface Board Location

7. Remove the scanner interface board.
8. Set switches SW1 and SW2 in accordance with Table 4-19. The location switches SW1 and SW2 are shown in Figure 4-41.
9. Replace the scanner interface board, top shield plate, rear feet, and top cover.

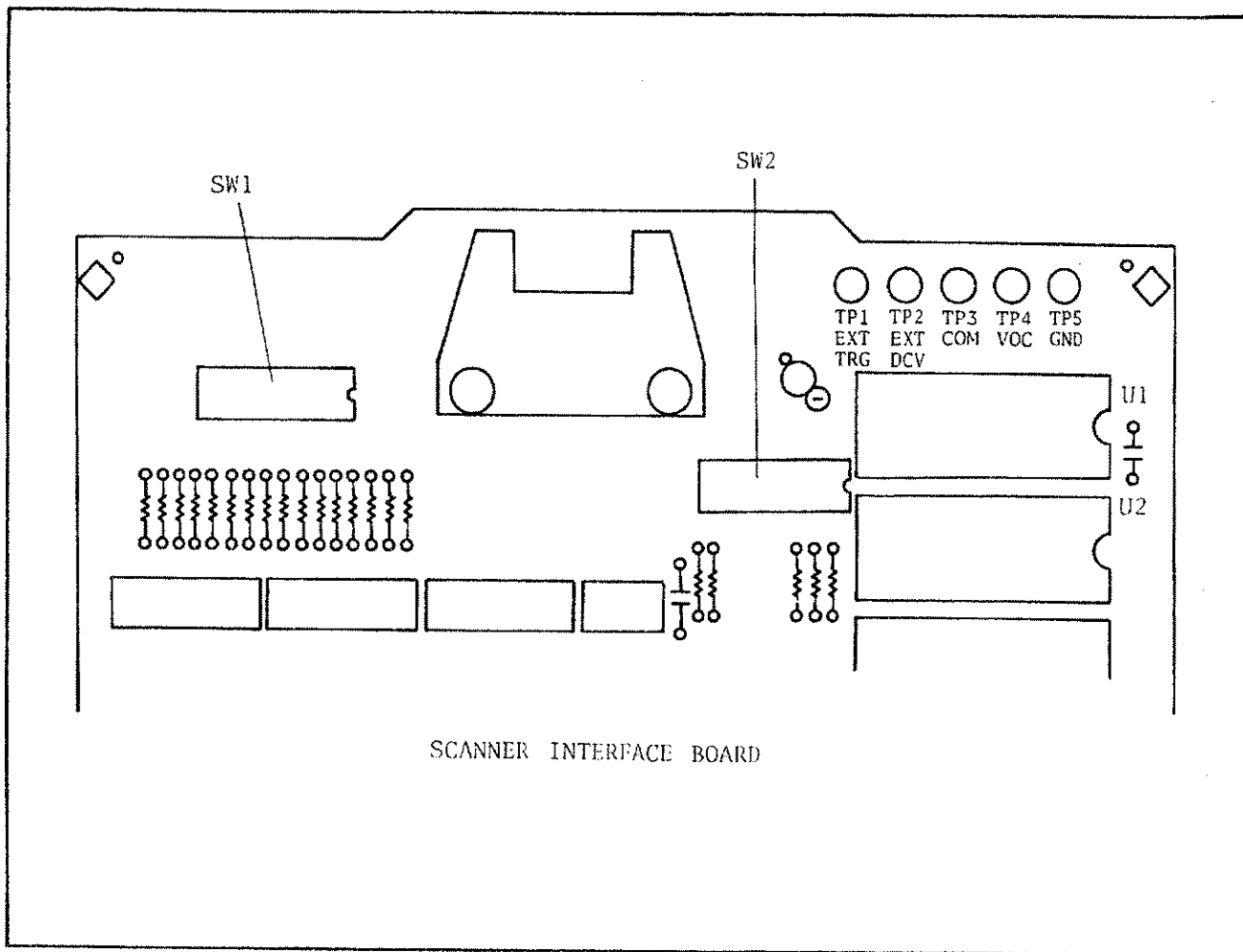

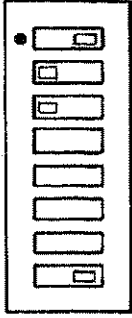
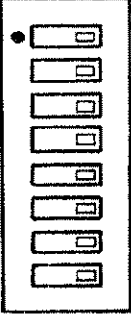
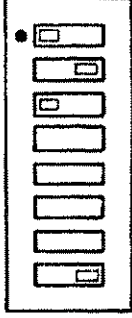
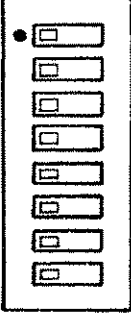
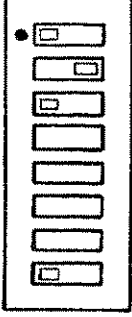
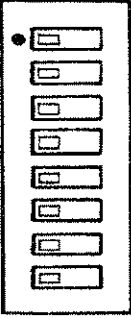
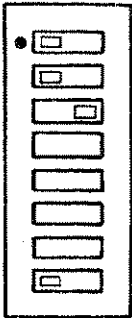

Figure 4-41. SW1 and SW2 Switch Locations

Table 4-19. SW1 and SW2 Settings

EXT _DCV	SW1	SW2
<p>5V ~ 6V Factory shipped Setting</p>	 <p>OFF ← ON</p>	 <p>OFF ← ON</p>
<p>6V ~ 8V</p>	 <p>OFF ← ON</p>	 <p>OFF ← ON</p>
<p>8V ~ 9V</p>	 <p>OFF ← ON</p>	 <p>OFF ← ON</p>
<p>9V ~ 15V</p>	 <p>OFF ← ON</p>	 <p>OFF ← ON</p>

4-5-5. OPERATION

The following procedures are discussed in this paragraph:

- Compensation Data Selection
- Compensation Methods
- Displaying Compensation Data
- Block Data Transfer via HP-IB

When the preceding functions are used with the scanner interface, the multi-compensation mode must be set to **ON** even if only the block data transfer is used. Perform the following steps to set the multi-compensation mode to **ON**.

1. Press the **MENU** and **NEXT** keys.
2. Press the '**MULTI COMPEN**' softkey.
3. Press the '**ON**' softkey.

NOTE

When the multi-compensation mode is set via HP-IB, use the **MCOM** command.

MCOM0 command: Set the multi-compensation mode to **OFF**
MCOM1 command: Set the multi-compensation mode to **ON**

[COMPENSATION DATA SELECTION]

The compensation data for each scanner channel is stored in the scanner interface's internal memory, and each set of compensation data is assigned a channel number. To select compensation data, the channel number must be set using the /CH0 to /CH7 signals, and the /CH_VALID signal on the rear panel connector, or the CNO= command via HP-IB.

NOTE

When the 4278A is triggered or when the 4278A starts a compensation data measurement (for example: when the 'OPEN COMPEN' softkey is pressed), the 4278A acknowledges the channel number. So if "CNO=10" is sent via HP-IB, the 4278A will not set the channel number to 10 until the 4278A is triggered or until the 4278A starts a compensation data measurement.

1. When the rear panel scanner interface connector is used

The channel number (compensation data selection) can be selected with the channel selection signals (/CH0 to /CH7) and the channel valid signal (/CH_VALID). The /CH0 to /CH7 signals are the 8-bit binary signals. /CH0 is the LSB, and /CH7 is the MSB.

For example,

/CH0	/CH1	/CH2	/CH3	/CH4	/CH5	/CH6	/CH7	CHANNEL No.
1	0	0	0	0	0	0	0	1
0	1	0	0	0	0	0	0	2
0	0	1	0	0	0	0	0	4
0	0	0	1	0	0	0	0	8
0	0	0	0	1	0	0	0	16
0	0	0	0	0	1	0	0	32
0	0	0	0	0	0	1	0	64
0	0	0	0	0	0	0	1	128

1: LOW
0: HIGH

If /CH_VALID is set to HIGH when the channel number is set using the /CH0 to /CH7 signals, the 4278A cannot acknowledge the channel number, and the 4278A will use the currently specified compensation data.

2. When the HP-IB interface (OPTION 101) is used

The channel number used to select the compensation data can be set using the CNO= command via HP-IB. The channel number is set from 0 to 255 in steps of 1. For example, the sample program for the channel number=20 is as follows.

```
10 OUTPUT 717;"MCOM1" ! Set the multi compen. mode to ON
20 OUTPUT 717;"CNO=20" ! Set the CH. No to 20
30 OUTPUT 717;"*TRG" ! Make the 4278A accepted the CH.NO
40 END
```

[COMPENSATION METHODS]

To use the OPEN, SHORT, STANDARD compensation function for each scanner channel for multi compensation, perform the following steps.

OPEN Compensation

Perform the following steps to use the OPEN compensation function for each scanner channel.

1. Select the scanner channel (select the channels in sequence starting with CHANNEL 0).
2. Set the 4278A's channel number equal to that selected in step 1.
3. Open the selected scanner channel measurement contacts.
4. Press the '**OPEN COMPEN**' softkey or send the **XOP** command via HP-IB. Wait for the end of open compensation measurement.
5. Increment the scanner channel and the 4278A's channel number by one to the next channel number, and repeat steps 1 through 4 until this procedure has been performed for all channels.
6. Press the '**OPEN ON**' softkey or send the HP-IB **OPEN1** command to enable compensation calculations for subsequent measurements.

SHORT Compensation

Perform the following steps to use the **SHORT** compensation function for each scanner channel.

1. Select the scanner channel (select the channels in sequence starting with CHANNEL 0).
2. Set the 4278A's channel number equal to that selected in step 1 to store the selected channel's compensation data.
3. Short the selected channels measurement contacts.
4. Press the '**SHORT COMPEN**' softkey or send the **XSH** command via HP-IB. Wait for the end of short compensation measurement.
5. Increment the scanner's and the 4278A's channel numbers by one to the next channel number, and repeat steps 1 through 4 until this procedure has been performed for all scanner channels.
6. Press the '**SHORT ON**' softkey or send the HP-IB **SHOR1** command to enable the compensation calculations for subsequent measurements.

STANDARD Compensation

Perform the following steps to use the **STANDARD** compensation function for each scanner channel.

1. Prepare a capacitor to use as the reference standard (premeasured values for the **Cp-D** and **Cp-G** parameters).
2. Press the '**STD PARMTR**' softkey and press either the '**C-D**' or '**C-G**' softkey to select the parameter. When the HP-IB is used, send either the **SPAR1** command for **C-D** parameter or the **SPAR2** command for **C-G** parameter.
3. Enter the standard's (premeasured) reference value using either the '**C=**', '**D=**' or '**G=**' softkeys, or the **C=**, **D=** or **G=** commands via HP-IB .
4. Select the scanner channel (select the channels in sequence starting with CHANNEL 0).
5. Set the 4278A's channel number equal to that selected in step 1 to store the selected channel's compensation data.
6. Connect the standard to the selected channel.
7. Press the '**STD COMPEN**' softkey or send the HP-IB **XSTD** command. Wait for the end of standard compensation measurement.
8. Increment the scanner's and the 4278A's channel number by one to the next channel number, and repeat steps 4 through 7 until this procedure has been performed for all scanner channels.

NOTE

Reference data for only one standard reference can be stored at any one time. The standard reference data is common for each channel. Therefore, you must connect the same standard to each scanner channel and perform the compensation.

9. Press the '**STD ON**' softkey or send the HP-IB **STD1** command to enable compensation calculation for subsequent measurements.

[DISPLAYING COMPENSATION DATA]

When you want to display the compensation data for a channel, perform the following steps.

1. Select the channel you want to read.
2. Press the **MENU** key and press the **NEXT** key twice.
3. Press the '**VALUE MONITR**' softkey.
4. Press the '**OPEN**' softkey to display the open compensation data on the monitor line.
5. Press the '**SHORT**' softkey to display the short compensation data on the monitor line.
6. Press the '**STD**' softkey to display the standard measurement data on the monitor line.
7. Press the **NEXT** key and '**STD REF**' softkey to display the standard reference data on the monitor line. (The standard reference data does not depend on which channel is selected).

NOTE

A channels compensation data is only displayed on the monitor line when the multi-compensation mode is set to ON. If the display page is set to the STATUS PAGE, the OPEN, SHORT, STANDARD compensation on/off indicators are displayed instead of the compensation data. The standard reference and offset data are displayed on the status page because reference data for only one standard reference can be stored at a time, and only one set of offset data can be stored (the standard reference data and the offset data are common to all channels). When you want to display the compensation data for all channels, use the value monitor function.

NOTE

When the value monitor function is used, and the channel number is changed, the monitor value displayed on the LCD will change according to the channel selected. The measurement time is increased by the amount of time required to display the compensation data of the channel. During normal measurements the value monitor function is set to **OFF**.

When you want to read the compensation data for any channel via HP-IB, use the following HP-IB device dependent commands.

OPM? command OPEN compensation data query
SHM? command SHORT compensation data query
STM? command STANDARD compensation measurement data query
STR? command STANDARD compensation reference data query

To read a channel's compensation data via HP-IB, use the following procedure and sample program as a guide.

1. Set the 4278A's HP-IB address to 17.
2. Load BASIC and input the following program. (This program can be used with HP 9000 series 200 or 300 computers).

10	ASSIGN @Hp_4278a TO 717	
20	REMOTE @Hp_4278a	
30	OUTPUT 717;"MCOM1"	
40	OUTPUT 717;"CNO=10"	Channel Selection
50	OUTPUT 717;"*TRG"	
60	WAIT .1	
70	OUTPUT 717;"OPM?"	OPEN
80	ENTER 717;Open_c,Open_g	
90	PRINT "OPEN: Cp=";Open_c,"G=";Open_g	
100	OUTPUT 717;"SHM?"	SHORT
110	ENTER 717;Short_l,Short_r	
120	PRINT "SHORT: Ls=";Short_l,"R=";Short_r	
130	OUTPUT 717;"STM?"	STD (Meas)
140	ENTER 717;Std_meas_c,Std_meas_d	
150	PRINT "STD_MEAS: C=";Std_meas_c,"D=";Std_meas_d	
160	OUTPUT 717;"STR?"	STD (Ref)
170	ENTER 717;Std_ref_c,Std_ref_d	
180	PRINT "STD_REF: C=";Std_ref_c,"D=";Std_ref_d	
190	END	

NOTE

In this example channel 10 is selected. If you want to select a different channel, change the "CNO=10" statement in line 40 to the channel you want to read. For example, to read the compensation data for the channel 20, use "CNO=20" in place of "CNO=10".

3. Run the program. The compensation data for channel 10 will be displayed on the computer as follows.

```

OPEN: Cp= 4.67024E-14      G= 3.10998E-9
SHORT: Ls= 3.03034E-8     R= .176588
STD_MEAS: C= 4.68034E-10  D= .000572526
STD_REF: C= 4.6804E-10    D= .0005
  
```

[BLOCK DATA TRANSFER VIA HP-IB (OPTION 101)]

When Option 101 and Option 301 are installed in the 4278A, up to 500 measurements values (measurement and comparison results) can be stored in the data buffer in sequential measurement order. All measurement data stored in the data buffer can be transferred at once using **DATA?** command. The data buffer is structured as a queue, so if the data buffer is full (500 measurement and comparison results are already stored in the data buffer) and the 4278A performs one more measurement, the first measurement data will be lost when the new data is stored into the last measurement data position in the buffer.

NOTE

A block data transfer cannot be performed by using the **DST** command.

NOTE

CLEARING THE DATA BUFFER

The measurement result data buffer is cleared when any of the following actions take place. If the controller tries to get the measurement data using **DATA?** command when the data buffer is empty, the error message "Query error" will be displayed (error number is 32.)

1. When the controller gets the measurement data using **DATA?** command.
2. When ***RST** command is sent via HP-IB
3. When ***CLS** command is sent via HP-IB
4. When the one of any 4278A control settings is changed

The 4278A offers two block data formats for HP-IB data transfer to the controller, **ASCII** and **BINARY**.

• **ASCII FORMAT**

When the 4278A transfers a block of data in the ASCII format, DATA A, DATA B and BIN NO. data are repeated for as many sets of data are in the buffer (500 sets of data maximum). The measurement data with the BIN NO. is only transferred when the DBIN1 command is sent. The ASCII format syntax diagram is shown in Figure 4-42.

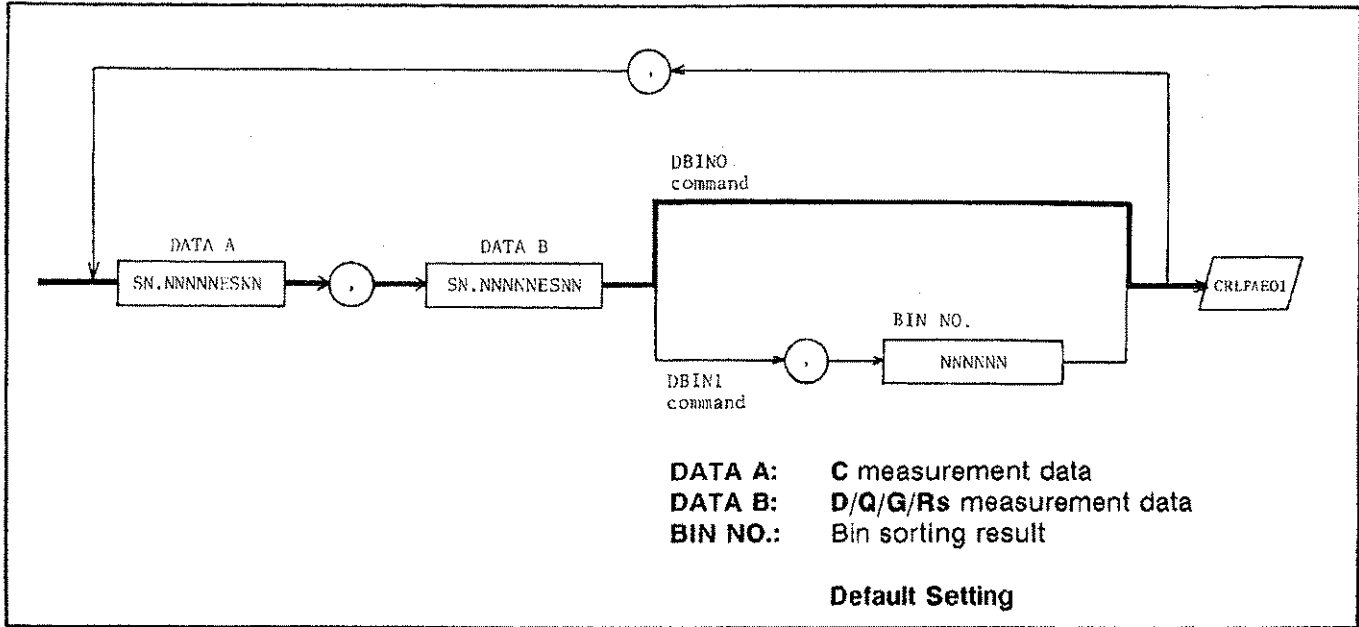

Figure 4-42. ASCII Format Syntax

A sample BASIC program for ASCII block data transfer is shown in Figure 4-43. This sample program can be run on the HP 9000 series 200 or 300 computers. When the sample program is run, the 4278A is triggered five hundreds times, and all measurement data and binning results are transferred as a block, and displayed. The BLOCK DATA transfer rate for this sample program with an HP 9000 series 200 (9816) computer is approximately 3.3 seconds.

```

10  DIM Result(1:500,1:3)
20  ASSIGN @Hp4278a TO 717
30  REMOTE @Hp4278a
40  OUTPUT @Hp4278a; "*RST"
50  OUTPUT @Hp4278a; "TRIG2"
60  OUTPUT @Hp4278a; "*SRE1"
70  OUTPUT @Hp4278a; "DFMT1"
80  OUTPUT @Hp4278a; "DBIN1"
90  OUTPUT @Hp4278a; "MCOM1"
100 OUTPUT @Hp4278a; "COMP1"
110 ON INTR 7 GOTO Meas_end
120 FOR I=1 TO 500
130   ENABLE INTR 7;2
140   OUTPUT @Hp4278a; "*TRG"
150   Waiting:GOTO Waiting
160   Meas_end:5=SPOLL(@Hp4278a)
170   NEXT I
180   OUTPUT @Hp4278a; "DATA?"
190   ENTER @Hp4278a;Result(*)
200   PRINT Result(*)
210   END

```

Control Settings

Measurement

Data Transfer

A description of each program line follows:

Lines 10: Dimension the data array
20: Assign address 717 to the Hp4278a
30: Put the 4278A into the REMOTE mode
40: Initialize the HP 4278A
50: Set the trigger mode to EXT_TRIG
60: Enable BO for SRQ
70: Set the output format to ASCII
80: Set the data output with BIN number
90: Set the multi compensation mode to ON
100: Set the comparator to ON
110: Go to the Meas_end label line, on receiving an SRQ interrupt
120: Repeat until the loop counter passes a specific value.
130: Enable the interrupt
140: Trigger the HP 4278A
150: Wait for the end of the measurement
160: Clear the status byte
170: Repeat until the loop counter is greater than the specified value
180: Read the block data
190: Enter the block data
200: Display the block data
210: End the program

Figure 4-43. Sample ASCII Format Program

• **BINARY FORMAT**

When the 4278A transfers block data using the BINARY format, DATA A, DATA B and BIN NO. data are repeated for as many sets of data are in the buffer (500 sets of data maximum). The measurement data with BIN NO. is only transferred when the DBIN1 command is sent. The BINARY format syntax diagram is shown in Figure 4-44.

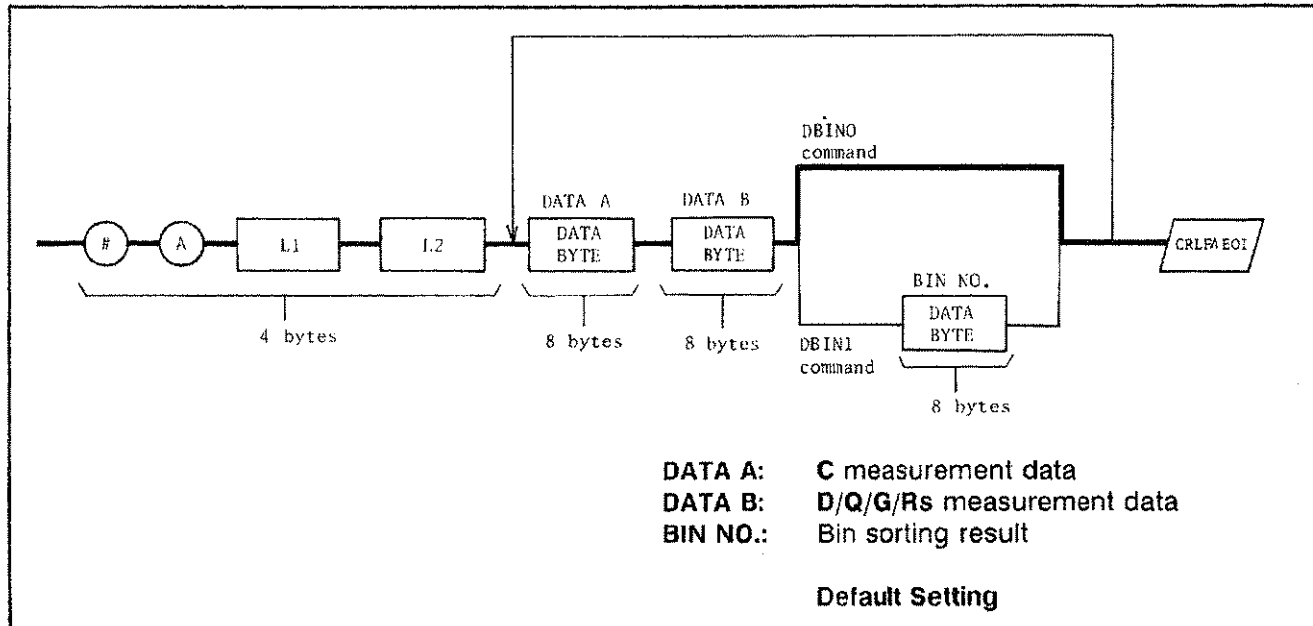

Figure 4-44. BINARY Format

The BASIC sample program for block data transmission in the ASCII format is shown in Figure 4-45. This sample program can be run on the HP 9000 series 200 or 300 computers. When the sample program is run, the 4278A is triggered five hundreds times, and all measurement data and binning results are transferred as a binary block of data, and displayed. Then the BLOCK DATA transmission in the sample program with HP 9000 Series 200 (9816) computer is approximately 0.8 seconds.

```

10  DIM Result(1:500,1:3)
20  INTEGER Header_1,Header_2
30  ASSIGN @Hp4278a TO 717;FORMAT ON
40  ASSIGN @Binary TO 717;FORMAT OFF
50  REMOTE @Hp4278a
60  OUTPUT @Hp4278a;"*RST"
70  OUTPUT @Hp4278a;"TRIG2"
80  OUTPUT @Hp4278a;"*SRE1"
90  OUTPUT @Hp4278a;"DFMT2"
100 OUTPUT @Hp4278a;"DBIN1"
110 OUTPUT @Hp4278a;"MCOM1"
120 OUTPUT @Hp4278a;"COMP1"
130 ON INTR 7 GOTO Meas_end
140 FOR I=1 TO 500
150   ENABLE INTR 7;2
160   OUTPUT @Hp4278a;"*TRG"
170   Waiting:GOTO Waiting
180   Meas_end:S=SPOLL(@Hp4278a)
190   NEXT I
200 OUTPUT @Hp4278a;"DATA?"
210 ENTER @Binary;Header_1,Header_2,Result(*)
220 PRINT Result(*)
230 END

```

Control Settings

Measurement

Data Transfer

A description of each program line follows:

Lines	<p>10: Dimension the data array</p> <p>20: Declare Header_1 and Header_2 as INTEGER variable</p> <p>30: Assign address 717 to the Hp4278a and set it to ASCII</p> <p>40: Assign address 717 to the Binary and set it to BINARY</p> <p>50: Put the 4278A into the REMOTE mode</p> <p>60: Initialize the HP 4278A</p> <p>70: Set the trigger mode to EXT_TRIG</p> <p>80: Enable B0 for SRQ</p> <p>90: Set the output format to BINARY</p> <p>100: Set the data output with BIN number</p> <p>110: Set the multi compensation mode to ON</p> <p>120: Set the comparator to ON</p> <p>130: Go to the Meas_end label line, on receiving an SRQ interrupt</p> <p>140: Repeat until the loop counter passes a specific value.</p> <p>150: Enable the interrupt</p> <p>160: Trigger the HP 4278A</p> <p>170: Wait for the end of the measurement</p> <p>180: Clear the status byte</p> <p>190: Repeat until the loop counter is greater than the specified value</p> <p>200: Read the block data</p> <p>210: Enter the block data</p> <p>220: Display the block data</p> <p>230: End the program</p>
-------	--

Figure 4-45. Sample BINARY Format Program

SECTION 5

GENERAL INFORMATION

5-1. INTRODUCTION	5-1
5-2. SPECIFICATIONS	5-1
5-3. COMPONENTS NOT COVERED BY WARRANTY	5-1
5-4. SAFETY CONSIDERATIONS	5-1
5-5. INSTRUMENTS COVERED BY THIS MANUAL	5-1
5-6. OPERATING ENVIRONMENT	5-2
5-7. INSTALLATION OF OPTIONS 907, 908, AND 909	5-2
5-8. STORAGE AND SHIPMENT	5-4
5-8-1. ENVIRONMENT	5-4
5-8-2. ORIGINAL PACKAGING	5-4
5-8-3. USING OTHER PACKING MATERIALS	5-4
5-9. ELECTRICAL OPTION MODIFICATIONS	5-5



1
2
3
4
5
6
7
8
9
10
11
12
13
14
15
16
17
18
19
20
21
22
23
24
25
26
27
28
29
30
31
32
33
34
35
36
37
38
39
40
41
42
43
44
45
46
47
48
49
50
51
52
53
54
55
56
57
58
59
60
61
62
63
64
65
66
67
68
69
70
71
72
73
74
75
76
77
78
79
80
81
82
83
84
85
86
87
88
89
90
91
92
93
94
95
96
97
98
99
100

SECTION 5

GENERAL INFORMATION

5-1. INTRODUCTION

This section covers the specifications, supplemental performance characteristics, installation, and other information about the HP 4278A.

5-2. SPECIFICATIONS

Table 5-7 lists complete 4278A specifications. These specifications are the performance standards or limits against which the instrument is tested. When shipped from the factory, the 4278A meets the specifications listed in Table 5-7. Section 6 contains the procedures for verifying the 4278A's specifications. Table 5-8 lists supplemental performance characteristics. Supplemental performance characteristics are not specifications but they are typical characteristics included as additional information for the operator.

5-3. COMPONENTS NOT COVERED BY WARRANTY

The memory card is not covered under the 4278A's warranty. If the memory card becomes defective even within the warranty period of the 4278A, the cost of the memory card must be paid.

5-4. SAFETY CONSIDERATIONS

The 4278A conforms to the safety requirements of the International Electromechanical Committee, (IEC), Safety Class I instruments and is shipped from the factory in a safe state.

5-5. INSTRUMENTS COVERED BY THIS MANUAL

Hewlett-Packard uses a two-part nine character serial number which is stamped on the serial number plate (see Figure 5-1) attached to the instrument's rear panel. The first four digits and the letter are the serial prefix and the last five digits are the suffix. The letter placed between the two sections identifies the country where the instrument was manufactured. The prefix is the same for all identical instruments; it changes only when a change is made to the instrument. The suffix, however, is assigned sequentially and is different for each instrument. The contents of this manual apply to instruments with the serial number prefixes listed under Serial Numbers on the title page.

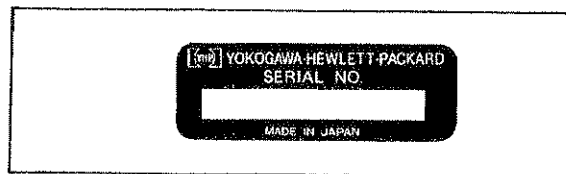

Figure 5-1. Serial Number Plate

An instrument manufactured after the printing of this manual may have a serial number prefix that is not listed on the title page. This unlisted serial number prefix indicates the instrument is different from those described in this manual. The manual for a new instrument may be accompanied by a yellow Manual Changes supplement or have a different manual part number. The Manual Changes supplement contains "change information" that explains how to adapt the manual to newer instruments.

In addition to change information, the supplement may contain information for correcting errors (Errata) in the manual. To keep this manual as current and accurate as possible, Hewlett-Packard recommends that you periodically request the latest Manual Changes supplement. The supplement for this manual is identified by this manual's printing date and its part number, both of which appear on the manual's title page. Complimentary copies of the supplement are available from Hewlett-Packard. If the serial prefix or number of an instrument is lower than that on the title page of this manual, see APPENDIX A, BACK DATING CHANGES.

For information concerning a serial number prefix that is not listed on the title page or in the Manual Change supplement, contact the nearest Hewlett-Packard office.

Listed on the title page of this manual is microfiche part number. This number can be used to order 4 by 6 inch microfilm transparencies of the manual pages. Each microfiche contains up to 60 photo-duplicates of the manual pages. The microfiche package also includes the latest manual changes supplement as well as all pertinent service notes. To order an additional manual, use the part number listed on the title page of this manual.

5-6. OPERATING ENVIRONMENT

Temperature The 4278A may be operated in ambient temperatures ranging from 0 to 55°C.

Humidity The instrument may be operated in environments with relative humidities up to 95% at 40°C. The 4278A, however, should be protected from temperature extremes which could cause condensation within the instrument.

5-7. INSTALLATION OF OPTIONS 907, 908, AND 909

The 4278A can be rack mounted and used as a component of a measurement system. Information for rack mounting the 4278A is provided in Figure 5-2.

Option	Description	Kit Part Number
907	Handle Kit	HP PN 5061-9690
908	Rack Flange Kit	HP PN 5061-9678
909	Rack Flange & Handle Kit	HP PN 5061-9684

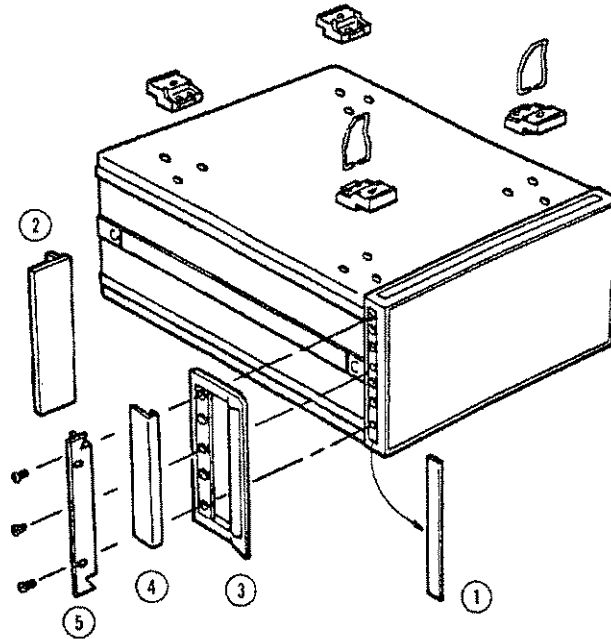

1. Remove the adhesive-backed trim strips 1 from the left and right front sides of the 4278A.
2. **HANDLE INSTALLATION:** Attach the front handles 3 to the sides using the screws provided and attach the trim strip 4 to the handle.
3. **RACK MOUNTING:** Attach the rack mount flange 2 to the left and right front sides of the 4278A using the screws provided.
4. **HANDLE AND RACK MOUNTING:** Attach the front handle 3 and the rack mount flange 5 together on the left and right front sides of the 4278A using the screws provided.
5. When rack mounting the 4278A (3 and 4 above), remove all four feet (lift bar on the inner side of the foot, and slide the foot toward the bar).

Figure 5-2. Rack Mount Kits

5-8. STORAGE AND SHIPMENT

5-8-1. ENVIRONMENT

The 4278A should be stored in a clean, dry environment. The following environmental limitations apply for both storage and shipping:

Temperature:	-20 to 60 °C
Humidity:	up to 95% (at 40 °C)

To prevent condensation from forming on the inside of the 4278A, protect the 4278A against temperature extremes.

5-8-2. ORIGINAL PACKAGING

A container and packing materials identical to those used in factory packaging are available through your closest Hewlett-Packard sales office. If the instrument is being returned to Hewlett-Packard for servicing, attach a tag indicating the service required, the return address, the model number, and the full serial number. Mark the container **FRAGILE** to help ensure careful handling. In any correspondence, refer to the instrument by model number and its full serial number.

5-8-3. USING OTHER PACKING MATERIALS

The following general instructions should be used when repacking with commercially available materials:

1. Wrap the 4278A in heavy paper or plastic. When shipping to a Hewlett-Packard sales office or service center, attach a tag indicating the service required, return address, model number, and the full serial number.
2. Use a strong shipping container. A double-walled carton made of 350 pound test material is adequate.
3. Use enough shock absorbing material (3 to 4 inch layer) around all sides of the instrument to provide a firm cushion and to prevent movement inside the container. Use cardboard to protect the control panel.
4. Seal the shipping container securely.
5. Mark the shipping container **FRAGILE** to help ensure careful handling.
6. In any correspondence, refer to the 4278A by model number and its full serial number.

CAUTION

Do NOT package the 4278A with a memory card inserted.

5-9. ELECTRICAL OPTION MODIFICATIONS

Electrical options can be added or deleted after you receive the 4278A. Tables 5-1 through 5-6 list the necessary parts, and the modification procedures are given in the Maintenance Manual.

NOTE

The part numbers listed below and the part numbers listed in the Maintenance Manual may need to be changed when circuit enhancements are made. Contact your nearest Hewlett-Packard service center to confirm the part numbers before ordering parts.

Table 5-1. Parts Necessary to Add the 1MHz Test to Option 001 Units

HP Part Number	Description	QTY.
04278-66503	1MHz Transducer Board Assembly	1
04278-61606	Coaxial Cable Assembly "B"	1
04278-61604	Coaxial Cable Assembly "D"	1
04278-61612	Coaxial Cable Assembly "H"	1
04278-61613	Coaxial Cable Assembly "I"	1

Table 5-2. Parts Necessary to Add the 1kHz Test to Option 002 Units

HP Part Number	Description	QTY.
04278-66504	1kHz Transducer Board Assembly	1
04278-61607	Coaxial Cable Assembly "A"	1
04278-61605	Coaxial Cable Assembly "C"	1
04278-61603	Coaxial Cable Assembly "E"	1

Table 5-3. Parts Necessary to Shift the Test Frequency by 1%

HP Part Number	Description	QTY.
1813-0551	Crystal Oscillator Module 8.08MHz	1
5080-3152	"04278-66572" Label	1

Table 5-4. Parts Necessary for not shifting the Test Frequency

HP Part Number	Description	QTY.
1813-0550	Crystal Oscillator Module 8.00MHz	1

Table 5-5. Parts Necessary to Add Option 101 HP-IB Interface

HP Part Number	Description	QTY.
04278-66520	#101 HP-IB Board Assembly	1
04278-00210	HP-IB Connector Panel	1
04278-61621	Flat-cable Assembly	1
2190-0577	Washer	2

Table 5-6. Parts Necessary to Add Option 201 Handler Interface

HP Part Number	Description	QTY.
04278-66530	#201 Handler Interface Board Assembly	1
04278-00211	Handler Interface Connector Panel	1
04278-61622	Flat-cable Assembly	1
0515-1551	Screw M3-L 10 P-H	2
0535-0031	Nut Hex W/ locker	2

Table 5-6-1. Parts Necessary to Add Option 202 Handler Interface

HP Part Number	Description	QTY.
04278-66531	#202 Handler Interface Board Assembly	1
04278-00213	Handler Interface Connector Panel	1
04278-61622	Flat-cable Assembly	1
0515-1551	Screw M3-L 10 P-H	2
0535-0031	Nut Hex W/ locker	2

Table 5-6-2. Parts Necessary to Add Option 301 Scanner Interface

HP Part Number	Description	QTY.
04278-66540	#301 Scanner Interface Board Assembly	1
04278-00216	Scanner Interface Connector Panel	1
04278-61632	Flat-cable Assembly	1
0515-1551	Screw M3-L 10 P-H	2
0535-0031	Nut Hex W/ locker	2

NOTE

The Option 301 scanner interface can only be installed in instruments with ROM version 3.0 and above.

Table 5-7. Specifications (Sheet 1 of 17)

GENERAL

OPERATING ENVIRONMENT:

Temperature: 0°C to 55°C

Relative Humidity: ≤95% RH @ 40°C.
Condensation must be avoided.

STORAGE ENVIRONMENT:

Temperature: -20°C to +60°C

Relative Humidity: ≤95% RH @ 40°C.

SAFETY:

Based on IEC-348, CSA-BULLETIN-556B and UL-1244

POWER REQUIREMENTS:

Line Voltage: 100, 120, and 220VAC ±10%, 240VAC +5% -10%

Line Frequency: 48 to 66Hz

Power Consumption: 200VA max.

DIMENSIONS:

Approximately 426W by 177H by 498D (mm)

WEIGHT:

Approximately 15kg (33lb., standard)

DISPLAY:

Dot-matrix liquid crystal display (LCD). Displays measurement values with a resolution of 4, 5, or 6 digits (max. 999999 counts), front panel control settings, comparator limits, and the comparator's decision output.

BASIC SPECIFICATIONS

PARAMETER MEASURED:

Cp-D, Cp-Q, Cp-G, Cs-D, Cs-Q, and Cs-ESR

Where:

Cp is the capacitance in parallel circuit mode
Cs is the capacitance in series circuit mode
D is the dissipation factor
Q is the quality factor ($=1/D$)
G is the conductance in the parallel circuit mode
ESR is equivalent series resistance

TEST SIGNALS:

Frequency: 1kHz and 1MHz, $\pm 0.02\%$

Signal Level: 0.1Vrms to 1Vrms, $\pm 10\%$ ($C \leq 20\mu\text{F}$), in 0.1Vrms steps

Output Impedance: 1.5 Ω , 20 Ω , and 100 Ω , set automatically in accordance with the capacitance range used.

MEASUREMENT CIRCUIT MODE:

Parallel equivalent circuit (**Cp-D**, **Cp-Q**, and **Cp-G**)

Series equivalent circuit (**Cs-D**, **Cs-Q**, and **Cs-ESR**)

MEASUREMENT TERMINAL:

Four-terminal pair, guarded

RANGING:

Auto and Manual

TRIGGER MODE:

Internal, External, and Manual

TEST CABLE LENGTH:

Selection of 0m, 1m, and 2m

Table 5-7. Specifications (Sheet 3 of 17)

MEASUREMENT TIME MODE:

Integration Time: SHORT, MEDIUM, and LONG

Measurement Times

Mode	SHORT	MEDIUM	LONG
Time ¹	6.5±0.5ms	10.0±1ms	21.0±1ms

¹ Measurement time includes Settling, Integration (analog measurements), Calculation, and Comparison times.

Averaging:

Displays or outputs the averaged value as the measurement data. The average rates which can be selected are -- 1, 2, 4, 8, 16, 32, 64, 128, and 256.

Delay Time:

The time delay between the trigger and the start of a measurement can be set between 0 to 1000ms, in 1ms steps.

NOTE

No additional measurement time is required for measurements performed in an overload (shorted capacitor) condition.

CAPACITANCE MEASUREMENT RANGE:

1kHz Measurement: 100pF to 100µF full scale, 7 decade ranges

Can measure up to 200% of full scale at $D \leq 0.5$

1MHz Measurement:

Normal Mode: 1pF to 1024pF full scale, 11 decade ranges

Can measure up to 125% of full scale at $D \leq 1$

High Accuracy Mode: max. 2048pF ($D \leq 0.05$)

In the 1MHz High Accuracy Mode, capacitance ranges are user-definable. That is, the capacitance value you enter will be the **CENTER** of the range, and the range covered will be $\pm 30\%$ of that value. For example, if you enter 1000pF, the capacitance range will be 700 to 1300pF.

Table 5-7. Specifications (Sheet 4 of 17)

MEASUREMENT RANGE & RESOLUTION:

PARAMETER	1kHz	1MHz
Cp, Cs	0.001pF to 200.000µF	0.00001pF to 1280.00pF 0.00001pF to 2662.40pF
D	0.00001 to 9.99999	0.00001 to 9.99999 .000001 to .999999
Q	0.1 to 99999.9	0.1 to 99999.9 1.0 to 99999.9
G	< 0.63 × Crdg mS	< 0.63 × Crdg S < 0.31 × Crdg S
ESR	<16/Crdg Ω	< 16/Crdg mΩ < 8/Crdg mΩ

Q is displayed as the result of $1/D$. The **C** ranges apply when $D \leq 0.5$ at 1kHz, $D \leq 1$ at 1MHz Normal Mode and $D \leq 0.05$ at 1MHz High Accuracy Mode. The **ESR** and **G** ranges depend on the measured value of **C** (Crdg is reading of **C** in µF).

Ranges at 1MHz represent for: Normal Mode
 High Accuracy Mode

MEASUREMENT ACCURACY:

Specified at the front panel **UNKNOWN** connectors or at the ends of the standard 1m or 2m test leads when all of the following conditions are satisfied.

- (1) Warm up time ≥ 10 minutes
- (2) Ambient temperature $23^{\circ}\text{C} \pm 5^{\circ}\text{C}$; rate of temperature change $< 0.2^{\circ}\text{C}/\text{minute}$
- (3) Test cable length set to 0, 1 or 2m (HP 16048A/B/D)
- (4) **OPEN / SHORT** compensation and temperature compensation have been performed.

Accuracies are relative to the calibration standards. Absolute accuracy is given as the sum of the relative measurement accuracy plus the calibration uncertainty.

Table 5-7. Specifications (Sheet 5 of 17)

1kHz MEASUREMENT:

Tables A-1 and A-2 lists the 1kHz measurement accuracies, when all of the following conditions are satisfied.

- (1) $D \leq 0.1$
- (2) $0 < \alpha \leq 1.0$ at the 100pF range through 10 μ F range, and $0.2 \leq \alpha$ at the 100 μ F range (when $1 < \alpha \leq 2$, apply 1 to α) where $\alpha = \text{Crdg}/\text{Cf}$

Crdg: Reading of C (in μ F)
 Cf: Full scale value of C range (in μ F)

- (3) The open admittance (Yopen) and the short impedance (Zshort) before performing the OPEN/SHORT compensation are:

$$Z_{\text{short}} < 0.1 / Y_{\text{dut}}$$

$$Y_{\text{open}} < 0.1 / Z_{\text{dut}}$$

Where Ydut: Admittance of DUT
 Zdut: Impedance of DUT

- (4) Test signal level (Vosc): $0.3\text{V} < V_{\text{osc}} \leq 1\text{V}$
 (Multiply 1/3 to the marked term(*) when test signal level is 0.1 to 0.3V.)

Table A-1. 1kHz Measurement (C, D)

C range	Measurement Parameter	
	Cp, Cs	D
100 pF		
1 nF	$(0.13 + 0.03/k_0)\% + (0.05 + *0.25/k_0)\%$	$(0.13 + 0.03/k_0)\% + (0.001 + *0.005/k_0)/\alpha$
10 nF	$(0.08 + 0.02/k_0)\% + (0.03 + *0.02/k_0)\%$	$(0.08 + 0.02/k_0)\% + (0.0006 + *0.0004/k_0)/\alpha$
100 nF	$(0.04 + 0.01/k_0)\% + (0.015 + *0.01/k_0)\%$	$(0.04 + 0.01/k_0)\% + (0.0003 + *0.0002/k_0)/\alpha$
1 μ F		
10 μ F		
100 μ F	$(0.13 + 0.06/k_0)\% + (0.55 + *3.13/k_0) \cdot \alpha^2\%$ $(0.08 + 0.05/k_0)\% + (0.05 + *0.25/k_0) \cdot \alpha^2\%$ $(0.04 + 0.03/k_0)\% + (0.13 + *0.13/k_0) \cdot \alpha^2\%$	$(0.13 + 0.06/k_0)\% + (0.005 + *0.031/k_0) \cdot \alpha$ $(0.08 + 0.05/k_0)\% + (0.0005 + *0.0025/k_0) \cdot \alpha$ $(0.04 + 0.03/k_0)\% + (0.0013 + *0.0013/k_0) \cdot \alpha$

Table 5-7. Specifications (Sheet 6 of 17)

Table A-2. 1kHz Measurement (G, ESR)

C range	Measurement Parameter	
	G	ESR
100 pF		
1 nF	$\{(7.9 + *1.6 / k_0) + (3.1 + *16 / k_0) / \alpha\} \cdot \text{Crdg } \mu\text{S}$	$\{(0.2 + *0.04 / k_0) + (0.08 + *0.4 / k_0) / \alpha\} \cdot \frac{1}{\text{Crdg}} \Omega$
10 nF	$\{(5 + *1.3 / k_0) + (1.9 + *1.3 / k_0) / \alpha\} \cdot \text{Crdg } \mu\text{S}$	$\{(0.13 + *0.03 / k_0) + (0.05 + *0.03 / k_0) / \alpha\} \cdot \frac{1}{\text{Crdg}} \Omega$
100 nF	$\{(2.5 + *0.63 / k_0) + (0.94 + *0.63 / k_0) / \alpha\} \cdot \text{Crdg } \mu\text{S}$	$\{(0.06 + *0.02 / k_0) + (0.02 + *0.02 / k_0) / \alpha\} \cdot \frac{1}{\text{Crdg}} \Omega$
1 μF		
10 μF		
100 μF	$\{(7.9 + *3.8 / k_0) + (35 + *196 / k_0) \cdot \alpha\} \cdot \text{Crdg } \mu\text{S}$	$\{(0.2 + *0.1 / k_0) + (0.88 + *5 / k_0) \cdot \alpha\} \cdot \frac{1}{\text{Crdg}} \Omega$
	$\{(5 + *3.1 / k_0) + (3.1 + *16 / k_0) \cdot \alpha\} \cdot \text{Crdg } \mu\text{S}$	$\{(0.13 + *0.08 / k_0) + (0.08 + *0.4 / k_0) \cdot \alpha\} \cdot \frac{1}{\text{Crdg}} \Omega$
	$\{(2.5 + *1.6 / k_0) + (7.9 + *7.9 / k_0) \cdot \alpha\} \cdot \text{Crdg } \mu\text{S}$	$\{(0.06 + *0.04 / k_0) + (0.2 + *0.2 / k_0) \cdot \alpha\} \cdot \frac{1}{\text{Crdg}} \Omega$

¹ For the temperature range between 0°C and 18°C, or between 28°C and 55°C, the measurement accuracy is given by multiplying the values shown in Table A by two. In the 100pF range at 28°C to 55°C, the measurement accuracy is given by multiplying the values shown in Table A by three.

² Accuracies are read as:

- C: $\pm(\% \text{ of reading} + \% \text{ of full scale})$
- D: $\pm(\% \text{ of reading} + \text{absolute D value})$
- G: $\pm(\text{absolute G value})$
- ESR: $\pm(\text{absolute ESR value})$

³ Accuracies in the table represent:

SHORT MODE
MEDIUM MODE
LONG MODE

- ⁴ $\alpha = \text{Crdg} / \text{Cf}$
- $k_0 = \text{Vosc} / 1\text{V}$
- Crdg: Reading of C (in μF)
- Cf: Full scale value of C range (in μF)
- Vosc: Test signal level (in V)

Table 5-7. Specifications (Sheet 7 of 17)

1MHz MEASUREMENT:

Normal Mode:

Tables B-1 and B-2 lists the measurement accuracies for the 1MHz normal mode measurement when all of the following conditions are satisfied.

- (1) $D \leq 0.1$
- (2) $0 < \alpha < 1.25$ at the all measurement range.

where $\alpha = \text{Crdg} / \text{Cf}$

Crdg: Reading of C (in pF)

Cf: Full scale value of C range (in pF)

- (3) $C_{\text{open}} \ll C_{\text{dut}}$

Where C_{open} : Capacitance of measurement terminal with no connections, before performing the open compensation.

C_{dut} : Capacitance of the DUT after performing the open/short compensation.

Table B-1. 1MHz Normal Mode Measurement (C,D)

C range [pF]	Measurement Parameter		
	C_p, C_s	D	
1	$0.3\% + (0.8 / k_0)\%$	$0.3\% + (0.006 / k_0) / \alpha$	
	$0.2\% + (0.06 / k_0)\%$	$0.2\% + (0.003 + 0.001 / k_0) / \alpha$	
	$0.05\% + (0.06 / k_0)\%$	$0.1\% + (0.001 / k_0) / \alpha$	
2	$0.3\% + (0.4 / k_0)\%$	$0.3\% + (0.005 / k_0) / \alpha$	
	$0.2\% + (0.03 / k_0)\%$		
	$0.05\% + (0.03 / k_0)\%$		
4	$0.2\% + (0.0015 + 0.0005 / k_0) / \alpha$		
8			
16			
32			
64			
128			
256			$0.3\% + (0.4 / k_0)\%$
512		$0.2\% + (0.02 / k_0)\%$	
1024			

Table 5-7. Specifications (Sheet 8 of 17)

Table B-2. 1MHz Normal Mode Measurement (G, ESR)

C range [pF]	Measurement Parameter	
	G	ESR
1	$0.3\% + (0.019 + 0.05 / k_0 / \alpha) \cdot \text{Crdg } \mu\text{S}$	$0.3\% + (960 / k_0) \cdot \frac{1}{\alpha} \cdot \frac{1}{\text{Crdg}} \Omega$
	$0.2\% + (0.013 + 0.003 / k_0 / \alpha) \cdot \text{Crdg } \mu\text{S}$	$0.2\% + (480 + 160 / k_0) \cdot \frac{1}{\alpha} \cdot \frac{1}{\text{Crdg}} \Omega$
	$0.05\% + (0.003 + 0.003 / k_0 / \alpha) \cdot \text{Crdg } \mu\text{S}$	$0.1\% + (160 / k_0) \cdot \frac{1}{\alpha} \cdot \frac{1}{\text{Crdg}} \Omega$
2	$0.3\% + (0.019 + 0.025 / k_0 / \alpha) \cdot \text{Crdg } \mu\text{S}$	$0.3\% + (480 / k_0) \cdot \frac{1}{\alpha} \cdot \frac{1}{\text{Crdg}} \Omega$
	$0.2\% + (0.013 + 0.002 / k_0 / \alpha) \cdot \text{Crdg } \mu\text{S}$	
	$0.05\% + (0.003 + 0.002 / k_0 / \alpha) \cdot \text{Crdg } \mu\text{S}$	$0.2\% + (240 + 80 / k_0) \cdot \frac{1}{\alpha} \cdot \frac{1}{\text{Crdg}} \Omega$
4		
8	$0.3\% + (0.019 + 0.025 / k_0 / \alpha) \cdot \text{Crdg } \mu\text{S}$	$0.05\% + (80 / k_0) \cdot \frac{1}{\alpha} \cdot \frac{1}{\text{Crdg}} \Omega$
16	$0.2\% + (0.013 + 0.001 / k_0 / \alpha) \cdot \text{Crdg } \mu\text{S}$	
32	$0.05\% + (0.003 + 0.001 / k_0 / \alpha) \cdot \text{Crdg } \mu\text{S}$	$0.3\% + (480 / k_0) \cdot \frac{1}{\alpha} \cdot \frac{1}{\text{Crdg}} \Omega$
64		
128		$0.2\% + (240 + 80 / k_0) \cdot \frac{1}{\alpha} \cdot \frac{1}{\text{Crdg}} \Omega$
256		
512		$0.1\% + (80 / k_0) \cdot \frac{1}{\alpha} \cdot \frac{1}{\text{Crdg}} \Omega$
1024		

¹ For the temperature range between 8°C and 18°C, or between 28°C and 38°C, the measurement accuracy is given by multiplying the values shown in Table B by two. For the temperature range between 0°C and 8°C, or between 38°C and 55°C, the measurement accuracy is given by multiplying values shown in Table B by three.

² Accuracy is read as:

- C: ±(% of reading + % of full scale)
- D: ±(% of reading + absolute D value)
- G: ±(% of reading + absolute G value)
- ESR: ±(% of reading + absolute ESR value)

³ Accuracies in the table represent:

SHORT MODE
MEDIUM MODE
LONG MODE

- ⁴ $\alpha = \text{Crdg}/\text{Cf}$
 $k_0 = \text{Vosc}/1\text{V}$
 Crdg: Reading of C (in pF)
 Cf: Full scale value of C range (in pF)
 Vosc: Test signal level (in V)

Table 5-7. Specifications (Sheet 9 of 17)

High Accuracy Mode:

Tables C-1 and C-2 lists the measurement accuracies for the 1MHz high accuracy mode measurements when all of the following conditions are satisfied.

(1) $D \leq 0.05$

(2) $0.7 \leq \alpha \leq 1.3$ at $Crc > 2pF$.

$Crc - 0.6pF \leq Crdg \leq Crc + 0.6pF$ at $Crc \leq 2pF$.

Where $\alpha = Crdg / Crc$

Crdg: Reading of C (in pF)

Crc: Nominal value entered for C range (in pF)

(3) $Copen \ll Cdut$

Where Copen: Open capacitance of the measurement terminal with no connections, before performing the open compensation.

Cdut: capacitance of DUT after performing the open/short compensation

Table C-1. 1MHz High Accuracy Mode Measurement (C, D)

Entry Value Crc (pF)	Measurement Parameter	
	Cp, Cs	D
$0 \leq Crc \leq 2$	$0.2\% + (0.002 / k_0) pF$	$(0.004 + 0.004 / k_0) \cdot \frac{1}{Crdg}$
	$0.1\% + (0.0004 / k_0) pF$	$(0.0012 + 0.0004 / k_0) \cdot \frac{1}{Crdg}$
	$0.08\% + (0.0004 / k_0) pF$	$(0.0006 / k_0) \cdot \frac{1}{Crdg}$
$2 < Crc \leq 4$	$(0.2 + 0.2 / k_0) \%$	$0.002 + 0.002 / k_0$
	$0.1\% + (0.0004 / k_0) pF$	$0.0006 + 0.0002 / k_0$
	$0.06\% + (0.0004 / k_0) pF$	$0.0001 + 0.0002 / k_0$
$4 < Crc \leq 256$	$(0.2 + 0.2 / k_0) \%$	$0.002 + 0.002 / k_0$
	$(0.1 + 0.01 / k_0) \%$	$0.0006 + 0.0001 / k_0$
	$(0.04 + 0.01 / k_0) \%$	$0.0001 + 0.0001 / k_0$
$256 < Crc \leq 1024$	$(0.2 + 0.2 / k_0) \%$	$0.002 + 0.002 / k_0$
	$(0.1 + 0.01 / k_0) \%$	$0.0006 + 0.0001 / k_0$
	$(0.06 + 0.01 / k_0) \%$	$0.0002 + 0.0001 / k_0$
$1024 < Crc \leq 2048$	$(0.2 + 0.2 / k_0) \%$	$0.002 + 0.002 / k_0$
	$(0.1 + 0.01 / k_0) \%$	$0.0006 + 0.0001 / k_0$
	$(0.1 + 0.01 / k_0) \%$	$0.0003 + 0.0001 / k_0$

Table 5-7. Specifications (Sheet 10 of 17)

Table C-2. 1MHz High Accuracy Mode Measurement (G, ESR)

Entry Value Crc(pF)	Measurement Parameter	
	G	ESR
$0 \leq Crc \leq 2$	$0.013 \cdot Crdg + 0.013 / k_0$ μS	$(640 + 640 / k_0) / Crdg^2$ Ω
	$0.0038 \cdot Crdg + 0.0025 / k_0$ μS	$(190 + 64 / k_0) / Crdg^2$ Ω
	$0.0038 / k_0$ μS	$(96 / k_0) / Crdg^2$ Ω
$2 < Crc \leq 4$	$(0.013 + 0.013 / k_0) \cdot Crdg$ μS	$(320 + 320 / k_0) / Crdg$ Ω
	$0.0038 \cdot Crdg + 0.0025 / k_0$ μS	$(96 + 32 / k_0) / Crdg$ Ω
	$0.0006 \cdot Crdg + 0.0025 / k_0$ μS	$(16 + 32 / k_0) / Crdg$ Ω
$4 < Crc \leq 256$	$(0.013 + 0.013 / k_0) \cdot Crdg$ μS	$(320 + 320 / k_0) / Crdg$ Ω
	$(0.0038 + 0.0006 / k_0) \cdot Crdg$ μS	$(96 + 16 / k_0) / Crdg$ Ω
	$(0.0006 + 0.0006 / k_0) \cdot Crdg$ μS	$(16 + 16 / k_0) / Crdg$ Ω
$256 < Crc \leq 1024$	$(0.013 + 0.013 / k_0) \cdot Crdg$ μS	$(320 + 320 / k_0) / Crdg$ Ω
	$(0.0038 + 0.0006 / k_0) \cdot Crdg$ μS	$(96 + 16 / k_0) / Crdg$ Ω
	$(0.0013 + 0.0006 / k_0) \cdot Crdg$ μS	$(32 + 16 / k_0) / Crdg$ Ω
$1024 < Crc \leq 2048$	$(0.013 + 0.013 / k_0) \cdot Crdg$ μS	$(320 + 320 / k_0) / Crdg$ Ω
	$(0.0038 + 0.0006 / k_0) \cdot Crdg$ μS	$(96 + 16 / k_0) / Crdg$ Ω
	$(0.0019 + 0.0006 / k_0) \cdot Crdg$ μS	$(48 + 16 / k_0) / Crdg$ Ω

¹ For the temperature range between 8°C and 18°C, or between 28°C and 38°C, the measurement accuracy is given by multiplying the values shown in Table C by two. For the temperature range between 0°C and 8°C, or between 38°C and 55°C, the measurement accuracy is given by multiplying the values is shown in Table C by three.

² Accuracies are read as:

C: \pm (% of reading + absolute C value)

D: \pm (absolute D value)

G: \pm (absolute G value)

ESR: \pm (absolute ESR value)

³ Accuracies in the table represent:

SHORT MODE
MEDIUM MODE
LONG MODE

⁴ $k_0 = Vosc/1V$

Crdg: Reading of C (in pF)

Vosc: Test signal level (in V)

Table 5-7. Specifications (Sheet 11 of 17)

CALIBRATION UNCERTAINTY:

Calibration uncertainty when the 4278A is shipped from factory is shown in the following tables.

C range (1kHz)	Uncertainty	
	C	D
100μF	0.03 %	0.0003
10μF		
1μF	0.025 %	0.0003
100nF		0.0002
10nF		0.0001
1nF		
100pF		

C range (1MHz)		Uncertainty	
Normal Mode	Hi. Acc.	C	D
512pF - 1024pF	≥ 512pF	0.1 %	0.0003
1pF - 256pF	< 512pF	0.05 %	0.0003

Note: To obtain the absolute accuracies for G and ESR, the following equations are added to each of the relative accuracy.

$$G : 2\pi \times (\text{frequency}) \times (\text{measured C value}) \times (\text{uncertainty of D}) \text{ [S]}$$

$$\text{ESR: } \frac{(\text{uncertainty of D})}{2\pi \times (\text{frequency}) \times (\text{measured C value})} \text{ (}\Omega\text{)}$$

COMPENSATION:

OPEN Compensation:

The open compensation function compensates for the stray admittance (C, G) of the test fixture.

Compensation Range: $G \leq 20\mu\text{S}$, unlimited for C

SHORT Compensation:

The short compensation function compensates for the residual impedance (L, R) of the test fixture.

Compensation Range: $R \leq 20\Omega$, unlimited for L

Note: OPEN and SHORT compensation can be performed at 1kHz and 1MHz independently.

Standard Compensation:

The standard compensation function is used to compensate for other errors by using the working standard's reference value and the actual measurement value.

Table 5-7. Specifications (Sheet 12 of 17)

Temperature Compensation:

The temperature compensation function is used to minimize the temperature induced measurement error portion of the analog measurement error.

OFFSET FUNCTION:

Arithmetic compensation for measurement offset errors is performed by entering the proper compensation value.

AVAILABLE FUNCTIONS

COMPARATOR:

10-bin sorting for the primary parameter, and go/no-go testing for the secondary parameters. Usually the primary parameter is capacitance and the secondary parameters are **D**, **Q**, **ESR**, or **G**, but this can be changed.

Sorting Modes:

Sequential sorting into un-nested bands with absolute limits, and tolerance sorting into nested bands with absolute or percentage limits.

Decision Output:

Bin number, out of bins, status information are displayed. Also output via handler interface and HP-IB interface, if these interface Options are installed.

Bin Counts:

A maximum of 999,999 for each bin.

Monitor:

Displays all limits with bin counts or decision outputs with the measurement values can be displayed.

MEMORY CARD:

External memory for storing and recalling control settings, and comparator limits data.

KEYBOARD LOCK-OUT:

Disables all front panel operation except for resetting KEYBOARD LOCK-OUT.

SELF TEST:

Checks basic instrument operation.

Table 5-7. Specifications (Sheet 13 of 17)

OPTIONS

COMMON OPTIONS:

Option 001 -- 1kHz Test Frequency Only:

All capabilities/functions available except for 1MHz measurements.

Option 002 -- 1MHz Test Frequency Only:

All capabilities/functions available except for 1kHz measurements.

Option 003 -- 1% Frequency Shift:

Test frequency is 1% higher than the standard unit to prevent possible test signal interference when the component test contacts are located close to those of other test units.

DATA OUTPUT/REMOTE CONTROL OPTIONS:

Option 101 -- HP-IB Interface:

Remote control and data output (ASCII and binary) via the HP-IB. Based on IEEE-STD488 and ANSI-MC1.1.

Remote Control All the front panel controls except for the power line switch.

Data Output all of the control setting status, measurement values, self test results, comparator's limit values, decision output, and bin count data

Table 5-7. Specifications (Sheet 14 of 17)

HANDLER INTERFACE OPTIONS:

Option 201 -- Handler Interface:

Output signal:	Negative true, open collector, photo isolated.
Decision output:	Bin number, out of bins, and rejection status.
Index:	Analog measurement complete.
Measurement complete:	Full measurement complete.
Alarm:	Notification that a momentary power failure was detected, or that an anomaly was detected during self test or during an A-D conversion within a measurement cycle.
Input signal:	Photo isolated.
Keylock:	Front panel keyboard lockout
External trigger:	Pulse width $\geq 1\mu\text{s}$

Option 202 -- Handler Interface:

Output signals:	Opto-isolated and Open collector with internal pull-up resistor (to + 5V), or external pull-up resistor and pull-up supply voltage (+ 40V, 80ma maximum).
Decision output :	Bin number.
EOC:	End Of Conversion A/D Output.
BUSY:	4278A is busy with conversion and calculation.
Input signal:	Opto-isolated or Open collector TTL. Opto-isolated input is a current input (5mA - 60mA). TTL input is a schmitt-trigger input (hysteresis = 0.8V) with an internal 1K Ω pull-up resistor.
START IN:	Input trigger to start measurement. Minimum required pulse width is $\geq 5\mu\text{s}$ (50 μs with W11 installed).

Table 5-7. Specifications (Sheet 15 of 17)

SCANNER INTERFACE OPTIONS:

Option 301 -- Scanner Interface:

The scanner interface adds the following functions to the 4278A.

1. Timing synchronization between an external component scanner and the 4278A.
2. After storing up to 500 sets of measurement data, block transfers the stored data to the controller via HP-IB.
3. Independently compensate each channel of the scanner.

Option 301 is installed only in instruments with ROM-based firmware 3.0 and above.

Interface Connector: Amphenol 14 pin connector

Maximum Number of Channel: 256

Input Signal:

/CH0 to /CH7: 8-bit parallel input signals for selecting the channel number.

/CH_VALID: Signal valid or invalid for **/CH0** to **/CH7**.

EXT_TRIG: External trigger signal (1 bit)

Output Signal:

/INDEX: Analog measurement complete (1 bit).

/EOM: Full measurement complete (1 bit).

Multi-Channel Compensation:

The multi channel compensation can store OPEN, SHORT, STANDARD compensation data for each channel independently, and compensate each channel.

OTHER OPTIONS:

Option 907 -- Front Handle Kit

Option 908 -- Rack Flange Kit

Option 909 -- Rack Flange/Handle Kit

Table 5-7. Specifications (Sheet 16 of 17)

ACCESSORIES

FURNISHED ACCESSORIES:

Memory Card	HP PN 04278-89001, 1ea.
Power Cable	Depends on what country the 4278A is being used in. Refer to Table 2-2.

AVAILABLE ACCESSORIES:

Test Fixtures, Test Leads:

HP 16334A	(1m, Tweezer-type for Chip Components)
HP 16047A	(0m, Direct-coupled to UNKNOWN terminals)
HP 16047C	(0m, Direct-coupled to UNKNOWN terminals)
HP 16048A	(1m, BNC)
HP 16048B	(1m, SMC)
HP 16048D	(2m, BNC)

Memory Card:

HP PN 04278-89001	Memory Card, 1ea.
HP 16470A	Memory Card Set, 10ea.

HP-IB Interconnection Cables for Option 101:

HP 10833A	HP-IB Cable, 1m
HP 10833B	HP-IB Cable, 2m
HP 10833C	HP-IB Cable, 4m
HP 10833D	HP-IB Cable, 0.5m

Table 5-7. Specifications (Sheet 17 of 17)

Handler Interface Connector for mating with Option 201:

HP PN 1251-0084 Connector 36 pin (AMPHENOL)

Impedance Standards:

HP 16380A Standard Air Capacitor Set
(1,10,100, and 1000pF)

HP 16380C Capacitance Standard Set (0.01,0.1, and 1 μ F)

HP 16074A Calibration R-L Standard
(0.1, 1, 10, and 100 Ω and 1, 10, and 100k Ω)

Maintenance Accessories:

HP PN 04278-65001 Handler Simulator (for Option 201, 202)

HP PN 04278-61635 Cable (for Option 202)

HP PN 04278-65301 Scanner Simulator (for Option 301)

HP PN 04278-66596 Extender Board (Half size board)

HP PN 04278-66597 Extender Board (Digital board)

HP PN 04278-66598 Extender Board (Analog Board)

HP PN 04278-90100 Maintenance Manual

SUPPLEMENTAL CHARACTERISTICS

Table 5-8. Supplemental Performance Characteristics (sheet 1 of 3)

STABILITY:

Applies to measurement time LONG at constant temperature.

C: $\leq 0.01\%/day$

D: $\leq 0.0001/day$

TEMPERATURE COEFFICIENTS:

For measurement time LONG and temperature range $23^{\circ}C \pm 5^{\circ}C$.

C: $\leq 0.01\%/^{\circ}C$

D: $\leq 0.00004/^{\circ}C$ (@ 1MHz High Accuracy Mode)

D: $\leq 0.0001/^{\circ}C$ (@ 1kHz and 1MHz Normal Mode)

MEASUREMENT RECOVERY TIME:

Within 1ms after an overload condition (due to a shorted capacitor connected to the **UNKNOWN**) is removed. Measurement time under overload is the same as the specified measurement time.

SETTLING TIMES:

Typical settling time for test signal or range selection.

Test frequency: 100ms

Signal level: 100ms

Range: 100ms (Manual and Remote)

INPUT PROTECTION:

Internal circuit protection against a capacitor discharging into the **UNKNOWN** terminals. The maximum capacitor voltage is given as:

$$V_{max} = \sqrt{2/C} \quad (V_{max} \leq 1kV)$$

where: **C** is capacitance in farads.

MEASUREMENT TIME:

MEASUREMENT TIME MODE	MEASUREMENT TIME			
	SETTLING	ANALOG	DIGITAL	TOTAL
SHORT	1ms	1.7ms	4ms	$6.5 \pm 0.5ms$
MEDIUM	1ms	5.4ms	4ms	$10 \pm 1ms$
LONG	1ms	13.6ms	6ms	$21 \pm 1ms$

Table 5-8. Supplemental Performance Characteristics (sheet 2 of 3)

NOTE

- (1) **SETTLING:** Settling time.
ANALOG: Analog measurement time.
DIGITAL: Calculation and comparison.
- (2) Individual times for settling, analog measurement, calculation and comparison are supplemental performance characteristics (not specified).
- (3) Display time is additional to measurement time and dependent on display page as given below:

DISPLAY PAGE	DISPLAY TIME
MEAS PAGE	5.0ms
LIMIT PAGE	2.0ms
SORT PAGE	2.4ms
STATUS PAGE	0.0ms

- (4) For data transfer time, refer to supplemental characteristics of the interface options.

ACCURACY AT D<0.1:

Multiply the following parameters to obtain the accuracy values shown in Tables A, B, and C.

$$\begin{aligned} \Delta C/C: & \quad \sqrt{1+D^2} \\ \Delta D: & \quad 1+D \\ \Delta G: & \quad \sqrt{1+(G/w/C)^2} \\ \Delta R: & \quad \sqrt{1+(w \times C \times R)^2} \end{aligned}$$

Where, **C, D, G, R** is the measurement reading.
 (@ 1kHz, 1MHz Normal Mode Measurement)

HP-IB (OPTION 101):

Data output: Max. 75 bytes/ms, depending on the controller being used.

Handshake: Typical 2 to 3ms (when used with an HP 9826/9836), depending on the controller being used.

Table 5-8. Supplemental Performance Characteristics (sheet 3 of 3)

SCANNER INTERFACE (OPTION 301):

Electrical Characteristics:

(1) Input signal characteristics: photo isolate, negative true

Signal Name	Input Voltage Rate		External Pull-Up Voltage	Input Current
	High	Low		
/CH0 to /CH7 /CH_VALID	Pull-Up Voltage	≤1 V	5 to 15 V	5 to 20 mA
EXT_TRIG	Pull-Up Voltage	≤1 V	5 to 15 V	6.3 to 15 mA

(2) Output signal characteristics: Opto-isolated, Open Collector, Negative True

Signal Name	External Pull-Up Voltage	Maximum Current
/INDEX /EOM	max. 15 V	6 mA

Measurement time:

When multi channel compensation is performed, the following times are added to the measurement time.

Test Freq.	Compen. Data Switching Time	Calculation Time and Binning Time	Measurement Time
1 kHz	+approx. 0.8 ms	+approx. 0.6 ms	+approx. 1.4 ms
1 MHz	+approx. 0.8 ms	+approx. 1.5 ms	+approx. 2.3 ms

note: 1. Add the compensation data switching time to the measurement time when delay time = 0 ms.

2. The value monitor function: OFF

SECTION 6

PERFORMANCE TESTS

6-1. INTRODUCTION	6-1
6-2. TEST EQUIPMENT	6-1
6-3. PERFORMANCE TEST RECORD	6-2
6-4. CALIBRATION CYCLE	6-2
6-5. TEST FREQUENCY ACCURACY TEST	6-4
6-6. TEST SIGNAL LEVEL ACCURACY TEST	6-5
6-7. 1KHZ CAPACITANCE ACCURACY TEST	6-7
6-8. 1MHZ CAPACITANCE ACCURACY TEST	6-12
6-9. STORE AND LOAD FUNCTION TEST	6-18
6-10. HP-IB INTERFACE TEST (OPTION 101 ONLY)	6-19
6-11. HANDLER INTERFACE FUNCTION TEST (OPTION 201)	6-21
6-12. HANDLER INTERFACE FUNCTION TEST (OPTION 202)	6-25
6-13. SCANNER INTERFACE FUNCTION TEST (OPTION 301)	6-28

1
2
3
4
5
6
7
8
9
10
11
12
13
14
15
16
17
18
19
20
21
22
23
24
25
26
27
28
29
30
31
32
33
34
35
36
37
38
39
40
41
42
43
44
45
46
47
48
49
50
51
52
53
54
55
56
57
58
59
60
61
62
63
64
65
66
67
68
69
70
71
72
73
74
75
76
77
78
79
80
81
82
83
84
85
86
87
88
89
90
91
92
93
94
95
96
97
98
99
100

SECTION 6

PERFORMANCE TESTS

6-1. INTRODUCTION

This section provides the test procedures to verify that the HP 4278A meets the specifications listed in Table 5-7. All tests can be performed without accessing the interior of the instrument. Performance tests are used to perform incoming inspection and to verify that the 4278A is within its performance specifications after troubleshooting or adjustment have been performed. If the performance tests indicate that the 4278A is not within specifications, check your test setup, then proceed to Adjustments or Troubleshooting as required.

NOTE

Allow the 4278A to warm up for at least 10 minutes before you execute any of the performance tests.

NOTE

Performance tests are valid only when performed in an ambient temperature of $23^{\circ}\text{C} \pm 5^{\circ}\text{C}$.

6-2. TEST EQUIPMENT

Table 6-1 lists the test equipment required to perform the tests described in this section. Use only calibrated test instruments when performance testing the 4278A. If the recommended test equipment is not available, equipment with specifications equal to or surpassing those of the recommended equipment may be used.

NOTE

Components used as standards must be (1) calibrated using an instrument whose specifications are traceable to the National Institute of Standards and Technology (NIST) or an equivalent standards group, or (2) calibrated directly by an authorized calibration organization, such as NIST. The calibration cycle depends on the stability specification of each component.

6-3. PERFORMANCE TEST RECORD

Record the results of each performance test in the Performance Test Record located at the end of this section. The performance record lists each test, parameters tested, and acceptable tolerance limits. Keep a record of past performance test results for comparison purposes to help indicate any possible areas of developing trouble.

NOTE

The test limits indicated in each performance test do not take into account the measurement errors induced by the test equipment used. Be sure to consider this when determining whether the 4278A meets its indicated specifications.

6-4. CALIBRATION CYCLE

The 4278A requires periodic performance verification. How often you verify performance depends on the operating and environmental conditions. Check the 4278A using the performance tests described in this section at least once a year. To minimize instrument downtime and to ensure optimum operation, perform preventive maintenance and calibration at least twice a year.

Table 6-1. Recommended Test Equipment (1 of 2)

Equipment	Requirements	Recommended Model
Electronic Counter	Frequency: 1kHz to 1MHz Accuracy: <<0.02%	HP 5314A
RMS Voltage Meter	Frequency: 1kHz to 1MHz Accuracy: $\leq 1.0\%$ Voltage range: 0.1Vrms to 1.0Vrms	HP 3400A
Standard Capacitor	Capacitance Range: 1pF to 1 μ F Frequency : 1kHz, 1MHz Calibration Accuracy: <0.01%	HP 16380A HP 16380C
Resistance Standard	OPEN reference SHORT reference 0 Ω standard resistor 10 Ω standard resistor	HP 16074A Standard Resistor Set
Adaptor	BNC(f)-to-BNC(f), 4ea.	HP PN 1250-0080
Cable	BNC(m)-to-BNC(m), 30cm	HP PN 8120-1838

Table 6-1. Recommended Test Equipment (2 of 2)

Equipment	Requirements	Recommended Model
Test Leads	Cable Length, (1m) Cable Length, (2m)	HP 16048A HP 16048D
HP-IB Cable	HP-IB cable, 1m	HP 10833A
Computer	HP Technical Computer	HP 9826
Memory Card	(furnished accessory)	HP PN 04278-89001
Handler Simulator		HP PN 04278-65001
Cable		HP PN 04278-61635
Scanner Simulator		HP PN 04278-65301

6-5. TEST FREQUENCY ACCURACY TEST

This test verifies that the accuracy of the 4278A's test signal frequency is within $\pm 0.02\%$.

NOTE

If the 4278A is equipped with Option 001, perform steps 1 through 3. If the 4278A is equipped with Option 002, perform steps 1, 2, 4, and 5.

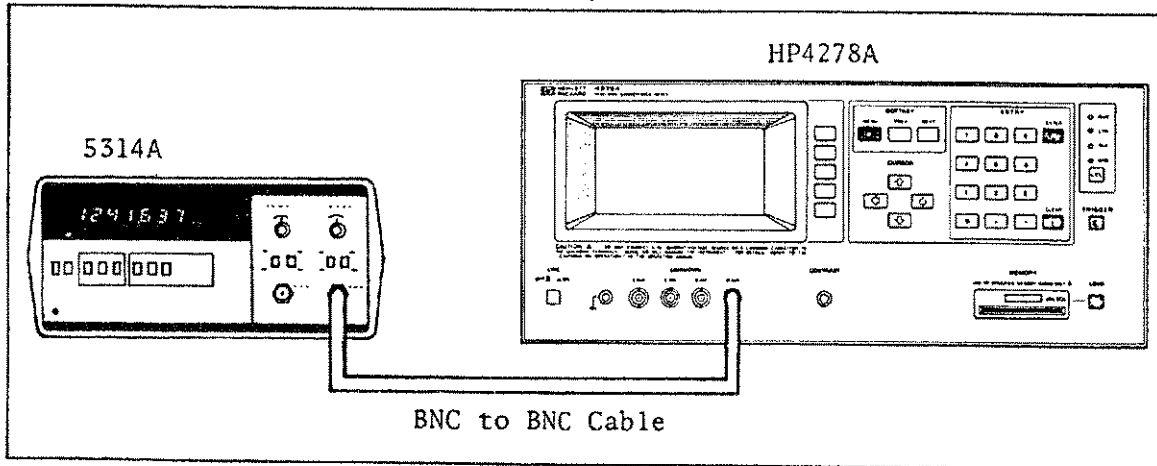

Figure 6-1. Test Frequency Accuracy Test Setup

EQUIPMENT:

Electronic Counter
BNC(m)-to-BNC(m) Cable, 30cm

HP 5314A
HP PN 8120-1838

PROCEDURE:

1. Connect **INPUT B** of the 5314A to the 4278A's Hcur terminal as shown in Figure 6-1.
2. Set the controls of the 4278A as follows:

Test Frequency	1kHz
OSC level	1.0Vrms
Other Controls	Initial Settings
3. Confirm that the frequency is $1\text{kHz} \pm 0.2\text{Hz}$.
4. Set the test frequency to 1MHz.
5. Confirm that the frequency is $1\text{MHz} \pm 200\text{Hz}$.

NOTE

If the 4278A is equipped with Option 003, the test limits are $1.01\text{kHz} \pm 0.202\text{Hz}$ at 1kHz and $1.01\text{MHz} \pm 202\text{Hz}$ at 1MHz.

6-6. TEST SIGNAL LEVEL ACCURACY TEST

This test verifies that the 4278A's test signal level is within the specified level accuracy of $\pm 10\%$.

NOTE

If the 4278A is equipped with Option 001, perform steps 1 through 3. If the 4278A is equipped with Option 002, perform steps 1, 4, and 5.

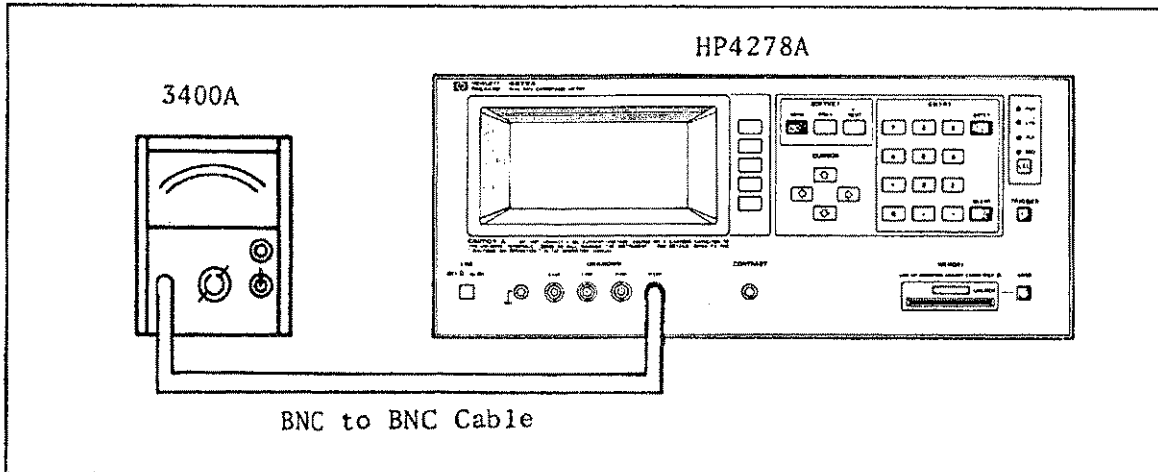

Figure 6-2. Test Signal Level Accuracy Test Setup

EQUIPMENT:

RMS Voltage Meter

HP 3400A

BNC(m)-to-BNC(m) Cable, 30cm

HP PN 8120-1838

PROCEDURE:

1. Connect the 3400A to the 4278A as shown in Figure 6-2.
2. Set the 4278A's controls as follows:

Test Frequency	1kHz
Measurement Range	10 μ F
Other Controls	Initial Settings

3. Set the **OSC level** in accordance with Table 6-2, and confirm that the output level of the 4278A is within the test limits given in Table 6-2.

4. Change the 4278A's controls as follows:

Test Frequency	1MHz
Measurement Range	1024pF
Other Controls	Initial Settings

5. Repeat step 3.

Table 6-2. Test Signal Level Test Limits

OSC Level	Test Limits
0.1V	0.09V to 0.11V
0.2V	0.18V to 0.22V
0.3V	0.27V to 0.33V
0.4V	0.36V to 0.44V
0.5V	0.45V to 0.55V
0.6V	0.54V to 0.66V
0.7V	0.63V to 0.77V
0.8V	0.72V to 0.88V
0.9V	0.81V to 0.99V
1.0V	0.90V to 1.10V

6-7. 1kHz CAPACITANCE ACCURACY TEST

This capacitance test verifies the 4278A's measurement accuracy at 1kHz. Capacitance accuracy checks are made by connecting a standard capacitor to the 4278A and comparing measurement results with the calibrated values of the standard. Accuracies for dissipation factors near zero are also checked during this test.

NOTE

If the 4278A is equipped with Option 002, proceed to paragraph 6-8.

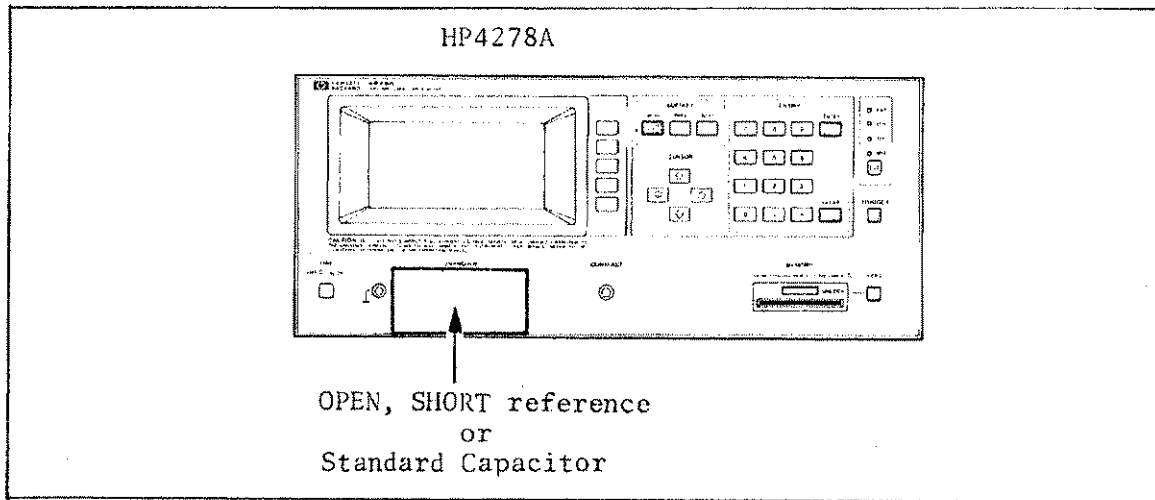

Figure 6-3. Capacitance Accuracy Test Set Up 1

EQUIPMENT:

100pF Standard Capacitor	HP 16383A	} HP 16380A
1000pF Standard Capacitor	HP 16384A	
0.01 μ F Standard Capacitor	HP 16385A	} HP 16380C
0.1 μ F Standard Capacitor	HP 16386A	
1 μ F Standard Capacitor	HP 16387A	
0 Ω standard resistor	} HP 16074A	Standard resistor set
10 Ω standard resistor		
OPEN reference		
SHORT reference		
Test Leads	HP 16048A	
	HP 16048D	
BNC(f)-to-BNC(f) Adapter	HP PN 1250-0080 (4ea.)	

PROCEDURE:

1. Connect the **OPEN** reference to the 4278A's **UNKNOWN** terminals.
2. Set the 4278A's controls as follows:

Test Frequency	1kHz
Measurement Parameter	Cp-D
Measurement Range	100pF
OSC Level	1.0Vrms
INTEG TIME	LONG
Trigger Mode	MAN TRIG
Cable Length	0m
Other Controls	Initial Settings

[0m Open Compensation]

3. Press the **MENU** key.
4. Press the **NEXT** key.
5. Press the '**COMPEN**' softkey.
6. Press the '**OPEN COMPEN**' softkey. Wait for the completion of the measurement.
7. Press the '**OPEN ON**' softkey.

[0m Short Compensation]

8. Disconnect the **OPEN** reference, and connect the **SHORT** reference to the **UNKNOWN** terminals.
9. Press the **NEXT** key.
10. Press the '**SHORT COMPEN**' softkey. Wait for the completion of the measurement.
11. Press the '**SHORT ON**' softkey.

[Temperature Compensation]

12. Press the **NEXT** key three times, then press the '**TEMP COMPEN**' softkey.

[Range Change Accuracy Check]

13. Disconnect the **SHORT** reference, and connect the 100pF standard capacitor to the **UNKNOWN** terminals.
14. Press the **TRIGGER** key.
15. Confirm that **Cp** and **D** are within the test limits in Table 6-3.
16. Set the standard capacitor and the measurement range in accordance with Table 6-3, and repeat steps 14 and 15.
17. Set the **OSC** level to 0.3V.
18. Repeat steps 14 through 16.

Table 6-3. 1kHz Capacitance Accuracy Test limits 1

Setting		Test Limits	
Standard Capacitor	Measurement Range	Cp	D
100pF	100pF	C.V. $\pm 0.100\text{pF}$ (C.V. $\pm 0.102\text{pF}$)	± 0.00060 (± 0.00062)
1000pF	1nF	C.V. $\pm 0.00100\text{nF}$ (C.V. $\pm 0.00102\text{nF}$)	± 0.00060 (± 0.00062)
0.01 μF	10nF	C.V. $\pm 0.0100\text{nF}$ (C.V. $\pm 0.0102\text{nF}$)	± 0.00070 (± 0.00072)
0.1 μF	100nF	C.V. $\pm 0.100\text{nF}$ (C.V. $\pm 0.102\text{nF}$)	± 0.00070 (± 0.00072)
1 μF	1 μF	C.V. $\pm 0.00100\mu\text{F}$ (C.V. $\pm 0.00102\mu\text{F}$)	± 0.00080 (± 0.00082)

C.V. : Calibration value of each standard capacitor.

Cp and **D** limit values in parenthesis only apply for the **OSC LEVEL 0.3V** setting.

19. Disconnect the 1 μF standard capacitor, and connect the 0 Ω standard resistor to the **UNKNOWN** terminals.
20. Change the 4278A's controls as follows:

Measurement Parameter	Cs-Rs
Measurement Range	100 μF
Osc Level	1.0Vrms

21. Press the **TRIGGER** key.
22. Note the value of R_s as R_0 (Ω).
23. Disconnect the 0Ω standard resistor, and connect the 10Ω standard resistor to the **UNKNOWN** terminals.
24. Press the **TRIGGER** key.
25. Note the value of R_s as R_{10} (Ω).
26. Calculate the following formula:

$$R = R_{10} - R_0 \text{ (}\Omega\text{)}$$

27. Confirm that the calculated value for R is within the range of C.V. ± 0.01348 (Ω).

[1m Open Compensation]

28. Disconnect the 10Ω standard resistor, and connect the **OPEN** reference using the 16048A test leads as shown in Figure 6-4.

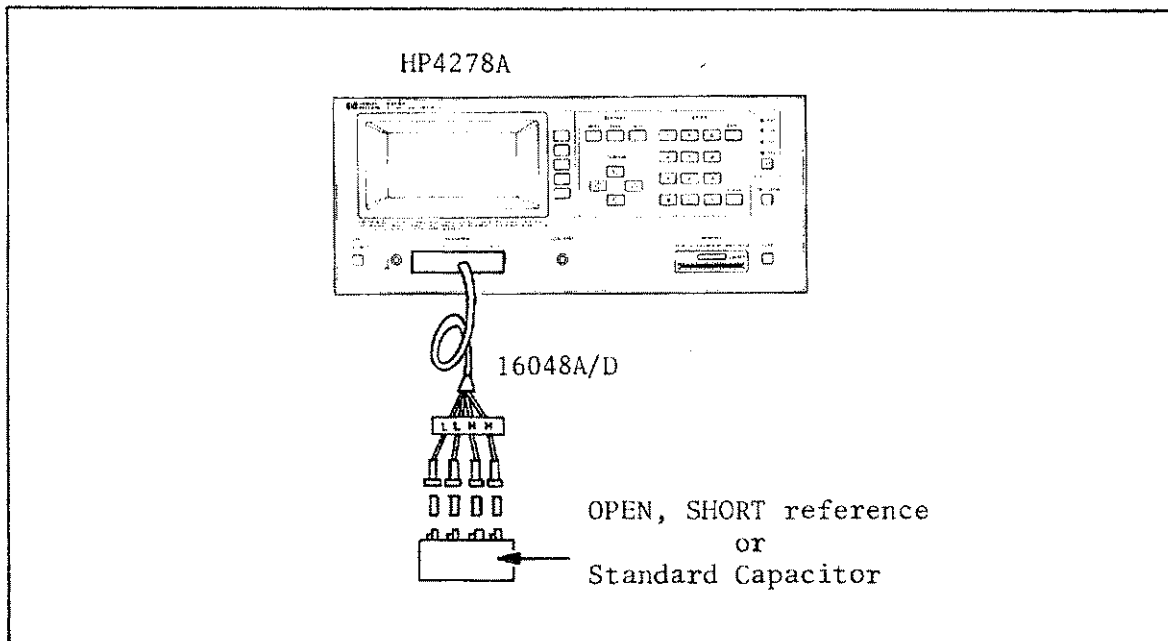

Figure 6-4. 1kHz Capacitance Accuracy Test Setup 2

29. Change the 4278A's controls as follows:

Measurement Parameter	Cp-D
Measurement Range	100pF
Cable Length	1m

30. Press the **MENU** key, the **NEXT** key, and the '**COMPEN**' softkey.
31. Press the '**OPEN COMPEN**' softkey. Wait for the completion of the measurement. Confirm that '**OPEN ON**' is set to **ON**.

[1m Short Compensation]

- 32. Disconnect the **OPEN** reference, and connect the **SHORT** reference to the test leads.
- 33. Press the **NEXT** key.
- 34. Press the '**SHORT COMPEN**' softkey. Wait for completion of the measurement. Confirm that '**SHORT ON**' is set to **ON**.

[Cable Length Compensation Accuracy Check]

- 35. Disconnect the **SHORT** reference and connect the 100pF standard capacitor to the test leads.
- 36. Press the **TRIGGER** key.
- 37. Confirm that **Cp** and **D** are within the test limits in Table 6-4.

[2m Open/Short Compensation and Cable Length Compensation Accuracy Check]

- 38. Disconnect the 16048A test leads and the 100pF standard capacitor. Connect the **OPEN** reference using the 16048D test leads.

NOTE

Make sure there is a good connection between the 4278A's front panel ground terminal (next to the **UNKNOWN** terminals) and the 16048D's ground lead. The ground lead of the 16048D's end of cable should be connected to nothing.

- 39. Set the cable length to 2m.
- 40. Repeat steps 30 through 37.

Table 6-4. 1kHz Capacitance Accuracy Test Limits 2

Setting	Test limits	
Cable Length	Cp	D
1m	C.V. $\pm 0.100\mu\text{F}$	± 0.00060
2m	C.V. $\pm 0.100\mu\text{F}$	± 0.00060

C.V. : Calibration value of the 100pF standard capacitor

6-8. 1MHz CAPACITANCE ACCURACY TEST

This test verifies capacitance measurement accuracy at 1MHz. Capacitance accuracy checks are made by connecting a standard capacitor to the 4278A and comparing the measurement results with the calibrated values of the standard. Measurement accuracy of dissipation factors near zero are also checked in this test.

NOTE

If the 4278A is equipped with Option 001, proceed to the next test.

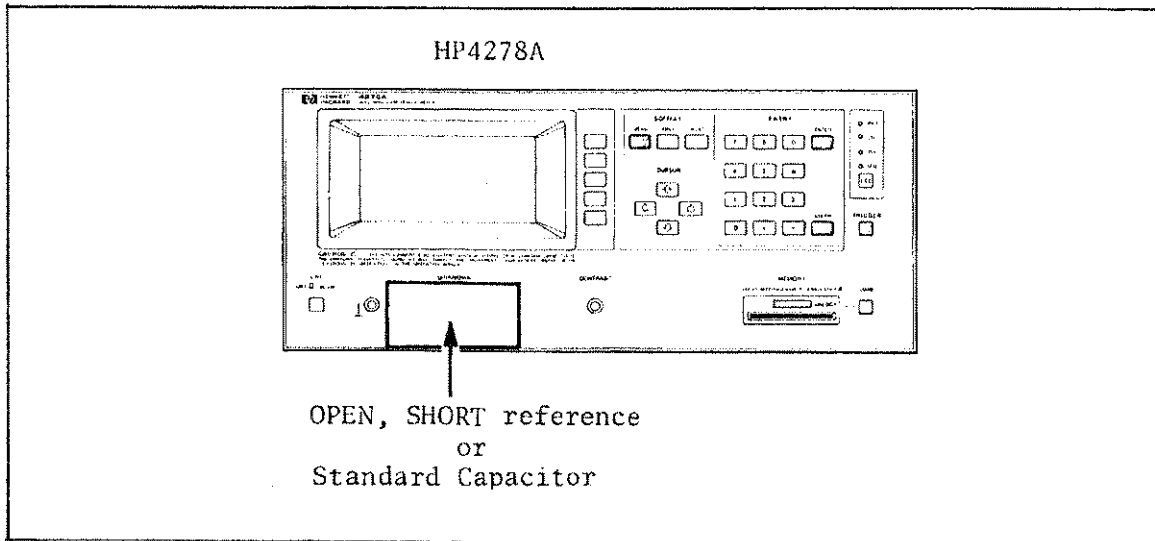

Figure 6-5. 1MHz Capacitance Accuracy Test Set up 1

EQUIPMENT:

1pF Standard Capacitor	HP 16381A	} HP 16380A
10pF Standard Capacitor	HP 16382A	
100pF Standard Capacitor	HP 16383A	
1000pF Standard Capacitor	HP 16384A	
OPEN reference	} HP 16074A	} Standard Resistor Set
SHORT reference		
Test Leads	HP 16048A	
	HP 16048D	
BNC(f)-to-BNC(f) Adapter	HP PN 1250-0080 (4ea.)	

PROCEDURE:

1. Connect the **OPEN** reference to the **UNKNOWN** terminals.
2. Set the 4278A's controls as follows:

Test Frequency	1MHz
HI ACC Mode	ON
Measurement Parameter	Cp-D
INTEG TIME	LONG
Measurement Range	1pF
OSC Level	1.0Vrms
Cable Length	0m
Trigger Mode	MAN TRIG
Other Controls	Initial Settings

[0m Open Compensation]

3. Press the **MENU** key.
4. Press the **NEXT** key.
5. Press the '**COMPEN**' softkey.
6. Press the '**OPEN COMPEN**' softkey. Wait for the measurement to finish.
7. Press the '**OPEN ON**' softkey.

[0m Short Compensation]

8. Disconnect the **OPEN** reference, and connect the **SHORT** reference to the **UNKNOWN** terminals.
9. Press the **NEXT** key.
10. Press the '**SHORT COMPEN**' softkey. Wait for the measurement to finish.
11. Press the '**SHORT ON**' softkey.

[Temperature Compensation]

12. Press the **NEXT** key three times, then press the '**TEMP COMPEN**' softkey.

[Range Change Accuracy Check]

13. Disconnect the **OPEN** reference, and connect the 1pF standard capacitor to the **UNKNOWN** terminals.
14. Press the **TRIGGER** key.
15. Confirm that **Cp** and **D** are within the test limits in Table 6-5.
16. Set the standard capacitor and the measurement range in accordance with Table 6-5. Repeat steps 14 and 15.

Table 6-5. 1MHz Capacitance Accuracy Test limits 1

Setting		Test Limits	
Standard Capacitor	Measurement Range	Cp	D
1pF	1pF	C.V. $\pm 0.0017\text{pF}$	± 0.0009
10pF	10pF	C.V. $\pm 0.010\text{pF}$	± 0.0005
100pF	100pF	C.V. $\pm 0.10\text{pF}$	± 0.0005
1000pF	1000pF	$1.0003 \cdot \text{C.V.} \pm 1.0\text{pF}$	0.00004 ± 0.0006

C.V. : Calibration Value of each standard capacitor at 1kHz

NOTE

The 16380A standard capacitor set is calibrated at 1kHz. Each calibration value at 1MHz of 1pF, 10pF, and 100pF standard capacitor can use the calibration value at 1kHz. But the 1000pF standard capacitor's Calibration value at 1MHz must use the calibration value at 1kHz plus 0.03%. (Refer to the 16380A Data Sheet).

[High Accuracy Mode Accuracy Check]

17. Disconnect the 1000pF standard capacitor, and connect the 10pF standard capacitor to the **UNKNOWN** terminals.
18. Set the measurement range to 8.32pF.
19. Press the **TRIGGER** key.

20. Confirm that **C_p** and **D** are within the test limits in Table 6-6.
21. Set the measurement range in accordance with Table 6-6. Repeat steps 19 and 20.

Table 6-6. 1MHz Standard Capacitance Accuracy Test Limits 3

Setting	Test limits	
	C _p	D
8.32pF	C.V. ±0.010pF	±0.0005
12.16pF	C.V. ±0.010pF	±0.0005
15.04pF	C.V. ±0.010pF	±0.0005

C.V. : Calibration Value of the 10pF Standard Capacitor at 1kHz

[Integration Time Change Accuracy Check]

22. Set the 4278A's controls as follows:

HI ACC Mode	OFF
Measurement Range	8pF

23. Press the **TRIGGER** key.
24. Confirm that **C_p** and **D** are within the test limits in Table 6-7.
25. Set the **INTEG TIME** in accordance with Table 6-7. Repeat steps 23 and 24.

Table 6-7. 1MHz Standard Capacitance Accuracy Test Limits 4

Setting	Test Limits	
	C	D
LONG	C.V. ±0.0116pF	±0.0007
MED	C.V. ±0.0266pF	±0.0019
SHORT	C.V. ±0.067pF	±0.0043

C.V. : Calibration value of the 10pF Standard Capacitor at 1kHz

[1m Open Compensation]

26. Disconnect the 10pF standard capacitor, and connect the OPEN reference using the 16048A test leads as shown in Figure 6-6.

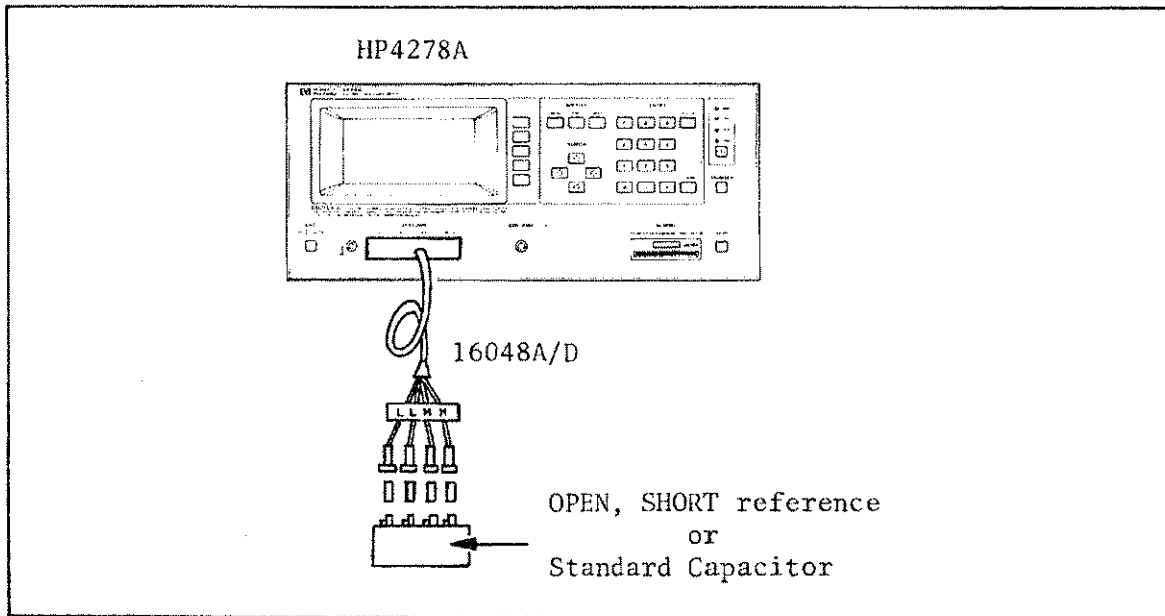

Figure 6-6. 1MHz Capacitance Accuracy Test Setup 2

27. Set the 4278A's controls as Follows:

HI ACC Mode	ON
Measurement Range	100pF
Cable Length	1m
INTEG TIME	LONG

28. Press the **MENU** and **NEXT** keys, then the '**COMPEN**' softkey.
29. Press '**OPEN COMPEN**' softkey. Wait for the completion of the measurement. Confirm that '**OPEN ON**' is set to ON.

[1m Short Compensation]

30. Disconnect the OPEN reference. Connect the SHORT reference to the test leads.
31. Press the **NEXT** key.
32. Press the '**SHORT COMPEN**' softkey. Wait for completion of the measurement. Confirm that '**SHORT ON**' is set to ON.

[Cable Length Compensation Accuracy Check]

33. Disconnect the SHORT reference. Connect the 100pF standard capacitor to the test leads.
34. Press the TRIGGER key.
35. Confirm that **C_p** and **D** are within the test limits in Table 6-8.

Table 6-8. 1MHz Standard Capacitance Accuracy Test Limits 5

Setting Cable Length	Test Limits	
	C	D
1m	C.V.±0.10pF	±0.0005
2m	C.V.±0.10pF	±0.0005

C.V. : Calibration value of the 100pF Standard Capacitor at 1kHz

[2m Open/Short Compensation and Cable Length Compensation Accuracy Check]

36. Disconnect the 16048A test leads and the 100pF standard capacitor. Connect the 16048D test leads to the **UNKNOWN** terminals. Connect the OPEN reference to the test leads.

NOTE

Make sure there is a good connection between the 4278A's front panel ground terminal (next to the **UNKNOWN** terminals) and the 16048's ground lead. The ground lead of the 16048D's end of cables should be connected to nothing.

37. Set the cable length to 2m.
38. Repeat steps 28 through 35.

6-9. STORE AND LOAD FUNCTION TEST

This test verifies the 4278A's ability to store information to, and load information from a memory card.

EQUIPMENT:

Memory Card

HP PN 04278-89001

PROCEDURE:

1. Insert the memory card into the **MEMORY** card slot.
2. Set the 4278A's controls as follows:

Display Page Format	STATUS PAGE
Measurement Parameter	Cp-G
Integration Time	MED
Averaging Time	4
Other Settings	Initial Settings

3. Execute the following key sequence:

- [MENU] key
- [PREV] key
- ['MEMORY CARD'] softkey
- ['STORE'] softkey
- [ENTER] key

4. Remove the memory card.
5. Turn the 4278A off.
6. Turn the 4278A on.
7. Reinsert the memory card.
8. Press the **LOAD** key.
9. Confirm that the 4278A's Display Page Format, Measurement Parameter, Integration Time, and Averaging Rate are the same as the control settings established in step 2.

6-10. HP-IB INTERFACE TEST (OPTION 101 ONLY)

This test verifies the 4278A'S HP-IB function.

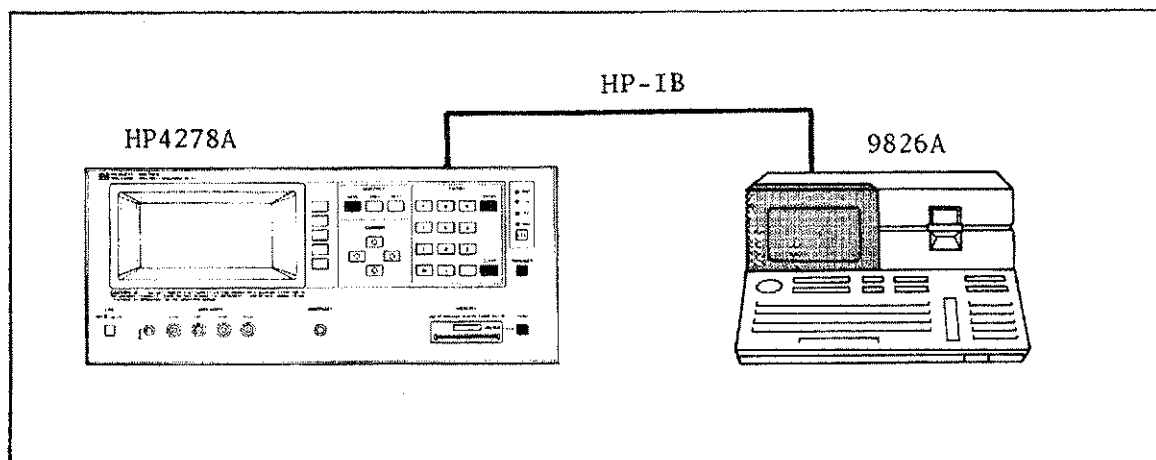

Figure 6-8. HP-IB Interface Test Setup

EQUIPMENT:

Personal Technical Computer
HP-IB Cable

HP 9826
HP 10833A

PROCEDURE:

1. Set the 4278A's HP-IB address to 17.
2. Set up the equipment as shown in Figure 6-8. Use the HP 9826's interface Select Code (7).
3. Load BASIC and input the following program (do not RUN the program yet, however).

```
10 DIM A$(38)
20 OUTPUT 717;"IDN?"
30 ENTER 717;A$
40 PRINT A$
50 OUTPUT 717;"SRE32"
60 OUTPUT 717;"ABC"
70 PRINT SPOLL(717)
80 END
```

4. Press the HP 9826A's STEP key three times to single step to line number 20.
5. Confirm that the LTN and RMT lamps are lit and that the softkey label page cannot be changed by pressing the NEXT key.

6. Press the **LCL** key on the 4278A.
7. Confirm that the **LTN** lamp stays lit, the **RMT** lamp goes out, and the softkey label page can be changed by pressing the **NEXT** key.
8. Press the **STEP** key on the HP 9826 to execute line 30 and confirm that the **TLK** lamp is lit.
9. Step to line 40 and confirm that the following message is displayed on the HP 9826.

"HEWLETPACKARD,4278A,0000A00000,REVn.nn"

n.nn : ROM-based firmware version

10. Step to line 60, and confirm that the **SRQ**, **LTN**, and **RMT** lamps are lit.
11. Step to line 80 and confirm that the status byte value displayed on the HP 9826 is greater than 96.

6-11. HANDLER INTERFACE FUNCTION TEST (OPTION 201 ONLY)

This test verifies option 201 handler interface functions.

EQUIPMENT:

Handler Simulator

HP PN 04278-65001

PROCEDURE:

1. Disconnect the power cable from the 4278A and allow enough time (a few minutes), for the internal capacitors to discharge.

WARNING

DANGEROUS ENERGY/VOLTAGE EXISTS WHEN THE 4278A IS IN OPERATION AND FOR A TIME AFTER IT IS POWERED DOWN. ALLOW A FEW MINUTES FOR THE INTERNAL CAPACITORS TO DISCHARGE.

2. Disconnect the two rear feet which lock the top cover and rear panel together.
3. Fully loosen the top cover retaining screws located on the rear of the top cover.
4. Slide the top cover towards the rear and lift it off. The top shield plate will be visible.
5. Remove the top shield plate to expose the PC boards.
6. Disconnect the flat cable connected to the handler interface board. The handler interface board is the one with the **BLACK** and **ORANGE** extractors (See Figure 6-9).

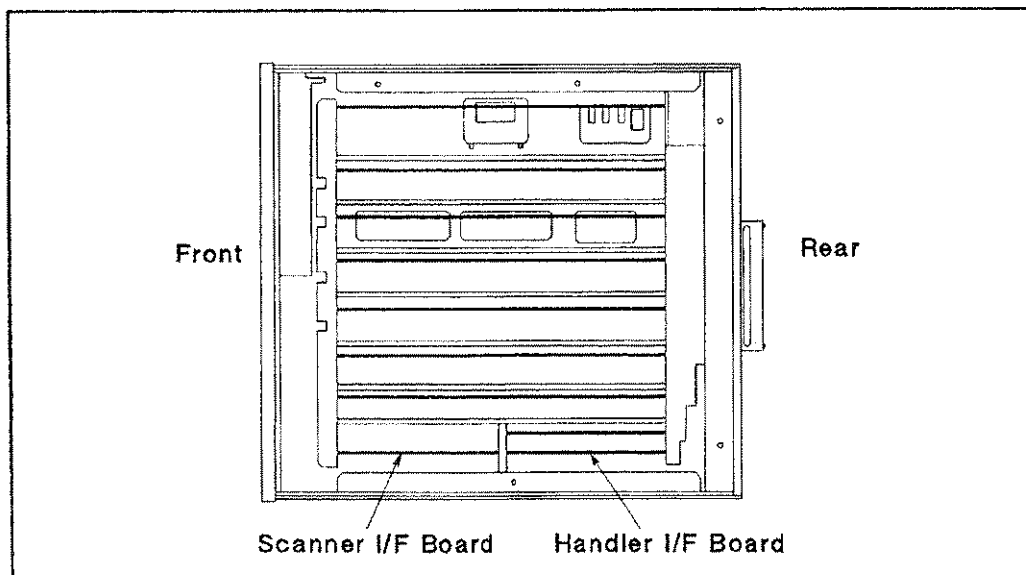

Figure 6-9. Interface Board Location

7. Remove the handler interface board.

NOTE

Before performing step 8, note the jumper settings in order to return them to the same setting at the end of this function test.

8. Set the jumpers on the handler interface board the same settings as when the board is shipped from the factory referring to Figure 6-10.

OPEN : W1, W2, W3, W5, W6, W8, W9, W10
SHORT : W4, W7, W11
OPEN (remove) : R101 thru R121

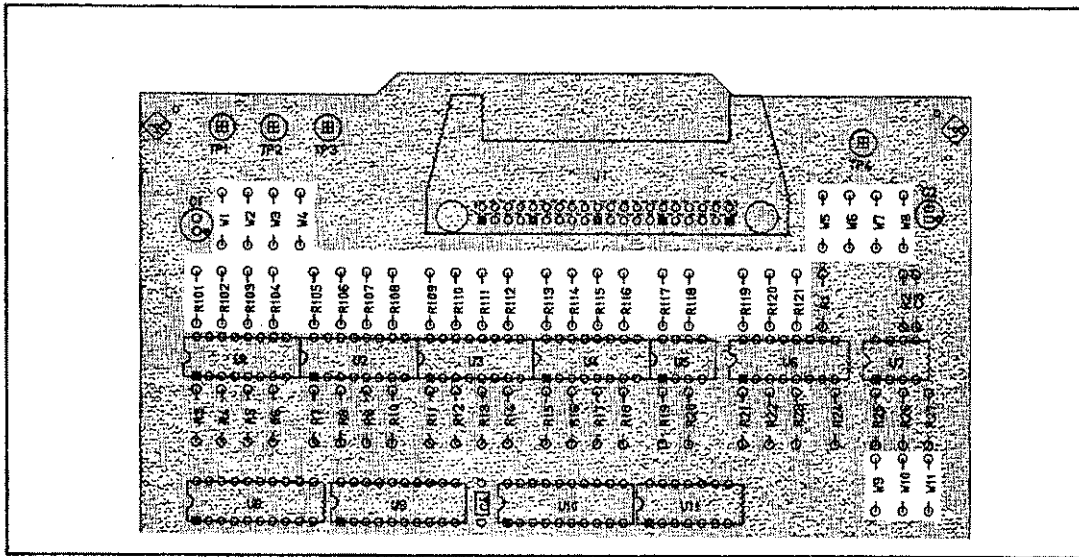

Figure 6-10. Jumper Settings

9. Replace the interface board, top shield plate and top cover.

10. Turn the 4278A on.

11. Connect the handler interface connector on the 4278A's rear panel to the handler simulator as shown in Figure 6-11.

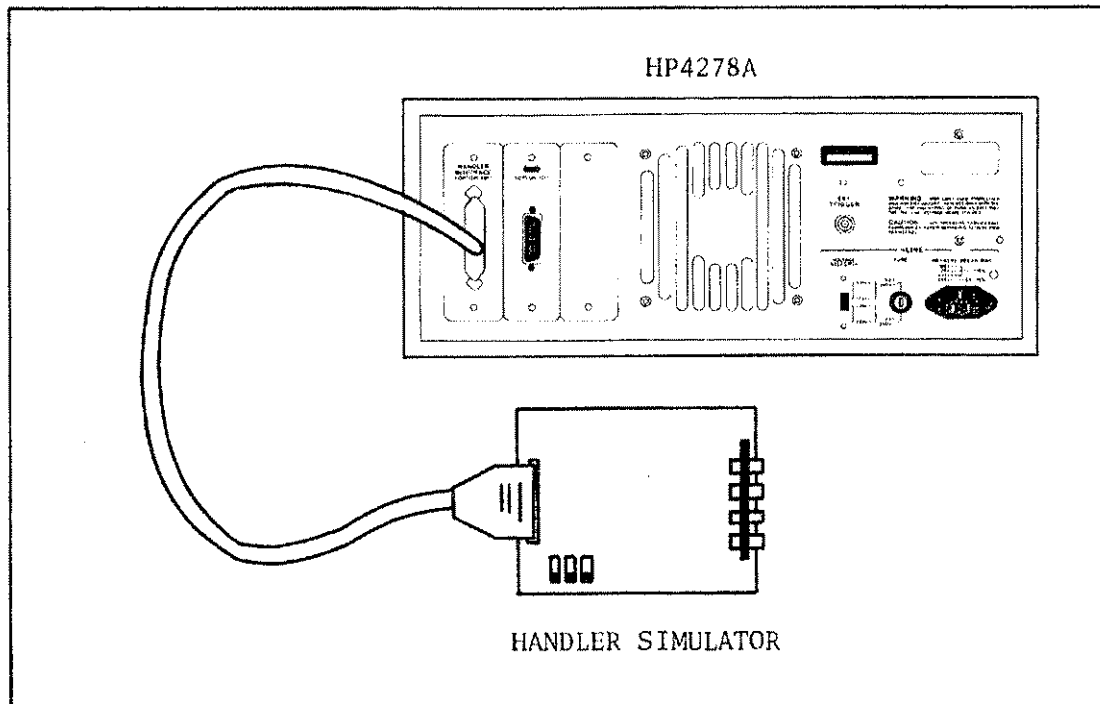

Figure 6-11. Handler Interface Test Setup (Option 201)

12. Press the **MENU** key.
13. Press the **PREV** key.
14. Press the **'SVC FNCTN'** softkey.
15. Press the **'SELF TEST'** softkey.
16. Press the **'TEST NO.='** softkey, the **1** and **4** numeric **ENTRY** keys, and the **ENTER** key to establish the **"TEST No.14 HANDLER I/F TEST"**.
17. Press the **'TEST START'** softkey.

18. Confirm that the LEDs on the handler simulator board light in the sequence shown in Figure 6-12.

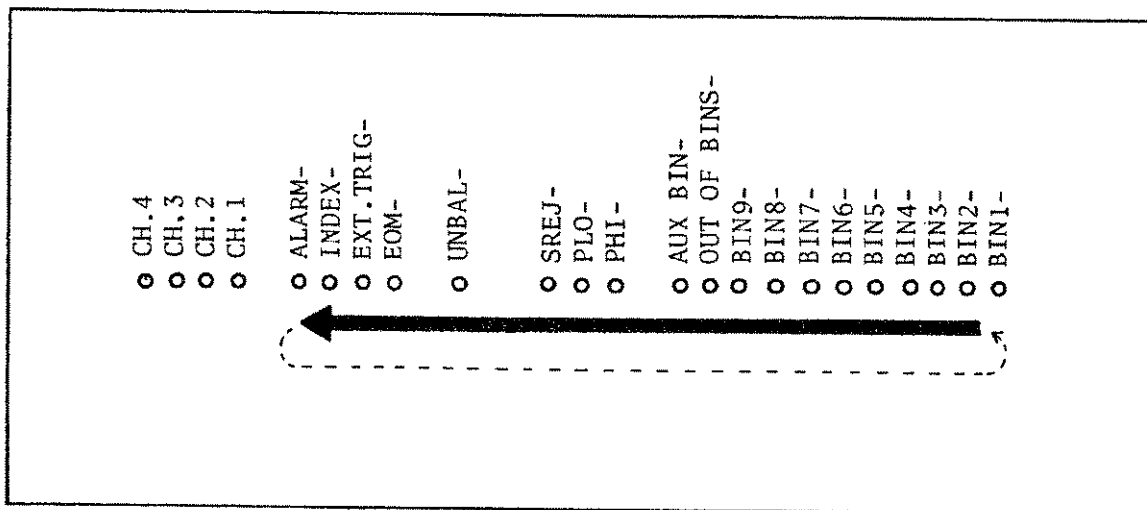

Figure 6-12. Handler Interface Function Check (Option 201)

19. Press the 'exit TEST' softkey.

CAUTION

DO NOT EXECUTE ANY SELF TEST EXCEPT FOR THE HANDLER I/F TEST OR THE 4278A WILL BECOME INOPERATIVE. THE REMAINING SELF TESTS ARE FOR SERVICE USE ONLY.

20. Replace the jumpers and resistors to previous setting.
21. Replace the top shield plate, rear feet, and top cover.

6-12. HANDLER INTERFACE FUNCTION TEST (OPTION 202 ONLY)

This test verifies option 202 handler interface functions. When this test is performed the following LEDs **WILL NOT** turn ON because the signals they represent are not used by the Option 202 handler interface board.

PHI-, PLO-, SREJ-, UNBAL- and ALARM-

EQUIPMENT:

Handler Simulator
Cable

HP PN 04278-65001
HP PN 04278-61635

PROCEDURE:

1. Perform steps 1 through 5 described on page 6- .
2. Disconnect the flat cable connected to the handler interface board. The handler interface board is the one with the **BROWN** and **ORANGE** extractors (See Figure 6-9).
3. Remove the handler interface board.

NOTE

Before performing step 4, note the jumper settings in order to return them to the same setting at the end of this function test.

4. Set the jumpers on the handler interface board the same settings as when the board is shipped from the factory referring to Figure 6-13.

OPEN : W1, W4, W5, W7, W8, W11, W12
 SHORT : W2, W3, W6, W9, W10, W13
 OPEN (remove) : R101 thru R113

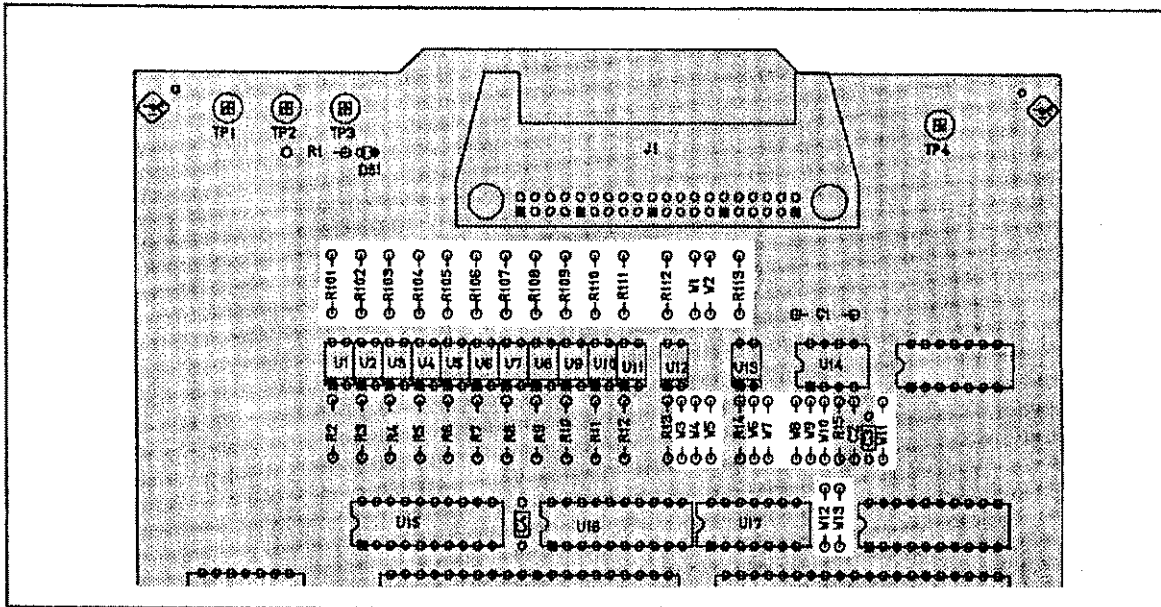

Figure 6-13. Jumper Settings

5. Replace the handler interface board, top shield plate and the top cover.
6. Turn the 4278A on.
7. Connect the handler interface connector on the 4278A's rear panel to the handler simulator as shown in Figure 6-14.

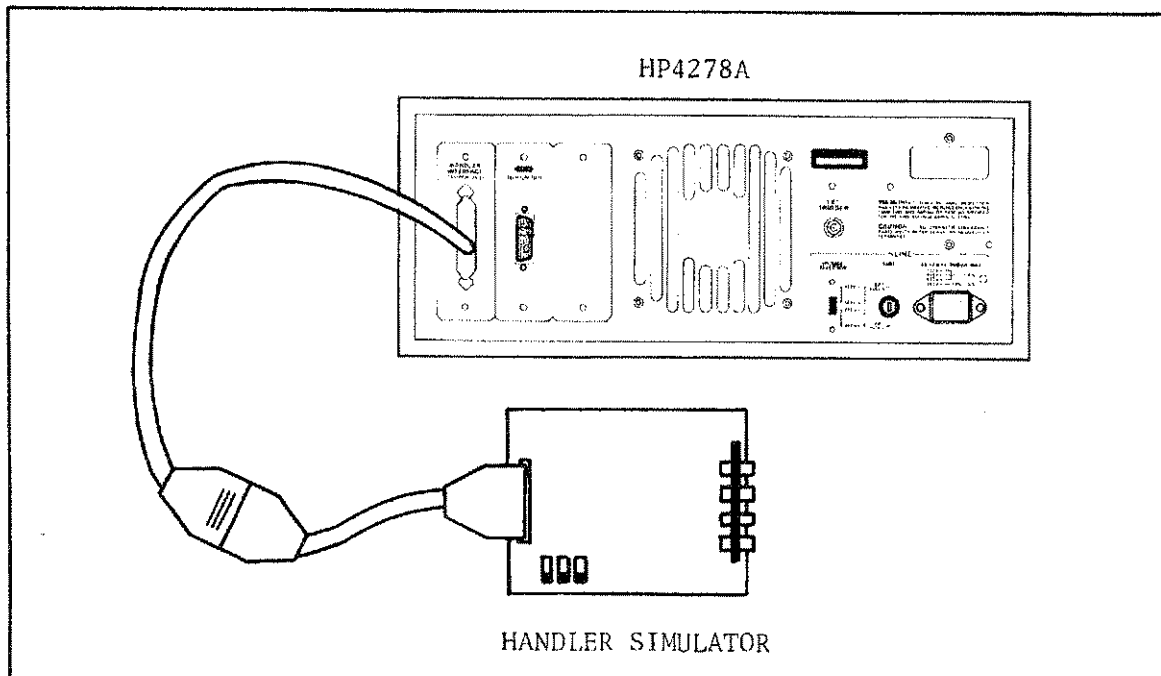

Figure 6-14. Handler Interface Test Setup (Option 202)

8. Press the **MENU** key.
9. Press the **PREV** key.
10. Press the '**SVC FNCTN**' softkey.
11. Press the '**SELF TEST**' softkey.
12. Press the '**TEST NO.=**' softkey, the 1 and 4 numeric **ENTRY** keys, and the **ENTER** key to establish the "**TEST No.14 HANDLER I/F TEST**".
13. Press the '**TEST START**' softkey.
14. Confirm that the LEDs on the handler simulator board light in the sequence shown in Figure 6-15.

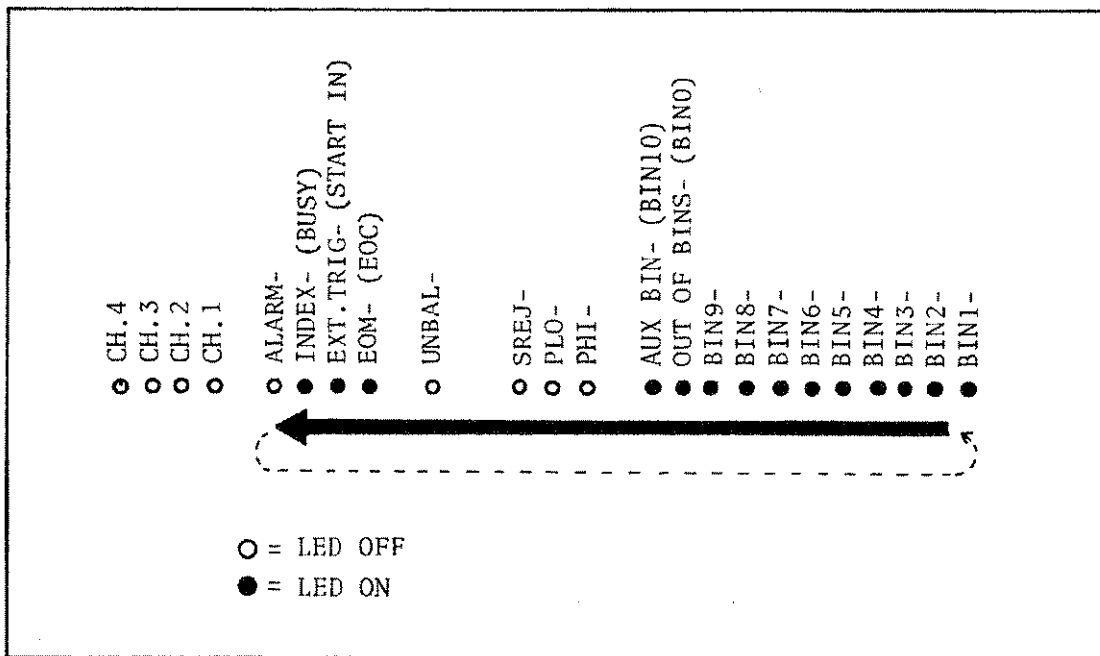

Figure 6-15. Handler Interface Function Check (Option 202)

15. Press the '**exit TEST**' softkey.

CAUTION

DO NOT EXECUTE ANY SELF TEST EXCEPT FOR THE HANDLER I/F TEST OR THE 4278A WILL BECOME INOPERATIVE. THE REMAINING SELF TESTS ARE FOR SERVICE USE ONLY.

16. Replace the jumpers and resistors to previous setting.
17. Replace the top shield plate, rear feet, and top cover.

6-13. SCANNER INTERFACE FUNCTION TEST (OPTION 301 ONLY)

This test verifies option 301 scanner interface functions.

EQUIPMENT:

Scanner Simulator

HP PN 04278-65301

PROCEDURE:

1. Perform steps 1 through 5 described on page 6- .
2. Disconnect the flat cable connected to the scanner interface board. The scanner interface board is the one with the **BLACK** and **YELLOW** extractors (See Figure 6-9).
3. Remove the scanner interface board.
4. Set SW1 and SW2 on the scanner interface board to the same settings as when the board is shipped from the factory referring to Figure 6-16.

NOTE

Before performing step 4, note the switch settings in order to return to the same settings at the end of this function test.

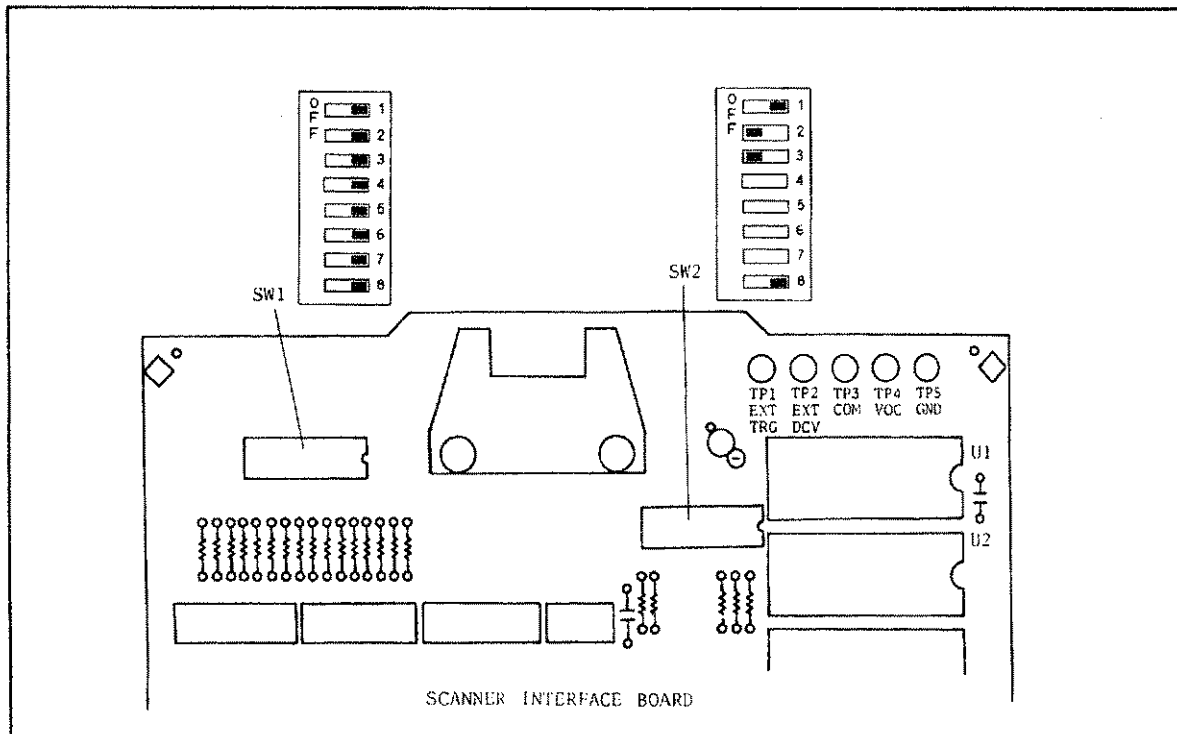

Figure 6-16. SW1 and SW2 settings

5. Replace the scanner interface board and reconnect the flat cable.

NOTE

Step 6 supplies +5 V to the scanner simulator.

6. Use the appropriate power leads and clips to apply +5 V to the scanner simulator, by making connections between TP2(GND) on the scanner simulator and TP5(GND) on the scanner interface board. Connect between TP1(5 V) on the scanner simulator, and TP4(VCC) on the scanner interface board. Figure 6-16 shows the location of TP4 and TP5 on the scanner interface board.
7. Turn the 4278A on.
8. Connect the cable furnished with the scanner simulator to the scanner I/O connector on the rear panel of the 4278A. Refer to Figure 6-17.

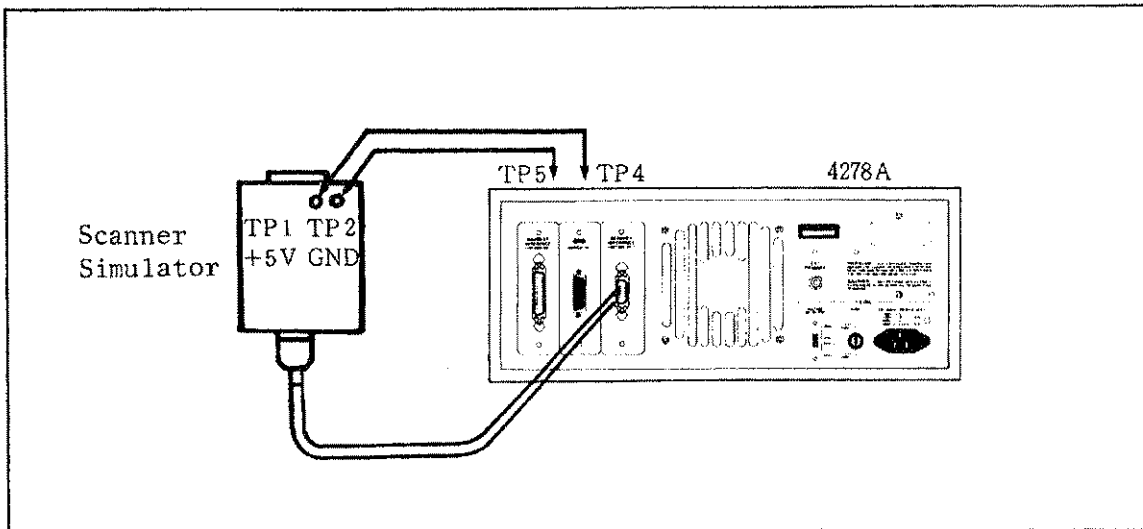

Figure 6-17. Scanner Simulator Connections

9. Press the **MENU** key.
10. Press the **PREV** key.
11. Press the '**SVC FNCTN**' softkey.
12. Press the '**SELF TEST**' softkey.
13. Press the '**TEST NO=**' softkey, the 1, 7 numeric **ENTRY** keys, and the **ENTER** key to establish the "TEST NO.17 SCANNER I/F I/O test".
14. Press the '**TEST START**' softkey.

15. Watch the scanner simulator to confirm that the 4278A's settings displayed in the message area are the same as the signal output.
16. Press the 'exit TEST' softkey.

CAUTION

DO NOT EXECUTE ANY SELF TEST EXCEPT FOR THE ABOVE SELF TESTS OR THE 4278A WILL BECOME INOPERATIVE. THE REMAINING SELF TESTS ARE FOR SERVICE USE ONLY!

17. Set SW1 and SW2 on the scanner interface board to their settings before this test.
18. Replace the top shield plate, rear feet, and top cover.

PERFORMANCE TEST RECORD

Hewlett-Packard 4278A
1kHz/1MHz Capacitance Meter

Tested by _____
Date _____
Serial No. _____

Test	Results		
	Minimum	Actual	Maximum
6-5. TEST FREQUENCY ACCURACY TEST			
Test Frequency: 1kHz	999.8Hz	_____	1000.2Hz
1MHz	999.8kHz	_____	1000.2kHz
Option 003			
Test Frequency: 1kHz	1009.798Hz	_____	1010.202Hz
1MHz	1009.798kHz	_____	1010.202kHz
6-6. TEST SIGNAL LEVEL ACCURACY TEST			
Freq.: 1kHz			
OSC level:	0.1V	0.09V	0.11V
	0.2V	0.18V	0.22V
	0.3V	0.27V	0.33V
	0.4V	0.36V	0.44V
	0.5V	0.45V	0.55V
	0.6V	0.54V	0.66V
	0.7V	0.63V	0.77V
	0.8V	0.72V	0.88V
	0.9V	0.81V	0.99V
	1.0V	0.90V	1.10V
Freq.: 1MHz			
OSC level:	0.1V	0.09V	0.11V
	0.2V	0.18V	0.22V
	0.3V	0.27V	0.33V
	0.4V	0.36V	0.44V
	0.5V	0.45V	0.55V
	0.6V	0.54V	0.66V
	0.7V	0.63V	0.77V
	0.8V	0.72V	0.88V
	0.9V	0.81V	0.99V
	1.0V	0.90V	1.10V

Test		Results		
		Minimum	Actual	Maximum
6-7. 1kHz CAPACITANCE MEASUREMENT ACCURACY TEST				
[Range Change Accuracy Check]				
OSC level=1V Meas. Range:100pF		C	C.V.- 0.100pF	C.V.+ 0.100pF
		D	-0.00060	0.00060
	1nF	C	C.V.- 0.00100nF	C.V.+ 0.00100nF
		D	-0.00060	0.00060
	10nF	C	C.V.- 0.0100nF	C.V.+ 0.0100nF
		D	-0.00070	0.00070
	100nF	C	C.V.- 0.100nF	C.V.+ 0.100nF
		D	-0.00070	0.00070
	1μF	C	C.V.- 0.00100μF	C.V.+ 0.00100μF
		D	-0.00080	0.00080
OSC level=0.3V Meas. Range:100pF		C	C.V.- 0.102pF	C.V.+ 0.102pF
		D	-0.00062	0.00062
	1nF	C	C.V.- 0.00102nF	C.V.+ 0.00102nF
		D	-0.00062	0.00062
	10nF	C	C.V.- 0.0102nF	C.V.+ 0.0102nF
		D	-0.00072	0.00072
	100nF	C	C.V.- 0.102nF	C.V.+ 0.102nF
		D	-0.00072	0.00072
	1μF	C	C.V.- 0.00102μF	C.V.+ 0.00102μF
		D	-0.00082	0.00082
	R = R10 - R0		C.V.- 0.01348Ω	C.V.+ 0.01348Ω

Test		Results		
		Minimum	Actual	Maximum
[Cable Length Compensation Accuracy Check]				
Cable Length: 1m	C	C.V.- 0.100pF	_____	C.V.+ 0.100pF
	D	-0.00060	_____	0.00060
Cable Length: 2m	C	C.V.- 0.100pF	_____	C.V.+ 0.100pF
	D	-0.00060	_____	0.00060
6-8. 1MHz CAPACITANCE MEASUREMENT ACCURACY TEST				
[Range Change Accuracy Check]				
Meas. Range: 1pF	Cp	C.V.- 0.0017pF	_____	C.V.+ 0.0017pF
	D	-0.0009	_____	0.0009
Meas. Range: 10pF	Cp	C.V.- 0.010pF	_____	C.V.+ 0.010pF
	D	-0.0005	_____	0.0005
Meas. Range: 100pF	Cp	C.V.- 0.10pF	_____	C.V.+ 0.10pF
	D	-0.0005	_____	0.0005
Meas. Range: 1000pF	Cp	1.0003×C.V. -1.0pF	_____	1.0003×C.V. +1.0pF
	D	-0.0006	_____	0.0006
[High Accuracy Mode Accuracy Check]				
Meas. Range: 8.32pF	Cp	C.V.- 0.010pF	_____	C.V.- 0.010pF
	D	-0.0005	_____	-0.0005
Meas. Range: 12.16pF	Cp	C.V.- 0.010pF	_____	C.V.- 0.010pF
	D	-0.0005	_____	-0.0005
Meas. Range: 15.04pF	Cp	C.V.- 0.010pF	_____	C.V.- 0.010pF
	D	-0.0005	_____	-0.0005

Test		Results		
		Minimum	Actual	Maximum
[Integ Time Change Accuracy Check]				
Integ.Time: LONG	C	C.V.- 0.0116pF	_____	C.V.+ 0.0116pF
	D	-0.0007	_____	0.0007
Integ.Time: MED	C	C.V.- 0.0266pF	_____	C.V.+ 0.0266pF
	D	-0.0019	_____	0.0019
Integ.Time: SHORT	C	C.V.- 0.067pF	_____	C.V.+ 0.067pF
	D	-0.0043	_____	0.0043
[Cable Length Compensation Accuracy Check]				
Cable Length: 1m	C	C.V.- 0.10pF	_____	C.V.+ 0.10pF
	D	-0.0005	_____	0.0005
Cable Length: 2m	C	C.V.- 0.10pF	_____	C.V.+ 0.10pF
	D	-0.0005	_____	0.0005
6-9. STORE AND LOAD FUNCTION TEST				
		PASS	_____	FAIL
6-10. HP-IB INTERFACE TEST (OPTION 101 ONLY)				
		PASS	_____	FAIL
6-11. HANDLER INTERFACE FUNCTION TEST (OPTION 201 ONLY)				
		PASS	_____	FAIL
6-12. HANDLER INTERFACE FUNCTION TEST (OPTION 202 ONLY)				
		PASS	_____	FAIL
6-13. SCANNER INTERFACE FUNCTION TEST (OPTION 301 ONLY)				
		PASS	_____	FAIL

APPENDIXES

APPENDIX A, MANUAL CHANGES	A-1
APPENDIX B, SOFTKEY TREE	B-1
APPENDIX C, DISPLAY MESSAGES	C-1
APPENDIX D, POSSIBLE PROBLEMS AND THEIR SOLUTIONS	D-1

1
2
3
4
5
6
7
8
9
10
11
12
13
14
15
16
17
18
19
20
21
22
23
24
25
26
27
28
29
30
31
32
33
34
35
36
37
38
39
40
41
42
43
44
45
46
47
48
49
50
51
52
53
54
55
56
57
58
59
60
61
62
63
64
65
66
67
68
69
70
71
72
73
74
75
76
77
78
79
80
81
82
83
84
85
86
87
88
89
90
91
92
93
94
95
96
97
98
99
100

1
2
3
4
5
6
7
8
9
10
11
12
13
14
15
16
17
18
19
20
21
22
23
24
25
26
27
28
29
30
31
32
33
34
35
36
37
38
39
40
41
42
43
44
45
46
47
48
49
50
51
52
53
54
55
56
57
58
59
60
61
62
63
64
65
66
67
68
69
70
71
72
73
74
75
76
77
78
79
80
81
82
83
84
85
86
87
88
89
90
91
92
93
94
95
96
97
98
99
100

APPENDIX A

MANUAL CHANGES

This appendix contains information for adapting this manual to HP 4278A's to which the content of this manual does not directly apply.

To adapt this manual to your 4278A, refer to Table A and make all of the manual changes listed opposite your 4278A's serial number.

If your 4278A's serial number is not listed on the title page of this manual or in Table A, it may be documented in a yellow MANUAL CHANGES supplement. For additional information on serial number coverage, refer to INSTRUMENTS COVERED BY THIS MANUAL in Section 5.

Table A. Manual Changes by Serial Number

Serial Prefix or Number	Make Manual Changes
2725J00473 and below	1, 2, 3, 4
2725J00564 and below	1, 2, 3
2830J01114 and below	1, 2
2830J01159 and below	1

CHANGE 1

The followings are changes to adapt this manual to instruments with firmware version 2.0 and below.

Page 4-1, paragraph 4-2. **OPTION 101 HP-IB INTERFACE**

The following HP-IB device dependent commands cannot be used.

OPM? command: OPEN Compensation Measured Value Query
SHM? command: SHORT Compensation Measured Value Query
STM? command: STANDARD Compensation Measured Value Query
STR? command: STANDARD Compensation Reference Value Query

Thus delete the description for these commands on the following pages.

Page 4-37, 4-55	OPM? command
Page 4-41, 4-55	SHM? command
Page 4-44, 4-55	STM? command
Page 4-45, 4-55	STR? command

CHANGE 2

The followings are changes to adapt this manual to instruments with firmware version 2.1 and below.

Page 4-1, paragraph 4-2. **OPTION 101 HP-IB INTERFACE**

The following HP-IB device dependent commands cannot be used.

CCOU? command: BIN Count Query of the selected channel
CNO= command: Channel number selection
MCOM command: MULTI-COMPEN mode OFF/ON

Thus delete the description for these commands on the following pages.

Page 4-18, 4-56	CCOU? command
Page 4-19, 4-55	CNO= command
Page 4-34, 4-55	MCOM command

Page 4-63, paragraph 4-2-8. **STATUS BYTE**

Change the description of the bit 1 of the status byte, as follows.

BIT 1 (always 0) : This bit is always set to 0 (zero).

Page B-2, APPENDIX B. SOFTKEY TREE

Change the figures of 'Softkey Page 2 of 4' and 'Softkey Page 4 of 4', as follows.

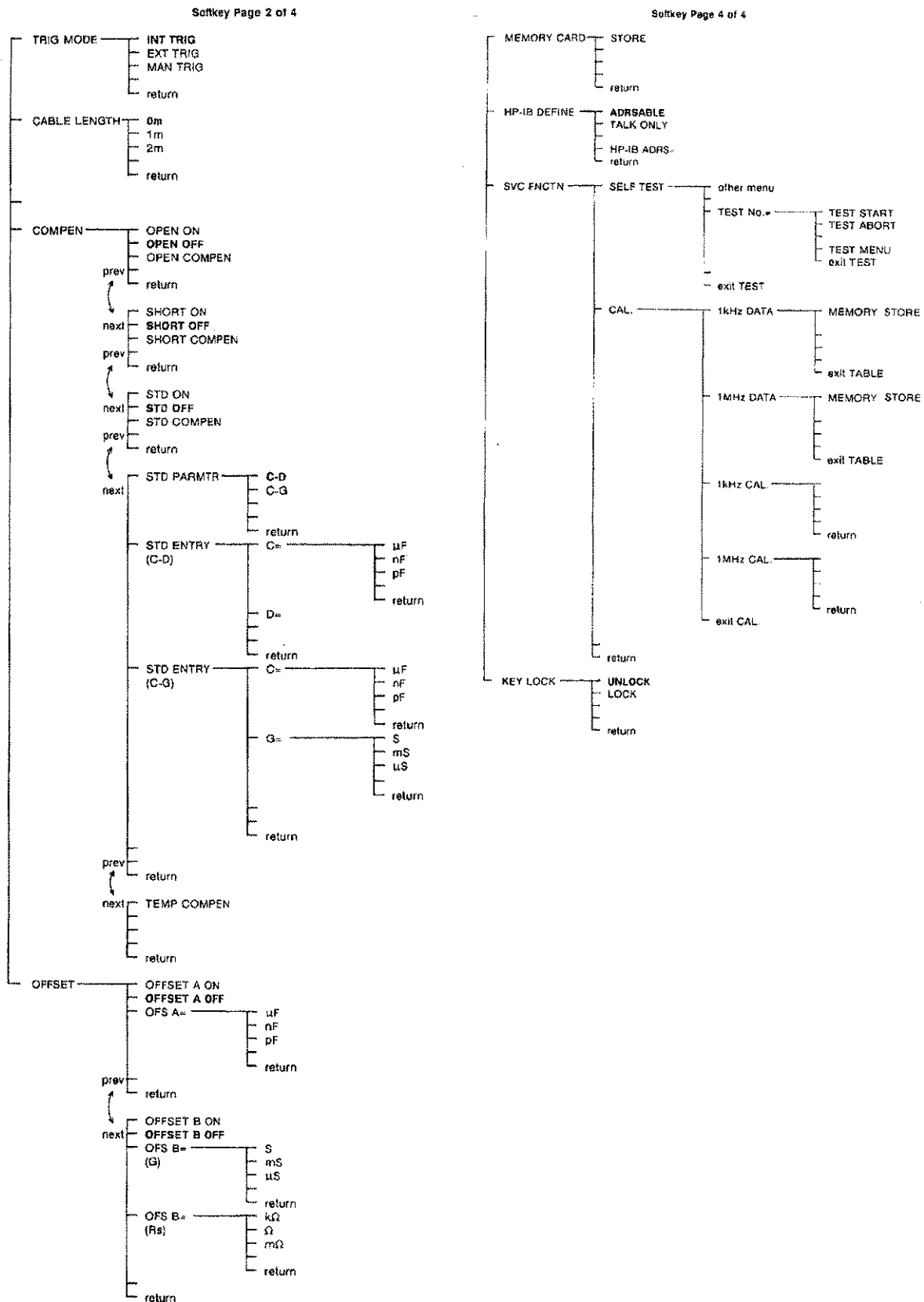

CHANGE 3

The followings are changes to adapt this manual to instruments with firmware version 3.0 and below.

Page 4-48, *IDN? command

Change the description of *IDN? command as follows.

The *IDN? command returns both the instrument's model name and the ROM version number as follows:

HEWLETPACKARD,4278A,0000A00000,REVn.n

Where: REVn.n is ROM version number.

CHANGE 4

The following changes adapt this manual to instruments with firmware version 3.01 and below.

Page 4-62, Table 4-2. Data Transfer Rate

Change the table as follows.

1. Typical data transfer rate using the ENTER command with an HP 9000 Series 200 (9816) computer.

Format	Data Type	Transfer Rate
ASCII	Data without BIN NO.	approx. 8.78ms
	Data with BIN NO.	approx. 9.82ms
BINARY	Data without BIN NO.	approx. 5.23ms
	Data with BIN NO.	approx. 6.02ms

2. Typical data transfer rate using the TRANSFER command with an HP 9000 Series 200 (9816) computer.

Format	Data Type	Transfer Rate
ASCII	Data without BIN NO.	approx. 5.23ms
	Data with BIN NO.	approx. 5.24ms
BINARY	Data without BIN NO.	approx. 5.18ms
	Data with BIN NO.	approx. 5.19ms

Page 5-25, Table 5-8. Supplemental Performance Characteristics, HP-IB (OPTION 101):

Change the data as follows.

Data output: Max. 100 bytes/ms, depending on the controller being used.

APPENDIX B

SOFTKEY TREE

This appendix shows the HP 4278A's softkey tree. **Bolded** softkey labels indicate default settings.

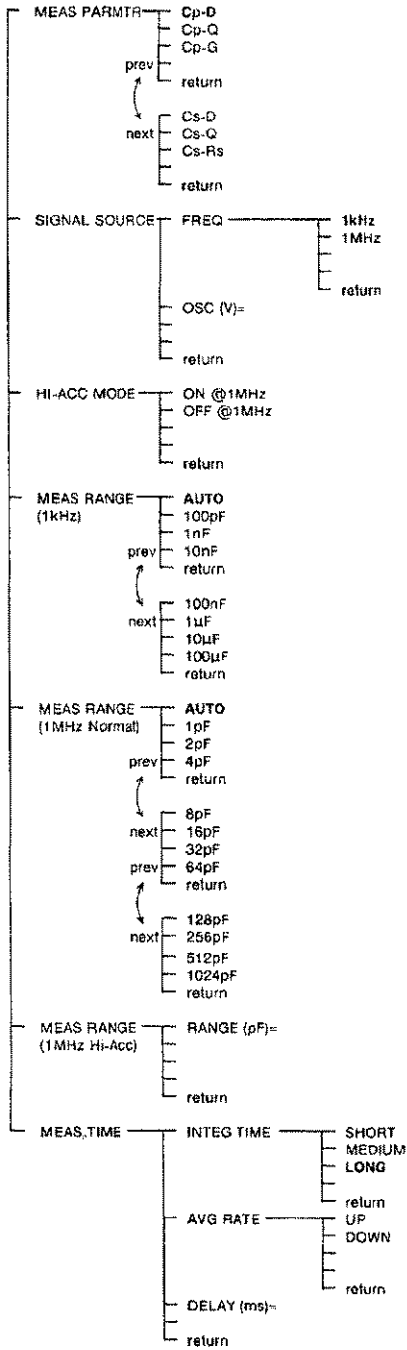

Next

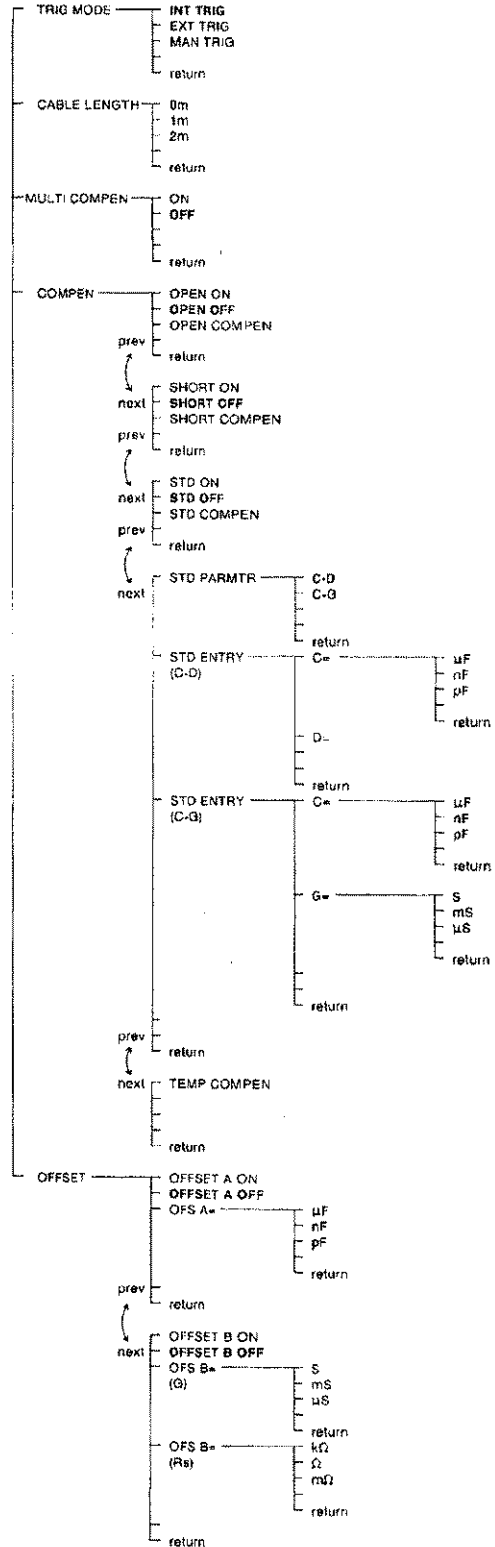

dot

NEXT

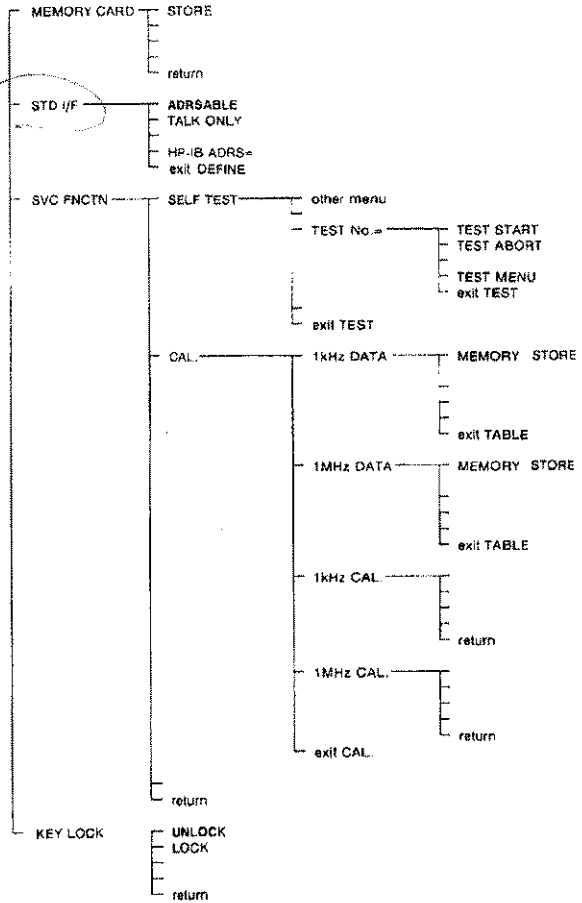
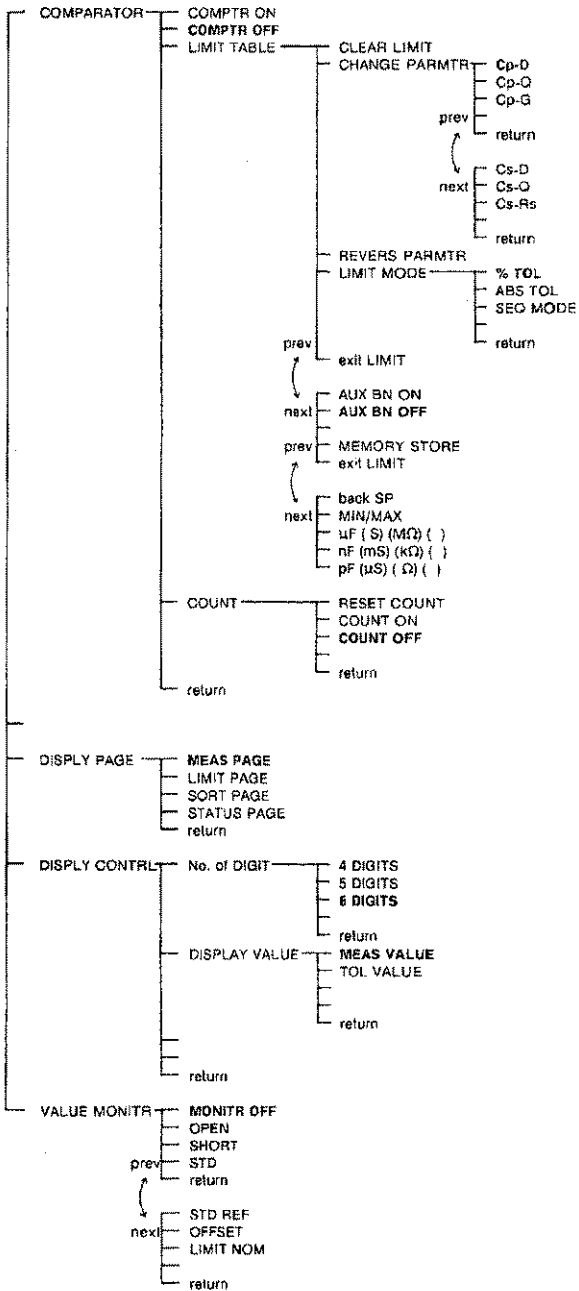

NOTES

1
2
3
4
5
6
7
8
9
10
11
12
13
14
15
16
17
18
19
20
21
22
23
24
25
26
27
28
29
30
31
32
33
34
35
36
37
38
39
40
41
42
43
44
45
46
47
48
49
50
51
52
53
54
55
56
57
58
59
60
61
62
63
64
65
66
67
68
69
70
71
72
73
74
75
76
77
78
79
80
81
82
83
84
85
86
87
88
89
90
91
92
93
94
95
96
97
98
99
100

APPENDIX C

DISPLAY MESSAGES

This appendix explains the HP 4278A's display messages.

The condition of the 4278A is displayed on the LCD Message Line. Display messages consist of Comments, Error Messages, and Error Messages of Power-on Self Test. Comments instruct the operator what to do, and informs the operator when the 4278A has completed a special operation (compensation, etc.). Error Messages indicates an operator error or a memory card read/write error. Error Messages of Power-on Self Test indicates an hardware failure.

Comments and error messages of power-on self test are listed in alphabetical order. Error messages are listed in the numerical order of the error numbers.

COMMENTS

Comment	Meaning
auto load complete	This message will be displayed when the 4278A is turned on with a memory card inserted. Auto loading from the memory card was successfully completed.
Loading completed	This message will be displayed after the message "Now loading ..." is displayed. Loading from the memory card was successfully completed.
Now loading...	This message will be displayed when the LOAD key is pressed to load the control settings from the memory card.
Now storing...	This message will be displayed when the ' STORE ' softkey is pressed to store the control settings to the memory card.
Open offset compen. completed	This message will be displayed after the completion of a successful open compensation data acquisition measurement.

Comment	Meaning
Press ENTER key to clear limits	This message will be displayed when the ' CLEAR LIMIT ' softkey is pressed. This is a confirmation inquiry to determine if the operator really wants to clear the limits.
Press ENTER to store	This message will be displayed when the ' STORE ' softkey is pressed. This is a confirmation inquiry to determine if the operator really wants to update the contents of the memory card.
Short offset compen. completed	This message will be displayed after the successful completion of a short compensation data acquisition measurement.
Std. compensation completed	This message will be displayed after the successful completion of a standard compensation data acquisition measurement.
Storing completed	This message will be displayed after the "Now storing ..." message is displayed. Storing to the memory card was successfully completed.
Temp compensation completed	This message will be displayed after the ' TEMP COMPEN ' softkey is pressed. Temperature compensation data acquisition measurement was successfully completed.

Comment	Meaning
<p>VerA.AA BBCC OPT-DDD, EEE</p>	<p>This message is displayed when the 4278A is turned on. "A.AA" indicates the firmware version. "BB" indicates the last two digits of the firmware release year. "CC" indicates the week that the firmware was released.</p> <p>When "DDD" is "***" the 4278A is not supplied with Options 001 or 002. When "DDD" is "001" or "002", the 4278A is supplied with Options 001 or 002, respectively.</p> <p>When "EEE" is "***" the 4278A is not supplied with Option 003. When "EEE" is "003", the 4278A is supplied with Option 003.</p>
<p>Warning, Compen data out of range</p>	<p>The compensation data measurement result is excessive, but will still be effective.</p>
<p>Warning, Limit Table is empty</p>	<p>The comparator function was turned on when the limit table was not set.</p>

ERROR MESSAGES

NOTE

Use the **ERR?** command to read error numbers via the HP-IB bus. The operation that caused the error message will be ignored and the 4278A will not be affected by the operation.

No.	Error Message	Meaning
1	Command error	This message will be displayed when an unspecified remote control command is sent. The command is ignored.
2	Syntax error	This message will be displayed when a syntax error exists in the entered value or the remote control command. The command is ignored.
3	Auto load failed	This message will be displayed when the 4278A is turned on with a memory card inserted and auto loading failed. The 4278A is set to the default settings.
4	Out of parameter range	This message will be displayed when the entered value is out of the settable range. The command is ignored.
5	Hi-Acc not allowed at 1kHz	This message will be displayed when the 'ON @1MHz' softkey is pressed while the test frequency is set to 1kHz.
6	Incorrect tolerance setting	This message will be displayed when the 'TOL VALUE' softkey is pressed and the limit mode is 'SEQ MODE'.
7	Store failed	This message will be displayed when the storing control setting to the memory card failed.

No.	Error Message	Meaning
8	Illegal device	This message will be displayed when the LOAD key was pressed without a memory card being inserted or when a non-HP specified memory card is inserted. This will be displayed also when un-initialized memory cards are used.
9	Load failed	This message will be displayed when the loading of control settings from a memory card failed.
10	Limit data already set	This message will be displayed when the operator tried to change the limit table without first clearing it.
11	You must enter the units	This message will be displayed when limit data is entered into the limit table without the units being specified.
12	Improper high/low limits	This message will be displayed when the low limit is greater than the high limit, or vice versa.
13	A2 B'd is not installed	This message will be displayed when you execute the A2 board self test without the A2 board being installed.
14	A3 B'd is not installed	This message will be displayed when you execute the A3 board self test without the A3 board being installed.
15	A4 B'd is not installed	This message will be displayed when you execute the A4 board self test without the A4 board being installed.
16	A5 B'd is not installed	This message will be displayed when you execute the A5 board self test without the A5 board being installed.
17	A6 B'd is not installed	This message will be displayed when you execute the A6 board self test without the A6 board being installed.

No.	Error Message	Meaning
18	Numeric overflow	This message will be displayed when you try to send numeric data that is not of the IEEE-32 bit format via HP-IB.
19	Compensation data is unmeasurable	The measurement circuit was unable to measure the OPEN, SHORT, or STANDARD data.
20	A6 B'd is not working	This message will be displayed when the A-D converter on the A6 board is not working properly. Hardware problem.
21	Out of range	The value entered into the limit table is out of range.
22	MIN/MAX not allowed for Nominal	The 'MIN/MAX' softkey is not usable for the nominal value when using the tolerance sorting mode.
23	MENU not allowed in Limit Table	The MENU key is inhibited when editing the limit table data. Press the 'exit LIMIT ' softkey first.
24	MENU not allowed in Self Test	The MENU key is inhibited during the self test operation. Press the 'exit TEST ' softkey first.
25	MENU not allowed in Calibration	The MENU key is inhibited during the calibration operation.
26	Operation not allowed	This message will be displayed when you try to perform an operation that is inhibited in the instrument's current state.
27	MEMORY CARD is write protected	The ' STORE ' softkey was pressed when the write protect switch, inside the 4278A, was set to the write protect position.
28	Different parameters of OFS B	The ' OFFSET B ON ' softkey was pressed when the B parameter was not the same as the entered offset B value.

No.	Error Message	Meaning
29	Check the connection & standard	This message will be displayed when the raw measurement data for calculating the analog calibration data cannot be measured.
30	Standard data table is incomplete	The calibration cannot be performed if all of the standard's calibration values aren't entered into the standard data table.
31	EEPROM write failed	This message will be displayed when the 4278A fails to write the analog calibration data to the EEPROM.
32	Query Error	This message is displayed when the MULTI_COMPEN mode is set to ON and the DATA? command is sent when the data buffer empty.

ERROR MESSAGES OF POWER-ON SELF TEST

When a hardware failure is detected on the power-on self test, the following error messages will be displayed. Refer to the HP 4278A Maintenance Manual (HP PN 04278-90100) for details.

Error Messages	Meaning
A6 B'd is not working	This message is displayed when the A-D converter's End Of Conversion signal from the A6 board is not output.
A40 B'd EEPROM CSUM ERROR	This message is displayed when the EEPROM for the scanner interface is incorrect. The back-up data (compensation data etc.) in this EEPROM is lost.
ANALOG TEST (1kHz) FAILED	This message is displayed when the boards used for the 1kHz measurement have failed.
ANALOG TEST (1MHz) FAILED	This message is displayed when the boards used for the 1MHz measurement have failed.
EEPROM CSUM ERROR NO=0	This message is displayed when the check sum of EEPROM (0) is incorrect. The calibration data in the EEPROM is lost.
EEPROM CSUM ERROR NO=1	This message is displayed when the EEPROM #1 check sum is incorrect. The back-up data (compensation data etc.) in the EEPROM is lost.
RAM TEST ERROR	This message is displayed when the RAM read/write test fails.
ROM CHECK SUM ERROR NO=XX	This message is displayed when the check sum of any of the programmed ROMs is incorrect.

APPENDIX D

POSSIBLE PROBLEMS AND THEIR SOLUTIONS

The default control settings were not achieved when the 4278A was turned on.

Make sure that a memory card is not installed, because the 4278A will load the stored settings from the memory card if it is inserted when the 4278A is turned on.

No characters appear on the LCD.

Check that the **CONTRAST** control knob is not turned fully CCW or CW.

"Illegal device" message appears when the LOAD key is pressed.

Remove and reinsert the memory card, and press the **LOAD** key. If this message reappears, press the '**STORE**' softkey. Then try to **LOAD** again. If **LOAD** still fails, the memory card is defective.

Front panel keys are inactive.

Check for the following:

The **KEY LOCK** function is off.

The **KEY LOCK** handler interface line is not active.

The HP-IB **RMT** status indicators are not lit.

MEAS PARMTR cannot be changed.

Check that the comparator function is not on. While the built-in comparator function is on, the measurement parameter is determined by the comparator's limit table, and not by the '**MEAS PARMTR**' softkey.

Measurement speed is slower than the Specification data.

Change the display format to the status or limit format (**COUNT** is off). The measurement page and the sorting format take time to change the displayed values.

"UNBAL" is displayed on the LCD.

Set the measurement range for the capacitor under test. If you don't know what capacitance range to use, change the test frequency to 1kHz and set the Ranging Mode to **AUTO**.

"-----" is displayed on the LCD.

Turn off the correction and offset functions. Change the **MEAS PARMTR** to **Cp-G**.

"Memory card write protected" is displayed.

The 4278A's memory protect function is implemented with a switch in the 4278A rather than on the memory card. Refer to the Maintenance Manual for more information.