

**HP 4194A
Impedance/Gain-Phase
Analyzer**

Operation Manual

MANUAL IDENTIFICATION

Model Number: HP 4194A
Date Printed: December 1996
Part Number: 04194-90011

This supplement contains information for correcting manual errors and for adapting the manual to newer instruments that contains improvements or modifications not documented in the existing manual.

To use this supplement

1. Make all ERRATA corrections
2. Make all appropriate serial-number-related changes listed below

SERIAL PREFIX OR NUMBER	MAKE MANUAL CHANGES
All	1

◆ New Item

SERIAL PREFIX OR NUMBER	MAKE MANUAL CHANGES

ERRATA

CHANGES 1

Change the company name from YOKOGAWA-HEWLETT-PACKARD, LTD., or its abbreviation, YHP to Hewlett-Packard Japan, Ltd.

CHANGE1 containns the information needed to adapt the HP 4194A's manual.

NOTE

Manual change supplement are revised as often as necessary to keep manuals as current and accurate as possible. Hewlett-Packard recommends that you periodically request the latest edition of this supplement. Free copies are available from all HP offices. When requesting copies, quote the manual identification information from your supplement, or the model number and print date from the title page of the manual.



The pink sheet titled “CAUTION ON OPERATION”

Change the page title as follows.

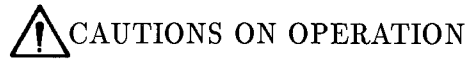

Delete the second paragraph.

(Fuse A23F1 has been replaced for the protection circuit.)

First page of the front matter “SAFETY SUMMARY”

Add the following note.

Note *HP 4194A complies with INSTALLATION CATEGORY II and POLLUTION DEGREE 2 in IEC1010-1. HP 4194A is INDOOR USE product.*

Note *LEDs in this product are Class 1 in accordance with IEC825-1.*

CLASS 1 LED PRODUCT

Forth page of the front matter “SAFTY SYMBOLS”

Add the following symbols.



On (Supply).



Off (Supply).



In position of push-button switch.



Out position of push-button switch.



Affixed to product containing static sensitive devices - use anti-static handling procedures to prevent electrostatic discharge damage to component

Page iii “TABLE OF CONTENTS”

Change the SECTION2 as follows.

SECTION2

INSTALLATION

2-1. Introduction 2-1

2-2. Incoming Inspection 2-1

2-3. Preparation for Use 2-1

 2-3-1. Interconnecting Units 2-1

 2-3-2. Interconnection Cables 2-2

 2-3-3. Power requirements 2-3

 2-3-4.  Line Voltage and Fuse Selection 2-4

 2-3-5. Power Cable 2-4

 2-3-6. Operation Environment 2-6

 2-3-7. Electromagnetic Compatibility 2-6

 2-3-8. Ventilation Requirements 2-6

 2-3-9. Instruction for Cleaning 2-6

 2-3-10. Rack/Handle Installation 2-7

Change the 3-1-1 as follows.

3-1-1.  Front PANEL FEATURES 3-2

Page1-3 “Figure 1-2. Serial Number Plate”

Change the Serial Number Plate as follows.

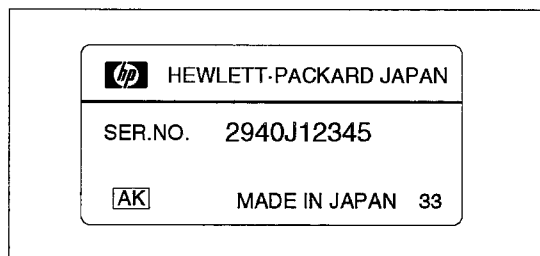

Figure 1-2. Serial Number Plate

Page1-36 "GENERAL SPECIFICATIONS"

Add the Operating Altitude.

Operating Altitude 0m to 2000m

Page2-1 "2-2.INITIAL INSPECTION"

Change the INITIAL INSPECTION as follows.

2-2.Incoming Inspection

WARNING

To avoid hazardous electrical shock, do not turn on the HP 4194A when there are signs of shipping damage to any portion of the outer enclosure (for example, covers, panel, or display)

Inspect the shipping container for damage. If the shipping container or cushioning material is damaged, it should be kept until the contents of the shipment have been checked for completeness and the HP 4194A has been checked mechanically and electrically. The contents of the shipment should be as listed in Table 2-1.. If the contents are incomplete, if there is mechanical damage or defect, or if the analyzer does not pass the power-on selftests, notify the nearest Hewlett-Packard office. If the shipping container is damaged, or the cushioning material shows signs of unusual stress, notify the carrier as well as the Hewlett-Packard office. Keep the shipping materials for the carrier's inspection.

Table 2-1.HP 4194A Contents

Description	Qty.	HP Part Number
HP 4194A		
16047A Test Fixture	1	—
BNC Adapter(f-f)	1	1250-0080
BNC-BNC Cable	4	8120-1838
BNC-BNC Cable	1	04194-61601
Cable Assy-Power	1	04194-61603
Cable Assy-Control	1	04194-61602
Rear Panel Lock Foot Kit Full Modules	1	5061-9699
Power cable ¹	1	—
Operation Manual	1	04194-90011
Option 350 50Ω		
BNC Cable-30cm	2	8120-1838
BNC Cable-60cm	1	8120-1839
Option 375 75Ω		
BNC Cable-30cm	2	04194-61640
BNC Cable-60cm	1	04194-61641
Option 907 Handle Kit		
Handle kit	1	5061-9690
Option 908 Rack Flange Kit		
Rack Flange Kit	1	5061-9678
Option 909 Rack Flange & Handle Kit		
Rack Flange & Handle Kit	1	5061-9684

¹ Power Cable depends on where the instrument is used, see "2-3-5. Power Cable".

Page2-3 "2-3-4. Line Voltage and Fuse Selection"

Change the Line Voltage and Fuse Selection as follows.

2-3-4.Line Voltage and Fuse Selection

The HP 4194A requires a power source of 100 V~,120 V~,220 V~,240 V~ ac.Select the line voltage from 100V, 120V, 220V, and 240 V using the two voltage selectors on the rear panel. (Refer to the figure 2-2.)

Manual Change

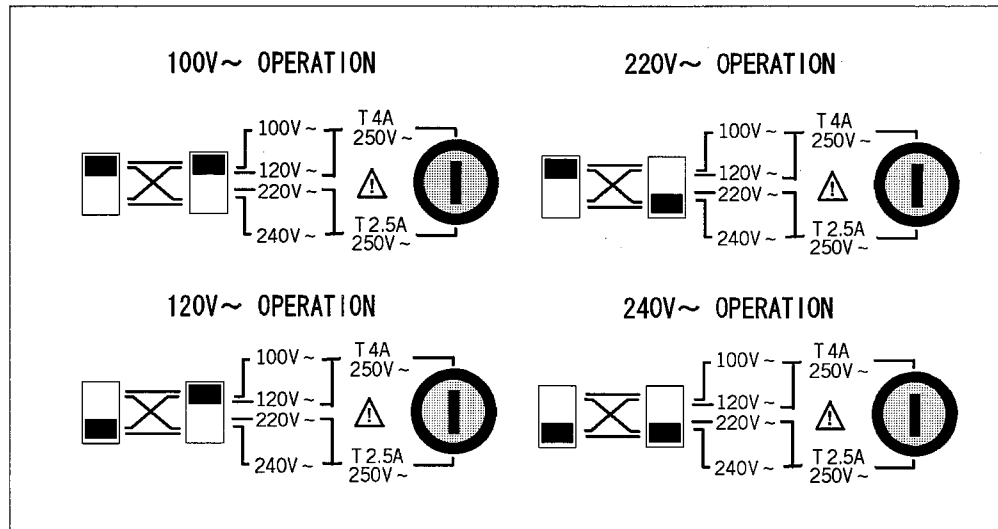

Figure 2-2. Line Voltage and Fuse Selection

Use a screwdriver to set the Line Voltage Selector switch to the appropriate voltage.

CAUTION

Before connecting the instrument to the power source, make sure that the correct fuse has been installed and the Line Voltage Selection Switch is correctly set.

Line Voltage Selection

Select the proper voltage selector according to the Table 2-2.

Table 2-2. Line Voltage Selection

Voltage Selector	Line Voltage
100 V~	90-110 V, 48-66 Hz
120 V~	108-132 V, 48-66 Hz
220 V~	198-242 V, 48-66 Hz
240 V~	216-252 V, 48-66 Hz

! Fuse Selection

Select proper fuse according to the Table 2-3. Current ratings for the fuse are printed under the fuseholder on the rear panel, and are listed, along with the fuse's HP part number, in Table 2-3.

Table 2-3. Fuse Selection

Operating Voltage	Fuse Rating/Type	Fuse Part Number
100 V~ 120 V~	4A 250Vac UL/CSA type Nomal Blow	2110-0055
220 V~ 240 V~	2.5A 250Vac UL/CSA type Slow Blow	2110-0015

If you need this fuse, contact your nearest Hewlett-Packard Sales and Service Office.

To remove the fuse, turn the fuse holder counterclockwise until the fuse pops out.

CAUTION

Use the proper fuse for the line voltage selected. Use only fuses with the required current rating and of the specified type as replacements. DO NOT use a mended fuse or short-circuit the fuse-holder in order to by-pass a blown fuse. Find out what caused the fuse to blow!

Page2-4 “2-3-5. Power Cable”

Change the Power Cable as follows.

2-3-5. Power Cable

In accordance with international safety standards, this instrument is equipped with a three-wire power cable. When connected to an appropriate ac power outlet, this cable grounds the instrument frame.

The type of power cable shipped with each instrument depends on the country of destination. Refer to Figure 2-2. for the part numbers of the power cables available.

WARNING

For protection from electrical shock, the power cable ground must not be defeated. The power plug must be plugged into an outlet that provides a protective earth ground connection.

<p>OPTION 900 United Kingdom</p>  <p>Plug : BS 1363A, 250V Cable : HP 8120-1351</p>	<p>OPTION 901 Australia / New Zealand</p>  <p>Plug : NZSS 198/AS C112, 250V Cable : HP 8120-1369</p>
<p>OPTION 902 European Continent</p>  <p>Plug : CEE-VII, 250V Cable : HP 8120-1689</p>	<p>OPTION 903 U.S. / Canada</p>  <p>Plug : NEMA 5-15P, 125V, 15A Cable : HP 8120-1378</p>
<p>OPTION 904 U.S. / Canada</p>  <p>Plug : NEMA 6-15P, 250V, 15A Cable : HP 8120-0698</p>	<p>OPTION 905* Any country</p>  <p>Plug : CEE 22-VI, 250V Cable : HP 8123-1396</p>
<p>OPTION 906 Switzerland</p>  <p>Plug : SEV 1011.1959-24507 Type 12, 250V Cable : HP 8120-2104</p>	<p>OPTION 912 Denmark</p>  <p>Plug : DHCR 107, 220V Cable : HP 8120-2956</p>
<p>OPTION 917 India / Republic of S.Africa</p>  <p>Plug : SABS 164, 250V Cable : HP 8120-4211</p>	<p>OPTION 918 Japan</p>  <p>Plug : JIS C 8303, 125V, 15A Cable : HP 8120-4753</p>
<p>NOTE: Each option number includes a 'family' of cords and connectors of various materials and plug body configurations (straight, 90° etc.).</p> <p>* Plug option 905 is frequently used for interconnecting system components and peripherals.</p>	

Figure 2-3. Power Cable Supplied

Page2-6 “2-3-6. Operation Environment”

Change the Operation Environment as follows.

2-3-6. Operating Environment

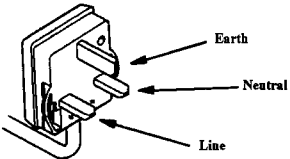
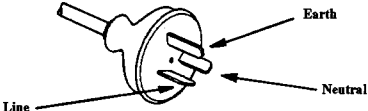
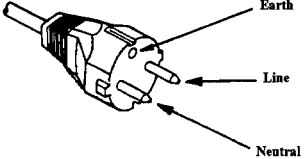
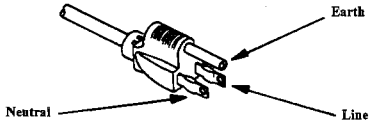
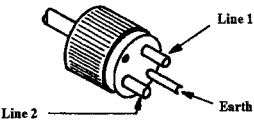
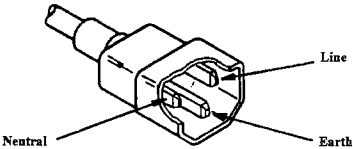
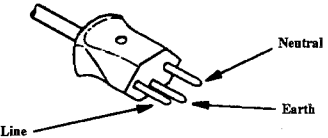
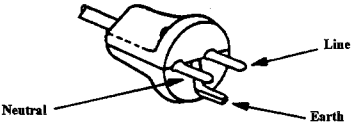
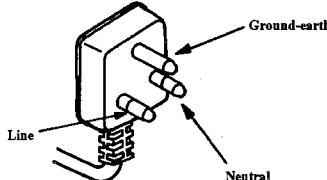
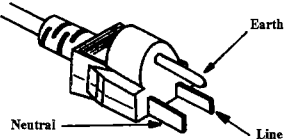
The HP 4194A must be operated under within the following environment conditions, and sufficient space must be kept behind the HP 4194A to avoid obstructing the air flow of the cooling fans.

Temperature: 0°C to 55°C

Humidity: less than 95% RH at 40°C

Note The HP 4194A must be protected from temperature extremes which could cause condensation within the instrument.

Add the section 2-3-7., 2-3-8., 2-3-9.,and 2-3-10. as follows.

2-3-7. Ventilation Requirements

To ensure adequate ventilation, make sure that there is adequate clearance around the HP 4194A.

2-3-8. Electromagnetic Compatibility

This product has been designed and tested to the requirements of the Electromagnetic Compatibility (EMC) Directive 89/336/EEC. To use a properly shielded cable or shielded coaxial cable (such as those recommended in the General Information and the Performance Test) to connect each of the ports to their respective controllers, peripherals, equipments or devices may ensure to meet the requirements.

2-3-9. Instruction for Cleaning

To prevent electrical shock, disconnect the HP 4194A power cable from the receptacle before cleaning. Use a dry cloth or a cloth slightly dipped in water to clean the casing. Do not attempt to clean the HP 4194A internally.

2-3-10. Rack/Handle Installation

The analyzer can be rack mounted and used as a component in a measurement system. Figure 2-6. shows how to rack mount the HP 4194A.

Table 2-4. Rack Mount Kits

Option	Description	HP Part Number
907	Handle Kit	5061-9690
908	Rack Flange Kit	5061-9678
909	Rack Flange & Handle Kit	5061-9684

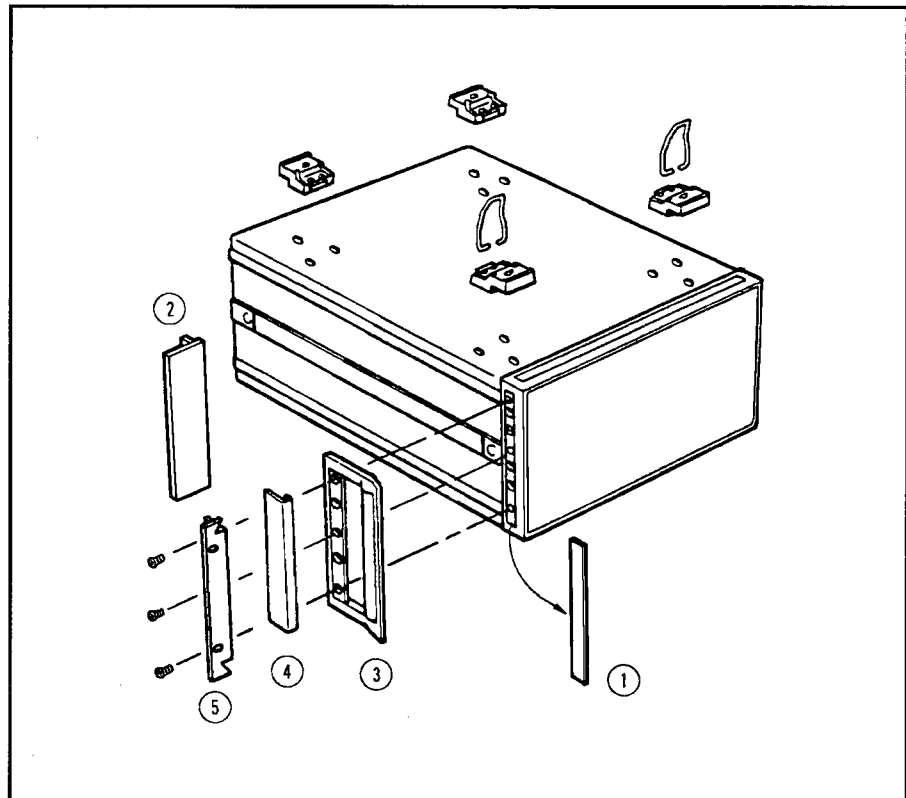

Figure 2-6. Rack Mount Kits Installation

Option 907 Handle Kit

Option 907 is a handle kit containing a pair of handles and the necessary hardware to attach them to the instrument.

Installing the Handle

1. Remove the adhesive-backed trim strips ① from the left and right front sides of the HP 4194A. (Refer to Figure 2-6.)
2. Attach the front handles ② to the sides using the screws provided.
3. Attach the trim strips ③ to the handles.

Option 908 Rack Flange Kit

Option 908 is a rack flange kit containing a pair of flanges and the necessary hardware to mount them to the instrument in an equipment rack with 482.6 mm (19 inches) horizontal spacing.

Mounting the Rack

1. Remove the adhesive-backed trim strips ① from the left and right front sides of the HP 4194A. (Refer to Figure 2-6.)
2. Attach the rack mount flange ④ to the left and right front sides of the HP 4194A using the screws provided.
3. Remove all four feet ⑤ (lift bar on the inner side of the foot, and slide the foot toward the bar.)

Option 909 Rack Flange & Handle Kit

Option 909 is a rack mount kit containing a pair of flanges and the necessary hardware to mount them to an instrument which has handles attached, in an equipment rack with 482.6 mm (19 inches) spacing.

Mounting the Handle and Rack

1. Remove the adhesive-backed trim strips 1 from the left and right front sides of the HP 4194A.
2. Attach the front handle 3 and the rack mount flange 5 together on the left and right front sides of the HP 4194A using the screws provided.
3. Remove all four feet (lift bar on the inner side of the foot, and slide the foot toward the bar).

Page3-2 "Figure3-1 Front Panel Features"

Change the following figure.

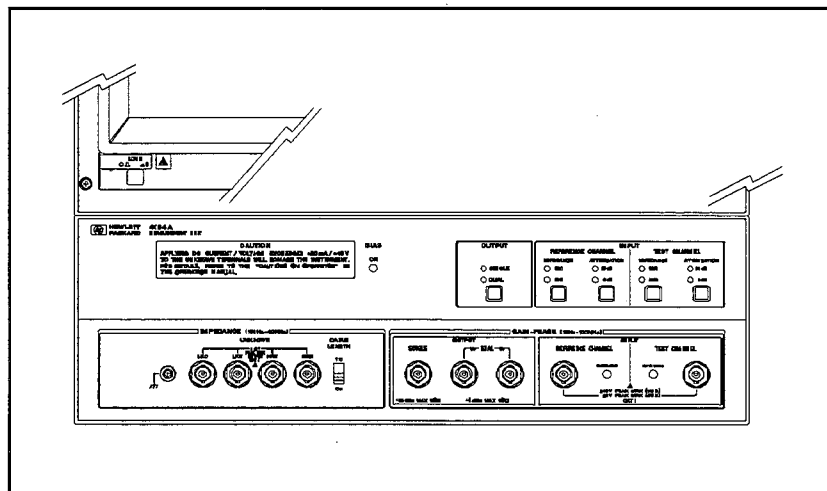

Figure 3-1 Front Panel Features

Manual Change

Page3-8 "PANEL FEATURES"

Change the "19.GAIN-PHASE INPUT CONNECTORS" as follows and add the description.

19. GAIN-PHASE INPUT CONNECTORS

INSTALLATION CATEGORY I

Change the "23.UNKNOWN Terminals" as follows and add the description.

23. UNKNOWN Terminals

Available four terminal-pair test fixtures or test leads are refer to the Accessories Selection Guide For Impedance Measurements (Catalog number 5963-6834E).

INSTALLATION CATEGORY I

Change the "24.GROUND Terminal" as follows.

24.FRAME Terminal

MANUAL CHANGES

HP 4194A

Impedance/Gain-Phase Analyzer

MANUAL IDENTIFICATION

Model Number: HP 4194A

Date Printed: Apr. 1989

Part Number: 04194-90001

This supplement contains information for correcting manual errors and for adapting the manual to newer instruments that contain improvements or modifications not documented in the existing manual.

To use this supplement

1. Make all ERRATA corrections
2. Make all appropriate serial-number-related changes listed below

SERIAL PREFIX OR NUMBER	MAKE MANUAL CHANGES	SERIAL PREFIX OR NUMBER	MAKE MANUAL CHANGES

ERRATA

"SERIAL NUMBERS" on the front cover of this manual:

Change description as follows:

This manual applies directly to instruments whose serial number prefix is 2617J and above, or whose ROM-based firmware is revision 2.2, 2.3, 2.4 and above.

NOTE

Manual changes supplements are revised as often as necessary to keep manuals as current and accurate as possible. Hewlett-Packard recommends that you periodically request the latest edition of this supplement. Free copies are available from all HP offices. When requesting copies, quote the manual identification information from your supplement, or the model number and print date from the title page of the manual.

Date/Div: November 1990/33

Page: 1 of 1



Printed in Japan

CAUTIONS ON OPERATION

EXTERNAL BIASING: PRECAUTIONS AND LIMITATIONS

When measuring a device or circuit which is biased from an external source, **DO NOT** allow the dc voltage applied to the HP 4194A's measurement terminals (L_{cur} , L_{pot} , H_{pot} , H_{cur} , OUTPUT, REFERENCE Channel and TEST Channel) to exceed the limits given in Figures A and B, below.

If a dc voltage exceeding the limits shown in Figure A is applied to the UNKNOWN terminals, an internal fuse, A23F1, will blow to protect the 4194A's measurement circuits. The symptoms of and the replacement procedure for a blown A23F1 are given below. Note, however, that this problem will not occur if the 4194A's built-in dc bias source is used.

Special precautions should be followed when making gain-phase measurements on active networks and circuits. If excessive voltage is applied to the REFERENCE Channel or TEST Channel, serious damage to the 4194A will result.

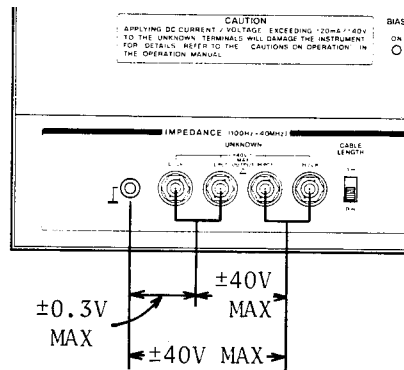

Figure A. External Bias Limits for Impedance Measurements

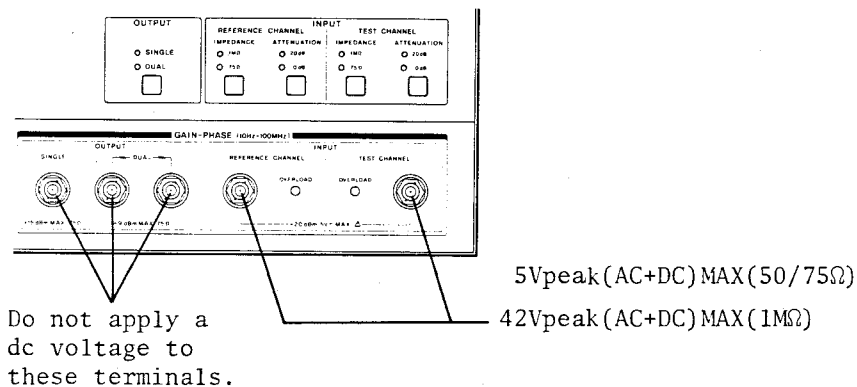

Figure B. External Bias Limits for Gain-Phase Measurements

CAUTIONS ON OPERATION

The settings of the HP 4194A in the memory will be erased when it has been turned off for approximately three weeks.

DECLARATION OF CONFORMITY

according to ISO/IEC Guide 22 and EN 45014

Manufacturer's Name: Hewlett-Packard Japan, Ltd.

Manufacturer's Address: 1-3-2, Murotani, Nishi-ku, Kobe-shi, Hyogo, 651-22 Japan

declares, that the product

Product Name: Impedance / Gain-Phase Analyzer

Model Number(s): HP 4194A

Product Options: This declaration covers all options of the above product.

conforms to the following Product Specifications:

Safety: IEC 1010-1:1990+A1 / EN 61010-1:1993

EMC: CISPR 11:1990 / EN 55011:1991 - Group 1 Class A ¹⁾
EN 61000-3-3:1995 / IEC 1000-3-3:1994
EN 50082-1:1992
IEC 801-2:1991 - 4 kV CD, 8 kV AD
IEC 801-3:1984 - 3 V/m
IEC 801-4:1988 - 0.5 kV Signal Lines, 1 kV Power Lines

Supplementary Information:

The product herewith complies with the requirements of the EMC Directive 89/336/EEC, the Low Voltage Directive 73/23/EEC and carries the CE marking accordingly.

LEDs in this product are Class 1 in accordance with IEC 825-1.

1) The product was tested in a typical configuration.

Kobe, December 1, 1996

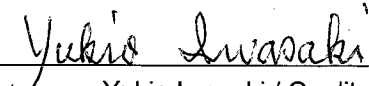

Yukio Iwasaki / Quality Manager

European Contact: Your local Hewlett-Packard Sales and Service Office or Hewlett-Packard GmbH, Department HQ-TRE,
Herrenberger Straße 130, D-71034 Böblingen (FAX:+49-7031-14-3143)

Herstellerbescheinigung

GERÄUSCHEMISSION

LpA < 70 dB
am Arbeitsplatz
normaler Betrieb
nach DIN 45635 T. 19

Manufacturer's Declaration

ACOUSTIC NOISE EMISSION

LpA < 70 dB
operator position
normal operation
per ISO 7779

SAFETY SUMMARY

The following general safety precautions must be observed during all phases of operation, service, and repair of this instrument. Failure to comply with these precautions or with specific warnings given elsewhere in this manual violates safety standards of design, manufacture, and intended use of the instrument. Hewlett-Packard Company assumes no liability for the customer's failure to comply with these requirements.

GROUND THE INSTRUMENT

To minimize shock hazard, the instrument chassis and cabinet must be connected to an electrical ground. The instrument is equipped with a three-conductor ac power cable. The power cable must either be plugged into an approved three-contact electrical outlet or used with a three-contact to two-contact adapter with the grounding wire (green) firmly connected to an electrical ground (safety ground) at the power outlet. The power jack and the mating plug of the power cable meet International Electrotechnical Commission (IEC) safety standards.

DO NOT OPERATE IN AN EXPLOSIVE ATMOSPHERE

Do not operate the instrument in the presence of flammable gases or fumes. Operation of any electrical instrument in such an environment constitutes a definite safety hazard.

KEEP AWAY FROM LIVE CIRCUITS

Operating personnel must not remove instrument covers. Component replacement and internal adjustments must be made by qualified maintenance personnel. Do not replace components with power cable connected. Under certain conditions, dangerous voltages may exist even with the power cable removed. To avoid injuries, always disconnect power and discharge circuits before touching them.

DO NOT SERVICE OR ADJUST ALONE

Do not attempt internal service or adjustment unless another person, capable of rendering first aid and resuscitation, is present.

USE CAUTION WHEN EXPOSING OR HANDLING THE CRT

Breakage of the cathode-ray tube (CRT) causes a high velocity scattering of glass fragments (implosion). To prevent CRT implosion, avoid rough handling or jarring of the instrument. Handling of the CRT shall be done only by qualified maintenance personnel using approved safety mask and gloves.

DO NOT SUBSTITUTE PARTS OR MODIFY INSTRUMENT

Because of the danger of introducing additional hazards, do not install substitute parts or perform any unauthorized modification to the instrument. Return the instrument to a Hewlett-Packard Sales and Service Office for service and repair to ensure that safety features are maintained.

DANGEROUS PROCEDURE WARNINGS

Warnings, such as the example below, precede potentially dangerous procedures throughout this manual. Instructions contained in the warnings must be followed.

WARNING

Dangerous voltages, capable of causing death, are present in this instrument. Use extreme caution when handling, testing, and adjusting.

CERTIFICATION

Hewlett-Packard Company certifies that this product met its published specifications at the time of shipment from the factory. Hewlett-Packard further certifies that its calibration measurements are traceable to the United States National Bureau of Standards, to the extent allowed by the Bureau's calibration facility, and to the calibration facilities of other International Standards Organization members.

WARRANTY

This Hewlett-Packard instrument product is warranted against defects in material and workmanship for a period of one year from date of shipment, except that in the case of certain components listed in Section 1 of this manual, the warranty shall be for the specified period. During the warranty period, Hewlett-Packard Company will, at its option, either repair or replace products which prove to be defective.

For warranty service or repair, this product must be returned to a service facility designated by HP. Buyer shall prepay shipping charges to HP and HP shall pay shipping charges to return the product to Buyer. However, Buyer shall pay all shipping charges, duties, and taxes for products returned to HP from another country.

HP warrants that its software and firmware designated by HP for use with an instrument will execute its programming instructions when properly installed on that instrument. HP does not warrant that the operation of the instrument, or software, or firmware will be uninterrupted or error free.

LIMITATION OF WARRANTY

The foregoing warranty shall not apply to defects resulting from improper or inadequate maintenance by Buyer, Buyer-supplied software or interfacing, unauthorized modification or misuse, operation outside of the environment specifications for the product, or improper site preparation or maintenance.

NO OTHER WARRANTY IS EXPRESSED OR IMPLIED. HP SPECIFICALLY DISCLAIMS THE IMPLIED WARRANTIES OF MERCHANTABILITY AND FITNESS FOR A PARTICULAR PURPOSE.

EXCLUSIVE REMEDIES

THE REMEDIES PROVIDED HEREIN ARE BUYER'S SOLE AND EXCLUSIVE REMEDIES. HP SHALL NOT BE LIABLE FOR ANY DIRECT, INDIRECT, SPECIAL, INCIDENTAL, OR CONSEQUENTIAL DAMAGES, WHETHER BASED ON CONTRACT, TORT, OR ANY OTHER LEGAL THEORY.

ASSISTANCE

Product maintenance agreements and other customer assistance agreements are available for Hewlett-Packard products.

For any assistance, contact your nearest Hewlett-Packard Sales and Service Office. Addresses are provided at the back of this manual.

SAFETY SYMBOLS

General Definitions of Safety Symbols Used On Equipment or In Manuals.



Instruction manual symbol: the product will be marked with this symbol when it is necessary for the user to refer to the instruction manual in order to protect against damage to the instrument.



Indicates dangerous voltage (terminals fed from the interior by voltage exceeding 1000 volts must be so marked).

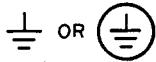

Protective conductor terminal. For protection against electrical shock in case of a fault. Used with field wiring terminals to indicate the terminal which must be connected to ground before operating equipment.



Low-noise or noiseless, clean ground (earth) terminal. Used for a signal common, as well as providing protection against electrical shock in case of fault. A terminal marked with this symbol must be connected to ground in the manner described in the installation (operating) manual, and before operating the equipment.

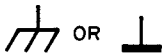

Frame or chassis terminal. A connection to the frame (chassis) of the equipment which normally includes all exposed metal structures.



Alternating current (power line).



Direct current (power line).



Alternating or direct current (power line).

WARNING

A **WARNING** denotes a hazard. It calls attention to a procedure, practice, condition or the like, which, if not correctly performed or adhered to, could result in injury or death to personnel.

CAUTION

The **CAUTION** sign denotes a hazard. It calls attention to an operating procedure, practice, condition or the like, which, if not correctly performed or adhered to, could result in damage to or destruction of part or all of the product.

Note

A Note denotes important information. It calls attention to a procedure, practice, condition or the like, which is essential to highlight.

Herstellerbescheinigung

Hiermit wird bescheinigt, daß das Gerät HP 4194A Impedance/Gain-Phase Analyzer in Übereinstimmung mit den Bestimmungen von Postverfügung 1046/84 funkentstört ist.

Der Deutschen Bundespost wurde das Inverkehrbringen dieses Gerätes angezeigt und die Berechtigung zur Überprüfung der Serie auf Einhaltung der Bestimmungen eingeräumt.

Anm: Werden Meß- und Testgeräte mit ungeschirmten Kabeln und/oder in offenen Meßaufbauten verwendet, so ist vom Betreiber sicherzustellen, daß die Funk-Entstörbestimmungen unter Betriebsbedingungen an seiner Grundstücksgrenze eingehalten werden.

GERÄUSCHEMISSION

LpA < 70 dB
am Arbeitsplatz
normaler Betrieb
nach DIN 45635 T. 19

Manufacturer's Declaration

This is to certify that this product, the HP 4194A Impedance/Gain-Phase Analyzer, meets the radio frequency interference requirements of directive 1046/84. The German Bundespost has been notified that this equipment was put into circulation and was granted the right to check the product type for compliance with these requirements.

Note: If test and measurement equipment is operated with unshielded cables and/or used for measurements on open set-ups, the user must insure that under these operating conditions, the radio frequency interference limits are met at the border of his premises.

ACOUSTIC NOISE EMISSION

LpA < 70 dB
operator position
normal operation
per ISO 7779

HP 4194A Impedance/Gain-Phase Analyzer
Operation Manual



HP Part No. 04194-90011
Printed in JAPAN December, 1996

Notice

Hewlett-Packard to Agilent Technologies Transition

This manual may contain references to HP or Hewlett-Packard. Please note that Hewlett-Packard's former test and measurement, semiconductor products and chemical analysis businesses are now part of Agilent Technologies. To reduce potential confusion, the only change to product numbers and names has been in the company name prefix: where a product name/number was HP XXXX the current name/number is now Agilent XXXX. For example, model number HP8648 is now model number Agilent 8648.

Contacting Agilent Sales and Service Offices

The sales and service contact information in this manual may be out of date. The latest service and contact information for your location can be found on the Web at:

<http://www.agilent.com/find/assist>

If you do not have access to the Internet, contact your field engineer or the nearest sales and service office listed below. In any correspondence or telephone conversation, refer to your instrument by its model number and full serial number.

United States

(tel) 1 800 452 4844
(fax) 1 800 829 4433

Canada

(tel) +1 877 894 4414
(fax) +1 888 900 8921

Europe

(tel) (31 20) 547 2323
(fax) (31 20) 547 2390

Latin America

(tel) (305) 269 7500
(fax) (305) 269 7599

Japan

(tel) (81) 426 56 7832
(fax) (81) 426 56 7840

Australia

(tel) 1 800 629 485
(fax) (61 3) 9210 5947

New Zealand

(tel) 0 800 738 378
(fax) 64 4 495 8950

Asia Pacific

(tel) (852) 3197 7777
(fax) (852) 2506 9284



Agilent Technologies

Printed in USA July 2004

HOW TO USE THIS MANUAL

General Information, Section 1, describes what is included with your HP 4194A, what additional accessories are available, and the Specifications. Before installing the HP 4194A and turning it on, check to see that your HP 4194A has all the furnished accessories listed in this section. Then go to Section 2, Installation.

Installation, Section 2, describes how to link the Control unit and Measurement unit, how to install the Rack Mounting Kit (Option 907, 908, and 909), how to set the Line Voltage Selection switches, and how to connect the power cord.

NOTE

To ensure operator safety, mount both units as described in paragraph 2-3-1 of Section 2.

Getting Started in Section 3 is designed to help the first-time user. This section describes how to turn on the HP 4194A, and gives some operating hints.

Impedance/Gain-Phase Measurement in Section 3 describes the use of the HP 4194A IMPEDANCE/GAIN-PHASE ANALYZER in making typical measurements on several common devices. These measurements were selected as examples which cover topics of general interest in a manner which demonstrates the capabilities of the HP 4194A.

Reference in Section 3 is an encyclopedia of front panel operation details. This section is an alphabetical listing of front panel sections, hardkeys and terms. The each MENU hardkey topic shows the menu of softkey labels it will display on the screen and describes each softkey command in detail.

Extended Capabilities in Section 3 describes in detail the special capabilities of the HP 4194A.

CONTENTS

SECTION 1 GENERAL INFORMATION

- 1-1. Introduction 1-1
- 1-2. Description 1-2
- 1-3. Specifications 1-2
- 1-4. Safety Considerations 1-3
- 1-5. Instruments Covered By This Manual 1-3
- 1-6. Options 1-41
- 1-7. Accessories Supplied 1-42
- 1-8. Accessories Available 1-43

SECTION 2 INSTALLATION

- 2-1. Introduction 2-1
- 2-2. Initial Inspection 2-1
- 2-3. Preparation for Use 2-1
 - 2-3-1. Interconnecting Units 2-1
 - 2-3-2. Interconnection Cables 2-2
 - 2-3-3. Power Requirements 2-3
 - 2-3-4. Line Voltage and Fuse Selection 2-3
 - 2-3-5. Power Cable 2-4
 - 2-3-6. Operating Environment 2-6
- 2-4. HP-IB Connections 2-6
- 2-5. Installation of Options 907, 908 and 909 2-7
 - 2-5-1. Option 907 2-7
 - 2-5-2. Option 908 and 909 2-8
- 2-6. Storage and Shipment 2-8
 - 2-6-1. Environment 2-8
 - 2-6-2. Original Packaging 2-9
 - 2-6-3. Other Packaging 2-9

SECTION 3 OPERATION

- 3-1. Introduction 3-1
 - 3-1-1. Front Panel Features 3-2
- 3-2. Getting Started 3-11
 - 3-2-1. Instrument Turn On 3-11
 - 3-2-2. Operating Hints 3-13

CONTENTS (cont.)

- 3-3. Impedance Measurements 3-14
 - 3-3-1. Ceramic Chip Capacitor 3-14
 - 3-3-2. Ceramic Resonator 3-25
 - 3-3-3. Impedance Measurement Using a Probe 3-39
- 3-4. Gain-Phase Measurements 3-46
 - 3-4-1. Bandpass Filter 3-46
 - 3-4-2. RF Amplifier Gain Compression 3-63
- 3-5. Reference 3-69
 - *Softkey Index* 3-137
- 3-6. Extended Capabilities 3-139
 - 3-6-1. Register Manipulation 3-139
 - 3-6-2. Arithmetic Operation 3-148
 - 3-6-3. HP-IB 3-150
 - 3-6-4. Auto Sequence Program 3-176
 - 3-6-5. Compensation (Calibration) 3-195
 - 3-6-6. Programmed Points Table 3-206
 - 3-6-7. Copy 3-214
 - 3-6-8. Equivalent Circuit Function 3-219
 - 3-6-9. External I/O 3-225

SECTION 4

PERFORMANCE TEST

- 4-1. Introduction 4-1
- 4-2. Test Equipment 4-1
- 4-3. Performance Test Record 4-1
- 4-4. Calibration Cycle 4-2
- 4-5. Pretest Preparations 4-4
- 4-6. Internal Synthesizer Frequency Test 4-7
- 4-7. Gain-Phase Measurement Accuracy Test 4-9
- 4-8. Test Equipment Calibration 4-19
- 4-9. Amplitude Measurement Accuracy Test 4-27
- 4-10. Gain-Phase Measurement Signal Level Test 4-40
- 4-11. Power Splitter Test 4-45
- 4-12. Gain-Phase Measurement Crosstalk Test 4-47
- 4-13. Impedance Measurement Signal Level Test 4-49
- 4-14. Impedance Measurement Accuracy Test 4-53
- 4-15. Impedance Measurement Level Monitor Test 4-55
- 4-16. DC Bias Voltage Test 4-58
- 4-17. HP-IB Performance Test 4-60

APPENDICES

- Appendix A. Back Dating A-1
- Appendix B. Softkey Tree B-1
- Appendix C. SAVE Function C-1

CONTENTS (cont.)

Appendix D.	System Messages	D-1
Appendix E.	Program Codes	E-1
Appendix F.	Calibration Reference Values	F-1
Appendix G.	Interpolation Measurement Frequencies	G-1
1-1.	Specifications	1-4
1-2.	Supplemental Performance Characteristics	1-38
1-3.	Options	1-41
1-4.	Accessories Available	1-43
3-1.	Measurement Parameter Formulas for Impedance Measurement	3-75
3-2.	Register Setting Range	3-139, 140
3-3.	Arithmetic Operators	3-148
3-4.	HP-IB Interface Capability	3-150
3-5.	Registers and Data Formats	3-169
3-6.	Data Transfer Rate	3-173
3-7.	Sweep Parameters and Program Codes	3-207
3-8.	Recommended Plotters and Printers	3-214
3-9.	Capability of Three Modes	3-215
3-10.	Equivalent Circuit Model Selection Guide	3-224
4-1.	Recommended Test Equipment	4-2
4-2.	Internal Synthesizer Frequency Test Limits (Standard 4194As)	4-8
4-3.	Internal Synthesizer Frequency Test Limits (Opt. 001)	4-8
4-4.	Gain-Phase Measurement Accuracy Test Limits 1	4-10
4-5.	Gain-Phase Measurement Accuracy Test Limits 2	4-12
4-6.	Gain-Phase Measurement Accuracy Test Limits 3	4-15
4-7.	Gain-Phase Measurement Accuracy Test Limits 4	4-16
4-8.	Gain-Phase Measurement Accuracy Test Limits 5	4-16
4-9.	Gain-Phase Measurement Accuracy Test Limits 6	4-18
4-10.	LF Amplitude Measurement Accuracy Test Limits input impedance 50 Ω /75 Ω	4-29
4-11.	LF Amplitude Measurement Accuracy Test Limits input impedance 1M Ω	4-31
4-12.	HF Amplitude Measurement Accuracy Test Limits input impedance 50 Ω /75 Ω	4-33
4-13.	HF Amplitude Measurement Accuracy Test Limits input impedance 1M Ω	4-35
4-14.	Low Level Amplitude Measurement Accuracy Test Limits input impedance 50 Ω /75 Ω	4-37
4-15.	Low Level Amplitude Measurement Accuracy Test Limits input impedance 1M Ω	4-39
4-16.	Impedance Measurement Accuracy Test Limits 1	4-54
4-17 to 4-19	not assigned	
4-20.	DC Bias Voltage Test Limits	4-67

ILLUSTRATIONS

- 1-1. Model 4194A and Accessories 1-1
- 1-2. Serial Number Plate 1-3

- 2-1. Interconnection Cables 2-2
- 2-2. Line Voltage and Fuse Selection 2-4
- 2-3. Power Cables Supplied 2-5
- 2-4. Typical HP-IB System Interconnection 2-6
- 2-5. HP-IB Interfacing 2-7

- 3-1. Panel Features 3-2
- 3-2. Power on Default Screen 3-12
- 3-3. HP 16085A Connection 3-14
- 3-4. Power-On Default Display 3-16
- 3-5. Auto Scaled 3-17
- 3-6. Self-Resonant Point 3-18
- 3-7. EQUIVALENT CIRCUIT MODE page 3-19
- 3-8. Calculation Results 3-19
- 3-9. Cs-D Measurement Display 3-20
- 3-10. Sweep Start Value Entry 3-21
- 3-11. AUTO SCALED 3-22
- 3-12. o-Marker and *-Marker 3-23
- 3-13. Deviation 3-24
- 3-14. Mounting the DUT 3-27
- 3-15. Full Sweep Measurement 3-27
- 3-16. o-Marker's Position 3-28
- 3-17. +-Marker's Position 3-29
- 3-18. Expand Sweep 3-29
- 3-19. 30MHz Center Frequency 3-30
- 3-20. Data A Auto Scaled 3-31
- 3-21. Optimum Sweep Span 3-31
- 3-22. Auto Scale B 3-32
- 3-23. Sweep Span 300 KHz 3-32
- 3-24. Resonant Point 3-34
- 3-25. Anti-Resonant Point 3-34
- 3-26. Frequency Characteristics of Conductance and Susceptance 3-36
- 3-27. Table display 3-37
- 3-28. RECTAN A-B Display 3-38
- 3-29. Probe Connection To 4194A 3-39
- 3-30. OS Calibration Standard 3-41
- 3-31. Probe and Test Fixtures 3-42
- 3-32. DUT Connection 3-44
- 3-33. Probe Default Data 3-44
- 3-34. Resonant Points 3-45
- 3-35. Equivalent Constants 3-45
- 3-36. BPF Connection to 4194A 3-47
- 3-37. Auto-scaled Measurement Data 3-50
- 3-38. Passband Insertion Loss 3-51
- 3-39. -3dB Bandwidth 3-52
- 3-40. Width Read 3-52
- 3-41. Partial Analysis On 3-55
- 3-42. o-Marker on Minimum Point 3-55
- 3-43. o-Marker on Maximum Point 3-56
- 3-44. Passband Ripple 3-57

ILLUSTRATIONS (cont.)

- 3-45. Passband Insertion (Expansion mode) 3-58
- 3-46. Passband Insertion (Normal mode) 3-58
- 3-47. Group Delay 3-60
- 3-48. Relationship of Factors 3-61
- 3-49. RF Amplifier Connection to HP 4194A 3-63
- 3-50. -3dB Gain Compression Point 3-67
- 3-51. Reference Marker Read 3-68
- 3-52. Screen 3-69
- 3-53. Sweep Types 3-70
- 3-54. Scale Types 3-71
- 3-55. SOFTKEYS 3-71
- 3-56. MENU Keys 3-72
- 3-57. FUNCTION menu 3-74
- 3-58. IMPEDANCE menu 3-74
- 3-59. GAIN-PHASE menu 3-76
- 3-60. Monitor display 3-77
- 3-61. MONITOR menu 3-77
- 3-62. SWEEP menu 3-79
- 3-63. EXPAND MARKER 3-80
- 3-64. Frequency Sweep 3-80
- 3-65. DC BIAS Sweep 3-81
- 3-66. OSC Level(V) Sweep 3-81
- 3-67. COMPENSATION menu 3-82
- 3-68. DISPLAY menu 3-84
- 3-69. Rectangular A-B 3-85
- 3-70. RECTAN X-A&B menu Scale 3-85
- 3-71. Rectangular A-B Scale Type 3-86
- 3-72. Rectangular A-B menu 3-86
- 3-73. TABLE 3-87
- 3-74. TABLE menu 3-87
- 3-75. SUPERIMPOSE menu 3-88
- 3-76. Display after AUTO SCALE 3-89
- 3-77. AMAX=6.00000E+01 3-90
- 3-78. Direct Key In 3-90
- 3-79. New A MAX value 3-90
- 3-80. Line Number 3-91
- 3-81. A Table 3-91
- 3-82. MARKER/L CURSOR menu 3-93
- 3-83. o Marker Display(RECTAN X-A&B) 3-94
- 3-84. o-Marker on Table 3-95
- 3-85. o-MARKER menu 3-95
- 3-86. o REF - MKR display 3-97
- 3-87. o Ref - MKR menu 3-97
- 3-88. Line Cursor display 3-98
- 3-89. Line Cursor and o REF-LCURS menu 3-98
- 3-90. o REF- LCURS display 3-99
- 3-91. o- & -Marker Display 3-101
- 3-92. "o- & -MKRS" menu 3-101
- 3-93. Partial Sweep Range 3-103
- 3-94. Partial Analysis Range 3-105
- 3-95. MORE MENUS menu 3-106
- 3-96. PROGRAM menu 3-107
- 3-97. Program Editor Page 3-107
- 3-98. HP-IB DEFINE menu 3-110
- 3-99. COPY menu 3-111

ILLUSTRATIONS (cont.)

- 3-100. PLOT menu 3-112
- 3-101. P1, P2 NORMAL 3-113
- 3-102. P1, P2 GRATICULE 3-113
- 3-103. PSCALE=(P1, P2) 3-113
- 3-104. EQUIVALENT CIRCUIT 3-114
- 3-105. EQV CKT menu MODE page 3-114
- 3-106. PROGRAM TABLE, and SET PROGRAM TABLE menu 3-116
- 3-107. statement menu 3-118
- 3-108. SWEEP MODE Keys 3-118
- 3-109. TRIGGER Keys 3-119
- 3-110. LOCAL and COPY Key 3-120
- 3-111. AVERAGING VIEW Key 3-121
- 3-112. Noise Reduction by Averaging 3-121
- 3-113. The Weighting Factor 3-122
- 3-114. o Marker and Line cursor 3-123
- 3-115. EDIT keys 3-124
- 3-116. Parameter Keys 3-125
- 3-117. Sweep Start 3-125
- 3-118. SAVE Command 3-128
- 3-119. COMMENT 3-129
- 3-120. Step Up/Down Keys 3-130
- 3-121. ENTRY Keys 3-131
- 3-122. UNKNOWN Terminals 3-133
- 3-123. Trigger Pulse 3-134
- 3-124. External Trigger Pulse 3-135
- 3-125. Z Register Operations 3-149
- 3-126. Syntax Diagram for Select and String Data Type Commands 3-155
- 3-127. Syntax Diagram for Immediate Execution and Data Entry Commands 3-156
- 3-128. Program Message Element 3-157
- 3-129. Alpha Header 3-157
- 3-130. Character Header 3-157
- 3-131. Numeric Data Type 3-158
- 3-132. Syntax Diagram for NR1 3-158
- 3-133. Syntax Diagram for NR2 3-159
- 3-134. Syntax Diagram for NR3 3-159
- 3-135. Suffix 3-160
- 3-136. String Data Syntax Diagram 3-160
- 3-137. Character Data Syntax Diagram 3-161
- 3-138. Syntax for SR1, SR2, and SR3 3-162
- 3-139. Syntax Diagram for FMT2 and FMT3 3-171
- 3-140. FMT2 Data Format 3-171
- 3-141. FMT3 Data Format 3-172
- 3-142. Status Byte 3-174
- 3-143. Mask Byte 3-175
- 3-144. Program Editor Page 3-183
- 3-145. Examples for "SWTRG" Code 3-187
- 3-146. Softkey Menu for Compensation 3-195
- 3-147. Fixture Connection Diagram 3-196
- 3-148. Parasitic Elements of Test Fixture 3-197
- 3-149. Programmed Points Table Menu 3-206
- 3-150. Programmed Points Table 3-207
- 3-151. Limit Data Display 3-210
- 3-152. HP-IB DEFINE Menu 3-214
- 3-153. COPY Menu and PLOT Menu 3-216

ILLUSTRATIONS (cont.)

- 3-154. PSCALE= P1x, P1y, P2x, P2y 3-217
 - 3-155. PSCALE Area 3-217
 - 3-156. P1, P2 Selection 3-218
 - 3-157. EQV CKT Menus 3-219
 - 3-158. Measurement Results (Z-Phase) 3-220
 - 3-159. Equivalent Parameters Calculation Results 3-221
 - 3-160. F Characteristics Calculation and Measurement Data 3-222
 - 3-161. Calculated F Characteristics 3-222
 - 3-162. Wrong Constants and Frequency Characteristics 3-223
 - 3-163. 8-Bit I/O Connector 3-225
-
- 4-1. Programmed Points Table 1 for Impedance Performance Tests 4-6
 - 4-2. Programmed Points Table 2 for Gain-Phase Performance Tests 4-6
 - 4-3. Internal Synthesizer Frequency Test Setup 4-7
 - 4-4. Gain-Phase Measurement Accuracy Test Setup: 50 Ω 4-9
 - 4-5. Gain-Phase Measurement Accuracy Test Setup: 75 Ω 4-13
 - 4-6. Gain-Phase Measurement Accuracy Test Setup: 1M Ω 4-17
 - 4-7. HP 8495A Calibration Setup 1 4-19
 - 4-8. HP 8495A Attenuator Calibration Setup 2 4-20
 - 4-9. HP 11667A Tracking Error Calibration Setup 1 4-21
 - 4-10. HP 11667A Tracking Error Calibration Setup 2 4-23
 - 4-11. HP 11852A Insertion Loss Calibration Setup 1 4-23
 - 4-12. HP 11852A Insertion Loss Calibration Setup 2 4-25
 - 4-13. HP 11852A Insertion Loss Calibration Setup 3 4-25
 - 4-14. HP 11852A Insertion Loss Calibration Setup 4 4-26
 - 4-15. Amplitude Measurement Accuracy Test Setup 1 4-27
 - 4-16. Amplitude Measurement Accuracy Test Setup 2 4-30
 - 4-17. Amplitude Measurement Accuracy Test Setup 3 4-31
 - 4-18. Amplitude Measurement Accuracy Test Setup 4 4-34
 - 4-19. Amplitude Measurement Accuracy Test Setup 5 4-36
 - 4-20. Amplitude Measurement Accuracy Test Setup 6 4-38
 - 4-21. Gain-Phase Measurement Signal Level Test Setup 1 4-40
 - 4-22. Gain-Phase Measurement Signal Level Test Setup 2 4-43
 - 4-23 to 4-24 not assigned
 - 4-25. Power Splitter Test Setup 1 4-45
 - 4-26. Power Splitter Test Setup 2 4-46
 - 4-27. Gain-Phase Measurement Crosstalk Test Setup 4-47
 - 4-28. Impedance Measurement Signal Level Test Setup 1 4-49
 - 4-29. Impedance Measurement Signal Level Test Setup 2 4-51
 - 4-30. Impedance Measurement Accuracy Test Setup 1 4-53
 - 4-31 to 4-32 not assigned
 - 4-33. Impedance Measurement V Level Monitor Test Setup 1 4-55
 - 4-34. Impedance Measurement V Level Monitor Test Setup 2 4-56
 - 4-35 not assigned
 - 4-36. DC Bias Voltage Test Setup 4-58
 - 4-37. HP-IB Performance Test Setup 4-60

SECTION 1 GENERAL INFORMATION

- 1-1. **Introduction 1-1**
- 1-2. **Description 1-2**
- 1-3. **Specifications 1-2**
- 1-4. **Safety Considerations 1-3**
- 1-5. **Instruments Covered by this Manual 1-3**
- 1-6. **Options 1-41**
- 1-7. **Accessories Supplied 1-42**
- 1-8. **Accessories Available 1-43**

SECTION 1 GENERAL INFORMATION

1-1. INTRODUCTION

This operation manual contains the information required to install, operate, and test the Hewlett-Packard Model 4194A Impedance/Gain-Phase Analyzer. Figure 1-1 shows the 4194A and its supplied accessories. This section covers specifications, instrument identification, description, options, and accessories.

Listed on the title page of this manual is a microfiche part number. This number can be used to order 4 x 6 inch microfilm transparencies of the manual. Each microfiche contains up to 60 photo-duplicates of the manual pages. The microfiche package also includes the latest manual changes supplement as well as all pertinent service notes. To order an additional manual, use the part number listed on the title page of this manual.

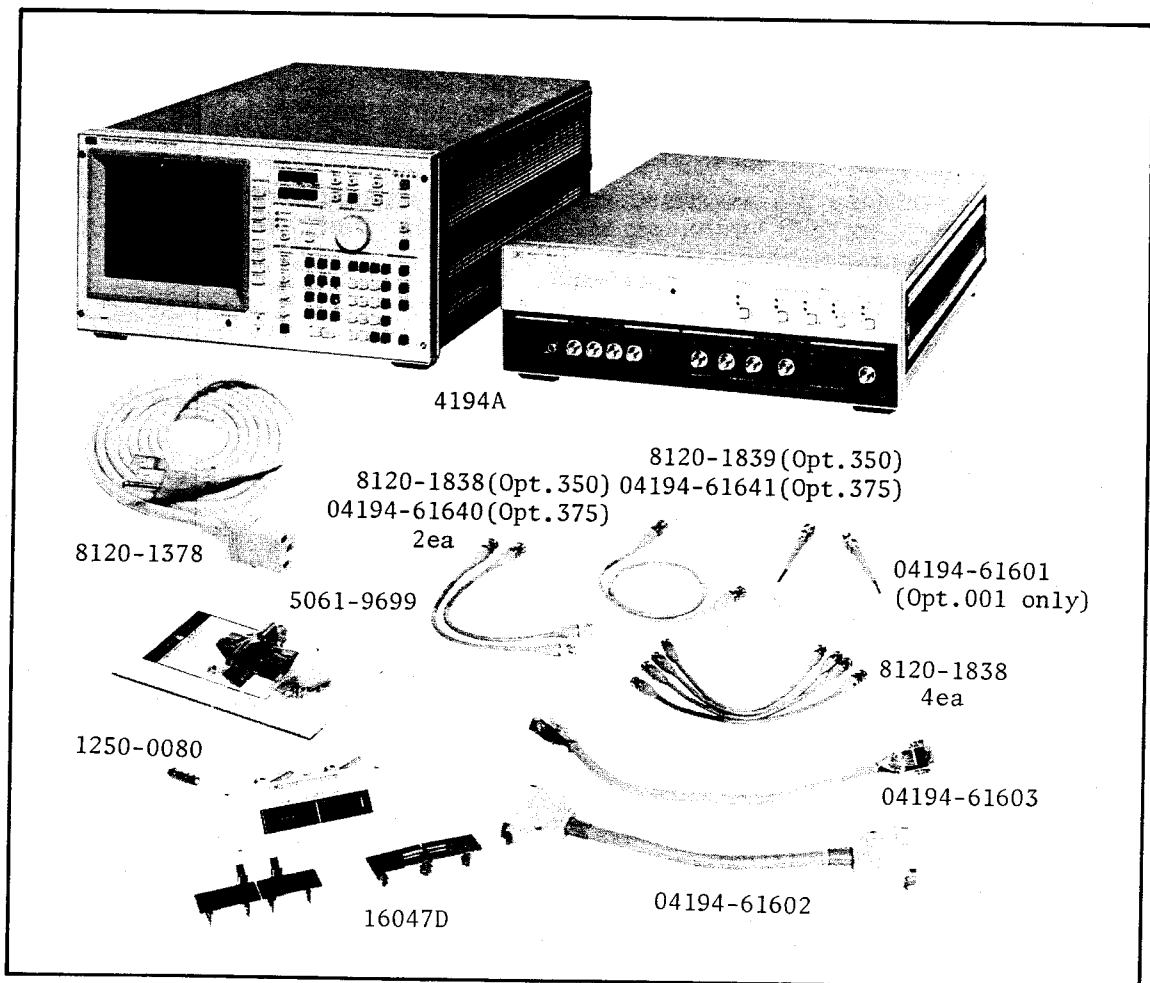

Figure 1-1. Model 4194A and Accessories

GENERAL INFORMATION

1-2. DESCRIPTION

The HP 4194A features eleven Impedance and four Gain-Phase measurement functions and covers a frequency range of 100Hz to 40MHz for Impedance, and from 10Hz to 100MHz for Gain-Phase. The output level, with an adjustable dc bias level of $\pm 40V$, ranges from 10mV to 1Vrms for Impedance and from -65dBm to +15dBm for Gain-Phase. Sweep Parameters include Frequency and OSC level for both Impedance and Gain-Phase functions with the addition of dc Bias for the Impedance function. Up to 401 individual sweep points can be selected for special applications. The basic measurement accuracy is 0.17% of reading for Impedance and 0.1dB/0.5° for Gain-Phase.

Note

When the probe from the 41941A/B Probe kit is used the frequency range for impedance measurement is 10kHz to 100MHz.

The 4194A's menu-driven software uses eight softkeys located next to the menu display area of the CRT. Menus are selected by pressing the **MENU** key which corresponds to the desired operation. Current marker information and sweep parameters are displayed above and below the CRT graticule as status information.

Measurement information displayed on the 4194A's CRT is stored as complex data. Using this storage technique and the math processing capabilities of the 4194A, several display formats may be derived from the same trace data and changes in scale may be made without repeating the measurement.

The 4194A's graticules are electronically generated, making overlays unnecessary when producing a log grid. In the log sweep mode, the graticule changes to reflect changes in the start and stop parameter values.

The 4194A provides HP-IB interface capability for complete remote control of all front panel control key settings and test parameter settings. This feature makes it possible to integrate the 4194A into a measurement system, improve DUT throughput, improve circuit design efficiency, and reduce the component development cycle.

Other features of the 4194A include Auto Sequence Program (ASP), dumping the display to a printer or plotter, program table for GO/NO GO testing, equivalent circuit mode, and the ability to save and recall five instrument states.

The HP 4194A consists of a CONTROL unit and a MEASUREMENT unit. The CONTROL unit displays the measurement results, and the MEASUREMENT unit interfaces directly to the devices to be measured.

1-3. SPECIFICATIONS

Table 1-1 lists complete 4194A specifications. These specifications are the performance standards or limits against which the instrument is tested. When shipped from the factory, the 4194A meets the specifications listed in Table 1-1. The specification test procedures are covered in Section 4. Table 1-2 lists supplemental performance characteristics. Supplemental performance characteristics are not specifications but are typical characteristics included as additional information for the operator.

1-4. SAFETY CONSIDERATIONS

The 4194A conforms to the safety requirements of an IEC (International Electromechanical Committee) Safety Class I instrument and is shipped from the factory in a safe condition. This operation manual contains information, cautions, and warnings which must be followed to ensure safe operation and to maintain the instrument in a safe condition.

1-5. INSTRUMENTS COVERED BY THIS MANUAL

Hewlett-Packard uses a two-section nine character serial number which is stamped on the serial number plate (Figure 1-2) attached to the instrument's rear-panel. The first four digits and the letter are the serial prefix and the last five digits are the suffix. The letter placed between the two sections identifies the country where the instrument was manufactured. The prefix is the same for all identical instruments; it changes only when a change is made to the instrument. The suffix, however, is assigned sequentially and is different for each instrument. The contents of this manual apply to instruments with the serial number prefixes listed under Serial Numbers on the title page.

An instrument manufactured after the printing of this manual may have a serial number prefix that is not listed on the title page. This unlisted serial number prefix indicates the instrument is different from those described in this manual. The manual for this new instrument may be accompanied by a yellow Manual Changes supplement or have a different manual part number. This supplement contains "change information" that explains how to adapt the manual to the newer instrument.

In addition to change information, the supplement may contain information for correcting errors (Errata) in the manual. To keep this manual as current and accurate as possible, Hewlett-Packard recommends that you periodically request the latest Manual Changes supplement. The supplement for this manual is identified with this manual's print date and part number, both of which appear on the manual's title page. Complimentary copies of the supplement are available from Hewlett-Packard. If the serial prefix or number of an instrument is lower than that on the title page of this manual, see APPENDIX A, BACK DATING.

For information concerning a serial number prefix that is not listed on the title page or in the Manual Change supplement, contact the nearest Hewlett-Packard office.

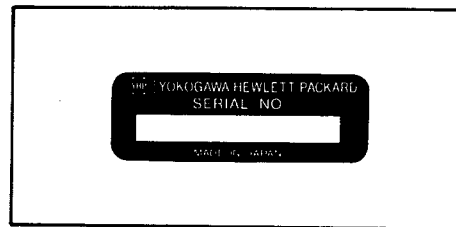

Figure 1-2. Serial Number Plate

Table 1-1. Specifications (sheet 1 of 33)

IMPEDANCE MEASUREMENT

The 4194A provides two impedance measurement functions either of which can be selected by using the 'IMPEDANCE' (Program code: FNC1) or 'IMP with Z PROBE' (Program code: FNC3) softkeys. The latter function is provided for use with the 41941A/B Impedance Probe Kit. The specifications on both functions are listed separately and more specific information for the **IMP with Z PROBE** function when used with the probe is described in the 41941A/B Operation Note.

1. IMPEDANCE MEASUREMENT (FNC1):

Measurement Parameters: |Z| (impedance), |Y| (admittance), θ (phase), R (resistance), X (reactance), G (conductance), B (susceptance), L (inductance), C (capacitance), D (dissipation factor), Q (quality factor =1/D), 20 parameter combinations are available.

Test Frequency:

- * Range: 100Hz to 40MHz with CABLE LENGTH switch set to 0m.
100Hz to 15MHz with CABLE LENGTH switch set to 1m.
- * Resolution: 1mHz
- * Accuracy: ± 20 ppm, at 23°C ± 5 °C

OSC Level:

- * Range: 10mV to 1Vrms (≤ 10 MHz),
10mV to 0.5Vrms (> 10 MHz). (UNKNOWN terminals open)
- * Resolution: 3 digits
- * Accuracy: ± 1 dB at 100kHz, at 23°C ± 5 °C
- * Flatness: ± 1 dB
- * Output Impedance: 50 Ω (option 350), 75 Ω (option 375)
- * Harmonics: ≤ -45 dBc
- * Non-Harmonic Spurious: ≤ -42 dBc
- * Phase Noise: ≤ -90 dBc/ $\sqrt{\text{Hz}}$ (2kHz offset)

Table 1-1. Specifications (sheet 2 of 33)

* Units:	V, dBm, dBV
NOTE	
dBc indicates a measurement relative to the carrier (set) frequency.	
DC Bias Level:	
* Range:	0 to $\pm 40V$
* Resolution:	10mV
* Accuracy:	$\pm(0.12\% + 12mV)$, at $23^{\circ}C \pm 5^{\circ}C$
* Output Impedance:	50 Ω (Opt. 350), 75 Ω (Opt 375)
* Maximum Current:	Depends on the DUT impedance $\pm 20mA$, ($ Z \leq 400\Omega$) $\pm 10mA$, ($ Z \leq 3.2k\Omega$) $\pm 1.2mA$, ($ Z \leq 25k\Omega$) $\pm 150\mu A$, ($ Z > 25k\Omega$)
Sweep Function:	
* Sweep Parameters:	Frequency, OSC Level, DC Bias
* Maximum Sweep Range:	
Frequency:	100Hz to 40MHz with the CABLE LENGTH switch is set to 0m. 100Hz to 15MHz with CABLE LENGTH switch set to 1m.
OSC Level:	26dB (max)
DC Bias:	0 to $\pm 40V$
* Entry:	START/STOP or CENTER/SPAN
* Sweep Type:	LIN, LOG, ZERO SPAN
* Sweep Mode:	REPEAT, SINGLE, MANUAL
* Direction:	UP, DOWN
Number of Measurement Points:	2 to 401 points (maximum 261 points at OSC Level sweep)
Measurement Circuit Modes:	Series equivalent circuit, parallel equivalent circuit

Table 1-1. Specifications (sheet 3 of 33)

Ranging:	Auto
Measurement Terminal:	Four-Terminal Pair configuration
Auto Compensation:	
* Auto Zero Offset Compensation:	Compensates for test fixture residual impedance and stray admittance.
* Auto Calibration:	Calibrates probe or fixture using the calibration standards.
* Compensation Method:	Interpolation or All Points
* Interpolation Method:	Fifty-three fixed frequency points for 0m CABLE LENGTH and twenty-eight points for 1m CABLE LENGTH over the full frequency range. Linear interpolation is performed at the specified points.
* All Points Method:	Same as the specified measurement points.
* Compensation Range:	Same as the measurement range.
Test Cable Length:	0m or 1m.
Max. Input DC Current/Voltage:	±20mA / ±40V.
Level Monitor:	Monitor test voltage across and current through the DUT.
* Range:	1mV to 1Vrms, 1µA to 20mA.
* Accuracy: (at 23°C ±5°C)	

	≤1MHz	≤10MHz	>10MHz
Voltage	10%±1mV		
Current	10%±15nA	10%±(60×f)nA	10%±(600×f)nA

f: frequency (MHz)

Table 1-1. Specifications (sheet 4 of 33)

Measurement Range and Maximum Resolution:

Measurement Parameter	Range	Max. Resolution
Z , R, X	10mΩ to 100Ω	100μΩ
Y , G, B	10nS to 100S	1nS
θ	± 180°	0.01°
L	1nH to 100kH	10pH
C	10fF to 0.1F	0.1fF
D	0.001 to 10	0.0001
Q	0.1 to 1000	0.1

Measurement Accuracy:

Accuracy is specified at the UNKNOWN terminals under the following conditions.

1. Warm Up Time: > 30 minutes
2. Ambient Temperature: 23°C ±5°C
(The error doubles from 0°C to 40°C temperature range)
3. CABLE LENGTH Switch: 0m
4. Auto Zero Offset Compensation: On

Accuracy depends on the test frequency, magnitude of impedance measured, test signal level, integration time, and number of samples averaged.

* |Z|-θ Accuracy:

|Z| Accuracy:
$$Z_a = \frac{A1}{\alpha} + A2 + \left(\frac{B1}{|Z_m|} + B2 \cdot |Z_m| \right) \times \frac{100}{\alpha} \quad [\%]$$

θ Accuracy:
$$\theta_a = \frac{Z_a}{100} \cdot \frac{180}{\pi} \quad [^\circ]$$

Where |Z_m| is |Z| measured and α is test signal level in volts. A1, A2, B1, and B2 are obtained from Graph 1, 4, 7, or 10.

For example, Frequency = 100kHz, |Z_m| = 1kΩ, test signal level = 1V, INTEG TIME = MED, and number of sample averaged = 4, then A1 = 0.023, A2 = 0.15, B1 = .25mΩ, B2 = 2.5nS, and α = 1 therefore,

$$Z_a = \frac{0.023}{1} + 0.15 + \left(\frac{2.5 \times 10^{-3}}{1 \times 10^3} + 2.5 \times 10^{-9} \times 1 \times 10^3 \right) \times \frac{100}{1} = 0.17\%$$

GENERAL INFORMATION

Table 1-1 Specifications (sheet 5 of 33)

* |Y| -θ Accuracy:

|Y| Accuracy:
$$Y_a = \frac{A1}{\alpha} + A2 + \left(B1 \cdot |Y_m| + \frac{B2}{|Y_m|} \right) \times \frac{100}{\alpha} \quad [\%]$$

θ Accuracy:
$$\theta_a = \frac{Y_a}{100} \cdot \frac{180}{\pi} \quad [^\circ]$$

where |Y_m| is |Y| measured and α is test signal level in volts. A1, A2, B1 and B2 are obtained from Graph 1, 4, 7 or 10.

* R, X Accuracy (depends on D):

	D ≤ 0.2	0.2 < D ≤ 5	5 < D
R _a	± X _m · $\frac{Z_a(x)}{100}$ (Ω)	$\frac{Z_a(r)}{\cos\theta}$ [%]	Z _a (*) [%]
X _a	Z _a (x) [%]	$\frac{Z_a(x)}{\sin\theta}$ [%]	± R _m · $\frac{Z_a(r)}{100}$ [Ω]

where θ is phase angle,

$$Z_a(x) = \frac{A1}{\alpha} + A2 + \left(\frac{B1}{X_m} + B2 \cdot X_m \right) \times \frac{100}{\alpha} \quad [\%]$$

$$Z_a(r) = \frac{A1}{\alpha} + A2 + \left(\frac{B1}{R_m} + B2 \cdot R_m \right) \times \frac{100}{\alpha} \quad [\%]$$

X_m is measured X, R_m is measured R, and α is test signal level in volts. A1, A2, B1, and B2 are obtained from Graph 1, 4, 7 or 10.

* G, B Accuracy (depends on D):

	D ≤ 0.2	0.2 < D ≤ 5	5 < D
G _a	± B _m · $\frac{Y_a(s)}{100}$ [S]	$\frac{Y_a(s)}{\cos\theta}$ [%]	Y _a (ε) [%]
B _a	Y _a (s) [%]	$\frac{Y_a(s)}{\sin\theta}$ [%]	± G _m · $\frac{Y_a(s)}{100}$ [S]

where θ is phase angle,

$$Y_a(s) = \frac{A1}{\alpha} + A2 + \left(B1 \cdot B_m + \frac{B2}{B_m} \right) \times \frac{100}{\alpha} \quad [\%]$$

$$Y_a(\epsilon) = \frac{A1}{\alpha} + A2 + \left(B1 \cdot G_m + \frac{B2}{G_m} \right) \times \frac{100}{\alpha} \quad [\%]$$

B_m is measured B, G_m is measured G, α is test signal level in volts. A1, A2, B1, and B2 are obtained from Graph 1, 4, 7 or 10.

Table 1-1. Specifications (sheet 6 of 33)

* D Accuracy:

	$D \leq 0.2$	$D > 0.2$
Da	$\frac{Za}{100}$	$\frac{Za}{100} \cdot (1+D^2)$

where Za is |Z| accuracy (refer to |Z|- θ Accuracy).

* L Accuracy (depends on D):

	$D \leq 0.2$	$D > 0.2$
L	La	$La \cdot (1+D)$

where

$$La = \frac{A1}{\alpha} + A2 + \left(\frac{B1}{|Z_L|} + B2 \cdot |Z_L| \right) \times \frac{100}{\alpha} \quad [\%]$$

where $|Z_L| = 2\pi \cdot f \cdot L_m$, f is frequency in Hz and L_m is measured L. A1, A2, B1, and B2 are obtained from Graph 2, 5, 8 or 11.

* C Accuracy (depends on D):

	$D \leq 0.2$	$D > 0.2$
C	Ca	$Ca \cdot (1+D)$

where

$$Ca = \frac{A1}{\alpha} + A2 + \left(\frac{B1}{|Z_C|} + B2 \cdot |Z_C| \right) \times \frac{100}{\alpha} \quad [\%]$$

where

$$|Z_C| = \frac{1}{2\pi \cdot f \cdot C_m}$$

f is frequency in Hz and C_m is measured C. A1, A2, B1 and B2 are obtained from Graph 3, 6, 9 or 12.

* Accuracy when CABLE LENGTH switch=1m:

Add the following term to A2 in Graph 1 to 12 when CABLE LENGTH switch is set to 1m.

$$\frac{3 \cdot f \text{ [MHz]}}{10}$$

where $f \leq 15\text{MHz}$.

Table 1-1. Specifications (sheet 7 of 33)

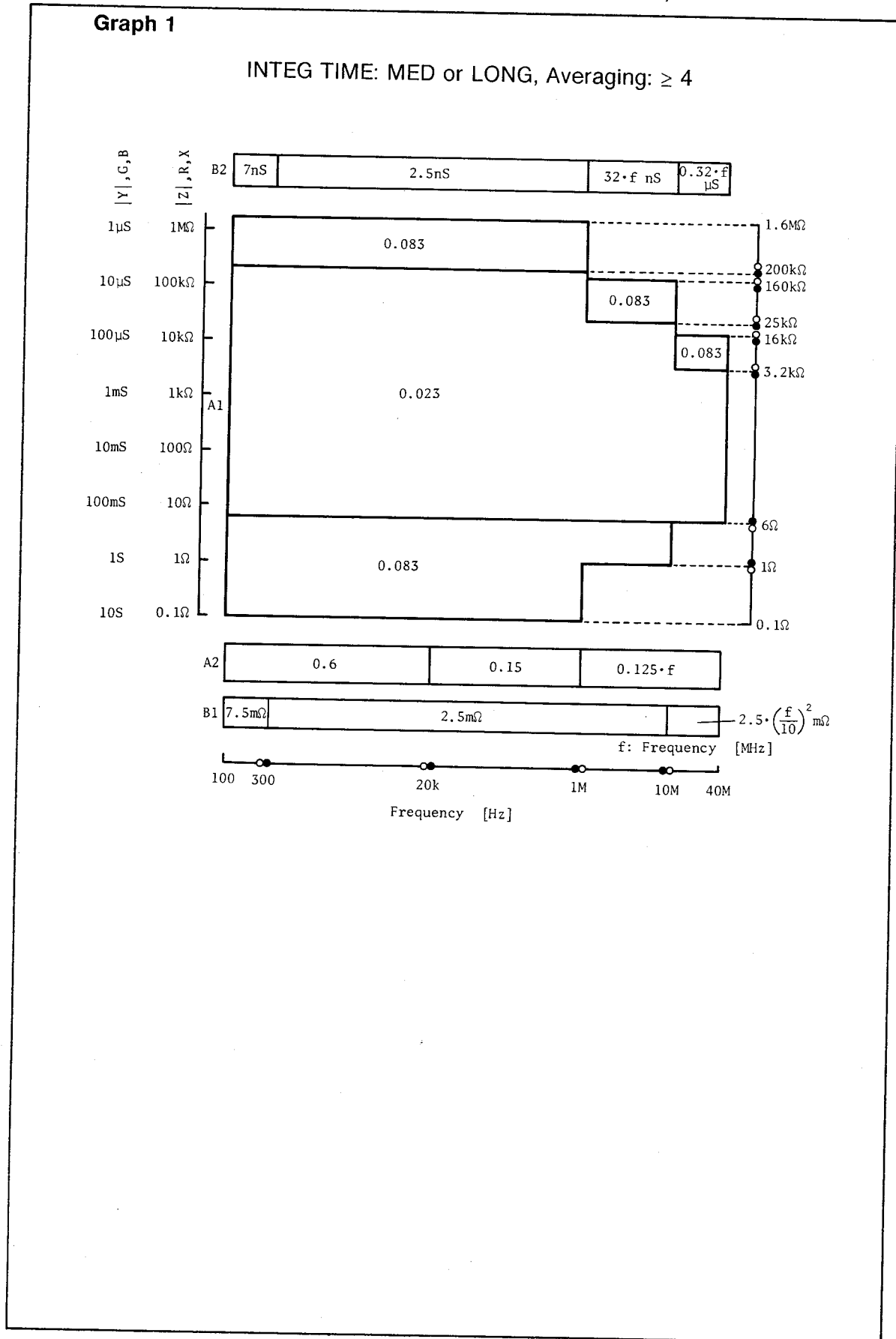
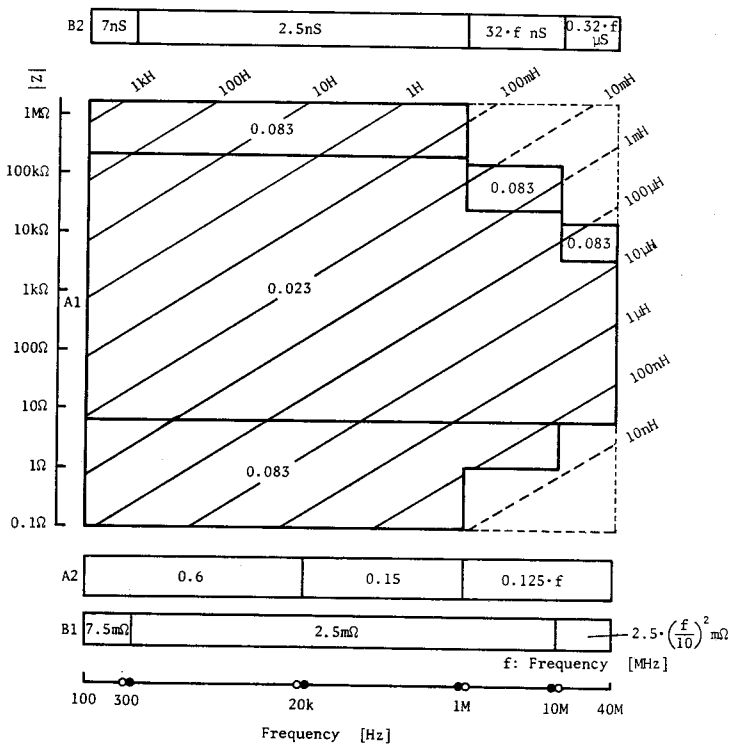

Table 1-1. Specifications (sheet 8 of 33)

Graph 2

INTEG TIME: MED or LONG, Averaging: ≥ 4



Graph 3

INTEG TIME: MED or LONG, Averaging: ≥ 4

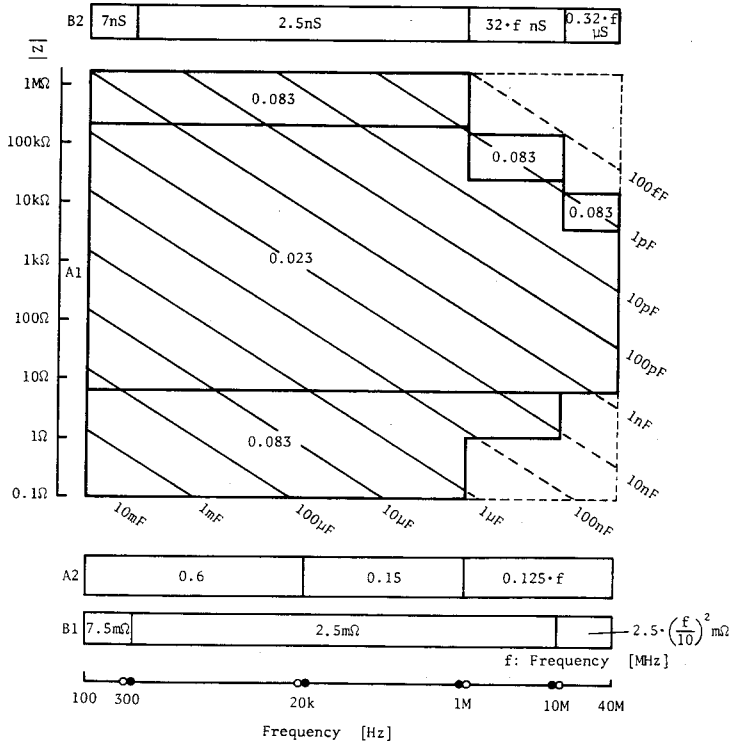

GENERAL INFORMATION

Table 1-1. Specifications (sheet 9 of 33)

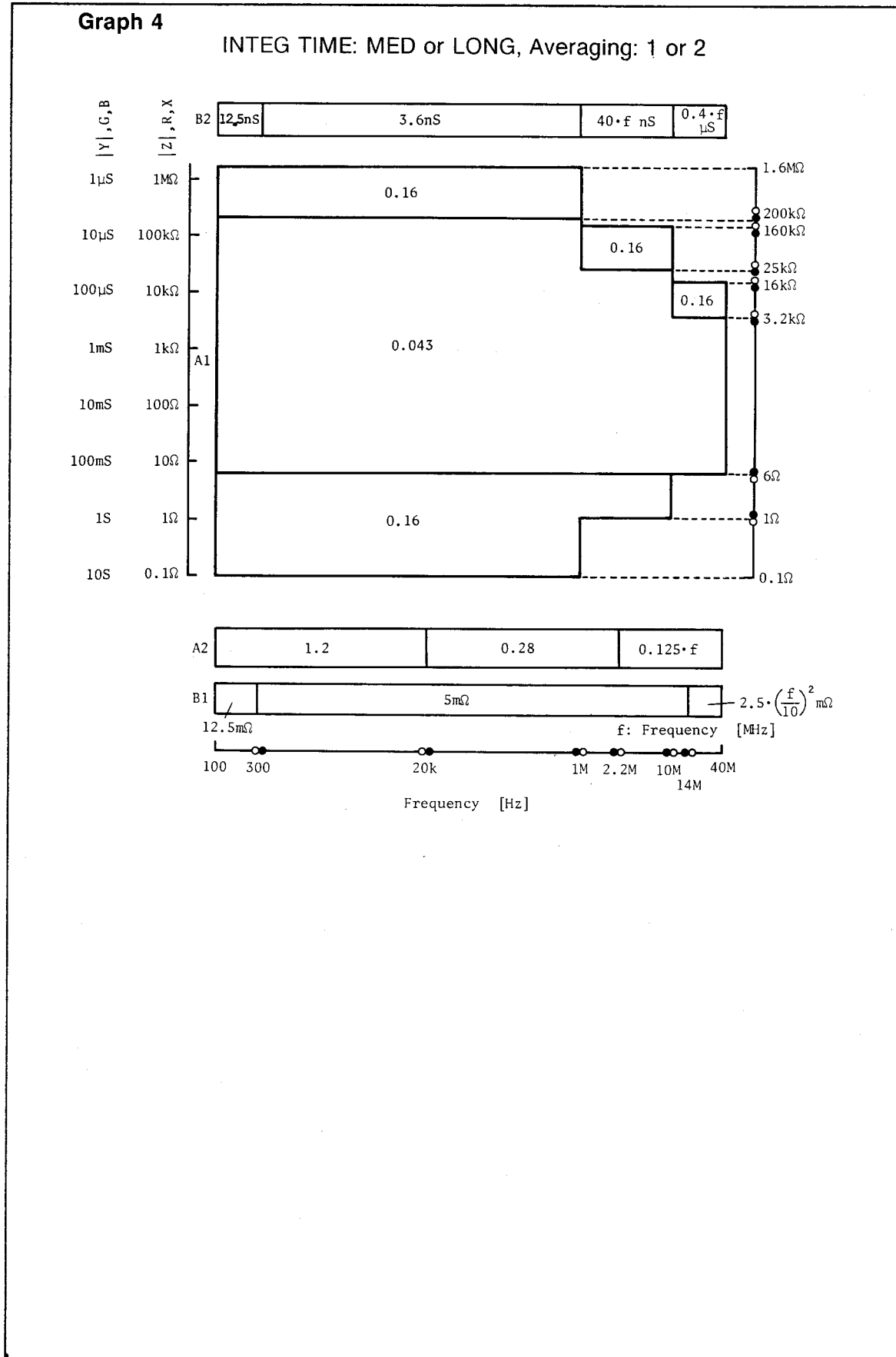
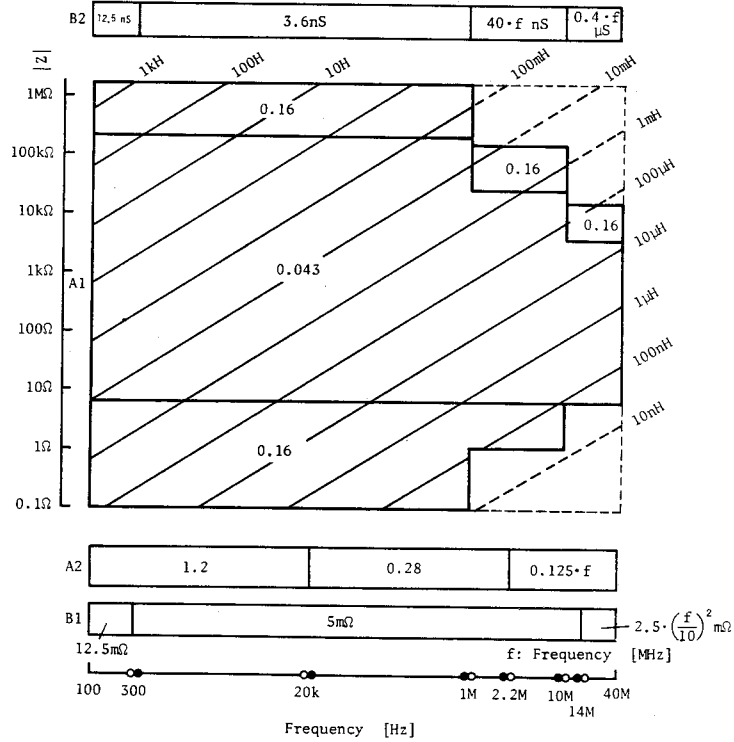

Table 1-1. Specifications (sheet 10 of 33)

Graph 5

INTEG TIME: MED or LONG, Averaging: 1 or 2



Graph 6

INTEG TIME: MED or LONG, Averaging: 1 or 2

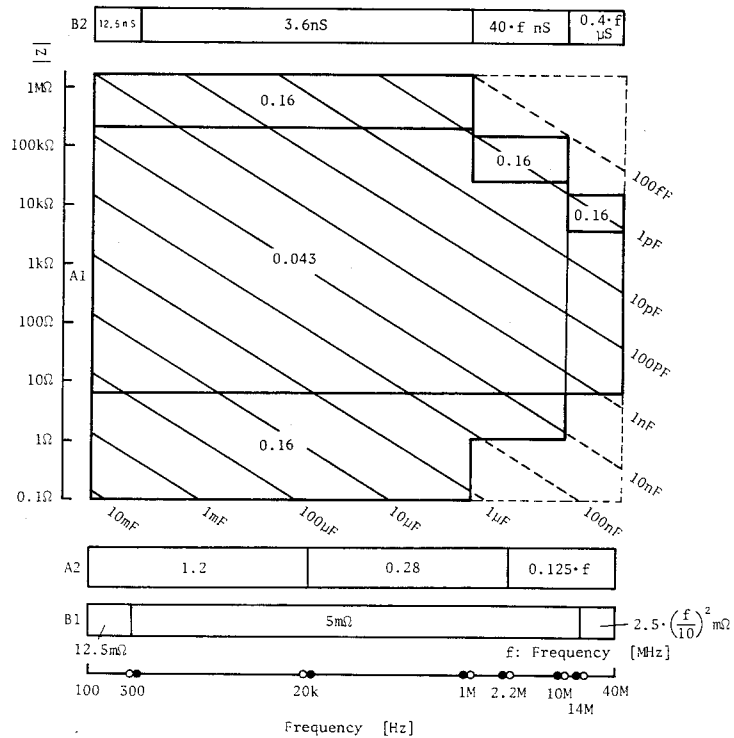

GENERAL INFORMATION

Table 1-1. Specifications (sheet 11 of 33)

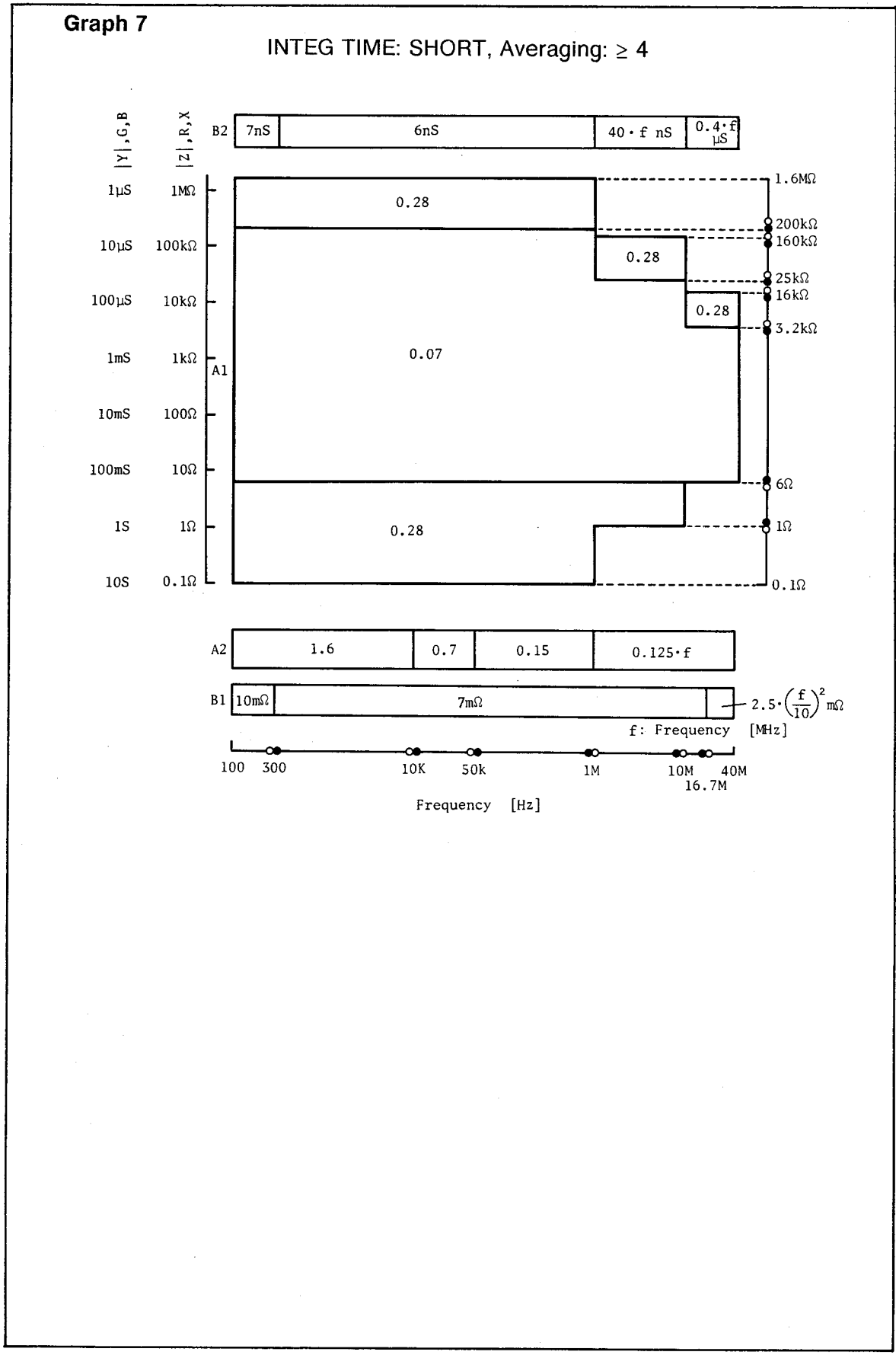
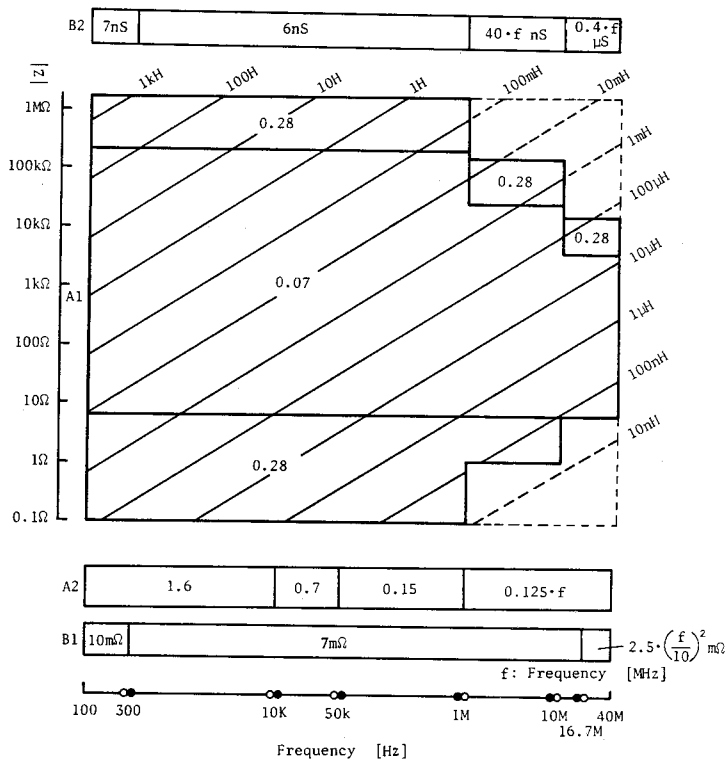

Table 1-1. Specifications (sheet 12 of 33)

Graph 8

INTEG TIME: SHORT, Averaging: ≥ 4



Graph 9

INTEG TIME: SHORT, Averaging: ≥ 4

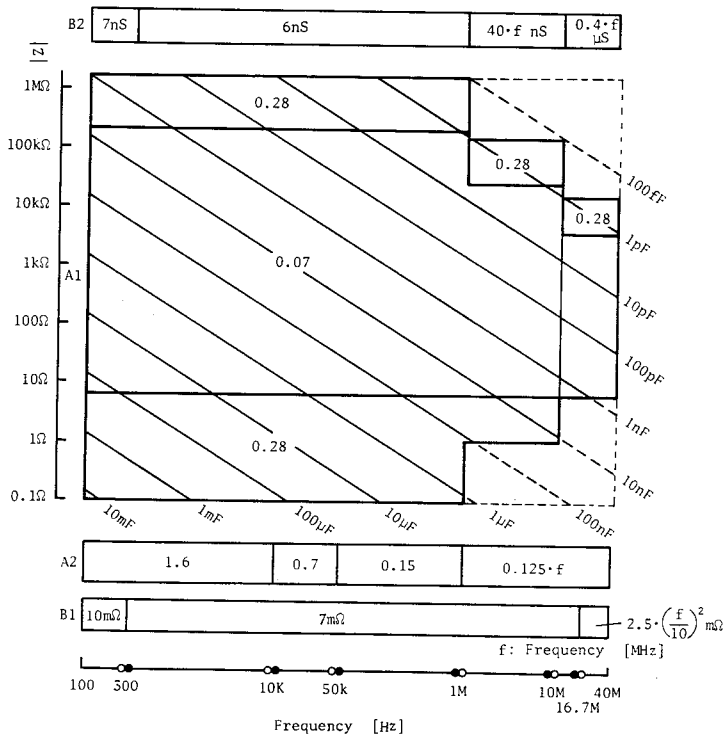

GENERAL INFORMATION

Table 1-1. Specifications (sheet 13 of 33)

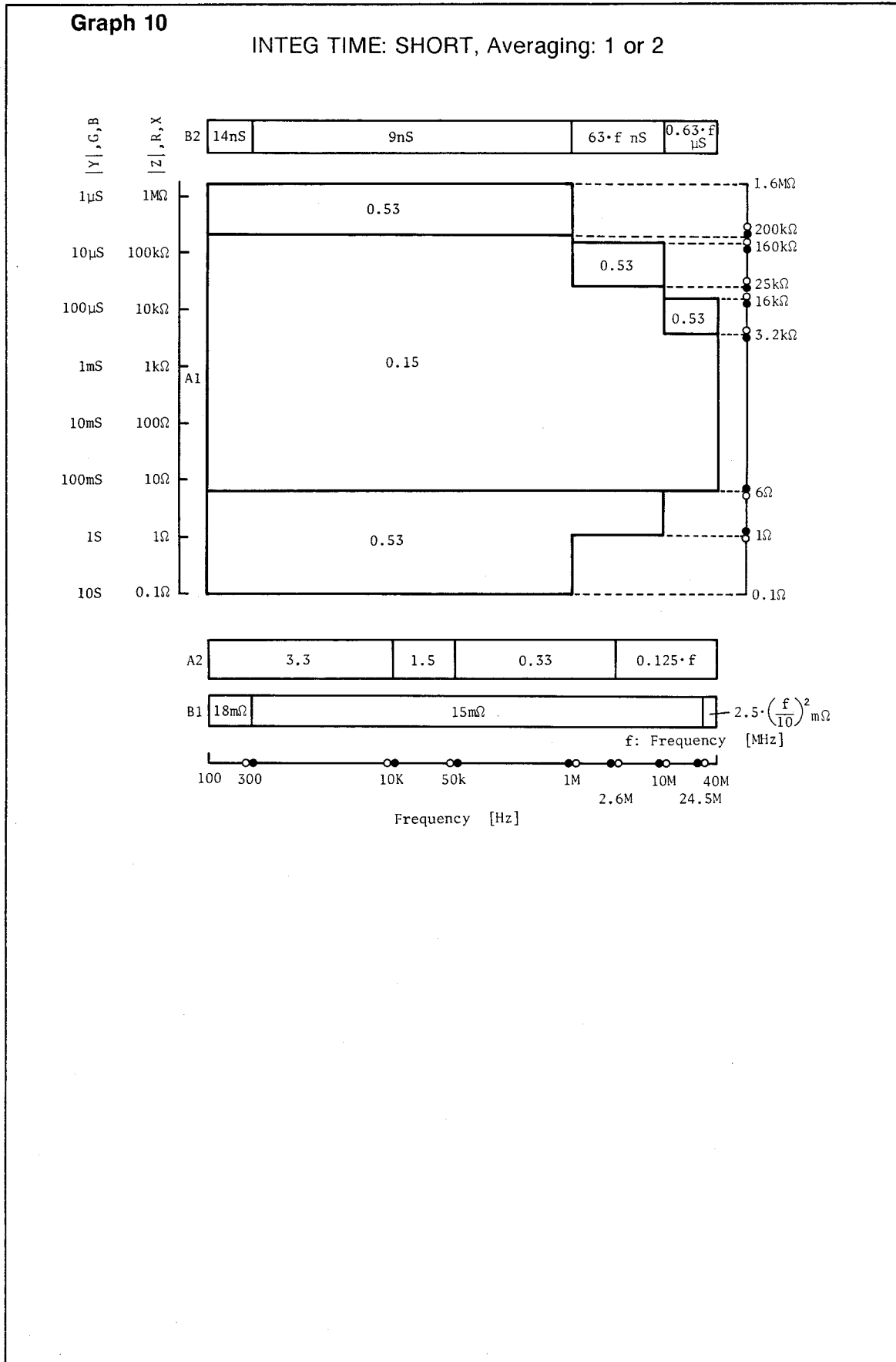
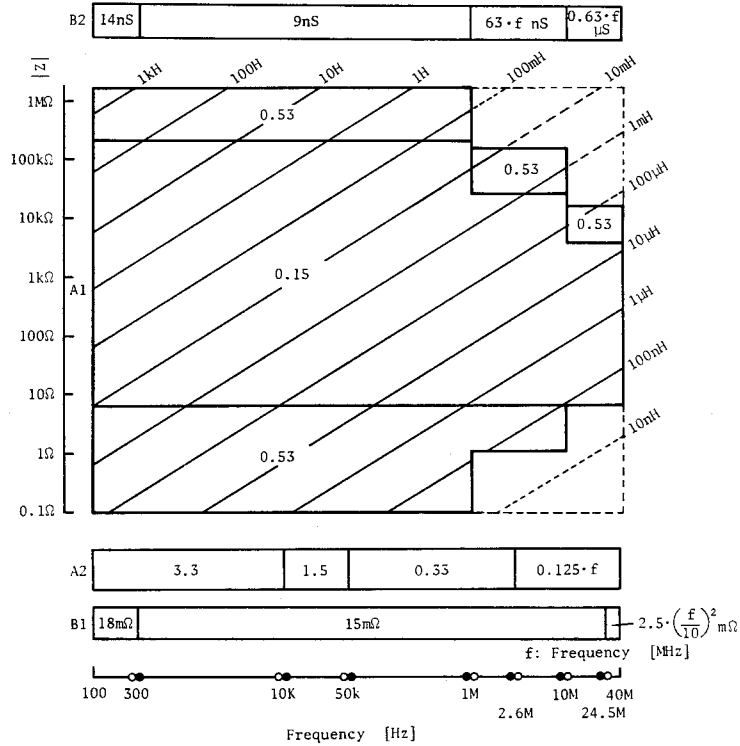

Table 1-1. Specifications (sheet 14 of 33)

Graph 11

INTEG TIME: SHORT, Averaging: 1 or 2



Graph 12

INTEG TIME: SHORT, Averaging: 1 or 2

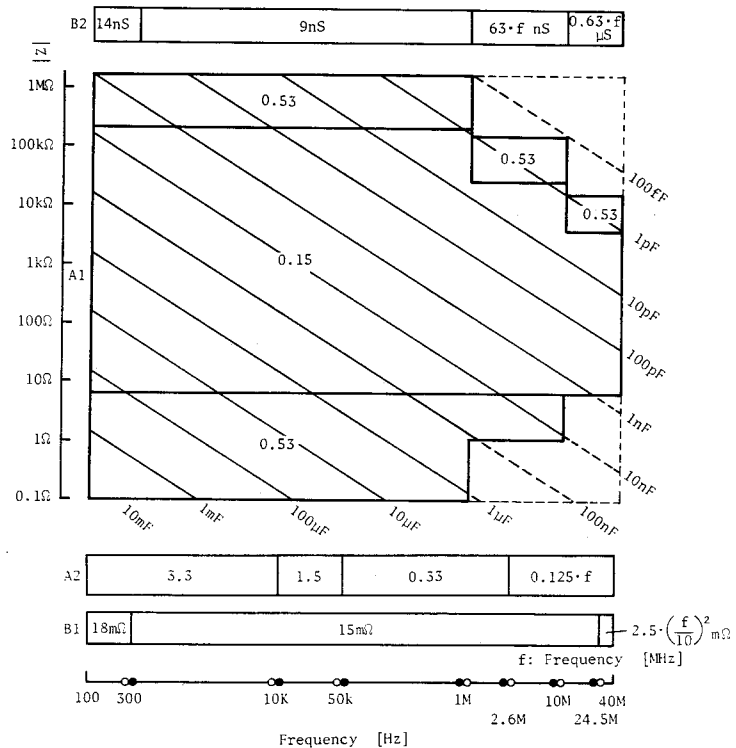

Table 1-1. Specifications (sheet 15 of 33)

2. IMPEDANCE MEASUREMENT (FNC3):	
Measurement Parameters:	Same as Impedance Measurement (FNC1).
Test Frequency:	Same as Gain-Phase Measurement
OSC Level:	Same as Gain-Phase Measurement
DC Bias Level: (Output from Hcur BNC terminal)	
* Range, Resolution, Accuracy, Output Impedance:	Same as Impedance Measurement (FNC1).
* Maximum Current:	±20mA
Sweep Function:	Same as Gain-Phase Measurement, plus DC Bias Sweep capability of Impedance Measurement (FNC1).
Number of Measurement Points:	Same as Gain-Phase Measurement
Output Characteristics:	Same as Gain-Phase Measurement
Input Characteristics:	Same as Gain-Phase Measurement
Auto Compensation:	
* Auto Zero Offset Compensation:	Compensates for test fixture residual impedance and stray admittance.
* Auto Calibration:	Calibrates probe or fixture using the calibration standards.
* Compensation Method:	Interpolation or All Points
* Interpolation Method:	Seventy fixed frequency points over the full frequency range. Linear interpolation is performed at the specified points.
* All Points Method:	Same as the specified measurement points.
* Compensation Range:	Same as the measurement range.

Table 1-1. Specifications (sheet 16 of 33)

GAIN-PHASE MEASUREMENT**Measurement Parameters:**

* Amplitude:

Ratio: Tch/Rch (dB, Linear Ratio)

Absolute: Tch, Rch (V, dBm, dBV)

Tch; Test Channel, Rch; Reference Channel

* Phase: (degree, radian)

* Group Delay: τ (seconds)**Test Frequency:**

* Range: 10Hz to 100MHz

* Resolution: 1mHz

* Accuracy: $\pm 20\text{ppm}$ ($23^\circ\text{C} \pm 5^\circ\text{C}$)**OSC Level (Single and Dual Outputs):*** Range: -65dBm to +15dBm (50 Ω load for option 350, and 75 Ω load for option 375)

* Resolution: 0.1dB

* Accuracy: $\pm 0.8\text{dB}$ (+15dBm, 100kHz at $23^\circ\text{C} \pm 5^\circ\text{C}$)
Add the larger of $\pm 0.02\text{dB/dB}$ or 0.2dB (<+15dBm)* Flatness: $\pm 1\text{dB}$ (+15dBm, 10Hz to 100MHz)
Add the larger of $\pm 0.02\text{dB/dB}$ or 0.2dB (<+15dBm)

* Entry Unit: dBm, dBV, V

Table 1-1. Specifications (sheet 17 of 33)

Sweep Function:	
* Sweep Parameter:	Frequency, OSC Level
* Maximum Sweep Range:	
Frequency:	10Hz to 100MHz
OSC Level:	26dB (max)
* Entry:	START/STOP or CENTER/SPAN
* Sweep Type:	LIN, LOG, ZERO SPAN
* Sweep Mode:	REPEAT, SINGLE, MANUAL
* Direction:	UP, DOWN
Number of Measurement Points:	2 to 401 points (maximum 261 points at OSC Level sweep)
Aperture Frequency (Group Delay Measurement):	
* Range:	0.5% to 100% of frequency span
* Maximum Resolution:	Depends on the numbers of measurement points (N).
	Maximum Resolution = $200 \div (N-1)$ [%]
	(when N=2, maximum resolution is 100%)
Output Characteristics:	
* Output:	SINGLE, DUAL (built-in power splitter)
* Connector:	50Ω Type Female BNC
* Harmonics:	≤ -40dBc (≤ 1MHz) ≤ -35dBc (≤ 10MHz) ≤ -30dBc (> 10MHz)
* Non-Harmonic Spurious:	< -42dBc or -90dBm, whichever is larger (≤ 40MHz) < -36dBc or -90dBm, whichever is larger (> 40MHz)
* Phase Noise:	< -90dBc/√Hz (≤40MHz, 2kHz Offset) < -80dBc/√Hz (>40MHz, 2kHz Offset)

Table 1-1. Specifications (sheet 18 of 33)

Single Output:	
* Impedance:	50Ω (option 350), 75Ω (option 375)
VSWR:	< 1.1 (-65dBm to 5dBm) < 1.4 (5dBm to 15dBm)
Dual Output (Built-in Power Splitter):	
* Insertion Loss:	6dB
* Output Tracking:	< 0.1dB, < 3°
* Equivalent Output SWR:	< 1.10
Input Characteristics:	
* Input:	Reference Channel (Rch), Test Channel (Tch)
* Impedance:	50Ω (option 350), 75Ω (option 375) VSWR <1.10 (option 350), <1.15 (option 375) (DC Coupling)
	1MΩ, shunt capacitance is 28pF ±2pF (AC Coupling)
* Attenuator:	0dB, 20dB
* Connector:	50Ω Type Female BNC
* Maximum Allowable Input Level:	
50Ω, 75Ω:	+20dBm (AC), 5Vp (AC+DC)
1MΩ:	2.24Vrms (AC), 42Vp (AC+DC)
* Crosstalk (between Rch and Tch):	<-96dB (≤70MHz), <-86dB (>70MHz)
* Noise Floor:	<-107dBm (<50kHz) <-114dBm (50kHz ≤ f ≤ 50MHz) <-105dBm (50MHz <)
* Residual Response:	<-101dBm (0dB Input Attenuator) <-81dBm (20dB Input Attenuator)

GENERAL INFORMATION

Table 1-1. Specifications (sheet 19 of 33)

Auto Offset Compensation:	Automatic compensation for insertion loss and frequency response of the test system.
Level Monitor:	Monitor the input level of the Reference and Test channels in units of dBm, dBV and Volts.
* Range, Accuracy:	Equal to the range and accuracy of the Amplitude Absolute (Tch, Rch) measurement.
Measurement Range:	
* Amplitude:	Tch/Rch (Ratio): 0 to ± 120 dB
Tch, Rch (Absolute):	-107dBm to -5dBm (0dB Attenuator) -87dBm to 15dBm (20dB Attenuator)
* Phase:	$\pm 180^\circ$, (can display phase continuously using the phase scale expansion function)
* Group Delay:	0.1ns to 1s
Measurement Resolution (max):	
* Amplitude:	0.001dB
* Phase:	0.01°
* Group Delay:	0.1ns

Table 1-1. Specifications (sheet 20 of 33)

Measurement Accuracy:

Accuracy is specified at the measurement terminals under the following conditions:

1. Warm-up time: >30min
2. Ambient Temperature: 23 °C ±5 °C
3. Auto Offset Compensation: ON

Amplitude Ratio (Tch/Rch), Phase Accuracy:

Tch/Rch (Ratio) and phase accuracy are the sum of each channel's accuracy given in the Tch/Rch and Phase Accuracy graphs. The following is an example of calculating accuracy.

INTEG TIME = MED, Averaging = 4,
 Frequency: 100kHz
 Input Impedance: 50Ω
 Rch Attenuator: 20dB
 Tch Attenuator: 0dB
 Rch Input Level: 0dBm
 Tch Input Level: -35dBm
 Accuracy: 0.15dB, 0.75°
 (sum of 0.05dB/0.25° + 0.1dB/0.5°)

Group Delay Accuracy:

Accuracy is derived from the following equation. Phase accuracy $\theta_a(R)$ and $\theta_a(T)$ are read from the Tch/Rch and Phase Accuracy graphs.

$$\tau_a = \frac{\theta_a(R) + \theta_a(T)}{360 \times \Delta F} \text{ [s]}$$

where,

- ΔF : Aperture frequency (Hz)
 $\theta_a(R)$: Reference channel phase accuracy (°)
 $\theta_a(T)$: Test channel phase accuracy (°)

Absolute Amplitude (Tch, Rch) Accuracy:

Accuracy is read from the Tch and Rch Accuracy graphs. Shaded areas in the graphs are reference data, not guaranteed specifications.

GENERAL INFORMATION

Table 1-1. Specifications (sheet 22 of 33)

Graph 13

Tch/Rch and Phase Accuracy (input impedance 50Ω, 75Ω)

INTEG TIME: MED or LONG, Averaging: ≥4

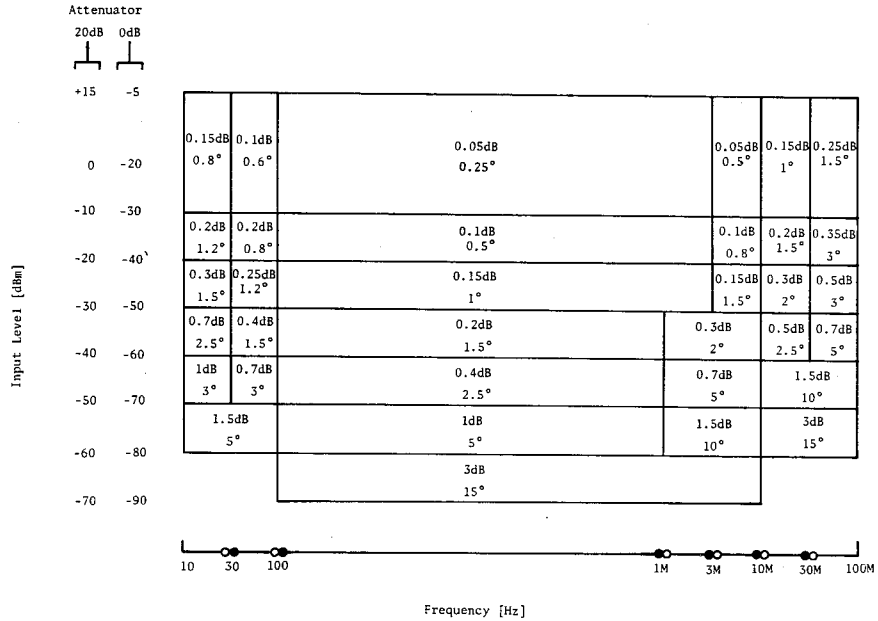

Graph 14

Tch/Rch and Phase Accuracy (input impedance 1MΩ)

INTEG TIME: MED or LONG, Averaging: ≥4

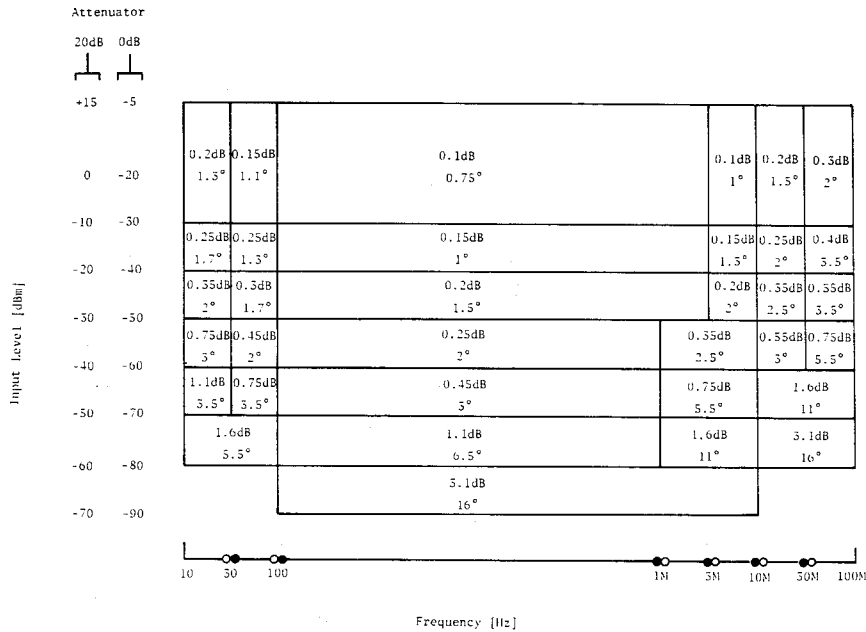
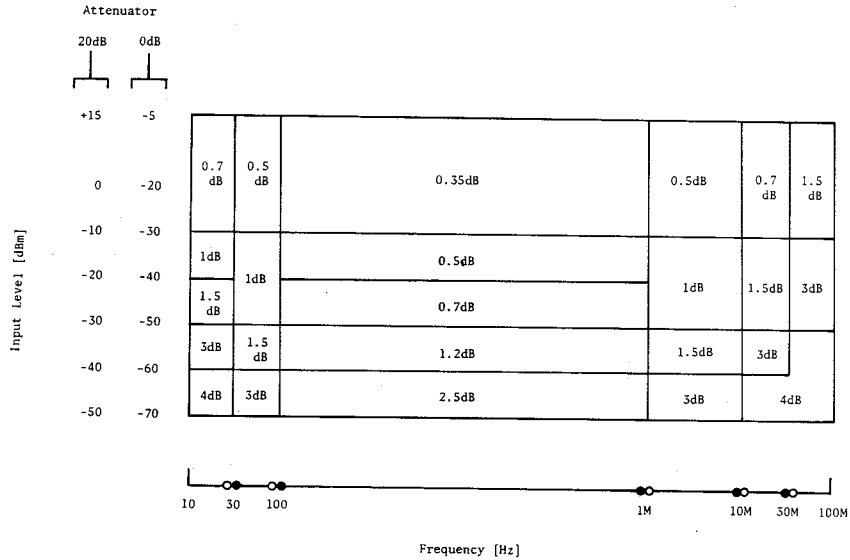

Table 1-1. Specifications (sheet 23 of 33)

Graph 15

Tch and Rch Accuracy (input impedance 50Ω, 75Ω)

INTEG TIME: MED or LONG, Averaging: ≥4



Graph 16

Tch and Rch Accuracy (input impedance 1MΩ)

INTEG TIME: MED or LONG, Averaging: ≥4

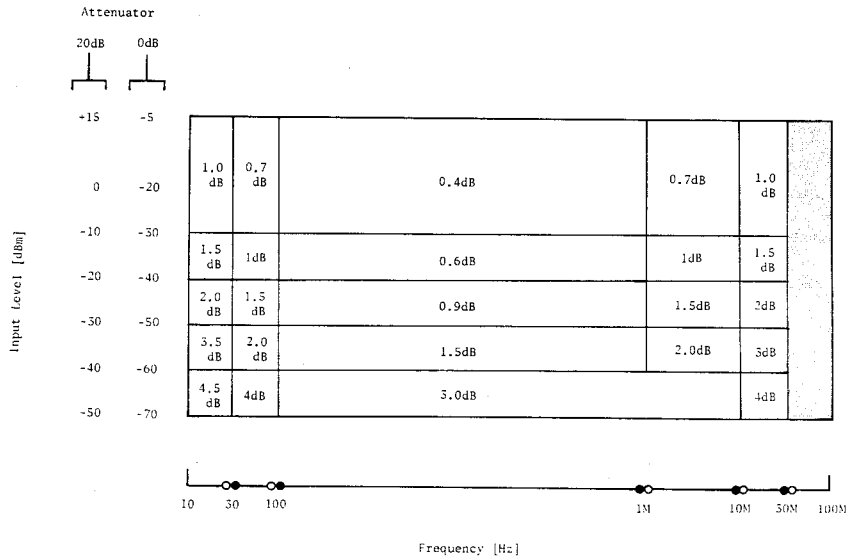

 is not specified

GENERAL INFORMATION

Table 1-1. Specifications (sheet 24 of 33)

Graph 17

Tch/Rch and Phase Accuracy (input impedance 50Ω, 75Ω)

INTEG TIME: MED OR LONG, Averaging: 1 or 2

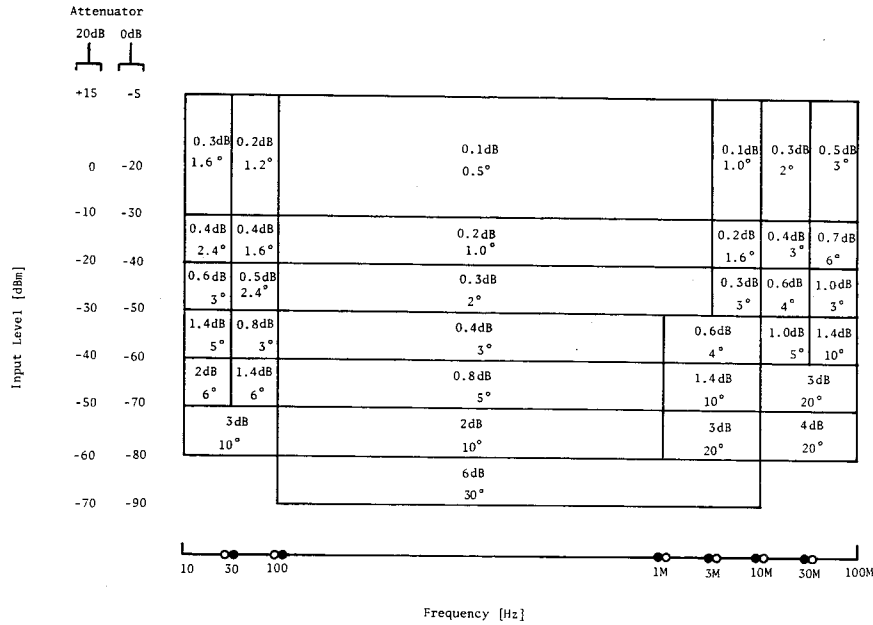

Graph 18

Tch/Rch and Phase Accuracy (input impedance 1MΩ)

INTEG TIME: MED OR LONG, Averaging: 1 or 2

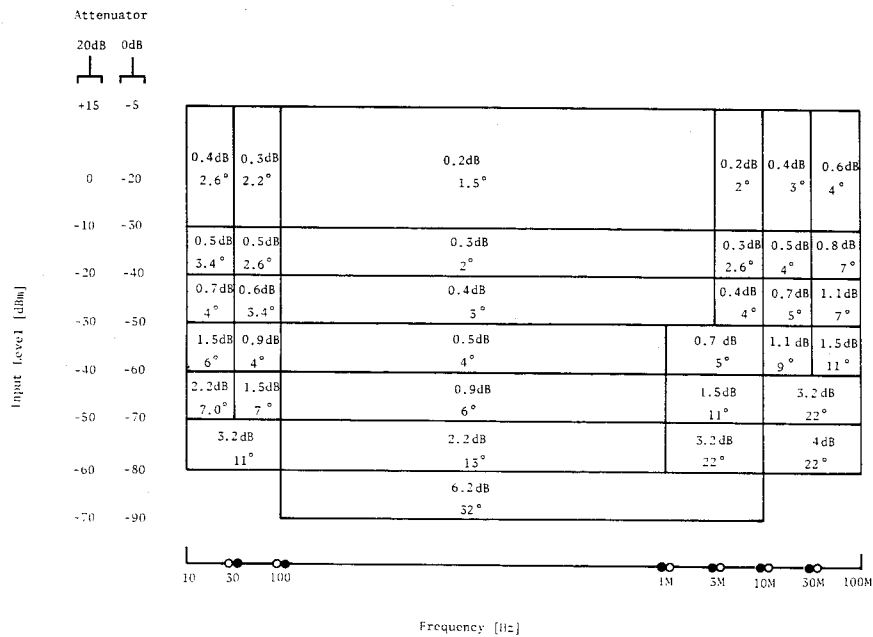
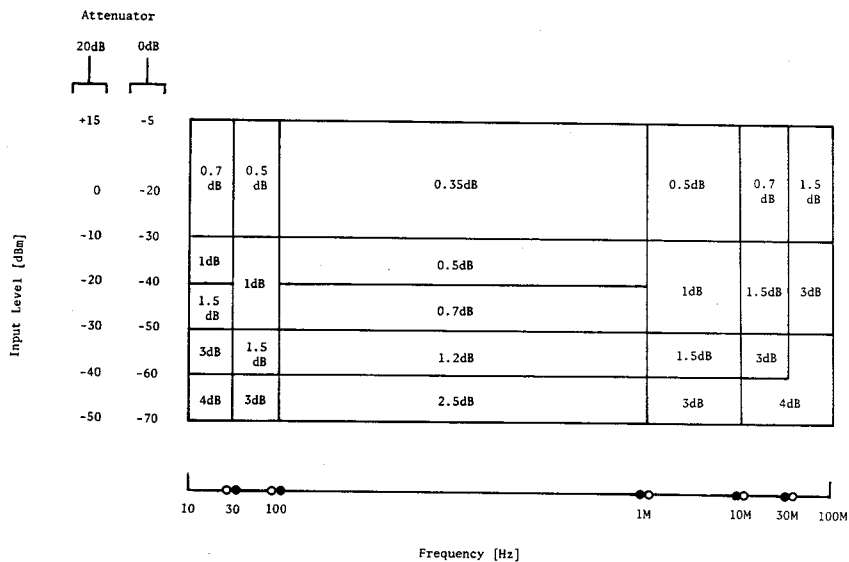

Table 1-1. Specifications (sheet 25 of 33)

Graph 19

Tch, Rch Accuracy (input impedance 50Ω, 75Ω)

INTEG TIME: MED OR LONG, Averaging: ≥1



Graph 20

Tch, Rch Accuracy (input impedance 1MΩ)

INTEG TIME: MED OR LONG, Averaging: 1

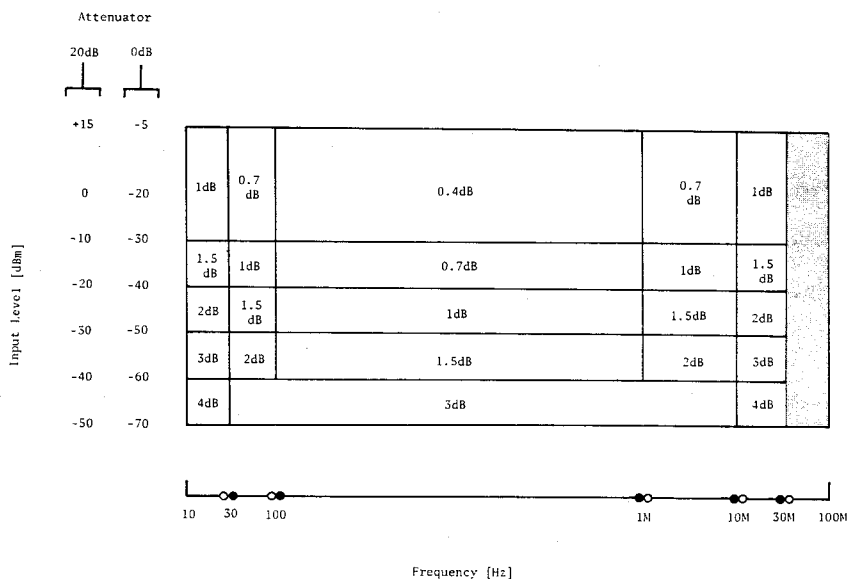

 is not specified

GENERAL INFORMATION

Table 1-1. Specifications (sheet 26 of 33)

Graph 21

Tch/Rch and Phase Accuracy (input impedance 50Ω, 75Ω)

INTEG TIME: SHORT, Averaging: ≥4

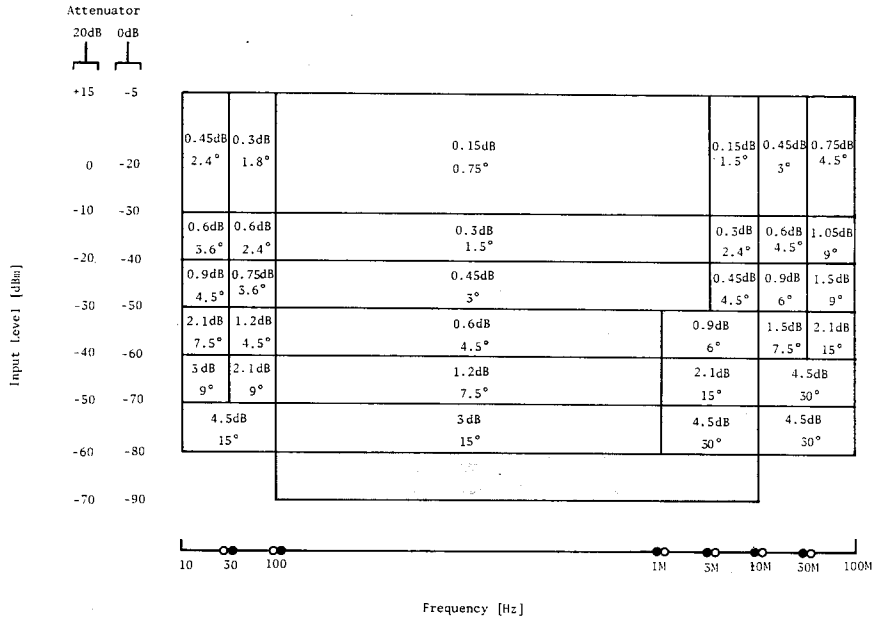

Graph 22

Tch/Rch and Phase Accuracy (input impedance 1MΩ)

INTEG TIME: SHORT, Averaging: ≥4

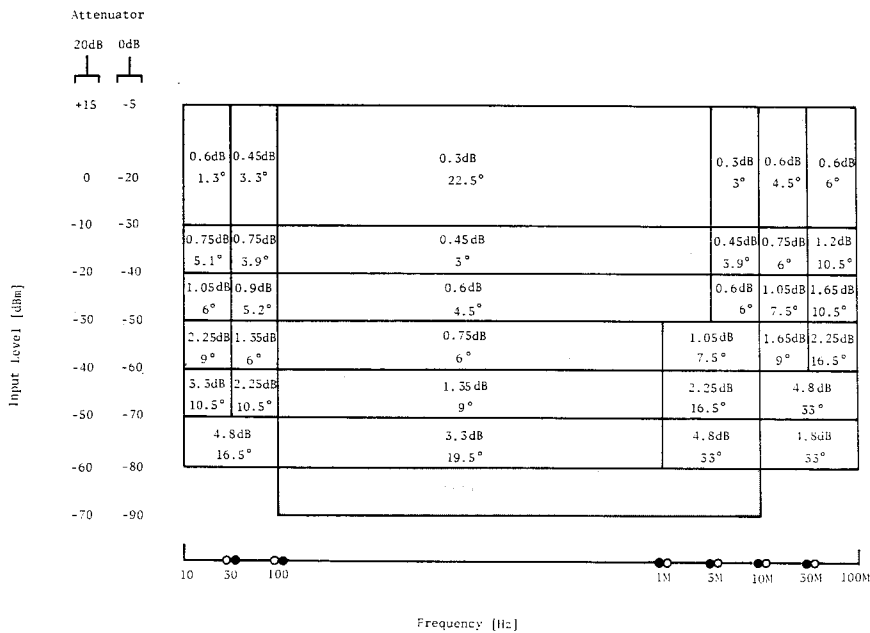

is not specified

Table 1-1. Specifications (sheet 27 of 33)

Graph 23

Tch, Rch Accuracy (input impedance 50Ω, 75Ω)

INTEG TIME: SHORT, Averaging: ≥4

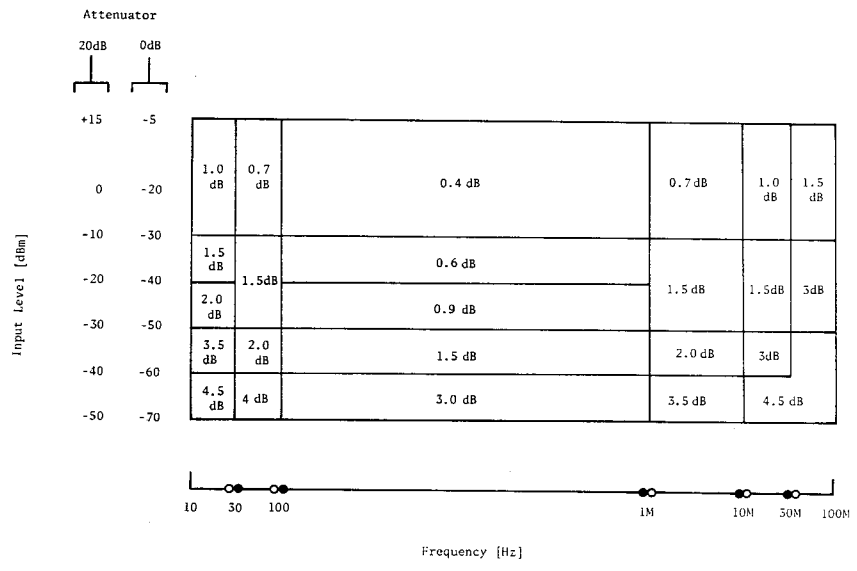

Graph 24

Tch, Rch Accuracy (input impedance 1MΩ)

INTEG TIME: SHORT, Averaging: ≥4

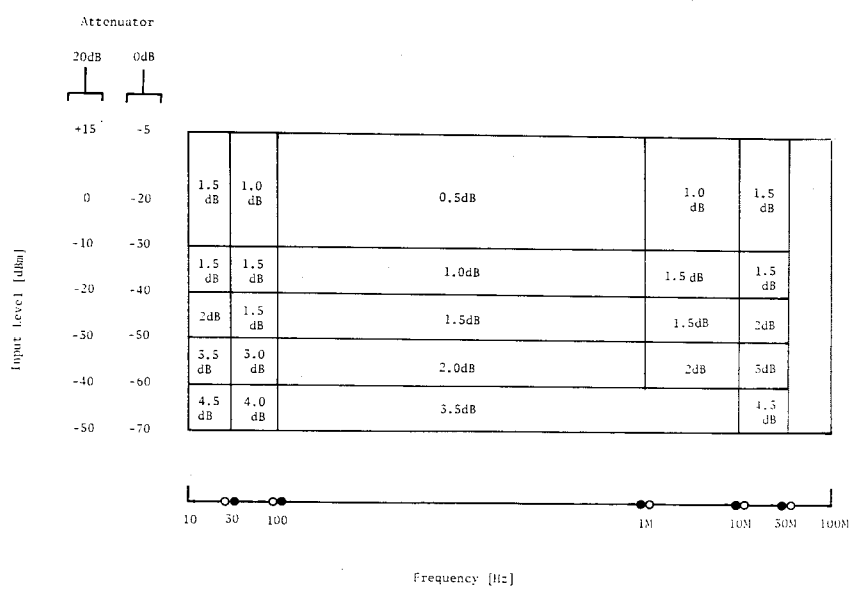

is not specified

GENERAL INFORMATION

Table 1-1. Specifications (sheet 28 of 33)

Graph 25

Tch/Rch and Phase Accuracy (input impedance 50Ω, 75Ω)

INTEG TIME: SHORT, Averaging: ≥1

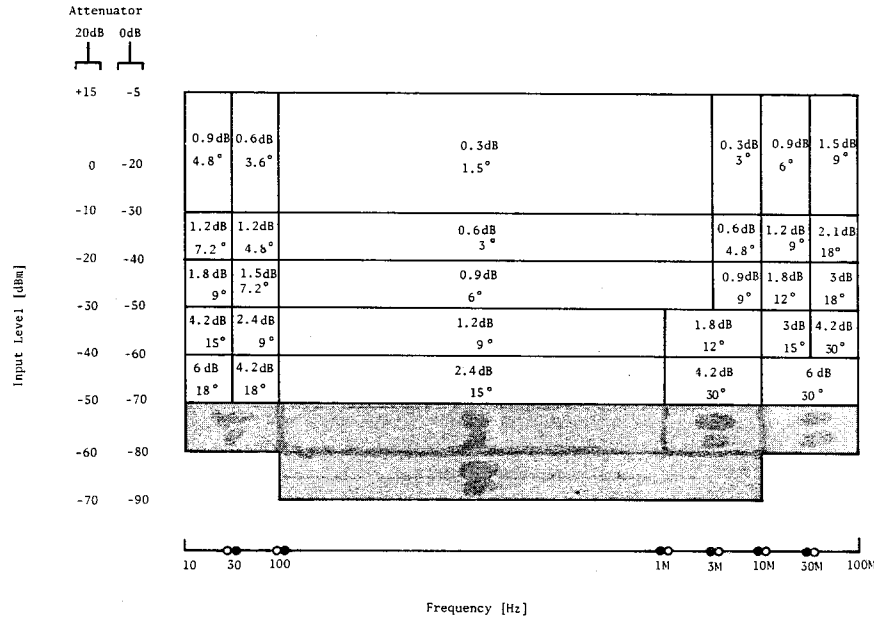

Graph 26

Tch/Rch and phase Accuracy (input impedance 1MΩ)

INTEG TIME: SHORT, Averaging: ≥1

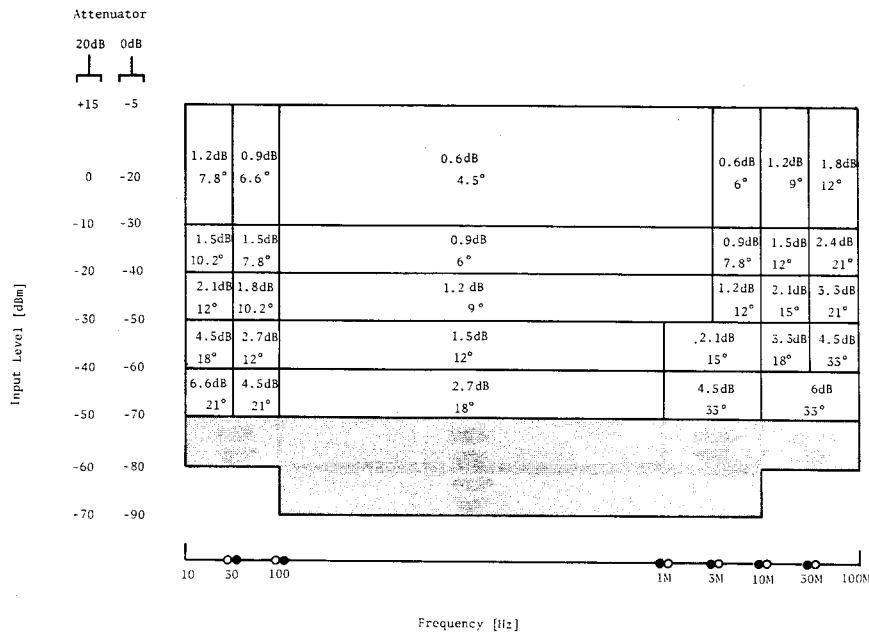

is not specified

Table 1-1. Specifications (sheet 33 of 34)

Graph 27

Tch, Rch Accuracy (input impedance 50Ω, 75Ω)

INTEG TIME: SHORT, Averaging ≥1

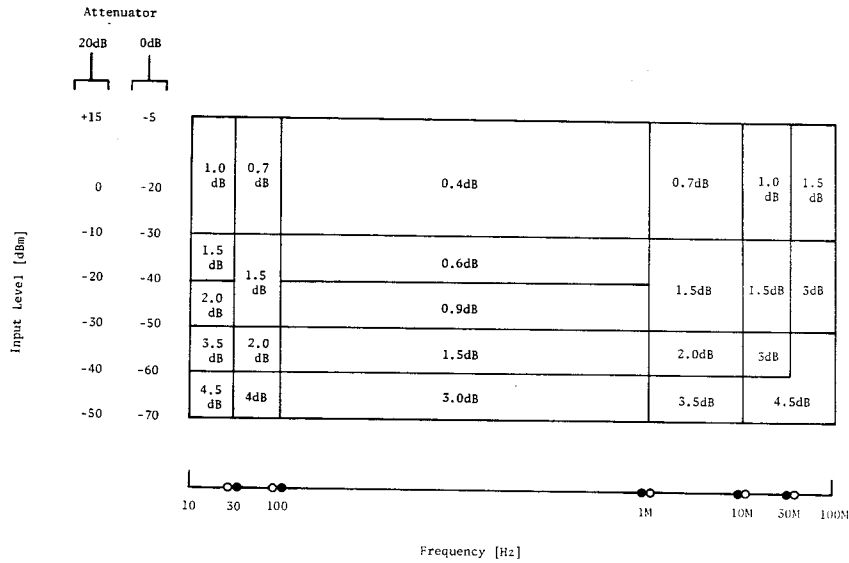

Graph 28

Tch, Rch Accuracy (input impedance 1MΩ)

INTEG TIME: SHORT, Averaging : ≥1

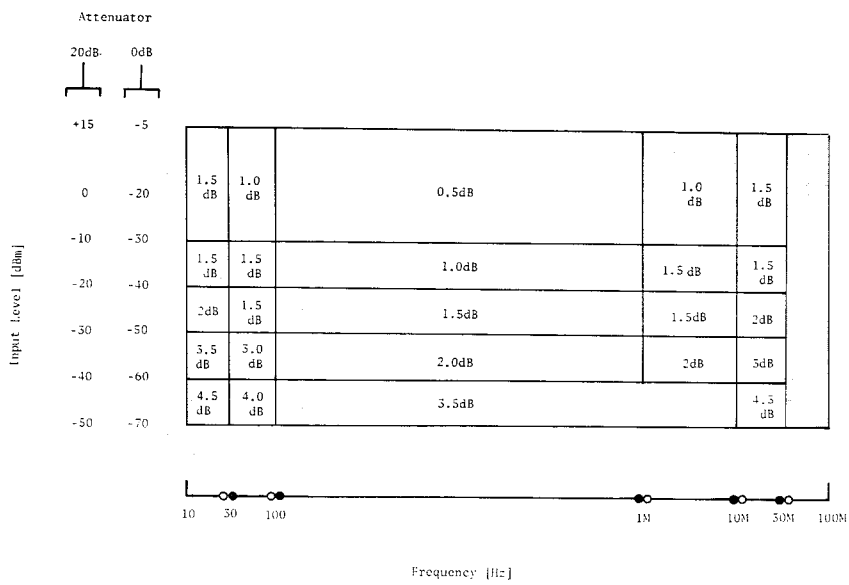

 is not specified

Table 1-1. Specifications (sheet 29 of 33)

IMPEDANCE, GAIN-PHASE COMMON SPECIFICATIONS	
Integration Time:	<p>SHORT, MED, LONG</p> <p>SHORT: approx. 500μs MED : approx. 5ms LONG : approx. 100ms</p> <p>(for frequencies ≥ 30KHz)</p>
Averaging:	Number of samples averaged are, 1, 2, 4, 8, 16, 32, 64, 128 and 256
Trigger Mode:	Internal, External and Manual
Delay Time:	0 to 3600s (1ms step)
Partial Sweep:	Sweep between two markers (o, *) without changing the sweep range or resolution.
Expand Markers Sweep:	Expand sweep range between two markers (o, *) to increase the sweep resolution.
Program Points Measurement:	Program up to 401 measurement points.
DISPLAY	
CRT:	color CRT
* Visible Area:	7.5inch (140mm x 108mm)
* Resolution:	576 x 432 dots
Display Mode:	Two rectangular modes and one table mode
* Rectangular (X-A&B):	Sweep parameter is on the X-axis and two measurement parameters are on the Y-axis.

Table 1-1. Specifications (sheet 30 of 33)

* Rectangular (A-B):	One measurement parameter is on the X-axis, another measurement parameter is on the Y-axis.
* Table:	One sweep parameter and two measurement parameters are displayed numerically in tabular form.
Display Control:	Autoscale, Superimpose and Storage
Display Digit:	6 digits
Maximum Display Count:	999999
Phase Scale Expansion:	Display phase continuously ($> \pm 180^\circ$)
Comment:	Display up to a 44 character comment on the CRT.
ANALYSIS	
Marker:	
* Modes:	
Single Marker:	Display measurement value for a sweep parameter.
Delta Marker:	Display difference between the o- (reference) and *- markers
Double Markers:	Set partial and expand markers sweep range using two markers.
* Control:	Rotary knob, key-in or remote control through HP-IB.
Line-Cursor:	
* Modes:	
Line-Cursor Mode:	Display a sweep parameter value for a measurement value using interpolation.
Delta-Line Cursor Mode:	Display sweep parameter value for the difference between the o (reference) marker and the line-cursor.
* Control:	Rotary knob, key-in or remote control through HP-IB.

Table 1-1. Specifications (sheet 31 of 33)

Equivalent Circuit Function:	Perform analysis using five equivalent circuit models consisting of 3 or 4 constants (L, C, R)												
* Approximation:	Approximate equivalent circuit constants using impedance measurement data.												
* Simulation:	Simulate the frequency characteristics of impedance by specifying the equivalent circuit constants.												
Arithmetic Operations:	+, -, *, /, SQR, **, E, EXP, LOG, LN, SIN, COS, TAN, ATAN, ABS, PI(π), DIF (differential), DEG, RAD												
Data Register Manipulation:	Use arithmetic operators and functions to manipulate data registers.												
* Register:	<table border="1"> <thead> <tr> <th>Name</th> <th>Application</th> <th>Size</th> </tr> </thead> <tbody> <tr> <td>A, B</td> <td>Display</td> <td>401</td> </tr> <tr> <td>C, D</td> <td>Superimpose</td> <td>401</td> </tr> <tr> <td>E - J RA - RL total: 18 registers</td> <td>General</td> <td>401</td> </tr> </tbody> </table>	Name	Application	Size	A, B	Display	401	C, D	Superimpose	401	E - J RA - RL total: 18 registers	General	401
Name	Application	Size											
A, B	Display	401											
C, D	Superimpose	401											
E - J RA - RL total: 18 registers	General	401											
* Example:	A = A + E A = DIF (A)												
Complex Matrix Operation	Perform operations using registers, arithmetic operators, functions and constants.												
GO/NO-GO Limits:	Set min and max limits for measurement points Up to 16 sets of 26 measurement points can be set (401 points max).												

Table 1-1. Specifications (sheet 32 of 33)

PROGRAMMING	
Auto Sequence Program (ASP):	Control the HP 4194A's operation using the internal program language. ASP programs can be entered using the front panel keys or down loaded from a host computer using HP-IB.
* ASP Commands:	Common to HP-IB remote control commands.
* Basic Commands:	IF, THEN, FOR, NEXT, PAUSE, WAIT, BEEP, DISP, GOTO, GOSUB, RETURN, OUTPUT, INPUT, END, SEND
* Arithmetic Operators, Functions:	+, -, *, /, **, E, SQR, EXP, LOG, LN, SIN, COS, TAN, ATAN, ABS, PI(π), DIF, DEG, RAD, =, <, >, ≤, ≥, <>, AND, OR
* Maximum Program Size:	300 lines per program
* Program Memory Size:	17k Bytes of non-volatile memory
* Edit:	ASP commands can be entered using the front panel keys.
HP-IB Data Output & Remote Control:	IEEE STD 488-1978 and IEEE STD 728-1982
* Interface Functions:	SH1, AH1, T5, TE0, L4, LE0, SR1, RL1, PP0, DC1, DT1, C0, E1
* Data Output Format:	ASCII and Binary (IEEE 32 bit and IEEE 64 bit)
Copy:	Copy to HP plotters or printers set to the LISTEN only mode without an external computer.
* Dump Mode:	Copy the CRT display on a graphics printer.
* Plot Mode:	Copy the CRT display on a plotter for a color hardcopy.
* Print Mode:	Copy measurement data in tabular form on a printer.
Save/Get:	Save up to five sets of 4194A conditions in non-volatile memory (compensation data, measurement conditions, display scale, etc)

GENERAL INFORMATION

Table 1-1. Specifications (sheet 33 of 33)

GENERAL SPECIFICATIONS	
External Trigger:	BNC Female (rear terminal), TTL level
Program Start Trigger:	BNC Female (rear terminal), TTL level
External Reference Frequency Input (rear panel):	
* Frequency:	10/N MHz, $\leq \pm 10\text{ppm}$ (N is an integer from 1 to 10)
* Level:	-1 to 20dBm
* Input Impedance:	Typically 50 Ω
* Connector:	BNC Female
Reference Frequency Output (rear panel):	
* Frequency:	10MHz
* Level:	10dBm (50 Ω load)
* Connector:	BNC Female
8 Bit I/O Port:	D-SUB Connector (25 pin), TTL logic level
Operating Temperature and Humidity:	0 °C to 40 °C, 95% RH at 40 °C
Storage Temperature:	-30 °C to 60 °C
Safety:	Based on IEC-348, ANSI-C-39.5, and UL-1244.
Power:	100, 120, 220V $\pm 10\%$, 240V -10% +5% 48Hz to 66Hz, 400VA (max)
Dimensions:	425(W) x 375(H) x 620(D) (mm)
Weight:	37kg (net) 39kg (with furnished accessories)
OPTION 001 (HIGH STABILITY FREQUENCY REFERENCE)	
Test Frequency Accuracy:	$\pm 1\text{ppm}$ (23 °C ± 5 °C)
Test Frequency Stability:	$\pm 1 \times 10^{-8}$ /day (23 °C ± 5 °C)

Table 1-2. Supplemental Performance Characteristics (sheet 1 of 3)

SUPPLEMENTAL CHARACTERISTICS

(Supplemental characteristics are not guaranteed.)

Measurement Speed: Average speed per point in a sweep measurement. Speed depends on test frequency, integration time (I.T.) and the number of samples averaged.

* Impedance Measurement: See Graph 29.

* Gain-Phase Measurement: See Graph 30.

Measurement Speed and Averaging (N > 1):

Measurement time for number of samples averaged > 1 is calculated using the following equation.

$$t_n = \frac{2}{3} \cdot t_1 \cdot n + \frac{1}{3} \cdot t_1$$

where, t1 = measurement time when averaging = 1 (refer to the Measurement Speed graph), n = number of samples averaged, tn = measurement speed for averaging n samples

HP-IB Data Transfer Time: When using an HP9000 Series 200 computer the number of points transferred is 401.

* ASCII: 840ms

* Binary: 90ms (IEEE 64-bit) 50ms (IEEE 32-bit)

GENERAL INFORMATION

Table 1-2. Supplemental Performance Characteristics (sheet 2 of 3)

Measurement Accuracy (Impedance Measurement for FNC1):

* $|Z|$ - θ Accuracy:

when $10\text{m}\Omega < |Z| < 0.1\Omega$ or $1.6\text{M}\Omega < |Z| < 100\text{M}\Omega$

$$Z_a = 3 \cdot \frac{A1}{\alpha} + A2 + \left(\frac{B1}{|Z_m|} + B2 \cdot |Z_m| \right) \times \frac{100}{\alpha} \quad [\%]$$

$$\theta_a = \frac{Z_a}{100} \cdot \frac{180}{\pi} \quad [^\circ]$$

where $|Z_m|$ is $|Z|$ measured and α is test signal level in volts. Apply A1, A2, and B2 values specified for 0.1Ω and $1\text{M}\Omega$ which can be obtained from Graphs 1, 4, 7, or 10.

* $|Y|$ - θ Accuracy:

when $10\text{nS} < |Y| < 1.6\mu\text{S}$ or $10\text{S} < |Y| < 100\text{S}$

$$Y_a = 3 \cdot \frac{A1}{\alpha} + A2 + \left(B1 \cdot |Y_m| + \frac{B2}{|Y_m|} \right) \times \frac{100}{\alpha} \quad [\%]$$

$$\theta_a = \frac{Y_a}{100} \cdot \frac{180}{\pi} \quad [^\circ]$$

where $|Y_m|$ is $|Y|$ measured and α is the test signal level in volts. Apply A1, A2, and B2 values specified for $1.6\mu\text{S}$ and 10S obtained from Graph 1, 4, 7, or 10.

Table 1-2. Supplemental Performance Characteristics (sheet 3 of 3)

Graph 29.

Impedance Measurement Speed
(Number of samples averaged is 1.)

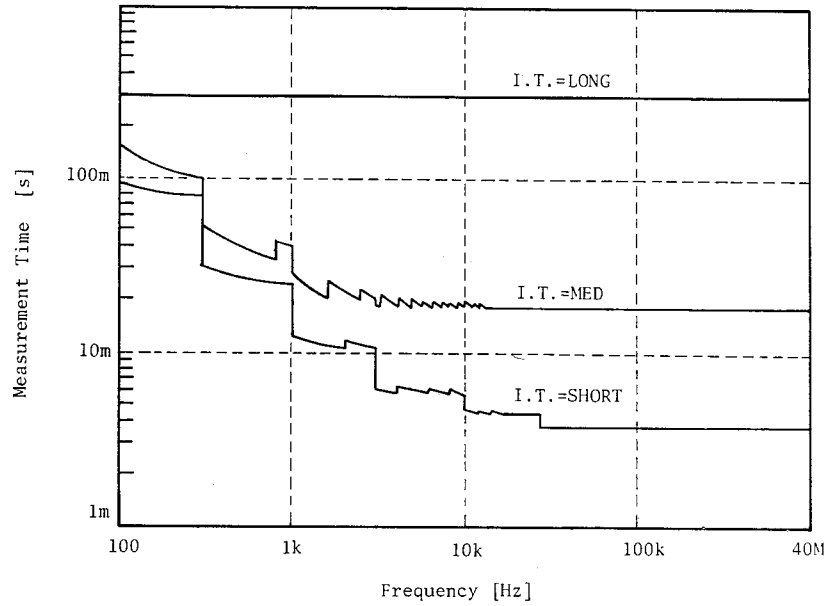

Graph 30.

Gain-Phase Measurement Speed
(Number of samples averaged is 1.)

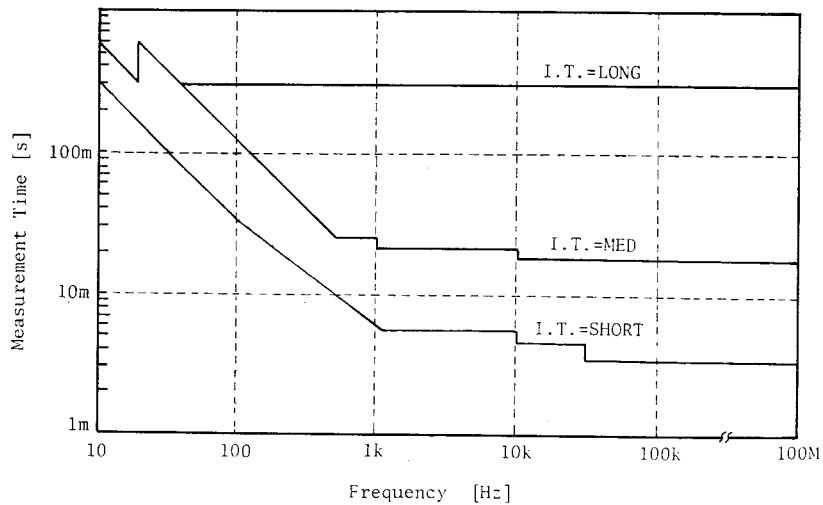

Note

Add 1.7ms when the automatic calibration is set to ON. ('CAL on/off' soft-key is on.)

GENERAL INFORMATION

1-6. OPTIONS

Options are modifications to the standard instrument that implement the user's special requirements for minor functional changes. The 4194A has seven options as listed in Table 1-3.

Table 1-3. Options

Option Number	Description
001	High Stability Frequency Reference. Test Frequency Accuracy: $\pm 1 \text{ ppm}$ ($23^\circ \text{C} \pm 5^\circ$) Test Frequency Accuracy: $\pm 1 \times 10^{-8} / \text{day}$ ($23^\circ \text{C} \pm 5^\circ$)
350	50 Ω
375	75 Ω
907	Front Handle Kit. *1
908	Rack Flange Kit. *1
909	Rack and Handle Kit. *1
910	Extra Operation Manual (English)

*1: Installation procedures for these options are detailed in Section 2.

GENERAL INFORMATION

1-7. ACCESSORIES SUPPLIED

The HP Model 4194A Impedance/Gain-Phase Analyzer, along with its furnished accessories, is shown in Figure 1-1. The furnished accessories are also listed below.

Description	QTY	HP Part Number or Model Number
Test Fixture	1 ea.	16047D
BNC Cable - 30cm	2 ea.	8120-1838 (Opt. 350) 04194-61640 (Opt. 375)
BNC Cable - 60cm	1 ea.	8120-1839 (Opt. 350) 04194-61641 (Opt. 375)
BNC Adapter (f-f)	1 ea.	1250-0080
BNC-BNC Cable	4 ea.	8120-1838
BNC-BNC Cable (Opt. 001 only)	1 ea.	04194-61601
Cable Assy - Power	1 ea.	04194-61603
Cable Assy - Control	1 ea.	04194-61602
Rear Panel Lock Foot Kit Full Modules	1 ea.	5061-9699
Power Cable	1 ea.	8120-1378

1-8. ACCESSORIES AVAILABLE

For certain measurements and for convenience in connecting samples, twelve types of accessories are available. Each accessory is designed to meet the various measurement requirements of different DUTs. All accessories were developed with careful consideration to accuracy, reliability, and ease of measurement. A brief description and photo of each available accessory is given in Table 1-4.

Table 1-4. Accessories Available (sheet 1 of 5)

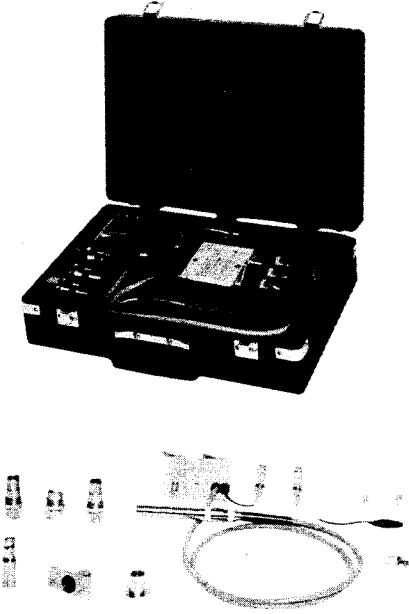
Model	Description																										
<p>HP 41941A HP 41941B</p> 	<p>Impedance Probe Kit for HP 4194A</p> <p>When the probe is combined and used with the HP 4194A for Impedance measurement, the test frequency range extends to 100 MHz. Contains the following accessories in a carrying case.</p> <table border="0"> <tr> <td>Impedance Probe*</td> <td>1ea.</td> </tr> <tr> <td>0 S Calibration Standard</td> <td>1ea.</td> </tr> <tr> <td>0 Ω Calibration Standard</td> <td>1ea.</td> </tr> <tr> <td>50 Ω Calibration Standard</td> <td>1ea.</td> </tr> <tr> <td>Probe Socket</td> <td>1ea.</td> </tr> <tr> <td>Spare Pin Set (10 Pins)</td> <td>1ea.</td> </tr> <tr> <td>Spare Clip Set (3 Clips)</td> <td>1ea.</td> </tr> <tr> <td>Spare N-type Pin Set (5 Pins)</td> <td>1ea.</td> </tr> <tr> <td>BNC Adapter</td> <td>1ea.</td> </tr> <tr> <td>Component Adapter</td> <td>1ea.</td> </tr> <tr> <td>Ground Adapter</td> <td>1ea.</td> </tr> <tr> <td>Ground Lead</td> <td>1ea.</td> </tr> <tr> <td>Carrying case*</td> <td>1ea.</td> </tr> </table> <p>Accessories indicated with * differ for the model and option number specified and the rest are furnished in common.</p> <p>HP 41941A Option 350: 1.5 m long probe for HP 4194A Option 350.</p> <p>HP 41941A Option 375: 1.5 m long probe for HP 4194A Option 375.</p> <p>HP 41941B Option 350: 3 m long probe for HP 4194A Option 350.</p> <p>HP 41941B Option 375: 3 m long probe for HP 4194A Option 375.</p> <p>Maximum applied dc bias voltage is ±150 V/ ±0.5 A, max. 25W.</p>	Impedance Probe*	1ea.	0 S Calibration Standard	1ea.	0 Ω Calibration Standard	1ea.	50 Ω Calibration Standard	1ea.	Probe Socket	1ea.	Spare Pin Set (10 Pins)	1ea.	Spare Clip Set (3 Clips)	1ea.	Spare N-type Pin Set (5 Pins)	1ea.	BNC Adapter	1ea.	Component Adapter	1ea.	Ground Adapter	1ea.	Ground Lead	1ea.	Carrying case*	1ea.
Impedance Probe*	1ea.																										
0 S Calibration Standard	1ea.																										
0 Ω Calibration Standard	1ea.																										
50 Ω Calibration Standard	1ea.																										
Probe Socket	1ea.																										
Spare Pin Set (10 Pins)	1ea.																										
Spare Clip Set (3 Clips)	1ea.																										
Spare N-type Pin Set (5 Pins)	1ea.																										
BNC Adapter	1ea.																										
Component Adapter	1ea.																										
Ground Adapter	1ea.																										
Ground Lead	1ea.																										
Carrying case*	1ea.																										

GENERAL INFORMATION

Table 1-4. Accessories Available (sheet 2 of 5)

Model	Description
<p data-bbox="245 222 391 247">HP 16334A</p> 	<p data-bbox="740 222 1328 254">HP 16334A Test Fixture for Chip Components:</p> <p data-bbox="740 289 1357 411">Test Fixture (tweezer type) for measurement of miniature, leadless components such as chip capacitors. The correction block for ZERO offset adjustment is furnished.</p> <p data-bbox="740 447 1357 569">Maximum applied dc bias voltage: ± 42 V Cable length setting: 1 m Length (connection terminal - end of fixture): approx. 133 cm</p>
<p data-bbox="245 663 391 688">HP 16047B</p> 	<p data-bbox="740 663 1263 695">HP 16047B Test Fixture with Safe Guard:</p> <p data-bbox="740 730 1357 890">Test Fixture (cable connection type) for general measurement of both axial and radial lead components at frequencies below 2 MHz. Three kinds of contact inserts are furnished (same as those for the HP 16047D Test Fixture).</p> <p data-bbox="740 926 1357 1047">DC bias of up to ± 35 V can be applied using the HP 4194A (a protective cover provides for operator safety). Cable length: approximately 40 cm</p>
<p data-bbox="245 1110 391 1136">HP 16047C</p> 	<p data-bbox="740 1110 1256 1142">HP 16047C High Frequency Test Fixture:</p> <p data-bbox="740 1178 1357 1362">Test Fixture (direct attachment type) especially appropriate for high frequency measurements requiring high accuracy. Two screw knobs facilitate and ensure optimum contact of electrodes and sample leads. Maximum applied dc bias voltage is ± 35 V.</p>
<p data-bbox="245 1461 391 1486">HP 16048A</p> 	<p data-bbox="740 1461 1036 1493">HP 16048A Test Leads:</p> <p data-bbox="740 1528 1357 1619">Test Leads (four terminal pair) with BNC connectors for connecting user-fabricated test fixtures.</p> <p data-bbox="740 1654 1357 1776">Maximum applied dc bias voltage: ± 200 V Cable length setting: 1 m Length (connection terminal - end of fixture): approx. 95 cm</p>

Table 1-4 Accessories available (sheet 3 of 5)

1 General Information

Model	Description
<p data-bbox="321 226 467 256">HP 16048B</p> 	<p data-bbox="815 231 1425 294">HP 16048B Test Leads with RF Miniature Connector:</p> <p data-bbox="815 325 1425 420">Test Lead (four terminal pair) with miniature RF connectors suitable for connecting user-fabricated test fixtures in systems applications.</p> <p data-bbox="815 451 1425 577">Maximum applied dc bias voltage: ± 200 V Cable length setting: 1 m Length (connection terminal - end of fixture): approx. 93 cm</p>
<p data-bbox="321 640 467 669">HP 16048C</p> 	<p data-bbox="815 640 1356 672">HP 16048C Test Leads with Alligator Clips:</p> <p data-bbox="815 703 1425 798">Test Leads with dual alligator clips for testing components of various shapes and sizes at frequencies below 100 kHz.</p> <p data-bbox="815 829 1226 924">Applicable measurement ranges: Capacitance 1000 pF Inductance 100 H</p> <p data-bbox="815 955 1425 1081">Maximum applied dc bias voltage: ± 35 V Cable length setting: 1 m Length (connection terminal - end of fixture): approx. 128 cm</p>
<p data-bbox="321 1144 467 1173">HP 16065A</p>  <p data-bbox="321 1564 467 1593">HP 16085A</p> 	<p data-bbox="815 1144 1226 1176">HP 16065A External Bias Fixture:</p> <p data-bbox="815 1207 1425 1375">Test Fixture (cable connection type) for measurement of either axial- or radial-lead components at frequencies between 50 Hz and 2 MHz. Three kinds of contact inserts are furnished (same as those for the HP 16047D Test Fixture).</p> <p data-bbox="815 1407 1425 1501">DC bias up to ± 200 V can be applied (a protective cover provides for operator safety). Cable length: Approximately 40 cm</p> <p data-bbox="815 1564 1185 1596">HP 16085A Terminal Adapter:</p> <p data-bbox="815 1627 1425 1816">This Terminal Adapter converts 4 terminal pair connector to an APC-7 connector. This adapter allows you to connect the HP 16092A Spring Clip Fixture and HP 16093A/B Binding Post Fixtures to the 4-terminal pair terminals of the HP 4194A.</p>

GENERAL INFORMATION

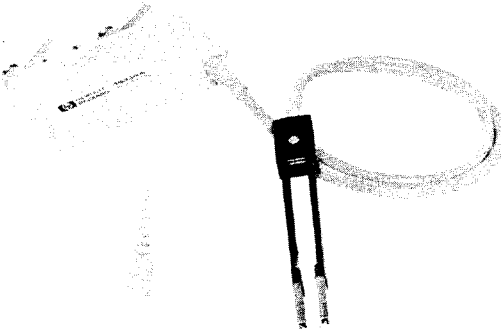
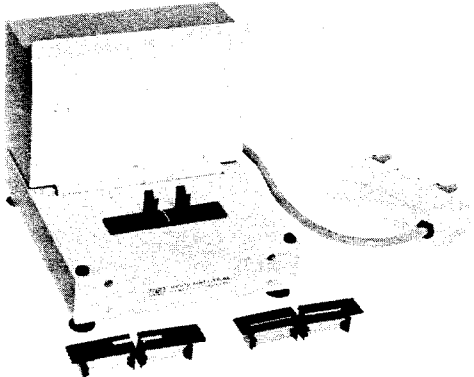
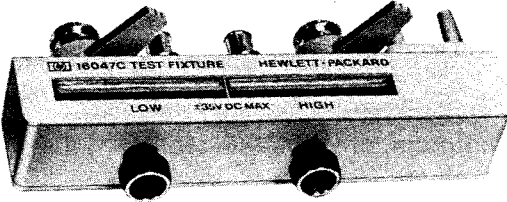
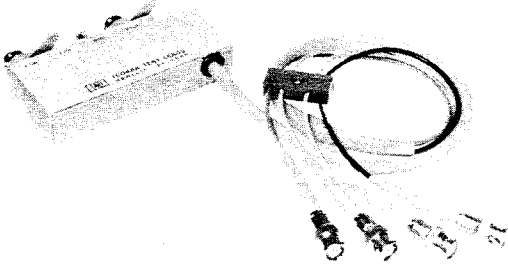
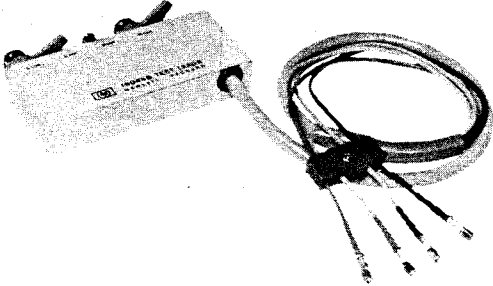
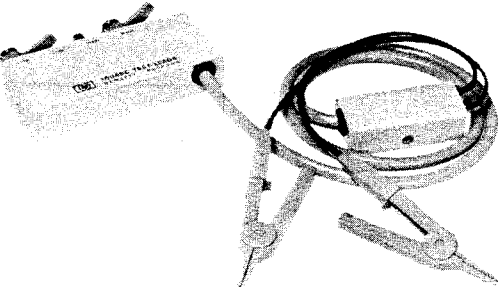
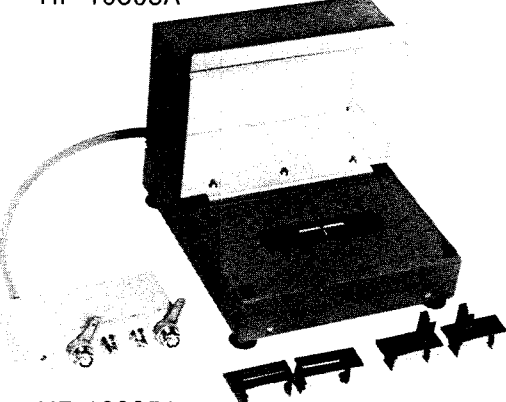
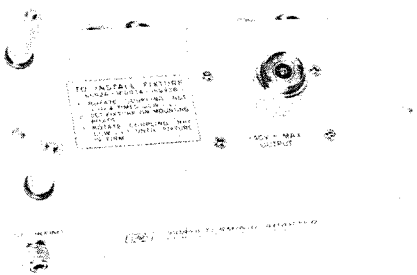
Table 1-4 Accessories Available (sheet 4 of 5)

Model	Description														
<p data-bbox="233 233 375 260">HP 16086A</p> 	<p data-bbox="727 233 1057 260">HP 16086A Accessory Kit:</p> <p data-bbox="727 296 1338 352">Contains the following accessories in a carrying case.</p> <table data-bbox="727 390 1263 611"> <tr> <td>16085A Terminal Adapter</td> <td>1ea.</td> </tr> <tr> <td>16092A Spring Clip Fixture</td> <td>1ea.</td> </tr> <tr> <td>600Ω Feedthrough Termination</td> <td>2ea.</td> </tr> <tr> <td>10:1 Divider Probe</td> <td>2ea.</td> </tr> <tr> <td>1:1 Divider Probe</td> <td>2ea.</td> </tr> <tr> <td>BNC Cable 60cm</td> <td>2ea.</td> </tr> <tr> <td>BNC Cable 120cm</td> <td>1ea.</td> </tr> </table> <p data-bbox="727 642 1338 768">The carrying case has space for the HP 16047D furnished with HP 4194A, and for the HP 16093A/B Binding Post Fixtures, which is purchased separately.</p>	16085A Terminal Adapter	1ea.	16092A Spring Clip Fixture	1ea.	600Ω Feedthrough Termination	2ea.	10:1 Divider Probe	2ea.	1:1 Divider Probe	2ea.	BNC Cable 60cm	2ea.	BNC Cable 120cm	1ea.
16085A Terminal Adapter	1ea.														
16092A Spring Clip Fixture	1ea.														
600Ω Feedthrough Termination	2ea.														
10:1 Divider Probe	2ea.														
1:1 Divider Probe	2ea.														
BNC Cable 60cm	2ea.														
BNC Cable 120cm	1ea.														
<p data-bbox="233 835 375 863">HP 16092A</p> 	<p data-bbox="727 835 1122 863">HP 16092A Spring Clip Fixture:</p> <p data-bbox="727 898 1338 1056">Test Fixture (mate with APC-7 connector) for measurement of both axial and radial lead components and lead-less chip elements. Spring clip contacts are capable of holding samples of dimensions given below:</p>  <p data-bbox="727 1440 1338 1497">A combined slide gauge provides direct read-out of the physical length of the test sample.</p> <p data-bbox="727 1535 1338 1629">Usable frequency range: dc to 500 MHz. Electrical length: 0.34 cm typical. Maximum applied dc bias voltage: ±40 V.</p>														

Table 1-4 Accessories Available (sheet 5 of 5)

Model	Description
<p data-bbox="313 226 456 254">HP 16093A</p> 	<p data-bbox="808 233 1110 260">HP 16093A Test Fixture:</p> <p data-bbox="808 296 1414 478">Test Fixture (mate with APC-7 connector) for measurement of both axial and radial lead miniature components. Two binding post terminals at an interval of 7mm on the terminal deck ensure optimum contact of terminals and sample leads.</p>  <p data-bbox="808 863 1414 957">Usable frequency range: dc to 250 MHz. Electrical length: 0.34 cm typical. Maximum applied dc bias voltage: ± 40 V</p>
<p data-bbox="313 1020 456 1047">HP 16093B</p> 	<p data-bbox="808 1020 1219 1047">HP 16093B Binding Post Fixture:</p> <p data-bbox="808 1083 1414 1241">Test Fixture (mate with APC-7 connector) for general measurement of both axial and radial lead components. Three binding post terminals are located on the terminal deck as shown below:</p>  <p data-bbox="808 1629 1414 1724">Usable frequency range: dc to 125 MHz. Electrical length: 0.34 cm, typical. Maximum applied dc bias voltage: ± 40 V</p>

NOTES

SECTION 2 INSTALLATION

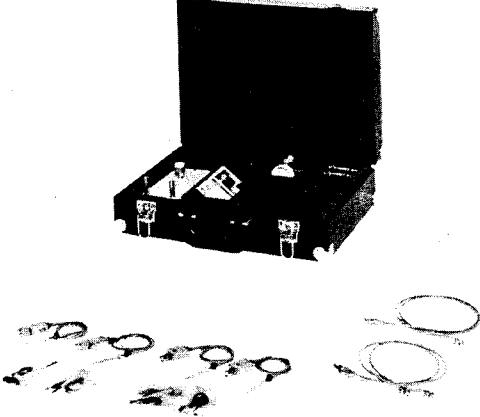
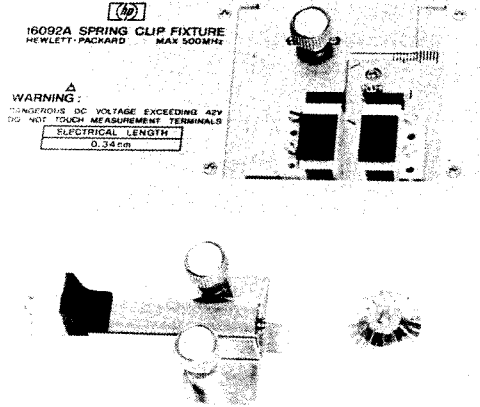
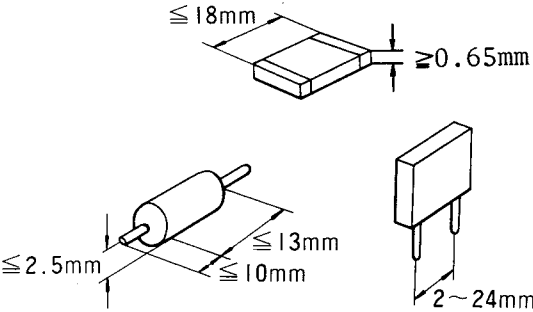
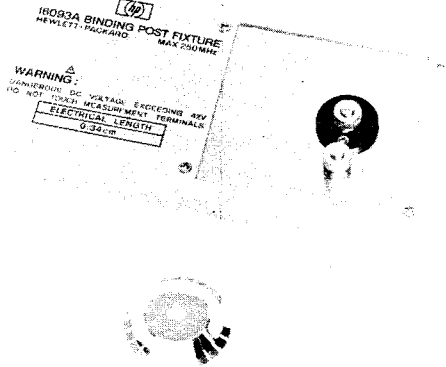
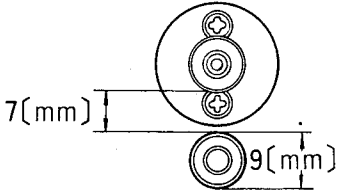
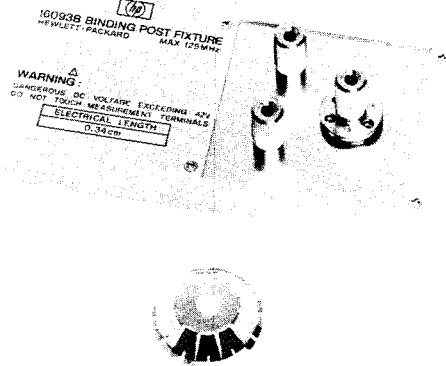
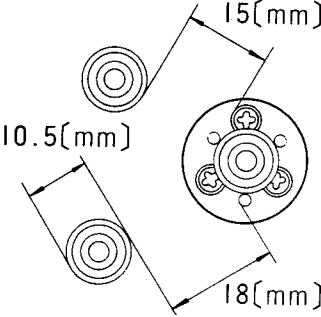
- 2-1. **Introduction** 2-1
- 2-2. **Initial Inspection** 2-1
- 2-3. **Preparation for Use** 2-1
 - 2-3-1. Interconnecting Units 2-1
 - 2-3-2. Interconnection Cables 2-2
 - 2-3-3. Power Requirements 2-3
 - 2-3-4. Line Voltage and Fuse Selection 2-3
 - 2-3-5. Power Cable 2-4
 - 2-3-6. Operating Environment 2-6
- 2-4. **HP-IB Connections** 2-6
- 2-5. **Installation of Options 907, 908, and 909** 2-7
 - 2-5-1. Option 907 2-7
 - 2-5-2. Options 908 and 909 2-8
- 2-6. **Storage and Shipment** 2-8
 - 2-6-1. Environment 2-8
 - 2-6-2. Original Packaging 2-9
 - 2-6-3. Other Packaging 2-9

SECTION 2

INSTALLATION

2-1. INTRODUCTION

This section provides installation instructions for the HP 4194A Impedance/Gain-Phase Analyzer. Information is also included on initial inspection and damage claims, preparation for using the 4194A, packaging, storage, and shipping.

2-2. INITIAL INSPECTION

The 4194A, as shipped from the factory, meets all the specifications listed in Table 1-1. Upon receiving the instrument, inspect the shipping container for damage. If the shipping container or cushioning material is damaged, it should be kept until the contents of the shipment have been checked for completeness and the instrument has been verified mechanically and electrically. The contents of the shipping container should be as shown in Figure 1-1. The procedures for checking electrical performance are given in Section 4. If the shipment is incomplete, if the instrument is damaged in any way, or if the instrument does not pass the Performance Tests outlined in Section 4, notify the nearest Hewlett-Packard sales office. If the shipping container is damaged, notify the carrier as well as Hewlett-Packard. Keep the shipping materials for the carrier's inspection. The HP sales office will arrange for repair or replacement without waiting for the claim to be settled.

2-3. PREPARATION FOR USE

2-3-1. Interconnecting Units

The 4194A consists of two modules, a Control Unit and a Measurement Unit, which are shipped in two separate containers. To facilitate handling and to allow proper connection between the two units, you must mount the Control Unit atop the Measurement Unit with the furnished Rear Panel Lock Foot Kit (Full Modules, PN 5061-9699). The mounting procedure is as follows.

1. Remove the feet from the bottom cover of the Control Unit.
2. Install the Rear Panel Lock Foot Kit. Follow the instructions provided with the kit. Once the kit has been installed, the two units will be firmly secured to each other, allowing you to pick up the 4194A without having to disconnect the cables at the rear.

INSTALLATION

2-3-2. Interconnection Cables

Install the interconnection cables between the rear panels of both units as shown in Figure 2-1.

- Cable (1). -- Connect this cable assembly (PN 04194-61603) between J6 of the Measurement Unit and J6 of the Control unit. Use a small standard screwdriver to tighten the screws on the cable connectors.
- Cable (2). -- Connect this cable assembly (PN 04194-61602) between J5 of the Measurement Unit and J5 of the Control Unit. Lock down the cable connectors with the spring clips.
- Cable (3). -- Connect these four BNC cables (PN 8120-1838) between J1, J2, J3, and J4 of the Measurement and Control units.
- Cable (4). -- Option 001 units only. Connect this BNC cable (PN 04194-61601) between the REFERENCE OVEN connector on the Measurement Unit and the EXTERNAL REFERENCE connector on the Control unit.

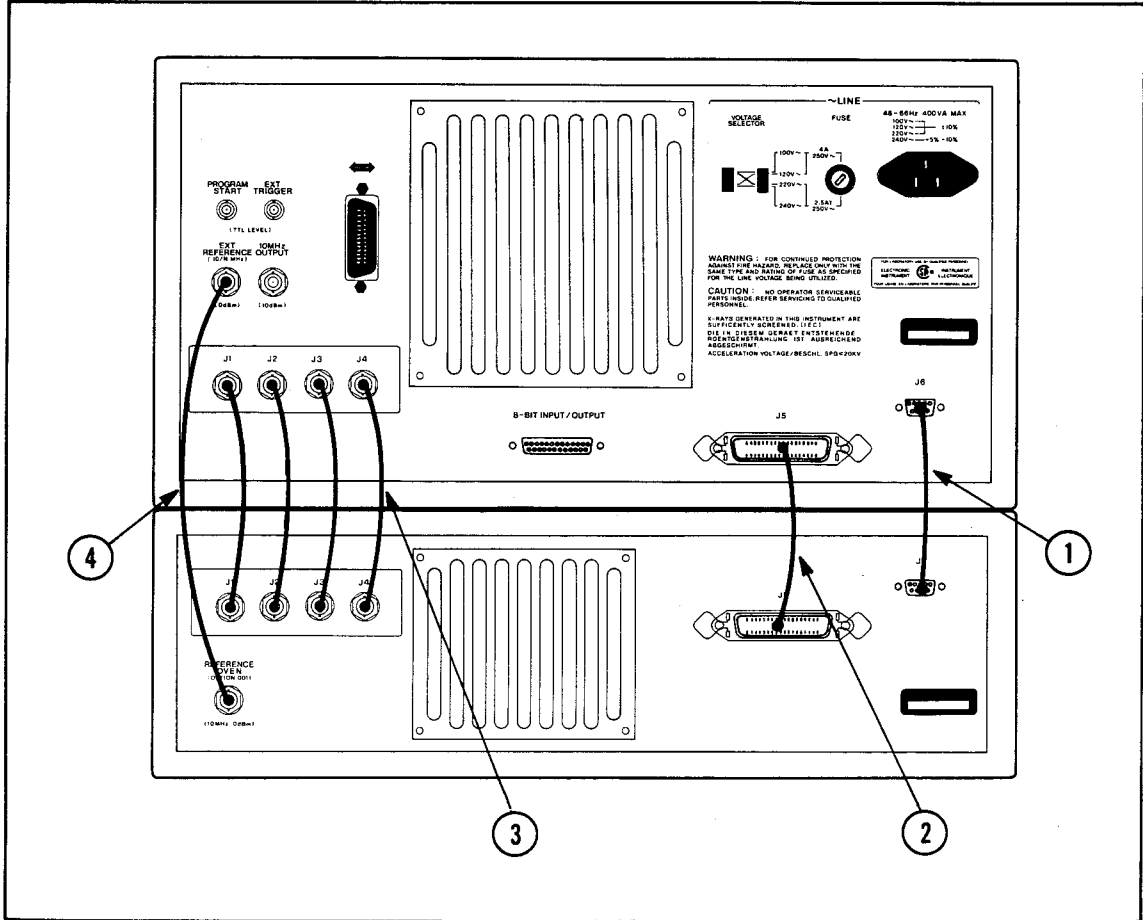

Figure 2-1. Interconnection Cables

2-3-3. Power Requirements

The 4194A requires a power source of 100, 120, 220 volts ac $\pm 10\%$, or 240 volts ac $+5\%$ -10% , 48 to 66Hz single phase; power consumption is 400VA maximum.

WARNING

THIS IS A SAFETY CLASS 1 PRODUCT (PROVIDED WITH A PROTECTIVE EARTH TERMINAL). A NONINTERRUPTABLE SAFETY EARTH GROUND MUST BE PROVIDED FROM THE MAIN POWER SOURCE TO THE INSTRUMENT'S POWER INPUT TERMINALS, POWER CORD, OR SUPPLIED POWER CORD SET. WHENEVER THE SAFETY EARTH GROUND HAS BEEN IMPAIRED, THE INSTRUMENT MUST BE MADE INOPERATIVE AND SECURED AGAINST ANY UNINTENDED OPERATION. IF THIS INSTRUMENT IS TO BE ENERGIZED VIA AN AUTOTRANSFORMER FOR VOLTAGE REDUCTION, MAKE SURE THAT THE COMMON TERMINAL IS CONNECTED TO THE EARTH POLE OF THE POWER SOURCE.

2-3-4. Line Voltage and Fuse Selection

CAUTION

BEFORE CONNECTING THE INSTRUMENT TO THE POWER SOURCE, MAKE SURE THAT THE CORRECT FUSE HAS BEEN INSTALLED AND THE LINE VOLTAGE SELECTION SWITCH IS SET TO THE CORRECT VOLTAGE.

Figure 2-2 provides instructions for line voltage and fuse selection. Current ratings for the fuse are printed under the fuse-holder on the instrument's rear-panel and are listed, along with the fuse's HP part number, in Figure 2-2.

When removing the installed fuse, turn the fuse holder cap counterclockwise with a flat-head screwdriver until it pops out.

CAUTION

USE THE PROPER FUSE FOR THE LINE VOLTAGE SELECTED. MAKE SURE THAT ONLY FUSES WITH THE REQUIRED CURRENT RATING AND OF THE SPECIFIED TYPE ARE USED AS REPLACEMENTS. THE USE OF A MENDED FUSE OR THE SHORT-CIRCUITING OF THE FUSE-HOLDER MUST BE AVOIDED.

INSTALLATION

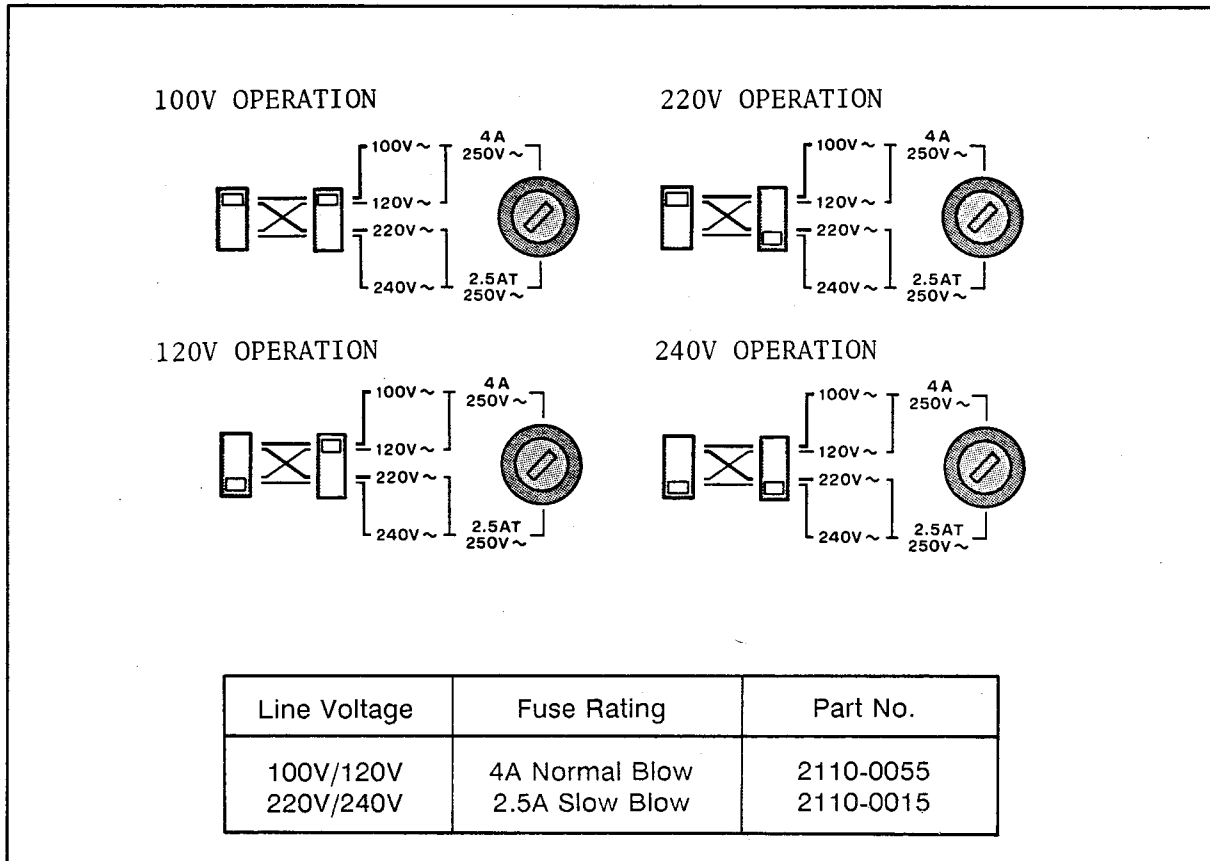

Figure 2-2. Line Voltage and Fuse Selection

2-3-5. Power Cable

To protect operating personnel, the National Electrical Manufacturer's Association (NEMA) recommends that the instrument panel and cabinet be grounded. The 4194A is equipped with a three-conductor power cable, which, when plugged into an appropriate ac power receptacle, grounds the instrument. The offset pin on the power cable is the ground wire.

To preserve the protection feature when operating the instrument from a two contact outlet, use a three-prong to two-prong adapter (PN 1251-8196) and connect the green pigtail on the adapter to power-line ground.

CAUTION

THE POWER PLUG MUST BE INSERTED INTO AN OUTLET THAT PROVIDES A PROTECTIVE EARTH CONNECTION. YOU MUST NOT USE AN EXTENSION CORD (POWER CABLE) WITHOUT A PROTECTIVE CONDUCTOR (GROUND).

Figure 2-3. shows the available power cords used in various countries. Also shown is the standard power cord furnished with the instrument. HP Part Numbers, applicable standards for power plugs, electrical characteristics, and the countries using each power cord are listed in Figure 2-3. For assistance in selecting the correct power cable, contact the nearest Hewlett-Packard sales office.

INSTALLATION

<p>OPTION 900 United Kingdom</p>  <p>Plug: BS 1363A, 250V Cable: HP 8120-1351</p>	<p>OPTION 901 Australia/New Zealand</p>  <p>Plug: NZSS 198/AS C112, 250V Cable: HP 8120-1369</p>
<p>OPTION 902 European Continent</p>  <p>Plug: CEE-VII, 250V Cable: HP 8120-1689</p>	<p>OPTION 903 U.S./Canada</p>  <p>Plug: NEMA 5-15P, 125V, 15A Cable: HP 8120-1378</p>
<p>OPTION 904 U.S./Canada</p>  <p>Plug: NEMA 6-15P, 250V, 15A Cable: HP 8120-0698</p>	<p>OPTION 905* Any country</p>  <p>Plug: CEE 22-VI, 250V Cable: HP 8120-1396</p>
<p>OPTION 906 Switzerland</p>  <p>Plug: SEV 1011.1959-24507 Type 12, 250V Cable: HP 8120-2104</p>	<p>OPTION 912 Denmark</p>  <p>Plug: DHCR 107, 220V Cable: HP 8120-2956</p>
<p>OPTION 917 India/Republic of S.Africa</p>  <p>Plug: SABS 164, 250V Cable: HP 8120-4211</p>	<p>OPTION 918 Japan</p>  <p>Plug: JIS C 8303, 125V, 15A Cable: HP 8120-4755</p>
<p>NOTE: Each option number includes a 'family' of cords and connectors of various materials and plug body configurations (straight, 90° etc.).</p> <p>* Plug option 905 is frequently used for interconnecting system components and peripherals.</p>	

Figure 2-3. Power Cables Supplied

INSTALLATION

2-3-6. Operating Environment

Temperature. The 4194A may be operated in environments with ambient temperatures ranging from 0° C to 55° C.

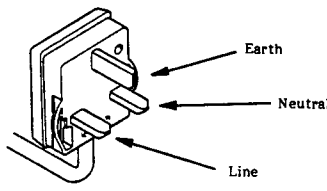
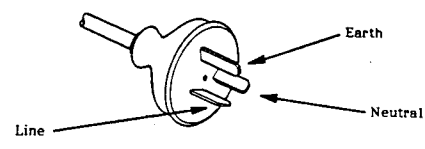
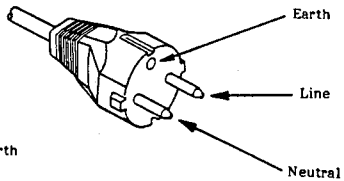
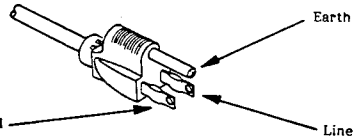
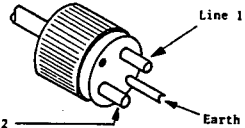
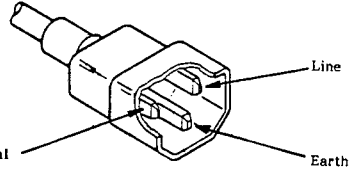
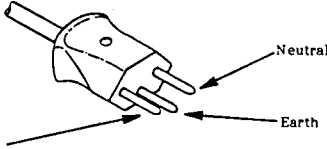
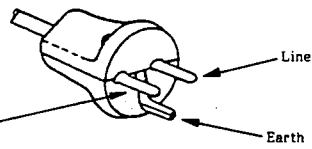
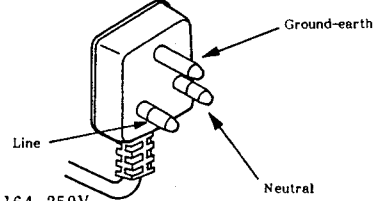
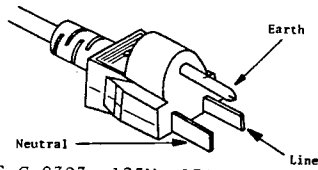
Humidity. The instrument may be operated in environments with relative humidities to 95% at 40° C. The 4194A, however, should be protected from temperature extremes which could cause condensation within the instrument.

2-4. HP-IB CONNECTIONS

The 4194A is designed for operation on the Hewlett-Packard Interface Bus (HP-IB).

Note

HP-IB is Hewlett-Packard's implementation of IEEE Standard 448-1978, "Standard Digital Interface for Programmable Instrumentation."

The 4194A is connected to the HP-IB by connecting an HP-IB interface cable to the HP-IB connector on the rear panel. Figure 2-4 illustrates a typical HP-IB system interconnection.

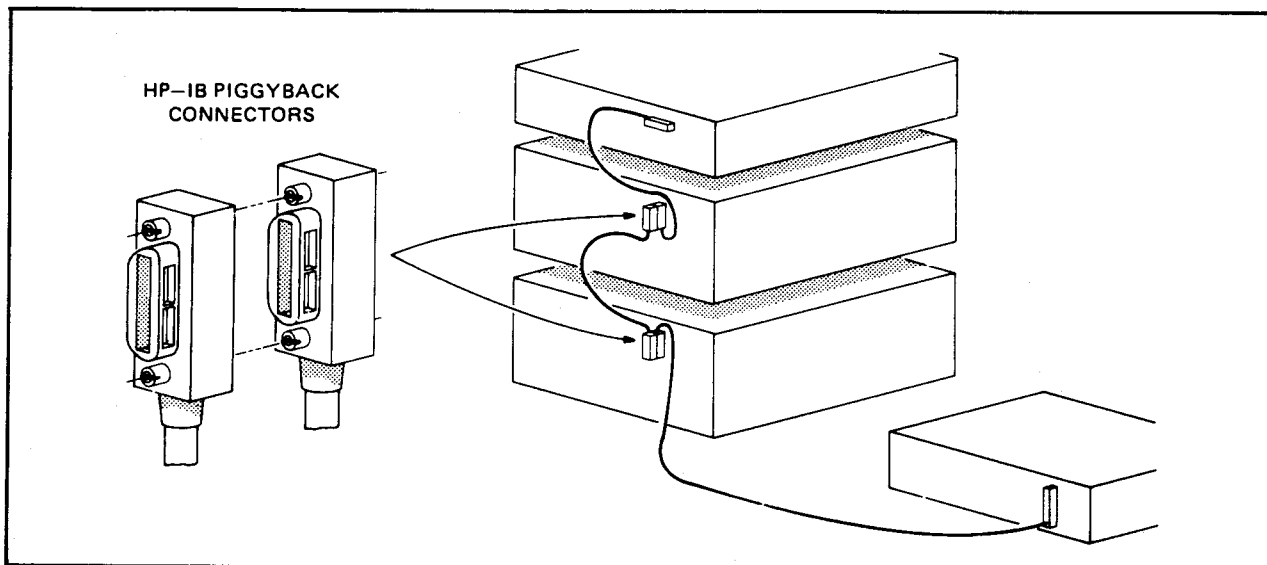

Figure 2-4. Typical HP-IB System Interconnection

With the HP-IB system, up to 15 HP-IB-compatible instruments can be interconnected. HP 10833 HP-IB cables have identical piggy-back connectors on each end so that several cables can be connected to a single source without special adapters or switch boxes. System components and devices can be connected in virtually any configuration as long as a path exists between each device and the controller. Avoid stacking more than three or four cables on any one connector. If too many connectors are stacked together, their weight can produce sufficient leverage to damage the connector mounting. Be sure that each connector is screwed firmly in place to keep it from working loose during use. The 4194A uses all of the available HP-IB lines from the HP-IB connector, so damage to any connector pin may adversely affect HP-IB operation. See Figure 2-5.

CAUTION

THE 4194A CONTAINS METRIC THREADED HP-IB CABLE MOUNTING STUDS. THE METRIC VERSION OF THE HP 10833A, B, C, OR D HP-IB CABLE FASTENERS ARE DISTINGUISHED FROM THE ENGLISH VERSION BY COLOR. ENGLISH THREADED FASTENERS ARE SILVER; METRIC THREADED FASTENERS, BLACK. DO NOT ATTEMPT TO MATE SILVER AND BLACK FASTENERS TO EACH OTHER. IF YOU DO, THE THREADS WILL BE DAMAGED.

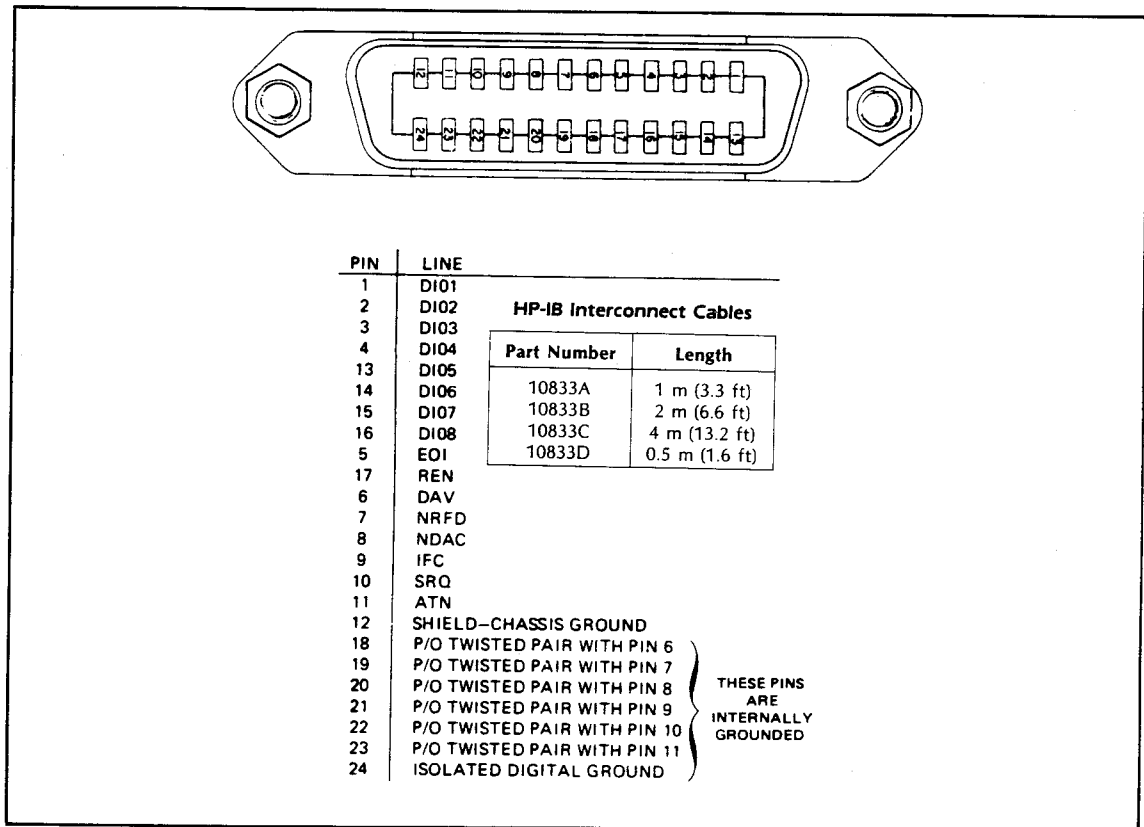

Figure 2-5. HP-IB Interfacing

2-5. INSTALLATION OF OPTIONS 907, 908, AND 909

2-5-1. Option 907

Because the 4194A is heavy, install the Front Handle Kit (Option 907, HP Part No. 5061-9689 and 5061-9691) to facilitate instrument handling on the bench.

Install the Front Handle Kit according to the instructions included with the kit. Remove the adhesive-backed trim strips from the front panel frame and then attach the handles and new trim strips.

INSTALLATION

2-5-2. Options 908 and 909

The 4194A can be rack-mounted and operated as part of a measurement system.

CAUTION

BEFORE RACK-MOUNTING THE 4194A, THE REAR PANEL LOCK FOOT KIT LINKING THE CONTROL AND MEASUREMENT UNITS TOGETHER MUST BE DISASSEMBLED, THEN THE UNITS MUST BE RACK-MOUNTED SEPARATELY IN THE CABINET.

1. Install the Rack Flange Kit (Option 908, PN 5061-9677 and 5061-9679) or the Rack & Handle Kit (Option 909, PN 5061-9683 and 5061-9685) according to the instructions included with the kit.
2. Remove the plastic feet from the bottom of both units (lift tab, and slide the foot in the direction of the tab).
3. Install an instrument support rail on each side of the instrument rack. The instrument support rails, used to support the weight of the instrument, are included with HP rack-mount cabinets.

WARNING

THE WEIGHT OF THE 4194A MUST BE SUPPORTED BY INSTRUMENT SUPPORT RAILS INSIDE THE INSTRUMENT RACK. DO NOT, UNDER ANY CIRCUMSTANCES, ATTEMPT TO RACK-MOUNT THE HP 4194A USING ONLY THE FRONT FLANGES.

THE 4194A'S CONTROL UNIT IS HEAVY (APPROXIMATELY 23 kg.). USE EXTREME CARE WHEN LIFTING IT.

4. Two people should lift the 4194A to its position in the rack on top of the instrument support rails.
5. Use the appropriate fasteners to fasten the 4194A's Rack-Mount Flanges to the front of the rack-mount cabinets.

2-6. STORAGE AND SHIPMENT

2-6-1. Environment

The should be stored in a clean, dry environment. The following environmental limitations apply to both storage and shipment:

Temperature: -55 to 75° C
Humidity: up to 95% (at 40° C)

To prevent condensation inside the 4194A, protect the instrument against temperature extremes.

2-6-2. Original Packaging

CAUTION

BEFORE PACKING 4194A FOR SHIPMENT, THE REAR PANEL LOCK FOOT KIT, WHICH SECURES THE CONTROL UNIT TO THE MEASUREMENT UNIT, MUST BE REMOVED. THE UNITS MUST BE PACKAGED SEPARATELY TO PREVENT DAMAGE DURING TRANSIT.

Containers and materials identical to those used in factory packaging are available through Hewlett-Packard offices. If the instrument is being returned to Hewlett-Packard for servicing, attach a tag indicating the service required, the return address, the model number, and the full serial number. Mark the container **FRAGILE** to ensure careful handling. In any correspondence, refer to the instrument by model number and its full serial number.

2-6-3. Other Packaging

The following general instructions should be used when repacking with commercially available materials:

1. Wrap the 4194A in heavy paper or plastic. If shipping to a Hewlett-Packard sales office or service center, attach a tag indicating the service required, return address, model number, and the full serial number.
2. Use a strong shipping container. A double-walled carton made of 350 pound test material is adequate.
3. Use enough shock absorbing material (3 to 4 inch layer) around all sides of the 4194A to provide a firm cushion and to prevent movement inside container. Protect the front-panel using cardboard.
4. Seal the shipping container securely.
5. Mark the shipping container **FRAGILE** to help ensure careful handling.
6. In any correspondence, refer to 4194A by model number and full serial number.

- 3-1. INTRODUCTION 3-1**
 - 3-1-1. Front Panel Features 3-2

- 3-2. GETTING STARTED 3-11**
 - 3-2-1. Instrument Turn On 3-11
 - 3-2-2. Operating Hints 3-13

- 3-3. IMPEDANCE MEASUREMENTS 3-14**
 - 3-3-1. Ceramic Chip Capacitor 3-14
 - 3-3-1-1. Measurement Set Up 3-14
 - 3-3-1-2. Self-Resonant Impedance and Frequency 3-16
 - 3-3-1-3. Equivalent Circuit Constants 3-18
 - 3-3-1-4. Series-Capacitance and Dissipation Factor 3-20

 - 3-3-2. Ceramic Resonator 3-25
 - 3-3-2-1. Measurement Set Up 3-25
 - 3-3-2-2. Compensation 3-26
 - 3-3-2-3. Resonant and Anti-Resonant Points 3-28
 - 3-3-2-4. Conductance and Susceptance 3-35
 - 3-3-2-5. TABLE and RECTAN A-B Displays 3-37

 - 3-3-3. Impedance Measurement Using a Probe 3-39
 - 3-3-3-1. Measurement Setup 3-39
 - 3-3-3-2. Compensation 3-40
 - 3-3-3-3. Measurement Data 3-45

- 3-4. GAIN-PHASE MEASUREMENTS 3-46**
 - 3-4-1. Bandpass Filter 3-46
 - 3-4-1-1. Measurement Set Up 3-47
 - 3-4-1-2. Passband Insertion Loss Measurement 3-50
 - 3-4-1-3. -3dB and -60dB Bandwidth Measurement 3-51
 - 3-4-1-4. Passband Ripple 3-53
 - 3-4-1-5. Passband Phase Insertion 3-57
 - 3-4-1-6. Passband Group Delay 3-59

 - 3-4-2. RF Amplifier Gain Compression 3-63
 - 3-4-2-1. Measurement Set Up 3-64
 - 3-4-2-2. -3dB Gain Compression Point 3-67

3-5. REFERENCE 3-69

Screen 3-69
Comment Line 3-69
Menu Area 3-69
Keyboard Input Line 3-70
System Message Area 3-70
Monitor Area 3-70
Graticule 3-70
Softkeys 3-71
EXT REF/UNLOCK Lamps 3-72
MENU Keys 3-72
Softkey Architecture 3-73
FUNCTION Key 3-74
SWEEP Key 3-79
COMPEN KEY 3-82
DISPLAY Key 3-84
MKR/L CURS Key 3-93
MORE MENUS Key 3-106
SWEEP MODE Keys 3-118
REPEAT Key 3-118
SINGLE Key 3-119
MANUAL Key 3-119
START Key 3-119
TRIGGER Keys 3-119
INT Key 3-119
Ext/MAN Key 3-120
HP-IB Status Indicators 3-120
LCL Key 3-120
COPY Key 3-120
INTEG TIME Key 3-121
AVERAGING (VIEW) Key 3-121
MARKER/L CURSOR Knob 3-122
BLUE/GREEN Keys 3-123
EDIT Keys 3-124
FORWARD Key 3-124
BACK Key 3-124
DELETE CHARACTER Key 3-124
INSERT CHARACTER Key 3-124
CLEAR LINE Key 3-124
RECALL Key 3-125
PARAMETER Keys 3-125
START Key 3-125
STOP Key 3-126
STEP Key 3-126
 ΔF Key 3-126
CENTER Key 3-126
SPAN Key 3-127
N Key 3-127
BIAS OFF KEY 3-127
SPOT FREQ Key 3-127
SPOT BIAS Key 3-127
OSC LEVEL Key 3-127
SAVE/GET Keys 3-127
DELAY TIME Key 3-128
CMT Key 3-129
STEP UP/DOWN Keys 3-130
ENTRY Keys 3-131
UNIT Keys 3-132
MHz/V Key 3-132
KHz/dBm Key 3-132

Hz/dBV Key 3-132
Engineering Unit Keys 3-132
ENTER/EXECUTE Key 3-133
BIAS ON Lamp 3-133
UNKNOWN Terminals 3-133
CABLE LENGTH Switch 3-133
GAIN-PHASE OUTPUT 3-134
GAIN-PHASE INPUT 3-134
PROGRAM START Connector 3-134
EXT TRIGGER Connector 3-135
8-BIT INPUT/OUTPUT 3-135
10MHz OUTPUT Connector 3-135
REFERENCE OVEN Connector 3-135
EXT REFERENCE Connector 3-135
Rechargeable Battery 136

**** SOFTKEY INDEX **** 3-137

3-6. EXTENDED CAPABILITIES 3-139

3-6-1. Register Manipulation 3-139

- 3-6-1-1. Internal Registers 3-139
- 3-6-1-2. Array Variables 3-140
- 3-6-1-3. Array Variable Operation Rules 3-142
- 3-6-1-4. Single Variables 3-143
- 3-6-1-5. Complex Matrix Operation 3-146

3-6-2. Arithmetic Operation 3-148

3-6-3. HP-IB 3-150

- 3-6-3-1. 4194A's HP-IB Interface 3-150
- 3-6-3-2. 4194A's HP-IB Capability 3-150
- 3-6-3-3. 4194A's HP-IB Address 3-151
- 3-6-3-4. 4194A's HP-IB Commands 3-151
- 3-6-3-5. HP-IB Bus Commands 3-152
- 3-6-3-6. Device Dependent Commands and Syntax Diagrams 3-154
- 3-6-3-7. Message Elements 3-157
- 3-6-3-8. Program Examples 3-163
- 3-6-3-9. Data Transfer 3-168
- 3-6-3-10. Transfer Rate 3-173
- 3-6-3-11. Status Byte 3-174
- 3-6-3-12. Masking the Status Byte 3-175

3-6-4. Auto Sequence Program 3-176

- 3-6-4-1. HP 4194A ASP Capability 3-176
- 3-6-4-2. BASIC Statements 3-178
- 3-6-4-3. ASP Set-up 3-183
- 3-6-4-4. Program Editing 3-185
- 3-6-4-5. Program Execution 3-190
- 3-6-4-6. File Management 3-191
- 3-6-4-7. ASP Copy 3-194

3-6-5. Compensation (Calibration) 3-195

- 3-6-5-1. Compensation for Impedance Measurement 3-195
- 3-6-5-2. ZERO-OPEN/SHORT measurement 3-197
- 3-6-5-3. ZERO-OPEN/SHORT compensation 3-200

- 3-6-5-4. Calibration Using Calibration Standards 3-200
- 3-6-5-5. Messages for Compensation
(Impedance Measurement) 3-203

- 3-6-5-6. Compensation for Gain-Phase Measurement 3-204
- 3-6-5-7. Phase Compensation 3-205

- 3-6-6. **Programmed Points Table 3-206**
 - 3-6-6-1. Table Set Up 3-206
 - 3-6-6-2. Programmed Points Measurement 3-212
 - 3-6-6-3. Table Copy 3-213

- 3-6-7. **Copy 3-214**
 - 3-6-7-1. HP 4194A Configuration 3-214
 - 3-6-7-2. Recommended Plotters and Printers 3-214
 - 3-6-7-3. Copy Capabilities 3-215
 - 3-6-7-4. Copy Procedure 3-216
 - 3-6-7-5. Plot Size 3-217

- 3-6-8. **Equivalent Circuit Function 3-219**
 - 3-6-8-1. Equivalent Circuit Mode Softkeys 3-219
 - 3-6-8-2. Measurement Procedures 3-220
 - 3-6-8-3. Equivalent Circuit Mode Selection 3-223
 - 3-6-8-4. Error Messages 3-224

- 3-6-9. **External I/O 3-225**

SECTION 3

OPERATION

3-1. INTRODUCTION

This section provides information for operating the 4194A Impedance/Gain-Phase Analyzer. Included are turn on procedures and measurement examples; descriptions of the front and rear-panel controls, displays, LED indicators, and connectors; and a description of the 4194A's enhanced measurement and analysis capabilities.

WARNINGS, CAUTIONS, and Notes are given throughout and must be carefully followed to ensure the operator's safety and the serviceability of the instrument.

WARNING

BEFORE TURNING THE INSTRUMENT ON, BE SURE ALL PROTECTIVE EARTH TERMINALS, EXTENSION CORDS, AUTO-TRANSFORMERS AND DEVICES CONNECTED TO THE INSTRUMENT ARE CONNECTED TO EARTH GROUND. ANY INTERRUPTION OF EARTH GROUND CAN CAUSE A POTENTIAL SHOCK HAZARD WHICH COULD RESULT IN PERSONAL INJURY.

ONLY FUSES WITH THE REQUIRED CURRENT RATING AND OF THE SPECIFIED TYPE CAN BE USED. DO NOT USE A SUBSTITUTE FOR THE PROPER FUSE OR SHORT CIRCUIT THE FUSE-HOLDER. TO DO SO COULD CAUSE A SHOCK OR FIRE HAZARD.

CAUTION

BEFORE THE INSTRUMENT IS TURNED ON, BE SURE TO SET THE VOLTAGE SELECTOR TO THE LINE VOLTAGE TO BE USED OR DAMAGE TO THE INSTRUMENT MAY RESULT.

3-1-1. Front Panel Features

Figure 3-1 describes the 4194A's front panel features. Detailed information about front- and rear-panel controls is given in paragraph 3-5.

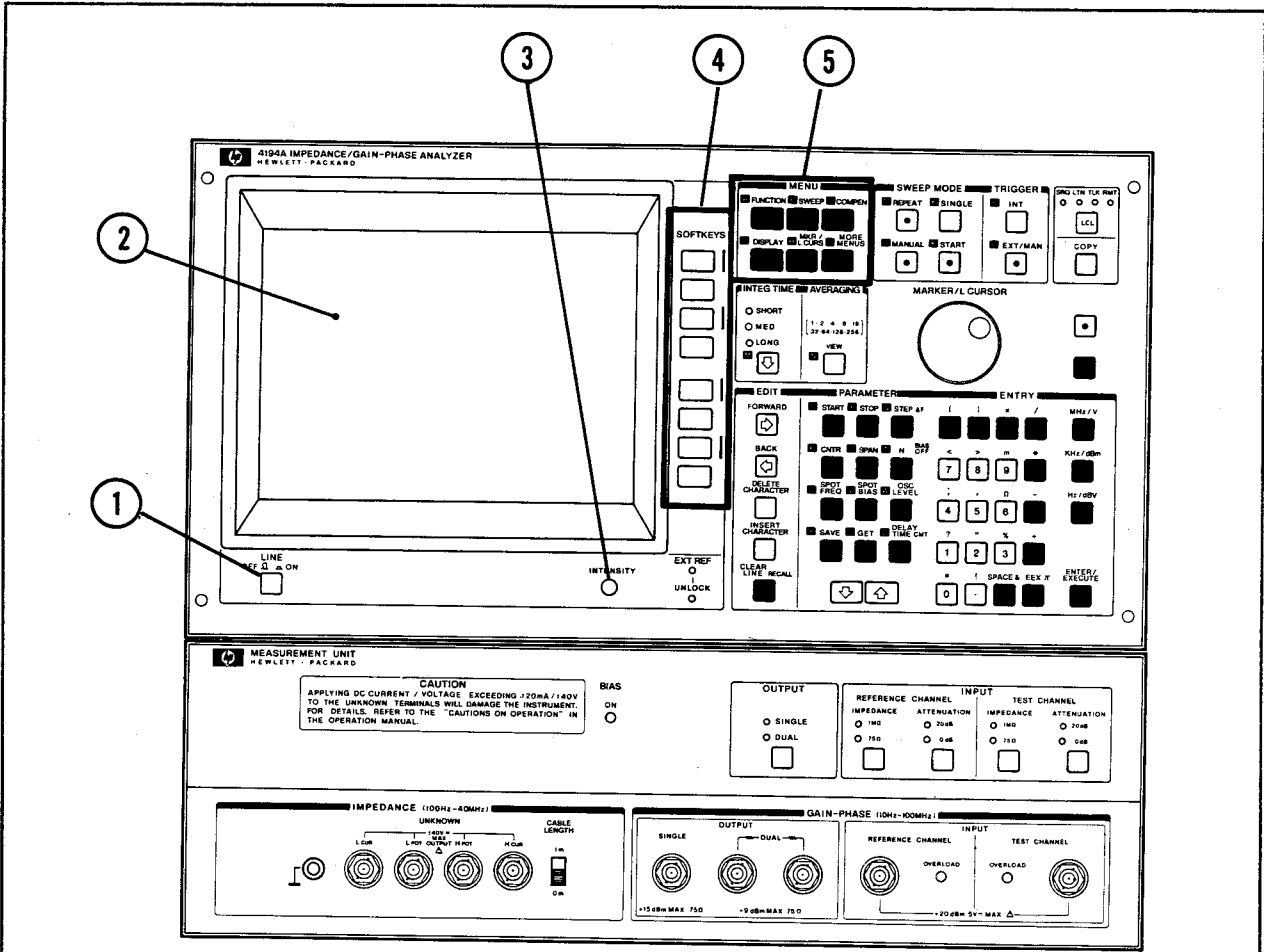

1. LINE ON/OFF SWITCH:

Turns the instrument on and off.

2. SCREEN AREA:

Displays all measurement setups, marker information, measurement results, softkey labels, special user functions, operator comments, error codes, system messages, and warnings. All displayed information, except for the softkey labels, can be dumped directly to an HP-IB printer without the need for an external controller.

Note

When a softkey is pressed, its label will change to **Intensified Green** unless otherwise stated.

3. INTENSITY:

Used to adjust the CRT's trace brightness.

Figure 3-1. Panel Features (1 of 9)

4. SOFTKEYS:

These eight keys are used to select menu items. Softkeys are used to setup measurements and to select parameters and functions.

5. MENU Keys:

These keys are used to display labels of softkeys menus. To set up a measurement, press (in the following order) the **FUNCTION**, **SWEEP**, **COMPEN**, **DISPLAY**, and **MKR/L CURS** key. The following menus can be accessed by using the **MENU** keys. For more information refer to paragraph 3-5.

FUNCTION:

Impedance, Gain-Phase, Impedance with Z probe, and Monitor menu.

SWEEP:

Linear sweep, Log sweep, Sweep up, Sweep down, Programmed measurement on/off, and Expand markers.

COMPEN:

OFST REF STORE, A OFFSET on/off, B OFFSET on/off, Open offset on/off, Short offset on/off, Zero open, Zero short, OS cal, 0Ω cal, STD cal, CAL on/off, Interpolate, ALL points, θ scale normal, and θ scale expansion.

DISPLAY:

Rectangular X-A & B, Rectangular A-B, Table, Superimpose, and Limit on/off.

MKR/L CURS:

o-marker, o-reference *-marker, Line cursor, o-reference line-cursor, o- & *-markers, and off.

MORE MENUS:

Program, HP-IB define, Copy menu, Self test, Measurement page, Equivalent circuit, and Set program table.

Figure 3-1. Panel Features (2 of 9)

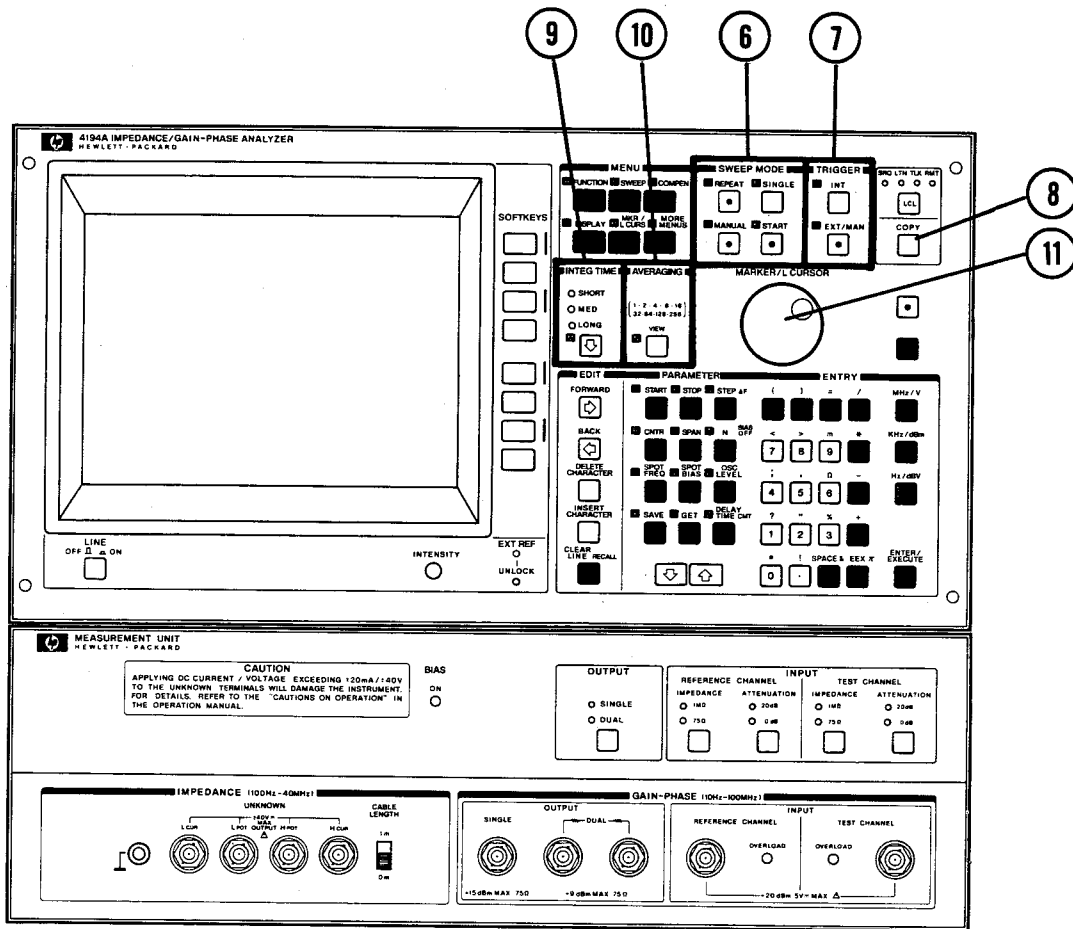

6. SWEEP MODE Keys

REPEAT:

This key is used to select the continuous sweep mode.

SINGLE:

This key is used to select triggered single sweep.

MANUAL:

This key is used to select **MANUAL SWEEP**, rotating the **MARKER/L CURSOR** knob sweeps the selected parameter.

START:

This key immediately stops the sweep in progress and initiates a new sweep. This key is effective only in the REPEAT and SINGLE sweep modes.

Figure 3-1. Panel Features (3 of 9)

7. TRIGGER KEYS

INT:

INTernal triggering, which enables measurements to be repeated automatically and is the 4194A's default setting.

EXT/MAN:

The external trigger input on the back panel is used to input a trigger pulse to the 4194A. Use the **EXT/MAN** key on the front panel to trigger the 4194A manually if you are not using an external trigger signal.

8. COPY

This key starts or stops the dumping of screen information to an HP-IB plotter or printer.

9. INTEG TIME

This key selects the digital integration time. **MED** or **LONG** integration times are selected to minimize noise on the trace. **SHORT** is the initial control setting. The integration time can be changed at any time, even during a measurement.

10. AVERAGING

This key is used to change and view the weighting factor (N) selected by the user. The default weighting factor is 1. Averaging is useful for removing the effects of noise from a trace. It is best to select a small value for the weighting factor if you wish to adjust the response of the device under test in real time. When small values of weighting factor are used the response time will be faster than when large values are used. If you want a very good "final" picture, select a value of 256. The larger the weighting factor is (greater number of samples averaged), the greater will be the reduction of noise effects.

11. MARKER/L CURSOR KNOB

This knob may be used to position the marker (o or *) and line cursor on the screen.

Figure 3-1. Panel Features (4 of 9)

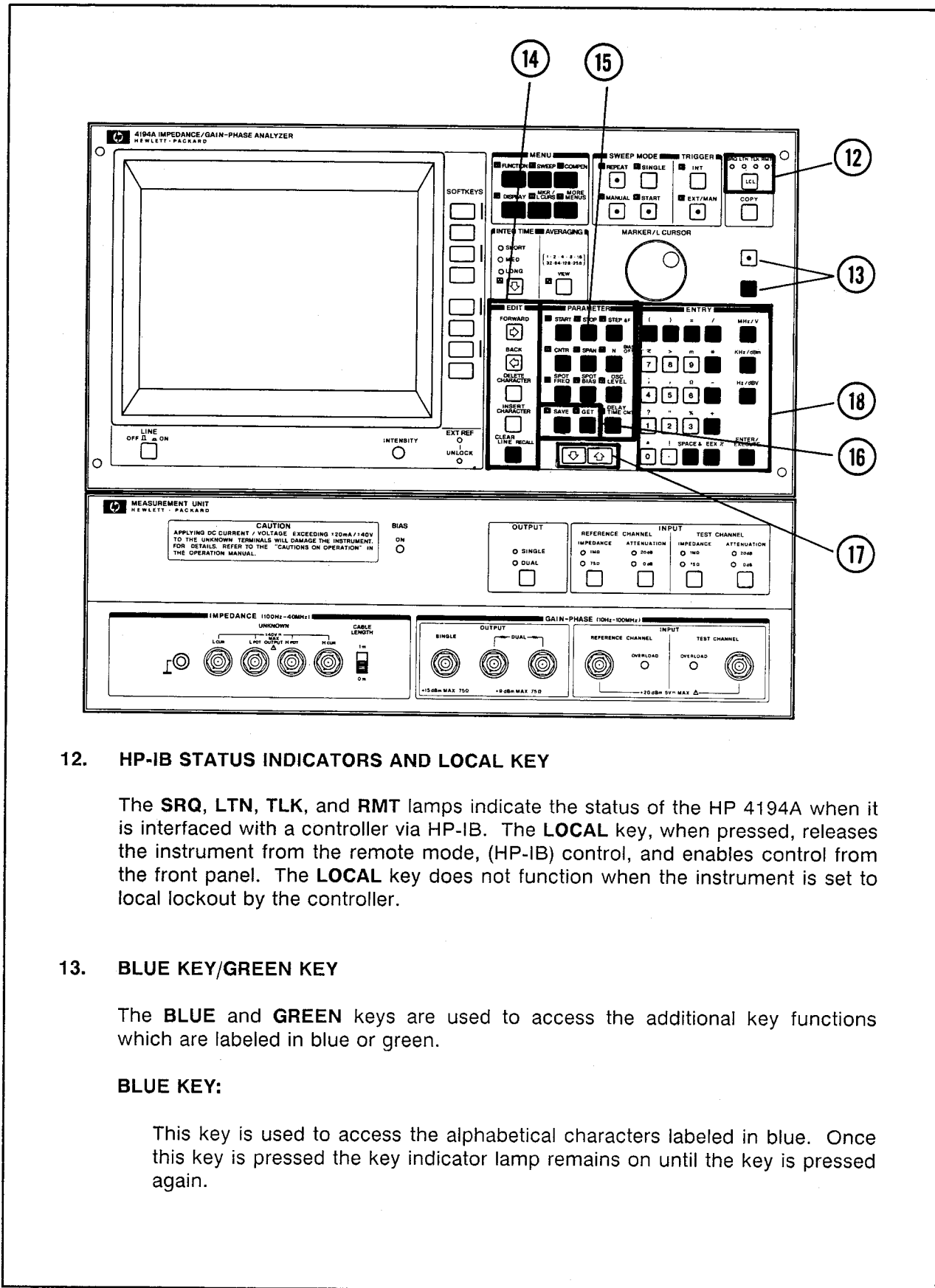

12. HP-IB STATUS INDICATORS AND LOCAL KEY

The **SRQ**, **LTN**, **TLK**, and **RMT** lamps indicate the status of the HP 4194A when it is interfaced with a controller via HP-IB. The **LOCAL** key, when pressed, releases the instrument from the remote mode, (HP-IB) control, and enables control from the front panel. The **LOCAL** key does not function when the instrument is set to local lockout by the controller.

13. BLUE KEY/GREEN KEY

The **BLUE** and **GREEN** keys are used to access the additional key functions which are labeled in blue or green.

BLUE KEY:

This key is used to access the alphabetical characters labeled in blue. Once this key is pressed the key indicator lamp remains on until the key is pressed again.

Figure 3-1. Panel Features (5 of 9)

GREEN KEY:

This key is used to access the special symbols labeled in green and is valid for one operation only. It must be pressed each time a green-labeled key function is used.

14. EDIT KEYS

These keys are used to enter and edit the data displayed in the Limit table, Program and Keyboard Input Line.

15. PARAMETER SELECT KEYS

These keys are used to enter new values for the various test parameters in conjunction with the **ENTRY** keys and the **ENTER/EXECUTE** key. Pressing a test parameter key will cause the value of the selected test parameter to be displayed on the Keyboard Input Line.

16. SAVE and GET KEYS

These keys are used to save or recall front-panel control settings, test parameter values, calibration data, and reference data. The information saved can be recalled using the **GET** key, even if the instrument has been turned off.

17. STEP UP/DOWN KEYS

Can be used to set the optimum sweep parameter values and scale size.

18. ENTRY KEYS

These keys are used to input test parameter values, register numbers for **SAVE** and **GET**, and reference data for the deviation measurements. The three units keys and the **ENTER/EXECUTE** key instruct the instrument to read the data set with the **PARAMETER** select keys and the **ENTRY** keys. Data is not input until one of these keys is pressed.

Figure 3-1. Panel Features (6 of 9)

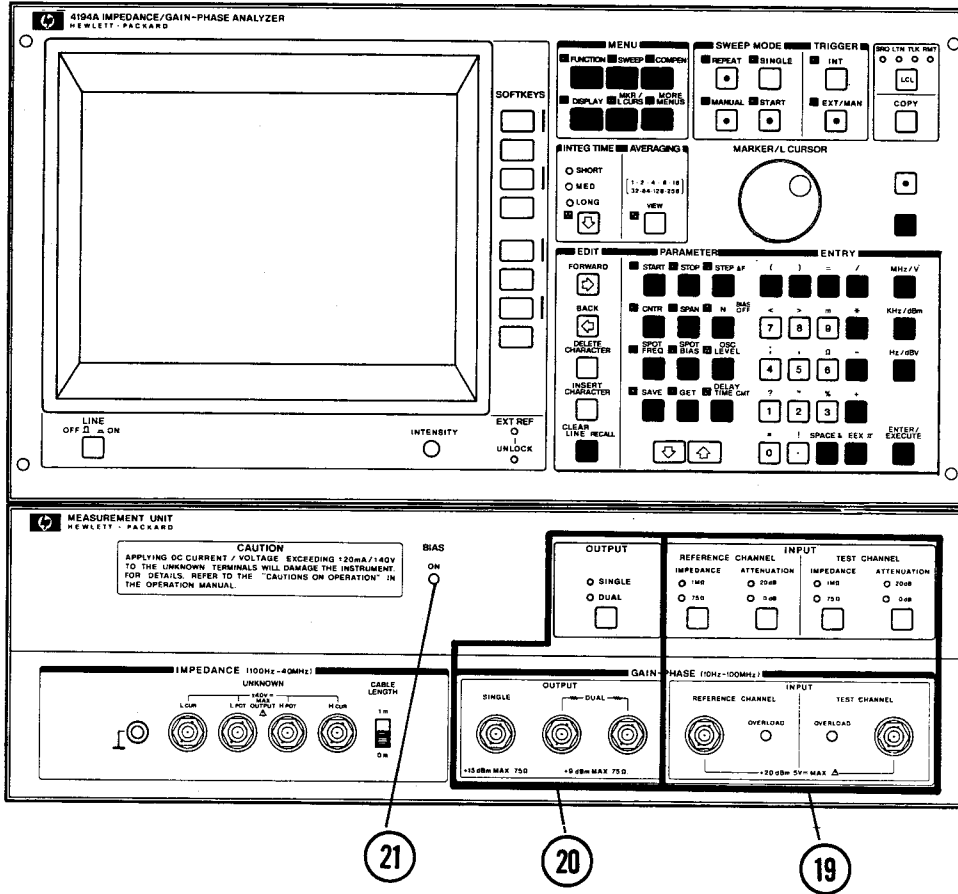

19. GAIN-PHASE INPUT CONNECTORS

The GAIN-PHASE input connectors are used in conjunction with the OSC OUTPUT connectors when making Gain-Phase measurements. The inputs are protected against overvoltage by sensing input signal levels greater than $\pm 5.0V$ and then switching the input impedance to $1M\Omega$. The input may be overloaded without switching the input impedance if the signal level beyond the input attenuation exceeds $0dBm$ or $20dBm$, but does not exceed $\pm 5.0V$. This condition causes inaccurate data to be displayed, and is indicated by a beep, illumination of the red alarm LED for the channel which is in the **OVERLOAD** state and a warning message is displayed on the screen.

Note

If an overload occurs during a slow or a single sweep, inaccurate trace data may remain on the screen. You should reduce the input level and start a new sweep before taking measurement values.

Figure 3-1. Panel Features. (7 of 9)

20. GAIN-PHASE OUTPUT CONNECTORS

These connectors are the outputs used for Gain-Phase Measurements, and are controlled by the keys in the PARAMETER and ENTRY sections. The characters across the bottom right of the screen show the frequency and amplitude of the test signal source. The **DUAL** outputs are the outputs from a power splitter which supplies two in-phase, equal amplitude, output signals. The output impedance is approximately 50Ω . The output signal level is variable from -65dBm to 15dBm when terminated into 50Ω (option 350) or 75Ω (option 375).

Note

The Gain-Phase Input and Output connectors are used for Impedance measurement with the '**IMP with Z PROBE**' function (Program code: FNC3).

21. BIAS ON Indicator

Lights when the internal DC bias is used, and goes off when the **BIAS OFF** (green labeled) key is pressed.

Figure 3-1. Panel Features. (8 of 9)

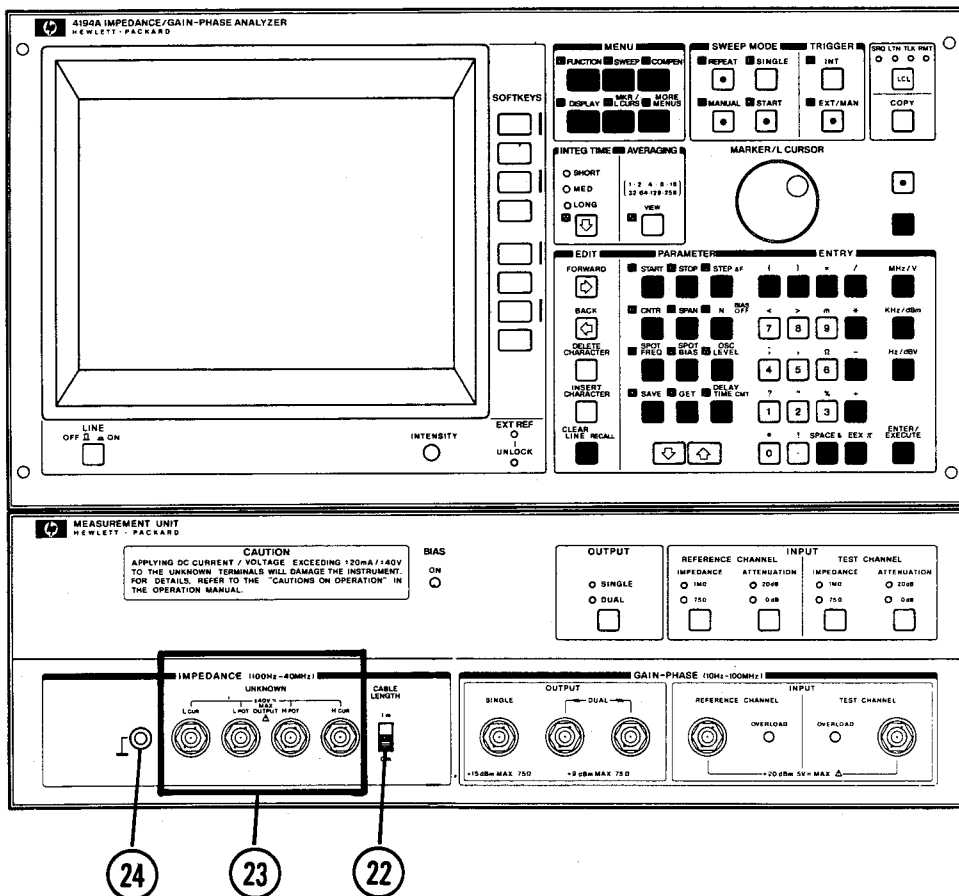

22. CABLE LENGTH SELECTOR SWITCH

This switch is effective only in the impedance measurement mode. It facilitates the balancing of the measuring bridge circuit and minimizes measurement errors when the standard 1m test leads are used.

23. UNKNOWN TERMINALS

The UNKNOWN TERMINALS are used for making impedance measurements, these four BNC connectors provide the means to connect DUT's in a four-terminal pair configuration: High current terminal (H_{cur}), High potential terminal (H_{pot}), Low current terminal (L_{cur}), and Low potential terminal (L_{pot}). The four terminal pair test fixture attaches directly to these terminals.

24. GROUND TERMINAL

This terminal is tied to chassis ground.

Figure 3-1. Panel Features. (9 of 9)

3-2. GETTING STARTED

This section is designed to help get the first time user going and ready to make measurements. The 4194A must be configured and fused for the available line voltage and safely connected to the power line before it is turned on. Refer to Section 2, Installation, for more details.

3-2-1. Instrument Turn On

1. Before connecting power to the 4194A:

- 1) Set the rear panel **VOLTAGE SELECTOR** switch to the position corresponding to the power line voltage to be used.

Line Voltage Selector	Line Voltage
100V	90V to 110V at 48Hz to 66Hz
120V	108V to 132V at 48Hz to 66Hz
220V	198V to 242V at 48Hz to 66Hz
240V	216V to 252V at 48Hz to 66Hz

WARNING

TO AVOID SERIOUS INJURY, BE SURE THAT THE POWER CORD IS DISCONNECTED BEFORE REMOVING OR INSTALLING THE LINE FUSE.

- 2) Verify that the proper line fuse is installed in the rear-panel fuse-holder:

Voltage Selector	Fuse Type
100/120V	4A, 250V, Normal Blow
220/240V	2.5A, 250V, Slow Blow

Note

Refer to Section 2 for the HP Part Number of the fuse.

WARNING

TO PROTECT OPERATING PERSONNEL, THE 4194A CHASSIS AND CABINET MUST BE GROUNDED. THE 4194A IS EQUIPPED WITH A THREE-WIRE POWER CORD WHICH, WHEN PLUGGED INTO AN APPROPRIATE RECEPTACLE, PROVIDES A EARTH GROUND FOR THE INSTRUMENT. TO PRESERVE THIS PROTECTION FEATURE THE POWER PLUG SHOULD ONLY BE INSERTED INTO A THREE-TERMINAL RECEPTACLE HAVING A PROTECTIVE EARTH GROUND CONTACT. THE PROTECTIVE ACTION MUST NOT BE NEGATED BY THE USE OF AN EXTENSION CORD OR ADAPTER THAT DOES NOT MAKE THE REQUIRED EARTH GROUND CONNECTION. GROUNDING ONE CONDUCTOR OF A TWO-CONDUCTOR OUTLET IS NOT SUFFICIENT PROTECTION.

ENSURE THAT ALL DEVICES CONNECTED TO THE 4194A ARE CONNECTED TO THE PROTECTIVE EARTH GROUND.

OPERATION

2. Set the front panel power switch to **OFF**.
3. Connect the ac power cord to the rear panel **LINE** connector.
4. Switch the Cable Length switch to the " 0m " position.
5. Turn the instrument on. Verify that all front panel LED's simultaneously illuminate for approximately three seconds.
6. Verify that "**Memory test in progress**" is displayed on the System Message Line several seconds after the 4194A is turned on.

Note

When the 4194A is turned on, a self-test of ROM and RAM memory is performed. If **ERROR** is displayed, contact the nearest HP office.

WARNING

SERVICING MUST BE PERFORMED ONLY BY TRAINED SERVICE PERSONNEL.

7. Verify the cooling fans are running and the following LED's are on.

- 1) REPEAT (SWEEP MODE)
- 2) START (SWEEP MODE)
- 3) INT (TRIGGER)
- 4) SHORT (INTEG TIME)
- 5) EXT REF *1
- 6) DUAL (OUTPUT)
- 7) 50 Ω (INPUT Reference Channel/Test Channel)
- 8) 0dB (INPUT Reference Channel/Test Channel)

*1: If the 4194A is equipped with Option 001, High Stability Frequency Reference, or an external Signal is applied to the External Reference connector.

8. The power on default screen should appear as in Figure 3-2.

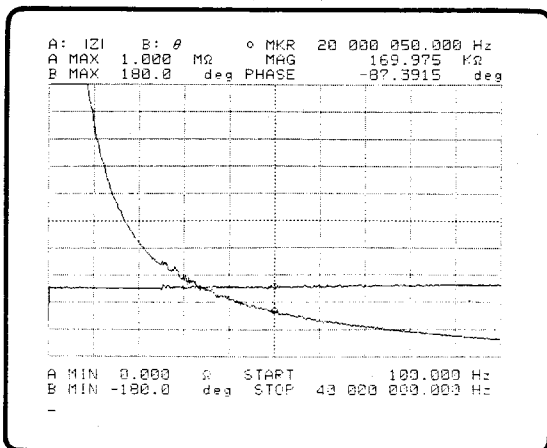

Figure 3-2. Power on Default Screen

3-2-2. Operating Hints

1. Use the following key sequence to set up a measurement, and input the required information and parameters.
 - 1) **FUNCTION**
 - 2) **SWEEP**
 - 3) **COMPEN**
 - 4) **DISPLAY**
 - 5) **MKR/L CURS**

This sequence is a good logical setup sequence.

2. The 4194A is menu-driven using the **MENU** keys to display various menus. If the menu displayed is not the menu that you want, select "more x/x" softkey, or press a **MENU** key. If you do not want to enter data after beginning data entry abort by pressing the 'return' softkey, or by pressing a **MENU** key to exit. Data entries must be terminated by selection of a units key (**MHz**, **V**, **dBm**, etc.) or the **ENTER/EXECUTE** key, no entry is made if a unit key is not selected.
3. A beeper will sound to attract the user's attention when an Operation/Measurement Error message is displayed in the System Message Area, or when a measurement is aborted.
4. If the 4194A is used in a measurement system, all frequency references should be phase-locked to a common frequency standard. The 4194A will phase-lock to a frequency reference applied to its External Reference connector if the signal is between -1 to 20dBm and the frequency is an integer division (1-10) of 10MHz. The 4194A can also be used as the system reference via its 10MHz Output (0dBm). Both connectors are located on the rear panel.
5. The 4194A requires a 30 minute warm up before it will meet all specifications, however, the instrument is operable during the warm-up period.

OPERATION

3-3. IMPEDANCE MEASUREMENTS

The Impedance and Gain-Phase measurement sections contain step by step instructions demonstrating how to use the 4194A. The DUTs were selected to show full usage of the 4194A's Impedance Measurement capabilities. For details on the operating features, refer to the Reference and Extended Capabilities paragraphs in this section.

Press the keys listed on the left side of each page, including front panel keys and the softkeys displayed in the Menu Area of the screen.

When the 4194A is turned on, some of softkeys are selected as the default settings. In the following procedures, the softkeys selected as the default settings when the instrument is turned on are skipped in order to present a simple and easy to follow procedure.

3-3-1. Ceramic Chip Capacitor

A 100nF ceramic chip capacitor is used as the DUT for the Impedance Measurement Demonstration and the following characteristics will be measured:

1. Impedance at the DUT's Self-Resonant Frequency
2. Equivalent Circuit Constants
3. Series-Capacitance and Dissipation Factor

3-3-1-1. Measurement Setup

Measurement setup begins with the connection of the Test Fixture to the UNKNOWN Terminals on the front panel of the 4194A.

1. Mount the HP 16092A Spring Clip Fixture on the HP 16085A Terminal Adapter.
2. Connect the 16085A to the UNKNOWN Terminals on the front panel of the 4194A as shown in Figure 3-3.
3. Mount the chip capacitor on the 16092A fixture.

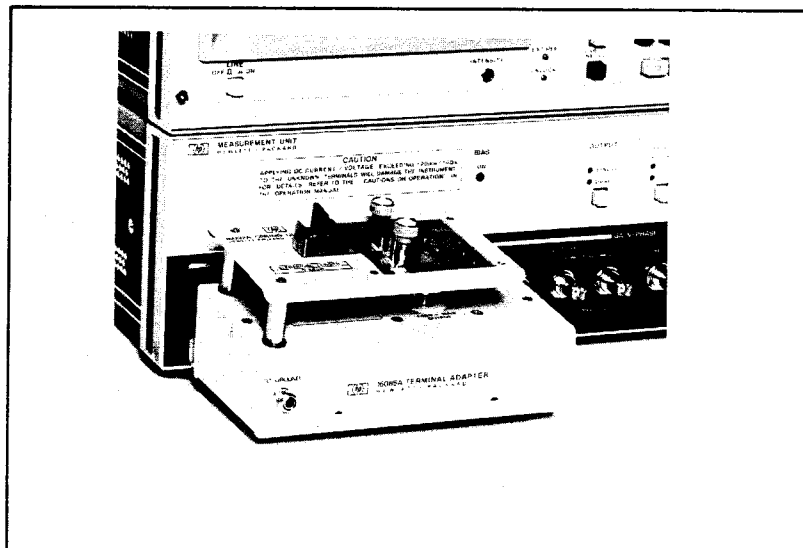

Figure 3-3. HP 16085A Connection

CLEAR LINE



Key used to clear all information on the Keyboard Input Line and System Message Area.

BLUE



Key used to access the alphabetical characters labeled in blue. The lamp in the key will light.

R



S



T



Entry "Reset" command. "RST" will be displayed at Keyboard Input Line.

ENTER/EXECUTE



Pressing the **ENTER/EXECUTE** key starts execution the using the data entered. All settings and data are reset, and the sweep mode will be set to Single Sweep.

OPERATION

Note

The RST command resets the instrument to the power-on default conditions except for the following.

1. The Sweep mode is set to **SINGLE** sweep (code: SWM2).
2. Data registers (**A ~ D**), general purpose registers (RA ~ RL), registers for compensation, **Rn**, **Z**, and all read-only registers are not reset.
3. The Program **WORK AREA** is not cleared from memory.

REPEAT



SWEEP MODE section key used to set the sweep mode to the **REPEAT** sweep mode. The lamp in the key will light. Figure 3-4 shows the measurement data.

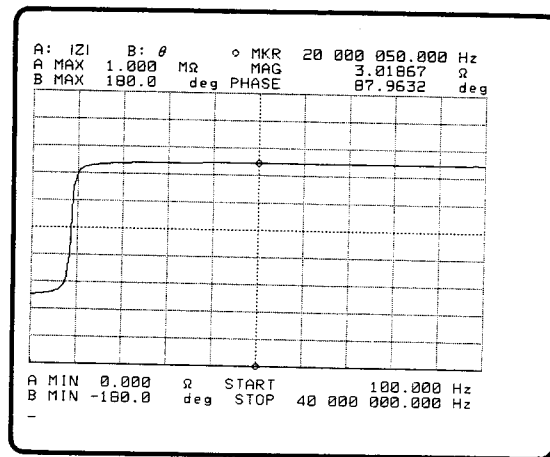

Figure 3-4. Power-On Default Display

3-3-1-2. Self-Resonant Impedance and Frequency

The IMPEDANCE Measurement function, and the $|Z|-\theta$ measurement parameters are selected by default, therefore you don't need to press a FUNCTION key.

SWEEP



MENU section key used to display the **SWEEP** menu for selection of the measurement sweep type and the sweep parameters.

LOG SWEEP



Softkey used to set the sweep type to **LOG**. **SWEEP UP** and **FREQ** are the default settings selected, therefore we will skip the process for setting them.

DISPLAY



This key is used to display the "DISPLAY" menu. (RECTAN X-A&B's label should be intensified green.)

menu



This softkey is used to display a submenu. RECTAN X-A&B menu will be displayed.

**A SCALE
LOG**



Softkey used to set the scale for data A to LOG. The vertical scale will be changed to **LOG**.

**AUTO
SCALE A**



Softkey used to scale data A so that it fills the graticule without clipping the trace as shown in Figure 3-5.

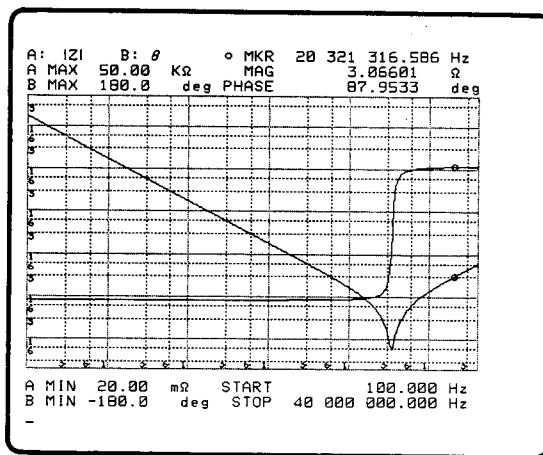

Figure 3-5 Auto Scaled

SINGLE



SINGLE SWEEP key in the **SWEEP MODE** section. The lamp in the key will light.

START



Key in the **SWEEP MODE** section, used to trigger a sweep in the **SINGLE SWEEP** mode. The lamp in the key will light until one measurement sweep is completed.

MKR/L CURS



Key used to display the **MKR/L CURS** menu. The label of the o-MKR should be intensified green.

menu



Softkey used to display the lower level menu. The o-MKR menu will be displayed.

3: Operation

OPERATION

o MKR
->MIN (A) 

Softkey used to move the o-marker to the measurement point containing the lowest measurement value as shown in Figure 3-6.

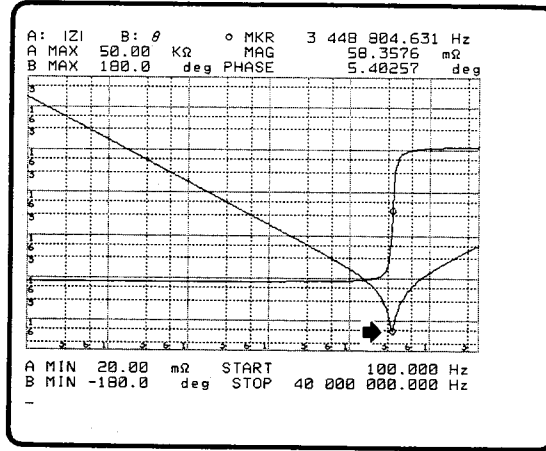

Figure 3-6. Self-Resonant Point

In the Marker Area, the following measurement results can be read directly.

1. Self-Resonant Frequency: 3.448804MHz
2. Self-Resonant Impedance: 58.3576m Ω

3-3-1-3. Equivalent Circuit Constants

The 4194A's Equivalent Circuit Mode calculates the equivalent circuit constants, and simulates the frequency characteristics. In this section, we will show you how to obtain the equivalent circuit constants using the data taken in the previous example.

MORE MENUS



Displays the **MORE MENUS** menu and allows us to access the EQV CKT mode.

EQV
CKT 

Softkey used to get into the **EQUIVALENT CIRCUIT** mode, and displays the EQUIVALENT CIRCUIT MODE page shown in Figure 3-7.

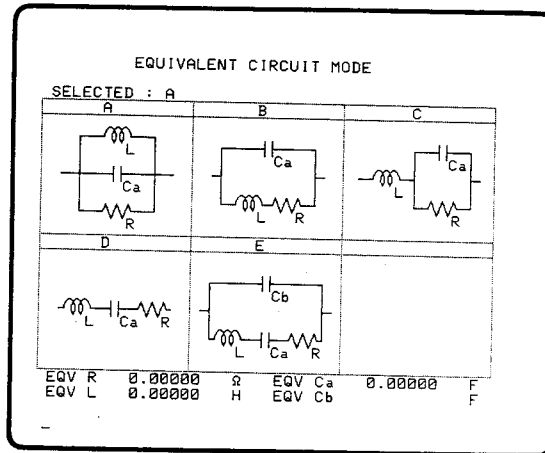

Figure 3-7. EQUIVALENT CIRCUIT MODE page



Softkey used to select CKT D.



Softkey used to start the equivalent parameter calculation. The "Calculating EQV parameters" message will be displayed in the System Message Area for several seconds, then "Calculation complete" will be displayed. The results will be shown at the bottom of the EQV CKT display as shown in Figure 3-8.

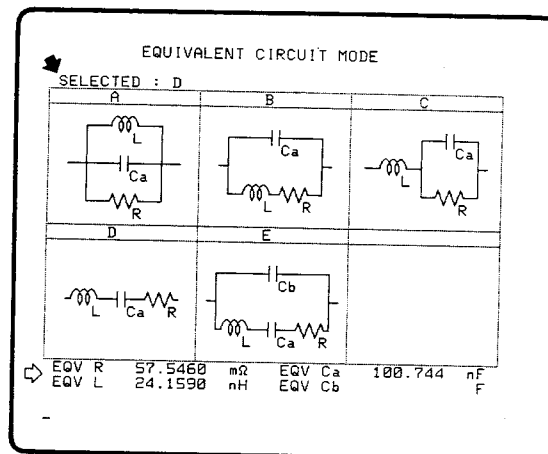

Figure 3-8. Calculation Results

The following parameters can be read from the display.

1. EQV R = 57.5460mΩ
2. EQV L = 24.1590nH
3. EQV Ca = 100.744nF

OPERATION

3-3-1-4. Series-Capacitance and Dissipation Factor

The series-capacitance (Cs) and the dissipation factor (D) of a chip capacitor will be measured over a frequency range of 1KHz to 3MHz. The displayed values of Cs and D are the difference between the start and stop values.

FUNCTION



Displays the **FUNCTION** menu, and is used to select the measurement function and parameters. The **IMPEDANCE** label should be intensified green.

IMPE- DANCE



Selects the Impedance measurement function and displays the **IMPEDANCE** menu. The $|Z|-\theta$'s label should be green.

Cs-D



Selects the Cs-D measurement parameters. The screen will change as shown in Figure 3-9.

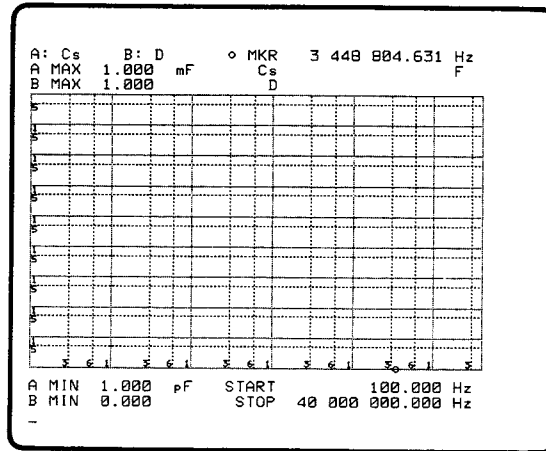

Figure 3-9. Cs-D Measurement Display

SWEEP



The **SWEEP** key in the **MENU** section displays the **SWEEP** menu and allows you to select the sweep parameters, sweep type (linear or log) and sweep direction.

LIN SWEEP



This softkey selects the linear sweep mode. The softkey label will change to intensified green, and the horizontal scale will change to **LINEAR**.

START



A **PARAMETER** section key used to specify the start value of the sweep parameter. The "START=(current value)" command will appear on the Keyboard Input Line.

1

ENTRY section key. "START=1" will be displayed as shown in Figure 3-10.

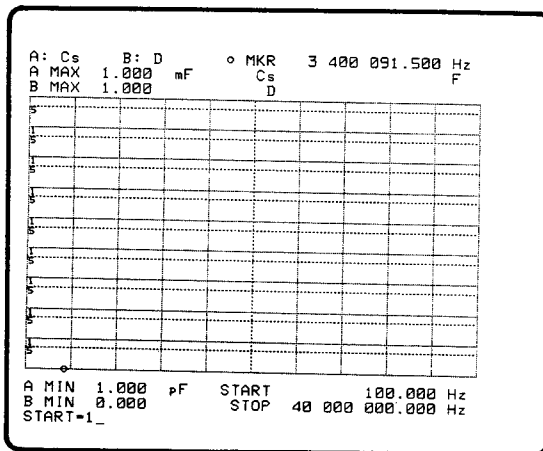

Figure 3-10. Sweep Start Value Entry

KHz/dBm



ENTRY section key used to select kHz as the units entry, and instructs the instrument to read the data on the Keyboard Input Line.

STOP



PARAMETER section key used to specify the stop value of the sweep parameter. "STOP=(current value)" will appear on the Keyboard Input Line.

3

ENTRY section key. "STOP=3" will be displayed.

MHz/V



ENTRY section key used to select MHz as units entry, and instructs the instrument to read the data on the Keyboard Input Line.

START



SWEEP MODE section key used to start a new sweep, the lamp in the key will remain lit until the sweep is complete.

DISPLAY



MENU section display key used to specify the display format. The **DISPLAY** menu will be displayed and the **RECTAN X-A&B** label should be intensified green.

3: Operation

OPERATION

menu

Displays the lower level menu. The **RECTAN X-A&B** menu will be displayed.

A SCALE
LIN

Softkey sets the scale for data A to linear. The vertical scale will be changed to linear.

AUTO
SCALE A

Softkey used to scale data A to fill the graticule without clipping the trace.

more
1/3

Softkey used to display additional menus.

AUTO
SCALE B

Softkey used to scale data B to fill the graticule without clipping the trace as shown in Figure 3-11.

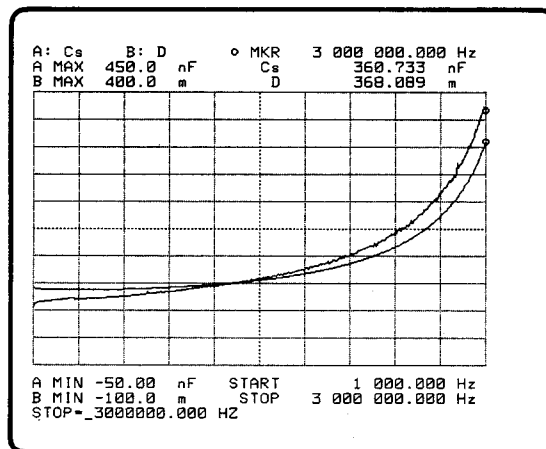

Figure 3-11. AUTO SCALED

MKR/L CURS



MENU section key used to display the **MKR/L CURS** menu.

o & *
MKRS

Softkey used to select the o- & *-MKRS mode. The label of the softkey will change to green and, the o- and *-markers will appear on both traces.

menu

Displays the submenu. The o- & *-MKRS menu will be displayed.

MKR=

Softkey used to move the o-marker. "MKR=" command will appear at Keyboard Input Line.

1

ENTRY section key.

KHz/dBm



ENTRY section key used to select kHz as the units entry, and instructs the instrument to read the data on the Keyboard Input Line. The o-marker will move to the sweep start position.

SMKR=



Softkey used to move the *-marker. "SMKR=" command will appear on Keyboard Input Line.

3

ENTRY section key.

MHz/V



ENTRY section key used to select MHz as the units entry, and instructs the instrument to read the data on the Keyboard Input Line. The *-marker will move to the position of the end of sweep position as shown in Figure 3-12.

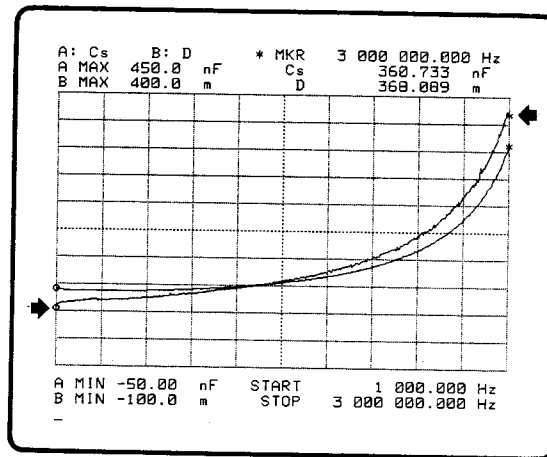

Figure 3-12. o-Marker and *-Marker

OPERATION

return

Softkey used to display the previous menu. The **MKR/L CURS** menu will be displayed. (The o- & *-MKRS's label should change to green.)

o REF
* MKR

Softkey used to select the "o-REF- *-MKR" mode. The difference between o- and *-markers is displayed in the Marker Area as shown in Figure 3-13.

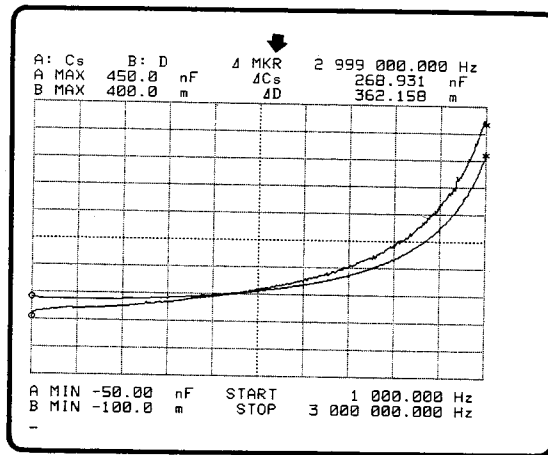

Figure 3-13. Deviation

3-3-2. Ceramic Resonator

A 30MHz ceramic resonator will be used as the DUT for the Impedance Measurement Demonstration. The following characteristics of the DUT will be measured, and both the TABLE and RECTAN A-B display will be shown on the screen.

1. Resonant Frequency (f_r) and Impedance (Z_r)
2. Anti-Resonant Frequency (f_a) and Impedance (Z_a)
3. Frequency Characteristics of Conductance (G) and Susceptance (B)

3-3-2-1. Measurement Setup

RESET the 4194A then connect the furnished 16047D Test Fixture.

CLEAR LINE



Key used to clear all information on the Keyboard Input Line and the System Message Area.

BLUE



Key used to access the alphabetical characters labeled in blue. The key lamp will light.

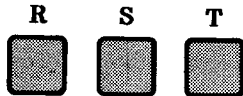

Entry "RST" command.

ENTER/EXECUTE



Key used to execute a command on the data entry line. All data and settings will be reset, and the sweep mode will be set to **SINGLE** sweep.

Connect the 16047D Test Fixture to the UNKNOWN Terminals on the front panel of the 4194A.

Note

Leave the contacts of the HP 16047D open.

OPERATION

3-3-2-2. Compensation

In this section we will measure the ZERO OPEN and ZERO SHORT offsets, and the measurement data will be used to compensate for the effects of parasitic elements of the 16047D Test Fixture.

COMPEN



Key used to display the compensation (**COMPEN**) menu and to take the offset measurements to obtain the data for compensation.

Note

The INTERPOLATION mode, and θ scale normal were selected as the default settings.



ZERO
OPEN

Softkey selects the open offset measurement for the compensation. The "ZOPEN" command will appear at Keyboard Input Line, and the "Press ENTER for zero open" will be at System Message Area.

ENTER/EXECUTE



Key used to start the open offset measurement to collect data to be used for compensation. The "Measuring zero open" message will be displayed for several seconds, then the "Zero open compen complete" message will appear. The measurement data will not be displayed.

Use a shorting bar to short the 16047D's contacts together.



ZERO
SHORT

Select the compensation short-offset measurement. The "ZSHRT" command will appear on the Keyboard Input Line, and "Press ENTER for zero short" will appear in the System Message Area.

ENTER/EXECUTE



Starts the short-offset measurement for compensation. The message "Measuring zero short" will be displayed for several seconds, then "Zero short compen complete" will be displayed. Measurement data will not be displayed.



OPEN OFS
on/off

Softkey used to compensate measurements using previously acquired open-offset data.



SHRT OFS
on/off

Softkey used to compensate measurements using previously acquired short-offset data.

Mount the DUT on the 16047D fixture as shown in Figure 3-14.

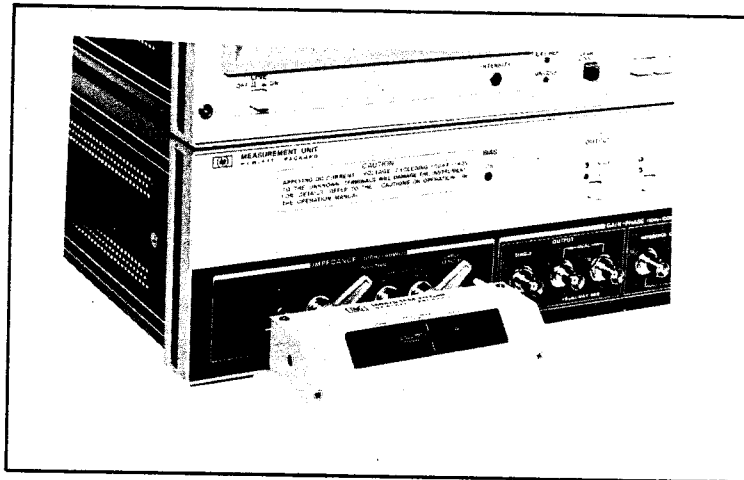

Figure 3-14. Mounting the DUT

REPEAT



Key used to set the sweep mode to the **REPEAT** mode. The **REPEAT** key lamp will light.

The display will change as shown in Figure 3-15.

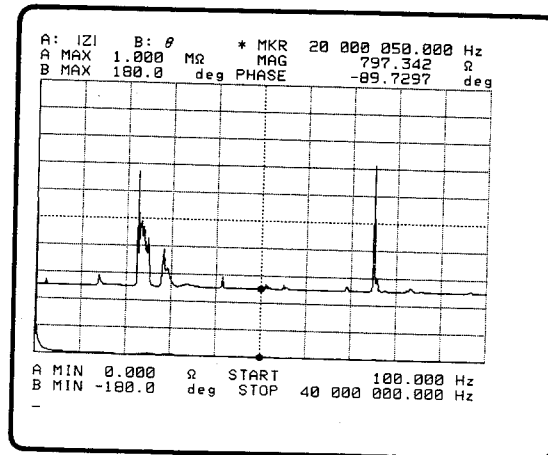

Figure 3-15. Full Sweep Measurement

OPERATION

3-3-2-3. Resonant and Anti-Resonant Points

In this section, the Resonant Frequency (f_r), Resonant Impedance (Z_r), Anti-Resonant Frequency (f_a), and Anti-Resonant Impedance (Z_a) will be measured.

The following settings are selected by default.

1. Measurement Function: Impedance
2. Measurement Parameter: $|Z|-\theta$
3. Sweep Parameter: Frequency
4. Sweep Type: Linear

MKR/L CURS



Displays the **MKR/L CURS** menu.



Selects the Double Marker mode, the Double Marker menu will be displayed by pressing the 'menu' softkey.



Displays the lower level menu. The o- & *-MKRS menu will be displayed.



Softkey used to control the o-marker using the **MARKER/L CURSOR** knob.

MARKER/L CURSOR knob

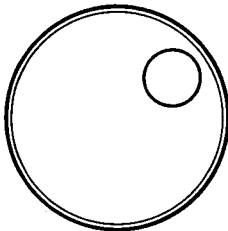

Move the o-marker by rotating the **MARKER/L CURSOR** knob to the position shown in Figure 3-16.

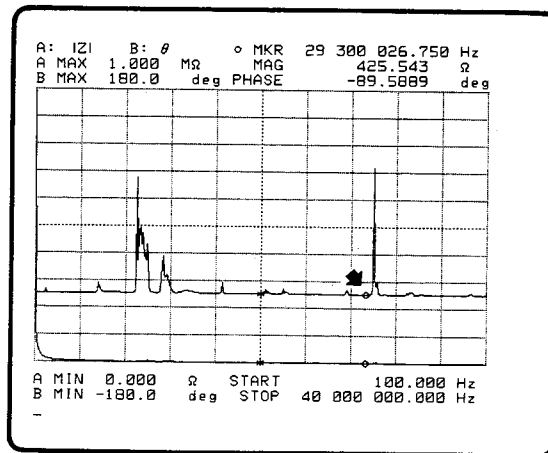
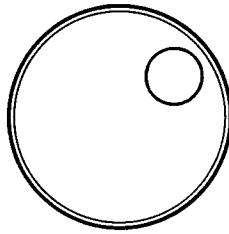

Figure 3-16. o-Marker's Position



Softkey used to control the *-marker using the **MARKER/L CURSOR** knob.

MARKER/L CURSOR Knob



Move the *-marker by rotating the **MARKER/L CURSOR** knob, to the position shown in Figure 3-17.

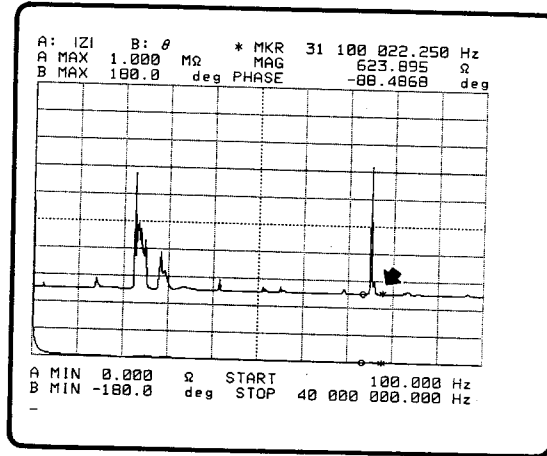

Figure 3-17. *-Marker's Position

SWEEP



Displays the **SWEEP** menu to allow you to select the sweep parameter, sweep type (linear or log) and sweep direction.

EXPAND MKRS



Softkey used to expand the sweep display, defined using the o- and *-marker, to cover the full display as shown in Figure 3-18.

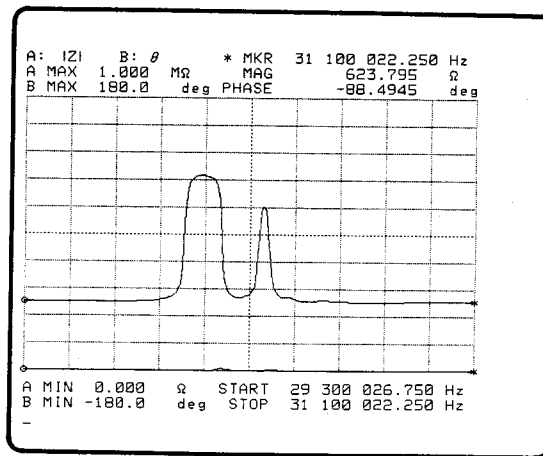

Figure 3-18. Expand Sweep

OPERATION

CNTR



PARAMETER section key used to specify the center value of the sweep parameter. "CENTER= (current value)" command will appear on Keyboard Input Line.



Enter the center frequency. Since a 30MHz ceramic resonator is being used try a center frequency of 30MHz first.

MHz/V



Instructs the instrument to read the Keyboard Input Line for data. The center frequency will be changed to 30MHz as shown in Figure 3-19.

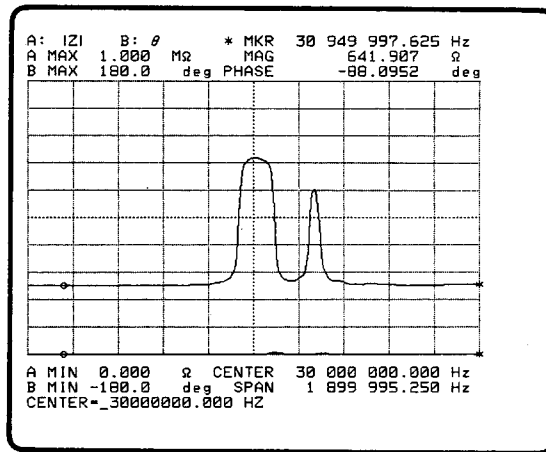

Figure 3-19. 30MHz Center Frequency

DISPLAY



MENU section key used to specify the display format. The **DISPLAY** menu will be displayed and the **RECTAN X-A&B** label will change to intensified green.

menu

Display the **RECTAN X-A&B** menu.

A SCALE LOG

Sets the data A scale log. The vertical axis scale will change to log.

AUTO SCALE A

Scales data A to fill the graticule without clipping the trace as shown in Figure 3-20.

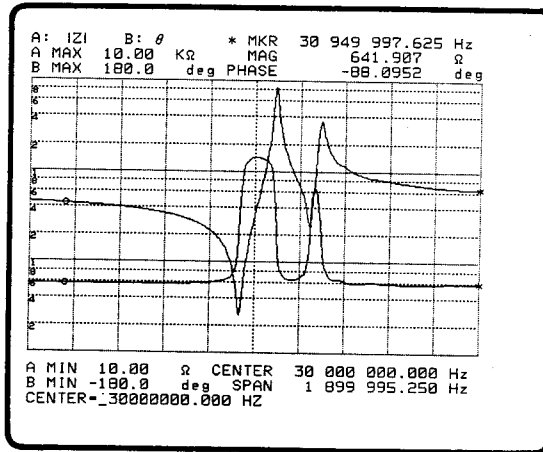

Figure 3-20. Data A Auto Scaled

SPAN



Specifies the sweep span. "SPAN=(current value)" will be displayed on Keyboard Input Line.



Reduces the value entered on the Keyboard Input Line. The **SWEEP SPAN** will be reduced.



Same as above.



Same as above. The **SWEEP SPAN** will be reduced as shown in Figure 3-21.

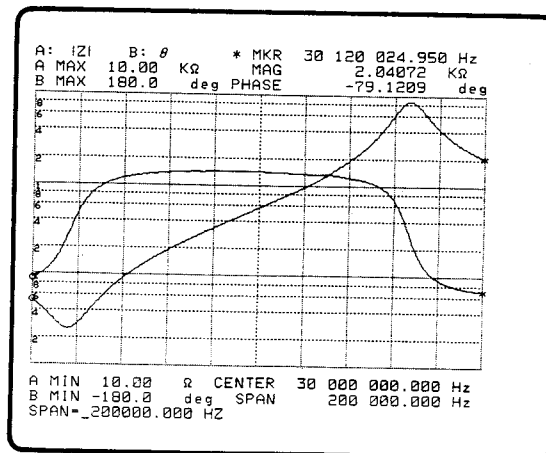

Figure 3-21. Optimum Sweep Span

OPERATION

more
1/3

Displays an additional menu.

AUTO SCALE B

Scales data B to fill the graticule without clipping the trace as shown in Figure 3-22.

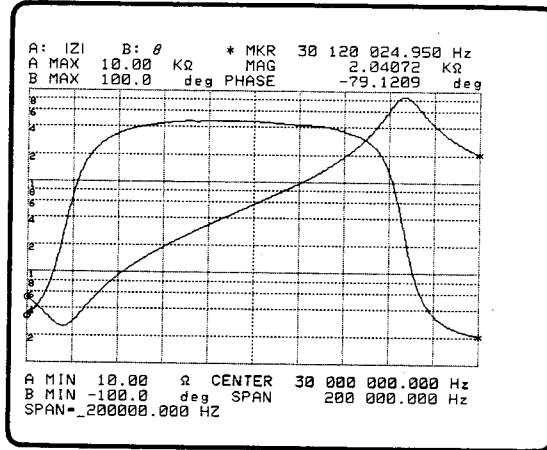

Figure 3-22. Auto Scale B

Enter value for the sweep span.

KHz/dBm



Selects kHz as the units entry, and instructs the instrument to read the data on the Keyboard Input Line. The sweep span will be increased as shown in Figure 3-23.

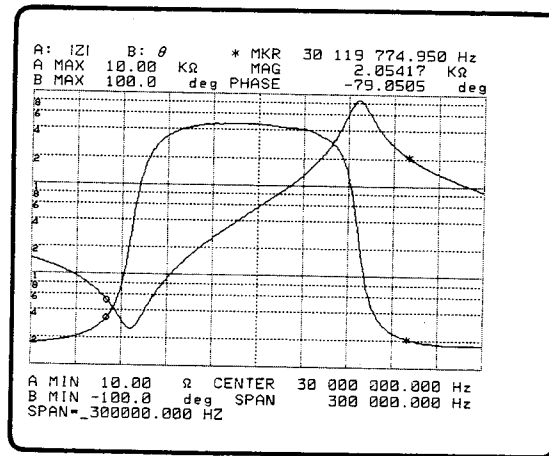

Figure 3-23. Sweep Span 300KHz

SINGLE



Selects the **SINGLE SWEEP** mode.

MKR/L CURS



Displays the **MKR/L CURS** menu to be used to select the Marker/L Curs mode. The o- & *- MKRS label will change to intensified green.



Selected while in the Single Marker mode, display the Single Marker menu by pressing the 'menu' softkey.



Displays the Single Marker menu.

OPERATION

o MKR
->MIN(A)

Moves the o-marker to the measurement point containing the lowest measurement value as shown in Figure 3-24.

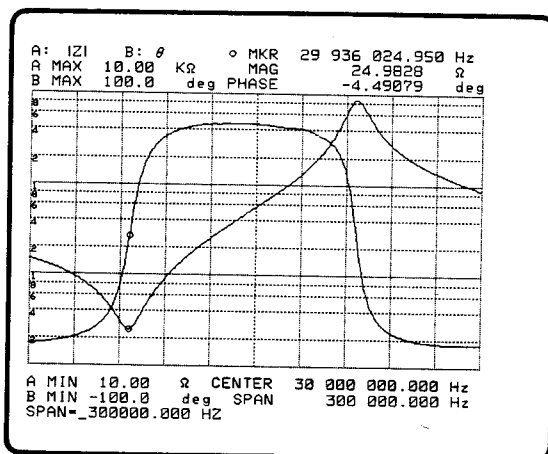

Figure 3-24. Resonant Point

The Resonant Frequency and the Resonant Impedance can be read directly from the display as shown below.

1. Resonant Frequency (f_r): 29.936MHz
2. Resonant Impedance (Z_r): 24.98 Ω

o MKR
->MAX(A)

Moves the o-marker to the measurement point containing the largest measurement value as shown in Figure 3-25.

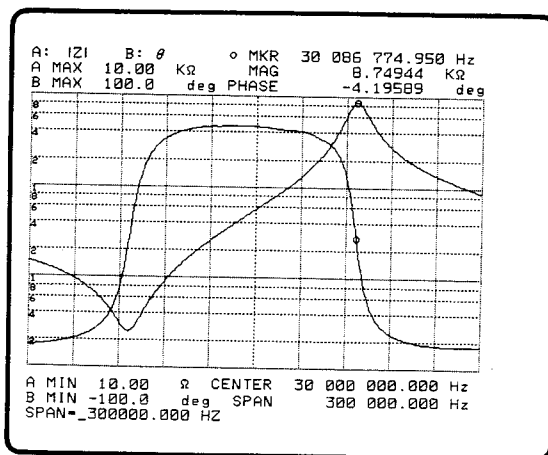



Figure 3-25. Anti-Resonant Point

The Anti-Resonant Frequency and Impedance can be read directly from the display as shown below.

1. Anti-Resonant Frequency (f_a): 30.087MHz
2. Anti-Resonant Impedance (Z_a): 8.749K Ω

3-3-2-4. Conductance and Susceptance

In this section, the frequency characteristics of the Conductance and Susceptance will be displayed.

o MKR
->MIN(A) 

Moves the o-marker to the measurement point containing the lowest measurement value.

CNTR



Specifies the center value of the sweep parameter. The "CENTER=(current value)" command will appear on Keyboard Input Line.

BLUE



Access the alphabetical characters labeled in blue. The **BLUE** key's LED will light.

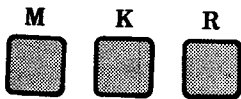

Entry the "MKR" command. The frequency corresponding to the position of the o-marker will be entered as the center frequency.

ENTER/EXECUTE



Execute the command entry.

FUNCTION



Displays the **FUNCTION** menu, and selects the measurement function and measurement parameters.

IMPE-
DANCE 

Selects the Impedance measurement function and displays the **IMPEDANCE** menu.

more
1/3 

Displays an additional measurement parameter menu.

OPERATION



Selects G (Conductance) and B (Susceptance) as the measurement parameters.

START



Start a single sweep. The lamp in the key will light and one measurement sweep will be performed.

DISPLAY



Displays the "DISPLAY" menu. The RECTAN X-A&B label will be intensified green.



Display the RECTAN X-A&B menu



Set the scale for data A to linear. The vertical axis scale will change to linear.



Scale data A to fit the full graticule without clipping the trace.



Display the additional measurement parameter menu.



Scale data B as shown in Figure 3-26. The frequency characteristics Conductance and the Susceptance frequency characteristics will be displayed.

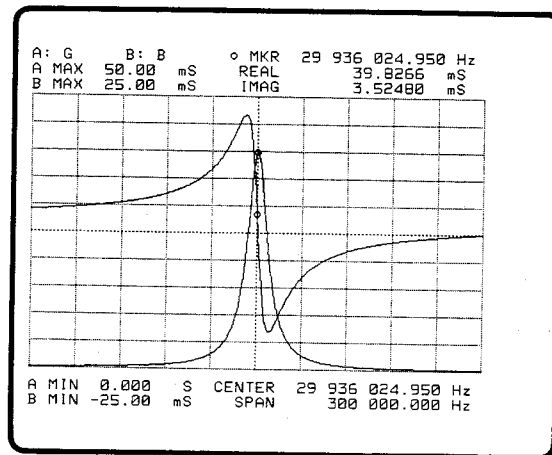

Figure 3-26. Frequency Characteristics of Conductance and Susceptance

3-3-2-5. TABLE and RECTAN A-B displays

The frequency characteristics are displayed in a TABLE, and the RECTAN A-B display (Circle Diagram Display of Admittance Characteristics) are displayed.

DISPLAY



Displays the "DISPLAY" menu. The RECTAN X-A&B's label should be intensified green.

TABLE



Select the TABLE mode to display the measurement data in the TABLE format shown in Figure 3-27. The o-marker in the TABLE can be moved using the **MARKER/L CURS** knob.

N	FREQUENCY [Hz]	REAL [S]	IMAG [S]
191	29 928 524.950	20.2934	21.6972
192	29 929 274.950	22.2674	21.5684
193	29 930 024.950	24.4084	21.2070
194	29 930 774.950	26.7022	20.5393
195	29 931 524.950	29.1003	19.5029
196	29 932 274.950	31.5459	18.0175
197	29 933 024.950	33.9061	16.0400
198	29 933 774.950	36.0603	13.5612
199	29 934 524.950	37.8570	10.5633
200	29 935 274.950	39.1504	7.17998
201	29 936 024.950	39.8266	3.52480
202	29 936 774.950	39.7901	-241.364
203	29 937 524.950	39.0412	-3.00323
204	29 938 274.950	37.6974	-7.22315
205	29 939 024.950	35.8722	-10.1701
206	29 939 774.950	33.6961	-12.6109
207	29 940 524.950	31.3240	-14.5541
208	29 941 274.950	28.0916	-16.0067
209	29 942 024.950	26.4872	-17.0190
210	29 942 774.950	24.1973	-17.6703
211	29 943 524.950	22.0546	-18.0173

MEASURE N= CENTER 29 936 024.950 Hz
 SWEEP N= 1 → 401 SPAN 300 000.000 Hz

Figure 3-27. Table display

The 'menu' softkey will display the TABLE menus which are used to scroll through the table. If you have pressed the 'menu' softkey, press the 'return' softkey to return to the **DISPLAY** menu.

3: Operation

OPERATION

RECTAN
A-B

Select the **RECTANGULAR A-B** mode, and displays the measurement data using the RECTAN A-B format shown in Figure 3-28.

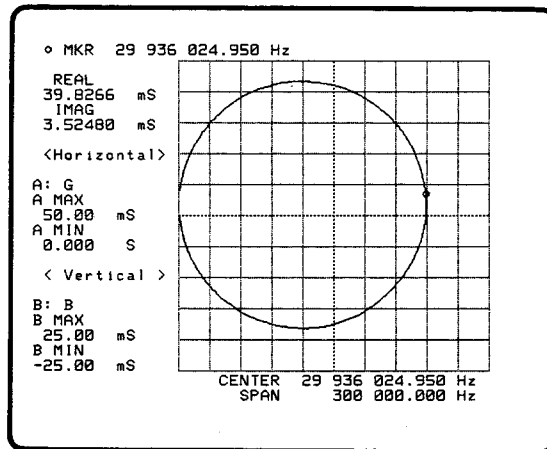

Figure 3-28. RECTAN A-B Display

3-3-3. Impedance Measurement Using a Probe

When the probe is combined and used with the 4194A the frequency sweep range for the Impedance measurement extends up to 100MHz. The probe is included in the 41941A/B Impedance Probe Kit which is an accessory of the 4194A. Connect the probe to the Gain-Phase section of the 4194A and use the measurement function, ('**IMP with Z PROBE**' softkey) for measurement. This section will show how to set up and calibrate the probe in conjunction with the test fixtures used for the measurement. Figure 3-29 shows the probe connection to the 4194A. A 80MHz crystal resonator is used for the DUT.

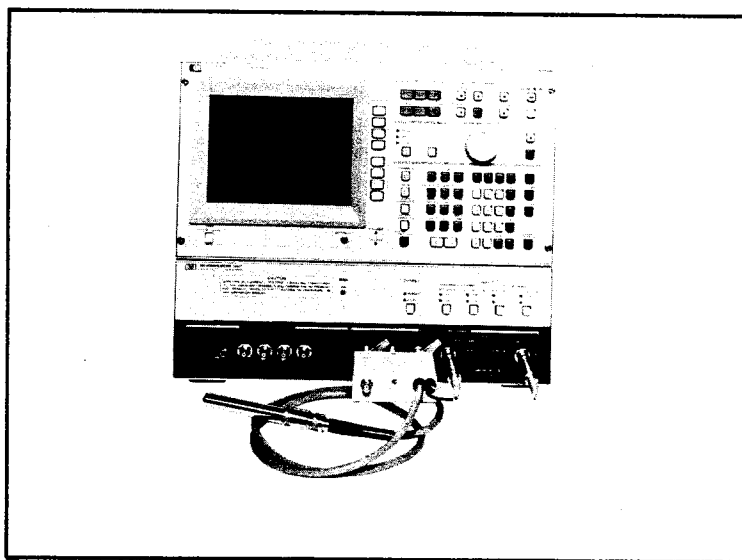

Figure 3-29. Probe Connection to 4194A

3-3-3-1. Measurement Setup

Measurement setup begins by initializing the 4194A with a **RST** command, using the following procedure.

1. Press the **CLEAR LINE** key and input the **RST** command using the **BLUE** key and the alphabetical keys on the front panel.
2. Press **ENTER/EXECUTE**.

At this point the instrument is in Impedance mode ('**IMPEDANCE**' softkey is on) and the sweep mode is set to the Single sweep mode.

**IMP with
Z PROBE**



Softkey used to select the Impedance measurement function (**IMP with Z PROBE**) in which the frequency sweep range extends to 100MHz. The Gain-Phase section will be used for measurement.

The $|Z|-\theta$ parameter is now selected. The default frequency range set is as follows.

Start frequency = 10kHz
Stop frequency = 100MHz

OPERATION

The spot Osc. level is set to 500mV.

In the Measurement Unit (bottom section of the instrument) the followings are set as defaults.

OUTPUT section: **SINGLE** mode

INPUT section (R-channel): 50 Ω (or 75 Ω), 0dB attenuation

(T-channel): 50 Ω (or 75 Ω), 20dB attenuation

3-3-3-2. Compensation

This section shows the compensation method for the Impedance Probe using the three calibration standards supplied with the 41941A/B Impedance Probe Kit. The test fixtures to be connected to the probe are also compensated. When the test fixture is connected to the probe, perform the probe calibration first to extend the 4194A's calibration to the end of the probe, then perform the **ZERO-OPEN/SHORT** offset measurements for the test fixture.

COMPEN



Key used to display the softkey menu for the compensation.

more
1/3



Softkey used to display the second page of the softkey menu for compensation.

The Interpolation method is the default setting.

more
2/3



Display the probe calibration softkeys.

Probe Calibration

1) 0S CALibration

Put the 0S calibration standard (P/N 41941-65003) onto the tip of the probe as shown in Figure 3-30.

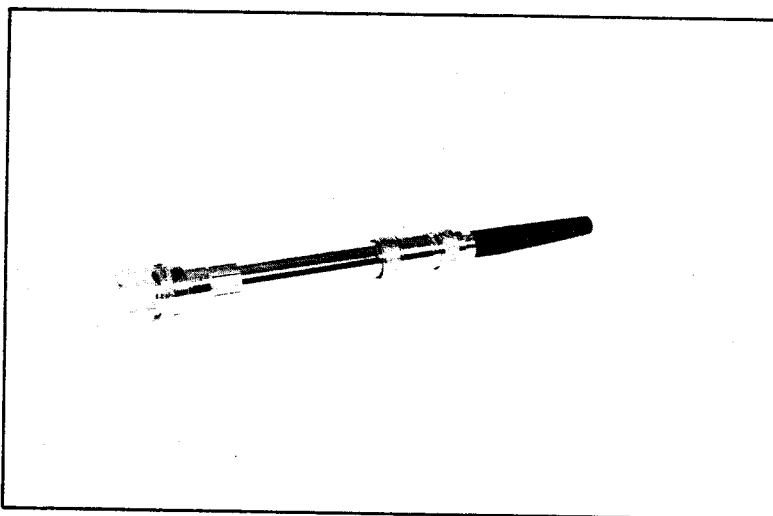

Figure 3-30. 0S Calibration Standard

CAL on/off

Softkey used to set the probe calibration on or off with respect to the measurement results. This softkey is **ON** by default. Pressing this softkey sets the calibration to **OFF**.

0S CAL

Softkey used to command a **0S** calibration measurement of the calibration standard. The message, "Press ENTER for 0S cal" will be displayed.

ENTER/EXECUTE

Key used to start the 0S calibration measurement. A single sweep will be performed.

2) 0Ω CALibration

Set the 0Ω calibration standard (P/N 41941-65001) in place of the 0S calibration standard.

0Ω CAL

Softkey used to command a 0Ω calibration standard measurement.

ENTER/EXECUTE

Key used to start the measurement. A single sweep will be made.

3:Operation

OPERATION

3) 50Ω CALibration

Set the 50Ω calibration standard (P/N 41941-65002) in place of the 0Ω calibration standard.

STD CAL  Softkey used to measure the calibration data for 50Ω calibration standard.

ENTER/EXECUTE
 Key used to command a 50Ω calibration measurement. A single sweep will be made.

Note

The calibration data will not be displayed on the screen while the measurement is in progress. You will see no change.

Now all of the calibration data needed for probe calibration has been collected.

CAL on/off  Softkey used to compensate the subsequent measurements using the calibration data acquired. The measurement results will be calibrated each time a measurement is made. The softkey will change to green.

Note that the 4194A's reference plane now extends to the end of the probe.

ZERO-OPEN/SHORT measurements

Connect the HP 16099A and 16093A test fixtures to the 41941A Impedance Probe as shown in Figure 3-31. These test fixtures were chosen to show how test fixtures are interconnected to the probe and used.

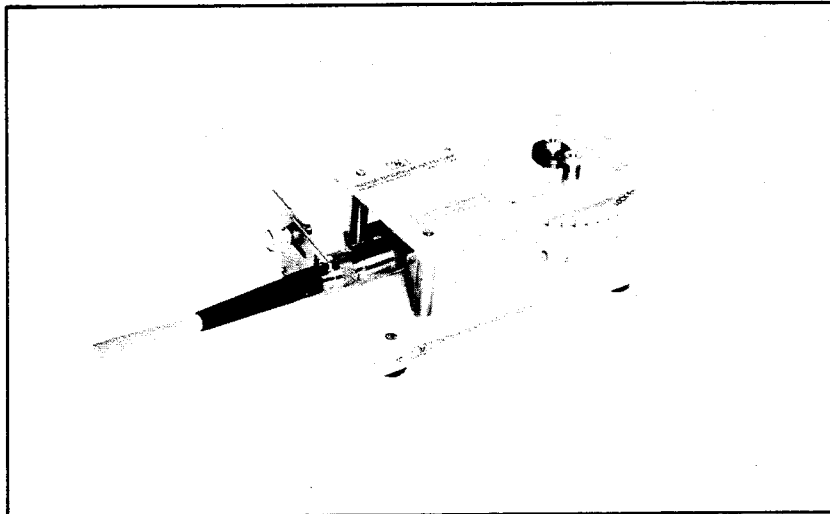



Figure 3-31. Probe and Test Fixtures

COMPEN
 Displays the first page of the softkey menu for compensation.

1) **ZERO OPEN** measurement

Leave the contacts of the 16093A open.



Softkey used to command a **ZERO-OPEN** offset measurement of both test fixtures.

ENTER/EXECUTE



Note that the Interpolation compensation method is used.

Starts the offset measurement. The messages, "Measuring zero open" and "Zero open compen complete" will be sequentially displayed in the System Message Area.

Sweep mode is set to **SINGLE** sweep.

2) **ZERO SHORT** measurement

Short the contacts of the 16093A using the attached gold plated ground spring. Remove the knob from the center post and slide in the ground spring along the shaft then tighten it with the knob.



Softkey used to command a **ZERO-SHORT** offset measurement of the test fixtures.

ENTER/EXECUTE



Starts the measurement. The messages, "Measuring zero short" and "Zero short compen complete" will be displayed in the System Message Area.

The sweep mode is set to **SINGLE** sweep.



Softkey used to compensate measurements using the **ZERO-OPEN/SHORT** offset data.



Note

The display data on the screen will not change while a **ZERO-OPEN/SHORT** measurement is in progress.

OPERATION

Remove the ground spring and mount the DUT on the 16093A Binding Posts as shown in Figure 3-32.

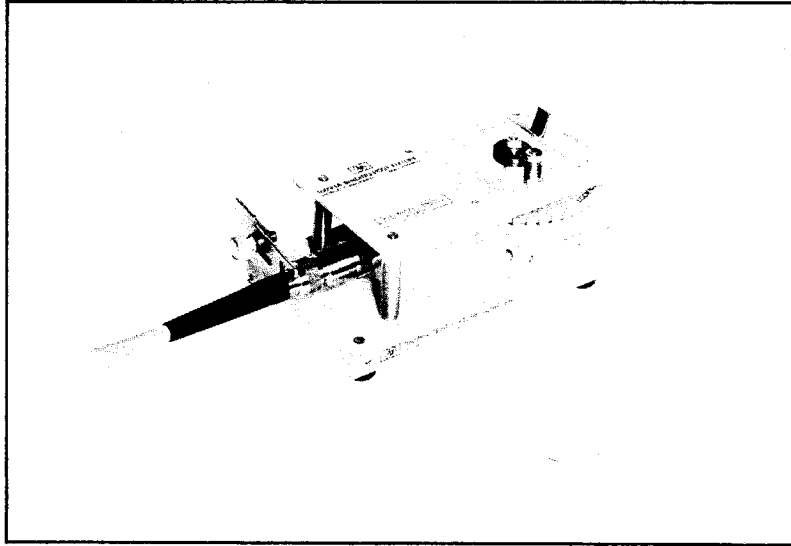

Figure 3-32. DUT Connection

REPEAT



Key used to set the sweep mode to the Repeat mode.

The display will change as shown in Figure 3-33.

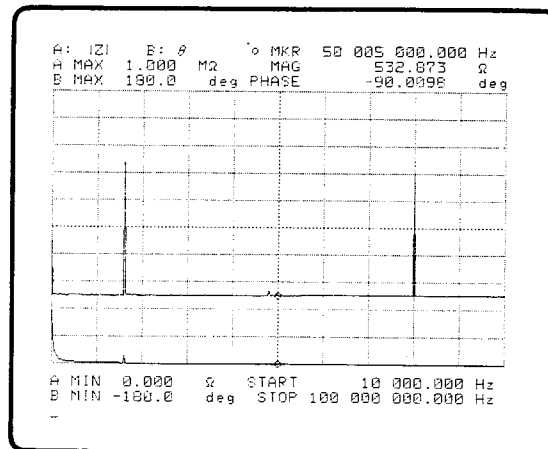

Figure 3-33. Probe Default Data

3-3-3-3. Measurement Data

In this section a crystal resonator will be characterized using the equivalent circuit mode. First set the center frequency to 80MHz and the span frequency to 15kHz to zoom in on the area of interest. The Resonant Frequency (fr), Resonant Impedance (Zr), Anti-Resonant Frequency (fa), and Anti-Resonant Impedance (Za) of this resonator can be measured using the marker functions. Typical results are shown in Figure 3-34.

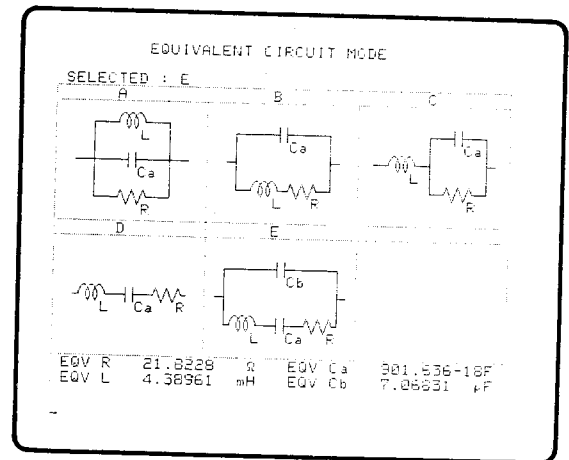
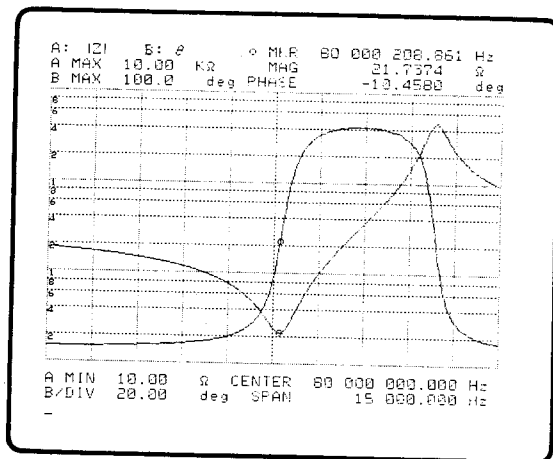

Figure 3-34. Resonant Points Figure 3-35. Equivalent Constants

To obtain the equivalent circuit constants select Circuit Model E to calculate these approximations. Typical results are shown in Figure 3-35. Use the operation procedures demonstrated in the previous measurement example. The resonator's Q factor at the resonant frequency, relative capacitance r, and the figure of merit M of this particular resonator are calculated as follows.

$$Q = \frac{2\pi f_r L}{R} = 101000$$

$$r = \frac{C_b}{C_a} = 7840$$

$$M = \frac{1}{2\pi f_r C_b R} = \frac{Q}{r} = 12.9$$

To characterize the resonator with higher accuracy use the All points compensation method for both probe and test fixture compensation. Set the calibration frequency range to the same range as the measurement range (in this case, CENTER=80MHz and SPAN=15KHz).

OPERATION

3-4. GAIN-PHASE MEASUREMENT

The following devices were selected for testing to cover topics of general interest and common usage, and to demonstrate most of the capabilities of the 4194A for Gain-Phase measurements. For details on operating features, see the REFERENCE and EXTENDED CAPABILITY paragraphs in this section. As you read this section press the keys on the instrument listed at the left of each page. The keys mentioned above include the front panel keys, the **Marker/Lcursor** knob on the front panel, and the softkeys displayed on the screen. Note that the keys in the **MENU** section are used only to display a menu of softkey labels (menus) and the rest of keys are mainly used to select measurement parameters.

- 1) Bandpass filter
 - (1) Measurement setup
 - (2) Using the marker/lcursor (line cursor) to make measurements

- 2) Gain compression of an RF amplifier
 - (1) Measurement setup
 - (2) Measure -3dB gain compression point

3-4-1. Bandpass Filter

Connect the filter to the 4194A as shown in Figure 3-36. The bandpass filter used in this example has a center frequency of 21.4MHz but the methods are the same for any bandpass filter. This measurement exercise will demonstrate how to use the 4194A to characterize a bandpass filter.

The contents are:

- 1) How to set up the instrument state to make a measurement
- 2) How to use the marker/lcursor to make measurements.
 - (1) Measure the passband insertion loss
 - (2) Measure the -3dB and -60dB bandwidth
 - (3) Measure the passband ripple
 - (4) Measure the passband phase insertion
 - (5) Measure the passband group delay

Note

The default parameter values are as follows.

Start Frequency = 10.000Hz
Stop Frequency = 100MHz
Spot OSC Level = 0.0dBm

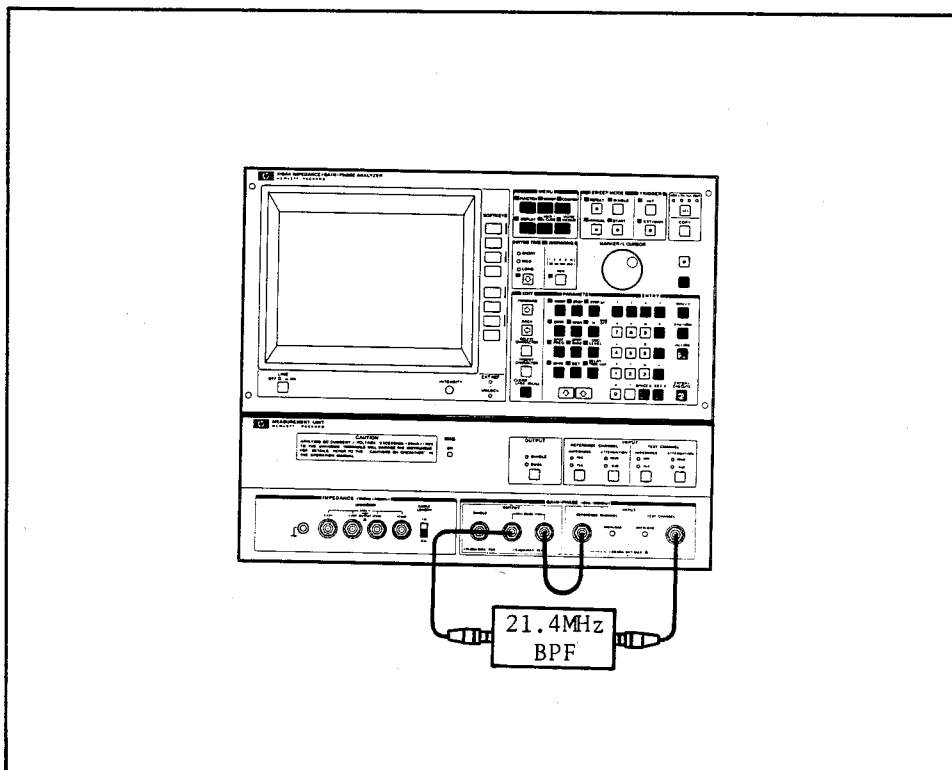

Figure 3-36. BPF Connection to 4194A

3-4-1-1. Measurement Setup

The 4194A provides default settings. The following steps set up the "RST" command to initialize the instrument.

- (1) Press the **CLEAR LINE** key in the **EDIT** section. The "Keyboard Input Line" is cleared.
- (2) Press the **blue** key and input "RST" on the "Keyboard Input Line" using the alphabetical keys on the front panel.
- (3) Press **ENTER/EXECUTE**.

Note









The RST command resets the 4194A to the power-on default state except as follows.

- (1) The Sweep mode is set to **SINGLE** sweep (code: SWM2).
- (2) Data registers (**A ~ D**), general purpose registers (**RA ~ RL**), registers for compensation, **Rn**, **Z**, and all read-only registers are not reset.
- (3) The Program **WORK AREA** is not cleared from memory.

OPERATION

The default softkeys will be intensified so you can easily recognize them. The Input and Output section of the Measurement Unit (bottom unit) are initialized to their default states. Check the illuminated indicators. If you make a mistake or find yourself lost, press the key in the **MENU** section to display the original menu. Note that the program code is affixed to each key just for reference.

At this point the instrument is in Impedance mode and the $|Z|-\theta$ function is selected. The sweep mode is now set to the **SINGLE** Sweep mode.

KEY	DESCRIPTION
GAIN PHASE  < FNC2 >	This softkey is used to set the 4194A's measurement mode to Gain-Phase. Tch/Rch(dB)- θ is selected as the default Gain-Phase mode.
CNTR  < CENTER =>	Key in the PARAMETER section used to set the center frequency. When this key is pressed, " CENTER= (current value) ", is displayed on the "Keyboard Input Line ".
	Data entry (keys in the ENTRY section)
MHz/V 	ENTRY section key used to select MHz as units for entry. Note the change in the entry field.
SPAN  < SPAN =>	PARAMETER section key is used to set the frequency span. When this key is pressed, " SPAN= (current value) " is displayed in the "Keyboard Input Line" field.
	Data entry
KHz/dBm 	ENTRY section key used to select KHz as units for entry.
The above two settings are equivalent to:	
Start Frequency = 21.35MHz Stop Frequency = 21.45MHz	
OSC LEVEL  < OSC =>	PARAMETER section key used to set SPOT OSC LEVEL in dBm, dBV, or V units. When this key is pressed, " OSC= (current value) " will be displayed on the "Keyboard Input Line".



Data entry

KHz/dBm



ENTRY section key used to select dBm as the units entry.

COMPEN



MENU section key used to select the compensation parameters. The parameters will be displayed in the softkey area when this key is pressed.

** Get ready to make the offset data measurement **

To get the offset data, replace the Device Under Test with a BNC barrel, BNC(f) to BNC(f) adapter.

START



<SWTRG>

SWEEP MODE section key used to trigger a complete sweep. Press this key to take the offset data.

Both traces should be flat lines indicating that the offset data are nearly 0dB and 0°.

OFST REF STORE



<OFSTR>

Softkey used to store the offset data for data A (Gain) and data B (Phase). "Offset reference stored" will be momentarily displayed in the "System Message Area".

** End of the offset data measurement **

Replace the BNC adapter with the DUT.

REPEAT



<SWM1>

SWEEP MODE key used to change the sweep mode to Repeat.

A OFFSET on/off



<AOF1>

Softkey used to make the offset data valid for data A.

B OFFSET on/off



<BOF1>

Softkey used to make the offset data valid for data B.

DISPLAY



MENU section key that selects the data display format. The parameters will be displayed in the softkey area.

The X-A&B display format is selected.

menu



Softkey used to display a menu from which more parameters related to the X-A&B display format can be selected.

AUTO SCALE A



<AUTOA>

Softkey used to scale trace data A to fit within the graticule.

OPERATION

- more** Softkey used to set more parameters related to the display format.
1/3
- AUTO** Softkey used to scale data B to fit within the graticule.
SCALE B
- <AUTOB>**

Figure 3-37 shows the display data at this state. Two markers are located on the traces at mid-screen.

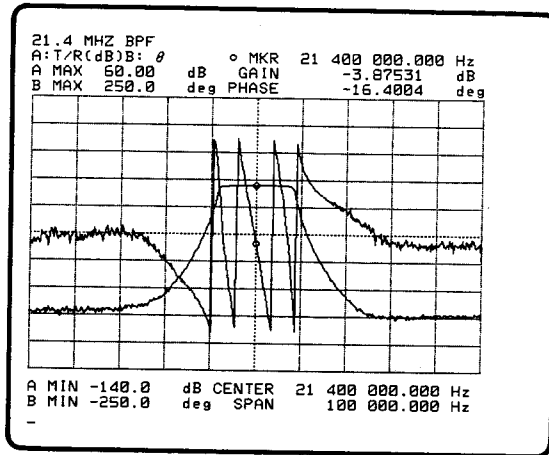

Figure 3-37. Auto-scaled Measurement Data

Now the set-up is complete and a measurement can be taken. Most measurements are taken using the marker and the line cursor.

3-4-1-2. Passband Insertion Loss Measurement

Since it is not necessary to display data B for the next three measurements erase trace data B from the screen.

- DISP B** Erases trace data B from the screen.
on/off
- <DPB0>**
- SINGLE** **SWEEP MODE** section key used to select **SINGLE** Sweep.
- <SWM2>**
- MKR/L CURS** **MENU** section key used to display the Marker/L(ine) Cursor menu of softkeys.

"Single Marker Mode" is selected as the default setting.

Note

The knob in the **MARKER/L CURSOR** section is used to move the marker or the line cursor along the trace and the information in the Marker/L Cursor Area changes to reflect the new readings. The line cursor will be discussed later.

menu

Softkey used to display a menu from which more parameters related to the marker position can be selected.

o MKR
->MAX(A)
<MKMXA>

Softkey used to move the o-marker position to the maximum point on the data A trace.

Now the passband insertion loss is determined and displayed in the Marker/L Cursor Area. Figure 3-38 shows the passband insertion loss data.

The passband insertion loss is -3.84445dB

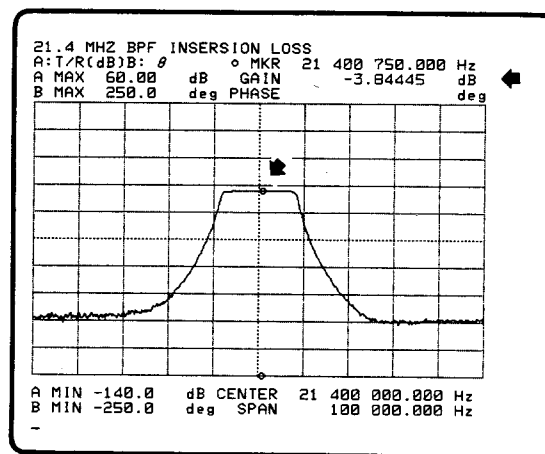

Figure 3-38. Passband Insertion Loss

return

Softkey used to return to the first page of the softkey menu.

3-4-1-3. -3dB and -60dB Bandwidth Measurement

o REF-
LCURS
<MCF4>

Softkey used to display the line cursor on the screen with the o-marker ON. This is called the as " Delta Line Cursor Mode "

menu

Softkey used to display a menu from which more parameters related to the line cursor position can be selected.

OPERATION

DLCURS= 
 <DLCURS=>

Softkey used to set the line cursor to the desired position with respect to the o-marker. When this key is pressed, "DLCURS= (current value)" will be displayed on the "Keyboard Input Line" block.

Data entry

ENTER/EXECUTE



Key used to execute the command with the data entered. Pressing this key moves the line cursor to the -3dB position.

Now the -3dB bandwidth can be calculated using the LEFT and RIGHT values, which are displayed in the Marker/L Cursor Area as shown in Figure 3-39.

$$\text{-3dB bandwidth} = (\text{RIGHT}) - (\text{LEFT})$$

WIDTH
read 
 <WIDTH>

Softkey used to read the difference between the LEFT and RIGHT positions

The -3dB bandwidth will be displayed in the Marker/L Cursor Area as shown in Figure 3-40.

For the -60dB bandwidth measurement, input "DLCURS=-60".

The shape factor is calculated as follows formula.

$$\text{Shape Factor} = \frac{\text{-60dB BW}}{\text{-3dB BW}}$$

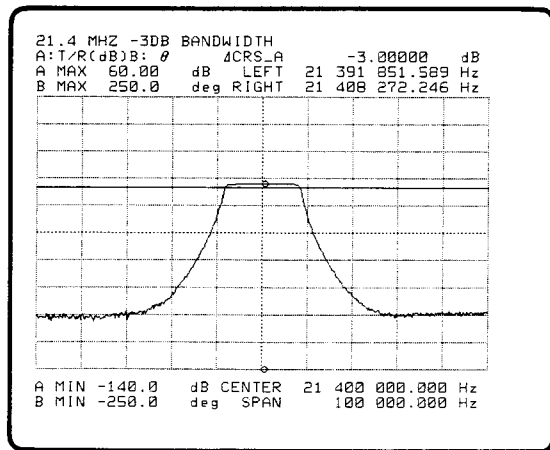

Figure 3-39. -3dB Bandwidth

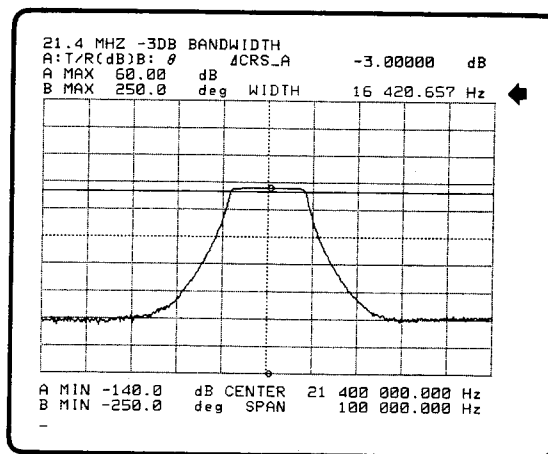



Figure 3-40. WIDTH Read

Note

The "LCURSL", "LCURSR", and "WID" registers are provided to store the above three values. See Paragraph 3-6-1-4 for more information.

return  Softkey used to return to the original softkey menu.

3-4-1-4. Passband Ripple

The "Double Marker Mode" is used for this measurement. The analysis range for passband ripple measurement can be set by using the o-marker and *-marker. To facilitate this operation use a smaller value for the SPAN frequency.

Press the **SPAN** key and input, "SPAN=16 KHz", using the keys in the **ENTRY** section. Press the **START** key in the **SWEEP MODE** section and the '**AUTO SCALE A**' softkey in the display section. The trace for the passband area will now expand. Return to the MKR/L CURS section.

o & *
MKRS  Softkey used to set the o-marker and *-marker to the mid-screen position of the trace.
<MCF5>

menu  Softkey used to display the softkey menu for the "Double Marker mode".

o MKR
control  Softkey that allows you to control the o-marker position using the **MARKER/L CURSOR** knob. Rotate the knob to set the o-marker at the starting point of the range to be analyzed.

OPERATION

* MKR
control

Softkey used to control the *-marker position with the **MARKER/L CURSOR** knob. Set the *-marker on the end point of the analysis range by rotating the knob.

Note

1) Partial Analysis Range

The 4194A provides Partial Analysis Range capability so you can define the analysis range, using the o-marker and *-marker, to perform an analysis on. For a Passband Ripple measurement, set both markers to the passband area. The area outside of the markers will be excluded. An example will be shown later.

2) Partial Sweep Range

The 4194A provides Partial Sweep Range capability so you can select the desired sweep range. The sweep range can be set using the o-marker and the *-marker. When this method is used only the specified area will be swept. The **'STORE SWP RNG'** and **'PART SWP on/off'** softkeys are used.

3) Marker Expansion Sweep

Furthermore the 4194A provides Marker Expansion sweep capability so you can measure the desired sweep range with better resolution. The sweep range can be set using the o-marker and *-marker.

The difference between 2) and 3) is how the sweep resolution is selected. In the case of 2), the sweep resolution is defined by the settings of the SPAN frequency and the value of NOP.

Sweep resolution = SPAN/NOP

In the case of 3), the sweep resolution is defined by the settings of the sweep range determined by the markers and the value of NOP.

Sweep resolution = (o-marker - *-marker) / NOP

You can obtain higher sweep resolution when using this method. To execute the marker expansion sweep use the **'EXPAND MKRS'**. This softkey is included in the **SWEEP** section.

more
1/2

Softkey used to select more parameters related to this measurement.

**STORE
ANA RNG**
<ARSTR>

Softkey used to store the partial analysis range defined by the o-marker and *-marker.

PART ANA
on/off
 <ANA1>

Softkey used to turn the partial analysis range on. In addition, when this key is pressed, the (Δ) triangle shaped markers will appear beneath the bottom line of graticule. Figure 3-41 shows the data with partial analysis on.

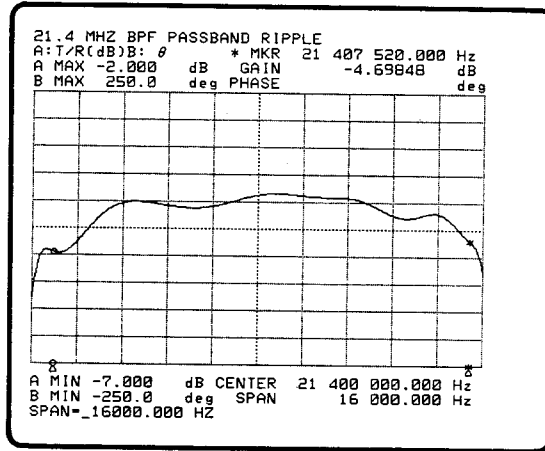

Figure 3-41. Partial Analysis On

o MKR
->MIN(A)
 <MKMNA>

Softkey used to move the o-marker position to the minimum point of the data A trace within the specified analysis range. Figure 3-42 shows the trace with the o-marker set to the minimum point.

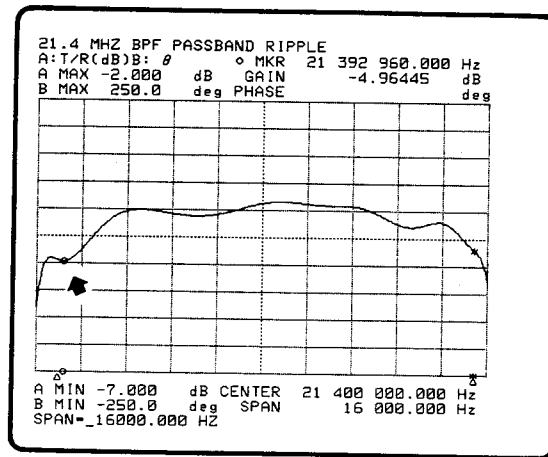

Figure 3-42. o-Marker on Minimum Point

OPERATION

At this point you must perform the following operations.

- 1) Press the **CLEAR LINE** key.
- 2) Input " SMKR=MKR " on the "Keyboard Input Line". Press the **BLUE** key then input the characters.
- 3) Press **ENTER/EXECUTE**. When these operations are performed the *-marker will move to the minimum point of the data A trace within the specified range.

o MKR
->MAX(A)
<MKMXA>

Softkey used to move the o-marker position to the maximum point of the data A in the specified range. Figure 3-43 shows the trace with the o-marker set to the maximum point.

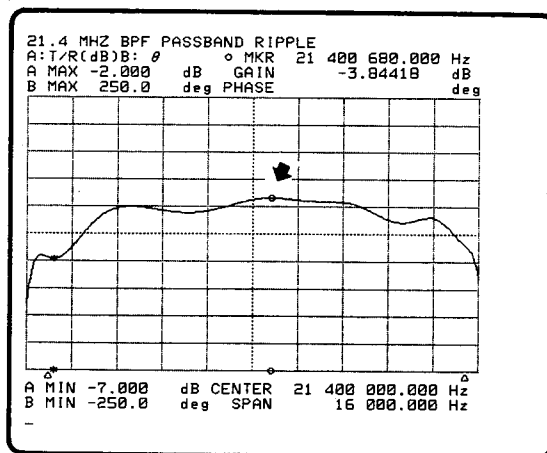

Figure 3-43. o-Marker on Maximum Point

return

Softkey used to display the first page of the current menu.

o REF-
* MKR
<MCF2>

This softkey selects the "Delta Marker Mode". The *-marker's position can be set to any point with respect to the o-marker.

Now, the passband ripple is detected and displayed in the Marker/L Cursor Area as shown in Figure 3-44.

The passband ripple is 1.12028dB.

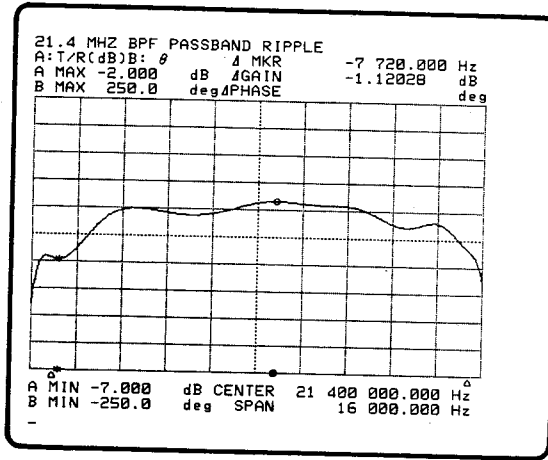

Figure 3-44. Passband Ripple

o MKR
<MCF1>

Softkey used to select the "Single Marker Mode".

3-4-1-5. Passband Phase Insertion

To redisplay the trace for data B back on the CRT, press the 'DISP B on/off' softkey in the **DISPLAY** section. There are two types of phase data display format, 360° phase wraps and phase expansion, either of which can be selected using a softkey in the **COMPEN** section.

COMPEN



MENU section key used to select the compensation parameters.

θ SCALE
exp
<PHS2>

Softkey used to set the phase display format to the expansion mode.

The following procedure is required to display the phase data in the proper scale on the CRT.

Press the '**AUTO SCALE B**' softkey in the **DISPLAY** section to scale the data B trace to fit within the graticule.

The span frequency is reset to 100kHz.

To obtain the data, press the **START** key in the **SWEEP MODE** section and '**AUTO SCALE A**' softkey to scale the data.

OPERATION

Moving the marker using the rotary knob allows phase measurement to be made at any point along the trace. The Phase data can be read in the Marker/ L Cursor Area. The Phase angle at 21.40075MHz is -769.900° . Figure 3-45 shows the pass-band phase insertion data using the phase expansion mode. Figure 3-46 shows the data with normal phase display format for comparison.

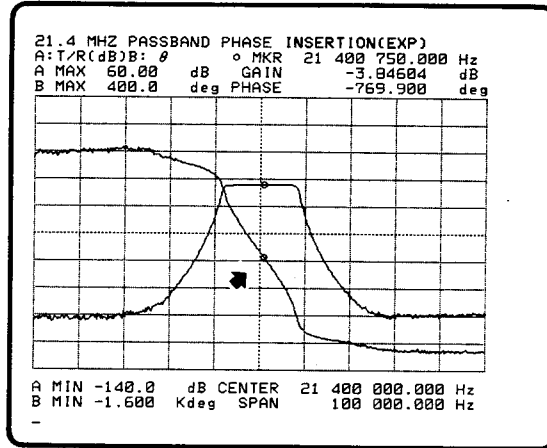

Figure 3-45. Passband Phase Insertion (Expansion mode)

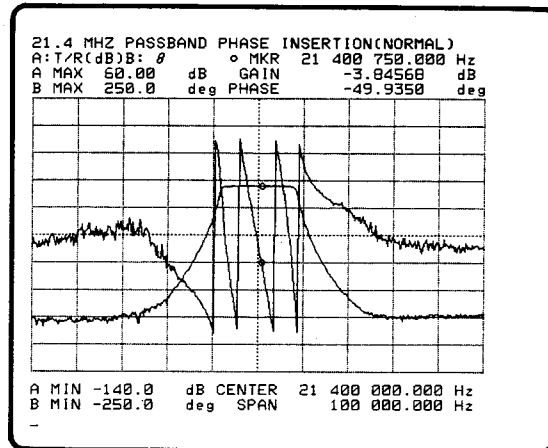



Figure 3-46. Passband Phase Insertion (Normal mode)

3-4-1-6. Passband Group Delay

Press the **FUNCTION** key to select this measurement.

- FUNCTION**



Key used to display the softkey menu for selecting the measurement function.
- GAIN PHASE**



<FNC2>

Softkey used to set the measurement mode to Gain-Phase.
- Tch/Rch (dB)-τ**



<GPP3>

This softkey is used to set the 4194A's measurement mode to Group Delay measurement. The relative gain or loss of the Reference Input and the Test Input can be monitored also.

Note

1) When making a group delay measurement, the following two parameters must be set as listed below:

- (1) Sweep parameter : Frequency
- (2) Programmed points measurement : OFF
- (3) Sweep type : Linear

If any of these parameters are not set correctly, an Error message such as " Only FREQ & LIN sweep allowed" will appear in the "System Message Area".

2) If the **MANUAL** sweep has been selected when you enter the Group Delay measurement, the sweep mode will be automatically changed to the **REPEAT** sweep mode.

- (green)**



Key used to enter comments, physical constants, and certain special symbols. It must be pressed each time a green labeled key function is to be used.
- Δ F**



<DFREQ=>

Key in the **PARAMETER** section used to set the delay aperture. When this key is pressed, " DFREQ= (current value) " will be displayed on the "Keyboard Input Line".

$$\text{Delay aperture} = \text{Span frequency} * \Delta F(\%)$$

ΔF setting lies within the range of 0.5% to 100%. The default value is 0.5%.



Data entry

OPERATION

ENTER/EXECUTE



Key used to execute the data entry.

START



<SWTRG>

SWEEP MODE section key used to trigger a complete sweep. Press this key to take the group delay data.

You must perform the following operations to scale the traces to just fit within the graticule. Press the '**AUTO SCALE A**' and '**AUTO SCALE B**' softkeys in the **DISPLAY** section.

Moving the marker with the rotary knob allows the Group Delay to be measured at any point along the data B trace. Group Delay data can be read in the Marker/L Cursor Area on the screen. The Group Delay at 21.4MHz is 123.207 μ sec. See Figure 3-47. Note that the SPAN frequency has been changed to 30kHz.

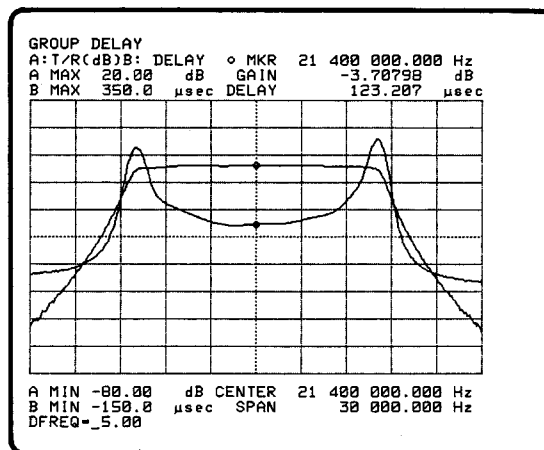

Figure 3-47. Group Delay

Note

When you change the delay aperture while a measure cycle is in progress, the sweep will be aborted and the measurement will be rerun.

The group delay, τ (seconds) is expressed using the following formula.

$$\tau = d\phi / (360 * df)$$

where $d\phi$ is the phase difference of the two points in degrees.

df is the delay aperture in Hz.

For the 4194A, the group delay at point N, $\tau(N)$ is represented by the following formula.

$$\tau = \frac{ \{ \phi(N - \Delta N) - \phi(N + \Delta N) \} }{ 360 * \text{SPAN freq. (Hz)} * \Delta F (\%) } * 100 \text{ (second)}$$

where

N is the center point to measure the group delay.

ΔN is the number of point(s) apart from the center point and is calculated using the following formula.

$$\Delta N = \frac{ (\text{NOP} - 1) * \Delta F (\%) }{ 200 }$$

NOP is the Number of Points, select a value from 2 to 401.

$\phi(N - \Delta N)$ is a measured phase value at start point.

$\phi(N + \Delta N)$ is a measured phase value at stop point.

$\Delta F(\%)$ has been explained previously.

Figure 3-48 shows an illustration which shows the relationship of the above factors.

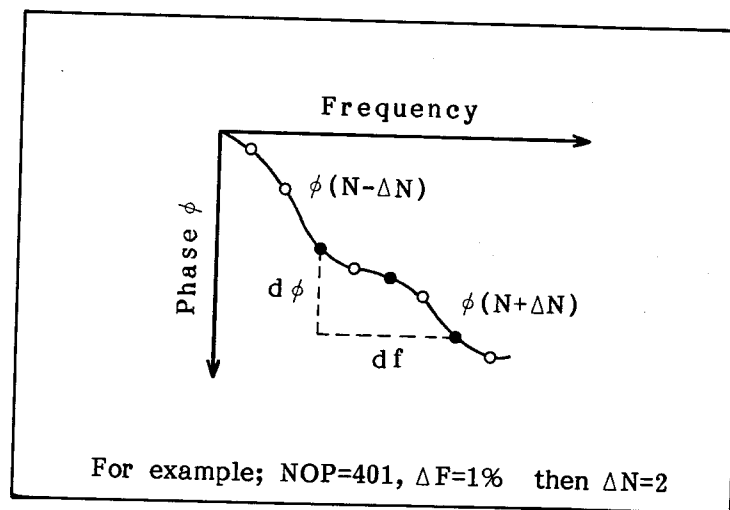

Figure 3-48. Relationship of Factors

OPERATION

Note

(1) ΔN will be substituted when the following cases occur.

1) In case of $(N + \Delta N) > \text{NOP}$, $\phi(N+\Delta N) = \phi(\text{NOP})$

2) In case of $(N - \Delta N) < 1$, $\phi(N-\Delta N) = \phi(1)$

(2) When you change the setting of $\Delta F(\%)$, ΔN is also changed.

3-4-2. RF Amplifier Gain Compression

Connect the RF amplifier to the 4194A as shown in Figure 3-49. Note that the receiver inputs, Reference and Test channels, will begin to overload when the input signal level exceeds 20dBm or 5Vrms with an input impedance setting of 50Ω. So if it is possible for the RF amplifier being tested to have an output level higher than this specified level, you must connect the attenuator between the output of amplifier and the receiver input. The RF amplifier used in this example has a gain of approximately 40dB. The RF amplifier is swept from -50dBm to -24dBm with frequency set to 10MHz so the internal 20dB attenuator is selected to be used with the Test channel. This measurement exercise will demonstrate the following:

- 1) How to set up the instrument to make a **GAIN COMPRESSION** measurement.
- 2) How to use the marker/line cursor to measure the -3dB gain compression point.

Note

OSC Level (dBm) sweep range is limited to 26dBm and must be set to the Linear mode.

Default values of related parameter are as follows.

Start OSC Level = -26.0dBm
 Stop OSC Level = 0.0dBm
 Spot Frequency = 100KHz

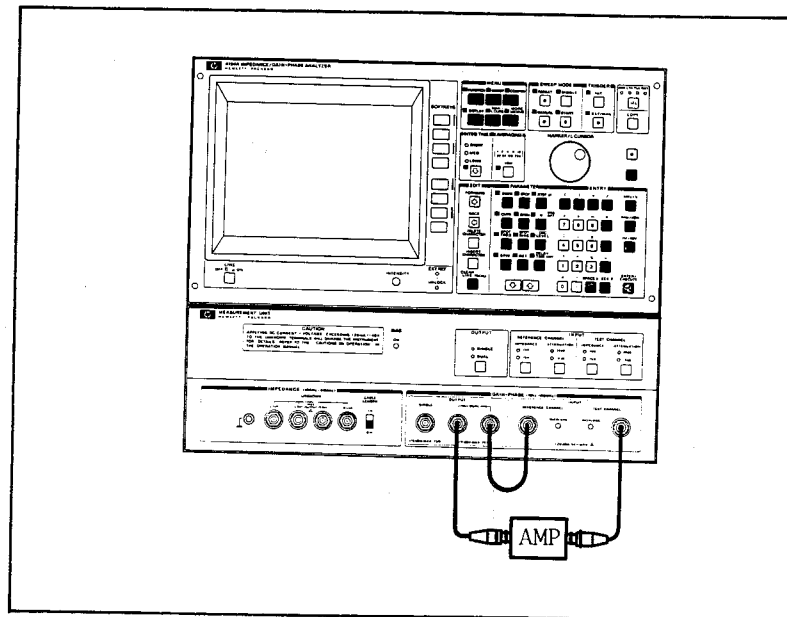

Figure 3-49. RF Amplifier Connection to HP 4194A

OPERATION

3-4-2-1. Measurement Set Up

CAUTION





DO NOT CONNECT THE RF AMPLIFIER BEFORE SETTING THE MEASUREMENT PARAMETERS TO AVOID DAMAGING THE INSTRUMENT.

As in the previous demonstration the measurement set up begins by initializing the instrument.

- 1) Press the **CLEAR LINE** key.
- 2) Press the **BLUE** key and input ' RST ' on the "Keyboard Input Line".
- 3) Press **ENTER/EXECUTE**.

The instrument is now in the Impedance mode and the $|Z|-\theta$ function is selected.

Before pressing any key in the **MENU** section you must set the 20dB attenuator to **ON** for the Test channel input. See the Measurement Unit (bottom unit). The sweep mode is now set to **SINGLE** sweep.

KEY	DESCRIPTION
(TEST CHANNEL) ATTENUATION  <ATT2>	INPUT section key of the Measurement Unit (bottom unit). When this key is pressed the indicator for 20dB attenuator will light. (Indicator for 0dB will go off.) 20dB and 0dB are toggled using this key.
GAIN PHASE  <FNC2>	Softkey used to set the 4194A's measurement mode to Gain-Phase.
SWEEP 	MENU section key used to select the sweep parameters. Related softkeys will be displayed when this key is pressed.
more 1/2 	Softkey used to set other parameters related to the sweep mode.
OSC LVL (dBm)  <SWP4>	Softkey used to select OSC LEVEL (dBm) as a sweep parameter

START

 <START=>

PARAMETER section key used to set the start OSC level. When this key is pressed, "START= (current value)", will be displayed on the "Keyboard Input Line".

   Data entry

KHz/dBm

ENTRY section key used to select dBm as unit for entry.

STOP

 <STOP=>

PARAMETER section key used to set the stop OSC level. When this key is pressed, "STOP= (current value)", will be displayed on the "Keyboard Input Line".

   Data entry

KHz/dBm

ENTRY section key used to select dBm as unit for entry.

**SPOT
 FREQ**

 <FREQ=>

PARAMETER section key used to set the SPOT FREQ.

   Data entry

MHz/V

ENTRY section key used to select MHz as the units entry.

COMPEN

MENU section key used to select the parameters for compensation. Press this key to display the parameters.

OPERATION

** Getting ready for the offset data measurement. **

To obtain the offset data, use a BNC barrel, BNC(f) to BNC(f) adapter in the place of the DUT.

START



<SWTRG>

SWEEP MODE section key used to start a complete sweep. Press this key to obtain the offset data.

**OFST REF
STORE**



<OFSTR>

Softkey used to store the offset data for A (Gain). (Offset data for B is also measured but not used in this example.) The message, "Offset reference stored" will be displayed.

** End of the offset data measurement. **

Replace the BNC adapter with the DUT.

REPEAT



<SWM1>

SWEEP MODE section key used to set the sweep mode to REPEAT.

**A OFFSET
on/off**



<AOF1>

Softkey used to validate offset data for data A.

DISPLAY



MENU section key used to select the data display format. Press this key to display the softkeys.

menu



Softkey used to display more parameters related to the X-A&B format.

**AUTO
SCALE A**



<AUTOA>

Softkey described previously.

**more
1/3**



Displays more parameters related to the display function.

**DISP B
on/off**













<DPB0>

Erases data B from the screen.

3-4-2-2. -3dB Gain Compression Point

The trace you now see on the CRT is amplifier input vs. gain. The gain is constant where the trace is level and is compressed where the trace rolls off. To measure the -3dB gain compression point enter into the **MKR/L CURS** section.

- MKR/L CURS**  **MENU** section key used to display the Marker/L(ine) Cursor softkey menu. Now you are in the **Single Marker Mode**.
- menu**  Displays more parameters related to the marker position.
- o MKR ->MAX(A)**  Softkey used to move the o-marker position to the maximum point on the trace of data A.
<MKMXA>
- return**  Returns to the first page of the softkey menu.
- o REF-LCURS**  Softkey used to set the o-marker and the line cursor on the screen. This is called the "Delta Line Cursor mode"
<MCF4>
- menu**  Displays the softkey menu for this mode.
- DLCURS=**  Softkey used to set the line cursor to the desired position with respect to the o-marker's position. When this key is pressed "DLCURS= (current value)" will be displayed on the Keyboard Input Line.
<DLCURS=>
-  **3**  Data entry
- ENTER/EXECUTE**  Executes the commands using the data entered. Pressing this key moves the line cursor to the -3dB position. Figure 3-50 shows the -3dB gain compression point data. The Line Cursor (LEFT) magnitude is the input level at which the amplifier has a gain compression of -3dB.

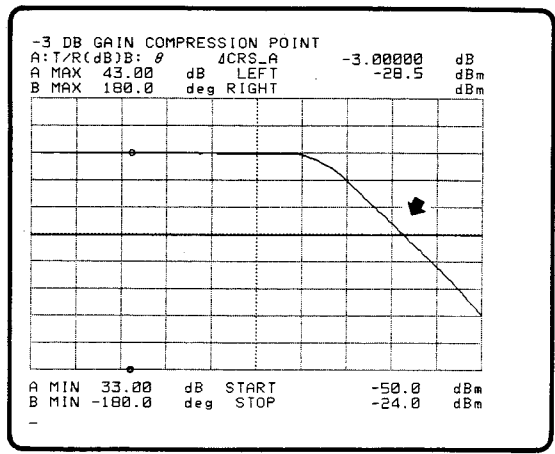

Figure 3-50. -3dB Gain Compression Point

3: Operation

OPERATION

o REF
 READ 
 <REFRD>

Press this softkey to show the data for o-marker's position (maximum point of data A). Figure 3-51 shows the difference. The marker is positioned at the point of highest gain for the amplifier.

The difference between the maximum point and the -3dB gain compression point can now be calculated. Difference = $44.2 - 28.5 = 15.7\text{dB}$

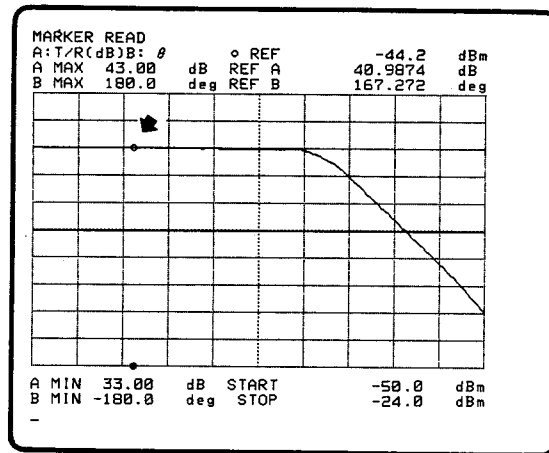

Figure 3-51. Reference Marker Read

Note

If you move the line cursor using the rotary knob, the display in the Marker/L Cursor Area will change to that shown in the previous figure.

For more thorough testing of the amplifier, run this test again at other frequencies.

3-5. REFERENCE

This section lists the keys and their menus, the front panel sections and some of the terms used throughout this manual. The listing is made from the top to the bottom of the 4194A's front panel layout. It is assumed that the operator is an experienced user and is only referring to this section for details.

Screen

The CRT displays all measurement setups, measurement results, softkey labels, special user functions, error codes, and system messages shown in Figure 3-52. All displays, with the exception of softkey labels can be dumped directly to an HP-IB printer without a controller.

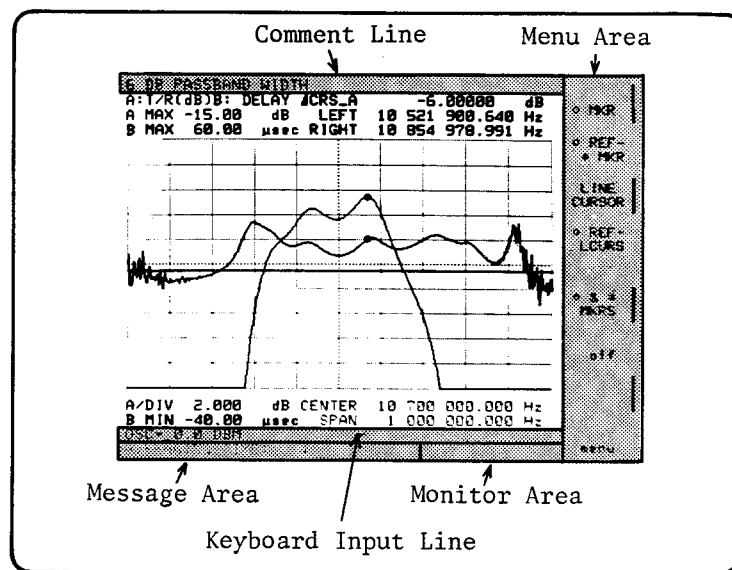

Figure 3-52. Screen

Comment Line

The Comment Line is located at the top of the screen as shown in Figure 3-52, and is used to display a comment or the title of a measurement. The comment on this line can be dumped to the printer or plotter without a controller. Refer to the **COMMENT** key in this section for more details.

Menu Area

The menu area is located at the right side of the screen, and displays the softkey menus as shown in Figure 3-52. The softkey labels displayed in this area can not be dumped to an HP-IB printer.

OPERATION

Keyboard Input Line

The Keyboard Input Line is the line located on the screen as shown in Figure 3-52, and is used to enter a new parameter value, comments, and register number for SAVE/GET. The data on the Keyboard Input Line can be modified with the **EDIT** and **ENTRY** keys. To enter data, press one of the three unit keys or the **ENTER/EXECUTE** key.

Note

Three units keys (**MHz/V**, **KHz/dBm**, **Hz/dBV**) and the **ENTER/EXECUTE** key instruct the instrument to read the data input with the **ENTRY** keys. Data is not input until one of these keys is pressed.

System Message Area

The System Message Area is a line located at the bottom of the screen as shown in Figure 3-52, and is used to display Error messages, Instructions, and the Averaging value. The instructions are displayed in yellow and error messages in red.

Monitor Area

The Monitor Area is located at the right side of the system message area as shown in Figure 3-52, and displays the level of the test signal applied to the DUT if the 'MONITOR menu' softkey and its menu are selected.

Graticule

The Graticule is a scale for measuring quantities displayed on the screen. The 4194A has different graticules for LOG and LINEAR sweep types. The **LIN SWEEP**, **LOG SWEEP** softkeys are accessed by first pressing the **SWEEP** key in the **MENU** section, and can be used to select the sweep type as shown in Figure 3-53.

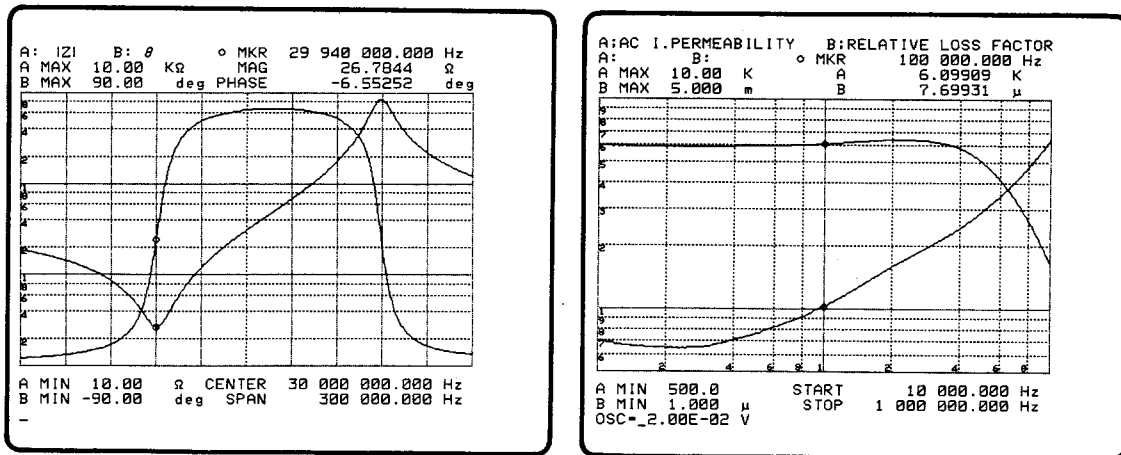

LIN SWEEP

LOG SWEEP

Figure 3-53. Sweep Types.

The 'A SCALE LIN', 'B SCALE LIN', 'A SCALE LOG', and 'B SCALE LOG' softkeys are accessed by first pressing a **DISPLAY** key in **MENU** section, and can be used to select the scale for DATA A or DATA B independently as shown in Figure 3-54.

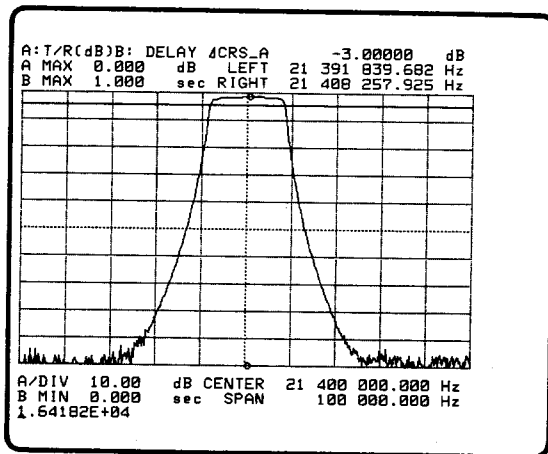

LIN SWEEP, A SCALE LIN

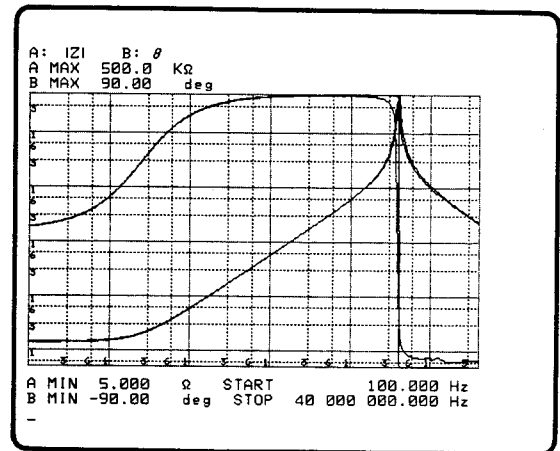

LOG SWEEP, A SCALE LOG

Figure 3-54. Scale Types.

Softkeys

The eight keys with no stenciling next to the menu area of the screen, shown in Figure 3-55, are called **SOFTKEYS**, and are used to select from the menu which is displayed using the **MENU** keys.

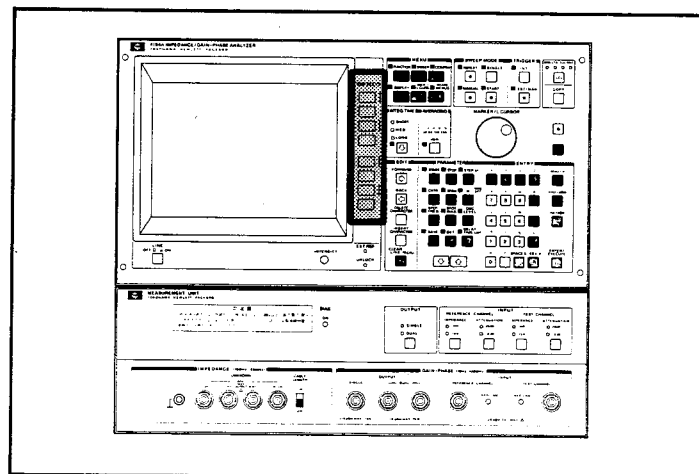

Figure 3-55. Softkeys

OPERATION

EXT REF/UNLOCK Lamps

The **EXT/REF** lamp turns on when a reference signal is applied to the **EXTERNAL REFERENCE** connector on the rear panel, and phase locked. If it is not phase locked, the **EXT REF** lamp will go out and the **UNLOCK** lamp will light. To improve the stability of the internal synthesizer, a reference signal may be applied from the **OVEN REFERENCE** output connector (Option 001 High Stability Frequency Reference) or from an external signal source. The reference signal must meet the following specifications:

Frequency	10/N MHz, = < 10ppm (N is integer from 1 to 10.)
Level	-1 to 20dBm

Input impedance is approximately 50Ω.

MENU Keys

The **MENU** keys consist of the following six keys shown in Figure 3-56.

FUNCTION key	SWEEP key
COMPEN key	DISPLAY key
MKR/L CURS key	MORE MENUS key

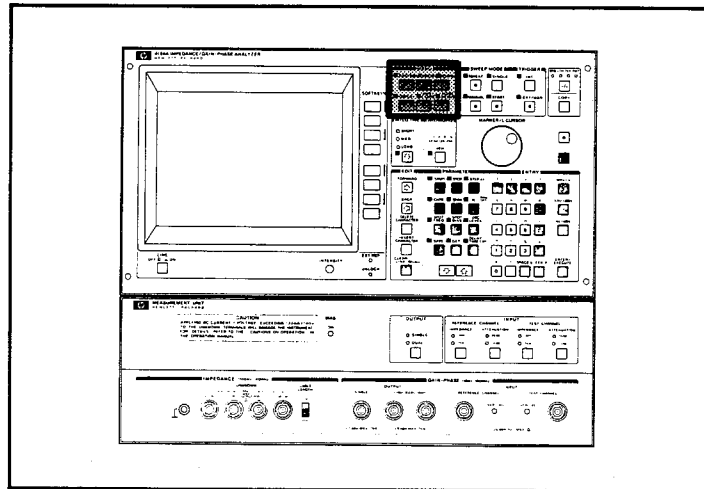

Figure 3-56. MENU Keys

The only function of these keys is to display a menu of the softkey labels, and all softkey labels are accessed via only these keys. The softkey menus are displayed in menu area on the screen, then selected by pressing the **SOFTKEY** next to softkey label.

When you start a new measurement, press the **FUNCTION** key first then select, in order, the **SWEEP** key, **COMPEN** key, **DISPLAY** key and **MKR/L CURS** key. The **MORE MENUS** key is used to select the additional capabilities, **PROGRAM**, **COPY**, **HP-IB** and etc.

Softkey Architecture

There are some softkeys whose only function is to display other softkeys.

menu:

The **menu** softkey is used to display the lower level menu of the label which has been selected from a (higher level) menu. If a "menu" label is displayed, the menu label must be pressed after the ordinary selection.

more x/2, and more x/3:

This softkey is used to display a menu which is at the same level as that of the displayed menu. If the softkey you want is not displayed, press this key to get other softkeys.

return:

This softkey is used to return to the upper level menu than that of the displayed menu. If this softkey is not displayed, then the displayed menu doesn't have an upper level menu.

OPERATION

FUNCTION key:

This key is used to display the menu of softkeys shown in Figure 3-57. When you start a new measurement, this key should be pressed first to select the measurement function which is being made, Impedance measurement or Gain-Phase measurement. If a MONITOR function is required, press the 'MONITOR menu' softkey, after the selection of the measurement function. Press the 'IMPEDANCE', 'GAIN-PHASE', or 'IMP with Z PROBE' softkey (even if it is green already) to get the lower measurement parameter's menus.

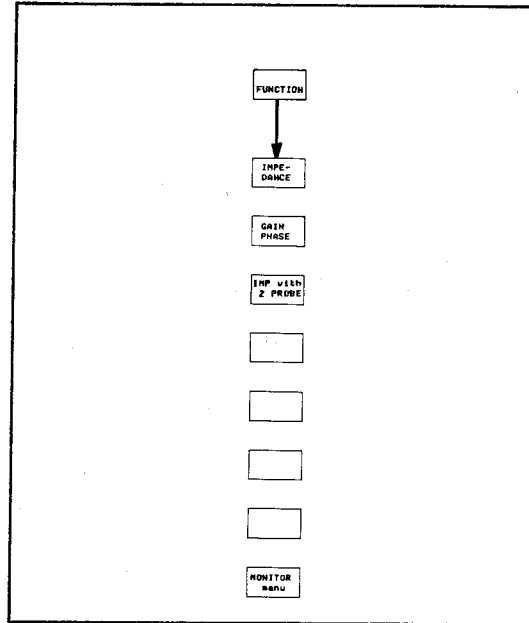

Figure 3-57. FUNCTION menu

IMPEDANCE:

The **IMPEDANCE** softkey is used to display the measurement parameter combination menus for Impedance measurement as shown in Figure 3-58. The 4194A simultaneously measures two independent, complementary impedance parameters in each measurement cycle. This combination of measurement parameters represents both the resistive and reactive characteristics of the sample. A total of fifteen measurement parameters make up the twenty parameter combinations which can be selected. The primary measurement parameters are displayed as DATA A in yellow, and the subordinate parameters are displayed as DATA B in blue.

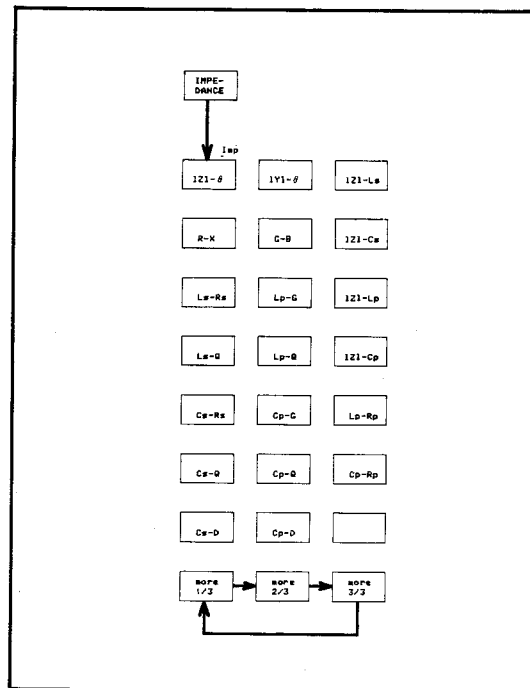

Figure 3-58. Impedance Menu

The 4194A measures R+jX (impedance) in the equivalent series circuit mode and G+jB (admittance) in the equivalent parallel circuit mode. Other impedance parameters are calculated using R+jX or G+jB and the equations in Table 3-1.

Table 3-1. Measurement Parameter Formulas for Impedance Measurement

Measurement Parameters	Circuit Mode	
	Series	Parallel
Z	$\sqrt{R^2 + X^2}$	
Y		$\sqrt{G^2 + B^2}$
θ	If R ≥ 0, $\tan^{-1}\left(\frac{X}{R}\right)$	If G ≥ 0, $\tan^{-1}\left(\frac{B}{G}\right)$
	If R < 0, $180(\text{deg}) - \tan^{-1}\left(\frac{X}{ R }\right)$	If G < 0, $180(\text{deg}) - \tan^{-1}\left(\frac{B}{ G }\right)$
Ls	$\frac{X}{\omega}$	
Cs	$\frac{1}{\omega X}$	
Q	$\frac{ X }{R}$	$\frac{ B }{G}$
D	$\frac{R}{ X }$	$\frac{G}{ B }$
Lp		$\frac{1}{\omega B}$
Rp		$\frac{1}{G}$
Cp		$\frac{B}{\omega}$

Z : Absolute Impedance	Y : Absolute Admittance
R : Resistance	G : Conductance
X : Reactance	B : Susceptance
L : Inductance	C : Capacitance
Q : Quality Factor	D : Dissipation Factor
θ : Phase Angle	

3: Operation

IMP with Z PROBE:

This softkey displays the measurement parameters for the Impedance measurement when using a probe. The softkey menus to be displayed are exactly the same as those displayed when the 'IMPEDANCE' softkey is pressed. This function is provided for use with the Probe. Connect the probe to the Gain-Phase section. The following summarizes the differences with the 'IMPEDANCE' function.

1. Frequency can be swept from 10Hz to 100MHz.
2. Osc. level can be set from -65dBm to 15dBm.
3. The Gain-Phase section of the 4194A is used for measurement.

See Paragraph 3-3-3, "Impedance Measurement Using Probe" for more information.

OPERATION

GAIN PHASE:

The **GAIN PHASE** softkey is used to display the measurement function menu keys for Gain-Phase measurement as shown in Figure 3-59.

Tch/Rch(dB)- θ :

This softkey is used to measure the relative amplitude (dB) of the reference channel and the test channel on the GAIN-PHASE INPUT terminal. The result is displayed as DATA A. Also the phase difference between the reference input and the test input are measured in degree and displayed as DATA B on the screen.

Tch/Rch- θ :

This softkey is used to measure the relative amplitude (V) of the reference channel and the test channel on the GAIN-PHASE INPUT terminal. The result is displayed as DATA A. Also the phase difference between the reference input and test input is measured in degrees and displayed as DATA B on the screen.

Tch/Rch(dB)- τ :

This softkey is used to measure the relative amplitude (dB) of the reference channel and the test channel in the GAIN-PHASE INPUT terminal. The result is displayed as DATA A. Also the group delay between the reference channel and the test channel is measured in seconds and displayed as DATA B.

Rch-Tch(V):

This softkey is used to measure the absolute amplitude of the reference channel and test channel in V (volts). The results for the reference channel is displayed as DATA A, and for the test channel is displayed as DATA B.

Rch-Tch(dBm):

This softkey is used to measure the absolute amplitude of the reference channel and test channel in dBm. The results for the reference channel is displayed as DATA A, and the test channel is displayed as DATA B.

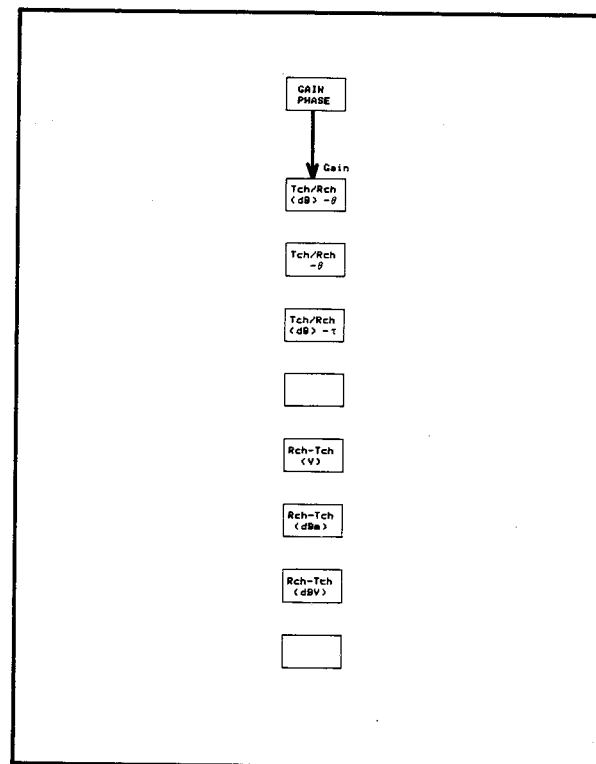

Figure 3-59. Gain-Phase Menu

Rch-Tch(dBV):

This softkey is used to measure the absolute amplitude of the reference channel and test channel in dBV. The results for the reference channel is displayed as DATA A, and for the test channel is displayed as DATA B.

MONITOR menu:

This softkey is used to display the softkeys as shown in Figure 3-61. These keys are used to monitor the level of the test signal applied to the DUT or the current through the DUT. The result is displayed in the monitor area of the screen as shown in Figure 3-60.

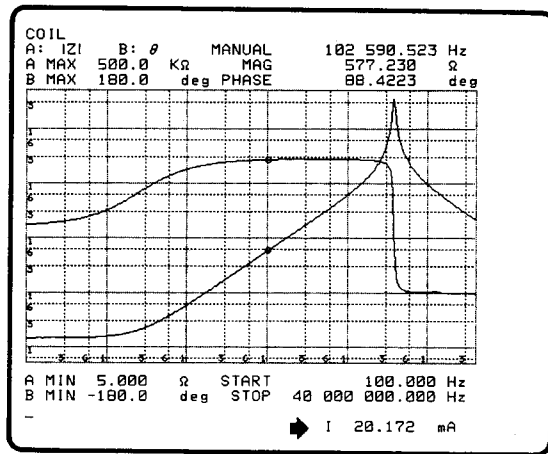

Figure 3-60. Monitor display

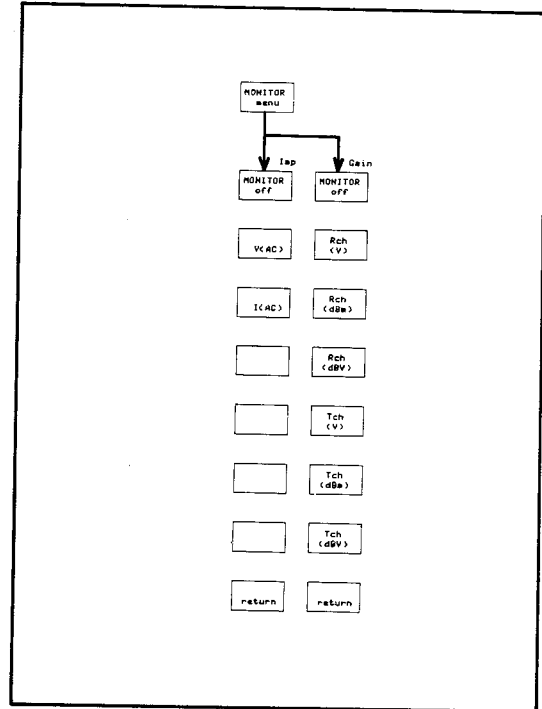

Figure 3-61. Monitor Menu

MONITOR off:

This softkey is used to turn off the monitor function.

V(AC):

This softkey is used to monitor the level (V) of the test signal applied to the DUT during an Impedance Measurement.

I(AC):

This softkey is used to monitor the current through the DUT during an Impedance Measurement.

Rch(V):

This softkey is used to monitor the level (V) of the test signal applied to the Reference Channel Connector during a Gain-Phase measurement.

OPERATION

Rch(dBm):

This softkey is used to monitor the level (dBm) of the test signal applied to the Reference Channel Connector during a Gain-Phase measurement.

Rch(dBV):

This softkey is used to monitor the level (dBV) of the test signal applied to the Reference Channel Connector during a Gain-Phase measurement.

Tch(V):

This softkey is used to monitor the level (V) of the test signal applied to the Test Channel Connector during a Gain-Phase measurement.

Tch(dBm):

This softkey is used to monitor the level (dBm) of the test signal applied to the Test Channel Connector during a Gain-Phase measurement.

Tch(dBV):

This softkey is used to monitor the level (dBV) of the test signal applied to the Test Channel Connector during a Gain-Phase measurement.

I/V MON menu:

This softkey, accessible only from the **EDIT** mode, is used to display the **MONITOR** menu keys for Impedance Measurements.

GAIN MON menu:

This softkey, accessible only from the **EDIT** mode, is used to display the **MONITOR** menu keys for Gain-Phase Measurements.

SWEEP Key:

The **SWEEP** key is used to display the menu of softkeys shown in Figure 3-62. These softkeys are used to select the type of sweep and the sweep parameters. If a Gain-Phase measurement was selected previously from the **FUNCTION** menu, the DC BIAS label wouldn't be displayed because the DC BIAS SWEEP function is not available for Gain-Phase measurements. The default settings are LIN SWEEP, SWEEP UP, and FREQ. Be sure to press the 'more 1/2' softkey after selecting the sweep type, to get the sweep parameter menu. When OSC LEVEL (dBm) or OSC LEVEL (dBV) is selected, LINEAR SWEEP will be selected automatically, therefore, they do not have softkeys.

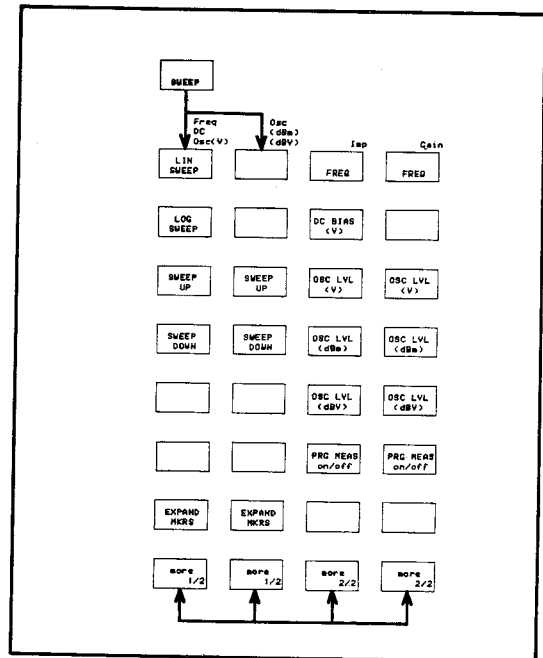

Figure 3-62. Sweep Menu

LIN SWEEP:

The '**LIN SWEEP**' softkey is used to select the linear sweep for the **SWEEP** function

LOG SWEEP:

The '**LOG SWEEP**' softkey is used to select the **LOG SWEEP** function.

SWEEP UP:

The '**SWEEP UP**' softkey is used to select the min. value to max. value sweep direction (from left to right) sweep test parameter.

SWEEP DOWN:

The '**SWEEP DOWN**' softkey used to select the minimum and maximum values for a right to left sweep.

PRG MEAS on/off:

The '**PRG MEAS on/off**' softkey is used to select a Programmed Points Measurement. Before pressing (the label is intensified green) this key, the appropriate Programmed Points Table should be called using the "PTN" command or the **SET PROG TABLE** function in the **MORE MENUS** section, otherwise, Table 1 will be selected as by default. The sweep parameters, start/stop values, and measurement points specified in the table are used, therefore the sweep test parameters (FREQ, DC BIAS, and OSC LEVEL) displayed by the 'more 1/2' softkey are ignored. If a table has not been set defined, "programmed points table empty" error message will be displayed. Refer to the **PROGRAMMED POINTS TABLE** in Paragraph 3-6-6-2 for more details.

OPERATION

EXPAND MKRS:

The 'EXPAND MKRS' softkey is used to expand the part of the sweep between the o-marker and *-marker into a full span sweep as shown in Figure 3-63. The start and stop values of the sweep parameter will be revised. To select the o-marker and *-marker, press the MKR/L CURS key then select the 'o & * MKRS' softkey.

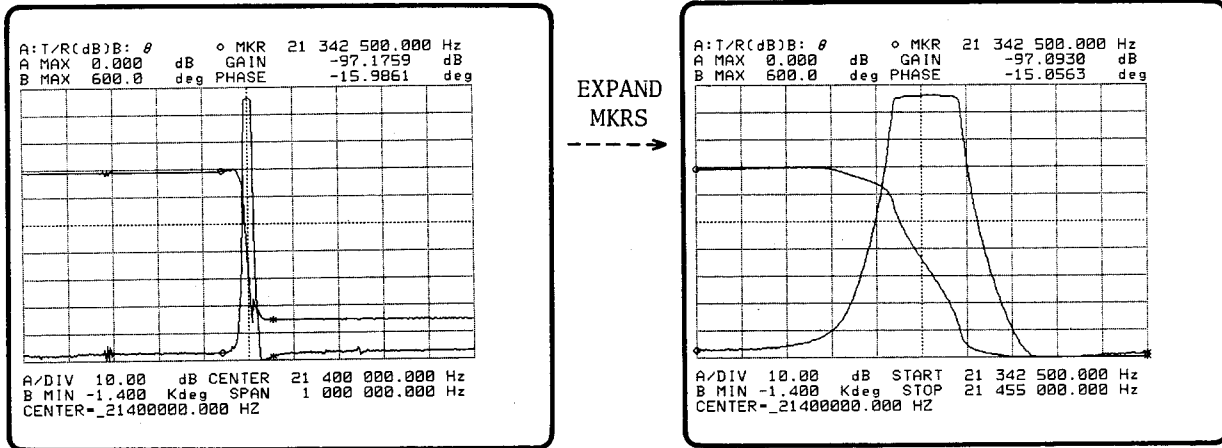

Figure 3-63. EXPAND MARKER

FREQ:

The 'FREQ' softkey is used to select frequency as the sweep test parameter. FREQUENCY is the power-on default parameter. When this key is selected (the label is green), the units in parameter area of the screen are displayed as shown in Figure 3-64.

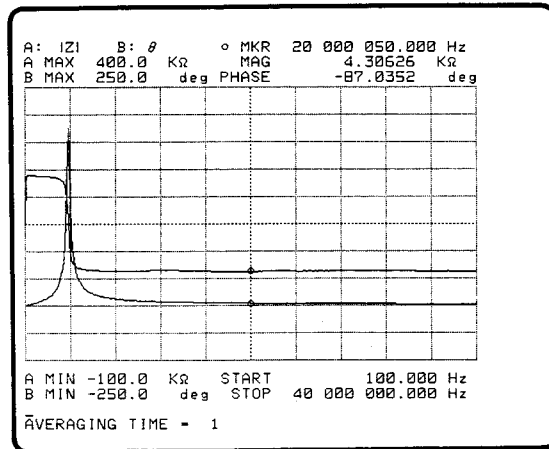

Figure 3-64. Frequency Sweep

DC BIAS (V):

Softkey used to select DC BIAS(V) as the sweep test parameter. When this key is selected, the units in parameter area of the screen are displayed as shown in Figure 3-65.

If Gain Phase measurement was selected previously, this softkey doesn't appear because DC BIAS is not available for Gain-Phase measurements.

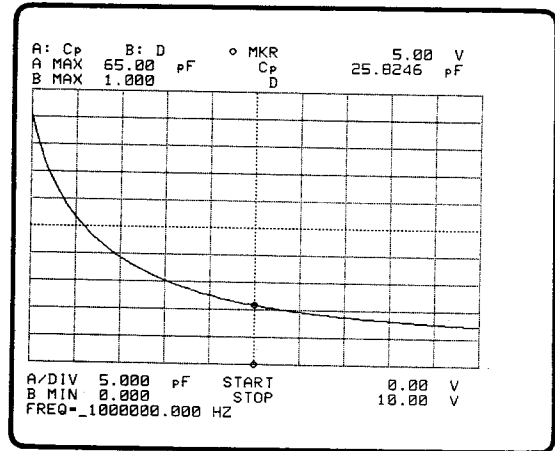

Figure 3-65. DC BIAS Sweep

OSC LEVEL (V):

This softkey is used to select level (V) as the sweep the test parameter. When this key is selected the units in parameter area on the screen are displayed as shown in Figure 3-66.

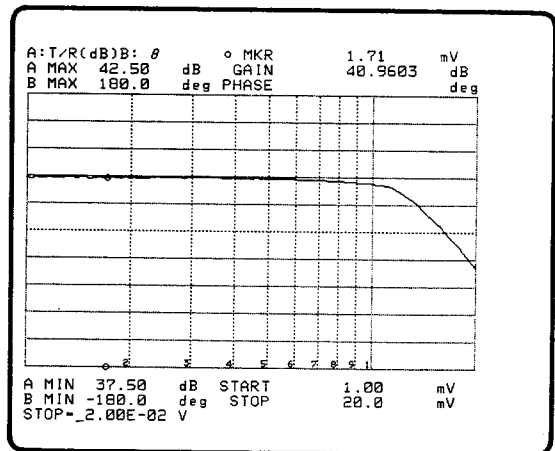

Figure 3-66. OSC Level(V) Sweep

OSC LEVEL (dBm):

This softkey is used to select level (dBm) as the sweep test parameter.

OSC LEVEL (dBV):

This softkey is used to select the level (dBV) as the sweep test parameter.

3: Operation

OPERATION

COMPEN Key:

This key is used to display the menu of softkeys as shown in Figure 3-67, and is used to compensate the residual influence due to the test fixture. Refer to **COMPENSATION**, Paragraph 3-6-5 for more details.

OPEN OFS on/off:

This softkey is used to set the **ZERO OPEN** offset data ON or OFF with respect to the measurement results. This key is a push-to-toggle, two position switch.

SHRT OFS on/off:

This softkey is used to set the **ZERO SHORT** offset data ON or OFF with respect to the measurement results. This key is a push-to-toggle, two position switch. Intensification of the label indicates that the switch is in the "on" position.

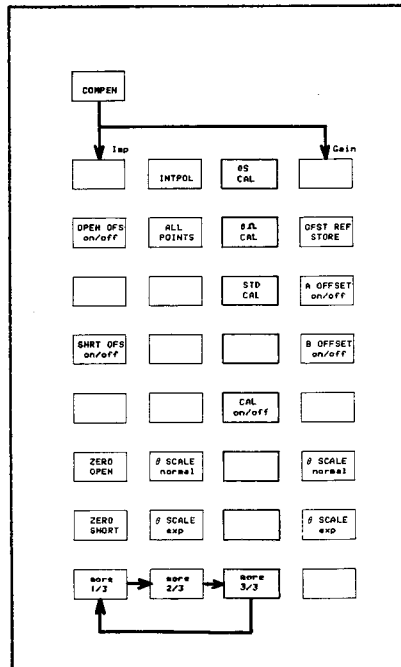

Figure 3-67. Compensation menu

ZERO OPEN:

This softkey is used to start a **ZERO OPEN** measurement and store the measurement results (stray admittance) into the registers.

ZERO SHORT:

This softkey is used to start a **ZERO SHORT** measurement and store the measurement results (residual impedance) into the registers.

INTERPOLATION:

Use this softkey to select the Interpolation method of compensation. This compensation method uses the OFFSET DATA from an OPEN/SHORT measurement and the CALIBRATION DATA from measurements on STANDARDS to compensate the measurement system. Measurements are taken at a number of points across the full sweep range, and the effective value for the points between these measured points will be calculated using the linear interpolation method. See Paragraph 3-6-5 for more information.

ALL POINTS:

Use this softkey to select the All points method of compensation. In this compensation method the offset and calibration data for the fixture are measured at each point, not calculated. Frequency, Osc level or DC Bias can be used as the sweep parameter. For the Osc level or DC Bias sweep modes the offset and calibration data will be stored with reference to the spot frequency at which they were obtained. See Paragraph 3-6-5 for more information.

 θ SCALE normal:

This softkey is used to set phase scale to the normal mode. The phase trace represents 360° phase wraps in this mode.

 θ SCALE exp:

This softkey used to set phase scale to the expansion mode in which the phase trace is continuously expanded.

OFST REF STORE:

Stores the offset data measured and displayed on the screen into an array type register. The message, "Offset reference stored", is displayed in the system message area after this key is pressed.

A OFFSET on/off, B OFFSET on/off:

Sets the offset data to ON or OFF for the data A or B. This key is a push-to-toggle, two position switch.

0S CAL:

Obtains calibration data (for stray admittance) of the fixture using the 0S calibration standard. When you use the probe included in the 41941A/B Impedance Probe kit, use 0S calibration standard (P/N 41941-65003).

0 Ω CAL

Obtains the calibration data (for residual impedance) of the fixture using the 0 Ω calibration standard. When you use the probe included in the 41941A/B Impedance Probe Kit, use 0 Ω calibration standard (P/N 41941-65001).

OPERATION

STD CAL:

This softkey is used to obtain the calibration data of a fixture by using a calibration standard. When you use the probe included in the 41941A/B Impedance Probe Kit, use 50Ω calibration standard (P/N 41941-65002).

CAL on/off

Use this softkey to make the calibration valid or invalid with respect to the subsequent measurement results. Measurement results will be automatically calibrated using the calibration data acquired using the three calibration standards. When a softkey label is intensified, it is ON.

DISPLAY Key:

This key is used to display the menu shown in Figure 3-68. These softkeys may be used to modify the display format on the screen without changing the measurement function or the results. Select one of the **menu** keys to display the lower level menu keys.

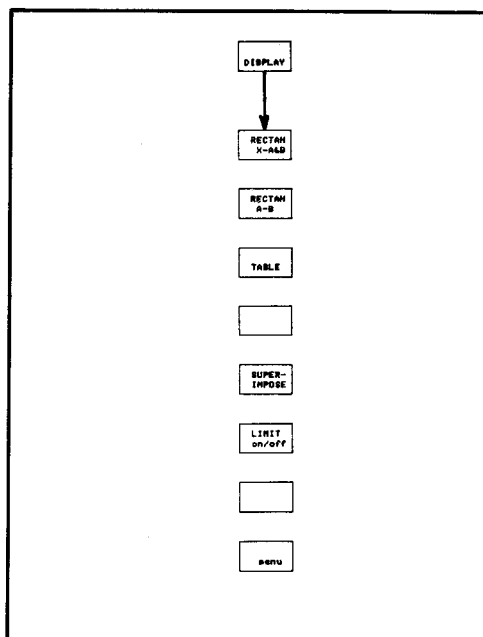

Figure 3-68. DISPLAY menu

RECTAN X-A&B:

This softkey is used to select the scale format that displays both data A and data B displayed on the vertical axis, and the sweep test parameter is displayed on the horizontal axis, see Figure 3-69. Press the 'menu' softkey after an ordinary selection and the lower level menu will be displayed, see Figure 3-70. Lower level menus are used to modify the vertical scale.

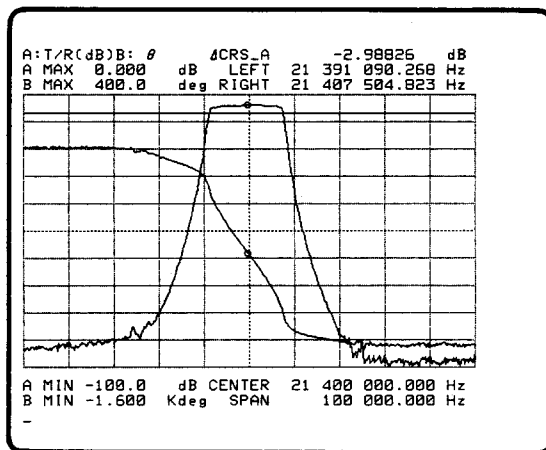

Figure 3-69. Rectangular A-B

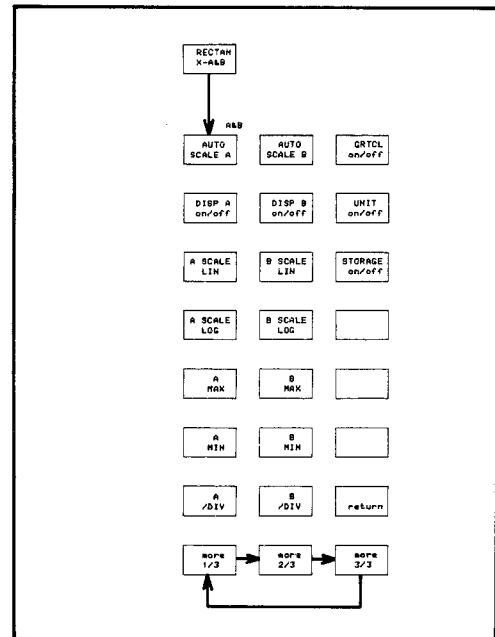

Figure 3-70. RECTAN X-A&B menu Scale

OPERATION

RECTAN A-B:

This softkey used to select the scale format that displays DATA A on the horizontal axis and DATA B on the vertical axis as shown in Figure 3-71. The vertical and horizontal scales can be modified using the lower level menus which are displayed using the 'menu' softkey as shown in Figure 3-72.

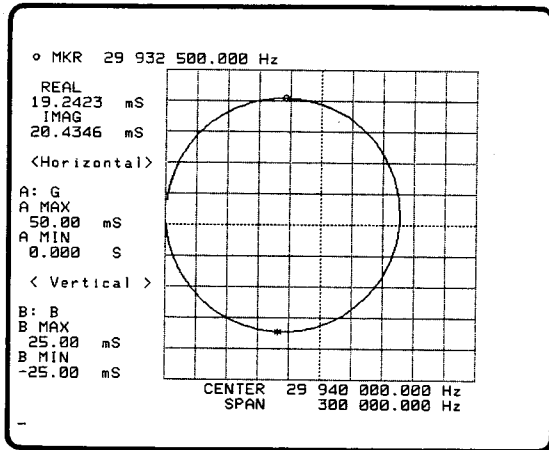

Figure 3-71. Rectangular A-B Scale Type.

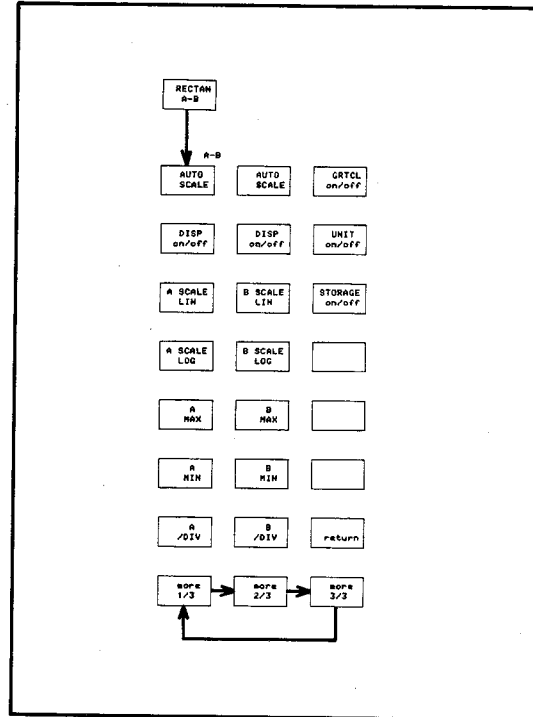

Figure 3-72. Rectangular A-B menu

TABLE:

Selects the TABLE format as shown in Figure 3-73. A table is used to view the measurement results in tabular rather than graphic form. A table displays the sweep parameter value and DATA A and B at each measurement point including the measurement point "N". Before using this table, all Function, Sweep, and Parameters must be defined to obtain the correct results.

Press the 'TABLE' softkey, then the 'menu' softkey, and the first page of the table will be displayed as shown in Figure 3-73, and the lower level menu will appear as shown in Figure 3-74. If the table is empty, press the REPEAT or START key in the SWEEP MODE section to start a sweep then DATA A and B will be displayed in the table.

N	FREQUENCY [Hz]	REAL [S]	IMAG [S]
181	29 925 000.000	8.44092	17.2629
182	29 925 750.000	9.07831	17.6621
183	29 926 500.000	9.78295	18.0717
184	29 927 250.000	10.5758	18.4904
185	29 928 000.000	11.4618	18.8928
186	29 928 750.000	12.4404	19.2702
187	29 929 500.000	13.5302	19.6346
188	29 930 250.000	14.7428	19.9574
189	29 931 000.000	16.0935	20.2179
190	29 931 750.000	17.5914	20.3877
191	29 932 500.000	19.2423	20.4346
192	29 933 250.000	21.0515	20.3182
193	29 934 000.000	22.9845	19.9806
194	29 934 750.000	25.0777	19.3998
195	29 935 500.000	27.2670	18.4938
196	29 936 250.000	29.4987	17.2814
197	29 937 000.000	31.6938	15.4731
198	29 937 750.000	33.7352	13.2846
199	29 938 500.000	35.5820	10.6285
200	29 939 250.000	36.8342	7.58321
201	29 940 000.000	37.6228	4.24984

MEASURE N= CENTER 29 940 000.000 Hz
SWEEP N= 1 --> 401 SPAN 300 000.000 Hz

Figure 3-73. TABLE

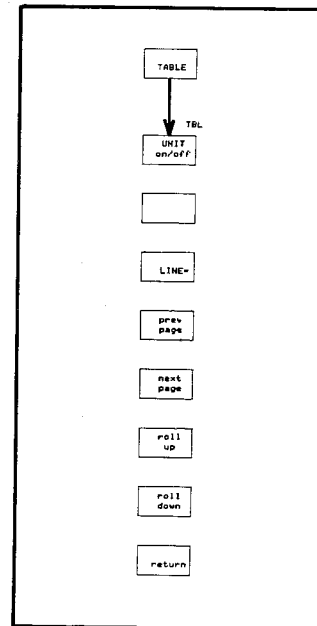

Figure 3-74. TABLE menu

The parameters displayed under the table can be changed by using the **PARAMETER** and **ENTRY** keys. When a parameter is changed, the DATA in the table will be erased. So if **SINGLE** sweep is set, the **START** key must be pressed once to acquire new DATA in the table. The table can be printed out using an HP-IB printer without the need of a controller, refer to the Extended Capabilities Paragraph in this section for more details.

SUPERIMPOSE:

This softkey is used to display the menu shown in Figure 3-75. The SUPERIMPOSE function is used to compare the old and new data. Data can be stored, and recalled later to be displayed on the screen with the new data for a overlay comparison.

LIMIT on/off:

This softkey is used to display the limit data (maximum and minimum values) specified in the Programmed points table together with the measurement is being made.

OPERATION

AUTO SCALE, AUTO SCALE A, and AUTO SCALE B:

These softkeys are used to quickly scale the trace to fit the full graticule without clipping the trace. Press the **AUTO SCALE** key to automatically rescale and display the data. A/B MAX, A/B MIN, and A/B DIV will also be recalculated and the values will be displayed on the screen menu. AUTO SCALE is available only for the RECTANGULAR A-B scale, and it modifies the scales for DATA A (horizontal axis) and DATA B (vertical axis) simultaneously. The AUTO SCALE A, AUTO SCALE B are available only for RECTANGULAR X-A&B scale, and modify the scale of the DATA A and B independently.

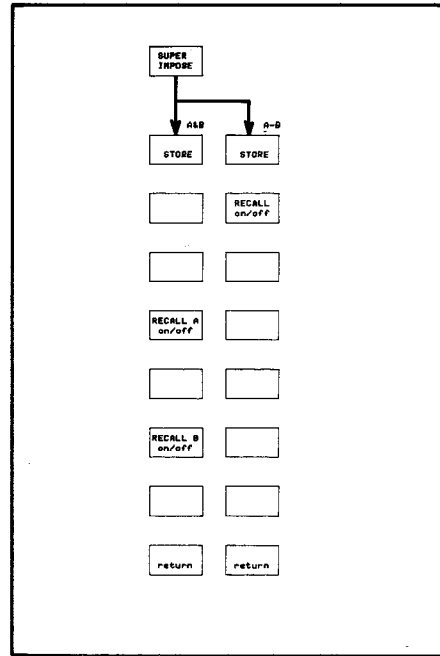

Figure 3-75 Superimpose Menu

DISP on/off, DISP A on/off, and DISP B on/off:

These softkeys are used to erase data from the screen, or to recall data to the on the screen. DISPLAY on/off is available only for the RECTANGULAR A-B scale, and functions for DATA A and B simultaneously. The DISPLAY A on/off, and DISPLAY B on/off are available only for the RECTANGULAR X-A&B scale, and function for DATA A and B independently. This softkey is a push-to-toggle, two position switch.

UNIT on/off:

The 'UNIT on/off' softkey is used to eliminate and recall units to the screen. This softkey is a two position, push-to-toggle switch.

GRTCL on/off:

The 'GRTCL on/off' softkey is used to eliminate or recall the graticule display. This key is a push-to-toggle, two position switch. This softkey is available only for the RECTANGULAR X-A&B and RECTANGULAR A-B scales.

A SCALE LIN, and B SCALE LIN:

These softkeys are used to set the DATA's vertical scale to LINEAR. The scale is divided into ten equal parts. LINEAR or LOG scale types can be selected, LINEAR is the default selection.

Note

At the RECTANGULAR X-A&B scale, the **A SCALE LIN/LOG** keys are higher priority than the **B SCALE LIN/LOG** keys if DISP A on/off is on. So the **B SCALE LIN/LOG** keys are not activated. The **B SCALE LIN/LOG** keys would be activated if the DISP A on/off is off, and the DISP B on/off is on.

STORAGE on/off:

This softkey is used to display all data which is measured after turning on this key. This is useful to watch the transition of the measurement data. All data stored are erased when the 'STORAGE on/off' softkey is turned off. This softkey is a push-to-toggle, two position switch.

A SCALE LOG, and B SCALE LOG:

These softkeys are used to set the DATA's vertical scale to LOG. LINEAR and LOG scale types can be selected. The LINEAR scale is the default selection.

Note

In the RECTANGULAR X-A&B scale, the **A SCALE LIN/LOG** keys are of higher priority than the **B SCALE LIN/LOG** keys. If DISP A on/off is on, the **B SCALE LIN/LOG** keys are not activated. The **B SCALE LIN/LOG** keys would be activated if the DISP A on/off is off, and DISP B on/off is on.

A MAX, B MAX, A MIN, and B MIN:

These softkeys are used to change the MAX or MIN value of the scale in order to obtain the optimum scale, as described below.

1. Press the **AUTO SCALE A** or **AUTO SCALE B** key to modify the scale. DATA will be in the scale as shown in Figure 3-76.

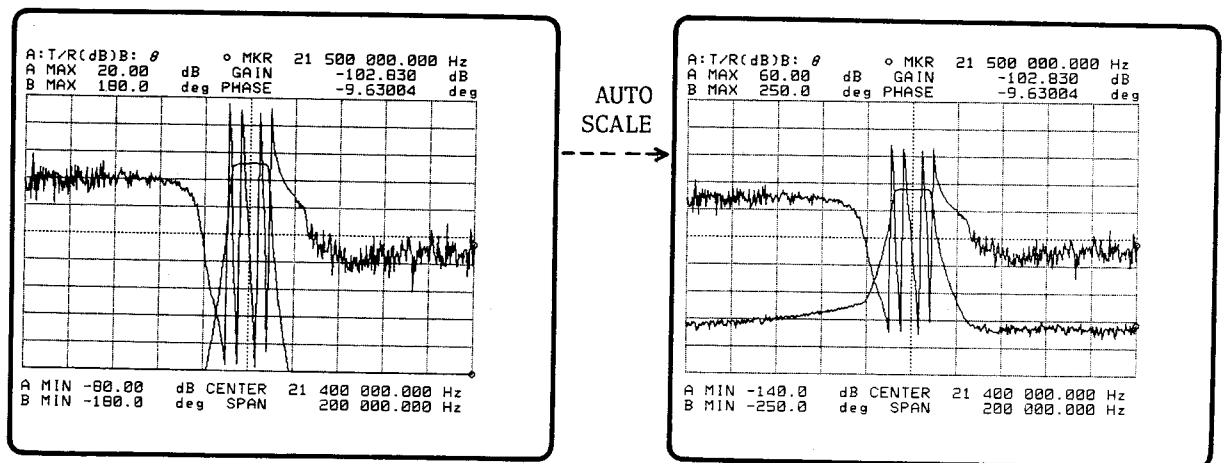

Figure 3-76. Display after AUTO SCALE

OPERATION

2. Press the '**A MAX (B MAX)**' softkey. AMAX=(current value) will be displayed on Keyboard Input Line as shown in Figure 3-77.

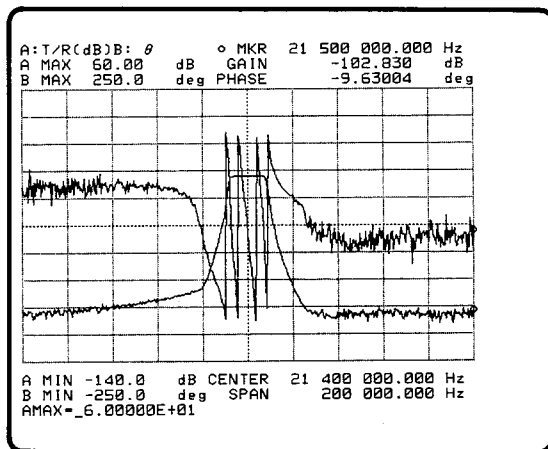

Figure 3-77. AMAX=6.00000E+01

3. Press the **STEP UP/DOWN** key, or enter directly using the input keys in the entry section as shown in Figure 3-78. The scale will change as shown in Figure 3-79.

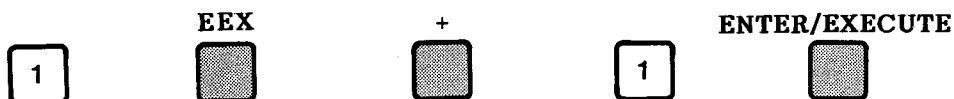

Figure 3-78. Direct Key In

Note

The unit keys (**MHz/V**, **KHz/dBm**, **Hz/dBV**) and the **ENTER/EXECUTE** key are used to instruct the instrument to read the data set with the **ENTRY** keys. Data is not input until one of these keys is pressed.

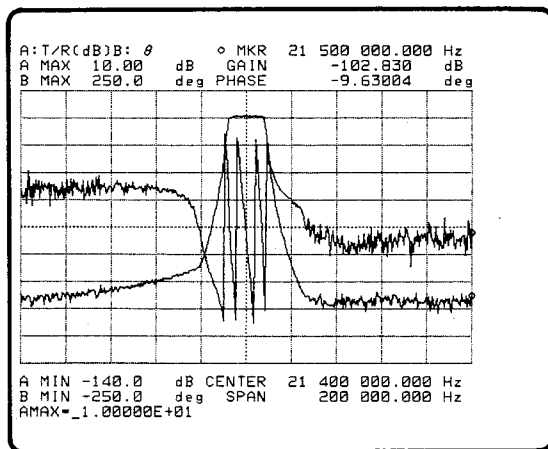

Figure 3-79. New A MAX value.

- Change **A MIN** and **B MIN**, if necessary, as well as **A MAX**.

A /DIV, and B /DIV:

These softkeys are used to obtain the optimum /DIV.

LINE=:

This softkey is used to set the starting point of the table equal to the measurement point number "N" which you entered.

- Press the '**LINE=**' softkey. "LINE=" will be displayed on Keyboard Input Line.
- Enter a number for "N" as shown in Figure 3-80, then press **ENTER/EXECUTE**.



Figure 3-80. Line Number

- The table change as shown in Figure 3-81.

N	FREQUENCY [Hz]	GAIN [dB]	PHASE [deg]
201	21 400 000.000	-3.83901	-16.4531
202	21 400 500.000	-3.81296	-38.7051
203	21 401 000.000	-3.81942	-60.9756
204	21 401 500.000	-3.84438	-83.2565
205	21 402 000.000	-3.86523	-105.626
206	21 402 500.000	-3.87250	-128.285
207	21 403 000.000	-3.87987	-151.475
208	21 403 500.000	-3.91860	-175.314
209	21 404 000.000	-4.01252	160.330
210	21 404 500.000	-4.14265	135.642
211	21 405 000.000	-4.24161	110.547
212	21 405 500.000	-4.24599	84.3568
213	21 406 000.000	-4.17591	56.8436
214	21 406 500.000	-4.18746	24.6903
215	21 407 000.000	-4.40494	-9.52792
216	21 407 500.000	-4.66759	-47.4122
217	21 408 000.000	-5.26391	-96.0227
218	21 408 500.000	-9.14850	-154.281
219	21 409 000.000	-15.9242	165.849
220	21 409 500.000	-22.4236	142.625
221	21 410 000.000	-29.0910	127.261

MEASURE N= CENTER 21 400 000.000 Hz
SWEEP N= 1 → 401 SPAN 200 000.000 Hz

Figure 3-81. A Table

previous page:

Use this softkey to see the previous page of the table.

next page:

Use this softkey to see the next page of the table.

OPERATION

roll up and roll down:

These softkeys are used to scroll up or down through a table.

STORE:

This softkey is used to simultaneously store data A and B into registers **C** and **D**. Data is stored until new data is written or power is turned off.

RECALL on/off:

This softkey is used to simultaneously recall data A and B in the RECTAN A-B scale mode. The recalled trace is displayed in light green. This softkey is two position, push-to-toggle.

RECALL A on/off, RECALL B on/off:

This softkey is used to independently recall the data A and B. Data A is displayed in yellow, and the data B is blue. This softkey is two position, push-to-toggle.

X-A&B menu:

This softkey is used to display the lower level menu keys used to modify the vertical scale of the RECTANGULAR X-A&B graticule. This key is only accessible only while in the **EDIT** mode.

A-B menu:

This softkey is used to display the lower level menu keys used to modify the vertical and horizontal scales of the RECTANGULAR A-B graticule. This softkey is accessible only while in the **EDIT** mode.

TABLE menu:

This softkey is used to display the lower level menu keys '**UNIT on/off**', '**LINE=**'. This key is accessible only while in the **EDIT** mode.

MKR/L CURS key:

The **MARKER/L CURSOR** key is used to display the softkey menu shown in Figure 3-82. The **MARKER/L CURSOR** function has the following modes:

1. o-MARKER mode (Single Marker Mode)
2. o-REF- *-MKR mode (Delta Marker Mode)
3. LINE CURSOR mode (Line Cursor Mode)
4. o-REF- LCURS mode (Delta Line Cursor Mode)
5. o- & *-MKRS mode (Double Marker Mode)
6. off mode

After selecting one of these modes, press the 'menu' softkey to display the lower level menus.

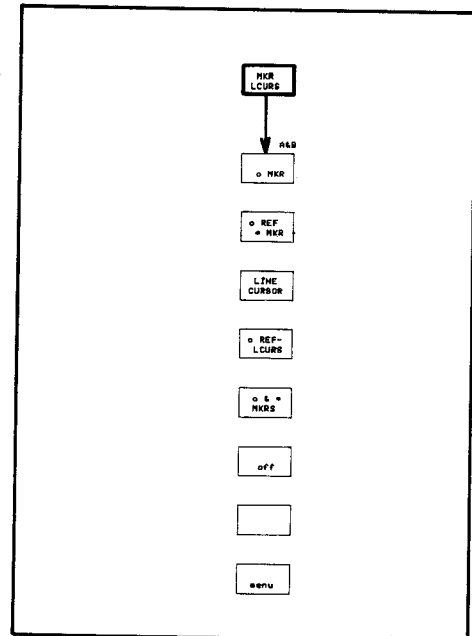

Figure 3-82. MARKER/L CURSOR menu

OPERATION

o MKR:

The 'o MKR' softkey is used to select the "o MARKER" mode (Single Marker Mode). In the "RECTAN X-A&B" mode, two o-markers appear on both traces. In the "RECTAN A-B" mode, one o-marker appears on the trace. Data corresponding to the o-marker position will be displayed in the Marker Area as shown in Figure 3-83.

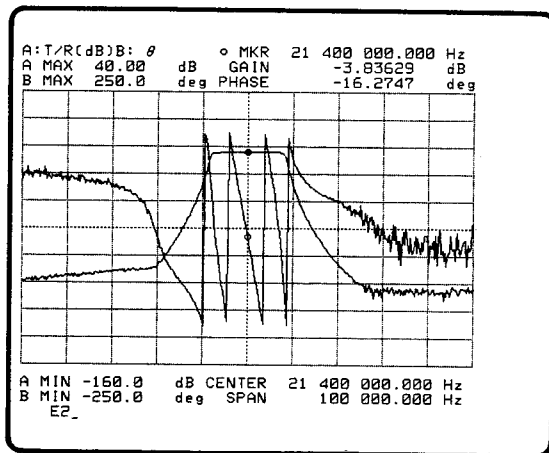

Figure 3-83. o Marker Display (RECTAN X-A&B)

A description of the three data fields in the Marker Area of the display shown in Figure 3-76 is given below:

1. o MKR 21 400 000.000Hz: The sweep parameter value at the position of the o-marker.
2. GAIN -3.83629dB: Data A corresponding to the position of the o-marker.
3. PHASE -16.2747° : Data B corresponding to the position of the o-marker.

If the TABLE mode has been selected, an o-marker will appear next to the "N" as shown in Figure 3-84. The marker position can be moved using the **MARKER/L CURSOR** knob, or the 'MKR=' softkey.

To select this mode,

1. Press the 'o MKR' softkey. The "o-MKR" label will change to intensified green.
2. Press the 'menu' softkey, then "o-MARKER menu" will be displayed as shown in Figure 3-85.

To exit this mode,

1. Press the 'return' softkey. The **MKR/L CURS** menu will be redisplayed.
2. Press the 'off' softkey. The "off" softkey label will change to intensified green and the o-marker will disappear.

The default setting is the o-marker.

N	FREQUENCY [Hz]	GAIN [dB]	PHASE [deg]
191	21 397 500.000	-4.13131	82.9278
192	21 397 750.000	-4.13111	71.7771
193	21 398 000.000	-4.12351	60.7670
194	21 398 250.000	-4.10734	49.7895
195	21 398 500.000	-4.08376	38.8491
196	21 398 750.000	-4.05450	27.9489
197	21 399 000.000	-4.02033	17.0058
198	21 399 250.000	-3.98410	6.04756
199	21 399 500.000	-3.94901	-4.93070
200	21 399 750.000	-3.91645	-15.9627
201	21 400 000.000	-3.89023	-27.0444
202	21 400 250.000	-3.87197	-38.1645
203	21 400 500.000	-3.86201	-49.2992
204	21 400 750.000	-3.86110	-60.4254
205	21 401 000.000	-3.86756	-71.5805
206	21 401 250.000	-3.87042	-82.7343
207	21 401 500.000	-3.88188	-93.8655
208	21 401 750.000	-3.90479	-105.033
209	21 402 000.000	-3.91499	-116.241
210	21 402 250.000	-3.92191	-127.531
211	21 402 500.000	-3.92616	-138.906

MEASURE N= CENTER 21 400 000.000 Hz
SWEEP N= 1 + 401 SPAN 100 000.000 Hz

Figure 3-84. o-Marker on Table

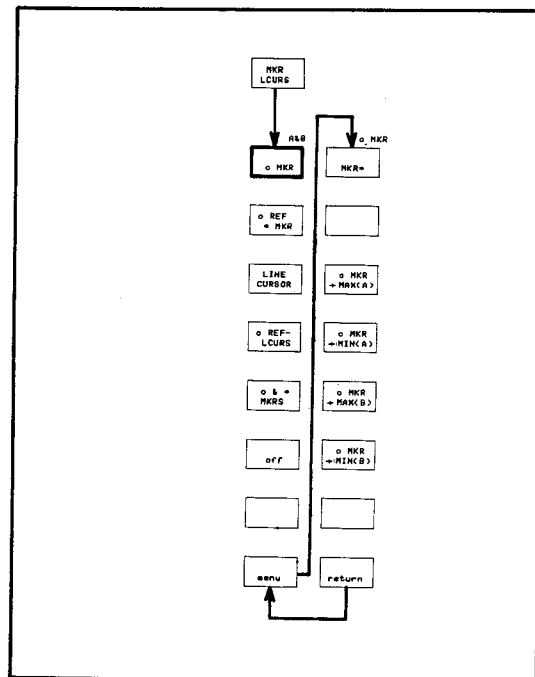

Figure 3-85. o-MARKER menu

MKR =:

Softkey used to move the markers by entering a sweep parameter value.

To use this key:

1. Press the 'o MKR' or 'o & * MKRS' softkey, and the 'menu' softkey. The "o MKR menu" or "o & * MKRS menu" will be displayed in the Menu Area.
2. Press the 'MKR =:' softkey, and the "MKR=" command will be displayed on the Keyboard Input line.
3. Enter the location to where you want to move the marker.
4. Press **ENTER/EXECUTE** to move the marker to the new location.
5. The data corresponding to the position of the marker will be displayed in Marker Area.

Note

If the entered value does not correspond to an existing measurement point then the marker will move to closest measurement point. The data corresponding to the position of the marker will be displayed in Marker Area.

OPERATION

o MKR --> MAX(A), and o MKR --> MAX(B):

These softkeys are used to move the marker to the measurement point with the greatest measured value. The data corresponding to the position of the marker will be displayed in Marker Area. If the analysis range is specified, the point will be searched for over the specified range.

o MKR --> MIN(A), and o MKR --> MIN(B):

These softkeys are used to move the marker to the measurement point with the smallest measured value. The data corresponding to the position of the marker will be displayed in the Marker Area. If the analysis range is specified, the point will be searched for over the specified range.

o REF- * MKR:

This softkey is used to set the "o REF- * MKR" (Delta Marker) mode. The 'o REF- * MKR' softkey is displayed only when the RECTAN X-A&B mode is selected. The o-marker and *-marker will appear on the traces as shown in Figure 3-86. The data displayed in the Marker Area is the deviation of the sweep parameter values and of measurement data A and B corresponding to the positions of the o-marker and the *-marker.

To select the Delta Marker mode:

1. Press the **MKR/L CURS** key. The **MKR/L CURS** menu will be displayed in Menu Area as shown in Figure 3-87.
2. Press the 'o REF-* MKR' softkey. The "o REF- * MKR" label will change to intensified green.
3. Press the 'menu' softkey. The o REF- * MKR menu will be displayed as shown in Figure 3-87.

The *-marker's position can be moved using the **MARKER/L CURSOR** knob and the '**DMKR=**' softkey. The o-marker cannot be moved. The o-marker's position must be specified using the "o MKR mode."

To exit the Delta Marker mode:

1. Press the 'return' softkey. The **MKR/L CURS** menu will return.
2. Press the 'off' softkey.

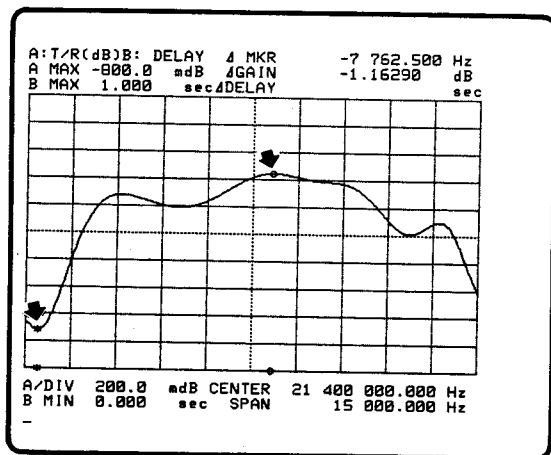

Figure 3-86. o REF - * MKR display

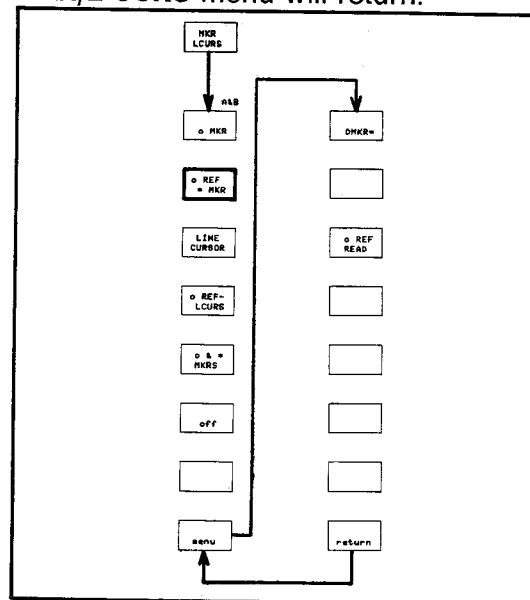

Figure 3-87. o REF- * MKR menu

DMKR=:

The '**DMKR=**' softkey is used to move the "*" -marker" by specifying the deviation.

To specify the deviation perform the following steps:

1. Press the '**o REF- * MKR**' softkey and the '**menu**' softkey. The **o REF- * MKR** menu will be displayed.
2. Press the '**DMKR=**' softkey. The "DMKR=" command will be displayed on Keyboard Input Line.
3. Enter the deviation value.
4. Press one of unit keys or the **ENTER/EXECUTE** key. The "*" -marker will move to the position of the deviation, and the deviations will be displayed in the Marker Area.

Note

If the deviation value entered does not correspond to an existing measurement points then the "*" -marker will move to measurement point closest to the deviation.

OPERATION

o-REF READ:

The 'o-REF READ' softkey is used to display the data corresponding to the position of the "o-marker" in the Marker Area of the screen. To turn this function off, rotate the **MARKER/L CURSOR** knob, and the data for the *-marker or the line cursor will return to the Marker Area. This softkey can be accessed only in the "o REF- * MKR", or "o REF- LCURS" mode.

LINE CURSOR:

The 'LINE CURSOR' softkey is used to select the "LINE CURSOR mode". The data corresponding to the measurement points (right and left) where the line cursor crosses the measurement traces will be displayed in Marker Area as shown below and in Figure 3-88.

CRS_A (or CRS_B): Data value where the Line Cursor is located.

LEFT: Sweep parameter value at the left crossing point.

RIGHT: Sweep parameter value at the right crossing point.

If there are 3 or more crossing points, the data at the extreme left and right crossing points will be displayed. Rotate the **MARKER/L CURSOR** knob to move the **LINE CURSOR** up and down on the display. Press the 'menu' softkey to display the menu shown in Figure 3-89.

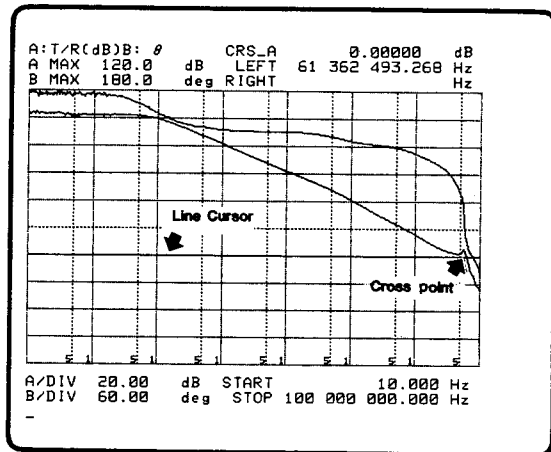

Figure 3-88. Line Cursor Display

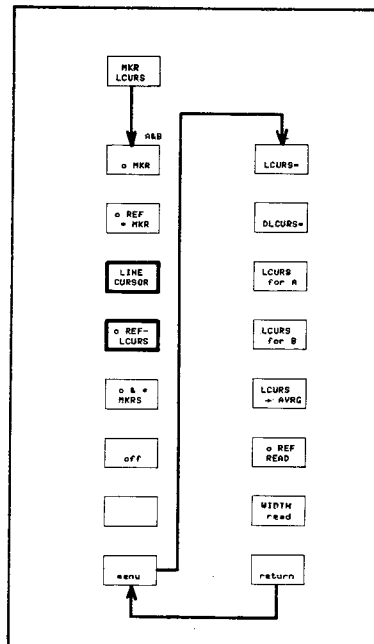

Figure 3-89. Line Cursor and o REF-LCURS menu

o-REF- LCURS:

This softkey is used to select the "o REF-LCURS (Delta Line Cursor) mode". In this mode, the o-marker and line cursor appear as shown in Figure 3-90.

The data displayed in the Marker Area is as follows:

1. **Δ CRS A:** The deviation between the measurement data corresponding to the position of the o-marker and line cursor.
2. **LEFT/RIGHT:** The sweep parameter values corresponding to the position of the crossing points between the line cursor and the data (A or B). Pressing the 'menu' softkey to display the menu shown in Figure 3-90.

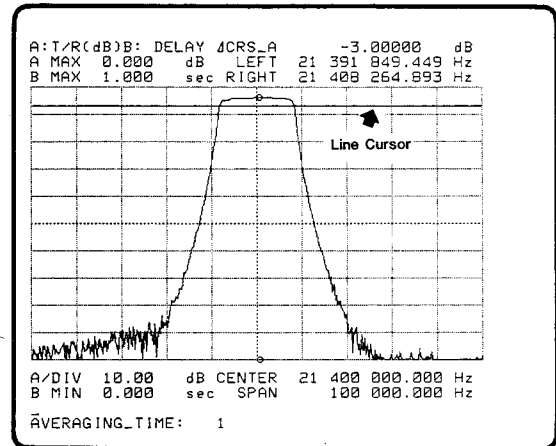

Figure 3-90. o REF- LCURS display

LCURS=:

The 'LCURS=' softkey is used to move the line cursor by specifying the measurement parameter value.

To move the line cursor:

1. Select 'LINE CURSOR' or 'o REF- LCURS' softkey.
2. Press the 'LCURS=' softkey, the "LCURS=" command will be displayed on Keyboard Input line.
3. To select data A or B, press the 'LCURS for A' or 'LCURS for B' softkey.
4. Enter the measurement parameter value of the location that you want to move the line cursor to.
5. Press the **ENTER/EXECUTE** key, the line cursor will move to the selected location.
6. The data corresponding to the positions of the line cursor will be displayed in the marker area.

OPERATION

DLCURS=:

The '**DLCURS=**' softkey is used to move the line cursor by specifying the deviation value of the measurement data corresponding to the position of both the o-marker and line cursor.

To use this softkey:

1. Press the '**o REF- LCURS**' softkey and then the '**menu**' softkey. The "o REF- LCURS" menu" will be displayed.
2. Press the '**DLCURS=**' softkey, and the "DLCURS=" command will be displayed on Keyboard Input line.
3. To select between data A and B, press the '**LCURS for A**' or the '**LCURS for B**' softkey in the menu.
4. Enter the deviation value of the location where you want to move the line cursor to.
5. Press **ENTER/EXECUTE**, and the line cursor will move to the location.
6. The new deviation and the data will be displayed in Marker Area.

LCURS for A:

This softkey is used to select data A to be referenced by the line cursor. To select data A, press this softkey.

LCURS for B:

The '**LCURS for B**' softkey is used to select data B to be referenced by the line cursor. Press this softkey to select data B.

LCURS --> AVRG:

When this softkey is pressed the 4194A takes the average of all of the measurement points in the analysis range.

To get the averaging position:

1. Select the data set to be averaged using the '**LCURS for A**' or '**LCURS for B**' softkey.
2. Press the '**LCURS → AVRG**' softkey. The line cursor will move to the averaged position.
3. The value of the averaged data will be displayed in Marker Area.

Note

If you are in the partial analysis mode, then the averaging function will be performed only over the specified range and any measurements outside of this range will be ignored.

WIDTH read:

This softkey is used to read the difference value between two registers, **LCURSR** and **LCURSL**. When this softkey is pressed while in the **LINE CURSOR** or **o REF-LCURS** mode, the **WIDTH** value will be displayed in the Marker/L Cursor Area. Note that if only one or no point of intersection exists, then the **WIDTH** value will not be displayed in the Marker/L Cursor Area. The Width display will be released when the Line Cursor is moved with the Rotary knob.

o- & *-MKRS:

This softkey is used to select the **o & * MKRS** (Double Marker) mode. In this mode, the **o-** and ***-**markers appear as shown in Figure 3-91. The Partial Sweep Range and Partial Analysis Range can be specified using these markers. The markers can be moved independently by rotating the **MARKER/L CURSOR** knob and using the '**o-MKR control**' and '*** MKR control**' softkeys. The data displayed in the Marker Area also can be selected using softkeys. Pressing the '**menu**' softkey, will display the **o- & *-MKRS** menu as shown in Figure 3-92.

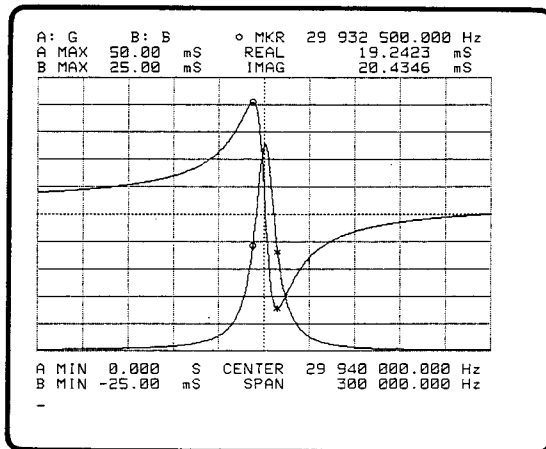

Figure 3-91. o- & *-Marker Display

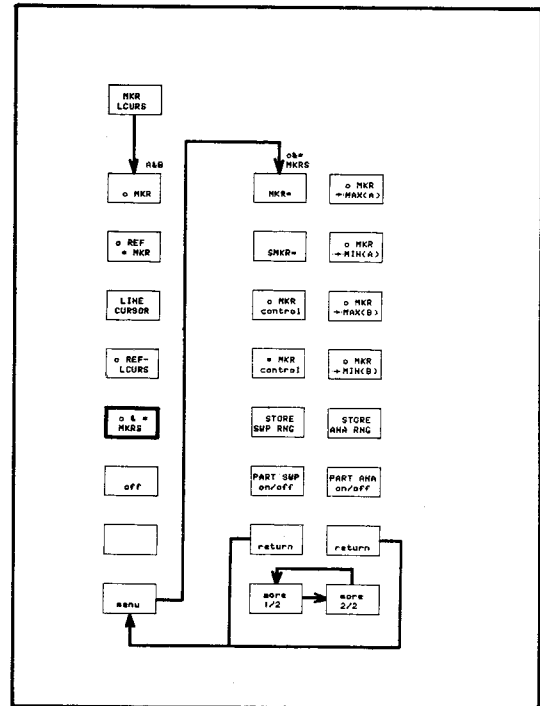

Figure 3-92. "o- & *-MKRS" menu

3: Operation

OPERATION

SMKR=:

This softkey is used to move the *-marker by entering the sweep parameter value using the **ENTRY** keys.

To move the *-marker:

1. Press the **MKR/L CURS** key. The **MKR/L CURS** menu will be displayed.
2. Press the '**o & * MKRS**' softkey to display the "o & * MKRS menu".
3. Press the '**SMKR=**' softkey, "SMKR=" will be displayed on the Keyboard Input Line.
4. Enter the sweep parameter value for the position where you want to place the *-marker.
5. Press **ENTER/EXECUTE**.
6. The *-marker will move to the selected position.
7. To verify the position, press the '* **MKR control**' softkey. The value corresponding to the position of *-marker will be displayed.

Note

If the sweep parameter value entered does not correspond to an existing measurement point then the *-marker will move to the nearest measurement point.

o-MKR control, *-MKR control:

This softkey is used to select the o- or *-marker, and displays the data corresponding to the position of the marker in Marker Area. The marker selected can be moved by rotating the **MARKER/L CURSOR** knob.

To use these softkeys:

1. Press the **MKR/L CURS** key. The **MKR/L CURS** menu will be displayed.
2. Press the '**o & * MKRS**' softkey, and then the '**menu**' softkey. The **o & * MKRS** menu will be displayed.
3. Select and press one of these keys to display the data. The marker can be moved using the **MARKER/L CURSOR** knob.

STORE SWP RNG:

This softkey is used to store the sweep range specified by the markers (o and *) for a partial sweep.

To use this softkey:

1. Press the **MKR/L CURS** key to display the **MKR/L CURS** menu.
2. Press the 'o & * MKRS' softkey and then the 'menu' softkey to display the "o-& *-MKRS menu".
3. Move the o- and *-marker using the 'o MKR control' and '* MKR * control' softkeys to the start- and stop-positions of the partial sweep range you want.
4. Press the **'STORE SWP RNG'** softkey.
5. To verify the range settings, press the **'PART SWP on/off'** softkey, the "PART SWP on/off" label should intensify. The " " marks will be displayed below the graticule as shown in Figure 3-93, and the partial sweep will be performed between the limits set by the markers.

Partial sweep will not be performed if the **'PART SWP on/off'** softkey is in the "off" state.

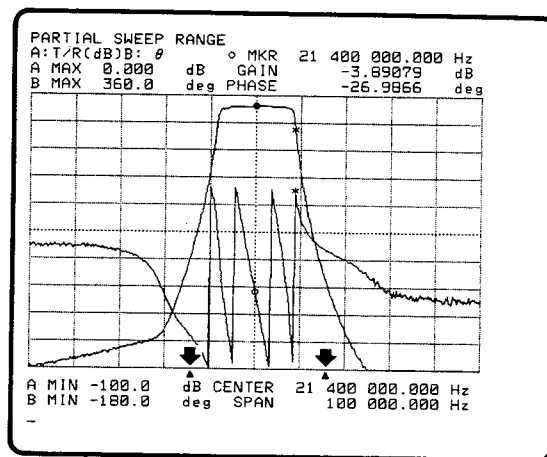

Figure 3-93. Partial Sweep Range

OPERATION

PART SWP on/off:

This softkey is used to perform a partial sweep over the range specified by the o- and *-markers and previously stored using the **'STORE SWP RNG'** softkey. This key is a two position push-to-toggle switch. Intensification of a label indicates that it is **ON**, otherwise it is **OFF**.

To use the **'PART SWP on/off'** softkey:

1. Press the **'o & * MKRS'** softkey and then the **'menu'** softkey. The "o-& *-MKRS menu" will be displayed.
2. Move the o- and *-marker using the **'o MKR control'** and **'* MKR control'** softkeys to the start- and stop-positions of the partial sweep range you want.
3. Press the **'STORE SWP RNG'** softkey.
4. Press the **'PART SWP on/off'** softkey, the softkey label should change to intensified green. The "▲" marks will be displayed below the graticule as shown in Figure 3-93, and a partial sweep will be performed over the range set by the markers.
5. To exit the partial sweep mode and return to the full sweep mode press this key again.

STORE ANA RNG:

This softkey is used to store the analysis range specified by the o- and *-markers in the partial analysis mode. If the Partial Analysis Range has been specified, all analysis is performed only over the specified range and any measurements outside of this range will be ignored.

To use this key:

1. Press the **'o & * MKRS'** softkey and then the **'menu'** softkey to display the **o-& *-MKRS** menu.
2. Move the o-marker and *-marker using the **'o MKR control'** and **'* MKR control'** softkeys to select the partial analysis range you want.
3. Press the **'STORE ANA RNG'** softkey.
4. Verify the range settings by pressing the **'PART ANA on/off'** softkey, the soft key label should change to intensified green. The "▲" marks will be displayed below the graticule as shown in Figure 3-94.

Partial analysis will not be performed if the **'PART ANA on/off'** softkey is in the "off" state.

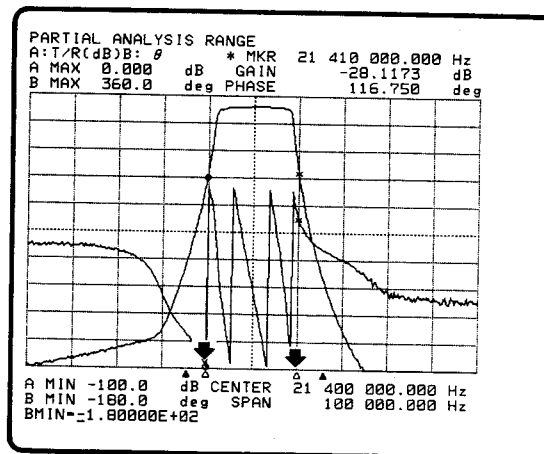

Figure 3-94. Partial Analysis Range

PART ANA on/off:

This softkey is used to perform a partial analysis over the range specified by the o- and *-markers and previously stored using the **'STORE ANA RNG'** softkey. This key is a two position push-to-toggle switch. Intensification of the label indicates it is **ON**, otherwise it is **OFF**.

To use this softkey:

1. Press the 'o & * MKRS' softkey and then the 'menu' softkey. The "o-& *-MKRS menu" will be displayed.
2. Move the o- and *-markers using the 'o MKR control' and '* MKR control' softkeys to the desired limits for the partial analysis sweep range.
3. Press the **'STORE ANA RNG'** softkey.
4. Press the **'PART ANA on/off'** softkey the softkey label will change to intensified green. The "▲" marks will be displayed below the graticule as shown in Figure 3-94.
5. To exit the partial analysis mode and return to the full analysis mode, press the **'PART ANA on/off'** softkey again.

off:

This softkey is used to exit the marker and line cursor modes, and to delete the markers and line cursor from the screen. The partial sweep and partial analysis which have been previously specified are active in this mode. To turn off them, the "o & * MKRS mode" must be recalled.

OPERATION

MORE MENUS key:

This key is used to display the menus as shown in Figure 3-95. PROGRAM, HP-IB DEFINE, COPY menu, SELF TEST, measure page, EQUIVALENT CIRCUIT, and SET PROG TABLE can be accessed.

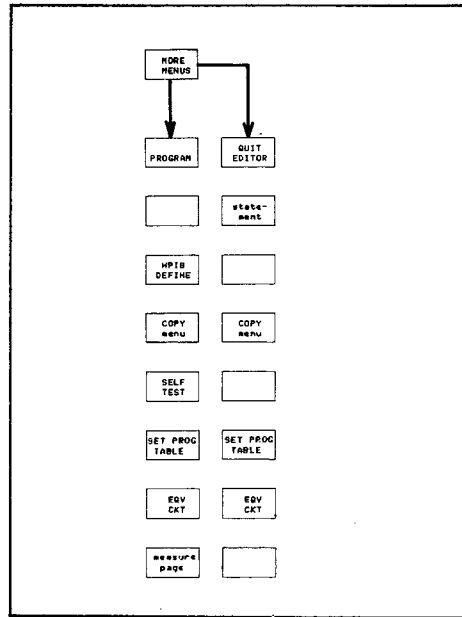

Figure 3-95. MORE MENUS menu

PROGRAM:

This softkey is used to display the menus as shown in Figure 3-96. These menus are used to edit and execute an auto sequence program. Refer to Auto Sequence Program under the EXTENDED CAPABILITIES in Section 3 for more details.

EDIT:

This softkey is used to edit a new program or a stored programs. Before editing a new program, scratch the program in the working area with pressing 'SCRATCH' softkey and **ENTER/EXECUTE**.

CAUTION

SAVE THE PROGRAM IN THE WORKING AREA USING THE 'STORE' SOFTKEY BEFORE SCRATCHING, BECAUSE USING THE 'SCRATCH' SOFTKEY WILL SCRATCH ALL PROGRAM LINES IN THE WORK AREA.

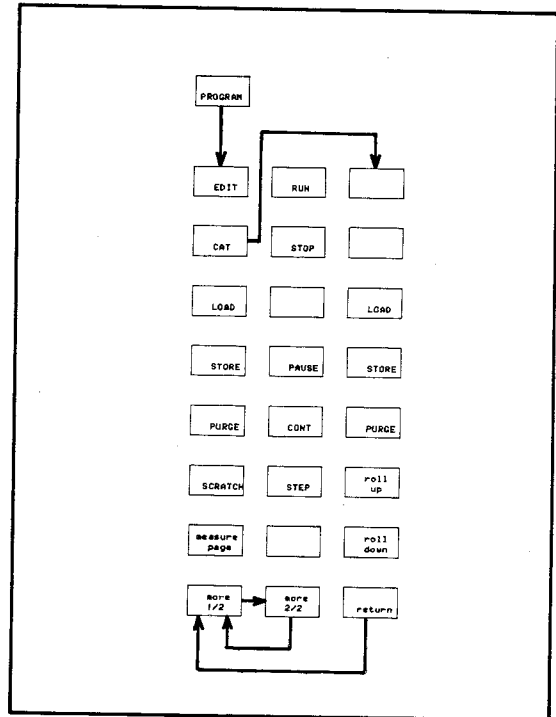

Figure 3-96. PROGRAM menu

Select this key to display the "EDIT" command on the Keyboard Input Line. Then enter the program-edit line number (for example 100) that you want to start the program with, then press **ENTER/EXECUTE**. A Program Editor Page will be displayed as shown in Figure 3-97. Then you can start to edit a new program. If a program-edit line number is not entered, line "10" will be displayed by default.

To edit a program which is stored in program storage area of 4194A, use the 'LOAD' softkey to call the program into the working area, then select the 'EDIT' softkey and enter the line number which you want to edit, as shown below.

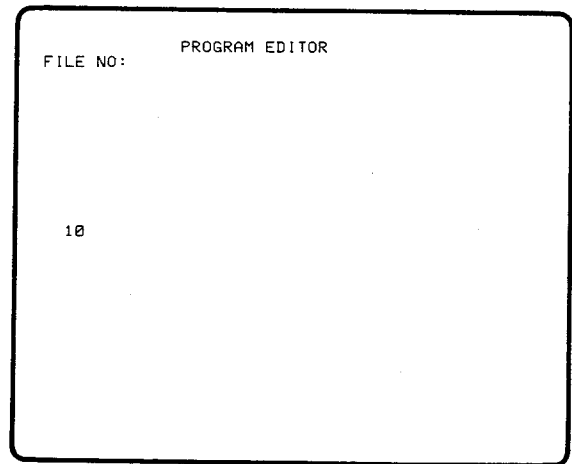

Figure 3-97 Program Editor Page

Press the 'LOAD' softkey, 5 key, **ENTER/EXECUTE** key, 'EDIT' softkey, 1, 0, 0, keys, and the **ENTER/EXECUTE** key,

The program (File No. 5) will be displayed and the cursor will be positioned at program-edit line 100. Now you can edit the program from line 100. If a program edit line number is not defined, the cursor will be positioned at line 10 by default.

3: Operation

OPERATION

CAT:

This softkey is used to display the Program Catalog of programs stored in the program storage area. You can find out the file number comment of the program from the program Catalog List.

LOAD:

This softkey is used to call the program to the work area (screen). To execute or to edit, the program must be called into the work area from the program storage area of the 4194A. Press the '**LOAD**' softkey and enter the file number of the required program, then press **ENTER/EXECUTE**. Pressing the '**EDIT**' softkey and the **ENTER/EXECUTE** key will display the program.

STORE:

This softkey is used to store the program into the program storage area. Press this softkey and enter a file number, then press **ENTER/EXECUTE**. A file number of 1 to 999 can be selected. If the file number already exist, the system message "The same file number exists" will be displayed. In this case, the old file will be purged before storing the new program, otherwise the file number of the new program should be changed. When the program is stored, a comment (max of 19 characters) can be attached on the file by using " " as shown below.

STORE4, "comment"

A "comment" will be displayed in the FILE COMMENT area of PROGRAM CATALOG LIST. Programs are stored in nonvolatile memory so they are not lost when the instrument is turned off.

PURGE:

This softkey is used to purge a file which is stored in the program storage area. Press the **'PURGE'** softkey and the **PURGE** command will be displayed on Keyboard Input Line, then enter the file number to be purged and press **ENTER/EXECUTE**. The file will be deleted from PROGRAM CATALOG LIST. The program in the work area will not be affected.

SCRATCH:

SCRATCH is used to delete a program from the work area. Press this softkey and **ENTER/EXECUTE**. When editing a new program, the program in the working area must be scratched using this softkey. The programs in the program storage area will not be affected.

CAUTION

BEFORE EXECUTING THE SCRATCH COMMAND USE THE 'STORE' SOFTKEY TO SAVE THE PROGRAM IN THE WORK AREA BECAUSE THE SCRATCH COMMAND DELETES ALL PROGRAM LINES IN THE WORK AREA.

measure page:

This softkey is used to exit the **PROGRAM** function and return to the **MEASUREMENT** function. The **DISPLAY** menu will be displayed.

RUN:

This softkey is used to start the program which is in the work area. While a program is executing, all keys and softkeys, except for the **'STOP'** and **'PAUSE'** softkeys, are locked out. Execution always starts from the top of the program.

STOP:

The **STOP** softkey is used to stop program execution. To restart from the top of the program press the **'RUN'** or **'STEP'** softkey. The **'CONT'** softkey will not restart program execution.

PAUSE:

The **PAUSE** softkey is used to stop program execution. To start program execution at the next program line, press the **'CONT'** or **'STEP'** softkey. After pressing one of these softkeys, all of the keys and softkeys will be unlocked.

CONT:

This softkey is used to start program execution from the point it was stopped by the **'PAUSE'** softkey.

OPERATION

STEP:

This softkey is used to execute a program step by step. If the execution has been stopped by pressing the '**STOP**' softkey, execution will be started from the start of the program. If a program was stopped with the '**PAUSE**' softkey, execution will start at the next statement.

roll up and roll down:

These are the softkeys used to scroll up or down through a program.

HP-IB DEFINE:

This softkey is used to display the menu shown in Figure 3-98, and is used to define the instrument's HP-IB Interface. The 4194A interface to an HP-IB bus with or without a controller. The ADDRESSABLE and TALK ONLY modes can be selected, and HP-IB also can be set by using the '**HP-IB ADDRESS**' softkey. (There are no address switches.) The HP-IB address which has been set is stored in non-volatile memory. If the contents of nonvolatile memory are destroyed, the HP-IB address defaults to 17. Refer to HP-IB under Extended Capabilities in this section for more details.

ADDRESSABLE:

This softkey is used to set the 4194A to the Addressable mode.

TALK ONLY:

This softkey is used to set the 4194A to the Talk Only mode.

HP-IB ADDRESS:

This softkey is used to view and to set the 4194A's HP-IB address. This address is set by default to 17 and may be set to any number from 0 to 30, inclusive.

- 1) Press the HP-IB ADDRESS softkey, then be sure "ADRS=(current value)" is displayed on the Keyboard Input Line.
- 2) If the address needs to be changed, enter the new address (from 0 to 30), then press **ENTER/EXECUTE**.
- 3) To verify that the new address is set, press the '**HP-IB ADDRESS**' softkey.

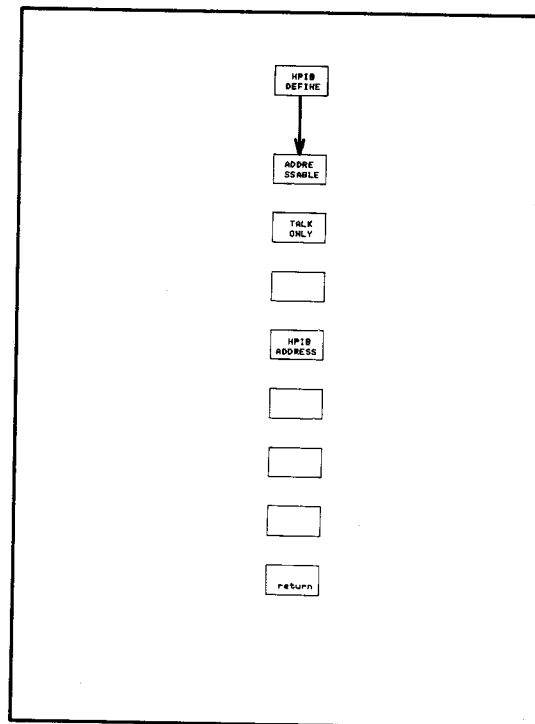

Figure 3-98. HP-IB DEFINE menu

COPY menu:

This softkey is used to display the menus shown in Figure 3-99. The menus are used to reproduce the display on paper using a plotter or printer without a controller. The 4194A must be in **TALK ONLY** mode. The printer must be configured to the **LISTEN ONLY** mode.

Note

Refer to **COPY** in **EXTENDED CAPABILITIES**, Paragraph 3-6-7 for more details.

PLOT mode:

This softkey is used to plot the information on the display screen onto a plotter. After this key is pressed, the '**PLOT menu**' softkey must be pressed to get the other menus required to set the 4194A and the plotter. Press the **COPY** key to start printing. In the **PLOT** mode, only **RECTANGULAR X-A&B**, and **RECTANGULAR A-B** are available.

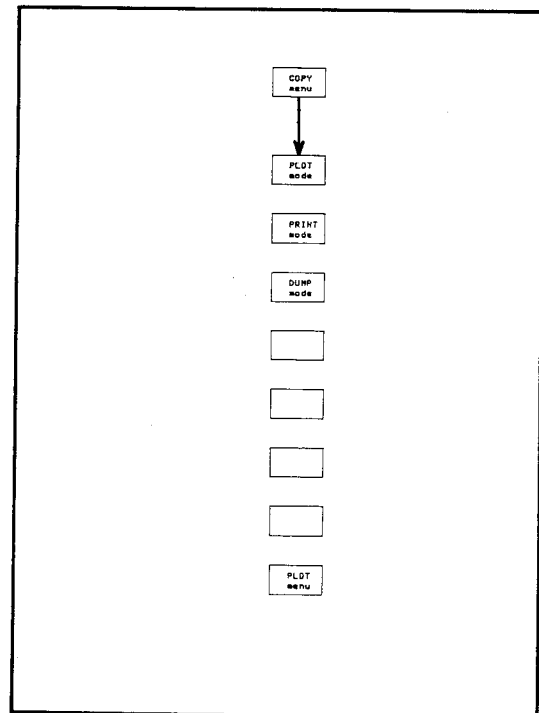
Figure 3-99. **COPY** menu**Note**

If you try to use **TABLE**, **EQUIVALENT CIRCUIT**, **EDIT**, **CATALOG** and **SELF TEST** to plot with a plotter, an error message, "can plot only X-A&B/A-B page", will be displayed on Keyboard Input Line when the **COPY** key is pressed.

PRINT mode:

This softkey is used to print **RECTANGULAR X-A&B**, **RECTANGULAR A-B**, **TABLE**, **ASP PROGRAM**, **CATALOG**, and **PROGRAMMED POINTS TABLE** to a printer without the need of a controller. Press the **COPY** key to start printing.

DUMP mode:

This softkey is used to dump the information on the display to a printer equipped with Raster Graphics Capability. All information displayed on the screen, except for the softkey menus, can be dumped to a printer.

OPERATION

PLOT menu:

This softkey is used to display the menu shown in Figure 3-100. After the '**PLOT mode**' softkey is pressed, press this key to get more menus for selecting the plot parameters, and setting the plot size.

ALL:

This softkey is used to plot all the information in the display screen, except the softkey menus.

GRTCL & DATA:

This softkey is used only to plot the following items.

- DATA A
- DATA B
- DATA C (superimpose is on.)
- DATA D (superimpose is on.)
- Graticule

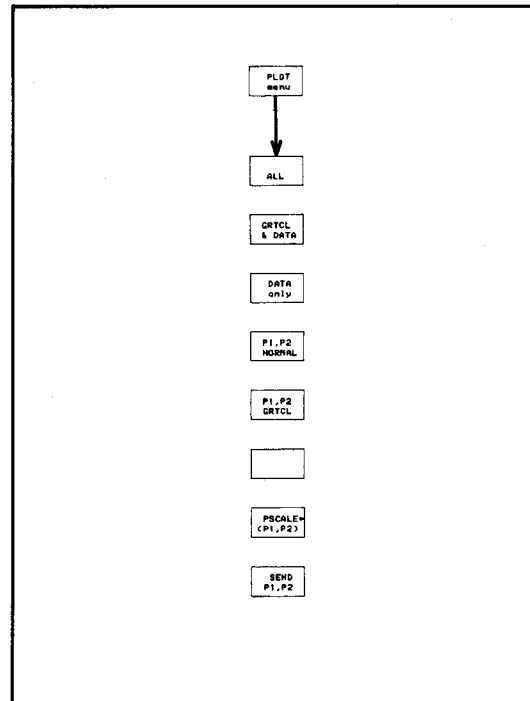

Figure 3-100. PLOT menu

DATA only:

The '**DATA only**' softkey used to plot only the following items.

- DATA A
- DATA B
- DATA C (if superimpose is on)
- DATA D (if superimpose is on)

P1, P2 NORMAL:

This softkey is used to plot all information shown on the screen into the area scaled using P1 and P2 as shown in Figure 3-101.

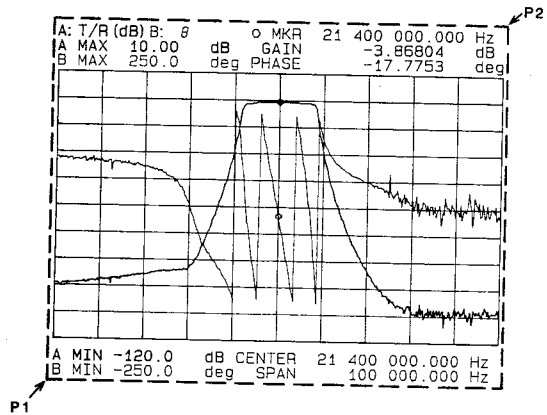

Figure 3-101. P1, P2 NORMAL

P1, P2 GRTCL:

This softkey is used to plot only the screen graticule into the area scaled using P1 and P2, as shown in Figure 3-102. The information outside of the graticule will be plotted outside of the area.

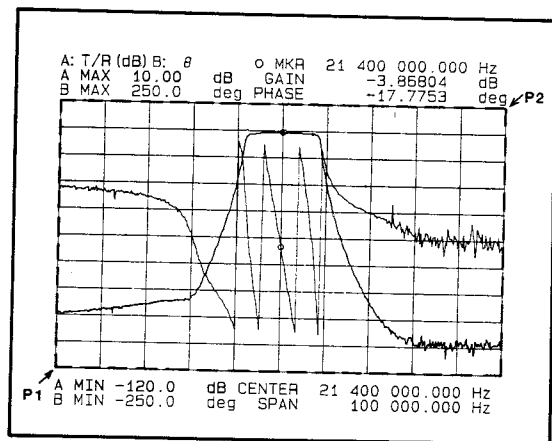

Figure 3-102. P1, P2 GRATICULE

PSCALE=(P1, P2):

This softkey is used to set new values for P1 and P2. Select this softkey, then enter new values using as delimiters "," as shown in Figure 3-103 and press **ENTER/EXECUTE**. The values are stored in non-volatile memory, and called to the Keyboard Input Line when this key is pressed. If the values are accidentally lost from memory, the default values, 2000, 800, 9200, 7208 will be displayed on the Keyboard Input Line. Refer to EXTENDED CAPABILITY, Paragraph 3-6-7-5 for more details.

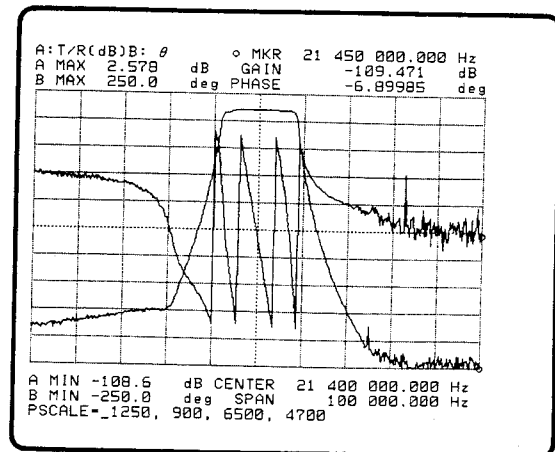

Figure 3-103. PSCALE=(P1, P2)

OPERATION

SEND P1,P2:

The 'SEND P1 P2' softkey is used to send new values for P1 and P2 to the plotter. To set the new plot size, change P1 and P2 using PSCALE=(P1, P2), then press this softkey. The new P1 and P2 will be stored in the plotter, and they can be verified by using the P1 and P2 keys on the plotter's front panel.

SELF TEST:

This softkey is used by trained service personnel to initiate tests, adjustments and troubleshooting of the 4194A. **SELF TEST** is a Service function, so if you get into the **SELFTEST** mode, press the 'TEST END' softkey to exit.

measure page:

This softkey is used to exit the **PROGRAM** function and the **MORE MENU** function, and return to the measurement function display, the **DISPLAY** menu will be displayed in the menu area.

EQV CKT:

This softkey is used to select the **EQUIVALENT CIRCUIT** function, and to display the EQUIVALENT CIRCUIT MODE page and the menu shown in Figures 3-104 and 3-105. This function is used to approximate the equivalent circuit parameters, and to simulate the DUT's the frequency characteristic when the value of the parameters are changed.

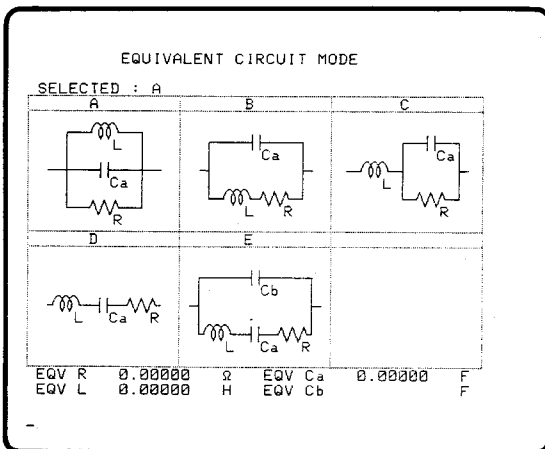

Figure 3-104. EQUIVALENT CIRCUIT

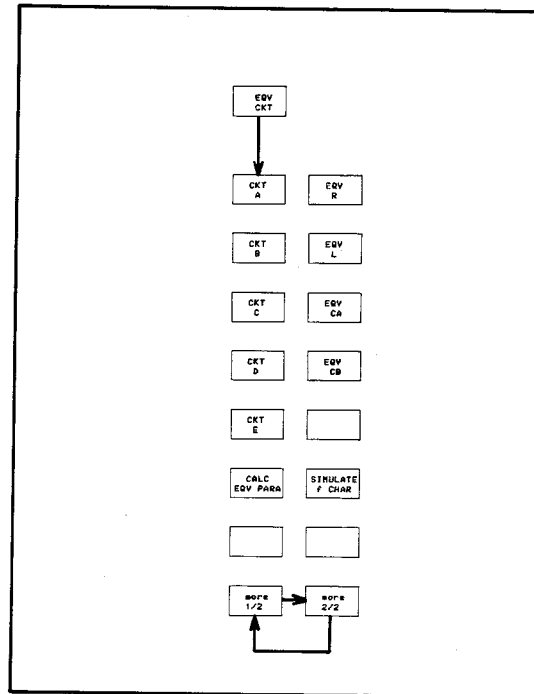

Figure 3-105. EQV CKT menu MODE Page

CKT A/B/C/D/E:

Use this softkey select the equivalent circuit mode to be used for calculating equivalent circuit parameters, and to simulate the frequency characteristics of the selected equivalent circuit. It is very important to select the appropriate equivalent-circuit mode for the DUT being analyzed. CKT A is the power on default selection. Refer to the EQUIVALENT CIRCUIT paragraph under EXTENDED CAPABILITIES in this section for more details.

CALC EQV PARA:

Press the '**CALC EQV PARA**' softkey to calculate the equivalent-circuit parameters. The message, "Calculating EQV parameters", will appear in the System Message Area for several seconds, then the message, "Calculation complete", will be displayed in the System Message Area and the calculated parameters will be displayed at the bottom of the display. Because the data will be used for calculation, the data taken by the Impedance measurement function or from a Programmed Points table must be stored in registers A and B.

EQV R/L/CA/CB:

Press this softkey to change the equivalent parameter values (R, L, CA, CB) at the bottom of the EQUIVALENT CIRCUIT MODE page.

To use them:

1. Press the equivalent circuit softkey for the equivalent circuit that you want to change. The "**EQVR=**" (**EQVL=**, **EQVCA=**, or **EQVCB=**) command will be displayed on the Keyboard Input Line.
2. Enter a new value using the **ENTRY** keys, and press **ENTER/EXECUTE**.
3. The entered value will be displayed at the bottom of the EQUIVALENT CIRCUIT MODE page.

SIMULATE f CHAR:

Press this softkey to calculate frequency characteristics according to the parameters and the equivalent circuit mode specified by the user. The message, "Calculating f characteristics", will be displayed for several seconds, then the message "Calculation complete" will appear. The frequency characteristics calculated will be displayed with the data which is stored in the A and B register. The main purpose of this function is to verify that the calculated equivalent parameters are approximated close enough to the measured characteristics of the DUT. Simulated data will be stored into the C and D registers and displayed.

OPERATION

SET PROG TABLE:

Used to display the PROGRAM TABLE and its menu shown in Figure 3-106. Refer to PROGRAMMED POINT TABLE under EXTENDED CAPABILITIES in this section for more details.

PROGRAMMED POINTS TABLE 1				
SWEEP: FREQUENCY(Hz)				
N	SWEEP POINTS	MINIMUM	LIMIT FOR DATA	MAXIMUM
1	21 357 000.000	0.00000	5.00000E-02	5.00000E-02
2	21 388 000.000	0.00000	5.00000E-02	5.00000E-02
3	21 388 600.000	0.00000	5.00000E-02	5.00000E-02
4	21 389 000.000	0.00000	5.00000E-02	5.00000E-02
5	21 389 000.000	2.50000E-02	7.50000E-02	7.50000E-02
6	21 390 400.000	5.00000E-02	1.50000E-01	1.50000E-01
7	21 391 000.000	1.50000E-01	3.00000E-01	3.00000E-01
8	21 391 600.000	3.50000E-01	5.00000E-01	5.00000E-01
9	21 392 200.000	5.00000E-01	6.00000E-01	6.00000E-01
10	21 392 800.000	5.50000E-01	6.50000E-01	6.50000E-01
11	21 400 000.000	5.50000E-01	6.50000E-01	6.50000E-01
12	21 407 200.000	5.50000E-01	6.50000E-01	6.50000E-01
13	21 407 800.000	5.00000E-01	6.00000E-01	6.00000E-01
14	21 408 400.000	3.50000E-01	5.00000E-01	5.00000E-01
15	21 409 000.000	1.50000E-01	3.00000E-01	3.00000E-01
16	21 409 600.000	4.00000E-02	1.50000E-01	1.50000E-01
17	21 410 200.000	2.00000E-02	7.00000E-02	7.00000E-02
18	21 410 800.000	0.00000	5.00000E-02	5.00000E-02
19	21 411 400.000	0.00000	5.00000E-02	5.00000E-02
20	21 412 000.000	0.00000	5.00000E-02	5.00000E-02
21	21 415 000.000	0.00000	5.00000E-02	5.00000E-02

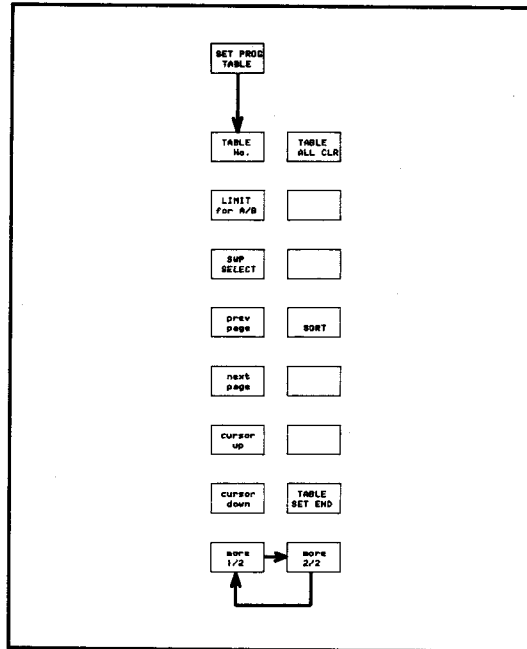

Figure 3-106. PROGRAM TABLE, and SET PROGRAM TABLE menu

TABLE No:

Used to select table 1 through 16. When SET PROG TABLE is selected, PROGRAMMED POINT TABLE "1" is the Power-on default selection. Pressing this softkey increments the table number and displays the new table. You can use any table displayed on the screen to make a new table.

LIMIT for A/B:

The 'LIMIT for A/B' softkey is used to select the data to be limited by this table. This is a push-to-toggle softkey. Pressing this key will change the LIMIT FOR DATA to A or to B.

SWP SELECT:

Press this softkey to select the sweep parameters. The default parameter is FREQUENCY, pressing this key will change the sweep parameter in the following order, DC BIAS(V), OSC LEVEL(V), OSC LEVEL(dBm) and OSC LEVEL(dBV). A sweep parameter must be selected for each table.

previous page:

Shows the previous page of your program table.

next page:

Shows the next page of your program table.

cursor up:

Pressing this softkey moves the cursor up one line. If you continue pressing this softkey down, the cursor will continue moving toward the top of the table and when it reaches the top of the table it will jump to the bottom of the table and start up again.

cursor down:

This softkey moves the cursor down one line each time it is pressed. If you hold the key down, the cursor will continue to move toward the bottom of the table and cycles until you release the key.

TABLE ALL CLR:

Press this softkey to clear the displayed table to be edited and displayed on the screen. The comment "ENTER to execute All CLEAR" will be displayed in yellow, press **ENTER/EXECUTE** if you want to clear the table.

Note

Don't use this key to delete a single line, if you do, you will lose all data you entered into the table. Use the **CLEAR LINE** key in the **EDIT** section to delete a single line.

SORT:

Arranges the order of the sweep parameter values entered into the table, and renumbers them.

TABLE SET END:

Press this softkey to exit the **SET PROGRAM TABLE** function. If you are in the **SET PROGRAM TABLE** function, all keys are locked except for the **EDIT** keys, **ENTRY** keys and the displayed softkeys. Press this softkey to release the lock, to exit the **SET PROGRAM TABLE** function, and to move to other functions.

POINT=:

This softkey is displayed in the edit mode, and is pressed to enter the SWEEP POINT, MAXIMUM value, and MINIMUM value from an AUTO SEQUENCE PROGRAM or an HP-IB program to the table. When this softkey is pressed, "POINT=" will be displayed on the line being edited.

Enter the point and values in the following format: POINT=(sweep point), (minimum value), (maximum value) then press **ENTER/EXECUTE** to enter the data. Press again to enter the next point data.

OPERATION

QUIT EDITOR:

Press this softkey to quit the **EDITOR** mode. If you want to exit from the **EDITOR** mode, press the **MORE MENUS** key, then press this softkey.

statement:

This softkey is used to display the menus shown in Figure 3-107. These fifteen BASIC statements can be used in Auto Sequence Programs. Refer to Auto Sequence Program under **EXTENDED CAPABILITIES** in this section for more details.

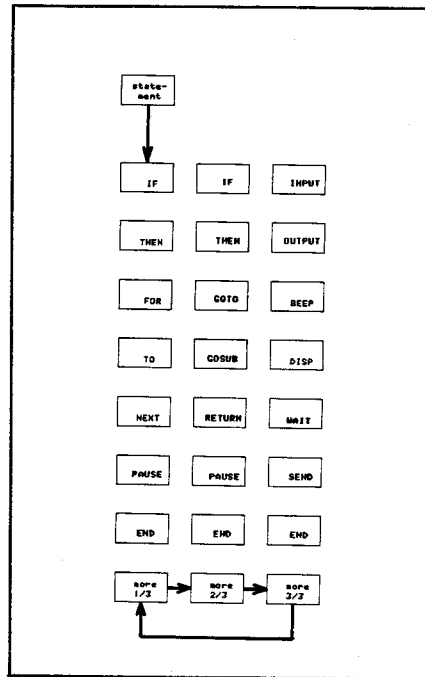

Figure 3-107. Statement Menu

SWEEP MODE Keys:

These keys are used to select **REPEAT**, **SINGLE** or **MANUAL** sweep. These keys start and stop a measurement sweep. The default sweep selection is **REPEAT**.

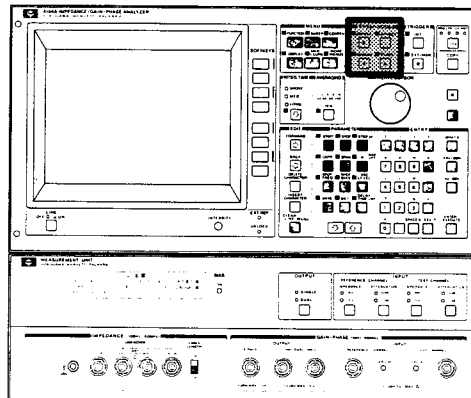

Figure 3-108. SWEEP MODE Keys

REPEAT Key:

Press this key to start a new sweep after the completion of each sweep. Pressing the **START** key will reset the sweep in progress; after waiting for recovery and settling to take place the next sweep will begin. The results of the previous measurement sweep are updated during each new measurement sweep.

SINGLE Key:

Press this key to select the **SINGLE** sweep mode. A single sweep is made each time the **START** key is pressed. When this key is pressed, the sweep in progress is reset to the ready state. While in **SINGLE** sweep mode the **START** key is pressed to start a new sweep, and may also be used to stop the sweep in progress and start a new sweep.

MANUAL Key:

Press this key to manually sweep using the **MARKER/L CURSOR** knob. When in the **MANUAL** sweep mode, the **START** key lamp will be on.

Pressing this key, stops the sweep in progress and the 0 marker will appear on the trace (from a previous measurement), and "MANUAL=" will be displayed on the Keyboard Input Line. Data for the marker point will be indicated on the marker block.

To make a new measurement at the point of interest, enter the value which indicates the point of interest, such as of a frequency, on Keyboard Input Line, then press **ENTER/EXECUTE** or one of the unit keys. The marker will move to the selected point. Rotate the **MARKER/L CURSOR** knob to make a new sweep and measurement.

Note

MANUAL SWEEP does not allow the user to make measurements at a point that wouldn't be sampled in an automatic sweep of the same span. The new value must be within the sweep range set.

START Key:

Press this key to immediately stop the sweep in progress and start a new sweep. This key is effective only in the **REPEAT** and **SINGLE** sweep modes.

TRIGGER Keys:

These keys are used to select 4194A's triggering mode used to initiate measurements. The default selection is **INTERNAL** trigger.

INT Key:

Press this key to select internal trigger. In this trigger mode measurements are automatically repeated. Trigger speed depends on the type of measurement, test frequency, and the measurement mode.

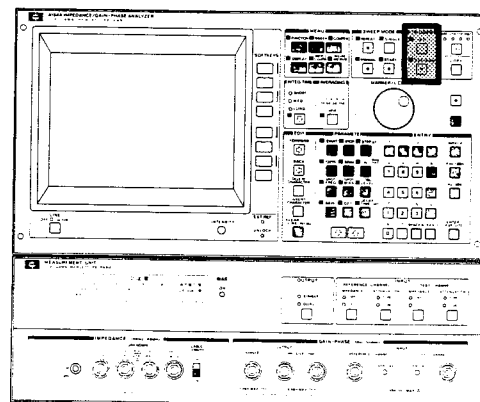

Figure 3-109. TRIGGER Keys

OPERATION

EXT/MAN Key:

This key selects the external trigger input on the back panel as the trigger source. Measurements can also be triggered via HP-IB, refer to the paragraph HP-IB under Extended Capabilities in this section.

If an EXT Trigger pulse is not applied, the measurement will be triggered each time the **EXT/MAN** key is pressed.

HP-IB Status Indicators:

The HP-IB Status Indicators consist of four LED lamps located on the front panel. These lamps when show the existing status of the 4194A in the HP-IB system as follows, when on.

- SRQ** : 4194A'S SRQ signal to the controller is on the HP-IB line.
- LISTEN** : The 4194A is set to be listener.
- TALK** : The 4194A is set to be talker.
- REMOTE** : The 4194A is in the remote mode.

LCL Key:

The **LOCAL** key is located in the HP-IB Status block on the front panel. This block has four LED indicators to show the HP-IB status for REMOTE, TALK, LISTEN and SRQ. If the REMOTE LED is illuminated, none of the front panel keys are effective until until the **LOCAL** key returns LOCAL control (Which extinguishes the REMOTE LED). If the HP-IB controller has sent the LOCAL LOCKOUT command and the REMOTE LED is illuminated, the **LOCAL** key can not gain LOCAL control.

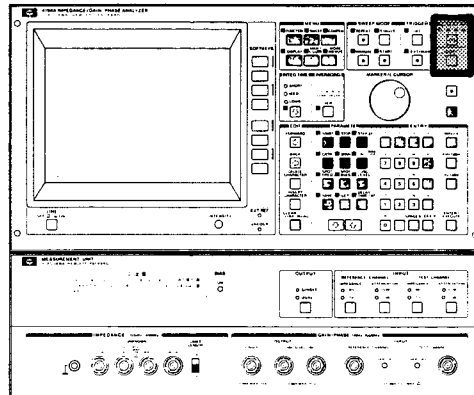

Figure 3-110. **LOCAL** and **COPY** Keys

COPY Key:

Press the **COPY** key to copy a screen display using an HP-IB connected printer or plotter. Before pressing the **COPY** key, set the 4194A to TALK ONLY and the printer or plotter to LISTEN ONLY, then press the **MORE MENUS** key to select the COPY mode (PLOT, PRINT, or DUMP). For more details, refer to COPY under EXTENDED CAPABILITIES in this section.

To abort the COPY command, press this key again.

INTEG TIME Key:

Selects the digital integration time. MED or LONG integration times eliminate noise on the trace but increases the sweep time. SHORT is the default setting at power on. To select an integration time, press the **INTEG TIME** key. Each time you press this key the integration time changes to the next value in order, SHORT, MED and LONG and then back to SHORT. The integration time can be changed at any time, even during a measurement. The approximate integration time for each mode is:

SHORT	500μsec
MED	5msec
LONG	100msec

AVERAGING (VIEW) Key:

Press this key to view and select the weighting factor. The default weighting factor is 1. The weighting factor can be set to 1, 2, 4, 8, 32, 64, 128, or 256. Averaging is used for reducing the effects of noise. When adjusting the response of a device it is best to select a lower value weighting factor, (like 1, 2, or 4) shows the response faster than a large weighting factor. If you want a very good "final" picture, then select a weighting factor of 256. The greater the weighting factor, the more noise will be averaged out, see Figure 3-112.

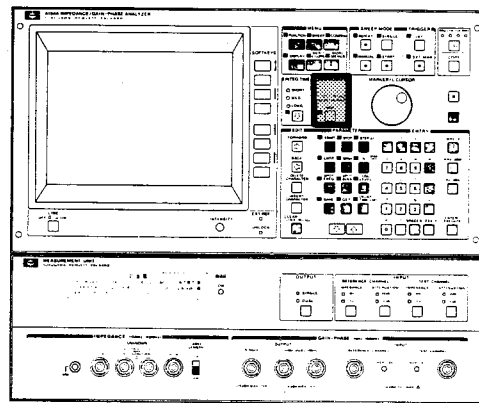
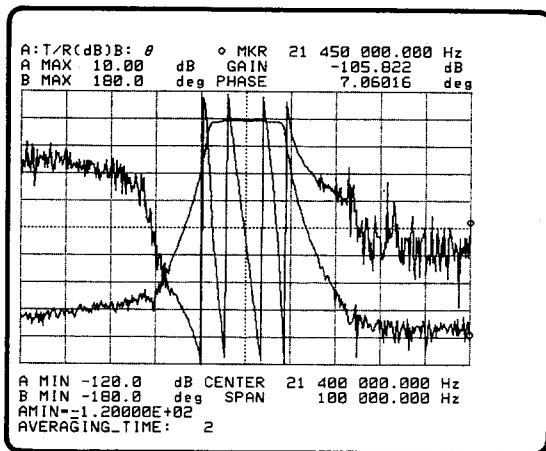
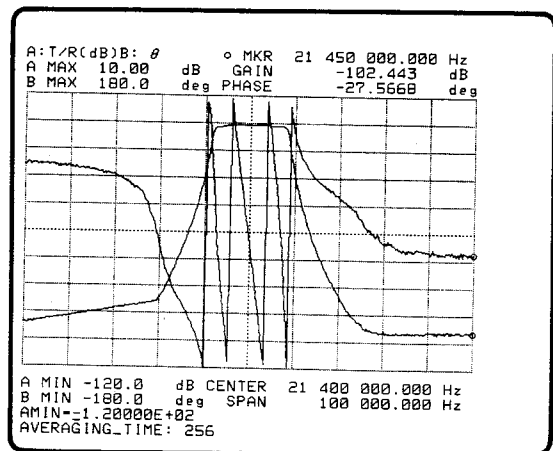

Figure 3-111. AVERAGING VIEW Key



1. Weighting factor=2



2. Weighting factor=256

Figure 3-112. Noise Reduction by Averaging

OPERATION

How to set the weighting factor:

Green View



1. Press the **GREEN** key, and then press the **VIEW** key in the **AVERAGING** section.
2. The current weighting factor will be displayed in **yellow** on the System Message Line as shown in Figure 3-113.

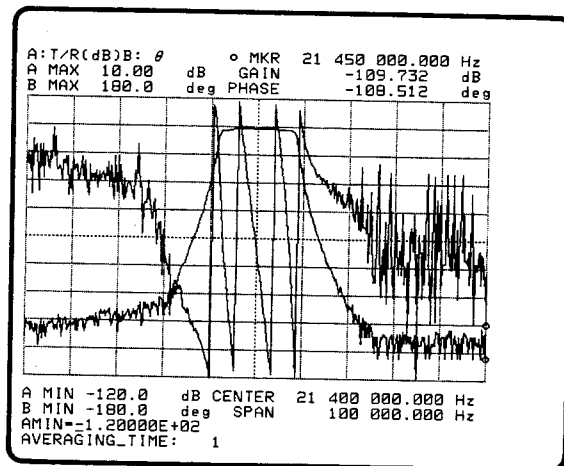

Figure 3-113. The Weighting Factor

View



3. Press the **VIEW** key until the weighting factor you want is displayed.

MARKER/L CURSOR Knob:

This knob controls the marker (o or *) and the line cursor. The marker and line cursors are selected using the softkey menus accessed by using the **MARKER/L CURSOR** key as follows:

1. Press the **MKR/L CURS** key in the the **MENU** section.
2. Select the 'o MKR' or 'LINE CURSOR' softkey.

- The o-Marker, or Line-cursor will appear on the screen as shown in Figure 3-114.

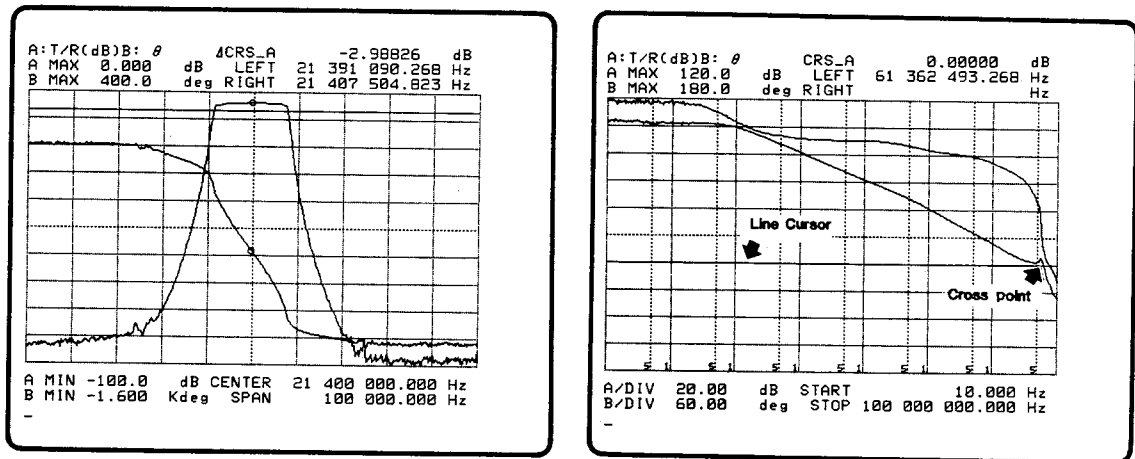

o Marker

Line Cursor

Figure 3-114. o Marker and Line cursor

Rotating the knob clockwise moves the marker from the sweep starting point to the stopping point, and the line cursor from the minimum to maximum point of the analytical range. The marker and line cursor may be used to read data from the displayed trace. The data for the point selected with the marker or line cursor will be displayed in the marker block.

This knob also controls the marker displayed in the **MANUAL** sweep mode.

BLUE/GREEN Keys:

Press these keys are used to access the additional key functions which are labeled in blue or green.

BLUE Key:

Press the **BLUE** key to access the alphabetical characters labeled in blue. These characters are used to enter comments, variables, commands, and program names. Once this key is pressed (key indicator lamp on), it remains on until pressed again, or if the unit keys or the **ENTER/EXECUTE** key is pressed. When the **COMMENT** key (green-labeled) is pressed after pressing the **GREEN** key, the **BLUE** key is automatically set to ON (key indicator lamp on).

GREEN Key:

Press the **GREEN** key to access the special symbols labeled in green. It must be pressed each time a green-labeled key function is desired.

OPERATION

EDIT Keys:

These keys are used to correct data entries which are displayed in the program, a table or the Keyboard Input Line.

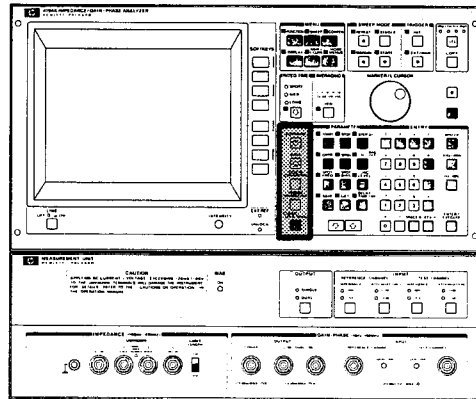

Figure 3-115. EDIT keys

FORWARD Key:

Press this key to move the cursor one space to the right one position. When this key is held down the cursor will move from the start to the end of the displayed text.

BACK Key:

Press this key to move the cursor to the left one space. When this key is held down the cursor will move from the end to the start of the displayed text.

DELETE CHARACTER Key:

Deletes the character at the cursor's position. The cursor remains at the same position and all text to the right of the deleted character moves one position to the left as each character is deleted. When this key is held down characters will be continuously deleted.

INSERT CHARACTER Key:

Pressing this key sets the **INSERT CHARACTER** mode. The character at the cursor's position will be displayed in inverse video. When a new character is entered the character at cursor's position and all text to the right of the cursor will move right one position and the character entered will appear at the cursor's position. When the character is entered the cursor will move to the right one space. Press the **INSERT CHARACTER** key again to exit from this mode.

CLEAR LINE Key:

This key is used to clear all text from the keyboard Input Line and the System Message Area, then returns the cursor to the home position (left-most). The **CLEAR LINE** key is also used to delete the command on the program edit line in an ASP program and the input value in the programmed Points table.

RECALL Key:

This key is used to redisplay previous entries or commands on the Keyboard Input Line to be used again. Press the **GREEN** key then the **RECALL** key.

PARAMETER keys:

The **PARAMETER** keys are located next to the **EDIT** keys shown in Figure 3-116. These keys are used in conjunction with the **ENTRY** keys and the **ENTER** key, when assigning values to the various test parameters, to monitor the test parameters, and to save and recall front-panel control settings. When a test parameter key is pressed the value of the selected test parameter is displayed on the Keyboard Input Line. Only one test parameter can be selected at a time. Alphabetical characters labeled in blue are accessible by first pressing the **BLUE** key.

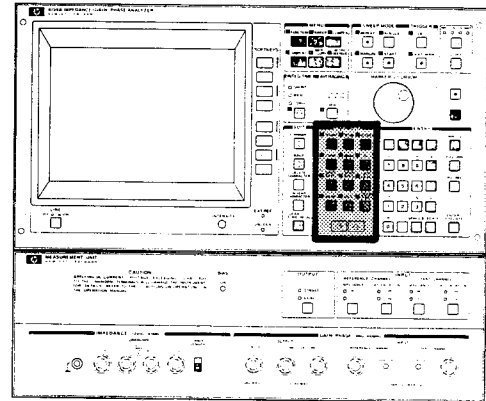

Figure 3-116. Parameter Keys

START key:

The **START** key is used to enter the sweep starting value.

To enter a new start value:

- 1) Using the **FUNCTION** and **SWEEP** keys and their **START** softkeys ("START= (current value)" will be displayed on the Keyboard Input Line as shown in Figure 3-117), select the appropriate sweep type and sweep parameters, then press the **START** key.

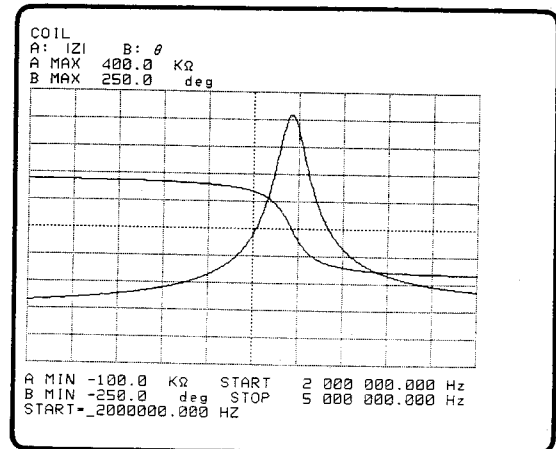

Figure 3-117. Sweep Start

- 2) Modify the value using the **STEP UP/DOWN** keys, or enter a new value using the numeric keys in the **ENTRY** section. Use the **EDIT** keys to correct data entered.

OPERATION

- 3) When the numeric keys are used, press one of the **UNIT** keys or the **ENTER/EXECUTE** key in the **ENTRY** section to enter the data. If you need to change the units, use one of the unit keys. Otherwise the **ENTER/EXECUTE** key can be used.

Note

Three units keys (**MHz/V**, **KHz/dBm**, **Hz/dBV**) and the **ENTER/EXECUTE** key instruct the instrument to read the data set using **ENTRY** keys. Data are not input until one of these keys is pressed. The Zero Span Sweep is made by entering the same for the **START** and **STOP** parameters.

STOP key:

The **STOP** key is used to enter sweep stop data. Data entry for this parameter is accomplished in the same manner as for the **START** key. The **STOP** parameter values appear below the graticule.

STEP key:

The **STEP** key is used when entering the step size. Data entry for this parameter is accomplished in the same manner as for the **START** key. Changing the step size will also change the N (number of measurement points).

(Δ)_F key:

(Δ)_F is used to set the delay aperture (%) for the group delay measurement. Delay aperture is the frequency span over which the 4194A evaluates phase and calculates group delay. Frequency span is in percent-of-span which can be set from 0.5% to 100% in 0.1% steps. The power-on default value is 0.5%.

To set the delay aperture, press the **GREEN** key and the **(Δ)_F** key, "DFREQ=(current value)" will be displayed on the Keyboard Input Line, enter the new value (%), then press **ENTER/EXECUTE**. Group delay is measured in units of time. The readings are from 0.1nsec to 1 second.

A Large aperture has more of a smoothing effect on the trace than a smaller aperture. The Delay aperture is somewhat dependent upon the NOP (number of points) selected. When NOP is 201, the delay aperture cannot be less than 1% of the span. The 4194A automatically changes aperture from 0.5% to the larger value when NOP is changed. The aperture is increased to 2% when NOP=101 is entered, and is increased to 4% when NOP is 51. Refer to A BANDPASS FILTER under GAIN-PHASE MEASUREMENT in this section for more details.

CENTER key:

The **CENTER** key is used in the same manner as the **START** key for entering the value for the sweep center point. There is no defined center point when LOG sweep is selected. **START** and **STOP** information below the graticule changes to **CENTER** and **SPAN** when either of the latter two are selected.

SPAN key:

The **SPAN** key is used in the same manner as the **START** key for entering the values for the sweep span represented by the graticule. When LOG sweep is used there is no sweep span selection. A Zero Span Sweep is made by entering a zero for the SPAN parameter.

N key:

The **N** key is used to change the number of measurement points measured by the 4194A. The default value for N is 401 points. The user may select 401 or less. The larger numbers provide a smoother trace while the lower number of points per sweep allow a faster SWEEP TIME. To enter a value for N, press the **N** key then change the current value displayed in Keyboard Input Line using the **STEP UP/DOWN** keys or **ENTRY** keys. When the **ENTRY** keys are used to modify N, the **ENTER/EXECUTE** key must be pressed to enter the new value.

BIAS OFF key:

The **BIAS OFF** key is used to reset the DC BIAS. Press the **GREEN** key and DC bias will be reset and the BIAS ON Indicator will turn off.

SPOT FREQ key:

This key is used in the same manner as the **START** key for entering SPOT FREQUENCY data for DC BIAS or OSC LEVEL sweep measurements. When spot bias is set the BIAS ON Indicator will light. To reset the bias, press the **GREEN** key and the **BIAS OFF** (labeled in green) key.

SPOT BIAS key:

This key is used in the same manner as the **START** key for entering SPOT BIAS data for frequency or OSC LEVEL sweep measurements. When SPOT BIAS is set, the BIAS ON Indicator lights. To reset the bias, press the **GREEN** key and then the BIAS OFF (labeled in green) key.

OSC LEVEL key:

The **OSC** key is used in the same manner as the **START** key for entering OSC LEVEL data for FREQUENCY or DC BIAS sweep measurements.

SAVE/GET keys:

The 4194A is equipped with five non-volatile storage registers. These registers are used to save five instrument states. An instrument state is the total set of instrument parameters. This feature is convenient for saving a complex and/or frequently used test configurations and reusing them later without having to re-enter them. Stored instrument states are preserved in the registers even if the instrument has been turned off. This feature improves efficiency in applications where repetitive measurements are to be made.

OPERATION

Almost all front-panel control settings and test parameter settings, including reference data and zero calibration data, can be saved. Refer to APPENDIX C for more information.

Use the following procedure to save and recall measurement conditions;

1. Set the front-panel controls and test parameters as desired.
2. Press the **SAVE** key and enter a register number (0 ~ 4), the "SAVE" command and the number are displayed in the Keyboard Input line on the screen as shown in Figure 3-118.
3. Press the **ENTER/EXECUTE** key. All front-panel control settings and test parameter settings are now stored in the specified register.

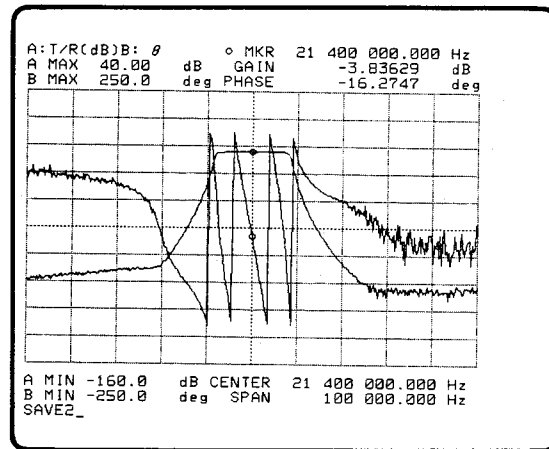

Figure 3-118. SAVE Command

4. To recall the control settings and test parameters saved in step 3, press the **GET** key, the register number, and press **ENTER/EXECUTE**.

Parameters which can be saved and recalled are listed in Appendix C, **SAVE FUNCTION**.

DELAY TIME key:

The **DELAY TIME** key is used to set the Delay Time. Delay time is used to measure devices which take a long time to be stable after changing the parameters, this delay time is required to delay the measurement until the parameter changing has settled. To set the delay time, press the **DELAY TIME** key ("DTIME=(CURRENT VALUE)" will be displayed), and enter the delay time (for example 1000 for 1sec delay) using the **ENTRY** keys, then press **ENTER/EXECUTE**. The time is entered numerically in 1msec steps from 1msec to 3,600,000 msec (1 hour). The power on default setting is 0msec.

CMT key:

This key is used when entering a comment into the Comment Area located at top of the screen.

To enter a comment:

1. Press the **GREEN** key then the **COMMENT** key.
2. "CMT" will be displayed on the Keyboard Input Line of the screen as shown in Figure 3-119, and **BLUE** key's lamp will light.
3. Enter any comments you want using the **ENTRY** keys and any other keys, then terminate the comment by ".".

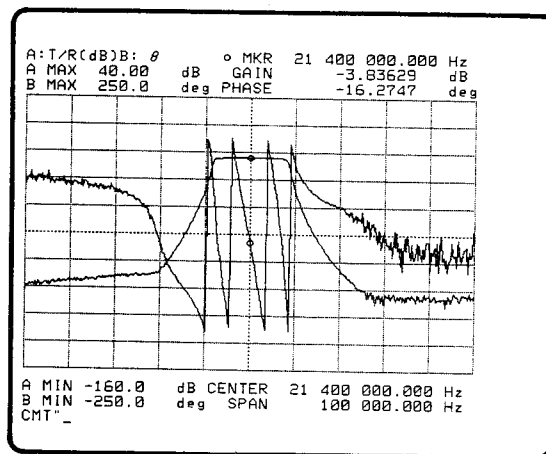

Figure 3-119. COMMENT

Note

BLUE and **GREEN** keys can be used to access the characters labeled in blue or green. All keys in the **EDIT** section can be to edit comments.

4. Press **ENTER/EXECUTE** and the comments will be moved to the COMMENT AREA at the top of the screen.

An external controller is not needed to dump the comment displayed in the Comment Area to a printer or plotter. To delete the COMMENT displayed in the COMMENT AREA, enter a blank ("CMT") to the Keyboard Input Line, then press **ENTER/EXECUTE**.

OPERATION

Step Up/Down Keys:

To change the parameter values and prefix values displayed on the screen, the actual value can be entered directly using the **ENTRY** keys. However, a more convenient tool, the **STEP UP/DOWN** keys can be used to modify and determine the optimum sweep parameter values and the scale size.

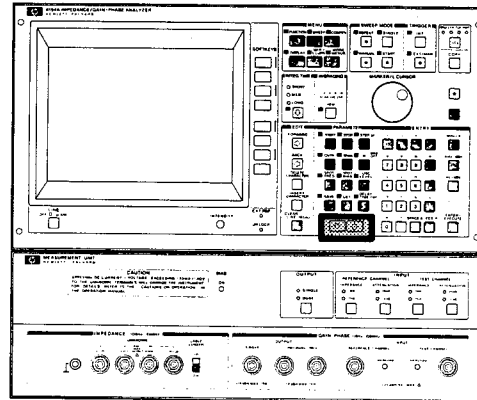

Figure 3-120. Step Up/Down Keys

When the **STEP UP/DOWN** key is used to change a value, it is not necessary to use the unit keys or the **ENTER/EXECUTE** key to enter the new value. The **STEP UP/DOWN** keys can be used to change the values of the following parameters.

SCALE	A DIV	(softkey)
	B DIV	(softkey)
	A MAX	(softkey)
	A MIN	(softkey)
	B MAX	(softkey)
	B MIN	(softkey)
SWEEP PARAMETERS	START	(key)
	STOP	(key)
	STEP	(key)
	CENTER	(key)
	SPAN	(key)
	N	(key)

Note

DC BIAS can not be changed using the **STEP** Keys.

Press the parameter or prefix softkey which you want to change, the header code and its current value will be displayed on the keyboard input line. Press the **STEP (UP/DOWN)** key once, and look for the new value to be displayed on the keyboard input line, then if necessary, press the **STEP (UP/DOWN)** key again as necessary. Continue this procedure until you get the optimum display on the screen.

* **A MAX, A MIN, B MAX, B MIN**

When using the linear scale, if the **STEP UP** key is pressed, the new value will be the "current value + one division", if the **STEP DOWN** key is pressed, the new value will be the "current value - one division". If the division does not change, then both the MAX and MIN are changed one division simultaneously.

When using the log scale, the step value depends on the number of the decades indicated on the screen. Pressing the **STEP UP/DOWN** increases/decreases a line of the graticule indicated.

* **START/STOP** parameters

Pressing the **STEP UP/DOWN** key increases/decreases the step value by 1-2-5 steps, then changes the START or STOP value.

Pressing the **STEP UP/DOWN** key increases/decreases the step value by 1-2-5 steps, then changes the START or STOP value.

* **CENTER** parameter

The **STEP UP/DOWN** key increases/decreases the center value by one tenth of the SPAN setting.

* **Other parameters and Scale softkeys:**

The most significant value changes in a 1-2-5 step sequence.

ENTRY Keys:

The **ENTRY** keys consist of a numeric keypad, arithmetic operation keys, three units keys, and the **ENTER/EXECUTE** key as shown in Figure 3-121. These keys are used to enter or to modify numeric values, comments, or arithmetic expressions. Data entered using these keys is displayed on the Keyboard Input Line or in the program tables. When new entries are made using the keypad or arithmetic operators, one of the units keys or the **ENTER/EXECUTE** key must be pressed before the new entry is completed. The new data is not input until one of these keys is pressed. When the **ENTER/EXECUTE** key is pressed, data displayed on the screen is stored in the display buffer. Data stored in the display buffer can be recalled by pressing the **RECALL** key.

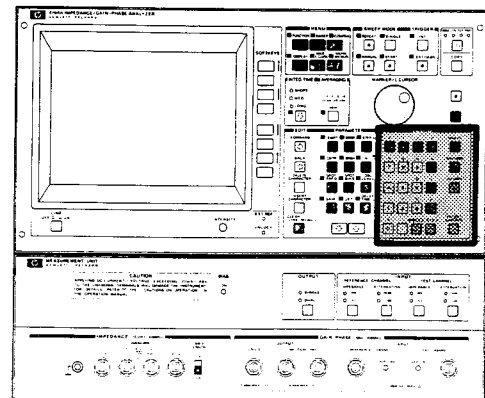

Figure 3-121. **ENTRY** Keys

The keys labeled in green are accessed by first pressing the **GREEN** key.

OPERATION

UNIT Keys:

The following unit keys are located in the **ENTRY** section.

MHz/V key
KHz/dBm key
Hz/dBV key

Note

The **MHz/V**, **KHz/dBm** and **Hz/dBV** units keys, and the **ENTER/EXECUTE** key instruct the instrument to read the data set with the **ENTRY** keys. Data is not input until one of these keys is pressed.

MHz/V Key:

Enters the value input from the **ENTRY** keys in MHz for frequency, or in V for bias voltage or signal level.

KHz/dBm Key:

Enters the value input from the **ENTRY** keys in KHz for frequency, or in dBm for signal level.

Hz/dBV Key:

Enters the value input from the **ENTRY** keys in Hz for frequency, or in dBV for bias voltage or signal level.

ENGINEERING UNIT Keys:

The following five engineering unit keys can be used in place of the unit keys to terminate entered numeric values.

M	mega	1,000,000
K	kilo	1,000
m	milli	0.001
U	micro	0.000 001
N	nano	0.000 000 001
P	pico	0.000 000 000 001

Examples:

BLUE key, H , Z , ENTER/EXECUTE key	Hz
BLUE key, M , H , Z , ENTER/EXECUTE key	MHz
BLUE key, D , B , M , ENTER/EXECUTE key	dBm
GREEN key, m , BLUE key, D , B , M , ENTER/EXECUTE key	mdBm
BLUE key, D , B , V , ENTER/EXECUTE key	dBV
GREEN key, m , BLUE key, V , ENTER/EXECUTE key	mV
BLUE key, U , V , ENTER/EXECUTE key	μV

Note

The three unit keys (**MHz/V**, **KHz/dBm**, **Hz/dBV**) and the **ENTER/EXECUTE** key instruct the instrument to read the data input with the **ENTRY** keys. Data is not input until one of these keys is pressed.

ENTER/EXECUTE Key:

This key is used to enter parameter values, alphanumeric characters, special characters, and the unit indicators displayed on the screen. This key is also used to execute the GET, SAVE, and EDITOR commands. An arithmetic expression entered using the **ENTRY** keys is executed when this key is pressed. For ASP editing, press this key to go to the next line.

BIAS ON Lamp

The **BIAS ON** lamp comes on when the internal DC bias is used by selecting the DC BIAS(V) sweep parameter or using the **SPOT BIAS** key, and goes off when the other sweep parameters are selected or when the **BIAS OFF** (labeled green) key is pressed.

UNKNOWN Terminals

Used for impedance measurements - $|Z|$, $|Y|$, R, G, L, C, X, B, and Phase - these four BNC connectors provide the means to connect DUT's -components or networks - in a four terminal pair configuration:

High current terminal (H_{cur}), High potential terminal (H_{pot}), Low current terminal (L_{cur}), and Low potential terminal (L_{pot}).

Four terminal pair test fixture attaches directly to these terminals.

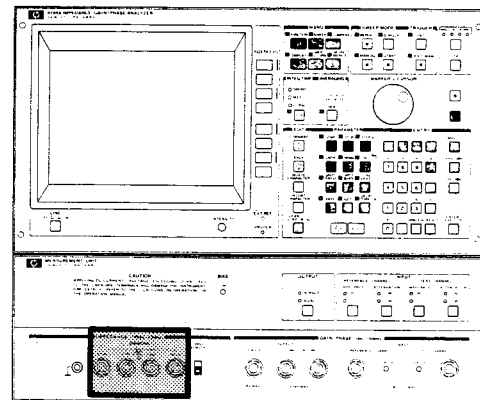

Figure 3-122. UNKNOWN Terminals

CABLE LENGTH Switch

This switch is used for impedance measurements only. It facilitates balancing of the measurement bridge circuit and minimizes measurement errors when the standard 1 meter test lead is used. For more detailed information about the standard 1 meter leads, refer to the paragraph Accessories Available in Section 1.

- 1m: Set to this position when using the standard 1 meter test lead. Appropriate compensation is made for propagation delay and phase error caused by the test leads when making high frequency measurements.
- 0m: Set to this position when using a direct attachment type fixture (connect to the UNKNOWN terminals).

OPERATION

GAIN-PHASE OUTPUT

The **GAIN-PHASE OUTPUT** terminal is the signal source for Gain-Phase Measurements, and its output is controlled by the **PARAMETER** and **ENTRY** section keys. The characters across the bottom right of the screen show the status of the frequency and amplitude of the source. They are used in conjunction with the **REFERENCE** Channel connector and the **TEST** Channel connector during transmission characteristics measurements. The **GAIN-PHASE** output provides a 10Hz to 100MHz stimulus signal for the network under test (the output of the network is connected to **TEST** Channel) and the reference signal for the **REFERENCE** Channel. The **DUAL** outputs are obtained by using a power splitter which gives two in phase and equal amplitude output signals. Output impedance is approximately 50Ω (option 350) or 75Ω (option 375). The output signal level is variable from -65dBm to +15dBm when terminated into 50Ω or into 75Ω.

GAIN-PHASE INPUT

GAIN-PHASE INPUT is used in conjunction with the **OSC OUTPUT** connectors during measurement of transmission characteristics. The 10Hz - 100MHz signal from the **OSC OUTPUT** is applied to the **REFERENCE** Channel connector directly, and the **TEST** Channel connector via the network under test. Both inputs have overvoltage protection circuitry to sense signal levels greater than ±5.0Vpk and switches the input impedance to 1MΩ if signals above this threshold are sensed. The input may be overloaded without switching the input impedance if the signal level beyond the input attenuation exceeds -0dBm or 20 dBm, but does not exceed ±5.0Vpk. This condition causes inaccurate information to be displayed and is indicated by a beep, illumination of the red alarm LEDs labeled "OVERLOAD" over each overloaded input and a warning message displayed on the screen.

Note

If an overload occurs during a **slow** or **single** sweep, inaccurate trace data may remain on the screen. It is recommended that a new sweep be taken with reduced input levels before measurement values are taken.

PROGRAM START Connector (rear panel)

The **PROGRAM START** connector is used to input an external TTL level trigger pulse to start an auto sequence program. The auto sequence program is triggered by the low-to-high transition of a TTL logic signal or a switch connected to 5V through pull-up resistor and to ground to give the same low-to-high transition. An Auto Sequence Program is also triggered via HP-IB, refer to the HP-IB under **EXTENDED CAPABILITIES** in this section. Refer to Figure 3-123 for the specifications of the trigger pulse.

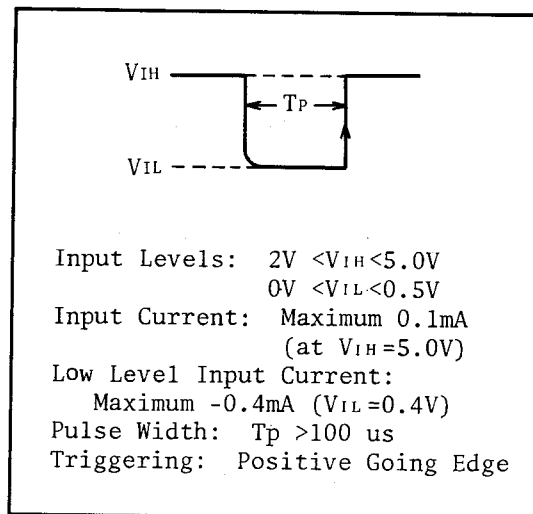

Figure 3-123. Trigger Pulse

EXT TRIGGER Connector (rear panel)

This connector is used for external trigger inputs. The **TRIGGER** key on the front panel must be set to the **EXT/MAN** mode. The 4194A triggers a measurement on the low-to-high transition of a TTL logic level signal as shown in figure 3-124. When triggering in the **EXT/MAN** mode you must allow enough time for the 4194A to complete the current measurement. If the trigger signal is received before a measurement is completed it will be ignored.

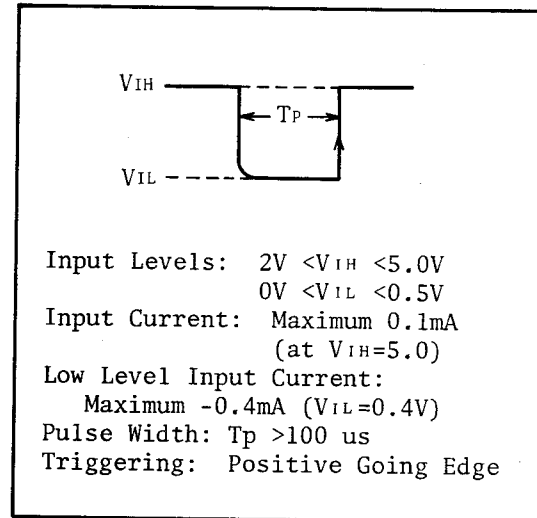

Figure 3-124. External Trigger Pulse

8-BIT INPUT/OUTPUT Connector (rear panel)

This connector is used to communicate with the peripheral device. More specific information is provided in Paragraph 3-6-9.

10MHz OUTPUT Connector (rear panel)

Supplies a 10MHz signal (approx. 3Vp-p) to phase-lock external instruments. The Output impedance is approximately 50Ω .

REFERENCE OVEN Output Connector (rear panel)

(Option 001 only)

A REFERENCE OVEN is supplied only with the High Stability Frequency Option #001, and supplies a 10MHz reference signal to the **EXT REFERENCE** connector to improve the stability of the internal synthesizer. This connector should be connected to the EXT REFERENCE connector with the furnished BNC cable. When this connection is made, the EXT REF lamp on the front panel will illuminate.

EXT REFERENCE Connector (rear panel)

Supplies a 1MHz or 10MHz reference signal from an external signal source to improve the stability of the internal synthesizer. Connect to the **REFERENCE OVEN** Connector on the rear panel with the furnished BNC cable if the 4194A is equipped with the option 001. The input impedance is approximately 50Ω .

OPERATION

Rechargeable Battery

This instrument is equipped with a rechargeable battery that provides power for the storage registers when the instrument is off. The battery is automatically recharged when the instrument is on. Specifications are given below.

Operating Time:	approximately 3 weeks after a full charge.
Recharge Time:	approximately 48 hours. (Time required to fully recharge the battery.)
Lifetime:	approximately 5 years (at 25 °C)

SOFTKEY INDEX

A /DIV	3-91	IMP with Z PROBE	3-75
A MAX	3-89	INTERPOLATION	3-83
A MIN	3-89	LCURS → AVRG	3-100
A OFFSET on/off	3-83	LCURS for A	3-100
A SCALE LIN	3-88	LCURS for B	3-100
A SCALE LOG	3-89	LCURS=	3-99
A-B menu	3-92	LIMIT for A/B	3-116
ADDRESSABLE	3-110	LIMIT on/off	3-87
ALL	3-112	LIN SWEEP	3-79
ALL POINTS	3-83	LINE CURSOR	3-98
AUTO SCALE	3-88	LINE=	3-91
AUTO SCALE A	3-88	LOAD	3-108
AUTO SCALE B	3-88	LOG SWEEP	3-79
B /DIV	3-91	measure page	3-114
B MAX	3-89	menu	3-73
B MIN	3-89	MKR=	3-95
B OFFSET on/off	3-83	MONITOR menu	3-77
B SCALE LIN	3-88	MONITOR off	3-77
B SCALE LOG	3-89	more x/2	3-73
CALC EQV PARA	3-115	more x/3	3-73
CAL on/off	3-84	next page	3-91, 116
CAT	3-108	o & * MKRS	3-101
CKT A	3-115	o MKR	3-93
CKT B	3-115	o MKR → MAX(A)	3-96
CKT C	3-115	o MKR → MAX(B)	3-96
CKT D	3-115	o MKR → MIN(A)	3-96
CKT E	3-115	o MKR → MIN(B)	3-96
CONT	3-109	o MKR control	3-102
COPY menu	3-111	o REF READ	3-98
cursor up	3-117	o REF-LCURS	3-99
cursor down	3-117	o REF-* MKR	3-96
DATA only	3-112	off	3-105
DC BIAS(V)	3-81	OFST REF STORE	3-83
DISP A on/off	3-88	OPEN OFS on/off	3-82
DISP B on/off	3-88	OSC LEVEL(dBm)	3-81
DISP on/off	3-88	OSC LEVEL(dBV)	3-81
DLCURS=	3-100	OSC LEVEL(V)	3-81
DMKR=	3-97	P1,P2 GRTCL	3-113
DUMP mode	3-111	P1,P2 NORMAL	3-113
EDIT	3-107	PART ANA on/off	3-105
EQV CA	3-115	PART SWP on/off	3-104
EQV CB	3-115	PAUSE	3-109
EQV CKT	3-114	PLOT menu	3-112
EQV L	3-115	PLOT mode	3-111
EQV R	3-115	POINT=	3-117
EXPAND MKRS	3-80	previous page	3-91, 116
FREQ	3-80	PRG MEAS on/off	3-79
GAIN MON menu	3-78	PRINT mode	3-111
GAIN-PHASE	3-76	PROGRAM	3-106
GRTCL & DATA	3-112	PSCALE=(P1,P2)	3-113
GRTCL on/off	3-88	PURGE	3-109
HPIB ADDRESS	3-110	QUIT EDITOR	3-118
HPIB DEFINE	3-110	Rch(V)	3-77
I(AC)	3-77	Rch(dBV)	3-78
I/V MON menu	3-78	Rch(dBm)	3-78
IMPEDANCE	3-74	Rch-Tch(V)	3-76

OPERATION

SOFTKEY INDEX

Rch-Tch(dBV)	3-77
Rch-Tch(dBm)	3-76
RECALL A on/off	3-92
RECALL B on/off	3-92
RECALL on/off	3-92
RECTAN A-B	3-86
RECTAN X-A&B	3-85
return	3-73
roll down	3-92, 110
roll up	3-92, 110
RUN	3-109
SCRATCH	3-109
SELF TEST	3-114
SEND P1,P2	3-114
SET PROG TABLE	3-116
SHRT OFS on/off	3-82
SIMULATE f CHAR	3-115
SMKR=	3-102
SORT	3-117
statement	3-118
STD CAL	3-84
STEP	3-110
STOP	3-109
STORAGE on/off	3-89
STORE	3-92, 108
STORE ANA RNG	3-104
STORE SWP RNG	3-103
SUPERIMPOSE	3-87
SWEEP DOWN	3-79
SWEEP UP	3-79
SWP SELECT	3-116
TABLE	3-87
TABLE ALL CLR	3-117
TABLE menu	3-92
TABLE NO.	3-116
TABLE SET END	3-117
TALK ONLY	3-110
Tch(V)	3-78
Tch(dBm)	3-78
Tch(dBV)	3-78
Tch/Rch(dB)- θ	3-76
Tch/Rch(dB)- τ	3-76
Tch/Rch- θ	3-76
UNIT on/off	3-88
V(AC)	3-77
WIDTH read	3-101
X-A&B menu	3-92
ZERO OPEN	3-82
ZERO SHORT	3-82
* MKR control	3-102
θ SCALE exp	3-83
θ SCALE normal	3-83
0S CAL	3-83
0 Ω CAL	3-83

3-6. EXTENDED CAPABILITIES

This chapter gives specific operating instructions for the 4194A's functions. The following information will help you to use the 4194A efficiently.

3-6-1. Register Manipulation

3-6-1-1. Internal Registers

The 4194A has various internal registers to store measurement parameters, analysis results, display data, etc. Paragraphs 3-6-1-1 through 3-6-1-4 will introduce these registers. These registers have arithmetic and logical operation capability and also permit register to register transfers. The registers are sometimes called variables and are categorized into two groups, single variables and array variables, according to their data structures. Each variable has its own name which is used in this discussion. You CANNOT create your own register names. Table 3-2 shows the setting range of the registers.

Table 3-2. Register Setting Range (1 of 2)

Register Name	Value Range
A, B, C, D, E, F, G, H, I, J, RA, RB, RC, RD, RE, RF, RG, RH, RI, RJ, RK, RL, OFSTA, OFSTB, OG, OB, SR, SX, TYG, TYB, TZR, TZX, TSTDR, TSTDX, MYG, MYB, MZR, MZX, MSTDR, MSTDX, LCURS, DLCURS, EQVR, EQVL, EQVCA, EQVCB	±1E-37 to ±9.99999E+37 Res. 6 digits mantissa
Rn, Z	±1E-37 to ±9.999999999999E+37 Res. 12 digits mantissa
AMAX, AMIN, ADIV, BMAX, BMIN, BDIV	±1E-37 to ±9.999E+37 Res. 4 digits mantissa

IMPEDANCE MEASUREMENT ('IMPEDANCE' mode):

Register Name	Parameter	Value Range
START, STOP, STEP, CENTER, SPAN, MANUAL, MKR, SMKR, DMKR, FREQ	FREQUENCY	Min. 100.000 Hz Max. 40 000 000.000 Hz ¹ Res. 15 000 000.000 Hz ² Res. 0.001 Hz
START, STOP, STEP, CENTER, SPAN, MANUAL, MKR, SMKR, DMKR, OSC	OSC Level	Min. 10.0 mV Max. 1.0 V ³ Res. 0.5 V ⁴ SPAN 26.0 dB
START, STOP, STEP, CENTER, SPAN, MANUAL, MKR, SMKR, DMKR, BIAS	DC BIAS	Min. -40.00 V Max. -40.00 V Res. 0.01 V

- 1: CABLE LENGTH = 0 m 2: CABLE LENGTH = 1 m
- 3: Frequency Range 100 Hz to 10 MHz (10MHz inclusive)
- 4: Frequency Range 10 MHz to 40 MHz (10MHz exclusive)

3: Operation

Table 3-2. Register Setting Range (2 of 2)

GAIN-PHASE MEASUREMENT ('GAIN PHASE' mode):
 IMPEDANCE MEASUREMENT ('IMP with Z PROBE' mode):

Register Name	Parameter	Value Range
START, STOP, STEP, CENTER, SPAN, MANUAL, MKR, SMKR, DMKR, FREQ	FREQUENCY	Min. 10.000 Hz Max. 100 000 000.000 Hz Res. 0.001 Hz
START, STOP, STEP, CENTER, SPAN, MANUAL, MKR, SMKR, DMKR, OSC	OSC Level	Min. -65.0 dBm Max. +15.0 dBm Res. 0.1 dB SPAN 26.0 dB
START, STOP, STEP, CENTER, SPAN, MANUAL, MKR, SMKR, DMKR, BIAS	DC BIAS	Min. -40.00 V Max. -40.00 V Res. 0.01 V

NOTE

DC BIAS is not applicable for GAIN-PHASE MEASUREMENT ('GAIN PHASE' mode).

3-6-1-2. Array Variables

Array variables are used mainly to store or save display and offset data used for calibration. Each array variable is composed of 401 register elements. Either all of the elements or an individual element can be manipulated at one time. See the next paragraph for the register manipulation.

1. Registers **A** and **B** are used to store A and B data in real time. You can enter the desired parameters into these registers by using the front panel keys and displaying them. The contents of both registers displayed on the screen as data A and B. They must be transferred to the general purpose registers to save their contents.
2. Registers **C** and **D** are used to store superimpose data or simulation data.

- 1) Superimpose data

When the '**STORE**' softkey is pressed the data being displayed will be stored into these registers. The C=A and D=B register transfers are made automatically.

- 2) Simulation data

When the '**SIMULATE f CHAR**' softkey is pressed while in the equivalent circuit mode, simulation data will be stored into the **C** and **D** registers. These registers must be transferred to general purpose registers in order to be saved.

3. Registers **E, F, G, H, I,** and **J** (General purpose registers) are used to save the display data **A, B,** and the Superimpose data, **C** and **D**. These registers are non-volatile through battery back up. To save or recall the following, register transfers must be used.

For example

to save: E=A F=B G=C H=D
to recall: A=E B=F C=G D=H

4. Registers **RA, RB, RC, RD, RE, RF, RG, RH, RI, RJ, RK,** and **RL** are used as the general purpose registers. The difference between these registers and registers, **E** through **J** are volatile or nonvolatile (using battery backup). These registers are provided to save the contents of the registers used for calibration. See lines 9 to 11 for the registers related to probe calibration.
5. Register **X** (Read-Only) is used to store each point of a sweep parameter being used. This register has no back-up capability.
6. Registers **OFSTA** and **OFSTB** are used to save the offset data for A and B for GAIN-PHASE measurements. When the '**OFST REF STORE**' soft-key is pressed in the COMPENSATION mode, offset data is saved. (Note that OFSTR command does same thing.) These registers are always saved.
7. Registers **OG** and **OB** are used to store the ZERO OPEN offset data for G and B values of an Impedance measurement.
8. Registers **SR** and **SX** are used to store the ZERO SHORT offset data for R and X values of an Impedance measurement.
9. Registers **TYG, TYB, MYG,** and **MYB** are used to store theoretical and measured values of the 0S calibration standard in the complex form ($G + jB$). These registers are used only when the All points method of compensation is selected. See Paragraph 3-6-5 for details.
10. Registers **TZR, TZX, MZR,** and **MZX** are used to store the calculated and measured value of the 0Ω calibration standard in the complex form of ($R + jX$). These registers are used only when All points compensation is used. See Paragraph 3-6-5 for details.
11. Registers **TSTDR, TSTDX, MSTD,** and **MSTDX** are used to store the theoretical and the measured value of the 50Ω calibration standard in the complex form of ($R + jX$). These registers are used only for All Points compensation. See Paragraph 3-6-5 for details.

Note

1. See paragraph 3-6-5 for information on registers and compensation.
2. Registers **A, B, C, D,** are volatile registers. Remember that if you need to save the data in these registers you must first transfer the data to the general purpose registers, **E** through **J,** before the next measurement or before the instrument is turned off.
3. The registers listed on lines 9 thru 11 can be used as general purpose registers if they are not being used for calibration.

OPERATION

3-6-1-3. Array Variable Operation Rules

Array variable operation rules using some examples and single variables operation rules will now be discussed. All of the elements or an individual element can be manipulated. A single element is indicated by parentheses.

1. Array variable vs Array variable(s)

When an element is not defined, all of the elements will be operated on. See examples below.

```
A = E : A(1)=E(1),...,A(401)=E(401)
A = E + F : A(1)=E(1)+F(1),...,A(401)=E(401)+F(401)
A = SQR(E) : A(1)=SQR(E1),...,A(401)=SQR(E(401))
A(10) = E(20)
C = A AND B : C(1)=A(1) AND B(1),...,C(401)=A(401) AND B(401)
C(100) = A(10) AND B(20)
A > B
A(10) < B(20)
```

Note

A > B is equal to A(401) > B(401) operation.

2. Array variable vs Single variable(s)

```
A = 10 : A(1)=10,....,A(401)=10
A(10) = 100
A = R0 + 10
A(10) > 20
```

3. Array variable vs Array variable(s) and Single variable(s)

```
A = E+10 : A(1)=E(1)+10,....,A(401)=E(401)+10
A = E*R0
A(10) = E(30)*5
A(100) = A(100)*5
C = A OR 0(zero)
A(100) = A(100) OR 0(zero)
```

4. Single variable vs Array variable(s)

```
R0 = A(10)
R0 = E(5)-F(5)
```

5. Single variable vs Array variable(s) and Single variable(s)

```
R10 = 20*LOG(X(200))
START = MKR
STOP = SMKR
```

Note

- (1) Register Rn (n=0 to 99) can be used as element designator for array variables.
For example in an ASP program:

```

10 FOR R1=1 TO 401
20 E(R1)=MON
30 NEXT R1
40 A=E
      
```
- (2) When Partial Analysis is ON, only the parameters between the o- & *-markers are used. For example, if the equation $A=A+10$ is made with the NOP range of 100 to 200, only A(100) to A(200) will be changed.
- (3) When a single variable or single element of the array variable is designated on the left side of an equation, you must set the same type of variable on the right side. You can not set array variables with all elements on the right side.
- (4) The examples shown above demonstrate how to use array variables. Refer to these examples when you are working on different applications.

3-6-1-4. Single Variables

Single variables used for storing measurement parameters and analysis results. Because each register has a different data format, you must be careful when making register to register transfers. If a register is transferred to another register that has less significant figures, the data being transferred will be rounded off.

1. **Rn (n=0 to 99)** can be used as a general purpose registers. R0 to R99, a total of 100 registers, are available. When you use the **FOR ... TO ... NEXT** construct you must use one of these registers as the loop counter.
2. **Z** is used to store an arithmetic operation result made on the "Keyboard Input Line" block. The content of this register is updated each time an operation is performed. See paragraph 3-6-2 for practical use.
3. **MON (Read-Only)** is used to store the monitor data. When the instrument is set to the monitor function, monitor data is stored in this register each time a measurement is made. The contents of this register are updated.
4. **START, STOP, STEP, CENTER, SPAN, and NOP** are used to set up sweep parameters. NOP is number of points that partitions the sweep range. NOP has a range of 2 to 401. These registers interact so the contents of a register may influence another.
5. **MANUAL** is used to set a manual measurement point (HZ/V/dBm/dBV) of a sweep parameter. Measurement is made only at this point.
6. **FREQ, OSC, and BIAS** are used to set spot parameters. For example, when the frequency is set as a sweep parameter OSC and BIAS can be used as spot parameters.

OPERATION

7. **DFREQ** is used to set the delay aperture (0.5% to 100%) for Group Delay measurements, and is set with respect to the span frequency.
8. **DTIME** is used to set the delay time. The instrument will wait for a specified time before making a measurement at each measurement point. Setting range is 0 to 1 hour with 1msec. resolution.
9. **GONG (Read-Only)** is used to store GO/NO-GO result (1=GO, 0=NO-GO). Comparison to the limit settings (maximum value and minimum value) on the programmed points table.
10. **AMAX, AMIN, and ADIV** are used to set scale factors for data A.
 - AMAX** is used to set the maximum point (value).
In the "X-A&B" mode, **AMAX** means value of top position.
In "A-B" mode, **AMAX** means value of extreme right position on X-axis.
 - AMIN** is used to set the minimum point (value).
In the "X-A&B" mode, **AMIN** means value of bottom position.
In "A-B" mode, **AMIN** means value of extreme left position on X-axis.
 - ADIV** is used to set scale division (value).
In case of a Linear scale, $ADIV = (AMAX - AMIN) / 10$
11. **BMAX, BMIN, and BDIV** are used to set scale factors for data B.
 - BMAX** is used to set a maximum point (value).
 - BMIN** is used to set a minimum point (value).
 - BDIV** is used to set scale division (value). In the case of a Linear scale, $BDIV = (BMAX - BMIN) / 10$
12. **MKR, SMKR, and DMKR** are used to set marker position.
 - MKR** is used to set the 0 marker position on the X-axis using the absolute value. The instrument must be set to the "Single Marker Mode" or to "Double Marker Mode".
 - SMKR** is used to set the *-marker position on the X-axis using the absolute value. The instrument must be set to the "Double Marker Mode".
 - DMKR** is used to set *-marker position with respect to 0-marker position on the X-axis. The instrument must be set to the "Delta Marker Mode". You must set the difference value between them.

13. **MKRA, MKRB, SMKRA, SMKRB, DMKRA, and DMKRB (Read-Only)** are used to read marker position. All of these registers are Read-Only.
- MKRA** is used to read the data A value at the o-marker position on the Y-axis.
 - MKRB** is used to read the data B value at the o-marker position on the Y-axis.
 - SMKRA** is used to read the data A value at the *-marker position on the Y-axis.
 - SMKRB** is used to read the data B value at the *-marker position on the Y-axis.
 - DMKRA** is used to read the difference in value of data A between the o-marker and *-marker on the Y-axis. The instrument must be set to the "Delta Marker Mode".
 - DMKRB** is used to read the difference in value of data B between the o-marker and *-marker on the Y-axis. The instrument must be set to the "Delta Marker Mode".
14. **LCURS** and **DLCURS** are used to set a line-cursor position. You must select data A or data B for this settings. Commands, MCF0, MCF3, MCF4, CUR1, and CUR2 are related.
- LCURS** sets the line-cursor position on the Y-axis by absolute value.
 - DLCURS** sets the difference value between o-marker and line-cursor on the Y-axis. The instrument must be set to the "Delta Line Cursor Mode".
15. **LCURSL** and **LCURSR** are used to read the line-cursor position on X-axis where it intersects with data A or B. These registers are Read-Only.
- LCURSL** is used to read the extreme left position among intersecting points.
 - LCURSR** is used to read the extreme right position among intersecting points.
16. **WID** is used to read the difference value between registers, **LCURSR** and **LCURSL** (**LCURSR** - **LCURSL**). When only one or no point of intersection exists, then the zero (0) will be stored into the **WID** register. Note that this is a Read-Only register.
17. **EQVR, EQVL, EQVCA, and EQVCB** are used to set parameters or store calculation results for equivalent circuits.
- EQVR** is used for equivalent circuit R.
 - EQVL** is used for equivalent circuit L.
 - EQVCA** is used for equivalent circuit Ca.
 - EQVCB** is used for equivalent circuit Cb.

OPERATION

18. **LINE** is used to set top line number for Table display.
19. **PTN** is used to set programmed points table number.
20. **STN** is used to set self test number.
21. **ADRS** is used to set the instrument's HP-IB address(0 to 30).
22. **NOA** is used to set averaging number (1, 2, 4, 8, 16, 32, 64, 128, or 256).

Note

The **PSCALE** and **POINT** registers can not be used to contain variables.

1. **PSCALE** is used to set plot scale (left, bottom, right, top). Setting range is 0 to 100000 (=2500mm) with 1 (=0.025mm) resolution.
2. **POINT** is used to set programmed points (point, minimum, maximum). Setting range and resolution for the sweep point are equal to those of the sweep parameter. See paragraph 3-6-6. for more information.

3-6-1-5. Complex Matrix Operation

The 4194A has the capability to perform the complex matrix operations using the registers introduced in the previous paragraph. The operation syntax is as follows.

1. When array type registers (variables) are used:

$\langle Va1, Va2 \rangle = \langle \text{Equation 1, Equation 2} \rangle \text{ OP } \langle \text{Equation 3, Equation 4} \rangle$

Where, Va1 and Va2 are the array type variables except for the X register. OP is an arithmetic operator, (*), (/), (+), or (-). In the < > parentheses, the register or equation which indicates the real part is positioned at the left and the imaginary part is positioned at the right. The operation result will be stored into the Va1 and Va2 registers. Note that the operation is made only in the specified analysis range.

For example,

$$\langle RA, RB \rangle = \langle A, B \rangle - \langle C, D \rangle$$

This operation is equal to the following.

$$RA + jRB = (A - C) + j(B - D)$$

As an another example,

$$\langle A, B \rangle = \langle A+1.0, B+R0 \rangle + \langle \text{SIN}(A)*B, \text{COS}(B*C(10)) \rangle$$

2. When single registers (variables) are used:

$\langle Vs1, Vs2 \rangle = (\text{Equation 1}, \text{Equation 2}) \text{ OP } (\text{Equation 3}, \text{Equation 4})$

Where, Vs1 and Vs2 are the single variables, Rn (n=0 to 99). In the equations, the single variable, single element of the array variables or even constants can be used.

For example,

$\langle R1, R2 \rangle = \langle A(100), B(100) \rangle - \langle C(100), D(100) \rangle$

$\langle R1, R2 \rangle = \langle \text{PI} + \text{SIN}(R0/3), 50 \rangle - \langle A(100) + R1, 1.0E+01 \rangle$

Note

1. In the equation (1 to 4) all the arithmetic operators listed in Table 3-3 and () parentheses can be used.
2. This expression can be used in an ASP Program in the multi-statement form.

OPERATION

3-6-2. Arithmetic Operations

A list of the 4194A's arithmetic operators is given in Table 3-3. These arithmetic operators can be used in HP-IB programs, Auto Sequence programs, and for arithmetic operations in the "Keyboard Input Line" block. "Keyboard Input Line" block provides you with immediate execution capability, and you can view the results of an arithmetic operation. To perform an arithmetic operation, key in the expression and then press **ENTER/EXECUTE**. Typical key strokes are shown in the table. The result will be displayed on the "Systems Message Area" entry section in floating point format. SN.NNNNNNNNNNNESNN (S: +/-, E: exponent, N: digit, 0 to 9)

Results of arithmetic operations are always displayed in scientific notation consisting of a 12-digit mantissa and a 2-digit exponent. Note that an arithmetic operation result obtained with "Keyboard Input Line" block will be stored in " register Z " which is automatically updated each time an operation is performed. This is very convenient when you are performing sequential operations. See the examples shown in Figure 3-125.

Arithmetic hierarchy of the operators is as follows:

- ** : exponentiation
- *,/ : multiplication and division
- +,- : addition and subtraction

When parentheses are used this hierarchy will change.

Table 3-3. Arithmetic Operators

Code	Name	Example
+	addition	5+3
-	subtraction	5-3
*	multiplication	5*3
/	division	5/3
**	exponentiation	5**3
SQR	square root	SQR(5)
LOG	common logarithm	LOG(5)
LN	natural logarithm	LN(5)
EXP	exponential	EXP(5)
SIN	sine	SIN(5)
COS	cosine	COS(5)
TAN	tangent	TAN(5)
ATAN	arctangent	ATAN(5)
ABS	absolute	ABS(-5)
PI	pi(=3.14..)	PI
E	scientific notation	5E3
DEG	degree	DEG
RAD	radian	RAD
DIF	differential	DIF(X)
=		
<		
>		
<=		
>=		
<>		
AND		
OR		

Key Strokes	Display Data = Z Register
2*3 ENTER/EXECUTE	6.00000000000E+00
Z-3 ENTER/EXECUTE	3.00000000000E+00
SQR(Z) ENTER/EXECUTE	1.73205080757E+00

Figure 3-125. Z Register Operations

Note

The following are some examples of operations which can be performed from the entry section.

1. Immediate execution commands and Select commands are performed by entering the command name using the alphabetical keys on the front panel and pressing **ENTER/EXECUTE**, after which the designated command or measurement function is immediately executed. For example if you type RST and press **ENTER/EXECUTE**, the 4194A is immediately reset to the default settings.
2. Data entry commands from the **PARAMETER** section, the **MANUAL** command from the sweep mode section, or commands from the **AVERAGING** section, are displayed in the entry section of the display. These commands always include the equal sign (=) when displayed. You enter the parameters and then press **ENTER/EXECUTE**. For example if you press **START**, "**START=**" will be displayed and you enter the parameters and press **ENTER/EXECUTE**.
3. Logical codes such as **AND** or **OR**, and the comparative codes such as **<**, **>**, and **<=** can be used only in the **IF ... THEN** construct of an ASP program.
4. Function **DIF(X: array variable)**

DIF(X) listed in the Table is used in connection with the array variables shown below.

A, B, C, D, E, F, G, H, I, J, X, OG, OB, SR, SX, OFSTA, OFSTB

For example, $A=DIF(A)$, $I=DIF(B)+10$

The result must be stored in the array variable register.

$$\text{DIF value (at point N)} = \frac{\Delta Y}{\Delta X}$$

Where, ΔY is the difference between measurement data points N-1 and N+1.

ΔX is the difference value of the sweep parameter between points N-1 and N+1.

The DIF value at the start or stop point can be calculated by using the following or preceding data point.

OPERATION

3-6-3. HP-IB

3-6-3-1. 4194A's HP-IB Interface

The 4194A can be controlled via the easy to use, high performance HP-IB bus which links the 4194A to other instruments, desktop computers, and minicomputers to form an automated measurement system. HP-IB is Hewlett-Packard's implementation of IEEE Standard 488-1978, Digital Interface for Programmable Instrumentation.

3-6-3-2. 4194A's HP-IB Capability

Table 3-4 shows the 4194A's, IEEE Standard 488-1978, HP-IB capabilities and functions. These functions provide the means for an instrument to receive, process and transmit, commands, data, and status over the HP-IB bus.

Table 3-4. HP-IB Interface Capability

Code	Function
SH 1	Complete Source Handshake capability
AH 1	Complete Acceptor Handshake capability.
T 5	Basic Talker; serial poll; unaddressed if MLA; Talk-Only
L 4	Basic Listener; unaddressed if MTA; no Listen Only
SR 1	Complete Service Request capability
RL 1	Complete Remote/Local capability
DC 1	Complete Device Clear capability
DT 1	Complete Device Trigger capability
C 0	No Controller capability
E 1	Drivers are open-collector

3-6-3-3. 4194A's HP-IB Address

The 4194A's HP-IB address is stored in non-volatile memory and can be set to any address from 0 to 30 using the front panel entry keys. If the contents of address-memory are destroyed, the HP-IB address defaults to address 17. Use the following operations to read or change the HP-IB address. To display the current address of the HP 4194A

1. Press the **MORE MENUS** key.
2. Press the '**HP-IB DEFINE**' softkey.
3. Press the '**HP-IB ADDRESS**' softkey.

The current address will appear on the "Keyboard Input Line" block as shown below.

ADRS= 17

To change the address

4. Input the new address using the keys in the **ENTRY** section. Note the change in the entry block.
5. Press **ENTER/EXECUTE**.

3-6-3-4. 4194A's HP-IB Commands

The 4194A's HP-IB commands are categorized as HP-IB bus commands and 4194A device dependent commands.

1. HP-IB bus commands have the same meaning in all HP-IB systems. The bus commands available for the 4194A are described in paragraph 3-6-3-5.
2. 4194A device dependent commands have meaning only for the 4194A and its functions. Device dependent commands are described in paragraph 3-6-3-6. See **APPENDIX E** for the 4194A's Program Codes.

Note

The HP-IB system interface clearly distinguishes between the two types of commands, because HP-IB bus commands are placed on the bus when the interface is in the command mode and the device dependent commands are placed on the bus during the data mode. When the ATN (ATTENTION) line is true (LOW) the 4194A is placed in the COMMAND MODE, and when the ATN line is false (HIGH) the 4194A is placed in the DATA MODE.

OPERATION

3-6-3-5. HP-IB Bus Commands

The 4194A will respond to the following bus commands. An HP 200 series BASIC statement is used in the description of each command as an example. Also the three letter command abbreviations used in the IEEE 488-1978 nomenclature are shown in parentheses following each statement.

1. **ABORT I/O (IFC):**

ABORT I/O halts all bus activity and causes the 4194A to become deselected.

ABORT 7

2. **CLEAR LOCKOUT/SET LOCAL:**

CLEAR LOCKOUT/SET LOCAL removes devices on the bus from the local lockout mode and returns them to local (front panel) control. The difference between this and LOCAL is in the addressing method.

LOCAL 7

3. **DEVICE CLEAR (SDC or DCL):**

This command may be addressed (SDC; selected device clear) or unaddressed (DCL; clears all devices). The 4194A will initialize itself when this command is received. It is good programming practice to begin your program with this command.

CLEAR 7: clears all devices on port 7

CLEAR 717: clears the instrument addressed at 17

4. **LOCAL (GTL):**

LOCAL returns control of a listening device to its front panel.

LOCAL 717

5. **LOCAL LOCKOUT (LLO):**

LOCAL LOCKOUT disables the **LOCAL** key of all devices on the bus. After this command is sent you will be unable operate the 4194A from the front panel. Execute the **LOCAL** command to undo LOCAL LOCKOUT.

LOCAL LOCKOUT 7

6. REMOTE:

This command is used to set the 4194A to remote. When this command is sent the front panel will be disabled except for the LCL key. If LOCAL LOCKOUT is active then the LCL front panel key will also be disabled.

REMOTE 7: sets all devices on port 7 to remote

REMOTE 717: sets the instrument addressed at 17 to remote.

7. SERIAL POLL:

This command places the status byte on the bus. The eight bits of the status byte shows the 4194A's operating state. See paragraph 3-6-3-11 for more information on the status byte.

Var=SPOLL(717): the instrument addressed at 17 is serially polled.

8. SERVICE REQUEST:

The 4194A is capable of generating an SRQ (Service Request) control signal when it requires the controller to take action. SRQ can be thought of as an interrupt which indicates to the controller that information is ready to be transmitted and/or an error condition exists in the instrument. When the 4194A issues an SRQ it also sets Bit 6 of the status byte. Bit 6 is the RQS (Request Service) bit, sometimes referred to as the "status bit" in connection with a poll. When the 4194A is serially polled it will clear the RQS bit and the SRQ line which is one of the five management (control) lines of the system interface. Any bit in the status byte can initiate an SRQ. The status byte may be masked by the user to determine which bits caused the 4194A to set the SRQ line. See paragraph 3-6-3-11 for more information on the status byte.

9. TRIGGER (GET):

Enables the 4194A to respond to a **TRIGGER** bus command. This command may be sent to a selected device or to all devices addressed as listeners on the HP-IB bus. The 4194A must be addressed to listen before the trigger message is sent. Refer to Bit 4 of the status byte in paragraph 3-6-3-11 for information on how to insure triggering.

SEND 7;UNL MTA LISTEN 17

TRIGGER 7

UNL = UNLISTEN: unaddresses all listeners

MTA = MY TALK ADDRESS: sets the controller to talk

LISTEN: sets the instrument addressed as 17 to listen

OPERATION

Note

1. The 4194A has no Parallel Poll capability.
2. See the "BASIC Interfacing Techniques for HP Series 200 Computers" for further description of the HP-IB bus commands.

3-6-3-6. Device Dependent Commands and Syntax Diagrams

This paragraph describes the two types of syntax diagrams used to define the construction of all device dependent HP-IB program messages, commands and instructions. The syntax diagram is mainly described in connection with the device dependent HP-IB program commands which are categorized into four groups, Select Commands, String Data Type Commands, Immediate Execution Commands, and Data Entry Commands respectively.

1. **SELECT COMMANDS and STRING DATA TYPE COMMANDS:**

The select commands require you to select the parameters to define the instrument's measurement function. Figure 3-126 shows the syntax diagram used for constructing the **SELECT** command and the **STRING DATA TYPE** command. This syntax diagram is defined by IEEE Standard 728-1982, Codes and Format Conversions. The select commands use the HR1-NR1 route. HR1 is an alpha header which defines the 4194A's measurement function. NR1 is an integer which indicates the selection number. This type of command facilitates the machine-to-machine communication which will be used to define the 4194A's measurement function.

For example

FNC1: sets the measurement function to Impedance measurement.
FNC2: sets the measurement function to Gain-Phase measurement.
DSP1: sets the CRT display to "X-A&B" mode.
DSP2: sets the CRT display to "A-B" mode.
SWP1: sets the sweep parameter to the Frequency.
SWP3: sets the sweep parameter to the Osc-level(V)

This syntax diagram is also used when string data is included in a message. The string data type is used when an ASP program is down-loaded from the controller to the 4194A or when a comment is put on the CRT. The string data type command uses the HR1-STRING route shown in the syntax diagram in Figure 3-126. The STRING DATA type commands consists of two commands, CMT and PROG.

For example:

```
CMT" 70MHZ BPF SORTING PROGRAM "  
PROG"10 R0=10", "20 IF R1 R0 THEN GOTO 50", "30 .....", "100 END"
```

Note

1. Either type of quotation mark characters, (") or ('), can be used in string data type commands.
2. The method for writing an ASP program using HP-IB will be discussed in paragraph 3-6-3-8.

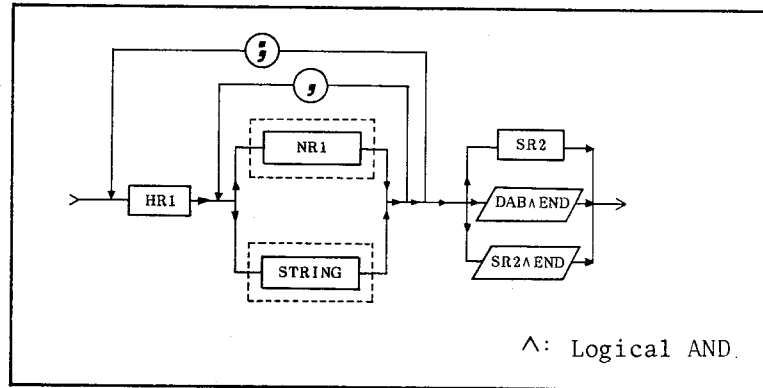

Figure 3-126. Syntax Diagram for Select and String Data Type Commands

2. IMMEDIATE EXECUTION COMMANDS and DATA ENTRY COMMANDS

Figure 3-127 shows the other syntax diagram used for constructing these two commands. This syntax diagram is also defined by IEEE 728-1982.

IMMEDIATE EXECUTION commands do not contain numeric data and are executed immediately. The data block field is bypassed.

For example

SPSTR:

This command stores the superimpose data into registers **C** and **D**.

RST:

This command resets the instrument to the default settings.

SCRATCH:

This command clears the ASP working area.

DATA ENTRY Commands require the data entries to set the measurement parameters. All of the registers discussed in Paragraph 3-6-1 are included in this group. The data defined here includes the numeric data (NR) and also the character data, that is, the register names. Furthermore the arithmetic operation is permitted to use on the right side of the equation. Note that the header (HR3) used here always includes (=) notation. See the Note, following the examples, on the special notations.

OPERATION

For example,

When numeric data (NR1, NR2 or NR3 including Suffix) is entered:

START=100HZ, STOP=50.5MHZ, STEP=1.5E+2HZ MKR=10KHZ,
SMKR=50KHZ, AMAX=100

When string data (register name) is entered ;

START=MKR, STOP=SMKR, STEP=R0

When an arithmetic operation is entered;

START=STOP*0.5
STEP=(STOP-START)/401

Note

1. For data entry commands, use of the special character, (=), as a header delimiter permits the generation of more readable messages. When you transmit the register data to the controller you must use the Query Message Command, (?), following the register name. This case is included in this syntax diagram. The data block field is bypassed.
2. Notations such as HR1, NR1, SR2 used in the figures will be explained in the next paragraph.

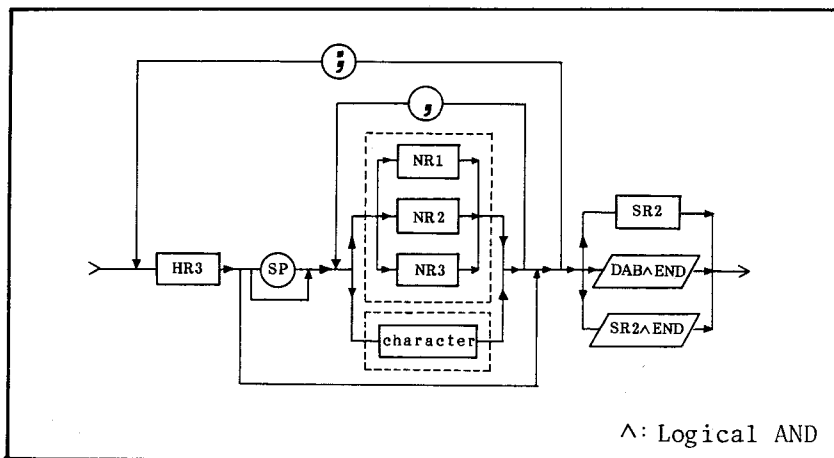

Figure 3-127. Syntax Diagram for Immediate Execution and Data Entry Commands

3-6-3-7. Message Elements

This paragraph explains the message elements that compose the syntax diagrams shown in the previous paragraph. Figure 3-128 presents a very simplified structure to illustrate the program message elements. This figure should be viewed as a single program message or instruction. In real applications a series of program instructions are required. Descriptions are similar to those in IEEE Standard 728-1982.

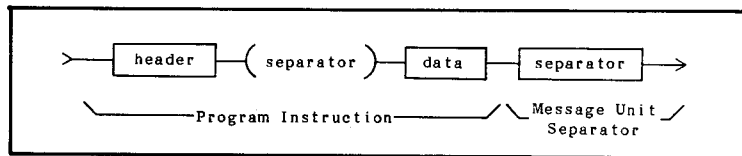

Figure 3-128. Program Message Element

1. Header Field:

A header field may be used to select a specific function.

- 1) **HR1 (Alpha Header)** Figure 3-129 shows the syntax diagram for HR1. An Alpha header is a sequence of one or more alpha characters (A ~ Z). This header is used for Select Commands and String data type program instructions.

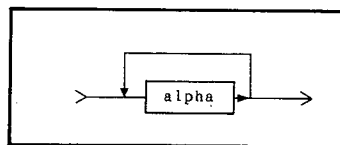

Figure 3-129. Alpha Header

- 2) **HR2 (Formatted Header)** is not used in the 4194A.
- 3) **HR3 (Character Header)** Figure 3-130 shows the syntax diagram for HR3. A character header is a sequence of one or more alpha characters. For the 4194A, one of the following cases occurs.

A series of Alpha characters: immediate execution commands
(register name)+(=): data entry commands
(register name)+(?): used for the data transfer

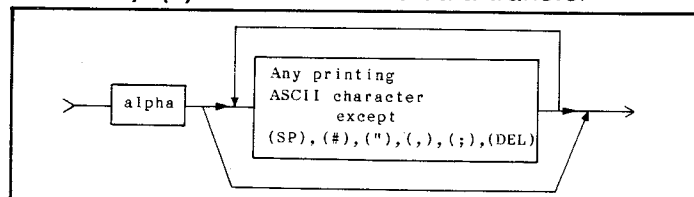

Figure 3-130. Character Header

3:Operation

OPERATION

2. Data Field:

The data field may be represented by the following data types, Numeric, String and Character.

1) Numeric data type (NR)

The decimal positional representation of numeric values, commonly called numeric representation may be implemented in any of three formats shown Figure 3-131. A description of the suffix is included.

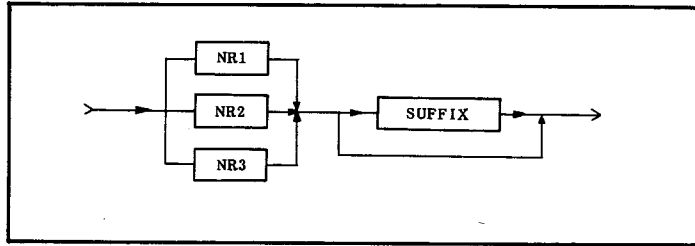

Figure 3-131. Numeric Data Type

(1) NR1 (Integer):

Figure 3-132 shows the syntax for NR1. NR1 consists of a set of implicit point representations of numeric values, that is, a radix point is implicitly considered to be placed at the end of the string of digits. Both the unsigned and the signed representations may contain leading spaces. NR1 is useful for integer numeric data.

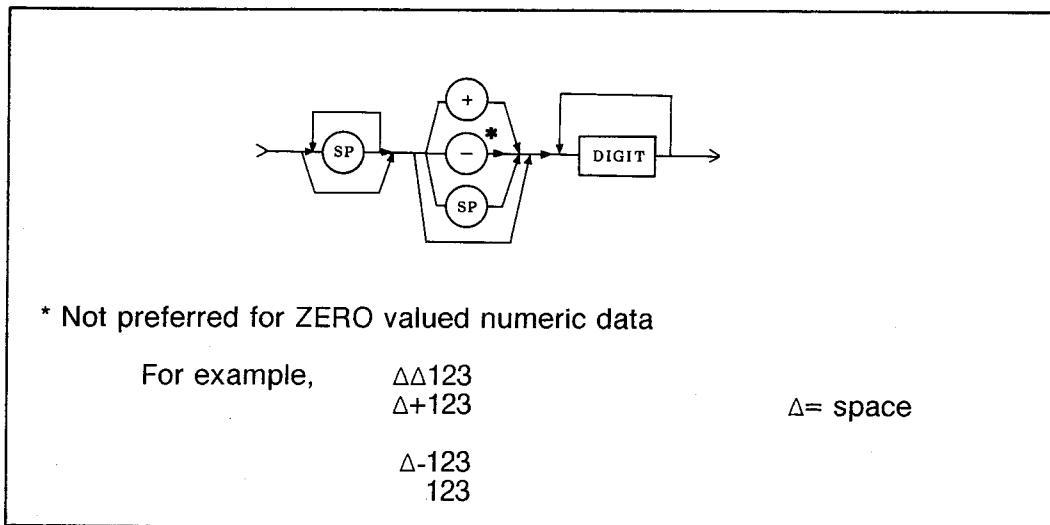

Figure 3-132. Syntax Diagram for NR1

(2) NR2 (Fixed Point):

Figure 3-133 shows the syntax for NR2. NR2 consists of a set of explicit point representations of numeric values with the radix point indicated by a decimal point, (.). For clarity the radix point should be preceded by at least one digit, a zero when the number is less than one. NR2 is useful for numeric data which contains a fraction.

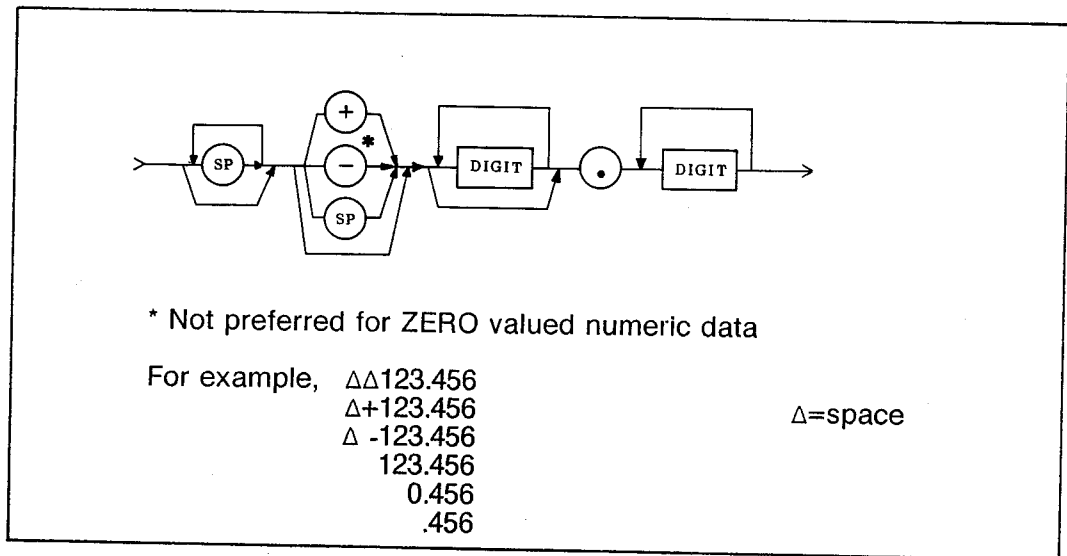

Figure 3-133. Syntax Diagram for NR2

(3) **NR3 (Floating Point):**

Figure 3-134 shows the syntax for NR3. NR3 consists of a set of scaled representations with either implicit radix point together with exponential notation.

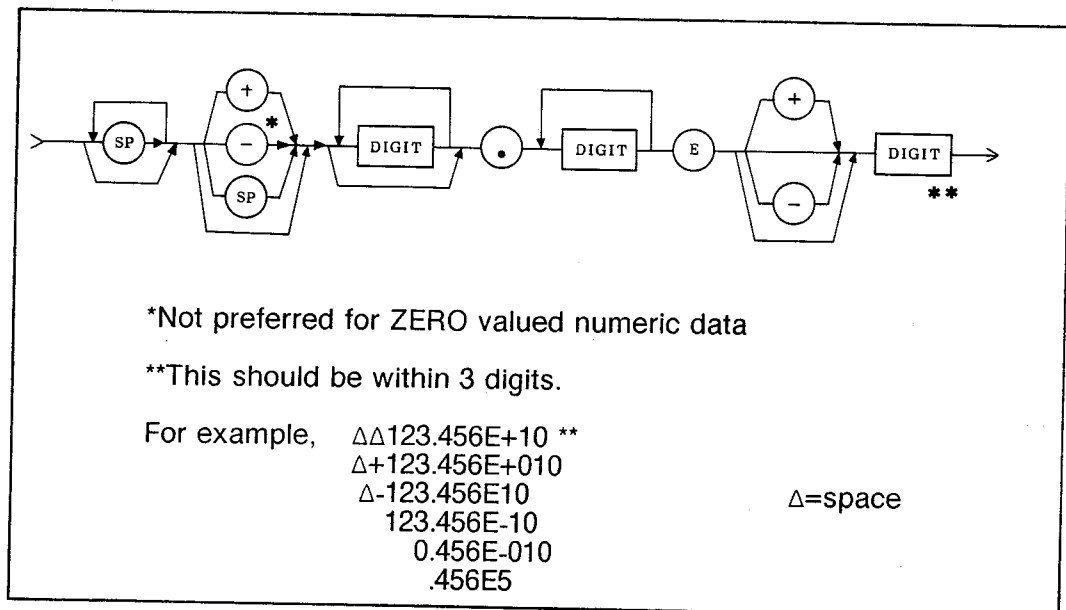

Figure 3-134. Syntax Diagram for NR3

(4) **Suffix:**

Figure 3-135 shows the suffixes available for the 4194A. As a special form of NR representation, a suffix following the numeric value is permitted. The suffix is related closely to NR in that it expresses the associated units.

OPERATION

<u>Multipliers</u>	<u>Factor</u>	<u>Representation</u>
	+6	
mega	10	M
	+3	
killo	10	K
	-3	
milli	10	m
	-6	
micro	10	U
	-9	
nano	10	N
	-12	
pico	10	P

For examples,

1.23M = 1.23E+06
 1.23K = 1.23E+03
 1.23N = 1.23E-09

Figure 3-135. Suffix

2) String Data Type:

Figure 3-136 shows the string data syntax diagram. This data type is mostly used when writing an ASP program via the HP-IB. The string data field allows any 7-bit ASCII character, including the non-printable characters, to be used in a message. The string data type permits the use of format effectors such as CR, LF, and SP(ace) to correctly format text. Each string data field begins and ends with (") or ('). It is possible to include the quotation marks (") or (') within the text by sending two sequential characters, (")(") or (')(').

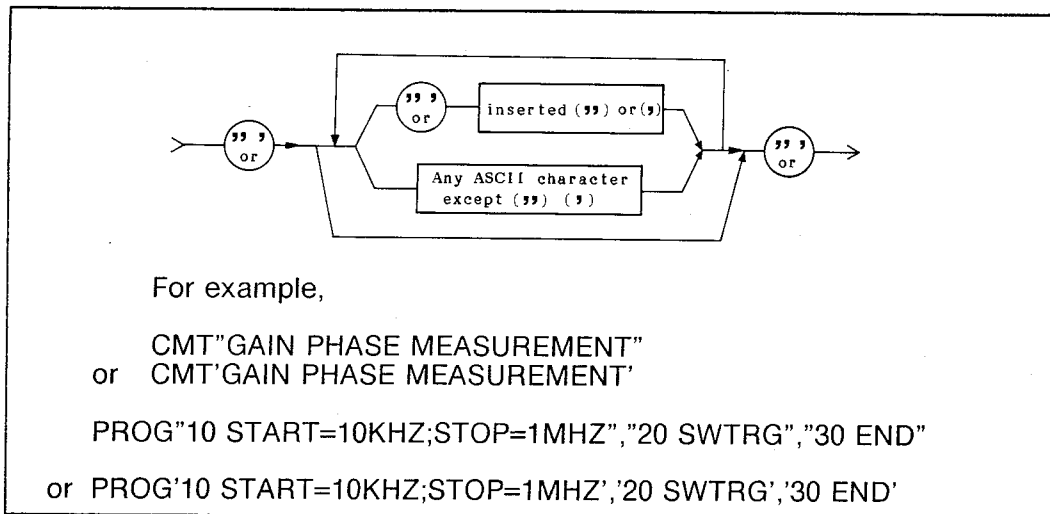

Figure 3-136. String Data Syntax Diagram

3) Character Data Type:

Figure 3-137 shows the character data syntax diagram. The character data type is used where words and text will more clearly describe the nature of a program instruction than does numeric data type. Character data always begin with an alpha character. In the 4194A the register name is used as character data.

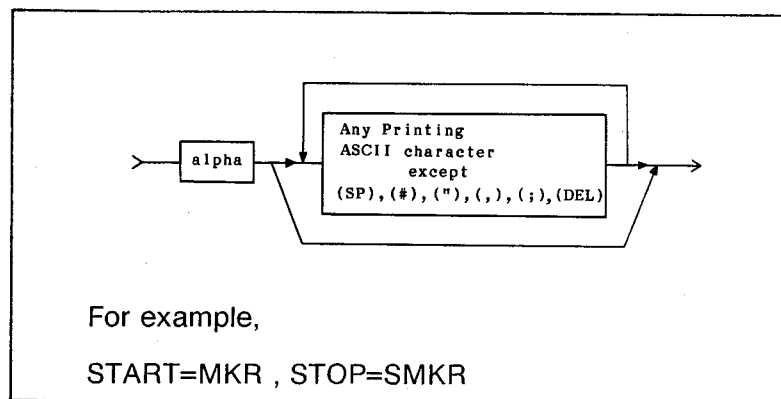

Figure 3-137. Character Data Syntax Diagram

3. Message Separators (SR):

A Message separator is a means to distinguish between different messages. This is useful for transmitting related sets of data and for distinguishing message streams. Separators fall into three broad categories based on a hierarchical relationship to one another. The hierarchy is SR3 > SR2 > SR1. Figure 3-138 shows the simplified syntax of each separator.

OPERATION

1) Separator Level 1 (SR1):

The SR1 separator is the lowest order separator, typically used to identify the end of the lowest level of message element or data fields. Two separators exist at this level, comma (,) and semicolon (;). Both of them are used in the syntax diagrams shown above.

2) Separator Level 2 (SR2):

An SR2 separator is typically used to separate a sequence of message units at a distinctly higher level than that of the SR1. Two separators also exist at this level, CR/LF or NL.

3) Separator Level 3 (SR3):

SR3 is the highest order separator used when one or a series of program messages has been completed. The **END** message is typically used.

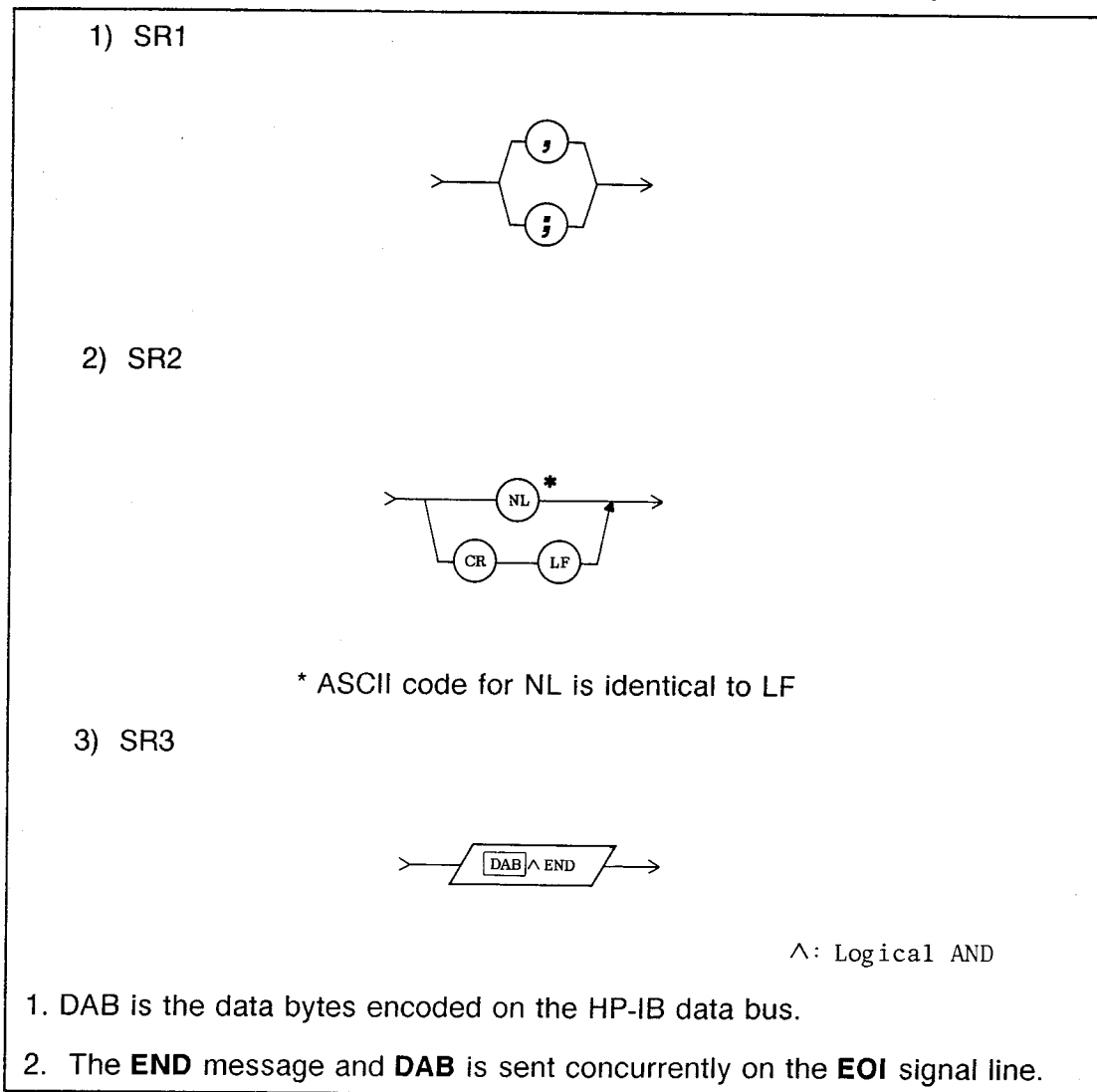

Figure 3-138. Syntax for SR1, SR2 and SR3

3-6-3-8. Program Examples

This paragraph shows three program examples using the HP Series 200 computer. The contents are as follows:

- Program 1. Demonstrates the measurement of Band Pass Filter (BPF) passband insertion loss and how to dump or plot data.
- Program 2. Demonstrates data transfer using the FMT1 and FMT2 data formats.
- Program 3. Demonstrates how to down-load an ASP program via HP-IB.

Note

See the list of 4194A Program Codes in APPENDIX E.

Program 1.

```

10      ! This program demonstrates insertion loss
20      ! measurement on the HP 4194A.
30      ! Data is taken and output on a printer or plotter.
40      ! --- A 21.4 MHZ BFF is used as an example---
50      !
60      !
70      Ads=717  ! The HP 4194A's HP-IB address
80      Dump=701 ! Printer's HP-IB address(Raster Graphic type)
90      Plot=705 ! Plotter's HP-IB address (HP-GL type)
100     M_end=2  !Status bit(B1) for end of sweep
110     D_end=8  !Status bit(B3) for end of copy
120     !
130     REMOTE Ads
140     !
150     !
160     ! **** MEASUREMENT****
170     !
180     OUTPUT Ads;"RST"  !Initialize the HP 4194A
190     !
200     ! ( See the default settings listed on APPENDIX E.)
210     !
220     OUTPUT Ads;"RQS2" ! Unmask and enable B1 for SRQ
230     !
240     !
250     ! Set the 4194A to the Gain-Phase mode
260     !
270     !
280     OUTPUT Ads;"FNC2"
290     ! Sweep parameters
300     OUTPUT Ads;"CENTER=21.4 MHZ;SPAN=100 KHZ;OSC=0 DBM"
310     !
320     OUTPUT Ads;"PHS2" !Phase scale to Expansion mode
330     !
340     OUTPUT Ads;"SWM2" ! Set sweep mode to Single
350     OUTPUT Ads;"ITM2" ! Set integration time to Medium(5msec.)
360     OUTPUT Ads;"SWTRG" !Make single measurement
370     !

```

OPERATION

```
380 LOOP
390 EXIT IF BINAND(SPOLL(Ads),M_end)
400 END LOOP
410 !
420 ! Title of data
430 !
440 OUTPUT Ads;"CMT'21.4 MHZ BPF PASSBAND INSERTION LOSS'"
450 !
460 ! Set scale parameter to Auto scale mode
470 !
480 OUTPUT Ads;"AUTOA;AUTOB"
490 !
500 ! Set o-marker to maximum point of data A(Gain)
510 !
520 OUTPUT Ads;"MKMXA"
530 ! Display data
540 OUTPUT Ads;"MKRA?"
550 ENTER Ads;Mkra
560 DISP "PASSBAND INSERTION LOSS=";Mkra;" dB"
570 !
580 ! *****CRT DUMP*****
590 !
600 OUTPUT Ads;"RQSB" ! Unmask and enable B3 for SRQ
610 !
620 !
630 OUTPUT Ads;"CPYM3" !Set dump mode
640 OUTPUT Ads;"COPY"
650 SEND 7;UNL TALK Ads MOD 100 LISTEN Dump MOD 100 DATA
660 !
670 DISP "WAITING FOR CRT DUMP COMPLETION"
680 !
690 LOOP
700 STATUS 7,7;S !Read bus control and data lines
710 EXIT IF BINAND(S,1024) !Check for SRQ asserted
720 END LOOP
730 !
740 DISP "CRT DUMP IS COMPLETE"
750 !
760 BEEP
770 !
780 ! Passband insertion loss data is shown in the marker
790 ! information block of dumped sheet
800 !
810 S=SPOLL(Ads)
820 OUTPUT Ads;"RQSO" !Reset mask to default
830 !
840 LOCAL Ads
850 !
860 END
```

```

580 ! *****IN CASE OF PLOTTER***
590 !
600 OUTPUT Ads;"RQS8"
610 !
620 !
630 ! Set plot scale using PSCALE=(P1,P2) softkey
640 !
650 !
660 ! Plot scale (Pix=left,Ply=bottom,P2x=right,P2y=top)
670 !
680 ! Send plot scale (1=0.025mm) to plotter
690 ! using the SENDPS command
700 !
710 ON INTR 7 GOTO Plot_end ! Defines SRQ interrupt
720 ENABLE INTR 7,2 ! Allow SRQ to interrupt
730 !
740 OUTPUT Ads;"SENDPS"
750 SEND 7;UNL TALK Ads MOD 100 LISTEN Plot MOD 100 DATA
760 WAIT 1
770 OUTPUT Ads;"CPYM1" ! Set plot mode
780 OUTPUT Ads;"COPY"
790 SEND 7;UNL TALK Ads MOD 100 LISTEN Plot MOD 100 DATA
800 !
810 DISP "WAITING FOR PLOT COMPLETION"
820 !
830 Loop:GOTO Loop ! Idle Loop, waiting for interrupt
840 !
850 Plot_end:DISABLE INTR 7 !Disable SRQ to interrupt
860 !
870 DISP "PLOT IS COMPLETE"
880 !
890 BEEP
900 !
910 OUTPUT Ads;"RQS0"
920 !
930 LOCAL Ads
940 !
950 END

```

Note

Plot scale: There are three ways to send the plot scale to the plotter.

1. Set up the plot scale in the 4194A using the 'PSCALE=(P1,P2)' softkey and send it to the plotter. Pressing this softkey displays "PSCALE=(current values)" on the "Keyboard Input Line" block. Input the desired scale parameters and press **ENTER/EXECUTE**. Use the **SENDPS** command to send the plot scale to the plotter via HP-IB. "SENDPS" is a program code that sends the plot scale parameters from the 4194A to the plotter. This method was demonstrated in the preceding example.
2. Use the HP-GL IP command. Set the plotter as a Listener and send the plot scale directly from the controller to the plotter using this command.

For Example:

```

DATA"IP0,0,9000,7200;"
SEND 7;UNL MTA LISTEN Plot MOD 100 DATA

```

3. When the 4194A is configured for TALK ONLY and the plotter as LISTEN ONLY, the plot scale can be set directly from the 4194A to the plotter by pressing the 'SEND P1,P2' softkey. See **COPY** in EXTENDED CAPABILITY, Paragraph 3-6-7 for more information.

OPERATION

Program 2.

```
10      ! This program shows how to transfer
20      ! array type register
30      !(Array type register contains 401 internal elements)
40      ! Register A is used as an example
50      !
60      ! *****When "FMT1"(ASCII format) is used*****
70      !
80      OPTION BASE 1 !This statement specifies the default
90                  !lower bound of arrays
100     !(Lower bound is set to 1)
110     DIM A(401)
120     Ads=717
130     REMOTE Ads
140     OUTPUT Ads;"A?"
150     ENTER Ads;A(*)
160     PRINT A(*);!Register elements A(1) to A(401)
170             !are displayed
180     BEEP
190     END

10      !*****When "FMT2" (64 Bit floting point binary=HP Series
20      !      200 computer real number) is used*****
30      !
40      OPTION BASE 1
50      DIM Junk#[4] !Set "#, A, LL"as "Junk#"
60      REAL R(401) BUFFER !Reserve BUFFER for
70                  !floating points array
80      !
90      ASSIGN @Ads TO 717;FORMAT ON !Assign ASCII format
100     !
110     !
120     !
130     !*****Try to change NOP and take a measurement*****
140     !
150     REMOTE @Ads
160     OUTPUT @Ads;"SWM2" !Single sweep
170     !
180     OUTPUT @Ads;"NOP=401"
190     OUTPUT @Ads;"SWTRG" !Take single measurement
200     !
210     !*****End of measurement*****
220     !
230     OUTPUT @Ads;"FMT2;A?" ! IEEE 64 Bits Format
240     ENTER @Ads USING "#,4A";Junk# !Enter the leading bytes
250             !into an unused string
260     !
270     ASSIGN @Ads;FORMAT OFF !Assign internal format
280     !
290     ENTER @Ads;R(*) !Enter Binary Real Data
300     !
310     FOR I=1 TO 401
320     PRINT USING "SD.DDDDDE";R(I) !Arrange print format
330             !same as instruments' table
340             !format
350     NEXT I
360     BEEP
370     END
```

Program 3.

```

10      ! This program shows how to set up the ASP program via
20      ! HP-IB
30      !
40      Ads=717
50      REMOTE Ads
60      OUTPUT Ads;"SCRATCH" !Erase editor page
70      !
80      !
90      ! Set up ASP program
100     ! When you use program code,
110     ! PROG with HP Series 200 computer,
120     ! Use CHR$(34) instead of "(double quotation mark)
130     ! as shown below
140     ! CHR$(34)="
150     !
160     OUTPUT Ads;"PROG"&CHR$(34)&"10 RST"&CHR$(34)
170     OUTPUT Ads;"PROG"&CHR$(34)&"20 FNC2"&CHR$(34)
180     OUTPUT Ads;"PROG"&CHR$(34)&"30 CENTER=21.4MHZ"&CHR$(34)
190     OUTPUT Ads;"PROG"&CHR$(34)&"40 SPAN=100KHZ"&CHR$(34)
200     OUTPUT Ads;"PROG"&CHR$(34)&"50 OSC=0 DBM"&CHR$(34)
210     OUTPUT Ads;"PROG"&CHR$(34)&"60 SWTRG"&CHR$(34)
220     OUTPUT Ads;"PROG"&CHR$(34)&"70 AUTOA;AUTOB"&CHR$(34)
230     OUTPUT Ads;"PROG"&CHR$(34)&"80 DPBO;MKMXA;RO=MKRA"&CHR$(34)
240     OUTPUT Ads;"PROG"&CHR$(34)&"90 DISP 'INSERTION LOSS=',RO"&CHR$(34)
250     OUTPUT Ads;"PROG"&CHR$(34)&"100 CMT 'PASSBAND INSERTION LOSS'"&CHR$(34)
260     OUTPUT Ads;"PROG"&CHR$(34)&"110 CPYM3"&CHR$(34)
270     OUTPUT Ads;"PROG"&CHR$(34)&"120 COPY"&CHR$(34)
280     OUTPUT Ads;"PROG"&CHR$(34)&"130 END"&CHR$(34)
290     !
300     ! Exit from editor page
310     !
320     OUTPUT Ads;"STORE1,'21.4MHZ BPF'"
330     !
340     BEEP
350     !
360     DISP "ASP DOWNLOAD IS COMPLETE"
370     !
380     END

```

OPERATION

3-6-3-9. Data Transfer

The 4194A offers three data formats, FMT1, FMT2, and FMT3 to transfer certain types of register data to the controller through the HP-IB bus. Each of three data formats has a different data transfer rate that will be discussed in paragraph 3-6-3-10. The 4194A becomes ready to output the register data when it receives the Query Message Command (?) following the register name.

Examples:

1. **Single variable:**

```
OUTPUT717;"R1?"  
ENTER717;R1
```

2. **Array variable:**

```
OUTPUT717;"A?"  
ENTER717;A(*)
```

Note

1. The registers used in the 4194A are listed in Table 3-5. Table 3-5 also shows the register data formats in ASCII mode.
2. When you transfer an array variable, A, B, OFST(A or B), X, O(G or B) or S(R or X), the register elements specified by the NOP value will be sent. In the case of the general purpose registers, C, D, E to J, RA to RL and registers for calibration, all elements (401 points) will be transferred at one time.
3. See paragraph 3-6-1 for a more concrete description of the registers.

Table 3-5. Registers and Data Formats

ASCII format	Code
SN.NNNNNESNN	A, B, C, D, E, F, G, H, I, J, RA, RB, RC, RD, RE, RF, RG RH, RI, RJ, RK, RL OG, OB, SR, SX, TYG, TYB, MYG, MYB, TZR, TZX, MZR MZX, TSTDR, TSTDY, MSTDR, MSTDY AMAX, AMIN, ADIV, BMAX, BMIN, BDIV MKRA, MKRB, SMKRA, SMKRB, DMKRA, DMKRB, LCURS, DLCURS MON, EQVR, EQVL, EQVCA, EQVCB
SNNNNNNNN.NNN	START, STOP, STEP, CENTER, SPAN, MANUAL, FREQ, X, MKR SMKR, DMKR, WID, LCURSR, LCURSL, OSC, BIAS, DFREQ
SN.NNNNNNNNNNESNN	Rn (n=0 ~ 99), Z
SNNNNNNNNNN	NOP, NOA, DTIME, GONG, PTN

1. FMT1 (ASCII mode):

FMT1 is the default data format. When FMT1 is active the 4194A transfers data using ASCII format. Register data is represented by one of the following ASCII formats. See Table 3-5 for the registers and their data formats.

OPERATION

- 1) Fixed length 12 ASCII characters (Real type register) used for the registers that have 32 bit floating point number.

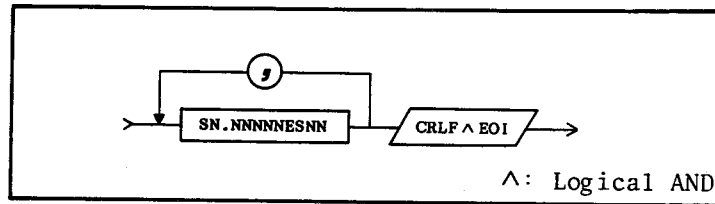

- 2) Fixed length 14 ASCII characters (Long real type register) used for registers that are used to hold a 64 bit floating point number. (Leading space expression)

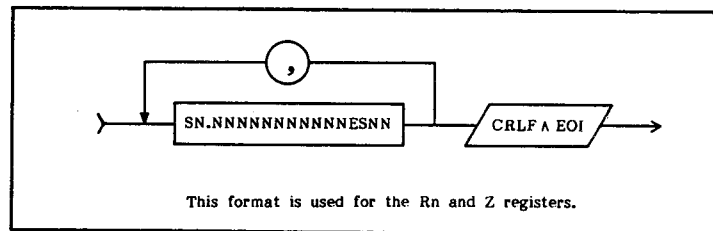
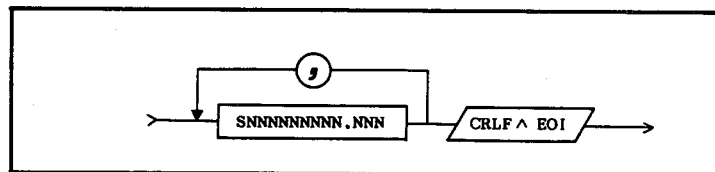

This format is used for the Rn and Z registers.

- 3) Fixed length 11 ASCII characters (Integer type register) used for registers that are used for 16 bit integer numbers. (Leading space expression.)

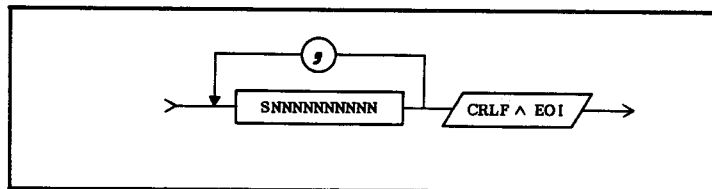

2. FMT2 (Binary mode, IEEE 64 BIT Format):

FMT2 is the 64 bit floating point binary specified in the IEEE Standard 728-1982. This is the same data format used by the HP Series 200 computers. Figure 3-139 shows the syntax diagram used for FMT2 and FMT3. This is one of the block data syntax diagrams defined by the IEEE Standard 728-1982. A block data field initiated by a unique code, the number, (#) sign. A second byte, (A), designates the data type. L1 and L2 is the block length bytes that indicates the number of data bytes in the the data block (L1: high byte, L2: low byte). The count includes all data bytes and the terminator, CR/LF(2 bytes), if they are used. Figure 3-140 shows the floating point format used for the FMT2.

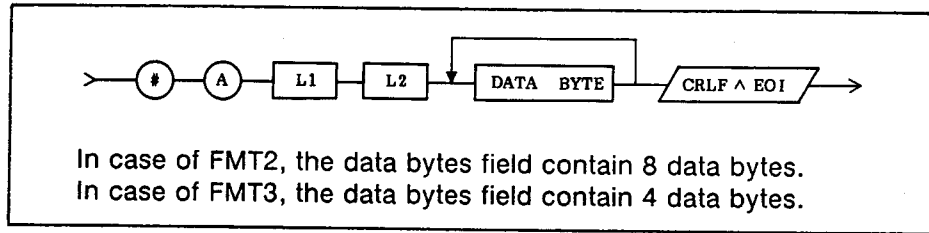

Figure 3-139. Syntax Diagram for FMT2 and FMT3

Data Byte (8 Bytes) for FMT2 is represented as follows.

SEEEEEEE EEEEEMFFF FFFFFFFF FFFFFFFF FFFFFFFF FFFFFFFF FFFFFFFF FFFFFFFF

- Where;
- S : the sign bit of the fractional part (1 bit)
 - E : the exponent part (11 bits)
 - M : the most significant bit of the fractional part
 - F : an intermediate fractional bit (52 bits)
 - L : the least significant fractional bit

Real Number (RN) can be defined as follows.
(EXP: Exponent part of number, f: Fractional part of number)

- When $0 < e < 11111111111$ (2047)

$$RN = (-1)^S \times 2^{(EXP-1023)} \times \left(1 + f / (2^{52}) \right)$$

- When $e = 0$

$$RN = (-1)^S \times 2^{-1022} \times \left(f / (2^{52}) \right)$$

- When $e = 0, f = 0,$

$$RN = 0$$

For example,

$$\begin{aligned} S &= 1 \\ EXP &= 011111111111 \quad (1023) \\ f &= 1000 \ 00000000 \ 00000000 \ 00000000 \ 00000000 \\ &\quad 00000000 \ 00000000 \quad (2^{51}) \end{aligned}$$

$$\begin{aligned} RN &= (-1)^1 \times 2^{(1023-1023)} \times \left(1 + (2^{51} / 2^{52}) \right) \\ &= -1 \times 1 \times 1.5 \\ &= -1.5 \end{aligned}$$

Figure 3-140. FMT2 Data Format

3. FMT3 (Binary mode, IEEE 32 BIT Format):

Figure 3-141 shows the floating point format used for FMT3. Note that FMT3 has the fastest data transfer rate.

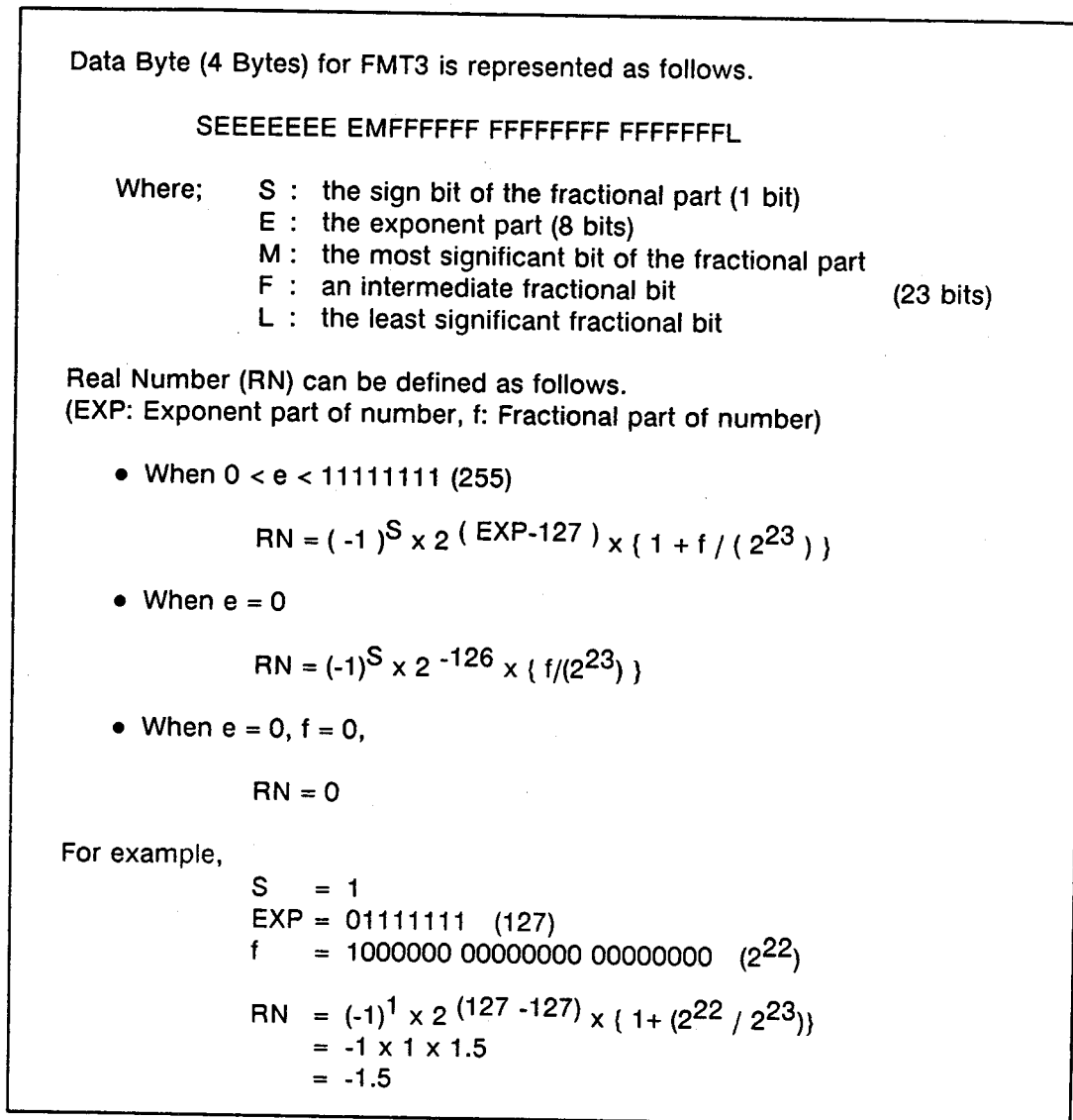

Figure 3-141. FMT3 Data Format

3-6-3-10. Transfer Rate

As described previously, each data format has a different data transfer rate. Table 3-6 shows the typical data transfer rate when an array variable register consisting of 401 register elements is used.

Table 3-6. Data Transfer Rate

1. Data transfer rate using the **ENTER** command with an HP Series 200 (9816) computer.

Code	Format	Transfer Time
FMT1	Block ASCII (a-type)	840ms
FMT2	Block Binary (64-bit)	140ms
FMT3	Block Binary (32-bit)	70ms

2. Data transfer rate using the **TRANSFER** command with an HP Series 200 (9816) computers.

Code	Format	Transfer Time
FMT2	Block Binary (64-bit)	90ms
FMT3	Block Binary (32-bit)	50ms

OPERATION

3-6-3-11. The Status Byte

The status byte is an 8-bit word that the 4194A places on the HP-IB bus when it is serially polled. The value of each bit indicates the status of an internal 4194A function. Bits are set to "1" and reset to "0". The status byte and individual bit assignments are shown in Figure 3-142.

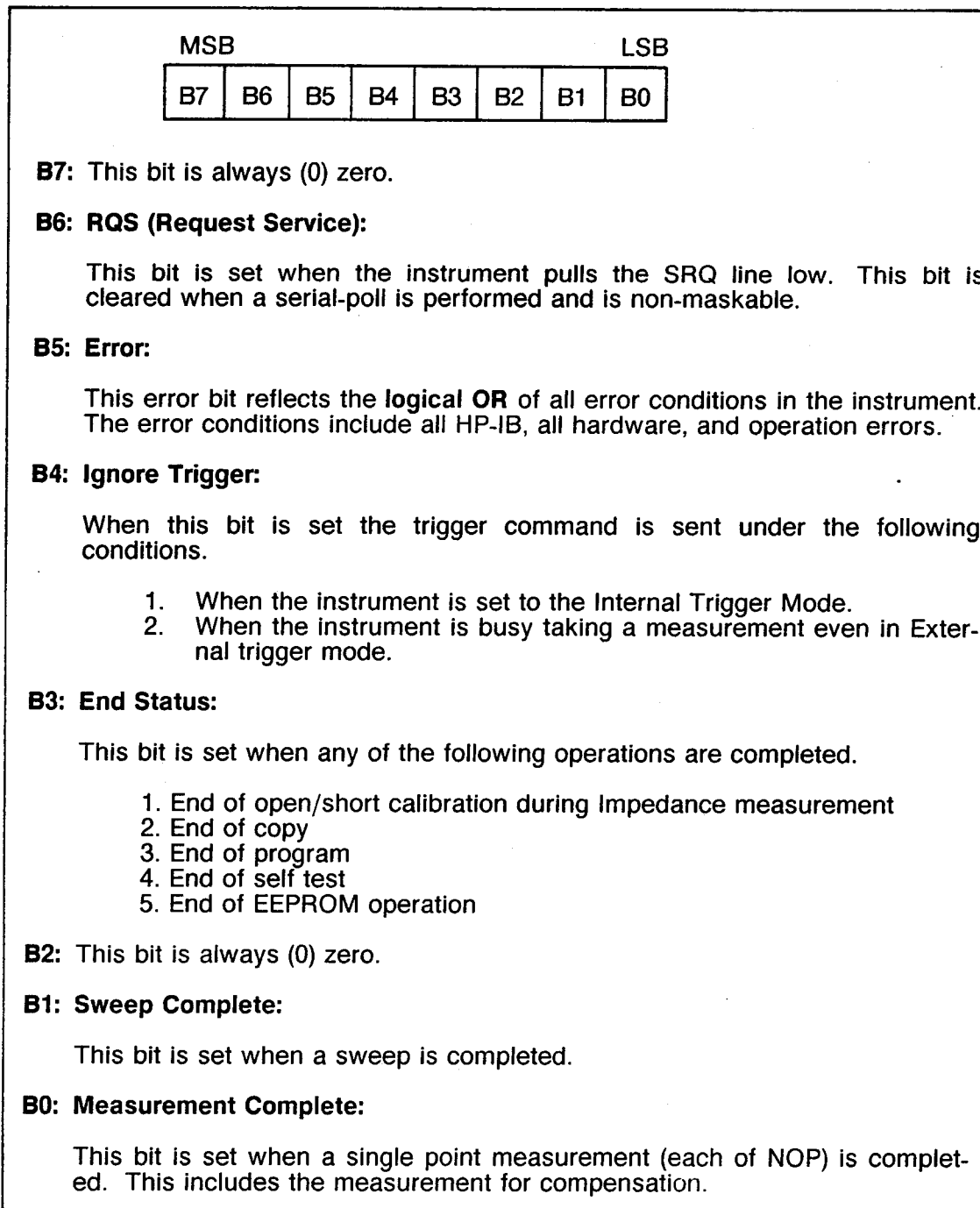

Figure 3-142. Status Byte

Note

1. The status byte is cleared by the controller's serial polling, while BIT 6 (RQS) of the status byte is set to 1.
2. The status byte can be read by sending the STB? query message command. The status byte will not be cleared by this command.

3-6-3-12. Masking the Status Byte

A service request will be generated when any unmasked bit in the status byte is set. The SRQ mask may be loaded by sending an RQS command followed by an ASCII mask byte. The mask byte definition is shown in Figure 3-143.

Status Bit	"0"	"1"
B7(always 0)	-	-
B6(RQS)	Not maskable	
B5(Error)	mask B5	enable B5 SRQ
B4(Ignore trigger)	mask B4	enable B4 SRQ
B3(End status)	mask B3	enable B3 SRQ
B2(always 0)	-	-
B1(Sweep complete)	mask B1	enable B1 SRQ
B0(Measurement complete)	mask B0	enable B0 SRQ

Figure 3-143. Mask Byte

Note

1. In the default instrument state the setting is RQS0 (all zero: all bits masked). RQS ranges from RQS0 to RQS255. For example, RQS3 enables B0 and B1 for SRQ.

3-6-4. Auto Sequence Program

3-6-4-1. HP 4194A ASP Capability

The 4194A has an internal programming capability for instrument control without the aid of an externally connected computer. The 4194A is controlled as if it were being controlled via the HP-IB bus. Setting up an ASP (Auto Sequence Program) requires no special programming knowledge. It can be written by pressing the desired keys and softkeys on the front panel in sequential order. Each key has a program code assigned to it which is displayed on the program-edit line when the key is pressed. In addition, softkeys used for program editing are different from those used for normal front panel operation. The softkeys are automatically changed as you key in a program.

The following program codes can be used in the ASP mode.

1. 4194A's device dependent HP-IB codes.
 2. 4194A's BASIC program commands and statements.
 3. 4194A's arithmetic operators.
1. The 4194A's device dependent HP-IB codes can be used. They are common to both the applications, however in case of ASP, the device dependent HP-IB codes will appear on the screen, actually on the program edit line, when the designated key or softkey is pressed. This is very convenient because you do not have to type them in using the front panel alphabetical keys. The device dependent HP-IB codes are classified into four groups according to their function, Immediate Execution Commands, Select Commands, Data Entry Commands, and String Data Type Commands. See paragraph 3-6-3-6 for more information.

During ASP program editing, some of the **Select Commands** require you to select one of the parameters displayed on the "keyboard input line" block. For example, when you press the key for INTEGRATION TIME, 'ITM' will appear on the program-edit line and 'SHORT=1', 'MED=2', 'LONG=3' will appear on the "keyboard input line" block. Input the appropriate number to select the integration time.

Data Entry Commands always require you to enter parameters from front panel. These commands are always displayed with (=) notation. All of the numeric data type (NR) including the suffix shown in paragraph 3-6-3-7 can be used for parameter settings.

String Data Type Command, CMT(comment), can be used. The CMT (green) key is provided on the front panel. The PROG command is not used.

2. **BASIC** commands used by the 4194A are categorized into two groups for convenience, BASIC program statements and BASIC program commands.

BASIC program statements used for program editing are input using softkeys. The statement will be displayed on the program-edit line when the designated softkey is pressed. Softkeys for BASIC program statements will appear on the screen only when the instrument is in the ASP program editing mode. These statements will be discussed in the next paragraph.

BASIC program commands used for program execution and file management are input using softkeys. Some of these commands are displayed on the "keyboard input line" block when a softkey is pressed. These commands will be discussed in the Program Execution section (paragraph 3-6-3-5) and in the Program File Management section (paragraph 3-6-3-6) respectively.

3. Arithmetic operators that can be used here have been listed in Table 3-3. See paragraph 3-6-2.

Note

- 1) Among the 4194A's device dependent HP-IB codes some do not have a correspondence to a front panel key, in which case you must input the command using the alphabetical keys on the front panel. Press the **BLUE** key and enter the name. This is necessary in the following cases.
 - (1) When you set any of the array variables (data entry commands). You cannot enter parameters into the X register because it is a read-only register.
 - (2) When you set the single variables (data entry commands), Rn(n=0 to 99) and Z. Registers, MON, GONG, MKRA, MKRB, SMKRA, SMKRB, DMKRA, DMKRB, LCURSL, LCURSR, and WID are Read-Only registers.
 - (3) When you set the RST immediate execution command.

You can, of course, input key-assigned command names by using the alphabetical keys on the front panel. See the 4194A program codes in **APPENDIX E**.

- 2) When editing ASP programs, after you enter the statements for one program line press **ENTER/EXECUTE** advance to the next line.

OPERATION

3-6-4-2. BASIC Statements

The BASIC language statements that can be used in ASP programs are introduced here. There are fifteen BASIC program statements, and you can display them on the screen using the following procedure.

1. Press the **MORE MENUS** key.
2. Press the following keys in sequence to display the 'statement' softkey, **PROGRAM** softkey, **EDIT** softkey, and the **ENTER/EXECUTE** key.
3. Press the 'statement' softkey.
4. First page of the BASIC statements, (IF), (THEN), (FOR), (TO), (NEXT), (PAUSE), and (END) are displayed.
5. To go to the second page, press the 'more 1/3' softkey. Then the BASIC statements, (IF), (THEN), (GOTO), (GOSUB), (RETURN), (PAUSE), and (END) will be displayed.
6. To go to the third page, press the 'more 2/3' softkey. Then the BASIC statements, (INPUT), (OUTPUT), (BEEP), (DISP), (WAIT), (SEND) and (END) will be displayed.

Any of these BASIC program statements can be inserted into a program-edit line by pressing the appropriate softkey.

BASIC program statements

In the following paragraphs the 4194A's BASIC program statements are described in detail. The line numbers used in the following examples are just for convenience. The syntax diagrams and practical examples for each statement or a group of statements are shown.

1. IF ... THEN

This statement group (construct) provides conditional branching.

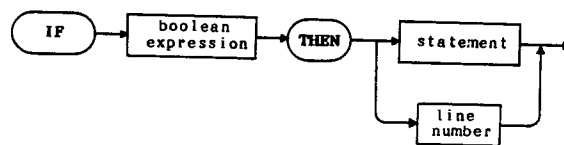

```
10 IF A(10) > 5 THEN R0=1
20 IF R10 <> 1 THEN GOTO 50 (or THEN 50)
```

2. FOR ... TO ... NEXT

This construct defines a loop which is repeated until the loop counter passes a specific value.

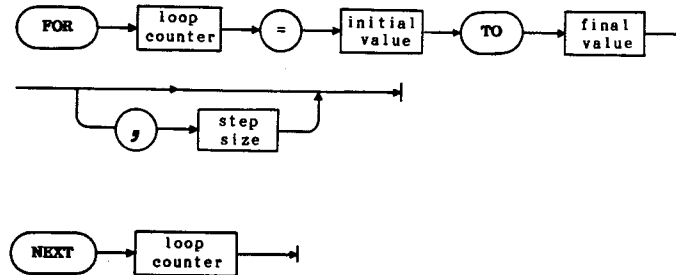

```

10 FOR R5=1 TO 100 , 5
.
.
.
100 NEXT R5
    
```

- * Rn (n=0 to 99) should be used as a loop counter.
- * When the step size is not defined, it is automatically set to either +1 or -1 according to the values input.
- * Single variables (START, STOP, STEP,...) can be used as the initial value, final value, and step size . See paragraph 3-6-1-4 for more information on single variables.
- * The maximum number of times a **FOR ... TO ... NEXT** construct can be nested is 10 times in a program.

3. GOTO

This statement transfers program execution to the specified line. The specified line must be in the current context.

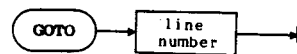

```

10 R10=5
.
.
.
100 GOTO 10 (Jump to line number 10)
    
```

3. Operation

4. GOSUB and RETURN

This construct transfers program execution to a subroutine at the specified line. The specified line must be in the current context. The current program line is remembered in anticipation of the Return instruction.

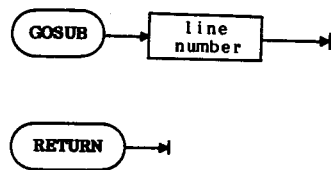

```
10 GOSUB 200 ( Jump to line number 200 for subroutine )
20 R1=R10*R20
```

```
.
.
.
```

```
200 START=1MHZ ( Subroutine starts from here )
```

```
.
.
.
```

```
300 RETURN ( Subroutine ends. Jump back to line number 20 )
```

* The maximum number of times a **GOSUB ... NEXT** construct can be nested is 10 times in a program.

5. INPUT and OUTPUT

These two statements are used for **EXTERNAL I/O** operations

Note

These INPUT and OUTPUT statements **CAN NOT** be treated as equal to the usual BASIC statements. See paragraph 3-6-9 for further explanation.

6. WAIT

This statement will cause the instrument to wait approximately the number of seconds specified by the figures following the statement. Wait time range is from 0 to approximately 10 minutes. Setting resolution is 10msec. If WAIT 153 is set, the wait time is rounded off to 150msec.

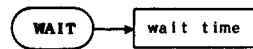

50 WAIT 535 (wait time = 540msec)

7. PAUSE

This statement suspends program execution. This statement is released when one of the following BASIC program commands is executed. The softkeys are provided for these commands. These BASIC program commands are explained in paragraph 3-6-4.4.

CONT(inue)

Causes the program to continue at the next step.

RUN

When this command softkey is pressed, program will start over from the top of program.

STEP

When this command softkey is pressed, the program will be executed in the SINGLE step mode.

STOP

Press this command softkey to stop program execution.

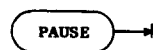

50 PAUSE Program execution will be suspended here.

8. BEEP

This command causes the 4194A to emit an audible tone for 150msec.



50 BEEP (The instrument will beep.)

OPERATION

9. DISP

When this command is executed, either the comments or the contents of register Rn will be displayed on the "System Message Area".

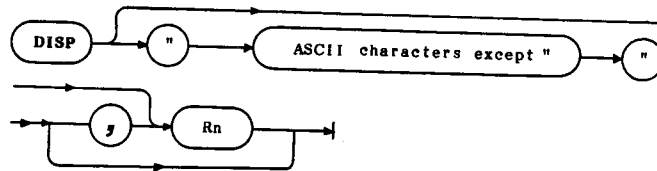

* in case of comments,

50 DISP " GO "

then 'GO' will be displayed in the "System Message Area".

in case of Rn,

50 DISP " R1= ", R1

then 'R1= contents of R1' is displayed in the "System Message Area". Up to 29 characters can be inserted into the comment field.

10. END

This command marks the end of the program. When this command is executed the program stops. This command can be used more than one time in a program.

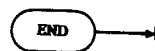

300 END (Program ends here)

11. SEND

This statement is used to output the character string to an external device connected to the HP-IB bus.

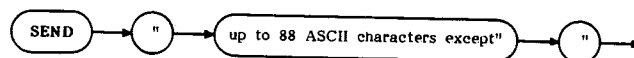

The 4194A must be set up as a TALKER and externally connected devices must be configured as LISTENERS.

The **SEND** statement can be used in the multi-statement form.

3-6-4-3. ASP Set-Up

To enter the ASP program editor page the following operations are required.

1. Press the **MORE MENUS** key.
2. Press the '**PROGRAM**' softkey.
3. Press the '**EDIT**' softkey, '**EDIT**' is displayed on the "Keyboard Input Line" block.
4. Press **ENTER/EXECUTE**.

The PROGRAM EDITOR page (sometimes referred to as the ASP work area) will be displayed and the cursor will be at line 10.

Note

Cursor Position: If you would like to position the cursor at a desired line number, key in that line number following '**EDIT**' by pressing the numeric keys on front panel. For example, to set the cursor on the line number 100, key in 100 ('**EDIT**'100) and press **ENTER/EXECUTE**.

Figure 3-144 shows the PROGRAM EDITOR page when no program exists in the ASP work area. This happens after the **SCRATCH** command is executed or when the instrument is turned on. It is recommended to start editing a new program from this state. The default line number is 10 and increments by 10 for each new line number. The line number can be set from 1 to 32767 allowing 82 characters in a line. The total number of lines is limited to 300. Now you can input the desired HP-IB codes or BASIC program statements including the parameters by pressing the keys or softkeys on the front panel. The softkeys will be displayed when you press any of the keys in the **MENU** section. When you want to exit from the editor page press the '**QUIT EDITOR**' softkey.

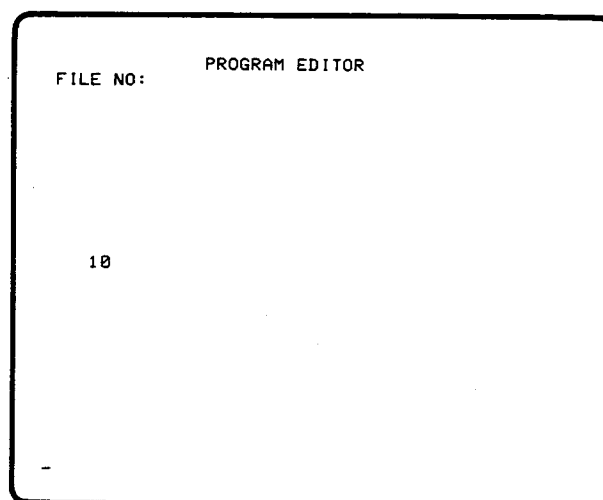

Figure 3-144. Program Editor Page

Note

1. Insert the **RST** (reset) command in the first step of the ASP program, as shown below, so you don't have to set the default settings. To recognize the default settings when programming, execute the '**RST**' command from the Keyboard Input Line before entering the program editor to intensify the default setting softkeys.

```

10 RST (Press ENTER/EXECUTE)
20 FNC2 (Press ENTER/EXECUTE)
.....

```

The **RST** command resets the 4194A to the power-on default conditions with the following exceptions.

- (1) The sweep mode is set to **SINGLE** sweep (code: **SWM2**).
 - (2) Data registers (**A** to **D**), general purpose registers (**RA** to **RL**), compensation registers, **Rn**, **Z**, and all read-only registers are not reset.
 - (3) The program **WORK AREA** is not cleared from memory.
2. The ASP editor allows you to use multi-statement programming. The statement separator is the semicolon (;). The maximum allowable statement length on one line is 82 characters, including line number, separators, and spaces. Commands input in the multi-statement form will be automatically rearranged internally in the proper order. An example of multi-statement input is shown below.

```

10 RST
20 FNC2;GPP1;.....

```

The following commands, however, must be on separate lines.

(4194A Initialization)	RST
(Sweep)	SWTRG, TRIG
(Copy)	COPY
(Compensation)	ZOPEN, ZSHRT, CALY, CALZ, CALSTD
(Programmed Points Table)	POINT
(Equivalent Circuit)	EQDSP, EQCAL, FCHRS
(ASP Commands)	LOAD, STORE, PURGE, RUN, CONT, PPAUSE, PSTEP, PSTOP, PROG
(ASP Statements)	IF ... THEN, FOR ... TO ... NEXT, PAUSE WAIT

The following four commands can be used as multiple commands on the same line only when they are the last command on the line.

GOTO, GOSUB, RETURN, END

For example:

```

100 START=10KHZ;STOP=10MHZ;GOTO 200

```

3. The comment, CMT" ", can be inserted in the program-edit line. Press the **GREEN** and **COMMENT** key, then you will see **CMT** on the program-edit line.
4. The amount of memory available for the program work area is 32768 bytes (17024 bytes for program storage). So the maximum number of program-edit lines is limited by this value. The byte count is based on 10+(number of characters input on each line).
5. The Program editor does not check for syntax or parameter setting errors. These errors are checked for by the system interpreter during program execution. When an error is found, the message, "Error NNN in LLLLL" will be displayed. NNN indicates an error code number listed in APPENDIX D, and LLLLL represents the line number where the error was detected.
6. The following **EDIT** section keys are used to edit programs, arrow (**FORWARD, BACK**), **DELETE CHAR**, **INSERT CHAR**, and (**CLEAR LINE/RECALL**) keys. See paragraph 3-5 for more information on these keys.
7. The Step keys in the **PARAMETER** section are used to scroll program text up or down on the display.

3-6-4.4. Program Editing

Now you are ready to edit a program. This paragraph shows one example to guide you through program editing.

1. This program demonstrates the measurement of passband insertion loss of a 21.4MHz Band Pass Filter (BPF). This example shows how to insert program codes into the program-edit line by using the front panel keys and softkeys. For an explanation of how to input the program using the front panel keys see the example of key and softkey usage shown in "Gain-Phase Measurement" paragraph (3-4-1). Underlined codes are automatically displayed on the program-edit line when the designated key is pressed.

```

10 RST
20 FNC2
30 CENTER=21.4 MHZ;SPAN=100 KHZ
40 OSC=0 DBM
50 SWM2
60 SWTRG
70 AUTOA
80 AUTOB
90 DPB0
100 MKMxA
110 R0=MKRA
120 DISP"INSERTION LOSS=",R0
130 CMT"PASSBAND INSERTION LOSS"
140 END

```

Key Strokes:

Supposing you are in the Edit mode and the program editor page is displayed on the CRT. The operations described in parentheses must be performed before pressing the designated softkey.

OPERATION

Note

/key name/ indicates a front panel key and 'key name' indicates a softkey.

- 10 /blue/ /R/ /S/ /T/ /ENTER/ /blue/
(Press the "FUNCTION" KEY.)
- 20 'GAIN PHASE' /ENTER/
- 30 /CNTR/ /2/ /1/ /./ /4/ /MHz/V/ /green/ /;/
/SPAN/ /1/ /0/ /0/ /KHz/dBm/
/ENTER/
- 40 /OSC LEVEL/ /0/ /KHz/dBm/ /KHz/dBm/ /ENTER/
- 50 /SINGLE/ /ENTER/
- 60 /START/ /ENTER/
(Sequentially press /DISPLAY/ and 'X-A&B menu'.)
- 70 'AUTO SCALE A' /ENTER/
(Press 'more 1/3'.)
- 80 'AUTO SCALE B' /ENTER/
- 90 'DISP B on/off' /0/ /ENTER/
(Sequentially press /MKR/L CURS/, 'more 1/2', and 'o MKR menu')
- 100 'o MKR>MAX(A)' /ENTER/
- 110 /blue/ /R/ /0/ /=/ /M/ /K/ /R/ /A/ /ENTER/ /blue/
(Sequentially press /MORE MENUS/, 'statement', 'more 1/3', and 'more 2/3')
- 120 'DISP' /green/ /"/ /blue/ /I/ /N/ /S/ /E/ /R/ /T/ /I/
/O/ /N/ /space/ /L/ /O/ /S/ /S/ /=/ /green/ /"/
/green/ /,/ /R/ /0/ /ENTER/
- 130 /green/ /CMT/ /P/ ..comment.. /S/ /green/ /"/ /ENTER/
/blue/
(Press /MORE MENUS/ and 'statement')
- 140 'END' /ENTER/

When you have finished editing your program, press **MORE MENUS** and **'QUIT EDITOR'** to exit from the **EDIT** mode. The message, "EXIT editor" will be displayed in the message area. Program codes can be input using multiple-statements using the semicolon, (;) as a separator.

Note

The program code,"SWTRG", has different meanings in the following cases.

1. In the case of INT(ernal) trigger mode:
The instrument executes a complete sweep.
2. In the case of **EXT/MAN** trigger mode:
This command only initiates a sweep.

Figure 3-145 shows program examples.

Program example for case (1).	Program example for case (2)
10 SWM2 (Single sweep)	10 SWM2
20 TRGM1 (INT trigger)	20 TRGM2 (EXT trigger)
30 SWTRG	30 SWTRG
40 E=A;F=B	40 FOR R0=1 TO 401
.	50 TRIG
.	60 NEXT R0
.	70 E=A;F=B
	:

Figure 3-145. Examples for "SWTRG" code

OPERATION

2. The following program demonstrates the sorting of Crystal resonators using the Delta frequency (Parallel resonating frequency - Series resonating frequency) to display the GO/NO-GO results on the CRT. To execute this program press (RUN). See the "Programmed Point Table" in EXTENDED CAPABILITY, Paragraph 3-6-6 for more information.

```
10 RST !INITIALIZE, SWP TO SINGLE
20 CENTER=30 MHZ;SPAN=500 KHZ
30 OSC=0.5 V
40 SWTRG !SWEEP
50 ASC2 !LOG SCALE
60 AUTOA;AUTOB !SCALING
70 MKMXA !MKR TO MAX
80 RO=MKR
90 MKMNA !MKR TO MIN
100 R1=MKR
110 R2=R1-R0 !DELTA F
120 IF R2>1.50E+5 THEN 160
130 IF R2<1.45E+5 THEN 180
140 DISP "GO"
150 GOTO 190
160 DISP "NO-GO(HIGH)"
170 GOTO 190
180 DISP "NO-GO(LOW)"
190 BEEP
200 END
```

Note

1. An ASP program can be run or continued by supplying a signal through the connector labeled **PROGRAM START**, on the 4194A's rear panel. To continue the program, the following two codes must be set in context.

(line number) **PAUSE**
TRIG (Program will continue when the program start command is received through the rear panel connector.)

2. When you use the ASP **COPY** command, set the 4194A as TALK ONLY mode before running the program.
3. To insert the command code in between the program-edit lines already set, perform the following operation. For example, insert the **BEEP** statement at line number 105.

```
100 SWTRG
110 ASC2
120 AUTOA
```

- 1) Move the cursor to line 120.
- 2) Input 05 and press the **CLEAR LINE** key.

- 3) Then input 'BEEP' and press the **ENTER/EXECUTE** key. 'BEEP' is one of the statements included under the 'statement' softkey.

Then the program will be modified to:

```
100 SWTRG
105 BEEP
110 ASC2
120 AUTOA
```

4. ! (Remark sign) can be used to input the comment on the program-edit line.

For example,

```
100 SWTRG ! SWEEP START
```

5. REGISTER?, DISP? and CMT? query commands

To print out the measurement results or comment directly to the printer, the 4194A provides the **DISP?** and **CMT?** query commands. Set the 4194A to TALK ONLY and the printer to LISTEN ONLY.

For example,

```
100 DISP " BANDWIDTH(HZ)=",R1
110 DISP?
.
.
.
200 MKR?
.
.
.
```

When line number 110 is executed, the contents specified with DISP will be printed out. When line number 200 is executed, the contents of the MKR register will be printed out.

OPERATION

3-6-4-5. Program Execution

Be sure that the program discussed here is in the **WORK AREA**. So your desired program must be loaded before running. Syntax errors will be checked by the system interpreter during program execution. In addition, the setting errors such as parameter range, function mode are also checked during program execution. When an error occurs a message will be displayed on the "System Message Area", in the following form, "Error NNN in LLLLL". NNN indicates an error code number listed in APPENDIX D and LLLLL represents the program line number where the error was found.

Five **BASIC** program commands, via softkeys, are provided for this work. These commands are executed immediately when pressed. So you do not have to press the **ENTER** key. These commands can be displayed on the screen by the following operation.

1. Press the **MORE MENUS** key.
2. Press the **'PROGRAM'** softkey.
3. Press the **'more1/2'** softkey.

The following **BASIC** commands will appear.

RUN

When this command softkey is pressed, execution of the program in the work area will start. A program will always start from the beginning. While the program is running, all softkeys and keys are deactivated, except for the **'STOP'** and **'PAUSE'** softkeys.

Note

An ASP program can be started by sending a start command to the rear panel "PROGRAM START" input. See paragraph 3-5.

STOP

This command softkey terminates program execution. While in the STOP state, the **'CONT'** softkey is not effective, however the **'STEP'** softkey can be used to single step a program from the top of the program.

PAUSE

This command softkey suspends program execution. If the **'CONT'** or **'STEP'** softkey is pressed, program execution will start from the next line. If the **'RUN'** softkey is pressed, the program will start from the beginning. All key and softkey inputs can be accepted while in the PAUSED state.

CONT(inue)

This command softkey resumes execution of a paused program at the command after the **'PAUSE'** softkey was pressed. This command is effective only while in the **PAUSED** state.

STEP

This command softkey performs single step execution of a program. In the **STOP** state, the '**STEP**' softkey single steps the program from the top. In the **PAUSE** state, the '**STEP**' softkey single steps a program starting at a specified line number.

Note

1. Program execution will be suspended if the **SEND** or **COPY** commands are used in an ASP program without connecting the external device (Listener). Press the '**STOP**' softkey to exit from the suspended state.
2. If you press the '**EDIT**' softkey and then the **ENTER/EXECUTE** key after the error is detected in an ASP program, the cursor will be positioned at the program edit line where the error was detected.
3. If these keys are pressed after you stop the program in progress, the cursor will be positioned at the program-edit line which would be executed next after the '**stop**' softkey was pressed.

3-6-4-6. File Management

The following file management **BASIC** program commands are provided. These commands are frequently used for listing, storing or loading, and deleting programs. Also note that you can make a file comment at the same time you execute the **STORE** command. These command softkeys can be displayed by using the following procedure.

1. Press **MORE MENUS**.
2. Press the '**PROGRAM**' softkey and the the following six commands will appear on the screen.

EDIT

This command softkey is used when you enter the **PROGRAM EDITOR** page. This was explained in paragraph 3-6-4-3.

CAT(alog)

When you press this softkey and "PROGRAM CATALOG LIST" will be displayed on the screen. This list contains the following information.

AVAILABLE MEMORY

Indicates the rest of memory capacity available for new program in bytes.

FILE NO.

Indicates the file numbers of the programs in memory.

BYTE(USED)

Indicates how many bytes are used for each program.

OPERATION

FILE COMMENT

Displays the comment that had been put on each program when it was stored.

Note

The total number of files that can be stored in nonvolatile memory is limited to 30.

LOAD and STORE

These commands softkeys are used when the program is stored into or loaded from memory. See the paragraph on operation for a description on how to enter a program name with the **STORE** command.

Operation syntax diagram is as follows.

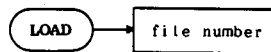

then press **ENTER/EXECUTE**

LOAD10, and press **ENTER/EXECUTE**

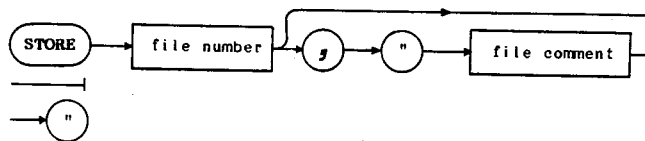

then press **ENTER/EXECUTE**

STORE20," 70MHZ BPF SORTING PROGRAM ", then press **ENTER/EXECUTE**

File numbers from 1 to 999 can be input. A file comment may be up to 19 characters in length.

PURGE

This command softkey is used to delete a program from memory.

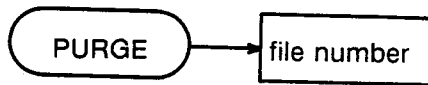

Then press **ENTER/EXECUTE**.

PURGE 10, then press **ENTER/EXECUTE**

SCRATCH

This command softkey is used to delete a program from the PROGRAM EDITOR page (work area). It is recommended that this command be executed before starting to edit a new program.



Then press **ENTER/EXECUTE**.

SCRATCH then press **ENTER/EXECUTE**

Note

Memory capacity in the 4194A: The 4194A provides the following storage capacity for the work area and program storage area.

working area:	32768 bytes (volatile memory)
program storage area:	17024 bytes (nonvolatile battery back-up)

OPERATION

3-6-4-7. ASP Copy

To make a copy of the ASP program in the program editor page perform the following operations.

1. Press **MORE MENUS**.
 2. Press the '**COPY menu**' softkey.
 3. Press the '**PRINT mode**' softkey.
 4. Press **MORE MENUS**.
 5. Press the '**HPIB DEFINE**' softkey.
 6. Press the '**TALK ONLY**' softkey.
 7. Set the attached printer to the Listen Only mode.
 8. Press **MORE MENUS**.
 9. Press the '**PROGRAM**' softkey.
 - * If the program you want to copy is on the editor page, just press the '**EDIT**' softkey and **ENTER/EXECUTE**.
 - * If your program is in the program storage area, move it to the editor page using the '**LOAD**' and '**EDIT**' softkey. Press the '**LOAD**' softkey, input the file number, and press **ENTER/EXECUTE**.
- Press the '**EDIT**' softkey and then **ENTER/EXECUTE**.
10. Press the '**QUIT EDITOR**' softkey.
 11. Press the **COPY** key and the printer will start printing.

Note

ASP is stored to the memories which are non-volatile through battery back up. If the battery is depleted, or if the 4194A is repaired, the data stored in the memory may be lost. Keep a hard copy of the program listing.

3-6-5. Compensation (Calibration)

All test fixtures including the probe fixture or measurement circuits have parasitic elements which will affect measurement accuracy of the 4194A. Parasitic elements can be measured and used as offset or calibration data for compensation. The compensation data must be taken in advance of the measurement and used for compensation. Compensation softkey menus can be displayed by pressing the **COMPEN** key. Figure 3-146 shows the softkey menus for Impedance and Gain-Phase measurements for compensation. The softkey menus for Impedance and Gain-Phase measurements are different except for the softkeys related to phase compensation.

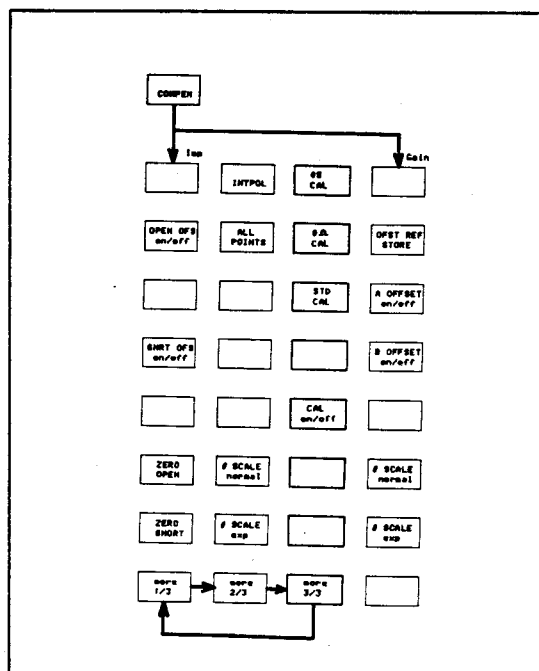

Figure 3-146. Softkey Menu for Compensation

3-6-5-1. Compensation for Impedance Measurement

Impedance measurement compensation softkeys are separated into two groups.

- 1) **ZERO-OPEN/SHORT** offset measurement. Obtains offset data for test fixtures.
- 2) Calibration measurement using standards. This measurement is provided to calibrate the probe fixture included in the 41941A/B Impedance Probe Kit. Three calibration standards are included for calibration measurement.

Note

1. These compensation methods are available for both functions specified with the **'IMPEDANCE'** or **'IMP with Z PROBE'** softkeys.
2. The 41941A/B Impedance Probe Kit is an accessory of the 4194A. Using the probe fixture extends the frequency range for the Impedance measurement of the 4194A to 100MHz. Connect the probe to the Gain-Phase section of the 4194A and select the **'IMP with Z PROBE'** softkey for measurement. See paragraph 3-3-3 for more information.

OPERATION

3. Calibration measurement using the calibration standards can be applied to the probe fixture supplied with the 41941A/B Impedance Probe Kit and to the other fixture of passive elements (must be expressed by four terminal constants) and can be terminated with the calibration standards.

The connection diagram in Figure 3-147 shows the measurements relationship.

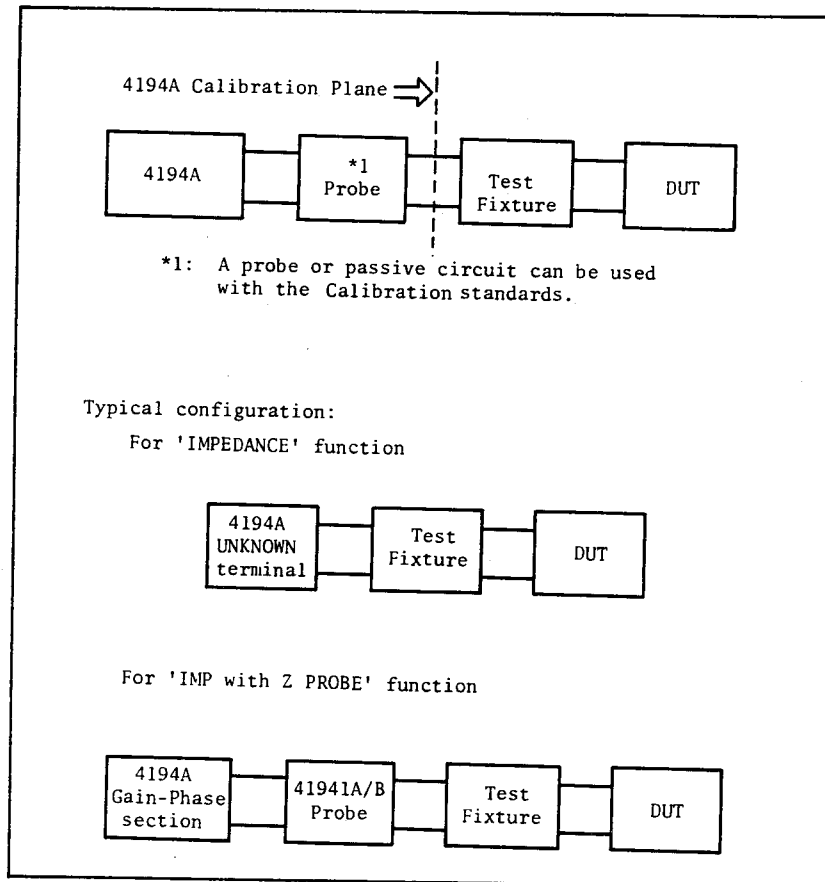

Figure 3-147. Fixture Connection Diagram

In the case of '**IMPEDANCE**' the test fixture is usually connected directly to the UNKNOWN terminals of the 4194A. In the case of '**IMP with Z PROBE**' the probe is connected to the Gain-Phase section of the 4194A and the test fixture is used with the probe if needed. The 4194A's calibration plane will extend to the DUT by performing offset or calibration measurements for the fixtures.

There are two methods of performing offset or calibrated measurements, the "Interpolation method", and the "All points method".

1. Interpolation method (Program code: CMPN1)

The power-on default setting where offset or calibration data is taken at all preset frequency points independent of the sweep range set. The effective data for each measurement point over the specified range is calculated using linear interpolation. The preset frequency points are as follows.

For the '**IMPEDANCE**' (Program code: FNC1):

$f = 100\text{Hz} \sim 40\text{MHz}$ (CABLE LENGTH switch = 0m)	53 points
$f = 100\text{Hz} \sim 15\text{MHz}$ (CABLE LENGTH switch = 1m)	28 points

For the 'IMP with Z PROBE' (FNC3):

$$f = 10\text{Hz} \sim 100\text{MHz}$$

70 points

Select the frequency sweep mode when you use the Interpolation method to acquire offset or calibration data.

If the Osc. level or DC Bias sweep mode is selected for the measurement with the interpolation method on, the offset or calibration data for the spot frequency point being set will be used for compensation.

2. All points method (Program code: CMPN2)

In the All points method the offset or calibration data are taken at each sweep point over the your specified sweep range. Set the calibration sweep range to the same range as the measurement range to be used. This method is available for frequency sweep mode and the Osc. level or DC Bias sweep mode. For the Osc. level or DC Bias sweep mode offset or calibration data is measured and stored in conjunction with the spot frequency being set.

Note

Offset data or calibration data taken by using the All points method is effective only for the specified measurement parameters used for measurement. So whenever you change the parameters such as sweep mode, sweep range, sweep type, Osc level, INTEG time, or even the NOP number you must perform the offset data or calibration data measurement again to update. The 4194A displays various error messages whenever the improper settings are found in order to ensure the accurate measurements. See paragraph 3-6-5-6 for more information.

3-6-5-2. ZERO-OPEN/SHORT Measurement

All measurement errors existing along the test fixture are represented as parallel stray parameters ($Y=G+jB$) and series residual parameters ($Z=R+jX$) as shown in Figure 3-148.

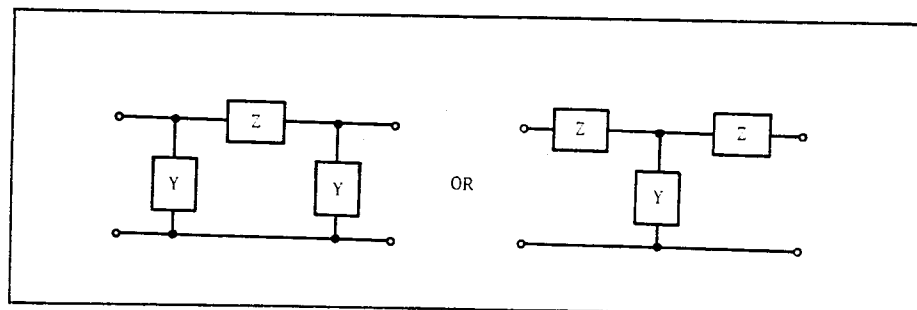

Figure 3-148. Parasitic Elements of Test Fixture

OPERATION

To measure the offset data the '**ZERO OPEN**' and '**ZERO SHORT**' softkeys are used. When the test fixture is attached to the probe, calibrate the probe first and set the '**CAL on/off**' softkey to **ON** before performing this measurement. See Paragraph 3-3-3 for more information.

Note

1. The following messages appear when the improper setting is found.

"Open/Short must be in IMP"

The message appears when the **ZERO OPEN/SHORT** measurement is attempted in the Gain Phase measurement (Program code: FNC2) mode.

"Open/Short must be in f swp"

The sweep parameter must be set to the frequency mode in the Interpolation compensation method.

2. Set the **CABLE LENGTH** switch to either 1m or 0m when connecting the test fixture to the UNKNOWN terminals. For example, when the 16048A Test Fixture is used, set this switch to the 1m position. The 0m position should be selected for the direct attachment type of test fixtures such as the 16047D. The frequency sweep range differs according to the switch position.

0m : 100Hz ~ 40MHz

1m : 100Hz ~ 15MHz

3. ZERO OPEN/SHORT measurement data will not be displayed on the screen while in the offset measurement mode.

Use the following procedure to perform the ZERO OPEN and ZERO SHORT measurements. The procedure is shown in sequence.

1. ZERO OPEN measurement (Program code: ZOPEN)

- 1) Connect the test fixture to the UNKNOWN terminals. Leave the fixture's contacts open.

Note

When the test fixture is connected to the probe, calibrate the probe first and set the '**CAL on/off**' softkey to **ON** before performing the **ZERO-OPEN/SHORT** measurements.

- 2) Make sure you are in the Impedance measurement mode. Select the '**IMPEDANCE**' or '**IMP with Z PROBE**' softkey.
- 3) Press the **COMPEN** key.
- 4) Press the 'more 1/3' softkey.
- 5) Select either the Interpolation method or the All points method by pressing the '**INTPOL**' or '**ALL POINTS**' softkey. The softkey selected changes to intensified **Green**.

- 6) Press the 'more 2/3' and 'more 3/3' softkeys in sequence to return to the first page. (Or press the **COMPEN** key)
- 7) Select the sweep parameter and other settings for measurement.

When you selected the All points method set the sweep range to the same range as the measurement range to be used. Use the frequency sweep mode if you select the Interpolation method.

- 8) Press the '**ZERO OPEN**' softkey then the message, "Press ENTER zero open" will be displayed in the System Message Area.
- 9) Press the **ENTER/EXECUTE** key. The sweep mode is now set to **Single** sweep and a single measurement will be made.

2. ZERO SHORT measurement (Program code: ZSHRT)

CAUTION

BEFORE PROCEEDING WITH THE ZERO SHORT MEASUREMENT SET THE DC BIAS TO OFF USING THE FRONT PANEL KEY. IF THE MEASUREMENT IS MADE WITH DC BIAS ON THE WARNING MESSAGE "DC CURRENT OVERLOAD" MAY APPEAR AND RESULTS BECOME USELESS.

- 10) Short the fixture's contacts together using the shorting piece. Use the attached shorting piece if supplied with the fixture.
- 11) Press the '**ZERO SHORT**' softkey then the message, "Press ENTER for zero short" will be displayed.
- 12) Press the **ENTER/EXECUTE** key to make a measurement.

Both the ZERO-OPEN/SHORT offset data are now stored into the memory in connection with the compensation method, Interpolation or All points.

Note

1. Measurement conditions are indicated in the System Message Area.
 - 1) While a measurement is in progress: "Measuring zero (open or short)".
 - 2) When the measurement is completed: "Zero (open or short) compen completed."
2. To abort a measurement press the '**ZERO OPEN**' or '**ZERO SHORT**' softkey again. The message "Zero (open or short) compen aborted" will be displayed and a beep generated.
3. A ZERO-OPEN/SHORT measurement can be run using the **EXT/MAN** trigger mode.

OPERATION

3-6-5-3. ZERO-OPEN/SHORT Compensation

To make the ZERO OPEN/SHORT offset data valid or invalid with respect to the subsequent measurement results the following two softkeys are used.

1. The '**OPEN OFS on/off**' softkey is used to set the offset data acquired by the ZERO OPEN measurement to ON (Program code: OPN1) or OFF (OPN0) with respect to the measurement results. The softkey label will change to intensified green when it is **ON**.

In the case of the Interpolation method the offset data effective for your specified range will be calculated using the linear interpolation method and stored into the **OG** and **OB** registers when this softkey is set to **ON**.

In the case of the All points method the G and B values measured by the **ZERO OPEN** measurement will be stored into to the **OG** and **OB** registers when this softkey is set to **ON**.

2. The '**SHRT OFS on/off**' softkey is used to set the offset data acquired by the ZERO SHORT measurement to ON (Program code: SHT1) or OFF (SHT0) with respect to the measurement results. It will change to green when it is **ON**. This softkey behaves in the same as the '**OPEN OFS on/off**' softkey except that registers, **SR** and **SX** are used.

3-6-5-4. Calibration Using Calibration Standards

The softkeys, '**OS CAL**', '**0Ω CAL**', and '**STD CAL**' are provided basically to obtain calibration data for the probe. Connect the probe to the Gain-Phase section of the 4194A and select the measurement function, '**IMP with Z PROBE**' measurement. To calibrate the probe accurately, both the calculated and measured calibration data are used. The reference values to calculate the theoretical calibration data for each calibration standard are prestored into the 4194A's nonvolatile memory as shown below.

0S calibration standard (P/N 41941-65003)	: 0[S] + 0.31E-12[F]
0Ω calibration standard (P/N 41941-65001)	: 0[Ω] + 0[H]
50Ω calibration standard (P/N 41941-65002)	: 50[Ω] + 5.75E-9[H]

Note

1. These values are effective only for the calibration standards specified by the parts number shown in the parentheses. Probe standards are included in the 41941A/B Impedance Probe Kit.
2. Refer to APPENDIX F on how to set the reference values of calibration standards to the 4194A's internal nonvolatile memory. The reference values can be set independently for the function, '**IMPEDANCE**' (FNC1) and '**IMP with Z PROBE**' (FNC3).

In the Interpolation method the calculated calibration data for all preset frequency points are calculated first using these values and then the data effective for the your specified range will be linear interpolated and used. For the All points method the theoretical calibration data for your specified range will be directly calculated and stored into the designated array registers in the complex form as shown below.

Calibration standards	Stored form	Registers
0S	$G + jB$	TYG, TYB
0Ω	$R + jX$	TZR, TZX
50Ω	$R + jX$	TSTDR, TSTDX

The measured calibration data for each standard will be measured and stored into the memory. Three softkeys, '0S CAL', '0 Ω CAL', and 'STD CAL' are used for this measurement. In the case of the Interpolation method the calibration data for all preset frequency points are measured and the data effective for your specified range will be linearly interpolated and used. For the All points method the calibration data are directly stored into the designated array registers in the complex form as shown below.

Calibration standard	Stored form	Registers
0S	$G + jB$	MYG, MYB
0Ω	$R + jX$	MZR, MZX
50Ω	$R + jX$	MSTDR, MSTDX

These registers are used to store calculated and measured calibration data for the All points method. See paragraph 3-6-1-2 for more information.

The following shows the operation procedure used to acquire calibration data using the three calibration standards.

1. 0S calibration (Program code: CALY)

- 1) Connect the probe to the Gain-Phase section of the 4194A.
- 2) Place the 0S calibration standard on the end of the probe.
- 3) Press the **FUNCTION** key and select the 'IMP with Z PROBE' softkey (FNC3).
- 4) Press the **COMPEN** key.
- 5) Press the 'more 1/3' softkey.
- 6) Press the 'INTPOL' or 'ALL POINTS' softkey to select the compensation method.
- 7) Press the 'more 2/3' softkey.
- 8) Select the sweep parameter and other settings for measurement.

OPERATION

If you selected the All points method set the sweep range to the same range as the measurement range to be used.

- 9) Press the '**OS CAL**' softkey and "Press ENTER for OS cal" will be displayed.
- 10) Press the **ENTER/EXECUTE** key. A single measurement is made and the sweep mode is set to the Single sweep mode. The message, "calibration completed" will be displayed and the calibration data will be stored for use with the selected measurement function.

2. 0 Ω calibration (Program code: CALZ)

The operation procedure for 0 Ω calibration is the same as that for the OS calibration except that the 0 Ω standard and '**0 Ω CAL**' softkey are used instead of the OS standard and '**OS CAL**' softkey.

3. 50 Ω calibration (Program code: CALSTD)

The operation procedure for 50 Ω calibration is the same as that for the OS calibration except that the 50 Ω standard and '**STD CAL**' softkey are used.

Note

1. Calibration data will not be displayed on the screen while the calibration measurement is in progress.
2. Calibration data is stored in connection with the measurement function, '**IMPEDANCE**' or '**IMP with Z PROBE**'. The calibration data taken with the '**IMP with Z PROBE**' function can not be used for the '**IMPEDANCE**' measurement and the reversed case is also inhibited.
3. To abort a measurement press the same softkey again. The message will appear.
4. The calibration measurement can be run using the **EXT/MAN** trigger mode.

'CAL on/off' softkey

The '**CAL on/off**' softkey is used to make the calibration valid (Program code: CAL1) or invalid (CAL0) with respect to the measurement results. When this softkey is set to **ON** the measurement results will automatically be calibrated every time a measurement is made. If the setting being set is improper (not matched to those stored with the calibration data) the 4194A displays the error message. The error messages are described in the next.

3-6-5-5. Messages for Compensation (Impedance)

The 4194A displays the following messages to ensure the correct and accurate measurements. The message appears when the measurement function or parameter is changed while the compensation is being set to **ON**.

- (1) "Offset data not suitable"
- (2) "All CAL data not suitable"
- (3) "0S CAL data not suitable"
- (4) "0 Ω CAL data not suitable"
- (5) "STD CAL data not suitable"

Message (1) is directly related to the ZERO-OPEN/SHORT compensation and the rest of them are related to calibration using the calibration standards. When the softkeys for both compensations are ON, the messages for the calibration (2) ~ (5) are prioritized.

Message (1) appears when:

- 1) Measurement points (sweep points) are changed because the sweep range or sweep type (Linear or Log.) is changed in the All points method.
- 2) Sweep parameter such as frequency, Osc. level or DC Bias is changed in the All points method.
- 3) Spot frequency is changed when the Osc. level or DC Bias is selected as the sweep parameter in the All points method.

Messages (2) appears when:

- 1) The measurement points (sweep points) are changed in the All points method.
- 2) The sweep parameter (Frequency, Osc. level or DC Bias) is changed in the All points method.
- 3) The spot frequency is changed while in the Osc. level or DC Bias sweep mode in the All points method.

One of the four messages (2) ~ (5) appears when:

The measurement function is changed (only **'IMPEDANCE'** to **'IMP with Z PROBE'** direction) regardless of which compensation method (Interpolation or All points) is selected. When two or more messages are received simultaneously the messages will be prioritized in the order that they were sent (from 2 to 5).

OPERATION

3-6-5-6. Gain-Phase measurement Compensation

The offset data for Gain-Phase measurement can be obtained by pressing the '**OFST REF STORE**' softkey, (Program code "OFSTR"). The sweep mode can be set either to the Single or Repeat modes. When this softkey is pressed the offset data are stored into the array registers, **OFSTA** and **OFSTB**. Register transfers, **OFSTA=A** and **OFSTB=B** are automatically made.

The following operations are required to make the offset data measurement.

- 1) Make a Through-connection by replacing the DUT with a BNC adapter, such as a BNC barrel, BNC(f)-to-BNC(f) adapter.
- 2) Make sure that you are in the Gain-Phase mode.
- 3) Set the sweep range and the other parameters for the measurement.
- 4) Set the sweep mode to the Single Sweep mode. In this mode you can recognize the end of sweep clearly.
- 5) Press the **COMPEN** key. The '**OFST REF STORE**' softkey will be displayed.
- 6) Press **START** and wait for the sweep to complete.
- 7) Press the '**OFST REF STORE**' softkey. "Offset reference stored" will be displayed on the screen.

Note

The stored offset data is effective for only the specified measurement parameters used for the offset measurement. So, whenever you change the measurement parameters such as sweep range or sweep type, you must perform a new offset measurement.

'A/B OFFSET on/off' softkeys

To enable the compensation for the measurement results the following two softkeys are provided.

- (1) '**A OFFSET on/off**' softkey (Program code "AOF1" or "AOF0") is used to set the offset data ON ("AOF1") or OFF ("AOF0") for data A. The softkey intensifies when it is **ON**.
- (2) '**B OFFSET on/off**' softkey (Program code "BOF1" or "BOF0") is used to set the offset data ON ("BOF1") or OFF("BOF0") for data B. The softkey intensifies when it is **ON**.

The measurement results will automatically be compensated (calibrated) every time a measurement is made.

Note

1. The compensation methods discussed in this paragraph are valid for relative gain or loss in the (dB) measurement mode. The compensated data are expressed by the following equation. $A = (A-OFSTA)$
 $B = (B-OFSTA)$

In the case of relative gain or loss in absolute values the following operations must be performed. $A = A/OFSTA$, $B = B/OFSTB$. This can be done on the "Keyboard Input Line" block or in the program (ASP or HP-IB).

3-6-5-7. Phase Compensation

Phase compensation is performed using the following softkeys.

1. The ' θ **SCALE normal**' softkey (Program code "PHS1") is used to set phase scale to the normal mode. In this mode, the phase trace represents 360° phase wraps.
2. The ' θ **SCALE exp**' softkey (Program code "PHS2") is used to set phase scale to the expansion mode in which the phase trace is continuously expanded.

OPERATION

3-6-6. Programmed Points Table

Programmed points tables are provided so you can set the desired sweep point parameters for programmed points measurements. These measurements are used to analyze particular regions with better sweep resolution around the point of interest and you can make GO/NO-GO judgments by setting the minimum and maximum values. The GO/NO-GO result is stored in the "GONG" register as GO=1 or NO-GO=0. The limit line can be displayed on the screen with the measurement results so you can check what part of the measurement is out of tolerance.

3-6-6-1. Table Set Up

There are two ways to set up a programmed points table.

1. Set up the table using the 4194A's programmed points table editor.
2. Set up the table using the program code, "POINT=". This method is used when the table is set up via HP-IB or in an ASP program.

1. Table editor

The table editor can be entered by performing the following front panel operations. Program codes are shown in < "code" >.

- 1) Press **MORE MENUS**.
- 2) Press the '**SET PROG TABLE**' softkey, < "PTSET" >. Figure 3-149 shows the softkey menu for the programmed Points table. The first page of the softkey menu will be displayed on the screen. Concurrently the programmed points table (Table number: 1) will be displayed also. (This is one of the 16 tables originally set.) Any measurement in progress is suspended and the sweep mode is set to **SINGLE** sweep.

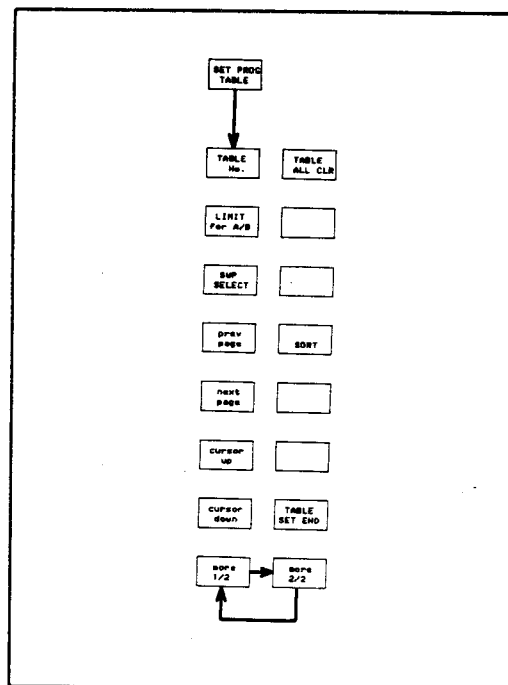

Figure 3-149. Programmed Points Table Menu

- 3) Press the 'TABLE No.' softkey < "PTN=" > if you want to work on another table. To select the table number (1 to 16) press this softkey repeatedly until the table you want appears. Figure 3-150 shows one example of a programmed points table.

PROGRAMMED POINTS TABLE 1			
SHEEP:FREQUENCY(Hz)		LIMIT FOR DATA A	
N	SHEEP POINTS	MINIMUM	MAXIMUM
1	100 000.000	-5.00000E+00	9.99999E+37
2	200 000.000	-5.00000E+00	9.99999E+37
3	400 000.000	-5.00000E+00	9.99999E+37
4	500 000.000	-7.00000E+00	9.99999E+37
5	600 000.000	-2.20000E+01	-5.00000E+00
6	800 000.000	-4.50000E+01	-2.00000E+01
7	1 000 000.000	-6.50000E+01	-4.00000E+01
8	1 400 000.000	-9.40000E+01	-7.70000E+01
9	1 500 000.000	-9.99999E+37	-8.20000E+01
10	1 500 000.000	-9.99999E+37	-8.50000E+01
11	2 000 000.000	-9.99999E+37	-8.00000E+01
12	3 000 000.000	-9.99999E+37	-8.50000E+01
13	4 000 000.000	-9.99999E+37	-8.00000E+01
14	6 000 000.000	-9.99999E+37	-8.00000E+01
15	8 000 000.000	-9.99999E+37	-8.00000E+01
16	10 000 000.000	-9.99999E+37	-8.00000E+01
17			

Figure 3-150. Programmed Points Table

- 4) Press the 'SWP SELECT' softkey to select one of the five sweep point parameters. Press this softkey repeatedly until the desired parameter is displayed on the screen. This selection becomes effective when the table is blank. The message, "Can't change while data exists" will alert you by beeping when this key is invalid. Five sweep parameters and their program codes are shown in Table 3-7. The range setting is equivalent to that specified for normal operation.

Table 3-7. Sweep Parameters and Program Codes

Sweep parameter	Program Code
1. Frequency (Hz)	"PTSWP1"
2. DC Bias (V)	"PTSWP2"
3. OSC. (V)	"PTSWP3"
4. OSC. (dBm)	"PTSWP4"
5. OSC. (dBV)	"PTSWP5"

3 Operation

OPERATION

- 5) Now you are ready to edit the programmed points table. The cursor will appear on the first line (Nop=1). You must set at least two sweep points to make a measurement. (Remember that the NOP has a range of 2 to 401.) You can use the **MHz/V**, **KHz/dBm**, or **Hz/dBV** keys in the **ENTRY** section to set the sweep points. Minimum and maximum value set for each sweep point will be used for a GO/NO-GO judgment and the limit line display. Their default values are as follows:

Minimum= -9.99999E+37 Maximum= +9.99999E+37

The limit values can be set for either data A or data B. This selection is made using the **LIMIT for A/B** softkey. Press this softkey and the message "LIMIT FOR A" (yellow) or "LIMIT FOR B" (blue) will be alternately displayed at the top of the table. Note that this setting is saved in connection with the table number, (< "LMF1" > for data A and < "LMF2" > for data B). If you do not need to make a GO/NO-GO judgment you can disregard the limit values.

The Edit sequence is as follows.

- 1) Select the sweep point.
- 2) Press the arrow key (-->) to move the cursor to the next minimum value.
- 3) Select the minimum value. Press the arrow key (-->) again to move the cursor to next (maximum) value.
- 4) Select the maximum value. Press **ENTER/EXECUTE**. The cursor will move to the next line.
- 5) Repeat sequence (1) to (4) until you complete the table.

If you try to enter the same value into the table twice, the message "The same sweep point exist" will be displayed and a beep will be generated. The cursor will move to the next line where the duplicate value was found.

- 6) Press the **'more 1/2'** softkey to display the second page of the softkey menu.
- 7) Press the **'TABLE SET END'** softkey

The **'TABLE SET END'** softkey is used to indicate the end of a table-edit. Press this key when you complete the settings. < "PTEND" > The softkey menu will return to the preceding menu.

- * The **'TABLE ALL CLR'** softkey is used to cancel all settings. When this softkey and the **ENTER/EXECUTE** are pressed the table will be cleared. (The message " ENTER to execute All-CLEAR " will be displayed after you pressed this softkey.) It is recommended that you execute this softkey command when you create a new table. < "PTCLR">
- * The **'SORT'** softkey is used to align the sweep points table in the sequential order of their values. < "PTSRT" >

Note

- (1) If you use the unit keys in the **ENTRY** section or the **ENTER/EXECUTE** key to input the Sweep point, the default values will be automatically set to the minimum and maximum values. Use these keys when you skip over these settings.

- (2) Table number

By default 16 tables are created originally and each table permits up to 26 sweep points to be set. When you need to set more than 26 points for a single measurement you can set up to 401 sweep points in a table. The total number of tables decreases by one for each additional 26 sweep points.

- (3) 'prev page' and 'next page' softkeys

These softkeys are used to display previous or next page of the table.

- (4) 'cursor up' and 'cursor down' softkeys

These softkeys are used to move the cursor up and down.

- (5) Edit keys

The **EDIT** section keys are used to edit a table. When deleting a specific sweep point, move the Cursor to the sweep point and press the **CLEAR LINE** key.

- (6) Step Up/Down keys

These two keys are used to roll up or down through the table-edit page in one line steps.

OPERATION

Limit data display

The 'LIMIT on/off' softkey in the **DISPLAY** section is used to set up a GO/NO-GO comparison and to display the limit data. When this softkey is ON, the GO/NO-GO result will be stored in the **GONG** register each time a measurement is made. The **GONG** register is set to NO-GO(=0) when any measurement point is out of tolerance. In the X-A&B display mode the Limit data will be superimposed with the measurement results. ("LMSP0" <off> or "LMSP1" <on>) Figure 3-151 shows one example of a limit data display. Note that this softkey can be set to **ON** only when a programmed points measurement is in progress.

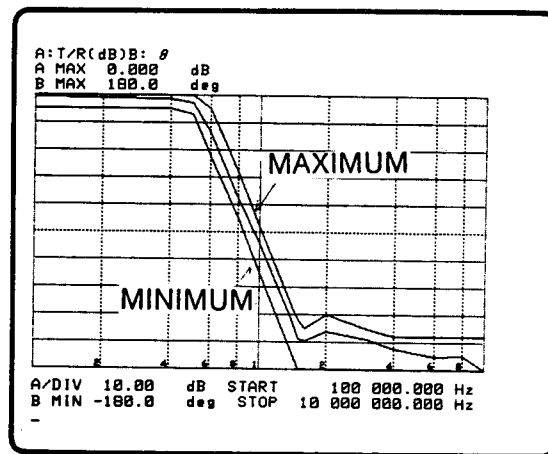

Figure 3-151. Limit Data Display

2. POINT= command

"POINT= (point, minimum, maximum)" command is used to edit a programmed points table via HP-IB or in an ASP program.

In an ASP program the 'POINT=' softkey is displayed in one of the softkey menus. The following operations are required to set up a program. Suppose that you are in the **EDIT** mode and (*) means to press **ENTER/EXECUTE**.

- (1) Press the **MORE MENUS** key.
- (2) Press the 'SET PROG TABLE' softkey. (*)
- (3) Press the 'TABLE No.' softkey. "PTN=" is displayed on the program-edit line. Enter the desired value using the numeric keys. (*)
- (4) Press the 'TABLE ALL CLR' softkey. (*)
- (5) Press the 'SWP SELECT' softkey and enter the value. (*)
- (6) Press the 'LIMIT for A/B' softkey and enter the value. (*)
- (7) Press the 'POINT=' softkey and "POINT=" will be displayed on the program-edit line.

- (8) Enter the sweep point and press the **GREEN** key and the comma (,).
- (9) Enter the minimum value and press the **GREEN** key and the comma (,).
- (10) Enter the maximum value. (*)
- (11) Repeat the sequence (7) to (10) until you complete the table.
- (12) Press the '**SORT**' softkey. (*)
- (13) Press the '**TABLE SET END**' softkey. (*)

Here is one example that exhibits the program flow.

```
(line number)  PTSET  (Set up programmed points table)
                PTN=1  (Set the table number to 1)
                PTCLR  (Clear the table)
                PTSWP1 (Set the sweep parameter to Frequency)
                LMF1   (Limit for data A)
                POINT=1000,-10,-5
                POINT=1005,-10,-5
                POINT=1010,-20,-10
                .
                .
                .
                PTSRT (Table sorting)
                PTEND (End of table set up)
                PPM1  (Set measurement on)
                LMSP1 (Limit data display and GO/NO-GO judgment)
                SWM1  (Set sweep mode to Repeat)
```

Note

- (1) If you are not using the limit values you can skip them by pressing **ENTER/EXECUTE** immediately after you set the sweep point. The default values will be set.
- (2) **POINT=** can be set using the **FOR .. TO .. NEXT** construct. Use the Rn register as a loop counter.
- (3) The **PTCLR** code must be set before setting the **PTSWP** code. The **PTCLR** code is valid when programmed points measurement is **OFF (PPM0)**.
- (4) The **PTSET**, **PTSRT**, and **PTEND** codes can be deleted.
- (5) Set "**LMSP1**" code after you set the "**PPM1**" code. Because the limit data display becomes valid when the programmed points measurement is being set to **ON**.
- (6) If the error was found during program execution, the program will stop. If this happens, exit from the programmed points table mode by pressing the **MORE MENUS** key, '**SET PROG TABLE**' softkey, '**more 1/2**' and '**TABLE SET END**' softkeys.
- (7) For an HP-IB program set the program codes as shown above.

OPERATION

3-6-6-2. Programmed Points Measurement

To perform a programmed points measurement, the following softkey or program code must be entered before you trigger the start of the measurement.

In the case of front panel operation,

- 1) Press the **SWEEP** key and the 'more 1/2' softkey. The '**PRG MEAS on/off**' softkey will appear on the screen. You must set this softkey to **ON** when you make a measurement. The softkey label will change to intensified green when it is **ON**. To abort a programmed points measurement you must set this key to **OFF**. Note the change of the softkey label to determine on and off. The **START** and **STOP** values of the selected sweep parameter are displayed on the bottom section of screen.

For an ASP program,

- 1) Press the **SWEEP** key.
- 2) Press the 'more 1/2' softkey.
- 3) Press the '**PRG MEAS on/off**' softkey and "PPM" will appear on the program-edit line and the message "ON=1, OFF=0" will appear on the "Keyboard Input Line" block.
- 4) Press the numeric key (1), then press the semicolon (;) or the **ENTER/EXECUTE** key to go next step. "PPM1" will be input on the program-edit line. To abort, set PPM0.

For HP-IB

The program code, PPM1, must be set in the program. PPM0 command will abort.

Note

- (1) While the programmed points measurement is being made all the program codes related to this measurement except for "PTN=" and "LMSP 1/0" can not be activated.
- (2) When the programmed points measurement is set to ON, the parameter settings such as range, or the polarity are checked. If any of them has an error then the error message such as "Invalid prog. points table" will be displayed on the screen and measurement will not start.
- (3) Before you make a measurement, compensate the fixture attached to the instrument using the sweep points that were set.
- (4) When you change the basic measurement function (Imp. to G.-P. or G.-P. to Imp. mode), the programmed points measurement is automatically turned **OFF**.

3-6-6-3. Table Copy

To make a copy of the programmed points table the following operations are required.

- 1) Press the **MORE MENUS** key.
- 2) Press the '**COPY menu**' softkey.
- 3) Press the '**PRINT mode**' softkey.
- 4) Press the **MORE MENUS** key again.
- 5) Press the '**HP-IB DEFINE**' softkey.
- 6) Press the '**TALK ONLY**' softkey.
- 7) Set the attached printer to the **Listen Only** mode.
- 8) Press the '**return**' softkey.
- 9) Press the '**SET PROG TABLE**' softkey. Table number (1) is now selected. If you want to change it press the '**TABLE No.**' softkey then enter the table number, and make sure that the contents of the table are properly set. Press the '**more 1/2**' softkey. Press the '**TABLE SET END**' softkey to exit from the table operation.
- 10) Press the **COPY** key. The printer will now start printing.

Note

The programmed points table is stored in nonvolatile memory (through battery back up). If the battery is depleted, or if the 4194A is repaired, the data stored in the memory may be lost. Keep a hard copy of the programmed points table.

OPERATION

3-6-7. Copy

The 4194A has the capability to dump the information on the screen to an HP-IB plotter or printer, without the need of a controller. The information to be copied must be on the screen when the **COPY** key is pressed.

3-6-7-1. HP 4194A Configuration

The plotter and printer must be configured for **LISTEN ONLY** and the 4194A must be configured for **TALK ONLY** mode.

To configure the 4194A:

1. Press the **MORE MENUS** key, then select the 'HPIB DEFINE' softkey, the HP-IB DEFINE menu will be displayed as shown in Figure 3-152.
2. Press the 'TALK ONLY' softkey and look for the softkey label to turn green.
3. Press the 'return' softkey or the **MORE MENUS** key to return to the **MORE MENUS** menu.

Now the 4194A has been configured to TALK ONLY. The plotter and printer must be configured to LISTEN ONLY according to the procedures given in their respective manuals.

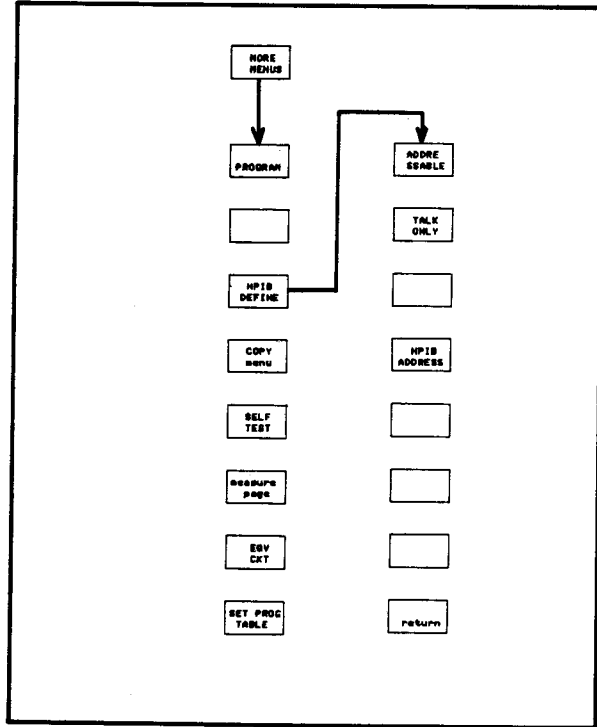

Figure 3-152. HP-IB DEFINE menu

3-6-7-2. Recommended Plotters and Printers

Table 3-8 lists the recommended Plotters and Printers.

Table 3-8. Recommended Plotters and Printers

Plotter	HP 7470A	(PLOT mode only)	2 colors
	HP 7475A	(PLOT mode only)	6 colors
	HP 7550A	(PLOT mode only)	8 colors
Printer	HP 2671A	(PRINT mode only)	
	HP 2671G	(PRINT, DUMP mode only)	
	HP 2673A	(PRINT, DUMP mode only)	
	HP 2225A	(PRINT, DUMP mode only)	

3-6-7-3. COPY Capabilities

There are three copy modes; the **PLOT**, **PRINT**, and **DUMP** modes. In the PLOT mode, a plotter must be connected to the 4194A, and in the PRINT and DUMP modes, a printer must be connected. Table 3-9 shows the copy capabilities of these three modes.

Table 3-9. Capability of Three Modes

CRT page	PLOT mode	PRINT mode	DUMP mode
RECTANGULAR X-A&B	Yes	Yes	Yes
RECTANGULAR A-B	Yes	Yes	Yes
TABLE	No	Yes	Yes
PROGRAMMED POINT TABLE	No	Yes	Yes
CIRCUIT MODE	No	No	Yes
EDIT	No	Yes	Yes
CATALOG	No	Yes	Yes

Yes: Available

No: Not available. One of the following error messages "Can plot only X-A&B/A-B page" or "Can't print data on this page" will be displayed in System Message Area.

OPERATION

3-6-7-4. Copy Procedure

1. Connect a plotter or printer to the 4194A via an HP-IB cable.
2. Place the information you want to copy on the screen. If it is necessary, set the Sweep Mode to SINGLE or the Trigger Mode to EXT/MAN to hold the information on the screen.

3. Press the **MORE MENUS** key, and select the 'COPY menu' softkey, the **COPY** menu will be displayed in the Menu Area of the screen as shown in Figure 3-153.

4. If a printer is used, select the 'PRINT mode' or 'DUMP mode' softkey and press the **COPY** key. The information will now be printed. If the error message, "Can't print data on this page" is displayed, select the **DUMP** mode and press the **COPY** key again if your printer can be used in the **DUMP** mode.

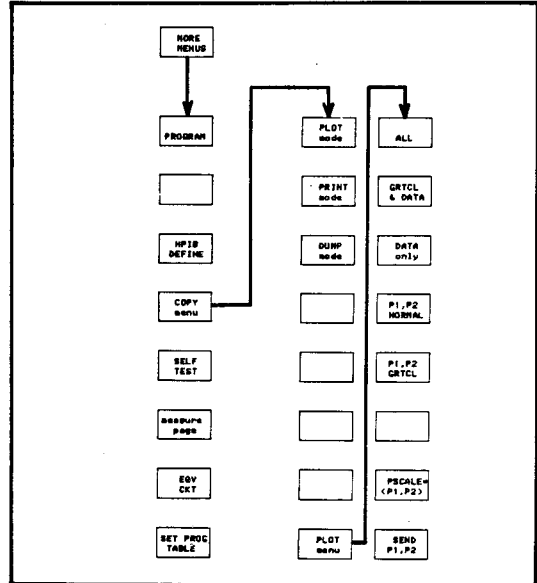

Figure 3-153. COPY and PLOT menus

5. If a plotter is connected, select the 'PLOT mode' softkey, and press the 'PLOT menu' softkey. The **PLOT** menu will now be displayed as shown in Figure 3-153.
6. Select one of the following softkeys, 'ALL', 'GRTCL & DATA' or 'DATA only'. If the 'ALL' softkey is selected, all information, except for the softkey menu, will be plotted.
7. Select one of the following softkeys, 'P1,P2 NORMAL' or 'P1, P2 GRTCL'. Refer to the following paragraph, "Plot Size" for more details about these softkeys.
8. If P1 and P2 have been set, they will be stored into the storage registers, and setting them is not necessary. Otherwise press the 'PSCALE=(P1,P2)' softkey, "PSCALE=(current values)" will be displayed on the Keyboard Input Line. If the current values of P1 and P2 do not give the plot size you want then refer to the following paragraph "Plot Size" for changing the values of P1 and P2.
9. If P1 and P2 have been sent to the plotter, it is not necessary to press the 'SEND P1,P2' softkey. Otherwise press the 'SEND P1,P2' softkey. Be sure that P1 and P2 have been sent to the printer, by pressing the **P1** and **P2** keys on the front panel of the plotter.
10. Press the **COPY** key to plot the information on the screen. (To abort the copy, press the **COPY** key again.)

3-6-7-5. Plot Size

The plot size can be set using the 'PSCALE=(P1,P2)' softkey. When this softkey is pressed, "PSCALE=(current values)" will be displayed and the new values can be entered. Press the **ENTER/EXECUTE** key to store the new values in the 4194A. When the 'PSCALE=(P1,P2)' softkey is pressed these stored values can be recalled, even if the 4194A had been turned off. If no values have been entered, then the default values shown below will be displayed.

PSCALE= 2000, 800, 9200, 7208

The values of P1 and P2 can be sent to the plotter by pressing the 'SEND P1,P2' softkeys.

The **PSCALE** command is displayed as shown below,

PSCALE= P1x, P1y, P2x, P2y

P1x, P1y, P2x, P2y define the PSCALE Area as shown in Figure 3-154. One point equals 0.025mm. For example, PSCALE= 2000, 800, 9200, and 7208, defines the PSCALE Area as shown in Figure 3-155.

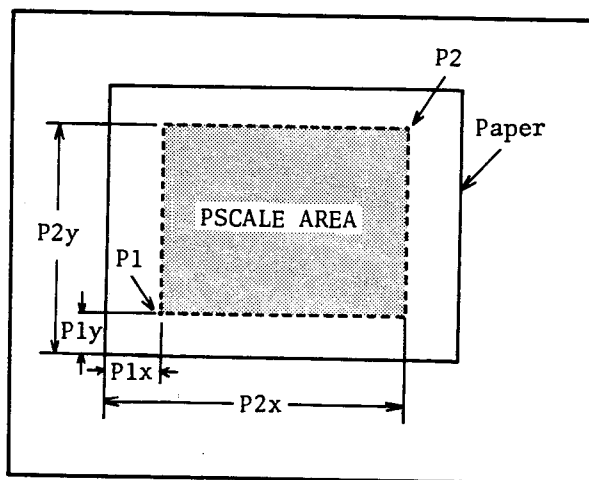

Figure 3-154. PSCALE= P1x, P1y, P2x, P2y

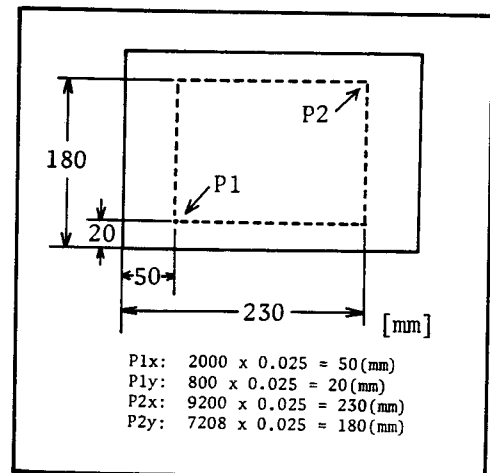
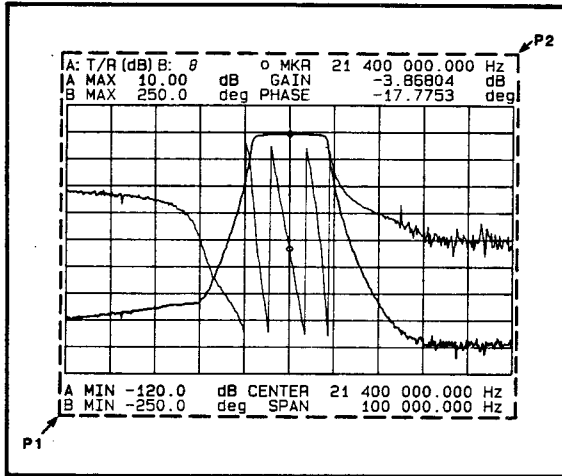

Figure 3-155. PSCALE Area

OPERATION

All information on the screen will be plotted inside of the area defined by PSCALE, if the 'P1, P2 NORMAL' softkey is selected. The information outside of the graticule will be plotted to the outside of the PSCALE Area if 'P1, P2 GRTCL' is selected, as shown in Figure 3-156.



(P1, P2 NORMAL)

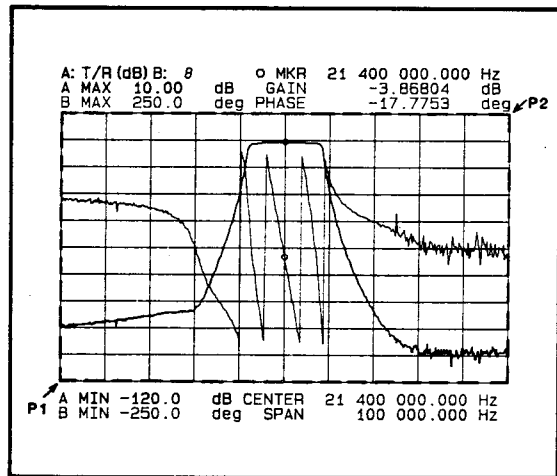

(P1, P2 GRTCL)

Figure 3-156. P1, P2 Selection

3-6-8. Equivalent Circuit Function

The 4194A's Equivalent Circuit function has two modes of operation, calculate the equivalent circuit parameters, and simulate the equivalent circuit's frequency characteristics. The 4194A calculates the approximate value of each equivalent circuit parameter for which ever equivalent circuit mode is selected by the user. Before calculation, the data taken by the Impedance measurement function or defined in a programmed point table must be in the A and B registers.

These simulation modes can use values entered by the user or the values approximated by calculation, to calculate the equivalent circuit frequency characteristics. When the calculations are complete, the calculated data is used to display the frequency characteristics on the screen in the RECTAN X-A&B format and the calculated data is stored in the **C** and **D** registers. This function is mainly used to confirm that the equivalent circuit parameter approximations are close enough to the characteristics of the DUT.

3-6-8-1. Equivalent Circuit Mode Softkeys

Press the **MORE MENUS** key. The '**EQV CKT**' softkey will appear in the Menu Area. Press this softkey to display the menu shown in Figure 3-157. To display the simulation softkeys, press the '**more 1/2**' softkey.

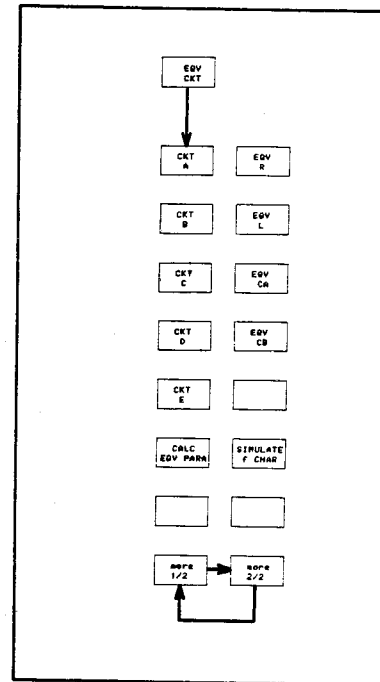

Figure 3-157. EQV CKT menus

Note

When the '**EQV CKT**' softkey is pressed in the middle of the measurement, the measurement will be aborted and the sweep mode will be set to the Single sweep mode.

3 Operation

OPERATION

3-6-8-2. Measurement Procedures

This section will give a step by step demonstration of the EQUIVALENT CIRCUIT capabilities to show how to use these capabilities. The DUT is a 9.98MHz crystal resonator. Before selecting the EQUIVALENT CIRCUIT function, the characteristics of the DUT are first measured using the Impedance Measurement function. This measurement data is used to calculate the equivalent circuit parameters and to display for comparison with the calculated frequency characteristics.

1. Connect the DUT to the test fixture (HP 16047D).
2. Reset the 4194A using the **RST** command.
3. Configure the 4194A as follows:

Measurement Function	Impedance Measurement
Measurement Parameters	$ Z -\theta$
Sweep Parameter	Frequency
Sweep Type	Linear
A Scale Type	Log
Center Frequency	9.985MHz
Sweep Span	50KHz

4. The measurement results will be displayed on the screen as shown in Figure 3-158. Use the '**AUTO SCALE A**' and '**AUTO SCALE B**' softkeys to scale the measured data.

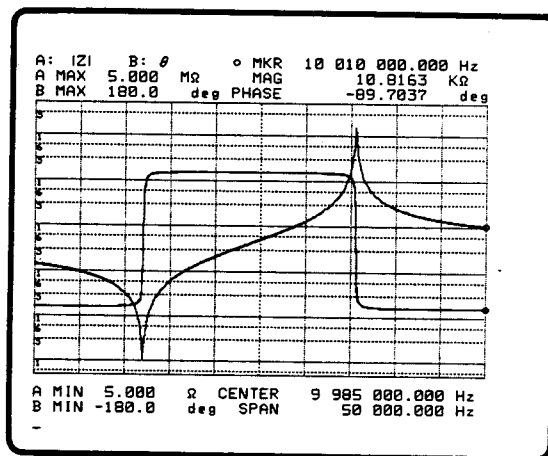

Figure 3-158. Measurement Results ($|Z|-\theta$)

5. Press the **MORE MENUS** key.
6. Press the '**EQV CKT**' softkey. The Equivalent Circuit Mode page will be displayed.
7. Press the '**CKT E**' softkey. The softkey label (CKT E) and the circuit mode E display will change to green.

Note

Circuit "E" is the best circuit model to use for a crystal resonator. It is very important to select the correct circuit mode to minimize calculation errors.

- Press the 'CALC EQV PARA' softkey. The message "Calculating EQV parameters" will appear in the System Message Area for several seconds. Then the "Calculation Complete" message will appear and the calculated parameters will be displayed as shown in Figure 3-159.

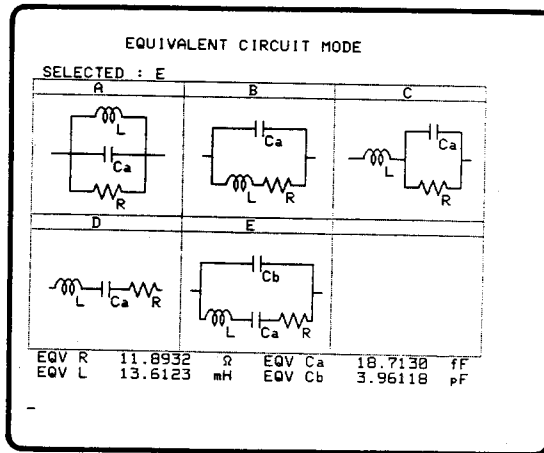

Figure 3-159. Equivalent Parameters Calculation Results

- Determine if the parameters are approximated close enough to the DUT, the simulation can be used to calculate the frequency characteristics using the calculated parameters and the equivalent circuit mode specified by the user. Press the 'more 1/2' softkey to display the extra menus.

OPERATION

- Press the '**SIMULATE f CHAR**' softkey. The "Calculating f characteristics" message is displayed for several seconds. Then the "Calculation complete" message will be displayed, and the calculated frequency characteristics and the measurement data taken in step 4 will be displayed together, see Figure 3-160. If the calculated parameters are very accurate, the calculated characteristics and the measurement data will overlap.

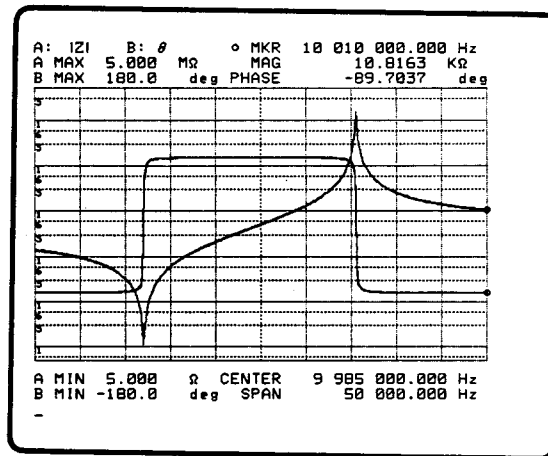

Figure 3-160. F Characteristics Calculation and Measurement Data

- To delete the data taken in step 4 from the screen, press the **DISPLAY** key and the 'menu' softkey, then set the '**DISP A on/off**' softkey to **OFF**. Press softkey 'more 1/3' and set softkey '**DISP B on/off**' to **OFF**. Only simulated data will remain on the screen, see Figure 3-161.

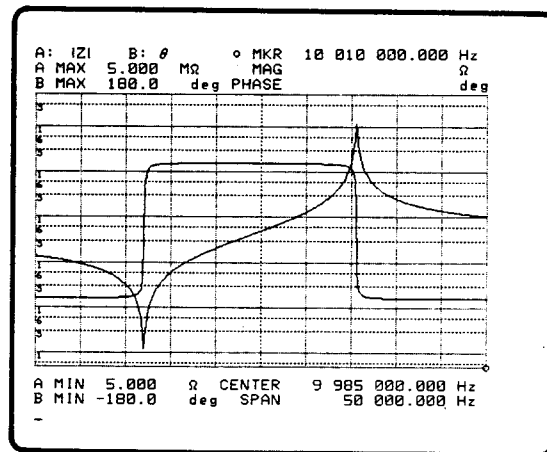

Figure 3-161. Calculated F Characteristics

Note

- For simulation, functions, $|Z|-\theta$, $|Y|-\theta$, R-X, or G-B can be used. Select a function and press softkey '**SIMULATE f CHAR**'.
- '**SIMULATE f CHAR**' stores Simulated data into registers **C** and **D**.

3-6-8-3. Equivalent Circuit Model Selection

The selection of the equivalent circuit mode is most important to obtain the correct calculation of the equivalent circuit parameters and the frequency characteristics. In the previous demonstration, circuit model "E" was selected because a crystal resonator was used as the DUT. If circuit mode "A" had been selected, the wrong parameters and frequency characteristics would have been calculated as shown in Figure 3-162. Refer to Table 3-10 for the correct selection of an equivalent circuit model.

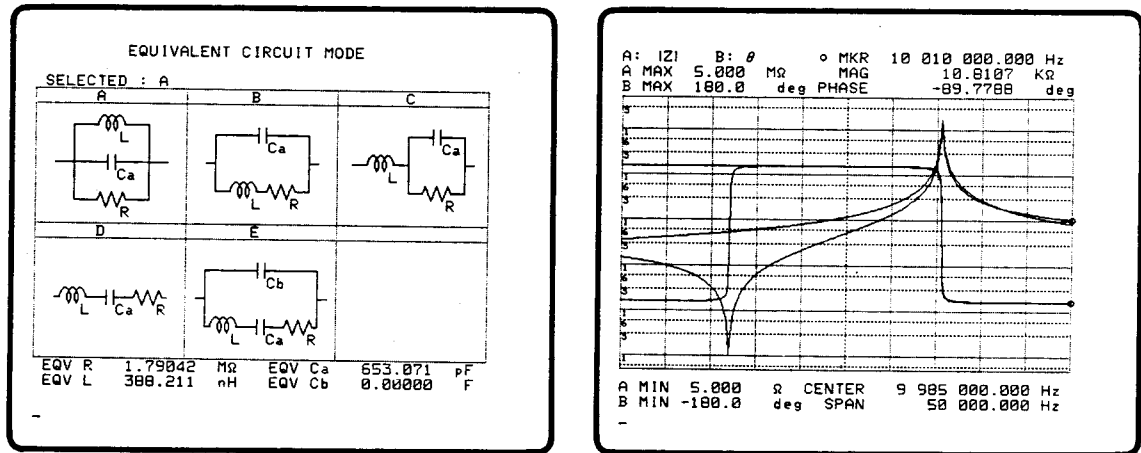
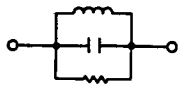
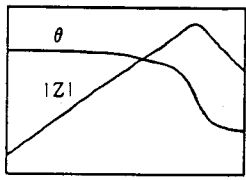
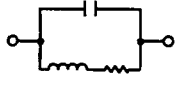
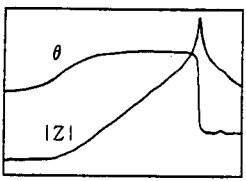
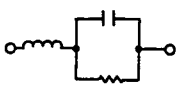
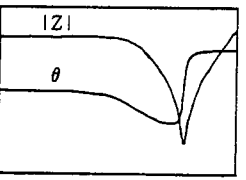
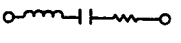
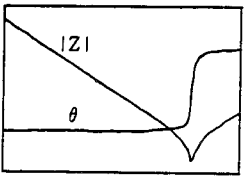
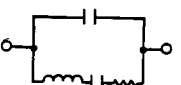
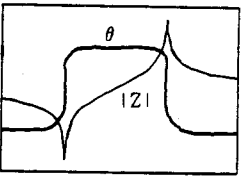

Figure 3-162. Wrong Constants and Frequency Characteristics

3: Operation

OPERATION

Table 3-10. Equivalent Circuit Model Selection Guide

Equivalent Circuit	Types of DUTs	$ Z $ - θ f-characteristics
<p>A</p> 	<ul style="list-style-type: none"> Coils with high core loss 	
<p>B</p> 	<ul style="list-style-type: none"> Coils in general Resistors 	
<p>C</p> 	<ul style="list-style-type: none"> High-value resistors 	
<p>D</p> 	<ul style="list-style-type: none"> Capacitors 	
<p>E</p> 	<ul style="list-style-type: none"> Resonators (crystal, ceramic, ferrite) 	

3-6-8-4. Error Messages

Before the Equivalent Circuit Mode is selected, the following settings must be performed. Otherwise an error message as shown below will be displayed.

Settings	Error Message
FUNCTION: Impedance	"Change function to impedance"
SWEEP PARAMETER: Frequency	"Change sweep to frequency"
MEAS PARAMETER: $ Z $ - θ or $ Y $ - θ	"Change parameter to Z- θ / Y- θ "
NOP: 3 or more(in analytical range)	"N must be ≥ 3 in ana. range"

3-6-9. External I/O

The 4194A has an 8-bit Input/Output port for communicating with peripheral devices. Communication is through the rear-panel connector labeled "8-bit INPUT/OUTPUT." Figure 3-163 shows the connector and its pin assignments. DI(0)-DI(7) and DO(0)-DO(7) are 8-bit parallel I/O ports, respectively. They can be accessed using BASIC's INPUT and OUTPUT statements in an ASP program. The two preceding statements were introduced in paragraph 3-6-4-2.

1. 8-bit Input

The **BASIC** statement "INPUT" is used in connection with registers Rn(n=0 to 99). The syntax is:

```
INPUT Rn(n=0 to 99)
```

For example if you use INPUT R0 then the data on the input port will be stored into register R0 as a decimal expression. On the input port D7 is the MSB and D0 is the LSB.

2. 8-bit Output

The BASIC statement "OUTPUT" use, and its syntax is as follows.

```
OUTPUT Rn(n=0 to 99)
```

or

```
OUTPUT BBBBBBBB (8-bit binary value starting from MSB=D07)
```

B=0 is assigned to low level and B=1 is assigned to high level. For example, if you use 'OUTPUT 11110000' the output port levels will be as follows.

(D07 to D04)= 1, (D03 to D00=0)

Note

1. Logic levels are TTL.
2. The EOM (End of Measurement) and EOS (End of Sweep) signals are output from pins 11 and 12, respectively. These signals are negative going, are about 350ns long, and have no direct relationship to the IO port. They can be used for auxiliary purposes.
3. The connector is a D-SUB connector series D25 (25 pins)

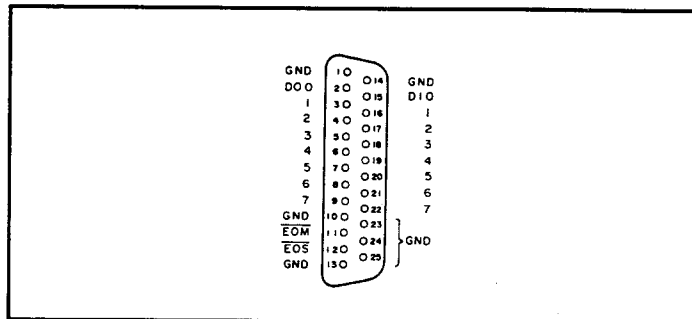

Figure 3-163. 8-bit I/O Connector

SECTION 4

PERFORMANCE TEST

- 4-1. INTRODUCTION 4-1
- 4-2. TEST EQUIPMENT 4-1
- 4-3. PERFORMANCE TEST RECORD 4-1
- 4-4. CALIBRATION CYCLE 4-2
- 4-5. PRETEST PREPARATIONS 4-4
- 4-6. INTERNAL SYNTHESIZER FREQUENCY TEST 4-7
- 4-7. GAIN-PHASE MEASUREMENT ACCURACY TEST 4-9
 - 4-7-1. 50 Ω Input Test (option 350 only) 4-9
 - 4-7-2. 75 Ω Input Test (option 375 only) 4-13
 - 4-7-3. 1M Ω Input Test 4-17
- 4-8. TEST EQUIPMENT CALIBRATION 4-19
 - 4-8-1. Step Attenuator Insertion Loss Calibration 4-19
 - 4-8-2. Power Splitter Tracking Error Calibration 4-21
 - 4-8-3. 50 Ω - 75 Ω Pad Calibration (option 375 only) 4-23
- 4-9. AMPLITUDE MEASUREMENT ACCURACY TEST 4-27
 - 4-9-1. 50 Ω (75 Ω) Input Test, LF 4-27
 - 4-9-2. 1M Ω Input Test, LF 4-30
 - 4-9-3. 50 Ω (75 Ω) Input Test, HF 4-31
 - 4-9-4. 1M Ω Input Test, HF 4-34
 - 4-9-5. 50 Ω (75 Ω) Input Test, Low Level 4-36
 - 4-9-6. 1M Ω Input Test, Low Level 4-38
- 4-10. GAIN-PHASE MEASUREMENT SIGNAL LEVEL TEST 4-40
 - 4-10-1. Signal Level Accuracy: 100kHz 4-40
 - 4-10-2. HF Signal Level Flatness 4-42
 - 4-10-3. LF Signal Level Flatness 4-43
- 4-11. POWER SPLITTER TEST 4-45
- 4-12. GAIN-PHASE MEASUREMENT CROSSTALK TEST 4-47
- 4-13. IMPEDANCE MEASUREMENT SIGNAL LEVEL TEST 4-49
 - 4-13-1. Signal Level Accuracy: 100kHz 4-49
 - 4-13-2. HF Signal Level Flatness 4-50
 - 4-13-3. LF Signal Level Flatness 4-51
- 4-14. IMPEDANCE MEASUREMENT ACCURACY TEST 4-53
- 4-15. IMPEDANCE MEASUREMENT LEVEL MONITOR TEST 4-55
 - 4-15-1. LF Level Monitor 4-55
 - 4-15-2. HF Level Monitor 4-56
- 4-16. DC BIAS VOLTAGE TEST 4-58
- 4-17. HP-IB PERFORMANCE TEST 4-60

PERFORMANCE TEST RECORD i

SECTION 4

PERFORMANCE TESTS

4-1. INTRODUCTION

This section provides the test procedures used to verify the 4194A's specifications listed in Table 1-1. All tests can be performed without access to the interior of the instrument. Performance tests are used to perform incoming inspection and to verify that the 4194A meets performance specifications after troubleshooting or adjustment. If the performance tests indicate that the 4194A is not operating within the specified limits, check your test setup. Proceed to Adjustments or Troubleshooting if necessary.

Note

Be sure to allow the 4194A to warm up for at least 30 minutes before you perform any performance tests.

Note

Perform all performance tests at an ambient temperature of $23^{\circ}\text{C}\pm 5^{\circ}\text{C}$.

4-2. TEST EQUIPMENT

Table 4-1 lists the test equipment required to perform the tests described in this section. Use only calibrated test instruments when performance testing the 4194A. If the recommended test equipment is not available, equipment with specifications that equal or surpass those of the recommended equipment may be used.

Note

Components used as standards must be (1) calibrated using an instrument whose specifications are traceable to the National Bureau of Standards (NBS) or an equivalent standards group, or (2) calibrated directly by an authorized calibration organization such as NBS. The calibration cycle depends on the stability specification of each component.

4-3. PERFORMANCE TEST RECORD

Record the results of each performance test in the Performance Test Record located at the end of this section. This record lists each test, the parameters tested, and the acceptable limits. Keep a record of past performance test results for comparison purposes to help indicate any possible areas of weakness.

PERFORMANCE TESTS

Note

The test limits indicated in each performance test do not take into account the measurement errors induced by the test equipment used for each test. Be sure to consider this when determining whether the 4194A meets its indicated specifications.

4-4. CALIBRATION CYCLE

The 4194A requires periodic performance verification. How often you verify performance depends on operating and environmental conditions. Check the 4194A using the performance tests described here at least once a year. To minimize instrument down-time and to ensure optimum operation, perform preventive maintenance and calibration at least twice a year.

Table. 4-1. Recommended Test Equipment (sheet 1 of 2)

Equipment	Critical Specifications	Recommended Model	Quantity	
			50Ω ¹	75Ω ²
Frequency Counter	Maximum Frequency: > 100 MHz Accuracy: < 0.25 ppm	HP 5385A Option 004	1	1
Digital Voltmeter	ACV: (true RMS) Freq. Range: 10 Hz to 100 kHz Voltage Range: 10 mV to 1 V Accuracy: < 1 % DCV: Voltage Range: ±10 mV to ±40 V Accuracy: < 0.03 %	HP 3456A	1	1
Power Meter & Power Sensor	Freq. Range: 100 kHz to 100 MHz Power Range: -2 dBm to +16 dBm Accuracy: < 0.02 dB	HP 436A HP 8482A	1 1	1 1
HP-IB Controller	No Substitute	HP 9836 or HP 9826	1	1
Standard Capacitor	Capacitance Range: 1 pF to 1 μF Terminals: Four Terminal Pair Freq. Range: 100 Hz to 10 MHz Nominal Accuracy: < 0.17 % Calibration Accuracy: < 0.01 %	HP 16380A HP 16380C	1 1	1 1
Coaxial Step Attenuator	Atten. Range: 0 dB to 70 dB Atten. Step: 10 dB Calib. Accuracy: < 0.01 dB Maximum Frequency: > 100 MHz	HP 8495A Option 001 Option H04 ³	1	1
Power Splitter	Two Resistor Type	HP 11667A	1	1

Table. 4-1. Recommended Test Equipment (sheet 2 of 2)

Equipment	Critical Specifications	Recommended Model	Quantity	
			50Ω ¹	75Ω ²
Feedthrough Termination	BNC(m)-BNC(f), 50 Ω BNC(m)-BNC(f), 75 Ω	PN 04192-61002 PN 04192-61003	2 0	1 2
Test Fixture	Four Terminal Pair (furnished)	HP 16047D	1	1
Cables Coaxial	BNC(m)-BNC(m), 30 cm, 50 Ω BNC(m)-BNC(m), 60 cm, 50 Ω BNC(m)-BNC(m), 30 cm, 75 Ω BNC(m)-BNC(m), 60 cm, 75 Ω	PN 8120-1838 PN 8120-1839 PN 04194-61640 PN 04194-61641	4 1 0 0	4 1 2 1
HP-IB Cable		HP 18033A	1	1
Test Lead	Alligator Clips to Dual Banana	HP 11002A	1	1
Adapters	N(m)-BNC(m), 50 Ω N(m)-BNC(f), 50 Ω N(f)-BNC(m), 50 Ω N(f)-BNC(f), 50 Ω BNC(f)-BNC(f), 50 Ω BNC(f)-Dual Banana Plug 50 Ω - 75 Ω Minimum Loss Pad N(f)-BNC(m), 75 Ω N(f)-BNC(f), 75 Ω	PN 1250-0082 PN 1250-0780 PN 1250-0077 PN 1250-1474 PN 1250-0080 PN 1251-2277 HP 11852A PN 1250-1534 PN 1250-1536	1 5 1 1 1 1 0 0 0	1 8 0 1 1 1 3 3 1
<p>¹: Quantity required for HP 4194A Option 350 Performance Tests.</p> <p>²: Quantity required for HP 4194A Option 375 Performance Tests.</p> <p>³: To purchase an HP 8495A with calibration data for the performance tests, specify Option H04. For more information about attenuator calibration, contact your nearest Hewlett-Packard service center.</p>				

4: Performance Test

4-5. PRETEST PREPARATIONS

Before proceeding with the performance tests, prepare the HP 4194A by performing the following setup procedure. This procedure explains how to set up, save, and recall the instrument settings and programmed points tables required for performance testing.

Note

In the remainder of this section, softkeys are indicated in boldface and enclosed in single quotes (e.g., '**SET PROG TABLE**'), and hardkeys are indicated in boldface only (e.g., **Blue**).

PROCEDURE:

1. Set the front panel **CABLE LENGTH** switch to 0m.
2. Press the **CLEAR LINE**, **Blue**, **R**, **S**, **T**, and **ENTER/EXECUTE** keys to initialize the HP 4194A.
3. Press the **MORE MENUS** key and '**SET PROG TABLE**' softkey, and Programmed Points Table 1 will be displayed.
4. Press the '**more 1/2**' and '**TABLE ALL CLR**' softkeys, then press **ENTER/EXECUTE** key to clear the displayed table.
5. Press the '**more 2/2**' softkey, then press the '**SWP SELECT**' softkey until "**SWEEP : FREQUENCY(Hz)**" is displayed at the top of the table.
6. Enter the frequencies listed in Figure 4-1 into the **SWEEP POINTS** column of Programmed Points Table 1.

Note

The minimum and maximum limits for each sweep point are default values which are automatically displayed when one of the unit keys is pressed.

7. Press the '**TABLE NO.**' softkey to display Programmed Points Table 2.
8. Press the '**more 1/2**' and '**TABLE ALL CLR**' softkeys, then press **ENTER/EXECUTE** key to clear Programmed Points Table 2.
9. Press the '**more 2/2**' softkey, then press the '**SWP SELECT**' softkey until "**SWEEP : FREQUENCY(Hz)**" is displayed at the top of the table.
10. Enter the frequencies listed in Figure 4-2 into the **SWEEP POINTS** column of Programmed Points Table 2.

PERFORMANCE TESTS

11. Press the 'more 1/2' and 'TABLE SET END' softkeys.
12. Press the **Blue**, **P**, **T**, **N**, **=**, **1**, and **ENTER/EXECUTE** keys to access Programmed Points Table 1.
13. Press the **SWEEP** key, then press the '**LOG SWEEP**', '**more 1/2**', and '**PRG MEAS on/off**' softkeys.
14. Set the **INTEG TIME** to **MED**, then press the **AVERAGING** key until "**AVERAGING TIME = 4**" is displayed.
15. Press the **SAVE**, **1**, and **ENTER/EXECUTE** keys to save the instrument states established in steps 12 through 14.
16. Press the **FUNCTION** key and the '**GAIN-PHASE**' softkey.
17. Press the **Blue**, **P**, **T**, **N**, **=**, **2**, and **ENTER/EXECUTE** keys to access Programmed Points Table 2.
18. Press the **SWEEP** key.
19. Press the 'more 1/2' and '**PRG MEAS on/off**' softkeys.
20. Press the **SAVE**, **2**, and **ENTER/EXECUTE** keys to save the measurement parameters established in steps 16 through 19.
21. Turn the 4194A off, then turn it back on again.
22. Press the **GET**, **1**, and **ENTER/EXECUTE** keys.
23. Confirm that the 4194A's control settings are as follows.

FUNCTION	IMPEDANCE, Z - θ
SWEEP	FREQUENCY, LOG, PROGRAMMED POINTS #1
INTEG TIME	MED
AVERAGING TIME	4

24. Press the **GET**, **2**, and **ENTER/EXECUTE** keys.
25. Confirm that the 4194A's control settings are as follows.

FUNCTION	GAIN-PHASE, Tch/Rch (dB) - θ
SWEEP	FREQUENCY, LOG, PROGRAMMED POINTS #2
INTEG TIME	MED
AVERAGING TIME	4

PERFORMANCE TESTS

PROGRAMMED POINTS TABLE 1
SWEEP:FREQUENCY(Hz) LIMIT FOR DATA A

N	SWEEP POINTS		MINIMUM	MAXIMUM
1		100.000	-9.99999E+37	9.99999E+37
2	1	000.000	-9.99999E+37	9.99999E+37
3	10	000.000	-9.99999E+37	9.99999E+37
4	29	000.000	-9.99999E+37	9.99999E+37
5	30	000.000	-9.99999E+37	9.99999E+37
6	100	000.000	-9.99999E+37	9.99999E+37
7	500	000.000	-9.99999E+37	9.99999E+37
8	1	000 000.000	-9.99999E+37	9.99999E+37
9	3	000 000.000	-9.99999E+37	9.99999E+37
10	10	000 000.000	-9.99999E+37	9.99999E+37
11	40	000 000.000	-9.99999E+37	9.99999E+37
12				

Figure 4-1. Programmed Points Table 1 for Impedance Performance Tests

PROGRAMMED POINTS TABLE 2
SWEEP:FREQUENCY(Hz) LIMIT FOR DATA A

N	SWEEP POINTS		MINIMUM	MAXIMUM
1		10.000	-9.99999E+37	9.99999E+37
2		100.000	-9.99999E+37	9.99999E+37
3	1	000.000	-9.99999E+37	9.99999E+37
4	10	000.000	-9.99999E+37	9.99999E+37
5	100	000.000	-9.99999E+37	9.99999E+37
6	1	000 000.000	-9.99999E+37	9.99999E+37
7	10	000 000.000	-9.99999E+37	9.99999E+37
8	30	000 000.000	-9.99999E+37	9.99999E+37
9	80	000 000.000	-9.99999E+37	9.99999E+37
10	100	000 000.000	-9.99999E+37	9.99999E+37
11				

Figure 4-2. Programmed Points Table 2 for Gain-Phase Performance Tests

4-6. INTERNAL SYNTHESIZER FREQUENCY TEST

This test verifies the accuracy of the test frequency.

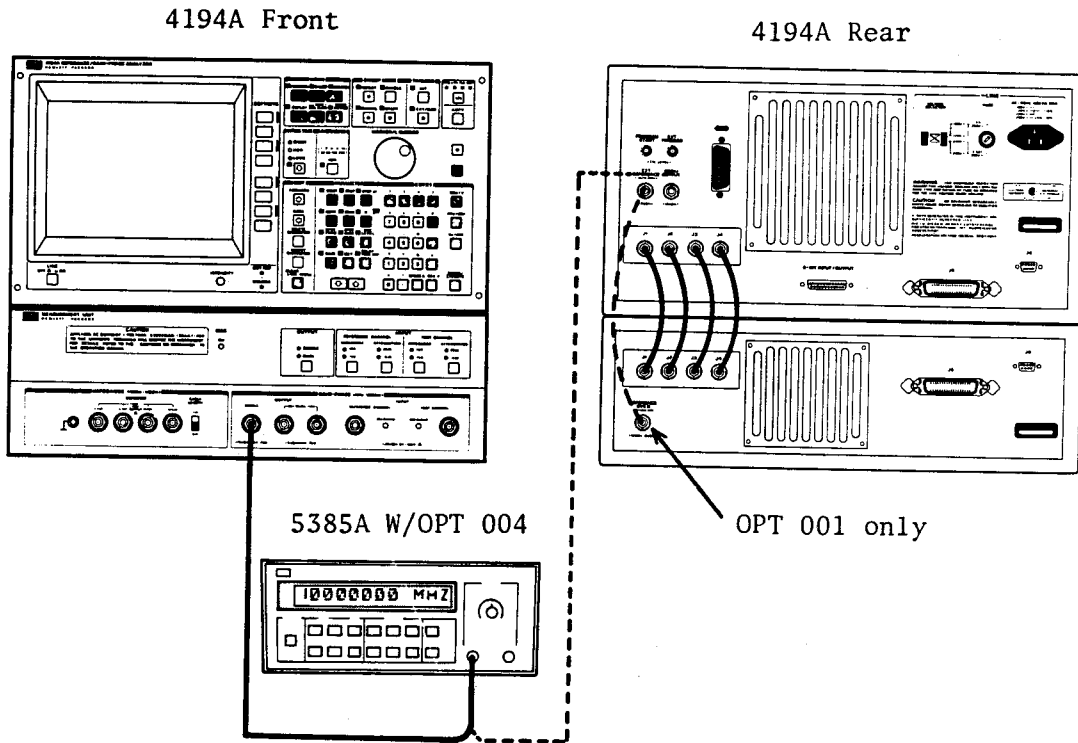

Figure 4-3. Internal Synthesizer Frequency Test Setup

EQUIPMENT:

Frequency Counter
BNC-to-BNC Cable, 61cm

HP 5385A Opt. 004
PN 8120-1839

PROCEDURE:

1. Set up the 4194A as shown in Figure 4-3.

Note

If performance testing a 4194A equipped with Option 001, disconnect the cable from the EXT REFERENCE connector on the rear panel of the Control Unit.

2. Connect the 5385A's **INPUT A** to the 4194A's **SINGLE OUTPUT** terminal.

PERFORMANCE TESTS

3. Press the **GET**, **2**, and **ENTER/EXECUTE** keys.
4. Set the **SWEEP MODE** to **MANUAL**.
5. Set the **OUTPUT** to **SINGLE**.
6. Set the test frequency to **1MHz** by using the **MARKER/L CURSOR** knob.
7. Confirm that the frequency displayed on the 5385A is within the test limits listed in the **SINGLE OUTPUT** row of Table 4-2 for the frequency tested.
8. Repeat steps 6 and 7 at **10MHz** and **100MHz**.
9. Disconnect the **BNC-to-BNC** cable from the **SINGLE OUTPUT** terminal and connect it to the **10MHz OUTPUT** terminal on the Control Unit's rear panel.
10. Confirm that the frequency displayed on the 5385A is within the test limits listed in the **10MHz OUTPUT** row of Table 4-2.

Note

Perform the following steps only if your 4194A is equipped with Option 001.

11. Reconnect the cable from the **REFERENCE OVEN** connector on the Measurement Unit's rear panel to the Control Unit's rear panel **EXT REFERENCE** connector.
12. Repeat steps 6 through 10, but confirm the displayed frequency with those listed in Table 4-3 (instead of Table 4-2) for each frequency tested.

Table 4-2. Internal Synthesizer Frequency Test Limits (Standard 4194As)

Output	Test Frequency	Test Limits
SINGLE OUTPUT	1MHz	0.99998MHz ~ 1.00002MHz
	10MHz	9.9998MHz ~ 10.0002MHz
	100MHz	99.998MHz ~ 100.002MHz
10MHz OUTPUT	any setting	9.9998MHz ~ 10.0002MHz

Table 4-3. Internal Synthesizer Frequency Test Limits (Opt. 001)

Output	Test Frequency	Test Limits
SINGLE OUTPUT	1MHz	0.999999MHz ~ 1.000001MHz
	10MHz	9.99999MHz ~ 10.00001MHz
	100MHz	99.9999MHz ~ 100.0001MHz
10MHz OUTPUT	any setting	9.99999MHz ~ 10.00001MHz

4-7. GAIN-PHASE MEASUREMENT ACCURACY TEST

This two part test verifies 4194A gain-phase measurement accuracy. If performance testing a 75Ω instrument (option 375), proceed to paragraph 4-7-2.

4-7-1. 50Ω INPUT TEST (OPTION 350 ONLY)

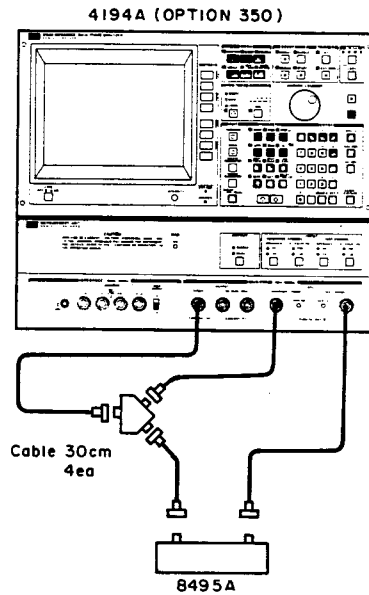

Figure 4-4. Gain-Phase Measurement Accuracy Test Setup: 50Ω

EQUIPMENT:

Coaxial Step Attenuator	HP 8495A Opt. 001	
Power Splitter	HP 11667A	1 ea.
BNC(m)-BNC(m) Cable, 50 Ω, 30 cm	PN 8120-1838	4 ea.
N(m)-BNC(f) Adapter, 50 Ω	PN 1250-0780	5 ea.

PROCEDURE:

1. Set up the 4194A as shown in Figure 4-4.
2. Press the **GET**, **2**, and **ENTER/EXECUTE** keys.
3. Set the 4194A to **SINGLE OUTPUT**.
4. Set the **OSC LEVEL** to **-1dBm**.
5. Press the **DISPLAY** key, then press the 'TABLE' softkey.
6. Set the 8495A to **0dB**.

PERFORMANCE TESTS

7. Press the **SWEEP MODE START** key.

Note

For the remainder of the performance tests, unless otherwise specified, the **START** key means the **SWEEP MODE START** key.

8. When the **START** key lamp goes out, press the **COMPEN** key, then press the '**OFST REF STORE**', '**A OFFSET on/off**', and '**B OFFSET on/off**' softkeys.
9. Set the 8495A to 10dB.
10. Press the **START** key.
11. When the **START** key lamp goes out, confirm that the displayed gain-phase values are within the limits listed in Table 4-4 for the **10dB** attenuator setting.
12. Repeat steps 9 through 11 for the **20dB** through **70dB** attenuator settings and confirm that the displayed values are within the limits listed in Table 4-4 for each attenuator setting.
13. Set the **OSC LEVEL** to **-40dBm**.
14. Set the 8495A to **10dB**.
15. Press the **START** key.
16. When the **START** key lamp goes out, confirm that the displayed gain-phase values are within the limits listed in Table 4-5 for the **10dB** attenuator setting.
17. Repeat steps 14 through 16 for the **20dB** through **40dB** attenuator settings and confirm that the displayed values are within the limits listed in Table 4-5 for each attenuator setting.

Table 4-4. Gain-Phase Measurement Accuracy Test Limits 1 (1 of 2)

Atten. Set.	Freq.	Gain	Phase
10dB	.10Hz	Cv(1)±0.3dB	±1.6°
	100Hz	Cv(1)±0.1dB	±0.5°
	1kHz	Cv(1)±0.1dB	±0.5°
	10kHz	Cv(1)±0.1dB	±0.5°
	100kHz	Cv(1)±0.1dB	±0.5°
	1MHz	Cv(1)±0.1dB	±0.5°
	10MHz	Cv(10)±0.1dB	±1°
	30MHz	Cv(10)±0.3dB	±2°
	100MHz	Cv(100)±0.5dB	±3°

PERFORMANCE TESTS

Table 4-4. Gain-Phase Measurement Accuracy Test Limits 1 (2 of 2)

Atten. Set.	Freq.	Gain	Phase
20dB	10Hz	Cv(1)±0.3dB	±1.6°
	100Hz	Cv(1)±0.1dB	±0.5°
	1kHz	Cv(1)±0.1dB	±0.5°
	10kHz	Cv(1)±0.1dB	±0.5°
	100kHz	Cv(1)±0.1dB	±0.5°
	1MHz	Cv(1)±0.1dB	±0.5°
	10MHz	Cv(10)±0.1dB	±1°
	30MHz	Cv(10)±0.3dB	±2°
30dB	100MHz	Cv(100)±0.5dB	±3°
	10Hz	Cv(1)±0.35dB	±2°
	100Hz	Cv(1)±0.15dB	±0.75°
	1kHz	Cv(1)±0.15dB	±0.75°
	10kHz	Cv(1)±0.15dB	±0.75°
	100kHz	Cv(1)±0.15dB	±0.75°
	1MHz	Cv(1)±0.15dB	±0.75°
	10MHz	Cv(10)±0.15dB	±1.3°
40dB	30MHz	Cv(10)±0.35dB	±2.5°
	100MHz	Cv(100)±0.6dB	±4.5°
	10Hz	Cv(1)±0.45dB	±2.3°
	100Hz	Cv(1)±0.2dB	±1.25°
	1kHz	Cv(1)±0.2dB	±1.25°
	10kHz	Cv(1)±0.2dB	±1.25°
	100kHz	Cv(1)±0.2dB	±1.25°
	1MHz	Cv(1)±0.2dB	±1.25°
50dB	10MHz	Cv(10)±0.2dB	±2°
	30MHz	Cv(10)±0.45dB	±3°
	100MHz	Cv(100)±0.75dB	±4.5°
	1MHz	Cv(1)±0.25dB	±1.75°
60dB	10MHz	Cv(10)±0.35dB	±2.5°
	30MHz	Cv(10)±0.65dB	±3.5°
	100MHz	Cv(100)±0.95dB	±6.5°
	1MHz	Cv(1)±0.45dB	±2.75°
70dB	10MHz	Cv(10)±0.75dB	±5.5°
	30MHz	Cv(10)±1.65dB	±11°
	100MHz	Cv(100)±1.75dB	±11.5°
	1MHz	Cv(1)±1.05dB	±5.25°
	10MHz	Cv(10)±1.55dB	±10.5°
	30MHz	Cv(10)±3.15dB	±16.0°
	100MHz	Cv(100)±3.25dB	±16.5°

Note

Cv(1), Cv(10), and Cv(100) in the above table are the calibration values of the 8495A at 1MHz, 10MHz, and 100MHz, respectively.

PERFORMANCE TESTS

Table 4-5. Gain-Phase Measurement Accuracy Test Limits 2

Atten. Set.	Freq.	Gain	Phase
10dB	10Hz	Cv(1)±1dB	±4°
	100Hz	Cv(1)±0.35dB	±2.5°
	1kHz	Cv(1)±0.35dB	±2.5°
	10kHz	Cv(1)±0.35dB	±2.5°
	100kHz	Cv(1)±0.35dB	±2.5°
20dB	10Hz	Cv(1)±1.3dB	±4.5°
	100Hz	Cv(1)±0.55dB	±3.5°
	1kHz	Cv(1)±0.55dB	±3.5°
	10kHz	Cv(1)±0.55dB	±3.5°
	100kHz	Cv(1)±0.55dB	±3.5°
30dB	10Hz	Cv(1)±1.8dB	±6.5°
	100Hz	Cv(1)±1.15dB	±6°
	1kHz	Cv(1)±1.15dB	±6°
	10kHz	Cv(1)±1.15dB	±6°
	100kHz	Cv(1)±1.15dB	±6°
40dB	100Hz	Cv(1)±3.15dB	±16°
	1kHz	Cv(1)±3.15dB	±16°
	10kHz	Cv(1)±3.15dB	±16°
	100kHz	Cv(1)±3.15dB	±16°

Note

Cv(1), Cv(10), and Cv(100) in the above table are the calibration values of the 8495A at 1MHz, 10MHz, and 100MHz, respectively.

4-7-2. 75Ω INPUT TEST (OPTION 375 ONLY)

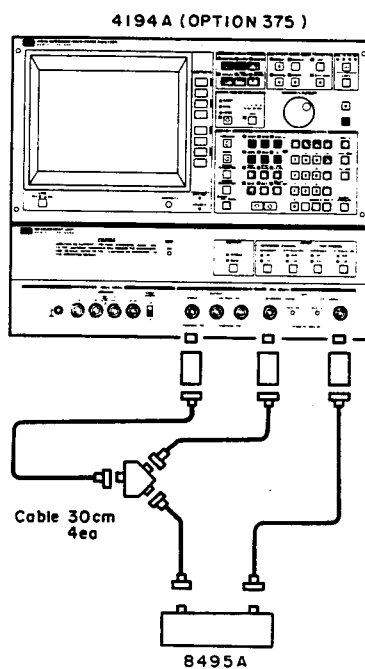

Figure 4-5. Gain-Phase Measurement Accuracy Test Setup: 75Ω

EQUIPMENT:

Coaxial Step Attenuator	HP 8495A Opt. 001	
Power Splitter	HP 11667A	1 ea.
50 Ω - 75 Ω Minimum Loss Pad	HP 11852A	3 ea.
BNC(m)-BNC(m) Cable, 50 Ω, 30 cm	PN 8120-1838	4 ea.
N(m)-BNC(f) Adapter, 50 Ω	PN 1250-0780	8 ea.
N(f)-BNC(m) Adapter, 75 Ω	PN 1250-1534	3 ea.

PROCEDURE:

1. Set up the 4194A as shown in Figure 4-5.
2. Press the **GET**, **2**, and **ENTER/EXECUTE** keys.
3. Set the 4194A to **SINGLE OUTPUT**.
4. Set the **OSC LEVEL** to **10.4dBm**.
5. Press the **DISPLAY** key, then press the **'TABLE'** softkey.
6. Set the 8495A to **0dB**.
7. Press the **START** key.
8. When the **START** key lamp goes out, press the **COMPEN** key, then press the **'OFST REF STORE'**, **'A OFFSET on/off'**, and **'B OFFSET on/off'** softkeys.

PERFORMANCE TESTS

9. Set the 8495A to **10dB**.
10. Press the **START** key.
11. When the **START** key lamp goes out, confirm that the displayed gain-phase values are within the limits listed in Table 4-6 for the **10dB** attenuator setting.
12. Repeat steps 9 through 11 for the **20dB** through **70dB** attenuator settings and confirm that the displayed values are within the limits listed in Table 4-6 for each attenuator setting.
13. Set the **OSC LEVEL** to **-8.6dBm**.
14. Set the 8495A to **10dB**.
15. Press the **START** key.
16. When the **START** key lamp goes out, confirm that the displayed gain-phase values are within the limits listed in Table 4-7 for the **10dB** attenuator setting.
17. Repeat steps 14 through 16 for the **20dB** and **30dB** attenuator settings and confirm that the displayed values are within the limits listed in Table 4-7 for each attenuator setting.
18. Set the **OSC LEVEL** to **-38.6dBm**.
19. Set the 8495A to **10dB**.
20. Press the **START** key.
21. When the **START** key lamp goes out, confirm that the displayed gain-phase values are within the limits listed in Table 4-8 for the **10dB** attenuator setting.
22. Repeat steps 19 through 21 for the **20dB** and **30dB** attenuator settings and confirm that the displayed values are within the limits listed in Table 4-8 for each attenuator setting.

PERFORMANCE TESTS

Table 4-6. Gain-Phase Measurement Accuracy Test Limits 3.

Atten. Set.	Freq.	Gain	Phase
10dB	10Hz	Cv(1)±0.3dB	±1.6°
	100Hz	Cv(1)±0.1dB	±0.5°
	1kHz	Cv(1)±0.1dB	±0.5°
	10kHz	Cv(1)±0.1dB	±0.5°
	100kHz	Cv(1)±0.1dB	±0.5°
	1MHz	Cv(1)±0.1dB	±0.5°
	10MHz	Cv(10)±0.1dB	±1°
	30MHz	Cv(10)±0.3dB	±2°
	100MHz	Cv(100)±0.5dB	±3°
20dB	10Hz	Cv(1)±0.3dB	±1.6°
	100Hz	Cv(1)±0.1dB	±0.5°
	1kHz	Cv(1)±0.1dB	±0.5°
	10kHz	Cv(1)±0.1dB	±0.5°
	100kHz	Cv(1)±0.1dB	±0.5°
	1MHz	Cv(1)±0.1dB	±0.5°
	10MHz	Cv(10)±0.1dB	±1°
	30MHz	Cv(10)±0.3dB	±2°
	100MHz	Cv(100)±0.5dB	±3°
30dB	1MHz	Cv(1)±0.15dB	±0.75°
	10MHz	Cv(10)±0.15dB	±1.3°
	30MHz	Cv(10)±0.35dB	±2.5°
	100MHz	Cv(100)±0.6dB	±4.5°
40dB	1MHz	Cv(1)±0.2dB	±1.25°
	10MHz	Cv(10)±0.2dB	±2°
	30MHz	Cv(10)±0.45dB	±3°
	100MHz	Cv(100)±0.75dB	±4.5°
50dB	1MHz	Cv(1)±0.25dB	±1.75°
	10MHz	Cv(10)±0.35dB	±2.5°
	30MHz	Cv(10)±0.65dB	±3.5°
	100MHz	Cv(100)±0.95dB	±6.5°
60dB	1MHz	Cv(1)±0.45dB	±2.75°
	10MHz	Cv(10)±0.75dB	±5.5°
	30MHz	Cv(10)±1.65dB	±11°
	100MHz	Cv(100)±1.75dB	±11.5°
70dB	1MHz	Cv(1)±1.05dB	±5.25°
	10MHz	Cv(10)±1.55dB	±10.5°
	30MHz	Cv(10)±3.15dB	±16.0°
	100MHz	Cv(100)±3.25dB	±16.5°

Note

Cv(1), Cv(10), and Cv(100) in the above table are the calibration values of the 8495A at 1MHz, 10MHz, and 100MHz, respectively.

4: Performance
Test

PERFORMANCE TESTS

Table 4-7. Gain-Phase Measurement Accuracy Test Limits 4

Atten. Set.	Freq.	Gain	Phase
10dB	10Hz	Cv(1)±0.35dB	±2°
	100Hz	Cv(1)±0.15dB	±0.75°
	1kHz	Cv(1)±0.15dB	±0.75°
	10kHz	Cv(1)±0.15dB	±0.75°
	100kHz	Cv(1)±0.15dB	±0.75°
20dB	10Hz	Cv(1)±0.45dB	±2.3°
	100Hz	Cv(1)±0.2dB	±1.25°
	1kHz	Cv(1)±0.2dB	±1.25°
	10kHz	Cv(1)±0.2dB	±1.25°
	100kHz	Cv(1)±0.2dB	±1.25°
30dB	10Hz	Cv(1)±0.85dB	±3.3°
	100Hz	Cv(1)±0.25dB	±1.75°
	1kHz	Cv(1)±0.25dB	±1.75°
	10kHz	Cv(1)±0.25dB	±1.75°
	100kHz	Cv(1)±0.25dB	±1.75°

Table 4-8. Gain-Phase Measurement Accuracy Test limits 5

ATTEN. SET.	FREQ.	GAIN	PHASE
10dB	10Hz	Cv(1)±1.7dB	±5.5°
	100Hz	Cv(1)±0.6dB	±4°
	1kHz	Cv(1)±0.6dB	±4°
	10kHz	Cv(1)±0.6dB	±4°
	100kHz	Cv(1)±0.6dB	±4°
20dB	10Hz	Cv(1)±2.3dB	±7.5°
	100Hz	Cv(1)±1.2dB	±6.5°
	1kHz	Cv(1)±1.2dB	±6.5°
	10kHz	Cv(1)±1.2dB	±6.5°
	100kHz	Cv(1)±1.2dB	±6.5°
30dB	100Hz	Cv(1)±3.2dB	±16.5°
	1kHz	Cv(1)±3.2dB	±16.5°
	10kHz	Cv(1)±3.2dB	±16.5°
	100kHz	Cv(1)±3.2dB	±16.5°

Note

Cv(1), Cv(10), and Cv(100) in the above tables are the calibration values of the 8495A at 1MHz, 10MHz, and 100MHz, respectively.

4-7-3. 1MΩ INPUT TEST

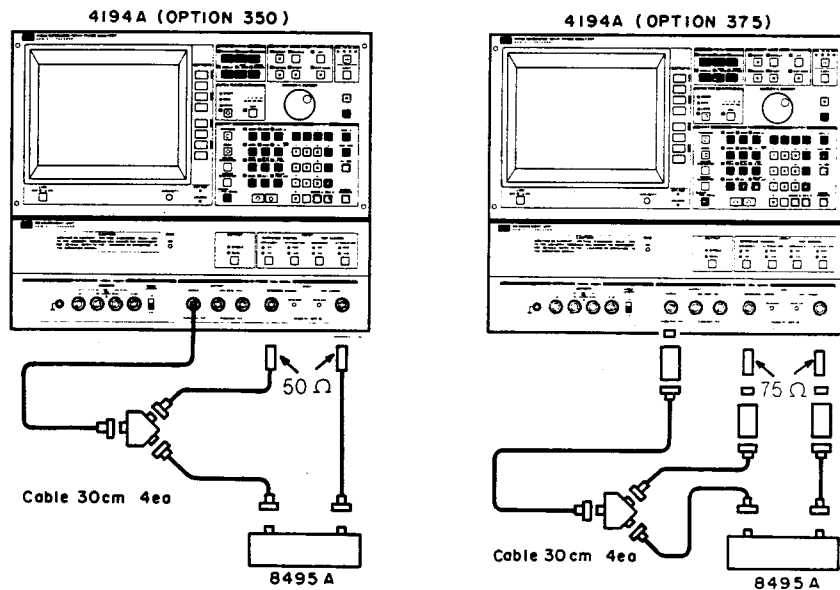

Figure 4-6. Gain-Phase Measurement Accuracy Test Setup: 1MΩ

EQUIPMENT:

Coaxial Step Attenuator	HP 8495A Opt. 001		
Power Splitter	HP 11667A	1 ea.	1 ea.
BNC(m)-BNC(m) Cable, 50 Ω, 30 cm	PN 8120-1838	4 ea.	4 ea.
N(m)-BNC(f) Adapter, 50 Ω	PN 1250-0780	5 ea.	8 ea.
Feedthrough Termination, 50 Ω	PN 04192-61002	2 ea.	
50 Ω - 75 Ω Minimum Loss Pad	HP 11852A		3 ea.
Feedthrough Termination, 75 Ω	PN 04192-61003		2 ea.
N(f)-BNC(m) Adapter, 75 Ω	PN 1250-1534		3 ea.
		Opt350	Opt375

PROCEDURE:

1. Set up the 4194A as shown in Figure 4-6.
2. Press the **GET**, **2**, and **ENTER/EXECUTE** keys.
3. Set the 4194A to **SINGLE OUTPUT**.
4. Set the **OSC LEVEL** to **-1dBm** for Option 350 instruments, or **10.4dBm** for Option 375 instruments.
5. Press the **DISPLAY** key and the 'TABLE' softkey.
6. Set both the **REFERENCE** and **TEST CHANNEL INPUT IMPEDANCE** to **1MΩ**.
7. Set the 8495A to **0dB**.
8. Press the **START** key.

PERFORMANCE TESTS

9. When the **START** key lamp goes out, press the **COMPEN** key, then press the **'OFST REF STORE'**, **'A OFFSET on/off'**, and **'B OFFSET on/off'** softkeys.
10. Set the 8495A to **20dB**.
11. Press the **START** key.
12. When the **START** key lamp goes out, confirm that the displayed gain-phase values are within the test limits listed in Table 4-9.

Table 4-9. Gain-Phase Measurement Accuracy Test Limits 6

Freq.	Gain	Phase
10Hz	Cv(1)±0.4dB	±2.6°
100Hz	Cv(1)±0.2dB	±1.5°
1kHz	Cv(1)±0.2dB	±1.5°
10kHz	Cv(1)±0.2dB	±1.5°
100kHz	Cv(1)±0.2dB	±1.5°
1MHz	Cv(1)±0.2dB	±1.5°
10MHz	Cv(10)±0.2dB	±2°
30MHz	Cv(10)±0.4dB	±3°
100MHz	Cv(100)±0.6dB	±4°

4-8. TEST EQUIPMENT CALIBRATION

This three part procedure is for obtaining the calibration values of the test equipment used during performance testing.

Note

If you have not performed the Gain-Phase Measurement Accuracy Test in paragraph 4-7, do so before you perform this procedure.

4-8-1. STEP ATTENUATOR INSERTION LOSS CALIBRATION

This procedure is for measuring the 0dB setting insertion loss of the 8495A.

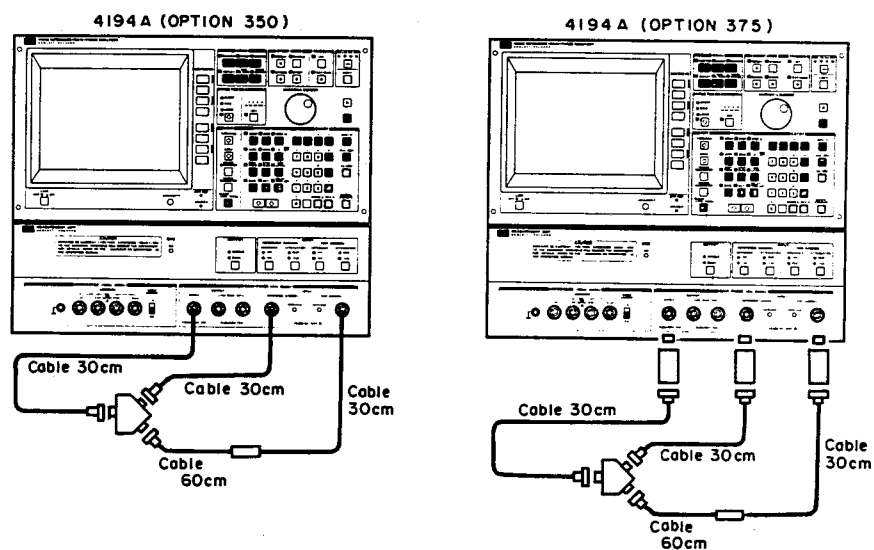

Figure 4-7. HP 8495A Attenuator Calibration Setup 1

EQUIPMENT:

Coaxial Step Attenuator	HP 8495A Opt. 001		
Power Splitter	HP 11667A	1 ea.	1 ea.
BNC(m)-BNC(m) Cable, 50 Ω , 30 cm	PN 8120-1838	3 ea.	3 ea.
BNC(m)-BNC(m) Cable, 50 Ω , 60 cm	PN 8120-1839	1 ea.	1 ea.
N(m)-BNC(f) Adapter, 50 Ω	PN 1250-0780	5 ea.	8 ea.
BNC(f)-BNC(f) Adapter, 50 Ω	PN 1250-0080	1 ea.	1 ea.
50 Ω - 75 Ω Minimum Loss Pad	HP 11852A		3 ea.
N(f)-BNC(m) Adapter, 75 Ω	PN 1250-1534		3 ea.
		Opt350	Opt375

PROCEDURE:

1. Set up the 4194A as shown in Figure 4-7.
2. Initialize the 4194A.
3. Set the 4194A as follows:

FUNCTION	GAIN-PHASE, Tch/Rch (dB) - θ
SWEEP MODE	SINGLE
INTEG TIME	MED
AVERAGING TIME	4
CENTER	10MHz
SPAN	0Hz
OSC LEVEL	-1dBm (10.4dBm for Opt. 375)
OUTPUT	SINGLE

4. Press the **START** key.
5. When the **START** key lamp goes out, press the **MKR/L CURS** key, then press the 'LINE CURSOR', 'menu', 'LCURS for A', and 'LCURS → AVRG' softkeys.
6. Press the **CLEAR LINE**, **Blue**, **R**, **0**, **=**, **L**, **C**, **U**, **R**, **S**, and **ENTER/EXECUTE** keys to store the LCURS value into the R0 register.
7. Disconnect the BNC(f)-to-BNC(f) adapter and connect the 8495A as shown in Figure 4-8.

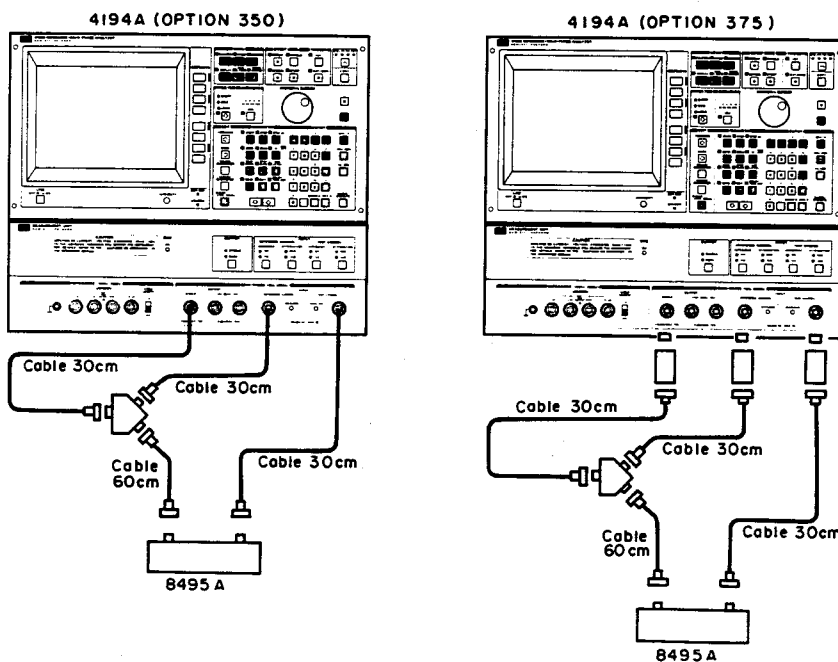

Figure 4-8. HP 8495A Attenuator Calibration Setup 2

8. Set the 8495A to 0dB.

PERFORMANCE TESTS

9. Press the **START** key.
10. When the **START** key lamp goes out, press the '**LCURS → AVRG**' softkey.
11. Press the **CLEAR LINE, Blue, R, 1, 0, =, R, 0, -, L, C, U, R, S,** and **ENTER/EXECUTE** keys to store the 8495A's insertion loss value (at the 0dB setting) into the R10 register.
12. Press the **CLEAR LINE, Blue, R, 1, 0** and **ENTER/EXECUTE** keys to display the value stored in R10.
13. Confirm that the displayed value is less than 0.1dB. If this reading is greater than 0.1dB, make sure your setup is correct and repeat this procedure.

4-8-2. POWER SPLITTER TRACKING ERROR CALIBRATION

This procedure is for measuring and storing the calibration value of the 11667A and the cables used during performance testing.

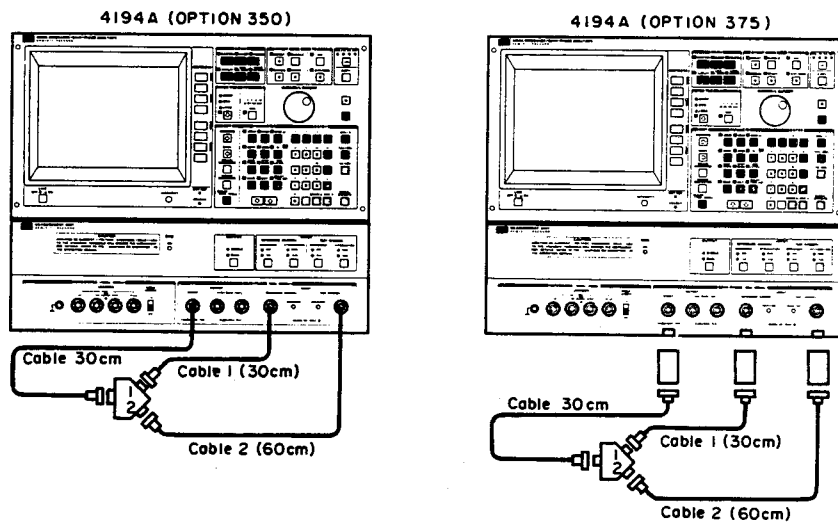

Figure 4-9. HP 11667A Tracking Error Calibration Setup 1

EQUIPMENT:

Power Splitter	HP 11667A		
BNC(m)-BNC(m) Cable, 50 Ω, 30 cm	PN 8120-1838	2 ea.	2 ea.
BNC(m)-BNC(m) Cable, 50 Ω, 60 cm	PN 8120-1839	1 ea.	1 ea.
N(m)-BNC(f) Adapter, 50 Ω	PN 1250-0780	3 ea.	6 ea.
50 Ω - 75 Ω Minimum Loss Pad	HP 11852A		3 ea.
N(f)-BNC(m) Adapter, 75 Ω	PN 1250-1534		3 ea.
		Opt350	Opt375

PROCEDURE:

1. Label the 11667A's output ports as #1 and #2 (see Figure 4-9).
2. Label the 30cm cable as #1 and the 61cm cable as #2 (see Figure 4-9).

Note

Do not remove the labels from the 11667A or the cables when finished with this calibration. This equipment is required for other tests.

3. Set up the 4194A as shown in Figure 4-9.

Note

When testing Option 375 instruments, do not disconnect the 11852As from the 4194A until this procedure is completed.

4. Initialize the 4194A.
5. Set the 4194A as follows:

FUNCTION	GAIN-PHASE, Tch/Rch (dB) - θ
SWEEP MODE	SINGLE
INTEG TIME	MED
AVERAGING TIME	4
CENTER	10MHz
SPAN	0Hz
OSC LEVEL	-1dBm (10.4dBm for Opt. 375)
OUTPUT	SINGLE

6. Press the **START** key.
7. When the **START** key lamp goes out, press the **MKR/L CURS** key, then press the **'LINE CURSOR'**, **'menu'**, **'LCURS for A'**, and **'LCURS → AVRG'** softkeys.
8. Press the **CLEAR LINE**, **Blue**, **R**, **0**, **=**, **L**, **C**, **U**, **R**, **S**, and **ENTER/EXECUTE** keys to store the LCURS value into the R0 register.
9. Reconnect cables 1 and 2 as shown in Figure 4-10 (cable 1 to the TEST CHANNEL; cable 2 to the REFERENCE CHANNEL).

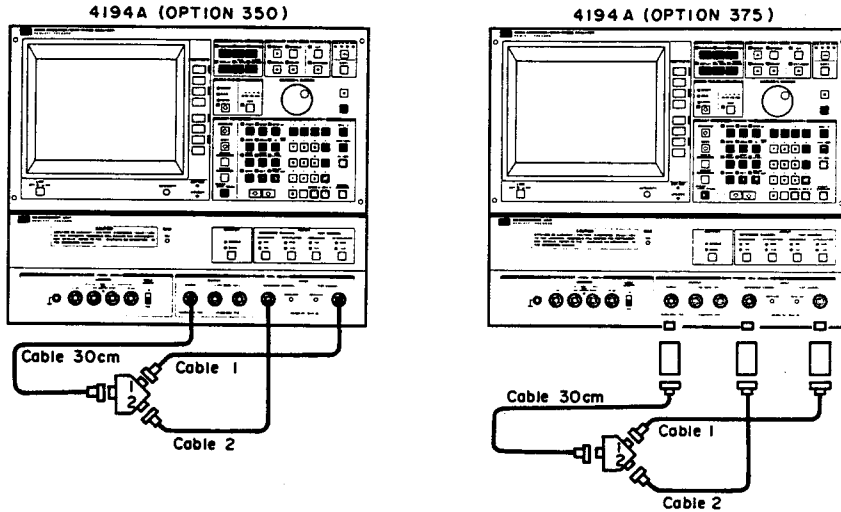

Figure 4-10. HP 11667A Tracking Error Calibration Setup 2

10. Press the **START** key.
11. When the **START** key lamp goes out, press the 'LCURS for A' and 'LCURS → AVRG' softkeys.
12. Press the **CLEAR LINE**, **Blue**, **R**, **1**, **1**, **=**, **(**, **L**, **C**, **U**, **R**, **S**, **-**, **R**, **0**, **)**, **/**, **2**, and **ENTER/EXECUTE** keys to store the tracking error calibration value (11667A and cables) into the R11 register.
13. Press the **CLEAR LINE**, **Blue**, **R**, **1**, **1**, and **ENTER/EXECUTE** keys to display the value stored in R11.
14. Confirm that the displayed value is $0\text{dB} \pm 0.1\text{dB}$. If this reading is not within limits, make sure your setup is correct and repeat this procedure.

4-8-3. 50Ω - 75Ω PAD CALIBRATION (OPTION 375 ONLY)

This procedure is for measuring the insertion loss of the HP 11852A 50Ω - 75Ω Minimum Loss Pads used when performance testing 4194As equipped with Option 375.

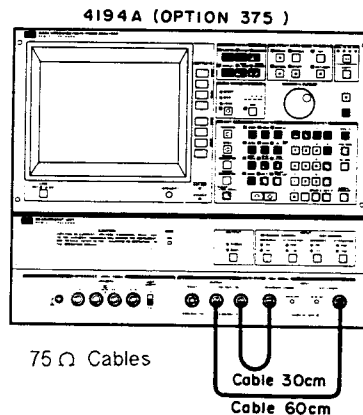

Figure 4-11. HP 11852A Insertion Loss Calibration Setup 1

4: Performance Test

EQUIPMENT:

Power Splitter	HP 11667A	
BNC(m)-BNC(m) Cable, 50 Ω , 30 cm	PN 8120-1838	2 ea.
BNC(m)-BNC(m) Cable, 50 Ω , 60 cm	PN 8120-1839	1 ea.
BNC(m)-BNC(m) Cable, 75 Ω , 30 cm	PN 04194-61640	1 ea.
BNC(m)-BNC(m) Cable, 75 Ω , 60 cm	PN 04194-61641	1 ea.
N(m)-BNC(m) Adapter, 50 Ω	PN 1250-0082	1 ea.
N(m)-BNC(f) Adapter, 50 Ω	PN 1250-0780	6 ea.
N(f)-BNC(f) Adapter, 75 Ω	PN 1250-1536	1 ea.
50 Ω - 75 Ω Minimum Loss Pad	HP 11852A	3 ea.
N(f)-BNC(m) Adapter, 75 Ω	PN 1250-1534	3 ea.

PROCEDURE:

1. Label the three 11852As as A, B, and C.
2. Interconnect the OUTPUT and INPUT terminals using 75 Ω cables as shown in Figure 4-11.
3. Initialize the 4194A.
4. Set the 4194A as follows:

FUNCTION	GAIN-PHASE, Tch/Rch (dB) - θ
SWEEP MODE	SINGLE
INTEG TIME	MED
AVERAGING TIME	4
CENTER	10MHz
SPAN	0Hz
OSC LEVEL	10.4dBm
OUTPUT	DUAL

5. Press the **START** key.
6. When the **START** key lamp goes out, press the **MKR/L CURS** key, then press the '**LINE CURSOR**', '**menu**', '**LCURS for A**', and '**LCURS \rightarrow AVRG**' keys.
7. Press the **CLEAR LINE**, **Blue**, **R**, **0**, **=**, **L**, **C**, **U**, **R**, **S**, and **ENTER/EXECUTE** keys to store the LCURS value into the R0 register.
8. Set up the 4194A as shown in Figure 4-12.

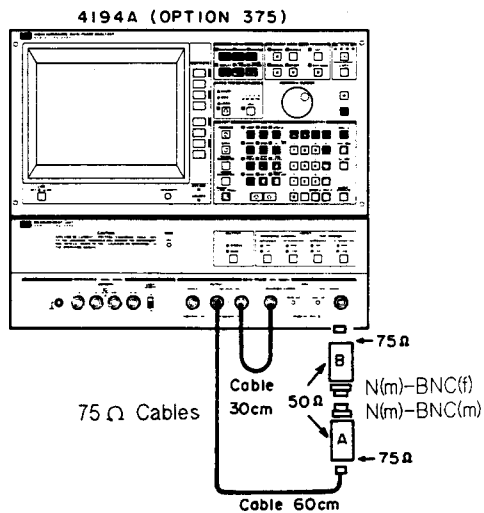

Figure 4-12. HP 11852A Insertion Loss Calibration Setup 2

9. Press the **START** key.
10. When the **START** key lamp goes out, press the 'LCURS → AVRG' softkey.
11. Press the **CLEAR LINE**, **Blue**, **R**, **1**, **=**, **(**, **R**, **0**, **-**, **L**, **C**, **U**, **R**, **S**, **)**, **/**, **2**, and **ENTER/EXECUTE** keys.
12. Change the setup as shown in Figure 4-13 using 50Ω cables. Connect **PAD A** to the **TEST CHANNEL** and **PAD B** to the **REFERENCE CHANNEL**.

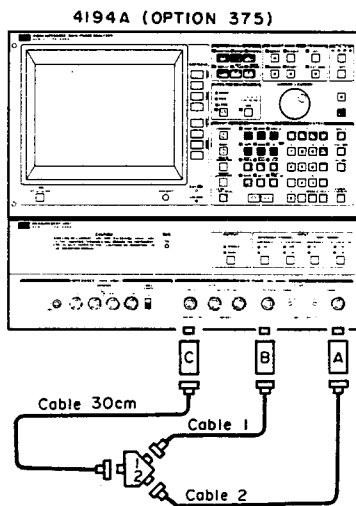

Figure 4-13. HP 11852A Insertion Loss Calibration Setup 3.

13. Set the 4194A to **SINGLE OUTPUT**, then press the **START** key.
14. When the **START** key lamp goes out, press the '**LCURS → AVRG**' softkey.
15. Press the **CLEAR LINE**, **Blue**, **R, 0, =, L, C, U, R, S**, and **ENTER/EXECUTE** keys.
17. Interchange **PADS A** and **B**, as shown in Figure 4-14.

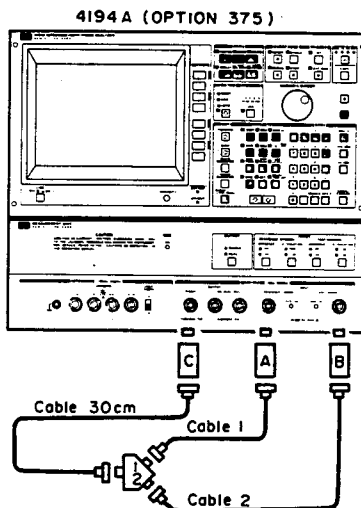

Figure 4-14. HP 11852A Insertion Loss Calibration Setup 4

18. Press the **START** key.
19. When the **START** key lamp goes out, press the '**LCURS → AVRG**' softkey.
20. Press the **CLEAR LINE**, **Blue**, **R, 1, 2, =, R, 1, +, (, L, C, U, R, S, -, R, 0,), /, 4**, and **ENTER/EXECUTE** keys to store the insertion loss value of **PAD A** into the R12 register.
21. Press the **CLEAR LINE**, **Blue**, **R, 1, 2**, and **ENTER/EXECUTE** keys.
22. Confirm that the displayed value is $5.7\text{dB} \pm 0.1\text{dB}$. If this reading is not within limits, make sure your setup is correct and repeat this procedure.
23. Press the **CLEAR LINE**, **Blue**, **R, 1, 3, =, R, 1, -, (, L, C, U, R, S, -, R, 0,), /, 4**, and **ENTER/EXECUTE** keys to store the insertion loss value of **PAD B** into the R13 register.
24. Press the **CLEAR LINE**, **Blue**, **R, 1, 3**, and **ENTER/EXECUTE** keys to display the value stored in R13.
25. Confirm that the displayed value is $5.7\text{dB} \pm 0.1\text{dB}$. If this reading is not within limits, make sure your setup is correct and repeat this procedure.

4-9. AMPLITUDE MEASUREMENT ACCURACY TEST

This six part procedure verifies amplitude measurement accuracy at low and high frequencies and with a low-level input.

4-9-1. 50Ω (75Ω) INPUT TEST, LF

This test verifies amplitude measurement accuracy at 10Hz, 100Hz, 1kHz, and 10kHz when the 4194A's INPUT IMPEDANCE is set to 50Ω/75Ω.

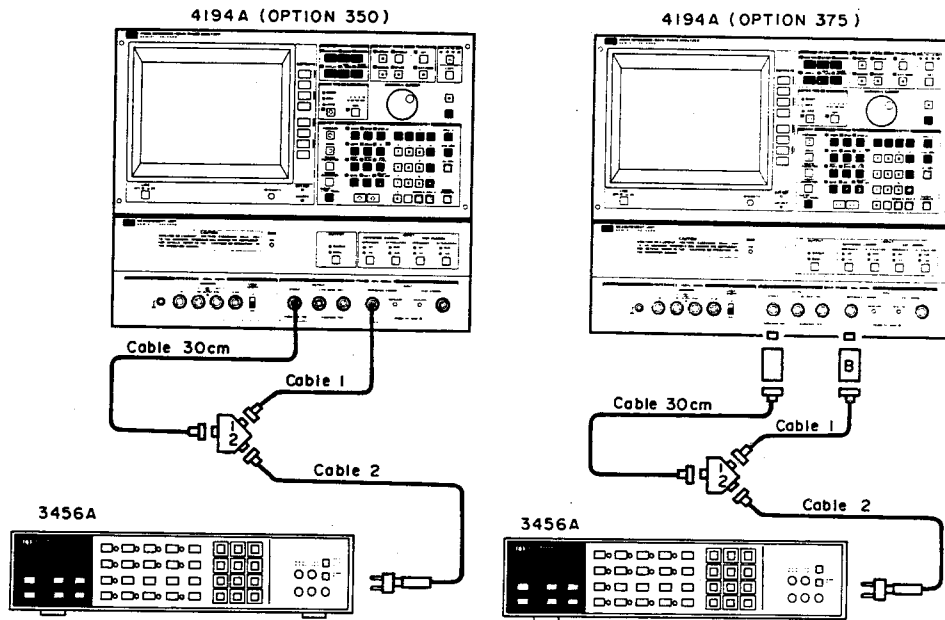

Figure 4-15. Amplitude Measurement Accuracy Test Setup 1

EQUIPMENT:

Digital Voltmeter	HP 3456A		
Power Splitter	HP 11667A	1 ea.	1 ea.
BNC(m)-BNC(m) Cable, 50 Ω, 30 cm	PN 8120-1838	2 ea.	2 ea.
BNC(m)-BNC(m) Cable, 50 Ω, 60 cm	PN 8120-1839	1 ea.	1 ea.
Feedthrough Termination, 50 Ω	PN 04192-61002	1 ea.	1 ea.
N(m)-BNC(f) Adapter, 50 Ω	PN 1250-0780	3 ea.	5 ea.
BNC(f)-Dual Banana Plug Adapter	PN 1251-2277	1 ea.	1 ea.
N(f)-BNC(f) Adapter, 75 Ω	PN 1250-1536		2 ea.
50 Ω - 75 Ω Minimum Loss Pad	HP 11852A		2 ea.
N(f)-BNC(m) Adapter, 75 Ω	PN 1250-1534		2 ea.
		Opt350	Opt375

One of the 30 cm cable must be the cable labeled 1. The 60 cm cable must be the cable labeled 2.

One of the Minimum Loss Pad must be the pad labeled B.

PROCEDURE:

1. Set up the equipment as shown in Figure 4-15.
2. Set the 3456A as follows:

Measurement function	ACV
Filter	ON
3. Press the 3456A's **MATH** and **4** keys (to set the dBm mode).
4. Press the 3456A's **5**, **0**, **STORE**, and **4** keys (to set 50Ω characteristic impedance).
5. Press the **GET**, **2**, and **ENTER/EXECUTE** keys.
6. Press the '**GAIN PHASE**' and '**Rch-Tch (dBm)**' softkeys.
7. Set the 4194A to **SINGLE OUTPUT**.
8. Set the **SWEEP MODE** to **MANUAL**.
9. Set the **OSC LEVEL** to **-1dBm** (10.4dBm for Opt. 375).
10. Set the test frequency to **10Hz** using the **MARKER/L CURSOR** knob.
11. Using the 4194A's built-in calculator function, perform the following calculation.

Pm - MKRA + R11 for 50Ω 4194As, or

Pm - MKRA + R11 - R13 for 75Ω 4194As.

where **Pm** is the measurement value displayed on the 3456A
MKRA is the measurement value displayed on the 4194A
R11 is the tracking error of the 11667 and cables 1 and 2
R13 is the insertion loss of PAD B
12. Confirm that the displayed result is within the test limits listed in Table 4-10 for the frequency tested.
13. Repeat steps 10 through 12 at **100Hz**, **1kHz**, and **10kHz**.
14. Set the **REFERENCE (TEST) CHANNEL ATTENUATION** to **20dB** and repeat steps 10 through 13.
15. Disconnect the cable from the **REFERENCE CHANNEL** and reconnect it to the **TEST CHANNEL**.
16. Repeat steps 10 through 14, substituting **MKRB** for **MKRA** in step 11.

PERFORMANCE TESTS

Table 4-10. LF Amplitude Measurement Accuracy Test Limits
Input Impedance 50Ω/75Ω

	Frequency	Test Limits
REFERENCE CHANNEL ATTENUATION=0dB	10Hz	±0.70dB
	100Hz	±0.35dB
	1kHz	±0.35dB
	10kHz	±0.35dB
REFERENCE CHANNEL ATTENUATION=20dB	10Hz	±0.70dB
	100Hz	±0.35dB
	1kHz	±0.35dB
	10kHz	±0.35dB
TEST CHANNEL ATTENUATION=0dB	10Hz	±0.70dB
	100Hz	±0.35dB
	1kHz	±0.35dB
	10kHz	±0.35dB
TEST CHANNEL ATTENUATION=20dB	10Hz	±0.70dB
	100Hz	±0.35dB
	1kHz	±0.35dB
	10kHz	±0.35dB

Note

Proceed to the next test without dismantling the present test setup.

4-9-2. 1M Ω INPUT TEST, LF

This test verifies amplitude measurement accuracy at 10Hz, 100Hz, 1kHz, and 10kHz when the 4194A's INPUT IMPEDANCE is set to 1M Ω .

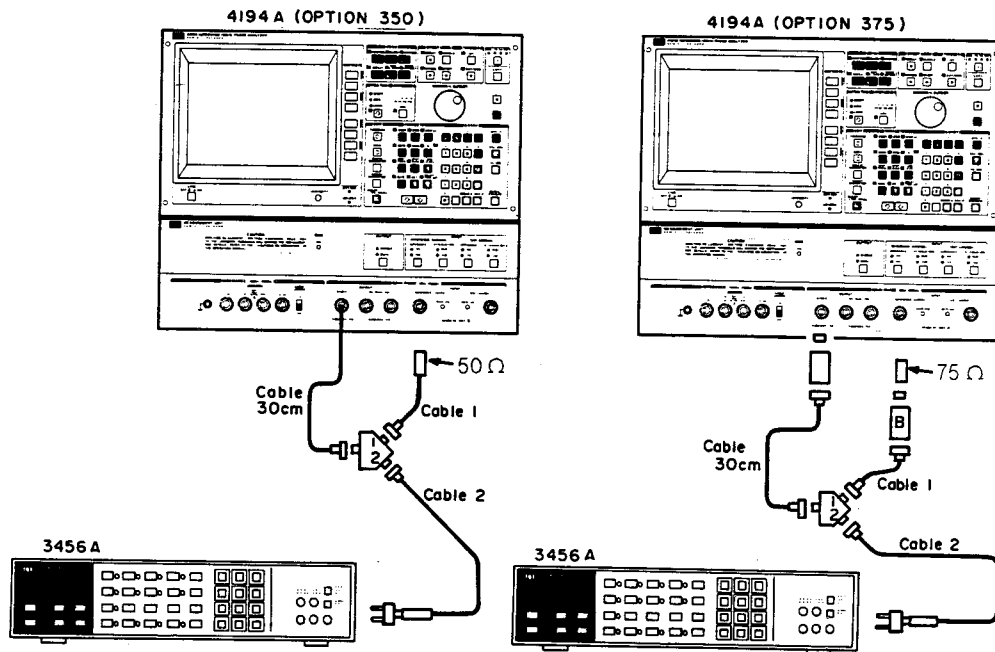

Figure 4-16. Amplitude Measurement Accuracy Test Setup 2

EQUIPMENT:

Same as the previous test, plus:

Feedthrough Termination, 50 Ω
 Feedthrough Termination, 75 Ω

PN 04192-61002	1 ea.
PN 04192-61003	1 ea.
	Opt350 Opt375

PROCEDURE:

1. Connect the appropriate (50 Ω or 75 Ω) feedthrough termination to the REFERENCE CHANNEL as shown in Figure 4-16.
2. Set the 4194A's INPUT IMPEDANCE to 1M Ω .
3. Repeat the procedure in paragraph 4-9-1 from step 10, using the test limits listed in Table 4-11.
4. Remove the feedthrough terminations from cables 1 and 2 and reconnect cable 1 to the REFERENCE CHANNEL. Then disconnect the 3456A and go on to the next test. Leave the setup as it is.

PERFORMANCE TESTS

Table 4-11. LF Amplitude Measurement Accuracy Test Limits
Input Impedance 1M Ω

	Frequency	Test Limits
REFERENCE CHANNEL ATTENUATION = 0dB	10Hz	± 1.0 dB
	100Hz	± 0.4 dB
	1kHz	± 0.4 dB
	10kHz	± 0.4 dB
REFERENCE CHANNEL ATTENUATION = 20dB	10Hz	± 1.0 dB
	100Hz	± 0.4 dB
	1kHz	± 0.4 dB
	10kHz	± 0.4 dB
TEST CHANNEL ATTENUATION = 0dB	10Hz	± 1.0 dB
	100Hz	± 0.4 dB
	1kHz	± 0.4 dB
	10kHz	± 0.4 dB
TEST CHANNEL ATTENUATION = 20dB	10Hz	± 1.0 dB
	100Hz	± 0.4 dB
	1kHz	± 0.4 dB
	10kHz	± 0.4 dB

4-9-3. 50 Ω (75 Ω) INPUT TEST, HF

This test verifies amplitude measurement accuracy at 100kHz, 1, 10, 30, and 100MHz when the 4194A's INPUT IMPEDANCE is set to 50 Ω /75 Ω .

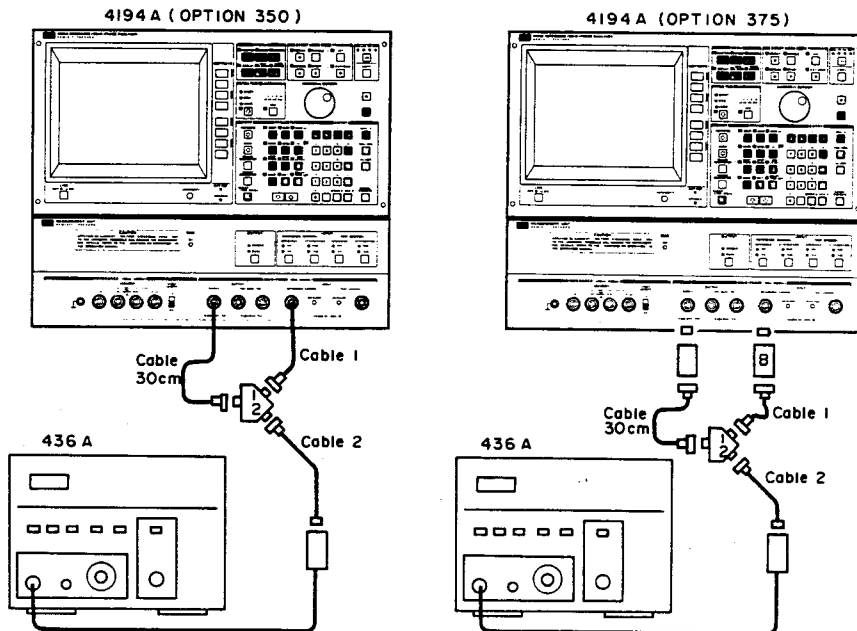

Figure 4-17. Amplitude Measurement Accuracy Test Setup 3

EQUIPMENT:

Same as the equipment for test 4-9-1 (minus the 3456A) plus:

Power Meter	HP 436A
Power Sensor	HP 8482A
N(f)-BNC(f) Adapter, 50 Ω	PN 1250-1474

PROCEDURE:

1. Set up the 4194A as shown in Figure 4-17 and set the 436A's measurement function to dBm.
2. Set the test frequency to 100kHz using the **MARKER/L CURSOR** knob.
3. Set the CAL FACTOR % control on the 436A (in accordance with the cal chart on the 8482A) to compensate for the 8482A's Cal Factor at 100kHz.
4. Using the 4194A's built-in calculator function, perform the following calculation.

$P_m - MKRA + R_{11}$ for 50 Ω 4194As, or

$P_m - MKRA + R_{11} - R_{13}$ for 75 Ω 4194As.

where P_m is the measurement value displayed on the 436A,
 $MKRA$ is the measurement value displayed on the 4194A,
 R_{11} is the tracking error of the 11667 and cables 1 and 2, and
 R_{13} is the insertion loss of PAD B

5. Confirm that the displayed result is within the test limits listed in Table 4-12 for the frequency tested.
6. Repeat steps 2 through 5 at 1, 10, 30, and 100MHz.
7. Set the REFERENCE (TEST) CHANNEL ATTENUATION to 20dB and repeat steps 2 through 6.
8. Disconnect the cable from the REFERENCE CHANNEL and reconnect it to the TEST CHANNEL.
9. Repeat steps 2 through 7, substituting **MKRB** for **MKRA** in step 4.

PERFORMANCE TESTS

Table 4-12. HF Amplitude Measurement Accuracy Test Limits
Input Impedance 50Ω/75Ω

	FREQUENCY	Test Limits
REFERENCE CHANNEL ATTENUATION = 0dB	100kHz 1MHz 10MHz 30MHz 100MHz	±0.35dB ±0.35dB ±0.5dB ±0.7dB ±1.5dB
REFERENCE CHANNEL ATTENUATION = 20dB	100kHz 1MHz 10MHz 30MHz 100MHz	±0.35dB ±0.35dB ±0.5dB ±0.7dB ±1.5dB
TEST CHANNEL ATTENUATION = 0dB	100kHz 1MHz 10MHz 30MHz 100MHz	±0.35dB ±0.35dB ±0.5dB ±0.7dB ±1.5dB
TEST CHANNEL ATTENUATION = 20dB	100kHz 1MHz 10MHz 30MHz 100MHz	±0.35dB ±0.35dB ±0.5dB ±0.7dB ±1.5dB

4-9-4. 1MΩ INPUT TEST, HF

This test verifies amplitude measurement accuracy at 100kHz, 1, 10, and 30MHz when the 4194A's INPUT IMPEDANCE is set to 1MΩ.

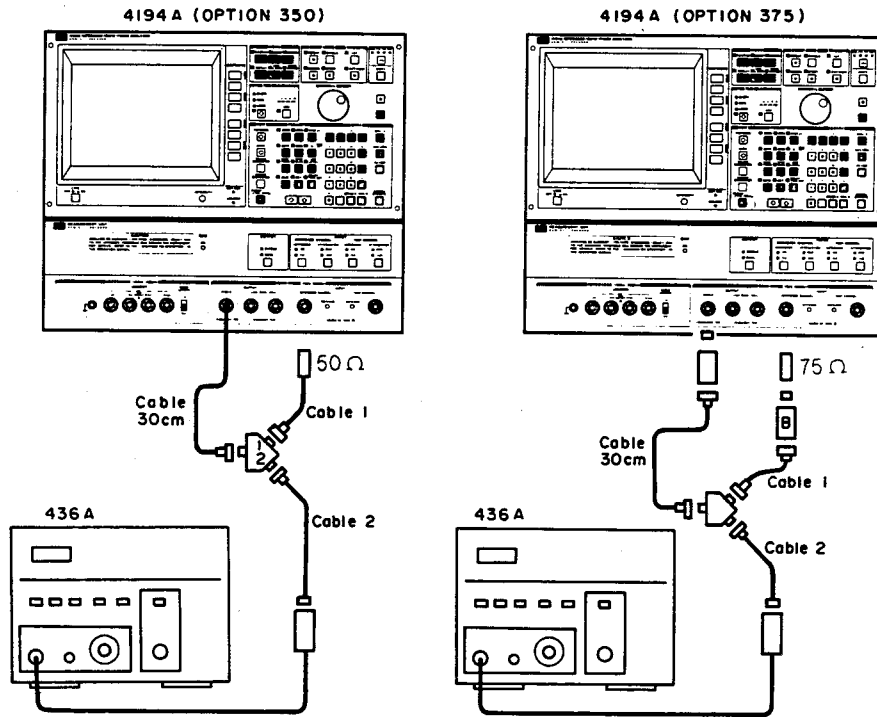

Figure 4-18. Amplitude Measurement Accuracy Test Setup 4.

EQUIPMENT:

Same as the previous test, plus:

Feedthrough Termination, 50 Ω	PN 04192-61002	1 ea.
Feedthrough Termination, 75 Ω	PN 04192-61003	1 ea.
		Opt350 Opt375

PROCEDURE:

1. Connect the appropriate (50Ω or 75Ω) feedthrough termination to the REFERENCE CHANNEL as shown in Figure 4-18.
2. Set the 4194A's INPUT IMPEDANCE to 1MΩ.
3. Repeat the procedure in paragraph 4-9-3 from step 2. Use the test limits listed in Table 4-13.

PERFORMANCE TESTS

4. Remove the feedthrough termination connected to cable 1.

Note

Proceed to the next test without dismantling the present test setup or changing any 4194A settings.

Table 4-13. HF Amplitude Measurement Accuracy Test Limits
Input Impedance $1M\Omega$

	Frequency	Test Limits
REFERENCE CHANNEL ATTENUATION = 0dB	100kHz	$\pm 0.4\text{dB}$
	1MHz	$\pm 0.4\text{dB}$
	10MHz	$\pm 0.7\text{dB}$
	30MHz	$\pm 1.0\text{dB}$
REFERENCE CHANNEL ATTENUATION = 20dB	100kHz	$\pm 0.4\text{dB}$
	1MHz	$\pm 0.4\text{dB}$
	10MHz	$\pm 0.7\text{dB}$
	30MHz	$\pm 1.0\text{dB}$
TEST CHANNEL ATTENUATION = 0dB	100kHz	$\pm 0.4\text{dB}$
	1MHz	$\pm 0.4\text{dB}$
	10MHz	$\pm 0.7\text{dB}$
	30MHz	$\pm 1.0\text{dB}$
TEST CHANNEL ATTENUATION = 20dB	100kHz	$\pm 0.4\text{dB}$
	1MHz	$\pm 0.4\text{dB}$
	10MHz	$\pm 0.7\text{dB}$
	30MHz	$\pm 1.0\text{dB}$

4-9-5. 50Ω (75Ω) INPUT TEST, LOW LEVEL

This test verifies low input level amplitude measurement accuracy at 100kHz, 1, 10, 30, and 100MHz when the input impedance is set to 50Ω/75Ω.

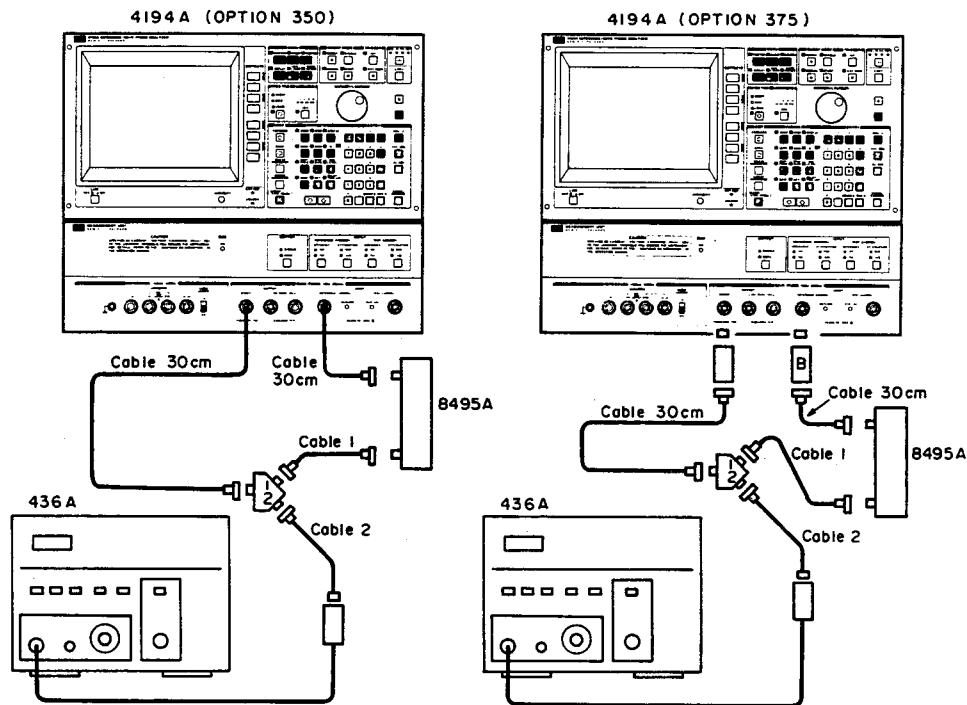

Figure 4-19. Amplitude Measurement Accuracy Test Setup 5.

EQUIPMENT:

Same as the previous test minus a feedthrough termination, plus:

Coaxial Step Attenuator	HP 8495A Opt. 001	
BNC(m)-BNC(m) Cable, 50 Ω, 30 cm	PN 8120-1838	
N(m)-BNC(f) Adapter, 50 Ω	PN 1250-0780	2 ea.

PROCEDURE:

1. Set up the 4194A as shown in Figure 4-19.
2. Set the 8495A to **60dB**.
3. Set the **OSC LEVEL** to **-4dBm** (**7.4dBm** for Opt. 375).
4. Set the test frequency to **100kHz** using the **MARKER/L CURSOR** knob.
5. Set the **CAL FACTOR %** control on the 436A (in accordance with the cal chart on the 8482A) to compensate for the 8482A's Cal Factor at **100kHz**.

PERFORMANCE TESTS

6. Use the 4194A's calculator function to perform the following calculations.

$$\begin{aligned} &P_m - MKRA - R_{10} + R_{11} - C_v && \text{for } 50\Omega \text{ 4194As, or} \\ &P_m - MKRA - R_{10} + R_{11} - R_{13} - C_v && \text{for } 75\Omega \text{ 4194As.} \end{aligned}$$

Where **P_m** is the measurement value displayed on the 436A
MKRA is the measurement value displayed on the 4194A
R₁₀ is the insertion loss of the 8495A
R₁₁ is the tracking error of the 11667A and cables 1 and 2
R₁₃ is the insertion loss of PAD B
C_v is the 8495A's 60 dB calibration value at 1MHz

7. Confirm that the displayed results is within the test limits listed in Table 4-14 for the frequency tested.
8. Repeat steps 4 through 7 at 1MHz, 10MHz, 30MHz, and 100MHz. Use the 8495A's 1MHz calibration value for the 1MHz measurement, the 10MHz calibration value for the 10MHz and 30MHz measurements, and the 100MHz calibration value for the 100MHz measurement.
9. Disconnect the cable from the REFERENCE CHANNEL and reconnect it to the TEST CHANNEL.
10. Repeat steps 4 through 8, substituting **MKRB** for **MKRA** in step 6.
11. Proceed to the next test without dismantling the present test setup or changing any 4194A settings.

Table 4-14. Low Level Amplitude Measurement Accuracy Test Limits
 Input Impedance 50Ω/75Ω

Frequency	Test Limits
100 kHz	±2.5 dB
1 MHz	±2.5 dB
10 MHz	±3 dB
30 MHz	±4 dB
100 MHz	±4 dB

PERFORMANCE TESTS

4-9-6. 1M Ω INPUT TEST, LOW LEVEL

This test verifies low input level amplitude measurement accuracy at 100kHz, 1, 10, and 30MHz when the input impedance is set to 1M Ω .

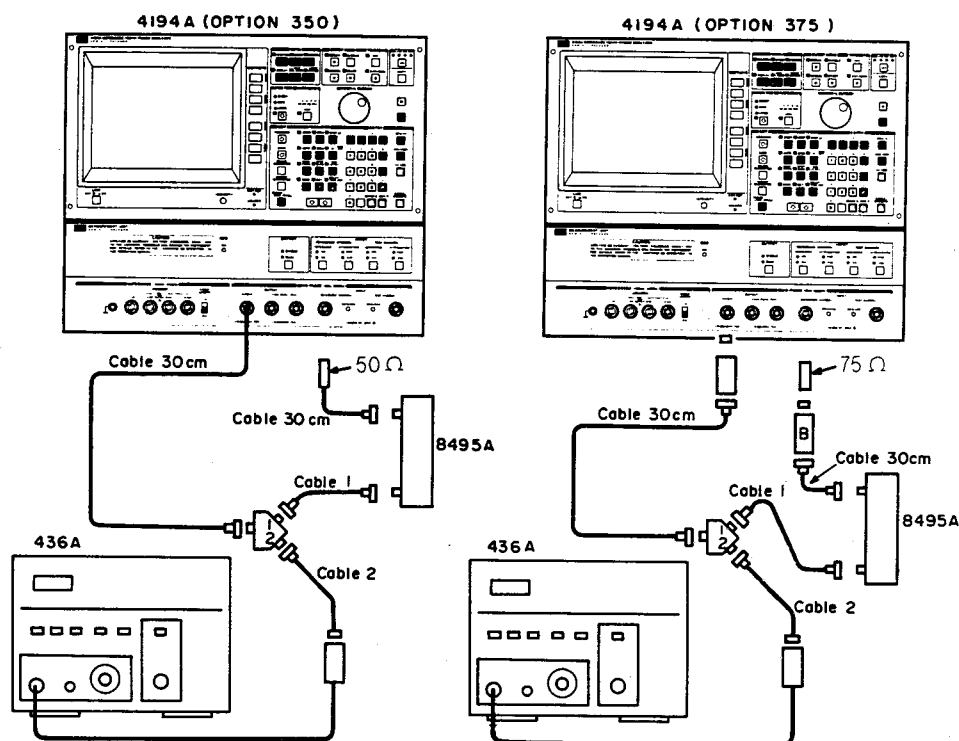

Figure 4-20. Amplitude Measurement Accuracy Test Setup 6

EQUIPMENT:

Same as the previous test, plus:

Feedthrough Termination, 50 Ω
Feedthrough Termination, 75 Ω

PN 04192-61002

1 ea.

PN 04192-61003

1 ea.

Opt350 Opt375

PROCEDURE:

1. Connect the appropriate (50 Ω or 75 Ω) feedthrough termination to the REFERENCE CHANNEL as shown in Figure 4-20.
2. Set the 4194A's INPUT IMPEDANCE to 1M Ω .
3. Repeat the procedure in paragraph 4-9-5 from step 4. Use the test limits listed in Table 4-15.

PERFORMANCE TESTS

Table 4-15. Low Level Amplitude Measurement Accuracy Test Limits
Input Impedance $1M\Omega$

Frequency	Test limits
100kHz	$\pm 3\text{dB}$
1MHz	$\pm 3\text{dB}$
10MHz	$\pm 3\text{dB}$
30MHz	$\pm 4\text{dB}$

4-10. GAIN-PHASE MEASUREMENT SIGNAL LEVEL TEST

This three part test checks test signal level accuracy for gain-phase measurement.

4-10-1. SIGNAL LEVEL ACCURACY: 100kHz

This test verifies the accuracy of the test signal level at 100 kHz.

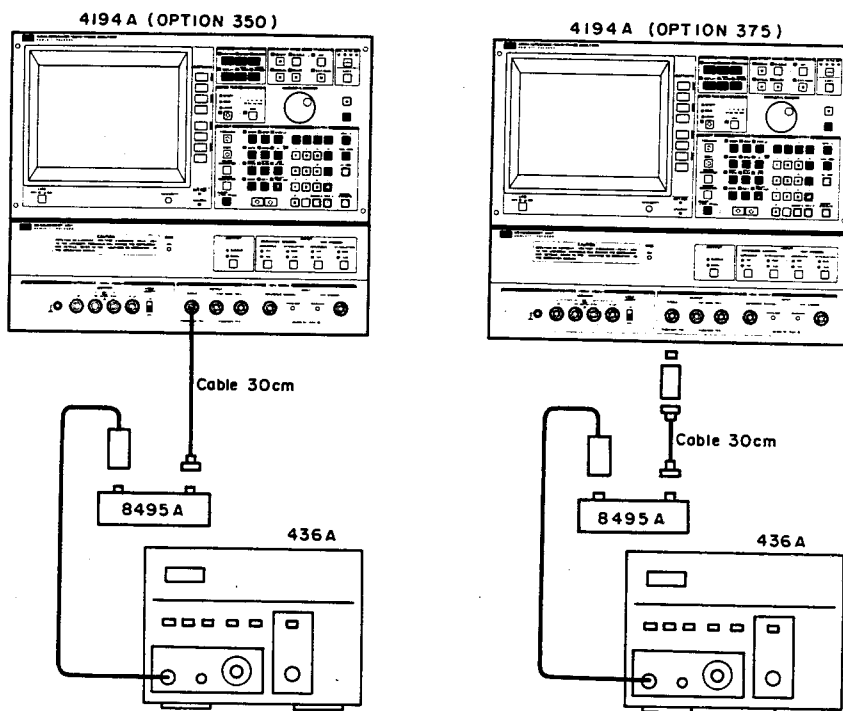

Figure 4-21. Gain-Phase Measurement Signal Level Test Setup 1

EQUIPMENT:

Power Meter	HP 436A		
Power Sensor	HP 8482A		
Coaxial Step Attenuator	HP 8495A Opt. 001		
BNC(m)-BNC(m) Cable, 50 Ω , 30 cm	PN 8120-1838	1 ea.	1 ea.
N(m)-BNC(f) Adapter, 50 Ω	PN 1250-0780	1 ea.	2 ea.
50 Ω - 75 Ω Minimum Loss Pad	HP 11852A		1 ea.
N(f)-BNC(m) Adapter, 75 Ω	PN 1250-1534		1 ea.
		Opt350	Opt375

PROCEDURE:

1. Set up the equipment as shown in Figure 4-21.
2. Press the **GET**, **2**, and **ENTER/EXECUTE** keys.

PERFORMANCE TESTS

3. Set the 4194A to **SINGLE OUTPUT**.
4. Set the **SWEEP MODE** to **MANUAL**.
5. Set the test frequency to **100kHz** using the **MARKER/L CURSOR** knob.
6. Set the 8495A to **10dB**.
7. Set the **OSC LEVEL** to **15dBm**.
8. Set the **CAL FACTOR %** control on the 436A (in accordance with the cal chart on the 8482A) to compensate for the 8482A's Cal Factor at **100kHz**.
9. Confirm that the value displayed on the 436A is as follows.

For 50Ω instruments:

$$15\text{dBm} - (R10 + C_v) \pm 0.8\text{dB}$$

For 75Ω instruments:

$$15\text{dBm} - (R10 + C_v + R13) \pm 0.8\text{dB}$$

where **R10** is the 8495A's insertion loss calibration value

C_v is the 8495's 10dB calibration value at 1MHz

R13 is the insertion loss of PAD B.

10. Note the amplitude value displayed on the 436A as **PREF(15)**. This value will be used in the following test.
11. Set the **OSC LEVEL** to **5dBm**.
12. Set the 8495A to **0dB**.
13. Confirm that the value displayed on the 436A is as follows.

For 50Ω instruments:

$$5\text{dBm} - R10 \pm 1.0\text{dB}.$$

For 75Ω instruments:

$$5\text{dBm} - (R10 + R13) \pm 1.0\text{dB}.$$

14. Note the amplitude value displayed on the 436A as **PREF(5)**. This value will be used in the following test.

Note

Proceed to the next test without dismantling the present test setup or changing any 4194A settings.

4-10-2. HF SIGNAL LEVEL FLATNESS

This test verifies the flatness of the test signal level at high frequencies.

EQUIPMENT:

Same as the previous test.

PROCEDURE:

1. Set the 8495A to **10dB** and set the 4194A's **OSC LEVEL** to **15dBm**.
2. Set the **CAL FACTOR %** control on the 436A (in accordance with the cal chart on the 8482A) to compensate for the 8482A's Cal Factor at **10MHz**.
3. Set the test frequency to **10MHz**.
4. Confirm that the signal level (dBm) displayed on the 436A is **PREF(15)±1dBm**.
5. Repeat steps 2 through 4 at **30, 80, and 100MHz**.
6. Set the 8495A to **0dB** and set the 4194A's **OSC LEVEL** to **5dBm**.
7. Set the **CAL FACTOR %** control on the 436A (in accordance with the cal chart on the 8482A) to compensate for the 8482A's Cal Factor at **10MHz**.
8. Set the test frequency to **10MHz**.
9. Confirm that the signal level (dBm) displayed on the 436A is **PREF(5)±1.2dBm**.
10. Repeat steps 7 through 9 at **30, 80, and 100MHz**.

Note

Disconnect the power meter from the attenuator and proceed to the next test without dismantling the present test setup or changing any of the 4194A's settings.

4-10-3. LF SIGNAL LEVEL FLATNESS

This test verifies the flatness of the signal level at low frequencies.

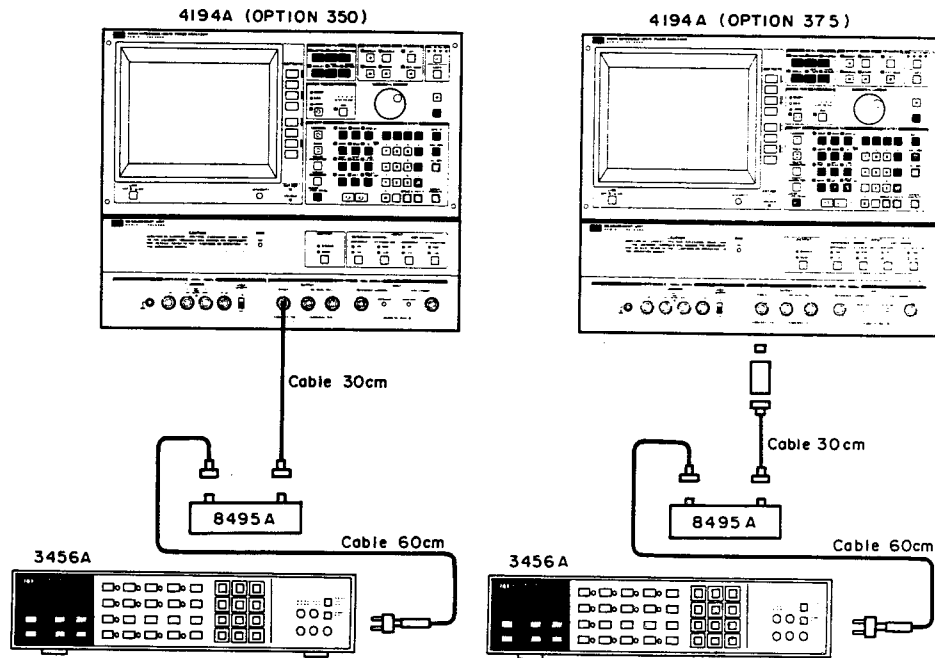

Figure 4-22. Gain-Phase Measurement Signal Level Test Setup 2

EQUIPMENT:

Digital Voltmeter
 Coaxial Step Attenuator
 BNC(m)-BNC(m) Cable, 50 Ω , 30 cm
 BNC(m)-BNC(m) Cable, 50 Ω , 60 cm
 Feedthrough Termination, 50 Ω
 N(m)-BNC(f) Adapter, 50 Ω
 BNC(f)-Dual Banana Plug Adapter
 50 Ω - 75 Ω Minimum Loss Pad
 N(f)-BNC(m) Adapter, 75 Ω

HP 3456A		
HP 8495A Opt. 001		
PN 8120-1838	1 ea.	1 ea.
PN 8120-1839	1 ea.	1 ea.
PN 04192-61002	1 ea.	1 ea.
PN 1250-0780	2 ea.	3 ea.
PN 1251-2277	1 ea.	1 ea.
HP 11852A		1 ea.
PN 1250-1534		1 ea.
	Opt350	Opt375

PROCEDURE:

1. Set the **OSC LEVEL** to 15dBm.
2. Set the 8495A to 10dB.
3. Connect the 3456A to the 8495A as shown in Figure 4-22.
4. Set the 3456A as follows:

Measurement function	ACV
Filter	ON

PERFORMANCE TESTS

5. Press the 3456A's **MATH** and **4** keys (to set the dBm mode).
6. Press the 3456A's **5**, **0**, **STORE**, and **4** keys (to set 50 Ω characteristic impedance).
7. Set the test frequency to **100kHz**.
8. Note the value displayed on the 3456A as **PREF(15)**.
9. Set the test frequency to **10Hz**.
10. Confirm that the signal level value displayed on the 3456A is **PREF(15) \pm 1dBm**.
11. Repeat steps 9 and 10 at **100Hz**, **1kHz**, and **10kHz**.
12. Set the **OSC LEVEL** to **5dBm**.
13. Set the 8495A to **0dB**.
14. Set the test frequency to **100kHz**.
15. Note the value displayed on the 3456A as **PREF(5)**.
16. Set the test frequency to **10Hz**.
17. Confirm that the signal level value displayed on the 3456A is **PREF(5) \pm 1.2dBm**.
18. Repeat steps 16 and 17 at **100Hz**, **1kHz**, and **10kHz**.

4-11. POWER SPLITTER TEST

This test verifies output tracking of the internal power splitter.

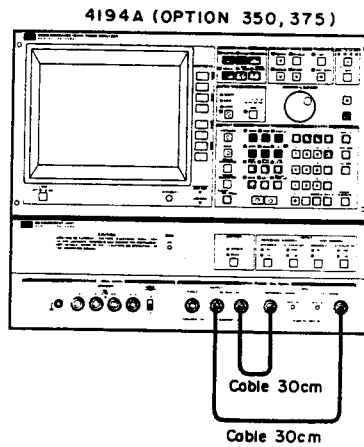

Figure 4-25. Power Splitter Test Setup 1

EQUIPMENT:

BNC(m)-BNC(m) Cable, 50 Ω , 30 cm	PN 8120-1838	2 ea.
BNC(m)-BNC(m) Cable, 75 Ω , 30 cm	PN 04194-61640	2 ea. Opt350 Opt375

PROCEDURE:

1. Set up the equipment as shown in Figure 4-25.
2. Initialize the 4194A.
3. Set the 4194A as follows:

FUNCTION	GAIN-PHASE, Tch/Rch (dB) - θ
SWEEP MODE	SINGLE
INTEG TIME	MED
AVERAGING TIME	4
REFERENCE CHANNEL ATTEN.	20dB
TEST CHANNEL ATTEN.	20dB
4. Press the **START** key.
5. When the **START** key lamp goes out, press the **COMPEN** key.
6. Press the '**OFST REF STORE**', '**A OFFSET on/off**', and '**B OFFSET on/off**' softkeys.
7. Change the cables as shown in Figure 4-26.

4: Performance Test

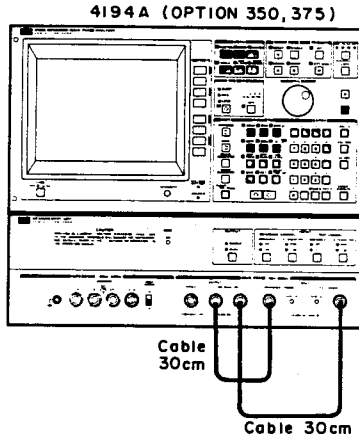

Figure 4-26. Power Splitter Test Setup 2

8. Press the **START** key.
9. When the **START** key lamp goes out, press the **DISPLAY** key and the 'menu' softkey.
10. Enter the following key sequence.
AMAX = 1.0dBm, and AMIN = -1.0dBm.
11. Press the 'more 1/3' softkey.
12. Enter the following key sequence.
BMAX = 30 and BMIN = -30.
13. Confirm that trace A is $0\text{dBm} \pm 0.2\text{dBm}$ (1 division), and that trace B is $0^\circ \pm 6^\circ$ (1 division).

4-12. GAIN-PHASE MEASUREMENT CROSSTALK TEST

This test verifies that the gain-phase measurement crosstalk is within specifications.

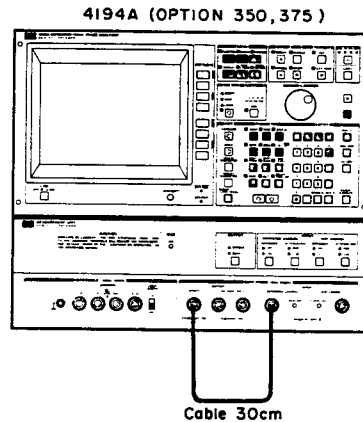

Figure 4-27. Gain-Phase Measurement Crosstalk Test Setup

EQUIPMENT:

BNC(m)-BNC(m) Cable, 50 Ω , 30 cm	PN 8120-1838	1 ea.
BNC(m)-BNC(m) Cable, 75 Ω , 30 cm	PN 04194-61640	1 ea.
		Opt350 Opt375

PROCEDURE:

1. Set up the equipment as shown in Figure 4-27.
2. Initialize the 4194A and set as follows:

FUNCTION	GAIN-PHASE, Tch/Rch (dBm) - θ
SWEEP	LOG
SWEEP MODE	SINGLE
INTEG TIME	MED
AVERAGING	4
OSC LEVEL	-5dBm
OUTPUT	SINGLE
3. Press the **START** key.
4. When the **START** key lamp goes out, press the **DISPLAY** key and the 'menu' softkey.
5. Press the 'AMAX' softkey and the -, 5, 0, and KHz/dBm keys to set the top of the scale to -50dBm.

PERFORMANCE TESTS

6. Press the **'AMIN'** softkey and the **-, 1, 5, 0, KHz/dBm** keys to set the bottom of the scale to **-150dBm**.
7. Press the **'more 1/3'** and **'DISP B on/off'** softkeys to turn off **DISP B (Phase)**.
8. Press the **MKR/L CURS** key, the **'LINE CURSOR'**, **'menu'**, and **'LCURS='** softkeys, and the **-, 8, 6,** and **KHz/dBm** keys.
9. Confirm that the **A** trace is displayed below the **LINE CURSOR**.
10. Set the **STOP** frequency to **70MHz**.
11. Press the **START** key.
12. When the **START** key lamp goes out, press the **'LCURS='** softkey and the **-, 9, 6,** and **KHz/dBm** keys.
13. Confirm that the **A** trace is displayed below the **LINE CURSOR**.

4-13. IMPEDANCE MEASUREMENT SIGNAL LEVEL TEST

This three part test verifies the accuracy and flatness of the impedance measurement signal.

4-13-1. SIGNAL LEVEL ACCURACY: 100kHz

This test verifies the accuracy of the impedance measurement test signal level at 100kHz.

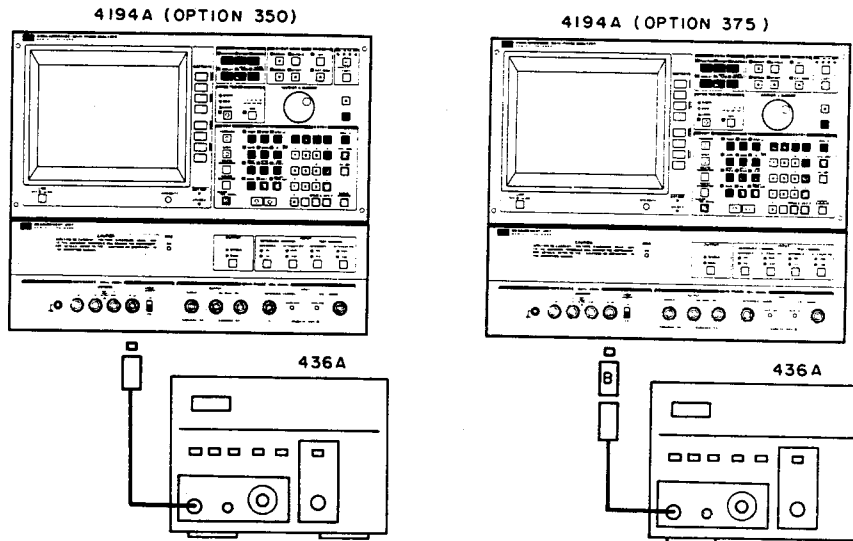

Figure 4-28. Impedance Measurement Signal Level Test Setup 1

EQUIPMENT:

Power Meter	HP 436A	
Power Sensor	HP 8482A	
N(f)-BNC(m) Adapter, 50 Ω	PN 1250-0077	1 ea.
50 Ω - 75 Ω Minimum Loss Pad	HP 11852A	1 ea.
N(f)-BNC(m) Adapter, 75 Ω	PN 1250-1534	1 ea.
		Opt350 Opt375

PROCEDURE:

1. Connect the 436A to the 4194A's UNKNOWN Hcur terminal as shown in Figure 4-28.
2. Set the power meter's measurement function to **dBm**.
3. Set the CAL FACTOR % control on the 436A (in accordance with the cal chart on the 8482A) to compensate for the 8482A's Cal Factor at **100kHz**.
4. Press the **GET**, **1**, and **ENTER/EXECUTE** keys.

4: Performance Test

PERFORMANCE TESTS

5. Set the **OSC LEVEL** to **1V**.
6. Set the **SWEEP MODE** to **MANUAL**.
7. Set the test frequency to 100kHz using the **MARKER/L CURSOR** knob.
8. Confirm that the value displayed on the 436A is as follows.

For HP 4194A option 350 (50 Ω instruments):

7.0 dBm \pm 1 dB

For HP 4194A option 375 (75 Ω instruments):

(5.23 dBm - R13) \pm 1 dB

Where R13 is the insertion loss of Pad B.

9. Note the value displayed on the 436A as **PREF**. This value will be used in the next test.

Note

Proceed to the next test without dismantling the present test setup or changing any of the HP 4194A's settings.

4-13-2. HF SIGNAL LEVEL FLATNESS

This test verifies the flatness of the impedance measurement test signal level at high frequencies.

EQUIPMENT:

Same as the previous test.

PROCEDURE:

1. Set the frequency to **500kHz**.
2. Set the **CAL FACTOR %** control on the 436A (in accordance with the cal chart on the HP 8482A) to compensate for the HP 8482A's Cal Factor at **500kHz**.
3. Confirm that the value displayed on 436A is **PREF \pm 1 dB**.
4. Repeat steps 1 through 3 at **1, 3, 10, and 40MHz**.

Note

Set the 436A aside and proceed to the next test without changing any of the HP 4194A settings.

4-13-3. LF SIGNAL LEVEL FLATNESS

This test verifies the flatness of the impedance measurement test signal level at low frequencies.

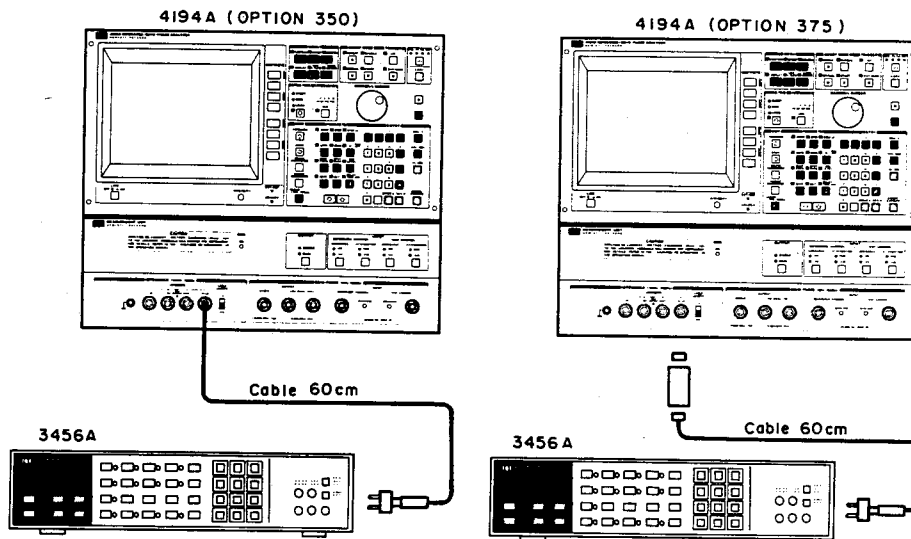

Figure 4-29. Impedance Measurement Signal Level Test Setup 2

EQUIPMENT:

Digital Voltmeter	HP 3456A		
BNC(m)-BNC(m) Cable, 50 Ω , 60 cm	PN 8120-1839	1 ea.	1 ea.
Feedthrough Termination, 50 Ω	PN 04192-61002	1 ea.	1 ea.
BNC(f)-Dual Banana Plug Adapter	PN 1251-2277	1 ea.	1 ea.
N(m)-BNC(f) Adapter, 50 Ω	PN 1250-0780		1 ea.
50 Ω - 75 Ω Minimum Loss Pad	HP 11852A		1 ea.
N(f)-BNC(m) Adapter, 75 Ω	PN 1250-1534		1 ea.
		Opt350	Opt375

PROCEDURE:

1. Set up the equipment as shown in Figure 4-29.
2. Set the 3456A as follows:

Measurement Function	ACV
Filter	ON
3. Press the 3456A's **MATH** and **4** keys (to set the dBm mode).
4. Press the **5**, **0**, **STORE**, and **4** keys on the 3456A.
5. Set the test frequency to **100kHz** and note the value displayed on the 3456A as **PREF.**

4: Performance Test

PERFORMANCE TESTS

6. Set the test frequency to **100Hz** and confirm that the value displayed on the 3456A is $P_{REF} \pm 1dB$.
7. Repeat step 6 at **1kHz** and **10kHz**.

4-14. IMPEDANCE MEASUREMENT ACCURACY TEST

This test verifies the accuracy of the 4194A impedance measurement.

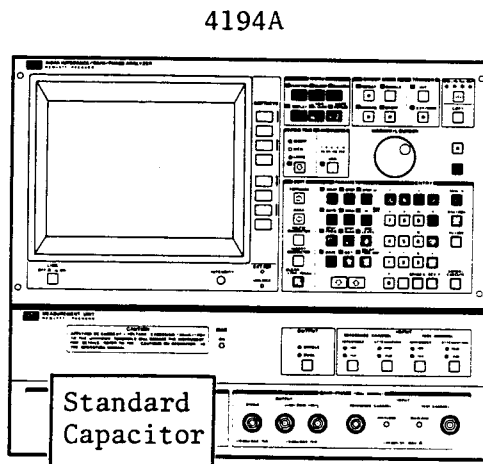

Figure 4-30. Impedance Measurement Accuracy Test Setup 1

EQUIPMENT:

Standard Capacitor, 1 pF	HP 16381A	} HP 16380A
Standard Capacitor, 10 pF	HP 16382A	
Standard Capacitor, 100 pF	HP 16383A	
Standard Capacitor, 1000 pF	HP 16384A	
Standard Capacitor, 0.01 μ F	HP 16385A	} HP 16380C
Standard Capacitor, 0.1 μ F	HP 16386A	
Standard Capacitor, 1 μ F	HP 16387A	

PROCEDURE:

1. Press the **GET**, **1**, and **ENTER/EXECUTE** keys.
2. Press the **'IMPEDANCE'**, **'more 1/3'**, and **'Cp-D'** softkeys.
3. Press the **DISPLAY** key and the **'TABLE'** softkey.
4. Set the **OSC LEVEL** to **1Vrms**.
5. Connect the **1pF** Standard Capacitor to the **UNKNOWN** connectors as shown in Figure 4-30.

4: Performance Test

PERFORMANCE TESTS

6. Press the **START** key.
7. When the **START** key lamp goes out, execute $A = A - (Cv)$, where Cv is the calibrated value of the standard capacitor.
8. The values (both in the **Cp [F]** column and **D []** column) in the TABLE Display must be within the limits listed in Table 4-16.
9. Repeat steps 5 through 9 using the **10pF, 100pF, 1000pF, 0.01μF, 0.1μF, and 1μF** Standard Capacitors, respectively.

Note

The 16380C's Standard Capacitors do not require Dissipation factor test.

Table 4-16. Impedance Measurement Accuracy Test Limits 1

Standard Capacitor	Test Frequency	C Test Limits	D Test Limits
1pF	100kHz	±6.27fF	±6.27m
	1MHz	±2.09fF	±2.09m
	3MHz	±9.64fF	±9.64m
10pF	10kHz	±107.1fF	±10.7m
	100kHz	±20.9fF	±2.09m
	1MHz	±17.3fF	±1.73m
	3MHz	±44.5fF	±4.45m
	10MHz	±132fF	±13.2m
100pF	1kHz	±1.07pF	±10.7m
	10kHz	±659fF	±6.59m
	100kHz	±173fF	±1.73m
	1MHz	±170fF	±1.70m
1000pF	100Hz	±17.9pF	±17.9m
	1kHz	±6.59pF	±6.59m
	10kHz	±6.23pF	±6.23m
	100kHz	±1.70pF	±1.70m
	500kHz	±1.70pF	±1.70m
0.01μF	1kHz	±62.3pF	
0.1μF	1kHz	±620pF	
1μF	1kHz	±6.21nF	

4-15. IMPEDANCE MEASUREMENT LEVEL MONITOR TEST

This three part test is used to check the accuracy of the test signal voltage and the current level monitor used for impedance measurements.

4-15-1. LF LEVEL MONITOR

This test verifies the accuracy of the test signal voltage monitor at low frequencies.

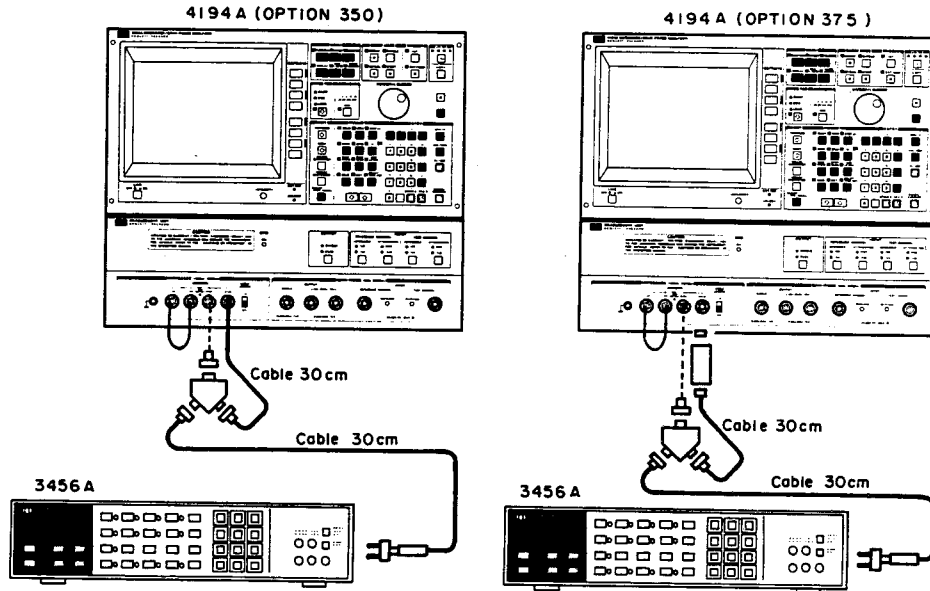

Figure 4-33. Impedance Measurement V Level Monitor Test Setup 1

EQUIPMENT:

Digital Voltmeter	HP 3456A		
Power Splitter	HP 11667A	1 ea.	1 ea.
BNC(m)-BNC(m) Cable, 50 Ω, 30 cm	PN 8120-1838	2 ea.	2 ea.
BNC(m)-BNC(m) Cable, 50 Ω, 60 cm	PN 8120-1839	1 ea.	1 ea.
Feedthrough Termination, 50 Ω	PN 04192-61002	1 ea.	1 ea.
BNC(f)-Dual Banana Plug Adapter	PN 1251-2277	1 ea.	1 ea.
N(m)-BNC(m) Adapter, 50 Ω	PN 1250-0082	1 ea.	1 ea.
N(m)-BNC(f) Adapter, 50 Ω	PN 1250-0780	2 ea.	3 ea.
50 Ω - 75 Ω Minimum Loss Pad	HP 11852A		1 ea.
N(f)-BNC(m) Adapter, 75 Ω	PN 1250-1534		1 ea.
		Opt350	Opt375

PROCEDURE:

1. Set up the equipment as shown in Figure 4-33. Connect the 11667A's INPUT PORT to the H port terminal.

4: Performance Test

- Set the 3456A as follows:

Measurement Function	ACV
Filter	ON

- Press the **GET**, **1**, and **ENTER/EXECUTE** keys.
- Press the **'MONITOR menu'** and **'V(AC)'** softkeys.
- Set the **SWEEP MODE** to **MANUAL**.
- Set the **OSC LEVEL** to **1Vrms**.
- Set the test frequency to **100Hz**.
- Enter the value displayed on the 3456A into the **R0** register.
- Confirm that the **V MONITOR** value displayed on the 4194A is:

$$1.8 \times R0 - 1mV \sim 2.2 \times R0 + 1mV$$
- Repeat steps 7 through 9 at **1, 10, 29, and 30kHz**.

Note

Disconnect the 30cm cable between the 3456A and the 11667A and proceed to the next test without dismantling the present test setup or changing any of the 4194A's settings.

4-15-2. HF LEVEL MONITOR

This test verifies the accuracy of the test signal voltage level monitor at high frequencies.

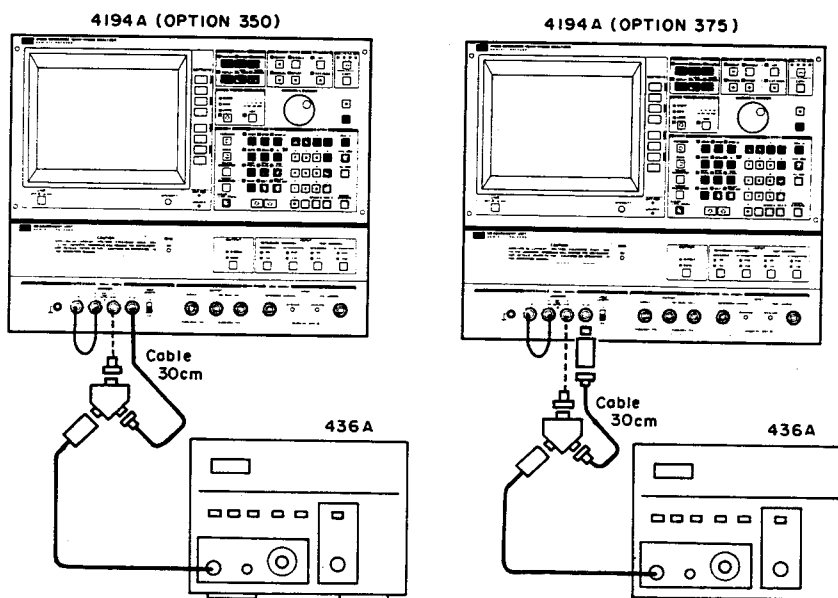

Figure 4-34. Impedance Measurement V Level Monitor Test Setup 2

EQUIPMENT:

Power Meter	HP 436A		
Power Sensor	HP 8482A		
Power Splitter	HP 11667A	1 ea.	1 ea.
BNC(m)-BNC(m) Cable, 50 Ω, 30 cm	PN 8120-1838	2 ea.	2 ea.
N(m)-BNC(m) Adapter, 50 Ω	PN 1250-0082	1 ea.	1 ea.
N(m)-BNC(f) Adapter, 50 Ω	PN 1250-0780	1 ea.	2 ea.
50 Ω - 75 Ω Minimum Loss Pad	HP 11852A		1 ea.
N(f)-BNC(m) Adapter, 75 Ω	PN 1250-1534		1 ea.
		Opt350	Opt375

PROCEDURE:

1. Set up the equipment as shown in Figure 4-34.
2. Set the 436A's measurement function to dBm.
3. Set the test frequency to **100kHz**.
4. Set the CAL FACTOR % control on the 436A (in accordance with the cal chart on the 8482A) to compensate for the 8482A's Cal Factor at **100kHz**.
5. Enter the 436A's displayed value into register R0.
6. Using the 4194A's built-in calculator function, convert R0 (dBm) to a voltage value. Enter the following key sequence.

$$R1 = 10^{((R0 - 13.01)/20)}$$

This is equivalent to the following equation.

$$R1 = 10^{(R0 - 13.01)/20}$$

7. Confirm that the V MONITOR value displayed on the 4194A is:

$$1.8 \times R1 - 1mV \sim 2.2 \times R1 + 1mV$$
8. Repeat steps 3 through 7 at **1MHz** and **10MHz**.
9. Set the **OSC LEVEL** to **0.5Vrms**.
10. Repeat steps 3 through 7 at **40MHz**.

4-16. DC BIAS VOLTAGE TEST

This test verifies the accuracy of the 4194A's dc bias voltage.

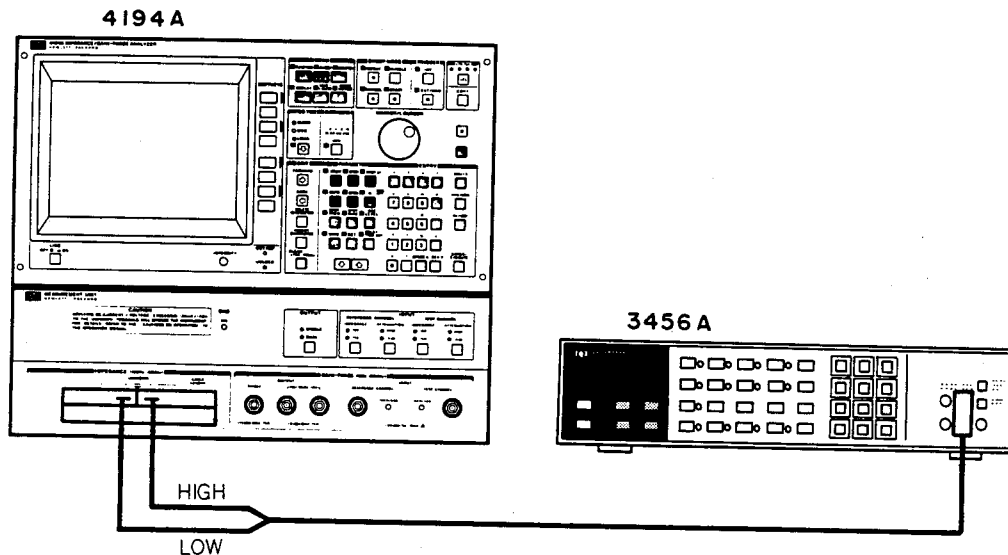

Figure 4-36. DC Bias Voltage Test Setup

EQUIPMENT:

Digital Voltmeter	HP 3456A
Test Fixture	HP 16047D
Test Leads, Alligator Clips	HP 11002A

PROCEDURE:

1. Set up the equipment as shown in Figure 4-36.
2. Initialize the 4194A and the 3456A.
3. Set the **OSC LEVEL** to 10mV.
4. Set the **SWEEP MODE** to **MANUAL**.
5. Set the test frequency to 40MHz.
6. Press the **SPOT BIAS**, **0**, and **MHz/V** keys. Confirm that the **BIAS** lamp is ON (lit).
7. Confirm that the voltage value displayed on the 3456A is between 12mV and -12mV.
8. Press the **SPOT BIAS**, **4**, **0**, and **MHz/V** keys.

PERFORMANCE TESTS

9. Confirm that the voltage value displayed on the 3456A is between 39.94V and 40.06V.
10. Press the **SPOT BIAS**, **-**, **4**, **0**, and **MHz/V** keys.
11. Confirm that the voltage value displayed on the 3456A is between -40.06V and -39.94V.
12. Press the **SWEEP** key and the 'more 1/2' and 'DC BIAS(V)' softkeys.
13. Set the **START** voltage to **0.01V**.
14. Set the **STOP** voltage to **20.48V**.
15. Press the **N** (PARAMETER key), **1**, **2**, and **ENTER/EXECUTE** keys.
16. Press the **SWEEP** key and the 'LOG SWEEP' softkey.
17. Set the **BIAS** voltage to **0.01V** using the **MARKER/L CURSOR** knob.
18. Confirm that the voltage value displayed on the 3456A is within the test limits listed in Table 4-20 for the bias voltage tested.
19. Repeat steps 16 and 17 for each bias voltage listed in Table 4-20.

Table 4-20. DC Bias Voltage Test Limits

Bias Voltage	Test Limits
0.01V	-0.002V to 0.022V
0.02V	0.008V to 0.032V
0.04V	0.028V to 0.052V
0.08V	0.068V to 0.092V
0.16V	0.148V to 0.172V
0.32V	0.308V to 0.332V
0.64V	0.627V to 0.653V
1.28V	1.266V to 1.294V
2.56V	2.545V to 2.575V
5.12V	5.102V to 5.138V
10.24V	10.216V to 10.264V
20.48V	20.443V to 20.517V

WARNING

BE SURE TO TURN OFF THE INTERNAL BIAS VOLTAGE AFTER THIS TEST.

4-17. HP-IB PERFORMANCE TEST

This test verifies the HP-IB performance.

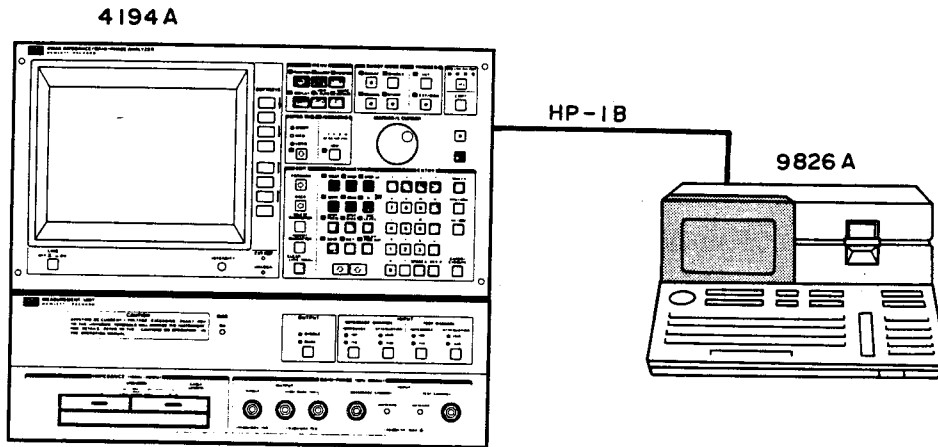

Figure 4-37. HP-IB Performance Test Setup

EQUIPMENT:

- | | |
|-----------------------------|-----------|
| Personal Technical Computer | HP 9826 |
| HP-IB Cable | HP 10833A |
| Test Fixture | HP 16047D |

PROCEDURE:

1. Connect the HP 4194A to the 9826 using an HP-IB cable. Use the 9826's built-in HP-IB port (select code is 7).
2. Press the **MORE MENUS**, '**HPIB DEFINE**', '**ADDRESSABLE**', '**HPIB ADDRESS**', 1, 7, and **ENTER/EXECUTE** keys to set the HP 4194A's HP-IB address to 17.
3. Load BASIC and input the following program (don't run it, though).

```

10 DIM A$(10),B$(35),C$(10)
20 OUTPUT 717;"ID?"
30 ENTER 717;A$,B$,C$
40 PRINT A$,B$,C$
50 OUTPUT 717;"RQS32"
60 OUTPUT 717;"ABC"
70 PRINT SPOLL(717)
80 END
    
```

4. Press the **STEP** key on the 9826 keyboard three times to execute up to line number 20.
5. Confirm that the **LTN** and **RMT** lamps are lit and that all HP 4194A keys, except for the **LCL** key, are disabled.

6. Press the **LCL** key.
7. Confirm that the **LTN** lamp stays lit, the **RMT** lamp goes out, and that all keys are enabled.
8. Step (press the **STEP** key on the 9826) to program line 30 and confirm that the **TLK** lamp is lit.
9. Step to program line 40 and confirm that the following message is displayed on the 9826.

"HP4194A IMPEDANCE/GAIN-PHASE_ANALYZER OPT350 (OPT375)".
10. Step to program line 60, and confirm that the **SRQ**, **LTN**, and **RMT** lamps are lit.
11. Step to program line 80 and confirm that the status byte value displayed on the 9826 is greater than 96.

NOTE

PERFORMANCE TEST RECORD

Hewlett-Packard
 Model 4194A
 Impedance/Gain-Phase Analyzer

Tested by: _____
 Date: _____
 Serial No.: _____

Test	Results		
	Minimum	Actual	Maximum
4-6. INTERNAL SYNTHESIZER FREQUENCY TEST			
Without Option 001 Frequency Setting			
1MHz	0.99998MHz	_____	1.00002MHz
10MHz	9.9998MHz	_____	10.0002MHz
100MHz	99.998MHz	_____	100.002MHz
10MHz OUTPUT	9.9998MHz	_____	10.0002MHz
With Option 001 Frequency Setting			
1MHz	0.999999MHz	_____	1.000001MHz
10MHz	9.99999MHz	_____	10.00001MHz
1MHz	99.9999MHz	_____	100.0001MHz
10MHz OUTPUT	9.99999MHz	_____	10.00001MHz
4-7. GAIN-PHASE MEASUREMENT ACCURACY TEST			
4-7-1. Measurement Accuracy: 50Ω Instruments			
OSC LEVEL: -1dBm ATTENUATOR: 10dB			
Cv(1)= Cv(10)= Cv(100)=			
10Hz	Gain Phase	Cv(1)-0.3dB -1.6°	Cv(1)+0.3dB 1.6°
100Hz	Gain Phase	Cv(1)-0.1dB -0.5°	Cv(1)+0.1dB 0.5°
1kHz	Gain Phase	Cv(1)-0.1dB 0.5°	Cv(1)+0.1dB 0.5°

4: Performance Test

Test		Results		
		Minimum	Actual	Maximum
10kHz	Gain Phase	Cv(1)-0.1dB -0.5°	_____	Cv(1)+0.1dB 0.5°
100kHz	Gain Phase	Cv(1)-0.1dB -0.5°	_____	Cv(1)+0.1dB 0.5°
1MHz	Gain Phase	Cv(1)-0.1dB -0.5°	_____	Cv(1)+0.1dB 0.5°
10MHz	Gain Phase	Cv(10)-0.1dB -1.0°	_____	Cv(10)+0.1dB 1.0°
30MHz	Gain Phase	Cv(10)-0.3dB -2.0°	_____	Cv(10)+0.3dB 2.0°
100MHz	Gain Phase	Cv(100)-0.5dB -3.0°	_____	Cv(100)+0.5dB 3.0°
ATTENUATOR: 20dB				
Cv(1)=				
Cv(10)=				
Cv(100)=				
10Hz	Gain Phase	Cv(1)-0.3dB -1.6°	_____	Cv(1)+0.3dB 1.6°
100Hz	Gain Phase	Cv(1)-0.1dB -0.5°	_____	Cv(1)+0.1dB 0.5°
1kHz	Gain Phase	Cv(1)-0.1dB -0.5°	_____	Cv(1)+0.1dB 0.5°
10kHz	Gain Phase	Cv(1)-0.1dB -0.5°	_____	Cv(1)+0.1dB 0.5°
100kHz	Gain Phase	Cv(1)-0.1dB -0.5°	_____	Cv(1)+0.1dB 0.5°
1MHz	Gain Phase	Cv(1)-0.1dB -0.5°	_____	Cv(1)+0.1dB 0.5°
10MHz	Gain Phase	Cv(10)-0.1dB -1.0°	_____	Cv(10)+0.1dB 1.0°
30MHz	Gain Phase	Cv(10)-0.3dB -2.0°	_____	Cv(10)+0.3dB 2.0°
100MHz	Gain Phase	Cv(100)-0.5dB -3.0°	_____	Cv(100)+0.5dB 3.0°

Test		Results		
		Minimum	Actual	Maximum
ATTENUATOR: 30dB				
Cv(1)= Cv(10)= Cv(100)=				
10Hz	Gain Phase	Cv(1)-0.35dB -2.0°	_____	Cv(1)+0.35dB 2.0°
100Hz	Gain Phase	Cv(1)-0.15dB -0.75°	_____	Cv(1)+0.15dB 0.75°
1kHz	Gain Phase	Cv(1)-0.15dB -0.75°	_____	Cv(1)+0.15dB 0.75°
10kHz	Gain Phase	Cv(1)-0.15dB -0.75°	_____	Cv(1)+0.15dB 0.75°
100kHz	Gain Phase	Cv(1)-0.15dB -0.75°	_____	Cv(1)+0.15dB 0.75°
1MHz	Gain Phase	Cv(1)-0.15dB -0.75°	_____	Cv(1)+0.15dB 0.75°
10MHz	Gain Phase	Cv(10)-0.15dB -1.3°	_____	Cv(10)+0.15dB 1.3°
30MHz	Gain Phase	Cv(10)-0.35dB -2.5°	_____	Cv(10)+0.35dB 2.5°
100MHz	Gain Phase	Cv(100)-0.6dB -4.5°	_____	Cv(100)+0.6dB 4.5°
ATTENUATOR: 40dB				
Cv(1)= Cv(10)= Cv(100)=				
10Hz	Gain Phase	Cv(1)-0.45dB -2.3°	_____	Cv(1)+0.45dB 2.3°
100Hz	Gain Phase	Cv(1)-0.2dB -1.25°	_____	Cv(1)+0.2dB 1.25°
1kHz	Gain Phase	Cv(1)-0.2dB -1.25°	_____	Cv(1)+0.2dB 1.25°
10kHz	Gain Phase	Cv(1)-0.2dB -1.25°	_____	Cv(1)+0.2dB 1.25°

4: Performance Test

Test		Results		
		Minimum	Actual	Maximum
100kHz	Gain Phase	Cv(1)-0.2dB -1.25°		Cv(1)+0.2dB 1.25°
1MHz	Gain Phase	Cv(1)-0.2dB -1.25°		Cv(1)+0.2dB 1.25°
10MHz	Gain Phase	Cv(10)-0.2dB -2.0°		Cv(10)+0.2dB 2.0°
30MHz	Gain Phase	Cv(10)-0.45dB -3.0°		Cv(10)+0.45dB 3.0°
100MHz	Gain Phase	Cv(100)-0.75dB -4.5°		Cv(100)+0.75dB 4.5°
ATTENUATOR: 50dB				
Cv(1)= Cv(10)= Cv(100)=				
1MHz	Gain Phase	Cv(1)-0.25dB -1.75°		Cv(1)+0.25dB 1.75°
10MHz	Gain Phase	Cv(10)-0.35dB -2.5°		Cv(10)+0.35dB 2.5°
30MHz	Gain Phase	Cv(10)-0.65dB -3.5°		Cv(10)+0.65dB 3.5°
100MHz	Gain Phase	Cv(100)-0.95dB -6.5°		Cv(100)+0.95dB 6.5°
ATTENUATOR: 60dB				
Cv(1)= Cv(10)= Cv(100)=				
1MHz	Gain Phase	Cv(1)-0.45dB -2.75°		Cv(1)+0.45dB 2.75°
10MHz	Gain Phase	Cv(10)-0.75dB -5.5°		Cv(10)+0.75dB 5.5°
30MHz	Gain Phase	Cv(10)-1.65dB -11.0°		Cv(10)+1.65dB 11.0°
100MHz	Gain Phase	Cv(100)-1.75dB -11.5°		Cv(100)+1.75dB 11.5°

Test		Results		
		Minimum	Actual	Maximum
ATTENUATOR: 70dB				
Cv(1)= Cv(10)= Cv(100)=				
1MHz	Gain Phase	Cv(1)-1.05dB -5.25°		Cv(1)+1.05dB 5.25°
10MHz	Gain Phase	Cv(10)-1.55dB -10.5°		Cv(10)+1.55dB 10.5°
30MHz	Gain Phase	Cv(10)-3.15dB -16.0°		Cv(10)+3.15dB 16.0°
100MHz	Gain Phase	Cv(100)-3.25dB -16.5°		Cv(100)+3.25dB 16.5°
OSC LEVEL: -40dBm ATTENUATOR: 10dB				
Cv(1)= Cv(10)= Cv(100)=				
10Hz	Gain Phase	Cv(1)-1.0dB -4.0°		Cv(1)+1.0dB 4.0°
100Hz	Gain Phase	Cv(1)-0.35dB -2.5°		Cv(1)+0.35dB 2.5°
1kHz	Gain Phase	Cv(1)-0.35dB -2.5°		Cv(1)+0.35dB 2.5°
10kHz	Gain Phase	Cv(1)-0.35dB -2.5°		Cv(1)+0.35dB 2.5°
100kHz	Gain Phase	Cv(1)-0.35dB -2.5°		Cv(1)+0.35dB 2.5°
ATTENUATOR: 20dB				
Cv(1)= Cv(10)= Cv(100)=				
10Hz	Gain Phase	Cv(1)-1.3dB -4.5°		Cv(1)+1.3dB 4.5°
100Hz	Gain Phase	Cv(1)-0.55dB -3.5°		Cv(1)+0.55dB 3.5°

Test		Results		
		Minimum	Actual	Maximum
1kHz	Gain Phase	Cv(1)-0.55dB -3.5°	_____	Cv(1)+0.55dB 3.5°
10kHz	Gain Phase	Cv(1)-0.55dB -3.5°	_____	Cv(1)+0.55dB 3.5°
100kHz	Gain Phase	Cv(1)-0.55dB -3.5°	_____	Cv(1)+0.55dB 3.5°
ATTENUATOR: 30dB				
Cv(1)= Cv(10)= Cv(100)=				
10Hz	Gain Phase	Cv(1)-1.8dB -6.5°	_____	Cv(1)+1.8dB 6.5°
100Hz	Gain Phase	Cv(1)-1.15dB -6.0°	_____	Cv(1)+1.15dB 6.0°
1kHz	Gain Phase	Cv(1)-1.15dB -6.0°	_____	Cv(1)+1.15dB 6.0°
10kHz	Gain Phase	Cv(1)-1.15dB -6.0°	_____	Cv(1)+1.15dB 6.0°
100kHz	Gain Phase	Cv(1)-1.15dB -6.0°	_____	Cv(1)+1.15dB 6.0°
ATTENUATOR: 40dB				
Cv(1)= Cv(10)= Cv(100)=				
100Hz	Gain Phase	Cv(1)-3.15dB -16.0°	_____	Cv(1)+3.15dB 16.0°
1kHz	Gain Phase	Cv(1)-3.15dB -16.0°	_____	Cv(1)+3.15dB 16.0°
10kHz	Gain Phase	Cv(1)-3.15dB -16.0°	_____	Cv(1)+3.15dB 16.0°
100kHz	Gain Phase	Cv(1)-3.15dB -16.0°	_____	Cv(1)+3.15dB 16.0°

Test		Results		
		Minimum	Actual	Maximum
4-7-2. Measurement Accuracy: 75Ω Instruments				
OSC LEVEL: 10.4dBm ATTENUATOR: 10dB				
Cv(1)= Cv(10)= Cv(100)=				
10Hz	Gain Phase	Cv(1)-0.3dB -1.6°	_____	Cv(1)+0.3dB 1.6°
100Hz	Gain Phase	Cv(1)-0.1dB -0.5°	_____	Cv(1)+0.1dB 0.5°
1kHz	Gain Phase	Cv(1)-0.1dB -0.5°	_____	Cv(1)+0.1dB 0.5°
10kHz	Gain Phase	Cv(1)-0.1dB -0.5°	_____	Cv(1)+0.1dB 0.5°
100kHz	Gain Phase	Cv(1)-0.1dB -0.5°	_____	Cv(1)+0.1dB 0.5°
1MHz	Gain Phase	Cv(1)-0.1dB -0.5°	_____	Cv(1)+0.1dB 0.5°
10MHz	Gain Phase	Cv(10)-0.1dB -1.0°	_____	Cv(10)+0.1dB 1.0°
30MHz	Gain Phase	Cv(10)-0.3dB -2.0°	_____	Cv(10)+0.3dB 2.0°
100MHz	Gain Phase	Cv(100)-0.5dB -3.0°	_____	Cv(100)+0.5dB 3.0°
ATTENUATOR: 20dB				
Cv(1)= Cv(10)= Cv(100)=				
10Hz	Gain Phase	Cv(1)-0.3dB -1.6°	_____	Cv(1)+0.3dB 1.6°
100Hz	Gain Phase	Cv(1)-0.1dB -0.5°	_____	Cv(1)+0.1dB 0.5°
1kHz	Gain Phase	Cv(1)-0.1dB -0.5°	_____	Cv(1)+0.1dB 0.5°
10kHz	Gain Phase	Cv(1)-0.1dB -0.5°	_____	Cv(1)+0.1dB 0.5°

Test		Results		
		Minimum	Actual	Maximum
100kHz	Gain Phase	Cv(1)-0.1dB -0.5°		Cv(1)+0.1dB 0.5°
1MHz	Gain Phase	Cv(1)-0.1dB -0.5°		Cv(1)+0.1dB 0.5°
10MHz	Gain Phase	Cv(10)-0.1dB -1.0°		Cv(10)+0.1dB 1.0°
30MHz	Gain Phase	Cv(10)-0.3dB -2.0°		Cv(10)+0.3dB 2.0°
100MHz	Gain Phase	Cv(100)-0.5dB -3.0°		Cv(100)+0.5dB 3.0°
ATTENUATOR: 30dB				
Cv(1)=				
Cv(10)=				
Cv(100)=				
1MHz	Gain Phase	Cv(1)-0.15dB -0.75°		Cv(1)+0.15dB 0.75°
10MHz	Gain Phase	Cv(10)-0.15dB -1.3°		Cv(10)+0.15dB 1.3°
30MHz	Gain Phase	Cv(10)-0.35dB -2.5°		Cv(10)+0.35dB 2.5°
100MHz	Gain Phase	Cv(100)-0.6dB -4.5°		Cv(100)+0.6dB 4.5°
ATTENUATOR: 40dB				
Cv(1)=				
Cv(10)=				
Cv(100)=				
1MHz	Gain Phase	Cv(1)-0.2dB -1.25°		Cv(1)+0.2dB 1.25°
10MHz	Gain Phase	Cv(10)-0.2dB -2.0°		Cv(10)+0.2dB 2.0°
30MHz	Gain Phase	Cv(10)-0.45dB -3.0°		Cv(10)+0.45dB 3.0°
100MHz	Gain Phase	Cv(100)-0.75dB -4.5°		Cv(100)+0.75dB 4.5°

Test		Results		
		Minimum	Actual	Maximum
ATTENUATOR: 50dB				
Cv(1)=				
Cv(10)=				
Cv(100)=				
1MHz	Gain Phase	Cv(1)-0.25dB -1.75°		Cv(1)+0.25dB 1.75°
10MHz	Gain Phase	Cv(10)-0.35dB -2.5°		Cv(10)+0.35dB 2.5°
30MHz	Gain Phase	Cv(10)-0.65dB -3.5°		Cv(10)+0.65dB 3.5°
100MHz	Gain Phase	Cv(100)-0.95dB -6.5°		Cv(100)+0.95dB 6.5°
ATTENUATOR: 60dB				
Cv(1)=				
Cv(10)=				
Cv(100)=				
1MHz	Gain Phase	Cv(1)-0.45dB -2.75°		Cv(1)+0.45dB 2.75°
10MHz	Gain Phase	Cv(10)-0.75dB -5.5°		Cv(10)+0.75dB 5.5°
30MHz	Gain Phase	Cv(10)-1.65dB -11.0°		Cv(10)+1.65dB 11.0°
100MHz	Gain Phase	Cv(100)-1.75dB -11.5°		Cv(100)+1.75dB 11.5°
ATTENUATOR: 70dB				
Cv(1)=				
Cv(10)=				
Cv(100)=				
1MHz	Gain Phase	Cv(1)-1.05dB -5.25°		Cv(1)+1.05dB 5.25°
10MHz	Gain Phase	Cv(10)-1.55dB -10.5°		Cv(10)+1.55dB 10.5°
30MHz	Gain Phase	Cv(10)-3.15dB -16.0°		Cv(10)+3.15dB 16.0°
100MHz	Gain Phase	Cv(100)-3.25dB -16.5°		Cv(100)+3.25dB 16.5°

Test		Results		
		Minimum	Actual	Maximum
OSC LEVEL: -8.6dBm ATTENUATOR: 10dB Cv(1)= Cv(10)= Cv(100)=				
10Hz	Gain Phase	Cv(1)-0.35dB -2.0°	_____	Cv(1)+0.35dB 2.0°
100Hz	Gain Phase	Cv(1)-0.15dB -0.75°	_____	Cv(1)+0.15dB 0.75°
1kHz	Gain Phase	Cv(1)-0.15dB -0.75°	_____	Cv(1)+0.15dB 0.75°
10kHz	Gain Phase	Cv(1)-0.15dB -0.75°	_____	Cv(1)+0.15dB 0.75°
100kHz	Gain Phase	Cv(1)-0.15dB -0.75°	_____	Cv(1)+0.15dB 0.75°
ATTENUATOR: 20dB Cv(1)= Cv(10)= Cv(100)=				
10Hz	Gain Phase	Cv(1)-0.45dB -2.3°	_____	Cv(1)+0.45dB 2.3°
100Hz	Gain Phase	Cv(1)-0.2dB -1.25°	_____	Cv(1)+0.2dB 1.25°
1kHz	Gain Phase	Cv(1)-0.2dB -1.25°	_____	Cv(1)+0.2dB 1.25°
10kHz	Gain Phase	Cv(1)-0.2dB -1.25°	_____	Cv(1)+0.2dB 1.25°
100kHz	Gain Phase	Cv(1)-0.2dB -1.25°	_____	Cv(1)+0.2dB 1.25°

Test		Results		
		Minimum	Actual	Maximum
ATTENUATOR: 30dB				
Cv(1)= Cv(10)= Cv(100)=				
10Hz	Gain Phase	Cv(1)-0.85dB -3.3°	_____	Cv(1)+0.85dB 3.3°
100Hz	Gain Phase	Cv(1)-0.25dB -1.75°	_____	Cv(1)+0.25dB 1.75°
1kHz	Gain Phase	Cv(1)-0.25dB -1.75°	_____	Cv(1)+0.25dB 1.75°
10kHz	Gain Phase	Cv(1)-0.25dB -1.75°	_____	Cv(1)+0.25dB 1.75°
100kHz	Gain Phase	Cv(1)-0.25dB -1.75°	_____	Cv(1)+0.25dB 1.75°
OSC LEVEL= -38.6dBm				
ATTENUATOR: 10dB				
Cv(1)= Cv(10)= Cv(100)=				
10Hz	Gain Phase	Cv(1)-1.7dB -5.5°	_____	Cv(1)+1.7dB 5.5°
100Hz	Gain Phase	Cv(1)-0.6dB -4.0°	_____	Cv(1)+0.6dB 4.0°
1kHz	Gain Phase	Cv(1)-0.6dB -4.0°	_____	Cv(1)+0.6dB 4.0°
10kHz	Gain Phase	Cv(1)-0.6dB -4.0°	_____	Cv(1)+0.6dB 4.0°
100kHz	Gain Phase	Cv(1)-0.6dB -4.0°	_____	Cv(1)+0.6dB 4.0°
ATTENUATOR: 20dB				
Cv(1)= Cv(10)= Cv(100)=				
10Hz	Gain Phase	Cv(1)-2.2dB -7.5°	_____	Cv(1)+2.2dB 7.5°
100Hz	Gain Phase	Cv(1)-1.2dB -6.5°	_____	Cv(1)+1.2dB 6.5°

4: Performance
Test

Test		Results		
		Minimum	Actual	Maximum
1kHz	Gain Phase	Cv(1)-1.2dB -6.5°	_____	Cv(1)+1.2dB 6.5°
10kHz	Gain Phase	Cv(1)-1.2dB -6.5°	_____	Cv(1)+1.2dB 6.5°
100kHz	Gain Phase	Cv(1)-1.2dB -6.5°	_____	Cv(1)+1.2dB 6.5°
ATTENUATOR: 30dB				
Cv(1)= Cv(10)= Cv(100)=				
100Hz	Gain Phase	Cv(1)-3.2dB -16.5°	_____	Cv(1)+3.2dB 16.5°
1kHz	Gain Phase	Cv(1)-3.2dB -16.5°	_____	Cv(1)+3.2dB 16.5°
10kHz	Gain Phase	Cv(1)-3.2dB -16.5°	_____	Cv(1)+3.2dB 16.5°
100kHz	Gain Phase	Cv(1)-3.2dB -16.5°	_____	Cv(1)+3.2dB 16.5°
4-7-3.	Measurement Accuracy: 1MΩ Input Impedance			
Option 350 OSC LEVEL= -1dBm				
Option 375 OSC LEVEL= 10.4dBm				
Cv(1)= Cv(10)= Cv(100)=				
10Hz	Gain Phase	Cv(1)-0.4dB -2.6°	_____	Cv(1)+0.4dB 2.6°
100Hz	Gain Phase	Cv(1)-0.2dB -1.5°	_____	Cv(1)+0.2dB 1.5°
1kHz	Gain Phase	Cv(1)-0.2dB -1.5°	_____	Cv(1)+0.2dB 1.5°
10kHz	Gain Phase	Cv(1)-0.2dB -1.5°	_____	Cv(1)+0.2dB 1.5°
100kHz	Gain Phase	Cv(1)-0.2dB -1.5°	_____	Cv(1)+0.2dB 1.5°

Test		Results		
		Minimum	Actual	Maximum
1MHz	Gain	Cv(1)-0.2dB	_____	Cv(1)+0.2dB
	Phase	-1.5°	_____	1.5°
10MHz	Gain	Cv(10)-0.2dB	_____	Cv(10)+0.2dB
	Phase	-2.0°	_____	2.0°
30MHz	Gain	Cv(10)-0.4dB	_____	Cv(10)+0.4dB
	Phase	-3.0°	_____	3.0°
100MHz	Gain	Cv(100)-0.6dB	_____	Cv(100)+0.6dB
	Phase	-4.0°	_____	4.0°

Test	Results		
	Minimum	Actual	Maximum
4-8. EQUIPMENT CALIBRATION			
4-8-1. HP 8495A Coaxial Step Attenuator Calibration			
R10	0.0dB	_____	0.1dB
4-8-2. HP 11667A Power Splitter Tracking Error Calibration			
R11	-0.1dB	_____	0.1dB
4-8-3. HP 11852A Minimum Loss Pad Calibration: 75Ω Instruments			
PAD A R12	-5.8dB	_____	-5.6dB
PAD B R13	-5.8dB	_____	-5.6dB
4-9. AMPLITUDE MEASUREMENT ACCURACY TEST			
4-9-1. LF Measurement Accuracy: 50Ω/75Ω Input Impedance			
Option 350 OSC LEVEL= -1dBm			
Option 375 OSC LEVEL= 10.4dBm			
REFERENCE CHANNEL ATTENUATION= 0dB			
10Hz	-0.7dB	_____	0.7dB
100Hz	-0.35dB	_____	0.35dB
1kHz	-0.35dB	_____	0.35dB
10kHz	-0.35dB	_____	0.35dB
REFERENCE CHANNEL ATTENUATION= 20dB			
10Hz	-0.7dB	_____	0.7dB
100Hz	-0.35dB	_____	0.35dB
1kHz	-0.35dB	_____	0.35dB
10kHz	-0.35dB	_____	0.35dB

Test	Results		
	Minimum	Actual	Maximum
TEST CHANNEL ATTENUATION= 0dB			
10Hz	-0.7dB	_____	0.7dB
100Hz	-0.35dB	_____	0.35dB
1kHz	-0.35dB	_____	0.35dB
10kHz	-0.35dB	_____	0.35dB
TEST CHANNEL ATTENUATION= 20dB			
10Hz	-0.7dB	_____	0.7dB
100Hz	-0.35dB	_____	0.35dB
1kHz	-0.35dB	_____	0.35dB
10kHz	-0.35dB	_____	0.35dB
4-9-2. LF Measurement Accuracy: 1MΩ Input Impedance			
Option 350 OSC LEVEL= -1dBm			
Option 375 OSC LEVEL= 10.4dBm			
REFERENCE CHANNEL ATTENUATION= 0dB			
10Hz	-1.0dB	_____	1.0dB
100Hz	-0.4dB	_____	0.4dB
1kHz	-0.4dB	_____	0.4dB
10kHz	-0.4dB	_____	0.4dB
REFERENCE CHANNEL ATTENUATION= 20dB			
10Hz	-1.0dB	_____	1.0dB
100Hz	-0.4dB	_____	0.4dB
1kHz	-0.4dB	_____	0.4dB
10kHz	-0.4dB	_____	0.4dB
TEST CHANNEL ATTENUATION= 0dB			
10Hz	-1.0dB	_____	1.0dB
100Hz	-0.4dB	_____	0.4dB
1kHz	-0.4dB	_____	0.4dB
10kHz	-0.4dB	_____	0.4dB

4: Performance Test

Test	Results		
	Minimum	Actual	Maximum
TEST CHANNEL ATTENUATION= 20dB			
10Hz	-1.0dB	_____	1.0dB
100Hz	-0.4dB	_____	0.4dB
1kHz	-0.4dB	_____	0.4dB
10kHz	-0.4dB	_____	0.4dB
4-9-3. HF Measurement Accuracy: 50Ω/75Ω Input Impedance			
Option 350 OSC LEVEL= -1dBm			
Option 375 OSC LEVEL= 10.4dBm			
REFERENCE CHANNEL ATTENUATION= 0dB			
100kHz	-0.35dB	_____	0.35dB
1MHz	-0.35dB	_____	0.35dB
10MHz	-0.5dB	_____	0.5dB
30MHz	-0.7dB	_____	0.7dB
100MHz	-1.5dB	_____	1.5dB
REFERENCE CHANNEL ATTENUATION= 20dB			
100kHz	-0.35dB	_____	0.35dB
1MHz	-0.35dB	_____	0.35dB
10MHz	-0.5dB	_____	0.5dB
30MHz	-0.7dB	_____	0.7dB
100MHz	-1.5dB	_____	1.5dB
TEST CHANNEL ATTENUATION= 0dB			
100kHz	-0.35dB	_____	0.35dB
1MHz	-0.35dB	_____	0.35dB
10MHz	-0.5dB	_____	0.5dB
30MHz	-0.7dB	_____	0.7dB
100MHz	-1.5dB	_____	1.5dB
TEST CHANNEL ATTENUATION= 20dB			
100kHz	-0.35dB	_____	0.35dB
1MHz	-0.35dB	_____	0.35dB
10MHz	-0.5dB	_____	0.5dB
30MHz	-0.7dB	_____	0.7dB
100MHz	-1.5dB	_____	1.5dB

Test	Results		
	Minimum	Actual	Maximum
<p>4-9-4. Measurement Accuracy: 1MΩ Input Impedance</p> <p>Option 350 OSC LEVEL= -1dBm Option 375 OSC LEVEL= 10.4dBm</p> <p>REFERENCE CHANNEL ATTENUATION= 0dB</p> <p>100kHz -0.4dB 1MHz -0.4dB 10MHz -0.7dB 30MHz -1.0dB</p> <p>REFERENCE CHANNEL ATTENUATION= 20dB</p> <p>100kHz -0.4dB 1MHz -0.4dB 10MHz -0.7dB 30MHz -1.0dB</p> <p>TEST CHANNEL ATTENUATION= 0dB</p> <p>100kHz -0.4dB 1MHz -0.4dB 10MHz -0.7dB 30MHz -1.0dB</p> <p>TEST CHANNEL ATTENUATION= 20dB</p> <p>100kHz -0.4dB 1MHz -0.4dB 10MHz -0.7dB 30MHz -1.0dB</p>			
<p>4-9-5. Low Level Measurement Accuracy: 50/75Ω</p> <p>Option 350 OSC LEVEL= -4dBm Option 375 OSC LEVEL= 7.4dBm</p> <p>100kHz -2.5dB 1MHz -2.5dB 10MHz -3dB 30MHz -4dB 100MHz -4dB</p>			

Test	Results		
	Minimum	Actual	Maximum
<p>4-9-6. Low Level Measurement Accuracy: 1MΩ Input Impedance</p> <p>Option 350 OSC LEVEL= -4dBm</p> <p>Option 375 OSC LEVEL= 7.4dBm</p> <p>100kHz 1MHz 10MHz 30MHz</p>	<p>-3dB -3dB -3dB -4dB</p>	<p>_____ _____ _____ _____</p>	<p>3dB 3dB 3dB 4dB</p>
<p>4-10. GAIN-PHASE MEASUREMENT SIGNAL LEVEL TEST</p> <p>4-10-1. Signal Level Accuracy: 100kHz</p> <p>OSC LEVEL= 15dBm FREQ.= 100kHz R10+Cv+R13= Pref(15)=</p> <p>OSC LEVEL= 5dBm FREQ.= 100kHz R10+R13= Pref(5)=</p> <p>4-10-2. HF Signal Level Flatness</p> <p>OSC LEVEL= 15dBm ATTENUATOR= 10dB</p> <p>10MHz 30MHz 80MHz 100MHz</p>	<p>14.2dBm- (R10+Cv+R13)</p> <p>4dBm- (R10+R13)</p> <p>Pref(15)-1 = _____</p> <p>Pref(15)-1 = _____</p> <p>Pref(15)-1 = _____</p> <p>Pref(15)-1 = _____</p>	<p>_____ _____ _____ _____</p>	<p>15.8dBm- (R10+Cv+R13)</p> <p>6dBm- (R10+R13)</p> <p>Pref(15)+1 = _____</p> <p>Pref(15)+1 = _____</p> <p>Pref(15)+1 = _____</p> <p>Pref(15)+1 = _____</p>

Test	Results		
	Minimum	Actual	Maximum
OSC LEVEL= 5dBm ATTENUATOR= 0dB			
10MHz	Pref(5)-1.2 = _____	_____	Pref(5)+1.2 = _____
30MHz	Pref(5)-1.2 = _____	_____	Pref(5)+1.2 = _____
80MHz	Pref(5)-1.2 = _____	_____	Pref(5)+1.2 = _____
100MHz	Pref(5)-1.2 = _____	_____	Pref(5)+1.2 = _____
4-10-3. LF Signal Level Flatness			
OSC LEVEL= 15dBm ATTENUATOR= 10dB Pref(15)=			
10Hz	Pref(15)-1 = _____	_____	Pref(15)+1 = _____
100Hz	Pref(15)-1 = _____	_____	Pref(15)+1 = _____
1kHz	Pref(15)-1 = _____	_____	Pref(15)+1 = _____
10kHz	Pref(15)-1 = _____	_____	Pref(15)+1 = _____
OSC LEVEL= 5dBm ATTENUATOR= 0dB Pref(5)=			
10Hz	Pref(5)-1.2 = _____	_____	Pref(5)+1.2 = _____
100Hz	Pref(5)-1.2 = _____	_____	Pref(5)+1.2 = _____
1kHz	Pref(5)-1.2 = _____	_____	Pref(5)+1.2 = _____
10kHz	Pref(5)-1.2 = _____	_____	Pref(5)+1.2 = _____

4: Performance
Test

Test	Results		
	Minimum	Actual	Maximum
4-11. POWER SPLITTER TEST			
A trace	PASS	_____	FAIL
B trace	PASS	_____	FAIL
4-12. GAIN-PHASE MEASUREMENT CROSSTALK TEST			
Frequency > 70MHz Maximum: -86dB			
A trace	PASS	_____	FAIL
Frequency ≤ 70MHz Maximum: -96dB			
A trace	PASS	_____	FAIL

Test	Results		
	Minimum	Actual	Maximum
4-13. IMPEDANCE MEASUREMENT SIGNAL LEVEL TEST			
4-13-1. Impedance Signal Level Accuracy: 100kHz			
OSC LEVEL 1Vrms			
R13= Pref=	6dBm-R13 = _____	_____	8dBm-R13 = _____
4-13-2. HF Impedance Signal Level Flatness			
OSC LEVEL 1Vrms			
500kHz	Pref-1 = _____	_____	Pref+1 = _____
1MHz	Pref-1 = _____	_____	Pref+1 = _____
3MHz	Pref-1 = _____	_____	Pref+1 = _____
10MHz	Pref-1 = _____	_____	Pref+1 = _____
40MHz	Pref-1 = _____	_____	Pref+1 = _____
4-13-3. LF Impedance Signal Level Flatness			
OSC LEVEL 1Vrms			
Pref=			
100Hz	Pref-1 = _____	_____	Pref+1 = _____
1kHz	Pref-1 = _____	_____	Pref+1 = _____
10kHz	Pref-1 = _____	_____	Pref+1 = _____

Test		Results		
		Minimum	Actual	Maximum
4-14. IMPEDANCE MEASUREMENT ACCURACY TEST				
1pF STANDARD				
100kHz	C	-6.27fF	_____	6.27fF
	D	-6.27m	_____	6.27m
1MHz	C	-2.09fF	_____	2.09fF
	D	-2.09m	_____	2.09m
3MHz	C	-9.64fF	_____	9.64fF
	D	-9.64m	_____	9.64m
10pF STANDARD				
10kHz	C	-107fF	_____	107fF
	D	-10.7m	_____	10.7m
100kHz	C	-20.9fF	_____	20.9fF
	D	-2.09m	_____	2.09m
1MHz	C	-17.3fF	_____	17.3fF
	D	-1.73m	_____	1.73m
3MHz	C	-44.5fF	_____	44.5fF
	D	-4.45m	_____	4.45m
10MHz	C	-132fF	_____	132fF
	D	-13.2m	_____	13.2m
100pF STANDARD				
1kHz	C	-1.07pF	_____	1.07pF
	D	-10.7m	_____	10.7m
10kHz	C	-659fF	_____	659fF
	D	-6.59m	_____	6.59m
100kHz	C	-173fF	_____	173fF
	D	-1.73m	_____	1.73m
1MHz	C	-170fF	_____	170fF
	D	-1.70m	_____	1.70m

Test		Results		
		Minimum	Actual	Maximum
1000pF STANDARD				
100Hz	C	-17.9pF	_____	17.9pF
	D	-17.9m	_____	17.9m
1kHz	C	-6.59pF	_____	6.59pF
	D	-6.59m	_____	6.59m
10kHz	C	-6.23pF	_____	6.23pF
	D	-6.23m	_____	6.23m
100kHz	C	-1.70pF	_____	1.70pF
	D	-1.70m	_____	1.70m
500kHz	C	-1.70pF	_____	1.70pF
	D	-1.70m	_____	1.70m
0.01μF STANDARD				
1kHz	C	-62.3pF	_____	62.3pF
0.1μF STANDARD				
1kHz	C	-620pF	_____	620pF
1μF STANDARD				
1kHz	C	-6.21nF	_____	6.21nF

Test	Results		
	Minimum	Actual	Maximum
4-15. IMPEDANCE MEASUREMENT LEVEL MONITOR TEST			
4-15-1. LF Level Monitor			
V Monitor OSC Level= 1Vrms			
100Hz	1.8×R0-1mV	_____	2.2×R0+1mV
1kHz	1.8×R0-1mV	_____	2.2×R0+1mV
10kHz	1.8×R0-1mV	_____	2.2×R0+1mV
29kHz	1.8×R0-1mV	_____	2.2×R0+1mV
30kHz	1.8×R0-1mV	_____	2.2×R0+1mV
4-15-2. HF Level Monitor			
100kHz	1.8×R0-1mV	_____	2.2×R0+1mV
1MHz	1.8×R0-1mV	_____	2.2×R0+1mV
10MHz	1.8×R0-1mV	_____	2.2×R0+1mV
OSC Level= 0.5Vrms			
40MHz	1.8×R0-1mV	_____	2.2×R0+1mV

Test	Results		
	Minimum	Actual	Maximum
4-16. DC BIAS VOLTAGE TEST			
0V	-12mV	_____	12mV
40V	39.940V	_____	40.060V
-40V	-39.940V	_____	-40.060V
0.01V	-0.002V	_____	0.022V
0.02V	0.008V	_____	0.032V
0.04V	0.028V	_____	0.052V
0.08V	0.068V	_____	0.092V
0.16V	0.148V	_____	0.172V
0.32V	0.308V	_____	0.332V
0.64V	0.627V	_____	0.653V
1.28V	1.266V	_____	1.294V
2.56V	2.545V	_____	2.575V
5.12V	5.102V	_____	5.138V
10.24V	10.216V	_____	10.264V
20.48V	20.443V	_____	20.517V
4-17. HP-IB INTERFACE PERFORMANCE TEST	PASS	_____	FAIL

Appendix A: **Back Dating A-1**

Appendix B: **Softkey Tree B-1**

Appendix C: **Save Function C-1**

Appendix D: **System Messages D-1**

D-1. Comments **D-1**

D-2. Error Messages **D-6**

D-3. Error Code Numbers **D-17**

Appendix E: **Program Codes E-1**

E-1. HP 4194A Program Codes **E-1**

E-2. Program Codes in Alphabetical Order **E-4**

E-3. HP 4194A ASCII Character Codes **E-4**

E-4. Suffix **E-5**

E-5. Status Byte **E-5**

E-6. Register Setting Range **E-5**

E-7. Default Parameter Values **E-6**

Appendix F: **Calibration Reference Values F-1**

Appendix G: **Interpolation Measurement Frequencies G-1**

This section contains information for 4194A's to which the content of this manual does not directly apply.

To adapt this manual to your instrument, refer to Table A and make all of the manual changes listed opposite your instrument's serial number.

If your instrument serial number is not listed on the title page of this manual or in Table A, it may be documented in the yellow MANUAL CHANGES supplement. For additional information on serial number coverage, refer to **INSTRUMENTS COVERED BY MANUAL** in Section 1.

Table A. Manual Changes by Serial Number

Serial Prefix or Number	Make Manual Changes
2521J00195 and below (Version 2.0)	1, 2
2521J00196 and above (Version 2,1)	2

CHANGE 1

- 1) The GOTO, GOSUB, RETURN, and END statements can not be used in multi-statement form in an ASP program.
- 2) **Rn** and **Z** registers are expressed with 6 digits mantissa.
- 3) Program codes, LMX(a) and LMN(a) are not included.
- 4) Error messages listed in **APPENDIX D** must be changed as follows.

Error #	Message	Description
27:	STEP value too small	NOP value overflowed (NOP>401) because the STEP value was too small. Check the START, STOP, and STEP values.
28:	STEP>SPAN error	Setting error. The STEP value was set larger than the SPAN value while in the linear sweep mode.
29:	NOP value too large	The STEP value can not be set because because the NOP value is too large. Check NOP, START, STOP, and STEP.

APPENDIX A

30: o & * markers not displayed	SRSTR or ARSTR command is executed without selecting the Double Marker mode.
34: o & * markers not displayed	'EXPAND MKRS' softkey is pressed or the MKEXP command is executed without setting Double Marker mode.
40: Out of range	Setting error. <ol style="list-style-type: none">1. MAX, MIN value for display scale is out of range.2. Negative value was set to / DIV=.3. Zero value was included when LOG mode was selected. This happens in DC Bias sweep mode.
46: Can't change swp parameters	You can not change sweep parameter if sweep points are already set in the programmed points table. Clear the table before changing it.
79: Multi statement not allowed	Command or Basic statement (construct) designated as single statement type is used in multistatement form. Check the command lists in paragraph 3-6-4-3.

The error codes 124 to 128 and 130 to 132 are not included.

CHANGE 2

1. The following softkeys are not included and consequently all the description related to them become ineffective.

(FUNCTION)	'IMP with Z PROBE'
(COMPENSATION)	'OS CAL', '0ΩCAL', 'STD CAL', 'CAL on/off'
(ASP)	'SEND'
(MKR/L CURS)	'WIDTH read'
2. The array registers, **RA ~ RL**, **T(M)YG**, **T(M)YB**, **T(M)ZR**, **T(M)ZX**, **T(M)STDR**, and **T(M)STDx** are not included.
3. The single register, **WID** is not included.
4. Paragraph 3-6-1-5 "Complex Matrix Operation" does not function.
5. Sweep mode will be set to REPEAT mode after an RST command is executed.
6. DISP? and CMT? query commands are not available.
7. ! (Remark) code can not be used in an ASP program.

8. The default **COPY** mode is **Plot**.
9. All points compensation method prohibits Osc. level and DC Bias sweep.
10. Simulation can be made only when the measurement parameter is set either to $Z-\theta$ or $Y-\theta$ (Equivalent Circuit Function).
11. Program syntax, "OUTPUT Rn(n=0 to 99)" used for 8-Bit I/O control is not available.

APPENDIX B illustrates the softkey labels page by page and specifies what functions are included under each key in the **MENU** section. Softkey labels displayed on the CRT are somewhat different for front panel operation and ASP editing.

A solid line indicates a softkey sequence for front panel operation.
 A dotted line indicates a softkey sequence for ASP editing.
 The Program Code assigned for each softkey is shown by the softkey label.

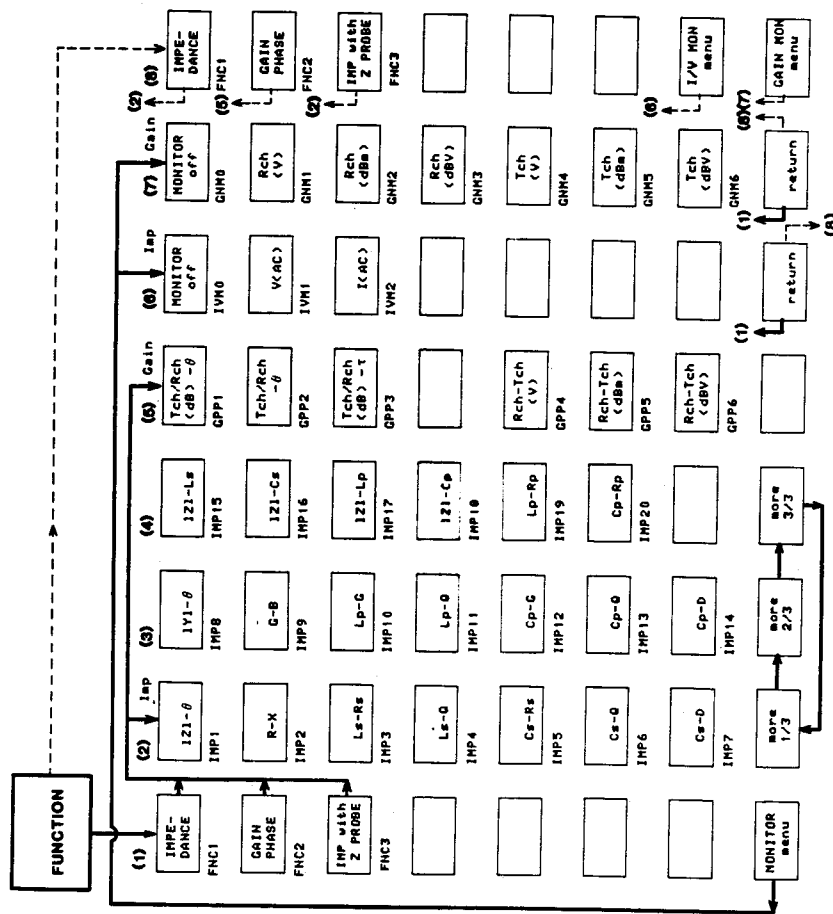

APPENDIX B

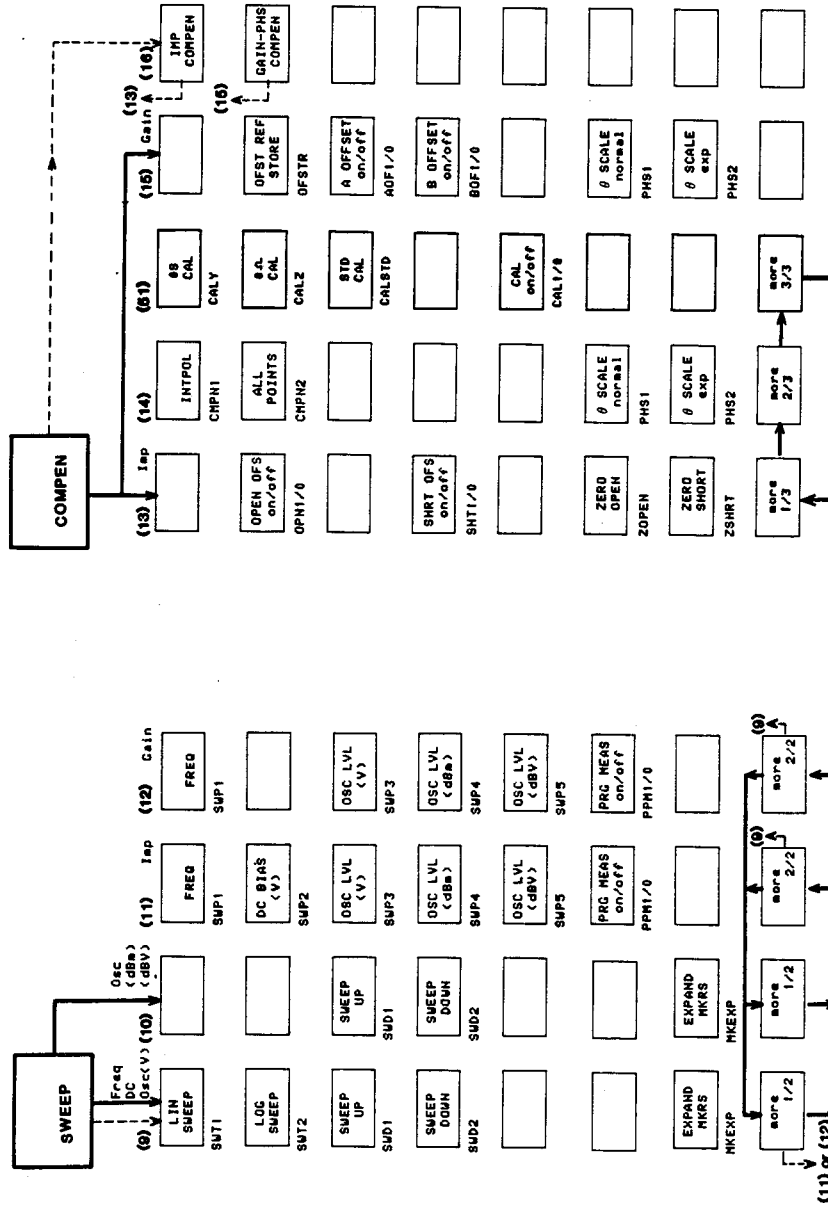

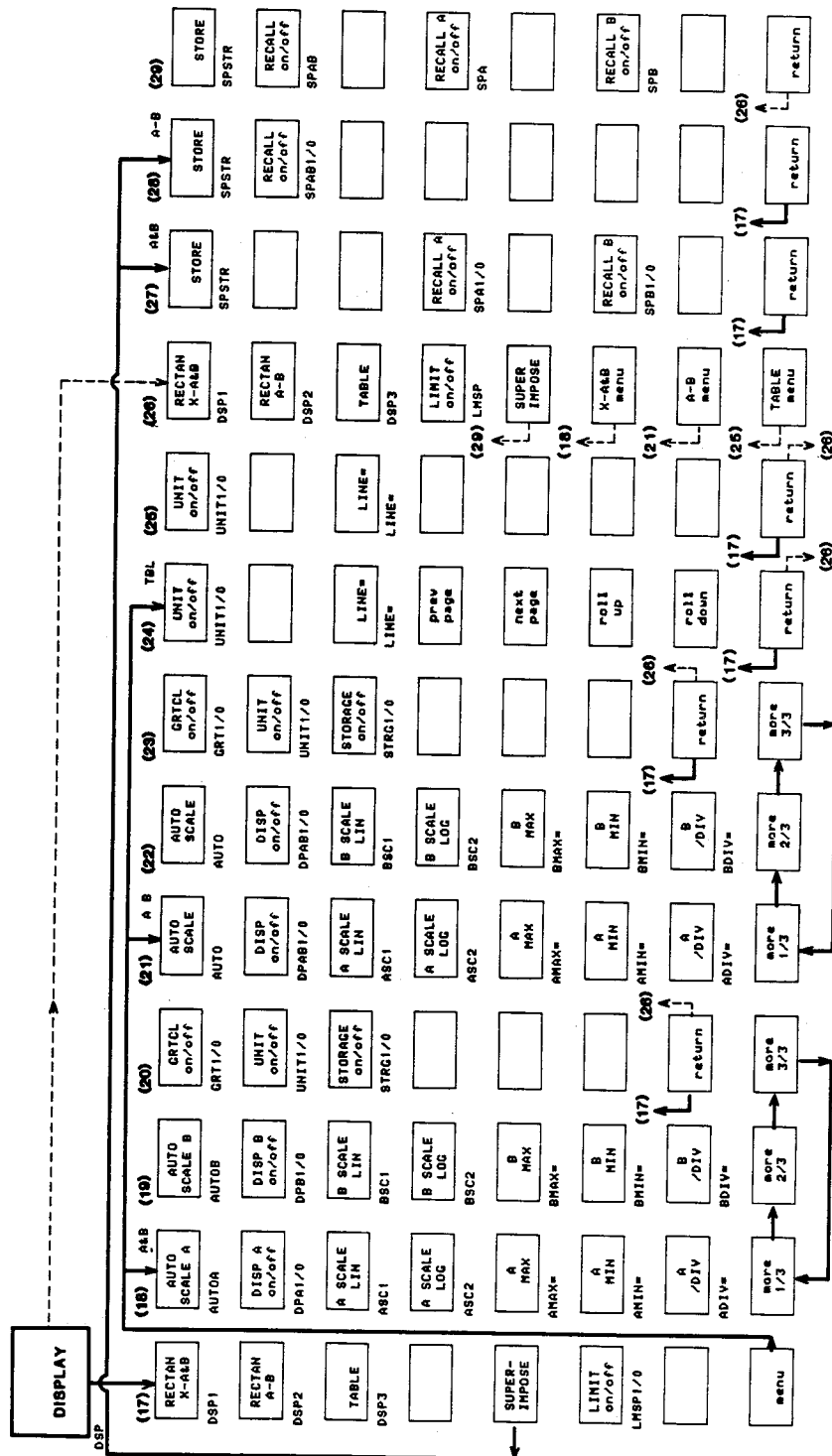

APPENDIX B

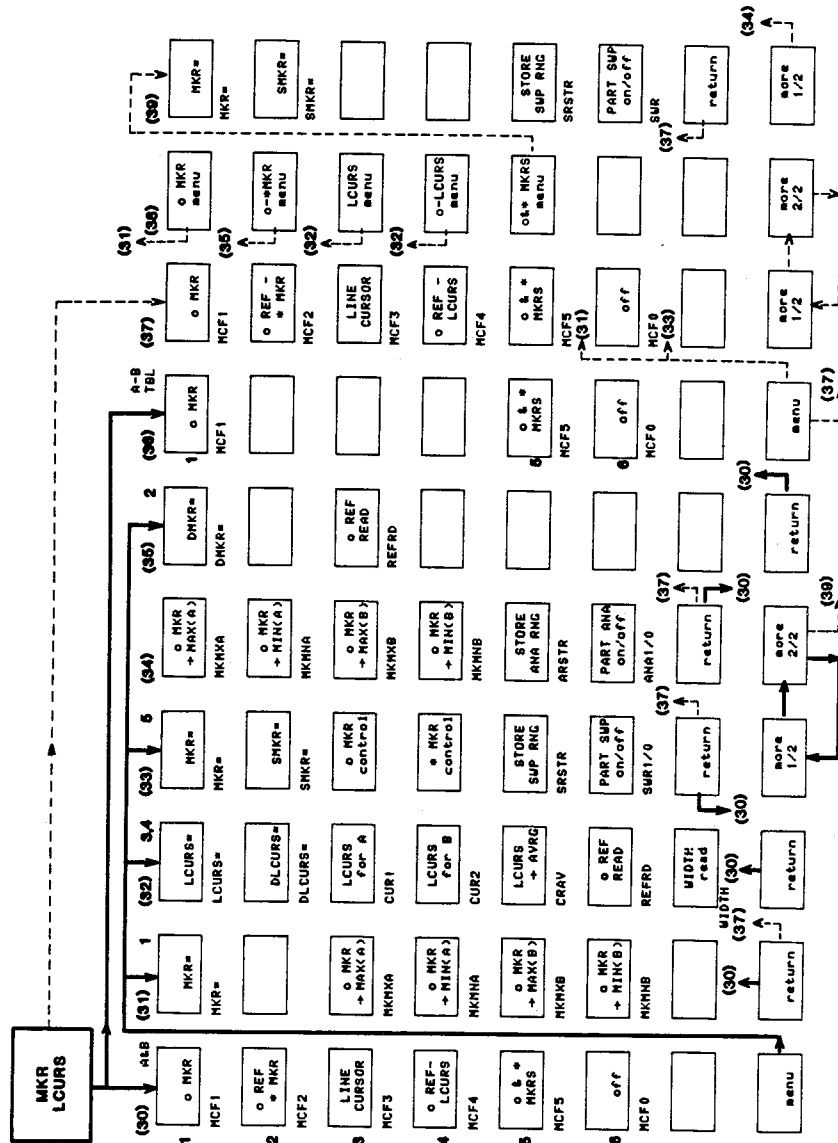

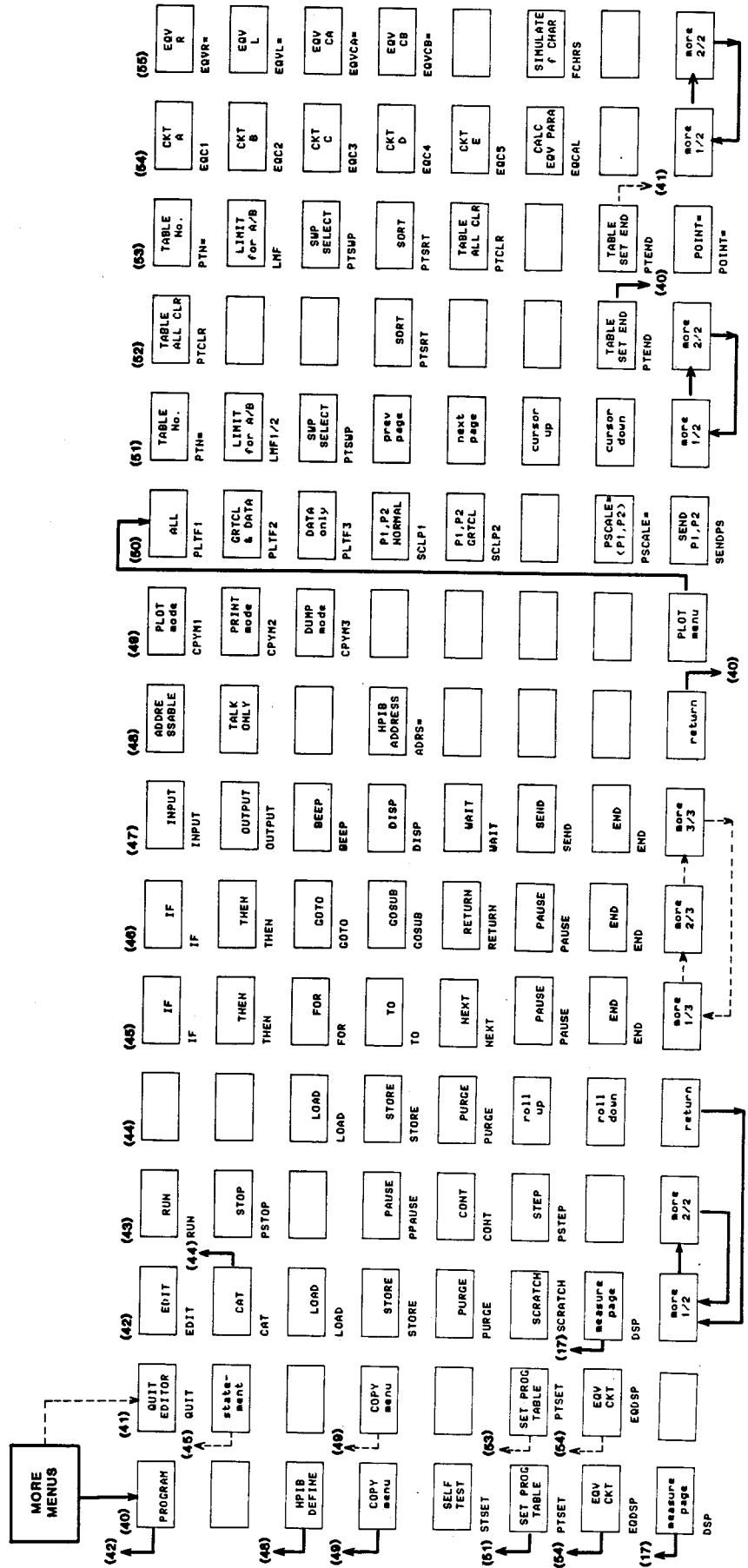

1. * Indicates codes that are saved in non-volatile memory when the "SAVE" key is pressed. The **SAVE** key is effective when the instrument is idle or in the measurement mode, except in the following cases.
 - 1) Editing the Programmed Points table.
 - 2) Editing an ASP program.
 - 3) Copying.

The **SAVE** command can be used in an ASP or HP-IB program.

2. When the **GET** key is pressed, the 4194A will display the measurement page.
3. # indicates codes that are always stored in non-volatile memory.
4. Programmed points tables and ASP programs are stored in non-volatile memory.

APPENDIX C

code	code	code	code
A	EDIT	MSTDX	* SMKR
* ADIV	EP	MYB	SMKRA
# ADRS	* EQC	MYG	SMKRB
* AMAX	EQCAL	MZR	* SPA
* AMIN	EQDSP	MZX	* SPAB
* ANA	* EQVCA	* NOA	* SPAN
* AOF	* EQVCB	* NOP	* SPB
ARSTR	* EQVL	OB	SPSTR
* ASC	* EQVR	# OFSTA	SR
* ATR	# F	# OFSTB	SRSTR
* ATT	FCHRS	OFSTR	* START
AUTO	* FMT	OG	STB?
AUTOA	* FNC	* OPN	STEND
AUTOB	* FREQ	* OSC	* STEP
B	# G	* PHS	STN
* BDIV	GET	* PLTF	* STOP
BIAS	* GNM	POINT	STORE
* BMAX	GONG	PPAUSE	* STRG
* BMIN	* GPP	* PPM	STSET
* BOF	* GRT	PROG	STSTP
* BSC	# H	# PSCALE	STSTR
C	# I	PSTEP	* SWD
CAL	* IMP	PSTOP	* SWM
CAT	* ITM	PT	* SWP
* CENTER	* IVM	PTCLR	* SWR
* CMT	# J	PTEND	* SWT
* CMPN	* LCURS	* PTN	SWTRG
CONT	LCURSL	PTSET	SX
COPY	LCURSR	PTSRT	* TRGM
* CPYM	LINE	# PTSWP	TRIG
CRAV	# LMF	PURGE	TSTDR
* CUR	* LMSP	* PWS	TSTDX
D	LOAD	QUIT	TYB
DCOFF	* MANUAL	REFRD	TYG
* DFREQ	* MCF	R(A~L)	TZR
* DLCURS	MKEXP	Rn	TZX
* DMKR	MKMNA	* RQS	* UNIT
DMKRA	MKMNB	RST	WID
DMKRB	MKMXA	RUN	WIDTH
* DPA	MKMXB	RZ	X
* DPAB	* MKR	SAVE	* ZIR
* DPB	MKRA	* SCLP	* ZIT
* DSP	MKR	SCRATCH	ZSHRT
* DTIME	MON	SENDPS	ZOPEN
# E	MSTDR	* SHT	Z

The HP 4194A displays system messages in the " SYSTEM MESSAGE AREA " to inform the user of various conditions. The system messages fall into two categories: comments (instructions or informative messages) and error messages. The comments are displayed in yellow and the error messages in red. They are listed here in alphabetical order. When the 4194A is under remote control via the HP-IB, the comments marked with a * and all error messages will set Bit-3 (End Status) and Bit-5 (Error), respectively, setting the SRQ bit of the **STATUS BYTE**. Use the "RQS" command to mask these bits if needed. Each error message has an error code number, all of which are listed in D-3 (Error Code Numbers).

D-1. Comments (displayed in yellow)

Comment	Description
A/B data stored into C/D	Appears when the ' STORE ' softkey is pressed while in the SUPERIMPOSE mode.
All CAL data not suitable	Appears when all of the calibration data is invalid because measurement conditions have changed.
Adjust R68@A22B'd	This comment is related to Self Test. The Self Test must be run by an HP Service Engineer. If you have entered the self-test mode, press the ' TEST END ' softkey to exit.
All CLEAR aborted	Appears if a key other than the ENTER key is pressed. (Pressing the ' TABLE ALL CLR ' softkey and ENTER key is the normal sequence.) This is related to the programmed points table.
AVERAGING TIME = ***	Appears when a key in the AVERAGING section is pressed. Pressing this key repeatedly changes the number (***).
Calculating EQV parameters	Appears when the ' CALC EQV PARA ' softkey is pressed or the EQCAL command is executed.
Calculating f characteristics	Appears when the ' SIMULATE f CHAR ' softkey is pressed or the FCHRS command is executed.
Calculation complete	Displayed when "Calculating EQV or f characteristics" are completed.
Calibrating	This comment appears when a calibration measurement using the calibration standards is being performed.

APPENDIX D

Comment	Description
Calibration aborted	This comment appears when a calibration measurement is aborted by pressing the ' OS CAL ', ' 0Ω CAL ', or ' STD CAL ' softkey.
Calibration complete	This comment appears when the calibration measurement is complete.
Copy aborted	Appears when the COPY key is pressed during a copy operation.
*Copy complete	Appears when the copy is complete.
DIV has changed	Appears when the value of ADIV or BDIV has changed
ENTER to execute All CLEAR	Appears when the ' TABLE ALL CLR ' softkey is pressed. (Press ENTER to execute.)
ENTER to setup SELF TEST	This comment is related to Self Test. Self Test must be run by an HP Service Engineer. If you have entered the self-test mode press the ' TEST END ' softkey to exit.
Exceeds lower limit	STEP (down) key operation has reached the lowest value which can be set. The STEP key is available for the display scale (MIN, MAX), sweep parameter (START, STOP, STEP, CENTER, SPAN, etc.), and NOP.
Exceeds upper limit	The STEP (up) key operation has reached the highest value which can be set.
Exit editor	Appears when the ' QUIT EDITOR ' softkey is pressed to exit from the program editor page.
Exit programmed points table	Appears when the ' TABLE SET END ' softkey is pressed.
Freq. 100 to 15MHz at 1m	Appears when the Cable Length Switch is changed from 0m to 1m in the Impedance Measurement.
Input buffer full	The character string entered on the Key Board Input Line exceeds 88 characters.

Comment	Description
Invalid step parameter	The STEP (up or down) key is pressed when an invalid parameter is selected. The STEP key is available when the parameters: (A or B) DIV, (A or B)MAX, (A or B)MIN, START, STOP, STEP, CENTER, SPAN, OR NOP are selected.
MAX has changed	Appears when the value of AMAX or BMAX has changed.
Measuring zero open	Appears when a ZERO OPEN measurement is being performed.
Measuring zero short	Appears when a ZERO SHORT measurement is being made.
Memory full	Appears when the program volume in the working area exceeds the memory capacity allotted for it. Memory size is 32768 bytes.
Memory test complete	This comment is related to Self Test. Self Test must be performed by an HP Service Engineer. If you have entered the self-test mode press the ' TEST END ' softkey to exit.
Memory test in progress	Appears during the memory test at turn on.
MIN has changed	Appears when the value of AMIN or BMIN has changed.
Not calculate τ in Zero Span	Appears when the Zero Span mode is set during a Group Delay measurement.
Not in PLOT mode	Appears when the ' PLOT menu ' softkey is pressed or commands related to the PLOT is executed without selecting the PLOT mode.
Not in TALK ONLY mode	Appears when the COPY key is pressed without configuring the 4194A to the TALK ONLY mode while in the Local mode.
Offset data not suitable	Appears when the offset data taken by using the zero-open/short measurement are invalid because measurement conditions have changed.

APPENDIX D

Comment	Description
Offset reference stored	Appears when the ' OFST REF STORE ' softkey is pressed while in the COMPENSATION mode.
Out of line number	Appears when a program line number greater than 32767 is entered.
PHASE TRACK test in progress	This comment is related to Self Test. Self Test must be performed by an HP Service Engineer. If you have entered the self-test mode press the ' TEST END ' softkey to exit.
Press ENTER for STD cal	Appears when the ' STD CAL ' softkey is pressed. Press ENTER/EXECUTE for calibration measurement.
Press ENTER for zero open	Appears when the ' ZERO OPEN ' softkey is pressed. (Press the ENTER key to execute.)
Press ENTER for zero short	Appears when the ' ZERO SHORT ' softkey is pressed. (Press the ENTER to execute.)
Press ENTER for OS cal	Appears when the ' OS CAL ' softkey is pressed. Press ENTER/EXECUTE to make the calibration measurement.
Press ENTER for 0Ω cal	Appears when the ' 0Ω CAL ' softkey is pressed. Press ENTER/EXECUTE .
Prog. points measure aborted	Appears when the programmed points measurement is aborted by changing the 4194A's measurement function mode, Impedance to Gain-Phase or the reverse case.
Send P1,P2 to PLOTTER	Appears when the ' SEND P1,P2 ' softkey is pressed.
STD CAL data not suitable	Appears when the standard calibration data is invalid because measurement conditions have changed.
Step ignored > 20 times	STEP (up or down) key was pressed more than 20 times sequentially.
Test complete	This comment is related to Self Test. Self Test must be performed by an HP Service Engineer. If you have entered the self-test mode press the ' TEST END ' softkey to exit.
The same sweep point exist	Appears when the same sweep point is entered in the programmed points table again. Maximum and minimum values are updated if they are entered.

Comment	Description
Unit is msec	Appears when the DELAY TIME key in the PARAMETER section is pressed. DTIME can be set in millisecond units.
Unit is % of frequency span	Appears when the ΔF (green labeled) key in the PARAMETER section is pressed.
VCO test in progress	This comment is related to Self Test. Self Test must be performed by HP Service Engineer. If you have entered the self-test mode press the ' TEST END ' softkey to exit.
Ver n.n month/day/year YYWW OPT350 (or 375)	Appears when the power-on memory check is passed. This is an instrument version number and release date.
Write complete	This comment is related to Self Test. Self Test must be performed by an HP Service Engineer. If you have entered the self-test mode press the ' TEST END ' softkey to exit.
Writing to EEPROM	This comment is related to Self Test. Self Test must be performed by an HP Service Engineer. If you have entered the self-test mode press the ' TEST END ' softkey to exit.
Zero open compen aborted	Appears when the ' ZERO OPEN ' softkey is pressed or the ZOPEN command is executed during a ZERO OPEN measurement.
*Zero open compen complete	Appears when ZERO OPEN is complete.
Zero short compen aborted	Appears when the ' ZERO SHORT ' softkey is pressed or the SHRT command is executed during a ZERO SHORT measurement.
*Zero short compen complete	Appears when ZERO SHORT is complete.
0S CAL data not suitable	Appears when the 0S calibration data is invalid because of measurement conditions changing.
0 Ω CAL data not suitable	Appears when the 0 Ω calibration data is invalid because of measurement conditions changing.
ΔF (DFREQ) has changed	DFREQ value has been changed by the new NOP setting.
θ expand mode has released	Appears when the manual sweep mode is selected while in the phase expansion mode. Phase compensation will be set to [θ SCALE normal] mode.

APPENDIX D

D-2. Error Messages (displayed in red)

Error Message	Description
AC current overload	Hardware failure. Short the Lpot and Lcur terminals using the furnished BNC cable. If this message remains on, contact your nearest HP Service Office.
AC overload on R ch input	Hardware failure. The R Input channel is being overdriven by an excessively high signal during a Gain-Phase measurement. Remove the connector from the R channel input. If this message remains on, contact your nearest HP Service Office. If it disappears, reduce the signal level or use an attenuator.
AC overload on T ch input	Hardware failure. The T Input channel is being overdriven by an excessive signal input during a Gain-Phase measurement. Remove the connector from the T channel input. If this message remains on, contact your nearest HP Service Office. If it disappears, reduce the signal level or use an attenuator.
AC voltage overload	Hardware failure. Remove Test Fixture or cables connected to the UNKNOWN terminal. If this message remains on, contact your nearest HP Service Office.
Allowed in Z- θ /Y- θ /R-X/G-B	Appears when the 'SIMULATE f CHAR' softkey is pressed or the FCHRS command is executed without selecting Z- θ , Y- θ , R-X, or G-B mode.
Average must be 2**n(n=0 to 8)	Setting error. Unassigned number was set to NOA. Select one from (1, 2, 4, 8, 16, 32, 64, 128, or 256).
Back up memory full	ASP program storage area is full. This check is done when the STORE command is executed. Delete old files (programs) or shorten the program to be stored.
Back up RAM data lost	Data in backup RAM has been destroyed. RAM is automatically initialized. This check is performed at turn-on.
Bias must be -40 to +40 V	Setting error. DC bias(V) sweep parameters or Spot DC Bias(V) is out of range. DC Bias(V) must be set in -40(V) to 40(V).

Error Message	Description
Box full	No space in table remains to set programmed sweep points. 16 tables are originally set and each table permits up to 26 sweep points to be set.
Bridge unbalanced	Hardware failure. Remove the Test Fixture or cables connected to the UNKNOWN terminal. If this message still remains, contact your nearest HP Service Office.
Cable length mismatching	When the GET key is pressed, the recalled Cable length switch position and the current switch setting is different. Set the CABLE LENGTH switch on the front panel to the correct position. This message appears only for Impedance measurements.
Calibration must be in IMP	Appears when the calibration measurement is executed without selecting the Impedance measurement.
Can plot only X-A&B/A-B page	In plot mode, only X-A&B or A-B page can be plotted. Use print or dump mode.
Can't calculate EQV parameter	Equivalent circuit parameter, such as R, L, CA, or CB can not be calculated.
Can't change scale > 20 times	Scale parameters such as AMAX or ADIV can not be changed more than 20 times in a sweep.
Can't change while data exist	You can not change sweep parameter if sweep point is already set in the programmed points table. Clear the table before changing it.
Can't enter spot bias in G/φ	Spot DC Bias can not be set during a Gain-Phase measurement.
Can't measure τ in prog. point	Programmed points measurement can not be made while making a Group Delay measurement. This error message appears when PPM1 command is executed or the ' PRG MEAS on/ off ' softkey is set on during the Group delay measurement, or a Group Delay measurement was selected while making a programmed points measurement.
Can't print data on this page	In the print mode, can't copy the equivalent circuit page and the self test page. Use the plot or dump mode.

APPENDIX D

Error Message	Description
Can't select manual sweep	Manual sweep mode is not available for group delay measurements.
Can't set MKR in o REF mode	' MKR= ' is not available in the " Delta Marker Mode " and " Delta Line Cursor Mode ". ' MKR= ' can be set in the " Single Marker Mode " or " Double Marker Mode ".
Can't sweep bias in G/ ϕ	DC Bias can not be used as a sweep parameter for Gain-Phase measurement.
Change Cable Length switch	Self Test message. The Self Test must be run by a HP Service Engineer.
Change function to impedance	Equivalent circuit mode is available only in Impedance measurements. Change function to Impedance measurement.
Change parameter to Z- θ /Y- θ	To execute an equivalent parameter calculation set the parameter to Z- θ or Y- θ mode.
Change sweep to frequency	Set the sweep parameter to frequency for the equivalent circuit function.
Command syntax error	Command syntax you used is not permitted in the 4194A. Check program.
CPU-(A/B) RAM R/W error, nnnnnnH	Hardware failure. Turn the instrument on and off. If this message appears again, contact your nearest HP Service Office. nnnnnnH: RAM address error
DC current overload	Hardware failure. Remove Test Fixture or cables connected to the UNKNOWN terminal. If this message still remains, contact your nearest HP Service Office.
DC overload on R ch input	Hardware failure. The R input channel is being overdriven by an excessive signal input in the Gain-Phase measurement. Remove the connector from the R channel input. If this message appears again, contact your nearest HP Service Office. If it disappears, reduce the signal level or use an attenuator.
DC overload on T ch input	Hardware failure. The T input channel is being overdriven by an excessive signal input in the Gain-Phase measurement. Remove the connector from the T channel input. If this message appears again, contact your nearest HP Service Office. If it disappears, reduce the signal level or use an attenuator.

Error Message	Description
DC voltage overload	Hardware failure. Remove the Test Fixture or cables connected to the UNKNOWN terminals. If this message remains on, contact your nearest HP Service Office.
Delay aperture 0.5 to 100%	Setting error. Delay aperture (DFREQ=) for Group Delay measurement must be set within the range of 0.5% to 100%.
Delay time 0 to 3600000ms	Setting error. Delay time (DTIME=) must be set within the range of 0 to 3600000msec.
Directory full	Directory for ASP program file is full. You can not store more than 30 files into the ASP program storage area.
DISP syntax error	Basic statement " DISP " syntax error.
Divide by zero error	Arithmetic error. You can not divide dividend by zero.
EEPROM check sum error	Hardware failure. Appears when calibration data in the EEPROM has been destroyed. Contact your nearest HP Service Office.
END statement not found	Basic statement " END " can not be found in the ASP program.
File number does not exist	The ASP file number to load or purge does not exist. Use the Basic command, " CAT " to display file list and check.
File number must be 1 to 999	File number input by the store command is out of range
FOR NEXT syntax error	Basic statement construct, "FOR .. TO .. NEXT" syntax error. If this construct is used more than 10 times in a program this error message will also be displayed.
Fractional N loop - unlocked	Hardware failure. Contact your nearest HP Service Office.
Fractional N loop + unlocked	Hardware failure. Contact your nearest HP Service Office.
Freq. must be 10 to 100MHz	Setting error. Frequency sweep parameter or Spot frequency is out of range. Frequency must be set within the range of 10Hz to 100MHz for the Gain-Phase measurement.

APPENDIX D

Error Message	Description
Freq. must be 100 to 15MHz	Setting error. Frequency must be set within the range of 100Hz to 15MHz with 1m Cable Length setting for the Impedance measurement.
Freq. must be 100 to 40MHz	Setting error. Frequency must be set within the range of 100Hz to 40MHz with 0m Cable Length setting for the Impedance measurements.
Freq. must be -20M to 150MHz	This message is related to self-test.
GOSUB RETURN syntax error	Basic statement construct, "GOSUB".. "RETURN" syntax error. If this construct is used more than 10 times in a program this error message will also be displayed.
GOTO syntax error	Basic statement, "GOTO" syntax error.
HP-IB char strings too long	The strings (***) set on the HP-IB command, OUTPUT; *** is too long. The strings must be within 3K Bytes.
IF THEN syntax error	Basic statement construct, "IF..THEN" syntax error.
Illegal state	Appears when an illegal command executed or a syntax error is detected.
Improper delimiter	Syntax error. Delimiter such as (;), (CR/LF), or (,) was used improperly or no delimiter has been detected.
Improper entry unit	Setting error. Unit key such as HZ, V, DBM, or DBV was used improper way.
Improper numeric expression	Setting error. Numeric expression was improper.
Improper scale value	Setting error. 1. Negative value was used with /DIV= 2. Zero value was used in the log mode.
INPUT syntax error	Basic statement, "INPUT" syntax error.
Integer overflow	Appears when the overflow was detected during an 8-bit I/O operation. This message relates directly to the 8-bit output command, "OUTPUT Rn".
INTPOL cal must be in f SWP	Sweep parameter must be set to the frequency mode for a calibration data measurement using the interpolation method.
Invalid LOG/LN argument	Arithmetic operator, LOG or LN was used improperly.

Error Message	Description
Invalid parameter range	<p>PSCALE, LINE, PTN, or ADRS is out of the specified range. Setting ranges are:</p> <p>PSCALE: 0 to 100000 (=2500mm) LINE: 1 to 401 PTN: 1 to 16 ADRS: 0 to 30</p>
Invalid prog. points table	<p>Programmed points table includes improper sweep point value. This check is made every time a programmed points measurement is performed.</p>
Invalid select code number	<p>Input error. Select number is set wrong for select command such as FNC#, DSP#. Check the 4194A Program Code list.</p>
Invalid SIN/COS argument	<p>Arithmetic operator, SIN or COS is improperly used.</p>
Invalid SQR argument	<p>Arithmetic operator, SQR is improperly used.</p>
#Invalid step parameter	<p>STEP (up or down) key is pressed when invalid parameter is being selected. The STEP key is available when the parameter is: (A or B)DIV, (A or B)MAX, (A or B)MIN, START, STOP, STEP, CENTER, SPAN, or NOP.</p>
Line cursor not displayed	<p>CRAV command is available only in "Line Cursor Mode" or "Delta Line Cursor Mode". (CRAV is a command that moves the line cursor to the averaged data point.)</p>
Line number not found	<p>No specified line for "GOTO", "GOSUB", or "THEN" statement is found. Check ASP program line number.</p>
Line number syntax error	<p>Improper line number (program-edit line) is set in ASP program. Check ASP program line number.</p>
LOG swp not allowed in OSC_dB	<p>Log sweep type can not be used for OSC (dBV or dBm) level sweep.</p>
Markers not displayed	<p>MKMX (A or B) or MKMN (A or B) command is executed without selecting "Single Marker Mode" or "Double Marker Mode".</p>
MINIMUM > MAXIMUM error	<p>Minimum value was set larger than the maximum value in the programmed points table. Check the table and correct.</p>

APPENDIX D

Error Message	Description
Min. Resolution <= STEP <= SPAN	Setting error. The STEP value input was out of the specified range.
Multi statement not allowed	Command or Basic statement (construct) designated as single statement type is used in multi-statement form. Examples: RST, SWTRG, IF ... THEN, etc.
Must be 0 <=SPAN <=26dB	Setting error. SPAN value for OSC sweep mode must be set within 26dBm regardless what measurement mode (Impedance or Gain-Phase) is selected.
Must be 0 <=SPAN <=full range	SPAN=(STOP-START)
N must be >=2 in ana. range	NOP number assigned in partial analysis range (between o & * markers) must be >=2. Set the partial analysis range as NOP >=2 by changing the marker position. This check is done when the 'STORE ANA RNG' softkey is pressed or the ARSTR command is executed.
N must be >=3 in ana. range	NOP number assigned in partial analysis range (between o & * markers) must be >=3 to make the job related to the equivalent circuit. Set the partial analysis range as NOP >=3 by changing marker position. This check is done when one of the following softkey commands are executed. 'EQV CKT' softkey : EQDSP 'CALC EQV PARA' softkey : EQCAL 'SIMULATE f CHAR' softkey : FCHRS
N must be >=2 in sweep range	NOP number assigned in partial sweep range (between o & * markers) must be >=2. Set the partial sweep range as NOP >=2 by changing the marker position. This check is done when the 'STORE SWP RNG' softkey is pressed or the SPSTR command is executed.
Negative data exist in A_REG	Negative data has been detected in the A register while an EQUAL calculation is in progress.
No ASP program in memory	No program in the work area. This check is done when executing the RUN or STEP commands. Create or load a program.
No save data in backup memory	No saved data was found when the "GET" function is executed.
NOP must be 2 to 401	Setting error. NOP number must be set within the range of 2 to 401.

Error Message	Description
NOP value too large	The STEP value can not be set because the NOP value is too large. This can happen even though NOP is $2 \leq \text{NOP} \leq 401$. Check NOP, START, STOP, and STEP.
Not allowed in LOG scale	'(A or B)/DIV' softkey is pressed when display is in Log scale mode.
Not allowed in LOG sweep	The CENTER, SPAN, or STEP value can not be set when Log sweep is selected.
Not allowed in manual sweep	Appears when the phase expansion mode is selected while in the Manual sweep mode.
Not allowed in prog measure	The MKEXP command is executed when the programmed points measurement is being made.
Not allowed in Zero Span	The commands, FCHRS , EQCAL , OR EQV(R, L, CA, CB) is executed when the zero span measurement is being made.
Not continuable	The Basic command " CONT " was executed when ASP program was in the STOP status. This command is effective only in the PAUSE status.
Not in o & * MKRS mode	<ol style="list-style-type: none"> 1. EXPAND MARKERS (command: MKEXP) was selected without setting the Double Marker mode. 2. SRSTR (partial sweep) or ARSTR (partial analysis) was selected without setting the Double Marker mode.
Not in prog. points measure	'LIMIT on/off' softkey is set on or the LMSP1 command is executed when the programmed points measurement is off.
Number of points full	Number of sweep points set in a programmed points table exceeds 401.
Offset compen must be in G/θ	The OFSTR command is executed in the Impedance measurement mode. This command is only available in the Gain-Phase measurement mode.
Only FREQ & LIN sweep allowed	The sweep parameter and type must be set to the Frequency and Linear mode respectively for Group Delay measurement.

APPENDIX D

Error Message	Description
Open/short must be in f swp	Sweep parameter must be set to the Frequency mode for ZERO OPEN/SHORT measurements.
Open/short must be in IMP	ZOPEN or ZSHRT command is executed in the Gain-Phase measurement. These commands are available only in the Impedance measurement mode.
Osc must be -65 thru +15 dBm	Setting error. OSC sweep parameter or Spot OSC level must be set within the range of -65dBm to +15dBm for Gain-Phase measurements.
Osc must be -27 to 13 dBm	Impedance measurement. Osc level (dBm) is out of range.
Osc must be -40 to 0 dBV	Impedance measurement. Osc level (dBV) is out of range.
Osc must be 126 μ to 1.26 V	Gain-Phase measurement. Osc level (V) is out of range.
Osc must be 154 μ V to 1.54V	Gain-Phase measurement Osc level is out of range. Appears only in Option 375 instruments.
Osc must be -28.8 to 11.2dBm	Impedance measurement Osc level is out of range. Appears only in Option 375 instruments.
Osc must be -76.2 to 3.8dBV	Gain-Phase measurement Osc level set is out of range. Appears only in Option 375 instruments.
Osc must be -78 to 2 dBV	Gain-Phase measurement Osc level (dBv) is out of range.
Osc must be 10mV to 1 V	Setting error. OSC sweep parameter or Spot OSC level must be set within 10mV to 1V in the Impedance measurement mode.
Out of (1E-37 <-> 9.99999E+37)	Setting error. Setting range for the registers must be within 9.99999E-37 to 1E+38. Check the register setting range listed in REGISTER MANIPULATION.
Out of range in MAXIMUM	Setting error. Maximum value set in the programmed points table is out of range.
Out of range in MINIMUM	Setting error. Minimum value set in the programmed points table is out of the specified range.
Out of range in SWEEP POINTS	Sweep point set in the programmed points table is out range.

Error Message	Description
OUTPUT syntax error	Basic statement, "OUTPUT" syntax error.
Programmed points table empty	No sweep point is set in a programmed points table. This check is performed when the 'PRG MEAS on/ off' softkey is pressed or the PPM1 command is executed. Sweep points must be ≥ 2 .
Real math overflow	Overflow was detected during a 64 Bit floating point computation.
Real math underflow	Underflow was detected during a 64 Bit floating point computation.
(A/B:) ROM check sum error, nnn	Hardware failure. Contact your nearest HP Service Office.
Select o marker mode	o marker must be on when selecting the Double Marker mode or Delta Marker mode. Selecting the Single Marker mode before performing the Double or Delta mode.
Sign must be same in LOG swp	Setting error. START and STOP value have different polarity or include 0 (V) in the DC Bias Log sweep mode. Sweep type is automatically changed to Linear concurrently with this message.
Statement too complex	Expression used in an ASP program is too complex to calculate.
STEP > SPAN error	Setting error. The STEP value was set larger than the SPAN value while in the Linear sweep mode.
String buffer full	While in an ASP program the number of characters on a program line exceeded 88 characters.
Subscript out of range	Setting error. For example, when the content of register R1 is 500, A(R1) can not be performed.
Syntax error in MAXIMUM	Syntax error. Maximum value set in the programmed points table is improper.
Syntax error in MINIMUM	Syntax error. The minimum value set in the programmed points table is improper. Syntax error.
Syntax error in SWEEP POINTS	Sweep point for the programmed points table is set improperly. Syntax error.

APPENDIX D

Error Message	Description
The same file number exist	The same ASP file number already exists. Use another file number to store program.
Undefined symbol	Undefined symbol was detected. Check the list of 4194A program codes, suffix or arithmetic operators.
Value range error	Setting error. Value set for arithmetic operator is improper.
WAIT syntax error	Basic statement, "WAIT" syntax error.
Write failed	This message is related to the Self Test. The self Test must be run by an HP Service Engineer.

D-3. Error Code Numbers

Error code numbers can be read via the HP-IB using "ERR?" command. When an error is detected while an ASP program is in progress the message, "Error NNN in LLLLL", will be displayed instead of the designated error message. NNN indicates an error code number and LLLLL represents the line number where the error was detected.

No.	Error Message
1	(A/B:) ROM check sum error, nnn
2	Back up RAM data lost
3	EEPROM check sum error
4	CPU-(A/B) RAM R/W error, nnnnnnH
5	Undefined symbol
6	Improper numeric expression
7	Out of (1E-37 <--> 9.99999E+37)
8	Improper delimiter
9	Command syntax error
10	Invalid select code number
11	Invalid parameter range
12	Not allowed in LOG sweep
13	LOG swp not allowed in OSC_dB
14	NOP must be 2 to 401
15	Freq. must be 100 to 40MHz
16	Freq. must be 100 to 15MHz
17	Freq. must be 10 to 100MHz
18	Osc must be 10m to 1V or Osc must be -27 to 13dBm or Osc must be -28.8 to 11.2dBm or Osc must be -40 to 0dBV or Osc must be -28.8 to 11.2dBm
19	
20	Osc must be -65 thru +15dBm or Osc must be 154 μ to 1.54V or Osc must be 126 μ to 1.26V or Osc must be -76.2 to 3.8dBV or Osc must be -78 to 2dBV
21	Must be $0 \leq \text{SPAN} \leq 26\text{dB}$
22	Bias must be -40 to +40V
23	Improper entry unit
24	Sign must be same in LOG swp
25	Can't sweep bias in G/ ϕ
26	Can't enter spot bias in G/ ϕ
27	Min. Resolution $\leq \text{STEP} \leq \text{SPAN}$
28	STEP > SPAN error
29	NOP value too large
30	Not in o & * MKRS mode
31	Can't set MKR in o REF mode
32	N must be ≥ 2 in sweep range

APPENDIX D

No.	Error Message
33	N must be ≥ 2 in ana. range
34	
35	Markers not displayed
36	Line cursor not displayed
37	
38	
39	Not allowed in LOG scale
40	Improper scale value
41	
42	
43	Open/Short must be in IMP
44	Open/Short must be in f swp
45	Offset compen must be in G/ϕ
46	Can't change while data exists
47	Box full
48	Number of points full
49	MINIMUM > MAXIMUM error
50	Syntax error in SWEEP POINTS
51	Syntax error in MINIMUM
52	Syntax error in MAXIMUM
53	Not in prog. points measure
54	Programmed points table empty
55	Invalid prog. points table
56	Change function to impedance
57	Change parameter to $Z-\theta/Y-\theta$
58	Change sweep to frequency
59	N must be ≥ 3 in ana. range
60	String buffer full
61	Line number syntax error
62	The same file number exists
63	File number does not exist
64	Directory full
65	Back up memory full
66	No ASP program in memory
67	Not continuable
68	
69	WAIT syntax error
70	GOTO syntax error
71	IF THEN syntax error
72	FOR NEXT syntax error
73	GOSUB RETURN syntax error
74	DISP syntax error
75	OUTPUT syntax error
76	INPUT syntax error
77	Line number not found
78	END statement not found
79	Integer overflow
80	Divide by zero error
81	Real math overflow
82	Real math underflow
83	Value range error
84	Invalid SIN/COS argument
85	Invalid LOG/LN argument
86	Invalid SQR argument
87	HP-IB char strings too long
88	Can plot only X-A&B/A-B page
89	Can't print data on this page

No.	Error Message
90	No save data in backup memory
91	Average must be 2^n (n=0 to 8)
92	Delay aperture 0.5 to 100%
93	Only FREQ & LIN sweep allowed
94	Can't measure τ in prog. point
95	Delay time 0 to 3600000ms
96	AC overload on R ch input
97	AC overload on T ch input
98	DC overload on R ch input
99	DC overload on T ch input
100	AC voltage overload
101	AC current overload
102	DC voltage overload
103	DC current overload
104	Bridge unbalanced
105	Fractional N loop + unlocked
106	
107	(External reference unlock)
108	Fractional N loop - unlocked
109	
110	Out of range in SWEEP POINTS
111	Out of range in MINIMUM
112	Out of range in MAXIMUM
113	Negative data exist in A_REG
114	Can't calculate EQV parameter
115	Not allowed in Zero Span
116	Can't select manual sweep
117	
118	Can't change scale >20 times
119	File number must be 1 to 999
120	Not allowed in prog. measurement
121	Must be $0 \leq \text{SPAN} \leq \text{full range}$
122	
123	Cable length mismatching
124	Select o marker mode
125	Multi statement not allowed
126	Illegal state
127	Not allowed in manual sweep
128	Subscript out of range
129	
130	Calibration must be in IMP
131	Statement too complex
132	Allowed in Z- θ /Y- θ /R-X/G-B
133	INTPOL cal must be in f SWP
200	Write failed
201	Bridge unbalanced
202	Change CABLE LENGTH
203	
204	Freq. must be -20M to 150MHz

E-1. HP 4194A PROGRAM CODES

Note

- (1) (*) indicates a selected code as power-on default setting.
- (2) (Code=) indicates data write/read type registers.
- (3) (#) indicates Read-Only type registers.
- (4) (\$) indicates battery back-up registers.

1: MENU

1-a : FUNCTION

Code	Function
*FNC1	: Impedance measurement ('IMPEDANCE')
FNC2	: Gain-Phase measurement
FNC3	: Impedance measurement ('IMP with Z PROBE')
measurement function for impedance	
*IMP1	: Z - θ
IMP2	: R-X
IMP3	: Ls-Rs
IMP4	: Ls-Q
IMP5	: Cs-Rs
IMP6	: Cs-Q
IMP7	: Cs-D
IMP8	: Y - θ
IMP9	: G-B
IMP10	: Lp-G
IMP11	: Lp-Q
IMP12	: Cp-G
IMP13	: Cp-Q
IMP14	: Cp-D
IMP15	: Z - Ls
IMP16	: Z - Cs
IMP17	: Z - Lp
IMP18	: Z - Cp
IMP19	: Lp-Rp
IMP20	: Cp-Rp
measurement function for gain-phase	
*GPF1	: Tch/Rch (dB) - θ
GPF2	: Tch/Rch - θ
GPF3	: Tch/Rch (dB) - T
GPF4	: Rch-Tch (V)
GPF5	: Rch-Tch (dBm)
GPF6	: Rch-Tch (dBV)
monitor function for impedance	
*IVM0	: Off
IVM1	: V (AC)
IVM2	: I (AC)
monitor function for gain-phase	
*GNM0	: Off
GNM1	: Rch (V)
GNM2	: Rch (dBm)
GNM3	: Rch (dBV)
GNM4	: Tch (V)
GNM5	: Tch (dBm)
GNM6	: Tch (dBV)

1-b : SWEEP

sweep parameter	
*SWP1	: Frequency
SWP2	: DC Bias (Impedance measurement Only)
SWP3	: Osc level (V)
SWP4	: Osc level (dBm) (Linear sweep Only)
SWP5	: Osc level (dBV) (Linear sweep Only)
sweep type	
*SWT1	: Linear
SWT2	: Log.
sweep direction	
*SWD1	: Up
SWD2	: Down

1-b : SWEEP(continued)

Code	Function
programmed point measurement	
*PPM0	: Off
PPM1	: On
o-marker to *-marker sweep	
MKEXP	: Execute sweep between markers.

1-c : COMPENSATION

compensation for impedance measurement	
*CMPN1	: Interpolation mode
CMPN2	: All points mode
ZOPEN	: Start open calibration
ZSHRT	: Start short calibration
*OPN0	: Open calibration off
OPN1	: Open calibration on
*SHT0	: Short calibration off
SHT1	: Short calibration on
CALV	: Start 0S calibration
CALZ	: Start 0 Ω calibration
CALSTD	: Start 50 Ω (standard) calibration
*CAL0	: Standard calibration off
CAL1	: Standard calibration on
*PHS1	: Phase scale to normal mode
PHS2	: Phase scale to expansion mode
compensation for gain-phase measurement	
OFSTR	: Store offset reference
*AOF0	: Data A offset off
AOF1	: Data A offset on
*BOF0	: Data B offset off
BOF1	: Data B offset on
*PHS1	: Phase scale to normal mode
PHS2	: Phase scale to expansion mode

1-d : DISPLAY

display mode	
*DSP1	: X-A&B
DSP2	: A-B
DSP3	: Table
display function effective for X-A&B mode	
AUTOA	: Autoscale A
AUTOB	: Autoscale B
DPA0	: Display data A off
*DPA1	: Display data A on
DPB0	: Display data B off
*DPB1	: Display data B on
*ASC1	: Data A scale to Linear
ASC2	: Data A scale to Log.
*BSC1	: Data B scale to Linear
BSC2	: Data B scale to Log.
AMAX=	: Maximum value for data A scale
AMIN=	: Minimum value for data A scale
BMAX=	: Maximum value for data B scale
BMIN=	: Minimum value for data B scale
ADIV=	: Scale division for data A (Linear scale Only)
BDIV=	: Scale division for data B (Linear scale Only)
GRTO	: Graticule off
*GR1	: Graticule on
UNIT0	: Unit display off
*UNIT1	: Unit display on
*STRG0	: Storage mode off
STRG1	: Storage mode on

1-d : DISPLAY(continued)

Code	Function
display function effective for A-B mode	
AUTO	: Autoscale A/B both
DPAB0	: Display data A/B both off
*DPAB1	: Display data A/B both on
*ASC1	: Data A scale to Linear
ASC2	: Data A scale to Log.
*BSC1	: Data B scale to Linear
BSC2	: Data B scale to Log.
AMAX=	: Maximum value for data A scale
AMIN=	: Minimum value for data A scale
EMAX=	: Maximum value for data B scale
EMIN=	: Minimum value for data B scale
ADIV=	: Scale division for data A (Linear scale Only)
BDIV=	: Scale division for data B (Linear scale Only)
GRT0	: Graticule off
*GRT1	: Graticule on
UNIT0	: Unit display off
*UNIT1	: Unit display on
*STRG0	: Storage mode off
STRG1	: Storage mode on

display function effective for Table mode

UNIT0	: Unit display off
*UNIT1	: Unit display on
LINE=	: Top line number (1 to 401)

superimpose display function effective for X-A&B mode

SPSTR	: Store superimpose data
*SPA0	: Superimpose data A off
SPA1	: Superimpose data A on
*SPB0	: Superimpose data B off
SPB1	: Superimpose data B on

*LMSP0	: Limit-superimpose off
LMSP1	: Limit-superimpose on

superimpose display function effective for A-B mode

SPSTR	: Store superimpose data
*SPAB0	: Superimpose data A/B both off
SPAB1	: Superimpose data A/B both on

1-e : MKR/LCURS

marker/line cursor function effective for X-A&B mode

MCFO	: Marker/Lcursor off
*MCF1	: o-marker on
MCF2	: o-marker and *-marker both on
MCF3	: Lcursor on
MCF4	: o-marker/lcursor both on
MCF5	: o-marker and *-marker both on
MKR=	: o-marker setting on X-axis position
MKMXA	: o-marker to maximum point of data A
MKMXA	: o-marker to minimum point of data A
MKMXB	: o-marker to maximum point of data B
MKMXB	: o-marker to minimum point of data B
LCURS=	: Lcursor setting on Y-axis
DLCURS=	: Difference value between o-marker and lcursor on Y-axis
*CUR1	: Lcursor for data A
CUR2	: Lcursor for data B
CRAV	: Lcursor to average point of data
REFRD	: Read o-marker position
WIDTH	: Read difference value of LCURSR and LCURSL
SMKR=	: *-marker setting on X-axis
SRSTR	: Store sweep range
*SWR0	: Partial sweep range off
SWR1	: Partial sweep range on
*ANA0	: Partial analysis range off
ANA1	: Partial analysis range on
ARSTR	: Store analysis range
DMKR=	: Difference value between o-marker and *-marker on X-axis.

marker/lcursor function effective for A-B and Table modes

MCFO	: Marker/Lcursor both off
*MCF1	: o-marker on
MCF5	: o-marker and *-marker both on
MKR=	: o-marker setting on X-axis
MKMXA	: o-marker to maximum point of data A
MKMXA	: o-marker to minimum point of data A
MKMXB	: o-marker to maximum point of data B
MKMXB	: o-marker to minimum point of data B
SMKR=	: *-marker setting on X-axis
SRSTR	: Store sweep range
*SWR0	: Partial sweep range off
SWR1	: Partial sweep range on
ARSTR	: Store analysis range
*ANA0	: Partial analysis range off
ANA1	: Partial analysis range on

1-f : MORE MENUS

Code	Function
BASIC program commands for ASP	
EDIT	: EDIT--->(line number 1 to 32767)
CAT	: CATalog
LOAD	: LOAD--->(file number 1 to 999)
STORE	: STORE--->(file number 1 to 999), "comment"
PURGE	: PURGE--->(file number 1 to 999)
SCRATCH	: SCRATCH working area
RUN	: RUN
PSTOP	: STOP
PPAUSE	: PAUSE
CONT	: CONTINUE
PSTEP	: STEP
QUIT	: QUIT editor

BASIC program statements for ASP

IF	:
THEN	:
FOR	:
TO	:
NEXT	:
GOTO	:
GOSUB	:
RETURN	:
INPUT	:
OUTPUT	:
WAIT	:
PAUSE	:
BEEP	:
DISP	:
END	:
SEND	:

HP-IB definition

*ADRS=	: HP-IB address(0 to 30)
--------	--------------------------

copy function

COPY	: Excute copy(plot/print/dump)
CPY1	: Plot
CPY2	: Print
*CPY3	: Dump
#PSCALE	: Plot scale(left,bottom,right,top)
*SCLP1	: Set plot scale(P1,P2) to normal
SCLP2	: Set plot scale(P1,P2) to graticule base
*PLTF1	: Plot (all)
PLTF2	: Plot (graticule/data both)
PLTF3	: Plot (data only)
SENDPS	: Send plot scale(P1,P2) to plotter

self test

STSET	: Set up self test page
STN=	: Set self test number
STSTR	: Start self test
STSTP	: Stop self test
STEND	: End self test page

equivalent circuit

EQDSP	: Display equivalent circuit page
*EQC1	: Select equivalent circuit to A
EQC2	: Select B
EQC3	: Select C
EQC4	: Select D
EQC5	: Select E
EQCAL	: Calculate equivalent circuit parameters
EQVR=	: Equivalent circuit parameter R(Ω)
EQVL=	: Equivalent circuit parameter L(H)
EQVCA=	: Equivalent circuit parameter Ca(F)
EQVCB=	: Equivalent circuit parameter Cb(F)
FCRS	: Simulate frequency characteristics

set programmed point table

PTSET	: Set programmed points table page
PTN=	: Programmed points table number(1 to 16)
PTCLR	: Clear programmed points table
PTSWP1	: Sweep parameter to Frequency
PTSWP2	: Sweep parameter to DC bias
PTSWP3	: Sweep parameter to Osc level(V)
PTSWP4	: Sweep parameter to Osc level(dBm)
PTSWP5	: Sweep parameter to Osc level(dBV)
*LMF1	: Limit for data A
LMF2	: Limit for data B
POINT=	: Programmed point(point, minimum, maximum)
PTSRT	: Sort programmed points table
PTEND	: End programmed points table set-up

2: SWEEP

Code	Function
*SWM1	: Sweep mode to Repeat
SWM2	: Sweep mode to Single
SWM3	: Sweep mode to Manual point mode
MANUAL-	: Manual point HZ/V/dBm/dBV
SWTRG	: Sweep start trigger

3: TRIGGER

*TRGM1	: Internal trigger mode
TRGM2	: Ext/Manual trigger mode
TRIG	: Measurement trigger for External mode.

4: INTEG TIME

*ITM1	: Integration time to Short (500usec.)
ITM2	: Integration time to Medium (5msec.)
ITM3	: Integration time to Long (100msec.)

5: AVERAGING

NOA-	: Averaging number (1,2,4,8,16,32,64,128 or 256)
------	--

6: PARAMETER

START-	: HZ/V/dBm/dBV
STOP-	: HZ/V/dBm/dBV
STEP-	: HZ/V/dBm/dBV
CENTER-	: HZ/V/dBm/dBV
SPAN-	: HZ/V/dBm/dBV
NOP-	: Number of measurement points (2 to 401)
FREQ-	: Spot frequency(HZ)
BIAS-	: Spot bias voltage(V)
OSC-	: Spot osc level(V/dBm/dBV)
SAVE	: Save measurement state(0 to 4)
GET	: Get(recall) measurement state
DTIME-	: Delay time (0 to 1 hour in msec.)
DFREQ-	: Delay aperture(0.50 to 100.00%)
DCOFF	: DC bias off
CMT	: Input comment on display data

7: MEASUREMENT UNIT

*PWS1	: Power splitter to DUAL mode
PWS2	: Power splitter to SINGLE mode
*ATR1	: Reference channel attenuation to 0dB
ATR2	: Reference channel attenuation to 20dB
ZIR1	: Reference channel input impedance to 1M Ω
*ZIR2	: Reference channel input impedance to 50 Ω
*ATT1	: Test channel attenuation to 0dB
ATT2	: Test channel attenuation to 20dB
ZIT1	: test channel input impedance to 1M Ω
*ZIT2	: Test channel input impedance to 50 Ω

8: OTHERS

Code	Function
------	----------

Instrument initialization

RST	: Reset the instrument
-----	------------------------

Note

The RST command resets the instrument to the power-on default conditions except for the following settings.

1. Sweep mode is set to the Single sweep mode (code : SWM2) and the traces on the screen will be erased.
2. Data registers(A - D), general purpose registers (RA - RL), all registers for compensation, Rn, Z, and all read-only type registers are not reset.
3. Program WORK AREA is not cleared.

local maximum

LMX(a)	: Move the o-marker to the first peak position within the specified range. Move the *-marker to the last peak position within the specified range.
--------	---

local minimum

LMN(a)	: Move the o-marker to the first valley position within the specified range. Move the *-marker to the last valley position within the specified range.
--------	---

Note

1. LMX(a) or LMN(a) is used in connection with the array variables except for X register.
Example , LMX(A), LMN(B)
2. Select the "Double Marker Mode" (Code :MCF5)
3. When only a peak or valley exists within the specified range, the o-marker moves to maximum or minimum point and *-marker moves to Sweep Start point.
When no peak or valley exists, the o-marker moves to Sweep Start point and *-marker moves to Sweep Stop point.

array variables

A-	: Register for display data A
B-	: Register for display data B
C-	: Register for superimpose data A
D-	: Register for superimpose data B
#E-	: General purpose register
#F-	: General purpose register
#G-	: General purpose register
#H-	: General purpose register
#I-	: General purpose register
#J-	: General purpose register
RA-	: General purpose register
RB-	: General purpose register
RC-	: General purpose register
RD-	: General purpose register
RE-	: General purpose register
RF-	: General purpose register
RG-	: General purpose register
RH-	: General purpose register
RI-	: General purpose register
RJ-	: General purpose register
RK-	: General purpose register
RL-	: General purpose register

#OFSTA-	: Register to save offset data for display A
#OFSTB-	: Register to save offset data for display B

OG-	: Register to store OPEN offset data in G value
OB-	: Register to store OPEN offset data in B value
SR-	: Register to store SHORT offset data in R value
SX-	: Register to store SHORT offset data in X value
TYG-	: Register to store OS calibration data in G value
TYB-	: Register to store OS calibration data in B value
MYG-	: Register to store OS calibration data in G value
MYB-	: Register to store OS calibration data in B value
TZR-	: Register to store 0 Ω calibration data in R value
TZX-	: Register to store 0 Ω calibration data in X value
MZR-	: Register to store 0 Ω calibration data in R value
MZX-	: Register to store 0 Ω calibration data in X value
TSTDZ-	: Register to store 50 Ω calibration data in R value
TSTDY-	: Register to store 50 Ω calibration data in Y value
MSTDZ-	: Register to store 50 Ω calibration data in R value
MSTDY-	: Register to store 50 Ω calibration data in Y value

@ X	: Register to store each point of sweep parameter
-----	---

single variables

Rn-	: General purpose register Rn(n=0 to 99)
Z-	: Register for "Keyboard Input Line" block
@ MON	: Register to store monitor data
@ GONG	: GO/NO-GO result(1=GO,0=NOGO)
@ MKRA	: o-marker reading value on Y-axis for data A
@ MKRB	: o-marker reading value on Y-axis for data B
@ SMKRA	: *-marker reading value on Y-axis for data A
@ SMKRB	: *-marker reading value on Y-axis for data B
@ DMKRA	: Difference value between o-marker and *-marker on Y-axis for data A
@ DMKRB	: Difference value between o-marker and *-marker on Y-axis for data B
@ LCURSL	: Line cursor left reading value
@ LCURSR	: Line cursor right reading value
@ WID	: Difference value between LCURSR and LCURSL

masking status byte

RQS(0)	: Mask the status byte(RQS0 means all masked)
--------	---

data transfer format

*FMT1	: Data format(ASCII mode)
FMT2	: Data format(Binary 64 bit)
FMT3	: Data format(Binary 32 bit)

ASP programming via HP-IB

PROG	: Create ASP program via HP-IB
------	--------------------------------

E-2. Program Codes in alphabetical order

(See the designated location in " E-1. HP 4194A Program Codes " for complete description.)

Code	Location	Code	Location	Code	Location	Code	Location
A	(8)	EQDSP	(1-f)	OFSTA	(8)	SPAB	(1-d)
ADIV	(1-d)	EQVCA	(1-f)	OFSTB	(8)	SPAN	(6)
ADRS	(1-f)	EQVCB	(1-f)	OFSTR	(1-c)	SPB	(1-d)
AMAX	(1-d)	EQVL	(1-f)	OG	(8)	SPSTR	(1-d)
AMIN	(1-d)	EQVR	(1-f)	OPN	(1-c)	SR	(8)
ANA	(1-e)	F	(8)	OSC	(6)	SRSTR	(1-e)
AOF	(1-c)	FCHRS	(1-f)	PHS	(1-c)	START	(6)
ARSTR	(1-e)	FMT	(8)	PLTF	(1-f)	STEND	(1-f)
ASC	(1-d)	FNC	(1-a)	POINT	(1-f)	STEP	(6)
ATR	(7)	FREQ	(6)	PPAUSE	(1-f)	STN	(1-f)
ATT	(7)	G	(8)	PPM	(1-b)	STOP	(6)
AUTO	(1-d)	GET	(6)	PROG	(8)	STORE	(1-f)
AUTOA	(1-d)	GNM	(1-a)	PSCALE	(1-f)	STRG	(1-d)
AUTOB	(1-d)	GONG	(8)	PSTEP	(1-f)	STSET	(1-f)
B	(8)	GPP	(1-a)	PSTOP	(1-f)	SISTP	(1-f)
BDIV	(1-d)	GRT	(1-d)	PTCLR	(1-f)	STSTR	(1-f)
BIAS	(6)	H	(8)	PTEND	(1-f)	SWD	(1-b)
BMAX	(1-d)	I	(8)	PTN	(1-f)	SWM	(2)
BMIN	(1-d)	IMP	(1-a)	PTSET	(1-f)	SWP	(1-b)
BOF	(1-c)	ITM	(4)	PTSRT	(1-f)	SWR	(1-e)
BSC	(1-d)	IVM	(1-a)	PTSWP	(1-f)	SWT	(1-b)
C	(8)	J	(8)	PURGE	(1-f)	SWTRG	(2)
CAL	(1-c)	LCURS	(1-e)	FWS	(7)	SX	(8)
CALSTD	(1-c)	LCURSL	(8)	QUIT	(1-f)	TRGM	(3)
CALY	(1-c)	LCURSR	(8)	RA	(8)	TRIG	(3)
CALZ	(1-c)	LINE	(1-d)	RB	(8)	TSTDR	(8)
CAT	(1-f)	LMF	(1-f)	RC	(8)	TSTDX	(8)
CENTER	(6)	LMN	(8)	RD	(8)	TYB	(8)
CMT	(6)	LMSP	(1-f)	RE	(8)	TYG	(8)
CMFN	(1-c)	LMX	(8)	REFRD	(1-e)	TZR	(8)
CONT	(1-f)	LOAD	(1-f)	RF	(8)	TXZ	(8)
COPY	(1-f)	MANUAL	(2)	RG	(8)	UNIT	(1-d)
CPYM	(1-f)	MCF	(1-e)	RH	(8)	WID	(8)
CRAV	(1-e)	MKEXP	(1-b)	RI	(8)	WIDTH	(1-e)
CUR	(1-e)	MKMNA	(1-e)	RJ	(8)	X	(8)
D	(8)	MKMNB	(1-e)	RK	(8)	ZIR	(7)
DCOFF	(6)	MKMNA	(1-e)	RL	(8)	ZIT	(7)
DFREQ	(6)	MKMXB	(1-e)	Rn	(8)	ZSHRT	(1-c)
DLCURS	(1-e)	MKR	(1-e)	RQS	(8)	ZOPEN	(1-c)
DMKR	(1-e)	MKRA	(8)	RST	(8)	Z	(8)
DMKRA	(8)	MKRB	(8)	RUN	(1-f)		
DMKRB	(8)	MON	(8)	SAVE	(6)		
DPA	(1-d)	MSTDR	(8)	SCLP	(1-f)		
DPAB	(1-d)	MSTDX	(8)	SCRATCH	(1-f)		
DPB	(1-d)	MYB	(8)	SEND	(1-f)		
DSP	(1-d)	MYG	(8)	SENDPS	(1-f)		
DTIME	(6)	MZR	(8)	SHT	(1-c)		
E	(8)	MZX	(8)	SMKR	(1-e)		
EDIT	(1-f)	NOA	(5)	SMKRA	(8)		
EQC	(1-f)	NOP	(6)	SMKRB	(8)		
EQCAL	(1-f)	OB	(8)	SPA	(1-d)		

E-3. HP 4194A ASCII Character Codes

(The HP 4194A unique codes are (*)marked on decimal number)

Character	Dec	Character	Dec	Character	Dec	Character	Dec
	0	SPACE	32	@	64	'	96
α (alpha)	*1	!	33	A	65	a	97
β (beta)	*2	"	34	B	66	b	98
ω (omega)	*3	#	35	C	67	c	99
	4	\$	36	D	68	d	100
	5	%	37	E	69	e	101
	6	&	38	F	70	f	102
	7	'	39	G	71	g	103
	8	(40	H	72	h	104
	9)	41	I	73	i	105
LF	10	*	42	J	74	j	106
	11	+	43	K	75	k	107
	12	,	44	L	76	l	108
CR	13	-	45	M	77	m	109
	14	.	46	N	78	n	110
Ω (ohm)	*15	/	47	O	79	o	111
l (bar)	*16	0	48	P	80	p	112
l (bar)	*17	1	49	Q	81	q	113
	18	2	50	R	82	r	114
+ (arrow)	*19	3	51	S	83	s	115
	20	4	52	T	84	t	116
→ (arrow)	*21	5	53	U	85	u	117
√ (root)	*22	6	54	V	86	v	118
π (pi)	*23	7	55	W	87	w	119
Δ (delta)	*24	8	56	X	88	x	120
μ (mu)	*25	9	57	Y	89	y	121
° (degree)	*26	:	58	Z	90	z	122
	27	;	59	[91	{	123
φ (phi)	*28	<	60	\	92		124
Γ (gamma)	*29	=	61]	93	}	125
θ (theta)	*30	>	62	^	94	τ (tau)	*126
λ (lambda)	*31	?	63	-	95	° (circle)	*127

E-4. SUFFIX

Suffix:	M (mega) =E+06	Engineering Units:	HZ
	K (kilo) =E+03		KHZ
	m (milli) =E-03		MHZ
	U (micro) =E-06		V
	N (nano) =E-09		DBV
	P (pico) =E-12		DBM

E-5. STATUS BYTE

MSB				LSB			
B7	B6	B5	B4	B3	B2	B1	B0

B7 : always 0
 B6 : RQS
 B5 : Error (Hardware trips)
 B4 : Ignore trigger
 B3 : End status
 B2 : always 0
 B1 : Sweep complete
 B0 : Measurement complete

E-6. REGISTER SETTING RANGE

Register Name	Value
A, B, C, D, E, F, G, H, I, J RA, RB, RC, RD, RE, RF, RG, RH, RI, RJ, RK, RL OFSTA, OFSTB, OG, OB, SR, SX TYG, TYB, TZR, TZX, TSTDR, TSTDY MYG, MYB, MZR, MZX, MSTDR, MSTDY LCURS, DLCURS EQVR, EQVL, EQVCA, EQVCB	$\pm 1E-37 \sim \pm 9.99999E+37$ Res. 6 digits mantissa
Rn, Z	$\pm 1E-37 \sim \pm 9.99999E+37$ Res. 12 digits mantissa
AMAX, AMIN, ADIV EMAX, EMIN, EDIV	$\pm 1E-37 \sim \pm 9.999E+37$ Res. 4 digits mantissa

IMPEDANCE MEASUREMENT ('IMPEDANCE' mode) :

Register Name	Mode	Value
START, STOP, STEP CENTER, SPAN MANUAL, MKR, SMKR, DMKR FREQ	Frequency	Min. 100.000 HZ Max. 40 000 000.000 HZ *1 Res. 15 000 000.000 HZ *2 Res. 0.001 HZ
START, STOP, STEP CENTER, SPAN MANUAL, MKR, SMKR, DMKR OSC	OSC Level	Min. 10.0 mV *3 Max. 1.00 V *3 Min. 10.0 mV *4 Max. 0.50 V *4 Res. 1 $\frac{\mu}{V}$ Span 26.0 dB
START, STOP, STEP CENTER, SPAN MANUAL, MKR, SMKR, DMKR BIAS	DC Bias	Min. -40.00 V Max. +40.00 V Res. 0.01 V

*1: Cable Length= 0 m *2: Cable Length= 1 m
 *3: Frequency range 100 Hz to 10 MHz (10 MHz inclusive)
 *4: Frequency range 10 MHz to 40 MHz

IMPEDANCE MEASUREMENT ('IMP with Z PROBE' mode) :

Register Name	Mode	Value
START, STOP, STEP CENTER, SPAN MANUAL, MKR, SMKR, DMKR FREQ	Frequency	Min. 10.000 HZ Max. 100 000 000.000 HZ Res. 0.001 HZ
START, STOP, STEP CENTER, SPAN MANUAL, MKR, SMKR, DMKR OSC	OSC Level	Min. -65.0 dBm Max. +15.0 dBm Res. 0.1 dB Span 26.0 dB
START, STOP, STEP CENTER, SPAN MANUAL, MKR, SMKR, DMKR BIAS	DC Bias	Min. -40.00 V Max. +40.00 V Res. 0.01 V

GAIN-PHASE MEASUREMENT ('GAIN PHASE' mode) :

Register Name	Mode	Value
START, STOP, STEP CENTER, SPAN MANUAL, MKR, SMKR, DMKR FREQ	Frequency	Min. 10.000 HZ Max. 100 000 000.000 HZ Res. 0.001 HZ
START, STOP, STEP CENTER, SPAN MANUAL, MKR, SMKR, DMKR OSC	OSC Level	Min. -65.0 dBm Max. +15.0 dBm Res. 0.1 dB Span 26.0 dB

E-7. DEFAULT PARAMETER VALUES

SWEEP RANGE :

IMPEDANCE MEASUREMENT ('IMPEDANCE' mode)

Register Name	Frequency(HZ)	DC Bias(V)	OSC(mV)	OSC(dBm)	OSC(dBV)
START	100.000	0.00	10.0	-26.0	-39.0
STOP	*40 000 000.000	0.00	110.0	0.0	-13.0
STEP	*15 000 000.000 99 999.750	0.10	1.0	0.2	0.2
NOP	401	101	101	131	131

* 40 MHZ (Cable Length= 0 m) 15 MHZ (Cable Length= 1 m)

IMPEDANCE MEASUREMENT ('IMP with Z PROBE' mode)

Register Name	Frequency(HZ)	DC Bias(V)	OSC(mV)	OSC(dBm)	OSC(dBV)
START	10 000.000	0.00	10.0	-26.0	-39.0
STOP	100 000 000.000	0.00	110.0	0.0	-13.0
STEP	249 975.000	0.10	1.0	0.2	0.2
NOP	401	101	101	131	131

GAIN-PHASE MEASUREMENT ('GAIN PHASE' mode)

Register Name	Frequency(HZ)	OSC(mV)	OSC(dBm)	OSC(dBV)
START	10.000	10.0	-26.0	-39.0
STOP	100 000 000.000	110.0	0.0	-13.0
STEP	249 999.975	1.0	0.2	0.2
NOP	401	101	131	131

Note

- (1) CENTER & SPAN can be defined as :

$$\text{CENTER} = (\text{START} + \text{STOP}) / 2$$

$$\text{SPAN} = (\text{STOP} - \text{START})$$

- (2) Relationship between STEP & NOP

$$\text{STEP} = \frac{1}{(\text{NOP} - 1)} (\text{STOP} - \text{START})$$

STEP value is rounded to its designated resolution.

$$\text{NOP} = \frac{(\text{STOP} - \text{START})}{\text{STEP}} + 1$$

NOP is rounded to an integer value.

SPOT PARAMETER :

Register Name	'IMPEDANCE'mode	'GAIN-PHASE'mode	'IMP with Z PROBE'mode
FREQ	100 000.000 Hz	100 000.000 Hz	10 000 000.000 Hz
BIAS	0.00 V	0.00 V	0.00 V
OSC	500 mV	0.0 dBm	500 mV

OTHER PARAMETERS :

Register Name	Default Value
NOA	1
NOP	401
DFREQ	0.50 %
DTIME	0 msec

Appendix F describes the calibration reference values, and how to change them.

The calibration reference values are used as standards to compare the actual **CALIBRATION** measurement values of the standards. If you have accurate, calibrated standards with well defined equivalent circuits, you can extend the calibration plane to the end of the extension where calibration standards are connected. The stray admittance and residual impedance of the extension more from the calibration plane should be compensated using the **ZERO OFFSET** capability.

The reference calibration values each for **IMPEDANCE** measurement with UNKNOWN terminals (FNC1) and for **IMPEDANCE** measurement with **GAIN-PHASE** terminals (FNC3) are stored in the 4194A's EEPROM. When the 4194A is shipped from the factory, FNC1's reference calibration values are not assigned but FNC3's are assigned as the calibration standards of the 41941A/B.

Calibration Reference Value Modification Procedure

1. Disconnect the power cable from the 4194A and allow a few minutes for the internal capacitors to discharge.

WARNING

DANGEROUS ENERGY/VOLTAGE EXISTS WHEN 4194A IS IN OPERATION AND JUST AFTER IT IS POWERED DOWN. ALLOW A FEW MINUTES FOR THE INTERNAL CAPACITORS TO DISCHARGE.

2. Fully loosen the control unit's (the upper unit's) top cover retaining screw located at the rear of the top cover.
3. Slide the top cover towards the rear and lift off. The top shield plate will be visible.
4. Remove the top shield plate to expose the PC boards.
5. Change jumper A8W2 to its lowest position.

Note

The A8 board is the one with the black and gray extractors. Jumper A8W2 is located right hand most side of the A8 board.

6. Reinstall the A8 board.

APPENDIX F

WARNING

DANGEROUS ENERGY/VOLTAGE EXIST INSIDE OF THE 4194A. DO NOT TOUCH THE INSIDE OF THE 4194A WHEN IT IS ON.

7. Connect the power cable and turn the 4194A on.
8. Press the **MORE MENUS** key, '**SELF TEST**', **ENTER/EXECUTE**, '**TEST No.**' softkeys. The self test menu will appear on the screen and "STN=" will be displayed on the keyboard input line.
9. Press **3, 8**, and **ENTER/EXECUTE**. SELF TEST #38 screen will be displayed.
10. Select '**for FNC1**' or '**for FNC3**'

Note

If you use the 41941A/B Impedance Probe Kit do not change the reference values for FNC3, or the measurement accuracy specifications for the impedance probe will not be met.

11. Press the '**0S**' softkey and enter your 0S termination's conductance (G) in Siemens and the parallel capacitance (Cp) in Farads with a comma (,) delimiter, then press **ENTER/EXECUTE**.
12. Press '**0 Ω** ' softkey and enter the value of your 0 Ω termination's resistance (R) in Ω , the series inductance (Ls) in Henrys, and unit with comma (,) delimiter, then press **ENTER/EXECUTE**.
13. Press the '**STD**' softkey and enter your standard resistor's resistance (R) in Ω and the series inductance (Ls) in Henrys with a comma (,) as the delimiter, then press **ENTER/EXECUTE**.
14. Confirm that the values you've entered are displayed on the screen.

CAUTION

DO NOT EXECUTE ANY SELF TEST OTHER THAN #38, OR THE 4194A MAY BECOME INOPERATIVE. OTHER SELF TESTS ARE FOR SERVICE USE ONLY.

15. Turn off the 4194A and disconnect the power cable from the 4194A and allow a few minutes for the internal capacitors to discharge.
16. Remove the A8 board and reset A8W2 to its upper position.
17. Replace the A8 board, top shield plate and top cover.

The default calibration reference values for FNC1 and FNC3 are shown below.

(1) for FNC1

0 S	= 0.00000	S + 0.00000	F
0 Ω	= 0.00000	Ω + 0.00000	H
STD	= 50.0000	Ω + 0.00000	H

(2) for FNC3

0 S	= 0.00000	S + 310.000	fF
0 Ω	= 0.00000	Ω + 0.00000	H
STD	= 50.0000	Ω + 5.75000	nH

Appendix G lists the preset frequencies at which compensation measurements are taken.

'IMPEDANCE' Function

100Hz	1kHz	10kHz	100kHz	1MHz	10MHz	20MHz	30MHz	40MHz
200Hz	2kHz	29.999999kHz	150kHz	2MHz	11MHz	21MHz	31MHz	
300Hz	5kHz	30kHz	300kHz	4MHz	12MHz	22MHz	32MHz	
400Hz		50kHz	500kHz	6MHz	13MHz	23MHz	33MHz	
500Hz		70kHz		8MHz	14MHz	24MHz	34MHz	
					15MHz	25MHz	35MHz	
					16MHz	26MHz	36MHz	
					17MHz	27MHz	37MHz	
					18MHz	28MHz	38MHz	
					19MHz	29MHz	39MHz	

CABLE LENGTH switch 0m; 53 points (100Hz to 40MHz)
 CABLE LENGTH switch 1m; 28 points (100Hz to 15MHz)

'IMP with Z PROBE' Function

10Hz	100Hz	1kHz	10kHz	100kHz	1MHz	10MHz	100MHz
15Hz	150Hz	1.5kHz	11kHz	120kHz	1.5MHz	15MHz	
20Hz	200Hz	2kHz	13kHz	150kHz	2MHz	20MHz	
25Hz	250Hz	2.5kHz	15kHz	200kHz	2.5MHz	25MHz	
30Hz	300Hz	3kHz	20kHz	250kHz	3MHz	30MHz	
40Hz	500Hz	5kHz	25kHz	300kHz	5MHz	35MHz	
50Hz	700Hz	7kHz	29.999999kHz	350kHz	7MHz	40MHz	
60Hz			30kHz	500kHz		45MHz	
80Hz			40kHz	700kHz		50MHz	
			50kHz			55MHz	
			60kHz			60MHz	
			80kHz			65MHz	
						70MHz	
						75MHz	
						80MHz	
						85MHz	
						90MHz	
						95MHz	

NOTES

REGIONAL SALES AND SUPPORT OFFICES

If you need technical assistance with a Hewlett-Packard test and measurement product or application, please contact the Hewlett-Packard office or distributor in your country.

Asia Pacific:

Hewlett-Packard Asia Pacific Ltd
17-21/F Shell Tower, Times Square,
1 Matheson Street, Causeway Bay,
Hong Kong
(852) 2599 7070

Australia/New Zealand:

Hewlett-Packard Australia Ltd.
31-41 Joseph Street
Blackburn, Victoria 3130
Australia
131 347 ext. 2902

Canada:

Hewlett-Packard Canada Ltd.
5150 Spectrum Way
Mississauga, Ontario
L4W 5G1
(905) 206 4725

**In Europe, Africa and Middle East
please call your local HP sales office
or representative:**

Austria/East Central Europe:
(1) 25000-0

Belgium and Luxembourg:
(02) 778 34 17

Czech Republic:
(2) 471 7327

Denmark:
45 99 10 00

Finland:
(90) 88 721

France:
(1) 69.82.65.00

Germany:

(0180) 532 62-33

Greece:

(1) 7264045

Hungary:

(1) 252 4705

Ireland:

(01) 284 4633

Israel:

(03) 5380 333

Italy:

02 - 92 122 999

Netherlands:

(020) 547 6669

Norway:

(22) 73 56 00

Poland:

(22) 37 50 65

Portugal:

(11) 301 73 30

Russia:

(095) 956 2126

South Africa:

(011) 806 1000

Spain:

900 123 123

Sweden:

(08) 444 20 00

Switzerland:

(01) 735 7111

Turkey:

(212) 224 59 25

United Kingdom:

(01344) 366 666

**For European countries
not listed,
contact:**

Hewlett-Packard
International Sales Europe
Geneva, Switzerland
Tel: +41-22-780-4111
Fax: +41-22-780-4770

Japan:

Hewlett-Packard Japan Ltd.
Measurement Assistance Center
9-1, Takakura-cho, Hachioji-shi,
Tokyo 192, Japan
Tel: (81) 426 48 0722
Fax: (81) 426 48 1073

Latin America:

Hewlett-Packard
Latin American Region Headquarters
5200 Blue Lagoon Drive
9th Floor
Miami, Florida 33126
U.S.A.
(305) 267 4245/4220

United States:

Hewlett-Packard Company
Test and Measurement Organization
5301 Stevens Creek Blvd.
Bldg. 51L-SC
Santa Clara, CA 95052-8059
1 800 452 4844

