

# HP 3852A Data Acquisition/Control Unit

## High-Speed FET Multiplexer Accessories

HP 44711A/B, HP 44712A, and HP 44713A/B

## Configuration and Programming Manual

This is the HP 44711A/B, 44712A, and 44713A/B High-Speed FET Multiplexer Configuration and Programming Manual. Insert this manual and tab page into the Plug-In Accessories Configuration and Programming Manuals Binder.



©Copyright Hewlett-Packard Company 1991



\*44711-90002\*

Manual Part Number: 44711-90002  
Microfiche Part Number: 44711-99002

Printed: JANUARY 1991 Edition 2  
Printed in USA E0191



# **HP 3852A Data Acquisition/Control Unit**

**High-Speed FET Multiplexer Accessories**

**HP 44711A/B, HP 44712A, and HP 44713A/B**

**Configuration and Programming Manual**



©Copyright Hewlett-Packard Company 1991

Manual Part Number: 44711-90002  
Microfiche Part Number: 44711-99002

Printed: JANUARY 1991 Edition 2  
Printed in USA E0191



# Printing History

---

The Printing History shown below lists the printing dates of all Editions and Updates created for this manual. The Edition number changes as the manual undergoes subsequent revisions. Editions are numbered sequentially starting with Edition 1. Updates, which are issued between Editions, contain individual replacement pages which the customer uses to update the current Edition of the manual. Updates are numbered sequentially starting with Update 1. When a new Edition is created, all Updates associated with the previous Edition are merged into the manual. Each new Edition or Update also includes a revised copy of this printing history page.

Many product updates and revisions do not require manual changes and, conversely, manual corrections may be done without accompanying product changes. Therefore, do not expect a one-to-one correspondence between product updates and manual updates.

Edition 1 (Part Number 44702-90001)	.....	MARCH 1987
Edition 2 (Part Number 44702-90002)	.....	JANUARY 1991

### RESTRICTED RIGHTS LEGEND

Use, duplication, or disclosure by the Government is subject to restrictions as set forth in subdivision (b)(3)(ii) of the Rights in Technical Data and Computer Software clause at 52.227-7013.

Hewlett-Packard Company  
3000 Hanover Street, Palo Alto, California 94304





**Herstellerbescheinigung**

Hiermit wird bescheinigt, daß das Gerät/System HP 3852A  
in Übereinstimmung mit den Bestimmungen von Postverfügung 1046/84 funkentstört ist.

Der Deutschen Bundespost wurde das Inverkehrbringen dieses Gerätes/Systems angezeigt und die Berechtigung zur Überprüfung der Serie auf Einhaltung der Bestimmungen eingeräumt.

**Zusatzinformation für Meß- und Testgeräte**

Werden Meß- und Testgeräte mit ungeschirmten Kabeln und/oder in offenen Meßaufbauten verwendet, so ist vom Betreiber sicherzustellen, daß die Funk-Entstörbestimmungen unter Betriebsbedingungen an seiner Grundstücksgrenze eingehalten werden.

**Manufacturer's declaration**

This is to certify that the equipment HP 3852A  
is in accordance with the Radio Interference Requirements of Directive FTZ 1046/84. The German Bundespost was notified that this equipment was put into circulation, the right to check the series for compliance with the requirements was granted.

**Additional Information for Test- and Measurement Equipment**

If Test- and Measurement Equipment is operated with unshielded cables and/or used for measurements on open set-ups, the user has to assure that under operating conditions the Radio Interference Limits are still met at the border of his premises.

**NOTICE**

The information contained in this document is subject to change without notice.

HEWLETT-PACKARD MAKES NO WARRANTY OF ANY KIND WITH REGARD TO THIS MATERIAL, INCLUDING, BUT NOT LIMITED TO, THE IMPLIED WARRANTIES OF MERCHANTABILITY AND FITNESS FOR A PARTICULAR PURPOSE. Hewlett-Packard shall not be liable for errors contained herein or for incidental or consequential damages in connection with the furnishing, performance or use of this material.

Hewlett-Packard assumes no responsibility for the use or reliability of its software on equipment that is not furnished by Hewlett-Packard.

This document contains proprietary information which is protected by copyright. All rights are reserved. No part of this document may be photocopied, reproduced or translated to another language without the prior written consent of Hewlett-Packard Company.

Copyright © 1985 by HEWLETT-PACKARD COMPANY



### **CERTIFICATION**

*Hewlett-Packard Company certifies that this product meets its published specifications at the time of shipment from the factory. Hewlett-Packard further certifies that its calibration measurements are traceable to the National Institute of Standards and Technologies, to the extent allowed by the the Institute's calibration facility, and to the calibration facilities of other International Standards Organization members.*

### **WARRANTY**

This Hewlett-Packard instrument product is warranted against defects in materials and workmanship for a period of one year from date of shipment. During the warranty period, Hewlett-Packard Company will, at its option, either repair or replace products which prove to be defective.

For warranty service or repair, this product must be returned to a service facility designated by -hp-. Buyer shall prepay shipping charges to -hp- and -hp- shall pay shipping charges to return the product to Buyer. However, Buyer shall pay all shipping charges, duties, and taxes for products returned to -hp- from another country.

Duration and conditions of warranty for this instrument may be superceded when the instrument is integrated into (becomes a part of) other -hp- instrument products.

Hewlett-Packard warrants that its software and firmware designated by -hp- for use with an instrument will execute its programming instructions when properly installed on that instrument. Hewlett-Packard does not warrant that the operation of the instrument, or software, or firmware will be uninterrupted or error free.

### **LIMITATION OF WARRANTY**

The foregoing warranty shall not apply to defects resulting from improper or inadequate maintenance by Buyer, Buyer-supplied software or interfacing, unauthorized modification or misuse, operation outside of the environmental specifications for the product, or improper site preparation or maintenance.

**NO OTHER WARRANTY IS EXPRESSED OR IMPLIED. HEWLETT-PACKARD SPECIFICALLY DISCLAIMS THE IMPLIED WARRANTIES OF MERCHANTABILITY AND FITNESS FOR A PARTICULAR PURPOSE.**

### **EXCLUSIVE REMEDIES**

**THE REMEDIES PROVIDED HEREIN ARE BUYER'S SOLE AND EXCLUSIVE REMEDIES. HEWLETT-PACKARD SHALL NOT BE LIABLE FOR ANY DIRECT, INDIRECT, SPECIAL, INCIDENTAL, OR CONSEQUENTIAL DAMAGES, WHETHER BASED ON CONTRACT, TORT, OR ANY OTHER LEGAL THEORY.**

### **ASSISTANCE**

*Product maintenance agreements and other customer assistance agreements are available for Hewlett-Packard products.*

*For any assistance, contact your nearest Hewlett-Packard Sales and Service Office. Addresses are provided at the back of this manual.*





## **SAFETY SUMMARY**

The following general safety precautions must be observed during all phases of operation, service, and repair of this instrument. Failure to comply with these precautions or with specific warnings elsewhere in this manual violates safety standards of design, manufacture, and intended use of the instrument. Hewlett-Packard Company assumes no liability for the customer's failure to comply with these requirements.

### **GROUND THE INSTRUMENT**

To minimize shock hazard, the instrument chassis and cabinet must be connected to an electrical ground.

### **DO NOT OPERATE IN AN EXPLOSIVE ATMOSPHERE**

Do not operate the instrument in the presence of flammable gases or fumes. Operation of any electrical instrument in such an environment constitutes a definite safety hazard.

### **KEEP AWAY FROM LIVE CIRCUITS**

Operating personnel must not remove instrument covers. Component replacement and internal adjustments must be made by qualified maintenance personnel. Under certain conditions, dangerous voltages may exist even with the instrument switched off. To avoid injuries, always disconnect input voltages and discharge circuits before touching them.

### **DO NOT SERVICE OR ADJUST ALONE**

Do not attempt internal service or adjustment unless another person, capable of rendering first aid and resuscitation, is present.

### **DO NOT SUBSTITUTE PARTS OR MODIFY INSTRUMENT**







Because of the danger of introducing additional hazards, do not install substitute parts or perform any unauthorized modification to the instrument. Return the instrument to a Hewlett-Packard Sales and Service Office for service and repair to ensure that safety features are maintained.

### **DO NOT OPERATE A DAMAGED INSTRUMENT**

Whenever it is possible that the safety protection features built into this instrument have been impaired, either through physical damage, excessive moisture, or any other reason, REMOVE POWER and do not use the instrument until safe operation can be verified by service-trained personnel. If necessary, return the instrument to a Hewlett-Packard Sales and Service Office for service and repair to ensure that safety features are maintained.

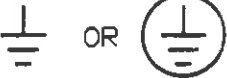
# Operating and Safety Symbols

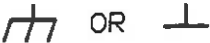
## Symbols Used On Products And In Manuals

-  **LINE** AC line voltage input receptacle.
-  Instruction manual symbol affixed to product. Cautions the user to refer to respective instruction manual procedures to avoid possible damage to the product.
-  Indicates dangerous voltage – terminals connected to interior voltage exceeding 1000 volts.
-  OR  Protective conductor terminal. Indicates the field wiring terminal that must be connected to earth ground before operating equipment – protects against electrical shock in case of fault.
-  Clean ground (low-noise). Indicates terminal that must be connected to earth ground before operating equipment – for single common connections and protection against electrical shock in case of fault.
-  OR  Frame or chassis ground. Indicates equipment chassis ground terminal – normally connects to equipment frame and all metal parts.
-  **ATTENTION  
Static Sensitive** Affixed to product containing static sensitive devices – use anti-static handling procedures to prevent electrostatic discharge damage to components.

---

### NOTE

#### NOTE

*Calls attention to a procedure, practice, or condition that requires special attention by the reader.*

---

---

### CAUTION

#### CAUTION

*Calls attention to a procedure, practice, or condition that could possibly cause damage to equipment or permanent loss of data.*

---

---

### WARNING

#### WARNING





*Calls attention to a procedure, practice, or condition that could possibly cause bodily injury or death.*

---

## WARNING, CAUTION, and NOTE Symbols

Some labels on the HP 3852A, HP 3853A, and plug-in accessories include an international warning symbol (triangle with subscripted number) which refers the reader to the manuals for further information. This table shows the warning symbols used for the HP 3852A/3853A and plug-in accessories. Refer to the manual set for specific information on WARNINGS, CAUTIONS, or NOTES referenced with a warning symbol.

**HP 3852A WARNING, CAUTION, and NOTE Symbols**

Symbol	Meaning	Location
	Shock hazard originating outside the instrument (field wiring)	<ul style="list-style-type: none"> <li>. Analog Extender Connector on Power Supply Modules</li> <li>. Terminal modules on plug-in accessories</li> <li>. Component module covers on plug-in accessories</li> </ul>
	Treat all channels as "one circuit" for safety purposes.	<ul style="list-style-type: none"> <li>. Inside terminal modules on plug-in accessories</li> <li>. Metal cover on component modules of plug-in accessories</li> </ul>
	Maximum number of certain plug-in accessories to be installed into an HP 3852A or HP 3853A.	<ul style="list-style-type: none"> <li>. HP 44701A, HP 44702A/B, HP 44727A/B/C plug-in accessories</li> </ul>
	If High-Speed FET multiplexers are used with the HP 44702A/B, ribbon cable may be connected.	<ul style="list-style-type: none"> <li>. HP 44711A, 44712A, 44713A (referenced on HP 44702A and HP 44702B)</li> </ul>



## TABLE OF CONTENTS

### Chapter 1 – Introduction

Manual Contents . . . . .	.1-1
Multiplexer Descriptions . . . . .	.1-2
Modes of Operation . . . . .	.1-2
Primary Applications . . . . .	.1-3
Measurement Guidelines . . . . .	.1-4
Warnings, Cautions, and Notes . . . . .	.1-7
Getting Started . . . . .	.1-9

### Chapter 2 – Configuring the HP 44711A/B

Chapter Contents . . . . .	.2-1
Block Diagram Description . . . . .	.2-1
Terminal Module Configuration . . . . .	.2-4
Installing Attenuators . . . . .	.2-4
Installing Low-Pass Filters . . . . .	.2-5
Current Sensing . . . . .	.2-6
Field Wiring Connections . . . . .	.2-6
Terminal Module Connections . . . . .	.2-6
Voltage Measurements Connections . . . . .	.2-6
Resistance Measurements Connections . . . . .	.2-7
Temperature Measurements Connections . . . . .	.2-9
Installation and Checkout . . . . .	.2-9
Check HP 44711A/B ID . . . . .	.2-11
Verify Wiring Connections . . . . .	.2-11
Read Channel State . . . . .	.2-12

### Chapter 3 – Configuring the HP 44712A

Chapter Contents . . . . .	.3-1
Block Diagram Description . . . . .	.3-1
Field Wiring Connections . . . . .	.3-4
Terminal Module Connections . . . . .	.3-4

Voltage Measurement Connections . . . . .	.3-4
Installation and Checkout . . . . .	.3-7
Check HP 44712A ID . . . . .	.3-7
Verify Wiring Connections . . . . .	.3-8
Read Channel State . . . . .	.3-8

### Chapter 4 – Configuring the HP 44713A/B

Chapter Contents . . . . .	.4-1
Block Diagram Description . . . . .	.4-1
Terminal Module Configuration . . . . .	.4-5
Installing Attenuators . . . . .	.4-5
Installing Low-Pass Filters . . . . .	.4-5
Current Sensing . . . . .	.4-5
Field Wiring Connections . . . . .	.4-7
Terminal Module Connections . . . . .	.4-7
Voltage Measurements Connections . . . . .	.4-7
Thermocouple Measurement Connections . . . . .	.4-8
Installation/Checkout . . . . .	.4-10
Check HP 44713A/B ID . . . . .	.4-10
Verify Wiring Connections . . . . .	.4-12
Read Channel State . . . . .	.4-12

### Chapter 5 – Programming the Multiplexers

Programming Overview . . . . .	.5-1
Command Summary . . . . .	.5-1
Example Program Titles . . . . .	.5-2
Making Measurements . . . . .	.5-3
Voltage Measurements . . . . .	.5-4
Current Measurements . . . . .	.5-8
Resistance Measurements . . . . .	.5-9
Temperature Measurements . . . . .	.5-13



# **Chapter 1**

## **Introduction**

# Contents

Manual Contents . . . . .	.1-1
Multiplexer Descriptions . . . . .	.1-2
Modes of Operation . . . . .	.1-2
Primary Applications . . . . .	.1-3
Measurement Guidelines . . . . .	.1-4
Warnings, Cautions, and Notes . . . . .	.1-7
Getting Started . . . . .	.1-9



# Introduction

---

## Manual Contents

This manual shows how to configure and program five HP 3852A high-speed FET multiplexer accessories:

- HP 44711A 24-Channel High-Speed FET Multiplexer
- HP 44711B 24-Channel High-Speed FET Multiplexer
- HP 44712A 48-Channel High-Speed Single-Ended FET Multiplexer
- HP 44713A 24-Channel High-Speed FET Multiplexer with Thermocouple Compensation.
- HP 44713B 24-Channel High-Speed FET Multiplexer with Thermocouple Compensation.

The B version of both the HP 44711 and HP 44713 have been developed to provide reduced settling time for use with the HP 44704A High-Speed Voltmeter's high resolution modes. Configuring and programming are the same for A and B versions.

In this manual, each multiplexer is referred to by its product number (HP 44711A/B, HP 44712A, or HP 44713A/B). Refer to the HP 3852A Mainframe Configuration and Programming Manual for additional information on the accessories. The manual has five chapters:

- **Introduction** contains a manual overview, summarizes multiplexer descriptions, lists WARNINGS, CAUTIONS, and NOTES which apply to the multiplexers, and shows suggested steps to get started.
- **Configuring the HP 44711A/B** contains a block diagram description of the HP 44711A/B and shows how to configure and connect field wiring to the terminal module.
- **Configuring the HP 44712A** contains a block diagram description of the HP 44712A and shows how to connect field wiring to the terminal module.
- **Configuring the HP 44713A/B** contains a block diagram description of the HP 44713A/B and shows how to configure and connect field wiring to the terminal module.
- **Programming the Multiplexers** shows how to program the multiplexers for voltage, current, resistance, and temperature measurements.

# Multiplexer Descriptions

The high-speed FET multiplexers switch (multiplex) signals from up to 24 two-wire inputs (HP 44711A/B and HP 44713A/B) or up to 48 single-ended inputs (HP 44712A). Measurements are made by the HP 44701A Integrating Voltmeter, the HP 44702A/B or HP 44704A High-Speed Voltmeters, or by external voltmeters.

## Modes of Operation

Each high-speed FET multiplexer has two modes of operation: backplane and ribbon cable. With backplane operation, the mainframe controls multiplexer operation. With ribbon cable operation (applicable to the HP 44702A/B and HP 44704A in Scanner Mode only), the HP 44702A/B or 44704A operates independently of the mainframe to control the multiplexers and make measurements.

### HP 44711A/B 24-Channel High-Speed FET Multiplexer

The HP 44711A/B consists of a component module and a 24-channel terminal module. User field wiring connects to the terminal module and signals are sent to switches on the component module. Each channel on an HP 44711A/B can be independently configured so multiple functions can be measured on the same accessory.

As noted, the HP 44711A/B has two modes of operation: backplane and ribbon cable. With backplane operation, the multiplexer is controlled by the mainframe with measurements made by an HP 44701A Integrating Voltmeter, by an HP 44702A/B or 44704A High-Speed Voltmeter, or by an external voltmeter. Maximum switching rate for backplane operation is 5500 channels/second (with mainframe ROM revision 2.0 or greater).

With ribbon cable operation, the HP 44711A/B is connected to an HP High-Speed Voltmeter (HP 44702A/B or 44704A) by a dedicated interface bus (ribbon cable). In ribbon cable operation, the HP High-Speed voltmeter operates independently of the mainframe and maximum switching rate is 100,000 channels/second.

### HP 44712A 48-Channel High-Speed Single-Ended FET Multiplexer

The HP 44712A uses the same component module as the HP 44711A but uses a 48-channel terminal module. Since only the HIGH terminal is switched, measurements with the HP 44712A are called single-ended measurements. Modes of operation and switching speeds for the HP 44712A are the same as for the HP 44711A.

## HP 44713A/B 24-Channel High-Speed FET Multiplexer

The HP 44713A uses the same component module as the HP 44711A. The HP 44713B uses the same component module as the HP 44711B. The HP 44713A/B adds an isothermal block on the terminal module for thermocouple measurement compensation. A thermistor mounted on the isothermal block measures the reference temperature and the mainframe uses "software compensation" to normalize measured temperature to a 0°C reference. Modes of operation for the HP 44713A/B are the same as for the HP 44711A/B. The HP 44713B provides reduced settling time compatible with the HP 44704A High-Speed Voltmeter's high resolution modes.

### Primary Applications

Table 1-1 shows recommended measurements and primary applications for the HP 44711A/B, HP 44712A, and HP 44713A/B.

**Table 1-1. Primary Applications**

Multiplexer	Recommended Measurements	Primary Applications
HP 44711A/B	<ul style="list-style-type: none"> <li>- AC/DC Voltage</li> <li>- AC/DC Current [1]</li> <li>- 4-Wire Ohms [2]</li> <li>- RTDs [3]</li> <li>- Thermistors [4]</li> </ul>	<ul style="list-style-type: none"> <li>- Differential measurements</li> <li>- Up to 24 inputs</li> <li>- Up to 100,000 channels/sec</li> <li>- Max input 10.24V peak.</li> </ul>
HP 44712A	<ul style="list-style-type: none"> <li>- AC/DC Voltage</li> </ul>	<ul style="list-style-type: none"> <li>- Single-ended measurements</li> <li>- Up to 48 inputs</li> <li>- Up to 100,000 channels/sec</li> <li>- Max input 10.24V peak.</li> </ul>
HP 44713A/B	<ul style="list-style-type: none"> <li>- AC/DC Voltage</li> <li>- AC/DC Current [1]</li> <li>- 2-Wire Ohms [5]</li> <li>- Thermocouple [6]</li> </ul>	<ul style="list-style-type: none"> <li>- Thermocouple measurements</li> <li>- Up to 24 inputs</li> <li>- Up to 100,000 channels/sec</li> <li>- Max input 10.24V peak.</li> </ul>
<p>Notes:</p> <p>[1] = Requires installation of resistor on terminal module.</p> <p>[2] = 2-wire ohms measurements are NOT recommended for the HP 44711A/B, 44712A, and 44713A/B due to high ON resistance (about 3.2 kΩ).</p> <p>[3] = 4-wire ohms measurement method recommended. HP 3852A supports Type 85 (<math>\alpha = 0.00385 \Omega/\Omega/^{\circ}\text{C}</math>) and Type 92 (<math>\alpha = 0.003916 \Omega/\Omega/^{\circ}\text{C}</math>) RTDs.</p> <p>[4] = 4-wire ohms measurement method recommended. HP 3852A supports Type 2252 (2252 Ω), 5K (5000 Ω), and 10K (10,000 Ω) thermistors.</p> <p>[5] = 2-wire ohms measurements intended for open thermocouple detection only.</p> <p>[6] = HP 3852A conversion program applicable only to B, E, J, K, N14 (AWG 14), N28 (AWG 28), R, S, and T types. Other thermocouples can be measured with user-supplied temperature conversion programs.</p>		

## Measurement Guidelines

Guidelines to make voltage, current, resistance, or temperature measurements with the HP 44711A/B, HP 44712A, or HP 44713A/B follow.

### Voltage Measurements

The HP 44711A/B, HP 44712A, and HP 44713A/B can be used for AC or DC voltage measurements. However, the HP 44711A/B and HP 44713A/B have differential capability while the HP 44712A has only single-ended measurement capability.

For higher accuracy voltage measurements, use the HP 44711A/B or HP 44713A/B to measure up to 24 channels per multiplexer. For measurements which do not require highest accuracy, use the HP 44712A to measure up to 48 channels per multiplexer.

### Current Measurements

The HP 44711A/B and HP 44713A/B use current sensing to make current measurements. When making a current sensing measurement, the voltage across a user-supplied shunt resistor is measured and the current is calculated (in the controller) using the measured voltage and the shunt resistance value.

---

### NOTE

*Current sensing measurements are not recommended when making temperature measurements on the same HP 44713A/B terminal module since the heat produced by the shunt resistor may affect the accuracy of the temperature measurements.*

---

### Resistance Measurements

The HP 44711A/B can be used for 2-wire ohms and 4-wire ohms measurements. The HP 44712A and HP 44713A/B can be used for 2-wire ohms measurements only.

#### ● 2-Wire Ohms Measurements:

You CAN use 2-wire ohms to make up to 24 resistance measurements per HP 44711A/B or HP 44713A/B or up to 48 resistance measurements per HP 44712A. However, since each FET has up to 1.6 k $\Omega$  of ON resistance (3.2 k $\Omega$  total/channel), 2-wire ohms measurements are NOT recommended.

- **4-Wire Ohms Measurements:**

Using 4-wire ohms measurements virtually eliminates the error caused by the field wiring resistances. The current through the unknown resistance is the same regardless of the wiring resistance, but the voltmeter measures only the voltage across the unknown resistance, not across the combined field wiring resistance and the unknown resistance.

The 4-wire ohms function is essential when highest accuracy is required. Since each 4-wire ohms measurement requires two channels, up to 12 resistance measurements can be made per HP 44711A/B accessory.

### **Temperature Measurements**

The HP 44711A/B can be used to make 4-wire ohms temperature measurements of resistance temperature detectors (RTDs) and thermistors. The HP 44713A/B can be used to measure thermocouple temperatures. Although the HP 44712A and HP 44713A/B CAN be used for 2-wire ohms temperature measurements, this is not recommended due to high ON resistance of the FETs (about 3 k $\Omega$ ) which causes errors in 2-wire ohms measurements.

- **RTD Measurements:**

The resistance temperature detector (RTD) is a temperature sensitive resistor that is typically stable, accurate, and linear. The HP 3852A resistance-to-temperature conversions support Type 85 and Type 92 RTDs (temperature coefficients ( $\alpha$ ) of 0.00385  $\Omega/\Omega/^\circ\text{C}$  and 0.003916  $\Omega/\Omega/^\circ\text{C}$ , respectively, and resistance values of 100  $\Omega$  at 0 $^\circ\text{C}$ ).

Most RTDs have small resistance values (typically less than 300  $\Omega$ ) which makes RTDs unusable with 2-wire ohms measurements. Thus, the most accurate RTD measurement method is the 4-wire ohms measurement function. Since each 4-wire ohms measurement requires two channels, a single HP 44711A/B can be used to make up to 12 RTD measurements.

- **Thermistor Measurements:**

Thermistors are capable of detecting small changes in temperature and are used in applications where temperature extremes are not too high. Most thermistors have negative temperature coefficients so their resistance value decreases with increasing temperature.

The HP 3852A allows thermistors to be measured using 4-wire ohms. Since each 4-wire ohms measurement requires two channels, up to 12 thermistors can be measured per HP 44711A/B. The HP 3852A resistance-to-temperature conversions support Type 2252, 5K, and 10K thermistors (resistance values at 25 $^\circ\text{C}$  of 2252  $\Omega$ , 5 k $\Omega$ , and 10 k $\Omega$ , respectively).

● **Thermocouple Measurements:**

Thermocouples provide simple, durable, inexpensive, and relatively accurate temperature sensors for a wide variety of applications and environmental conditions. The thermocouple is a junction of two dissimilar metals which produces a voltage related to the junction temperature.

The HP 44713A/B is primarily used for thermocouple measurements. Up to 24 thermocouple measurements can be made per HP 44713A/B multiplexer. The HP 3852A temperature conversions support B, E, J, K, N14, N28, R, S, and T type thermocouples.

Since channels on the HP 44713A/B can be independently configured and software compensation is used, any mixture of thermocouple types can be measured. However, separate commands must be executed for each type of thermocouple.

The HP 3852A does not directly measure the temperature of thermocouples, but measures the voltages generated by the thermocouples. The measured voltage is a function of the actual temperature of the thermocouples.

The problem with this is that the voltage measured by the HP 3852A is different from the actual thermocouple voltage (due to junction voltages on the terminal module) unless some compensating technique is used. The HP 3852A uses a technique called software compensation. Refer to Table 1-2 for the steps used for software compensated thermocouple measurements.

**Table 1-2. Thermocouple Software Compensation Steps**

1. Measure the resistance of the thermistor mounted on the isothermal connector block and compute the isothermal block reference temperature ( $T_{ref}$ ).
2. Measure the voltage produced by the thermocouple system ( $V_t$ ).
3. Convert the isothermal block reference temperature ( $T_{ref}$ ) to a thermocouple reference voltage ( $V_{ref}$ ). Since the thermocouple reference voltage depends upon the type of thermocouple being compensated, the value returned for  $V_{ref}$  will be different for each type of thermocouple.
4. Compute the absolute value of  $V_t$  (step 2) -  $V_{ref}$  (step 3). That is,  $V = |V_t - V_{ref}|$
5. Convert  $V$  computed in step 4 to an equivalent temperature in °C.

# Warnings, Cautions, and Notes

This section summarizes WARNINGS, CAUTIONS, and NOTES which apply to the HP 44711A/B, HP 44712A, and HP 44713A/B. You should review the WARNINGS and CAUTIONS before handling or configuring any multiplexer.

---



## WARNING

*SHOCK HAZARD. Only qualified, service-trained personnel who are aware of the hazards involved should install, remove, or configure any accessory. Before touching any installed accessory, turn off all power to the mainframe, extenders, and to all external devices connected to the mainframe, extenders, or accessories.*

---



## WARNING

*POSSIBLE OPERATOR INJURY. For safety, consider all accessory channels to be at the highest potential applied to any channel. Under most conditions of failure, the relays on the relay multiplexers will remain in the position programmed before the failure.*

*However, for some equipment failures, the relays may not remain in their programmed state. If the relays settle in the closed state, the relay contacts may weld together and the highest voltage present on any one channel may be present on all channels. This condition may cause operator injury if the terminals are touched, or further equipment damage may result.*

---





---

## WARNING

**MAXIMUM VOLTAGE LIMITATIONS.** *The HP 3852A and the HP 3853A internal analog buses interconnect the multiplexer and voltmeter accessories to form one circuit. To protect against possible personal injury due to equipment failure or programming error, limitations are placed on the potentials that can appear between any two points in the circuit (or between the circuit and chassis). These limitations are listed for the HP 3852A, HP 3853A, and all plug-in accessories. For any given set of accessories installed in the mainframe or extender, the maximum potential between any two points is determined by the accessory with the LOWEST peak voltage limitations, as follows. (If the analog extender cable is NOT connected between the mainframe and the extenders, each instrument is considered as a separate circuit.)*

Instrument/Accessory	Peak Voltage
HP 3852A Mainframe	354 V
HP 3853A	354 V
HP 44701A Integrating Voltmeter	354 V
HP 44702A/B or HP 44704A High-Speed Voltmeter	42 V
HP 44705A/08A/17A/18A 20-Channel Relay Multiplexers	170 V
HP 44705H/08H 20-Channel High-Voltage Relay Multiplexers	354 V
HP 44706A 60-Channel Relay Multiplexer	42 V
HP 44709A/10A/11A/12A/13A FET Multiplexers	42 V

---

---

## NOTE

**SHIELDED CABLE REQUIRED.** *For measurements with the HP 44702A/B or HP 44704A High-Speed Voltmeter, shielded twisted-pair cable is required for connections to the HP 44711A/B, 44712A, or 44713A/B terminal module. shielded twisted-pair cable is highly recommended for measurements with the HP 44701A Integrating Voltmeter.*

*You can order the appropriate cable from your nearest Hewlett-Packard Sales and Support Office. Order HP part number 03498-61602 which is a 2 meter cable with crimped and heat-shrunk wires attached to the braided shield at both ends.*

---

---

## NOTE

**HP-IB ADDRESS.** *The example programs in this manual use "709" as the HP-IB address for the HP 3852A. Specific slot and channel numbers are also used. Program syntax and data return formats apply to the HP Series 200/300 controllers. Modify slot and channel numbers and program syntax as required.*

---



# Getting Started

To use an HP 44711A/B, HP 44712A, or HP 44713A/B for your application, you will need to do three things:

- Define your application.
- Configure the multiplexer.
- Program the multiplexer.

## Define Your Application

The first step is to define your application and select the multiplexer for the requirements of your application. When selecting devices to be connected, refer to the Specifications appendix in the HP 3852A Mainframe Configuration and Programming Manual to ensure that the voltage and current requirements of your application are within multiplexer specifications.

## Configure the Multiplexer

The next step is to configure the multiplexer for your application. If you use the HP 44711A/B, refer to Chapter 2 - Configuring the HP 44711A/B for terminal module configuration and field wiring connections.

If you use the HP 44712A, refer to Chapter 3 - Configuring the HP 44712A to connect field wiring to the terminal module. If you use the HP 44713A/B, refer to Chapter 4 - Configuring the HP 44713A/B for terminal module configuration and field wiring connections.

## Program the Multiplexer

When the multiplexer has been configured, the third step is to program the accessory for your application. Refer to Chapter 5 - Programming the Multiplexers to program the multiplexer for voltage, current, resistance, or temperature measurements, as applicable.



# **Chapter 2**

## **Configuring the HP 44711A/B**

# Contents

Chapter Contents . . . . .	2-1
Block Diagram Description . . . . .	2-1
Terminal Module Configuration . . . . .	2-4
Installing Attenuators . . . . .	2-4
Installing Low-Pass Filters . . . . .	2-5
Current Sensing . . . . .	2-6
Field Wiring Connections . . . . .	2-6
Terminal Module Connections . . . . .	2-6
Voltage Measurements Connections . . . . .	2-6
Resistance Measurements Connections . . . . .	2-7
Temperature Measurements Connections . . . . .	2-9
Installation and Checkout . . . . .	2-9
Check HP 44711A/B ID . . . . .	2-11
Verify Wiring Connections . . . . .	2-11
Read Channel State . . . . .	2-12

# Configuring the HP 44711A/B

---

---

## Chapter Contents

This chapter shows how to configure the HP 44711A and HP 44711B multiplexers. The HP 44711B provides reduced settling time for use with the HP 44704A High-Speed Voltmeter's high resolution modes. Otherwise, the A and B versions of the HP 44711 are identical. The chapter contains a block diagram description of the HP 44711A/B, shows how to hardware configure the terminal module, and shows how to connect field wiring to the terminal module.

When you have configured the HP 44711A/B for your application, refer to Chapter 5 - Programming the Multiplexers to program the HP 44711A/B for voltage, current, resistance, or temperature measurements.

## Block Diagram Description

The HP 44711A/B consists of a 24-channel terminal module and a component module as shown in Figure 2-1. Field wiring from your application sensors connects to the terminal module and the signals are sent to switches on the component module.

### Component Module

The component module consists of 28 switches divided into two categories: bank switches and tree switches. Each switch consists of two Field Effect Transistors (FETs), one each for HIGH and LOW lines. There are 24 bank switches divided into two groups of 12 channels each: Bank A (channels 0 through 11) and Bank B (channels 12 through 23).

---

### NOTE

*Only one channel per bank can be closed at a time. Closing a second channel in a bank will open any previously closed channel in that bank.*

---

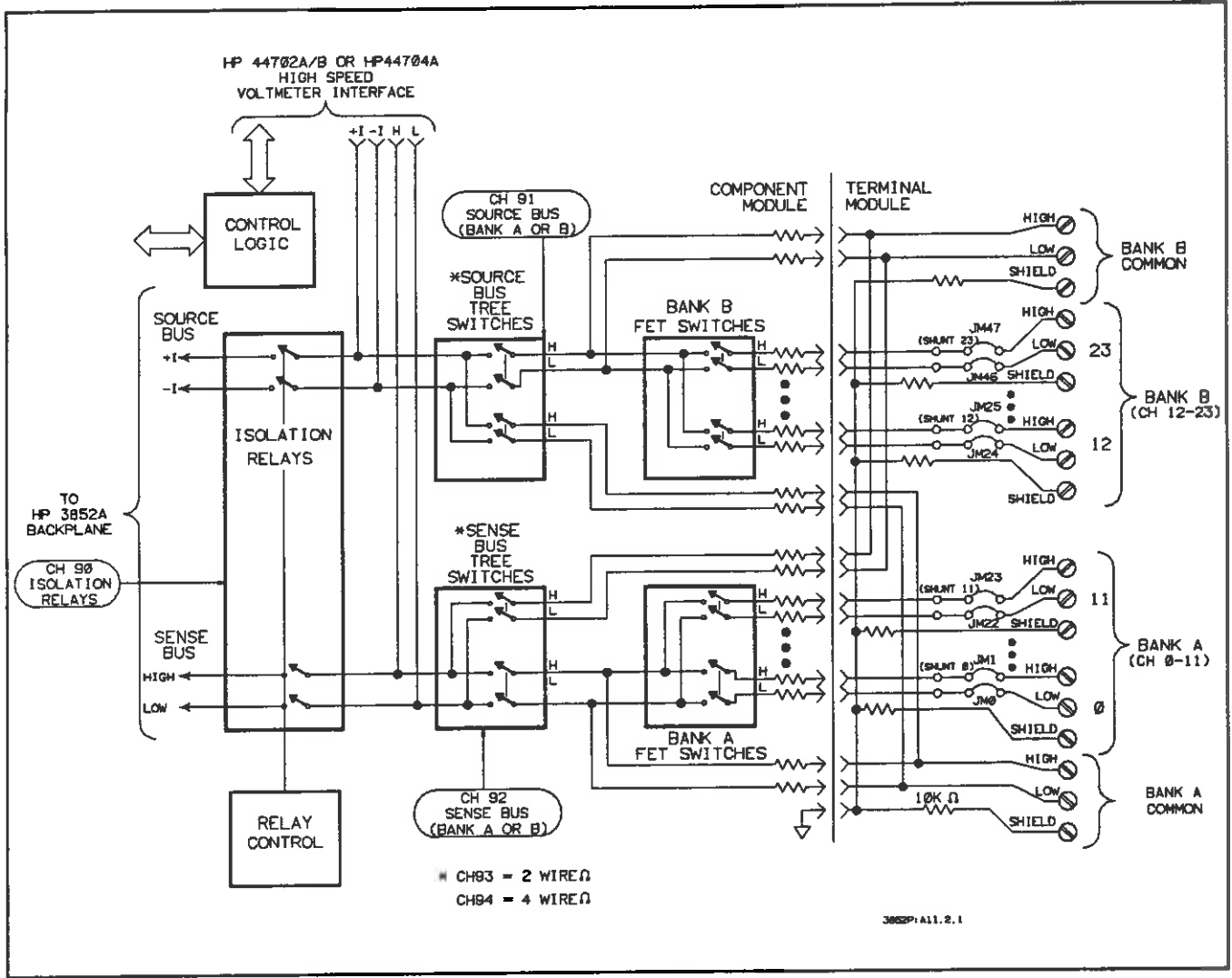

Figure 2-1. HP 44711A/B Block Diagram

The component module contains two types of tree switches: Source Bus and Sense Bus. Each bank has a Source Bus tree switch and a Sense Bus tree switch. The tree switches determine signal flow to and from the mainframe backplane or to an HP 44702A/B or HP 44704A High-Speed Voltmeter interface bus. Tree switches also isolate unused bank switches from the backplane and from the high speed interface bus.

Sense Bus tree switches provide connections to the backplane or to the HP High-Speed Voltmeter interface bus for voltage measurements. Source Bus tree switches provide backplane connections to the HP 44701A or HP High-Speed Voltmeters (HP 44702A/B or HP 44704A) current sources (+I and -I) for resistance measurements. Source Bus tree switches also provide connections to the HP High-Speed Voltmeter current sources (+I and -I) via the high speed voltmeter interface bus for resistance measurements.

The component module has two isolation relays which allow the HP 44711A/B to be isolated from the mainframe backplane. Isolation relays can be used to reduce leakage currents on the backplane or when using the backplane at voltages greater than the  $\pm 10.24$  V peak limitation of the HP 44711A/B.

Isolation relays are automatically opened when voltages greater than  $\pm 12$  volts peak are detected on the backplane or when the HP 44711A/B is used with an HP High-Speed Voltmeter in ribbon cable mode.

### **Terminal Module**

The terminal module has 24 channels of terminal connectors to connect field wiring and a BANK A COMMON and BANK B COMMON connection. The BANK A COMMON and BANK B COMMON terminals can be used to connect an external voltmeter or for diagnostic procedures.

As factory configured, there is a 10 k $\Omega$  current limiting resistor in series with each input channel SHIELD terminal and with the BANK A and BANK B COMMON SHIELD terminals.

### **Channel Definitions**

Table 2-1 defines channel numbers for the HP 44711A/B. When using high-level commands (such as CONFMEAS or MEAS), the appropriate tree switches and bank switches are automatically closed along with the measurement channel by the command. However, when using low-level commands such as CLOSE, the appropriate bank and tree switch channels (as defined in Table 2-1) must be specified as well as the measurement channel.

For example, to make voltage measurements on channel 0 using CLOSE, you will need to close the Sense Bus tree switch (channel 92), the isolation relay (channel 90), and the measurement channel (channel 0).

To make 2-wire ohms measurements with CLOSE, the easiest way is to close channel 93 (2-wire ohms), the isolation relay (channel 90), and the measurement channel. Or, to make 4-wire ohms measurements, close channel 94 (4-wire ohms), the isolation relay (channel 90), and the measurement channel.

**Table 2-1. HP 44711A/B Channel Definitions**

Channel	Definitions
0 - 11	Bank A Switches
12 - 23	Bank B Switches
90	Isolation Relays
91	Source Bus Tree Switch (Bank A or Bank B)*
92	Sense Bus Tree Switch (Bank A or Bank B)*
93	2-Wire Ohms Configuration
94	4-Wire Ohms Configuration

Notes:  
 \* = The Source or Sense Bus is connected to Bank A if a channel from 0 through 11 is selected. The Source or Sense Bus is connected to Bank B if a channel from 12 through 23 is selected.

## Terminal Module Configuration

This section shows how to install attenuators and low-pass filters on the HP 44711A/B terminal module for input signal conditioning and shows how to install resistors on the terminal module for current sensing applications. Figure 2-2 shows typical configurations for attenuators, low-pass filters, and current sensing.

### Installing Attenuators

As required, you can install attenuators in each channel to reduce input signals to a usable level. Figure 2-2 shows how to install an attenuator on channel 20 of the terminal module. To install the attenuator, remove the SERIES JM40 and SERIES JM41 jumpers and install resistors R1 and R3 in their places. Then, install resistor R2 in the SHUNT UC20 position. To maintain the best common mode noise rejection, use  $R1 = R3$ . Attenuation is:

$$V_{out} = V_{in} \left[ \frac{R2}{(R1 + R2 + R3)} \right]$$



# Installing Low-Pass Filters

As required, you can also install low-pass filters for input signal conditioning on each channel. Figure 2-2 shows how to install a low-pass filter on channel 11 of the terminal module. To install the low-pass filter, remove the SERIES JM22 and SERIES JM23 jumpers and install resistors R1 and R2 in their places. Then, install capacitor C in the SHUNT UC11 position. To maintain best common mode noise rejection, use  $R1 = R2$ . The filter time constant is:

$$T_f = C(R1 + R2)$$

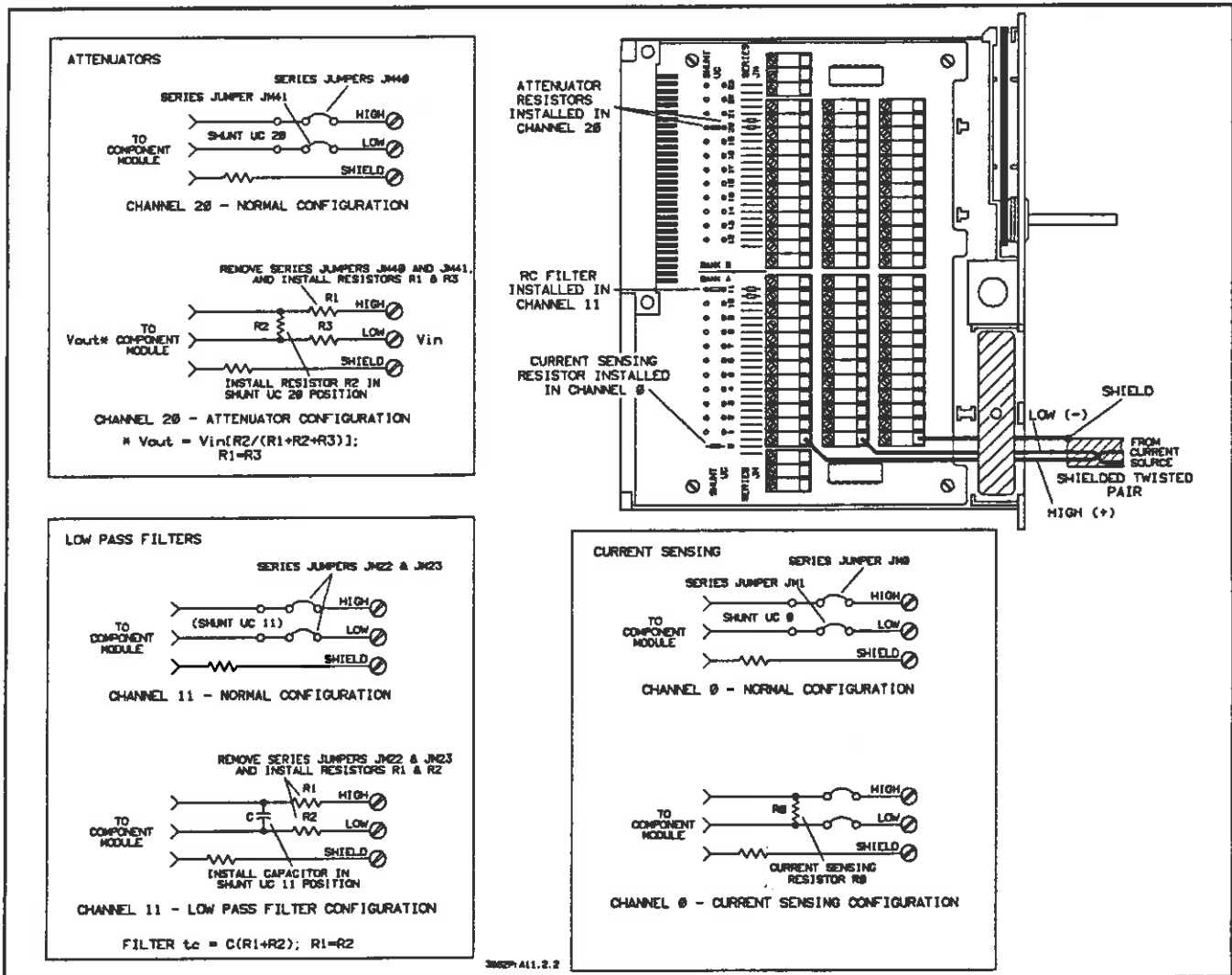

Figure 2-2. HP 44711A/B Terminal Module Configuration

**Current Sensing** The HP 44711A/B uses current sensing to make current measurements. When making a current sensing measurement, the voltage across a shunt resistor is measured and the current is calculated by the controller using the measured voltage and the shunt resistance value.

Figure 2-2 shows how to configure channel 0 for current sensing measurements. In Figure 2-2, a 250  $\Omega$  shunt resistor (R0) is installed in the shunt position (SHUNT UC0) for channel 0 on the terminal module. Note that the SERIES JM jumper (JM0 in this example) MUST be in place on each channel used for current measurements.

## Field Wiring Connections

When the terminal module is configured, the next step is to connect field wiring from your application to the terminal module. This section shows example field wiring connections to the HP 44711A/B terminal module for voltage, resistance, or temperature measurements.

### Terminal Module Connections

Figure 2-3 shows the HP 44711A/B terminal module with the cover removed. Each of the 24 channels has a HIGH, LOW, and SHIELD terminal. Terminals 0 through 11 in Bank A are for channels 0 through 11 respectively. Terminals 12 through 23 in Bank B are for channels 12 through 23 respectively.

When connecting field wiring to the terminal module, route the wires under the strain relief clamp and tighten the clamp screw to reduce the chance of wires being pulled out of the terminal connectors. If the clamp screw is loosened far enough, the strain relief clamp can be rotated to make it easier to route the wiring.

When connecting components such as resistors, the lead length may be too short to route through the strain relief clamp. In this case, the components will have to be stored inside the terminal module. When connecting these components, make sure that no leads are shorted together and bend the leads to allow the terminal module cover to be replaced.

### Voltage Measurements Connections

The HP 44711A/B can switch signals for up to 24 differential DC or AC voltage measurements. HIGH and LOW are switched on each selected channel. A SHIELD line is provided on each channel for maximum common mode noise rejection but is not switched.

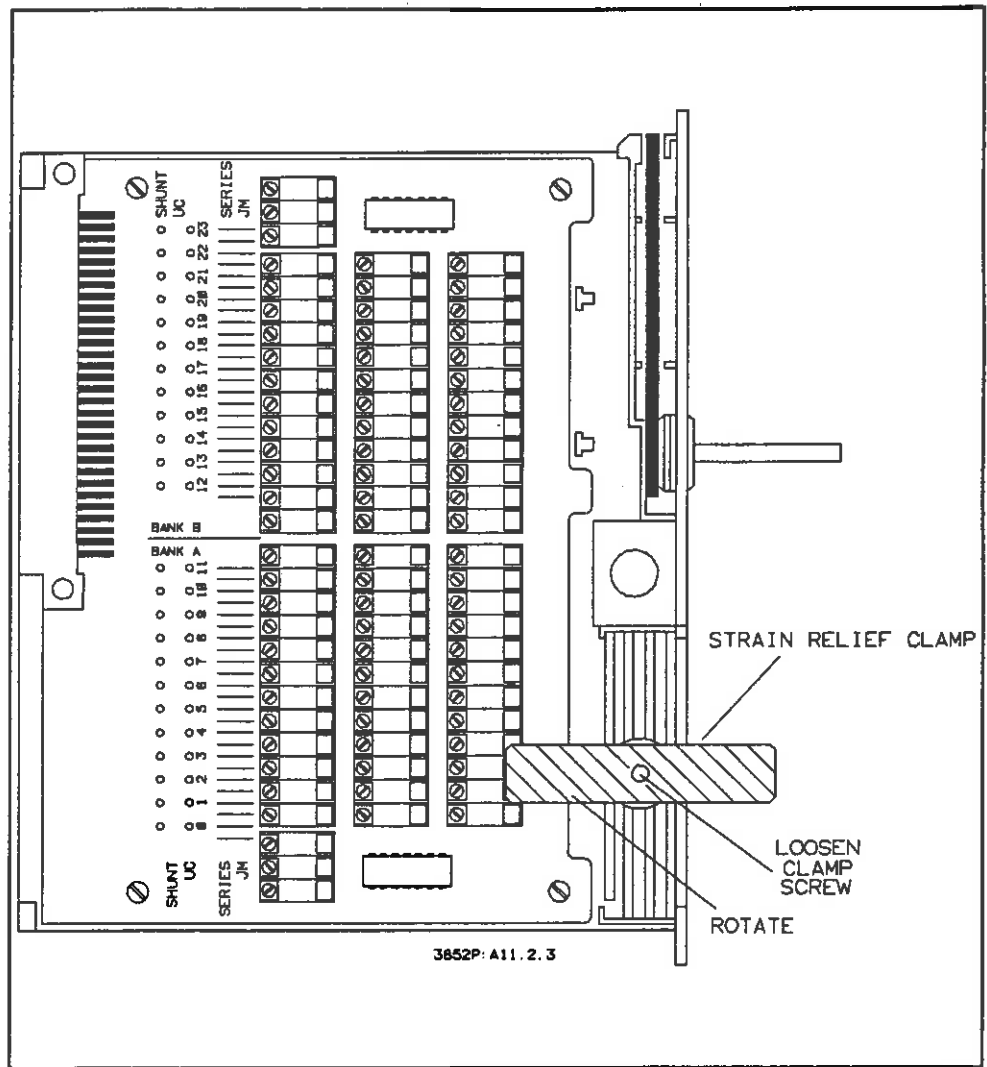

Figure 2-3. HP 44711A/B Terminal Module

Figure 2-4 shows typical voltage measurement connections to channel 0 on the terminal module. Note that shielded cable is required for measurements with the HP 44702A/B and HP 44704A voltmeter and is highly recommended for measurements with the HP 44701A voltmeter. For the HP 44702A/B voltmeter, connect an external resistor (R) between V0 LO and the shield, as shown in Figure 2-4.

## Resistance Measurements Connections

Because of the high ON resistance (about 3.2 k $\Omega$  per channel), only 4-wire ohms are recommended for HP 44711A/B resistance measurements. Figure 2-5 shows typical 4-wire ohms connections of a resistance (R0) connected to channels 0 and 12 using shielded, twisted-pair cable. Channel 0 is the voltage Sense channel and channel 12 is the current Source channel for the measurement.

VOLTAGE MEASUREMENTS

HP 44711A/B TERMINAL MODULE

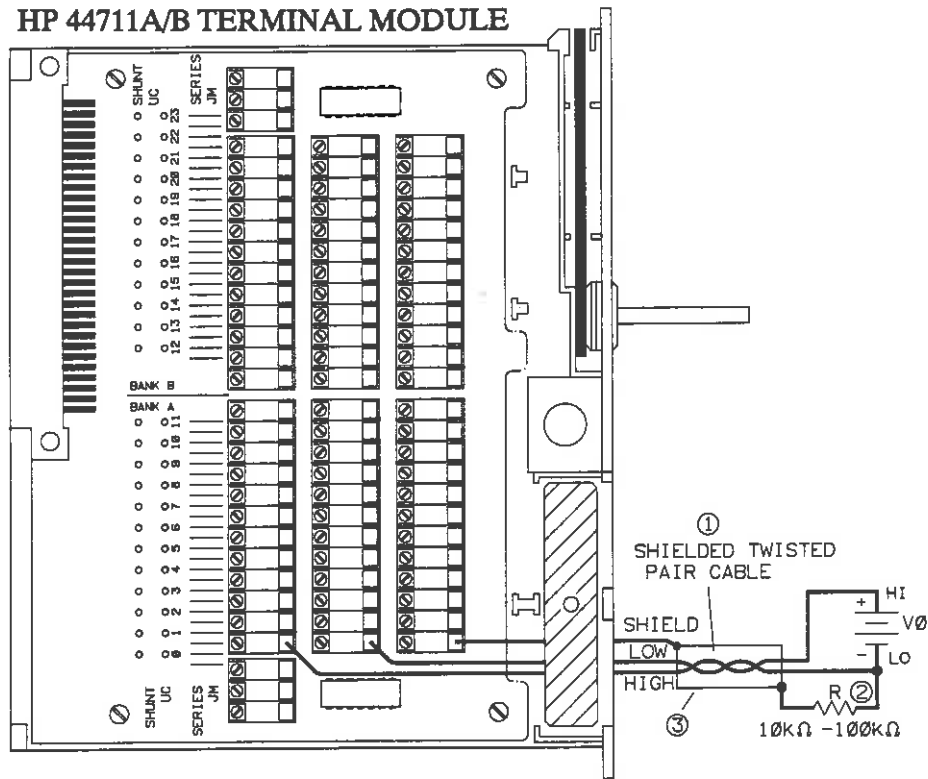

3852P: A11. 2. 4

**Notes:**

[1] = Shielded cable is required for HP 44702A/B and HP 44704A measurements and is highly recommended for HP 44701A measurements.

[2] = For HP 44701A measurements, make a direct connection from the shield to VO LO.

[3] = If shield cable is not used (HP 44701A measurements only), connect separate lead from channel 0 SHIELD to VO LO.

Figure 2-4. HP 44711A/B Voltage Connections

Each 4-wire ohms measurement requires two channels, one from Bank A and one from Bank B. When connecting a resistor to the terminal module for 4-wire ohms measurements, use two channels separated by 12 (such as channels 0 and 12, channels 1 and 13, etc.).

In Figure 2-5, one end of the Sense cable (channel 0) shield lead connects to the channel 0 SHIELD and the other end connects to R0 LO. However, although one end of the Source cable (channel 12) shield lead connects to channel 12 SHIELD, the other end of the shield lead does not connect to R0 LO. Do NOT connect the Source cable shield lead to R0 LO, as this will reduce the effective compliance voltage.

If you do not use shielded cable, connect channel 0 HIGH and LOW and channel 12 HIGH and LOW terminals to the resistor and connect a separate lead from the Sense channel (channel 0) SHIELD terminal to R0 LO. However, measurement accuracy with unshielded leads will not be as high as with shielded cable, since unshielded leads do not provide noise immunity.

## Temperature Measurements Connections

This subsection shows how to connect RTDs and thermistors to the HP 44711A/B terminal module for temperature measurements using 4-wire ohms. Each 4-wire RTD or thermistor measurement requires two channels, one from Bank A and one from Bank B. When connecting an RTD or thermistor to the terminal module for a 4-wire measurement, use two channels that are separated by 12 (such as channels 0 and 12, channels 1 and 13, etc.). See Figure 2-5 in "Resistance Measurements Connections" for a typical connection diagram.

## Installation and Checkout

This section shows how to check identity, verify field wiring connections, and read channel states of an HP 44711A/B.

---

### NOTE

*For ribbon cable operation, the cable must be connected between the HP 44711A/B and the HP 44702A/B or HP 44704A voltmeter. For backplane operation, the ribbon cable must NOT be connected. Refer to the HP 3852A Mainframe Configuration and Programming Manual to connect or disconnect the ribbon cable*

---

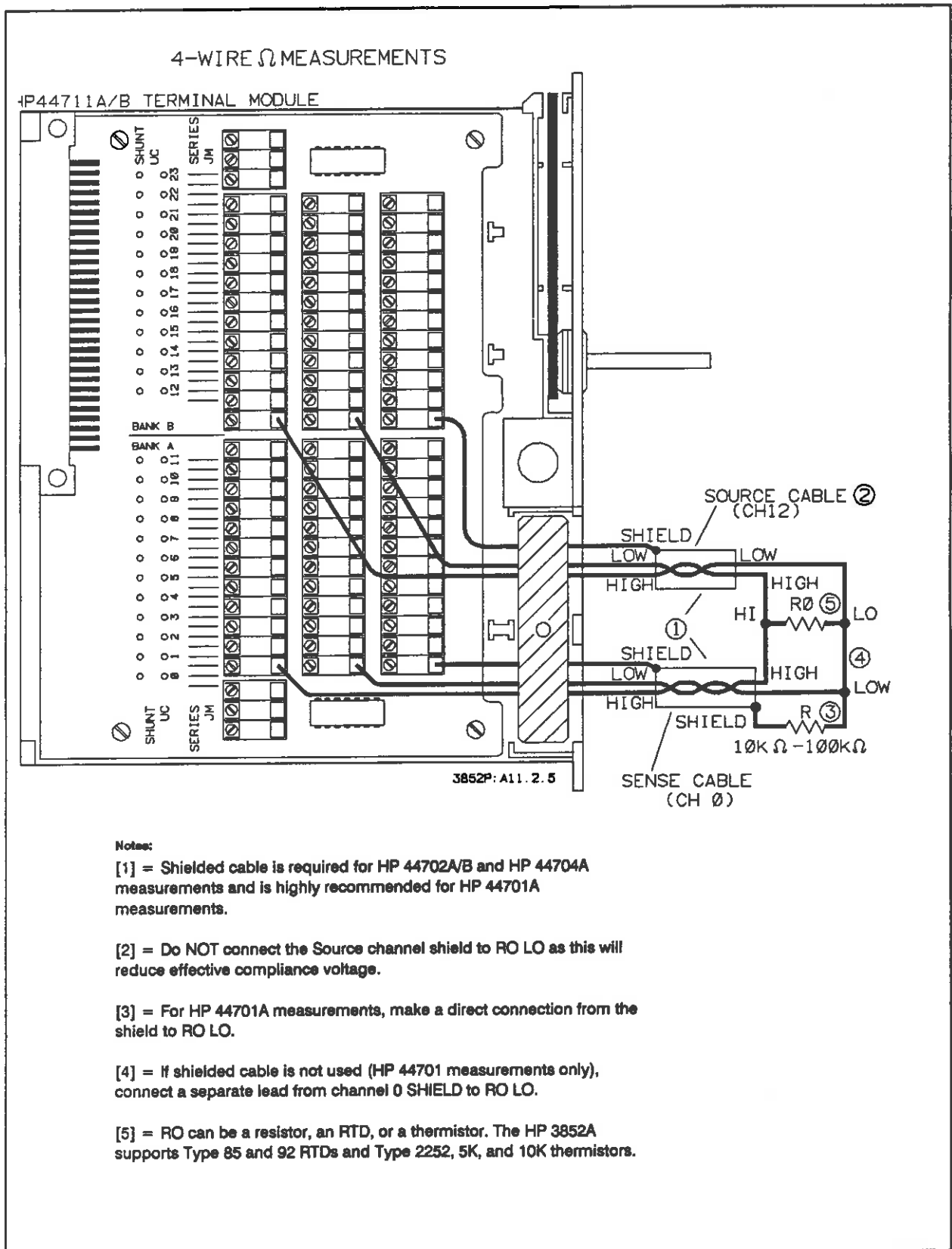

**Figure 2-5. HP 44711A/B 4-Wire Ohms Connections**

## Check HP 44711A/B ID

When you have connected field wiring to the terminal module, replace the terminal module cover and install the HP 44711A/B in the desired mainframe or extender slot. Refer to the HP 3852A Mainframe Configuration and Programming Manual to connect the terminal module to the component module and to install the HP 44711A/B.

Then, use ID? to check the HP 44711A/B ID. At power-on, an HP 44711A/B returns 44711. An HP 44711A/B component module only (no terminal module attached) returns 447XXX. (If the terminal module is removed after power-on, the accessory still returns 44711.)

If the multiplexer does not return 44711 be sure you have addressed the correct slot and the terminal module is installed. If these are correct but the correct ID code is not returned, refer to the HP 3852A Assembly Level Service Manual for service procedures.

### Example: Checking Accessory ID

This program queries the identity of an accessory in slot 5 of the mainframe. An HP 44711A in this slot returns 44711A.

```
10 OUTPUT 709;"ID? 500"           ! Query ID in mainframe slot 5
20 ENTER 709;A$                   ! Enter ID
30 PRINT A$                        ! Display ID
40 END
```

## Verify Wiring Connections

To verify that field wiring has been properly connected to the terminal module, you can send MONMEAS (Monitor/Measure) from the mainframe front panel or from a controller. MONMEAS can be used to check DC voltage or resistance connections.

### Example: Checking Wiring Connections

This program uses MONMEAS to verify wiring connections to channels 500 through 523 of an HP 44711A. CONF configures the voltmeter in slot 6 for DC voltage measurements.

The 24 channels are scanned and measured one at a time starting with channel 500. Press the SADV KEY key on the mainframe front panel to advance the scan to the next channel. When the scan is advanced past the last channel (channel 523), the scan stops and the last measurement remains on the display.

```
10 OUTPUT 709;"USE 600"           ! Use voltmeter in mainframe slot 6
20 OUTPUT 709;"CONF DCV"         ! Set DC volts function on voltmeter
30 OUTPUT 709;"MONMEAS DCV,500-523" ! Monitor/measure ch 500 through 523
40 END
```

## Read Channel State

CLOSE? can be used to determine the state of HP 44711A/B channels. This command returns 0, 1, 2, 3, or 4 as shown in Table 2-2 for each channel queried. (CLOSE? returns only 0 (open) or 1 (closed) for the state of the isolation relays and the tree switches.)

Table 2-2. Values Returned by CLOSE?

Value Returned*	Channel State
0	Channel Open
1	Channel Closed - not connected to a bus
2	Channel Closed - connected to Sense Bus
3	Channel Closed - connected to Source Bus
4	Channel Closed - connected to both buses

Note:  
\* = Only 0 (open) or 1 (closed) is returned for isolation relays (channel 90) and tree switches (channel 91 or 92).

### Example: Reading Channel State

This program uses CLOSE? to check the state of channels 500 through 504 on an HP 44711A. RST (reset) resets the multiplexer to its power-on state with all channels open. CLOSE closes channel 503, the isolation relay (channel 590), and the Sense Bus tree switch (channel 592). OPEN opens the channel, the isolation relay, and the tree switch.

```
10 OUTPUT 709;"RST 500"           ! Open all chs
20 INTEGER State(O:4)             ! Define controller array
30 OUTPUT 709;"CLOSE 503,590,592" ! Close ch 503, iso relay, tree switch
40 OUTPUT 709;"CLOSE? 500-504"    ! Query state of chs 500 through 504
50 ENTER 709;State(*)            ! Enter channel states
60 PRINT State(*)                 ! Display channel states
70 OUTPUT 709;"OPEN 503,590,592"  ! Open ch 503, iso relay, tree switch
80 END
```

Since channel 503 was the only channel closed and was connected to the Sense Bus tree switch, a typical return is:

```
0 0 0 2 0
```



# **Chapter 3**

## **Configuring the HP 44712A**

# Contents

Chapter Contents . . . . .	3-1
Block Diagram Description . . . . .	3-1
Field Wiring Connections . . . . .	3-4
Terminal Module Connections . . . . .	3-4
Voltage Measurement Connections . . . . .	3-4
Installation and Checkout . . . . .	3-7
Check HP 44712A ID . . . . .	3-7
Verify Wiring Connections . . . . .	3-8
Read Channel State . . . . .	3-8

# Configuring the HP 44712A

---

---

## Chapter Contents

This chapter shows how to configure the HP 44712A multiplexer. It contains a block diagram description of the HP 44712A and shows how to connect field wiring to the terminal module.

When you have configured the HP 44712A, refer to Chapter 5 - Programming the Multiplexers to program the HP 44712A for voltage measurements.

## Block Diagram Description

The HP 44712A consists of a 48-channel terminal module and a component module as shown in Figure 3-1. Field wiring from your application sensors connects to the terminal module and the signals are sent to switches on the component module.

### Component Module

The component module consists of two types of switches: bank switches and tree switches. There are 48 bank switches divided into two groups of 24 channels each: Bank A and Bank B. The HP 44712A switches the HIGH line only. LOW is common to all channels and to chassis but is not switched.

---

### NOTE

*Only one channel per bank can be closed at a time. Closing a second channel in a bank will open any previously closed channel in that bank.*

---

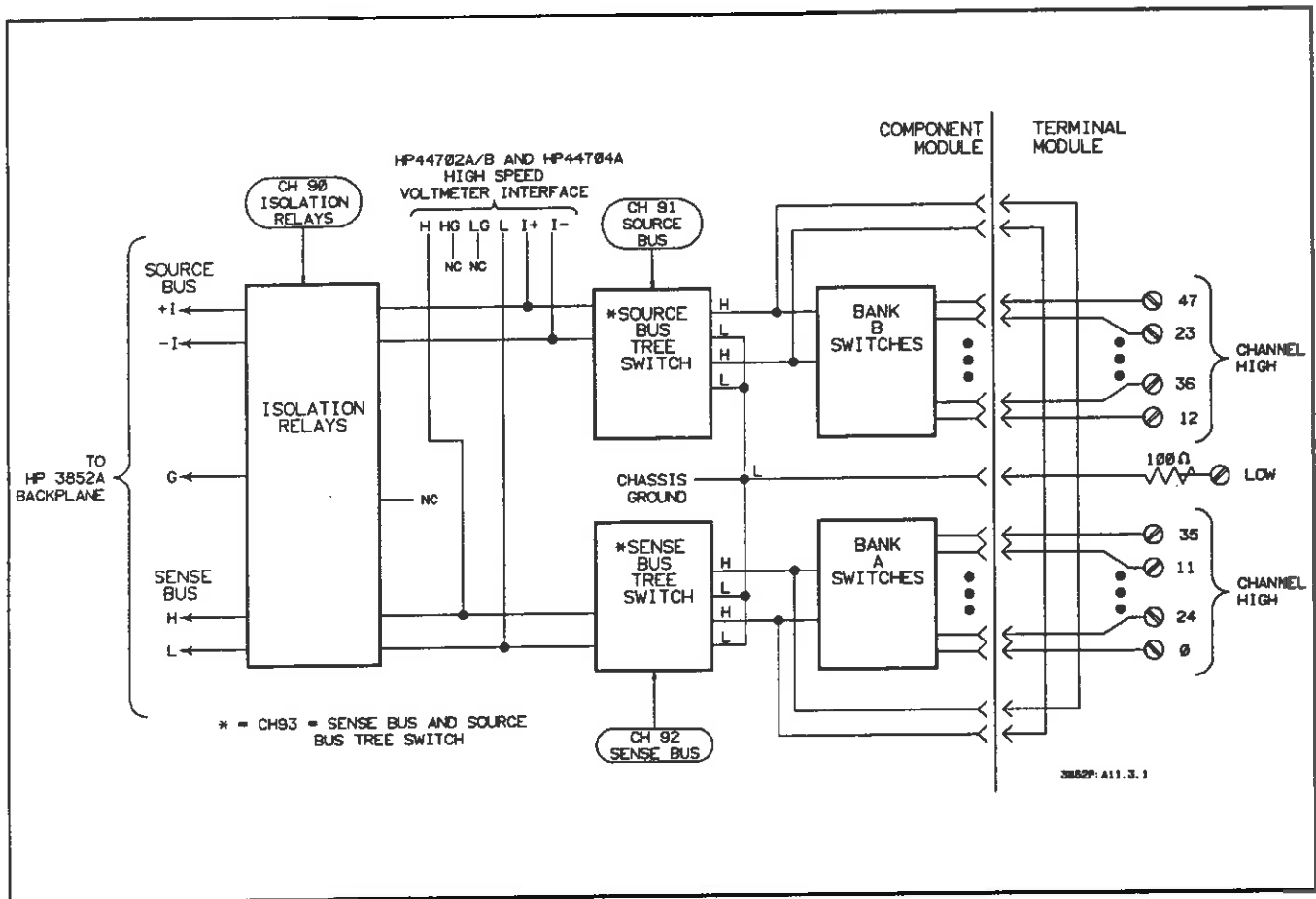

Figure 3-1. HP 44712A Block Diagram

The component module has two types of tree switches: two Source Bus and two Sense Bus. Tree switches control signal flow to and from the mainframe backplane and isolate the bank switches from the backplane when they are not in use.

Sense Bus tree switches provide connections to the mainframe backplane and to the HP High-Speed Voltmeter interface (ribbon cable) for voltage measurements. Source Bus tree switches provide backplane connections to the HP 44701A or HP High-Speed voltmeter (HP 44702A/B or HP 44704A) current sources (+I and -I) for 2-wire ohms measurements. Source Bus tree switches also provide ribbon cable interface connections (I+ and I-) for 2-wire ohms measurements.

The component module includes isolation relays which allow the HP 44712A to be isolated from the backplane. Isolation relays can be used to reduce the leakage current on the backplane or to use the backplane at voltages greater than the HP 44712A voltage specifications.

The HP 44712A has overvoltage protection circuitry which opens the isolation relays when voltages greater than  $\pm 12$  V peak are detected on the backplane. The isolation relays are also opened when ribbon cable operation is used.

### **Terminal Module**

The terminal module contains 48 terminals to connect field wiring. As factory configured, there is a protection resistor in series with the common LOW terminals.

### **Channel Definitions**

Table 3-1 shows the channel definitions for the HP 44712A. If you use high-level commands (such as CONFMEAS and MEAS) to program the HP 44712A, you need to specify only the measurement channels since CONFMEAS or MEAS automatically closes the proper channels and switches for the measurement selected.

However, if you use low-level commands such as CLOSE, you will need to specify the switches to be closed. For example, to make voltage measurements on channel 0, you will need to close the measurement channel (channel 0), the isolation relay (channel 90), and the Sense Bus tree switch (channel 92). Or, to make 2-wire ohms measurements on channel 0, close the Sense Bus and Source Bus tree switches (channel 93) and the measurement channel (channel 0).

**Table 3-1. HP 44712A Channel Definitions**

Channel	Definitions
0 - 11	Bank A Switches
12 - 23	Bank B Switches
90	Isolation Relays
91	Source Bus Tree Switch (Bank A or Bank B)*
92	Sense Bus Tree Switch (Bank A or Bank B)*
93	2-Wire Ohms Configuration
94	4-Wire Ohms Configuration

Notes:  
 \* = The Source or Sense Bus is connected to Bank A if a channel from 0 through 11 is selected. The Source or Sense Bus is connected to Bank B if a channel from 12 through 23 is selected.

## Field Wiring Connections

This section shows typical field wiring connections to the HP 44712A terminal module for voltage measurements.

### Terminal Module Connections

Figure 3-2 shows the HP 44712A terminal module with the cover removed. Each of the 48 channels has a HIGH terminal (numbered 0 through 47). There are 24 LOW terminals. All LOW channels are common to one another and to chassis ground.

When connecting field wiring to the terminal module, route the wires under the strain relief clamp and tighten the clamp screw to reduce the chance of wires being pulled out of the terminal connectors. If the clamp screw is loosened far enough, the strain relief clamp can be rotated to make it easier to route the wiring.

When connecting components such as resistors, the lead length may be too short to route through the strain relief clamp. In this case, the components will have to be stored inside the terminal module. When connecting these components, make sure that no leads are shorted together and bend the leads to allow the terminal module cover to be replaced.

### Voltage Measurement Connections

The HP 44712A can switch signals for up to 48 single-ended DC or AC voltage measurements. Figure 3-3 shows typical voltage measurement connections to channel 0.

---

#### NOTE

*Because the high ON resistance of the FET switches (approximately 3 kΩ) limits the accuracy of 2-wire ohms measurements, resistance measurements are not recommended for the HP 44712A.*

---

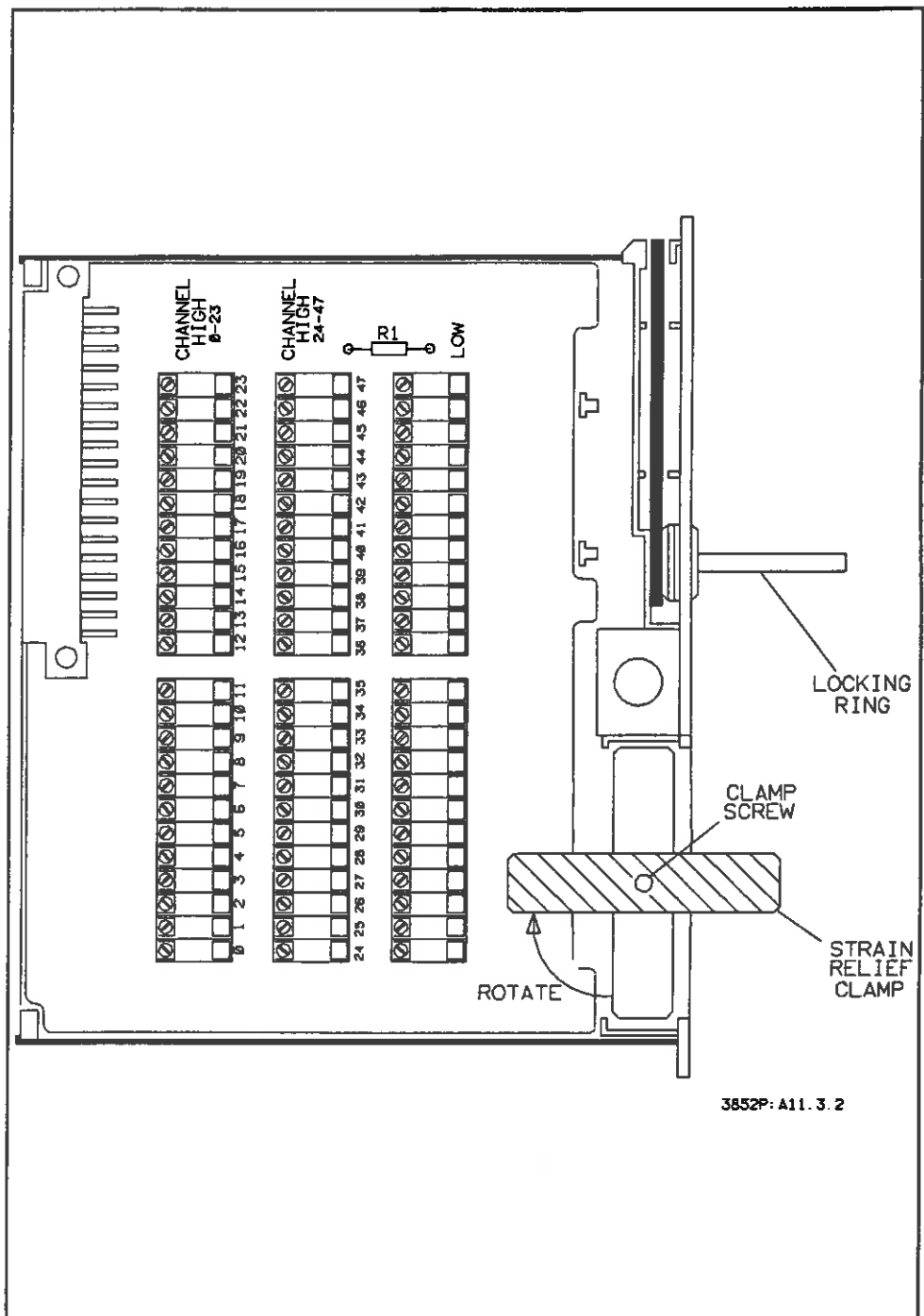

**Figure 3-2. HP 44712A Terminal Module**

Since shielded, twisted-pair Cable reduces measurement noise, shielded cable is required for measurements with an HP 44702A/B and HP 44704A voltmeter and is highly recommended for measurements with the HP 44701A voltmeter. For the HP 44702A/B or HP 44704A voltmeter connect an external resistor (R) between V0 LO and the shield, as shown in Figure 3-3.

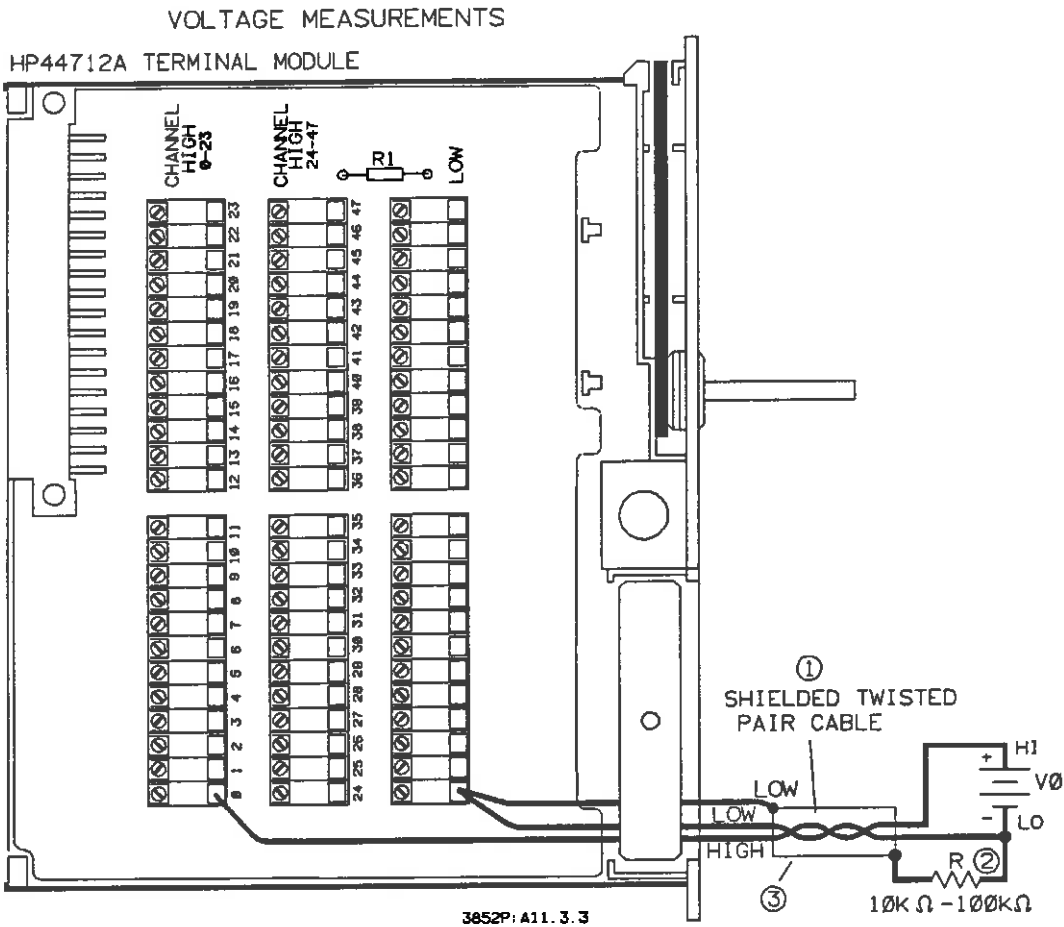

**Notes:**

[1] = Shielded cable is required for HP 44702A/B and HP 44704A measurements and is highly recommended for HP 44701A measurements.

[2] = For Hp 44701a measurement, make a direct connection from the shield to V0 LO.

**Figure 3-3. HP 44712A Voltage Connections**



# Installation and Checkout

This section shows how to check identity, verify field wiring connections, and read channel states of an HP 44712A.

---

## NOTE

*For ribbon cable operation, the cable must be connected between the HP 44712A and the HP 44702A/B or HP 44704A voltmeter. For backplane operation, the ribbon cable must NOT be connected. Refer to the HP 3852A Mainframe Configuration and Programming Manual to connect or disconnect the ribbon cable.*

---

### Check HP 44712A ID

When you have connected field wiring to the terminal module, replace the terminal module cover and install the HP 44712A in the desired mainframe or extender slot. Refer to the HP 3852A Mainframe Configuration and Programming Manual to connect the terminal module to the component module and to install the HP 44712A.

Then, use ID? to check the HP 44712A ID. At power-on, an HP 44712A returns 44712. An HP 44712A component module only (no terminal module attached) returns 447XXX. (If the terminal module is removed after power-on, the accessory still returns 44712.)

If the multiplexer does not return 44712 be sure you have addressed the correct slot and the terminal module is installed. If these are correct but the correct ID code is not returned, refer to the HP 3852A Assembly Level Service Manual for service procedures.

#### Example: Checking Accessory ID

This program queries the identity of an accessory in slot 5 of the mainframe. An HP 44712A in this slot returns 44712A.

```
10 OUTPUT 709;"ID? 500"           / Query ID in mainframe slot 5
20 ENTER 709;A$                   / Enter ID
30 PRINT A$                         / Display ID
40 END
```

## Verify Wiring Connections

To verify that field wiring has been properly connected to the terminal module, you can send MONMEAS (Monitor/Measure) from the mainframe front panel or from a controller. MONMEAS can be used to check DC voltage or resistance connections.

### Example: Checking Wiring Connections

This program uses MONMEAS to verify wiring connections to channels 500 through 547 of an HP 44712A. CONF configures the voltmeter in slot 6 for DC voltage measurements.

The 48 channels are scanned and measured one at a time starting with channel 500. Press the SADV KEY key on the mainframe front panel to advance the scan to the next channel. When the scan is advanced past the last channel (channel 547), the scan stops and the last measurement remains on the display.

```
10 OUTPUT 709;"USE 600"           ! Use voltmeter in mainframe slot 6
20 OUTPUT 709;"CONF DCV"         ! Set DC volts function on voltmeter
30 OUTPUT 709;"MONMEAS DCV,500-547" ! Monitor/measure ch 500 through 523
40 END
```

## Read Channel State

CLOSE? can be used to determine the state of HP 44712A channels. This command returns a 0, 1, 2, 3, or 4 as shown in Table 3-2 for each channel queried. (CLOSE? returns only 0 (open) or 1 (closed) for the state of the isolation relays and the tree switches.)

Table 3-2. Values Returned by CLOSE?

Value Returned*	Channel State
0	Channel Open
1	Channel Closed - not connected to a bus
2	Channel Closed - connected to Sense Bus
3	Channel Closed - connected to Source Bus
4	Channel Closed - connected to both buses

Note:  
\* = Only 0 (open) or 1 (closed) is returned for isolation relays (channel 90) and tree switches (channel 91 or 92).

### Example: Reading Channel State

This program uses CLOSE? to check the state of channels 500 through 504 on an HP 44712A. RST (reset) resets the multiplexer to its power-on state with all channels open. CLOSE closes channel 503, the isolation relays (channel 590), and the Sense Bus tree switch (channel 592). OPEN opens the channel, the isolation relay, and the tree switch.

```
10 OUTPUT 709;"RST 500"           ! Open all chs
20 INTEGER State(0:4)             ! Define controller array
30 OUTPUT 709;"CLOSE 503,590,592"  ! Close ch 503, iso relay, tree switch
40 OUTPUT 709;"CLOSE? 500-504"    ! Query state of chs 500 through 504
50 ENTER 709;State(*)             ! Enter channel states
60 PRINT State(*)                 ! Display channel states
70 OUTPUT 709;"OPEN 503,590,592"  ! Open ch 503,iso relay, tree switch
80 END
```

Since channel 503 was the only channel closed and was connected to the Sense Bus tree switch, a typical return is:

```
0 0 0 2 0
```



# **Chapter 4**

## **Configuring the HP 44713A/B**

# Contents

Chapter Contents . . . . .	4-1
Block Diagram Description . . . . .	4-1
Terminal Module Configuration . . . . .	4-5
Installing Attenuators . . . . .	4-5
Installing Low-Pass Filters . . . . .	4-5
Current Sensing . . . . .	4-5
Field Wiring Connections . . . . .	4-7
Terminal Module Connections . . . . .	4-7
Voltage Measurements Connections . . . . .	4-7
Thermocouple Measurement Connections . . . . .	4-8
Installation/Checkout . . . . .	4-10
Check HP 44713A/B ID . . . . .	4-10
Verify Wiring Connections . . . . .	4-12
Read Channel State . . . . .	4-12

# Configuring the HP 44713A/B

---

## Chapter Contents

This chapter shows how to configure the HP 44713A and HP 44713B multiplexer. The HP 44713B provides reduced settling time for use with the HP 44704A High-Speed Voltmeter's high resolution modes. Otherwise, the A and B versions of the HP 44713 are identical. The chapter contains a block diagram description of the HP 44713A/B, shows how to configure the terminal module, and shows how to connect field wiring to the terminal module.

When you have configured the HP 44713A/B, refer to Chapter 5 - Programming the Multiplexers to program the multiplexer for voltage, current, or thermocouple measurements.

## Block Diagram Description

The HP 44713A/B consists of a 24-channel terminal module and a component module as shown in Figure 4-1. Field wiring from application sensors connects to the terminal module and signals are sent to switches on the component module.

An isothermal connector block on the terminal module provides the reference junction for thermocouple measurements. A thermistor on the block is used to measure the reference temperature. The HP 3852A uses software compensation to compensate for the reference temperature when making thermocouple measurements.

### Component Module

The component module consists of 28 switches divided into two categories: tree switches and bank switches. Each switch consists of two Field Effect Transistors (FET), one each for HIGH and LOW input lines. There are 24 bank switches, divided into two banks: Bank A (channels 0 through 11) and Bank B (channels 12 through 23).

## NOTE

*Only one channel per bank can be closed at a time. Closing a second channel in a bank will open any previously closed channel in that bank.*

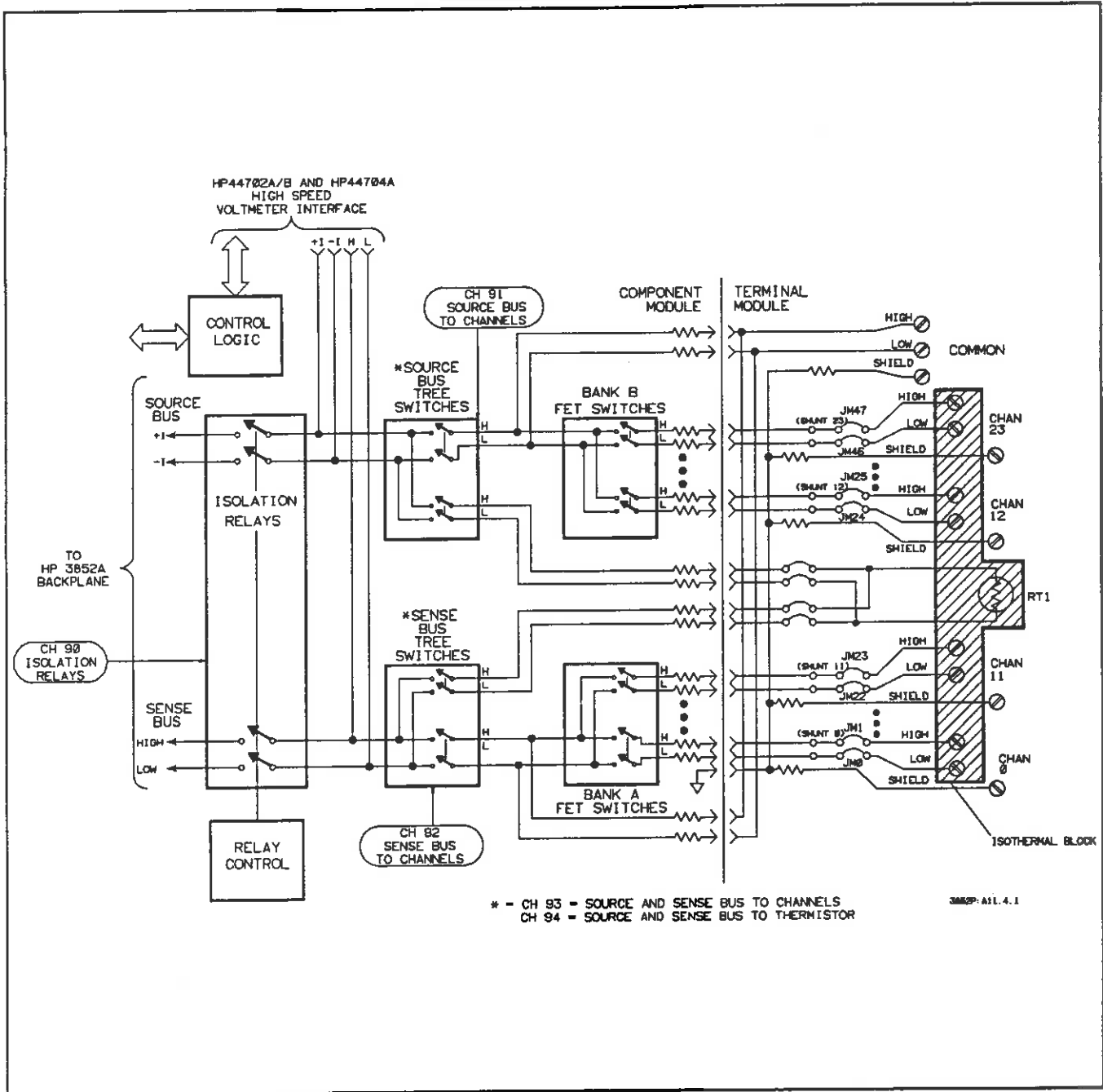

**Figure 4-1. HP 44713A/B Block Diagram**



The component module contains two types of tree switches: Source Bus and Sense Bus. Each bank has a Source Bus tree switch and a Sense Bus tree switch. The tree switches determine signal flow to and from the mainframe backplane or to the HP 44702A/B and HP 44704A High-Speed Voltmeter interface bus. Tree switches also isolate unused bank switches from the backplane and from the high speed interface bus.

Sense Bus tree switches provide connections to the backplane or to the HP 44702A/B and HP 44704A interface bus for voltage measurements. Source Bus tree switches provide backplane connections to the HP 44701A, HP 44702A/B, or HP 44704A voltmeter current sources (+I and -I) for resistance measurements. Source Bus tree switches also provide connections to the HP 44702A/B and HP 44704A current sources (+I and -I) via the high speed voltmeter interface bus for resistance measurements.

---

### NOTE

*Two tree switches of the same type cannot be used simultaneously (e.g., only one of the two Sense Bus tree switches can be closed at a time). Closing a second tree switch will open any previously closed tree switch of the same type.*

---

The component module has two isolation relays which allow the HP 44713A/B to be isolated from the mainframe backplane. Isolation relays can be used to reduce leakage currents on the backplane or when using the backplane at voltages greater than the  $\pm 10.24$  V peak limitation of the HP 44713A/B.

Isolation relays are automatically opened when voltages greater than  $\pm 12$  volts peak are detected on the backplane or when the HP 44713A/B is used with an HP High-Speed Voltmeter (HP 44702A/B or HP 44704A) in ribbon cable mode.

### Terminal Module

The terminal module contains 24 channels of terminal connectors for field wiring, a COMMON terminal and an isothermal block with a  $5\text{ k}\Omega$  thermistor (RT1) which is used to measure the isothermal temperature (the reference temperature).

The bank switch terminals are connected together on the terminal to form the COMMON terminal. The COMMON terminals can be used to connect an external monitoring device for diagnostic purposes. As factory configured, there are  $10\text{ k}\Omega$  current limiting resistors in series with the channel input lines and with the COMMON output lines.

## Channel Definitions

Table 4-1 shows channel definitions for the HP 44713A/B. If you use high-level commands (such as CONFMEAS or MEAS) to close channels, the high-level command automatically closes the proper channels and switches for the measurement selected. However, if you use low-level commands such as CLOSE for measurements, you will need to specify the switches to be closed.

For example, to make voltage measurements on channel 0, you will need to close the Sense Bus tree switch (channel 92), the isolation relay (channel 90), and the measurement channel (channel 0).

To make 2-wire ohms resistance measurements, you can close the Sense Bus and Source Bus tree switches, the isolation relay, and the measurement channel or you can close the isolation relays, channel 93, and the measurement channel.

---

### NOTE

*Due to high ON resistance of the FETs (about 3 k $\Omega$ ), 2-wire ohms measurements are recommended ONLY for open thermocouple detection.*

---

For example, to make 2-wire ohms measurements on channel 0, you can close the Source Bus tree switch (channel 91), the Sense Bus tree switch (channel 92), the isolation relays (channel 90), and the measurement channel (channel 0). Or, you can close the isolation relay (channel 90), the Source and Sense Bus Tree Switch to Channels (channel 94), and the measurement channel (channel 0).

To measure the reference temperature (by measuring the thermistor on the isothermal block), close the isolation relays (channel 90) and the Source and Sense Bus tree switches to the thermistor (channel 94).

Table 4-1. HP 44713A/B Channel Definitions

Channel	Definitions
0 - 11	Bank A Switches
12 - 23	Bank B Switches
90	Isolation Relays
91	Source Bus Tree Switch (Bank A or Bank B)*
92	Sense Bus Tree Switch (Bank A or Bank B)*
93	2-Wire Ohms Configuration
94	4-Wire Ohms Configuration

Notes:  
 \* = The Source or Sense Bus is connected to Bank A if a channel from 0 through 11 is selected. The Source or Sense Bus is connected to Bank B if a channel from 12 through 23 is selected.

## Terminal Module Configuration

This section shows how to install attenuators and low-pass filters on the HP 44713A/B terminal module for input signal conditioning and shows how to install resistors on the terminal module for current sensing applications. Figure 4-2 shows typical configurations for attenuators, low-pass filters, and current sensing.

### Installing Attenuators

As required, you can install attenuators in each channel to reduce input signals to a usable level. Figure 4-2 shows how to install an attenuator on channel 20 of the terminal module. To install the attenuator, remove the SERIES JM40 and SERIES JM41 jumpers and install resistors R1 and R3 in their places. Then, install resistor R2 in the SHUNT UC20 position. To maintain the best common mode noise rejection, use  $R1 = R3$ . Attenuation is:

$$V_{out} = V_{in} \left[ \frac{R2}{(R1 + R2 + R3)} \right]$$

### Installing Low-Pass Filters

As required, you can also install low-pass filters for input signal conditioning on each channel. Figure 4-2 shows how to install a low-pass filter on channel 11 of the terminal module. To install the low-pass filter, remove the SERIES JM22 and SERIES JM23 jumpers and install resistors R1 and R2 in their places. Then, install capacitor C in the SHUNT UC11 position. To maintain best common mode noise rejection, use  $R1 = R2$ . The filter time constant is:

$$T_f = C(R1 + R2)$$

### Current Sensing

The HP 44713A/B uses current sensing to make current measurements. When making a current sensing measurement, the voltage across a shunt resistor is measured and the current is calculated by the controller using the measured voltage and the shunt resistance value.

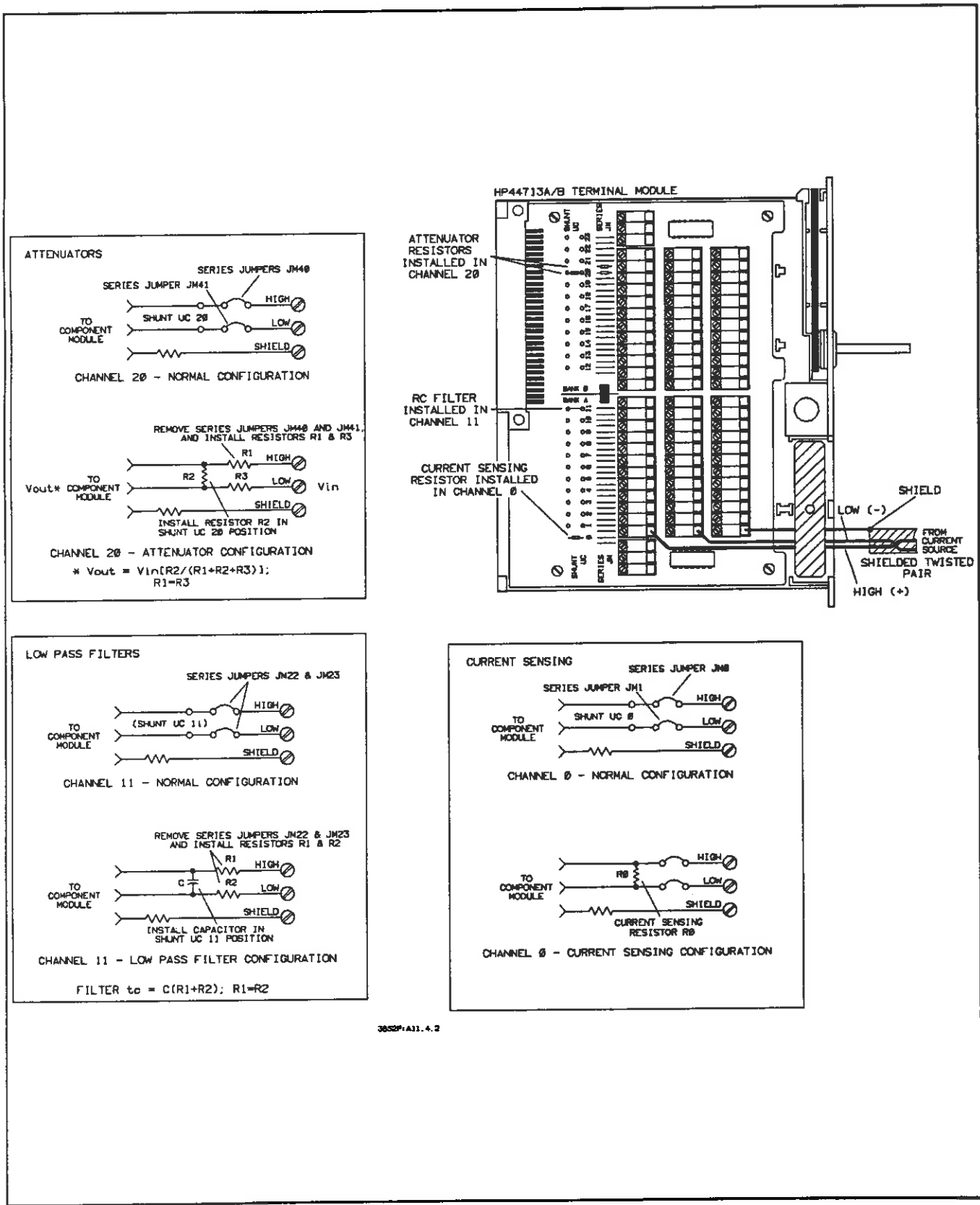

3852P-A11.4.2

Figure 4-2. HP 44713A/B Terminal Module Configuration

Figure 4-2 shows how to configure channel 0 for current sensing measurements. In Figure 4-2, a 250  $\Omega$  shunt resistor (R0) is installed in the shunt position (SHUNT UC0) for channel 0 on the terminal module. Note that the SERIES JM jumper (JM0 in this example) MUST be in place on each channel used for current measurements.

## Field Wiring Connections

When the terminal module is configured, the next step is to connect field wiring from your application to the terminal module. This section shows example field wiring connections to the HP 44713A/B terminal module for voltage, resistance, or temperature measurements.

### Terminal Module Connections

Figure 4-3 shows the HP 44713A/B terminal module with the cover removed. Each of the 24 channels has a HIGH, LOW, and SHIELD terminal. Terminals 0 through 11 in Bank A are for channels 0 through 11 respectively. Terminals 12 through 23 in Bank B are for channels 12 through 23 respectively.

When connecting field wiring to the terminal module, route the wires under the strain relief clamp and tighten the clamp screw to reduce the chance of wires being pulled out of the terminal connectors. If the clamp screw is loosened far enough, the strain relief clamp can be rotated to make it easier to route the wiring.

When connecting components such as resistors, the lead length may be too short to route through the strain relief clamp. In this case, the components will have to be stored inside the terminal module. When connecting these components, make sure that no leads are shorted together and bend the leads to allow the terminal module cover to be replaced.

### Voltage Measurements Connections

Figure 4-4 shows typical voltage measurement connections to channel 0 on the terminal module. Note that shielded cable is required for measurements with the HP 44702A/B and HP 44704A voltmeters and is highly recommended for measurements with the HP 44701A voltmeter. For the HP 44702A/B or HP 44704A voltmeter, connect an external resistor (R) between V0 LO and the shield, as shown in Figure 4-4.

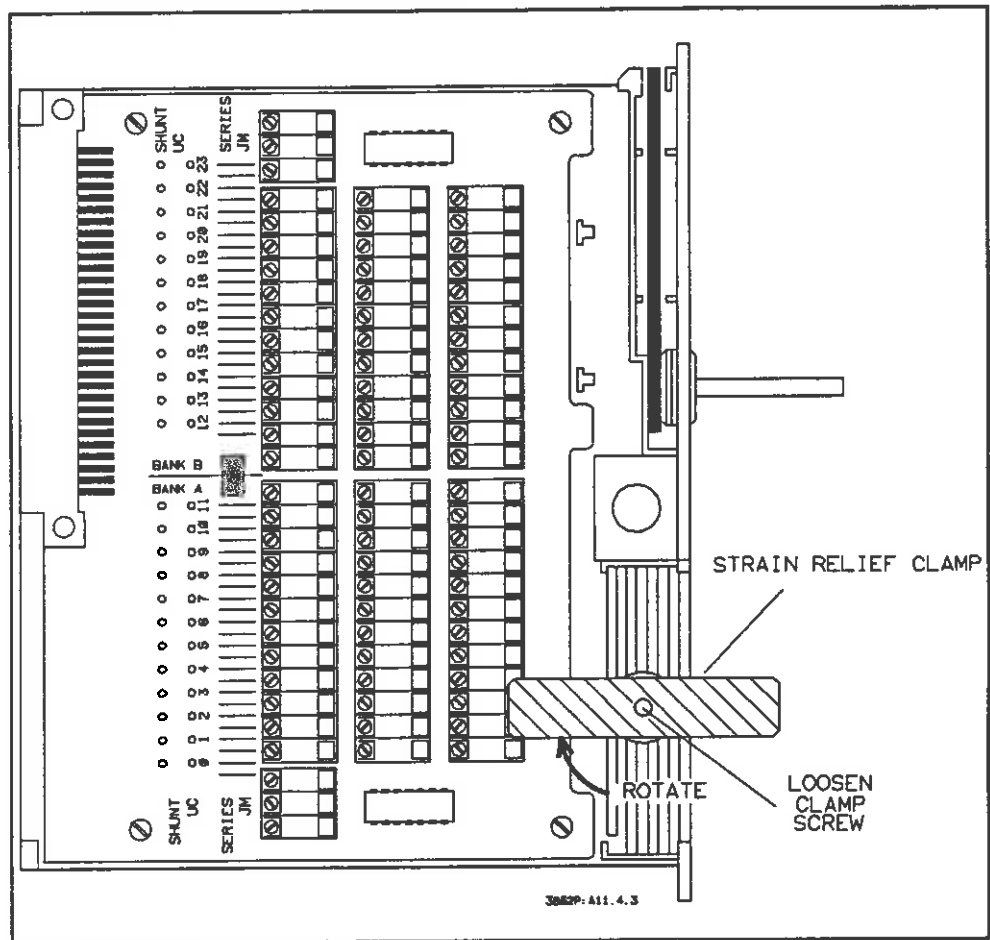

Figure 4-3. HP 44713A/B Terminal Module

## Thermocouple Measurement Connections

A primary function of the HP 44713A/B is to make temperature measurements using thermocouples. Since the channels on the HP 44713A/B can be independently configured and software compensation is used, any mixture of thermocouple types can be measured using the HP 44713A/B.

Although the HP 3852A temperature conversions support only B, E, J, K, N14, N28, R, S, and T type thermocouples, you can measure other thermocouples by using your own temperature linearization program. Before connecting thermocouples to the terminal module, refer to Table 4-2 for connection guidelines.

## Voltage Measurements

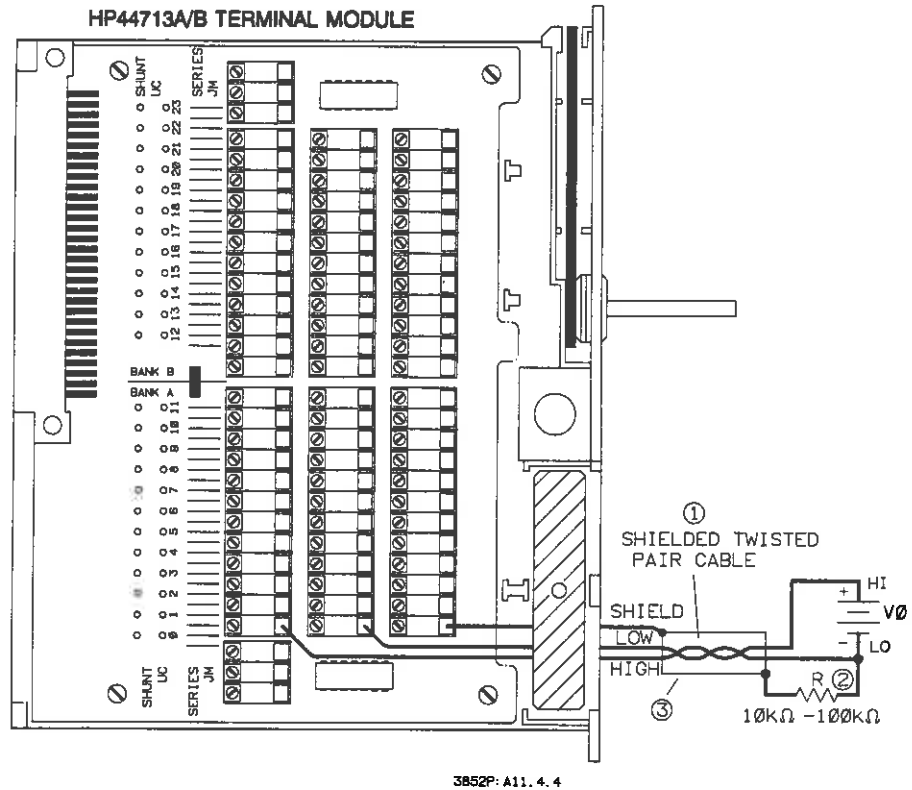

### Notes:

[1] = Shielded cable is required for HP 44702A/B and HP 44704A measurements and is highly recommended for HP 44701A measurements.

[2] = For HP 44701A measurements, make a direct connection from the shield to VO LO.

[3] = If shield cable is not used (HP 44701A measurements only), connect separate lead from channel 0 SHIELD to VO LO.

Figure 4-4. HP 44713A/B Voltage Connections

**Table 4-2. Thermocouple Connection Guidelines**

1. Use the largest thermocouple wire possible that will not shunt significant heat away from the measurement area.
2. Use thermocouple wire that is well within its rating.
3. Avoid mechanical stress and vibration that could strain the thermocouple wires.
4. For long runs, use a shielded, twisted-pair thermocouple extension cable and connect the shield to the SHIELD terminal on the terminal module.
5. Avoid steep temperature gradients.
6. In hostile environments, use proper sheathing material to reduce adverse effects on thermocouple wires.

See Figure 4-5 for example thermocouple (TC0) connections to channel 0. Connect the negative metal lead (red lead) to channel 0 LOW and connect the positive metal lead to channel 0 HIGH. If high common mode noise rejection is required, connect the shield lead from the thermocouple to channel 0 SHIELD.

## Installation/Checkout

This section shows how to check identity, verify field wiring connections, and read channel states of an HP 44713A/B.

---

### NOTE

*For ribbon cable operation, the cable must be connected between the HP 44713A/B and the HP 44702A/B or HP 44704A voltmeter. For backplane operation, the ribbon cable must NOT be connected. Refer to the HP 3852A Mainframe Configuration and Programming Manual to connect or disconnect the ribbon cable*

---

### Check HP 44713A/B ID

When you have connected field wiring to the terminal module, replace the terminal module cover and install the HP 44713A/B in the desired mainframe or extender slot. Refer to the HP 3852A Mainframe Configuration and Programming Manual to connect the terminal module to the component module and to install the HP 44713A/B.

Then, use ID? to check the HP 44713A/B ID. At power-on, an HP 44713A/B returns 44713. An HP 44713A/B component module only (no terminal module attached) returns 447XXX. (If the terminal module is removed after power-on, the accessory still returns 44713.)



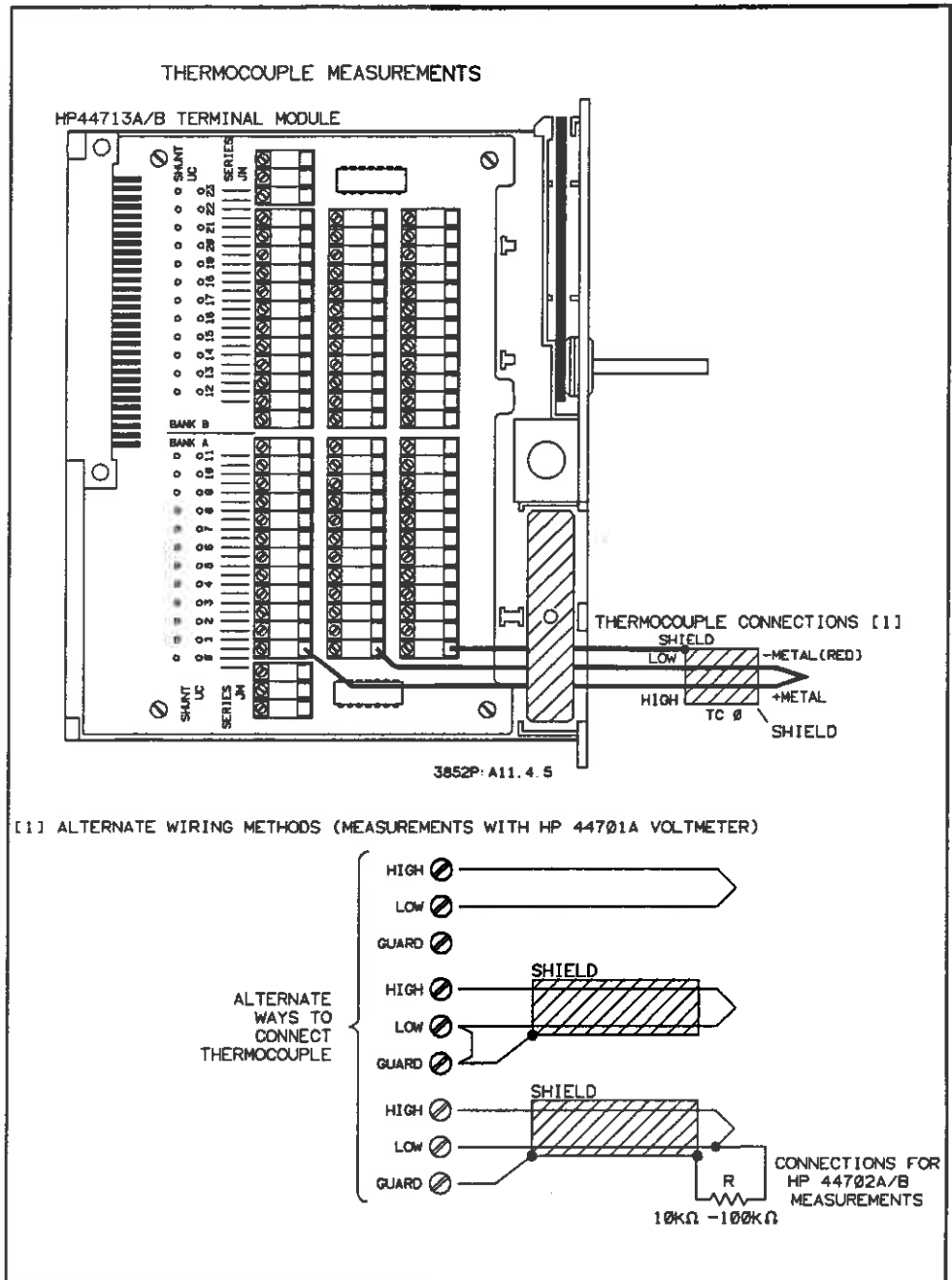

**Figure 4-5. HP 44713A/B Thermocouple Connections**

If the multiplexer does not return 44713 be sure you have addressed the correct slot and the terminal module is installed. If these are correct but the correct ID code is not returned, refer to the HP 3852A Assembly Level Service Manual for service procedures.

#### **Example: Checking Accessory ID**

This program queries the identity of an accessory in slot 5 of the mainframe. An HP 44713A/B in this slot returns 44713A.

```
10 OUTPUT 709;"ID? 500"           ! Query ID in mainframe slot 5
20 ENTER 709;A$                   ! Enter ID
30 PRINT A$                        ! Display ID
40 END
```

## **Verify Wiring Connections**

To verify that field wiring has been properly connected to the terminal module, you can send MONMEAS (Monitor/Measure) from the mainframe front panel or from a controller. MONMEAS can be used to check DC voltage or resistance connections.

#### **Example: Checking Wiring Connections**

This program uses MONMEAS to verify wiring connections to channels 500 through 523 of an HP 44713A. CONF configures the voltmeter in slot 6 for DC voltage measurements.

The 24 channels are scanned and measured one at a time starting with channel 500. Press the SADV KEY key on the mainframe front panel to advance the scan to the next channel. When the scan is advanced past the last channel (channel 523), the scan stops and the last measurement remains on the display.

```
10 OUTPUT 709;"USE 600"           ! Use voltmeter in mainframe slot 6
20 OUTPUT 709;"CONF DCV"         ! Set DC volts function on voltmeter
30 OUTPUT 709;"MONMEAS DCV,500-523" ! Monitor/measure ch 500 through 523
40 END
```

## **Read Channel State**

CLOSE? can be used to determine the state of HP 44713A/B channels. This command returns a 0, 1, 2, 3, or 4 as shown in Table 4-3 for each channel queried. (CLOSE? returns only 0 (open) or 1 (closed) for the state of the isolation relays and the tree switches.)

**Table 4-3. Values Returned by CLOSE?**

Value Returned*	Channel State
0	Channel Open
1	Channel Closed - not connected to a bus
2	Channel Closed - connected to Sense Bus
3	Channel Closed - connected to Source Bus
4	Channel Closed - connected to both buses

Note:  
 \* = Only 0 (open) or 1 (closed) is returned for isolation relays (channel 90) and tree switches (channel 91 or 92).

**Example: Reading Channel State**

This program uses CLOSE? to check the state of channels 500 through 504 on an HP 44713A. RST (reset) resets the multiplexer to its power-on state with all channels open. CLOSE closes channel 503, the isolation relays (channel 590), and the Sense Bus tree switch (channel 592). OPEN opens the channel, the isolation relay, and the tree switch.

```

10 OUTPUT 709;"RST 500"           ! Open all chs
20 INTEGER State(0:4)             ! Define controller array
30 OUTPUT 709;"CLOSE 503,590,592" ! Close ch 503, iso relay, tree switch
40 OUTPUT 709;"CLOSE? 500-504"   ! Query state of chs 500 through 504
50 ENTER 709;State(*)            ! Enter channel states
60 PRINT State(*)                 ! Display channel states
70 OUTPUT 709;"OPEN 503,590,592" ! Open ch 503, iso relay, tree switch
80 END

```

Since channel 503 was the only channel closed and was connected to the Sense Bus tree switch, a typical return is:

0 0 0 2 0



# **Chapter 5**

## **Programming the Multiplexers**

# Contents

<b>Programming Overview</b> . . . . .	<b>5-1</b>
<b>Command Summary</b> . . . . .	<b>5-1</b>
<b>Example Program Titles</b> . . . . .	<b>5-2</b>
<b>Making Measurements</b> . . . . .	<b>5-3</b>
<b>Voltage Measurements</b> . . . . .	<b>5-4</b>
<b>Current Measurements</b> . . . . .	<b>5-8</b>
<b>Resistance Measurements</b> . . . . .	<b>5-9</b>
<b>Temperature Measurements</b> . . . . .	<b>5-13</b>

# Programming the Multiplexers

---

---

## Programming Overview

This chapter shows how to program the HP 44711A/B, HP 44712A, or HP 44713A/B multiplexer for voltage, current, resistance, or temperature measurements, as applicable. The chapter has two sections:

- **Programming Overview** includes an overview of the chapter contents, summarizes HP 44711A/B/44712A/44713A/B commands, and lists the titles of the example programs in the chapter.
- **Making Measurements** shows how to make voltage, current, resistance, or temperature measurements with an HP 44701A Integrating Voltmeter or with an HP 44702A/B or HP 44704A High-Speed Voltmeter.

### Command Summary

Table 5-1 is an alphabetical listing of commands which apply to the HP 44711A/B, HP 44712A, and HP 44713A/B. Refer to the HP 3852A Command Reference Manual for a complete description of these commands.

**Table 5-1. Command Summary**

<b>CLOSE <i>ch_list</i></b> Closes a single multiplexer channel or a list of channels specified by <i>ch_list</i>
<b>CLOSE? <i>ch_list</i> [INTO <i>name</i>] or [fmt]</b> Queries the state of the channels specified by <i>ch_list</i>
<b>CLWRITE [<i>ribbon_bus</i>] <i>ch_list</i> [RANGE <i>range_list</i>] [USE <i>ch</i>]</b> Sets channel and range lists to be scanned and used by the High-Speed Voltmeter.
<b>CONF <i>function</i> [USE <i>ch</i>]</b> Configure the voltmeter measurement function specified by <i>function</i> .
<b>CONFMEAS <i>function ch_list</i> [NSCAN <i>number</i>][USE <i>ch</i>] [INTO <i>name</i>] or [fmt]</b> Configure the voltmeter and measures a function specified by <i>function</i> on the multiplexer channels specified by <i>ch_list</i> . (NSCAN is valid only for mainframe firmware revision 2.2 and greater.)
<b>ID? [<i>slot</i>]</b> Returns the identity of the accessory in the slot addressed by <i>slot</i> .
<b>MEAS <i>function ch_list</i> [NSCAN <i>number</i>] [USE <i>ch</i>] [INTO <i>name</i>] or [fmt]</b>
<b>MONMEAS <i>function ch_list</i> [USE <i>ch</i>]</b> Monitors and measures a function specified by <i>function</i> on the channels specified by <i>ch_list</i> . This command is useful to check wiring connections to the terminal module.
<b>OPEN <i>ch_list</i></b> Opens a multiplexer channel or list of channels specified by <i>ch_list</i> . This command is used to open channels and place them in a safe state after measurements have been made.
<b>RST [<i>slot</i>]</b> Resets the accessory in the slot specified by <i>slot</i> to its power-on state.

**Example Program Titles** Table 5-2 lists the titles of the example programs in this chapter. Unless noted, all examples apply to either backplane operation or to ribbon cable operation.

When “ribbon cable only” is specified, the example applies ONLY to measurements with the HP 44702A/B or HP 44704A High-Speed Voltmeter in Scanner Mode with the ribbon cable connected. For ribbon cable measurements, the HP 44702A/B or HP 44704A must be set for Scanner Mode (SCANMODE ON), the ribbon cable between the multiplexer and the HP 44702A/B or HP 44704A must be connected, and TERM RIBBON must be set.



When “backplane only” is specified, the example applies to measurements with the HP 44701A Integrating Voltmeter, or the HP 44702A/B or HP 44704A High-Speed Voltmeter when the input is via the mainframe backplane. For backplane measurements with the HP 44702A/B or HP 44704A, the ribbon cable must NOT be connected.

**Table 5-2. Example Program Titles**

Title	Description	Multiplexers
Voltage Measurements Using CONFMEAS	<b>Voltage Measurements</b> Measure 24 voltages using CONFMEAS.	HP 44711A/B, HP 44713A/B
Voltage Measurements Using CLWRITE	Measure 9 voltages using CLWRITE. (ribbon cable only)	HP 44711A/B, HP 44713A/B
Voltage Measurements Using CLOSE	Measure a voltage using CLOSE (backplane only).	HP 44711A/B, HP 44713A/B
Single-Ended Voltage Measurements	Measure 48 voltages using CONFMEAS.	HP 44712A
DC Current Measurements	<b>Current Measurements</b> Make a DC current sensing measurement using CONFMEAS.	HP 44711A/B, HP 44713A/B
4-Wire Ohms Measurements Using CONFMEAS	<b>Resistance Measurements</b> Measure 24 resistances using 4-wire ohms and CONFMEAS.	HP 44711A/B
4-Wire Ohms Measurements Using CLWRITE	Measure 9 resistances using 4-wire ohms and CLWRITE (ribbon cable only).	HP 44711A/B
4-Wire Ohms Measurements Using CLOSE	Measure a resistance using 4-wire ohms and CLOSE (backplane only).	HP 44711A/B
RTD Measurements	<b>Temperature Measurements</b> Measure temperature using an RTD and CONFMEAS.	HP 44711A/B
Thermocouple Measurements	Make 20 temperature measurements using J-type thermocouples and CONFMEAS.	HP 44713A/B
Isothermal Block Reference Temperature	Measure the isothermal block (reference) temperature of an HP 44713A/B using CONFMEAS.	HP 44713A/B

## Making Measurements

This section shows how to make voltage, current, resistance, or temperature measurements using an HP 44711A/B, HP 44712A, or HP 44713A/B multiplexer with an HP 44701A, an HP 44702A/B, or an HP 44704A voltmeter. Refer to Table 5-2 for a list of example program titles.

All example programs in this section use a multiplexer in slot 5 of the mainframe and an HP 44701A voltmeter in slot 6 or an HP 44702A/B or HP 44704A High-Speed Voltmeter in slots 6 and 7 (programming address 600) of the mainframe.

In general, program examples show how to make measurements with the HP 44702A/B or HP 44704A voltmeter in Scanner Mode (SCANMODE ON) with the ribbon cable connected from the HP 44702A/B or HP 44704A to the multiplexer.

---

### NOTE

*The HP 44704A High-Speed Voltmeter in its default 13 bit resolution mode (RESOL 13) can be substituted for the HP 44702A/B in all examples.*

---

To modify the programs for measurements with the HP 44702A/B or HP 44704A in System Mode, change "SCANMODE ON" to "SCANMODE OFF" and disconnect the ribbon cable. To modify the programs for measurements with the HP 44701A voltmeter, delete the line containing "SCANMODE ON" and disconnect the ribbon cable.

---

### NOTE

- 1. When a program example is labeled "ribbon cable only", the measurement can be done only with an HP High-Speed Voltmeter in the Scanner Mode with the ribbon cable connected and TERM RIBBON set. CLOSE, CLOSE?, and OPEN commands will not work for ribbon cable measurements.*
  - 2. When a program example is labeled "backplane only", the ribbon cable must NOT be connected and TERM BOTH (HP 44701A) or TERM INT (HP High-Speed Voltmeter) must be set. The CLWRITE command does not apply to backplane measurements.*
- 

## Voltage Measurements

Four examples to measure DC voltages on an HP 44711A/B, HP 44712A, or HP 44713A/B follow. The first example uses CONFMEAS for 24 voltage measurements; the second uses CONF and CLWRITE (ribbon cable measurements only) to take 9 voltage measurements; the third uses CLOSE (backplane measurements only) to measure a single channel; and the fourth uses CONFMEAS for 48 single-ended voltage measurements.

### Example: Voltage Measurements Using CONFMEAS

This program measures DC voltages connected to channels 500 through 523 of an HP 44711A or HP 44713A using an HP 44702A/B in Scanner Mode. See

Figure 2-4 for typical connections to the HP 44711A/B. See Figure 4-4 for typical connections to the HP 44713A/B.

In line 40, CONFMEAS DCV,500-523 configures the voltmeter for DC voltage measurements and measures each of the 24 channels once. Since Scanner Mode is set (SCANMODE ON in line 30), CONFMEAS also sets TERM RIBBON.

```
10 DIM Volts[0:23]                ! Define controller array
20 OUTPUT 709;"USE 600"           ! Use voltmeter in mainframe slot 6
30 OUTPUT 709;"SCANMODE ON"      ! Set Scanner Mode
40 OUTPUT 709;"CONFMEAS DCV,500-523" ! Set DC volts, meas ch 500-523
50 ENTER 709;Volts(*)            ! Enter 24 readings
60 PRINT USING "K,/";Volts(*)    ! Display 24 readings
70 END
```

For a set of 5 V 5% inputs, a typical return is:

```
4.993
4.993
.
.
4.994
```

24 readings

### Example: Voltage Measurement Using CLWRITE

#### Ribbon Cable Only

This program measures DC voltages connected to channels 500-502 of an HP 44711A or HP 44713A using an HP 44702A/B. See Figure 2-4 for typical connections to the HP 44711A/B. See Figure 4-4 for typical connections to the HP 44713A/B.

In lines 60 - 90, RDGSMODE COMPLETE trims the data in the voltmeter buffer to that generated by two prescans plus one postscan (as set by PRESCAN 2 and POSTSCAN 1). CLWRITE SENSE,500-502 sets the ribbon cable interface for DC voltage measurements and specifies channels 500 through 502 as the channels in the channel list.

In lines 100 - 120, STTRIG EXT0 sets the Stop trigger source to the EXT0 port, STSLOPE HL sets the slope of the input to high-to-low, and SCTRIG INT sets the Scan trigger source to internal.

When SCTRIG INT is executed, the voltmeter makes continuous passes through channels 500 through 502 until a low-going pulse is input to the

EXT0 port and the Stop Trigger occurs. The voltmeter then makes one postscan pass and halts.

In line 130, XRDGS transfers 9 readings (2 prescans + 1 postscan pass of three channels). Since RDGSMODE COMPLETE is set, the readings transferred are from the last two prescans before the Stop Trigger occurs plus the readings from the single postscan. For example, if 8 prescans occurred before the Stop Trigger, the 3 readings from prescans #7 and #8 plus the 3 readings from postscan #1 are transferred by XRDGS.

```

10 DIM Volts(0:8)                                ! Dimension controller array
20 OUTPUT 709;"RST 600"                          ! Reset HP 44702A/B
30 OUTPUT 709;"USE 600"                          ! Use voltmeter in mainframe slot 6
40 OUTPUT 709;"SCANMODE ON"                     ! Set Scanner Mode
50 OUTPUT 709;"CONF DCV"                        ! Set DC volts
60 OUTPUT 709;"RDGSMODE COMPLETE"               ! Trim to 2 prescans + 1 postscan
70 OUTPUT 709;"CLWRITE SENSE,500-502"          ! Set ribbon cable to DC volts
80 OUTPUT 709;"PRESCAN 2"                       ! Set 2 prescans
90 OUTPUT 709;"POSTSCAN 1"                     ! Set 1 postscan
100 OUTPUT 709;"STTRIG EXT0"                    ! Set EXT0 port as Stop Trig source
110 OUTPUT 709;"STSLOPE HL"                    ! Set Stop Trig slope for HL
120 OUTPUT 709;"SCTRIG INT"                    ! Set Scan Trig source to internal
130 OUTPUT 709;"XRDGS 600"                     ! Transfer 9 readings
140 ENTER 709;Volts(*)                          ! Enter 9 readings
150 PRINT USING "K,/";Volts(*)                 ! Display 9 readings
160 END

```

For a set of 9 V 5V% voltage sources connected to channels 500-502, a typical return (values in Volts) follows. The return assumes k prescan passes before the Stop Trigger (low-going pulse into EXT0) occurred.

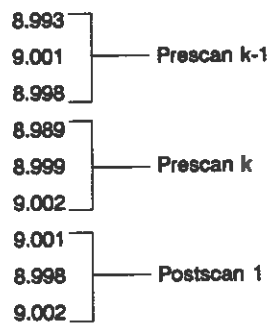

### Example: Voltage Measurements Using CLOSE

#### Backplane Only

This program uses CLOSE to measure the voltage connected to channel 500 of an HP 44711A or HP 44713A using an HP 44702A/B voltmeter in System

Mode (SCANMODE OFF). See Figure 2-4 for typical connections to the HP 44711A/B. See Figure 4-4 for typical connections to the HP 44713A/B.

---

### CAUTION

*The CLOSE command does not close channels in a break-before-make fashion. Therefore, the command can cause damage to the multiplexer accessory (relay or FET) and external system if it is used to force one channel open by closing another. This applies to channels in the same bank, in separate banks tied together by tree relays, and to the relays themselves.*

*Before a channel is closed with the CLOSE command, use the OPEN command to open the channel that is currently closed. This prevents any two channels from being closed at the same time and reduces the risk of damaging your equipment.*

---

---

### NOTE

*CLOSE is a low-level command intended for individual switch control in special signal routing applications. It is not the easiest way to do routine measurements since the tree switches and the isolation relays are not automatically configured as with the high-level commands.*

---

In the program, CLOSE closes the measurement channel (channel 500), the Sense Bus tree switch (channel 592), and the isolation relays (channel 590) on the HP 44711A or HP 44713A. CONF configures the voltmeter for DC voltage measurements, TRIG triggers the voltmeter to take a single measurement, and CHREAD sends the reading from the voltmeter to the output buffer. OPEN opens the channel, the isolation relays, and the Sense Bus tree switch after the measurement has been taken.

---

### NOTE

*To use the program for an AC voltage measurement with the HP 44701A voltmeter, substitute the following line for line 30:*

```
30 OUTPUT 709;"CONF ACV"
```

---

```

10 OUTPUT 709;"USE 600"           ! Use voltmeter in mainframe slot 6
20 OUTPUT 709;"CLOSE 500,590,592" ! Close ch 500, iso relays, tree switch
30 OUTPUT 709;"CONF DCV"         ! Set DC volts
40 OUTPUT 709;"TRIG SGL"        ! Trigger voltmeter
50 OUTPUT 709;"CHREAD 600"      ! Transfer reading to output buffer
60 ENTER 709;A                  ! Enter reading
70 PRINT A                      ! Display reading
80 OUTPUT 709;"OPEN 500,590,592" ! Open ch 500, iso relays, tree switch
90 END

```

A typical return from a 5V 5% input is:

4.987

### Example: Single-Ended Voltage Measurements

This program uses CONFMEAS to measure DC voltages connected to channels 500 through 547 of an HP 44712A using an HP 44702A/B in Scanner Mode. See Figure 3-3 for typical connections to the HP 44712A.

In line 40, CONFMEAS DCV,500-547 configures the voltmeter for DC voltage measurements and measures each of the 48 channels once. Since Scanner Mode is set (SCANMODE ON in line 30), CONFMEAS also sets TERM RIBBON.

```

10 DIM Volts(0:47)              ! Dimension controller array
20 OUTPUT 709;"USE 600"        ! Use voltmeter in mainframe slot 6
30 OUTPUT 709;"SCANMODE ON"    ! Set Scanner Mode
40 OUTPUT 709;"CONFMEAS DCV,500-547" ! Set DC volts, meas ch 500-547
50 ENTER 709;Volts(*)          ! Enter 48 readings
60 PRINT USING "K,/" ;Volts(*) ! Display 48 readings
70 END

```

For a set of 9 V 5V% inputs, a typical return is:

```

8.93
8.995
.
.
8.974

```

} 48 readings

## Current Measurements

An example follows to show how to program the HP 44711A/B or HP 44713A/B for DC current measurements.

---

## NOTE

*Current sensing measurements are not recommended when making temperature measurements on the same HP 44713A/B terminal module since the heat produced by the shunt resistor may affect the accuracy of the temperature measurements.*

---

### Example: DC Current Measurements

This program uses CONFMEAS to measure DC voltage across a 250  $\Omega$  shunt resistor on channel 500 of an HP 44711A or HP 44713A using an HP 44702A/B in System Mode. CONFMEAS configures the voltmeter for DC voltage measurements and measures the channel once.

The equivalent current value is computed in the controller by using  $\text{Current} = \text{Volts}/250$  (line 40). See Figure 2-2 to install a shunt resistor on the HP 44711A/B terminal module. See Figure 4-2 to install a shunt resistor on the HP 44713A/B terminal module.

```
10 OUTPUT 709;"USE 600"           / Use voltmeter in mainframe slot 6
20 OUTPUT 709;"CONFMEAS DCV,500" / Set DC volts, measure ch 500
30 ENTER 709;Volts                / Enter DC voltage value
40 PRINT Volts/250                / Display DC current value = Volts/250
50 END
```

If a 250  $\Omega$  5% resistor is used, a typical return from a current source which is outputting 10 mA (value in Amps) is:

.01004

## Resistance Measurements

Three examples follow to show how to make resistance measurements with an HP 44711A/B. The first example uses 4-wire ohms and CONFMEAS, the second uses 4-wire ohms and CLWRITE (ribbon cable measurement only), and the third uses 4-wire ohms and CLOSE (backplane measurements only).

### Example: 4-Wire Ohms Measurements Using CONFMEAS

This program uses CONFMEAS to measure resistances connected to channels 500 through 523 of an HP 44711A using an HP 44702A/B in Scanner Mode. See Figure 2-5 for typical connections to the HP 44711A/B.

In line 40, CONFMEAS OHMF configures the voltmeter for 4-wire ohms measurements and measures each of the 24 channels once. Since Scanner Mode is set (SCANMODE ON in line 30), CONFMEAS also sets TERM RIBBON.

```

10 DIM Ohms(0:23)                ! Dimension controller array
20 OUTPUT 709;"USE 600"          ! Use voltmeter in mainframe slot 6
30 OUTPUT 709;"SCANMODE ON"     ! Set Scanner Mode
40 OUTPUT 709;"CONFMEAS OHMF,500-523" ! Set 4-wire ohms, meas ch 500-523
50 ENTER 709;Ohms(*)            ! Enter 24 readings
60 PRINT USING "K,.";Ohms(*)    ! Display 24 readings
70 END

```

For a set of 5 k $\Omega$  5% resistors, a typical return (values in Ohms) is:

```

4928.34
5024.9
.
.
5008.38

```

} 24 readings

### Example: 4-Wire Ohms Measurements Using CLWRITE

#### Ribbon Cable Only

This program measures resistances connected to channels 500-502 of an HP 44711A using an HP 44702A/B in Scanner Mode. See Figure 2-5 for typical connections to the HP 44711A/B.

In lines 60 - 90, RDGSMODE COMPLETE trims the data in the voltmeter buffer to that generated by two prescans plus one postscan (as set by PRESCAN 2 and POSTSCAN 1). CLWRITE SEP, 500-502 sets the ribbon cable interface for 4-wire ohms measurements and specifies channels 500 through 502 as the channels in the channel list.

In lines 100 - 120, STTRIG EXT0 sets the Stop Trigger source to the EXT0 port, STSLOPE HL sets the slope of the input to high-to-low, and SCTRIG INT sets the Scan Trigger source to internal.

When SCTRIG INT is executed, the voltmeter makes continuous passes through channels 500 through 502 until a low-going pulse is input to the EXT0 port and the Stop Trigger occurs. The voltmeter then makes one postscan pass and halts.



In line 130, XRDGS transfers 9 readings (2 prescans + 1 postscan pass for three channels). Since RDGSMODE COMPLETE is set, the readings transferred are from the last two prescans before the Stop Trigger occurs plus the readings from the postscan pass. For example, if 8 prescans occurred before the Stop Trigger, the data from prescans #7 and #8 plus the data from postscan #1 are transferred by XRDGS.

```

10 DIM Ohms(0:8)                                / Dimension controller array
20 OUTPUT 709;"RST 600"                          / Reset HP 44702A/B
30 OUTPUT 709;"USE 600"                          / Use voltmeter in mainframe slot 6
40 OUTPUT 709;"SCANMODE ON"                      / Set Scanner Mode
50 OUTPUT 709;"CONF OHMF"                        / Set 4-wire ohms
60 OUTPUT 709;"RDGSMODE COMPLETE"               / Trim to 2 prescans + 1 postscan
70 OUTPUT 709;"CLWRITE SEP,500-502"            / Set ribbon cable to 4-wire ohms
80 OUTPUT 709;"PRESCAN 2"                       / Set 2 prescans
90 OUTPUT 709;"POSTSCAN 1"                     / Set 1 postscan
100 OUTPUT 709;"STTRIG EXT0"                   / Set EXT0 port as Stop Trigger source
110 OUTPUT 709;"STSLOPE HL"                    / Set Stop Trig slope for HL
120 OUTPUT 709;"SCTRIG INT"                    / Set Scan Trig source to internal
130 OUTPUT 709;"XRDGS 600"                     / Transfer 9 readings
140 ENTER 709;Ohms(*)                           / Enter 9 readings
150 PRINT USING "K,/";Ohms(*)                  / Display 9 readings
160 END

```

For a set of 10 k $\Omega$  5% resistors connected to channels 500-502, a typical return (values in Ohms) follows. The return assumes k prescan passes before the Stop Trigger (low-going pulse into EXT0) occurred.

9993	}	Prescan k-1
9993.3		
9993.5		
9999.1	}	Prescan k 3
9999		
9999		
9998.3	}	Postscan 1
9998.5		
9998.6		

### Example: 4-Wire Ohms Measurements Using CLOSE

#### Backplane Only

This program makes a 4-wire ohms measurement of channel 500 of an HP 44711A using CLOSE and an HP 44702A/B in System Mode. See Figure 2-5 for typical connections to the HP 44711A/B.

---

## CAUTION

*The CLOSE command does not close channels in a break-before-make fashion. Therefore, the command can cause damage to the multiplexer accessory (relay or FET) and external system if it is used to force one channel open by closing another. This applies to channels in the same bank, in separate banks tied together by tree relays, and to the relays themselves.*

*Before a channel is closed with the CLOSE command, use the OPEN command to open the channel that is currently closed. This prevents any two channels from being closed at the same time and reduces the risk of damaging your equipment.*

---

---

## NOTE

*CLOSE is a low-level command intended for individual switch control in special signal routing applications. It is not the easiest way to do routine measurements since the tree switches and the isolation relays are not automatically configured as with the high-level commands.*

---

In the program, CLOSE closes the measurement channel (channel 500) and configures the HP 44711A for 4-wire ohms measurements (channel 594). CONF configures the voltmeter for 4-wire ohms measurements; TRIG triggers the voltmeter to take a single measurement; and CHREAD transfers the resistance value from the voltmeter to the output buffer. OPEN opens the channel and disconnects it from the backplane after the measurement has been taken.

10 OUTPUT 709;"USE 600"	<i>! Use voltmeter in mainframe slot 6</i>
20 OUTPUT 709;"CLOSE 500,590,594"	<i>! Close ch 500, config for 4-wire ohms</i>
30 OUTPUT 709;"CONF OHMF"	<i>! Config voltmeter for 4-wire ohms meas</i>
40 OUTPUT 709;"TRIG SGL"	<i>! Trigger the voltmeter</i>
50 OUTPUT 709;"CHREAD 600"	<i>! Transfer reading to output buffer</i>
60 ENTER 709;A	<i>! Enter reading</i>
70 PRINT A	<i>! Display reading</i>
80 OUTPUT 709;"OPEN 500,590,594"	<i>! Open ch and tree switches</i>
90 END	<i>!</i>

For a 10 k $\Omega$  5V% resistor, a typical return (value in Ohms) is:

9999.98

## Temperature Measurements

Three example programs to measure temperature follow. The first example shows how to program the HP 44711A/B for RTD measurements, the second example shows how to program the HP 44713A/B for thermocouple measurements, and the third example shows how to measure the isothermal block (reference temperature) on an HP 44713A/B.

### Example: RTD Measurements

This program uses CONFMEAS to measure a Type 92 RTD connected to channel 500 of an HP 44711A using 4-wire ohms and an HP 44702A/B in Scanner Mode. See Figure 2-5 for typical connections to the HP 44711A/B.

In line 30, CONFMEAS RTD92,500 sets 4-wire ohms measurement of a Type 92 RTD and sets channel 500 as the Sense Channel. (The mainframe automatically configures channel 512 as the Source Channel.) Since Scanner Mode is set (SCANMODE ON in line 20), CONFMEAS also sets TERM RIBBON.

```
10 OUTPUT 709;"USE 600"           ! Use voltmeter in mainframe slot 6
20 OUTPUT 709;"SCANMODE ON"      ! Set Scanner Mode
30 OUTPUT 709;"CONFMEAS RTD92,500" ! Conf for type 92 RTD, meas ch 500
40 ENTER 709;A                   ! Enter temperature
50 PRINT A                        ! Display temperature
60 END
```

A typical return value (in °C) for a Type 92 RTD at room temperature is:

24.54297

### Example: Thermocouple Measurements

This program uses CONFMEAS to make temperature measurements of J-type thermocouples connected to channels 500 through 523 of an HP 44713A using an HP 44702A/B in Scanner Mode. See Figure 4-5 for typical connections to the HP 44713A/B.

In line 40, CONFMEAS TEMPj,500-523 sets measurement of a J-type thermocouple and sets channels 500 through 523 as the channels to be scanned. Since Scanner Mode is set (SCANMODE ON in line 30), CONFMEAS also sets TERM RIBBON.

```

10 DIM Temp(0:23)                               ! Define controller array
20 OUTPUT 709;"USE 600"                          ! Use voltmeter in mainframe slot 6
30 OUTPUT 709;"SCANMODE ON"                     ! Set Scanner Mode
40 OUTPUT 709;"CONFMEAS TEMPJ,500-523"! Conf for J-type t-couple, meas ch
50 ENTER 709;Temp(*)                             ! Enter 24 temperature readings
60 PRINT USING "K,/";Temp(*)                    ! Print readings
70 END

```

For J-Type thermocouples at room temperature, a typical return (values in °C) is:

```

24.542
24.5415
.
.
.
25.856

```

} 24 readings

### Example: Isothermal Block Reference Temperature

The HP 3852A linearization program supports B, E, J, K, N14, N28, R, S, and T type thermocouples. However, to use a different type of thermocouple for temperature measurements, you will need to measure the reference temperature (isothermal block temperature) to use in your own linearization program. This program shows how to measure the reference temperature of an HP 44713A in slot 5 using CONFMEAS and an HP 44702A/B in Scanner Mode.

```

10 OUTPUT 709;"USE 600"                          ! Use voltmeter in mainframe slot 6
20 OUTPUT 709;"SCANMODE ON"                     ! Set Scanner Mode
30 OUTPUT 709;"CONFMEAS REFT,500"              ! Meas ref temp in mainframe slot 5
40 ENTER 709;A                                  ! Enter reference temperature
50 PRINT A                                       ! Display reference temperature
60 END                                           !

```

For an HP 44713A/B at room temperature, a typical return (value in °C) is:

24.438

# Index



# Index

---

## A

- AC current
  - example programs, 5-8
  - measurement connections, 2-6, 4-5
- AC voltage
  - example programs, 5-4
  - measurement connections, 2-6, 3-4, 4-7
- Attenuators, installing, 2-4, 4-5

## B

- Bank switches, 2-1, 3-1, 4-1
- Block diagram description, 2-1, 3-1, 4-1

## C

- Capabilities, 1-4
- Channel definitions, 2-3, 3-3, 4-4
- Checking ID, 2-11, 3-3, 4-4
- Command summary, 5-2
- Connections
  - current, 2-6, 4-5
  - resistance, 2-7,
  - temperature, 2-9, 4-8
  - voltage, 2-6, 3-4, 4-7
- Current sensing, 2-6, 4-5

## D

- DC current
  - example programs, 5-8
  - measurement connections, 2-6, 4-5
- DC voltage
  - example programs, 5-4
  - measurement connections, 2-6, 3-4, 4-7

## F

- Four-wire ohms
  - example programs, 5-9
  - measurement connections, 2-7

## I

- Identity, checking, 2-11, 3-7, 4-10
- Installation/checkout
  - HP 44711A, 2-9
  - HP 44712A, 3-7
  - HP 44713A, 4-10
- Installing
  - attenuators, 2-4, 4-5
  - low-pass filters, 2-4, 4-5
  - shunt resistors, 2-6, 4-5
- Introduction, 1-1
- Isolation relays, 2-3, 3-3, 4-3

## L

- Low-pass filters, installing, 2-4, 4-5

## M

- Making Measurements
  - AC current, 5-8
  - AC voltage, 5-4
  - DC current, 5-8
  - DC voltage, 5-4
  - four-wire ohms, 5-9
  - RTDs, 5-13
  - thermistors, 5-9
  - thermocouples, 5-13
- Measurement connections
  - current, 2-6, 4-5
  - resistance, 2-6, 4-5
  - temperature, 2-9, 4-8
  - voltage, 2-6, 3-4, 4-7

## R

- Reading channel state, 2-12, 3-8, 4-12
- Resistance
  - example programs, 5-9
  - measurement connections, 2-7, 4-8
- RTDs
  - example programs, 5-13
  - measurement connections, 2-9

## S

- Shunt resistors, installing, 2-6, 4-5
- Strain relief, 2-6, 3-4, 4-7

## T

- Temperature
  - example programs, 5-13
  - measurement connections, 2-9, 4-8
- Thermistors
  - example programs, 5-9
  - measurement connections, 2-9
- Thermocouples,
  - example programs, 5-13
  - measurement connections, 4-8
- Tree switches, 2-1, 3-1, 4-1

## V

- Verifying wiring connections, 2-11, 3-8, 4-12
- Voltage
  - example programs, 5-4
  - measurement connections, 2-6, 3-4, 4-7

