



HEWLETT
PACKARD

REMOTE OPERATION MANUAL

HP 3784A
DIGITAL TRANSMISSION ANALYZER

SERIAL NUMBERS

This manual applies directly to instruments with serial numbers prefixed 2902U.

© Copyright HEWLETT-PACKARD LIMITED 1989
SOUTH QUEENSFERRY, WEST LOTHIAN, SCOTLAND

Manual Part Number: 03784-90001
Microfiche Part Number: 03784-90026

Printed: April 1989

WARNING

READ THE FOLLOWING NOTES BEFORE INSTALLING OR SERVICING ANY INSTRUMENT.

1. **IF THIS INSTRUMENT IS TO BE ENERGISED VIA AN AUTO-TRANSFORMER MAKE SURE THAT THE COMMON TERMINAL OF THE AUTO-TRANSFORMER IS CONNECTED TO THE NEUTRAL POLE OF THE POWER SOURCE.**
2. **THE INSTRUMENT MUST ONLY BE USED WITH THE MAINS CABLE PROVIDED. IF THIS IS NOT SUITABLE, CONTACT YOUR NEAREST HP SERVICE OFFICE. THE MAINS PLUG SHALL ONLY BE INSERTED IN A SOCKET OUTLET PROVIDED WITH A PROTECTIVE EARTH CONTACT. THE PROTECTIVE ACTION MUST NOT BE NEGATED BY THE USE OF AN EXTENSION CORD (POWER CABLE) WITHOUT A PROTECTIVE CONDUCTOR (GROUNDING).**
3. **BEFORE SWITCHING ON THIS INSTRUMENT:**
 - (a) **Make sure the instrument input voltage selector is set to the voltage of the power source.**
 - (b) **Ensure that all devices connected to this instrument are connected to the protective (earth) ground.**
 - (c) **Ensure that the line power (mains) plug is connected to a three-conductor line power outlet that has a protective (earth) ground. (Grounding one conductor of a two-conductor outlet is not sufficient).**
 - (d) **Check correct type and rating of the instrument fuse(s).**

Contents

Chapter 1	Page
Remote Operation	1-1
Choosing Between The HP-IB and RS-232-C Interface.....	1-1
Hewlett Packard Interface Bus (HP-IB)	1-2
What is the HP-IB?	1-2
Connecting The HP 3784A To The HP-IB	1-3
Operating Distances.....	1-3
Communicating with the Controller.....	1-3
Programming the HP 3784A.....	1-4
Sending Data to the HP 3784A.....	1-4
Command Terminators	1-4
Invalid Commands.....	1-5
Reading Data from the HP 3784A	1-5
Note on the Syntax of Strings	1-5
Examples	1-5
Message Format	1-6
Character	1-6
String	1-6
Numeric	1-6
Example Programs.....	1-8
Example 1 Code Error Injection and Measurement.....	1-8
Frequency Measurement.....	1-9
Jitter Tolerance Measurement.....	1-10
Universal Commands.....	1-11
Device Clear (DCL) and Selective Device Clear (SDC).....	1-11
Interface Clear (IFC)	1-11
Serial Poll.....	1-12
Remote Enable (REN).....	1-12
Local Lockout (LLO).....	1-12
Local (LCL).....	1-13
HP-IB Addresses	1-14
HP-IB Capability.....	1-15
Addressable Mode/Talk Only Mode.....	1-16
Selecting Addressable Mode.....	1-16
Selecting Talk Only Mode.....	1-16

Chapter 2	Page
RS-232-C Operation	2-1
Introduction	2-1
What is RS-232-C?.....	2-1
Operating Considerations	2-2

Contents (continued)

Operating Distances	2-2
Hardwire Operation	2-2
Cabling for Computers Configured as DTE.....	2-2
Cabling for Computers Configured as DCE.....	2-4
Configuring the Computer for Hardwire Operation	2-6
Configuring Your Computer RS-232-C Interface.....	2-6
Using a Computer to Control the HP3784A.....	2-7
Introduction	2-7
Setting up the Computer	2-7
Connecting the Computer to the HP 3784A	2-8
Using a Data Terminal to Control the HP 3784A.....	2-10
Introduction	2-10
Procedure.....	2-10
MODEM OPERATION.....	2-13
Connecting the HP 3784A to the Modem	2-13
RS-232-C Cables	2-13
Re-configuring the HP 3784A Data Rate Select Strapping.....	2-15
Configuring the HP 3784A RS-232-C Remote (Modem) Interface	2-17
Subpage [SETUP A].....	2-19
Half Duplex Operation	2-19
Full Duplex Operation	2-19
Handshake (ENQ/ACK or XON/XOFF).....	2-20
DTR (optional manual control)	2-21
Subpage [SETUP B].....	2-22
Speed	2-22
Setting Parity	2-23
Stop Bits	2-23
HP 3784A Character Format.....	2-23
Subpage [STATUS].....	2-24
HP 3784A RS-232-C Default Settings.....	2-24
ADDITIONAL INFORMATION.....	2-25
Device Clear - RS-232-C Equivalent of	2-25
Remote, Local and Local Lockout.....	2-25
Service Requests/Status Reporting Over RS-232-C	2-26
More About ENQ/ACK and XON/XOFF Handshakes	2-26
XON/XOFF Handshake	2-28
[RX ONLY].....	2-28
[TX ONLY].....	2-28
[RX & TX].....	2-28

Chapter 3	Page
Command Syntax - HP-IB/RS-232-C	3-1
List of Instrument Commands.....	3-1
HP 3785A/B Compatible Commands.....	3-6
HP-IB Common Capability Messages.....	3-10

Contents (continued)

Reset Command (RST)	3-10
Self-Test Command.....	3-10
Remote Command (RMT).....	3-11
Local Command (LCL).....	3-11
Clear Command (CLR).....	3-11
Configuration Command (CON)	3-12
Key Query (KEY?)	3-12
Request Service Mask Command (RQS).....	3-13
Identification Query (ID?).....	3-14
Revision Date Query (REV?).....	3-14
Serial Number (SER).....	3-15
Error Code Query (ERR?).....	3-15
Ready Code Query (RDY?).....	3-15
Status/Events Query (STA?)	3-16
Status Query (STB?)	3-16
Options Query (OPT?).....	3-16
HP 3784A Command Set	3-17
Transmitter Clock Commands.....	3-17
Transmitter Clock Command (TCL).....	3-17
Transmitter Clock Rate Command (TCR).....	3-17
Transmitter Clock Phase (TCP).....	3-18
Transmitter Clock Offset (TCO).....	3-18
Transmitter Clock Frequency (TCF).....	3-18
Receiver Clock Commands	3-19
Receiver Clock Rate Command (RCR).....	3-19
Receiver Clock Phase (RCP).....	3-19
Configuration Commands	3-20
Transmitter Interface Format Command (TIF)	3-20
Receiver Configuration Format Command (RCF)	3-20
Receiver Interface Format Command (RIF)	3-21
Transmitter Ternary Interface Code (TTI)	3-21
Receiver Ternary Interface Code (RTI).....	3-21
Binary Interface Level (BIL)	3-22
Transmitter Pattern Command (TPT)	3-22
Receiver Pattern Command (RPT)	3-23
Control Octet Timing (TOC)	3-23
Selectable Port (SEL)	3-23
Data Pattern Commands.....	3-24
Transmitter Word Pattern Command (TWD).....	3-24
Receiver Word Pattern Command (RWD).....	3-24
Alternate Word Pattern Command (ALW).....	3-24
Alternate Switched Internal/External (ALS).....	3-25
Alternate Word Frequency (ALF).....	3-25
Transmitter PRBS Pattern Selection (TPP).....	3-26
Receiver PRBS Pattern Selection (RPP).....	3-26
Transmitter PRBS Zero Substitution Command (TZN)	3-27
Receiver PRBS Zero Substitution Command (RZN)	3-27
Error Add Commands.....	3-28

Contents (continued)

Error Add Command (EAD)	3-28
Error Add Type Command (EAT)	3-28
Error Add Ratio (EAR)	3-28
Single Error Add Command (SEA)	3-29
Jitter Generator Commands	3-30
Jitter Option Select (JOS)	3-30
Jitter Modulation Source Command (JMS)	3-30
Jitter Modulation Frequency Command (JFR)	3-31
Jitter Modulation Amplitude Command (JAM)	3-31
Jitter Manual Sweep Mask Command (JMA)	3-32
Programmable Jitter Tolerance Masks (JMK)	3-32
Jitter Mask Type (JMT)	3-33
Jitter Q Factor (JQF)	3-33
Jitter Receiver Commands	3-34
Jitter Filter (JFI)	3-34
Jitter Measurement Input (JMI)	3-34
Jitter Receiver Reference Clock (JRC)	3-34
Jitter Display Rate (JDR)	3-35
Jitter Receiver Range (JRA)	3-35
Jitter Receiver Peak Threshold (JPT)	3-35
Measurement Commands	3-37
Code or Offset Measurement Selection Command (MEA)	3-37
Alarm Mask Command (AMR)	3-37
Display Command (DI)	3-38
Peak Select Command (PS)	3-38
Result Query Commands	3-39
Bit Error Result Query (RSB?)	3-39
Code Error Result Query (RSC?)	3-39
Cumulative Slip Deciseconds Query (RSS?)	3-39
Jitter Hits Result Query (RSJ?)	3-40
Jitter Receiver Amplitude Query (RSR?)	3-40
Jitter Maximum Amplitude Query (RSM?)	3-40
Frequency Measurement Result Query (RSF?)	3-41
Frequency Offset Result Query (RSO?)	3-41
Analysis Result Query Command (ANR?)	3-41
Analysis Threshold Result Query (ATR?)	3-42
Alarm Duration Query (ALD?)	3-42
Alarm Status Query (ALM?)	3-42
Elapsed Time Query Command (ELP?)	3-43
Current Answer Query (CA)	3-43
Query Annunciators (QA)	3-44
Analysis Threshold Commands	3-45
Availability Threshold Command (ATA)	3-45
Error Seconds Threshold Command (ATB)	3-45
Severely Errored Seconds Threshold Command (ATC)	3-45
Degraded Minutes Threshold Command (ATD)	3-46
Error/Interval Threshold Command (ATE)	3-46
2-10 Error/Interval Threshold Command (ATF)	3-46

Contents (continued)

Greater than 10 Error/Interval Threshold Command (ATG).....	3-47
Error Burst Threshold Command (ATH).....	3-47
Unavailability Threshold Command (ATI).....	3-47
Analysis Long Term Mean Error Ratio Threshold (ATJ).....	3-48
Logging Commands.....	3-49
Logging Mode (LOG).....	3-49
Real Time Logging During Gating Type of Result (LDT).....	3-49
Real Time Page-4 Results (Logging During Gating) (LDR).....	3-49
Real Time Logging During Gating Counts/Second (LDC).....	3-50
Logging at End of Gating Summary (LEG).....	3-51
Logging Error Thresholds Summary Trigger (LET).....	3-52
Logging Freq Offset Threshold Summary Trigger (LOT).....	3-52
Real Time Logging Peak Jitter Amplitude Threshold Trigger (LPT).....	3-53
Logging Graphics (LGF).....	3-53
Logging Squelch (LSQ).....	3-54
Miscellaneous Commands.....	3-55
Gating Type Command (GTY).....	3-55
Interval Command (INT).....	3-55
Gating Period Comand (GPR).....	3-55
Audio Command (AUD).....	3-56
Audio Source Command (AUS).....	3-56
Beep Command (BEEP).....	3-56
Save Panel Command (SAV).....	3-57
Recall Panel Command (RCL).....	3-57
Date Set-Up Command (DAT).....	3-57
Time Set-Up Command (TIM).....	3-57
Start Gating Command (STR).....	3-58
Stop Gating Command (STP).....	3-58
Plot Jitter Tolerance Graph (PJT).....	3-58
Plot Jitter Transfer Function Graph (PJX).....	3-58
Plot Stop (PSP).....	3-59
Logging Port Configuration Command (LDV).....	3-59
External RS-232 Printer Command (PTR).....	3-59
RS-232 Set-Up Command (MDM).....	3-60
Keyboard Lock Command (KLK).....	3-61
Firmware Revision Number (FRN?).....	3-62
HP-IB Address Command (ADR).....	3-62
Jitter Sub-Test Command (JST).....	3-62

Appendix A Error Codes

Page
A-1

Introduction.....	A-1
Common Capability Errors.....	A-1
Parse Time Errors.....	A-1
Execution Time Errors.....	A-2

Contents (continued)

Internal Errors.....	A-2
Self-test Errors.....	A-3
Option or Capability Errors.....	A-3

Appendix B Page Programming the Status Registers B-1

Introduction	B-1
HP 3784A Status Registers.....	B-1
Status Register B.....	B-2
Interrogating Status Register B.....	B-4
Status Register B - Example Program	B-5
Status Register A	B-6
Interrogating Status Register A.....	B-7
Programming a Service Request.....	B-8
Service Request Example Program	B-9
Alarm Register	B-10
Interrogating the Alarm Status Register.....	B-11
Generating an SRQ from an Alarm Condition.....	B-12
Alarm Register - Example Program	B-13
Ready Register.....	B-14
Detailed Description of Ready Register.....	B-14
Interrogating the Ready Register.....	B-15
Ready Register - Example Program	B-15

Appendix C Page DEFAULT SETTINGS C-1

Appendix D Page RS-232-C Interchange Circuits (DTE) D-1

Appendix E Page Important RS-232-C Information E-1

Contents (continued)

	Page
Appendix F	
General RS-232-C Information	F-1
General RS-232-C Information	F-1
The Signals	F-2
Ground	F-2
Data	F-2
Modem Control	F-2
Synchronous Clocks	F-2
Secondary Channel	F-2
Other Signals	F-3
RS-232-C Pin Assignment	F-4
Standards	F-5
Signal Level	F-5
Modem Control	F-6
Group 1 - Line Control	F-6
Group 2 - Data Flow Control	F-7
Appendix G	
Setting Up Your Datacomms Hardware	G-1
Configuring the System	G-1



Figure 1-1 The HP 3784A Digital Transmission Analyzer and Accessories Supplied

This manual contains information on how to operate the instrument remotely using a suitable desk-top or mainframe computer as a controller. The manual is conveniently divided into three parts. The first part deals with remote operation using the *HP-IB interface; the second part with remote operation using the *RS-232-C (modem) interface; and the third part contains a table of the command syntax used with the HP 3784A (applicable to both HP-IB and RS-232-C).

* HP-IB is the Hewlett Packard Interface Bus and provides compatibility between a controller and external devices such as the HP 3784A. It also conforms to the IEEE standard 488-1978, ANSII standard MC 1.1 and IEC Recommendation 625-1.

* RS-232-C is a data communications standard maintained by the Electronics Industries Association (EIA). An equivalent international standard is CCITT V.24/V.28.

1.1 Choosing Between The HP-IB and RS-232-C Interface

The RS-232-C interface is a serial interface, whereas the HP-IB is a parallel interface. Communication over the RS-232-C interface mutually excludes the connection of other instruments. If the configuration requires other instruments to be connected, this must be done via the HP-IB interface.

The RS-232-C interface does not support the same interrupt capability or equivalent of HP-IB serial polling when the HP 3784A requires service.

Long distance communication via the HP-IB interface requires the inclusion of bus extenders (such as the HP37201, HP37202, HP37203 or HP37204) plus modems, whereas the RS-232-C interface connects directly to the modem.

In many cases it is not simply a matter of linking the computer via a cable plus a couple of modems to the instrument and sending data messages. Other factors like distance between computer and instrument, baud rate selection, hardwired or modem link, full duplex or half duplex, selection of ENQ/ACK or XON/XOFF, have to be determined before setting computer, instrument and modems accordingly.

NOTE

A separate RS-232-C port is available for use with an external printer. Information on this and how to use an external printer on the HP-IB are contained in the Operating and Calibration Manual.

1.2 Hewlett Packard Interface Bus (HP-IB)

1.3 What is the HP-IB?

The Hewlett Packard Interface Bus (HP-IB) is Hewlett Packard's implementation of the IEEE standard 488-1978, ANSI standard MC 1.1 and IEC Recommendation 625-1.

The HP-IB Interface is easy to use and allows great flexibility in communicating data and controlling information between the controller and the HP 3784A. It is one of the easiest methods of constructing automatic test systems.

Devices on the bus fall into at least one of three categories, talkers, listeners or controllers. As an example of the simplest system (i.e. without a controller), one instrument could be configured to continuously send data - known as TALKING and the other instrument (such as a printer) could be configured to continuously receive data - known as LISTENING. Most devices can perform both roles, TALK or LISTEN, but not simultaneously. Usually a controller manages the operation of which instrument TALKS and which instrument LISTENS.

The HP 3784A can TALK and LISTEN but only when it is designated to do so by a suitable controller. The controller may also manage other instruments connected in the same bus configuration, addressing only one instrument, to carry out the data transfer or TALK function. Table 1-7 includes a listing of the HP 3784A's total HP-IB capability.

Further information on HP-IB standards and concepts is available in the following publications:-

IEEE Interface Standard 488-1978

ANSI Interface Standard MC 1.1

Improving Measurements in Engineering and Manufacturing (HP P/N 5952-0078)

Condensed Description of the Hewlett Packard Interface Bus (HP P/N 59401-90030)

1.4 Connecting The HP 3784A To The HP-IB

You should consider the following when connecting the HP 3784A to the bus:-

- Operating distances
- Communicating with the controller (Address)

1.4.1 Operating Distances

Up to 15 instruments can be connected on a local bus system, but it is important to ensure that the maximum HP-IB cable length between instruments is less than 2 metres. In addition the total cabling should not exceed 20 metres.

Some useful cable part numbers are listed in Table 1-1.

Table 1-1. Cable Part Numbers

Length	Part Number	
1m	HP10833A	For distances up to 1000m a suitable bus extender such as a HP37203A or a HP37201A can be used. Two bus extenders are required, one at the local bus and one at the remote bus. For distances beyond 1000m two HP37201A bus extenders with suitable modems must be employed.
2m	HP10833B	
4m	HP10833C	
0.5m	HP10833D	

Note: The 4m cable may be used under certain conditions, usually the driver loading has to be altered to ensure satisfactory operation.

1.4.2 Communicating with the Controller

When configuring a system it is important that each device in that system has a unique address. To configure the HP 3784A for HP-IB, select Page 8 on the front panel then set the Remote Port to HP-IB and select the desired address using the Cursor Position and UPDATE / keys.

```

8 Remote Port. [HP-IB]      Address [05]
Status. Local

Remote error number.      0

```

Preset Address:- The HP 3784A is factory preset to address 05.

Note: When selecting an address remember most HP desk top computers are factory preset to address 21, Disc drives to 00 and Printers to 01.

Remote Operation

Talk/Listen Addresses:- With most Hewlett Packard controllers it is sufficient to use the device address; the controller automatically sends the talk and listen characters. In the case of the controllers which have multiple I/O facilities, ie, the HP 200/300 Series, the HP-IB interface selected is usually factory preset to 7. Thus to address the HP 3784A with a factory preset address of 05, the controller sends:-

OUTPUT 705; (HP 3784A Listen Address)
OR
ENTER 705; (HP 3784A Talk Address)

1.5 Programming the HP 3784A

In most cases programming the HP 3784A is simply a matter of finding out what the Page settings are locally and converting these to the appropriate HP-IB data messages. These are listed in Table 3-1.

1.5.1 Sending Data to the HP 3784A

Using an HP 200/300 Series Controller a typical message sent to the instrument is:-

OUTPUT 705; "MEA1; RPT1"

The OUTPUT statement which includes the HP 3784A listen address, 05, is separated by a semicolon from the data message "MEA1; RPT1".

Data Messages:-

- are usually a 3 letter mnemonic
- each mnemonic is usually followed by a parameter which indicates an instrument setting.
- more than one command can be sent in the data message. Each however must be separated by a semicolon.

1.5.2 Command Terminators

With non-HP controllers it may be necessary to send a suitable command terminator after the data message, the terminator can be:-

- ASCII newline (identical to the linefeed character, LF)
- ASCII carriage return + 1 linefeed, CR/LF

Similarly when the HP 200/300 Series Controllers use explicit statements to address the instrument, and send data messages a suitable CR/LF terminator must be used. This method of addressing is useful when the same message has to be sent to multiple listeners simultaneously.

e.g. SEND 7; UNL MTA LISTEN 5 LISTEN 7 DATA "TIM 01,00,00" & CHR \$(13) & CHR \$(10)

This addresses two HP 3784A's at address 5 and 7 and simultaneously sets the time to 1 o'clock. The data message is followed by a carriage return CHR \$(13), and line feed CHR \$(10).

In most HP controllers the CR/LF is sent automatically when BASIC OUTPUT statements are used.

1.5.2.1 Invalid Commands

A command will be rejected if:

- It contains a syntax error
- It cannot be identified
- It has too few or too many parameters
- A parameter is out of range
- It is out of context

All subsequent commands in the same string will be ignored.

1.5.3 Reading Data from the HP 3784A

It is possible to interrogate the individual settings and status of the HP 3784A by using the "QUERY" commands described in Table 3-1 i.e. commands with an integral question mark (IPL?).

The following two examples in HP Basic illustrate how data can be retrieved. More examples are given in paragraph 1-7 Example Programs.

- a string variable
- two variables

1.5.4 Note on the Syntax of Strings

When sending strings to the instrument either the double quote (") or the single quote (') may be used, the former being more suited to PASCAL programs which make use of single quote, the latter being more suited to use in BASIC programs, which uses double quote as a delimiter. In this manual the double quote has been used throughout.

1.5.4.1 Examples

String Variable:-

10 DIM A\$(50)	! Dimensions size of string
20 OUTPUT 705;"ATA?"	! Requests Analysis threshold for % Availability
30 ENTER 705:A\$! Enters it into the string
40 PRINT A\$! Prints string
50 END	

A typical result printed is 1, 75.75 where 1 indicates that the threshold is enabled and 75.75 represents the % Availability threshold selected i.e. 75.75%.

Two Variables:-

```
10 OUTPUT 705;"ATA?"
20 ENTER 708:A,B
```

Remote Operation

```
30 PRINT A,B  
40 END
```

A typical result printed is 1 75.75. Variable A contains the enable/disable bit and Variable B the selected threshold.

The format of the data returned from the HP 3784A is described in Message Format.

1.6 Message Format

The HP 3784A has the capability of returning data in the following formats:-

```
CHARACTER  
STRING  
NUMERIC
```

1.6.1 Character

Returns alphabetic character(s) and/or number(s) and should be entered into a string variable.

Example:-

```
10 OUTPUT 705; "ID?"  
20 ENTER 705; String $  
30 PRINT String $  
40 END
```

Returns HP 3784A

1.6.2 String

Returns an ASCII string of "4 digits U 5 digits" enclosed in " " and should be entered into a string variable.

Example:

```
10 OUTPUT 705; "SER?"  
20 ENTER 705; String $  
30 PRINT String $  
40 END
```

Possible Result = "3784U00001"

1.6.3 Numeric

Returns one of three numeric formats and can be entered into a string or numeric variable.

The three formats are:-

- (a) A signed integer
- (b) A signed number with embedded decimal point.
- (c) A signed number with embedded decimal point and exponent

(a) A Signed Integer

Example:-

```

10 OUTPUT 705; "ERR?"           ! Requests the contents of the error
20 ENTER 705; String $         register.
30 PRINT String $
40 END

```

Possible Result = -129

(b) A Signed Number with Embedded Decimal Point.

Example:-

```

10 OUTPUT 705; "ATD?"         ! Requests the threshold for the %
20 ENTER 705; String $       Degraded minutes Analysis.
30 PRINT String $
40 END

```

Possible Result = 1, 32.35

The first number, 1, indicates whether or not it is enabled.

(c) A Signed Number with Embedded Decimal Point and Exponent.

```

10 OUTPUT 705; "ATE?"         ! Requests the Analysis Threshold for 1 er-
20 ENTER 705; String $       ror/interval pass/fail test.
30 PRINT String $
40 END

```

Possible Result = 0, 8.9E4

The first number, 0, indicates whether or not it is enabled.

1.7 Example Programs

The HP 3784A offers a large choice of commands for remote operation. The decision of whether to use the instrument over the HP-IB or the RS-232-C interface should have already been decided, if not there is some advice at the beginning of the REMOTE section to help. The following example programs are written in HP 200/300 SERIES BASIC which allow the instrument to be operated remotely on either interface. The programs will run using BASIC 4.0 with a minimum basic 2.1 system boot.

The programs are not intended for use in customised applications, but to highlight some possible uses of the instrument.

1.7.1 Example 1 Code Error Injection and Measurement

In the following program the HP 3784A Transmitter is set to inject code errors into the HDB3 coded PRBS test pattern and the errors measured at the Receiver.

Procedure

1. Switch on the HP 3784A and connect the TX DATA OUT port to the RX TERNARY DATA IN port using a suitable cable.
2. Connect a cable from the HP 3784A rear panel HPIB port to the Computer HP-IB Interface connector.
3. Select Page 8 Remote Port and set as follows:

8 Remote Port. [HP-IB]	Address [05]
Status. Local	
Remote error number.	0

4. Type in the following program then press the Controller PSE and RUN keys.

```

10 ! DEMO PROGRAM TO SET HP 3784A TO INJECT CODE ERRORS INTO THE
20 ! TRANSMITTER TEST PATTERN AND MEASURE AT THE RECEIVER. THE
30 ! MEASUREMENT IS PERFORMED OVER A 5 SECOND GATING PERIOD.
40 DIM Result$(50)
50 Hp3784=705
60 REMOTE Hp3784
70 CLEAR Hp3784
80 PRINTER IS 1 !SETS CRT AS PRINTER
90 PRINT CHR$(12) ! CLEARS SCREEN
100 OUTPUT Hp3784;"RCL0"
110 OUTPUT Hp3784;"EAD2;EAT2;EAR3"
120 OUTPUT Hp3784;"MEA1"
130 OUTPUT Hp3784;"GTY2;GPR0,0,0,5;INT1"
140 OUTPUT Hp3784;"STR"
150 WAIT 5
160 OUTPUT Hp3784;"RSC?1"
170 ENTER Hp3784;Results$
180 PRINT Results$
190 END
    
```

1.7.2 Frequency Measurement

When the HP 3784A is configured to make measurements on Binary data , the frequency of the binary clock signal is automatically measured and the result displayed on Page 4 [ERROR RESULTS]. This program returns the value of the Rx Frequency.

Procedure

1. Connect the TX DATA OUT port to RX BIN DATA IN and the TX CLOCK OUT port to the RX CLOCK IN port.
2. Connect a cable from the HP 3784A rear panel HP-IB port to the Computer HP-IB Interface connector.
3. Select Page 8 Remote Port and set as follows:

8 Remote Port. [HP-IB]	Address [05]
Status. Local	
Remote error number.	0

4. Set the Computer to EDIT mode; type in the following program and press the PSE and RUN keys.

```

10  !DEMO PROGRAM TO MEASURE RX FREQUENCY. TX CLOCK SET TO VAR 1000KHZ
20  ! AND TX PATTERN TO 8 BIT WORD 10110110.
30  DIM Result$(50)
40  Hp3784=705
50  REMOTE Hp3784
60  CLEAR Hp3784
70  PRINTER IS 1 ! SETS CRT AS PRINTER
80  PRINT CHR$(12)!CLEARS SCREEN
90  OUTPUT Hp3784;"RCL0"
91  WAIT 2
100 OUTPUT Hp3784;"TIF3;BIL1"
110 OUTPUT Hp3784;"TCL3;TCF1000000"
120 OUTPUT Hp3784;"TPT2;TWD 8,'10110110'"
130 OUTPUT Hp3784;"GTY2;GPR0,0,0,5;INT1"
140 OUTPUT Hp3784;"STR"
150 WAIT 6
160 OUTPUT Hp3784;"RSF?"
170 ENTER Hp3784;Results$
180 PRINT Results$
190 END

```

1.7.3 Jitter Tolerance Measurement

The following program sets the HP 3784A to perform a Jitter Tolerance measurement using SPOT MASK modulation. System Tolerance to jitter is verified at four points on the CCITT Jitter Tolerance Mask.

The front panel ALARMS are interrogated (using the Alarm Register) to determine whether the jitter introduced at either of the SPOT frequencies has caused Bit or Code errors. A decimal value equal to the contents of the Alarm Register is displayed at the end of the program. Refer to Appendix B for detailed information on the Alarm Register.

Procedure

1. Connect the TX DATA OUT port to the RX TERNARY DATA IN PORT. In a practical example the TX DATA OUT PORT would be connected to the system under test, and the system output to the RX TERNARY DATA IN port.
2. Connect a cable from the HP 3784A rear panel HP-IB port to the Computer HP-IB Interface connector.
3. Select Page 8 Remote Port and set as follows:

8 Remote Port. [HP-IB]	Address [05]
Status. Local	
Remote error number.	0

4. Set the Computer to EDIT mode, and type in the following program and press the PSE and RUN keys.

```

10  ! DEMO PROGRAM TO SET THE HP3784A TO MAKE A JITTER TOLERANCE
20  ! MEASUREMENT USING SPOT MASK MODULATION.
30  ! THE SYSTEM TOLERANCE TO JITTER IS VERIFIED AT FOUR POINTS
40  ! ON THE CCITT JITTER TOLERANCE MASK.
50  ! THE HP3784A FRONT PANEL ALARMS ARE INTERROGATED USING THE
60  ! ALARM REGISTER IN SHOWN IN THE EXAMPLE IN APPENDIX B.
70  DIM Results$(50)
80  Hp3784=705
90  REMOTE Hp3784
100 CLEAR Hp3784
110 PRINTER IS 1 ! SETS CRT AS PRINTER
120 PRINT CHR$(12) ! CLEARS SCREEN
130 OUTPUT Hp3784;"RCL0"
140 OUTPUT Hp3784;"JMS4"
150 OUTPUT Hp3784;"STR"
160 WAIT 4
170 OUTPUT Hp3784;"JMA100"
180 WAIT 4
190 OUTPUT Hp3784;"JMA1000"
200 WAIT 4
210 OUTPUT Hp3784;"JMA10000"
220 WAIT 4
230 OUTPUT Hp3784;"JMA100000"
240 OUTPUT Hp3784;"ALM?"
250 WAIT 4
260 OUTPUT Hp3784;"STP"
270 ENTER Hp3784;Results$
280 PRINT Results$
290 END

```

1.8 Universal Commands

DEVICE CLEAR
SELECTIVE DEVICE CLEAR
INTERFACE CLEAR
SERIAL POLL
REMOTE ENABLE
GO TO LOCAL

1.8.1 Device Clear (DCL) and Selective Device Clear (SDC)

These commands are normally sent at the start of a program to clear the instrument. The instrument is returned to the initialised condition regardless of the current state. The initialised condition is as follows:

- Stopped gating
- All buffers flushed
- Stop asserting SRQ
- Service request mask set to ERR
- Clear all errors
- Clear status, alarm change and key registers
- Ready register set to 1 (Ready for new command)

The Device Clear command using HP 200/300 Series Basic is:-

CLEAR 7 (where 7 is the Bus I/O select code)

The Selective Device Clear command using HP 200/300 Series Basic is:-

CLEAR 705 (where 7 is the Bus I/O select code and 05 is the device Address)

1.8.2 Interface Clear (IFC)

The HP 3784A response to Interface Clear is to return to the listener idle state; it does not affect the parser or any of the internal buffers.

The IFC command using HP 200/300 Series Basic is:-

ABORT 7

1.8.3 Serial Poll

The instrument can be serial polled at any time to retrieve the value of the primary status byte. A serial poll will also clear the rsv message (SRQ line) if this is set.

The recommended sequence for performing a serial poll is as follows..

```
UNL
controller listen
instrument talk
SPE          --->
read status byte  <---  send status byte
SPD
UNT
```

The meaning of each bit in the SRQ status byte is given in Table 1-2.

1.8.4 Remote Enable (REN)

The Remote command instructs the HP 3784A to accept instructions via HP-IB. When the HP3784A receives this command it illuminates the front panel REMOTE LED and the display on Page 8 Remote Port is as follows:

8 Remote Port. [HP-IB]	Address [05]
Status. Remote	
Listen	
Remote error number.	0

The instrument is put into the remote state by setting the REN signal line and addressing the instrument to listen. The instrument will accept commands while in local mode only if they do not change the configuration of the instrument. If a command is sent while the instrument is in local mode, an error (-201) will be generated.

Although the instrument is remote, you can still use the keys on the HP 3784A which allow you to access the information on the various pages. The CHANGE keys can also be used to view the various results on Page 4 (Measurements). The keys always disabled while the instrument is remote are EXEC, START/STOP and AUDIO.

An example of the Remote command using HP 200/300 Series Basic is:-

REMOTE 705 (where 7 is the bus I/O select code and 05 is the device address)

1.8.5 Local Lockout (LLO)

It is recommended that the Local Lockout command is sent after the Remote command to ensure the controller has sole control of the HP 3784A at all times. It disables the LOCAL key but still allows you to view the various pages and parameters using the Page and Position keys. The display on Page 8 Remote Port is as follows:

```

8 Remote Port. [HP-1B]      Address [05]
Status. Remote Local Lockout
      Listen
Remote error number.      0

```

To assert the Local Lockout command the Controller should send the REN meta-message followed by the LLO meta message.

When in the RWLS state (remote with local lockout), asserting the LOCAL field of the remote control page will cause bit 2 (FPS) of the status byte to be set, generating an SRQ if the SRQ mask is enabled. It is then at the discretion of the Controller whether to return the instrument to local control or ignore the request.

An example of the Local Lockout command using HP 200/300 Series Basic is:

LOCAL LOCKOUT 7 (configures all the instruments on the bus to the Local Lockout condition.)

1.8.6 Local (LCL)

The Local command returns the HP 3784A from Remote Control to local front panel control. The following two examples of the Local command using HP 200/300 Series Basic produce different results.

- (a) LOCAL 7 (Where 7 is the bus I/O select code. This returns all devices on interface 7 to the Local mode and cancels Local Lockout if present.)

The display is as follows:

```

8 Remote Port. [HP-1B]      Address [05]
Status. Local
Remote error number.      0

```

- (b) LOCAL 705 (Where 7 is the bus I/O select code and 05 is the device address. If Local Lockout is not present then the display is as shown for LOCAL 7, but if Local Lockout is present then the display is as follows:)

```

8 Remote Port. [HP-1B]      Address [05]
Status. Local Local Lockout
Remote error number.      0

```

Note: Local Lockout is still displayed. This does not stop Local operation, it is simply an indication that there is still Local Lockout on the bus and when the HP 3784A is returned to Remote control, Local Lockout is automatically present.

1.9 HP-IB Addresses

In the Command mode of addressing the talk and listen addresses are chosen from the ASCII character set listed in Table 1-2. When a device receives one of these characters while ATN is true, it becomes addressed.

Table 1-2. HP-IB Addresses

Device	Talk	Listen
0	@	SP
1	A	!
2	B	"
3	C	6#
4	D	\$
5	E	%
6	F	&
7	G	'
8	H	(
9	I)
10	J	*
11	K	+
12	L	,
13	M	-
14	N	.
15	O	/
16	P	0
17	Q	1
18	R	2
19	S	3
20	T	4
21	U	5
22	V	6
23	W	7
24	X	8
25	Y	9
26	Z	:
27	[;
28	\	<
29]	=
30	Ø	>

1.10 HP-IB Capability

The interface functions available with the HP 3784A are listed in Table 1-3 (compatible with IEEE 488-1978).

Table 1-3. HP-IB Capability

Code	Description
SH1	Complete source handshake capability
AH1	Complete acceptor handshake capability
T5	Basic talker, serial poll, talk only mode, unaddress if My Listen Address (MLA)
TE0	No extended talker capability
L4	Basic listener, unaddress if My Talk Address (MTA)
LE0	No extended listener capability
SR1	Complete Service Request capability
RL1	Complete Remote-Local capability
PP0	No parallel poll capability
DC1	Complete device clear capability
DT0	No device trigger capability
C0	No controller capability

1.11 Addressable Mode/Talk Only Mode

The HP 3784A is designed to function in two modes: 'talk only' and an 'addressable mode'. There is no capability for 'listen only'. In talk only mode the front and rear panel controls are responsive and actively control the instrument. While in addressable mode the instrument can operate under either local or remote control. In local operation, all the front and rear panel controls are responsive and control the instrument. In remote operation all functional controls are inoperative, with the exception of the Page and Cursor Position controls, the instrument being controlled by the HP-IB controller. The front panel display will reflect the remote programming commands received.

At power on the instrument assumes the local state. Under local control all HP-IB commands will be ignored. To gain control of the instrument the controller must put the instrument into the remote state. This is accomplished by sending REN (remote enable) with the instrument listen address. The instrument can be returned to local control by asserting the LOCAL field on the remote configuration page (Page 8) or by the controller sending the GTL (go to local) meta-message or the 'LCL' command. Asserting the LOCAL field will not return the instrument to the local state if the controller has issued REN+LLO (remote with local lockout).

1.11.1 Selecting Addressable Mode

Set Page 8 Remote Port as follows:

```
8 Remote Port. [HP-IB]      Address [05]
Status. Local

Remote error number.    0
```

```
HELP. Remote control can be either by
HP-IB or RS232 but when HP-IB talk only
mode is required (see page 9) then HP-IB
remote control must be deselected on p8.
```

1.11.2 Selecting Talk Only Mode

Select Page 8 Remote Port and Page 9 Logging Port and set as follows:

```
8 Remote Port. [RS232] Subpage [SETUP A]
Connection [ MODEM ]      Duplex [FULL]
Enq/Ack [ON ]            Xon/Xoff [RX & TX]
```

```
9 Logging Port. [HP-IB]

Status. Talk only mode
```

2.1 Introduction

The RS-232-C Modem interface offers an alternative to the HP-IB as a means of communication with the Digital Transmission Analyzer (HP 3784A). Using this interface allows the instrument to be operated either a few feet away, using a simple 3-wire cable, or several thousand miles away, using suitable modems connected via the telephone network. However, several conditions and requirements must be considered, these are covered later in this section.

2.1.1 What is RS-232-C?

RS-232-C is an American data communication standard maintained by the Electronic Industries Association (EIA). An equivalent international standard is CCITT V.24/V.28.

The standard defines the functional, electrical and mechanical details of a serial interface for use in connecting Data Terminal Equipment (DTE), for example a computer, terminal or printer to Data Communication Equipment (DCE), usually a modem. It does not specify the format, transmission speed or protocol

For more information see General RS-232-C Information, refer to Appendix F.

2.2 Operating Considerations

Before information can be successfully transferred between the HP 3784A and your Computer or Terminal, a communication link must first be established. As part of the setting up process you must set the necessary protocol parameters at both the HP 3784A and your Terminal or Computer to be identical with each other. You must also choose the correct cabling arrangement to suit your situation. In many instances, the choice is up to you, particularly if your Terminal and the HP 3784A are in close proximity, (less than 50 feet). In other cases your choice is limited by the communications medium used, such as Modem or cable loss considerations.

If the HP 3784A and your Terminal are in close proximity (ie. within the same building), and you can connect a three-wire, (Tx, Rx and GND), RS232 cable between the HP 3784A and your Controller, then refer to the section headed 'Hardware Operation'. Otherwise, for much longer distances you may have to resort to a telephone link with Modem interfaces. In this instance refer to the section 'Modem Operation'.

2.2.1 Operating Distances

In the hardware configuration distance between computer and instrument largely depends on the cable capacitance and baud rate. In many cases the recommended maximum length of cable, 15 metres (50 feet) can be greatly exceeded by careful choice of cable and baud rate. The cable capacitance has the biggest effect on choice of baud rate causing distortion/loss of serial data, particularly at the highest speed settings. Using Modems and the telephone network the operating distance is virtually unlimited.

2.3 Hardware Operation

In this mode of operation, the computer or terminal is connected directly to the instrument. Before establishing your connection, it is necessary to establish whether your computers RS-232-C interface is configured as data Terminal Equipment (DTE) or Data Communications Equipment (DCE). In simple terms, if transmitted data emanates from your computer or terminals TXD or TX pin (on the RS-232-C interface connector), then it will be a DTE. If transmitted data emanates from the RXD or RX pin then it will be a DCE. The HP 3784A is always a DTE.

2.4 Cabling for Computers Configured as DTE

If you have used or know your computer can be used to communicate with a modem, then its interface is almost certainly configured as Data Terminal Equipment (DTE). The configuration for a hardwired connection in this case is as shown in Figure 2-1. Note the TX and RX lines are crossed.

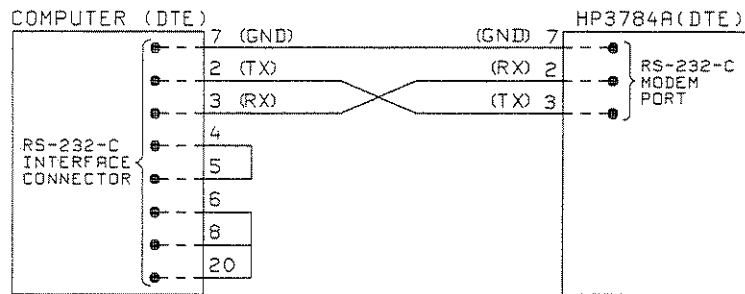

Figure 2-1 Cabling for Computers Configured as DTE

NOTE

These pin numbers refer to the 25 way D-type RS-232-C connector as found on the HP 3784A rear panel, which may differ from computer to computer.

Some computers may require hardwire connections across their RS-232-C interface, to simulate the initial handshake that takes place in a modem prior to data exchange. The easiest way of doing this is to connect the computers RS-232-C Request To Send (RTS) line (pin 4) to its Clear To Send line (pin 5). Also connect the Data Set Ready (pin 6), Data Carrier Detect (pin 8) and Data Terminal Ready (pin 20) lines together.

It may be however that your terminal or computer is flexible enough to ignore these lines, and therefore do not need these links.

When configured for hardwire operation the HP 3784A does not require any of the modem signal lines to be active, therefore it does not require these connections.

2.5 Cabling for Computers Configured as DCE

Computers are configured this way to mimic a modem interface, allowing direct connection of terminals or peripherals configured as a DTE. In instances where the computer is configured as a DCE, the TX, RX connections are straight pin to pin as shown in Figure 2-2.

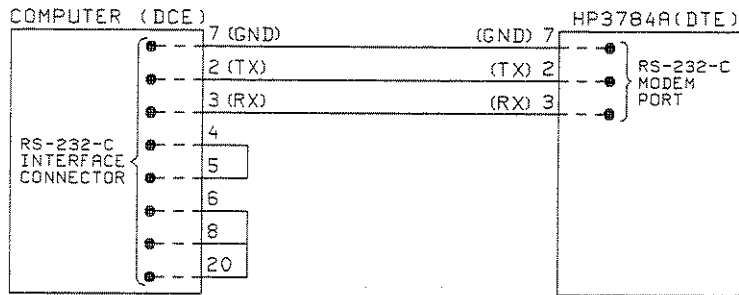

Figure 2-2 Cabling for Computers Configured as DCE

Configuring the HP 3784A RS-232-C Modem Interface for Hardwire Operation

Once the computer is connected to the HP 3784A, both instrument and computer must be configured to have matching speed and character formats etc. The following steps illustrate how to configure the HP 3784A for Hardwire operation at 1200 baud, paced by the Xon/Xoff [Rx & Tx] handshake, with 0's parity and 1 stop bit set.

1. Connect the instrument and computer as shown in Figure 2-1 (for computers configured as a DTE). Useful part numbers of RS-232-C cables are contained in Table 2-1, Page 2-14.
2. Select Page 8 subpage [SETUP A] on the HP 3784A. Page 8 is subdivided into 3 sections. The other subpages are selected by the "subpage" field.

```

8 Remote Port. [RS232] Subpage [SETUP A]
Connection [HARDWIRED]
Enq/Ack [OFF]      Xon/Xoff I OFF ]
    
```

Use the CURSOR and , keys to change the selectable fields to give the above display.

3. Change the subpage to display [SETUP B] and select the remaining parameters shown below.

```

8 Remote Port. [RS232] Subpage [SETUP B]
Speed [ 1200 ]

7 Bit Data Parity [0's ] Stop Bits [1]
    
```

The following selections are available on this subpage.

Speed	Parity	Stop Bits
[300]	[0 s]	[1]
[600]	[1 s]	[2]
[1200]	[ODD]	
[1800]	[EVEN]	
[2400]		
[4800]		
[9600]		
[SELECT]		

The speed, parity and stop bits selected at the HP 3784A must match these selected at the computer. If the speed is set to [SELECT] the instrument will default to 1200 baud in the HARDWIRE configuration.

4. A third page [STATUS] is available, providing a visual indication of any activity on the TXD and RXD lines.

```

8 Remote Port. [RS232] Subpage [STATUS ]
Status. Local
TXD RXD RTS CTS DSR DCD DTR
Remote error number. 0
    
```

NOTE 1: The TXD and RXD indicators are toggled during data transmission and reception. When there is no data activity the indicators will be OFF.

Error Codes are also displayed on this subpage. Appendix A contains a list of error codes and their descriptions.

2.6 Configuring the Computer for Hardwire Operation

Instructions on how to do this are usually given in one of the computer user manuals. In the case of the HP 200/300 Series desktop computers, we recommend that you connect a HP98628A Datacomms Interface card to the computer. Configuration details for this card can be found in the appropriate Interfacing Techniques manual accompanying your computer. Figure 2-3 below shows the IO signals for the HP98628A Datacomm interface and how they are connected to the HP 3784A.

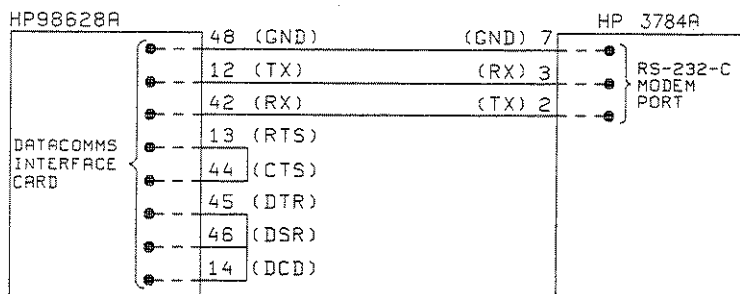

Figure 2-3 Cabling for Datacomms Interface to HP 3784A

Once your terminal/computer is cabled as shown in Figure 2-3, and both computer and HP 3784A are set to the same settings, then try sending the query command "ID? <cr> <lf>". Note that <cr> <lf> is typically performed by the 'RETURN' or 'ENTER' keys on computers/terminals. The command line delimiter must at least be <lf>. The HP 3784A will reply with the same delimiter it received, i.e. <cr><lf> or <lf>.

The HP 3784A should reply 'HP 3784A' to the terminal /computer screen. Monitor the instruments actions on Page 8 Remote Port (Subpage [STATUS]). Activity should be seen on RXD and then TXD indicators on Page 8 display. If you see activity only on RXD and a remote error number occurs, then either your computer, or the HP 3784A's settings are wrong. Corrective action should be taken. If no activity can be seen and you are sure your computer/terminal sent 'ID?' then the cabling may be wrong. Reverse TX and RX to correct.

Refer now to Appendix F for general information on RS-232-C.

2.7 Configuring Your Computer RS-232-C Interface

As there are likely to be as many variations for configuring computers, as there are computers, there is no quick guide on how to set up your computer. In other words you must refer to your computer manual(s). In the case of the HP 200/300 Series computers it is essential that a HP98628A Datacomms Interface card is fitted. This interface may be configured by means of 3 banks of dual-in-line switches on the card itself or by program control. Example programs, using program control statements to configure the HP98628A Datacomms Interface, are given later in this section.

2.8 Using a Computer to Control the HP3784A

2.8.1 Introduction

The following procedure gives a practical example of how to control the HP 3784A via the RS-232-C interface, using the HP 9807A Integral Personal Computer. Although the procedure is written specifically for the HP 9807A Computer, the basic methods described here apply for any type of Computer. Please refer to your Computer manual for equivalent instructions where specific instructions are given for the HP 9807A.

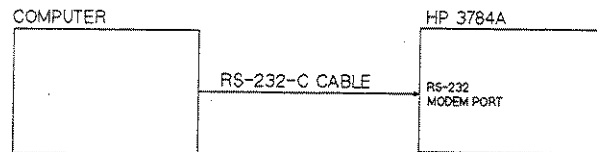

2.8.2 Setting up the Computer

1. Insert an HP-UX Technical Basic disc into the Computer disc drive and boot-up the Computer by switching the Computer ON.
2. Assign an interface select code to the serial path. For this example the number 9 is chosen. Type the following on your Computer:

Assign 9 to "serial.b" (Note: serial.b must be typed in lower case)

Note: 'b' is the title of the rear panel serial interface port on the HP 9807A.

3. Refer to your Computer users manual and make a note of the serial interface Default Settings. For the HP 9807A P.C. they are as follows:
 - Transfer rate = 300 baud
 - Autohandshake = Off
 - Character length = 7
 - Parity = Odd.
 - Stop bits = 1.
5. Refer to your Computer users manual to determine whether your Computer is configured as a DTE (Data Terminal Equipment) or DCE (Data Communications Equipment).

The HP 9807A is configured as a DTE. Since the HP 3784A is also configured as a DTE the connection from HP 9807A to HP 3784A is one of DTE to DTE.

2.8 .2.1 Connecting the Computer to the HP 3784A

The type of connection to be used is "HARDWIRED" since it is a simple case of connecting the Computer to the HP 3784A without the use of Modems etc. The type of cable used is shown in the following diagram.

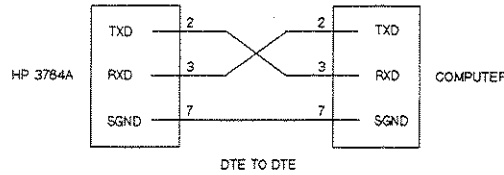

6. If your Computer is configured as a 'DCE' the HARDWIRED connection to the HP 3784A will be as follows.

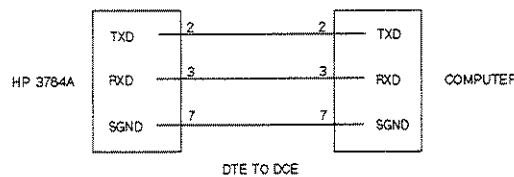

7. Connect a cable (DTE to DTE type) from the HP 9807A rear panel Serial Interface port to the HP 3784A rear panel RS232 MODEM port.
8. Switch-on the HP 3784A.
9. Set the HP 3784A to its default settings by selecting Page 1 Preset [PANEL] and recalling Panel Memory 0.
10. For the Computer and HP 3784A to communicate correctly via the RS-232-C serial interface, the protocol parameters for each device must be the same.

Set the HP 3784A RS-232-C settings on Page 8 Remote Port as per the HP 9807A RS-232-C default settings listed in step 4, or those for your own Computer.

The RS-232-C settings on Page 8 Remote should be set as follows for the HP 9807A Computer.

```
8 Remote Port. [RS232] Subpage [SETUP B]
Speed [ 300 ]

7 Bit Data Parity [ODD] Stop Bits [1]
```

```
8 Remote Port. [RS232] Subpage [SETUP A]
Connection [HARDWIRED]
Enq/Ack [OFF] Xon/Xoff [ OFF ]
```

11. Leave the HP 3784A display set to Page 8 Remote, Subpage [STATUS].
12. The HP 3784A is now ready to receive commands from the Computer, and return information on results/instrument settings etc.

Send the HP 3784A Remote by typing the following:

OUTPUT 9;"RMT"

Press <RETURN>

Observe that the HP 3784A Page 8 display indicates 'RXD' momentarily, Local Lockout is displayed and the instrument Remote LED illuminates.

13. Reset the HP 3784A to local operation by typing OUTPUT 9;"LCL"
14. Try typing the following series of commands and observe the HP 3784A settings change on the relevant page as each command is issued.

This sequence of commands sets the Transmitter Internal Clock and, Word Pattern, adds Bit Errors at a rate of 1.0E-4 and selects a Single 5 second gating period. A measurement is started, and at the end of the measurement interval the result is returned to the Computer display.

- a. OUTPUT 9;"RMT"sends the HP 3784A remote.
- b. OUTPUT 9;"TCL1;TCR2"sets Transmitter Clock to [STD RATE] [8M]. (see Page 2 Tx Setup)
- c. OUTPUT 9;"TPT2;TWD8;'11001100'".....sets Tx Pattern to [WORD] [8 bit] [11001100]. (see Page 2 Tx Setup)
- d. OUTPUT 9;"EAD2;EAT1;EAR4".....adds Bit Errors at a rate of 1.0E4. (see Page 2 Tx Setup)
- e. OUTPUT 9;"GTY2;GPR0,0,0,5".....selects a [SINGLE] five second gating period (see page 5 Gating Period)
- f. OUTPUT 9;"STR".....starts the HP 3784A gating.
- g. OUTPUT 9;"RSB?2".....requests measurement result to be returned.
- h. ENTER 9;A\$
- i. DISP A\$Display reads 1, 4224 (Rx Bit Error Count)

2.9 Using a Data Terminal to Control the HP 3784A

2.9.1 Introduction

The following procedure explains how to control the HP 3784A remotely via the RS-232-C interface using an HP Data Terminal. The procedure is written specifically for an HP 700/92 Data Terminal, however the method used may be applied to any Data Terminal Equipment (DTE).

The keys referred to in this procedure may not be identical to those for your Terminal; where this is the case you will have to substitute the keys on your Terminal for those given in the following procedure.

2.9.2 Procedure

1. In order to connect the Data Terminal and HP 3784A correctly via the RS-232-C interface, it is necessary to determine whether each device is configured as a 'DTE' or 'DCE' (Data Communications Equipment). Refer to your users manual for information on instrument configuration. In this example both Data Terminal and HP 3784A RS232 MODEM port are configured as a DTE. The type of cable used to connect a DTE to DTE is as follows:

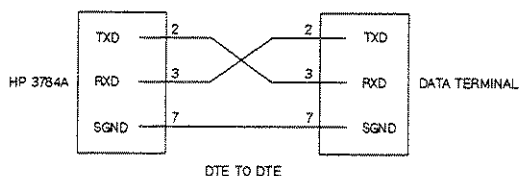

2. Connect the Data Terminal DATACOMM port using a DTE - DTE cable to the HP 3784A rear panel RS232 MODEM port.

Data Terminal Configuration

3. On the HP 700/92 Data Terminal Keyboard press the **SYSTEM** key to show the **SYSTEM** soft keys.
4. Press **<config keys>** (F8).
5. Press **<terminal config>** (F5) key.
6. Set the **TERMINAL CONFIGURATION** settings as follows:
 Set Datacomm/ExtDev to PORT1/PORT2
 Local Echo [ON]
 Leave all other settings as they are.
7. Press the **<SAVE CONFIG>** (F1)key.

Setup Datacomm Configuration

8. Press the <config keys> (F8) key.
9. Press the <datacomm config> (F3) key.
10. Set the Terminal to the following:
 Baud Rate [300] Parity/Data Bits [ODD/7] Enq/Ack [NO]
 RecvPace[Xon/Xoff]
 Leave all other settings as they are.
11. Press the <SAVE CONFIG> key (F1) to store the new settings.

Auto Line Feed

12. Press the <MODES> key and set auto line feed to ON by pressing the <AUTO LF> (F8) key. An asterisk will appear in the soft key field.

Remote Operation

13. Set to Remote by pressing the <REMOTE MODE> (F4) key, (an asterisk will appear in the soft key field).

Configure HP 3784A

14. Switch-on the HP 3784A and select Page 8 Remote Port.
 Set the Remote Port field to [RS232].

```
8 Remote Port. [RS232] Subpage [STATUS ]
Status. Local

Remote error number.    0
```

15. Set the HP 3784A RS-232-C protocol parameters on Page 8 Remote Port to the settings given for the Data Terminal (see step 10). Page 8 settings should be as follows:

```
8 Remote Port. [RS232] Subpage [SETUP A]
Connection [HARDWIRED]
Enq/Ack [OFF]           Xon/Xoff [TX ONLY]
```

```
8 Remote Port. [RS232] Subpage [SETUP B]
Speed [ 300 ]

7 Bit Data Parity [ODD ] Stop Bits [1]
```

16. Set Page 8 Remote to display the [STATUS] subpage.

17. The Data Terminal and HP 3784A are now configured to communicate with each other via the RS-232-C serial interface.
18. Send the HP 3784A remote by typing RMT on the Data Terminal Keyboard. Observe that the HP 3784A display flashes RXD momentarily and Local Lockout is set. The front panel REMOTE LED is also illuminated.
19. Try typing the following program and observe the HP 3784A display changing as the commands are issued. Press the <cr> key after each command is typed, or separate each command with a semicolon.

Example Program

10. RMT.....sets the HP 3784A remote.
20. TCL1;TCR1;TCP0.....sets Tx Clock to STD rate, 2MHz, Clock Out [NORM] See Page 2 Tx Setup)
30. TPT1;TPP1.....sets the Tx Pattern to [PRBS] -[9] (see Page 2 Tx Setup)
40. EAD2;EAT1;EAR5Adds Bit Errors at a rate of 1.0E5. (see Page 2 Tx Setup)
50. GTY2;GPR0,0,0,6.....selects a six second Single gating period. (see Page 5 Gating Period)
60. STRstarts the instrument gating.
70. RSB?1.....requests measurement result to be displayed.

Observe the result displayed on the Data Terminal screen.

Validity Flag:1 Bit Error result: 123

2.10 MODEM OPERATION

2.11 Connecting the HP 3784A to the Modem

The simplest way to connect the HP 3784A to a modem is to use the accessory cable (HP5060-4461) supplied with HP 3784A.

If this is not available, or the connector is not compatible with your modem, then it is recommended that the cable you use should have a conductor for each of the signals implemented by the HP 3784A (see Table D-1 in Appendix D).

2.12 RS-232-C Cables

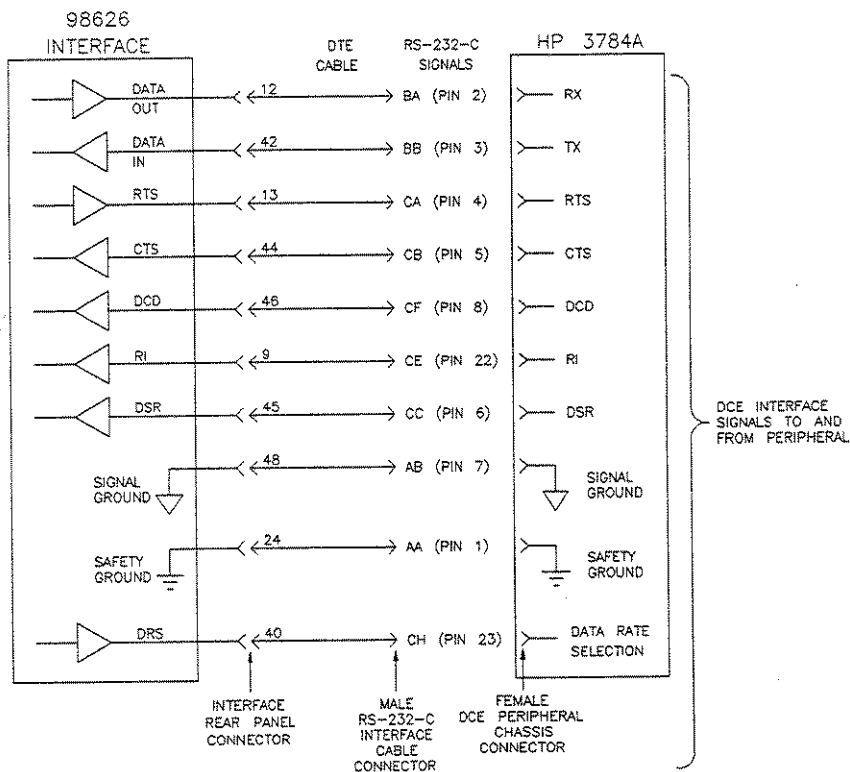

Figure 2-4 DTE Cable Interconnection Diagram

Table 2-1. RS-232-C Cables

PART & PRODUCT NUMBER	DESCRIPTION	USED FOR
5060-4461	25 pin male to 25 pin male RS-232-C cable	Connecting HP 3784A to modem
13222M	European 50 pin to 25 pin RS-232-C modem cable	Connecting an HP200/300 series computer to modem
13222N	US 50 pin to 25 pin RS-232-C modem cable	Connecting an HP200/300 series computer to modem
15563	Telephone cable 3m (with spade terminals)	Connecting modem to telephone output
15561A	Telephone cable 4.2m (Bell modular)	Connecting modem to telephone output
15562A	Jack cable 3m (European)	Connecting modem to telephone output

Most modems can be strapped to ignore various signals so you may be able to use a simpler cable, but do not omit the CTS (Clear To Send), *DCD (Data Carrier Detect) or DSR (Data Set Ready) control signals because the HP 3784A requires these to enable transmission and reception.

NOTE

Normally, when the HP 3784A is configured for modem connection, the Data Terminal Ready signal is permanently on. However, for users who require manual control of Data Terminal Ready, this can be selected by means of an internal DIL switch prior to power-on. Manual control of Data Terminal Ready is explained later in this section.

* This signal is called Line Signal Detect in the RS-232-C standard. However, the mnemonic LSD is also used by modem manufacturers for Long Space Disconnect so, to avoid confusion, the HP 3784A uses the common alternative mnemonic Data Carrier Detect (DCD).

2.13 Re-configuring the HP 3784A Data Rate Select Strapping

Some modems can operate at two data rates, normal operation is at the higher rate, say 1200 bps, but if the circuit quality is poor causing errors then the modem can be switched to a lower rate, say 300bps, which although slower is less error sensitive.

The RS-232-C defines two circuits, CH and CI as data rate selectors. The circuit definitions are identical except that CH is used by the DTE to control the modem speed - an ON condition from the DTE directs the modem to adapt to the higher rate; and CI is used by the modem to control the DTE. The two circuits CH and CI are mutually exclusive, and are both assigned to pin 23. The decision as to which circuit to implement i.e. whether the DTE (HP 3784A) or modem controls speed selection is left up to "the supplier".

This is not a very satisfactory arrangement because a dual-speed modem that can be used to originate and answer a data transmission ideally needs both circuits CH and CI.

The HP 3784A overcomes this by employing what has become a fairly widely adopted solution, using pin 12 (normally the Secondary Received Line Signal Detect) as the CI circuit. The HP 3784A is factory preset to have the CH circuit, on pin 23, high (+V), selecting the high speed setting on the modem, and pin 12 re-defined as the CI circuit. The HP 3784A has two test links which allow the strapping to be changed to (A and D) or (B and D), or C.

- A - CH circuit pin 23 connected to +V (high) - select high speed
- B - CH circuit pin 23 connected to -V (low) - selects low speed
- C - CI Data Rate Select line connected to pin 23
- D - CI Data Rate Select line connected to pin 12

To change the HP 3784A CI circuit strapping from pin 12 to pin 23 at the RS-232-C Modem output port proceed as follows.

1. Remove the power cable from the instrument, and any other cable connections.
2. Unscrew and remove the four corner feet on the HP 3784A rear panel, and withdraw the rear panel to give access to the A26 Remote Control Assembly.

3. Move the modem-rate-select strapping links, from the factory preset positions (A and D), to positions (B and D) or C. Note a parking position is available to accommodate the surplus test link when only one position is selected. See Figure 2-5 for the link positions.

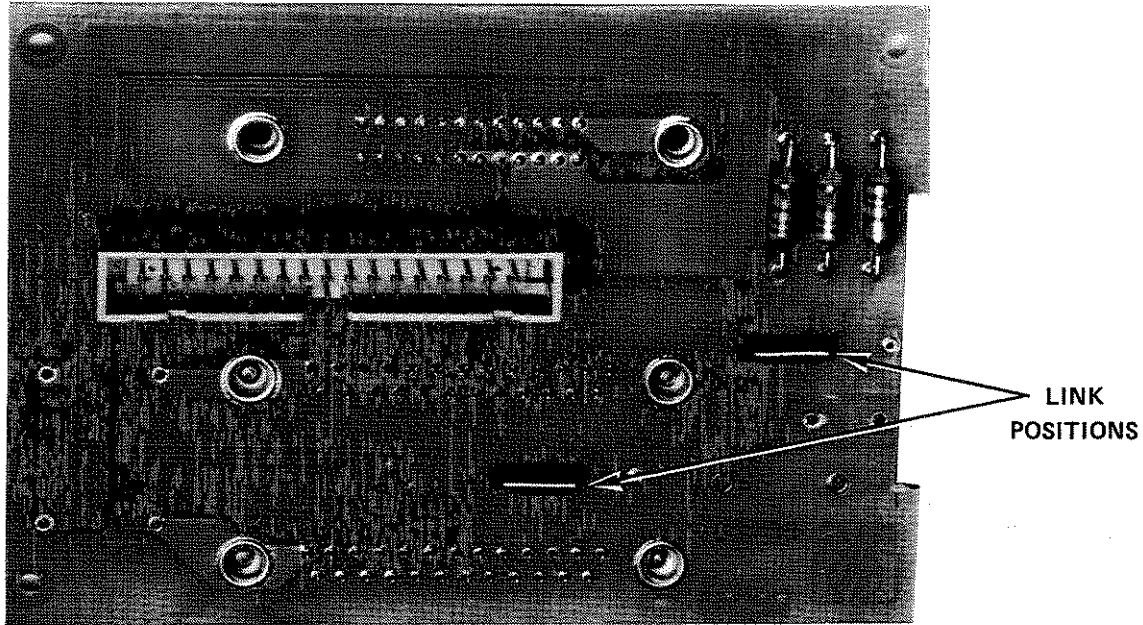

Figure 2-5 Link Positions

NOTE

Some of the more recent modems have the ability to sense speed from the first characters transmitted and with some modems such as the HP37212B modem, there is a choice of 3 speeds. In the HP37212B modem there is no CH connection, the speed is sensed automatically from the received characters. In the case of the HP37212A modem which is dual speed, the user has the choice of using a hardwire CH line (on pin 23) or using the 37212A's speed sensing facility (disconnecting pin 23).

2.14 Configuring the HP 3784A RS-232-C Remote (Modem) Interface

Having completed the cabling, you will now need to configure both the HP 3784A and your computer to have compatible speed, character format etc. so that they can communicate.

This section describes the configuration options available in the HP 3784A. The computer configuration details will be specific to the particular machine used so a practical example of connecting the HP 3784A to an HP 200/300 Series computer is given in Appendix G. Hopefully this will give you enough detail to get your system working.

The following pages show all the available selections on the RS-232-C (modem) interface, and give a detailed description to help you make your choice of the available parameters.

Note: It is important to ensure the HP 3784A is set-up with Page 8 displayed - Page 9 also has RS-232-C fields to configure the Logging Port and you may sometimes select this page in error.

Available Selections

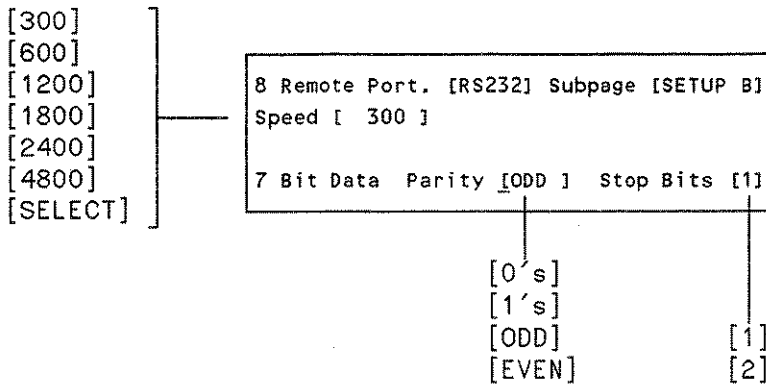
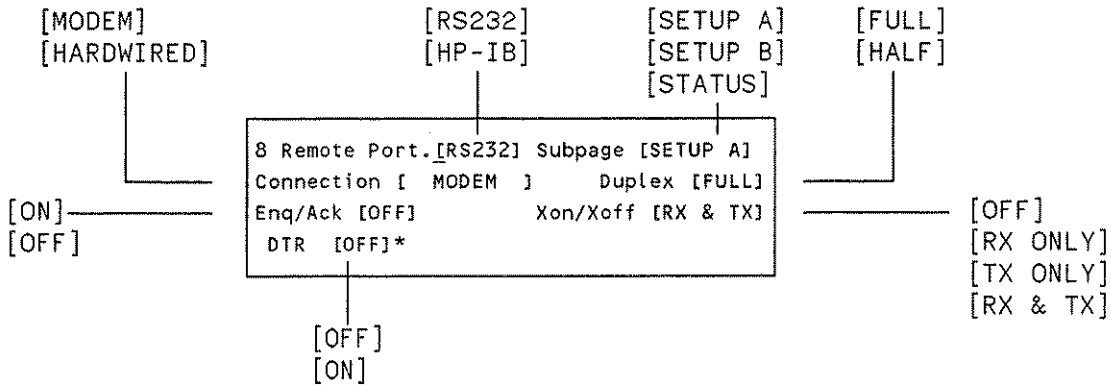

NOTE
 The High Speed and Low Speed parameters are available when [SELECT] is chosen as the Speed parameter.

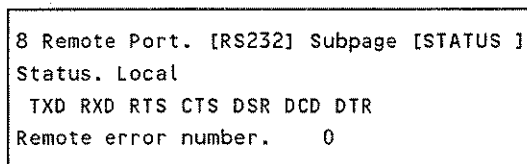
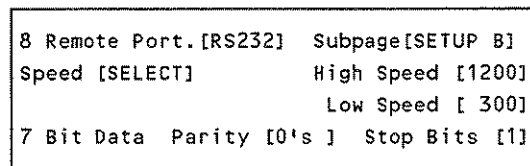

2.15 Subpage [SETUP A]

```

8 Remote Port. [RS232] Subpage [SETUP A]
Connection [ MODEM ] Duplex [FULL]
Enq/Ack [ON] Xon/Xoff [RX & TX]
DTR [OFF]*

```

Communications may be half or full duplex depending on the type of modem used, and because this affects the way in which the HP 3784A operates the Request To Send/Clear To Send Handshake, it is important to select the correct duplex configuration for your modem.

2.15.1 Half Duplex Operation

In this mode of operation, transmission and reception is bi-directional, but not at the same time. Some modems can only accommodate half duplex operation. When half-duplex is selected, the XON/XOFF field disappears because the XON/XOFF handshake requires a full duplex link to operate.

Sending Data

Subject to Data Terminal Ready and Data Set Ready both being ON, then when the HP 3784A has data to transmit, it will transmit data when the modem responds with Clear To Send ON. Once the data has been sent, the HP 3784A turns Request To Send OFF.

Receiving Data

The HP 3784A will receive data if Data Terminal Ready, Data Set Ready and Data Carrier Detect are ON.

Note: In accordance with RS-232-C, when the HP 3784A is configured for half-duplex operation it will NOT turn Request To Send ON if Clear To Send is already ON.

2.15.2 Full Duplex Operation

This mode of operation allows simultaneous transmission and reception between instrument and computer using suitable modems and a dual channel link.

Sending Data

Subject to Data Terminal Ready and Data Set Ready both being ON, then the HP 3784A will turn Request To Send ON permanently.

Receiving Data

The HP 3784A will receive data if Data Terminal Ready, Data Set Ready and Data Carrier Detect are ON.

2.15.3 Handshake (ENQ/ACK or XON/XOFF)

The HP 3784A offers a choice of handshake, Enq/Ack or Xon/Xoff, to pace the data. Your choice may be limited by what is available on your computer or by the data link. If a full duplex link is being used, and your computer offers either handshake, we would suggest you use XON/XOFF [RX&TX]. If a half duplex link is in operation your choice of handshake is limited to ENQ/ACK or NO HANDSHAKE, (since XON/XOFF requires a full duplex link).

In situations where you are forced to use NO HANDSHAKE, (both Enq/Ack and Xon/Xoff [OFF]) you may have to reduce the transmission speed (baud-rate) to a suitable level to ensure data integrity is maintained. The speed will usually be less than 1200bps in such circumstances.

The total number of choices available on the HP 3784A are given below.

- NO HANDSHAKE -This is with both Enq/Ack and Xon/Xoff [OFF]. With no handshake the upper data rate may be limited to <1200bps.

- Enq/Ack [ON] -The main advantage of this handshake is it works on either half or full-duplex links. The data block size is not standard, though 80 characters is the size most commonly used.

- Xon/Xoff [RX] -In this instance the HP 3784A paces the rate at which the computer transmits data, by sending XON and XOFF characters to the computer. (ie HP 3784A receives data).

- Xon/Xoff [TX] -In this instance the computer paces the rate at which the HP 3784A transmits data by sending XON and XOFF characters to the HP 3784A.

- Xon/Xoff [RX&TX] -With this handshake the computer paces the rate at which the HP 3784A sends data and the HP 3784A paces the rate at which the computer sends data.

For those unfamiliar with the RS-232-C handshakes, a short section headed MORE ABOUT THE ENQ/ACK and XON/XOFF HANDSHAKE describes the data transfer between instrument and computer. See Page 2-26.

2.15.4 DTR (optional manual control)

Instruments leaving the factory have this field blanked, DTR is factory preset to be ON at all times. If the diagnostic switch S1 is set to ON the choice to select DTR [ON] or DTR [OFF] is available to the operator. The switch is located at the front of the instrument and can be viewed by removing the top cover. See Figure 2-6.

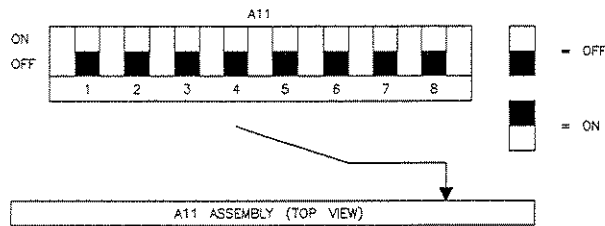

Figure 2-6 Diagnostic Switch

For modem connections DTR is normally required to be ON.

If the factory preset switch S1 is set to ON the DTR [OFF] DTR [ON] field is displayed (on Page 8, Subpage A).

Using this field, Data Terminal Ready can be turned on prior to manually originating or answering a call, or it will turn on automatically in response to a signal on Ring Indicator.

The DTR field will always reflect the state of the Data Terminal Ready signal at the interface.

During the progress of a call Data Terminal Ready will be ON, but can be manually turned OFF to cause the modem to disconnect.

In all cases, if Data Set Ready does not turn ON within 60 seconds of Data Terminal Ready being turned ON then Data Terminal Ready will automatically turn OFF. If Data Set Ready turns OFF, for example at the end of a call then Data terminal Ready will turn OFF.

As for normal operation, Data Terminal Ready and Data Set Ready must be ON for communications to proceed.

2.16 Subpage [SETUP B]

8 Remote Port. [RS232]	Subpage [SETUP B]
Speed [SELECT]	High Speed [1200]
	Low Speed [300]
7 Bit Data Parity [0's]	Stop Bits [1]

2.16.1 Speed

The speed, parity and stop bit settings of the HP 3784A must be set to match those at your computer, which in turn must be set having considered the modem speed settings and quality of data link.

Speed [300]
 [600]
 [1200]
 [1800]
 [2400]
 [4800]
 [9600]
 [SELECT]

The HP 3784A offers a choice of baud rates. The choice of speed will be largely dependent on the hardware in use. A SELECT option offers a dual speed capability for use with modems having this capability.

Speed [SELECT]

High Speed [300]	Low Speed [300]	For dual rate modems which implement the RS-232-C Data Rate Select (DCE source), the SELECT option allows the speed to be determined by the state of the circuit. When the SELECT option is chosen, additional High Speed and Low Speed fields appear. These speeds should be matched to the data rates associated with the ON and OFF states of the circuit CI - Data Rate Select in the modem.
[600]	[600]	
[1200]	[1200]	
[1800]	[1800]	
[2400]	[2400]	
[4800]	[4800]	
[9600]	[9600]	

Note: If the connection field is set to Connection [HARDWIRED] when the Speed [SELECT] field is displayed, then the speed will default to 1200 baud.

RS-232-C states that for Data Rate Select "an on condition shall select the higher data signaling rate". Therefore the range of speeds available in one field is restricted by the setting of the other, so that the low speed setting can never be higher than the high speed and vice versa.

This facility is incorporated so that if you are experiencing excessive transmission errors at the high data rate, you can re-establish communications at the low data rate without re-configuring the HP 3784A - which may be at a remote site.

Note: Special care must be taken when configuring HP 200/300 Series computers using the HP98628A Datacomms Interface card - if the datacomms card is configured by means of program control the Data Rate Select line is pulsed every time a computer RESET occurs. This may occasionally force your modem to select a lower speed incompatible with your program setting. This can be overcome by using the hardwire dual-in-line switches on the HP98628A card to set the computer speed or amending the program to allow for this.

2.16.2 Setting Parity

The parity options available are;

0's	-The parity bit is always zero
1's	-The parity bit is always one
ODD	-The parity bit is set to 0 or 1 so that there are an odd number of 1's in the code.
EVEN	-The parity bit is set to 0 or 1 so that there are an even number of 1's in the code.

Parity NONE is not provided because it is normally used in conjunction with 8 bit data, 7 bit data with no parity, and 8 bit data with parity are unusual combinations.

2.16.3 Stop Bits

It is necessary for the serial line to return to the "marking" condition between characters so that a "mark" to "space" transition, necessary for receiver synchronization, occurs at the start of each character. Normally one stop bit is sufficient to achieve this but historically 1.5 or 2 stop bits were required if the receiving hardware was electro-mechanical, and could not "recover" quickly (for example a "Teletype").

The HP 3784A offers 1 or 2 stop bits.

2.16.3.1 HP 3784A Character Format

The bottom line of the display describes the asynchronous character data format. In general the format of asynchronous data is

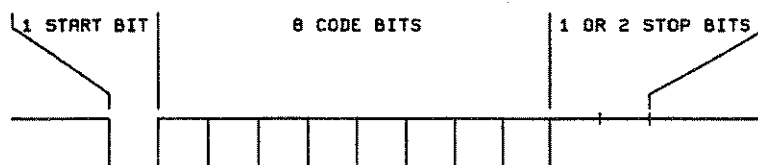

Figure 2-7 Character Format

The 8 code bits normally consist of 7 ASCII data bits, transmitted least significant bit first, followed by 1 parity bit.

In some circumstances, for example to access a printer's alternative character set, it is useful for a full 8 bits of data to be transmitted and to achieve this, the parity bit is usually sacrificed. This is commonly referred to as "ASCII 8 bit" or "8 bit data".

The HP 3784A does not use 8 bit data, and the fixed string "7 Bit Data" is simply intended as a reminder to the user.

2.17 Subpage [STATUS]

The status of the RS-232-C lines can be monitored by selecting Page 8 Subpage [STATUS] on the HP 3784A.

```

8 Remote Port. [RS232] Subpage [STATUS ]
Status. Local
TXD RXD RTS CTS DSR DCD DTR
Remote error number. 0
    
```

The status field identifies whether the instrument is REMOTE or LOCAL, and applies to both RS-232-C and HP-IB.

The other mnemonics shown on the page are for illustration only, they will only appear when that particular circuit line is true (+V at the interface). The exception to this is the TXD and RXD status indicators, because of the high repetition rate it is not possible to represent those lines directly, and hence these lines are toggled for the duration of the data transmission. The TXD and RXD indicators remain OFF in the absence of data.

The meaning of each indicator is summarized below.

- | | | | |
|------|-----------------------|---|-------------------------------------|
| TXD | - Transmitted Data | } | Hardwired or modem status indicator |
| RXD | - Received Data | | |
| RTS | - Request To Send | } | Modem status indicators |
| CTS | - Clear To Send | | |
| DSR | - Data Set Ready | | |
| DCD | - Data Carrier Detect | | |
| *DTR | - Data Terminal Ready | | |

* This is factory preset to be on all the time. See section headed DTR (optional manual control) for details of how to change this setting.

2.17.1 HP 3784A RS-232-C Default Settings

The HP 3784A is shipped with the following default settings and will be initialized to this configuration in the event of continuous memory loss (but not by a RST command).

Connection	[MODEM]
Duplex	[FULL]
Enq/Ack	[OFF]
Xon/Xoff	[Rx/Tx]
Speed	[1200]
High Speed	[1200]
Low Speed	[300]
Parity	[1's]
Stop Bits	[1]

2.18 ADDITIONAL INFORMATION

2.19 Device Clear - RS-232-C Equivalent of

The HP 3784A will detect a "Break" signal from a computer and, at the end of the "Break" signal, perform a Device Clear action. This action is the same as the HP-IB Device Clear.

- All buffers are flushed
- All errors are cleared
- Stopped gating
- Clear status, alarm change and key registers
- Ready register set to 1 (Ready for new command)
- Clears the SRQ bit in the status register
- The RQS mask is reconfigured as if "RQS ERR" has been sent.

Note: Although there is no way of detecting Service Requests, as in the HP-IB interface, you can monitor the instrument status by periodically checking the RQS bit (bit 6) in Status Register B. See RS-232-C Service Requests/Status Checking.

On HP 200/300 Series computers fitted with the HP98628A datacomms interface card a "Break" signal is sent (using HP BASIC) by sending:

```
CONTROL 20,6;1
```

The duration of the "Break" signal is determined by the setting of control register 39 (on the HP98628A Interface card) - the break time should be set to its default value.

When writing programs to control the HP 3784A, over the RS-232-C interface, we would recommend you include a Break/Device Clear in your program, appropriately positioned immediately after the datacomms link between computer and instrument is established - preceding your first message to the HP 3784A.

2.20 Remote, Local and Local Lockout.

The first instruction to the HP 3784A, before any message commands can be sent must be "RMT" (e.g. OUTPUT 20;"RMT").* This is the RS-232-C equivalent of sending the instrument REMOTE and addressing it over the HP-IB. In all cases when the HP 3784A is in the remote mode, over the RS-232-C interface, it is in the LOCAL LOCKOUT state with the LOCAL key disabled. For HARDWIRE operation the instrument can only be returned from REMOTE to LOCAL by the "LCL" command (e.g. OUTPUT 20;"LCL").* For MODEM operation, loss of Data Set Ready automatically returns the instrument to the local mode. This means the remote message must always be sent after any accidental disconnection.

* These messages can be sent when using HP 200/300 Series computers fitted with an HP98628 Datacomms card (interface address 20).

2.21 Service Requests/Status Reporting Over RS-232-C

THERE IS NO SERVICE REQUEST INTERRUPT CAPABILITY ON THE RS-232-C INTERFACE. The RS-232-C interface uses a serial datacomms protocol and does not lend itself, in the same way as the HP-IB interface, to issuing parallel interrupts. You can however monitor the status of the instrument by checking Status Register B, bit 6. This is the RQS bit, which would normally cause the HP 3784A to issue a service request (SRQ) if the instrument was being controlled over the HP-IB. The RQS bit will only be set when the appropriate bits in the service request mask are set. This allows you to determine which latched event causes the service request bit to be set.

Listed below are some program-line examples in HP 200/300 Series BASIC to demonstrate how to set-up and monitor the HP 3784A status.

```

100  OUTPUT Sc; "RQS, EOG"
      |
      |
1000 Check_status:  ! Waiting loop till EOG is true
1010  WAIT 1
1020  OUTPUT Sc; "STB?"
1030  ENTER Sc; Stb
1040  IF NOT (Stb, 6) THEN GOTO Check_status
1050  RETURN

```

Sc is the interface select code, and in the case of the HP98628A it is usually 20.

Line 100 sets the Service Request mask to set the RQS bit when the End of Gating (EOG) bit is set.

Lines 1000 to 1050 are a simple GOSUB to check when the RQS bit 6 is set. When bit 6 is set the program RETURN(s) at line 1050.

2.22 More About ENQ/ACK and XON/XOFF Handshakes

At higher data rates a handshake is essential, to pace the data and hold up transmission when a receiving buffer is nearly full. The HP 3784A allows you the choice of either ENQ/ACK, XON/XOFF, or if you desire NO HANDSHAKE. The following brief descriptions highlight the handshake sequence of ENQ/ACK and XON/XOFF.

ENQ/ACK HANDSHAKE

In this instance all received data is paced by an ENQ/ACK handshake. (ENQ/ACK is provided on receive only).

1. Transmitter checks to see if the receiver is ready to accept data.

→ ENQ

ACK ←

2. The receiver responds affirmatively it can receive data.

3. The transmitter sends a data block.....and → DATA
 checks to see if it can send more data.
 (Typical block size may be between 80 to 100
 characters). → ENQ

4. The receiver buffer is near to a buffer
 overflow situation, and does not respond.

5. The transmitter times out after a pre-set
 time period and re-enquires and again → ENQ
 [The time-out may be anything between 2-60
 seconds]

→ ENQ

6. The receiver sends a positive acknowledg-
 ment to say it can receive, i.e. the receive
 buffer has sufficient memory space.

ACK ←

7. The transmitter sends out the next block of
 data. → DATA

And the process repeats. The HP 3784A as the receiver has no prior knowledge of the size of the data
 block the transmitter will send, and therefore sets the buffer size to a maximum of 128. The ENQ/ACK
 handshake will work in both FULL DUPLEX and HALF DUPLEX mode.

NOTE

If the ENQ/ACK handshake and the XON/XOFF are both set to OFF the user must
 ensure data blocks sent to the HP 3784A do not exceed the buffer size of 128 bytes.

2.23 XON/XOFF Handshake

2.23.1 [RX ONLY]

With this field selected, the HP 3784A controls the rate at which it receives data by sending XOFF (X is an abbreviation for transmitter) and XON characters to the controller. **Most computers use ASCII codes, DC1 for XON and DC3 for XOFF.** (The HP 3784A Xon/Xoff selection must match the controller).

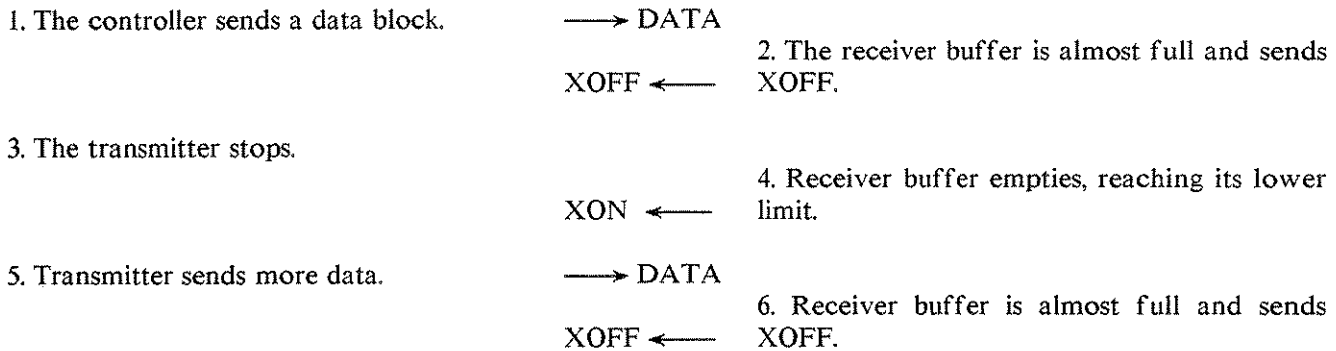

And the procedure repeats. The HP 3784A receiver buffer is 128 bytes long and has a lower limit at 10 characters (XON is sent when it reaches this limit). The upper limit of the buffer is set to 32 characters. The vast amount of headroom, particularly at the upper limit of the buffer, ensures the HP 3784A accepts data in situations where the transmitter does not recognize XOFF immediately.

Note: Since the handshake requires XOFF to be sent during data transmission this is only available when FULL DUPLEX is selected.

2.23.2 [TX ONLY]

When this field is selected, the controller paces the rate at which the HP 3784A transmits data by sending XON/XOFF characters. This is available on FULL DUPLEX only. An example of an XON/XOFF handshake is given in the description for Xon/Xoff [RX ONLY]. **Most computers use ASCII codes, DC1 for XON and DC3 for XOFF.** (The HP 3784A Xon/Xoff selection must match the controller).

2.23.3 [RX & TX]

When this field is selected, the controller paces the rate at which the HP 3784A sends data and the HP 3784A paces the rate at which it receives data. This is available on FULL DUPLEX only. An example of XON/XOFF handshake is given in the description for Xon/Xoff [RX ONLY]. **Most computers use ASCII codes, DC1 for XON and DC3 for XOFF.** (The HP 3784A Xon/Xoff selection must match the controller).

3.1 List of Instrument Commands

Listed here is the complete set of GPIB commands accepted by the instruments, indicating those which are included only for compatibility with HP 3785A/B and those which are common capabilities (CC). In the individual command listing, where the command has an associated numeric parameter, these parameters can be substituted for the adjacent alphanumeric string to assist in writing clearer control program statements. The mnemonics (in alphabetical order) and a brief description is given below:-

Table 3-1. GPIB Mnemonics

Description	Mnemonic	Page
HP-IB address	ADR	3-62
HP-IB address query	ADR?	3-62
Alarm durations query	ALD?	3-42
Alternate word frequency	ALF	3-25
Alternate word frequency query	ALF?	3-25
Alarm status query	ALM?	3-42
Alternate switched int/ext	ALS	3-25
Alternate switched int/ext query	ALS?	3-25
Alternate word pattern	ALW	3-24
Alternate word pattern query	ALW?	3-24
Jitter modulation amplitude (HP 3785A/B)	AM	3-7
Alarm mask register	AMR	3-37
Alarm mask register query	AMR?	3-37
Analysis results query	ANR?	3-41
Availability threshold	ATA	3-45
Availability threshold query	ATA?	3-45
Error seconds threshold	ATB	3-45
Error seconds threshold query	ATB?	3-45
Severely errored seconds threshold	ATC	3-45
Severely errored seconds threshold query	ATC?	3-45
Degraded minutes threshold	ATD	3-46
Degraded minutes threshold query	ATD?	3-46
1 error/int threshold	ATE	3-46
1 error/int threshold query	ATE?	3-46
2-10 error/int threshold	ATF	3-46
2-10 error/int threshold query	ATF?	3-47
>10 error/int threshold	ATG	3-47
>10 error/int threshold query	ATG?	3-47
Burst threshold	ATH	3-47
Burst threshold query	ATH?	3-47

Table 3-1. HPIB Mnemonics (continued)

Description	Mnemonic	Page
Unavailability threshold	ATI	3-47
Unavailability threshold query	ATI?	3-48
LTMER threshold	ATJ	3-48
LTMER threshold query	ATJ?	3-48
Analysis threshold results	ATR?	3-41
Control auto sweep (HP 3785A/B)	AU	3-7
Audio enable	AUD	3-56
Audio enable query	AUD?	3-56
Audio source	AUS	3-56
Audio source query	AUS?	3-56
Sound beeper	BEEP	3-56
Binary interface level	BIL	3-22
Binary interface level query	BIL?	3-22
Current answer query (HP 3785A/B)	CA	3-43
Instrument clear command (CC)	CLR	3-11
Instrument configure	CON	3-12
Instrument configure query	CON?	3-12
Data set-up	DAT	3-57
Date query	DAT?	3-57
Data format (Euro)	DF	3-7
Display command (HP 3785A/B)	DI	3-38
Jitter display rate (HP 3785A/B)	DR	3-7
Error add	EAD	3-28
Error add query	EAD?	3-28
Error add ratio	EAR	3-28
Error add ratio query	EAR?	3-28
Error add type	EAT	3-28
Error add type query	EAT?	3-28
Elapsed time query	ELP?	3-43
Last remote error query (CC)	ERR?	3-15
Select external clock (HP 3785A/B)	ET	3-7
Jitter modulation source (HP 3785A/B)	EX	3-7
Jitter filter (HP 3785A/B)	FI	3-7
Flag setting (HP 3785A/B)	FL	3-7
Jitter modulation frequency (HP 3785A/B)	FR	3-7
Firmware revision number query	FRN?	3-62
Transmitter clock rate (HP 3785A/B)	GE	3-55
Gating period	GPR	3-56
Gating period query	GPR?	3-55
Gating type	GTY	3-55

Table 3-1. HPIB Mnemonics (continued)

Gating type query	GTY?	3-55
Instrument identification query (CC)	ID?	3-14
Input format (HP 3785B)	IF	3-7
Gating period (HP 3785A/B)	IN	3-7
Interval type	INT	3-55
Interval type query	INT?	3-55
Select internal clock (HP 3785A/B)	IT	3-7
Jitter application (HP 3785A/B)	JA	3-7
Jitter modulation amplitude	JAM	3-31
Jitter modulation amplitude query	JAM?	3-32
Jitter display rate	JDR	3-35
Jitter display rate query	JDR?	3-35
Jitter filter	JFI	3-34
Jitter filter query	JFI?	3-34
Jitter modulation frequency	JFR	3-31
Jitter modulation frequency query	JFR?	3-31
Manual set mask frequency	JMA	3-32
Manual set mask frequency query	JMA?	3-32
Jitter measurement input	JMI	3-34
Jitter measurement input query	JMI?	3-34
Program jitter tolerance mask	JMK	3-32
Programmable jitter tolerance mask query	JMK?	3-33
Jitter modulation source	JMS	3-30
Jitter modulation source query	JMS?	3-31
Jitter mask type	JMT	3-33
Jitter mask type query	JMT?	3-33
Jitter option select	JOS	3-30
Jitter option query	JOS?	3-30
Jitter peak threshold	JPT	3-35
Jitter peak threshold query	JPT?	3-36
Jitter range	JRA	3-35
Jitter range query	JRA?	3-35
Jitter receiver ref clock	JRC	3-34
Jitter receiver ref clock query	JRC?	3-35
Jitter Q factor	JQF	3-33
Jitter Q factor query	JQF?	3-33
Jitter sub-test	JST	3-62
Last panel key query (CC)	KEY?	3-12
Keyboard lock	KLK	3-61
Keyboard lock query	KLK?	3-61
Go local command (CC)	LCL	3-11
Logging during gating type	LDT	3-49
Logging during gating type query	LDT?	3-49
Logging port configuration command	LDV	3-59
Logging port query	LDV?	3-59

Table 3-1. HPIB Mnemonics (continued)

Description	Mnemonic	Page
Logging during gating results	LDR	3-49
Logging during gating results query	LDR?	3-50
Logging during gating intervals	LDC	3-50
Logging during gating intervals query	LDC?	3-50
Logging at end of gating	LEG	3-51
Logging at end of gating query	LEG?	3-51
Logging error thresholds	LET	3-52
Logging error thresholds query	LET?	3-52
Logging graphics	LGF	3-53
Logging graphics query	LGF?	3-54
Logging enable	LOG	3-49
Logging enable query	LOG?	3-49
Logging freq offset threshold	LOT	3-52
Logging freq offset threshold query	LOT?	3-52
Logging jitter peak threshold	LPT	3-53
Logging jitter peak threshold query	LPT?	3-53
Logging squelch	LSQ	3-54
Logging squelch query	LSQ?	3-54
Manual set mask frequency (HP 3785A/B)	MA	3-7
Modem set-up	MDM	3-60
Modem set-up query	MDM?	3-60
Measurement selection command	MEA	3-37
Measurement selection query	MEA?	3-37
Jitter measurement input (HP 3785A/B)	MI	3-7
Gating type (HP 3785A/B)	MO	3-7
Option structure query (CC)	OPT?	3-16
Plot Jitter Tolerance	PJT	3-58
Plot Jitter Transfer Function	PJX	3-58
Peak select command (HP 3785A/B)	PS	3-38
Jitter peak threshold (HP 3785A/B)	PT	3-7
Printer set-up	PTR	3-59
Printer set-up query	PTR?	3-59
Plot Stop	PSP	3-59
Query annunciators (HP 3785A/B)	QA	3-44
Query firmware revision (HP 3785A/B)	QF	3-7
Jitter range (HP 3785A/B)	RA	3-7
Jitter receiver ref clock (HP 3785A/B)	RC	3-7
Receiver configuration format	RCF	3-20
Receiver configuration format query	RCF?	3-20
Recall panel	RCL	3-57
Receiver clock phase	RCP	3-19
Receiver clock phase query	RCP?	3-19

Table 3-1. HPIB Mnemonics (continued)

Description	Mnemonic	Page
Receiver clock rate	RCR	3-19
Receiver clock rate query	RCR?	3-19
Ready register query (CC)	RDY?	3-15
Receiver clock rate (HP 3785A/B)	RE	3-7
Firmware revision number query (CC)	REV?	3-14
Receiver interface format	RIF	3-21
Receiver interface format query	RIF?	3-21
Go remote command (CC)	RMT	3-11
Receiver PRBS pattern	RPP	3-26
Receiver PRBS pattern query	RPP?	3-26
Receiver data pattern	RPT	3-23
Receiver data pattern query	RPT?	3-23
Set request service mask (CC)	RQS	3-13
Query request service mask (CC)	RQS?	3-13
Bit error result query	RSB?	3-39
Code error results query	RSC?	3-39
Frequency measurement result query	RSF?	3-41
Jitter hit results query	RSJ?	3-40
Receiver jitter maximum amplitude query	RSM?	3-40
Frequency offset result query	RSO?	3-41
Receiver jitter amplitude query	RSR?	3-40
Clock slip result query	RSS?	3-39
Reset instrument (CC)	RST	3-10
Receiver ternary interface code	RTI	3-21
Receiver ternary interface code query	RTI?	3-21
Receiver word pattern	RWD	3-24
Receiver word pattern query	RWD?	3-24
Receiver PRBS zero substitute	RZN	3-27
Receiver PRBS zero substitute query	RZN?	3-27
Save panel	SAV	3-57
Single error add	SEA	3-29
Set serial number	SER	3-15
Serial number query (CC)	SER?	3-15
Selectable port	SEL	3-23
Selectable port query	SEL?	3-23
Stop gating (HP 3785A/B)	SP	3-7
Start gating (HP 3785A/B)	ST	3-7
Status register A query (CC)	STA?	3-16
Status register B query (CC)	STB?	3-16
Stop gating	STP	3-58
Start gating	STR	3-58

Table 3-1. HPIB Mnemonics (continued)

Description	Mnemonic	Page
Transmitter clock frequency	TCF	3-18
Transmitter clock frequency query	TCF?	3-18
Transmitter clock source	TCL	3-17
Transmitter clock source query	TCL?	3-17
Transmitter clock offset	TCO	3-18
Transmitter clock offset query	TCO?	3-18
Transmitter clock phase	TCP	3-18
Transmitter clock phase query	TCP?	3-18
Transmitter clock rate	TCR	3-17
Transmitter clock rate query	TCR?	3-17
Set real time (HP 3785A/B)	TI	3-7
Transmitter interface	TIF	3-20
Transmitter interface query	TIF?	3-20
Time set-up	TIM	3-57
Time query	TIM?	3-57
Transmitter octet timing	TOC	3-23
Transmitter octet timing query	TOC?	3-23
Transmitter PRBS pattern	TPP	3-26
Transmitter PRBS pattern query	TPP?	3-26
Transmitter data pattern	TPT	3-22
Transmitter data pattern query	TPT?	3-22
Self-test command (CC)	TST	3-11
Transmitter ternary interface code	TTI	3-21
Transmitter ternary interface code query	TTI?	3-21
Transmitter word pattern	TWD	3-24
Transmitter word query	TWD?	3-24
Transmitter PRBS zero substitute	TZN	3-27
Transmitter PRBS zero substitute query	TZN?	3-27
Jitter modulation amplitude (HP 3785A/B)	ZR	3-7

3.1.1 HP 3785A/B Compatible Commands

To simplify integration into existing systems the instrument accepts the commands of the old HP 3785A/B. Note that these commands are a subset of the new command set and that some measure should be taken to ensure the condition of unused parameters (such as "RCL 0").

Parameters are the same as the parameters of the equivalent command unless shown in the table or referred to in the notes. It is strongly recommended that in new applications that the new command set should be used. The commands are given below in the order that they appear in the HP 3785A/B operating manuals.

Table 3-2. Commands compatible with HP 3785A/B

Command	Equivalent	Description
DRn	JDR n	Display Rate
RAn	JRA n	Jitter Receiver Range
PSn		Jitter Peak Select (SEE NOTE 1)
FRn	JFR freq	Jitter Modulation Frequency (SEE NOTE 11)
AMn	JAM amp	Jitter Modulation Amplitude (SEE NOTE 11)
EXn	JMS n	Jitter Modulation Source (n=1,2)
MA n	JMA freq	Jitter Mask Manual Sweep point (SEE NOTE 11)
AU1	JMS3	Start Auto Sweep Jitter Mask
AU2	JMS2	Stop Auto Sweep Mask
IT	TCL INTERNAL	Select internal clock source
ET	TCL EXTERNAL	Select external clock source
GE n	TCRn	Select Generator Clock Rate
RE n	RCRn	Select Receiver Clock Rate
DI n		Display (SEE NOTE 1)
PTn	JPT amp	Jitter Peak Threshold
TI n	TIM hh,mm,ss	Set Real Time (SEE NOTE 2)
INn	GPR dd,hh,mm,ss	Set Gating Time (SEE NOTE 3)
ST	STR	Start
SP	STP	Stop
MO n	GTYn	Gating Mode
JA1	TPT 5	Jitter Application 1000 Word
JA2	TPT 4	Thru data mode
JA3	TPT 6	Jitter Application Clock
DFn	TIF n; RIF n	Interface Format (SEE NOTE 4) (HP 3785A only)
IFn	DIF n	Data Input Format (SEE NOTE 4) (HP 3785B only)
FI n	JFI n	Jitter Filter
MI n	JMI n	Jitter Measurement Input
RCn	JRC n	Jitter Receiver Reference Clock
ZR	JAM 0	Zero Reference Jitter Amplitude
CA		SEE NOTE 1
QA		Query annunciators
QFn		SEE NOTE 5
LN	(CON?)	SEE NOTE 6
LD	(CON)	SEE NOTE 6
FL		SEE NOTE 8

Notes:

1. The "DI" and "PS" commands are included to select the result returned with the "CA" command. These commands have no direct equivalent in the new instruments and are implemented for compatibility only. The "CA" query command is replaced by several new query commands in the new command set.
2. The "TI" command has a parameter of the form "hhmmss" whereas the "TIM" command has three parameters separated by commas ("hh, mm, ss").
3. The "IT" command has a parameter of the form "hhmmss" whereas the "GPR" command has four parameters separated by commas ("dd, hh, mm, ss").

To obtain gating periods of greater than 23 hours, 59 mins and 59 secs the "GRP" command must be used.

4. In European instruments the "DF" command affects both the transmitter outputs and receiver inputs. The commands "TIF"/"RIF"/"RCF" are used in the new instruments; to give independent control of Tx and Rx. The coding of the parameters is also different. When using "IF" the receiver level is set to "ASTX".
5. The "QFn" command has no meaning in the context of these instruments. Firmware revisions are identified by use of the "FRN?" command. A suitable dummy message is returned in response to this command.
6. The "LN" and "LD" commands are not implemented since the content of the block is inadequate to describe the instrument condition. These commands should be replaced, "CON" for "LD" and "CON?" for "LN". Note that the block is MUCH larger.
7. The message terminator in the new HP3784/5 is always the same as that used in the command, so if you send CA1<CR><LF> you will receive the result terminated by <CR><LF>.
8. The "FL" command is used to control a number of conditions depending upon its parameters. The implementation status of each is given below, Y=Yes - implemented, N=No - unimplemented, A=Always set this way. N.B. Output messages are not implemented - use logging system instead.
9. The response to serial poll is always that used in the new instrument which is bit weighted rather than the codes used by the HP 3785.
10. The "device clear" meta-message does not return the instrument to its default condition as in the old HP 3785A/B.
11. The "FR" command will attempt to force the modulation source to internal and the "AM" command will attempt to force the modulation source to spot mask, both provided that the HP3784 is not gating.

Table 3-3. FL commands from HP 3785A/B

Command	Meaning
FL1	Issue answers in peripheral format
FL2	Issue answers in controlled format
FL3	(unused)
FL4	(unused)
FL5	Do not issue answers at EOG
FL6	Issue answers at EOG
FL7	Do not prefix messages with time
FL8	Do prefix messages with time
FL9	Do not issue HS messages automatically
FL10	Do issue HS messages automatically
FL11	True only if one or more HS have occurred
FL12	Always true
FL13	Do not issue general control messages
FL14	Do issue general control messages
FL15	Use ' as message terminator (SEE NOTE 7 ABOVE)
FL16	Use CR/LF as message terminator (SEE NOTE 7 ABOVE)
FL17-31	Control of service request mechanism (as in HP 3785A/B)
FL32	SRQ when ANY key is pressed (Not just LOCAL as in HP 3785)
FL33-38	Control of service request mechanism

3.2 HP-IB Common Capability Messages

This section describes all the commands recommended by "HP recommended practice for common instrument capabilities" 8 August 1983. These include meta-message equivalents for use with communication media other than HP-IB (for this instrument RS232), and commonly used commands.

3.2.1 Reset Command (RST)

The reset action message presets the instrument to its default state. A full listing of this default state is given in Appendix C. The predefined state is as follows :-

- Configuration defined by preset panel 0
- Stopped gating
- All buffers flushed
- Stop asserting SRQ
- Service request mask set to ERR.
- Clear all errors
- Clear status, alarm change and key registers.
- Ready register set to 1 (ready for new command)

The HP-IB parser and executor are also reset by this command, of the form :-

```
"RST"
```

3.2.2 Self-Test Command

The self test command performs a selected self-test on the instrument. A subsequent response of "0" to the "ERR?" query command indicates that the test has passed, any other number indicates a failure (see Appendix A for a list of the error codes). Note the BER test can only be run on instruments with BER capability, also the jitter self-test can only be run on instruments with jitter hardware fitted. For tests 1-3, the various functions of the instrument are suspended. Thus, the remote control bus is held off for a maximum of 25s in the case of HPIB, while for RS232 all communications and handshakes are ignored. Attempting to change the instruments settings during any test may result in test failure.

The jitter test will comprise all the jitter sub-tests, to run them separately refer to the JST command.

The command takes the form :-

```
"TST <n>"  <n> = 1 CPU      : Test CPU ROM/RAM etc
              2 RS232     : Test RS232 remote port loopback
              3 PORT      : Test Printer port loopback
              4 CLOCK     : Test transmitter clock synth
              5 BER       : Test BER Tx and Rx
              6 JITTER    : Test jitter Tx and Rx
```

3.2.3 Remote Command (RMT)

This command is equivalent to the REN+LLO meta-message and is included for use with non HPIB communication media (ie RS232). When used the instrument will go remote with local lockout. The command is as follows :-

```
"RMT"
```

3.2.4 Local Command (LCL)

This command is equivalent to the clear local lockout and RTL meta-message and is included for use with non HPIB communications media (ie RS232). When used the instrument will disable local lockout and return to local. The command is as follows :-

```
"LCL"
```

3.2.5 Clear Command (CLR)

This command clears all instrument errors and flushes all buffers without affecting the programmed state of the instrument. This command is equivalent to the DCL or SDC meta-messages and is provided for remote interfaces other than HPIB (i.e. RS-232). The following things are performed by executing this command :-

- Stopped gating
- All buffers flushed
- Stop asserting SRQ
- Service request mask set to ERR.
- Clear all errors
- Clear status, alarm change and key registers.
- Ready register set to 1 (Ready for new command)

The command is as follows :-

```
"CLR"
```

3.2.6 Configuration Command (CON)

This command takes as its parameter a block of data which specifies the instrument's internal setup state. The block is a IEEE Std 728 "#H" format. This is intended only for restoring an instrument state saved using the CON? query and hence its internal format is not elaborated.

NOTE: This command does not record the settings of remote control sources, or current states of HP-IB registers. It is equivalent in scope to store/recall preset panels. One block should not be compared with another in a comparison attempt as redundant but variable information is included in the block.

The command is as follows :-

```
"CON #H"
```

The complement of this command is used to enquire about the configuration of the instrument; it returns the configuration of the instrument in exactly the same form, namely the IEEE Std 728 "#H" data block. The length of the block will not exceed 1000 characters. The command is as follows :-

```
"CON?"
```

Returns :-

```
"#H"
```

3.2.7 Key Query (KEY?)

This command returns the value of the last key pressed on the front panel. The value is returned as an integer whose meaning is given below. If no key was pressed since the last time the command was used, 0 is returned. Note that this command does not wait until a key is pressed. The command is as follows :-

```
"KEY?"
```

Returns :-

```
"<n>"                    <n> = 1 .. 12
```

Table 3-4. Keycodes

Keycode	Description
1	Log on demand
2	Local
3	Log stop
4	Help
5	Next Page
6	Up Position
7	Next Change
8	Audio
9	Page/Index
10	Left Position
11	Right Position
12	Start/Stop
13	Execute
14	Previous Page
15	Down Position
16	Previous Change
17	Single Error

3.2.8 Request Service Mask Command (RQS)

This command is used to enable or disable the reasons for SRQ. It has a parameter which corresponds to a 16 bit integer used to ask the various causes for SRQ. The reasons for SRQ are given in Appendix B and are represented as a 16 bit integer. Associated with status register A is a mask which enables or disables the various sources (ie only the positive edge of a bit in status register A with it's corresponding mask bit enabled will cause an SRQ). It is this mask that the Service Request command addresses. The command is as follows :-

```
"RQS <n>"      <n> = 0 .. 4095
```

The mask has an identical bit map as status register A, and can be set in three different ways.

- 1) The parameter can be a single 16 bit integer, corresponding to the addition of binary weighted bits wishing to be enabled, e.g. if we wished to enable EOG and ERR then the command would be :-

```
"RQS 288"
```

- 2) The parameter can be a list of the binary weighted integers corresponding to all those sources wishing to be enabled separated by commas, e.g. if we wished to enable EOG, ERR and FPS then the command would be :-

```
"RQS 256, 4, 32"
```

- 3) The parameter can be a list of three letter mnemonics defined in Appendix B, separated by commas. Eg. if we wished to enable ERR, RDY and LCL then the command would be :-

```
"RQS ERR, RDY, LCL"
```

As well as the three methods of passing the parameter outlined above, any combination may be used, remembering that the result is always evaluated to a 16 bit integer. Care should be taken to ensure the resultant integer is in range and the desired sources are enabled (although range checking is done, no checking of constituent parameters is performed to ensure that they are binary values). There are two other special parameters to this command. They are "RQS ON" and "RQS OFF". "RQS OFF" is not equivalent to "RQS 0" because it disables all reasons for SRQ but remembers the stored mask. Upon receipt of the "RQS ON" command service requests should be enabled again with the same mask as before (NOTE any positive edges of sources with their mask set should be caught, so that they will SRQ when the "RQS ON" command is sent). If the "RQS ON" command is sent without a corresponding "RQS OFF" command sent before it, the instrument shall assume the "RQS ERR" state as a default.

The complement of this command is used to inspect the Service Request mask. The command responds with a 16 bit integer equivalent to the binary weighted values of those sources which are enabled (outlined in appendix B). The command is as follows :-

"RQS?"

Returns:-

"<n>" <n> = 0 .. 4095

3.2.9 Identification Query (ID?)

This command is a request for identification from the instrument. This is included to be compatible with "common capabilities" and as a standard response. The command is as follows:-

"ID?"

Returns :-

"HP3784A" for HP3784A European Jitter & Ber Test Set

3.2.10 Revision Date Query (REV?)

This command is a request for the instruments firmware revision date and the latest applicable Codes and Formats document (HP728) and Capabilities document to which the instrument was designed. The instrument returns two four digit date codes separated by a comma, these date codes are in standard HP serial number format (a four digit code, where the first two digits indicate the year (from 1960), and the next two indicate the week (01 and 52). The firmware revision date comes first, followed by the Codes and Formats date. The command is as follows :-

REV?"

Returns :-

"<dddd>, <dddd>" <dddd> = date code

3.2.11 Serial Number (SER)

This command is used to program an instrument with a serial number; it will retain that number for as long as the non-volatile memory remains uncorrupted. If the NVM should fail, then the serial number assumes the default value (See APPENDIX C). Note : Either single or double quotes around the string parameter are acceptable, as long as the opening quote is the same as the closing quote. The command is as follows:-

```
"SER "ddddUnnnnn""      <dddd> = 0000..9999
                        <nnnnn> = 00000..99999
```

The complement of this command is a request for the instrument to return it's individually assigned serial number. The command is as follows:-

```
"SER?"
```

Returns :-

```
"ddddUnnnnn"
```

3.2.12 Error Code Query (ERR?)

This command is a request to read the instrument's error register. The error register contains an integer in the range -32768 to 32767. The error codes have various meanings, some defined by "common capabilities" and some instrument dependent (see appendix A for a full listing). If no error exists at the time of enquiry, then "0" is returned. The error register is cleared on reading the register or by sending the CLR command.

The error register will also contain the result of a remotely initiated selftest command. This is cleared as above. The command is as follows :-

```
"ERR?"
```

Returns :-

```
"<n>"          <n> = -32768 .. 32767
```

3.2.13 Ready Code Query (RDY?)

This command is a request to read the instrument's ready register. The result is a binary weighted decimal integer. The meanings of the bits is given in Appendix B. The command is as follows:-

```
"RDY?"
```

Returns :-

```
"<n>"          <n> = 0 .. 63
```

3.2.14 Status/Events Query (STA?)

This command is a request for the instrument to return the contents of status register A. It responds with an integer which represents the 16 bit binary weighted contents of the status register bits. A detailed description of status register A is given in appendix B. The command is as follows:-

"STA?"

Returns :-

"<n>" <n> = 0 .. 32767

3.2.15 Status Query (STB?)

This command is a request for the instrument to return the contents of status register B. It responds with an integer which represents the 8 bit binary weighted contents of the status register bits. The act of executing this command also clears the RQS bit in status registers A and B (similar to the serial poll). A detailed description of status register B is given in status register B is given in appendix B. The command is as follows:-

"STB?"

Returns :-

"<n>" <n> = 0 .. 255

3.2.16 Options Query (OPT?)

This command is a request for the instrument to return its option number. The command is as follows:-

"OPT?"

Returns :-

""<d>"" <d> : Coded as per table below

Table 3-5. Coding of OPT? command

<d>	Meaning
STD	Standard instrument
001	HP 3784 option 001
002	HP 3784 option 002
006	HP 3784 option 006

3.3 HP 3784A Command Set

3.4 Transmitter Clock Commands

The following commands configure the clock source for the transmitter.

3.4.1 Transmitter Clock Command (TCL)

Selects the clock source for the transmitter. (See also "TIF").

```
"TCL <n>"   <n> = 1  STANDARD : Internal Clock Oscillator
              2  EXTERNAL  : External Clock Source
              3  VARIABLE  : Variable rate
```

The corresponding query returns the current instrument mode, in integer form as described above

```
"TCL?"
```

Returns :-

```
<n>           <n> = 1 .. 3
```

3.4.2 Transmitter Clock Rate Command (TCR)

Select transmitter clock rate. Command set <a> is used in standard European Instruments.

NOTE: Some frequencies are not allowed on some options - for details see specifications in Section 6 of the Operating/Calibration Manual.

```
"TCR <a>"   <a> = 0  F704KHZ : 704KHz Clock Rate
              1  F2MHZ   : 2MHz Clock Rate
              2  F8MHZ   : 8MHz Clock Rate
              3  F27MHZ  : 27MHz Clock Rate
              4  F34MHZ  : 34MHz Clock Rate
              5  F64KHZ  : 64KHz Clock Rate
```

The corresponding query returns the transmitter clock rate, in integer form as described above:-

```
"TCR?"
```

Returns :-

```
<n>           <n> = 0 .. 5
```

3.4.3 Transmitter Clock Phase (TCP)

Selects the clock phase for the Tx clock when Tx in thrudata mode:

```
"TCP <n>"    <n> = 0 NORMAL    : Normal or TRUE sense of clock
              1 INVERTED   : Inverted or FALSE sense of clock
```

The corresponding query returns the Tx clock phase, in integer form as described above:

```
"TCP?"
```

Returns :-

```
<n>          <n> = 0 .. 1
```

3.4.4 Transmitter Clock Offset (TCO)

Selects the frequency offset of the internal clock. This command only works when the transmitter clock source is set to STANDARD or VARIABLE. When using this command simultaneously with TCF or TCR, it is recommended that a wait for the alarm register "LOC" bit be performed after each command.

```
"TCO <offset>"    <offset> = -99..99 : Frequency offset in PPM.
```

The corresponding query returns the frequency offset, in integer form as described above:-

```
"TCO?"
```

Returns :-

```
<offset>        <offset> = -99 .. 99
```

3.4.5 Transmitter Clock Frequency (TCF)

Selects the variable frequency of the transmitter clock. Note: Only certain frequency values are permitted, see instrument specifications.

```
"TCF <freq>"    <freq> = 1000 ... 50016000 : Clock freq
                10KHz .. 50.016MHz   : Clock freq
```

The corresponding query returns the frequency of the transmitter clock, in integer form as described above. When in STANDARD mode the frequency returned is that set by the TCR/TCO commands. When in VARIABLE mode it returns the number set by TCF <freq> above. When in EXTERNAL mode the measured external clock frequency is given; the flag indicates the validity of the measurement:-

```
"TCF?"
```

Returns :-

```
<flag>, <freq>" <flag> = 0 .. 1 : Result valid
                <freq> = 1..50021001 : Clock freq in Hz
```

3.5 Receiver Clock Commands

The following commands configure the clocking of the receiver.

3.5.1 Receiver Clock Rate Command (RCR)

Select receiver clock rate. Command set <a> is used in standard European Instruments. Note some frequency options are not allowed on some instrument options - see instrument specifications for details.

```
"RCR <a>"   <a> =  0  F704KHZ : 704KHz Clock Rate
                1  F2MHZ   : 2MHz Clock Rate
                2  F8MHZ   : 8MHz Clock Rate
                3  F27MHZ  : 27MHz Clock Rate
                4  F34MHZ  : 34MHz Clock Rate
                5  F64KHZ  : 64KHz Clock Rate
```

The corresponding query returns the receiver clock rate, in integer form as described above:-

```
"RCR?"
```

Returns:-

```
<n>           <n> =  0 .. 5
```

3.5.2 Receiver Clock Phase (RCP)

Selects the clock phase for the Rx clock when Rx in binary mode:

```
"RCP <n>"   <n> =  0  NORMAL   : Normal or TRUE sense of clock
                1  INVERTED  : Inverted or FALSE sense of clock
```

The corresponding query returns the rx clock phase, in integer form as described above:

```
"RCP?"
```

Returns :-

```
<n>           <n> =  0 .. 1
```

3.6 Configuration Commands

The following commands configure the data formats/levels and the configuration of the instrument.

3.6.1 Transmitter Interface Format Command (TIF)

Selects the transmitter output interface. Codirectional interface is only permitted when operating at 64kbit/s (OPT-006), at other rates error 606 will be generated.

When STANDARD tx clock is selected, the interface choice is limited as per specifications. When VAR or EXT tx clock is selected, the interface choice will be free except that the T75TERM setting will change from +2.37V to +1.0V in going through 34.368MHz-10% from below and will change from +1.0V to +2.37V in going through 8.448MHz+10% from above.

```
"TIF <a>"   <a> = 1 T75TERM   : 75ohm Unbalanced Output
                2 T120TERM  : 120ohm Balanced Output
                3 BINARY    : Binary Outputs
                4 CODIRECT  : Codirectional Interface
```

The corresponding query returns the transmitter interface level, in integer form as described above:-

```
"TIF?"
```

Returns :-

```
<n>           <n> = 1 .. 4
```

3.6.2 Receiver Configuration Format Command (RCF)

Selects the receiver configuration. Sending the autosetup command will result in the instrument attempting to lock onto the incoming signal in the receiver. During autosetup, the receiver configuration will return to the "MANUAL" setting.

```
"RCF <a>"   <a> = 1 MANUAL : Receiver independent of transmitter
                2 AUTO   : Receiver attempts to auto-configure
                3 ASTX  : Receiver follows transmitter settings
```

The corresponding query returns the receiver configuration, in integer form as described above. The reply to "RCF?" during AUTO is "1" as the instrument immediately switches to manual.

```
"RCF?"
```

Returns :-

```
<n>           <n> = 1 .. 3
```

3.6.3 Receiver Interface Format Command (RIF)

Selects the receiver input interface. Codirectional interface is only available at 64kbit/s (OPT-006).

```
"RIF <a>"   <a> =  1  R75MON   : 75ohm Unbalanced Monitor
                2  R75TERM  : 75ohm Unbalanced Terminated
                3  R120TERM : 120ohm Balanced Terminated
                4  R120MON  : 120ohm Balanced Monitor
                5  BINARY   : Binary Inputs
                11 CODIRECT : Codirectional Interface
```

The corresponding query returns the receiver interface level, in integer form as described above:-

```
"RIF?"
```

Returns :-

```
<n>           <n> =  1 .. 5, 11
```

3.6.4 Transmitter Ternary Interface Code (TTI)

Selects the ternary interface coding type for the transmitter.

```
I <n>"   <n> =  1  HDB3 : Select HDB3 Code
                2  AMI  : Select AMI Code
```

The corresponding query returns the interface coding type, in integer form as described above

```
TTI?"
```

Returns :-

```
<n>           <n> =  1 .. 2
```

3.6.5 Receiver Ternary Interface Code (RTI)

Selects the ternary interface coding type for the receiver.

```
"RTI <n>"   <n> =  1  HDB3 : Select HDB3 Code
                2  AMI   : Select AMI Code
```

The corresponding query returns the interface coding type, in integer form as described above:-

```
"RTI?"
```

Returns :-

```
<n>           <n> =  1 .. 2
```

3.6.6 Binary Interface Level (BIL)

Selects the binary interface level used for the transmitter and receiver in the HP3784A. This command applies to data and clock output in binary and thru data mode.

```
"BIL <n>"   <n> = 1 TTL : Select TTL levels
                2 ECL : Select ECL levels
```

The corresponding query returns the binary interface level, in integer form as described above

```
"BIL?"
```

Returns :-

```
<n>           <n> = 1 .. 2
```

3.6.7 Transmitter Pattern Command (TPT)

Selects the pattern type used by the BER generator. Selections 1..3 are available in BER only instruments. Selections 1..6 are available in BER & jitter instruments.

```
"TPT <n>"   <n> = 1 PRBS      : PRBS pattern
                2 WORD       : Select Word patterns
                3 ALTWORD    : Select Alternating word pattern
                4 THRU DATA : Select Thru-data mode
```

The corresponding query returns the BER pattern type, in integer form as described above:-

```
"TPT?"
```

Returns :-

```
<n>           <n> = 1 .. 4
```

3.6.8 Receiver Pattern Command (RPT)

Selects the pattern type used by the BER receiver.

```
RPT <n>"   <n> = 1 PRBS : PRBS pattern
              2 WORD : Select Word patterns
              3 ASTX : As selected by TPT command
```

The corresponding query returns the BER pattern type, in integer form as described above:-

```
RPT?"
```

Returns :-

```
<n>           <n> = 1 .. 3
```

3.6.9 Control Octet Timing (TOC)

Enables or disables octet timing at 64kbit/s level. This command only applies when 64kbit/s interfaces are fitted.

```
"TOC <n>"   <n> = 0 DISABLED : Disable octet timing
              1 ENABLED  : Enable octet timing
```

The corresponding query returns the status of the octet timing, in integer form as described above

```
"TOC?"
```

Returns :-

```
<n>           <n> = 0 .. 1
```

3.6.10 Selectable Port (SEL)

Selects the selectable rear panel port to output either the transmitter pattern trigger or the receiver clock signal.

```
SEL <n>"   <n> = 0 TXTRIG : Output tx pattern trigger
              1 RXCLOCK : Output rx clock signal
```

The corresponding query returns the status of port in integer form as described above:-

```
"SEL?"
```

Returns :-

```
<n>           <n> = 0 .. 1
```

3.7 Data Pattern Commands

The following commands are acceptable to all versions of the instrument with data pattern generators and receivers. The commands relate to the setup of the BER part of the instrument.

3.7.1 Transmitter Word Pattern Command (TWD)

Selects the word length and data pattern used by the BER Tx when the selected pattern is set "TPT WORD". Note that word length <n> gives the number of digits in the data string <d>, e.g. TWD 2,"10" ; TWD 6,"101100"

```
"TWD <n>,"<d>""      <n> = 1..16           : Word length
                    <d> = <n> characters "0" or "1" : Word data
```

The corresponding query returns the word length and pattern:-

```
"TWD?"
```

Returns :-

```
<n>,"<d>"
```

3.7.2 Receiver Word Pattern Command (RWD)

Selects the word length and data pattern used by the BER Rx when the selected pattern is set "RPT WORD". Note that word length gives the number of digits in the data string.

```
"RWD <n>,"<d>""      <n> = 1..16           : Word length
                    <d> = <n> characters "0" or "1" : Word data
```

The corresponding query returns the word length and pattern:-

```
"RWD?"
```

Returns :-

```
<n>,"<d>"
```

3.7.3 Alternate Word Pattern Command (ALW)

Selects the alternate word data pattern used by the BER Tx when the selected pattern is set "RPT ALTWORD". The words are always fixed at 8 bits.

```
"ALW "<aaaaaaaa>","<bbbbbbbb>""  <a> = "0" or "1" : A-word
                                <b> = "0" or "1" : B-word
```

The corresponding query returns the alternate word pattern:-

```
"ALW?"
```

Returns

```
""<aaaaaaaa>","<bbbbbbbb>""  <a> = "0" or "1" : A-word
                                <b> = "0" or "1" : B-word
```

3.7.4 Alternate Switched Internal/External (ALS)

Selects the source of the alternate word switchover to be derived from the internal jitter frequency synthesizer or from the external modulation port. Note that this is affected by "JMS". This command is unavailable in BER only versions of the instrument.

```
"ALS <n>"  <n> = 0 INTERNAL : Use internal
              1 EXTERNAL : Use external
```

The corresponding query returns the source of alternate word switchover, in integer form as described above:-

```
"ALS?"
```

Returns :-

```
<n>          <n> = 0 .. 1
```

3.7.5 Alternate Word Frequency (ALF)

Selects the switchover frequency of the alternate word, note that this in fact changes the jitter modulation frequency source. It only controls alternate word switching when "ALS INTERNAL" has been selected. This command is unavailable in BER only instruments.

```
"ALF <freq>"  <freq> = 1 to 1.00E+5   : Frequency in Hz
                  or 1.00 to 999HZ   : Frequency in Hz
                  or 1.00 to 100KHZ   : Frequency in KHz
```

The corresponding query returns the alternate word frequency, in integer form as described above:-

```
"ALF?"
```

Returns :-

```
"<freq>"      <freq> = 1.00E+00 .. 1.00E+05
```

3.7.6 Transmitter PRBS Pattern Selection (TPP)

Selects the length of PRBS pattern used when pattern is set "TPT PRBS".

```
"TPP <n>"   <n> = 1 PRBS9   : PRBS pattern length 29 -1 bits
                2 PRBS11  : PRBS pattern length 211 -1 bits
                3 PRBS15  : PRBS pattern length 215 -1 bits
                4 PRBS17  : PRBS pattern length 217 -1 bits
                5 PRBS20  : PRBS pattern length 220 -1 bits
                6 PRBS23  : PRBS pattern length 223 -1 bits
                7 PRBS6   : PRBS pattern length 26  -1 bits
```

The corresponding query returns the current transmitter PRBS pattern, in integer form as described above:-

```
"TPP?"
```

Returns :-

```
<n>           <n> = 1 .. 7
```

3.7.7 Receiver PRBS Pattern Selection (RPP)

Selects the length of receiver PRBS pattern used when pattern is set "RPT PRBS".

```
"RPP <n>"   <n> = 1 PRBS9   : PRBS pattern length 29 -1 bits
                2 PRBS11  : PRBS pattern length 211 -1 bits
                3 PRBS15  : PRBS pattern length 215 -1 bits
                4 PRBS17  : PRBS pattern length 217 -1 bits
                5 PRBS20  : PRBS pattern length 220 -1 bits
                6 PRBS23  : PRBS pattern length 223 -1 bits
                7 PRBS6   : PRBS pattern length 26  -1 bits
```

The corresponding query returns the receiver current PRBS pattern, in integer form as described above:-

```
"RPP?"
```

Returns :-

```
<n>           <n> = 1 .. 7
```

3.7.8 Transmitter PRBS Zero Substitution Command (TZN)

Selects Number of zeros substituted into the Tx PRBS sequence:-

"TZN <n>" <n> = 0..999 : Number of zeros substituted

The corresponding query returns the number of zeros substituted, in integer form as described above:-

"TZN?"

Returns :-

<n> <n> = 0 .. 999

3.7.9 Receiver PRBS Zero Substitution Command (RZN)

Selects Number of zeros substituted into the Rx PRBS sequence:-

"RZN <n>" <n> = 0..999 : Number of zeros substituted

The corresponding query returns the number of zeros substituted, in integer form as described above:-

"RZN?"

Returns :-

<n> <n> = 0 .. 999

3.8 Error Add Commands

These commands control the error add mechanism in the tx pattern generator. These commands only apply to instruments which have BER capability.

3.8.1 Error Add Command (EAD)

Selects the method of error addition into the transmitter data stream.

```
"EAD <n>"   <n> = 0 OFF    : Error add disabled
              1 SINGLE : Add single errors only
              2 RATIO  : Add errors at fixed ratio
```

The corresponding query returns the error add mode, in integer form as described above:-

```
"EAD?"
Returns :-
```

```
<n>           <n> = 0 .. 2
```

3.8.2 Error Add Type Command (EAT)

Selects where error add is to be performed, to have effect the "EAD" command must be set to other than "OFF". Code errors cannot be added to binary transmitted data.

```
"EAT <n>"   <n> = 1 BIT   : Add errors to bit stream
              2 CODE   : Add errors to coding
```

The corresponding query returns the error add type, in integer form as described above:-

```
"EAT?"
Returns :-
```

```
<n>           <n> = 1 .. 2
```

3.8.3 Error Add Ratio (EAR)

Selects error add ratio. The instrument must previously be set "EAD VARIABLE".

```
"EAR <rate>"   <rate> = 3 .. 6 : Error Add 1 in 10<rate>
```

The corresponding query returns the error add ratio, in integer form as described above:-

```
"EAR?"
Returns :-
```

```
<rate>         <rate> = 3 .. 6
```

3.8.4 Single Error Add Command (SEA)

This command injects a single error into the generator output stream provided that the generator is in single error mode. If not error (400) is produced. This command is equivalent to pressing the front panel ERROR ADD key.

"SEA"

3.9 Jitter Generator Commands

The following commands are acceptable to versions of the instrument with jitter generators, namely HP 3784A opt 002. When operating the generator in variable frequency mode, jitter will only be available when the clock frequency is within 10% of an installed jitter generation range. Use of jitter generator commands when out of range will result in errors being reported. In EXT clock mode the measured TX CLOCK IN frequency will determine, in the same way as variable frequency mode, whether or not the jitter generator will be available. The EXT clock measured frequency will be sampled every 3s and will cause jitter generator range selection or generator deselection as appropriate. This monitoring will be disabled during jitter plotting.

3.9.1 Jitter Option Select (JOS)

This command permits HP 3784A with jitter option to appear to be the HP 3784A STD, i.e. To appear to have BER capability only. Specifically, it:

- Clears the jitter generator effectively to "0 REF".
- Removes all jitter setup and measurement from the instrument display.
- Disallows any jitter remote control operation.
- Forces the ALTWORLD selection to EXTERNAL modulation only.

```
"JOS <n>"   <n> = 1 STD   : Appear to be HP 3784A STD
                2 SELF   : Appear with jitter option
```

The corresponding query returns the option in integer form as described above:-

```
"JOS?"
```

Returns :-

```
<n>           <n> = 1 .. 2
```

3.9.2 Jitter Modulation Source Command (JMS)

Selects jitter generator modulation source. Sending "JMS AUTO" starts sweep of jitter mask at minimum frequency. Sending any other "JMS" command stops the sweep. The mask used is determined from the tx clock rate selected.

```
"JMS <n>"   <n> = 1 EXTERNAL : External Modulation
                2 INTERNAL  : Internal Modulation
                3 AUTO      : Sweep Mask
                4 MANUAL    : Manual set mask point
```

The corresponding query returns the modulation source, in integer form as described above:-

```
"JMS?"
```

Returns :-

```
<n>          <n> = 1 .. 4
```

3.9.3 Jitter Modulation Frequency Command (JFR)

Selects the frequency of the jitter modulation in the jitter generator. This command should only be used when the modulation source is "INTERNAL". Note: Only the first three digits of the number are significant. This parameter should not be changed by 20% in any one command, then to wait for status register-A "SET" bit going from FALSE to TRUE.

```
"JFR <freq>"  <freq> = 1 to 0.84E+6   : Frequency in Hz
                  or 1.00 to 840HZ    : Frequency in Hz
                  or 1.00 to 840KHZ   : Frequency in kHz
                  or 0.84MHZ         : Frequency in MHz
```

The corresponding query returns the jitter modulation frequency, in integer form as described above:-

```
"JFR?"
```

Returns :-

```
"<flag>,<freq>"  <flag> = 0 .. 1           : Validity Flag
                  <freq> = 1.00E+00 .. 8.40E+05 : Frequency
```

3.9.4 Jitter Modulation Amplitude Command (JAM)

Selects the jitter modulation amplitude in Unit Intervals. This command should only be used when the jitter modulation source is "INTERNAL". The command "JAM 0" or "JAM 0.00" selects the instrument "0 REF" condition. This is when the tx clock comes directly from the internal clock synthesizer with no modulation present. Any other "JAM" command will switch in the jitter modulator for the tx clock range selected for the jitter amplitude requested.

It is not recommended to change the jitter amplitude from a low value (less than 2.5UIpp) to a large value (greater than 9.5UIpp) in one large step. Rather than select a halfway value and then to wait for status register-A SET bit from FALSE to TRUE.

```
"JAM <ampl>"  <ampl> = 0.00 .. 10.10 : Unit Intervals peak-peak.
```

The corresponding query returns the jitter modulation amplitude, in real form as described above. **WARNING:** While the above is the demand jitter amplitude, the query yields the actual (measured) jitter amplitude of the transmitter. These may not be the same.

"JAM?"

Returns :-

```
"<ref>,<n>"  <ref> = 0 .. 2      : 0 set to 0 REF
                                     1 result valid
                                     2 result invalid (">Bounds")
                <n> = 0.000 .. 10.10 : Jitter amplitude
```

3.9.5 Jitter Manual Sweep Mask Command (JMA)

Selects a frequency point on the jitter mask. The instrument must be set to manual mask jitter modulation source. The instrument will set the jitter modulation amplitude to the current mask value for the given frequency. This parameter should not be changed by 20% in any one command, then to wait for SET flag in status register-A.

```
"JMA <freq>"  <freq> = 1 to 1.10E+6  : Frequency in Hz
                                     or 1.00 to 999HZ   : Frequency in Hz
                                     or 1.00 to 999KHZ  : Frequency in KHz
                                     or 1.10MHZ        : Frequency in MHz
```

The corresponding query returns the manual set mask frequency, in integer form as described above. The validity flag is set if the jitter modulation source is manual mask:-

"JMA?"

Returns :-

```
"<flag>,<freq>"
```

3.9.6 Programmable Jitter Tolerance Masks (JMK)

This command sets up the user programmable jitter tolerance mask for the current rate selection and should only be sent when the jitter modulation source is either "INTERNAL" or "EXTERNAL". There is a programmable mask for each of the jitterable clock rates. There are between 2 and 6 points per mask specified by <n>, only points up to and including <fn>,<an> will be used. Unused points should be specified as freq=10, amplitude=1 or some other rogue value - though note that even rogue values will be range checked. Points which are not increasing in jitter frequency will be sorted and swapped round when the mask is first used. NB Points of frequency < 10Hz are not swept.

```
"JMK <n>,<f1>,<a1>,<f2>,<a2>,<f3>,<a3>,<f4>,<a4>,<f5>,<a5>,<f6>,<a6>"
```

```
<n> =          2 .. 6
<fn> = 1.00E+01 .. 1.10E+06
<an> =          0.02 .. 10.10
```

The complementary command returns the programmable mask for the current range selected in the form shown above.

```
"JMK?"
```

Returns :-

```
"<n>,<f1>,<a1>,<f2>,<a2>,<f3>,<a3>,<f4>,<a4>,<f5>,<a5>,<f6>,<a6>"
```

3.9.7 Jitter Mask Type (JMT)

This command selects between the standard and the programmable jitter mask when operating in sweep mode. Note there are sets of tolerance masks for each of the primary rates in the instrument option.

```
"JMT <n>"   <n> = 1 STD  : Select Standard Mask
              2 PROG : Select Programmable mask
```

The corresponding query returns the jitter mask type, in integer form as described above:-

```
"JMT?"
```

Returns :-

```
<n>           <n> = 1 .. 2
```

3.9.8 Jitter Q Factor (JQF)

This command selects between the high and low Q standard jitter tolerance masks when the primary operating rate is 2 or 8MHz.

```
"JQF <rate>,<q>"  <rate> = 2      : Q factor at 2MHz rate
                  = 8      : Q factor at 8MHz rate
                  <q> = 1  LOW : Select Low-Q mask
                  = 2  HIGH : Select High-Q mask
```

The corresponding query returns the jitter mask type, in integer form as described above:-

```
"JQF? <rate>"
```

Returns :-

```
<q>           <q> = 1 .. 2
```

3.10 Jitter Receiver Commands

The following commands are acceptable to versions of the instrument with jitter receivers, namely HP 3784A opt 002.

3.10.1 Jitter Filter (JFI)

This command selects the filters to be used for jitter measurement. The command "JFI 4" is included for compatibility with the HP 3785A/B only; when subsequently queried ("JFI?") the answer will be "0".

```
"JFI <n>"    <n> = 0 NONE : No filters
                1 HP1  : Selects HP1/LP filter
                2 HP2  : Selects HP2/LP filter
                3 LP   : Selects LP filter
                4 NONE : No filters (as "JFI 0")
```

The corresponding query returns the jitter filters, in integer form as described above:-

```
"JFI?"
```

Returns :-

```
<n>          <n> = 0 .. 3
```

3.10.2 Jitter Measurement Input (JMI)

This command enables/disables the rear-panel measurement input. The command "JMI 2" is retained for HP 3785A/B compatibility.

```
"JMI <n>"    <n> = 0 DISABLED : Not in use
                1 ENABLED  : Use rear-panel measurement input
                2 DISABLED : Not in use
```

The corresponding query returns the status of the measurement input, in integer form as described above:-

```
"JMI?"
```

Returns :-

```
<n>          <n> = 0 .. 1
```

3.10.3 Jitter Receiver Reference Clock (JRC)

Selects the source of the jitter receiver reference clock. When set to external the jitter receiver reference clock is derived from the rear panel BNC. When internal the reference clock is output through the same port. The command "JRC 2" is retained for compatibility with HP 3785A/B.

```
"JRC <n>"    <n> = 0 INTERNAL : Use internal reference
                1 EXTERNAL : Use external reference
                2 INTERNAL : Use internal reference
```

The corresponding query returns the source for the Jitter Receiver Reference clock in integer form as described above:-

```
"JRC?"
```

Returns :-

```
<n>          <n> = 0 .. 1
```

3.10.4 Jitter Display Rate (JDR)

Selects the rate at which the receiver jitter display is updated and the generator display when external modulation input is used. The SLOW, MED and FAST rates have refresh cycles enabling measurement at jitter frequencies of >0.1Hz, >1.0Hz, >10Hz.

```
"JDR <n>"   <n> = 1 SLOW : Slow Display rate    ( >0.1Hz )
              2 MED  : Medium display rate   ( >1.0Hz )
              3 FAST : Fast display rate     ( >10Hz  )
```

The corresponding query returns the display rate, in integer form as described above:-

```
"JDR?"
```

Returns :-

```
<n>          <n> = 1 .. 3
```

3.10.5 Jitter Receiver Range (JRA)

Selects the jitter receiver range to a choice of 1UIp-p or 10UIp-p.

```
"JRA <n>"   <n> = 1 RANGE1 : Jitter range 1UI p-p
              2 RANGE10 : Jitter range 10UI p-p
```

The corresponding query returns the jitter range, in integer form as described above:-

```
"JRA?"
```

Returns :-

```
<n>          <n> = 1 .. 2
```

3.10.6 Jitter Receiver Peak Threshold (JPT)

Selects receiver peak threshold for jitter hits.

```
"JPT <thres>" <thres> = 0.050 .. 0.500 : Range 1UI
                   00.50 .. 5.00   : Range 10UI
```

The corresponding query returns the jitter receiver peak threshold, in real number form as described above-

"JPT?"

Returns :-

<thres> <thres> = (as above)

3.11 Measurement Commands

The commands in this section relate to the setup of measurements and result access in all instruments.

3.11.1 Code or Offset Measurement Selection Command (MEA)

Selects either code or frequency offset measurement. Only for instruments with BER capability. This selection is only relevant when operating in Rx ternary interface mode. When in binary input mode frequency measurement is always made.

```
"MEA <n>"   <n> = 1  CODE   : Code error measurement
                2  OFFSET  : Frequency offset measurement
```

The corresponding query returns the measurement selected, in integer form as described above:-

```
"MEA?"
```

Returns :-

```
<n>           <n> = 1 .. 2
```

3.11.2 Alarm Mask Command (AMR)

Sets up Alarm Mask Register (AMR). This register is used to determine under what conditions the Alarm Change (ALC) bit in the Status Register A should be set. If a bit in the Alarm Status register changes (either from 1 to 0 or vice-versa), and the corresponding bit in Alarm Mask Register is set, the ALC bit in Status Register A and the ALC bit in Status Register B are set. The ALC bit is cleared by the ALM?, RST, CLR, DCL or SDC commands.

The argument to AMR can be specified in a number of ways:-

- As a binary-weighted integer (see table in Appendix B)
- As a list of integer values (which are wire OR'ed)
- As a list of alarm mnemonics.

```
"AMR <n>"   <n> = 0 .. 8191
                To disable all alarms,
                specify AMR 0 or AMR NONE.
```

The corresponding query returns the current value of Alarm Mask Register in integer form as described above.

```
"AMR?"
```

Returns :-

```
<n>           <n> = 0 .. 8191
```

3.11.3 Display Command (DI)

Selects the result output with the "CA" command. This command is included for compatibility with the HP 3785A/B. It has no effect on the front panel or measurements performed.

```
"DI <n>"   <n> = 1 : Selects Hits
              2 : Selects Hit Seconds
              3 : Selects Hit Free Seconds
              4 : Selects Time
              5 : Selects Interval
```

3.11.4 Peak Select Command (PS)

Selects the peak type output with the "CA" command. This command is included for compatibility with the HP 3785A/B. It has no effect on the front panel or measurements performed.

```
"PS <n>"   <n> = 1 : Selects Peak-Peak result
              2 : Selects Positive Peak
              3 : Selects Negative Peak
```

3.12 Result Query Commands

This section contains all measurement result query commands. If these commands are executed outside gating, the last gating period results are returned; during gating the results returned are dependent on the type of measurement period. If the instrument is in either Manual or Single mode, the results returned are the "in period" results; if the instrument is in a repetitive mode, the results returned are the results from the last gating period. Some results are not always available, therefore they return not only the result but a validity flag.

NOTE: The commands in this section have the effect of clearing the EOG and LOG bits in Status Registers A and B.

3.12.1 Bit Error Result Query (RSB?)

This command requests one of the bit error results. The format of the results returned will depend upon the selected result.

```
"RSB? <n>"   <n> = 1 COUNT       : Return Error Count Result
                2 RATIO         : Return Error Ratio Result
                3 INTERVAL      : Return Error (Deci)Seconds
                4 FREEINTERVAL  : Return Error Free (Deci)Seconds
```

Returns:-

```
"<flag>,<n>"  <flag> = 0 .. 1       : Validity Flag
                <n> = 0 .. 999999999 : Count, Seconds Result
                <n> = 0 .. 1.0E0     : Ratio Result (REAL)
```

3.12.2 Code Error Result Query (RSC?)

This command requests one of the code error results. This command is only valid in the HP 3784A. The format of the result returned will depend upon the selected result.

```
"RSC? <n>"   <n> = 1 COUNT       : Return Error Count Result
                2 RATIO         : Return Error Ratio Result
                3 INTERVAL      : Return Error (Deci)Seconds
                4 FREEINTERVAL  : Return Error Free (Deci)Seconds
```

Returns:-

```
"<flag>,<n>"  <flag> = 0 .. 1       : Validity Flag
                <n> = 0 .. 999999999 : Count, Seconds Result
                <n> = 0 .. 1.0E0     : Ratio Result (REAL)
```

3.12.3 Cumulative Slip Deciseconds Query (RSS?)

This command requests the slip decisecond result. Available for rx PRBS patterns only.

```
"RSS?"
```

Returns:-

```
"<flag>,<n>"   <flag> = 0 .. 1           : Validity Flag
                  <n> = 0 .. 99999999.9 : Slip Deciseconds Result
```

3.12.4 Jitter Hits Result Query (RSJ?)

This command requests one of the hit counter results. This command is only valid in option 002 instruments. The format of the result returned will depend upon the selected result.

```
"RSJ? <n>"   <n> = 1 COUNT           : Return Error Count Result
              3 INTERVAL           : Return Error (Deci)Seconds
              4 FREEINTERVAL       : Return Error Free (Deci)Seconds
```

Returns:-

```
"<flag>,<n>"   <flag> = 0 .. 1           : Validity Flag
                  <n> = 0 .. 9999999999 : Count, Seconds Result
```

3.12.5 Jitter Receiver Amplitude Query (RSR?)

This command requests the current jitter receiver amplitude. This command is only valid in the HP 3784A opt 002. Note that the result format changes with the receiver range selection. The validity flag in this result also indicates result overrange and reflects the "> Bounds" field on the jitter amplitude results field. This field indicates when the received jitter +ve/-ve peak amplitudes are greater than 0.505UI or 5.05UI (range dependent) or the pk-pk amplitude is greater than 1.01UIpp or 10.10UIpp (range dependent) or the jitter reference is "out of lock".

```
"RSR? <n>"   <n> = 1 PEAKPEAK       : Return Peak-Peak Amplitude
              2 POSPEAK            : Return Positive Peak Amplitude
              3 NEGPEAK            : Return Negative Peak Amplitude
```

Returns :-

```
"<flag>,<n>"   <flag> = 0 .. 1           : Flag=1 if valid
                  <n> = 0.000... 10.23 : Unit Intervals Jitter (pk-pk)
                  <n> = -5.05... 5.05  : Unit Intervals Jitter (pk)
```

3.12.6 Jitter Maximum Amplitude Query (RSM?)

This command requests the maximum peak-peak jitter amplitude in the period. This command is only valid in the HP 3784A opt 002. Note that result format changes with the receiver range selection.

```
"RSM?"
```

Returns :-

```
"<flag>,<n>"   <flag> = 0 .. 1           : Validity Flag
                  <n> = 0.000 .. 10.23 : Peak-Peak Max Amplitude Result
```

3.12.7 Frequency Measurement Result Query (RSF?)

This command requests the binary frequency measurement result. Only relevant when Rx interface is binary or 64 kbit/s codirectional.

"RSF?"

Returns:-

```
"<flag>,<n>"    <flag> = 0 .. 1      : Validity Flag
                  <n> = 0 .. 50016000 : Frequency in Hz
```

3.12.8 Frequency Offset Result Query (RSO?)

This command requests the result of the frequency offset measurement result. The answer is given in ppm offset from the nearest standard rate, up to ± 999 ppm. Only relevant when Rx interface is ternary and measurement is frequency offset.

"RSO?"

Returns:-

```
"<flag>,<n>"    <flag> = 0 .. 1      : Validity Flag
                  <n> = -999..+999 : Frequency offset in ppm
```

3.12.9 Analysis Result Query Command (ANR?)

This command requests a particular analysis result. Format of that result is dependent on the type of that result (could be count, ratio, percentage).

```
"ANR? <n>"      <n> = 1 AVAILABILITY : Return Availability
                  2 SEVERE          : Return Severely Errored Secs
                  3 ERRORSECONDS    : Return Error Seconds
                  4 DEGRADED        : Return Degraded Minutes
                  5 DISTRIB1        : Return ES(dS) with 1 err
                  6 DISTRIB2        : Return ES(dS) with 2-10 errs
                  7 DISTRIB10       : Return ES(dS) with >10 errs
                  8 BURST           : Return Number of Bursts
                  9 UNAVAILABILITY  : Return Unavailability
                  10 LTMER          : Return Long Term Mean Error Ratio
```

Returns :-

```
"<flag>,<n>"    <flag> = 0 .. 1      : Validity Flag
                  <n> = 1.0E-99..1.0E+99 : Result
```

3.12.10 Analysis Threshold Result Query (ATR?)

This command requests the results of the analysis threshold go/no-go measurements. Each of the measurements has an associated threshold which at the end of gating is compared to the result. If the result is worse than the threshold then that test fails. Each test can be either enabled or disabled (always returning N/A if it is disabled). If there is no result for the measurement yet (e.g. with Degraded Mins) the test will fail if enabled. An overall PASS/FAIL result is provided by ANDing all the tests which are enabled.

NOTE: The go/nogo calculations are performed shortly after the end of gating and may be held up if logging or other activity is taking place.

"ATR?"

Returns :-

"<flag>,<overall>,<ATA>,<ATB>,<ATC>,<ATD>,<ATE>,<ATF>,<ATG>,<ATH>,<ATI>,<ATJ>"

<flag>	= 0 .. 1	: Validity Flag
Other Parameters	= 0	: Fail
	1	: Pass
	2	: Not Applicable (N/A)

3.12.11 Alarm Duration Query (ALD?)

This command returns the total number of seconds for which a particular alarm has been present in the current or last gating period. Resolution is to the nearest decisecond. Jitter lock alarm is unavailable in BER only instruments.

"ALD? <n>"	<n> = 1	POWER	: Power loss
	2	TXCLOCK	: Tx Clock transitions loss
	3	RXCLOCK	: Rx Clock transitions loss
	4	DATA	: Data transitions loss
	5	LOCK	: Jitter Sync Lock Loss
	6	SYNC	: Pattern Sync Loss
	7	AIS	: Alarm Indication Signal

Returns:-

"<flag>,<duration>"	<flag>	= 0 .. 1
	<duration>	= 0 .. 8639999.0

3.12.12 Alarm Status Query (ALM?)

Returns the current value of alarm status register 1 as a binary-weighted 16 bit integer. A full description of the bits is given in Appendix B.

"ALM?"

Returns :-

<n> <n> = 0..8191

3.12.13 Elapsed Time Query Command (ELP?)

This command requests the current time from the start of the gating period. Validity flag indicates 1 from start of first gating period after instrument is powered up with no memory of previous settings. In other words all RAM is re-initialised. It remains "valid" thereafter.

"ELP?"

Returns :-

"<flag>,<dd>,<hh>,<mm>,<ss>"	<flag> = 0 .. 1	: Validity Flag
	<dd> = 0 .. 99	: Days
	<hh> = 0 .. 23	: Hours
	<mm> = 0 .. 59	: Minutes
	<ss> = 0 .. 59	: Seconds

3.12.14 Current Answer Query (CA)

This command requests the current answer and is provided for compatibility with the HP 3785A/B only. It is an all encompassing result returning query command. The use of this command is not recommended for new remote control applications. Results are always returned in controller format. Invalid results yield an answer "9.999E+99". With <n>=3 the result returned depends upon the last "PS" command. With <n>=5 the result returned depends upon the last "DI" command. This command is not available in BER only instruments.

"CA <n>"	<n> = 1	: Generator Frequency
	2	: Generator Amplitude
	3	: Receiver Amplitude
	4	: Receiver Amplitude Max
	5	: Jitter Analysis

Returns :-

n=1:	"<r>"	<r> = 0 .. 1.10 E6	: Generator Frequency
n=2:	"<r>"	<r> = 0..20.23	: Generator Amplitude
n=3:	PS=1: "<r>"	<r> = 0..20.23	: Receiver Peak-Peak Ampl
	PS=2: "<r>"	<r> = 0..20.23	: Receiver Pos-Peak Ampl
	PS=3: "<r>"	<r> = 0..20.23	: Receiver Neg-Peak Ampl
n=4:	"<r>"	<r> = 0..20.23	: Max in Interval Pk-Pk
n=5:	DI=1: "<r>"	<r> = 0..99999999	: Hit Count
	DI=2: "<r>"	<r> = 0..99999999	: Hit Seconds
	DI=3: "<r>"	<r> = 0..99999999	: Hit Free Intervals
	DI=4: "<d><h><m><s>"		: Real Time
	DI=5: "<d><h><m><s>"		: Time Interval

NOTE: Result field widths are always 8 characters, unless invalid indicator is returned.

3.12.15 Query Annunciators (QA)

This command produces a one byte response indicating the status of some of the alarm bits. The command is provided for HP 3785A/B compatibility purposes only; its use in new applications is not recommended.

NOTE: The reply is a single byte. There is no following separator.

"QA"

Returns :-

"<flag>" <flag> = 0 .. 64 : Flags

The bits are binary weighted as follows:-

DB7	DB6	DB5	DB4	DB3	DB2	DB1	DB0
0	0	RUN	RXL	0	RXC	RXD	TXC

BIT 0 : TXC Generator Clock Input (1=Transitions Present)

BIT 1 : RXD Receiver Ternary Data Input (1=Transitions Present)

BIT 2 : RXC Receiver Clock Input (1=Transitions Present)

BIT 4 : RXL Receiver In Lock

BIT 5 : RUN Instrument is currently gating

3.13 Analysis Threshold Commands

This section of commands addresses the analysis threshold measurements made by the instrument. Each of the analysis measurements performed on the BER data stream has an associated threshold on which a simple pass or fail test can be performed at the end of gating. Each threshold is separately enabled and an overall pass or fail is given.

3.13.1 Availability Threshold Command (ATA)

Selects the threshold for the Percentage Availability test.

```
"ATA <enable>,<threshold>"  <enable>    = 0 OFF : Test enabled
                               1 ON  : Test disabled
                               <threshold> = 0.00..100.00
```

The corresponding query indicates if the test is enabled and the current value of the threshold, as described above:-

```
"ATA?"
```

Returns :-

```
<enable>,<threshold>
```

3.13.2 Error Seconds Threshold Command (ATB)

Selects the threshold for the Percentage Error Seconds test.

```
"ATB <enable>,<threshold>"  <enable>    = 0 OFF : Test enabled
                               1 ON  : Test disabled
                               <threshold> = 0.00..100.00
```

The corresponding query indicates if the test is enabled and the current value of the threshold, as described above:-

```
"ATB?"
```

Returns :-

```
<enable>,<threshold>
```

3.13.3 Severely Errored Seconds Threshold Command (ATC)

Selects the threshold for the Percentage Severely Errored Seconds test.

```
"ATC <enable>,<threshold>"  <enable>    = 0 OFF : Test enabled
                               1 ON  : Test disabled
                               <threshold> = 0.00..100.00
```

The corresponding query indicates if the test is enabled and the current value of the threshold, as described above:-

"ATC?"

Returns :-

<enable>,<threshold>

3.13.4 Degraded Minutes Threshold Command (ATD)

Selects the threshold for the Percentage Degraded Minutes Test.

```
"ATD <enable>,<threshold>"  <enable>    = 0 OFF : Test enabled
                               1 ON  : Test disabled
                               <threshold> = 0.00..100.00
```

The corresponding query indicates if the test is enabled and the current value of the threshold, as described above:-

"ATD?"

Returns :-

<enable>,<threshold>

3.13.5 Error/Interval Threshold Command (ATE)

Selects the threshold for the 1 Error/Interval test.

```
"ATE <enable>,<threshold>"  <enable>    = 0 OFF : Test enabled
                               1 ON  : Test disabled
                               <threshold> = 0..9.9E+9
```

The corresponding query indicates if the test is enabled and the current value of the threshold, as described above:-

"ATE?"

Returns :-

<enable>,<threshold>

3.13.6 2-10 Error/Interval Threshold Command (ATF)

Selects the threshold for the 2-10 Error/Interval test.

```
"ATF <enable>,<threshold>"  <enable>    = 0 OFF : Test enabled
                               1 ON  : Test disabled
                               <threshold> = 0..9.9E+9
```

The corresponding query indicates if the test is enabled and the current value of the threshold, as described above:-

```
"ATF?"
```

Returns :-

```
<enable>,<threshold>
```

3.13.7 Greater than 10 Error/Interval Threshold Command (ATG)

Selects the threshold for the >10 Error/Interval test.

```
"ATG <enable>,<threshold>"  <enable>    = 0 OFF : Test enabled
                               1 ON   : Test disabled
                               <threshold> = 0..9.9E+9
```

The corresponding query indicates if the test is enabled and the current value of the threshold, as described above:-

```
"ATG?"
```

Returns :-

```
<enable>,<threshold>
```

3.13.8 Error Burst Threshold Command (ATH)

Selects the threshold for the Error Burst test.

```
"ATH <enable>,<threshold>"  <enable>    = 0 OFF : Test enabled
                               1 ON   : Test disabled
                               <threshold> = 0..9.9E+9
```

The corresponding query indicates if the test is enabled and the current value of the threshold, as described above:-

```
"ATH?"
```

Returns :-

```
<enable>,<threshold>
```

3.13.9 Unavailability Threshold Command (ATI)

Selects the threshold for the Percentage Unavailability test.

```
"ATI <enable>,<threshold>"  <enable>    = 0 OFF : Test enabled
                               1 ON   : Test disabled
                               <threshold> = 0.00..100.00
```

The corresponding query indicates if the test is enabled and the current value of the threshold, as described above:-

"ATI?"

Returns :-

<enable>,<threshold>

3.13.10 Analysis Long Term Mean Error Ratio Threshold (ATJ)

Selects the threshold for the LTMER test.

```
"ATJ <enable>,<threshold>"  <enable> = 0 OFF : Test enabled
                               1 ON  : Test disabled
                               <threshold> = 1.0E-19..1.0E-01
```

The corresponding query indicates if the test is enabled and the current value of the threshold, as described above:-

"ATJ?"

Returns:-

<enable>,<threshold>

3.14 Logging Commands

This section contains all the commands relevant to setting up the data logging. Logging requests are restricted in BER only instruments and appropriate error messages are generated.

Where "MEAS2" is referred to, this is either the code error measurement or the frequency offset measurement, as currently selected on the results page (of using the "MEA" command).

3.14.1 Logging Mode (LOG)

Selects the logging to be disabled or to log in text or graphics mode.

```
"LOG <n>"      <n> = 0 NONE      : Disable logging
                  1 TEXT       : Textual logging
                  2 GRAPHIC    : Graphical logging
```

The corresponding query returns the logging status, in integer form as described above:-

```
"LOG?"
```

Returns :-

```
<n>              <n> = 0 .. 2
```

3.14.2 Real Time Logging During Gating Type of Result (LDT)

Selects the type of real time logging result. (This is also known as log during gating). This corresponds to the "Log" field of the "REAL TIME" set up of the "Data Log" page. Note that "ALARMS" are always logged when textual logging is enabled, regardless of the settings of this field.

NOTE: "LDT 1" is not available during repeating gating periods.

```
"LDT <n>"      <n> = 0 NONE      : No result or interval count
                  1 RESULT    : "Page-4 Result" as in LDR command
                  2 COUNT     : Errors/sec as in LDC command
```

The corresponding query returns the real time logging during gating type, in integer form as described above:-

```
"LDT?"
```

Returns :-

```
<n>              <n> = 0 .. 2
```

3.14.3 Real Time Page-4 Results (Logging During Gating) (LDR)

Selects which real time page-4 results are logged, and under what conditions, when result logging is selected. Alarm changes are always logged during gating regardless of the settings of this command.

NOTE: The following restrictions apply:

Instrument Configuration	Not Allowed
BER + Jitter BER only	'LDR NONE, NONE, <trig>' <jitter> = 1.4 or <trig> = 4.5

"LDR <error>,<jitter>,<trig>"

```

<error>      =  1  BIT      : Bit errors
               2  MEAS2    : Code or Freq
               3  BOTH     : Bit & Meas2
               4  NONE     : Alarms only

<jitter>     =  0  NONE     : Disabled
               1  PEAKPEAK : Peak-Peak Result
               2  HIT      : Hit Results
               3  BOTH     : Peak-Peak & Hits
               4  TXFREQ   : Tx Jitter Frequency

<trig>      =  1  BIT      : Bit Error Secs
               2  CODE     : Code Error Secs
               3  DEMAND   : On Demand Only
               4  HIT      : Hit Seconds
               5  PEAK     : Jitter Amplitude
    
```

The corresponding query returns the page-4 results set up, in integer form as described above:-

"LDR?"

Returns :-

"<error>,<jitter>,<trig>"

3.14.4 Real Time Logging During Gating Counts/Second (LDC)

Selects which error counts per second are logged, when this logging is selected via the "LDT" command.

```

"LDC <int>"          <int> =  1  BIT : Bit errors/second count
                       2  CODE : Code errors/second count
                       3  HIT  : Hit counts/second
    
```

The corresponding query returns the real time logging errors/second selection, in integer form as described above:-

"LDC?"

Returns :-

1..3

3.14.5 Logging at End of Gating Summary (LEG)

Selects what is to be logged in summary at end of gating and under what conditions. This corresponds to the "SUMMARY" set up on the "Data Log" page.

NOTE: The following restrictions apply:

Instrument Configuration	Not Allowed
BER only	'LEG <ber>,<jitter>,<alarms>,HITCOUNT'
BER only	'LEG <ber>,ON,<alarms>,<trig>'

"LEG <ber>,<jitter>,<alarms>,<trig>"

- <ber> = 0 NONE : No results
- 1 BIT : Bit errors
- 2 MEAS2 : Code or Freq
- 3 ANALYSIS : Analysis
- 4 ALL : All results

- <jitter> = 0 OFF : No analysis
- 1 ON : Print jitter analysis

- <alarms> = 0 OFF : No alarms
- 1 ON : Print alarms

- <trig> = 1 ALWAYS : Always print
- 2 BITRATIO : BER>Thres
- 3 BITCOUNT : Bit Count>0
- 4 MEAS2RATIO: CER>Thres OR Offset>Thres
- 5 CODECOUNT : Code Count>0
- 6 HITCOUNT : Hit Count>0

The corresponding query returns the "SUMMARY" set up at end of gating, in integer form as described above:

```
"LEG?"
```

Returns :-

```
"<ber>,<jitter>,<alarms>,<trig>"
```

3.14.6 Logging Error Thresholds Summary Trigger (LET)

Selects the end of gating summary trigger threshold for bit and code error ratio triggers. The appropriate trigger conditions as set by "LEG" will ensure correct operation.

```
"LET <bit-thres>,<code-thres>"  
  
      <bit-thres>,  
      <code-thres> = 3 .. 9 : BER Threshold
```

The corresponding query returns the thresholds, in integer form as described above:-

```
"LET?"
```

Returns :-

```
"<bit-thres>,<code-thres>"
```

3.14.7 Logging Freq Offset Threshold Summary Trigger (LOT)

Selects end of gating summary freq offset trigger threshold. For this to operate correctly, freq offset measurements should be selected. If the threshold is set to <off-thres> then logging will occur when freq offset is greater than +n or less than -n.

```
"LOT <off-thres>"      <off-thres> = 1 .. 999 : freq offset magnitude
```

The corresponding query returns the threshold, in integer form as described above:-

```
"LOT?"
```

Returns :-

```
"<off-thres>"
```

3.14.8 Real Time Logging Peak Jitter Amplitude Threshold Trigger (LPT)

Selects the positive and negative peak jitter amplitude threshold trigger for real time logging. The appropriate "REAL TIME" logging trigger should be selected for correct operation and will trigger during gating if the measured positive or negative peak jitter amplitude is greater than the trigger threshold:-

```
"LPT <thres>"  <thres> = 0.050 .. 0.500 : Range 1UI
                  00.50 .. 5.00 : Range 10UI
```

The corresponding query returns the peak threshold, in real form as described above:-

```
"LPT?"
```

Returns :-

```
"<thres>"
```

3.14.9 Logging Graphics (LGF)

Selects what is to be logged as graphs. This mode is only available with repeating gating periods.

NOTES:

1. Jitter can only be plotted on jitter instruments.
2. <plot2> choice of CODE or OFFSET depends on which second measurement is currently selected (MEA). In non-jitter instruments with receiver binary interface selected, <plot2> must be a null plot. This is not permitted as a normal selection.

```
"LGF <plot1>,<plot2>
```

```

    <plot1>      =  1  BIT           : Bit Error Ratio
                  2  RXJIT          : Rx Jitter Pk-Pk UI
                  3  TXJIT          : Tx Jitter Pk-Pk UI
                  4  POSPEAK        : Positive Peak UI
                  5  NEGPEAK        : Negative Peak UI

    <plot2>      =  1  CODE           : Code Ratio
                  2  RXJIT          : Rx Jitter Pk-Pk UI
                  3  TXJIT          : Tx Jitter Pk-Pk UI
                  4  POSPEAK        : Positive Peak UI
                  5  NEGPEAK        : Negative Peak UI
                  6  OFFSET          : Rx freq offset
                  7  NULL           : No plotting
```

The corresponding query returns the logging graphics status, in integer form as described above:-

"LGF?"

Returns :-

"<plot1>,<plot2>"

3.14.10 Logging Squelch (LSQ)

Selects logging squelch for real time during gating text logging. The squelch occurs on the occurrence of logging triggers for ten consecutive seconds. Unsquelching occurs on the occurrence of the first trigger free second.

"LSQ <sque>"	<sque> =	0	OFF	:	Don't squelch
		1	ON	:	Squelch

The corresponding query returns the logging squelch status, in integer form as described above:-

"LSQ?"

Returns :-

"<sque>"

3.15 Miscellaneous Commands

This section contains all action commands not covered in the preceding sections.

3.15.1 Gating Type Command (GTY)

This command sets the gating mode of the instrument. Gating is actually started by using the STR command and stopped using the STP command, whatever the gating type. In the single and repeat modes, the instrument is gating continuously, but the results are only updated at the end of a gating period whereas in manual mode, the results are updated every 100 milliseconds.

```
"GTY <n>"      <n> =  1 MANUAL      : Manual
                  2 SINGLE      : Single interval
                  3 REPEAT      : Repeat interval
```

The complementary command returns the current gating type in integer form as described above:-

```
"GTY?"
```

Returns :-

```
<n>              <n> =  1 .. 3
```

3.15.2 Interval Command (INT)

This command sets the interval type to be used by the error seconds or deciseconds measurements.

```
"INT<n>"      <n> =  1 SECONDS      : Seconds
                  2 DECISECONDS: DeciSeconds
```

The complementary command returns the current gating type in integer form as described above:-

```
"INT?"
```

Returns :-

```
<n>              <n> =  1 .. 2
```

3.15.3 Gating Period Comand (GPR)

This command sets the gating period (also referred to as the gating interval). The default interval is 1 second.

```
"GPR <days>,<hours>,<minutes>,<seconds>"
```

```
<days>      = 0 .. 99
<hours>      = 0 .. 23
<minutes>    = 0 .. 59
<seconds>    = 0 .. 59
```

The complementary command returns the current gating period in the same form as shown above. Each returned field is two characters wide.

"GPR?"

Returns :-

<days>,<hours>,<minutes>,<seconds>

3.15.4 Audio Command (AUD)

This command selects if errors will cause the instrument to beep when it detects errors.

"AUD <n>" <n> = 0 OFF : Off
 1 ON : On

The complementary command returns whether the beeper is enabled to sound on errors in integer form as described above.

"AUD?"

Returns :-

<n> <n> = 0 .. 1

3.15.5 Audio Source Command (AUS)

This command selects the error source for the audio output.

"AUS <n>" <n> = 1 BIT : Bit Errors
 2 CODE : Code Errors
 3 HIT : Jitter Hits

The complementary command returns the error source for the audio output, in integer form as described above.

"AUS?"

Returns :-

<n> <n> = 1..3

3.15.6 Beep Command (BEEP)

This command causes an audio "beep" to be made by the instrument. It has no local equivalent operation and is as follows:-

"BEEP"

3.15.7 Save Panel Command (SAV)

This command instructs the instrument to save its current configuration in one of the non-volatile memory locations. They are numbered 1 thru 5.

```
"SAV <n>"      <n> = 1 .. 5
```

3.15.8 Recall Panel Command (RCL)

This command instructs the instrument to configure itself as defined in one of the non-volatile memory locations, dependent upon the associated parameter. Recalling panel 0 will reset the instrument to its default settings (similar to "RST" command).

```
"RCL <n>"      <n> = 0 .. 5
```

3.15.9 Date Set-Up Command (DAT)

This command selects the date of the instrument, in terms of the year, month and day. If a non-existent date is passed (31st November), then an error (-212) is generated. This command is equivalent to setting the "Date" field on page 6, and is as follows :-

```
"DAT <years>,<months>,<days>"  <years> = 1960 .. 2059
                                <months> = 1 .. 12
                                <days>  = 1 .. 31
```

The complementary command returns the date in string form as shown above.

```
"DAT?"
```

Returns :-

```
<years>,<months>,<days>
```

3.15.10 Time Set-Up Command (TIM)

This command selects the time for the instrument in terms of hours, minutes and seconds. This command is equivalent to setting the "Time" field on page 6, and is as follows :-

```
"TIM <hours>,<mins>,<secs>"  <hours> = 0 .. 23
                                <mins>  = 0 .. 59
                                <secs>  = 0 .. 59
```

The complementary command returns the time in string form as shown above.

```
"TIM?"
```

Returns :-

```
<hours>,<mins>,<secs>
```

3.15.11 Start Gating Command (STR)

This command causes the instrument to start gating, the type of gating being defined by the "GTY" command. This command is always valid, and clears all error counters before commencing. This command is equivalent to pressing the Start/Stop button on the front panel when not gating, and is as follows:-

"STR"

NOTES:

1. There will be a delay of up to 400mS between the execution of this command and the actual start of gating. This is because the start of gating must be synchronised to the instruments internal 100mS clock.
2. If this command is sent during gating an error (-250) is generated. If it is not a manual gating period and the gating period is set to zero then error (-252) is generated.

3.15.12 Stop Gating Command (STP)

This command causes the instrument to stop gating, irrespective of the type of gating it is performing. The results are now left unchanged and can be inspected at leisure. This command is equivalent to pressing the Start/Stop button on the front panel during gating, and is as follows:-

"STP"

NOTES:

1. There will be a delay of up to 200mS between the execution of this command and the actual end of gating. This is because the end of gating must be synchronised to the instruments internal 100mS clock.
2. If this command is sent while the instrument has stopped, an error (-251) is generated.

3.15.13 Plot Jitter Tolerance Graph (PJT)

This command starts the plotting of jitter tolerance graph on the external graphics printer (auto-plot). This command is only valid on HP 3784A OPT-002. Auto-mask sweep is terminated by this command.

"PJT"

3.15.14 Plot Jitter Transfer Function Graph (PJX)

This command either calibrates the jitter transfer function or starts the plotting of jitter transfer function (jitter gain) on the external graphics printer (auto-plot), selection is by parameter. This command is only valid on jitter boxes. Auto-mask sweep is terminated by this command.

NOTE: Filter HP 2/LP is selected above HP 2 corner freq.

Following a change of Rx clock rate the calibration table is cleared and recalibration is required. If calibration is not performed, a back to back gain of unity is assumed.

"PJX <mode>" <mode> = 0 CAL : Calibrate
 1 P1 : Plot 1dB scale
 2 P10 : Plot 10dB scale

3.15.15 Plot Stop (PSP)

This command stops the plotting or calibration sweep started by "PJT" or "PJX <mode>" commands. This command is only valid on option 002 instruments.

```
"PSP"
```

3.15.16 Logging Port Configuration Command (LDV)

This command selects between RS232 and HP-IB talk only as the data logging port. This command is not allowed if the remote control port is HP-IB as this constrains the logging port to RS232.

```
"LDV <port>"  <port> = 1 HP-IB  : Port to HP-IB talk only
                  2 RS232  : Port to RS232
```

The corresponding query returns the status of the port in integer form as described above

```
"LDV?"
```

Returns :-

```
<n>          <n> = 0 .. 1
```

3.15.17 External RS-232 Printer Command (PTR)

This command configures the RS-232 printer port.

```
"PTR <baud_rate>,<parity>,<stop_bits>,<ENQ/ACK>,<Xon/Xoff>"
```

```
<baud_rate> = 110
              150
              300
              600
              1200
              2400
              4800
              9600
```

```
<parity> = 1 ODD    : odd
           2 EVEN   : even
           3 ZEROS  : zeros
           4 ONES   : ones
           5 NONE   : none
```

```
<stop_bits> = 1      : 1 Stop Bit
              2      : 2 Stop Bits
```

```
<ENQ/ACK> = 0 OFF : Off
              1 ON  : On

<Xon/Xoff> = 0 OFF : Off
              1 ON  : On
```

The complementary command returns the printer setup status as a sequence of integers.

```
"PTR?"
```

Returns :-

```
"<baud_rate>, <parity>, <stop_bits>, <ENQ/ACK>, <Xon/Xoff>"
```

3.15.18 RS-232 Set-Up Command (MDM)

This command configures the RS-232 control port to the desired setup.

NOTE: XON/XOFF is not in context when half duplex is selected, although it can be selected at any time.

```
"MDM <connection>, <baud_rate>, <ci_low>, <ci_high>,
  <parity>, <stop_bits>, <dtr>, <duplex>, <ENQ/ACK>, <Xon/Xoff>"
```

```
<connection> = 1 : HARDWIRED : Hardwired
                2 : MODEM : Modem
```

```
<baud_rate> = 300
               600
               1200
               1800
               2400
               4800
               9600
               0 (selectable by CI)
```

```
<ci_low> = 300
            600
            1200
            1800
            2400
            4800
            9600
```

```
<ci_high> = 300
             600
             1200
             1800
             2400
             4800
             9600
```

```

<parity> = 1 : Odd
           2 : Even
           3 : Zeros
           4 : Ones

<stop_bits> = 1 : 1 Stop Bit
              2 : 2 Stop Bits

<dtr> = 0 : OFF : Off
        1 : ON  : On

<duplex> = 1 : HALF : Half
           2 : FULL : Full

<ENQ/ACK> = 0 OFF : Off
            1 ON  : On

<Xon/Xoff> = 0 OFF      : None
              1 RXONLY : Rx only
              2 TXONLY : Tx only
              3 RXTX   : Rx and Tx

```

The complementary command returns the modem setup status as a sequence of integers.

```
"MDM?"
```

Returns :-

```
"<connection>, <baud_rate>, <ci_low>, <ci_high>,
<parity>, <stop_bits>, <dtr>, <duplex>, <ENQ/ACK>, <Xon/Xoff>"
```

3.15.19 Keyboard Lock Command (KLK)

This command selects or deselects the keyboard lock. When locked all keys except [POWER] become inactive.

```
"KLK <n>"      <n> = 0 OFF : Keyboard lock disable
                  1 ON  : Keyboard lock enable
```

The complementary command returns the status of keyboard lock in integer form as described above.

```
"KLK?"
```

Returns :-

```
<n> = 0..1
```

3.15.20 Firmware Revision Number (FRN?)

This command is an enquiry as to the revision number of the firmware installed in the instrument. The revision date is returned in standard Hewlett-Packard date format i.e. the first two weeks indicate the year since 1960 and the second two indicate the week number.

"FRN?"

Returns :-

"<yyww>" <yyww> = 2301 .. 9952

3.15.21 HP-IB Address Command (ADR)

This command selects the HP-IB address for the instrument and is only executable in RS-232 mode:-

"ADR <n>" <n> = 0 .. 30

The complementary command returns the HP-IB address, in integer form as shown above.

"ADR?"

Returns :-

"<n>" <n> = 0 .. 30

3.15.22 Jitter Sub-Test Command (JST)

This command runs the jitter sub-tests as selected. See the cabling table in the specifications for the correct cabling arrangement for these tests. See also the "TST" command.

"JST <n>" <n> = 0 ALL : Run tests 1..4 (Same as "TST JITTER")
 1 CLOCK : Run jitter clock tests
 2 DATA : Run jitter data tests
 3 FREQ : Run jitter frequency tests
 4 FILTER : Run jitter filter tests

Introduction

Within this appendix are listed all the error codes for the instruments. They are separated into common capability and instrument dependent, and are accessed by the ERR? command.

Common Capability Errors

The error codes that appear under this section are the recommended error numbers as defined in the document "Reserved HP-IB commands, recommended practice for common capabilities". They are divided into three sections, although there may be a few instrument dependent error codes appearing under these sections also. These will be indicated appropriately.

Parse Time Errors

The errors listed here occur during the parsing of HP-IB commands. Error codes -100 to -199:-

- 100 Command error (Unknown command)
- 101 Invalid character received
- 110 Command header error
- 111 Header delimiter error
- 120 Numeric argument error
- 121 Wrong data type (Numeric expected)
- 122 Precision error; rounding occurred
- 123 Numeric overflow
- 129 Missing numeric argument
- 130 Non numeric argument error
- 131 Wrong data type (char expected)
- 132 Wrong data type (string expected)
- 133 Wrong data type (block type #A required)
- 134 Data overflow : string or block too long
- 135 Error in #H block
- 139 Missing non numeric argument
- 141 Command buffer overflow
- 142 Comma is not a legal command separator
- 143 Argument delimiter error
- 144 Comma is not a legal command separator
- 150* Invalid message unit delimiter
- 151* CR found without following LF

- 160* RS232 Parity Error
- 161* RS232 Framing Error

Error Codes

- 162* RS232 UART Overrun Error
- 163* RS232 Internal Input Buffer Overrun Error

* Instrument dependent error code.

Execution Time Errors

These errors are caused at execution time of HP-IB commands. Error codes -200 to -299 :-

- 200 No can do (generic execute error)
- 201 Not executable in local mode
- 202 Settings lost due to RTL or PON
- 203 Trigger ignored
- 211 Legal command, but settings conflict
- 212 Argument out of range
- 221 Busy doing something else
- 222 Insufficient capability or configuration
- 231 Input buffer full or overflow
- 232 Output buffer full or overflow
- 240* Command provided thru meta-message only
- 241* Command not implemented
- 250* Command illegal during gating
- 251* Command illegal when not gating
- 252* Cannot start with gating period of zero
- 253* Cannot start during selftest or autoseup or plotting
- 260* Jitter command ignored - jitter generator out of range

* Instrument dependent error code.

Internal Errors

The instrument has detected a hardware problem that prevents operation, causing these errors. Error codes -300 to -399:-

- 300 Device failure (generic "hard" error)
- 301 Interrupt fault
- 302 System error
- 303 Time out
- 310 RAM error
- 311 RAM failure (hard error)
- 312 RAM data loss (soft error)
- 320 ROM error
- 321 ROM checksum
- 322 Hardware and Firmware incompatible
- 330 Power on test failed
- 340 Self test failed

Self-test Errors

There is only one self-test error, which indicates that the instrument has failed one of the tests specified in the TST command. No errors are reported by the power-on tests. Full error lists are given in the HP 3784A Service Manual. Error codes 1 to 599 :-

- 1..99 Synthesizer Test Errors
- 100..299 Jitter Tx and Rx Test Errors
- 300..399 BER Tx and Rx Test Errors
- 400..499 CPU Self-Test Errors
- 500..509 RS232 Port Loopback Test Errors
- 510..519 RS232 Port Loopback Test Errors

Option or Capability Errors

The error codes in this section are issued if a legal command is received, but it cannot be executed due to insufficient capability or unsuitable option configuration. They are all diagnosed by the remote control parser or executor. Error codes 600 to 699 :-

- 600 Instrument has no jitter measurement capability
- 601 Instrument has no BER measurement capability
- 602 Instrument does not have N.American interface levels
- 603 Instrument does not have European interface levels
- 604 Frequency option not available
- 605 Instrument does not have jitter & BER capability
- 606 Instrument does not have 64KBs interfaces
- 608 Command only permitted in RS-232 operation.
- 609 Command only permitted in HP-IB operation

- 620 This parameter of "FL" command is unimplemented
- 621 HP 3785 command unavailable in new implementation



-



-



Programming the Status Registers

B

Introduction

The HP 3784A Status Registers are a powerful aid for anyone controlling the HP 3784A remotely. The purpose of this section is to illustrate the advantage of using the Status Registers in Remote Control Operation. Using the Status Registers in your programs should allow for more efficient programs which run faster.

The Status Registers have two functions:-

- 1) They enable you to determine the current state of the instrument by interrogating the register contents via the HP-IB/RS 232 C interfaces.
- 2) They flag certain conditions within the instrument as quickly as possible to an external controller.

This can be done two ways, by continually polling the appropriate register for change or by setting up the HP 3784A to generate a Service Request (SRQ) The SRQ is available only when using the HP-IB interface and is fully explained in the 'Programming a Service Request' Section in paragraph B.1.3.2.

NOTE

Rapid polling of the status registers can lead to certain low priority instrument functions to run slower. These include the display and data logging and auto-plotting (OPT-002). It is left to the user's discretion as to whether any delays between successive polls be included in program writing.

HP 3784A Status Registers

The HP 3784A has four Status Registers which are as follows:-

- Status Register A
- Status Register B
- Alarm Register
- Ready Register

Status Register B

This is a 8-bit register which contains basic information about the state of the instrument.

The contents of Status Register B (also called the Status Byte) are as follows:-

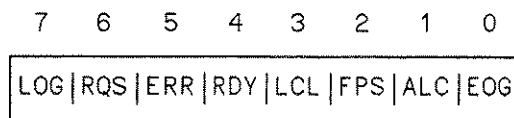

Figure B-1 Status Register B

Table B-1. Status Register B

Bit	Decimal Value	Description
0	1	EOG: End of Gating. This bit is set when the instrument reaches the end of its gating period, whether it is manual (START/STOP key), single or repetitive (set at the end of each repetitive period). There may be a delay of up to 200ms between the actual end of gating and this flag being set. Cleared by the STR, CLR or RST command, Device Clear, Selective Device Clear or any command that causes measurement results to be output.
1	2	ALC: Alarm Change. This bit is set when any of the alarms in the alarm status register change and their corresponding mask in the alarm mask register is enabled. Cleared by the ALM?, CLR or RST command, Device Clear or Selective Device Clear command.
2	4	FPS: Front Panel Service Request. This is set when a front panel key has been pressed. Cleared by the KEY?, CLR or RST command, Device Clear or Selective Device Clear command.
3	8	LCL: Local Operation. This is set when the HP3784A has just powered up. Cleared by the STA?, STB?, CLR or RST command, Device Clear or Selective Device Clear command.
4	16	RDY: Ready. A direct reflection of the DRO bit (bit 3) of the Ready Register.
5	32	ERR: Error. An error of some description has occurred (see ERR? command and the list of Error Codes for further information). Cleared by the CLR or RST command, Device Clear or Selective Device Clear command. Some errors such as ROM Checksum will not be cleared until the ROM is changed.
6	64	RQS: Service Requested. This bit is set if an SRQ is generated for any reason. Cleared by a serial poll, or the STB?, CLR or RST command, Device Clear or Selective Device Clear command.
7	128	SET: A remote SET FREQUENCY(jitter or ALWORD), SET AMPLITUDE or SPOT MASK command has been fully executed in instruments with jitter capability and another similar command can now be sent. Cleared up to 400 ms after the start of another 'SET' command, Device Clear (DCL) or Selective Device Clear (SDC).

Remote Operation

Interrogating Status Register B

Depending on whether you are controlling the HP 3784A via the RS-232-C or HP-IB interface, you have either one or two ways of interrogating Status Register B.

The simplest method is to use the STB? command. This command can be used for both HP-IB and RS-232-C operation. This command returns a decimal value which is equal to the contents of Status Register B (i.e. Status Byte).

```
OUTPUT 705;"STB?"  
ENTER 705;Value  
PRINT Value
```

This will display the Status Byte. However more often it is necessary to test if a particular bit has been set. In this case an additional command is required. For example should you wish to test if the HP 3784A has reached the End of the Gating Period, which means interrogating Bit 0 of the Register.

```
IF BIT(Value,0) THEN PRINT "EOG Bit set"
```

If Bit 0 is set then the message will be printed.

The alternative way to read the Status Byte (HP-IB operation only) is using the Serial Poll (SPOLL) instruction. The SPOLL command is one of the HP-IB universal commands which apply to any instrument controlled over HP-IB. The format of the command is as follows.

```
Value=SPOLL(705)
```

This would return contents of Register B and assign it to the variable " Value"

Note: The SPOLL instruction does not send the instrument into "Remote" mode.

Status Register B - Example Program

The following program illustrates how the two methods of interrogating Status Register B would typically be used.

```

10  ! Program to demonstrate different methods of detecting end of gating
20  ! by using SPOLL or by polling Status Register B
30  !
40  Hp3784=705           ! Assign address to variable Hp3784
50  CLEAR 7             ! Clear interface 7
60  REMOTE Hp3784       ! Send 3784A into remote mode
70  OUTPUT Hp3784;"RCL0" ! Set the 384 to the default settings
80  WAIT 1              ! Allow time for default settings to settle
90  OUTPUT Hp3784;"GTY2;GPR 00,00,00,10" ! Set gating type and period
100 OUTPUT Hp3784;"STR" ! Start the gating period
110 CALL Stb_3784(Hp3784) ! Call the STB routine
120 OUTPUT Hp3784;"STR" ! Start the gating period
130 WAIT 1              ! Allow time for EOG bit to clear
140 CALL Spoll_3784(Hp3784) ! Call the SPOLL routine
150 END                 ! End of the program
160 SUB Stb_3784(Hp3784) ! Routine using STB? command
170 Loop1:              !
180   OUTPUT Hp3784;"STB?" ! Read the value of STATUS B
190   WAIT .1
200   ENTER Hp3784;Value   ! Enter it into variable Value
210   IF BIT(Value,0) THEN ! Test if the EOG bit is set
220     PRINT "GATING COMPLETE"
230     SUBEXIT            ! If EOG bit set then exit routine
240   END IF
250   GOTO Loop1          ! If EOG bit not set, go back and re-read
260 SUBEND
270 SUB Spoll_3784(Hp3784) ! Routine using SPOLL command
280 Loop2:              !
290   Value=SPOLL(Hp3784) ! Read the value of STATUS B
300   IF BIT(Value,0) THEN ! Test the EOG bit
310     PRINT "GATING COMPLETE"
320     SUBEXIT            ! Exit from subroutine
330   END IF
340   GOTO Loop2          ! If EOG BIT not set, go back and re-read
350 SUBEND

```

Status Register A

This is a 16-bit register which conveys information about the state of the HP 3784A Measurement Hardware. It is as shown in Figure B-2

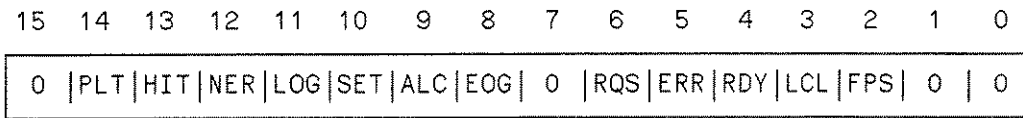

Figure B-2 Status Register A

Table B-2. Status Register A

Bit	Decimal Value	Description
0	1	Not used in this instrument.
1	2	Not used in this instrument.
2	4	FPS: Front Panel Service Request. A front panel key has been pressed. Cleared by the KEY?, CLR, or RST command, Device Clear or Selective Device Clear command.
3	8	LCL: Local Operation. Set when the HP 3784A has just powered up. Cleared by the STA?, STB?, CLR or RST command, Device Clear or Selective Device Clear command.
4	16	RDY: Ready. A direct reflection of the DRO bit (bit 3) of the Ready Register.
5	32	ERR: Error. An error of some description has occurred (see ERR? command and the list of error codes for further information). Cleared by the CLR or RST command, Device Clear or Selective Device Clear command. Some errors such as ROM checksum will not be cleared until the ROM is changed. This bit is set at default.
6	64	RQS: Service Requested. This bit is set if an SRQ is generated for any reason. Cleared by a serial poll, STB?, CLR or RST command, Device Clear or Selective Device Clear command.
7	128	Not used in this instrument.
8	256	EOG: End of Gating. This bit is set when the instrument reaches the end of its gating period, whether it is manual (START/STOP key), single or repetitive (set at the end of each repetitive period). There may be a delay of up to 200ms between the actual end of gating and this flag being set. Cleared by the STR, CLR or RST command, Device Clear, Selective Device Clear or any command that causes measurement results to be output.

Table B-2. Status Register A (continued)

Bit	Decimal Value	Description
9	512	ALC: Alarm Change. This is set when any of the alarms in the alarm status register change and the corresponding mask in the alarm mask register is enabled. Cleared by the ALM?, CLR or RST command, Device Clear or Selective Device Clear command.
10	1024	SET: A remote SET FREQUENCY (Jitter or Altword), SET AMPLITUDE or SPOT MASK command as been fully executed in instruments with jitter capability the start of another 'SET' command, Device Clear (DCL) or Selective Device Clear (SDC).
11	2048	LOG: Logging occurred. This bit is set when the data logging has been triggered either during or at the end of the gating period. Cleared by the CLR or RST command, Device Clear, Selective Device Clear or any command that causes measurement results to be output.
12	4096	NER: No Error. The syntax of the last command line was OK. This bit is cleared following command syntax checks and set after successful command execution. Note: Due to the effect of the STA? command this bit will always appear to be cleared, however its usage is anticipated in respect of SRQ generation. This is included for compatibility with the HP3785A/B.
13	8192	HIT: Jitter Hit. This bit indicates a hit interval was detected and is similar to the JHT bit in the Alarm Register, note however in this case it will only SRQ on the start of hits. The flag is reset following the end of the hit interval. This bit is only updated during gating. This is included for compatibility with the HP3785A/B.
14	16384	PLT: Plot complete. This is set at the end of a Jitter Auto or CAL Plot. It indicates that the plot is finished and further operations can be performed. It is reset when the Plot starts.
15	32768	ZERO: This is included to ensure a positive number number is returned for the STA? response in 16 bit computers.

Status Register A is an expanded version of Status Register B. It contains all the information of Status Register B but also includes information which is required to adhere to the HP Common Capabilities for HP-IB Operation. The main application of Status Register A is the ability to generate Service Requests when any one of its bits are set.

Interrogating Status Register A

There is only one method of interrogating Status Register A. This is using the STA? command which returns the contents of the register. The command format is the same as shown previously in Example B.1.

Programming a Service Request

When controlling over HP-IB operation, the HP 3784A has the ability to interrupt a Controller when any bit or combination of bits is set in Status Register A. This interrupt is called a Service Request (SRQ).

The advantage of using a Service Request (SRQ) is that a Controller can continue with other tasks while the HP 3784A completes its current task. When the HP 3784A completes its task it generates a SRQ. This suspends the printing of results by the Controller, which reads the HP 3784A result, then continues with the printing.

The condition(s) for generating an SRQ is dependent on the Service Request Mask setting. The Service Request Mask is a direct reflection of Status Register A and masks out all sixteen bits of Status Register A, preventing any SRQ being generated. If any bit of the Service Request Mask is set, the corresponding bit in Status Register A will generate an SRQ when it becomes set. The command for programming the Service Request Mask is the "RQS" command.

This is best explained by the following example which will generate an SRQ on the HP 3784A reaching the end of the gating period.

The sequence of events are as shown in the following diagram:-

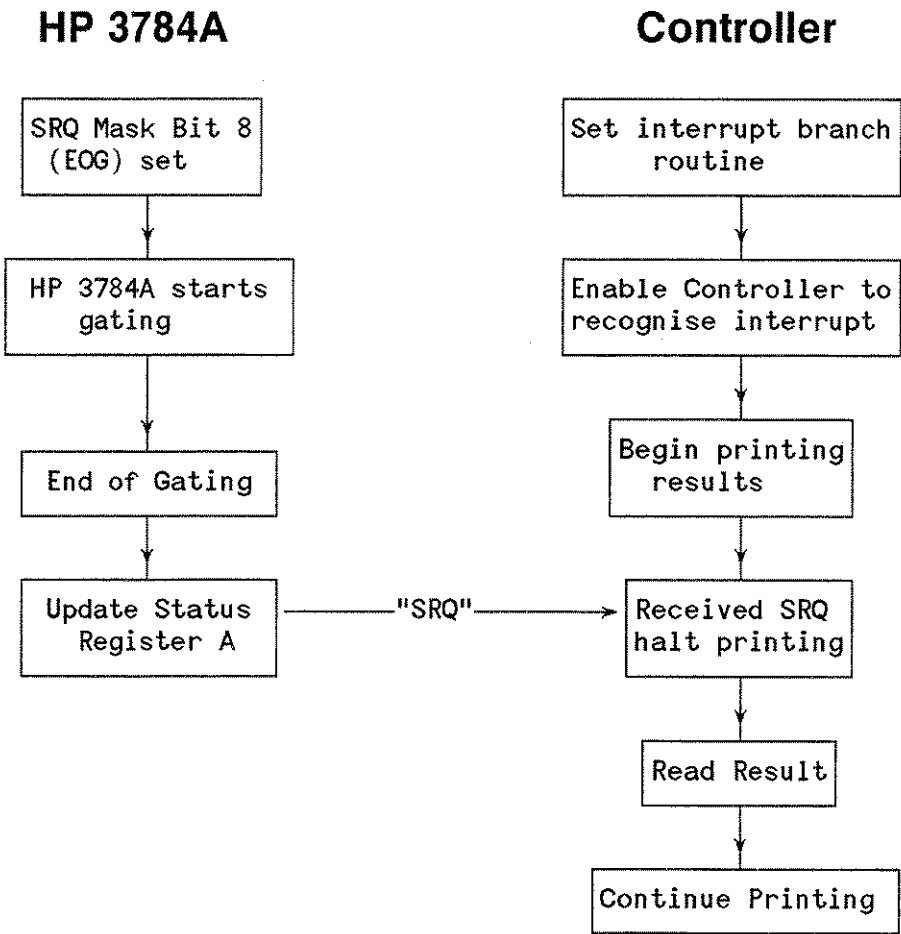

The command for setting the Service Request Mask is "RQS". The command can specify the value that the Mask requires to be set at or it can use the mnemonic of the register bit. For example to set the Service Request Mask to generate an SRQ on the ERR bit becoming set in Status Register A, the command is "RQS 32" or "RQS ERR".

To enable all bits of the Service Request Mask use the command "RQS ON". To clear the Service Request Mask use the command "RQS OFF".

Service Request Example Program

The following program illustrates the use of the Service Request Mask in conjunction with Status Register A. It generates an SRQ on the HP 3784A reaching the end of its gating period.

```

10  ! Program to demonstrate detecting end of gating using the Service Request
20  !
30  Hp3784=705          ! Assign address to variable Hp3784
40  CLEAR 7             ! Clear interface 7
50  REMOTE Hp3784       ! Send the 3784 into Remote mode
60  OUTPUT Hp3784;"RQS 256" ! Set the 3784 to generate a Service Request
70                          ! at the end of the gating period
80  ON INTR 7 GOTO Service ! Set the Computer to jump to routine
90                          ! "Service" on receipt of a Service Request
100 ENABLE INTR 7;2      ! Enable the computer to recognise a Service
110                          ! Request
120 OUTPUT Hp3784;"RCL0" ! Set the 3784 to the default settings
130 OUTPUT Hp3784;"GT2;GPR 00,00,00,05" ! Set the gating period to 5 secs
140 OUTPUT Hp3784;"STR"  ! Start the gating period
150 Task:                ! Meanwhile do another task
160     DISP "Waiting for Service Request"
170     GOTO Task
180 Service: !
190     DISP "Service Request received - end of gating" ! Display message
200     A=SPOLL(Hp3784) ! Clear the Service Request
210     OUTPUT Hp3784;"RQS OFF" ! Disable all reasons for a
220                          ! Service Request
230     GOTO Task ! Return to printing
240 END

```

Alarm Register

The Alarm Register is a direct reflection of the current state of the front panel ALARM leds. It is as shown in Figure B-3

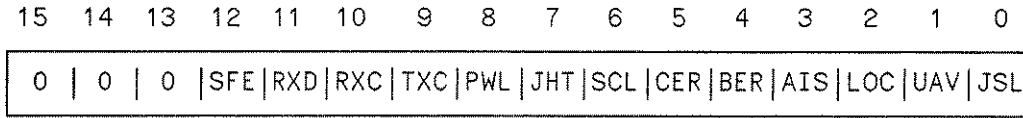

Figure B-3 Alarm Register

Table B-3. Alarm Status Register

Bit	Decimal Value	Description
0	1	JSL: Jitter sync loss. This bit indicates the status of jitter sync. It is set when jitter loss exists.
1	2	UAV: Unavailability. This bit is set during gating only, when the system under test is deemed unavailable. The system under test is deemed available at the start of gating and the flag remains as history at the end of gating.
2	4	LOC: (Synth Lock) This bit is set when the Synthesizer is in a state of unlock.
3	8	AIS: Alarm Indication Signal. This bit is set when an Alarm Indication Signal is detected in the received data stream. The AIS is defined as per specifications.
4	16	BER: Bit Errors. This bit is set when the receiver detects bit errors and cleared when no bit errors are present.
5	32	CER: Code Errors. This bit is set when the receiver detects code errors and cleared when no code errors are present.
6	64	SCL: Sync Loss. Pattern Sync loss is an error ratio approximation on the information bits. Refer to HP 3784A specifications.
7	128	JHT: Jitter Hits. This bit is set on detection of any Jitter Hits.

Table B-3. Alarm Status Register (continued)

Bit	Decimal Value	Description
8	256	PWL: Power Loss. This is not an instantaneous reading unlike the rest but is an indication of power loss history in the present gating period. It is set if power loss has occurred during gating and cleared at the start of the next gating period.
9	512	TXC: Transmitter Clock Loss. This bit is set when no clock can be detected at the Tx Clock Input.
10	1024	RXC: Receiver Clock Loss. This is set when no transitions can be detected at the front panel RX Clock In port.
11	2048	RXD: Receiver Ternary Data Loss. This bit is set when there are no transitions on the selected Ternary Data In port.
12	4096	SFE: Auto Scan at Frequency Extremity. This bit is set when Autoscan has reached maximum allowable frequency and is cleared when Autoscan has reached minimum allowable frequency.
13	8192	This bit is not used.
14	16384	This bit is not used.
15	32768	This bit is not used.

Interrogating the Alarm Status Register

The Alarm register is interrogated simply by using the Alarm Status Query command ALM?. This returns the decimal value which is equal to the contents of the Alarm Register, however the Alarm Register has an additional feature. Like Status Register A the Alarm Register has the ability to generate Service Requests. The conditions for generating the Service Request are controlled by the Alarm Mask Register.

This is best explained as follows:-

The Alarm Change Bit ALC in the Status Registers A and B can monitor the state of any bit in the Alarm Register through the Alarm Mask Register. Depending on which bits of the Alarm Mask Register are enabled the corresponding bit in the Alarm Register is monitored.

To generate a Service Request requires careful setting of both the Service Request Mask and the Alarm Mask Register.

Generating an SRQ from an Alarm Condition

This is explained in the following example which generates a Service Request on the HP 3784A detecting a Sync Loss condition.

The sequence of events are as shown in the following diagram:-

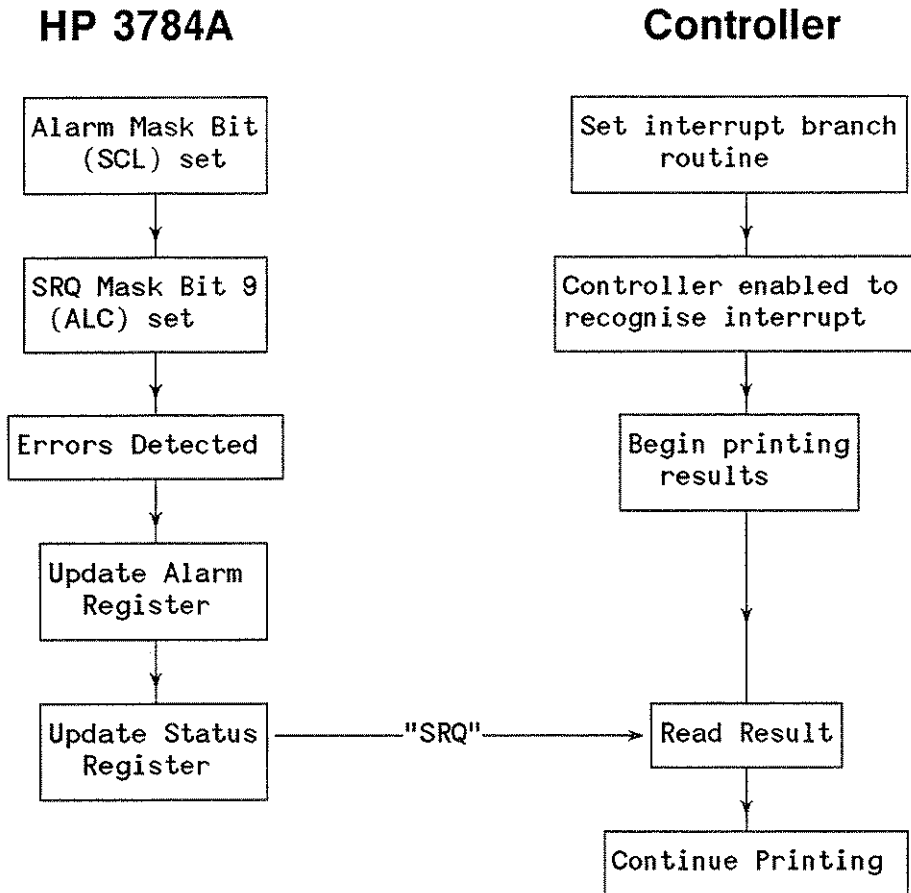

When the Sync Loss condition occurs within the HP 3784A, bit 6 of the Alarm Register is set. As the corresponding bit is set in the Alarm Mask Register this will cause the Alarm Change Bit (ALC), Bit 9, in Status Register A to be set. With the corresponding bit in the Service Request Mask set, this causes an SRQ to be generated.

The command for setting the Alarm Mask is "AMR". The command can specify the value that the Mask requires to be set at or it can use the mnemonic of the register bit. For example to set the Alarm Mask for the Bit Errors (BER) condition to set the ALC bit in Status Register A, use the command "AMR 4" or "AMR BER".

Alarm Register - Example Program

```

10      ! This program generates a Service Request on a Sync Loss ALARM.
20      ! Before running the program connect the HP 3784A TX DATA OUT port
30      ! to the RX TERNARY DATA IN port.
40      ! When the program is running, disconnect the cable from the RX
50      ! TERNARY DATA IN port to create a Sync Loss condition.
60      !
70      Hp3784=705           ! Assign 705 to variable Hp3784
80      OUTPUT Hp3784;"RCL0" ! Recall the HP 3784 default settings
90      WAIT 2              ! Allow HP 3784 time to settle
100     A=SPOLL(Hp3784)     ! Clear any previous Service Request
110     OUTPUT Hp3784;"AMR 64" ! Enable bit 6 (SCL) on the Alarm Mask Register
120     OUTPUT Hp3784;"RQS 512" ! Enable bit 9 (ALC) on the Service request Mask
130     ON INTR 7 GOTO Alarm ! Set the Computer to jump to routine Service on
140     !                   receipt of a Service request
150     ENABLE INTR 7;2     ! Enable the Computer to recognize a Service
160     !                   Request on interface 7
170 Task: !
180     PRINT "Waiting"    ! Routine to demonstrate the Computer can perform
190     GOTO Wait_loop     ! another task
200 Alarm: !
210     DISP "Sync Loss"  ! Indicate the Service Request has been received
220     A=SPOLL(Hp3784)   ! Clear the Service Request from the HP 3784A
230     OUTPUT Hp3784;"RQS OFF" ! Disable HP 3784 Service Request generation
240     GOTO Task         ! Return to printing
250     END

```

Ready Register

The Ready Register as the name implies indicates the "readiness" of the instrument to proceed with the next operation. It is shown in Figure B-4.

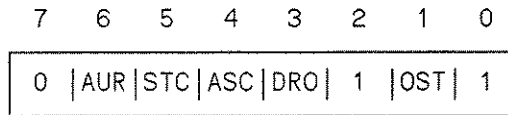

Figure B-4 Ready Register

Detailed Description of Ready Register

Table B-4. Ready Register

Bit	Decimal Value	Description
0	1	Not used in HP 3784A.
1	2	OST: Operation Started. This bit is used to indicate whether the instrument is gating or not. Set by the STR command and cleared by the STP command.
2	4	Not used in HP 3784A.
3	8	DRO: Data Ready for Output. This bit is set whenever the HP 3784A is replying to a result query command. Although this bit always appears set, its usage is anticipated in respect of SRQ generation.
4	16	ASC: Auto Setup Complete. This bit is set when the auto setup is complete, and cleared when it is started.
5	32	STC: Self Test Complete. This bit is cleared following a request for Self Test and set on completion of testing.
6	32	AUR: Autorange complete. This bit is set when in transmitter 'EXT' clock the Tx Jitter Modulator autorange function has just completed. It occurs every 3 secs while in this mode. The bit is cleared by the RDY? command.
7	64	Not used in this instrument.

Interrogating the Ready Register

The Ready Register can only be interrogated by one method, that is using the RDY? command. This returns the value of the Ready Register.

Bits 0, 2 and 3 are reserved for HP-IB common capability and are not intended for general programming use.

Ready Register - Example Program

The following program gives a typical example of how the READY Register could be used.

```
10      ! Program to detect Auto Setup complete and then start measurement
20      !
30      Hp3784=705                ! Assign 705 to variable Hp3784
40      CLEAR 7                  ! Clear the HP 3784
50      OUTPUT Hp3784;"RCF2"     ! Set the HP 3784 to autoconfigure itself
60      Loop1: !
70      OUTPUT Hp3784;"RDY?"     ! Continually poll the READY Register
80      WAIT .1                  ! Delay to allow Register update
90      ENTER Hp3784;Value
100     IF BIT(Value,4) THEN Proceed ! Check for ASC bit set
110     GOTO Loop1               ! Continue polling
120     Proceed: !
130     DISP "Autoconfigure complete" ! Indicate that the bit is set
140     OUTPUT Hp3784;"STR"      ! Start the measurement gating
150     END
```



DEFAULT SETTINGS

C

The following settings are used for the instrument following backup RAM failure. The 'RST' command and 'RCL O' command reset the instrument to these conditions (except remote control defaults).

Table C-1. Default Settings

Parameter	Setting
System:	
SRQ Mask Register	ERR (32)
Status Register A (STA)	LCL, RDY, SET, NER, PLT (21528)
Alarm Register	Depends on external conditions
Alarm Mask Register	0
Ready Register	DRO, ASC, STC (57)
Error Register	0
Key Register	0
Transmitter Clock	
Transmitter Clock Source	Internal
Transmitter Clock Rate	34MHz
Transmitter Clock Phase	Normal
Transmitter Frequency Offset	+Oppm
Transmitter Clock Frequency	2048.0kHz **
	* This default only when [VAR] source selected following reset.
Receiver Clock:	
Receiver Clock Rate	34MHz**
Receiver Clock Phase	Normal**
Configuration	
Transmitter Interface Format	75ohm Term
Receiver Configuration Format	As Tx
Receiver Interface Format	75ohm Term**
Data Input Format	Mon
Transmitter Ternary Interface Code	HDB3
Receiver Ternary Interface Code	HDB3**
Binary Interface Level	TTL
Transmitter Pattern	PRBS
Receiver Pattern	As Tx**
	** These defaults only when [MAN] Rx configuration selected following reset.

Table C-1. Default Settings (continued)

Parameter	Setting
Data Patterns:	
Transmitter Word Length	4
Transmitter Word Pattern	"1000"
Receiver Word Length	4
Receiver Word Pattern	"1000"
Alternate Word "A"	"10001000"
Alternate Word "B"	"11111111"
Alternate Switched	External
Alternate Word Frequency	10.0Hz
Transmitter PRBS Pattern	PRBS-23
Receiver PRBS Pattern	PRBS-23
Transmitter PRBS Zero Sub	000
Receiver PRBS Zero Sub	000
Error Add:	
Error Add	Off
Error Add Type	Bit
Error Add Ratio	10E-3
Jitter Generator:	
Jitter Option Select	On (SEE NOTE 1)
Jitter Modulation Source	Internal
Jitter Modulation Frequency	1.00kHz
Jitter Modulation Amplitude	0.05UI p-p
Jitter Mask Type	Standard
Jitter Programmable Masks	(See Table C-2)
Jitter Q Factor	Low-Q
Jitter Receiver:	
Jitter Filters	None
Jitter Measurement Input	Disabled
Jitter RX Ref Clock	Internal
Jitter Display Rate	Fast
Jitter Receiver Range	Range 10
Jitter Receiver Peak Threshold	5.00UI
Measurements:	
Display (DI Setting)	1
Peak Select (PS Setting)	1

Table C-1. Default Settings (continued)

Parameter	Setting
Analysis Thresholds:	
Enable Flags	OFF
ATA, Availability Threshold	100%
ATB, ES Threshold	0%
ATC, Severely Errored Secs	0%
ATD, Degraded Mins	0%
ATE, 1 err/interval	0
ATF, 2-10 err/interval	0
ATG, >10 err/interval	0
ATH, Error Bursts	0%
ATI, Unavailability	0%
ATJ, Long Term Mean Error Ratio	1.0E-10
Logging	
Logging Mode	None
Log During Gating - Error	Bit
Log During Gating - Jitter	Peak-Peak
Log During Gating - Trigger	Only on Demand
Log During Gating - Interval	Bit Error Interval
Log End of Gating - What	None
Log End of Gating - Analysis	Off
Log end of Gating - Alarm	Off
Log end of Gating - Trigger	Always
Log Error Threshold - Bit	10E-3
Log Error Threshold - Code	10E-3
Log Peak Threshold	2.50UI
Logging Graphics - Plot 1	Bit
Logging Graphics - Plot 2	Code
Logging Squelch	Off
Miscellaneous:	
Gating Type	Manual
Interval Type	Seconds
Gating Period	Od Oh Im Os
Audio	Off
Audio Source	Bit Errors
Date (SEE NOTE 2)	1st Jan. 1984
Time (SEE NOTE 2)	00:00:00
Keyboard Lock	Off

Table C-1. Default Settings (continued)

Parameter	Setting
Printer:	
Baud Rate	9600
Parity	None
Stop Bits	1
ENQ/ACK	OFF
XON/XOFF	OFF
HP-IB Remote Control: (SEE NOTE 2)	
Address	5
Source of remote control	HP-IB
RS232 Remote Control: (SEE NOTE 2)	
Connection	Modem
Baud Rate	1200
Ci Low	300
Ci High	1200
Parity	Ones
Stop Bits	1
DTR	Off
Duplex	Full
ENQ/ACK	Off
XON/XOFF	Rx and Tx

NOTES

(1) Default only if jitter option fitted.

(2) These settings unaffected by "RST" or "RCL 0" but are set to these values following non-volatile memory failure.

Table C-2. Default Programmable Jitter Tolerance Mask Values.

Euro Rate	Number of Points	Frequency
2MHz	2	10.0Hz 50.0kHz
8MHz	2	10.0Hz 100kHz
34MHz	2	10.0Hz 400kHz

Table C2 gives the default values for programmable jitter tolerance masks.



RS-232-C Interchange Circuits (DTE)

D

Table D-1. RS-232-C Interchange Circuits (DTE)

Pin	Circuit	Circuit Name	Comments	V.24
GROUND				
1	AA	Protective Ground		101
7	AB	Signal Ground	This is the common return for all signals. On some modems this line is strapped to pin 1.	102
DATA				
2	BA	Transmitted Data (Tx)	This line carries the transmit data from the DTE. (The DTE cannot transmit data unless Request To Send (RTS), Clear To Send (CTS), Data Set Ready (DSR) and Data Terminal Ready (DTR) are ON).	103
3	BB	Received Data (Rx)	This is the received data line at the DTE.	104
CONTROL				
4	CA	Request To Send (RTS)	The DTE sets this line ON when it wishes to transmit. Data transmission cannot however take place until the DCE completes the handshake by setting Clear to Send (CTS) ON.	105
5	CB	Clear To Send (CTS)	This is issued in response to Request To Send (RTS). When this line is OFF no transmission can take place.	106
6	CC	Data Set Ready (DSR)	This line is set to ON as soon as the call is established. This is the way the DCE (usually a modem) tells the DTE "your through and I'm ready to receive the next instruction" (usually by the RTS/CTS handshake).	107
8	CF	Received Line Signal Detector - sometimes called Data Carrier Detect (DCD)*	An ON state indicates to the DTE the received signal was within the correct limits.	109
20	CD	Data Terminal Ready (DTR)	An ON condition indicates the DTE is ready to transmit or receive data.	108.2

Table D-1. RS-232-C Interchange Circuits (DTE) (continued)

Pin	Circuit	Circuit Name	Comments	V.24
22	CE	Ring Indicator	An ON condition on this circuit alerts the terminal to an incoming call.	125
23	CH/CI	Data Signal Rate Selector (DTE/DCE)	An ON condition on circuit CH, from the DTE, selects the higher rate, or range of rates and an OFF signal selects the lower. Circuit CI works from the modem to the terminal.	111/ 112

Important RS-232-C Information

E

Important points to note for RS-232-C operation.

- The HP 3784A rear panel "RS232 MODEM" port is used for both MODEM and HARDWIRE operation.
- When operating via the RS-232-C interface with the instrument configured for HARDWIRE, the only way the instrument can be returned to the local mode is by means of the "LCL" command. The LOCAL key is inoperative when the instrument is being controlled via the RS-232-C Interface.
- If the instrument is configured for MODEM operation, the HP 3784A automatically returns to the LOCAL mode when the modem disconnects from the telephone line (and DTR goes false). This means the instrument requires a "RMT" command to reconfigure each time the data link is (re) established.
- Incorrect cabling or faulty cables/connectors is the most common reason for failure to establish communication over the RS-232-C Interface for the first time.
- It is important to remember, when using the HP200/300 series computers, pressing the RESET key (to reset the BASIC operating system) automatically resets the HP98628A Datacomms card. This means that you are unable to perform immediate EXECUTE instructions, over the RS-232-C to the instrument, unless you either re-run a program to reconfigure the HP98628A card or set the 3 dual-in-line switches on the HP98628A to the required configuration.
- If you write your own programs remember the first instruction over the RS-232-C Interface, once a data link is established, should be a "BREAK" signal. This performs the equivalent of an HP-IB Device Clear. A short wait, of approximately 2 seconds, should be included in the program to allow the instrument to settle after a "BREAK" signal. After this the next instruction should be the "RMT" instruction to the HP 3784A.



General RS-232-C Information

The Electronic Industries Association (EIA) standard RS-232-C defines "the interconnection of data terminal equipment (DTE) and data communication equipment (also known as data circuit terminating equipment) (DCE) employing serial binary data interchange". In short it defines how to connect anything to a modem.

Data Terminal Equipment is a generic term for anything you might connect to a modem, for example a terminal, computer or printer. Data Communication Equipment is the name used for a modem, which is often called a "data set" in the USA.

The interface is a wire from the terminal equipment (DTE) to the modem (DCE) carrying the data to be transmitted, a wire from the modem (DCE) to the terminal equipment (DTE) carrying the received data, and a common ground wire. The signals are called Transmitted Data, Received Data and Signal Ground.

The EIA gave these signals the mnemonics BA, BB and AB, which are often ignored in favour of the more meaningful mnemonics TXD, RXD and SGND.

The RS-232-C standard suggests that the interface could be implemented using a 25 pin D-type connector, on which Transmitted Data, Received Data and Signal Ground occupy pins 2, 3 and 7 respectively. The remaining 22 pins are used for an assortment of functions, the primary one being modem (DCE) control.

RS-232-C is also widely used outside its original scope for the local, or hardwired interconnection of two pieces of Data Terminal Equipment, most commonly the connection of a peripheral device to a computer.

The interface was not designed to be symmetrical, so the driver/receiver configurations of Data Terminal Equipment and Data Communications Equipment are different. This presents a problem when the RS-232-C interface is used for hardwired interconnections between two DTEs.

There is often confusion about which DTE should "play" DCE, and about what should be done with the various modem control lines. These are basically redundant in the hardwired situation, but often need to be held in the correct state for communication to proceed. Break-out boxes, reversing cables, null-modems and so on are used to solve these problems.

Controller manufacturers commonly configure their peripheral ports to "look like" Data Circuit Terminating Equipment so that peripheral devices (correctly configured as Data Terminal Equipment) can be plugged in easily.

When it is required to connect a controller to a modem then usually a more sophisticated datacomms interface card is required, or at least a special cable.

The Signals

Ground

Pin 1 is Protective Ground and should be connected to chassis. Pin 7 is Signal Ground and is the common reference for all signal lines.

Data

Pin 2 is Transmitted Data which passes from the DTE to the DCE, pin 3 is Received Data which passes from the DCE to the DTE.

Modem Control

Modems, especially when connected to the public switched telephone network (PSTN), are not always ready to transmit/receive data and therefore extra signals are required for modem control and handshaking to ensure data integrity. Pins 4, 5, 6, 8, 20, 22 and 23 are required for full modem control and these are described in the next section.

Synchronous Clocks

The RS-232-C interface can be used for either asynchronous or synchronous transmission; pins 15,17 and 24 are allocated to "clocks" for asynchronous transmission. For synchronous applications these pins can be ignored.

Secondary Channel

Pins 12, 13, 14, 16, and 19 are allocated to the control of a secondary or backward channel. Sometimes, a low bandwidth channel is squeezed into the telephone line bandwidth below the main channel for use in status signalling or other supervisory functions.

However, few modems support this facility and, perhaps as a consequence, these (otherwise unused) pins have been used by manufacturers for all sorts of purposes.

Other Signals

Pins 9 and 10 are "reserved for data set testing" typically they are used by the modem to provide high and low RS-232-C signal levels.

Pin 21 is the Signal Quality Detector, which indicates whether the received line signal is good or bad (rarely used).

Finally pins 11, 18 and 25 are unassigned, but see note below.

NOTE

For modems conforming to the CCITT standards V.21, V.23, V.26, V.26 bis, V.27, V.27 ter, and V.29, the second (1980) edition of ISO 2110 defines pin 18 as local analog loopback control, and re-defines pin 21 as remote loopback control (for point-to-point circuits only). RS-232-C has not been revised to follow ISO 2110-1980. Instead the EIA technical committees have produced IEB #14, "Application notes on Loop Test Interface circuits using RS-232-C," as a guide to the joint use of RS-232-C and the test circuits defined in ISO 2110-1980.

RS-232-C Pin Assignment

The pin assignment of RS-232-C is given below, an asterisk marks those implemented by the HP 3784A. All signal names in RS-232-C standard are as viewed from the DTE. The list of numbers in the column titled V.24 are the designations of the equivalent signals in the CCITT V.24 interface standard.

Pin	Circuit	Circuit Name	V.24
		GROUND	
1*	AA	Protective Ground	101
7*	AB	Signal Ground	102
		DATA	
2*	BA	Transmitted Data (TXD)	103
3*	BB	Received Data (RXD)	104
14	SBA	Secondary Transmitted Data	118
16	SBB	Secondary Received Data	119
		CONTROL	
4*	CA	Request To Send (RTS)	105
5*	CB	Clear To Send (CTS)	106
6*	CC	Data Set Ready (DSR)	107
8*	CF	Received Line Signal Detector - sometimes called Data Carrier Detect (DCD)	109
12	SCF	Secondary Received Line Signal Detector	122
13	SCB	Secondary Clear To Send	121
19	SCA	Secondary Request To Send	120
20*	CD	Data Terminal Ready (DTR)	108.2
21	CG	Signal Quality Detector	110
22*	CE	Ring Indicator	125
23*	CH/CI	Data Signal Rate Selector (DTE/DCE)	111/112
		TIMING	
15	DB	Transmit Signal Element Timing (DCE)	114
17	DD	Receive Signal Element Timing (DCE)	115
24	DA	Transmit Signal Element Timing (DTE)	113
9	-	Reserved for data set testing	-
10	-	Reserved for data set testing	-
11	-	unassigned	-
18	-	unassigned	-
25	-	unassigned	-

Redefinition of pins 18, 21 as per ISO 2110-1980

Pin	Cct	Description	V.24
18	-	Local Loopback	141
21	-	Remote Loopback (for point to point circuits only)	140

Standards

RS-232-C is an American interface standard which has become the de facto industry standard. The equivalent international standard is CCITT V.24/V.28 and they relate to each other as follows:

- RS-232-C The electrical, mechanical and functional definition of a serial interface between DTE and DCE.
- V.28 The electrical definition of a serial interface circuit. This is identical to the corresponding chapter in RS-232-C.
- V.24 The functional definition of signals between a DTE and DCE. This is a super-set of the signals defined in RS-232-C because it also includes the signals required to control an Automatic Calling Unit. Where a circuit is common to RS-232-C and V.24, its definition is the same in both standards.
- RS-366 The American standard for Automatic Calling Unit control.
- ISO 2110 V.24 does not assign pin numbers to the signals it defines, however ISO 2110-1980 fills the gap by assigning the sub-set of V.24 signals which are common with RS-232-C to have the same pin assignments as RS-232-C.
- EIA IEB#9 "Application Notes for EIA Standard RS-232-C" provides useful background information.

Signal Level

For all interchange signals, the function is ON when the voltage at the receiver is more positive than +3 volts with respect to signal ground, and OFF when the voltage at the receiver is more negative than -3 volts. The function is not defined in the transition region between +3 and -3 volts.

Notation	Interchange Negative	Voltage Positive
Binary State Signal Condition Function	1 Marking OFF	0 Spacing ON

A loaded circuit driver should produce a signal magnitude in the range 5V to 15V, to allow a 2V noise margin. The output voltage of an open-circuit driver should not exceed 25V. The HP 3784A transmits voltage levels of +/-12V.

Modem Control

The following descriptions are extremely brief and are only intended as an overview. The reader is referred to the RS-232-C standard for the full definition.

The modem control signals can be separated into two groups, those responsible for answering, holding and dropping the telephone line, and those responsible for controlling data flow once the line is established.

Group 1 - Line Control

Circuit CC - Data Set Ready (CCITT 107)

In the broadest sense Data Set Ready on tells the DTE "you're through". More specifically, it means that the modem is connected to the line, has completed any call establishment procedure and is NOT in a test, talk or dial mode.

Circuit CD - Data Terminal Ready (CCITT 108.2)

Data Terminal Ready indicates that the terminal equipment is ready to communicate.

This signal controls the switching of the modem to the communications channel in that Data Terminal Ready must be on before the modem can connect to the communications channel and must remain on to maintain the connection. If Data Terminal Ready is turned off then the modem will disconnect.

Circuit CE - Ring Indicator (CCITT 125)

The on condition indicates that the modem has detected a ringing signal on the line. The signal is on during "rings" and off between "rings". The signal is off at all other times. This signal can be monitored by the DTE and used to turn DTR (Data Terminal Ready) on, thus allowing an auto-answer modem to answer the incoming call.

Group 2 - Data Flow Control

Circuit CA - Request to Send (CCITT 105)

This circuit is used to ready the DCE for data transmission and, on a half duplex channel, to control the direction of data transmission of the local DCE.

Turning RTS (Request To Send) on instructs the DCE to enter the transmit mode. Once the DCE is ready to transmit, it indicates this by turning CTS (Clear To Send) on. Turning RTS off instructs the DCE to complete transmission of all data passed, and then assume a non-transmit (full duplex DCE) or receive (half duplex DCE) mode as appropriate. The DCE responds to this by turning Clear To Send off.

When RTS is turned off, it should not be turned on again until CTS has been turned off by the DCE.

Circuit CB - Clear to Send (CCITT 106)

CTS (Clear To Send) indicates whether or not the DCE is ready to transmit data.

CTS on, together with RTS (Request To Send), DSR (Data Set Ready) and DTR (Data Terminal Ready) all on, indicates to the DTE that data will be transmitted to the line, whilst CTS indicates to the DTE that it should not pass data on TXD (Transmitted Data).

The RTS/CTS handshake is primarily intended for use with DCEs that are not always capable of transmitting (half duplex or receive only modems).

Full duplex modems can (once the line is established) always transmit and therefore often do not implement the RTS/CTS handshake; instead they ignore RTS and simply turn CTS permanently on.

Half duplex modems cannot by their nature always transmit and therefore the RTS/CTS handshake must be implemented fully. A DTE must not turn RTS on if CTS is already on.

Although both modes of operation are acceptable within the framework of the RS-232-C standard, they are incompatible and it is for this reason that the HP 3784A provides the half/full duplex selection.

Circuit CF - Data Carrier Detect (CCITT 109)

DCD (Data Carrier Detect) indicates whether or not the DCE is receiving a line signal which is suitable for demodulation. If the line signal is lost, DCD will turn off after an appropriate guard delay.

On half duplex channels DCD is held off whenever RTS is on and for a brief interval after RTS turns off. For this reason, if no other, RTS must be monitored by a half duplex modem.

DCD on is used to qualify the reception of data from the DCE; in fact the DCE clamps RXD (Received Data) to the marking state when DCD is off.

Circuit CH/CI - Data Rate Select (CCITT 111/112)

Some modems can operate at two data rates. Normal operation is at the higher rate, say 1200bps, but if the circuit quality is poor and causing errors then the modem can be switched to a "fallback" rate, say 300bps, which, whilst slower, is less error sensitive.

RS-232-C defines two circuits, CH and CI, as data rate selectors. The circuit definitions are identical except that CH is sourced by the DTE, whilst CI is sourced by the DCE. CH is used where the DTE is controlling the transmission speed, for example at the "originate" end of a dial up line. CI is used where the modem is indicating received transmission speed so that the DTE can adapt to it - for example at the "answer" end of a dialup line. The two circuits are functionally mutually exclusive and, probably as a consequence, have both been assigned to pin 23. The decision as to which circuit to implement, i.e. whether the DTE or the DCE is to source the signal, is left to "the supplier". This is a very unsatisfactory arrangement because a dual-speed modem that can be used to originate or answer a data transmission ideally needs both circuit CH and circuit CI. The widely adopted solution is to use the normal pin, 23, for circuit CH and to re-define pin 12 (normally Sec Rec's Line signal Detect) as circuit CI. The HP 3784A has internal test links on the A26 Assembly to accommodate this.

Setting Up Your Datacomms Hardware

G

Setting Up Your Datacomms Hardware"

Figure G-1 shows a typical configuration for long distance communication between an HP 200/300 Series computer and the HP 3784A. The system uses HP 37212A modems in the datacomms link.

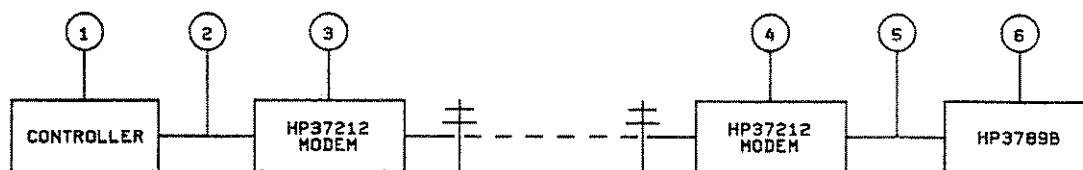

Figure G-1 System Configuration

Configuring the System

Although many of the points listed below are instrument specific, relating to the particular computer or modem, similar rules apply when alternative equipment is being used.

1. CONFIGURING THE COMPUTER. In this instance an HP 200/300 Series desktop computer is used. The computer also requires a HP98628A Datacomms Interface which must be set to match the modem and instrument operating criteria.

- The HP98628A Datacomms Interface can be set by means of 3 banks of dual-in-line switches; described in the HP98628A manual, or by software, see program example.
- The system requires a minimum of Basic 3.0 with binary files CS80, DCOMM, DISC, HPIB, CLOCK, ERR, IO, KBD, MS and IPEV. when booting-up. The binary files SERIAL, GRAPH and MAT are optional.
- The computer (and Datacomms interface) is configured as a DTE defaulting to:

Duplex	[FULL]
Enq/Ack	[OFF]
Xon/Xoff	[RX & TX]
Speed	[1200]
Parity	[1's]
Stop Bit	[1]

- The HP 200/300 Series computers built-in serial interface, labeled Datacom on some controllers and serial on others, is not used because the BASIC Workstation System Driver "SERIAL" does not support ENQ/ACK and DC1/DC3 handshakes.

2. CHECKING THE CABLE. The interconnecting cable between computer and modem should be wired as shown.

NOTE

Not all RS-232-C devices are wired the same. To ensure proper operation, you must know whether the peripheral device is wired as DTE or DCE. The interface cable option and associated adapter cable, if needed, must be configured to properly mate with the female DTE chassis connector.

The following diagram shows the input and output signals for the Datacomms Interface and how they are connected to the modem.

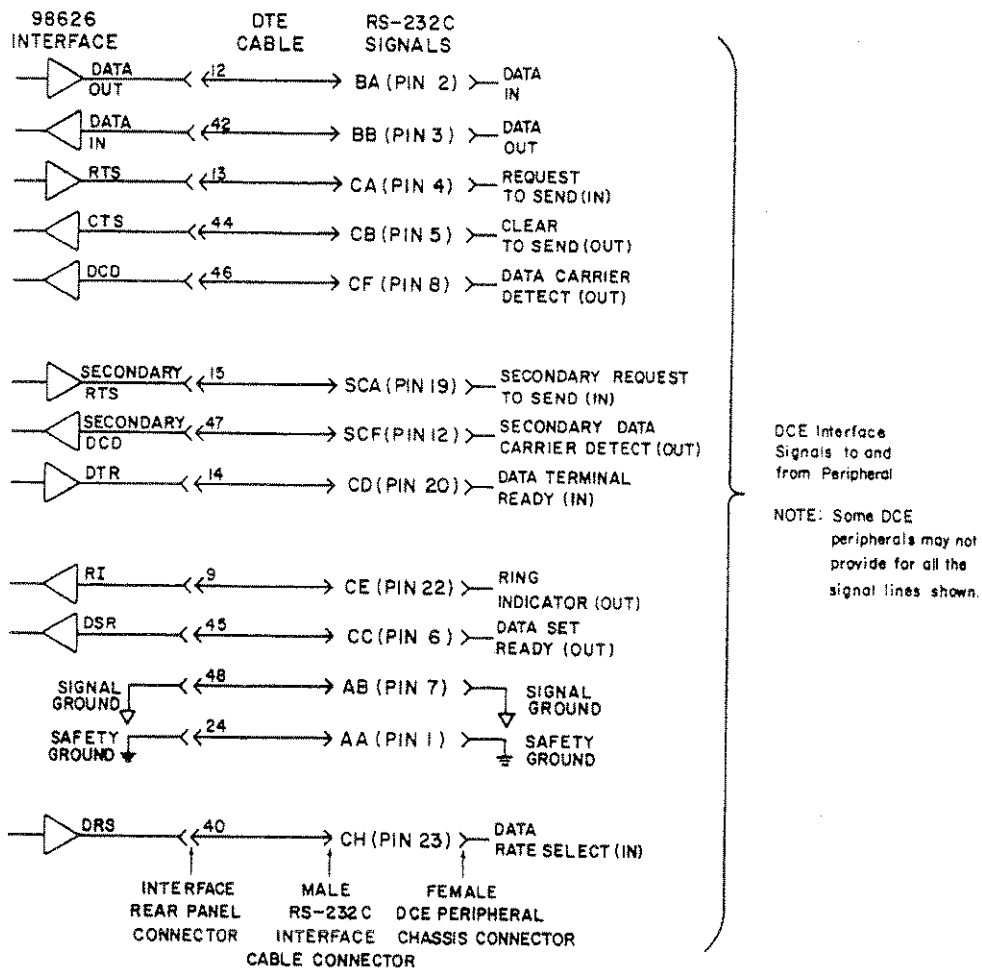

Figure G-2 DTE Cable Interconnection Diagram

3. CONFIGURING THE LOCAL MODEM

There is no substitute for reading the modem operating/user manual to become acquainted with all the idiosyncrasies of whatever modem you have chosen. The local HP37212A modem is set as follows.

Front Panel - All switches out

Internal Presets - Ensure the power cable is disconnected.

- (a) Remove the HP37212A front and rear plastic trims. The trims are released by pushing the "ear" flaps of the trim outwards and at the same time easing the trim from the modem. See HP37212A User Manual (37212-90001) page 2-5.
- (b) Set all the slide switches on the 8 position dual-in-line switch to the left, except for switch 11. The modem is now configured; in computer mode; in the Bell 212A mode; for Asynchronous data; for 10 Bit Data (1 start + 7 data + 1 parity + 1 stop); Auto Answer disabled; and with no modem lines (such as DSR/CTS/DCD or DTR) forced on. See Figure G-3.

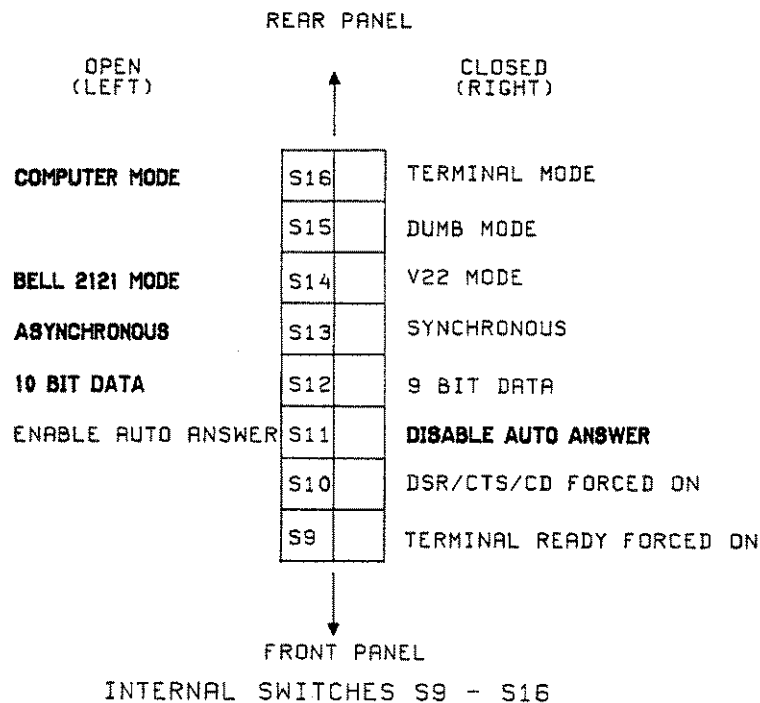

Figure G-3 Modem Switch Position

- (c) Connect a suitable telephone cable to the TELCO socket on the rear panel of the HP37212A. The modem is now connected to the telephone line. The telephone handset may be connected to the phone socket adjacent to the TELCO socket (on the rear panel). This connection is absolutely essential if manual dial-up is going to be used. In the case of auto dialling using a HP 200/300 Series computer, connecting the telephone handset is optional.
- (d) Move the telephone LINE SELECT link to the appropriate position for LEASED or DIAL UP lines. See HP37212A manual page G-3.

- (e) Remove the speed select links. See 37212A manual page A-9. The HP37212A modem should be set to automatically sense the speed of the data (see 37212A modem User's Manual, page 4-29) with the hardwired speed sensing capability disconnected. The reason for this is the datacomms interface configuration program resets the HP98628A interface at the beginning of each program cycle. This reset may cause the Data Rate Select line (DRS) on pin 23 to toggle which in turn may cause the modem to select a 300 baud rate. If this happens (and the controller is set to a 1200 baud rate) communication is lost. To overcome this problem remove the hardwire speed sensing CH/CI SELECT links (see Page A-9 in the 37212A Users Manual.) Alternatively, remove the connections at the RS-232-C connector pins 23 and 12.

The HP37212A is now ready for operation. The covers may now be replaced, and the power cable connected.

4. CONFIGURING THE REMOTE MODEM

- Front Panel** - All switches out
- Internal Presets** - Ensure the power cable is disconnected

- (a) Remove the HP37212A top cover using the procedure described as for the LOCAL MODEM.
- (b) Set all the slide switches on the 8 position dual-in-line switch to the left, except for switches 9 and 15. The HP37212A modem is now configured; in the computer mode; in the Dumb mode; in the Bell 212A mode; for Asynchronous data; for 10 bit data (1 start + 7 data + 1 parity + 1 stop); Auto Answer Enabled; and with DTR forced on. See Figure G-4.

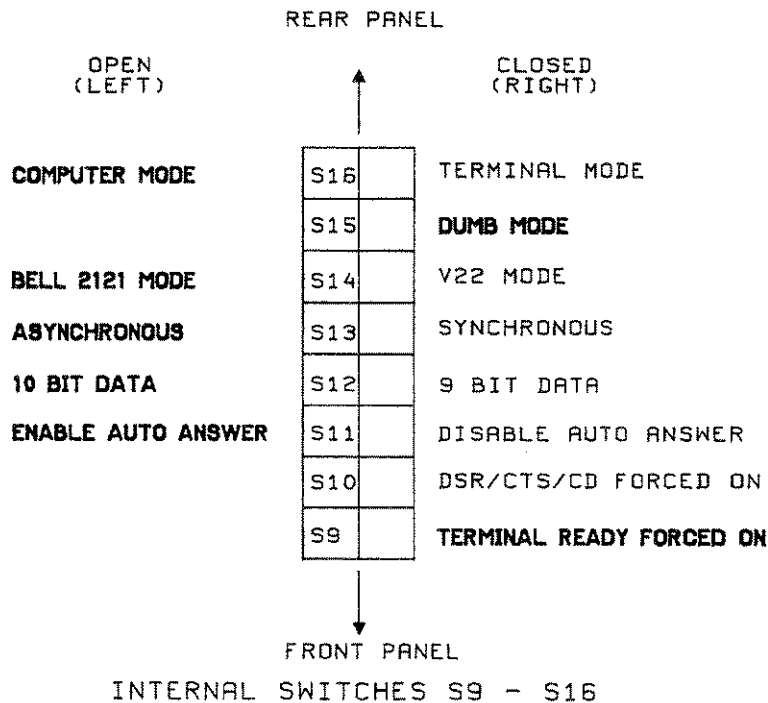

Figure G-4 Modem Switch Position

- (c) Connect a suitable telephone cable to the TELCO socket on the rear panel of the HP37212A. The modem is now connected to the telephone line.

5. The interconnecting cable between modem and HP 3784A is a direct pin for pin matching cable connection as shown below in Figure G-5.

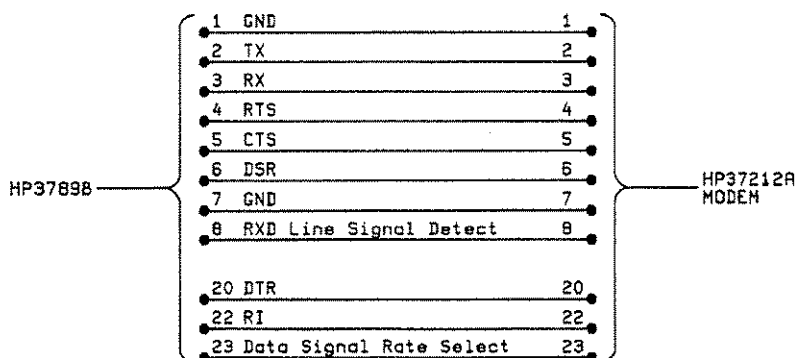

Figure G-5

6. THE HP 3784A SETTINGS.

You are now at the stage where the HP 3784A is ready to be configured for operation on the RS-232-C interface. The instrument configuration must match exactly the configuration set up at the computer. In this instance the HP 3784A should be set for:

```

9 Remote Port: [RS232] Subpage [Setup A]
Connection [ MODEM ] Duplex [FULL]
Enq/Ack [OFF] Xon/Xoff [RX & Tx]
DTR [ON]*
    
```

* This is not normally displayed, being factory preset to DTR ON, if however this field is present set DTR to ON.

```

9 Remote Port: [RS232] Subpage [SETUP B]
Speed [ 1200 ]

7 Bit Data Parity [1's] Stop Bits [1]
    
```

The system is now configured and ready to run. As is often the case in data communications the system sometimes fails to run correctly first time. Some points to help should you encounter difficulties are listed on the next page, however if the system fails to operate it may be useful to check the modem link without the computer. The integrity of the datacom link can be checked by forcing DTR on at the local modem, connecting a telephone handset to the modem, dialing the number and waiting to see if the carrier detect indicator (CD) on the local modem illuminates. To do this with our existing system the modem power cable should be temporarily disconnected prior to removing the modem top cover. Setting the dual-in-line slide switch 9 to the right hand-side forces DTR on. Reconnect the telephone cable and connect a telephone handset to the modem PHONE socket (on the rear panel). Re-connect the power cable. Firstly dial the number of the remote modem immediately followed by depressing the DATA button on the local modem. After a period between one and five minutes the CD LED on the local modem should illuminate, indicating successful modem link-up is established.



A

- Accessory Cable, 2-13
- Additional Information, 2-25
- ADDRESSABLE MODE/TALK ONLY MODE, 1-16
- Alarm Duration Query (ALD?), 3-42
- Alarm Mask Command (AMR), 3-37
- Alarm Register , B-10
- Alarm Status Query (ALM?), 3-42
- Alternate Switched Internal/External (ALS), 3-25
- Alternate Word Frequency (ALF), 3-25
- Alternate Word Pattern Command (ALW), 3-24
- Analysis Result Query Command (ANR?), 3-41
- ANALYSIS THRESHOLD COMMANDS, 3-45
- Analysis Threshold Result Query (ATR?), 3-42
- Audio Command (AUD), 3-56
- Audio Source Command (AUS), 3-56
- Availability Threshold Command (ATA), 3-45

B

- Beep Command (BEEP), 3-56
- Binary Interface Level (BIL), 3-22
- Bit Error Result Query (RSB?), 3-39

C

- Cabling For Computers Configured As DCE, 2-4
- Cabling For Computers Configured As DTE, 2-2
- Character Format, 2-23
- Choosing Between The HP-IB And RS-232-C Interface, 1-1
- Clear Command (CLR), 3-11
- Clear To Send, F-7
- Code Error Result Query (RSC?), 3-39
- Code or Offset Measurement Selection Command (MEA), 3-37
- Command Terminators, 1-4
- Common Capability Errors, A-1
- Communicating With The Controller, 1-3
- Configuration Command (CON), 3-12
- CONFIGURATION COMMANDS, 3-20
- Configure Computer RS-232-C Interface, 2-6
- Configure HP 3784A RS-232-C Modem Interface, 2-4
- Configure The HP 3784A RS-232-C Modem Interface, 2-16
- Configuring The Computer For Hardwire Operation, 2-6
- Configuring The System, G-1

Connecting The HP 3784A To The HP-IB, 1-3
Connecting The HP 3784A To The Modem, 2-13
Control Octet Timing (TOC), 3-23
Cumulative Slip Deciseconds Query (RSS?), 3-39
Current Answer Query (CA?), 3-43

D

Data Carrier Detect, F-8
DATA PATTERN COMMANDS, 3-24
Data Rate Select Strapping, 2-14
Data Rate Select, F-8
Data Set Ready, F-6
Data Terminal Ready, F-6
Date Set-up Command (DAT), 3-57
DCE, 2-2
Device clear, 1-11
Display Command (DI), 3-38
DTE, 2-2
DTR, 2-21

E

Elapsed Time Query Command (ELP?), 3-43
ENQ/ACK:XON/XOFF Handshakes, 2-26
Error Add Command (EAD), 3-28
ERROR ADD COMMANDS, 3-28
Error Add Ratio (EAR), 3-28
Error Add Type Command (EAT), 3-28
Error Burst Threshold Command (ATH), 3-47
Error Code Query (ERR?), 3-15
Error Seconds Threshold Command (ATB), 3-45
Error/Interval Threshold Command (ATE), 3-46
EXAMPLE PROGRAMS, 1-8
Execution Time Errors, A-2
External RS-232 Printer Command (PTR), 3-59

F

Firmware Revision Number (FRN?), 3-62
Frequency Measurement Result Query (RSF?), 3-41
Frequency Measurement, 1-9
Frequency Offset Result Query (RSO?), 3-41
Full Duplex Operation, 2-19

G

Gating Period Command (GPR), 3-55
Gating Type Command (GTY), 3-55
General RS-232-C Information, F-1

H

Half Duplex Operation, 2-19
 Handshake, 2-20
 Hardwire Operation, 2-2
 HP 3784A Command Set, 3-17
 HP 3784A Status Registers, B-1
 HP 3785A/B Compatible Commands, 3-6
 HP-IB Address Command (ADR), 3-62
 HP-IB ADDRESSES, 1-14
 HP-IB Capability, 1-15
 HP-IB Common Capability Messages, 3-10

I

Identification Query (ID?), 3-14
 Interface Clear, 1-11
 Internal Errors, A-2
 Interval Command (INT), 3-55
 Introduction, B-1
 Invalid Commands, 1-5

J

Jitter Display Rate (JDR), 3-35
 Jitter Filter (JFI), 3-34
 JITTER GENERATOR COMMANDS, 3-30
 Jitter Hits Result Query (RSJ?), 3-40
 Jitter Manual Sweep Mask Command (JMA), 3-32
 Jitter Mask Type (JMT), 3-33
 Jitter Maximum Amplitude Query (RSM?), 3-40
 Jitter Measurement Input (JMI), 3-34
 Jitter Modulation Amplitude Command (JAM), 3-31
 Jitter Modulation Frequency Command (JFR), 3-31
 Jitter Modulation Source Command (JMS), 3-30
 Jitter Option Select (JOS), 3-30
 Jitter Q Factor (JQF), 3-33
 Jitter Receiver Amplitude Query (RSR?), 3-40
 JITTER RECEIVER COMMANDS, 3-34
 Jitter Receiver Peak Threshold (JPT), 3-35
 Jitter Receiver Range (JRA), 3-35
 Jitter Receiver Reference Clock (JRC), 3-34
 Jitter Sub-test Command (JST), 3-62
 Jitter Tolerance Measurement, 1-10

K

Key Query (KEY?), 3-12
 Keyboard Lock Command (KLK), 3-61

L

LIST OF INSTRUMENT COMMANDS, 3-1
Local Command (LCL), 3-11
Local Lockout (LLO), 1-12
Local (LCL), 1-13
Logging At End Of Gating Summary (LEG), 3-51
LOGGING COMMANDS, 3-49
Logging Error Thresholds Summary Trigger (LET), 3-52
Logging Freq Offset Threshold Summary Trigger (LOT), 3-52
Logging Graphics (LGF), 3-53
Logging Mode (LOG), 3-49
Logging Port Configuration Command (LDV), 3-59
Logging Squelch (LSQ), 3-54

M

MEASUREMENT COMMANDS, 3-37
MESSAGE FORMAT, 1-6
MISCELLANEOUS COMMANDS, 3-55
Modem Control, F-2, F-6
Modem Operation, 2-13

N

Note On The Syntax Of Strings, 1-5

O

Operating Considerations, 2-2
Operating Distances RS-232-C, 2-2
Operating Distances, 1-3
Option or Capability Errors, A-3
Options Query (OPT?), 3-16

P

Parse Time Errors, A-1
Peak Select Command (PS), 3-38
Plot Jitter Tolerance Graph (PJT), 3-58
Plot Jitter Transfer Function Graph (PJX), 3-58
Plot Stop (PSP), 3-59
Preset Address, 1-3
Programmable Jitter Tolerance Masks (JMK), 3-32
Programming The HP 3784A, 1-4

Q

Query Annunciators (QA), 3-44

R

Reading Data From The HP 3784A, 1-5

Ready Code Query (RDY?), 3-15

Ready Register, B-14

Real Time Logging During Gating Counts/Second (LDC), 3-50

Real Time Logging During Gating Type Of Result (LDT), 3-49

Real Time Logging Peak Jitter Amplitude Threshold Trigger (LPT), 3-53

Real Time Page-4 Results (Logging During Gating) (LDR), 3-49

Recall Panel Command (RCL), 3-57

RECEIVER CLOCK COMMANDS, 3-19

Receiver Clock Phase (RCP), 3-19

Receiver Clock Rate Command (RCR), 3-19

Receiver Interface Format Command (RIF), 3-21

Receiver Pattern Command (RPT), 3-23

Receiver PRBS Pattern Selection (RPP), 3-26

Receiver Ternary Interface Code (RTI), 3-21

Receiver Word Pattern Command (RWD), 3-24

Remote Command, 3-11

Remote Enable, 1-12

Remote, Local And Local Lockout., 2-25

Request Service Mask Command (RQS), 3-13

Request To Send, F-7

Reset Command, 3-10

RESULT QUERY COMMANDS, 3-39

Revision Date Query (REV?), 3-14

Ring Indicator, F-7

RS-232-C Set-up Command (MDM), 3-60

RS-232-C Cables, 2-13

RS-232-C Default Settings, 2-24

RS-232-C Pin Assignment, F-4

RS-232-C Signal Level, F-5

RS-232-C, F-5

Programmable Jitter Tolerance Masks

S

Save Panel Command (SAV), 3-57

Secondary Channel, F-2

Selectable Port (SEL), 3-23

Selecting Addressable Mode, 1-16

Selecting Talk Only Mode, 1-16

Selective Device Clear, 1-11

Self-Test Command, 3-10

Self-Test Errors, A-3

Sending Data To The HP 3784A, 1-4

Serial Number (SER), 3-15

Serial Poll, 1-12
Service Requests/Status Reporting Over RS-232-C, 2-26
Setting Parity, 2-23
SETTING UP YOUR DATACOMMS HARDWARE, G-1
Single Error Add Command (SEA), 3-29
Speed, 2-22
Start Gating Command (STR), 3-58
Status Query (STB?), 3-16
Status Register A, B-6
Status Register B, B-2
Status/Events Query (STA?), 3-16
Stop Bits, 2-23
Stop Gating Command (STP), 3-58
Synchronous Clocks, F-2

T

Time Set-up Command (TIM), 3-57
Transmitter Clock Command (TCL), 3-17
TRANSMITTER CLOCK COMMANDS, 3-17
Transmitter Clock Frequency (TCF), 3-18
Transmitter Clock Offset (TCO), 3-18
Transmitter Clock Phase (TCP), 3-18
Transmitter Clock Rate Command (TCR), 3-17
Transmitter Interface Format Command (TIF), 3-20
Transmitter Pattern Command (TPT), 3-22
Transmitter PRBS Pattern Selection (TPP), 3-26
Transmitter Ternary Interface Code (TTI), 3-21
Transmitter Word Pattern Command (TWD), 3-24

U

Unavailability Threshold Command (ATI), 3-47
Universal Commands, 1-11
Using A Computer To Control The HP 3784A, 2-7
Using A Data Terminal To Control The HP 3874A, 2-10

V

V.24, F-5
V.28, F-5

W

What Is RS-232-C?, 2-1
WHAT IS THE HP-IB?, 1-2

Hewlett-Packard Sales and Service Offices

US FIELD OPERATIONS HEADQUARTERS

Hewlett-Packards Company
19320 Pruneridge Avenue
Cupertino, CA 95014, USA
(800) 752-0900

California

Hewlett-Packard Co.
1421 South Manhattan Ave.
Fullerton, CA 92631
(714) 999-6700

Hewlett-Packard Co.
301 E. Evelyn
Mountain View, CA 94041
(415) 694-2000

Colorado

Hewlett-Packard Co.
24 Inverness Place, East
Englewood, CO 80112
(303) 649-5000

Georgia

Hewlett-Packard Co.
2000 South Park Place
Atlanta, GA 30339
(404) 955-1500

Illinois

Hewlett-Packard Co.
5201 Tollveiw Drive
Rolling Meadows, IL 60008
(708) 255-9800

New Jersey

Hewlett-Packard Co.
120 W. Century Road
Paramus, NJ 07653
(201) 599-5000

Texas

Hewlett-Packard Co.
930 E. Campbell Rd.
Richardson, TX 75081
(214) 231-6101

EUROPEAN OPERATIONS HEADQUARTERS

Hewlett-Packards S.A.
150, Route du Nant-d'Avril
1217 Meyrin 2\Geneva
Switzerland
(41 22) 780.811

France

Hewlett-Packard France
1 Avenue Du Canada
Zone D'Activite De Courtaboeuf
F-91947 Les Ulis Cedex
France
(33 1) 69 82 60 60

Germany

Hewlett-Packard GmbH
Berner Strasse 117
60000 Frankfurt 56
West Germany
(49 69) 500006-0

Great Britain

Hewlett-Packard Ltd.
Eskdale Road,
Winnersh Triangle
Wokingham,
Berkshire RG11 5DZ
England
(44 734) 696622

INTERCON OPERATIONS HEADQUARTERS

Hewlett-Packard Company
3495 Deer Creek Rd.
Palo Alto, California 94304-1316
(415) 857-5027

Australia

Hewlett-Packard Australia Ltd.
31-41 Joseph Street
Blackburn, Victoria 3130
(61 3) 895-2895

Canada

Hewlett-Packard (Canada) Ltd.
17500 South Service Road
Trans-Canada Highway
Kirkland, Quebec H9J 2X8
Canada
(514) 697-4232

Japan

Yokogawa-Hewlett-Packard Ltd.
1-27-15 Yabe, Sagamihara
Kanagawa 229, Japan
(81 427) 59-1311

China

China Hewlett-Packard, Co.
38 Bei San Huan X1 Road
Shuang Yu Shu
Hai Dian District
Beijing, China
(86 1) 256-6888

Singapore

Hewlett-Packard Singapore
Pte. Ltd.
1150 Depot Road
Singapore 0410
(65) 273 7388

Taiwan

Hewlett-Packard Taiwan
8th Floor, H-P Building
337 Fu Hsing North Road
Taipie, Taiwan
(886 2) 712-0404

