

HP 3588A Operating Manual

This Operating Manual is a subset of the
the HP 3588A Operating Manual Set
(HP Part Number 03588-90000)



Printed in U.S.A.

Print Date: March 1990

©Hewlett-Packard Company, 1990. All rights reserved.
8600 Soper Hill Road Everett, Washington 98205-1298





SAFETY SUMMARY

The following general safety precautions must be observed during all phases of operation, service, and repair of this instrument. Failure to comply with these precautions or with specific warnings elsewhere in this manual violates safety standards of design, manufacture, and intended use of the instrument. Hewlett-Packard Company assumes no liability for the customer's failure to comply with these requirements. This is a Safety Class 1 instrument.

GROUND THE INSTRUMENT

To minimize shock hazard, the instrument chassis and cabinet must be connected to an electrical ground. The instrument is equipped with a three-conductor ac power cable. The power cable must either be plugged into an approved three-contact electrical outlet or used with a three-contact to two-contact adapter with the grounding wire (green) firmly connected to an electrical ground (safety ground) at the power outlet. The power jack and mating plug of the power cable meet International Electrotechnical Commission (IEC) safety standards.

DO NOT OPERATE IN AN EXPLOSIVE ATMOSPHERE

Do not operate the instrument in the presence of flammable gases or fumes. Operation of any electrical instrument in such an environment constitutes a definite safety hazard.

KEEP AWAY FROM LIVE CIRCUITS

Operating personnel must not remove instrument covers. Component replacement and internal adjustments must be made by qualified maintenance personnel. Do not replace components with power cable connected. Under certain conditions, dangerous voltages may exist even with the power cable removed. To avoid injuries, always disconnect power and discharge circuits before touching them.

DO NOT SERVICE OR ADJUST ALONE

Do not attempt internal service or adjustment unless another person, capable of rendering first aid and resuscitation, is present.

DO NOT SUBSTITUTE PARTS OR MODIFY INSTRUMENT

Because of the danger of introducing additional hazards, do not install substitute parts or perform any unauthorized modification to the instrument. Return the instrument to a Hewlett-Packard Sales and Service Office for service and repair to ensure the safety features are maintained.

DANGEROUS PROCEDURE WARNINGS

Warnings, such as the example below, precede potentially dangerous procedures throughout this manual. Instructions contained in the warnings must be followed.

Warning



Dangerous voltages, capable of causing death, are present in this instrument. Use extreme caution when handling, testing, and adjusting.

SAFETY SYMBOLS

General Definitions of Safety Symbols Used On Equipment or In Manuals.



Instruction manual symbol: the product will be marked with this symbol when it is necessary for the user to refer to the instruction manual in order to protect against damage to the instrument.



Indicates dangerous voltage (terminals fed from the interior by voltage exceeding 1000 volts must be so marked.)

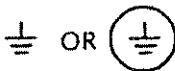

Protective conductor terminal. For protection against electrical shock in case of a fault. Used with field wiring terminals to indicate the terminal which must be connected to ground before operating equipment.



Low-noise or noiseless, clean ground (earth) terminal. Used for a signal common, as well as providing protection against electrical shock in case of a fault. A terminal marked with this symbol must be connected to ground in the manner described in the installation (operating) manual, and before operating the equipment.



Frame or chassis terminal. A connection to the frame (chassis) of the equipment which normally includes all exposed metal structures.



Alternating current (power line.)



Direct current (power line.)



Alternating or direct current (power line.)

Warning



The **WARNING** sign denotes a hazard. It calls attention to a procedure, practice, condition or the like, which if not correctly performed or adhered to, could result in injury or death to personnel.

Caution



The **CAUTION** sign denotes a hazard. It calls attention to an operating procedure, practice, condition or the like, which, if not correctly performed or adhered to, could result in damage to or destruction of part or all of the product.

Note



The **NOTE** sign denotes important information. It calls attention to procedure, practice, condition or the like, which is essential to highlight.

Table of Contents

PART I - Introduction

Chapter 1: Before You Begin

How to Use this Book	1-1
Are you using the correct book?	1-1
Hardkeys and Softkeys	1-2
Where to find Additional Information	1-3
Using the [Help] key	1-3
The Getting Started Guide	1-3
Other Information	1-3
About the Analyzer	1-4

Chapter 2: Front-Panel Overview

Input	2-1
Autoranging	2-2
Input Over-Range (RNG)	2-3
Input Overload (OVL)	2-3
Input Trip	2-4
The 50 Ω Input	2-4
The 75 Ω Input	2-4
The 1 M Ω Input	2-5
Active Probe Power Connector	2-6
Source	2-7
Disk Drive	2-9
Power Switch	2-10
“Hardkeys” and “Softkeys”	2-11
Display Area	2-12
Mini-state	2-12
Marker Readout	2-13
Status Indicator Area	2-14
Trace Box A and Trace Box B	2-15
Pop-up Message Area	2-16
Y-axis Notation	2-16
X-axis Notation	2-17
Status Message Area	2-18
Trace Title	2-18
CRT care and cleaning	2-19
Marker Keys and Knob	2-20
The Marker Keys	2-20
The Knob	2-20

Numeric Entry Keys	2-21
Active Entry	2-21
The Arrow Keys	2-22
Alpha Entry Keys	2-23
Measurement Keys	2-24
Display Keys	2-25
System Keys	2-26
The Preset Key	2-27
The Help Key	2-31

Chapter 3: Rear-Panel Overview

Fuse, Voltage Selector, and Line connector	3-1
HP-IB connector	3-1
Port 1	3-3
External Reference Input (EXT REF IN)	3-4
Oven Reference Output (OVEN REF OUT)	3-5
Reference Output (REF OUT)	3-6
External Trigger Input (EXT TRIG)	3-7
Trigger Output (TRIG OUT)	3-8

PART II - Making Measurements

Chapter 4: Swept Spectrum Measurements

Swept Spectrum Overview	4-1
Oversweep	4-3
Resolution Bandwidth	4-3
Video Filtering and Video Bandwidth	4-4
Bandwidth Coupling	4-5
Overview	4-5
Changing Bandwidth Coupling	4-5
Turning Off Bandwidth Coupling	4-9
Sweep Time	4-10
Manual Sweep	4-14
Zero Span	4-15
Overview	4-15
Special Considerations for Zero Span	4-16

Chapter 5: Narrow Band Zoom Measurements

Introduction	5-1
Setting the Center Frequency	5-2
High-Accuracy Zoom versus High-Resolution Zoom	5-2

Chapter 6: Marker Functions

The Main Marker	6-1
The Offset Marker	6-2
Marker Readout	6-2
Marker-to-peak	6-3
Marker-to-next-right-peak, Marker-to-next-left-peak	6-3
Marker-to-center-frequency	6-4
Offset-to-span	6-4
Peak Track	6-5
Frequency Counter	6-6
Overview	6-6
Counting Behavior	6-6
Noise Level	6-7
Overview	6-7
Special Considerations	6-7
Noise Measurements and Trace Data	6-9
Limit Testing	6-10
Overview	6-10
Absolute and Relative Limits	6-10

Chapter 7: Measurement Enhancements

Scalar Network Measurements	7-1
Introduction	7-1
Special Considerations for Scalar Network Measurements	7-2
Normalization	7-2
Trace Math	7-3
Overview	7-3
Special Considerations	7-3
Video Averaging	7-5
Overview	7-5
Special Considerations	7-5
Peak Hold	7-6
Signal Track	7-6
Modifying the Step Size	7-7
Locating signals quickly by stepping [CENTER FREQUENCY]	7-7
SAMPLE TASK: Modifying step size to position the center frequency	7-8
Low-distortion mode	7-10
Overview	7-10
What does it do?	7-10
Additional Considerations	7-10

Table of Contents (Continued)

Chapter 8: Manual Sweep

Introduction	8-1
Using Manual Sweep	8-2
Special Considerations for Manual Sweep	8-3
The Manual Measurement Point	8-4
Stepping the Manual Frequency	8-4
SAMPLE TASK: Stepping the Manual Frequency over a Wide Span	8-5

PART III - Reference

Chapter 9: Key Reference

How to use this chapter	9-1
Key Reference	9-2
Alpha entry menu	9-3
Alpha entry mode	9-3

Chapter 10: Menu Map

Measurement Group	10-1
Display Group	10-3
Marker Group	10-5
System Group	10-6

Before You Begin

How to Use this Book

Are you using the correct book?

This operating manual provides a detailed overview of the analyzer's controls and features. As such, it's the correct book to use if you're already comfortable with the HP 3588A Spectrum Analyzer and what you really need is more in-depth information about specific instrument controls and features.

If you haven't used the analyzer before—or haven't used it very much—make sure you've already read the *HP 3588A Getting Started Guide*. This contains sample measurement tasks and essential background information necessary for you to get comfortable, quickly, with the HP 3588A Spectrum Analyzer.

To learn about:	Read:
Averaging	<i>Getting Started, Operating Manual</i>
<i>Basic measurements</i>	Getting Started
Copy operations	Getting Started
Display formats	<i>Getting Started Operating Manual</i>
Keystroke recording	<i>Getting Started</i>
Limits	Getting Started
Measurement enhancements	<i>Operating Manual</i>
Measurement types	Operating Manual
Normalizing measurement results	Getting Started
Scalar network measurements	<i>Getting Started Operating Manual</i>
Spectrum analyzer basics	<i>Getting Started</i>

Hardkeys and Softkeys

Before you use this book, it's important to understand the difference between hardkeys and softkeys.

Hardkeys are front-panel buttons whose functions are always the same. Hardkeys have a label printed directly on the key itself. Throughout this book, they are printed like this: [**Hardkey**].

Softkeys are keys whose functions change with the analyzer's current menu selection. A softkey's function is indicated by a video label to the left of the key (on the edge of the analyzer's screen). The companion video labels to the left of the ten softkeys form the *softkey menu*. Throughout this book, softkeys are printed like this: [SOFTKEY].

Some softkeys toggle through different settings. Toggle softkeys have a highlighted word in their label that changes with each press of the softkey. Throughout this book, toggle softkeys are depicted as they *appear after you make the keypress*. For example, "toggle to [FREQ CNTR **ON** OFF]" means to press [FREQ CNTR ON/OFF] until the word ON is highlighted.

Where to find Additional Information

Using the [Help] key

The [Help] key on the analyzer's front panel provides fast, easy-to-read information about specific instrument controls and features. Using [Help] is particularly convenient when you need assistance and you don't have the analyzer's *Getting Started Guide* or *Operating Manual* near at hand.

The [Help] key is also a good way to learn about the analyzer (or to refresh your memory if you don't use it often). The help facility also has an index that lets you request information by key name or by topic.

The Getting Started Guide

As we mentioned earlier, the *Getting Started Guide* contains sample measurement tasks necessary for you to get comfortable, quickly, with the HP 3588A Spectrum Analyzer. Each sample task demonstrates several commonly-encountered spectrum analyzer measurements. At the same time, each task gradually introduces additional analyzer features. By the time you finish the sample tasks, you'll have a good understanding of the analyzer's most-often-used controls and features. The *Getting Started Guide* also includes essential background information for people who haven't used a spectrum analyzer before.

You should read the *Getting Started Guide* before reading any other documentation for the HP 3588A Spectrum Analyzer.

Other Information

For additional information about the HP 3588A Spectrum Analyzer, use the following:

- For specifications, installation instructions, and performance tests, see the *HP 3588A Performance Test Guide*.
- For service information, see the *HP 3588A Service Manual*.
- To help you operate the analyzer remotely via HP-IB, see the *HP 3588A HP-IB Programming Reference*.
- To learn more about HP Instrument BASIC (a subset of the HP BASIC programming language), see *Using HP Instrument BASIC with the HP 3588A Spectrum Analyzer*.

Additionally, you will find applications information in numerous Hewlett-Packard application notes. These are available from your local HP Sales and Service Office. In particular, you might want to request some of the following application notes:

- AN 150 series (several application notes—some recently updated—that cover many topics dealing with spectrum analysis).
- AN 246-1: *Optimizing the Dynamic Range of the HP 3585A Spectrum Analyzer*.
- AN 378-1: *Harmonic Distortion Measurements*.

About the Analyzer

The Hewlett-Packard 3588A is a swept-tuned spectrum analyzer with a frequency range of 10 Hz to 150 MHz. As such, the instrument is a general-purpose design tool for measurement and evaluation of many electronic devices. In addition, a built-in source (tracking generator) lets you perform scalar network analysis for filters, amplifiers, and other devices. You can also operate the analyzer remotely, via the HP-IB, to make automated measurements—a feature that's particularly useful for repetitive tasks (such as those encountered in production-line testing).

The HP 3588A offers two measurement types—*Swept Spectrum* and *Narrow Band Zoom*. Both provide excellent resolution and operate at speeds far greater than conventional analyzers. Swept spectrum measurements provide the performance and features found in traditional Hewlett-Packard swept-tuned analyzers, but incorporate very sharp digital IF filters to provide improved frequency resolution (down to 1.14 Hz). For narrow band zoom measurements, the analyzer uses an implementation of the Fast Fourier Transform to provide faster measurements with even greater resolving power.

Faster measurements are possible with swept spectrum measurements since the analyzer uses digital IF filters. With selectivity nearly twice that of analog filters, digital filters offer faster measurements while still resolving low-level carrier sidebands. Additionally, the inherent predictability of digital filters permits the analyzer to sweep even faster, using a built-in correction algorithm. This provides increased measurement speed (up to four times faster than conventional swept-tuned analyzers for comparable measurements), with no additional amplitude error or resolution loss.

Narrow Band Zoom provides the fastest spectrum measurements (more than thirty times faster than swept-tuned analyzers for comparable measurements), with resolution performance unequalled by traditional technologies. Narrow Band Zoom can be used for spans of 40 kHz and less, and is ideal for narrowband analysis of close-in sidebands.

How is the HP 3588A Different than Previous Hewlett-Packard Swept-Tuned Analyzers?

For spans larger than 40 kHz, the HP 3588A functions exclusively as a traditional swept-tuned analyzer (but faster than previous analyzers). For spans smaller than 40 kHz, you have the choice of making swept spectrum measurements (with resolution down to nearly 1 Hz) or narrow band zoom measurements (with resolution down to about 3 mHz – yes, that's millihertz).

Narrow Band Zoom uses a Fast Fourier Transform (FFT) rather than a sweeping local oscillator to convert input data from the time domain to the frequency domain. The distinction between these two technologies is not important right now. The only important thing to know is that a combined swept-tuned/FFT analyzer is an analyzer with both wide frequency range and excellent frequency resolution/amplitude accuracy for small spans.

To learn more about swept spectrum measurements, see chapter 4. To learn more about narrow band zoom measurements, see chapter 5.

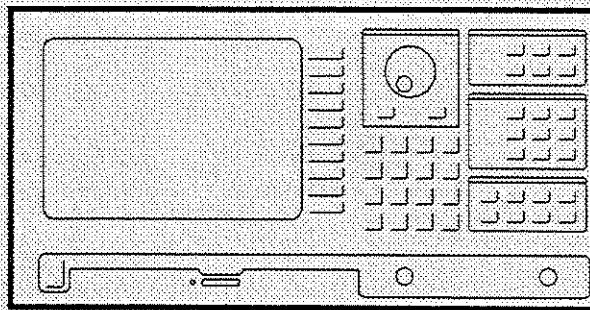

HP 3588A Spectrum Analyzer



Front-Panel Overview

With few exceptions, individual hardkeys (and their associated softkeys) are not described in this section. For specific information about a particular hardkey or softkey, see chapter 9, “Key Reference.” Alternatively, use the analyzer’s [Help] key to learn about a hardkey or softkey.

Input

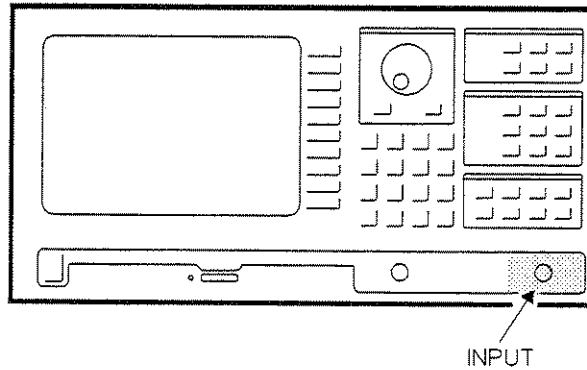

The analyzer has one input connector. The input is a dc-coupled single-ended (unbalanced) input. However, the input is dc-coupled only as far as the input attenuators—from a measurement perspective, the analyzer is ac-coupled.

To specify the input impedance, press [Input]. Then use the appropriate softkey to select the 50 Ω , 75 Ω , or 1 M Ω input impedance.

The HP 3588A Spectrum analyzer has five input ranges. The following table shows the maximum allowable input levels for each range:

Maximum input levels for each range

50 Ω	75 Ω	1 M Ω
20 dBm (2.24 Vrms)	21.76 dBm (3.35 Vrms)	
10 dBm (707 mVrms)	11.76 dBm (1.06 Vrms)	
0 dBm (223 mVrms)	1.76 dBm (335 mVrms)	0 dBm * (223 mVrms) (-13 dBV)
-10 dBm (70.7 mVrms)	-8.23 dBm (106 mVrms)	
-20 dBm (22.4 mVrms)	-18.23 dBm (33.5 mVrms)	

* referenced to 50 Ω

Maximum allowable dc offsets

50 Ω	75 Ω	1 M Ω
± 4 volts dc	± 4 volts dc	± 25 volts dc

Autoranging

When autoranging is on, the analyzer continuously monitors the amplitude of the input signals and, if necessary, automatically changes the input range. If the input signal increases enough to exceed the current input range, the analyzer changes to a less-sensitive input range. If the input signal decreases enough to compromise the dynamic range of the current measurement, the analyzer changes to a more-sensitive input range.

When autoranging occurs, you'll see an "AUTORANGE IN PROGRESS" message on the screen.

You can also request an autorange operation at any time—simply press the [SINGLE AUTORANGE] softkey. Autoranging does not have to be on for this single autorange to occur. If the currently-selected range is adequate for the current input signal, the analyzer performs an autorange procedure but does not change the current range.

Because the 1 M Ω input impedance is limited to one input range, autoranging is inactive if you select the 1 M Ω input impedance.

Input Over-Range (RNG)

Over-range occurs when the input signal exceeds the currently-selected input range, but does not overload the analog-to-digital converter in the analyzer's final IF stage. If this happens, the RNG status indicator appears at the lower right-hand corner of the screen.

When autoranging is on, an over-range condition simply causes the analyzer to change to a less-sensitive input range—unless the maximum input range is already selected. If autoranging is off, the analyzer does not change to a less-sensitive range.

Over-range lets you know that your measurement data may be questionable, since the input signal is high enough to cause gain compression or distortion products in excess of the analyzer's published specifications. Simply reduce the input signal (or change to a less-sensitive input range, if possible).

Note



Over-range is sensitive to broadband signals—that is, it will be triggered even if the over-range frequency component is outside the analyzer's current frequency span. Thus the RNG indicator may appear even if you're viewing a frequency span with no over-range components.

Input Overload (OVLD)

Overload occurs when the input signal is strong enough to overload the analog-to-digital converter in the analyzer's IF stage. When this happens, the OVLD status indicator appears at the lower right-hand corner of the screen.

The analyzer's response to an overload condition (OVLD) is similar to an over-range condition (RNG). If autoranging is on, the analyzer autoranges, if possible.

OVLD lets you know that the analog-to-digital converter in the analyzer's final IF is overloaded. When this happens, there may be significant distortion and your measurement data can be seriously compromised. To fix an OVLD condition, simply reduce the input signal (or change to a less-sensitive input range, if you can).

Note



Unlike an over-range condition, OVLD occurs only for signals that are within the currently-selected frequency span. This is because the OVLD detector monitors the analog-to-digital converter at the analyzer's IF stage. Out-of-band signals are not detected (though large components just below and just above the displayed frequency range may cause an OVLD condition).

Input Trip

If you exceed the maximum absolute input level, the analyzer's protective circuit-breaker may trip (50/75Ω input only). After removing the input signal, press [**Input**] and then [**CLEAR INP TRIP**].

Caution



Although the analyzer's input has protection circuitry, signals greater than the following may damage the analyzer:

50/75Ω input	1 MΩ input
RF signals greater than +26 dBm (50Ω) or +28 dBm (75Ω)	
dc offsets greater than ± 4 V	peak (combined ac/dc) signals greater than ± 25 volts peak
peak (combined ac/dc) signals greater than ± 4 V _{peak}	

The 50Ω Input

This is the most commonly used input impedance. When selected, the input connector is terminated with a 50Ω resistance.

Since the default impedance is 50Ω, this will be the input configuration selected after you turn on the analyzer or press [**Preset**].

The 75Ω Input

When you select the 75Ω input impedance, the analyzer makes the necessary adjustments to calculate dBm values for a 75Ω input impedance. However, the input remains terminated with a 50Ω resistance—and you must therefore connect a 25Ω adapter (a series feedthrough barrel) between the input signal and the analyzer's input. This provides the necessary 75-to-50Ω conversion.

The 1 M Ω Input

The 1 M Ω input provides a high-impedance, input useful for general-purpose measurements up to 40 MHz, where optimal amplitude accuracy and dynamic range are not required. Because this input is shunted by approximately 30 pF, you can attach a compatible high-impedance oscilloscope probe.

Although the 1 M Ω input restricts the analyzer to a single input range (maximum input of 223 mVrms), there are nonetheless many measurement situations where the 1 M Ω input is extremely useful. For example, if you need to do the following:

- perform in-circuit probing of low-frequency devices.
- bridge a terminated transmission line without disturbance.
- terminate the 1 M Ω input to match the output impedance of a specific signal source.

Note



The 1 M Ω input is designed to measure frequencies up to 40 MHz. Although the 1 M Ω input is functional over the entire frequency range of the analyzer, measurement performance above 40 MHz is not specified.

Active Probe Power Connector

Some in-circuit measurements require even less capacitance than the 30 pF provided by the analyzer's 1 M Ω input. For these situations, you can use an active probe in conjunction with the 50 Ω input. Power for the active probe is supplied by this small connector located between the input and source connectors.

There is currently one active probe available that is compatible with the HP 3588A Spectrum Analyzer—the HP 41800A Active Probe. You may also use the HP 1120A 500 MHz Active Probe, although this probe is no longer manufactured.

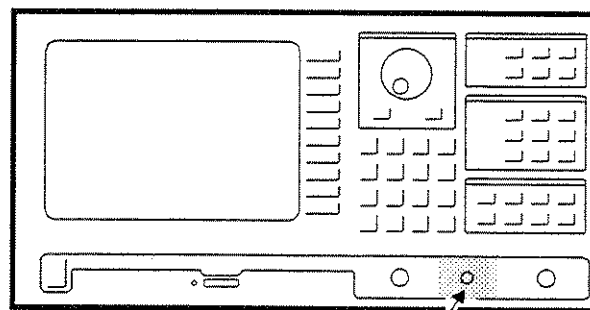

Active Probe Power

Source

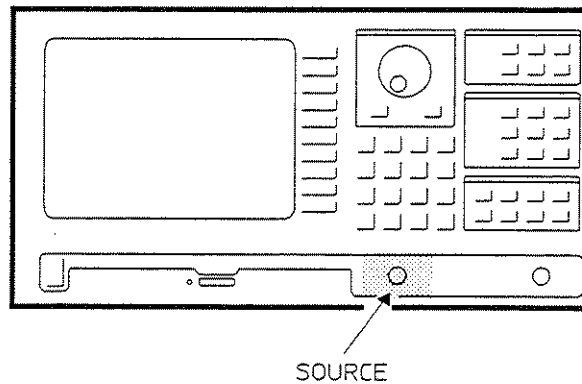

When activated, the source connector supplies a sinusoidal signal whose frequency follows (tracks) the analyzer's swept-tuned (or manually-tuned) frequency. At any given time, the source frequency is tuned to the same frequency as the center frequency of the analyzer's input receiver. This feature is similar to the "tracking generator" output provided on older Hewlett-Packard spectrum analyzers.

One type of measurement you can make using the analyzer's source is a swept frequency-response measurements. This is a good way to characterize the amplitude vs. frequency response of filters, amplifiers, and other electronic devices. Incidentally, the 3588A Spectrum Analyzer performs scalar (amplitude-only) network measurements. To learn more about scalar network measurements, see chapter 7, "Measurement Enhancements."

You can select a 50 or 75 Ω impedance for the analyzer's source. If you select 75 Ω , you must connect a 25 Ω adapter (a series feedthrough barrel) between the source connector and the input of your test device. This provides the necessary 50-to-75 Ω conversion. The return loss of the source output (regardless of impedance selected) is greater than 20 dB.

You can set the source to automatically change its impedance if the input impedance setting is changed. You can do this by pressing [COUPLE TO INPUT Z] under the source menu.

The source output is protected and can tolerate input signals of less than 4 volts peak. The source circuit-breaker will trip if you connect a signal that exceeds this level. After removing the accidentally-connected signal, press [**Source**] and then [**CLEAR SRCE TRIP**].

Caution



Although the analyzer's source has protection circuitry, the following signals accidentally applied to the source connector may damage the analyzer:

- RF signals greater than +20 dBm (50Ω) or +22 dBm (75Ω)
 - dc offsets greater than +3V.
 - peak (combined ac/dc) input level greater than +3 V_{peak}.
-

Disk Drive

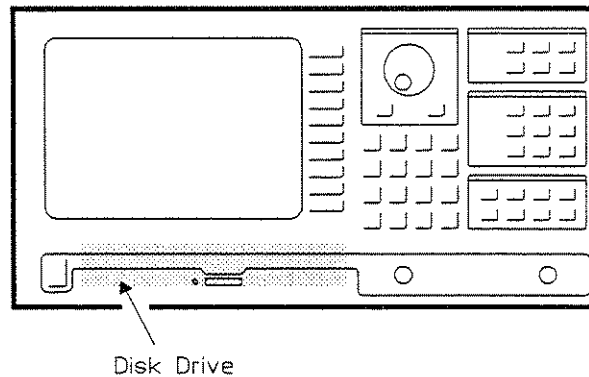

The analyzer has a built-in 3.5-inch flexible disk drive that you can use to load HP Instrument BASIC programs. You can also use the disk drive to store traces, instrument setup states, limit tests, math functions, and HP Instrument BASIC programs. *Analyzers equipped with Option 004 do not have an internal disk drive.*

The disk drive accepts the standard gray 3.5-inch, 710 kilobyte double-sided flexible disks (for example, the HP 92192A). If you load disks that are already formatted, keep in mind that the disk drive recognizes only those disks that have been formatted using the Logical Interchange Format (LIF).

Note



The disk drive is designed for operation in a typical office environment. Use of the equipment in an environment containing dirt, dust, or corrosive substances will drastically reduce the life of the disc drive and the flexible disks. The disks should be stored in a dry, static-free environment.

Power Switch

The analyzer's power switch has two positions: on (I) and standby (⊖). In the standby position, the analyzer appears off but line power is still applied to the instrument's power supply.

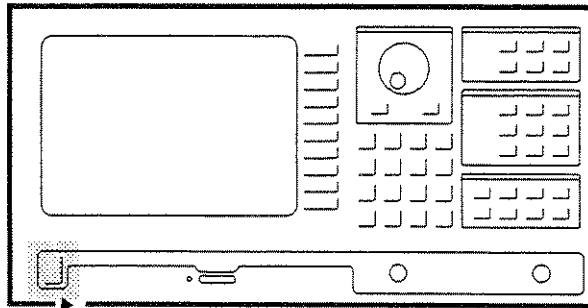

Power Switch

“Hardkeys” and “Softkeys”

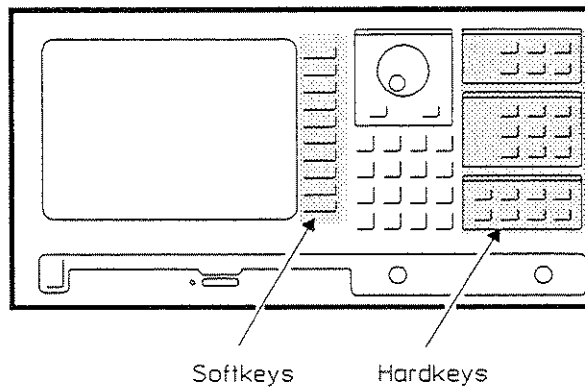

Hardkeys are front-panel buttons whose functions are always the same. Hardkeys have a label printed directly on the key itself. Throughout this book, they are printed like this: [**Hardkey**].

Softkeys are keys whose functions change with the analyzer’s current menu selection. A softkey’s function is indicated by a video label to the left of the key (on the edge of the analyzer’s screen). The companion video labels to the left of the ten softkeys form the *softkey menu*. Throughout this book, softkeys are printed like this: [SOFTKEY].

Some softkeys toggle through different settings. Toggle softkeys have a highlighted word in their label that changes with each press of the softkey. Throughout this book, toggle softkeys are depicted as they appear after you make the keypress. For example, “toggle to [**FREQ CNTR ON** OFF]” means to press [FREQ CNTR ON/OFF] until the word ON is highlighted.

Display Area

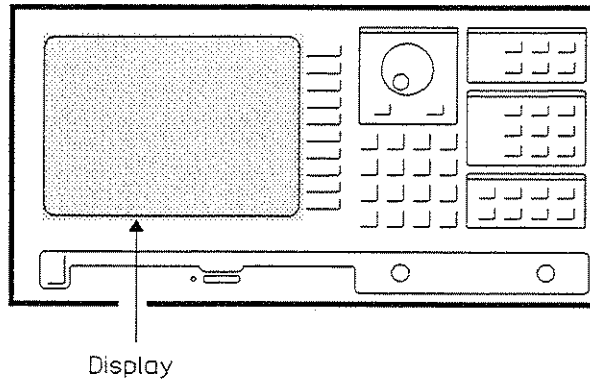

Mini-state

The “mini-state” is a small area that shows several of the analyzer’s current settings, including:

- Range.
- Resolution bandwidth (swept spectrum measurements only).
- Video bandwidth (swept spectrum measurements only).
- Sweep time (swept spectrum measurements only).
- High Accuracy or High Resolution position (narrow band zoom measurements only).

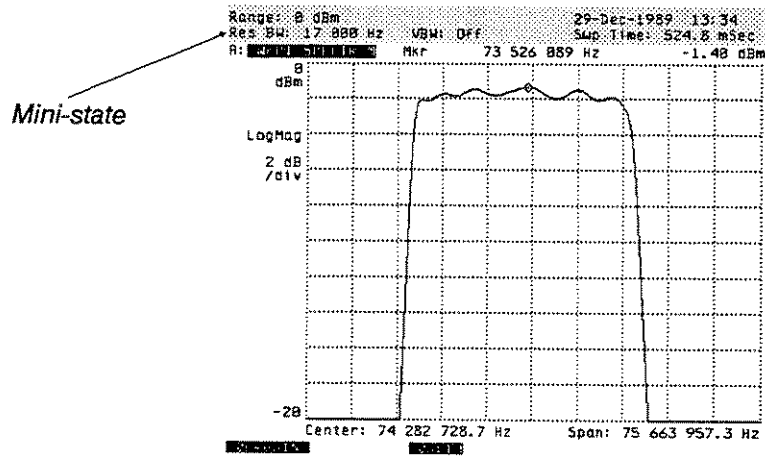

Marker Readout

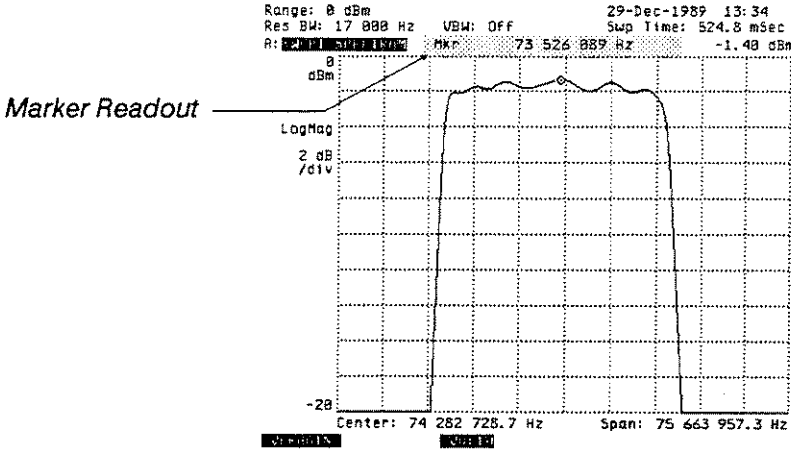

The marker readout provides the amplitude and frequency coordinates of the current marker position. When the offset marker is on, the marker readout indicates amplitude and frequency relative to the point where you zeroed the offset marker.

The marker's frequency value is only as accurate as the current display resolution—for maximum accuracy, use the frequency counter. To learn more about the frequency counter, see chapter 6, "Measurement Enhancements." To learn more about display resolution and frequency resolution, see the sidebar on peak detection in chapter 4, "Swept Spectrum Measurements."

Status Indicator Area

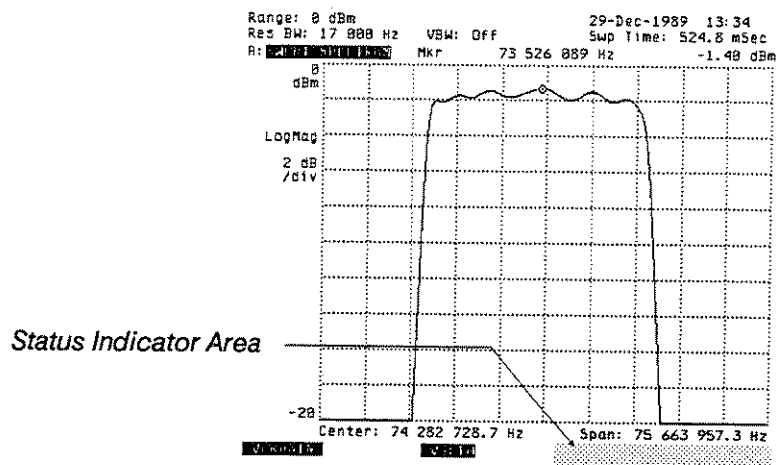

From time to time, various status indicators appear at the bottom right-hand corner of the analyzer's screen. The indicators are visible only while the conditions they represent remain active. These status indicators are:

- RMT (remote); indicates the presence of an external device that has control of the analyzer's HP-IB.
- SRQ (service request); indicates an analyzer request, via HP-IB, to communicate with the current HP-IB controller.
- UNCAL (uncalibrated sweep); indicates a condition where the current sweep time is too fast for the current resolution bandwidth (RBW) to ensure an accurate measurement.
- REF (reference); indicates the presence of an external frequency reference—from either the analyzer's optional temperature-controlled reference or an external reference signal.
- RNG (range); indicates an under/over range condition.
- OVLD (overload); indicates an overload in the analyzer's analog-to-digital converter. This message occurs when you overload the analyzer's least-sensitive range.

Trace Box A and Trace Box B

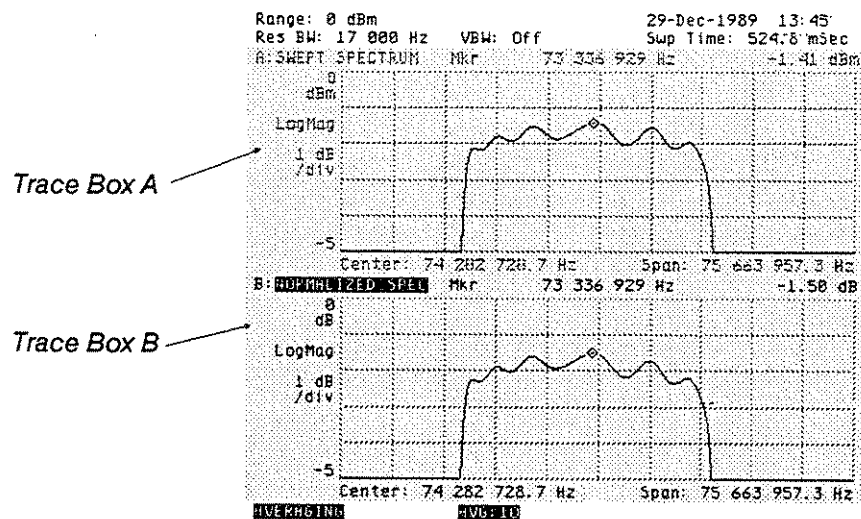

The analyzer has two display traces. You can display these two traces several ways—single (one trace at a time), upper/lower (trace A on top, trace B on bottom), or front/back (one trace overlaid on the other). Each trace shows measurement data with 401 points of resolution, regardless of span.

It's important to understand that both Trace A and Trace B are independent and are not dedicated to showing specific parameters. Rather, you can display one of four different types of information:

- Input Spectrum (current measurement data).
- Functions F1 through F5 (math functions).
- Constants K1 through K5 (math constants).
- Data Registers D1 through D8 (you can save traces, limits, and math functions to a data register and then subsequently display them using the [Trace Data] hardkey).
- Normalized Spectrum (the current input spectrum divided by a stored normalization trace).

One trace is “active” at any given time (indicated by the highlighted trace title). The active trace is the target of any adjustments you make with the display keys. For example, if you press [Trace Data] and press [DATA REG (D1-D8)] to call up a stored trace, the stored trace will only appear in the currently active trace.

Pressing [Active Trace] lets you designate, alternately, Trace A or Trace B as the active trace.

The [Marker] and [Marker Fctn] hardkeys are also tied to the active trace. Although the markers for both Trace A and Trace B are always coupled (if you have both Trace A and Trace B displayed you will see both markers moving together), other marker functions are dedicated to the active trace. For example, if you press [Marker] and [PEAK SEARCH], the marker will move to the peak on the active trace only.

Pop-up Message Area

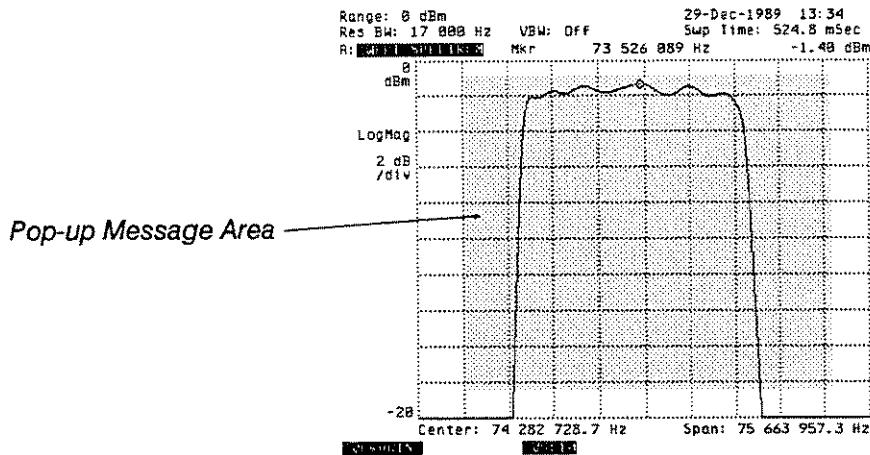

When necessary, the analyzer displays a pop-up message window at the center of the screen. Some examples of these messages are:

- Autorange in progress.
- Calibration in progress.
- User error.
- Hardware errors.

Y-axis Notation

The y-axis notation includes the Trace Type (Log Magnitude or Linear Magnitude) and the top and bottom values amplitude values for the current y-axis scale.

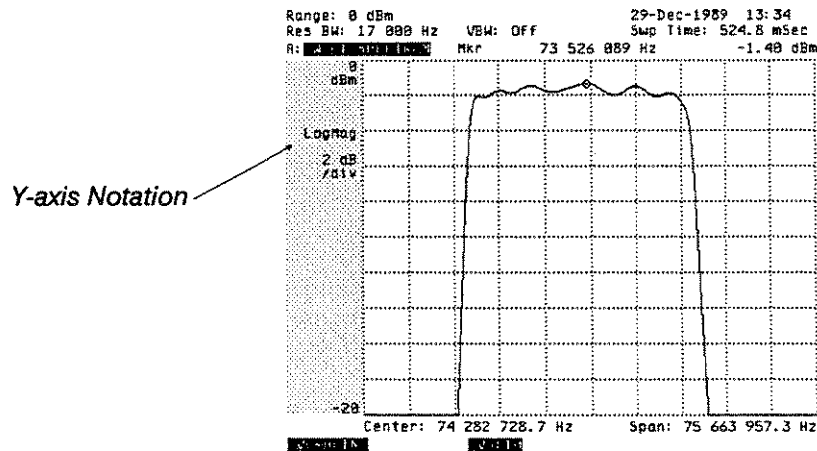

X-axis Notation

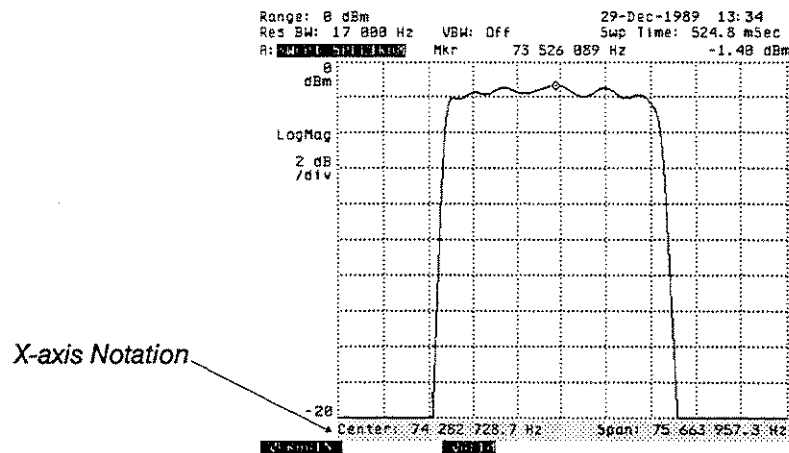

The x-axis notation indicates the frequency range the analyzer is using to make the current measurement. For stored traces, the x-axis notation indicates the frequency range used to acquire the stored data.

The x-axis notations indicates the frequency range one of two ways:

- by showing the center frequency and span (for example, a center frequency of 55 MHz and a span of 90 MHz).
- by showing the start and stop frequencies (for example, a start frequency of 10 MHz and a stop frequency of 100 MHz).

The particular notation used reflects the most recent way you entered frequency range parameters. For example, if you used the [SPAN] or [CENTER] softkeys to specify a frequency range, the analyzer will express the frequency range using span and center frequencies. If you used the [START] and [STOP] softkeys, the analyzer will use start and stop frequencies.

Status Message Area

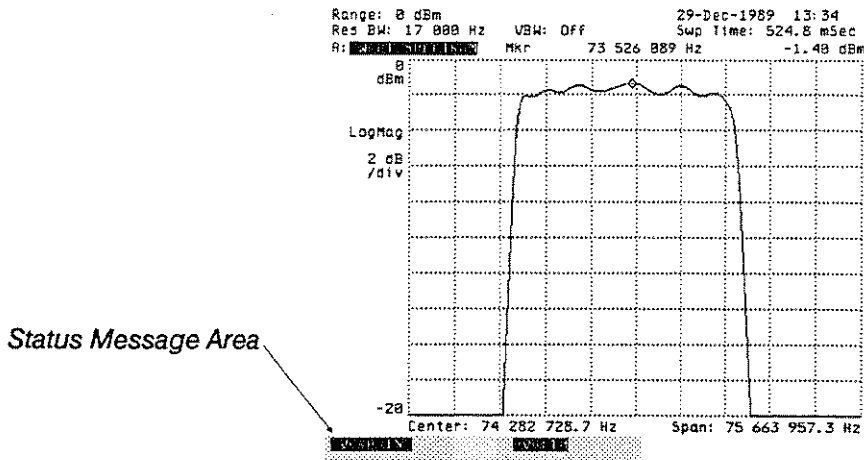

Status messages appear at the lower left corner of the screen. These messages keep you informed about current measurement conditions. Examples of status messages include:

- Averaging.
- Waiting for trigger.
- Waiting for arm.
- settling.
- Taking data (for spans less than 625 Hz—narrow band zoom only).

Trace Title

You can specify a trace title by pressing [Trace Data], [TRACE TITLE], and using the alpha shift keys and numeric keypad.

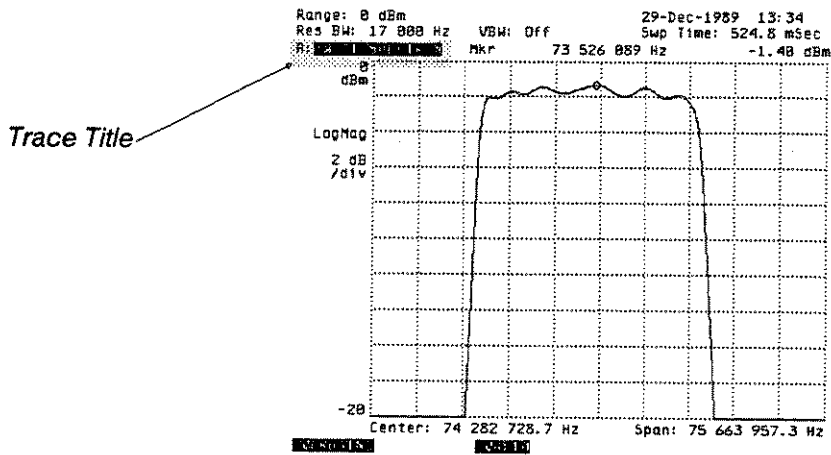

CRT care and cleaning

The analyzer's CRT is protected by a plastic screen that also provides RFI shielding. During normal operating conditions, the only cleaning that should be required is an occasional dusting with a soft brush. A household-type tack cloth, or other type of lint remover, may also be used.

If foreign material adheres to the screen, dampen a soft, lint-free cloth moistened with a mild detergent (diluted with water) and carefully wipe the screen.

The plastic screen is not operator replaceable. In the unlikely event that it becomes damaged, contact your nearest Hewlett-Packard Sales/Service office.

Warning



Do not apply any water mixture directly to the screen or allow moisture to go behind the front panel. Moisture behind the front panel will severely damage the instrument and may present a shock hazard.

To clean, dampen a soft, lint-free cloth and carefully wipe the screen. Use only a mild detergent mixed with water.

Marker Keys and Knob

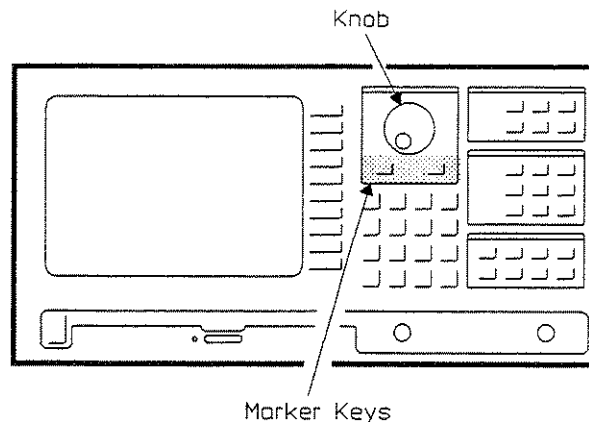

The Marker Keys

The marker keys call up menus that let you control the location and movement of the on-screen marker. These controls affect only the markers for the currently-active trace.

The Knob

The *knob* is an RPG (rotary pulse generator) that controls two things—movement of the on-screen marker and continuous entry of numeric values. Usually, the knob simply moves the marker. Turn the knob to the right and the marker moves to the right. Turn to the left and the marker moves left. The faster you turn the knob, the faster the marker moves. If you have both Trace A and Trace B displayed, you will see both markers moving together.

After pressing a softkey that requires a numeric entry, the knob becomes dedicated to numeric entry. Turn the knob to the right and the analyzer steps through larger numeric entries. Turn to the left and the analyzer steps through increasingly smaller entries.

Although the analyzer uses a default step size to control the “sensitivity” of the knob—that is, the interval between each numeric entry as you turn the knob—you can select your own “step size.” Press [**Freq**], toggle to [STEP SIZE AUTO **USER**], and press [**USER STEP SIZE**]. Then use the numeric keypad to enter your own step size. To learn more about setting the step size to your best advantage, see chapter 7, “Measurement Enhancements.”

When numeric entry is active, an entry box appears at the top of the screen with the currently-selected numeric value. This box remains on screen for several seconds to give you a chance to enter a numeric value. If you don’t make an entry, the box disappears after several seconds. If you use the knob (or, alternatively, the numeric entry keypad) to make an entry, this box remains on the screen. After you complete your entry, the box soon disappears and the knob returns to marker movement.

Numeric Entry Keys

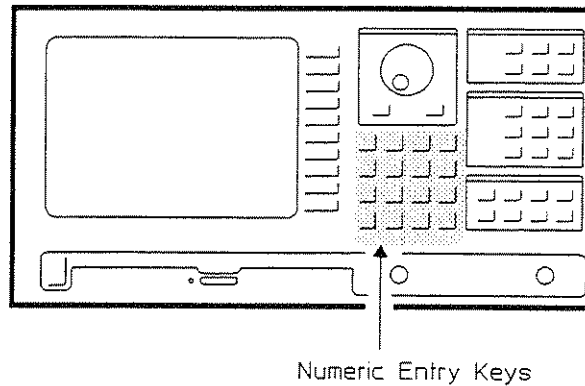



The numeric entry keys work the same way as the knob does during numeric entry. Use the numeric entry keys when you need to enter specific values. If you only need approximate values, it may be easier to use the knob instead of the numeric entry keys.

Active Entry

It isn't always necessary to first press a softkey before making a numeric entry. A highlighted softkey is the softkey that is currently dedicated to the numeric keypad.

For example, press [**Freq**]. If the [**CENTER**] softkey is highlighted, pressing any of the numeric keypad keys automatically brings up a numeric entry window for center frequency. You don't have to press [**CENTER**] to set the center frequency.

The Arrow Keys

Like the knob, you can use the arrow keys to step through larger or smaller numeric entries. Press [] to step through increasingly larger numeric entries—for example, to raise the current center frequency). Press [] to step through increasingly smaller numeric entries—for example, to lower the current center frequency.

You can use the arrow keys to modify a numeric entry at any time—unlike the knob, which you can use for numeric entry only after pressing a softkey to activate the numeric entry mode.

And like the knob, the analyzer uses the same default step size to control the “sensitivity” of the arrow keys—that is, the interval between each numeric entry as you press an arrow key.

As we mentioned earlier, you can select your own “step size.” Press [**Freq**], toggle to [**STEP SIZE AUTO USER**], and press [**USER STEP SIZE**]. Then use the numeric keypad to enter your own step size. To learn more about setting the step size to your best advantage, see chapter 7, “Measurement Enhancements.”

Alpha Entry Keys

It is occasionally necessary to specify alpha characters—for example, when entering a trace title or when saving or recalling a specific file. During these times, the analyzer automatically shifts certain front-panel keys to an alpha entry keys (note the alpha characters engraved on the front panel below these hardkeys). When it's no longer necessary to enter alpha characters, the analyzer automatically returns these hardkeys to their normal functions.

Measurement Keys

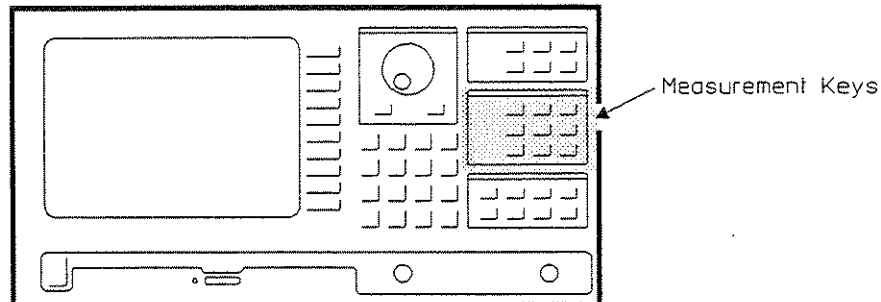

The Measurement keys let you control the analyzer's input configuration, measurement range, and measurement resolution. Here's a brief summary of the Measurement keys and their significant functions:

- [**Meas Type**] switches between swept spectrum and narrow band zoom measurements.
- [**Freq**] determines the frequency range measured.
- [**Res BW**] adjusts the resolution bandwidth and video bandwidth.
- [**Meas Restart**] initiates a new measurement.
- [**Range/Input**] sets the current input range and impedance.
- [**Sweep**] adjusts the sweep time and controls the local oscillator during manually-swept measurements.
- [**Trigger**] provides trigger choices and manual arming.
- [**Average/Peak Hold**] lets you select exponentially-averaged or peak-hold measurements.
- [**Source**] controls the analyzer's source output.

Display Keys

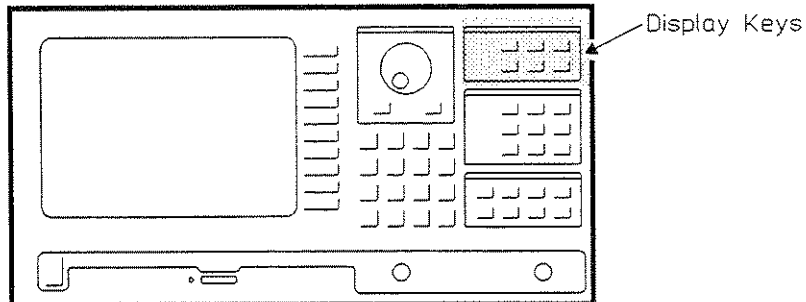

The Display keys let you control what appears on the analyzer's two traces. Since only one trace is "active" at any given time, only one trace is the target of any adjustments you make using the display keys. Here's a brief summary of the Display keys and their significant functions:

- [**Trace Type**] switches between a log magnitude or linear magnitude display.
- [**Trace Data**] determines the type of data shown on the active display—this can be current measurement data or stored data.
- [**Scale**] adjusts the position and size of the displayed data.
- [**Math**] lets you define math functions and constants, to be used when performing math operations with measurement data.
- [**Format**] selects the number of traces displayed and adjusts their appearance. Pressing [**Format**] also lets you view the analyzer's "setup state"—a listing of the analyzer's current measurement parameters.

System Keys

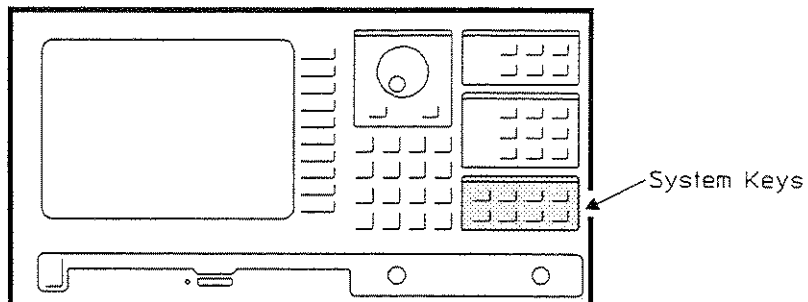

The System keys let you control how the analyzer communicates the external devices, the HP-IB controller, and external measurement programs. Here's a brief summary of the System keys and their significant functions:

- [**Help**] provides information about specific analyzer controls and functions (see “The Help Key” later in this chapter).
- [**Save/Recall**] lets you save and recall stored traces, instrument states, limits, math operations, and HP INSTRUMENT BASIC programs.
- [**Disk Utilities**] provides useful utilities to let you format, delete, and examine files stored on the currently-selected mass storage device (including the analyzer's internal RAM disks and flexible disk drive or external disks).
- [**Special Functions**] lets you perform a calibration procedure and set the analyzer's internal clock.
- [**User Define**] lets you create (and run) HP Instrument BASIC programs *if your analyzer is equipped with the HP Instrument BASIC option*.
- [**Plot/Print**] controls selection and configuration of an external plotter or printer.
- [**Local/HP-IB**] provides HP-IB options when the analyzer is under local (front panel) control.
- [**Preset**] returns most of the analyzer settings to their default positions (see “The Preset Key” later in this chapter).

The Preset Key

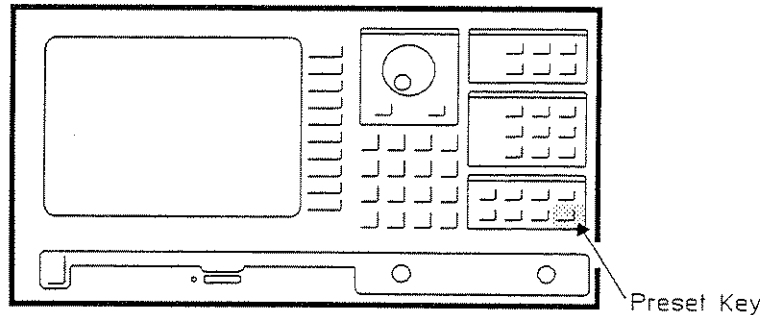

Pressing [**Preset**] returns most of the analyzer settings to their default positions.

Before pressing [**Preset**], you may want to save the analyzer's settings, particularly if your measurement setup was rather complex. You can save an instrument setup state to disk by pressing [**Save/Recall**] and using [**SAVE STATE**].

If you simply want a hardcopy of the instrument setup state, press [**Format**]. Then press [**SETUP STATE**] to view a listing of the analyzer's current setup state. Then press [**Plot/Print**] and [**PLOT ALL**] or [**PRINT ALL**].

MEASUREMENT	Type: Swept Spectrum	Low Dist: Off
FREQUENCY	Start: 100 000 Hz	
	Stop: 150 000 000 Hz	
	Center: 75 050 000 Hz	
	Span: 149 900 000 Hz	
SWEEP	Time: 260.80 mSec	Mode: Auto
RES BW	Value: 17 000 Hz	Coupling: On
	Vid Filt: Off	Video BW: 26 000 Hz
NOISE	Bandwidth: 18 100 Hz	Correction: 42.6 dB
SOURCE	Status: Off	Level: -10 dBm
	Impedance: 50 Ohms	
INPUT	Range: 10 dBm	Autorange: On
	Impedance: 50 Ohm	
TRIGGER	Type: Free Run	Arm: Auto
AVERAGE	Type: Off	Number: 10

Front-Panel Overview
The Preset Key

Keep in mind that pressing [**Preset**] is not the same thing as turning off the analyzer and turning it on again (a power-up cycle). There are some settings that are unaffected by preset but are changed when a power-up cycle occurs. These include:

- Definitions of constants and functions.
- Contents of data registers.
- HP Instrument BASIC programs currently loaded.
- Memory size.
- Scratch option.
- Renumber start and increment.
- Secure start and end line.

Additionally, there are even some settings that survive both [**Preset**] and power-up. You must change these settings from the front-panel or via HP-IB. These settings include:

- Storage configuration (default disk selection).
- System controller mode (system controller or addressable-only).
- HP-IB, Disk, Printer, and Plotter addresses.
- Disk volume and unit numbers.
- Time and date.

MARKER group	
[Marker] Hardkey	[Marker Fctn] hardkey
X Entry: 75.05 MHz Offset: Off Marker: On	Peak Trk: Off Freq Cntr: Off Noise Lvl: Off
DISPLAY group	
[Active Trace] hardkey	[Format] hardkey
Active Trace: A	Display Format: Single Graticule: On
[Meas Data] hardkey	[Scale] hardkey
Trace A: Input Spectrum Trace B: Input Spectrum Trace Title (A): default Trace Title (B): default	Vertical /Div: 10 dB Ref Track: On
[Trace Type] hardkey	
Trace Type: Log Magnitude	

MEASUREMENT group	
[Avg/Pk Hold] hardkey	[Freq] hardkey
Average/Pk Hold option: Off Number Averages: 10	Center: 75.05 MHz Span: 149.9 MHz Start: 100.0 kHz Stop: 150.0 MHz Step Size: Auto User Step Size: 1 kHz Signal Trk: OFF
[Meas Type] hardkey	[Range/Input] hardkey
Meas Type: Swept Spectrum	Autorange: On Input Impedance: 50 Ω 1 Meg Ref Imped: 50 Ω
[Res BW] hardkey	[Source] hardkey
Res BW: 17 kHz Vid Filtr: Off BW Couple: On Zoom Type: Hi Accrcy Zoom	Source State: Off Source Amplitude: - 10.0 dBm Amplitude Step: 0.1 dBm Output Z: 50 Ω Z Coupling: On
[Sweep] hardkey	[Trigger] hardkey
Sweep: Auto Manual Freq 75.05 MHz Sweep Time : 260.8 ms Sample Time: 4 us Oversweep: On	Trigger Type: Free Run Arm: Auto

Front-Panel Overview
The Preset Key

SYSTEM group	
[Disk Util] hardkey	[Local/HP-IB] hardkey
Format Option: 0 Interleave Factor: 1 Catalog: Off	Echo: Off
[Plot/Print] hardkey	[Spcl Fctn] hardkey
Trace A Pen: 2 Trace B Pen: 3 Marker A Pen: 5 Marker B Pen: 6 Alpha Pen: 4 Graticule Pen: 1 Trace A Line Type: Solid User Defined line A: -4096 Trace B Line Type: Solid User Defined line B: -4096 Plot Speed: Fast (50 cm/s) User Defined speed: 50 cm/s Page Eject: On	Auto Cal: On Beeper: On Srce 10dB: Out Srce 20dB A: Out Srce 20dB B: Out Srce DAC Atten: 0 dB

These parameters are not affected by [Preset], but are returned to the following values at power-up:

Registers	[User Define] hardkey
Function registers: cleared Constant registers: cleared Data registers: cleared Limit registers: cleared	Memory Size: 8192 bytes Scratch option: Scratch Start Line # (renumber): 10 Increment (renumber): 10 Start Line # (secure): 1 End Line # (secure): 32766

These parameters are retained in non-volatile RAM, so they are not affected by [Preset] or power-up:

[Disk Util] hardkey	[Local/HP-IB] hardkey
Default Disk	Controller Capability Analyzer Address Plotter Address Printer Address
[Spcl Fctn] hardkey	
Time Date	

The Help Key

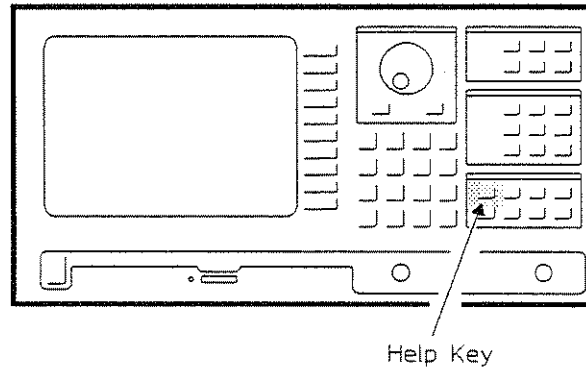

The [**Help**] key provides fast, easy-to-read information about specific instrument controls and features. Using [**Help**] is particularly convenient when you need assistance and you don't have the analyzer's *Getting Started Guide* or *Operating Manual* near at hand.

The [**Help**] key is also a good way to learn about the analyzer (or to refresh your memory if you don't use it often). The help facility also has an index that lets you request information by key name or by topic.



Rear-Panel Overview

Fuse, Voltage Selector, and Line connector

For information about these items, see the *HP 3588A Performance Test Guide*.

HP-IB connector

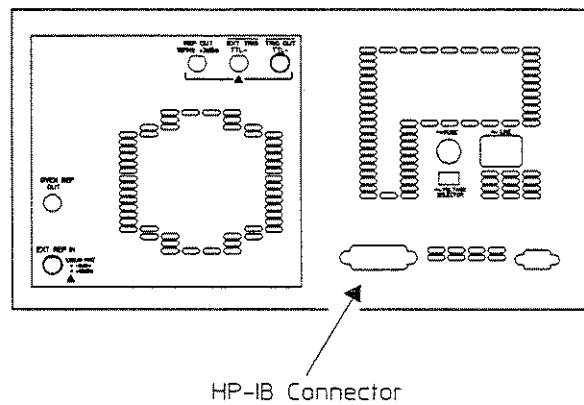

The HP 3588A Spectrum Analyzer is compatible with the Hewlett-Packard Interface Bus (HP-IB). The HP-IB is Hewlett-Packard's implementation of the IEEE Standard 4882.

To connect the analyzer to a compatible HP-IB device, use an HP-IB interface cable. The total allowable transmission path length is 2 meters times the number of devices or 20 meters, whichever is less. Operating distances can be extended using an HP-IB extender.

To learn more about controlling the analyzer over the HP-IB, see the *HP 3588A HP-IB Programming Reference*.

Caution



The analyzer contains metric-threaded HP-IB cable mounting studs as opposed to English threads. Metric-threaded HP-IB cable lockscrews must be used to secure the cable to the analyzer. Metric-threaded fasteners are colored black while English-threaded fasteners are colored silver.

Port 1

This connector is not active at this time.

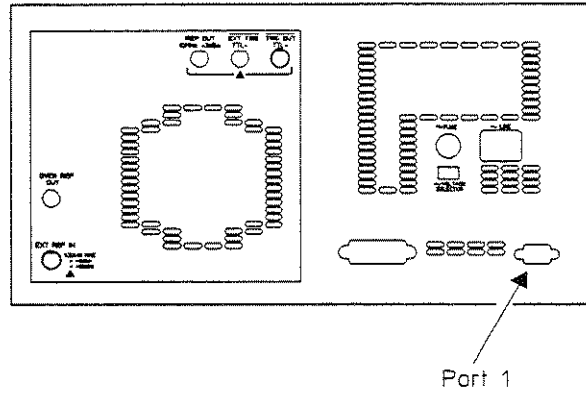

External Reference Input (EXT REF IN)

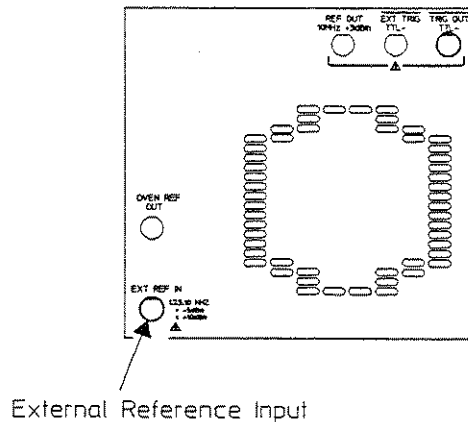

The analyzer has an internal 10 MHz frequency reference that can be locked to the optional temperature-controlled 10 MHz reference or to an external frequency standard. This allows the analyzer to make measurements with even greater frequency accuracy.

If your HP 3588A analyzer is equipped with an optional temperature-controlled reference, there will be an OVEN REF OUT connector on the rear panel. There should be a BNC jumper in place between the EXT REF IN connector and the OVEN REF OUT connector. If the jumper is not connected, the analyzer's internal 10 MHz reference will not be locked to the temperature-controlled reference.

Alternatively, you can connect an external frequency standard to the External Reference Input. This signal must be a 1 MHz, 2 MHz, 5 MHz, or 10 MHz sine or square wave, and should be between -5 dBm and +10 dBm. The impedance is nominally 50Ω, but is not critical.

The REF status indicator (at the lower right-hand corner of the analyzer's screen) is visible when there is a signal applied to the External Frequency Reference connector. If the external reference becomes unstable (or is not at the proper frequency), the REF indicator disappears and an "external reference unlock" message appears on the analyzer's screen.

Oven Reference Output (OVEN REF OUT)

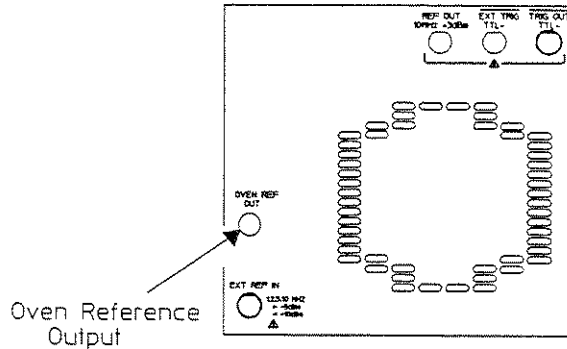

Your HP 3588A analyzer may be equipped with an optional 10 MHz crystal oven. If your analyzer has this temperature-controlled reference, there will be an OVEN REF OUT connector on the rear panel.

There should be a BNC jumper in place between the EXT REF IN connector and the OVEN REF OUT connector. If the jumper is not connected, the analyzer's internal 10 MHz reference will not be locked to the temperature-controlled reference.

Keep in mind that the temperature-controlled reference requires approximately fifteen minutes to warm up. In fact, no signal at all appears at the oven output connector during this warm-up period. So if you've just turned on the analyzer, the analyzer's uses its internal 10 MHz reference until the oven reference is warmed up.

Reference Output (REF OUT)

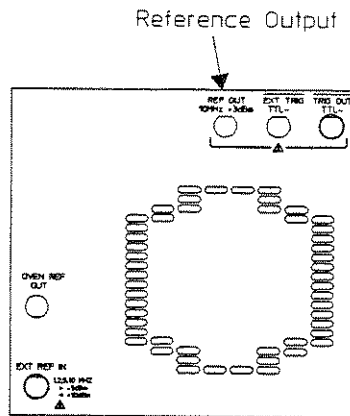

The analyzer's 10 MHz internal reference is available at this connector. This is a +3 dBm signal (nominal) at 50 Ω .

If you connect the REF OUT signal on one analyzer to the EXT REF IN connector on another HP 3588A analyzer, the second analyzer's internal 10 MHz reference will be locked to the first analyzer's 10 MHz reference. A third analyzer can be locked to the second analyzer, and so forth. This arrangement is useful if the first analyzer contains an optional temperature-controlled 10 MHz reference or is locked to an external frequency standard.

To minimize phase noise, do not connect more than several analyzers together in this manner. If it's necessary to synchronize more than several analyzers, you should use an external frequency standard in conjunction with a central distribution network.

External Trigger Input (EXT TRIG)

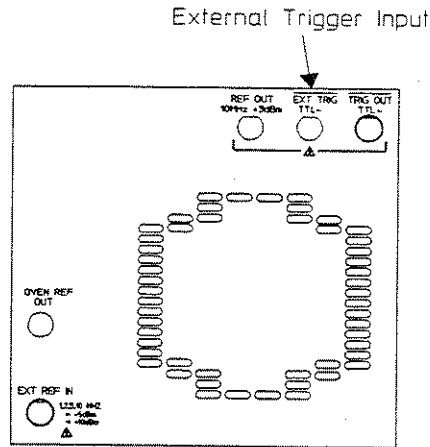

This input lets you synchronize a measurement with an external device. If you've selected the external trigger mode (using the [**Trigger**] hardkey), the analyzer will begin a measurement when the external trigger line goes low (TTL-level signals). A trigger also occurs when you short the center pin to ground (the shell of the EXT TRIG connector).

If you've selected automatic arming, subsequent trigger signals are ignored while the measurement is in progress. If you've selected manual arming, the analyzer ignores trigger signals until you press the [**ARM**] softkey (or send this command via HP-IB).

Trigger Output (TRIG OUT)

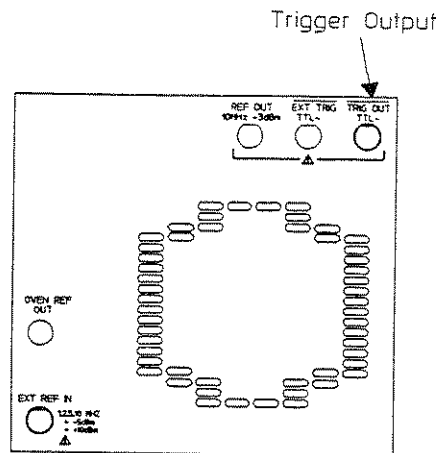

When the analyzer begins a measurement, the TTL-level signal on this connector goes low. This provides a convenient signal to synchronize an external device.

Swept Spectrum Measurements

There are two measurement types available with the HP 3588A Spectrum Analyzer—swept spectrum measurements and narrow band zoom measurements. This chapter explains the swept spectrum measurement type and the measurements you can make with it.

Swept Spectrum Overview

When you select the swept spectrum measurement type, the HP 3588A Spectrum Analyzer functions as a traditional triple-conversion, swept-tuned spectrum analyzer. The specified frequency range extends from 10 Hz to 150 MHz, though you can measure frequencies less than 10 Hz. However, the analyzer's performance below 10 Hz is not specified.

If you've used a swept-tuned spectrum analyzer already, you should have no trouble making measurements with the HP 3588A. And even if you haven't used a spectrum analyzer before, you'll find the HP 3588A quite easy to learn. In either case, you might want to step through some of the sample measurement tasks outlined in the *HP 3588A Getting Started Guide*, if you haven't done so already.

If swept spectrum measurement type is not already selected, simply press [**Preset**]—this is the green hardkey. Since swept spectrum is the default setting, the analyzer is always operating as a swept spectrum analyzer after you've preset the instrument. Alternatively, you can switch to swept spectrum by pressing [**Meas Type**] and then pressing [**SWEPT SPECTRUM**].

Local Oscillator Feedthrough

When viewing frequency spans that start at 0 Hz (or very close to 0 Hz), a spectral line is usually visible at the extreme left of the analyzer's display. This is the local oscillator feedthrough – sometimes called “zero response.” The energy measured here, in the first few display points, is not due to the input signal. Rather, it is energy measured from the analyzer's own local oscillator.

As the analyzer sweeps from 0 Hz, the action of the variable local oscillator and its associated mixer effectively “tune” the analyzer's input to 0 Hz. When the analyzer is tuned to 0 Hz (and only at 0 Hz), the local oscillator is running at the same frequency as the mixer's IF frequency. At this point, some of the local oscillator signal bleeds through the first mixer stage. As a result, this energy passes through the first IF filter and subsequently into the detector stage. This creates a response on the analyzer's display even though no input signal is present.

Local oscillator feedthrough is common to all swept-tuned analyzers. It is not specific to any particular analyzer. Local oscillator feedthrough diminishes as you view frequency spans that start significantly above 0 Hz.

In the HP 3588A, the input is ac-coupled, so the “zero response” is contributed solely by the local oscillator feedthrough – not a combination of dc offset and local oscillator feedthrough if the analyzer had a dc-coupled input.

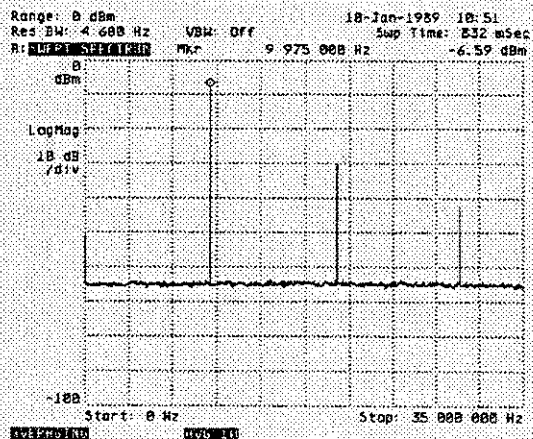

Typical Spectrum Analyzer Display, Showing L.O. Feedthrough at 0 Hz (extreme left)

Oversweep

Unlike traditional swept-tuned analyzers that use analog IF (intermediate frequency) filters, the HP 3588A uses digital IF filters. These digital filters settle in a more predictable way than comparable analog filters. This means the analyzer can make faster measurements—particularly at narrow resolution bandwidths—than spectrum analyzers with analog IF filters.

The inherent predictability of digital IF filters allows the HP 3588A Spectrum Analyzer to use a built-in correction algorithm to “oversweep” its digital filters—yet still maintain both amplitude and frequency accuracy. This allows the analyzer to sweep even faster (up to four times faster than conventional swept-tuned analyzers for comparable measurements).

Oversweep is useful for most measurement situations, and is automatically turned on when you turn on the analyzer. However, slightly inaccurate results may occur when measuring non-stationary signals.

The oversweep feature is not available when the analyzer’s source is on. If oversweep is on, it will be turned off automatically when you turn on the analyzer’s source (this prevents slight measurement inaccuracies). When you turn off the source, oversweep resumes.

To turn off oversweep, press [**Sweep**] and toggle to [**OVERSWEEP ON OFF**]. To turn oversweep on again, toggle to [**OVERSWEEP ON OFF**].

Resolution Bandwidth

Resolution bandwidth—often called RBW—determines the analyzer’s frequency resolution. It also affects how fast the analyzer makes a measurement, since resolution bandwidth affects the analyzer’s sweep time. Normally, resolution bandwidth is adjusted automatically as you select different frequency spans.

Because resolution bandwidth also affects sweep time, manually selecting a narrower resolution bandwidth can slow down a measurement more than necessary. Selecting a resolution bandwidth that is too wide, on the other hand, does not provide adequate resolution and will obscure spectral components that are close together.

Resolution bandwidth is one of the most important parameter settings in a swept-tuned spectrum analyzer. To learn more about resolution bandwidth—and what it does—see the sidebar called “Understanding Resolution Bandwidth and Video Bandwidth.”

Video Filtering and Video Bandwidth

Video filtering is another feature common to many swept-tuned spectrum analyzers. A video filter is a variable bandwidth low-pass filter placed between the analyzer's detector and the display. The amount of video filtering is determined by the video bandwidth—often called VBW.

Video filtering is normally off. To turn on video filtering, press [**Res BW**] and toggle to [**VID FLTR ON OFF**]. Then press [**VIDEO BW**] and use the numeric entry keys or the knob to specify the video bandwidth. The range of available video bandwidth varies, depending on the current resolution bandwidth setting.

It's important to understand the difference between resolution bandwidth and video bandwidth. Narrowing resolution bandwidth reduces noise in a measurement. In contrast, video filtering does not reduce noise—instead, it simply reduces the variation in the noise level, and smooths the noise floor. Video filtering—like resolution bandwidth—also affects the analyzer's sweep time. Using a narrow video bandwidth slows down a measurement considerably.

To learn more about video bandwidth—and what it does—see the sidebar called “Understanding Resolution Bandwidth and Video Bandwidth.”

Bandwidth Coupling

Overview

The automatic adjustment of resolution bandwidth, sweep time, and video bandwidth for different frequency spans is called “bandwidth coupling.” It is an important feature, and one common to most swept-tuned spectrum analyzers.

For example, if you select a 100 kHz to 150 MHz span (a large span) the analyzer automatically selects a resolution bandwidth of 17 kHz. If you select a 100 kHz to 200 kHz span (a much smaller span) the analyzer automatically selects a resolution bandwidth of 580 Hz.

Video bandwidth works the same way. If you’ve turned on video filtering, the analyzer automatically selects an appropriate level of video filtering. For example, if you select a 100 kHz to 150 MHz span, the analyzer selects a video bandwidth of 26 kHz. When you select a 100 kHz to 200 kHz span, the analyzer selects a video bandwidth of 900 Hz.

For most measurement situations, bandwidth coupling provides the best compromise between frequency resolution and speed. And for most measurements, bandwidth coupling is generally preferable since it greatly simplifies your measurement setup. Of course, you can override these automatically-selected settings at any time.

Changing Bandwidth Coupling

You can easily override the current resolution bandwidth or video bandwidth selection by manually entering a setting of your own. For example, to use a different resolution bandwidth, press [**Res BW**], [RES BW], and then use the numeric entry keys or the knob to specify a new resolution bandwidth setting (anywhere from a maximum of 17 kHz to a minimum of about 1 Hz).

If you override a current resolution bandwidth or video bandwidth setting, the analyzer remembers the adjustment you made and uses this adjustment when calculating appropriate resolution or video bandwidths for different spans. For example, if you changed to a narrower resolution bandwidth than the default RBW (the one selected automatically), the analyzer maintains a narrower-than-normal resolution bandwidth for subsequent spans.

To reset the resolution bandwidth coupling to the analyzer’s original settings, press [BW COUPLE PRESET]. This lets you preset bandwidth coupling without having to press [**Preset**]—and losing your current setup state in the process.

Understanding Resolution Bandwidth and Video Bandwidth

Brief Review: Spectrum Analyzers and Radio Receivers

Understanding resolution bandwidth and video bandwidth is often easier if we compare a swept-tuned spectrum analyzer to a general-coverage communications radio receiver. Both devices, at the block level, are actually quite similar. Consider the following:

- The front-end of a swept-tuned spectrum analyzer and a communications radio receiver are nearly identical. Both are superheterodyne devices that use local oscillators and multiple mixing stages to convert the signals of interest down to intermediate frequencies, where fixed-tuned filters can more easily provide good frequency resolution. And like many communications radio receivers, swept-tuned spectrum analyzers use multiple conversion (several IF stages) to more easily reject image frequencies. Both devices can also vary the bandwidth of the final IF filter to control selectivity. In fact, it's only after the detector stage that the circuit diagrams for a typical spectrum analyzer and a radio receiver begin to look quite different.
- Both devices have variable local oscillators to examine frequencies of interest. In the spectrum analyzer, the local oscillator usually sweeps across a range of frequencies (this eventually translates to a visual sweep between the start and stop frequencies of the spectrum you're examining). In the radio receiver, the local oscillator can also be varied, but is set to a single frequency while listening to a particular broadcast station.
- Both devices use a detector after the final IF stage to recover the incoming signal. In a spectrum analyzer, the detected signal is converted to a dc value (representing its amplitude) and then sent to the display-driver circuitry—where you can view the signal on a CRT display. In a radio receiver, the detected signal is demodulated (to recover its original ac modulation) and then sent to an audio amplifier and then to headphones or a loudspeaker that you can use to monitor the signal.

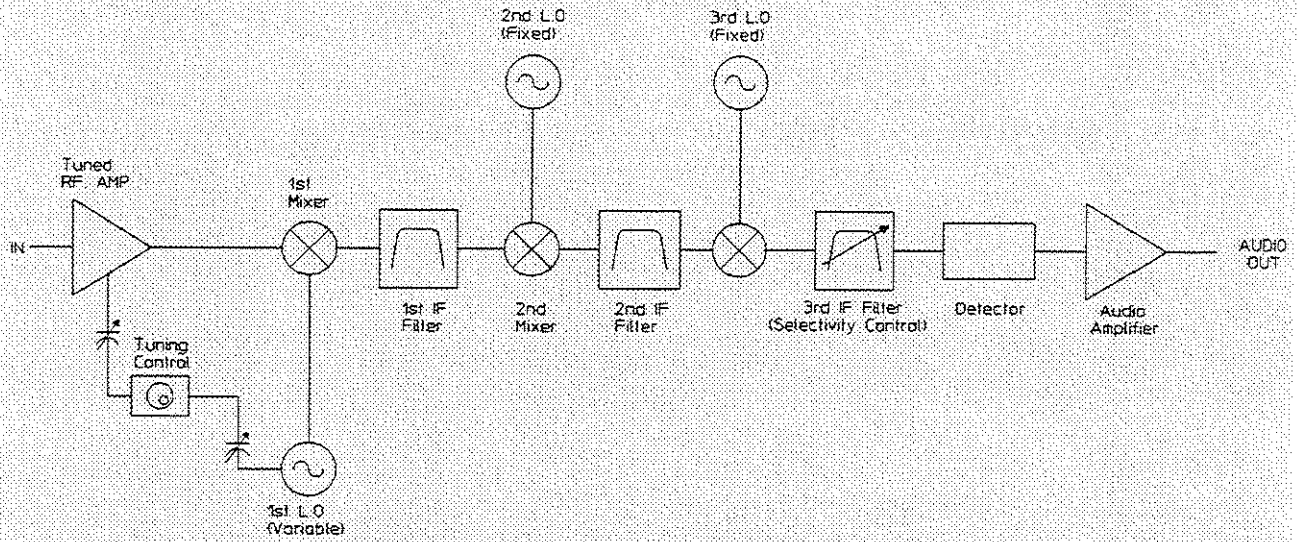

Typical Superheterodyne Communications Radio Receiver

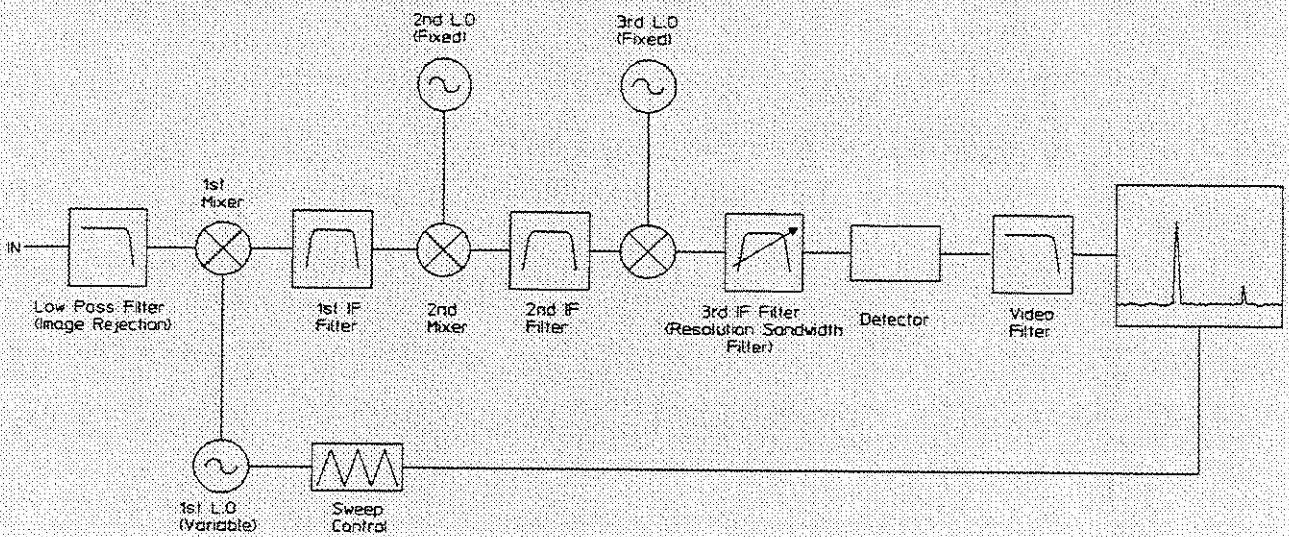

Typical Swept-tuned Spectrum Analyzer

Understanding Resolution Bandwidth and Video Bandwidth (continued)

Resolution Bandwidth versus Video Bandwidth

In the spectrum analyzer, resolution bandwidth is determined by the bandwidth of the analyzer's final IF filter. Video bandwidth is determined by the amount of low-pass filtering used between the spectrum analyzer's detector and the display. In the radio receiver, the resolution bandwidth is analogous to the various settings available for the final IF bandwidth filter (usually called a "selectivity" adjustment). The video filter is analogous to a variable filter placed between the radio receiver's detector and the audio amplifier (though in fact, few radios actually have such a filter).

In the spectrum analyzer, narrowing the resolution bandwidth lowers the noise floor because there is less noise power within the bandwidth of a narrower filter. This occurs because noise is equally distributed across the frequency spectrum, and so the noise floor is lowered as you progressively restrict the range of frequencies fed to the detector circuit. The trade-off is a reduced information bandwidth (the range of frequencies examined at any given time). For a radio receiver, reduced IF bandwidth limits the audio bandwidth of the detected signal, producing poorer-quality audio, but offers greater selectivity and provides a signal with less noise.

In the spectrum analyzer, narrowing the video bandwidth simply reduces the variance in the noise level (if the output of the spectrum analyzer was an analog meter, using video filtering would be equivalent to dampening the meter movement). This smooths the noise level—and in some cases, can reveal low-level signals that might otherwise be obscured. In the radio receiver, video filtering would be analogous to using a low-pass filter before the output amplifier to attenuate the higher frequencies (a "noise filter" or "noise limiter").

Some spectrum analyzers (such as the HP 3588A) are equipped with a "video averaging" feature. This lets you average successive traces. Because both video filtering and video averaging both smooth the noise floor, the results of an averaged measurement without video filtering are often similar to a single trace with video filtering.

Video averaging with the HP 3588A Spectrum Analyzer is an rms exponential average and is actually a better approximation of noise than video filtering. Also, if you need to smooth the noise floor, video-averaged measurements are faster than a single video-filtered trace, since a series of averaged measurements will reveal a complete frequency span much faster than the slower progression of a single, video-filtered trace.

Turning Off Bandwidth Coupling

If you want to turn off bandwidth coupling, press [**Res BW**] and toggle to [**BW COUPLE ON OFF**]. When you turn off bandwidth coupling, you must manually set appropriate resolution bandwidth and video bandwidth settings to make useful measurements.

Keep in mind that when bandwidth coupling is off, you must be careful not to use too fast a sweep time for the current combination of resolution bandwidth and frequency span. If you do so, the **UNCAL** status indicator appears. This indicates an uncalibrated sweep—this reminds you that the analyzer is sweeping too fast to ensure an accurate measurement.

Sweep Time

Sweep time is the time required for the analyzer to complete one full sweep on the display. Normally, sweep time is adjusted automatically. The analyzer selects an appropriate sweep time, based on the frequency span and the resolution bandwidth you have selected.

You can also set the sweep time manually. Simply press [**Sweep**] and [**SWEEP TIME**], then enter a value for sweep time. If you select a sweep time that's too fast for the current frequency span and resolution bandwidth settings, the UNCAL status message appears in the lower right hand corner of the display. This indicates that the analyzer is sweeping too fast to make an accurate measurement.

On some spectrum analyzers, sweep time is called “scan time.” Also, sweep time is sometimes expressed as “sweep speed” or “sweep rate”— expressed either in hertz/second or time/graticule division.

Note



When the analyzer's peak detector is on, increasing the sweep time can cause apparent increases in the noise floor level—assuming you hold the span and resolution bandwidth constant. With longer sweep times, the analyzer spends more time detecting peaks for a given display point. This increases the chance that a larger peak will be detected, if the frequencies represented by the display point contain only noise energy.

To learn more about the peak detector and its function, see “The Peak Detector” sidebar later in this chapter.

Peak Detecting and Display Resolution

What is a peak detector and why is one needed?

The measurement results that you view on the HP 3588A's CRT screen are actually made up of 401 evenly-spaced discrete points. For swept spectrum measurements, these 401 points represent the continuous range of frequencies that the analyzer evaluates during each frequency sweep – extending from the currently-selected start frequency to the currently-selected stop frequency. For narrow band zoom measurements, these 401 points are the results obtained from the analyzer's FFT algorithm (see chapter 5). The analyzer always uses 401 points to represent measurement data, regardless of selected frequency span or measurement type.

During swept spectrum measurements, the analyzer evaluates all frequencies within its displayed frequency span but is only able to display 401 points. During a swept measurement, the analyzer's peak detector looks for a peak between two display point frequencies and transfers the amplitude of this peak to a nearby display point. This ensures that all measured spectral peaks are visible.

For narrow band zoom measurements, peak detection isn't needed. All frequencies within a Narrow Band Zoom measurement span are evaluated, due to the nature of the FFT algorithm. To learn more about Narrow Band Zoom measurements, see chapter 5.

Digital Storage

All spectrum analyzers require some form of display storage to retain, on a CRT screen, the relatively slow-moving results of a swept spectrum measurement. Early spectrum analyzers used CRTs with long-persistence phosphors (or storage meshes behind the CRT face) to maintain a visible trace throughout an entire frequency sweep. Modern spectrum analyzers use digital technology to convert the analog output from an analyzer's video detector to binary numbers in an internal memory. These values are then displayed on the analyzer's CRT screen.

Although digital storage requires a display with a finite number of display points, there are tremendous advantages to digitizing measurement results. Many functions, such as trace math, were unobtainable with older spectrum analyzers. Digitizing measurement results also makes it easy to save and recall traces and to transfer measurement data to other instruments (for example, over the HP-IB).

The 401-point Display

As we mentioned earlier, the analyzer always displays measurement data with a 401-point resolution – even though the analyzer does evaluate all frequencies within its displayed frequency span. The peak detector, in effect, compensates for the limited display resolution.

To better understand the concept of display resolution, move the main marker from display point to display point. Notice how the marker jumps to each point – you cannot put the marker between points. As you move the marker, also notice how the marker readout steps through a series of discrete frequencies that corresponds to each display point.

For each frequency span, the analyzer assigns a discrete frequency value to each display point by dividing the current frequency span by 400. The analyzer then uses the specified start frequency to calculate nominal frequency values for each of the remaining 400 points.

When the peak detector finds a spectral peak between the nominal frequencies that define a pair of display points, it transfers the amplitude of this peak to a nearby display point. The analyzer moves any peak detected between two display points to the leftmost display point for each pair of display points.

The Relationship between Frequency Resolution and Display Resolution

For swept spectrum measurements, your ability to resolve two closely-spaced components—that is, the analyzer's ability to place each component on its own display point—may be limited by the display resolution. However, the maximum resolution obtainable is actually determined by the resolution bandwidth you've selected. As you select increasingly narrower spans, the display resolution improves until the point where you reach the maximum resolution available with the current resolution bandwidth setting.

For narrow band zoom measurements, the analyzer's frequency resolution is determined by the combination of frequency span and the zoom type (high-accuracy or high-resolution). As you narrow your measurement span, your frequency resolution increases. To learn more about narrow band zoom measurements, see chapter 5.

Resolution limited by current resolution bandwidth setting: If the resolution bandwidth is insufficient to reveal two closely-spaced components, the peak detector simply sees these two components as a single frequency and displays them on a single display point. The amplitude of the two components is combined, though it varies from sweep to sweep as the phase relationship between the two components changes.

Resolution limited by current display resolution: If the display resolution is insufficient to reveal two closely-spaced components—but the current resolution bandwidth setting does provide enough resolution to distinguish two separate components—the peak detector takes the larger of the two components and places it on a single display point. However, were you to narrow the span enough—keeping the resolution bandwidth constant—you would be able to view two discrete frequency components as the display resolution improved.

When should you turn off the peak detector?

The peak detector is normally on (it defaults to on when you turn on the analyzer). You should use the peak detector for all spectrum measurements—if you don't, you won't be able to see spectral peaks that occur between the display point frequencies.

To turn off the peak detector, press [Meas Type] and toggle to [PEAK DET ON **OFF**]. To avoid a slight frequency skew when making scalar network measurements, turn off the peak detector. You may also want to turn off the peak detector when making certain types of noise measurements—though when you use the analyzer's noise marker, the peak detector is automatically disabled for the duration of the noise marker calculation.

The Peak Detector and the noise floor

Since the analyzer keeps positive peaks and rejects negative peaks when the peak detector is on, the average level of random noise appears to increase. This effect is more pronounced for longer sweep times. When the analyzer spends more time sweeping, there is an increased probability that it will detect more positive excursions of the noise.

Use the noise level function to measure the true energy of the noise floor (the peak detector is disabled while analyzer calculates the noise level). To make a noise level measurement, press [Marker Fctn] and toggle to [NOISE LVL **ON OFF**]. After you turn on the noise level function, the marker readout indicates noise (normalized to a 1 Hz bandwidth) for the current marker position. To learn more about the noise level function, see chapter 6, "Marker Functions."

Manual Sweep

For swept spectrum measurements, sweep times can be very long for small spans—particularly when using a narrow resolution bandwidth. If you press [**Sweep**] and then toggle to [**SWEEP AUTO MAN**], you can disable the analyzer's automatic sweep and enable manual sweep. Manual sweep lets you tune the analyzer to a discrete frequency. This lets you measure the amplitude of discrete frequencies without waiting for the analyzer to sweep through an entire span—a considerable advantage when using both a narrow resolution bandwidth and a narrow video bandwidth.

Manual sweep is also useful when making automated measurements. Using manual sweep dramatically reduces measurement time since it's much faster to transfer amplitude data for a single frequency over the HP-IB rather than sending data for the entire 401-point display.

When using manual sweep, the analyzer is, in effect, a fixed-tuned receiver. You can change the tuned frequency with the knob or by entering a discrete frequency with the numeric entry keypad. You can also step through a series of discrete frequencies by setting the step size accordingly. To learn more about all this, see chapter 8, "Manual Sweep."

Zero Span

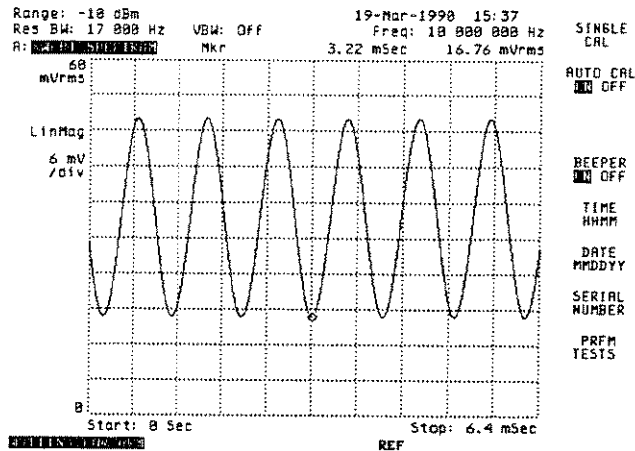

Overview

In Zero Span mode, the analyzer's local oscillator remains at a single frequency—in other words, the analyzer acts as a fixed-tuned receiver. This is similar to manual sweep mode. But unlike manual sweep mode (in which you examine a signal at a only one display point), zero span lets you examine a signal on all 401 display points and in the *time domain* as well.

Zero span lets you view the amplitude of a test signal or amplitude modulation of a fixed carrier. To tune to a desired frequency, simply press [CENTER] and enter an appropriate frequency with the knob or the numeric entry keypad.

Zero Span is the only measurement type where measurement data is shown in the *time domain*, not the frequency domain. When looking at a zero span trace, the vertical axis still represents amplitude, but the horizontal axis represents time. This lets you view the amplitude of a test signal versus time. Here are a few applications:

- Observing the amplitude modulation of a carrier frequency.
- Checking the long-term amplitude stability of a test signal.
- Adjusting a filter or other network to pass (or stop) a particular frequency.
- Adjusting the frequency of a test signal to match a frequency reference (by adjusting the beat frequency to 0 Hz).

Note



Zero span is available only when the analyzer is making swept spectrum measurements. It is not available when making narrow band zoom measurements.

Special Considerations for Zero Span

For successful measurements in zero span mode, keep in mind the following characteristics:

- *Narrow resolution bandwidth settings can make it difficult to locate a test signal.* If there are no other signals near your test signal, use the maximum resolution bandwidth (17 kHz). Otherwise, you may have difficulty finding your test signal—particularly if you haven't set the center frequency to exactly the same frequency as your test signal. Because the analyzer functions as a fixed-tuned receiver in zero span, the analyzer's "tuning" is too sharp with a narrow resolution bandwidth to detect a test signal that isn't exactly at the specified center frequency.
- *Narrow resolution bandwidth settings provide selectivity to exclude closely-spaced signals.* If you carefully set the center frequency, you can use a narrow resolution bandwidth to exclude signals that are close to the frequency of your test signal.
- *For modulated signals, use a resolution bandwidth setting wide enough to reveal the modulation.* If you're using zero span to view amplitude modulation of a carrier frequency, make sure you've adjusted the resolution bandwidth setting wide enough to include the modulated signal. Modulation frequencies greater than one-half the current resolution bandwidth may not be visible—these frequencies are attenuated more than 3 dB and therefore fall outside the passband of the resolution bandwidth filter.
- *Select appropriate trace type.* If you want to measure amplitude in dBm, use the logarithmic magnitude trace type. If you want to measure amplitude in volts, use the linear magnitude trace type. When viewing modulation waveforms use linear magnitude trace type—the logarithmic magnitude scale distorts the shape of the displayed modulation trace.
- *Use manual trigger arming to freeze the zero span trace.* When viewing modulation waveforms in zero span, you can use manual trigger arming to freeze the trace. This makes it easier to examine the display since the analyzer does not make another measurement until you press [ARM].

Narrow Band Zoom Measurements

There are two measurement types available with the HP 3588A Spectrum Analyzer—swept spectrum measurements and narrow band zoom measurements. This chapter explains the narrow band zoom measurement type and the measurements you can make with it.

Introduction

If you've used a swept-tuned spectrum analyzer before, you already know that measurements of small frequency spans are very time-consuming. Traditionally, swept-tuned analyzers have required very long sweep times for small frequency spans, due to the narrow resolution bandwidths required to provide adequate frequency resolution. The narrower the resolution bandwidth, the more time it takes for the resolution bandwidth filters to settle. In fact, a swept-tuned analyzer's sweep time is proportional to the square of the resolution bandwidth. As you choose increasingly narrower resolution bandwidths (for example, when trying to resolve close-in sidebands) the time it takes to make a measurement *increases exponentially*. This characteristic is common to all conventional swept-tuned spectrum analyzers.

However, the HP 3588A Spectrum Analyzer can make narrow band measurements very quickly with narrow band zoom. This lets you make measurements for small spans (40 kHz and less) much faster than you can with a swept spectrum measurement. For narrow band zoom measurements, the analyzer uses an FFT (Fast Fourier Transform—an implementation of the Discrete Fourier Transform) to convert the input data from the time domain to the frequency domain. The result is measurement capability more than thirty times faster than conventional swept-only analyzers.

Narrow Band Zoom is ideal for narrowband analysis of close-in sidebands. And it's easy to do. First set the analyzer's center frequency to the carrier frequency you want to examine. Then press [Meas Type] and then [NARROW BAND ZOOM].

Setting the Center Frequency

Narrow band zoom measurements are particularly useful when examining modulation or noise sidebands of a spectral component. The easiest way to position a frequency span when using narrow band zoom is to specify the center frequency. For example, to place a 40 kHz span around a 10 MHz component, you simply press [Freq], [CENTER], and enter 10 MHz.

To measure a series of equally-spaced components—a series of harmonics, for example—you can step the center frequency and examine each harmonic and its close-in sidebands. To do this, you must first set the step size to the fundamental's frequency. To learn how to use this technique, see “Modifying the Step Size” in chapter 7, “Measurement Enhancements.”

High-Accuracy Zoom versus High-Resolution Zoom

When making narrow band zoom measurements, you can select a high-accuracy zoom or a high-resolution zoom. The default selection is high-accuracy zoom.

If you need to measure the absolute or relative amplitude of a spectral component with great accuracy—for example, when using a fixed sine stimulus—use high-accuracy zoom. Simply press [Res BW], then select [HI ACCRCY ZOOM].

If it's more important to measure a component's frequency, use high-resolution zoom. Simply press [Res BW], then select [HI RES ZOOM].

Generally, high-resolution zoom offers greater resolution than the high-accuracy zoom. However, the shape factor of the filters used does affect the detection of very small signals if a much larger signal is present. So for looking at close-in sidebands, you may find that you get better resolution using *high-accuracy zoom*, rather than high-resolution zoom.

Marker Functions

The Main Marker

The analyzer's main marker lets you determine the absolute frequency and amplitude of a spectral component. As you move the marker with the knob, the marker readout tells you the frequency and the amplitude of the component at the current marker position.

There's also an offset marker. When you turn on the offset marker, the main marker indicates frequency and amplitude values relative to the offset marker position.

The Offset Marker

You can use the offset marker to find the amplitude and frequency of one frequency component relative to another—for example, the relationship between a fundamental frequency and its harmonic.

Zeroing the offset marker at one point provides the reference point for the main marker. Until you rezero the offset marker at another point, the zero position remains where you set it—even if you turn the offset marker off and then back on again. But the zero position will be lost if you press [**Preset**] or turn the analyzer off.

When you press [**ZERO OFFSET**], the analyzer uses the current main marker position—both x-axis and y-axis values—to anchor the offset marker. However, if you've turned on the analyzer's frequency counter, the offset marker will be zeroed at the counted frequency. And if you've turned on the noise level marker, the offset marker will be zeroed at the noise level reading.

The analyzer also keeps the zero point *even if this point is no longer within the current frequency span*. For example, you can zero the offset marker at 10 MHz, and then change to a span that starts at 50 MHz and stops at 70 MHz—and the marker readout will still provide the offset from 10 MHz.

The ability to keep the zero point when the zero point is no longer within the current span is very useful. This lets you step through several narrow spans to find low-level harmonics after initially zeroing on the fundamental. To learn more about this, see “Locating signals quickly by stepping [**CENTER FREQUENCY**]” in chapter 7, “Measurement Enhancements.”

Marker Readout

The marker readout provides the amplitude and frequency values for the current marker position. When the offset marker is on, the marker readout indicates amplitude and frequency relative to the point where you zeroed the offset marker.

For zero span measurements, the marker readout shows time, not frequency.

To turn off the marker and the marker readout, toggle to [**MARKER ON ON**]. If you print or plot when the marker is off, the marker and marker readout will not be included on the printout or plot.

The marker's frequency value is only as accurate as the current display resolution—for maximum accuracy, use the frequency counter. To learn more about the frequency counter, see “Frequency Counter” later in this chapter. To learn more about display resolution and frequency resolution, see the sidebar on peak detection in chapter 4, “Swept Spectrum Measurements.”

Marker-to-peak

To locate the frequency component with the greatest amplitude, press [MKR --> PEAK]. The analyzer then moves the main marker to this peak.

Marker-to-next-right-peak, Marker-to-next-left-peak

Press [NXT RIGHT PEAK] to move the main marker to the next peak to the right of the current marker position. Press [NXT LEFT PEAK] to move the main marker to the next peak to the left of the current marker position.

The “next right peak” or “next left peak” must be a minimum distance from the current marker location and a minimum height above the noise floor. These minimums are defined by a peak search algorithm. If the requirements of the algorithm are not met, the marker doesn't move.

Autoscaling is sometimes necessary to reveal additional peaks.

Marker-to-center-frequency

Press [MKR --> CTR FREQ] to make the current main marker position the new center frequency. To place the center frequency more accurately, turn on the frequency counter before pressing [MKR --> CTR FREQ]. When the counter is on, the analyzer uses the counter frequency as the new center frequency.

Setting the center frequency accurately makes it easier to locate components when you select increasingly smaller frequency spans—particularly when switching to narrow band zoom measurements. Alternatively, you can use [SIGNAL TRK ON/OFF] to keep the largest component at the center when using smaller spans. See “Signal Tracking” in chapter 7, “Measurement Enhancements.”

Center frequency is also important when making measurements using Zero Span and Manual Sweep. To learn about Zero Span, see chapter 4, “Swept Spectrum Measurements.” To learn about Manual Sweep, see chapter 8, “Manual Sweep.”

Offset-to-span

The offset marker-to-span feature lets you quickly display a frequency span of interest, without specifying start or stop frequencies. Simply zero the offset marker at the point where you want the new span to start, and place the main marker on the desired stop point. After pressing [OFS MKR --> SPAN], the analyzer creates a new span based on the position of the offset and main markers.

Peak Track

When peak tracking is on, the analyzer automatically moves the main marker to the peak spectral line every time a new spectrum is displayed. To turn on peak tracking, toggle to [PEAK TRK **ON** OFF].

Peak track is available for both Swept Spectrum and Narrow Band Zoom measurements.

You can also use peak tracking for manual sweep. In manual sweep, peak track updates the marker—via marker readout—every time the display is updated with the manual sweep result.

Note

Peak track will turn the marker ON if it is not already ON.



Frequency Counter

Overview

When you turn on the frequency counter, the marker readout no longer reflects the nominal frequency value for the display point. Rather, the analyzer calculates a more accurate frequency value every time it sweeps past the marker position. If the offset marker is on, the counter shows the frequency offset from the offset marker position.

To turn on the frequency counter, press [**Marker Fctn**] and toggle to [**FREQ CNTR ON OFF**].

The frequency counter is especially useful for accurately entering a frequency value during numeric entry. If you've turned on the counter, the analyzer uses the frequency counter—not the marker position—when you press [**Marker Value**]. As we mentioned earlier, setting the center frequency accurately is particularly important before making narrow band zoom measurements.

Counting Behavior

When the counter is on for swept measurements, the analyzer sweeps to the marker position, counts, and then completes the sweep. If you've selected manual sweep, the analyzer simply counts the currently-tuned manual frequency. During narrow band zoom measurements, the analyzer completes one measurement and then counts.

When a count has been completed, the marker readout is labeled “Cntr” and its x-axis value is highlighted.

The frequency counter only counts data from the current input spectrum. If you select trace data that is not linked to the input spectrum—for example, the contents of a data register—no count value is displayed.

Noise Level

Overview

For swept spectrum measurements, you can use the noise level function to measure noise density. To make a noise level measurement, press [**Marker Fctn**] and toggle to [**NOISE ON OFF**].

After you turn on the noise level function, the marker readout indicates rms noise spectral density (normalized to a 1 Hz bandwidth) at the main marker position. When the offset marker is on, the noise level readout is relative to the offset marker position.

During swept spectrum measurements, the analyzer sweeps to the marker position, measures the noise level, and then completes the sweep. The noise density measurement is independent of the current resolution bandwidth, sweep speed, or frequency span.

If you've selected manual sweep, the analyzer simply measures noise at the current manual frequency.

Special Considerations

The following conditions must be met before the analyzer can accurately measure noise level:

- The noise you are measuring must be random noise.
- The analyzer's resolution bandwidth must be narrow enough to exclude any discrete signals (such as tones) from the noise measurement.
- The analyzer's resolution bandwidth must be narrow enough to resolve a relatively flat portion of the noise floor—this is particularly important when you are measuring low-frequency noise or phase noise.
- If you're using a logarithmic magnitude trace type, the analyzer expresses noise level in units of dBm/Hz—this is the amount of power for a 1 Hz-wide spectrum. For a linear magnitude trace type, the analyzer expresses noise in units of V/rt(Hz)—that is, volts per square root of Hertz.

What is Random Noise Spectral Density?

Theoretically, a complex random noise signal consists of an infinite number of frequency components. Each component in such a signal would contribute an infinitesimal amount to the total power.

If you could measure such a random noise signal with a spectrum analyzer having an infinitesimally narrow bandwidth, the noise reading would be zero at all frequencies. Conversely, if you could measure random noise with a spectrum analyzer having an infinite bandwidth, the noise reading would be infinite!

Since all physical systems have finite bandwidths, these two measurement extremes are never encountered. However, the theory here does reveal something about the nature of noise—and it shows you how it's possible to characterize a finite quantity of random noise with respect to a specific measurement bandwidth. And it also shows why the level of noise is directly proportional to the measurement bandwidth.

In physics, density is used to describe quantity per unit volume, unit area, or unit length. In the same way, density is applied to noise theory to characterize the amount of noise (usually, as power) per unit of bandwidth.

We know that we can't really measure the noise power at a specific frequency—since no spectrum analyzer has a measurement resolution so narrow that it can exclude every frequency but one. But we can easily measure the average value of the total noise normalized to a relatively-narrow measurement bandwidth. And if this narrow measurement bandwidth is narrow enough to resolve a flat portion of the noise power spectrum, we can assume that the average noise power is directly proportional to the analyzer's noise power bandwidth.

Noise power bandwidth is the ideal rectangular filter bandwidth having the same power response as the actual gaussian-shaped filter. In the HP 3588A, this is 1.06 times the true 3 dB-bandwidth established by the current resolution bandwidth setting.

Noise Measurements and Trace Data

The noise level marker can only measure noise in the current input spectrum. If you select trace data that is not linked to the current input spectrum—for example, the contents of a data register—no noise value is displayed.

If you view trace data that is linked to the input spectrum—for example, a normalized spectrum or a function definition that uses an input spectrum—the noise level marker is still available. However, the noise level reading will *not* be corrected to reflect the normalized measurement or math function performed.

Since the analyzer's noise level function provides noise density only at the current marker position, you must use trace math to generate an entire trace normalized to a 1 Hz bandwidth. To do this, you can divide the input spectrum by the square root of the noise bandwidth (NBW) to generate a noise spectral density trace. NBW is a calculated value that changes with the current measurement setup. To learn more, see “Trace Math” in chapter 7, “Measurement Enhancements.”

Limit Testing

Overview

A limit test is a line (or set of lines) that you create to check the performance of a signal source or a device-under-test. When limit testing is on, the analyzer compares a current measurement or a stored trace to the limit you've selected.

A limit appears as a single line (upper or lower limit) or two lines (upper and lower limit). If a trace exceeds the boundaries of these lines, the limit test fails. Limit testing is useful for go/no go checking since a limit test quickly tells you if your device-under-test passes or fails a particular limit test.

You can build a limit line—an upper limit, a lower limit, or set of both upper and lower limits—in several different ways:

- By using the knob (or numeric entry) to arbitrarily construct a limit line.
- By saving a trace, recalling it as a limit, and shifting this newly-created limit up or down to form an upper or lower limit.
- Via HP-IB.

To learn how to build limits, see chapter 6, “Limit Testing” in the *HP 3588A Getting Started Guide*.

Absolute and Relative Limits

There are two ways you can use a limit—as an *absolute* limit or as a *relative* limits. Once you've created a limit, you can use it as an absolute limit or a relative limit, depending on your current measurement situation.

Absolute limits always remain at a fixed amplitude. Use an absolute limit, for example, to make sure a test signal does not exceed a specific amplitude.

Relative limits, on the other hand, are not tied to a specific amplitude. If you make a limit relative, its position on the screen does not change when you change the reference level. You can use a relative limit, for example, to check the relative levels of a test signal's harmonic distortion—or to check the shape (but not the insertion loss) of a filter.

Measurement Enhancements

Scalar Network Measurements

Introduction

You can use the analyzer's built-in source to make swept frequency-response measurements. This is a good way to characterize the amplitude versus frequency response of filters, amplifiers, and other electronic devices. To learn more about making scalar network measurements—and to step through a sample measurement task—see the *HP 3588A Getting Started Guide*.

Note



The HP 3588A Spectrum Analyzer performs scalar (amplitude-only) network measurements. You cannot use the analyzer to make phase measurements.

Special Considerations for Scalar Network Measurements

For successful scalar network measurements with the HP 3588A Spectrum Analyzer, be sure to do the following:

- *Turn Off Autoranging.* Press [**Range/Input**] and then toggle to [**AUTORANGE ON OFF**]. If you don't turn off autoranging, the analyzer will try to adjust its input range as the output of the test device changes—and consequently will be unable to complete a measurement.
- *Specify input range.* Press [**Range/Input**] and then [**RANGE**]. Then use the knob or numeric keypad to specify an input range appropriate for your test device.
- *Specify source amplitude.* Press [**Source**] and toggle to [**SOURCE ON OFF**] to turn on the source. Then press [**SOURCE AMPLITUDE**] and use the knob or numeric keypad to specify an appropriate level. Select an output level appropriate for your test device—if your device has gain, set the source amplitude an appropriate level below the top of the input range to avoid overloading the input.
- *Turn off the peak detector.* Press [**Meas Type**] and toggle to [**PEAK DET ON OFF**]. This turns off the analyzer's peak detector. The peak detector, while necessary for most measurements, should not be used for most scalar network measurements. Otherwise, a slight frequency skew will occur. To learn more about the peak detector, see the sidebar on peak detection in chapter 4, "Swept Spectrum Measurements."

Normalization

For maximum accuracy in a scalar network measurement, you can subtract any anomalies introduced by the test fixture. Normalization also cancels out minor amplitude flatness errors in the analyzer's source.

Normalization is necessary only when you want to measure insertion loss and amplitude flatness of a test device with great precision. For general device characterization, it's not really necessary.

To make a normalized measurement, remove your test device and replace it with a barrel connector. This removes your test device from the measurement path. Now make a network measurement (without the test device)—this reveals the amplitude errors introduced by the test fixture and the analyzer's source. Don't forget to record the results by pressing [**Trace Data**] and [**SAVE NORM REFERENCE**].

Afterwards, replace your test device and make another network measurement. Then press [**Trace Data**] and [**NORMALIZED SPECTRUM**]. This lets you view the response of the test device with the amplitude errors removed (normalized). To learn more about normalizing a scalar network measurement—and to step through a sample normalization sequence—see the *HP 3588A Getting Started Guide*.

Trace Math

Overview

Trace math lets you perform a variety of operations on current (or stored) traces. You can use trace math to modify the results of a spectrum measurement—for example, to compensate for a fixed gain (or loss) in a measurement system.

You can also use trace math to normalize measurement results for scalar network analysis. However, this really isn't necessary since the analyzer performs the normalization process automatically when you use the [SAVE NORM REFERENCE] and [NORMALIZED SPECTRUM] softkeys (see “normalization” earlier in this chapter).

A math function can contain the current input spectrum, a stored trace, or a constant. You can also use the square root of the current noise bandwidth (NBW) to generate a noise spectral density trace—this is useful when you need an entire trace normalized to a 1 Hz bandwidth. By the way, NBW is a calculated value that changes with the current measurement setup (you can see this value by viewing the setup state).

Special Considerations

It's not difficult to use trace math, but there are some things you should know before building your own math functions:

- Math functions are specified by entering the definition with operands and operators in infix (standard algebraic) notation.
- Constants must be defined as real numbers.
- To view the results of a trace math operation, press [Trace Data] and use the appropriate softkeys to call up the results for a particular math function.
- To exit any math menu without affecting any function of constant definitions, simply press any hardkey.

Using Logarithmic Values with Trace Math

Keep in mind that the analyzer performs trace math in linear units, not logarithmic units. This is true regardless of trace type (linear or logarithmic). For logarithmic trace displays, all math operations occur *before* the analyzer converts measurement data from linear to logarithmic units. This is important when you need to add (or subtract) units with logarithmic values—for example, if you need to compensate for a gain or loss in your measurement system.

Suppose you want to add 3 dB to your measurement results. You can't build a math function that simply adds 3 dB since math operations are done with linear units. Instead, you must take the input spectrum and multiply it by antilog of the offset (in dB) that you want. This converts the 3 dB to linear units—and you can express this offset as $10^{x/20}$, where x is the dB offset.

So if you want to add 3 dB, you must multiply the input spectrum by 1.413. If you want to subtract 3 dB, you can divide the input trace by 1.413 (or conversely, you could multiply the input spectrum by 0.707).

Video Averaging

Overview

When averaging is on, the analyzer combines the results of the most recent measurement—that is, a single frequency sweep or one Narrow Band Zoom measurement—to the accumulated results of previous measurements. Once averaging is on, it continues until you turn off averaging. It does not stop automatically after a certain number of averages.

Video averaging does not lower the actual noise level. However, it does *smooth* the noise floor and, in some cases, can reveal low-level components that would be obscured by the more uneven noise floor of an unaveraged measurement.

Averaging in the HP 3588A is an exponential average. This means the number of averages you select determines the weighting of old data versus new data, not simply the total number of averages calculated. As you increase the number of averages, new data is weighted less. Exponential averaging is particularly useful for tracking data that changes over time.

To calculate the average, the analyzer uses this formula:

$$\text{next value} = \frac{1}{N} (\text{new value}) + \frac{N-1}{N} (\text{current value})$$

where N is a weighting factor (the number of averages you've specified).

Special Considerations

With exponential averaging, it's important to set the number of averages carefully. If there are too few averages in the measurement, the averaging will not smooth out variances. But if there are too many averages, the analyzer may not track subtle changes occurring within the data.

For example, if you set N to 100, the new sweep data is weighted by 1/100 and the current data by 99/100. You can see that for this example, each successive sweep does not change the trace very much. If you change the input signal, the displayed trace will show these changes very slowly.

Now consider another example—setting N equal to 5. Here the new sweep data is weighted by 1/5 and the current data by 4/5. In this case, each sweep can make a considerable difference to the trace. If you change the input signal, the displayed trace will show these changes much more quickly.

Peak Hold

When you turn on the peak hold function, the analyzer shows the maximum amplitude value recorded for each point in the display. The analyzer updates these results after each measurement, and continue to do so until you turn off peak hold.

Peak hold is a convenient way to measure the frequency drift of a particular spectral component. You might want to zero the offset marker at this frequency component when you first turn on peak hold—this makes it easier to find the point where the signal drifted *from*.

By the way, do not confuse peak hold with *peak track* or *signal track*. Peak hold provides the maximum values at each display point. Peak track moves the main marker to follow the largest signal (see chapter 6, “Marker Functions”). And signal track changes the center frequency to follow a changing signal.

Signal Track

Like the peak hold feature, signal track is also useful when measuring drifting signals. But signal tracking doesn't just show how far a peak has drifted—it actually changes the analyzer's center frequency to follow the drifting signal.

When you turn on signal track, the analyzer changes its center frequency automatically to track the peak (the component with the largest amplitude in the current measurement span). To turn on signal track, press [Freq] and then toggle to [SIGNAL TRK ON OFF].

The effect of signal track is similar to the effect you would get by continuously pressing [MKR PEAK] and then [MKR CTR FREQ]. The difference, of course, is that the analyzer can do this quickly enough to ensure that signal track occurs once for each measurement.

Special considerations:

- In order for the analyzer to track a drifting signal, drift must be less than the current span divided by the sweep time.
- Signal track is not available for manual sweeps.

Modifying the Step Size

If you press [**Freq**], you will see the [**STEP SIZE AUTO/USER**] and [**USER STEP SIZE**] softkeys. These two softkeys are very useful, since you can use them to select your own step size. This makes it much easier (and faster) to perform certain measurements—especially if you use the frequency counter to more accurately set the step size.

As we mentioned in chapter 2, step size controls the “sensitivity” of both the knob and the arrow keys. By “sensitivity” we mean the interval between each numeric entry as you turn the knob.

You can modify the default step size to better select the following parameters:

- Center frequency.
- Start frequency.
- Stop frequency.
- Manual frequency.

toggling to [**STEP SIZE AUTO USER**] and then setting your own step size is particularly useful just before you step through *center frequency* or *manual frequency*. As you’ll see in a moment, setting your own step size makes it easy to locate harmonics of a test signal.

To learn about step size and manual sweep measurements, see chapter 8, “Manual Sweep.”

Locating signals quickly by stepping [**CENTER FREQUENCY**]

For measurements with relatively small spans, it’s often necessary to quickly move to a different center frequency outside the current span. For example, suppose you’re using a narrow span to look at close-in modulation products of a test signal. If you wanted to look for similar modulation products for a harmonic of this test signal, you could manually enter a different center frequency. But there’s a much faster and more accurate way—by setting your own step size.

If you’re looking at harmonics, you can use the frequency counter to more accurately characterize the fundamental frequency. The lets you locate the harmonics easier—particularly for narrow band zoom measurements—by stepping though different center frequencies.

Use the following sample task to discover this useful measurement enhancement.

SAMPLE TASK: Modifying step size to position the center frequency

This task demonstrates how to set step size to quickly change the center frequency. This method is useful for both swept spectrum and narrow band zoom measurements. In the example here, we'll examine a test signal and its harmonics.

1. Press [**Preset**].

Pressing [**Preset**] returns most of the analyzer settings to their default positions.

2. Connect the signal source to the analyzer's input.

In the example here, we've used a 10 MHz signal from an RF generator. The frequency and amplitude of the signal is not critical.

Our test signal is amplitude-modulated by a 1 kHz sine wave.

3. Press [**Marker**]

This moves the marker to the fundamental.

[**MKR --> PEAK**].

4. Press [**Marker Fctn**].

This turns on the frequency counter.

Then toggle to
[**FREQ CNTR ON OFF**].

5. Press [**Marker**]

This moves the fundamental to the center of the current span. Because the counter is on, the analyzer uses the counted frequency for the new center frequency.

[**MKR --> CTR FREQ**].

6. Press [**Meas Type**]

[**NARROW BAND ZOOM**].

7. Press [Freq].

Toggle to [STEP SIZE AUTO **USER**].

Press [USER STEP SIZE]

[Marker Value].

8. If you need to, you can

press [SPAN] and use the knob or the arrow keys to move to a smaller frequency span.

9. Press [CENTER].

Now press use the arrow keys to step to the test signal's harmonics.

You've just specified your own step size—a step size that's equal to the fundamental's frequency.

Remember, if you press [Marker Value] during numeric entry, the analyzer uses the counted frequency.

In the example here, we changed to a 10 kHz span. We also turned on video averaging.

Each press of the up arrow key steps you to a higher harmonic.

Each press of the down arrow key steps you back through the lower harmonics—until you return to the fundamental again.

You can go back to the fundamental, turn on the offset marker, and measure the relative amplitude of each harmonic.

Low-distortion mode

Overview

All spectrum analyzers introduce low-level distortion products to the signals they are measuring—the relative level of these products varies, but all analyzers introduce them. Since these distortion products are very low, you can ignore them in many measurement situations.

However, the distortion contribution of an analyzer becomes important when you are measuring spectral components that are within 10 dB of the analyzer's published distortion specifications. In these measurement situations, using low-distortion mode can improve your measurement results.

What does it do?

Low-distortion mode automatically configures the analyzer to make the lowest distortion measurement possible. No other adjustments are necessary.

Although low-distortion mode lets you make the lowest distortion measurement possible, it cannot *eliminate* the possibility that the analyzer may contribute very small amounts of distortion to your measurement. To learn about the maximum distortion that the analyzer may contribute, see the HP 3588A's published specifications.

Additional Considerations

Here's what else you should know:

- When you turn on the low-distortion mode, the analyzer's noise floor increases. However, you can offset this increase by narrowing the resolution bandwidth (swept spectrum measurements) or by selecting "high-resolution zoom" (narrow band zoom measurements).
- Low-distortion mode is not available when using the analyzer's 1M Ω input.
- You can't toggle to [**AUTORANGE ON OFF**] while in low-distortion mode. However, you can perform a single autorange by pressing [**SINGLE AUTORANGE**].

Manual Sweep

Introduction

For swept spectrum measurements, sweep times can be very long for small spans—particularly when using a narrow resolution bandwidth. If you press [**Sweep**] and then toggle to [**SWEEP AUTO MAN**], you can disable the analyzer's automatic sweep and enable manual sweep. Manual sweep lets you tune the analyzer to a discrete frequency. This lets you measure the amplitude of discrete frequencies without waiting for the analyzer to sweep through an entire span—a considerable advantage when using both a narrow resolution bandwidth and a narrow video bandwidth.

Manual sweep is particularly useful when making automated measurements. Using manual sweep may reduce measurement time if you simply want to check the amplitude of several discrete frequencies—that's because it's faster to transfer amplitude data for a few frequencies over the HP-IB rather than sending data for the entire 401-point display.

When using manual sweep, the analyzer is, in effect, a fixed-tuned receiver. You can change the tuned frequency with the knob or by entering a discrete frequency with the numeric entry keypad. You can also step through a series of discrete frequencies by setting the step size accordingly.

Using Manual Sweep

In manual sweep, the analyzer's local oscillator remains at a single frequency—in other words, the analyzer acts as a fixed-tuned receiver. To tune to a desired frequency, simply press [MANUAL FREQ], then enter an appropriate frequency with the knob or the numeric entry keypad. Generally, you should use the numeric keypad to select an approximate manual frequency—then use the knob to search for a peak near the target frequency. In effect, you're using the knob to “fine-tune” the local oscillator.

You can change the *sample time* by pressing [SAMPLE TIME] and using the knob or numeric entry keypad to specify a new value. The sample time is the time the analyzer takes to characterize the manual frequency. If you select a shorter sample time, it's easier to use the knob to adjust the manual frequency. However, you should use longer sample times (greater than $1/\text{RBW}$) when you're making averaged measurements with manual sweep—this ensures independent samples for each measurement and provides more accurate noise averaging.

Measurements made with manual sweeping take longer to set up, but can take much less time to measure than with automatic (normal) sweeping—particularly with narrow resolution bandwidths. Use manual sweep, for example, when you want to:

- Measure the amplitude of a specific frequency, without waiting for the analyzer to sweep through unwanted frequencies.
- Jump from frequency to frequency without waiting for the analyzer to sweep through unwanted frequencies. And if you use the offset marker, you can quickly measure the relative amplitudes of these frequencies as well.
- Adjust the output amplitude of a signal generator.
- Adjust a filter or other network to pass (or stop) a particular frequency.

Special Considerations for Manual Sweep

For successful manual sweep measurements, keep in mind the following characteristics:

- *Narrow resolution bandwidth settings can make it difficult to locate a test signal.* If there are no other signals near your test signal, use the maximum resolution bandwidth (17 kHz). Otherwise, you may have difficulty finding your test signal—particularly if you haven't set the center frequency to exactly the same frequency as your test signal. Because the analyzer functions as a fixed-tuned receiver in manual sweep, the analyzer's "tuning" is too sharp with a narrow resolution bandwidth to detect a test signal that isn't exactly at the specified center frequency.
- *Narrow resolution bandwidth settings provide selectivity to exclude closely-spaced signals.* If you carefully set the center frequency, you can use a narrow resolution bandwidth to exclude signals that are close to the frequency of your test signal.
- *Narrow resolution bandwidths settings provide better noise reduction.* Use a narrow resolution bandwidth to lower the noise floor—this maximizes the dynamic range.
- *Select appropriate trace type.* If you want to measure amplitude in dBm, use the logarithmic magnitude trace type. If you want to measure amplitude in volts, use the linear magnitude trace type.
- *You can use the frequency counter and the noise level function.* Both the frequency counter and the noise level marker are available in manual sweep—although using either will slow your measurement.
- *The manual frequency you specify must be within the current span.* If you specify a manual frequency that is outside the current span, the analyzer "snaps" the manual frequency to the nearest available frequency. For example, if you specify a manual frequency *below* the current span, the analyzer sets the manual frequency to the span's start frequency. Conversely, if you specify a manual frequency *above* the current span, the analyzer sets the manual frequency to the span's stop frequency.
- *The sample time is important for averaged measurements.* When making averaged measurements, you should set the sample time greater than $1/\text{RBW}$. This ensures independent samples for each measurement and provides more accurate noise averaging.

The Manual Measurement Point

The manual measurement point is the display point (one of 401 points) that represents the current manual frequency. As you change the manual frequency, the manual measurement point changes.

When you toggle to manual sweeping, the analyzer stops updating the measurement trace for all display points except the manual measurement point. If the amplitude of the manual frequency changes slightly, the manual measurement point “wiggles.”

To learn more about display points, see chapter 4, “Swept Spectrum Measurements.”

Stepping the Manual Frequency

You can step the manual frequency to quickly measure equally-spaced signals over a wide span. Using manual sweep lets you use a narrow resolution bandwidth to lower the noise floor—thus maximizing the dynamic range. This lets you make a measurement much faster than you could using the analyzer’s automatic sweep.

Use the following sample task to learn how to step the manual frequency.

SAMPLE TASK: Stepping the Manual Frequency over a Wide Span

This task demonstrates how to step the manual frequency to measure equally-spaced signals in a wide span. In the example here, we'll characterize the harmonics of a 1 MHz signal using manual sweep. After the initial setup, this type of measurement can be performed in several seconds—but a comparable measurement using automatic sweep would take over a minute!

1. Press [**Preset**].

Pressing [**Preset**] returns most of the analyzer settings to their default positions.

2. Connect the signal source to the analyzer's input.

In the example here, we've used a 1 MHz signal from an RF generator. The frequency and amplitude of the signal is not critical.

3. Press [**Freq**].

In the example here, we selected a span of about 10 MHz, starting at 100 kHz.

Use the [**START**], [**STOP**], or [**SPAN**] softkeys to select an appropriate frequency span.

4. Press [**Res BW**] and select a resolution bandwidth of 290 Hz.

Using a RBW of 290 Hz provides good frequency resolution, but slows the measurement considerably.

In a few moments, we'll make a measurement with the same resolution bandwidth, but make it much faster using manual sweep.

5. Press

[**BW COUPLE PRESET**].

This returns to the default setting for resolution bandwidth.

If you need to review bandwidth coupling, see "Bandwidth Coupling" in chapter 4, "Swept Spectrum Measurements."

6. Press [**Marker**]

This moves the marker to the fundamental.

[**MKR --> PEAK**].

Manual Sweep
Stepping the Manual Frequency

7. Press [**Marker Fctn**].

Then toggle to
[**FREQ CNTR ON OFF**].

8. Press [**Freq**].

Toggle to [**STEP SIZE AUTO USER**].

Press [**USER STEP SIZE**]

[**Marker Value**].

9. Press [**Sweep**].

Then press
[**MANUAL FREQ**]

[**Marker Value**].

10. Press [**Marker Fctn**].

Then toggle to
[**FREQ CNTR ON OFF**].

11. Toggle to

[**SWEEP AUTO MAN**].

12. Press [**Res BW**] and select a
resolution bandwidth of
290 Hz.

This turns on the frequency counter.

You've just specified your own step size—a step size that's equal to the fundamental's frequency.

Since the counter is on, the analyzer uses the counted frequency when you press [**Marker Value**].

You've just set the manual frequency to the fundamental frequency.

Even though we haven't yet toggled from automatic to manual sweep, the analyzer will accept a manual frequency value.

This turns off the frequency counter.

The counter is no longer needed—we used it here simply to set both the center frequency step size and the manual frequency more accurately.

This turns on manual sweep.

We've again narrowed the resolution bandwidth to 290 Hz. But now that we're using manual sweep, this narrow RBW doesn't slow the measurement as much.

13. Press [**Sweep**] again.

Now use the arrow keys to step through each harmonic.

14. Use the arrow keys to return the manual frequency to the fundamental.

Now press [**Marker**]

[**ZERO OFFSET**].

15. Press [**Sweep**].

Again, use the arrow keys to step through each harmonic.

Each press of the up arrow key steps you to a higher harmonic.

Each press of the down arrow key steps you back through the lower harmonics—until you return to the fundamental again.

If you can't find some of the higher harmonics, your test signal may have drifted somewhat. You can use a wider resolution bandwidth to find them—you can go back and re-enter the manual frequency and the frequency step size more accurately.

If you accidentally step below or above the current span, the analyzer resets the manual frequency. If this happens, you will have to reset the manual frequency—use the numeric entry keys and the knob to do so.

You can go back to the fundamental, turn on the offset marker, and measure the relative amplitude of each harmonic.

Now you can measure the relative levels of each harmonic.



Key Reference

How to use this chapter

This chapter contains the same information as the analyzer's on-line help facility. Like on-line help, there are definitions here for both hardkeys and softkeys—and information about more general topics. Also included are softkeys that appear when your instrument is equipped with the HP Instrument BASIC option.

This chapter is arranged alphabetically. To find an individual hardkey or softkey, simply use this chapter as you would a dictionary. The topic entries are also arranged alphabetically and are mixed with the hardkey and softkey entries.

If you don't know the name of a hardkey, a softkey, or a topic entry, use the index at the back of this book. The index is where you should go to locate information by concept. The index also guides you to related information in the first eight chapters of this book.

Key Reference

[ABORT HP-IB] softkey

Key Path: [Local/HP-IB]

Press [ABORT HP-IB] to halt any HP-IB activity initiated by the analyzer.

[ABORT PLOT/PRNT] softkey

Key Path: [Plot/Print]

Press [ABORT PLOT/PRNT] to stops the current plot or print operation before it is completed.

[Active Trace] hardkey

The analyzer has two independent display buffers for trace data: trace A and trace B. The [Active Trace] hardkey allows you to toggle between these two buffers, making one active and the other inactive, so they can be modified separately.

When you use a two-trace format, annotation fonts and line types indicate which trace is active. A bold font and solid line are used for the active trace. A ghosted font and dotted line are used for the inactive trace. When you use the single-trace screen format, only the active trace is displayed.

With a few exceptions, the softkeys grouped under the following hardkeys only affect the active trace:

- [Trace Type].
- [Trace Data].
- [Scale].
- [Marker].
- [Marker Fctn].

[ADDRESSBL ONLY] softkey

See Controller Capability softkey group.

Alpha entry menu

The alpha entry menu and its submenus provide access to special characters and string editing functions when the analyzer is in the alpha entry mode.

[ENTER] accepts the current string and exits the alpha entry mode. [CANCEL/RETURN] abandons the string and exits alpha entry. [CLEAR ENTRY] deletes the string, but does not exit alpha entry.

[DELETE CHARACTER] deletes the character under the cursor. [INSERT SPACE] inserts a space to the left of the cursor. The two “Morechars” softkeys bring up submenus for inserting special characters to the left of the cursor.

[UPPERCASE lowercase] specifies whether alpha characters (entered by pressing redefined hardkeys) should be upper-case (A-Z) or lower-case (a-z).

Alpha entry mode

Some analyzer keys prompt you to enter a text string. Once you have pressed such a key, the analyzer enters alpha entry mode and remains there until you accept or abandon the string. You accept the string by pressing [ENTER]. You abandon the string by pressing [CANCEL/RETURN].

Most hardkeys are redefined as alpha characters when the analyzer is in alpha entry mode. Engraved letters, adjacent to the lower right corners of these keys, tell you which characters they will insert in a string.

The [Help], [Preset], number, decimal point, and [Back Space] hardkeys are not redefined, but the [+/-] hardkey is. It inserts a minus (or dash) in the string rather than toggling a number between positive and negative values.

Hint: Use the knob to change the position of the text cursor when you edit a string.

Additional characters and editing functions are made available via the alpha entry menu.

[ALPHA PEN] softkey

Key Path: [Plot/Print] —> [DEFINE PLOT] —> [DEFINE PLOT PENS]

Press [ALPHA PEN] to specify which plotter pen should be used for plotting the instrument state and the disk catalog.

When you plot a trace, the alpha pen is used for the state information (at the top of the screen) and for any status or error information.

Key Reference
[AMPLITUDE STEP] softkey

[AMPLITUDE STEP] softkey

Key Path: [Source]

Use [AMPLITUDE STEP] to define the effect of the knob and arrow keys on the value of [SOURCE AMPLITUDE]. You are prompted to define the effect in dB of amplitude change.

The value of [AMPLITUDE STEP] determines the smallest amplitude change possible when you turn the knob slowly. It also determines the amplitude change that results when you press an arrow key once.

[ANALYZER ADDRESS] softkey

Key Path: [Local/HP-IB]

Press this softkey when you want to change the analyzer's HP-IB address. A prompt is displayed so you can enter the new address.

Note



The analyzer's address is saved in non-volatile memory, so it is retained when you turn the analyzer off and on.

The range of valid addresses for the analyzer includes all integer values from 0 through 30.

[ARM AUTO/MAN] softkey

Key Path: [Trigger]

Press this softkey to toggle between automatic and manual arming of the analyzer's triggering system.

The analyzer's hardware must settle before the triggering system can be armed. If you select automatic arming, the analyzer arms itself immediately after settling. If you select manual arming, the analyzer pauses after settling and waits for you to arm the trigger with the [ARM] softkey.

Hardware settling occurs each time you change the frequency span and—for swept spectrum measurements—each time a new sweep begins. Settling time increases when you decrease the span, resolution bandwidth, or video bandwidth.

[ARM] softkey

Key Path: [Trigger]

Press the [ARM] softkey to enable triggering when manual arming is selected.

If you press [ARM] before the message “WAITING FOR ARM” is displayed (in the lower-left corner of the screen), the key-press is ignored.

Note

The “WAITING FOR ARM” message is obscured when HP-IB echo is turned on.



[AUTO CAL ON/OFF] softkey

Key Path: [Spcl Fctn]

Press [AUTO CAL ON/OFF] to enable and disable the analyzer’s autocalibration function (autocal).

Note

Autocal is enabled automatically whenever you turn the analyzer on or press the [Preset] hardkey.



When autocal is enabled, the analyzer is automatically calibrated several times during the first hour of operation. After the first hour, it is automatically calibrated at one-hour intervals. When autocal is disabled, the analyzer is only calibrated when you press [SINGLE CAL].

Automatic calibrations do not interrupt narrow band zoom or noise level measurements. They only start after these measurements are complete.

Key Reference
[AUTO MEMORY] softkey

[AUTO MEMORY] softkey

Key Path: [User Define] —> [UTILITIES]

Press [AUTO MEMORY] to automatically allocate stack space for your program.

Hint: If you press [MEMORY SIZE], the value displayed in the resulting entry box tells you how many bytes of volatile RAM was allocated.

[AUTO MEMORY] provides a convenient way to allocate stack space for programs you develop in the analyzer or load via the HP-IB. If the automatically-set value is not adequate, use [MEMORY SIZE] to change it.

Note



If you encounter the message “ERROR 2 Memory overflow.” while your program is running, you need to allocate more stack space.

[AUTO SCALE] softkey

Key Path: [Scale]

Each time you press the [AUTO SCALE] softkey, the active trace is rescaled and repositioned vertically to provide the best display of your data.

“Best display” is determined by an autoscaling algorithm, which changes the values of [REFERENCE LEVEL] and [VERTICAL/DIV]. The new values are used until you do one of the following:

- Manually enter a new value for either parameter.
- Press [AUTO SCALE] again.
- Toggle reference level tracking from off to on.
- Change the input range while reference level tracking is on.

[AUTORANGE ON/OFF] softkey

Key Path: [Range/Input]

Press [AUTORANGE ON/OFF] to enable and disable continuous autoranging.

When continuous autoranging is on, the analyzer monitors the level of your input signal and selects the best input range for that signal. It changes the range under these circumstances:

- If the signal level increases enough to overdrive the input circuitry, the analyzer selects a less sensitive input range.
- If the signal level decreases enough to compromise dynamic range, the analyzer selects a more sensitive range.

Note

If you change the range manually, autoranging is turned off.



Continuous autoranging is not available when low-distortion mode is enabled or when the 1 megohm input impedance is selected. However, single autoranging is available for low distortion mode.

Note

Turn autoranging off when you are making a scalar network measurement.



Key Reference
[Avg/Pk Hld] hardkey

[Avg/Pk Hld] hardkey

Press this hardkey for access to the analyzer's video average and peak hold functions. Both allow you to combine the results of several measurements in one trace.

[VIDEO AVERAGE] and [PEAK HOLD], like all other softkeys in bracketed groups, are mutually exclusive. You can't select them both at the same time. Select [OFF] if you don't want either function to be active.

[Back Space] hardkey

Use [Back Space] to correct mistakes in the following situations:

- When entering or editing a text string: Press [Back Space] to delete the character to the left of the cursor.
- When entering a number: Press [Back Space] to delete the last digit of the number.
- When defining a math function: Press [Back Space] to delete the last operator or operand in the definition.

[BEEPER ON/OFF] softkey

Key Path: [Spcl Fctn]

Press [BEEPER ON/OFF] to enable and disable the analyzer's beeper.

An enabled beeper emits an audible tone when some messages are displayed. Also, if [FAIL BEEP ON/OFF] is ON during limit testing, an enabled beeper emits an audible tone when a trace falls outside the specified limits.

[BLANK ANNOTATN] softkey

Key Path: [Format]

Each trace box is surrounded by fields that define the trace within that box. These fields are collectively referred to as trace annotation. Press the [BLANK ANNOTATN] softkey to turn this annotation off.

Note



You must preset the analyzer to turn on blanked annotation from the front panel. You must send DISP:ANN ON over the HP-IB to turn on blanked annotation without presetting.

Fields surrounding the trace box contain the following information:

- Directly above—marker readouts.
- Directly below—x-axis labeling.
- To the left—y-axis labeling.

When trace annotation is turned off, these fields are not displayed on the screen and they are not printed or plotted.

[BLANK DISPLAY] softkey

Key Path: [Format]

With the exception of the softkey labels, all information on the analyzer's screen can be blanked (turned off). You can accomplish this by pressing the [BLANK DISPLAY] softkey.

Note



You must preset the analyzer to turn on a blanked screen from the front panel. You must send DISP ON over the HP-IB to turn on a blanked screen without presetting.

When the screen is blanked, the message "Display Blanking On" replaces all other information. Only this message is plotted or printed.

Key Reference
[BW COUPLE ON/OFF] softkey

[BW COUPLE ON/OFF] softkey

Key Path: [Res BW]

Press [BW COUPLE ON/OFF] to enable and disable bandwidth coupling.

When bandwidth coupling is on, the analyzer automatically adjusts the resolution bandwidth, video bandwidth, and sweep time when you change the frequency span.

Note

Bandwidth coupling is not active during narrow band zoom measurements.



The order of dependency among coupled parameters (from least dependent to most) follows:

Span —> Resolution BW —> Video BW —> Sweep Time

Span is completely unaffected when another coupled parameter changes. Sweep time is affected when *any* other coupled parameter changes.

Note

Video bandwidth is always coupled to resolution bandwidth, even when coupling is turned off.



If you change the value of a dependent parameter, a new relationship is established between that parameter and the one that precedes it in the dependency-chain. If bandwidth coupling is on, the analyzer attempts to maintain the new relationship when the less-dependent parameter changes.

For example, if you select a narrower-than-normal resolution bandwidth for the current span, the analyzer automatically selects a narrower-than-normal resolution bandwidth for all subsequent spans.

Hint: You can return the coupled parameters to their default relationships by pressing the [BW COUPLE PRESET] softkey.

[BW COUPLE PRESET] softkey

Key Path: [Res BW]

Press [BW COUPLE PRESET] to restore the optimum relationships between the following parameters (even when bandwidth coupling is disabled):

- Frequency span.
- Resolution bandwidth.
- Video bandwidth.
- Sweep time.

The optimum relationships provide the best compromise between frequency resolution and speed for most swept spectrum measurements.

Note



The analyzer automatically maintains the relationship between coupled parameters if you enable bandwidth coupling.

The optimum relationships between coupled parameters follow:

- resolution bandwidth (RBW) = span / 100
- video bandwidth = RBW * 1.54
- sweep time = (span / RBW²) / 2 (with oversweep on)
- sweep time = (span / RBW²) * 2 (with oversweep off)

When the analyzer cannot realize the optimum RBW, it selects the next largest available RBW. When it cannot realize the optimum sweep time, it selects the shortest available time that can provide calibrated measurement results.

Key Reference
[CATALOG ON/OFF] softkey

[CATALOG ON/OFF] softkey

Key Path: [Save/Recall] or [Disk Util]

This softkey toggles the disk catalog on and off. The catalog describes the contents of the default disk in a tabular format.

The catalog header includes the disk's volume name, formatting time and date, and available space. The file descriptions include each file's name, size (in bytes), and type. They also include each file's last-changed time and date.

You can simplify many file operations by turning the catalog on. When the catalog is on, you can select one of the listed files with the knob. Then when you request a file operation that prompts for a filename, the name of the selected file is automatically placed in the prompt.

The catalog is turned off automatically when you do any of the following:

- Eject a flexible disk whose catalog is being displayed.
- Press any hardkey in the MARKER, DISPLAY, or MEASUREMENT group.
- Press any hardkey other than [Save/Recall] or [Disk Util] in the SYSTEM group.

[CENTER] softkey

Key Path: [Freq]

The function of the [CENTER] softkey depends on the analyzer's zero span state:

- Zero span selected: The analyzer acts as a fixed-tuned receiver. [CENTER] tunes the receiver to the frequency you want to analyze.
- Zero span not selected: The analyzer acts as a spectrum analyzer. [CENTER] defines the center of a frequency band you want to analyze.

[CENTER] and [SPAN] act together to define a frequency band; the current value of one softkey is held constant when you change the value of the other. You can also use [START] and [STOP] to define a band, but [CENTER] and [SPAN] are more convenient when you are zooming on a single peak in the spectrum.

Hint: Press [CENTER] to change x-axis annotation from start/stop to center/span.

The range of values for [CENTER] is 0 Hz to 150 MHz (although the analyzer's performance is not specified below 10 Hz). You can change [CENTER]'s value in the usual ways, but with the following enhancements:

- You can control the sensitivity of the knob and arrow keys with [STEP SIZE AUTO/USER] and [USER STEP SIZE].
- You can set [CENTER] to the marker's current x-axis value with the [Marker Value] hardkey. (Pressing the [MKR --> CTR FREQ] softkey has a similar effect.)

Certain combinations of [CENTER] and [SPAN] can define x-axis limits that are outside the range of 0 to 150 MHz. (For example, a lower limit of 5 MHz results when [CENTER] = 5 MHz, [SPAN] = 20 MHz.) When this happens, any portion of a trace that falls outside the range is blanked (not displayed).

Change sign [(+ / -)] hardkey

This hardkey has two functions:

- When you are changing a numeric parameter: Press this hardkey to toggle your entry between positive and negative values or to change the sign of an exponent.
- When you are changing a text string: Press this hardkey to insert a dash (or minus sign) to the left of the cursor.

Changing numeric parameters

You can change the value of numeric parameters in the following ways:

- Enter a value with the number keys.
- Step the current value up or down with the arrow keys.
- Scroll the current value up or down with the knob.

Note



Scrolling a value is similar stepping a value with one important exception: the numeric entry softkey's entry box *must* be displayed before you turn the knob.

Some numeric parameters can also be changed using the [Marker Value] hardkey. If a parameter can be changed in this way, it is noted under the softkey description.

[CLEAR ENTRY] softkey

Press this softkey to delete all characters from a text string during alpha entry.

[CLEAR INP TRIP] softkey

Key Path: [Range/Input]

Press the [CLEAR INP TRIP] softkey to reset (close) the analyzer's input-protection relay.

The input-protection relay is tripped (opened) if the signal level at the INPUT connector is significantly above the maximum input range. A message on the screen tells you when the relay has been tripped.

[CLEAR SCREEN] softkey

Key Path: [User Define] —> [DISPLAY FORMAT]

Press this softkey to clear the portion of the screen allocated to your HP Instrument BASIC program.

[CLEAR SRCE TRIP] softkey

Key Path: [Source]

Press the [CLEAR SRCE TRIP] softkey to reset (close) the analyzer's source-protection relay.

The source-protection relay is tripped (opened) if the signal level at the SOURCE connector is significantly above the maximum source amplitude or if excessive dc voltage is present. A message on the screen tells you when the relay has been tripped.

[CONFIRM DELETE] softkey

Key Path: [Marker Fctn] —> [LIMIT TEST] —> [DEFINE UPPER LIM] —> [DELETE ALL]

or: [Marker Fctn] —> [LIMIT TEST] —> [DEFINE LOWER LIM] —> [DELETE ALL]

Press this softkey to confirm your intention to delete a limit.

[CONSTANT (K1-K5)] softkey (Math)

Key Path: [Math] —> [DEFINE Fx]

When you are defining a function, press [CONSTANT (K1-K5)] to gain access to the [CONSTANT Kx] softkeys. These softkeys let you specify the contents of corresponding constant registers as function operands.

See also Operand Menu.

[CONSTANT (K1-K5)] softkey (Trace Data)

Key Path: [Trace Data]

Press [CONSTANT (K1-K5)] for access to the [Kx] softkeys. Each [Kx] key displays the magnitude of a constant you have defined.

Note

Constants are defined under the [Math] hardkey.



Key Reference
[CONSTANT Kx] softkeys

[CONSTANT Kx] softkeys

Key Path: [Math] —> [DEFINE Fx] —> [CONSTANT (K1-K5)]

When you are defining a function, press one of the [CONSTANT Kx] softkeys to specify the contents of the corresponding constant register as an operand. The abbreviation “Kx” is added to the end of the definition.

[CONTINUE] softkey

Key Path: [User Define]

or: [User Define] —> [DEBUG]

Press [CONTINUE] to resume execution of a paused program. Execution resumes from the point at which the program was paused.

Note



You can only continue a paused program. However, you can restart any program from its first statement by pressing [RUN].

Controller Capability softkey group

Key Path: [Local/HP-IB]

Use the softkeys in this group to specify whether the analyzer should be the system controller in your HP-IB system. The following general rules will help you decide which key to select:

- Select [SYSTEM CONTROLLER] if you want to initiate plotting or printing from the analyzer's front panel.
- Select [SYSTEM CONTROLLER] if you want to control other HP-IB devices with an HP Instrument BASIC program.
- Select [ADDRESSBL ONLY] if you want to operate the analyzer via an external HP-IB controller.

Copy Disk softkeys

Key Path: [Disk Util]

[COPY DISK] just displays a menu. The menu contains all the softkeys you need to copy the contents of one disk to another disk:

- [SOURCE DISK] prompts you for the disk specifier of the disk you want to copy.
- [DESTIN DISK] prompts you for the disk specifier of the disk that will receive the new copy.
- [PERFORM DISK COPY] copies the contents of the source disk to the destination disk.

Note



Any files on the destination disk are overwritten (lost) when you press [PERFORM DISK COPY].

When a disk prompt is displayed, it already contains the specifier for the default disk. You can use the specifier in the prompt or modify it with the alpha entry keys. Since you can not copy a disk onto itself (for example, INT: to INT:), you must modify the specifier in one of the prompts.

You must increase the size of the destination disk if it isn't large enough to accept the contents of the source disk. You do this by reformatting the destination disk using a different format option.

Copy File softkeys

Key Path: [Disk Util]

[copy file] just displays a menu. The menu contains all the softkeys you need to create a new copy of a file:

- [SOURCE FILENAME] prompts you for the name of the file you want to copy.
- [DESTIN FILENAME] prompts you for the name you want to give the new copy.
- [PERFORM FILE COPY] creates a new copy of a file based on your entries in the two filename prompts.

Source and destination files are assumed to be on the default disk unless you precede filenames with disk specifiers. Use specifiers when you want to copy from one disk to another.

Hint: To copy all files from one disk to another, use the [COPY DISK] softkeys.

When a filename prompt is displayed, it already contains a name. If the catalog is off, the prompt contains the filename last entered. If the catalog is on, the prompt contains the name of the file currently highlighted. You can use the name in the prompt or modify it with the alpha entry keys.

Key Reference
[COUPLE TO INPUT Z]

[COUPLE TO INPUT Z]

See Output Impedance softkey group.

[DASHED] softkey

See [LINE TYPE] softkeys.

[DATA REG (D1-D8)] softkey (Math)

Key Path: [Math] —> [DEFINE Fx]

When you are defining a function, press [DATA REG (D1-D8)] to gain access to the [DATA REG Dx] softkeys. These softkeys let you specify the contents of corresponding data registers as function operands.

[DATA REG (D1-D8)] softkey (Trace Data)

Key Path: [Trace Data]

Press [DATA REG (D1-D8)] for access to the [Dx] softkeys. Each [Dx] key displays the contents of one of the analyzer's eight data registers.

You can use options under the [SAVE TRACE] and [RECALL TRACE] softkeys to load any data register. You can use [SAVE NORM REFERENCE] to load D8.

[Data Reg Dx] softkeys

Key Path: [Math] —> [DEFINE Fx] —> [DATA REG (D1-D8)]

When you are defining a function, press one of the [DATA REG Dx] softkeys to specify the contents of the corresponding data register as an operand. The abbreviation "Dx" is added to the end of the definition.

See also Operand Menu.

Data registers

The analyzer has eight data registers: D1 through D8. Each register holds a complete trace, one that you have saved from the current measurement or recalled from a disk. The trace in a register can be displayed directly or it can be used as an operand in a function.

Caution



The data registers are cleared each time you turn the analyzer off. Copy important traces to any disk (except the volatile RAM disk) before power-down or they will be lost.

[DATE MMDDYY] softkey

Key Path: [Spcl Fctn]

Press [DATE MMDDYY] to display the current date at the top of the screen. The date is read from the analyzer's battery-backed clock.

After pressing this softkey, you can enter a new date with the number keys. The date must be entered in the format noted on the softkey label: the first two digits set the month, the second two digits set the day, the last two set the year. Here's an example:

August 3, 1990—Press [DATE MMDDYY], [0], [8], [0], [3], [9], [0], [ENTER]

[DEBUG] softkey

Key Path: [User Define]

[DEBUG] displays a menu. The softkeys in the menu help you locate and correct errors in your HP Instrument BASIC program.

The Debug menu keeps [RUN] and [CONTINUE] from the main HP Instrument BASIC menu and adds the following softkeys:

- [SINGLE STEP] lets you execute your program one line at a time.
- [LAST ERROR] lets you examine the last error number and message generated by your program.
- [EXAMINE VARIABLE] lets you examine the current value of any program variable.
- [RESET] lets you reset HP Instrument BASIC to its default state.

Key Reference
Decimal point [(.)] hardkey

Decimal point [(.)] hardkey

This hardkey has two functions:

- When you are changing a numeric parameter: Press this hardkey to enter a decimal point.
- When you are changing a text string: Press this hardkey to insert a period (or decimal point) to the left of the cursor.

[DEFAULT DISK] softkey

Key Path: [Save/Recall]

or: [Disk Util]

This softkey displays a menu that allows you to select a default disk. Whenever you request operations that require disk access—things like saving and renaming files—the analyzer performs these operations on the default disk.

You can override the default disk selection by including a disk specifier in any filename or device prompt. But if you select the disk you use most often as the default, you won't need to enter specifiers.

You can select one of the following as the default disk (although the optional disk may not be installed):

- Non-volatile RAM disk.
- Volatile RAM disk
- Internal disk (optional).

Caution



The volatile RAM disk is cleared each time you turn the analyzer off. Copy important files to another disk before power-down or they will be lost.

[DEFAULT PENS] softkey

Key Path: [Plot/Print] → [DEFINE PLOT] → [DEFINE PLOT PENS]

Press [DEFAULT PENS] to return plotter pen assignments to the following preset values:

- [TRACE A PEN] = 2.
- [TRACE B PEN] = 3.
- [MARKER A PEN] = 5.
- [MARKER B PEN] = 6.
- [ALPHA PEN] = 4.
- [GRATICULE PEN] = 1.

[DEFINE Fx] softkey

Key Path: [Math]

The analyzer has five function registers: F1 through F5. Each register holds a trace math function that you define. To change the definition of a particular function or to display its current definition, press the corresponding [DEFINE Fx] softkey.

Note



The trace resulting from a particular function can be displayed by selecting the corresponding [Fx] softkey under the [Trace Data] hardkey.

A trace math function is used to add, subtract, multiply, or divide some combination of the following: measurement data, stored trace data, constants, and other functions. The analyzer does some limited tracking of units during these operations.

A function is defined via two alternating menus: an operand menu and an operator menu. The menus alternate in a manner that allows you to define the function in standard algebraic notation.

All math operations are performed on linear rather than logarithmic data. Since you cannot create functions that add or subtract logarithmic values, you must create equivalent functions that multiply or divide linear values. (This is why a normalized spectrum is defined as “SPEC/D8.”)

Suppose you want to add 3 dB to your measurement results. Just convert the logarithmic offset to its linear equivalent and multiply your results by this value. Use this formula for the conversion:

$$10^{(n/20)} \quad \text{where } n \text{ is the dB offset}$$

If you place the value (1.413 for this example) in K1, define the function as “SPEC*K1.”

Key Reference
[DEFINE Kx] softkey

When you change a function's definition, the old definition is displayed in a small box in the center of the screen. The new definition—the one you are constructing with the operand and operator menus—is displayed at the top of the screen.

The old definition is in effect until you complete the new one by pressing the operator menu's [ENTER] softkey. Until you press [ENTER], you can abandon the new definition (and retain the old one) by pressing any hardkey or a [CANCEL/RETURN] softkey.

The [Back Space] hardkey is used to correct mistakes. It deletes the last operand or operator in the new definition.

[DEFINE Kx] softkey

Key Path: [Math]

The analyzer has five constant registers: K1 through K5. Each register holds a trace math constant that you define. To change the magnitude of a particular constant or to display its current magnitude, press the corresponding [DEFINE Kx] softkey.

Use the numeric entry keys to change the value of the specified constant. You can accept the new value by pressing the [ENTER] softkey. Until you press [ENTER], you can reject the new value (and retain the old one) by pressing any hardkey or the [CANCEL/RETURN] softkey.

[DEFINE LOWER LIM] softkey

Key Path: [Marker Fctn] —> [LIMIT TEST]

[DEFINE LOWER LIM] displays a menu. The softkeys in the menu allow you to define or alter the lower limit for the active trace.

You define the lower limit as a series of line segments. Here's how you use the softkeys in this menu to define the segments:

- [MOVE MKR HORIZONTAL]: This lets you define the frequency value of a segment endpoint.
- [MOVE MKR VERTICAL]: This lets you define the amplitude value of a segment endpoint.
- [START SEGMENT]: Press this softkey after you have defined the starting point of a segment.
- [FINISH SEGMENT]: Press this softkey after you have defined the ending point of a segment.

- [MOVE ALL VERTICAL]: This lets you alter the amplitude value of all endpoints at once.
- [DELETE ALL]: This deletes all segments at once.
- [DELETE SEGMENT]: This deletes the segment that is vertically aligned with the limit marker.

After you define a lower limit, it is maintained in a limit register. The amplitude values of the limit are maintained without units, so they assume the amplitude unit of the current display—the unit used for the reference level.

Hint: You can also create a lower limit from a trace. Just save the trace with [SAVE TRACE], then recall it with [RECALL LOWER LIM].

[DEFINE PLOT PENS] softkey

Key Path: [Plot/Print] —> [DEFINE PLOT]

The [DEFINE PLOT PENS] softkey displays a menu. You use the softkeys in the menu to assign plotter pens to various items on the analyzer's screen:

- [TRACE A PEN]: Used for trace A and all of its trace-specific annotation.
- [TRACE B PEN]: Used for trace B and all of its trace-specific annotation.
- [MARKER A PEN]: Used for trace A's main and offset markers.
- [MARKER B PEN]: Used for trace B's main and offset markers.
- [ALPHA PEN]: Used for information that is not trace-specific.
- [GRATICULE PEN]: Used for the graticules.

One softkey—[DEFAULT PENS]—returns the other softkeys in this menu to their preset values.

Key Reference
[DEFINE PLOT] softkey

[DEFINE PLOT] softkey

Key Path: [Plot/Print]

The [DEFINE PLOT] hardkey displays a menu. You use the softkeys in this menu to do the following things:

- Specify plotter pens for various items on the analyzer's screen.
- Specify a line type for trace A and trace B.
- Specify a plotting speed.
- Enable and disable your plotter's page-eject feature.

A box is displayed in the center of the screen while you are defining plot parameters. The box contains the currently specified pen numbers and line types.

Note



Check your plotter's documentation to be sure that it supports the plot parameters you request.

[DEFINE UPPER LIM] softkey

Key Path: [Marker Fctn] —> [LIMIT TEST]

[DEFINE UPPER LIM] displays a menu. The softkeys in the menu allow you to define or alter the upper limit for the active trace.

You define the upper limit as a series of line segments. Here's how you use the softkeys in this menu to define the segments:

- [MOVE MKR HORIZONTAL]: This lets you define the frequency value of a segment endpoint.
- [MOVE MKR VERTICAL]: This lets you define the amplitude value of a segment endpoint.
- [START SEGMENT]: Press this softkey after you have defined the starting point of a segment.
- [FINISH SEGMENT]: Press this softkey after you have defined the ending point of a segment.
- [MOVE ALL VERTICAL]: This lets you alter the amplitude value of all endpoints at once.
- [DELETE ALL]: This deletes all segments at once.
- [DELETE SEGMENT]: This deletes the segment that is vertically aligned with the limit marker.

After you define an upper limit, it is maintained in a limit register. The amplitude values of the limit are maintained without units, so they assume the amplitude unit of the current display—the unit used for the reference level.

Hint: You can also create an upper limit from a trace. Just save the trace with [SAVE TRACE], then recall it with [RECALL UPPER LIM].

[DELETE ALL FILES] softkey

Key Path: [Disk Util]

Press [DELETE ALL FILES] to remove all files from one of the disks. The files are deleted from the default disk unless you change the disk specifier in the prompt.

Hint: To remove just one file from the disk, use the [DELETE FILE] softkey.

When you press [DELETE ALL FILES], you are prompted to enter the disk specifier of the disk you want to clear. The specifier of the default disk is automatically placed in the prompt, but you can change it with the alpha entry keys.

Note



When you press the [ENTER] softkey to complete entry of a disk specifier, the disk is cleared without further prompting. Be sure the name is correct before pressing [ENTER].

[DELETE ALL] softkey

Key Path: [Marker Fctn] —> [LIMIT TEST] —> [DEFINE UPPER LIM]

or: [Marker Fctn] —> [LIMIT TEST] —> [DEFINE LOWER LIM]

Press [DELETE ALL] to delete an entire limit.

This softkey deletes the active trace's upper limit if you pressed [DEFINE UPPER LIM] to enter the menu. It deletes the active trace's lower limit if you pressed [DEFINE LOWER LIM] to enter the menu.

[DELETE CHARACTER] softkey

Press this softkey to delete the character under the text cursor during alpha entry or program editing.

Hint: Use the knob to place the text cursor over the character you want to delete.

Key Reference
[DELETE FILE] softkey

[DELETE FILE] softkey

Key Path: [Disk Util]

Press [DELETE FILE] to remove a file from one of the disks. The file is deleted from the default disk unless you include a disk specifier in the filename prompt.

Hint: To remove all files from a disk at once, use the [DELETE ALL FILES] softkey.

It's often easier to delete files when the catalog is on. You can select the file you want to delete by turning the knob. Then when you press [DELETE FILE], the name of the selected file is automatically placed in the prompt.

When the catalog is off, the last-entered filename is placed in the prompt. You can modify the name in the prompt with the alpha entry keys.

Note



When you press the [ENTER] softkey to complete entry of a filename, the file is deleted without further prompting. Be sure the name is correct before pressing [ENTER].

[DELETE LINE] softkey

Key Path: [User Define] —> [EDIT]

Press [DELETE LINE] to delete the line containing the text cursor when you are editing a program.

The deleted line is placed in a one-line buffer. You can recall the deleted line into another part of your program with the [RECALL LINE] softkey.

[DELETE SEGMENT] softkey

Key Path: [Marker Fctn] —> [LIMIT TEST] —> [DEFINE UPPER LIM]

or: [Marker Fctn] —> [LIMIT TEST] —> [DEFINE LOWER LIM]

Press [DELETE SEGMENT] to delete one segment of a limit. The analyzer deletes the segment that is vertically aligned with the limit marker.

If you pressed [DEFINE UPPER LIM] to enter the menu, this key deletes a segment from the active trace's upper limit. If you pressed [DEFINE LOWER LIM] to enter the menu, this key deletes a segment from the active trace's lower limit.

Disk specifiers

The analyzer contains three different storage devices (all referred to as disks). So when you press a softkey that accesses a disk function, you are prompted to specify which disk the function should act on. Use the following disk specifiers:

- “INT:” specifies the internal disk .
- “RAM:” specifies the volatile RAM disk .
- “NVRAM:” specifies the non-volatile RAM disk.

When you press a softkey that prompts you for a filename, you can prefix the filename with a disk specifier. This allows you to access a file on a disk other than the default disk. For example, enter “INT:MYCONFIG” to access a file named “MYCONFIG” that resides on the internal disk.

[Disk Util] hardkey

The softkeys grouped under [Disk Util] are used to perform various file and disk management operations:

- Renaming files.
- Deleting files.
- Copying files.
- Formatting disks.
- Packing disks.

Note

To save and recall files, use the softkeys grouped under [Save/Recall].



The analyzer displays a prompt and enters alpha entry mode when it's time to identify the file or disk you want to modify. Use the default filename displayed in the prompt or modify the name with the alpha entry keys. When the filename is correct, press [enter] to start the operation.

You can do two things to simplify disk and file management operations:

- Designate the disk you use most often as the default disk.
- Display the disk catalog.

You only need to enter a filename to identify a file on the default disk. You must enter a disk specifier and a filename to identify a file on any other disk.

When the catalog is displayed, you don't need to type the name of a file you want to modify. Instead, you can just select the file with the knob before bringing up the filename prompt. The name of the file you select is automatically placed in the prompt.

Key Reference
[DESTIN DISK] softkey

[DESTIN DISK] softkey

See Copy Disk softkeys.

[DESTIN FILENAME] softkey

See Copy File softkeys.

Display Format softkey group (BASIC)

Key Path: [User Define] —> [display format]

The softkeys in this group allow you to specify which part of the analyzer's screen should be used for HP Instrument BASIC programs. Program statements such as PRINT, MOVE, and DRAW require that some portion of the display be allocated for their use.

- [OFF] allocates no display area to your program.
- [FULL] allocates to your program that portion of the display used by a full-height trace box. The full display is 29 text rows high and 58 columns wide. The lower left corner (for MOVE and DRAW) is (0,0). The upper right corner is (475,355).
- [UPPER] allocates to your program that portion of the display used by the upper half-height trace box. The upper display is 14 text rows high and 58 columns wide. The lower left corner is (0,0). The upper right corner is (475,173).
- [LOWER] allocates to your program that portion of the display used by the lower half-height trace box. The lower display is the same size as the upper display.

[/] (Divide) softkey

See Operator Menu.

Display Format softkey group

Key Path: [Format]

Use the Display Format softkey group to select one of three formats for trace display or to select a summary of the current instrument setup.

- [SINGLE] displays only one trace (the active trace) using a single, full-height trace box.
- [UPPER/LOWER] displays both traces using two half-height trace boxes. Trace A is displayed in the upper box.
- [FRONT/BACK] displays both traces using one full-height trace box. The active trace is drawn with a solid line, the inactive trace with a dotted line.
- [SETUP STATE] summarizes the current state of the most important measurement setup parameters. Use this display and one of the plot or print softkeys to document the instrument setup for a particular measurement.

[DISPLAY FORMAT] softkey

Key Path: [User Define]

[DISPLAY FORMAT] displays a menu. You can use the softkeys in the menu to do the following things:

- Specify the portion of the analyzer's display to be used for HP Instrument BASIC program output.
- Clear the portion of the display that is being used for program output.

[Dx] softkeys

Key Path: [Trace Data] —> [DATA REG D1-D8]

Press one of the [Dx] softkeys to display the contents of the corresponding data register.

You can use options under the [SAVE TRACE] and [RECALL TRACE] softkeys to load any data register. You can use [SAVE NORM REFERENCE] to load D8.

[DOTTED] softkey

See [LINE TYPE] softkeys.

Key Reference
[ECHO ON/OFF] softkey

[ECHO ON/OFF] softkey

Key Path: [Local/HP-IB]

Press this softkey to enable and disable the echoing (display) of TMSL command mnemonics to the analyzer's screen. TMSL mnemonics are used to operate the analyzer via the HP-IB.

With echoing turned on, you can operate the analyzer from the front panel and it will display the command mnemonics you must send over the bus to achieve the same results. Mnemonics are displayed in the lower-left corner of the screen.

Note



The lower-left corner of the screen is also used for measurement status messages (things like "Averaging" and "Waiting for Arm"). When echoing is on, these messages are not displayed.

Not every keystroke generates an HP-IB command. For example, you must press [Freq], [CENTER], [5], [0], [MHz] before the command "FREQ:CENT 50 MHz" is echoed to the screen.

[EDIT] softkey

Key Path: [User Define]

Press [EDIT] to view or edit your HP Instrument BASIC program. The analyzer enters HP Instrument BASIC edit mode and remains in this mode until you press [END EDIT].

Most hardkeys are redefined as alpha characters when the analyzer is in HP Instrument BASIC edit mode. Engraved letters, adjacent to the lower right corners of these keys, tell you which characters they will insert in your program.

The [Help], [Preset], number, decimal point, and [Back Space] hardkeys are not redefined, but the [+/-] hardkey is. It inserts a minus (or dash) in your program rather than toggling a number between positive and negative values.

Use the knob to position the text cursor in your program. When you turn the knob clockwise, the cursor moves to the right of a line and then down to the next line. When you turn the knob counter-clockwise, the cursor moves to the left and then up.

Note



If you change or insert a program line, be sure to press [ENTER] before moving to another line with the knob; otherwise, the change will be lost.

Additional characters and editing function are made available via the HP Instrument BASIC edit menu and its submenus.

Key Reference
[ENABLE RECORDING] softkey

[ENABLE RECORDING] softkey

Key Path: [User Define]

Press [ENABLE RECORDING] to begin recording front-panel keystrokes.

Keystroke recording allows you to create an HP Instrument BASIC program that mimics a series of keystrokes. It works by converting your keystrokes to equivalent HP-IB commands and then enclosing the commands in BASIC OUTPUT statements.

When you have finished recording keystrokes, press [User Define] to disable recording. You can view or edit this program by pressing [EDIT]. You can execute the program by pressing [RUN].

Hint: Be sure to record a [Meas Restart] keystroke before you record a keystroke that requires good measurement data (such as [MARKER --> PEAK]). This ensures that the measurement will be complete before your program uses the data.

The OUTPUT statements created by keystroke recording are entered into the current program. If the program buffer is empty, the analyzer first creates an ASSIGN statement and an END statement. OUTPUT statements are then inserted ahead of the END statement.

If the program buffer already contains a program, OUTPUT statements are inserted ahead of the program line containing the text cursor. You can position the text cursor by pressing [EDIT] and then turning the knob.

You can *not* record the following front panel operations:

- Redefinition of the analyzer's controller capabilities. HP-IB commands are not allowed to do this.
- Saving or recalling of HP Instrument BASIC programs. A program cannot be saved or recalled while it is running.
- Any other HP Instrument BASIC operation. These operations are all grouped under the [User Define] hardkey, which disables keystroke recording.

The recorded version of a few front-panel operations may require additional programming—usually to synchronize program execution with the analyzer's measurement sequence. Here is an example:

During manual arming, any attempts to arm the analyzer before it is ready are ignored. When you operate the analyzer from the front panel, you can simply wait until the WAITING FOR ARM message is displayed and then press [ARM].

If you record this operation, you must add a routine that simulates your waiting for the message. The routine should check the RDY_FOR_ARM bit in one of the analyzer's registers and hold off the ARM command until the bit is set.

See your HP Instrument BASIC manual for more information about synchronization.

[END EDIT] softkey

Key Path: [User Define] —> [EDIT]

Press [END EDIT] when you have finished editing or viewing your program.

When you press [END EDIT] you are returned to the main HP Instrument BASIC menu. You can RUN the edited program immediately, but it is best to save your changes first.

Note



You must save or resave an edited program or the changes will be lost when you turn the analyzer off.

[END LINE #] softkey

Key Path: [User Define] —> [UTILITIES] —> [SECURE]

Before you secure an HP Instrument BASIC program (protect it against viewing), you must specify the range of lines you want to secure. Press [END LINE #] to specify the last line in the range. An entry box is displayed so you can enter a new value.

After you have specified the first and last lines, press [PERFORM SECURE] to secure those lines and all lines that fall between them. When you edit or print a secured line, you will see an asterisk (*) rather than program statements after the line number.

Key Reference
[ENTER] softkey (program edit)

[ENTER] softkey (program edit)

Key Path: [User Define] —> [EDIT]

or: [User Define] —> [EDIT] —> [TYPING UTILITIES]

Press [ENTER] to accept the changes you've made while editing a line of your HP Instrument BASIC program. If the editor detects no syntax errors, the line is accepted.

Note



If you move the text cursor off of the line before you press [ENTER], the changes you've made are lost.

If the editor is in insert line mode when you press [ENTER], it creates a blank line below the current line and moves the text cursor to that new line. If the editor is not in insert line mode when you press [ENTER], it just moves the text cursor to the next line of the program.

[ENTER] softkey

The [ENTER] softkey is displayed when you are creating or editing a text string during alpha entry. When you are done typing, press [ENTER] to accept the new string.

Note



You can abandon the new string by pressing [CANCEL/RETURN].

[ENTER] is sometimes displayed when you are changing a numeric parameter with the number keys. As with alpha entry, you use it to accept the new value.

[EXAMINE VARIABLE] softkey

Key Path: [User Define] —> [DEBUG]

Press [EXAMINE VARIABLE] to view the contents of a program variable. *See also* [DEBUG] softkey.

Note



Your HP Instrument BASIC program must be paused, stopped, or in single-step mode before you can examine a variable.

When you press [EXAMINE VARIABLE], the analyzer prompts you to enter a variable name. You enter a name using the alpha entry keys.

You can examine array variables in one of two ways. Display the entire array by entering *array_name(*)* in the entry box. Display a single element of the array by entering *<array name>* (*<element number>*).

The analyzer uses up to 10 lines (of 40 characters each) to display variables. Those containing more than 400 characters are truncated.

Key Reference
[EXTERNAL TRIGGER] softkey

[EXTERNAL TRIGGER] softkey

Key Path: [Trigger]

Press [EXTERNAL TRIGGER] when you must synchronize a measurement to an external trigger signal.

Connect a trigger source—one that provides a TTL-level signal—to the EXT TRIG connector on the analyzer's rear panel.

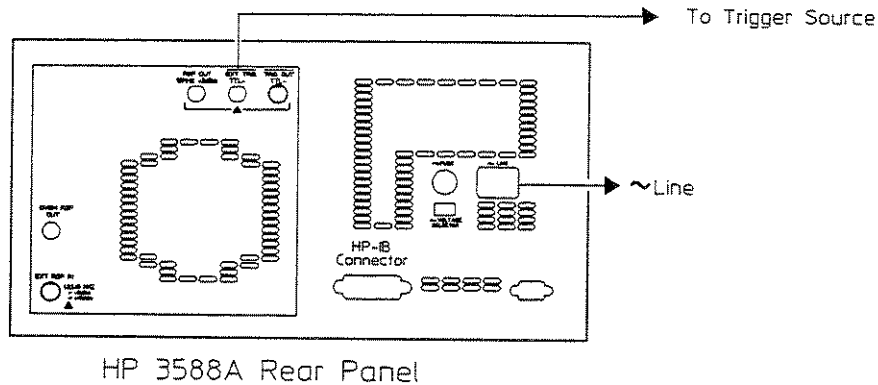

Once the analyzer has been armed, it is triggered by a high-to-low transition of the external trigger signal. (It is triggered by the falling edge of the transition.)

After the analyzer has been triggered, additional transitions of the external trigger signal are ignored until the measurement is complete and the analyzer is re-armed.

Note



A measurement consists of a single data update—one sweep, one FFT, or one update of the manual frequency.

[FAIL BEEP ON/OFF] softkey

Key Path: [Marker Fctn] —> [LIMIT TEST]

Press [FAIL BEEP ON/OFF] to enable and disable the limit-fail beeper for the active trace.

The limit-fail beeper emits an audible tone when all of the following conditions are met:

- [FAIL BEEP ON/OFF] is toggled to ON.
- [BEEPER ON/OFF] is toggled to ON.
- [TEST EVAL ON/OFF] is toggled to ON.
- The trace falls outside its current limits.

[FINISH SEGMENT] softkey

Key Path: [Marker Fctn] —> [LIMIT TEST] —> [DEFINE UPPER LIM]

or: [Marker Fctn] —> [LIMIT TEST] —> [DEFINE LOWER LIM]

Limits are defined as a series of line segments. Press [FINISH SEGMENT] to anchor a segment's ending point at the position of the limit marker.

Press [START SEGMENT] to anchor a segment's starting point. Use [MOVE MKR HORIZONTAL] and [MOVE MKR VERTICAL] to position the limit marker.

When you press [FINISH SEGMENT] to anchor an ending point, the analyzer automatically anchors the starting point of a new segment at the same position. This makes it easier for you to build continuous limit lines.

Hint: You can abandon the automatically generated starting point. Just press [START SEGMENT] after you have repositioned the limit marker.

Fonts

Fonts provide different ways to display the same character. Here's how the fonts are used in the analyzer:

- *Plain font*: This is used for most help text, most softkey labels, and for annotation of the active trace.
- *Ghosted font*: This is used for annotation of the inactive trace and for labeling of inactive softkeys.
- *Highlighted font (inverse video)*: This is used to indicate the active option for softkeys that toggle, the active numeric entry softkey in a menu, and the active link in help text.
- *Underlined font*: This is used to indicate inactive links in help text.

[FORMAT DISK] softkey

Key Path: [Disk Util]

The format disk softkey displays a menu. The softkeys in the menu allow you to define some formatting parameters and to format a disk using those definitions:

- [FORMAT OPTION]: Lets you define the storage capacity of the disk.
- [INTRLEAVE FACTOR]: Lets you define the spacing between sectors (only used for flexible disks).
- [PERFORM FORMAT]: Starts formatting the disk *after* prompting you for the disk specifier.

Note



The analyzer's internal disk drive can read and write single-sided disks, but it can only format double-sided disks.

[50 OHMS] softkey

See Input Impedance softkey group.

[50 OHMS OUTPUT Z] softkey

See Output Impedance softkey group.

[Format] hardkey

The [Format] hardkey displays a menu that is used to configure the analyzer's screen. The softkeys in this menu allow you to do the following things:

- Select one of three formats for displaying traces.
- Display a summary of current analyzer settings.
- Reduce the amount of information on the screen.

[FORMAT OPTION] softkey

Key Path: [Disk Util] —> [FORMAT DISK]

Press [FORMAT OPTION] to define the storage capacity of the disk you will format. An entry box is displayed so you can enter a new value.

The format options are actually encoded values that give you the following capacities:

Option	RAM	NVRAM	Internal disk
0	64k	63k	640k
1	640k	63k	640k
2	710k	63k	710k
3	788k	63k	788k
4	270k	63k	—
5	640k	63k	64k

Note



If you enter a format option greater than 5, the formatting process is aborted when you press [PERFORM FORMAT] and [ENTER].

You can change [FORMAT OPTION] in the usual ways, but with the following conditions:

- Any value you enter with the number keys is changed to the closest integer in the range 0-5.
- When you turn the knob slowly or press an arrow key one time, the format option changes by 1.

Key Reference
[FREE RUN TRIGGER] softkey

[FREE RUN TRIGGER] softkey

Key Path: [Trigger]

Press [FREE RUN TRIGGER] if you don't need to trigger your measurements with a special signal. Free run (or continuous) triggering allows the analyzer to trigger itself as soon as it is armed.

Note



If you want the analyzer to take data continuously, you must select both free run triggering and automatic arming.

[FREQ CNTR ON/OFF] softkey

Key Path: [Marker Fctn]

Press [FREQ CNTR ON/OFF] to enable and disable the analyzer's frequency counter.

You can use the frequency counter to more accurately determine the frequency of the largest signal at the main marker position. The measured frequency is displayed as the marker readout's x-axis value.

Note



When offset marker is on, the frequency readout is relative to the offset marker position.

You may want to turn the counter on before you use [MKR --> CTR FREQ] or [Marker Value] to change the value of a frequency parameter. The analyzer will use the counted frequency rather than the less accurate display point frequency for the parameter's new value.

Hint: If the count seems inconsistent at frequencies below 100 kHz, decrease the resolution bandwidth. (The presence of the second mixer image in the third IF makes this necessary.)

During swept spectrum measurements, the analyzer sweeps to the marker position, counts, and then completes the sweep. (If manual sweeping is selected, the analyzer just counts at the manual frequency.) During narrow band zoom measurements, the analyzer completes one measurement and then counts.

When a count has been completed, the marker readout is labeled "Cntr" and its x-axis value is highlighted.

The frequency counter only counts data from the current input spectrum. If you select trace data that is not linked to the input spectrum—for example, the contents of a data register—no count value is displayed.

The following trace data is linked to the current input spectrum:

- An input spectrum.
- A normalized spectrum.
- A function definition that uses an input spectrum (contains the abbreviation "SPEC").

Key Reference
[Freq] hardkey

[Freq] hardkey

The [Freq] hardkey displays a menu. You use the softkeys in this menu primarily to select the band of frequencies (or in the case of [zero span], the single frequency) you want to analyze.

Note



An additional frequency softkey—[MANUAL FREQ]—is located under the [Sweep] hardkey.

There are two pairs of softkeys in this menu that allow you to define a frequency band—one of the pairs is [CENTER] and [SPAN], the other is [START] and [STOP]. In each of these pairs, the current value of one softkey is held constant when you change the value of the other.

Note



The offset between [START] and [STOP] is held constant during narrow band zoom measurements.

X-axis scaling is normally linked to the frequency parameters. So if you set [START] to 10 MHz and [STOP] to 30 MHz, then a trace's x-axis will start at 10 MHz and stop at 30 MHz. X-axis scaling is linked to [SWEEP TIME] if [ZERO SPAN] is selected.

Two softkeys in the Freq menu define special frequency bands with one key-press:

- [FULL SPAN] defines a 150 MHz span centered at 75 MHz.
- [ZERO SPAN] defines a 0 Hz span centered at the current center frequency.

You can alter the analyzer's frequency parameters in steps using either the knob or the arrow hardkeys. Two softkeys in the Freq menu—[STEP SIZE USER/AUTO] and [USER STEP SIZE]—allow you to define the step.

The last softkey in the Freq menu—[SIGNAL TRK ON/OFF]—gives you access to an analyzer function that can track a drifting signal.

Note



Some softkeys in the Freq menu behave differently for each of the two measurement types. For more information, see the description for each softkey.

Frequency resolution of the display

Each trace box is divided along its x axis into 401 evenly-spaced points. For frequency-domain measurements, these points determine the frequency resolution of the analyzer's display.

Display resolution is *not* the same as measurement resolution. The measurement resolution is determined by the resolution bandwidth (swept measurements) or by the zoom type (narrow band zoom measurements).

Each display point has a nominal value. This is the value used for the marker's x-axis readout (unless the frequency counter is on). The nominal value of the first point (point 0) is the start frequency. The nominal value of the last point (point 400) is the stop frequency.

Each display point represents a band of frequencies, not just its nominal frequency. For swept measurements using the peak detector and for all narrow band zoom measurements, the amplitude of the largest signal in the band becomes the amplitude of the point. The width of this band is related to the current frequency span:

$$\text{point bandwidth} = \text{span} / 400$$

For swept spectrum measurements, a display point represents the frequencies between its nominal frequency and the nominal frequency of the display point to its right.

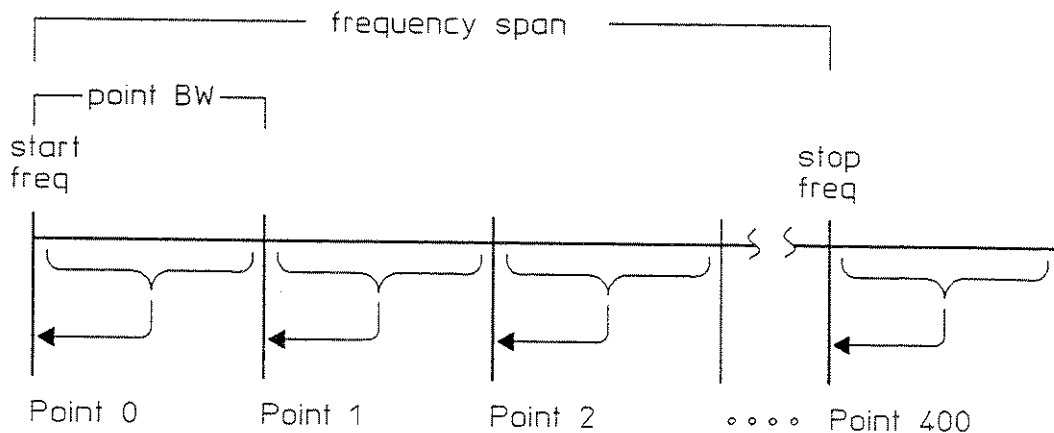

Key Reference
[FRONT/BACK] softkey

For narrow band zoom measurements, a display point represents all frequencies between $(NF - 1/2 PBW)$ and $(NF + 1/2 PBW)$. NF is the nominal frequency and PBW is the point bandwidth.

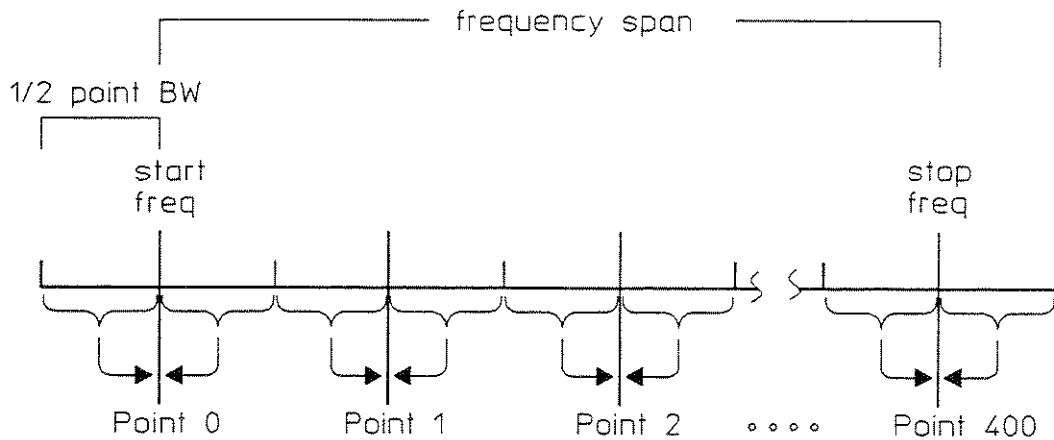

[FRONT/BACK] softkey

See Display Format softkey group (trace).

[FULL SPAN] softkey

Key Path: [Freq]

The [FULL SPAN] softkey gives you a quick way to set the analyzer to its widest frequency span for the current measurement type:

- 40 kHz—for narrow band zoom.
- 150 MHz—for swept spectrum.

[FULL SPAN] doesn't change the center frequency (CF) for narrow band zoom. However, it resets CF to 75 MHz for swept spectrum so the sweep will start at 0 Hz.

Use [FULL SPAN] and a swept spectrum measurement to locate a signal. You can then narrow the span (with [CENTER] and [SPAN] or [START] and [STOP]) for more detailed analysis. At spans less than 40 kHz, use narrow band zoom for shorter measurement times.

[FUNCTION (F1-F5)] softkey (Math)

Key Path: [Math] → [DEFINE Fx]

When you are defining a function, press [FUNCTION (F1-F5)] to gain access to the [FUNCTION Fx] softkeys. These softkeys let you specify the contents of other function registers as operands in the function you are defining. *See also* Operand Menu.

Note



Some functions can *not* be used in the definition of another function. Restrictions are described under the [FUNCTION Fx] softkeys.

[FUNCTION (F1-F5)] softkey (Trace Data)

Key Path: [Trace Data]

Press [FUNCTION (F1-F5)] for access to the [Fx] softkeys. Each [Fx] key displays the result of a function you have defined.

Note



A function must be defined before it can be displayed. Functions are defined under the [Math] hardkey.

[FUNCTION Fx] softkeys

Key Path: [Math] → [DEFINE Fx] → [FUNCTION (F1-F5)]

When you are defining a function, press one of the [FUNCTION Fx] softkeys to specify the contents of the corresponding function register as an operand. The abbreviation “Fx” is added to the end of the definition, except in the following case:

When you redefine a function, you can insert the old definition of that function into the new one by selecting the corresponding [FUNCTION Fx] softkey. For example, assume that the old definition of F2 is “(SPEC+K1)*D1.” If you press the [FUNCTION F2] softkey while redefining F2, “(SPEC+K1)*D1” is inserted into the new definition.

Key Reference
[Fx] softkeys

[Fx] softkeys

Key Path: [Trace Data] —> [FUNCTION (F1-F5)]

Press one of the [Fx] softkeys to display the result of the corresponding user-defined function.

Note



A function must be defined before it can be displayed. Functions are defined under the [Math] hardkey.

Goto Line softkeys

Key Path: [User Define] —> [edit]

The [GOTO LINE] softkeys let you move the text cursor directly to a particular line of the program you are editing. You can specify the line either by its number or its label.

Use the number keys to specify a line number. Use the hardkeys with engraved letters, the underscore (_) softkey, and the [UPPERCASE/lowercase] softkey to specify a label. Then when you press [ENTER], the text cursor moves to the specified line.

If you enter a line number that doesn't exist, the cursor moves to the closest line. If you enter a label that doesn't exist, the cursor remains on the current line.

Hint: To go to the end of the program, enter a line number greater than that of the last line (for example, 99,999).

[GRATICULE ON/OFF] softkey

Key Path: [Format]

Trace boxes can be overlaid with graticules (or grids). These graticules help you estimate the x and y values of a particular point on a trace. You can toggle graticules on and off with the [GRATICULE ON/OFF] softkey.

When graticules are turned off, they are not displayed on the screen and they are not printed or plotted. However, borders remain to define the limits of the trace boxes.

[GRATICULE PEN] softkey

Key Path: [Plot/Print] —> [DEFINE PLOT] —> [DEFINE PLOT PENS]

Press [GRATICULE PEN] to specify which plotter pen should be used for plotting trace graticules.

The graticule pen is also used for the borders around the instrument state and the disk catalog.

Hardkeys

There are five groups of hardkeys on the analyzer's front panel:

- DISPLAY.
- MARKER.
- MEASUREMENT.
- Numeric entry.
- SYSTEM.

The keys in these groups are referred to as hardkeys because the function assigned to each key never changes (except during alpha entry and program editing). In contrast, the function assigned to each softkey can change.

A "hardkey label" is printed directly on each hardkey. The label tells you which function is assigned to that key. In the help text, hardkeys are represented by surrounding hardkey labels with braces (for example, "The [Help] hardkey is used to...").

An engraved letter appears at the lower-right corner of most hardkeys. This letter tells you which alpha character will be inserted to the left of the text cursor when you press a hardkey during alpha entry or program editing.

Key Reference
[Help] hardkey

[Help] hardkey

For help on a hardkey or softkey (except [Preset]): Press the key.

To display a cross-referenced topic: Turn the knob (if necessary) until the link is highlighted, then press [4].

To access any other Help function: Press the appropriate number key. (For example, press [6] to go to the next page.) Numbers are mapped as follows:

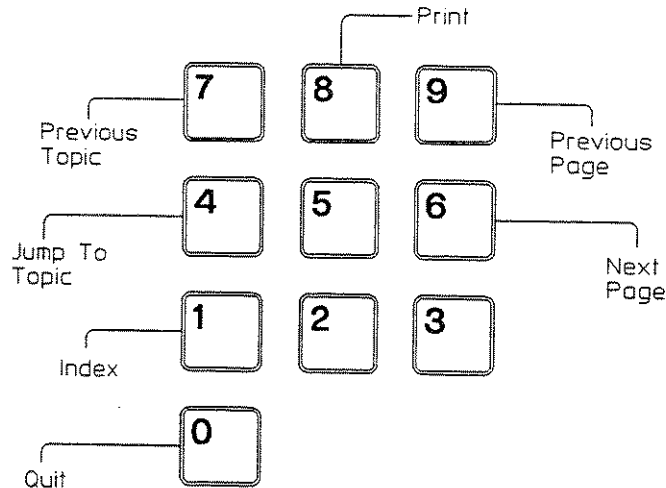

Many help topics contain cross-reference links. These links allow you to move quickly between related topics. When there is one link on a page, it is highlighted. When there are two or more links on a page, only one is highlighted; the others are underlined.

On pages with multiple links, use the knob to select the link that interests you, then press [4] to jump to the topic it references. After reading the cross-referenced topic, just press [7] to return to the original topic.

If you decide to follow links to additional topics, it's still easy to return to the original topic when you are done. The analyzer keeps track of the last 20 topics displayed so you can retrace your path. Just press [7] several times to reach the original topic.

You can page through a help topic by pressing [6] and [9] or by turning the knob. Turn the knob clockwise to go to the next page or counter-clockwise to go to the previous page. If there are two or more links on a page, the knob moves the highlight through the links before paging.

You can display the index by pressing [1]. The index contains an alphabetical listing of all help topics available in the analyzer. Each of these topics can be selected by turning the knob and displayed (or “jumped to”) by pressing [4].

Most topics listed in the index describe the hardkeys and softkeys, but some are of a more general nature. These more general topics are only available via the index or links.

Some index entries are just there to help guide you to the right topic. These entries are marked “(XREF).”

Caution



The [Preset] hardkey will preset the analyzer settings even when you are using Help. Select “Preset hardkey.” in the Help index if you just want information on that key.

Press [8] to print one page of a help topic. The analyzer must be the system controller. The printer must be turned on, attached to the analyzer’s HP-IB connector, and set to the address specified under the [printer address] softkey.

HP-IB controllers

When you connect devices via the HP-IB, one device must coordinate activity on the bus. The coordinating device is called the “controller.” The HP 3588A can act as a controller.

Sometimes, you may have more than one device on the bus that can function as a controller. Only one of these devices can coordinate bus activity at any given time. The device that is currently coordinating bus activity is called the “active controller.”

One device on the bus must be designated as the “system controller.” The system controller can always take control of the bus—even if it is not currently the active controller. The HP 3588A is designated as the system controller if you press [SYSTEM CONTROLLER].

The HP 3588A cannot function as the system controller when [ADDRESSBL ONLY] is selected, but it can function as the active controller. The current active controller must simply pass control to the analyzer.

HP-IB overview

HP-IB, the Hewlett-Packard interface bus, allows you to build an integrated test system from individual devices (instruments and computers). If a device complies with the IEEE 488.1 standard, HP-IB cables can link it into a system. The HP 3588A is such a device.

Each device is assigned a unique HP-IB address. This allows one device, referred to as the controller, to coordinate the activities of all other devices on the bus. The controller can issue an instruction to a particular device by prefacing the instruction with the device’s address.

[HP-IB TRIGGER] softkey

Key Path: [Trigger]

Press [HP-IB TRIGGER] when you must synchronize a measurement to a trigger command issued via the HP-IB.

The HP-IB connector on the analyzer's rear panel must first be connected to the controller that issues the trigger command.

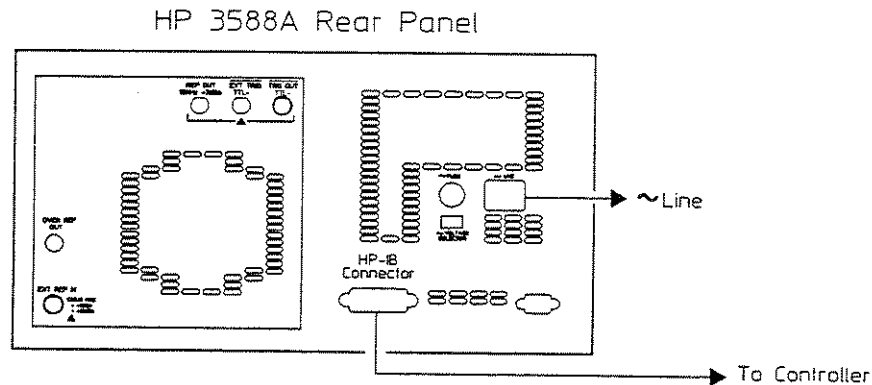

Once the analyzer has been armed, it is triggered by one of three HP-IB commands:

- Group Execute Trigger (GET)
- *TRG
- TRIG:IMM

After the analyzer has been triggered, additional HP-IB trigger commands are ignored until the measurement is complete and the analyzer is re-armed. The controller can detect these conditions by reading the analyzer's status registers.

For more information about HP-IB triggering, see the *HP 3588A HP-IB Programming Reference*.

HP Instrument BASIC edit menu

The HP Instrument BASIC edit menu and its submenus provide access to special characters and editing functions when the analyzer is in the HP Instrument BASIC edit mode.

[enter] accepts any changes you have made to the current line. [END EDIT] exits the HP Instrument BASIC edit mode and displays the User Define menu.

Three softkeys—[INSERT LINE], [DELETE LINE], and [RECALL LINE]—allow you to reorganize your program one line at a time. Another line-oriented softkey—[GOTO LINE]—lets you move the text cursor quickly to a particular line number or program label.

There are two character-oriented softkeys. [INSERT SPACE] inserts a space character to the left of the text cursor. [DELETE CHARACTER] deletes the character under the text cursor.

The [TYPING UTILITIES] softkey displays a menu that gives you access to additional characters, HP Instrument BASIC keywords, and a case-shifting function. The menu also contains a [CANCEL/RETURN] softkey so you can return to the main editing menu.

Inactive softkeys

Some softkeys are inactive for particular analyzer setups. For example, [RES BW] is inactive during narrow band zoom measurements. This is because [RES BW] only controls measurement resolution for swept spectrum measurements. (The zoom type softkeys control resolution for narrow band zoom measurements.)

You can change the setting of an inactive softkey, but the analyzer doesn't use the new setting until the key becomes active. For example, you can change [RES BW] while [NARROW BAND ZOOM] is selected, but the analyzer doesn't use the new setting until you select [SWEEP SPECTRUM].

The analyzer uses a ghosted font to indicate that a softkey is inactive.

[INCREMENT] softkey

Key Path: [User Define] —> [UTILITIES] —> [RENUMBER]

Before you renumber an HP Instrument BASIC program, press [INCREMENT] to specify the increment between the renumbered lines. An entry box is displayed so you can enter a new value.

After you have specified the starting line number and the increment between line numbers, press [PERFORM RENUMBER] to renumber your program.

Input Impedance softkey group

Key Path: [Range/Input]

This group of softkeys allows you select impedance of the analyzer's input circuitry.

When you select [50 OHMS], the input connector is terminated with a 50 ohm resistance. The dBm calculations for input range and trace amplitudes assume an input impedance of 50 ohms.

When you select [75 OHMS], the input connector is still terminated with a 50 ohm resistance, but dBm calculations assume an input impedance of 75 ohms.

Note



When [75 OHM] is selected, you *must* use the 25 ohm adapter barrel (supplied with the analyzer) for accurate results. Insert the adapter between your test signal and the input connector.

When you select [1 MEGOHM], the input connector is terminated with a 1 megohm resistance. The dBm calculations use the impedance value you specify under the [1 MEG REF IMPEDANCE] softkey.

Three special restrictions apply when you select the 1 megohm input impedance:

- Only the 0 dBm range (referenced to 50 ohms) is available. (Continuous autoranging is disabled as a result.)
- The analyzer's performance is only specified between 10 Hz and 40 MHz.
- Source impedance does not match input impedance, even if [COUPLE TO INPUT Z] is selected.

[INPUT SPECTRUM] softkey

Key Path: [Trace Data]

Press [INPUT SPECTRUM] to display the contents of the input spectrum buffer in the active trace. The buffer contains calibrated input data from the current measurement.

The analyzer sends new input data to the input spectrum buffer each time a measurement is completed. If the video average or peak hold function is selected, the data is combined with the current contents of the buffer. The buffer is then updated with the combined data. If neither of these functions are selected, the buffer is updated immediately with the new data.

Key Reference
Insert < chars > softkeys

Insert < chars > softkeys

Key Path: [User Define] —> [EDIT] —> [TYPING UTILITIES]

Each [INSERT <chars>] softkey gives you access to special characters during program editing. When you press one of these softkeys, the characters listed after “INSERT” are displayed in a menu. You can then insert one of these characters to the left of the text cursor by pressing the corresponding softkey.

Note



A [CANCEL/RETURN] softkey is displayed so you can return to the Typing Utilities menu without inserting a special character.

[INSERT KEYWORD] softkey

Key Path: [User Define] —> [EDIT] —> [TYPING UTILITIES]

The [INSERT KEYWORD] softkey allows you to insert complete keywords to the left of the text cursor when you are editing a program.

Here's how you insert a keyword:

1. Press [INSERT KEYWORD].
2. Press the hardkey whose engraved letter corresponds to the first character of the keyword you want.
3. Locate the keyword in the resulting menu. (If more than nine keywords begin with the same character, you may need to press a [MORE] softkey to locate the keyword you want.)
4. Insert the keyword in your program by pressing the corresponding softkey.

Note



A [CANCEL] softkey is displayed so you can return to the Typing Utilities menu without inserting a keyword.

[INSERT LINE] softkey

Key Path: [User Define] —> [EDIT]

Press [INSERT LINE] to enable and disable insert line mode when you are editing an HP Instrument BASIC program.

When the editor enters insert line mode, it creates a blank line above the current line (the one containing the text cursor) and moves the cursor to that line. When the editor exits insert line mode, it deletes the current line and moves the text cursor to the next line.

Hint: To save the contents of the current line, press [ENTER] before you exit insert line mode.

When the editor is in insert line mode, it adds a new line after the current line each time you press [ENTER] (assuming the current line contains no syntax errors). This continues until you exit insert line mode—either by pressing [INSERT LINE] or by moving the text cursor to another line with the knob.

[INSERT SPACE] softkey

Press this softkey to insert a space to the left of the text cursor during alpha entry or program editing.

[INTERNAL DISK] softkey

Key Path: [Save/Recall] —> [DEFAULT DISK]

or: [Disk Util] —> [DEFAULT DISK]

This softkey selects the analyzer's internal disk as the default disk.

The internal disk uses 3.5-inch flexible disks (double-sided, double density) for storage. You must format each diskette before you use it.

Note



The internal disk is optional. If this softkey is ghosted, the option is not installed.

[INTO Dx] softkey

See [SAVE TRACE] softkeys.

Key Reference
[INTO FILE] softkey

[INTO FILE] softkey

See [SAVE TRACE] softkeys.

[INTRLEAVE FACTOR] softkey

Key Path: [Disk Util] —> [FORMAT DISK]

Press [INTRLEAVE FACTOR] to define the ordering of sectors on the 3.5-inch flexible disks you will format in the internal disk drive. An entry box is displayed so you can enter a new value.

Save and recall operations are more efficient (faster) when you select the proper interleave factor. The analyzer's internal disk drive is most efficient when using disks formatted with an interleave factor of 1.

You can change [INTRLEAVE FACTOR] in the usual ways, but with the following conditions:

- Any value you enter with the number keys is changed to the closest integer in the range 1-255.
- When you turn the knob slowly or press an arrow key one time, the current interleave factor changes by 1.

[Kx] softkeys

Key Path: [Trace Data] —> [CONSTANT (K1-K5)]

Press one of the [Kx] softkeys to display the magnitude of the corresponding user-defined constant.

Note

Constants are defined under the [Math] hardkey.



[LAST ERROR] softkey

Key Path: [User Define] —> [DEBUG]

Press [LAST ERROR] to redisplay the last error message generated by your HP Instrument BASIC program. See also [DEBUG] softkey.

Limit registers

The analyzer has four limit registers: one upper and one lower limit register for each of the two traces. Each register holds a complete limit (also called a limit line).

You can load a register either by creating a limit or by recalling a limit from one of the disks. To view the contents of a limit register, do the following:

1. Press [**Active Trace**] (if necessary) to activate the trace associated with the limit.
2. Toggle [**LINES ON/OFF**] to ON.
3. Scale the trace with [**VERTICAL/DIV**] and [**REFERENCE LEVEL**] to bring the limit into view.

Note



The contents of limit registers are not affected by [**Preset**], but they are lost when you turn the analyzer off.

Key Reference
[Limit Test] softkey

[Limit Test] softkey

Key Path: [Marker Fctn]

The [LIMIT TEST] softkey displays a menu. The menu gives you access to all the softkeys you need to define limits (also called limit lines) and to test trace data against those limits.

A special submenu allows you to define limits interactively from the front panel. Two softkeys in the Limit Test menu provide access to this submenu:

- [DEFINE UPPER LIMIT].
- [DEFINE LOWER LIMIT].

Two limit type softkeys let you specify how the upper and lower limits should respond to changes in the reference level setting:

- [ABSOLUTE LIMIT].
- [RELATIVE LIMIT].

The remaining softkeys in the Limit Test menu have the following functions:

- [LINES ON/OFF] lets you enable and disable display of the limits.
- [TEST EVAL ON/OFF] lets you enable and disable evaluation of trace data against the limits.
- [FAIL BEEP ON/OFF] lets you specify whether the analyzer should beep when a limit test is failed.

Each limit is defined as a series of line segments and maintained in a limit register. (These segments need not be joined at their endpoints.) Each segment's amplitude values assume the current display unit—the unit used for the reference level.

Hint: *You can create a limit from a trace. Just save the trace with [SAVE TRACE], then recall it with [RECALL UPPER LIM] or [RECALL LOWER LIM].*

Limit Type softkey group

Key Path: [Marker Fctn] —> [LIMIT TEST]

The two softkeys in this group determine how upper and lower limits will respond when you change the reference level setting.

When you select [ABSOLUTE LIMIT], the absolute y-axis value of the limit lines is held constant when the reference level changes. The effect on the analyzer's screen is that the lines move when you change the reference level.

When you select [RELATIVE LIMIT], the y-axis offset between the limit lines and the reference level is held constant when the reference level changes. In this case, the lines *don't* move when you change the reference level.

[LINE TYPE] softkeys

Key Path: [Plot/Print] —> [DEFINE PLOT] —> [TRACE A LINE TYPE]

or: [Plot/Print] —> [DEFINE PLOT] —> [TRACE B LINE TYPE]

The line type softkeys let you specify the line pattern that will be used to plot each of the analyzer's two traces.

Three softkeys provide the most commonly selected line types:

- [SOLID].
- [DOTTED].
- [DASHED].

Two more softkeys let you request additional line types that may be supported by your plotter. Press [USER LINE TYPE] to enter the encoded value that requests a particular line type. Press [USER DEFINED] to activate the user line type.

Line type changes apply only to trace A if you pressed [TRACE A LINE TYPE] to display these softkeys. They apply only to trace B if you pressed [TRACE B LINE TYPE].

Key Reference
[LINEAR MAGNITUDE] softkey

[LINEAR MAGNITUDE] softkey

Key Path —> [Trace Type]

Press the [LINEAR MAGNITUDE] softkey when you want to display linear magnitude on the y-axis versus frequency (or time) on the x-axis.

X-axis units for this coordinate system are “seconds” when zero span is selected. They are “Hz” at all other times.

Y-axis units are V_{rms} when you are displaying an input spectrum.

[LINES ON/OFF] softkey

Key Path: [Marker Fctn] —> [LIMIT TEST]

Press [LINES ON/OFF] to enable and disable the display of limit lines for the active trace.

Note



The analyzer can evaluate a trace against the current limits even when limit lines are not displayed. Just toggle [TEST EVAL ON/OFF] to ON.

[Local/HP-IB] hardkey

Press the [Local/HP-IB] hardkey for one of the following reasons:

- To gain access to softkeys that define the analyzer's HP-IB parameters.
- To return the analyzer to local control when it is being operated via the HP-IB.
- To abort a running HP Instrument BASIC program.

The softkeys grouped under this hardkey allow you to do the following things:

- Abort HP-IB operations initiated by the analyzer.
- Specify the analyzer's controller capabilities.
- Set the analyzer's address.
- Tell the analyzer what addresses you are using for attached peripherals.
- Specify whether HP-IB mnemonics should be echoed to the display when equivalent keys are pressed.
- Interrupt a controller that is operating the analyzer via the HP-IB.

When the analyzer is being operated via the HP-IB, all hardkeys on the analyzer's front panel—except for [Local/HP-IB]—are disabled. You can press [Local/HP-IB] to suspend remote (HP-IB) operation and reenable local (front-panel) operation.

Note



If the analyzer has received the Local Lockout command via the HP-IB, *all* hardkeys are disabled. In this case, you can not reenable front-panel operation by pressing [Local/HP-IB].

The analyzer cancels any pending *OPC command or query when you suspend remote operation.

See the *HP 3588A HP-IB Programming Reference* for more information about remote operation of the analyzer.

Key Reference
[LOG MAGNITUDE] softkey

[LOG MAGNITUDE] softkey

Key Path: [Trace Type]

Press the [LOG MAGNITUDE] softkey when you want to display logarithmic magnitude on the y-axis versus frequency (or time) on the x-axis.

X-axis units for this coordinate system are “seconds” when zero span is selected. They are “Hz” at all other times.

Y-axis units are dBm when you are displaying an input spectrum. Y-axis values are determined by the following formula:

$$10 * \log((\text{Magnitude}^2) / (.001 * Z))$$

When the analyzer’s input impedance is set to 50 ohms or 75 ohms, “Z” equals the input impedance. When the analyzer’s input impedance is set to 1 megohm, “Z” equals the value you have specified in [1 MEG REF IMPEDANCE].

[LOW DIST ON/OFF] softkey

Key Path: [Meas Type]

Press [LOW DIST ON/OFF] to enable and disable the analyzer's low-distortion mode.

Spectrum analyzers introduce low-level distortion products of the signals they are measuring. The relative level of these products varies, but all analyzers introduce them.

The distortion contribution of an analyzer becomes important when you are measuring spectral components that are near the analyzer's distortion specification.

Low-distortion mode reduces the distortion contribution of the HP 3588A's analog input circuitry. If you are measuring components that are within 10 dB of the published distortion specification, this mode may improve your measurement results.

Note



Continuous autoranging is not possible in low-distortion mode, but you can still use the [SINGLE AUTORANGE] softkey.

Low distortion comes at a price—the analyzer's noise floor increases. However, you can offset this increase by reducing the value of [RES BW] (for swept spectrum measurements) or by selecting [HI RES ZOOM] (for narrow band zoom measurements).

Note



Low-distortion mode is not available if you have selected an input impedance of 1 megohm.

Key Reference
[MANUAL FREQ] softkey

[MANUAL FREQ] softkey

Key Path: [Sweep]

Press [MANUAL FREQ] to change the analyzer's measurement frequency during manual sweeps. An entry box is displayed so you can enter a new frequency.

The range of values for [MANUAL FREQ] is limited by the current values of [START] and [STOP]. You can change the manual frequency in the usual ways, but with the following enhancements and exceptions:

- You can control the sensitivity of the knob and arrow keys with [STEP SIZE AUTO/USER] and [USER STEP SIZE].
- The automatic step size is 1/30 of the resolution bandwidth or the width of one display point, whichever is smaller.
- You can set [MANUAL FREQ] to the marker's current x-axis value with the [Marker Value] hardkey.
- The [MANUAL FREQ] entry box is displayed until you press a nonnumeric hardkey. While the box is displayed, the knob can only be used to change the manual frequency.

When you use the knob to sweep the manual frequency, you can skip some display points if you turn the knob too fast. If this happens, just use the arrow keys or the number keys to avoid skipping points.

Note



The value of [MANUAL FREQ] can change when you redefine the frequency band. If the current value falls outside the new band, it changes to the closest available value within the band.

[MARKER A PEN] softkey

Key Path: [Plot/Print] → [DEFINE PLOT] → [DEFINE PLOT PENS]

Press [MARKER A PEN] to specify which plotter pen should be used for plotting trace A's main and offset markers.

The marker A pen is also used to plot the x- and y-axis coordinates of trace A markers (when you use the [PLOT MARKER] and [PLOT OFFST MKR] softkeys) and to plot limit lines.

[MARKER B PEN] softkey

Key Path: [Plot/Print] —> [DEFINE PLOT] —> [DEFINE PLOT PENS]

Press [MARKER B PEN] to specify which plotter pen should be used for plotting trace B's main and offset markers.

The marker B pen is also used to plot the x- and y-axis coordinates of trace B markers (when you use the [PLOT MARKER] and [PLOT OFFST MKR] softkeys) and to plot limit lines.

[Marker Fctn] hardkey

The [Marker Fctn] hardkey displays a menu. You use the softkeys in this menu to control special marker functions in the active trace. (The marker readout is displayed directly above the trace box.)

Note

Basic marker functions are available under the [Marker] hardkey.



The analyzer's special marker functions allow you to do the following things:

- Automatically position the main marker on the largest peak each time a trace is updated.
- Use a counter to more accurately determine signal frequency at the main marker position.
- Determine the noise level at the main marker position.
- Define limits and enable limit testing.

Key Reference
[Marker] hardkey

[Marker] hardkey

The [Marker] hardkey displays a menu. You use the softkeys in this menu to control basic marker functions in the active trace. (The marker readout is displayed directly above the trace box.)

Note



Additional marker functions are available under the [Marker Fctn] hardkey.

The analyzer's basic marker functions allow you to do the following things:

- Enable and disable all markers or just the offset markers.
- Position the main marker and the offset marker along a trace (includes peak search).
- Change frequency parameters (center and span) based on the markers' x-axis positions.
- Change the reference level based on the main marker's y-axis position.

Hint: When a numeric entry box is displayed, turning the knob changes the value in the box; it does not move the marker. To ensure that the knob will move the marker, press [Marker] first.

[MARKER ON/OFF] softkey

Key Path: [Marker]

Press [MARKER ON/OFF] to enable the main marker or to disable all markers at once.

When you toggle this softkey to OFF, both markers—main and offset—in both traces are turned off. The marker readout and the following marker functions are also turned off:

- Peak tracking.
- Frequency counting.
- Noise level measuring.

When you toggle this softkey to ON, the main marker and the marker readout are turned on automatically. However, you must turn on the offset markers and the listed marker functions with the appropriate softkeys.

[Marker Value] hardkey

Press [Marker Value] to use the current value of the marker readout for the active numeric entry softkey.

[Marker Value] uses the x-axis readout if the numeric entry softkey requires a frequency value. It uses the y-axis readout if the softkey requires an amplitude value.

[Marker Value] does not use the displayed y-axis readout if the noise marker is enabled. Instead, it uses the value that would be displayed if the noise marker was disabled.

[Marker Value] can not be used at all for frequency parameters when zero span is selected. This is because the readout's x-axis unit is seconds rather than hertz in this case.

[MARKER X ENTRY] softkey

Key Path: [Marker]

Press [MARKER X ENTRY] when you want to place the main marker on a particular display point of the active trace.

The analyzer has one main marker for each trace. The main marker is the diamond-shaped marker that follows trace contours. You move the main marker to a new point on a trace by changing its x-axis value. The analyzer then displays the x and y values of that point in the marker readout.

You don't need to select [MARKER X ENTRY] to move the main marker with the knob. The knob is assigned to move the marker unless a numeric entry box is displayed. However, you *must* select [MARKER X ENTRY] if you want to move the marker by pressing the arrow keys or by entering a value with the number keys.

If you turn the knob slowly or press an arrow key one time, the marker moves by one display point. If you use the number keys, you can either move the marker to a particular display-point number (0-400) or to a particular frequency or time (depending on the current x-axis units).

Note



When you enter a frequency, the marker is moved to the display point containing that frequency.

Frequency values are bounded by the current start and stop frequencies. Time values (used only when zero span is selected) are bounded by 0 seconds and the current sweep time.

Marker search keys

Four softkeys allow you to search for peaks on the active trace:

- [MKR --> PEAK]: Finds the highest peak once.
- [NXT RIGHT PEAK]: Finds the closest peak to right of marker.
- [NXT LEFT PEAK]: Finds the closest peak to left of marker.
- [PEAK TRK ON/OFF]: Finds the highest peak each time trace updates.

A peak is a local maximum on a trace. The slope of a trace is positive to the left of a peak and negative to the right. In addition, the slope on one side of a peak must not change for at least one vertical division (one-half division if the display format is upper/lower).

[Math] hardkey

The softkeys grouped together under [Math] are used to define trace math functions and constants.

The trace resulting from a particular function or constant can be displayed by pressing the corresponding [Fx] or [Kx] softkey under the [Trace Data] hardkey.

Note



The analyzer does some limited tracking of units in trace math operations.

All math operations are performed on linear rather than logarithmic data. Since you cannot create functions that add or subtract logarithmic values, you must create equivalent functions that multiply or divide linear values. (This is why a normalized spectrum is defined as "SPEC/D8.")

Suppose you want to add 3 dB to your measurement results. Just convert the logarithmic offset to its linear equivalent and multiply your results by this value. Use this formula for the conversion:

$$10^{(n/20)} \quad \text{where } n \text{ is the dB offset}$$

If you place the value (1.413 for this example) in K1, define the function as "SPEC*K1."

[Meas Restart] hardkey

Press this hardkey to restart a measurement. When you restart a measurement, the following things must take place (in the order listed) before the analyzer begins taking data:

1. The measurement hardware must settle.
2. The trigger conditions must be met.

The beginning of data collection is different for each of the following setups:

- Swept spectrum and autosweeping selected: The analyzer begins sweeping at the start frequency.
- Swept spectrum and manual sweeping selected: The analyzer begins sampling the amplitude of the manual frequency.
- Swept spectrum and zero span selected: The analyzer begins sampling the amplitude of the center frequency.
- Narrow band zoom selected: The analyzer begins gathering a new block of time-domain data (for transformation to the frequency domain).

[Meas Restart] has a special synchronizing function when you use keystroke recording to create an HP Instrument BASIC program. When you replay the program, keystrokes recorded after [Meas Restart] are not executed until the measurement is complete.

[Meas Type] hardkey

The [Meas Type] hardkey displays a menu. Use the softkeys in this menu to do the following things:

- Change between swept spectrum and narrow band zoom measurements.
- Enable and disable the low-distortion mode.
- Enable and disable the peak detector.

Key Reference
[MEMORY SIZE] softkey

[MEMORY SIZE] softkey

Key Path: [User Define] —> [UTILITIES]

Press [MEMORY SIZE] to allocate stack space (in bytes of volatile RAM) for your program. An entry box is displayed so you can specify a new value.

Stack space is the portion of memory used for temporary storage of program variables that are not stored in COM. It provides the program's "working space."

Stack space is set automatically when you recall a program or press [AUTO MEMORY]. However, the automatically generated stack space is not appropriate for some programs. Here are two examples:

- Programs that call subprograms recursively usually require more stack space.
- Programs that have many subprograms but don't "nest" them deeply when running usually require less stack space.

Acceptable values for memory size range from 1200 bytes to 3 megabytes (in 2 byte increments).

Note



If you encounter the message "ERROR 2 Memory overflow." while your program is running, you need to allocate more stack space.

Menu definition

The term "menu" simply refers to softkey labels that are displayed concurrently. For example, when you press the [Avg/Pk Hld] hardkey, the softkey labels [OFF], [VIDEO AVERAGE], [PEAK HOLD], and [NUMBER AVERAGES] appear. These labels are referred to collectively as the Avg/Pk Hld menu.

[-] (Minus) softkey

See Operator Menu.

[MKR --> CTR FREQ] softkey

Key Path: [Marker]

When you press [MKR --> CTR FREQ], the analyzer's center frequency is reset to current x-axis value of the main marker (the diamond-shaped marker). The marker is then moved to the new center frequency.

Here's how [MKR --> CTR FREQ] works in some special cases:

- The analyzer uses the measured frequency at the main marker if the frequency counter is on.
- The analyzer uses the main marker value even if the offset marker is on.

There is another way to change the center frequency based on the marker value: press [CENTER], then [Marker Value]. However, this method has the following disadvantages:

- The main marker does not move to the new center frequency.
- The analyzer uses the offset value if the offset marker is on.

[MKR --> PEAK] softkey

Key Path: [Marker]

Press the [MKR --> PEAK] softkey to move the marker to the highest peak on the active trace.

Once moved, the marker remains at the new x-axis location until you do one of the following things:

- Turn the knob (with no entry box displayed).
- Press another marker-search key.
- Enter a new x-axis location (using [MARKER X ENTRY]).

Note



The analyzer can automatically move the marker to the highest peak each time the active trace is updated. To enable this feature, turn on peak tracking.

Key Reference
[MKR --> REF LEVEL] softkey

[MKR --> REF LEVEL] softkey

Key Path: [Marker]

When you press [MKR --> REF LEVEL], the analyzer's reference level is reset to the current y-axis value of the main marker (the diamond-shaped marker).

Here's how [MKR --> REF LEVEL] works in some special cases:

- The analyzer uses the y-axis position of the main marker even if the noise level measurement is enabled.
- The analyzer uses the main marker value even if the offset marker is on.

There is another way to change the reference level based on the marker value: press [REFERENCE LEVEL], then [Marker Value]. However, this has one disadvantage: the analyzer uses the offset value if the offset marker is on.

[MORECHARS] softkeys

Each MORECHARS softkey gives you access to special characters for alpha entry. When you press one of these softkeys, the characters listed after "MORECHARS" are displayed in a menu. You can then insert one of these characters to the left of the text cursor by pressing the corresponding softkey.

Note



A [CANCEL/RETURN] softkey is displayed so you can return to the alpha entry menu without inserting a special character.

[MOVE ALL VERTICAL] softkey

Key Path: [Marker Fctn] —> [LIMIT TEST] —> [DEFINE UPPER LIM]

or: [Marker Fctn] —> [LIMIT TEST] —> [DEFINE LOWER LIM]

Press [MOVE ALL VERTICAL] when you want to move an entire limit up or down.

The value of [MOVE ALL VERTICAL] specifies an amplitude offset for every segment in the limit. The offset is referenced to the limit's original position.

You can change the current value by turning the knob, pressing an arrow key, or entering a new value with a number key.

[MOVE MKR HORIZONTAL] softkey

Key Path: [Marker Fctn] —> [LIMIT TEST] —> [DEFINE UPPER LIM]

or: [Marker Fctn] —> [LIMIT TEST] —> [DEFINE LOWER LIM]

Press [MOVE MKR HORIZONTAL] when you want to move the limit marker horizontally.

Limits are defined as a series of line segments. The limit marker's horizontal position defines the x-axis value of a segment endpoint.

It's easiest to position the limit marker by turning the knob. When [MOVE MKR HORIZONTAL] is active, the knob moves the marker along the x-axis. When [MOVE MKR VERTICAL] is active, the knob moves the marker along the y-axis.

You can also position the limit marker by entering a discrete value for [MOVE MKR HORIZONTAL] with the number keys. The unit for horizontal values is hertz (Hz).

When you are ready to anchor a segment endpoint at the position of the limit marker, just press [START SEGMENT] or [FINISH SEGMENT].

[MOVE MKR VERTICAL] softkey

Key Path: [Marker Fctn] —> [LIMIT TEST] —> [DEFINE UPPER LIM]

or: [Marker Fctn] —> [LIMIT TEST] —> [DEFINE LOWER LIM]

Press [MOVE MKR VERTICAL] when you want to move the limit marker vertically.

Limits are defined as a series of line segments. The limit marker's vertical position defines the y-axis value of a segment endpoint.

It's easiest to position the limit marker by turning the knob. When [MOVE MKR VERTICAL] is active, the knob moves the marker along the y-axis. When [MOVE MKR HORIZONTAL] is active, the knob moves the marker along the x-axis.

You can also position the limit marker by entering a discrete value for [MOVE MKR VERTICAL] with the number keys. Vertical values assume the amplitude unit of the current display—the reference level unit.

When you are ready to anchor a segment endpoint at the position of the limit marker, just press [START SEGMENT] or [FINISH SEGMENT].

[*] (Multiply) softkey

See Operator Menu.

Key Reference
[NARROW BAND ZOOM] softkey

[NARROW BAND ZOOM] softkey

Key Path: [Meas Type]

Press [NARROW BAND ZOOM] when you want to make measurements at spans below 40 kHz. You can also make swept spectrum measurements at these narrow spans, but comparable narrow band zoom measurements can be made in much less time.

During narrow band zoom measurements, the analyzer fixes its local oscillator (LO) frequency. The signal in the IF around the center frequency you specify is then sampled over time. The resulting block of time-domain data is then transformed to the frequency domain using the Fast Fourier Transform (FFT).

Note



You can control the frequency resolution of narrow band zoom measurements with the Zoom Type softkeys.

The analyzer maintains the current center frequency when you change from swept spectrum to narrow band zoom measurements. However, it selects a new span (from the 16 available in narrow band zoom) according to the following rules:

- If the current span is greater than or equal to 40 kHz, you get a 40 kHz span.
- If the current span is less than 40 kHz, you get the closest available span that is greater than or equal to the current span.

The analyzer also maintains the current center frequency when you change from narrow band zoom to swept spectrum measurements. But in this case, it restores the span from the previous swept spectrum measurement.

[NOISE LVL ON/OFF] softkey

Key Path: [Marker Fctn]

Press [NOISE LVL ON/OFF] softkey to enable and disable the analyzer's noise level function.

You can use the noise level function to determine the noise spectral density (normalized to a 1 Hz bandwidth) at the main marker position. The measured noise level is displayed as the marker readout's y-axis value.

Note



When offset marker is on, the noise level readout is relative to the offset marker position.

During swept spectrum measurements, the analyzer sweeps to the marker position, measures the noise level, then completes the sweep. (Or if manual sweeping is selected, the analyzer just measures noise at the manual frequency.) When a noise level measurement has been completed, the marker readout's y-axis value is highlighted.

Note



The noise level function is not available for narrow band zoom measurements.

The following conditions must be met before the analyzer can accurately measure noise level:

- The noise you are measuring must be random noise.
- The analyzer's resolution bandwidth (RBW) must be narrow enough to exclude any discrete signals (such as tones) from the noise measurement.
- The analyzer's RBW must be narrow enough to resolve a relatively flat portion of the noise floor. (This is especially important when you are measuring low-frequency noise or phase noise.)

Key Reference
[NOISE LVL ON/OFF] softkey

Noise level is expressed as the amount of power in a 1 Hz bandwidth for a logarithmic magnitude trace. The unit is dBm/Hz. Noise level is expressed as the rms noise voltage in a 1 Hz bandwidth for a linear magnitude trace. The unit is $V/\sqrt{\text{Hz}}$ —volts per square root of hertz.

The noise level marker only measures noise in the current input spectrum. If you select trace data that is not linked to the input spectrum—for example, the contents of a data register—no noise value is displayed.

If you select trace data that is linked to the input spectrum— either a normalized spectrum or a math function that uses an input spectrum—the noise level marker is still available. However, the noise level reading is not corrected to reflect the normalization or the math operations.

[NON-VOL RAM DISK] softkey

Key Path: [Save/Recall] —> [DEFAULT DISK]

or: [Disk Util] —> [DEFAULT DISK]

Press [NONVOL RAM DISK] when you want to use some of the analyzer's battery-backed RAM as the default disk.

The contents of the non-volatile RAM disk are retained when you turn the analyzer off. They will be available when you turn it back on.

The non-volatile RAM disk is initialized at the factory with approximately 63 kilobytes of storage space. You can not change the size of the non-volatile RAM disk. All format options reformat the disk to the same size.

[NORMLIZED SPECTRUM] softkey

Key Path: [Trace Data]

Press [NORMLIZED SPECTRUM] to display a normalized spectrum in the active trace.

To create a normalized spectrum, the analyzer divides calibrated input data (the data displayed when you press [INPUT SPECTRUM]) by a reference trace. The reference trace is stored in data register D8 when you press [SAVE NORM REFERENCE].

Key Reference
[NUMBER AVERAGES] softkey

[NUMBER AVERAGES] softkey

Key Path: [Avg/Pk Hld]

The [NUMBER AVERAGES] softkey uses a single value (“N” in the following description) to specify both a weighting factor and a count for video averaging.

During video averaging, new and old measurement data is combined to create an average value for each point on the trace. The analyzer uses this formula to combine the data:

$$[(1/N) * \text{new}] + [(N-1)/N) * \text{old}]$$

The count is important when you use HP Instrument BASIC’s keystroke recording feature. If the recorded keystroke sequence includes [Meas Restart], subsequent keystrokes are held off until N measurements are completed.

Note



The analyzer does *not* stop measuring after N measurements. If you want the analyzer to stop measuring, select manual arming.

Numeric entry softkeys

Some softkeys let you change numeric parameters. If a menu contains just one such softkey, the key is active when you enter the menu. If a menu contains two or more of these softkeys, only one of them is active when you enter the menu.

Note



The analyzer indicates that a numeric entry softkey is active by highlighting the whole softkey label.

The active numeric entry softkey is ready to accept a new value at any time. You don't need to press it before entering a new value with the number keys or stepping the old value with the arrow keys.

When you start entering a new value with the number keys, the softkey's entry box is displayed at the top of the screen. The box remains on the screen until you either complete or abort the entry. You complete an entry by pressing the [ENTER] softkey or a unit softkey. You abort an entry by pressing [CANCEL/RETURN].

When you step the value of a numeric entry softkey with the arrow keys, the entry box is displayed for a couple of seconds so you can see the new value.

You *do* need to press a numeric entry key, even the active one, if you want to change its value by turning the knob. The knob is normally used to move the marker, and can only be used for numeric entry if an entry box is displayed.

When you press a numeric entry key, its entry box is displayed at the top of the screen for a couple of seconds. If you start turning the knob while the box is still up, the box remains up until you stop. You can watch the value change as you turn the knob.

Note



Changes made with the arrow keys and the knob take effect immediately.

Key Reference
[NXT LEFT PEAK] softkey

[NXT LEFT PEAK] softkey

Key Path: [Marker]

Press [NXT LEFT PEAK] to move the main marker one peak to the left of its current location in the active trace.

A peak is a local maximum on a trace. The slope of a trace is positive to the left of a peak and negative to the right. In addition, the slope on one side of a peak must not change for at least one vertical division (one-half division if the display format is upper/lower).

The “next left peak” must be at least one display point to the left of the current marker location. If the peak search algorithm doesn’t find a peak, the marker doesn’t move.

Hint: Decrease the value of [VERTICAL/DIV] to increase the number of peaks found.

Use any of the marker-search keys—including [NXT LEFT PEAK]—with offset markers to quickly measure frequency and amplitude differences between two signals.

[NXT RIGHT PEAK] softkey

Key Path: [Marker]

Press [NXT RIGHT PEAK] to move the main marker one peak to the right of its current location in the active trace.

A peak is a local maximum on a trace. The slope of a trace is positive to the left of a peak and negative to the right. In addition, the slope on one side of a peak must not change for at least one vertical division (one-half division if the display format is upper/lower).

The “next right peak” must be at least one display point to the right of the current marker location. If the peak search algorithm doesn’t find a peak, the marker doesn’t move.

Hint: Decrease the value of [VERTICAL/DIV] to increase the number of peaks found.

Use any of the marker-search keys—including [NXT RIGHT PEAK]—with offset markers to quickly measure frequency and amplitude differences between two signals.

[OFF] softkey (Avg/Pk Hld)

Key Path: [Avg/Pk Hld]

Press this softkey to disable the video average and peak hold functions. When [OFF] is selected, each trace update represents the results of a single measurement.

[OFFSET ON/OFF] softkey

Key Path: [Marker]

Press [OFFSET ON/OFF] to enable and disable the offset marker for the active trace.

The analyzer has one offset marker for each trace. The offset marker is the square-shaped marker that remains at a fixed location—even when a trace is updated. To reposition the offset marker, you must move the main marker to a new location and then press [ZERO OFFSET].

When the offset marker is on, the analyzer subtracts the offset marker position from the main marker position to establish the x and y values of the marker readout. The readout is preceded by the delta symbol to show that this difference is being displayed.

Use the offset markers with any of the marker-search keys to quickly measure frequency and amplitude differences between two signals.

[OFFST MKR --> SPAN] softkey

Key Path: [Marker]

When you press [OFFST MKR --> SPAN], the analyzer's span is reset to the absolute value of the frequency difference between the main marker and the offset marker.

Note



For narrow band zoom measurements: If the offset doesn't exactly match one of the available spans, the analyzer selects the next larger span.

Here's how [OFFST MKR --> SPAN] positions the new span along the x-axis:

- For swept spectrum measurements: [START] is set to the smaller of the two markers' frequencies and [STOP] is set to the larger.
- For narrow band zoom measurements: [CENTER] is set to (main marker freq + offset marker freq) / 2.

[OFFST MKR --> SPAN] does nothing if the offset markers are turned off. It also does nothing if zero span is selected.

[1 MEGOHM] softkey

See Input Impedance softkey group.

Key Reference
[1 MEG REF IMPEDANCE] softkey

[1 MEG REF IMPEDANCE] softkey

Key Path: [Range/Input]

Press this softkey to change the reference impedance used in dBm calculations.

The analyzer only uses the reference impedance for dBm calculations when the you select the 1 megohm input impedance. It uses the nominal impedance for these calculations when you select either the 50 or 75Ω input impedance. *See also* Input Impedance softkey group.

Operand menu

Key Path: [Math] → [DEFINE Fx]

You specify the data to be used in a function by pressing the softkeys in the operand menu or one of its submenus.

[SPECTRUM] selects calibrated input data as an operand. [SQRT(NBW)] selects the square root of the noise equivalent bandwidth as an operand. [DATA REG (D1-D8)], [CONSTANT (K1-K5)], and [FUNCTION (F1-F5)] all display submenus for selecting the contents of a particular register as an operand.

Use the opening parenthesis softkey—“(” —and the closing parenthesis softkey—“)” —(available in the operator menu) to specify the order in which operations should be performed. [CANCEL/RETURN] is used to abandon the function definition you are creating in favor of the one that already exists.

Operator menu

Key Path: [Math] —> [DEFINE Fx] —> Operator menu

You specify which math operations a function will perform by pressing the softkeys in the Operator menu. The following operations are available: addition, subtraction, multiplication, and division.

Note



The analyzer does some limited tracking of units in trace math operations.

The closing parenthesis softkey—“)””—is used in conjunction with the opening parenthesis—“(”—softkey (available in the Operand menu) to specify the order in which operations should be performed.

[ENTER] completes a new function definition. If you have used fewer closing parentheses than opening parentheses, [ENTER] adds enough to create a balance.

[CANCEL/RETURN] is used to abandon the function definition you are creating in favor of the one that already exists.

Output Impedance softkey group

Key Path: [Source]

This group of softkeys allows you to select the output impedance of the analyzer's source.

When you select [50 OHMS OUTPUT Z], the output impedance is set to 50 ohms. The dBm calculations for source amplitude assume a 50 ohm output impedance.

When you select [75 OHMS OUTPUT Z], the output impedance is still set to 50 ohms, but dBm calculations for source amplitude assume a 75 ohm output impedance.

Note



If [75 OHMS OUTPUT Z] is selected, the actual and requested source amplitude only match if you use the 25Ω adapter barrel supplied with the analyzer. Insert the adapter between the source connector and your test device.

When you select [COUPLE TO INPUT Z], the output impedance tracks changes in input impedance with one exception: If you switch from the 50 or 75Ω input impedance to the 1 megohm input impedance, the output impedance retains its current setting.

Key Reference
[OVERSWEEP ON/OFF] softkey

[OVERSWEEP ON/OFF] softkey

Key Path: [Sweep]

Press [OVERSWEEP ON/OFF] to enable and disable oversweeping. Oversweeping allows the HP 3588A to make swept measurements up to four times faster than other swept-tuned analyzers.

Note Oversweeping is not available for narrow band zoom measurements.



The HP 3588A uses a digital resolution bandwidth (RBW) filter rather than the analog filter used in more conventional swept-tuned analyzers. One property of digital filters makes oversweeping possible: they settle more predictably than analog filters.

Since the settling of its digital RBW filter is predictable, the HP 3588A can correct for sweep times that are too fast to allow complete settling. The correction algorithm maintains the analyzer's amplitude and frequency accuracy in these "overswept" conditions.

Note Oversweeping increases the RBW filter's shape factor by about 30 percent.



The oversweep correction algorithm makes an important assumption about the signals being analyzed—it assumes that they are not changing in frequency during the sweep. This assumption is invalid when you are using the analyzer's tracking source, so oversweeping is automatically disabled when the source is on.

When video filtering is disabled, the analyzer provides calibrated measurement results for sweep rates at or below the following limits (given in Hz/s):

- Oversweep on: $(RBW^2) * 2$
- Oversweep off: $(RBW^2) / 2$

Where *RBW* is the resolution bandwidth (in Hz)

You can not always select a sweep time that allows you to achieve the maximum calibrated sweep rate. Quantization effects produced by the analyzer's digital IF filter and local oscillator (LO) can limit the availability of calibrated sweep times. These effects are most noticeable at narrow spans.

Hint: You can sometimes make shorter calibrated sweep times available by increasing or decreasing the span a bit (10 to 20 percent).

[PACK DISK] softkey

Key Path: [Disk Util]

Press [PACK DISK] when you want to increase the amount of usable space on one of the disks.

When you press [PACK DISK], you are prompted to enter the disk specifier for the disk you want to pack. The prompt already contains the specifier for the default disk, but you can modify it with the alpha entry keys.

When you delete files from a LIF-formatted disk, you sometimes leave spaces that are too small to be used for new files. [PACK DISK] recovers these unusable spaces by shifting the remaining files forward on the disk until the files are directly adjacent to each other.

As files are shifted forward, the spaces between files are effectively shifted to a large block of usable space at the end of the disk. The result of this shifting is more usable space on the disk.

[PAGE EJCT ON/OFF] softkey

Key Path: [Plot/Print] —> [DEFINE PLOT]

Press [PAGE EJCT ON/OFF] to enable and disable your plotter's page-eject feature. The state you select is used for all plotting operations initiated by the analyzer.

Note



Check your plotter's documentation to be sure that it supports the requested page-eject state.

[(] (Left Parenthesis) softkey

See Operand Menu.

[)] (Right Parenthesis) softkey

See Operator Menu.

Key Reference
[PEAK DET ON/OFF] softkey

[PEAK DET ON/OFF] softkey

Key Path: [Meas Type]

Press [PEAK DET ON/OFF] to enable and disable the analyzer's peak detector.

Note



The peak detector should be on for *all* swept spectrum measurements. It should be off for scalar network measurements (made with the tracking source).

The peak detector compensates for the limited frequency resolution of the analyzer's display. Each trace box is divided along its x axis into 401 evenly-spaced points, which limits display resolution to 1/400th of the current span.

The analyzer could not accurately display the amplitude of signals between display points if each point represented only a single frequency. Signals could even be completely missed if the setting of resolution bandwidth was much narrower than the point spacing.

When the peak detector is on, a display point represents all frequencies between its nominal frequency and the nominal frequency of the point to its right. The amplitude of the largest signal detected in that band of frequencies is used as the amplitude of the point.

When the peak detector is off, a display point represents a single frequency—the nominal frequency of the point to its right. All frequencies are shifted left by one display point.

Hint: Use the frequency counter to measure the true frequency of a displayed peak.

Since the analyzer keeps positive peaks and rejects negative peaks when the peak detector is on, the average level of random noise appears to increase. This effect is more pronounced for longer sweep times. When the analyzer spends more time sweeping, there is an increased probability that it will detect more positive excursions of the noise.

Hint: Use the noise level function to measure the true energy of the noise floor.

[PEAK HOLD] softkey

Key Path: [Avg/Pk Hld]

Press [PEAK HOLD] when you want the analyzer to maintain the peak value of each display point over the course of several measurements.

When [PEAK HOLD] is selected, the results of a completed measurement are compared, point by point, with currently displayed trace. The maximum value of each point is retained and displayed in the updated trace.

Note



Peak hold is purely a display function. The maximum value of each point is *not* reset when you change the analyzer's measurement parameters. To reset the displayed data, you must turn peak hold off and back on.

Peak hold is especially useful for detecting transient signals. It is also useful for observing a signal whose frequency changes over time.

[PEAK TRK ON/OFF] softkey

Key Path: [Marker Fctn]

Press [PEAK TRK ON/OFF] to enable and disable the analyzer's peak tracking function.

When peak tracking is on, the analyzer automatically positions the main marker on the largest peak of the active trace each time the trace is updated. The marker readout reflects any changes in the marker position.

When peak tracking is off, the main marker only moves from its current x-axis position when you do one of the following things:

- Turn the knob (with no entry box displayed).
- Press a marker-search key.
- Enter a new x-axis position (using [MARKER X ENTRY]).

Note



Peak tracking is not available during manual sweeps.

Key Reference
[PERFORM DISK COPY] softkey

[PERFORM DISK COPY] softkey

See Copy Disk softkeys.

[PERFORM FILE COPY] softkey

See Copy File softkeys.

[PERFORM FORMAT] softkey

Key Path: [Disk Util] —> [FORMAT DISK]

Press [PERFORM FORMAT] when you want to format a disk. After you identify the disk, it is formatted using the current values of [FORMAT OPTION] and [INTRLEAVE FACTOR].

Note



The analyzer's internal disk drive can only format double-sided flexible disks.

When you press [PERFORM FORMAT], you are prompted to enter the disk specifier for the disk you want to format. The prompt already contains the specifier for the default disk, but you can modify it with the alpha entry keys.

You can append a volume name to the disk specifier when you format a disk. Just position the cursor after the colon and enter a name of six characters or less.

Hint: Use a unique volume name for each flexible disk to help you keep track of your data. The name will be displayed in the upper-left corner of the catalog.

[PERFORM RENUMBER] softkey

Key Path: [User Define] —> [UTILITIES] —> [RENUMBER]

Press [PERFORM RENUMBER] to renumber the lines of your HP Instrument BASIC program.

The number of the first line will be the value specified in [START LINE #]. The increment between lines will be the value specified in [INCREMENT].

[PERFORM SCRATCH] softkey

Key Path: [User Define] —> [UTILITIES] —> [SCRATCH]

Press [PERFORM SCRATCH] to scratch (delete) your program and/or its variables. The selection you made in the Scratch Options softkey group determines what will be deleted. *See* Scratch Options softkey group.

[PERFORM SECURE] softkey

Key Path: [User Define] —> [UTILITIES] —> [SECURE]

Press [PERFORM SECURE] to secure the portion of your program specified by [START LINE #] and [END LINE #].

Secured lines cannot be viewed in the HP Instrument BASIC editor or printed with [PRINT PROGRAM]. An asterisk (*) replaces program statements on secured program lines.

Caution



Secured program lines can *not* be unsecured. Be sure to keep an unsecured version of the program for your own records.

Performance test softkeys

Key Path: [Spcl Fctn]

The [PRFM TESTS] softkey displays a menu. Use the softkeys in the menu to enable special hardware setups when you are testing the analyzer's performance.

Here are the softkeys in the Prfm Tests menu:

- [CALIBRATR TO INPUT].
- [SRCE 10dB IN/OUT].
- [SRCE 20dB A IN/OUT].
- [SRCE 20dB B IN/OUT].
- [SRCE DAC ATTEN].

You should only use these softkeys as directed in your *HP 3588A Performance Test Guide*.

Key Reference
[PERIPHERL ADDRESSES] softkey

[PERIPHERL ADDRESSES] softkey

Key Path: [Local/HP-IB]

Use the softkeys grouped under [PERIPHERL ADDRESSES] to tell the analyzer what addresses are currently assigned your HP-IB peripherals. The peripherals can either be plotters or printers.

[PLOT ALL] softkey

Key Path: [Plot/Print]

Press the [PLOT ALL] softkey to plot everything on the analyzer's screen (except for the softkey labels).

[PLOT ALL] allows you to plot any of the following things:

- Traces.
- The instrument state.
- The disk catalog.
- Output from an HP Instrument BASIC program.

However, it does not allow you to plot HP Instrument BASIC programs or Help screens. They can only be printed.

You can define most plot parameters under the [DEFINE PLOT] softkey, but you must change plot scaling parameters on the plotter itself.

Note



Plotting is only possible if the [SYSTEM CONTROLLR] softkey is selected and if the value entered under the [PLOTTER ADDRESS] softkey matches the setting on your plotter.

[PLOT GRATICULE] softkey

Key Path: [Plot/Print]

Press [PLOT GRATICULE] to plot every graticule that is currently displayed on the analyzer's screen. Graticules are always plotted with solid lines.

You can define most plot parameters under the [DEFINE PLOT] softkey, but you must change plot scaling parameters on the plotter itself.

Note



Plots are only executed if the [SYSTEM CONTROLLER] softkey is selected and if the value entered under the [PLOTTER ADDRESS] softkey matches your plotter's HP-IB address setting.

[PLOT MARKER] softkey

Key Path: [Plot/Print]

Press [PLOT MARKER] to plot every main marker that is currently displayed on the analyzer's screen. Markers are annotated with their x-axis and y-axis coordinates.

You can define most plot parameters under the [DEFINE PLOT] softkey, but you must change plot scaling parameters on the plotter itself.

Note



Plots are only executed if the [SYSTEM CONTROLLER] softkey is selected and if the value entered under the [PLOTTER ADDRESS] softkey matches your plotter's HP-IB address setting.

Key Reference
[PLOT OFFST MKR] softkey

[PLOT OFFST MKR] softkey

Key Path: [Plot/Print]

Press [PLOT OFFST MKR] to plot every offset marker that is currently displayed on the analyzer's screen. Markers are annotated with their x-axis and y-axis coordinates.

You can define most plot parameters under the [DEFINE PLOT] softkey, but you must change plot scaling parameters on the plotter itself.

Note



Plots are only executed if the [SYSTEM CONTROLLR] softkey is selected and if the value entered under the [PLOTTER ADDRESS] softkey matches your plotter's HP-IB address setting.

[PLOT SPEED] softkey

Key Path: [Plot/Print] —> [DEFINE PLOT]

Press [PLOT SPEED] for access to the plot speed softkeys. The speed you specify with these softkeys will be used for all plot operations.

Note



Check your plotter's documentation to be sure that it supports the requested plotting speed.

Plot Speed softkeys

Key Path: [Plot/Print] —> [DEFINE PLOT] —> [PLOT SPEED]

The plot speed softkeys let you specify the plotting speed for all plotting operations initiated by the analyzer.

Two softkeys provide the most commonly selected plotting speeds:

- [SLOW (10 cm/s)]
- [FAST (50 cm/s)]

Two more softkeys let you request additional plotting speeds that may be supported by your plotter. Press [USER PLOT SPEED] to enter a new speed (units are cm/s). Press [USER DEFINED] to activate the user plot speed.

[PLOT TRACE] softkey

Key Path: [Plot/Print]

Press [PLOT TRACE] to plot every trace that is currently displayed on the analyzer's screen. Traces are plotted without graticules, annotation or markers.

You can define most plot parameters under the [DEFINE PLOT] softkey, but you must change plot scaling parameters on the plotter itself.

Note



Plots are only executed if the [SYSTEM CONTROLLER] softkey is selected and if the value entered under the [PLOTTER ADDRESS] softkey matches your plotter's HP-IB address setting.

Key Reference
[Plot/Print] hardkey

[Plot/Print] hardkey

The softkeys grouped under the [Plot/Print] hardkey are used to control the plotting and printing of screen contents.

Note



The [system contrllr] softkey must be selected before plotting or printing. Also, [PLOTTER ADDRESS] and [PRINTER ADDRESS] must be correct.

Five softkeys in this menu allow you to plot selected portions of the analyzer's screen:

- [PLOT ALL].
- [PLOT TRACE].
- [PLOT MARKER].
- [PLOT OFFST MKR].
- [PLOT GRATICULE].

There are three additional softkeys:

- [DEFINE PLOT] provides access to submenus that allow you to define plot parameters.
- [PRINT ALL] prints everything on the screen (except the softkey labels).
- [ABORT PLOT/PRINT] lets you stop the current plot or print before it is completed.

Plots are scaled according to the established limits on the plotter. The analyzer can't redefine these limits; you must change them on the plotter.

Print information is sent as a bit-mapped graphic, so your printer must have raster-dump capabilities. Mapping of screen pixels to printer pixels is one-to-one.

The softkeys grouped under [Plot/Print] allow you to plot or print the following things:

- Traces.
- The instrument state.
- The disk catalog.
- Output from an HP Instrument BASIC program.

However, these softkeys do *not* allow you to plot or print HP Instrument BASIC programs or Help screens. A program is printed when you press the [PRINT PROGRAM] softkey (in the User Define menu). A displayed Help screen is printed when you press [8].

[PLOTTER ADDRESS] softkey

Key Path: [Local/HP-IB] —> [PERIPHERAL ADDRESSES]

Press this softkey to tell the analyzer what address is currently assigned to your HP-IB plotter. (See your plotter's documentation if you don't know how to determine its HP-IB address.) A prompt is displayed so you can enter the address.

Note



The plotter address is saved in non-volatile memory, so it is retained when you turn the analyzer off and on.

When you plot screen contents, the analyzer looks for a plotter at the address specified with this softkey. If there isn't a plotter at the specified address, the plot is aborted.

[+] (Plus) softkey

See Operator Menu.

Key Reference
[Preset] hardkey

[Preset] hardkey

You can return the analyzer to a known state by pressing [Preset]. This known state provides a convenient starting point when you are setting up a new measurement.

The analyzer's preset state is described on the following pages. Individual parameters are organized first by hardkey group, then by hardkey.

Note



The listed parameters are also returned to their preset values at power-up unless you have created an AUTO_ST file.

MARKER group	
[Marker] Hardkey	[Marker Fctn] hardkey
X Entry: 75.05 MHz Offset: Off Marker: On	Peak Trk: Off Freq Cntr: Off Noise Lvl: Off
DISPLAY group	
[Active Trace] hardkey	[Format] hardkey
Active Trace: A	Display Format: Single Graticule: On
[Meas Data] hardkey	[Scale] hardkey
Trace A: Input Spectrum Trace B: Input Spectrum Trace Title (A): default Trace Title (B): default	Vertical /Div: 10 dB Ref Track: On
[Trace Type] hardkey	
Trace Type: Log Magnitude	

MEASUREMENT group	
[Avg/Pk Hold] hardkey	[Freq] hardkey
Average/Pk Hold option: Off Number Averages: 10	Center: 75.05 MHz Span: 149.9 MHz Start: 100.0 kHz Stop: 150.0 MHz Step Size: Auto User Step Size: 1 kHz Signl Trk: OFF
[Meas Type] hardkey	[Range/Input] hardkey
Meas Type: Swept Spectrum	Autorange: On Input Impedance: 50 Ω 1 Meg Ref Imped: 50 Ω
[Res BW] hardkey	[Source] hardkey
Res BW: 17 kHz Vid Fitr: Off BW Couple: On Zoom Type: Hi Accrcy Zoom	Source State: Off Source Amplitude: - 10.0 dBm Amplitude Step: 0.1 dBm Output Z: 50 Ω Z Coupling: On
[Sweep] hardkey	[Trigger] hardkey
Sweep: Auto Manual Freq 75.05 MHz Sweep Time : 260.8 ms Sample Time: 4 us Oversweep: On	Trigger Type: Free Run Arm: Auto

Key Reference
 [Preset] hardkey

SYSTEM group	
[Disk Util] hardkey	[Local/HP-IB] hardkey
Format Option: 0 Interleave Factor: 1 Catalog: Off	Echo: Off
[Plot/Print] hardkey	[Spcl Fctn] hardkey
Trace A Pen: 2 Trace B Pen: 3 Marker A Pen: 5 Marker B Pen: 6 Alpha Pen: 4 Graticule Pen: 1 Trace A Line Type: Solid User Defined line A: -4096 Trace B Line Type: Solid User Defined line B: -4096 Plot Speed: Fast (50 cm/s) User Defined speed: 50 cm/s Page Ejct: On	Auto Cal: On Beeper: On Srce 10dB: Out Srce 20dB A: Out Srce 20dB B: Out Srce DAC Atten: 0 dB

These parameters are not affected by [Preset], but are returned to the following values at power-up:

Registers	[User Define] hardkey
Function registers: cleared Constant registers: cleared Data registers: cleared Limit registers: cleared	Memory Size: 8192 bytes Scratch option: Scratch Start Line # (renumber): 10 Increment (renumber): 10 Start Line # (secure): 1 End Line # (secure): 32766

These parameters are retained in non-volatile RAM, so they are not affected by [Preset] or power-up:

[Disk Util] hardkey	[Local/HP-IB] hardkey
Default Disk	Controller Capability Analyzer Address Plotter Address Printer Address
[Spcl Fctn] hardkey	
Time Date	

[PRINT ALL] softkey

Key Path: [Plot/Print]

Press the [PRINT ALL] softkey to print everything on the analyzer's screen (except for the softkey labels).

[PRINT ALL] prints any of the following things:

- Traces.
- The instrument state.
- The disk catalog.
- Output from an HP Instrument BASIC program.

[PRINT ALL] does *not* print HP Instrument BASIC programs or Help screens. Press [PRINT PROGRAM] (in the User Define menu) to print a program. Press [8] to print a displayed Help screen.

Print information is sent as a bit-mapped graphic, so your printer must accept raster dumps. Mapping of screen pixels to printer pixels is one-to-one.

Note



Printing is only possible if the [SYSTEM CONTROLLER] softkey is selected and if the value entered under the [PRINTER ADDRESS] softkey matches the setting on your printer.

[PRINT PROGRAM] softkey

Key Path: [User Define]

Press [PRINT PROGRAM] to print (list) your HP Instrument BASIC program. The following things must be true in order for your program to print:

The analyzer must be the system controller. The printer must be turned on, attached to the analyzer's HP-IB connector, and set to the address specified under the [PRINTER ADDRESS] softkey.

Key Reference
[PRINTER ADDRESS] softkey

[PRINTER ADDRESS] softkey

Key Path: [Local/HP-IB] —> [PERIPHERL ADDRESSES]

Press this softkey to tell the analyzer what address is currently assigned to your HP-IB printer. (See your printer's documentation if you don't know how to determine its HP-IB address.) A prompt is displayed so you can enter the address.

Note



The printer address is saved in non-volatile memory, so it is retained when you turn the analyzer off and on.

When you print screen contents, the analyzer looks for a printer at the address specified with this softkey. If there isn't a printer at the specified address, the print is aborted.

[RANGE] softkey

Key Path: [Range/Input]

Press [RANGE] to manually change the sensitivity of the analyzer's input circuitry.

The range setting determines the maximum ac signal level that can be applied to the input connector without overdriving the input circuitry. The following table shows the maximum signal level for each of the analyzer's five ranges:

50Ω	75Ω	1 MΩ
20 dBm (2.24 Vrms)	21.76 dBm (3.35 Vrms)	
10 dBm (707 mVrms)	11.76 dBm (1.06 Vrms)	
0 dBm (223 mVrms)	1.76 dBm (335 mVrms)	0 dBm * (223 mVrms) (-13 dBV)
-10 dBm (70.7 mVrms)	-8.23 dBm (106 mVrms)	
-20 dBm (22.4 mVrms)	-18.23 dBm (33.5 mVrms)	

* Referenced to 50Ω

Note



Only the 0 dBm (referenced to 50 ohms) range is available if you select the 1 MΩ input impedance.

The easiest way to change the range is to use the arrow keys. If you enter a range with the number keys, the value is automatically changed to the next larger available range.

Note



If reference level tracking is turned on, the reference level changes when you change the range.

If you choose to set the range manually, you should watch for the over-range (RNG) and overload (OVLD) indicators at the bottom of the screen. They are displayed when the input circuitry is being overdriven as a reminder that you should either change to a less sensitive range or reduce the input signal level.

The over-range indicator is sensitive to all signals between 0 and 150 MHz—including those that are outside the current span. As a result, you may see RNG displayed even when a trace contains no over-range components. The overload indicator is only sensitive to signals within the current span.

Either indicator may be displayed briefly when the analyzer is autoranging.

[Range/Input] hardkey

The [Range/Input] hardkey displays a menu. You use the softkeys in this menu primarily to adjust the sensitivity and impedance of the analyzer's input circuitry.

Note



The menu also contains a softkey that allows you to reset the input's protective relay.

[RE-SAVE PROGRAM] softkey

Key Path: [Save/Recall] —> [SAVE MORE]

Use [RE-SAVE PROGRAM] to save the changes you make while editing the current HP Instrument BASIC program. You can not use [SAVE PROGRAM] for this purpose, because it doesn't allow you to overwrite an existing program (in this case, the last-saved version of the program you are editing).

Both softkeys save your program to the default disk unless you include a disk specifier in the filename prompt.

Caution



The volatile RAM disk is cleared each time you turn the analyzer off. Copy important programs to another disk before power-down or they will be lost.

When you save a program, you are prompted for a filename. If the catalog is off, the prompt contains a default filename: either PROG or the name of the last-saved program. If the catalog is on, the prompt contains the name of the file currently highlighted. You can use the name in the prompt or modify it with the alpha entry keys.

Key Reference
[RECALL LINE] softkey

[RECALL LINE] softkey

Key Path: [User Define] —> [EDIT]

Press [RECALL LINE] to recall the last line you deleted when you are editing a program.

A line is always recalled with its original line number. You must change this number if you want the recalled line to remain at its new location when you press [ENTER]. The new line number must fall between the line numbers of adjacent program lines.

Hint: If you press [INSERT LINE] before [RECALL LINE], you will be able to see the line numbers of both adjacent lines.

[RECALL LOWER LIM] softkey

Key Path: [Save/Recall] —> [RECALL MORE]

Use [RECALL LOWER LIM] to recall a limit line into the lower limit register of the active trace. The limit line is recalled from the default disk unless you include a disk specifier in the filename prompt.

Hint: You can create a limit from a trace. Just save the trace with [SAVE TRACE], then recall it with [RECALL UPPER LIM] or [RECALL LOWER LIM].

When you recall a lower limit, you are prompted for a filename. If the catalog is off, the prompt contains a default filename: L_LIM. If the catalog is on, the prompt contains the name of the file currently highlighted. You can use the name in the prompt or modify it with the alpha entry keys.

[RECALL MATH] softkey

Key Path: [Save/Recall] —> [RECALL MORE]

Use [RECALL MATH] to recall a complete set of math definitions—all functions and constants—from one of the disks. The definitions are recalled from the default disk unless you include a disk specifier in the filename prompt.

When you recall a set of math definitions, you are prompted for a filename. If the catalog is off, the prompt contains a default filename: MATH. If the catalog is on, the prompt contains the name of the file currently highlighted. You can use the name in the prompt or modify it with the alpha entry keys.

[RECALL MORE] softkey

Key Path: [Save/Recall]

[RECALL MORE] just displays a menu. Softkeys in the menu allow you to recall any of the following:

- A limit definition (upper or lower).
- A set of math definitions.
- An HP Instrument BASIC program.

[RECALL PROGRAM] softkey

Key Path: [Save/Recall] —> [RECALL MORE]

Use [RECALL PROGRAM] to load an HP Instrument BASIC program into the analyzer. The program is recalled from the default disk unless you include a disk specifier in the filename prompt.

When you recall a program, you are prompted for a filename. If the catalog is off, the prompt contains a default filename: either PROG or the name of the last program you saved or recalled. If the catalog is on, the prompt contains the name of the file currently highlighted. You can use the name in the prompt or modify it with the alpha entry keys.

[RECALL STATE] softkey

Key Path: [Save/Recall]

Use [RECALL STATE] to replace the current instrument state with a saved state. The state is recalled from the default disk unless you include a disk specifier in the filename prompt.

The recalled state includes math definitions. The contents of the function and constant registers are overwritten by these definitions.

Hint: If you want to recall a state and keep your current math definitions, do this:

1. Save the math definitions.
2. Recall the state.
3. Recall the math definitions you just saved.

When you recall a state, you are prompted for a filename. If the catalog is off, the prompt contains a default filename: STATE. If the catalog is on, the prompt contains the name of the file currently highlighted. You can use the name in the prompt or modify it with the alpha entry keys.

Key Reference
[RECALL TRACE] softkeys

[RECALL TRACE] softkeys

Key Path: [Save/Recall]

The softkeys grouped under [RECALL TRACE] let you load a trace into one of the analyzer's data registers. The trace is recalled from the default disk unless you include a disk specifier in the filename prompt.

Note



To display the recalled trace, you must select the corresponding data register under the [Trace Data] hardkey.

When you recall a trace, you are prompted for a filename. If the catalog is off, the prompt contains a default filename: TRACE. If the catalog is on, the prompt contains the name of the file currently highlighted. You can use the name in the prompt or modify it with the alpha entry keys.

[RECALL UPPER LIM] softkey

Key Path: [Save/Recall] —> [RECALL MORE]

Use [RECALL UPPER LIM] to recall a limit line into the upper limit register of the active trace. The limit line is recalled from the default disk unless you include a disk specifier in the filename prompt.

Hint: You can create a limit from a trace. Just save the trace with [SAVE TRACE], then recall it with [RECALL UPPER LIM] or [RECALL LOWER LIM].

When you recall an upper limit, you are prompted for a filename. If the catalog is off, the prompt contains a default filename: U_LIM. If the catalog is on, the prompt contains the name of the file currently highlighted. You can use the name in the prompt or modify it with the alpha entry keys.

[REF TRACK ON/OFF] softkey

Key Path: [Scale]

The [REF TRACK ON/OFF] softkey toggles reference-level tracking on and off for the active trace.

“Reference level” defines the upper limit of a trace box. When tracking is turned on, this upper limit is tied to the current input range. Each time the range changes, the upper limit of the trace box changes to match.

You can still use [REFERENCE LEVEL] or [AUTO SCALE] to change the reference level while tracking is on. If you do this, the analyzer remembers the resulting offset between the input range and reference level. Then if the range changes, the analyzer reestablishes the offset. Here’s an example:

- Initial conditions: Ref tracking = on, input range = 0 dBm, ref level = 5 dBm.
- Range: Input range = 10 dBm.
- Result: Ref level = 15 dBm.

The setting of [REF TRACK ON/OFF] is ignored for the following kinds of trace data:

- Constants.
- Data registers (includes recalled traces).

When tracking is turned off (or when it is being ignored), you must use the [REFERENCE LEVEL] softkey to explicitly set the reference level.

Key Reference
[REFERENCE LEVEL] softkey

[REFERENCE LEVEL] softkey

Key Path: [Scale]

Press the [REFERENCE LEVEL] softkey when you want to reposition the active trace along its vertical axis. To lower the trace, increase the reference level value.

Reference level defines the upper limit of the active trace box. It defines this limit using linear units (Vrms) or logarithmic units (dBm), depending on the coordinate system being used. Use options under the [Trace Type] hardkey to select a coordinate system.

Note



You can link the trace box's upper limit to the current input range by turning on reference level tracking.

Rename File softkeys

Key Path: [Disk Util]

[rename file] just displays a menu. The menu contains all the softkeys you need to rename a file:

- [ORIGINAL FILENAME] prompts you for the file's current name.
- [NEW FILENAME] prompts you for the file's new name.
- [PERFORM RENAME] renames a file based on your entries in the two filename prompts.

When you press [PERFORM RENAME], the analyzer renames a file on the default disk. To rename a file on one of the other disks, you must enter that disk's specifier in both filename prompts.

A name is automatically entered into each filename prompt. If the catalog is off, each prompt contains the filename last entered. If the catalog is on, each prompt contains the name of the file currently highlighted. You can use the name in the prompt or modify it with the alpha entry keys.

[RENUMBER] softkey

Key Path: [User Define] —> [UTILITIES]

[RENUMBER] displays a menu. You use the softkeys in the menu to do three things:

- Specify the first line number of a renumbered program.
- Specify the increment between renumbered lines.
- Renumber a program based on the specified first line number and increment.

[Res BW] hardkey

The softkeys grouped under the [Res BW] hardkey are used primarily to control the analyzer's measurement resolution

Five of the softkeys are only available for swept spectrum measurements:

- [RES BW] lets you select one of 15 bandwidths for the analyzer's resolution filter. Use smaller values to increase measurement resolution.
- [VID FLTR ON/OFF] lets you enable and disable the analyzer's video filter.
- [VIDEO BW] lets you select a bandwidth for the video filter. Use smaller values to smooth the noise floor.
- [BW COUPLE ON/OFF] lets you enable and disable bandwidth coupling. When coupling is enabled, the analyzer automatically adjusts res BW, video BW, and sweep time when you change the span.
- [BW COUPLE PRESET] lets you optimize res BW, video BW and sweep time for the current span.

Two of the softkeys are only available for narrow band zoom measurements:

- [HI ACCRCY ZOOM].
- [HI RES ZOOM].

These softkeys let you select one of two resolution values for narrow band zoom measurements. [HI ACCRCY ZOOM] is the best choice for most measurements.

Key Reference
[RES BW] softkey

[RES BW] softkey

Key Path: [Res BW]

Press [RES BW] to change the bandwidth of the analyzer's resolution filter—the final intermediate frequency (IF) filter. The bandwidth of this filter controls the frequency resolution of swept spectrum measurements.

The analyzer can just resolve two signals of equal amplitude when their frequencies differ by the current resolution bandwidth (RBW). To see these signals on the display, however, you must select a span that separates the signals by at least one display point.

Note



When bandwidth coupling is on, the analyzer automatically adjusts the RBW as you change the span.

You can lower the noise floor of a trace by narrowing the RBW. (This occurs because there is less noise energy within the bandwidth of a narrower filter.) However, smaller RBWs require longer sweep times.

[RESET] softkey

Key Path: [User Define] —> [DEBUG]

Press [RESET] to reset your HP Instrument BASIC program.

When you reset a program, all HP-IB interfaces it has used are reset and all open files are closed. You can not continue a program that has been reset. If you use [SINGLE STEP] after [RESET], execution begins at the first line of the program. *See also* [DEBUG] softkey.

Note



[RESET] does not affect your program's variables or HP Instrument BASIC's display area.

[RUN] softkey

Key Path: [User Define]

or: [User Define] —> [DEBUG]

Press [RUN] to begin execution of your HP Instrument BASIC program. After all variables not in COM are initialized, execution begins with the first statement.

Note



If the program is paused, you can resume execution by pressing [CONTINUE].

[SAMPLE TIME] softkey

Key Path: [Sweep]

Press [SAMPLE TIME] to specify how long the analyzer should measure at a single frequency during manual sweeps. An entry box is displayed so you can enter a new time.

Note



The time *between* measurements can be significantly longer than the sample time.

You can change [SAMPLE TIME] in the usual ways, but with the following conditions:

- The analyzer changes any value you enter with the number keys to the closest available value.
- The current sample time is changed by a factor of 2 when you turn the knob slowly or press an arrow key one time.

Hint: Shorter sample times make it easier to use the knob for manual sweeping, but longer times (greater than 1/RBW) ensure independent samples for each measurement. Use the longer sample times when you average manual sweeps.

Key Reference
[SAVE AUTO STATE] softkey

[SAVE AUTO STATE] softkey

Key Path: [Save/Recall]

[SAVE AUTO STATE] saves the current instrument state to a special file on the non-volatile RAM disk. The file is called AUTO_ST.

When you turn the analyzer on, it searches for AUTO_ST and uses the contents to define its power-up state. The analyzer searches two disks for the file. They are searched in the following order:

1. Non-Volatile RAM disk.
2. Internal disk.

The analyzer uses the power-up state described under [Preset] if it does not find an AUTO_ST file.

Hint: Any state file can be renamed AUTO_ST and used to define the analyzer's power-up state.

[SAVE LOWER LIM] softkey

Key Path: [Save/Recall] —> [SAVE MORE]

Use [SAVE LOWER LIM] to save the lower limit line of the active trace to one of the disks. The limit line is saved to the default disk unless you include a disk specifier in the filename prompt.

Caution



The volatile RAM disk is cleared each time you turn the analyzer off. Copy important limit files to another disk before power-down or they will be lost.

When you save a lower limit, you are prompted for a filename. If the catalog is off, the prompt contains a default filename: L_LIM. If the catalog is on, the prompt contains the name of the file currently highlighted. You can use the name in the prompt or modify it with the alpha entry keys.

Note



When you enter a filename that already exists, the original file is overwritten without additional prompting.

[SAVE MATH] softkey

Key Path: [Save/Recall] —> [SAVE MORE]

Use [SAVE MATH] to save a complete set of math definitions—all functions and constants—to one of the disks. The math file is saved to the default disk unless you include a disk specifier in the filename prompt.

Caution



The volatile RAM disk is cleared each time you turn the analyzer off. Copy important math files to another disk before power-down or they will be lost.

When you save a set of math definitions, you are prompted for a filename. If the catalog is off, the prompt contains a default filename: MATH. If the catalog is on, the prompt contains the name of the file currently highlighted. You can use the name in the prompt or modify it with the alpha entry keys.

Note



When you enter a filename that already exists, the original file is overwritten without additional prompting.

[SAVE MORE] softkey

Key Path: [Save/Recall]

[SAVE MORE] just displays a menu. Softkeys in the menu allow you to save any of the following:

- A limit definition (upper or lower).
- A set of math definitions.
- An HP Instrument BASIC program.

Key Reference
[SAVE NORM REFERENCE] softkey

[SAVE NORM REFERENCE] softkey

Key Path: [Trace Data]

Press [SAVE NORM REFERENCE] to save the contents of the active trace to data register D8.

Calibrated input data (the data displayed when you press [INPUT SPECTRUM]) is divided by the contents of D8 to create a normalized spectrum.

[SAVE PROGRAM] softkey

Key Path: [Save/Recall] —> [SAVE MORE]

When you create a new HP Instrument BASIC program, use [SAVE PROGRAM] to save it for the first time. Saving a program with this softkey protects you from accidentally overwriting a file with the same name. Then to save changes you make while editing the program, use [RE-SAVE PROGRAM].

Both softkeys save your program to the default disk unless you include a disk specifier in the filename prompt.

Caution



The volatile RAM disk is cleared each time you turn the analyzer off. Copy important programs to another disk before power-down or they will be lost.

When you save a program, you are prompted for a filename. If the catalog is off, the prompt contains a default filename: either PROG or the name of the last program you saved or recalled. If the catalog is on, the prompt contains the name of the file currently highlighted. You can use the name in the prompt or modify it with the alpha entry keys.

[SAVE STATE] softkey

Key Path: [Save/Recall]

Use [SAVE STATE] to save the current instrument state to one of the disks. The state is saved to the default disk unless you include a disk specifier in the filename prompt.

Caution



The volatile RAM disk is cleared each time you turn the analyzer off. Copy important state files to another disk before power-down or they will be lost.

The instrument state includes function and constant register contents. It does not include traces, limit lines, or data register contents.

When you save a state, you are prompted for a filename. If the catalog is off, the prompt contains a default filename: STATE. If the catalog is on, the prompt contains the name of the file currently highlighted. You can use the name in the prompt or modify it with the alpha entry keys.

Note



When you enter a filename that already exists, the original file is overwritten without additional prompting.

Key Reference
[SAVE TRACE] softkeys

[SAVE TRACE] softkeys

Key Path: [Save/Recall]

The softkeys grouped under [SAVE TRACE] let you save the active trace to one of the following places:

- [INTO FILE] lets you save to the default disk (or to any disk if you include a disk specifier).
- [INTO Dx] lets you save into data register x.

Caution



The volatile RAM disk and all data registers are cleared each time you turn the analyzer off. Copy important trace files to another disk before power-down or they will be lost.

When you save to a disk, you are prompted for a filename. If the catalog is off, the prompt contains a default filename: TRACE. If the catalog is on, the prompt contains the name of the file currently highlighted. You can use the name in the prompt or modify it with the alpha entry keys.

Note



When you enter a filename that already exists, the original file is overwritten without additional prompting.

[SAVE UPPER LIM] softkey

Key Path: [Save/Recall] —> [SAVE MORE]

Use [SAVE UPPER LIM] to save the upper limit line of the active trace to one of the disks. The limit line is saved to the default disk unless you include a disk specifier in the filename prompt.

Caution



The volatile RAM disk is cleared each time you turn the analyzer off. Copy important limit files to another disk before power-down or they will be lost.

When you save an upper limit, you are prompted for a filename. If the catalog is off, the prompt contains a default filename: U_LIM. If the catalog is on, the prompt contains the name of the file currently highlighted. You can use the name in the prompt or modify it with the alpha entry keys.

Note



When you enter a filename that already exists, the original file is overwritten without additional prompting.

Key Reference
[Save/Recall] hardkey

[Save/Recall] hardkey

The softkeys grouped under [Save/Recall] are used to load traces into the analyzer's data registers and to save and recall the following kinds of files:

- Traces.
- Instrument states.
- Limit definitions.
- Math definitions.
- HP Instrument BASIC programs.

Note



To rename, copy, or delete files, use the softkeys grouped under “[Disk Util]”.

The analyzer can access files on one of three disks (although one of these disks is optional):

- Non-volatile RAM disk.
- Volatile RAM disk.
- Internal disk (optional).

Caution



The volatile RAM disk is cleared each time you turn the analyzer off. Copy important files to another disk before power-down or they will be lost.

The analyzer displays a prompt and enters alpha entry mode when it's time to identify the file you want to save or recall. Use the default filename displayed in the prompt or modify the name with the alpha entry keys. When the filename is correct, press [enter] to start the save or recall operation.

You can do two things to simplify save and recall operations:

- Designate the disk you use most often as the default disk.
- Display the disk catalog.

You only need to enter a filename to identify a file on the default disk. You must enter a disk specifier and a filename to identify a file on any other disk.

When the catalog is displayed, you don't need to type the name of a file you want to recall or overwrite. Instead, you can just select the file with the knob before bringing up the filename prompt. The name of the file you select is automatically placed in the prompt.

[Scale] hardkey

Softkeys grouped under the [Scale] hardkey are used to alter the vertical scaling and vertical position of the active trace.

Horizontal “scaling and position” are determined by your measurement’s center frequency and frequency span. Change these values with softkeys grouped under [Freq].

You can display trace data using either linear or logarithmic vertical coordinates. You select one of these options with the softkeys grouped under [Trace Type].

Scratch Options softkey group

Key Path: [User Define] —> [utilities] —> [SCRATCH]

Press one of the softkeys in this group to specify what will be deleted when you press [PERFORM SCRATCH].

Each softkey specifies some combination of your HP Instrument BASIC program and its variables:

- [SCRATCH] specifies the program and all of its variables *except* those in COM.
- [SCRATCH C] specifies all program variables—including those in COM—but *not* the program itself.
- [SCRATCH A] specifies the program and all of its variables including those in COM.

[SCRATCH] softkey

Key Path: [User Define] —> [UTILITIES]

[SCRATCH] displays a menu. You use the softkeys in the menu to do two things:

- Select which combination of your HP Instrument BASIC program and its variables you want to delete.
- Delete the selected combination.

[SCRATCH C] softkey

See Scratch Options softkey group

[SCRATCH A] softkey

See Scratch Options softkey group

Key Reference
[SECURE] softkey

[SECURE] softkey

Key Path: [User Define] —> [UTILITIES]

[SECURE] displays a menu. You use the softkeys in the menu to do two things:

- Specify a range of lines in your program that you want to secure.
- Secure (protect against viewing) the specified range of lines.

Caution



Secured program lines can *not* be unsecured. Be sure to keep an unsecured version of the program for your own records.

[SERIAL NUMBER] softkey

Key Path: [Spcl Fctn]

Press this softkey to display your analyzer's serial number.

[SETUP STATE] softkey

See Display Format softkey group (trace).

[75 OHMS] softkey

See Input Impedance softkey group.

[75 OHMS OUTPUT Z] softkey

See Output Impedance softkey group.

[SIGNL TRK ON/OFF] softkey

Key Path: [Freq]

The analyzer can change its center frequency automatically to track a drifting signal. The [SIGNL TRK ON/OFF] softkey allows you to enable and disable this feature.

When signal tracking is enabled, the analyzer adjusts the value of [CENTER] to keep the largest signal centered in the current frequency span. The effect of signal tracking is similar to the effect you would get by continuously pressing the following key sequence:

[MKR --> PEAK], [MKR --> CTR FREQ].

The difference, of course, is that the analyzer can do this quickly enough to ensure that it occurs once for each measurement.

Note

Signal tracking is not available for manual sweeps.



[SINGLE] softkey

See Display Format softkey group (trace).

Key Reference
[SINGLE AUTORANGE] softkey

[SINGLE AUTORANGE] softkey

Key Path: [Range/Input]

Press [SINGLE AUTORANGE] to autorange the analyzer when continuous autoranging is disabled.

Single autoranging selects the best range for the current input signal. It changes the range once under these circumstances:

- If the signal level is large enough to overdrive the input circuitry, the analyzer selects a less sensitive input range.
- If the signal level is small enough to compromise dynamic range, the analyzer selects a more sensitive range.

Note



Autoranging is not possible when the 1 megohm input impedance is selected.

[SINGLE STEP] softkey

See [DEBUG] softkey.

[SINGLE CAL] softkey

Key Path: [Spcl Fctn]

Press [SINGLE CAL] to calibrate the analyzer one time. Calibration starts as soon as you press the key interrupting any measurement in progress.

Note



Enable the analyzer's autocalibration function if you want calibrations to occur automatically.

[SINGLE STEP] softkey

Key Path: [User Define] —> [DEBUG]

Press [SINGLE STEP] to execute one line of your HP Instrument BASIC program.

The first time you press [SINGLE STEP], the analyzer performs a pre-run operation and then displays the first line to be executed. On subsequent presses, the analyzer executes the displayed line and then displays the next line to be executed. (Program lines are displayed at the top of the screen.)

If your program is paused, single-stepping begins with the line following the last-executed line. If your program has been stopped or reset, single-stepping begins with the first line.

Note



If you change (edit) a paused program, it is reset automatically.

You can use [EXAMINE VARIABLE] to see what has happened after each line is executed.

Softkeys in bracketed groups

Some softkeys are grouped together with a bracket, like this:

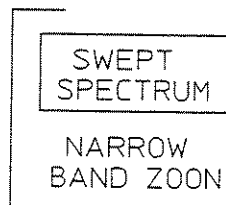

The keys in such a group select options that are mutually exclusive—at any given time, only one of the options can be active. The analyzer indicates which option is active by drawing a box around that option's softkey label. In the example above, [swept spectrum] is active.

Softkeys that toggle

Some softkeys control analyzer functions that have only two states (for example, on and off). Each time you press one of these keys, the associated function toggles (switches) from one state to the other.

Here is an example of a toggling softkey:

```
SWEEP  
[ AUTO/MAN ]
```

The analyzer indicates which state is active by highlighting the corresponding text on the softkey label. In the example above, manual sweep is active. If you were to press this example softkey, the state would toggle to autosweep.

Softkeys

The analyzer has ten softkeys that are arranged in a column to the right of the screen. They are referred to as softkeys because the function assigned to each key can change. In contrast, the function assigned to each hardkey never changes.

For example, when you press the [**Source**] hardkey, the first softkey is used to turn the analyzer's source on and off. But when you press the [**Plot/Print**] hardkey, the first softkey is used to initiate a plot of the analyzer's screen.

A softkey's current meaning is determined by its "softkey label." The label is displayed on the screen, adjacent to the softkey. Also, softkey labels surrounded by brackets are used to represent softkeys in help text (for example, "The [input spectrum] softkey is used to...").

Special types of softkeys include the following: those that can toggle between two states, those that are part of a bracketed group, and those that are inactive for some analyzer setups.

[SOLID] softkey

See [LINE TYPE] softkeys.

[SOURCE AMPLITUDE] softkey

Key Path: [Source]

Press this key when you want to change the output amplitude of the source. You are prompted to enter a new output level (either in dBm or Vrms).

The range of values for [SOURCE AMPLITUDE] is – 59.9 dBm to 10 dBm (when the output impedance is 50Ω). The smallest possible increment between values is 0.1 dB. You can change the amplitude in the usual ways, but with the following enhancements:

- You can control the sensitivity of the knob and arrow keys with [AMPLITUDE STEP].
- You can set source amplitude to the marker's current y-axis value with [Marker Value].

Note



If the 75Ω output impedance is selected, the actual amplitude will match the entered amplitude only if you remember to use the 25Ω adapter barrel supplied with the analyzer.

[Source] hardkey

The softkeys grouped under the [Source] hardkey are used to control the analyzer's tracking source (sometimes called a tracking generator). The softkeys allow you to do the following things:

- Turn the source on and off.
- Change the output amplitude.
- Select the output impedance.
- Reset the source's protective relay.

The source's sinusoidal output follows or "tracks" the receiver's tuned frequency. Because the receiver is tuned differently in the following measurements, the source frequency is controlled differently for each:

- Swept spectrum—The source frequency sweeps through the specified frequency band at the same rate as the receiver's tuned frequency.
- Manual sweep—The source frequency tracks the current manual sweep frequency.
- Narrow band zoom—The source frequency is fixed at the analyzer's center frequency.

Note



Source output between 0 and 150 MHz is possible, but performance below 10 Hz is not specified.

Key Reference
[SOURCE ON/OFF] softkey

[SOURCE ON/OFF] softkey

Key Path: [Source]

Press this softkey to toggle the analyzer's source on and off. When the source is off, the output amplitude is approximately -100 dBm.

Note



Oversweeping is automatically disabled when you turn the source is on. The amplitude corrections that make oversweeping possible are not valid when a signal is sweeping with the receiver.

If you are using the source to make a scalar network measurement, turn the peak detector off. The peak detector is necessary for most spectrum measurements, but introduces a slight frequency skew in scalar network measurements.

[SOURCE DISK] softkey

See Copy Disk softkeys.

[SOURCE FILENAME] softkey

See Copy File softkeys.

[SPAN] softkey

Key Path: [Freq]

Use [SPAN] to define the width of a frequency band you want to analyze.

[CENTER] and [SPAN] act together to define a frequency band; the current value of one softkey is held constant when you change the value of the other. You can also use [START] and [STOP] to define a band, but [CENTER] and [SPAN] are more convenient when you are zooming in on a single peak in the spectrum.

Hint: Press [CENTER] to change x-axis labels from start/stop to center/span.

Certain combinations of [CENTER] and [SPAN] may define x-axis limits that are outside the range of 0 to 150 MHz. (For example, a lower limit of 5 MHz results when [CENTER] = 5 MHz, [SPAN] = 20 MHz.) When this happens, any portion of a trace that falls outside the range is blanked (not displayed).

When bandwidth coupling is on, changes in span may cause changes in the following parameters:

- Resolution bandwidth.
- Video bandwidth.
- Sweep time.

The range of values for [SPAN] depends on the measurement type selected:

- When [SWEPT SPECTRUM] is selected: the range is 10 Hz to 150 MHz. You can also enter a span of 0 Hz, which has the same effect as pressing the [ZERO SPAN] softkey. (Values between 0 and 10 Hz are rounded up to 10 Hz.)
- When [NARROW BAND ZOOM] is selected: [SPAN] is limited to 16 discrete values. The values range from 1.22 Hz to 40 kHz and are derived from the following formula: $40,000 / 2^n$ (n has integer values ranging from 0 through 15.)

You can change [SPAN]'s value in the usual ways, but with the following enhancements and exceptions:

- When [SWEPT SPECTRUM] is selected: You can control the sensitivity of the knob and arrow keys with [STEP SIZE AUTO/USER] and [USER STEP SIZE]. Steps in autostep mode are members of a 1-2-5 series.
- When [NARROW BAND ZOOM] is selected: Any value you enter from the numeric keypad is rounded to the next largest available span.
- When the offset marker is on: You can set [SPAN] to the marker readout's current x-axis value with the [Marker Value] hardkey. (Pressing the [OFFST MKR --> SPAN] softkey has a similar effect.)

Key Reference
[Spcl Fctn] hardkey

[Spcl Fctn] hardkey

[Spcl Fctn] groups infrequently used softkeys under one hardkey. The softkeys allow you to do the following things:

- Calibrate the analyzer.
- Turn the beeper on and off.
- Set the battery-backed clock's time and date .
- Display your analyzer's serial number.
- Enable special hardware setups during performance tests.

[SPECTRUM] softkey

Key Path: [Math] —> [DEFINE Fx]

When you are defining a function, press [SPECTRUM] to specify calibrated input data as an operand. The abbreviation "SPEC" is added to the end of the definition. *See also* Operand Menu.

[SQRT(NBW)] softkey

Key Path: [Math] —> [DEFINE Fx]

When you are defining a function, press the [SQRT(NBW)] softkey to select the square root of the noise equivalent bandwidth as an operand. The abbreviation "SQRT(NBW)" is added to the end of the definition.

To generate a power spectral density trace, you can divide the power value at each point of the input spectrum by the square root of the current noise equivalent bandwidth. This normalizes power values so that they approximate the values obtained with a 1 Hz resolution bandwidth. *See also* Operand Menu.

Note

The noise bandwidth for the current measurement is noted in the setup state.



[START] and [STOP] softkeys

Key Path: [Freq]

Use [START] and [STOP] together to define a frequency band you want to analyze. [START] defines the band's lower limit, [STOP] defines its upper limit.

Here's how [START] and [STOP] work together for each of the two measurement types:

- For swept spectrum measurements: the value of one is held constant when you change the value of the other.
- For narrow band zoom measurements: the offset between [START] and [STOP] is held constant when you change the value of either.

Hint: Press [START] or [STOP] to change x-axis annotation from center/span to start/stop.

You can also use [CENTER] and [SPAN] to define a frequency band. In fact, these two keys are usually more convenient when you are zooming on a single peak in the spectrum.

[START] and [STOP] both accept the same range of values: 0 Hz to 150 MHz (although the analyzer's performance is not specified below 10 Hz). You can change either key's value in the usual ways, but with the following enhancements:

- You can control the sensitivity of the knob and arrow keys with [STEP SIZE AUTO/USER] and [USER STEP SIZE].
- You can set either key to the marker's current x-axis value with the [Marker Value] hardkey.

The HP 3588A only sweeps up (from a lower frequency to a higher one), so it enforces the following relationship:

$$[\text{START}] \leq [\text{STOP}]$$

If you enter a new start or stop frequency that violates this relationship, both keys are set to the new frequency. (This has the same effect as pressing [ZERO SPAN].)

Key Reference
[START LINE #] softkey (Renumber)

[START LINE #] softkey (Renumber)

Key Path: [User Define] —> [UTILITIES] —> [RENUMBER]

Before you renumber an HP Instrument BASIC program, press [START LINE #] to specify the new line number for the first line. An entry box is displayed so you can enter a new value.

Note



Renumbering acts on the entire program. [START LINE #] is used for the first program line after renumbering. It does not specify where renumbering should begin in the original program.

After you have specified the starting line number and the increment between line numbers, press [PERFORM RENUMBER] to renumber your program.

[START LINE #] softkey (Secure)

Key Path: [User Define] —> [UTILITIES] —> [SECURE]

Before you secure an HP Instrument BASIC program (protect it against viewing), you must specify the range of lines you want to secure. Press [START LINE #] to specify the first line in the range. An entry box is displayed so you can enter a new value.

After you have specified the first and last lines, press [PERFORM SECURE] to secure those lines and all lines that fall between them. When you edit or print a secured line, you will see an asterisk (*) rather than program statements after the line number.

[START SEGMENT] softkey

Key Path: [Marker Fctn] —> [LIMIT TEST] —> [DEFINE UPPER LIM]

or: [Marker Fctn] —> [LIMIT TEST] —> [DEFINE LOWER LIM]

Limits are defined as a series of line segments. Press [START SEGMENT] to anchor a segment's starting point at the position of the limit marker.

Press [FINISH SEGMENT] to anchor a segment's ending point. Use [MOVE MKR HORIZONTAL] and [MOVE MKR VERTICAL] to position the limit marker.

[STEP SIZE AUTO/USER] softkey

Key Path: [Freq]

Press this softkey to toggle between the analyzer-determined (AUTO) and user-determined (USER) step size for the following frequency parameters:

- [CENTER].
- [START].
- [STOP].
- [MANUAL FREQ].

When you change the value of these parameters, step size determines the effect of the knob and arrow keys:

- For the knob, it determines the smallest frequency change possible when you turn the knob slowly.
- For the arrow keys, it determines the frequency change that results when you press an arrow key once.

If you toggle to USER, step size is defined with the [USER STEP SIZE] softkey. If you toggle to AUTO, step size is defined by the following formulas:

- For [CENTER]: $[\text{SPAN}] / 400$
- For [START] and [STOP]: $[\text{SPAN}] / 10$
- For [MANUAL FREQ], the smaller of the following: $[\text{RES BW}] / 30$ or $[\text{SPAN}] / 400$
- For [CENTER], [START] and [STOP] in zero span: $[\text{RES BW}] / 10$

Key Reference
[SWEEP AUTO/MAN] softkey

[SWEEP AUTO/MAN] softkey

Key Path: [Sweep]

Press this softkey to toggle between automatic and manual sweeping during swept spectrum measurements.

Note [SWEEP AUTO/MAN] is not used for narrow band zoom measurements.



When you toggle this softkey to AUTO, the analyzer sweeps automatically through the specified band of frequencies. You can control the speed of automatic sweeps with the [SWEEP TIME] softkey.

When you toggle this softkey to MAN, the analyzer measures at discrete points within the specified band of frequencies. You define these points by changing the value of [MANUAL FREQ]. You can manually “sweep” through these points by using the knob to continuously change the value of [MANUAL FREQ].

Note The value of [MANUAL FREQ] is maintained as you toggle between automatic and manual sweeping.



When you toggle to manual sweeping, the trace updates stop for all points except the manual measurement point. (The manual measurement point is the display point that contains the manual frequency). Most of the trace appears to “freeze,” but the manual measurement point appears to “wobble.”

While you are changing the manual frequency, the main marker tracks the manual measurement point, but it's also possible to move the marker independently.

Hint: If the [MANUAL FREQ] entry box is displayed, you can only use the knob to change the manual frequency. Press [Sweep], [Marker], or some other hardkey to remove the entry box from the screen and free the knob for marker movement.

[Sweep] hardkey

The [Sweep] hardkey displays a menu. Use the softkeys in this menu to control the analyzer's sweep across the band of frequencies you are analyzing.

The Sweep menu contains the following softkeys:

- [sweep auto/man] lets you enable and disable manual sweeping.
- [MANUAL FREQ] lets you specify the measurement frequency during manual sweeping.
- [SWEEP TIME] lets you control the amount of time it takes to complete an automatic sweep.
- [SAMPLE TIME] lets you control the amount of time it takes to measure a single frequency during manual sweeping.
- [OVERSWEEP ON/OFF] lets you enable and disable oversweeping.

Note



These softkeys are not used for narrow band zoom measurements; they are only used for swept spectrum measurements.

Key Reference
[SWEEP TIME] softkey

[SWEEP TIME] softkey

Key Path: [Sweep]

Sweep time specifies how much time the analyzer takes to complete a sweep when automatic sweeping is selected. When you press the [SWEEP TIME] softkey, an entry box is displayed so you can enter a new time.

Automatic sweeping works one of two ways:

- For all measurements except zero span: The analyzer sweeps its local oscillator (LO) through the specified frequency band in the amount of time specified by [SWEEP TIME].
- For zero span measurements: The analyzer samples the amplitude of the current center frequency over the amount of time specified by [SWEEP TIME].

When the peak detector is on, increasing the sweep time can cause apparent increases in the noise floor level (assuming you hold the span and resolution bandwidth constant).

With longer sweep times, the analyzer spends more time detecting peaks for a given display point. This increases the chance that a larger peak will be detected (if the frequencies represented by the point contain only noise energy).

You can change [SWEEP TIME] in the usual ways, but with the following conditions:

- The analyzer changes any value you enter with the number keys to the closest available value.
- The current sweep time is changed by a factor of 2 when you turn the knob slowly or press an arrow key one time.

When you change the sweep time, this creates a new relationship between the sweep *rate* and the resolution bandwidth. If bandwidth coupling is turned on, the analyzer maintains this new relationship by changing the sweep time when the resolution bandwidth changes.

When you press [BW COUPLE PRESET], the analyzer chooses the shortest available sweep time that can provide calibrated measurement results. If you specify a shorter sweep time, the UNCAL indicator is displayed on the bottom line of the screen.

Note



The analyzer-selected sweep time is usually shorter when oversweeping is turned on.

[SWEPT SPECTRUM] softkey

Key Path: [Meas Type]

Press [SWEPT SPECTRUM] when you plan to use the HP 3588A as a traditional swept-tuned spectrum analyzer.

During swept spectrum measurements, the analyzer gathers frequency-domain measurement data by mixing your input signal with a sweeping local oscillator (LO) and then detecting the difference frequency. The analyzer's display appears to sweep through the band of frequencies you have specified.

Swept spectrum measurements offer several measurement options that are not available during narrow band zoom measurements:

- Wider spans (up to 150 MHz).
- Manual sweeping.
- Zero span analysis.
- Noise level markers.

However, narrow band zoom measurements provide much shorter measurement times at spans below 40 kHz.

Note



You can control the frequency resolution of swept spectrum measurements with the [RES BW] softkey.

The analyzer maintains the current center frequency when you change from swept spectrum to narrow band zoom measurements. However, it selects a new span (from the 16 available in narrow band zoom) according to the following rules:

- If the current span is greater than or equal to 40 kHz, you get a 40 kHz span.
- If the current span is less than 40 kHz, you get the closest available span that is greater than or equal to the current span.

The analyzer also maintains the current center frequency when you change from narrow band zoom to swept spectrum measurements. But in this case, it restores the span from the previous swept spectrum measurement.

[SYSTEM CONTROLLER] softkey

See Controller Capability softkey group.

Key Reference
[TEST EVAL ON/OFF] softkey

[TEST EVAL ON/OFF] softkey

Key Path: [Marker Fctn] —> [LIMIT TEST]

Press [TEST EVAL ON/OFF] to enable and disable testing of the active trace against its current limits.

Note



If you want limit lines to be displayed during the test, toggle [LINES ON/OFF] to ON.

A trace fails a limit test if any of its points fall outside the current limits. Results of the test are displayed in the lower-left corner of the trace box.

[TIME HHMM] softkey

Key Path: [Spcl Fctn]

Press [TIME HHMM] to display the current time at the top of the screen. The time is read from the analyzer's battery-backed clock.

After pressing this softkey, you can enter a new time with the number keys. The time must be entered in a 24-hour format: the first two digits set the hour, the second two digits set the minute. Here are a couple of examples:

- 8:05 am—Press [TIME HHMM], [0], [8], [0], [5], [ENTER]
- 3:42 pm—Press [TIME HHMM], [1], [5], [4], [2], [ENTER]

[TRACE A LINE TYPE] softkey

Key Path: [Plot/Print] —> [DEFINE PLOT]

Press [TRACE A LINE TYPE] for access to the line type softkeys. The line type you specify with these softkeys will be used to plot trace A.

Note



Check your plotter's documentation to be sure that it supports the requested line type.

[TRACE A PEN] softkey

Key Path: [Plot/Print] —> [DEFINE PLOT] —> [DEFINE PLOT PENS]

Press [TRACE A PEN] to specify which plotter pen should be used for plotting trace A and all of its trace-specific annotation.

Trace-specific annotation includes the following items:

- Trace title.
- Marker readout.
- X-axis annotation.
- Y-axis annotation.
- Limit test results.

[TRACE B LINE TYPE] softkey

Key Path: [Plot/Print] —> [DEFINE PLOT]

Press [TRACE B LINE TYPE] for access to the line type softkeys. The line type you specify with these softkeys will be used to plot trace B.

Note



Check your plotter's documentation to be sure that it supports the requested line type.

Key Reference
[TRACE B PEN] softkey

[TRACE B PEN] softkey

Key Path: [Plot/Print] —> [DEFINE PLOT] —> [DEFINE PLOT PENS]

Press [TRACE B PEN] to specify which plotter pen should be used for plotting trace B and all of its trace-specific annotation.

Trace-specific annotation includes the following items:

- Trace title.
- Marker readout.
- X-axis annotation.
- Y-axis annotation.
- Limit test results.

Trace boxes

A trace box is a bounded area of the screen that is used to display trace data. There are two trace box sizes: full-height and half-height.

A full-height trace box is used for the single and front/back trace formats. The graticule for this box is ten divisions high and ten divisions wide.

Note



When you use the front/back trace format, the vertical dimension of the full-height box is slightly compressed to make room for the second trace's annotation.

Two half-height trace boxes are used for the upper/lower trace format. The graticules for these boxes are only five divisions high but are still ten divisions wide. When you switch from full-height to half-height trace boxes, the readout of vertical units per division is halved.

[Trace Data] hardkey

The softkeys grouped under the [Trace Data] hardkey allow you to do two things:

- Select the data to be displayed in the active trace box.
- Create a title for the active trace.

Note



You can display a function or constant using the options under this hardkey. However, you must define a function or constant using the options under the [Math] hardkey.

[TRACE TITLE] softkey

Key Path: [Trace Data]

You can use the [TRACE TITLE] softkey to create a title for the active trace. The title can be up to 15 characters long.

The analyzer enters alpha entry mode when you press [TRACE TITLE]. To exit this mode and keep the new trace title, press [ENTER]. To exit this mode and reject the new title (while retaining the old one), press [CANCEL/RETURN].

Hint: The title you enter replaces the analyzer's default title. To restore the default, just enter a title with no characters. (Press [TRACE TITLE], [CLEAR ENTRY], [ENTER].)

[Trace Type] hardkey

Trace data can be displayed in different coordinate systems. Softkeys grouped under the [Trace Type] hardkey allow you to select a coordinate system for the active trace.

The coordinate systems offered in this analyzer are:

- Logarithmic magnitude versus frequency (or time).
- Linear magnitude versus frequency (or time).

[Trigger] hardkey

The [Trigger] hardkey displays a menu. The softkeys in this menu allow you to synchronize an HP 3588A measurement with some external event.

The analyzer uses a two-stage triggering system to hold off measurements. The first stage of the system just arms the second, enabling it to respond to a trigger event. Two softkeys in the Trigger menu—[arm auto/man] and [ARM]—allow you to control the first stage.

The second stage of the triggering system is the trigger itself. After it has been armed, this stage of the system waits for a trigger event. Three softkeys in the Trigger menu allow you to specify the nature of the trigger event:

- [FREE RUN TRIGGER].
- [EXTERNAL TRIGGER].
- [HP-IB TRIGGER].

A measurement begins when the triggering system has been armed and triggered.

Hint: To manually trigger a single measurement (one sweep, one FFT, or one update of the manual frequency), select [FREE RUN TRIGGER] and toggle [ARM AUTO/MAN] to MAN. With this setup, you can trigger a single measurement by pressing [ARM].

Key Reference
[TYPING UTILITIES] softkey

[TYPING UTILITIES] softkey

Key Path: [User Define] —> [EDIT]

The [TYPING UTILITIES] softkey displays a menu. The menu and its submenus let you do the following things when you are editing a program:

- Insert special characters.
- Insert keywords.
- Shift the case of alpha characters.

The Typing Utilities menu also repeats the [ENTER], [INSERT SPACE], and [DELETE CHARACTER] softkeys, which are all available in the main editing menu.

Note



The [CANCEL/RETURN] softkey in the Typing Utilities menu just returns you to the main editing menu. It has no effect on the current line of your program.

[()] (Underscore) softkey

See Goto Line softkeys.

[UPPER/LOWER] softkey

See Display Format softkey group (trace).

[UPPERCASE LOWERCASE] softkey

Press this softkey to toggle between upper-case and lower-case any time during alpha entry or program editing.

This softkey has the same function as a “Caps” or “Caps Lock” key on a standard keyboard; it determines the case of alpha characters typed into a text string. When UPPERCASE is highlighted, all alpha characters you enter will be upper-case (A-Z). When lowercase is highlighted, alpha characters will be lower-case (a-z).

[User Define] hardkey

The [User Define] hardkey gives you access to all HP Instrument BASIC softkeys (except those used to save and recall a program).

Note



If the HP Instrument BASIC option is not installed, the analyzer displays an error message when you press this key.

[User Define] has a special purpose in each of the following situations:

- HP Instrument BASIC's keystroke recording feature is enabled. In this situation, you can press [User Define] to end the current recording session.
- An HP Instrument BASIC program is running. In this situation, you can press [User Define] to pause the program. (You can also stop a program in other ways.)

[USER SRQ] softkeys

Key Path: [Local/HP-IB]

Press [USER SRQ] to gain access the softkeys [USER SRQ 0] through [USER SRQ 9]. Each of the numbered SRQ softkeys allows you to interrupt an external HP-IB controller from the analyzer's front panel.

The number on each SRQ softkey corresponds to the number of a bit in the analyzer's User Status event register. When you press one of these keys, the corresponding bit is briefly pulsed high (logic 1).

Note



These keys are only useful if the analyzer's User Status register set is programmed to respond to them. See the *HP 3588A HP-IB Programming Reference* for more information.

Key Reference
[USER STEP SIZE] softkey

[USER STEP SIZE] softkey

Key Path: [Freq]

Use [USER STEP SIZE] to define the effect of the knob and arrow keys on the value of the following frequency parameters:

- [CENTER].
- [START].
- [STOP].
- [MANUAL FREQ].

When you change the value of these parameters, the value of [USER STEP SIZE] defines the following things:

- The smallest frequency change possible when you turn the knob slowly.
- The frequency change that results when you press an arrow key once.

Note



The value you specify for [USER STEP SIZE] is only used if you toggle [STEP SIZE AUTO/USER] to USER.

[UTILITIES] softkey

Key Path: [User Define]

The softkeys grouped under [UTILITIES] let you do the following things for your HP Instrument BASIC program:

- Allocate memory for the program's stack.
- Scratch (delete) the program and its variables.
- Renumber its lines.
- Secure some or all of its lines.

[VERTICAL/DIV] softkey

Key Path: [Scale]

Press the [VERTICAL/DIV] softkey when you want to compress or expand the active trace along its vertical axis. To compress the trace, increase the value of [VERTICAL/DIV].

The vertical axis of a trace box is divided by equally-spaced graticule lines or tick marks. [VERTICAL/DIV] lets you define the height of each division.

Note



There are ten vertical divisions when the trace format is single or front/back. There are only five divisions when the trace format is upper/lower.

A suffix menu lets you define the vertical scale in linear units (Vrms) or logarithmic units (dB) depending on the coordinate system being used. You can select a coordinate system under the [Trace Type] hardkey.

[VID FLTR ON/OFF] softkey

Key Path: [Res BW]

Press [VID FLTR ON/OFF] to enable and disable the analyzer's video filter.

The video filter has a display-smoothing function. It reduces noise variance so you can see signals that are close to the noise floor. You adjust the video filter's bandwidth to control the degree of smoothing.

Note



You can also use video averaging to reduce noise variance.

You can't use the video filter for narrow band zoom measurements.

Key Reference
[VIDEO AVERAGE] softkey

[VIDEO AVERAGE] softkey

Key Path: [Avg/Pk Hld]

Press this softkey to enable video averaging—an rms (power) averaging function that combines the results of several measurements. Video averaging reduces noise variance so you can see signals that are close to the noise floor.

When video average is selected, the results of a completed measurement are combined, point by point, with the previous input spectrum. The combined results are retained and displayed as the updated input spectrum. The analyzer uses this formula to combine data:

$$[(1/N) * \text{new}] + [(N-1)/N) * \text{old}]$$

“N” is a weighting factor that you specify under the [NUMBER AVERAGES] softkey. As the formula indicates, new data is weighted more heavily than old data once the analyzer has averaged the results of N measurements. Averaging that combines data in this manner is often referred to as exponential averaging.

Note



The analyzer does *not* stop measuring after N measurements. If you want the analyzer to stop measuring, select manual arming.

Averaging is tightly coupled to the following measurement parameters. If you change one, the average count is reset to 0 and the input spectrum is reset to the results of the next measurement:

- Measurement type (swept or narrow band zoom).
- Low distortion state.
- Oversweep state.
- Frequency band (center, span, start, or stop).

- Resolution bandwidth.
- Video filter state.
- Video bandwidth (if video filter is on).
- Zoom type (high accuracy or high resolution).

- Sweep state.
- Manual frequency (if sweep state is manual).
- Input range.
- Input impedance.
- 1 MΩ reference impedance (if 1 MΩ impedance is selected).

[VIDEO BW] softkey

Key Path: [Res BW]

Press [VIDEO BW] to adjust the bandwidth of the analyzer's video filter.

When you decrease the bandwidth of the video filter, the noise variance of swept spectrum measurements is reduced so you can see signals close to the noise floor.

Smaller video bandwidths require longer sweep times for a given span and resolution bandwidth. If bandwidth coupling is on, the sweep time is adjusted automatically when you change the video bandwidth.

If you use the number keys to change the value of [VIDEO BW], the value you enter is rounded up to the next largest video bandwidth.

Seven video bandwidths are available for each resolution bandwidth (RBW) setting. They are determined by multiplying RBW by the following values:

- 1.54
- 0.62
- 0.29
- 0.14
- 0.068
- 0.034
- 0.017

Note



The analyzer always maintains the specified ratio between resolution bandwidth and video bandwidth, even when bandwidth coupling is disabled.

Key Reference
[VOLATILE RAM DISK] softkey

[VOLATILE RAM DISK] softkey

Key Path: [Save/Recall] —> [DEFAULT DISK]

or: [Disk Util] —> [DEFAULT DISK]

Press [VOLATILE RAM DISK] when you want to use some of the analyzer's volatile RAM as the default disk .

Caution



The volatile RAM disk is cleared each time you turn the analyzer off. Copy important files to another disk before power-down or they will be lost.

When you turn the analyzer on, a 64 kilobyte volatile RAM disk is created. If you need more storage space, you must reformat the disk with a different format option.

File operations are much faster on the volatile RAM disk than on the internal disk. This makes the volatile RAM disk very useful for HP Instrument BASIC programs.

Volume name

Volume names allow you to uniquely identify each of your flexible disks. They are displayed in the upper-left corner of the disk catalog.

A volume name can be up to six characters long. You assign it to a disk before formatting. Just append the name to the disk specifier in the [PERFORM FORMAT] prompt.

[ZERO OFFSET] softkey

Key Path:[Marker]

Press [ZERO OFFSET] to move the offset marker to the position of the main marker in the active trace.

Here's how [ZERO OFFSET] works in some special cases:

- When the frequency counter is on, the analyzer uses the measured frequency at the main marker for the x value of the offset marker.
- When the noise level measurement is enabled, the analyzer uses the measured noise level at the main marker for the y value of the offset marker.

If the offset marker isn't already on, it is turned on automatically when you press [ZERO OFFSET].

[ZERO SPAN] softkey

Key Path: [Freq]

Use [ZERO SPAN] to observe modulation of a signal. When you press [ZERO SPAN] the analyzer acts as a fixed-tuned receiver. You tune the receiver with [CENTER].

Note

[ZERO SPAN] is only available for swept spectrum measurements.



Modulating frequencies greater than one-half of the current [RES BW] setting are attenuated more than 3 dB. These frequencies fall outside the passband of the resolution bandwidth filter.

Zero span can be especially useful for the following tasks:

- Observing the amplitude modulation of a carrier frequency.
- Checking for long-term amplitude instabilities in a fixed sine source.
- Adjusting a filter network to pass or stop a particular frequency.
- Matching an oscillator frequency to a reference (by adjusting the beat frequency to 0 Hz).

Zoom defined

The term zoom (or zooming) is used to describe the process of narrowing the frequency span to better resolve some portion of the spectrum.

On the HP 3588A display, each span is divided into 401 evenly-spaced points. As you narrow the span, the frequency increment between points decreases, thus increasing the display resolution.

Zoom Type softkey group

Key Path: [Res BW]

The two keys in this softkey group let you choose between greater amplitude accuracy and greater frequency resolution for narrow band zoom measurements.

- [HI ACCRCY ZOOM] provides greater amplitude accuracy.
- [HI RES ZOOM] provides greater frequency resolution.

Hint: When you are trying to resolve closely-spaced signals that differ greatly in amplitude, [HI ACCRCY ZOOM] sometimes provides better frequency resolution.



Menu Map

Measurement Group

[**Meas Type**] hardkey

[SWEPT SPECTRUM]

[NARROW BAND ZOOM]

[LOW DIST ON OFF]

[PEAK DET ON OFF]

[**Freq**] hardkey

[CENTER]

[SPAN]

[FULL SPAN]

[ZERO SPAN]

[START]

[STOP]

[STEP SIZE AUTO USER]

[USER STEP SIZE]

[SIGNAL TRK ON OFF]

[**Res BW**] hardkey

[RES BW]

[VID FLTR ON OFF]

[VIDEO BW]

[BW COUPLE ON OFF]

[BW COUPLE PRESET]

[HI ACCRCY ZOOM]

[HI RES ZOOM]

[**Meas Restart**] hardkey

[**Range/Input**] hardkey

[RANGE]

[AUTORANGE ON OFF]

[SINGLE AUTORANGE]

[50 OHMS]

[75 OHMS]

[1 MEGOHM]

[1 MEG REF IMPEDANCE]

[CLEAR INP TRIP]

Menu Map
Measurement Group

[**Sweep**] hardkey
[SWEEP AUTO MAN]
[MANUAL FREQ]
[SWEEP TIME]
[SAMPLE TIME]
[OVERSWEEP ON OFF]

[**Trigger**] hardkey
[FREE RUN TRIGGER]
[EXTERNAL TRIGGER]
[HP-IB TRIGGER]
[ARM AUTO MAN]
[ARM]

[**Avg/Peak Hold**] hardkey
[OFF]
[VIDEO AVERAGE]
[PEAK HOLD]
[NUMBER AVERAGES]

[**Source**] hardkey
[SOURCE ON OFF]
[SOURCE AMPLITUDE]
[AMPLITUDE STEP]
[50 OHMS OUTPUT Z]
[75 OHMS OUTPUT Z]
[COUPLE TO INPUT Z]
[CLEAR SRCE TRIP]

Display Group

[**Active Trace**] hardkey

[**Format**] hardkey

[SINGLE]

[UPPER/ LOWER]

[FRONT/ BACK]

[SETUP STATE]

[GRATICULE ON OFF]

[BLANK ANNOTATN]

[BLANK DISPLAY]

[**Trace Data**] hardkey

[INPUT SPECTRUM]

[FUNCTION (F1-F5)]

[Fx]

[CONSTANT (K1-K5)]

[Kx]

[DATA REG (D1-D8)]

[Dx]

[NORMLIZED SPECTRUM]

[SAVE NORM REFERENCE]

[TRACE TITLE]

[**Math**] hardkey

[DEFINE F1]

[SPECTRUM]

[+]

[-]

[*]

[/]

[()]

[ENTER]

[DATA REG (D1-D8)]

[DATA REG Dx]

[CONSTANT (K1-K5)]

[CONSTANT Kx]

[FUNCTION (F1-F5)]

[FUNCTION Fx]

[SQRT(NBW)]

[()]

[DEFINE Fx]

[DEFINE Kx]

Menu Map
Display Group

[**Trace Type**] hardkey
[LOG MAGNITUDE]
[LINEAR MAGNITUDE]

[**Scale**] hardkey
[AUTO SCALE]
[VERTICAL /DIV]
[REF TRACK ON OFF]
[REFERENCE LEVEL]

Marker Group

[Marker] hardkey

- [MKR --> PEAK]
- [MKR --> CTR FREQ]
- [MKR --> REF LEVEL]
- [ZERO OFFSET]
- [MARKER X ENTRY]
- [NXT RIGHT PEAK]
- [NXT LEFT PEAK]
- [OFFST MKR --> SPAN]
- [OFFSET ON OFF]
- [MARKER ON OFF]

[Marker Fctn] hardkey

- [PEAK TRK ON OFF]
- [FREQ CNTR ON OFF]
- [NOISE LVL ON OFF]
- [LIMIT TEST]
 - [LINES ON OFF]
 - [TEST EVAL ON OFF]
 - [FAIL BEEP ON OFF]
 - [ABSOLUTE LIMIT]
 - [RELATIVE LIMIT]
 - [DEFINE UPPER LIM]
 - [MOVE MKR HORIZNTAL]
 - [MOVE MKR VERTICAL]
 - [START SEGMENT]
 - [FINISH SEGMENT]
 - [MOVE ALL VERTICAL]
 - [DELETE ALL]
 - [DELETE SEGMENT]
 - [DEFINE LOWER LIM]

System Group

[Preset] hardkey

[User Define] hardkey

[RUN]

[CONTINUE]

[EDIT]

[ENTER]

[INSERT SPACE]

[INSERT LINE]

[DELETE LINE]

[RECALL LINE]

[DELETE CHARACTER]

[TYPING UTILITIES]

[ENTER]

[INSERT SPACE]

[INSERT KEYWORD]

[DELETE CHARACTER]

[UPPERCASE lowercase]

[INSERT +-*^/=()]

[INSERT &#;:;@|]

[INSERT \$<>[]{} \]

[INSERT ~%!?'_]

[GOTO LINE]

[ENTER]

[(_)]

[UPPERCASE lowercase]

[END EDIT]

[PRINT PROGRAM]

[User Define] hardkey (continued)

- [UTILITIES]
 - [MEMORY SIZE]
 - [AUTO MEMORY]
 - [SCRATCH]
 - [SCRATCH]
 - [SCRATCH C]
 - [SCRATCH A]
 - [PERFORM SCRATCH]
 - [RENUMBER]
 - [START LINE #]
 - [INCREMENT]
 - [PERFORM RENUMBER]
 - [SECURE]
 - [START LINE #]
 - [END LINE #]
 - [PERFORM SECURE]
- [ENABLE RECORDING]
- [DEBUG]
 - [RUN]
 - [CONTINUE]
 - [SINGLE STEP]
 - [LAST ERROR]
 - [EXAMINE VARIABLE]
 - [RESET]
- [DISPLAY FORMAT]
 - [OFF]
 - [FULL]
 - [UPPER]
 - [LOWER]
 - [CLEAR SCREEN]

Menu Map
System Group

[Help] hardkey

[Save/Recall] hardkey

[SAVE TRACE]

[INTO FILE]

[INTO Dx]

[SAVE STATE]

[SAVE AUTO STATE]

[SAVE MORE]

[SAVE UPPER LIM]

[SAVE LOWER LIM]

[SAVE MATH]

[SAVE PROGRAM]

[RE-SAVE PROGRAM]

[CATALOG ON OFF]

[RECALL TRACE]

[FROM FILE INTO Dx]

[CATALOG ON OFF]

[RECALL STATE]

[RECALL MORE]

[RECALL UPPER LIM]

[RECALL LOWER LIM]

[RECALL MATH]

[RECALL PROGRAM]

[CATALOG ON OFF]

[CATALOG ON OFF]

[DEFAULT DISK]

[NON-VOL RAM DISK]

[VOLATILE RAM DISK]

[INTERNAL DISK]

[CATALOG ON OFF]

[**Disk Util**] hardkey

- [RENAME FILE]
 - [ORIGINAL FILENAME]
 - [NEW FILENAME]
 - [PERFORM RENAME]
 - [CATALOG ON OFF]
- [DELETE FILE]
- [DELETE ALL FILES]
- [COPY FILE]
 - [SOURCE FILENAME]
 - [DESTIN FILENAME]
 - [PERFORM FILE COPY]
 - [CATALOG ON OFF]
- [COPY DISK]
 - [SOURCE DISK]
 - [DESTIN DISK]
 - [PERFORM DISK COPY]
 - [CATALOG ON OFF]
- [PACK DISK]
- [FORMAT DISK]
 - [FORMAT OPTION]
 - [INTRLEAVE FACTOR]
 - [PERFORM FORMAT]
 - [CATALOG ON OFF]
- [CATALOG ON OFF]
- [DEFAULT DISK]

[**Local/HP-IB**] hardkey

- [ABORT HP-IB]
- [SYSTEM CONTROLLR]
- [ADDRESSBL ONLY]
- [ANALYZER ADDRESS]
- [PERIPHERL ADDRESSES]
 - [PLOTTER ADDRESS]
 - [PRINTER ADDRESS]
- [ECHO ON OFF]
- [USER SRQ]
 - [USER SRQ x]

Menu Map
System Group

[Plot/Print] hardkey

- [PLOT ALL]
- [PLOT TRACE]
- [PLOT MARKER]
- [PLOT OFFST MKR]
- [PLOT GRATICULE]
- [DEFINE PLOT]
 - [DEFINE PLOT PENS]
 - [DEFAULT PENS]
 - [TRACE A PEN]
 - [TRACE B PEN]
 - [MARKER A PEN]
 - [MARKER B PEN]
 - [ALPHA PEN]
 - [GRATICULE PEN]
 - [TRACE A LINE TYPE]
 - [SOLID]
 - [DOTTED]
 - [DASHED]
 - [USER DEFINED]
 - [USER LINE TYPE]
 - [TRACE B LINE TYPE]
- [PLOT SPEED]
 - [SLOW (10 cm/S)]
 - [FAST (50 cm/S)]
 - [USER DEFINED]
 - [USER PLOT SPEED]
- [PAGE EJCT ON OFF]
- [PRINT ALL]

[Spcl Fctn] hardkey

- [SINGLE CAL]
- [AUTO CAL ON OFF]
- [BEEPER ON OFF]
- [TIME HHMM]
- [DATE MMDDYY]
- [SERIAL NUMBER]
- [PRFM TESTS]
 - [CALIBRATR TO INPUT]
 - [SRCE 10dB IN OUT]
 - [SRCE 20dB A IN OUT]
 - [SRCE 20dB B IN OUT]
 - [SRCE DAC ATTEN]

Index

A

absolute marker
 See main marker
active entry
 See numeric entry keys
active probe 2-6
active trace
 See display
alpha entry keys 2-23, 9-3
alpha entry mode 2-23, 9-3
arrow keys 2-22
autoranging 2-2, 9-7
 during scalar network measurements 7-2
averaging
 See video averaging

B

bandwidth coupling 4-5, 9-10
 changing 4-5
 disabling 4-9
 preset 9-11
beeper 9-8

C

calibration, automatic 9-5
center frequency and zero span 9-13
controller capability 9-16
 See also HP-IB
copy operations
 disk copying 9-17
 file copying 9-17
CRT cleaning
 See display
CW mode
 See manual sweep

D

data collection
 See measurement restart
data registers
 See trace math
disk
 catalog 9-12
 default 9-20
 delete disk option 2-9
 format options 9-39

 formatting 9-38, 9-88
 interleave factor 9-56
 internal 2-9, 9-55
 non-volatile 9-77
 packing 9-85
 specifiers 9-27
 utilities 9-27
 volatile 9-146
 volume name 9-146
disk copying
 See copy operations
display
 active trace 2-15
 annotation blanking 9-9
 autoscaling 9-6
 blanking 9-9
 CRT care and cleaning 2-19
 display resolution 4-11
 fonts used 9-38
 format options 9-29
 graticule 9-46
 mini-state 2-12
 pop-up message area 2-16
 reference level 9-108
 reference-level tracking 9-107
 status indicator area 2-14
 status message area 2-18
 trace boxes 2-15
 trace title 2-18, 9-139
 x-axis notation 2-17
 y-axis notation 2-16
display keys 2-25
display resolution 9-43
 See also frequency resolution and display resolution

E

entry down key
 See arrow keys
entry up key
 See arrow keys
EXT REF IN
 See external reference input
EXT TRIG
 See external trigger input
external reference input 3-4
external trigger 9-36
external trigger input 3-7

F

- FFT measurements
 - See narrow band zoom measurements
- file copying
 - See copy operations
- files
 - deleting all 9-25
 - deleting individual 9-26
- formatting
 - See disk
- frequency counter 6-6, 9-41
 - for numeric entry 6-6
- frequency resolution and display resolution 4-12
- frequency span 9-127
 - start and stop 9-129
- frequency span, full 9-44
- frequency step size 9-131

H

- hardkeys 1-2, 2-11, 9-47
- help key 2-31, 9-48
- high-accuracy zoom
 - See narrow band zoom measurements
- high-resolution zoom
 - See narrow band zoom measurements
- HP Instrument BASIC
 - automemory 9-6
 - debug utility 9-19
 - deleting characters 9-25
 - deleting lines 9-26
 - display format 9-28
 - editing 9-31, 9-46, 9-52, 9-54
 - keystroke recording 9-32
 - memory size 9-70
 - program stepping 9-123
 - re-saving programs 9-103
 - renumbering lines 9-88
 - scratch options 9-119
 - securing programs 9-33, 9-120
 - utilities 9-142
 - variables 9-35
- HP-IB 9-50, 9-61
 - connector 3-1
 - controllers 9-50
 - mnemonic echo 9-30
 - trigger 9-51
 - user SRQ 9-141

I

- input 2-1
 - input trip 2-4
 - over-range 2-3
 - overload 2-3
- input autoranging
 - See autoranging
- input impedance
 - 1 Megohm 2-5
 - 50 ohm 2-4
 - 75 ohm 2-4
- input levels
 - maximum allowable 2-4
 - maximum for each range 2-2

K

- knob, the 2-20

L

- limit testing 6-10, 9-58
 - beeper 9-37
- limits
 - absolute 6-10
 - relative 6-10
- local oscillator feedthrough 4-2
- local/HP-IB
 - See controller capability
- low-distortion mode 7-10, 9-63

M

- main marker 6-1
 - marker-to-center-frequency 6-4, 9-71
 - marker-to-peak 6-3, 9-71
 - marker-to-reference-level 9-72
 - next-left-peak 6-3, 9-80
 - next-right-peak 6-3, 9-80
 - See also offset marker
 - peak track 6-5
- manual frequency
 - See manual sweep
- manual frequency stepping
 - See step size
- manual sweep 4-14, 8-1, 9-132
 - manual frequency 8-2, 9-64
 - manual measurement point 8-4
 - sample time 8-2
 - special considerations 8-3
- marker
 - See main marker
 - marker readout 2-13
 - marker value 9-67

marker functions 6-1, 9-65 - 9-66

See also main marker

See also offset marker

marker keys 2-20

marker readout 6-2

measurement keys 2-24

measurement restart 9-69

menu map 10-1

N

narrow band zoom measurements 5-1, 9-74

high-accuracy zoom 5-2

high-resolution zoom 5-2

See also swept spectrum measurements

network measurements

See scalar network measurements

noise density

See noise level

noise level 6-7, 9-75

and recalled traces 6-9

See also random noise spectral density

special considerations 6-7

noise marker

See noise level

normalization

See scalar network measurements

numeric entry 9-79

changing numeric parameters 9-14

entry box 2-20

with the knob 2-20

numeric entry keys 2-21

active entry 2-21

O

offset marker 6-2, 9-81

See also main marker

offset-to-span 6-4, 9-81

OVEN REF OUT

See oven reference output

oven reference output 3-5

oversweep 4-3, 9-84

OVL D

See input

P

peak detector 9-86

and the noise floor 4-13

disabling 4-13

peak detector, the 4-11

peak hold 7-6, 9-87

difference between peak track

and signal track 7-6

peak track 9-87

performance test 9-89

plotter

page eject 9-85

plotting

assigning pens 9-23

default pens 9-21

plot parameters 9-24

plotting/printing measurement results 9-94

preset key 2-27, 9-96

preset state 9-96

R

radio receivers

See spectrum analyzers and radio receivers

random noise spectral density 6-8

RBW

See resolution bandwidth

REF OUT

See reference output

reference output 3-6

resolution bandwidth 4-3, 4-6, 9-109

resolution bandwidth coupling

See bandwidth coupling

RNG

See input

S

save/recall operations 9-118

scalar network measurements 7-1

special considerations 7-2

scalar network measurements

normalization of 7-2

scan time

See sweep time

setup state 2-27

after power-up 2-28

after preset 2-28

printing 2-27

signal track 7-6, 9-121

See also peak track

softkeys 1-2, 2-11, 9-123

toggle 1-2

softkeys, toggle 2-11

source 2-7, 9-125

amplitude 9-125

amplitude step size 9-4

output impedance 9-83

protection circuitry 2-8

span

See frequency span

special function keys 9-128

Index (Continued)

spectrum analyzers and radio receivers 4-6
status message area
 See display
step size 2-20
 and center frequency 7-7
 and center frequency (sample task) 7-8
 and manual frequency 8-4
 and manual frequency (sample task) 8-5
 modifying 7-7
 user 7-7
 using the frequency counter to set 7-7
sweep time 4-10, 9-134
sweep, manual
 See manual sweep
swept spectrum measurements 4-1, 9-135
 See also narrow band zoom measurements
system keys 2-26

T

time, setting (analyzer's clock) 9-136
trace math 7-3
 and logarithmic values 7-4
 constants 9-22
 data registers 9-19, 9-29
 functions 9-21, 9-45
 operand menu 9-82
 operator menu 9-83
 special considerations 7-3
trace title
 See display
tracking generator
 See source
TRIG OUT
 See trigger output
trigger 9-139
 arming 9-4
 free run 9-40
trigger output 3-8

V

VBW
 See video bandwidth
video averaging 7-5, 9-144
 special considerations 7-5
 See also video filtering
video bandwidth 4-4, 4-6, 9-145
video filtering 4-4, 4-6
 See also video averaging

W

waveform math
 See trace math

Z

zero response
 See local oscillator feedthrough
zero span 4-15
 special considerations 4-16
zoom, definition 9-147

