



HEWLETT
PACKARD

OPERATING, PROGRAMMING AND CONFIGURATION MANUAL

MODEL 3488A

SWITCH/CONTROL UNIT

IMPORTANT NOTICE

Any changes made in instruments manufactured after this printing will be found in a "Manual Changes" supplement supplied with this manual. Be sure to examine this supplement, if one exists for this manual, for any changes which apply to your instrument and record these changes in the manual.

WARNING

The 3488A uses latching relays on the 44470A, 44471A, 44472A, and 44473A Option assemblies. The state of these relays can only be altered under front panel or program control. This is an advantage in the sense that, under most conditions of failure, the relays will remain in whatever state your program has set them. However, in the case of power or equipment failure, any application requiring a failsafe method of insuring that the circuits under control are in a known state must be provided by the installer.

In case of component failure or programming error, any voltage input to an option card may be present on any other terminal on the same option card.

WARNING

If any of the following symptoms exists, or are even suspected, remove the instrument from service. Do not use the instrument until safe operation can be verified by service-trained personnel.

- 1. Visible damage.*
- 2. Severe transport stress.*
- 3. Prolonged storage under adverse conditions.*
- 4. Failure to perform intended measurements.*

If necessary, return the instrument to a Hewlett-Packard Sales and Service Office for service and repair to ensure that safety features are maintained.

Manual Part No. 03488-90002

Microfiche Part No. 03488-90052

Printed: October 1986

Herstellerbescheinigung

Hiermit wird bescheinigt, daß das Gerät/System HP 3488A
in Übereinstimmung mit den Bestimmungen von Postverfügung 1046/84 funkentstört ist.

Der Deutschen Bundespost wurde das Inverkehrbringen dieses Gerätes/Systems angezeigt und die Berechtigung zur Überprüfung der Serie auf Einhaltung der Bestimmungen eingeräumt.

Zusatzinformation für Meß- und Testgeräte

Werden Meß- und Testgeräte mit ungeschirmten Kabeln und/oder in offenen Meßaufbauten verwendet, so ist vom Betreiber sicherzustellen, daß die Funk-Entstörbestimmungen unter Betriebsbedingungen an seiner Grundstücksgrenze eingehalten werden.

Manufacturer's declaration

This is to certify that the equipment HP 3488A
is in accordance with the Radio Interference Requirements of Directive FTZ 1046/84. The German Bundespost was notified that this equipment was put into circulation, the right to check the series for compliance with the requirements was granted.

Additional Information for Test- and Measurement Equipment

If Test- and Measurement Equipment is operated with unshielded cables and/or used for measurements on open set-ups, the user has to assure that under operating conditions the Radio Interference Limits are still met at the border of his premises.

NOTICE

The information contained in this document is subject to change without notice.

HEWLETT-PACKARD MAKES NO WARRANTY OF ANY KIND WITH REGARD TO THIS MATERIAL, INCLUDING, BUT NOT LIMITED TO, THE IMPLIED WARRANTIES OF MERCHANTABILITY AND FITNESS FOR A PARTICULAR PURPOSE. Hewlett-Packard shall not be liable for errors contained herein or for incidental or consequential damages in connection with the furnishing, performance or use of this material.

Hewlett-Packard assumes no responsibility for the use or reliability of its software on equipment that is not furnished by Hewlett-Packard.

This document contains proprietary information which is protected by copyright. All rights are reserved. No part of this document may be photocopied, reproduced or translated to another language without the prior written consent of Hewlett-Packard Company.

How To Use This Manual

This Operating, Programming and Configuration Manual has been designed as both a tutorial operating manual for the 3488A and a reference manual for each of the 3488A options. You will find concise operating and programming information in the first four chapters. Chapter 5 shows you how to install your 3488A and also provides specification and warranty information.

The last half of this manual is composed of six chapters, one for each of the six 3488A option assemblies. These option reference chapters provide installation and configuration information for qualified service-trained personnel. Option dependent programming information is also provided for each option.

Finally, to help you in setting up your test or measurement system, two appendices have been included. The first helps you document your test system. The second, gives a technical description of the HP-IB interface.

Here is an overview of what this manual contains:

▶ **Meet the 3488A Switch/Control Unit, Chapter 1 (Page 1)**

This chapter is designed to get you familiar with the 3488A. It describes the major features of the 3488A and the six different option assemblies available for the 3488A.

▶ **Using the 3488A, Chapter 2 (Page 21)**

Chapter 2 teaches you how to operate your 3488A. Remote programming as well as front panel operation is discussed. Several exercises are provided to enhance the discussion.

▶ **More Functions and Features, Chapter 3 (Page 51)**

In Chapter 3 you will learn to use the more advanced features of the 3488A. This includes scanning through a list of channels, pairing option assemblies together, and much more.

▶ **Advanced Remote Programming, Chapter 4 (Page 79)**

As the title says, this chapter deals with topics in advanced remote programming. Chapter 4 shows you how to increase throughput or program the 3488A to interrupt the system computer for any of a number of specific reasons. Program examples are given to enhance the discussion.

▶ **Operator Information, Chapter 5 (Page 95)**

Instructions for installing the 3488A, specifications, accessories, warranty information and much more is discussed in Chapter 5. You will need to read Chapter 5 before doing initial 3488A installation.

▶ **Option Reference Chapters (Chapters 6 - 11)**

Each of these chapters is devoted to one of the 3488A option assemblies and provides information unique to that option. Specific programming information is given with many application examples. In addition, complete installation and configuration procedures are provided.

▶ **Documentation Worksheet, Appendix A (Page 259)**

This simple worksheet will help you to plan your test system both with hardware wiring connections and when programming the system computer. Furthermore, it can be an aid in diagnosing system failures should they occur.

▶ **HP-IB, Appendix B (Page 265)**

HP-IB (IEEE 488-1978) is a carefully defined interface for instrumentation. This appendix gives a technical description of HP-IB for those unfamiliar with it.

The following chart shows chapters which are recommended reading for various types of 3488A users. You may fall into more than one category. For example, you may be an inexperienced programmer who installs the test system.

| Reader/User | Chapters | | | | | Command Summary | Option Reference Chapters | Appendix A | Appendix B |
|------------------------|----------|---|---|---|---|-----------------|---------------------------|------------|------------|
| | 1 | 2 | 3 | 4 | 5 | | | | |
| Installation Personnel | | | | | • | | • | • | • |
| First time user | • | • | | | | | | | |
| Advanced user | | • | • | | | | • | • | |
| Test System Programmer | | • | • | • | | • | • | | |

TABLE OF CONTENTS

| Chapter | Page | Chapter | Page |
|---|------|--|------|
| 1. Meet the 3488A | 1 | Storing and Recalling Channel Configurations | 51 |
| Introduction | 1 | Scanning Through a List of Channels | 53 |
| The Options | 1 | Using the STEP Command | 55 |
| Installation of Options | 2 | Using the CHAN Command | 55 |
| An Overview of the 3488A | 3 | External Increment and Channel Closed | 56 |
| Power-on Operations | 5 | Card Pair | 58 |
| Reset and Test | 6 | Using the Time Delay | 59 |
| Determining Option Card Type | 8 | COMMAND DIRECTORY | 61 |
| 44470A | 11 | | |
| Description | 11 | Chapter | Page |
| Applications | 11 | 4. Advanced Remote Programming | 79 |
| 44471A | 12 | Introduction | 79 |
| Description | 12 | Using the 3488A Input Buffer | 79 |
| Applications | 12 | 3488A HP-IB Capabilities | 81 |
| 44472A | 13 | CLEAR | 82 |
| Description | 13 | Examples | 82 |
| Applications | 13 | Comments | 82 |
| 44473A | 15 | LOCAL | 82 |
| Description | 15 | Examples | 82 |
| Applications | 15 | Comments | 82 |
| 44474A | 16 | LOCAL LOCKOUT | 83 |
| Description | 16 | Example | 83 |
| Applications | 17 | Comments | 83 |
| 44475A | 18 | REMOTE | 83 |
| Description | 18 | Examples | 83 |
| Applications | 18 | Comments | 83 |
| | | REQUEST SERVICE (SRQ) | 84 |
| Chapter | Page | How to Use SRQ | 84 |
| 2. Using the 3488A | 21 | Status Register and Status Byte | 85 |
| Introduction | 21 | Setting the SRQ Mask | 86 |
| Scope | 21 | Example 1. Front Panel SRQ | 87 |
| Note on Remote HP-IB Programming | 21 | Example 2. SRQ on End of Scan | 88 |
| Trying a Command | 23 | Sequence | 88 |
| Channel and Slot Definition | 24 | SPOLL | 91 |
| How to Close/Open a Channel | 25 | Example | 91 |
| How to VIEW a Channel | 27 | Comments | 91 |
| How to Monitor an Entire Option | | TRIGGER | 94 |
| Assembly | 28 | Examples | 94 |
| Monitoring a 44470A 10 Channel Multiplexer or 44471A General Purpose Relay Assembly | 29 | Comments | 94 |
| Monitoring a 44472A VHF Switch | 30 | | |
| Monitoring a 44473A Matrix Assembly | 31 | Chapter | Page |
| Monitoring a 44474A Digital I/O Assembly | 33 | 5. Operator Information | 95 |
| Monitor Tracking | 35 | Introduction | 95 |
| Resetting Individual Option Assemblies | 36 | Preparation for Use | 95 |
| Self Test | 36 | Unpacking Instructions | 95 |
| Using the Display | 38 | Initial Inspection | 96 |
| Handling Errors | 39 | Power Requirements | 96 |
| Reading the Error Register | 41 | Line Voltage Selection | 97 |
| The STATUS Command | 42 | Power Line Fuse Replacement | 97 |
| Using the Built-in Quick Reference Guide | 44 | Grounding Requirements | 98 |
| | | Power Cords and Receptacles | 98 |
| Chapter | Page | Instrument Mounting | 98 |
| 3. More Functions and Features | 51 | HP-IB Interface Connections | 99 |
| Introduction | 51 | HP-IB Address Selection | 99 |
| | | Options and Accessories | 101 |
| | | Warranty Information | 102 |
| | | Certification | 102 |
| | | Warranty | 102 |
| | | Limitation of Warranty | 102 |

| | |
|--|-----|
| Exclusive Remedies | 103 |
| Assistance | 103 |
| Limitation of Warranty for Option 015 | 103 |
| Safety Summary | 103 |
| Specifications | 105 |
| Environmental Requirements | 105 |
| Miscellaneous | 106 |
| How to Obtain Repair Service | 106 |
| 3488A Serial Number | 106 |
| General Shipping Instructions | 106 |
| Cleaning | 106 |

| Chapter | Page |
|--|------|
| 6. 44470A Relay Multiplexer | 109 |
| Introduction | 109 |
| Operation | 109 |
| Channels | 110 |
| Commands | 111 |
| CLOSE a channel | 111 |
| Description | 111 |
| Examples | 111 |
| OPEN a channel | 112 |
| Description | 112 |
| Example | 112 |
| VIEW a channel | 112 |
| Description | 112 |
| Example | 112 |
| CARD TYPE | 113 |
| Description | 113 |
| Example | 113 |
| CARD RESET | 113 |
| Description | 113 |
| Example | 113 |
| CARD PAIR | 114 |
| Description | 114 |
| Example | 114 |
| Example | 114 |
| SCAN LIST | 115 |
| Description | 115 |
| Example | 115 |
| Notes | 115 |
| STEPping Through the Scan List | 116 |
| Description | 116 |
| Example | 116 |
| CHANnel command | 116 |
| Description | 116 |
| Example | 117 |
| CARD MONITOR mode | 117 |
| Description | 117 |
| Example | 117 |
| Advanced Operations | 118 |
| External Increment and Channel Closed | 118 |
| DELAY | 119 |
| Description | 119 |
| Examples | 120 |
| HP-IB Interface Commands | 120 |
| 44470A Assembly Installation | 120 |
| Configuration | 125 |
| Accessories | 126 |

| | |
|--|-----|
| △ Specifications | 126 |
| Applications | 126 |
| Example 1. 4-Wire Ohms | 127 |
| Example 2. Scanning Using Channel Closed | 129 |
| Example 3. Scanning Using External Increment and Channel Closed | 130 |
| Example 4. Single Ended Measurements | 131 |

| Chapter | Page |
|--|------|
| 7. 44471A General Purpose Relay | |
| Introduction | 135 |
| Module | 135 |
| Operation | 136 |
| Channels | 136 |
| Commands | 137 |
| CLOSE a channel | 137 |
| Description | 137 |
| Examples | 137 |
| OPEN a channel | 138 |
| Description | 138 |
| Examples | 138 |
| VIEW a channel | 138 |
| Description | 138 |
| Example | 138 |
| CARD TYPE | 139 |
| Description | 139 |
| Example | 139 |
| CARD RESET | 139 |
| Description | 139 |
| Example | 139 |
| CARD PAIR | 140 |
| Description | 140 |
| Example | 140 |
| Example | 140 |
| SCAN LIST | 141 |
| Description | 141 |
| Example | 141 |
| Notes | 141 |
| STEPping through the Scan List | 142 |
| Description | 142 |
| Example | 142 |
| CHANnel Command | 142 |
| Description | 142 |
| Example | 143 |
| CARD MONITOR mode | 143 |
| Description | 143 |
| Example | 143 |
| Advanced Operations | 144 |
| External Increment and Channel Closed | 144 |
| DELAY | 145 |
| Description | 145 |
| Examples | 146 |
| HP-IB Interface Commands | 146 |
| 44471A Assembly Installation | 147 |
| Configuration | 151 |
| Using Varistors | 155 |
| Accessories | 155 |
| △ Specifications | 155 |

| | |
|--|------|
| Application Examples..... | 156 |
| Example 1. Using the 44471A as an Actuator..... | 156 |
| Example 2. Using the 44471A as a Resistance Programmer..... | 157 |
| Example 3. Single Ended Measurements..... | 159 |
| Chapter | Page |
| 8. 44472A Dual 4 – 1 VHF Switch Module..... | 163 |
| Introduction..... | 163 |
| Operation..... | 164 |
| Channels..... | 164 |
| Commands..... | 165 |
| CLOSE a channel..... | 166 |
| Description..... | 166 |
| Example..... | 166 |
| OPEN a channel..... | 166 |
| Description..... | 166 |
| Examples..... | 166 |
| VIEW a channel..... | 167 |
| Description..... | 167 |
| Example..... | 167 |
| CARD TYPE..... | 167 |
| Description..... | 167 |
| Example..... | 168 |
| CARD RESET..... | 168 |
| Description..... | 168 |
| Example..... | 168 |
| CARD PAIR..... | 168 |
| Description..... | 168 |
| Example..... | 168 |
| Example..... | 169 |
| SCAN LIST..... | 169 |
| Description..... | 169 |
| Example..... | 169 |
| Notes..... | 169 |
| STEPping through the Scan List..... | 170 |
| Description..... | 170 |
| Example..... | 170 |
| CHANnel Command..... | 171 |
| Description..... | 171 |
| Examples..... | 171 |
| CARD MONITOR mode..... | 171 |
| Description..... | 171 |
| Example..... | 172 |
| Advanced Operations..... | 172 |
| External Increment and Channel Closed..... | 172 |
| DELAY..... | 174 |
| Description..... | 174 |
| Examples..... | 174 |
| HP-IB Interface Commands..... | 174 |
| 44472A Assembly Installation..... | 175 |
| Specifications..... | 176 |
| Applications..... | 177 |
| Isolation Impedance..... | 177 |
| Topologies..... | 178 |



| | |
|---|------|
| Chapter | Page |
| 9. 44473A 4 × 4 Matrix Switch Module.. | 183 |
| Introduction..... | 183 |
| Operation..... | 184 |
| Channels..... | 184 |
| Commands..... | 185 |
| CLOSE a channel..... | 186 |
| Description..... | 186 |
| Examples..... | 186 |
| OPEN a channel..... | 186 |
| Description..... | 186 |
| Examples..... | 186 |
| VIEW a channel..... | 187 |
| Description..... | 187 |
| Example..... | 187 |
| CARD TYPE..... | 187 |
| Description..... | 187 |
| Example..... | 188 |
| CARD RESET..... | 188 |
| Description..... | 188 |
| Example..... | 188 |
| CARD PAIR..... | 188 |
| Description..... | 188 |
| Example..... | 188 |
| Example..... | 189 |
| SCAN LIST..... | 189 |
| Description..... | 189 |
| Example..... | 189 |
| Notes..... | 190 |
| STEPping through the Scan List..... | 190 |
| Description..... | 190 |
| Example..... | 190 |
| CHANnel Command..... | 191 |
| Description..... | 191 |
| Examples..... | 191 |
| CARD MONITOR mode..... | 191 |
| Description..... | 191 |
| Advanced Operations..... | 193 |
| External Increment and Channel Closed..... | 193 |
| DELAY..... | 194 |
| Description..... | 194 |
| Examples..... | 195 |
| HP-IB Interface Commands..... | 195 |
| 44473A Assembly Installation..... | 196 |
| Accessories..... | 200 |
| Specifications..... | 200 |
| Applications..... | 200 |
| Example 1. Extending the Matrix..... | 200 |
| Example 2. Extending the Matrix to 4 × 40..... | 205 |
| Chapter | Page |
| 10. 44474A Digital I/O Module..... | 209 |
| Introduction..... | 209 |
| Operation..... | 210 |
| Bit Definition..... | 210 |
| Commands..... | 212 |
| CLOSE a bit..... | 213 |
| Description..... | 213 |
| Examples..... | 213 |



| | |
|--------------------------------|-----|
| OPEN a Bit | 214 |
| Description | 214 |
| Example | 214 |
| VIEW a Bit | 214 |
| Description | 214 |
| Example | 214 |
| CARD RESET | 215 |
| Description | 215 |
| Example | 215 |
| CARD PAIR | 215 |
| Description | 215 |
| Example | 215 |
| Example | 216 |
| DIGITAL WRITE Command | 216 |
| Description | 216 |
| Example | 216 |
| Example | 217 |
| DIGITAL READ | 218 |
| Description | 218 |
| Example | 219 |
| CARD MONITOR Mode | 219 |
| Description | 219 |
| Example | 219 |
| DIGITAL MODE Command | 220 |
| Description | 220 |
| Mode Definition | 220 |
| Polarity Definition | 225 |
| External Increment Definition | 226 |
| SCAN LIST | 227 |
| Description | 227 |
| Example | 228 |
| Notes | 228 |
| STEPping Through the Scan List | 228 |
| Description | 228 |
| Example | 229 |
| CHANnel Command | 229 |
| Description | 229 |
| Examples | 229 |
| DELAY time | 230 |
| Description | 230 |
| Examples | 230 |

| | |
|--|-----|
| DIGITAL BINARY WRITE | 230 |
| Description | 230 |
| Example | 231 |
| DIGITAL BINARY READ | 231 |
| Description | 231 |
| Example | 232 |
| HP-IB Interface Commands | 232 |
| 44474A Assembly Installation | 233 |
| Accessories | 237 |
| Specifications | 237 |
| Applications | 237 |
| Example 1. Scanning Using External Increment and Channel Closed | 237 |
| Example 2. Limit Switch Sensing | 239 |

| | |
|---|------|
| Chapter | Page |
| 11. 44475A Breadboard Assembly | 241 |
| Introduction and Description | 241 |
| Warranty | 242 |
| Getting Started | 242 |
| Specifications | 242 |
| Assembling the Breadboard | 244 |
| Loading the Components | 244 |
| Mounting Your Custom Circuitry | 246 |
| Component Height/Protrusion Restrictions | 246 |
| Using Wire-Wrap Components | |
| Lead Length | 247 |
| Breadboard Top and Bottom Edges | 247 |
| Power Supply and Ground Traces | 247 |
| Soldering | 247 |
| Assembling the Hardware | 247 |
| Breadboard Installation | 248 |
| Terminal Block | 250 |
| Controlling the Breadboard Ports | 252 |
| SREAD Command | 252 |
| SWRITE Command | 253 |

APPENDICES

| | |
|---|-----|
| A | 259 |
| B | 265 |

LIST OF TABLES

| Table | Page |
|---|------|
| 2-1. Self Test Errors | 37 |
| 5-1. Accessories | 101 |
| 5-2. 3488A General Specifications | 107 |
| 6-1. Channel Addressing Scheme | 111 |
| 6-2. Option 010 44470A 10 Channel Relay Multiplexer Module Specifications | 134 |
| 7-1. Channel Addressing Scheme | 137 |
| 7-2. Option 011 44471A 10 Channel General Purpose Relay Module Specifications | 162 |
| 8-1. Channel Addressing Scheme | 165 |
| 8-2. Option 012 44472A Dual 4 Channel VHF Switch Module Specifications | 181 |
| 9-1. Channel Addressing Scheme | 185 |
| 9-2. Option 013 44473A 4 x 4 Matrix Switch Module Specifications | 207 |
| 10-1. Polarity Specifier | 225 |
| 10-2. Option 014 44474A 16 Bit Digital I/O Module Specifications | 239 |
| 11-1. Required Components for 8-bit I/O Ports | 244 |
| 11-2. Parts Supplied With the 44465A Breadboard | 247 |
| B-1. 3488A Bus Capabilities | 269 |
| B-2. HP-IB Worksheet | 270 |

LIST OF ILLUSTRATIONS

| Figure | Page | | |
|--------|------|---|---|
| 1-1. | 10 | 44470A Simplified Schematic | 7-13. High Voltage Actuator 157 |
| 1-2. | 12 | 44471A Simplified Schematic | 7-14. Binary Resistance Programming . . 158 |
| 1-3. | 14 | 44472A Simplified Schematic | 7-15. Voltage Divider 159 |
| 1-4. | 15 | 44473A Simplified Schematic | 7-16. Single-ended Measurements 160 |
| 1-5. | 17 | 44474A Simplified Schematic | 8-1. 44472A Simplified Schematic . . . 164 |
| 1-6. | 19 | Breadboard Interface Circuitry | 8-2. Rear Panel View of the 3488A . . . 176 |
| 2-1. | 29 | Simplified Schematic for 44470A and 44471A | 8-3. Option Card 177 |
| 2-2. | 30 | Simplified Schematic for 44472A | 8-4. Two 44472A's in "T" Configuration 179 |
| 2-3. | 32 | 44473A Simplified Schematic | 8-5. 4 × 4 Matrix 179 |
| 2-4. | 35 | 44474A Simplified Schematic | 8-6. Tree Configuration 180 |
| 2-5. | 42 | Status Byte | 9-1. 44473A Simplified Schematic . . . 184 |
| 3-1. | 59 | Delay Timing | 9-2. Rear Panel View of the 3488A . . . 197 |
| 4-1. | 85 | Status Byte and SRQ Mask | 9-3. Option Card 198 |
| 4-2. | 89 | 3488A Channel Scanning | 9-4. Terminal Block 198 |
| 4-3. | 91 | Status Byte | 9-5. Strain Relief Assembly 199 |
| 5-1. | 97 | AC Line Voltage Selection Switch | 9-6. Cable Routing 199 |
| 5-2. | 98 | Power Cords | 9-7. 4 × 8 Matrix 201 |
| 5-3. | 99 | Typical HP-IB System Interconnection | 9-8. 4 × 12 Matrix 202 |
| 5-4. | 100 | 3488A HP-IB Address Codes | 9-9. 4 × 16 Matrix 203 |
| 6-1. | 110 | 44470A Simplified Schematic | 9-10. 4 × 20 Matrix 204 |
| 6-2. | 122 | Rear Panel View of the 3488A | 9-11. 8 × 8 Matrix 205 |
| 6-3. | 122 | Option Card | 9-12. 4 × 40 Matrix 206 |
| 6-4. | 123 | Terminal Block | 10-1. 44474A Simplified Schematic . . . 210 |
| 6-5. | 123 | Strain Relief Housing | 10-2. Output Bit Simplified Drawing . . . 211 |
| 6-6. | 124 | Cable Routing | 10-3. Input Bit Simplified Drawing 212 |
| 6-7. | 124 | Attaching the Terminal Block | 10-4. Scan Timing 227 |
| 6-8. | 125 | Diagram of simple Attenuator | 10-5. Rear Panel View of the 3488A . . . 234 |
| 6-9. | 126 | Attenuator Board Locations | 10-6. Option Card 234 |
| 6-10. | 128 | 4-Wire Ohms Measurements | 10-7. Terminal Block 235 |
| 6-11. | 129 | Channel Closed | 10-8. Strain Relief Housing 235 |
| 6-12. | 131 | External Increment and Channel Closed | 10-9. Cable Routing 236 |
| 6-13. | 132 | Single Ended Scanning | 10-10. Attaching the Terminal Block . . . 236 |
| 7-1. | 136 | 44471A Simplified Schematic | 10-11. External Increment and Channel Closed 238 |
| 7-2. | 148 | Rear Panel View of the 3488A | 10-12. Limit Switch Sensing 239 |
| 7-3. | 149 | Option Card | 11-1. 44475A Breadboard 241 |
| 7-4. | 149 | Terminal Block | 11-2. 44475A Breadboard Option Dimensions and Component Height/Protrusion Restrictions 243 |
| 7-5. | 150 | Strain Relief Housing | 11-3. Component Mounting 245 |
| 7-6. | 150 | Cable Routing | 11-4. Breadboard Schematic 246 |
| 7-7. | 151 | Attaching the Terminal Block | 11-5. Hardware Assembly 249 |
| 7-8. | 152 | Contact Protection Networks | 11-6. Rear Panel of the 3488A 250 |
| 7-9. | 153 | RC Protection Network | 11-7. Strain Relief Housing 251 |
| 7-10. | 154 | Locations for Protection Networks | 11-8. Cable Routing 251 |
| 7-11. | 155 | Varistor | 11-9. Attaching the Terminal Block . . . 252 |
| 7-12. | 156 | Low Voltage Actuator | A-1. Worksheet Examples 259 |
| | | | B-1. HP-IB Interface 266 |



Chapter 1

Meet the 3488A Switch/Control Unit

Introduction

Whether you are involved in large production test systems or small R&D bench systems, the 3488A Switch/Control Unit can make the task of signal switching much easier. The 3488A, with its various options, is designed to switch analog signals from low level voltmeter inputs to 250 @ 2A power supplies. The option assemblies can be combined for many topologies providing the combination you need for your test system.

Your 3488A is fully programmable from any HP-IB* compatible computer. But more than that, it has a full function keyboard complete with its own built-in quick reference guide.

Six option assemblies are available for the 3488A to cover many types of switching or control needs. All option assemblies, except for the VHF switch, are provided with a removable terminal block assembly for convenience in wiring. Any combination of up to five option assemblies can be installed in your 3488A. The assemblies are easy to install and can identify themselves to the 3488A front panel or the system computer.

The Options

Six Option assemblies are available for the 3488A including:

44470A A 10 Channel (2 wire) Relay Multiplexer provides high impedance for
Option 010 switching low level signals (with $< 3 \mu\text{V}$ differential offset) but can also
switch high level signals (250V, 2A).

44471A A 10 Channel General Purpose Relay Module designed to cover miscella-
Option 011 neous switching needs, this module consists of 10 Single Pole Single
Throw (SPST) relays, each capable of switching up to 250V @ 2A.

44472A A Dual 4 channel VHF Switch provides high frequency (DC to 300 MHz,
Option 012 usable to 500 MHz) switching. Crosstalk is -80 dB to 100 MHz and
 -60 dB to 300 MHz. BNC connectors are provided for coaxial systems.

* HP-IB (Hewlett-Packard Interface Bus) is Hewlett-Packard's implementation of IEEE Standard 488-1978 and ANSI MC1.1.

44473A A 4 channel by 4 channel (2 wire) Matrix Switch for those applications
Option 013 requiring a convenient way to connect a group of test instruments to multiple test points. Each channel is rated at 250V @ 2A.

44474A A 16 channel Digital Input/Output Module. Sixteen bidirectional data lines
Option 014 with a variety of handshake modes make up this option. All lines are TTL compatible. Use this card to sense limit switches, actuators for (up to 30 Vdc, 125 mA), or communication via a digital logic interface.

44475A A Breadboard for mounting custom designed circuits for use in a test
Option 015 system.

These options are described in more detail at the end of this chapter.

Installation of Options

When you initially received your 3488A from the factory, the option assemblies you ordered were not installed in the mainframe. In order to perform the examples given in this manual, the option assemblies should be installed before continuing. Instructions for qualified service-trained personnel to install and configure the option assemblies are found in the individual option reference chapters at the end of this manual.

Front Panel

The front panel of the 3488A is designed for ease of use by grouping functionally related keys together. This page is a pictorial tour of the front panel highlighting the display and functional groups of keys.

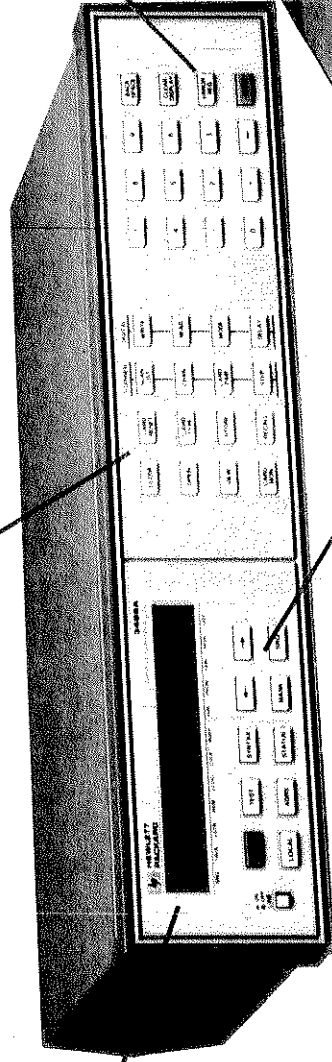

Display

The display is actually a 12 character window used to view the 128 character alphanumeric display. Scrolling of the window, either left or right, is accomplished with the two arrow keys just below the display window. Error messages, instructions, and commands are all shown in the display. In addition, messages up to 127 characters (upper case alpha, numerals, and some punctuation) may be sent to the display by the system computer.

In addition, 12 annunciators are used to indicate the current state of the 3488A.

Operation Keys

All of the major functions of the 3488A can be controlled by these 16 keys. The first two columns of keys are the general operation keys and are described in Chapter 2. Keys in the SCANNER column and DIGITAL column provide more flexibility when using the 3488A. These keys are described in Chapter 3.

Numeric Keypad

These keys are used to specify channel numbers or slot numbers for the Operation keys. In addition, if you make a mistake when entering a command, the BACK SPACE and CLEAR DISPLAY keys are used to edit the display before the EXECUTE key is pressed. The ERROR REGISTER key is used to determine the nature of errors when they occur.

Option Slots

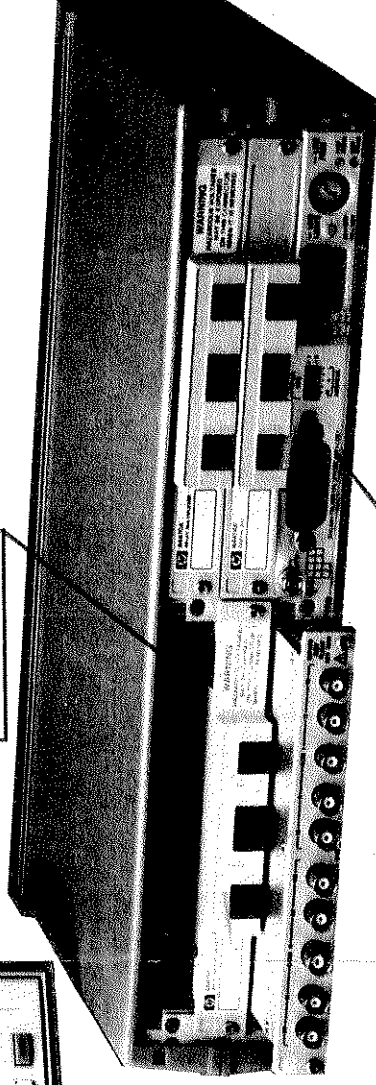

HP-IB Connector

Serial Number Plate (on cabinet bottom)

Control Keys

In this group, the 5 keys in the top row have the following functions:



Press this key to reset the 3488A to its power-on state. This means that all relays in the 3488A are opened and all digital bits in the 44474A assembly are cleared (high impedance).



SYNTAX is used with the other keys on the front panel to provide a built-in quick reference guide to commands for 3488A. The use of this key is described in more detail in Chapter 2.



These two keys are used to scroll the display window either left or right, respectively.



The bottom 5 keys pertain to HP-IB interface functions and will be discussed in detail in Chapter 4.



TEST is used to perform a self test of the 3488A. Any errors are noted in the display. The self test can be done at any time because no relays change state during the test.

Power-on Operations

Before you apply ac power to the 3488A, check to be sure that the ac line voltage selection switch was set correctly and the proper fuse installed. For installation information, refer to Chapter 5 of this manual.

When the 3488A is turned on, it automatically executes a power-on reset sequence. This sequence includes the following steps:

1. Identify all option assemblies present and reset them (all relays open).
2. Reset all HP-IB interface functions (i.e., SRQ, TALK, REMOTE, etc. See Chapter 4).
3. Read the HP-IB address switches.
4. Set all parameters to default values (i.e., no scan list or card pair, Static mode on Digital I/O option, etc.).
5. Perform internal self test.
6. Assert power-on SRQ if enabled by rear panel switch (see Chapter 4).

After pressing the LINE switch, wait for the display to contain only a lazy "T" on the far left side. A "beep" will sometimes be heard as the 3488A power supplies turn on.

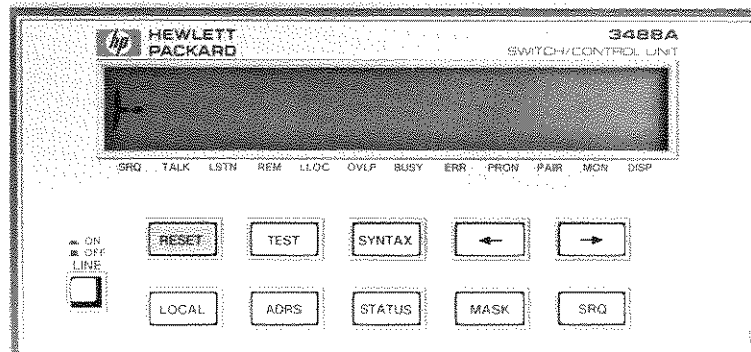

The entire power-on sequence takes approximately 2 seconds to complete. After this, while the instrument is operating, it will periodically (5 times per second) poll the five option slots to verify that all options are still in place. The 3488A will perform a complete power-on reset if an option has been removed or a new one inserted while the instrument is operating. This provides faster operation of the 3488A because it knows what options are in each of the slots and doesn't have to verify for the proper option each time a command is executed.

If an error is encountered during the turn on self test, a message would be displayed instead of the lazy T. This error message has the form: FAILED N, where N is the sum of the failures of the tests. Possible test results are:

- Test #1, RAM (Random Access Memory) Failure
- Test #2, ROM (Read Only Memory) Failure
- Test #4, Internal Timer Failure
- Test #8, IO Chip Failure

For example, FAILED 1 means that the RAM test failed, FAILED 3 means that both RAM and ROM tests failed. The self test is discussed in detail in Chapter 2.

In addition to the self test, several other failures are possible. At power-on, the 3488A will verify that all relays are open on 44470A, 44471A, and 44473A options after the instrument has been reset. If one or more relays did not open, the message "ERR 8: LOGIC" will be displayed. Error messages are also described in detail in Chapter 2.

Note that if the Power-On SRQ switch on the 3488A back panel is on, the PRON and SRQ annunciators will also be on in the display. Power-On SRQ is a means of signaling the computer that the 3488A has been turned on and is discussed in more detail in Chapter 4.

Reset and Test

At any time while you are using the 3488A, you can reset it to its turn on state by pressing the orange colored RESET button. The only things that are not changed are the stored states (see Chapter 3).

You can also perform the internal self tests by pressing the TEST button. When you do this, watch the display carefully. First, the display indicates the model number, then every segment in the display (except for the top dot on the colon between characters) turns on, including the annunciators.

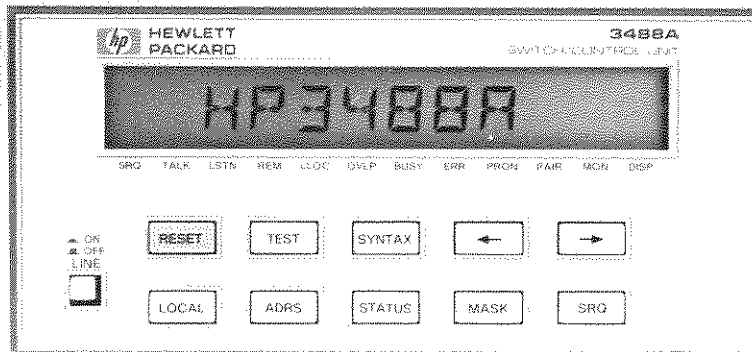

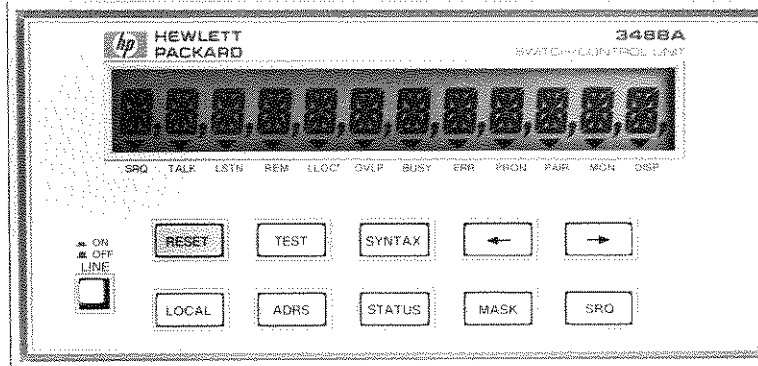

Following this "starburst" display, the internal self tests are run. When all tests pass, the message "SELF-TEST OK" appears in the display. Remember, the self test can be done at any time because no relay or digital I/O bits change state during the test.

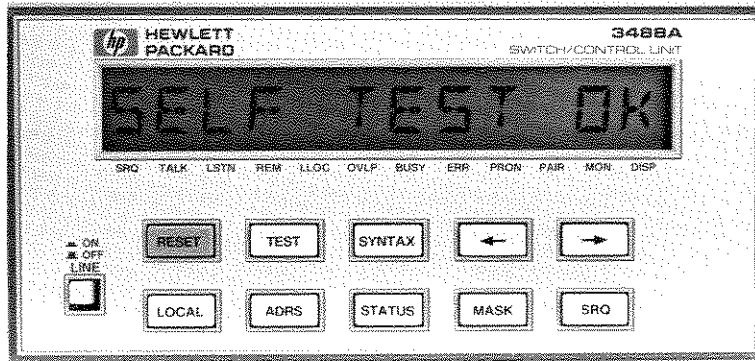

Should any of the tests fail, a message is displayed in the form "FAILED N" where N is the sum of all failures found in the series of tests. These internal self tests can greatly reduce initial troubleshooting time. More information on self test can be found in Chapter 2.

Determining Option Card Type

Throughout this manual, we will provide several examples showing the versatility and friendliness of the 3488A. This first example demonstrates how the display is used to hold messages and one of the keyboard functions: CARD TYPE.

CARD TYPE is provided so that you can determine the type of option assembly installed in any of the five 3488A slots. Be sure to write down what options are installed in each of the five slots. You will need this information as you perform the exercises throughout this manual.

To determine what option is in slot 1 of the 3488A, perform the following steps:

Press:



The 3488A display will show:

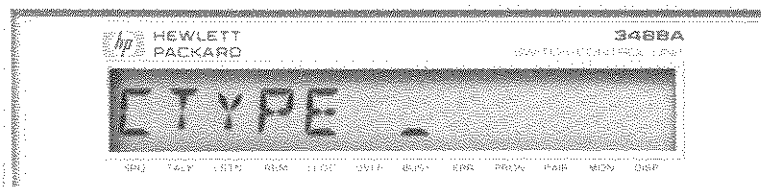

CTYPE is an acronym of CARD TYPE. The underline bar (cursor) means that the 3488A is waiting for a slot number. Since we want to investigate slot 1, press the numeric key 1.

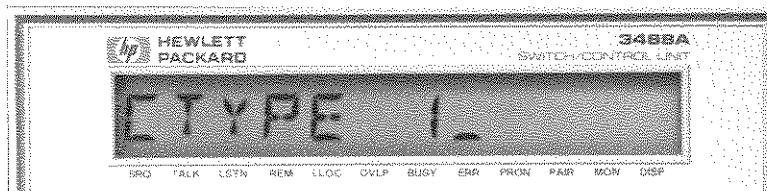

Now, press the execute key.

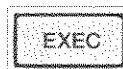

The 3488A display should show the slot number on the far left followed by the name of the assembly installed in that slot. For example, if a 44470A 10 Channel Relay Multiplexer is installed in slot 1, the display will show:

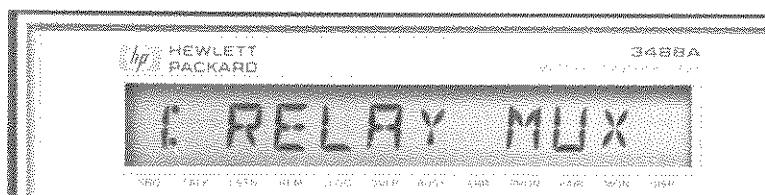

Now, press and hold the left arrow key to scroll the display window. The option assembly model number will appear in the display.

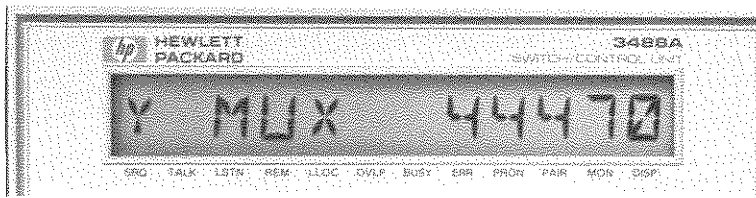

Now let's do the same for slots 2 through 5. Press the CARD TYPE key, a numeric key for the slot you want to investigate, followed by the Execute [EXEC] key. Don't forget to scroll the display and write down the type of option in each slot.

The following chart shows the responses for the six different option assemblies available for the 3488A as well as the display if no card is present in the specified slot.

| Card Type | Display | |
|---------------------------|------------|-------|
| Slot is empty | NO CARD | 00000 |
| 10 CH. Relay Multiplexer | RELAY MUX | 44470 |
| 10 CH. General Purpose | GP RELAY | 44471 |
| Dual 4 Channel VHF Switch | VHF SW | 44472 |
| 4X4 Matrix Switch | MATRIX SW | 44473 |
| 16 Bit Digital I/O | DIGITAL IO | 44474 |
| Breadboard | BREADBOARD | 44475 |

The following BASIC language program, written for an -hp- Series 80 computer, shows how this same information can be obtained from the system computer. If you are not familiar with computer programming, Chapter 2 will show you how to begin programming to control the 3488A.

```

10 ! CARD TYPE PROGRAM
20 ! -HP- 85 VERSION
30 ! -HP- 3488A AT ADDRESS 709
40 DIM A$(16)
50 PRINT "SLOT          CARD TYPE" @ PRINT
60 FOR I=1 TO 5
70 OUTPUT 709 ; "CTYPE";I
80 ENTER 709 ; A$
90 PRINT TAB(2);I;TAB(10);A$
100 NEXT I
110 END

```

WARNING

The 3488A uses latching relays on the 44470A, 44471A, 44472A, and 44473A Option assemblies. The state of these relays can only be altered under front panel or program control. This is an advantage in the sense that, under most conditions of failure, the relays will remain in whatever state your program has set them. However, in the case of power or equipment failure, any application requiring a failsafe method of insuring that the circuits under control are in a known state must be provided by the installer.

In case of component failure or programming error, any voltage input to an option card may be present on any other terminal on the same option card.

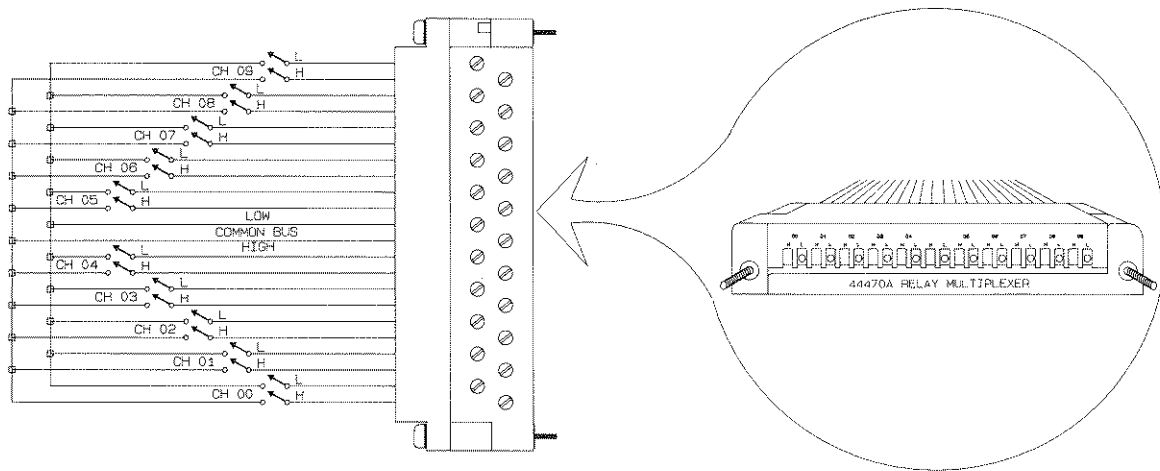

Figure 1-1. 44470A Simplified Schematic

3488-1-1

44470A

10 Channel Relay Multiplexer Option Option 010

Description

The -hp- Model 44470A (3488A Option 010) provides 10 channels to switch (multiplex) signals to a common point. Typically, the common point will be connected to some measuring device such as a voltmeter. In this case, the individual relays will connect to separate signal sources. Conversely, the common point may be connected to one signal source and each relay to a different test device.

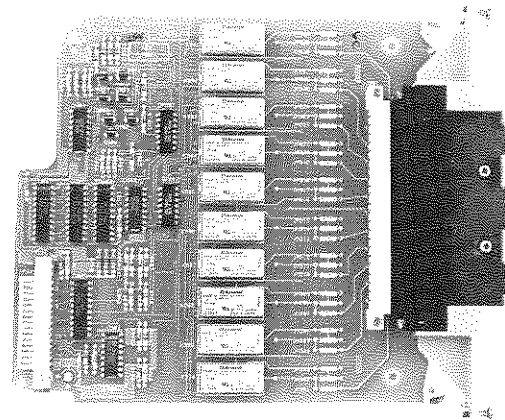

Each channel on this option consists of two sets of contacts (double pole - single throw). The relays have low thermal offset characteristics making them ideal for precision low level measurements. Multiple channel closures are allowed or it can be operated in a mode where only one relay is closed at a time (break-before-make).

Each relay is rated at 250V, 2A. A removable terminal block is provided for convenience in wiring and also provides strain relief for cables.

Applications

Figure 1-1 is a simplified schematic of the 44470A. Use this 10 channel multiplexer to switch analog signals to a DMM or other instruments. Low differential offset characteristics ensure accurate measurements on low level signals. In addition, this option has the capacity to switch high level signals up to 250V & 2A. Provisions are made on board for series/shunt components on each channel. Two 44470A options can be combined with the Card Pair function for performing 4-Wire resistance measurements.

44471A

10 Channel General Purpose Relay Module Option 011

Description

The General Purpose relay option contains 10 independent single pole, single throw switches. Two main uses for this option are providing independent signal switch contacts and use as an actuator* (to apply operating power to a device). Any combination of channels can be closed at any time.

All of the relays have low thermal offset characteristics making them ideal for independent (not multiplexed) signal switching. Space is provided on board for arc suppression components for switching inductive loads. A detachable terminal block that provides easy wire connections and strain relief is also provided.

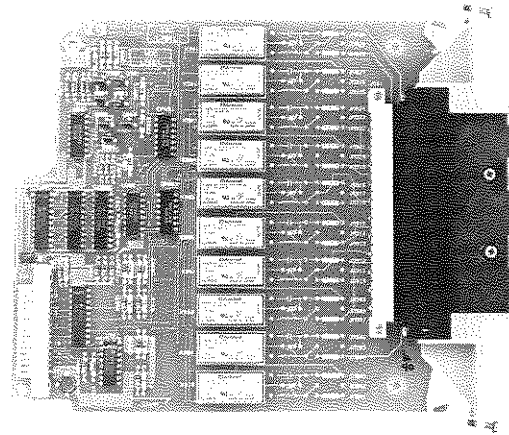

Applications

Use this option where non-multiplexed signal switching is needed. Because multiple channels can be closed sequentially, two channels can be used to switch signal High and Low. The option can also be used as an actuator for line voltage. Figure 1-2 is a simplified schematic of the option assembly.

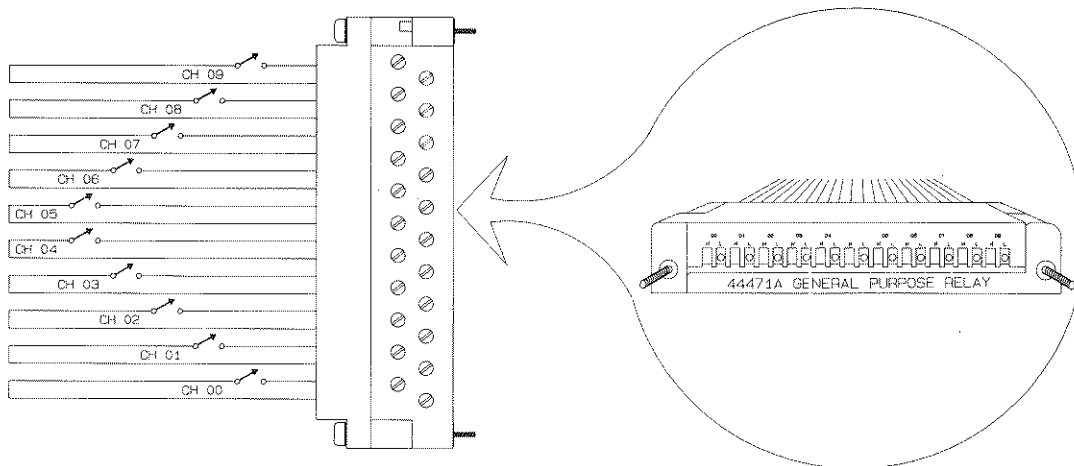

Figure 1-2. 44471A Simplified Schematic

*The 44474A Digital I/O option can also be used as an actuator with signals up to 125 mA and 30V.

44472A

Dual 4 Channel VHF Switch Option Option 012

Description

This option provides dual 4 channel coaxial multiplexers for broadband signal switching to 300 MHz (usable to 500 MHz). Cross talk is -80dB to 100 MHz and -60 dB from 100 MHz to 300 MHz ($50\ \Omega$ termination). The 2 groups of 4 channels are isolated from each other and from chassis ground to reduce ground loops. The shield (low) of each channel is common to its group of four channels.

Connections are made via BNC connectors mounted directly on the option.

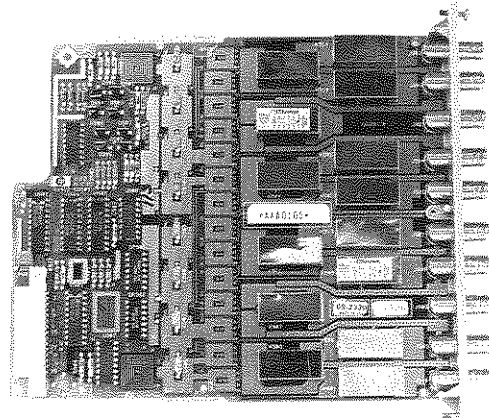

Applications

This option is excellent for high frequency signal where isolation and a $50\ \Omega$ characteristic impedance is important. Multiple options can be connected together forming various types of multiplexers. This option can also be used with pulse and digital circuits where signal integrity and fast rise time is important.

Almost anywhere BNC connectors are used, this option will find a place. It is ideal for wide dynamic range measurements with oscilloscopes or spectrum analyzers. The simplified functional schematic shown in Figure 1-3 shows both groups of channels.

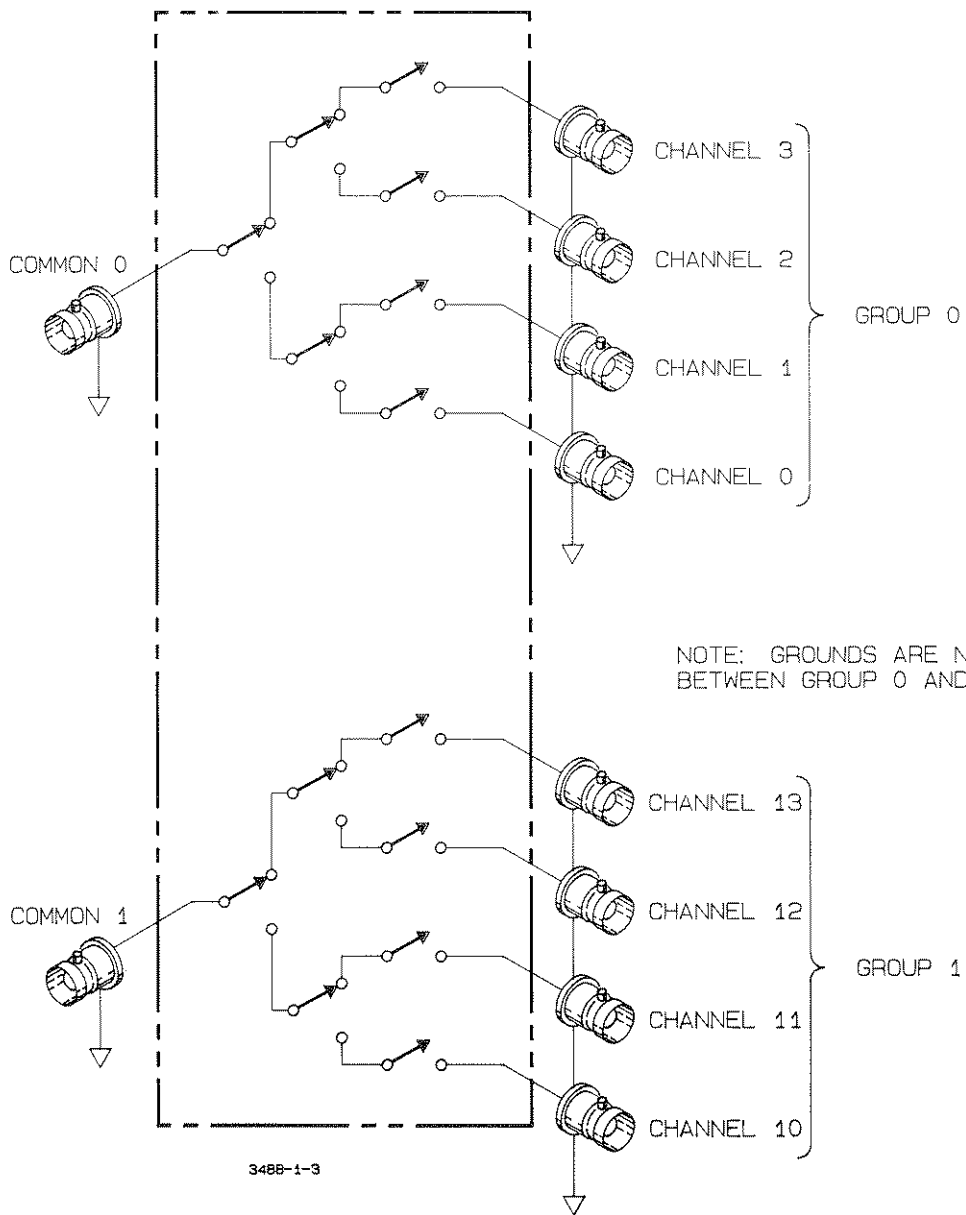

Figure 1-3. 44472A Simplified Schematic

44473A

4-by-4 Matrix Switch Option Option 013

Description

The 44473A is a 4X4 matrix with each switch in the matrix switching both signal high and signal low. Refer to the simplified schematic below. Any combination of the 4 "rows" may be connected to any combination of the 4 "columns".

Multiple 44473A Matrix Switch options can be combined to create a 4X8, 4X12, 8X8, 4X16, or even 4X20 matrix. Connections to the matrix option are made via a removable terminal block which also provides strain relief for the wires.

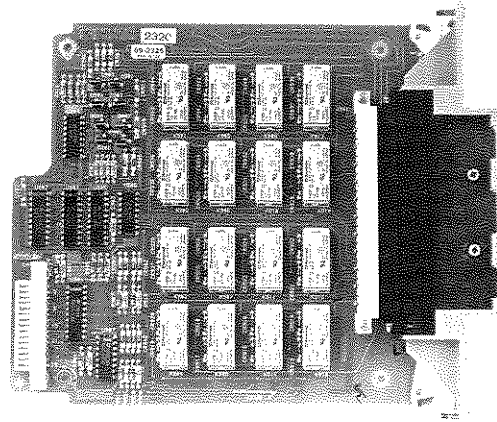

Applications

Matrix switching provides a convenient way to connect a group of test instruments to multiple points on a device or to multiple devices. The matrix offers highly flexible switching for testing multi-port devices over a frequency range of DC to 100kHz. Multiplexer options (44470A) can be used to connect the matrix switched signals to each one of several devices under test.

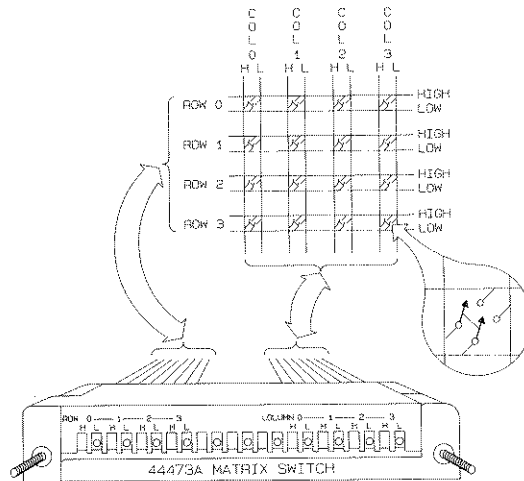

Figure 1-4. 44473A Simplified Schematic

44474A

16 Channel Digital I/O Option Option 014

Description

The 44474A consists of 16 bi-directional lines plus four handshake (interface control) lines. Each of the 16 I/O lines is TTL compatible and can act as a digital input or sense line, or as a + 5 volt driven output. With an external power supply and pull-up resistors, this option can act as a digital I/O port for logic "High" levels of up to 30 volts and 125 mA. The lines can be programmed for "positive" or "negative" logic (high true or low true) and share a common signal Low.

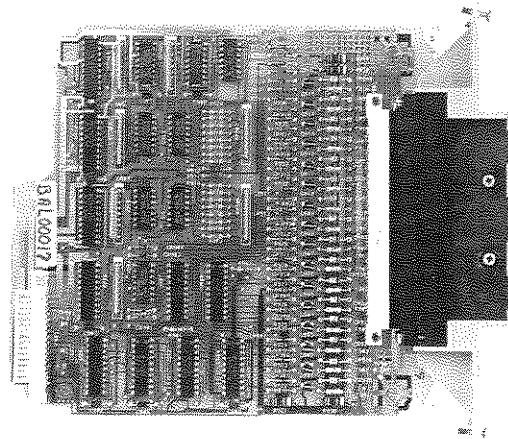

Control of the 16 I/O lines can be done on an individual, line by line basis. When

controlled this way, the lines are assigned addresses of 00 to 15. For other operations, the data lines can be divided into two 8-bit ports, port 0 is data lines 00 through 07 and port 1 is data lines 08 through 15. Alternately, all 16 lines can be addressed simultaneously as a word.

Three basic modes of operation are available for I/O control or handshaking. These modes are discussed in detail in chapter 3.

- ▶ The Static mode (default) allows asynchronous data I/O. Use this mode for actuating or sensing switch contact closures to ground. (Asynchronous means that inputs and outputs are independent of any handshaking.)
- ▶ The "Strobe" modes can trigger 16 bit words to be written to or read from external circuits (such as counter and A/D converter outputs).
- ▶ The "Handshake" mode allows communication with digital equipment by providing a 2-wire handshake plus direction line for input and output.

Applications

Scanning:

Each of the 16 I/O lines can sink up to 125 mA at 30 volts for actuation of external devices including:

- ▶ High voltage/high current relays and switches
- ▶ Programmable coaxial switches (such as -hp- 33311B/C, 8761A/B)
- ▶ Programmable attenuators (such as -hp- 355E/F, 8490 & 33320 series)

Sensing:

- ▶ Limit switch sensing
- ▶ Monitoring position of test fixture in production
- ▶ Digital communication (bidirectional)

In addition, the lines can be used to sense switch contact closures. Features such as "External Increment" and "Channel Closed" are also provided for hardware synchronization of the 3488A with other equipment in the system. Typical uses include scanning of channels synchronized to the measuring voltmeter and incrementing stored states. A detachable terminal block with strain relief is provided for wire connections.

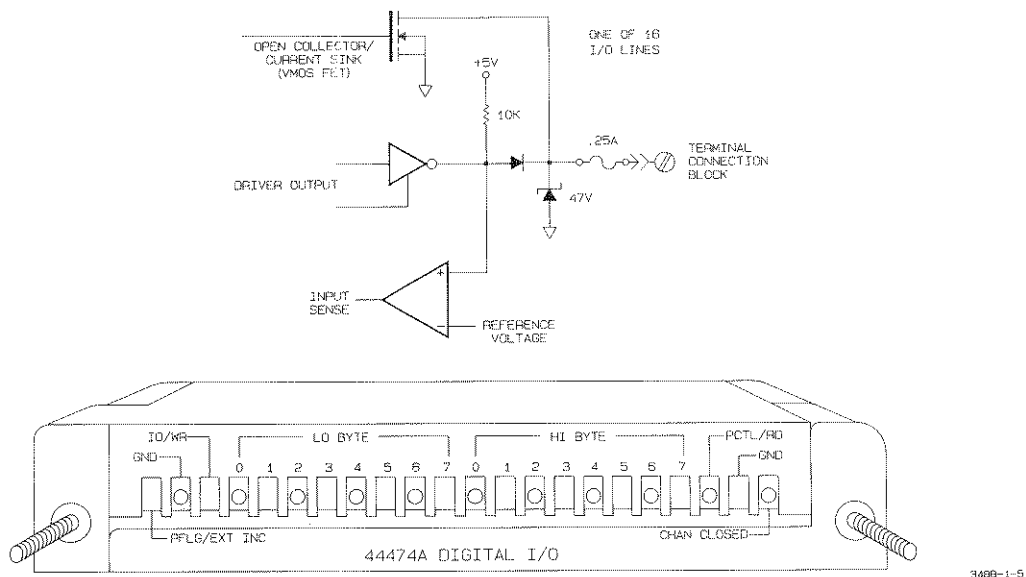

Figure 1-5. 44474A Simplified Schematic

44475A

Breadboard Option Option 015

Description

The Breadboard option provides a place for design engineers or technicians to mount custom designed circuits for use with the 3488A. Occasionally, some desired function may not be available on a standard option module. In such instances, the Breadboard option provides the ideal solution.

Components are specified (but not supplied with the breadboard card) for interfacing the breadboard to the 3488A backplane. When these components are used, the breadboard then provides 8 static input and 8 static output lines. Two commands are available to read and write to the breadboard.

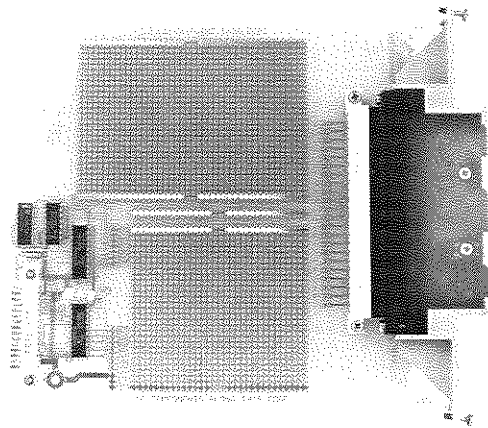

Note. At reset, the 3488A writes the value "0" to the output port.

Applications

A combination of perforated holes (0.1" centers) and bus strips (for external power supplies) is provided. No power supplies are provided from the 3488A mainframe (except for the interface circuitry) and headroom limitations preclude wire wrap sockets.

Uses for the breadboard include:

- ▶ Mounting signal conditioning circuits prior to multiplexing.
- ▶ Mounting small components such as buzzers for alarms, etc.

The following schematic shows the interface circuitry for the 3488A backplane. Refer to the 44475A option reference chapter for more information on using the Breadboard.

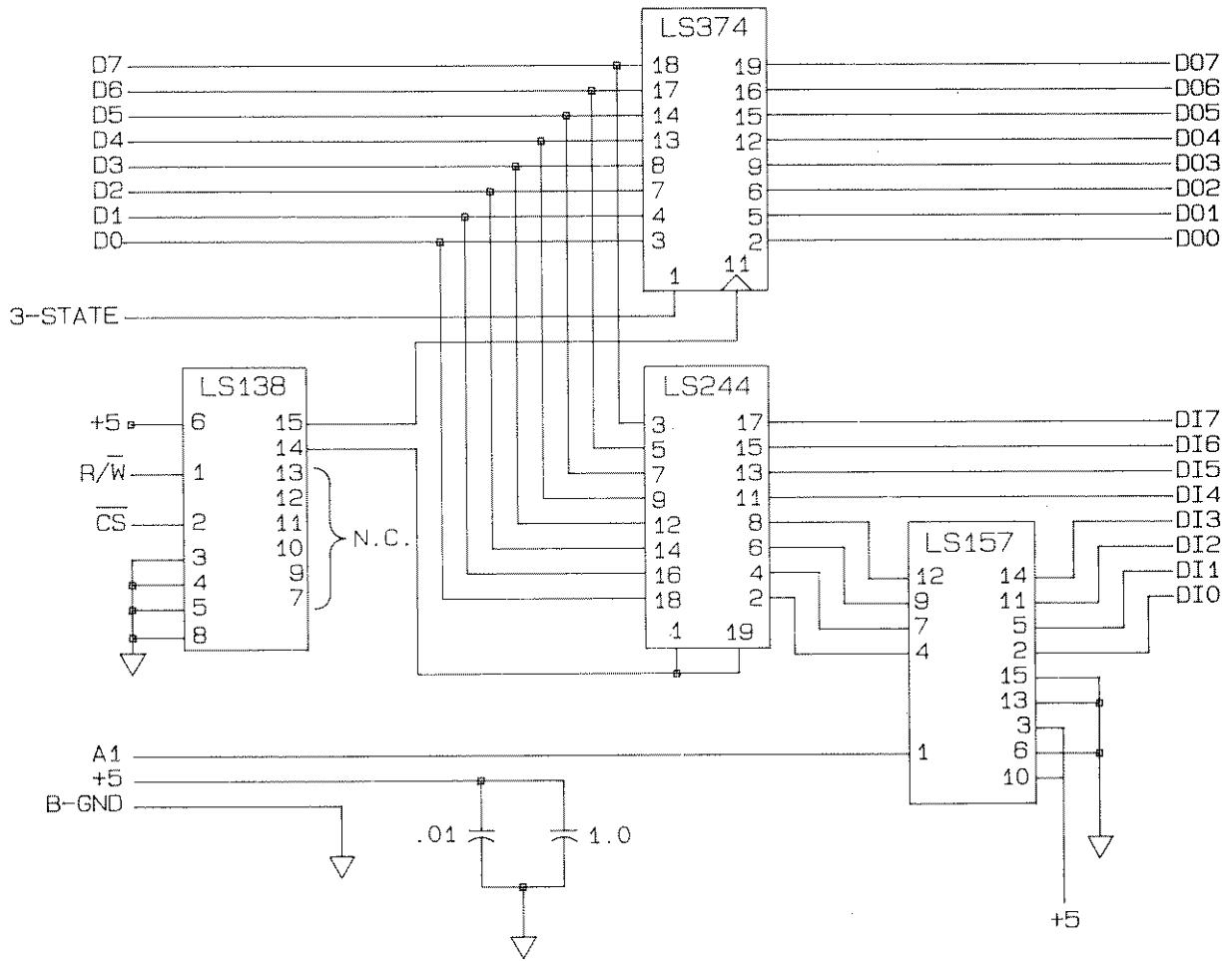

3488-1-6

Figure 1- 6. Breadboard Interface Circuitry



Chapter 2

Using the 3488A

Introduction

In Chapter 1 we learned how to turn on the 3488A and were introduced to the six option assemblies. We also discovered that the instrument is easy to operate and instructed it to show us what option assembly is installed in each of the mainframe slots. Now it is time to put the 3488A to work on your own application. Your 3488A, whether used stand alone or with a system computer, puts signal switching and device control at your disposal.



Scope

This chapter looks at operating the 3488A remotely via HP-IB as well as from the front panel. Emphasis will be placed on remote programming the instrument from a system computer. If you are not familiar with the Hewlett-Packard Interface Bus (HP-IB) or some of the terms used in this chapter, Appendix B contains a concise description of HP-IB.

The descriptions used in this chapter are written in general terms to optimize the flow of information regardless of the computer you are using. This means that both the novice and experienced programmer will be operating the 3488A productively with minimum instruction time. Many example programs are provided to enhance the discussion. All of these example programs are given in an enhanced BASIC (Beginners All-purpose Symbolic Instruction Code) programming language such as the -hp- Series 200 or Series 80 desktop computers use.

Note on Remote HP-IB Programming

If you are interested in controlling the 3488A only from the front panel, you may skip this section. It is important to understand the following information for remote programming regardless of the type of computer used.

| | |
|---|--|
| Do This | |
| Press: | The 3488A will display its HP-IB address in the form: ADDRESS: XX. The factory preset address is 09. |
|  |  |

Each instrument you connect to the HP-IB interface has a unique address assigned to it. The address provides a method for the system computer to select individual instruments for sending data to or receiving information from. In upcoming programming examples, we will use the statement OUTPUT 709. The word OUTPUT is a statement specific to certain -hp- computers for moving data out of the computer. The number 709 refers to the computers interface select code (isc), which is 7, and the 3488A HP-IB address which is 09. Only one instrument connected to the interface can have the address 09. If you need to change the address of the 3488A, refer to the HP-IB Address section in Chapter 5 of this manual. All examples in this manual will have the 3488A at address 09.

The following diagram shows how commands are sent to the 3488A.

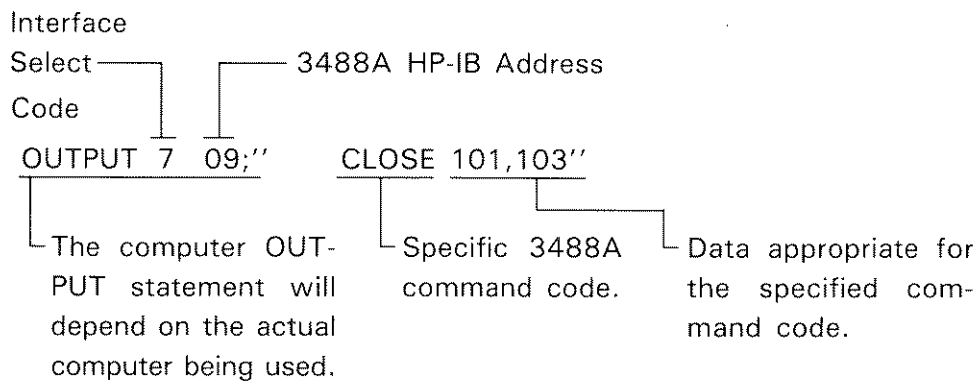

Almost all of the 3488A command codes require some type of information following it. This information is simply called data. At the end of Chapter 3 are several brown pages that describe all of the command codes the 3488A responds to and the types of data required for each code.

Trying a Command

Operation of the 3488A, whether remotely from the system computer or from its front panel, is simple and straightforward. In fact, almost any command that can be executed from the 3488A front panel can be done remotely just by duplicating the front panel activities.

To illustrate this, press the 3488A TEST key. We saw in Chapter 1 that when you do this, the 3488A goes into its Self Test mode. First, it displays its Model number, then a "starburst" pattern, and finally the message "SELF TEST OK" (or if any have failed the appropriate message is displayed).

How can we do the same thing from the system computer? It's simple, just send the message "TEST" to the 3488A. If you have an -hp- Series 200 or Series 80 desktop computer,* execute the following command exactly as shown:

```
OUTPUT 709; "TEST"                [EXECUTE]
                                   (on the Series 80,
                                   press [END LINE])
```

Note that whether the TEST key is pressed on the front panel, or the message TEST is sent from the system computer, the 3488A executes its internal test. The only observable difference is the instrument does not display its model number or the starburst pattern when TEST is executed from the computer. The 3488A will display the SELF TEST OK message.

Later in this chapter we will learn to read back the results of the Self Test to the system computer. Remember, virtually any command you can execute from the 3488A front panel can be duplicated on the system computer and sent to the 3488A.

* If you don't have a Series 80 or Series 200 computer, read through this section anyway as it provides a basis for later discussions. Be sure to read through the I/O Programming manual for your computer to find out how to send command messages.

Channel and Slot Definition

Before we look further at operating the 3488A, we need to define the word 'channel'. A channel refers to an individual relay on an option assembly (or individual bits on the 44474A Digital I/O option). Therefore, when we speak of closing a channel, we are referring to closing a specified relay (or bit). Channel numbers are always two digit numbers.

Channel addresses, on the other hand, are determined by which slot a particular option assembly is installed in. The Channel Address is a three digit number where the first digit specifies the slot (1-5) and the last two digits are the channel number. For example, channel address 102 specifies slot 1, channel number 02.

The following chart shows the two digit channel numbering sequence for the different option assemblies. Refer to the simplified schematics in Chapter 1 if necessary.

| Option Module | Channel Numbering Sequence |
|---|---|
| 44470A, 10 Channel Multiplexer | 00, 01, 02, 03 ... 08, 09 |
| 44471A, 10 Channel General Purpose Switch | 00, 01, 02, 03 ... 08, 09 |
| 44472A, VHF Switch | Group 0: 00, 01, 02, 03 Group 1: 10, 11, 12, 13 |
| 44473A Matrix Switch | Row: 0, 1, 2, 3 Column: 0, 1, 2, 3 |
| 44474A Digital I/O Assembly | Specify the channel number in Row-Column format. i.e., channel number 12 means row 1, column 2. Individual Bits: 00, 01, 02, 03, ...15 (The 44474A has other modes where 8-bit bytes or 16-bit words can be specified. These modes are discussed in detail in Chapter 3.) |

How to Close/Open a Channel

Regardless of the type of option assembly you are using, CLOSE and OPEN commands can be used to control the channels. At turn-on or after reset, all channels in the 3488A are open.

The structure of the command for closing a channel is:

CLOSE (channel address)

Pressing the 'CLOSE' key on the 3488A front panel causes the word 'CLOSE' to appear in the display. Now, enter the address of the channel you want to close. Follow this by pressing the gray 'EXECute' key. For example, if you have a 44470A, 10 channel multiplexer in slot 1 and you want to close channel 3, you would press the following sequence of keys:



| CLOSE a | Slot | Channel | Execute |
|---------|------|---------|---------|
| channel | 1 | 3 | |

Closing channels remotely is just as easy. Press the CLOSE 103 keys again (do not press EXEC). Now look at the 3488A display. To close channel 103 from a system computer simply duplicate (without the cursor) what you see in the 3488A display.

OUTPUT 709; "CLOSE 103"

Anything that you can do from the 3488A front panel can also be done remotely by simply duplicating what you see in the display.

More than one channel can be closed at a time by separating the channel addresses with a comma. For example:

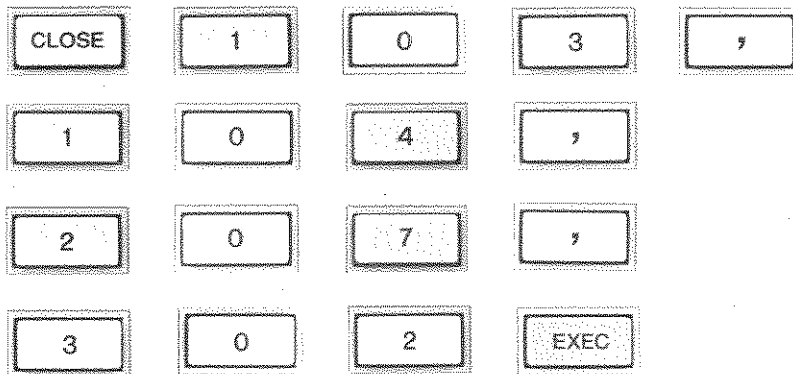

(CLOSE 103, 104, 207, 302)

Note in this last example, channels from different slots were closed with one CLOSE command.

To close multiple channels remotely, again simply duplicate the display:

OUTPUT 709; "CLOSE 103, 104, 207, 302" [EXECUTE] or
[END LINE]

When using the CLOSE command with the 44474A Digital I/O Assembly, the specified bits will be 'cleared' to a logical 0 state (low impedance). Remember also, to use CLOSE and OPEN with the Digital I/O assembly, the assembly must be in either Static Mode 1 or Mode 2 (Mode 1 is default). Refer to the DMODE command for more information.

Opening a channel is just as easy as closing one. The command structure for opening a channel is:

OPEN (channel address)

If you need to open channel 03 in slot 1, simply execute the command OPEN 103.

OUTPUT 709; "OPEN 103" [EXECUTE] or
[END LINE]

or



Open the Slot channel EXECute
channel 1 add. 03

More than one channel can be opened with the OPEN command just by separating the addresses with a comma.

OUTPUT 709; "OPEN 103,104,207,302"

or

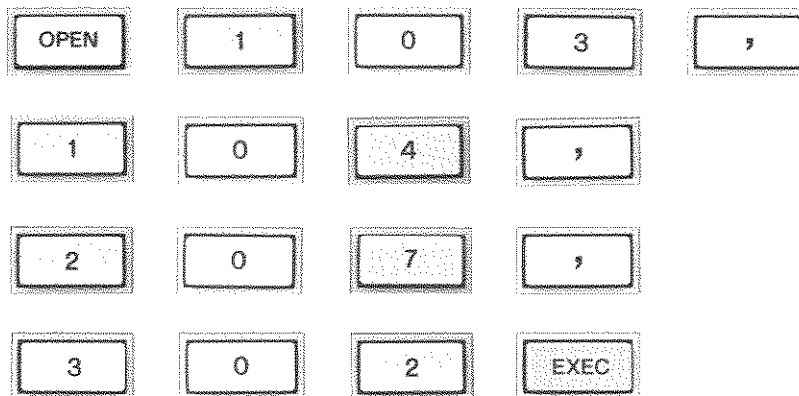

If you should try to close a channel that does not exist, an execution error will be displayed: ERR 2: EXEC. Scrolling the display to the left shows the last twelve characters up to and including the error. This provides a simple way to determine where an error occurred.



Command

CLOSE <relay address> [, <relay Address>, ...]

OPEN <relay address> [, <relay Address>, ...]

Note, <> means a mandatory item, [] is an optional item. These are not keystrokes or displayed.

How to VIEW a Channel

There are times when you will want to look at a particular channel to determine if it is open or closed. The VIEW command allows you to do this very easily. To view a channel, execute the VIEW command followed by a channel address. To acquire the response, execute the computer's ENTER* command:

OUTPUT 709; "VIEW 103"

ENTER 709; A\$

DISP A\$

The computer display will show either "CLOSED 0" OR "OPEN 1". If a simple numeric variable had been used (A instead of A\$), only the number "0" or "1" would be displayed.

To do this from the 3488A front panel, duplicate the procedure:



* If you are using an -hp- Series 200 desktop computer, remember that all variables must be used in a running program before they can be used in statements executed from the keyboard.

If the channel specified is closed, the 3488A response will be "CLOSED 0". If the channel is open, the response will be "OPEN 1". Note that in the display, the channel address precedes the response.

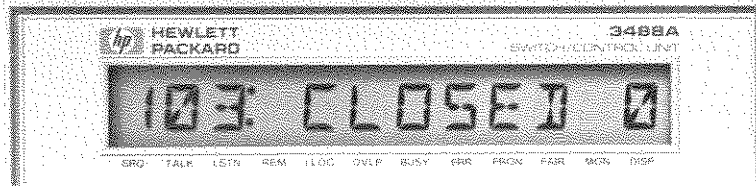

OR

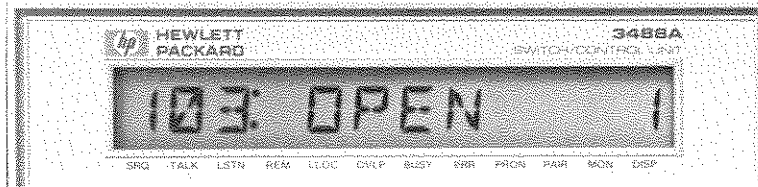

Command

VIEW (channel address)

How to Monitor an Entire Option Assembly

The VIEW command allowed viewing only one channel at a time and allowed reading the state of that relay with the system computer. For viewing all the channels on an option card, use the Card Monitor feature.

Card Monitor places the 3488A display in a mode where it is dedicated to monitoring the option assembly in a specified 3488A slot. Note that you cannot read back the monitor display to the computer. To enter the Card Monitor mode, execute CMON (acronym for Card MONitor) followed by a slot number (1-5).

OUTPUT 709; "CMON 3"

Implementing the Card Monitor mode from the keyboard is just as simple:



The following section describes the unique card monitor displays for each of the six options and the Monitor Tracking mode. A simplified schematic is provided for each of the options to help you visualize what the card monitor display is showing.

Monitoring a 44470A 10 Channel Multiplexer or 44471A General Purpose Relay Assembly

When using the monitor mode with either 44470A 10 Channel Multiplexer or 44471A 10 Channel General Purpose Relay options, the display will show the slot number (far left) and only those channels that are closed. The following photograph shows the format of the monitor for these two options.

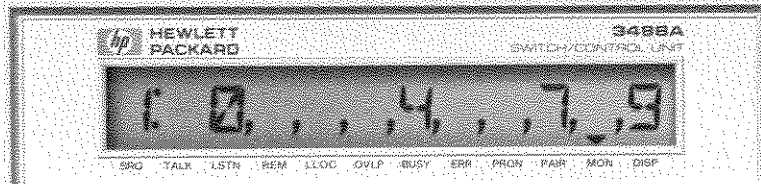

Slot 1, Channels 0, 4, 7 and 9 are closed

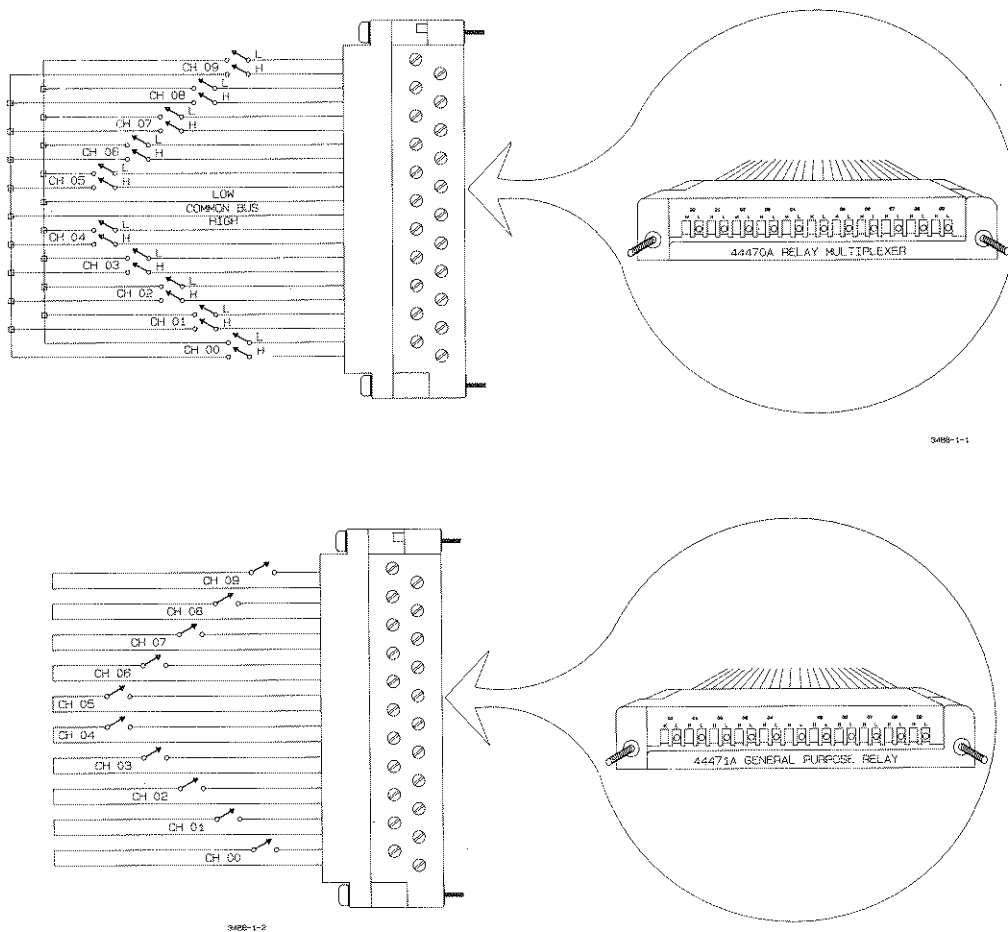
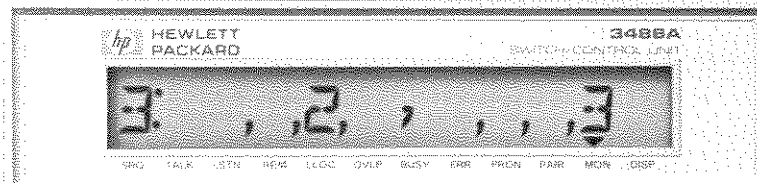

Figure 2-1. Simplified Schematic for 44470A and 44471A

Monitoring a 44472A VHF Switch

Because the 44472A assembly has two groups of 4 channel multiplexers (0 and 1), the monitor display is broken into two parts. The left half of the display monitors group 0, the right half monitors group 1. The following photograph shows the display after closing channels 302,313.



Slot 3 Group 0 has channel 2 closed Group 1 has channel 3 closed

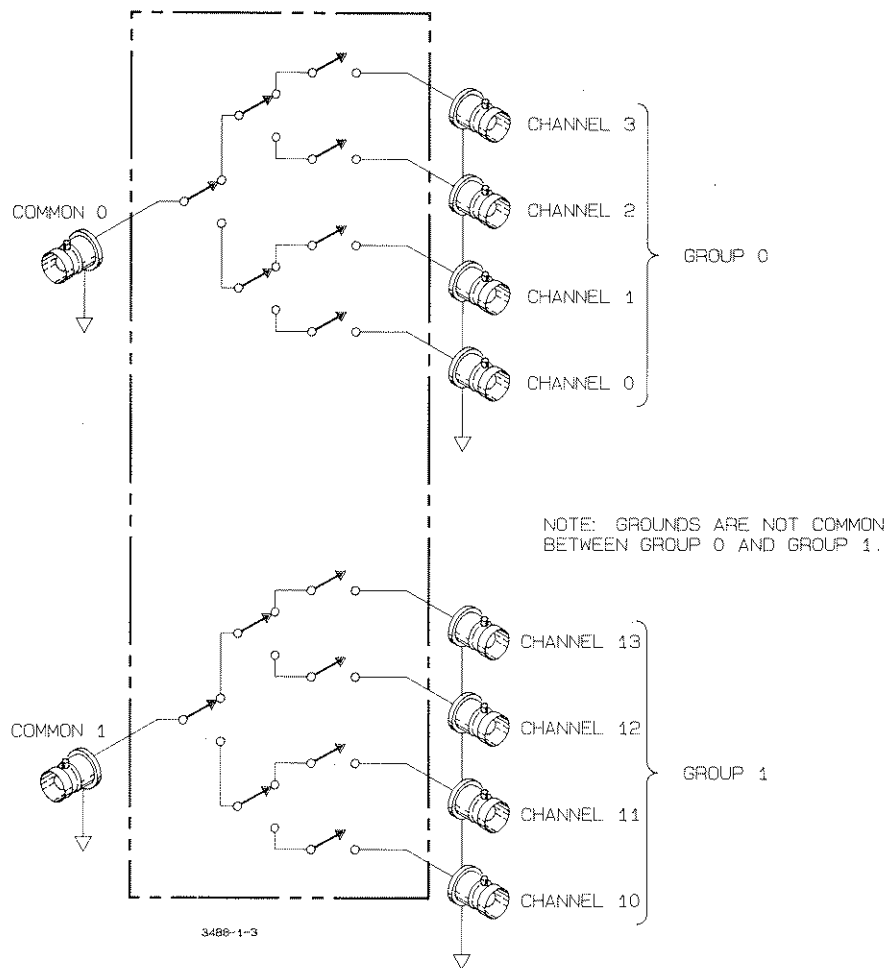
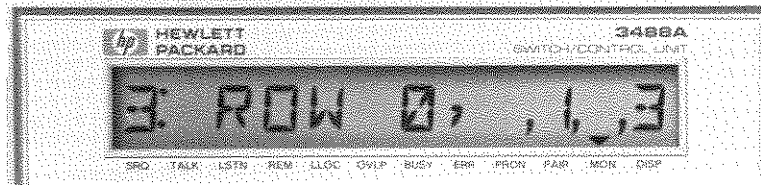

Figure 2-2. Simplified Schematic for 44472A

Monitoring a 44473A Matrix Assembly

There are two types of monitoring displays for the 44473A Matrix Assembly: monitoring ROWS and monitoring COLUMNS. A total of eight displays are possible, one for each of the four rows and four columns. When initially entering the Card Monitoring mode, the display will show which columns have a channel closed in row 0. Use the front panel arrow keys to sequence through the displays. The following displays show how the same matrix option can be monitored after executing the commands: CLOSE 301,303,323; CMON3.



Slot 3, Row 0 in Columns 1 and 3 are closed

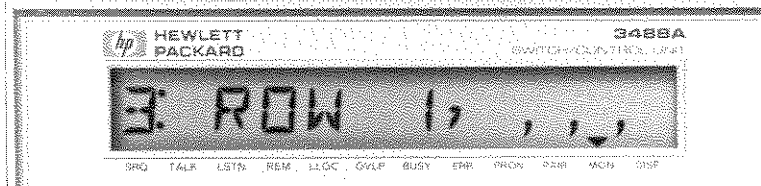

Slot 3, Row 1, nothing closed

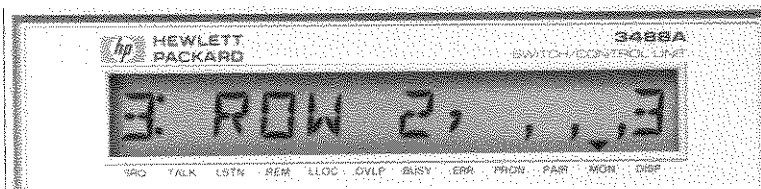

Slot 3, Row 2 in Column 3 is closed



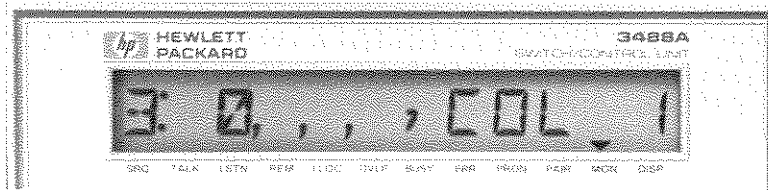

Slot 3, (Row) 0 in Column 1 is closed

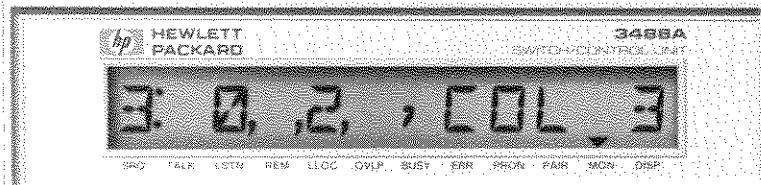

Slot 3, (Rows) 0 and 2 in Column 3 are closed

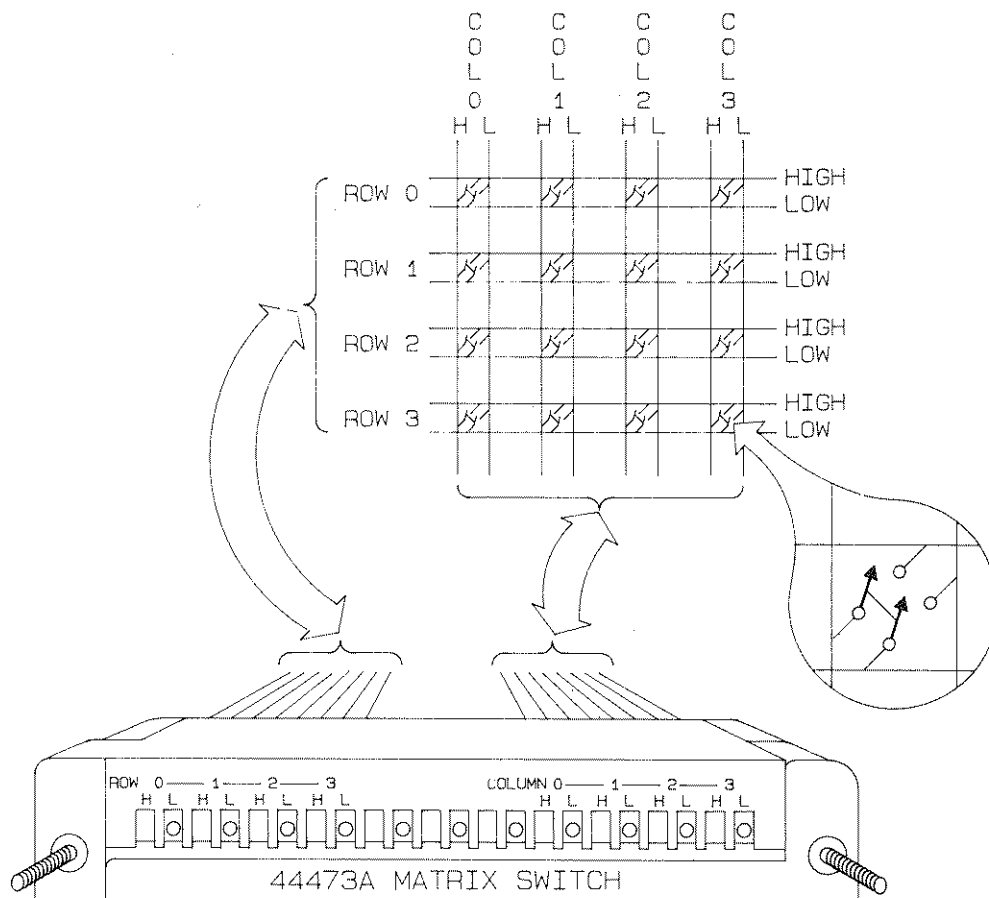

3488-1-4

Figure 2-3. 44473A Simplified Schematic

Monitoring a 44474A Digital I/O Assembly

The monitor display for the 44474A Digital I/O assembly is similar to the photograph below. The H and L represent the High order 8-bit byte and Low order 8-bit byte, respectively. A trailing decimal point for either byte indicates that the last operation on that byte was a write (or close) command (i.e., it is an output byte). If the decimal point does not appear, the byte was last read from (i.e., it is an input byte).

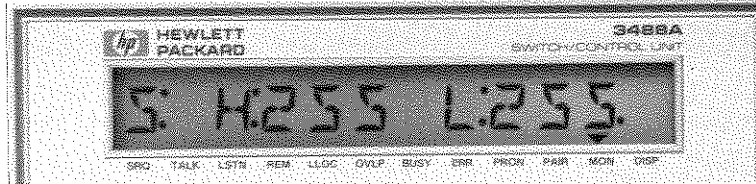

When initially entering the monitor mode, the display will indicate a decimal value. If the byte is an input byte (no trailing decimal point) the value is equal to the sum of the values of the bits that are high (logic 1, +5v). If the byte is an output byte, the value is equal to the sum of the values of the bits that are open (logic 1, high impedance). Refer to the following chart for a description of the bit values.

| | | | | | | | | | | | | | | | | |
|------------------|-----------------------|----|----|----|----|----|---|---|----------------------|----|----|----|---|---|---|---|
| Bit Number: | 15 | 14 | 13 | 12 | 11 | 10 | 9 | 8 | 7 | 6 | 5 | 4 | 3 | 2 | 1 | 0 |
| 8-bit byte value | 128 | 64 | 32 | 16 | 8 | 4 | 2 | 1 | 128 | 64 | 32 | 16 | 8 | 4 | 2 | 1 |
| | High order 8-bit Byte | | | | | | | | Low order 8-bit Byte | | | | | | | |

Execute the commands:

CLOSE 500, 501, 502, 503, 505, 506, 507; CMON 5

The display will show:

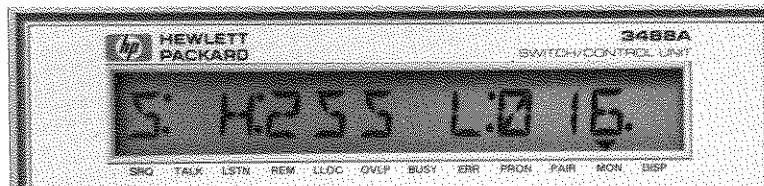

This indicates that the high byte (H) is operated as an input byte (default), and the low byte (L) is an output byte (indicated by the decimal point). Since only channel 4 was left open in the low byte, the displayed value is 16.

Pressing the front panel arrow keys causes the display to toggle between a decimal display and a hexadecimal display.

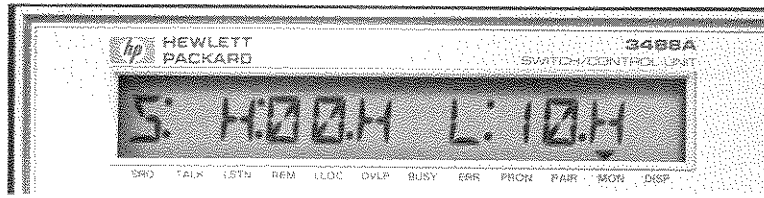

Here, the last H after each byte emphasizes the hexadecimal display.

If the last command sent to the 44474A option put it into the 16 bit word mode (port 2, see DWRITE in Chapter 3), the Monitor would be displayed as a 16 bit word:

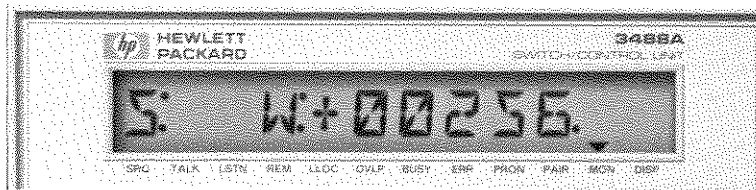

A positive number indicates that the value displayed is the sum of the bit values that are clear (logical true). A negative number indicates the displayed number is the 2's complement of the sum of the bit values. This is valid only for the default polarity. If the polarity has been changed by the DMODE command, the displayed value will still be in 2's complement format. Chapter 3 discusses the 16 bit mode in detail.

Pressing either of the arrow keys changes the display to hexadecimal format:

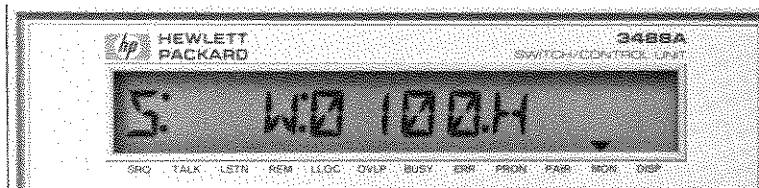

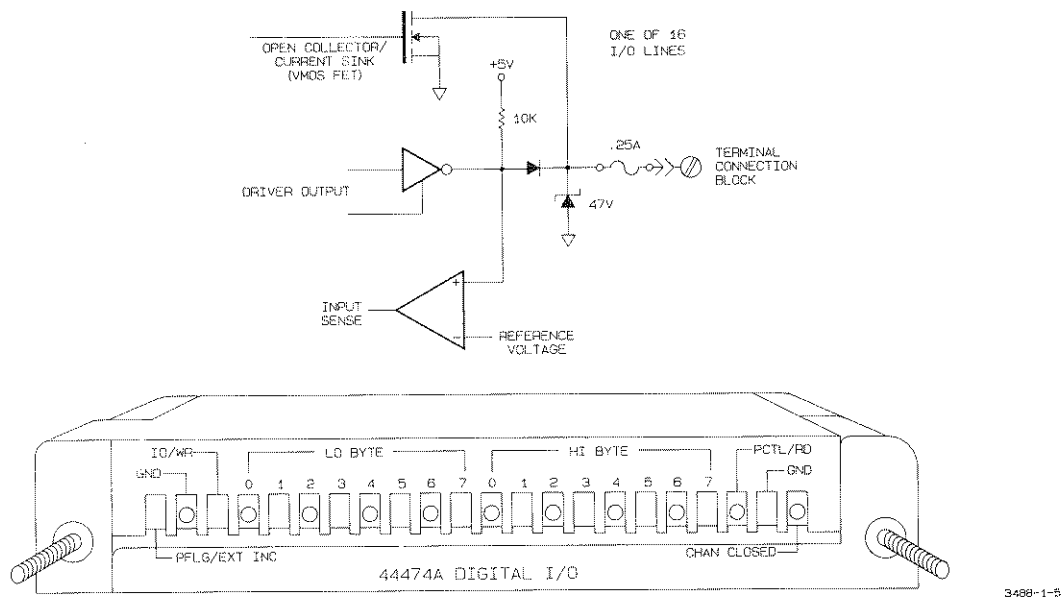

Figure 2-4. 44474A Simplified Schematic

Monitor Tracking

A second form of the Monitor mode is called Monitor Tracking. Monitor tracking permits the display to monitor the 3488A slot where the last operation (channel closure or open) was performed. To enter the Monitor tracking mode, execute CMON with a negative slot number, i.e., CMON-2. The slot number specified will be the first slot monitored. Then if you perform some other operation, such as close a channel in slot 5, the display will track the operation and begin monitoring slot 5.



Command

- CMON n where n is the slot number of the card to be monitored.
- CMON-n Monitor tracking mode starting with slot n.
- CMONO Exit card monitor mode.

Resetting Individual Option Assemblies

The orange RESET key on the front panel of the 3488A is used to reset the entire instrument. There may be times though when you need to reset only one option assembly to its power on state. That is the function of the CARD RESET command.

To reset a particular option from the system computer, execute the CRESET command with a specific slot number:

OUTPUT 709; "CRESET 2" (Resets the option in slot 2)

More than one option can be reset by separating the slot numbers with commas.

OUTPUT 709; "CRESET 1, 3" (Resets options in slots 1 and 3)

Option assemblies 44470A, 44471A, 44472A, and 44473A are reset to all channels open. For the 44470A, 44471A, and 44473A options only, the 3488A checks sense lines after the CRESET command to verify that all relays actually did open. If one or more relays remains closed, ERROR 8 is set. The 44474A Digital I/O assembly is reset to its static mode, 16 bit input configuration. The 44475A Breadboard Card is reset to all of its output lines low.



Command

CRESET (slot number)[,(slot number), ...]

Self Test

The Self Test feature of the 3488A provides you with a method of verifying proper instrument operation. When the front panel TEST key is pressed, or the command TEST is sent from the computer, the 3488A performs tests on its control circuitry (ROM, RAM, timer, etc.). The self test can be executed at any time because the option assemblies will not change state during the test.

Do This:

OUTPUT 709; "TEST"
ENTER 709; A
DISP A

or



Either of these two methods will initiate the functional tests of the internal control circuitry. If the test is initiated remotely from the computer, only the internal tests are performed. If the self test is initiated from the front panel, the test starts by displaying the model number: HP3488A. Self test then proceeds to turn on every segment in the display (except top dot in the colon between characters). The internal tests are then performed. When all the tests have passed, the 3488A displays: SELF TEST OK. If a failure is found, the message: FAILED nn is displayed, where nn is the sum of the values of all the tests that failed. Test results may also be read over the HP-IB interface. In this case, only the number nn is returned (0 is returned for no failures).

Table 2-1. Self Test Errors

| Error Number | Description |
|--------------|---|
| 1 | The internal storage RAM (Random Access Memory) has failed its self test. |
| 2 | ROM (Read Only memory) has failed. |
| 4 | The timer, used for delay timing, etc., has failed. |
| 8 | A limited self test on the HP-IB controller I.C. has failed. |

For all failures, refer to the 3488A Mainframe service manual.



Command

TEST

Using the Display

Three commands that can be executed from the system computer but not directly from the 3488A front panel involve the display. The first command we will look at enables you to write messages up to 128 characters long to the 3488A display. Execute the following command exactly as shown, substituting your real name after the DISP mnemonic.

```
OUTPUT 709; "DISP your name"           [EXECUTE] or  
                                           [END LINE]
```

Your message can contain any of the 64 ASCII characters with decimal values from 32 to 95 except the # sign and colon (:). All other characters will either cause an error (such as # or :) or will be ignored. If 129 characters are sent, the display will not respond. If 130 characters or more are sent, an error will result. Quotation marks (") are ignored. Lower case alphabet characters are displayed as upper case.

The displayed message will remain in the display until a RESET, LOCAL, CMON, DON, DOFF or another DISP command is executed.

The display can also be turned off. Executing the command

```
OUTPUT 709; "DOFF"
```

causes the 3488A to fill the display with hyphens and then ignore the display. The display is not updated after this although it takes approximately 10 minutes for the display to actually go blank. Turning the display off allows the 3488A to process commands quicker because it does not update the display. Normal rate of update is 5 times per second.

Turn the display back on by executing:

```
OUTPUT 709; "DON"
```

or by pressing the LOCAL key on the front panel.

Handling Errors

Perhaps you have tried to execute a command on the 3488A, but it only beeps and displays a cryptic error message. What do you do now?

The 3488A has the ability to show you where in the executed command an error was detected. For example, attempt to close channel 703. This can be done remotely from the computer or from the front panel. The 3488A display would show the following message:

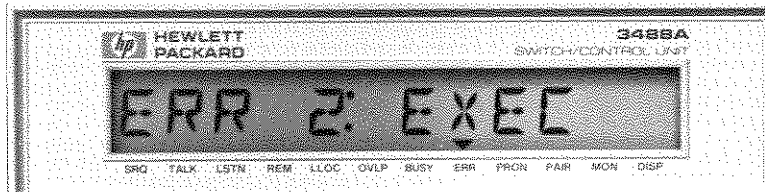

Now, press (and hold) the left arrow key. The last character in the display is the character that caused the error:

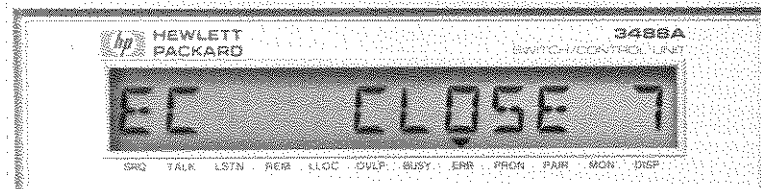

In this case, there is no slot 7. Therefore, that is the invalid character.

When an error occurs, a message is displayed and the error annunciator is turned on. To clear the annunciator, the Error Register must be read.

The possible error messages are:

| Errors | Description |
|---------------|--|
| ERR 1: SYNTAX | An unknown command was sent to the 3488A. For example, CLSE instead of CLOSE. |
| ERR 2: EXEC | The command mnemonic was correct, but for one or more of the following reasons, the command cannot be executed. a. Channel number out of range. b. Card type mismatch (i.e., execute DMODE on a Multiplexer, etc.) c. Attempt to recall a non-existent stored state, scan list or assembly program. |
| ERR 4: TRIG | The External Increment trigger pulse is occurring too fast. The 3488A cannot close channels as fast as the trigger pulse is occurring. |
| ERR 8: LOGIC | A relay bit that was instructed to close or open did not change state. |
| ERR 16: POWER | The ac power line is out of the allowable voltage range. |

Error messages appear in the display until the error is cleared or the display is written over by another command. When remote programming, it is possible to miss an error message. You would know that an error occurred by the error annunciator in the display. The Error Register can be used to determine the nature of the error in such a case.

Reading the Error Register

The front panel ERROR REG key or the ERROR command can be used to read the value of the 3488A's error register. This causes the instrument to display and send (to the system computer) a decimal value which is the sum of the values of the possible error conditions. The error register is cleared when it is read or when the 3488A is reset.

```
OUTPUT 709; "ERROR"  
ENTER 709; A  
DISP A
```

In addition, the 3488A can be programmed to halt all activities when an error occurs. Normally, after an error occurs, the 3488A will continue to accept commands. It is possible, as mentioned earlier, to miss an error message. The Error Halt (EHALT) mode, when enabled, will cause ALL HP-IB activity to cease. If EHALT is implemented, the computer should be programmed to timeout and reset the interface when HP-IB instruments do not respond. The 3488A can then be reset with an HP-IB CLEAR command (CLEAR 709). Also, pressing the front panel LOCAL key will return control to the 3488A.



Command

| | |
|---------|------------------------------|
| ERROR | Read the Error Register |
| EHALT 0 | Turn off the Error Halt mode |
| EHALT 1 | Turn on Error Halt mode |

The STATUS Command

The current state of the 3488A is monitored in a Status Byte. This Status Byte can be read, either remotely from the system computer or from the front panel to determine the current value. The decimal value displayed (or returned) is equal to the sum of the values in the Status Byte that are set:

| Status Byte Bit Number | Weighted Value | Description |
|------------------------|----------------|---|
| 0 | 1 | This bit will be set when a scan list has sequenced through to the last item in the list. |
| 1 | 2 | Bit 1 will be set when the 3488A has been asked for information and the data is available. |
| 2 | 4 | Power-on SRQ occurred. Note that this feature is switch selected on the back panel of the 3488A. |
| 3 | 8 | Front Panel SRQ key has been pressed. |
| 4 | 16 | The 3488A is ready to accept and process instructions (not busy). |
| 5 | 32 | An Error condition has occurred, refer to the section on handling errors. |
| 6 | 64 | The 3488A is setting the SRQ line in the HP-IB interface. See Chapter 4 for information and examples on remote interrupt programming. |
| 7 | 128 | Unused (always 0) |

| Bit 7 | Bit 6 | Bit 5 | Bit 4 | Bit 3 | Bit 2 | Bit 1 | Bit 0 |
|----------|---|--|--|--|---|--|--------------------------|
| Unused. | Set: SRQ interrupt. | Set: ERROR condition occurred. | Set: 3488A is ready for new instruction. | Set: Front Panel SRQ key has been pressed. | Set: Power-On SRQ switch set and power-on occurred. | Set: Requested information is available. | Set: End of Scan List. |
| Always 0 | Cleared: Condition causing SRQ is cleared or HP-IB SPOLL command or 3488A is reset. | Cleared: Error register is read or 3488A is reset. | Cleared: 3488A is busy executing previous instruction. | Cleared: STATUS command or 3488A reset. | Cleared: STATUS command or 3488A is reset. | Cleared: STATUS command, reading the data, or resetting the 3488A. Note, STATUS deletes old information. | Cleared: STATUS command. |

Figure 2-5. Status Byte

Bits 0, 1, 2 and 3 will be cleared after the Status Byte is read by the STATUS command. The Error bit, bit 5, will be set until the error register is read or the 3488A is reset. Bit 2 will be set when the rear panel Power-on SRQ switch is set (switch in up position) and the 3488A is turned on.

Bit 1 will be cleared by either reading the data that is available, requesting new data, or resetting the 3488A. Note that because bit 1 is cleared when new data is requested, executing the STATUS command remotely (requesting the value of the Status Byte) deletes the data that was available.

Similarly, bit 4 will be clear while the 3488A is busy executing an instruction. Therefore, bit 4 will always appear clear in response to the STATUS command. The SPOLL command (see Chapter 4) must be used to properly detect when the 3488A is not busy (bit 4) or when output data is available (bit 1).

Bit 6 is set when there is any one-to-one correspondence between bits set in the SRQ mask (see Chapter 4, Require Service) and bits set in the Status Byte. Bit 6 will only be cleared when the condition causing it to be set is cleared or by the HP-IB SPOLL message (see Chapter 4, Serial Poll). No other bits are cleared by SPOLL.

Do This:

OUTPUT 709; "STATUS"
ENTER 709; Z
DISP Z

"Z" will have a value of 0.

or



The display will show: STATUS: 000

Now, press the front panel SRQ key:

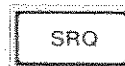

Again, execute the STATUS command.

OUTPUT 709; "STATUS"
ENTER 709; Z
DISP Z

"Z" will have a value of 8 which is the value for the front or panel SRQ key.

or



The display will show: STATUS: 008

As a second example, attempt to close an invalid channel:

OUTPUT 709; "CLOSE 7"

OUTPUT 709; "STATUS"

ENTER 709; Z

DISP Z

"Z" will have a value of 32 which indicates an error condition.

or

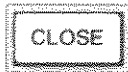

The display will show: STATUS: 032

Notes

1. The value returned is the sum of all condition values that are true.
2. Bit 6 is set only if a condition is true and the SRQ Mask has been set for that bit. See Chapter 4.
3. The Status Register is cleared at Reset.
4. Bit 2



Command

STATUS

Using the Built-in Quick Reference Guide

After becoming familiar with the 3488A, you will use this operator's manual less frequently. The structure of the various commands is straightforward. However, if you should forget the command structure, and not have this manual present to help, it is comforting to know that the 3488A has a Quick Reference Guide built into it. The Quick Reference Guide is available only from the front panel with the SYNTAX key.

To use the Quick Reference Guide, press the SYNTAX key followed by a command key. For example, to find out the command structure for closing a relay, press:



The display will show the following message (scroll the display to see all of it):

CLOSE <ADDRESS>[,<ADDRESS>]...; SEE REFERENCE 5 FOR ADDRESS

This means that to close a channel, use the command code CLOSE. This is to be followed by an address. But what is an address? And what are the brackets (<>, []) for?

The Quick Reference Guide says to SEE REFERENCE 5 FOR ADDRESS. Reference 5 contains a definition of an address. Press:

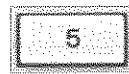

The display will show the following definition for ADDRESS:

ADDRESS: A THREE DIGIT NUMBER WITH THE FIRST NUMBER BEING SLOT AND THE NEXT TWO DIGITS BEING EITHER A RELAY NUMBER OR A BIT NUMBER

The numeric keypad contains rules and definitions. For example, to define the brackets <>, look at reference 0:



<>: PARAMETRIC ITEMS

Which means anything enclosed in this type of bracket is mandatory.











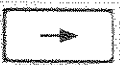

[]: OPTIONAL ITEMS

Which means anything enclosed in this type of bracket is optional.

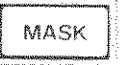
Getting back to closing a channel, we see that the command mnemonic is the word CLOSE. This is to be followed by a mandatory three digit channel address. Optional channel addresses can also be included by separating the addresses with a comma.





In general, the command and control keys provide instruction information. The numeric keys provide definitions. There are some keys that do not have a remote programming command code associated with them. These keys are shown as NA (Not Applicable). The following list shows the possible displays for each of the keys on the front panel.

| Key | Display | For more information see page: |
|---|--|--------------------------------|
|  | RESET | 6 |
|  | NA; SEE REFERENCE 3 | |
|  | NA; SEE REFERENCE 3 | |
|  | NA; SEE REFERENCE 3 | |
|  | NA; SEE REFERENCE 3 | 82 |
|  | NA; SEE REFERENCE 3 | 100 |
|  | STATUS; RETURNS WEIGHTED SUM OF 1:END OF SCAN, 2:OUTPUT AVAILABLE, 4:POWER ON, 8:FRONT PANEL SRQ, 16:READY, 32:ERROR, 64:RQS | 42 |
|  | MASK[<#>]; #: WEIGHTED SUM OF 1:END OF SCAN, 2:OUTPUT AVAILABLE, 4:POWER ON, 8:FRONT PANEL SRQ, 16:READY, 32:ERROR, | 85 |
|  | NA; SEE REFERENCE 3 | 84 |
|  | CLOSE <ADDRESS>[,<ADDRESS>]...; SEE REFERENCE 5 FOR ADDRESS | 25 |
|  | OPEN <ADDRESS>[,<ADDRESS>]...; SEE REFERENCE 5 FOR ADDRESS | 25 |
|  | VIEW <ADDRESS>; SEE REFERENCE 5 FOR ADDRESS | 27 |

| Key | Display | For more information see page: |
|------------|--|--------------------------------|
| CARD MON | CMON [-]<0/SLOT>; NEGATIVE SIGN SELECTS TRACKING MONITOR. TO EXIT, USE A PARAMETER OF 0. SEE REFERENCES 2 AND 4. | 28 |
| CARD RESET | CRESET <SLOT>[,<SLOT>]...; SEE REFERENCE 4 FOR SLOT | 36 |
| CARD TYPE | CTYPE <SLOT>; SEE REFERENCE 4 FOR SLOT | 8 |
| STORE | STORE <SETUP>; SEE REFERENCE 7 FOR SETUP | 51 |
| RECALL | RECALL <SETUP>; SEE REFERENCE 7 FOR SETUP | 51 |
| SCAN LIST | SLIST <ADDRESS/SETUP> [,</-> <ADDRESS/SETUP> ...]; USE NEGATIVE SIGN TO SCAN A CONSECUTIVE LIST. SEE REFERENCES 2, 5, AND 7. | 53 |
| CHAN | CHAN [<ADDRESS>]; SEE REFERENCE 5 FOR ADDRESS | 55 |
| CARD PAIR | CPAIR [<SLOT>,<SLOT>]; SEE REFERENCE 5 FOR ADDRESS | 58 |
| STEP | STEP | 55 |
| WRITE | DWRITE <SLOT><0><PORT>,<DATA>[,<DATA>]...; SEE REFERENCES 4 AND 6 | 216 |
| READ | DREAD <SLOT><0><PORT>[,<NUMBER OF READINGS>]; SEE REFERENCES 4 AND 6 | 218 |
| MODE | DMODE <SLOT>[,<HANDSHAKE MODE>],<POLARITY>] [,<EXTERNAL INCREMENT>]; SEE REFERENCES 4, 8 AND 9 | 220 |

| Key | Display | For more information see page: |
|-------|---|--------------------------------|
| DELAY | DELAY [<TIME IN MILLISECONDS>] | 59 |
| 0 | < >: PARAMETRIC ITEMS | |
| 1 | []: OPTIONAL ITEMS | |
| 2 | X/Y: USE EITHER X OR Y | |
| 3 | NA: NOT APPLICABLE | |
| 4 | SLOT: A NUMBER FROM 1 TO 5 THAT SELECTS ONE OF THE 3488A SLOTS | 24 |
| 5 | ADDRESS: A THREE DIGIT NUMBER WITH THE FIRST NUMBER BEING SLOT AND THE NEXT TWO DIGITS BEING EITHER A RELAY OR A BIT NUMBER | 24 |
| 6 | PORT: USE 0 TO SELECT LOWER BYTE, 1 TO SELECT UPPER BYTE AND 2 TO SELECT THE WORD. | 209 |
| 7 | SETUP: USE ANY NUMBER BETWEEN 1 AND 40. | 51 |
| 8 | THE HANDSHAKE MODES ARE 1:STATIC R OR W, 2:STATIC R & W, 3:R/W & STROBE, 4:RD & WR, 5:FULL HANDSHAKE. | 220 |
| 9 | TO INVERT LOGIC, USE A WEIGHTED SUM OF 1:LOW BYTE, 2:HIG HIGH BYTE, 4: PCTL, 8:PFLG, 16:I/O DIRECTION. SET E.I. TO 1 TO ENABLE. | 225 |
| ? | NA; SEE REFERENCE 3. | |

For more
information
see page:

| Key | Display | |
|---|--|----|
|  | NA; SEE REFERENCE 3. | |
|  | NA; SEE REFERENCE 3 | |
|  | ERROR; RETURNS WEIGHTED SUM OF 1:SYNTAX, 2:EXECUTION, 4:HARDWARE TRIG- GER TOO FAST, 8:LOGIC, 16:POWER SUPPLY. | 39 |
|  | NA; SEE REFERENCE 3 | |
|  | TEST; RETURNS WEIGHTED SUM OF 1:RAM FAILURE, 2:ROM FAILURE, 4:TIMER FAILURE, 8:I/O FAILURE | 36 |



Chapter 3

More Functions and Features

Introduction

So far you have learned the rudiments of closing and opening channels. But the 3488A opens up a wider range of possibilities with channel scanning, store and recall of channel setups, pairing cards together, and more. This chapter is devoted to helping you get the most efficient use out of your 3488A.

This chapter is broken down into two main sections for easy reference. The first of these sections shows you how to store up to 40 channel setups and recall them when needed. Scanning through a list of channels is discussed in the second section. You will also learn to pair options together for special measurement needs such as 4-wire ohms.

Storing and Recalling Channel Configurations

Often you may find it convenient to have a particular, repeatable channel configuration that encompasses several option assemblies. Opening and closing each individual channel each time you want the configuration becomes time consuming and cumbersome. The STORE and RECALL commands make this task very easy.

To store a channel configuration, simply set the channels to the configuration you need. Now, STORE the configuration in any of 40 registers (numbered 1 to 40). For example, to store a configuration in register 28, press:



Only the states of relays and digital I/O options in either static mode 1 or 2 will be stored. Digital I/O options that are not in the static mode are ignored. The current state of the 3488A will not be changed by executing the command. Also, display monitor mode, scan list, etc. are not stored.

Do This

Lets try a simple experiment to see how configurations are stored. First, press the front panel RESET key. Now close several channels on different option assemblies. For example:

```
CLOSE 101,103,106,204,302,206,410
```

Monitor one of the slots to make sure the channels are closed:

```
CMON 1
```

Store this setup in register 28

```
STORE 28
```

Now, at any time you want to reassert that same channel configuration, simply recall the register where the configuration was stored.



When a stored state is recalled, the 3488A reconfigures itself one slot at a time, beginning with slot 1, channel 00. Only relays and static digital output lines are stored and recalled.

Now, let's recall the configuration we stored earlier. First though, reset the 3488A by pressing the front panel RESET key. All the channels should open.

Now, recall the configuration:

```
RECALL 28
```

Monitor each of the slots and you will see that the channels we closed earlier are now closed again.

NOTE. When recalling stored setups, the 3488A begins with slot 1, channel 0 and sequences through each channel before proceeding to slot 2. After slot 2 is configured, then comes slot 3, and so on until slot 5 is configured. Configuring is done by either opening or closing appropriate channels.

When recalling a register, if no state was stored in the selected register, the 3488A will show an Error 2. If properly enabled, the 3488 will generate an SRQ interrupt

to the system computer (See Chapter 4). In this event, the 3488A will remain in its previous configuration.

Scanning Through a List of Channels

Scanning allows you to sequence through a list of relays, digital I/O lines, or stored setups. The scan list is made up of 85 channels (or setups) separated by commas. Contiguous channels may be specified by entering the first and last numbers separated with a hyphen.

The Scan List (SLIST) command is used to specify the channel sequence. A typical scan list command might look like:

```
SLIST 104,205,300-309,403
```

In this case, the scanning would start with channel 104. Then channel 205, followed by channel 300, then 301, 302, ... 308, 309 and finally, channel 403. Each closed channel is opened before the next channel closes (break-before-make). Channels may be scanned in any sequence. For example, if the sequence were specified as 309-300, then channel 309 would be closed first, followed by 308, 307, ... 302, 301, and finally 300. Scanning beyond the last channel in the list causes a wraparound to the first channel.

Before going further, let's look at a simple example. In this example, a 44470A Multiplexer card is installed in slot 1 of the 3488A.

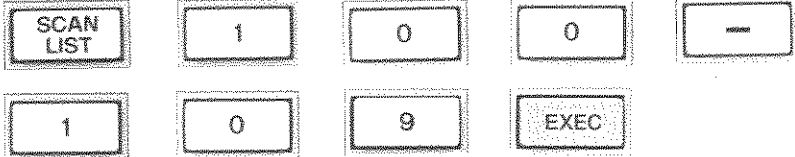
Do This: 

We now have a scan list composed of channels 100 through 109 specified. Now, let's monitor slot 1.



The display should look like:

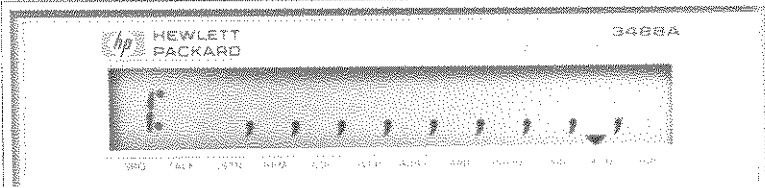

Now, step through the scan list by repeatedly pressing the STEP key. The first time you press it, channel 100 will close (0 in the monitor display). The next time STEP is pressed, channel 100 opens and channel 101 closes. Press the STEP key several times and watch the scan list wraparound to channel 100 again.

Scan lists can include any or all option assemblies except the 44475A Breadboard. A simple scan list to include all channels on the 44473A Matrix option would be: SLIST 400-433. This scan list will start with row 0, column 0 and step through column 1, column 2, and column 3; then it will move to Row 1, column 0, column 1, etc. Likewise, a scan list for the 44472A VHF Switch would be: SLIST 400-413. This scan list would step through each channel in group 0 and then group 1.

Remember that any command you can execute from the front panel can also be executed remotely from the system computer. The following program shows how the simple exercise we did earlier can be done from the computer.

```
10 OUTPUT 709 ;"SLIST 100-109;"  
   CMON 1"  
20 FOR I=1 TO 20  
30 OUTPUT 709 ;"STEP"  
40 WAIT 500  
50 NEXT I  
60 END
```

The WAIT statement in line 40 is only to allow you to watch the 3488A Monitor display. Line 40 can be eliminated but the 3488A display, which is updated 5 times per second, will not catch all the channel closures. Line 30 can be replaced by the HP-IB TRIGGER command (i.e., 30 TRIGGER 715). This can provide slightly faster operation.

Another feature of the scan list is a stop channel. Including the channel number "0" in the scan list, causes the previous channel to open but no channels to close. As an example, look at the scan list 100-104,0,105-109,0. After stepping to channel 104, the next STEP command opens channel 104 but no other channels close. Executing STEP again closes channel 105. The 0 channel at the end simply opens the last channel closed.

Using the STEP Command

The STEP command is used to sequence through a scan list. If STEP is executed and no scan list has been specified, an error will occur.

The 3488A uses a "pointer" to keep track of which channel in the list is currently closed. Whenever STEP is executed, the 3488A checks the pointer. If the current channel is either a relay or a digital I/O line, that channel is opened and the next channel in the list is checked. If the next channel in the list is a relay or digital I/O line, that channel will be closed. If the next channel in the list is a stored setup, that setup is recalled.

If the current channel is a stored setup, the pointer simply moves to the next channel in the list. Channels that were closed by the setup will remain closed. Resetting the 3488A does not clear the scan list.

Using the OPEN, CLOSE, or Card RESET commands will have no effect on the scan list pointer, even though the channel pointed to may change state. Furthermore, other closed channels on an option will remain closed until they are reached in the scanning sequence.

When a RECALL command is executed outside of the scan list, the 3488A will restore the specified state and will search the scan list and reset the pointer if that setup is found. This operation is identical to recalling a stored setup during scanning using the STEP command. Channels closed by recalling a setup will remain closed.

Remember also, any 44474A Digital I/O option in either static mode 1 or 2 will have been saved and recalled. If the 44474A option was reset (all bits clear) when the setup was stored, they will be reset when the setup is recalled.

Using the CHAN command

CHAN is used to open any channel previously closed by either CHAN or STEP and then close the new channel specified. Contrast this with the CLOSE command that does not open any other channels.

If a Scan List is in effect when CHAN is executed, the 3488A will not only close the specified channel but will also search through the scan list looking for the specified channel. If that channel is found in the Scan List, the Scan List pointer will be repositioned to it. Therefore, when STEP is executed, the next channel closed will be the next channel in the list, not the first channel in the list.

If CHAN is used to close a channel that is not found in the scan list, and then STEP is executed, the 3488A will open the channel closed by CHAN and close the first channel in the Scan List.

Example

```
10 OUTPUT 709 ;"SLIST 100-109,205,207,209,0"  
20 OUTPUT 709 ;"CHAN103" ! Closes channel 103 and positions pointer to 103  
30 OUTPUT 709 ;"STEP" ! channel 103 opens and 104 closes  
40 OUTPUT 709 ;"CHAN 207" ! opens channel 104, closes 207 and pointer to 207  
50 OUTPUT 709 ;"CHAN 313" ! opens 207, closes 313 and pointer to 100
```

If CHAN is executed with no channel number specified, the 3488A will output the channel that was last closed by either CHAN or STEP. If neither CHAN nor STEP were executed since the last reset, channel 0 will be output.

For Example:

```
10 OUTPUT 709 ;"CHAN"  
20 ENTER 709 ; A  
30 DISP A
```

External Increment and Channel Closed

There is yet another way to step through the Scan List. External Increment is a feature of the 44474A Digital I/O option that can be used to sequence through a scan list without system computer intervention. A typical application of the External Increment (EI) feature is to connect it to the Voltmeter Complete* connector on a voltmeter. In this way, when the voltmeter has completed a measurement it will cause the 3488A to increment (STEP) its scan list.

In addition, a Channel Closed (CC) pulse is available from the 44474A Digital I/O option which can be used to trigger the voltmeter when the next channel closes. The CC pulse is a 10 μ S, TTL compatible pulse.

The following program shows how a voltmeter with internal reading storage capabilities (-hp- 3456A) makes the task of scanning very easy. The main advantage with this type of measurement system is speed. Overall measurement speed is not dependent on the system computer. Furthermore, the system computer can be performing other tasks while the voltmeter and 3488A are making the measurements. When the 3488A has reached the end of the scan list, it can interrupt the system computer.

* Voltmeter Complete is a feature on certain -hp- digital voltmeters that signals the completion of a measurement. This is done by outputting a digital (TTL level) pulse.

In this example we will use two 44470A Multiplexers (channels 100-209). Connect the common bus of both options to the voltmeter input terminals. Also, remember to connect the 3456's Voltmeter Complete and External Trigger to the 44474A's Channel Closed line and External Increment, respectively.

```

10 ! EXTERNAL INCREMENT AND CHANNEL CLOSED EXAMPLE
20 ! -HP- 85 VERSION WITH -HP- 3488A SWITCH AND -HP- 3456A DVM
30 ! 3488A AT ADDRESS 709, 3456A AT ADDRESS 722
40 CLEAR 7
50 OUTPUT 709 ;"SLIST 100-209,0; DMODE 5,1,1,1; MASK 1"
60 OUTPUT 722 ;"T2RS1"
70 ON INTR 7 GOSUB 1000
80 ENABLE INTR 7;8
90 TRIGGER 709
100 !
110 ! MAINLINE PROGRAM GOES HERE
120 !
990 END
1000 P=SPOLL(709)
1010 OUTPUT 722 ;"S01-20STRRER"
1020 FOR I=20 TO 1 STEP -1
1030 ENTER 722 ; A(I)
1040 NEXT I
1050 RETURN

```

| Line | Description |
|-----------|--|
| 40 | CLEAR is used to reset the two instruments |
| 50 | This line sets the 3488A to the following conditions: SLIST 100-209 Scan list channels 100 to 209 DMODE 5,1,1,1 The 44474A option is in slot 5, It is set for handshake mode 1, polarity 1, and EI enabled. MASK 1 means End of Scan SRQ interrupt. |
| 60 | Sets 3456A to reading storage and external trigger. |
| 70-80 | Enables the -hp- 85 to respond to SRQ interrupt on End of Scan. |
| 90 | TRIGGER 709 same as STEP command for 3488A. |
| 100 | Body of the mainline program goes here. |
| 1000 | Serial Poll to clear the 3488A's interrupt. |
| 1010 | Set 3456A to recall readings |
| 1020-1040 | Recall the readings to the system computer. (last reading taken is first reading read back) |

As noted before, using Channel Closed or External Increment requires the use of a 44474A Digital I/O option. This deprives the user of the PFLG handshake line because it is used as EI. In other words, the Digital I/O option cannot be configured in the handshake mode when it is used for scanning. The program demonstrates the use of the DMODE command (for enabling EI) which is discussed in the next section.

Only one 44474A Digital option card at a time may be configured for EI scanning. If one card is enabled and another is subsequently enabled, the first will become disabled (and CC will be routed to the new card). A CC pulse will be generated whenever either STEP or CHAN is executed if the Digital I/O card is enabled for EI.

Card Pair

Card Pair is used to pair up two option assemblies of the same type, for example, two 44470A's. This operation effectively assigns both options to both slot numbers so that closing or opening a channel on either option performs the same operation on the corresponding channel on the paired option. This feature is especially useful when doing 4-wire scanning using a scan list.

Assigning the card pairs is accomplished with the CPAIR command. For example, to assign the options in slots 1 and 3 as a pair, execute: CPAIR 1,3

Two pairs of slots may be asserted at any time as long as they do not share a common slot. You can, for example, assign slot 1 with 3 as one pair and slot 4 with 5 as a second pair. Executing a Card Pair command will cancel any previous Card Pairing that involved either of the two specified slots.

To illustrate the CPAIR command, assume there are two 44470A Multiplexer options, one installed in slot 1, the second in slot 3. The command CPAIR 1,3 pairs the two options together. If you now execute CLOSE 105, both channels 105 and 305 will close. Likewise, if you execute CLOSE 307, both channels 307 and 107 will close.

The commands that can be used with CPAIR are: CLOSE, OPEN, CRESET, CHAN and STEP. The CHAN and STEP commands make the CPAIR feature useful for scanning. If two 44474A Digital I/O options are paired together, the DWRITE command can be used to write the same value to both options.

If CPAIR is executed with no slots specified, the 3488A will return the current slot pair information. When responding over HP-IB, four numbers are sent, separated by commas. The first two numbers specify the slots of pair 1, the second two numbers specify the slots of pair 2. For a front panel inquiry, the displayed response is preceded with the CPAIR: header and the two pairs are separated by spaces. The response for an inactive pair is 0,0 will be designated.

The following simple program illustrates the use of the Card Pair command.

```

10 ! CARD PAIR EXAMPLE
20 DIM A$(30)
30 OUTPUT 709 ;"CPAIR 1,2; CMON 2" ! setup card pair and card monitor
40 OUTPUT 709 ;"CPAIR" ! return card pair
50 ENTER 709 ; A$
60 DISP A$ ! A$ will show cards 1 and 2 paired together
70 OUTPUT 709 ;"SLIST 100-109" ! setup scan list
80 FOR I=1 TO 10
90 OUTPUT 709 ;"STEP" ! Step through scan list
100 WAIT 100
110 NEXT I
120 END

```

Using the Time Delay

When using the External Increment and Channel Closed features, a time delay can be programmed between when the channel is closed and when the CC pulse is output. This time delay can be used to allow test signals to settle before the measurement is made.

You specify the delay time as any time period between 0 and 32,767 mS (32.767 seconds) in 1 mS intervals. For example, to set an 0.1 second delay, execute: DELAY 100.

If no time period is specified with the DELAY command, the 3488A responds with the current value of the delay. For example:

```

10 OUTPUT 709 ;"DELAY"
20 ENTER 709 ; A
30 DISP A

```

Figure 3-1 shows the timing relationships for the scanning sequence using EI and CC. If either EI or the HP-IB TRIGGER command is received by the 3488A during the delay time, the instrument will wait until the delay time is complete before executing the channel STEP. If External Increment is received while the 3488A is executing a previous EI, an error will be generated (Trigger too fast) and STEP will be executed.

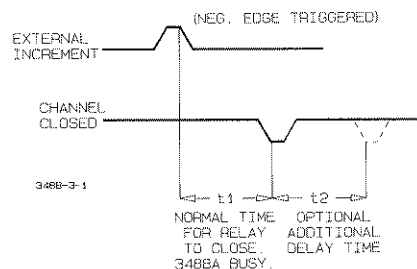

Figure 3-1. Delay Timing

www.valuetronics.com

COMMAND DIRECTORY

This command table for the 3488A is divided into three main categories:

- ▶ Standard Commands, appropriate for all 3488A option assemblies.
- ▶ Digital Commands used particularly with the 44474A Digital I/O module
- ▶ 3488A System commands

Refer to Chapters 2 and 3 in this manual for more information on channel addressing, etc. The following format is used to describe the commands.

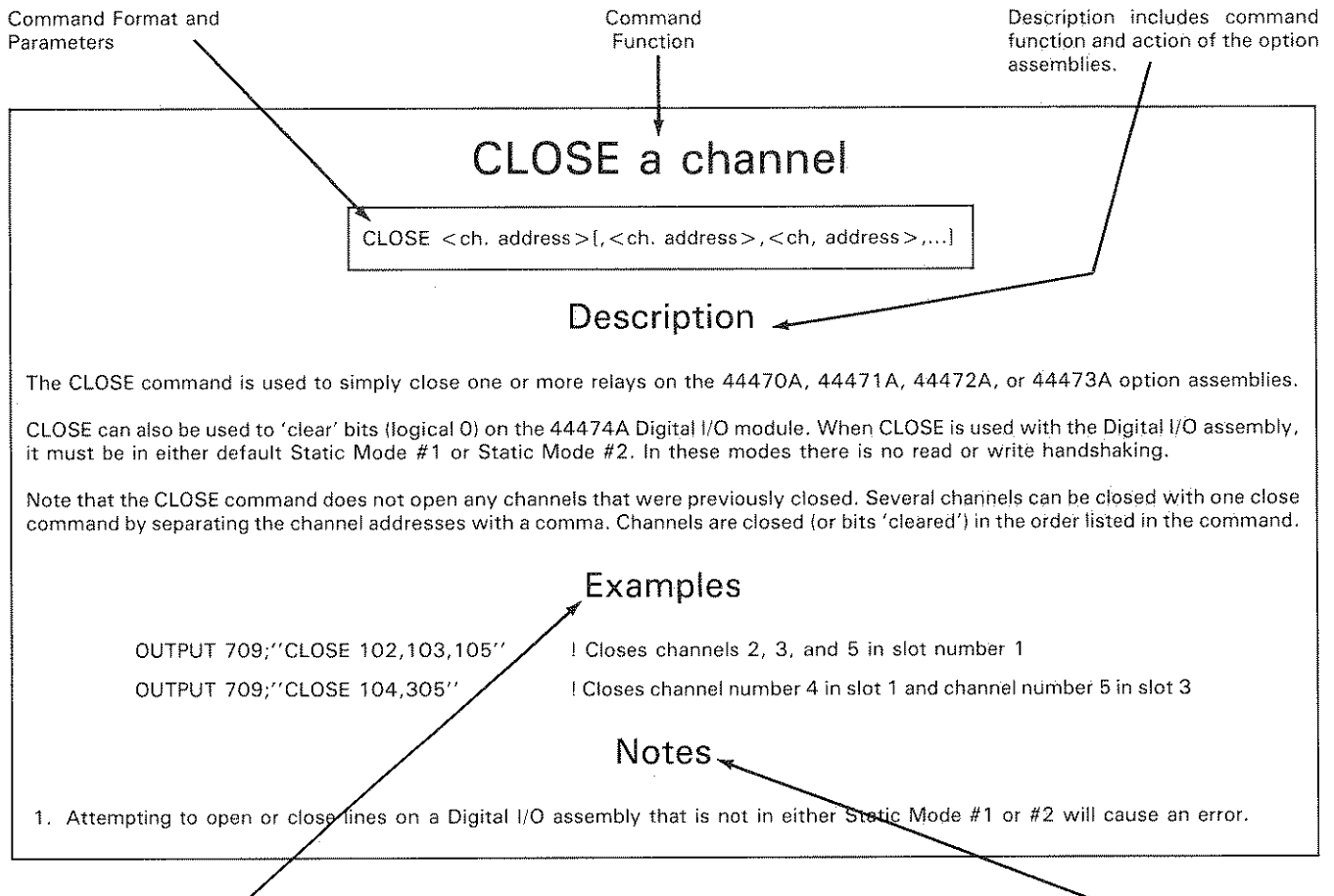

Examples are typical BASIC language statements with the 3488A at HP-IB address 709.

Notes include power-on state, where to look for more information, and special operating notes.

The 3488A expects numbers in either integer or floating point format. Note however, that numbers in floating point format are rounded to the nearest integer. For example, the command CLOSE 202.37 will be interpreted as CLOSE 202; CLOSE 202.5 will be interpreted as CLOSE 203. Numbers in exponential format will cause an error. Multiple commands separated by semicolons (;) may be used on one OUTPUT command. The 3488A complies with IEEE Standard P728.

Channel and bit address definitions adhere to the following conventions for the various option assemblies.

44470A 10 Channel Relay Multiplexer Module

Channel address is a three digit number. The first digit refers to the 3488A slot where the assembly is installed. This must be a number from 1 to 5. The next two digits refer to the specific channel number (00 - 09) on the assembly.

44471A 10 Channel General Purpose Relay Module

Channel address is a three digit number. The first digit refers to the 3488A slot where the assembly is installed. This must be a number from 1 to 5. The next two digits refer to the specific channel number (00 - 09) on the assembly.

44472A Dual 4 Channel VHF Switch

Channel address is a three digit number. The first digit refers to the 3488A slot where the assembly is installed. This must be a number from 1 to 5. The next digit refers to a specific channel group on the assembly. The third digit refers to a specific relay in that group. Relays are assigned channel numbers 00 - 03 and 10 - 13, corresponding to relay groups 0 and 1 respectively.

44473A 4X4 Matrix Switch Module

Channel address is a three digit number. The first digit refers to the 3488A slot where the assembly is installed. This must be a number from 1 to 5. The next digit represents the row (0 - 3) where the switch is located, and the third digit represents the column (0 - 3).

44474A 16 Channel Digital I/O Module

Bit address (used with CLOSE and OPEN) is a three digit number. The first digit refers to the 3488A slot where the assembly is installed. This must be a number from 1 to 5. The next two digits refer to a specific bit (00 - 15) on the assembly. Refer to Chapter 10 for more information on port modes and handshake modes.

In the following command descriptions, items in square brackets ([]) are optional, whereas items in < > brackets are mandatory.

CLOSE a channel

CLOSE <ch. address>[,<ch. address>,<ch. address>,...]

Description

The CLOSE command is used to simply close one or more relays on the 44470A, 44471A, 44472A, or 44473A option assemblies.

CLOSE can also be used to 'clear' bits (logical 0) on the 44474A Digital I/O module. When CLOSE is used with the Digital I/O assembly, it must be in either default Static Mode #1 or Static Mode #2. In these modes there is no read or write handshaking.

Note that the CLOSE command does not open any channels that were previously closed. Several channels can be closed with one close command by separating the channel addresses with a comma. Channels are closed (or bits 'cleared') in the order listed in the command.

Examples

OUTPUT 709;"CLOSE 102,103,105" ! Closes channels 2, 3, and 5 in slot number 1
 OUTPUT 709;"CLOSE 104,305" ! Closes channel number 4 in slot 1 and channel number 5 in slot 3

Notes

1. Attempting to open or close lines on a Digital I/O assembly that is not in either Static Mode #1 or #2 will cause an error.

OPEN a channel

OPEN <ch. address>[,<ch. address>,<ch. address>...]

Description

OPEN is used to open individual relays on the 44470A, 44471A, 44472A and 44473A assemblies. Relays are opened in the order listed.

In addition, OPEN can also be used to 'set' (logical 1) individual bits on the 44474A Digital I/O assembly. The Digital I/O assembly must be in either the default Static Mode #1 or Static Mode #2. In either static mode there is no read or write handshaking.

Examples

OUTPUT 709;"OPEN 103,105,107" ! Relays 3, 5, and 7 are opened in slot number 1

Notes

1. Attempting to open or close lines on a Digital I/O assembly that is not in either Static Mode #1 or #2 will cause an error.
2. Use the CARD RESET command to open all relays or set all digital I/O bits on an assembly. It is easier than listing each channel individually.

VIEW a channel

VIEW <ch. address >

Description

The VIEW command is used to look at the state, either open or closed of a particular channel or digital I/O bit. The 3488A responds with the string "OPEN 1" if the specified channel is open. If the specified channel is closed, the 3488A responds with the string "CLOSED 0". In the 3488A display, the channel address is displayed followed by a colon and the appropriate string.

Example

```

OUTPUT 709;"VIEW 105"      ! VIEWs channel 5 on slot number 1
ENTER 709; A$              ! input alphanumeric response from the 3488A
DISP A$                    ! A$ will either be "OPEN 1" or "CLOSED 0"

    or

ENTER 709; A               ! input numeric response from the 3488A
DISP A                     ! "A" will be either 1 or 0 for open or closed, respectively
    
```

Notes

1. When VIEWing a 44474A Digital line (bit), OPEN 1 means that the bit is set (pulled high, +5 volt). CLOSED 0 indicates that the bit is cleared (low impedance to ground).

CARD TYPE

CTYPE <slot >

Description

This command causes the 3488A to output the model name and number of the option module installed in the specified slot. If CTYPE is executed from the keyboard, the display shows both the slot and the option model number.

| Card Type | Description | |
|------------------------|-------------|-------|
| Slot is empty | NO CARD | 00000 |
| 10 Channel Multiplexer | RELAY MUX | 44470 |
| General Purpose Card | GP RELAY | 44471 |
| High Frequency Scanner | VHF SW | 44472 |
| Matrix Card | MATRIX SW | 44473 |
| Digital I/O Card | DIGITAL IO | 44474 |
| Breadboard | BREADBOARD | 44475 |

Example

```

OUTPUT 709;"CTYPE 3"      ! look for the card in slot 3
ENTER 709; A$              ! Card description will be displayed
DISP A$

    or

ENTER 709; A               ! only the numeric option model number is displayed i.e., "44470" for the 10 Ch. Multiplexer
DISP A
    
```

CARD RESET

```
CRESET <slot>[,<slot>,...]
```

Description

CARD RESET is used to reset all channels on the specified slot to their open state. Only options in the slots specified are affected. The 44474A Digital I/O option is reset to its default mode. This means that the 16 lines are set open (high impedance) and the option is in the Static Mode #1 (no handshaking).

Example

```
OUTPUT 709;"CRESET2" ! resets the option assembly in slot 2
```

CARD PAIR

```
CPAIR <slot>,<slot>
```

Description

CARD PAIR is used to pair up two cards of the same type, e.g., two 44470A's or two 44474A's. This operation will effectively assign both cards to both slot numbers so that closing or opening a channel on either card will perform the same operation on the respective channel on the other card. This feature is especially useful when doing 4-wire scanning with the 44470A's.

Executing a CPAIR command cancels any previous CPAIR command that involved either of the two cards. It is possible, however, to have two sets of card pairs, e.g. slots 1 paired with 2 and 3 paired with 4.

Example

```
OUTPUT 709;"CPAIR 1,3" ! sets the options in slots 1 and 3 as pairs
OUTPUT 709;"CLOSE 105" ! closes channels 105 and 305 simultaneously
```

CARD MONITOR mode

CMON <slot>

Description

CARD MONITOR places the 3488A display in a mode where it is dedicated to monitoring the option assembly in the specified slot (1 - 5). Specifying slot 0 causes the monitor mode to be cancelled.

Each option's monitor display and its meaning are summarized in the following displays:

| | |
|---|----------------------|
| 44470A Multiplexer | s: n,n,n,n,n,n,n,n,n |
| 44471A General Purpose | s: n,n,n,n,n,n,n,n,n |
| 44472A VHF Multiplexer | s: n,n,n,n;n,n,n,n |
| 44473A Matrix (monitoring Rows) | s: ROW r ;c,c,c,c |
| 44473A Matrix (monitoring Columns) | s: r,r,r,r; COL c |
| 44474A Digital I/O (Decimal monitoring of bytes) | s: H:bbb L:bbb |
| 44474A Digital I/O (Hexadecimal monitoring of bytes) | s: H:bbH L:bbH |
| 44474A Digital I/O (Decimal monitoring of word) | s: W:wwwww |
| 44474A Digital I/O (Hexadecimal monitoring of word) | s: W:wwwH |

where:

- s = slot number
- n = channel number
- r = row number
- c = column number
- bbb = digital data byte
- www = digital data word

Example

OUTPUT 709; "CMON 1" ! monitor only slot 1

OUTPUT 709; "CMON -1" ! monitor tracking mode starting with slot 1

Notes

1. A decimal point after the data byte or word on the 44474A monitor display indicates the port is configured as a write port.
2. When monitoring the 44474A Digital I/O option, pressing the front panel arrow keys causes the mode to toggle between decimal and hexadecimal display.
3. Monitor Tracking mode is asserted by specifying a negative slot number. The monitor starts with the specified slot but tracks to subsequent slots where channels are closed or opened. In other words, the monitor display shows the option slot where the last channel closure or opening took place.
4. Turn card monitor off by executing CMON 0.

SCAN LIST

```
SLIST [<ch. address>(, or -)<ch. address>...<ch. address>]
```

Description

Scanning allows you to specify a sequence of channels to be scanned. The sequence is specified as a list of up to 85 channel addresses (relay or digital I/O) and/or stored setups separated by commas. Channels from any of the option assemblies may be included in the list. Contiguous channels may be specified by entering the first channel address and the last channel address separated by a hyphen.

Use the STEP command to sequence through the scan list. When STEP is used to initiate scanning, the first channel in the list will be closed. Subsequently executing STEP causes the currently closed channel to open and the next channel in the list to close.

Normally, executing STEP after the end of the scan list is reached causes a wraparound to the beginning of the list. However, the number 0 may be inserted in the scan list to act as a stop channel. When "0" is reached in the course of scanning, the 3488A will open the last channel closed but will not close another channel and the Channel Closed pulse will not be generated.

CHAN may be used to specify a particular channel to close. If CHAN is used, any channel previously closed in the scan list will open and the channel specified by CHAN will close. In addition, if the channel closed by CHAN is specified in the scan list, subsequent scanning with the STEP command will start with that channel.

Example

```
OUTPUT 709;"SLIST104,205,300-309,410"
```

In this example, the scan list starts with channel 104, followed by channel 205, followed by channels 300, 301, 302, ... 309 and finally channel 410.

Notes

1. Any gaps or improper card types included in a [channel-channel] sequence will be ignored as long as the two numbers specified are valid.
2. Relays may be scanned in any sequence, i.e., 309-300.
3. STEPPing beyond the last channel specified in the scan list causes a wraparound to the first channel in the list unless "0" is used as stop channel.
4. Refer to the Advanced Operation section of this manual for information on using the External Increment and Channel Closed features.
5. If CHAN is used to close a channel outside of the scan list and then STEP is executed, the 3488A will open the channel first closed by CHAN and then close the first channel in the scan list.
6. The commands OPEN, CLOSE, CRESET, or RECALL will have no effect on the scan list even though the state of individual channels may change. Conversely, STEP, CHAN and SLIST have no effect on channels closed by CLOSE, or RECALL if those channels do not exist in the scan list.
7. Stored setups are specified by a number from 1 to 40 inclusive. See STORE and RECALL.

STEPing through the channel list

STEP

Description

The STEP command is used to sequence through a scan list. If STEP is executed and no scan list exists, the 3488A will generate an execution error; ERR 2.

Example

```
10 OUTPUT 709;"SLIST100-109,0;CMON 1"      ! sets up scan list
20 FOR I=1 TO 10
30 OUTPUT 709;"STEP"                        ! STEPs through the scan list
40 NEXT I
```

Notes

1. For more information, see topics of Channel Closed and External Increment.

CHANnel command

CHAN [<ch. address>]

Description

CHAN is used to open the last channel closed by either STEP or CHAN and close the specified channel. If no channel is specified with CHAN, the 3488A will display or output to the interface the number of the last channel closed by either STEP or CHAN. If no channel has been closed since the last reset, then CHAN returns the number 0.

Example

```
OUTPUT 709; "CHAN 105" ! Any channel previously closed by CHAN or STEP will open and channel 105 will close
```

Digital Mode Command

```
DMODE <slot>[, <mode>][, <polarity>][, <EI>]
```

Description

Digital Mode is used to establish the handshake mode and polarity of the 44474A Digital I/O assembly. It is also used to enable the External Increment and Channel Closed Pulse functions. The Mode specifier is as follows:

| Mode Type | Value |
|----------------------------------|-------|
| Static (default) Mode | 1 |
| Static 2 (read what was written) | 2 |
| R/W & Strobe mode | 3 |
| Read & Write Strobe mode | 4 |
| Handshake (no Ext. Inc.) mode | 5 |

The polarity specifier is as follows:

| Definition | Value |
|---|---------------------|
| Lower byte polarity | 1 = low true |
| Upper byte polarity | 2 = low true |
| PCTL Polarity (low ready) | 4 = low busy |
| PFLG Polarity (low ready) | 8 = low busy |
| I/O direction line polarity (High = input mode normally) | 16 = low input mode |

External Increment and Channel closed is enabled by a 1 in the EI specifier. They are disabled with an EI specifier of 0.

Example

```
OUTPUT715;"DMODE5,1,0,1" ! set the EXT. INC. & CH. CLOSED Mode and STATIC Mode #1
```

Notes

1. Contents of the DMODE register can be read by deleting the parameters and executing only: DMODE <slot>. The 3488A will respond with a display in the same form as you would send to set the DMODE in. (i.e., mode, polarity, EI)
2. At power on, all 44474A Digital I/O assemblies are put in Static Mode, with High True Logic on all lines, EI/CC are disabled.
3. For a more detailed explanation of the DMODE command, refer to Chapter 10.

Write to a Digital I/O

```
DWRITE <slot> <port> , <data> [, <data> ] ...
```

Description

Digital Write configures all or part of the 44474A to digital output ports and writes data to it. The 'PORT' portion of the command is always a two digit number and determines whether the high order eight bit byte (port 01) is written to, the low order eight bit byte (port 00) or the entire 16 bit word (port 02).

Example

```
OUTPUT 715; "DWRITE 501,124" ! Write the value 124 to Slot 5, port 01
```

```
OUTPUT 715; "DWRITE 502,24561" ! Write the value 24561 to the 16-bit port (port 02)
```

Notes

1. When writing to either of the 8-bit ports (ports 00 or 01), the value of the Data parameter must be between 0 and 255. When writing to the 16-bit port (port 02), the Data value can be between - 32768 and + 32767.
2. There is no limit to the number of data items that can be sent with the Digital Write command.
3. In the 16 bit mode (port 02) the data must be sent in 2's complement format.

Read From a Digital I/O

```
DREAD <slot> <port> [, # of times to read]
```

Description

Digital Read allows you to read the current status of the 44474A ports designated as inputs. The decimal value read back is equal to the sum of the values of the bits that are set. See the DWRITE command for an explanation of the port specifier.

Example

```
OUTPUT 715; "DREAD 502" ! Read the 16-bit input port one time only
```

```
OUTPUT 715; "DREAD500,10" ! Read the low order 8-bit port 10 times
```

Notes

1. If no value for number of reading is given, the specified port will be read only once.
2. The maximum number of times a port can be read with this command is 32767. For multiple readings, the 3488A must be in OLAP 1 mode.
3. When reading an 8-bit port, the values read back will be between 0 and 255. When reading the 16-bit port, the values read back will be between - 32768 and + 32767 (2's complement format).

Delay

DELAY [<time in mS>]

Description

The DELAY command is used to insert a time delay between the time that a channel is closed and the time that the next command can be executed and the Channel Closed pulse is output. The delay time can be specified from 0 to 32767 mS (32.767 seconds) in 1 mS increments. The delay time does not become effective until either CHAN or STEP is executed.

If there is not a time value sent with the DELAY command, the 3488A will respond by displaying the current value of the delay time. Remember that the Channel Closed pulse will use whichever 44474A assembly has External Increment enabled.

Example

OUTPUT 715: "DELAY 45" ! The delay time is 45 mS = .045 Sec.

Notes

1. Commands received by the 3488A during the delay time will be executed after the delay time is complete.

Digital Binary Write

DBW <slot><port>,#l<block of data>

Description

When the DBW command is received, the 3488A will interpret the block of data information that follows as a block of binary data to be output according to the slot/port specification and DMODE (polarity, handshake) command. In 16-bit mode (port 02), the data block is interpreted as being most significant byte first. The transfer is completed by setting the HP-IB EOI line true concurrently with the last byte of data.

Example

The following example is for an -hp- Series 80 computer:

```

10 CONTROL 7,16;128           ! Sets computer for EOI on last data byte
20 DIM A$(30)
30 IOBUFFER A$
40 A$="CMON5;DBW502,#IAS"    ! "AS" is block of data sent to 44474A
50 TRANSFER A$ TO 709 INTR
    
```

Digital Binary Read

DBR <slot><port>,[<number of times to read>]

Description

In the Digital Binary Read mode, data items are read and output according to the format setup by the slot/port specifier and the DMODE (for polarity and handshaking) command. If the 16-bit mode (port 01) is specified, data will be sent with the most significant byte first. The data transfer is terminated with the 3488A setting the HP-IB EOI line true concurrently with the last data byte sent.

When requesting multiple readings, the 3488A must be in the OLAP1 mode. The maximum number of readings that may be specified is 32,767.

Example

```

10 DIM A$(30)
20 IOBUFFER A$
30 A$="DBR502,1"             ! one digital binary reading
40 TRANSFER A$ TO 709 INTR
50 ENTER 709 USING "%,K"; B$ ! qualifiers "%,K" set computer to concurrent EOI and last data byte.
60 DISP B$
    
```

Reset the 3488A

RESET

Description

The RESET command is used to reset the 3488A to its power-on state. This includes the following sequence.

1. Identify all option assemblies and reset them (all relays open).
2. Read HP-IB address switches to establish the HP-IB address.
3. Set all parameters to their default conditions.

The following exceptions are made:

1. If RESET is executed from the system computer, interface functions are not affected (i.e., the 3488A stays in Remote mode, etc.). If the front panel RESET key is pressed, interface functions are reset.
2. Stored States are not destroyed (see STORE and RECALL).

Example

OUTPUT 709; "RESET"

Perform Internal 3488A Self Test

TEST

Description

TEST causes the 3488A to perform its internal self tests. When TEST is executed remotely from the system computer, only the internal tests are performed. When all the tests have passed, the message "SELF TEST OK" appears in the display. If any tests have failed, the message "FAILED nn" is displayed where nn is the sum of the values of the tests that have failed. Results of the tests can also be read back to the system computer; a value of 0 read back indicates all tests have passed.

Example

OUTPUT 709; "TEST"
ENTER 709; A
DISP A

When the front panel TEST key is pressed, the tests begin by turning on every segment in the display (except the top dot on the colon.) Following this, a complete power-on self test is performed. If no failures are found, the display indicates "SELF-TEST OK." If a failure is found, "FAILED nn" is displayed where nn is the sum of the values of all errors found.

The following table shows all possible failures and associated values.

- 1: RAM (Random Access Memory) failed
- 2: ROM (Read Only Memory) failed
- 4: Timer failed (used for delay, etc.)
- 8: IO chip failed (HP-IB interface)

Identify the 3488A

ID?

Description

If the 3488A is addressed to talk after sending the ID? command, it will output the string: HP3488A. This allows you to identify the HP-IB address of the 3488A.

Example

```
10 OUTPUT 709; "ID?"
20 ENTER 709; A$
30 DISP A$
```

! The computer display should show: HP3488A

OR

```
20 ENTER 709; A
30 DISP A
```

! The computer display should show: 3488

Status of the 3488A

STATUS

Description

STATUS permits reading the 3488A's Status Byte (See also SPOLL, Chapter 4). The STATUS command returns a decimal value which is the sum of the values of the individual bits that are set (condition is true).

Bits 0, 2, and 3 will be cleared after the STATUS command is executed. Bit 1 will be cleared only after the data is read from the 3488A, new data is requested, or the 3488A is reset. The Ready for Instructions bit (bit 4) will be cleared whenever the 3488A is busy executing instruction. For this reason, bit 4 will always be clear when STATUS is executed. SPOLL should be used to determine when the 3488A is ready for instructions. The Error bit (bit 5) will only be cleared after the Error Register is read. Bit 6, RQS, will only be cleared after STATUS if the condition that caused bit 6 to be set is cleared.

The following table shows the bits and their values.

| Bit | Weighted Value | Definition |
|-----|----------------|-----------------------------|
| 0 | 1 | End of scan sequence |
| 1 | 2 | Output available |
| 2 | 4 | Power-on SRQ asserted |
| 3 | 8 | Front panel SRQ key pressed |
| 4 | 16 | Ready for instructions |
| 5 | 32 | Error |
| 6 | 64 | RQS |
| 7 | 128 | Not used |

Example

```
10 OUTPUT 709; "STATUS"
20 ENTER 709; A
30 DISP A
```

Store the current channel setup

STORE <register number 1 to 40>

Description

Store is used to record the current state of the 3488A (closed channels, static digital output states, etc.) in the specified register number. This setup can be used later to return the 3488A to that state, it can also be used as part of a scan list.

Example

OUTPUT 709; "CLOSE 103,105,203,204,205; STORE 25"
This command stores the channel setup in register 25

OUTPUT 709; "RECALL 25"
This command recalls the setup from register 25

Notes

1. 44474A Digital I/O assemblies that are not in static mode are ignored.
2. The 3488A will not change the state of any channels when STORE is executed.
3. Resetting the 3488A does not affect the stored setups.

Recall the stored states

RECALL <register number 1 to 40>

Description

Once a setup has been stored, the RECALL command is used to re-assert that setup. When a stored state is recalled, the 3488A reconfigures itself, one slot at a time, beginning with slot 1, relay 00. Only relays and static Digital Outputs are recalled. This means that only those channels that are closed in the stored setup will be closed when the setup is recalled.

Example

OUTPUT 709; "CLOSE 103,104,202,204,206; STORE 10"
This command stores the channel setup in register 10

OUTPUT 709; "RECALL 10"
This command recalls register 10

Notes

1. If no state has been stored in the setup number selected, an error will result and the 3488A will send SRQ if it was enabled (see MASK). In this case, the 3488A remains in its previous state.

Error conditions

ERROR

Description

Error allows you to read the 3488A's error register. The decimal value returned is equal to the sum of the values of the possible error conditions, as defined below.

| Weighted Value | Error Condition |
|----------------|--|
| 1 | Syntax Error |
| 2 | Execution Error possible meanings include: a. Parameter out of range b. Card type mismatch c. Attempt to access a nonexistent stored state or scan list. |
| 4 | Hardware Trigger too Fast |
| 8 | Logic Failure |
| 16 | Power Supply Failure |

Example

10 OUTPUT 709; "ERROR"
20 ENTER 709; A
30 DISP A

Set the SRQ Mask

MASK [<decimal value>]

Description

The MASK command allows you to set the SRQ mask for certain conditions. (See Request Service, Chapter 4.) The decimal value loaded into the mask is equal to the sum of the values of the conditions that will cause an SRQ interrupt. The following table shows the possible conditions and values for an SRQ interrupt.

| Mask Bit | Weighted Value | Description |
|----------|----------------|--------------------------------|
| 0 | 1 | End of Scan Sequence |
| 1 | 2 | Output Available |
| 2 | 4 | Power-on SRQ true |
| 3 | 8 | Front panel SRQ key pressed |
| 4 | 16 | Ready for instructions |
| 5 | 32 | Error |
| 6 | | RQS (This bit is not maskable) |
| 7 | | Not used |

If no value is sent with the MASK command, the 3488A will display or output to the computer the current value of its SRQ mask.

Examples

OUTPUT 709;"MASK 8" ! Set the mask for Front Panel SRQ Key
 OUTPUT 709;"MASK 33" ! Set mask for ERROR (32) and End of Scan Sequence (1)
 10 OUTPUT 709; "MASK"
 20 ENTER 709; A
 30 DISP A ! THE CURRENT MASK VALUE IS DISPLAYED

Overlap on received command strings

OLAP <1 or 0>

Description

In the Overlap disabled mode (default, OLAP 0), the 3488A holds up HP-IB I/O communications while it processes received messages. If Overlap is enabled (OLAP 1), the 3488A will release the HP-IB as soon as the command message is received. Overlap enabled allows faster I/O operations but does not guarantee sequential operation of other devices on the bus. For more information, refer to Chapter 4.

Example

OUTPUT 709; "OLAP 1" ! Overlap is enabled

Notes

1. Overlap goes into effect on the first Bus communication after the OLAP message sent.
2. Overlap is only for commands received by the 3488A, not for data sent by the 3488A.
3. Default is Overlap disabled.
4. In Overlap enabled, users should monitor bit 4 in the 3488A Status Register to help insure sequential operation of other instruments on the HP-IB interface.
5. OLAP 1 is necessary for multiple readings from the 44474A Digital I/O option with the DREAD and DBR commands.

Stop on an Error (Error Halt)

EHALT <0 or 1>

Description

This command is used to enable (EHALT 1) the stop-on-error mode of the 3488A. When the 3488A discovers an error (see ERROR command), it will lockup the HP-IB interface (no HP-IB communication). ONCE THE HP-IB IS LOCKED UP, YOU MUST RESET THE HP-IB INTERFACE. THE 3488A CAN BE RESET BY EITHER PRESSING THE FRONT PANEL LOCAL KEY OR EXECUTING THE HP-IB CLEAR COMMAND. Default condition is EHALT disabled (EHALT 0) which allows HP-IB communication after an error is discovered.

Example

10 OUTPUT 709; "EHALT 1"

Write to the 3488A Display

```
DISP <ASCII character string>
```

Description

DISP lets you write messages up to 127 characters long to the 3488A's display. Any printable ASCII character (decimal value 32 and greater) can be displayed except for colons (:), semicolons (;) and pound signs (#). These two characters are interpreted as terminators thus ending the string. All other characters and any characters in excess of 127 will be discarded. Use the two arrow keys to scroll the display.

Example

OUTPUT 709; "DISP THIS IS THE 3488A SWITCH/CONTROL UNIT"

Notes

1. Delimiters such as Line Feed (lf), Carriage Return (cr), colons and semicolons are not allowed in the data string and will cause a 3488A error.
2. Quotation Marks within the ASCII character string are ignored.

Turning the Display ON or OFF

```
DON or DOFF
```

Description

The DOFF command allows you to turn the 3488A's display off. This allows the 3488A to operate faster because it no longer needs to update the display. After DOFF has been executed, the display will show a series of hyphens and then turn off. This hyphen series may stay in the display for approximately 10 minutes before the display actually clears.

The display will be reactivated by either the DON command or pressing the LOCAL key. Use DON to remove a message written to the display with the DISP command.

Example

OUTPUT 709; "DOFF"

OUTPUT 709; "DON"

Lockout the Keyboard

```
LOCK 1 activates LOCKOUT  
LOCK 0 (default) deactivates LOCKOUT
```

LOCK is similar to sending the Local Lockout command from the computer. Locking out the keyboard prevents the keyboard from being scanned thus permitting faster operation.

Example

OUTPUT 709; "LOCK1" ! Lockout the keyboard

1
2
3
4
5
6
7
8
9
10
11
12
13
14
15
16
17
18
19
20
21
22
23
24
25
26
27
28
29
30
31
32
33
34
35
36
37
38
39
40
41
42
43
44
45
46
47
48
49
50
51
52
53
54
55
56
57
58
59
60
61
62
63
64
65
66
67
68
69
70
71
72
73
74
75
76
77
78
79
80
81
82
83
84
85
86
87
88
89
90
91
92
93
94
95
96
97
98
99
100

Chapter 4

Advanced Remote Programming

Introduction

This chapter discusses topics useful to programmers experienced in HP-IB remote programming. The vast majority of all 3488A remote programming can be done without knowing or using the material in this chapter.

Using the 3488A Input Buffer

The 3488A has two modes for receiving commands from the system computer: Sequential and Overlap (OLAP). Sequential Mode (which is the default mode) simply means that the 3488A will not complete the HP-IB handshake process until the received command has been fully executed. Refer to Appendix B for more information on HP-IB handshake.

Picture the Sequential Mode this way:

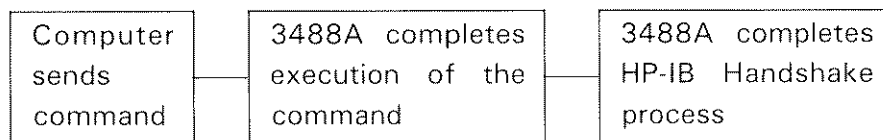

This means that the computer cannot send commands to any other device until the 3488A has completed execution of its command. This is beneficial because it guarantees that the 3488A will be ready (channel closed, etc.) before the computer tells some other device to do something (TRIGGER, etc.).

The Overlap Mode can be pictured like this:

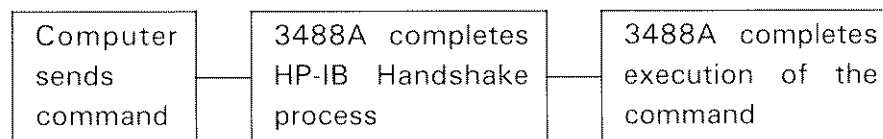

The advantage of the Overlap Mode is more "throughput". This means the computer can be performing other tasks while waiting for the 3488A to complete execution. Its disadvantage is that it does not guarantee sequential operation of other instruments on the interface bus.

The following two programs demonstrate the use of the Overlap mode. In the first program, with Overlap off, the 3488A will close channel 101 and then inhibit all HP-IB communication until the delay time is complete. When the delay is complete, the 3478A voltmeter is triggered.

In the second program, the 3488A releases the HP-IB interface allowing the voltmeter to trigger immediately, probably before the channel is closed. No other command will be executed by the 3488A until the delay time is complete.

Note in both program examples, the Overlap mode is asserted on a separate line in the program. This is because the Overlap mode (whether on or off) is not asserted until the next transmission from the system computer. Either carriage return (cr) line feed (lf) or some combination of two delimiters (e.g., two semicolons) must be received at the end of all command strings for OLAP off to work properly.

```
10 ! OVERLAP OFF EXAMPLE
20 ! -HP- 85 VERSION
30 ! 3488A AT ADDRESS 709, 3478A AT ADDRESS 723
40 CLEAR 7
50 OUTPUT 723 ;"T3" ! 3478A in single trigger mode
60 OUTPUT 709 ;"OLAP 0" ! default condition
70 OUTPUT 709 ;"DELAY 5000; CHAN 101"
80 TRIGGER 723 ! trigger the voltmeter
90 END
```

```
10 ! OVERLAP ON EXAMPLE
20 ! -HP- 85 VERSION
30 ! 3488A AT ADDRESS 709, 3478A AT ADDRESS 723
40 CLEAR 7
50 OUTPUT 723 ;"T3" ! 3478A in single trigger mode
60 OUTPUT 709 ;"OLAP 1" ! overlap mode on
70 OUTPUT 709 ;"DELAY 5000; CHAN 101"
80 TRIGGER 723 ! trigger the voltmeter
90 END
```

With the Overlap mode on, the Ready bit in the 3488A's Status Register can be checked with a serial poll (SPOLL, discussed later in this chapter) to insure sequential operation. Do not use the 3488A's STATUS command because the instrument will be busy executing the STATUS command and therefore the Ready bit will always be clear.

The next program shows how to continuously monitor the Status byte with a Serial Poll (SPOLL) to determine when the 3488A has completed it's task and is ready for the next event to occur. Bit 4 in the Status byte is the Ready for instruction bit and is checked in program line 80.

```
10 ! MONITOR STATUS BYTE EXAMPLE
20 ! -HP- 85 VERSION
30 ! 3488A AT ADDRESS 709
40 CLEAR 7
50 OUTPUT 723 ;"T3"
60 OUTPUT 709 ;"OLAP 1" ! overlap mode on
70 OUTPUT 709 ;"DELAY 10000;CHAN101"
80 P=SPOLL(709)
90 IF BIT(P,4)<>1 THEN GOTO 70
100 TRIGGER 723
110 END
```



Command

OLAP1 turns Overlap on
OLAP0 turns Overlap off

3488A HP-IB Capabilities

The following topics, arranged in alphabetical order, deal with specific HP-IB command messages (see Appendix B). These commands are functions of the HP-IB interface and all HP-IB compatible instruments will respond, in some manner, to them. Refer to the remote HP-IB programming manual for each instrument connected to the interface of your test system to see how they respond to these commands.

Refer also to the I/O programming manual for the computer you are using for specific information on the syntax and actions taken by the interface when sending the messages. The examples given here apply to the -hp- Series 80 and Series 200 desktop computers except where noted.

Many of the commands in this chapter have counterparts that can be executed from the 3488A front panel. This makes the commands both easy to learn as well as more valuable.

CLEAR

Examples

CLEAR 7 (device Clear)
CLEAR 709 (selected device Clear)

Comments

Upon receiving the CLEAR message, the 3488A will go into its reset routine. This means that all relays will open, the 44474A Digital I/O option will go to its default mode (all bits high impedance, static mode). Setups that have been stored are NOT destroyed.

LOCAL

Examples

LOCAL 7
LOCAL 709

Comments

The LOCAL 709 message clears the 3488A from the REMOTE mode and re-enables the front panel keyboard. Pressing the front panel LOCAL key accomplishes the same thing, provided the key has not been disabled with the LOCAL LOCKOUT message. LOCAL 7 removes every instrument on interface 7 from the REMOTE mode.

If the 3488A is in REMOTE with LOCAL LOCKOUT set (see next topic), the only way to return to front panel control is to either turn power off and then on again, or to execute the LOCAL 7 message. The command LOCAL 7 takes all instruments out of LOCAL LOCKOUT that are connected to that interface. The command LOCAL 709 would return the 3488A to front panel control but a subsequent REMOTE command (or OUTPUT 709) would return it to LOCAL LOCKOUT.

LOCAL LOCKOUT

Example

```
LOCAL LOCKOUT 7
```

Comments

The LOCAL LOCKOUT command locks out the 3488A's front panel keyboard including the LOCAL and SRQ keys. The lockout will remain in effect until it is cleared over the interface bus by sending the LOCAL message to the instrument or by cycling the 3488A's line switch.

REMOTE

Examples

```
REMOTE 7  
REMOTE 709
```

Comments

The REMOTE message is used to disable the 3488A's front panel switches (except the LOCAL and SRQ keys) and put it in remote program control. When the 3488A has been addressed to Listen, the REM annunciator in the display turns on to indicate that the instrument is in the Remote mode. To disable even the SRQ and LOCAL keys, use the LOCAL LOCKOUT message.

You will seldom find it necessary to execute the REMOTE command. The REMOTE command is independent of any other HP-IB activity and is sent on a single interface bus line called REN (see Appendix B). Most controllers set the REN line true at power-on or when reset, which has exactly the same effect as sending only REMOTE 7. Before any instrument will actually go into the remote state it must be addressed. Therefore, when the 3488A is first addressed, such as OUTPUT 709; "CLOSE 101", it will then go to the remote state.

REQUEST SERVICE (SRQ)

A very important feature of the 3488A is its ability to interrupt the system computer when certain specified conditions are met. Of course the system computer must be programmed to respond to the interrupt. The Require Service (SRQ) message is used to implement this feature and is independent of all other HP-IB activity. SRQ is sent on a single Interface Bus line (see Appendix B) called the SRQ line. The 3488A **MUST BE PROGRAMMED** to interrupt before it will actually attempt to interrupt the computer. The following list gives the possible causes of interrupt that the 3488A can be programmed for.

1. End of Scan Sequence. A series of channels can be designated as a scan list. The STEP command or HP-IB TRIGGER command causes the 3488A to increment through the scan list. When the last channel of the scan list is closed, the 3488A can interrupt the computer.

2. Output Available. If the computer has asked for some type of information, the 3488A can signal the computer that the information is available.

3. Power-on SRQ. The 3488A can interrupt the system computer when the 3488A is turned on (for example, if power to the 3488A were lost and later restored, the 3488A could signal the computer of the failure).

4. Front Panel SRQ. You can use the 3488A front panel SRQ key to manually interrupt the computer.

5. Ready for Instructions. When the 3488A completes some preassigned task, such as closing a list of relays, it can interrupt the computer. This is most useful in OLAP1 mode.

6. Error. There are several types of errors that can cause an interrupt. These include: syntax error, execution error, hardware trigger too fast, relay failure, and power supply failure. Refer to Chapter 2, Handling Errors, for more information.

How to Use SRQ

When the Require Service message (SRQ) is sent, the computer must first determine which instrument is requesting service (if more than one is capable of requesting service). This is done by conducting a SERIAL POLL (SPOLL) of each instrument connected to the interface. When an instrument is polled, it responds by sending a STATUS BYTE which indicates whether it requested service and if so, the nature of the request. If the Status Byte for the instrument polled indicates that the instrument was not requesting service, the computer would continue to poll the other instruments on the bus until the proper one is located. This, of course, assumes that the computer has been programmed to respond to SRQ and for the Serial Polling.

REQUEST SERVICE (SRQ) (Cont'd)

Status Register and Status Byte

The Status Register (see Status Command in Chapter 2) is used to monitor the six possible interrupt conditions. It is possible for one or more interrupt conditions to be true without the 3488A causing an interrupt. The interrupt will only occur when the SRQ mask has been set for particular conditions. Refer to Figure 4-1. Imagine the SRQ mask sitting over part of the Status Byte. If the SRQ mask is set for a certain condition, and that condition occurs, bit 6 of the Status Byte will go "true" (true being a logical 1). When bit 6 of the Status Byte is true, the 3488A will send the SRQ message to the computer and the SRQ annunciator will turn on. Remember, the system computer must be programmed to respond to the SRQ interrupt.

The Status Byte is an 8-bit byte that may be used to determine the current status of the 3488A regardless of whether an SRQ interrupt has occurred. The Status Byte comes from the Status Register and is output to the HP-IB in response to a Serial Poll or it can be displayed on the 3488A by pressing the STATUS key.

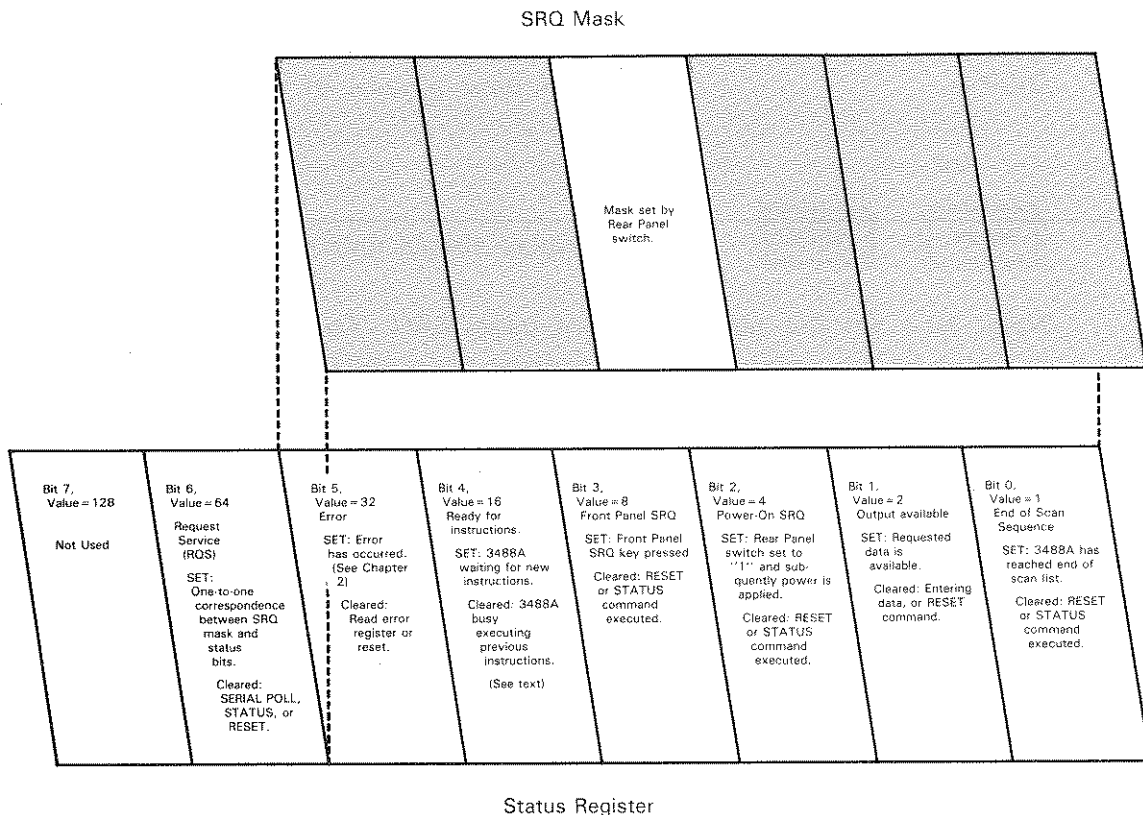

Figure 4-1. Status Byte and SRQ Mask

REQUEST SERVICE (SRQ) (Cont'd)

Setting the SRQ Mask

Setting the 3488A SRQ mask can be done from either the front panel or remotely from the system computer. The mask can even be interrogated to determine its setting.

The SRQ mask can only be set to mask bits 0 through 5 of the Status Register. Default mask value is 000. To set the mask, first determine which conditions you want to interrupt the system computer, e.g., End of Scan Sequence, Errors, Front Panel SRQ, etc. Sum together the weighted decimal values for those conditions (bits). Then, execute the MASK command with the decimal sum; that is, MASKxxx where xxx is the sum of the weighted values.

Do This:

To determine the current mask setting, execute the MASK command:

OUTPUT 709; "MASK"

ENTER 709; A

DISP A

"A" will have a value of 0.

or

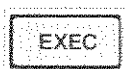
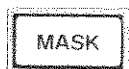

The display should indicate: MASK: 000

Now, let's set the mask for front panel SRQ. To do this, look at Figure 4-1. The weighted value for front panel SRQ is 8. So execute:

OUTPUT 709; "MASK 8"

or

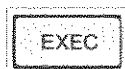

Verify that the mask is set to 8 by executing the MASK command.

Now, since the SRQ mask is set for front panel SRQ, pressing the SRQ key should cause the SRQ annunciator to turn on. This means that the 3488A is requesting service from the computer. But what is the benefit of all of this? The following examples demonstrate possible uses for the SRQ interrupts.

REQUEST SERVICE (SRQ) (Cont'd)

Example 1. Front Panel SRQ

The Front Panel SRQ feature of the 3488A provides you with a way of manually interrupting the controller from the instruments front panel. This feature is enabled by setting Bit 3 in the SRQ mask, command "MASK 8". Once this is done, pressing the 3488A front panel SRQ key causes the 3488A to request service (SRQ) from the system computer. The SRQ annunciator turns on in the display until the computer responds by executing a Serial Poll or a CLEAR command.

| | Line | Description |
|--|------|---|
| 10 ! Front panel SRQ example | 40 | The MASK 8 command sets the 3488A to respond to the front panel SRQ key. |
| 20 ! -HP- 85 version | | |
| 30 ! 3488A at address 709 | | |
| 40 OUTPUT 709 ;"MASK 8" | 50 | Line 50 tells the computer where to go in its program (line 1000) when an SRQ interrupt occurs. |
| 50 ON INTR 7 GOSUB 1000 | | |
| 60 ENABLE INTR 7;8 | 60 | ENABLE INTR actually enables the -hp- 85 computer to respond to interrupts on HP-IB interface 7. The number 8 is the octal code for SRQ interrupts (as described in the -hp- 85 I/O Programming Guide). |
| 70 GOTO 60 | | |
| 80 END | | |
| 1000 P=SPOLL(709) | | |
| 1010 IF BIT(P,3) THEN DISP "SRQ KEY PRESSED" ELSE DISP "P= ";P | | |
| 1020 STATUS 7,1 ; A | 70 | Line 70 is a simple loop that allows the program to continue running until someone presses the SRQ key on the 3488A front panel. |
| 1030 OUTPUT 709 ;"STATUS" | | |
| 1040 RETURN | | |
| | 1000 | SPOLL returns the 3488A Status Byte to variable P. |
| | 1010 | Bit 3 of the Status Byte is tested to make sure it is set. If it is, the message "SRQ KEY PRESSED" is displayed. If bit 3 is not set, something else caused the interrupt. |
| | 1020 | The STATUS command clears the -hp- 85 HP-IB Status/Control register so that it can respond to the next interrupt. |
| | 1030 | The Status register in the 3488A should be read and cleared so that it can cause future interrupts if necessary. |
| | 1040 | Return to where program was interrupted. |

REQUEST SERVICE (SRQ) (Cont'd)

Example 2. SRQ on End of Scan Sequence

Scanning (see SCAN LIST, Chap. 2) is a feature of the 3488A that allows it to sequence through a series of channels. When the 3488A has reached the end of that series, it would interrupt the system computer (SRQ). This allows the computer to perform other tasks while the 3488A keeps track of the scanning progress.

To enable the SRQ feature in the 3488A, bit 0 of the SRQ mask must be set. Remember that bit 0 will be true any time the end of a scan list is reached, but for the SRQ interrupt to occur the SRQ mask must be set. The mask bit pattern for End of Scan Sequence would look like:

| | | | | | | |
|--------|---|---|---|---|---|---|
| Bit #: | 5 | 4 | 3 | 2 | 1 | 0 |
| Value: | 0 | 0 | 0 | 0 | 0 | 1 |

To set the SRQ mask, we need to execute the command: MASK 1. Now, when the 3488A reaches the end of a scan sequence, it will interrupt the system computer via SRQ. The computer will only be interrupted if bit 0 is true, meaning end of scan sequence. Bits 1 through 5 will not interrupt the computer because the mask was not set for those bits. When the scan sequence reaches its end, the SRQ annunciator turns on in the 3488A display and will remain on until the computer responds by doing a serial poll, executing the CLEAR command, or the 3488A is turned off.

Let's illustrate how the SRQ on End of Scan Sequence could be used. In this illustration, two 44470A Multiplexer assemblies are used to scan through 20 channels of test points. An -hp- 3456A voltmeter connects to the common bus of both 44470A assemblies and will be used for voltage measurements.

In this particular example, the Channel Closed and External Increment functions of the 44474A Digital I/O assembly will be used. When a channel is closed, the 3488A will output a Channel Closed Pulse to the 3456A's External Trigger. Thus, the 3456A takes one voltage reading. After the voltmeter has completed the reading for that channel, it will output a Voltmeter Complete pulse to the 3488A's External Increment line. This in turn causes the current channel to open and closes the next channel in the list. This cycle continues until the end of the scan list.

REQUEST SERVICE (SRQ) (Cont'd)

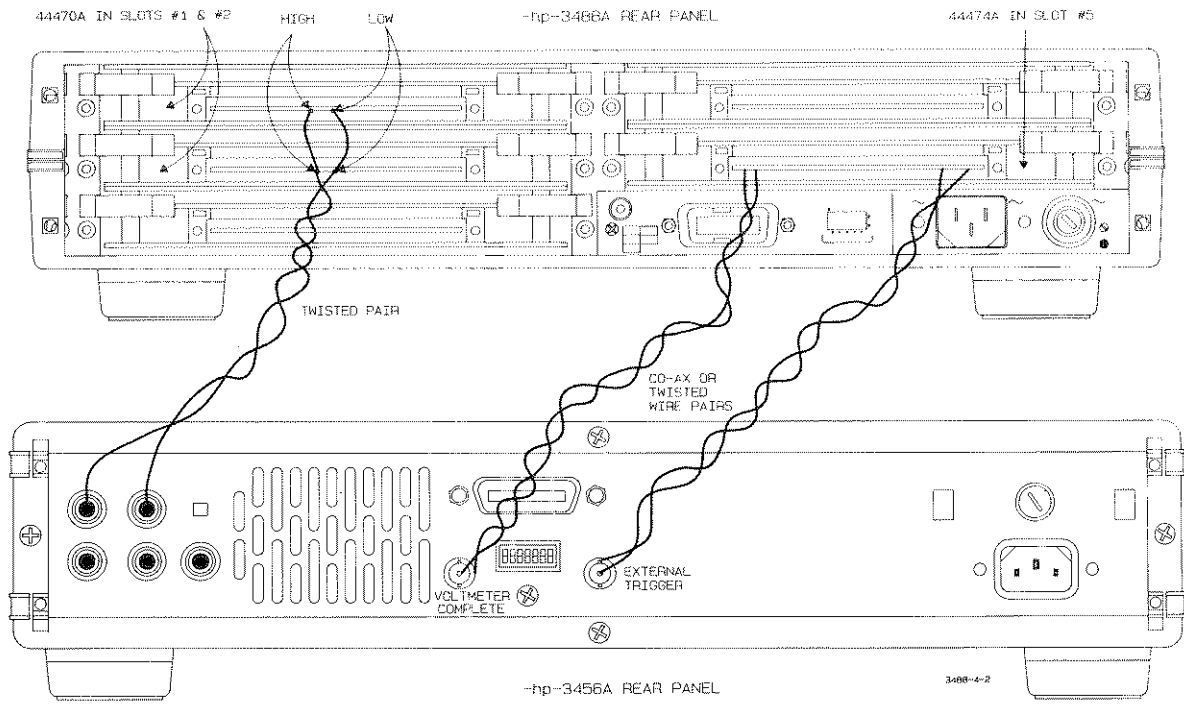

Figure 4-2. 3488A Channel Scanning

REQUEST SERVICE (SRQ) (Cont'd)

| | Line | Description |
|--|-----------|--|
| 10 ! End of Scan sequence SRQ e xample | 40 | Instructs the computer where to go (line 1000) when an interrupt occurs on interface 7. |
| 20 ! -HP- 85 version | | |
| 30 ! 3488a at address 709, 3456 A at address 722 | 50 | ENABLE INTR 7;8 actually enables the -hp- 85 to respond to the SRQ. SRQ is octal code "8" in the -hp- 85 HP-IB control register. |
| 40 ON INTR 7 GOSUB 1000 | | |
| 50 ENABLE INTR 7;8 | | |
| 60 OUTPUT 709 ; "SLIST 100-209,0 ; DMODE 5,1,0,1; MASK 1" | 60 | SLIST 100-209 sets the 3488A to scan the channels 100 through 209, these are the 44470A channels. The channel 0 means stop scanning. If the 0 is not used, the 3488A will start scanning through the channels again. DMODE 5,1,0,1 sets the 44474A (slot 5) for Channel Closed and External Increment. MASK 1 sets the SRQ mask for End of Scan SRQ. |
| 70 OUTPUT 722 ; "F1R1Z1T2R81" | 70 | These commands set the 3456A for DCV, Auto ranging, Autozero on, External Trigger, and Reading Storage on; respectively. |
| 80 TRIGGER 709 | 80 | TRIGGER 709 causes the 3488A to close the first channel in the list and begin the scan sequence. |
| 90 GOTO 90 ! Mainline program e oes here | 90-990 | These lines contain the main body of the program. |
| 100 END | | |
| 1000 P=SPOLL(709) | 1000 | This is the start of the interrupt subroutine. SPOLL returns the 3488A Status byte to variable "P". |
| 1010 IF BIT(P,0) THEN DISP "END OF SCAN REACHED" | 1010 | If bit 0 in the 3488A Status Byte is set, then display the message. If the bit is not set, something else caused the interrupt. |
| 1020 OUTPUT 722 ; "D020STR" | | |
| 1030 FOR I=1 TO 20 | | |
| 1040 OUTPUT 722 ; "RER" | | |
| 1050 ENTER 722 ; A(I) | 1020-1060 | These lines recall the 20 voltage readings from the 3456A. |
| 1060 DISP A(I) | 1080 | This STATUS command is used to clear the -hp- 85's Status/Control Register so that it can respond to the next interrupt. Do not confuse this STATUS with the STATUS for the 3488A. |
| 1070 NEXT I | | |
| 1080 OUTPUT 722 ; "D1" | 1090 | The Status register in the 3488A should be read and cleared so that it can cause future interrupts if necessary. |
| 1090 STATUS 7,1 ; R | | |
| 1100 OUTPUT 709 ; "STATUS" | 1110 | Return to where the program was interrupted. |
| 1110 RETURN | | |

S POLL

Example

P = S POLL (725)

Comments

Serial Poll (S POLL), like the 3488A STATUS command, allows you to determine the current status of your 3488A. When the 3488A receives the S POLL message, it returns the value of its Status Byte to the system computer. The value returned is the sum of the values of the individual bits that are set. Note that S POLL does not clear any of the bits in the Status Register except for bit 6, ROS. Use the STATUS command to clear the remaining bits.

S POLL differs from the STATUS command in that STATUS actually interrupts the internal processor. Thus, with STATUS, the 3488A will always appear busy (bit 4 clear). S POLL simply extracts the Status byte without interrupting the processor. Therefore, S POLL should always be used when determining the readiness of the instrument for further instructions (see OLAP).

The other main difference between S POLL and STATUS is with bit 1. If bit 1 is set, meaning data is available, and the STATUS command is sent, whatever data was available becomes lost and the value of the Status Byte replaces it in the output buffer. S POLL allows you to determine if data is available without destroying the data.

Figure 4-3 shows each of the eight bits in the Status Byte and their respective values. A description of the bits follows the figure.

| Bit 7 | Bit 6 | Bit 5 | Bit 4 | Bit 3 | Bit 2 | Bit 1 | Bit 0 |
|----------|---|---|---|---|--|---|---------------------------------|
| Unused. | Set: SRQ interrupt. | Set: ERROR condition occurred. | Set: 3488A is ready for new instruction. | Set: Front Panel SRO key has been pressed. | Set: Power-On SRQ switch set and power-on occurred. | Set: Requested information is available. | Set: End of Scan List. |
| Always 0 | Cleared: Condition causing SRQ is cleared or HP-IB S POLL command or 3488A is reset. | Cleared: Error register is read or 3488A is reset. | Cleared: 3488A is busy executing previous instruction. | Cleared: STATUS command or 3488A reset. | Cleared: STATUS command or 3488A is reset. | Cleared: STATUS command, reading the data, or resetting the 3488A. Note. STATUS deletes old information. | Cleared: STATUS command. |

Figure 4-3. Status Byte

SPOLL (Cont'd)

- Bit 0
End of Scan
Sequence
(value = 1) If a scan list has been set up and sequenced through, this bit will be set to a "1" when the last channel in the list is closed.
- Bit 1
Output
Available
(value = 2) This bit will be set when the computer asks for some piece of information and the information becomes available. For example, if the computer asks for the card type in slot 1, this bit will be set when that information becomes available.
- Bit 2
Power-on
SRQ
(value = 4) This bit is set to a 1 when a power-on reset has occurred. If the Power-on SRQ switch on the rear panel is set to the "1" or "up" position, bit 6 in the Status Byte will also be set, generating an SRQ interrupt. Bit 2 will be cleared if a reset due to the HP-IB CLEAR command or the RESET or STATUS keys on the front panel are pressed.
- Bit 3
Front Panel
SRQ
(value = 8) When bit 3 is set to a "1", it indicates that the front panel SRQ key has been pressed.
- Bit 4
Ready for
Instructions
(value = 16) This bit indicates that the 3488A has completed its last command and is ready for the next command. Note: this bit will always appear to be clear (low) (meaning busy) when executing STATUS. This is because the 3488A is busy while executing the STATUS command.
- Bit 5
Errors
(value = 32) When this bit is set, it indicates that an error of some type has occurred. Refer to Chapter 2, Handling Errors, for more information on the nature of possible error messages.
- Bit 6
Service
Request
(value = 64) This bit indicates that the 3488A is requesting service (SRQ) from the system computer. The bit is set to "1" whenever the SRQ mask is set for a particular event and the event occurs. This bit is also set to "1" at power on if the Power-on SRQ switch (3488A rear panel) is set to the up position. This bit is cleared by either a reset or a Serial Poll.
- Bit 7 This bit is not used and is always 0.

S POLL (Cont'd)

Try this simple exercise

Press the 3488A RESET key followed by the STATUS key. The display should show:

STATUS: 000

This indicates that none of the conditions are true. (Remember, Bit 4 is clear because the 3488A is busy executing the STATUS command and therefore not ready for more instructions until the command is finished.)

Now, execute the same commands from the system computer:

```
10 OUTPUT 709 ;"RESET"      10 OUTPUT 709 ;"RESET"  
20 OUTPUT 709 ;"STATUS"    20 A=SPOLL(709)  
30 ENTER 709 ; A          30 DISP A  
40 DISP A                  40 END  
50 END
```

The value of A should be 0 in the left hand example, and 16 (Ready for Instructions) in the right hand example.

Now, set up a simple scan list, for instance SLIST 200-202 and STEP through each of the channels. Execute lines 20 through 40 in either of the programs above (or simply press the STATUS key). The value returned should be 1 (End of Scan List) if you either pressed the STATUS key or executed the left hand program. If you executed the right hand program (SPOLL), the value returned is 17 (End of Scan List and Ready for Instructions).

Reset the 3488A and press the front panel SRQ key. Check the value of the Status byte. It should be either 8 (execute STATUS) or 24 (SPOLL).

TRIGGER

Examples

TRIGGER 7
TRIGGER 709

Comments

If the 3488A has been addressed to listen, the TRIGGER message (also known as the GET for Group Execute Trigger) will cause the same action as the 3488A STEP command. In other words, the commands TRIGGER 709 and OUTPUT 709; "STEP" perform exactly the same function.

Chapter 5

Operator Information

Introduction

Your 3488A Switch/Control Unit was engineered for ease of use and reliability. The instrument was carefully inspected before shipping and should be free of mechanical and electrical flaws and should be in proper working condition.

The information in this chapter covers initial setup, installation and checkout of your new 3488A. This chapter should be read prior to installing the instrument for use. Warranty information, specifications, accessories, etc., are also covered in this chapter.

Preparation For Use

Unpacking Instructions

When you are unpacking your 3488A for the first time, make certain that the options that you ordered have been received with your 3488A. The following items should also have been included:

| Qty. | Description |
|------|---|
| 1 | 3488A Operating, Programming and Configuration Manual |
| 1 | 3488A Mainframe Service Manual |
| 1 | Power cord |
| 1 | 250mA line fuse and black fuse cap |
| 1 | 500mA line fuse and gray fuse cap |

WARNING

If any of the following symptoms exist, or are even suspected, remove the instrument from service. Do not use the instrument until safe operation can be verified by service-trained personnel.

- 1. Visible damage.*
- 2. Severe transport stress.*
- 3. Prolonged storage under adverse conditions.*
- 4. Failure to perform intended measurements or functions.*

If necessary, return the instrument to a Hewlett-Packard Sales and Service Office for service and repair to ensure that safety features are maintained.

Initial Inspection

Your 3488A was carefully inspected before it left the factory. It should be free of marks or scratches and in proper working order upon receipt. You should, however, inspect the instrument for any damage that may have occurred in transit.

If the shipping container or cushioning material is damaged, it should be kept until the contents of the shipment have been checked for completeness and the instrument has been mechanically and electronically inspected. Save the shipping materials for the carrier.

Procedures for checking the electrical performance of the 3488A are given in the 3488A SERVICE MANUAL. If there is any mechanical damage, the contents are incomplete, or the instrument fails to pass its Operational Verification or Performance Tests, promptly notify the nearest Hewlett-Packard office. A list of hp- Sales and Service Offices is located in the back of this manual.

CAUTION

Before connecting the 3488A to an ac power source, verify that the ac power source matches the setting of the 3488A line voltage selection switch.

Power Requirements

The 3488A requires a power source either 86-127Vac or 195-253Vac, 48 to 66 Hz single phase. Maximum power consumption is 15VA (Volt-Amps). Remove all options from the left side (facing the back panel of the instrument) and verify that the ac line voltage selection switch is set to the nominal line voltage for your area.

Line Voltage Selection

If it is necessary to reset the ac line voltage selection switch (Figure 5-1), turn the instrument power off and remove the power cord from the rear of the instrument. With a small flatblade screwdriver move the switch to the appropriate position.

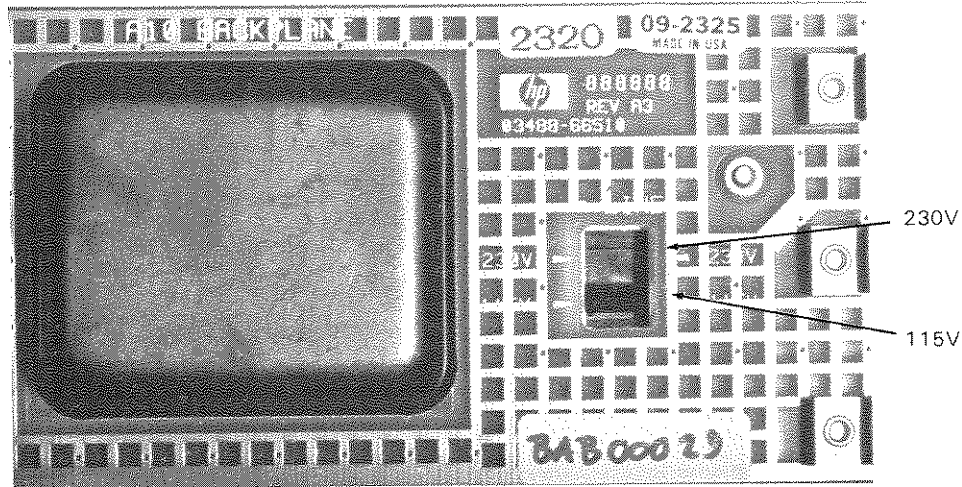

Figure 5-1. AC Line Voltage Selection Switch

Power Line Fuse Replacement

Two fuses with fuse caps and labels are provided with your 3488A. Select the one that is appropriate for the nominal line voltage in your area.

Replacement fuses are available from -hp- with the following part numbers:

| Line Voltage | Power Line Fuse | Fuse Cap |
|-----------------------------------|--|--------------------|
| 115Vac Nominal (87 to 127 Vac) | 500mA (-hp- Part Number 2110-0012) | Gray 2110-0565 |
| 230Vac Nominal (196-254 Vac) | 250mA (-hp- Part Number 2110-0489) | Black 2110-0567 |

The power line fuse is located on the rear panel of the 3488A in the lower right hand corner. To install or replace the fuse, turn the instrument off and remove the power cord from the rear of the instrument. With a small flatblade screwdriver rotate the fuse cap counterclockwise. Remove the fuse cap and replace the fuse with the appropriate type (see Figure 5-1). Reinstall the fuse cap and apply power.

Grounding Requirements

The 3488A is equipped with a three-conductor ac power cable. The power cable must either be plugged into an approved three-contact electrical outlet or used with a three-contact to two-contact adapter with the grounding wire (green) firmly connected to an electrical ground (safety ground). The 3488A's power jack and supplied power cable meet IEC (International Safety Commission) safety standards. A ground lug is mounted on the rear panel and is to be connected to a reliable earth ground when the power cord ground is unavailable.

Power Cords and Receptacles

Figure 5-2 shows the various power cord configurations that are available to provide power to the 3488A. The -hp- part number shown directly below the individual power plug drawing is the part number for the power cord complete with plug. If the appropriate power cord is not included with the instrument, notify the nearest -hp- Sales and Service Office.

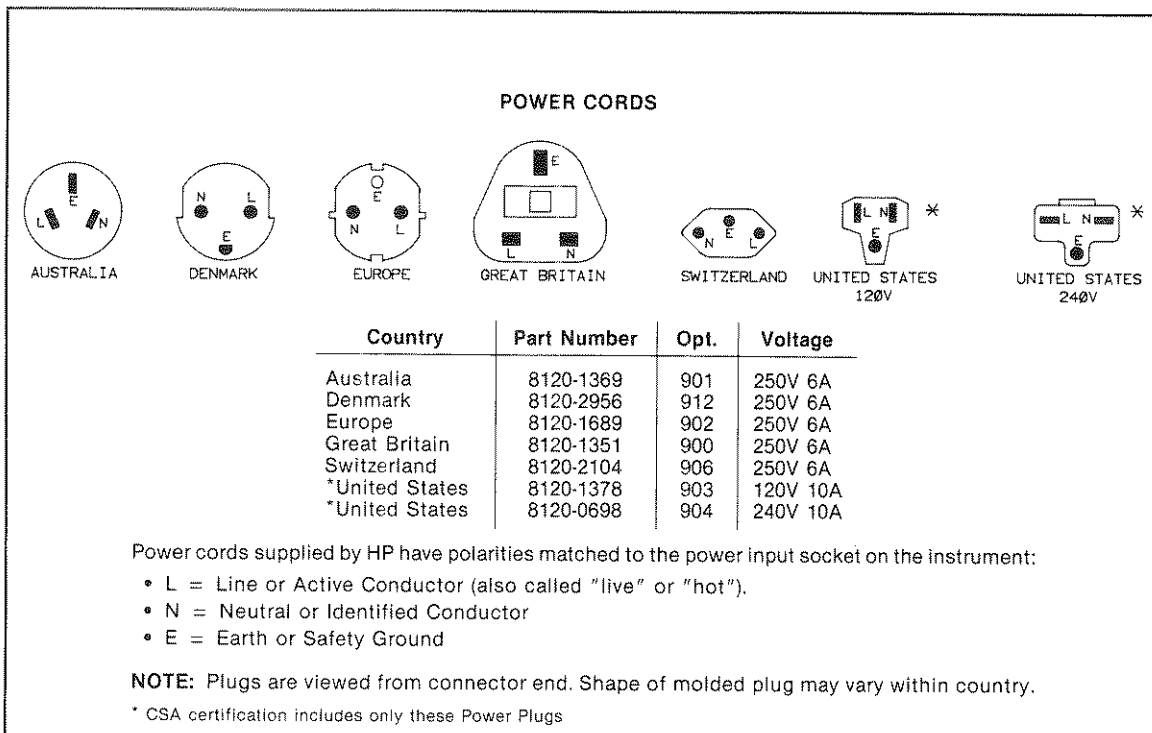

Figure 5-2. Power Cords

Instrument Mounting

The 3488A is equipped with feet and tilt stand in place, ready for use as a bench instrument. The front of the instrument may be elevated for convenience of operating

and viewing by extending the tilt stand. The instrument can also be mounted in a standard 19" rack with the optional rack mounting kits. See Table 5-1.

HP-IB Interface Connections

HP-IB (Hewlett-Packard Interface Bus) is Hewlett-Packard's implementation of IEEE Standard 488-1978, Standard Digital Interface for Programmable Instrumentation. Refer to Appendix B for more detailed information on HP-IB.

The 3488A's HP-IB connection is made by an HP-IB interface cable to the 24 pin HP-IB connector on the rear panel of the instrument. A typical interconnection of HP-IB compatible instruments is shown in Figure 5-3.

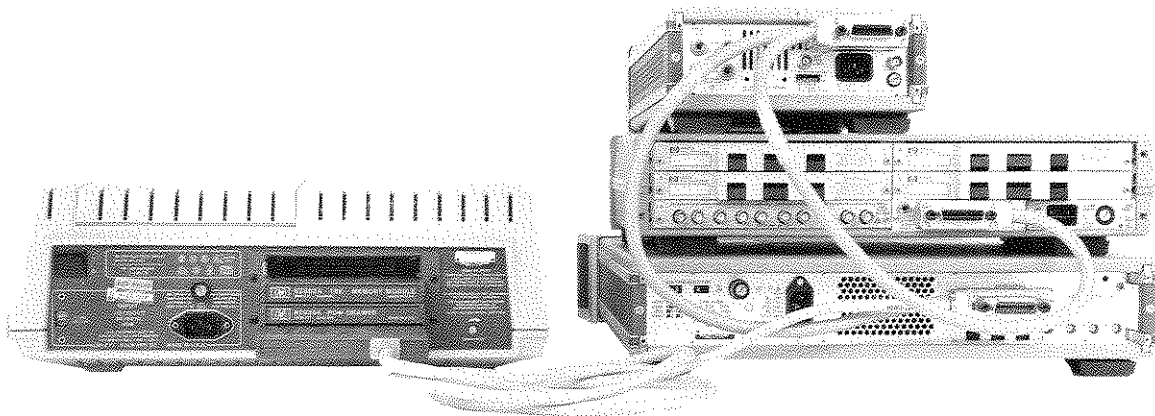

Figure 5-3. Typical HP-IB System Interconnection

A total of 15 HP-IB compatible instruments can be connected together by the same interface bus. Cables used with the interface bus have single male-female connectors at each end so that several cables can be stacked, thus allowing more than one cable to be attached to any instrument.

For best HP-IB performance, total HP-IB cable length for the system must not exceed 2 metres (6.5 feet) times the total number of instruments to be connected or 20 metres (65 feet), whichever is less.

HP-IB Address Selection

The HP-IB address of the 3488A is determined by the setting of five switches on the rear panel. These switches are read when the 3488A is turned on or reset. Normally, the 3488A leaves the factory with the address switches set to decimal "09". The corresponding ASCII code is a listen address of ")" and a talk address of "I". Refer to Figure 5-4 for other HP-IB address codes. The factory setting of the Power-on SRQ switch is off.

3488A Switch/Control Unit

Shown at Factory Default Address (09). This number is called the Primary Address.

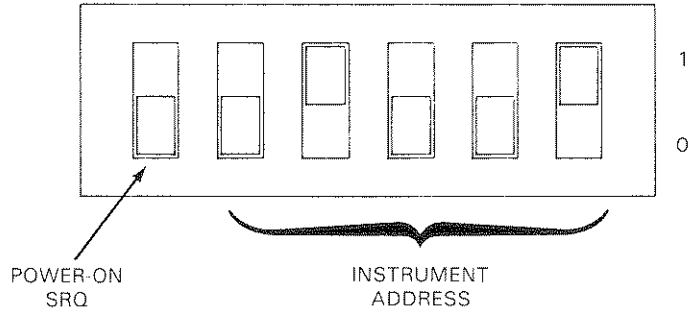

| ASCII Code Character | | Address Switches | | | | | 5-bit |
|----------------------|------|------------------|----|----|----|----|--------------|
| Listen | Talk | A4 | A5 | A6 | A7 | A8 | Decimal Code |
| SP | @ | 0 | 0 | 0 | 0 | 0 | 00 |
| ! | A | 0 | 0 | 0 | 0 | 1 | 01 |
| " | B | 0 | 0 | 0 | 1 | 0 | 02 |
| --# | C | 0 | 0 | 0 | 1 | 1 | 03 |
| \$ | D | 0 | 0 | 1 | 0 | 0 | 04 |
| --% | E | 0 | 0 | 1 | 0 | 1 | 05 |
| & | F | 0 | 0 | 1 | 1 | 0 | 06 |
| ' | G | 0 | 0 | 1 | 1 | 1 | 07 |
| (| H | 0 | 1 | 0 | 0 | 0 | 08 |
|) | I | 0 | 1 | 0 | 0 | 1 | 09 |
| * | J | 0 | 1 | 0 | 1 | 0 | 10 |
| + | K | 0 | 1 | 0 | 1 | 1 | 11 |
| , | L | 0 | 1 | 1 | 0 | 0 | 12 |
| - | M | 0 | 1 | 1 | 0 | 1 | 13 |
| . | N | 0 | 1 | 1 | 1 | 0 | 14 |
| / | O | 0 | 1 | 1 | 1 | 1 | 15 |
| 0 | P | 1 | 0 | 0 | 0 | 0 | 16 |
| 1 | Q | 1 | 0 | 0 | 0 | 1 | 17 |
| 2 | R | 1 | 0 | 0 | 1 | 0 | 18 |
| 3 | S | 1 | 0 | 0 | 1 | 1 | 19 |
| 4 | T | 1 | 0 | 1 | 0 | 0 | 20 |
| 5 | U | 1 | 0 | 1 | 0 | 1 | 21 |
| 6 | V | 1 | 0 | 1 | 1 | 0 | 22 |
| 7 | W | 1 | 0 | 1 | 1 | 1 | 23 |
| 8 | X | 1 | 1 | 0 | 0 | 0 | 24 |
| 9 | Y | 1 | 1 | 0 | 0 | 1 | 25 |
| : | Z | 1 | 1 | 0 | 1 | 0 | 26 |
| ; | [| 1 | 1 | 0 | 1 | 1 | 27 |
| < | | 1 | 1 | 1 | 0 | 0 | 28 |
| = |] | 1 | 1 | 1 | 0 | 1 | 29 |
| > | ~ | 1 | 1 | 1 | 1 | 0 | 30 |
| Talk Only | | 1 | 1 | 1 | 1 | 1 | |

Select Codes can be any integer 1 thru 12. Primary Addresses can be any integer 0 thru 30. 31 is not a valid HP-IB address.

Factory Default

Figure 5-4. 3488A HP-IB Address Codes

Options and Accessories

Table 5-1 lists the available accessories and options for your 3488A. These accessories are offered to help you maximize the useability and convenience of your 3488A.

Table 5-1. Accessories

| Description of Option/Accessory | Use this number when ordering with 3488A | Use this number when ordering separately |
|---|--|--|
| 10 Channel Relay Multiplexer Option with terminal connector | Option 010 | 44470A |
| Extra terminal connector block for 44470A | 44480A | 44480A |
| 10 Channel General Purpose Relay Option with terminal connector | Option 011 | 44471A |
| Extra terminal connector block for 44471A | 44481A | 44481A |
| Dual 4 channel VHF switch Option | Option 012 | 44472A |
| 4X4 Matrix Switch Option with terminal connector | Option 013 | 44473A |
| Extra terminal connector block for 44473A | 44483A | 44483A |
| 16 Bit Digital I/O | Option 014 | 44474A |
| Extra terminal connector block for 44474A | 44484A | 44484A |
| Breadboard | Option 015 | 44475A |
| Extra terminal connector block for 44475A | 44485A | 44485A |
| Side Handle Kit | Option 401 | 5061-1171 |
| Front Handle Kit | Option 907 | 5061-1170 |
| Rack Mount Kit | Option 908 | 5061-1168 |
| Rack Mount Kit with Front Handle | Option 909 | 5061-1169 |
| Additional set of 3488A Documentation | Option 910 | Order by part number: |
| 1 Metre HP-IB Cable | 10833A | 10833A |
| 2 Metre HP-IB Cable | 10833B | 10833B |
| 4 Metre HP-IB Cable | 10833C | 10833C |
| 0.5 Metre HP-IB Cable | 10833D | 10833D |
| 23 cm (9 in) BNC-BNC Cable | 10502A | 10502A |
| 122 cm (48 in) BNC-BNC | 10503A | 10503A |
| Dual Banana Plug (no cable) | 1251-2816 | 1251-2816 |
| BNC Tee (male-female-female) | 1250-0781 | 1250-0781 |

Warranty Information

Certification

Hewlett-Packard Company certifies that this product met its published specifications at the time of shipment from the factory. Hewlett-Packard further certifies that its calibration measurements are traceable to the United States National Bureau of Standards, to the extent allowed by the bureau's calibration facility, and to the calibration facilities of other International Standards Organization members.

Warranty

This Hewlett-Packard product is warranted against defects in material and workmanship for a period of one year from the date of shipment. During the warranty period, Hewlett-Packard will, at its option, either repair or replace products which prove to be defective.

For warranty or service repair, this product must be returned to a service facility designated by -hp-. Buyer shall prepay shipping charges to -hp- and -hp- shall pay shipping charges to return the product to Buyer. However, Buyer shall pay all shipping charges, duties, and taxes for products returned to -hp- from another country.

Duration and conditions of warranty for this instrument may be superceded when instrument is integrated into (becomes part of) other -hp- products.

Hewlett-Packard warrants that its software and firmware designated by -hp- for use with an instrument will execute its programming instructions when properly installed on that instrument. Hewlett-Packard does not warrant that the operation of the instrument, or software, or firmware will be uninterrupted or error free.

Limitation of Warranty

The foregoing warranty shall not apply to defects resulting from improper or inadequate maintenance by Buyer, Buyer-supplied software or interfacing, unauthorized modification or misuse, or improper site preparation or maintenance.

NO OTHER WARRANTY IS EXPRESSED OR IMPLIED. HEWLETT-PACKARD SPECIFICALLY DISCLAIMS THE IMPLIED WARRANTIES OF MERCHANTABILITY AND FITNESS FOR A PARTICULAR PURPOSE.

Exclusive Remedies

THE REMEDIES PROVIDED HEREIN ARE BUYERS SOLE AND EXCLUSIVE REMEDIES. HEWLETT-PACKARD SHALL NOT BE LIABLE FOR ANY DIRECT, INDIRECT, SPECIAL, INCIDENTAL, OR CONSEQUENTIAL DAMAGES, WHETHER BASED ON CONTRACT, TORT, OR OTHER LEGAL THEORY.

Assistance

Product maintenance agreements and other customer assistance agreements are available for Hewlett-Packard customers.

For any assistance, contact your nearest Hewlett-Packard Sales and Service Office. Addresses are provided in the back of this manual.

In addition to the above warranty, the following LIMITATION OF WARRANTY applies to the option 015, Breadboard assembly.

Limitation of Warranty for Option 015

The foregoing warranty shall not apply to defects resulting from improper or inadequate maintenance by Buyer. Buyer supplied software or interfacing, unauthorized modification or misuse, operation outside of the environmental specifications for the product, or improper site preparation or maintenance.

The design and implementation of any circuit used on this product is solely the responsibility of the Buyer. Hewlett-Packard Company does not warrant the Buyers circuitry or malfunctions of the 3488A or plug-in options that result from the Buyers circuitry. In addition, -hp- does not warrant any damage that occurs as a result of the Buyers circuit, including but not limited to the following:

1. Analog and digital sections are interconnected.
2. 3488A power supply limitations are exceeded.
3. Component height/protrusions restrictions are exceeded.
4. Maximum input voltage on the digital lines is exceeded.

Safety Summary

General safety precautions must be adhered to during all phases of operation of the 3488A. Failure to comply with these precautions or with specific warnings elsewhere in this manual violates safety standards of design manufacture, and intended use of the instrument. The Hewlett-Packard Company assumes no liability for the customer's failure to comply with these requirements.

Operating personnel must not remove instrument covers. Component replacement must be made by qualified service-trained personnel with a knowledge of the hazards involved. Under certain conditions, dangerous voltages may exist even with the power cable removed. To avoid injuries, always disconnect power and discharge circuits before touching them.

Do not operate the instrument in the presence of flammable gases or fumes. Operation of any electrical instrument in such an environment constitutes a definite safety hazard.

Warnings and Cautions precede potentially dangerous procedures throughout this manual. Instructions contained in the warnings and cautions must be followed. Safety symbols used on the instrument or in the manual include the following:

WARNING The **WARNING** sign denotes a hazard. It calls attention to a procedure, practice, condition, or the like, which, if not correctly performed or adhered to, could result in injury or death to personnel.

CAUTION The **CAUTION** sign denotes a hazard. It calls attention to an operating procedure, practice, condition, or the like, which, if not correctly performed or adhered to, could result in damage to all or part of the product.

NOTE The **NOTE** sign denotes important information. It calls attention to a procedure, practice, condition, or the like which is essential to highlight.



INSTRUCTION MANUAL SYMBOL. The product will be marked with this symbol when it is necessary for the user to refer to the instruction manual in order to protect against damage to the instrument.



Indicates dangerous voltage (terminal fed from the interior by voltages exceeding 1000 volts must be so marked in red).



Alternating Voltage/Current



Direct Voltage/Current.



This instrument or option assembly contains static sensitive devices. Use anti-static handling procedures to prevent electro-static discharge.

DO NOT OPERATE A DAMAGED INSTRUMENT

Whenever it is possible that the safety protection features built into this instrument have been impaired, either through physical damage, excessive moisture, or any other reason, REMOVE POWER and do not use the instrument until safe operation can be verified by service-trained personnel. If necessary, return the instrument to a Hewlett-Packard Sales and Service Office for service and repair to ensure that safety features are maintained.

Specifications

The specifications for the 3488A are the performance characteristics of the instrument which are certified. These specifications are listed at the end of this chapter, and are the performance standards or limits against which the instrument is tested. Included in the table are some supplemental characteristics of the 3488A. These should be considered as additional and general information for you, the user. Because of the many operating capabilities of the 3488A, exercise care when checking the instrument specifications.

Any changes in specifications due to manufacturing changes, design, or traceability to the National Bureau of Standards will be covered in a manual design change supplement.

Environmental Requirements

The 3488A should not be operated outside the ambient temperature range of 0°C to 55°C (32°F to 131°F) or stored outside the ambient temperature range of -40°C to +75°C (-40°F to +167°F).

WARNING

If any of the following symptoms exist, or are even suspected, remove the instrument from service. Do not use the instrument until safe operation can be verified by service-trained personnel.

- 1. Visible damage.*
- 2. Severe transport stress.*
- 3. Prolonged storage under adverse conditions.*
- 4. Failure to perform intended measurements or functions.*

If necessary, return the instrument to a Hewlett-Packard Sales and Service Office for service and repair to ensure that safety features are maintained.

Miscellaneous

How to Obtain Repair Service

You may have your 3488A repaired at an -hp- service center at anytime, whether it is under warranty or not. There is a charge for repairs after the one year warranty period. Contact you, local Sales and Service office for shipping instructions prior to returning the instrument. A list of Sales and Service Offices is located in the back of this manual.

3488A Serial Number

Each 3488A has a serial number printed on a plate on the bottom cover. This serial number has the form XXXXAYYYYY where the XXXX is the serial prefix, A is the country of origin (A = USA) and YYYYYY is the serial suffix.

We recommend that owners keep a separate record of this serial number. Should your instrument be lost or stolen, the complete serial number is often necessary for tracing and recovery, as well as for insurance claims.

In addition, each 3488A option assembly will have a Warranty Datecode label and an Electrical Revision Code label permanently applied to the circuit board. These numbers should also be recorded. Any communication with -hp- about the options should include these numbers.

General Shipping Instructions

Should you ever need to ship your 3488A, remove all option assemblies from the mainframe. Use clean handling and anti-static techniques when removing and packaging the option assemblies. WRAP THE OPTIONS IN ANTI-STATIC BAGS. Be certain that the mainframe and each option is packaged in a protective package (use the original shipping container and cushioning material) to avoid transit damage. Such damage is not covered by the warranty.

Attach a tag to the instrument identifying the owner and indicating the service or repair needed. Include the model number and serial number of the instrument and/or option cards. In any correspondence, identify the instrument by model and full serial number. We suggest that you always insure shipments.

Cleaning

Disconnect the 3488A from its power source before cleaning. Also, remove sources of power from the option assemblies. The instrument can be cleaned with a soft

cloth dampened either in clean water or in water containing a mild detergent. Do not use an excessively wet cloth or allow water inside the instrument. Do not use any abrasive cleaners, especially on the display. Do not press hard on the display.

WARNING

The 3488A uses latching relays on the 44470A, 44471A, 44472A, and 44473A Option assemblies. The state of these relays can only be altered under front panel or program control. This is an advantage in the sense that, under most conditions of failure, the relays will remain in whatever state your program has set them. However, in case of power or equipment failure, any application requiring a failsafe method of insuring that the circuits under control are in a known state must be provided by the installer.

In case of component failure or programming error, any voltage input to an option card may be present on any other terminal on the same option card.

Table 5-2. 3488A General Specifications

ENVIRONMENTAL

Operating: 0 - 55°C (32 - 130°F);
 Storage: -40 - 75°C (-40 - 165°F);
 Humidity: 95%, 0 - 40°C (32 - 104°F)

POWER

Line Voltage (Mains): 86-132V (115V) or 195-250V (230V) switch selectable, 48 - 440 Hz. Fused at 0.5A (115V) or 0.25A (230V).

Consumption: 6 VA (mainframe); 18 VA (maximum).

SIZE

89mm H (without removable feet) x 425mm W x 292mm D (3.5" x 16.75" x 11.5").
 Height (with removable feet): 100mm (4").
 Allow 76mm (3") additional depth for wiring.

WEIGHT

| | Net | | Shipping | |
|------------------|-----|------|----------|------|
| | kg. | lbs. | kg. | lbs. |
| 3488A mainframe— | 5.0 | 11.0 | 8.5 | 19.0 |
| Modules (ea.)— | 0.7 | 1.5 | 1.5 | 3.5 |
| Maximum Total— | 8.5 | 18.5 | 16.0 | 36.5 |

HP-IB (IEEE-488) Capabilities:

SH1 AH1 T6 TE0 L4 LE0 SR1 RL1 PPO DC1 DT1 E2

1
2
3
4
5
6
7
8
9
10
11
12
13
14
15
16
17
18
19
20
21
22
23
24
25
26
27
28
29
30
31
32
33
34
35
36
37
38
39
40
41
42
43
44
45
46
47
48
49
50
51
52
53
54
55
56
57
58
59
60
61
62
63
64
65
66
67
68
69
70
71
72
73
74
75
76
77
78
79
80
81
82
83
84
85
86
87
88
89
90
91
92
93
94
95
96
97
98
99
100

Chapter 6

44470A

Relay Multiplexer

Introduction

-hp- Model 44470A (3488A Option 010) Relay Multiplexer provides 10 channels of 2 wires each to switch analog signals to a common bus. The relays exhibit low thermal offset characteristics making them ideal for precision low level measurements*.

The individual relays on this option are rated at 250 Volts @ 2 Amps and can be operated in either a BBM mode (break before make) or in a mode where multiple channels may be closed together. This multiplexer option offers many possible uses including multiplexing signals directly to a measuring instrument or as an Input/Output multiplexer with the 44473A Matrix option. A removable terminal block assembly is provided for convenience in wiring and also provides strain relief for cables.

This chapter is designed to serve as a reference guide for using the 44470A Relay Multiplexer. As such, it contains programming information, installation and configuration information, and application examples.

WARNING

The 3488A Option 010, 44470A Multiplexer Assembly uses latching relays. The state of these relays can only be altered under program control. This is an advantage in the sense that, under most conditions of failure, the relays will remain in whatever state your program has set them. However, in case of power or equipment failure, any application requiring a failsafe method of insuring that the circuits under control are in a known state must be provided by the installer.

Operation

As shown in Figure 6-1, the 44470A Relay Multiplexer assembly consists of ten 2-wire relays connected to a common analog bus. Two modes of operation are possible: single channel, break-before-make or multiple channels closed together. Basically, there are two different ways the 44470A may be used: inputs from 10 different sources may be switched to the one common bus or one input (common bus) may be switched to 10 different places.

* Although the 44470 Multiplexer can be used to switch thermocouples, there is no offset compensation built-in and errors may occur.

An example of the first case would be when measuring up to 10 different voltage sources. Each channel connects to one voltage source and the common bus would connect to a digital voltmeter. As each relay is closed, the voltmeter measures that voltage. In this case only one relay would be closed at any one time.

To illustrate the second case, consider a dc voltage source being switched to several different loads. More than one relay might be closed at any one time.

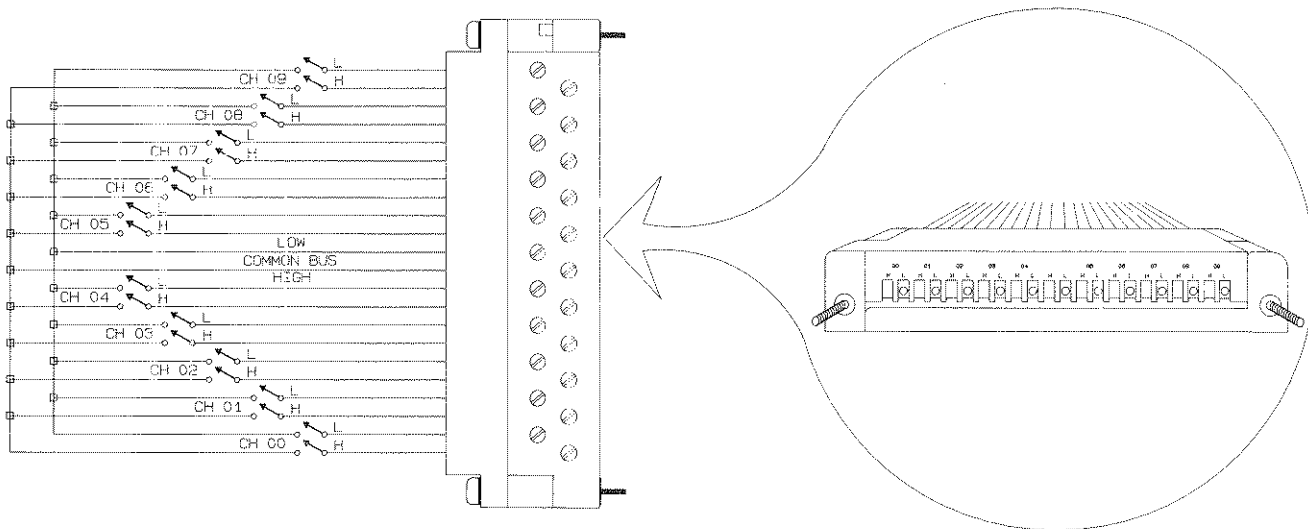

3488-1-1

Figure 6-1. 44470A Simplified Schematic

At turn on or reset (either from the front panel RESET key or the HP-IB CLEAR command), all channels on the 44470A will be opened.

Channels

A channel, as described in Chapter 2, refers to an individual relay, in this case a relay on the 44470A assembly. Therefore, when speaking of closing a channel, we are referring to closing a particular relay. Channel numbers are two digit numbers 00 through 09 and are repeated on each 44470A assembly. This can be seen by the numbering on the Terminal Block Edge Connector.

Channel addresses, on the other hand, are determined by which slot the 44470A assembly is mounted in. Channel addresses are a three digit number where the first digit specifies the particular slot where the 44470A option is installed. The last two digits are the channel number. For example, channel address 102 means slot number 1, channel 02.

The following table shows the channel addressing scheme for the five different slots.

Table 6-1. Channel Addressing Scheme

| Channel number as shown on the terminal block | Channel address if 44470A assembly is in slot number: | | | | |
|---|---|--------|--------|--------|--------|
| | Slot 1 | Slot 2 | Slot 3 | Slot 4 | Slot 5 |
| 00 | 100 | 200 | 300 | 400 | 500 |
| 01 | 101 | 201 | 301 | 401 | 501 |
| 02 | 102 | 202 | 302 | 402 | 502 |
| 03 | 103 | 203 | 303 | 403 | 503 |
| 04 | 104 | 204 | 304 | 404 | 504 |
| 05 | 105 | 205 | 305 | 405 | 505 |
| 06 | 106 | 206 | 306 | 406 | 506 |
| 07 | 107 | 207 | 307 | 407 | 507 |
| 08 | 108 | 208 | 308 | 408 | 508 |
| 09 | 109 | 209 | 309 | 409 | 509 |

Commands

Most of the 3488A commands can be used in controlling the 44470A option. In addition to the standard 3488A commands, two HP-IB interface commands directly effect the 44470A. All of these commands are described using a simple format of explanation.

In the following summary of command descriptions, square brackets ([]) indicate optional parameters, whereas items in < > brackets are mandatory. For further explanation of the command code mnemonics, refer to Chapters 2 and 3.

CLOSE a channel

Command Format: CLOSE <ch. address>[,<ch. address>,<ch. address>,...]

Description

The CLOSE command is used to simply close one or more channels on the 44470A. Note that the CLOSE command does not open any channels that were previously closed. Several channels can be closed with one CLOSE command by separating the channel addresses with a comma. If more than one channel is specified with the command, they are closed in the order listed.

Examples

OUTPUT 709;"CLOSE 102,103,105" ! Closes channels 2, 3, and 5 in slot number 1

OUTPUT 709;"CLOSE 104,305" ! Closes channel number 4 in slot 1 and channel number 5 in slot 3.

OPEN a channel

Command Format: OPEN <ch. address>[,<ch. address>,<ch.address>...]

Description

OPEN is used to open individual channels on the 44470A assembly. If more than one channel is specified in the OPEN list, they are opened in the order listed. Use the CARD RESET command to open all channels on an assembly. It is easier than listing each channel individually.

Example

```
OUTPUT 709;"OPEN 103,105,107"    ! 1 Relays 3, 5, and 7 are opened in slot
                                   number 1
```

VIEW a channel

Command Format: VIEW <ch. address>

Description

The VIEW command is used to look at the state (either open or closed) of a particular channel. The 3488A responds with the string "OPEN 1" if the specified channel is open. If the specified channel is closed, the 3488A responds with the string "CLOSED 0". In the 3488A display, the channel address is displayed followed by a colon and the appropriate string.

Example

```
10 OUTPUT 709;"VIEW 105"    ! VIEWs channel 5 on slot number 1
20 ENTER 709;A$             ! input the response from the 3488A
30 DISP A$                  ! A$ will either be "OPEN 1" or "CLOSED 0"
```

OR

```
20 ENTER 709; A
30 DISP A                    ! "A" will either be 1 or 0 (open or closed,
                               respectively)
```

CARD TYPE

Command Format: CTYPE <slot>

Description

This command causes the 3488A to respond with a description of what type of option card is located in the specified slot. The description includes the name of the card as well as the option number. In the display, the description is preceded by the specified slot number.

| Card Type | Description |
|------------------------|------------------|
| Slot is empty | NO CARD 00000 |
| 10 Channel Multiplexer | RELAY MUX 44470 |
| General Purpose Card | GP RELAY 44471 |
| High Frequency Scanner | VHF SW 44472 |
| Matrix Card | MATRIX SW 44473 |
| Digital I/O Card | DIGITAL IO 44474 |
| Breadboard Card | BREADBOARD 44475 |

Example

```
10 OUTPUT 709;"CTYPE 3"    ! look for the card in slot 3
20 ENTER 709;A$
30 DISP A$                  ! Card description will be displayed
```

CARD RESET

Command Format: CRESET <slot>[, <slot>, ...]

Description

CRESET is used to reset all channels on the 44470A assembly to their open state. Only cards in the slots specified are affected.

Example

```
OUTPUT 709;"CRESET 2"    ! resets the option assembly in slot 2
```

CARD PAIR

Command Format: CPAIR <slot>, <slot>

Description

Card PAIR is used to pair up two option assemblies of the same type, e.g., 44470A's. This operation will effectively assign both options to both slot numbers so that closing or opening a channel on either option will perform the same operation on the respective channel on the other option. This feature is especially useful when doing 4-wire scanning.

Commands used with the Card PAIR function are: CLOSE, OPEN, CRESET, CHAN and STEP. Of course, paired slots can be used as part of a scan list.

Executing a CPAIR command cancels any previous CPAIR command that involved either of the two options. It is possible, however, to have two sets of card pairs, e.g. slots 1 paired with 2 and 3 paired with 4.

Example

OUTPUT 709; "CPAIR 1,3" ! sets the options in slots 1 and 3 as pairs

OUTPUT 709; "CLOSE 105" ! closes channels 105 and 305 simultaneously

Executing the CPAIR command without specifying slot numbers allows you to determine which, if any, slots are paired together. Four numbers are returned separated by commas. The first two numbers specify slots in the first pair, the second two numbers specify the second pair. An inactive card pair is denoted by 0,0.

Example

OUTPUT 709; "CPAIR"

ENTER 709; A\$

DISP A\$

String variable A\$ will have the four slot numbers.
Note, you may have to dimension A\$ to 30.

At the back of this chapter is a section on applications. One of the application examples demonstrates the use of the CPAIR mode with 4-wire resistance measurements.

SCAN LIST

Command Format: SLIST [<ch. address>(, or -)<ch.address> . . . <ch. address>]

Description

Scan List allows you to specify a sequence of channels to be scanned. The sequence is specified as a list of up to 85 channel addresses (relay or digital I/O lines) and/or stored setups separated by commas. Contiguous channels may be specified by entering the first channel address and the last channel address separated by a hyphen. STEP is used to sequentially close channels in the list.

Example

```
10 OUTPUT 709;"SLIST 104,205,300-309,410,0"  
20 FOR I=1 TO 14  
30 OUTPUT 709; "STEP"  
40 NEXT I
```

In this example, the scan would start with channel 104, followed by channel 205, followed by channels 300, 301, 302, . . . 309 and finally channel 410. The 0 channel specified at the end of the list is a stop channel and opens the last channel closed (channel 410) but does not close any other channel.

Notes

1. Channels may be scanned in any sequence, i.e., 309-300.
2. Stepping beyond the last channel specified in the Scan List causes a wrap-around to the first channel in the list. The number 0 can be used as a stop channel.
3. Refer to the Advanced Operations section in this chapter for information on using the External Increment and Channel Closed features.
4. The commands OPEN, CLOSE, CRESET, or RECALL will have no effect on the Scan List even though the state of individual channels may change.
5. Stored setups may be recalled as part of the Scan List simply by specifying the register number. For example: SLIST 104,105,106,25,200,201. Here, register 25 has the stored setup.

STEPping Through the Scan List

Command Format: STEP

Description

STEP is used to open the the last channel closed and close the next channel in the Scan List. If STEP is executed and no Scan List exists, the 3488A will generate an execution error.

The 3488A uses a pointer to keep track of which channel in the Scan List is currently closed. When STEP is executed, that channel is opened and the next item in the list is checked. If the next item in the list is a relay or Digital I/O line, that channel is closed. If the next item in the list is a stored setup, that setup is recalled. Channels that are closed by a setup will remain closed, that is, they are not opened by the next execution of the STEP command.

For additional information see the Advanced Operation section of this chapter for Channel Closed and External Increment.

Example

```
10 OUTPUT 709;"SLIST 100 – 109;CMON 1"  
20 FOR I= 1 TO 10  
30 OUTPUT 709;"STEP"  
40 NEXT I
```

CHANnel command

Command Format: CHAN [<ch. address>]

Description

CHAN is used to open the last channel closed by either STEP or CHAN and close the specified channel. If no channel is specified with CHAN, the 3488A will respond with the number of the last channel closed by either STEP or CHAN. If no channel has been closed since the last reset, then CHAN returns the number 0.

If a Scan List is in effect when CHAN is executed, the 3488A will search through the list and position the Scan List pointer to the channel specified by CHAN. If CHAN specifies a channel that is not in the Scan List, and then STEP is executed, the 3488A will open the channel closed by CHAN and go to the beginning of the Scan List.

Example

OUTPUT 709; "CHAN 203" ! Closes channel 203

OUTPUT 709; "CHAN"

ENTER 709; A

DISP A

! Variable A will contain the last channel closed, i.e.,
203

CARD MONITOR mode

Command Format: CMON <slot>

Description

Card Monitor is used to look at the state of the individual option assemblies in the specified slot (1-5). Specifying 0 as the slot will cause the monitor mode to be cancelled. If a negative number is used for the slot, the 3488A will go to its monitor tracking mode.

When used to monitor the 44470A assembly, the display shows the slot number (extreme left) and those channels that are closed, separated by commas. The MONitor annunciator also comes on:

Example

OUTPUT 709;"CLOSE 103,105,107; CMON 1"

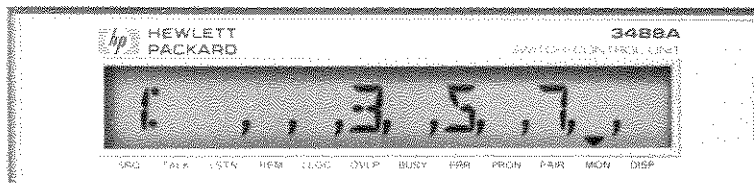

The format of the display can be summarized as:

s: n,n,n,n,n,n,n,n,n

where s represents the slot number being monitored and n is a one digit channel number.

Advanced Operations

Advanced Operations provide you with more capabilities when using the 3488A. It may be important, for example, to tell the system voltmeter when a channel has been closed and thus take a measurement. Or maybe you need to close the next channel in a scan list when some external event has taken place, perhaps as soon as the voltmeter has completed its reading. Most operations can be performed with only the basic commands, but for those times when you need something more, the advanced operations should meet your switching needs.

External Increment and Channel Closed

External Increment (EI) provides a method of sequencing through a scan list without system computer intervention. Typically, EI is connected to the Voltmeter Complete* output on a system voltmeter. Thus, when the voltmeter has completed its measurement, it signals the 3488A to step to the next channel in the list. The EI input is rising-edge triggered and TTL compatible.

Channel Closed (CC) provides a 15 μ S TTL pulse for signaling when a channel has been closed in the 3488A. This signal can be tied to the External Trigger input of a voltmeter to trigger it when a channel is closed. Together, EI and CC can be used with a system voltmeter to sequence through a scan list without any intervention by the system computer. Later in this chapter, examples number 2 and 3 will show how this can be done.

Using the External Increment and Channel closed features requires the use of a 44474A Digital I/O option. This also means that the Digital I/O option cannot be configured in Handshake Mode #5 when it is used for scanning (it can be used statically, however). The DMODE command is used to specify the handshake mode, Polarity, and External Increment (EI). Only one Digital I/O option can be configured for EI at a time. If one option is configured to accept EI and another is subsequently enabled, the first card will be disabled.

Even though the only specifier we are interested in is EI, the mode and polarity specifiers must be included. The format for specifying DMODE is as follows:

```
DMODE <slot>[, <mode>][, <polarity>][, <EI>]
```

* Voltmeter Complete is a feature on most Hewlett-Packard digital voltmeters to signal the completion of a measurement by means of a TTL compatible pulse.

The MODE specifier is as follows:

| Definition | Value |
|---------------------------|-------|
| Static Mode | 1 |
| Static mode for read back | 2 |
| R/W and Strobe | 3 |
| Rd & Wrt Strobe | 4 |
| Handshake (no EI) | 5 |

Any of the modes may be specified for use with External Increment except the Handshake mode (value 5).

The Polarity specifier is the sum of weighted values and is defined as follows:

| Definition | Value |
|-----------------------------|---------------------|
| Lower 8-bits polarity | 1 = Low true |
| Upper 8-bits polarity | 2 = Low true |
| PCTL Polarity | 4 = Low busy |
| PFLG Polarity | 8 = Low busy |
| I/O Direction line polarity | 16 = Low input mode |

EI is enabled by specifying 1. It is disabled with a specifier of 0.

Refer to Chapter 10 for more information on setting up the 44474A Digital I/O option for External Increment and Channel Closed.

Delay

Command Format: DELAY [<time in mS>]

Description

The DELAY command is used to insert a time delay between the time that a channel is closed and the time that the next command can be executed and the Channel Closed pulse is output. The delay time may be specified from 0 to 32,767 mS (32 seconds) in 1 mS increments. The delay time does not become effective until either CHAN or STEP is executed.

If any command is sent to the 3488A during the delay time, the command will be executed as soon as the delay time is complete. If there is not a time value sent with the DELAY command, the 3488A will respond with the current value of the delay time.

Remember that the Channel Closed pulse will be output from whichever 44474A assembly has External Increment enabled.

Examples

OUTPUT 709; "DELAY 2000; CHAN 101" ! The delay time is 2000 mS = 2 seconds

OUTPUT 709; "DELAY"

ENTER 709; A

DISP A

! Display the delay time

HP-IB Interface Commands

Only two interface commands affect the state of the 44470A channels: TRIGGER (Group Execute Trigger) and CLEAR (Device Clear or Selected Device Clear). TRIGGER performs the same function as the 3488A STEP command. In other words, the two commands:

TRIGGER 7 (or TRIGGER 709)

and

OUTPUT 709; "STEP"

perform the same function as far as the 44470A assembly is concerned.

CLEAR, whether a Device Clear or Selected Device Clear, simply resets the 3488A and hence all relays will go to their open state.

44470A Assembly Installation

This portion of the chapter is written specifically for the service trained technician. It provides the necessary information for a person trained in electronic circuitry to configure and install the option assembly. Carefully read through this section and adhere to all cautions and warnings.

WARNING

Only qualified service trained personnel should remove, configure, or install the 3488A option assemblies. Disconnect the 3488A power cord from the back of the instrument prior to installing the option assemblies.

WARNING

The 3488A Option 010,44470A Relay Multiplexer, uses latching relays. The state of these relays can only be altered under program control. This is an advantage in the sense that, under most conditions of failure, the relays will remain in whatever state your program has set them. However, in case of power or equipment failure, any application requiring a failsafe method of insuring that the circuits under control are in a known state must be provided by the installer.

In case of component failure or programming error, any voltage input to an option card may be present on any other terminal on the same option card.

When you initially received your 3488A, the option assemblies were not installed in the mainframe. Each option assembly was packaged separately along with a terminal block edge connector and a two piece strain relief housing. In addition, two labels were provided for option identification.

CAUTION

Use clean handling and anti-static procedures when removing, configuring and installing the option assemblies. The circuit boards must be kept clean to ensure compliance with impedance specifications. The option assemblies as well as the 3488A mainframe contains CMOS devices which are susceptible to static discharges.

A few simple steps are required to install the 44470A assembly. Carefully observe the orientation of the assembly and terminal block as you install them.

1. Pre-installation
 - a. Remove the ac power cord from the 3488A before installing any option assembly.
 - b. Position the 3488A with the rear panel towards you.
 - c. Select a slot. Refer to Figure 6-2, the 3488A has five slots for installing option assemblies. The 44470A can be used in any of the five slots.

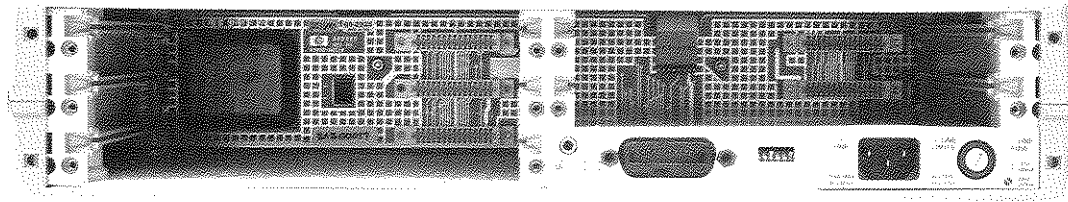

Figure 6-2. Rear Panel View Of The 3488A

2. Option assembly installation

- a. Hold the option assembly, component side down, by the metal shields. Insert the circuit card into the slot guides and slide toward the front of the instrument. Push firmly until the assembly 'snaps' into place. Fold the plastic levers toward the assembly. These levers lock the option into the mainframe.

NOTE

To remove the option assembly, simply unfold the plastic tab levers. This will release the locking mechanism and pull the option out of the mainframe connector.

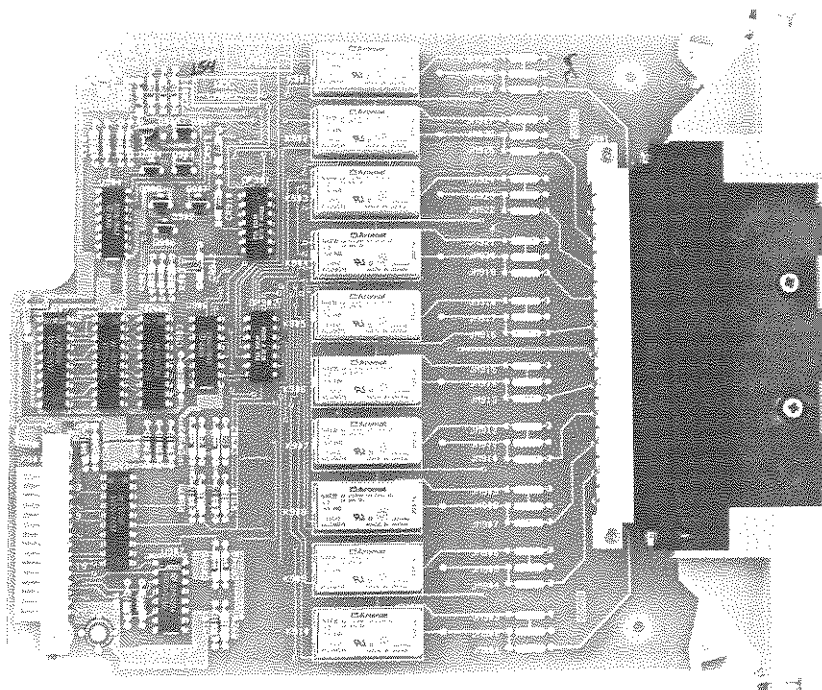

Figure 6-3. Option Card

3. Terminal Block Wiring

a. Wire the Terminal Block Edge Connector. The following photograph shows the channel connection sequence for the 44470A Terminal Block Edge Connector. This terminal block is keyed to fit only the 44470A assembly. Extra terminal blocks are available under the -hp- part number 44480A. This terminal block was designed to accept wires in the range of 18 to 26 AWG.



Figure 6-4. Terminal Block

4. Strain Relief

a. Secure the terminal block to the strain relief housing with the captive screws on the terminal block. Make certain that the screws used to tighten the connector wires to the terminal block are accessible through the strain relief housing.

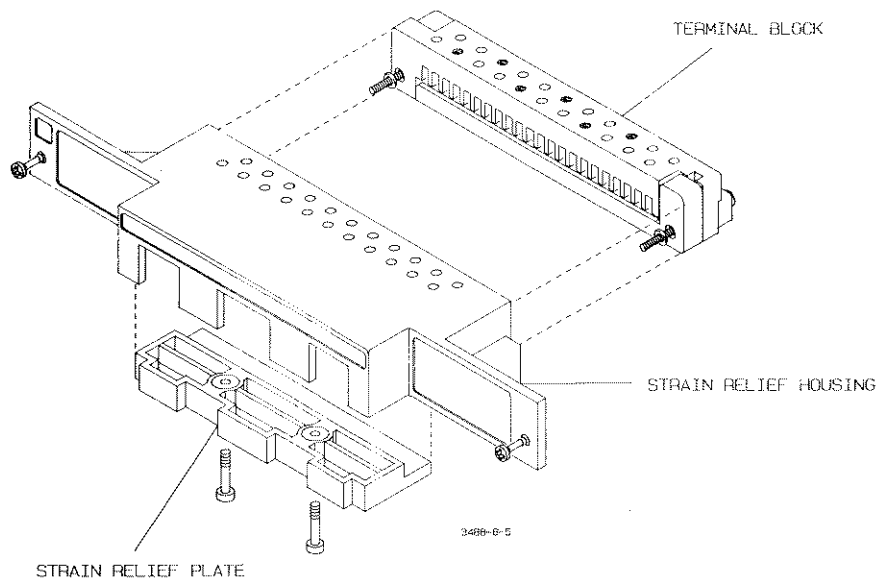

Figure 6-5. Strain Relief Housing

b. Route the wires evenly through the three strain relief cutouts. This will ensure a uniform amount of strain relief. If only a few wires are used, they should go through the middle cutout.

c. To protect wires smaller than 22AWG it is recommended that these wires be bundled together starting no more than 4" from the back of the 3488A. Failure to do so may cause wires to break at the strain relief. To illustrate the need for this, a 26AWG wire can survive about 7 to 8 pounds of tension before breaking. A bundle of 10, however, could survive up to 70 pounds of tension.

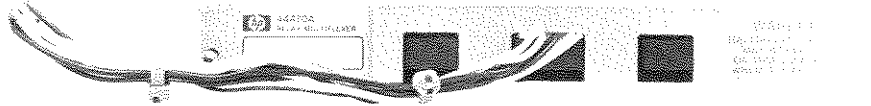

Figure 6-6. Cable Routing

d. Secure the strain relief plate to the strain relief housing (ribbed side toward housing). Do not over tighten the screws.

e. Push the terminal block with strain relief housing onto the option assembly connector. Tighten the two screws on either end of the housing.

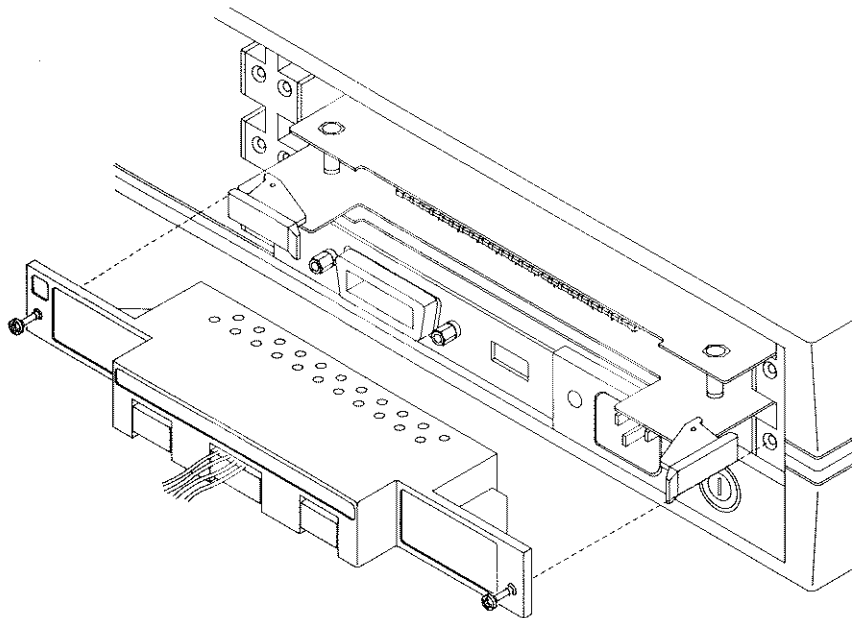

Figure 6-7. Attaching the Terminal Block

5. Labels

- a. Two labels were provided with the option assembly. One identifies the assembly as a 44470A Relay Multiplexer. There is space on the bottom of this label to type or write in a description of where this particular option is being used.
- b. Second, a series of numbered labels (1 to 5) is provided to help you identify the slot where the assembly is located. Select the appropriate number and place it in the upper left hand corner of the strain relief housing.

Configuration

Provisions have been made on the 44470A circuit board for installing simple attenuators or filter networks. An attenuator is composed of two resistors that act as a voltage divider. Three jumper locations are provided for installing components in the signal High lead, Low lead and as a shunt from High to Low. Consider the following diagram:

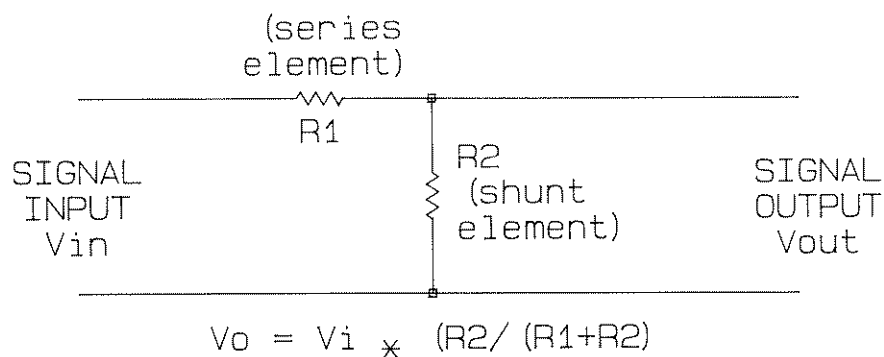

Figure 6-8. Diagram of Simple Attenuator

In order to install attenuators on the 44470A circuit board, the circuit board must be removed from the protective shields. Use caution as the 44470A assembly uses CMOS device which are susceptible to static discharge. Figure 6-9 shows the 44470A circuit board with the locations of where attenuators are to be installed.

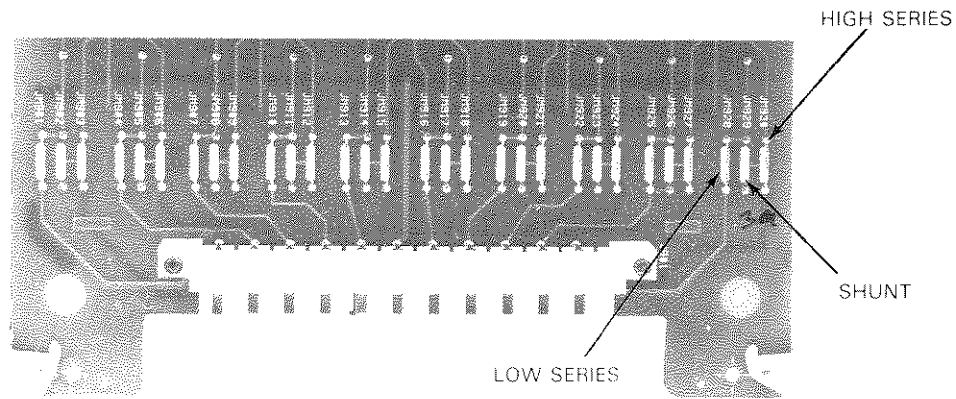

Figure 6-9. Attenuator Board Locations

One typical use for the shunt component is with 4–20 mA transducers. A 50 Ω , $\pm 1\%$, 0.5 watt resistor (-hp- part number 0699-0064) can be installed in the shunt location. The resultant voltage drop (transducer current through the resistor) can be measured by a system voltmeter. Thus, the 50 Ω resistor converts the 4–20 mA current to an 0.2 – 1 volt signal.

Accessories

-hp- part number 44480A provides an extra Screw Terminal Connector Block for the 44470A assembly.

Specifications

The specifications at the end of this chapter apply to only the 44470A assembly. These specifications are the performance standards or limits against which the assembly is tested. Do not exceed or surpass the specified limits.

Any changes in specification due to manufacturing changes, design, or traceability to the National Bureau of Standards will be covered in a manual change supplement.

Applications

The following four application examples demonstrate various uses of the 44470A Multiplexer option. Consideration should be given to your particular application before deciding which option assembly to use. The 44470A option is designed for use in measurements where noise bandwidth is not important, with a voltmeter for example. If your application requires higher isolation for noise rejection, such as with a spectrum analyzer, the 44472A VHF switch should be used.

Example 1. 4-Wire Ohms

In this example, we want to show how channel pair scanning is useful when making 4-wire ohms measurements. Two 44470A assemblies are required. Slots 1 and 2 of the 3488A will be used for the 44470A assemblies. Let's use an -hp- 3478A to make the measurements on 10 thermistors. The resistance value of the thermistors can be converted to temperature by the computer.

Connect the Ω 's sense leads of the 3478A to the common bus of one of the 44470A assemblies. It doesn't matter which assembly, but for this example, let's use the one in slot 2. Now, connect the 3478A's voltmeter input terminal to the common bus of the 44470A assembly in slot 1.

Figure 6-10 shows the voltmeter connections and how the thermistors are connected to both 44470A assemblies

A program to scan through the channels and trigger the voltmeter for the measurements is shown below. This program was written for -hp- Series 80 computers. For clarity, the program does not show the resistance to temperature conversion routine.

| | Line | Description |
|--|--------|---|
| 10 ! 4-Wire ohms example | | |
| 20 ! -HP- 85 version | | |
| 30 ! 3488A at address 709, 3478A at address 723 | | |
| 40 CLEAR 7 | | |
| 50 OUTPUT 709 ; "CPAIR 1,2, SLIS T 100-109" | 40 | CLEAR resets the 3488A and 3478A. |
| 60 OUTPUT 723 ; "H4T4" | | |
| 70 FOR I=1 TO 10 | | |
| 80 OUTPUT 709 ; "STEP" | 50 | Line 50 sets the 3488A to card pair slots 1 and 2 (CPAIR1,2) and sets the scan list for channels 100-109. |
| 90 TRIGGER 723 | | |
| 100 ENTER 723 ; A(I) | | |
| 110 NEXT I | | |
| 120 ! | | |
| 130 ! Resistance to temperature conversion routine goes here | 60 | This line programs the 3478A for 4-wire ohms measurements (H4) and trigger hold (T4). |
| 140 ! | | |
| 150 END | | |
| | 70-110 | Lines 70 through 110 set up a loop to scan through the channel list. The readings are stored in array A(I). |

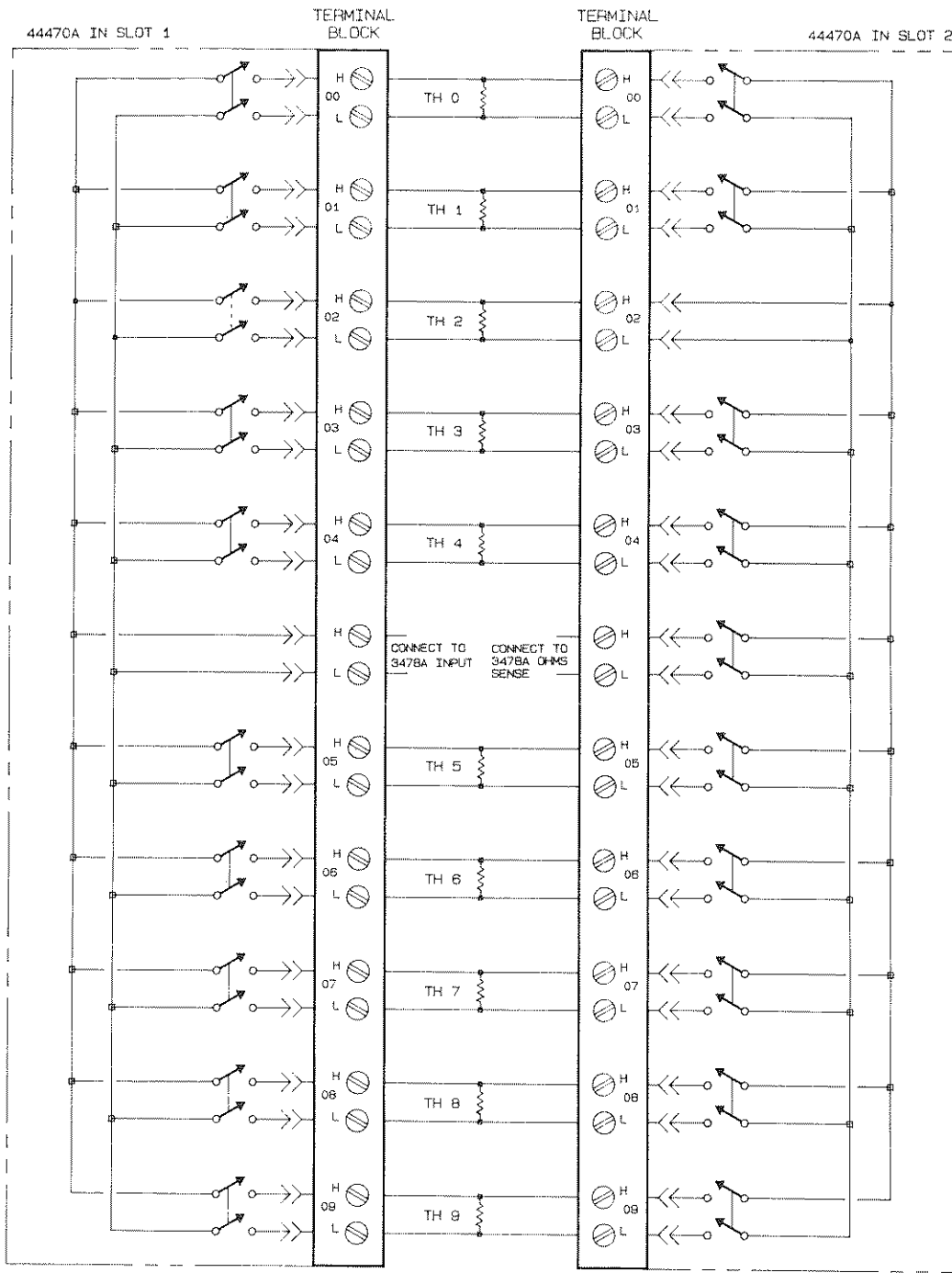

3488-B-10

Figure 6-10. 4-Wire Ohms Measurements

Example 2. Scanning Using Channel Closed

Suppose we want to scan channels 100 through 209 (44470A options in slots 1 and 2) using Channel Closed. The 44474A Digital I/O option will be in slot 5. For this example, we will again use an -hp- 3478A Digital Voltmeter.

Remember to connect both 44470A's common bus to the input terminals of the 3478A. Also, connect the 3478A's External Trigger Input port to the 44474A's Channel Closed line.

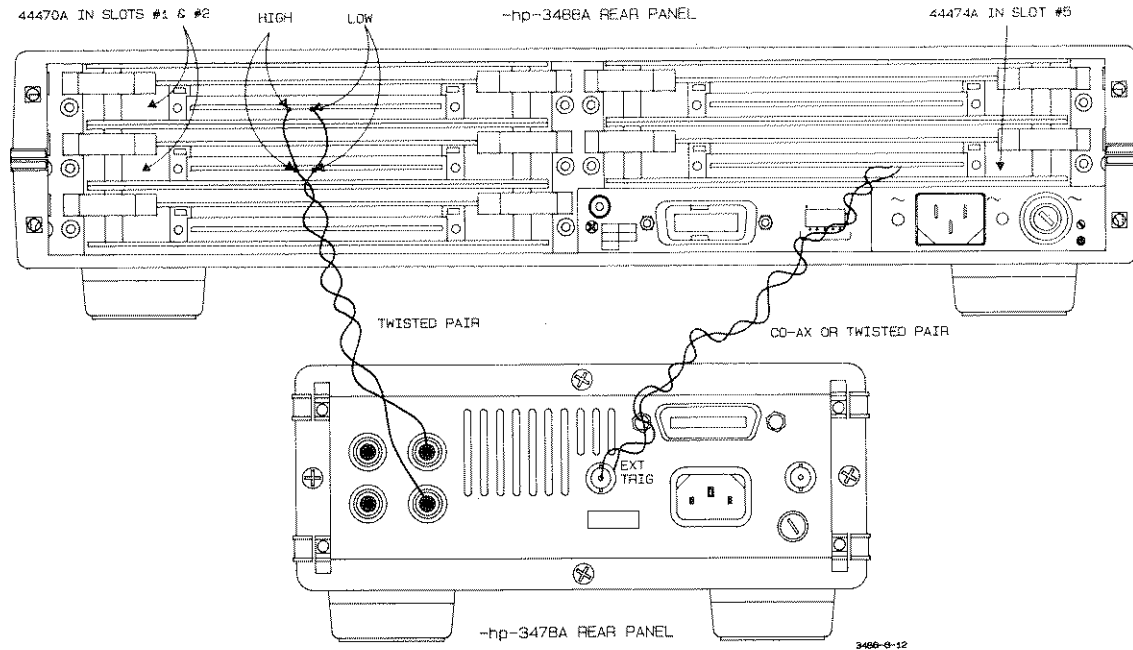

Figure 6-11. Channel Closed

The following program, written for an -hp- 85, shows the fundamental requirements for such a measurement system. Note the 3478A is triggered only by the Channel Closed pulse from the 44474A.

| Line | Description |
|---|--|
| 10 ! Channel Closed example | |
| 20 ! -HP- 85 version | |
| 30 ! 3488A at address 709, 3478 A at address 723 | |
| 40 CLEAR 7 | 40 CLEAR resets the 3488A and 3478A. |
| 50 OUTPUT 709 ;"SLIST 100-209,0 ; DMODE 5,1,1,1" | 50 This line sets the 3488A for a scan list (SLIST) on channels 100 through 209. It also enables the 44474A Digital I/O option (slot 5, mode 1, polarity 1, EI enabled) for External Increment and Channel Closed. |
| 60 OUTPUT 723 ;"H0T2" | 60 The 3478A is set to its Home mode (DC Volts, Auto-range, Single trigger, 4½ digit resolution, auto-zero on) with H0 and the External Trigger mode with T2. |
| 70 FOR I=1 TO 20 | |
| 80 OUTPUT 709 ;"STEP" | |
| 90 ENTER 723 ; A(I) | |
| 100 DISP I;A(I) | |
| 110 NEXT I | |
| 120 END | |
| 70-110 | Lines 70 through 110 set up a loop to step through the scan list. Each reading is read into array A(I). |

Example 3. Scanning Using External Increment and Channel Closed

Using a voltmeter with internal reading storage (such as the -hp- 3456A) makes the scanning even easier and faster. The main feature of this example is speed because as soon as the voltmeter completes one reading, the next channel is closed and a new reading initiated. Measurement speed is not dependent on the system computer.

Essentially, this program is the same as Example 2. Remember to connect the 44470A's common buss to the voltmeter input terminals and connect the voltmeter's External Trigger to the 3488A's Channel Closed line. Connect the 3456A's Voltmeter Complete to the 3488A's External Increment line.

The program sets the voltmeter for reading storage and then starts the scan sequence. As each reading is taken it is stored internally in the voltmeter and will be available to the computer later.

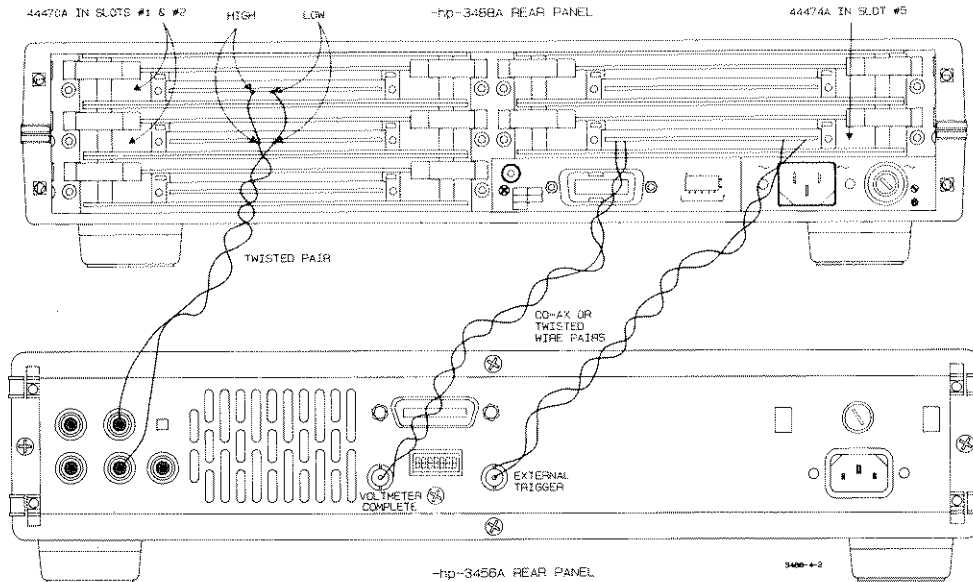

Figure 6-12. External Increment and Channel Closed

Refer to Chapter 10 for more information on setting up the Digital I/O option for External Increment and Channel Closed.

```

10 ! End of Scan sequence SRQ e
   example
20 ! -HP- 85 version
30 ! 3488a at address 709, 3456
   A at address 722
40 ON INTR 7 GOSUB 1000
50 ENABLE INTR 7;8
60 OUTPUT 709 ;"SLIST 100-209,0
   ; DMODE 5,1,0,1; MASK 1"
70 OUTPUT 722 ;"F1R1Z1T2RS1"
80 TRIGGER 709
90 GOTO 90 ! Mainline program e
   oes here
100 END
1000 P=SPOLL(709)
1010 IF BIT(P,0) THEN DISP "END
   OF SCAN REACHED"
1020 OUTPUT 722 ;"D020STR"
1030 FOR I=1 TO 20
1040 OUTPUT 722 ;"RER"
1050 ENTER 722 ; A(I)
1060 DISP A(I)
1070 NEXT I
1080 OUTPUT 722 ;"D1"
1090 STATUS 7,1 ; R
1100 OUTPUT 709 ;"STATUS"
1110 RETURN

```

Example 4. Single Ended Measurements

Using only 44470A Ten Channel Multiplexer options, a maximum of 50 channels (two wires) can be scanned for measurements. However, if you don't require the noise rejection of two wire measurements and the Lo side of all your signal sources can be connected together, you can use one 44471A and four 44470A options to provide up to 88 channels for single-ended measurements.

Figure 6-13 shows how these options are connected together in this example. Notice that all of the Hi terminals on the 44470A options connect to channel 0 on the 44471A. To measure any of the voltage sources connected to one of the Hi terminals, channel 0 on the 44471A must be closed. Furthermore, all the Lo terminals on the 44470A options connect to channel 1 on the 44471A. To measure any of

the voltage sources connected to the Lo terminals, Channel 0 must be opened and channel 1 closed. The remaining eight channels on the 44471A option can also be used for single ended measurements.

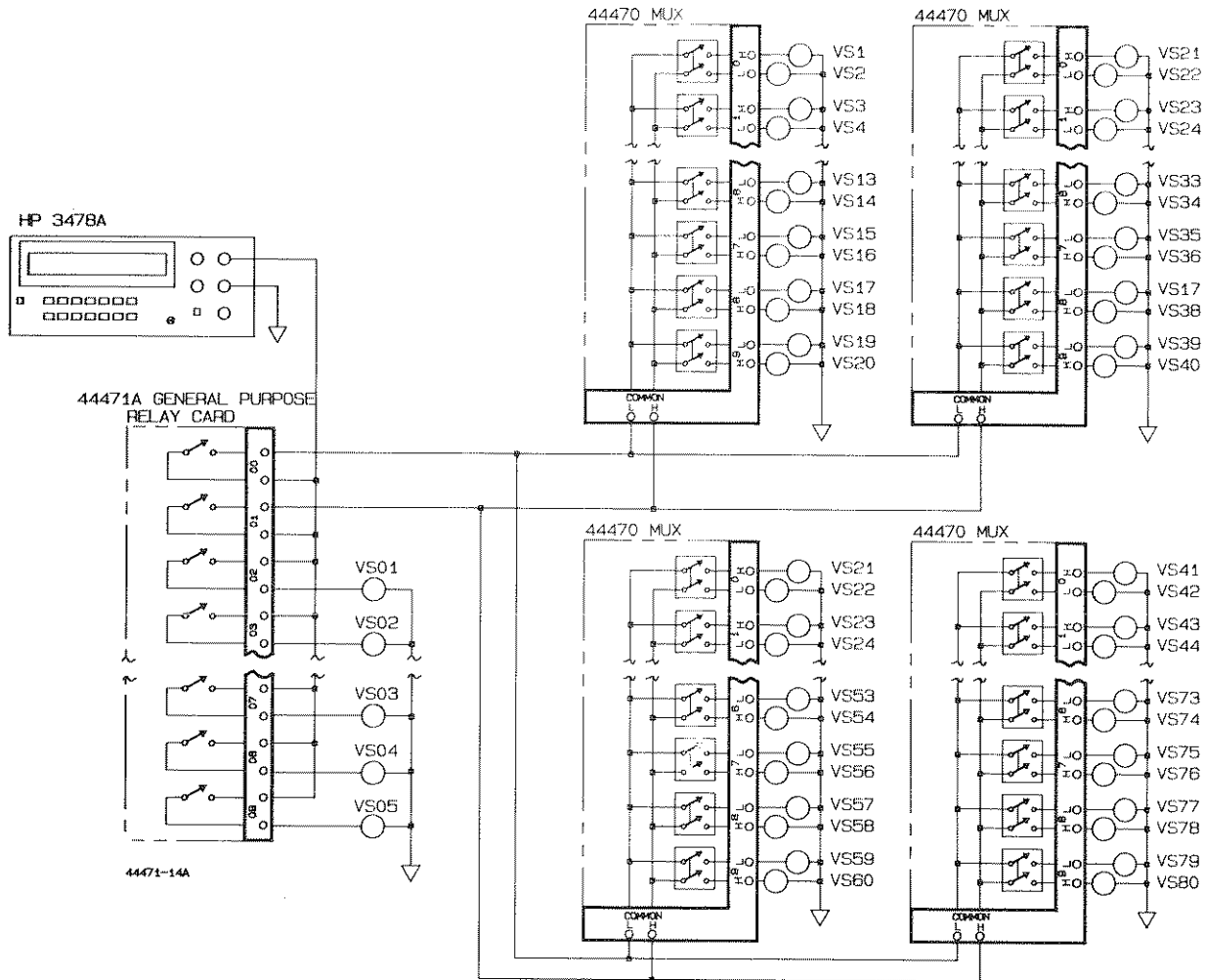

Figure 6-13. Single Ended Scanning

The associated program shows how to STEP through each of the 88 single ended channels. This program assumes that the 44471A option is mounted in slot 1 and the four 44470A's are installed in slots 2 through 5. The program uses an -hp- Model 3478A DVM for the measurements.

The program first sequences through the eight extra lines on the 44471A option (lines 50 - 90). Then, in lines 100 - 170, channel 100 is closed allowing measurements from the sources connected to the Hi terminals on the 44470A options. Finally, in lines 180 - 250, channel 100 is opened and channel 101 is closed permitting measurements from the Lo terminals on the 44470A options.

```

10 ! SINGLE ENDED SCANNING EXAMPLE
20 ! -HP- 85 VERSION WITH 3488A SWITCH AND 3478A DVM
30 ! 3488A AT ADDRESS 709, 3478A AT ADDRESS 723
40 OUTPUT 723 ;"T3"
50 OUTPUT 709 ;"SLIST 102-109,0; CMDN 1"
60 FOR I=2 TO 9 STEP 1
70 OUTPUT 709 ;"STEP"
80 TRIGGER 723
90 ENTER 723 ; A
100 PRINT "CHANNEL: ";I;"MEASUREMENT: ";A
110 NEXT I
120 ! MEASURE HI's
130 PRINT @ PRINT "HI CONNECTIONS MEASURED" @ PRINT
140 OUTPUT 709 ;"CLOSE 100; SLIST 200-509,0; CMDN -2"
150 FOR I=10 TO 50
160 OUTPUT 709 ;"STEP"
170 TRIGGER 723
180 ENTER 723 ; A
190 PRINT "CHANNEL: ";I;"MEASUREMENT: ";A
200 NEXT I
210 ! MEASURE LO's
220 PRINT @ PRINT "LO CONNECTIONS MEASURED" @ PRINT
230 OUTPUT 709 ;"OPEN 100;CLOSE101"
240 FOR I=51 TO 90
250 OUTPUT 709 ;"STEP"
260 TRIGGER 723
270 ENTER 723 ; A
280 PRINT "CHANNEL: ";I;"MEASUREMENT: ";A

```

Table 6-2. Option 010 44470A 10 Channel Relay Multiplexer Module Specifications

INPUT CHARACTERISTICS

Maximum Voltage (Terminal-terminal or terminal-chassis):
250 VDC, 250 VAC RMS, 350 VAC Peak

Maximum Current: (Per channel or module): 2 ADC, 2 AAC RMS

Maximum Power (Per channel or module): 60 W DC, 500 VA AC

Maximum power dissipated by user added components: 2 W

Thermal Offset: < 3 μ V differential or single ended

Closed Channel Resistance: < 2 Ω (end of relay life)

DC ISOLATION

| | <(40°C,60% RH) | <(40°C,95% RH) |
|--------------------------------|-----------------------------|------------------------------|
| Open Channel, Channel-Channel* | > 10 ¹¹ Ω | > 10 ⁹ Ω |
| Hi-Lo* | > 10 ¹⁰ Ω | > 10 ⁸ Ω |
| Channel-Chassis* | > 10 ¹⁰ Ω | > 5x10 ⁸ Ω |

(* with 1 channel closed)

AC ISOLATION/PERFORMANCE**

Capacitance:

| | |
|--------------------------------|---------|
| Open Channel, Channel-Channel* | < 5 pF |
| Hi-Lo* | < 27 pF |
| Channel-Chassis* | < 80 pF |

(* with 1 channel closed)

| (50 Ω termination) | 100 kHz | 1 MHz | 10 MHz |
|---------------------------|---------|--------|--------|
| Insertion Loss (dB) | < 0.20 | < 0.25 | < 0.50 |
| Crosstalk (dB) | < -73 | < -53 | < -33 |

**With chassis of all equipment connected, and with low of input lines connected to low of output lines (either directly or via 3488A switched channel).

Chapter 7

44471A

General Purpose Relay Module

Introduction

This option to the 3488A (option 011) provides 10 independent Single Pole – Single Throw (SPST, Form A) switches. Although the card will find many uses as an actuator assembly, its low thermal characteristics make it ideal for independent (non-multiplexed) signal switching.

The individual relays on this option are rated for a maximum, open circuit voltage of 250 Volts dc or ac rms. Maximum current per relay is 2 Amps dc or ac rms and maximum power per relay is 60 Watts dc or 500VA (Volt-amps) ac. Later in this manual a complete table of specifications is provided. Maximum closed channel resistance is $<2 \Omega$. Space is provided on the circuit board for adding contact protection circuits.

This chapter is designed to serve as a reference guide for using the 44471A General Purpose Relay Module. As such it contains programming information, installation, and configuration information, and application examples.

WARNING

The 3488A Option 011, 44471A Multiplexer Assembly uses latching relays. The state of these relays can only be altered under program control. This is an advantage in the sense that, under most conditions of failure, the relays will remain in whatever state your program has set them. However, in case of power or equipment failure, any application requiring a failsafe method of insuring that the circuits under control are in a known state must be provided by the installer.

In case of component failure or programming error, any voltage input to an option card may be present on any other terminal on the same option card.

Operation

Figure 7-1 shows that the 44471A General Purpose Relay Module consists of 10 independent Single Pole - Single Throw switches. More than one switch can be closed at a time. Therefore, if necessary, High and Low signal lines can be switched by using a pair of channels. An easier way of doing this, however, is to use two 44471A assemblies and use the CARD PAIR command (discussed later in this chapter).

Two modes of operation are possible, single channel break-before-make or multiple channels closed together. At turn on or reset (either from the front panel RESET key or the HP-IB CLEAR command), all relays on the 44471A will be opened.

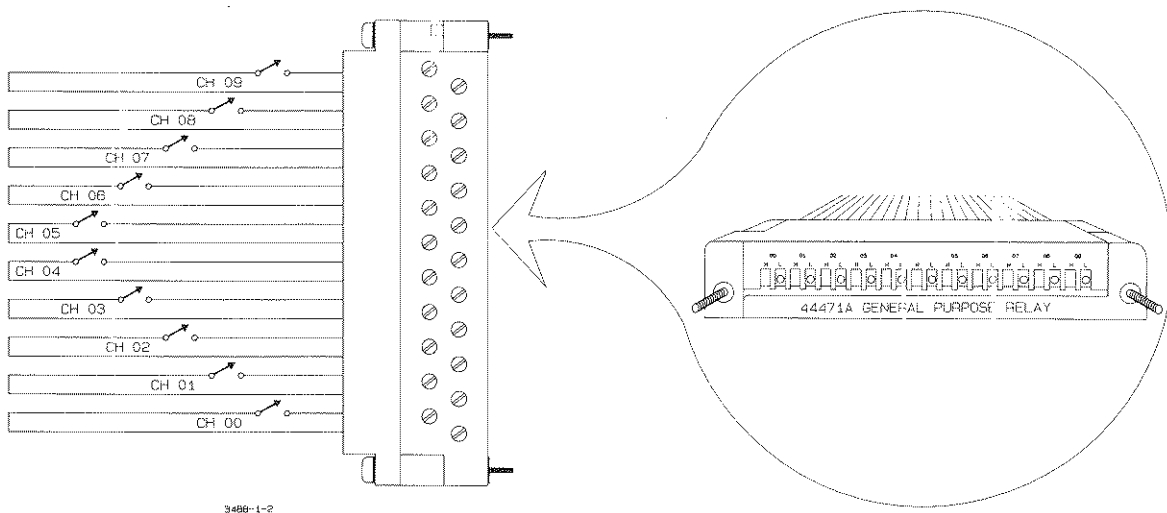

Figure 7-1. 44471A Simplified Schematic

Channels

A channel, as described in Chapter 2, refers to an individual relay, in this case a relay on the 44471A assembly. Therefore, when speaking of closing a channel, we are referring to closing a particular relay. Channel numbers are two digit numbers 00 through 09 and are repeated on each 44471A assembly. This can be seen by the numbering on the Terminal Block Edge Connector.

Channel addresses, on the other hand, are determined by which slot the 44471A assembly is installed in. Channel addresses are a three digit number where the first digit specifies the particular slot where the 44471A option is installed. The last two digits are the channel number. For example, channel address 102 means slot 1, channel 02.

The following table shows the channel addressing scheme for the five different slots.

Table 7-1. Channel Addressing Scheme

| Channel number as shown on the terminal block | Channel address if 44471A assembly is in slot number: | | | | |
|---|---|--------|--------|--------|--------|
| | Slot 1 | Slot 2 | Slot 3 | Slot 4 | Slot 5 |
| 00 | 100 | 200 | 300 | 400 | 500 |
| 01 | 101 | 201 | 301 | 401 | 501 |
| 02 | 102 | 202 | 302 | 402 | 502 |
| 03 | 103 | 203 | 303 | 403 | 503 |
| 04 | 104 | 204 | 304 | 404 | 504 |
| 05 | 105 | 205 | 305 | 405 | 505 |
| 06 | 106 | 206 | 306 | 406 | 506 |
| 07 | 107 | 207 | 307 | 407 | 507 |
| 08 | 108 | 208 | 308 | 408 | 508 |
| 09 | 109 | 209 | 309 | 409 | 509 |

Commands

Most of the 3488A commands can be used in controlling the 44471A assembly. In addition to the standard 3488A commands, two HP-IB interface commands can also affect the use of the 44471A. All of these commands are described using a simple format of explanation.

In the following summary of command descriptions, square brackets ([]) indicate optional parameters, whereas items in <> brackets are mandatory. For further explanation of the command code mnemonics, refer to Chapters 2 and 3.

CLOSE a channel

Command Format: CLOSE <ch. address>[,<ch. address>,<ch. address>,...]

Description

The CLOSE command is used to simply close one or more channels on the 44471A. Note that the CLOSE command does not open any channels that were previously closed. Several channels can be closed with one CLOSE command by separating the channel addresses with a comma; channels are closed in the order listed.

Examples

OUTPUT 709;"CLOSE 102,103,105" ! Closes channels 2, 3, and 5 in slot number 1

OUTPUT 709;"CLOSE 104,305" ! Closes channel number 4 in slot 1 and channel number 5 in slot 3.

OPEN a channel

Command Format: OPEN <ch. address>[,<ch. address>,<ch.address>...]

Description

OPEN is used to open individual channels on the 44471A assembly. If more than one channel is specified in the OPEN list, channels are opened in the order listed. Use the CARD RESET command to open all channels on an assembly. It is easier than listing each channel individually.

Examples

OUTPUT 709; "OPEN 103,105,107" ! Relays 3, 5, and 7 are opened in slot
number 1

VIEW a channel

Command Format: VIEW <ch. address>

Description

The VIEW command is used to look at the state (either open or closed) of a particular channel. The 3488A responds with the string "OPEN 1" if the specified channel is open. If the specified channel is closed, the 3488A responds with the string "CLOSED 0". In the 3488A display, the channel address is displayed followed by a colon and the appropriate string.

Example

10 OUTPUT 709; "VIEW 105" ! VIEWs channel 5 on slot number 1
20 ENTER 709;A\$! input the response from the 3488A
30 DISP A\$! A\$ will either be "OPEN 1" or "CLOSED 0"

CARD TYPE

Command Format: CTYPE <slot>

Description

This command causes the 3488A to respond with a description of what type of option card is located in the specified slot. The description includes the name of the card as well as the option number. In the display, the description is preceded by the specified slot number.

| Card Type | Description |
|------------------------|------------------|
| Slot is empty | NO CARD 00000 |
| 10 Channel Multiplexer | RELAY MUX 44470 |
| General Purpose Card | GP RELAY 44471 |
| High Frequency Scanner | VHF SW 44472 |
| Matrix Card | MATRIX SW 44473 |
| Digital I/O Card | DIGITAL IO 44474 |
| Breadboard Card | BREADBOARD 44475 |

Example

```
10 OUTPUT 709; "CTYPE 3"      ! look for the card in slot 3
20 ENTER 709; A$
30 DISP A$                    ! Card description will be displayed
```

CARD RESET

Command Format: CRESET <slot>[,<slot>,...]

Description

RESET is used to reset all channels on the 44471A assembly to their open state. Only cards in the slots specified are affected.

Example

```
OUTPUT 709; "CRESET 2"      ! resets the option assembly in slot 2
```

CARD PAIR

Command Format: CPAIR <slot>,<slot>

Description

CARD PAIR is used to pair up two option assemblies of the same type, e.g., 44471A's. This operation will effectively assign both options to both slot numbers so that closing or opening a channel on either option will perform the same operation on the respective channel on the other option.

Commands used with the Card PAIR function are: OPEN, CLOSE, CRESET, CHAN and STEP. Of course, paired slots can be used as part of a scan list.

Executing a CPAIR command cancels any previous CPAIR command that involved either of the two options. It is possible, however, to have two sets of card pairs, e.g. slot 1 paired with 2 and slot 3 paired with 4.

Example

```
OUTPUT 709;"CPAIR 1,3" !sets the options in slots 1 and 3 as pairs
OUTPUT 709;"CLOSE 105" !closes channels 105 and 305 simultaneously
```

Executing the CPAIR command without specifying any slot numbers allows you to determine which, if any, slots are paired together. Four numbers are returned separated by commas. The first two specify slots in the first pair, the second two numbers specify the second pair. An inactive card pair is denoted by 0,0.

Example

```
OUTPUT 709; "CPAIR"
ENTER 709; A$
DISP A$
```

String variable A\$ will have the four slot numbers.
Note, you may have to dimension A\$ to 30

SCAN LIST

Command Format: SLIST [<ch. address>(, or -)<ch.address> . . . <ch. address>]

Description

Scan LIST allows you to specify a sequence of channels to be scanned. The sequence is specified as a list of up to 85 channel addresses (relay or Digital I/O lines) and/or stored setups separated by commas. Contiguous channels may be specified by entering the first and last channel addresses separated by a hyphen. STEP is used to sequentially close channels in the list.

Example

```
10 OUTPUT 709;"SLIST 104,205, 300-309, 403,0"  
20 FOR I= 1 TO 14  
30 OUTPUT 709; "STEP"  
40 NEXT I
```

In this example, the scan would start with channel 104, followed by channel 205, then channels 300, 301, 302, ... 309, and finally channel 403. The 0 channel specified at the end of the list is a stop channel and opens the last channel closed (channel 403) but does not close any other channel.

Notes

1. Channels may be scanned in any sequence, i.e., 309-300.
2. Stepping beyond the last channel specified in the Scan List causes a wrap-around to the first channel in the list. The number 0 can be used as a stop channel.
3. Refer to the Advanced Operations section in this chapter for information on using the External Trigger and Channel Closed features.
4. The commands OPEN, CLOSE, CRESET, or RECALL will have no effect on the scan list even though the state of individual channels may change.
5. Stored setups may be recalled as part of a Scan List simply by specifying the register number. For example, SLIST 104,105,106,25,200,201. Here, register 25 has the stored setup.

STEPping through the Scan List

Command Format: STEP

Description

STEP is used to open the last channel closed and close the next channel in the Scan List. If STEP is executed and no Scan List exists, the 3488A will generate an error.

The 3488A uses a pointer to keep track of which channel in the Scan List is currently closed. When STEP is executed, that channel is opened and the next item in the list is checked. If the next item in the list is a relay or Digital I/O line, that channel is closed. If the next item in the list is a stored setup, that setup is recalled. Channels that are closed as part of a stored setup will remain closed, that is, they are not opened by the next execution of the STEP command.

For information on External Increment and Channel Closed, refer to the Advanced Operation section of this chapter.

Example

```
10 OUTPUT 709; "SLIST 100-109;CMON 1"  
20 FOR I=1 TO 10  
30 OUTPUT 709;"STEP"  
40 NEXT I
```

CHANnel Command

Command Format: CHAN [<ch. address>]

Description

CHAN is used to open the last channel closed by either STEP or CHAN (whichever was most recent) and close the specified channel. If no channel is specified with CHAN, the 3488A will respond with the last channel closed by either STEP or CHAN. If no channel has been closed since the last reset, then CHAN returns the number 0.

If a Scan List is in effect when CHAN is executed, the 3488A will search through the list and position the Scan List pointer to the channel specified by CHAN. If CHAN specifies a channel that is not in the Scan List, and the STEP is executed, the 3488A will open the channel closed by CHAN and then go to the beginning of the Scan List.

Example

OUTPUT 709; "CHAN 105" ! Closes channel 105

OUTPUT 709; "CHAN"

ENTER 709; A\$

DISP A\$! A\$ will contain the last channel closed, i.e., 105

CARD MONITOR mode

Command Format: CMON <slot>

Description

Card Monitor is used to look at the state of the individual option assemblies in the specified slot (1 – 5). Specifying slot 0 will cause the monitor mode to be cancelled. If a negative number is used for the slot, the 3488A will go to its monitor tracking mode.

When used to monitor the 44471A assembly, the display shows the slot number (extreme left) and those channels that are closed, separated by commas. The MONitor annunciator also comes on.

Example

OUTPUT 709;"CLOSE 102,103,107; CMON1"

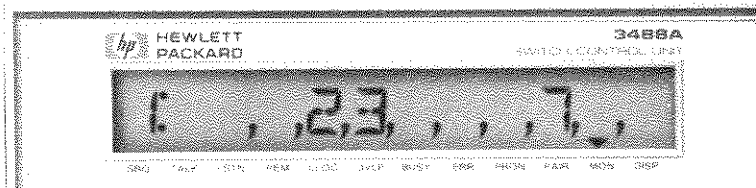

This photo shows slot 1, channels 2, 3 and 7 closed.

The format of the display can be summarized as:

s: n,n,n,n,n,n,n,n,n

where s represents the slot number being monitored and n is a channel number.

Advanced Operations

Advanced Operations provide you with more capabilities when using the 3488A. It may be important, for example, to tell the system voltmeter when a channel has been closed and thus take a measurement. Or maybe you need to close the next channel in a scan list when some external event has taken place, perhaps as soon as the voltmeter has completed its reading. Most operations can be performed with only the basic commands, but for those times when you need something more, the advanced operations should meet your switching needs.

External Increment and Channel Closed

External Increment (EI) provides a method of sequencing through a Scan List without system computer intervention. Typically, EI is connected to the Voltmeter Complete* output on a system voltmeter. Thus, when the voltmeter has completed its measurement, it signals the 3488A to step to the next channel in the list. The EI input is rising-edge triggered and TTL compatible.

Channel Closed (CC) provides a 15 μ S TTL pulse for signalling when a channel has been closed in the 3488A. This signal can be tied to the External Trigger input of a voltmeter to trigger it when a channel is closed. Together, EI and CC can be used with a system voltmeter to sequence through a scan list without any intervention by the system computer.

Using the External Increment and Channel Closed features requires the use of a 44470A Digital I/O option. This also means that the Digital I/O option cannot be configured in Handshake Mode #5 when it is used for scanning (it can be used statically, however). The DMODE command is used to specify the handshake mode, Polarity and EI. Only one Digital I/O option can be configured for EI at a time. If one option is configured to accept EI and another is subsequently enabled, the first card will be disabled.

Even though the only specifier we are interested in is EI, the mode and polarity specifiers must be included. The format for specifying DMODE is as follows:

```
DMODE <slot>[, <mode>][, <polarity>][, <EI>]
```

* Voltmeter Complete is a feature found on most Hewlett-Packard digital voltmeters to signal the completion of a measurement by means of a TTL compatible pulse.

The MODE specifier is as follows:

| Definition | Value |
|---------------------------|-------|
| Static Mode | 1 |
| Static Mode for read back | 2 |
| R/W & Strobe | 3 |
| RD & WT Strobe | 4 |
| HAndshake (no EI) | 5 |

Any of the Modes may be specified for use with External Increment except the Handshake Mode (value 5).

The Polarity specifier is the sum of weighted values and is defined as follows:

| Definition | Value |
|-----------------------------|---------------------|
| Lower 8-bits polarity | 1 = Low true |
| Upper 8-bits polarity | 2 = Low true |
| PCTL Polarity | 4 = Low busy |
| PFLG Polarity | 8 = Low busy |
| I/O Direction line Polarity | 16 = Low input mode |

EI is enabled by specifying 1. It is disabled with a specifier of 0.

Refer to Chapter 10 for more information on setting up the 44474A Digital I/O option for External Trigger and Channel Closed.

Delay

Command Format: DELAY [<time in mS>]

Description

The DELAY command is used to insert a time delay between the time that a channel is closed and the time the next command can be executed and the channel closed pulse is output. The delay time may be specified from 0 to 32,767 mS (32.767 seconds) in 1 mS increments. The delay time does not become effective until either CHAN or STEP is executed.

If any command is sent to the 3488A during the delay time, the command will be executed as soon as the delay time is complete. If there is not a time value sent with the DELAY command, the 3488A will respond with the current value of the delay time.

Remember that the Channel Closed pulse will use whichever 44474A assembly has External Increment enabled.

Examples

OUTPUT 709; "DELAY 45" ! The delay time is 45 mS = .045 Sec.

OUTPUT 709; "DELAY"

ENTER 709; A

DISP A ! Variable "A" will show the current delay value.

HP-IB Interface Commands

Only two interface commands affect the state of the 44471A channels: TRIGGER (Group Execute Trigger) and CLEAR (Device Clear or Selected Device Clear). TRIGGER performs the same function as the 3488A STEP command. In other words, the two commands:

TRIGGER 7 (or TRIGGER 709)

and

OUTPUT 709; "STEP"

perform the same function as far as the 44471A assembly is concerned.

CLEAR, whether a Device Clear or Selected Device Clear, simply resets the 3488A and hence all relays will go to their open state.

44471A Assembly Installation

This portion of the chapter is written specifically for the service trained technician. It provides the necessary information for a person trained in electronic circuitry to configure and install the option assembly. Carefully read through this section and adhere to all cautions and warnings.

WARNING

Only qualified service trained personnel should remove, configure, or install the 3488A option assemblies. Disconnect the 3488A power cord from the back of the instrument prior to installing the option assemblies.

The 3488A Option 011, 44471A Relay Multiplexer, uses latching relays. The state of these relays can only be altered under program control. This is an advantage in the sense that, under most conditions of failure, the relays will remain in whatever state your program has set them. However, in case of power or equipment failure, any application requiring a failsafe method of insuring that the circuits under control are in a known state must be provided by the installer.

In case of component failure or programming error, any voltage input to an option card may be present on any other terminal on the same option card.

When you initially received your 3488A, the option assemblies were not installed in the mainframe. Each option assembly was packaged separately along with a terminal block edge connector and a two piece strain relief housing. In addition, two labels were provided for option identification.

CAUTION

Use clean handling and anti-static procedures when removing, configuring and installing the option assemblies. The circuit boards must be kept clean to ensure compliance with impedance specifications. The option assemblies as well as the 3488A mainframe contains CMOS devices which are susceptible to static discharges.

A few simple steps are required to install the 44471A assembly. Carefully observe to orientation of the assembly and terminal block as you install them.

1. Pre-installation

- a. Remove the ac power cord from the 3488A before installing any option assembly.
- b. Face the rear panel of the 3488A toward you.
- c. Select a slot. Refer to Figure 7-2, the 3488A has five slots for installing option assemblies. The 44471A can be used in any of the five slots.

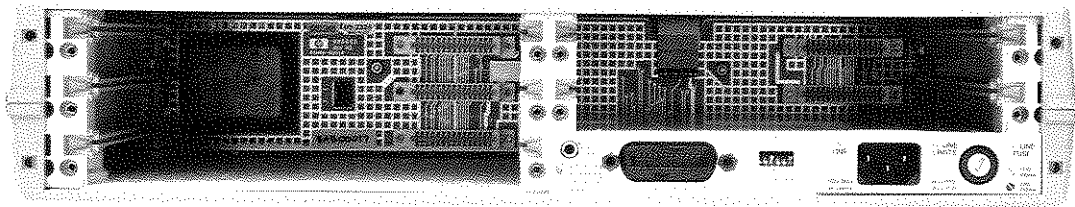

Figure 7-2. Rear Panel View of the 3488A

2. Option assembly installation

- a. Hold the option assembly, component side down, by the metal shields. Insert the circuit card into the slot guides and slide toward the front of the instrument. Push firmly until the assembly 'snaps' into place. Fold the plastic levers next to the assembly. These levers lock the option into the mainframe.

NOTE

To remove the option assembly, simply unfold the plastic tab levers. This will release the locking mechanism and pull the option out of the mainframe connector.

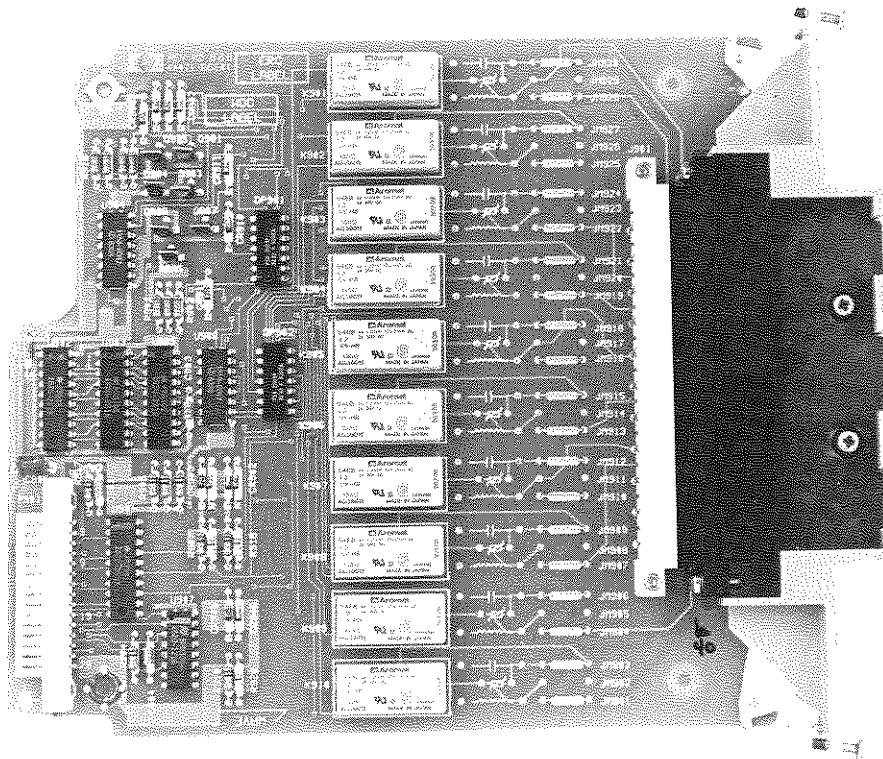

Figure 7-3. Option Card

3. Terminal Block Wiring

a. Wire the Terminal Block Edge Connector. The following photograph shows the channel connection sequence for the 44471A Terminal Block Edge Connector. This terminal block is keyed to fit only the 44471A assembly. Extra terminal blocks are available under the -hp- part number 44481A. This terminal block was designed to accept wires in the range of 18 to 26 AWG.



Figure 7-4. Terminal Block

4. Strain Relief

a. Secure the terminal block to the strain relief housing with the captive screws on the terminal block. Make certain that the screws used to tighten the connector wires to the terminal block are accessible through the strain relief housing.

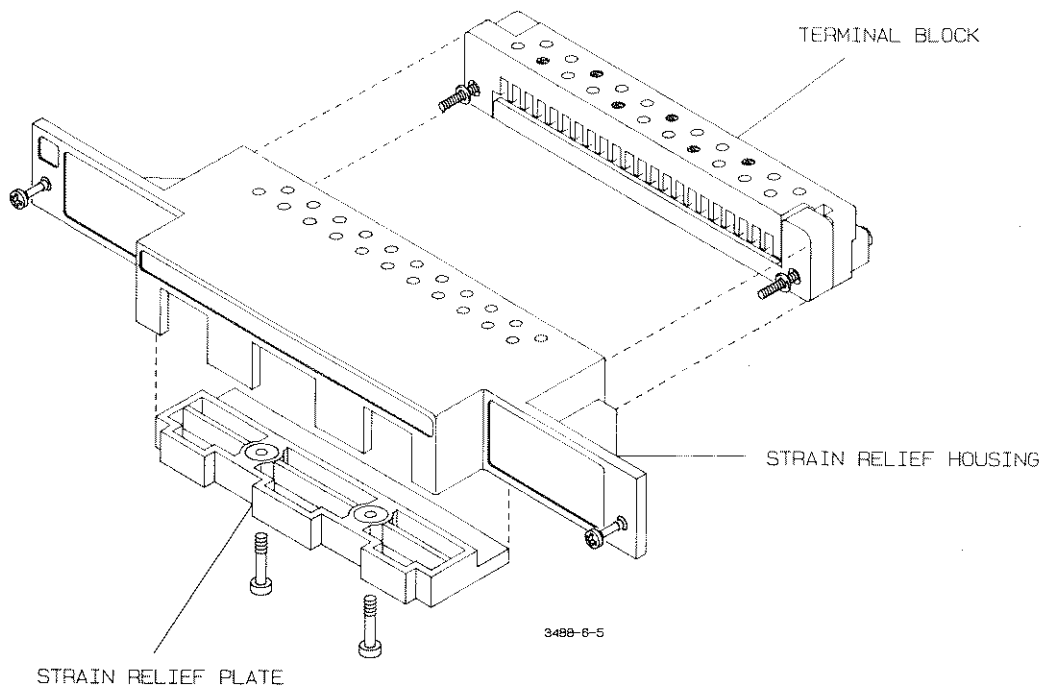

Figure 7-5. Strain Relief Housing

- b. Route the wires evenly through the three strain relief cutouts. This will ensure a uniform amount of strain relief. If only a few wires are used, they should go through the middle cutout.
- c. To protect wires smaller than 22AWG it is recommended that these wires be bundled together starting no more than 4" from the back of the 3488A. Failure to do so may cause wires to break at the strain relief. To illustrate the need for this, a 26AWG wire can survive about 7 to 8 pounds of tension before breaking. A bundle of 10, however, could survive up to 70 pounds of tension.

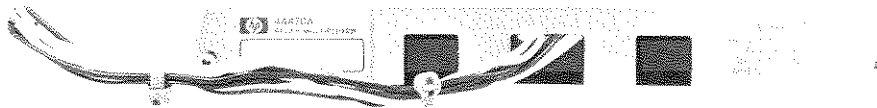

Figure 7-6. Cable Routing

- d. Secure the strain relief plate to the strain relief housing (ribbed side toward housing). Do not over tighten the screws.
- e. Push the terminal block with strain relief housing onto the option assembly connector. Tighten the two screws on either end of the housing.

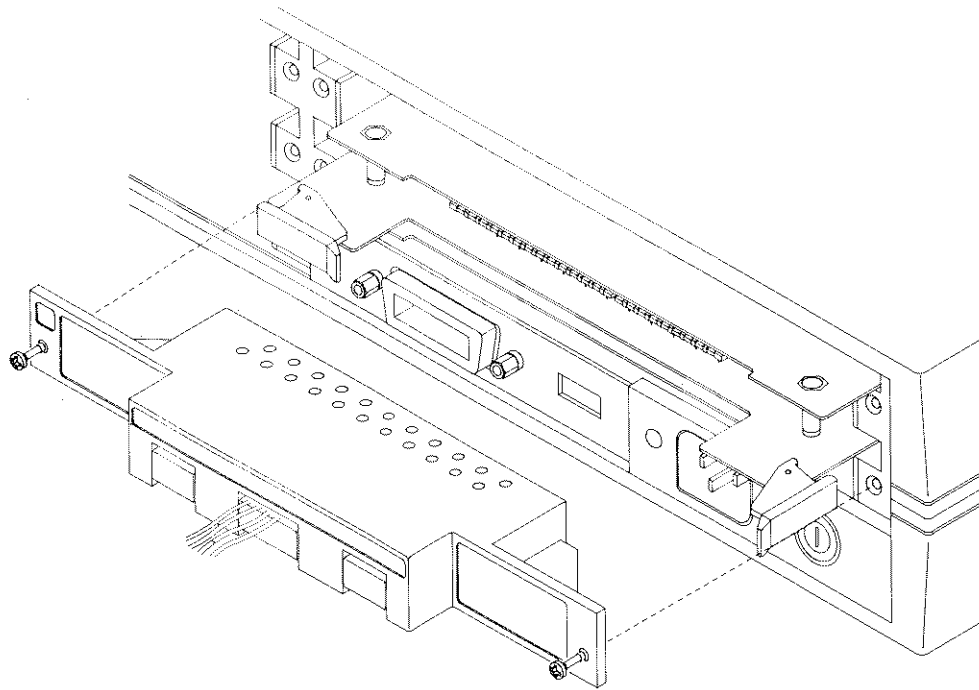

Figure 7-7. Attaching the Terminal Block

5. Labels

- a. Two labels were provided with the option assembly. One identifies the assembly as a 44471A Relay Multiplexer. There is space on the bottom of this label to type or write in a description of where this particular option is being used.

- b. Second, a series of numbered labels (1 to 5) is provided to help you identify the slot where the assembly is located. Select the appropriate label and place it in the upper left hand corner of the strain relief housing.

Configuration

Whenever relay contacts open or close, electrical breakdown can occur between the contacts. This can cause high frequency radiation, voltage and current surges, and physical damage to the relay contacts.

Provisions have been made on the 44471A circuit board for installing simple protection networks. These simple networks provide contact protection when actuating ac power line for inductive loads.

Although many types of contact protection networks can be used, only RC networks and varistors are described here. Refer to Figure 7-8.

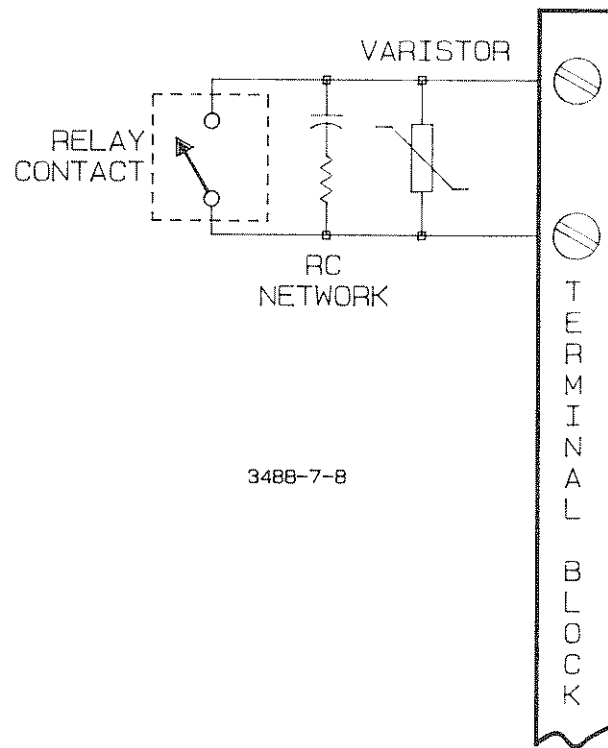

Figure 7-8. Contact Protection Networks

In designing RC protection networks, the protection resistor R_p is selected as a compromise between two values. The minimum value of R_p is determined by the maximum acceptable relay contact current (I_o). Referring to the specification table for this option, we find that the maximum allowable relay current (I_o) is 2 Amps ac rms or 2 Amps dc. Thus, the minimum value for R_p is V/I_o , where V is the peak value of the supply voltage.

$$R_p = V/I_o = V/2 \quad \text{Equation 1}$$

The maximum value for R_p is usually made equal to the load resistance, R_l . Therefore, the limits on R_p can be stated as:

$$V/I_o < R_p < R_l \quad \text{Equation 2}$$

Note, the actual value of I_o in a circuit is determined by the equation:

$$I_o = V/R_l \quad \text{Equation 3}$$

Where V is the peak value of the source voltage and R_l is the resistance of the load. Equations 1 and 2 use I_o as the maximum allowable relay current to determine the minimum value of R_p . The value for I_o calculated in Equation 3 will be used to determine the value of the protection capacitor, C_p .

In determining the value of the protection network capacitor C_p , there are several things that need to be considered. First, the total circuit capacitance (C) must be such that the peak voltage across the open relay contacts does not exceed 353 Volts peak ($250V_{rms} = 353 V_p$). The equation for determining the minimum allowable circuit capacitance is:

$$C \geq (I_o/353)12L \quad \text{Equation 4}$$

where L = the inductance of the load and I_o is the value calculated in Equation 3.

In reality, the total circuit capacitance (C) is made up of the wiring capacitance plus the value of the protection network capacitor C_p . Therefore, the minimum value for C_p should be the value obtained for the total circuit capacitance, C , from equation 3. Indeed, the actual value used for C_p should be substantially greater than the value calculated for C .

Let's work through an example and see what the typical values for an RC protection network might be. Our circuit is shown in Figure 7-9. The load is a small ac motor running off of a 120V ac line (170 V peak). This motor draws a maximum of 2 amps.

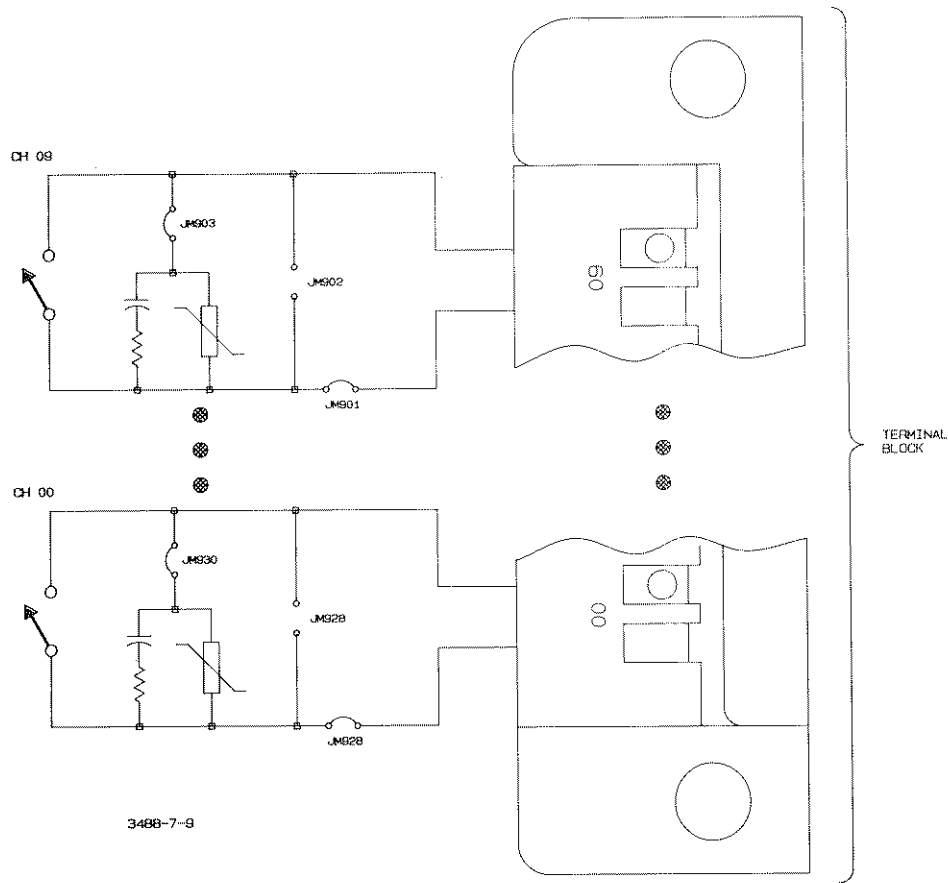

Figure 7-9. RC Protection Network

Using Equation 1 we can find the minimum value for R_p :

$$R_p = V/I_o = 170/2 = 85 \Omega$$

The maximum value for R_p would be equal to the load resistance or 400Ω . Therefore, any resistor (preferably at least 1 watt) between 85 and 400Ω 's will suffice.

To keep the peak contact voltage below $353V$ peak, use equation 3 to determine I_o :

$$I_o = V/R_1 = 170/400 = .425 A$$

Now use equation 4 to determine C :

$$C \geq (I_o/353)12L = (0.425/353)12(0.1) = 0.144 \mu F$$

Since R_p can vary between 85Ω 's and 400Ω 's, an appropriate protection network to be connected to this circuit is $R_p = 220 \Omega$'s and $C_p = 0.15 \mu F$.

Figure 7-10 shows where protection networks should be mounted on the 44471A circuit assembly. Note that with the RC network in shunt (parallel) with the the relay contacts, there is a loss of high isolation when the relay is open. Remember that only qualified service trained personnel should remove, configure, or install the option assemblies.

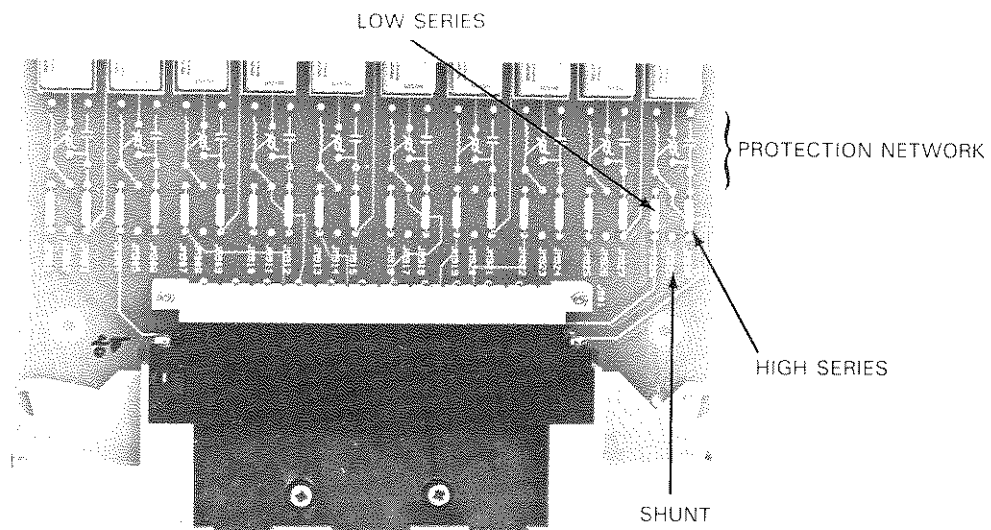

Figure 7-10. Locations for Protection Networks

Using Varistors

Just as contact protection circuits are important to suppress noise while relay contacts are opening and closing, transient protection should also be provided while the relays are open. This is the purpose of the varistor. When selecting a varistor, make certain that it has a voltage rating sufficient for your application. A typical 250 VAC varistor can be purchased from Hewlett-Packard with the part number 0837-0227.

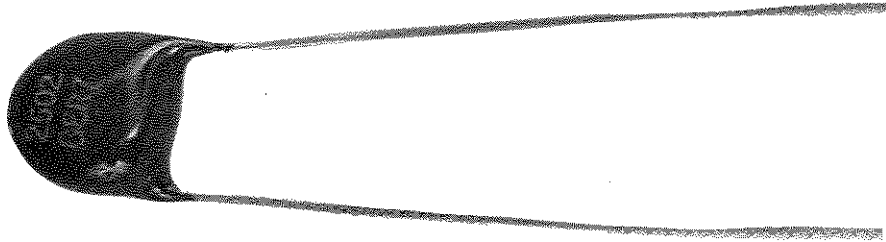

Figure 7-11. Varistor

CAUTION

When the 44471A option is used to switch power sources capable of delivering more than 2 amps, an external 2A fuse should be used to prevent accidental damage to the 44471A.

Accessories

-hp- part number 44481A provides an extra Screw Terminal Connector Block for the 44471A assembly.

Specifications

The specifications at the end of this chapter apply to only the 44471A assembly. These specifications are the performance standards or limits against which the assembly is tested. Do not exceed or surpass the specified limits.

Any changes in specifications due to manufacturing changes, design, or traceability to the National Bureau of Standards will be covered in a manual change supplement.

Application Examples

Example 1. Using the 44471A as an Actuator

One primary use of the 44471A General Purpose Switch is voltage switching for applications with 500VA or less. This example shows how to use the 44471A in two different applications: Low voltage switching (not requiring a snubber circuit) and High voltage switching requiring a snubber circuit.

Low Voltage Switching Procedure

Figure 7-12 shows two simple ways the 44471A can be used to switch operating power to low voltage devices. The top diagram illustrates how the relay switch is used to complete a circuit and sound the alarm. To sound the alarm, execute, CLOSE 100. (The 44471A Assembly is installed in slot 1 of the 3488A.) To turn off the alarm, execute OPEN 100.

The lower diagram demonstrates switching DC voltage (+5V) to operate some device. A typical application where this type of switching might be used is to supply operating power to a device under test. To apply power to the device, execute CLOSE 101. To remove operating power, execute OPEN 101.

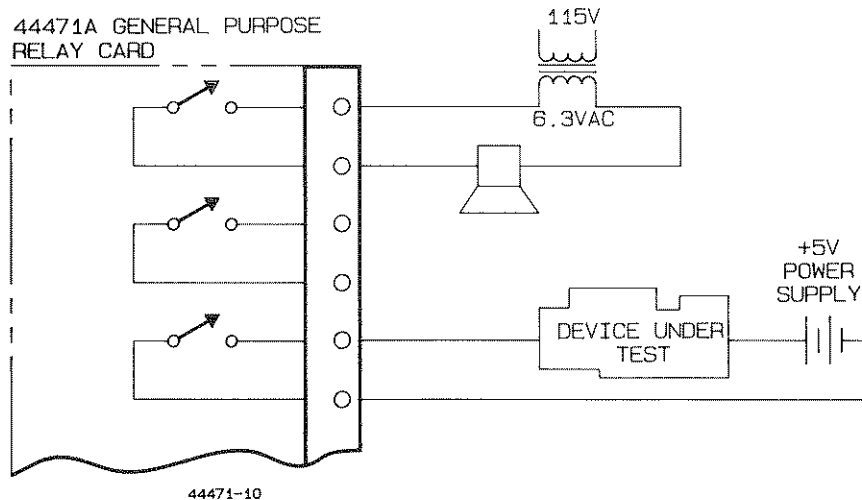

Figure 7-12. Low Voltage Actuator

High Voltage Switching Procedure

Since the relays on the 44471A can handle voltages up to 250V rms at 2 amps, it is ideally suited for switching ac line voltages to items such as air solenoids, lights, and motor starters. In this example we will see how the 44471A is used to control (turn on) motor starters.

Although the 44471A can directly control motors up to 2/3 horsepower, the range of motors it can handle can be greatly increased by using motor starters. This option assembly can be used to control the motor starter, essentially supplying the voltage to turn the starter on.

Generally, motor starters are only turned on for a short period of time. After that, the motor runs by itself and is turned off by some external circuit. In this example, the internal timer in the computer will be used to determine the "on" time of the motor starter: 3 seconds. Figure 7-13 shows a typical connection diagram and computer (BASIC) program.

CAUTION

Although a specific contact protection network (snubber circuit) is shown, you should consult the Configuration section of this manual before attempting to run the program and provide adequate contact protection for your particular circuit.

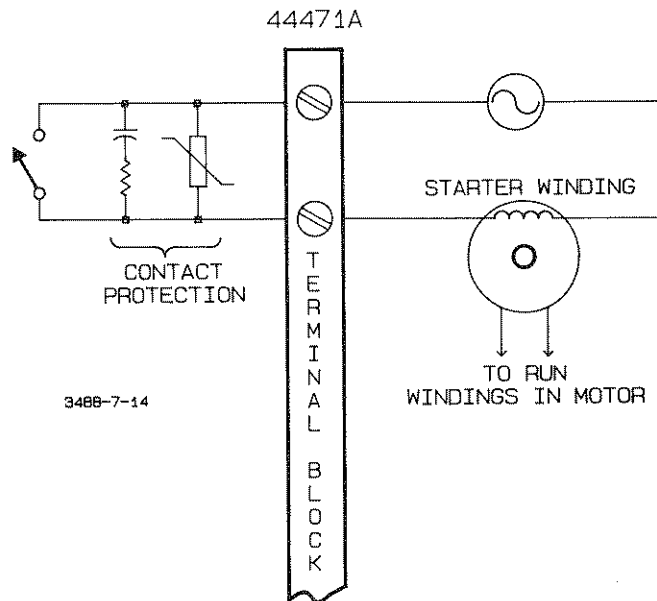

Figure 7-13. High Voltage Actuator

Example 2. Using the 44471A as a Resistance Programmer

Many types of power supplies and other electronic equipment use external resistor networks to "program" the output voltage. Change the external resistors and a change in out results. The 44471A provides an elegant solution to programming these types of devices.

Up to 1024 different values can be programmed by using only one 44471A assembly and 10 resistors. As shown in Figure 7-14, the relay contacts are wired in series with each other and in parallel with a string of binary weighted resistors. Any combination of channels may be closed providing the 1024 different possibilities.

For example, to select the 10 Ω resistor, close all relays except channel 0. To select the 20 Ω resistor, close all relays except channel 1. If you need 30 Ω , close all relays except channels 0 and 1 (10 Ω plus 20 Ω = 30 Ω). In this way, by selectively opening and closing combinations of channels, virtually any resistance value from 0 Ω to 1024 Ω (in 10 Ω increments) can be developed.

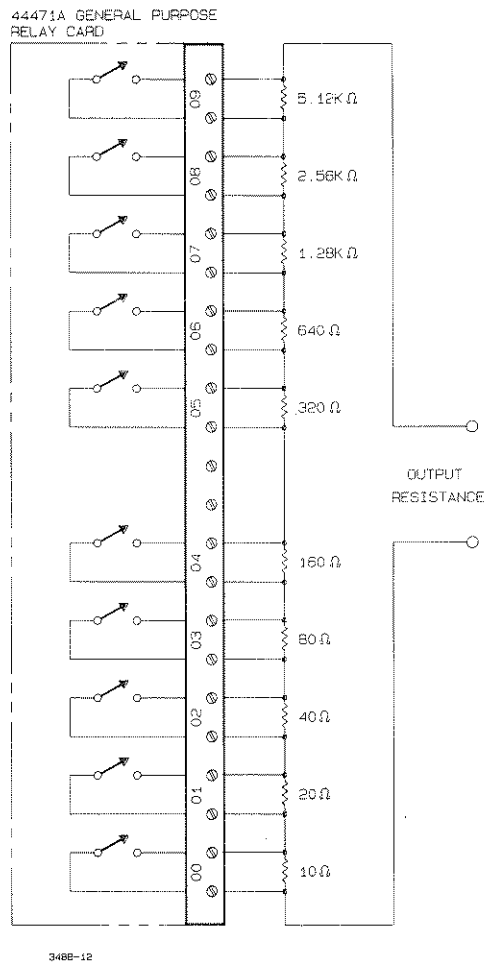

Figure 7-14. Binary Resistance Programming

There are many variations in this basic circuit. For example, if you only need 100 increments, equal value resistors can be used. If you use 10 Ω resistors, values of 10, 20, 30, 40, ... 80, 90, and 100 Ω can be developed.

In low current applications, a voltage can be applied across the resistors and the relays used to tap off the desired voltage. Refer to Figure 7-15.

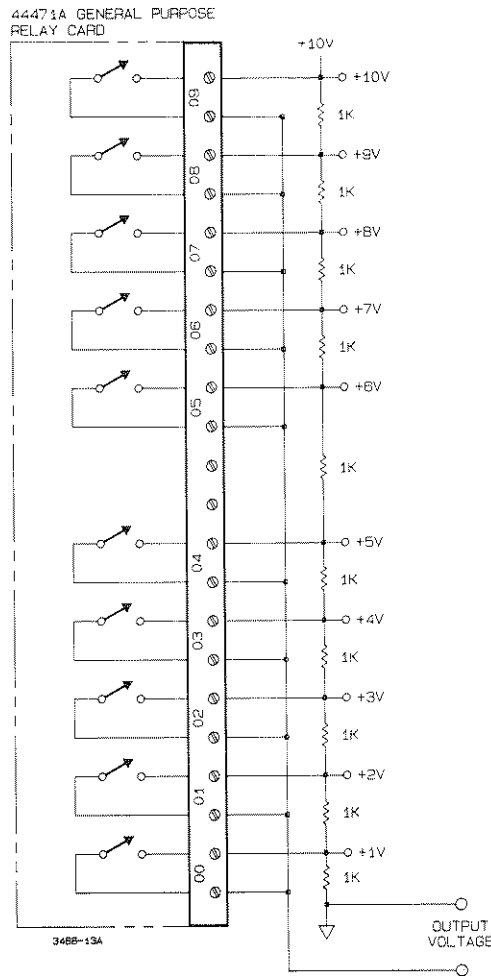

Figure 7-15. Voltage Divider

Example 3. Single Ended Measurements

Using only 44470A Ten Channel Multiplexer options, a maximum of 50 channels (two wires) can be scanned for measurements. However, if you don't require the noise rejection of two wire measurements and the Lo side of all your signal sources can be connected together, you can use one 44471A and four 44470A options to provide up to 88 channels for single-ended measurements.

Figure 7-16 shows how these options are connected together in this example. Notice that all of the Hi terminals on the 44470A options connect to channel 0 on the 44471A. To measure any of the voltage sources connected to one of the Hi terminals, channel 0 on the 44471A must be closed. Furthermore, all the Lo terminals on the 44470A options connect to channel 1 on the 44471A. To measure any of the voltage sources connected to the Lo terminals, Channel 0 must be opened and channel 1 closed. The remaining eight channels on the 44471A option can also be used for single ended measurements.

The associated program shows how to STEP through each of the 88 single ended channels. This program assumes that the 44471A option is mounted in slot 1 and the four 44470A's are installed in slots 2 through 5. The program uses an -hp- Model 3478A DVM for the measurements.

The program first sequences through the eight extra lines on the 44471A option (lines 40 - 90). Then, in lines 100 - 170, channel 0 is closed allowing measurements from the sources connected to the Hi terminals on the 44470A options. Finally, in lines 180 - 250, channel 0 is opened and channel 1 is closed permitting measurements from the Lo terminals on the 44470A options.

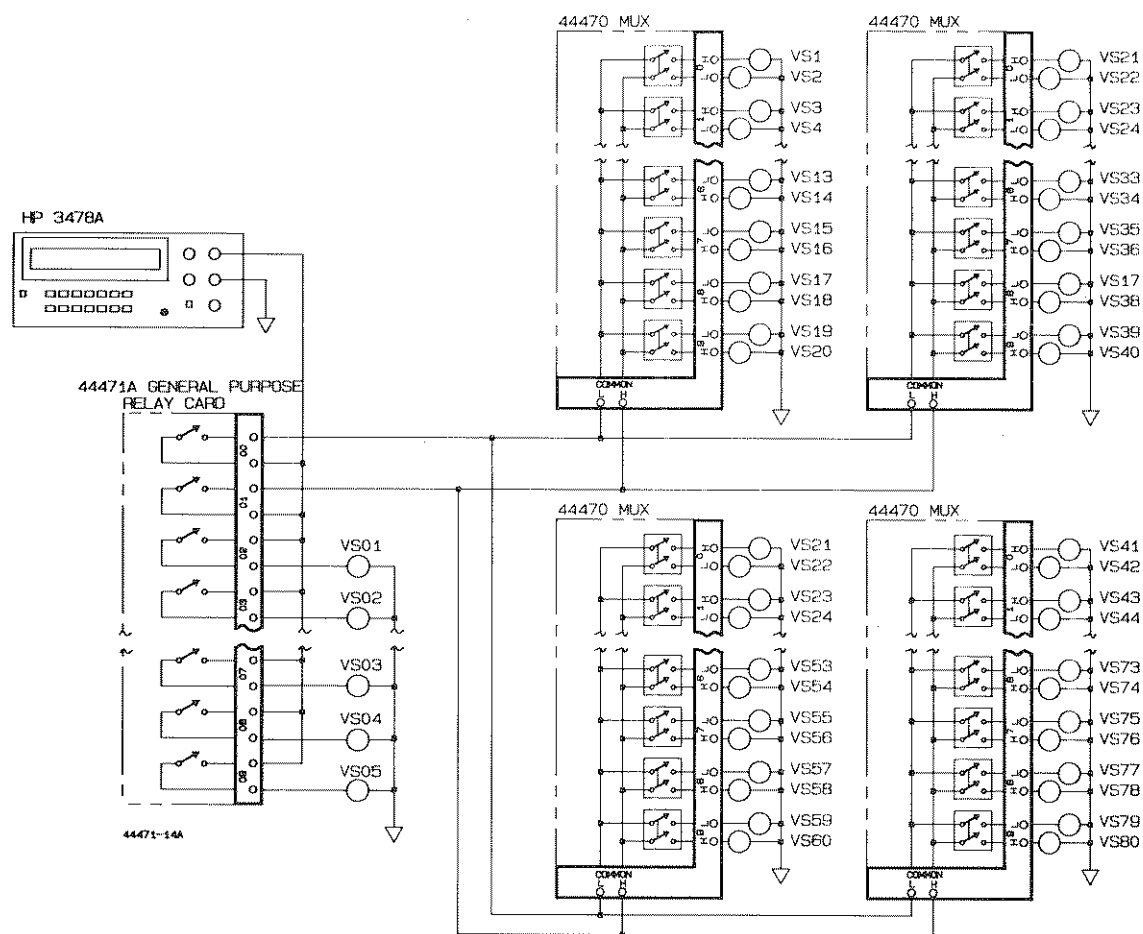

Figure 7-16. Single-ended Measurements

```

10 ! Single Ended scanning exam
   file
20 ! -HP- 85 version
30 ! 3488A at address 709, 3478
   A at address 723
40 OUTPUT 723 ; "T3"
50 OUTPUT 709 ; "RESET; SLIST 10
   2-109.0; CMON 1"
60 FOR I=2 TO 9 STEP 1
70 OUTPUT 709 ; "STEP"
80 TRIGGER 723
90 ENTER 723 ; A
100 PRINT "CHANNEL: "; I; "MEASURE
   MENT: "; A
110 NEXT I
120 ! Measure Hi's
130 PRINT @ PRINT "Hi CONNECTION
   S MEASURED:" @ PRINT
140 OUTPUT 709 ; "CLOSE 100; SLIST
   200-509.0; CMON -2"
150 FOR I=10 TO 50
160 OUTPUT 709 ; "STEP"
170 TRIGGER 723
180 ENTER 723 ; A
190 PRINT "CHANNEL: "; I; "MEASURE
   MENT: "; A
200 NEXT I
210 ! Measure Lo's
220 PRINT @ PRINT "Lo CONNECTION
   S MEASURED:" @ PRINT
230 OUTPUT 709 ; "OPEN 100; CLOSE
   101"
240 FOR I=51 TO 90
250 OUTPUT 709 ; "STEP"
260 TRIGGER 723
270 ENTER 723 ; A
280 PRINT "CHANNEL: "; I; "MEASURE
   MENT: "; A
290 NEXT I
300 OUTPUT 709 ; "RESET"
310 END

```

Table 7-2. Option 011 44471A 10 Channel General Purpose Relay Module Specifications

INPUT CHARACTERISTICS

Maximum Voltage (Terminal-terminal or terminal-chassis):
250 VDC, 250 VAC RMS, 350 VAC Peak

Maximum Current (Per channel): 2 ADC, 2 AAC RMS
(Per module): 20 ADC, 20 AAC RMS

Maximum Power (Per channel): 60 W DC, 500 VA AC
(Per module): 600 W DC, 5000 VA AC

Maximum power dissipated by user added components: 2 W

Thermal Offset < 3 μ V per channel

Closed Channel Resistance: < 2 Ω (end of relay life)

DC ISOLATION

| | < (40°C, 69% RH) | < (40°C, 95% RH) |
|---------------------------------------|----------------------------|-------------------|
| Open Channel, Channel-Channel* | > $10^{11}\Omega$ | > $10^9\Omega$ |
| Channel-Chassis* | > $5 \times 10^{11}\Omega$ | > $10^{10}\Omega$ |

(* with 1 channel closed)

AC ISOLATION/PERFORMANCE**

Capacitance:

| | |
|-------------------------|---------|
| Open Channel | < 7 pF |
| Channel-Channel* | < 10 pF |
| Channel-Chassis* | < 25 pF |

(* with 1 channel closed)

| (50 Ω termination) | 100 kHz | 1 MHz | 10 MHz |
|----------------------------|---------|--------|--------|
| Insertion Loss (dB) | < 0.20 | < 0.25 | < 0.50 |
| Crosstalk (dB) | < -73 | < -53 | < -33 |

** With chassis of all equipment connected, and with low of input lines connected to low of output lines (either directly or via 3488A switched channel).

Chapter 8

44472A

Dual 4 – 1 VHF Switch Module

Introduction

This option to the 3488A (option 012) provides two independent 4 channel to one coaxial multiplexers. These multiplexers are specifically designed for broadband signal switching up to 300MHz. This module is the logical choice for wide dynamic range measurements with spectrum and distortion analyzers.

Figure 8-1 shows a simplified schematic of the two multiplexers. Notice that the two groups are isolated from each other and also from the 3488A chassis ground. This eliminates ground loops. Furthermore, the shield (or low) of each channel is NOT switched; the shields of the four channels in each group are in common. Characteristic impedance is 50 Ω .

This chapter is designed to serve as a reference guide for using the 44472A VHF Switch Module. As such it contains programming information, installation and configuration information, and application examples.

WARNING

The 3488A Option 012, 44472A VHF Switch Module uses latching relays. The state of these relays can only be altered under program control. This is an advantage in the sense that, under most conditions of failure, the relays will remain in whatever state your program has set them. However, in case of power or equipment failure, any application requiring a failsafe method of insuring that the circuits under control are in a known state must be provided by the installer.

In case of component failure or programming error, any voltage input to an option card may be present on any other terminal on the same option card.

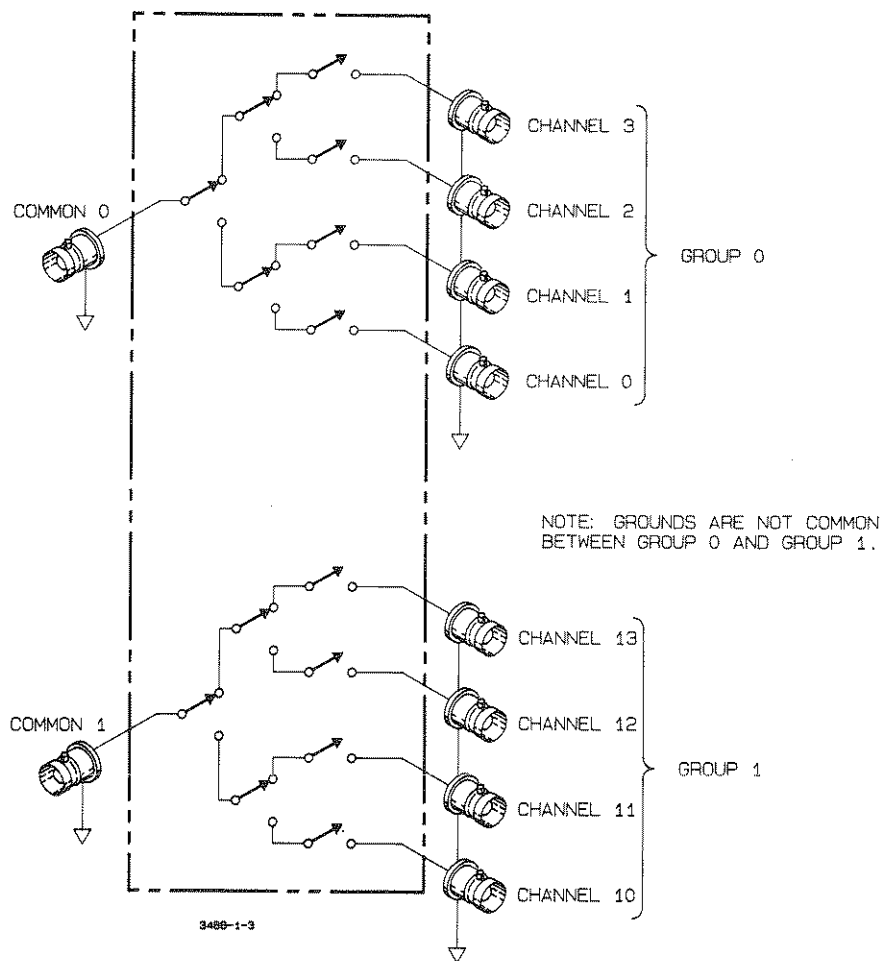

Figure 8-1. 44472A Simplified Schematic

Operation

Figure 8-1 shows that the 44472A VHF Switch Module consists of two independent 4-to-1 multiplexers. Only one channel may be connected to the common (per group) at a time. At turn on or reset (either from the front panel or the HP-IB CLEAR command), all relays on the 44472A option will be opened.

Each group on this option may be used as 1-of-4 inputs to one output or one input to 1-of-4 outputs. Connections to the option are made through 10 BNC (coaxial) connectors mounted directly on the circuit board.

Channels

A channel, as described in Chapter 2, refers to an individual set of relays on the 44472A assembly. Therefore, when we speak of closing a channel, we are referring to closing a particular set of relays, thereby connecting the common BNC to one of the four BNC inputs.

As shown on the terminal block (see Figure 8-1), channel numbers are two digit numbers assigned per group. The first digit is the group number (either a 0 or 1), the second digit specifies the channel in the group (0 through 3).

Channel addresses, on the other hand, are determined by which slot the 44472A assembly is installed in. Channel addresses are a three digit number where the first digit specifies the particular slot where the 44472A option is installed. The last two digits are the group/channel number. For example, channel address 102 means slot 1, group 0, and channel 2.

The following table shows the channel addressing scheme for the five different slots.

Table 8-1. Channel Addressing Scheme

| Channel number as shown on the terminal block | Channel address if 44472A assembly is in slot number: | | | | |
|---|---|--------|--------|--------|--------|
| | Slot 1 | Slot 2 | Slot 3 | Slot 4 | Slot 5 |
| Group 0 | | | | | |
| 00 | 100 | 200 | 300 | 400 | 500 |
| 01 | 101 | 201 | 301 | 401 | 501 |
| 02 | 102 | 202 | 302 | 402 | 502 |
| 03 | 103 | 203 | 303 | 403 | 503 |
| Group 1 | | | | | |
| 10 | 110 | 210 | 310 | 410 | 510 |
| 11 | 111 | 211 | 311 | 411 | 511 |
| 12 | 112 | 212 | 312 | 412 | 512 |
| 13 | 113 | 213 | 313 | 413 | 513 |

Commands

Most of the 3488A commands can be used in controlling the 44472A option. In addition to the standard 3488A commands, two HP-IB interface commands can also affect the use of the 44472A. All of these commands are described using a simple format of explanation.

In the following summary of command descriptions, square brackets ([]) indicate optional parameters, whereas items in < > brackets are mandatory. For further explanation of the command code mnemonics, refer to Chapters 2 and 3.

CLOSE a channel

Command Format: CLOSE <ch. address>[,<ch. address>,<ch. address>,...]

Description

The CLOSE command is used to simply close a channel on the 44472A. Note that the CLOSE command does not open any channels on other option assemblies that were previously closed. Only one channel per group on a 44472A option can be closed at any time. Several channels (on either a different group or option) can be closed with one CLOSE command by separating the channel addresses with a comma; channels are closed in the order listed.

Example

OUTPUT 709;"CLOSE 102,311" ! Closes channel number 02 in slot 1 and channel number 11 in slot 3.

OPEN a channel

Command Format: OPEN <ch. address>[,<ch. address>,<ch.address>...] .

Description

OPEN is used to open individual channels on the 44472A assembly. Channels are opened in the order listed. Use the CARD RESET command to open all channels on an assembly. It is easier than listing each one individually.

Examples

OUTPUT 709;"OPEN 100,112" ! Relays 100, 112 are opened in slot number 1

VIEW a channel

Command Format: VIEW <ch. address>

Description

The VIEW command is used to look at the state (either open or closed) of a particular channel. The 3488A responds with the string "OPEN 1" if the specified channel is open. If the specified channel is closed, the 3488A responds with the string "CLOSED 0". In the 3488A display, the channel address is displayed followed by a colon and the appropriate string.

Example

```
10 OUTPUT 709;"VIEW 102"    ! VIEWs channel 2 in group 0 on slot number 1
20 ENTER 709; A$            ! input the response from the 3488A
30 DISP A$                  ! A$ will either be "OPEN 1" or "CLOSED 0"
```

CARD TYPE

Command Format: CTYPE <slot>

Description

This command causes the 3488A to respond with a description of what type of option card is located in the specified slot. The description includes the name of the card as well as the option number. In the display, the description is preceded by the specified slot number.

| Card Type | Description |
|------------------------|------------------|
| Slot is empty | NO CARD 00000 |
| 10 Channel Multiplexer | RELAY MUX 44470 |
| General Purpose Card | GP RELAY 44471 |
| High Frequency Scanner | VHF SW 44472 |
| Matrix Card | MATRIX SW 44473 |
| Digital I/O Card | DIGITAL IO 44474 |
| Breadboard Card | BREADBOARD 44475 |

Example

```
10 OUTPUT 709;"CTYPE 3"      ! look for the card in slot 3
20 ENTER 709; A$
30 DISP A$                    ! Card description will be displayed
```

CARD RESET

Command Format: CRESET <slot>[,<slot>,...]

Description

CRESET is used to reset all channels on the 44472A assembly to their open state. Only cards in the slots specified are affected.

Example

```
OUTPUT 709;"CRESET 2"      ! resets the option assembly in slot 2
```

CARD PAIR

Command Format: CPAIR <slot>,<slot>

Description

CARD PAIR is used to pair up two option assemblies of the same type, e.g., 44472A's. This operation will effectively assign both options to both slot numbers so that closing or opening a channel on either option will perform the same operation on the respective channel on the other option.card.

Commands used with the Card PAIR function are: OPEN, CLOSE, CRESET, CHAN and STEP. Of course, paired slots can be used as part of a scan list.

Executing a CPAIR command cancels any previous CPAIR command that involved either of the two options. It is possible, however, to have two sets of card pairs, e.g. slot 1 paired with 2 and slot 3 paired with 4.

Example

```
OUTPUT 709;"CPAIR 1,3"      ! sets the options in slots 1 and 3 as pairs
OUTPUT 709;"CLOSE 102"     ! closes channels 102 and 302 simultaneously
```

Executing the CPAIR command without specifying any slot numbers allows you to determine which, if any, slots are paired together. Four numbers are returned separated by commas. The first two specify slots in the first pair, the second two numbers specify the second pair. An inactive card pair is denoted by 0,0.

Example

```
OUTPUT 709; "CPAIR"
```

```
ENTER 709; A$
```

```
DISP A$
```

String variable A\$ will have the four slot numbers. Note, you may have to dimension A\$ to 30 prior to executing.

SCAN LIST

Command Format: SLIST [<ch. address>(, or -)<ch.address> . . . <ch. address>]

Description

Scan List allows you to specify a sequence of channels to be scanned. The sequence is specified as a list of up to 85 channel addresses (relay or Digital I/O lines) and/or stored setups separated by commas. Contiguous channels may be specified by entering the first and last channel addresses separated by a hyphen. STEP is used to sequentially close channels in the list.

Example

```
10 OUTPUT 709:"SLIST 100-113,0; CMON 1"  
20 FOR I = 1 TO 8  
30 OUTPUT 709; "STEP"  
40 NEXT I
```

In this example, the scan would start with channel 100, proceed through the "0" group of channels and then through the "1" group of channels. The 0 channel specified at the end of the list is a stop channel and opens the last channel closed (channel 113) but does not close any other channel.

Notes

1. Channels may be scanned in any sequence, i.e., 113-100.
2. Stepping beyond the last channel specified in the Scan List causes a wrap-around to the first channel in the list. The number 0 can be used as a stop channel.

3. Refer to the Advanced Operations section in this chapter for information on using the External Trigger and Channel Closed features.

4. The commands OPEN, CLOSE, CRESET, or RECALL will have no effect on the scan list even though the state of individual channels may change.

5. Stored setups may be recalled as part of a Scan List simply by specifying the register number. For example, SLIST 100,101,102,24,120,121,122. Here, register 24 has the stored setup.

STEPping through the Scan List

Command format: STEP

Description

STEP is used to open the last channel closed and close the next channel in the Scan List. If STEP is executed and no Scan List exists, the 3488A will generate an error.

The 3488A uses a pointer to keep track of which channel in the Scan List is currently closed. Whenever STEP is executed, that channel is opened and the next item in the list is checked. If the next item in the list is a relay or Digital I/O line, that channel is closed. If the next item in the list is a stored setup, that setup is recalled. Channels that are closed as part of a stored setup will remain closed, that is, they are not opened by the next execution of the STEP command.

For information on External Increment and Channel Closed, refer to the Advanced Operation section of this chapter.

Example

```
10 OUTPUT 709; "SLIST 100-113;CMON 1"  
20 FOR I=1 TO 10 30  
OUTPUT 709;"STEP"  
40 NEXT I
```

CHANnel Command

Command Format: CHAN [<ch. address>]

Description

CHAN is used to open the last channel closed by either STEP or CHAN (whichever was most recent) and close the specified channel. If no channel is specified with CHAN, the 3488A will respond with the last channel closed by either STEP or CHAN. If no channel has been closed since the last reset, then CHAN returns the number 0.

If a Scan List is in effect when CHAN is executed, the 3488A will search the list and position the Scan List pointer to the channel specified by CHAN. If CHAN specifies a channel that is not in the Scan List, and then STEP is executed, the 3488A will open the channel closed by CHAN and go to the beginning of the Scan List.

Examples

OUTPUT 709; "CHAN 100" ! Closes channel 100

OUTPUT 709; "CHAN"

ENTER 709; A\$

DISP A\$

! A\$ will contain the last channel closed, i.e., 100

CARD MONITOR mode

Command Format: CMON <slot>

Description

Card Monitor is used to look at the state of the individual option assemblies in the specified slot (1-5). Specifying slot 0 will cause the monitor mode to be cancelled. If a negative number is used for the slot, the 3488A will go to its monitor tracking mode.

When used to monitor the 44472A VHF Switch, the display shows the slot number (extreme left) and the two groups of channels. The two groups are separated by a semicolon. Channels that are closed are shown in the display.

Example

OUTPUT 709; "CLOSE 201,213; CMON 2"

The resulting display looks like the following photograph.

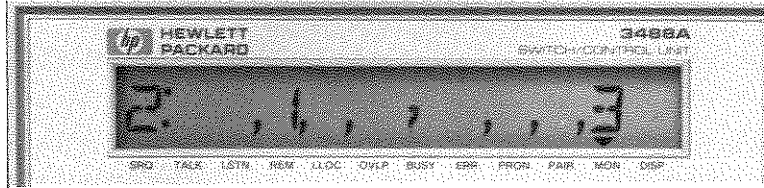

The format of the 44472A Card Monitor display can be summarized as:

s: n,n,n,n;n,n,n,n

Where s represents the slot number being monitored and n is a one digit channel number. The four channels to the left of the semicolon represent group 0, the four channels to the right are for group 1.

Advanced Operations

Advanced Operations provide you with more capabilities when using the 3488A. It may be important, for example, to tell the system voltmeter when a channel has been closed and thus take a measurement. Or maybe you need to close the next channel in a scan list when some external event has taken place, perhaps as soon as the voltmeter has completed its reading. Most operations can be performed with only the basic commands, but for those times when you need something more, the advanced operations should meet your switching needs.

External Increment and Channel Closed

External Increment (EI) provides a method of sequencing through a Scan List without system computer intervention. Typically, EI is connected to the Voltmeter Complete* output on a system voltmeter. Thus, when the voltmeter has completed its measurement, it signals the 3488A to step to the next channel in the list. The EI input is rising-edge triggered and TTL compatible.

* Voltmeter Complete is a feature found on most Hewlett-Packard digital voltmeters to signal the completion of a measurement by means of a TTL compatible pulse.

Channel Closed (CC) provides a 15 μ S TTL pulse for signalling when a channel has been closed in the 3488A. This signal can be tied to the External Trigger input of a voltmeter to trigger it when a channel is closed. Together, EI and CC can be used with a system voltmeter to sequence through a scan list without any intervention by the system computer.

Using the External Increment and Channel Closed features requires the use of a 44474A Digital I/O option. This also means that the Digital I/O option cannot be configured in handshake mode when it is used for scanning (it can be used statically, however). The DMODE command is used to specify the Handshake Mode, Polarity, and EI. Only one Digital I/O option can be configured for EI at a time. If one option is configured to accept EI and another is subsequently enabled, the first card will be disabled.

Even though the only specifier we are interested in is EI, the mode and polarity specifiers must be included. The format for specifying DMODE is as follows:

DMODE <slot>[, <mode>][, <polarity>][, <EI>]

The MODE specifier is as follows:

| Definition | Value |
|---------------------------|-------|
| Static Mode | 1 |
| Static Mode for read back | 2 |
| R/W & Strobe | 3 |
| Rd & Wrt Strobe | 4 |
| Handshake (no EI) | 5 |

Any of the Modes may be specified for use with External Increment except the Handshake Mode (value 5).

The Polarity specifier is the sum of weighted values and is defined as follows:

| Definition | Value |
|-----------------------------|---------------------|
| Lower 8-bits polarity | 1 = Low true |
| Upper 8-bits polarity | 2 = Low true |
| PCTL Polarity | 4 = Low busy |
| PFLG Polarity | 8 = Low busy |
| I/O Direction line Polarity | 16 = Low input mode |

EI is enabled by specifying 1. It is disabled with a specifier of 0.

DELAY

DELAY [<time in mS>]

Description

The DELAY command is used to insert a time delay between the time that a channel is closed and the time the next command can be executed and the channel closed pulse is output. The delay time may be specified from 0 to 32,767 mS (32.767 seconds) in 1 mS increments. The delay time does not become effective until either CHAN or STEP is executed.

If any command is sent to the 3488A during the delay time, the command will be executed as soon as the delay time is complete. If there is not a time value specified with the DELAY command, the 3488A will respond with the current value of the delay time.

Remember that the Channel Closed pulse will use whichever 44474A assembly has External Increment enabled.

Examples

OUTPUT 709; "DELAY 45" ! The delay time is 45 mS = .045 Sec.

OUTPUT 709; "DELAY"

ENTER 709; A

DISP A ! Variable 'A' will show the current delay value.

HP-IB Interface Commands

Only two interface commands affect the state of the 44472A channels: TRIGGER (Group Execute Trigger) and CLEAR (Device Clear or Selected Device Clear). TRIGGER performs the same function as the 3488A STEP command. In other words, the two commands:

TRIGGER 7 (or TRIGGER 709)

and

OUTPUT 709; "STEP"

perform the same function as far as the 44472A assembly is concerned.

CLEAR, whether a Device Clear or Selected Device Clear, simply resets the 3488A and hence all relays will go to their open state.

44472A Assembly Installation

This portion of the chapter is written specifically for the service trained technician. It provides the necessary information for a person trained in electronic circuitry to configure and install the option assembly. Carefully read through this section and adhere to all cautions and warnings.

WARNING

Only qualified service trained personnel should remove, configure, or install the 3488A option assemblies. Disconnect the 3488A power cord from the back of the instrument prior to installing the option assemblies.

The 3488A Option 011, 44472A VHF Switch uses latching relays. The state of these relays can only be altered under program control. This is an advantage in the sense that, under most conditions of failure, the relays will remain in whatever state your program has set them. However, in case of power or equipment failure, any application requiring a failsafe method of insuring that the circuits under control are in a known state must be provided by the installer.

In case of component failure or programming error, any voltage input to an option card may be present on any other terminal on the same option card.

CAUTION

Use clean handling and anti-static procedures when removing, configuring and installing the option assemblies. The circuit boards must be kept clean to ensure compliance with impedance specifications. The option assemblies as well as the 3488A mainframe contains CMOS devices which are susceptible to static discharges.

A few simple steps are required to install the 44472A assembly. Carefully observe to orientation of the assembly.

1. Pre-installation

- a. Remove the ac power cord from the 3488A before installing any option assembly.
- b. Position the rear panel of the 3488A toward you.
- c. Select a slot. Refer to Figure 8-2, the 3488A has five slots for installing option assemblies. The 44472A can be used in any of the five slots.

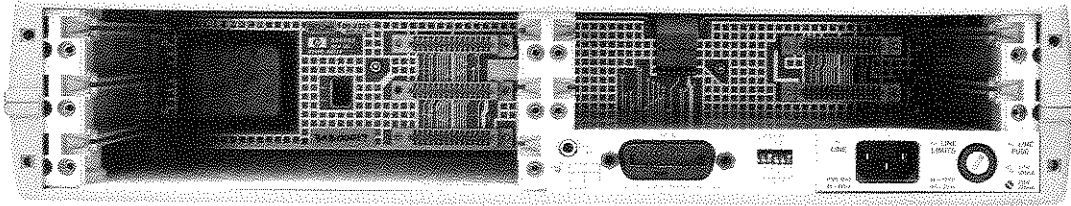

Figure 8-2. Rear Panel View of the 3488A

2. Option assembly installation

- a. Hold the option assembly, component side down, by the metal shields. Insert the circuit card into the slot guides and slide toward the front of the instrument. Push firmly until the assembly 'snaps' into place. Tighten the two side screws to hold the option in place.
- b. A series of five numbered labels (1 to 5) were provided with the option assembly. Select the number that indicates which 3488A slot you have installed the option in and place the sticker in the upper left hand corner of the option backpanel.

Specifications

The specifications at the end of this chapter apply to only the 44472A assembly. These specifications are the performance standards or limits against which the assembly is tested. Do not exceed or surpass the specified limits.

Any changes in specifications due to manufacturing changes, design, or traceability to the National Bureau of Standards will be covered in a manual change supplement.

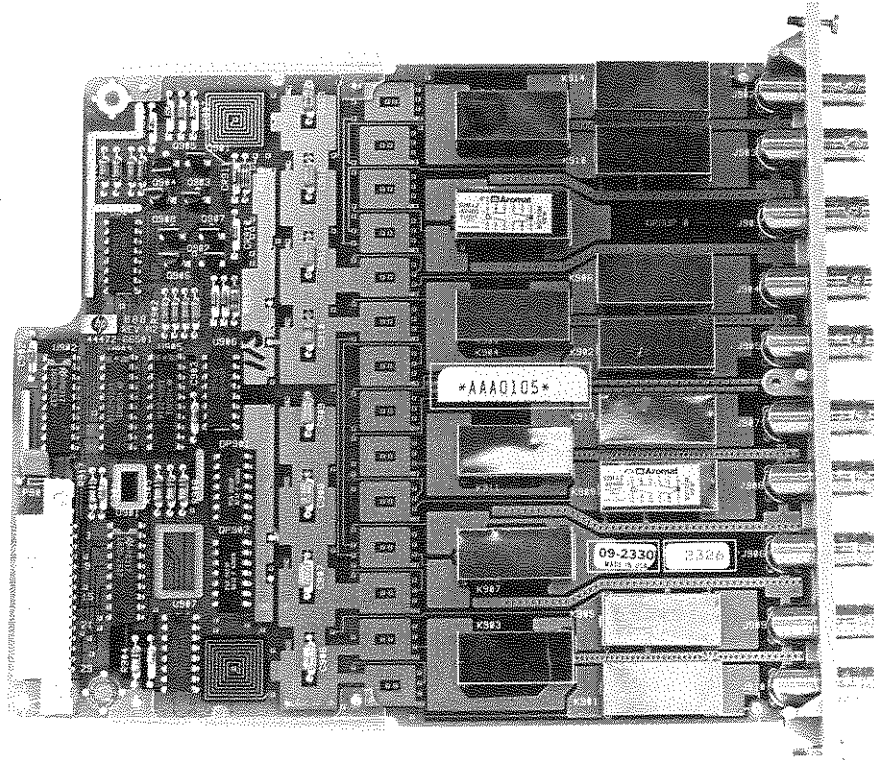

Figure 8-3. Option Card

Applications

There are many conceivable applications for the 44472A VHF Switch, many of which are not as obvious as others. It is definitely the right choice if you are switching signals in the 10 – 300 MHz range. Switching low frequency signals, in the audio range for example, you could use either the 44472A VHF Switch or the 44470A Multiplexer. The 44472A is not recommended for instruments that require high DC isolation from earth ground (such as a DVM).

Your choice should depend on your application.

Isolation Impedance

The 44472A option is a VHF switch having excellent on channel to off channel isolation over a bandwidth of dc to 300 MHz. This makes it possible to switch signals to instruments with very high bandwidths and not have adjacent channel interference. The adjacent channel interference is typically a driven signal but may also be broad-band noise picked up on the wiring to these channels.

Note also that for each group of four channels on the 44472A VHF switch, when all channels have been opened, the last channel to open in each group will exhibit approximately 20 dB less isolation than the other three channels in that group. Refer to the specifications at the end of this chapter. At power-on or reset, the last channel closed in group 0 is channel 00; in group 1, the last channel closed is 13.

Topologies

Two 1-to-4 VHF Multiplexers are provided on each 44472A module. These can be used independently, together, or in combination with other 44472A options. There are, however, trade-offs that must be considered.

Regardless of the topology (configuration) you are using, always use 50 Ω shielded coaxial cables to maintain both characteristic impedance and isolation. Keep cables as short as possible, especially in high frequency circuits or pulse circuits where a rise/fall time of <50nS is critical. Long cables can add considerable delay time which may cause timing problems. All test equipment; such as counters, spectrum analyzers, oscilloscopes, etc., must be terminated with a 50 Ω impedance to minimize reflection loss.

Figure 8-4 shows both multiplexers from one 44472A module connected together in a "T" configuration. This circuit provides a 1-of-8 multiplexer. VSWR becomes important here because the characteristic impedance of 50 Ω is lost. Considerable reflection may be present and could cause double triggering in counters, etc. This configuration should not be used with very narrow pulses or pulses with rise/fall times of 20nS or less.

The correct way to connect multiple 1 – of – 4 modules is shown in Figures 8-6 and 8-7. A general rule to keep in mind is never use BNC "T" connectors if full bandwidth performance is needed. Anytime a BNC "T" is used, VSWR will not be maintained in the test system.

One simple way to provide a simple 1 – of – 4 to 1 – of – 4 matrix is to connect the common connectors on two channel groups together, as shown in Figure 8-5. This configuration provides an excellent method of connecting four devices under test to four different test instruments and maintains the 50 Ω characteristic impedance.

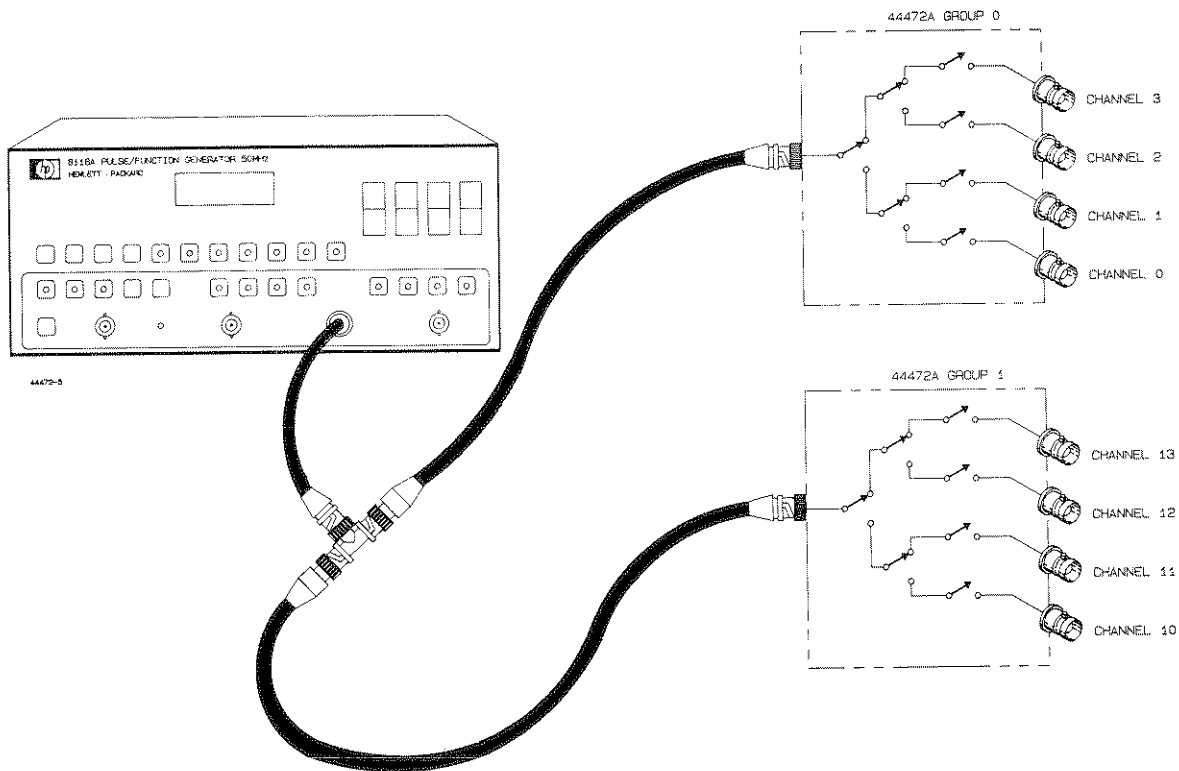

Figure 8-4. Two 44472A's in "T" Configuration

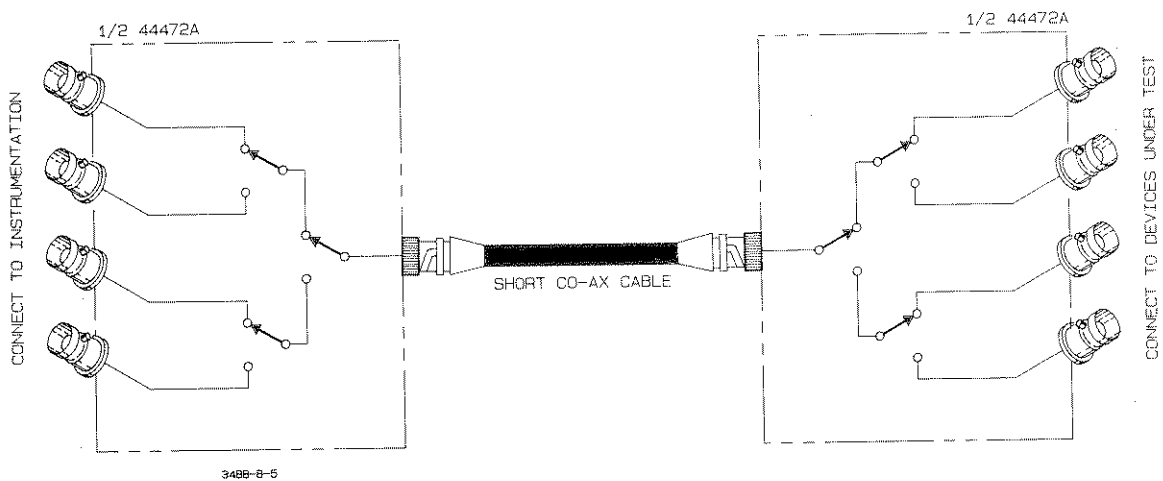

Figure 8-5. 4x4 Matrix

A tree configuration, like that shown in Figure 8-6, provides complete isolation while maintaining the 50 Ω characteristic impedance. It also provides 16 channels for test points. Again, keep cable length as short as possible especially between channel groups. Signal delay time has doubled because the signal must pass through two channel groups.

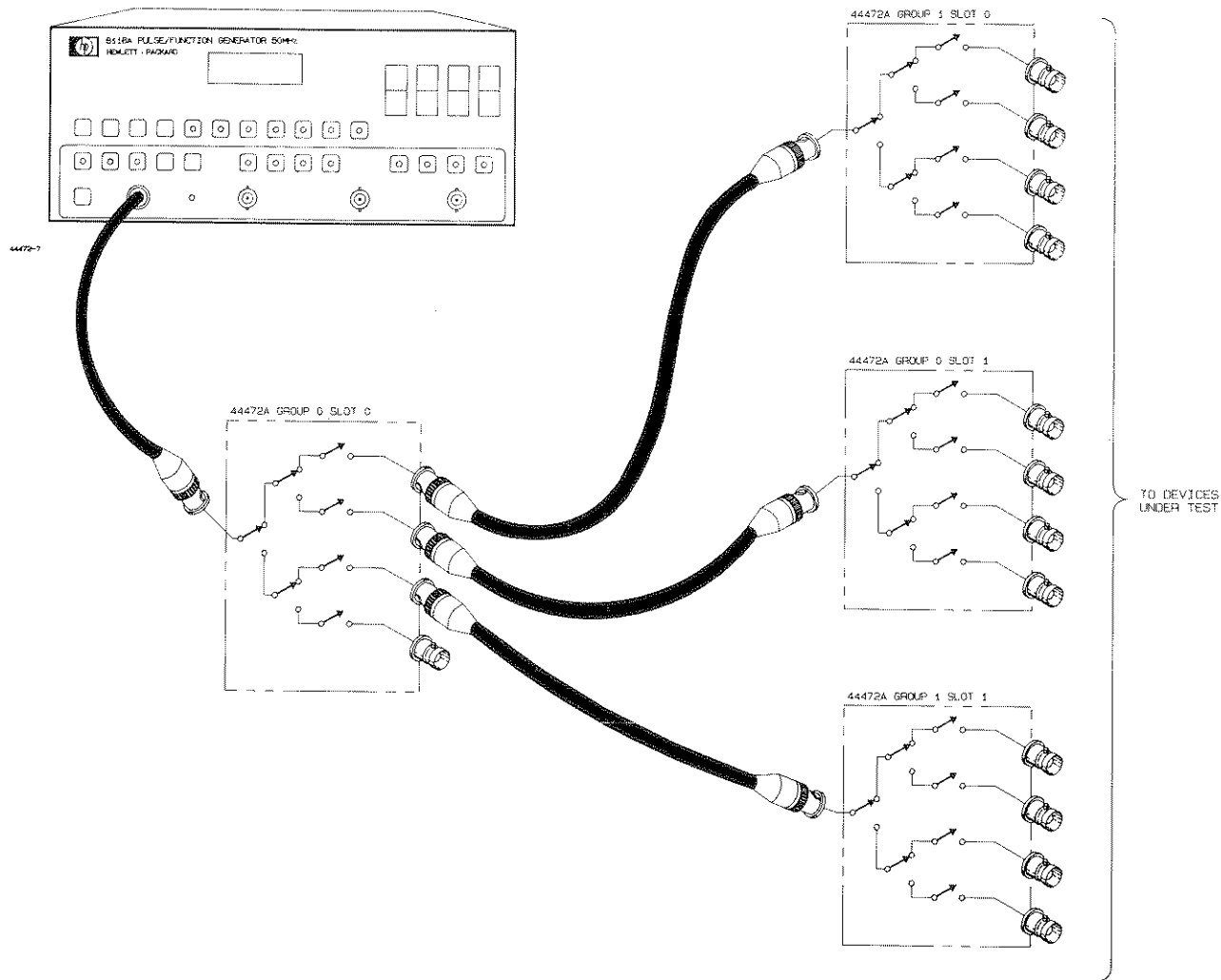

Figure 8-6. Tree Configuration

Table 8-2. Option 012 44472A Dual 4 Channel VHF Switch Module Specifications

INPUT CHARACTERISTICS

Maximum Voltage (Center-center, center-low): 250 VDC,
30 VAC RMS, 42 VAC Peak*; (Low-chassis, low-low): 42 VDC

Maximum Current (Per channel): 30 mA DC, 300 mA AC RMS*

Thermal Offset: < 15 μ V per channel

Characteristic Impedance: 50 Ω

Closed Channel Resistance: < 1 Ω (end of relay life)

*To maintain compliance with VDE class B or FTZ 1115/83 radiation limits, use semi-rigid or equivalent coax cable and limit signal to < 2x10⁷ V*Hz.

AC ISOLATION/PERFORMANCE

| (50 Ω termination) | 30 MHz | 100 MHz | 300 MHz |
|--|--------|---------|---------|
| Insertion Loss (dB) | < 0.5 | < 0.75 | < 1.25 |
| Crosstalk (dB) Channel-Channel, Channel-Common (within a group) | < -100 | < -85 | < -65 |
| Crosstalk group to group (dB) | < -85 | < -85 | < -50 |
| VSWR | < 1.06 | < 1.12 | < 1.43 |

Capacitance: Center-Center, Center-Common < 0.002 pF
Center-Low < 70 pF
Low-Chassis < 0.2 μ F

Rise Time: < 0.7 nsec

Signal Delay: < 2.5 nsec; Channel match < 90 psec

DC ISOLATION

< (40°C, 95% RH), between any 2 points: > 10⁷ Ω

GENERAL

All channels break-before-make within a group of 4 channels. When all channels in a group are opened, the last channel opened (or channel 00 or 13 following a group RESET) has channel-common isolation of > 80 dB @ 30 MHz, > 60 dB @ 100 MHz, & > 40 dB @ 300 MHz.

Connectors: BNC's



Chapter 9

44473A

4 × 4 Matrix Switch Module

Introduction

-hp- Model 44473A (3488A option 013) Matrix Switch provides a 4-by-4 matrix of switches. Each node or crosspoint in the matrix switches both signal Hi and Lo (2 wires). Refer to Figure 9-1 for a simplified schematic of the module.

Matrix switching provides a convenient way to connect a group of test instruments to multiple test points on a device or to multiple devices. This matrix switch offers highly flexible switching for testing devices over a frequency range of DC to 100 kHz.

Any combination of the 4 "inputs" (e.g., rows) may be connected to any combination of "outputs" (e.g., columns). Multiple 44473A options may be connected together to form a 4 × 8, 4 × 12, 4 × 16, 4 × 20 or 8 × 8 matrix. In addition, the Matrix option can be used in conjunction with other options (such as the 44470A ten channel Multiplexer) to provide a wide variety of switching combinations.

This chapter is designed to serve as a reference guide for using the 44473A Matrix Switch option. As such, it contains programming information, installation and configuration information, and application examples.

WARNING

The 3488A option 013 Matrix Switch uses latching relays. The state of these relays can only be altered under program control. This is an advantage in the sense that, under most conditions of failure, the relays will remain in whatever state your program has set them. However, in case of power or equipment failure, any application requiring a failsafe method of insuring that the circuits under control are in a known state must be provided by the installer.

In case of component failure or programming error, any voltage input to an option card may be present on any other terminal on the same option card.

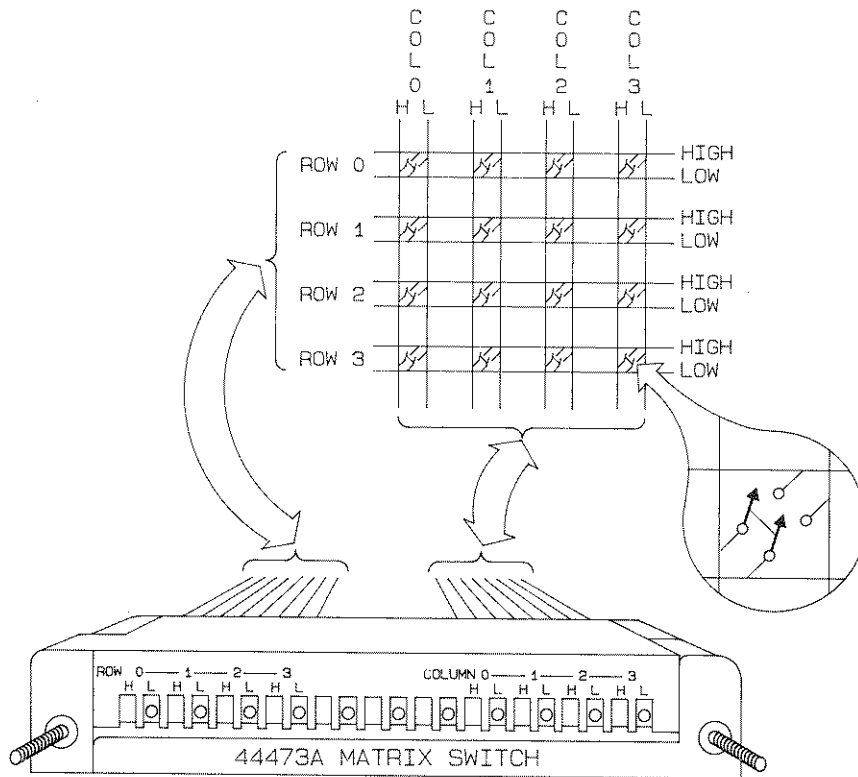

3488-1-4

Figure 9-1. 44473A Simplified Schematic

Operation

Figure 9-1 shows that the 44473A Matrix Switch option consists of sixteen 2-wire relays connected in a 4×4 matrix. More than one switch can be closed at a time allowing any combination of rows connected to columns. At turn on or reset (either reset from the 3488A front panel or from the HP-IB CLEAR command) all relays will be opened.

Channels

A channel, as described in Chapter 2, refers to an individual relay in the matrix. Therefore, when we speak of closing a channel, we are referring to closing a particular relay. Channel numbers are specified as a two digit number, XY, where X represents the row (0-3) and Y represents the column (0-3) where the relay resides. These channel numbers are repeated on each 44473A option and can be seen by the numbering on the terminal block.

Channel addresses, on the other hand, are determined by which slot the 44473A assembly is mounted in. Channel addresses are a three digit number where the first digit specifies the particular slot where the 44473A option is installed. The last two digits are the row/column channel number. For example, channel address 102 means the option is installed in slot #1; the relay is in row 0, column 2.

The following chart shows the channel addressing scheme for the five different slots.

Table 9-1. Channel Addressing Scheme

| Channel number (Row-Column) | Channel address if 44473A assembly is in slot number: | | | | |
|--------------------------------|--|--------|--------|--------|--------|
| | Slot 1 | Slot 2 | Slot 3 | Slot 4 | Slot 5 |
| 00 | 100 | 200 | 300 | 400 | 500 |
| 01 | 101 | 201 | 301 | 401 | 501 |
| 02 | 102 | 202 | 302 | 402 | 502 |
| 03 | 103 | 203 | 303 | 403 | 503 |
| 10 | 110 | 210 | 310 | 410 | 510 |
| 11 | 111 | 211 | 311 | 411 | 511 |
| 12 | 112 | 212 | 312 | 412 | 512 |
| 13 | 113 | 213 | 313 | 413 | 513 |
| 20 | 120 | 220 | 320 | 420 | 520 |
| 21 | 121 | 221 | 321 | 421 | 521 |
| 22 | 122 | 222 | 322 | 422 | 522 |
| 23 | 123 | 223 | 323 | 423 | 523 |
| 30 | 130 | 230 | 330 | 430 | 530 |
| 31 | 131 | 231 | 331 | 431 | 531 |
| 32 | 132 | 232 | 332 | 432 | 532 |
| 33 | 133 | 233 | 333 | 433 | 533 |

Commands

Most of the 3488A commands have an impact on the 44473A assembly. In addition to the standard 3488A commands, two HP-IB interface commands can also affect the use of the 44473A. All of these commands are described using a simple format of explanation.

In the following summary of command descriptions, square brackets ([]) indicate optional parameters, whereas items in < > brackets are mandatory. For further explanation of the command code mnemonics, refer to Chapters 2 and 3.

CLOSE a channel

Command Format: CLOSE <ch. address>[,<ch. address>,<ch. address>,...]

Description

The CLOSE command is used to simply close one or more channels on the 44473A. Note that the CLOSE command does not open any channels that were previously closed. Several channels can be closed with one close command by separating the channel addresses with a comma. Channels are closed in the order listed.

Examples

OUTPUT 709;"CLOSE 100,102,103" ! Closes channels 00, 02, and 03 in slot number 1

OUTPUT 709;"CLOSE 102,301" ! Closes channel number 02 in slot 1 and channel number 01 in slot 3.

OPEN a channel

Command Format: OPEN <ch. address>[,<ch. address>,<ch.address>...]

Description

OPEN is used to open individual channels on the 44473A assembly. If more than one channel is specified in the OPEN list, they will be opened in the order listed. Use the CARD RESET command to open all relays on an assembly. It is easier than listing each channel individually.

Examples

OUTPUT 709;"OPEN 100,102,103" ! Relays 00, 02, and 03 are opened in slot number 1

VIEW a channel

Command Format: VIEW <ch. address>

Description

The VIEW command is used to look at the state (either open or closed) of a particular channel. The 3488A responds with the string "OPEN 1" if the specified channel is open. If the specified channel is closed, the 3488A responds with the string "CLOSED 0". In the 3488A display, the channel address is displayed followed by a colon and the appropriate string.

Example

```
10 OUTPUT 709;"VIEW 102"    ! VIEWs channel 2 on slot number 1
20 ENTER 709; A$            ! input the response from the 3488A
30 DISP A$                  ! A$ will either be "OPEN 1" or "CLOSED 0"
```

CARD TYPE

Command Format: CTYPE <slot>

Description

This command causes the 3488A respond with a description of what type of option card is located in the specified slot. The description includes the name of the card as well as the option number. In the display, the description is preceded by the specified slot number.

| Card Type | Description | |
|------------------------|-------------|-------|
| Slot is empty | NO CARD | 00000 |
| 10 Channel Multiplexer | RELAY MUX | 44470 |
| General Purpose Card | GP RELAY | 44471 |
| High Frequency Scanner | VHF SW | 44472 |
| Matrix Card | MATRIX SW | 44473 |
| Digital I/O Card | DIGITAL IO | 44474 |
| Breadboard Card | BREADBOARD | 44475 |

Example

```
10 OUTPUT 709;"CTYPE 3"      ! look for the card in slot 3
20 ENTER 709; A$
30 DISP A$                    ! Card description will be displayed
```

CARD RESET

Command Format: CRESET <slot>[,<slot>,...]

Description

CRESET is used to reset all channels on the 44473A assembly to their open state. Only cards in the slots specified are affected.

Example

```
OUTPUT 709;"CRESET 2"      ! resets the option assembly in slot 2
```

CARD PAIR

Command Format: CPAIR <slot>,<slot>

Description

CARD PAIR is used to pair up two option assemblies of the same type, e.g., 44473A's. This operation will effectively assign both options to both slot numbers so that closing or opening a channel on either option will perform the same operation on the respective channel on the other option.

Commands used with the Card PAIR function are: CLOSE, OPEN, CRESET, CHAN and STEP. Of course, paired slots can be used as part of a scan list.

Executing a CPAIR command cancels any previous CPAIR command that involved either of the two options. It is possible, however, to have two sets of card pairs, e.g. slot 1 paired with 2 and slot 3 paired with 4.

Example

```
OUTPUT 709;"CPAIR 1,3"      ! sets the options in slots 1 and 3 as pairs
OUTPUT 709;"CLOSE 102"      ! closes channels 102 and 302 simultaneously
```

Executing the CPAIR command without specifying any slot numbers allows you to determine which, if any, slots are paired together. Four numbers are returned separated by commas. The first two numbers specify slots in the first pair, the second two numbers specify the second pair. An inactive card pair is denoted by 0,0.

Example

```
OUTPUT 709; "CPAIR"  
ENTER 709; A$  
DISP A$
```

String variable A\$ will have the four slot numbers. Note, you may have to dimension A\$ to 30 prior to executing.

SCAN LIST

Command Format: SLIST [<ch. address>(, or -)<ch.address>.<ch. address>]

Description

Scanning allows you to specify a sequence of channels to be scanned. The sequence is specified as a list of up to 85 channel addresses (relay or Digital I/O lines) and/or stored setups separated by commas. Contiguous channels may be specified by entering the first and last channel addresses separated by a hyphen. STEP is used to sequentially close channels in the list.

Example

```
10 OUTPUT 709; "SLIST 100-133,0;CMON 1"  
20 FOR I = 1 TO 16  
30 OUTPUT 709; "STEP"  
40 NEXT I
```

In this example, the scan would start with channel 100 and proceed through each column on row 0. The scan would then move to row 1 and sequence through each column. Next would come row 2 and sequence through each column, followed by row 3, each column. The 0 channels specified at the end of the scan list is a stop channel and opens the last relay closed (channel 133) but does not close any other channel.

Notes

1. Channels may be scanned in any sequence, i.e., 133-100.
2. Stepping beyond the last channel specified in the Scan List causes a wrap-around to the first channel in the list. The number 0 can be used as a stop channel.
3. Refer to the Advanced Operation section in this chapter for information on using the External Trigger and Channel Closed features.
4. The commands OPEN, CLOSE, CRESET, or RECALL will have no effect on the scan list even though the state of individual channels may change.
5. Stored setups may be recalled as part of a Scan List simply by specifying the register number. For example, SLIST 100,101,102,25,120,121,122. Here, register 25 has the stored setup.

STEPping through the Scan List

Command Format: STEP

Description

STEP is used to open the last channel closed and close the next channel in the Scan List. If STEP is executed and no Scan List exists, the 3488A will generate an error.

The 3488A uses a pointer to keep track of which channel in the Scan List is currently closed. When STEP is executed, that channel is opened and the next item in the list is checked. If the next item in the list is a relay or Digital I/O line, that channel is closed. If the next item in the list is a stored setup, that setup is recalled. Channels that are closed as part of a stored setup will remain closed, that is, they are not opened by the next execution of the STEP command.

For information on External Increment and Channel Closed, refer to the Advanced Operation section of this chapter.

Example

```
10 OUTPUT 709; "SLIST 100-133; CMON 1"  
20 FOR I=1 TO 10  
30 OUTPUT 709;"STEP"  
40 NEXT I
```

CHANnel Command

Command Format: CHAN [<ch. address>]

Description

CHAN is used to open the last channel closed by either STEP or CHAN (whichever was most recent) and close the specified channel. If no channel is specified with CHAN, the 3488A will display and output to the interface the last channel closed by either STEP or CHAN. If no channel has been closed since the last reset, then CHAN returns the number 0.

If a Scan List is in effect when CHAN is executed, the 3488A will search through the list and position the Scan List pointer to the channel specified by CHAN. If the channel specified by CHAN is not in the Scan List, and then STEP is executed, the 3488A will open the channel closed by CHAN and then go to the beginning of the Scan List.

Examples

OUTPUT 709; "CHAN 100" ! Closes channel 100

OUTPUT 709; "CHAN"

ENTER 709; A\$

DISP A\$! A\$ will contain the last channel closed, i.e., 100

CARD MONITOR mode

Command Format: CMON <slot>

Description

Card Monitor is used to look at the state of the individual option assemblies in the specified slot (1 – 5). Specifying slot 0 will cause the monitor mode to be cancelled. If a negative number is used for the slot, the 3488A will go to its monitor tracking mode.

There are two types of monitoring displays for the 44473A Matrix option: monitoring Rows and monitoring Columns. A total of eight displays are possible, one for each of the four rows and four columns. When initially entering the Card Monitor mode, the 3488A display will show which columns have a channel closed in Row 0. Use the front panel arrow keys to change to other displays. The following sequence of displays show how the same 44473A Matrix option can be monitored after executing the commands: CLOSE 301,303,323;CMON 3. The slot number is always shown at the far left.

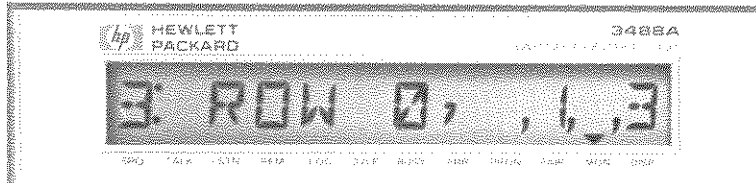

Slot 3, Row 0 in Columns 1 and 3 are closed.

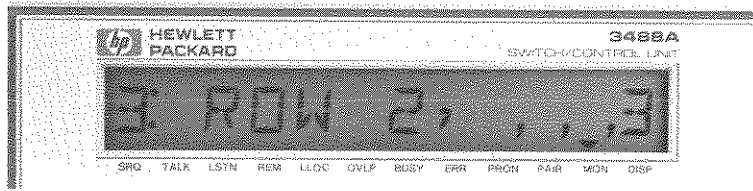
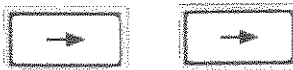

Slot 3, Row 2 in Column 3 is closed

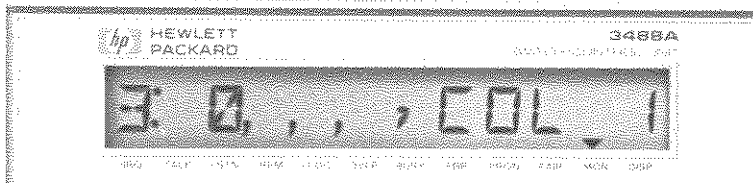

Slot 3, (Row) 0 in Column 1 is closed

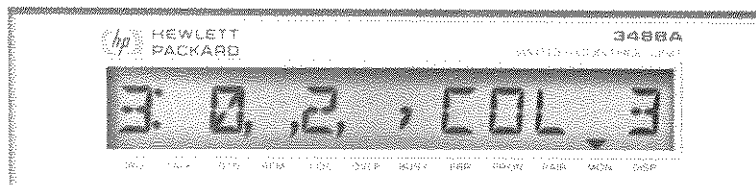

Slot 3, (Rows) 0 and 2 in Column 3 are closed

Advanced Operations

Advanced Operations provide you with more capabilities when using the 3488A. It may be important, for example, to tell the system voltmeter when a channel has been closed and thus take a measurement. Or maybe you need to close the next channel in a scan list when some external event has taken place, perhaps as soon as the voltmeter has completed its reading. Most operations can be performed with only the basic commands, but for those times when you need something more, the advanced operations should meet your switching needs.

External Increment and Channel Closed

External Increment (EI) provides a method of sequencing through a Scan List without system computer intervention. Typically, EI is connected to the Voltmeter Complete* output on a system voltmeter. Thus, when the voltmeter has completed its measurement, it signals the 3488A to step to the next channel in the list. The EI input is rising-edge triggered and TTL compatible.

Channel Closed (CC) provides a 15 μ S TTL pulse for signalling when a channel has been closed in the 3488A. This signal can be tied to the External Trigger input of a voltmeter to trigger it when a channel is closed. Together, EI and CC can be used with a system voltmeter to sequence through a scan list without any intervention by the system computer.

Using the External Increment and Channel Closed features requires the use of a 44470A Digital I/O option. This also means that the Digital I/O option cannot be configured in Handshake Mode #5 when it is used for scanning (it can be used statically, however). The DMODE command is used to specify the handshake mode, Polarity and EI. Only one Digital I/O option can be configured for EI at a time. If one option is configured to accept EI and another is subsequently enabled, the first card will be disabled.

Even though the only specifier we are interested in is EI, the mode and polarity specifiers must be included. The format for specifying DMODE is as follows:

DMODE <slot>[, <mode>][, <polarity>][, <EI>]

* Voltmeter Complete is a feature found on most Hewlett-Packard digital voltmeters that signal the completion of a measurement by means of a TTL compatible pulse.

The MODE specifier is as follows:

| Definition | Value |
|---------------------------|-------|
| Static Mode | 1 |
| Static Mode for read back | 2 |
| R/W & Strobe | 3 |
| Rd & Wt Strobe | 4 |
| HAndshake (no EI) | 5 |

Any of the Modes may be specified for use with External Increment except the Handshake Mode.

The Polarity specifier is the sum of weighted values and is defined as follows:

| Definition | Value |
|-----------------------------|---------------------|
| Lower 8-bits polarity | 1 = Low true |
| Upper 8-bits polarity | 2 = Low true |
| PCTL Polarity | 4 = Low busy |
| PFLG Polarity | 8 = Low busy |
| I/O Direction line Polarity | 16 = Low input mode |

EI is enabled by specifying 1. It is disabled with a specifier of 0.

DELAY

Command Format: DELAY [<time in mS>]

Description

The DELAY command is used to insert a time delay between the time that a channel is closed and the time the next command can be executed and the channel closed pulse is output. The delay time may be specified from 0 to 32,767 mS (32.767 seconds) in 1 mS increments. The delay time does not become effective until either STEP or CHAN is executed.

If any command is sent to the 3488A during the delay time, the command will be executed as soon as the delay time is complete. If there is not a time value sent with the DELAY command, the 3488A will respond by displaying the current value of the delay time.

Remember that the Channel Closed pulse will use whichever 44474A assembly has External Increment enabled.

Examples

OUTPUT 709; "DELAY 45" ! The delay time is 45 mS = .045 Sec.

OUTPUT 709; "DELAY"

ENTER 709; A

DISP A ! Variable 'A' will show the current delay value

HP-IB Interface Commands

Only two interface commands affect the state of the 44473A channels: TRIGGER (Group Execute Trigger) and CLEAR (Device Clear or Selected Device Clear). TRIGGER performs the same function as the 3488A STEP command. In other words, the two commands:

TRIGGER 7 (or TRIGGER 709)

and

OUTPUT 709; "STEP"

perform the same function as far as the 44473A assembly is concerned.

CLEAR, whether a Device Clear or Selected Device Clear, simply resets the 3488A and hence all relays will go to their open state.

44473A Assembly Installation

This portion of the chapter is written specifically for the service trained technician. It provides the necessary information for a person trained in electronic circuitry to configure and install the option assembly. Carefully read through this section and adhere to all cautions and warnings.

WARNING

Only qualified service trained personnel should remove, configure, or install the 3488A option assemblies. Disconnect the 3488A power cord from the back of the instrument prior to installing the option assemblies.

The 3488A Option 011, 44473A Relay Multiplexer, uses latching relays. The state of these relays can only be altered under program control. This is an advantage in the sense that, under most conditions of failure, the relays will remain in whatever state your program has set them. However, in case of power or equipment failure, any application requiring a failsafe method of insuring that the circuits under control are in a known state must be provided by the installer.

In case of component failure or programming error, any voltage input to an option card may be present on any other terminal on the same option card.

When you initially received your 3488A, the option assemblies were not installed in the mainframe. Each option assembly was packaged separately along with a terminal block edge connector and a two piece strain relief housing. In addition, two labels were provided for option identification.

CAUTION

Use clean handling and anti-static procedures when removing, configuring and installing the option assemblies. The circuit boards must be kept clean to ensure compliance with impedance specifications. The option assemblies as well as the 3488A mainframe contains CMOS devices which are susceptible to static discharges.

A few simple steps are required to install the 44473A assembly. Carefully observe the orientation of the assembly and terminal block as you install them.

1. Pre-installation

- a. Remove the ac power cord from the 3488A before installing any option assembly.
- b. Face the rear panel of the 3488A toward you.
- c. Select a slot. Refer to Figure 9-2, the 3488 has five slots for installing option assemblies. The 44473A can be used in any of the five slots.

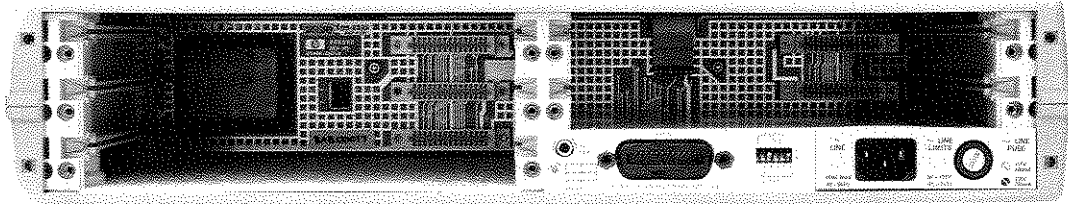

Figure 9-2. Rear Panel View of the 3488A

2. Option assembly installation

- a. Hold the option assembly, component side down, by the metal shields. Insert the circuit card into the slot guides and slide toward the front of the instrument. Push firmly until the assembly 'snaps' into place. Fold the plastic levers next to the assembly. These levers lock the option into the mainframe.

NOTE

To remove the option assembly, simply unfold the plastic tab levers. This will release the locking mechanism and pull the option out of the mainframe connector.

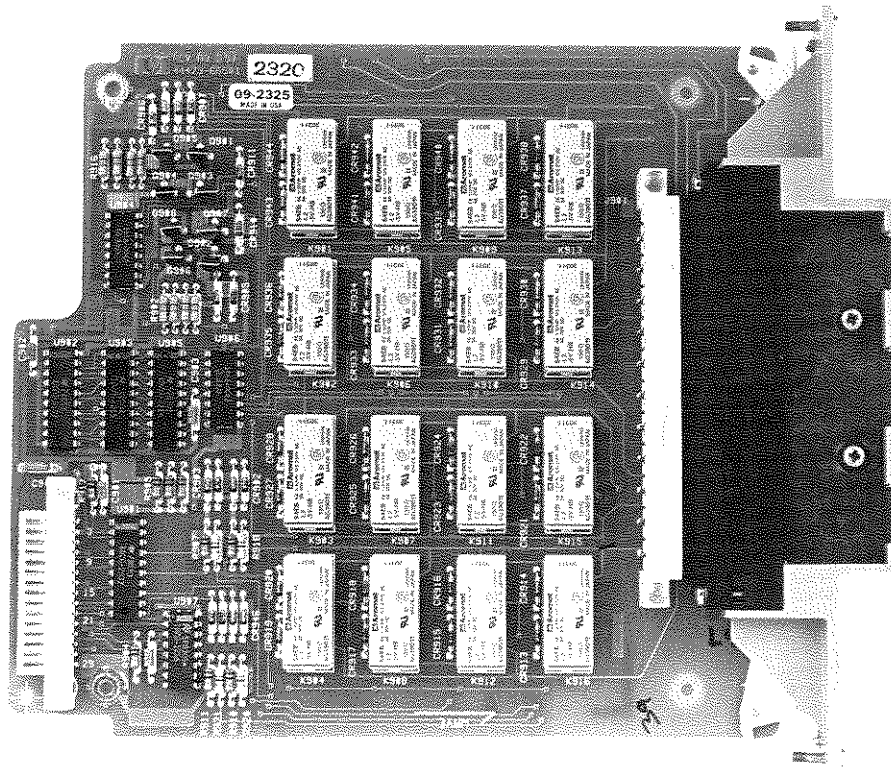

Figure 9.3. Option Card

3. Terminal Block Wiring

a. Wire the Terminal Block Edge Connector. The following photograph shows the channel connection sequence for the 44473A Terminal Block Edge Connector. This terminal block is keyed to fit only the 44473A assembly. Extra terminal blocks are available under the -hp- part number 44483A.



Figure 9.4. Terminal Block

4. Strain Relief

a. Secure the terminal block to the strain relief housing with the captive screws on the terminal block. Make certain that the screws used to tighten the connector wires to the terminal block are accessible through the strain relief housing.

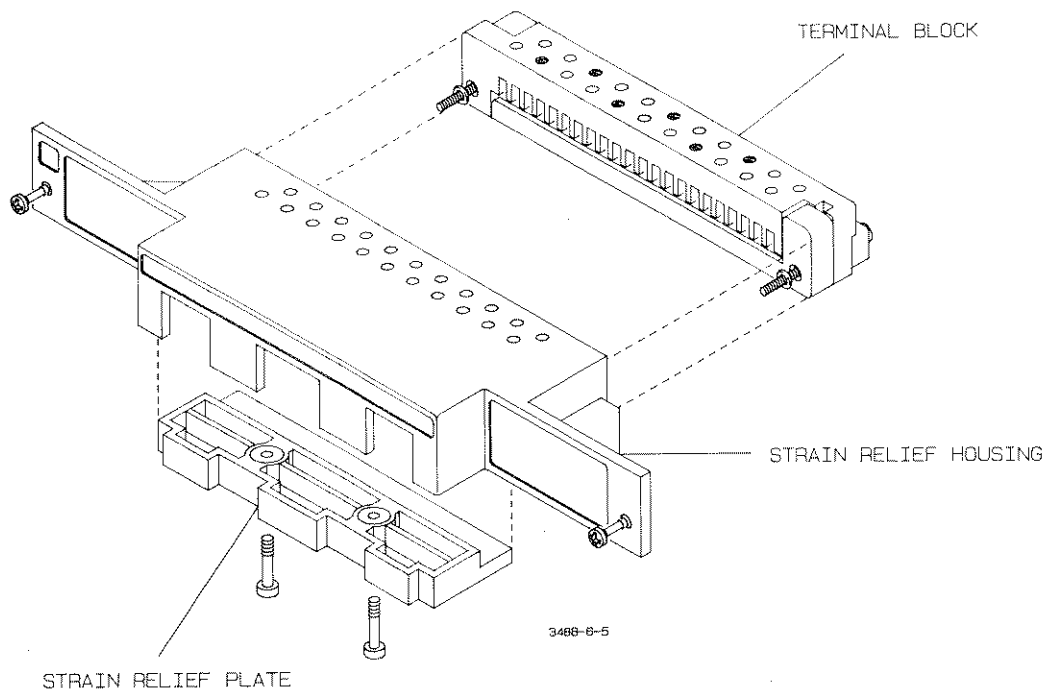

Figure 9-5. Strain Relief Assembly

b. Route the wires evenly through the three strain relief cutouts. This will ensure a uniform amount of strain relief. If only a few wires are used, they should go through the middle cutout.

c. To protect wires smaller than 22AWG it is recommended that these wires be bundled together starting no more than 4" from the back of the 3488A. Failure to do so may cause wires to break at the strain relief. To illustrate the need for this, a 26AWG wire can survive about 7 to 8 pounds of tension before breaking. A bundle of 10, however, could survive up to 70 pounds of tension.

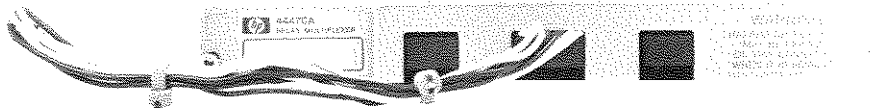

Figure 9-6. Cable Routing

d. Secure the strain relief plate to the strain relief housing (ribbed side toward housing). Do not over tighten the screws.

5. Labels

a. Two labels were provided with the option assembly. One identifies the assembly as a 44473A Matrix Switch. There is space on the bottom of this label to type or write in a description of where this particular option is being used.

b. Second, a series of numbered labels (1 to 5) is provided to help you identify the slot where the assembly is located. Select the appropriate numbered label and place it in the upper left hand corner of the strain relief housing.

Accessories

-hp- part number 44483A provides an extra Screw Terminal Connector Block for the 44473A assembly.

Specifications

The specifications at the end of this chapter apply to only the 44473A assembly. These specifications are the performance standards or limits against which the assembly is tested. Do not exceed or surpass the specified limits.

Any changes in specifications due to manufacturing changes, design, or traceability to the National Bureau of Standards will be covered in a manual change supplement.

Applications

Example 1. Extending the Matrix

Earlier in this manual it was stated that multiple 444703A Matrix options can be combined to form matrices of 4×8 , 4×12 , 4×16 , 4×20 and 8×8 . The purpose of this example is to show how these matrices are constructed. Figures 9-7 through 9-11 show the various configurations.

When wiring between option cards, keep wire length as short as possible to minimize noise and signal degradation.

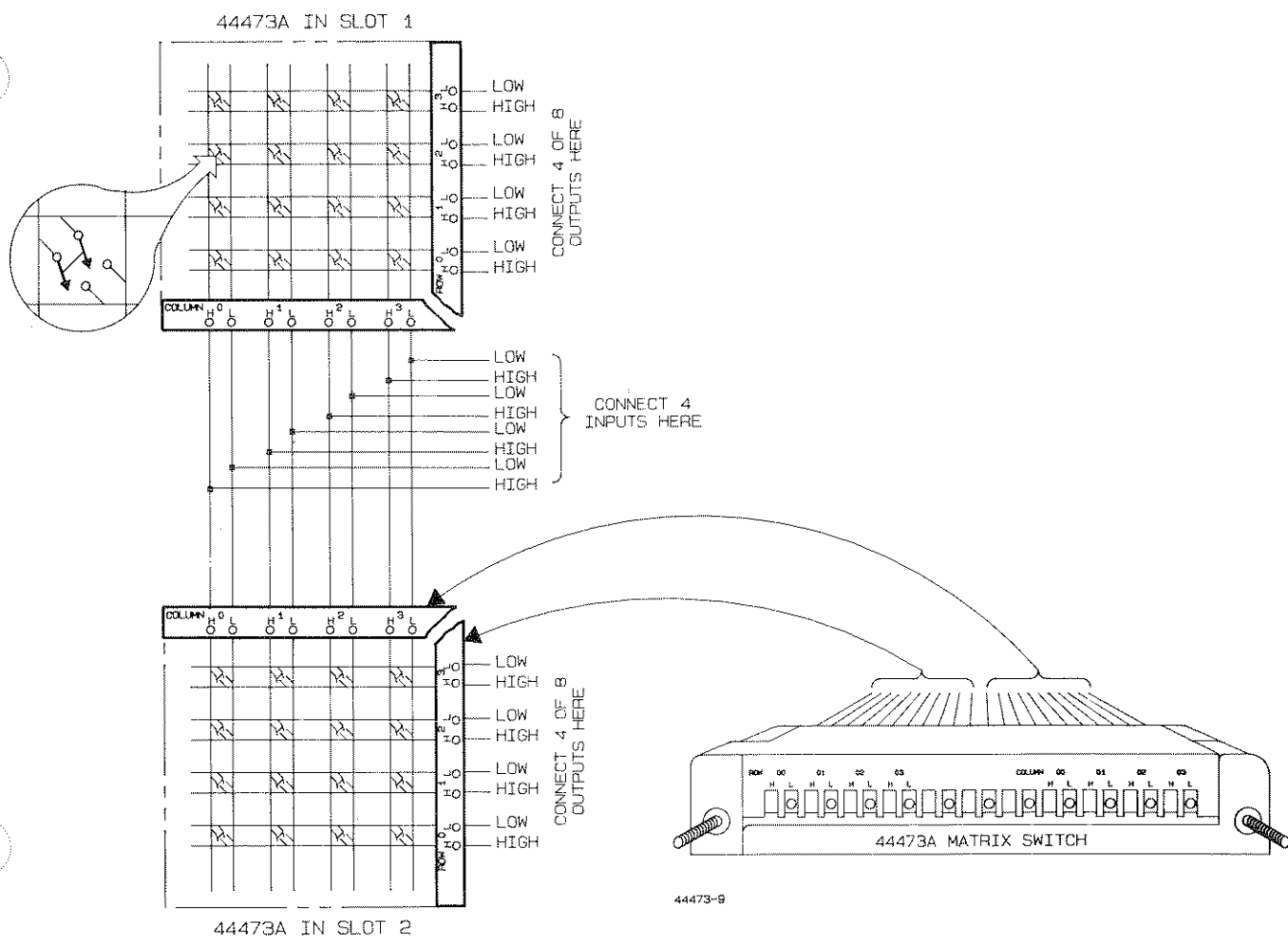
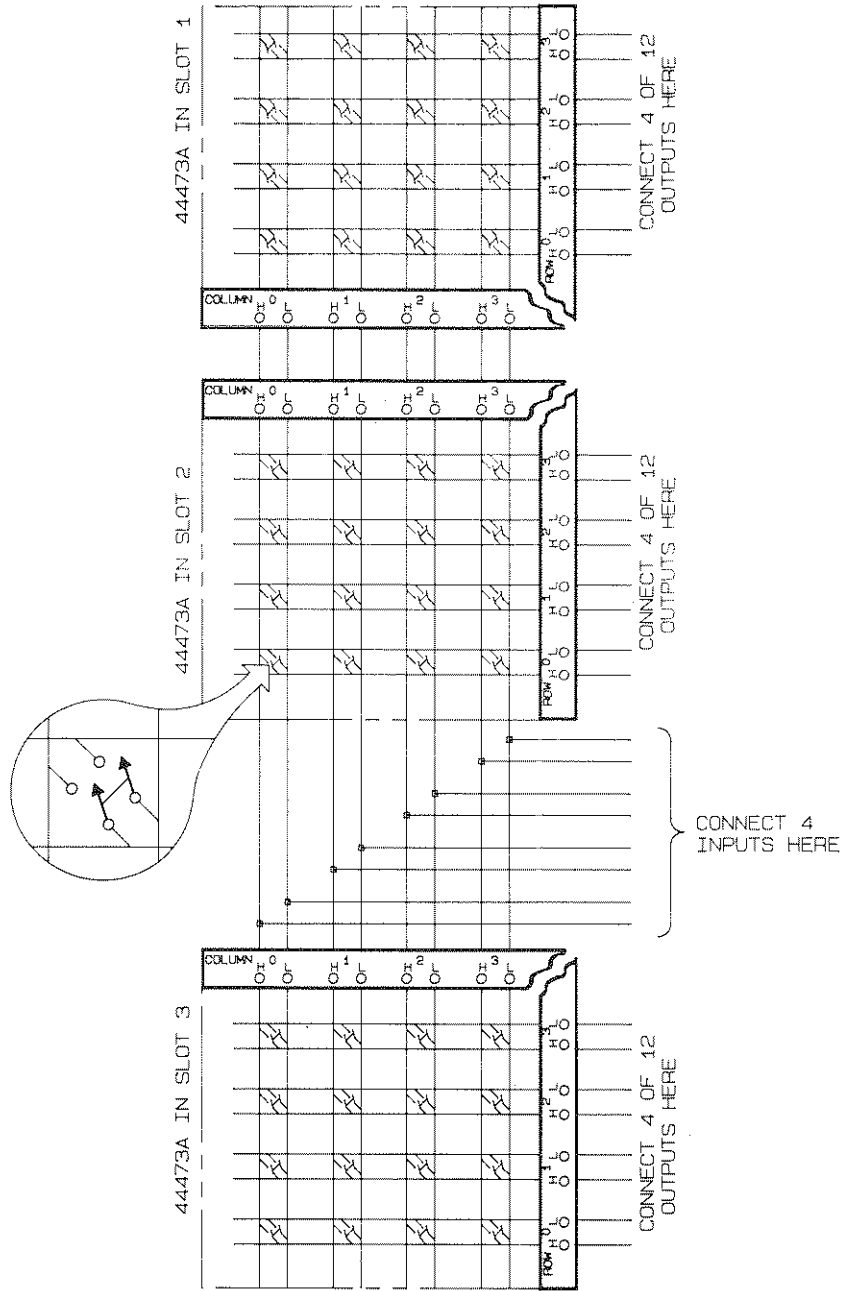
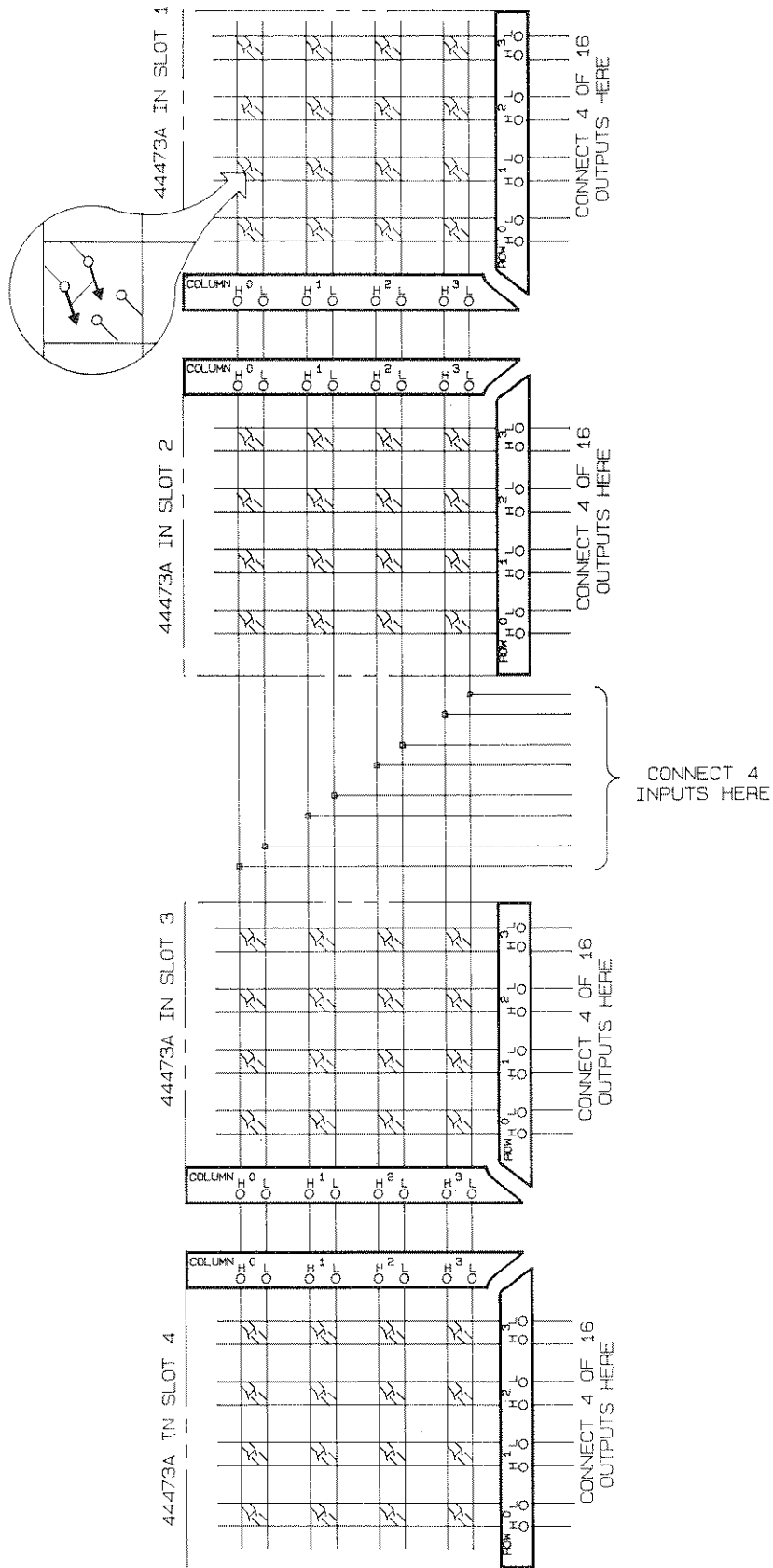

Figure 9-7. 4x8 Matrix



44473-10

Figure 9-8. 4x12 Matrix



44473-11

Figure 9-9. 4x16 Matrix

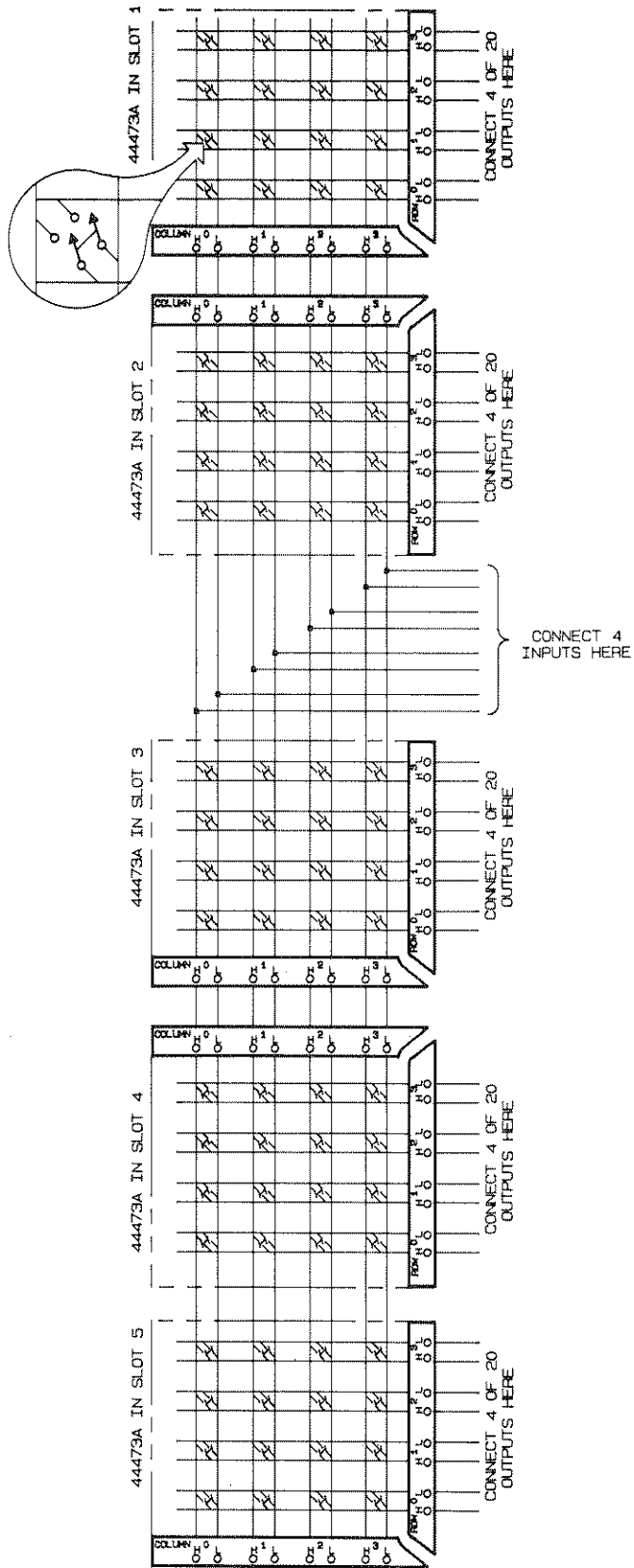

44473-12

Figure 9-10. 4x20 Matrix

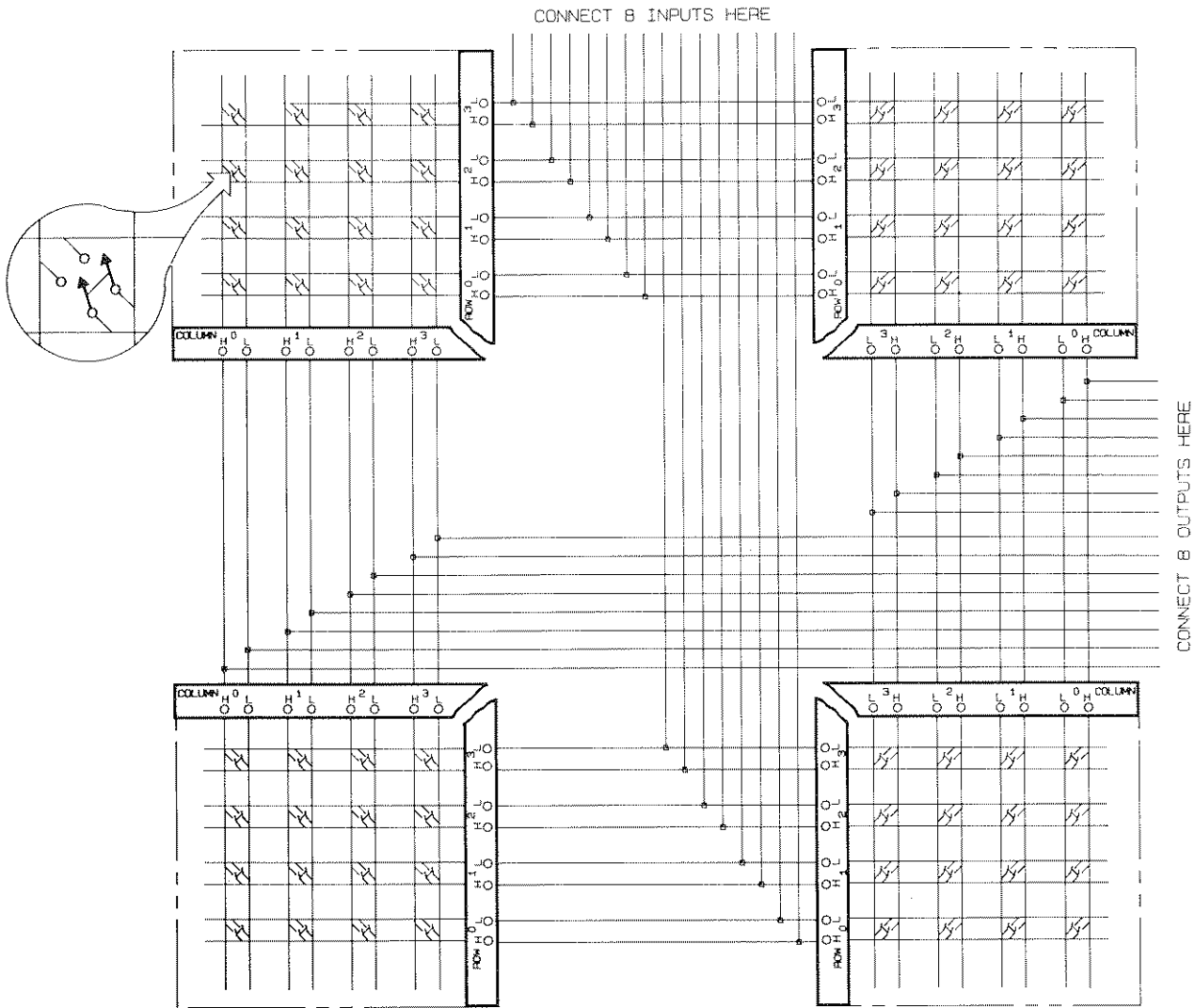

44473-13

Figure 9-11. 8x8 Matrix

Example 2. Extending the Matrix to 4x40

The 44473A, when used in conjunction with four 44470A Multiplexer options can provide for a matrix of 4 inputs to 40 outputs. Actually, any one of the inputs can be connected to up to 4 outputs. Figure 9-12 shows how this can be done. Again, when connecting between option cards, keep the wire lengths as short as possible to minimize noise and signal degradation.

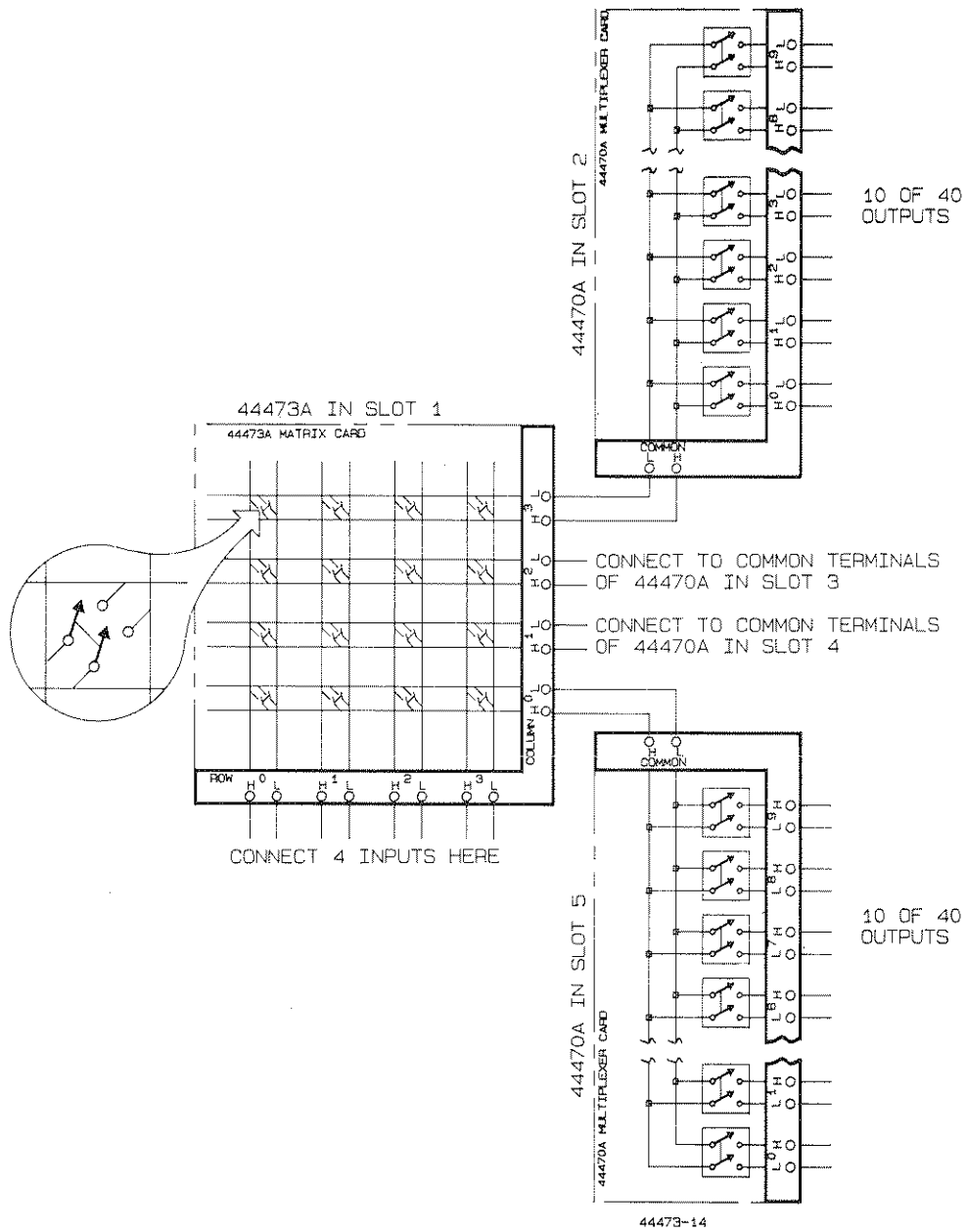

Figure 9-12. 4x40 Matrix

Table 9-2. Option 013 44473A 4 X 4 Matrix Switch Module Specifications

INPUT CHARACTERISTICS

Maximum Voltage (Terminal-terminal or terminal-chassis):
250 VDC, 250 VAC RMS, 350 VAC Peak

Maximum Current (Per channel): 2 ADC, 2 AAC RMS
(Per module): 8 ADC, 8 AAC RMS

Maximum Power (Per channel): 60 W DC, 500 VA AC
(Per module): 240 W DC, 2000 VA AC

Thermal Offset: <3 μ V differential

Closed Channel Resistance: < 3 Ω (end of relay life)

DC ISOLATION

| | <(40°C,60% RH) | <(40°C,95% RH) |
|--------------------------------|-----------------------------|------------------------------|
| Open Channel, Channel-Channel* | > 10 ¹¹ Ω | > 10 ⁹ Ω |
| Hi-Lo* | > 10 ¹⁰ Ω | > 10 ⁸ Ω |
| Channel-Chassis* | > 10 ¹⁰ Ω | > 5x10 ⁸ Ω |

(* with 1 channel closed)

AC ISOLATION/PERFORMANCE**

Capacitance:

| | |
|--------------------------------|--------|
| Open Channel, Channel-Channel* | < 5 pF |
| Hi-Lo* | <40 pF |
| Channel-Chassis* | <70 pF |

(* with 1 channel closed)

| (50 Ω termination) | 100 kHz | 1 MHz | 10 MHz |
|---------------------------|---------|--------|--------|
| Insertion Loss (dB) | < 0.30 | < 0.35 | < 0.90 |
| Crosstalk (dB) | < -76 | < -56 | < -36 |

**With chassis of all equipment connected, and with low of input lines connected to low of output lines (either directly or via 3488A switched channel).



Chapter 10

44474A

Digital I/O Module

Introduction

Option 014 to the 3488A provides 16 bidirectional data lines (channels) plus 4 lines used for control and handshaking. All lines are TTL compatible. Several modes of operation are possible, including:

- ▶ Addressing individual lines on a bit-by-bit basis, addressing as two 8-bit ports, or addressing all 16 lines as one word.
- ▶ Positive or negative true logic.
- ▶ Several handshake modes.
- ▶ "External Increment" and "Channel Closed" signals for hardware controlled scanning.
- ▶ Several commands to write data to and read data from the option.

This chapter is designed to serve as a reference guide for using the 44474A Digital I/O Option. As such, it contains programming information, installation, and configuration information, and application examples.

The two 8-bit ports are completely independent of each other and may be used separately. For instance, one port can be used for output operations, the other for input. They can also be used together for 16-bit operations. All data and control lines are TTL compatible.

Figure 10-1 shows a simplified schematic of the 44474A option. Note that all 16 I/O lines and 4 control lines share a common LO connection.

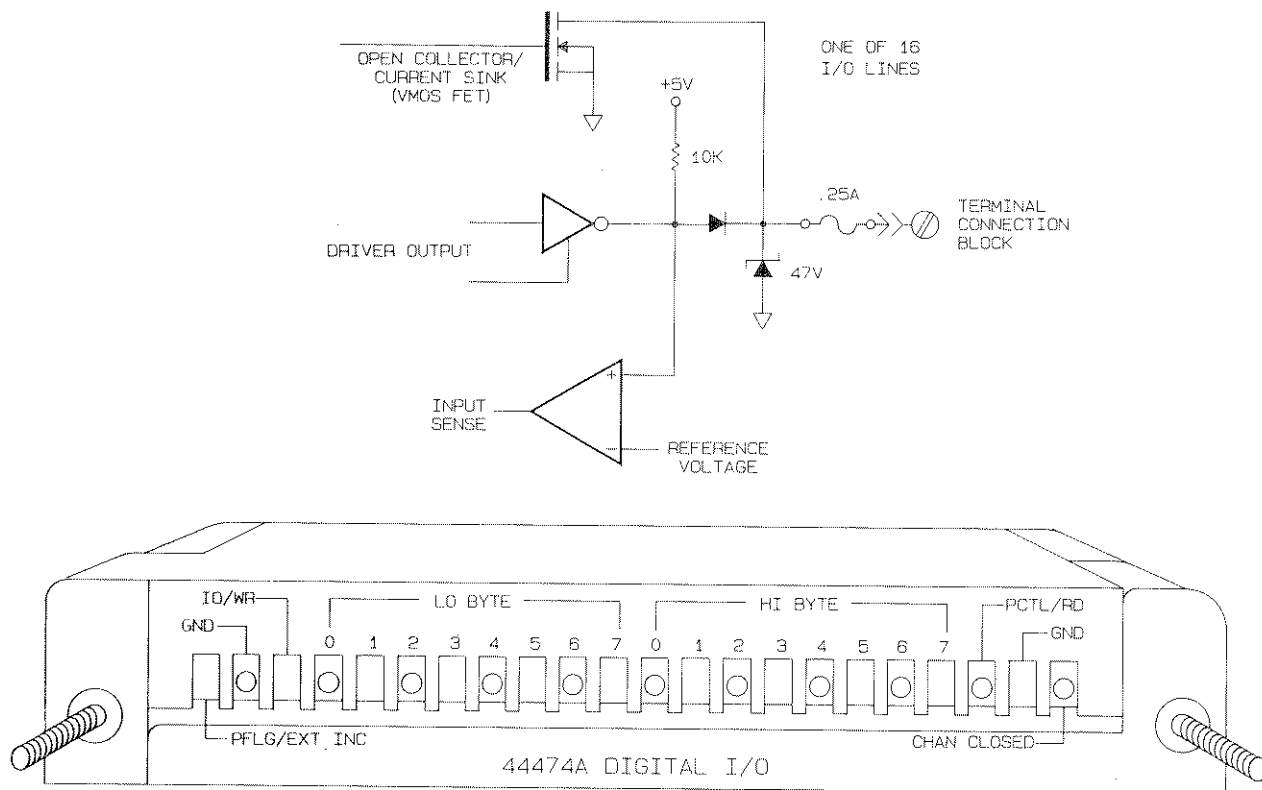

Figure 10-1. 44474A Simplified Schematic

Operation

Although several modes of operation are possible, the command discussions assume that the 44474A option is in its default Static Mode (#1, see DMODE command). This will be the case for either read or write operations. Later in this chapter you will learn to use the DMODE command and all the modes of operation.

Bit Definition

Each of the 16 I/O lines or bits, are bidirectional. This means that they can transfer information either outward (where the 3488A is controlling the bits) or inward (something external to the 3488A controls the bits and the 3488A reads them). The bits can be controlled or read either individually (bit-by-bit), as two groups of 8-bits each, or as one 16-bit word.

When used to output information, the individual bits act as switches. Because the 44474A is a digital I/O option, there are only two states for each of the bits. These two states are called Open and Closed. Figure 10-2 shows a very simple representation of one bit used as an output. The FET switch used on the 44474A can be thought of as a simple switch. Also shown in Figure 10-2 are two simple applications for the output bit.

Note that when speaking of the bit being Open, the switch is open (FET is high impedance) and point "A" is pulled up to the power supply voltage. Closed, means that the switch is closed (FET is low impedance) and point "A" is at circuit ground potential. When used in this mode, each of the output bits can sink up to 125 mA when used with up to a 30 volt supply.

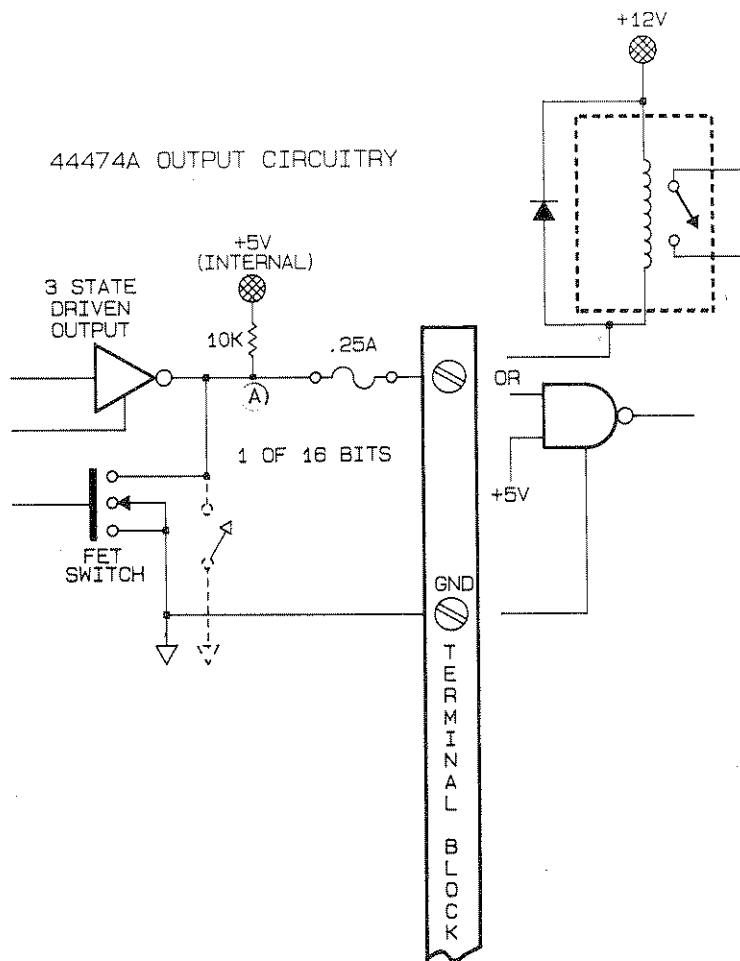

Figure 10-2. Output Bit Simplified Drawing

CAUTION

Grounding all bits and subsequently writing a 1 to all bits (bits pulled high), may cause the driver IC to exceed its power dissipation rating.

The 16 bits can also be used to input information. Figure 10-3 shows a simplified schematic of one input bit. Because the input bit has its own pull-up resistor, the bit can be used to detect switch closures to ground. Using external pull-ups, it can also be used with digital logic "high" levels of up to 30 volts.

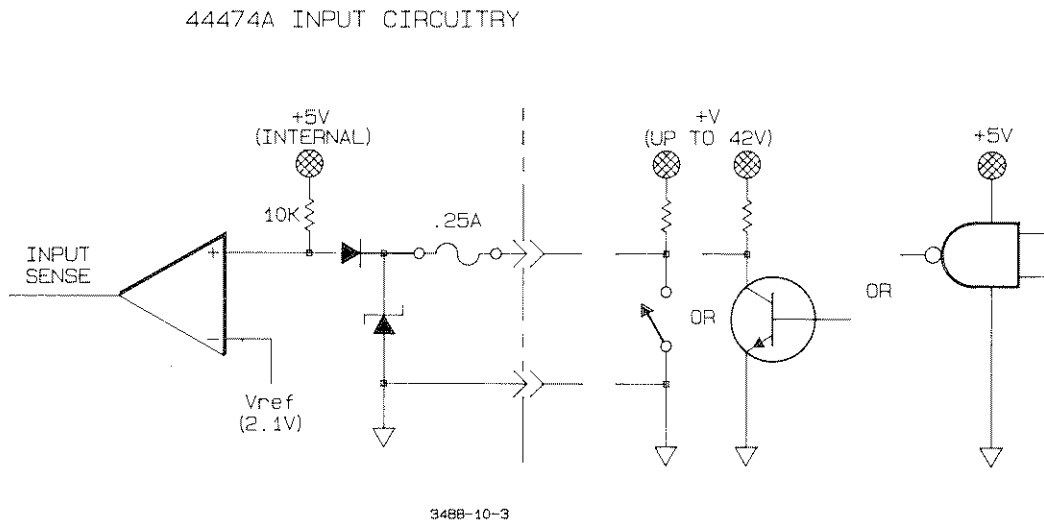

Figure 10-3. Input Bit Simplified Drawing

When used as input bits, Open means a positive voltage ($>2\text{v}$) is present and Closed means a voltage of <0.8 volts is present.

Commands

Now that we have seen a little of how the 16 bits can operate, let's learn how to control them. Most of the following commands are identical to the commands used for the other 3488A option assemblies, there are, however, some new ones. Remember, unless otherwise stated, the 44474A is assumed to be in its default Static mode (see DMODE command).

The 16 bits on the 44474A option can be addressed individually with the CLOSE, OPEN and VIEW commands. Bits, when addressed individually, are assigned a two digit number 00 through 15. The lo byte eight bits (see Figure 10-1) are assigned numbers 00 through 07. The Hi byte eight bits are assigned numbers 08 through 15.

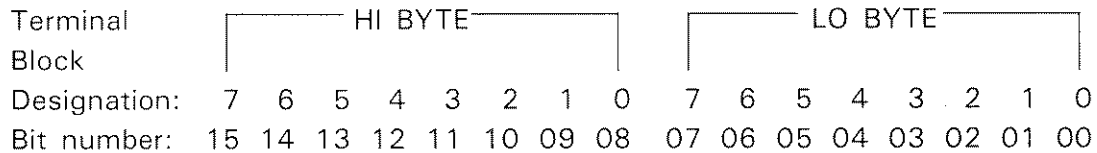

A bit address, however, is a three digit number where the first digit specifies the particular slot where the 44474A is installed. The last two digits in the bit address are the bit number. For example, bit address 503 means the 44474A is installed in slot 5, and we are addressing bit number 3 (Lo byte). Bit address 214 means slot 2, bit 14 (Hi byte).

In the following command discussions, square brackets ([]) indicate optional parameters, whereas items in < > brackets are mandatory. For further explanation of the command code mnemonics, refer to Chapters 2 and 3.

CLOSE a bit

Command Format: CLOSE <bit address>[,<bit address>,<bit address>,...]

Description

The CLOSE command is used to simply close (output mode only) one or more bits on the 44474A. Note that the CLOSE command does not open any bits (or relay channels) that were previously closed. Several bits can be closed with one CLOSE command by separating the bit addresses with a comma. If more than one bit is specified with the command, they are closed in the order listed.

The 44474A option must be in its Static Mode #1 or #2 when using CLOSE. Using the CLOSE command in any other mode will cause an error. See the DMODE command later in this chapter.

Examples

OUTPUT 709; "CLOSE 502,509,513" ! Closes bits 02, 09, and 13 in slot number 5

OUTPUT 709; "CLOSE 302, 104" ! Closes bit 02 in slot 3 and bit 04 in slot 1.

OPEN a Bit

Command Format: OPEN <bit address>[,<bit address>,<bit address>,...]

Description

OPEN is used to open individual bits on the 44474A option. If more than one bit is specified in the OPEN list, they are opened in the order listed. Use the CARD RESET command to open all bits on one 44474A assembly, it is easier than listing each bit.

The 44474A option must be in its Static Mode #1 or #2 when using OPEN. Using the OPEN command in any other mode will cause an error. See the DMODE command later in this chapter.

Example

OUTPUT 709; "OPEN 103,105,114" ! Opens bits 03, 05 and 14 in slot 1

VIEW a Bit

Command Format: VIEW <bit address>

Description

The VIEW command is used to look at one bit and determine whether it is open or closed. The 3488A responds with the string "OPEN 1" if the specified bit is open. If the specified bit is closed, the response is "CLOSED 0". In the 3488A display, the bit address is displayed followed by a colon and the appropriate response.

VIEW can only be used to look at input bits. If an attempt is made to VIEW an output bit, the 8-bit port where the single bit is located will revert to an input port.

Example

OUTPUT 709; "VIEW 105" ! Views bit 05 on slot 1
ENTER 709; A\$
DISP A\$! A\$ will either be "OPEN 1" or "CLOSED 0"

or

ENTER 709; A
DISP A ! "A" will either be 1 or 0 (Open or Closed, respectively)

CARD RESET

Command Format: CRESET <slot>[<slot>,<slot>,...]

Description

CRReset is used to reset the 44474A to its default Static mode (see DMODE). Also, all bits are Opened and are operating as input bits. There is no handshaking enabled.

Example

OUTPUT 709; "CRESET 3" ! resets the 44474A in slot 3

CARD PAIR

Command Format: CPAIR <slot>,<slot>

Description

Card Pair is used to pair up two option assemblies of the same type, e.g., 44474A's. This operation will effectively assign both options to both slot numbers so that almost any command executed to one option is also executed to the other.

Commands used with the card pair function are: CLOSE, OPEN, CRESET, DWRITE, DREAD, CHAN and STEP. Of course, paired options can be used as part of a scan list. Note, only one 44474A option can be enabled for External Increment and Channel Closed. Even with Card Pairing, only the 44474A that was enabled for EI and CC will continue to be enabled.

Executing a CPAIR command cancels any previous CPAIR that involved either of the two options. It is possible to have two sets of card pairs, e.g., slot 1 paired with 3 and slot 2 paired with 5. The only requisite is that both options within one pair be the same type.

Example

OUTPUT 709; "CPAIR 1,3" ! Sets the options in slots 1 and 3 as pairs
OUTPUT 709; "CLOSE 105" ! Closes bits 105 and 305

Executing the CPAIR command without specifying slot numbers allows you to determine which, if any, slots are paired together. Four numbers are returned separated by commas. The first two numbers specify slots in the first pair, the second two numbers specify the second pair. An inactive card pair is denoted by 0,0.

Example

```
OUTPUT 709; "CPAIR"  
ENTER 709; A$  
DISP A$
```

String variable A\$ will have the four slot numbers.
Note, you may have to dimension A\$ to 30 prior to executing.

DIGITAL WRITE Command

Command Format: DWRITE <slot> <port>, <decimal data>[, <decimal data>, ...]

Description

Digital write allows you to easily close more than one bit at a time. Using the Digital Write command configures all or part of the 44474A option as an output port. The port specifier is a two digit number that indicates whether the data is to be written to the Lo 8-bit byte (port 00), the Hi 8-bit byte (port 01) or as a 16-bit word (port 02).

The decimal data is the sum of the bit values that are to be open (+5 volts or greater depending on external circuitry). All bits not specified will be closed (~0 volts). Accordingly, the decimal data must be appropriate for the port specifier. When writing to an 8-bit byte, either port 00 or port 01, the decimal value must be between 0 and 255. Refer to Bit Value Table 1.

| | Hi Byte Port 01 | | | | | | | | Lo Byte Port 00 | | | | | | | |
|-------------|--------------------|----|----|----|----|----|----|----|--------------------|----|----|----|----|----|----|----|
| Bit number: | 15 | 14 | 13 | 12 | 11 | 10 | 09 | 08 | 07 | 06 | 05 | 04 | 03 | 02 | 01 | 00 |
| Bit Value: | 128 | 64 | 32 | 16 | 8 | 4 | 2 | 1 | 128 | 64 | 32 | 16 | 8 | 4 | 2 | 1 |

Bit Value Table 1.

Example

How would you close only bits 2 and 5 (values 4 and 32, respective) in slot 1 (port 00). The bit pattern could be represented as:

| | | | | | | | | |
|-------------|---|---|---|---|---|---|---|---|
| Bit Number: | 7 | 6 | 5 | 4 | 3 | 2 | 1 | 0 |
| Bit state: | 1 | 1 | 0 | 1 | 1 | 0 | 1 | 1 |

Where a "1" indicates the bit is open, and a "0" means the bit is closed. Summing the values for the open bits yields: $128 + 64 + 16 + 8 + 2 + 1 = 219$. Therefore, execute the command:

OUTPUT 709; "DWRITE 100, 219"

To close bits 10, 12 and 14 (values 4, 16, and 64, respective) in slot 5 (port 01), picture the bit pattern as:

| | | | | | | | | |
|-------------|----|----|----|----|----|----|---|---|
| Bit number: | 15 | 14 | 13 | 12 | 11 | 10 | 9 | 8 |
| Bit state: | 1 | 0 | 1 | 0 | 1 | 0 | 1 | 1 |

The sum of the values for the open bits is 171. Therefore, execute:

OUTPUT 709; "DWRITE 501, 171"

When writing to port 02, the 16 bit word, the decimal value can have a range of -32768 to $+32767$. Any time the summed value of the open bits would exceed $+32767$, the 2's complement form must be used and expressed as a negative number. Refer to Bit Value Table 2 for the bit values in the 16 bit word mode.

| | | | | | | | | | | | | | | | |
|-------------|-------|-------|------|------|------|------|-----|-----|-----|----|----|----|---|---|---|
| Bit Number: | 15 | 14 | 13 | 12 | 11 | 10 | 9 | 8 | 7 | 6 | 5 | 4 | 3 | 2 | 1 |
| Value: | 32768 | 16384 | 8192 | 4096 | 2048 | 1024 | 512 | 256 | 128 | 64 | 32 | 16 | 8 | 4 | 2 |

Bit Value Table 2.

Example

To close only bits 12, 9, 5 and 2 in slot 3 (port 02), the bit pattern could be represented as:

| | | | | | | | | | | | | | | | | |
|----------------|----|----|----|----|----|----|---|---|---|---|---|---|---|---|---|---|
| Bit Number: | 15 | 14 | 13 | 12 | 11 | 10 | 9 | 8 | 7 | 6 | 5 | 4 | 3 | 2 | 1 | 0 |
| Desired State: | 1 | 1 | 1 | 0 | 1 | 1 | 0 | 1 | 1 | 1 | 0 | 1 | 1 | 0 | 1 | 1 |

Normally, the summed bit values for the open bits would be 60891. This exceeds the limit of 32767 and therefore must be converted to 2's complement form. This conversion is a simple two step process.

First, complement, i.e, invert, the bit states:

| | | | | | | | | | | | | | | | | |
|-----------------|----|----|----|----|----|----|---|---|---|---|---|---|---|---|---|---|
| Bit Number: | 15 | 14 | 13 | 12 | 11 | 10 | 9 | 8 | 7 | 6 | 5 | 4 | 3 | 2 | 1 | 0 |
| Desired State: | 1 | 1 | 1 | 0 | 1 | 1 | 0 | 1 | 1 | 1 | 0 | 1 | 1 | 0 | 1 | 1 |
| Inverted State: | 0 | 0 | 0 | 1 | 0 | 0 | 1 | 0 | 0 | 0 | 1 | 0 | 0 | 1 | 0 | 0 |

Now, add 1 to the inverted state:

$$\begin{array}{r} 0001001000100100 \\ \quad \quad \quad \quad \quad + 1 \\ \hline 0001001000100101 \end{array}$$

This final result is the 2's complement form of the bit pattern we desire. Add together the values of the bits designated as 1's and execute that as a negative number:

OUTPUT 709; "DWRITE 502, -4645"

DIGITAL READ

Command Format: DREAD <slot> <port> [, <number of times to read data>]

Description

The DREAD command permits reading the input bits on the 44474A option. Like the DWRITE command, the port specifiers are 00 for the Lo 8-bit byte, 01 for the Hi 8-bit byte and 02 for reading the entire 16-bit word.

This command also permits multiple readings from the option with one command. If no "number of times to read data" is specified, the data will be read only once. Each reading is sent as six characters. In the case of multiple readings, the information is sent as a block with the readings separated by commas. If multiple reads are desired, the 3488A must be in the OLAP1 mode.

If the 44474A is in its Static Mode #1, the DREAD command will read the input data. In order to verify an output port, the 44474A must be in its Static Mode #2. This will enable reading the outputs.

Example

```
10 DIM A$(700)
20 OUTPUT 709; "OLAP 1"
30 OUTPUT 709; "DREAD 501, 100"      ! Take 100 readings
40 ENTER 709; A$                      ! Enter all 100 readings
50 DISP A$                             ! Display readings
60 END
```

Note, when data items are read over the HP-IB interface to the computer, the 3488A will remain busy until all items have been read by the computer.

CARD MONITOR Mode

Command Format: CMON <slot>

Description

The card monitor display for the 44474A Digital I/O option is similar to the photograph below. The H and L represent the High and Low 8-bit bytes, respectively. A trailing decimal point for either byte indicates that the last operation on that byte configured it as an output byte (e.g., DWRITE or CLOSE). If the decimal point does not appear, the byte is configured as an input byte.



When initially entering the card monitor mode, the display will indicate a decimal value. This decimal value is equal to the sum of the bit values that are in a high state. For an output byte, this means the the bits that are open. Refer to the following chart for a description of bit values.

| | Hi Byte | | | | | | | | Lo Byte | | | | | | | |
|-------------|---------|----|----|----|----|----|----|----|---------|----|----|----|----|----|----|----|
| Bit number: | 15 | 14 | 13 | 12 | 11 | 10 | 09 | 08 | 07 | 06 | 05 | 04 | 03 | 02 | 01 | 00 |
| Bit Value: | 128 | 64 | 32 | 16 | 8 | 4 | 2 | 1 | 128 | 64 | 32 | 16 | 8 | 4 | 2 | 1 |

Pressing either of the front panel arrow keys causes the display to switch to a hexadecimal (base 16) format for the display.

Example

If the last comand sent to the 44474A option put it into the 16 bit word mode (e.g., DWRITE to port 02), the monitor would also be displayed as a 16-bit word. A positive number indicates the sum of the bit values for the open bits. A negative number indicates the display is in 2's complement format.

To decode 2's complement format, first determine the binary representation for the display. Next, invert all bits and add 1. For example, if the display shows a -1234, the binary representation would be:

```

Bit Number:      15 14 13 12 11 10 9 8 7 6 5 4 3 2 1 0
Bit State:       0  0  0  0  0  1 0 0 1 1 0 1 0 0 1 0
  
```

Refer to the section on DWRITE for information on bit values.

Inverting this result gives a bit pattern of:

```

Bit Number:      15 14 13 12 11 10 9 8 7 6 5 4 3 2 1 0
True Bit State:  1  1  1  1  1  0 1 1 0 0 1 0 1 1 0 1
  
```

Now, add 1 to this and the result is:

```

Bit Number:      15 14 13 12 11 10 9 8 7 6 5 4 3 2 1 0
Bit State:       1  1  1  1  1  0 1 1 0 0 1 0 1 1 1 0
  
```

DIGITAL MODE Command

Command Format: DMODE <slot>[, <mode>][, <polarity>][, <EI>]

Description

This command is used to establish the handshake mode as well as polarity of the 16 I/O bits and control lines for the 44474A Digital I/O option. In addition, it is also used to enable/disable the External Increment and Channel Closed functions.

Mode Definition

Various handshaking modes are determined by the Mode specifier. This specifier is a number from 1 to 5 according to the following table:

| Mode | Specifier Number |
|-------------------------|------------------|
| Static | 1 |
| Static, read outputs | 2 |
| R/W and Strobe | 3 |
| Rd & WR Strobe | 4 |
| Handshake (no EI or CC) | 5 |

Note

Modes 3, 4 and 5 can only be used with port specifiers 00 and 02. Port 01 can be either Static Mode 1 or 2.

Static Mode #1

Static mode #1 is the default mode of the 44474A Digital I/O option. In this mode, data is transferred statically, that is, no read or write strobe pulses or handshaking. The I/O direction line is active though to indicate direction of transfer. This is shown in the following timing diagrams.

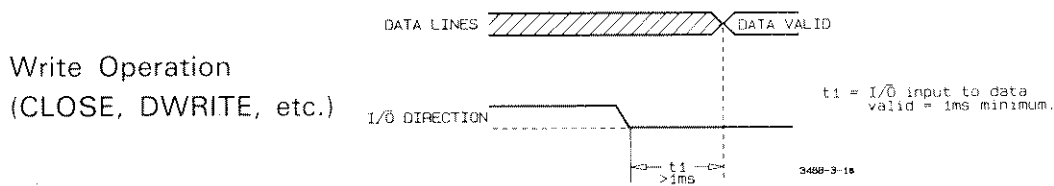

This diagram shows that approximately 1mS after the 3488A is instructed to write data to the 16 data I/O lines (I/O direction line goes to a low state), the 44474A takes control of the data lines.

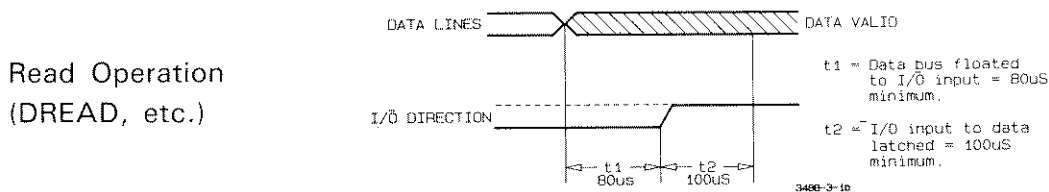

This diagram shows that $100\mu\text{S}$ after the 3488A is instructed to read the 16 Data I/O lines, it releases control of the lines and the I/O direction line goes to a high state. $120\mu\text{S}$ later, the data is actually read (latched).

Static Mode #2

Static Mode #2 acts just like Mode 1 except that the output lines are not disabled when the option is read (DREAD, etc.). This means that if a port is written to and then read from, the data read will be that which was just written to it. It is possible, however, that external devices might load the lines and cause a false read.

Timing for the I/O direction line is as shown in Mode #1, except for read. During a read operation, there is no change in the I/O direction line.

R/W and Strobe Mode #3

In this mode, the I/O direction line is still used to indicate direction of transfer (input or output) but the PCTL (Peripheral control) line is used to strobe the data.

During a Write operation, where the 3488A writes the data to some external device, the strobe pulse signifies that the data on the 16 Data I/O lines is valid. This is shown in the following timing diagram.

Write Operation

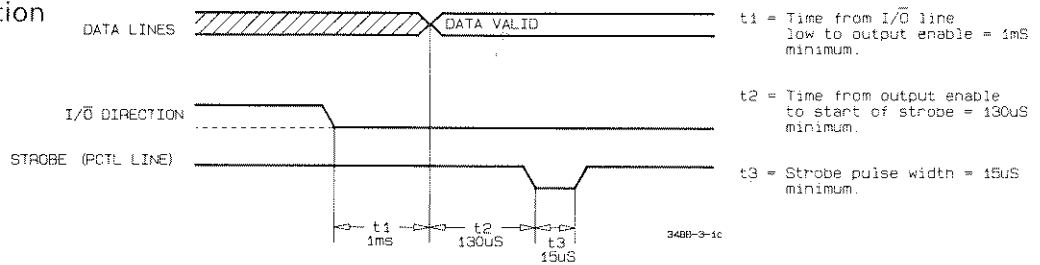

A Strobe pulse is used by the 3488A to signify that the data on the data lines is valid. Therefore, during a Write operation, the device receiving the data is triggered by the Strobe pulse.

The strobe pulse is used during a Read operation to signify that the 3488A has completed the read operation. This is shown in the following diagram.

Read Operation

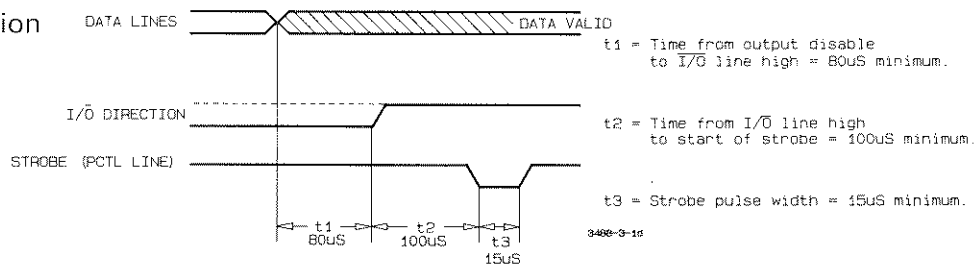

When used during a Read operation, the Strobe pulse signifies that the 3488A has latched (read) the data from the data lines.

Read and Write Strobe Mode #4

The Read and Write Strobe Mode uses the I/O direction line as a strobe pulse to indicate writing operations. The PCTL line is used to indicate Read operations. It is thus similar to the R/W and Strobe Mode #3 except separate control lines are used for the strobe pulses and there is no I/O direction line.

Write Operation

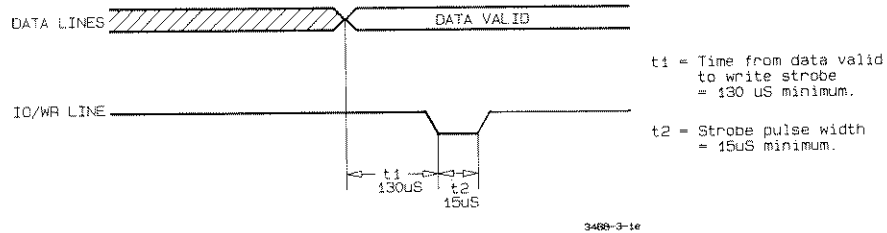

The IO/WR line is used to indicate that the data is valid on the data bus lines. IO/WR is used to trigger the receiving device.

Read Operation

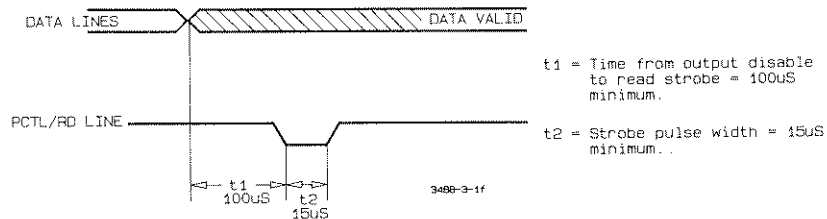

As in Mode #3, the PCTL/RD line is used to indicate to the sending device that the 3488A has latched (read) the data.

Handshake Mode #5

This fifth mode provides a complete two wire handshake with a data direction line. During Write operations, the PCTL line indicates that output data is valid; during Read operations, it indicates that the 44474A is "ready for data." The PFLG line is used by the peripheral device to indicate "ready for data" during write operations or "data valid" for read operations.

Remember, Write operations are the 3488A/44474A controlling the data on the 16 Data I/O lines. Two commands used during Write operations are DWRITE and CLOSE. Read operations are where external devices control the 16 data lines and the 3488A/44474A simply reads the data and controls the PCTL/RD line.

Write Operations

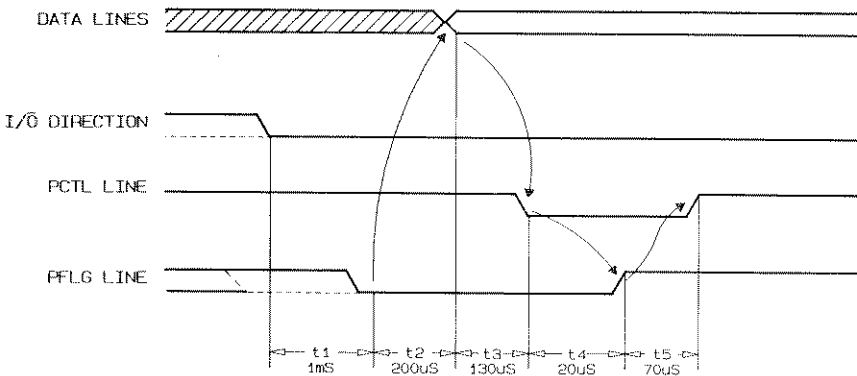

- t1 = Time from I/O line low to check for PFLG low = 1ms minimum.
- t2 = Time from PFLG low to data valid = 200us minimum.
- t3 = Time from data valid to PCTL low = 130us minimum.
- t4 = Time from PCTL low to check for PFLG high = 20us minimum.
- t5 = Time from PFLG to PCTL high = 70us minimum.

The complete handshaking sequence for Mode #5 is as follows: The 3488A checks to see if the receiving device has set the PFLG line low, this indicates the receiving device is ready to accept data. When PFLG is low, the 3488A sets the data on the data bus and sets PCTL low. The 3488A then waits for the receiving device to set PFLG high, indicating that it has latched the data. To complete the handshake, the 3488A sets PCTL high.

Read Operations

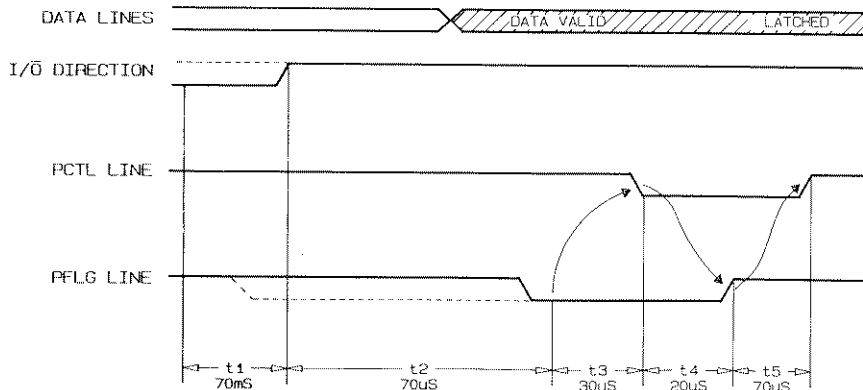

- t1 = Time from output disable to I/O line high = 70us minimum.
- t2 = Time from I/O line high to check for PFLG low = 70us minimum.
- t3 = Time from PFLG low to check for PCTL low = 30us minimum.
- t4 = Time from PCTL low to check PFLG high = 20us minimum.
- t5 = Time from PFLG high to PCTL high and data latched = 70us minimum.

As with the Write operation, the 3488A begins by testing PFLG for a low state, indicating that the data is valid. When PFLG is low, the 3488A sets PCTL low and waits for PFLG to go high. The 3488A will set PCTL high to indicate that it has completed the data read operation. Data on the data bus must remain valid until after the 3488A sets PCTL high.

Polarity Definition

The Polarity specifier for the DMODE command is used to set the polarity of both the 16 data lines and the handshake/control lines. When the polarity of the control lines is changed by this command, the 44474A will immediately change the states of the affected lines. For the data lines, the current state is not immediately changed, but the new polarity will be used in subsequent operations.

The polarity specifier in the DMODE command is decimal weighted and defined in Table 10-1.

Table 10-1. Polarity Specifier

| Definition | Value |
|---|---|
| Default, data lines high true (open), PCTL and PFLG low means ready, I/O Direction line high for ready. | 0 = Default |
| Lo 8-bit byte | 1 = Low true |
| Hi 8-bit byte | 2 = Low true |
| PCTL Polarity | 4 = Low means ready, High means busy |
| PFLG Polarity | 8 = Low means ready, High means busy |
| I/O Direction line polarity | 16 = Low means input, High means output |

To illustrate the use of the polarity specifier for the Hi and Lo bytes, consider that normally, that is the default mode, the 16 data lines are high (+5 volts) for open and lo (0 volts) for closed. This is true whether a write or read operation is performed. By inverting the polarity for either or both bytes, high (+5 volts) then becomes closed and lo (0 volts) becomes open.

Changing the polarity of the PCTL, PFLG or I/O Direction line will affect the handshaking control. Refer to the handshaking timing diagrams in the Mode definition. If you change the polarity of either the PCTL, PFLG, or I/O Direction lines, invert the drawing for that line. For example, the I/O direction line in Static Modes # 1 and 2 for a Write operation looks like:

Write Operation

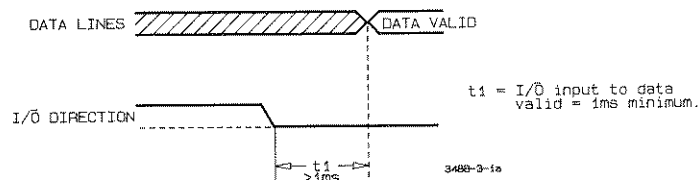

Here, a low on the I/O Direction line indicates a Write or output operation. After executing the command "DMODE 5,1,16,0" (polarity specifier of 16 changes the polarity of the I/O Direction Line), the diagram would look like:

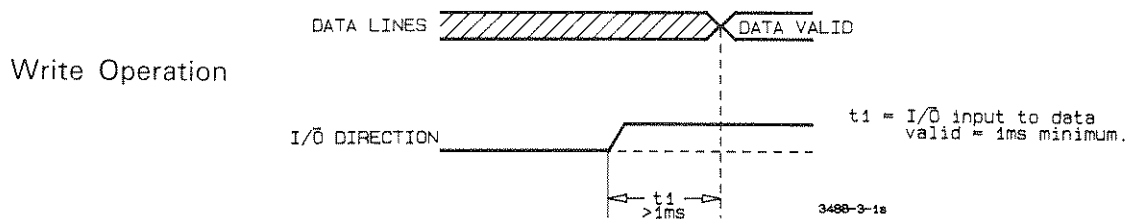

Now, the direction line effectively becomes inverted and a high means an output operation.

External Increment Definition

External Increment (EI) provides a method of sequencing through a scan list without system computer intervention. EI is enabled by specifying 1 in the EI specifier for DMODE and disabled by specifying 0.

Typically, EI is connected to the Voltmeter Complete* output on a system voltmeter. The Channel Closed line (CC) can be connected to the External Trigger input on the voltmeter. The scan is started by executing either STEP or CHAN. As soon as the channel closes, the 44474A outputs a CC pulse, triggering the voltmeter. As soon as the voltmeter completes its measurement, it outputs the Voltmeter complete pulse which increments the scan list. When the next channel closes, CC is once again sent and the process continues to sequence through the scan list.

The number 0 may be inserted in the scan list to act as a stop channel. When it is encountered, the 3488A opens the last channel closed but will not close a new one and CC is not sent.

Only one 44474A option can be configured for EI and CC use in scanning. If one option is enabled and another is subsequently enabled, the first will become disabled.

Figure 10-4 shows the timing relationship for the scan sequence when using EI and CC. If the 3488A receives either an EI or the HP-IB Trigger command while the instrument is busy with another command, the Step command will be executed as soon as the command in progress is completed. If EI is received while the 3488A is busy executing a previous EI, a "trigger too fast" error will be generated.

* Voltmeter Complete is a feature on most Hewlett-Packard digital voltmeters to signal the completion of a measurement by means of a TTL compatible pulse.

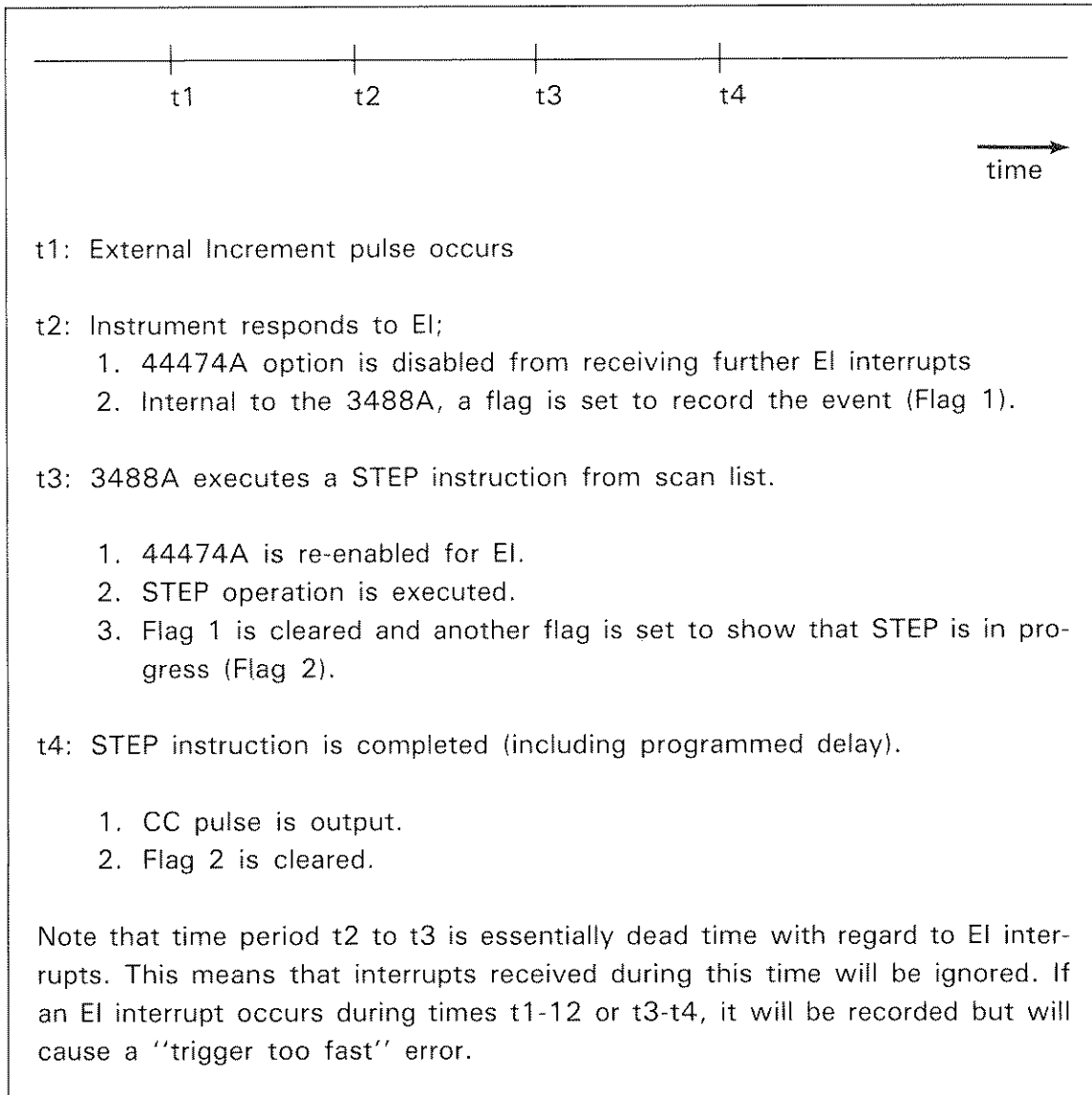

Figure 10-4. Scan Timing

SCAN LIST

Command Format: SLIST [<ch. address>(, or -)<ch.address>...<ch. address>]

Description

Scan List allows you to specify a sequence of channels to be scanned. The sequence is specified as a list of up to 85 channel addresses (relay or digital I/O bits) and/or stored setups separated by commas. Contiguous channel addresses may be specified by entering the first channel address and the last channel address separated by a hyphen. STEP is used to sequence through the list.

Example

```
10 OUTPUT 709; "SLIST 104,205,300 - 309,410,0"  
20 FOR I = 1 TO 14  
30 OUTPUT 709; "STEP"  
40 NEXT I
```

In this example, the scan would start by closing channel 104. After the next STEP command channel 104 would open and channel 205 closes. The next STEP causes 205 to open and 300 to close. Next, 300 opens and 301 closes. This continues until the number 0 is reached which opens channel 410 but closes no other channels.

Notes:

1. Channels may be scanned in any sequence, i.e., 309-300.
2. Stepping beyond the last channel specified in the scan list causes a wraparound to the first channel in the list unless the number 0 is used as a stop channel.
3. The commands OPEN, CLOSE, CRESET, or RECALL will have no effect on the scan list even though the state of individual channels may change.
4. Stored setups may be recalled as part of the scan list simply by specifying the register number. For example, SLIST 104-106,25,200,502. Here, register number 25 is recalled.
5. Channels that are closed by recalling a stored setup are not opened by subsequent STEP commands. Individual channels will be opened if and when they are encountered later in the scan list.
6. If a CRESET command is executed for a digital card that is currently being scanned (EE and CI are enabled), the card will be reset but the scan list will increment and close the next digital bit.

STEPping Through the Scan List

Command Format: STEP

Description

STEP is used to initiate and sequence through a scan list. If STEP is executed and no scan list is in effect, an error will be generated.

The 3488A uses an internal pointer to keep track of which channel in the list is currently closed. When STEP is executed, that channel opens and the next item in the list is checked. If the next item in the list is either a relay channel or digital I/O bit, that channel is closed. If the next item in the list is a stored setup, that setup is recalled. Channels that are closed by recalling a stored setup are not opened by the execution of STEP.

Example

```
10 OUTPUT 709; "SLIST 100-109,25,200,301,303"  
20 FOR I= 1 TO 14  
30 OUTPUT 709; "STEP"  
40 NEXT I
```

CHANnel Command

Command Format: CHAN [<ch. address>]

Description

CHAN is used to open the last channel closed by either STEP or CHAN and close the specified channel. If no channel is specified with CHAN, the 3488A will respond with the last channel closed by either STEP or CHAN. If no channel has been closed since the last reset, CHAN returns the number 0.

If a scan list is in effect when CHAN is executed, the 3488A will search through the list and position the scan list pointer to the channel specified by CHAN. If CHAN specifies a channel that is not in the scan list, and then STEP is subsequently executed, the 3488A will open the channel closed by CHAN and proceed to the beginning of the scan list.

Examples

```
OUTPUT 709; "CHAN 202"      ! closes channel 202  
  
OUTPUT 709; "CHAN"  
ENTER 709; A  
DISP A                      ! Variable "A" contains the last channel closed  
                             by CHAN, i.e., 202.
```

DELAY time

Command Format: DELAY [<time in mS>]

Description

The DELAY command is used to insert a time delay between the time that a channel is closed and the next command or Channel Closed pulse is executed. The Delay time is specified from 0 to 32,767 mS (32.767 seconds) in 1 mS intervals. The delay time does not become effective until either CHAN or STEP is executed.

If any command is sent to the 3488A during the delay time, the command will be executed as soon as the delay is complete. If there is not a time value sent with the DELAY command, the 3488A will respond with the current value of delay time.

Remember that the Channel Closed pulse will be sent after the delay time is complete from the 44474A option that has External Increment enabled.

Examples

OUTPUT 709; "DELAY 2000; CHAN 101"

OUTPUT 709; "DELAY"

ENTER 709;A

DISP A

! Display the current delay time: 2000 mS

DIGITAL BINARY WRITE

Command Format: DBW <slot> <port> ,#l<block data>

Description

When the DBW command is received, the 3488A will interpret the data that follows as a block of binary data. This data is to be output according to the mode set up for the option by the DMODE command. In the 16 bit mode (port 02), the incoming data is interpreted as being the high or most significant byte first.

Port definition is: port 00 is lo 8-bit byte, port 01 is high 8-bit byte, and port 02 is 16-bit word.

IMPORTANT. Transfer is completed by the HP-IB EOI line going true concurrently with the last byte of data. The following program shows how to implement EOI on the -hp- 80 series of computers.

Example

```

10 CONTROL 7,16;128
20 DIM A$(30)
30 IOBUFFER A$
40 A$="CMON 5;DBW 502, #IAS"
50 TRANSFER A$ TO 709

```

Line 10 configures the Series 80 computer HP-IB interface to set EOI true concurrent with the last character sent. Line 40 contains the actual commands that will be sent to the 3488A (line 50). The DBW 502,#IAS will send the ASCII characters A and S to the 44474A option. The final bit configuration will be:

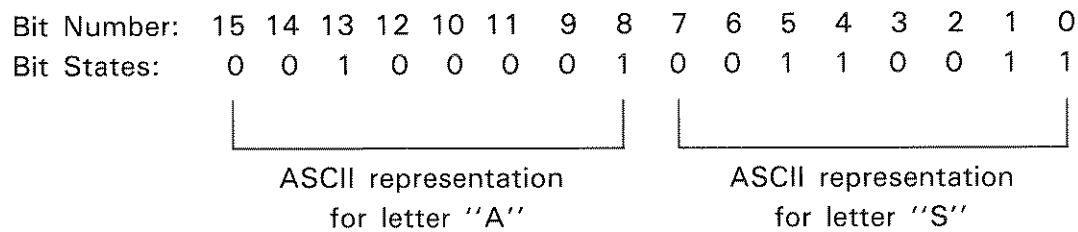

DIGITAL BINARY READ

Command Format: DBR <slot><port>,[<number of times to read>]

Description

In the binary read mode data items are read and sent according to the format set by the slot/port specifier and DMODE command. If 16-bit mode (port 02) is specified, data will be sent with the most significant (high) byte first. The data transfer is terminated by the 3488A setting EOI true on the HP-IB interface. This is done concurrently with the last byte of data output. The maximum number of data items that can be specified with the DBW command is 32,767.

Note. If more than one reading is requested, the 3488A must be in the OLAP1 mode. This command must be done on a separate program line because it does not become active in the 3488A until the first Bus communication after OLAP has been asserted.

Example

The following program shows how to configure a Series 80 computer for responding to EOI true concurrent with the last character sent.

```
10 DIM A$(30)
20 A$ = "DBR 502,1"
30 IOBUFFER A$
40 TRANSFER A$ TO 709 INTR
50 ENTER 709 USING "%,K"; B$
60 DISP B$
```

Line 50 uses the image specifiers % and K to respond to EOI true concurrent with the last character sent.

HP-IB Interface Commands

Only two interface commands affect the state of the 44474A channels: TRIGGER (Group Execute Trigger) and CLEAR (Device Clear or Selected Device Clear). TRIGGER performs the same function as the 3488A STEP command. In other words, the two commands:

TRIGGER 7 (or TRIGGER 709)

and

OUTPUT 709; "STEP"

perform the same function as far as the 44474A assembly is concerned.

CLEAR, whether a Device Clear or Selected Device Clear, simply resets the 3488A and hence all relays will go to their open state.

44474A Assembly Installation

This portion of the chapter is written specifically for the service trained technician. It provides the necessary information for a person trained in electronic circuitry to configure and install the option assembly. Carefully read through this section and adhere to all cautions and warnings.

WARNING

Only qualified service trained personnel should remove, configure, or install the 3488A option assemblies. Disconnect the 3488A power cord from the back of the instrument prior to installing the option assemblies.

When you initially received your 3488A, the option assemblies were not installed in the mainframe. Each option assembly was packaged separately along with a terminal block edge connector and a two piece strain relief housing. In addition, two labels were provided for option identification.

CAUTION

Use clean handling and anti-static procedures when removing, configuring and installing the option assemblies. The circuit boards must be kept clean to ensure compliance with impedance specifications. The option assemblies as well as the 3488A mainframe contains CMOS devices which are susceptible to static discharges.

A few simple steps are required to install the 44474A assembly. Carefully observe the orientation of the assembly and terminal block as you install them.

1. Pre-installation
 - a. Remove the ac power cord from the 3488A before installing any option assembly.
 - b. Position the 3488A with the rear panel towards you.
 - c. Select a slot. Refer to Figure 10-5, the 3488A has five slots for installing option assemblies. The 44474A can be used in any of the five slots.

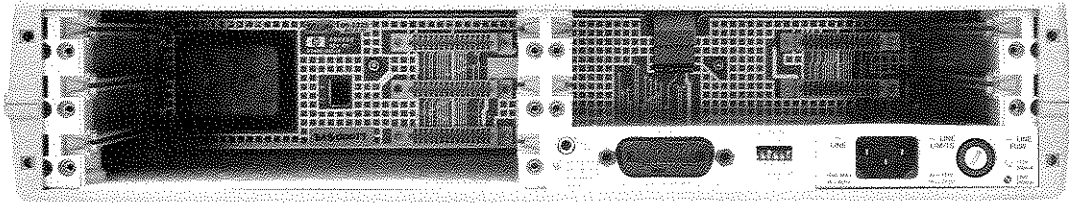

Figure 10-5. Rear Panel View of the 3488A

2. Option assembly installation

- a. Hold the option assembly, component side down, by the metal shields. Insert the circuit card into the slot guides and slide toward the front of the instrument. Push firmly until the assembly 'snaps' into place. Fold the plastic levers toward the assembly. These levers lock the option into the mainframe.

NOTE

To remove the option assembly, simply unfold the plastic tab levers. This will release the locking mechanism and pull the option out of the mainframe connector.

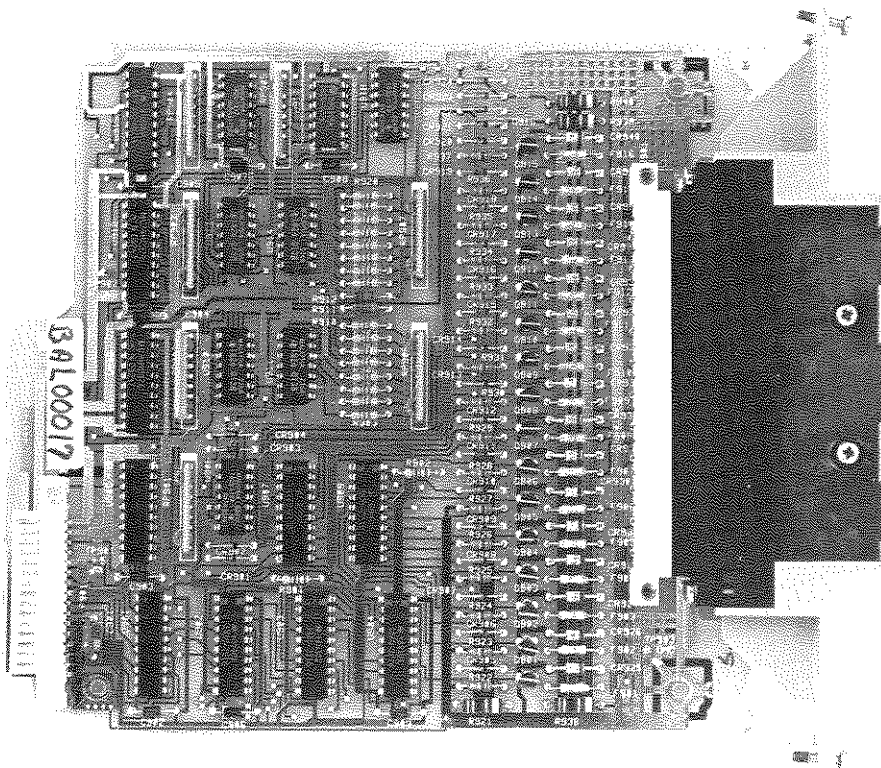

Figure 10-6. Option Card

3. Terminal Block Wiring

- a. Wire the Terminal Block Edge Connector. Figure 10-7 shows the channel connection sequence for the 44474A Terminal Block Edge Connector. This terminal block is keyed to fit only the 44474A assembly. Extra terminal blocks are available under the -hp- part number 44484A.



Figure 10-7. Terminal Block

4. Strain Relief

- a. Secure the terminal block to the strain relief housing with the captive screws on the terminal block. Make certain that the screws used to tighten the connector wires to the terminal block are accessible through the strain relief housing.

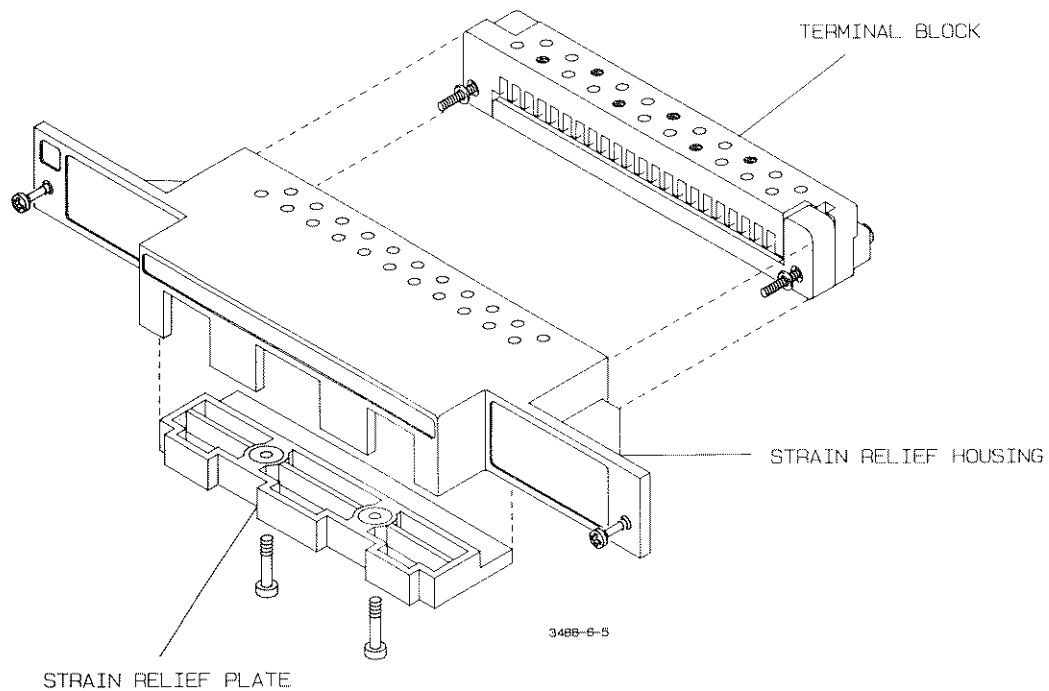

Figure 10-8. Strain Relief Housing

b. Route the wires evenly through the three strain relief cutouts. This will ensure a uniform amount of strain relief. If only a few wires are used, they should go through the middle cutout.

c. To protect wires smaller than 22AWG it is recommended that these wires be bundled together starting no more than 4" from the back of the 3488A. Failure to do so may cause wires to break at the strain relief. To illustrate the need for this, a 26AWG wire can survive about 7 to 8 pounds of tension before breaking. A bundle of 10, however, could survive up to 70 pounds of tension.

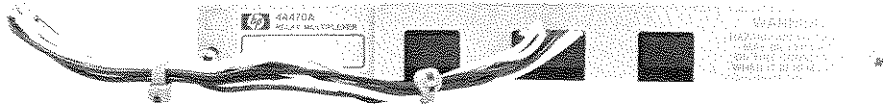

Figure 10-9. Cable Routing

d. Secure the strain relief plate to the strain relief housing (ribbed side toward housing). Do not over tighten the screws.

e. Push the terminal block with strain relief housing onto the option assembly connector. Tighten the two screws on either end of the housing.

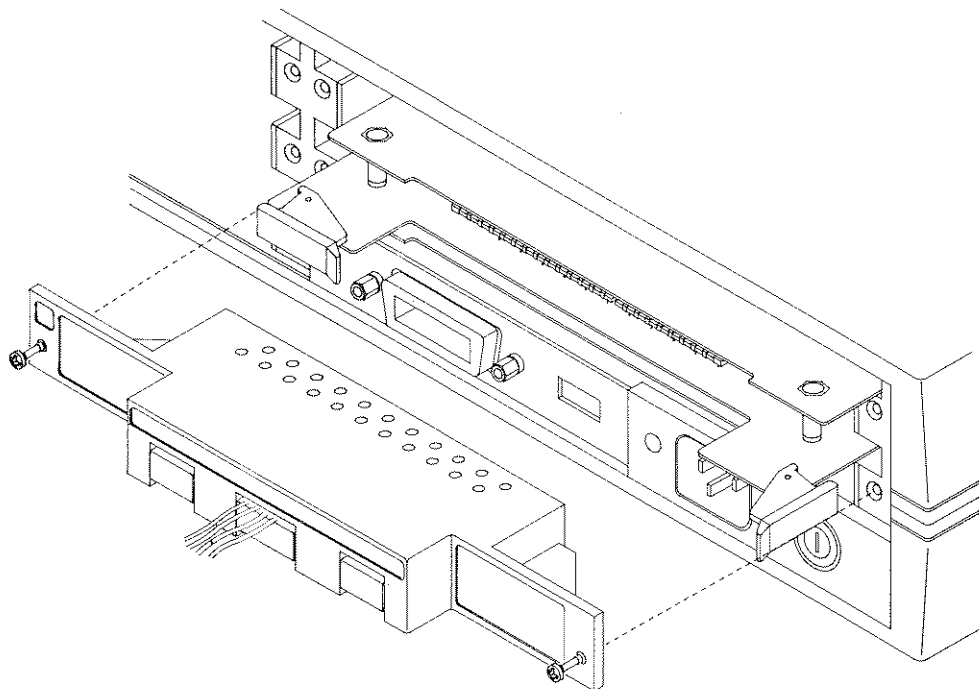

Figure 10-10. Attaching the Terminal Block

5. Labels

a. Two labels were provided with the option assembly. One identifies the assembly as a 44474A Relay Multiplexer. There is space on the bottom of this label to type or write in a description of where this particular option is being used.

b. Second, a series of numbered labels (1 to 5) is provided to help you identify the slot where the assembly is located. Select the appropriate numbered label and place it in the upper left hand corner of the strain relief housing.

Accessories

-hp- part number 44484A provides an extra Screw Terminal Connector block for use with the 44474A option.

Specifications

The specifications at the end of the manual apply only to the 44474A option. These specifications are the performance standards or limits against which the option is tested. Do not exceed or surpass these specified limits.

Any changes in specifications due to manufacturing changes, design, or traceability to the National Bureau of Standards will be covered in a manual change supplement.

Applications

The following application examples demonstrate various uses for the 44474A Digital I/O option.

Example 1. Scanning Using External Increment and Channel Closed

Using a voltmeter with internal reading storage (such as the -hp- 3456A) makes the scanning even easier and faster. The main feature of this example is speed because as soon as the voltmeter completes one reading, the next channel is closed and a new reading initiated. Measurement speed is not dependent on the system computer.

Remember to connect the 44470A's common bus's to the voltmeter input terminals and connect the voltmeter's External Trigger to the 3488A's Channel Closed line. Connect the 3456A's Voltmeter Complete to the 3488A's External Increment Line.

The program sets the voltmeter for reading storage and then starts the scan sequence. As each reading is taken it is stored internally in the voltmeter and will be available to the computer later.

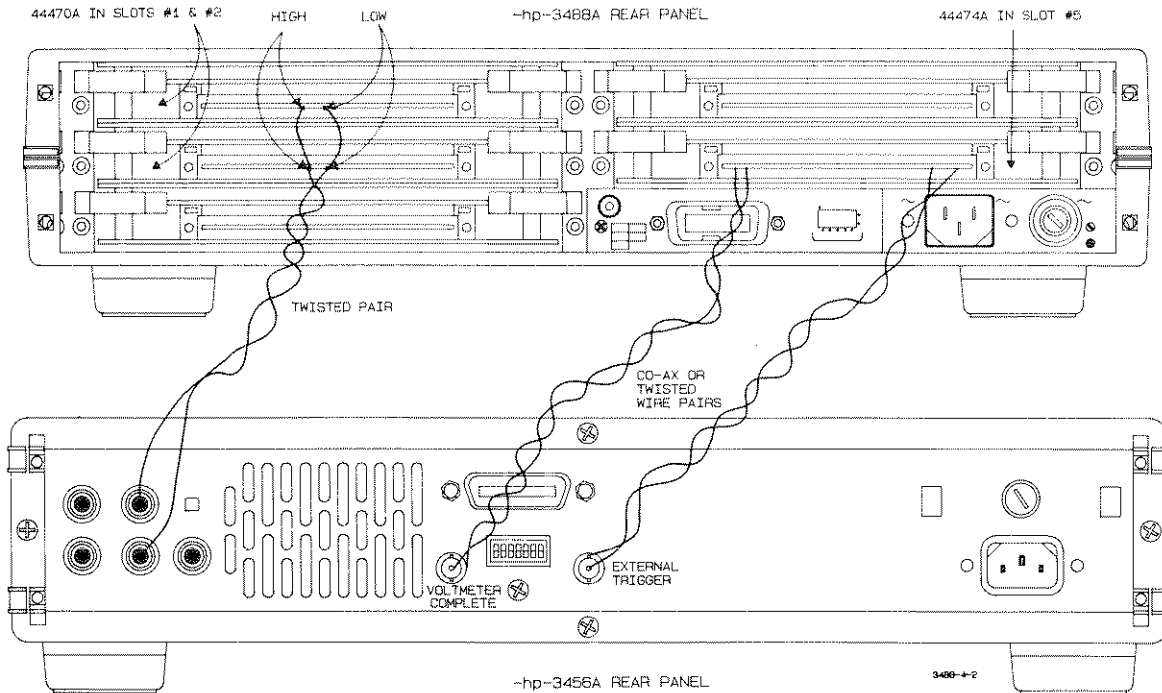

Figure 10-11. External Increment and Channel Closed

```

10 ! End of Scan sequence SRQ e
   xample
20 ! -HP- 85 version
30 ! 3488a at address 709, 3456
   A at address 722
40 ON INTR 7 GOSUB 1000
50 ENABLE INTR 7;8
60 OUTPUT 709 ;"SLIST 100-209.0
   ; DMODE 5.1,0.1; MASK 1"
70 OUTPUT 722 ;"FIR1Z1T2RS1"
80 TRIGGER 709
90 GOTO 90 ! Mainline program e
   oes here
100 END
1000 P=SPOLL(709)
1010 IF BIT(P,0) THEN DISP "END
   OF SCAN REACHED"
1020 OUTPUT 722 ;"D020STR"
1030 FOR I=1 TO 20
1040 OUTPUT 722 ;"RER"
1050 ENTER 722 ; A(I)
1060 DISP A(I)
1070 NEXT I
1080 OUTPUT 722 ;"D1"
1090 STATUS 7.1 ; R
1100 OUTPUT 709 ;"STATUS"
1110 RETURN

```

Example 2. Limit Switch Sensing

Figure 10-12 shows one bit of the 44474A wired for use as a digital input. In this example, when the switch is closed or the transistor turns on, the input bit will be closed. By continuously VIEWing that bit, it can be determined when the bit is closed. This is shown in the associated program.

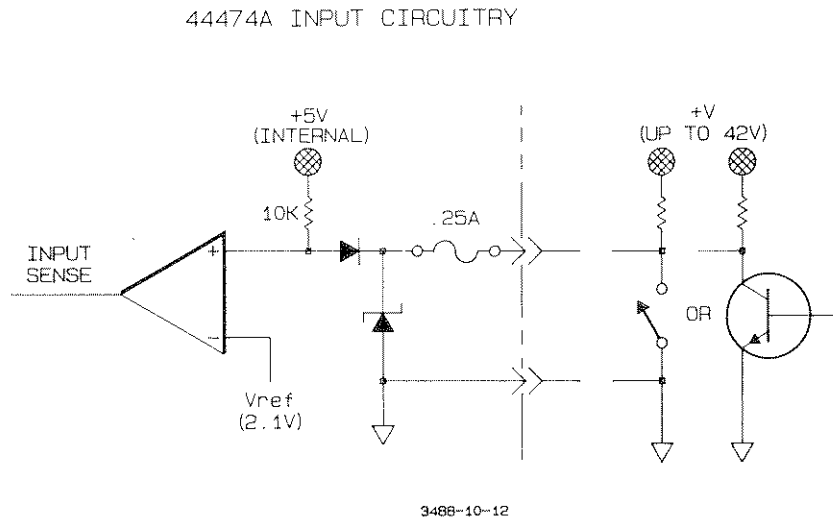

Figure 10-12. Limit Switch Sensing

Table 10-2. Option 014 44474A 16 Bit Digital I/O Module Specifications

I/O LINES

Maximum Voltage = +30V DC (Line-Chassis)

Output Characteristics

$V_{out}(high) \geq 2.4V @ I \leq 8 \text{ mA output}$
 $V_{out}(low) \leq 0.4V @ I \leq 16 \text{ mA input}$
 $I_{(low)} = 125\text{mA} @ V_{out}(low) \leq 1.25V$
 $I_{(low)}$ fused at 250 mA

Input Characteristics

$V_{in}(high) \geq 2V; V_{in}(low) \leq 0.8V$

HANDSHAKE LINES

Maximum Voltage = +5V DC (Line-Chassis)

Output Characteristics

$V_{out}(high) \geq 2.4V @ I \leq 400 \mu\text{A output}$
 $V_{out}(low) \leq 0.5V @ I \leq 2 \text{ mA input}$

Input Characteristics

$V_{in}(high) \geq 2.0V; V_{in}(low) \leq 0.8V$

External Increment: Advances 3488A to next programmed configuration on falling edge of TTL pulse, 0.25 μsec minimum width.

Channel Closed: Indicates completion of new configuration; TTL pulse, 10 μsec minimum width.



Chapter 11

44475A

Breadboard Assembly

Introduction and Description

This chapter provides the technical information necessary for the design engineer or technician to use the -hp- Model 44475A Breadboard option with a -hp- 3488A Switch/Control Unit. This chapter is not intended for use by operator (non-technical) individuals.

Mechanical parts supplied with the 44475A Breadboard are shown in Figure 11-1.

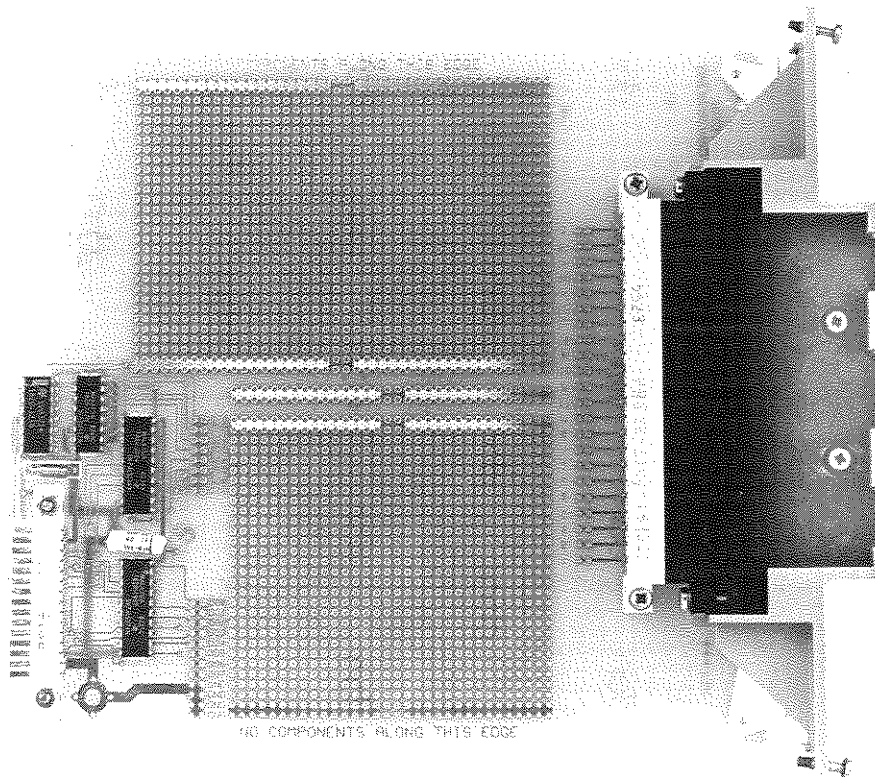

Figure 11-1. 44475A Breadboard

As shown in Figure 11-1, the 44475A Breadboard Option consists of two areas. These two areas are:

1. Breadboarding Grid consisting of holes on 0.10'' centers. There is a 0.030'' spacing between foil pads. Bus traces for power supply and ground, and provisions for the terminal Block Edge Connector.

2. Built in design (you must supply components) for providing an 8-bit digital input port and an 8-bit digital output port. Two commands are used to control the input and output ports, these are discussed later in this manual.

At the end of this chapter are two pages, each showing a full size view of both front and back sides of the 44475A Breadboard Assembly. These pages are provided to assist you in designing and laying out your circuits. You may want to tear one out and duplicate for future use.

Warranty

The Breadboard Option Warranty statement, located in Chapter 5, is different than the standard -hp- warranty statement. While -hp- is responsible for defects in material and workmanship of the blank circuit card and supplied hardware, -hp- is not responsible for the performance of the customers circuit. In addition, -hp- is not responsible for damage or improper operation of the 3488A or other plug-in options when the breadboard is installed.

Getting Started

Before designing and mounting any circuit on the breadboard, familiarize yourself with the interface circuitry on the two Breadboard ports. Also, the following list provides precautions and helpful hints to follow:

- * Observe all WARNINGS and CAUTIONS.
- * Make sure to observe all power supply, and wattage dissipation limitations.
- * Observe the component height/protrusion restrictions.
- * Avoid mounting components along the extreme edges of the circuit board.
- * Keep in mind that other option assemblies share the same 3488A backplane signals as your Breadboard. Use the recommended interface circuitry.

Specifications

Figure 11-2 shows the dimensions of the 44475A Breadboard Option including:

- Overall Length
- Height
- Grid hole spacing (center to center)
- Grid hole size (inside diameter)
- Component height/protrusion restrictions

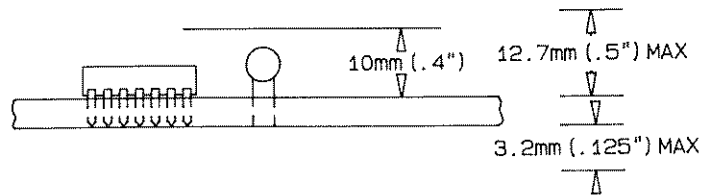
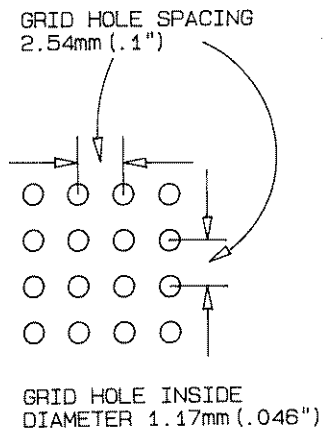
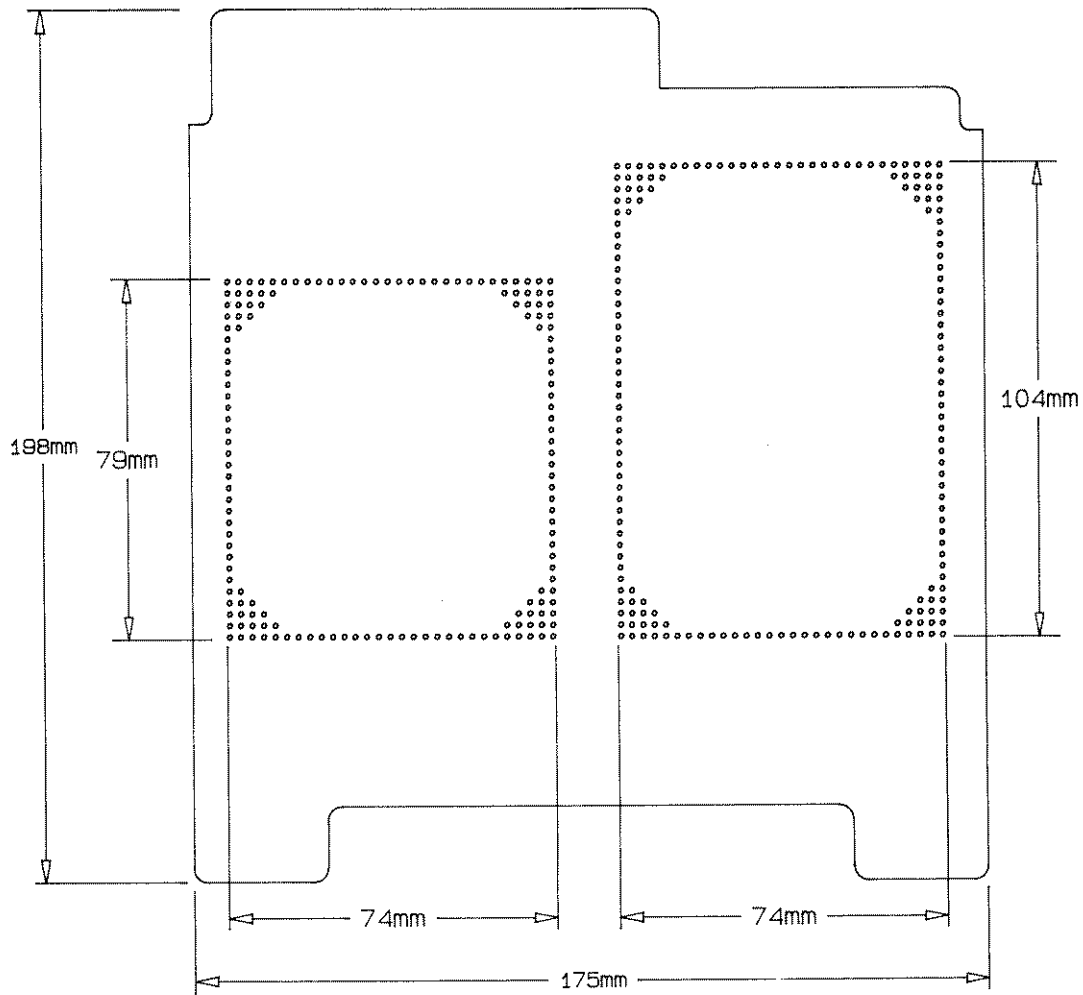

Figure 11-2. 44475A Breadboard Option Dimensions and Component Height/Protrusion Restrictions

Maximum Power dissipation: 2 watts

Maximum input voltage on Digital Input Port lines: 5.5 Volts

Power supply:

No power supply is provided from the 3488A to the breadboard grid area. Adequate power supplies must be provided by the user. A +5 volt supply is provided only for use with the 8-bit input and 8-bit output ports.

Maximum voltage on breadboard area: 42 VDC, 30 VACrms, 42 VACpeak

Assembling the Breadboard

Three steps are involved in assembling the 44475A Breadboard. The first step is to load the components (if your task requires them) for the 8-bit Input and 8-bit Output port. Components were not supplied for these ports.

Second, you will need to install your custom circuitry. Guidelines for doing this are given after a discussion on the I/O ports.

The third step is assembling the hardware supplied with the Breadboard. These parts are listed in Table 11-2.

Loading the Components

Components required, but not supplied, to use the 8-bit input and output ports are listed in Table 11-1. Figure 11-3 shows where these components are to be mounted on the Breadboard. Refer to the manufacturer's data sheet for load/drive specifications for the ports. A schematic diagram for the two ports is shown in Figure 11-4.

Table 11-1. Required Components For 8-bit I/O Ports

| Quantity | Description |
|----------|---|
| 1 | SN74LS138; 3 to 8 line decoder |
| 1 | SN74LS157; Quad 2 line to 1 line data Selector/Multiplexer (noninverted data outputs) |
| 1 | SN74LS244; Octal Buffers, line drivers, line receivers (noninverted 3-state outputs) |
| 1 | SN74LS374; Octal D-Type Flip-Flops (3-state outputs) |
| 1 | .01 μ F Capacitor, 10 volts |
| 1 | 1 μ F Capacitor, 10 volts |

CAUTION

Only Qualified service trained personnel should install or configure the breadboard assembly. Make certain that all power is removed from the breadboard before installing components. Use clean handling techniques and antistatic precautions.

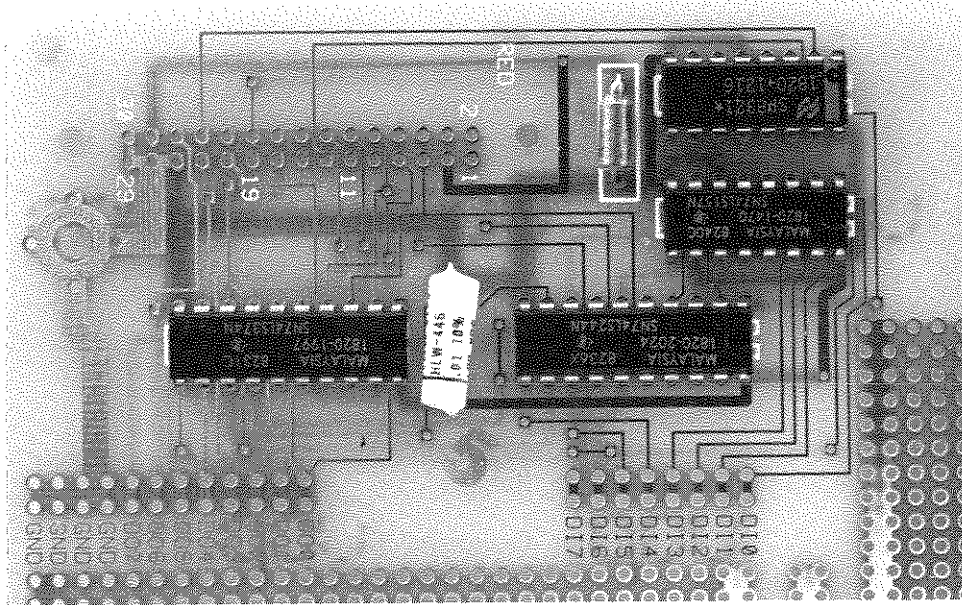

Figure 11-3. Component Mounting

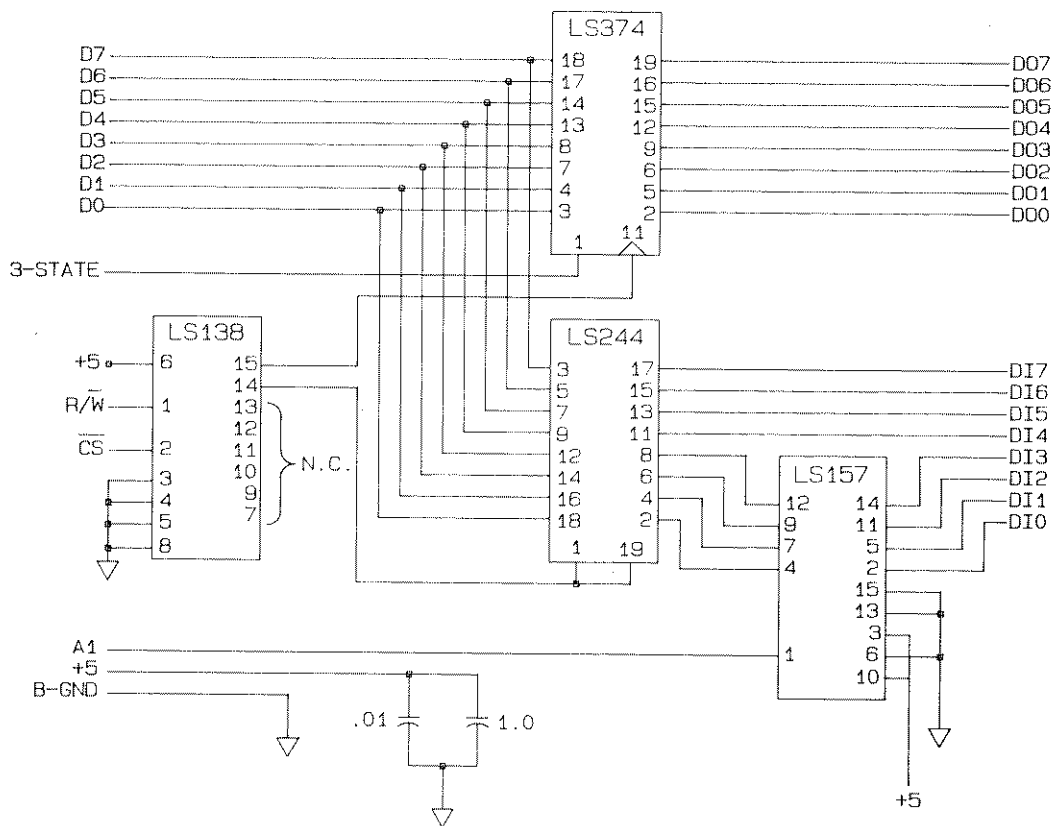

Figure 11-4. Breadboard Schematic

Mounting Your Custom Circuitry

This section of the chapter provides helpful guidelines for installing components on the 44475A Breadboard. Use the two full size photographs at the end of the chapter as an aid in laying out your custom circuitry.

Component Height/Protrusion Restrictions

Component height restrictions and how far the component leads extend through the circuit board are limited by the top and bottom shields. These shields must never be eliminated as they provide RF shielding as well as structural strength.

The absolute maximum component height allowed is 12.7 mm (0.50 in.). However, if the height of any component exceeds 10 mm, the conductive surface of the component must be insulated. On the circuit side of the Breadboard, the lead lengths are limited to 3.2 mm (0.125 in.) from the circuit board.

Using Wire-Wrap Components/Long Lead Length

Most Wire-Wrap components, such as IC sockets, will protrude through the circuit board further than the restrictions allow. When using such components make sure to cut the lead lengths to meet the restrictions noted in Figure 11-2.

Breadboard Top and Bottom Edges

Never mount components where they will occupy space along the extreme top and bottom edges of the circuit board. This space is needed to slide the breadboard into the grooves of the slot.

Power Supply and Ground Traces

Be careful to mount components so they are not across the power supply or ground traces.

Soldering

When soldering components on the breadboard, use a soldering iron with a 25 Watt (or less) rating and rosin core solder. Use of acid core solder will void the warranty.

Assembling the Hardware

Table 11-2 lists the hardware supplied with the 44475A Breadboard. Refer to the paragraphs following and Figure 11-5 for assembly information.

Table 11-2. Parts Supplied With the 44465A Breadboard

| Part Number | Qty. | Description |
|-------------|------|--|
| 44475-26501 | 1 | Breadboard circuit board |
| 03488-00602 | 1 | Bottom Shield |
| 03488-00603 | 1 | Top shield (component side) |
| 1251-8645 | 1 | 2 rows × 15 pins right angle connector (small connector) |
| 44475-62102 | 1 | 2 rows × 11 pins right angle connector (large connector) |
| 44475-62101 | 1 | Terminal Block, keyed for the breadboard connector |
| 5040-5193 | 1 | Connector Housing |
| 5040-5194 | 1 | Cable Clamp |
| 0515-0063 | 2 | Pan Head screw, 2.5 × 12 (metric) |
| 0515-0843 | 4 | Flat Head screw, 2.5 × 20 Lock (metric) |
| 0515-0845 | 2 | Pan Head screw, 3 × 18 Lock (metric) |
| 0535-0004 | 2 | Hex Nut, 3 × .5 |
| 0535-0008 | 2 | Hex Nut, 2.5 × .45 |
| 2190-0583 | 2 | Lock Washer |
| 2190-0584 | 2 | Lock Washer |

Refer to Figure 11-5. Mount the smaller (2×15 connectors) on the component side of the breadboard. Make certain that all pins are through the circuit board before soldering the pins. Use a low wattage (25 watts maximum) soldering iron and rosin core solder. This connector should be installed whether you intend to use the 8-bit I/O ports or not.

Next, mount the large connector (2×11 connectors). This large connector is specifically keyed to fit only the terminal block supplied with the Breadboard. Additional terminal blocks can be purchased using the part number 44485A. Again, make certain that all pins are through the circuit board before soldering. Also, be sure to firmly tighten the mounting screws before soldering the pins. This will help ensure that the circuit board is not bowed when soldering.

At this point you should mount your custom circuitry, making connections to the 8-bit I/O ports and the large connector. Make certain that all components and wiring do not exceed the height and protrusion specifications listed earlier in this chapter.

Attach the top and bottom shields as shown in Figure 11-5. Check for proper orientation of the shields before assembling.

NOTE

Under no circumstances should the shields be left off. The shields are used to reduce RFI (they connect to chassis ground, They are insulated to prevent arcing from adjacent circuitry, and they also provide some structural support.

Breadboard Installation

- a. Remove the ac power cord from the 3488A before installing or removing any option assembly.
- b. Position the rear panel of the 3488A towards you.
- c. Select a slot. Refer to Figure 11-6; the 3488A has five slots for installing option assemblies. the 44475A Breadboard may be installed in any of the five slots.

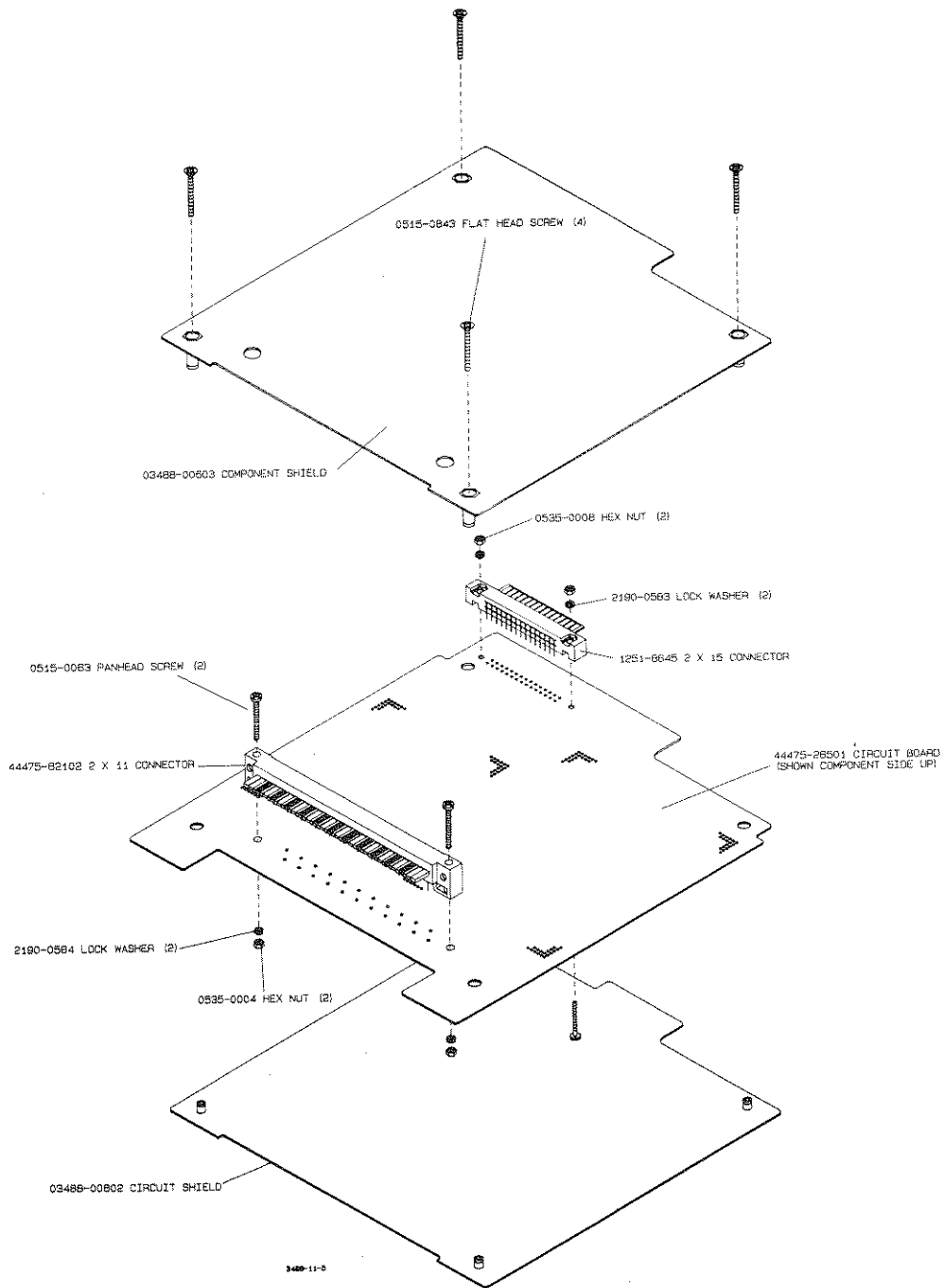

Figure 11-5. Hardware Assembly

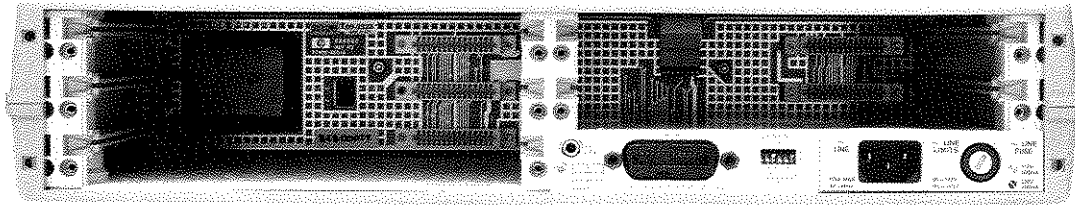

Figure 11-6. Rear Panel of the 3488A

d. Hold the assembled module, component side down, by the metal shields. Insert the circuit card into the slot guides and slide toward the front of the 3488A. Push firmly until the assembly 'snaps' in place. Fold the plastic levers toward the assembly. these levers lock the option into the mainframe.

NOTE

To remove an option assembly, simply unfold the the plastic levers. This will release the locking mechanism and pull the option out of the mainframe connector.

Terminal Block

a. Wire the terminal block to fit your custom circuit. This terminal block is keyed to fit only the 44475A Breadboard. Extra terminal blocks are available under the -hp- part number 44485A. This terminal block is designed to accept wires in the range of 18 to 26 AWG.

b. Secure the terminal block to the strain relief housing with the captive screws on the terminal block. Make certain that the screws used to tighten the connecting wires inside the terminal block are accessible through the strain relief housing.

c. Route the wires evenly through the three strain relief cutouts. This will ensure a uniform amount of strain relief. If only a few wires are used, they should go through the middle cutout.

d. To protect wires smaller than 22 AWG it is recommended that these wires be bundled together starting no more than 4'' from the back of the 3488A. Failure to do so may cause wires to break at the strain relief. To illustrate the need for this, a 26 AWG wire can survive about 7 to 8 pounds of tension before breaking. A bundle of 10, however, could survive up to 70 pounds of tension.

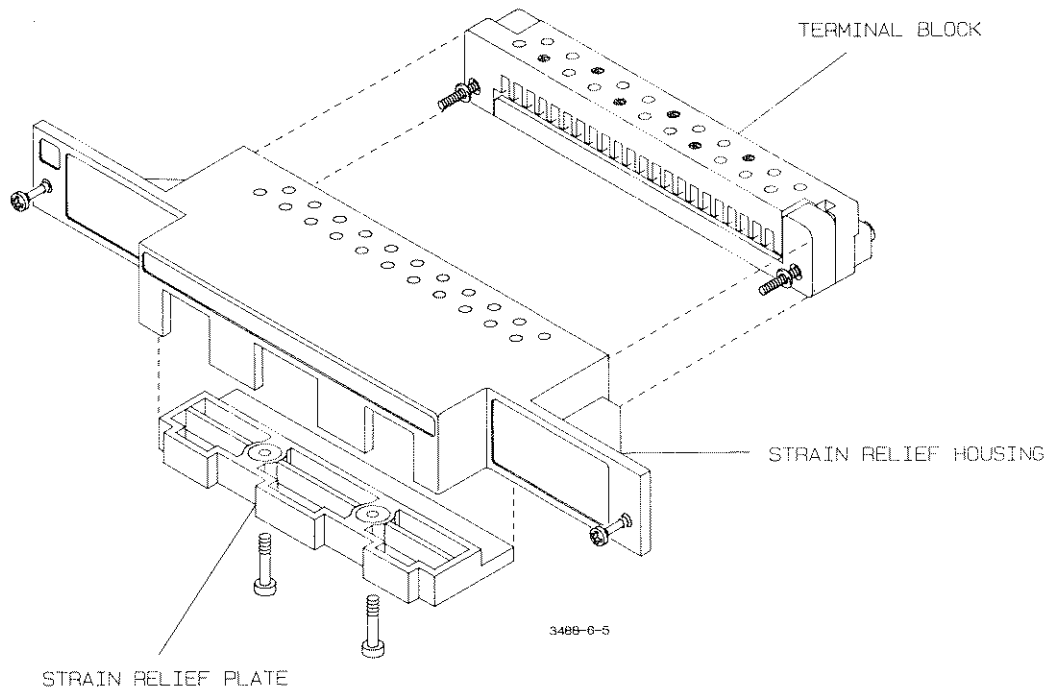

Figure 11-7. Strain Relief Housing

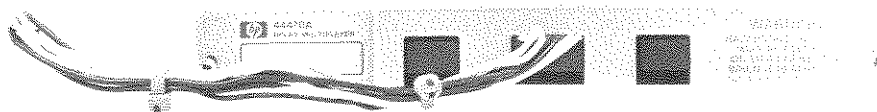

Figure 11-8. Cable Routing

e. Secure the strain relief plate to the strain relief housing (ribbed side toward the housing). Do not overtighten.

f. Push the terminal block with strain relief housing onto the the option assembly connector. Tighten the two screws on either end of the housing.

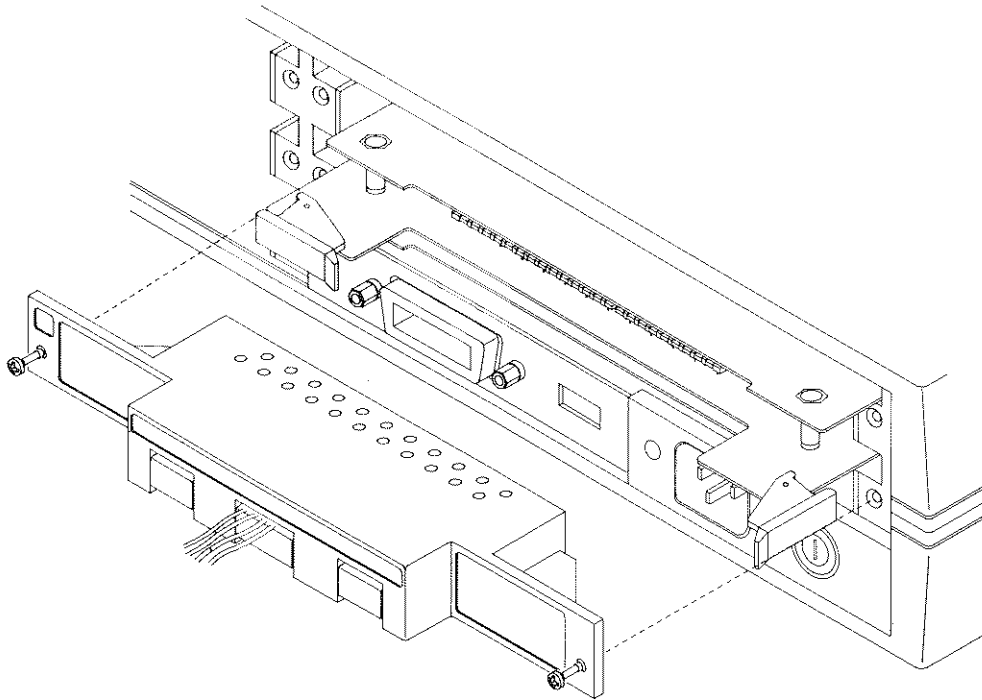

Figure 11-9. Attaching the Terminal Block

g. Two labels were provided with the option assembly. One identifies the assembly as a 44475A Breadboard. There is space at the bottom of this label to type or write in a description of the circuit installed on this breadboard.

h. Second, a series of numbered labels (1 to 5) is provided to help you identify where the assembly is installed. Select the appropriate number for the slot where the assembly is installed and place the label in the upper left hand corner of the strain relief housing.

Controlling the Breadboard Ports

Two 8-bit ports are available on the 44475A Breadboard. One port is a static read only port, the second port is static write only. Static means that there is no hand-shaking involved in data transfers. Use of the two ports requires that the components specified in the Assembly section be installed on the Breadboard.

Two commands are used to control the Breadboard; SREAD reads data from the input port and SWRITE writes data to the output port.

SREAD Command

The SREAD command uses the format: SREAD #04 where the # symbol represents the slot number where the 44475A Breadboard is installed. For example, if the Bread-

board is installed in slot 2, the command would be: SREAD 204. The number 04 specifies the Read register in the Breadboard circuitry. If a number other than 04 is used (any number between 0 and 7 will not cause an error), the value 255 will be returned, thus indicating a floating input. Data read back is in the form of a decimal number which is the sum of the binary weighted values of the bits that are high (+5 volts).

The following chart shows the bit values for the eight input bits:

| | | | | | | | | |
|----------------|-----|----|----|----|---|---|---|---|
| Bit Number: | 7 | 6 | 5 | 4 | 3 | 2 | 1 | 0 |
| Value if high: | 128 | 64 | 32 | 16 | 8 | 4 | 2 | 1 |

Example

```
10 OUTPUT 709; "DREAD 304"      ! BREADBOARD IN SLOT 3
20 ENTER 709; A
30 DISP A
```

If the data value read back were, for example, 46, it would indicate that bits 5 (value 32), 3 (value 8), 2 (value 4) and 1 (value 2) are in a high (+5 volt) state. Note that the sum of the values totals 46 ($32 + 8 + 4 + 2 = 46$). All remaining bits are in a low (ground) state.

SWRITE Command

The SWRITE command uses the format: SWRITE #00,<data>. Just as with with the SREAD command, the # symbol represents the slot number where the Breadboard is installed. The number 00 specifies the write or output port on the breadboard. Any number between 1 and 7 may be used without causing an error, however no action will be taken by the breadboard.

The data value is a decimal sum of the binary weighted values of the bits that are to be set high (+5 volts). Refer to the bit value chart under the SREAD command for bit value information.

External pull-up resistors are not required when using the output port because the integrated circuit driver uses Totem-Poll outputs. Do not exceed the current drive capacity of the IC.

Example

To set bits 1, 4, and 7 on the output port (bit values 2, 16 and 128 respectively, sum = 146), execute the command: SWRITE 500,146. Note that the Breadboard is installed in slot 5 for this example.



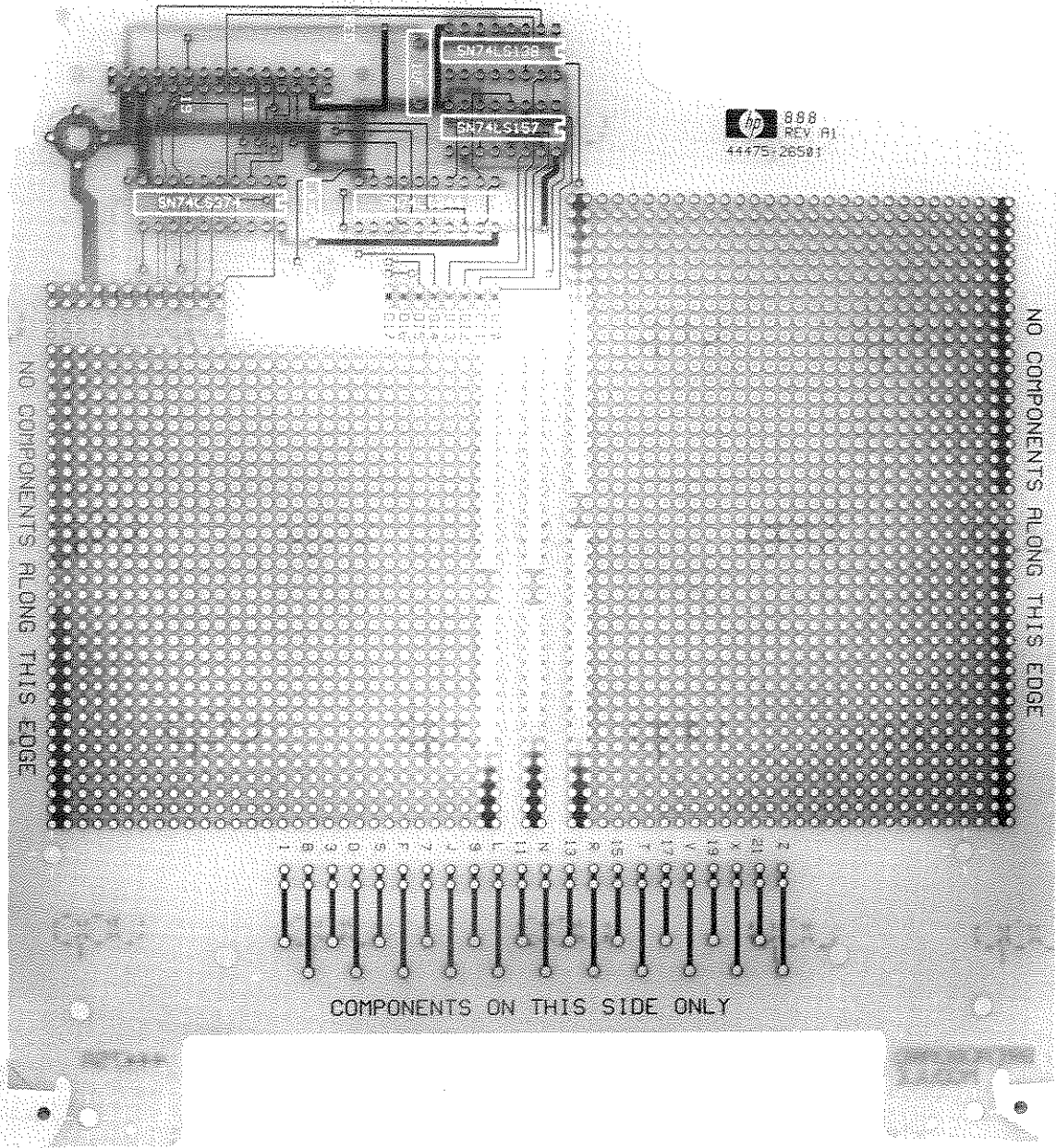

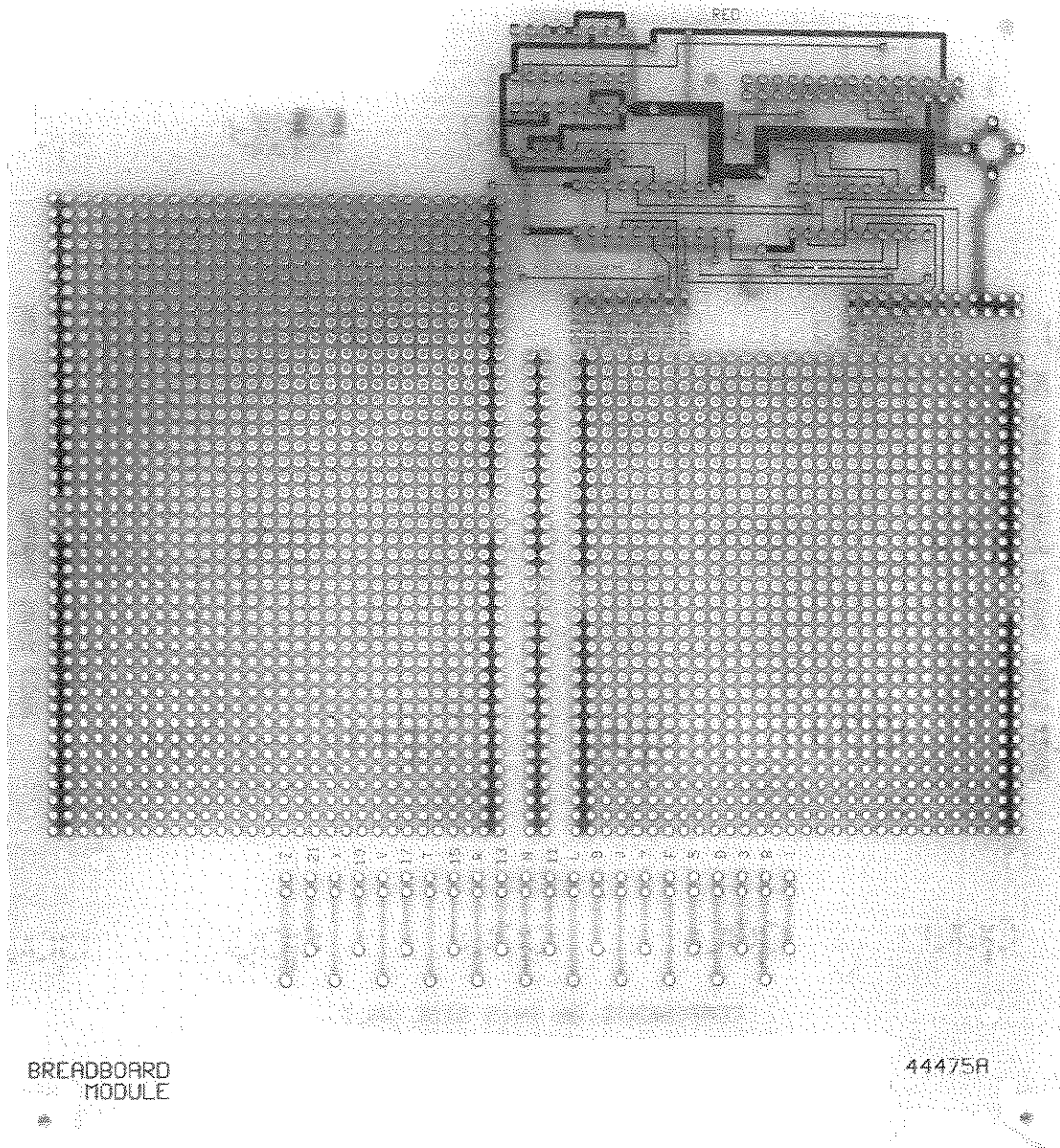

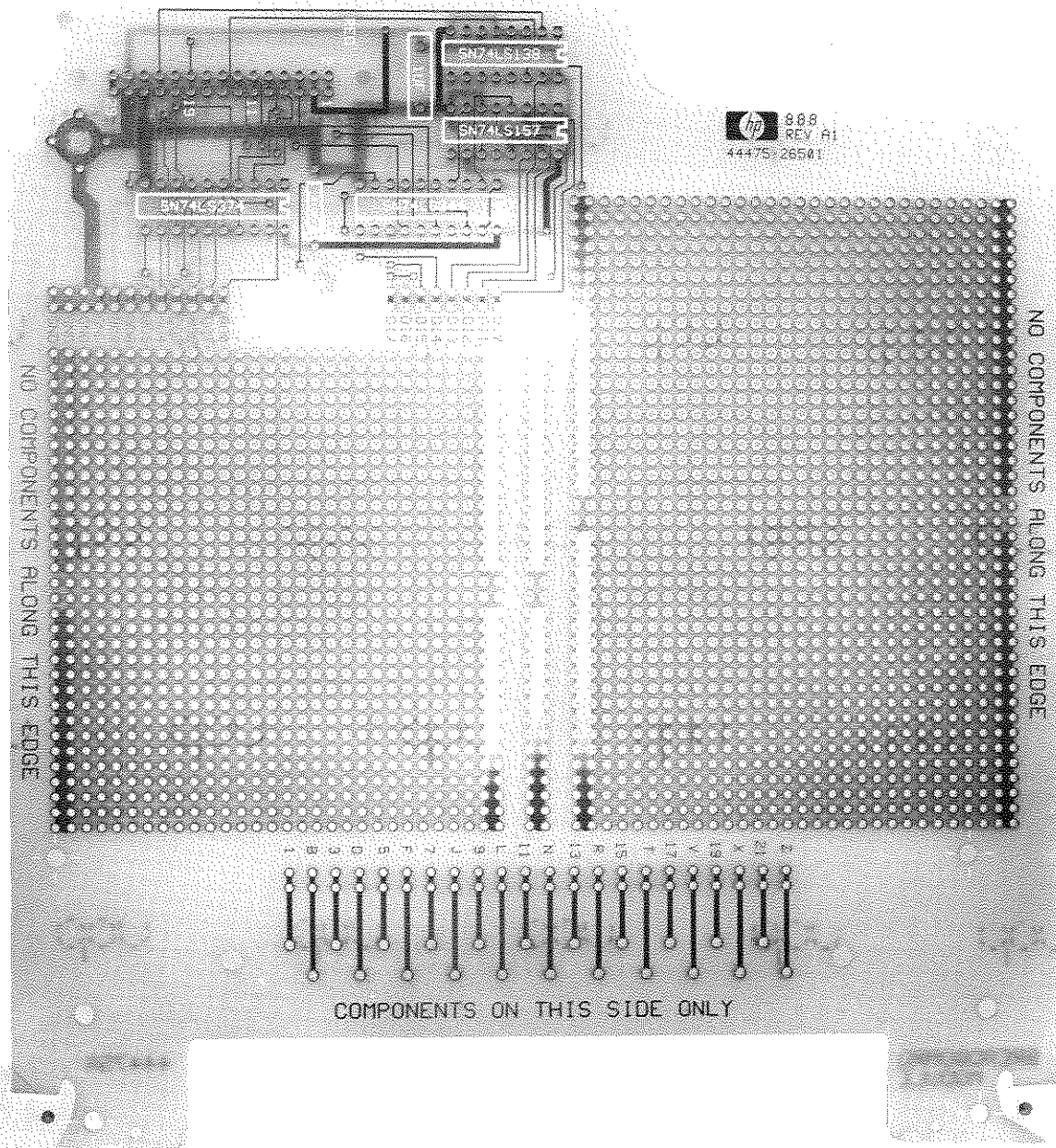

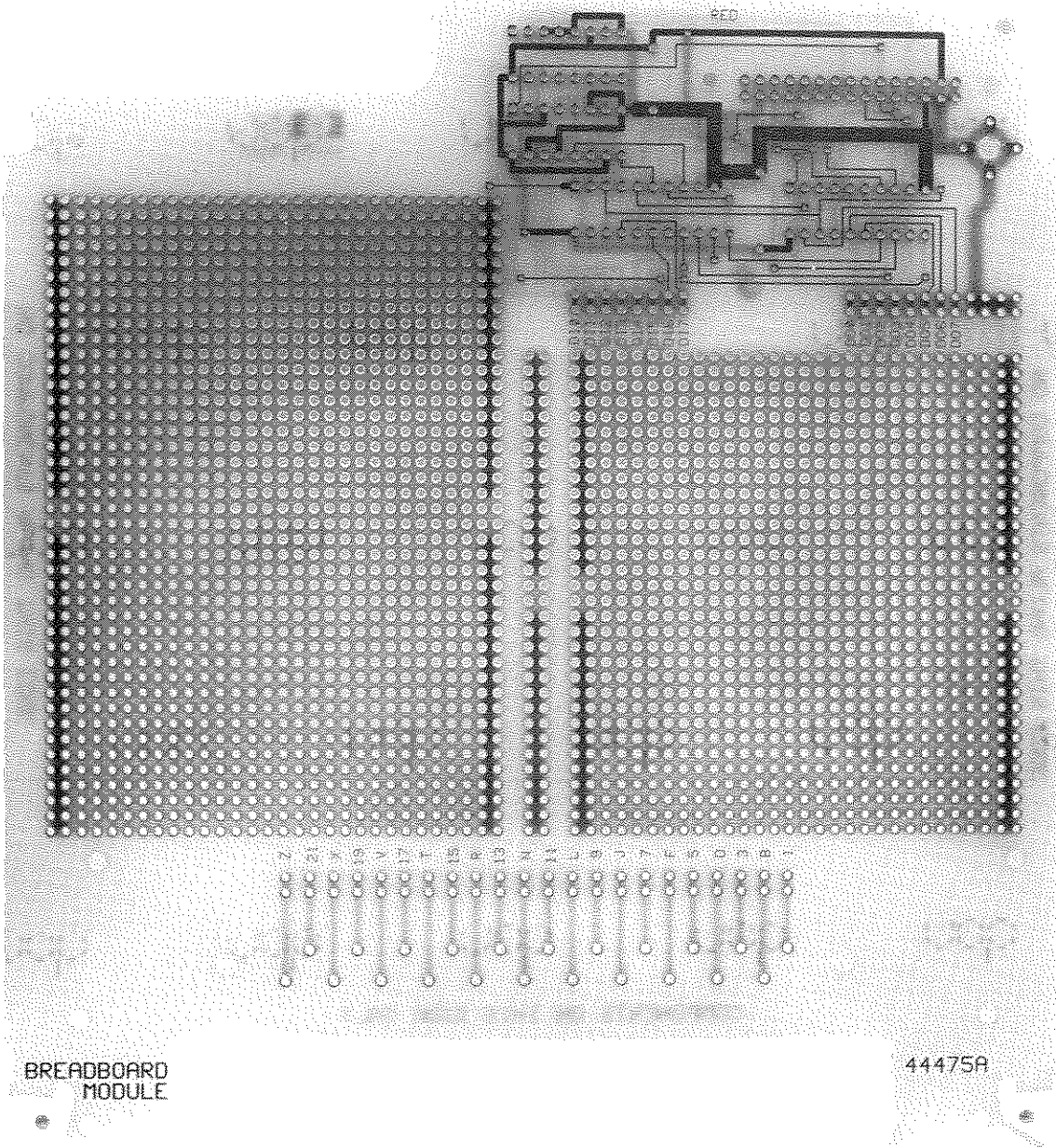

Appendix A Documentation Worksheet

Introduction

In any test system where you have a multitude of cables running from the test fixture to the measurement system, it is beneficial to document the system configuration. This will be especially beneficial later if you're attempting to diagnose system failures. This appendix presents a simple method of documenting your test system to help in the setup and wiring procedure as well as diagnostics. Only two worksheets are provided, therefore you may want to tear one out and duplicate it for future use.

Worksheets

While the test system is being configured and wired, you will want to fill out these Documentation Worksheets. Later, they can be used as a guide when debugging and writing computer programs for the test system. Instructions for completing the worksheets are found on the back of the worksheets.

These worksheets serve only as a guide for your system and need not be restricted to cabling associated with the 3488A. In other words, modify the worksheets to fit your own individual needs. Figure A-1 shows some examples of how the Worksheets may be filled out and the associated computer program. The program was developed using the worksheet as a guide.

| Date/Time | System Name: | | Test Area: | | | |
|-----------------------|----------------|---------|-------------------------|--------------------------|----------------|-----------------------------|
| 3488A Slot/Card Type | Card Terminals | Channel | From | To | Typical Values | Comments |
| SLOT 1 Relay mux | 00 | 100 | | 3478 DVM Through Com. | +5 ±.5% | Measure Power Supplies |
| " | 01 | 101 | | " | +12V | " " " |
| " | 02 | 102 | | " | -12V | " " " |
| SLOT 5 DIGITAL I/O | Lo 0 | Port 00 | Out. Disp. TEST 01-6 | | | USED AS INPUT BITS FOR |
| " | Lo 1 | " | " 01-B | | | Display TEST |
| " | Lo 2 | " | " 01-3 | | | " |
| SLOT 3 4x4 MATRIX | Row 1 | 31x | D.V.M. | | | |
| SLOT 3 4x4 MATRIX | Col 2 | 3x2 | | D.U.T. TEST Point A | | |
| " | Row 0 | 30x | Counter | | | |
| " | Col 1 | 3x1 | | D.U.T. TEST Point B | | |
| SLOT 2 G.P. Relay | 00 | 200 | | D.U.T. A1 | 120 VAC | Power Actuators For |
| " | 01 | 201 | | D.U.T. A2 | +27 VDC | DEVICE UNDER TEST TERMINALS |
| " | 02 | 202 | | D.U.T. A3 | -15 VDC | A1, B1, C1 |

Figure A-1. Worksheet Examples

Event Log

In addition to the Worksheets, you may want to maintain an Event Log. Types of Event Log entries include changes in the computer program, changes in the system setup, instrument calibration times, a record of down times, etc. Each entry should include at least the following:

1. What the event was and the extent of change.
2. Where the event took place or was observed.
3. When the occurrence happened or was noticed.
4. The fix.

Another piece of documentation you may find useful is a single page cover sheet to identify the documentation package. This cover sheet might incorporate a list of all instruments in the test system. This list should include both model and complete serial numbers. Also, you may want to include instrument calibration cycles, names and phone numbers of who to call in case of failures, etc.

This complete documentation package will contain a complete history of your test system. With it you can save both time and money because answers are available immediately.

DOCUMENTATION WORKSHEET INSTRUCTIONS

DATE/TIME: Indicate the date and time of the original setup here. Dates and/or times of minor alterations should be made in the left hand margin next to the addition or alteration.

SYSTEM NAME: The system name is used to identify a particular test system. This is especially important when more than one system is in use.

TEST AREA: This is an overall description of where the test system is being used or what it is measuring.

3488A SLOT/CARD TYPE: Refer to chapters 1 and 2 of this manual for a discussion of the 3488A slots and card types. The slot number as well as what type of 3488A option assembly is in that slot must be known when writing the test program.

CARD TERMINALS: Record the terminal block connector numbers for each connection. As a diagnostic aid it is important to record the terminal connections.

CHANNEL: This entry is the channel number that you will specify in the test program.

FROM - TO: Each channel on the 3488A will have some destination. Keep in mind the different types of options when filling in these two areas. For example, with the 10 Channel Multiplexer assembly, each channel may go to a different voltage source but the entire block will go to a voltmeter or other measurement device. Therefore, the FROM column might indicate the particular voltage source and the TO column could show the destination of the entire block, i.e. the voltmeter.

TYPICAL VALUE: Indicate the type of signal being switched and (if possible) its typical value.

COMMENTS: This entry should include anything not already specified that might be appropriate to the test. Possible entries include specific locations of test points, test limits, etc.

DOCUMENTATION WORKSHEET INSTRUCTIONS

DATE/TIME: Indicate the date and time of the original setup here. Dates and/or times of minor alterations should be made in the left hand margin next to the addition or alteration.

SYSTEM NAME: The system name is used to identify a particular test system. This is especially important when more than one system is in use.

TEST AREA: This is an overall description of where the test system is being used or what it is measuring.

3488A SLOT/CARD TYPE: Refer to chapters 1 and 2 of this manual for a discussion of the 3488A slots and card types. The slot number as well as what type of 3488A option assembly is in that slot must be known when writing the test program.

CARD TERMINALS: Record the terminal block connector numbers for each connection. As a diagnostic aid it is important to record the terminal connections.

CHANNEL: This entry is the channel number that you will specify in the test program.

FROM - TO: Each channel on the 3488A will have some destination. Keep in mind the different types of options when filling in these two areas. For example, with the 10 Channel Multiplexer assembly, each channel may go to a different voltage source but the entire block will go to a voltmeter or other measurement device. Therefore, the FROM column might indicate the particular voltage source and the TO column could show the destination of the entire block, i.e. the voltmeter.

TYPICAL VALUE: Indicate the type of signal being switched and (if possible) its typical value.

COMMENTS: This entry should include anything not already specified that might be appropriate to the test. Possible entries include specific locations of test points, test limits, etc.

Appendix B

HP-IB

Introduction

An interface is the means by which a computer and the 3488A or other instruments communicate. This appendix provides a more detailed overview of the HP-IB interface used with the 3488A. Although the information in this appendix is computer independent, much of the information is 3488A dependent.

General HP-IB Description

The Hewlett-Packard Interface Bus (HP-IB) is Hewlett-Packard's implementation of IEEE Standard 488-1978, "Standard Digital Interface for Programmable Instrumentation." HP-IB is a carefully defined interface which simplifies the integration of various instruments and computers into systems. The interface provides for messages to be transferred between two or more HP-IB compatible devices.

HP-IB is a parallel bus of 16 active signal lines grouped in three sets, according to function, to interconnect up to 15 devices. A pictorial view of the HP-IB connector and its pin designations are shown in Figure B-1. Also shown is a diagram of the interface connections and bus structure.

Eight signal lines, termed DATA lines, are in the first function set. The DATA lines are used to transmit data in the form of coded messages. These messages are used to program the instrument function, transfer measurement data, and coordinate instrument operation. Input and Output of all messages, in bit parallel - byte serial form, are also transferred on the DATA lines. A 7-bit ASCII code normally represents each piece of data.

Data is transferred by means of an interlocking "handshake" technique which permits data transfer (asynchronously) at the rate of the slowest active device used in that transfer. The three DATA BYTE CONTROL lines coordinate the handshaking and form the second functional group.

The remaining five GENERAL INTERFACE MANAGEMENT lines (third functional group) are used to manage the devices connected to the HP-IB. This includes activating all connected devices at once, clearing the interface, and others.

| PIN | LINE |
|-----|------------------------------|
| 1 | D101 |
| 2 | D102 |
| 3 | D103 |
| 4 | D104 |
| 13 | D105 |
| 14 | D106 |
| 15 | D107 |
| 16 | D108 |
| 5 | E01 |
| 17 | REN |
| 6 | DAV |
| 7 | NRFD |
| 8 | NDAC |
| 9 | IFC |
| 10 | SRQ |
| 11 | ATN |
| 12 | SHIELD-CHASSIS GROUND |
| 18 | P/O TWISTED PAIR WITH PIN 6 |
| 19 | P/O TWISTED PAIR WITH PIN 7 |
| 20 | P/O TWISTED PAIR WITH PIN 8 |
| 21 | P/O TWISTED PAIR WITH PIN 9 |
| 22 | P/P TWISTED PAIR WITH PIN 10 |
| 23 | P/O TWISTED PAIR WITH PIN 11 |
| 24 | ISOLATED DIGITAL GROUND |

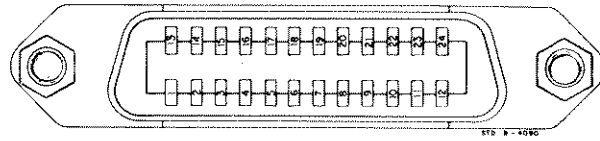

CAUTION

The 3488A contains metric threaded HP-IB cable mounting studs as opposed to English threads. Metric threaded -hp- 10631A, B, or C HP-IB cable lock screws must be used to secure the cable to the instrument. Identification of the two types of mounting studs and lock screws is made by their color. English threaded fasteners are colored silver and metric threaded fasteners are colored black. DO NOT mate silver and black fasteners to each other or the threads of either or both will be destroyed. Metric threaded HP-IB cable hardware illustrations and part numbers follow.

THESE PINS ARE INTERNALLY GROUNDED



LOCKSCREW
1390-0360

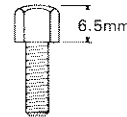

LONG MOUNTING STUD
0380-0643

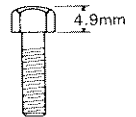

SHORT MOUNTING STUD
0380-0644

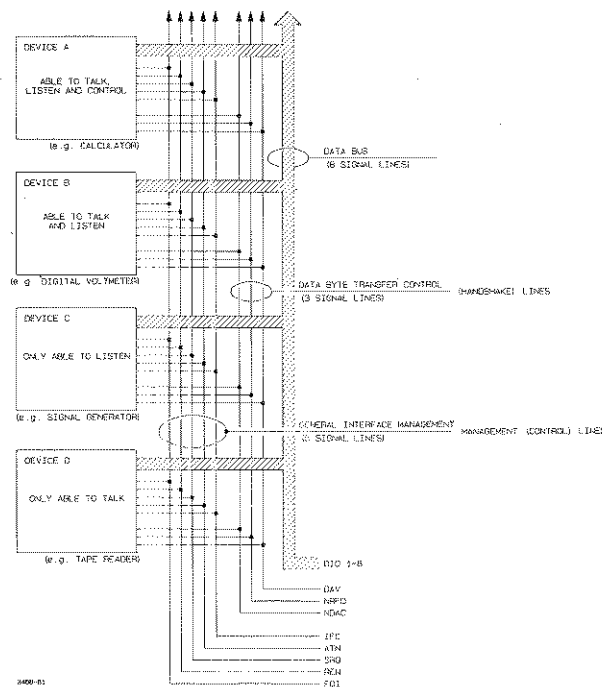

Figure B-1. HP-IB Interface

For a detailed description of the HP-IB lines, commands, internal operations, etc., refer to the HP-IB Abbreviated Description Manual, -hp- part number 5955-2903. A condensed description is also available in the Condensed Description of the Hewlett-Packard Interface Bus Manual, -hp- part number 59401-90090. These manuals are available through your local -hp Sales and Service Office.

Basic Device Communication Capabilities

With HP-IB, devices can be classified as either Controllers, Talkers, or Listeners. These are defined as follows:

a. Controllers. The device that can specify which device(s) connected to the bus is to be a Talker or a Listener. There are two types of controllers: an Active Controller and a System Controller. The Active Controller is the current controlling device. The System Controller can, however, take control of the Bus even if it is not the Active Controller. There can be only one active controller at any given time even if several controllers are connected to the interface.

b. Talkers. A Talker is any device that is able to send information over the Bus when it has been addressed. Only one talker may be active at a time; usually the one that is currently addressed to send data. All HP-IB computers, most HP-IB instruments and of course the 3488A, are Talkers.

c. Listeners. Devices which receive information over the HP-IB interface, when they are addressed to listen are called Listeners. A device may or may not be both a Talker and a Listener. The 3488A has Listener Capabilities.

Interface Terms

The following glossary defines many of the terms and concepts used to describe the HP-IB interface system.

- ▶ Address. Each device connected to the interface has a unique address assigned to it. In HP-IB, the address is generally set by switches on the instrument. The address is used to specify which device connected to the interface will receive (addressed to Listen) or send (addressed to Talk) information.
- ▶ Byte. A byte is a unit of information consisting of 8 binary digits called bits.
- ▶ Clear. The Clear message causes the listening device(s) or all the devices connected to the interface to return to their predefined device dependent state.
- ▶ Device. Any instrument or computer/calculator that is HP-IB compatible is called a Device.
- ▶ Device Dependent. Device Dependent refers to an action a device performs in response to information sent through the interface. The action is characteristic of a particular device and will probably vary with different devices.

- ▶ Polling. Polling is a process typically used by a controller to locate a device that has requested service from the controller. There are two types of polling: Serial Poll and Parallel Poll.
 1. Serial Poll. When the controller executes a Serial Poll, the addressed device sends one byte of operational information, called a Status Byte, to the controller. If more than one device connected to the interface is programmed to request service, each device must be serial polled until the device that actually requested service is located.
 2. Parallel Poll. This method obtains a Status Bit from 8 devices connected to the interface. The 3488A does not respond to a Parallel Poll.
- ▶ Require Service. A device can send this message at any time to signify that it needs some type of interaction with the controller. Sometimes it only indicates to the controller that some defined action has taken place. The device must be preprogrammed to send the Service Request (SRQ) and the controller must be preprogrammed to respond.

HP-IB Messages

Different types of information can be passed over the HP-IB to one or more devices. Some of this information is in the form of messages, most of which can be separated into two groups. One group can be classified by the address portion specified by the controller and the information that comprises the message. An example of a message from this group would be: OUTPUT 709;''SLIST100-109''. The second group can be classified as HP-IB management messages. This group is comprised of twelve messages and are called Bus Messages.

- a. DATA: The actual information (binary bytes) sent by a talker to one or more listeners. The information (data) can be in numeric form or a character string.
- b. TRIGGER: The Trigger message causes the listening device(s) to perform a device dependent action when addressed.
- c. CLEAR: The Clear message causes the listening device(s) or all the devices on the HP-IB to return to their predefined device-dependent state.
- d. REMOTE: This message causes the listening device(s) to switch from local front panel control to remote program control when addressed to listen.
- e. LOCAL: This message clears the REMOTE message from the listening device(s) and returns the device(s) to local front panel control.

f. LOCAL LOCKOUT: This message prevents a device operator from manually inhibiting remote program control.

g. CLEAR LOCKOUT AND SET LOCAL: With this message, all devices are removed from the LOCAL LOCKOUT mode and revert to LOCAL mode. The REMOTE message is also cleared for all devices.

h. REQUIRE SERVICE: A device can send this message at any time to signify the device needs some type of interaction with the controller. This message is cleared by the device's STATUS BYTE message if the device no longer requires service.

i. STATUS BYTE: The Status Byte is an 8-bit byte that represents the current status of a single device on the HP-IB. One bit indicates whether the device sent the REQUIRE SERVICE message and the remaining seven bits are device dependent. This byte is sent from the Talking device in response to a Serial Poll operation performed by the controller.

j. STATUS BIT: In response to a Parallel Poll operation, each device on the HP-IB sets or clears a specified DATA bit. The controller then looks at a complete eight bit byte to determine which device requires service.

k. PASS CONTROL: The bus management responsibility is transferred from the active controller to another controller by this message.

l. ABORT: The system controller sends this message to unconditionally assume control of the HP-IB from the active controller. The message will terminate all Bus communication but does not implement the CLEAR message.

3488A Bus Capabilities

The 3488A interfaces to the HP-IB as defined by the IEEE Standard 488-1978. The interface function subset which the 3488A implements is specified in Table B-1.

Table B-1. 3488A Bus Capabilities

| | |
|-----|--|
| SH1 | Source handshake - complete capabilities |
| AH1 | Acceptor Handshake - complete capabilities |
| T6 | Basic Talker, with Serial Poll, no Talk-only mode, unaddressed to Talk when it receives its Listen address |
| TE0 | No Extended Talker capabilities |
| L4 | Basic Listener, unaddressed to Listen when it receives its Talk address |
| LE0 | No Extended Listener |
| SR1 | Service Request - complete capabilities |
| RL1 | Remote Local- complete capabilities |
| PPO | No parallel Poll capabilities |
| DC1 | Device Clear - complete capabilities |
| DT1 | Device Trigger - complete capabilities |
| CO | No controller capabilities |

HP-IB Worksheet

The HP-IB worksheet (Table B-2) can be used to record the HP-IB capabilities of the HP-IB compatible devices in a system. The sheet may be filled in with the Bus message capability of your controller and for each HP-IB device. The Bus capability of the 3488A has already been filled in. Refer to your controller HP-IB I/O manual and the manual(s) for the other device(s) for their Bus Message capabilities. Once the sheet is filled in, you will then have a complete record of the HP-IB capabilities of your system.

Table B-2. HP-IB Worksheet

| Message | Device | | | | | | |
|---|-------------|--|--|--|--|--|--|
| Instrument Identification and HP-IB Address | MODEL 3488A | | | | | | |
| | LISTEN YES | | | | | | |
| | TALK YES | | | | | | |
| | ADDRESS 09 | | | | | | |
| DATA | S&R | | | | | | |
| TRIGGER | R | | | | | | |
| CLEAR | R | | | | | | |
| LOCAL | R | | | | | | |
| REMOTE | R | | | | | | |
| LOCAL LOCKOUT | R | | | | | | |
| CLEAR LO & SET LOCKOUT | R | | | | | | |
| REQUIRE SERVICE | S | | | | | | |
| STATUS Byte | S | | | | | | |
| STATUS BIT | N | | | | | | |
| S = SEND ONLY R = RECEIVE ONLY S&R = SEND AND RECEIVE N = NOT IMPLEMENTED MODEL LISTEN | | | | | | | |

INDEX

| A | Page |
|--------------------------------|---------------------------|
| Accessories | 101 |
| Actuator | 156 |
| Applications, 44470A | 11 |
| Applications, 44471A | 12 |
| Applications, 44472A | 13 |
| Applications, 44473A | 15 |
| Applications, 44474A | 17 |
| Applications, 44475A | 18 |
| Attenuators | 125 |
| | |
| B | Page |
| Bit Definition | 210 |
| Breadboard Assembly | 241 |
| Breadboard Interface Circuitry | 19 |
| Breadboard Module | 18 |
| | |
| C | Page |
| Card Monitor | 66 |
| Card Pair | 58,65 |
| Card Reset | 65 |
| Card Type | 8,64 |
| CHAN | 55,68,116,142,171,191,229 |
| Channel Closed | 56,118,144,172,193 |
| Channel Closed Example | 129,237 |
| Channel Definition | 24,110,136,164,184 |
| CLEAR | 82 |
| CLOSE | 25,63,111,137,166,186,213 |
| CMON | 66,117,143,171,191,219 |
| Command Directory | 61 |
| Commands | 23 |
| Configuration, 44470A | 125 |
| Configuration, 44471A | 151 |
| Control Keys | 3 |
| CPAIR | 58,65,114,140,168,188,215 |
| CRESET | 65,113,139,168,188,215 |
| CTYPE | 8,64,113,139,167,187 |
| | |
| D | Page |
| DBR | 71,231 |
| DBW | 71,230 |
| DELAY | 59,71,119,145,194,230 |
| Digital Binary Read | 71,231 |
| Digital Binary Write | 71,230 |
| Digital I/O | 16 |
| Digital I/O Module | 209 |
| Digital Mode | 69,220 |
| Display | 3,38,77 |
| DMODE | 69,220 |
| Documentation Worksheets | 259 |
| DREAD | 70,218 |
| DWRITE | 70,216 |

| E | Page |
|-------------------------------------|------------------------|
| EHALT | 76 |
| End of Scan Sequence, Example | 88 |
| ERROR | 75 |
| Error Messages | 6,40 |
| Errors | 39 |
| Event Log | 260 |
| Extending the Matrix Example | 200 |
| External Increment | 56,118,144,172,193,226 |
| External Increment Example | 130,237 |
| | |
| F | Page |
| Four-Wire Ohms | 127 |
| FRONT PANEL | 3 |
| Front Panel SRQ, Example | 87 |
| | |
| G | Page |
| General Purpose Relay | 135 |
| General Purpose Relay Module | 12 |
| | |
| H | Page |
| HP-IB Address | 22,99 |
| HP-IB Description | 265 |
| HP-IB Interface | 99 |
| HP-IB Messages | 268 |
| HP-IB Terms | 267 |
| | |
| I | Page |
| ID? | 73 |
| Input Buffer | 79 |
| Installation, 44470A | 120 |
| Installation, 44471A | 147 |
| Installation, 44472A | 175 |
| Installation, 44473A | 196 |
| Installation, 44474A | 233 |
| Isolation Impedance | 177 |
| | |
| K | Page |
| Keyboard | 77 |
| | |
| L | Page |
| Limit Switch Sensing | 239 |
| LOCAL | 82 |
| LOCAL LOCKOUT | 83 |
| | |
| M | Page |
| MASK | 75 |
| Matrix Switch | 15 |
| Matrix Switch Module | 183 |
| Mode Definition, Digital | 220 |
| MONITOR | 28 |
| Monitor Tracking | 35 |

| | |
|---|---------------------------|
| N | Page |
| Numeric Keypad | 3 |
| O | Page |
| OPEN | 25,63,112,138,166,186,214 |
| Operation Keys | 3 |
| Options | 101 |
| OVERLAP | 76,79 |
| P | Page |
| Polarity | 225 |
| Power Requirements | 96 |
| Power-on Operations | 5 |
| Programming | 21 |
| Q | Page |
| Quick Reference Guide | 44 |
| R | Page |
| RECALL | 51,74 |
| Relay Multiplexer | 11,109 |
| REMOTE | 83 |
| Reset | 6,36 |
| RESET | 72 |
| Resistance Programming Example | 157 |
| S | Page |
| Safety Summary | 103 |
| Scan List | 67,115 |
| Scanning | 53 |
| Single Ended Measurements Example | 131,159 |
| SLIST | 53,67,115,141,169,189,227 |
| Slot Definition | 24 |
| Specifications | 105,242 |
| Specifications, 44470A | 134 |
| Specifications, 44471A | 155 |
| Specifications, 44472A | 176 |
| Specifications, 44473A | 200 |
| Specifications, 44474A | 237 |
| SPLL | 91 |
| SREAD | 252 |
| SRQ | 84 |
| SRQ MASK | 75,85 |
| STATUS | 42,73 |
| Status Register | 85 |
| STEP | 55,68,116,142,170,190,228 |
| Stop on Error | 76 |
| STORE | 51,74 |
| SWRITE | 253 |
| SYNTAX | 44 |

| T | Page |
|------------------|---------------------------|
| Test | 6 |
| TEST | 72 |
| Time Delay | 59 |
| Topologies | 178 |
| TRIGGER | 94 |
| V | Page |
| Varistors | 155 |
| VHF Switch | 13,163 |
| VIEW | 27,64,112,138,167,187,214 |
| W | Page |
| Warranty | 102 |



Product Line Sales/Support Key

Key Product Line

- A Analytical
- CM Components
- C Computer Systems Sales only
- CH Computer Systems Hardware Sales and Services
- CS Computer Systems Software Sales and Services
- E Electronic Instruments & Measurement Systems
- M Medical Products
- MP Medical Products Primary SRO
- MS Medical Products Secondary SRO
- P Personal Computation Products
- * Sales only for specific product line
- ** Support only for specific product line

IMPORTANT: These symbols designate general product line capability. They do not insure sales or support availability for all products within a line, at all locations. Contact your local sales office for information regarding locations where HP support is available for specific products.

HP distributors are printed in italics.

HEADQUARTERS OFFICES

If there is no sales office listed for your area, contact one of these headquarters offices.

NORTH/CENTRAL AFRICA

Hewlett-Packard S.A.
7, Rue du Bois-du-Lan
CH-1217 MEYRIN 2, Switzerland
Tel: (022) 83 12 12
Telex: 27835 hpse
Cable: HEWPACKSA Geneve

ASIA

Hewlett-Packard Asia Ltd.
6th Floor, Sun Hung Kai Centre
30 Harbour Rd.
G.P.O. Box 795

HONG KONG

Tel: 5-832 3211
After Jan. 1, 1984
47th Floor, China Resources Bldg.
26 Harbour Rd., Wanchai

HONG KONG

Telex: 66678 HEWPA HX
Cable: HEWPACK HONG KONG

CANADA

Hewlett-Packard (Canada) Ltd.
6877 Goreway Drive
MISSISSAUGA, Ontario L4V 1M8
Tel: (416) 678-9430
Telex: 610-492-4246

EASTERN EUROPE

Hewlett-Packard Ges.m.b.h.
Liebigasse 1
P.O. Box 72
A-1222 VIENNA, Austria
Tel: (222) 2365110
Telex: 1 3 4425 HEPA A

NORTHERN EUROPE

Hewlett-Packard S.A.
Uilenstede 475
P.O. Box 999
NL-1180 AZ AMSTELVEEN
The Netherlands
Tel: 20 437771

SOUTH EAST EUROPE

Hewlett-Packard S.A.
7, Rue du Bois-du-Lan
CH-1217 MEYRIN 2, Switzerland
Tel: (022) 83 12 12
Telex: 27835 hpse
Cable: HEWPACKSA Geneve

OTHER EUROPE

Hewlett-Packard S.A.
P.O. Box
150, Rte du Nant-D'Avril
CH-1217 MEYRIN 2, Switzerland
Tel: (022) 83 8111
Telex: 22486 hpsa
Cable: HEWPACKSA Geneve

MEDITERRANEAN AND MIDDLE EAST

Hewlett-Packard S.A.
Mediterranean and Middle East
Operations
Atrina Centre
32 Kifissias Ave.
Paradissos-Amarousion, ATHENS
Greece
Tel: 682 88 11
Telex: 21-6588 HPAT GR
Cable: HEWPACKSA Athens

EASTERN USA

Hewlett-Packard Co.
4 Choke Cherry Road
ROCKVILLE, MD 20850
Tel: (301) 258-2000

MIDWESTERN USA

Hewlett-Packard Co.
5201 Tollview Drive
ROLLING MEADOWS, IL 60008
Tel: (312) 255-9800

SOUTHERN USA

Hewlett-Packard Co.
2000 South Park Place
P.O. Box 105005
ATLANTA, GA 30348
Tel: (404) 955-1500

WESTERN USA

Hewlett-Packard Co.
3939 Lankershim Blvd.
P.O. Box 3919
LOS ANGELES, CA 91604
Tel: (213) 506-3700

OTHER INTERNATIONAL AREAS

Hewlett-Packard Co.
Intercontinental Headquarters
3495 Deer Creek Road
PALO ALTO, CA 94304
Tel: (415) 857-1501
Telex: 034-8300
Cable: HEWPACK

ANGOLA

Telectra
Empresa Técnica de Equipamentos
R. Barbosa Rodrigues, 41-I DT.
Caixa Postal 6487
LUANDA
Tel: 355 15,355 16
E,P

ARGENTINA

Hewlett-Packard Argentina S.A.
Avenida Santa Fe 2035
Martinez 1640 BUENOS AIRES
Tel: 798-5735, 792-1293
Telex: 17595 BIONAR
Cable: HEWPACKARG
A,E,CH,CS,P
Biotron S.A.C.I.M. e I.
Av Paseo Colon 221, Piso 9
1399 BUENOS AIRES
Tel: 30-4846, 30-1851
Telex: 17595 BIONAR
M

AUSTRALIA

Adelaide, South Australia Office

Hewlett-Packard Australia Ltd.
153 Greenhill Road
PARKSIDE, S.A. 5063
Tel: 272-5911
Telex: 82536
Cable: HEWPAARD Adelaide
A*,CH,CM,,E,MS,P

Brisbane, Queensland Office

Hewlett-Packard Australia Ltd.
10 Payne Road
THE GAP, Queensland 4061
Tel: 30-4133
Telex: 42133
Cable: HEWPAARD Brisbane
A,CH,CM,E,M,P

Canberra, Australia

Capital Territory Office
Hewlett-Packard Australia Ltd.
121 Wollongong Street
FYSHWICK, A.C.T. 2609
Tel: 80 4244
Telex: 62650
Cable: HEWPAARD Canberra
CH,CM,E,P

Melbourne, Victoria Office

Hewlett-Packard Australia Ltd.
31-41 Joseph Street
BLACKBURN, Victoria 3130
Tel: 895-2895
Telex: 31-024
Cable: HEWPAARD Melbourne
A,CH,CM,CS,E,MS,P

Perth, Western Australia Office

Hewlett-Packard Australia Ltd.
261 Stirling Highway
CLAREMONT, W.A. 6010
Tel: 383-2188
Telex: 93859
Cable: HEWPAARD Perth
A,CH,CM,E,MS,P

Sydney, New South Wales Office

Hewlett-Packard Australia Ltd.
17-23 Talavera Road
P.O. Box 308
NORTH RYDE, N.S.W. 2113
Tel: 887-1611
Telex: 21561
Cable: HEWPAARD Sydney
A,CH,CM,CS,E,MS,P

AUSTRIA

Hewlett-Packard Ges.m.b.h.
Grottenhofstrasse 94
A-8052 GRAZ
Tel: (0316) 291 5 66
Telex: 32375
CH,E
Hewlett-Packard Ges.m.b.h.
Liebigasse 1
P.O. Box 72
A-1222 VIENNA
Tel: (0222) 23 65 11-0
Telex: 134425 HEPA A
A,CH,CM,CS,E,MS,P

BAHRAIN

Green Salon
P.O. Box 557
Manama
BAHRAIN
Tel: 255503-255950
Telex: 84419
P

Wael Pharmacy

P.O. Box 648

BAHRAIN

Wael Pharmacy
P.O. Box 648
BAHRAIN
Tel: 256123
Telex: 8550 WAEL BN
E,C,M

BELGIUM

Hewlett-Packard Belgium S.A./N.V.
Blvd de la Woluwe, 100
Woluwedal
B-1200 BRUSSELS
Tel: (02) 762-32-00
Telex: 23-494 palobren
A,CH,CM,CS,E,MP,P

BRAZIL

Hewlett-Packard do Brasil I.e.C. Ltda.
Alameda Rio Negro, 750
Alphaville
06400 BARUERI SP
Tel: (011) 421.1311
Telex: (011) 33872 HPBR-BR
Cable: HEWPACK Sao Paulo
A,CH,CM,CS,E,M,P

Hewlett-Packard do Brasil I.e.C. Ltda.

Avenida Epitacio Pessoa, 4864

22471 RIO DE JANEIRO-RJ

Tel: (021) 286.0237

Telex: 021-21905 HPBR-BR

Cable: HEWPACK Rio de Janeiro

A,CH,CM,E,MS,P*

ANAMED I.C.E.I. Ltda.

Rua Bage, 103

04012 SAO PAULO

Tel: (011) 570-5726

Telex: 021-21905 HPBR-BR

M

SALES & SUPPORT OFFICES

Arranged alphabetically by country

CANADA

Alberta

Hewlett-Packard (Canada) Ltd.
3030 3rd Avenue N.E.
CALGARY, Alberta T2A 6T7
Tel: (403) 235-3100
A,CH,CM,E*,MS,P*

Hewlett-Packard (Canada) Ltd.
11120A-178th Street
EDMONTON, Alberta T5S 1P2
Tel: (403) 486-6666
A,CH,CM,CS,E,MS,P

British Columbia

Hewlett-Packard (Canada) Ltd.
10691 Shellbridge Way
RICHMOND,

British Columbia V6X 2W7
Tel: (604) 270-2277
Telex: 610-922-5059
A,CH,CM,CS,E*,MS,P*

Manitoba

Hewlett-Packard (Canada) Ltd.
380-550 Century Street
WINNIPEG, Manitoba R3H 0Y1
Tel: (204) 786-6701
A,CH,CM,E,MS,P*

Nova Scotia

Hewlett-Packard (Canada) Ltd.
P.O. Box 931
900 Windmill Road
DARTMOUTH, Nova Scotia B2Y 3Z6
Tel: (902) 469-7820
CH,CM,CS,E*,MS,P*

Ontario

Hewlett-Packard (Canada) Ltd.
3325 N. Service Rd., Unit 6
BURLINGTON, Ontario P3A 2A3
Tel: (416) 335-8644
CS,M*

Hewlett-Packard (Canada) Ltd.
552 Newbold Street
LONDON, Ontario N6E 2S5
Tel: (519) 686-9181
A,CH,CM,E*,MS,P*

Hewlett-Packard (Canada) Ltd.
6877 Goreway Drive
MISSISSAUGA, Ontario L4V 1M8
Tel: (416) 678-9430
A,CH,CM,CS,E,MP,P

Hewlett-Packard (Canada) Ltd.
2670 Queensview Dr.
OTTAWA, Ontario K2B 8K1
Tel: (613) 820-6483
A,CH,CM,CS,E*,MS,P*

Hewlett-Packard (Canada) Ltd.
220 Yorkland Blvd., Unit #11
WILLOWDALE, Ontario M2J 1R5
Tel: (416) 499-9333
CH

Quebec

Hewlett-Packard (Canada) Ltd.
17500 South Service Road
Trans-Canada Highway
KIRKLAND, Quebec H9J 2M5
Tel: (514) 697-4232
A,CH,CM,CS,E,MP,P*

Hewlett-Packard (Canada) Ltd.
Les Galeries du Vallon
2323 Du Versant Nord
STE. FOY, Quebec G1N 4C2
Tel: (418) 687-4570
CH

CHILE

Jorge Calcagni y Cia. Ltda.
Av. Italia 634 Santiago
Casilla 16475
SANTIAGO 9
Tel: 222-0222
Telex: Public Booth 440001
A,CM,E,M

Olympia (Chile) Ltda.
Av. Rodrigo de Araya 1045
Casilla 256-V
SANTIAGO 21
Tel: (02) 22 55 044
Telex: 240-565 OLYMP CL
Cable: Olympiachile Santiagochile
CH,CS,P

CHINA, People's Republic of

China Hewlett-Packard Rep. Office
P.O. Box 418
1A Lane 2, Luchang St.
Beiwei Rd., Xuanwu District
BEIJING
Tel: 33-1947, 33-7426
Telex: 22601 CTSHP CN
Cable: 1920
A,CH,CM,CS,E,P

COLOMBIA

Instrumentación
H. A. Langebaek & Kier S.A.
Carrera 4A No. 52A-26
Apartado Aereo 6287
BOGOTA 1, D.E.
Tel: 212-1466
Telex: 44400 INST CO
Cable: AARIS Bogota
CM,E,M
Casa Humboldt Ltda.
Carrera 14, No. 98-60
Apartado Aereo 51283
BOGOTA 1, D.E.
Tel: 256-1686
Telex: 45403 CCAL CO.
A

COSTA RICA

Cientifica Costarricense S.A.
Avenida 2, Calle 5
San Pedro de Montes de Oca
Apartado 10159
SAN JOSÉ
Tel: 24-38-20, 24-08-19
Telex: 2367 GALGUR CR
CM,E,M

CYPRUS

Telerexa Ltd.
P.O. Box 4809
14C Slassinos Avenue
NICOSIA
Tel: 62698
Telex: 2894 LEVIDO CY
E,M,P

DENMARK

Hewlett-Packard A/S
Datavej 52
DK-3460 BIRKEROD
Tel: (02) 81-66-40
Telex: 37409 hpas dk
A,CH,CM,CS,E,MS,P
Hewlett-Packard A/S
Rolighedsvej 32
DK-8240 RISSKOV, Aarhus
Tel: (06) 17-60-00
Telex: 37409 hpas dk
CH,E

DOMINICAN REPUBLIC

Microprog S.A.
Juan Tomás Mejía y Cotes No. 60
Arroyo Hondo
SANTO DOMINGO
Tel: 565-6268
Telex: 4510 ARENTA DR (RCA) P

ECUADOR

CYEDE Cia. Ltda.
Avenida Eloy Alfaro 1749
Casilla 6423 CCI
QUITO
Tel: 450-975, 243-052
Telex: 2548 CYEDE ED
CM,E,P

Hospitalar S.A.

Robles 625
Casilla 3590
QUITO
Tel: 545-250, 545-122
Telex: 2485 HOSPPL ED
Cable: HOSPITALAR-Quito
M

EGYPT

International Engineering Associates
24 Hussein Hegazi Street
Kasr-el-Aini
CAIRO
Tel: 23829, 21641
Telex: IEA UN 93830
CH,CS,E,M
EGYPOR
P.O.Box 2558
42 El Zahraa Street
CAIRO, Egypt
Tel: 65 00 21
Telex: 93 337
P

EL SALVADOR

IPESA de El Salvador S.A.
29 Avenida Norte 1216
SAN SALVADOR
Tel: 26-6858, 26-6868
Telex: 20539 IPESASAL
A,CH,CM,CS,E,P

FINLAND

Hewlett-Packard Oy
Revontulentie 7
PL 24
SF-02101 ESPOO 10
Tel: (90) 4550211
Telex: 121563 hewpa sf
CH,CM,CS,P
Hewlett-Packard Oy
(Olarinluoma 7)
PL 24
02101 ESPOO 10
Tel: (90) 4521022
A,E,MS
Hewlett-Packard Oy
Aatoksenkatv 10-C
SF-40720-72 JYVASKYLA
Tel: (941) 216318
CH
Hewlett-Packard Oy
Kainvuntie 1-C
SF-90140-14 OULU
Tel: (981) 338785
CH

FRANCE

Hewlett-Packard France
Z.I. Mercure B
Rue Berthelot
F-13763 Les Milles Cedex
AIX-EN-PROVENCE
Tel: 16 (42) 59-41-02
Telex: 410770F
A,CH,E,MS,P*

Hewlett-Packard France
64, rue Marchand Saillant
F-61000 ALENCON
Tel: 16 (33) 29 04 42

Hewlett-Packard France
Boite Postale 503
F-25026 BESANCON
28 rue de la Republique
F-25000 BESANCON
Tel: 16 (81) 83-16-22
CH,M

Hewlett-Packard France
13, Place Napoleon III
F-29000 BREST
Tel: 16 (98) 03-38-35
Hewlett-Packard France
Chemin des Mouilles
Boite Postale 162
F-69130 ECULLY Cedex (Lyon)
Tel: 16 (78) 833-81-25
Telex: 310617F
A,CH,CS,E,MP

Hewlett-Packard France
Tour Lorraine
Boulevard de France
F-91035 EVRY Cedex
Tel: 16 6 077-96-60
Telex: 692315F
E

Hewlett-Packard France
Parc d'Activite du Bois Briard
Ave. du Lac
F-91040 EVRY Cedex
Tel: 16 6 077-8383
Telex: 692315F
E

Hewlett-Packard France
5, avenue Raymond Chanas
F-38320 EYBENS (Grenoble)
Tel: 16 (76) 25-81-41
Telex: 980124 HP GRENOB EYBE
CH

Hewlett-Packard France
Centre d'Affaire Paris-Nord
Bâtiment Ampère 5 étage
Rue de la Commune de Paris
Boite Postale 300
F-93153 LE BLANC MESNIL
Tel: 16 (1) 865-44-52
Telex: 211032F
CH,CS,E,MS

Hewlett-Packard France
Parc d'Activités Cadera
Quartier Jean Mermoz
Avenue du Président JF Kennedy
F-33700 MERIGNAC (Bordeaux)
Tel: 16 (56) 34-00-84
Telex: 550105F
CH,E,MS

Hewlett-Packard France
Immueble "Les 3 B"
Nouveau Chemin de la Garde
ZAC de Bois Briard
F-44085 NANTES Cedex
Tel: 16 (40) 50-32-22
CH**

**FRANCE (Cont'd)**

Hewlett-Packard France
125, rue du Faubourg Bannier
F-45000 ORLEANS
Tel: 16 (38) 68 01 63

Hewlett-Packard France
Zone Industrielle de Courtaboeuf
Avenue des Tropiques
F-91947 Les Ulis Cedex ORSAY
Tel: (6) 907-78-25
Telex: 600048F
A,CH,CM,CS,E,MP,P

Hewlett-Packard France
Paris Porte-Maillot
15, Avenue de L'Amiral Bruix
F-75782 PARIS CEDEX 16
Tel: 16 (1) 502-12-20
Telex: 613663F
CH,MS,P

Hewlett-Packard France
124, Boulevard Tourasse
F-64000 PAU
Tel: 16 (59) 80 38 02

Hewlett-Packard France
2 Allée de la Bourgonnette
F-35100 RENNES
Tel: 16 (99) 51-42-44
Telex: 740912F
CH,CM,E,MS,P*

Hewlett-Packard France
98 Avenue de Bretagne
F-76100 ROUEN
Tel: 16 (35) 63-57-66
CH** ,CS

Hewlett-Packard France
4 Rue Thomas Mann
Boite Postale 56
F-67033 STRASBOURG Cedex
Tel: 16 (88) 28-56-46
Telex: 890141F
CH,E,MS,P*

Hewlett-Packard France
Le Péripole
20, Chemin du Pigeonnier de la
Cépière
F-31083 TOULOUSE Cedex
Tel: 16 (61) 40-11-12
Telex: 531639F
A,CH,CS,E,P*

Hewlett-Packard France
9, rue Baudin
F-26000 VALENCE
Tel: 16 (75) 42 76 16

Hewlett-Packard France
Carolor
ZAC de Bois Briand
F-57640 VIGY (Metz)
Tel: 16 (8) 771 20 22
CH

Hewlett-Packard France
Immeuble Péricentre
F-59658 VILLENEUVE D'ASCQ Cedex
Tel: 16 (20) 91-41-25
Telex: 160124F
CH,E,MS,P*

**GERMAN FEDERAL
REPUBLIC**

Hewlett-Packard GmbH
Geschäftsstelle
Keithstrasse 2-4
D-1000 BERLIN 30
Tel: (030) 24-90-86
Telex: 018 3405 hpbln d
A,CH,E,M,P

Hewlett-Packard GmbH
Geschäftsstelle
Herrenberger Strasse 130
D-7030 BOBLINGEN
Tel: (7031) 14-0
Telex:
A,CH,CM,CS,E,MP,P

Hewlett-Packard GmbH
Geschäftsstelle
Emanuel-Leutze-Strasse 1
D-4000 DUSSELDORF
Tel: (0211) 5971-1
Telex: 085/86 533 hpdd d
A,CH,CS,E,MS,P

Hewlett-Packard GmbH
Geschäftsstelle
Schleefstr. 28a
D-4600 DORTMUND-Aplerbeck
Tel: (0231) 45001

Hewlett-Packard GmbH
Vertriebszentrale Frankfurt
Berner Strasse 117
Postfach 560 140
D-6000 FRANKFURT 56
Tel: (0611) 50-04-1
Telex: 04 13249 hpflm d
A,CH,CM,CS,E,MP,P

Hewlett-Packard GmbH
Geschäftsstelle
Aussenstelle Bad Homburg
Louisenstrasse 115
D-6380 BAD HOMBURG
Tel: (06172) 109-0

Hewlett-Packard GmbH
Geschäftsstelle
Kapstadtring 5
D-2000 HAMBURG 60
Tel: (040) 63804-1
Telex: 021 63 032 hphh d
A,CH,CS,E,MS,P

Hewlett-Packard GmbH
Geschäftsstelle
Heidering 37-39
D-3000 HANNOVER 61
Tel: (0511) 5706-0
Telex: 092 3259
A,CH,CM,E,MS,P

Hewlett-Packard GmbH
Geschäftsstelle
Rosslauer Weg 2-4
D-6800 MANNHEIM
Tel: (0621) 70050
Telex: 0462105
A,C,E

Hewlett-Packard GmbH
Geschäftsstelle
Messerschmittstrasse 7
D-7910 NEU ULM
Tel: 0731-70241
Telex: 0712816 HP ULM-D
A,C,E*

Hewlett-Packard GmbH
Geschäftsstelle
Ehhericherstr. 13
D-8500 NÜRNBERG 10
Tel: (0911) 5205-0
Telex: 0623 860
CH,CM,E,MS,P

Hewlett-Packard GmbH
Geschäftsstelle
Eschenstrasse 5
D-8028 TAUFKIRCHEN
Tel: (089) 6117-1
Telex: 0524985
A,CH,CM,E,MS,P

GREAT BRITAIN

See United Kingdom

GREECE

Kostas Karayannis S.A.
8 Omirou Street
ATHENS 133
Tel: 32 30 303, 32 37 371
Telex: 215962 RKAR GR
A,CH,CM,CS,E,M,P

PLAISIO S.A.
G. Gerardos
24 Stournara Street
ATHENS
Tel: 36-11-160
Telex: 221871
P

GUATEMALA

IPESA
Avenida Reforma 3-48, Zona 9
GUATEMALA CITY
Tel: 316627, 314786
Telex: 4192 TELTRO GU
A,CH,CM,CS,E,M,P

HONG KONG

Hewlett-Packard Hong Kong, Ltd.
G.P.O. Box 795
5th Floor, Sun Hung Kai Centre
30 Harbour Road
HONG KONG
Tel: 5-8323211
Telex: 66678 HEWPA HX
Cable: HEWPACK HONG KONG
E,CH,CS,P

CET Ltd.
1402 Tung Wah Mansion
199-203 Hennessy Rd.
Wanchia, HONG KONG
Tel: 5-729376
Telex: 85148 CET HX
CM

Schmidt & Co. (Hong Kong) Ltd.
Wing On Centre, 28th Floor
Connaught Road, C.
HONG KONG
Tel: 5-455644
Telex: 74766 SCHMX HX
A,M

ICELAND

Elding Trading Company Inc.
Hafnarvoll-Tryggvagotu
P.O. Box 895
IS-REYKJAVIK
Tel: 1-58-20, 1-63-03
M

INDIA

Computer products are sold through
Blue Star Ltd. All computer repairs and
maintenance service is done through
Computer Maintenance Corp.

Blue Star Ltd.
Sabri Complex II Floor
24 Residency Rd.
BANGALORE 560 025
Tel: 55660
Telex: 0845-430
Cable: BLUESTAR
A,CH*,CM,CS*,E

Blue Star Ltd.
Band Box House
Prabhadevi
BOMBAY 400 025
Tel: 422-3101
Telex: 011-3751
Cable: BLUESTAR
A,M

Blue Star Ltd.
Sahas
414/2 Vir Savarkar Marg
Prabhadevi
BOMBAY 400 025
Tel: 422-6155
Telex: 011-4093
Cable: FROSTBLUE
A,CH*,CM,CS*,E,M

Blue Star Ltd.
Kalyan, 19 Vishwas Colony
Alkapuri, BORODA, 390 005
Tel: 65235
Cable: BLUE STAR
A

Blue Star Ltd.
7 Hare Street
CALCUTTA 700 001
Tel: 12-01-31
Telex: 021-7655
Cable: BLUESTAR
A,M

Blue Star Ltd.
133 Kodambakkam High Road
MADRAS 600 034
Tel: 82057
Telex: 041-379
Cable: BLUESTAR
A,M

Blue Star Ltd.
Bhandari House, 7th/8th Floors
91 Nehru Place
NEW DELHI 110 024
Tel: 682547
Telex: 031-2463
Cable: BLUESTAR
A,CH*,CM,CS*,E,M

Blue Star Ltd.
15/16-C Wellesley Rd.
PUNE 411 011
Tel: 22775
Cable: BLUE STAR
A

Blue Star Ltd.
2-2-47/1108 Bolarum Rd.
SECUNDERABAD 500 003
Tel: 72057
Telex: 0155-459
Cable: BLUEFROST
A,E

Blue Star Ltd.
T.C. 7/603 Poornima
Maruthankuzhi
TRIVANDRUM 695 013
Tel: 65799
Telex: 0884-259
Cable: BLUESTAR
E

Computer Maintenance Corporation
Ltd.
115, Sarojini Devi Road
SECUNDERABAD 500 003
Tel: 310-184, 345-774
Telex: 031-2960
CH**



SALES & SUPPORT OFFICES

Arranged alphabetically by country

INDONESIA

BERCA Indonesia P.T.
P.O.Box 496/Jkt.
Jl. Abdul Muis 62
JAKARTA
Tel: 21-373009
Telex: 46748 BERSAL IA
Cable: BERSAL JAKARTA
P

BERCA Indonesia P.T.
P.O.Box 2497/Jk1
Antara Bldg., 17th Floor
Jl. Medan Merdeka Selatan 17
JAKARTA-PUSAT
Tel: 21-344-181
Telex: BERSAL IA
A,CS,E,M

BERCA Indonesia P.T.
P.O. Box 174/SBY.
Jl. Kutej No. 11
SURABAYA
Tel: 68172
Telex: 31146 BERSAL SB
Cable: BERSAL-SURABAYA
A*,E,M,P

IRAQ

Hewlett-Packard Trading S.A.
Service Operation
Al Mansoor City 9B/3/7
BAGHDAD
Tel: 551-49-73
Telex: 212-455 HEPAIRAQ IK
CH,CS

IRELAND

Hewlett-Packard Ireland Ltd.
82/83 Lower Leeson Street
DUBLIN 2
Tel: 0001 608800
Telex: 30439
A,CH,CM,CS,E,M,P
Cardiac Services Ltd.
Kilmore Road
Arlane
DUBLIN 5
Tel: (01) 351820
Telex: 30439
M

ISRAEL

Eidan Electronic Instrument Ltd.
P.O.Box 1270
JERUSALEM 91000
16, Ohaliav St.
JERUSALEM 94467
Tel: 533 221, 553 242
Telex: 25231 AB/PAKRD IL
A
Electronics Engineering Division
Motorola Israel Ltd.
16 Kremenetski Street
P.O. Box 25016
TEL-AVIV 67899
Tel: 3 88 388
Telex: 33569 Motil IL
Cable: BASTEL Tel-Aviv
CH,CM,CS,E,M,P

ITALY

Hewlett-Packard Italiana S.p.A.
Traversa 99C
Via Giulio Petroni, 19
I-70124 **BARI**
Tel: (080) 41-07-44
M

Hewlett-Packard Italiana S.p.A.
Via Martin Luther King, 38/III
I-40132 **BOLOGNA**
Tel: (051) 402394
Telex: 511630
CH,E,MS

Hewlett-Packard Italiana S.p.A.
Via Principe Nicola 43G/C
I-95126 **CATANIA**
Tel: (095) 37-10-87
Telex: 970291
C,P

Hewlett-Packard Italiana S.p.A.
Via G. Di Vittorio 9
I-20063 **CERNUSCO SUL NAVIGLIO**
(Milano)
Tel: (02) 923691
Telex: 334632
A,CH,CM,CS,E,MP,P

Hewlett-Packard Italiana S.p.A.
Via C. Colombo 49
I-20090 **TREZZANO SUL NAVIGLIO**
(Milano)
Tel: (02) 4459041
Telex: 322116
C,M

Hewlett-Packard Italiana S.p.A.
Via Nuova San Rocco a
Capodimonte, 62/A
I-80131 **NAPOLI**
Tel: (081) 7413544
Telex: 710698
A,CH,E

Hewlett-Packard Italiana S.p.A.
Viale G. Modugno 33
I-16156 **GENOVA PEGLI**
Tel: (010) 68-37-07
Telex: 215238
E,C

Hewlett-Packard Italiana S.p.A.
Via Pelizzo 15
I-35128 **PADOVA**
Tel: (049) 664888
Telex: 430315
A,CH,E,MS

Hewlett-Packard Italiana S.p.A.
Viale C. Pavese 340
I-00144 **ROMA EUR**
Tel: (06) 54831
Telex: 610514
A,CH,CM,CS,E,MS,P*

Hewlett-Packard Italiana S.p.A.
Via di Casellina 57/C
I-50018 **SCANDICCI-FIRENZE**
Tel: (055) 753863

Hewlett-Packard Italiana S.p.A.
Corso Svizzera, 185
I-10144 **TORINO**
Tel: (011) 74 4044
Telex: 221079
CH,E

JAPAN

Yokogawa-Hewlett-Packard Ltd.
152-1, Onna
ATSUGI, Kanagawa, 243
Tel: (0462) 28-0451
CM,C*,E

Yokogawa-Hewlett-Packard Ltd.
Meiji-Seimei Bldg. 6F
3-1 Hon Chiba-Cho
CHIBA, 280
Tel: 472 25 7701
E,CH,CS

Yokogawa-Hewlett-Packard Ltd.
Yasuda-Seimei Hiroshima Bldg.
6-11, Hon-dori, Naka-ku
HIROSHIMA, 730
Tel: 82-241-0611

Yokogawa-Hewlett-Packard Ltd.
Towa Building
2-3, Kaigan-dori, 2 Chome Chuo-ku
KOBE, 650
Tel: (078) 392-4791
C,E

Yokogawa-Hewlett-Packard Ltd.
Kumagaya Asahi 82 Bldg
3-4 Tsukuba
KUMAGAYA, Saitama 360
Tel: (0485) 24-6563
CH,CM,E

Yokogawa-Hewlett-Packard Ltd.
Asahi Shinbun Daiichi Seimei Bldg.
4-7, Hanabata-cho
KUMAMOTO, 860
Tel: (0963) 54-7311
CH,E

Yokogawa-Hewlett-Packard Ltd.
Shin-Kyoto Center Bldg.
614, Higashi-Shiokoji-cho
Karasuma-Nishiiru
Shiokoji-dori, Shimogyo-ku
KYOTO, 600
Tel: 075-343-0921
CH,E

Yokogawa-Hewlett-Packard Ltd.
Mito Mitsui Bldg
4-73, Sanno-maru, 1 Chome
MITO, Ibaraki 310
Tel: (0292) 25-7470
CH,CM,E

Yokogawa-Hewlett-Packard Ltd.
Sumitomo Seimei 14-9 Bldg.
Meieki-Minami, 2 Chome
Nakamura-ku
NAGOYA, 450
Tel: (052) 571-5171
CH,CM,CS,E,MS

Yokogawa-Hewlett-Packard Ltd.
Chuo Bldg.,
4-20 Nishinakajima, 5 Chome
Yodogawa-ku
OSAKA, 532
Tel: (06) 304-6021
Telex: YHPOSA 523-3624
A,CH,CM,CS,E,MP,P*

Yokogawa-Hewlett-Packard Ltd.
27-15, Yabe, 1 Chome
SAGAMIHARA Kanagawa, 229
Tel: 0427 59-1311

Yokogawa-Hewlett-Packard Ltd.
Daiichi Seimei Bldg.
7-1, Nishi Shinjuku, 2 Chome
Shinjuku-ku, **TOKYO** 160
Tel: 03-348-4611
CH,E

Yokogawa-Hewlett-Packard Ltd.
29-21 Takaido-Higashi, 3 Chome
Suginami-ku **TOKYO** 168
Tel: (03) 331-6111
Telex: 232-2024 YHPTOK
A,CH,CM,CS,E,MP,P*

Yokogawa-Hewlett-Packard Ltd.
Daiichi Asano Building
2-8, Odori, 5 Chome
UTSUNOMIYA, Tochigi 320
Tel: (0286) 25-7155
CH,CS,E

Yokogawa-Hewlett-Packard Ltd.
Yasuda Seimei Nishiguchi Bldg.
30-4 Tsuruya-cho, 3 Chome
YOKOHAMA 221
Tel: (045) 312-1252
CH,CM,E

JORDAN

Mouasher Cousins Company
P.O. Box 1387
AMMAN
Tel: 24907, 39907
Telex: 21456 SABCO JO
CH,E,M,P

KENYA

ADCOM Ltd., Inc., Kenya
P.O.Box 30070
NAIROBI
Tel: 331955
Telex: 22639
E,M

KOREA

Samsung Electronics HP Division
12 Fl. Kinam Bldg.
San 75-31, Yeoksam-Dong
Kangnam-Ku
Yeongdong P.O. Box 72
SEOUL
Tel: 555-7555, 555-5447
Telex: K27364 SAMSAN
A,CH,CM,CS,E,M,P

KUWAIT

Al-Khaldiya Trading & Contracting
P.O. Box 830 Safat
KUWAIT
Tel: 42-4910, 41-1726
Telex: 22481 Areeg k1
CH,E,M

Photo & Cine Equipment
P.O. Box 270 Safat
KUWAIT
Tel: 42-2846, 42-3801
Telex: 22247 Matin kt
P

LEBANON

G.M. Dolmadjian
Achrafieh
P.O. Box 165.167
BEIRUT
Tel: 290293
MP**
Computer Information Systems
P.O. Box 11-6274
BEIRUT
Tel: 89 40 73
Telex: 22259
C

LUXEMBOURG

Hewlett-Packard Belgium S.A./N.V.
Blvd de la Woluwe, 100
Woluwedel
B-1200 BRUSSELS
Tel: (02) 762-32-00
Telex: 23-494 paloben bru
A,CH,CM,CS,E,MP,P

MALAYSIA

Hewlett-Packard Sales (Malaysia)
Sdn. Bhd.
1st Floor, Bangunan British
American
Jalan Semantan, Damansara Heights
KUALA LUMPUR 23-03
Tel: 943022
Telex: MA31011
A,CH,E,M,P*

**MAYLAISIA (Cont'd)**

Protel Engineering
P.O.Box 1917
Lot 6624, Section 64
23/4 Pending Road
Kuching, **SARAWAK**
Tel: 36299
Telex: MA 70904 PROMAL
Cable: PROTELENG
A,E,M

MALTA

Philip Toledo Ltd.
Notabile Rd.
MRIEHEL
Tel: 447 47, 455 66
Telex: Media MW 649
E,P

MEXICO

Hewlett-Packard Mexicana, S.A.
de C.V.
Av. Periferico Sur No. 6501
Tepepan, Xochimilco
16020 **MEXICO D.F.**
Tel: 6-76-46-00
Telex: 17-74-507 HEWPACK MEX
A,CH,CS,E,MS,P
Hewlett-Packard Mexicana, S.A.
de C.V.
Ave. Colonia del Valle 409
Col. del Valle
Municipio de Garza Garcia
MONTERREY, Nuevo Leon
Tel: 78 42 41
Telex: 038 410
CH

ECISA

José Vasconcelos No. 218
Col. Condesa Deleg. Cuauhtémoc
MEXICO D.F. 06140
Tel: 553-1206
Telex: 17-72755 ECE ME
M

MOROCCO

Dolbeau
81 rue Karatchi
CASABLANCA
Tel: 3041-82, 3068-38
Telex: 23051, 22822
E

Gerep

2 rue d'Agadir
Boite Postale 156
CASABLANCA
Tel: 272093, 272095
Telex: 23 739
P

NETHERLANDS

Hewlett-Packard Nederland B.V.
Van Heuven Goedhartlaan 121
NL 1181KK **AMSTELVEEN**
P.O. Box 667
NL 1180 AR **AMSTELVEEN**
Tel: (020) 47-20-21
Telex: 13 216 HEPAC NL
A,CH,CM,CS,E,MP,P
Hewlett-Packard Nederland B.V.
Bongerd 2
NL 2906VK **CAPELLE A/D IJSSEL**
P.O. Box 41
NL 2900AA **CAPELLE A/D IJSSEL**
Tel: (10) 51-64-44
Telex: 2 1261 HEPAC NL
A,CH,CS,E

Hewlett-Packard Nederland B.V.
Pastoor Petersstraat 134-136
NL 5612 LV **EINDHOVEN**
P.O. Box 2342
NL 5600 CH **EINDHOVEN**
Tel: (040) 326911
Telex: 5 1484 hepae nl
A,CH*,E,M

NEW ZEALAND

Hewlett-Packard (N.Z.) Ltd.
5 Owens Road
P.O. Box 26-189
Epsom, **AUCKLAND**
Tel: 687-159
Cable: HEWPACK Auckland
CH,CM,E,P*

Hewlett-Packard (N.Z.) Ltd.
4-12 Cruickshank Street
Kilbirnie, **WELLINGTON 3**
P.O. Box 9443
Courtenay Place, **WELLINGTON 3**
Tel: 877-199
Cable: HEWPACK Wellington
CH,CM,E,P

Northrop Instruments & Systems Ltd.
369 Khyber Pass Road
P.O. Box 8602
AUCKLAND
Tel: 794-091
Telex: 60605
A,M

Northrop Instruments & Systems Ltd.
110 Mandeville St.
P.O. Box 8388
CHRISTCHURCH
Tel: 486-928
Telex: 4203
A,M

Northrop Instruments & Systems Ltd.
Sturdee House
85-87 Ghuznee Street
P.O. Box 2406
WELLINGTON
Tel: 850-091
Telex: NZ 3380
A,M

NORTHERN IRELAND

See United Kingdom

NORWAY

Hewlett-Packard Norge A/S
Folke Bernadottes vei 50
P.O. Box 3558
N-5033 **FYLLINGSDALEN** (Bergen)
Tel: 0047/5/16 55 40
Telex: 16621 hpnas n
CH,CS,E,MS

Hewlett-Packard Norge A/S
Österdalen 16-18
P.O. Box 34
N-1345 **ÖSTERÅS**
Tel: 0047/2/17 11 80
Telex: 16621 hpnas n
A,CH,CM,CS,E,MP

OMAN

Khimji Ramdas
P.O. Box 19
MUSCAT
Tel: 722225, 745601
Telex: 3289 BROKER MB MUSCAT
P

Suhail & Saud Bahwan
P.O.Box 169
MUSCAT
Tel: 734 201-3
Telex: 3274 BAHWAN MB

PAKISTAN

Mushko & Company Ltd.
1-B, Street 43
Sector F-8/1

ISLAMABAD

Tel: 51071
Cable: FEMUS Rawalpindi
A,E,M

Mushko & Company Ltd.

Oosman Chambers
Abdullah Haroon Road
KARACHI 0302
Tel: 524131, 524132
Telex: 2894 MUSKO PK
Cable: COOPERATOR Karachi
A,E,M,P*

PANAMA

Electrónico Balboa, S.A.
Calle Samuel Lewis, Ed. Alfa
Apartado 4929
PANAMA 5
Tel: 63-6613, 63-6748
Telex: 3483 ELECTRON PG
A,CM,E,M,P

PERU

Cia Electro Médica S.A.
Los Flamencos 145, San Isidro
Casilla 1030
LIMA 1
Tel: 41-4325, 41-3703
Telex: Pub. Booth 25306
CM,E,M,P

PHILIPPINES

The Online Advanced Systems
Corporation
Rico House, Amorsolo Cor. Herrera
Street
Legaspi Village, Makati
P.O. Box 1510
Metro MANILA
Tel: 85-35-81, 85-34-91, 85-32-21
Telex: 3274 ONLINE
A,CH,CS,E,M
Electronic Specialists and Proponents
Inc.
690-B Epifanio de los Santos Avenue
Cubao, **QUEZON CITY**
P.O. Box 2649 Manila
Tel: 98-96-81, 98-96-82, 98-96-83
Telex: 40018, 42000 ITT GLOBE
MACKAY BOOTH
P

PORTUGAL

Mundinter
Intercambio Mundial de Comércio
S.A.R.L.
P.O. Box 2761
Av. Antonio Augusto de Aguiar 138
P-LISBON
Tel: (19) 53-21-31, 53-21-37
Telex: 16691 munter p
M
Soquimica
Av. da Liberdade, 220-2
1298 **LISBOA Codex**
Tel: 56 21 81/2/3
Telex: 13316 SABASA
P

Telectra-Empresa Técnica de
Equipamentos Eléctricos S.A.R.L.
Rua Rodrigo da Fonseca 103
P.O. Box 2531
P-LISBON 1
Tel: (19) 68-60-72
Telex: 12598
CH,CS,E,P

PUERTO RICO

Hewlett-Packard Puerto Rico
Ave. Muñoz Rivera #101
Esq. Calle Ochoa
HATO REY, Puerto Rico 00918
Tel: (809) 754-7800

Hewlett-Packard Puerto Rico
Calle 272 Edificio 203
Urb. Country Club
RIO PIEDRAS, Puerto Rico
P.O. Box 4407
CAROLINA, Puerto Rico 00628
Tel: (809) 762-7255
A,CH,CS

QATAR

Computerbia
P.O. Box 2750
DOHA
Tel: 883555
Telex: 4806 CHPARB
P
Eastern Technical Services
P.O.Box 4747
DOHA
Tel: 329 993
Telex: 4156 EASTEC DH
Nasser Trading & Contracting
P.O.Box 1563
DOHA
Tel: 22170, 23539
Telex: 4439 NASSER DH
M

SAUDI ARABIA

Modern Electronic Establishment
Hewlett-Packard Division
P.O. Box 22015
Thuobah
AL-KHOBAR
Tel: 895-1760, 895-1764
Telex: 671 106 HPMEEK SJ
Cable: ELECTA AL-KHOBAR
CH,CS,E,M
Modern Electronic Establishment
Hewlett-Packard Division
P.O. Box 1228
Redec Plaza, 6th Floor
JEDDAH
Tel: 644 38 48
Telex: 4027 12 FARNAS SJ
Cable: ELECTA JEDDAH
CH,CS,E,M

Modern Electronic Establishment
Hewlett-Packard Division
P.O.Box 22015
RIYADH
Tel: 491-97 15, 491-63 87
Telex: 202049 MEERYD SJ
CH,CS,E,M
Abdul Ghani El Ajou
P.O. Box 78
RIYADH
Tel: 40 41 717
Telex: 200 932 EL AJOU
P

SCOTLAND

See United Kingdom

SINGAPORE

Hewlett-Packard Singapore (Sales)
Pte. Ltd.
#08-00 Inchcape House
450-2 Alexandra Road
P.O. Box 58 Alexandra Rd. Post Office
SINGAPORE, 9115
Tel: 631788
Telex: HPSGSO RS 34209
Cable: HEWPACK, Singapore
A,CH,CS,E,MS,P



SALES & SUPPORT OFFICES

Arranged alphabetically by country

SINGAPORE (Cont'd)

Dynamar International Ltd.
Unit 05-11 Block 6
Kolam Ayer Industrial Estate
SINGAPORE 1334
Tel: 747-6188
Telex: RS 26283
CM

SOUTH AFRICA

Hewlett-Packard So Africa (Pty.) Ltd.
P.O. Box 120
Howard Place CAPE PROVINCE 7450
Pine Park Center, Forest Drive,
Pinelands

CAPE PROVINCE 7405

Tel: 53-7954
Telex: 57-20006
A,CH,CM,E,MS,P
Hewlett-Packard So Africa (Pty.) Ltd.
P.O. Box 37099
92 Overport Drive
DURBAN 4067
Tel: 28-4178, 28-4179, 28-4110
Telex: 6-22954
CH,CM

Hewlett-Packard So Africa (Pty.) Ltd.
6 Linton Arcade
511 Cape Road
Linton Grange
PORT ELIZABETH 6000
Tel: 041-302148
CH

Hewlett-Packard So Africa (Pty.) Ltd.
P.O.Box 33345
Glenstantia 0010 TRANSVAAL
1st Floor East
Constantia Park Ridge Shopping
Centre
Constantia Park
PRETORIA
Tel: 982043
Telex: 32163
CH,E

Hewlett-Packard So Africa (Pty.) Ltd.
Private Bag Wendywood
SANDTON 2144
Tel: 802-5111, 802-5125
Telex: 4-20877
Cable: HEWPACK Johannesburg
A,CH,CM,CS,E,MS,P

SPAIN

Hewlett-Packard Española S.A.
Calle Entenza, 321
E-BARCELONA 29
Tel: 322.24.51, 321.73.54
Telex: 52603 hpbee
A,CH,CS,E,MS,P

Hewlett-Packard Española S.A.
Calle San Vicente S/No
Edificio Albia II
E-BILBAO 1
Tel: 423.83.06
A,CH,E,MS

Hewlett-Packard Española S.A.
C/ta. de la Coruña, Km. 16, 400
Las Rozas
E-MADRID
Tel: (1) 637.00.11
CH,CS,M

Hewlett-Packard Española S.A.
Avda. S. Francisco Javier, S/no
Planta 10. Edificio Sevilla 2,
E-SEVILLA 5
Tel: 64.44.54
Telex: 72933
A,CS,MS,P

Hewlett-Packard Española S.A.
Calle Ramon Gordillo, 1 (Entlo.3)
E-VALENCIA 10
Tel: 361-1354
CH,P

SWEDEN

Hewlett-Packard Sverige AB
Sunnanvagen 14K
S-22226 LUND
Tel: (046) 13-69-79
Telex: (854) 17886 (via Spånga
office)
CH

Hewlett-Packard Sverige AB
Östra Tullgatan 3
S-21128 MALMÖ
Tel: (040) 70270
Telex: (854) 17886 (via Spånga
office)

Hewlett-Packard Sverige AB
Västra Vintergatan 9
S-70344 ÖREBRO
Tel: (19) 10-48-80
Telex: (854) 17886 (via Spånga
office)
CH

Hewlett-Packard Sverige AB
Skalholtsgatan 9, Kista
Box 19
S-16393 SPÅNGA
Tel: (08) 750-2000
Telex: (854) 17886
Telefax: (08) 7527781
A,CH,CM,CS,E,MS,P

Hewlett-Packard Sverige AB
Frötällsgatan 30
S-42132 VÄSTRA-FRÖLUNDA
Tel: (031) 49-09-50
Telex: (854) 17886 (via Spånga
office)
CH,E,P

SWITZERLAND

Hewlett-Packard (Schweiz) AG
Clarastrasse 12
CH-4058 BASEL
Tel: (61) 33-59-20
A

Hewlett-Packard (Schweiz) AG
7, rue du Bois-du-Lan
Case Postale 365
CH-1217 MEYRIN 2
Tel: (0041) 22-83-11-11
Telex: 27333 HPAG CH
CH,CM,CS

Hewlett-Packard (Schweiz) AG
Allmend 2
CH-8967 WIDEN
Tel: (0041) 57 31 21 11
Telex: 53933 hpag ch
Cable: HPAG CH
A,CH,CM,CS,E,MS,P

SYRIA

General Electronic Inc.
Nuri Basha Ahnaf Ebn Kays Street
P.O. Box 5781
DAMASCUS
Tel: 33-24-87
Telex: 411 215
Cable: ELECTROBOR DAMASCUS
E

Middle East Electronics
P.O.Box 2308
Abu Rummaneh
DAMASCUS
Tel: 33 4 5 92
Telex: 411 304
M

TAIWAN

Hewlett-Packard Far East Ltd.
Kaohsiung Office
2/F 68-2, Chung Cheng 3rd Road
KAOHSIUNG
Tel: (07) 241-2318
CH,CS,E

Hewlett-Packard Far East Ltd.
Taiwan Branch
8th Floor
337 Fu Hsing North Road
TAIPEI

Tel: (02) 712-0404
Telex: 24439 HEWPACK
Cable: HEWPACK Taipei
A,CH,CM,CS,E,M,P
Ing Lih Trading Co.
3rd Floor, 7 Jen-Ai Road, Sec. 2
TAIPEI 100

Tel: (02) 3948191
Cable: INGLIH TAIPEI
A

THAILAND

Unimesa
30 Palpong Ave., Suriwong
BANGKOK 5
Tel: 235-5727
Telex: 84439 Simonco TH
Cable: UNIMESA Bangkok
A,CH,CS,E,M

Bangkok Business Equipment Ltd.
5/5-6 Dejo Road
BANGKOK
Tel: 234-8670, 234-8671
Telex: 87669-BEQUIPT TH
Cable: BUSIQUIPT Bangkok
P

TRINIDAD & TOBAGO

Caribbean Telecoms Ltd.
50/A Jerningham Avenue
P.O. Box 732
PORT-OF-SPAIN
Tel: 62-44213, 62-44214
Telex: 235,272 HUGCO WG
CM,E,M,P

TUNISIA

Tunisie Electronique
31 Avenue de la Liberte
TUNIS
Tel: 280-144
E,P

Corema
1 ter. Av. de Carthage
TUNIS
Tel: 253-821
Telex: 12319 CABAM TN
M

TURKEY

Teknim Company Ltd.
Iran Caddesi No. 7
Kavaklidere, ANKARA
Tel: 275800
Telex: 42155 TKNM TR
E

E.M.A.
Medina Eldem Sokak No.41/6
Yüksel Caddesi
ANKARA
Tel: 175 622
Telex: 42 591
M

UNITED ARAB EMIRATES

Emitac Ltd.
P.O. Box 2711
ABU DHABI
Tel: 82 04 19-20
Cable: EMITAC ABUDHABI

Emitac Ltd.
P.O. Box 1641
SHARJAH
Tel: 591 181
Telex: 68136 Emitac Sh
CH,CS,E,M,P

UNITED KINGDOM

GREAT BRITAIN

Hewlett-Packard Ltd.
Trafalgar House
Navigation Road
ALTRINCHAM
Cheshire WA14 1NU
Tel: 061 928 6422
Telex: 668068
A,CH,CS,E,M,MS,P

Hewlett-Packard Ltd.
Elstree House, Elstree Way
BOREHAMWOOD, Herts WD6 1SG
Tel: 01 207 5000
Telex: 8952716
E,CH,CS,P

Hewlett-Packard Ltd.
Oakfield House, Oakfield Grove
Clifton BRISTOL, Avon BS8 2BN
Tel: 0272 736806
Telex: 444302
CH,CS,E,P

Hewlett-Packard Ltd.
Bridewell House
Bridewell Place
LONDON EC4V 6BS
Tel: 01 583 6565
Telex: 298163
CH,CS,P

Hewlett-Packard Ltd.
Fourier House
257-263 High Street
LONDON COLNEY
Herts. AL2 1HA, St. Albans
Tel: 0727 24400
Telex: 1-8952716
CH,CS

Hewlett-Packard Ltd.
Pontefract Road
NORMANTON, West Yorkshire WF6 1RN
Tel: 0924 895566
Telex: 557355
CH,CS,P

Hewlett-Packard Ltd.
The Quadrangle
106-118 Station Road
REDHILL, Surrey RH1 1PS
Tel: 0737 68655
Telex: 947234
CH,CS,E,P

**GREAT BRITAIN (Cont'd)**

Hewlett-Packard Ltd.
Avon House
435 Stratford Road
Shirley, SOLIHULL, West Midlands
B90 4BL

Tel: 021 745 8800
Telex: 339105
CH,CS,E,P

Hewlett-Packard Ltd.
West End House
41 High Street, West End
SOUTHAMPTON
Hampshire SO3 3DQ
Tel: 04218 6767
Telex: 477138
CH,CS,P

Hewlett-Packard Ltd.
Eskdale Rd.
Winnersh, **WOKINGHAM**
Berkshire RG11 5DZ
Tel: 0734 696622
Telex: 848884
E

Hewlett-Packard Ltd.
King Street Lane
Winnersh, **WOKINGHAM**
Berkshire RG11 5AR
Tel: 0734 784774
Telex: 847178
A,CH,CS,E,M,MP,P

Hewlett-Packard Ltd.
Nine Mile Ride
Easthampstead, **WOKINGHAM**
Berkshire, 3RG11 3LL
Tel: 0344 773100
Telex: 848805
CH,CS,E,P

IRELAND**NORTHERN IRELAND**

Hewlett-Packard Ltd.
Cardiac Services Building
95A Finaghy Road South
BELFAST BT 10 0BY
Tel: 0232 625-566
Telex: 747626
CH,CS

SCOTLAND

Hewlett-Packard Ltd.
SOUTH QUEENSFERRY
West Lothian, EH30 9TG
Tel: 031 331 1188
Telex: 726882
CH,CM,CS,E,M,P

UNITED STATES**Alabama**

Hewlett-Packard Co.
700 Century Park South, Suite 128
BIRMINGHAM, AL 35226
Tel: (205) 822-6802
A,CH,M

Hewlett-Packard Co.
420 Wynn Drive
HUNTSVILLE, AL 35805
P.O. Box 7700
HUNTSVILLE, AL 35807
Tel: (205) 830-2000
CH,CM,CS,E,M*

Arizona

Hewlett-Packard Co.
8080 Pointe Parkway West
PHOENIX, AZ 85044
Tel: (602) 273-8000
A,CH,CM,CS,E,MS

Hewlett-Packard Co.
2424 East Aragon Road
TUCSON, AZ 85706
Tel: (602) 889-4631
CH,E,MS**

California

Hewlett-Packard Co.
99 South Hill Dr.
BRISBANE, CA 94005
Tel: (415) 330-2500
CH,CS

Hewlett-Packard Co.
P.O. Box 7830 (93747)
5060 E. Clinton Avenue, Suite 102
FRESNO, CA 93727
Tel: (209) 252-9652
CH,CS,MS

Hewlett-Packard Co.
P.O. Box 4230
1430 East Orangethorpe
FULLERTON, CA 92631
Tel: (714) 870-1000
CH,CM,CS,E,MP

Hewlett-Packard Co.
320 S. Kellogg, Suite B
GOLETA, CA 93117
Tel: (805) 967-3405
CH

Hewlett-Packard Co.
5400 W. Rosecrans Boulevard
LAWDALE, CA 90260
P.O. Box 92105
LOS ANGELES, CA 90009
Tel: (213) 970-7500
Telex: 910-325-6608
CH,CM,CS,MP

Hewlett-Packard Co.
3155 Porter Oaks Drive
PALO ALTO, CA 94304
Tel: (415) 857-8000
CH,CS,E

Hewlett-Packard Co.
4244 So. Market Court, Suite A
P.O. Box 15976
SACRAMENTO, CA 95852
Tel: (916) 929-7222
A*,CH,CS,E,MS

Hewlett-Packard Co.
9606 Aero Drive
P.O. Box 23333
SAN DIEGO, CA 92139
Tel: (619) 279-3200
CH,CM,CS,E,MP

Hewlett-Packard Co.
2305 Camino Ramon "C"
SAN RAMON, CA 94583
Tel: (415) 838-5900
CH,CS

Hewlett-Packard Co.
3005 Scott Boulevard
SANTA CLARA, CA 95050
Tel: (408) 988-7000
Telex: 910-338-0586
A,CH,CM,CS,E,MP

Hewlett-Packard Co.
5703 Corsa Avenue
WESTLAKE VILLAGE, CA 91362
Tel: (213) 706-6800
E*,CH*,CS*

Colorado

Hewlett-Packard Co.
24 Inverness Place, East
ENGLEWOOD, CO 80112
Tel: (303) 649-5000
A,CH,CM,CS,E,MS

Connecticut

Hewlett-Packard Co.
47 Barnes Industrial Road South
P.O. Box 5007
WALLINGFORD, CT 06492
Tel: (203) 265-7801
A,CH,CM,CS,E,MS

Florida

Hewlett-Packard Co.
2901 N.W. 62nd Street
P.O. Box 24210
FORT LAUDERDALE, FL 33307
Tel: (305) 973-2600
CH,CS,E,MP

Hewlett-Packard Co.
6177 Lake Ellenor Drive
P.O. Box 13910
ORLANDO, FL 32859
Tel: (305) 859-2900
A,CH,CM,CS,E,MS

Hewlett-Packard Co.
5750B N. Hoover Blvd., Suite 123
P.O. Box 15200
TAMPA, FL 33614
Tel: (813) 884-3282
A*,CH,CM,CS,E*,M*

Georgia

Hewlett-Packard Co.
2000 South Park Place
P.O. Box 105005
ATLANTA, GA 30348
Tel: (404) 955-1500
Telex: 810-766-4890
A,CH,CM,CS,E,MP

Hawaii

Hewlett-Packard Co.
Kawaiahao Plaza, Suite 190
567 South King Street
HONOLULU, HI 96813
Tel: (808) 526-1555
A,CH,E,MS

Illinois

Hewlett-Packard Co.
304 Eldorado Road
P.O. Box 1607
BLOOMINGTON, IL 61701
Tel: (309) 662-9411
CH,MS**

Hewlett-Packard Co.
1100 31st Street, Suite 100
DOWNERS GROVE, IL 60515
Tel: (312) 960-5760
CH,CS

Hewlett-Packard Co.
5201 Tollview Drive
ROLLING MEADOWS, IL 60008
Tel: (312) 255-9800
Telex: 910-687-1066
A,CH,CM,CS,E,MP

Indiana

Hewlett-Packard Co.
7301 No. Shadeland Avenue
P.O. Box 50807
INDIANAPOLIS, IN 46250
Tel: (317) 842-1000
A,CH,CM,CS,E,MS

Iowa

Hewlett-Packard Co.
1776 22nd Street, Suite 1
WEST DES MOINES, IA 50265
Tel: (515) 224-1435
CH,MS**

Kansas

Hewlett-Packard Co.
7804 East Funston Road, #203
WICHITA, KS 67207
Tel: (316) 684-8491
CH

Kentucky

Hewlett-Packard Co.
10300 Linn Station Road, #100
LOUISVILLE, KY 40223
Tel: (502) 426-0100
A,CH,CS,MS

Louisiana

Hewlett-Packard Co.
160 James Drive East
ST. ROSE, LA 70087
P.O. Box 1449
KENNER, LA 70063
Tel: (504) 467-4100
A,CH,CS,E,MS

Maryland

Hewlett-Packard Co.
3701 Koppers Street
BALTIMORE, MD 21227
Tel: (301) 644-5800
Telex: 710-862-1943
A,CH,CM,CS,E,MS

Hewlett-Packard Co.
2 Choke Cherry Road
ROCKVILLE, MD 20850
Tel: (301) 948-6370
A,CH,CM,CS,E,MP

Massachusetts

Hewlett-Packard Co.
1775 Minuteman Road
ANDOVER, MA 01810
Tel: (617) 682-1500
A,C,CH,CS,CM,E,MP,P*
Hewlett-Packard Co.
32 Hartwell Avenue
LEXINGTON, MA 02173
Tel: (617) 861-8960
CH,CS,E

Michigan

Hewlett-Packard Co.
4326 Cascade Road S.E.
GRAND RAPIDS, MI 49506
Tel: (616) 957-1970
CH,CS,MS

Hewlett-Packard Co.
1771 W. Big Beaver Road
TROY, MI 48084
Tel: (313) 643-6474
CH,CS

Minnesota

Hewlett-Packard Co.
2025 W. Larpenteur Ave.
ST. PAUL, MN 55113
Tel: (612) 644-1100
A,CH,CM,CS,E,MP

Missouri

Hewlett-Packard Co.
11131 Colorado Avenue
KANSAS CITY, MO 64137
Tel: (816) 763-8000
A,CH,CM,CS,E,MS

Hewlett-Packard Co.
13001 Hollenberg Drive
BRIDGETON, MO 63044
Tel: (314) 344-5100
A,CH,CS,E,MP



SALES & SUPPORT OFFICES

Arranged alphabetically by country

UNITED STATES (Cont'd)

Nebraska

Hewlett-Packard
10824 Old Mill Rd., Suite 3
OMAHA, NE 68154
Tel: (402) 334-1813
CM,MS

New Jersey

Hewlett-Packard Co.
120 W. Century Road
PARAMUS, NJ 07652
Tel: (201) 265-5000
A,CH,CM,CS,E,MP
Hewlett-Packard Co.
60 New England Av. West
PISCATAWAY, NJ 08854
Tel: (201) 981-1199
A,CH,CM,CS,E

New Mexico

Hewlett-Packard Co.
11300 Lomas Blvd., N.E.
P.O. Box 11634
ALBUQUERQUE, NM 87112
Tel: (505) 292-1330
CH,CS,E,MS

New York

Hewlett-Packard Co.
5 Computer Drive South
ALBANY, NY 12205
Tel: (518) 458-1550
A,CH,E,MS

Hewlett-Packard Co.
9600 Main Street
P.O. Box AC
CLARENCE, NY 14031
Tel: (716) 759-8621
CH

Hewlett-Packard Co.
200 Cross Keys Office Park
FAIRPORT, NY 14450
Tel: (716) 223-9950
CH,CM,CS,E,MS

Hewlett-Packard Co.
764 1 Henry Clay Blvd.
LIVERPOOL, NY 13088
Tel: (315) 451-1820
A,CH,CM,E,MS

Hewlett-Packard Co.
No. 1 Pennsylvania Plaza
55th Floor
34th Street & 8th Avenue
MANHATTAN NY 10119
Tel: (212) 971-0800
CH,CS,E*,M*

Hewlett-Packard Co.
250 Westchester Avenue
WHITE PLAINS, NY 10604
Tel: (914) 684-6100
CM,CH,CS,E

Hewlett-Packard Co.
3 Crossways Park West
WOODBURY, NY 11797
Tel: (516) 921-0300
A,CH,CM,CS,E,MS

North Carolina

Hewlett-Packard Co.
5605 Roanne Way
P.O. Box 26500
GREENSBORO, NC 27420
Tel: (919) 852-1800
A,CH,CM,CS,E,MS

Ohio

Hewlett-Packard Co.
9920 Carver Road
CINCINNATI, OH 45242
Tel: (513) 891-9870
CH,CS,MS

Hewlett-Packard Co.
16500 Sprague Road
CLEVELAND, OH 44130
Tel: (216) 243-7300
A,CH,CM,CS,E,MS

Hewlett-Packard Co.
962 Crupper Ave.
COLUMBUS, OH 43229
Tel: (614) 436-1041
Eff. Nov. 25, 1983
675 Brookside Blvd.
WESTERVILLE, OH 43081
CH,CM,CS,E*

Hewlett-Packard Co.
330 Progress Rd.
DAYTON, OH 45449
Tel: (513) 859-8202
A,CH,CM,E*,MS

Oklahoma

Hewlett-Packard Co.
304 N. Meridian, Suite A
P.O. Box 75609
OKLAHOMA CITY, OK 73147
Tel: (405) 946-9499
A*,CH,E*,MS

Hewlett-Packard Co.
3840 S. 103rd E. Avenue, #100
P.O. Box 35747
TULSA, OK 74153
Tel: (918) 665-3300
A*,CH,CS,M*

Oregon

Hewlett-Packard Co.
9255 S. W. Pioneer Court
P.O. Box 328
WILSONVILLE, OR 97070
Tel: (503) 682-8000
A,CH,CS,E*,MS

Pennsylvania

Hewlett-Packard Co.
111 Zeta Drive
PITTSBURGH, PA 15238
Tel: (412) 782-0400
A,CH,CS,E,MP

Hewlett-Packard Co.
2750 Monroe Boulevard
P.O. Box 713
VALLEY FORGE, PA 19482
Tel: (215) 666-9000
A,CH,CM,E,M

South Carolina

Hewlett-Packard Co.
Brookside Park, Suite 122
1 Harbison Way
P.O. Box 21708
COLUMBIA, SC 29221
Tel: (803) 732-0400
CH,E,MS

Hewlett-Packard Co.
Koger Executive Center
Chesterfield Bldg., Suite 124
GREENVILLE, SC 29615
Tel: (803) 297-4120

Tennessee

Hewlett-Packard Co.
224 Peters Road, Suite 102
P.O. Box 22490
KNOXVILLE, TN 37922
Tel: (615) 691-2371
A*,CH,MS

Hewlett-Packard Co.
3070 Directors Row
MEMPHIS, TN 38131
Tel: (901) 346-8370
A,CH,MS

Texas

Hewlett-Packard Co.
4171 North Mesa
Suite C-110
EL PASO, TX 79902
Tel: (915) 533-3555
CH,E*,MS**

Hewlett-Packard Co.
10535 Harwin Drive
P.O. Box 42816
HOUSTON, TX 77042
Tel: (713) 776-6400
A,CH,CM,CS,E,MP

Hewlett-Packard Co.
930 E. Campbell Rd.
P.O. Box 1270
RICHARDSON, TX 75080
Tel: (214) 231-6101
A,CH,CM,CS,E,MP

Hewlett-Packard Co.
1020 Central Parkway South
P.O. Box 32993
SAN ANTONIO, TX 78216
Tel: (512) 494-9336
CH,CS,E,MS

Utah

Hewlett-Packard Co.
3530 W. 2100 South
SALT LAKE CITY, UT 84119
Tel: (801) 974-1700
A,CH,CS,E,MS

Virginia

Hewlett-Packard Co.
4305 Cox Road
GLEN ALLEN, VA 23060
P.O. Box 9669
RICHMOND, VA 23228
Tel: (804) 747-7750
A,CH,CS,E,MS

Washington

Hewlett-Packard Co.
15815 S.E. 37th Street
BELLEVUE, WA 98006
Tel: (206) 643-4000
A,CH,CM,CS,E,MP

Hewlett-Packard Co.
Suite A
708 North Argonne Road
SPOKANE, WA 99212
Tel: (509) 922-7000
CH,CS

West Virginia

Hewlett-Packard Co.
4604 MacCorkle Ave.
P.O. Box 4297
CHARLESTON, WV 25304
Tel: (304) 925-0492
A,MS

Wisconsin

Hewlett-Packard Co.
150 S. Sunny Slope Road
BROOKFIELD, WI 53005
Tel: (414) 784-8800
A,CH,CS,E*,MP

URUGUAY

*Pablo Ferrando S.A.C. e I.
Avenida Italia 2877
Casilla de Correo 370
MONTEVIDEO
Tel: 80-2586
Telex: Public Booth 901
A,CM,E,M*

VENEZUELA

Hewlett-Packard de Venezuela C.A.
3RA Transversal Los Ruices Norte
Edificio Segre 1, 2 & 3
Apartado 50933
CARACAS 1071
Tel: 239-4133
Telex: 251046 HEWPACK
A,CH,CS,E,MS,P

Hewlett-Packard de Venezuela C.A.
Calle-72-Entre 3H y 3Y, No. 3H-40
Edificio Ada-Evelyn, Local B
Apartado 2646
4001, MARACAIBO, Estado Zulia
Tel: (061) 80.304
C,E*

Hewlett-Packard de Venezuela C.A.
Calle Vargas Rondon
Edificio Seguros Carabobo, Piso 10
VALENCIA
Tel: (041) 51 385
CH,CS,P

*Bioelectronica Medica C.A.
Calle Buen Pastor
Edif. Cota Mil-Piso 2 y Semi Sotano 1
Boleita Norte
Apartado 50710 CARACAS 1050A
Tel: 239 84 41
Telex: 26518*

ZIMBABWE

*Field Technical Sales
45 Kelvin Road, North
P.B. 3458
SALISBURY
Tel: 705 231
Telex: 4-122 RH
C,E,M,P*

July 1983 5952-6900

Indicates main office

HP distributors are printed in italics.