



OPERATING AND SERVICE MANUAL

MODEL 3330A/B AUTOMATIC SYNTHESIZER

3330A

Serial No. 1301A00203 and Greater

3330B

Serial No. 1313A01161 and Greater

IMPORTANT NOTICE

Any changes made in instruments with serial numbers greater than those stated on this title page will be noted on a change sheet supplied with this manual. If the serial number of your instrument is lower than that stated above, the manual can contain revisions that do not apply to your instrument. Backdating information located in Section VIII adapts this manual to these instruments.

WARNING

To help minimize the possibility of electrical fire or shock hazards, do not expose this instrument to rain or excessive moisture.

Manual Part No. 03330-90002

Microfiche Part No. 03330-90052

Copyright Hewlett-Packard Company 1972
P.O. Box 301, Loveland, Colorado, 80537 U.S.A

Printed: December 1976

HEWLETT  PACKARD

CERTIFICATION

Hewlett-Packard Company certifies that this instrument met its published specifications at the time of shipment from the factory. Hewlett-Packard Company further certifies that its calibration measurements are traceable to the United States National Bureau of Standards, to the extent allowed by the Bureau's calibration facility, and to the calibration facilities of other International Standards Organization members.

WARRANTY AND ASSISTANCE

This Hewlett-Packard product is warranted against defects in materials and workmanship for a period of one year from the date of shipment, except that in the case of certain components, if any, listed in Section I of this operating manual, the warranty shall be for the specified period. Hewlett-Packard will, at its option, repair or replace products which prove to be defective during the warranty period provided they are returned to Hewlett-Packard, and provided the proper preventive maintenance procedures as listed in this manual are followed. Repairs necessitated by misuse of the product are not covered by this warranty. **NO OTHER WARRANTIES ARE EXPRESSED OR IMPLIED, INCLUDING BUT NOT LIMITED TO THE IMPLIED WARRANTIES OF MERCHANTABILITY AND FITNESS FOR A PARTICULAR PURPOSE. HEWLETT-PACKARD IS NOT LIABLE FOR CONSEQUENTIAL DAMAGES.**

If this product is sold as part of a Hewlett-Packard integrated instrument system, the above warranty shall not be applicable, and this product shall be covered only by the system warranty.

Service contracts or customer assistance agreements are available for Hewlett-Packard products.

For any assistance, contact your nearest Hewlett-Packard Sales and Service Office. Addresses are provided at the back of this manual.

SECTION I GENERAL INFORMATION

1-1. INTRODUCTION.

1-2. This section contains general information about the -hp- Model 3330A/B Automatic Synthesizer. A general description plus information on specifications, accessories, and instrument identification is given.

1-3. SPECIFICATIONS.

1-4. Table 1-1 is a complete list of the Model 3330A/B critical specifications that are controlled by tolerances. Table 1-2 contains general information that describes the operating characteristics of the 3330A/B.

1-5. Any change in the specifications due to manufacturing, design, or traceability to the U.S. National Bureau of Standards will be covered by a manual change sheet. This manual and manual change sheet supersede all previous information concerning specifications of the 3330A/B.

1-6. DESCRIPTION.

1-7. The -hp- Model 3330A/B Automatic Synthesizer provides accurate and stable frequencies from 0.1 Hz to 13,000,999.9 Hz with a resolution of 0.1 Hz. Digital sweeping of frequency is standard on both the 3330A and 3330B. Selection of frequency and frequency sweep is accomplished by a front panel keyboard.

1-8. With the 3330A, the output amplitude is selected by a 0-13 dBm potentiometer. Maximum output voltage for both the 3330A and 3330B is 1 V rms into 50 ohms. The 3330B output amplitude is selected by the front panel keyboard. Output amplitude capability is +13.44 dBm to -86.55 dBm with a resolution of 0.01 dB. Digital sweeping of amplitude is also available on the 3330B.

1-9. OPTIONS.

1-10. The following options are available with the 3330A/B Synthesizer.

| | |
|--------|---|
| Option | |
| 001 | 75 ohm, 1 V rms, output |
| 002 | High stability Crystal Oven |
| 003 | Deletion of Crystal Oven |
| 004 | Isolated Digital Input |
| 005 | 5 V rms into 50 ohm Output Power Amplifier |
| 908 | Rack Mounting Kit |
| 910 | Additional Operating and Service Manual |

1-11. For more information concerning these options, contact your local -hp- Sales and Service Office, listed in Appendix B of this manual.

Table 1-1. Specifications.

| | |
|---|--|
| <p style="text-align: center;">3330A/B FREQUENCY SECTION</p> <p>Frequency Stability. Long term: $\pm 1 \times 10^{-8}$ per day $\pm 1 \times 10^{-7}$ per month</p> <p>Temperature: 20°C to 30°C: $\pm 1 \times 10^{-8}$ of frequency at 25°C. 0°C to 55°C: $\pm 1 \times 10^{-7}$ of frequency at 25°C.</p> <p>Signal to phase noise (integrated): > 50 dB down in a 30 kHz band, excluding ± 1 Hz centered on carrier.</p> <p>Harmonic Distortion. With full output amplitude, any harmonically related signal will be less than the following specified levels: - 60 dB with output from 5 Hz to 100 kHz - 50 dB with output from 100 kHz to 1 MHz - 40 dB with output from 1 MHz to 13 MHz</p> <p>Spurious. 3330A: > 70 dB below selected output. 3330B: > 70 dB below selected output or less than -110 dBm/50 Ω, whichever is greater.</p> | <p style="text-align: center;">3330A AMPLITUDE SECTION</p> <p>Amplitude. Maximum 2 Vrms $\pm 10\%$ open circuit. Maximum 1 Vrms $\pm 10\%$ into 50 ohms.</p> <p>Frequency Response (10 kHz Reference): ± 0.5 dB over total range.</p> <p style="text-align: center;">3330B AMPLITUDE SECTION</p> <p>Amplitude (10 kHz Reference, 25°C \pm 5°C + 13.44 dBm). 2.1 V rms open circuit $\pm 0.5\%$ (± 0.05 dB) 1.05 V rms into 50 ohms $\pm 0.5\%$ (± 0.05 dB).</p> <p>Attenuator Accuracy (10 kHz Reference): ± 0.02 dB/10 dB step.</p> <p>Sweep Output Stepped dc voltage proportional to sweep position of frequency or amplitude, 0 to +10 V.</p> <p>Accuracy: $\pm 0.2\%$ of full scale Linearity: $\pm 0.1\%$ of full scale</p> |
|---|--|

Table 1-1. Specifications. (Cont'd).

3330B AMPLITUDE SECTION (Cont'd)
Frequency Response (10 kHz Reference).

| 3330B Attenuator Setting (dBm) | | | Specification (dB) | |
|--------------------------------|-----------------------|-----------------------|--------------------|---|
| Standard | Option 001 | Option 005 | * Leveling OFF | Leveling SLOW (>10 Hz) or Leveling FAST (> 1 kHz) |
| + 13.44 to - 16.55 | + 11.68 to - 18.31 | + 26.99 to - 3.00 | ± 0.5 | ± 0.05 |
| - 16.55 to - 36.55 | - 18.31 to - 38.31 | - 3.00 to - 23.00 | ± 0.5 | ± 0.10 |
| - 36.55 to - 66.55 | - 38.31 to - 68.31 | - 23.00 to - 53.00 | ± 0.5 | ± 0.20 |
| - 66.55 to - 86.55 | - 68.31 to - 88.31 | - 53.00 to - 73.00 | ± 0.5 | ± 0.40 |

*For frequencies above 10 Hz and Leveling in OFF position, add 0.5 dB to Leveling SLOW (>10 Hz) or Leveling FAST (>1 kHz) specification.

Table 1-2. General Information.

| 3330A/B FREQUENCY SECTION | Largest digit changed | 0.1 Hz or 1 Hz | 10 Hz or 100 Hz | 1 kHz or 10 kHz | 100 kHz, 1 MHz or 10 MHz |
|--|--|-------------------------|-------------------------|---|---|
| | <p>Frequency Range: 0.1 Hz to 13,000,999.9 Hz</p> <p>Frequency Resolution: 0.1 Hz (8 digits + overrange).</p> <p>Internal Frequency Reference. 5 MHz crystal in temperature stabilized oven. Optional higher stability crystal oven (Option 002) or lower stability 20 MHz ambient temperature crystal (Option 003) references available.</p> <p>Frequency Reference Adjustments (5 MHz VCXO). Coarse: Internal adjustment adequate for 5 years of aging. Fine: 1 turn potentiometer on rear panel or ± 5 Vdc applied to REF TUNE IN and REF OSC switch in INT position: - 5 V: -.7 to -1.5 x 10⁻⁷ of value at 0 V + 5 V: +.5 to 1 x 10⁻⁷ of value at 0 V REF OSC switch in EXT position and no external reference applied: 20 to 40 ppm total adjustment range</p> <p>External Frequency Reference The 3330A/B may be phase locked with a 200 mV rms to 2 V rms signal that is any subharmonic of 20 MHz from 1 MHz through 10 MHz (i.e., 1 MHz, 2 MHz, 2.5 MHz, 5 MHz, 10 MHz). BNC female connector.</p> <p>Frequency switching and settling time: the time required for frequency switching and settling is a function of the largest frequency digit affected by the frequency change in question.</p> | <1 ms to within 500 µHz | <1 ms to within 0.05 Hz | <1 ms to within 5Hz: <50 ms to within 0.01 Hz | <1 ms to within 500 Hz: <50 ms to within 1 Hz |
| 3330A AMPLITUDE SECTION | | | | | |
| Amplitude Range: 0 dBm to + 13 dBm, front panel control | | | | | |
| Output Impedance: 50 ohm (75 ohm Option 001) | | | | | |
| Amplitude Modulation External modulation source required, rear panel BNC. DC to 100 kHz signal, 0.95 V rms for 95% modulation depth (0.01 V rms/1% depth). | | | | | |
| 3330B AMPLITUDE SECTION | | | | | |
| Amplitude Range: + 13.44 dBm to - 86.55 dBm into 50 ohms. | | | | | |
| Amplitude Resolution: 0.01 dB | | | | | |
| Output Impedance: 50 ohm (75 ohm Option 001) | | | | | |

Table 1-2. General Information.(Cont'd)

| <p>Display. Four digit readout in dBm referenced to 50 ohm. Display referenced to other impedances on special basis or internally adjustable by user to compensate for external attenuation or amplification.</p> <p>Amplitude Modulation. External modulation source required, rear panel BNC. 100 Hz to 100 kHz, 0.95 V rms for 95% modulation depth. LEVELING control must be in SLOW (> 10 Hz) position.</p> <p style="text-align: center;">DIGITAL REMOTE CONTROL</p> <p>All front panel controls with the exception of POWER and 3330A AMPLITUDE are programmable. Programming instructions are in a seven bit parallel ASCII code. Each control has an ASCII code assigned to it.</p> <p>Timing: Maximum of 310 μsec per digit to enter digits of frequency or amplitude. Maximum of 1 msec to enter and initiate program control codes. Maximum of 2.5 msec to enter and initiate sweep or calculate and output FIRST POINT.</p> <p>Input Control Lines: 7 "program data" lines</p> <p>1 "remote enable" line 1 "data valid" line</p> <p>Output Control Lines: 1 "not ready for data" line 1 "data not accepted" line</p> <p>Isolation: Isolation of the input and output control line grounds with respect to the 3330A/B output signal ground is available with Option 004.</p> <p>Logic Level Requirements:</p> <table border="0"> <thead> <tr> <th style="text-align: left;">State</th> <th style="text-align: left;">Requirements</th> </tr> </thead> <tbody> <tr> <td>"Low" (Logical "1")</td> <td>0 V to 0.4 V (5 mA max) or contact closure to ground through < 80 ohms</td> </tr> <tr> <td>"High" (Logical "0")</td> <td>2.4 V to 5 V or removal of contact closure to ground</td> </tr> </tbody> </table> <p>Outputs. Rear panel output: Rerouting of internal cable from front panel output to rear panel ALT OUTPUT female TRIAX connector yields rear panel output. No degradation of performance for rear panel output. Auxiliary Output: 20 to 33 MHz tracking output that is always 20 MHz above front panel output available at rear panel female BNC connector. Voltage is > 100 mV rms/50 ohms. 1 MHz sine wave reference output is available at rear panel female BNC connector. Voltage is > 220 mV rms/50 ohms. Digital Output: Digital signals available at rear of instrument to indicate various frequency or amplitude sweep parameters. Includes: Step Count: 0 to 1000 count on 12 BCD (8-4-2-1) lines to indicate sweep position. (e.g., count of 500 indicates center frequency or amplitude). Sweep Status: One line to indicate when instrument is sweeping. Step Ready: One line indicates the instrument has spent the selected time per step and is ready to go to the next step. Step Inhibit: One line which, when grounded, stops sweep on that step.</p> | State | Requirements | "Low" (Logical "1") | 0 V to 0.4 V (5 mA max) or contact closure to ground through < 80 ohms | "High" (Logical "0") | 2.4 V to 5 V or removal of contact closure to ground | <p>Sweep. Digital sweeping of both frequency and amplitude in the 3330B and frequency in the 3330A. When sweeping frequency automatically, the total sweep width may be as large as the entire frequency range or as small as 1 Hz. When sweeping amplitude automatically, the total sweep width may be as large as the entire amplitude range or as small as 0.1 dB. When sweeping frequency, each step of the frequency has the same stability as the frequency reference.</p> <p style="text-align: center;">GENERAL</p> <p>Operating Temperature: 0°C to +55°C</p> <p>Storage Temperature: -40°C to +70°C</p> <p>Turn on Time: Application of power to "On": < 20 min to within $\pm 1 \times 10^7$ of the final frequency. "Standby" to "On": < 15 seconds to full specifications.</p> <p>Power requirements. 115 V or 230 V $\pm 10\%$, 48 Hz to 66 Hz, (400 Hz line frequency operation on special basis). < 20 W standby, < 200 W on.</p> <p>Weight 3330A: 49 lb (22.1 kg). shipping 58 lb (26.4 kg). 3330B: 53 lb (24.0 kg). shipping 63 lb (28.6 kg).</p> <p>Dimensions: 16 3/4 in. wide x 7 in. high x 21 1/2 in. deep) (426 x 178 x 547 mm)</p> <p>Options</p> <p style="text-align: center;">75 Ohm - 1 V rms Output Power Amplifier Option 001 (Factory installation only)</p> <p>Attenuation and output referenced to 75 ohm. Amplitude range 3330A: + 11.3 dBm to - 1.7 dBm 3330B: + 11.68 to - 88.31 dBm</p> <p style="text-align: center;">High Stability Crystal Oven Option 002*</p> <p>10 MHz crystal reference in temperature stabilized oven. Frequency stability: Long term: $\pm 1 \times 10^{-9}$ per day $\pm 2 \times 10^{-8}$ per month Temperature: 20°C to 30°C $\pm 1 \times 10^{-9}$ of frequency at 25°C. 0°C to +55°C: $\pm 1 \times 10^{-8}$ of frequency at 25°C.</p> <p>Physical orientation: 5×10^{-8} total change in frequency for any physical orientation of instrument with respect to gravity.</p> <p>Frequency adjustments: same as standard instrument.</p> <p>*Field installable - order -hp- Accessory 11452A.</p> <p style="text-align: center;">Deletion of Crystal Oven Option 003*</p> <p>20 MHz ambient temperature crystal reference oscillator. Recommended for applications where only moderate frequency stability is needed or where the 3330A/B is to use an external reference.</p> |
|--|--|--------------|------------------------|--|-------------------------|--|---|
| State | Requirements | | | | | | |
| "Low" (Logical "1") | 0 V to 0.4 V (5 mA max) or contact closure to ground through < 80 ohms | | | | | | |
| "High" (Logical "0") | 2.4 V to 5 V or removal of contact closure to ground | | | | | | |

Table 1-2. General Information. (Cont'd)

| | |
|---|---|
| <p>Frequency stability: ± 10 parts in 10^6 yr. Frequency adjustments: rear panel 1 turn pot or rear panel voltage control input for 40×10^{-6} maximum control.</p> <p>*Standard Crystal Oven can be installed later - order -hp- Part Number 0410-0457.</p> | <p>5 V RMS - 50 Ohm Output Power Amplifier Option 005*</p> <p>This option gives the 3330A/B a 1/2 watt output. (5 volts rms into 50 ohms or 10 volts rms into an open circuit.)</p> |
| <p>Isolated Digital Input Option 004 (Factory installation only)</p> <p>With this option, the digital input lines are electrically isolated from the signal ground.</p> <p>DC Isolation ± 250 V AC Isolation > 30 dB, 0 to 1 MHz</p> | <p>Amplitude range</p> <p>3330A: + 27 dBm to + 14 dBm into 50 ohms 3330B: + 26.99 dBm to - 73 dBm into 50 ohms</p> <p>*For field installation - order -hp- Accessory 11455A (A model) 11455B (B model)</p> |

1-12. ACCESSORIES SUPPLIED.

1-13. Accessories supplied with the 3330A/B are as follows:

- One HP-IB Adapter, -hp- Part No. 11235A
- One Extender Board, -hp- Part No. 03330-66534
- One Extender Board, -hp- Part No. 03330-66535
- One Extender Board, -hp- Part No. 03330-66588

1-14. ACCESSORIES AVAILABLE.

1-15. Accessories available for the 3330A/B are as follows:

- | | |
|-----------|--|
| 11236B | Interfacing Cable |
| 11451A | Optional Interface Cable Kit |
| 11452A | Hi Stability Oven, Option 002 |
| 11455A | 5 V—50 Ω Output Option 005, 3330A |
| 11455B | 5 V—50 Ω Output Option 005, 3330B |
| 5060-8744 | Rack Mounting Kit |

- | | |
|------------|-------------------------------------|
| 10631A/B/C | HP-IB Cables |
| 11048C | 50 Ω Feedthrough (precision) |
| 11094C | 75 Ω Feedthrough (precision) |

1-16. INSTRUMENT AND MANUAL IDENTIFICATION.

1-17. Hewlett-Packard uses a two-section serial number. The first section (prefix) identifies a series of instruments. The last section (suffix) identifies a particular instrument within the series. If a letter is included with the serial number, it identifies the country where the instrument was manufactured. This manual is kept up-to-date with the instrument by a manual change sheet. If the serial prefix of your instrument differs from the one on the title page of this manual, refer to Section VIII for backdating information that will adapt this manual to your instrument. All correspondence with Hewlett-Packard should include the complete serial number.

SECTION II

INSTALLATION AND INTERFACING

2-1. INTRODUCTION.

2-2. This section contains information and instructions for the installation and shipping of the 3330A/B. Included are initial inspection procedures, power and grounding requirements, environmental information, repackaging for shipment, and interfacing.

2-3. INITIAL INSPECTION.

2-4. This instrument was carefully inspected both mechanically and electrically before shipment. It should be free of marks or scratches and in perfect electrical order upon receipt. To confirm this, the instrument should be inspected for physical damage in transit, and the electrical performance should be tested using the performance tests outlined in Paragraph 5-7. If there is damage or deficiency, see the warranty inside the front of this manual.

2-5. POWER REQUIREMENTS.

2-6. The 3330A/B operates from an ac power source of 48 to 66 Hz at the following voltages:

115 V + 5% - 10%
230 V + 5% - 10%

The 3330A/B is normally set for 115 V operation at the factory. Refer to Figure 2-1 for the procedure to change your instrument for operation on 230 V.

2-7. GROUNDING REQUIREMENTS.

2-8. To protect operating personnel, the National Electrical Manufacturers' Association (NEMA) recommends that the instrument panel and cabinet be grounded. The Model 3330A/B is equipped with a three-conductor power cable which, when plugged into an appropriate receptacle, grounds the instrument. The offset pin on the power cable is the ground wire.

WARNING

Your instrument is equipped with a power cord which grounds it when connected to a 3 contact grounded receptacle. Do not attempt to defeat this feature.

2-9. ENVIRONMENTAL REQUIREMENTS.

2-10. The 3330A/B is equipped with a cooling fan mounted on the rear panel. The instrument should not be mounted in any manner which would obstruct the flow of air through the instrument. The filter for the cooling fan can be removed and cleaned by flushing with soapy water. The 3330A/B should not be operated where the ambient temperature exceeds 0°C to 55°C (32°F to 131°F) or stored where the ambient temperature exceeds -40°C to 70°C (-40°F to 158°F).

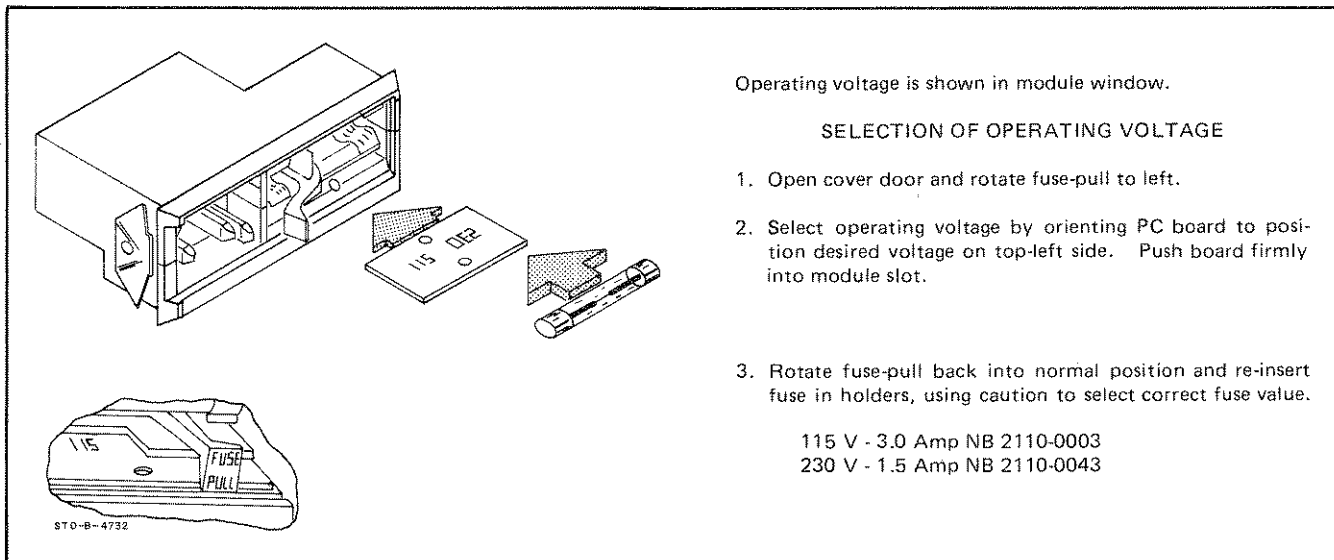

Figure 2-1. Voltage Selection.



WHEN MOUNTING THE 3330A/B IN AN INSTRUMENT RACK, CARE SHOULD BE TAKEN TO SUPPORT THE REAR OF THE INSTRUMENT. FAILURE TO DO SO MAY CAUSE DAMAGE TO THE INSTRUMENT.

2-11. REPACKAGING FOR SHIPMENT.

2-12. The following paragraphs contain a general guide for repackaging the instrument for shipment. Refer to Paragraph 2-13 if the original container is to be used; 2-14 if it is not. If you have any questions, contact your nearest -hp- Sales and Service Office (see Appendix B for office locations).

NOTE

If the instrument is to be shipped to Hewlett-Packard for service or repair, attach a tag to the instrument identifying the owner and indicating the service or repair to be accomplished. Include the model number and full serial number of the instrument. In any correspondence, identify the instrument by model number and full serial number.

2-13. Place instrument in original container with appropriate packing material and seal well with strong tape or metal bands. If original container is not available, one can be purchased from your nearest -hp- Sales and Service Office.

2-14. If original container is not to be used, proceed as follows:

- a. Wrap instrument in heavy paper or plastic before placing in an inner container.
- b. Place packing material around all sides of instrument and protect panel face with cardboard strips.

c. Place instrument and inner container in a heavy carton or wooden box and seal with strong tape or metal bands.

2-15. POWER CORDS AND RECEPTACLES.

2-16. Figure 2-2 illustrates the standard power cord configurations that are used throughout the United States and in other countries. The -hp- part number shown directly below each drawing is the part number for a 3330A/B power cord equipped with the appropriate mating plug for that receptacle. If the appropriate power cord plug is not included with the instrument, notify the nearest -hp- Sales and Service Office and a replacement cord will be provided. The 3330A/B power cord, power input receptacle and mating connectors meet the safety standards set forth by the International Electrotechnical Commission (IEC).

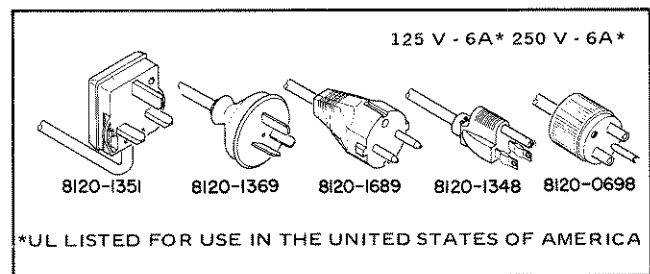

Figure 2-2. Power Cords.

2-17. INTERFACING.

2-18. The 3330A/B can be remotely programmed by any ASCII coded source. Section III, Paragraph 3-19, describes the remote input connector and signal requirements. Logic level requirements are listed in Table 1-2 (General Information). Several HP-IB programmable units can be paralleled together on the same HP-IB lines with the use of the 11236B interface cable, or an HP-IB adapter, 11235A, used with an HP-IB cable, 10631A, B, or C.

SECTION III OPERATING INSTRUCTIONS

3-1. INTRODUCTION.

3-2. This section contains information and instructions necessary for operation of the -hp- Model 3330A/B Automatic Synthesizer. Included is power and warm up information; functional identification of all indicators, controls and connectors; front panel programming information; remote programming information; and special applications information.

3-3. POWER - WARM UP.

3-4. The 3330A/B can be operated from any source of 115 V ± 10% or 230 V ± 10% at 48 to 66 Hz. The power receptacle on the rear panel contains the switch for selecting 115 V or 230 V and the input power fuse. The instrument leaves the manufacturer with the switch in the 115 V position. It is necessary to set the 115 V/230 V switch to the 230 V position when operating from a 230 V source. The 3330A/B has a two position (standby and on) power control on the front panel. The instrument takes < 15 seconds to reach full specification from the STBY position to the ON position. The instrument takes < 20 minutes to reach ± 1 x 10⁻⁷ of full frequency specifications from the application of external power to the ON position.

3-5. OPERATION.

3-6. Front panel operation of the 3330A/B requires selecting keyboard and slide switch controls in various sequences for desired modes of operation. The following explanations divide the controls into their functional descriptions (frequency, frequency step, amplitude, amplitude step, sweep) and their programming sequence. When the 3330A/B is initially turned on, the conditions set on the display and at the output are:

```

Frequency ..... 0.0 Hz
Amplitude ..... - 86.55 dBm
                    (Std. Instr. Only)
Frequency Step ..... 0.0 Hz
Amplitude Step ..... 0.00 dBm
Sweep ..... off *
    
```

* Sweep parameters are as set on sweep slide switches.

3-7. Frequency.

3-8. The frequency range of the 3330A/B is 0 Hz to 13000999.9 Hz with a 0.1 Hz resolution. The controls used to program a desired frequency (in the sequence they are selected) are **FREQ**, 0 through 9 digit keys, and **Hz**, **KHz**, or **MHz** range keys. A description of each control and indicator follows.

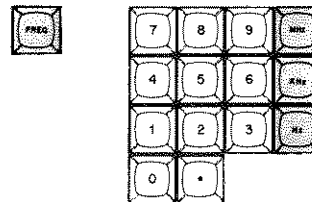
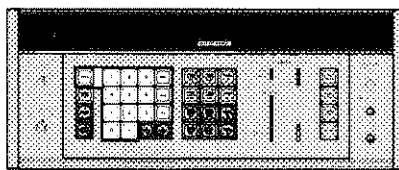

Controls:



Preface key for entering frequency. The **FREQ** key can be pressed at any time to recall the previous frequency entry.

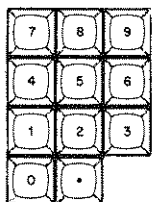

Digit keys. These keys are used to enter the desired frequency digits.



Range keys. Three ranges are available (MHz, KHz, and Hz). These keys complete the programming of a frequency. The frequency desired is displayed and applied to the 3330A/B output.

Indicators:



Indicates that the digits displayed directly to right of indicator are frequency.



Indicates the desired frequency selected. Digits are entered from right as frequency digit keys are pressed. Display is always in Hz. When Range key is selected, the decimal point is automatically placed for a Hz readout. Any digit below the tenth Hz digit is automatically rejected by the 3330A/B.



Error indicator. Indicates a programming error has been made. Selected program is out of range of the 3330A/B. OUT OF RANGE indicator also applies to frequency step, amplitude, and amplitude step. The 3330A/B will sweep, although the OUT OF RANGE indicator is lit, if the sweep starts from an in-range position. When the sweep reaches the out-of-range limit, the sweep holds until the last step of the sweep.

Example:

Program a frequency of 12345678.9 Hz.

Press **FREQ**

Press 1, 2, 3, 4, 5, 6, 7, 8, ., 9 digits.

Press **Hz**

3-9. Frequency Step.

3-10. The frequency step function is used when it is desired to sweep a certain range of frequencies or when it is desired to manually change the frequency by a specific amount. The controls used to program a frequency step (in the sequence they are selected) are **FREQ STEP**, 0 through 9 digit keys, and **Hz**, **KHz**, or **MHz** range keys. There are also six modifier keys which can be used to modify the programmed frequency or the programmed frequency step. A description of each control and indicator follows.

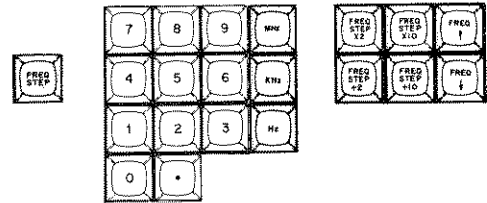
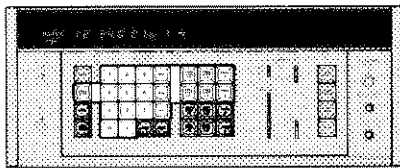

Controls:



Preface key for entering frequency step. The **FREQ STEP** key can be pressed at any time to recall the previous frequency step entry.

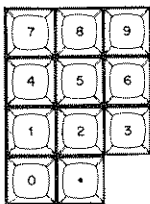

Digit keys. These keys are used to enter the desired frequency step digits. If the frequency step is used in conjunction with the Sweep function, it is necessary to consider the position of the **SWEEP STEPS** control in relation to the size of the frequency step (see Paragraph 3-15).



Range keys. Three ranges are available (Hz, KHz, and MHz). These keys complete the programming of the frequency step.



Frequency and frequency step modifier keys. These keys can be used to modify the frequency or frequency step. To modify the frequency, press the **FREQ ↑** or **FREQ ↓** key. The frequency will be changed up or down by the amount of the frequency step. If the **FREQ ↑** or **FREQ ↓** key is pressed and

held, the frequency will continue to change at the rate of the **TIME/STEP** (Paragraph 3-15) until the key is released. To modify the frequency step, press the **FREQ STEP × 2**, **FREQ STEP × 10**, **FREQ STEP ÷ 2**, or **FREQ STEP ÷ 10** key. The frequency step will be changed by the respective amount. Modification of frequency or frequency step can be made at any time. If made during the Sweep function, modification will occur at the end of each sweep.

Indicators:



Indicates that the digits displayed directly to right of indicator are frequency step.



Indicates the desired frequency step selected. Digits are entered from right as frequency step digit keys are pressed. Display is always in Hz. When range key is pressed, the decimal point is automatically placed for a Hz readout. Any digit below the tenth Hz digit is automatically rejected by the 3330A/B.

Example:

Program a frequency of 5 MHz
and a frequency step of 1 MHz.

- Press **FREQ**
- Press 5 digit
- Press **MHz**
- Press **FREQ STEP**
- Press 1 digit
- Press **MHz**

3-11. Amplitude.

3-12. In the 3330A a 0 dBm to +13 dBm front panel potentiometer is used to select the desired amplitude level. In the 3330B, the front panel keyboard is used to select any amplitude level from -86.55 dBm to +13.44 dBm with a resolution of 0.01 dB. The controls used to program a desired amplitude (in the sequence they are selected) are **AMPL**, 0 through 9 digit keys, and +dBm or -dBm. A **LEVELING** switch is provided to control the flatness of the amplitude. A description of each control and indicator follows.

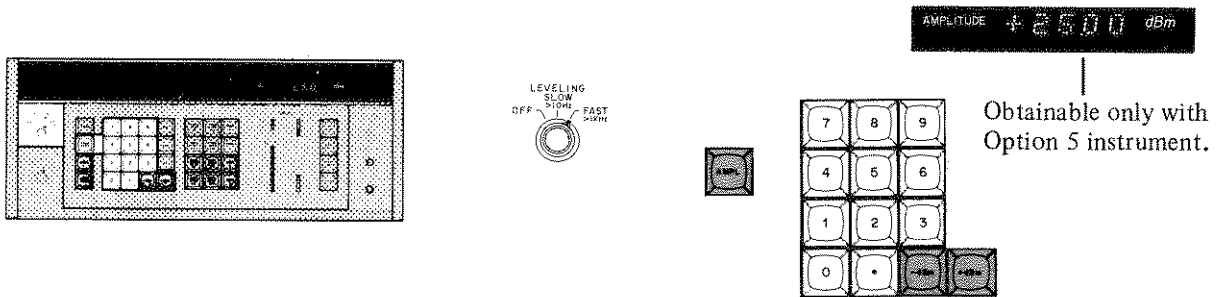

Controls: (3330B only)

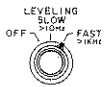

Amplitude level control. The frequency response of the 3330B is controlled by a thermopile in the amplitude section. The thermopile will respond to the peaks of the output sinewave if the programmed frequency is less than 10 Hz. To prevent this, the **LEVELING** control should be in the **OFF** position. This position removes the thermopile from the leveling loop. For frequencies between 10 Hz and 1 kHz additional filtering is added to eliminate the thermopile from reacting to the peaks of the output amplitude. For frequencies above 1 kHz, the additional filtering is removed to decrease the settling time of the output amplitude. *Do not use the **FAST** > 1 kHz position for frequencies less than 1 kHz or the **SLOW** > 10 Hz position for frequencies less than 10 Hz or the 3330B flatness and distortion specifications may be degraded.*



Preface key for entering amplitude. The **AMPL** key can be pressed at any time to recall the previous amplitude entry.

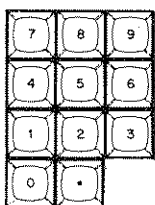

Digit keys. These keys are used to enter the desired amplitude digits.



Amplitude polarity keys. These keys complete the programming of an amplitude. The amplitude desired is displayed and applied to the 3330B output.

Indicators: (3330B only)



Indicates that the digits displayed directly to right of indicator are amplitude.



Indicates selected amplitude digits. Digits are entered from right as amplitude digit keys are pressed.

Example:

- Program an amplitude of +12.34 dBm.
- Press **AMPL**
- Press 1, 2, ., 3, 4 digits
- Press + dBm

3-13. Amplitude Step (3330B only)

3-14. The amplitude step function is used when it is desired to sweep a certain range of amplitude or when it is desired to manually change the programmed amplitude by a specific amount. The controls used to program an amplitude step (in the sequence they are selected) are **AMPL STEP**, 0 through 9 digit keys, and -dBm or +dBm. There are also six modifier keys which can be used to modify the programmed amplitude or the programmed amplitude step. A description of each control and indicator follows.

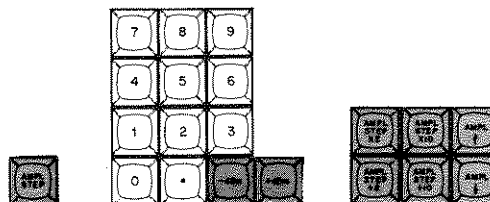
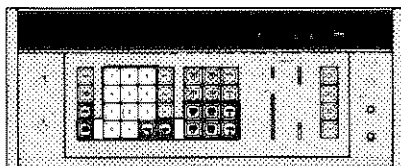

Controls:



Preface key for entering amplitude step. The AMPL STEP key can be pressed at any time to recall the previous amplitude step entry.

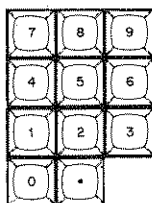

Digit keys. These keys are used to enter the desired amplitude step digits. If the amplitude step is used in conjunction with the Sweep function, it is necessary to consider the position of the SWEEP STEPS control in relation to the size of the amplitude step (see Paragraph 3-15).



Amplitude polarity keys. The polarity keys complete the programming of amplitude step.



Amplitude modifier keys. These keys can be used to modify the amplitude or the amplitude step. To modify the amplitude, press the AMPL ↑ or AMPL ↓ key. The amplitude will change by the amount of the amplitude step. If the AMPL ↑ or the AMPL ↓ is pressed and held, the amplitude will change at the rate of the TIME/STEP (Paragraph 3-15) until the key is released. To modify the amplitude step, press the AMPL STEP x 2, AMPL STEP x 10, AMPL STEP ÷ 2, or AMPL STEP ÷ 10 key. Modification of the amplitude or the amplitude step can be made at any time. If made during the sweep mode, the modification will occur at the end of each sweep cycle.

Indicators:



Indicates that the digits displayed directly to right are amplitude step.



Indicates selected amplitude step digits. Digits are entered from right as amplitude digit keys are pressed.

Example:

- Program an amplitude of - 30.00 dBm and an amplitude step of 5.00 dBm
- Press AMPL
- Press 3, 0 digits
- Press - dBm
- Press AMPL STEP
- Press 5 digit
- Press - dBm or + dBm

3-15. Frequency and Amplitude Sweep.

3-16. The 3330A/B frequency and the 3330B amplitude can be swept over a specific range. The sweep is a digital sweep which steps the frequency or amplitude to each point. The sweep controls include the function switch (FREQ, AMPL), direction switch (UP, DOWN, BOTH), SWEEP TIME/STEP switch, SWEEP STEPS, FIRST POINT, START SINGLE, and START CONT. To use the sweep mode, a frequency and a frequency step, or an amplitude and an amplitude step, must be programmed. In choosing the frequency or amplitude and the size of the frequency step or amplitude step, the frequency and amplitude limits of the 3330A/B should be considered along with the position of the SWEEP STEPS control. The number of steps chosen will be divided evenly on either side of the frequency or amplitude. If the frequency step or amplitude step is too large, the 3330A/B will OUT OF RANGE and the sweep will stop. Use the following formula to determine if the settings chosen will OUT OF RANGE the 3330A/B:

1. $A + \frac{B \times C}{2} = \leq 13.0009999 \text{ MHz}$
 $\leq + 13.44 \text{ dBm}$
2. $A - \frac{B \times C}{2} = \geq 0 \text{ Hz}$
 $\geq - 86.55 \text{ dBm}$

Where:

- A = f frequency or amplitude
- B = SWEEP STEPS
- C = frequency step or amplitude step

When sweeping frequency, 1/2 the total sweep width (formula 1 - formula 2) cannot exceed 10 MHz or the 3330A/B will OUT OF RANGE. A description of the controls used to program a desired sweep and the indicators used for sweep follows.

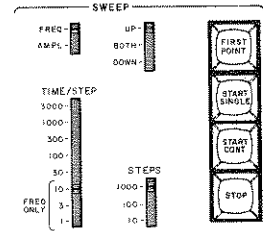
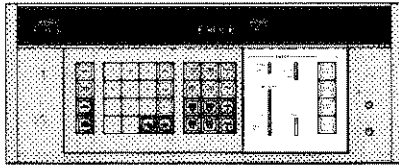

Controls:



Function switch: selects function of sweep.



Direction switch. Selects the direction of sweep. Used in conjunction with FIRST POINT to find the minimum and maximum frequency or amplitude. When in UP position, sweep starts at minimum frequency or amplitude and sweeps to maximum frequency or amplitude. When in DOWN position, sweep starts at maximum frequency or amplitude and sweeps to minimum frequency or amplitude. When in BOTH position, sweep starts at minimum frequency or amplitude, sweeps to maximum, and back to minimum.

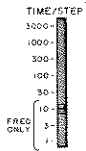

SWEEP TIME/STEP. Selects time for each step when sweeping or modifying frequency or amplitude. Can be changed during sweep.



SWEEP STEPS. Selects number of steps in each sweep. Must be considered when selecting frequency step or amplitude step.



Convenience key. This key, when used in conjunction with the SWEEP direction switch, causes the 3330A/B to display and output the starting point of the sweep selected. If the SWEEP direction switch is in the UP or BOTH position, the display and 3330A/B output will go to the minimum (starting point) frequency or amplitude in the sweep range. If the SWEEP direction switch is in the DOWN position, the display and 3330A/B output will go to the maximum (starting point) frequency or amplitude in the sweep range. If FIRST POINT key is pressed while the sweep is in progress, the sweep will stop. Display and 3330A/B output will go to the starting point of the sweep range.



Start key for single sweep. When pressed, 3330A/B will make one complete sweep.



Start key for continuous sweep. When pressed instrument will sweep the parameters selected until stopped.



Stop sweep key. Stops sweep and returns instrument display and output to center frequency or amplitude.

Indicators:



Indicates that the digits displayed directly to the right of CTR FREQUENCY indicator or CTR AMPLITUDE indicator are the frequency or amplitude digits selected. This indicator operates only when continuous sweep is in progress and the FREQ key or AMPL key has been pressed.



Indicates that the digits displayed directly to right of MIN or MAX FREQUENCY or MIN or MAX AMPLITUDE indicators are starting point digits of sweep. Display is dependent on SWEEP direction control and FIRST POINT key.



Indicates sweep is in operation. Function swept (frequency or amplitude) is indicated by an arrow. Only one arrow will be illuminated.

Example:

Program a continuous frequency sweep from 0 Hz to 25 kHz. Use maximum steps allowed. Set amplitude for +13.44 dBm.

Steps are divided equally on either side of frequency, therefore, frequency = 25 kHz ÷ 2 = 12.5 kHz.

Maximum SWEEP STEPS = 1000, therefore, Frequency Step = 25 kHz ÷ 1000 = 25 Hz. To insure the sweep end points (MIN - MAX FREQUENCY) are not OUT OF RANGE:

$$A + \frac{B \times C}{2} = 12.5 \text{ kHz} + \frac{1000 \times 25 \text{ Hz}}{2} =$$

12.5 kHz + 12.5 kHz = 25 kHz =
MAX FREQUENCY.

$$A - \frac{B \times C}{2} = 12.5 \text{ kHz} - \frac{1000 \times 25 \text{ Hz}}{2} =$$

12.5 kHz - 12.5 kHz = 0 Hz =
MIN FREQUENCY.

- Set LEVELING to OFF
- Press **FREQ**
- Press 1, 2, ., 5 digits
- Press kHz
- Press **FREQ STEP**
- Press 2, 5 digits
- Press Hz
- Set SWEEP mode to **FREQ**
- Set SWEEP STEPS to 1000
- Set SWEEP TIME/STEP to desired time/step
- Set SWEEP direction to **UP**
- Press **FIRST POINT**. Display should indicate a **MIN**

- FREQUENCY** of .0 Hz.
- Set SWEEP direction to **DOWN**
- Press **FIRST POINT**. Display should indicate a **MAX FREQUENCY** of 25000.0 Hz.
- Set SWEEP direction to desired position.
- Press **AMPL**
- Press 1, 3, ., 4, 4 digits
- Press + dBm
- Press **START CONT** for continuous sweep or **START SINGLE** for single sweep.

3-17. Inputs and Outputs.

3-18. The 3330A/B front and rear panel inputs and outputs include front panel SWEEP OUTPUT and 50 Ω OUTPUT; rear panel BCD OUTPUTS (optional), ALT OUTPUT, RF + 20 MHz OUT, 1 MHz OUT, REF TUNE IN, EXT REF IN, AM IN, REMOTE CONTROL. Explanations of these inputs and outputs are as follows:

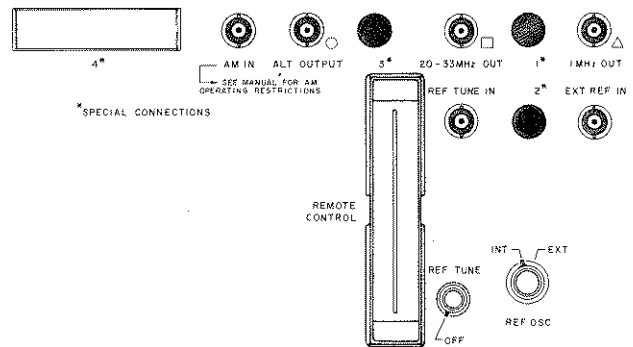
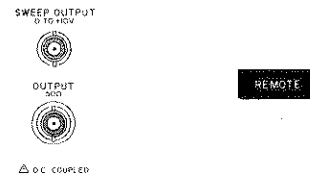
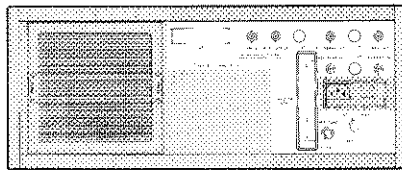
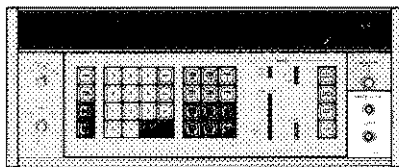

Provides a stepped dc output from 0 Vdc to 10 Vdc. Number of steps and time for each step are controlled by the SWEEP STEPS control and the SWEEP TIME/STEP control respectively. Each step represents the same step in the frequency or amplitude sweep.



3330A/B front panel output.



Special BCD output. The BCD frequency and amplitude information from the

3330A/B Controller which sets the 3330A/B frequency and amplitude is available at this connector. There are 33 lines of frequency information and 16 lines of amplitude information plus 1 ground line. (See Section IV for information concerning BCD signals). This output available by request only.



Amplitude Modulation Input. An external signal can be applied to this connector to amplitude modulate the 3330A/B signal.

3330A: A dc to 100 kHz signal may be used to amplitude modulate the 3330A signal. Percent of modulation is proportional to the AM IN voltage (0.95 V rms for 95% modulation, 0.01 V rms for 1% modulation). The 3330A front panel amplitude control can be varied to adjust the level of the carrier signal without changing the modulation percentage.

3330B: When an amplitude modulating signal is applied, the output power level is a combination of the carrier power and sideband power. The 3330B output is monitored by a thermal detector circuit, which is a constant power device. Therefore, when the amplitude modulating signal is applied, the carrier level is decreased to maintain a constant power level. Conversely, if the 3330B front panel amplitude control settings are changed to increase or decrease the carrier level, the sideband levels are decreased or increased accordingly. It is recommended that an oscilloscope be used at the 3330B output to observe the modulated signal and determine the percent of modulation. Because the characteristics of each instrument are slightly different, the curves shown in Figure 3-1 are an approximation of the AM voltage input needed in a standard instrument for the percent of modulation desired. The dB figure of each solid line curve represents the dB level below the highest output of each 10 dB step of the output attenuator. For example, the - 4 dB curve would apply for a front panel amplitude setting of +9.44 dB, - 0.56 dB, - 10.56 dB, etc.

NOTE

If the level of the modulated output signal exceeds 2.97 V peak-to-peak as observed on an oscilloscope (1.05 V rms), the signal will be degraded because of excessive limiting in the instrument. (14.14 V peak-to-peak, 5 V rms, for Option 005.)

The broken-line curve of Figure 3-1 can be used to determine the carrier level out of the 3330B for a given percent of modulation. The vertical axis labeled K represents the dB loss in carrier level due to the modulating voltage. Subtract this reading from the 3330B front panel amplitude setting to find the output carrier level.



3330A/B rear panel triaxial output jack. Requires internal cable change from front panel output jack.



Holes for special purpose jacks. (See Paragraph 3-24).



Output from Frequency Generating section of 3330A/B. Tracks front panel output with a 20 MHz offset. Output voltage = > 100 mV rms/50 ohms.



1 MHz output from 20 MHz VCXO Reference. Output Voltage = > 220 mV rms/50 ohms.

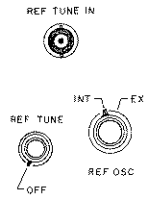

Reference input for tuning Reference Oscillator and Internal Reference Oscillator Adjust. With rear panel REF TUNE control in INT position (position 3330A/B), 5 Vdc changes frequency a maximum of 0.5 to 1×10^{-7} of frequency at 0 Vdc. - 5 Vdc changes frequency a maximum of - 0.7 to $- 1.5 \times 10^{-7}$ of frequency at 0 Vdc. With rear panel REF OSC in EXT position (standard 3330A/B) and no external reference applied, ± 5 Vdc changes frequency a nominal 4×10^{-5} of frequency at 0 Vdc. With REF OSC in INT position, the REF TUNE IN is applied to the 5 MHz VCXO. With REF OSC in EXT position, the REF TUNE IN is applied to the 20 MHz VCXO. If the REF OSC is in the EXT position and an external reference is used, the external reference signal overrides the REF TUNE IN. With the 3330A/B Option 003, the REF TUNE IN has a nominal 4×10^{-5} change of frequency at 0 Vdc if the REF OSC is in the INT position or EXT position with no external reference applied. With an external reference applied and the REF OSC in the EXT position, the external reference overrides the REF TUNE IN. In the 3330A/B Option 003, the REF TUNE IN is applied to the 20 MHz VCXO. The REF TUNE potentiometer on the rear panel of the 3330A/B has the same characteristics as the REF TUNE IN. The REF TUNE IN, however, will override the REF TUNE potentiometer if both are used.



Input for an external frequency reference. The 3330A/B 20 MHz VCXO is phase-locked to the external oscillator. Any sub-harmonic of 20 MHz from 1 MHz through 10 MHz, at 200 mV to 2 V, may be used.

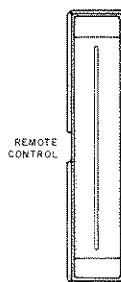

Remote Control input/output. The 3330A/B can be remotely controlled using a seven bit ASCII character format within the HP-IB (see Paragraph 3-19). Twelve lines are required for remote control. Also available at this connector are 15 lines of sweep information. A step count (0-1000) on 12, 1-2-4-8, BCD lines indicates the sweep position (count of 500 indicates center frequency). A sweep status line indicates when instrument is sweeping. A step ready line indicates the instrument has spent the prescribed time on one step and is ready to go to the next step. A step inhibit line is also available. When this line is grounded, the instrument will stop sweeping on that step. Figure 3-2 shows the input/output connector pin numbers and signal inputs/outputs for remote input and sweep output.

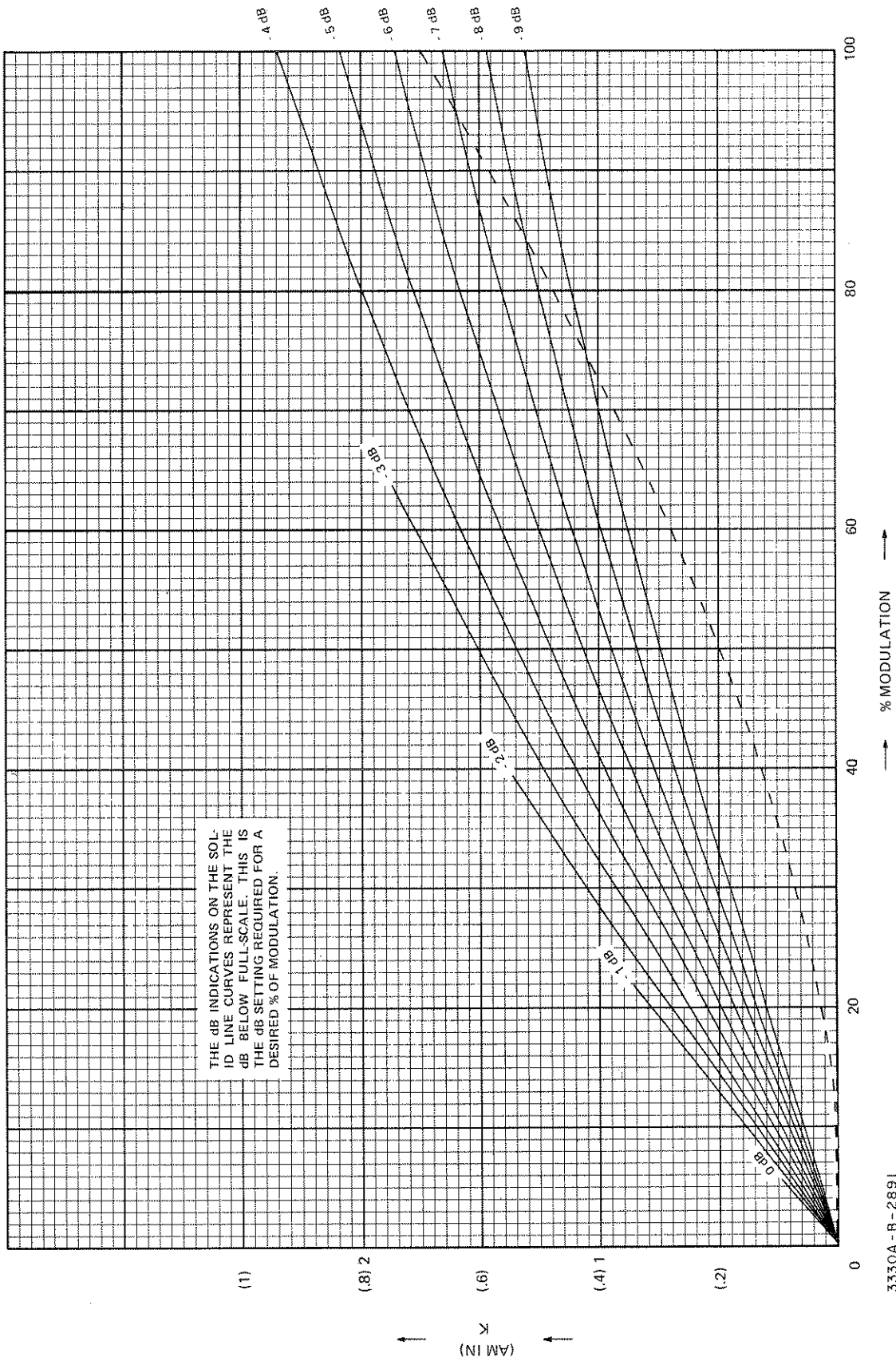

Figure 3-1. AM IN.

REMOTE

Indicates instrument is in remote programming mode.

3-19. Remote Hewlett-Packard Interface Bus (HP-IB) Programming.

3-20. The 3330A/B can be remotely programmed using a seven bit ASCII character format. An octal code is used to identify each HP-IB programming instruction. Table 3-1 lists the instructions for the 3330A/B and their equivalent octal codes. In order to exercise maximum capability, 12 input lines are required. Figure 3-2 shows the HP-IB remote input connector pin numbers and the signal inputs for each pin. All front panel functions on both the 3330A and 3330B are programmable with the exception of the POWER LINE and 3330A AMPLITUDE.

3-21. A major advantage of HP-IB programming is the capability of paralleling several 3330A/B Automatic Synthesizers, or complimentary HP-IB programmable instruments, to the same input lines. Each instrument can be given an individual address which only that instrument

recognizes. All 3330A/B Automatic Synthesizers leave the factory with an address of 44, but this address can easily be changed. To accomplish this, a series of jumpers on the Input Assembly (A6) of the controller section must be set in a binary fashion which corresponds to the octal code for the address desired. Table 3-2 gives the binary number and the corresponding octal code and ASCII character for the different addresses available. The 40 bit of the address is hard wired in the instrument. Only the 20-10-4-2-1 bits can be changed. Figure 3-3 shows the five jumpers for changing the address.

3-22. When the 3330A/B is initially turned on in the remote mode, the conditions programmed are the same as the conditions programmed at turn-on when operating from the front panel (see Paragraph 3-6).

3-23. To program the 3330A/B, the address preface ATN (Attention) is given followed by the address of the instrument to be programmed. Once the instrument has been addressed, it can be programmed by issuing the proper commands in the same manner as the instrument is

Table 3-1. 3330A/B HP-IB Programming Codes.

| Key/Switch Position | ASCII Character | Octal Code | Key/Switch Position | ASCII Character | Octal Code |
|---------------------|-----------------|------------|---------------------|-----------------|------------|
| (Address)* | \$ | 044 | Ampl (A) | N | 116 |
| | | | Ampl Step | O | 117 |
| Freq (F) | L | 114 | + dBm | ; | 073 |
| Freq Step | M | 115 | - dBm | < | 074 |
| 0 | 0 | 060 | Leveling Off | ← | 137 |
| 1 | 1 | 061 | Leveling Slow |]] | 135 |
| 2 | 2 | 062 | Leveling Fast | ↑ | 136 |
| 3 | 3 | 063 | | | |
| 4 | 4 | 064 | Ampl Step X10 | * | 042 |
| 5 | 5 | 065 | Ampl Step ÷ 10 | # | 043 |
| 6 | 6 | 066 | Ampl Step X 2 | & | 046 |
| 7 | 7 | 067 | Ampl Step ÷ 2 | ' | 047 |
| 8 | 8 | 070 | Ampl ↑ |) | 051 |
| 9 | 9 | 071 | Ampl ↓ | (| 050 |
| . | . | 072 | Ampl Sweep Mode | C | 103 |
| Hz | = | 075 | 1 ms/Step | P | 120 |
| kHz | > | 076 | 3 ms/Step | Q | 121 |
| MHz | ? | 077 | 10 ms/Step | R | 122 |
| | | | 30 ms/Step | S | 123 |
| Freq Step X10 | Space | 040 | 100 ms/Step | T | 124 |
| Freq Step ÷ 10 | ! | 041 | 300 ms/Step | U | 125 |
| Freq Step X2 | \$ | 044 | 1000 ms/Step | V | 126 |
| Freq Step ÷ 2 | % | 045 | 3000 ms/Step | W | 127 |
| Freq ↑ | * | 052 | Stop | X | 130 |
| Freq ↓ | + | 053 | Start Cont | Y | 131 |
| Freq Sweep Mode | B | 102 | Start Single | [| 133 |
| | | | First Point | z | 132 |
| Sweep Up | I | 111 | Clear* | ? | 077 |
| Sweep Down | J | 110 | | | |
| Sweep Both | K | 113 | | | |
| 10 Steps/SWP | D | 104 | | | |
| 100 Steps/SWP | E | 105 | | | |
| 1000 Steps/SWP | G | 107 | | | |

Address and clear must be accompanied by an ATN. On 3260A Card Reader ATN = 200 (address = 244, Clear = 277).

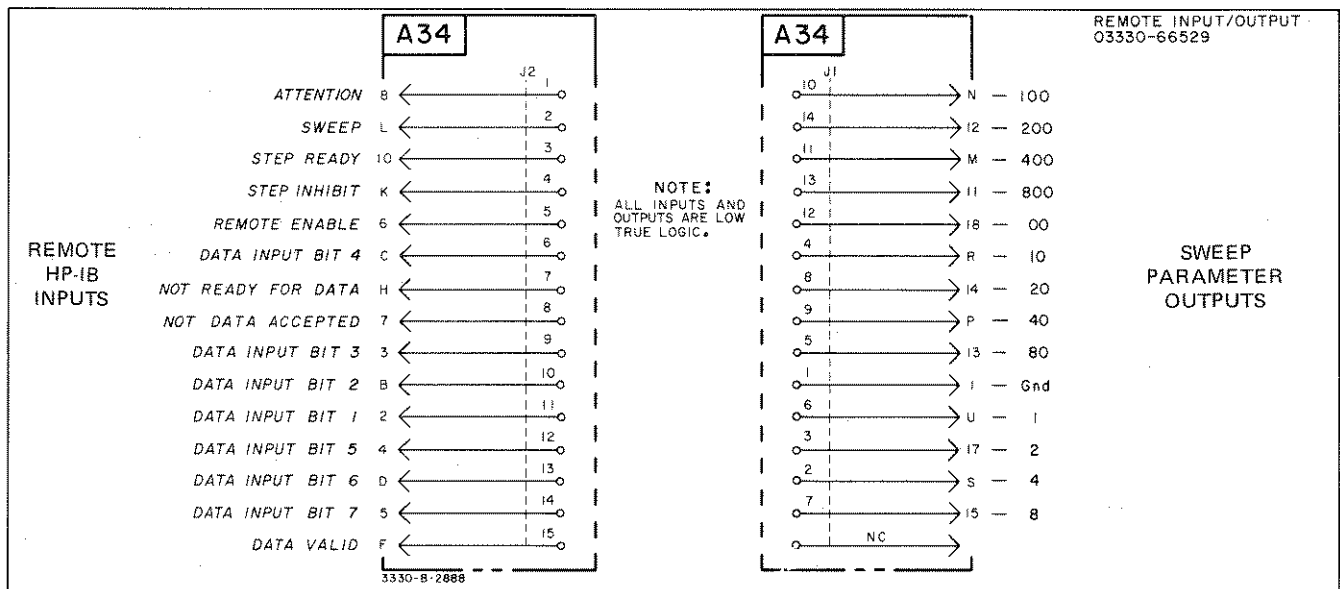

Figure 3-2. HP-IB Remote Input.

programmed from the front panel. If more than one instrument is paralleled on the same HP-IB, it is necessary to “clear” the line before addressing another instrument. The code for clearing the HP-IB is given in Table 3-1. A timing diagram for the output control lines is shown in Figure 3-4. A brief explanation of the timing functions is included with the figure.

3-24. Special Connectors.

3-25. The 3330A/B has been designed with several special interfacing possibilities available. These special connections allow interfacing with complementary equipment to increase the flexibility of the 3330A/B. The connections include an output from the 20 MHz VCXO, an output from N4 loop VTO, an input to the SL3 loop Phase Detector, and an input to the Mixer in the Output Section.

3-26. The special 20 MHz output, when connected, will

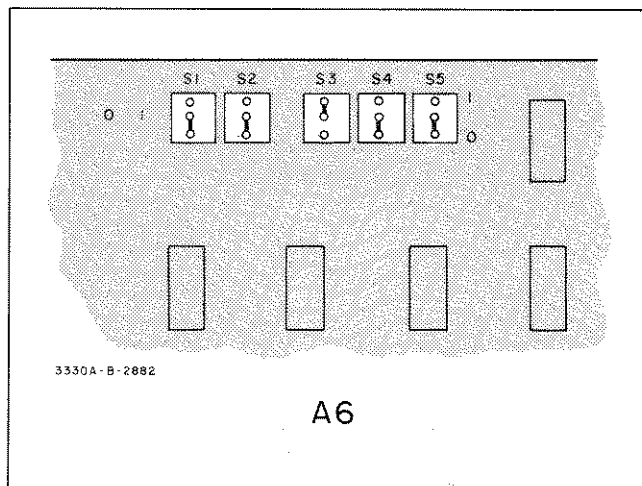

Figure 3-3. Addressing Jumpers.

Table 3-2. Addressing Codes.

| Bus Address | 40 | 20 SW1 | 10 SW2 | 4 SW3 | 2 SW4 | 1 SW5 |
|-------------|----|--------|--------|-------|-------|-------|
| 40 | 1 | 0 | 0 | 0 | 0 | 0 |
| 701 | 1 | 0 | 0 | 0 | 0 | 1 |
| 702 | 1 | 0 | 0 | 0 | 1 | 0 |
| 703 | 1 | 0 | 0 | 0 | 1 | 1 |
| 704 | 1 | 0 | 0 | 1 | 0 | 0 |
| 705 | 1 | 0 | 0 | 1 | 0 | 1 |
| 706 | 1 | 0 | 0 | 1 | 1 | 0 |
| 707 | 1 | 0 | 0 | 1 | 1 | 1 |
| 708 | 1 | 0 | 1 | 0 | 0 | 0 |
| 709 | 1 | 0 | 1 | 0 | 0 | 1 |
| 710 | 1 | 0 | 1 | 0 | 1 | 0 |
| 711 | 1 | 0 | 1 | 0 | 1 | 1 |
| 712 | 1 | 0 | 1 | 1 | 0 | 0 |
| 713 | 1 | 0 | 1 | 1 | 0 | 1 |
| 714 | 1 | 0 | 1 | 1 | 1 | 0 |
| 715 | 1 | 0 | 1 | 1 | 1 | 1 |
| 716 | 1 | 1 | 0 | 0 | 0 | 0 |
| 717 | 1 | 1 | 0 | 0 | 0 | 1 |
| 718 | 1 | 1 | 0 | 0 | 1 | 0 |
| 719 | 1 | 1 | 0 | 0 | 1 | 1 |
| 720 | 1 | 1 | 0 | 1 | 0 | 0 |
| 721 | 1 | 1 | 0 | 1 | 0 | 1 |
| 722 | 1 | 1 | 0 | 1 | 1 | 0 |
| 723 | 1 | 1 | 0 | 1 | 1 | 1 |
| 724 | 1 | 1 | 1 | 0 | 0 | 0 |
| 725 | 1 | 1 | 1 | 0 | 0 | 1 |
| 726 | 1 | 1 | 1 | 0 | 1 | 0 |
| 727 | 1 | 1 | 1 | 0 | 1 | 1 |
| 728 | 1 | 1 | 1 | 1 | 0 | 0 |
| 729 | 1 | 1 | 1 | 1 | 0 | 1 |
| 730 | 1 | 1 | 1 | 1 | 1 | 0 |

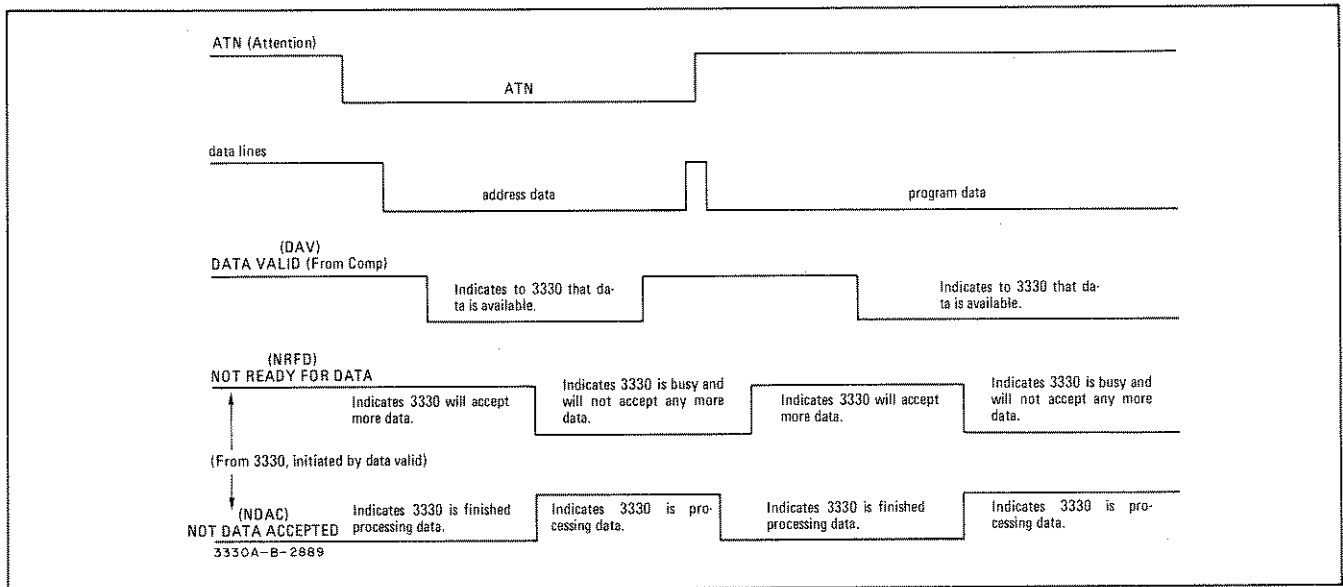

Figure 3-4. HP-IB Timing Diagram.

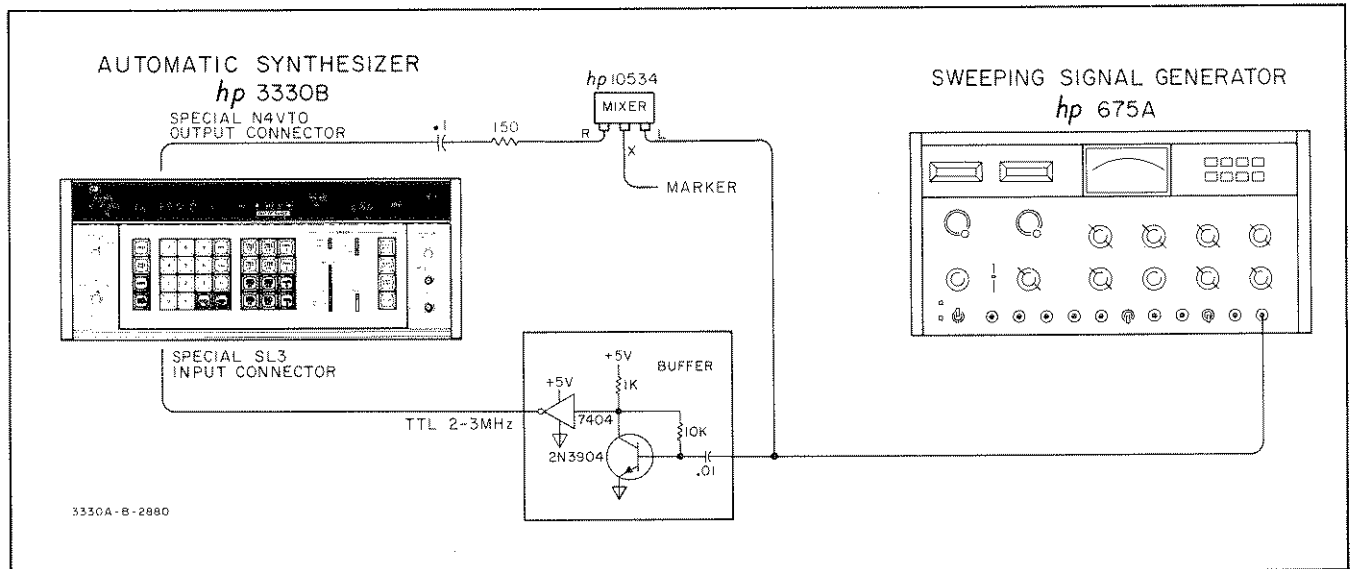

Figure 3-5. Special N4 Loop and SL3 Loop Connectors.

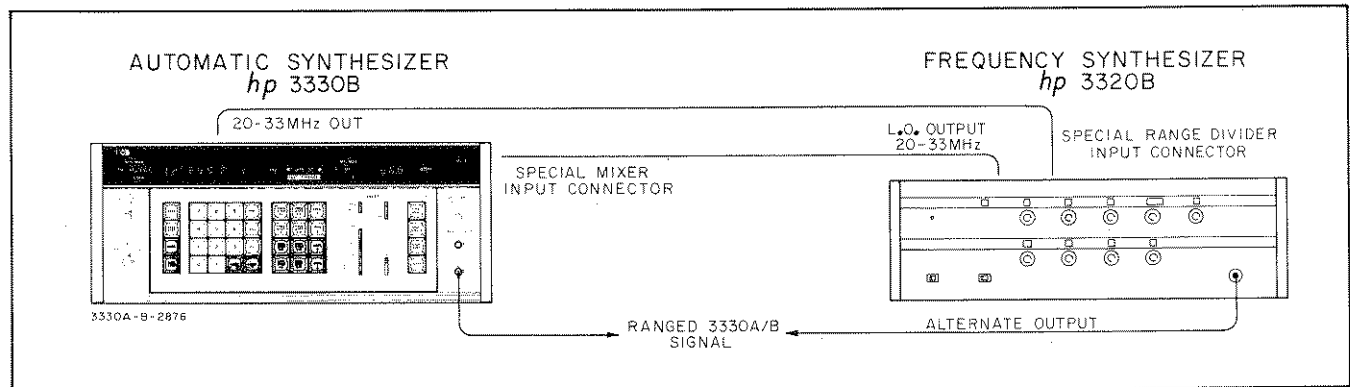

Figure 3-6. Special Mixer Input Connector.

supply the 20 MHz reference frequency to the rear panel. This signal has the same accuracy and stability as the 5 MHz reference oscillator but a significant level of spurious and harmonic content is present.

3-27. The special N4 loop VTO output will supply the N4 loop VTO signal divided by 10 to the rear panel. This output is designed to be used in conjunction with the special SL3 loop Phase Detector input. The SL3 loop input allows the operator to apply an external TTL logic signal of 2-3 MHz to increase the resolution of the 3330A/B output. The resolution of the 3330A/B output will be determined by the resolution of the external 2-3 MHz. The output from the N4 loop VTO can be externally mixed with the external 2-3 MHz signal to provide marker pulses (see Figure 3-5).

3-28. The special Mixer input is designed to be used in conjunction with the 20-33 MHz OUT on the 3330A/B rear panel. The 20-33 MHz OUT is applied to a special 3320A/B where it is divided by factors of 10 in the 3320A/B range dividers (see Figure 3-6). The 20-33 MHz OUTPUT on the rear panel of the 3320A/B is applied to the 3330A/B special Mixer input. The resulting output of the 3330A/B is a stable frequency which can be ranged by factors of 10. The full capability of the 3330B amplitude range and sweep can be used.

3-29. For more information concerning these special connections, contact your local -hp- Sales and Service Office.

3-30. SWITCHING TRANSIENTS.

3-31. Frequency Switching.

3-32. The transients encountered in the 3330A/B output as

a result of frequency switching (frequency step or sweep, for example) are related to the frequency changes in the ÷ N and Summation Loop circuits. The severity and duration of the transients are a function of the magnitude and significance of the digits being switched. The simplified block diagram in Figure 3-7 shows how the frequency digits are added in each loop to obtain the final output frequency. From this it can be seen that the transients of phase-lock loop 1 and summation loop 1 translate directly to the output, while transients resulting in the other loops are reduced in proportion to the frequency division. Figure 3-8 shows three examples of frequency switching transients.

3-33. Amplitude Switching.

3-34. The nature of transients introduced by amplitude switching depends on whether or not the step attenuator is involved. For example, when stepping from + 3.44 to + 3.45 dBm during an amplitude sweep, the step attenuator goes from 10 to 0 dB while the leveling loop electronic attenuator goes from 0.00 to 9.99 dB. The resulting behavior is shown in Figure 3-10.

3-35. An open-loop reset signal enables the electronic attenuator to switch to about 20% of final value within a few milliseconds. The remaining part of the transient is governed by the closed-loop time constant and is about 35 ms with the front panel LEVELING switch set for FAST, or about 350 ms in SLOW. (The slow response is provided to permit leveling at output frequencies as low as 10 Hz.)

3-36. When the 3330B is turned on with the LEVELING control in the OFF or FAST position and subsequently changed to SLOW, there will be no output for a period of about six seconds after changing to SLOW. It is therefore recommended that when remotely programming the first

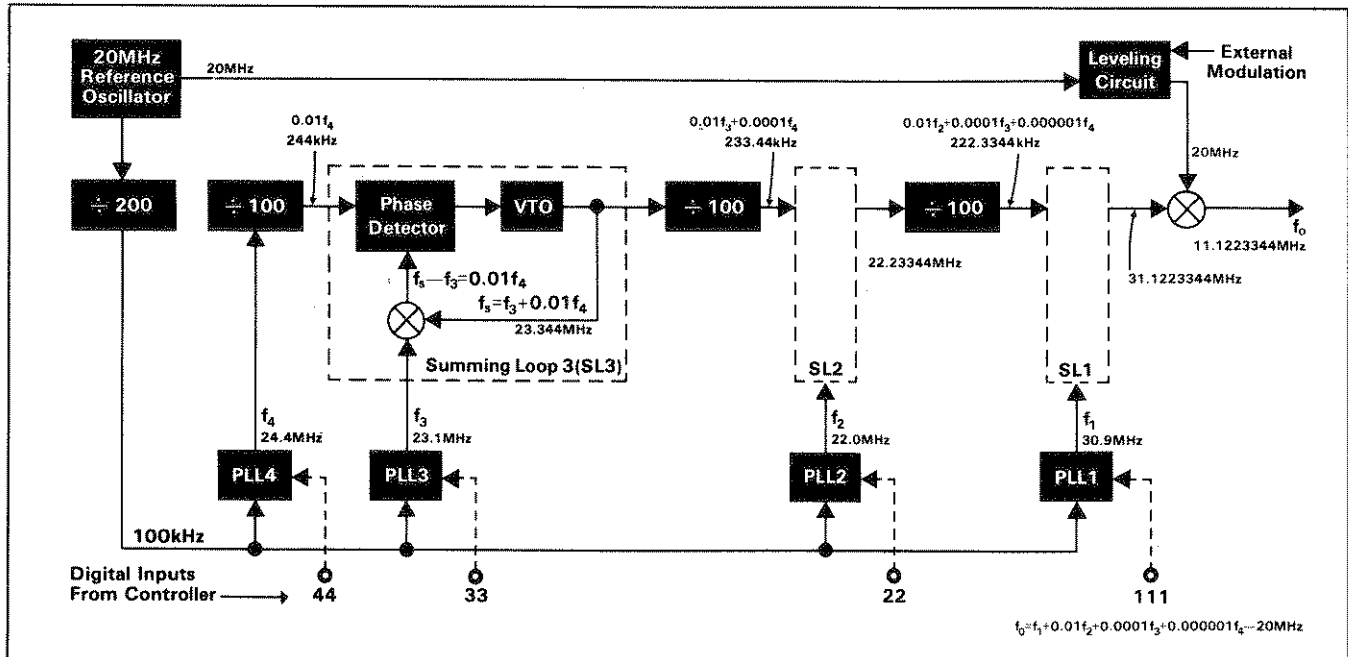

Figure 3-7. Simplified Block Diagram of Frequency Generating Circuits.

change to SLOW after turn on, a wait of at least six seconds be included in the program. This situation does not exist if the control is in the SLOW position when the instrument is

first turned on, nor does it occur after the first change to SLOW. Also, output is continuous if the instrument is turned on in OFF or FAST and is not changed to SLOW.

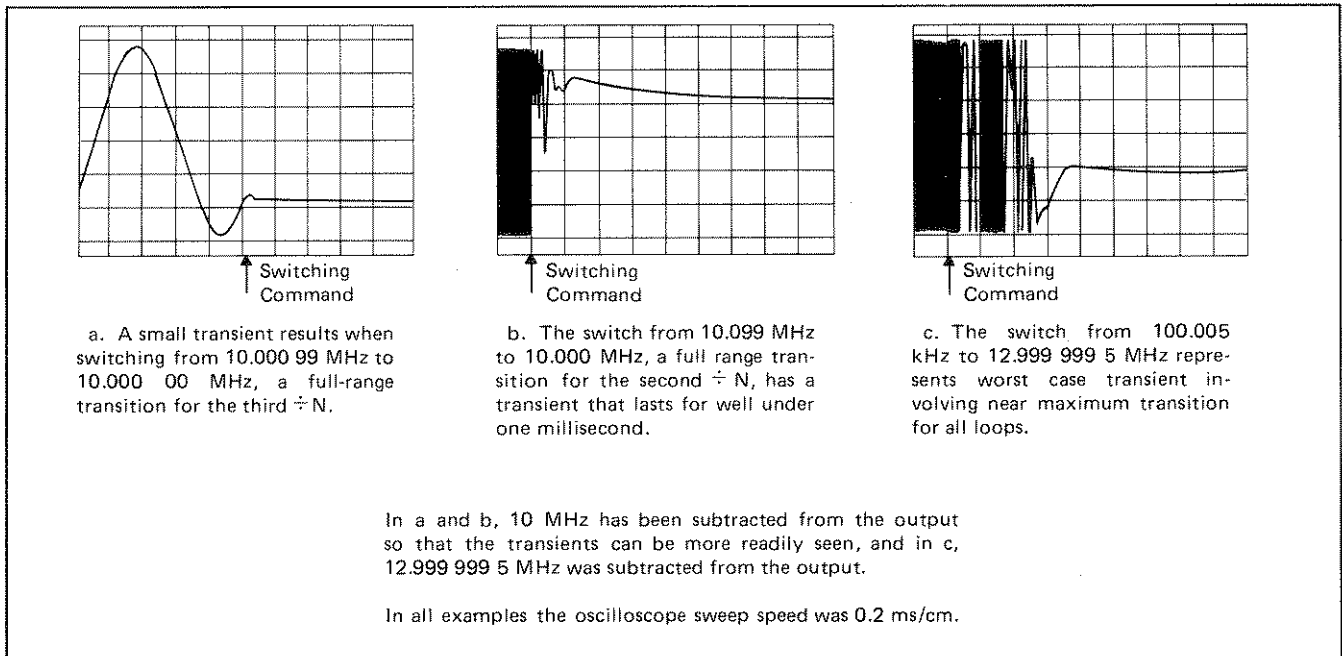

Figure 3-8. Frequency Switching Transients.

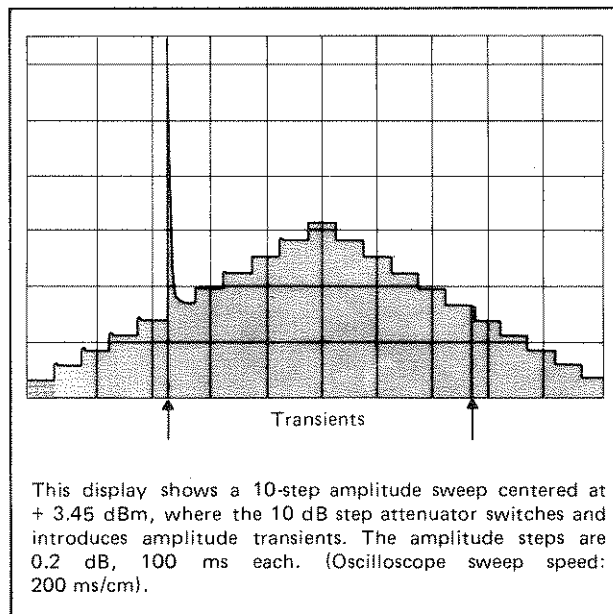

Figure 3-9. Amplitude Switching Transients.

