

---

# Operating and Programming Manual

## HP 3324A Synthesized Function/Sweep Generator

### SERIAL NUMBERS

This manual applies to instruments with serial number 2836G00111 and higher. Any change made in instruments having serial numbers higher than the above numbers will be found in a "Manual Changes" supplement supplied with this manual. Be sure to examine the supplement for changes which apply to your instrument, and record these changes in the manual.



HP Part No. 03324-90011

Microfiche Part No. 03324-95011

Printed in Federal Republic of Germany May 1990

Edition 1

---

## Notice

### Subject Matter Notice

The information in this document is subject to change without notice.

**Hewlett-Packard makes no warranty of any kind with regard to this printed material, including, but not limited to, the implied warranties of merchantability and fitness for a particular purpose.**

Hewlett-Packard shall not be liable for errors contained herein or for incidental or consequential damages in connection with the furnishing, performance or use of this material.

### Copyright

This document contains proprietary information which is protected by copyright. All rights are reserved. No part of this document may be photocopied, reproduced or translated into another language without the prior consent of Hewlett-Packard GmbH.

© Copyright 1989 by Hewlett-Packard GmbH  
Herrenberger Strasse 130, D-7030 Boeblingen  
Federal Republic of Germany

---

## Printing History

New editions are complete revisions of the manual. Update packages, which are issued between editions, contain additional and replacement pages to be merged into the manual by the customer. The date on the title page and back cover of the manual only changes when a new edition is published. When an edition is reprinted, all the prior updates to the edition are incorporated. No information is incorporated into a new edition unless it appears in a prior update.

<b>Edition 1</b>	<b>April 1989</b>	<b>03324-90011</b>	<b>E0489</b>
Update 1	January 1990	03324-90022	E0190

---

## Safety

This product has been designed and tested according to International Safety Requirements. To ensure safe operation and to keep the product safe, the information, cautions and warnings in this manual must be heeded.

---

## Preface

### Introduction

This manual provides the information required when either operating the HP 3324A from the front panel or programming it from a remote controller.

### What is in this manual?

- Chapter 1: Instrument Introduction*  
Gives a brief description of the instrument and its features.
- Chapter 2: Front and Rear Panel Overview*  
Gives a brief description of the features on the front and rear panels.
- Chapter 3: Instrument Operation*  
Describes the operating principles of the HP 3324A.
- Chapter 4: Getting Started*  
Shows how to power on and gives examples of using the HP 3324A as a function generator and sweep generator.
- Chapter 5: Parameters*  
Describes how to use the parameter keys **Freq**, **Ampl**, **Offs** and **Phase**.
- Chapter 6: Waveforms*  
Describes how to select the required waveform function.
- Chapter 7: Sweep*  
Describes how to perform sweeps.
- Chapter 8: Utilities*  
Describes the features in **Util**.
- Chapter 9: Programming the HP 3324A*  
Describes how to program the HP 3324A from a controller.

- Chapter 10: Status Reporting*  
Describes how to set and use interrupts in programming the HP 3324A.
- Chapter 11: HP-IB Commands and Programming Examples*  
Briefly describes the HP-IB commands, and gives programming examples.
- Chapter 12: Performance Tests*  
Gives the procedures to verify the in-spec performance of the HP 3324A.
- Appendix A: Specifications*  
Lists the HP 3324A specifications.
- Appendix B: Options and Accessories*  
Gives details of all the options and accessories available for the HP 3324A.
- Appendix C: Installation*  
Describes the steps when inspecting the newly arrived instrument, and gives the procedure when claiming for damage.
- Appendix D: HP-IB Overview*  
Gives a brief description of the Hewlett-Packard Interface Bus (HP-IB).
- Appendix E: HP 3324A Command Syntax*  
Describes all of the HP-IB commands for the HP 3324A in alphabetical order.
- Appendix F: Error Messages*  
Shows the error messages that can be obtained while using the HP 3324A.
- Appendix G: Backdating*  
Contains information on earlier versions of the instrument.

*Index*

*Sales and  
Service Office  
Directory*

---

## Limited Warranty

### Warranty

This Hewlett-Packard instrument product is warranted against defects in material and workmanship for a period of one year from date of shipment. During the warranty period, HP will, at its option, either repair or replace products which prove to be defective.

For warranty service or repair, this product must be returned to a service facility designated by HP. Buyer shall prepay shipping charges to HP and HP shall pay shipping charges to return the product to Buyer. However, Buyer shall pay all shipping charges, duties, and taxes for products returned to HP from another country.

HP warrants that its software and firmware designated by HP for use with an instrument will execute its programming instructions when properly installed on that instrument. HP does not warrant that the operation of the instrument, software, or firmware will be uninterrupted or error free.

### Limitation of Warranty

The foregoing warranty shall not apply to defects resulting from improper or inadequate maintenance by Buyer, Buyer-supplied software or interfacing, unauthorized modification or misuse, operation outside of the environmental specifications for the product, or improper site preparation or maintenance.

No other warranty is expressed or implied. HP specifically disclaims the implied warranties of Merchantability and Fitness for a Particular Purpose.

**Exclusive Remedies**

The remedies provided herein are Buyer's sole and exclusive remedies. HP shall not be liable for any direct, indirect, special, incidental, or consequential damages, whether based on contract, tort, or any other legal theory.

**Assistance**

Product maintenance agreements and other customer assistance agreements are available for Hewlett-Packard products. For any assistance, contact your nearest Hewlett-Packard Sales and Service Office. Addresses are provided at the back of this manual.

**Certification**

Hewlett-Packard Company certifies that this product met its published specifications at the time of shipment from the factory. Hewlett-Packard further certifies that its calibration measurements are traceable to the United States National Institute of Standards and Technology, to the extent allowed by the Institute's calibration facility, and to the calibration facilities of other International Standards Organization members.

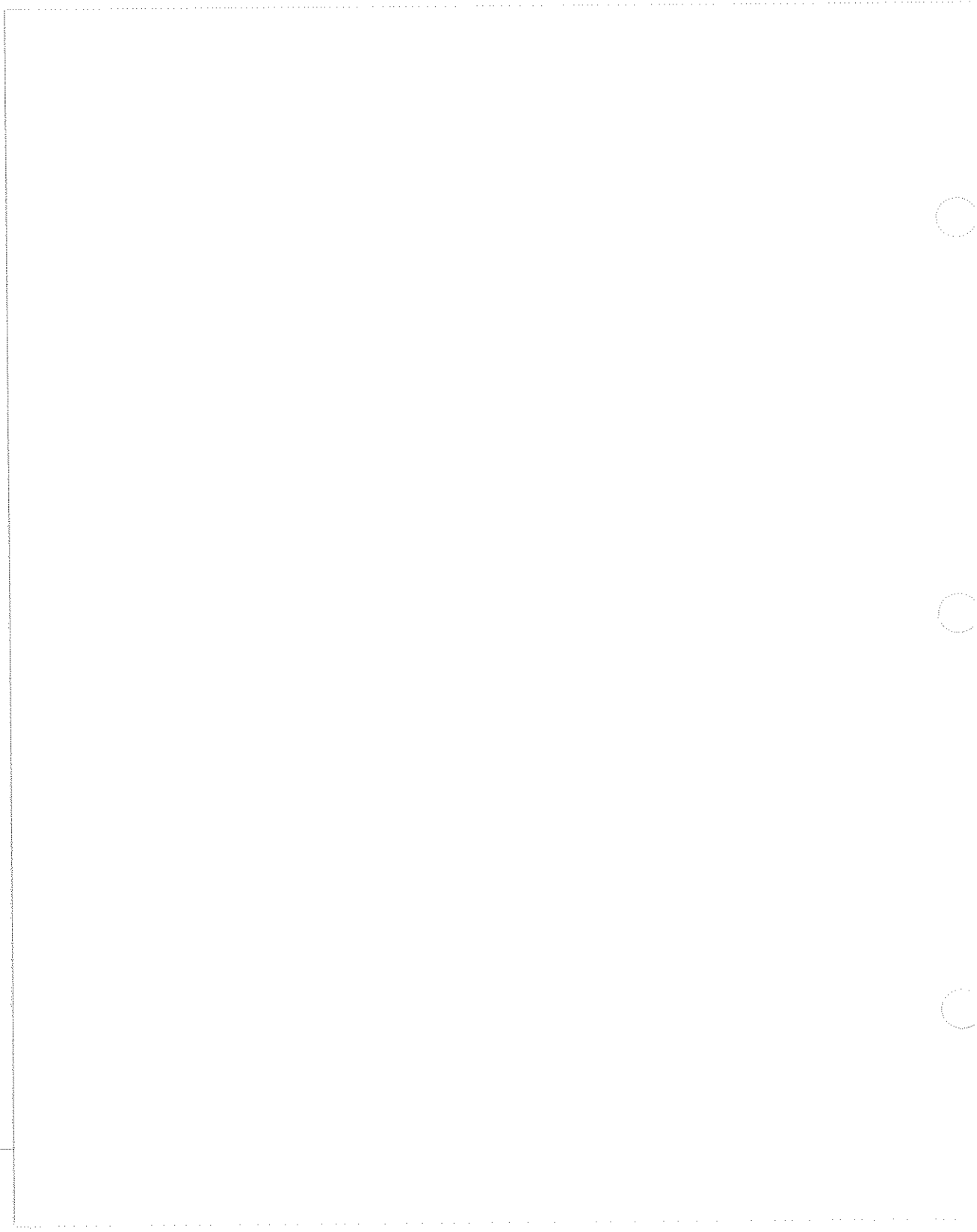



# Contents

---

<b>1. Instrument Introduction</b>	
Introduction . . . . .	1-1
Key Features . . . . .	1-1
Operating Concept . . . . .	1-2
Local Mode . . . . .	1-2
Remote Mode . . . . .	1-2
About this Manual . . . . .	1-3
Brief Operating Hints . . . . .	1-3
About the Note . . . . .	1-4
<b>2. Front and Rear Panel Overview</b>	
Introduction . . . . .	2-1
Front Panel . . . . .	2-1
Display (1) . . . . .	2-1
Sweep (2) . . . . .	2-1
WaveForm (3) . . . . .	2-1
SELECT/MODIFY (4) . . . . .	2-2
PARAMeters (5) . . . . .	2-2
DATA (6) . . . . .	2-2
SWEEP (7) . . . . .	2-2
Save Recall (8) . . . . .	2-2
Signal on off (9) . . . . .	2-2
Front Rear (9) . . . . .	2-3
Main Signal Output Connector (10) . . . . .	2-3
Sync Out (11) . . . . .	2-3
Shift Key (12) . . . . .	2-3
Local (13) . . . . .	2-3
Util (14) . . . . .	2-3
Stand-by (15) . . . . .	2-3
Rear Panel . . . . .	2-4

HP-IB Connector (16) . . . . .	2-4
Main Signal Output Connector (17) . .	2-4
Phase Cal In (18) . . . . .	2-4
Phase Cal Out (19) . . . . .	2-4
10 MHz Oven (20) . . . . .	2-4
AC Line (21) . . . . .	2-5
Ext Ref In (22) . . . . .	2-5
Ref Out (23) . . . . .	2-5
Aux 0 dBm (24) . . . . .	2-5
Sync Out (25) . . . . .	2-5
Z-blank (26) . . . . .	2-5
X-drive (27) . . . . .	2-5
Marker (28) . . . . .	2-5

### 3. Instrument Operation

Introduction . . . . .	3-1
Before Power-on . . . . .	3-1
Power-on . . . . .	3-1
Turn-on State . . . . .	3-2
Input/Output Signals . . . . .	3-4
Main Signal Output . . . . .	3-4
Synchronization Outputs . . . . .	3-5
Phase Calibration Input . . . . .	3-5
Phase Calibration Output . . . . .	3-6
10 MHz Oven Output . . . . .	3-6
External Frequency Reference Input .	3-6
Frequency Reference Output . . . . .	3-7
Sweep Z-blank . . . . .	3-7
Marker . . . . .	3-7
X-drive . . . . .	3-8
Aux 0 dBm 21-60 MHz . . . . .	3-9
Shift Key . . . . .	3-9
DATA Keys . . . . .	3-10
Example . . . . .	3-10
SELECT/MODIFY Keys . . . . .	3-11
Select . . . . .	3-11
Modify . . . . .	3-11
Example . . . . .	3-13

Edit . . . . .	3-13
Example . . . . .	3-14
Saving/Recalling Instrument States . . . . .	3-15
Saving Instrument States . . . . .	3-15
Example . . . . .	3-16
Recalling Instrument States . . . . .	3-16
Example . . . . .	3-16
<b>4. Getting Started</b>	
Introduction . . . . .	4-1
Powering Up . . . . .	4-1
The HP 3324A as a Function Generator . . . . .	4-2
The HP 3324A as a Sweep Generator . . . . .	4-5
<b>5. Parameters</b>	
Introduction . . . . .	5-1
Entering a New Value . . . . .	5-2
Modifying a Parameter . . . . .	5-3
Modify Example . . . . .	5-4
Editing a Parameter . . . . .	5-4
Example . . . . .	5-5
Frequency . . . . .	5-6
High-Voltage Option . . . . .	5-6
Example . . . . .	5-7
Amplitude . . . . .	5-7
Amplitude Calibration . . . . .	5-8
High-Voltage Option . . . . .	5-9
Example . . . . .	5-10
DC Offset . . . . .	5-10
Offset Only, No AC Function . . . . .	5-11
AC with DC Offset . . . . .	5-11
High-Voltage Option . . . . .	5-13
Example . . . . .	5-13
Phase . . . . .	5-14
Example . . . . .	5-15
Automatic Phase Calibration . . . . .	5-16
Changing the Output Signal Cable	
Delay . . . . .	5-17

Example . . . . .	5-17
Changing the Calibration Cable Delay	5-19
<b>6. Waveforms</b>	
Introduction . . . . .	6-1
Example . . . . .	6-3
<b>7. Sweep</b>	
Introduction . . . . .	7-1
Multi-Interval Sweep . . . . .	7-4
Setting up a Multi-Interval Sequence . . . . .	7-8
Example . . . . .	7-11
Multi-Marker Sweep . . . . .	7-15
Setting up a Multi-Marker Interval . . . . .	7-17
Example . . . . .	7-20
The Sweep Keys . . . . .	7-22
Reset Start . . . . .	7-22
$\Delta f \times 2$ $\Delta f / 2$ . . . . .	7-23
Example . . . . .	7-23
MKr▷CF . . . . .	7-23
Example . . . . .	7-23
<b>8. Utilities</b>	
Introduction . . . . .	8-1
Setting the Default Parameters . . . . .	8-1
Choosing the Number of Stores/Intervals . . . . .	8-3
Changing the HP-IB Address . . . . .	8-4
Choosing HP 3325A Compatibility . . . . .	8-4
Performing a Self-test . . . . .	8-5
Checking for Option 003 or Option 004 . . . . .	8-5
Changing the Output Signal Cable Delay . . . . .	8-6
Changing the Calibration Cable Delay . . . . .	8-6
Checking the Software Revision . . . . .	8-7
Switching the High-Voltage Output On . . . . .	8-7

<b>9. Programming the HP 3324A</b>	
Introduction . . . . .	9-1
The HP 3324A HP-IB Capabilities . . . . .	9-1
The Interpreter . . . . .	9-2
HP-IB Display Indicators . . . . .	9-4
Accepted Characters . . . . .	9-5
HP-IB Messages . . . . .	9-6
Command Groups and Data Transfer	
Modes . . . . .	9-7
Omitting the Mnemonic . . . . .	9-10
Synchronizing after a Syntax Error . . . . .	9-11
Setting the HP-IB Address . . . . .	9-11
<b>10. Status Reporting</b>	
Introduction . . . . .	10-1
Status Byte . . . . .	10-1
Forcing an SRQ . . . . .	10-6
Service Request Enable . . . . .	10-7
Example 1 . . . . .	10-8
Example 2 . . . . .	10-9
<b>11. HP-IB Commands and Programming Examples</b>	
Introduction . . . . .	11-1
Notes . . . . .	11-5
Programming Examples . . . . .	11-10
Function Generator . . . . .	11-10
Program . . . . .	11-10
Multi-Interval Sweep Generator . . . . .	11-11
Program . . . . .	11-12
Multi-Marker Sweep Generator . . . . .	11-13
Program . . . . .	11-13

<b>12. Performance Tests</b>	
Introduction . . . . .	12-1
Equipment Required . . . . .	12-1
Test Record . . . . .	12-1
Test Failure . . . . .	12-2
Instruments Specification . . . . .	12-2
Performance Tests . . . . .	12-2
Harmonic Distortion . . . . .	12-5
Specifications . . . . .	12-5
Equipment Required . . . . .	12-5
Procedure . . . . .	12-5
High-Voltage Output (Option 002) . . . . .	12-6
Spurious Signal . . . . .	12-8
Specifications . . . . .	12-8
Equipment Required . . . . .	12-8
Mixer Spurious Procedure . . . . .	12-8
Close-in Spurious (Fractional N Spurs)	
Procedure . . . . .	12-10
Integrated Phase Noise . . . . .	12-11
Specifications . . . . .	12-11
Equipment Required . . . . .	12-11
Procedure . . . . .	12-11
Ramp Retrace Time . . . . .	12-13
Specifications . . . . .	12-13
Equipment Required . . . . .	12-13
Procedure . . . . .	12-13
Frequency Accuracy . . . . .	12-14
Specifications . . . . .	12-14
Equipment Required . . . . .	12-14
Procedure . . . . .	12-14
Phase Increment Accuracy . . . . .	12-15
Specifications . . . . .	12-15
Equipment Required . . . . .	12-15
Procedure . . . . .	12-15
Amplitude Accuracy . . . . .	12-18
Specifications . . . . .	12-18
Equipment Required . . . . .	12-18

Amplitude Accuracy at Frequencies upto 100 KHz Procedure . . . . .	12-18
High-Voltage Output (Option 002) . . .	12-25
Amplitude Flatness (Frequencies above 100 KHz) . . . . .	12-27
High-Voltage Output (Option 002) . . .	12-29
DC Offset Accuracy (DC Only) . . . . .	12-30
Specifications . . . . .	12-30
Equipment Required . . . . .	12-30
Procedure . . . . .	12-30
Attenuator Test . . . . .	12-31
High-Voltage Output (Option 002) . . .	12-31
DC Offset Accuracy with AC Functions . .	12-32
Specifications . . . . .	12-32
Equipment Required . . . . .	12-32
Procedure . . . . .	12-32
Triangle Linearity . . . . .	12-34
Specifications . . . . .	12-34
Equipment Required . . . . .	12-34
Procedure . . . . .	12-34
Ramp Period Variation . . . . .	12-38
Specifications . . . . .	12-38
Equipment Required . . . . .	12-38
Procedure . . . . .	12-38
Automatic Phase Calibration (Options 003 and 004) . . . . .	12-40
Specifications . . . . .	12-40
Equipment Required . . . . .	12-40
Procedure . . . . .	12-41
Test Record 1 . . . . .	12-43
Test Record 2 . . . . .	12-44
Test Record 3 . . . . .	12-45
Test Record 4 . . . . .	12-46
Test Record 5 . . . . .	12-47
Test Record 5 . . . . .	12-48
Test Record 5 . . . . .	12-49
Test Record 5 . . . . .	12-50
Test Record 6 . . . . .	12-51

Test Record 7 . . . . .	12-52
Test Record 8 . . . . .	12-53
Test Record 8 . . . . .	12-54
Test Record 9 . . . . .	12-55
<b>A. Specifications</b>	
Waveforms . . . . .	A-1
Frequency . . . . .	A-1
Main Signal Output (Supplementary) . .	A-2
Amplitude . . . . .	A-2
Sinewave Spectral Purity . . . . .	A-4
Squarewave Characteristics (Supplementary) . . . . .	A-5
Triangle/Ramp Characteristics . . . . .	A-5
DC Offset . . . . .	A-6
Phase Offset . . . . .	A-6
Frequency Sweep . . . . .	A-7
Auxiliary Outputs (Supplementary) . . .	A-8
Auxiliary Inputs (Supplementary) . . .	A-9
HP-IB Control (Supplementary) . . . .	A-9
Option 001 High-Stability Frequency Reference . . . . .	A-10
Option 002 High-Voltage Output . . . .	A-10
Automatic Phase Calibration Options . .	A-11
General (Supplementary) . . . . .	A-13
<b>B. Options and Accessories</b>	
Introduction . . . . .	B-1
Option 001 High-Stability Frequency Reference . . . . .	B-2
Option 002 High-Voltage Output . . . .	B-3
Options 003 and 004 Automatic Phase Calibration . . . . .	B-4



<b>C. Installation</b>	
Introduction . . . . .	C-1
Safety Considerations . . . . .	C-1
Initial Inspection . . . . .	C-2
Power Requirements . . . . .	C-2
Line Voltage Selection . . . . .	C-3
Power Cable . . . . .	C-5
HP-IB Connector . . . . .	C-7
HP-IB Logic Levels . . . . .	C-7
Operating Environment . . . . .	C-8
Temperature . . . . .	C-8
Humidity . . . . .	C-8
Instrument Cooling . . . . .	C-9
Claims and Repackaging . . . . .	C-9
Storage and Shipment . . . . .	C-10
Return Shipments to HP . . . . .	C-10
<b>D. HP-IB Overview</b>	
Introduction . . . . .	D-1
Description of the HP-IB . . . . .	D-1
Capabilities of the HP-IB . . . . .	D-3
Number of Interconnected Devices . . . . .	D-3
Interconnection Path . . . . .	D-3
Maximum Cable Length . . . . .	D-3
Message Transfer Method . . . . .	D-3
Data Transfer Rate . . . . .	D-3
Address Capability . . . . .	D-3
Multiple Controller Capability . . . . .	D-3
Interface Circuits . . . . .	D-3
Bus Structure . . . . .	D-4
HP-IB Management (Control) Lines . . . . .	D-4
ATN - Attention . . . . .	D-4
SRQ - Service Request . . . . .	D-5
REN - Remote Enable . . . . .	D-5
IFC - Interface Clear . . . . .	D-5
EOI - End or Identity . . . . .	D-5
Talk/Listen Addresses . . . . .	D-6
Bus Commands . . . . .	D-8

Abort . . . . .	D-8
Clear . . . . .	D-8
Clear Lockout/Set Local . . . . .	D-9
Local . . . . .	D-9
Local Lockout . . . . .	D-9
Parallel Poll . . . . .	D-9
Pass Control . . . . .	D-9
Remote . . . . .	D-9
Serial Poll . . . . .	D-10
Service Request . . . . .	D-10
Trigger . . . . .	D-10

**E. HP 3324A Command Syntax**

Introduction . . . . .	E-1
Syntax Drawing Rules . . . . .	E-1
HP-IB Command List . . . . .	E-2
AC; Amplitude Calibration . . . . .	E-3
AM; Amplitude . . . . .	E-4
AP; Assign Zero Phase . . . . .	E-5
CM; HP 3325A Compatible . . . . .	E-6
FR; Frequency . . . . .	E-8
FU; Waveform Function . . . . .	E-9
HV; High-Voltage Output . . . . .	E-10
IER; Program Error Query . . . . .	E-11
IOPT; Options Query . . . . .	E-12
ISE; System Error Query . . . . .	E-13
MD; Data Transfer Mode . . . . .	E-15
MF; Marker Frequency . . . . .	E-16
MKS; Select Markers . . . . .	E-17
MMF; Multi-Marker Frequency . . . . .	E-18
MMS; Multi-Interval/ Marker . . . . .	E-19
MS; Status Byte Mask . . . . .	E-20
MTI; Multi-Marker Sweep Time . . . . .	E-22
MUP; Multi-Marker Stop Frequency . . . . .	E-23
MUT; Multi-Marker Start Frequency . . . . .	E-24
OF; DC Offset . . . . .	E-25
OOE; Output Enable . . . . .	E-26
PC; Phase Calibration . . . . .	E-27

PH; Phase . . . . .	E-28
RE; Recall State . . . . .	E-29
RF; Rear or Front Signal Output . . . . .	E-30
RTT; Retrace Time . . . . .	E-31
SC; Start Continuous Sweep . . . . .	E-32
SGS; Select Intervals . . . . .	E-33
SM; Sweep Mode . . . . .	E-34
SNI; Number of Intervals . . . . .	E-35
SNR; Number of Stores . . . . .	E-36
SP; Sweep Stop Frequency . . . . .	E-37
SR; Store State . . . . .	E-38
SS; Start Single Sweep . . . . .	E-39
ST; Sweep Start Frequency . . . . .	E-40
TCD; Calibration Cable Delay . . . . .	E-41
TE; Perform Self-test . . . . .	E-42
TI; Sweep Time . . . . .	E-43
XMF; Multi-Interval Marker Frequency . . . . .	E-45
XSM; Multi-Interval Mode . . . . .	E-46
XSP; Multi-Interval Stop Frequency . . . . .	E-47
XST; Multi-Interval Start Frequency . . . . .	E-48
XTI; Multi-Interval Sweep Time . . . . .	E-49

<b>F. Error Messages</b>	
Introduction . . . . .	F-1
<b>G. Backdating</b>	
Introduction . . . . .	G-1
<b>H. Sales and Service Office Directory</b>	
Information . . . . .	H-1
Asia . . . . .	H-1
Canada . . . . .	H-1
Eastern Europe . . . . .	H-2
Northern Europe . . . . .	H-2
South East Europe . . . . .	H-2
Middle East and Central Africa . . . . .	H-3
United Kingdom . . . . .	H-3
United States of America . . . . .	H-3

Eastern USA . . . . .	H-3
Midwestern USA . . . . .	H-4
Southern USA . . . . .	H-4
Western USA . . . . .	H-4
Other International Areas . . . . .	H-4

**Index**

## Reader Comment Sheet

### Electronic Instruments Group

We welcome your evaluation of this manual. Your comments and suggestions will help us to improve our publications. Please use and attach additional pages if necessary.

Manual Number: \_\_\_\_\_

Please circle the following Yes or No:

- Is this manual well organized? Yes   No
- Is the information technically correct? Yes   No
- Are concepts and wording easy to understand? Yes   No

Comments: \_\_\_\_\_

\_\_\_\_\_  
\_\_\_\_\_  
\_\_\_\_\_  
\_\_\_\_\_

Name: \_\_\_\_\_

Title: \_\_\_\_\_

Company: \_\_\_\_\_

Address: \_\_\_\_\_

City: \_\_\_\_\_

State: \_\_\_\_\_ Zip: \_\_\_\_\_

Please tear out, fold, fix and mail in.



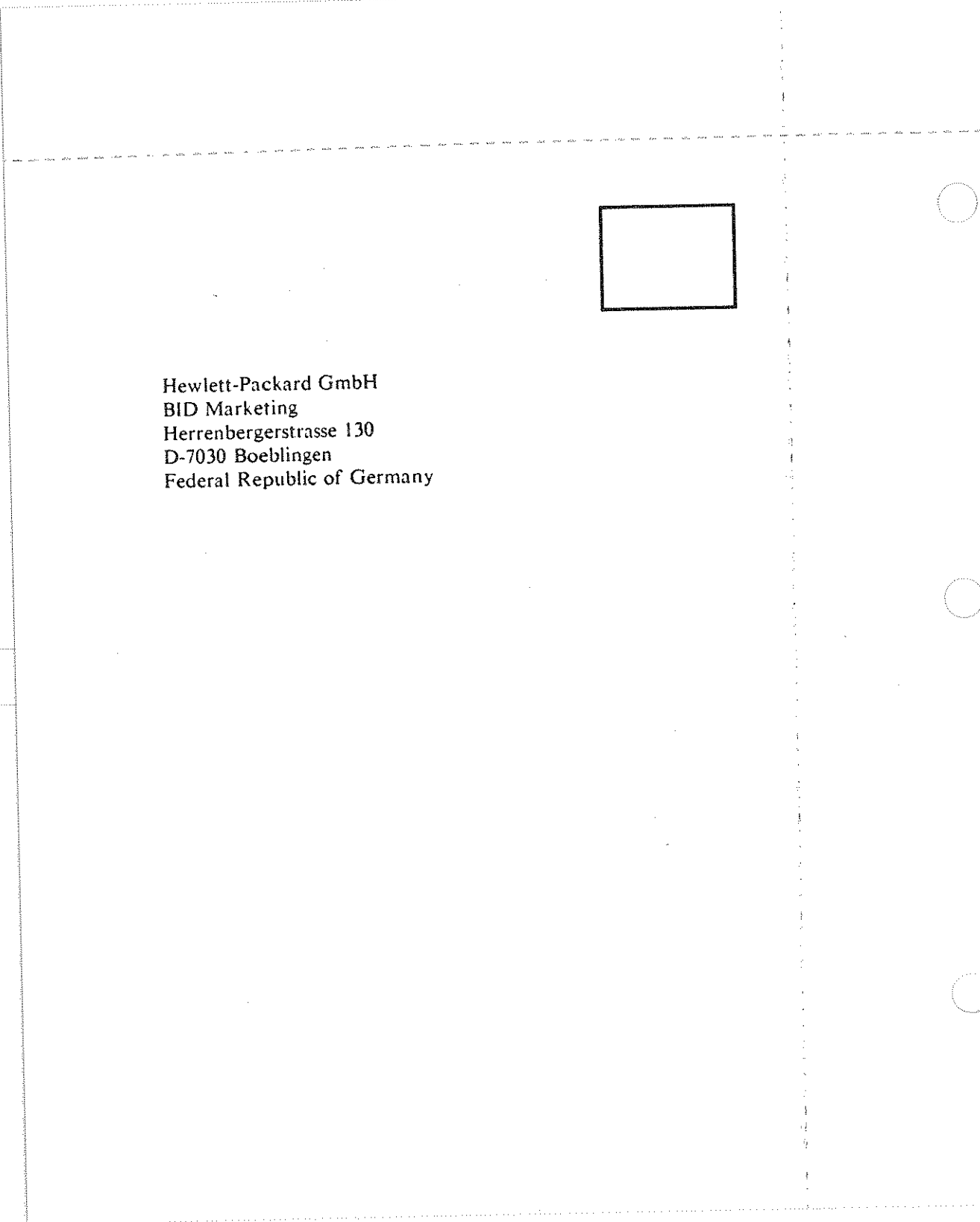

Hewlett-Packard GmbH  
BID Marketing  
Herrenbergerstrasse 130  
D-7030 Boeblingen  
Federal Republic of Germany



## Instrument Introduction

---

### Introduction

The HP 3324A Synthesized Function/Sweep Generator is a multi-task generator, which can be used as:

- **a reference source**  
Produces a sinewave of a specified frequency, amplitude, DC offset and phase.
- **a function generator**  
Produces various waveforms at a specified frequency, amplitude, DC offset and phase.
- **a sweep generator**  
Produces logarithmical and linear frequency sweeps.

---

### Key Features

- 6 different waveforms can be output
- Variable offsets and amplitudes
- Can be used as a DC source
- Multi-interval or multi-marker sweep capabilities
- Sweep sequencer
- Combined linear and logarithmic sweeps
- Phase-continuous sweep
- Remote mode capabilities, that is, it can be programmed from a controller connected by HP-IB
- Save/recall of instrument settings

---

## **Operating Concept**

The HP 3324A has been designed so that it can be used in either of two modes:

- a. **Local Mode:** Using the front panel to initiate operations.
- b. **Remote Mode:** Using an external computer as the controller.

### **Local Mode**

The HP 3324A is constructed so that the functions needed to operate the instrument are contained in four main menus, Parameter, Waveform, Sweep and Utilities. Each of the menus is described in its own separate chapter (chapters 5 to 8).

### **Remote Mode**

The remote mode is used to control the HP 3324A by an external computer and its operations can therefore be performed by a series of programmable commands. An explanation of the way in which to program the HP 3324A can be found in Chapters 9, 10, 11 and Appendices D and E.



---

## About this Manual

This manual is basically divided into two main parts:

- A part which describes the local control of the instrument (chapters 2 to 8).
- A part which describes the remote control of the instrument (chapters 9 to 11).

The examples in the local control part are shown in such a way that on the left side of the page the keystrokes are shown, while the right side gives an explanation of what happens. All hardkeys are shown in a box as they are on the instrument, for example, the **FREQ** key is represented by **Freq** in this manual. The only exceptions are the blue **SHIFT** key and the yellow **MODIFY** key. “SHIFT” and “MODIFY” are not printed on the keys, but to simplify things they are shown as **Shift** and **Modify** in this manual. The arrow keys are represented by **←**, **→**, **↑** and **↓**.

---

## Brief Operating Hints

To obtain the menu that you require, press the relevant hardkey. The position of the cursor, which is not shown as a line, is shown by blinking of the display. For example, if the cursor is on “FREQ” in the Parameter menu, then “FREQ” will blink. When data is being entered, the position of the cursor is shown by a line.

To move around the menu use the **←**, **→**, **↑** and **↓** keys to move the cursor one position. To move to the extremes use the **⏪**, **⏩**, **▲** and **▼** keys.

---

## About the Note

### Note



---

The NOTE sign is used to show where additional information beneficial to the reader can be found. This information refers to specific situations or operations.

---

## Front and Rear Panel Overview

---

### Introduction

This chapter contains basic information about the front and rear panels of the HP 3324A. The descriptions given should be read in conjunction with the foldouts at the front of this chapter.

---

### Front Panel

The front panel can be divided into 15 main component areas, each of which is described here. The various parts of the display are described along with the relevant key or connector.

#### Display (1)

The display is the only visible output for the HP 3324A. It is used to show the current status of the instrument and the functions available when one of the main menus has been activated.

#### **Sweep** (2)

The **Sweep** key causes the sweep menu to be shown in the display. It is then possible to program the sweep functions that you require. See Chapter 7 Sweep for a description of the sweep function.

#### **WaveForm** (3)

The **WaveForm** key causes the waveform menu to be shown in the display. It is then possible to choose the waveform that you require. See Chapter 6 Waveform for a description of the waveforms available.

**SELECT/MODIFY (4)**

These keys are used to alter data and to move the cursor within menus or the display. The function of the keys depends on the current menu or value displayed. For more information see Chapter 3 Instrument Operation.

**PARAMeters (5)**

The PARAMeter keys allow you to view, enter or change the frequency, amplitude, DC offset and phase of the main output signal. See Chapter 5 Parameters.

**DATA (6)**

The DATA keys are used to input data. A data entry must be confirmed by either the unit key or if appropriate, the **Enter** key. See Chapter 3 Instrument Operation.

**SWEEP (7)**

The SWEEP keys are for use in conjunction with the Sweep menu (2). The **Reset Start** key starts, stops and resets the sweeps.  **$\Delta f \times 2$**  and  **$\Delta f / 2$**  keys cause the sweep frequency bandwidth to be doubled and halved respectively. **MKR>CF** causes the sweep bandwidth to be centered on the marker frequency. See Chapter 7 Sweep.

**Save Recall (8)**

The **Save** and **Recall** keys allow you to save and recall instrument settings. See Chapter 3 Instrument Operation.

**Signal on off (9)**

The **Signal on off** key enables/disables the main output signal that comes from (10) or (17). When the signal is on, either at the front or rear connector, the signal LED is lit. See Chapter 3 Instrument Operation.

**Front Rear (9)**

The **Front Rear** key causes the main signal output to be either at the front connector (10) or the rear connector (17). If the signal is at the rear output “REAR-ONLY” is shown in the display.

**Main Signal Output Connector (10)**

Standard output impedance is 50Ω. High-voltage option (002) output impedance is nominally < 3Ω at DC, and < 10Ω at 1 MHz.

**Sync Out (11)**

A squarewave synchronized output signal is available at this connector. The signal is synchronized with the output signal crossover point (zero volts or DC offset voltage). The connector functions for frequencies upto 60 MHz.

**Shift Key (12)**

The blue **shift** key must be pressed to access the key functions labelled in blue. If **Shift** is pressed “S” is shown in the display until the next key is pressed.

**Local (13)**

This key returns the HP 3324A from remote control to front-panel control unless local lockout has been programmed.

**Util (14)**

The **Util** key accesses the Utilities menu, which contains a variety of functions from setting the HP-IB address to recalling the default settings. See Chapter 8 Utilities.

**Stand-by (15)**

The **Stand-by** switch powers up or powers down the instrument. In the stand-by mode, if power is applied to the instrument, power is supplied to the Oven Assembly Option 001 and High-voltage Assembly Option 002, if installed.

---

## Rear Panel

The rear panel can be divided into 13 main component areas, each of which are described here.

### HP-IB Connector (16)

The HP-IB connector is used to connect the HP 3324A onto the Hewlett-Packard Interface Bus so that it can be used in remote mode and accessed by a controller.

### Main Signal Output Connector (17)

Standard output impedance is  $50\Omega$ . High-voltage option (002) output impedance is nominally  $< 3\Omega$  at DC, and  $< 10\Omega$  at 1 MHz.

### Phase Cal In (18)

Used to connect two HP 3324As, one that has option 003 installed and one that has option 004. The two instruments can then be phase calibrated. The Phase Cal In of one instrument must be connected to the Phase Cal Out of the other.

### Phase Cal Out (19)

Used to connect two HP 3324As, one that has option 003 installed and one that has option 004. The two instruments can then be phase calibrated. The Phase Cal Out of one instrument must be connected to the Phase Cal In of the other.

### 10 MHz Oven (20)

This signal is present only in instruments with option 001. Normally it is connected to the Ext Ref In connector (22) with the BNC cable supplied with option 001 (HP p/n=8120-2682).

**AC Line (21)** The AC line connector assembly enables the HP 3324A to be powered from the mains. The assembly is a three-pronged receptacle to provide chassis ground through the power cable for operator protection.

**Ext Ref In (22)** This external frequency reference may be used to phase-lock the internal 30 MHz oscillator. If an external reference is present "EXT-REF" is shown in the display.

**Ref Out (23)** A 1 MHz signal from the HP 3324A reference circuits is available here.

**Aux 0 dBm (24)** A squarewave signal is available at this output for frequencies between 21 MHz and 60 MHz.

**Sync Out (25)** A squarewave synchronized output signal is available at this connector. The signal is synchronized with the output signal crossover point (zero volts or DC offset voltage), and functions for frequencies between 1 MHz and 60 MHz.

**Z-blank (26)** A TTL-compatible output is present during a sweep operation.

**X-drive (27)** This output ramps from 0 V to 10 V during a sweep.

**Marker (28)** This TTL-compatible output goes low at the selected marker frequency during a sweep, and goes high at completion of the sweep, in the multi-interval mode. In the multi-marker mode the signal pulses low at the selected marker frequency.

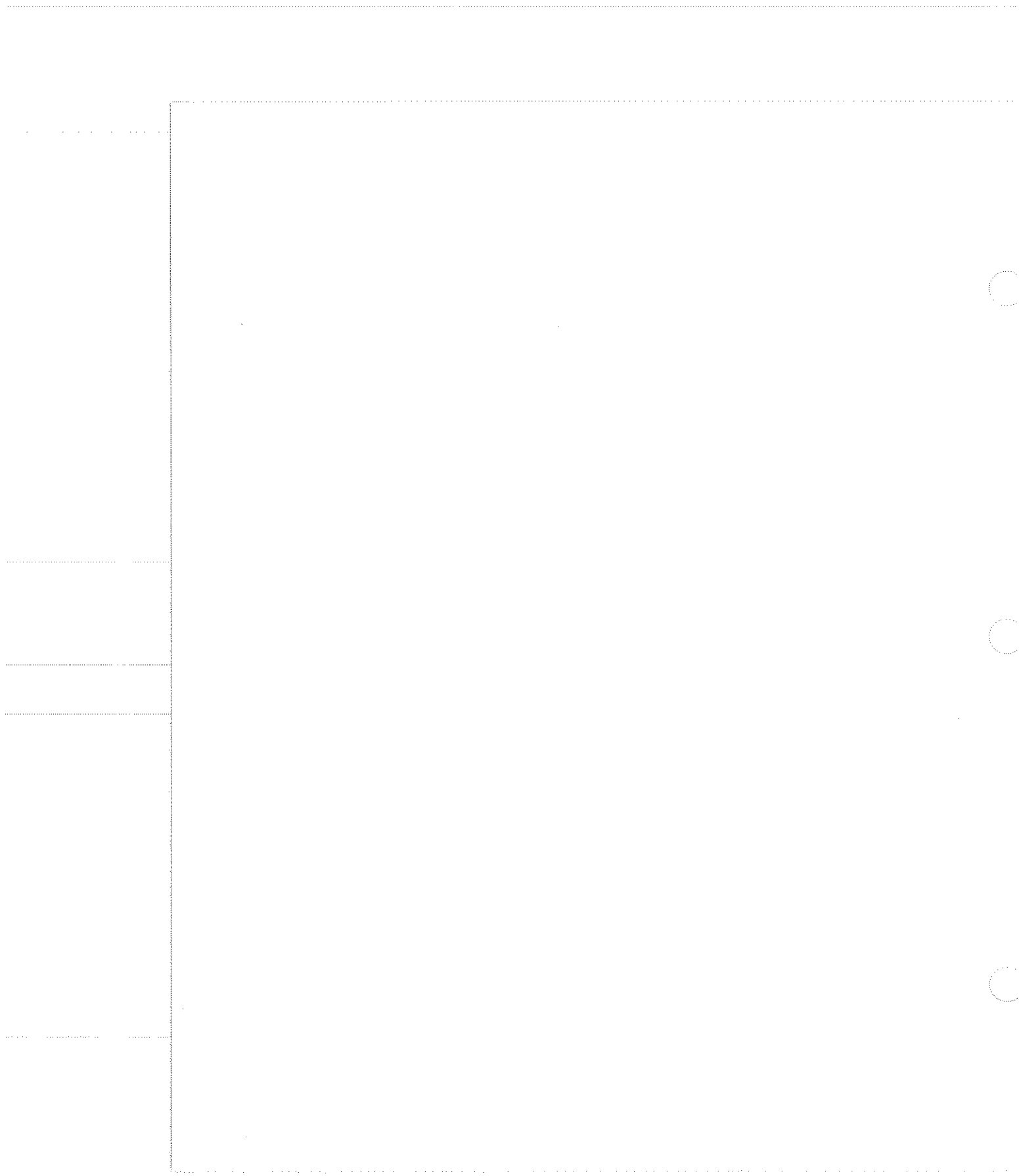

C

C

C



## Instrument Operation

---

### Introduction

This chapter describes the operating principles of the HP 3324A. It describes the powering on procedure, the various outputs available and how to use both the DATA keys and the SELECT/MODIFY keys.

---

### Before Power-on

#### Caution



Before connecting the HP 3324A to an AC power source make sure that the instrument is set for the local line-voltage. This will avoid damage to the instrument.

---

How to check for the local line-voltage setting and the fuses is described in Appendix C Installation.

Read the safety summary at the beginning of this manual.

---

### Power-on

The HP 3324A power switch has two positions, STAND-BY and ON. Power is supplied to some of the circuits at any time that the instrument is connected to the AC power source.

The instrument is equipped with a power connection at the rear, so that the instrument can be disconnected from the line power. Disconnect the power cord either at the rear power-inlet or at the AC line-power source (receptacle). One of these must be accessible at all times. If the instrument is installed in a cabinet, it must be disconnected from the line power by means of the system's line-power switch.

In the STAND-BY mode power is supplied to the Oven Assembly Option 001, if installed, so that a constant oven temperature is maintained, eliminating the need for a long warm-up period. Power is also applied to the high-voltage option (option 002), though no output is enabled.



The HP 3324A is turned ON by pressing the power switch (**Stand-by**). Power is then applied to all of the HP 3324A circuits, and self-tests are then performed. If a self-test failure occurs (if an error is shown), ship the instrument to an HP Service Center for repair.

---

## Turn-on State

The initial state of the HP 3324A depends on if the instrument is in the HP 3325A compatibility mode or not. The mode can be set and seen in the Utilities menu (see Chapter 8).

In the non-compatible mode, at power-on the last setting used is the new state. Any setting stored previous to power-down will still be stored in the memory.

In the HP 3325A compatible mode all stores are deleted, and a default setting becomes the new state. Table 3-1 shows the power-on state for the HP 3325A compatible mode. The main signal output is enabled at power-on (LED to the right of the **Signal on off** key is lit).

**Table 3-1.**  
**HP 3325A Compatible Power-on State**

Parameter	Power-on State
Function	Sine
Frequency	1000 Hz
Amplitude	1 mV(p-p)
Phase	0 degrees
DC Offset	0 V
Selected Output	1 (front)
Output	1 (on)
Marker/Interval Mode	1 (multi-interval)
No. of stores	10 (0 to 9)
Retrace Time	0 sec. (auto-retrace)
<b>Multi-Interval Sweep:</b>	
Sweep Mode	1 (linear, all intervals)
Start Frequency	1 MHz (all intervals)
Stop Frequency	10 MHz (all intervals)
Marker Frequency	5 MHz (all intervals)
Sweep Time	1 sec. (all intervals)
Activated Intervals	1 (only the first interval)
<b>Multi-Marker Sweep:</b>	
Start Frequency	1 MHz
Stop Frequency	10 MHz
Marker Frequency	5 MHz (all markers)
Sweep Time	1 sec.
Activated Markers	1 (only the first marker)

---

## Input/Output Signals

The HP 3324A has a total of 13 BNC connectors, located on both the front and rear panels. The use of each connector is explained in the following sections.



### Caution



---

A maximum of 42 V can be applied as an external voltage to any of BNC connectors because of the HP 3324A's floating ground.

---

## Main Signal Output

This output connector is the main output of the HP 3324A. The parameters of the signal, that is the waveform, frequency, amplitude, offset, phase, and whether it is swept or not, corresponds to what is programmed by the user. The standard HP 3324A provides selectable front or rear panel 50Ω signal outputs. At power-on the front connector is enabled. To enable the rear connector, press **Front Rear** (**shift** **Signal on off**). "REAR-ONLY" is then shown in the display. The **Front Rear** key toggles between the front and rear panel signal output connectors. To enable the main signal output, press **Signal on off**. The LED to the right of the key then lights. The **Signal on off** key toggles between an enabled and a disabled output. The main signal output is switched off when the auxiliary TTL clock waveform is chosen.

### Note



---

At output amplitudes of <50 mV in extreme environmental conditions, it is recommended to use a double shielded BNC cable. For example, use HP p/n 5180-2459 (1.22 m, RG58V Triax, 50Ω).

---



### Synchronization Outputs

A squarewave with the frequency and phase of the main signal output is available at the front and rear panel Sync (synchronized) Out connectors. The Sync transition occurs at the signal zero-crossing or when the signal crosses the DC offset voltage. The connectors function for frequencies between 1 mHz and 21 MHz as a phase-synchronous sinewave. When the auxiliary TTL clock waveform is chosen, the main signal output is switched off, and the synchronized outputs function as TTL clocks for frequencies from 1 mHz to 60 MHz.

The output impedance of either front- or rear-panel sync output is approximately 50Ω. When connected to a 50Ω coaxial cable that is terminated by a 50Ω resistive load, the sync signal levels are:

Low level < +0.2 V  
High Level > +1.2 V

### Note



If a sync output is connected to a 50Ω coaxial cable that is terminated by a high impedance load ( $\geq 1 \text{ M}\Omega$ ) the voltage levels are approximately twice the values given above. However, the improper termination of the 50Ω system will cause ringing of the positive and negative transitions of the sync signal.

### Phase Calibration Input

This input must be connected to the Phase Cal Output of another HP 3324A. One of the instruments must have option 003 installed and the other option 004. The two instruments can then be phase calibrated. Use the standard cable (supplied) to connect the Phase Cal Input of option 003 (slave) to the Phase Cal Output of option 004 (master).

### **Phase Calibration Output**

This output must be connected to the Phase Cal Input of another HP 3324A. One of the instruments must have option 003 installed and the other option 004. The two instruments can then be phase calibrated. Use the standard cable (supplied) to connect the Phase Cal Output of option 004 (master) to the Phase Cal Input of option 003 (slave).

### **10 MHz Oven Output**

The 10 MHz oven squarewave output signal is available at a connector on the rear panel if the high-stability frequency reference (option 001) is installed. Option 001 is a temperature stabilized 10 MHz oscillator which provides improved frequency stability. Normally it is connected to the Ext Ref In connector with the BNC cable supplied with option 001 (HP p/n=8120-2682).

### **External Frequency Reference Input**

The External Ref In connector phase-locks the HP 3324A to external frequency references (from quartz oscillators). Phase-locking to an external frequency reference transfers the external reference's frequency accuracy and aging rate to the HP 3324A. The external reference controls the standard 30 MHz internal reference oscillator frequency. The external reference level must be from 0 dBm to +20 dBm ( $50\Omega$ ), and the frequency must be within 10 ppm of 10 MHz, or a sub-multiple thereof down to 1 MHz (for example, 10, 5, or 1 MHz). The front panel "EXT-REF" annunciator will light to indicate that an external reference is being used. The internal reference oscillator is phase locked to the external reference, and a phase lock detector circuit causes the "EXT-REF" light to flash if synchronization is lost.

### **Note**



---

A bad reference input signal with large spurs may result in increased spurious signals at the main output connectors.

---

**Frequency Reference Output**

The Ref Out 1 MHz connector supplies a 1 MHz squarewave derived from the frequency reference of the HP 3324A. The squarewave has a level greater than 0 dBm (50Ω) and can be used to phase-lock an analyzer or other instrumentation to the frequency reference of the HP 3324A.

**Sweep Z-blank**

A TTL-compatible output is present during a sweep operation, as follows:

Single sweep: Goes low at the start of the sweep, and high when the sweep stops.

Continuous sweep: Goes low at the start of the sweep, high when the sweep stops and until the retrace time is over, and then goes low again at the start of the next sweep.

When the Z-blank output is low, it is possible to sink current through a relay or another device. The maximum ratings are:

- Maximum current sink: 200 mA
- Allowed voltage range: 0 V to +45 V DC
- Maximum power: 1 W  
(voltage at output x current)

**Marker**

The marker output is a TTL-compatible output. It is high at the start of a sweep up, goes low at the selected marker frequency. It remains low until the end of the interval in the multi-interval mode, while in the multi-marker mode the signal goes high again after approximately 1 ms. No marker output is present during a log sweep.

### **X-drive**

The X-drive output signal is only present during a sweep operation, as follows:

**Single sweep:** 0 V at the start of the sweep, increasing linearly to  $> +10$  V at the sweep stop. The voltage remains at this level until the reset prior to the start of another sweep.

**Continuous sweep:** 0 V at the start of the sweep, increasing linearly to  $> +10$  V at the sweep stop. Resets automatically to 0 V and remains there until the retrace time is over, and then starts again.

The X-drive output has a nominal voltage of  $+10.5$  V at the end of a sweep. This final voltage is specified to be greater than 10.0 V, so that compatibility with oscilloscopes having a horizontal sensitivity of 10.0 V for full-screen deflection is ensured.

The X-drive output voltage is linear with time for both linear and logarithmic sweep modes.

### **Note**



---

The X-drive is held low all of the time (without notice) if the total sweep time is more than 100 seconds.

---

If more than one interval is swept then the X-drive stops for approximately 2 ms at each interval end. When use with an oscilloscope in X-Y mode, this provides convenient “markers” at the boundaries (the beam emits a bright bar when the X-drive stops).



### Aux 0 dBm 21-60 MHz

The rear-panel Aux 0 dBm 21 – 60 MHz connector supplies a squarewave signal for frequencies between 21 and 60 MHz. The amplitude of the signal is 0 dBm. To obtain a 21 – 60 MHz frequency, the auxiliary TTL clock waveform (“AUX”) must be selected. The connector has an output impedance of 50Ω.

---

### **Shift** Key

Some keys control two functions. The first function name appears on the key itself and is activated by pressing the key. If a key has another function, its name appears in blue below the key and it is activated by first pressing the blue **Shift** key. This manual may refer to shifted key names with or without reminding you to press the **Shift** key first. Always look for both names of a key when searching the front panel for a key name.

When the **Shift** is pressed, “S” appears to the left of the display to indicate that the shifted key names may be selected.

### Note



In this manual the blue key is referred to as **Shift**, even though “Shift” is not written on the key.

---

## DATA Keys

The DATA keys are used in conjunction with most of the other keys and the display. For an explanation of the secondary functions **Ampl Cal**, **Phase Cal** and **Assign Phase 0** see Chapter 5.

Entering setup values with the numeric keypad is a simple 3-step process:

1. Select a parameter to change.
2. Enter the required value (most significant value first).
3. End the entry with the relevant unit key.

If you type in a wrong digit use the **BackSpace** key to clear it. As on calculators the **BackSpace** key clears the digit to the left of the cursor.

If an entered value exceeds the range limits, the HP 3324A ignores the entered value, briefly displays the error, and then puts the instrument into the edit mode.

The **→**, **□** and **Enter** keys are used when entering a sweep interval or marker sequence. **→** means “from to” and **□** means “and then”. **Enter** is used to end the sequence (see Chapter 7).

**CHS** is used to enter a negative phase or DC offset value (see Chapter 5).





### Example

Consider changing the amplitude to 1 V(p-p).



- |    | Keystrokes                    | Result                           |
|----|-------------------------------|----------------------------------|
| 1. | <b>Ampl</b> <b>1</b> <b>V</b> | An amplitude of 1 V(p-p) is set. |

---

## SELECT/MODIFY Keys



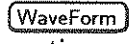



The SELECT/MODIFY keys are used in conjunction with most of the other keys and the display. The four arrow keys are referred to as the , ,  and  keys in this manual.

### Select

The select mode is used to move through the menus to a certain item/point, which can then be activated with the  key. For example, to choose the squarewave output, press the  key to display the current waveform and the options available. Move the cursor with the arrows to the squarewave symbol, and press . A squarewave output signal will then be activated if all the parameters are valid for this waveform.

### Modify

The modify mode is entered by pressing the yellow key. The yellow key is referred to as the  key in this manual. The arrow keys are used to modify the displayed value. "M" is shown in the display, to indicate that you are in the modify mode. The cursor is automatically placed on the most significant digit (to the far left).

Use the  and  keys to select the digit for modification as indicated by the cursor. Pressing the  selects the next most significant digit; pressing the  selects the next least significant digit. Pressing  or  causes the cursor to spring to the extremes.

To delete a digit, again place the cursor to the right of the digit you wish to delete and press .

There are two ways to change a digit in the modify mode:

- Type in a new digit value by pressing the number on the numeric keypad. There is no need to press **Enter**.
- Use the **Incr**/**Decr** keys to increase/decrease the digit by 1. Holding the key in will increase/decrease the value at a faster rate. Note that, except on the most significant digit, increasing from 9 to 10 causes the 1 to be carried to the next digit position, and decreasing from 0 to 9 will cause the preceding digit to be decreased by one. See the example on the next page.

The modify mode is useful because the output is changed immediately, and does not need to be realised with a unit key. To leave the modify mode either press the yellow key again, or press one of the MENU or PARAM keys.

### Example

Consider a frequency of 125 KHz. You wish to see what happens when you increase the frequency to 225 KHz and back again in steps of 10 KHz.

	Keystrokes	Result
1.	<b>Freq</b>	The current frequency value is displayed.
2.	<b>1 2 5 KHz</b>	A frequency of 125 KHz is set.
3.	<b>Modify</b>	The modify mode is entered and the cursor is placed under the "1".
4.	<b>⇒</b>	The cursor is moved under the "2".
5.	<b>Incr</b> x 10 times	The frequency is increased in steps of 10 KHz upto 225 KHz.
6.	<b>Decr</b> x 10 times	The frequency is decreased in steps of 10 KHz down to 125 KHz.
7.	<b>Modify</b>	The modify mode is exited.

### Edit

With the modify keys a parameter is simultaneously updated at the output. However, the edit mode allows you to change a parameter without it being changed at the output, until the unit key is pressed. To activate the edit mode, press the blue **Shift** key and then the yellow **Modify** key, otherwise known as **Edit**.

The cursor is automatically placed to the left of the least significant digit (to the far right). To move the cursor to another digit use the **⇐** and **⇒** keys. There are two ways to change a digit in the edit mode:

- Type in a new digit value by pressing the number on the numeric keypad. There is no need to press **Enter**.
- Delete the digit before the cursor by pressing the **BackSpace** key.

To leave the edit mode either press the unit key to make the change, or press one of the Menu or Parameter keys to leave the value as it was.

### Example

Consider an amplitude of 4.075 V(p-p). You wish to see what happens when you increase the amplitude to 4.125 V(p-p).

	Keystrokes	Result
1.	<b>Ampl</b>	The current amplitude is shown in the display.
2.	<b>4</b> <b>.</b> <b>0</b> <b>7</b> <b>5</b> <b>V</b>	The amplitude is changed to 4.075 V(p-p).
3.	<b>Edit</b>	The edit mode is activated.
4.	<b>←</b>	The cursor moves under the "5".
5.	<b>BackSpace</b> x 2	The "7" and "0" are deleted.
6.	<b>1</b> <b>2</b>	The new value is inserted.
7.	<b>V</b>	The amplitude is changed to 4.125 V(p-p).

---

## Saving/Recalling Instrument States

An entire setting can be stored in one of upto 10 registers. These settings can then be recalled. The number of stores available depends on the number of intervals/stores set using the `(sto: xx int.: xx)` command contained in the Utilities menu (see Chapter 8).

At power-on, if the HP 3324A is in the HP 3325A compatible mode, all the stores will be deleted. If the instrument is in the non-compatible mode, the stores will contain the same information as previous to power-off. If the instrument is reset to default, all of the stores are deleted.

## Saving Instrument States

The current operating state is saved in the internal memory, when the `(Save)` key, a digit and then `(Enter)` are pressed. The digit range depends on the number of stores available. For example, when 10 stores can be used, the digit can be from 0 to 9. The digit specifies the memory location for storing the operating state. If two operating states are saved in the same memory location, the operating state saved first is overwritten.

### Note



---

Any phase information stored is invalid when recalled because the instrument performs an amplitude calibration on recall. The phase relationship between the output signal and the reference is not maintained when an amplitude calibration occurs.

---

### Example

Consider saving an instrument state in the 4th register.

#### Keystrokes

1. **Save** **4** **Enter**

#### Result

The present instrument setting is saved in register 4.

### Recalling Instrument States

An operating state is recalled from the internal memory, when the **Recall** key, a digit and then **Enter** are pressed. The digit specifies the memory location from which the operating state is to be recalled.

### Example

Consider recalling the instrument setting saved in register 4.

#### Keystrokes

1. **Recall** **4** **Enter**

#### Result

The instrument setting stored in register 4 is recalled.



## Getting Started

---

### Introduction

This chapter gives a very brief description of how to get started with the HP 3324A. This includes how to power up, an example of setting the parameters for a standard function generator, and an example of setting up a sweep.

---

### Powering Up

#### Caution



Before connecting the HP 3324A to an AC power source make sure that the instrument is set for the local line voltage. This will avoid damage to the instrument.

---

See Appendix C Installation, if you don't know how to do this.

To power on press the Stand-by switch on the front panel. The HP 3324A will then perform a series of self-tests. The initial state of the HP 3324A depends on if the instrument is in the HP 3325A compatibility mode or not. The mode can be set and seen in the Utilities menu (see Chapter 8).

In the non-compatible mode, at power-on the last setting used is the new state. Any settings stored previous to power-down will still be stored in the memory registers.

In the HP 3325A compatible mode, all stores are deleted and the default state is set. The main signal output is also enabled (LED to the right of the **Signal on/off** switch is lit).

---

## The HP 3324A as a Function Generator

The following is an example of how to set up the HP 3324A as a standard function generator. It shows how to choose a waveform, set the frequency, amplitude and offset of the output signal, and how to enable the signal.

- | Keystrokes         | Result                                     |
|--------------------|--|
| 1. <b>WaveForm</b> | The waveform menu is shown in the display. |

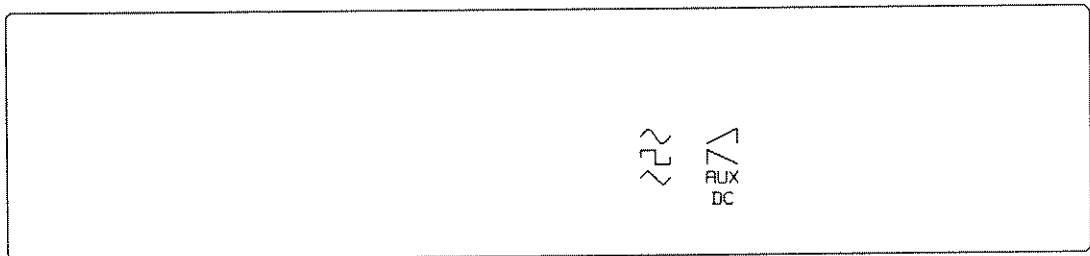





Figure 4-1. The Waveform Display

### Note



If the sinewave is not blinking, move the cursor until it does.

	Keystrokes	Result
2.	  	The triangle is selected as the signal waveform.

**Note**







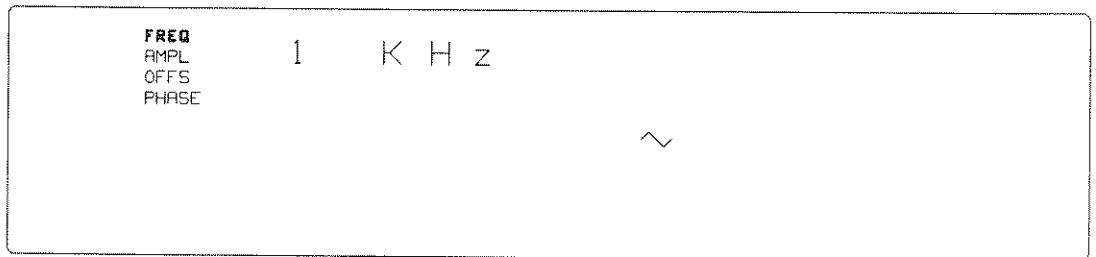

If the error “freq. out range” is shown here, do steps 3 and 4 before repeating steps 1 and 2. This is because the frequency is not valid for the waveform chosen.

	Keystrokes	Result
3.		The parameter menu is shown in the display, along with the current frequency.







**Figure 4-2. The Parameter Display**

	Keystrokes	Result
4.	  	The frequency of the main signal is changed to 10 KHz.
5.		The current amplitude is displayed.
6.	 	The amplitude of the main signal is changed to 1 V(p-p).

**Note**



If you get an incompatible error now it means that the amplitude is incompatible to the DC offset. Press , , and , to set the DC offset to 0 V. Press  and repeat step 6.

	<b>Keystrokes</b>	<b>Result</b>
7.	<b>⇩</b>	The current DC offset is displayed.
8.	<b>0</b> <b>V</b>	The DC offset of the main signal is changed to 0 V.
9.	<b>⇩</b>	The current phase is displayed.
10.	<b>0</b> <b>deg</b>	The phase of the main signal is changed to 0 degrees.

If the main signal output was already enabled, then each time a value was entered, the output signal was changed. If the output was disabled then perform the following step to enable it.

	<b>Keystrokes</b>	<b>Result</b>
11.	<b>Signal on off</b>	The LED to the left of the key lights, to show that the main signal output is enabled.

This example has shown how to set up the HP 3324A as a function generator.

## The HP 3324A as a Sweep Generator

The following is an example of how to set up the HP 3324A as a sweep generator. The example follows on from the one above. It shows how to set up three sweep intervals, and to cause a continuous sweep to be performed using these intervals.

- |    | Keystrokes   | Result                                  |
|----|--------------|---|
| 1. | <b>Sweep</b> | The sweep menu is shown in the display. |

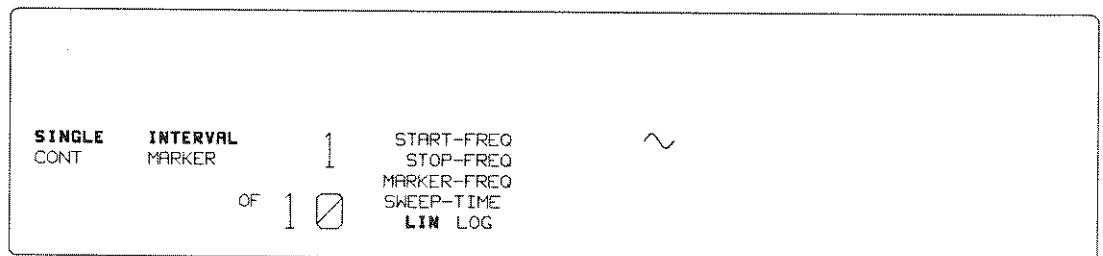

Figure 4-3. The Sweep Display

- |    | Keystrokes             | Result   |
|----|------------------------|--|
| 2. | <b>↓</b>               | The cursor (shown by blinking) is moved to "CONT", if it was on "SINGLE". If not move the cursor using the arrow keys to "CONT". |
| 3. | <b>Select 2 s</b>      | A continuous sweep is selected with a retrace time of two seconds.   |
| 4. | <b>⇒ ↑ Select</b>      | The multi-interval mode is selected and the current sweep sequence is displayed.   |
| 5. | <b>1 ⇒ 3 ⇒ 1 Enter</b> | An interval sequence of 1,2,3,2,1 is selected.   |

## Note



The sequence does not have to follow in series, that is 1, 2, 3, 1, 2. You can program the intervals in any sequence that you require, for example, 2, 3, 1, 3, 1, 2 and so on.

Now, each of the intervals must be programmed separately.

	Keystrokes	Result
6.	Use   until "1" is shown.	This selects the first interval and means that the information that you will enter afterwards, will refer to the first programmed interval.
7.		The start frequency for the 1st interval is changed to 1 KHz. The cursor is now on "START-FREQ".
8.		The stop frequency for the 1st interval is changed to 10 KHz. The cursor is now on "STOP-FREQ".
9.		The marker frequency for the 1st interval is changed to 5 KHz. The cursor is now on "MARKER-FREQ".
10.		The sweep time for the 1st interval is changed to 2 s. The cursor is now on "SWEEP-TIME".
11.		The 1st interval is set as a linear sweep. The cursor is now on "LIN".

Now the 2nd interval has to be programmed.

	Keystrokes	Result
12.		"2" is displayed. This means that the information that you will enter afterwards, will refer to the second programmed interval.
13.		The start frequency for the 2nd interval is changed to 900 Hz. The cursor is now on "START-FREQ".

	Keystrokes	Result
14.		The stop frequency for the 2nd interval is changed to 10 KHz. The cursor is now on "STOP-FREQ".
15.		The sweep time for the 2nd interval is changed to 2 s. The cursor is now on "SWEEP-TIME".
16.		The 2nd interval is set as a logarithmic sweep. The cursor is now on "LOG".

**Note**

No marker frequency has been set for the 2nd interval, as a log interval cannot have a marker.

Now the 3rd interval has to be programmed.

	Keystrokes	Result
17.		"3" is displayed. This means that the information that you will enter afterwards, will refer to the third programmed interval.
18.		The start frequency for the 3rd interval is changed to 5 KHz. The cursor is now on "START-FREQ".
19.		The stop frequency for the 3rd interval is changed to 1 KHz. The cursor is now on "STOP-FREQ".
20.		The marker frequency for the 3rd interval is changed to 3 KHz. The cursor is now on "MARKER-FREQ".
21.		The sweep time for the 3rd interval is changed to 2 s. The cursor is now on "SWEEP-TIME".
22.		The 3rd interval is set as a linear sweep. The cursor is now on "LIN".
23.		The sweep is output at the main signal connector.

This example has shown how to use the HP 3324A as a sweep generator.

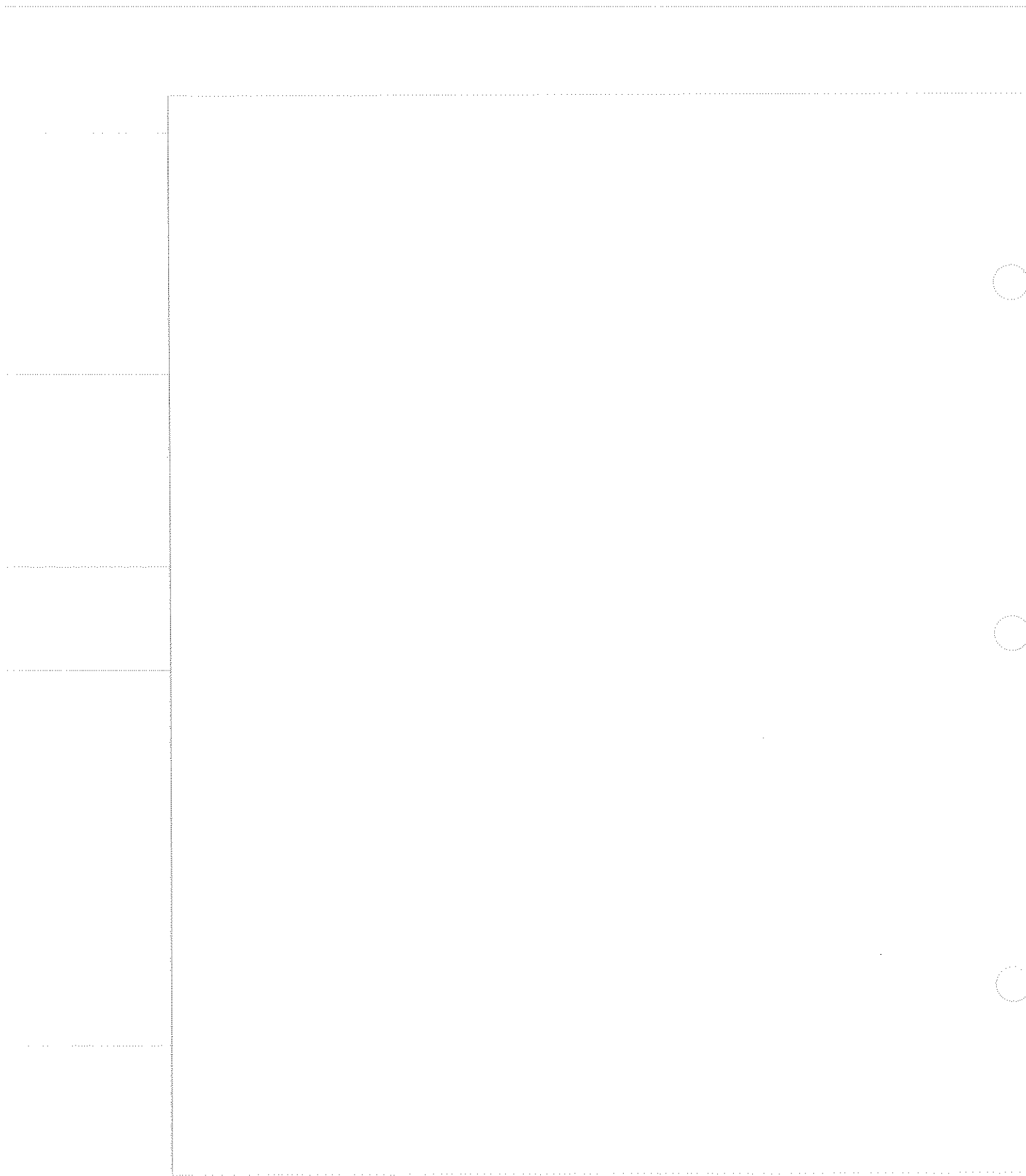



## Parameters

---

### Introduction

The Parameter keys **Freq**, **Ampl**, **Offs** and **Phase** enable you to display the frequency, amplitude, DC offset and phase values, respectively, of your output signal.

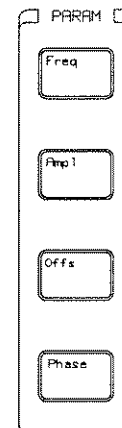
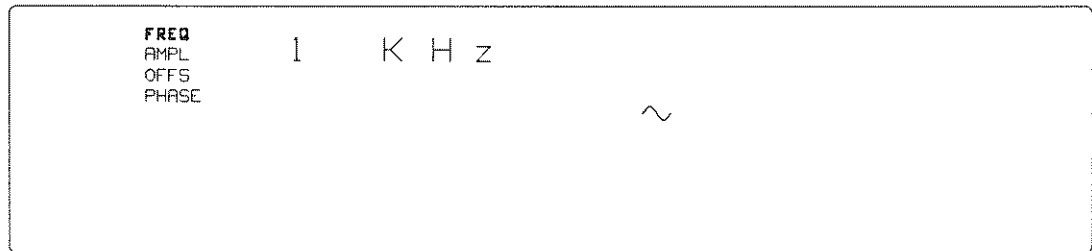



Figure 5-1. The Parameter Keys

When one of the keys is pressed, the current value is displayed along with the parameter key functions and the current waveform. The parameter chosen is shown in full-brightness, while the other three are shown in half-brightness. Figure 5-2 shows an example of the display when the **Freq** key has been pressed.



**Figure 5-2. The Parameter Display**

One of the other parameters can be viewed by either pressing the parameter key, or using the  or  keys to move the cursor up or down the Parameter menu. Putting the cursor (so that the parameter blinks) on “FREQ” displays the frequency, on “AMPL” displays the amplitude, on “OFFS” displays the DC offset, and on “PHASE” displays the phase.

---

### **Entering a New Value**

A new value is entered by activating the required parameter, entering the numerical data (with the keypad), and then pressing the appropriate unit key. The parameter is then immediately updated.

---

## Modifying a Parameter

A parameter can be simultaneously updated using the modify keys. This is done by activating the parameter that you wish to change, and then pressing the yellow **Modify** key (top left of the SELECT/MODIFY keys). "M" is shown in the display, to indicate that you are in the modify mode. The cursor is automatically placed on the most significant digit (to the far left). To move the cursor to another digit use the **←** and **→** keys. There are two ways to change a digit in the modify mode:

- Type in a new digit value by pressing the number on the numeric keypad. There is no need to press **Enter**.
- Use the **Incr/Decr** keys to increase/decrease the digit by 1. Holding the key in will increase/decrease the value at a faster rate. Note that, except on the most significant digit, increasing from 9 to 10 causes the 1 to be carried to the next digit position, and decreasing from 0 to 9 will cause the preceding digit to be decreased by one. See the example.

To delete a digit place the cursor to the right of the digit you wish to delete, and then press **BackSpace**.

The modify mode is useful because the output is changed immediately, and does not need to be realised with a unit key. To leave the modify mode either press the yellow **Modify** key again, or press one of the Menu or Parameter keys.

## Modify Example

Consider a frequency of 125 KHz. You wish to see what happens when you increase the frequency to 225 KHz and back again in steps of 10 KHz.

## Note



Make sure that the waveform is a sinewave or squarewave before doing this example, otherwise the frequency set will be too invalid and an error will be caused. (Press **Waveform**, move the cursor to the sinewave and press **Select**.)

### Keystrokes

1. **Freq**
2. **1 2 5 KHz**
3. **Modify** **⇒**
4. **Incr** ten times
5. **Decr** ten times **Modify**

### Result

- The Parameter menu is displayed with the current frequency shown.
- A frequency of 125 KHz is set.
- The modify mode is entered and the cursor is placed under the "2".
- This increases the frequency in steps of 10 KHz upto 225 KHz.
- This decreases the frequency in steps of 10 KHz down to 125 KHz, and then exits the modify mode.

## Editing a Parameter

With the modify keys a parameter is simultaneously updated at the output. However, the edit mode allows you to change a parameter without it being changed at the output, until the unit key is pressed. To activate the edit mode, press **Edit** (**Shift** key and then the **Modify** key). The cursor is automatically placed to the left of the least significant digit (to the far right). To move the cursor to another digit use the **⇐** and **⇒** keys.

There are two ways to change a digit in the edit mode:

- Type in a new digit value by pressing the number on the numeric keypad. There is no need to press **Enter**.
- Delete the digit before the cursor by pressing the **BackSpace** key.

To leave the edit mode either press the unit key to make the change, or press one of the Menu or Parameter keys to leave the value as it was.

### Example

Consider an amplitude of 4.075 V(p-p). You wish to see what happens when you increase the amplitude to 4.125 V(p-p).

	Keystrokes	Result
1.	<b>Ampl</b>	The current amplitude is shown in the display.
2.	<b>4</b> <b>.</b> <b>0</b> <b>7</b> <b>5</b> <b>V</b>	The amplitude is changed to 4.075 V(p-p).
3.	<b>Edit</b>	The edit mode is activated.
4.	<b>←</b>	The cursor moves under the "5".
5.	<b>BackSpace</b> <b>BackSpace</b>	The "7" and "0" are deleted.
6.	<b>1</b> <b>2</b>	The new value is inserted.
7.	<b>V</b>	The amplitude is changed to 4.125 V(p-p).

---

## Frequency

Press **[Freq]** (frequency) to display the frequency of the output signal. To change this value either

- enter a new value with the numeric keypad, and press the relevant unit key; **[MHz]**, **[KHz]**, or **[Hz]**.
- modify the existing value using the modify function.
- edit the existing value using the edit function.

Resolution of the frequency entry is 1 mHz for frequencies up to 999,999.999 Hz, independent of the waveform selected, and from 1 MHz upwards the resolution is 100 mHz. The frequency range is dependent on the waveform selected (see Chapter 6). During a frequency change, the main output is phase-continuous; that is, there are no phase discontinuities in the output waveform.

**Table 5-1. Frequency Ranges**

Function	Range
Sinewave	1 mHz to 21 000 000.000 Hz
Squarewave	1 mHz to 11 000 000.000 Hz
Triangle	1 mHz to 11 000.000 Hz
Pos. slope ramp	1 mHz to 11 000.000 Hz
Neg. slope ramp	1 mHz to 11 000.000 Hz
TTL/Aux	1 mHz to 60 000 000.000 Hz

## High-Voltage Option

When the high-voltage output is used (option 002 is installed), the load resistance must be greater than 500  $\Omega$  or distortion will result, particularly at higher frequencies. The maximum frequency for the sine and square waveforms is 1 MHz, while that for the triangle and ramps is 11 KHz.

**Example** The following example shows how to change the frequency to 10.7854 KHz:-

	Keystrokes	Result
1.	<b>Freq</b>	The Parameter display is shown. "FREQ" is high-lighted.
2.	<b>1 0 . 7 8 5 4</b>	"10.7854" is displayed.
3.	<b>KHz</b>	The frequency is then accepted and "10.7854 KHz" is displayed.

---

## Amplitude

Press **Ampl** (amplitude) to display the amplitude of the output signal. To change this value either

- enter a new value with the numeric keypad, and press the relevant unit key; **V**, **mV**, **V RMS**, **mV RMS** or **dBm**.
- modify the existing value using the modify function.
- edit the existing value using the edit function.

If a DC offset too large for the amplitude already programmed is entered or if the AC amplitude is increased beyond the level where the amplitude and offset are compatible, the error "ampl offs incomp" appears in the display momentarily, and the entry value is not accepted.

The amplitude range for each waveform is given in Table 5-2. The ranges given are only applicable when no DC offset has been set. When this is the case, see Table 5-4.

**Table 5-2. Amplitude Limits of AC Functions**

Function	Peak-to-Peak		RMS		dBm (50Ω)	
	min.	max.	min.	max.	min.	max.
Sinewave	1 mV	10 V	0.354 mV	3.536 V	-56.02	+23.98
Squarewave	1 mV	10 V	0.500 mV	5.000 V	-53.01	+26.99
Triangle	1 mV	10 V	0.289 mV	2.888 V	-57.78	+22.22
Pos. slope ramp	1 mV	10 V	0.289 mV	2.888 V	-57.78	+22.22
Neg. slope ramp	1 mV	10 V	0.289 mV	2.888 V	-57.78	+22.22

**Note**



At output amplitudes of <50 mV in extreme environmental conditions, it is recommended to use a double shielded BNC cable. For example, use HP p/n 5180-2459 (1.22 m, RG58V Triax, 50Ω).

The unit keys **V** and **mV** refer to the peak-to-peak values for AC functions. The HP 3324A unit keys convert the amplitude value between peak-to-peak, rms, or dBm for any waveform function. For example, if a sine wave amplitude of 10 V(p-p) is displayed, pressing the **V RMS** or **mV RMS** key will display the same amplitude as 3.536 Vrms, while pressing the **dBm** key displays the value as 23.98 dBm. When changing from one waveform to another, the last amplitude value displayed is held constant.

**Amplitude Calibration**

An amplitude calibration of the output signal can be performed on the HP 3324A. To do this, press the **Ampl Cal** key (**Shift** **7**). The main signal output is switched off while the calibration is in progress. An amplitude and offset calibration is performed automatically whenever the function is changed and at instrument turn-on.



## High-Voltage Option

When the high-voltage output is used (option 002 is installed), a maximum output of 40 V peak-to-peak is available into a high impedance. The load resistance must be more than 500 $\Omega$  or distortion will result, particularly at higher frequencies. To assure square wave overshoot of < 5% of the peak-to-peak output, the total capacitance connected to the output should be < 500 pF. An error will occur if the amplitude is given in dBm for the high-voltage option.

The amplitude limits for the high-voltage option is shown in Table 5-3. The ranges given are only applicable when no DC offset has been set. When this is the case, see Table 5-4.

## Note



When the high-voltage option is switched on, the output amplitude/offset “jumps” to its 4-fold value. When it is switched off, it is automatically decreased by a factor of four.

For example, the amplitude=1 V(p-p). Turning the high-voltage on causes the amplitude output to be 4 V(p-p). Turning the high-voltage off causes the amplitude output to be 1 V(p-p) again.

**Table 5-3. High-Voltage Output Amplitudes**

Function	Peak-to-Peak		RMS	
	min.	max.	min.	max.
Sinewave	4 mV	40 V	1.42 mV	14.14 V
Squarewave	4 mV	40 V	2.00 mV	20.00 V
Triangle	4 mV	40 V	1.16 mV	11.55 V
Pos. slope ramp	4 mV	40 V	1.16 mV	11.55 V
Neg. slope ramp	4 mV	40 V	1.16 mV	11.55 V

**Example** The following example shows how to change the amplitude to 2.309 Vrms (6.531 V(p-p))

	Keystrokes	Result
1.	<b>Ampl</b>	The Parameter display is shown. "AMPL" is highlighted.
2.	<b>2 . 3 0 9</b>	"2.309" is displayed.
3.	<b>V RMS</b>	The amplitude is accepted and "2.309 V RMS" is displayed.

---

## DC Offset

The **Offs** (DC offset) key enables you to display the DC offset of the output signal. To change this value, either

- enter a new value with the numeric keypad, and press the relevant unit key; **V** or **mV**. To enter a negative offset, press **CHS** before entering the value.
- modify the existing value using the modify function.
- edit the existing value using the edit function.

The DC offset range is dependent upon amplitude and the high-voltage option (if installed). See Table 5-4 for a list of the DC offsets allowed.

**Offset Only, No AC Function**

When the DC function is activated in the waveform menu (see Chapter 6), then no AC function is activated. The DC voltage output may then be programmed from 0 mV to  $\pm 5$  V, with 4 digit resolution.

**AC with DC Offset**

When DC offset is added to any AC function, there are minimum and maximum offset limits which must be observed. These limits are affected by the AC voltage and internal attenuator settings listed in Table 5-4. Resolution of a DC offset entry (with AC function) is determined by the resolution of the AC amplitude. The following equation may be used to determine maximum offset voltage:

$$\text{Maximum DC offset} = (5/A) - (\text{Amptd}/2)$$

where A = Attenuation factor (from Table 5-6) and Amptd = Amplitude in V(p-p) of the AC function.

If a DC offset too large for the amplitude already programmed is entered or if the AC amplitude is increased beyond the level where the amplitude and offset are compatible, the error "ampl/offc incomp" appears in the display momentarily, and the entry value is not accepted.

**Table 5-4.  
Maximum DC Offset with any AC Function**

AC Amplitude Entry (peak-to-peak)	Maximum DC Offset (+ or -)	Minimum DC Offset Entry	Range	Attenuation Factor
1.000 mV to 3.333 mV	with 4.500 mV to 3.333 mV	0.001 mV	7	A = 1000
3.334 mV to 9.999 mV	with 14.99 mV to 11.66 mV	0.001 mV	6	A = 300
10.00 mV to 33.33 mV	with 45.00 mV to 33.33 mV	0.010 mV	5	A = 100
33.34 mV to 99.99 mV	with 149.9 mV to 116.6 mV	0.010 mV	4	A = 30
100.0 mV to 333.3 mV	with 450.0 mV to 333.3 mV	0.100 mV	3	A = 10
333.4 mV to 999.9 mV	with 1.499 V to 1.166 V	0.100 mV	2	A = 3
1.000 V to 9.998 mV	with 4.500 V to 0.001 V	1.000 mV	1	A = 1

### High-Voltage Option

When the high-voltage output is used (option 002 is installed), the minimum and maximum permissible DC offset voltages may be determined by multiplying the amplitude and offset values in Table 5-4 by four. The equation given on the previous page must be changed to:

$$\text{Maximum DC offset} = (20/A) - (\text{Amptd}/2)$$

where A = Attenuation factor (from Table 5-4) and Amptd = Amplitude in V(p-p) of the AC function.

Resolution of a DC offset entry is determined by the resolution of the AC amplitude.

### Example

The following example shows how to change the DC offset to 1.0 V

	Keystrokes	Result
1.	<input type="button" value="Offs"/>	The Parameter display is shown. "OFFS" is highlighted.
2.	<input type="button" value="1"/>	"1" is displayed.
3.	<input type="button" value="V"/>	The DC offset is accepted, and "1 V DC" is displayed.

---

## Phase

The **Phase** key enables you to change the phase of the output signal, and can be used in the following situations:

- If two HP 3324A's have the automatic phase calibration options installed, that is one has option 003 installed and the other option 004. Changing the phase of one instrument with the **Phase** key will then change the phase between the calibrated instruments. For more detailed information and setup procedure see Automatic Phase Calibration.
- Another synthesized function generator (for example, another HP 3324A or an HP 3325A) can be synchronized with the HP 3324A (or vice versa). Either a reference frequency signal from the other instrument is connected to the external frequency reference input of the HP 3324A, or the signal from the frequency reference output of the HP 3324A is connected to the other instrument. If option 001, the High-Stability Frequency Reference is installed on one of the instruments, this can be used as a reference providing it is connected to the reference input of both instruments. "EXT-REF" is shown in the display if an external reference frequency is used. Changing the phase of the HP 3324A will then cause the phase between the two instruments to change accordingly.

### Note



---

In this case the phases of the two instruments are not calibrated, just locked.

---

To change the phase, either

- enter a new value with the numeric keypad, and press the unit key **deg**. To enter a negative phase, press **CHS** before entering the value.
- modify the existing value using the modify function.
- edit the existing value using the edit function.

### Note



For squarewave frequencies below 25 KHz, phase changes greater than 25° may result in a phase shift of  $\pm 180^\circ$  from the desired amount.

The phase limit is  $\pm 720.0^\circ$ , with a resolution of 0.1°.

After entering a phase shift, the new phase may be assigned the zero-phase position; subsequent changes in phase are made with reference to this value. To assign zero phase, press **Assign Phase 0** (**Shift** **1**).

### Example

The following example shows how to add a phase shift of  $-45^\circ$ :

	Keystrokes	Result
1.	<b>Phase</b>	The Parameter display is shown. "PHASE" is highlighted.
2.	<b>CHS</b>	A "-" is displayed.
3.	<b>4</b> <b>5</b>	"-45" is displayed.
4.	<b>deg</b>	The phase is accepted, and "-45 deg" is displayed.

## Automatic Phase Calibration

Two HP 3324As can be phase calibrated such that changing the phase of one instrument will alter it in respect to the other. To be able to do this it is necessary to have one of the HP 3324As installed with option 003 (slave), and the other with option 004 (master). If one of the instruments has option 001, High-Stability Frequency Reference, installed then the 10 MHz Oven Output should be connected to the External Reference Inputs of both instruments. Otherwise, the 1 MHz Reference Output of one of the instruments must be connected to the External Reference Input of the other. In both cases the Phase Cal Out of one must be connected to the Phase Cal In of the other and vice versa. Figure 5-3 shows an example of the second method.

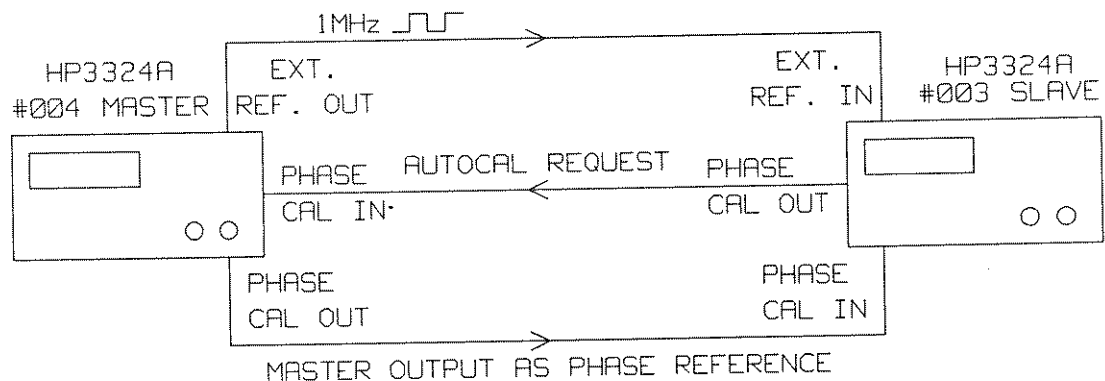

**Figure 5-3. Automatic Phase Calibration Setup**

Pressing the **Phase Cal** key on the slave (the one with option 003 installed) will cause a phase calibration between the two instruments to be performed. "phase calibrat." is shown shortly in the display of the slave, before displaying what was previously shown. The master instrument shows "phase master". Only the rear main output signal of each instrument are calibrated.



## Note



---

A phase calibration can only be performed from the slave (option 003). If the **Phase Cal** key of the master (option 004) is pressed, the error “start from slave” followed by “phase cal failed” is shown.

---

Whenever a frequency or amplitude is changed on one of the instruments then the phase calibration between the two instruments is lost. A new calibration must be started.

### Changing the Output Signal Cable Delay

When an automatic phase calibration option (003 or 004) is installed “Sig.d/ps: n”, where n is a value from 0 to 59999, will be displayed in the UTILS menu. This can be used to account for the delay caused by a difference in length of the cables connecting the device-under-test with the rear-signal output of the two HP 3324A’s containing options 003 and 004. If the two cables are the same then in both HP 3324A’s the “Sig.d/ps:” should be zero. To account for a difference in the cables enter the delay in one instrument with respect to the other, that is enter the delay in the one with the longer cable.

To alter the delay, either modify the present value or type in a new one between 0 and 59999 ps. A phase calibration (Press **Phase Cal**) must then be made to take into account the delay entered.

**Example.** The following example shows how to change the delay caused by a difference in the length of the cables connecting the device-under-test with the rear-signal output of the two HP 3324A’s containing options 003 and 004. Consider the following setup:

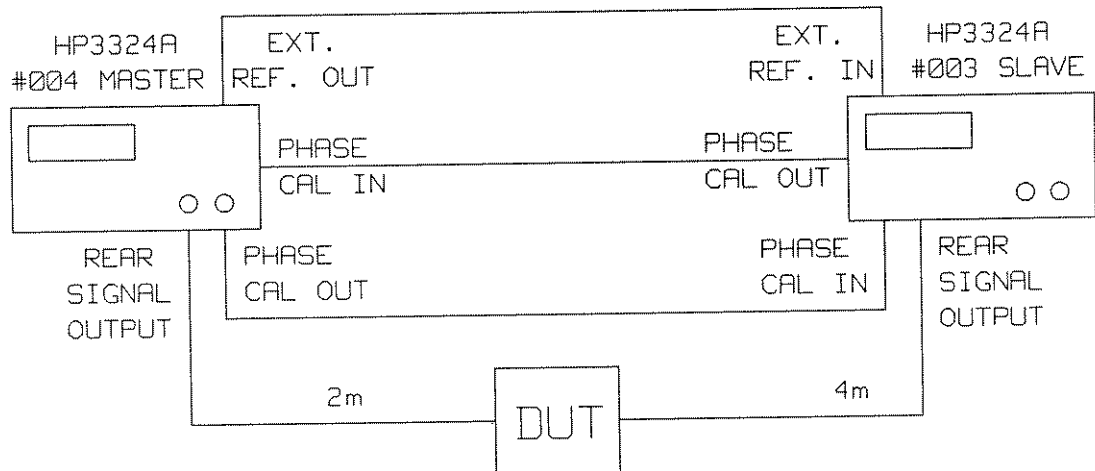

Figure 5-4. Signal Delay Setup

To work out the delay difference of the two instruments, replace the DUT with an oscilloscope.

Keystrokes	Result
1. <b>Util</b>	Press this on both HP 3324A's, so that the utilities menu is accessed.
2. <b>↑</b> or <b>↓</b>	Scroll through the menu on both HP 3324A's until "set default" is shown.
3. <b>↑</b> or <b>↓</b>	Scroll through the menu on both HP 3324A's until "Sig.d/ps:" is shown.
4. <b>Phase Cal</b>	Press this only on the slave instrument, so that an automatic phase calibration is performed. Then either measure the delay between the two signals on the scope, or calculate the delay caused by the difference in length of the cables.
5. <b>Modify</b> <b>Incr</b> or <b>Decr</b>	Do this only on the slave instrument, so that you change the delay due to the longer rear signal output cable of the slave, and modify the value until the required one is shown.
6. <b>Phase Cal</b>	Connecting the DUT to the two HP 3324A's, and press <b>Phase Cal</b> on the HP 3324A slave instrument, to calibrate the two signals.

### Changing the Calibration Cable Delay

When an automatic phase calibration option (003 or 004) is installed "Cal.d/ps: n", where n is a value from 0 to 59999, will be displayed in the UTILS menu. This can be used to account for the delay caused by changing the standard cable (supplied) for connecting the Phase Cal Out of the master (option 004) to the Phase Cal In of the slave (option 003). If the standard cable is used the delay in both instruments must be 0. If the cable is shorter enter a delay in the master instrument, and if the cable is longer enter a delay in the slave instrument.

To alter the delay, either modify the present value or type in a new one between 0 and 59999 ps. A phase calibration (Press **Phase Cal**) must then be made to take into account the delay entered.

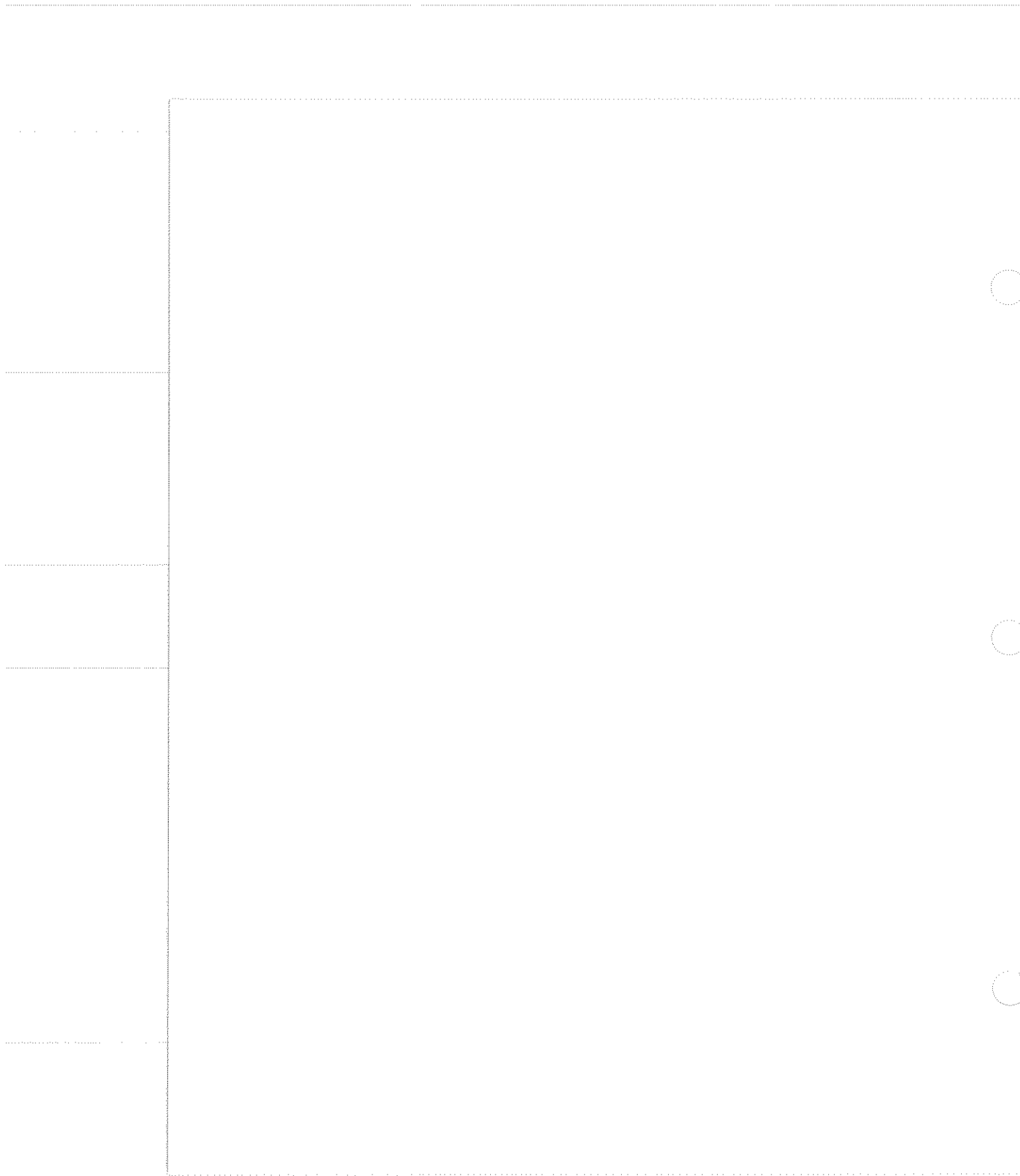

## Waveforms

### Introduction



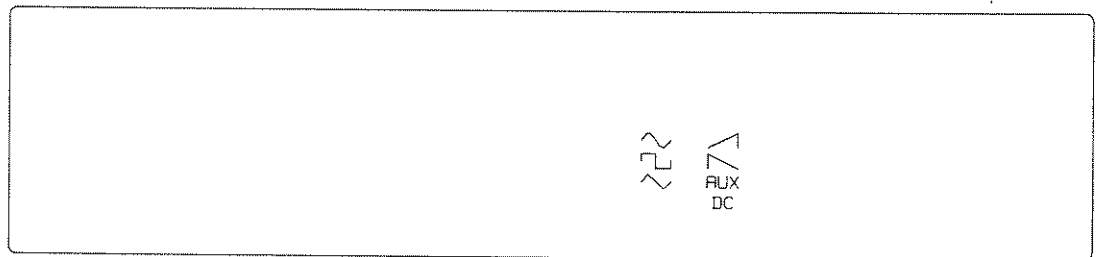

This chapter explains how to use the **WaveForm** key, which is one of the Menu keys.

Press **WaveForm** to display the available waveforms, as shown in Figure 6-1. The meaning of each of the symbols can be seen in Figure 6-2. The waveforms always shown are the sinewave, squarewave, triangle, positive slope ramp, negative slope ramp, auxiliary TTL clock and DC only outputs.



**Figure 6-1. Waveform Display**

The currently activated waveform is shown in full-brightness, and the position of the cursor with blinking. To change the waveform, move the cursor to the required waveform, using **←**, **→**, **↑** and **↓**, and then press **Select**. This waveform is then activated, so long as the frequency set is valid for this waveform. If not, the old waveform remains activated, and an error is shown.

WAVEFORM	SYMBOL
Sinewave	
Squarewave	
Triangle	
Pos. Ramp	
Neg. Ramp	
TTL Output	AUX
DC Output	DC

**Figure 6-2. Waveforms Available**

Once a waveform has been activated, the HP 3324A jumps back to the point (menu) previous to entering the waveform menu, except for the following cases:

- If you were previously in the Sweep menu, and select the "AUX" waveform, the instrument jumps to "FREQ" in the Parameters menu.
- If you were previously in the Sweep menu, and select "DC", the instrument jumps to "OFFS" in the Parameters menu.

If no DC offset has been entered, the output for each waveform function is centered about zero volts.

When "DC" is chosen, only the DC value, set by the DC offset key, **Offs**, is output. All AC functions are turned off.

The auxiliary TTL clock waveform, chosen by “AUX”, is an output that is compatible to TTL levels. Into a 50Ω impedance the high voltage-level is 1.2 V, while into an open impedance, the high voltage-level is 2.4 V. When “AUX” is selected, the main signal output is switched off. A TTL clock signal is output from the sync connectors for frequencies from 1 mHz to 60 MHz. A squarewave signal with an amplitude of 0 dBm is also output from the auxiliary 0 dBm 21 – 60 MHz connector for frequencies from 21 to 60 MHz. The TTL clock waveform cannot be used in the sweep mode, and its amplitude cannot be changed.

### Example

The following example shows how to change the present sinewave output into a negative slope ramp waveform:-

Keystrokes	Result
1. <b>WaveForm</b>	The waveforms are shown. (The sinewave should be blinking. If it isn't move the cursor until it does.)
2. <b>⇒</b>	The cursor moves to the positive slope ramp symbol.
3. <b>⇓</b>	The cursor moves to the negative slope ramp symbol.
4. <b>Select</b>	The negative slope ramp is activated as the output waveform.

### Note



If the error “freq. out range” is shown, it means that the frequency is invalid for the negative slope ramp. Change the frequency to 10 KHz by pressing **Freq** **1** **0** **KHz**, and repeat steps 1 – 4 again.

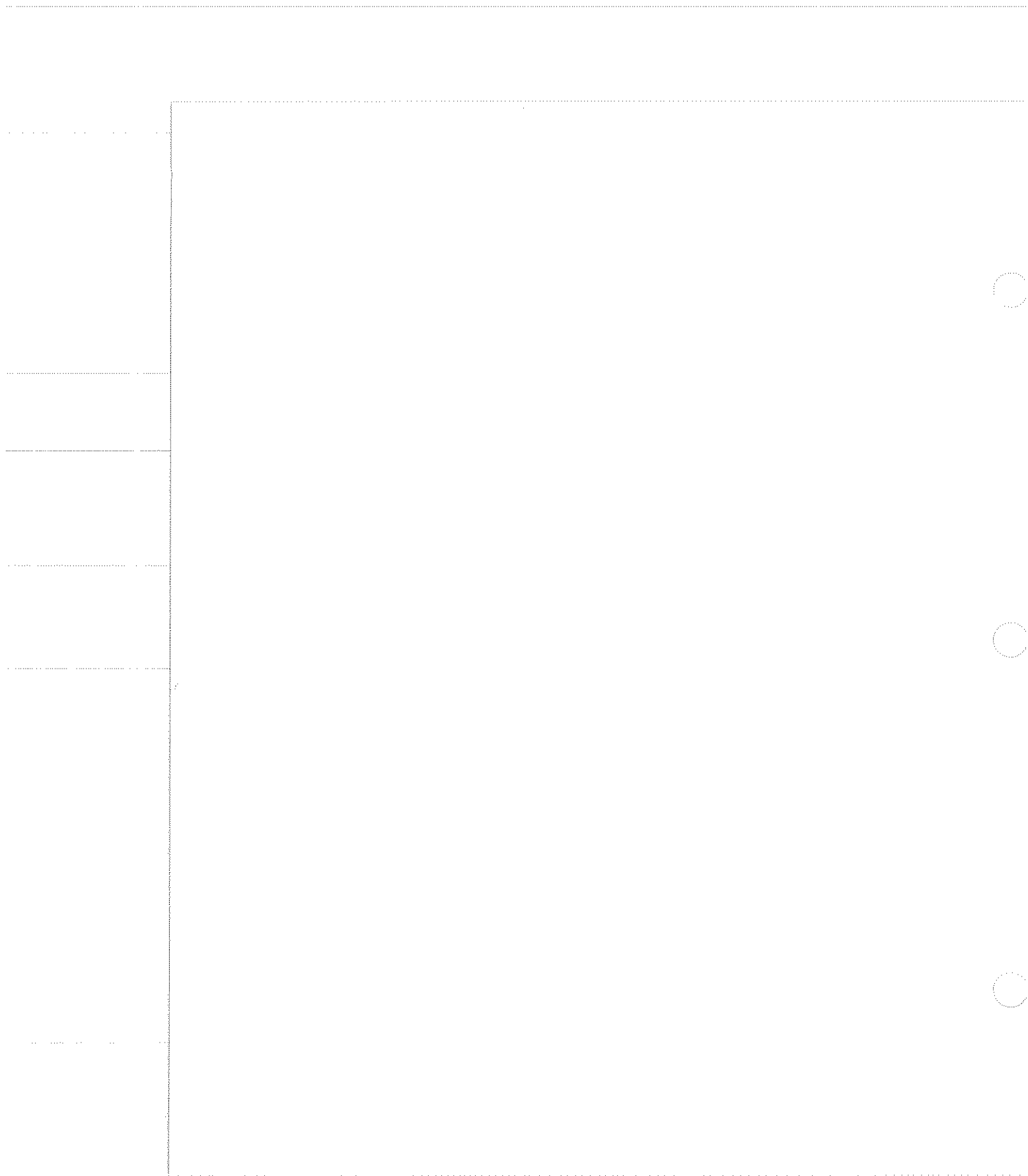



## Sweep

### Introduction

Pressing the **Sweep** key, one of the Menu keys, displays the Sweep menu, an example of which is shown in Figure 7-1.

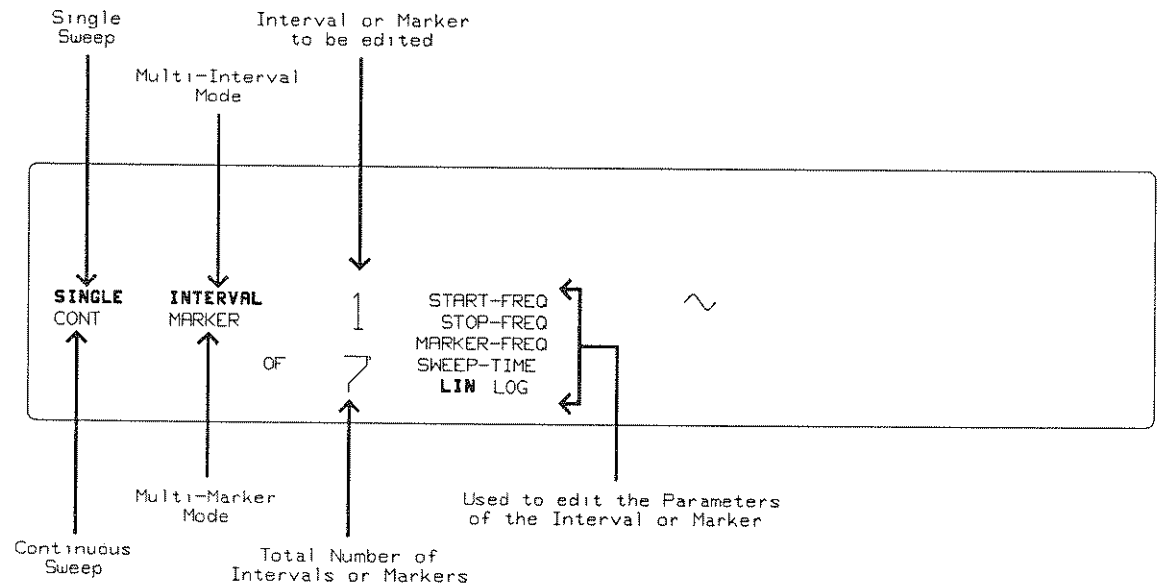

Figure 7-1. The Sweep Menu Display

The activated parameters/modes are shown in full-brightness while the others available in this menu are shown in half-brightness. The position of the cursor is shown by blinking.

The Sweep menu is used to set up the parameters of the sweep that you require. Two different kinds of sweep are available:

- the multi-interval sweep
- the multi-marker sweep

The multi-interval sweep is a sweep consisting of up to 50 individually-programmed (either remotely or from the front panel) intervals (segments). Each interval can be programmed with one marker frequency. This is useful, for example, for simulation of rotating signals for machines, or for PLL-testing.

The multi-marker sweep consists of only one linear interval, but up to 9 markers. This is useful, for example, for the evaluation of filter characteristics, or networks to determine critical frequencies.

When the Sweep menu is first entered after a reset (set default) or a change in the number of stores/intervals then the following default state is given. This is also the case at power-on, if the HP 3324A is in the HP 3325A compatible mode. If not, the instrument is powered up to the settings that were at power-down.

**Table 7-1. Sweep Default State**

<b>Parameter</b>	<b>Default State</b>
Marker/Interval Mode	1 (multi-interval)
No. of stores	10 (0 to 9)
Retrace Time	0 sec. (auto-retrace)
<b>Multi-Interval Sweep:</b>	
Sweep Mode	1 (linear, all intervals)
Start Frequency	1 MHz (all intervals)
Stop Frequency	10 MHz (all intervals)
Marker Frequency	5 MHz (all intervals)
Sweep Time	1 sec. (all intervals)
Activated Intervals	1 (only the first interval)
<b>Multi-Marker Sweep:</b>	
Start Frequency	1 MHz
Stop Frequency	10 MHz
Marker Frequency	5 MHz (all markers)
Sweep Time	1 sec.
Activated Markers	1 (only the first marker)

The start, stop and marker frequencies that can be programmed for an interval depend on the waveform chosen. The frequency ranges are:

**Table 7-2. Frequency Ranges**

Function	Range
Sinewave	0 to 21 000 000.000 Hz
Squarewave	0 to 11 000 000.000 Hz
Triangle	0 to 11 000.000 Hz
Pos. slope ramp	0 to 11 000.000 Hz
Neg. slope ramp	0 to 11 000.000 Hz

Logarithmic sweeps must have a start frequency of at least 1 Hz.

---

## Multi-Interval Sweep

A multi-interval sweep consists of from 1 upto 50 individually-programmed sweep intervals. The number of intervals available for programming can be set in the Utilities menu (see Choosing the Number of Stores/Intervals in chapter 8).

### Note



Changing the number of intervals will cause the HP 3324A to reset all sweep intervals to their default state, and all stores to be cleared, so don't program any intervals until you are sure you have enough available.

Each interval is programmed with its own start frequency, stop frequency, sweep time, marker frequency, and whether it is swept either linearly or logarithmically. A linear interval may be either up or down, this means that the stop frequency may be higher or lower than the start frequency. A logarithmic interval must be a sweep up, that is the stop frequency is higher than the start frequency. It must also have a sweep span of at least a decade.

The following figure shows an example of the three types of interval that can be programmed:

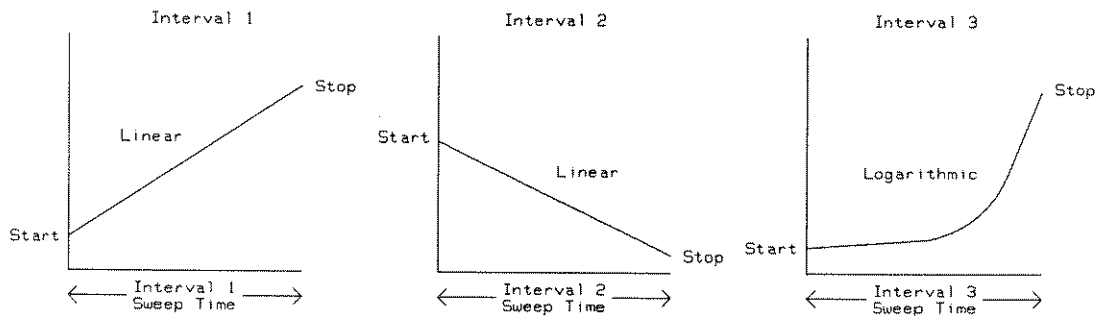

**Figure 7-2. Three Example Intervals**

For each linear interval one marker frequency can be set. Logarithmic intervals will not output a marker signal. The marker frequency must be such that it is either 1.5 ms in time from the start or stop frequency. The actual frequency depends on the start and stop frequencies and the interval sweep time.

For example, consider a start frequency of 0 Hz, a stop frequency of 10 MHz and a sweep time of 10 ms (that means to sweep 1 MHz requires 1 ms). The marker frequency can then be from 1.5 MHz to 8.5 MHz (that means 1.5 ms to 8.5 ms in time).

The marker output is a TTL-compatible output. It is high at the start of each interval, and when the marker frequency is reached it goes low, where it remains until the end of the interval.

Upto 50 individually-programmed intervals may be used in a customized sweep-sequence of upto 100 intervals. Any of the intervals may be used more than once, and the intervals can be programmed in any order (not necessarily the one in which they were programmed). Between each interval in the sequence there is a frequency switching time, depending on the frequency step involved:

- $\leq 12$  ms for a 100 KHz step
- $\leq 27$  ms for a 1 MHz step
- $\leq 72$  ms for a 20 MHz step

An example of a sequence can be shown using the three intervals mentioned earlier in the section. You can program a sequence so that, for example, interval 2, is followed by interval 3, and then comes interval 1. The following will then be output:

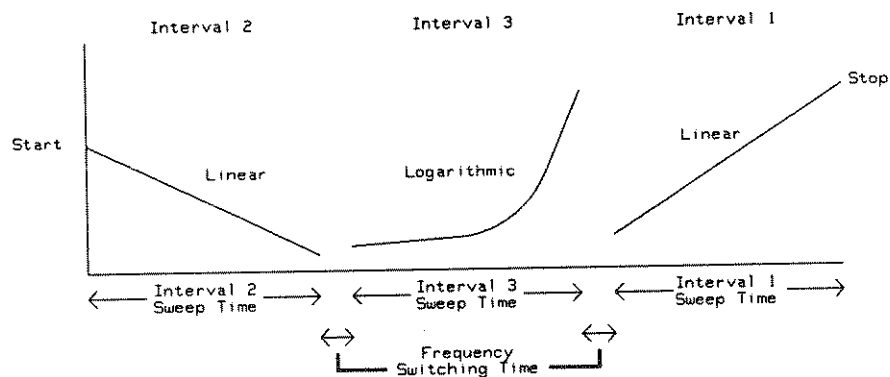

Figure 7-3. An Example Interval Sequence

The sweep sequence (which can consist of one interval) can be swept either singularly or continuously. A single sweep means that the HP 3324A sweeps from the start frequency of the first interval in the programmed sequence to the stop frequency of the last interval in the sequence, and then remains there. A continuous sweep means that the HP 3324A sweeps from the start frequency of the first interval in the programmed sequence to the stop frequency of the last interval in the sequence, and then remains there for a programmed time (retrace time), before starting again at the start frequency of the first interval. The retrace time ranges from 0 to 100,000 s. If a retrace time of 0 to 5 ms is entered, the retrace is automatic. This means that the retrace time is set to the sweep time of the last interval.

### Setting up a Multi-Interval Sequence

This section will show how to set up a multi-interval sweep sequence. Press **Sweep** to show the Sweep menu. To choose the multi-interval mode, put the cursor on "INTERVAL" and press **Select**. A display similar to that in Figure 7-4 will be shown.

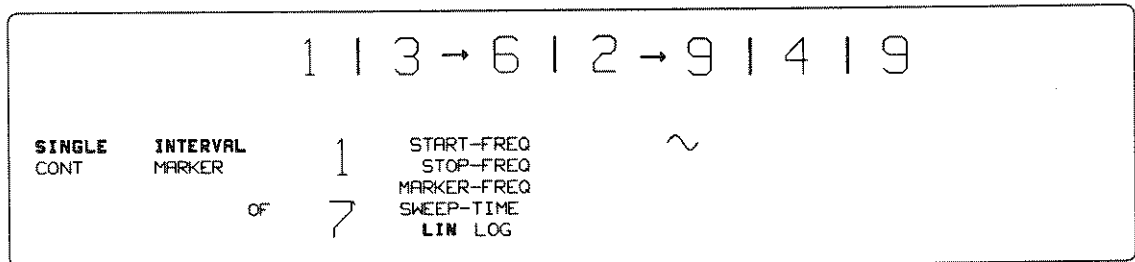

Figure 7-4. The Multi-Interval Display

In the sweep display, two values in the form "nn of xx" are shown (in the above example "nn" = "1" and "xx" = "7"). "nn" means the number of the interval whose parameters you will see if you look at the start frequency, stop frequency and so on. The "xx" means the number of intervals that can be programmed and used in the sweep sequences.

#### Note



If the number of intervals available is not enough for your needs, change the amount required now, because when a change in the number of stores/intervals is made all of the intervals are reset to the default value, and any stores are cleared.

To change the number of stores/intervals, press **Util** and scroll the menu until "sto.: xx int.: xx" is shown. Move the cursor under "int." and enter the value of intervals required. Press **Enter** to confirm this. (To get back to the Sweep menu, press **Sweep**.)



When "INTERVAL" has been selected the current sweep sequence is shown. In the above example that is 1|3→6|2→9|4|9. This means that the sequence 1,3,4,5,6,2,3,4,5,6,7,8,9,4,9 is swept. □ means "and then", while ⇔ means "through". The sequence can be changed with one of two methods:

- Entering a completely new sequence. Type in a new sequence using the data keys (interval numbers, □ and ⇔). Press **Enter** to activate the new sequence.
- Editing the present sequence. Press **Edit** to enter the edit mode. The cursor is placed at the end of the sequence. Move the cursor along the sequence with the ⇐ and ⇒ keys. To delete something from the sequence list, place the cursor on the succeeding character and press **BackSpace**. To add to the sequence list, place the cursor on the succeeding character and type in the new interval number, □ or ⇔.

To set up the parameters of an interval, place the cursor on the current interval number. To change this number either:

- use ↑ and ↓ to increase/decrease the value by one.
- type in the new number and press **Enter**.

If you get the error "invalid interval" this means that the interval that you have chosen does not exist (for example, you have chosen 11 when there are only 10 intervals available).

Having chosen the interval you wish to program, you can move onto changing the parameters. These are the interval start frequency ("START-FREQ"), interval stop frequency ("STOP-FREQ"), interval marker frequency ("MARKER-FREQ"), interval sweep time ("SWEEP-TIME"), linear sweep ("LIN") and logarithmic sweep ("LOG").

To do this press the  $\Rightarrow$  key. You will then move onto some point in the list of start frequency, stop frequency, and so on. The position depends on where the cursor was when you last left and is shown by the parameter blinking. You can then start changing any of the parameters that you wish, by just moving the cursor onto the required parameter, which will display the current value (unless you are on "LIN"/"LOG"). There are three ways to change a value:

- Type in a new value with the numeric keypad, and then press the appropriate unit key.
- Use the MODIFY keys.
- Edit the existing value with the edit function.

To select a linear or logarithmic sweep, put the cursor on "LIN" or "LOG" and press **Select**. If a logarithmic sweep is chosen, there is no need to program a marker frequency as this will not be activated in the logarithmic mode.

In the linear sweep mode, the  $\Delta f \times 2$  and  $\Delta f / 2$  keys may be used to double or halve the sweep bandwidth, respectively. The **Mkr $\rightarrow$ CF** (marker into center frequency) key centers the sweep band on the frequency value of the marker parameter. For more information on these keys see the Sweep Keys section at the end of this chapter.

After choosing a single or continuous sweep by setting the cursor on "SINGLE" or "CONT" and pressing **Select**, you can then start the sweep. Press **Reset Start** twice for a single sweep and just once for a continuous sweep (See the section Sweep Keys at the end of this section for more information on **Reset Start**).

### Example

This example shows how to enter the sweep menu, and set up a continuous multi-interval sweep containing three sweep intervals. The intervals will be swept in the order 2, 3, 1, and the retrace time will be 5 s.

The first thing to do is to enter the Sweep menu, choose the multi-interval mode, and set up the first interval, which will have a start frequency of 1 KHz, a stop frequency of 10 KHz, a marker frequency of 5 KHz, a sweep time of 2 s, and will be linearly swept.

	Keystrokes	Result
1.	<b>Sweep</b>	The Sweep menu is displayed.
2.	Move the cursor to "INTERVAL"	"INTERVAL" blinks.
3.	<b>Select</b>	This chooses a multi-interval sweep and the current sequence is shown.
4.	<b>⇒</b>	The cursor is moved onto the interval number.
5.	<b>↑</b> or <b>↓</b> to change the interval number to "1"	This means that the information that you will enter afterwards, refers to the first programmed interval.
6.	<b>⇒</b> <b>1</b> <b>KHz</b>	This sets a start frequency of 1 KHz for the 1st interval.

### Note



If "START-FREQ" is not blinking at this point, then move the cursor onto it, and type in **1** and **KHz** again.

	Keystrokes	Result
7.	<b>↓</b> <b>1</b> <b>0</b> <b>KHz</b>	This sets a stop frequency of 10 KHz for the 1st interval.
8.	<b>↓</b> <b>5</b> <b>KHz</b>	This sets a marker frequency of 5 KHz for the 1st interval.
9.	<b>↓</b> <b>2</b> <b>s</b>	This sets a sweep time of 2 s for the 1st interval.
10.	<b>↓</b> <b>Select</b> <b>↓</b>	This sets the 1st interval as a linear sweep and puts the cursor on "START-FREQ".

The following figure shows what the display will look like now:

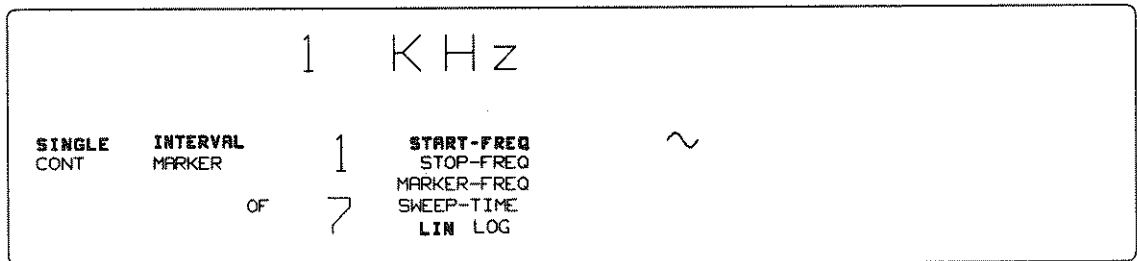

Figure 7-5. Example of 1st Interval

The second interval must now be programmed. It will have a start frequency of 900 Hz, a stop frequency of 10 KHz, a sweep time of 2 s, and will be swept logarithmically.

	Keystrokes	Result
11.		"2" is displayed. This means that the information that you will enter afterwards, refers to the second programmed interval.
12.		This sets a start frequency of 900 Hz for the 2nd interval.
13.		This sets a stop frequency of 10 KHz for the 2nd interval.
14.		This sets a sweep time of 2 s for the 2nd interval.
15.		This sets the 2nd interval as a logarithmic sweep and puts the cursor on "START-FREQ".

The following figure shows what the display will look like now:

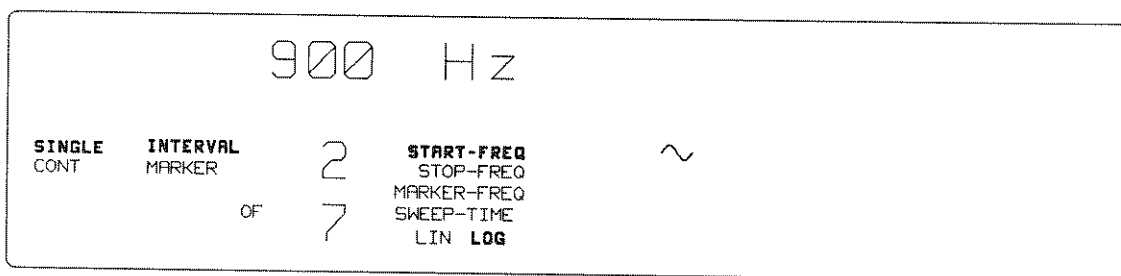

Figure 7-6. Example of 2nd Interval

The third interval must now be programmed. It will have a start frequency of 5 KHz, a stop frequency of 1 KHz, a marker frequency of 3 KHz, a sweep time of 2 s and will be swept linearly.

	Keystrokes	Result
16.	← ↑	"3" is displayed. This means that the information that you will enter afterwards, refers to the third programmed interval.
17.	⇒ 5 KHz	This sets a start frequency of 5 KHz for the 3rd interval.
18.	⇓ 1 KHz	This sets a stop frequency of 1 KHz for the 3rd interval.
19.	⇓ 3 KHz	This sets a marker frequency of 3 KHz for the 3rd interval.
20.	⇓ 2 s	This sets a sweep time of 2 s for the 3rd interval.
21.	⇓ Select ⇓	This sets the 3rd interval as a linear sweep and puts the cursor on "START-FREQ".

The following figure shows what the display will look like now:

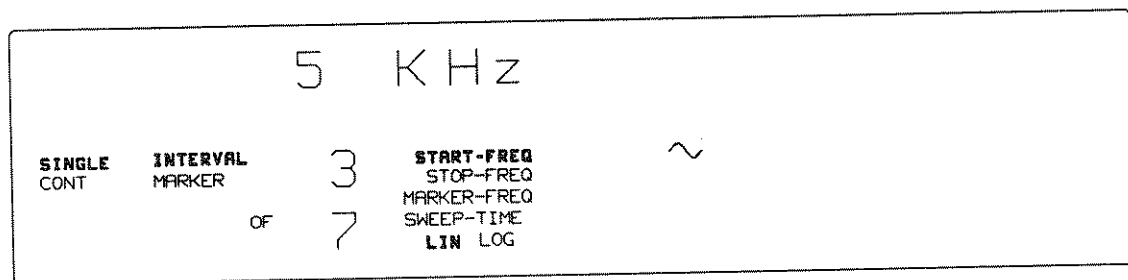

Figure 7-7. Example of 3rd Interval

Now the sequence must be set, the continuous mode chosen with a retrace time of 5 s, and the sweep started.

	Keystrokes	Result
22.	2  3 1 Enter	The interval sequence 2, 3, 1 is entered.
23.	Select	The current retrace time is shown, and a continuous mode has been chosen. "CONT" blinks from nothing to full-brightness.
24.	5 s	The retrace time is changed to 5 sec.
25.	Reset Start	The sweep is started.

## Multi-Marker Sweep

The multi-marker sweep consists of only one linear interval, but upto 9 markers. The frequency for each marker is programmed separately. You can then activate the markers that you require. The marker pulsewidth is approximately 1 ms.

For example consider having programmed the following interval.

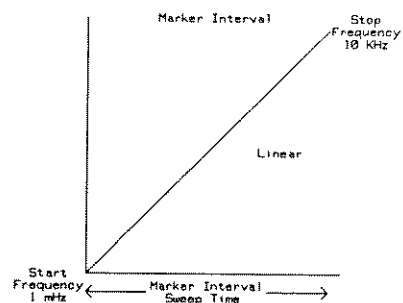

**Figure 7-8. An Example Marker Interval**

You can then program upto 9 marker frequencies. It does not matter which marker has which frequency, as they will be automatically sorted when the marker interval is started. You can then set the instrument so that only certain markers are output during the sweep.

For example, program 9 markers from 1 to 9 KHz in steps of 1 KHz. Then set the marker sequence so that only the odd frequencies are activated. You would then get the following marker signals:

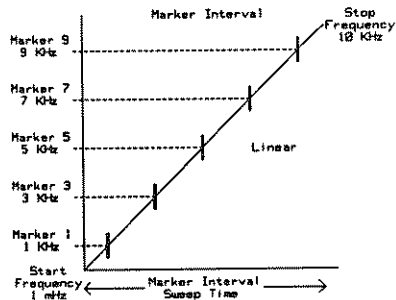

**Figure 7-9. An Example Marker Sequence**

**Note**



There is a minimal time difference of 1.5 ms between start- and marker-, marker- and marker-, and marker- and stop-frequencies. If a marker is too close to the start- or stop-frequency, it is not generated. If two markers are too close the second one (in time) is not generated.

The actual marker frequencies allowed depend not only on the start and stop frequencies, but also on the sweep time (the smaller the sweep time, the further apart the markers must be in the frequency domain). For example, consider a start frequency of 1 MHz, a stop frequency of 8.5 MHz and a sweep time of 8.5 ms (that means to sweep 1 MHz requires 1 ms). The marker frequencies can then be set at 1.5 MHz, 3 MHz, 4.5 MHz, 6 MHz, and 7 MHz (that means 1.5, 3, 4.5, 6, 7.5 ms in time). If the sweep time is 8.5 s (that means to sweep 1 MHz requires 1 s) the first marker can be set at 1.5 KHz, and the last one at 8.4985 MHz.

The marker output is a TTL-compatible output. It is high at the start of each interval, and when the marker frequency is reached it goes low for 1 ms, and then goes high again.



The marker interval can be swept either singularly or continuously. A single sweep means that the HP 3324A sweeps from the start frequency of the interval to the stop frequency, and then remains there. A continuous sweep means that the HP 3324A sweeps from the start frequency of the interval to the stop frequency, and then remains there for a programmed time (retrace time), before starting again at the start frequency. The retrace time ranges from 0 to 100,000 s. If a retrace time of 0 to 5 ms is entered, the retrace is automatic. This means that the retrace time is set to the sweep time of the interval.

### Setting up a Multi-Marker Interval

This section will show how to set up a multi-marker interval. Press **Sweep** to show the Sweep menu. To choose the multi-marker mode, put the cursor on "MARKER" and press **Select**. A display similar to that in Figure 7-10 will be shown.

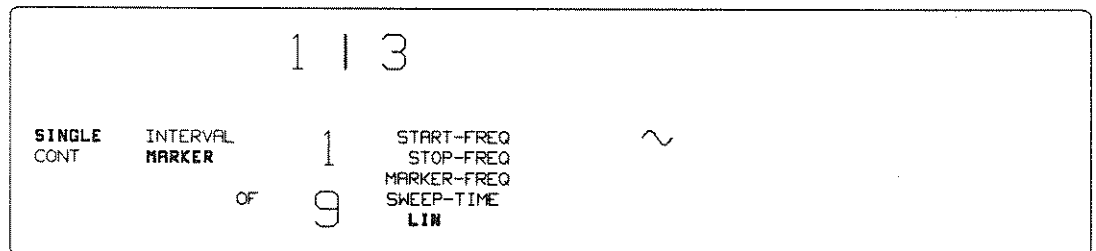

Figure 7-10. The Multi-Marker Display

In the sweep display, two values in the form “n of 9” are shown (in the above example “n” = “1”). “n” means the number of the marker whose frequency you will see if you put the cursor onto the marker frequency. The “9” is the number of markers that can be programmed and activated in the multi-marker interval.

The currently activated markers are shown. In the example display that means that marker 1 and marker 3 are activated. The markers activated can be changed with one of two methods:

- Entering the markers completely new. Type in the new markers using the data keys (interval numbers,  and ). Press  to activate the new markers.
- Editing the presently activated markers. Press the  key to enter the edit mode. The cursor is placed at the end of the list. Move the cursor along the list with  and  keys. To delete something from the list, place the cursor on the succeeding character and press . To add to the list, place the cursor on the succeeding character and type in the new marker number,  or .

To set up the marker frequency for the different markers you must place the cursor on the current marker number. To change this number either:

- use  and  to increase/decrease the value by one, or
- type in the new number and press .

If you get the error “invalid marker” this means that the marker that you have chosen does not exist (for example you have chosen 11 when there are only 9 markers available).

Having chosen the marker number you wish to program, you can move onto changing the frequency. To do this press **(⇒)**. You will then move onto the marker frequency. You can then change the frequency by either:

- Typing in a new value with the numeric keypad, and then pressing the appropriate unit key.
- Using the MODIFY keys.
- Editing the existing value using the edit function.

The start and stop frequencies, and sweep time of the interval can be changed when any of the marker frequencies is being looked at or changed. To do this place the cursor on the parameter to be changed and change it by doing either of the above. The interval is always swept linearly.

After choosing a single or continuous sweep by setting the cursor on "SINGLE" or "CONT" and pressing **(Select)**, you can then start the sweep. Press **(Reset Start)** twice for a single sweep and just once for a continuous sweep (See the section Sweep Keys at the end of this section for more information on **(Reset Start)**).

### Example

This example shows how to enter the sweep menu, and set up a single multi-marker sweep containing three markers. The start frequency will be 1 KHz, the stop frequency 10 KHz, and the sweep time 10 s. The markers will have the frequencies 3 KHz, 5 KHz and 7 KHz.

	Keystrokes	Result
1.	<b>Sweep</b>	The Sweep menu is displayed.
2.	Move the cursor to "MARKER"	"MARKER" blinks.
3.	<b>Select</b>	This chooses a multi-marker sweep and the currently activated markers are shown.
4.	<b>1</b> <b>→</b> <b>3</b> <b>Enter</b>	The markers 1, 2 and 3 are activated.
5.	<b>⇒</b>	The cursor is moved onto the marker number.
6.	<b>↑</b> or <b>↓</b> to change the marker number to "1"	This means that any marker information that you will enter afterwards, refers to the first marker.
7.	<b>⇒</b> <b>↑</b> <b>↑</b> <b>1</b> <b>KHz</b>	This sets a start frequency of 1 KHz for the interval.
8.	<b>↓</b> <b>1</b> <b>0</b> <b>KHz</b>	This sets a stop frequency of 10 KHz for the interval.
9.	<b>↓</b> <b>↓</b> <b>1</b> <b>0</b> <b>s</b>	This sets a sweep time of 10 s for the interval.
10.	<b>↑</b> <b>3</b> <b>KHz</b>	This sets a marker frequency of 3 KHz for the 1st marker.
11.	<b>←</b> <b>↑</b> <b>⇒</b> <b>5</b> <b>KHz</b>	This sets a marker frequency of 5 KHz for the 2nd marker.
12.	<b>←</b> <b>↑</b> <b>⇒</b> <b>7</b> <b>KHz</b>	This sets a marker frequency of 7 KHz for the 3rd marker.

The following display will be shown:

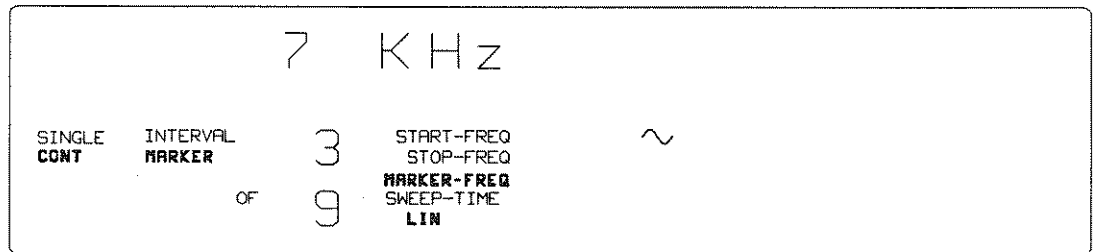

Figure 7-11. Marker Interval Example

A single sweep has to be chosen now and the sweep started.

- |     | Keystrokes  | Result                                     |
|-----|---|--|
| 13. | <input type="button" value="←"/> <input type="button" value="←"/> <input type="button" value="←"/> <input type="button" value="↑"/> <input type="button" value="Select"/> | A single sweep is chosen. "SINGLE" blinks. |
| 14. | <input type="button" value="Reset Start"/> <input type="button" value="Reset Start"/>   | The sweep is started.                      |

---

## The Sweep Keys

This section explains the use of the sweep keys placed to the right of the front panel.



Figure 7-12. The Sweep Keys

**Reset Start**

Once a sweep has been defined it can then be started. This is done using the **Reset Start** key. The **Reset Start** key performs three functions for the sweep operations:

- If a continuous or single sweep is in progress, **Reset Start** cancels the sweep. The signal then output is the current waveform at the frequency at which the sweep was stopped. Pressing **Reset Start** again will cause the sweep to be reset to the start of the sweep.

### Note



A sweep can also be stopped by pressing the **Freq** key. The signal then output is the current waveform at the frequency at which the sweep was stopped, that is when **Freq** was pressed.

- For single sweeps, the first press of the **Reset Start** key resets the sweep to the start of the sweep. Pressing the key again will cause the sweep to begin.
- For continuous sweeps, the first press of the **Reset Start** key resets the sweep to the start of the sweep and begins the sweep.

If a sweep has been stopped, reset or started can be seen on the right of the display, where an arrow is shown next to either “Reset”, “Run” or “Stop”.

$\Delta f \times 2$   $\Delta f / 2$

In the multi-interval linear sweep mode, the  $\Delta f \times 2$  and  $\Delta f / 2$  keys may be used to double or halve the sweep bandwidth, respectively. If one of the absolute sweep frequency limits (0 and 21 MHz for a sinewave) is exceeded, the new interval is clipped. The required span is maintained if possible (marker does not equal center frequency). If the new span is greater than the limit, then it is clipped to the limit (for example, for the sinewave, if the span exceeded 21 MHz, it would be clipped to 21 MHz).

#### Example

Consider the parameters start frequency 1 MHz, marker frequency 3 MHz, and stop frequency 5 MHz. Pressing  $\Delta f \times 2$  would cause the parameters to change to 0 MHz, 3 MHz, and 8 MHz.

$MKR \triangleright CF$

The  $MKR \triangleright CF$  (marker into center frequency) key centers the sweep band on the frequency value of the marker parameter in the multi-interval mode. The key is selected by pressing the blue  $\text{Shift}$  key followed by the  $\text{Reset Start}$  key. If, after moving the interval around the marker frequency, either the start or stop frequency exceeds 0/21 MHz, the span is reduced to allow a symmetric interval.

#### Example

Consider the parameters start frequency 0 MHz, marker frequency 3 MHz, and stop frequency 8 MHz. Pressing  $MKR \triangleright CF$  would cause the parameters to change to 0 MHz, 3 MHz, and 6 MHz. The center is maintained, while the span is changed.

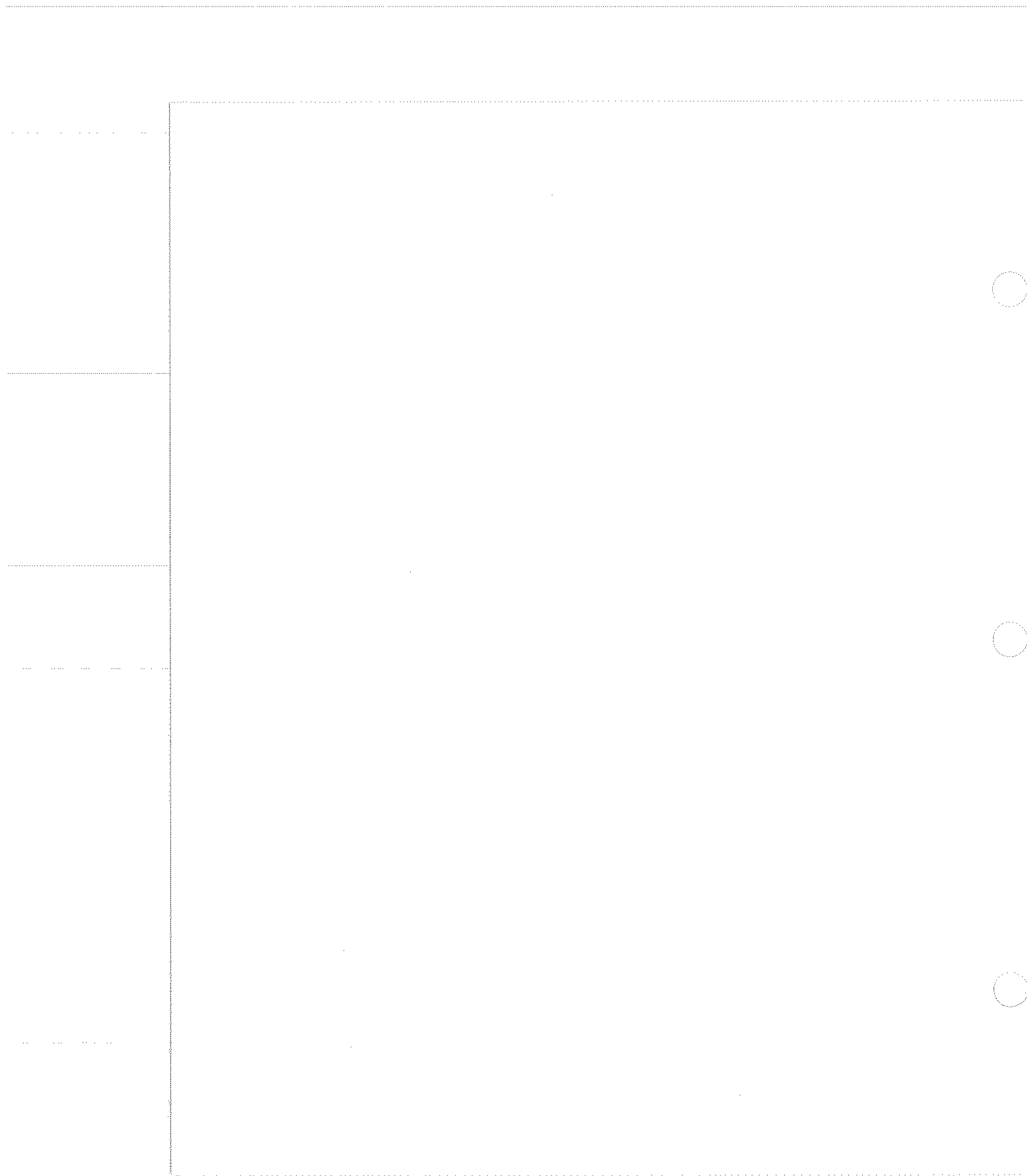



## Utilities

---

### Introduction

The utilities menu is accessed by pressing **Util**. In the display one of the parts of the menu is shown, which one depends on where the menu was last left. To access the other parts, scroll through the menu using the **↑** and **↓** arrow keys.

---

### Setting the Default Parameters

The instrument's parameters are set to their default values if "set default" is displayed and **Select** is pressed. The default parameters are shown in Table 8-1.

#### Note



Setting the HP 3324A to default will cause the instrument to clear all its stores.

---

**Table 8-1. Parameter Default Values**

Parameter	Default
Function	Sine
Frequency	1000 Hz
Amplitude	1 mV(p-p)
Phase	0 degrees
DC Offset	0 V
Selected Output	1 (front)
Output	1 (on)
Marker/Interval Mode	1 (multi-interval)
No. of stores	10 (0 to 9)
Retrace Time	0 sec. (auto-retrace)
<b>Multi-Interval Sweep:</b>	
Sweep Mode	1 (linear, all intervals)
Start Frequency	1 MHz (all intervals)
Stop Frequency	10 MHz (all intervals)
Marker Frequency	5 MHz (all intervals)
Sweep Time	1 sec. (all intervals)
Activated Intervals	1 (only the first interval)
<b>Multi-Marker Sweep:</b>	
Start Frequency	1 MHz
Stop Frequency	10 MHz
Marker Frequency	5 MHz (all markers)
Sweep Time	1 sec.
Activated Markers	1 (only the first marker)

---

## Choosing the Number of Stores/Intervals

When “sto: xx int: xx” is shown in the display the number of stores or intervals can be set. The number of stores refers to the number of memories available for storing instrument settings in. The number of intervals refers to the number of sweep intervals which can be defined.

Both of these parameters are coupled so that increasing one will decrease the other. The pairing is:

**Table 8-2.**  
**Number of Stores/Number of Intervals**

Number of Stores	Number of Intervals
10	7
9	8 - 9
8	10
7	11 - 12
6	13 - 15
5	16 - 19
4	20 - 23
3	24 - 30
2	31 - 39
1	40 - 50

### Note



Changing either the number of stores or intervals will cause the HP 3324A to reset all sweep intervals to their default state, and all stores to be cleared.

**Recommendation:** Use this command sparingly and only when absolutely necessary.

---

## Changing the HP-IB Address

If you wish to change the HP-IB address, scroll the utilities menu until "HPIB addr.: xx" is shown. Type in the address number required (0 to 30) and then press **Enter**.

The HP 3324A refuses to accept a new HP-IB address if it is in the remote state, or if it is addressed either as a listener or as a talker. Un-address the HP 3324A (via the controller) before changing the HP-IB address.

The default HP-IB address is 17.

---

## Choosing HP 3325A Compatibility

The HP 3324A can be set so that at power-on, it powers up just like the HP 3325A. This means that in the compatible mode the main output signal is enabled and the instrument is reset to its default setting, including clearing all of the instrument states stored. In the non-compatible mode at power-on, the main output signal is disabled, the instrument is turned on with the settings used previous to power-down, and none of the stores are cleared. Also, for the compatible mode log intervals in a continuous sweep are always approximated using two linear segments. In the non-compatible mode for a continuous sweep, the log intervals are approximated as in a single sweep for sweep times  $\geq 1$  s. For sweep times  $< 1$  s (down to 0.1 s) the two linear segment approximation is used.

To change the mode, display "compatib.: yes/NO" from the utilities menu. Place the cursor on the required mode and press **Select**. The activated mode is then shown in the uppercase and the other in the lowercase.

---

## Performing a Self-test

Two levels of self-test are available, a standard one and one in which everything is tested. The standard test is a simple pass or fail test, whereas the “all” test is one in which the reason for a failure is given. The “all” test is also an interactive test. If an error is shown return the instrument to an HP Service Center for repair.

To perform one of the self-tests, display “self: std./all” in the display. Place the cursor on the self-test that you wish to perform and press **Select**.

### Note



---

The “all” self-test performs a reset (as at power-on) and cannot be selected via HP-IB.

---

---

## Checking for Option 003 or Option 004

If you have the phase calibration options 003 or 004 installed in some instruments you can check to see what is installed by scrolling in the UTILS menu, until either “phase cal SLAVE” or “phase cal MASTER” is shown. “phase cal SLAVE” means that option 003 is installed and “phase cal MASTER” means that option 004 is installed. If neither options are installed, neither of these two statements are shown. See Automatic Phase Calibration in Chapter 5 for a description of how the calibration works.

---

## Changing the Output Signal Cable Delay

When an automatic phase calibration option (003 or 004) is installed "Sig.d/ps: n", where n is a value from 0 to 59999, will be displayed in the UTILS menu. This can be used to account for the delay caused by a difference in length of the cables connecting the device-under-test with the rear-signal output of the two HP 3324A's containing options 003 and 004. If the two cables are the same then in both HP 3324A's the "Sig.d/ps:" should be zero. To account for a difference in the cables enter the delay in one instrument with respect to the other, that is enter the delay in the one with the longer cable.

To alter the delay, either modify the present value or type in a new one between 0 and 59999 ps. A phase calibration (Press **Phase Cal**) must then be made to take into account the delay entered. For an example of how to do this see Automatic Phase Calibration in Chapter 5.

---

## Changing the Calibration Cable Delay

When an automatic phase calibration option (003 or 004) is installed "Cal.d/ps: n", where n is a value from 0 to 59999, will be displayed in the UTILS menu. This can be used to account for the delay caused by changing the standard cable (supplied) for connecting the Phase Cal Out of the master (option 004) to the Phase Cal In of the slave (option 003). If the standard cable is used the delay in both instruments must be 0. If the cable is shorter enter a delay in the master instrument, and if the cable is longer enter a delay in the slave instrument.

To alter the delay, either modify the present value or type in a new one between 0 and 59999 ps. A phase calibration (Press **Phase Cal**) must then be made to take into account the delay entered. See Automatic Phase Calibration in Chapter 5.

---

## Checking the Software Revision

In the utilities menu, one of the parts of the menu shows the software revision incorporated in the HP 3324A. Scroll the menu until "ROM rev. : x.x" is displayed. This is the software revision.

---

## Switching the High-Voltage Output On

If the high-voltage option 002 is installed, it can be either enabled or disabled as the main output signal. Scroll the utilities menu until "highvolt: ON/off" is displayed. Place the cursor on either "on" or "off" and press **Select**. The mode chosen is then shown in the uppercase and the other in the lowercase.

If the option is switched on "HIGH-VOLT" is shown in the display.

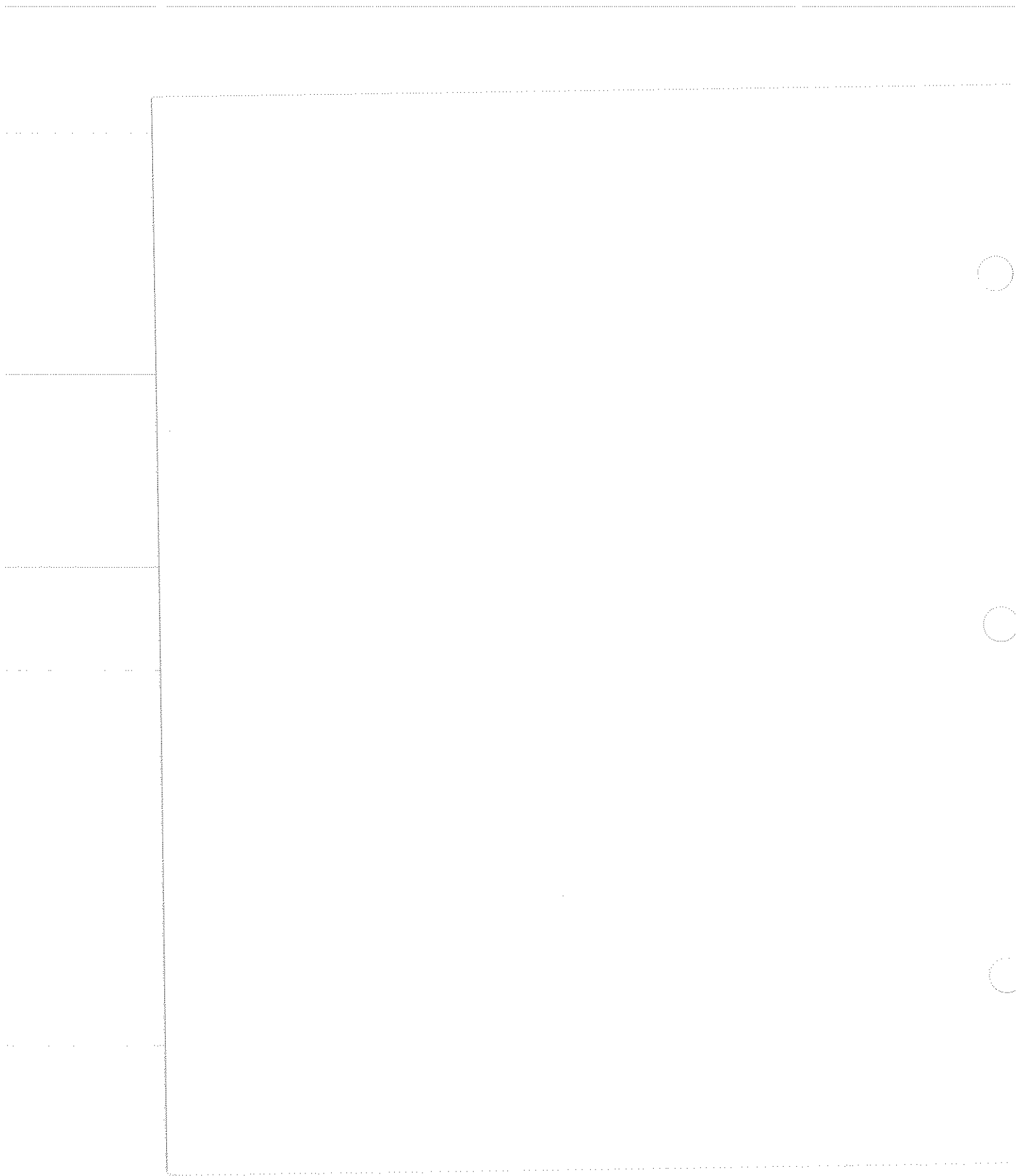



## Programming the HP 3324A

---

### Introduction

This chapter gives information on how to control the HP 3324A using a controller. For a list of the commands specific to the HP 3324A, see Chapter 11 and Appendix E. Programming information in this chapter is restricted to HP 3324A specifics and assumes that you have a working knowledge of HP-IB intrinsics. If you are not familiar with HP-IB, then refer to Appendix D and the following publications:

- HP publication 5952-0156, "Tutorial Description of HP-IB"
- ANSI/IEEE-488-1978, "Digital Interface for Programmable Instrumentation" published by the Institute of Electrical and Electronic Engineers

A complete syntax list of the HP 3324A programming commands can be found in Appendix E.

---

### The HP 3324A HP-IB Capabilities

The HP 3324A interfaces to the HP-IB as defined by the IEEE Standard 488.1. The interface functional subset which the HP 3324A implements is specified in Table 9-1.

**Table 9-1. HP-IB Capabilities**

Mnemonic	Function
SH1	Complete source handshake capability
AH1	Complete acceptor handshake capability
T6	Basic talker; serial poll; unaddressed to talk if addressed to listen; no talk only
L4	Basic listener; unaddressed to listen if addressed to talk; no listen only
SR1	Complete service request capability
RL1	Complete remote/local capability
PP0	No parallel poll capability
DC1	Device clear capability
DT1	Device trigger capability (accepted but ignored)
C0	No controller capability
E1	Driver electronics - open collector

---

## The Interpreter

The HP 3324A uses an interpreter that is mnemonic compatible to the HP 3325A.

### Note



Execution times for the HP 3324A HP-IB commands are slower than those for the HP 3325A. To make sure that a command has been processed, check the “Busy” bit in the status byte.

---

Chapter 11 and Appendix E show which HP 3324A commands are compatible to the HP 3325A and which are not.

The interpreter has a reset state which is entered once a reset signal (DCL or SDC) has been received from the HP-IB. These reset conditions are:

## 9-2 Programming the HP 3324A

**Table 9-2. Interpreter Reset State**

<b>Parameter</b>	<b>Reset State</b>
Function	Sine
Frequency	1000 Hz
Amplitude	1 mV(p-p)
Phase	0 degrees
DC Offset	0 V
Selected Output	1 (front)
Output	1 (on)
Marker/Interval Mode	1 (multi-interval)
No. of stores	10 (0 to 9)
Retrace Time	0 sec. (auto-retrace)
<b>Multi-Interval Sweep:</b>	
Sweep Mode	1 (linear, all intervals)
Start Frequency	1 MHz (all intervals)
Stop Frequency	10 MHz (all intervals)
Marker Frequency	5 MHz (all intervals)
Sweep Time	1 sec. (all intervals)
Activated Intervals	1 (only the first interval)
<b>Multi-Marker Sweep:</b>	
Start Frequency	1 MHz
Stop Frequency	10 MHz
Marker Frequency	5 MHz (all markers)
Sweep Time	1 sec.
Activated Markers	1 (only the first marker)
Data Transfer Mode	1 (unbuffered)
SRQ Mask	"@" (all SRQ disabled)
Default Mnemonic	FR (see section "Omitting the Mnemonic")

---

## HP-IB Display Indicators

The following list explains the indicators that can be seen in the display when the HP 3324A is being controlled remotely.

- “REMOTE” “REMOTE” is displayed when the HP 3324A is operating under remote control. While in remote (and local lockout is not in effect), only the **Local** key is recognized.
- “SRQ” The SRQ (service request) indicator is shown when the HP 3324A has requested service.
- “TLK” The talk indicator is shown when the HP 3324A is addressed to talk over the HP-IB.
- “LST” The listen indicator is shown when the HP 3324A is addressed to listen over the HP-IB.

## Accepted Characters

Table 9-3 lists all of the characters allowed by the interpreter. Note that all letters must be sent in the upper case, as lower case letters are ignored.

**Table 9-3. Accepted Characters**

Character	Description
HT, LF, CR, space	White spaces
“*”	Block terminator
“+”	Plus sign
“-”	Minus sign / Range separator
“ ”	Item separator
“.”	Decimal point
“0” - “9”	Digits / Integer
“,”	List terminator
“@” - “Z”	Letters

## HP-IB Messages

Table 9-4 shows which HP-IB messages are implemented/not implemented in the interpreter.

**Table 9-4. HP-IB Messages**

Command	Description	Treatment
DAB	Data byte	Implemented as usual
DCL	Device clear	Sets 3324 into reset state, see section "The Interpreter"
EOI	End or identify	End is treated as white space
GET	Group execute trigger	Not implemented
GTL	Go to local	Transparent to the interpreter
IFC	Interface clear	Transparent to the interpreter
LAG	Listen address group	Transparent to the interpreter
LLO	Local lock out	Transparent to the interpreter
MLA	My listen address	Not implemented
MTA	My talk address	Not implemented
PPC	Parallel poll config.	Not implemented
PPD	Parallel poll disable	Not implemented
PPE	Parallel poll enable	Not implemented
PPU	Parallel poll unconfig.	Not implemented
PPOLL	Parallel poll	Not implemented
REN	Remote enable	Transparent to the interpreter
SDC	Selected device clear	See DCL
SPD	Serial poll disable	Transparent to the interpreter
SPE	Serial poll enable	Transparent to the interpreter
TAD	Talk address	Transparent to the interpreter
TCT	Take control	Not implemented
UNL	Unlisten	Transparent to the interpreter
UNT	Untalk	Transparent to the interpreter

---

## Command Groups and Data Transfer Modes

The HP 3324A works in two separate data transfer modes. In mode 1, the unbuffered mode, commands are executed as soon as they are received. In mode 2, the buffered mode, the execution control depends on the command group to which a command belongs. See Chapter 11 for a list of the commands and their command groups.

### Group 0:

all commands are executed immediately (as in mode 1). All queries belong to this group.

### Groups 1,2 and 3:

all commands are not executed immediately, but are buffered until either the block terminator "\*" is received or a command from a different group is recognised (including 0).

An example of the way in which a mode 2 operates can be seen in the next command string:

```
"MD2 FU1 FR12.3MH PH5DE AM2VO OF1VO ST2,3MH  
SP2,5MH *"
```

The following happens inside the HP 3324A:

Command	Command Group	Treatment
MD2	Group 0	Executed immediately, HP 3324A is put into mode 2.
FU1	Group 1	Command is remembered but not executed.
FR12.3MH	Group 1	Command is remembered but not executed.
PH5DE	Group 0	Commands "FU1" and "FR12.3MH" are executed, along with command "PH5DE".
AM2VO	Group 1	Command is remembered but not executed.
OF1VO	Group 1	Command is remembered but not executed.
ST2,3MH	Group 2	Commands "AM2VO" and "OF1VO" are executed, command "ST2,3MH" is remembered but not executed.
SP2,5MH	Group 2	Command is remembered but not executed.
*	Block Terminator	Commands "ST2,3MH" and "SP2,5MH" are executed.

The data transfer mode 2, can be used to avoid parameter incompatibility errors.

Consider the following command string:

"FR12MH FU1"

In data mode 1, if the currently selected waveform is a sinewave, then the command will be executed. However, if the waveform is not a sinewave, then there will be an error, because the frequency is changed first and only a sinewave can have a 12 MHz frequency.

In data mode 2, these commands will always work.



A problem with the data transfer mode 2 is the effect of “non-coupling” errors. For example, consider the following command string:

“FU1 AM1V0 FR200MH OF1.33V0 \*”

The string “FR200MH” is syntactically correct, but it will always cause an execution error, as 200 MHz is illegal. This is a non-coupling error. The result is that all commands remembered and not executed, in this case, everything upto and including the error string, will be forgotten. Only “OF1.33V0” is executed (if it is still compatible with the unchanged amplitude).

In data transfer mode 1, the only command that will not be executed is the string “FR200MH”.

The following events will cause remembered, but not executed commands to be lost:

- power off
- remote to local change, initiated either locally or from remote
- an error while executing one of the remembered commands.

---

## Omitting the Mnemonic

It is possible to omit the mnemonic in a command. If the interpreter receives a numeric data element without a preceding mnemonic, it takes the last received mnemonic as default (only if the last received mnemonic accepts a numeric argument). From this point the interpreter behaves as if the mnemonic has been received in the normal manner.

We do not recommend you to use this feature, as it can cause problems when synchronizing after a syntax error.

An example of how to use the feature is, assume you have an automated test environment where you want to do some measurements with stimulus frequencies of 1, 2 and 3 MHz. This could be done in the following way:

```
Send program string "FR1MH"  
Do measurement  
Send program string "2MH"  
Do measurement  
Send program string "3MH"  
Do measurement
```

---

## Synchronizing after a Syntax Error

All interpreters/compiler have the problem of synchronizing themselves after a syntax error, with the incoming stream of characters. The HP 3324A interpreter scans the input stream after the error until it finds a valid mnemonic.

For example, consider the following string:

`"FRQ1.33MH AM2V0"`

The syntax error occurs after FR (the Q should not be there). The 1.33MH is lost, as the interpreter synchronizes on the AM.

---

## Setting the HP-IB Address

The HP-IB address can only be set from the front panel. Press the **Util** key and use the **↑** and **↓** keys to move around the menu so that the HP-IB address is shown in the display. To change the address, type in the required address with the keypad, and then press **Enter**.

The HP-IB refuses to accept a new HP-IB address if it is either in the remote state, or if it is addressed either as a listener or as a talker. Un-address the HP 3324A (via controller) before changing the address.

The default HP-IB address is 17.

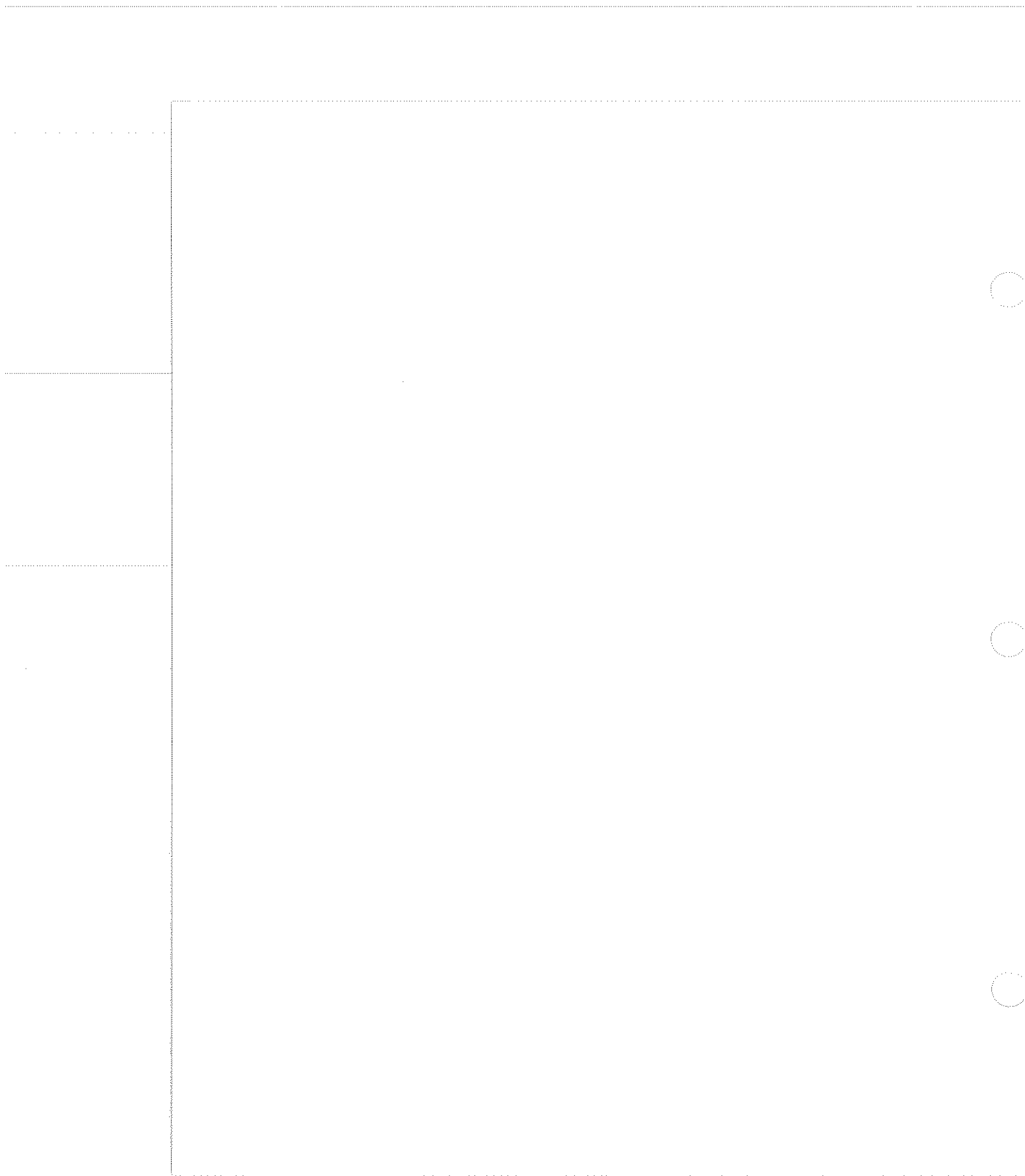

## Status Reporting

---

### Introduction

Another important feature of the HP 3324A is that you can program it to interrupt the controller when certain status/error conditions are met.

An 8-bit register, the Status Byte, contains the instrument's status.

In order for an interrupt to occur, it must be programmed via the Service Request Enable Mask. To see how to set the mask, see Service Request Enable.

At power-on the mask is reset to a value of 0.

---

### Status Byte

The Status Byte Register reflects the status of the instrument. The following diagram shows which bit of the Status Byte is allocated to which interrupt condition:

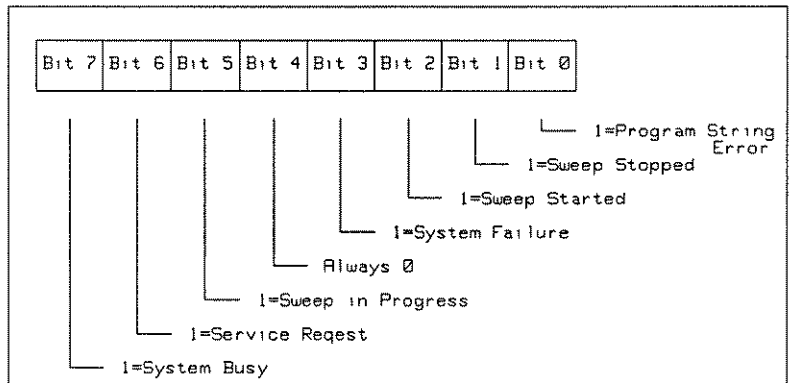

**Figure 10-1. The Status Byte**

**10-2 Status Reporting**

**Table 10-1. HP 3324A Status Byte Description**

Bit	Value	Description
0	1	<b>Program String Error.</b> Command string error. Use IER to query error number. Cleared by a serial poll or power on. Not cleared by HP-IB clear or IER command.
1	2	<b>STOP.</b> Sweep stopped; set by completion of a single sweep, or command that stops a sweep. Cleared by a serial poll.
2	4	<b>Start.</b> Sweep started; set when a single or continuous sweep starts. Cleared by a serial poll, completion of a single sweep, or any command that stops a sweep.
3	8	<b>Fail.</b> System failure; set by self-test failure, calibration failure, external reference unlock, or main oscillator unlock.
4	16	<b>Bit 4.</b> Always zero.
5	32	<b>Sweep.</b> Set when a sweep is in progress, clear when a sweep is in progress. Cannot be configured to cause an SRQ.
6	64	<b>Require Service.</b> Set when the HP 3324A requires service (sent SRQ).
7	128	<b>Busy.</b> Set while a command is being executed, clear when instrument is not busy. Cannot be configured to enable an SRQ.

The program string error bit is set when a command string is received that the interpreter does not understand, or when a command is not executable for some reason. When the "IER" query is sent, an error number will be returned, with the following meanings:

<b>Error Number</b>	<b>Error Description</b>
1	Entry parameter out of bounds
2	Invalid delimiter
3	Frequency too high for waveform function
4	Sweep time too small or too large
5	Offset - amplitude incompatible
6	Sweep frequency too large for function, start frequency too small, sweep bandwidth too small, start frequency greater than stop frequency
7	Unrecognisable mnemonic received
8	Unrecognisable data character received
9	High-voltage option does not exist
10	Index out of range for Xxx mnemonic
11	Missing comma
12	Numeric parameter out of range
13	Interval error in sweep sequence
14	Sweep sequence is too long



The system failure bit is set when a system failure is encountered. The specific error may be found by sending the "ISE" query, and evaluating the returned error number:

<b>System Failure Number</b>	<b>System Failure Description</b>
1	Amplitude calibration failed
2	Phase calibration failed
3	External reference unlocked
4	Main oscillator unlocked
5+	Self-test failed (report actual number to Service personnel).

Error numbers are not buffered. Only the newest error is given.

To decode the self-test failure subtract 5 from its value. Then convert to binary and for each bit that is set to "1", there is a specific error.

<b>Bit</b>	<b>Self-test Failure Description</b>
0	RAM/ROM test failed (ROM=signature test)
1	MFP (MC 68901) Test failed
2	Device bus test failed
3	Display test failed (display handshake)
4	DAC test failed (analog voltage generation)
5	FRAC-N chip test failed
6	VCO test failed
7	Sweep timer test failed
8	Offset test failed
9	Amplitude test failed

---

## Forcing an SRQ

An SRQ is forced when one of the above bits in the Status Byte Register goes from “0—> 1” AND the corresponding Service Request Enable Mask bit has been set. Bits 0-3 are never set if they are not enabled via the SRQ-mask command.

If this condition occurs the Request Service (RQS) bit is set to “1”.

The Request Service will remain at “1” until it has been read by a serial poll, i.e. if a service has been requested and a serial poll is done, the RQS bit of the Status Byte only states that there was a reason to request a service but NOT that the reason/condition still exists.

The Status Byte can be accessed using a serial poll.

The serial poll command transfers the value of the Status Byte to a variable. This includes the value of the RQS bit (bit 6 of the Status Byte). If a request has been made (RQS goes to “1”), as soon as a serial poll is done, the RQS is reset to “0”, so unless a status transition (or mask transition) takes place, the next serial poll will show a “0” at bit 6, even if the reason for the request still exists.

## Service Request Enable

The SRQ mask can be set to mask bits 0-3 of the Status Register. To set the mask first determine which conditions you want to interrupt the controller, for example sweep started, sweep stopped and so on. Determine the decimal number (1-16) corresponding to those conditions. A "1" in the mask byte enables the corresponding interrupt condition. Then output the "MS" instruction mnemonic followed by the appropriate character (as shown in Table 10-2).

**Table 10-2.**  
**SRQ Mask Programming Characters**

"Character"	D3-D0	System Fail	Sweep Start	Sweep Stop	Program Error
@	0000	off	off	off	off
A	0001	off	off	off	on
B	0010	off	off	on	off
C	0011	off	off	on	on
D	0100	off	on	off	off
E	0101	off	on	off	on
F	0110	off	on	on	off
G	0111	off	on	on	on
H	1000	on	off	off	off
I	1001	on	off	off	on
J	1010	on	off	on	off
K	1011	on	off	on	on
L	1100	on	on	off	off
M	1101	on	on	off	on
N	1110	on	on	on	off
O	1111	on	on	on	on

**Example 1** The following example shows how to set the SRQ mask, so that if a "0 → 1" transition of the Sweep Started or System Failure bit occurs, an interrupt is sent.

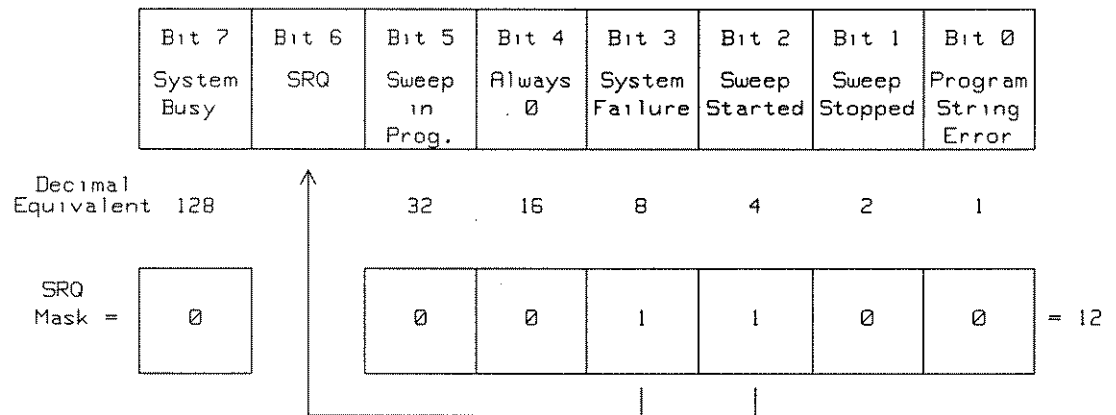

**Figure 10-2. An SRQ Mask Example**

The command to set this mask is:

```
OUTPUT 717; "MSL"
```

or

```
OUTPUT 717; "MS";CHR$(NUM("@")+12)
```

**Example 2** The following example shows how to use a serial poll in order to see when a sweep has started.

	<b>Program</b>	<b>Result</b>
10	SEND 7; CMD 20	Clears all HP-IB devices.
20	OUTPUT 717; "MSL"	Sets SRQ mask for bits 2 and 3 of the status byte.
30	S=SPOLL(717)	Serial polls the status byte.
40	IF BIT(S,6)=1 THEN 80	Checks value of Sweep Started bit.
50	OUTPUT 717; "SS SS*"	Resets and starts a single sweep.
60	WAIT .1	Pauses to let commands be carried out.
70	GOTO 30	Sweep is not started so go back to serial poll.
80	PRINT "Sweep Started"	Sweep started.
90	END	Program end.

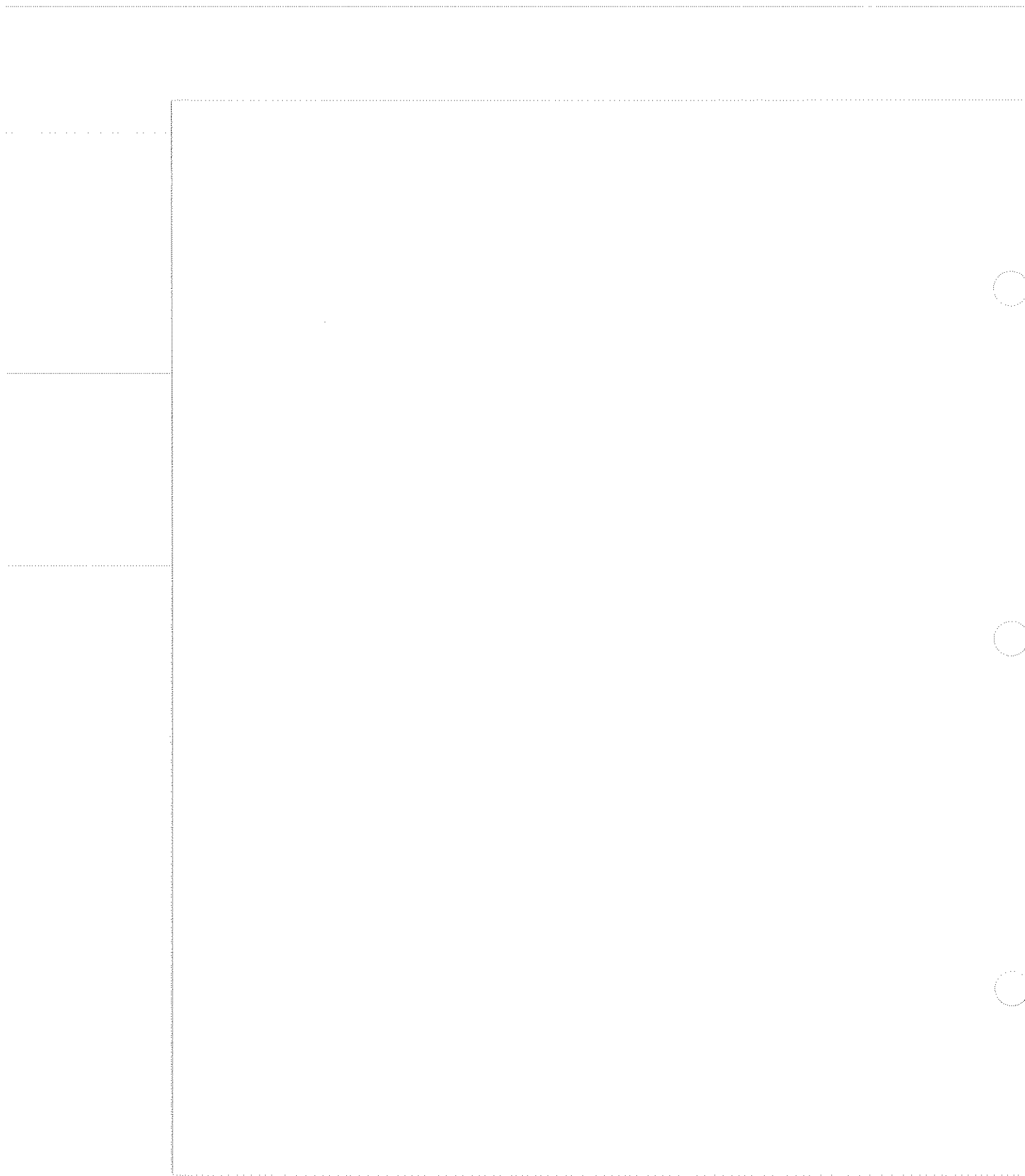

## HP-IB Commands and Programming Examples

### Introduction

This chapter gives a list of the HP 3324A HP-IB commands, in a functional order, and some programming examples. For the syntax diagram of a particular command, see Appendix E Command Syntax.

Some of the HP-IB commands cannot be used by the HP 3325A, as they are 3324A specific. These are shown in tables 11-1 and 11-2.

To create a query, add "I" (standing for "interrogate") to the beginning of the command. For example, the command to change the amplitude of the main signal is "AM". To ask for the current amplitude, you must send "IAM".

To check if the controller and the HP 3324A are talking with each other, send a query and look at the response from the HP 3324A. For example:

	Program	Result
10	DIM A\$[255]	Dimensions A\$.
20	OUTPUT 717;"IAM"	Queries the amplitude of the HP 3324A.
30	ENTER 717;A\$	The HP 3324A's amplitude is received by the controller.
40	PRINT A\$	The amplitude is displayed.
50	END	Program end.

The first thing to check if the amplitude is not shown, is that the HP-IB address set on the HP 3324A is the same as that you are using (in this case 17).

**Table 11-1. HP 3324A Command Summary**

Param. or Operation	Cmd grp	Query	Mne mon	Data	Delimiter	3325 comp?	See Notes
Data transfer mode	0	Y	MD	1 - unbuffered 2 - buffered	NA	Y	1
Mask SRQ	0	Y	MS	"@" - "O"	NA	Y	
Interrog. program error	0	-	IER	NA	NA	Y	
Interrog. options	0	-	IOPT	NA	NA	N	
Interrog. system error	0	-	ISE	NA	NA	Y	
Perform self-test	0	N	TE	NA	NA	Y	
Perform ampl. cal.	0	N	AC	NA	NA	Y	
Store set Recall set	0	N N	SR RE	0 - 9	NA	Y	5
No. of stores	0	Y	SNR	Integer	White	N	5,14
Compatib. mode	0	Y	CM	0 - off 1 - on	NA	N	
Function	1	Y	FU	0 - DC 1 - Sine 2 - Square 3 - Triangle 4 - Ramp up 5 - Ramp down 6 - Aux. TTL	NA	Y	
Frequency	1	Y	FR	Number	HZ - Hertz KH - KHz MH - MHz	Y	2,4

**11-2 HP-IB Commands and Programming Examples**



Table 11-1. HP 3324A Command Summary (continued)

Param. or Operation	Cmd grp	Query	Mne mon	Data	Delimiter	3325 comp?	See Notes
Amplitude	1	Y	AM	Number	VO - V(p-p) MV - mV(p-p) VR - V <sub>rms</sub> MR - mV <sub>rms</sub> DB - dBm	Y	3,4
DC Offset	1	Y	OF	Number	VO - Volt MV - mVolt	Y	3,4
Phase	0	Y	PH	Number	DE - Degree	Y	
Perform phase cal.	0	N	PC	NA	NA	N	
Set cal. delay	0	Y	TCD	Number	PS - psec.	N	
Set signal delay	0	Y	TSD	Number	PS - ps	N	
Assign 0 phase	0	N	AP	NA	NA	Y	
Select output	0	Y	RF	0 - front 1 - rear	NA	Y	
Output on/off	0	Y	OOFF	0 - off 1 - on	NA	N	
High-volt on/off	0	Y	HV	0 - off 1 - on	NA	Y	
Sweep							
Set no. of intervals	0	Y	SNI	Integer	White	N	5,14
Start/reset single sweep	0	N	SS	NA	NA	Y	10
Start/stop cont. sweep	0	N	SC	NA	NA	Y	11
Multi-int /marker	0	Y	MMS	1 - multi-int. 2 - multi-marker	NA	N	

Table 11-1. HP 3324A Command Summary (continued)

Param. or Operation	Cmd grp	Query	Mne mon	Data	Delimiter	3325 comp?	See Notes
Multi-Interval start freq	2	Y	ST	Number	See FR	Y	2
	2	Y	XST	Index, number		N	5,9
stop freq	2	Y	SP	Number		Y	
	2	Y	XSP	Index, number		N	
marker freq	2	Y	MF	Number		Y	
	2	Y	XMF	Index, number		N	
sweep time	2	Y	TI	Number	SE - sec.	Y	12
	2	Y	XTI	Index, number		N	9,12
sweep mode	2	Y	SM	1 - lin	NA	N	11
				2 - log			
	2	Y	XSM	Index, 1 - lin Index, 2 - log	NA	N	11
Retrace time	0	Y	RTT	Number 0 - auto	SE - sec.	N	13
Select intervals	0	Y	SGS	List	;	N	5,8
Multi-Marker start freq	3	Y	MUT	Number	See FR	N	2
	3	Y	MUP	Number		N	2
	3	Y	MMF	Index, number		N	2,6
	3	Y	MTI	Number	SE - sec.	N	12
	0	Y	MKS	List	;	N	7

**Notes** (1) The meaning of the command has been changed. See the section “Command Groups and Data Transfer Modes” in Chapter 9. The data transfer command, MD, allows you to select between a buffered and an unbuffered transfer mode. In the unbuffered mode, the command is executed immediately. In the buffered mode, the behaviour depends on the group that the command belongs to.

Group 0 commands execute the commands immediately. Group 1, 2 or 3 commands execute the commands as soon as a block terminator or a command from a different group is received.

(2) The frequency command, FR, allows you to set the frequency of your waveform.

**Table 11-2. Frequency Ranges**

Function	Range
Sinewave	1 mHz to 21 000 000.000 Hz
Squarewave	1 mHz to 11 000 000.000 Hz
Triangle	1 mHz to 11 000.000 Hz
Pos. slope ramp	1 mHz to 11 000.000 Hz
Neg. slope ramp	1 mHz to 11 000.000 Hz
TTL/Aux	1 mHz to 60 000 000.000 Hz

(3) The amplitude range for all AC functions, with no DC offset is 1.000 mV(p-p) to 10.00 V(p-p).

The DC offset range for all AC functions, with no amplitude is 1.000 mV(p-p) to 5.000 V(p-p).

DC offset and amplitude are coupled parameters, the compatible sub-ranges are:

**Table 11-3. Amplitude and DC Offset Limits**

AC Amplitude Entry (peak-to-peak)	Maximum DC Offset (+ or -)	Minimum DC Offset Entry
1.000 mV to 3.333 mV	with 4.500 mV to 3.333 mV	0.001 mV
3.334 mV to 9.999 mV	with 14.99 mV to 11.66 mV	0.001 mV
10.00 mV to 33.33 mV	with 45.00 mV to 33.33 mV	0.010 mV
33.34 mV to 99.99 mV	with 149.9 mV to 116.6 mV	0.010 mV
100.0 mV to 333.3 mV	with 450.0 mV to 333.3 mV	0.100 mV
333.4 mV to 999.9 mV	with 1.499 V to 1.166 V	0.100 mV
1.000 V to 9.998 mV	with 4.500 V to 0.001 V	1.000 mV

- (4) When the high voltage option (option 002) is used the frequency is restricted to:

upto 1 MHz for sine and square  
upto 10 KHz for triangle and ramps.

With the high voltage option, the amplitude and DC offset maximum values must be multiplied by a factor of 4.

- (5) The number of intervals and the number of stores are coupled parameters. Increasing one will automatically decrease the other. The pairing is:

**Table 11-4.**  
**Number of Stores/Number of Intervals**

Number of Stores	Number of Intervals
10	7
9	8 - 9
8	10
7	11 - 12
6	13 - 15
5	16 - 19
4	20 - 23
3	24 - 30
2	31 - 39
1	40 - 50

- (6) The index must be a value from 1 to 9.
- (7) The list must define the subset of enabled markers (not the sequence). All list elements must be in the range 1 to 9. The default list is "1" (only one marker, the first one).

- (8) The list defines the sequence of intervals. The range of list elements depends on the chosen number of intervals/stores. The default list is "1" (only one interval, the first one).
- (9) The valid range for the index depends on the number of intervals available.
- (10) The effect of the SS command depends on the state of the instrument. If the instrument is not sweeping and not in the sweep-reset state, then the SS command puts the instrument in the sweep-reset state at the sweep Start Frequency. If the instrument is already in the sweep-reset state, this command starts a single sweep. If the instrument is sweeping, this command stops the sweep and does not restart it.
- (11) A continuous sweep starts at the start frequency of the first interval in the sweep list (see SGS) and moves over all of the selected intervals. The mode of the retrace depends on the type of the last interval in the sweep list:

If the last interval is a logarithmic interval, then the retrace time is fixed and is approximately 15 ms. The output frequency is the start frequency of the first interval of the sweep sequence during this duration.

In all other cases, the retrace time is evaluated according to (13). The output frequency sweeps down/up from the stop frequency of the last interval in the sweep sequence to the start frequency of the first interval.

- (12) If the total sweep time (for multi-intervals, this is the sum over all selected intervals) is greater than 99.99 seconds, then the X-drive is switched off. This means that the X-drive output is held low all of the time. The Z-blank output, however, works as usual. Note that the retrace time is not included in the sweep time.
- (13) The retrace time is visible only in the continuous sweep mode. During the retrace the Z-blank output is passive (high), and the X-drive output is reset (low). There is a special entry, "0", for the retrace time. If "0" is entered then an "auto-retrace" mode is selected. The retrace time is then set to the sweep time of the last interval of the sequence list.
- (14) The stores/interval commands SNR and SNI must be used carefully. If one of these commands is sent then all store/recall registers are cleared (marked as "unused"), and all sweep intervals are set to their default values (start = 1 MHz, marker = 5 MHz, time = 1 sec., mode = lin).

---

## Programming Examples

The following sections give programming examples for the HP 3324A. The examples are divided into three different sections, a simple function generator, a multi-interval sweep generator and a multi-marker sweep generator. All of the programs assume the following:

1. an HP 9000, Series 200 or 300 Computer as controller
2. that BASIC is the programming language
3. that the HP 3324A is preset to HP-IB address 17

### Function Generator

The following program shows an example of how to program the HP 3324A as a function generator. The program shows how to:

1. clear all HP-IB devices (resets 3324A)
2. set a data transfer mode of 2
3. set the no. of stores to 10
4. set the waveform as a squarewave
5. set the frequency to 10 KHz
6. set the amplitude to 1 V(p-p)
7. set the DC offset to 4.5 V
8. set the phase to 45°
9. select the front output BNC
10. switch the output on

### Program

	Program	Result
10	SEND 7; CMD 20	Clears all HP-IB devices.
20	OUTPUT 717; "MD2"	Sets buffered data transfer mode.
30	OUTPUT 717; "SNR10"	Sets number of stores to 10.
40	OUTPUT 717; "FU2 FR10KH AM1VO OF4.5VO PH45DE *"	Sets waveform, frequency, amplitude, DC offset and phase to the above values.
50	OUTPUT 717; "RF1 OOF1"	Selects the front output BNC and switches it on.
60	END	Program end.



## Multi-Interval Sweep Generator

The following program shows an example of how to program the HP 3324A as a multi-interval sweep generator. The program assumes that the amplitude, waveform, data transfer mode, DC offset, phase, output and no. of intervals are the same as set in the previous example. The program then shows how to set five sweep intervals with the following parameters:

Interval 1:	start frequency	1 KHz
	stop frequency	3 KHz
	marker frequency	2 KHz
	sweep time	1 sec.
	sweep mode	linear
Interval 2:	start frequency	500 Hz
	stop frequency	10 KHz
	sweep time	1 sec.
	sweep mode	logarithmic
Interval 3:	start frequency	2 KHz
	stop frequency	4 KHz
	marker frequency	3 KHz
	sweep time	1 sec.
	sweep mode	linear
Interval 4:	start frequency	900 Hz
	stop frequency	10 KHz
	sweep time	1 sec.
	sweep mode	logarithmic
Interval 5:	start frequency	3 KHz
	stop frequency	5 KHz
	marker frequency	4 KHz
	sweep time	1 sec.
	sweep mode	linear

## Program

	Program	Result
10	OUTPUT 717; "XST1,1KH XSP1,3KH XMF1,2KH XTI1,1SE XSM1,1 *"	Programs interval 1 parameters.
20	OUTPUT 717; "XST2,500HZ XSP2,10KH XTI2,1SE XSM2,2 *"	Programs interval 2 parameters.
30	OUTPUT 717; "XST3,2KH XSP3,4KH XMF3,3KH XTI3,1SE XSM3,1 *"	Programs interval 3 parameters.
40	OUTPUT 717; "XST4,900HZ XSP4,10KH XTI4,1SE XSM4,2 *"	Programs interval 4 parameters.
50	OUTPUT 717; "XST5,3KH XSP5,5KH XMF5,4KH XTI5,1SE XSM5,1 *"	Programs interval 5 parameters.
60	OUTPUT 717; "RTT1SE MMS1 SGS1,3,5,2,4,5,1-5; *"	Sets retrace time of 1 sec., sets multi-interval mode and sets the interval sequence 1,3,5,2,4,5,1,2,3,4,5.
70	OUTPUT 717; "SC *"	Sets continuous sweep mode.
80	END	Program end.

## Multi-Marker Sweep Generator

The following program shows an example of how to program the HP 3324A as a multi-marker sweep generator. The program assumes that the previous two example programs have been run directly beforehand. The program sets the following information.

interval start frequency 1.0 KHz  
interval stop frequency 5.0 KHz  
interval sweep time 1.0 sec.  
marker 1 frequency 1.5 KHz  
marker 2 frequency 2.0 KHz  
marker 3 frequency 2.5 KHz  
marker 4 frequency 3.0 KHz  
marker 5 frequency 3.5 KHz  
marker 6 frequency 4.0 KHz  
marker 7 frequency 4.5 KHz

### Program

	Program	Result
10	OUTPUT 717; "SC*"	Stops current sweep from previous example.
20	OUTPUT 717; "MUT1KH MUP5KH MTI5SE *"	Sets interval parameters.
30	OUTPUT 717; "MMF1,1.5KH MMF2,2KH MMF3,2.5KH MMF4,3KH MMF5,3.5KH MMF6,4KH MMF7,4.5KH *"	Sets the marker frequencies.
40	OUTPUT 717; "MKS1-7 MMS2"	Activates markers and sets instrument in multi-interval mode.
50	OUTPUT 717; "SS SS*"	Resets and starts a single sweep.
60	END	Program end.



## Performance Tests

---

### Introduction

The procedures in this chapter test the performance of the instrument. The complete specifications to which the HP 3324A is tested are given in Appendix A. All tests can be performed without access to the interior of the instrument.

---

### Equipment Required

Equipment required for the performance tests are listed in Table 12-1. Recommended Test Equipment. Any equipment which satisfies the critical specifications given in the table may be substituted for recommended models.

---

### Test Record

Results of the performance tests may be tabulated in the Test Records provided at the end of this chapter. It is recommended that you fill out the Test Record and refer to it while doing the test. Since the test limits and set-up information are printed on the Test Record for easy reference, the record can also be used as an abbreviated test procedure (if you are familiar with test procedures). The Test Record can also be used as a permanent record and may be reproduced without written permission from Hewlett-Packard.

---

## Test Failure

If the HP 3324A fails any performance test, return the instrument to the nearest Hewlett-Packard Sales/Service Office for repair.

---

## Instruments Specification

Specifications are the performance characteristics of the instrument which are certified. These specifications, listed in Appendix A, are the performance standards or limits against which the HP 3324A can be tested.

Any changes in the specifications due to manufacturing changes, design, or traceability to the National Bureau of Standards will be covered in a manual change supplement or revised manual. The specifications listed here supercede any previously published.

---

## Performance Tests

The performance tests for the HP 3324A consist of the following:

- Harmonic Distortion
- Spurious Signal
- Integrated Phase Noise
- Ramp Retrace Time
- Frequency Accuracy
- Phase Increment Accuracy
- Amplitude Accuracy
- DC Offset Accuracy
- DC Offset Accuracy with AC Functions
- Triangle Linearity
- Ramp Period Variation
- Automatic Phase Calibration

**Table 12-1. Recommended Test Equipment**

Instrument	Critical Specifications	Recommended Model
Analog Oscilloscope	Vertical Bandwidth: DC to 275 MHz Deflection: 0.01 to 5 V/div Horizontal Sweep: 10 ns to 0.5 s/div x10 Magnification Delayed Sweep	HP 1725A
Digitizing Oscilloscope	Vertical Bandwidth: 1 GHz with random repetitive sampling technique Timebase accuracy:0.002%	HP 54111D
Electronic Counter	Frequency measurement Time Interval Average A to B Frequency Range: to 100 MHz Resolution: 11 digits	HP 5370B
AC/DC Digital Voltmeter	AC Function (True RMS) Ranges: 10 mV to 1000 V Bandwidth: 1 Hz to 10 MHz Resolution: 4.5 digits minimum DC Functions Ranges: 10 mV to 1000 V	HP 3458A
50Ω Feedthru Termination	Accuracy: ±1% Power Rating: 2 W	HP 10100C
Spectrum Analyzer	Frequency Range: 20 Hz to 40.1 MHz Spurious Responses: 80 dB below reference	HP 3585B
Double Balanced Mixer	Impedance: 50Ω Frequency Range: 1 – 20 MHz	HP 10534A
1 MHz Low Pass Filter	Cut-off Frequency: 1 MHz Stopband Atten: 50 dB by 4 MHz Stopband Freq: 4 – 80 MHz	Model J903, TTE Inc. 2214 S. Benny Ave. Los Angeles, CA 90064

**Table 12-1. Recommended Test Equipment (continued)**

Instrument	Critical Specifications	Recommended Model
15 KHz Filter	Consisting of: Resistor: 10 K $\Omega$ 1% Capacitor: 1600 pF 5%	
AC Voltmeter	Ranges: 0.1 to 1 V Frequency Range: 20 Hz - 1 MHz Input Impedance: $\geq 1$ M $\Omega$ Meter: Log scale Acc (100 Hz to 10 KHz): $\pm 1\%$	HP 400FL/3400A
Sinewave Signal Source	Frequency: 20 KHz Amplitude: 10 V(p-p) into 50 $\Omega$	HP 3324A/3325B
DC Power Supply	Volts: 0 to $\pm 5$ V Amps: 10 mA Floating Output	HP 6214A/6214B
Thermal Converter	Input Impedance: 50 $\Omega$ Input Voltage: 3 Vrms Frequency: 2 KHz to 20 MHz Frequency Response: $\pm 0.05$ dB 2 KHz to 20 MHz	HP 11049A/Ballantine Model 1395A-1 with cable 12577A Opt. 10 Ballantine Labs, Inc. P.O. Box 97 Boonton, NJ 07005
High-Speed DC Digital Voltmeter	DC Voltage: 0 to $\pm 10$ V External Trigger: Low True TTL Edge Trigger Trigger Delay: Selectable 10 to 140 $\mu$ s	HP 3437A
Resistors:	20 $\Omega$ 1/4 W 1% 30 $\Omega$ 1/4 W 1% 50 $\Omega$ 1/8 W 1% 475 $\Omega$ 2 W 1%	
Capacitor:	300 pF 5%	
BNC-to-Triax Adapter	Female BNC to Male Triax	HP 1250-0595
Adapter	BNC female to dual banana plug BNC Tee	HP 1251-2277 HP 1250-0781

**12-4 Performance Tests**



## Harmonic Distortion

This procedure tests the harmonic distortion of the HP 3324A sinewave output.

### Specifications

Harmonic distortion (relative to fundamental)

Fundamental Frequency	No Harmonic Greater Than
0.1 Hz to 199 KHz	-60 dB
200 KHz to 1.99 MHz	-40 dB
2 to 14.9 MHz	-30 dB
15 to 20 MHz	-25 dB

### Equipment Required

Spectrum Analyzer  
50 $\Omega$  Feedthru Termination  
Resistor 475 $\Omega$  2W 1%  
Resistor 50 $\Omega$  1/8W 1%  
Capacitor 300 pF 5%

### Procedure

1. Set the HP 3324A output as follows:

High-voltage	Output Off
Function	Sine
Frequency	20 MHz
Amplitude	999 mV(p-p)
2. Connect the signal output to the spectrum analyzer 50 $\Omega$  input.
3. Set the spectrum analyzer controls to display the fundamental and at least four harmonics. Verify that all harmonics are at least 25 dB below the fundamental.
4. Set the HP 3324A to 15 MHz and verify that all harmonics are at least 25 dB below the fundamental.

5. Set the HP 3324A to the following frequencies and verify the specified levels, relative to the fundamental.

14.9 MHz	-30 dB
2 MHz	-30 dB
1.99 MHz	-40 dB
200 KHz	-40 dB

6. Set the HP 3324A frequency to 50 KHz and the amplitude to 9.99 mV(p-p).
7. Set the spectrum analyzer controls to display the fundamental and at least three harmonics. (It may be necessary to decrease the video bandwidth to separate the harmonics from the noise floor.) Verify that all harmonics are at least 60 dB below the fundamental.
8. Set the HP 3324A to the following frequencies and verify that all harmonics are 60 dB below the fundamental.

10 KHz
1 KHz
100 Hz

### High-Voltage Output (Option 002)

Continued from the previous procedure.

1. Connect the HP 3324A signal output to the analyzer high-impedance input as shown in Figure 12-1.

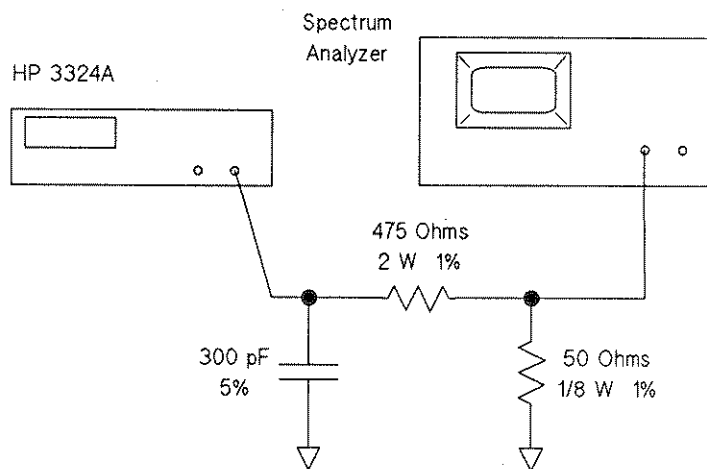

**Figure 12-1. Harmonic Distortion Verification Test Set-Up (High-Voltage Output)**

2. Select the high-voltage output on the HP 3324A. Set the amplitude to 40 V(p-p) and the frequency to 100 Hz.
3. Set the spectrum analyzer controls to display the fundamental and at least three harmonics. Verify that all harmonics are 60 dB below the fundamental.
4. Set the HP 3324A to the following frequencies and verify that their harmonics are below the specified level, relative to the fundamental.

10 KHz	-60 dB
100 KHz	-60 dB
200 KHz	-40 dB
1 MHz	-40 dB
5. Turn off the high-voltage output.

## Spurious Signal

This procedure tests the HP 3324A sinewave output for spurious signals. Circuits within the HP 3324A may generate repetitive frequencies that are not harmonically related to the fundamental output frequency.

### Specifications

All spurious signals must be more than 55 dB below the fundamental signal or less than  $-85$  dBm, whichever is greater.

### Equipment Required

Spectrum Analyzer

### Mixer Spurious Procedure

1. Connect the HP 3324A signal output to the spectrum analyzer  $50\Omega$  (RF) input and the HP 3324A EXT REF input to the analyzer 10 MHz reference output, as shown in Figure 12-2.

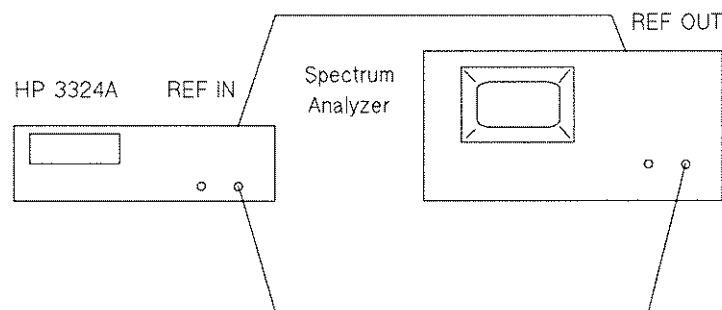

Figure 12-2. Mixer Spurious Test Set-Up

2. Set the HP 3324A as follows:

Function	Sine
Frequency	2.001 MHz
Amplitude	63.24 mV(p-p)

3. Set the analyzer controls as follows:

Center Frequency	2.001 MHz
Frequency Span	1 KHz
Video BW	100 Hz
Resolution BW	30 Hz

4. Adjust the spectrum analyzer to reference the fundamental to the top display graticule.
5. Without changing the reference level, change the spectrum analyzer center frequency to 27.999 MHz to display the 2:1 mixer spur. Verify that this spur is at least 55 dB below the fundamental.
6. Change the spectrum analyzer center frequency to 25.998 MHz to display the 3:2 mixer spur. Verify that this spur is at least 55 dB below the fundamental.
7. In a similar manner, change the HP 3324A frequency and the spectrum analyzer center frequency to the following frequencies. For each setting, verify that all spurious signals are 55 dB below the fundamental.

HP 3324A	Spectrum Analyzer Center Frequency	
	2:1 Spur	3:2 Spur
4.100 MHz	25.9 MHz	21.8 MHz
6.100 MHz	23.9 MHz	17.8 MHz
8.100 MHz	21.9 MHz	13.8 MHz
10.100 MHz	19.9 MHz	9.8 MHz
12.100 MHz	17.9 MHz	5.8 MHz
14.100 MHz	15.9 MHz	1.8 MHz
16.100 MHz	13.9 MHz	2.2 MHz
18.100 MHz	11.9 MHz	6.2 MHz
20.100 MHz	9.9 MHz	10.2 MHz

**Close-in Spurious  
(Fractional N Spurs)  
Procedure**

This procedure continues on from the previous one.

1. Set the HP 3324A to 5.001 MHz and the amplitude to 448.3 mV(p-p).

2. Set the spectrum analyzer controls as follows:

Center Frequency	5.001 MHz
Frequency Span	1 KHz
Video BW	100 Hz
Resolution BW	30 Hz

3. Adjust the spectrum analyzer to reference the fundamental to the top display graticule.

4. Without changing the reference level, change the spectrum analyzer center frequency to 5.002 MHz to display the API 1 spur. It may be necessary to decrease the video bandwidth to optimize the display resolution.

5. All spurious (non-harmonic) signals should be at least 55 dB below the fundamental.

6. Without changing the reference level, set the HP 3324A frequency and the spectrum analyzer center frequency to the frequencies listed below. For each setting, verify that all spurious signals are at least 55 dB below the fundamental.

HP 3324A	Spectrum Analyzer Center Frequency
5.0001 MHz	5.0011 MHz
5.00001 MHz	5.00101 MHz
5.000001 MHz	5.001001 MHz
20.001 MHz	20.002 MHz
20.001 MHz	20.003 MHz
20.001 MHz	20.004 MHz
20.001 MHz	20.005 MHz

## Integrated Phase Noise

This procedure tests the HP 3324A integrated phase noise.

### Specifications

-50 dB for a 30 KHz band centered on a 20 MHz carrier (excluding  $\pm 1$  Hz about the carrier).

### Equipment Required

Frequency Synthesizer  
Double Balanced Mixer  
50 $\Omega$  Feedthru Termination  
AC/DC Digital Voltmeter  
AC Voltmeter  
15 KHz Noise Equivalent Filter  
1 MHz Low Pass Filter

### Procedure

1. Connect the equipment as shown in Figure 12-3, connecting the 15 KHz noise equivalent filter output to the AC voltmeter. Phase lock the HP 3324A and the signal generator together.

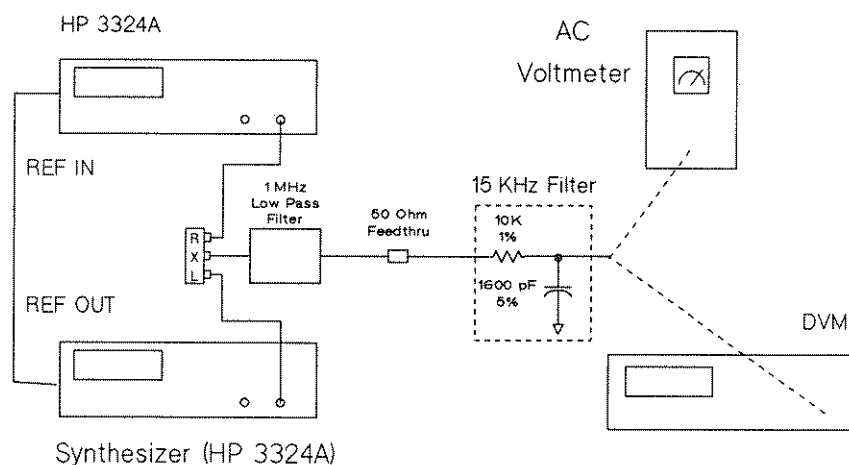

Figure 12-3. Integrated Phase Noise Test Set-Up

2. Set the HP 3324A as follows:

Function	Sine
Frequency	19.901 MHz
Amplitude	632 mV(p-p)

3. Set the synthesizer (reference) as follows:

Frequency	19.9 MHz
Amplitude	1.416 V(p-p)

4. Record the AC voltmeter reading (dB scale).

5. Change the HP 3324A frequency to 19.9 MHz.

6. Connect the 15 KHz filter output to the digital voltmeter.

7. Press the HP 3324A **Phase** key. Using the modify keys, adjust the output phase for a minimum reading on the digital voltmeter.

8. Disconnect the 15 KHz filter output from the digital voltmeter and connect it to the AC voltmeter.

9. Record the AC voltmeter reading (dB scale) and subtract it from the reading recorded in step 4. The difference should be  $-44$  dB or below. Add  $-6$  dB to this number and enter on the Performance Test Record. The 6 dB is a correction factor compensating for the folding action of the mixer.

**Note**



---

Frequencies used minimize the phase noise contribution of the frequency synthesizer.

---



---

**Ramp Retrace Time**

This procedure tests the HP 3324A retrace time of the positive and negative slope ramps.

**Specifications**       $\leq 3 \mu s$  90% to 10%

**Equipment Required**      Digitizing Oscilloscope

**Procedure**

1. Connect the HP 3324A signal output to the oscilloscope vertical input. (If your oscilloscope does not have a  $50\Omega$  input, use a  $50\Omega$  feedthru termination at the input.)
2. Set the HP 3324A as follows:

High-Voltage Output	Off
Function	Positive Slope Ramp
Frequency	10 KHz
Amplitude	10 V(p-p)
3. Adjust the oscilloscope vertical and horizontal controls so that the ramp retrace time from the 90% to 10% points can be measured. Retrace time should be less than  $3 \mu s$ . (Use the  $\Delta t$  mode.)
4. Change the HP 3324A function to a negative slope ramp and repeat step 3 for the rising edge from the 10% to 90% points.

---

**Frequency Accuracy**

This procedure compares the accuracy of the HP 3324A output signal to the specification.

**Specifications**

$\pm 5 \times 10^{-6}$  of selected frequency (20°C to 30°C).

**Equipment Required**

Electronic counter (calibrated within three months or with an accurate 10 MHz external reference input)

**Procedure**

1. Connect the HP 3324A signal output to the electronic counter channel A input with a 50 $\Omega$  feedthru termination. Allow the HP 3324A to warm up for 20 minutes and the counter's frequency reference to warm up for its specified period.
2. Set the HP 3324A output as follows:

High-Voltage Output	Off
Function	Sine
Frequency	20 MHz
Amplitude	0.99 V(p-p)
DC Offset	0 V
3. Set the counter to count the frequency of the A input with 0.1 Hz resolution, and adjust for stable triggering. The electronic counter should indicate 20,000,000.00 Hz  $\pm 100$  Hz.
4. Change the HP 3324A frequency 10 MHz. Change the function to a squarewave. The electronic counter should indicate 10,000,000.00 Hz  $\pm 50$  Hz.

5. Change the HP 3324A frequency 10 KHz. Change the function to a triangle. Set the counter to average 1000 periods. The electronic counter should indicate 100,000.00 ns  $\pm$ 0.5 ns.
6. Change the HP 3324A function to a positive slope ramp. The electronic counter should indicate 100,000.00 ns  $\pm$ 0.5 ns.

## Phase Increment Accuracy

This procedure compares the phase increment accuracy to the specification.

**Specifications**  $\pm$ 0.5°

**Equipment Required** Frequency Synthesizer  
Electronic Counter

**Procedure** 1. Connect the equipment as shown in Figure 12-4.

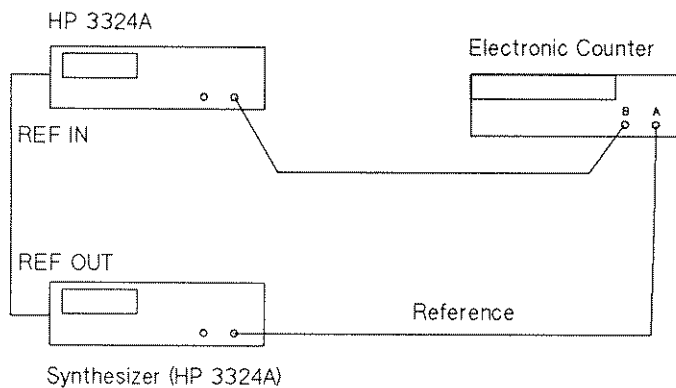

**Figure 12-4. Phase Increment Accuracy Test Set-Up**

2. Set the HP 3324A as follows:

High-Voltage Output	Off
Function	Sine
Frequency	100 KHz
Amplitude	13 dBm

3. Set the synthesizer as follows:

Frequency	0.1 MHz
Amplitude	13 dBm

4. Set the counter as follows:

Function	Time Interval Avg A to B
Frequency	
Resolution, N	$10^5$
Inputs	$50\Omega$ , separate
Slope A and B	Positive
Sample Rate	Maximum

5. Press the HP 3324A **Phase** key to display phase. Using the modify keys, adjust the phase until the counter reads approximately 200 ns. Press the blue **Shift** key, and then the **Assign Phase 0** key.
6. Set the counter sample rate to hold, then reset the counter. Record the counter reading (to 2 decimal places) on the Performance Test Record in the space for Zero Phase Time Interval. This is the phase difference (in nanoseconds) between the HP 3324A output and the reference signal.
7. Set the HP 3324A phase to  $-1^\circ$ .
8. Reset the counter. Record the counter reading (to 2 decimal places) in the space for  $1^\circ$  Increment Time Interval.

9. Determine the time difference between the counter readings in steps 8 and 6, and record in the Time Difference column. The difference should be  $\pm 0.5^\circ$ .
10. Set the HP 3324A phase to  $-10^\circ$ .
11. Reset the counter. Record the counter reading in the space for  $10^\circ$  Increment Time Interval.
12. Enter the time difference between the Zero Phase Time Interval and the reading in step 11 in the Time Difference column. This should be between  $\pm 0.5^\circ$ .
13. Set the HP 3324A phase to  $-100^\circ$ .
14. Reset the counter. Record the counter reading in the space for  $100^\circ$  Increment Time Interval.
15. Enter the time difference between the Zero Phase Time Interval and the reading in step 14 in the Time Difference column. This should be between  $\pm 0.5^\circ$ .

---

## Amplitude Accuracy

This procedure tests the amplitude accuracy of the HP 3324A AC function output signals.

### Specifications

See Appendix A

### Equipment Required

AC/DC Digital Voltmeter  
High Speed Digital DC Voltmeter  
50 $\Omega$ , 0 – 12 dB (1 dB/step) Attenuator  
50 $\Omega$  Feedthru Termination  
Thermal Converter  
Analog Oscilloscope  
Resistor 475 $\Omega$  2 W 1%  
Resistor 50 $\Omega$  1/8 W 1%  
Capacitor 300 pF 5%

### Note



---

For each new setting of the amplitude, press **Ampl Cal** to perform an amplitude calibration.

---

### Amplitude Accuracy at Frequencies upto 100 KHz Procedure

1. **Sinewave Test.** Connect the HP 3324A signal output through a 50 $\Omega$  feedthru termination to the AC digital voltmeter input.
2. Set the HP 3324A as follows:

High-Voltage Output	Off
Function	Sine
Frequency	100 Hz
Amplitude	3.536 Vrms (10 V(p-p))
DC Offset	0 V
3. Press the **Ampl Cal** key.
4. Read the AC voltmeter. Change the HP 3324A frequency to 1 KHz and 100 KHz and repeat. Verify that all three voltmeter readings are between 3.455 and 3.617 Vrms ( $\pm 0.2$  dB).

5. Change the HP 3324A amplitude to 1.061 Vrms (3 V(p-p)) and take AC voltage readings for 100 Hz, 1 KHz and 100 KHz as above. Verify that all three voltmeter readings are between 1.037 and 1.085 Vrms ( $\pm 0.2$  dB).
6. Change the HP 3324A amplitude to 0.3536 Vrms (1 V(p-p)) and set the DC offset to 1 mV. Set the HP 3324A frequency to 100 Hz, 1 KHz and 100 KHz, and read the AC voltage. Verify that all three readings are between 0.3370 and 0.3702 Vrms ( $\pm 0.4$  dB).
7. **Function Test.** Set up the equipment as shown in Figure 12-5.

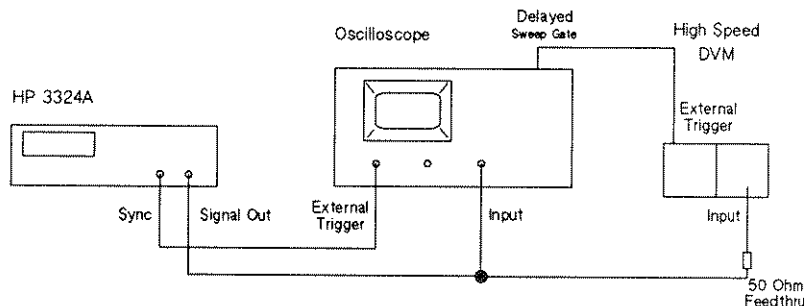

**Figure 12-5. Function Amplitude Accuracy Test Set-Up**

8. Set the HP 3324A as follows:

High-Voltage Option	Off
Function	Square
Frequency	99.9 Hz
Amplitude	10 V(p-p)
DC Offset	0 V

9. Set the oscilloscope as follows:

Display	A or B
Vertical Sensitivity	2 V/div
Trigger	Ext
Main Sweep	1 ms/div
Delayed Sweep	5 $\mu$ s/div

10. Set the voltmeter as follows:

Range	10 V
Trigger	Ext
Delay	0 s
Coupling	DC, 1 M $\Omega$

11. One cycle of the squarewave should fill the screen of the oscilloscope, and the sample time for the voltmeter should be seen as the intensified spot of the delayed sweep.

12. Press **Ampl Cal** on the HP 3324A.

13. Read the positive peak voltage of the attenuated waveform on the voltmeter. If the reading is not stable, alternatively press hold, then ext to repeat readings. Change the oscilloscope delay to read the negative peak. Add the two readings to obtain volts peak-to-peak. Verify that the sum is between 9.85 and 10.15 V.

14. Change the HP 3324A function to a triangle.

15. Adjust the oscilloscope delay to read the positive peak voltage on the high-speed digital voltmeter. Adjust the delay to read the negative peak on the voltmeter. Verify that the sum of the absolute values of the positive and negative peak voltages is between 9.85 and 10.15 V.



16. Change the HP 3324A function to a positive ramp.
17. Place the intensified spot on the positive peak.  
Alternatively press hold, then ext to repeat readings.  
Record the most positive reading.
18. Adjust the delay and read the negative peak. Ramp jitter should be visible on all ramp readings (the high-speed voltmeter will hold the readings). Verify that the sum of the absolute values of the positive and negative peaks is between 9.85 and 10.15 V.
19. Change the HP 3324A function to a negative ramp. Change the oscilloscope trigger to positive and take the negative ramp reading as above.
20. Change the HP 3324A function to a squarewave and the frequency to 1 KHz. Set the oscilloscope as follows:

Main Sweep	100 $\mu$ s/div
Delayed Sweep	0.05 $\mu$ s/div
21. Read the positive peak; push the negative trigger and read the negative peak. Verify that the sum of the absolute values is between 9.85 and 10.15 V.
22. Change the HP 3324A function to a triangle and the frequency to 2 KHz. Set the oscilloscope main sweep to 50  $\mu$ s/div. Adjust the delay and position. Set the positive and negative trigger to read the peaks. Verify that the sum is between 9.85 and 10.15 V.

23. Change the HP 3324A function to a positive ramp and the frequency to 500 Hz. Set the oscilloscope main sweep to 0.2 ms/div (adjust the sweep vernier to return the peaks to the center screen). Verify that the voltage is between 9.85 and 10.15 V.
24. Change the HP 3324A function to a negative ramp. Verify that the voltage is between 9.85 and 10.15 V.
25. Change the HP 3324A function to square and the frequency to 101 KHz. Return the oscilloscope sweep vernier to calibrate and set the main sweep to 0.5  $\mu$ s/div and magnify to off. Read the positive and negative peak voltages in the center of the screen. By pressing positive/negative trigger, verify that the voltage is between 9.50 and 10.50 V.
26. Change the HP 3324A frequency to 10 KHz and the function to triangle . Set the oscilloscope main sweep to 10  $\mu$ s/div and press magnify. Verify that the voltage is between 9.50 and 10.50 V.
27. Change the HP 3324A function to a positive ramp. Set the oscilloscope main sweep to 10  $\mu$ s/div. Adjust the delay to read the highest peak. Verify that the voltage is between 9 and 11 V.
28. Change the HP 3324A function to a negative ramp. Verify a voltage of between 9 and 11 V.

29. Change the HP 3324A amplitude to 3 V(p-p), and press **Ampl Cal**. Set the HP 3324A frequency to 99.9 Hz and the function to squarewave.

30. Repeat tests 9 through 28. Test limits are as follows:

Test	Frequency	Function	Minimum	Maximum
13	99.9 Hz	Square	2.955 V	3.045 V
15	99.9 Hz	Triangle	2.955 V	3.045 V
18	99.9 Hz	+ Ramp	2.955 V	3.045 V
19	99.9 Hz	- Ramp	2.955 V	3.045 V
21	1 KHz	Square	2.955 V	3.045 V
22	2 KHz	Triangle	2.955 V	3.045 V
23	500 Hz	+ Ramp	2.955 V	3.045 V
24	500 Hz	- Ramp	2.955 V	3.045 V
25	101 KHz	Square	2.700 V	3.300 V
26	10 KHz	Triangle	2.850 V	3.150 V
27	10 KHz	+ Ramp	2.700 V	3.300 V
28	10 KHz	- Ramp	2.700 V	3.300 V

31. Change the HP 3324A amplitude to 1 V(p-p), press **Ampl Cal** and set the DC offset to 1 mV. Set the frequency to 99.9 Hz and the function to square. Set the oscilloscope's vertical sensitivity to 0.05 V/div for all 1 V(p-p) tests.
32. Repeat tests 9 through 28. Test limits are as follows:

Test	Frequency	Function	Minimum	Maximum
13	99.9 Hz	Square	0.978 V	1.022 V
15	99.9 Hz	Triangle	0.973 V	1.027 V
18	99.9 Hz	+ Ramp	0.973 V	1.027 V
19	99.9 Hz	- Ramp	0.973 V	1.027 V
21	1 KHz	Square	0.978 V	1.022 V
22	2 KHz	Triangle	0.973 V	1.027 V
23	500 Hz	+ Ramp	0.973 V	1.027 V
24	500 Hz	- Ramp	0.973 V	1.027 V
25	100 KHz	Square	0.900 V	1.100 V
26	10 KHz	Triangle	0.938 V	1.062 V
27	10 KHz	+ Ramp	0.888 V	1.112 V
28	10 KHz	- Ramp	0.888 V	1.112 V

## High-Voltage Output (Option 002)

### Amplitude Accuracy for Frequencies to 100 KHz

This procedure continues from the previous one.

1. **Sinewave Test.** Connect the HP 3324A signal output to the AC voltmeter with a 6-foot cable. Connect a 500 $\Omega$ , 300 pF load (at either end) in parallel with the line.
2. Select the high-voltage output on the HP 3324A. "HIGH-VOLT" is shown in the display.
3. Set the HP 3324A function to a sinewave, the frequency to 2 KHz, and the amplitude to 14.14 Vrms (40 V(p-p)). Press **Ampl Cal**. The AC voltmeter reading should be between 13.86 and 14.42 Vrms.
4. **High-Voltage Function Test.** Connect the equipment as shown in Figure 12-6.

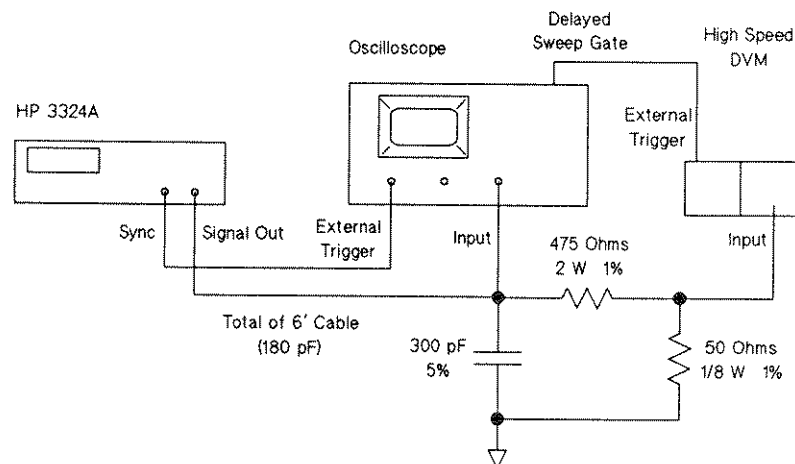

Figure 12-6. Function Amplitude Accuracy Test Set-Up (High-Voltage Output)

5. The voltage divider shown in Figure 12-6 is built into a small metal box with 2 BNC connectors. Parts used are:

R3, 475 $\Omega$  2 W 1%  
R4, 50 $\Omega$  1/8 W 2%  
C1, 300 pF 5%

Connect the tap to the input of the high-speed voltmeter, as shown in Figure 12-6.

6. Set the HP 3324A frequency to 2 KHz and the amplitude to 40 V(p-p). Set the voltmeter to the 1 V range and external trigger. Set the oscilloscope as follows:

Vertical Sensitivity	2 V/div
Trigger	External
Main Sweep	20 $\mu$ s/div
Delayed Sweep	0.05 $\mu$ s/div
Delay	615
Magnify	$\times 10$

7. Set the HP 3324A to squarewave and read the peak voltages on the voltmeter. Verify that the sum of the voltages is between 3.466 and 3.607 V(p-p).
8. Change the HP 3324A function to triangle, and read the peak voltages. The sum should be between 3.466 and 3.607 V(p-p).
9. Change the HP 3324A function to positive ramp. Change the oscilloscope main sweep to 0.1 ms/div and delay to 500. Verify a sum voltage of 3.466 to 3.607 V(p-p). Repeat for a negative ramp by changing the oscilloscope trigger to positive.

### Amplitude Flatness (Frequencies above 100 KHz)

1. Set the HP 3324A as follows:

Function	Sine
Frequency	1 KHz
DC Offset	0 V
Amplitude	10 dBm

2. Connect the HP 3324A signal output via a  $50\Omega$  ( $\pm 0.2\Omega$ ) feedthru to the DVM input. Set the DVM to measure AC voltage.
3. Press **Ampl** followed by **Ampl Cal**. Wait 2 seconds and record the voltmeter reading as  $V_{Orms}$ .
4. Connect the equipment as shown in Figure 12-7 (the thermal converter should be connected directly to the HP 3324A), and set the DVM to measure DC voltage.

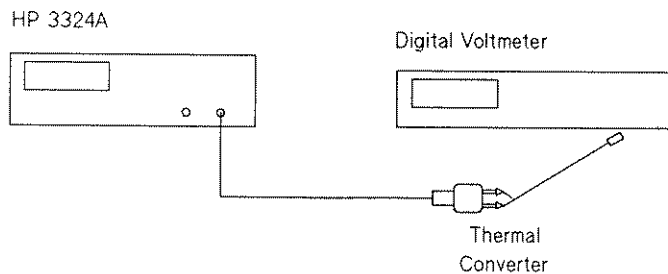

Figure 12-7. Amplitude Flatness Test Set-Up

#### Note



Do not exceed the rated voltage of the thermal converter. Any overload or high voltage transient may destroy the thermoelement.

The maximum voltage that can be measured with this setup is 18 dBm (6 V(p-p) or 1.7 Vrms). The minimum voltage is 8 dBm (2 V(p-p) or 0.57 Vrms).

5. Wait 3 minutes and record the DVM reading as  $V_{Odc}$ .

6. Set the 3324A frequency to 101 KHz, 500 KHz, 1 MHz, 5 MHz, 10 MHz, 15MHz, and 20 MHz, and record the voltmeter reading ( $V_{meas}$ ) at each frequency. In each case allow the thermal converter 10 seconds to stabilize.
7. Calculate the amplitude accuracy using the following equation:

$$Ampl.(dBm) = 20\log_{10} \left( \frac{V_{0rms}}{0.223607\sqrt{V_{0dc}}} \right) + 20\log_{10} (\sqrt{V_{meas}})$$

8. Verify that all results are within 9.4 dBm and 10.6 dBm (accuracy =  $\pm 0.6$  dB).
9. Change the HP 3324A frequency to 1 KHz and the amplitude to 18 dBm.
10. Repeat steps 2 to 7 and verify that all results are within 17.6 and 18.4 dBm (accuracy =  $\pm 0.4$  dB).
11. Disconnect the thermal converter from the HP 3324A output.
12. **Squarewave flatness.** Set the HP 3324A as follows:
 

High-Voltage Output	Off
Function	Square
Frequency	1 KHz
Amplitude	10 V(p-p)
DC Offset	0 V
13. Connect the HP 3324A signal output to an oscilloscope with a  $50\Omega$  feedthru termination. Set the oscilloscope as follows:

Vertical Sensitivity	2 V/div
Time/div	0.1 ms



14. Use the modify keys to increase the HP 3324A frequency from 1 KHz to 10.001 MHz in 2 MHz steps. Two lines will appear on the oscilloscope. Verify that they remain within 0.5 of a major division of 5 divisions apart for all 11 frequencies.

### High-Voltage Output (Option 002)

#### Amplitude Flatness above 100 KHz

This procedure continues from the previous one.

1. Connect the HP 3324A output to an oscilloscope with a 500 $\Omega$ , 300pF load (load attached at either end). The cable capacitance (30 pF/foot) must be included in the 300 pF. The HV divider (Figure 12-6) may be used with 6 feet of cable.
2. Set the oscilloscope as follows:

Vertical Sensitivity	10 V/div
Time/div	1 ms
3. Set the HP 3324A to 40 V(p-p) sinewave and 1 KHz. Adjust the oscilloscope intensity and focus for a sharp trace.
4. Use the modify keys to increase the HP 3324A frequency from 1 KHz to 1.001 MHz in 200 KHz steps. Verify that the width of the bright region of the screen is  $4 \pm 0.4$  divisions for all frequencies.

---

**DC Offset Accuracy (DC Only)**

This procedure tests the HP 3324A DC offset accuracy when no AC function output is present.

**Specifications** 1% of fullrange  $\pm 0.02$  mV

**Equipment Required** DC Digital Voltmeter  
50 $\Omega$  Feedthru Termination

- Procedure**
1. Connect the HP 3324A signal output directly to the 50 $\Omega$  feedthru termination and then with a cable to the DC digital voltmeter input.
  2. Set the output so that only the DC output is present.
  3. Set the HP 3324A DC offset to 5 V, then press **Ampl Cal**.
  4. The voltmeter reading should be between +4.950 and +5.050 V.
  5. Change the HP 3324A DC offset to -5 V. The voltmeter reading should be between -4.950 and -5.050 V.

### Attenuator Test

This procedure continues from the previous one.

1. Set the DC offset to the positive and negative voltages below. The digital voltmeter reading should be within the tolerances shown for each voltage.

DC Offset	Tolerances
$\pm 1.499$ V	$\pm 1.48399$ to $1.51401$ V
$\pm 499.9$ mV	$\pm 0.48488$ to $0.50491$ V
$\pm 149.9$ mV	$\pm 0.14838$ to $0.15142$ V
$\pm 49.99$ mV	$\pm 0.04947$ to $0.05051$ V
$\pm 14.99$ mV	$\pm 0.01482$ to $0.01516$ V
$\pm 4.999$ mV	$\pm 0.004929$ to $0.005069$ V
$\pm 1.499$ mV	$\pm 0.001464$ to $0.001534$ V

### High-Voltage Output (Option 002)

This procedure continues from the previous one.

1. Remove the  $50\Omega$  feedthru termination and connect the HP 3324A output directly to the voltmeter input.
2. Select the high-voltage output on the HP 3324A. "HIGH-VOLT" will be shown in the display.
3. Set the HP 3324A DC offset to 20 V. The voltmeter reading should be  $+19.775$  to  $20.225$  V.

---

## DC Offset Accuracy with AC Functions

This procedure tests the HP 3324A DC offset accuracy when an AC function output is present.

### Specifications

DC + AC, upto 1 MHz: 1.2%  
For ramps upto 10 KHz: 2.4%  
DC + AC, from 1 MHz to 20 MHz: 3%

### Equipment Required

DC Digital Voltmeter  
50Ω Feedthru Termination

### Procedure

1. Connect the equipment as shown in Figure 12-8. Set the voltmeter to measure DC voltage.

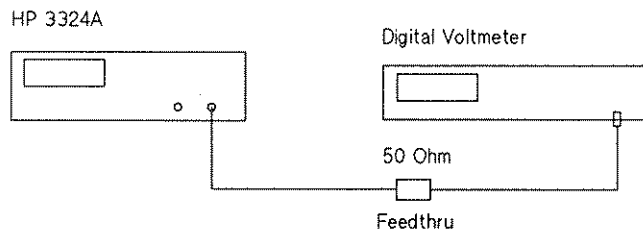

Figure 12-8. DC Offset Test Set-Up

2. Set the HP 3324A output as follows:

High-Voltage Output	Off
Function	Sine
Frequency	21 MHz
Amplitude	1 V(p-p)
DC Offset	+4.5 V

3. Press **Ampl Cal**. After amplitude calibration (approximately 2 seconds) the voltmeter reading should be +4.350 to +4.650 Vdc.
4. Change the HP 3324A DC offset to -4.5 V. The voltmeter reading should be -4.350 to -4.650 Vdc.
5. Change the HP 3324A frequency to 999.9 KHz. The voltmeter reading should be -4.440 to -4.560 Vdc.
6. Change the HP 3324A DC offset to +4.5 V. The voltmeter reading should be +4.440 to +4.560 Vdc.
7. Set the HP 3324A function to square. The voltmeter reading should be +4.440 to +4.560 Vdc.
8. Change the HP 3324A DC offset to -4.5 V. The voltmeter reading should be -4.440 to -4.560 Vdc.
9. Change the HP 3324A frequency to 9.9999 MHz. The voltmeter reading should be -4.350 to -4.650 Vdc.
10. Set the HP 3324A function to triangle, frequency to 9.9 KHz. The voltmeter reading should be -4.440 to -4.560 Vdc.
11. Set the function to positive ramp. The voltmeter should be -4.380 to -4.620 V.

## Triangle Linearity

This procedure tests the linearity of the HP 3324A triangle wave output. As the triangle and ramp outputs are generated by the same circuits, this procedure effectively tests the ramp linearity also.

**Specifications**  $\pm 0.05\%$  of full output, 10% to 90%, best fit straight line

## Equipment Required

High-speed DC Digital Voltmeter  
Resistor,  $20\Omega$  1/4 W 1%  
Resistor,  $30\Omega$  1/4 W 1%  
BNC-to-Triax Adapter

## Procedure

1. Connect the HP 3324A and the high-speed voltmeter through the divider as shown in Figure 12-9.

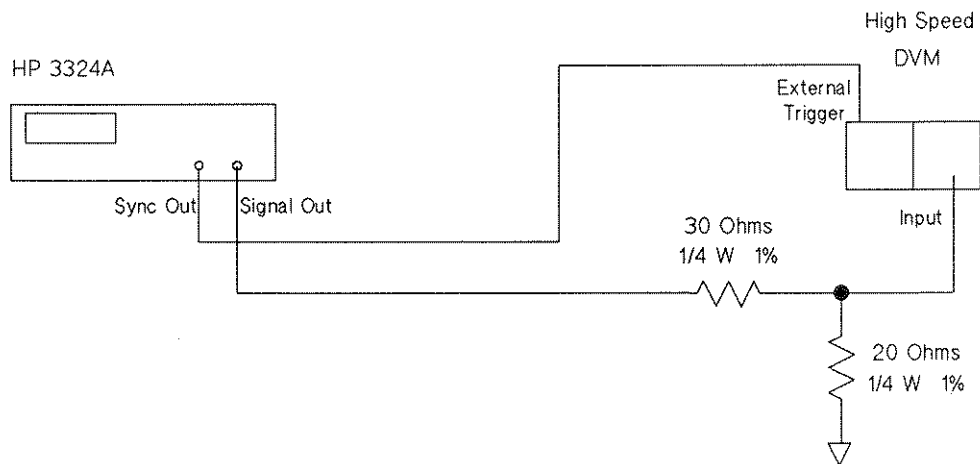

Figure 12-9. Triangle Linearity Test Set-Up

2. Set the HP 3324A output as follows:

High-Voltage Output	Off
Function	Triangle
Frequency	10 KHz
Amplitude	10 V(p-p)
DC Offset	0 V

3. Set the voltmeter as follows:

Range	1 V
Number of readings	1
Trigger	External

**Note**



The HP 3437A triggers on the negative going edge of the HP 3324A sync squarewave.

4. Set the voltmeter delay to 0.00003 (seconds). Record the voltmeter reading on the Performance Test Record under *Positive Slope Measurement, (10%)y<sub>1</sub>*. This is the 10% point on the positive slope of the triangle (see Figure 12-9).
5. Measure the voltage at each 10% segment point by setting the voltmeter delay to the following. Enter on the Performance Test Record in the appropriate spaces under *Positive Slope Measurement*.

Delay	Percent of Slope
0.000035	20
0.00004	30
0.000045	40
0.00005	50
0.000055	60
0.00006	70
0.000065	80
0.00007	90

6. Measure the voltage at each 10% segment point on the negative slope by setting the voltmeter delay to the following. Enter on the Performance Test Record in the appropriate spaces under *Negative Slope Measurement*.

Delay	Percent of Slope
0.00008	90
0.000085	80
0.00009	70
0.000095	60
0.0001	50
0.000105	40
0.00011	30
0.000115	20
0.00012	10

7. Algebraically add the voltages recorded in the *Positive Slope Measurement* column and enter the total in the  $\Sigma y$  space.
8. Multiply  $\Sigma y$  by 45 (which is  $\Sigma x$ ) and enter the result in the  $\Sigma x \Sigma y$  space.
9. Multiply each  $y$  value by the corresponding  $x$  value and enter in the  $x$  times  $y$  column. Total these values and enter in the  $\Sigma xy$  space.
10. The equation for determining the best fit straight line specification for each  $y$ -value is:

$$y = a_1 x + a_0$$

where  $a_1$  and  $a_0$  are constants to be calculated from the data taken previously.

**Note**



Calculate the values of  $a_1$  and  $a_0$  to at least five decimal places.



11. First determine the value of  $a_1$  using the following equation:

$$a_1 = \frac{\Sigma xy - \frac{\Sigma x \Sigma y}{n}}{\Sigma x^2 - \frac{(\Sigma x)^2}{n}}$$

where  $\Sigma x$ ,  $\Sigma y$ ,  $\Sigma xy$ ,  $\Sigma x \Sigma y$ ,  $\Sigma x^2$ , and  $(\Sigma x)^2$ , are the previously calculated values entered on the Performance Test Record.

where  $n=9$  (the number of points to be calculated).

12. Determine the value of  $a_0$  using the equation:

$$a_0 = \frac{\Sigma y}{n} - \frac{a_1 \Sigma x}{n}$$

13. Calculate the best fit straight line value for each point ( $y_1$  through  $y_9$ ) using the equation:

$$y = a_1 x + a_0$$

Enter each result on the Performance Test Record in the *Best Fit Straight Line* column.

14. For each delay ( $x$ ), subtract the calculated voltage ( $y'$ ) from the measured voltage ( $y$ ). Find the largest positive voltage difference ( $+V_{\max}$ ) and the largest negative difference ( $-V_{\max}$ ). Using the following formula, compute the % linearity.

$$\% \text{ linearity} = ((|+V_{\max}| + |-V_{\max}|) \div 8 \text{ volts}) \times 100\%$$

15. Algebraically add the voltages recorded in the Negative Slope Measurement column and enter the total in the  $\Sigma y$  space.

- Repeat steps 8 through 14 to determine the best fit straight line values and tolerances for the negative slope. The voltages measured and recorded in the *Negative Slope Measurement* column should be within the calculated tolerances.

---

## Ramp Period Variation

This procedure tests the variation between alternate cycles of the HP 3324A positive and negative slope ramps.

**Specifications** <  $\pm 1\%$  of period, maximum

**Equipment Required** Analog Oscilloscope, with delayed sweep

**Procedure**

- Connect the HP 3324A signal output to the oscilloscope vertical input. (Do NOT use a 10:1 probe.) Set the input switch to the  $50\Omega$  position. If your oscilloscope does not have a  $50\Omega$  input, use a  $50\Omega$  feedthru termination at the input.

- Set the HP 3324A output as follows:

Function	Negative Slope Ramp
Frequency	100 Hz
Amplitude	10 V(p-p)
DC Offset	0 V

- Set the oscilloscope as follows:

Vertical	2 V/div
Main Sweep	2.0 ms/div
Delayed Sweep	20 $\mu$ s/div
Trigger	Positive

4. With the oscilloscope horizontal controls set to main sweep, adjust the intensified portion of the trace to the reset (positive going) portion of the ramp.
5. Set the horizontal controls to delayed sweep and position the ramp reset portion near the center of the display.
6. The reset portion should show more than one line, as in Figure 12-9. The lines should not be separated by more than five divisions on the display.
7. Change the HP 3324A function to positive slope ramp and set the oscilloscope trigger to negative to verify the positive ramp.
8. Increase the HP 3324A frequency to 99.999999 Hz to check the low frequency ramps. Verify that ramp period variations do not exceed five divisions.

## Automatic Phase Calibration (Options 003 and 004)

This procedure tests the accuracy of the phase calibration options 003 (slave) and 004 (master).

### Specifications

	Sine/Sine			
	3 - 10 V(p-p)		0.3 - 10 V(p-p)	
1 mHz - 100 Hz	±1.5°	±2°	±1.5°	±2°
> 100 Hz - 1 MHz	±1°	±1.5°	±1°	±1.5°
> 1 MHz - 10 MHz	±1°	±2°	±1°	±3.5°
> 10 MHz - 21 MHz	±2.6°	±4°	±2.6°	±7°
	typ.		typ.	

	Square/Square			
	3 - 10 V(p-p)		0.3 - 10 V(p-p)	
1 mHz - 100 Hz	±1°	±1.5°	±1°	±1.5°
> 100 Hz - 1 MHz	±0.4°	±1°	±0.4°	±1°
> 1 MHz - 10 MHz	±1.2°	±2°	±1.2°	±3°
	typ.		typ.	

### Equipment Required

Digitizing Oscilloscope  
50Ω BNC Cables (2 off of the same length!)

### Note



Connect a 3324A signal to the oscilloscope and using an adder (splitter) HP 15109, check the oscilloscope interchannel accuracy and take the error into account.

**Procedure** 1. Connect the equipment as shown in Figure 12-10.

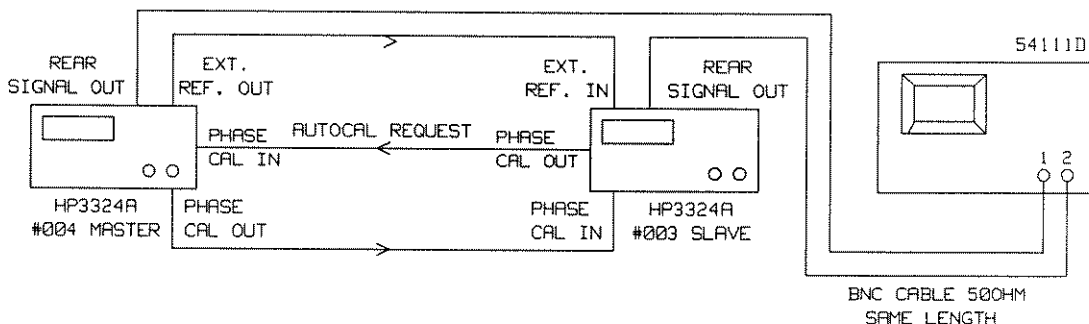

**Figure 12-10. Phase Calibration Test Set-Up**

2. Set the two HP 3324As as follows:

Util menu	Set default
Frequency	1 MHz
Amplitude	10 V(p-p)
Waveform	Sine
Signal ON	Rear

3. Connect the two 3324As for Phase Calibration.

4. Press **Ampl Cal** on both HP 3324As.

5. Press **Phase Cal** on the "slave" instrument (the one with option 003 installed).

6. Set the oscilloscope as follows:

Trigger Source	Channel 1, Trigger Level = 0.00 V, Slope = positive
Timebase	100 ns/div, Delay = 0.0s, Delay Ref at center
Display	Repetitive, Averaging On, Number of Averages = 64, Screen = single
Channel 2	Display On, Sensitivity = 2.00 V/div, Offset = 0.00 V, Input Coupling = dc, Input Impedance = 50Ω

Channel 1	Display On, Sensitivity = 2.00 V/div, Offset = 0.00 V, Input Coupling = dc, Input Impedance = 50Ω
Delta V	V Markers On, Marker 1 Position = Channel 1, Marker 2 Position = Channel 2, Preset Levels = 50-50%, Auto Level Set
Delta t	T Markers On, Start On Pos Edge 1, Stop on Pos Edge 1

7. Press **Phase Cal** on the “slave” instrument.
8. Press **Clear Display** on the scope and wait for # Avgs = 64.
9. Press **Edge Find**.
10. Check that  $\Delta t < 4.17$  ns.
11. Change the waveform of the two HP 3324As to square.
12. Select the Delta V menu on the scope and with preset levels at 50-50% press Auto Level Set.
13. Select the Delta T menu on the scope.
14. Press **Phase Cal** on the “slave” instrument.
15. Press **Clear Display** on the scope and wait for # Avgs = 64.
16. Press **Edge Find**.
17. Check that  $\Delta t < 2.78$  ns.

**Note**



---

With the above procedure the Phase Calibration at other frequencies and/or amplitudes can be measured.

---

## Test Record 1

Hewlett-Packard Model **3324A**  
Synthesized Function/Sweep Generator  
Serial Number  
Customer

Test Performed By  
Date  
Comments  
CSO No.

### Harmonic Distortion Test

Pass  Fail

#### Fundamental Frequency

#### Specification

20 MHz	-----	-25 dB
15 MHz	-----	-25 dB
14.9 MHz	-----	-30 dB
2 MHz	-----	-30 dB
1.99 MHz	-----	-40 dB
200 KHz	-----	-40 dB
10 KHz	-----	-60 dB
1 KHz	-----	-60 dB
100 Hz	-----	-60 dB

#### High-Voltage Output (Option 002)

100 Hz	-----	-60 dB
1 KHz	-----	-60 dB
10 KHz	-----	-60 dB
200 KHz	-----	-40 dB
1 MHz	-----	-40 dB

## Test Record 2

Hewlett-Packard Model **3324A**  
Synthesized Function/Sweep Generator  
Serial Number  
Customer

Test Performed By  
Date  
Comments  
CSO No.

### Spurious Signal Test

Pass  Fail

### Mixer Spurious

	2:1 spur	3:2 spur	Specification
2.001 MHz	-----	-----	-55 dB
4.100 MHz	-----	-----	-55 dB
6.100 MHz	-----	-----	-55 dB
8.100 MHz	-----	-----	-55 dB
10.100 MHz	-----	-----	-55 dB
12.100 MHz	-----	-----	-55 dB
14.100 MHz	-----	-----	-55 dB
16.100 MHz	-----	-----	-55 dB
18.100 MHz	-----	-----	-55 dB
20.100 MHz	-----	-----	-55 dB

### Close-in-Spurious

5.0001 MHz	-----	-55 dB
5.00001 MHz	-----	-55 dB
5.000001 MHz	-----	-55 dB
20.001 MHz	-----	-55 dB
20.001 MHz	-----	-55 dB
20.001 MHz	-----	-55 dB
20.001 MHz	-----	-55 dB



---

### Test Record 3

Hewlett-Packard Model **3324A**  
Synthesized Function/Sweep Generator  
Serial Number \_\_\_\_\_  
Customer \_\_\_\_\_

Test Performed By \_\_\_\_\_  
Date \_\_\_\_\_  
Comments \_\_\_\_\_  
CSO No. \_\_\_\_\_

#### Integrated Phase Noise Test

Pass  Fail

1st AC voltmeter reading \_\_\_\_\_ dB  
2nd AC voltmeter reading \_\_\_\_\_ dB

1st reading - 2nd reading = \_\_\_\_\_ dB

Specification

Result - 6 dB = \_\_\_\_\_ -50 dB

---

#### Ramp Retrace Time Test

Pass  Fail

Specification

Positive Slope Ramp \_\_\_\_\_  $\leq 3 \mu s$   
Negative Slope Ramp \_\_\_\_\_  $\leq 3 \mu s$

## Test Record 4

Hewlett-Packard Model 3324A  
 Synthesized Function/Sweep Generator  
 Serial Number  
 Customer

Test Performed By  
 Date  
 Comments  
 CSO No.

### Frequency Accuracy Test

Pass  Fail

Sine, 20 MHz	-----	±100 Hz
Square, 10 MHz	-----	±50 Hz
Triangle, 10 KHz (100,000 ns)	-----	±0.5 ns
Ramp, 10 KHz (100,000 ns)	-----	±0.5 ns

### Phase Increment Accuracy Test

Pass  Fail

	Measured	Minimum	Time Difference	Maximum
Zero Phase Time Interval	-----			
1° Increment Time Interval	-----	13.89 ns	-----	41.67 ns
10° Increment Time Interval	-----	263.89 ns	-----	291.67 ns
100° Increment Time Interval	-----	2763.89 ns	-----	2791.67 ns

## Test Record 5 (1 of 4)

Hewlett-Packard Model 3324A  
 Synthesized Function/Sweep Generator  
 Serial Number  
 Customer

Test Performed By  
 Date  
 Comments  
 CSO No.

### Amplitude Accuracy Test

Pass  Fail

Sinewave Test	Minimum	Measured	Maximum
Amplitude: 3.536 Vrms			
Sine, 100 Hz:	3.455 V	-----	3.617 V
Sine, 1 KHz:	3.455 V	-----	3.617 V
Sine, 100 KHz:	3.455 V	-----	3.617 V
Amplitude: 1.061 Vrms			
Sine, 100 Hz:	1.037 V	-----	1.085 V
Sine, 1 KHz:	1.037 V	-----	1.085 V
Sine, 100 KHz:	1.037 V	-----	1.085 V
Amplitude: 0.3536 Vrms			
DC, 1 mV			
Sine, 100 Hz:	0.3370 V	-----	0.3702 V
Sine, 1 KHz:	0.3370 V	-----	0.3702 V
Sine, 100 KHz:	0.3370 V	-----	0.3702 V

---

**Test Record 5****(2 of 4)****Amplitude Accuracy Test (continued)**

<b>Function Test</b>	<b>Minimum</b>	<b>Measured</b>	<b>Maximum</b>
<b>Amplitude: 10 V(p-p)</b>			
Square, 99.9 Hz	9.95 V	-----	10.15 V
Triangle, 99.9 Hz	9.85 V	-----	10.15 V
Pos. Ramp, 99.9 Hz	9.85 V	-----	10.15 V
Neg. Ramp, 99.9 Hz	9.85 V	-----	10.15 V
Square, 1 KHz	9.95 V	-----	10.15 V
Triangle, 2 KHz	9.85 V	-----	10.15 V
Pos. Ramp, 500 Hz	9.85 V	-----	10.15 V
Neg. Ramp, 500 Hz	9.85 V	-----	10.15 V
Square, 101 KHz	9.50 V	-----	10.50 V
Triangle, 10 KHz	9.50 V	-----	10.50 V
Pos. Ramp, 10 KHz	9.00 V	-----	11.00 V
Neg. Ramp, 10 KHz	9.00 V	-----	11.00 V
<b>Amplitude: 3 V(p-p)</b>			
Square, 99.9 Hz	2.955 V	-----	3.045 V
Triangle, 99.9 Hz	2.955 V	-----	3.045 V
Pos. Ramp, 99.9 Hz	2.955 V	-----	3.045 V
Neg. Ramp, 99.9 Hz	2.955 V	-----	3.045 V
Square, 1 KHz	2.955 V	-----	3.045 V
Triangle, 2 KHz	2.955 V	-----	3.045 V
Pos. Ramp, 500 Hz	2.955 V	-----	3.045 V
Neg. Ramp, 500 Hz	2.955 V	-----	3.045 V
Square, 101 KHz	2.700 V	-----	3.300 V
Triangle, 10 KHz	2.850 V	-----	3.150 V
Pos. Ramp, 10 KHz	2.700 V	-----	3.300 V
Neg. Ramp, 10 KHz	2.700 V	-----	3.300 V

## Test Record 5 (3 of 4)

### Amplitude Accuracy Test (continued)

Function Test	Minimum	Measured	Maximum
Amplitude: 1 V(p-p) DC: 1 mV			
Square, 99.9 Hz	0.978 V	-----	1.022 V
Triangle, 99.9 Hz	0.973 V	-----	1.027 V
Pos. Ramp, 99.9 Hz	0.973 V	-----	1.027 V
Neg. Ramp, 99.9 Hz	0.973 V	-----	1.027 V
Square, 1 KHz	0.978 V	-----	1.022 V
Triangle, 2 KHz	0.973 V	-----	1.027 V
Pos. Ramp, 500 Hz	0.973 V	-----	1.027 V
Neg. Ramp, 500 Hz	0.973 V	-----	1.027 V
Square, 101 KHz	0.900 V	-----	1.100 V
Triangle, 10 KHz	0.938 V	-----	1.062 V
Pos. Ramp, 10 KHz	0.888 V	-----	1.112 V
Neg. Ramp, 10 KHz	0.888 V	-----	1.112 V

### High-Voltage Output (Option 002)

Sinewave Test	Minimum	Measured	Maximum
Amplitude: 14.14 Vrms Sine, 2 KHz	13.86 V	-----	14.42 V

Function Test	Minimum	Measured	Maximum
Amplitude: 40 V(p-p)			
Square, 2 KHz	3.466 V	-----	3.607 V
Triangle, 2 KHz	3.466 V	-----	3.607 V
Pos. Ramp, 2 KHz	3.466 V	-----	3.607 V
Neg. Ramp, 2 KHz	3.466 V	-----	3.607 V

## Test Record 5 (4 of 4)

### Amplitude Accuracy Test (continued)

Amplitude Flatness Test	Min.	Calc. Ampl.	Max.
Sine, 10 dBm, 1 KHz	9.8 dBm	-----	10.2 dBm
101 KHz	9.4 dBm	-----	10.6 dBm
500 KHz	9.4 dBm	-----	10.6 dBm
1 MHz	9.4 dBm	-----	10.6 dBm
5 MHz	9.4 dBm	-----	10.6 dBm
10 KHz	9.4 dBm	-----	10.6 dBm
15 KHz	9.4 dBm	-----	10.6 dBm
20 KHz	9.4 dBm	-----	10.6 dBm
Sine, 18 dBm, 1 KHz	Min. 17.8 dBm	-----	Max. 18.2 dBm
101 KHz	17.6 dBm	-----	18.4 dBm
500 KHz	17.6 dBm	-----	18.4 dBm
1 MHz	17.6 dBm	-----	18.4 dBm
5 MHz	17.6 dBm	-----	18.4 dBm
10 KHz	17.6 dBm	-----	18.4 dBm
15 KHz	17.6 dBm	-----	18.4 dBm
20 KHz	17.6 dBm	-----	18.4 dBm
Square, 10 V(p-p)	Pass <input type="checkbox"/>		Fail <input type="checkbox"/>
High-Voltage Output (Option 002)			
Sine, 40 V(p-p)	Pass <input type="checkbox"/>		Fail <input type="checkbox"/>

## Test Record 6



Hewlett-Packard Model **3324A**  
 Synthesized Function/Sweep Generator  
 Serial Number  
 Customer

Test Performed By  
 Date  
 Comments  
 CSO No.

### DC Offset Accuracy Test (DC Only)

Pass  Fail

	Minimum	Measured	Maximum
5 V	+4.950 V	-----	+5.050 V
-5 V	-4.950 V	-----	-5.050 V
1.499 V	+1.48399 V	-----	+1.51401 V
-1.499 V	-1.48399 V	-----	-1.51401 V
499.9 mV	+0.49488 V	-----	+0.50491 V
-499.9 mV	-0.49488 V	-----	-0.50491 V
149.9 mV	+0.14838 V	-----	+0.15142 V
-149.9 mV	-0.14838 V	-----	-0.15142 V
49.99 mV	+0.04947 V	-----	+0.05051 V
-49.99 mV	-0.04947 V	-----	-0.05051 V
14.99 mV	+0.01482 V	-----	+0.01516 V
-14.99 mV	-0.01482 V	-----	-0.01516 V
4.999 mV	+0.004929 V	-----	+0.005069 V
-4.999 mV	-0.004929 V	-----	-0.005069 V
1.999 mV	+0.001464 V	-----	+0.001534 V
-1.999 mV	-0.001464 V	-----	-0.001534 V

### High-Voltage Output (Option 002)

20 V	+19.775 V	-----	+20.225 V
-20 V	-19.775 V	-----	-20.225 V



## Test Record 7

Hewlett-Packard Model **3324A**  
 Synthesized Function/Sweep Generator  
 Serial Number  
 Customer

Test Performed By  
 Date  
 Comments  
 CSO No.

### DC Offset Accuracy Test with AC Functions

Pass  Fail

	Minimum	Measured	Maximum
Sine, 21 MHz			
4.5 V	+4.350 V	-----	+4.650 V
-4.5 V	-4.350 V	-----	-4.650 V
Sine, 999.9 KHz			
4.5 V	+4.440 V	-----	+4.560 V
-4.5 V	-4.440 V	-----	-4.560 V
Square, 999.9 KHz			
4.5 V	+4.440 V	-----	+4.560 V
-4.5 V	-4.440 V	-----	-4.560 V
Square, 9.9999 MHz			
-4.5 V	-4.350 V	-----	-4.650 V
Triangle, 9.9 KHz			
-4.5 V	-4.440 V	-----	-4.560 V
Ramp, 9.9 KHz			
-4.5 V	-4.380 V	-----	-4.620 V



## Test Record 8

1 of 2

Hewlett-Packard Model **3324A**  
 Synthesized Function/Sweep Generator  
 Serial Number  
 Customer

Test Performed By  
 Date  
 Comments  
 CSO No.

### Triangle Linearity Test

Pass  Fail

x Values	Positive Slope Measurement	x times y	Calculated Best Fit Straight Line	Minimum Tolerance	Maximum Tolerance
$x_1 = 1$	(10%) $y_1$ -----	-----	$(y_1)$ -----	-----	-----
$x_2 = 2$	(20%) $y_2$ -----	-----	$(y_2)$ -----	-----	-----
$x_3 = 3$	(30%) $y_3$ -----	-----	$(y_3)$ -----	-----	-----
$x_4 = 4$	(40%) $y_4$ -----	-----	$(y_4)$ -----	-----	-----
$x_5 = 5$	(50%) $y_5$ -----	-----	$(y_5)$ -----	-----	-----
$x_6 = 6$	(60%) $y_6$ -----	-----	$(y_6)$ -----	-----	-----
$x_7 = 7$	(70%) $y_7$ -----	-----	$(y_7)$ -----	-----	-----
$x_8 = 8$	(80%) $y_8$ -----	-----	$(y_8)$ -----	-----	-----
$x_9 = 9$	(90%) $y_9$ -----	-----	$(y_9)$ -----	-----	-----

$\Sigma x = 45$        $\Sigma y$ -----       $\Sigma xy$ -----

$(\Sigma x)^2 = 2025$        $\Sigma x \Sigma y$ -----

$\Sigma x^2 = 285$

## Test Record 8

2 of 2

### Triangle Linearity Test (continued)

Pass  Fail

x Values	Negative Slope Measurement	x times y	Calculated Best Fit Straight Line	Minimum Tolerance	Maximum Tolerance
x <sub>1</sub> = 1	(10%) y <sub>1</sub> -----	-----	(y <sub>1</sub> )-----	-----	-----
x <sub>2</sub> = 2	(20%) y <sub>2</sub> -----	-----	(y <sub>2</sub> )-----	-----	-----
x <sub>3</sub> = 3	(30%) y <sub>3</sub> -----	-----	(y <sub>3</sub> )-----	-----	-----
x <sub>4</sub> = 4	(40%) y <sub>4</sub> -----	-----	(y <sub>4</sub> )-----	-----	-----
x <sub>5</sub> = 5	(50%) y <sub>5</sub> -----	-----	(y <sub>5</sub> )-----	-----	-----
x <sub>6</sub> = 6	(60%) y <sub>6</sub> -----	-----	(y <sub>6</sub> )-----	-----	-----
x <sub>7</sub> = 7	(70%) y <sub>7</sub> -----	-----	(y <sub>7</sub> )-----	-----	-----
x <sub>8</sub> = 8	(80%) y <sub>8</sub> -----	-----	(y <sub>8</sub> )-----	-----	-----
x <sub>9</sub> = 9	(90%) y <sub>9</sub> -----	-----	(y <sub>9</sub> )-----	-----	-----

$\Sigma x = 45$        $\Sigma y$ -----       $\Sigma xy$ -----

$(\Sigma x)^2 = 2025$        $\Sigma x \Sigma y$ -----

$\Sigma x^2 = 285$

### Ramp Period Variation Test

Pass  Fail

Negative Slope Ramp, 100 Hz      Pass

Positive Slope Ramp, 100 Hz      Pass

Positive Slope Ramp, 99.9 Hz      Pass

Fail

Fail

Fail

---

## Test Record 9

Hewlett-Packard Model **3324A**  
Synthesized Function/Sweep Generator  
Serial Number  
Customer

Test Performed By  
Date  
Comments  
CSO No.

**Automatic Phase Calibration Test**

Pass  Fail

Formula:

$$\Delta t = \{\text{PER}(\text{sec.}) \cdot \text{Spec}(\text{deg.})\} / 360(\text{deg.})$$

Sine, 1 MHz  
Square, 1 MHz

-----  $\Delta t < 4.17 \text{ ns}$   
-----  $\Delta t < 2.78 \text{ ns}$

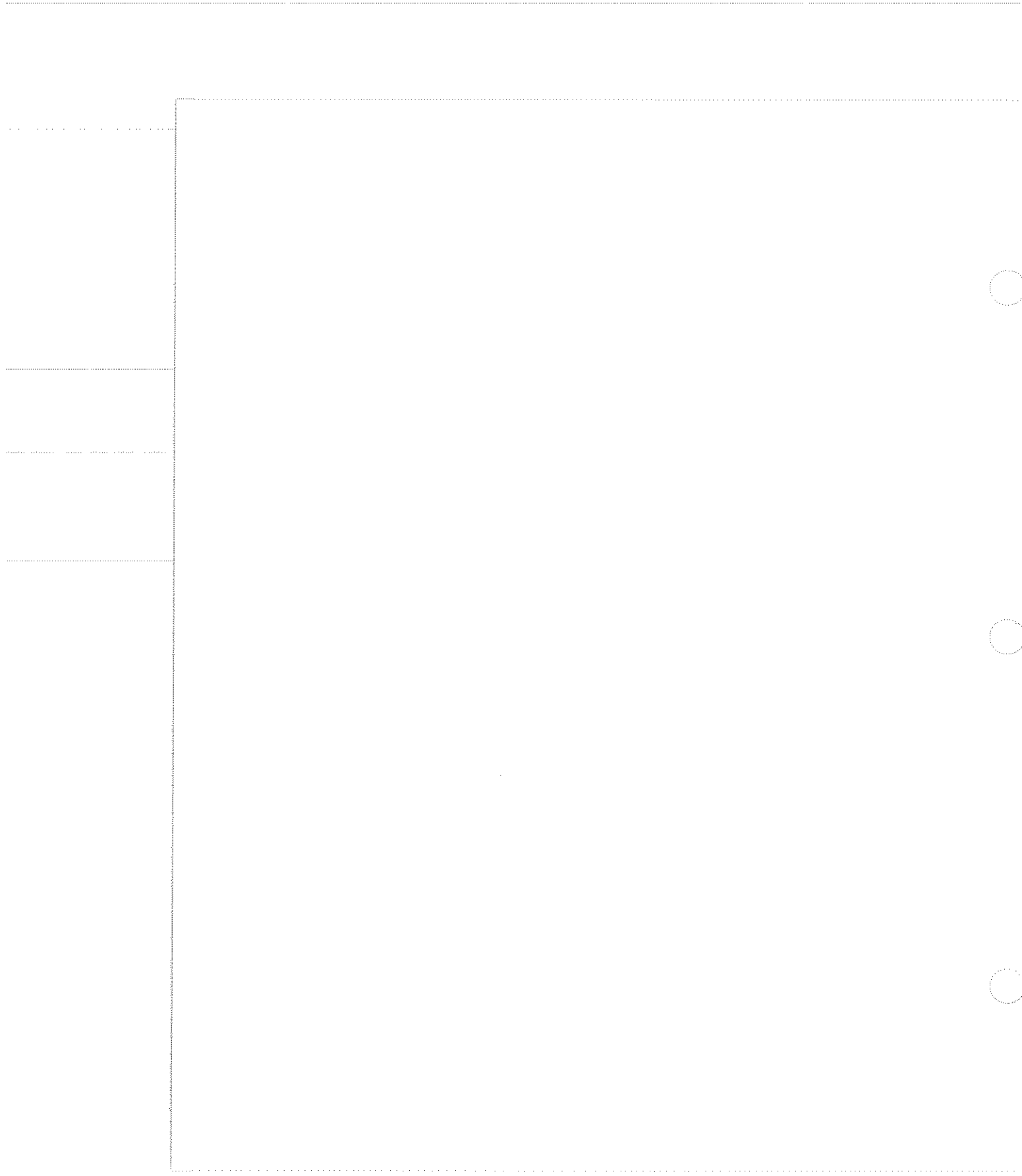

## Specifications

---

All specifications apply after a 30 minute warm-up period, and are valid from 0°C to 55°C ambient temperature. All specifications describe the warranted performance, except for the Main Signal Output, Squarewave Characteristics (also by Option 002), Auxiliary Outputs, Auxiliary Inputs, HP-IB Control and General specifications, which describe the typical performance.

---

## Waveforms

Sine, square, triangle, negative and positive ramps, DC and TTL clock.

---

## Frequency

Range	
Sine:	1 mHz - 21.000 000 0 MHz
Square:	1 mHz - 11.000 000 0 MHz
Triangle:	1 mHz - 11.000 000 0 KHz
Ramps:	1 mHz - 11.000 000 0 KHz
Auxiliary TTL clock:	1 mHz - 60.000 000 0 MHz

**Resolution:**

1 mHz, upto 999.999 999 KHz

100 mHz, from 1 MHz upto 21.000 000 0 MHz

**Accuracy:**

±5 ppm of selected value, from 20°C to 30°C, at time of calibration with standard frequency reference.

**Stability:**

±5 ppm/year, from 20°C to 30°C, standard (see also option 001, high-stability frequency reference).

**Warm-up Time:**

20 minutes to within specified accuracy.

---

**Main Signal Output  
(Supplementary)**

**Impedance:**

50Ω±1Ω, 0-10 KHz

**Return Loss:**

> 20 dB, 10 KHz to 20 MHz, except > 10 dB for > 3 V, 5 MHz to 20 MHz.

**Floating:**

Output may be floated upto 42 V peak (AC + DC).

**Connector:**

BNC, switchable between front and rear panel.

---

**Amplitude**

(All waveforms without DC offset, except auxiliary TTL clock).

**Range:**

1 mV to 10 V(p-p) in 8 amplitude ranges, 1-3-10 sequence, amplitude can be set up in rms and dBm also.

**Ranges (without DC offset):**

1 mV – 2.999 mV	100 mV – 299.9 mV
3 mV – 9.999 mV	300 mV – 999.9 mV
10 mV – 29.99 mV	1 V – 2.999 V
30 mV – 99.99 mV	3 V – 10.00 V

**Resolution:**

4 digits (0.03% of full range).

Function	peak-to-peak	rms	dBm (50Ω)
Sine	min. 1.000 mV	0.354 mV	-56.02
	max. 10.00 V	3.536 V	+23.98
Square	min. 1.000 mV	0.500 mV	-53.01
	max. 10.00 V	5.000 V	+26.99
Triangle/ Ramps	min. 1.000 mV	0.289 mV	-57.78
	max. 10.00 V	2.887 V	+22.22

**Accuracy (with 0 Vdc offset):**

Sinewave:

	0.001 Hz to 100 KHz	>100 KHz to 10 MHz	>10 MHz to 20 MHz
+23.98 to 13.52 dBm	±0.2 dB	±0.4 dB	±0.4 dB
<+13.52 to -16.02 dBm	±0.2 dB	±0.6 dB	±0.6 dB
<-16.02 to -56.02 dBm	±0.2 dB	±0.6 dB	±0.9 dB

Squarewave:

	0.001 Hz to 100 KHz	>100 KHz to 10 MHz
10 V(p-p) to 3 V(p-p)	±1.5%	±5%
<3 V(p-p) to 1 mV(p-p)	±2.2%	±10%

Triangle:

	0.001 Hz to 2 KHz	>2 KHz to 10 KHz
10 V(p-p) to 3 V(p-p)	±1.5%	±5.0%
<3 V(p-p) to 1 mV(p-p)	±2.7%	±6.2%

Ramps:

	0.001 Hz to 500 Hz	>500 Hz to 10 KHz
10 V(p-p) to 3 V(p-p)	±1.5%	±10.0%
<3 V(p-p) to 1 mV(p-p)	±2.7%	±11.2%

With DC offset, increase all sinewave tolerances by 0.2 dB and all function tolerances by 2%.

---

## Sinewave Spectral Purity

**Phase Noise:**

-50 dBc for a 30 KHz band centered on a 20 MHz carrier (excluding ±1 Hz about the carrier).

**Spurious:**

All non-harmonically related output signals will be more than 55 dB below the carrier, (-50 dBc with DC offset), or less than -85 dBm, whichever is the greater.



**Sinewave Harmonic Distortion:**

Harmonically related signals will be less than the following levels relative to the fundamental:

Frequency Range	Harmonic Level
0.1 Hz - 199 KHz	-60 dBc
200 KHz - 1.99 MHz	-40 dBc
2 MHz - 14.9 MHz	-30 dBc
15 MHz - 20 MHz	-25 dBc

---

**Squarewave Characteristics  
(Supplementary)**

**Rise/Fall Time:**

(10% to 90% of p-p output voltage):  $\leq 20$  ns

**Overshoot:**

5% of peak-to-peak amplitude at full output.

**Symmetry:**

$\leq 0.02\%$  of period +3 ns.

---

**Triangle/Ramp Characteristics**

**Linearity:**

(10% to 90%, 10 KHz):  $\pm 0.05\%$  of full peak-to-peak output voltage for each range.

**Ramp Retrace Time:**

(10% to 90%):  $\leq 3 \mu s$

**Period Variation for Alternate Ramp Cycles:**

$\leq 1\%$  of period.

---

## DC Offset

**Range:**

DC only (no AC signal): 0 to  $\pm 5\text{ V} / 50\Omega$

DC + AC: Maximum DC offset  $\pm 4.5\text{ V}$  on highest range; decreasing to  $\pm 4.5\text{ mV}$  on lowest range.

**Resolution:**

4 digits

**Accuracy:**

DC only:  $\pm 0.015\text{ mV}$  to  $\pm 50\text{ mV}$ , depends on offset chosen,  $\pm 0.02\text{ mV}$ .

DC + AC, upto 1 MHz:  $\pm 0.06\text{ mV}$  to  $\pm 60\text{ mV}$ , depends on AC output level;  $\pm 0.2\text{ mV}$  to  $\pm 120\text{ mV}$  for ramps to 10 KHz.

DC + AC, from 1 MHz to 20 MHz:  $\pm 15\text{ mV}$  to  $\pm 150\text{ mV}$ , depends on AC output level.

---

## Phase Offset

**Range:**

$719.9^\circ$  with respect to arbitrary starting phase or assigned zero phase. For squarewave frequencies below 25 KHz, phase changes greater than  $25^\circ$  may result in a phase shift of  $\pm 180^\circ$  from the desired amount.

**Resolution:**

$0.1^\circ$

**Increment Accuracy:**

$\pm 0.5^\circ$

**Stability:**

$\pm 1.0^\circ$  of phase/ $^\circ\text{C}$

---

## Frequency Sweep

### Sweep Sequence Modes:

Single, continuous.

### Sweep Function Modes:

#### Multi-Interval:

Upto 50 different intervals can be sequenced and repeated in any order in a sequence which can contain upto 100 intervals.

Frequency-switching-time between intervals (to within 1 Hz):

≤12 ms for a 100 KHz step.

≤27 ms for a 1 MHz step.

≤72 ms for a 20 MHz step.

#### Multi-Marker:

Upto 9 marker frequencies can be set if a standard sweep (no Multi-Interval) is performed. Reaching a marker frequency generates a high-to-low transition at the marker output. Time between start- and marker-frequencies, succeeding marker frequencies, and marker- and stop-frequencies are ≤1.5 ms.

#### Linear Sweep (settable for each interval):

Sweep time: 0.01 s to  $10^5$  s

Maximum sweep width: full frequency range of the main signal output for the waveform in use.

Minimum sweep width: 0 Hz

One marker frequency can be set in each interval.

#### Logarithmic Sweep (settable for each interval):

Sweep time: 0.1 s to  $10^5$  s

Maximum sweep width: full frequency range of the main signal output for the waveform in use.

Minimum start frequency: 1 Hz

Minimum sweep width: 1 decade

#### Phase Continuity:

Sweep is phase continuous over the full frequency range of the main output for all sweep modes.

---

## Auxiliary Outputs (Supplementary)

### **SYNC Output:**

1 mHz to 21 MHz phase synchronous squarewave with the same frequency as the main signal output, or 1 mHz to 60 MHz **Auxiliary TTL Clock** (main signal output switched off).

Output impedance:  $50\Omega$

Output levels: high level  $> 1.2\text{ V}$ , low level  $< 0.2\text{ V}$

Connector: BNC, front and rear panels.

Note: Level doubles into open input.

### **Auxiliary Frequency Output:**

Squarewave.

Frequency range: 21 MHz to 60 MHz

Output impedance:  $50\Omega$

Amplitude: 0 dBm

Connector: rear panel BNC.

### **X-axis Drive Output:**

(0 – 100 s sweeps only).

The ramp is proportional to the entire sweep time, including each individual interval sweep time and the switching times between intervals.

Load impedance:  $> 10\text{ K}\Omega$

Output level: 0 to +10 V

Connector: rear panel BNC.

### **Z-axis Blank Output:**

TTL compatible voltage levels capable of sinking current from a positive source. Current 200 mA, voltage 45 V, power dissipation max. 1 W.

Connector: rear panel BNC.

### **Sweep Marker Output:**

High to low transitions at selected marker frequencies.

TTL and CMOS compatible output levels. Pulswidth in

Multi-Marker mode: 1 ms.

Connector: rear panel BNC.

Fan out: 4

**1 MHz Reference Output**

1 MHz squarewave for phase locking additional instruments to the HP 3324A.

Output impedance: 50Ω

Output amplitude: 0 dBm

Connector: rear panel BNC.

---

**Auxiliary Inputs  
(Supplementary)**

**Reference Input**

For phase locking the HP 3324A to an external frequency reference.

Signal from 0 dBm to 20 dBm into 50Ω

Reference signal must be a sub-harmonic of 10 MHz from 1 MHz to 10 MHz.

Connector: rear panel BNC. With option 001 this input must be connected to the 10 MHz oven output.

---

**HP-IB Control  
(Supplementary)**

**Frequency Switching Time** (to within 1 Hz, exclusive of programming time):

≤10 ms for a 100 KHz step.

≤25 ms for a 1 MHz step.

≤70 ms for a 20 MHz step.

**Phase Switching Time** (to within 90° of phase lock, exclusive of programming time):

≤15 ms

**Amplitude Switching Time** (to within amplitude specification, exclusive of programming time):

<30 ms

**Interface functions:**

SH1, AH1, T6, L3, SR1, RL1, PP0, DC1, DT0, C0, E2

---

**Option 001  
High-Stability  
Frequency  
Reference**

**Aging Rate:**

$\pm 5 \times 10^{-8}$ /week after 72 hours continuous operation.  
 $\pm 1 \times 10^{-7}$ /month after 15 days continuous operation.

**Warm-up Time:**

Reference will be within  $\pm 1 \times 10^{-7}$  of final value 15 minutes after turn-on at 25°C, for an off time of less than 24 hours.

**10 MHz Oven Output:**

10 MHz squarewave for phase-locking additional instruments to the HP 3324A.

Output impedance: 50Ω

Output level: >4.5 dBm

Connector: rear panel BNC.

---

**Option 002  
High-Voltage  
Output**

**Frequency range:**

1 mHz to 1 MHz

**Amplitude:**

4 mV to 40 V(p-p) in 8 ranges, 4-12-40 sequence into 500Ω, < 500 pF load. Ranges are four times the standard instrument ranges, without DC offset.

Accuracy:  $\pm 2\%$  of full output for each range at 2 KHz.

Flatness:  $\pm 10\%$  relative to programmed amplitude.

**Sinewave Harmonic Distortion:**

Harmonically related signals will be less than the following levels (relative to the fundamental full output into 500Ω, 500 pF load):

Frequency Range	Harmonic Level
10 Hz - 199 KHz	-60 dBc
200 KHz - 1 MHz	-40 dBc

**Squarewave Rise/Fall Time:  
(Supplementary)**

≤125 ns, 10% to 90% of peak-to-peak output voltage with 500Ω, 500 pF load.

**Squarewave Overshoot:  
(Supplementary)**

≤10% of peak-to-peak output voltage with 500Ω, 500 pF load.

**Output Impedance:**

< 3Ω at DC, < 10Ω at 1 MHz.

**DC Offset:**

Range: 4 times the specified range of the standard instrument.

Accuracy: ±(1% of full output voltage for each range + 25 mV).

**Maximum Output Current:**

±40 mA peak.

---

**Automatic Phase  
Calibration  
Options**

The Automatic Phase Calibration options 003 (slave) and 004 (master) provide the automatic phase calibration between two HP 3324As without external measuring instruments. Option 003 has to be installed into one HP 3324A, option 004 has to be installed into the other instrument. Adjust factors for different cable delays between master/slave and 3324A/device-under-test can be entered in the UTILITY menu.

### Phase Error

The phase error is measured between the main signal outputs on the rear panel with either unequal or equal amplitudes and without DC offset. Phase is defined as the difference in rising edge to rising edge (measured with AC-coupled zero-crossing-points as reference points) for sine and squarewaves.

	Sine/Sine			
	3 - 10 V(p-p)		0.3 - 10 V(p-p)	
1 mHz - 100 Hz	±1.5°	±2°	±1.5°	±2°
> 100 Hz - 1 MHz	±1°	±1.5°	±1°	±1.5°
> 1 MHz - 10 MHz	±1°	±2°	±1°	±3.5°
> 10 MHz - 21 MHz	±2.6°	±4°	±2.6°	±7°
	typ.		typ.	

	Square/Square			
	3 - 10 V(p-p)		0.3 - 10 V(p-p)	
1 mHz - 100 Hz	±1°	±1.5°	±1°	±1.5°
> 100 Hz - 1 MHz	±0.4°	±1°	±0.4°	±1°
> 1 MHz - 10 MHz	±1.2°	±2°	±1.2°	±3°
	typ.		typ.	



---

**General  
(Supplementary)**

**Operating Environment:**

Temperature: 0°C to 55°C, if not otherwise stated.

Relative humidity: 95%, 0°C to 40°C

Storage temperature: -40°C to +75°C

**Power:**

100/120/220/240 V, ±10%; 48 to 66 Hz; 100 VA max.

Standby 20 VA max.

**Weight:**

11 kg net, 16.5 kg shipping.

**Dimensions:**

132.6 mm high x 425.5 mm wide x 497.5 mm deep  
(5.25 ins. H x 16.75 ins. W x 19.625 ins. D).

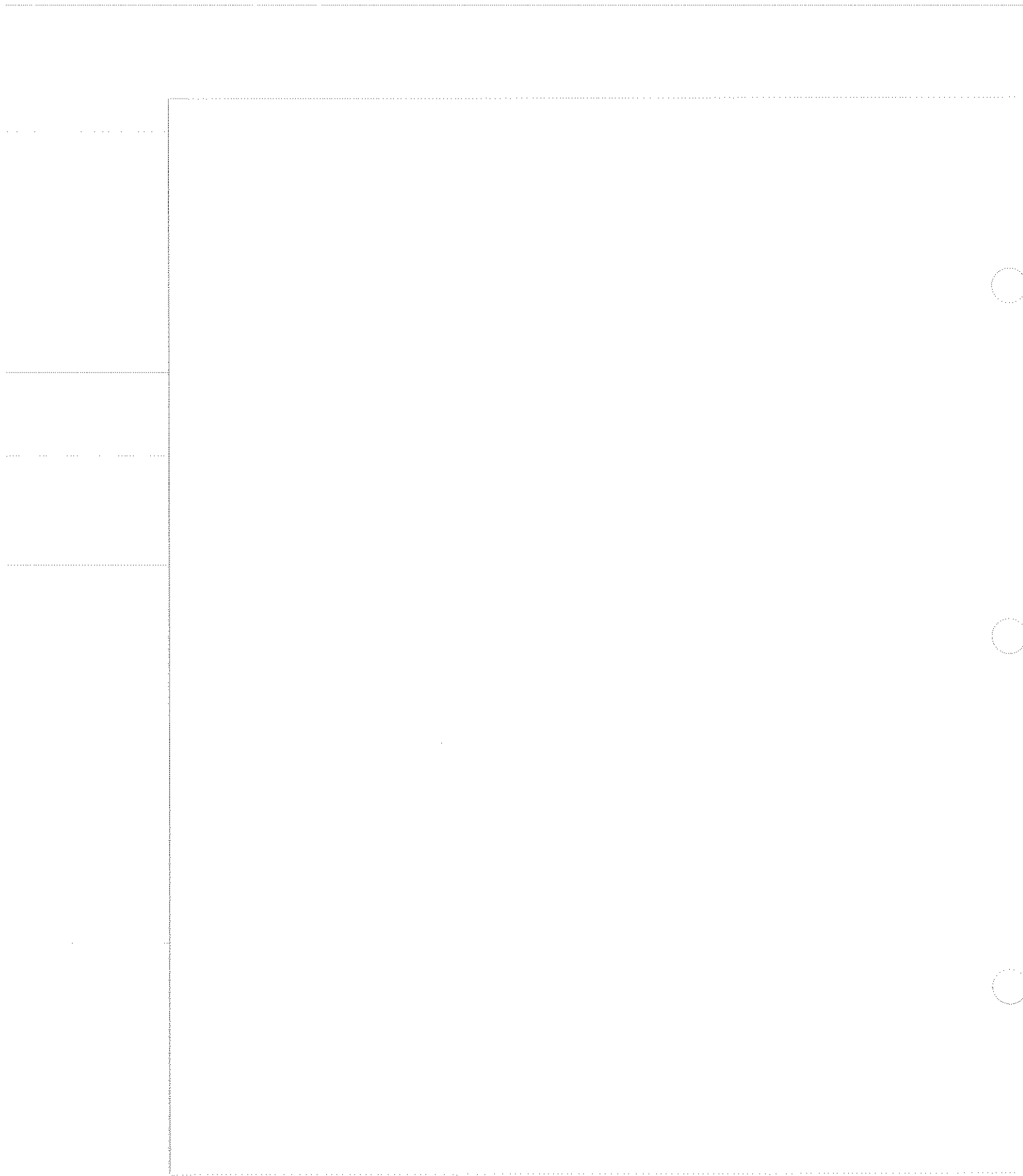

## Options and Accessories

### Introduction

This appendix gives an explanation of the options and accessories available for the HP 3324A. Table B-1 lists the options available for the HP 3324A. These options are available when the instrument is ordered by specifying the option number, or are available later by ordering the option part number (p/n).

**Table B-1. Options Available**

Option	Description
#001	High-Stability Frequency Reference
#002	High-Voltage Output
#003	Automatic Phase Calibration, Slave
#004	Automatic Phase Calibration, Master
#907	Front Handle Kit (p/n 5062-3989)
#908	Rack Mount Flange Kit (p/n 5062-3977)
#909	Rack Mount Flange and Front Handle Combination Kit (p/n 5062-3983)
#910	Set of Operating/Programming and Service Manuals (contains #915 and #916)
#915	Service Manual (p/n 03324-90001)
#916	Additional Operating and Programming Manual (p/n 03324-90011)
#W30	Two additional years of "Return-to-HP" Service

### Note



Automatic phase calibration between two 3324A requires that one instrument has option 003 installed and the other has option 004 installed.

---

## **Option 001 High-Stability Frequency Reference**

The high-stability frequency reference option is a 10 MHz temperature-stabilized crystal oscillator, which produces a signal at the 10 MHz oven output connector. The signal should be input to the HP 3324A frequency reference input (connect the 10 MHz oven output to the External Ref In connector with the BNC-to-BNC cable supplied). The 10 MHz oven signal has a level of 6 dBm (50Ω). The output signal is present whenever the HP 3324A is connected to a power source.

To reduce warm-up time and obtain maximum performance from an HP 3324A equipped with option 001, leave the HP 3324A connected to a power source. Power is supplied to option 001 whenever the HP 3324A is connected to a power source. An HP 3324A with option 001 requires 15 minutes of warm-up time to meet frequency specifications if power is disconnected for less than 24 hours. For more than 24 hours, the HP 3324A may require up to 72 hours warm-up time to meet the frequency specifications.

Option 001 can be installed at a later date. The instrument should be sent to an HP Service Center to do this. Please contact your local Sales Office for more information.

---

## Option 002 High-Voltage Output

The high-voltage output option increases the available output voltage range to a maximum of 40 V(p-p) (into high impedance). The maximum output frequency for the sine- and squarewaves is reduced to 1 MHz, and the output impedance of the main signal output is also decreased.

The high-voltage output can be switched on/off in the Utilities menu. Press **Util** and scroll through the menu until “highvolt: ON/off” is shown. Put the cursor on “on” or “off” and press **Select**. If the option is switched on “HIGH-VOLT” is shown in the display.

### Note



When the high-voltage option is switched on, the output amplitude/offset “jumps” to its 4-fold value. When it is switched off, it is automatically decreased by a factor of four.

For example, the amplitude=1 V(p-p). Turning the high-voltage on causes the amplitude output to be 4 V(p-p). Turning the high-voltage off causes the amplitude output to be 1 V(p-p) again.

---

The HP 3324A specifications apply when the external load is 500Ω and the total capacitance is <500 pF. The same entry procedures and display features apply as for the standard configuration. Maximum and minimum amplitudes are listed in the table below:

**Table B-2. High-Voltage Output Amplitudes**

Function	Peak-to-Peak		RMS	
	min.	max.	min.	max.
Sinewave	4 mV	40 V	1.42 mV	14.14 V
Squarewave	4 mV	40 V	2.00 mV	20.00 V
Triangle	4 mV	40 V	1.16 mV	11.55 V
Pos. slope ramp	4 mV	40 V	1.16 mV	11.55 V
Neg. slope ramp	4 mV	40 V	1.16 mV	11.55 V

Option 002 can be installed at a later date. The instrument should be sent to an HP Service Center to do this. Please contact your local Sales Office for more information.

---

### **Options 003 and 004 Automatic Phase Calibration**

Two HP 3324As can be phase calibrated such that changing the phase of one instrument will alter it in respect to the other. To be able to do this it is necessary to have one of the HP 3324As installed with option 003 (slave), and the other with option 004 (master). If one of the instruments has option 001, High-Stability Frequency Reference, installed then the 10 MHz Oven Output should be connected to the External Reference Inputs of both instruments. Otherwise, the 1 MHz Reference Output of one of the instruments must be connected to the External Reference Input of the other. In both cases the Phase Cal Out of one must be connected to the Phase Cal In of the other and vice versa. Figure B-1 shows an example of the second method.

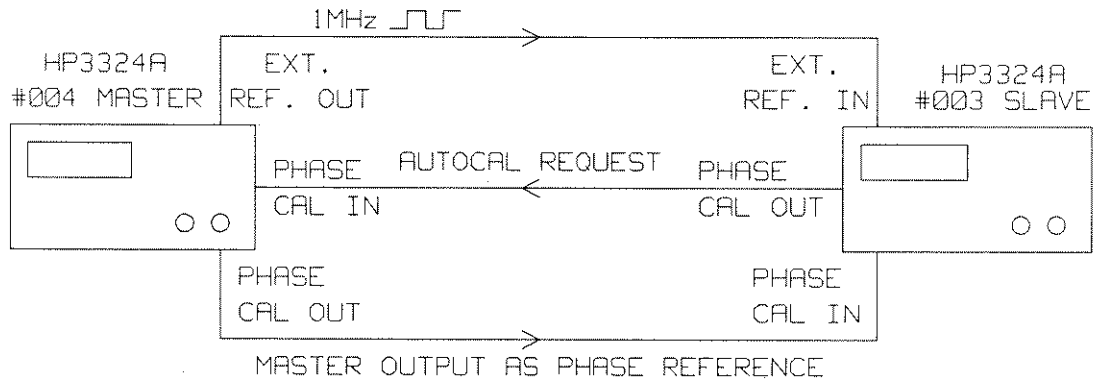

**Figure B-1. Automatic Phase Calibration Setup**

Pressing the **Phase Cal** key on the slave (the one with option 003 installed) will cause a phase calibration between the two instruments to be performed. “phase calibrat.” is shown shortly in the display of the slave, before displaying what was previously shown. The master instrument shows “phase master”. Only the rear main output signal of each instrument are calibrated.

**Note**



A phase calibration can only be performed from the slave (option 003). If the **Phase Cal** key of the master (option 004) is pressed, the error “start from slave” followed by “phase cal failed” is shown.

Whenever a frequency or amplitude is changed on one of the instruments then the phase calibration between the two instruments is lost. A new calibration must be started. For more information see Automatic Phase Calibration in Chapter 5.

Options 003 and 004 can be installed at a later date. The instrument should be sent to an HP Service Center to do this. Please contact your local Sales Office for more information.

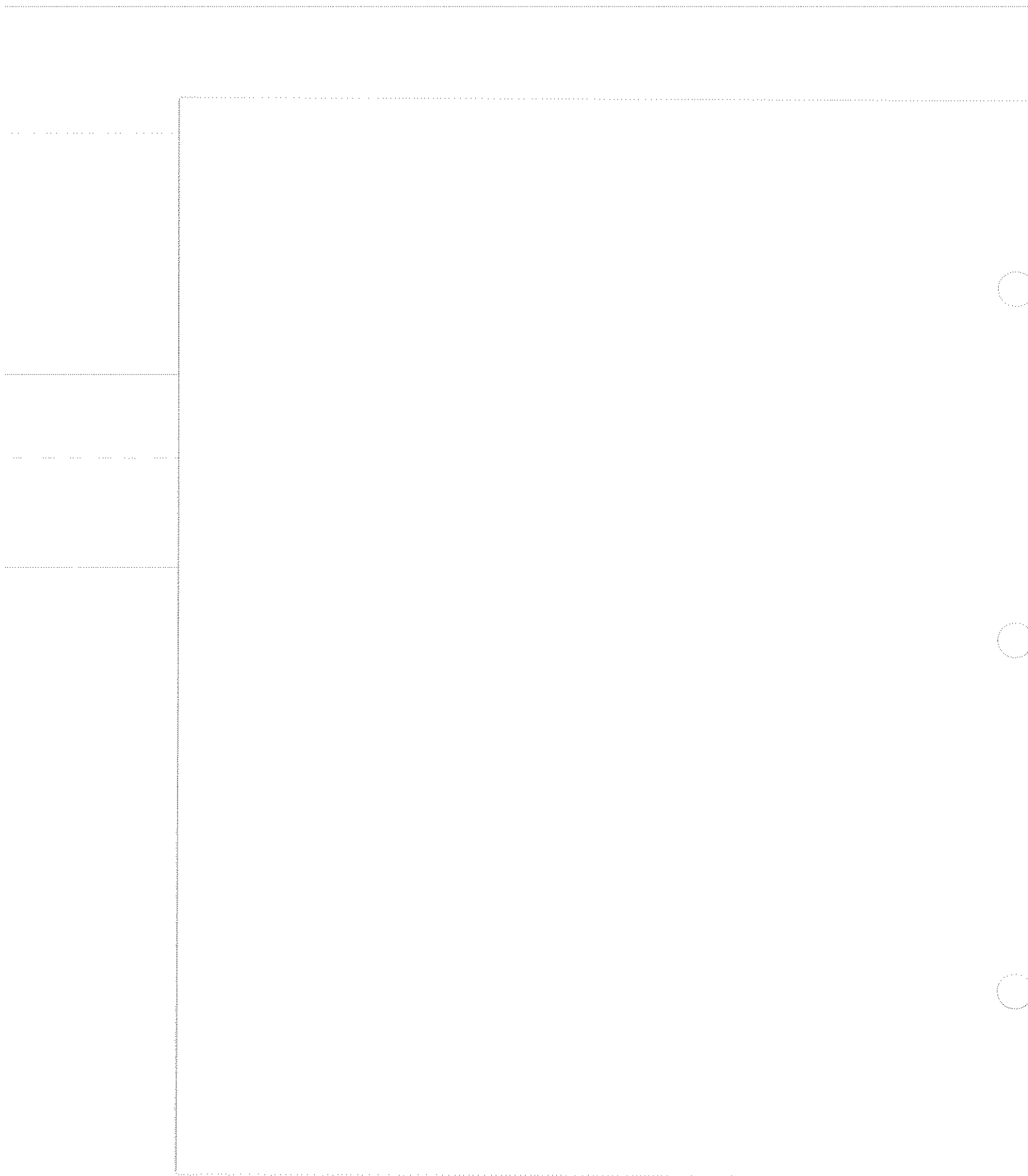



## **Installation**

---

### **Introduction**

This appendix provides installation instructions for the HP 3324A. It also includes information about initial inspection and damage claims, preparation for use, packaging, storage and shipment.

---

### **Safety Considerations**

The Model HP 3324A is a Safety Class 1 instrument (instrument with an exposed metal chassis that is directly connected to earth via the power supply cable). The symbol used to indicate a protective earth terminal in the instrument is .

Before operation, the instrument and manual, including the red safety page, should be reviewed for safety markings and instructions. These must then be followed to ensure safe operation and to maintain the instrument in safe condition.

Power is supplied to some of the HP 3324A circuits at any time that the instrument is connected to the AC power source. To disconnect from the line power, disconnect the power cord either at the rear power-inlet or at the AC line-power source (receptacle). One of these must be accessible at all times. If the instrument is installed in a cabinet, it must be disconnected from the line power by means of the system's line-power switch.

---

## Initial Inspection

Inspect the shipping container for damage. If the container or cushioning is damaged, it should be kept until the contents of the shipment have been checked for completeness and the instrument has been verified both mechanically and electrically.

Procedures for checking the operation of the instrument are given in Chapter 12 Performance Tests. If the contents are incomplete, mechanical damage or defect is apparent, or if an instrument does not pass the operator's checks, notify the nearest Hewlett-Packard office. Keep the shipping materials for carrier's inspection. The HP office will arrange for repair or replacement without awaiting settlement.

### Warning



---

**To avoid hazardous electrical shock, do not perform electrical tests when there are signs of shipping damage to any portion of the outer enclosure (covers, panels, etc.).**

---

---

## Power Requirements

### Caution



---

Before applying AC line power to the HP 3324A, ensure that the voltage selector on the HP 3324A bottom panel is set for the proper line voltage and the correct line fuse is installed in the fuse holder. Procedures for changing the line voltage selector and fuse are contained in the following section "Line Voltage Selection".

---

The HP 3324A can operate from any single-phase AC power source supplying 100 V, 120 V, 220 V or 240 V in the frequency range from 48 to 66 Hz (see Table C-1).

The maximum power consumption is 100 VA with all options installed.

**Table C-1. Line Voltage Ranges**

Selector Voltage	AC Voltage Range
100	90 – 108 V
120	108 – 126 V
220	198 – 231 V
240	216 – 252 V

## Line Voltage Selection

**Caution**



**BEFORE SWITCHING ON THE INSTRUMENT**, make sure that the instrument is set to the local line voltage and the correct line fuse is installed in the fuse holder.

The line voltage selector is set at the factory to correspond to the most commonly used line voltage of the country of destination. The line voltage selected for the HP 3324A is indicated by the switches on the bottom panel. Refer to Table C-1 for the line voltage ranges and Table C-2 to set the line voltage and select the appropriate fuse.

**Table C-2. Line Voltage and Fuse Selection**

Line Voltage	Fuse Type	HP Part Number
100 V / 120 V	T 750 mA, 250 V	2110-0360
220 V / 240 V	T 375 mA, 250 V	2110-0421

To change the line voltage and fuse:

1. Remove the power cord.
2. To check or replace the fuse, press the fuse holder in slightly, using a screw driver, and turn it to release the catch. Pull out the fuse holder.
3. To reinstall the fuse, insert a fuse with the proper rating into the fuse holder, place it back into position, and push in and turn, using a screw driver.
4. To change the line voltage, turn the instrument onto its back, so that the voltage selector switches are situated in the top right of the instrument.
5. Then using a screwdriver, move the switches into the position required for the voltage to be used, as shown in Figure C-1.

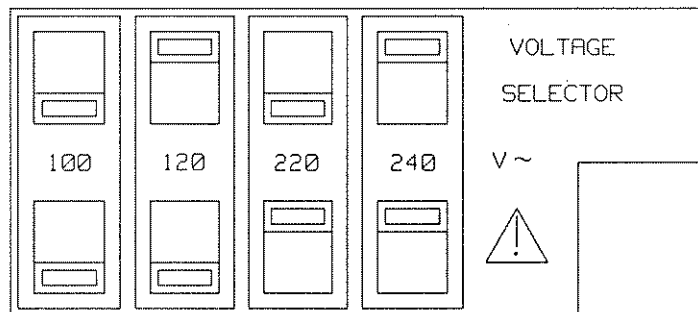

**Figure C-1. Voltage Selection Possibilities**

---

## Power Cable

In accordance with international safety standards, this instrument is equipped with a three-wire power cable. When connected to an appropriate AC power receptacle, this cable grounds the instrument cabinet. The type of power cable shipped with each instrument depends on the country of destination. Refer to Figure C-2 for the part numbers of the power cables available.

### Warning



To avoid the possibility of injury or death, the following precautions must be followed before the instrument is switched on.

- If this instrument is to be energised via an autotransformer for voltage reduction, ensure that the Common terminal is connected to the grounded pole of the power source.
- The power cable plug shall only be inserted into a socket outlet provided with a protective ground contact. The protective action must not be negated by the use of an extension cord without a protective conductor.
- Before switching on the instrument, the protective ground terminal of the instrument must be connected to a protective conductor. This is verified by using the power cord which is supplied with the instrument.
- Intentional interruption of the protective ground connection is prohibited.

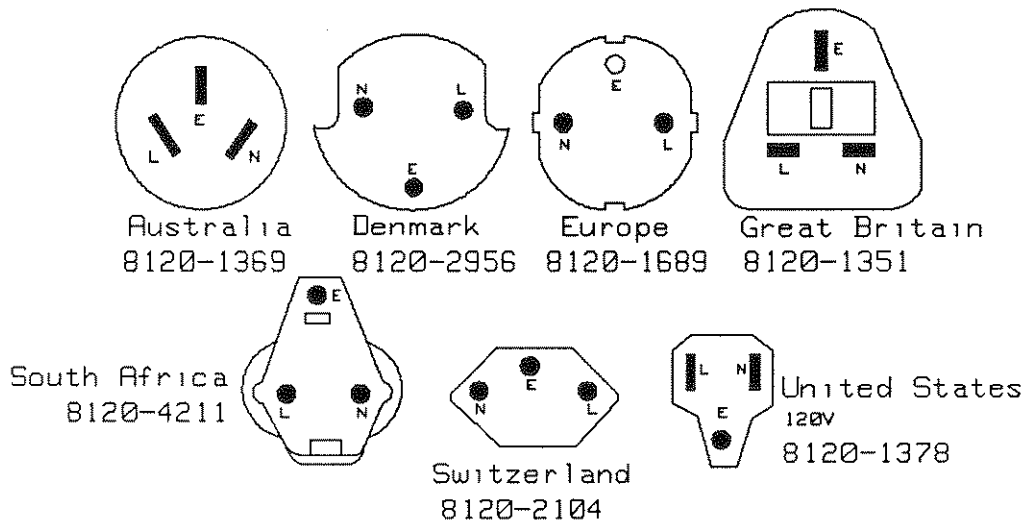

**Figure C-2. Power Cables - Plug Identification**

The following work should be carried out by a qualified electrician - all local electrical codes being strictly observed. If the plug on the cable does not fit the power outlet, or the cable is to be attached to a terminal block, cut the cable at the plug end and re-wire it.

The color coding used in the cable will depend on the cable supplied. If a new plug is to be connected, it should meet local safety requirements and include the following features:

- Adequate load-carrying capacity (see table of specifications in Appendix A).
- Ground connection.
- Cable clamp.

---

## HP-IB Connector

The rear panel HP-IB connector (Figure C-3), is compatible with the connector on Cable Assemblies 10833A, B, C and D. If a cable is to be locally manufactured, use male connector, HP part number 1251-0293.

---

## HP-IB Logic Levels

The HP 3324A HP-IB lines use standard TTL logic, the levels being as follows:

- True = Low = digital ground or 0 Vdc to 0.4 Vdc,
- False = High = open or 2.5 Vdc to 5 Vdc.

All HP-IB lines have LOW assertion states. High states are held at 3.0 Vdc by pull-ups within the instrument. When a line functions as an input, approximately 3.2 mA of current is required to pull it low through a closure to digital ground. When a line functions as an output, it will sink up to 48 mA in the low state and approximately 0.6 mA in the high state.

### Note



Isolation, the HP-IB line screens are not isolated from ground.

---

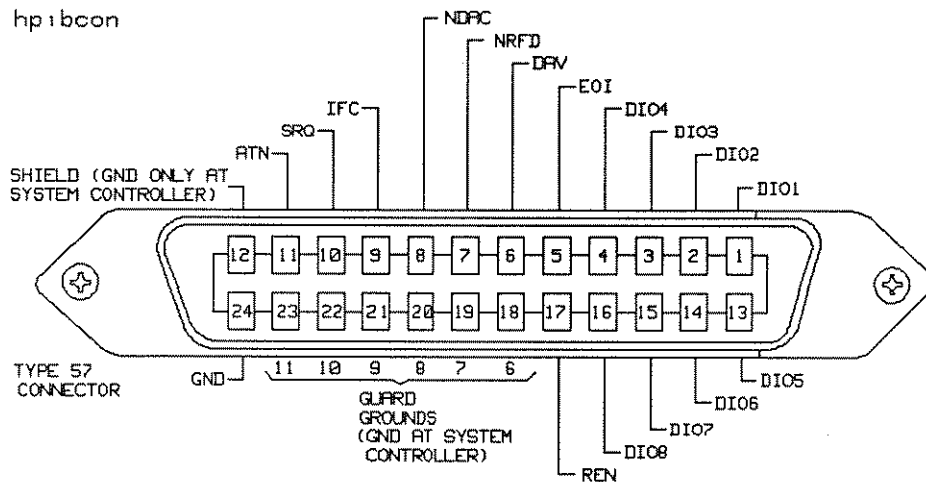

Figure C-3. HB-IB Connector

## Operating Environment

The following summarizes the HP 3324A operating environment ranges. In order for the HP 3324A to meet specifications, the operating environment must be within these limits.

### Warning



**The HP 3324A is not designed for outdoor use. To prevent potential fire or shock hazard, do not expose the HP 3324A to rain or other excessive moisture.**

### Temperature

The HP 3324A may be operated in temperatures from 0°C to 55°C.

### Humidity

The HP 3324A may be operated in environments with humidity up to 95% (0°C to +40°C). However, the HP 3324A should be protected from temperatures or temperature changes which cause condensation within the instrument.



**Note**

---

At output amplitudes of  $<50$  mV in extreme environmental conditions, it is recommended to use a double shielded BNC cable. For example, use HP p/n 5180-2459 (1.22 m, RG58V Triax,  $50\Omega$ ).

---

---

**Instrument Cooling**

The HP 3324A is equipped with a cooling fan mounted inside the rear panel. The instrument should be mounted so that air can freely circulate through it. When operating the HP 3324A, choose a location that provides at least 75 mm (3 inches) of clearance at the rear, and at least 25 mm (1 inch) of clearance at each side. Failure to provide adequate air clearance will result in excessive internal temperature, reducing instrument reliability.

---

**Claims and Repackaging**

If physical damage is evident or if the instrument does not meet specification when received, notify the carrier and the nearest Hewlett-Packard Service Office. The Sales/Service Office will arrange for repair or replacement of the unit without waiting for settlement of the claim against the carrier.

---

## Storage and Shipment

The instrument can be stored or shipped at temperatures between  $-40^{\circ}\text{C}$  and  $+75^{\circ}\text{C}$ . The instrument should be protected from temperature extremes which may cause condensation within it.

---

## Return Shipments to HP

If the instrument is to be shipped to a Hewlett-Packard Sales/Service Office, attach a tag showing owner, return address, model number and full serial number and the type of service required.

The original shipping carton and packing material may be re-usable, but the Hewlett-Packard Sales/Service Office will also provide information and recommendations on materials to be used if the original packing is no longer available or reusable. General instructions for repacking are as follows:

1. Wrap instrument in heavy paper or plastic.
2. Use strong shipping container. A double wall carton made of 350-pound test material is adequate.
3. Use enough shock-absorbing material (3 to 4 inch layer) around all sides of the instrument to provide a firm cushion and prevent movement inside container. Protect control panel with cardboard.
4. Seal shipping container securely.
5. Mark shipping container FRAGILE to encourage careful handling.
6. In any correspondence, refer to instrument by model number and serial number.

## **HP-IB Overview**

---

### **Introduction**

This appendix gives an overview of the Hewlett-Packard Interface Bus (HP-IB).

---

### **Description of the HP-IB**

The HP-IB is a bus structure that links the HP 3324A to desktop computers, minicomputers, and other HP-IB controlled instruments to form automated measurement systems. HP-IB is Hewlett-Packard's implementation of the IEEE Standard 488.1 and 488.2 (P981 Draft 18). Most of the technical terms used in this appendix are defined in these standards. The most important terms are:

**Controller:** A controller is the component of the system which functions as the controlling unit. In many cases the controller is a computer.

**Device:** A component of an HP-IB system which is not the controller but which receives program messages from it and sends response messages to it.

**Program Message:** A stream of data sent from a controller to a device.

**Response Message:** A stream of data sent from a device to a controller.

**Command:** A message unit which sets a value or starts an action in a device. No response message is expected.

**Query:** A message unit which causes a response message.

All of the active HP-IB interface circuits are contained within the various HP-IB controlled devices. The interconnecting cable is entirely passive and its role is limited to connecting the devices in parallel so that the data can be transferred from one device to another.

Every participating device must be able to perform at least one of the following roles; talker, listener or controller. The HP 3324A can be either a talker or a listener.

The full flexibility and power of the HP-IB is realized when a controller is added to the system. An HP-IB controller participates in the measurement by being programmed to automate, monitor, and co-ordinate instrument operation as well as process the measurement results. There may be more than one controller on the bus but only one can be active at any one time. (Changing the active controller is accomplished with the *pass control* bus message). One (and only one) of the controllers should be hard-wired as the *system controller*.

---

## Capabilities of the HP-IB

<b>Number of Interconnected Devices</b>	Upto 15 devices (maximum) may be on one contiguous bus.
<b>Interconnection Path</b>	The devices may be connected in either a star or linear bus network.
<b>Maximum Cable Length</b>	The total transmission path length = 2 meters times the number of devices, or 20 meters, whichever is less, with a maximum of 3 meters separating any two devices.
<b>Message Transfer Method</b>	Byte-serial, 8-bit parallel, asynchronous data transfer using a 3-wire handshake.
<b>Data Transfer Rate</b>	One megabyte per second (maximum) over limited distances; actual data rate depends upon the capability of the slowest device involved in the transmission.
<b>Address Capability</b>	Primary addresses: 31 talk, 31 listen; secondary (2-byte) addresses: 961 talk, 961 listen. 1 talker and 14 listeners, maximum, at one time. The HP 3324A has only primary address capability. Table D-1 lists the talk and listen HP-IB addresses.
<b>Multiple Controller Capability</b>	In systems with more than one controller, only one controller can be active at any one time. The active controller can pass control to another controller but only the system controller can assume unconditional control. Only one system controller is allowed per system.
<b>Interface Circuits</b>	Driver and receiver circuits are TTL compatible.

---

## Bus Structure

The HP-IB signal lines consist of eight data lines (D101 – D108), five bus management lines (explained in the following text), and three handshake lines. This is shown in Figure D-1.

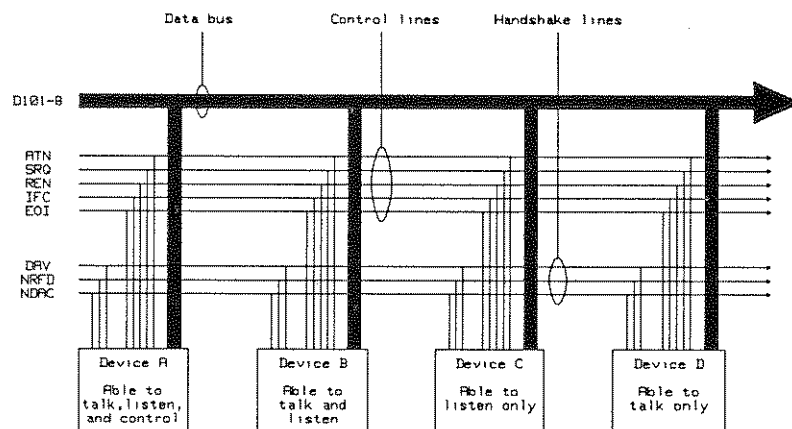

Figure D-1. HP-IB Bus Structure

---

## HP-IB Management (Control) Lines

### ATN - Attention

This line is used by the active controller to define how information on the data lines should be interpreted by other devices on the bus.

When ATN is low (true) the HP-IB is in the *command mode* and the data lines should be interpreted as *bus commands* (see “Bus Commands” later in this chapter). In the command mode the controller is active and all other devices are waiting for instructions. Also, devices

on the HP-IB are addressed or unaddressed as listeners or talkers while the bus is in the command mode.

When ATN is high (false) the HP-IB is in *data mode* and the data lines should be interpreted as device-dependent commands. In the data mode, data and instructions are transferred between devices on the HP-IB. Instructions transferred to the instrument are called *device-dependent commands*. All the commands specifically for the HP 3324A fall into this category. The HP 3324A device-dependent commands configure the HP 3324A, initiate data transfers, or define error-reporting conditions. These device-dependent commands are meaningless for other instruments. The HP 3324A device-dependent commands are listed in Chapter 11 Commands.

**SRQ - Service Request**

This line is set low (true) by any instrument requiring service. The controller should be programmed to respond to most service requests by polling the devices on the bus to determine which one initiated the request. The HP 3324A responds to a serial poll by putting its status byte on the data lines (see Chapter 10 Status and Event Reporting).

**REN - Remote Enable**

The system controller must set REN low and then address specific device(s) to listen before they can operate under remote control.

**IFC - Interface Clear**

Only the system controller can activate the IFC line. When IFC is set true (low), all devices on the bus become inactive.

**EOI - End or Identity**

This line is used to indicate the end of a multiple-byte transfer sequence (in the data mode), or by the controller, in conjunction with ATN, to execute a parallel poll.

---

## Talk/Listen Addresses

Each HP-IB device has at least one talk and one listen address unless the device is either totally transparent or is a talk-only or listen-only device. Device addresses are used by the active controller in the command mode (ATN true) to specify the talker (via a talk address) and the listener(s) (via listen addresses). Only one device may be addressed to talk at any one time.

The address of a device is usually preset at the factory but may be set to another value during system configuration. In the binary representation of the address, the device address is the decimal equivalent of the five least-significant bits of the address. (On HP-IB devices with selector switches, these are the five address switches). The address can be from 0 to 30 inclusive. The sixth and seventh bits determine if the address is a talk or listen address, respectively. High-level HP-IB controllers typically configure these two bits automatically. Table D-1 lists the HP-IB addresses if a controller requires the talk and listen addresses.

The talk and listen addresses fall within the printable ASCII character set. When a device receives one of these characters while ATN is true, it becomes addressed. The ASCII character “?” (ASCII 31) unaddresses all devices while ATN is true. The device address is used by HP-IB controllers, most of which automatically send the talk and listen address characters.



**Table D-1. HP-IB Addresses**

Device Address	Binary Address	Address Talk	Characters Listen
0	0000 0000	@	Space
1	0000 0001	A	!
2	0000 0010	B	”
3	0000 0011	C	#
4	0000 0100	D	\$
5	0000 0101	E	%
6	0000 0110	F	&
7	0000 0111	G	,
8	0000 1000	H	(
9	0000 1001	I	)
10	0000 1010	J	*
11	0000 1011	K	+
12	0000 1100	L	,
13	0000 1101	M	-
14	0000 1110	N	.
15	0000 1111	O	/
16	0001 0000	P	0
17	0001 0001	Q	1
18	0001 0010	R	2
19	0001 0011	S	3
20	0001 0100	T	4
21	0001 0101	U	5
22	0001 0110	V	6
23	0001 0111	W	7
24	0001 1000	X	8
25	0001 1001	Y	9
26	0001 1010	Z	:
27	0001 1011	[	;
28	0001 1100	\	<
29	0001 1101	]	=
30	0001 1110	^	>

---

## Bus Commands

The HP-IB interface system operates in one of two modes, controlled by the ATN bus management line: command mode (ATN true) or data mode (ATN false). (if an HP controller is used, the bus management lines are configured automatically and all necessary command strings are issued).

Bus commands are issued while the HP-IB is in the command mode. These commands may instruct the instrument's HP-IB interface to control the instrument (like Clear or Trigger) but are more often used for bus management (Remote, Local, Polls, Service Request, Abort interface activity, or Pass Control). Bus commands are issued through the use of one of the five bus management lines or through the eight-bit data bus. The bus commands and the HP 3324A responses to them are described in the following:

- Abort** The abort command (interface clear - IFC true) halts all HP-IB activity. The system controller assumes unconditional control of the bus. The HP 3324A responds by becoming unaddressed.
- Clear** The clear command causes all devices addressed to listen to reconfigure themselves to a predefined device-dependent condition. The HP 3324A responds to the clear command (both the device clear, DCL, and selective device clear, SDC) by clearing the interface command buffer of any pending commands, clearing the error register, and resetting the instrument to the preset state.

**Clear Lockout/Set  
Local**

The clear lockout/set local command removes all devices from the local lockout mode and returns the HP 3324A to local (front panel) control. The HP-IB is in the local mode because the REN bus management line is set false.

**Local**

The local command clears the remote command from the listening device and returns the listening device to local (front panel) control. If local lockout is not in effect, the HP 3324A responds by returning to front panel control. The Remote indicator on the front panel extinguishes if the HP 3324A is in Remote prior to the Local command.

**Local Lockout**

The local lockout command disables the **Local** front panel key to avoid operator interference. The HP 3324A front panel is locked out.

**Parallel Poll**

The parallel poll command is a controller operation used to obtain information from the devices under its control. The HP 3324A does not respond to this bus command.

**Pass Control**

The pass control command shifts system control from one controller to another. The HP 3324A does not respond to this command.

**Remote**

The remote command directs an instrument to take instructions from the HP-IB instead of the instrument's front panel. To implement the remote command, the controller must set the REN bus management line true. When the HP 3324A accepts the remote command, the Remote front panel indicator illuminates and the front panel is disabled except for the Local key which can return control of the instrument to the front panel if pressed. If the local lockout message is also issued, the mode cannot be changed from remote to local via the front panel **local** key.

**Serial Poll**

The serial poll is issued by the active controller along with a specific address. If the address matches the address setting of the HP 3324A, it responds by putting its status byte on the data lines for the controller to read. The HP 3324A status byte consists of eight bits indicating the states of several operating parameters.

**Service Request**

The service request (SRQ) bus management line is used by a device to indicate a need for attention from the controller. When the HP 3324A requires service (as is determined by the setting of the status byte mask) it issues an SRQ (pulls the SRQW line low), sets bit 6 of the status byte, and illuminates the front panel SRQ indicator. The SRQ is cleared by executing a serial poll of the HP 3324A. Bit 6, the require-service bit, is sometimes referred to as the status bit in connection with a poll. Bits 0, 1, 2, and 3 in the status byte may initiate an SRQ depending on the setting of the status byte mask. The status byte may be masked to select which of the four bits cause the HP 3324A to issue the SRQ.

**Trigger**

The group execute trigger (GET) or selective device trigger (SDT) command causes all addressed instruments with the HP-IB trigger capability to execute a predefined function simultaneously. The HP 3324A does not respond to the GET command.

## HP 3324A Command Syntax

---

### Introduction

This appendix contains the syntax of the HP-IB commands for the HP 3324A. The list of commands in this appendix are given in alphabetical order. For more information see Chapter 9 Remote Control of the HP 3324A and Chapter 11 HP-IB Commands. Some of the HP-IB commands are compatible to the HP 3325A Synthesizer/Function Generator. This means that programs written for the HP 3325A may be used for the HP 3324A, as long as only compatible commands are used. In the description of each command, it is stated whether they are compatible or not.

---

### Syntax Drawing Rules

All characters in circles or ovals are *terminal* symbols and must be sent exactly as shown. Items in boxes are *non-terminal* symbols; descriptions of these items are given following the syntax drawings. Spaces and lowercase letters are ignored; they can be inserted to improve readability.

The *Response* Format tables specify what is returned by the instrument in response to a query. All responses are terminated with <carriage return> and <line feed> with the HP-IB EOI (bus management line) active. The “#” symbol represents one digit or a character, as relevant.

## HP-IB Command List

The following table shows all of the HP-IB commands available, in alphabetical order:

**Table E-1. HP-IB Command List**

Mnemonic	Description	Mnemonic	Description
AC	Amplitude Calibration	PH	Phase
AM	Amplitude	RE	Recall State
AP	Assign Zero Phase	RF	Rear or Front Signal Output
CM	HP 3325A Compatible	RTT	Retrace Time
FR	Frequency	SC	Start Continuous Sweep
FU	Waveform Function	SGS	Select Intervals
HV	High-Voltage Output	SM	Sweep Mode
IER	Program Error Query	SNI	Number of Intervals
IOPT	Options Query	SNR	Number of Stores
ISE	System Error Query	SP	Sweep Stop Frequency
MD	Data Transfer Mode	SR	Store State
MF	Marker Frequency	SS	Start Single Sweep
MKS	Select Markers	ST	Sweep Start Frequency
MMF	Multi-Marker Frequency	TCD	Calibration Cable Delay
MMS	Multi-Interval/Marker	TE	Perform Self-test
MS	Status Byte Mask	TI	Sweep Time
MTI	Multi-Marker Sweep Time	TSD	Signal Cable Delay
MUP	Multi-Marker Stop Frequency	XMF	Multi-Interval Marker Frequency
MUT	Multi-Marker Start Frequency	XSM	Multi-Interval Mode
OF	DC Offset	XSP	Multi-Interval Stop Frequency
OOF	Output Enable	XST	Multi-Interval Start Frequency
PC	Phase Calibration	XTI	Multi-Interval Sweep Time

---

## AC; Amplitude Calibration

The AC command performs an amplitude calibration. If calibration is not successful, the FAIL bit of the status register is set.

Command is available on the HP 3325A.

### Syntax



## AM; Amplitude

The AM command sets the amplitude of the main signal. Sending IAM causes the instrument to output its current amplitude.

**Instrument Preset Value:** 1.0 mV(p-p)

Both commands are available on the HP 3325A.

### Syntax

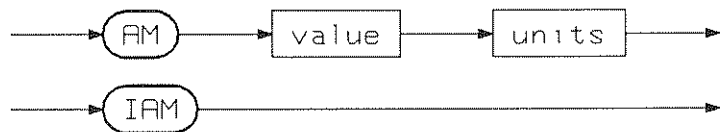

**Table E-2. AM “value” Range Given “units”**

“value” Range	“units”	Description	High Voltage
0.001 to 10.0	VO	V(p-p)	Off
0.004 to 40.0			On
1.0 to 10000.0	MV	mV(p-p)	Off
4.0 to 40000.0			On
0.000354 to 3.53	VR	Vrms	Off
0.00142 to 14.1			On
0.354 to 3530.0	MR	mVrms	Off
1.42 to 14100.0			On
-56.02 to 23.98	DB	dBm	Off
illegal			

**Table E-3. IAM Response Format**

Query Command	Current Units	Response Format
IAM	VO or MV	AM#####.#####VO
	VR or MR	AM#####.#####VR
	DB	AM-#####.###DB



---

## **AP; Assign Zero Phase**

The AP command assigns the current phase value to zero; subsequent changes in phase are referenced to this point.

Command is available on the HP 3325A.

### **Syntax**



## CM; HP 3325A Compatible

The CM command switches the HP 3324A to the HP 3325A compatible mode or to the non-compatible mode at power-on. The difference between the two modes is explained in the following table:

### HP 3325A Compatible Mode

	Compatibility On	Compatibility Off
Power On	The 3324A is reset like the 3325A	The 3324A keeps all its old parameters
Log Sweep	Log intervals are always approximated using two linear segments in the continuous sweep.	Log intervals are approximated as in a single sweep, for sweep times $\geq 1$ sec. in a continuous sweep. For sweep times $< 1$ sec. (down to 0.1 sec.) the two linear segment approximation is used.

Value after 'memory lost': 0

Command is not available on the HP 3325A.

Syntax

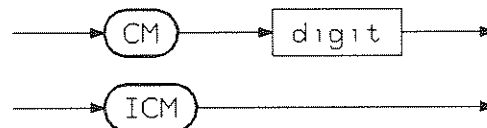

"digit"	Meaning
0	Disable compatibility mode.
1	Enable compatibility mode.

**Table E-4. ICM Response Format**

Query Command	Response Format
ICM	CM#

## FR; Frequency

The FR command sets the frequency of the function generator part of the instrument. IFR causes the instrument to output its current frequency.

**Instrument Preset value:** 1 KHz

Both commands are available on the HP 3325A.

### Syntax

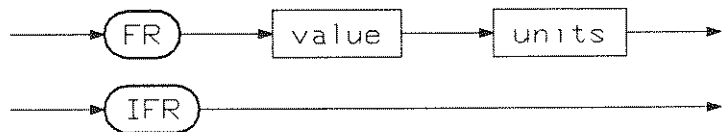

**Table E-5. FR “value” Range Given “units”**

“value” Range (sine)	“units”	Description
0.0 to 21000000.000	HZ	Hertz
0.0 to 21000.000000	KH	Kilohertz
0.0 to 21.000000	MH	Megahertz

**Table E-6. IFR Response Format**

Query Command	Response Format
IFR	FR#####.###HZ

### Note



If FR is sent while a sweep is running, the sweep will stop and a signal with the frequency set by FR will be output.

## FU; Waveform Function

The FU command selects the waveform function for the main signal output.

**Instrument Preset value: 1**

Both commands are available on the HP 3325A.

**Syntax**

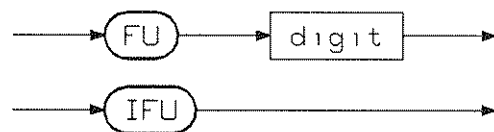

### Waveform Selections for "digit"

"digit"	Waveform
0	Selects DC only.
1	Selects Sinewave.
2	Selects Squarewave.
3	Selects Triangle.
4	Selects Positive Ramp.
5	Selects Negative Ramp.
6	Selects Aux. TTL.

**Table E-7. IFU Response Format**

Query Command	Response Format
IFU	FU#

## HV; High-Voltage Output

The HV command controls the high-voltage amplifier option for the main signal output.

**Instrument Preset value: 0**

Command is available on the HP 3325A.

**Syntax**

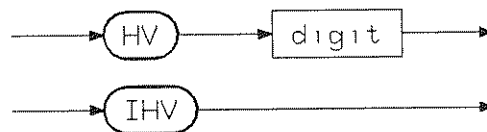

"digit"	Meaning
0	Disable the high-voltage amplifier.
1	Enable the high-voltage amplifier.

**Table E-8. IHV Response Format**

Query Command	Option Installed?	Response Format
IHV	Yes	HV#
	No	HV0

## IER; Program Error Query

This command queries the instrument for the most recent program error code. The query returns a one-digit code. If no error occurred, 0 is returned. Issuing the command clears the error code to 0.

Command is available on the HP 3325A.

### Syntax



Table E-9. IER Response Format

Query Command	Response Format
IER	ER##

Error Number	Error Description
1	Entry parameter out of bounds
2	Invalid delimiter
3	Frequency too high for waveform function
4	Sweep time too small or too large
5	Offset - amplitude incompatible
6	Sweep frequency too large for function, start frequency too small, sweep bandwidth too small, start frequency greater than stop frequency
7	Unrecognisable mnemonic received
8	Unrecognisable data character received
9	High-voltage option does not exist
10	Index out of range for Xxx mnemonic
11	Missing comma
12	Numeric parameter out of range
13	Interval error in sweep sequence
14	Sweep sequence is too long

## IOPT; Options Query

This command queries the instrument for the options that are installed. It returns the query in the form "OPTn1,n2,n3, ... ,nX" where n1 to nX are the options available at the present time. In each position, either a "0" or "00X" will be shown, where "0" means that the option is not installed and "00X" (X=option number) means that the option is installed.

Command is not available on the HP 3325A.

### Syntax



Table E-10. IOPT Response Format

Query Command	Response Format
IOPT	OPT###,###,...,###

### Note



The “#” are in this case not fixed, it could be one or it could be three.



## ISE; System Error Query

This command queries the instrument for the most recent system error code. The query returns a one-digit code. If no error occurred, 0 is returned. Issuing the command clears the error code to 0.

Command is not available on the HP 3325A.

### Syntax



**Table E-11. ISE Response Format**

Query Command	Response Format
ISE	SE#

System Failure Number	System Failure Description
1	Amplitude calibration failed
2	Phase calibration failed
3	External reference unlocked
4	Main oscillator unlocked
5+	Self-test failed (report actual number to Service personnel).

Error numbers are not buffered. Only the newest error is given.

To decode the self-test failure subtract 5 from its value. Then convert to binary and for each bit that is set to "1", there is a specific error.

<b>Bit</b>	<b>Self-test Failure Description</b>
0	RAM/ROM test failed (ROM=signature test)
1	MFP (MC 68901) Test failed
2	Device bus test failed
3	Display test failed (display handshake)
4	DAC test failed (analog voltage generation)
5	FRAC-N chip test failed
6	VCO test failed
7	Sweep timer test failed
8	Offset test failed

## MD; Data Transfer Mode

The MD command selects the HP-IB data transfer mode. In mode 1, the unbuffered mode, the commands are executed as soon as they are received. No other communications are permitted on the bus until the entire HP 3324A program string has been accepted and all but the last character processed. In mode 2, the buffered mode, the execution control depends on the command group to which a command belongs. See Command Groups and Data Transfer Modes in Chapter 9.

**Instrument Power-on, HP-IB Clear value:** 1

**Instrument Preset value:** not changed

Both commands are available on the HP 3325A.

### Syntax

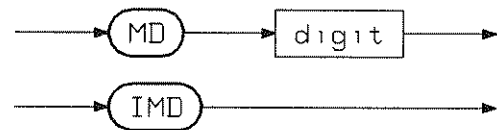

"digit"	Meaning
1	Each command processed when received.
2	Depends on command group for what happens.

**Table E-12. IMD Response Format**

Query Command	Response Format
IMD	MD#

## MF; Marker Frequency

The MF command sets the marker frequency of the first sweep interval. IMF causes the instrument to output the current marker frequency of the first sweep interval. The MF and IMF commands are identical to the XMF and IXMF commands, respectively, when an index of 1 is used. To set and read the marker frequencies of other sweep intervals, use the XMF and IXMF commands.

**Instrument Preset value:** 5.0 MHz

Both commands are available on the HP 3325A.

Syntax

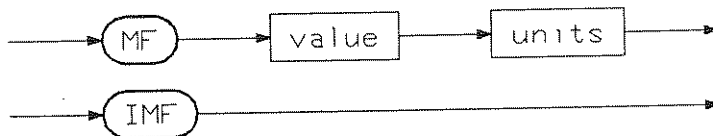

**Table E-13. MF "value" Range Given "units"**

"value" Range (sine)	"units"	Description
0.0 to 21000000.000	HZ	Hertz
0.0 to 21000.000000	KH	Kilohertz
0.0 to 21.000000	MH	Megahertz

**Table E-14. IMF Response Format**

Query Command	Response Format
IMF	MF#####.###HZ

## MKS; Select Markers

The MKS command allows you to select which markers you wish to activate when you have selected only one interval, but multi-markers with the MMS command. IMKS causes the instrument to output a list of the activated markers. Use the MMF command to set the frequency of the various markers.

**Instrument Preset value:** All 9 markers

Both commands are not available on the HP 3325A.

### Syntax

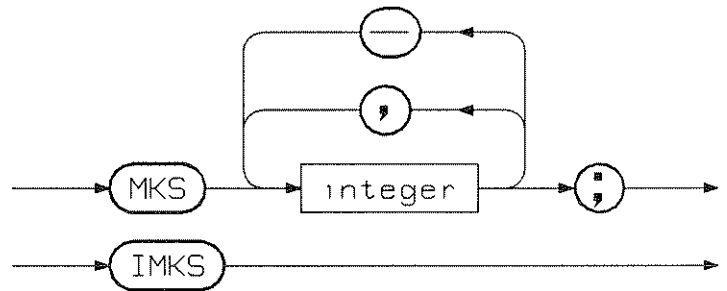

"integer"	Meaning
1 to 9	Upto 9 separate markers are allowed.

**Table E-15. IMKS Response Format**

Query Command	Response Format
IMKS	MKS#,#,#,#,#,#,;

## MMF; Multi-Marker Frequency

The MMF command sets the marker frequencies for a multi-marker interval. IMMF causes the instrument to output the current frequency for a particular marker. To activate the markers, use the MKS command.

**Instrument Preset value:** 5.0 MHz

Both commands are not available on the HP 3325A.

### Syntax

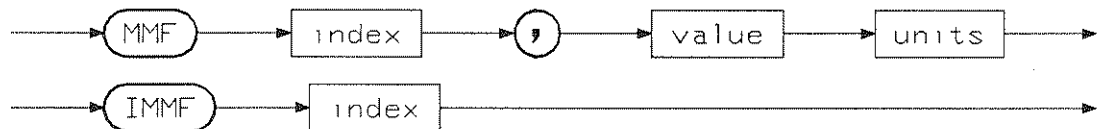

"index"	Meaning
1 to 9	Upto 9 separate markers are allowed.

**Table E-16. MMF "value" Range Given "units"**

"value" Range (sine)	"units"	Description
0.0 to 21000000.000	HZ	Hertz
0.0 to 21000.000000	KH	Kilohertz
0.0 to 21.000000	MH	Megahertz

**Table E-17. IMMF Response Format**

Query Command	Response Format
IMMF	MMF##.#####.###HZ

## MMS; Multi-Interval/ Marker

The MMS command selects whether multi-intervals or multi-markers is activated.

**Instrument Preset value:** 1 (Multi-intervals)

Both commands are not available on the HP 3325A.

### Syntax

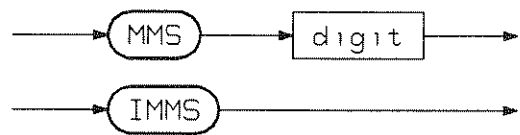

"digit"	Meaning
1	Multi-intervals selected, one marker/interval.
2	Multi-markers selected, one interval.

**Table E-18. IMMS Response Format**

Query Command	Response Format
IMMS	MMS#

---

## MS; Status Byte Mask

The MS command is used to set the status byte mask. Four lists in the status byte are capable of causing a service request (SRQ) when they are enabled (unmasked). They may be enabled or masked in any combination.

**Instrument Power-on,HP-IB Clear value:** @ (no bits enabled)

**Instrument Preset value:** not changed

The MS command is available on the HP 3325A, but the IMS command is not.

### Syntax

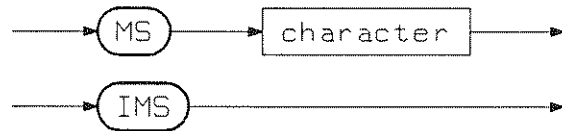



**Table E-19. Status Byte Mask Characters**

<b>"character"</b>	<b>System Fail</b>	<b>Sweep Start</b>	<b>Sweep Stop</b>	<b>Program Error</b>
@	off	off	off	off
A	off	off	off	on
B	off	off	on	off
C	off	off	on	on
D	off	on	off	off
E	off	on	off	on
F	off	on	on	off
G	off	on	on	on
H	on	off	off	off
I	on	off	off	on
J	on	off	on	off
K	on	off	on	on
L	on	on	off	off
M	on	on	off	on
N	on	on	on	off
O	on	on	on	on

**Table E-20. IMS Response Format**

<b>Query Command</b>	<b>Response Format</b>
IMS	MS#

## MTI; Multi-Marker Sweep Time

The MTI command is used to set the sweep time for the single interval when multi-markers are used.

**Instrument Power-on value:** 1.0 sec.

Both commands are not available on the HP 3325A.

### Syntax

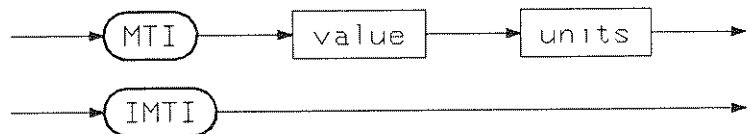

**Table E-21. MTI “value” Range Given “units”**

“value” Range	“units”	Description
0.0 to 100000	SE	Seconds

**Table E-22. IMTI Response Format**

Query Command	Response Format
IMTI	MTI#####.###SE

## MUP; Multi-Marker Stop Frequency

The MUP command is used to set the stop frequency for the single interval when multi-markers are used.

**Instrument Power-on value:** 10 MHz

Both commands are not available on the HP 3325A.

### Syntax

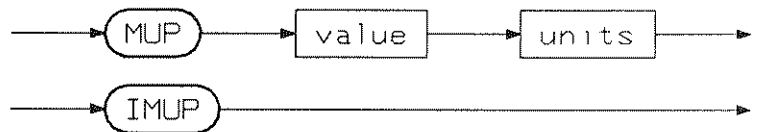

**Table E-23. MUP “value” Range Given “units”**

“value” Range (sine)	“units”	Description
0.0 to 21000000.000	HZ	Hertz
0.0 to 21000.000000	KH	Kilohertz
0.0 to 21.000000	MH	Megahertz

**Table E-24. IMUP Response Format**

Query Command	Response Format
IMUP	MUP#####.###HZ

## MUT; Multi-Marker Start Frequency

The MUT command is used to set the start frequency for the single interval when multi-markers are used.

**Instrument Power-on value:** 1 MHz

Both commands are not available on the HP 3325A.

### Syntax

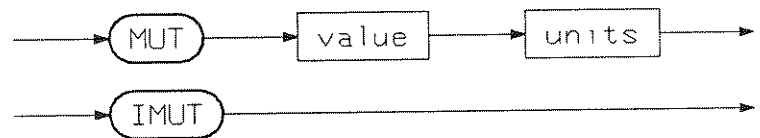

**Table E-25. MUT “value” Range Given “units”**

“value” Range (sine)	“units”	Description
0.0 to 21000000.000	HZ	Hertz
0.0 to 21000.000000	KH	Kilohertz
0.0 to 21.000000	MH	Megahertz

**Table E-26. IMUT Response Format**

Query Command	Response Format
IMUT	MUT#####.###HZ

## OF; DC Offset

The OF command sets the DC offset of the main signal. IOF causes the instrument to output its current DC offset. When programming DC offset with an AC function, the DC offset range is further restricted. See the discussion in Chapter 5 under the heading “AC with DC Offset”.

**Instrument Preset value:** 0.0 V(p-p)

Both commands are available on the HP 3325A.

### Syntax

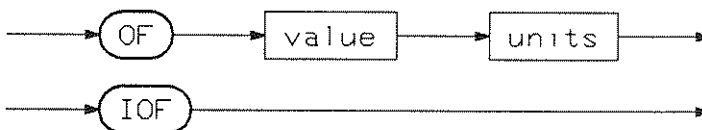

**Table E-27. OF “value” Range Given “units”**

“value” Range (DC only)	“units”	Description	High Voltage
-5.0 to 5.0	VO	Volts	Off
-20.0 to 20.0			On
-5000.0 to 5000.0	MV	Millivolts	Off
-20000.0 to 20000.0			On

**Table E-28. IOF Response Format**

Query Command	Current Units	Response Format
IOF	VO or MV	OF#####.#####VO

## OOF; Output Enable

The OOF command switches the main signal output on or off.

Instrument Preset value: 0

Both commands are not available on the HP 3325A.

Syntax

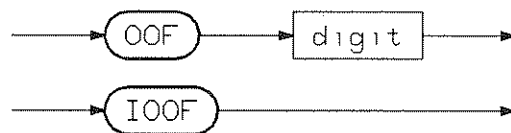

"digit"	Meaning
0	Disable main signal output.
1	Enable main signal output.

Table E-29. IOOF Response Format

Query Command	Response Format
IOOF	OOF#

---

## PC; Phase Calibration

The PC command causes a phase calibration between two HP 3324A's, one of which has option 003 (slave) installed and the other option 004 (master). The PC command can only be sent to the instrument with option 003 installed. This means that a phase calibration can only be started from the slave instrument.

Command is not available on the HP 3325A.

### Syntax



## PH; Phase

The PH command sets the phase of the main signal. Values outside the -720 to +720 range are treated as (value modulus 720). IPH causes the instrument to output its current phase.

**Instrument Preset value:** 0.0 Degrees

Both commands are available on the HP 3325A.

### Syntax

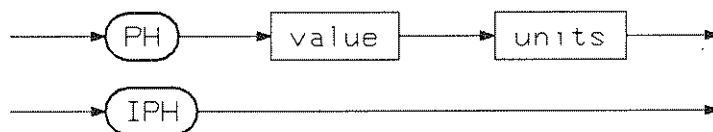

**Table E-30. PH “value” Range Given “units”**

“value” Range	“units”	Description
-720.0 to 720.0	DE	Degrees

**Table E-31. IPH Response Format**

Query Command	Response Format
IPH	PH#####.###DE



---

## RE; Recall State

The RE command recalls an instrument setup state from upto 10 memory locations. Locations 0 through 9 are programmed with the SR command.

### Note



If either the SNR or SNI command is sent, all of the stores are cleared. This also happens with an instrument reset, and at power-on if the instrument is in the HP 3325A compatible mode.

Command is available on the HP 3325A.

### Syntax



<u>"digit"</u>	<u>Meaning</u>
0 to 9	Recalls state stored in register 0 to 9.

## RF; Rear or Front Signal Output

### Note



The RF command determines whether the main signal is present at the rear or front BNC connector. IRF causes the instrument to output the current output port.

OOF is the command used to control the main output signal, RF only determines where the signal will be present.

Instrument Preset value: 1 (front)

Both commands are available on the HP 3325A.

### Syntax

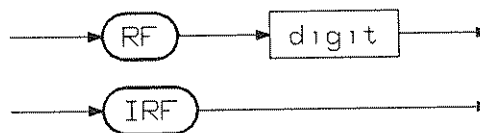

"digit"	Meaning
1	Set output at front panel.
2	Set output at rear panel.

Table E-32. IRF Response Format

Query Command	Response Format
IRF	RF#

## RTT; Retrace Time

The RTT command sets the retrace time for a swept signal. IRTT causes the instrument to output its current retrace time. A retrace time of 0 seconds means that automatic retrace time is set. This means that the sweep time of the last interval (if a linear interval) is set, or that the retrace time is set to approximately 3 ms (if a logarithmic interval).

**Instrument Preset value:** 0 (automatic)

Both commands are not available on the HP 3325A.

### Syntax

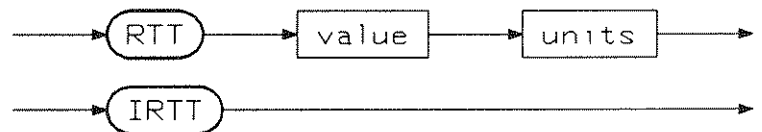

**Table E-33. RTT “value” Range Given “units”**

“value” Range	“units”	Description
0.0 to 100000	SE	Seconds

**Table E-34. IRTT Response Format**

Query Command	Response Format
IRTT	RTT#####.###SE

---

## **SC; Start Continuous Sweep**

The SC command starts a continuous sweep. If the instrument is already sweeping, this command stops the sweep and does not restart it. FR can also be used to stop a sweep.

Command is available on the HP 3325A.

### **Syntax**



## SGS: Select Intervals

The SGS command allows you to formulate a sequence of intervals when you have selected multi-intervals. ISGS causes the instrument to output a list of the sequence.

Both commands are not available on the HP 3324A.

### Syntax

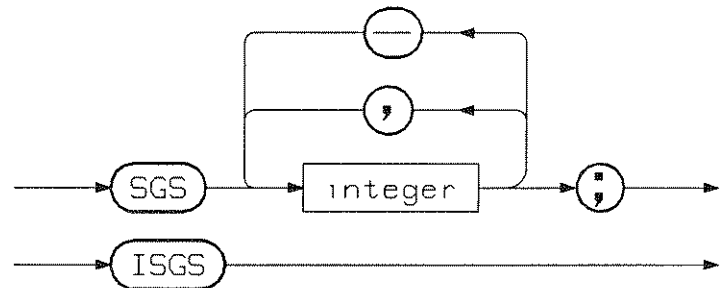

"integer"	Meaning
1 to any of "SNP"	The number of the interval.

"—" is the symbol for "through"

"," is the symbol for "and then"

**Table E-35. ISGS Response Format**

Query Command	Response Format
ISGS	SGS#,#,#,#,#,#,#,#;

## SM; Sweep Mode

The SM command sets the sweep mode of the first sweep interval. ISM causes the instrument to output the current sweep mode of the first sweep interval. The SM and ISM commands are identical to the XSM and IXSM commands, respectively, when an index of 1 is used. To set and read the sweep mode of other sweep intervals, use the XSM and IXSM commands.

**Instrument Preset value:** 1

Both commands are available on the HP 3325A.

### Syntax

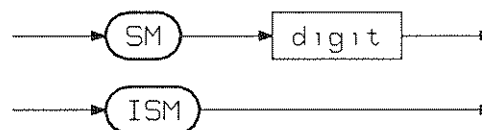

"digit"	Meaning
1	Selects Linear sweep mode.
2	Selects Logarithmic sweep mode.

**Table E-36. ISM Response Format**

Query Command	Response Format
ISM	SM#

## SNI; Number of Intervals

### Note



The SNI command sets the number of intervals. ISNI causes the instrument to output the current number of intervals.

Sending the SNI command causes all of the stores to be cleared, and all of the intervals to be set to the default value.

Both commands are not available on the HP 3325A.

### Syntax

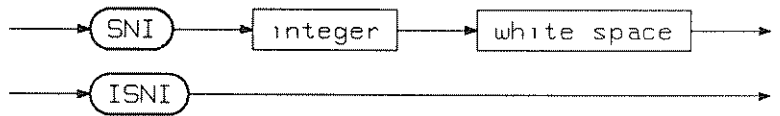

"integer"	Meaning
1 to 50	Enable this number of intervals.

"white space"	Meaning
space	All four are used to show the end of the integer.
tab	
newline	
EOI	

Table E-37. ISNI Response Format

Query Command	Response Format
ISNI	SNI#

## SNR; Number of Stores

The SNR command sets the number of stores. ISNR causes the instrument to output the current number of stores.

### Note



Sending the SNR command causes all of the stores to be cleared, and all of the intervals to be set to the default value.

Both commands are not available on the HP 3325A.

### Syntax

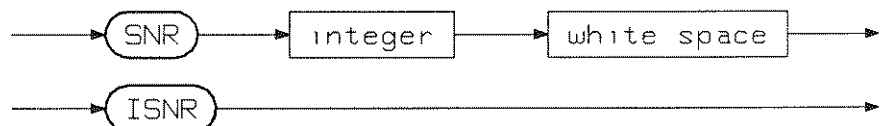

"integer"	Meaning
1 to 10	Enable this number of stores.

"white space"	Meaning
space	All four are used to show the end of the integer.
tab	
newline	
EOI	

Table E-38. ISNR Response Format

Query Command	Response Format
ISNR	SNR#



## SP; Sweep Stop Frequency

The SP command sets the stop frequency of the first sweep interval. ISP causes the instrument to output the current stop frequency of the first sweep interval. The SP and ISP commands are identical to the XSP and IXSP commands, respectively, when an index of 1 is used. To set and read the stop frequency of other sweep intervals, use the XSP and IXSP commands.

**Instrument Preset value:** 10 MHz

Both commands are available on the HP 3325A.

### Syntax

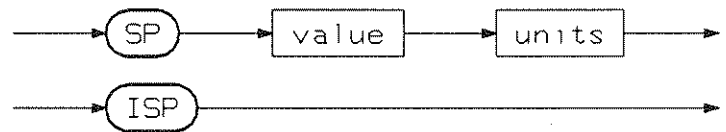

**Table E-39. SP “value” Range Given “units”**

“value” Range (sine)	“units”	Description
0.0 to 21000000.000	HZ	Hertz
0.0 to 21000.000000	KH	Kilohertz
0.0 to 21.000000	MH	Megahertz

**Table E-40. ISP Response Format**

Query Command	Response Format
ISP	SP#####.#####HZ

---

## SR; Store State

The SR command stores the current instrument setup state in one of upto 10 memory locations.

### Note



If either the SNR or SNI command is sent, all of the stores are cleared. This also happens with an instrument reset, and at power-on if the instrument is in the HP 3325A compatible mode.

Command is available on the HP 3325A.

### Syntax



"digit"	Meaning
0 to 9	Stores state in location 0 to 9.

---

## SS; Start Single Sweep

The effect of the SS command depends on the state of the instrument. If the instrument is not sweeping and not in the sweep-reset state, then the SS command puts the instrument in the sweep-reset state at the sweep Start Frequency. If the instrument is already in the sweep-reset state, this command starts a single sweep. If the instrument is sweeping, this command stops the sweep and does not restart it.

Command is available on the HP 3325A.

### Syntax



## ST; Sweep Start Frequency

The ST command sets the start frequency of the first sweep interval. IST causes the instrument to output the current start frequency of the first sweep interval. The ST and IST commands are identical to the XST and IXST commands, respectively, when an index of 1 is used. To set and read the start frequency of other sweep intervals, use the XST and IXST commands.

**Instrument Preset value:** 1 MHz

Both commands are available on the HP 3325A.

### Syntax

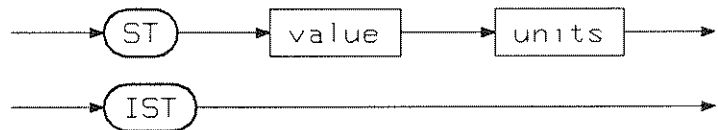

**Table E-41. ST “value” Range Given “units”**

“value” Range (sine)	“units”	Description
0.0 to 21000000.000	HZ	Hertz
0.0 to 21000.000000	KH	Kilohertz
0.0 to 21.000000	MH	Megahertz

**Table E-42. IST Response Format**

Query Command	Response Format
IST	ST#####.###HZ

## TCD; Calibration Cable Delay

The TCD command is used to account for the delay caused by changing the standard cable (supplied) for connecting the Phase Cal Out of the master (option 004) to the Phase Cal In of the slave (option 003).

**Instrument Preset value:** 0 ps

Command is not available on the HP 3325A.

### Syntax

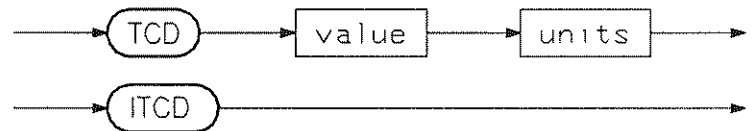

**Table E-43. TCD “value” Range Given “units”**

“value” Range	“units”	Description
0 to 59999	PS	Picoseconds

**Table E-44. ITCD Response Format**

Query Command	Response Format
ITCD	TCD#####.###PS

---

## **TE; Perform Self-test**

The TE command causes the instrument to perform a self-test.

Command is available on the HP 3325A.

### **Syntax**



## TI; Sweep Time

The TI command sets the sweep time of the first sweep interval. ITI causes the instrument to output the current sweep time of the first sweep interval. The TI and ITI commands are identical to the XTI and IXTI commands, respectively, when an index of 1 is used. To set and read the sweep time of other sweep intervals, use the XTI and IXTI commands.

**Instrument Preset value:** 1.0 sec.

Both commands are not available on the HP 3325A.

### Syntax

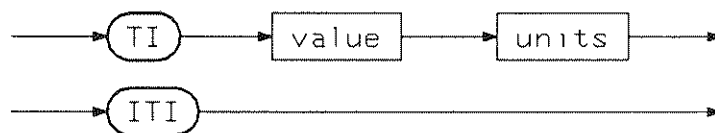

**Table E-45. TI “value” Range Given “units”**

“value” Range	“units”	Description
0.0 to 100000	SE	Seconds

**Table E-46. ITI Response Format**

Query Command	Response Format
ITI	TI#####.###SE

## TSD; Output Signal Cable Delay

The TSD command is used to account for the delay caused by a difference in length of the cables connecting the device-under-test with the rear-signal outputs of the two HP 3324A's containing options 003 and 004, when an automatic phase calibration is made.

**Instrument Preset value: 0 ps**

Command is not available on the HP 3325A.

**Syntax**

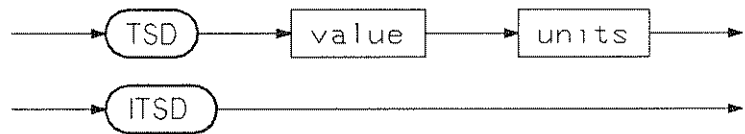

**Table E-47. TSD "value" Range Given "units"**

"value" Range	"units"	Description
0 to 59999	PS	Picaseconds

**Table E-48. ITSD Response Format**

Query Command	Response Format
ITSD	TSD#####.###PS



## XMF; Multi-Interval Marker Frequency

The XMF command sets the marker frequency for a particular sweep interval. IXMF causes the instrument to output the current marker frequency for a particular sweep interval. The XMF and IXMF commands are identical to the MF and IMF commands, respectively, when an index of 1 is used.

**Instrument Preset value:** 5.0 MHz

Both commands are not available on the HP 3325A.

### Syntax

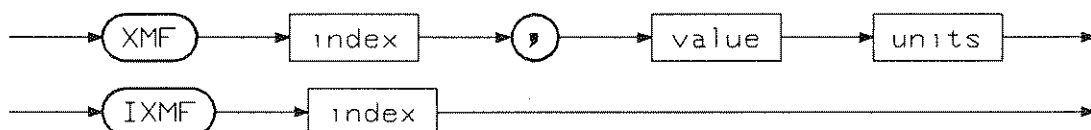

"index"	Meaning
1 to any of "SNI"	Sets frequency of interval.

**Table E-49. XMF "value" Range Given "units"**

"value" Range (sine)	"units"	Description
0.0 to 21000000.000	HZ	Hertz
0.0 to 21000.000000	KH	Kilohertz
0.0 to 21.000000	MH	Megahertz

**Table E-50. IXMF Response Format**

Query Command	Response Format
IXMF	XMF##,#####.###HZ

## XSM; Multi-Interval Mode

The XSM command sets the sweep mode for a particular sweep interval. IXSM causes the instrument to output the current sweep mode for a particular sweep interval. The XSM and IXSM commands are identical to the SM and ISM commands, respectively, when an index of 1 is used.

**Instrument Preset value:** 1 (Linear sweep mode)

Both commands are not available on the HP 3325A.

### Syntax

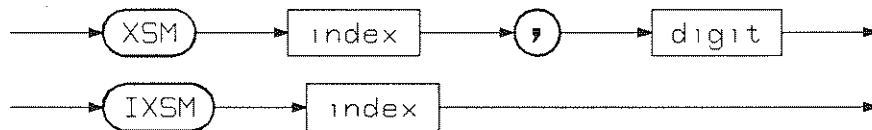

"index"	Meaning
1 to any of "SNI"	Sets mode of interval.

"digit"	Meaning
1	Selects Linear sweep mode.
2	Selects Logarithmic sweep mode.

**Table E-51. IXSM Response Format**

Query Command	Response Format
IXSM	XSM##,##

## XSP; Multi-Interval Stop Frequency

The XSP command sets the stop frequency for a particular sweep interval. IXSP causes the instrument to output the current stop frequency for a particular sweep interval. The XSP and IXSP commands are identical to the SP and ISP commands, respectively, when an index of 1 is used.

**Instrument Preset value:** 10 MHz

Both commands are not available on the HP 3325A.

### Syntax

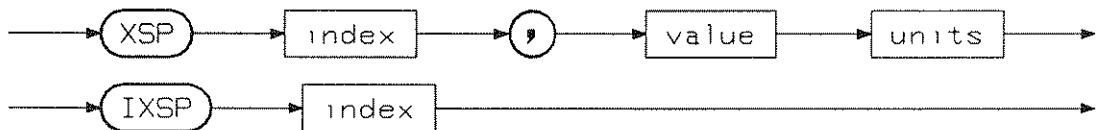

"index"	Meaning
1 to any of "SNI"	Sets stop frequency of interval.

**Table E-52. XSP "value" Range Given "units"**

"value" Range (sine)	"units"	Description
0.0 to 21000000.000	HZ	Hertz
0.0 to 21000.000000	KH	Kilohertz
0.0 to 21.000000	MH	Megahertz

**Table E-53. IXSP Response Format**

Query Command	Response Format
IXSP	XSP##,#####.###HZ

## XST; Multi-Interval Start Frequency

The XST command sets the start frequency for a particular sweep interval. IXST causes the instrument to output the current start frequency for a particular sweep interval. The XST and IXST commands are identical to the ST and IST commands, respectively, when an index of 1 is used.

**Instrument Preset value:** 1 MHz

Both commands are not available on the HP 3325A.

**Syntax**

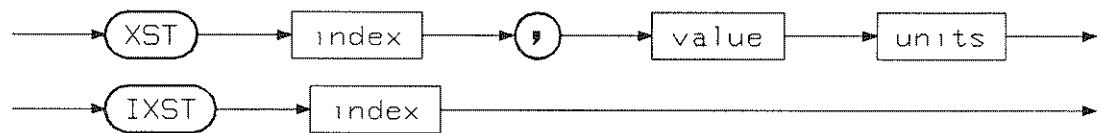

"index"	Meaning
1 to any of "SNI"	Sets start frequency of interval.

**Table E-54. XST "value" Range Given "units"**

"value" Range (sine)	"units"	Description
0.0 to 21000000.000	HZ	Hertz
0.0 to 21000.000000	KH	Kilohertz
0.0 to 21.000000	MH	Megahertz

**Table E-55. IXST Response Format**

Query Command	Response Format
IXST	XST##,#####.###HZ

## XTI; Multi-Interval Sweep Time

The XTI command sets the sweep time for a particular sweep interval. IXTI causes the instrument to output the current sweep time for a particular sweep interval. The XTI and IXTI commands are identical to the TI and ITI commands, respectively, when an index of 1 is used.

**Instrument Preset value:** 1.0 sec.

Both commands are not available on the HP 3325A.

### Syntax

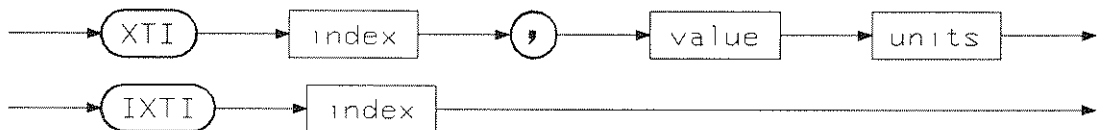

"index"	Meaning
1 to any of "SNI"	Sets sweep time of interval.

**Table E-56. XTI "value" Range Given "units"**

"value" Range	"units"	Description
0.0 to 100000	SE	Seconds

**Table E-57. IXTI Response Format**

Query Command	Response Format
IXTI	XTI##.#####.###SE



## **Error Messages**

---

### **Introduction**

This appendix contains a list of all the messages that can be obtained when the HP 3324A encounters an error.

The following list contains all of the errors possible when operating the HP 3324A from the front panel.

**MESSAGE:** **ampl/offs incomp**

**Command:** **Offs** or **Ampl**

**Cause:** There is an incompatibility between the amplitude and DC offset values.

**Remedy:** See chapter 5 for a table of the amplitude/offset values available, and re-enter an appropriate offset or amplitude.

**MESSAGE:** **ampl. out range**

**Command:** **Ampl**

**Cause:** The amplitude value entered is not valid.

**Remedy:** Enter an amplitude from 1 mV to 10 V(p-p).

**MESSAGE:** device is addr.

**Command:** "HPIB addr.: xx"

**Cause:** You are trying to change the HP-IB address, while the device is being addressed.

**Remedy:** Un-address the HP 3324A via the controller before changing the HP-IB address.

**MESSAGE:** freq. out range

**Command:**

**Cause:** The frequency is either too small or too large for the current waveform.

**Remedy:** See chapter 5 for a table of the frequency ranges available for the various waveforms.

**MESSAGE:** freq span < min

**Command:**

**Cause:** The frequency increment is too low in the multi-marker mode.

**Remedy:** Increase the frequency differences to at least 1.5 ms between markers and the start and stop frequencies.

**MESSAGE:** HPIB out range

**Command:** "HPIB addr.: xx"

**Cause:** The HP-IB address entered is not valid.

**Remedy:** Enter an HP-IB address between 0 and 30.



**MESSAGE: HVamp/dBm incomp**

**Command:** "highvolt ON/off" or **Ampl**

**Cause:** The amplitude cannot be in dBm for the high-voltage option.

**Remedy:** Enter the amplitude in Vrms or V(p-p).

**MESSAGE: index out range**

**Command:** "MARKER" or "INTERVAL"

**Cause:** An index for a sweep interval has been entered which does not exist.

**Remedy:** Enter an index that exists.

**MESSAGE: log frq span < min**

**Command:** **Start Reset**

**Cause:** The difference between the start and stop frequencies for the log sweep interval is too small.

**Remedy:** Increase the difference between the frequencies.

**MESSAGE: log swp time<.1s**

**Command:** **Reset Start**

**Cause:** The input log sweep time is less than 0.1 s.

**Remedy:** Enter a log sweep time for the interval of  $\geq 0.1$  ms.

**MESSAGE: log swp up only**

Command: **Start Reset**

Cause: A log sweep has been programmed to be swept downwards.

Remedy: Re-enter the log sweep stop-frequency to be higher than that of the start-frequency.

**MESSAGE: no log swp <1Hz**

Command: **Reset Start**

Cause: A log sweep has been set with a start-frequency of < 1 Hz.

Remedy: Re-enter a log sweep start-frequency of at least 1 Hz.

**MESSAGE: no phase-cal opt**

Command: **Phase Cal**

Cause: No phase calibration is available, as option 003 is not installed.

Remedy: Install option 003 or don't use this command.

**MESSAGE: no store here**

Command: **Recall**

Cause: No setting has been saved at this store number.

Remedy: There is no function that allows you to see which stores have a setting saved in them. You just have to try it out.

**MESSAGE:** no swp in TTL/DC

**Command:** **Reset Start**

**Cause:** A TTL clock or DC waveform is the current waveform. It is impossible to sweep with these waveforms.

**Remedy:** Change to one of the other waveforms.

**MESSAGE:** offs. out range

**Command:** **Offs**

**Cause:** The offset value entered is not valid.

**Remedy:** Enter an offset from 0 to  $\pm 5$  V for a DC only signal. For a DC and AC signal see the amplitude/offset table in chapter 5.

**MESSAGE:** phase cal failed

**Command:** **Phase Cal**

**Cause:** The attempted phase calibration has failed.

**Remedy:** Check to make sure that the two HP 3324As are connected properly.

**MESSAGE:** phase out range

**Command:** **Phase**

**Cause:** The phase value entered is not valid.

**Remedy:** Enter a phase value between  $-720^\circ$  and  $+720^\circ$ .

**MESSAGE:** seq > 100 interv

**Command:** "INTERVAL" (Enter)

**Cause:** The sequence entered contains more than 100 intervals.

**Remedy:** Reduce the number of intervals to 100 or less.

**MESSAGE:** startfr too high

**Command:** (Reset Start)

**Cause:** The start frequency for the interval is too large.

**Remedy:** Enter a smaller start frequency. The value depends on the waveform.

**MESSAGE:** stopfrq too high

**Command:** (Reset Start)

**Cause:** The stop frequency for the interval is too large.

**Remedy:** Enter a smaller stop frequency. The value depends on the waveform.

**MESSAGE:** store out range

**Command:** (Save)

**Cause:** The store to which you are trying to save does not exist.

**Remedy:** Press (Util) and scroll the display until you see "sto: xx int: yy". The "xx" is the number of stores that are available to you. Try to save your setting again using one of the available stores.

**MESSAGE:** `swp time < 10 ms`  
**Command:** "SWEEP-TIME"  
**Cause:** The input sweep time is less than 10 ms.  
**Remedy:** Enter a sweep time for the interval of  $\geq 10$  ms.

**MESSAGE:** `swp time > 100000 s`  
**Command:** "SWEEP-TIME"  
**Cause:** The input sweep time is greater than 100000 s.  
**Remedy:** Enter a sweep time for the interval of  $\leq 100000$  s.

**MESSAGE:** `syntax error`  
**Command:** Most commands.  
**Cause:** The entered syntax is incorrect.  
**Remedy:** Re-enter a valid syntax.

**MESSAGE:** `value out range`  
**Command:** Most commands.  
**Cause:** The value input is outside of the permissible range.  
**Remedy:** Re-enter a valid value.

**MESSAGE:** `wrong int in seq`  
**Command:** "INTERVAL"  
**Cause:** One of the intervals programmed in the sequence contains an error.  
**Remedy:** Either re-program the interval or take it out of the sequence.

**MESSAGE:** wrong seq index

**Command:** "INTERVAL"

**Cause:** One of the indices in the sweep sequence does not exist.

**Remedy:** Take the index out of the sweep sequence.

The following lists the programming errors that can be obtained and evaluated using the IER program error query:

<b>Error Number</b>	<b>Error Description</b>
1	Entry parameter out of bounds
2	Invalid delimiter
3	Frequency too high for waveform function
4	Sweep time too small or too large
5	Offset - amplitude incompatible
6	Sweep frequency too large for function, start frequency too small, sweep bandwidth too small, start frequency greater than stop frequency
7	Unrecognisable mnemonic received
8	Unrecognisable data character received
9	High-voltage option does not exist
10	Index out of range for Xxx mnemonic
11	Missing comma
12	Numeric parameter out of range
13	Interval error in sweep sequence
14	Sweep sequence is too long

The following lists the system errors that can be obtained and evaluated using the ISE system error query:

<b>System Failure Number</b>	<b>System Failure Description</b>
1	Amplitude calibration failed
2	Phase calibration failed
3	External reference unlocked
4	Main oscillator unlocked
5+	Self-test failed (report actual number to Service personnel).

Error numbers are not buffered. Only the newest error is given.

To decode the self-test failure subtract 5 from its value. Then convert to binary and for each bit that is set to "1", there is a specific error.

<b>Bit</b>	<b>Self-test Failure Description</b>
0	RAM/ROM test failed (ROM=signature test)
1	MFP (MC 68901) Test failed
2	Device bus test failed
3	Display test failed (display handshake)
4	DAC test failed (analog voltage generation)
5	FRAC-N chip test failed
6	VCO test failed
7	Sweep timer test failed
8	Offset test failed



## **Backdating**

---

### **Introduction**

This appendix contains backdating information, which adapts this manual to instruments with serial numbers other than that shown on the title page.

Changes are listed in the serial number order that they occurred in the manufacture of the instrument. However, in adapting this manual to an instrument with serial number lower than that shown on the title page, apply the changes in reverse order. That is, begin with the latest change that applies to the serial number in question.

At the time of print there are no backdating changes.



## Index

---

- A**
  - Accepted characters, 9-5
  - AC line connector assembly, 2-5
  - AC line voltage, C-3
  - Amplitude, 5-7
    - high-voltage option, 5-9
    - limits of AC functions, 5-7
  - Amplitude calibration, 5-8
  - Arrow keys, 3-11
  - Assign zero phase, 5-15
  - Attention (ATN) bus line, D-4
  - Automatic phase calibration, 5-16
  - Automatic phase calibration option, B-4
  - Auxiliary output connector, 2-5, 3-9
  
- B**
  - Backdating, G-1
  - Bandwidth vs. function, 5-6
  - Bus commands (HP-IB), D-8
  - Bus management lines (HP-IB), D-4
  
- C**
  - Calibration
    - amplitude, 5-8
  - Changing the bus address, 8-4, 9-11
  - Clear command, D-8
  - Clear lockout, D-9
  - Command groups, 9-7
  - Command syntax, E-1
  - Compatibility mode
    - setting the HP 3325A mode, 8-4
  - Compatibility mode
    - HP 3325A compatible power-on state, 3-3
  - Connector

HP-IB, C-7

Connectors

- 10 MHz oven output, 3-6
- 10 MHz oven output output, 2-4
- AC line assembly, 2-5
- auxiliary output, 2-5, 3-9
- external frequency reference input, 2-5, 3-6
- frequency reference output, 3-7
- HP-IB, 2-4
- main signal output, 2-3, 2-4, 3-4
- marker, 2-5
- marker output, 3-7
- phase calibration input, 2-4, 3-5
- phase calibration output, 2-4, 3-6
- reference output, 2-5
- synchronized output, 2-3, 3-5
- synchronous output, 2-5
- X-drive, 2-5, 3-8
- Z-blank, 2-5, 3-7

Continuous sweep, 7-7, 7-17

Converting units, 5-8

- D** Data entry, 3-10
- Data keys, 2-2, 3-10
- Data transfer modes, 9-7
- DC offset, 5-10
  - high-voltage option, 5-13
  - no AC function, 5-11
  - with AC function, 5-11
- Default address, 8-4, 9-11
- Description of the HP-IB, D-1
- Display, 2-1
- Display indicators
  - "AMPL", 5-2
  - "Cal.d/ps:", 5-19, 8-6
  - "compatib: yes/NO", 8-4
  - "CONT", 7-10, 7-19
  - "EXT-REF", 2-5, 3-6
  - "FREQ", 5-2
  - "HIGH-VOLT", 8-7
  - "highvolt: on/OFF", 8-7

"HPIB addr.: xx", 8-4  
"INTERVAL", 7-8  
"LIN", 7-9, 7-10  
"LOG", 7-9, 7-10  
"LST", 9-4  
"M", 3-11, 5-3  
"MARKER", 7-17  
"MARKER-FREQ", 7-9  
"OFFS", 5-2  
"PHASE", 5-2  
"phase cal MASTER", 8-5  
"phase cal SLAVE", 8-5  
"REAR-ONLY", 2-3, 3-4  
"REMOTE", 9-4  
"Reset", 7-23  
"ROM rev. xx.xx", 8-7  
"Run", 7-23  
"S", 2-3, 3-9  
"selft: std./all", 8-5  
"set default", 8-1  
"Sig.d/ps:", 5-17, 8-6  
"SINGLE", 7-10, 7-19  
"SRQ", 9-4  
"Start", 7-23  
"START-FREQ", 7-9  
"STOP-FREQ", 7-9  
"sto: xx int: xx", 8-3  
"SWEEP-TIME", 7-9  
"TLK", 9-4  
waveform symbols, 6-1  
Displaying the bus address, 8-4, 9-11

- E** Edit key, 3-13  
Edit mode, 3-13  
    editing a parameter, 5-4  
Error messages, F-1  
Examples  
    amplitude, 5-10  
    data mode, 3-10  
    DC offset, 5-13  
    edit mode, 3-14, 5-5

- frequency, 5-7
- function generator, 4-2
  - $\Delta f \times 2$ , 7-23
  - MKR▷CF, 7-23
  - modify mode, 3-13, 5-4
  - programming as a function generator, 11-10
  - programming as a multi-interval sweep generator, 11-11
  - programming as a multi-marker sweep generator, 11-13
  - recalling an instrument state, 3-16
  - saving an instrument state, 3-16
  - serial poll, 10-9
  - setting up a multi-interval sweep, 7-11
  - setting up a multi-marker sweep, 7-20
  - SRQ mask, 10-8
  - sweep generator, 4-5
  - waveform, 6-3
- External frequency reference input connector, 2-5, 3-6

**F** Frequency, 5-6

- high-voltage option, 5-6
- range vs. function, 5-6

Frequency reference option, B-2  
Frequency reference output connector, 3-7  
Front panel, 2-1

**G** Getting started

- as a function generator, 4-2
- as a sweep generator, 4-5
- powering up, 4-1

**H** High-voltage option, B-3

- amplitude, 5-9
- DC offset, 5-13
- frequency, 5-6
- switching the output on, 8-7

HP-IB



- command list, E-2
- commands, 11-1
- connector, 2-4, C-7
- description of, D-1

display indicators, 9-4  
HP 3324A capabilities, 9-1  
logic levels, C-7  
messages, 9-6  
setting the address, 8-4, 9-11

**I** Impedance  
of high-voltage output, 2-3, 2-4, A-11  
of main signal output, 2-3, 2-4  
Input signals, 3-4  
Instrument introduction, 1-1  
Interpreter, 9-2  
Intervals  
setting number of, 8-3

**K** Key features, 1-1

Keys

, 7-9, 7-18  
, 7-9, 7-18  
**Ampl**, 5-7  
**Ampl Cal**, 5-8  
arrow, 3-11  
**Assign Phase 0**, 5-15  
**BackSpace**, 3-10  
**CHS**, 3-10  
**Decr**, 3-12, 5-3  
**Edit**, 3-13, 5-4  
**Enter**, 3-10  
 **$\Delta f/2$** , 7-10, 7-23  
**Freq**, 5-6  
**Front Rear**, 2-3, 3-4  
 **$\Delta f \times 2$** , 7-10, 7-23  
**Incr**, 3-12, 5-3  
**Local**, 2-3  
**MKr▷CF**, 7-10, 7-23  
**Modify**, 3-11, 5-3  
**Offs**, 5-10  
**Phase**, 5-14  
**Phase Cal**, 5-14, 5-16  
**Recall**, 2-2, 3-16

Reset Start, 7-10, 7-22  
Save, 2-2, 3-15  
Select, 3-11  
Shift, 2-3, 3-9  
Signal on off, 2-2, 3-4  
Stand-by, 2-3, 3-2  
Sweep, 2-1, 7-1  
Util, 2-3, 8-1  
Waveform, 2-1  
WaveForm, 6-1

**L** Linear sweep interval, 7-4  
Local lockout, D-9  
Local mode, 1-2  
Logarithmic sweep interval, 7-4

**M** Main signal output connector, 2-3, 2-4, 3-4  
Marker connector, 2-5  
Marker frequency  
    multi-interval sweep, 7-5, 7-15  
Marker output connector, 3-7  
Messages  
    error, F-1  
Modify key, 3-11  
Modify mode, 2-2, 3-11  
    modifying a parameter, 5-3  
Multi-interval sweep, 7-2, 7-4  
    continuous, 7-7  
    linear interval, 7-4  
    logarithmic interval, 7-4  
    marker frequency, 7-5  
    sequence, 7-6  
    setting up a sequence, 7-8  
    single, 7-7  
Multi-marker sweep, 7-2, 7-15  
    continuous, 7-17  
    marker frequency, 7-15  
    setting up an interval, 7-17  
    single, 7-17



- O** Offset, 5-10
- Omitting the mnemonic, 9-10
- Options available, B-1
  - high-stability frequency reference, B-2
  - high-voltage output, B-3
  - phase calibration, B-4
- Output signals, 3-4
- Oven output connector (10 MHz), 2-4, 3-6
  
- P** Parameter default values, 8-1
- Parameter keys, 2-2, 5-1
- Parameters
  - amplitude, 5-7
  - DC offset, 5-10
  - frequency, 5-6
  - phase, 5-14
- Phase, 5-14
- Phase calibration, 5-14
- Phase calibration input connector, 2-4, 3-5
- Phase calibration output connector, 2-4, 3-6
- Power
  - before power-on, 3-1
  - cable, C-5
  - powering up, 4-1
  - power-on, 3-1
  - requirements, C-2
  
- R** Rear panel, 2-4
- Recalling instrument states, 3-16
- Reference output connector, 2-5
- Remote mode, 1-2, 9-1
- Remote operation command list, 11-1-4
  
- S** Safety considerations, C-1
- Sales offices, H-1
- Saving instrument states, 3-15
- Select key, 3-11
- Select mode, 2-2, 3-11
- Self-test, 8-5
- Service offices, H-1

- Setting the bus address, 8-4, 9-11
- Setting up a multi-interval sequence, 7-8
- Setting up a multi-marker interval, 7-17
- Shift key, 3-9
- Signals
  - input/output, 3-4
- Single sweep, 7-7, 7-17
- Software revision, 8-7
- Specifications, A-1
- SRQ
  - forcing an, 10-6
- State
  - sweep default, 7-2
  - turn-on, 3-2
- Status byte, 10-1
- Status reporting, 10-1
- Stores
  - setting number of, 8-3
- Sweep
  - default state, 7-2
  - keys, 2-2, 7-22
  - menu, 7-1
  - multi-interval, 7-2, 7-4
  - multi-interval continuous, 7-7
  - multi-interval marker frequency, 7-5
  - multi-interval single, 7-7
  - multi-marker, 7-2, 7-15
  - multi-marker continuous, 7-17
  - multi-marker marker frequency, 7-15
  - multi-marker single, 7-17
  - range vs. function, 7-4
  - sequence, 7-6
  - setting up a multi-interval sequence, 7-8
  - setting up a multi-marker interval, 7-17
- Synchronized output connector, 2-3, 3-5
- Synchronous output connector, 2-5
- Syntax, E-1
- Syntax drawing rules, E-1
- Syntax error
  - synchronizing after, 9-11

- T** Talk/listen addresses, D-6
- Tests
  - self-test, 8-5
- Trigger (HP-IB), D-10
- Turn-on state, 3-2
  
- U** Utilities, 8-1
  
- V** Viewing the bus address, 8-4, 9-11
- Voltage
  - AC line, C-3
  
- W** Warm-up time, A-2
- Waveforms, 6-1
  
- X** X-drive connector, 2-5, 3-8
  
- Z** Z-blank connector, 2-5, 3-7

