



HEWLETT  
PACKARD

## OPERATING AND SERVICE MANUAL

# MODEL 3320A/B FREQUENCY SYNTHESIZER

Serial Numbers: 1524A00446 and greater (Model 3320A)  
1532A01381 and greater (Model 3320B)

### IMPORTANT NOTICE

Any changes made in instruments with serial numbers greater than those stated on this title page will be noted on a change sheet supplied with this manual. If the serial number of your instrument is lower than that stated above, the manual can contain revisions that do not apply to your instrument. Backdating information located in Section VIII adapts this manual to these instruments.

### WARNING

*To help minimize the possibility of electrical fire or shock hazards, do not expose this instrument to rain or excessive moisture.*

Manual Part No. 03320-90002

Microfiche Part No. 03320-90052

©Copyright Hewlett-Packard Company 1971  
P.O. Box 301, Loveland, Colorado, 80537 U.S.A.

Printed: October 1976

### **CERTIFICATION**

*Hewlett-Packard Company certifies that this product met its published specifications at the time of shipment from the factory. Hewlett-Packard further certifies that its calibration measurements are traceable to the United States National Bureau of Standards, to the extent allowed by the Bureau's calibration facility, and to the calibration facilities of other International Standards Organization members.*

### **WARRANTY**

This Hewlett-Packard instrument product is warranted against defects in materials and workmanship for a period of 90 days from date of shipment [except that in the case of certain components listed in Section I of this manual, the warranty shall be for the specified period]. During the warranty period, HP will, at its option, either repair or replace products which prove to be defective.

Warranty service of this product will be performed at Buyer's facility at no charge within HP service travel areas. Outside HP service travel areas, warranty service will be performed at Buyer's facility only upon HP's prior agreement and Buyer shall pay HP's round trip travel expenses. In all other cases, products must be returned to a service facility designated by HP.

For products returned to HP for warranty service, Buyer shall prepay shipping charges to HP and HP shall pay shipping charges to return the product to Buyer. However, Buyer shall pay all shipping charges, duties, and taxes for products returned to HP from another country.

HP warrants that its software and firmware designated by HP for use with an instrument will execute its programming instructions when properly installed on that instrument. HP does not warrant that the operation of the instrument, or software, or firmware will be uninterrupted or error free.

### **LIMITATION OF WARRANTY**

The foregoing warranty shall not apply to defects resulting from improper or inadequate maintenance by Buyer, Buyer-supplied software or interfacing, unauthorized modification or misuse, operation outside of the environmental specifications for the product, or improper site preparation or maintenance.

**NO OTHER WARRANTY IS EXPRESSED OR IMPLIED. HP SPECIFICALLY DISCLAIMS THE IMPLIED WARRANTIES OF MERCHANTABILITY AND FITNESS FOR A PARTICULAR PURPOSE.**

### **EXCLUSIVE REMEDIES**

**THE REMEDIES PROVIDED HEREIN ARE BUYER'S SOLE AND EXCLUSIVE REMEDIES. HP SHALL NOT BE LIABLE FOR ANY DIRECT, INDIRECT, SPECIAL, INCIDENTAL, OR CONSEQUENTIAL DAMAGES, WHETHER BASED ON CONTRACT, TORT, OR ANY OTHER LEGAL THEORY.**

### **ASSISTANCE**

*Product maintenance agreements and other customer assistance agreements are available for Hewlett-Packard products.*

*For any assistance, contact your nearest Hewlett-Packard Sales and Service Office. Addresses are provided at the back of this manual.*



## **SAFETY SUMMARY**

The following general safety precautions must be observed during all phases of operation, service, and repair of this instrument. Failure to comply with these precautions or with specific warnings elsewhere in this manual violates safety standards of design, manufacture, and intended use of the instrument. Hewlett-Packard Company assumes no liability for the customer's failure to comply with these requirements. This is a Safety Class 1 instrument.

### **GROUND THE INSTRUMENT**

To minimize shock hazard, the instrument chassis and cabinet must be connected to an electrical ground. The instrument is equipped with a three-conductor ac power cable. The power cable must either be plugged into an approved three-contact electrical outlet or used with a three-contact to two-contact adapter with the grounding wire (green) firmly connected to an electrical ground (safety ground) at the power outlet. The power jack and mating plug of the power cable meet International Electrotechnical Commission (IEC) safety standards.

### **DO NOT OPERATE IN AN EXPLOSIVE ATMOSPHERE**

Do not operate the instrument in the presence of flammable gases or fumes. Operation of any electrical instrument in such an environment constitutes a definite safety hazard.

### **KEEP AWAY FROM LIVE CIRCUITS**

Operating personnel must not remove instrument covers. Component replacement and internal adjustments must be made by qualified maintenance personnel. Do not replace components with power cable connected. Under certain conditions, dangerous voltages may exist even with the power cable removed. To avoid injuries, always disconnect power and discharge circuits before touching them.

### **DO NOT SERVICE OR ADJUST ALONE**

Do not attempt internal service or adjustment unless another person, capable of rendering first aid and resuscitation, is present.

### **DO NOT SUBSTITUTE PARTS OR MODIFY INSTRUMENT**

Because of the danger of introducing additional hazards, do not install substitute parts or perform any unauthorized modification to the instrument. Return the instrument to a Hewlett-Packard Sales and Service Office for service and repair to ensure that safety features are maintained.

### **DANGEROUS PROCEDURE WARNINGS**

Warnings, such as the example below, precede potentially dangerous procedures throughout this manual. Instructions contained in the warnings must be followed.

#### **WARNING**

**Dangerous voltages, capable of causing death, are present in this instrument. Use extreme caution when handling, testing, and adjusting.**

## SAFETY SYMBOLS

### General Definitions of Safety Symbols Used On Equipment or In Manuals.



Instruction manual symbol: the product will be marked with this symbol when it is necessary for the user to refer to the instruction manual in order to protect against damage to the instrument.



Indicates dangerous voltage (terminals fed from the interior by voltage exceeding 1000 volts must be so marked).

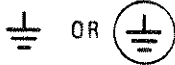

Protective conductor terminal. For protection against electrical shock in case of a fault. Used with field wiring terminals to indicate the terminal which must be connected to ground before operating equipment.



Low-noise or noiseless, clean ground (earth) terminal. Used for a signal common, as well as providing protection against electrical shock in case of a fault. A terminal marked with this symbol must be connected to ground in the manner described in the installation (operating) manual, and before operating the equipment.

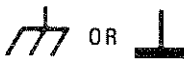

Frame or chassis terminal. A connection to the frame (chassis) of the equipment which normally includes all exposed metal structures.



Alternating current (power line).



Direct current (power line).



Alternating or direct current (power line).

**WARNING**

The WARNING sign denotes a hazard. It calls attention to a procedure, practice, condition or the like, which, if not correctly performed or adhered to, could result in injury or death to personnel.

**CAUTION**

The CAUTION sign denotes a hazard. It calls attention to an operating procedure, practice, condition or the like, which, if not correctly performed or adhered to, could result in damage to or destruction of part or all of the product.

**NOTE :**

The NOTE sign denotes important information. It calls attention to procedure, practice, condition or the like, which is essential to highlight.

# SECTION I GENERAL INFORMATION

## 1-1. INTRODUCTION.

1-2. This section contains general information about the Model 3320A/B Frequency Synthesizer. A general description plus information on specifications, accessories, and instrument identification is given.

## 1-3. SPECIFICATIONS.

1-4. Table 1-1 lists the Model 3320A/B Specifications, which are the performance standards against which the instrument is tested. The general information listed in Table 1-2 is not to be considered as specifications but as typical characteristics included as additional information for the user.

1-5. Any change in the specifications due to manufacturing, design, or traceability to the U.S. National Bureau of Standards will be listed on a manual change supplement included with this manual. The manual and manual change supplement supersede all previous information concerning specifications of the 3320A/B.

## 1-6. DESCRIPTION.

1-7. The Hewlett-Packard Model 3320A/B Frequency Synthesizer provides accurate and stable frequencies from 0.001 Hz to 12.9999 MHz. Frequency selection is by three controls that provide three digits of resolution plus an

**Table 1-1. Specifications.**

<p><b>Frequency accuracy</b> Vernier Out: <math>\pm 0.001\%</math> of setting for 6 mo, 0°C to 55°C. Vernier In: <math>\pm 0.01\%</math> of range for 6 mo, 0°C to 55°C.</p> <p><b>Frequency stability</b> Long term: <math>\pm 10</math> parts in <math>10^6</math> of setting per year (Vernier Out) with ambient temperature reference. Optional high stability crystal reference oven available (Option 002).</p> <p>Signal to phase noise (integrated), <math>&gt; 40</math> dB in 30 kHz band, excluding <math>\pm 1</math> Hz, centered on carrier, 10 MHz range, Vernier Out. Improves on lower frequency ranges.</p> <p><b>Spurious:</b> <math>&gt; 60</math> dB down.</p>	<p><b>Harmonic distortion:</b> with output frequencies <math>&gt; 0.1\%</math> of range at full output amplitude any harmonically related signal will be less than the following specified levels.</p> <ul style="list-style-type: none"> <li>- 60 dB with output from 5 Hz to 100 kHz.</li> <li>- 50 dB with output from 100 kHz to 1 MHz.</li> <li>- 40 dB with output from 1 MHz to 13 MHz.</li> </ul> <p style="text-align: center;"><b>3320A AMPLITUDE SECTION</b></p> <p><b>Amplitude:</b> maximum 2 V rms <math>\pm 10\%</math> open circuit, maximum 1 V rms <math>\pm 10\%</math> into 50 <math>\Omega</math>.</p> <p><b>Frequency response:</b> <math>\pm 2</math> dB over total range.</p> <p style="text-align: center;"><b>3320B AMPLITUDE SECTION</b></p> <p><b>Amplitude accuracy (absolute):</b> <math>\pm 0.05</math> dB at 10 kHz and +26.99 dBm (20°C to 30°C).</p> <p><b>Attenuator accuracy (10 kHz reference):</b> <math>\pm 0.02</math> dB/10 dB step.</p> <p><b>Frequency response (10 kHz reference):</b></p>
---	--

3320B ATTENUATOR SETTINGS (dBm)		SPECIFICATION (dB)	
Standard	Option 001	LEVELING OFF	LEVELING ON ( $> 10$ Hz)
+ 26.99 to - 3.00	+ 24.99 to - 5.00	$\pm 0.5$	$\pm 0.05$
- 3.01 to - 23.00	- 5.01 to - 25.00	$\pm 0.5$	$\pm 0.1$
- 23.01 to - 53.00	- 25.01 to - 55.00	$\pm 0.5$	$\pm 0.2$
- 53.01 to - 69.99*	- 55.01 to - 69.99**	$\pm 0.5$	$\pm 0.4$

\* - 73.00 dBm, remote control.  
\*\* - 75.00 dBm, remote control.

Table 1-2. General Information.

<p><b>Frequency range:</b> 0.01 Hz to 13 MHz in 7 ranges.  <b>Frequency ranges:</b>          10 MHz          1000 kHz          100 kHz          10 kHz          1000 Hz          100 Hz } Optional          10 Hz }          30% overrange on all ranges.</p> <p><b>Frequency resolution:</b></p> <table border="1"> <thead> <tr> <th>Range</th> <th>Vernier Out (local or remote)</th> <th>Vernier In (local)</th> <th>Vernier In (remote)</th> </tr> </thead> <tbody> <tr> <td>10 MHz</td> <td>10 kHz</td> <td>10 Hz</td> <td>1 kHz</td> </tr> <tr> <td>1000 kHz</td> <td>1 kHz</td> <td>1 Hz</td> <td>100 Hz</td> </tr> <tr> <td>100 kHz</td> <td>100 Hz</td> <td>0.1 Hz</td> <td>10 Hz</td> </tr> <tr> <td>10 kHz</td> <td>10 Hz</td> <td>0.01 Hz</td> <td>1 Hz</td> </tr> <tr> <td>1000 Hz</td> <td>1 Hz</td> <td>1 mHz</td> <td>0.1 Hz</td> </tr> <tr> <td>100 Hz</td> <td>0.1 Hz</td> <td>0.1 mHz</td> <td>0.01 Hz</td> </tr> <tr> <td>10 Hz</td> <td>0.01 Hz</td> <td>0.01 mHz</td> <td>0.001 Hz</td> </tr> </tbody> </table> <p><b>Internal frequency standard:</b> 20 MHz ambient temperature crystal.          Optional 5 MHz reference crystal oven available (Option 002).</p> <p><b>Phase locking:</b> the 3320A/B may be phase locked with a 200 mV to 2 V rms signal that is any subharmonic of 20 MHz from 1 MHz through 10 MHz (e.g., 1 MHz, 2 MHz, 2.5 MHz, 5 MHz, 10 MHz). BNC female connector.</p> <p><b>Rear panel output:</b> front or rear panel output is available. Can be easily changed by routing internal cable to front or rear female BNC connectors. No degradation of performance for rear panel output.</p> <p><b>Auxiliary outputs</b>          Tracking output: 20 MHz to 33 MHz offset signal. Tracks main output with 20 MHz offset. Rear panel female BNC, &gt; 100 mV rms/50 Ω.          1 MHz reference output: sine wave, rear panel female BNC, &gt; 220 mV rms/50 Ω (&gt; 0 dBm/50 Ω).          Low level output: same frequency as main output but remains between 50 mV rms and 158 mV rms (into 50 Ω) depending on main output level setting. May be used as counter output if wanted. Rear panel female BNC, sine wave.</p> <p style="text-align: center;"><b>3320A AMPLITUDE SECTION</b></p> <p><b>Amplitude range:</b> 0 dBm to + 13 dBm range through 3/4 turn front panel control (not programmable).  <b>Output impedance:</b> 50 Ω.</p> <p style="text-align: center;"><b>3320B AMPLITUDE SECTION</b></p> <p><b>Amplitude range:</b> + 26.99 dBm (1/2 watt) to - 69.99 dBm (- 73.00 dBm under remote control) into 50 Ω. (+ 26.99 dBm = 5 V rms into 50 Ω).  <b>Amplitude resolution:</b> 0.01 dB.  <b>Output impedance:</b> 50 Ω.</p> <p style="text-align: center;"><b>GENERAL 3320A/B</b></p> <p><b>Operating temperature:</b> 0°C to 55°C.  <b>Storage temperature:</b> - 40°C to + 70°C.</p>	Range	Vernier Out (local or remote)	Vernier In (local)	Vernier In (remote)	10 MHz	10 kHz	10 Hz	1 kHz	1000 kHz	1 kHz	1 Hz	100 Hz	100 kHz	100 Hz	0.1 Hz	10 Hz	10 kHz	10 Hz	0.01 Hz	1 Hz	1000 Hz	1 Hz	1 mHz	0.1 Hz	100 Hz	0.1 Hz	0.1 mHz	0.01 Hz	10 Hz	0.01 Hz	0.01 mHz	0.001 Hz	<p><b>Power requirements:</b> 115 V or 230 V ± 10%, 48 Hz to 63 Hz, &lt; 110 W, (400 Hz operation on special basis).</p> <p><b>Weight</b>          3320A: 45 lb. (20,4 kg).          Shipping: 59 lb (26,7 kg).          3320B: 47 lb. (21,3 kg).          Shipping: 61 lb. (27,5 kg).</p> <p><b>Outline drawing:</b></p> <p><b>NOTES:</b>          DIMENSIONS IN INCHES AND MILLIMETERS          (1) DIM BACK FRONT (INCLUDING FILLER STRIP)          FOR CABINET FRONT (INCLUDING FILLER STRIP)          DIM BACK REAR          (2) REAR APRON RECESS</p> <p><b>OPTIONS</b></p> <p style="text-align: center;"><b>75 Ohm Output Impedance          Option 001 3320A/B</b></p> <p>Attenuation and output referenced to 75 Ω.          Amplitude range (3320B only): + 24.99 dBm to - 69.99 dBm (- 75.00 dBm under remote control) into 75 Ω. (3320A only): - 2 dBm to + 11 dBm into 75 Ω.</p> <p style="text-align: center;"><b>Reference Crystal Oven*          Option 002 3320A/B</b></p> <p>5 MHz crystal in temperature stabilized oven.  <b>Long term stability:</b> ± 1 part in 10<sup>8</sup>/day.          ± 1 part in 10<sup>7</sup>/mo.  <b>Frequency accuracy:</b> ± 1 part in 10<sup>7</sup> of setting per month.          For field installation order accessory kit HP 11237A.</p> <p style="text-align: center;"><b>Parallel BCD Remote Control*          Option 003 3320A Only</b></p> <p>Allows digital remote control of frequency only on 3320A. Digital control of output level is not available on 3320A. The most significant digit of the Vernier may be programmed thus giving four digits, plus 30% overrange, control of frequency in seven ranges (two are optional).  <b>Control lines required:</b> 24 plus remote line.  <b>Logic levels:</b> TTL, "1" state low, non-isolated.  <b>Frequency switching and settling time:</b> ± 0.01% range, 15 ms, ± 0.001% range, 60 ms.          For field installation order accessory kit HP 11238A.</p> <p style="text-align: center;"><b>Parallel BCD Remote Control*          Option 004 3320B Only</b></p> <p>Allows full digital remote control of frequency and amplitude.          (1) Four digits of frequency, overrange, frequency range, Vernier In/Out, four digits of amplitude, and leveling loop response times are all controlled digitally. All front panel controls, except line switch, are disabled in remote.  <b>Control lines required:</b> 40 plus remote line.  <b>Logic levels:</b> TTL, "1" state low, non-isolated.  <b>Frequency switching and settling time:</b> ± 0.01% range, 15 ms; ± 0.001% range, 60 ms.  <b>Amplitude switching and settling time:</b> &lt; 1.5 s to rated accuracy.          For field installation order accessory kit HP 11239C.</p>
Range	Vernier Out (local or remote)	Vernier In (local)	Vernier In (remote)																														
10 MHz	10 kHz	10 Hz	1 kHz																														
1000 kHz	1 kHz	1 Hz	100 Hz																														
100 kHz	100 Hz	0.1 Hz	10 Hz																														
10 kHz	10 Hz	0.01 Hz	1 Hz																														
1000 Hz	1 Hz	1 mHz	0.1 Hz																														
100 Hz	0.1 Hz	0.1 mHz	0.01 Hz																														
10 Hz	0.01 Hz	0.01 mHz	0.001 Hz																														



**Table 1-2. General Information (cont'd).**

<p style="text-align: center;"><b>HP-IB Remote Control* Option 007 3320B Only</b></p> <p>Allows bit-parallel word-serial digital remote control of all functions. ① A 3320B with this option will recognize an address and then accept instructions in a serial fashion. Instructions are in a 7-bit parallel ASCII code. Due to the addressing feature, up to ten 3320B's (with this option) may be programmed from one programmer.</p> <p>This option uses ten digital input lines for control of all functions except the last vernier digit and line switch. Three digital output lines are provided.</p> <p>Full digital isolation is standard with this option.</p> <p><b>Timing:</b> max of 5 <math>\mu</math>s per word required to input program data.</p> <p><b>Logic level requirements:</b> (same as parallel BCD remote). Switching and settling times for frequency and amplitude are the same as with the parallel BCD remote option. For field installation, order accessory kit HP 11239C.</p>	<p>Logic Level Requirements for All Digital Remote Control Options.</p> <table border="1" style="width: 100%;"> <tr> <th style="text-align: center;">State</th> <th style="text-align: center;">Requirements</th> </tr> <tr> <td style="text-align: center;">"Low" (logical "1")</td> <td>0 V to 0.4 V (5 mA max.) or contact closure to ground through &lt; 80 ohms.</td> </tr> <tr> <td style="text-align: center;">"High" (logical "0")</td> <td>+ 2.4 V to + 5 V or removal of contact closure to ground.</td> </tr> </table> <p style="text-align: center;"><b>100 Hz and 10 Hz Ranges* Option 006 3320A/B</b></p> <p>Adds two lower frequency ranges, 100.0 Hz and 10.00 Hz, yielding greater resolution for low frequency outputs (see resolution section of specifications). These two ranges are fully programmable if digital remote options are installed.</p> <p>For field installation order accessory kit HP 11240A.</p> <p>*Field installable.</p> <p>① Except last vernier digit and line switch.</p>	State	Requirements	"Low" (logical "1")	0 V to 0.4 V (5 mA max.) or contact closure to ground through < 80 ohms.	"High" (logical "0")	+ 2.4 V to + 5 V or removal of contact closure to ground.
State	Requirements						
"Low" (logical "1")	0 V to 0.4 V (5 mA max.) or contact closure to ground through < 80 ohms.						
"High" (logical "0")	+ 2.4 V to + 5 V or removal of contact closure to ground.						

overrange digit, and a vernier control that provides two digits of resolution. A range control provides five ranges of 1000 Hz, 10 kHz, 100 kHz, 1000 kHz, and 10 MHz. The output frequencies are derived from a precision single frequency source by an indirect synthesis technique.

1-8. In the 3320A, the output amplitude is selected by a 0-13 dBm continuous potentiometer. Maximum output voltage is 1 V rms into 50  $\Omega$ . The 3320B has a range of +26.99 dBm to -69.99 dBm with a resolution of 0.01 dB. The output amplitude can be selected in steps of 0.01 dB, 0.1 dB, 1.0 dB, or 10 dB. Maximum output voltage of the 3320B is 5 V rms into 50  $\Omega$ .

**1-9. OPTIONS.**

1-10. The 3320A/B series of instruments include a total of nine options. These options are as follows:

3320A Options	3320B Options	Description
001	001	75 $\Omega$ Output Impedance
002	002	Reference Crystal Oven
003	004	Parallel BCD Remote Control
006	006	100 Hz and 10 Hz Ranges
	007	HP-IB Remote Control
908	908	Rack Mount Kit
910	910	Additional Operating and Service Manual

1-11. The 3320B Option 007, HP-IB (Hewlett-Packard Interface Bus) Remote Control utilizes a seven line data bus, a three line transfer bus, and four additional control bus lines to manage the flow of information over the data bus and the transfer bus. Data information is transferred in an ASCII (American Standard Code for Information Interchange) code. For more information concerning this and other options, refer to Table 1-2, Section III, or your local Sales and Service Office.

**1-12. ACCESSORIES SUPPLIED.**

1-13. Accessories supplied with the 3320A/B are listed in Table 1-3.

**Table 1-3. Accessories Supplied.**

-hp- Model or Part No.	Qty.	Description
11239-84401	1	HP-IB Adapter (Option 007 only)
03320-84411	1	Kit: Accessory Consists of:
03320-66530	1	PC Assy: Extender
03320-62703	2	Filter Assy: Fan

**1-14. ACCESSORIES AVAILABLE.**

1-15. Accessories available for the 3320A/B are listed in Table 1-4.

**Table 1-4. Accessories Available.**

-hp- Model or Part No.	Description
5060-8740	Rack Mount Kit
11237A	Option 002 Kit
11238A	Option 003 Kit (A only)
11238C	Option 004 Kit (B only)
11239C	Option 007 Kit (B only)
11240A	Option 006 Kit
11048C	50 $\Omega$ Feedthrough
11094B	75 $\Omega$ Feedthrough (Opt. 001 only)

**1-16. INSTRUMENT AND MANUAL IDENTIFICATION.**

1-17. This manual applies to instruments with the serial number prefix shown on the title page. If changes have been made in the instrument since this manual was printed, a "Manual Changes" supplement supplied with the manual will define these changes. Be sure to record these changes in your manual. Backdating information in Section VIII adapts the manual to instruments with serial number prefixes lower than those shown on the title page. Part numbers for the manual and the microfiche copy of the manual are also shown on the title page.





## SECTION II INSTALLATION

### 2-1. INTRODUCTION.

2-2. This section contains information and instructions necessary for the installation and shipping of the Model 3320A/B Frequency Synthesizer. Included are initial inspection procedures, power and grounding requirements, environmental information, power cord information, interfacing and instructions for repackaging for shipment.

### 2-3. INITIAL INSPECTION.

2-4. This instrument was carefully inspected both mechanically and electrically before shipment. It should be free of marks or scratches and in perfect electrical order upon receipt. To confirm this, the instrument should be inspected for physical damage in transit, and the electrical performance should be tested using the procedure outlined in Paragraph 5-7. If there is damage or deficiency, see the warranty inside the front cover of this manual.

### 2-5. POWER REQUIREMENTS.

2-6. The 3320A/B operates from an ac power source of 48 to 66 Hz at the following voltages:

115/120 V + 5% - 10%  
230/240 V + 5% - 10%

The 3320A/B is normally set for 115/120 V operation at the factory. Refer to Figure 2-1 for the procedure to change your instrument for operation on 230/240 V.

### 2-7. GROUNDING REQUIREMENTS.

2-8. To protect operating personnel, the National Electrical Manufacturer's Association (NEMA) recommends that the instrument panel and cabinet be grounded. The Model 3320A/B is equipped with a three-conductor power cable which, when plugged into an appropriate receptacle, grounds the instrument. The offset pin on the power cable is the ground wire.

### WARNING

*Your instrument is equipped with a power cord which grounds it when connected to a 3 contact grounded receptacle. Do not attempt to defeat this feature.*

### 2-9. ENVIRONMENTAL REQUIREMENTS.

2-10. The Model 3320A/B is equipped with a cooling fan mounted on the rear panel. The instrument should not be mounted in any manner which would obstruct the flow of air into the rear panel and out the perforated covers. The filters for the cooling fan can be removed and replaced or flushed with soapy water. Two extra filters are furnished as spares. The Model 3320A/B should not be operated where the ambient temperature range exceeds 0° C to 55° C (32° F to 131° F) or stored where the ambient temperature range exceeds -40° C to 70° C (-40° F to 158° F).

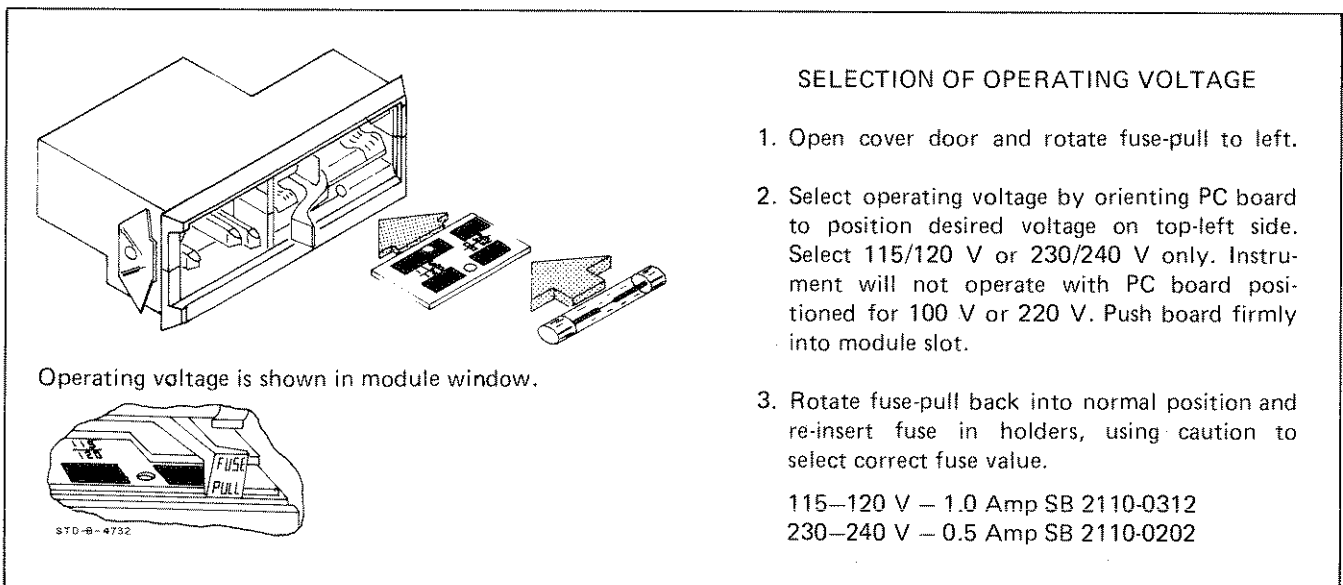

Figure 2-1. Voltage Selection.

## 2-11. REPACKAGING FOR SHIPMENT.

2-12. The following paragraphs contain a general guide for repackaging the instrument for shipment. Refer to Paragraph 2-13 if the original container is to be used; 2-14 if it is not. If you have any questions, contact your nearest -hp- Sales and Service Office (see Appendix B for office locations).

2-13. Place the instrument in the original container with appropriate packing material and seal well with strong tape or metal bands.

2-14. If the original container is not to be used, proceed as follows:

a. Wrap the instrument in heavy paper or plastic before placing in an inner container.

b. Place packing material around all sides of the instrument and protect the panel face with cardboard strips.

c. Place the instrument and the inner container in a heavy carton or wooden box and seal with strong tape or metal bands.

d. Mark the shipping container "DELICATE INSTRUMENT", "FRAGILE", etc.

### NOTE

*If the instrument is to be shipped to Hewlett-Packard for service or repair, attach a tag to the instrument identifying the owner and indicating the service or repair to be accomplished. Include the model number and full serial number of the instrument. In any correspondence, identify the instrument by model number and full serial number.*

## 2-15. POWER CORDS AND RECEPTACLES.

2-16. Figure 2-2 illustrates the power cord configurations available for use with the 3320A/B. The -hp- part number directly below each drawing is the part number for an instrument power cord equipped with a connector of that configuration. If the appropriate power cord is not included with the instrument, notify the nearest -hp- Sales and Service Office and a replacement cord will be provided.

## 2-17. INTERFACING.

### 2-18. Remote BCD Options.

2-19. The 3320A Option 003 and the 3320B Option 004 are designed for remote programming from an external BCD source. The remote input/output connector is shown

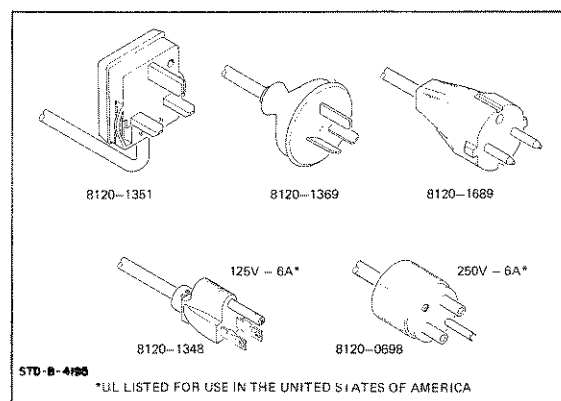

Figure 2-2. Power Cords.

in Figure 2-3. A complete description of the input/output signals and logic levels is given in Section III.

2-20. An interfacing connector (-hp- Part Number 1251-3056) and two connector covers (-hp- Part Number 10513-4001) are supplied for external connections. This connector can be wired to contribute to the user's application. A field installation kit (-hp- Part Number 11238A for the 3320A, or 11238C for the 3320B) is available for converting a standard 3320A or 3320B to a BCD remote controlled option. Installation instructions are supplied with the kit.

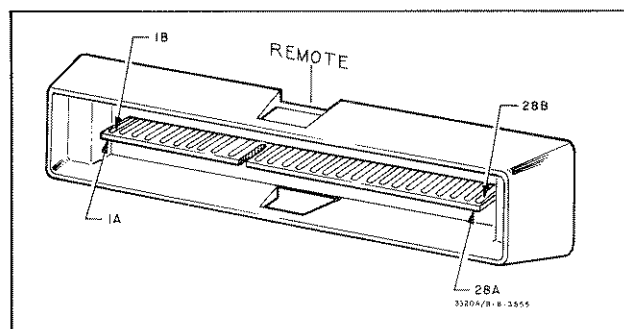

Figure 2-3. BCD Remote Connector.

### 2-21. Remote HP-IB Option.

2-22. The 3320B Option 007 is designed for remote programming from an external HP-IB (Hewlett-Packard Interface Bus, see Paragraph 1-11) source. The remote input/output connector is shown in Figure 2-4. A complete description of the input/output signals and logic levels required is given in Section III.

2-23. Remote programming sources for the 3320B Option 007 include the -hp- 9800 series Calculators and the -hp- 2100 series computers. The -hp- 11235A Adapter must be used to interface all HP-IB sources to the 3320B remote input.

2-24. There are three HP-IB cables available (see Table 2-1). Up to 15 instruments may be connected in parallel

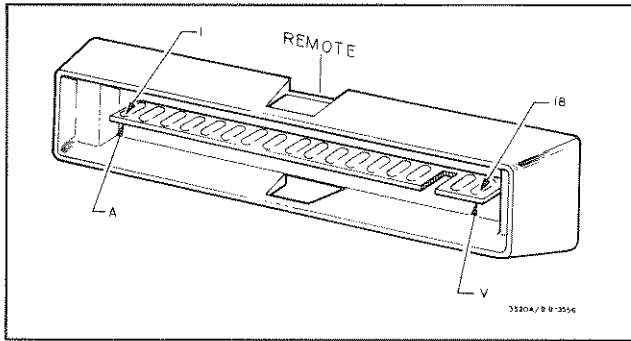

Figure 2-4. HP-IB Remote Connector.

using these cables; however, the following two restrictions must be observed.

1. When more than two instruments are connected to the bus, the cable length added for each additional instrument cannot exceed six feet per unit.
2. The total cable length to all units cannot exceed 51 feet.

The cables are listed with their respective lengths, in Table 2-1. A typical bus system is shown in Figure 2-5.

2-25. The -hp- 9800 series Calculators can be interfaced to the 3320B using the appropriate Interface Card and cables.

Table 2-1. HP-IB Cables.

Accessory Number	Length
10631A	3 ft.
10631B	6 ft.
10631C	12 ft.

2-26. The -hp- Model 2114, 2115, 2116 or 2100 computers can be interfaced using the -hp- Model 59310 Interface Kit. The 59310 kit includes an interface cable, a computer I/O card, and computer programming instructions. An -hp- 11235A Adapter must be used to interface the cable supplied with the 59310 kit to the 3320B.

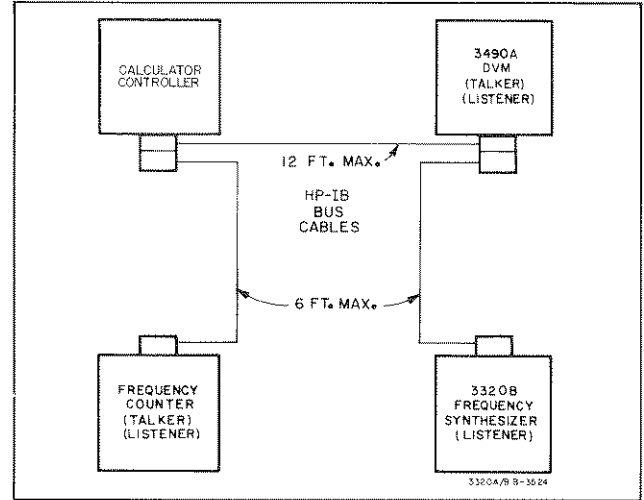
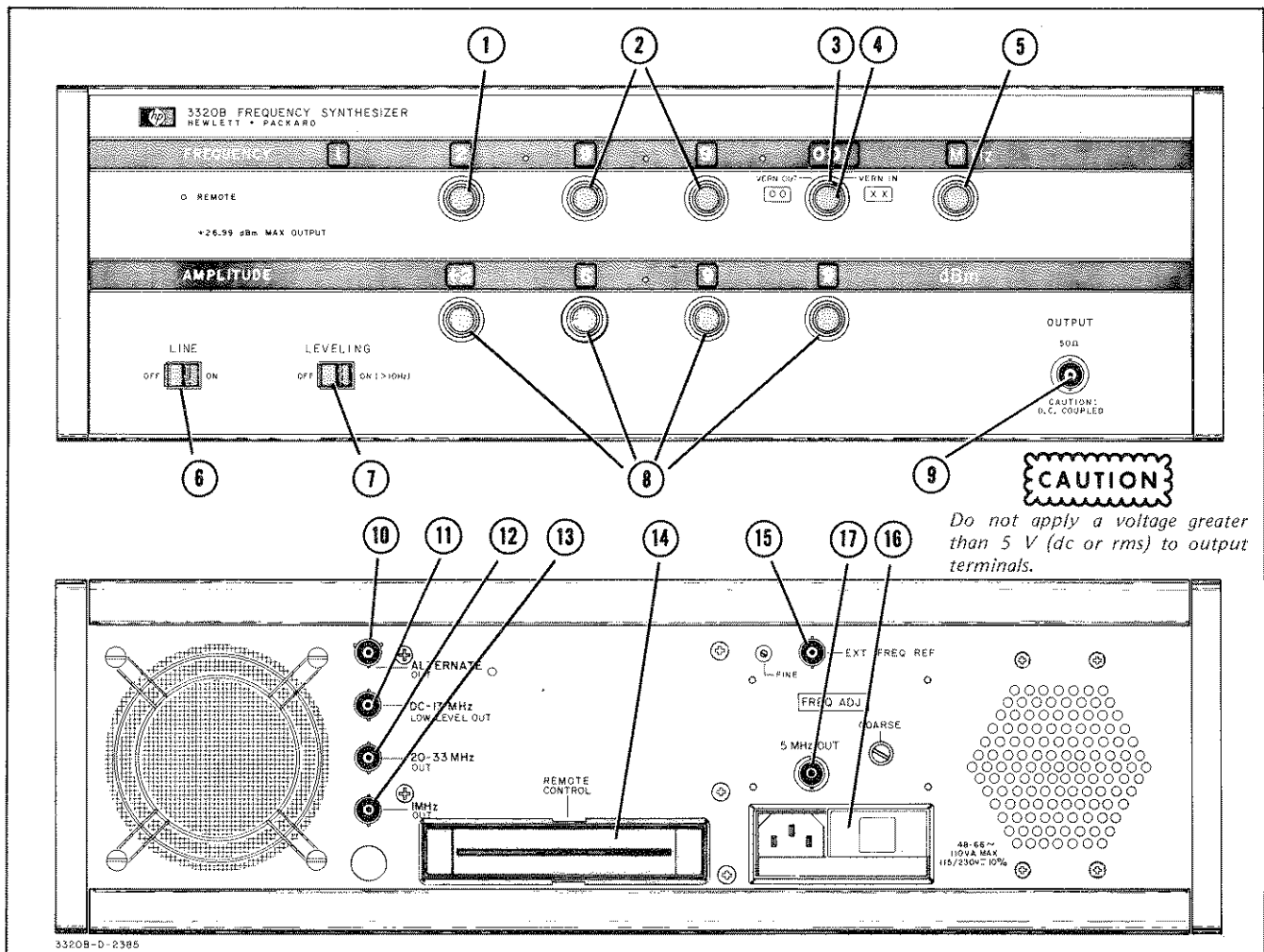

Figure 2-5. Typical HP-IB System.



**CAUTION**  
Do not apply a voltage greater than 5 V (dc or rms) to output terminals.

- ① Frequency control for most significant digit of output frequency. Also controls overrange digit (Paragraph 3-7).
- ② Frequency controls for second and third significant digit of output frequency (Paragraph 3-7).
- ③ Vernier: Controls two least significant digits of frequency (Paragraph 3-7).
- ④ VERN IN/VERN OUT: Turns vernier oscillator on or off (Paragraph 3-7).
- ⑤ RANGE: Controls range of frequency. 5 ranges in standard instrument - 1000 Hz, 10 kHz, 100 kHz, 1000 kHz, 10 MHz (Paragraph 3-7).
- ⑥ LINE: Power on/off control.
- ⑦ LEVELING: Controls the amplitude stability. Short loop for < 10 Hz. Long loop for > 10 Hz (Paragraph 3-12).
- ⑧ AMPLITUDE: Sets output amplitude from + 26.99 dBm to - 69.99 dBm (Paragraph 3-9).
- ⑨ Output jack: 3320A = 1 V rms into 50 ohms. 0-13 dB continuous adjustment. 3320B = 5 V rms into 50 ohms. + 26.99 dBm to - 69.99 dBm, 0.01 dB resolution.

- ⑩ Rear output: (Triax Connector) Same output as front panel output jack. Must move cable connector to rear jack from front jack. (See Section VIII, Manual Backdating.)
- ⑪ LOW LEVEL OUTPUT: Comes through 30 dB pad from output amplifier. Amplitude follows electronic attenuator setting (9.99 dB).
- ⑫ 20–33 MHz: Output from Mixer board. Indicates selected frequency out of Frequency Generating portion of Synthesizer (tracks front panel with 20 MHz offset).
- ⑬ 1 MHz: Divided output of Reference Oscillator out of Reference Phase Lock board.
- ⑭ Remote input connector for options 003, 004, and 007 (BCD and HP-1B) (Paragraphs 3-14, 3-17).
- ⑮ External Phase Lock: Input for Reference 5 MHz External Oven or External Phase Lock Signal.
- ⑯ Ac power input: Includes input power assembly.
- ⑰ Option 002 Reference Oscillator. 5 MHz crystal oscillator output and adjustments.

Figure 3-1. Controls, Indicators, and Connectors.

## SECTION III OPERATING INSTRUCTIONS

### 3-1. INTRODUCTION.

3-2. This section contains information necessary for operation of the -hp- Model 3320A/B Frequency Synthesizer. Included are descriptions and identification of front and rear panel controls, indicators and connectors, operating instructions, and remote programming information.

### 3-3. CONTROLS, INDICATORS and CONNECTORS.

3-4. A brief description of each control, indicator and connector is given in Figure 3-1. Controls, indicators and connectors requiring additional information are referenced to descriptive paragraphs within this section.

### 3-5. FRONT PANEL OPERATION.

3-6. The following paragraphs contain information for setting frequency, amplitude and leveling. Also included is information on remote programming and input/output connectors.

### 3-7. Frequency.

3-8. The 3320A/B provides five digits of frequency resolution plus an overrange digit. The frequency is determined by the position of the RANGE control, the two Vernier controls (VERN IN/VERN OUT and vernier frequency), and the three FREQUENCY controls. The three FREQUENCY controls set the three most significant digits and the overrange digit. The RANGE control places the decimal point. The vernier controls allow the operator to adjust two additional digits of frequency from 00 to 99. When the vernier control is in the VERN OUT position, these additional digits are always 00. Table 3-1 shows the control settings for maximum output in each of the five range positions.

Table 3-1. Frequency Control Settings.

Range	Frequency Digits (MAX)	Vernier Digits (MAX)
Hz	1299.	99
kHz	12.99	99
kHz	129.9	99
kHz	1299.	99
MHz	12.99	99

### 3-9. Amplitude.

3-10. The 3320A output amplitude is adjusted by a

0-13 dB potentiometer. Maximum output voltage for the 3320A is 1 V rms into 50 ohms or 2 V rms open circuit.

3-11. The 3320B output amplitude is adjusted by four front panel AMPLITUDE controls. Output levels from +26.99 dBm to -69.99 dBm with a resolution of 0.01 dB are obtainable. Each amplitude control operates independently, allowing changes of 0.01 dB, 0.1 dB, 1 dB or 10 dB in the output level. Maximum output voltage is 5 V rms into 50 ohms or 10 V rms open circuit.

### 3-12. Leveling.

3-13. The 3320B frequency response is determined by the position of the LEVELING control. For frequencies below 10 Hz, the LEVELING control should be in the OFF position. This prevents the thermopile in the leveling loop from responding to the instantaneous value of the output sinewave. For frequencies above 10 Hz, the thermopile will respond only to the true rms value of the output frequency, therefore, the LEVELING control should be in the ON (> 10 Hz) position.

### 3-14. REMOTE BCD PROGRAMMING.

3-15. The 3320A Option 003 and 3320B Option 004 can be remotely programmed with an 8-4-2-1 BCD code. All functions of the 3320A can be programmed *with the exception of amplitude, the last vernier digit, and the power switch*. All functions of the 3320B can be programmed *with the exception of the last vernier digit and the power switch*. There is no internal storage capability, therefore, the program lines must be held until the program is changed. Figure 3-2 shows the BCD input connector and the signal inputs for each pin. Paragraphs 3-16 through 3-33 explain each input/output signal. Logic levels for the BCD input/outputs are as follows:

State	Requirements
L = LOW (logical "1")	0 V to 0.4 V (5 mA max.) or contact closure to ground through <80 ohms.
H = HIGH (logical "0")	+ 2.4 V to + 5 V or removal of contact closure to ground.

### 3-16. Remote Enable.

3-17. The signal input labeled REN controls the remote/local mode of operation (REN LOW = remote, REN HIGH = local). When the 3320A/B is programmed to the remote mode, the front panel controls have no effect.



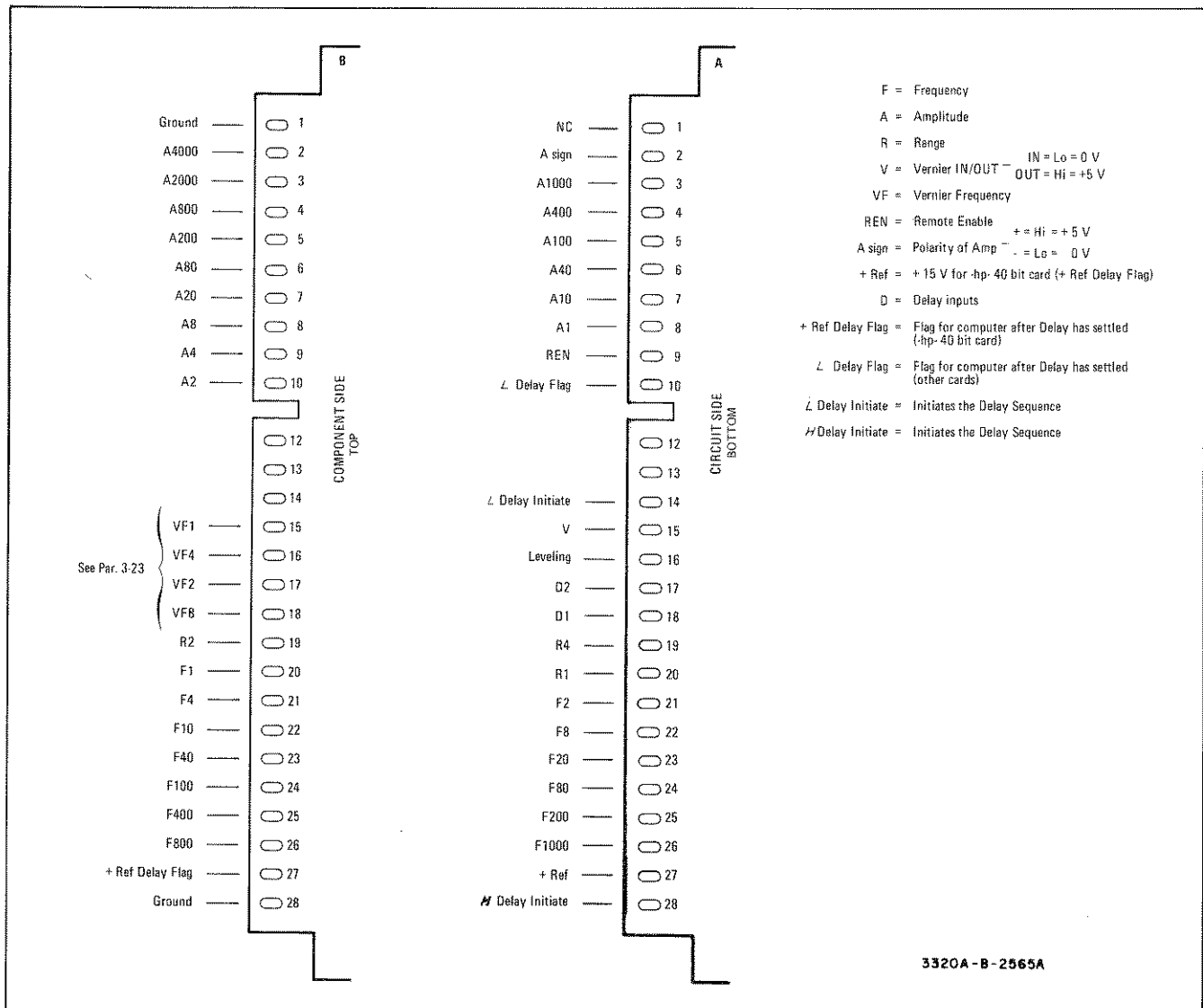
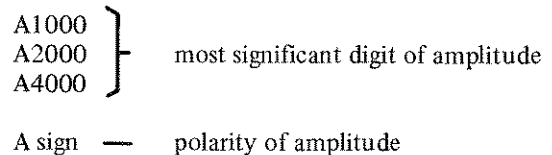
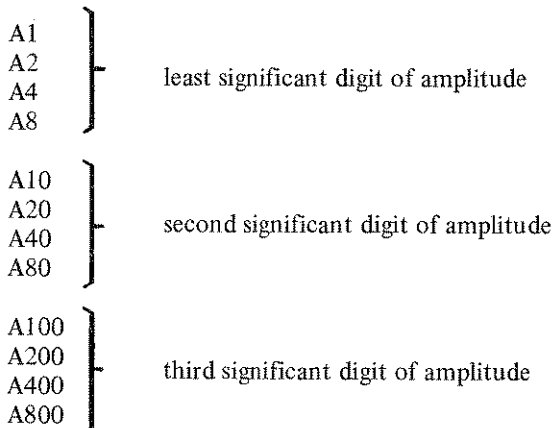

Figure 3-2. BCD Input Connector.

3-18. 3320B Amplitude.

3-19. The 16 signal inputs prefaced A control the four amplitude digits and the sign of the amplitude. The inputs representing each digit are as follows:



Each digit is programmed by applying an 8-4-2-1 BCD code representing the digit desired. The three least significant digits can be selected from 0 to 9. The most significant digit can be selected from 0 to 7. The A sign input determines the polarity of the amplitude. For a + dBm the input level must be HIGH. For a - dBm the input level must be LOW.



When remote programming is used, the minimum output is -73.00 dBm (-75.00 dBm Option 001). If the 3320B is programmed for a lower level, the output voltage increases.



Example amplitude program:

desired amplitude = - 12.34 dBm

<u>LSD</u>	<u>2 nd SD</u>
A1 = H	A10 = L
A2 = H	A20 = L
A4 = L	A40 = H
A8 = H	A80 = H
<u>3 rd SD</u>	<u>MSD and Sign</u>
A100 = H	A1000 = L
A200 = L	A2000 = H
A400 = H	A4000 = H
A800 = H	A sign = L

<u>3 rd MSD</u>	<u>Overrange</u>
F100 = H	F1000 = L
F200 = L	
F400 = H	
F800 = H	

\* MHz RANGE programmed (See Paragraph 3-24).

**3-22. Vernier.**

3-23. The signal input prefaced V and the four signal inputs prefaced VF control the vernier in/out and the vernier frequency. Programming conditions for vernier in/out are HIGH = out and LOW = in. *Only the first vernier digit can be remotely programmed.* The least significant digit remains at zero. Programming is accomplished by applying an 8-4-2-1 BCD code representing the digit desired.

**3-20. Frequency.**

3-21. The 13 signal inputs prefaced F control the three most significant frequency digits plus the overrange digit. The inputs representing each digit are as follows:

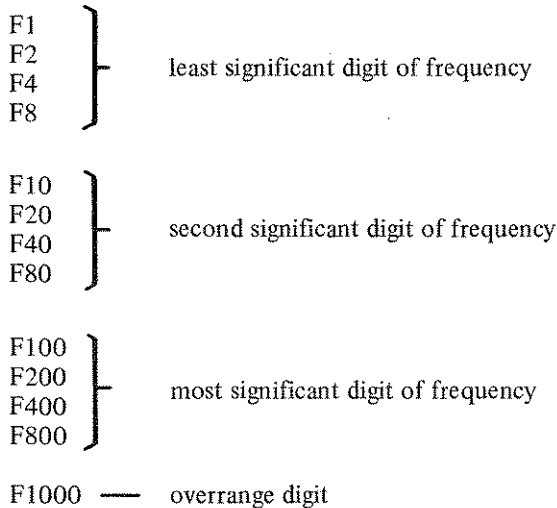

Each digit is programmed by applying an 8-4-2-1 BCD code representing the digit desired. All frequency digits can be selected from 0 to 9. The overrange digit can be either a 0 or a 1. **NOTE:** *Although the maximum frequency of the 3320A/B is specified as 12.99 MHz, it is possible to program a higher frequency. However, the response is not specified and will deteriorate.*

Example frequency Program:

desired frequency = 12.34 MHz \*

<u>LSD</u>	<u>2 nd SD</u>
F1 = H	F10 = L
F2 = H	F20 = L
F4 = L	F40 = H
F8 = H	F80 = H

**3-24. Range.**

3-25. The three signal inputs prefaced R control the position of the range switch. Each position is designated by a number. There are five range positions available (seven in the 3320A/B Option 006). Programming is accomplished by applying a 4-2-1 BCD code representing the number for the range position desired. The following list identifies the range position by number and respective range:

0 = 10 Hz	} Option 006
1 = 100 Hz	
2 = 1000 Hz	
3 = 10 kHz	
4 = 100 kHz	
5 = 1000 kHz	
6 = 10 MHz	

**3-26. Leveling.**

3-27. The signal input labeled Leveling controls the leveling mode of operation (leveling HIGH = ON (> 10 Hz), leveling LOW = OFF). The programmed frequency (or group of frequencies) must be considered when selecting the leveling mode. If a frequency of 10 Hz or less is programmed, the leveling should be programmed OFF. This will eliminate any distortion of the 3320B output caused by the leveling loop (see Paragraph 3-12). If a frequency greater than 10 Hz is programmed, the leveling should be programmed ON (> 10 Hz).

**3-28. Delay and Response.**

3-29. The two signal inputs prefaced D and the signal input/outputs labeled Delay Flag, L Delay Initiate, H Delay Initiate, + Ref. and + Ref. Delay Flag control the delay and response time of the 3320A/B.

3-30. The delay is simply an internal clock which counts for the time interval programmed by the D1 and D2 inputs. During the count sequence, the clock outputs a flag to the

external controller. This flag can be monitored to determine the accuracy which the 3320A/B frequency and the 3320B amplitude has settled. Table 3-2 lists the delay codes, the clock time interval and the tolerances to which the frequency and amplitude have settled. Figure 3-3 shows the timing sequence of the delay.

3-31. The delay sequence is started by programming a Delay Initiate (data strobe). Two Delay Initiate inputs are available. If the strobe output from the external controller is HIGH true, the H Delay Initiate input must be used. If the strobe output from the controller is LOW true, the L Delay Initiate input must be used.

**NOTE**

*The H Delay Initiate input is not TTL compatible. It may require a minimum of +4 V applied to this input to initiate the delay sequence.*

3-32. There are also two delay flag (Holdoff Flag) outputs available. The L Delay Flag output is standard LOW true TTL logic. When it is necessary to have a HIGH true delay flag, the positive reference voltage from the external controller (such as the -hp- 12556A 40 bit BCD Interface Card) can be applied to the + Ref. input. The + Ref. Delay Flag will be held at the + Ref. potential while the delay sequence is in progress. When the delay sequence is completed, the + Ref. Delay Flag will go LOW.

3-33. When the 3320B is programmed for a low frequency (below 1000 Hz) and the leveling is ON (> 10 Hz), the output can become distorted due to the response of the 3320B amplitude section. This response can be slowed to eliminate the distortion. This is accomplished by programming a delay code of 3. With all other delay codes, the response is in the fast mode. When the 3320B is in the local mode, the response is always in the slow mode.

**NOTE**

*When going from local to remote, the response is automatically set to the fast mode (delay code 0) Therefore, if low frequencies are programmed, the response should be set to the slow mode (delay code 3).*

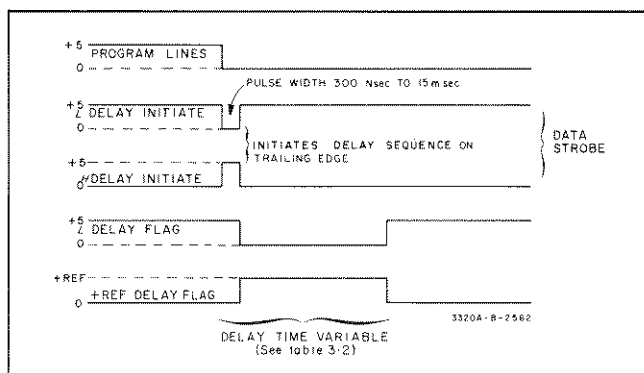

Figure 3-3. BCD Timing Sequence.

Table 3-2. Amplitude and Frequency Settling Times.

Delay Code	Time Interval	% of Range Frequency Tolerance	Amplitude Tolerance
0	15 ms	.01	--
1	60 ms	.001	--
2	300 ms	--	1 %
* 3	1500 ms	--	within rated accuracy

\* Response in slow mode (See Paragraph 3-33).

**3-34. REMOTE HP-IB PROGRAMMING.**

3-35. The HP-IB (Hewlett-Packard Interface Bus) remote control option permits the Model 3320B to operate on a single data/control bus with several other instruments. A typical HP-IB system is shown in Figure 4-8. Each bus contains eight data lines and seven control lines. The ASCII (American Standard Code for Information Interchange) code format is used to transfer data on the eight data lines.

3-36. A total of 15 instruments may be connected in parallel to the bus. Each instrument on the bus is assigned an address (or addresses) so that it can be selected individually by an external controller. This enables the external controller to determine which instruments will be communicating on the bus at any given time. An instrument will have a listen address if it can receive data, a talk address if it can transmit data, or both a listen and a talk address if it can both receive and transmit data. For example, the 3320B HP-IB option has only a listen address, which allows the controlling instrument to instruct the 3320B to receive programming information as outlined in the following paragraphs.

Table 3-3. Addressing Codes.

Address	40	20	10	4	2	1
40	1	0	0	0	0	0
41	1	0	0	0	0	1
42	1	0	0	0	1	0
43	1	0	0	0	1	1
44	1	0	0	1	0	0
45	1	0	0	1	0	1
46	1	0	0	1	1	0
47	1	0	0	1	1	1
50	1	0	1	0	0	0
51	1	0	1	0	0	1
52	1	0	1	0	1	0
53	1	0	1	0	1	1
54	1	0	1	1	0	0
55	1	0	1	1	0	1
56	1	0	1	1	1	0
57	1	0	1	1	1	1
60	1	1	0	0	0	0
61	1	1	0	0	0	1
62	1	1	0	0	1	0
63	1	1	0	0	1	1
64	1	1	0	1	0	0
65	1	1	0	1	0	1
66	1	1	0	1	1	0
67	1	1	0	1	1	1
70	1	1	1	0	0	0
71	1	1	1	0	0	1
72	1	1	1	0	1	0
73	1	1	1	0	1	1
74	1	1	1	1	0	0
75	1	1	1	1	0	1
76	1	1	1	1	1	0

3-37. The listen address for the 3320B is normally the ASCII character 3, octal code 063, but may be changed by means of internal jumper wires on the HP-IB Input Assembly (A37). Instructions for changing the address are given in Note 2, Figure 7-14. Table 3-3 lists the different addresses which can be assigned.

3-38. A principal advantage of the HP-IB system is that all information is routed over the same 15 lines. For this reason standard cables are used to connect each instrument to the bus. Section II lists the HP-IB cables available.

3-39. For convenience and brevity, each HP-IB signal line is identified by a mnemonic, which is an abbreviation of the signal name. Table 3-4 lists the seven control lines and eight data lines used on the HP-IB.

Table 3-4. HP-IB Signal Mnemonics.

Mnemonic	Signal Name
NDAC	Not Data Accepted
DAV	Data Valid
ATN	Attention
REN	Remote Enable
NRFD	Not Ready for Data
SRQ	Service Request
IFC	Interface Clear
DI01	Data Input/Output bits 1 through 8.
DI02	
DI03	
DI04	
DI05	
DI06	
DI07	
DI08	

3-40. An H preceding a mnemonic indicates that the signal is HIGH true, L indicates LOW is true. For example, L DAV indicates that a LOW true signal is required for a data Valid signal. All HP-IB lines are LOW true. Table 1-2 lists the signal levels required.

**NOTE**

*In the 3320B the Data Input/Output bit 8 (DI08) and Service Request (SRQ) are not used (no connections).*

3-41. All 3320B front panel functions are programmable with the exception of the last vernier digit and the line. Table 3-5 lists each of the functions and the octal codes, the ASCII character for each code, and the seven bit binary code for each octal code. The binary code is applied to the seven Data Input lines on the remote input/output connector. Figure 3-4 shows the remote connector pin numbers and the input/output signals for each pin.

Table 3-5. HP-IB Programming Codes.

Character	Octal	Binary	
?	077	0111111	*Address clear
A	101	1000001	Amplitude preface
C	103	1000011	Command (initiates delay)
D	104	1000100	Delay code preface
F	106	1000110	Frequency preface
K	113	1001011	Vernier "IN"
M	115	1001101	Vernier "OUT"
R	122	1010010	Range preface
V	126	1010110	**Vernier preface
+	053	0101011	Polarity of amplitude
-	055	0101101	Polarity of amplitude
0	060	0110000	Digits for address*, amplitude, frequency, vernier, etc.
1	061	0110001	
2	062	0110010	
3	063	0110011	
4	064	0110100	
5	065	0110101	
6	066	0110110	
7	067	0110111	Function execute Local enable
8	070	0111000	
9	071	0111001	
,	054	0101100	
I	111	1001001	

\*Address and clear must be accompanied by an ATN.  
\*\*Least significant vernier digit cannot be programmed.

Range Codes		
Character	Range	
0	10 Hz	} optional (A6 assembly)
1	100 Hz	
2	1000 Hz	
3	10 kHz	
4	100 kHz	
5	1000 kHz	
6	10 MHz	

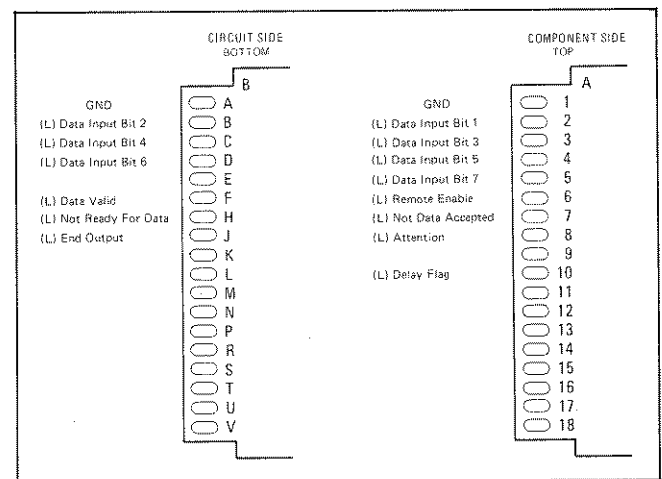

Figure 3-4. HP-IB Input Connector.

3-42. The first step in HP-IB programming is to address the 3320B. Addressing is accomplished by applying the address code to the data line, setting the ATN (Attention) LOW, and setting DAV (Data Valid) LOW. An example program is listed in Table 3-6. The 3320B does not have to be in the

remote mode to be addressed. Conversely, it must be addressed before it can be put into the remote mode.

**NOTE**

*When power is initially applied the 3320B may or may not be addressed. This is why the "Address Clear" command (ASCII ?) is recommended prior to addressing any instrument(s) on the HP-IB.*

3-43. To put the 3320B into the remote mode (after it has been addressed) set the REN (Remote Enable) LOW, MRE HIGH, apply the Function Execute code (ASCII comma) to the data lines, and set DAV LOW. The REN can be set LOW at any time prior to the Function Execute (ie., while addressing) but the 3320B will not go into the remote mode until the Function Execute and L DAV is applied. The Function Execute can be applied during the function programming sequence (See Notes, Table 3-6).

**Table 3-6. HP-IB Programming.**

Example: 5.0 kHz frequency Vernier Out, - 5.00 dBm Amplitude 60 ms delay.								
Instruction	State or Octal Code	Binary Codes						
		D107	D106	D105	D104	D103	D102	D101
		100	40	20	10	4	2	1
ATN	LOW							
Clear	077*	0	1	1	1	1	1	1
Address	063	0	1	1	0	0	1	1
REN	LOW							
ATN	HIGH							
R	122	1	0	1	0	0	1	0
4	064	0	1	1	0	1	0	0
'**	054	0	1	0	1	1	0	0
F	106	1	0	0	0	1	1	0
5	065	0	1	1	0	1	0	1
0	060	0	1	1	0	0	0	0
,	054	0	1	0	1	1	0	0
m	115	1	0	0	1	1	0	1
A	101	1	0	0	0	0	0	1
-	055	0	1	0	1	1	0	1
5	065	0	1	1	0	1	0	1
0	060	0	1	1	0	0	0	0
0	060	0	1	1	0	0	0	0
,	054	0	1	0	1	1	0	0
D	104	1	0	0	0	1	0	0
1	061	0	1	1	0	0	0	1
,	054	0	1	0	1	1	0	0
C	103	1	0	0	0	0	1	1

\*Each code applied to the data lines must be followed by a DAV LOW.

\*\*Instrument goes to remote mode at this time.

3-44. When power is initially applied, the 3320B may go to the remote mode for a few seconds, then to the local mode even if REN is held LOW. It will remain in the local mode until the address and a Function Execute is programmed.

3-45. When programmed to the remote mode, the condition of the 3320B output depends on the position of a jumper wire on the A38 assembly (See Figure 7-14). If there is a jumper wire between points A and B on the A38 assembly, the 3320B will go to the conditions listed below:

- FREQUENCY .....800 Hz
- RANGE .....1000 Hz
- AMPLITUDE .....- 69.00 dBm
- VERNIER..... OUT/0 Hz
- DELAY .....1500 ms
- LEVELING ..... ON(> 10 Hz)

If there is no jumper between points A and B on the A38 assembly, the 3320B will go to the previously remote programmed conditions when programmed to the remote mode. The 3320B leaves the factory with no jumper.

3-46. The second step in HP-IB programming is the function programming. This is accomplished by applying the ASCII code, representing the information desired, to the seven data lines and strobing the information into the 3320B. The LDAV is the strobe pulse. Each seven bit code applied to the data lines must be accompanied by an LDAV. The programming information for each 3320B function is applied in two parts, the preface command representing the function (ie., V for Vernier) and the desired digits for that function (i.e., 9 for a Vernier setting of 90). After each preface command and the digits have been strobed into the 3320B, they must be followed by a Function Execute.

3-47. If all functions have been programmed and it is desired to reprogram a specific function, it is only necessary to reprogram that function. When frequency or amplitude is programmed the instrument assumes the leading zeros. If an amplitude polarity is not programmed, the instrument assumes a + polarity.

**3-48. Handshake.**

3-49. The Data Valid (DAV), Not Ready for Data (NRFD), and Not Data Accepted (NDAC) signals form a "handshake" sequence, controlling the timing for data transfer on the Data lines. When an address code or a programming instruction is applied to the seven data lines, the external controller must set the DAV LOW. This indicates to the 3320B that data is available on the data lines. If the 3320B is not processing previous data, the NRFD will be HIGH and the NDAC will be LOW. Approximately three microseconds after the DAV is set LOW by the external controller, the 3320B will set NDAC HIGH and NRFD LOW. The NDAC indicates to the controller that the 3320B has accepted the data and is processing it. The NRFD signal also indicates to the external controller that the 3320B is not ready for more data. When the 3320B has set NRFD LOW and NDAC HIGH, the external controller can remove the DAV and the data from the data lines and replace it with new data. The cycle repeats until all programming is completed. Figure 3-5 shows the timing relationship between the DAV, NRFD, and NDAC signals.

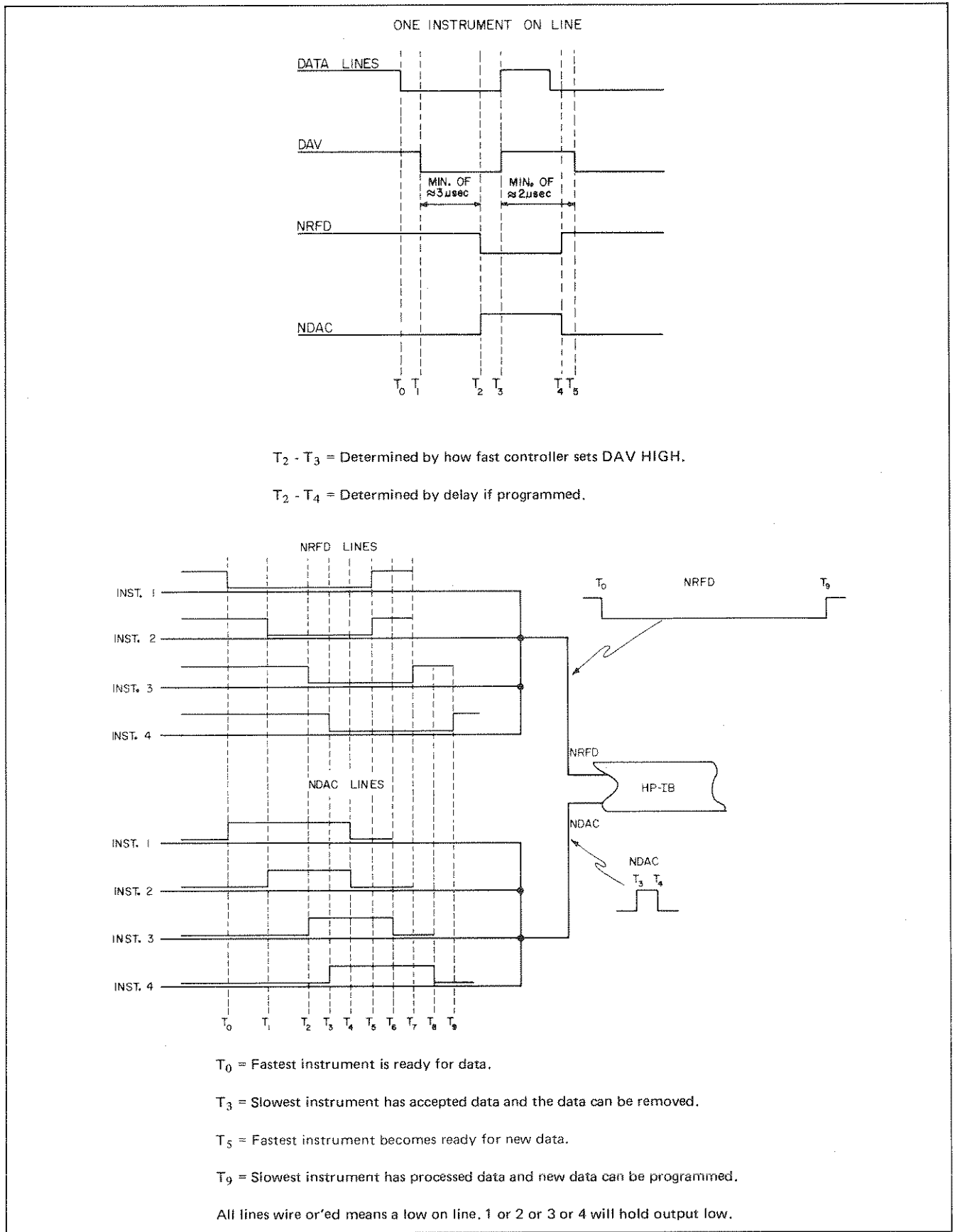

Figure 3-5. Handshake Timing Diagram.



3-50. It is not necessary for the external controller to monitor the NRFD or NDAC signals. However, if these signals are not monitored, the external controller must wait approximately three microseconds before removing the LDAV and the data from the data lines and applying new data, and approximately two microseconds before setting DAV LOW again. This ensures the 3320B has had time to accept and process the previous data.

3-51. The RFD line is also controlled by the delay programmed (See Paragraph 3-52). As soon as a Delay Initiate code (Octal code 103) is programmed, NRFD will remain LOW for the length of time programmed by the delay. If the NRFD signal is monitored, the user can be sure the 3320B amplitude and frequency has settled to the desired tolerance when NRFD goes HIGH.

**3-52. Delay Flag.**

3-53. The delay is generated by an internal clock which counts for the time internal programmed on the data lines. At the end of the count sequence, the clock outputs a flag to the external controller (delay flag or NRFD). This flag can be monitored to determine the accuracy to which the 3320B frequency and amplitude has settled. Table 3-7 lists the delay codes, the clock time interval, and the tolerances to which the frequency and amplitude have settled. The programmed delay code must be followed by a Delay Initiate (ASCII character C). This code initiates the delay sequence. The Delay Initiate code does not have to be followed by a Function Execute code.

Example: To program a delay of 60 ms,  
 ASCII            D - delay preface  
 ASCII            I - delay code (60 ms)  
 Programming     , - Function Execute  
 Characters       C - Delay Initiate

3-54. When the 3320B is programmed for a low frequency (below 1000 Hz) and the leveling is ON (> 10 Hz), the output can become distorted due to the response time of the amplitude section. The response can be slowed to eliminate this distortion by programming a delay code of 3. With all other delay codes the response is in the fast mode.

3-55. The delay code programmed also controls the leveling mode of operation (Delay Codes 0-3, LEVELING ON (> 10 Hz), Delay Code 4-7, LEVELING OFF). The programmed frequency (or group of frequencies) must be considered when selecting the leveling mode. If a frequency of 10 Hz or less is programmed, the leveling should be programmed OFF. This will eliminate any distortion of the 3320B output caused by the leveling loop (See Paragraph 3-12). If a frequency greater than 10 Hz is programmed, the leveling should be programmed ON (> 10 Hz).

**3-56. Interface Clear.**

3-57. The Interface Clear (IFC) signal allows the external controller to terminate all activity on the HP-IB lines. When this line is set low by the controller, the 3320B and all other instruments paralleled to the bus lines, will set all data lines, ATN, DAV, NRFD, and NDAC HIGH.

**3-58. REFERENCE CRYSTAL OVEN.**

3-59. The 3320A/B Option 002 is a standard instrument with an oven controlled, 5 MHz, reference crystal oscillator. The signal from the 5 MHz oscillator is applied to the reference phase lock assembly to phase lock the 20 MHz VCXO. The result is an increase in 3320A/B output frequency accuracy and stability (See Table 1-2). An Option 002 Field Installation Kit is obtainable by ordering Accessory Kit 11237A.

3-60. For operation, connect a short jumper cable between the 5 MHz OUT and EXT FREQ REF (both on rear panel). A circuit diagram for the Option 002 is shown in Figure 3-6.

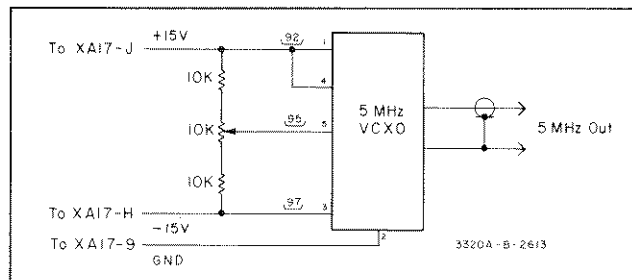

Figure 3-6. Option 002 Circuit Diagram.

Table 3-7. Settling Times.

Remote Control		3320 Operation			
Frequency of Operation	Delay Code	Leveling Mode	Settling Time	Frequency Tolerance (% of Range)	Amplitude Tolerance
≥ 1000 Hz	0	On	15 ms	.01	-
	1	On	60 ms	.001	-
	2	On	300 ms		1%
10 Hz ≤ f ≤ 1000 Hz	3*	On	1500 ms		**
≤ 10 Hz	4	Off	15 ms	.01	-
	5	Off	60 ms	.001	-
	6	Off	300 ms		1%
	7	Off	1500 ms		**

\* Use delay code 3 to eliminate distortion caused by low frequency and leveling on.

\*\* Denotes amplitude within rated accuracy.





