

# Installation Guide

**HP 16600A Series  
HP 16700A  
HP 16702A  
Measurement Modules**

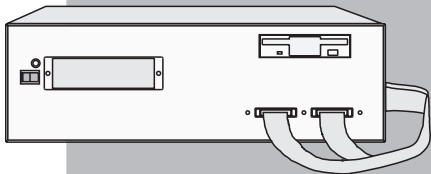

**HP 16600A**  
*Series*

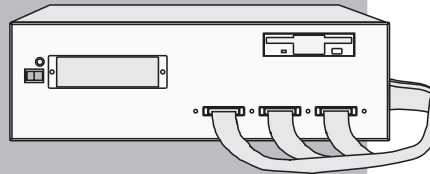
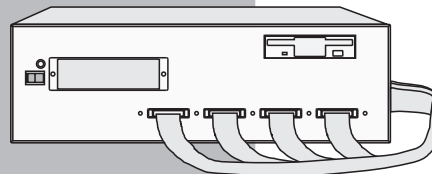
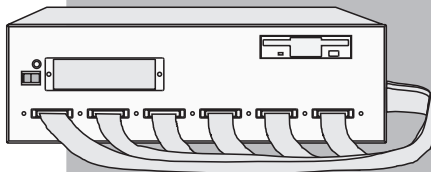
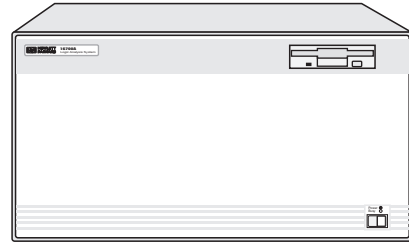

**HP 16700A**

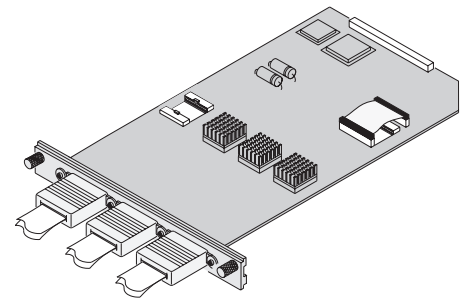

**Measurement  
Modules**

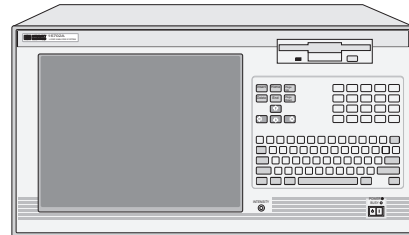

**HP 16702A**

**Logic Analysis Systems**

Publication Number 16700-97012

16allP01

© Copyright Hewlett-Packard Company 1999  
All Rights Reserved

 **HEWLETT  
PACKARD**

# Contents

## HP 16600A Series, HP 16700A, HP 16702A

<i>System Overview HP 16600A Series</i>	<b>3</b>
<i>System Overview HP 16700A</i>	<b>4</b>
<i>System Overview HP 16702A</i>	<b>5</b>
<i>Mouse and Keyboard</i>	<b>6</b>
<i>Monitor Connection</i>	<b>7</b>
<i>Proper Cooling</i>	<b>8</b>
<i>Monitor Configuration</i>	<b>9</b>
<i>Changing Monitors</i>	<b>11</b>
<i>LAN</i>	<b>12</b>
<i>Printers</i>	<b>13</b>
<i>CD-ROM Drive</i>	<b>15</b>
<i>External Disk Drive</i>	<b>17</b>
<i>CD-ROM Drive &amp; External Disk Drive</i>	<b>19</b>
<i>Software Installation</i>	<b>21</b>
<i>HP 16701A Expander Frame</i>	<b>24</b>
<i>Probing</i> 	<b>25</b>
<i>Self-Test</i>	<b>31</b>
<i>Specifications &amp; Characteristics</i>	<b>32</b>
<i>Disaster Recovery</i>	<b>33</b>
<i>Proper Cleaning</i>	<b>37</b>

## Measurement Modules

<i>General Installations</i>	<b>40</b>
<i>HP 16517/18A</i>	<b>41</b>
<i>HP 16522A</i>	<b>48</b>
<i>HP 16533/34A</i>	<b>53</b>
<i>HP 16550A</i>	<b>63</b>
<i>HP 16557D</i>	<b>68</b>
<i>HP 16710/11/12A</i>	<b>73</b>
<i>HP 16715/16/17/18/19A</i>	<b>76</b>
<i>HP E2485A</i>	<b>81</b>

# HP 16600A Series Overview

## HP 16600A Series

HP 16600A Series Mainframe  
(HP 16600A shown)

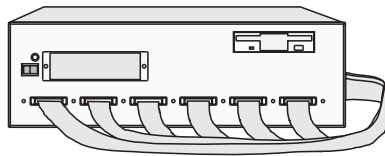

Power Cable

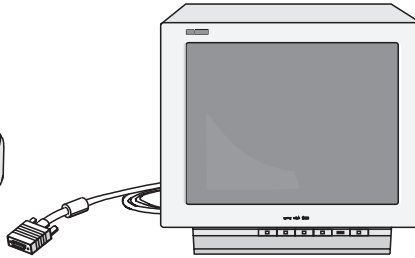

(If ordered)  
Monitor  
Monitor Cable  
Monitor Power Cable

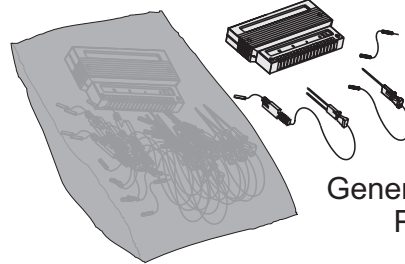
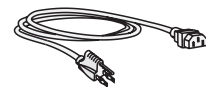

General Purpose  
Probes

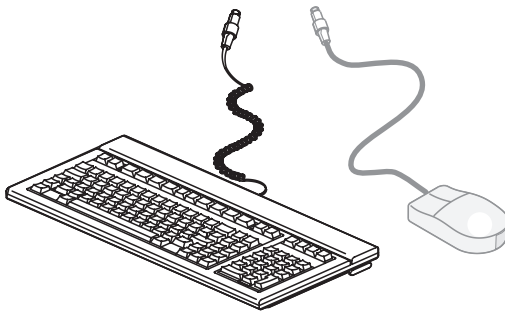

Keyboard and Mouse

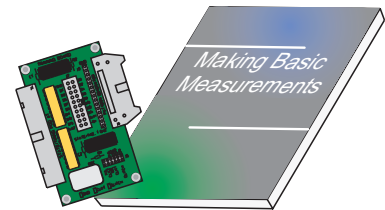

Training Kit and Demo Board

---

## Additional Connections

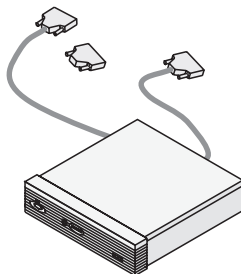

CD-ROM Drive  
(Required for  
software updates  
or install.)

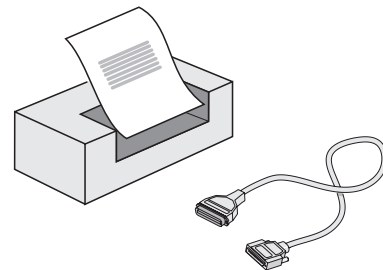

Printer and Cable

# HP 16700A Overview

## HP 16700A

HP 16700A  
Mainframe

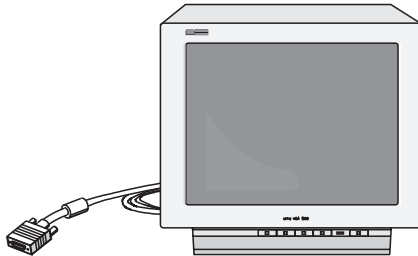

(If ordered)  
Monitor  
Monitor Cable  
Monitor Power Cable

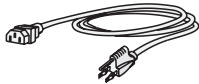

Power Cable

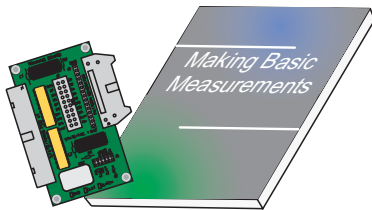

Training Board and Training Kit

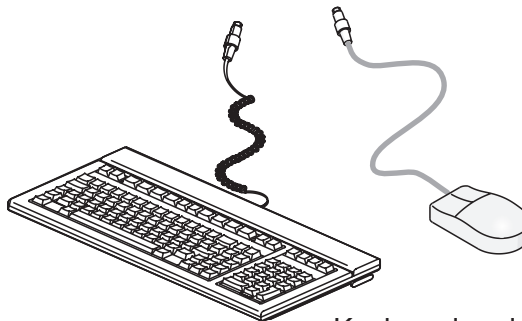

Keyboard and Mouse

---

## Additional Connections

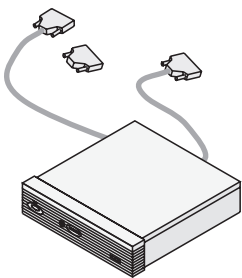

CD-ROM Drive  
(Required for  
software updates  
or install.)

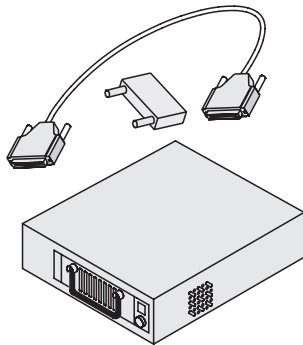

External  
Disk Drive (Data)  
and Cable

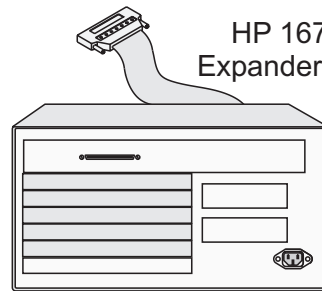

HP 16701A  
Expander Frame

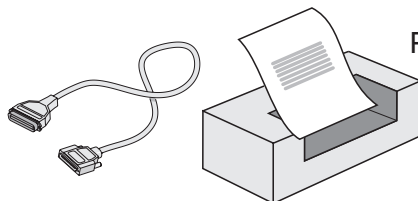

Printer and  
Cable

# HP 16702A Overview

## HP 16702A

HP 16702A  
Mainframe

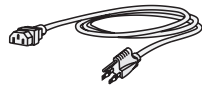
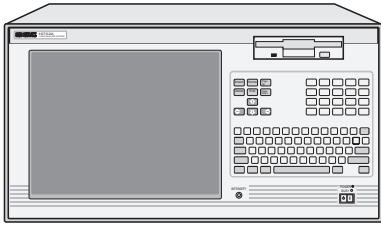

Mouse and  
Power Cable

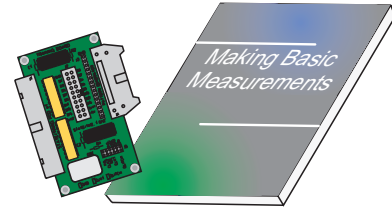
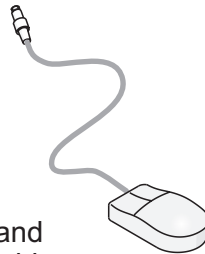

Training Board and  
Training Kit

---

## Additional Connections

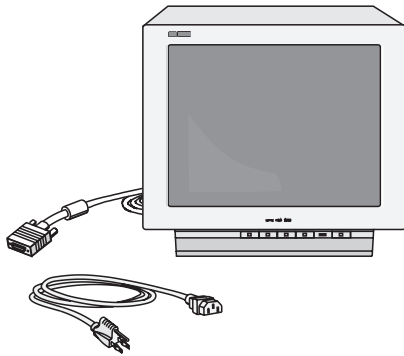

Monitor  
Monitor Cable and  
Monitor Power Cable  
(If ordered)

External  
Disk Drive (Data)  
and Cable

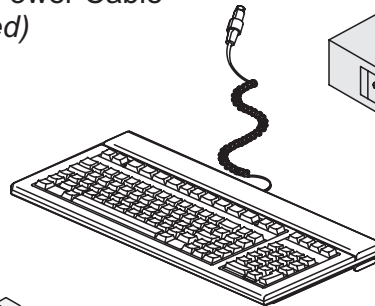
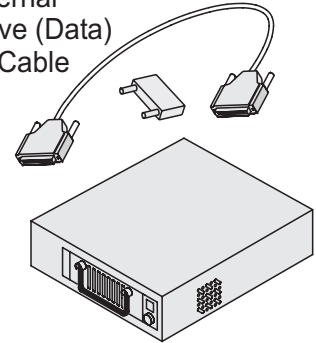

Keyboard

CD-ROM Drive  
(Required to  
install software.)

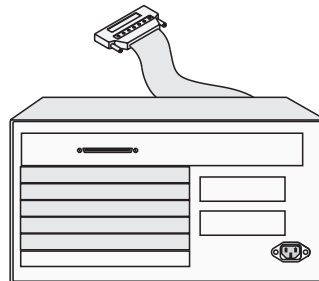
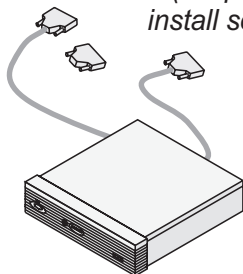

HP 16701A  
Expander Frame

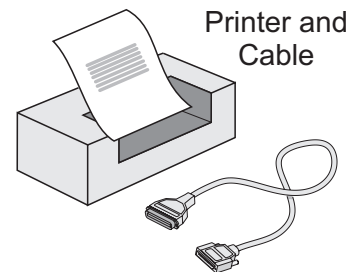

Printer and  
Cable

# Mouse and Keyboard

HP 16600A Series/ HP 16700A/ HP 16702A

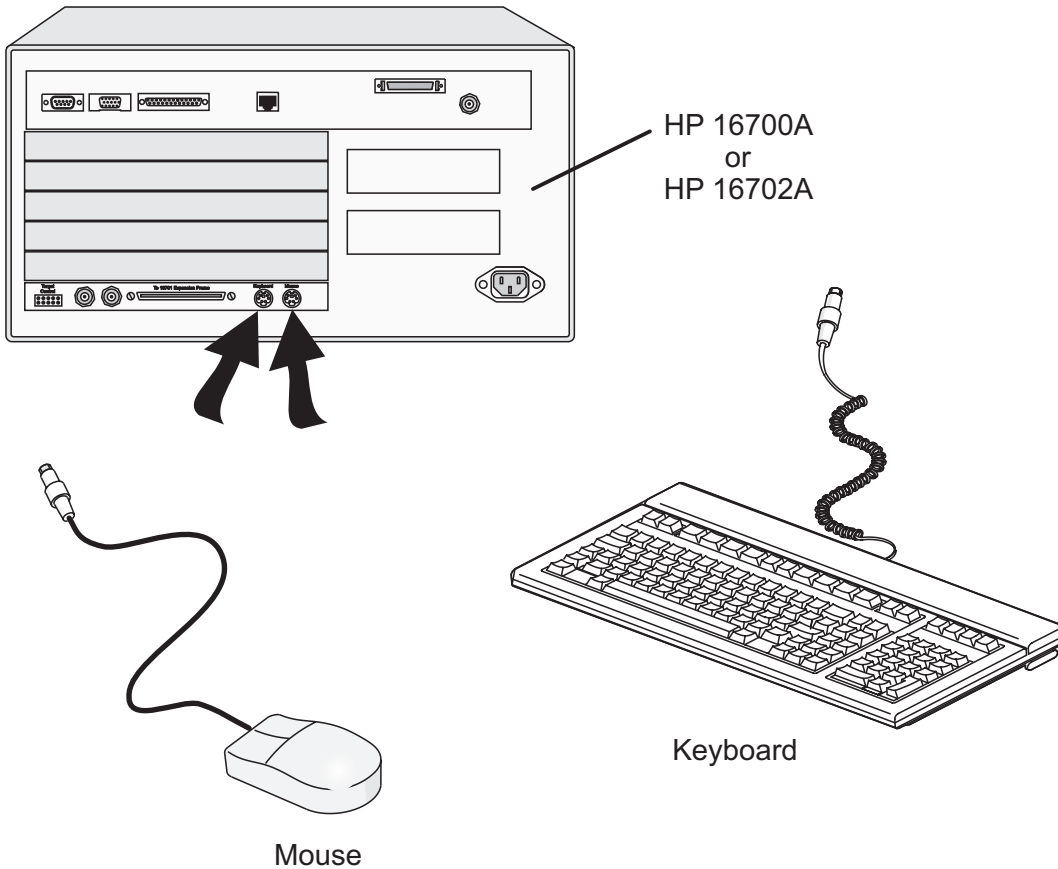

## Note!

The HP 16600A series and the HP 16700A must have the system mouse and keyboard installed for the system to boot up properly. (The HP 16702A requires only a mouse installed.)

Once enabled on the LAN, the system can be operated remotely without a keyboard or mouse.

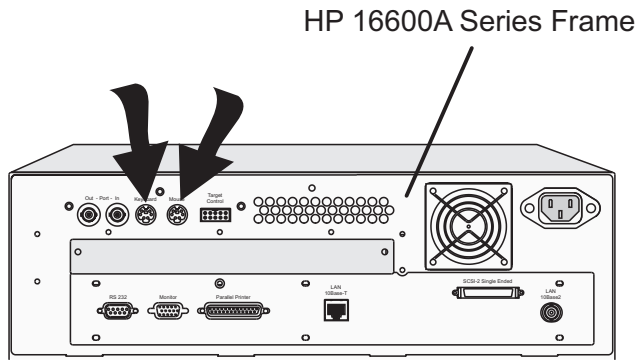

# Monitor Connection

**HP 16600A Series/ HP 16700A/ HP 16702A**

HP 16600A Series Mainframe

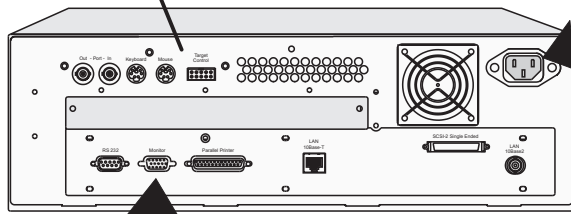

Power Cable

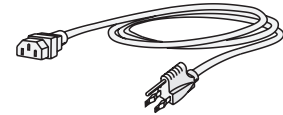

## Note!

If applicable, international versions of the power cables can be found in the accessories box.

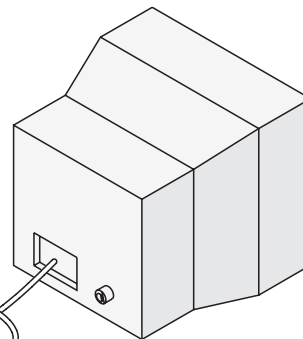

Monitor & Power Cable  
(Optional for HP 16702A)

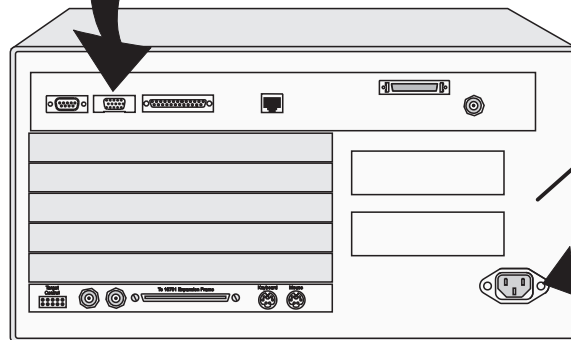
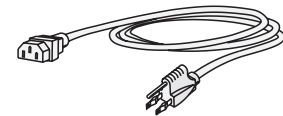

HP 16700A  
or  
HP 16702A

Power Cable

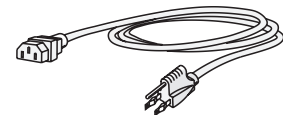

# Proper Cooling

## HP 16600A Series/ HP 16700A/ HP 16702A

Allow a minimum of 5 cm spacing between instruments for proper cooling.

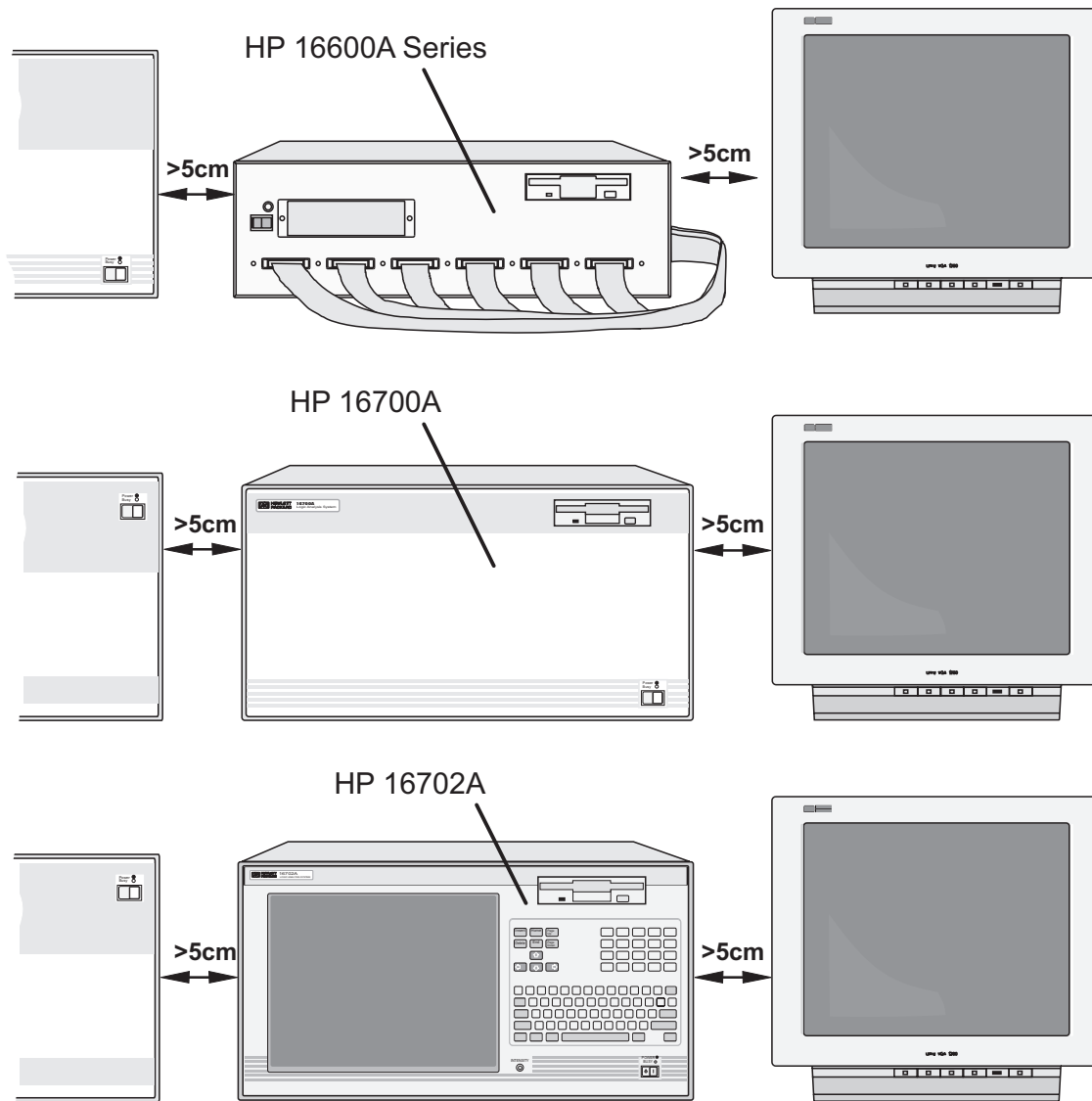



# Monitor Configuration

## HP 16600A Series and HP 16700A

### Note!

If you ordered the optional monitor with your logic analyzer, the monitor resolution setting is pre-configured for 1280 x 1024 at the factory.

If you already have a monitor and ordered your logic analysis system without the optional monitor, you will need to configure your monitor. The display will change on the screen every few seconds as the system cycles through the monitor resolution choices. Make the appropriate selection when it appears.

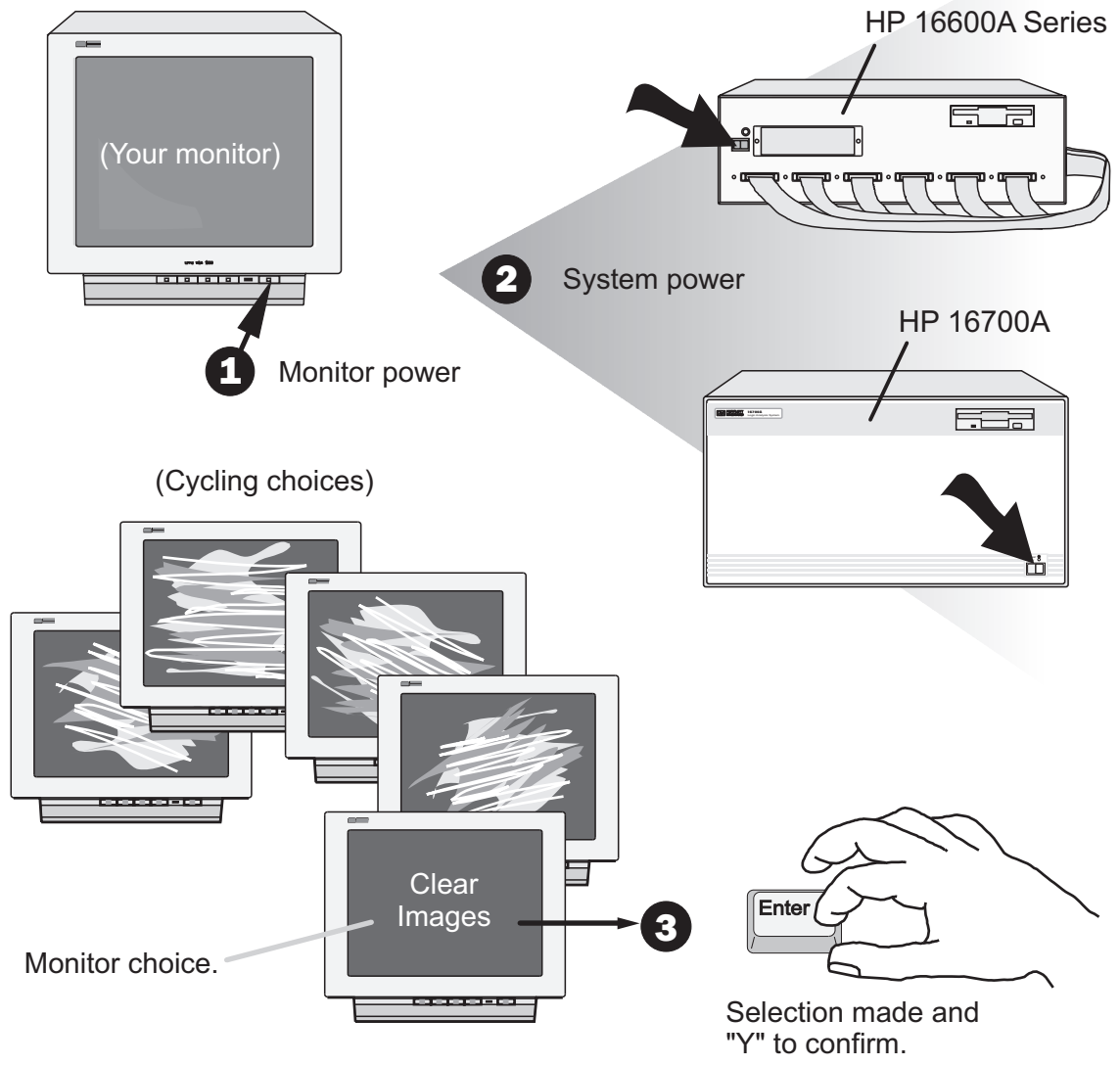

# Monitor Configuration

## HP 16702A

### Note!

Use this procedure if you wish to configure an optional monitor to an HP 16702A.

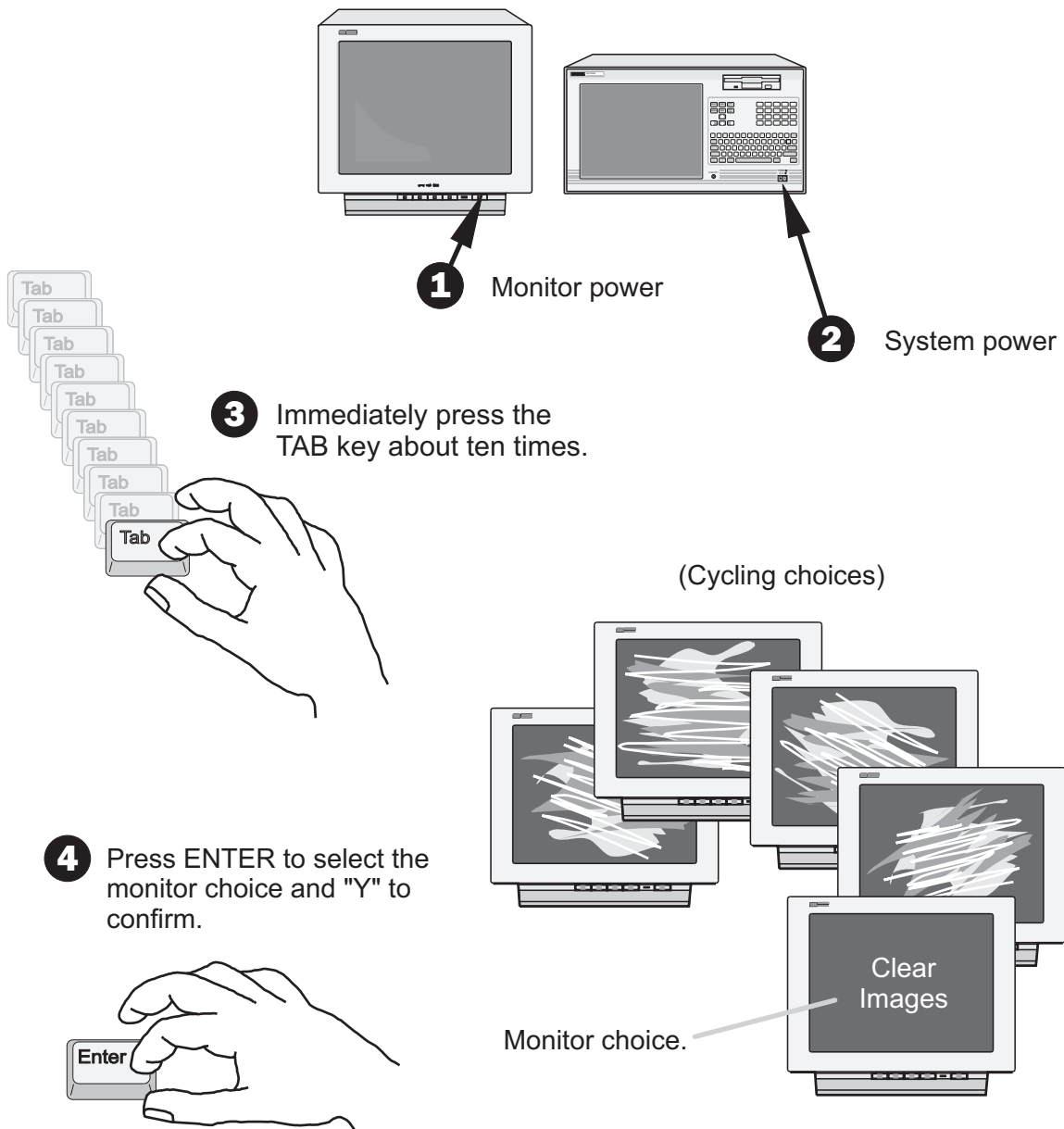

# Changing Monitors

**HP 16600A Series/ HP 16700A/ HP 16702A**

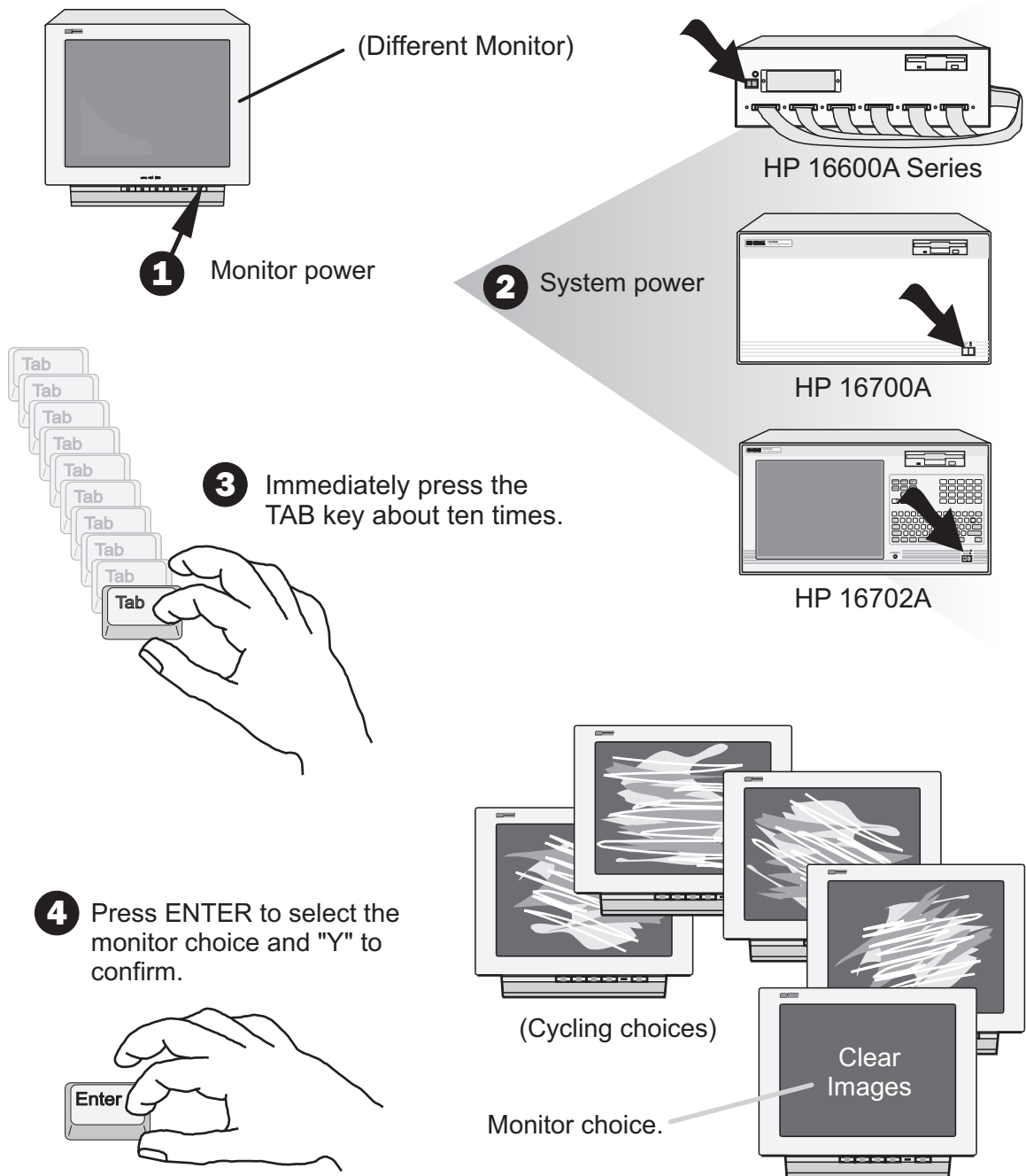

16allp11

# LAN

## HP 16600A Series/ HP16700A/ HP16702A

Online Help  
Icon



HP 16600A Series

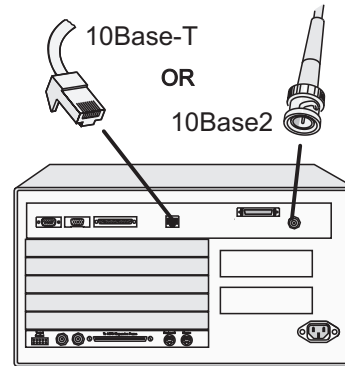
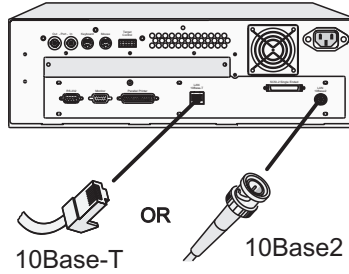

HP 16700A  
or  
HP 16702A

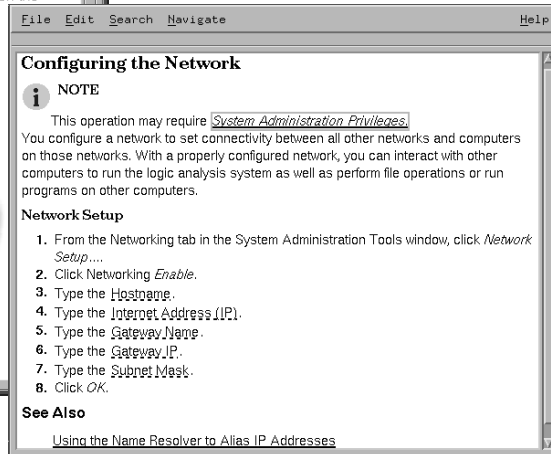
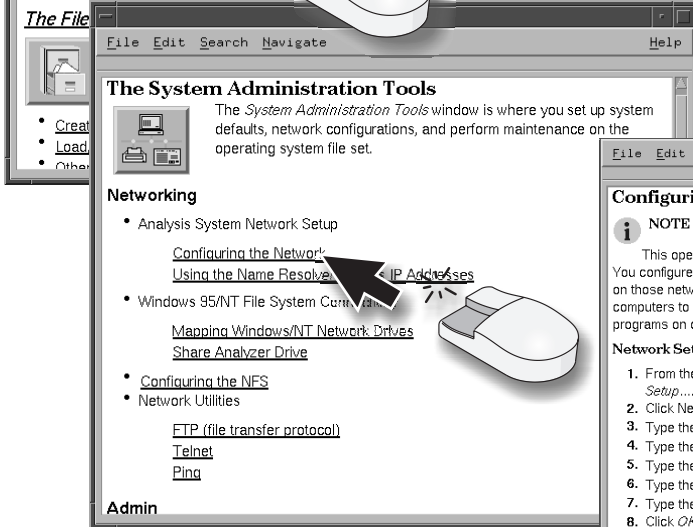
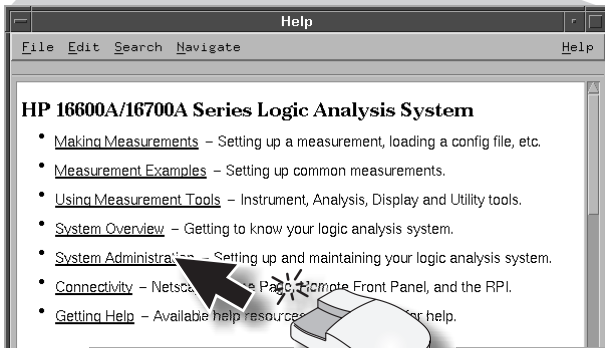

# Printers

**HP 16600A Series/ HP16700A/ HP16702A**

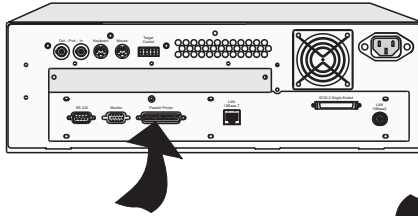
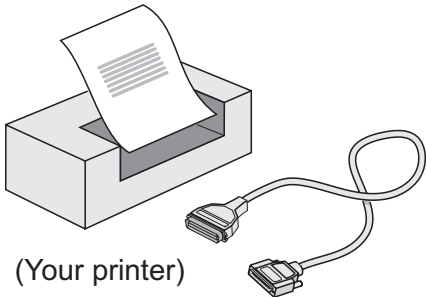

HP 16600A Series

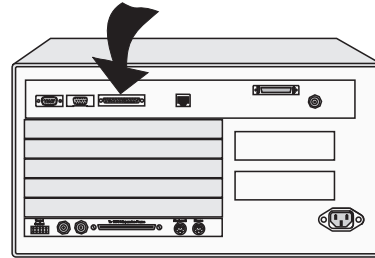

HP 16700A  
or  
HP 16702A

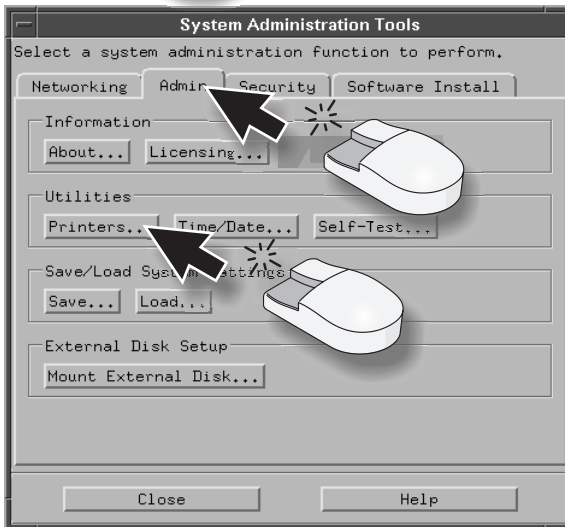
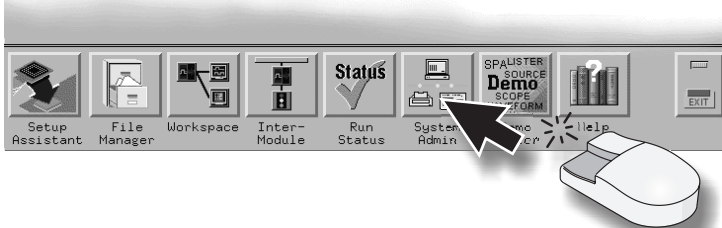

# Printers

**HP 16600A Series/ HP 16700A/ HP 16702A**

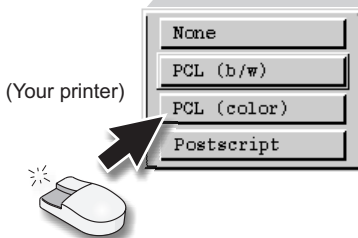
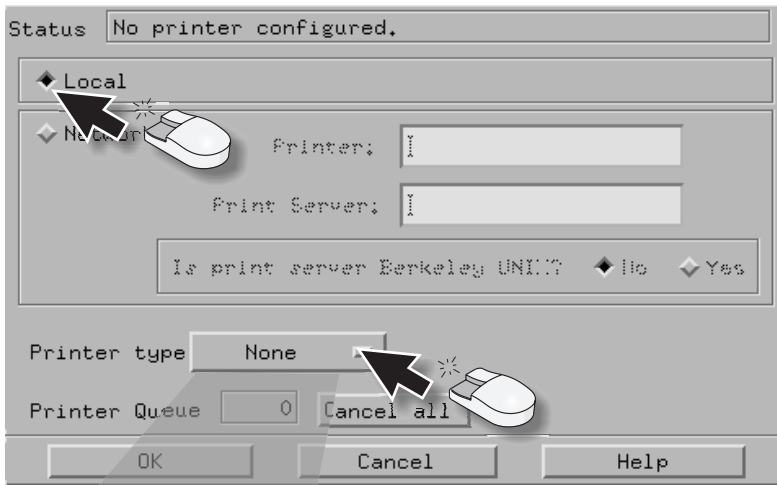

## Note!

Refer to the online help for networked printers setup.

- Help Main Menu
- System Administration
- Admin
- Print Options
- Printer Setup
- Network Printer Setup

Printer Setup  
**Done**

# CD-ROM Drive

**HP 16600A Series/ HP 16700A/ HP 16702A**

## CAUTION

A CD-ROM drive address setting of 6 or 7 could damage your hard drive.

Set the CD-ROM drive address to 2.

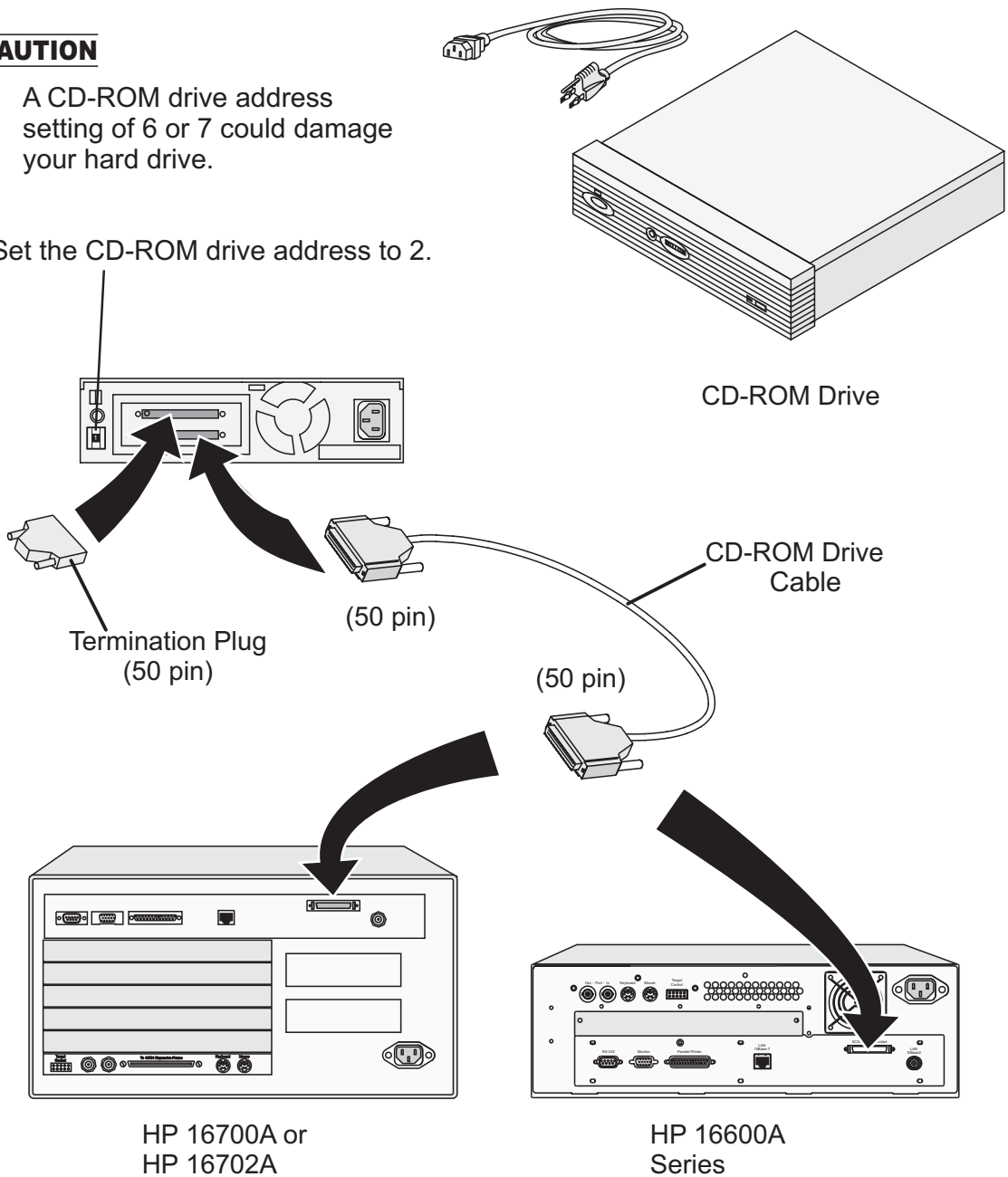

# CD-ROM Drive

**HP 16600A Series/ HP 16700A/ HP 16702A**

## Note!

When a system is shipped, the factory installs the current operating system and ordered processor support packages and tools.

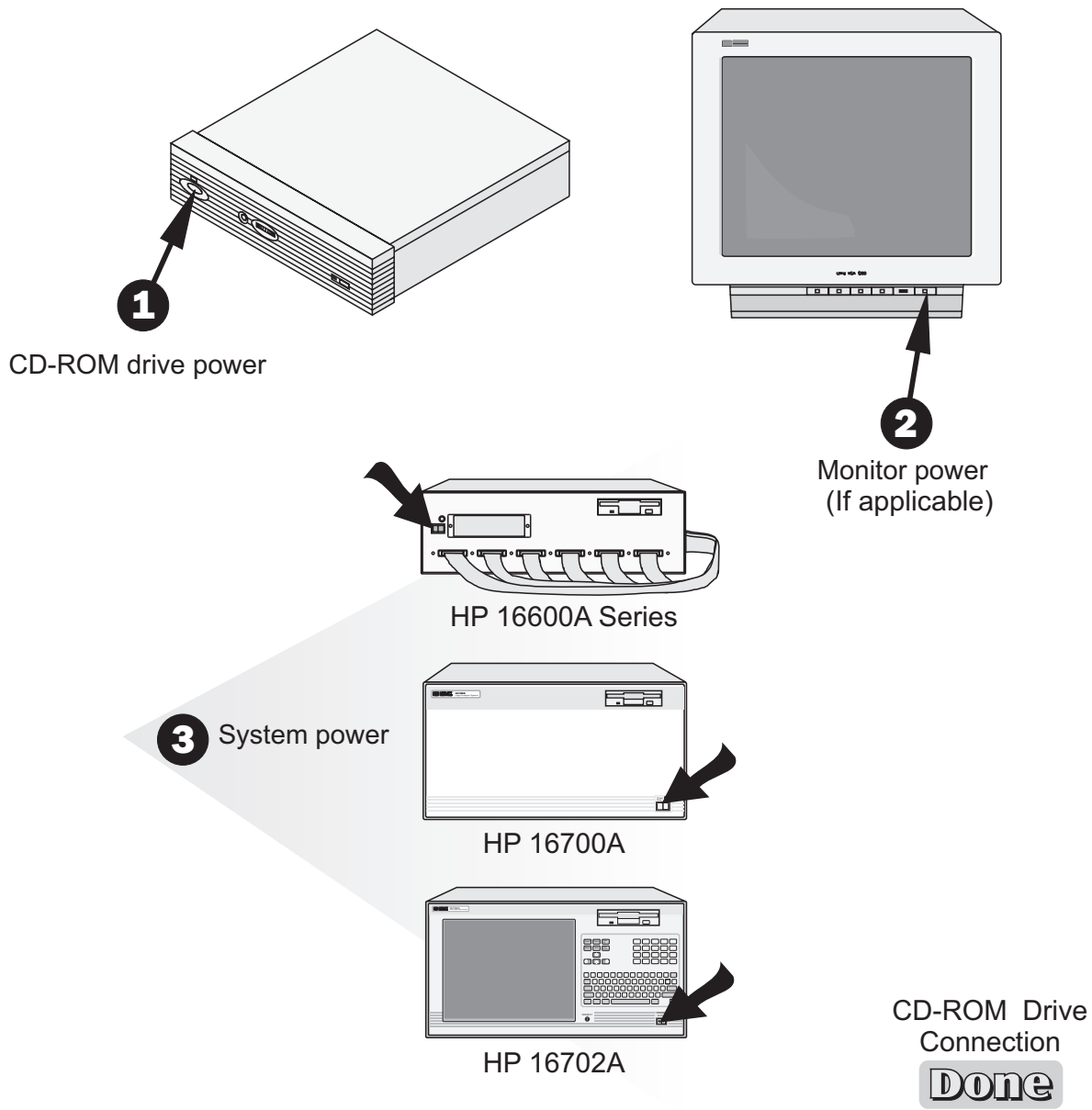



# External Disk Drive

**HP 16600A Series/ HP 16700A/ HP 16702A**

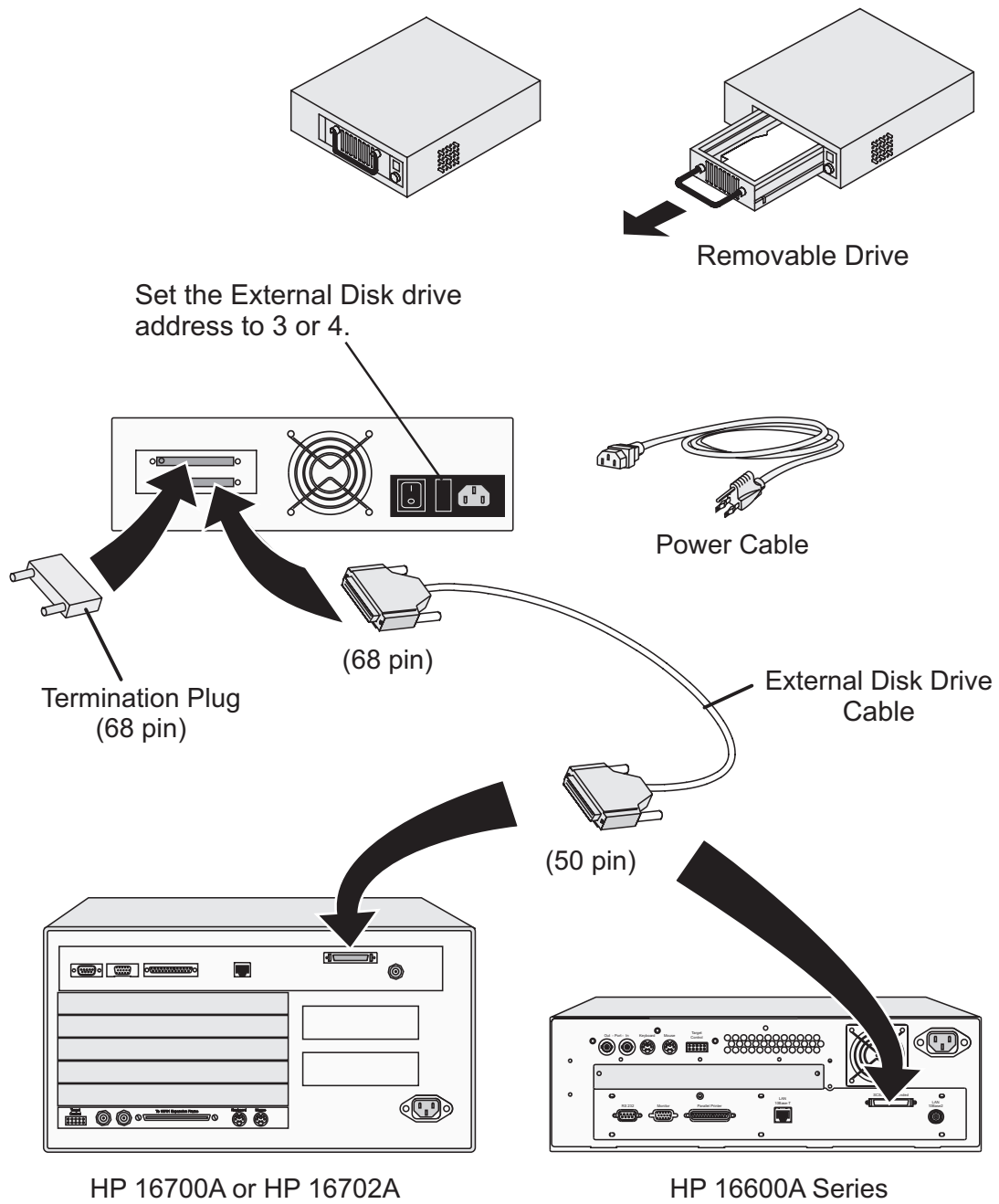

# External Disk Drive

**HP 16600A Series/ HP 16700A/ HP 16702A**

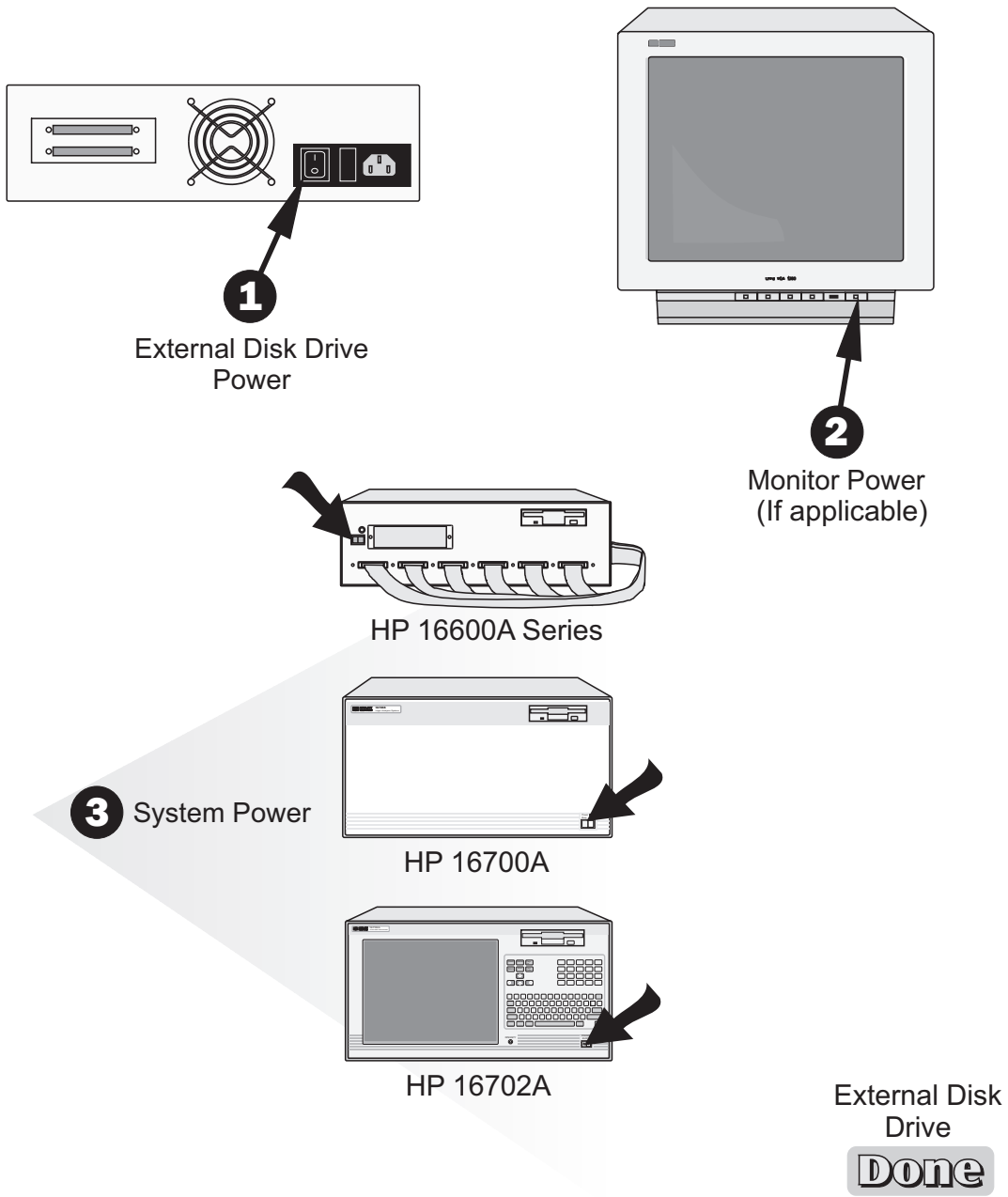

# External Disk Drive & CD-ROM

**HP 16600A Series/ HP 16700A/ HP 16702A**

A CD-ROM drive and an external disk drive(s) may be connected to the system at the same time.

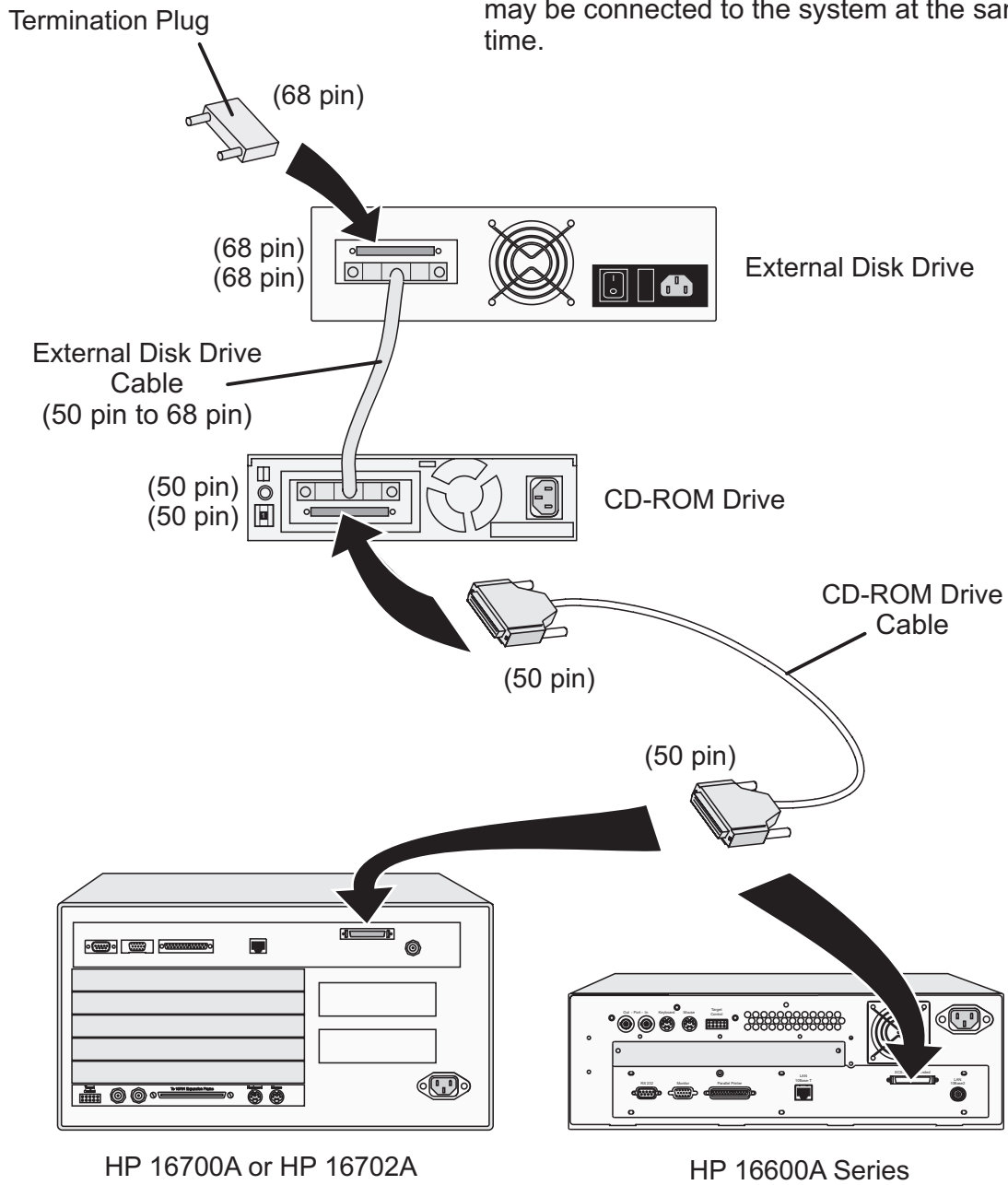

# External Disk Drive & CD-ROM

HP 16600A Series/ HP 16700A/ HP 16702A

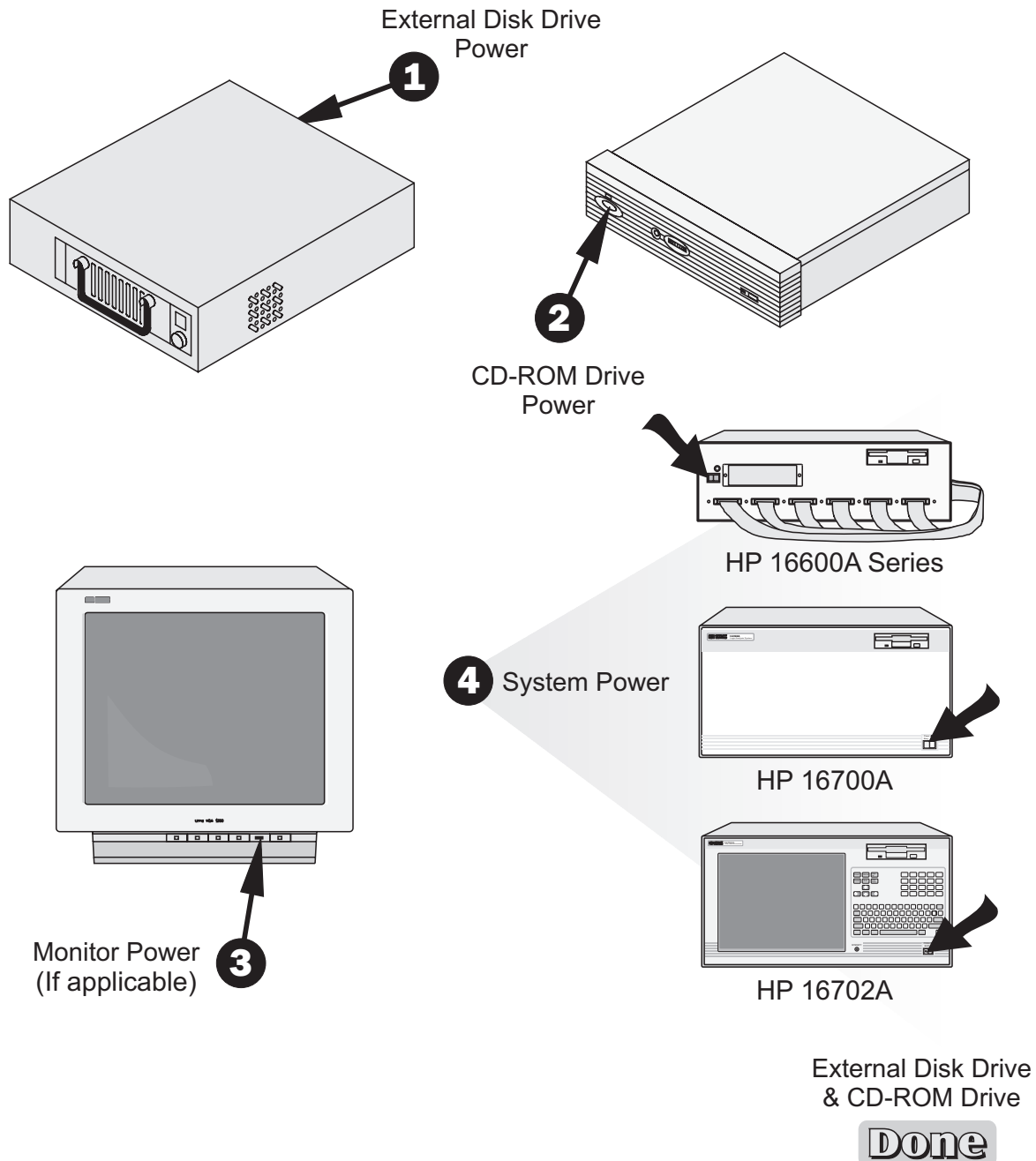

# Software Installation

**HP 16600A Series/ HP 16700A/ HP 16702A**

## Note!

When a system is shipped, the factory installs the current operating system and ordered processor support packages and tools.

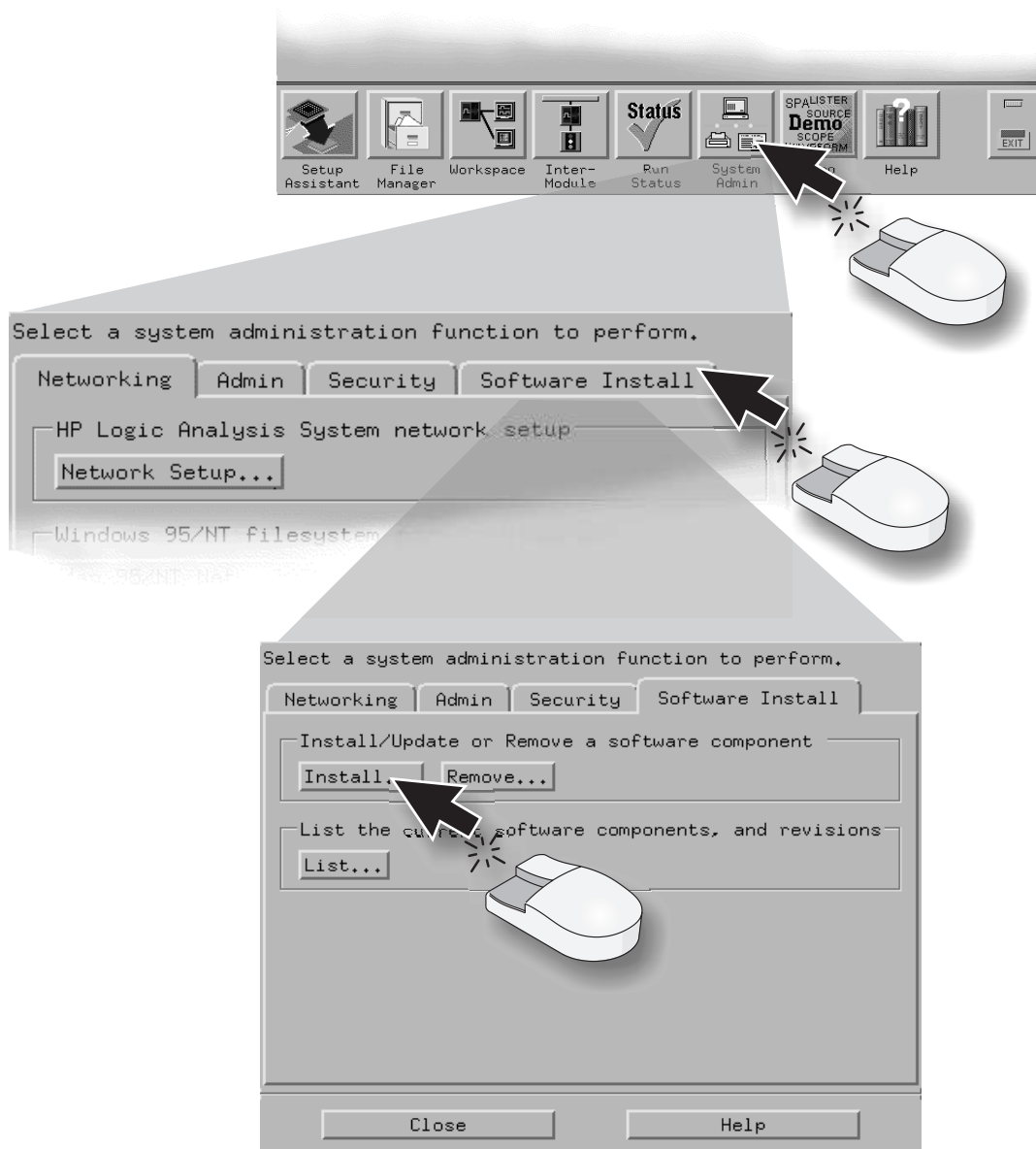

# Software Installation

HP 16600A Series/ HP 16700A/ HP 16702A

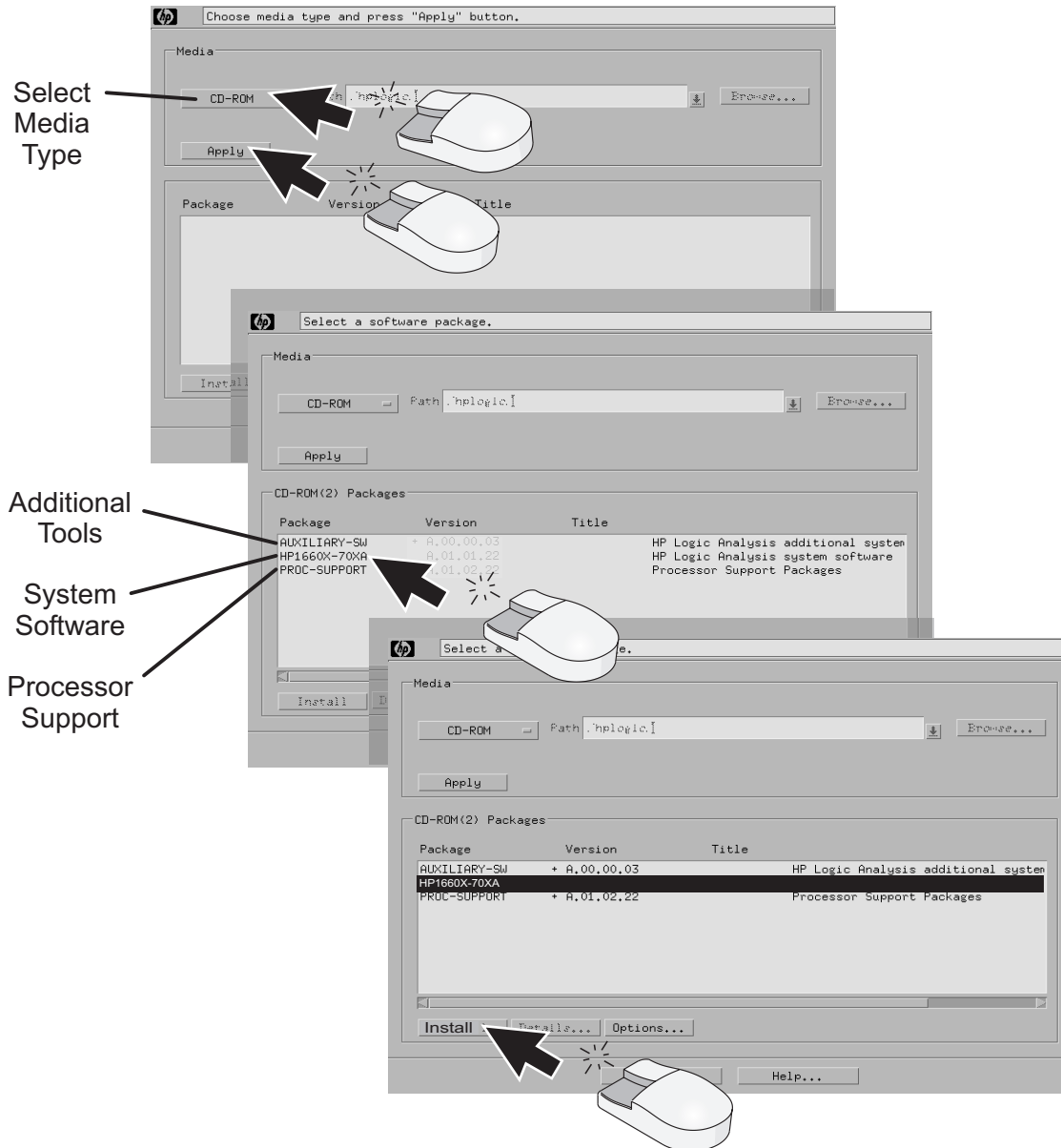

# Software Installation

HP 16600A Series/ HP 16700A/ HP 16702A

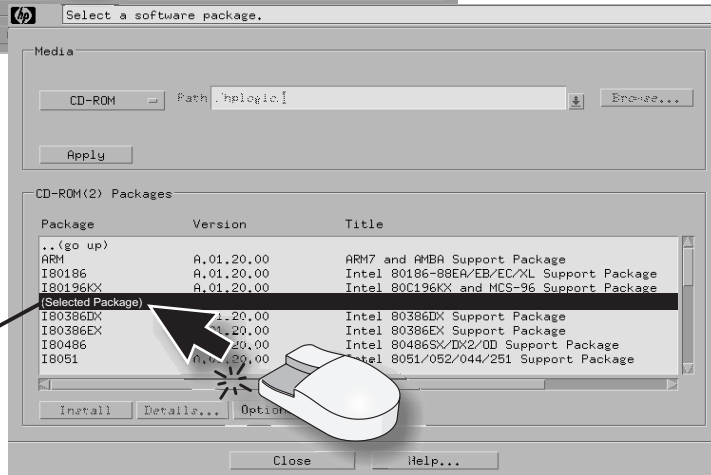
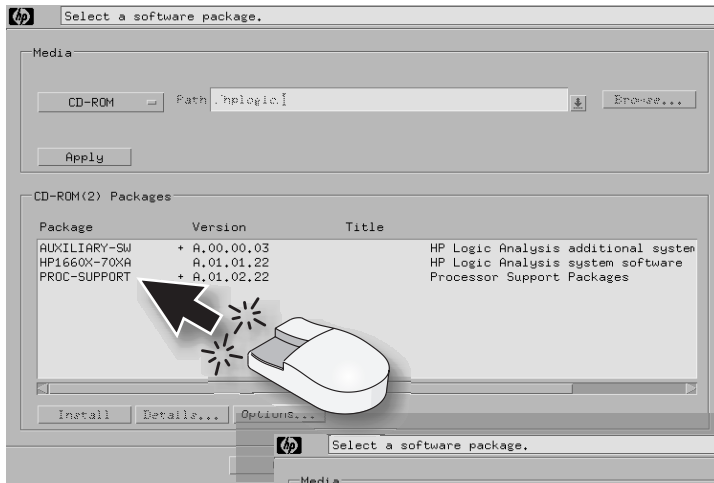

Select desired package.

## Note!

The system will automatically reboot if it is required by the newly installed package.

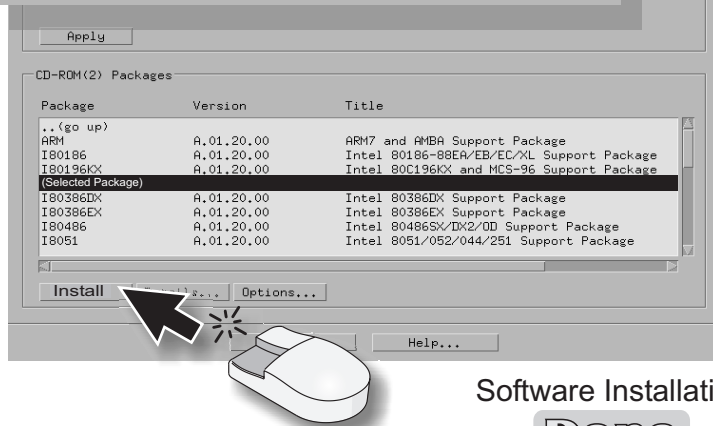

Software Installation

**Done**

# HP 16701A Expander Frame

**HP 16700A/ HP 16702A**

HP 16700A or HP 16702A

- 1** Install your measurement modules in the HP 16701A expander frame.
- 2** Connect the desired length interconnect cable and tighten the connector screws with the screw driver provided.
- 3** Connect the power cable to the HP 16701A.
- 4** Power up the HP 16700A or HP 16702A system.

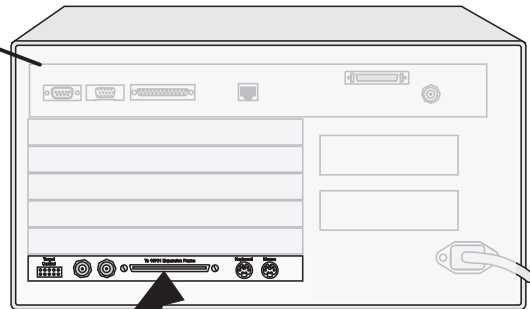

**HP 16701A Interconnect Cable**  
Choose from the 30cm (12 inch) length,  
or the 90 cm (36 inch) length.

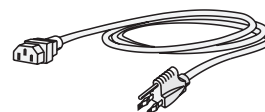
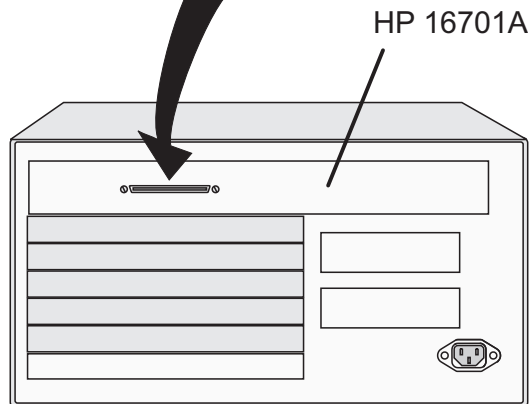
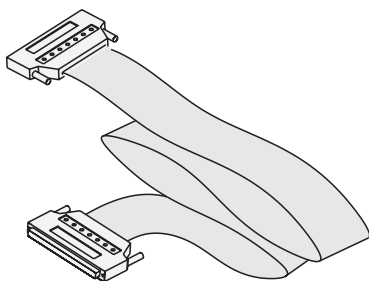



# Probing

## HP Logic Analyzer Modules

### General-Purpose Probing

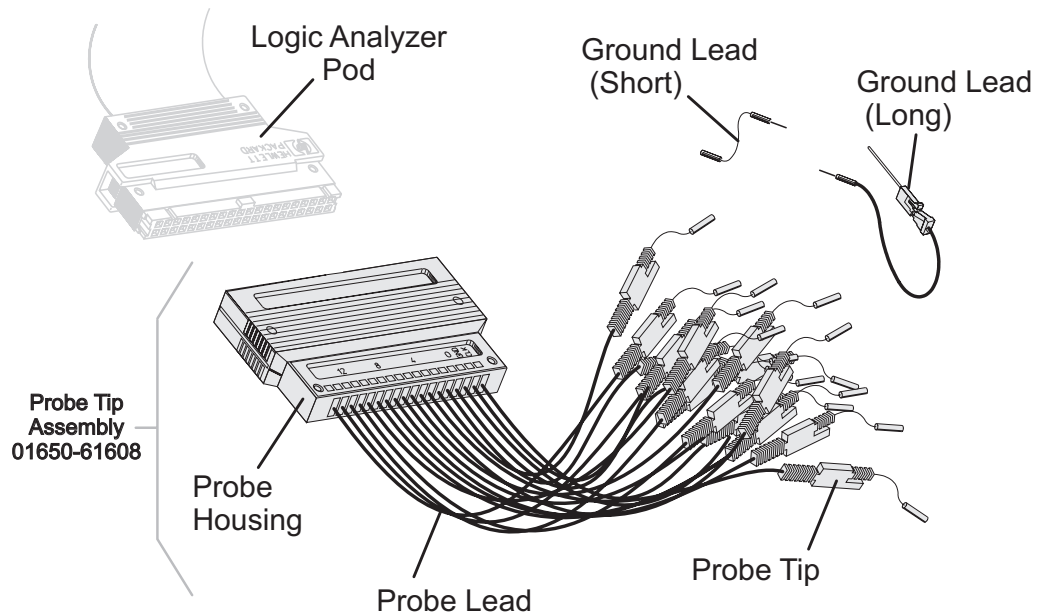

General-purpose probing requires connecting probe leads to individual signal lines. It is generally the most cumbersome method, but it is also the most flexible. Because of the passive design of the probe, there are no active circuits at the outer end of the cable.

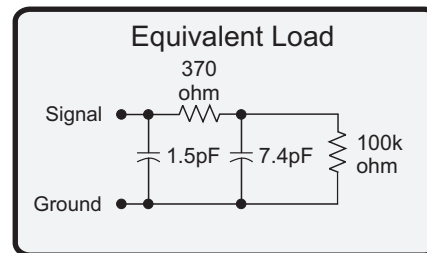
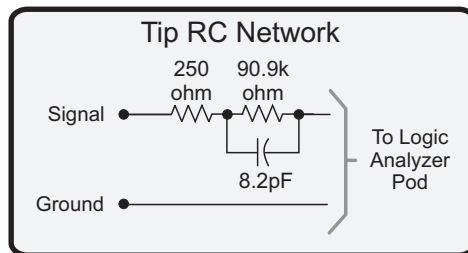

Includes logic analyzer

The advantages of this are:

- High input impedance. (See *Equivalent Load*.)
- Signal ground at the probe tip for high-speed timing signals.
- Inexpensive, removable probe tip assemblies.

# Probing

## HP Logic Analyzer Modules

### General-Purpose Probing

The signal and ground leads can be connected directly to the target system. This requires installing 0.63 mm (0.025 inch) square pins, or round pins with a diameter between 0.66 and 0.84 mm (0.026 and 0.033 inch) directly on the board. You can also use an IC test clip with pins with those dimensions.

You can also connect the leads using through-hole grabbers, which have small enough hooks to fit around adjacent IC pins, or by using surface-mount grabbers designed for fine surface-mount component leads.

Proper grounding will improve the signal quality and is essential for high speed measurements. Each pod has a pod ground lead, which must be used. You can use only this ground, but signal quality for high speed signals will be poor.

For better results, ground not only the pod, but every third or fourth lead.

For best results, and when probing signals with rise and fall times of 1 ns or less, ground each probe lead with no more than a 2-inch ground lead as well as grounding the pod with the pod ground lead.

- You can replace damaged leads. Disconnect individual probe leads by pushing on the latch at the lead base with a ball-point pen.
- Connect grabbers to the leads by slipping the end of the lead over the recessed pin located in the side of the grabber.

**Note!** The minimum input overdrive is the greater of 250 mV or 30% of signal amplitude. The maximum probe input voltage of each logic analyzer probe is 40 volts peak.

# Probing

## HP Logic Analyzer Modules

### Termination Adapter

The logic analyzer cable must have the proper RC network at its input in order to acquire data correctly. The optional Termination Adapter incorporates the RC network into a convenient package. It also reduces the number of pins required for the header on the target board from 40 pins to 20.

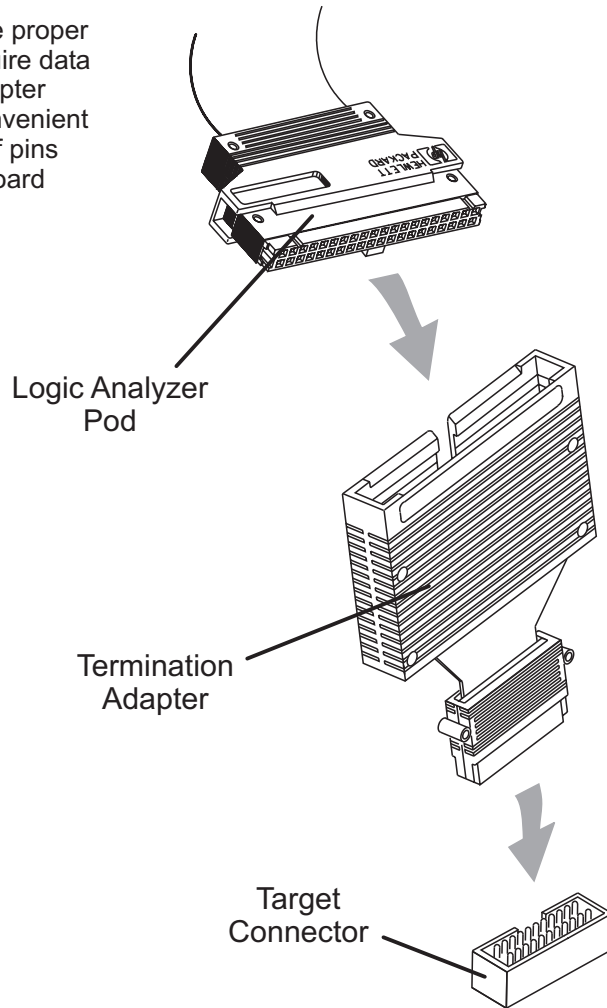

+5V	1	2	N/C
CLK1	3	4	D15
D14	5	6	D13
D12	7	8	D11
D10	9	10	D9
D8	11	12	D7
D6	13	14	D5
D4	15	16	D3
D2	17	18	D1
D0	19	20	GND

Target Connector Pinout  
(Top View)

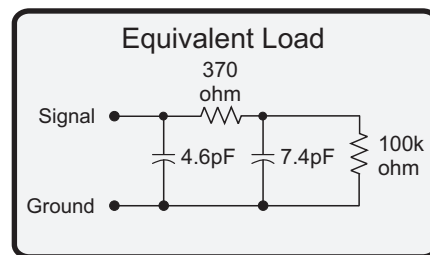
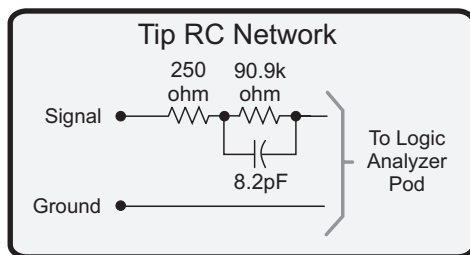

Includes logic analyzer

# Probing

## HP Logic Analyzer Modules

### Connecting Probes to a Target System Directly

You can connect the logic analyzer cable directly to a 40-pin connector, but you must install the proper RC network directly onto the target system board. Hewlett-Packard recommends two types of RC networks which are described in detail in the Application Note: **Probing Solutions for HP Logic Analysis Systems**.

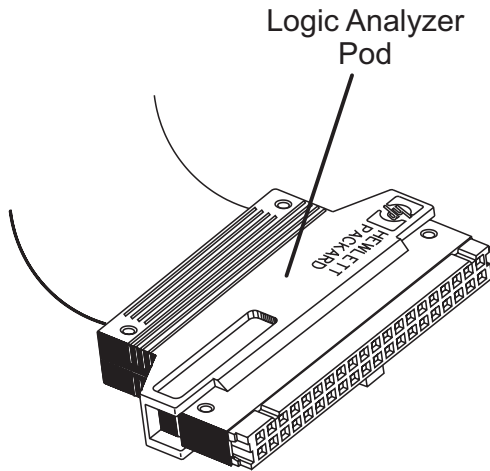

+5V	1	○	○	2	Power GND
CLK1	3	○	○	4	Signal GND
N/C	5	○	○	6	Signal GND
D15	7	○	○	8	Signal GND
D14	9	○	○	10	Signal GND
D13	11	○	○	12	Signal GND
D12	13	○	○	14	Signal GND
D11	15	○	○	16	Signal GND
D10	17	○	○	18	Signal GND
D9	19	○	○	20	Signal GND
D8	21	○	○	22	Signal GND
D7	23	○	○	24	Signal GND
D6	25	○	○	26	Signal GND
D5	27	○	○	28	Signal GND
D4	29	○	○	30	Signal GND
D3	31	○	○	32	Signal GND
D2	33	○	○	34	Signal GND
D1	35	○	○	36	Signal GND
D0	37	○	○	38	Signal GND
+5V	39	○	○	40	Power GND

Target Connector Pinout  
(Top View)

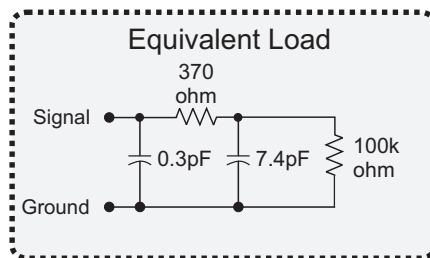
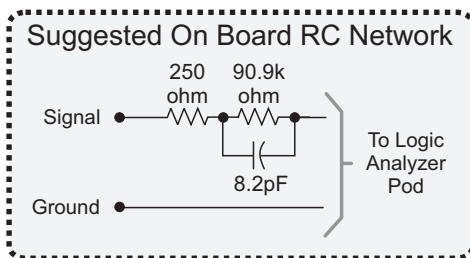

Includes on board RC network and logic analyzer

#### CAUTION



Do not exceed 0.33 amps per cable, or the cable will be damaged. The cable ground lines are chassis (earth) grounds and not "floating" grounds. All the lines are woven into a flat ribbon that is 4.5 feet long.

For more information, contact your Hewlett-Packard Sales office and ask for the Application Note: **Probing Solutions for HP Logic Analysis Systems**. (Or download from the web at: <http://www.agilent.com/find/LA-AppNotes/> )

16allp25

# Probing

## HP Logic Analyzer Modules

### High Density Adapter E5346A (With Tip RC Network)

The HP E5346A high-density adapter provides a convenient and easy way to connect an HP logic analyzer to the signals on your target system for packages that are difficult to probe, such as BGAs. An Amp "Mictor 38" connector must be installed on your target system board.

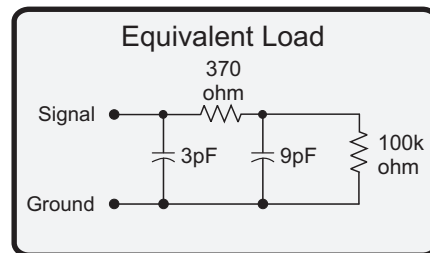
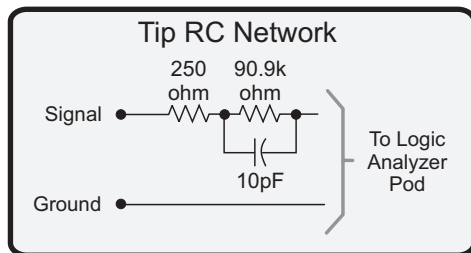
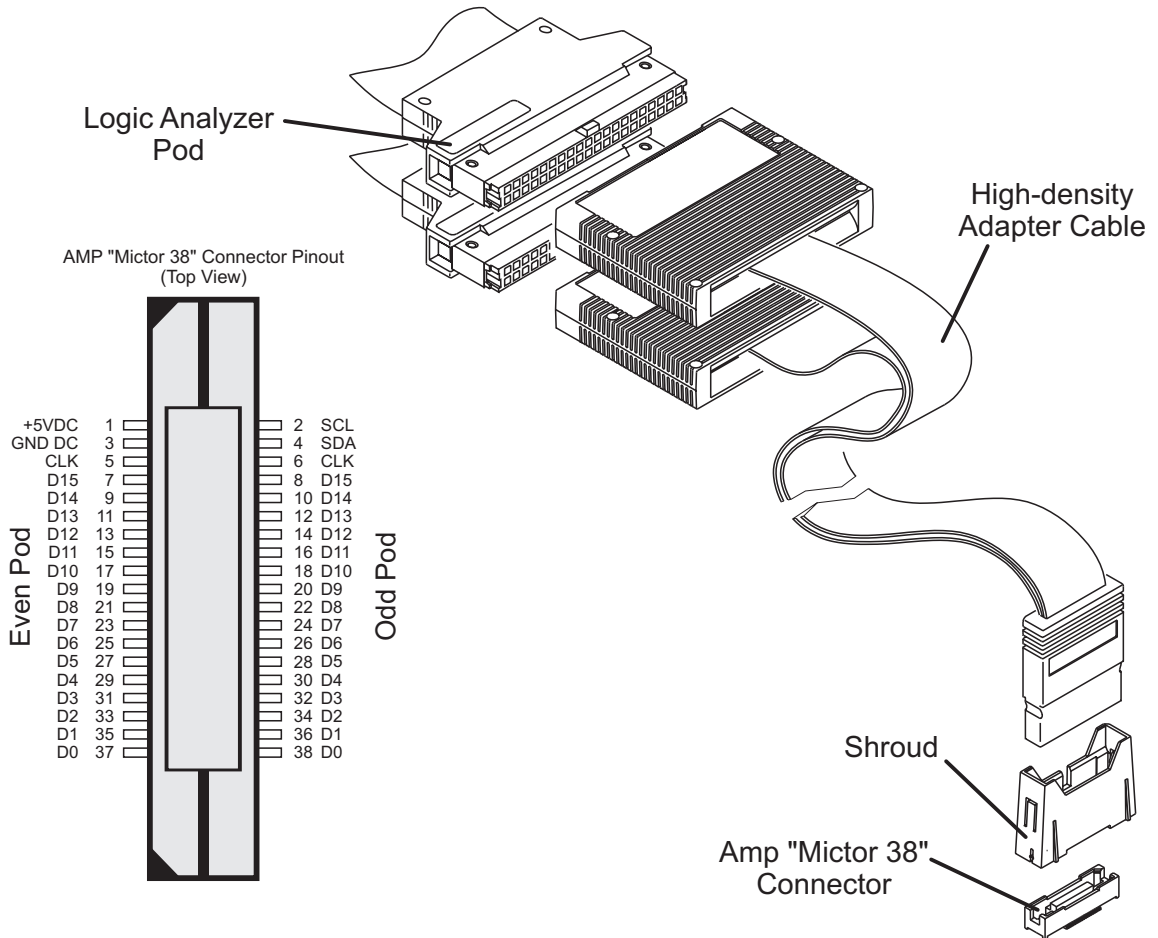

Includes logic analyzer

# Probing

## HP Logic Analyzer Modules

### High Density Adapter E5351A (No Tip Network)

The HP E5351A high-density adapter provides a convenient and easy way to connect an HP logic analyzer to the signals on your target system for packages that are difficult to probe, such as BGAs. The proper RC networks and an AMP "Mictor 38" connector must be installed on your target system board. See Application Note: **Probing Solutions for HP Logic Analysis Systems**.

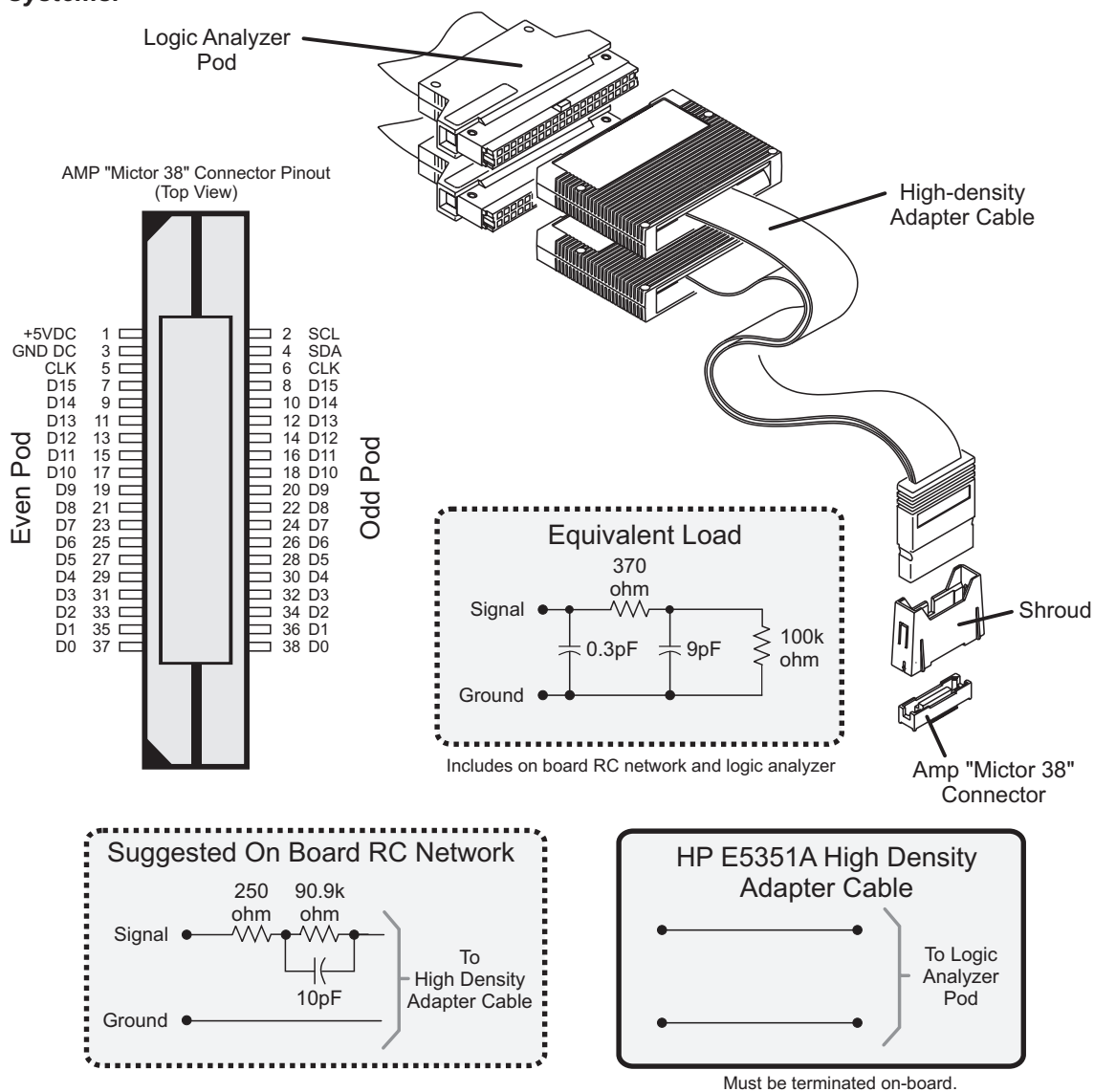

# Self-Test

HP 16600A Series/ HP 16700A/ HP 16702A

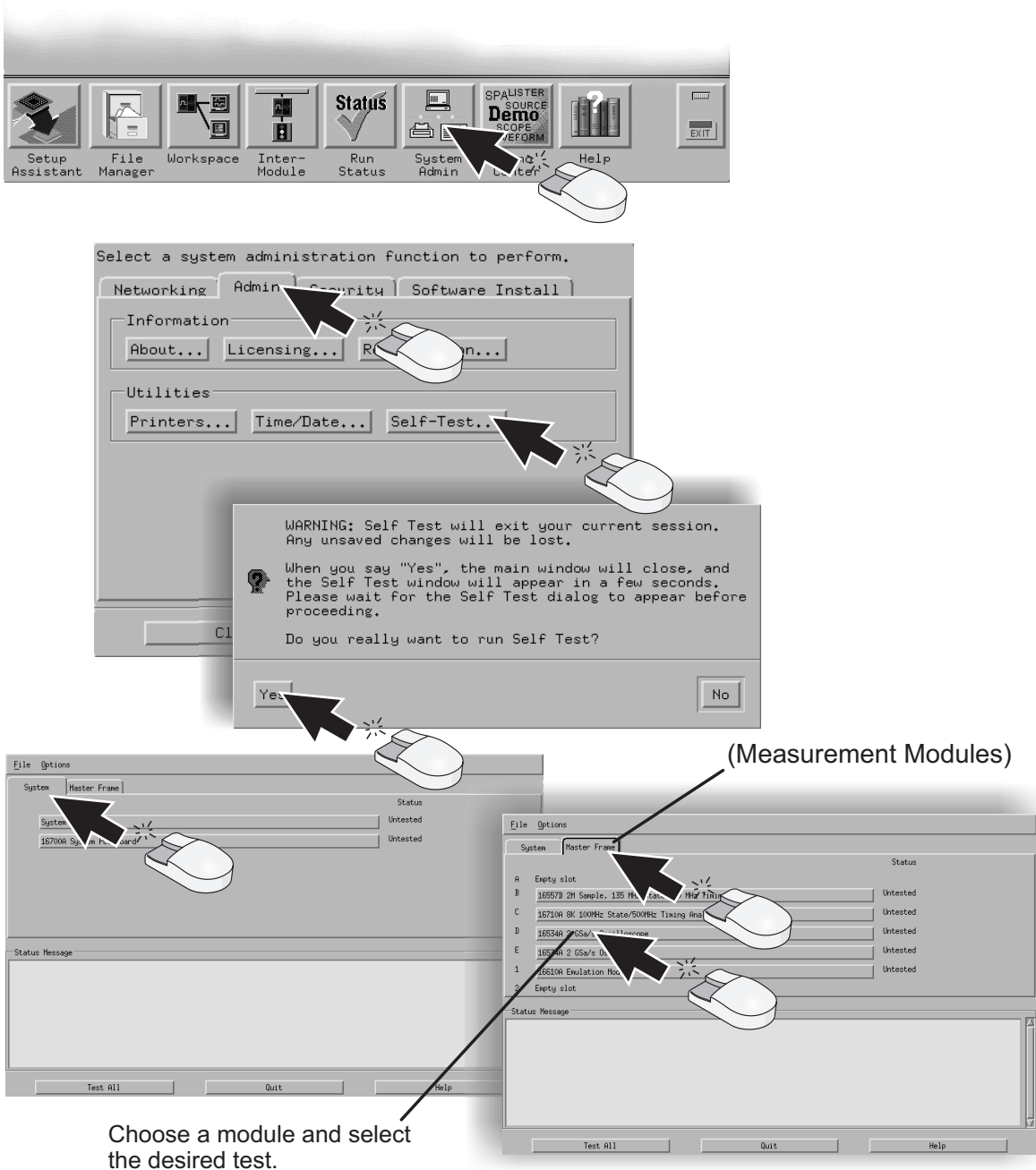

# Specifications & Characteristics

HP 16600A Series/ 16700A/ HP 16702A/ all Measurement Modules

Setup Assistant File Manager Workspace Instrument Module Status Run Status System Admin Demo Center Help EXIT

File Edit Search Navigate Help

### HP 16600A/16700A Series Logic Analysis System

- [Making Measurements](#) – Setting up a measurement, loading a config file, etc.
- [Measurement Examples](#) – Setting up common measurements.
- [Using Measurement Tools](#) – Instrument, Analysis, Display and Utility tools.
- [System Overview](#) – Getting to know your logic analysis system.
- [Sys...](#)
- [Get...](#)

The File...

### Master List of All Tool Help Volumes

All Instrument, Display, Utility, and Analysis tools, have their own specific help volume. The *Help* menu within each tool window accesses its own help volume. You can access specific *Tool Help Volumes* below, or, you can return to the [Main Help Volume](#).

#### The Instrument Tools

- [HP 16600-Series Built-In Logic Analyzer](#)
- [HP 16517A High Speed Timing Analyzer](#)
- [HP 16522A Pattern Generator](#)
- [HP 16533/34A Oscilloscopes](#)
- [HP 16550A Logic Analyzer](#)
- [HP 16554A Logic Analyzer](#)
- [HP 16555A/D Logic Analyzer](#)
- [HP 16556A/D Logic Analyzer](#)
- [HP 16557D Logic Analyzer](#)
- [HP 16710A Logic Analyzer](#)
- [HP 16711A Logic Analyzer](#)
- [HP 16712A Logic Analyzer](#)

See Also: [Using Symbols](#)

#### The Display Tools

#### Interface Reference

- [The Sampling Tab](#)
- [The Format Tab](#)
- [The Trigger Tab](#)
- [The Symbols Tab](#)
- [Specifications and Characteristics](#)
- [Main System Help](#)
- [Glossary of Terms](#)

Select an instrument.



# Disaster Recovery

**for HP 16600A Series/ 16700A/ HP 16702A**

## ***Reinstalling the Operating System.***

**CAUTION** *Read this section carefully before you attempt to reinstall the operating system from the CD-ROM using this procedure. **Everything on the hard drive will be overwritten, including user configuration, data files, and license passwords. To save your system's license information, as well as other system settings, refer to "Saving and Reloading System Settings" in this section.***

A batch process is used to autoloading the software and then reboot the instrument. The batch process waits for only a short timeout period for user interaction to abort the process. Otherwise, the hard drive will be initialized, the operating system will be uploaded, and the instrument will reboot.

The reinstallation process takes approximately one hour depending on the speed of the attached CD-ROM.

- 1** *If required, follow the steps in "Saving and Reloading System Settings" to create a backup file of your system settings and license passwords.*
- 2** *If required, follow the steps in this book to setup the instrument and CD-ROM drive. Insert the CD-ROM containing the instrument operating software into the CD-ROM drive. Allow a couple of moments for the media to settle after inserting the media.*
- 3** *If the LAN cable is connected, disconnect it from the instrument. If needed, turn on the system and initiate the monitor selection mode. (See the section in this book.) Otherwise, proceed to step 4.*
- 4** *Turn on the instrument and repeatedly press the [ESC] key on the keyboard to terminate the boot process. When the boot process is terminated, a prompt will be displayed.*

Main Menu: Enter command >

Press: <Enter>

Type: SEA <Enter>

The instrument will search for all viable boot devices on the bus, including the CD-ROM drive. The display will then show the boot devices:

Path Number	Device Path	Device Type
P0	SESCSI.6.0	QUANTUM FIREBALL ST4.3S
P1	SESCSI.1.0	TOSHIBA CD-ROM XM-5701TA

# Disaster Recovery

**for HP 16600A Series/ 16700A/ HP 16702A**

## ***Reinstalling the Operating System.***

- 5** At the prompt:

```
Main Menu: Enter command >
```

```
Type: BO P1 <Enter>
```

```
Interact with IPL (Y, N, Q) ?>
```

```
Type: N <Enter>
```

- 6** After about 30 seconds you will see the message:

```
WARNING: The configuration information calls for a non-interactive  
installation.
```

```
Press <Return> within 10 seconds to cancel batch mode  
installation:
```

- 7** **To abort the reinstallation process at this point:**

Press the [Return] key on the keyboard within 10 seconds. (If you do nothing within the 10 second timeout, the reinstallation process will begin. The instrument will completely reload the operating system software onto the hard disk drive.)

- 8** Processor Support Packages, Auxiliary Software, and user files must be installed manually once the operating system has been reinstalled.

- 9** Follow the steps in "Reloading System Settings" to restore any license passwords and system settings saved in step 1.

Recovery Process

**Done**

# Disaster Recovery

for HP 16600A Series/ 16700A/ HP 16702A

## Saving System Settings

By saving your system settings to a flexible disk or a mounted directory, you create a backup file that can be used to quickly setup systems, or restore current system settings after the Disaster Recovery procedure.

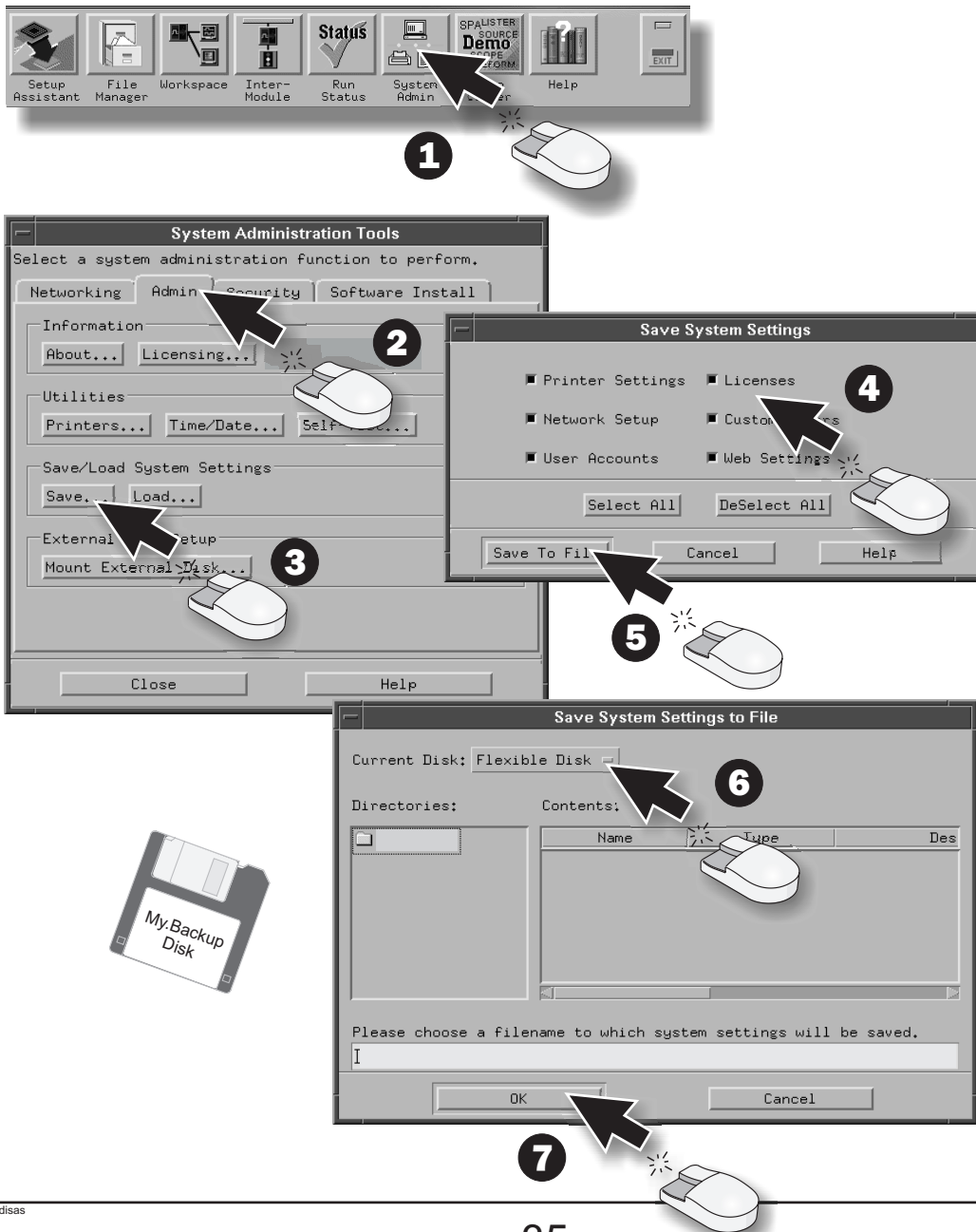

# Disaster Recovery

for HP 16600A Series/ 16700A/ HP 16702A

## Reloading System Settings

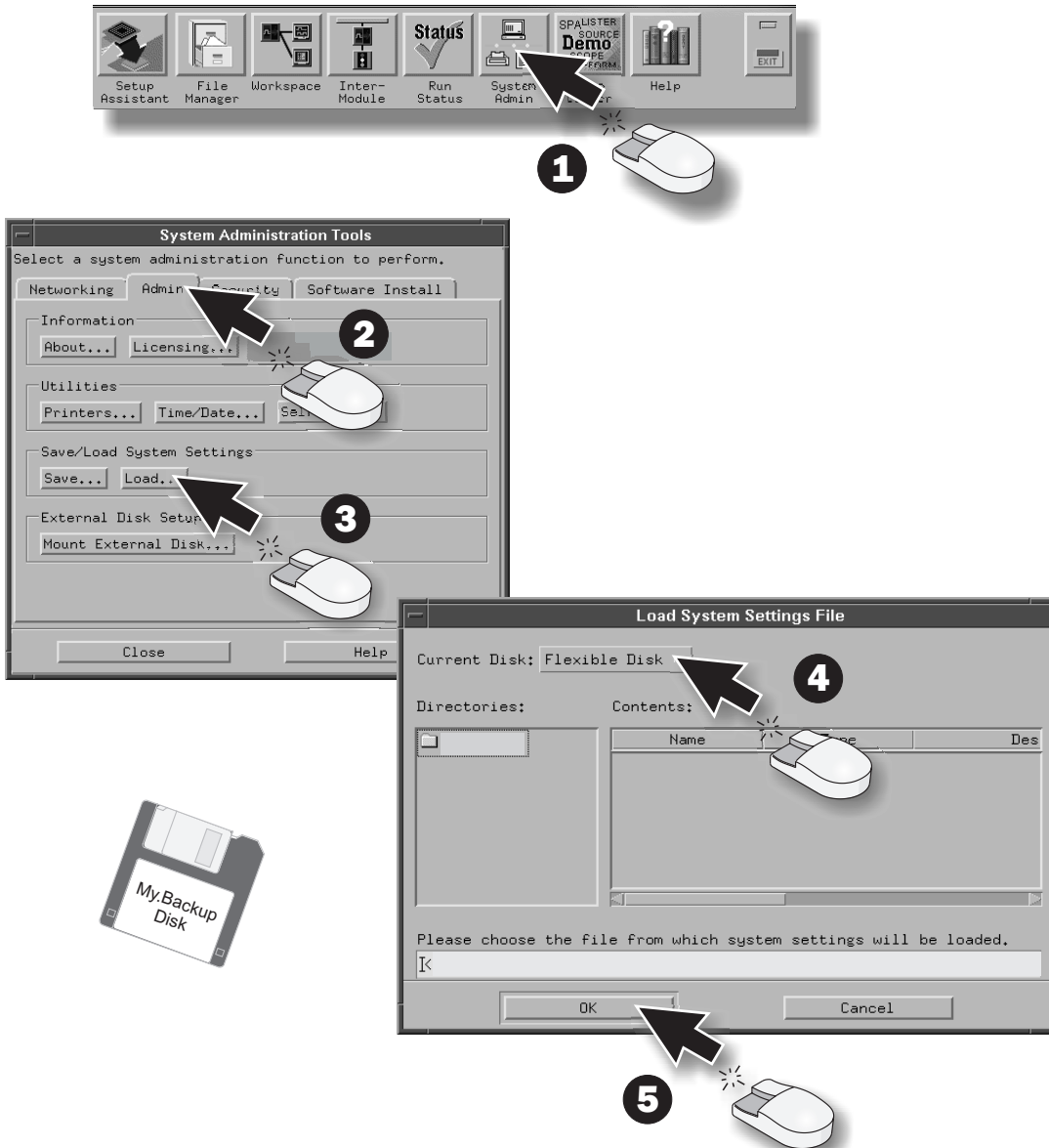

If an item is not valid, or was not initially saved to the file, the selection will be greyed out in the interface. Also, if no file extension is added, a ".set" extension is automatically added for you.

# Proper Cleaning

## ***HP 16600A Series/ HP 16700A/ HP 16702A/ Measurement Modules Instrument Cabinet and Module Front Panels***

### **CAUTION**

With the instrument unplugged, use mild soap and water to clean the cabinet of the instrument or the front of the modules. Harsh soap might damage the water-based paint. ***Do not immerse the instrument or modules in water.***

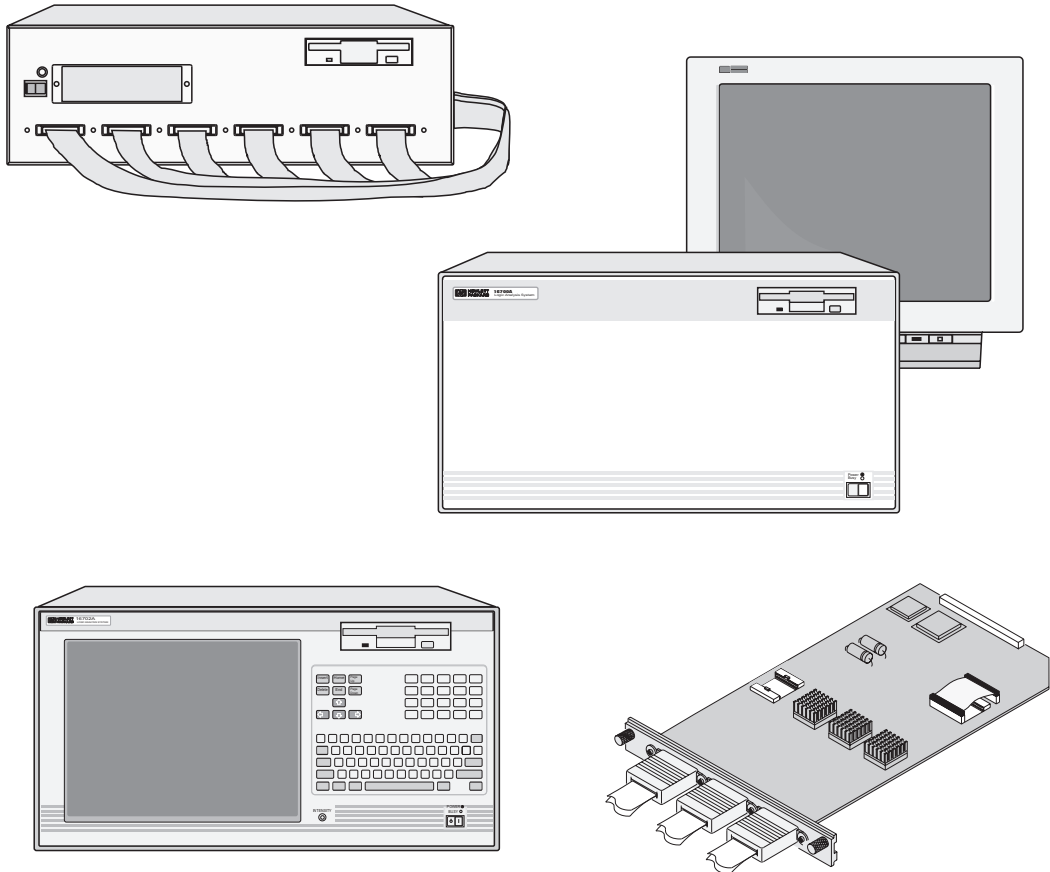



# Measurement Modules

*HP 16600A Series/ HP 16700A/ HP 16702A*

**HP 16517/18A**

**HP 16522A**

**HP 16533/34A**

**HP 16550A**

**HP 16557D**

**HP 16710/11/12A**

**HP 16715/16/17/18/19A**

**HP E2485A**

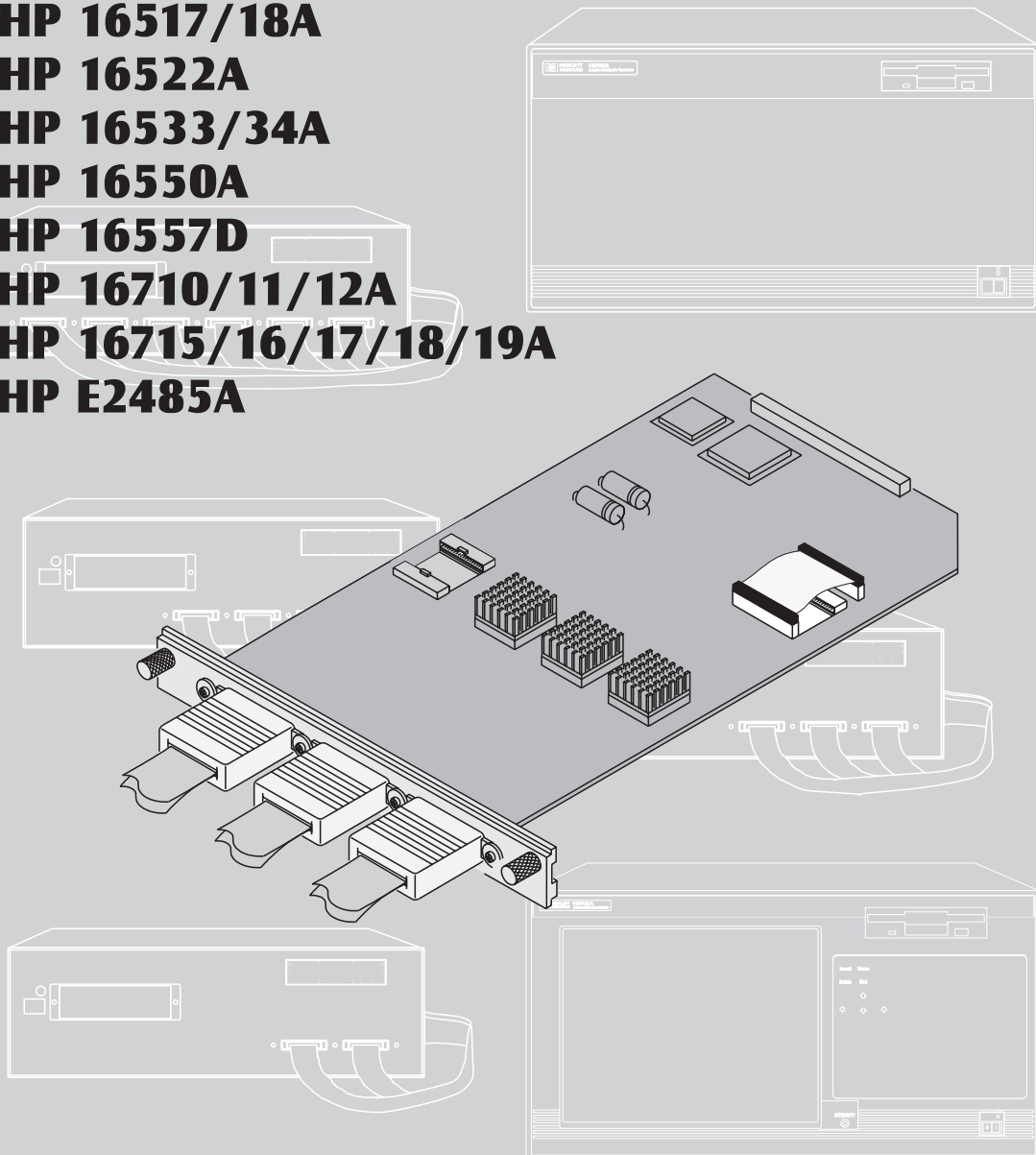

**hp** HEWLETT  
PACKARD

16alp21

# Measurement Modules

for HP 16600A Series/ HP 16700A/ HP 16702A

## General Installation

**CAUTION** Be sure the frame is unplugged before removing or installing modules.

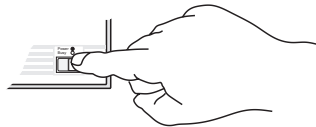

**1** Power down the system.

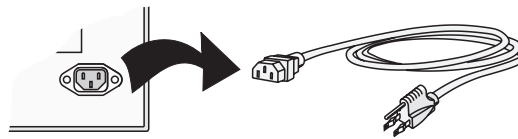

**2** Disconnect the power cable.

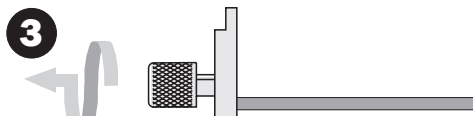

**4** Remove modules or filler panels.

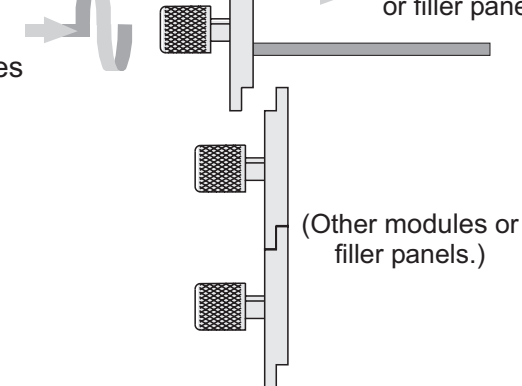
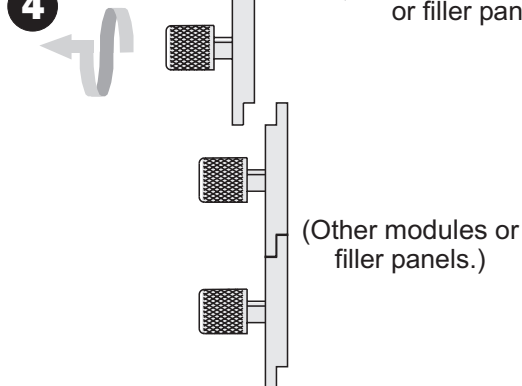

### CAUTION

Use a grounded wrist strap and mat when handling the modules. Gently apply pressure to the center of the module or filler panel while tightening the thumb screws. Use filler panels in empty slots for proper cooling.

Carefully slide the module into the frame and hand tighten the thumb screws. *If you are inserting more than one module, the tightening order is bottom module to top module.*

A single-module configuration can be installed in any available slot.

### Note!

Some modules require calibration if they are moved to a different slot. For calibration information, refer to the online help for the individual modules.

modgen



# HP 16517A/18A

for HP 16700A and HP 16702A

## 2-Card Module

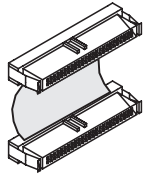

Expander

Master

2 Connector  
Cable

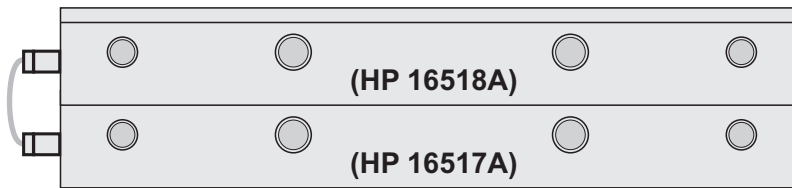
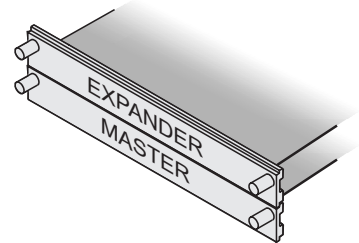

**OR**

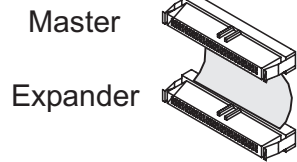

Master

Expander

2 Connector  
Cable

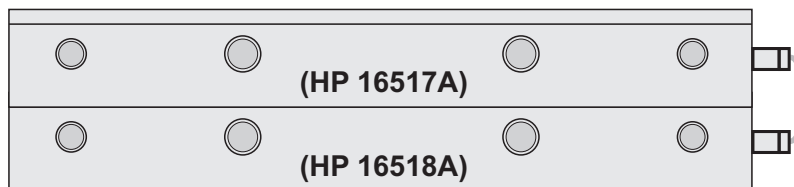
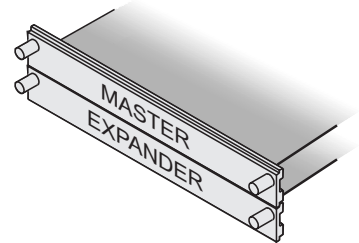

# HP 16517A/18A

for HP 16700A and HP 16702A

## 3-Card Module

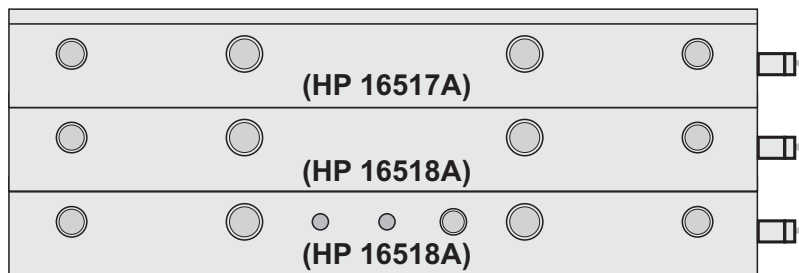
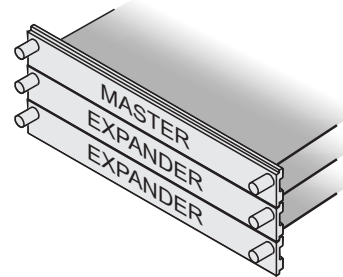
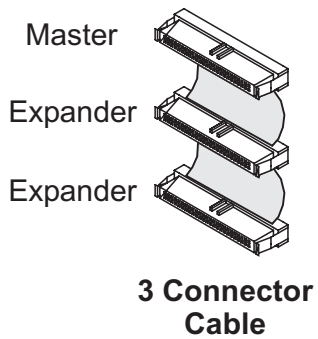

# HP 16517A/18A

for HP 16700A and HP 16702A

## 3-Card Module

2 Connector  
Cable

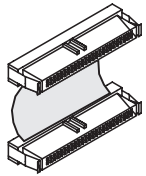

Expander

Master

Expander

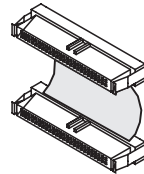

2 Connector  
Cable

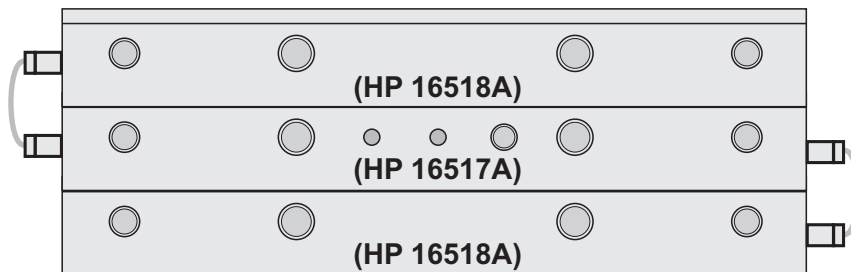
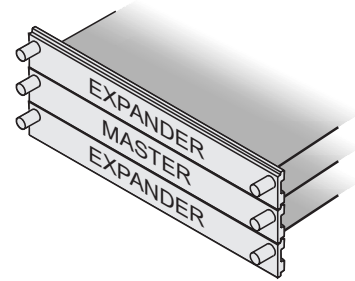

# HP 16517A/18A

for HP 16700A and HP 16702A

## 3-Card Module

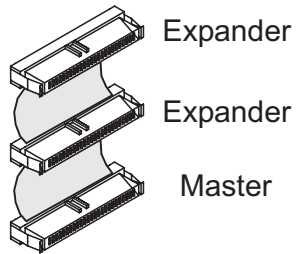

3 Connector  
Cable

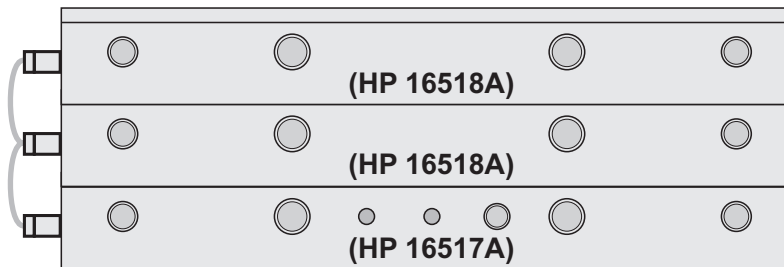
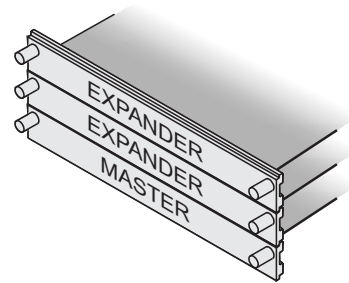

# HP 16517A/18A

for HP 16700A and HP 16702A

## 4-Card Module

2 Connector  
Cable

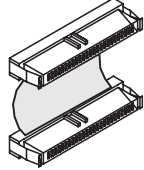

Expander

Master

Expander

Expander

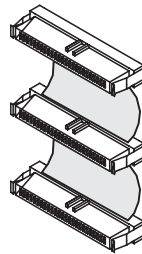

3 Connector  
Cable

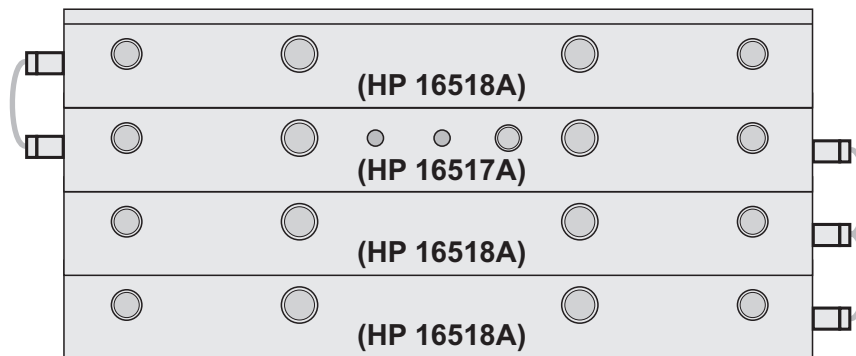
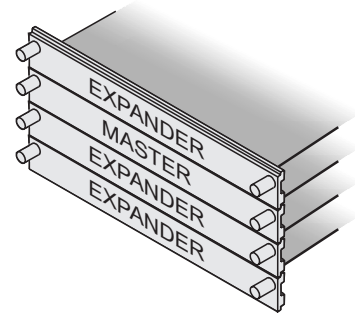

# HP 16517A/18A

for HP 16700A and HP 16702A

## 4-Card Module

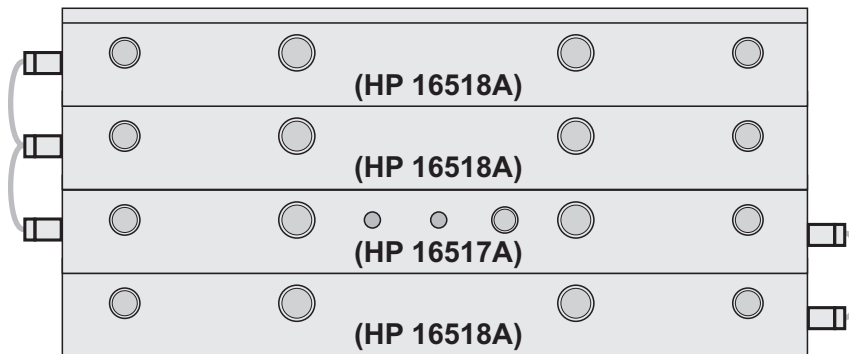
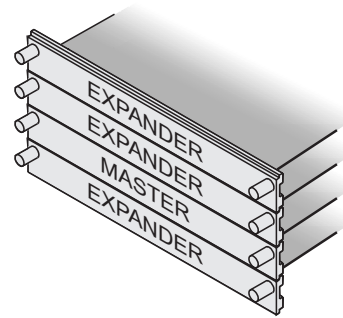
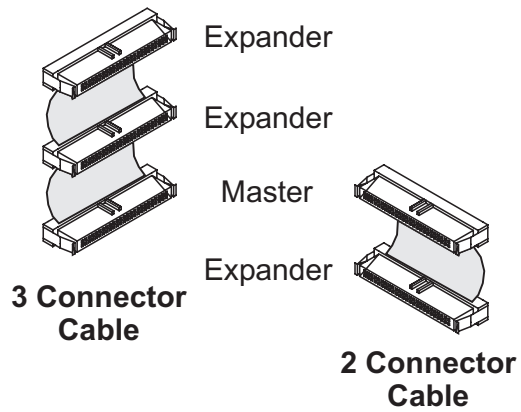

# HP 16517A/18A

for HP 16700A and HP 16702A

## 5-Card Module

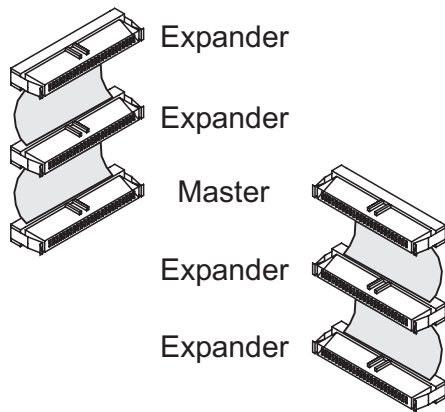

3 Connector Cables  
(Need 2)

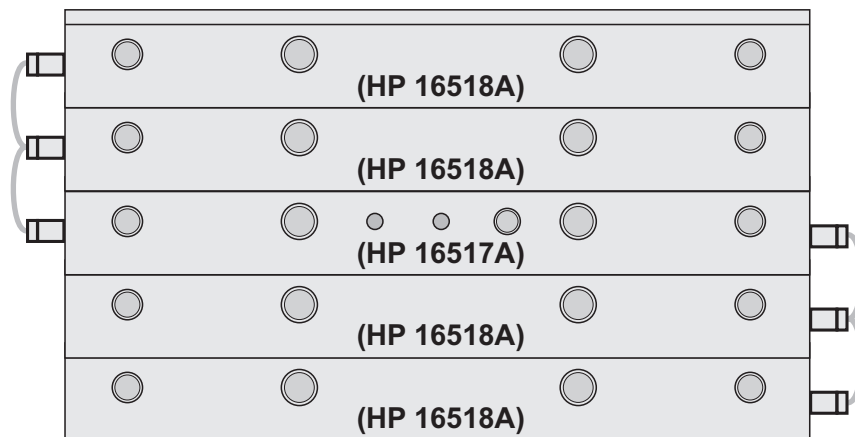
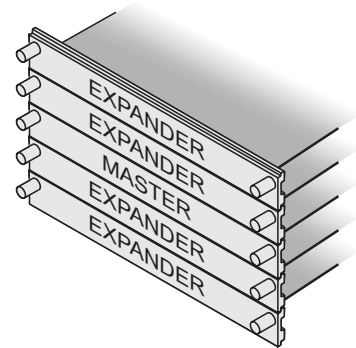

HP 16517/18A

**Done**

# HP 16522A

for HP 16600A Series/ HP 16700A/ HP 16702A

## Single-Card Module

Each HP 16522A shipped stand alone has the **2x10 cable** connected in the single-card module configuration.

2x10 cable connection for a single-card

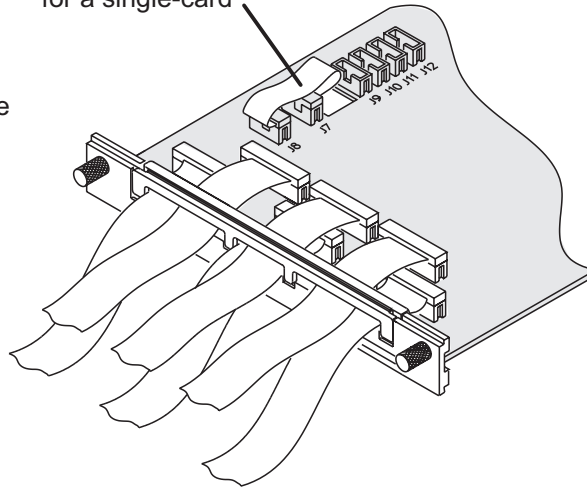

2x10 cable

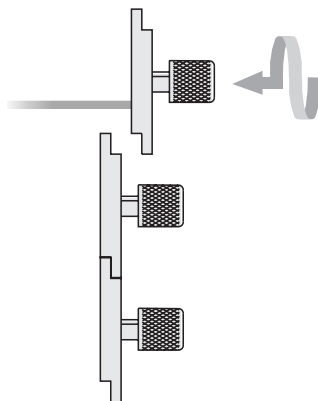
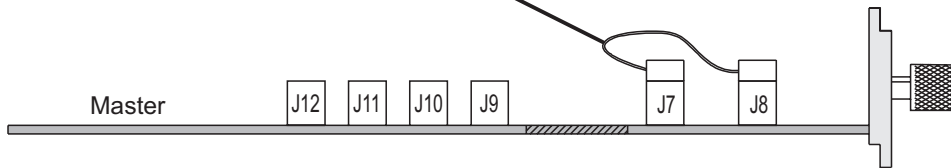

A single-card module configuration can be installed in any available slot.

### **CAUTION**

Be sure the frame is unplugged before removing or installing modules.

The following pages will show you how to connect the **2x10 cables** to configure two, three, four, and five-card modules.



# HP 16522A

for HP 16700A and HP 16702A

## 2-Card Module

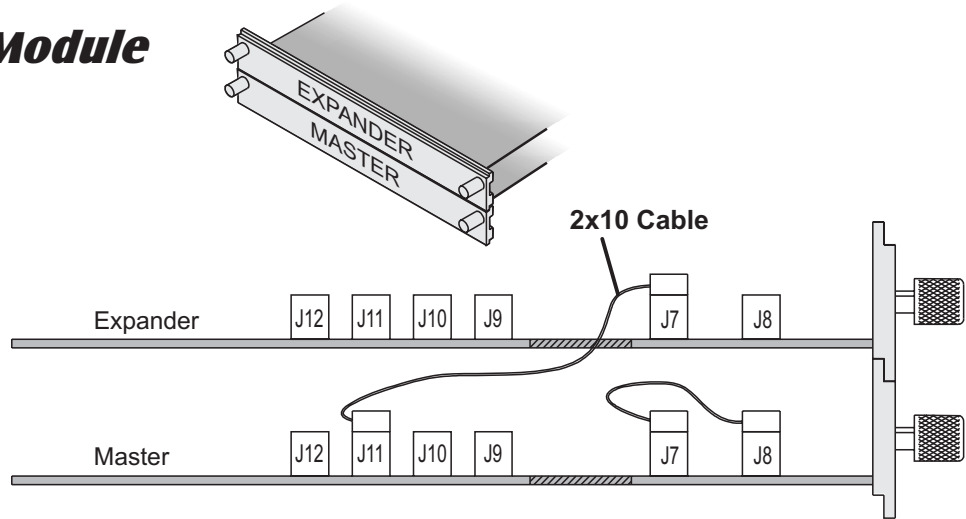

## 3-Card Module

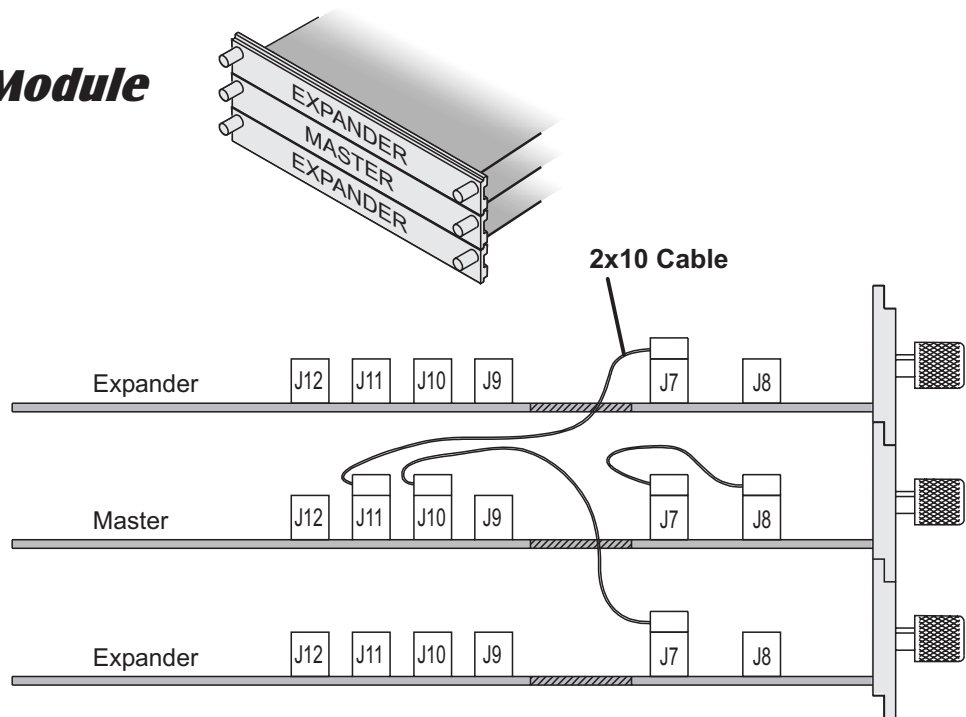

# HP 16522A

for HP 16700A and HP 16702A

## 4-Card Module

### Note!

Carefully slide the four cards half way into the mainframe slots.

Cable the bottom Expander to the Master Card first.

Cable the upper two Expanders to the Master Card.

Gently slide the cabled assembly fully into the frame and tighten.

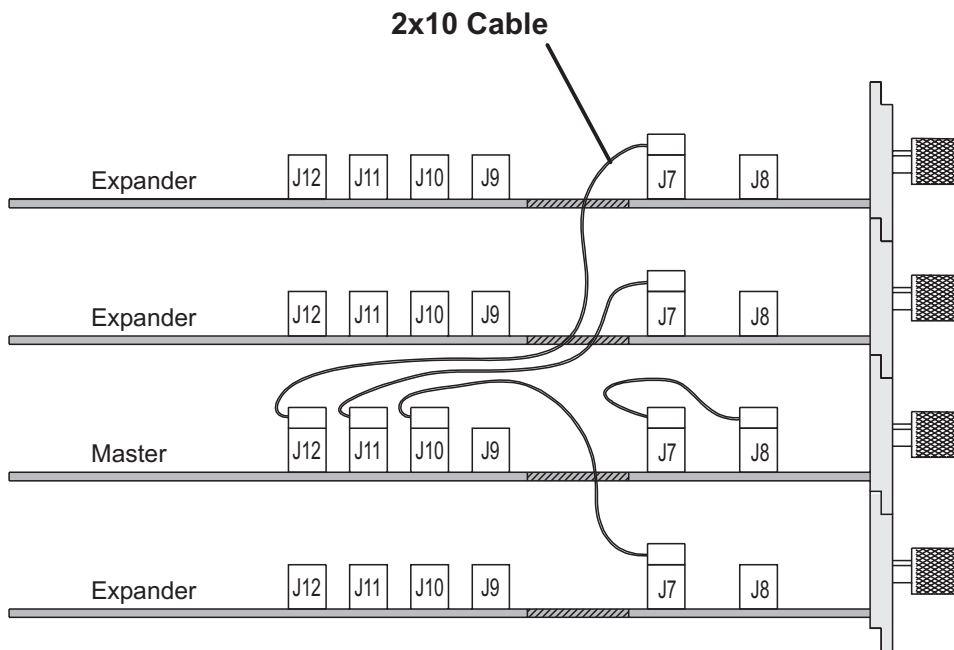
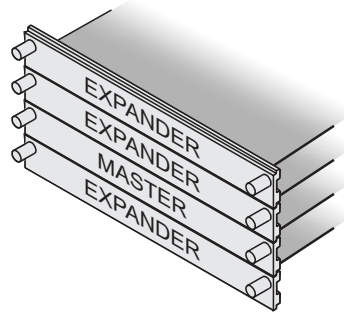

# HP 16522A

for HP 16700A and HP 16702A

## 5-Card Module

### Note!

Carefully slide the five cards half way into the mainframe slots.

Cable the bottom two Expanders to the Master first.

Cable the upper two Expanders to the Master.

Gently slide the cabled assembly fully into the frame and tighten.

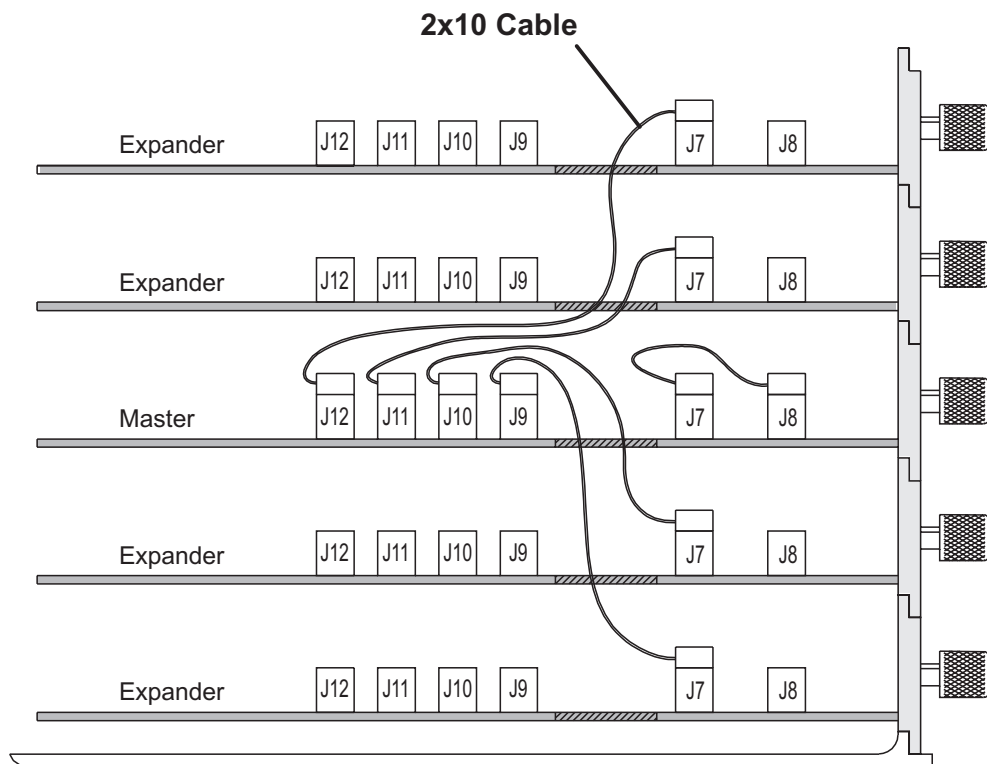
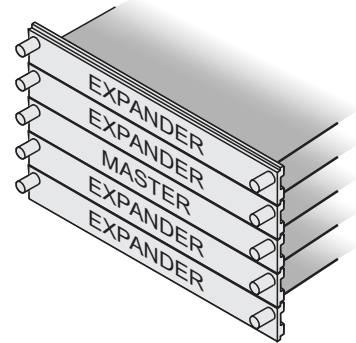

HP 16522A

**Done**



# HP 16533/34A Calibration

for HP 16600A Series/ HP 16700A/ HP 16702A

## Single-Card Module

- 1** Power down the mainframe and disconnect the power cable..

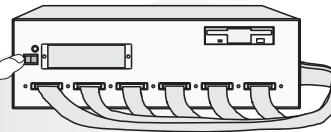

HP 16600A Series



HP 16700A

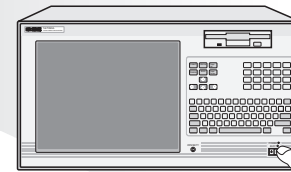

HP 16702A

- 2** Remove the module from the mainframe and set the PROTECTED / UNPROTECTED switch to UNPROTECTED.

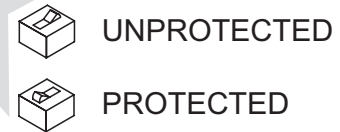
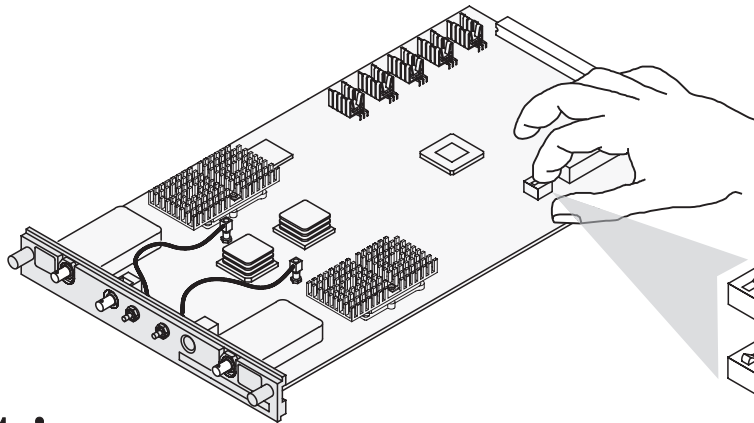

### Note!

If you calibrate this module without unprotecting the memory, the new calibration settings will not be saved when the system is shut down. The system will default to the previous settings. The new calibration settings would be effective for the current active session only.

# HP 16533/34A Calibration

for HP 16600A Series/ HP 16700A/ HP 16702A

## Single-Card Module

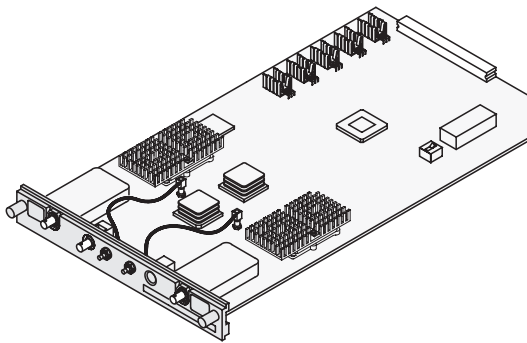
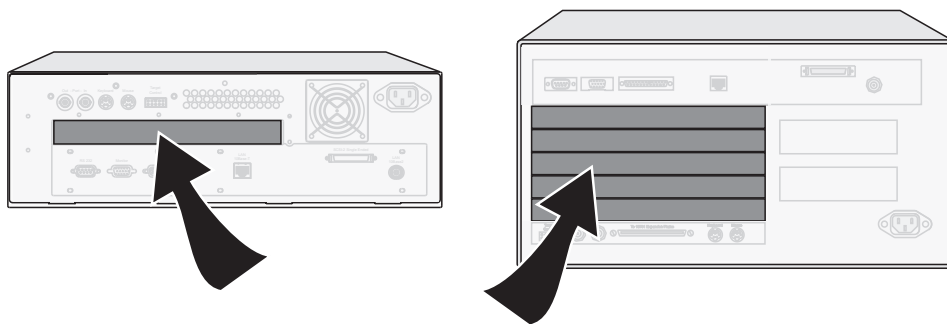

- 3** Reinstall the HP 16533A/34A module into the mainframe and reconnect the power cable.

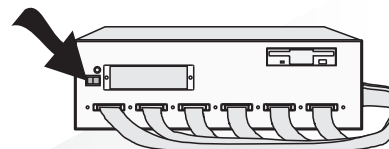

HP 16600A Series



Monitor power ON.  
(If applicable)

- 5** System power ON



HP 16700A



HP 16702A

# HP 16533/34A Calibration

for HP 16600A Series/ HP 16700A/ HP 16702A

## Single-Card Module



- 6** For more accurate calibration, allow the system 30 minutes to warm up.

- 7** Connect the BNC Tee and the (equal length) BNC cables to the module.

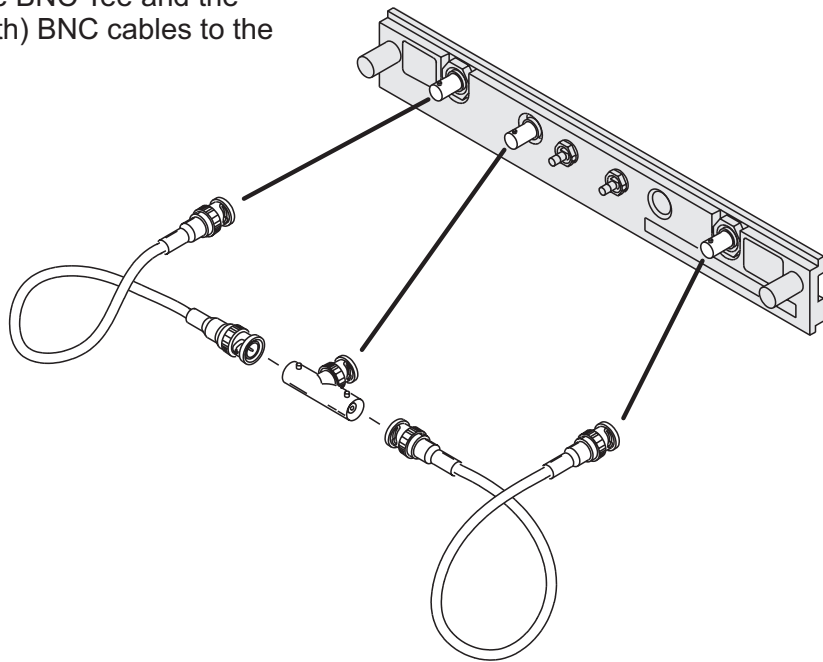

# HP 16533/34A Calibration

for HP 16600A Series/ HP 16700A/ HP 16702A

## Single-Card Module

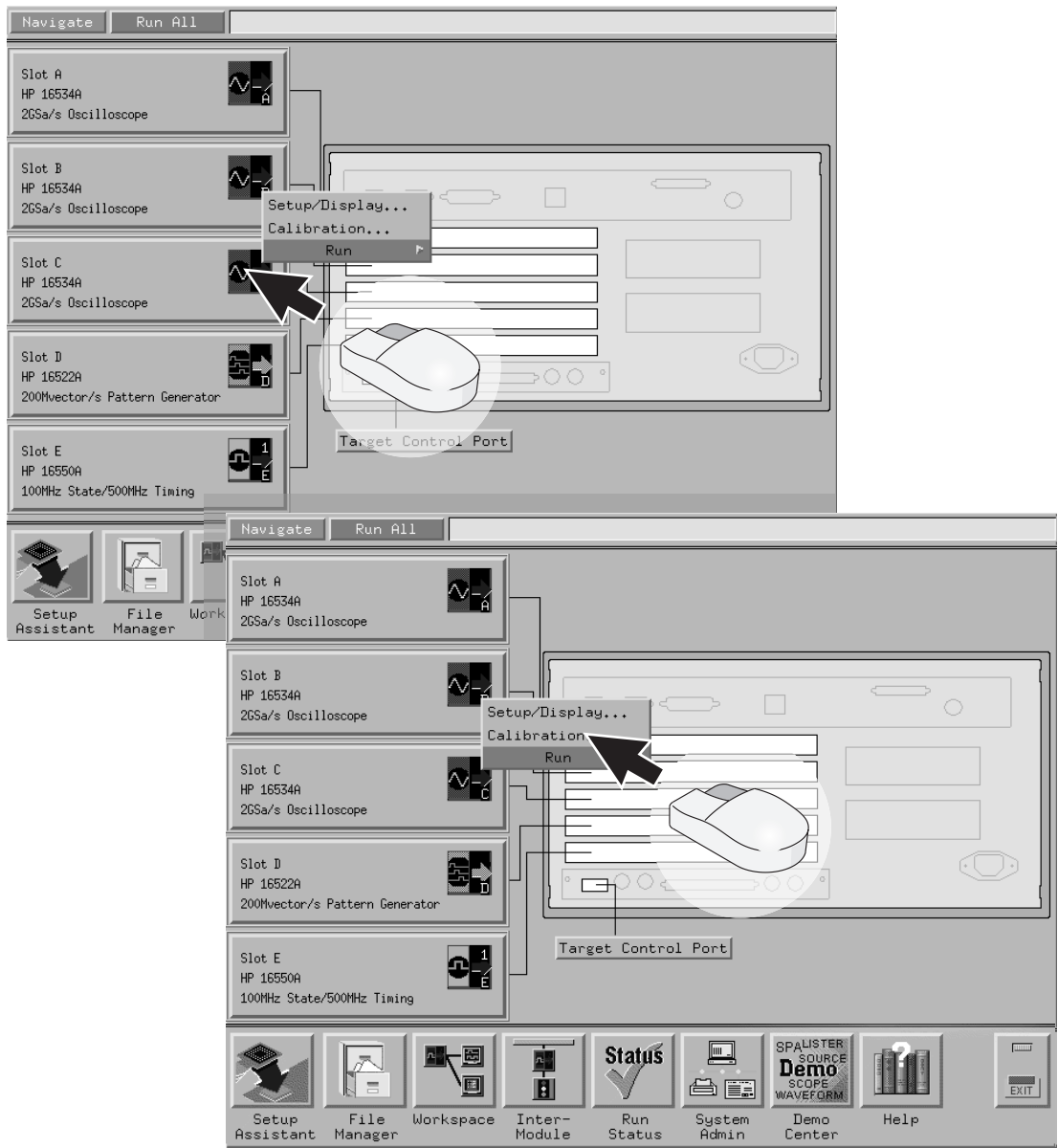



# HP 16533/34A Calibration

for HP 16600A Series/ HP 16700A/ HP 16702A

## Single-Card Module

File Help

Navigate Run

First select a Calibration Procedure, then press Run to begin calibration.

Calibration Controls

Procedure ADC through Logic Trigger

Ext Trig Skew

PROCEDURE	CHAN 1	CHAN 2	EXT TRIG
ADC	Pass	Pass	
Gain	Pass	Pass	
Offset	Pass	Pass	
Hysteresis	Pass	Pass	
Trigger Level	Pass	Pass	
Trigger Delay	Pass	Pass	
Logic Trigger	Pass	Pass	
Channel Skew			
Ext Trig Skew			Default

Calibration Utility Controls

BNC Output Probe Comp

Default Factors

Close

Channels 1 and 2 must be connected to the rear panel AC/DC CAL BNC with equal length cables. This will take approximately 15 minutes to complete. Are you ready to continue the calibration?

OK Cancel

File Help

Navigate Run

First select a Calibration Procedure, then press Run to begin calibration.

Calibration Controls

Procedure ADC through Logic Trigger

PROCEDURE	CHAN 1	CHAN 2	EXT TRIG
ADC	Pass	Pass	
Gain	Pass	Pass	
Offset	Pass	Pass	
Hysteresis	Pass	Pass	
Trigger Level	Pass	Pass	
Trigger Delay	Pass	Pass	
Logic Trigger	Pass	Pass	
Channel Skew			
Ext Trig Skew			Default

Calibration Utility Controls

BNC Output Probe Comp

Default Factors

Close

# HP 16533/34A Calibration

for HP 16600A Series/ HP 16700A/ HP 16702A

## Single-Card Module

Connect the BNC Tee, adapter, and the (equal length) BNC cables to the module.

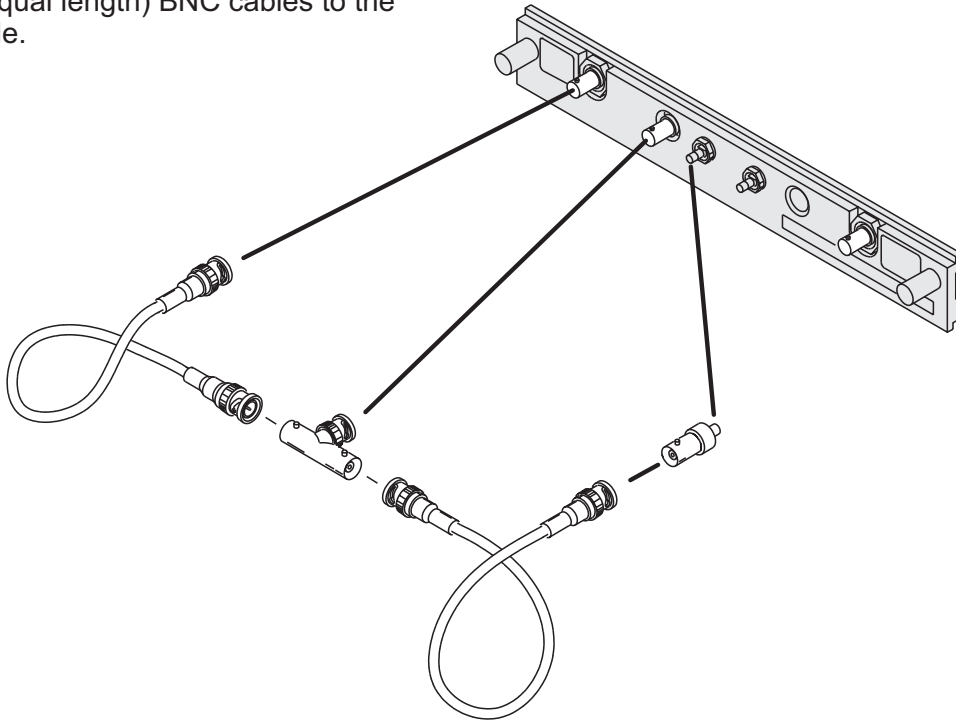

# HP 16533/34A Calibration

for HP 16600A Series/ HP 16700A/ HP 16702A

## Single-Card Module

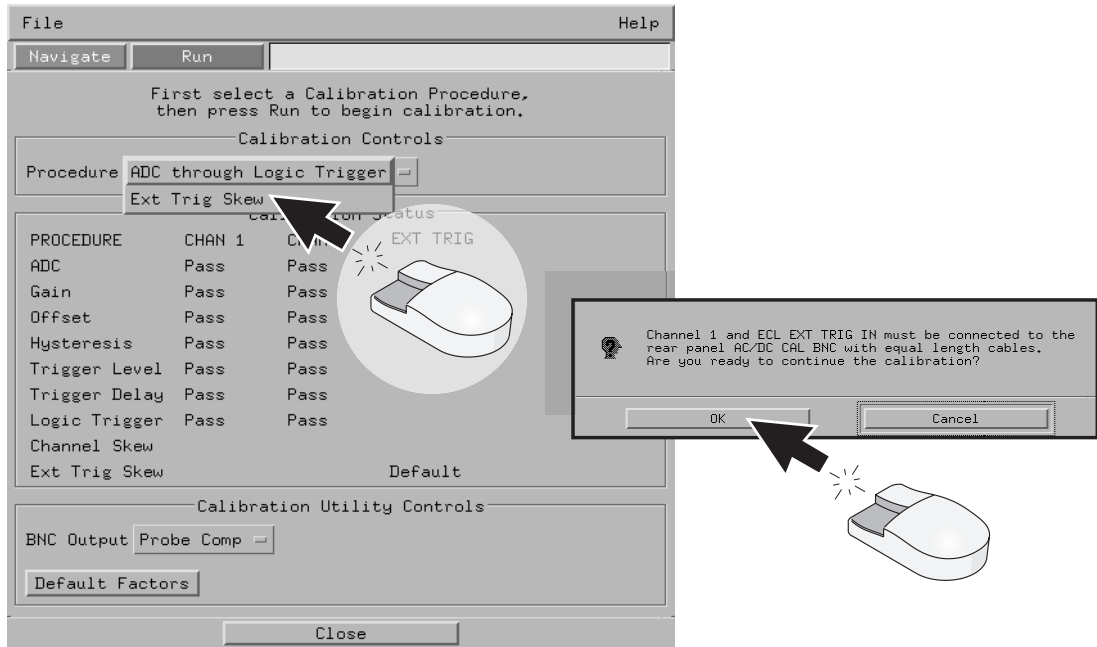

### Note!

Remember to set the PROTECTED/ UNPROTECTED switch back to PROTECTED.

Single Module Calibration

**Done**

# HP 16533/34A Calibration

for HP 16700A and HP 16702A

## Multi-Card Module

**Note!** Each of the individual boards of a multi-card module must first be calibrated as a single. (See previous pages: *HP 16533/34A Single-Card Module*.)

The following example is of a two-card module arrangement. Up to four cards may be configured as a module in an HP 16700A or an HP 16702A mainframe.

- Master
- Expander 1
- Expander 2
- Expander 3

**1** Connect the module cables.

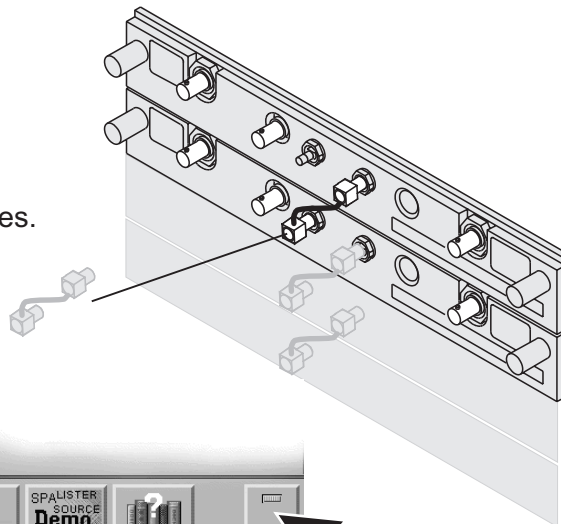

**2** Exit the current session and restart.

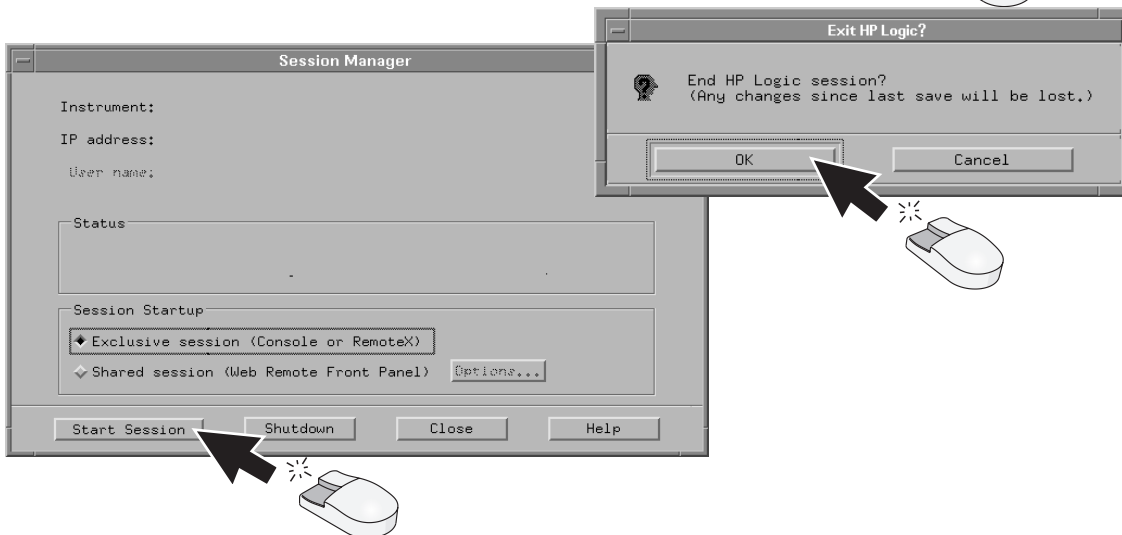
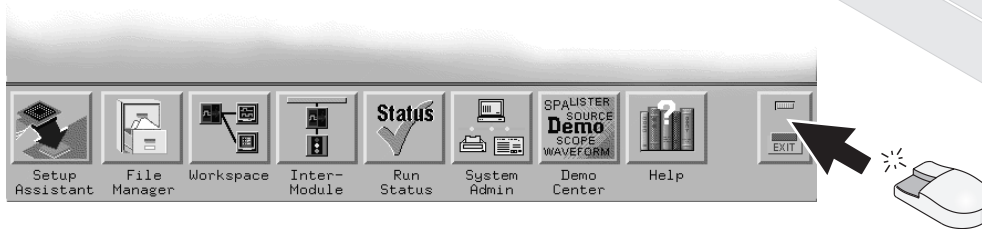

# HP 16533/34A Calibration

for HP 16700A and HP 16702A  
**Multi-Card Module**

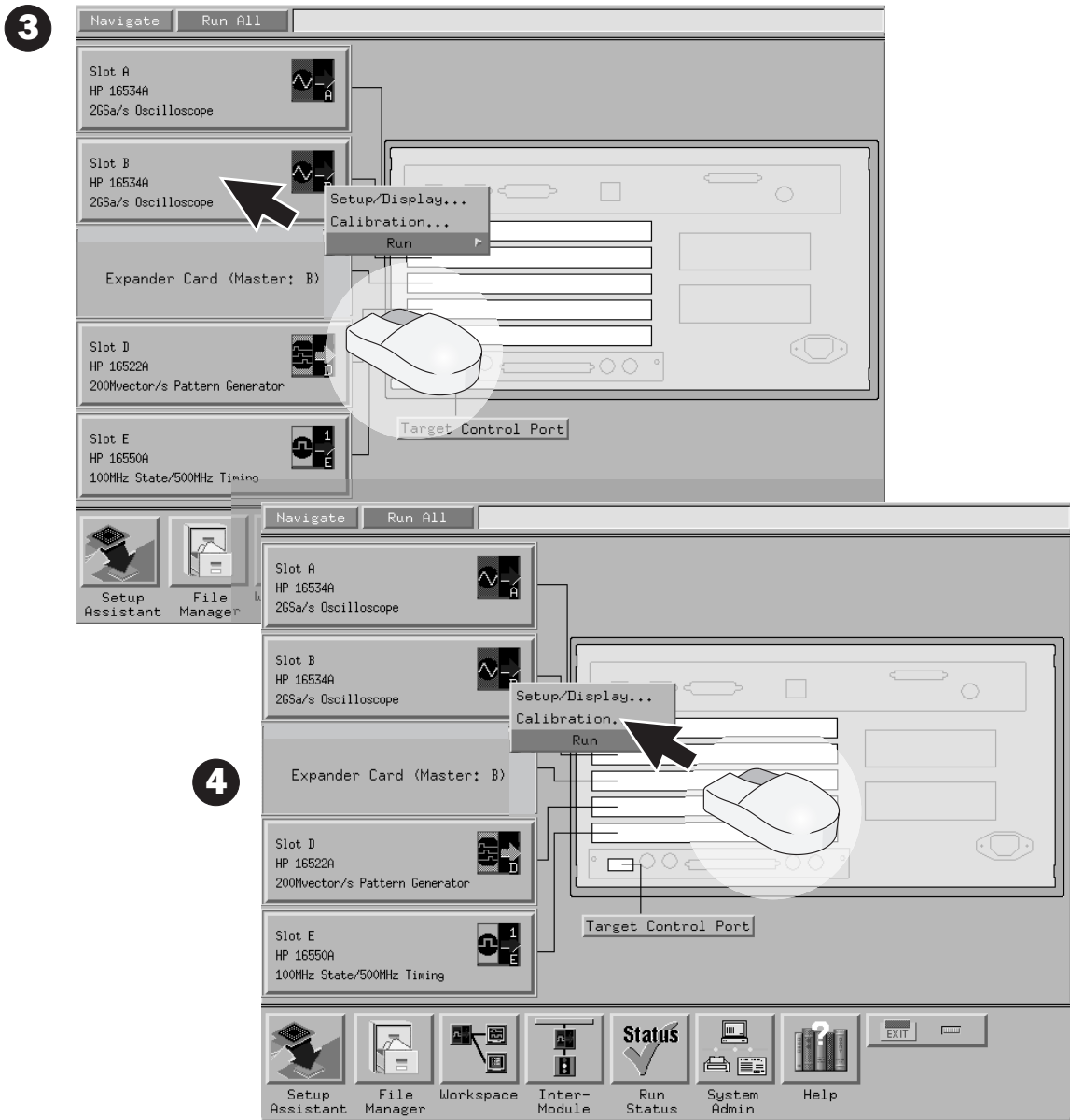

16533p09

# HP 16533/34A Calibration

for HP 16700A and HP 16702A

## Multi-Card Module

- 5** Connect the (equal length) BNC calibration between channel 1, AC/DC cal, and channel 1 of the second card. (Channel 1 of the third card next time etc. up to four cards.)

Chan. 1	Chan. 2
Chan. 1	Chan. 2
Chan. 1	Chan. 2
Chan. 1	Chan. 2

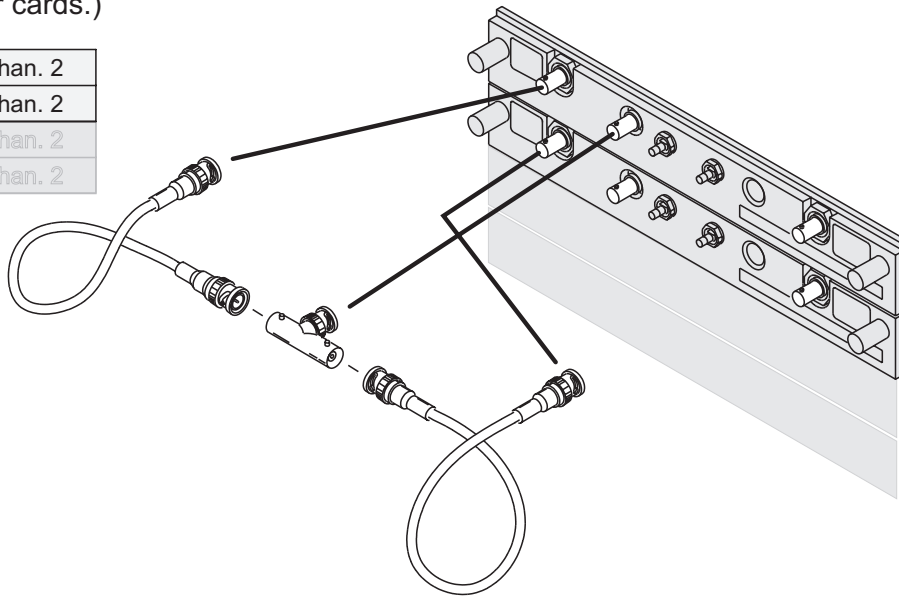

**6**



### Note!

Repeat steps 3 through 6 for each additional card in your multi-card module.

Select the appropriate combination for each additional card.

Remember to set the PROTECTED/ UNPROTECTED switch back to PROTECTED.

Multi-Module Calibration

**Done**

# HP 16550A

for HP 16600A Series/ HP 16700A/ HP 16702A

## Single-Card Module

### Note!

When ordered by itself, the card is cabled as a single module. Directions for connecting the cables are also printed on the circuit board.

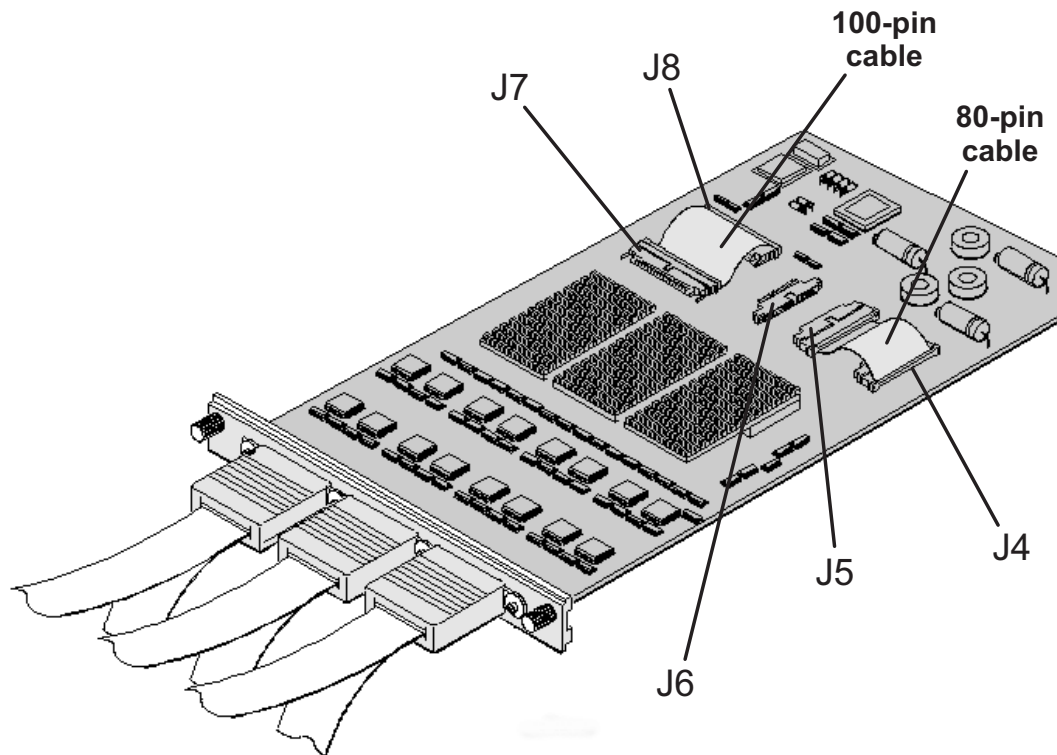

# HP 16550A

for HP 16700A and HP 16702A

## 2-Card Module

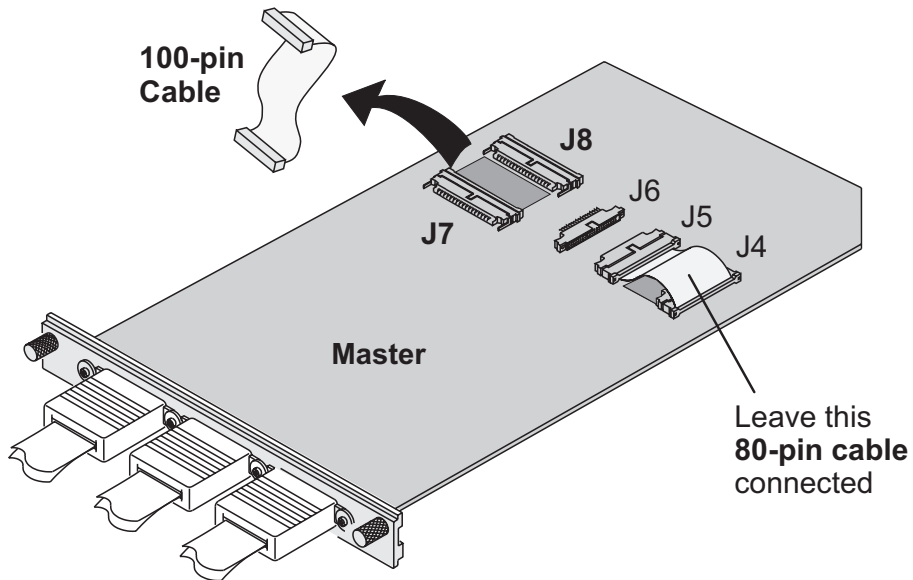
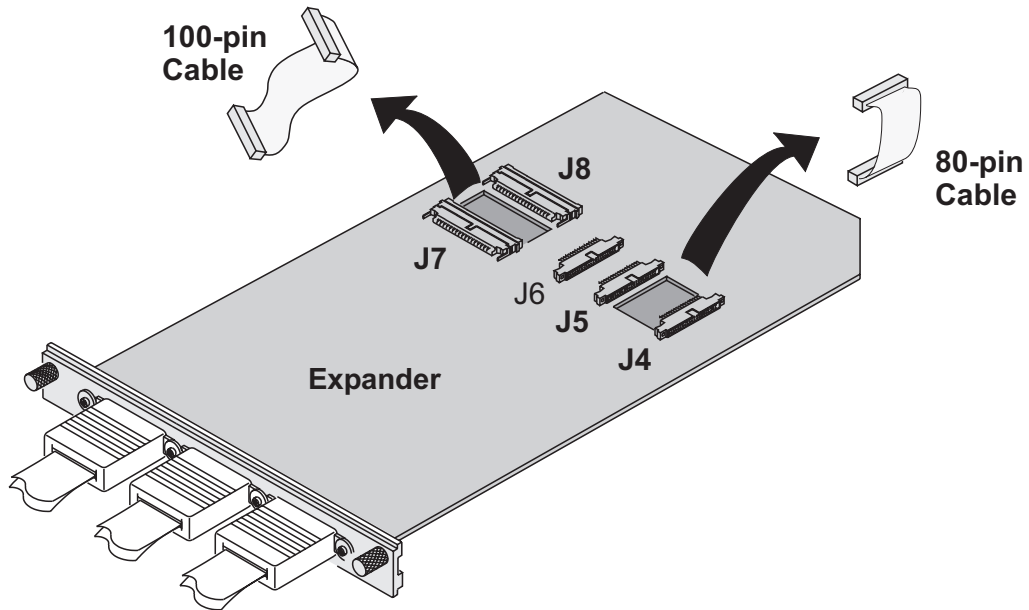



# HP 16550A

for HP 16700A and HP 16702A

## 2-Card Module

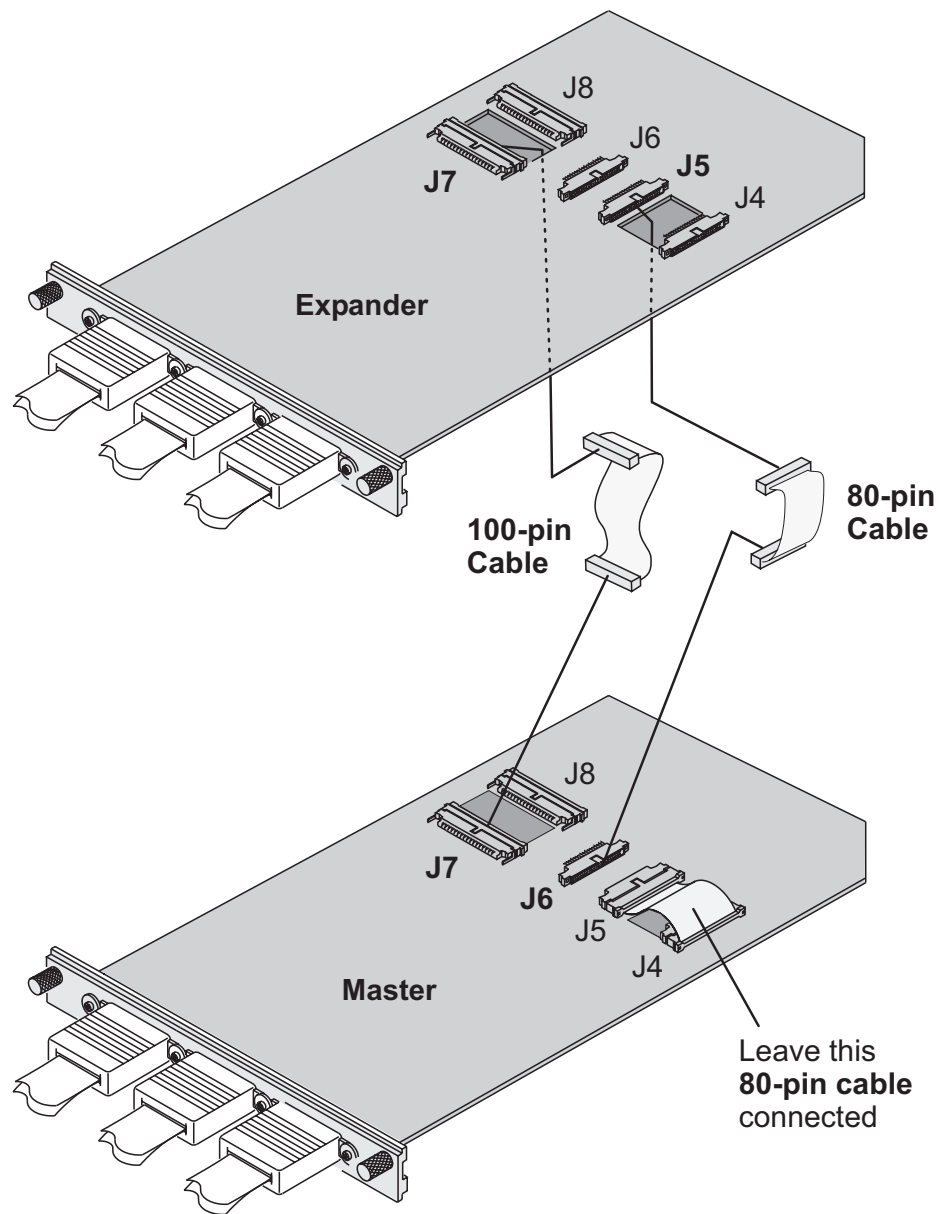

# HP 16550A

for HP 16700A and HP 16702A

## 2-Card Module

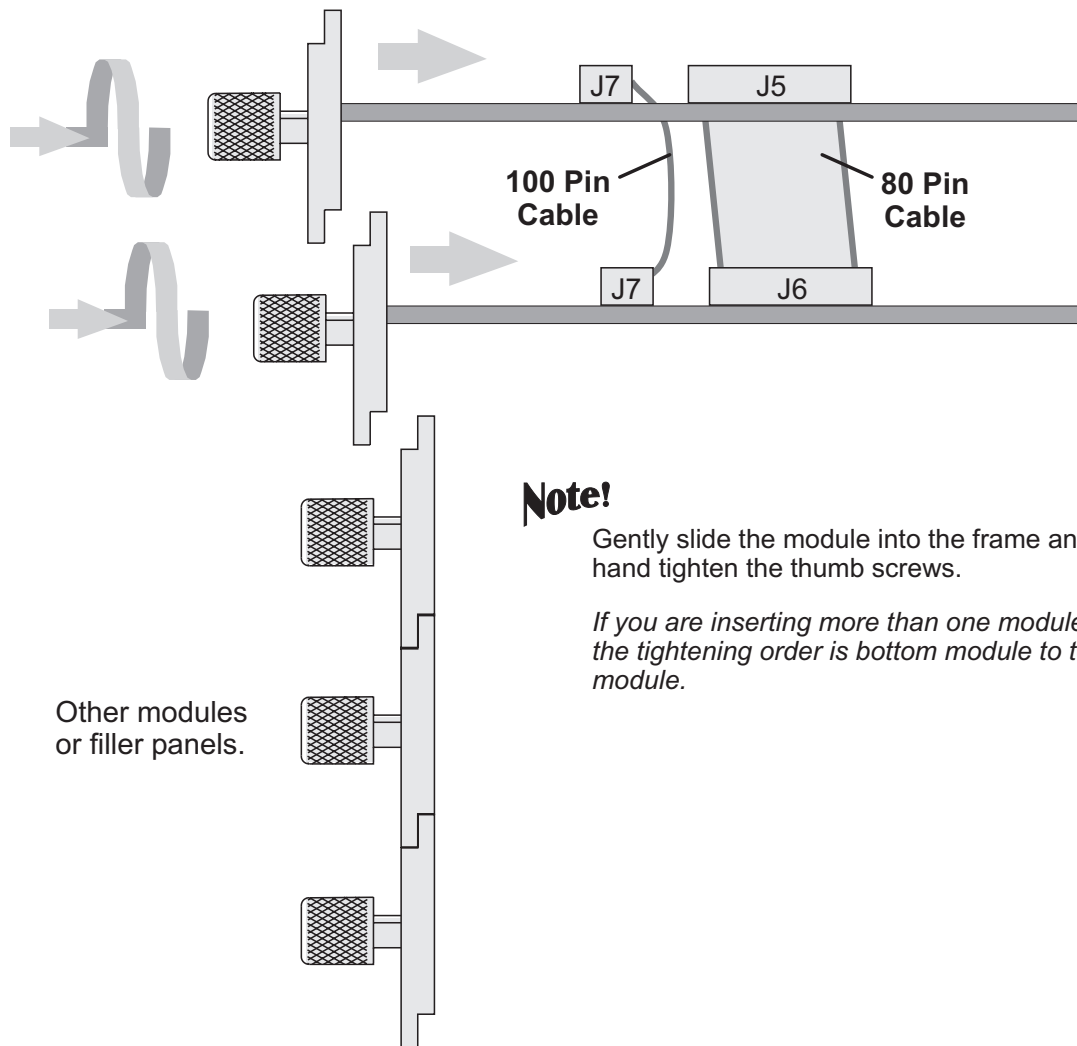

### Note!

Gently slide the module into the frame and hand tighten the thumb screws.

*If you are inserting more than one module, the tightening order is bottom module to top module.*

# HP 16550A

for HP 16700A and HP 16702A

## Multi-Module

Here are some examples of HP 16550A single and multi-card module arrangements.

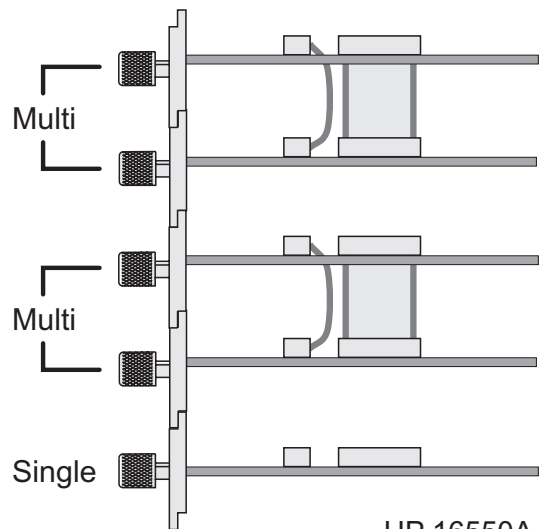
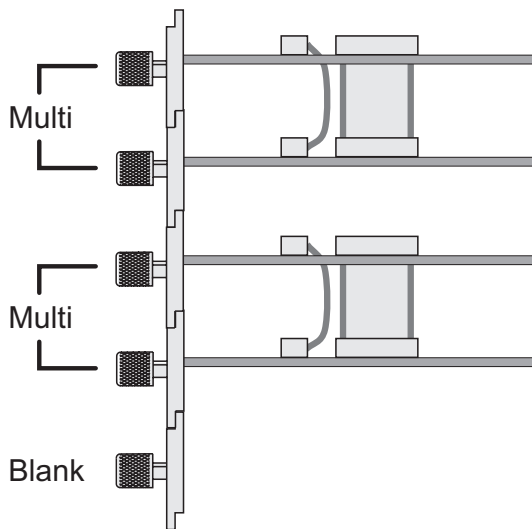
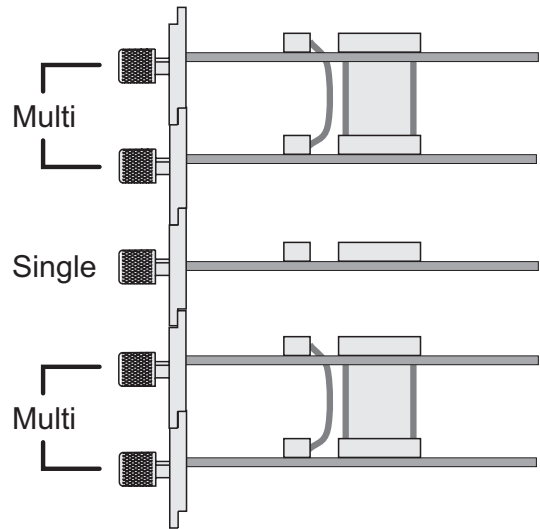
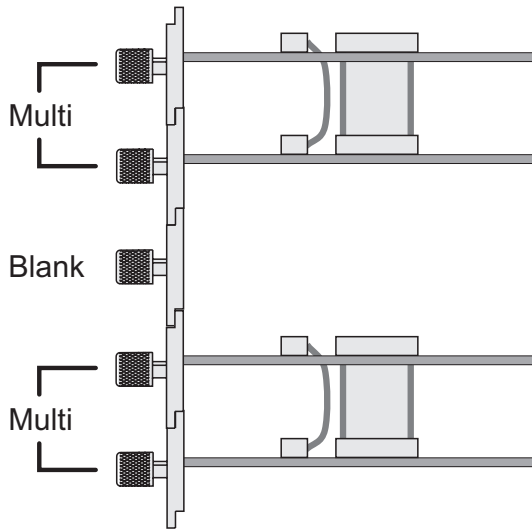

HP 16550A  
**Done**

# HP 16557D

for HP 16600A Series/ HP 16700A/ HP 16702A

## Single-Card Module

When ordered as a single card, the HP 16557D is shipped with the **2x10 cable** factory configured as a single card module.

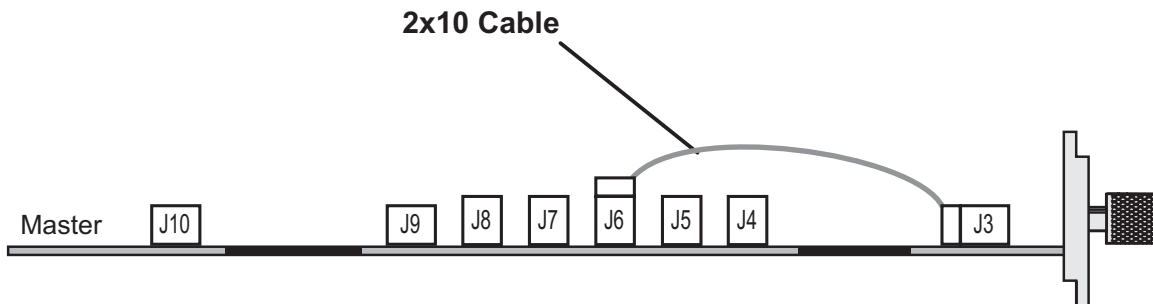
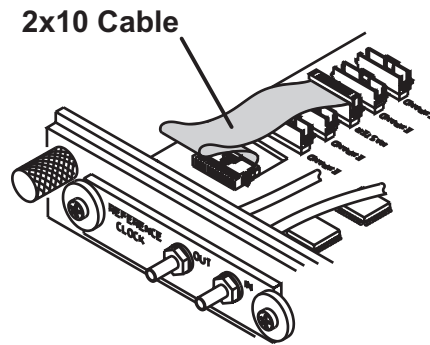

# HP 16557D

for HP 16700A and HP 16702A

## 2-Card Module

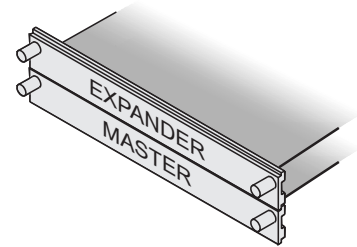

Find the required two connector **2x25 cables** and connect the cables as shown.

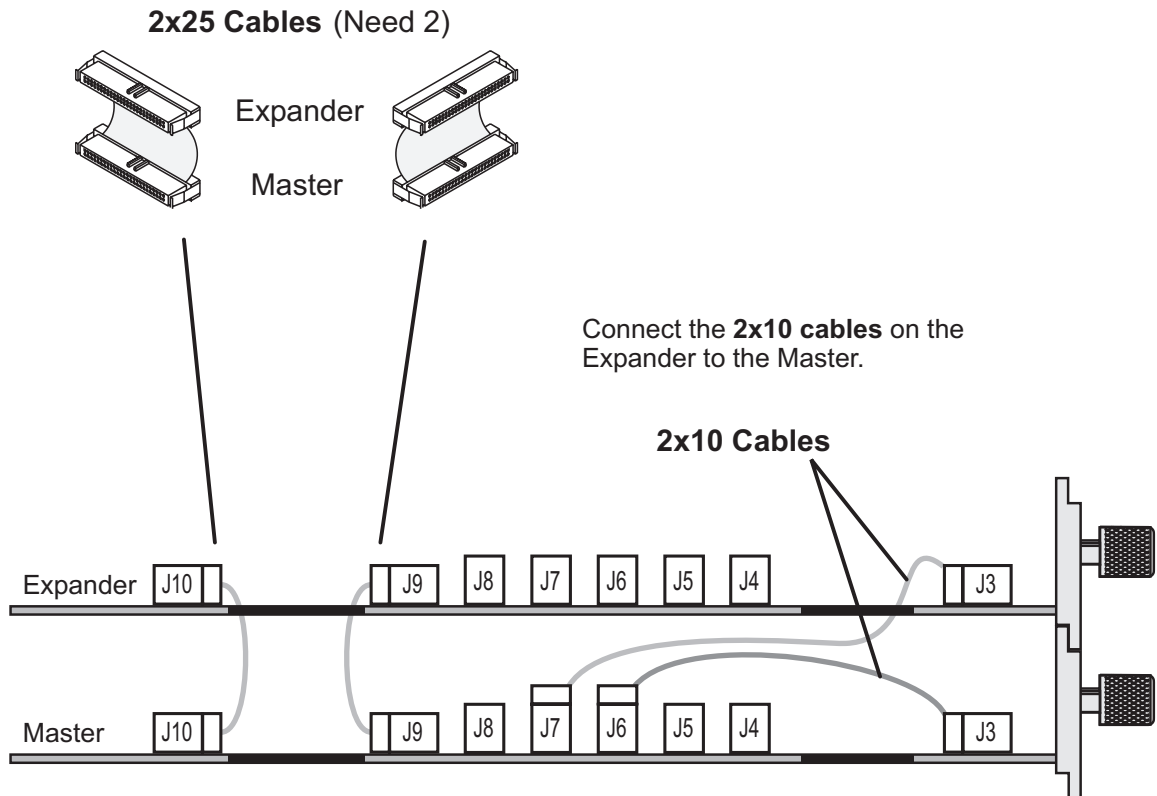

# HP 16557D

for HP 16700A and HP 16702A

## 3-Card Module

Find the required three connector **2x25 cables** and connect the cables as shown.

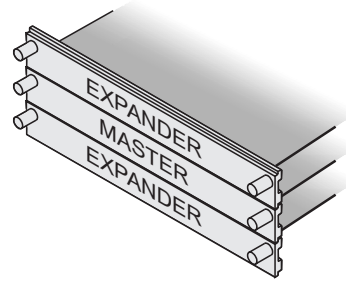

**2x25 Cables (Need 2)**

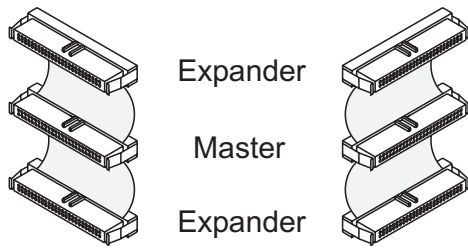

Connect the **2x10 cables** on the Expanders to the Master.

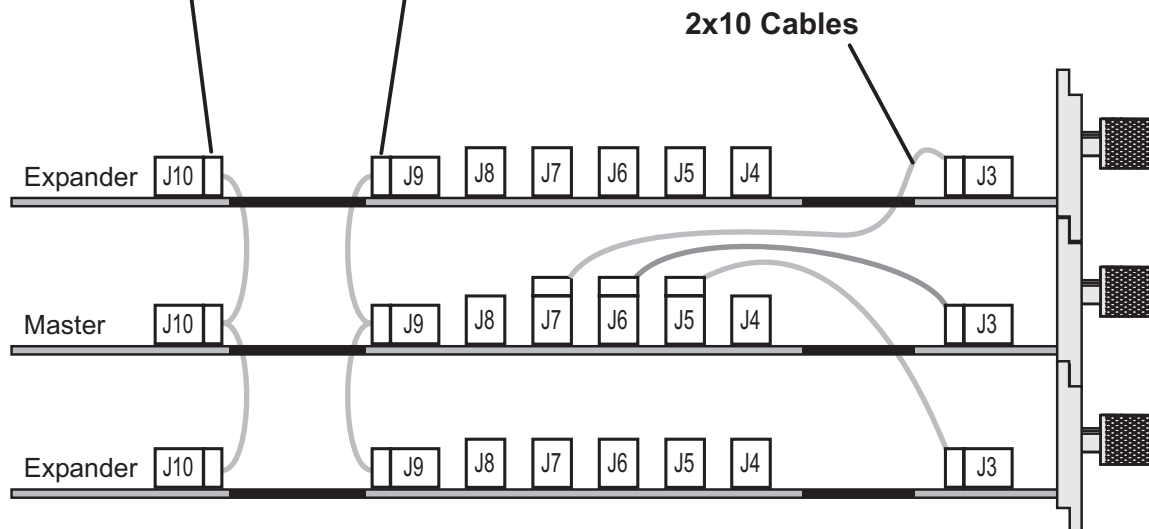

# HP 16557D

for HP 16700A and HP 16702A

## 4-Card Module

Find the required four connector **2x25 cables** and connect the cables as shown.

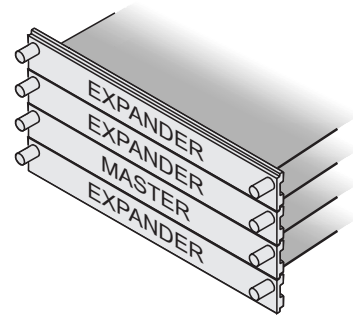

**2x25 Cables (Need 2)**

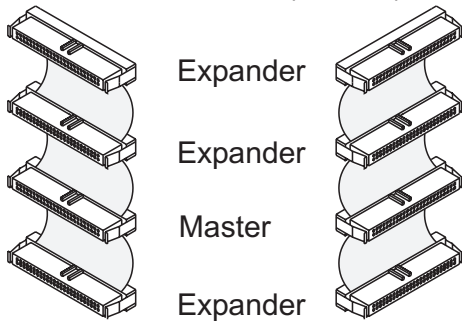

Connect the **2x10 cables** on the Expanders to the Master.

**2x10 Cables**

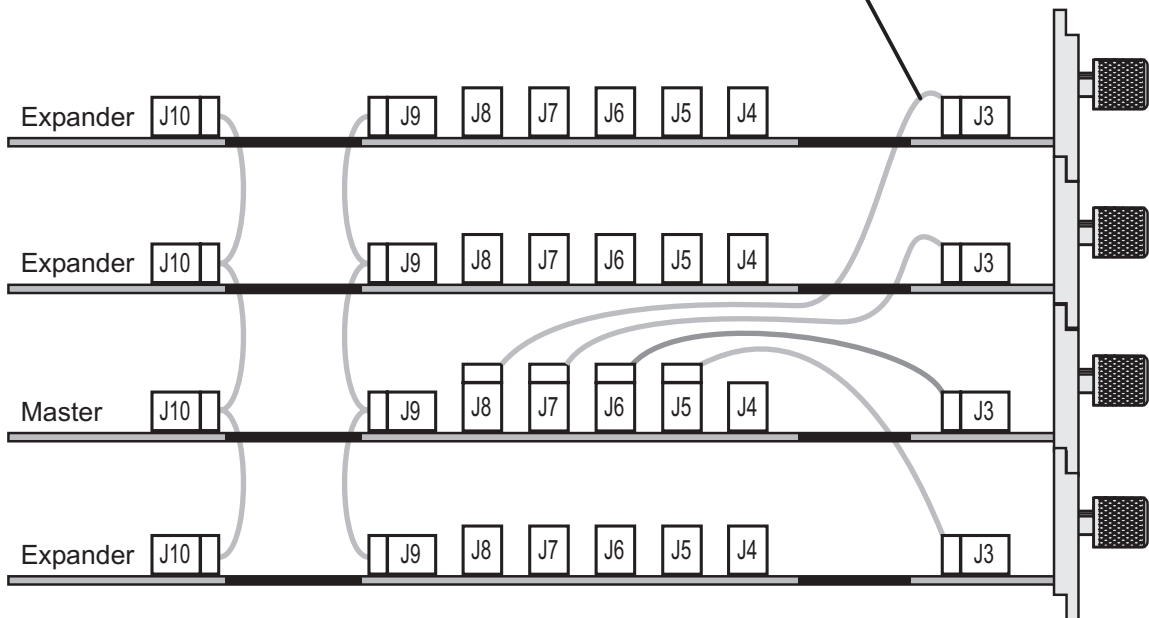

# HP 16557D

for HP 16700A and HP 16702A

## 5-Card Module

Find the required five connector **2x25 cables** and connect the cables as shown.

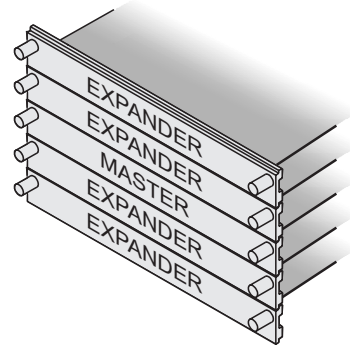

**2x25 Cables (Need 2)**

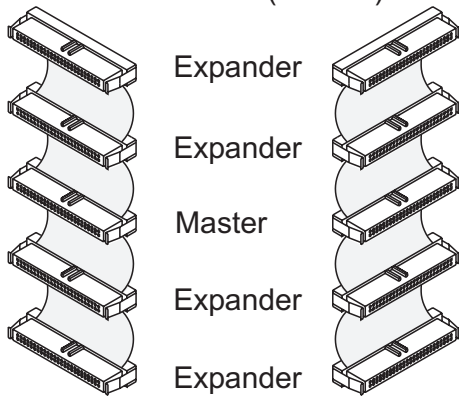

Connect the **2x10 cables** on the Expanders to the Master.

**2x10 Cables**

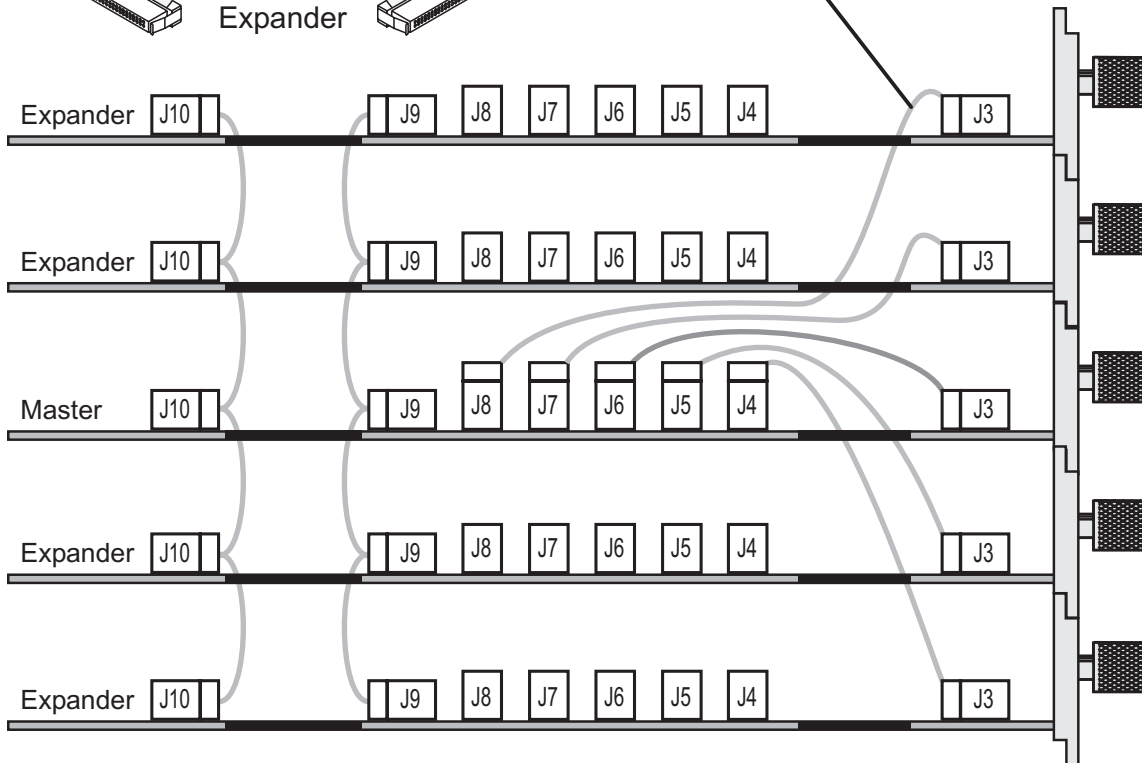



# HP 16710/11/12A

**HP 16600A Series/ HP 16700A/ HP 16702A**

## **Single-Card Module**

### **Note!**

The HP 16600A, 16700A, and 16702A require Rev. A.01.20.00 or higher. See the Software Installation chapter in the book. Select HP1660X-70XA.

A single HP 16710A, 16711A, and 16712A will have the **2x40** cable connected in the single-card configuration.

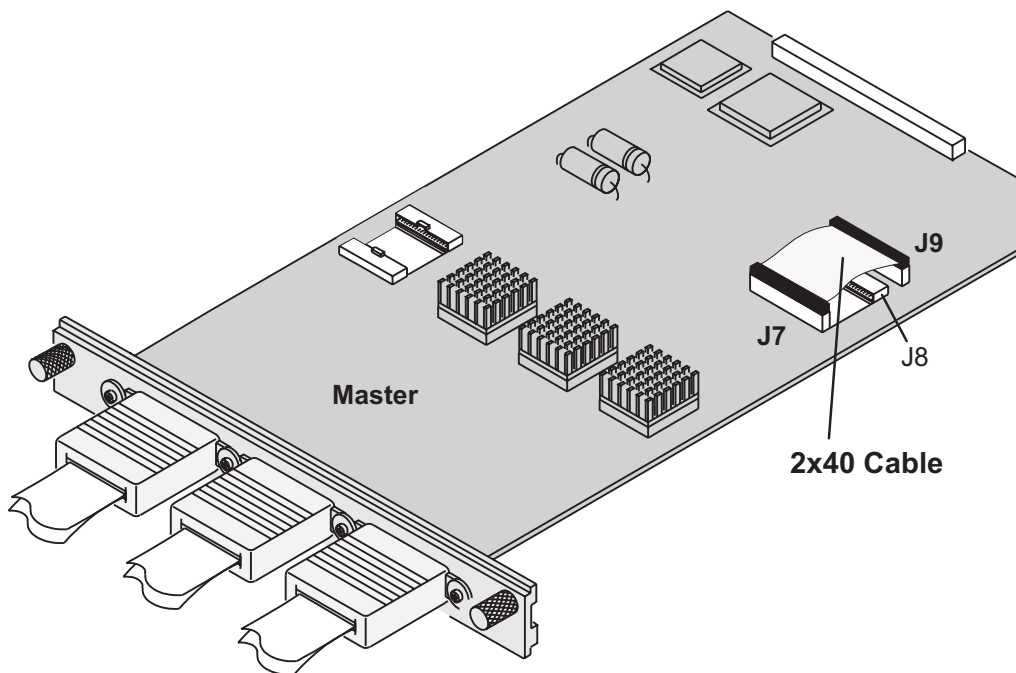

# HP 16710/11/12A

for HP 16700A and HP 16702A

## Multi-Card Module

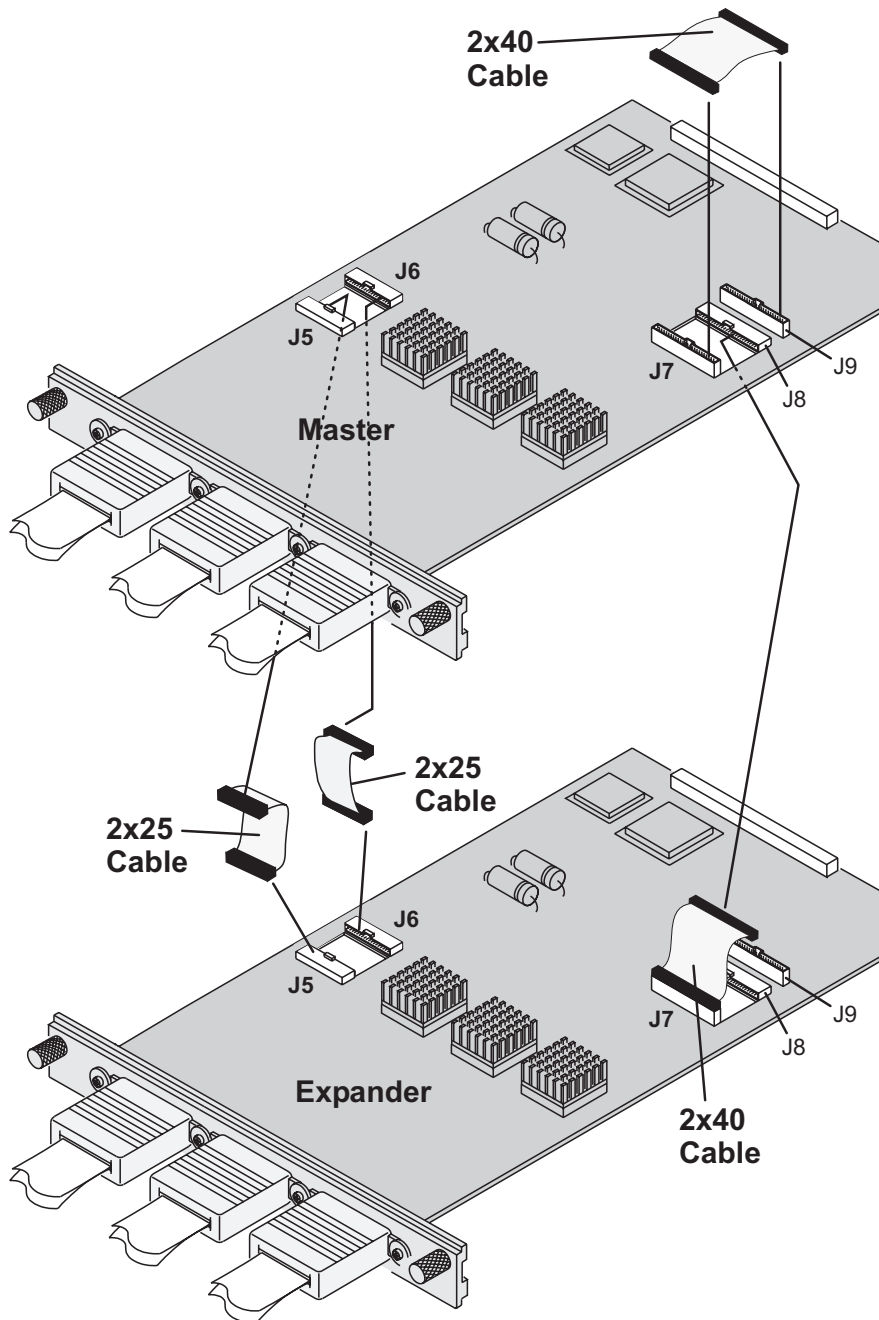

16710P03

# HP 16710/11/12A

for HP 16700A and HP 16702A

## Multi-Card Module

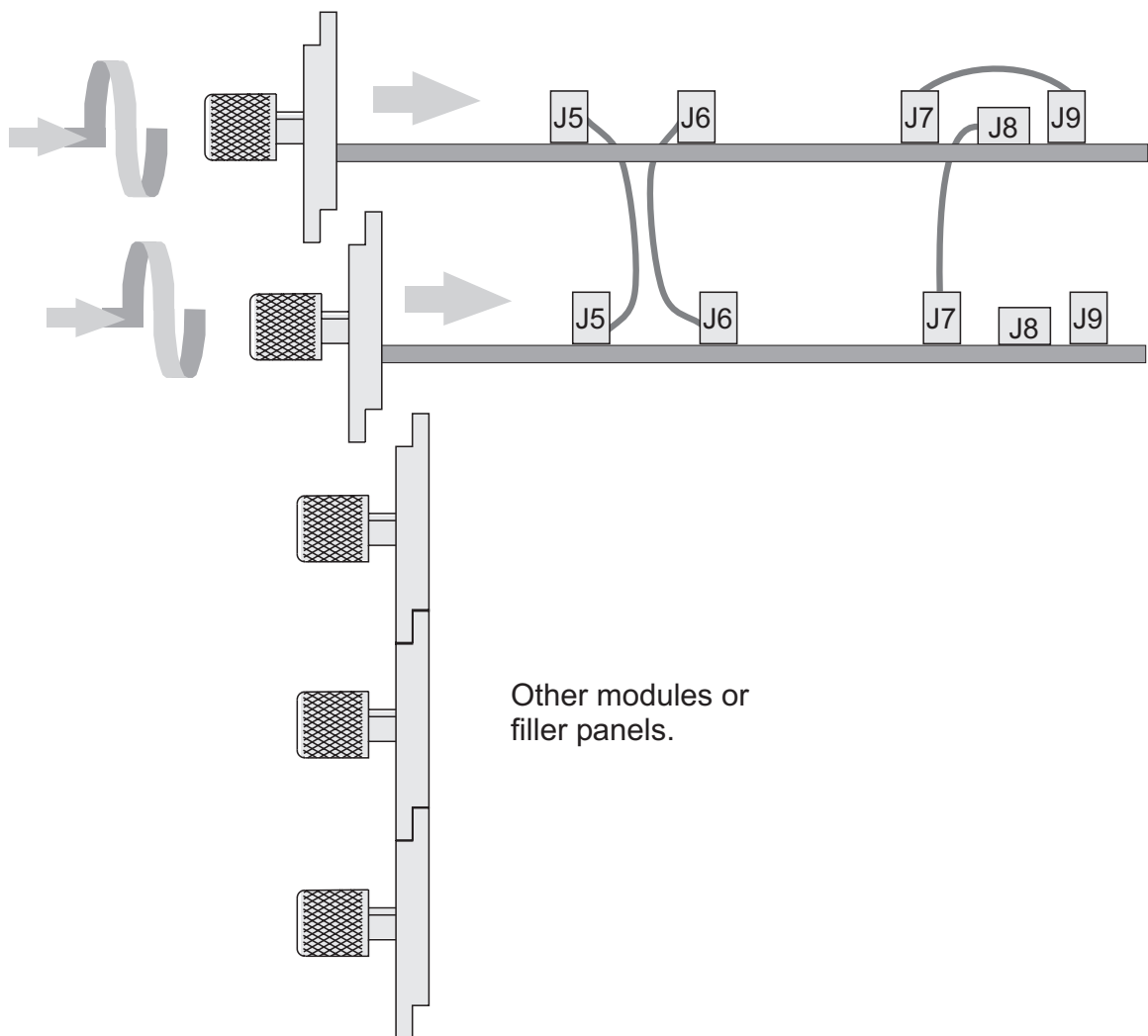

Multi-Card  
Module

**Done**

# HP 16715/16/17/18/19A

for HP 16700A and HP 16702A

## Single-Card Module

### Note!

A single HP 16715, 16, 17, 18, or 19A will have the **2x40** cable connected in the single-card configuration.

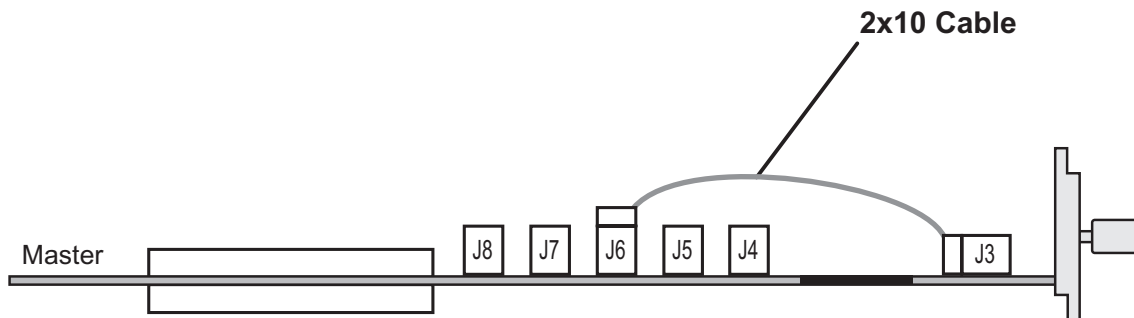

### Note!

The HP 16715, 16, and 17A's require software Rev. A.01.40.00 or higher.

HP 16718, and 19A's require software Rev. A.01.50.00 or higher. See the Software Installation chapter in this book. Select HP 1660X-70X.

# HP 16715/16/17/18/19A

for HP 16700A and HP 16702A

## 2-Card Module

Connect the **2x10 cable** of the Expander to the Master.

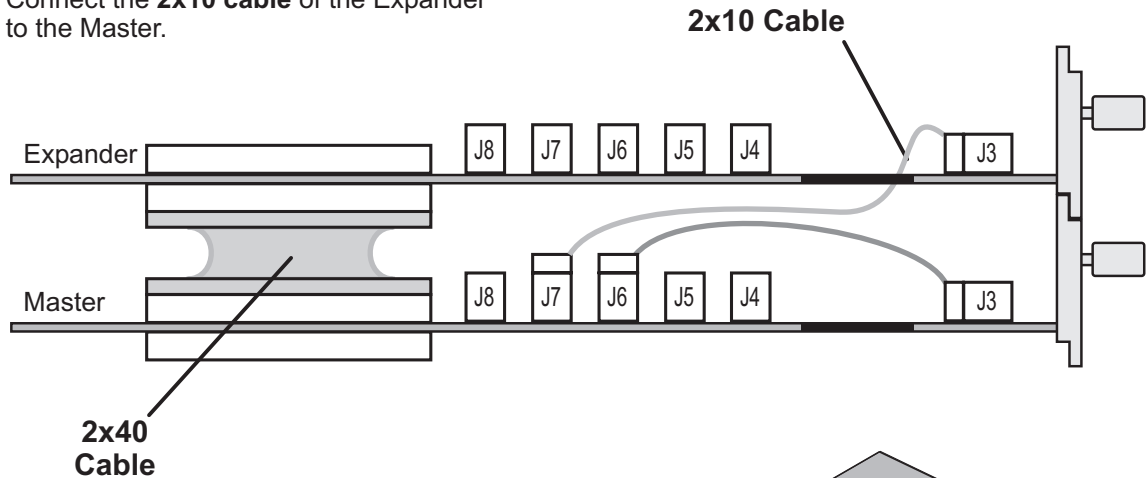

Open the accessory pouch and find two of the required **2x40 cables**. Connect the **2x40 cables** on the modules as shown.

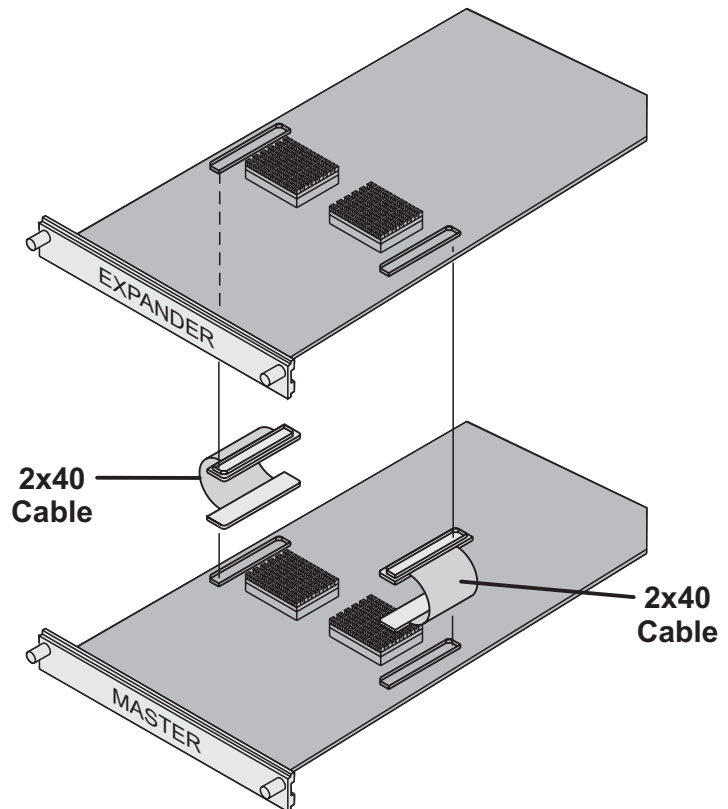

# HP 16715/16/17/18/19A

for HP 16700A and HP 16702A

## 3-Card Module

Connect the **2x10 cables** of the Expanders to the Master. Find the **2x40 cables** in the accessory pouch and connect them between the modules.

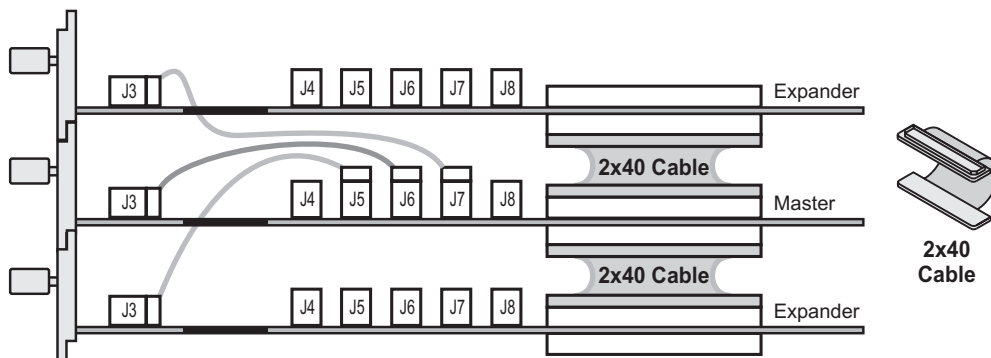
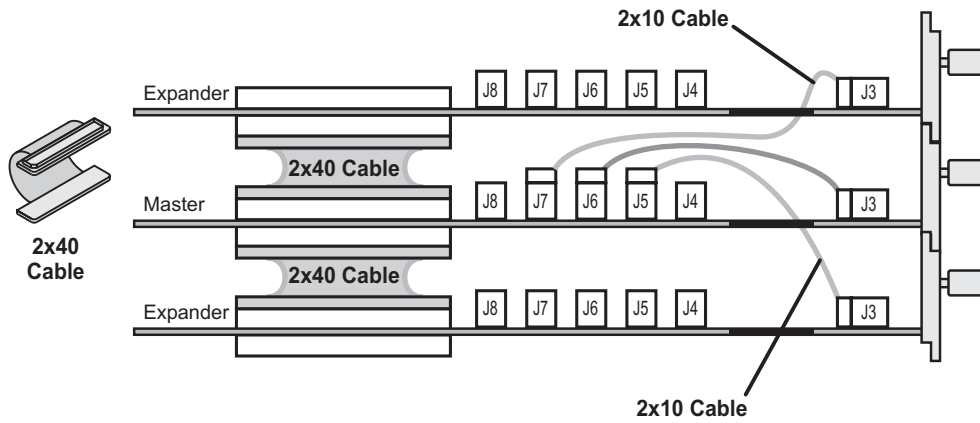

# HP 16715/16/17/18/19A

for HP 16700A and HP 16702A

## 4-Card Module

Connect the **2x10 cables** of the Expanders to the Master. Find the **2x40 cables** in the accessory pouch and connect them between the modules.

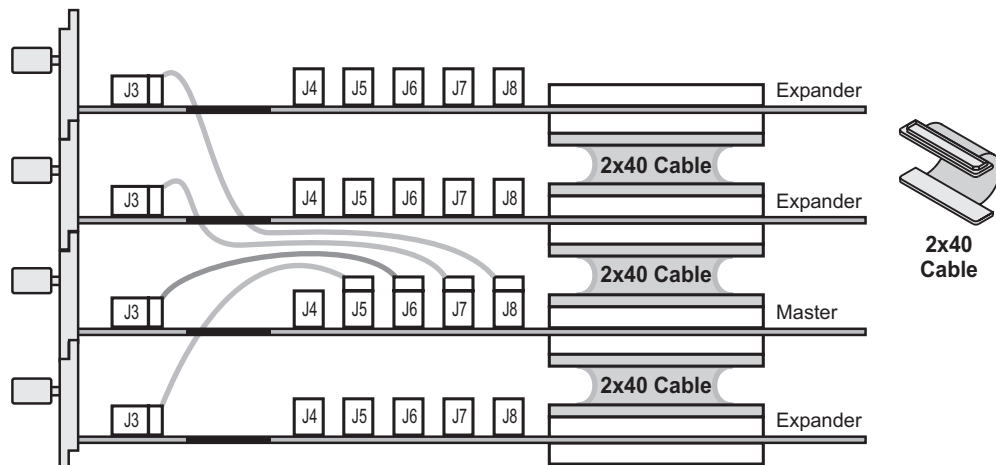
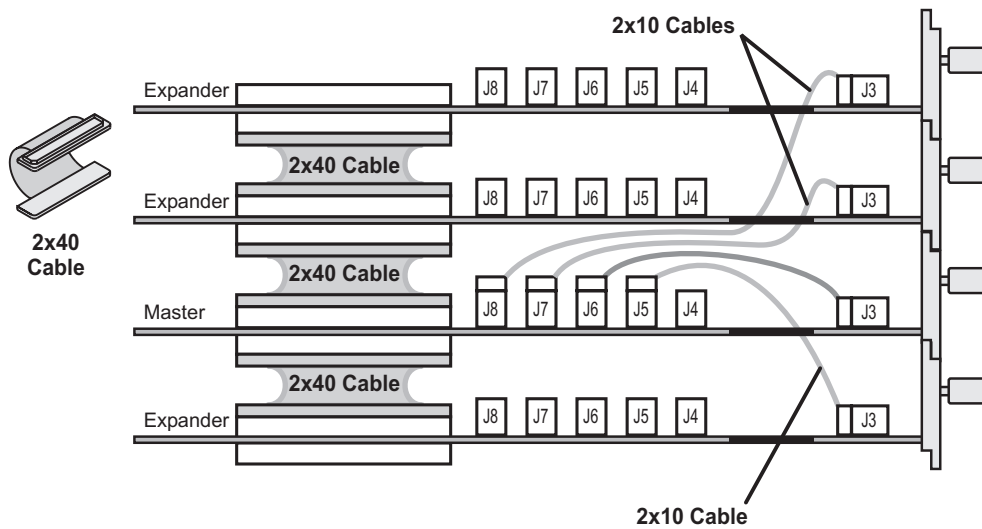

# HP 16715/16/17/18/19A

for HP 16700A and HP 16702A

## 5-Card Module

Connect the **2x10 cables** of the Expanders to the Master. Find the **2x40 cables** in the accessory pouch and connect them between the modules.

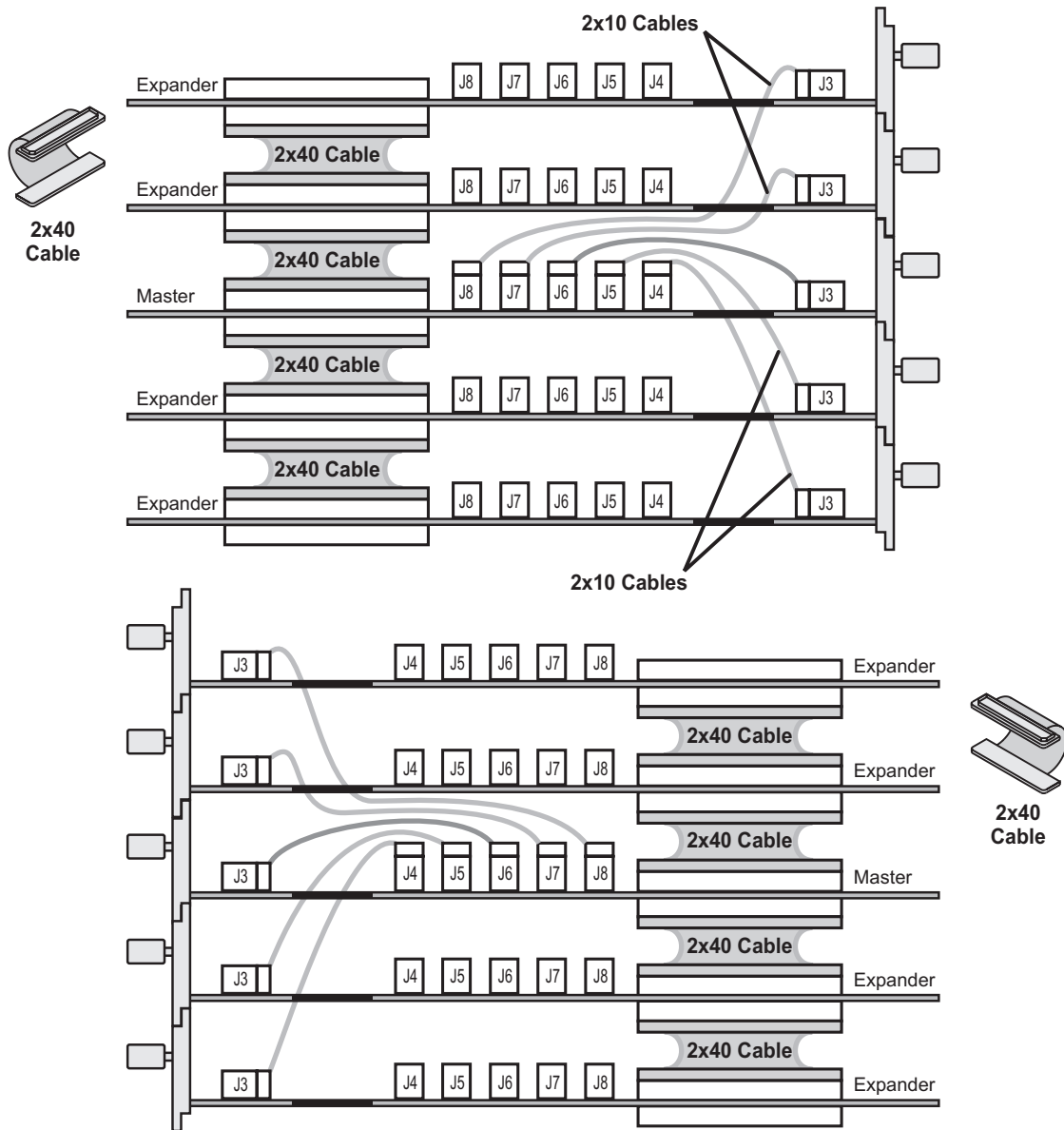



# HP E2485A

for HP 16700A and HP 16702A

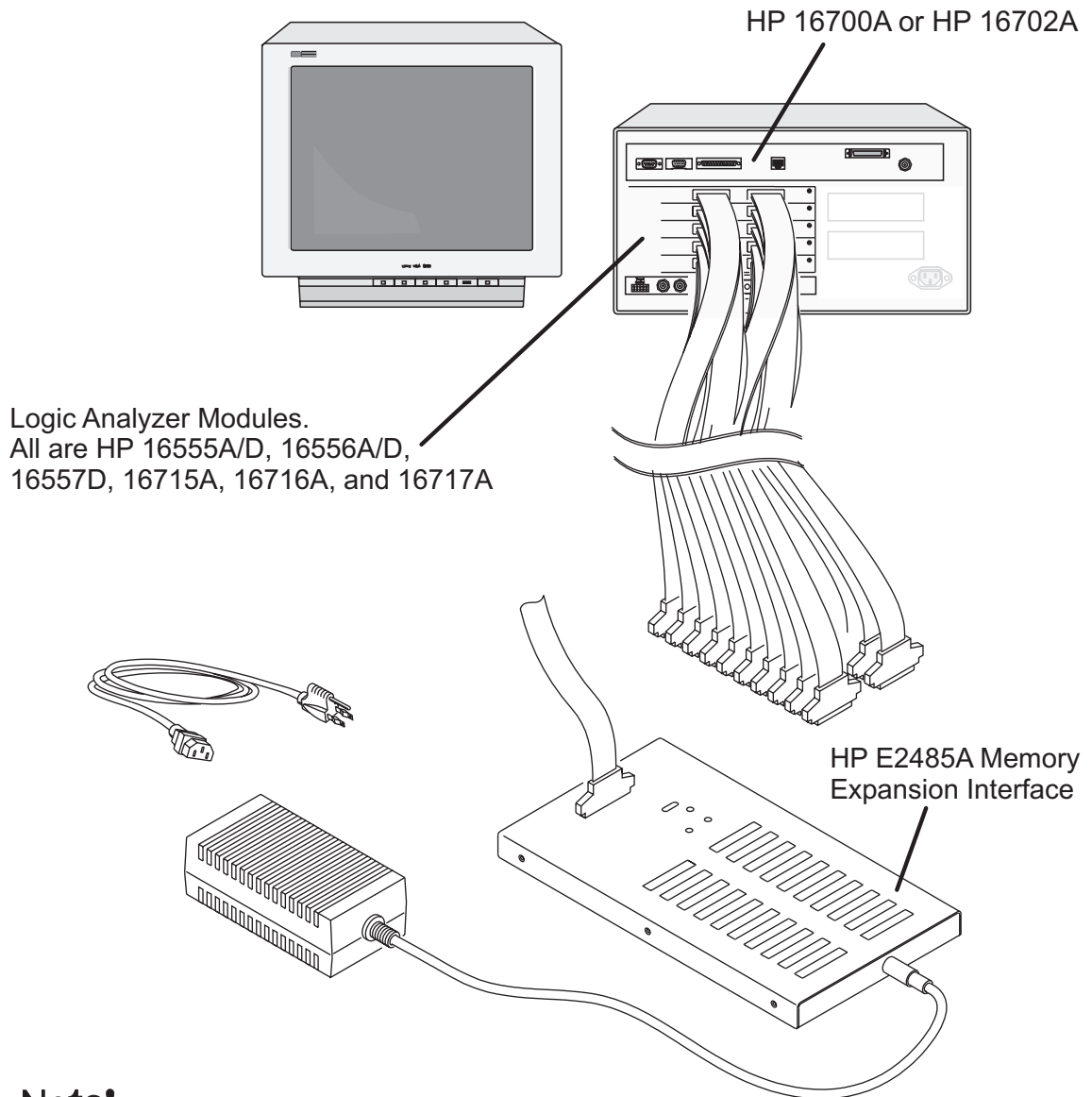

## Note!

The HP 16700A and HP 16702A require Rev. A.01.20.00 or higher and the HP E2485A software. See the software installation chapter in this book.

# HP E2485A

for HP 16700A and HP 16702A

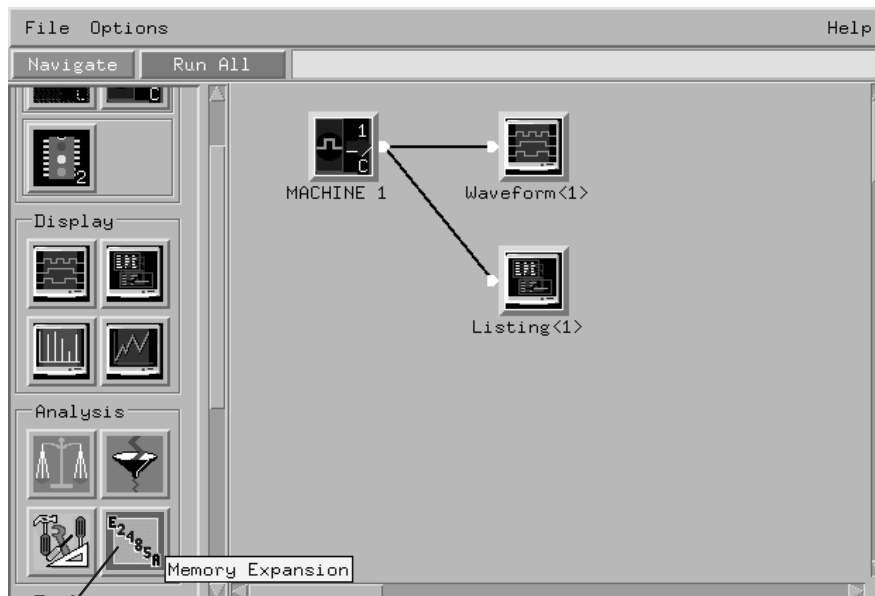
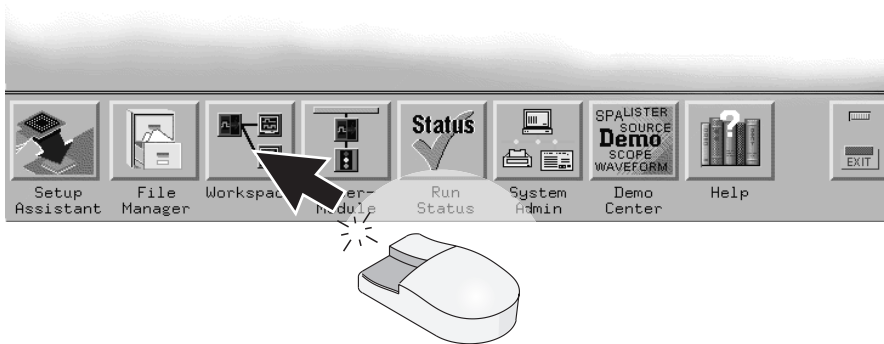

## Note!

If this icon does not appear in the toolbox, install the HP E2485A software now. See the Software Installation chapter in this book. Select *Auxiliary-SW* and *E2485A*.

# HP E2485A

**for HP 16700A and HP 16702A**

Move all pods to the unassigned pods list.

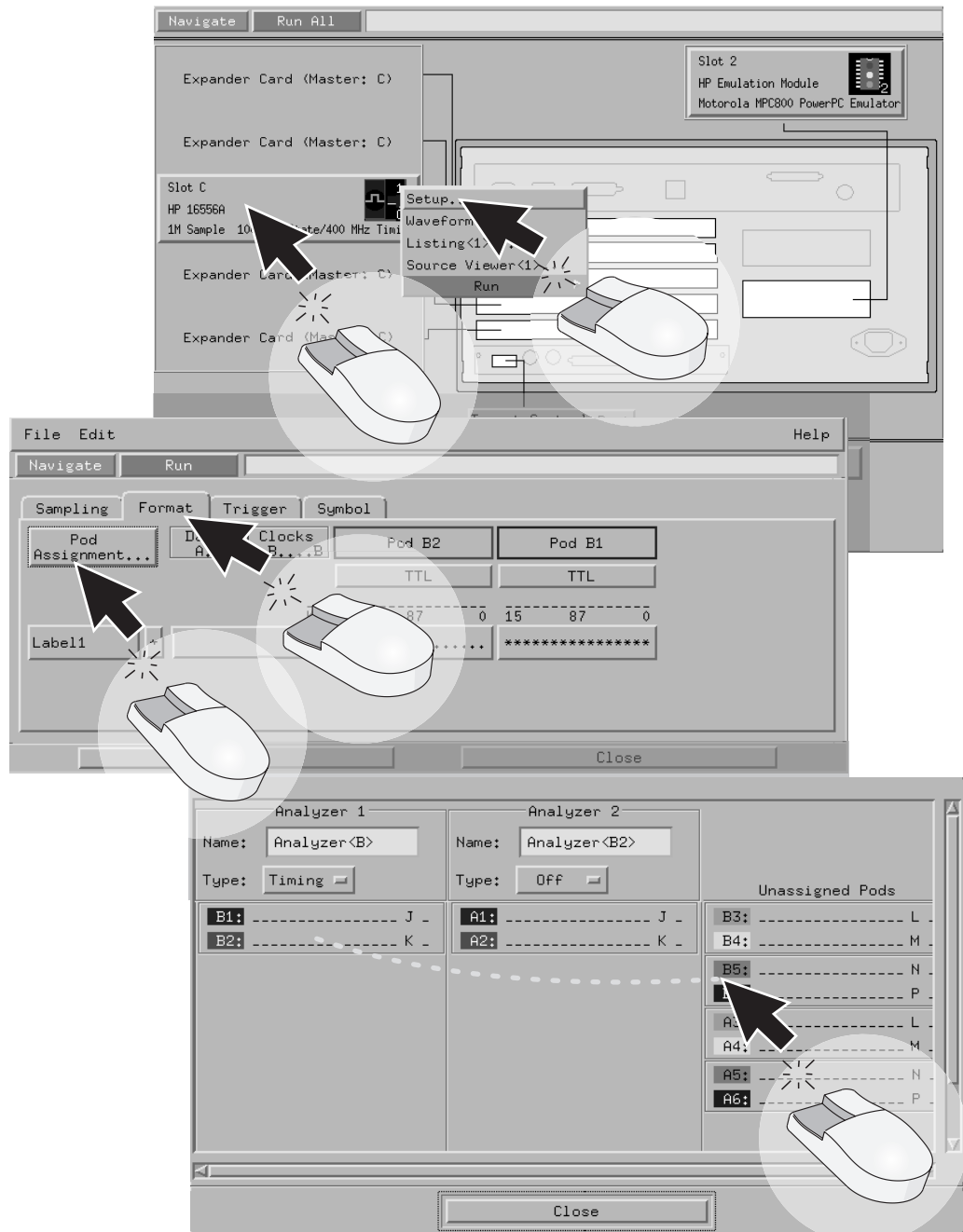

e2485p32

# HP E2485A

for HP 16700A and HP 16702A

Connect the pods of the logic analyzer module in the order on screen.

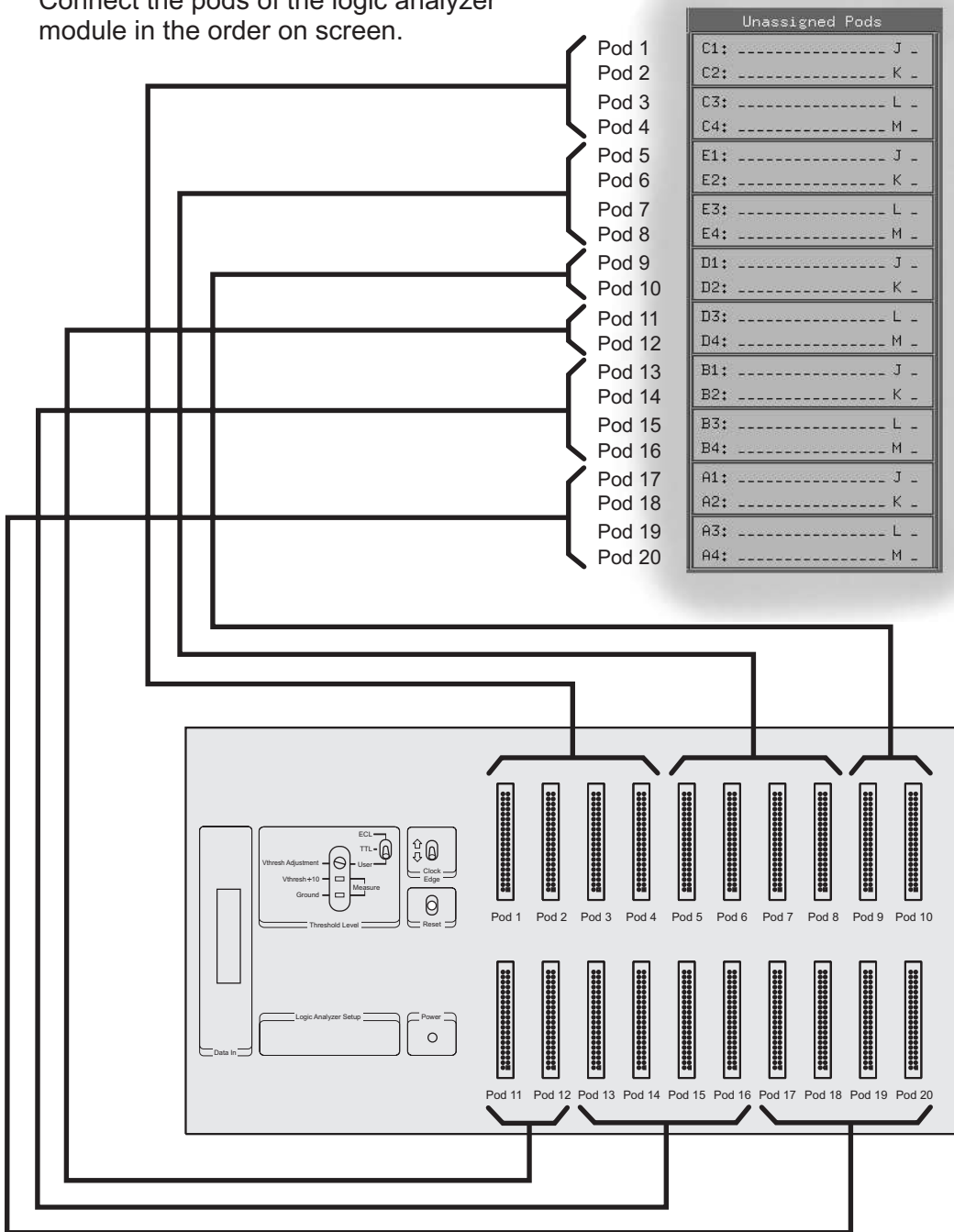

e2485p33

# HP E2485A

for HP 16700A and HP 16702A

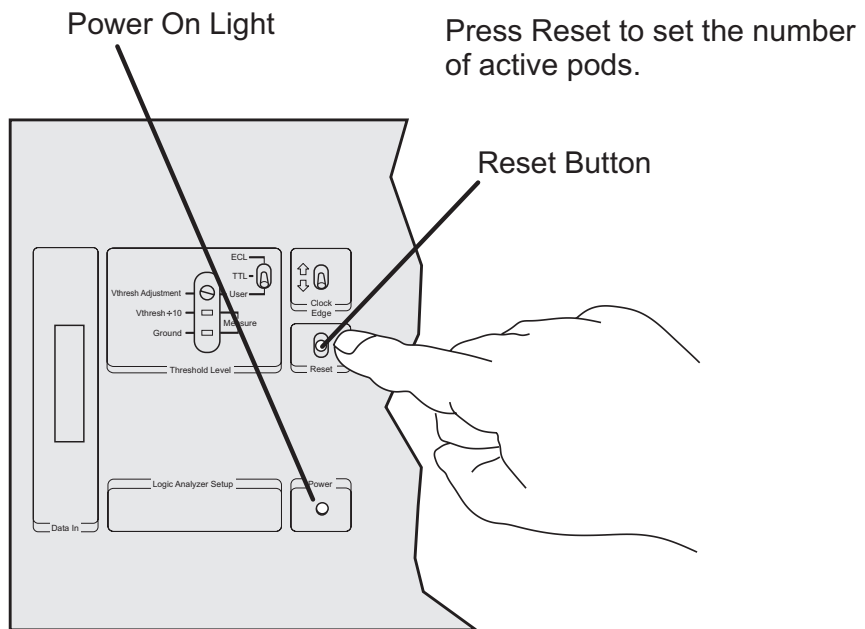
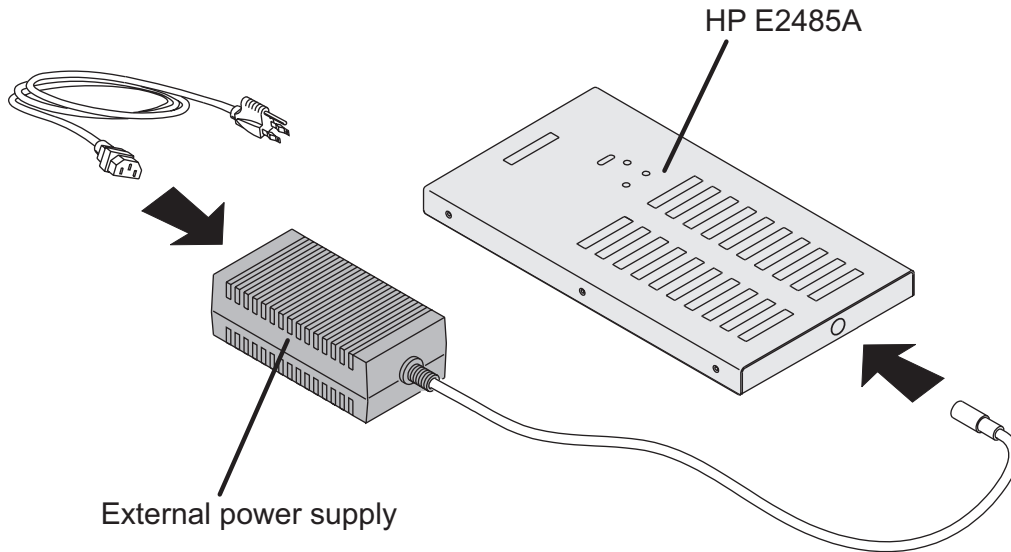

# HP E2485A

for HP 16700A and HP 16702A

Load a configuration file.

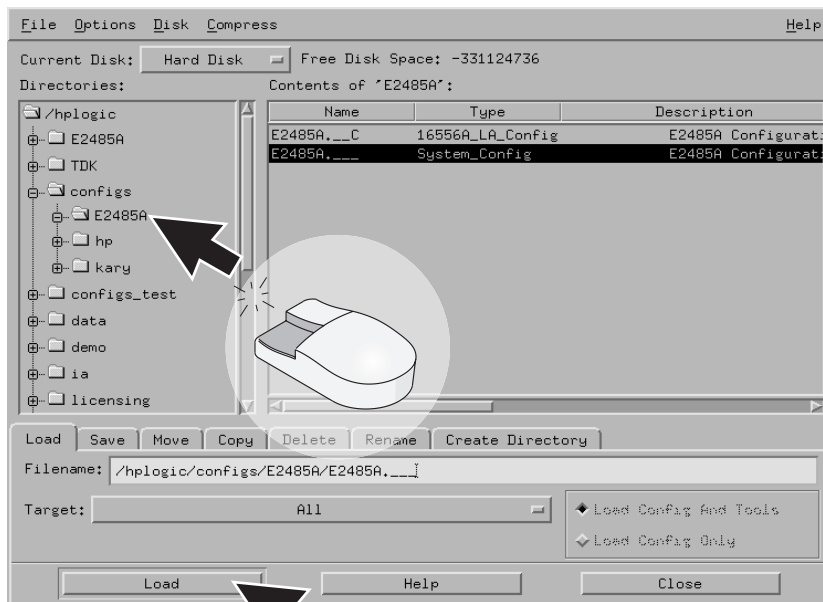
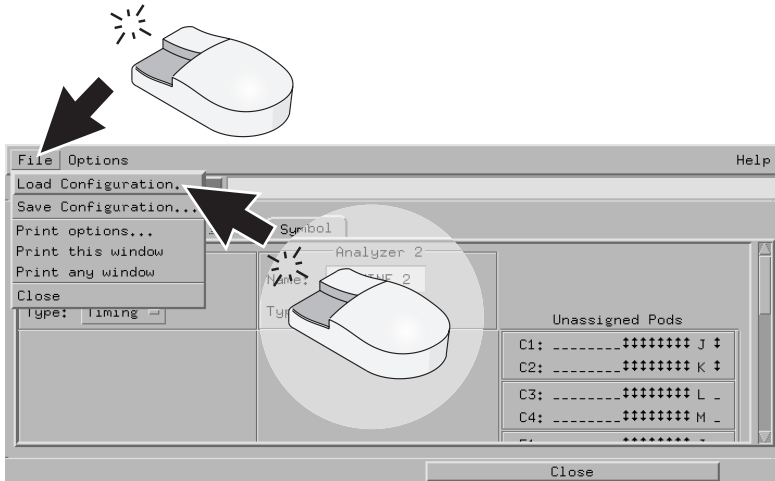

**Note!**  
See online help for information on customizing measurements.

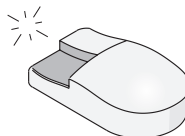

# HP E2485A

for HP 16700A and HP 16702A

Probing options.

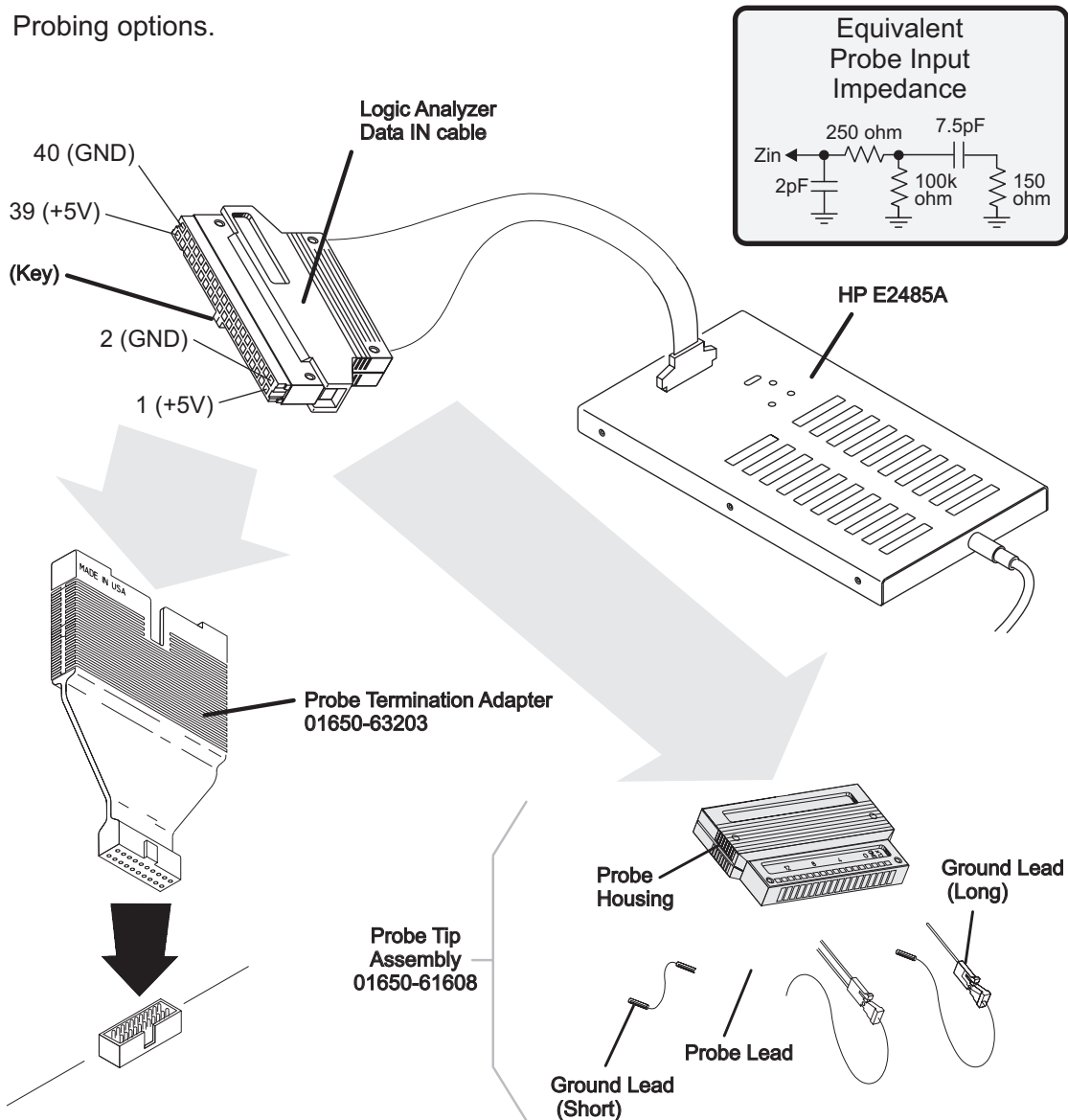

## Note!

The HP E2485A uses the same probing equipment as the logic analyzer. For more information, see the Probing chapter in this book.

# HP E2485A

## for HP 16700A and HP 16702A

Customize measurement setup.

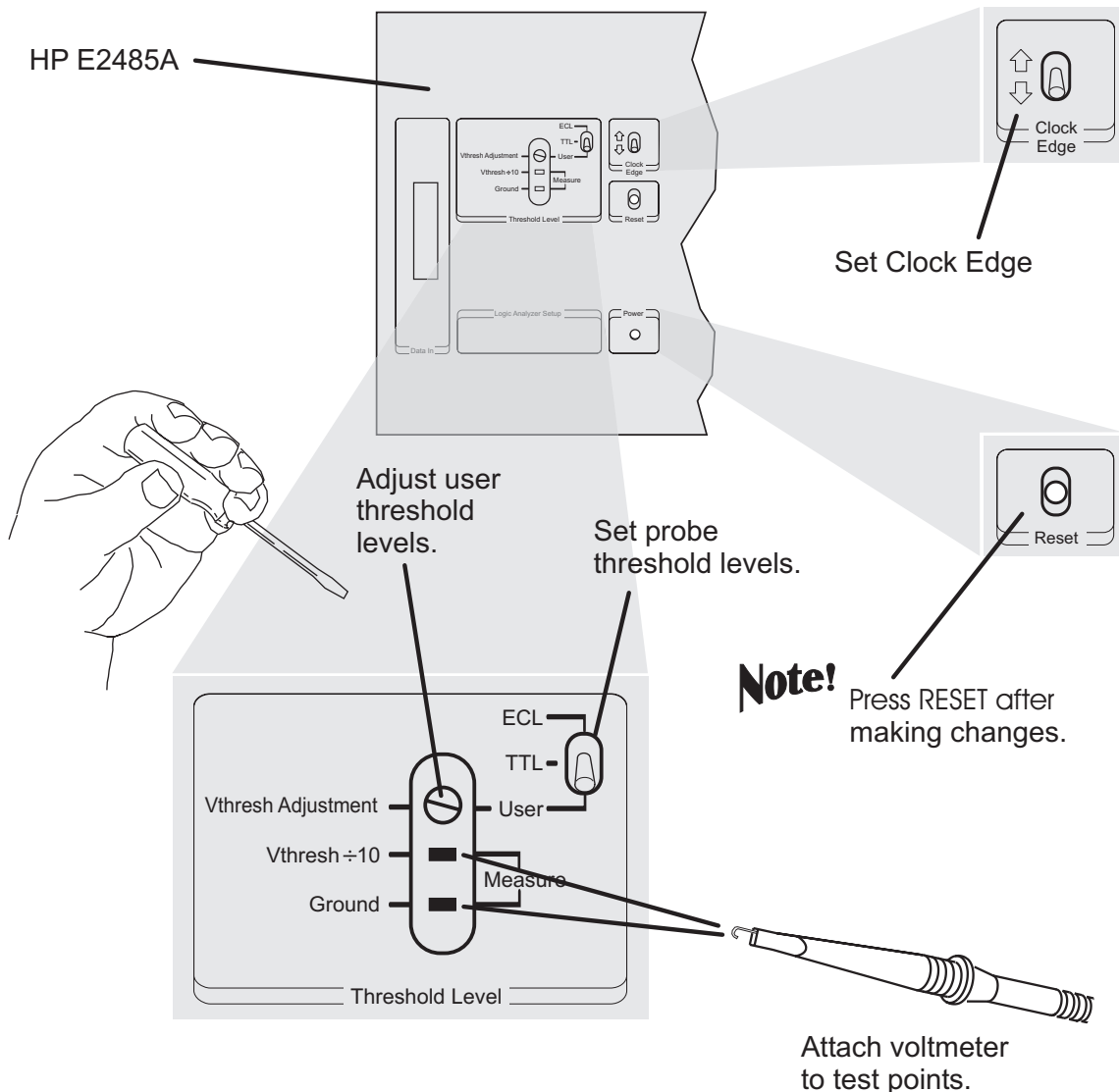

### Note!

Vthresh is the threshold voltage of your target system. Data sent from the HP E2485A to the logic analyzer uses TTL logic levels.

The HP E2485A cannot sample on both clock edges.



# HP E2485A

**for HP 16700A and HP 16702A**

## Specifications

Specifications are the performance standards against which the instrument is tested. Characteristics are not specifications, but are included as additional information. This instrument has no specifications.

## Characteristics

Maximum Memory Depth	40 M
Memory Depth Per Card	
HP 16555/6A	4 M
HP 16555/6/7D	8 M
HP 16716A	2M
HP 16715/17A	8M
Channel Count	16
Max. State Clock	100 MHz
Setup/Hold time	3.5 ns / 0 ns
Min. Clock Pulse Width	5 ns
Clocking	1 edge, rising or falling
Input Resistance	100 Kohm $\pm$ 2%
Input Capacitance	approx. 8 pF

## Cleaning the State Analyzer

With the E2485A unplugged, use mild soap and water to clean the cabinet of the instrument. Harsh soap might damage the water-based paint. Do not immerse the instrument in water.



# DECLARATION OF CONFORMITY

according to ISO/IEC Guide 22 and EN 45014

**Manufacturer's Name:** Hewlett-Packard Company

**Manufacturer's Address:** Colorado Springs Division  
1900 Garden of the Gods Road  
Colorado Springs, CO 80907 USA

declares, that the product

**Product Name:** Logic Analyzer

**Model Number(s):** HP 16600A, HP 16601A, HP 16602A, HP 16603A

**Product Options(s):** All

conforms to the following Product Specifications:

**Safety:** IEC 1010-1:1990+A1 / EN 61010-1:1993  
UL 3111  
CSA-C22.2 No. 1010.1:1993

**EMC:** CISPR 11:1990 / EN 55011:1991 Group 1, Class A  
IEC 555-2:1982 + A1:1985 / EN 60555-2:1987  
IEC 555-3:1982 + A1:1990 / EN 60555-3:1987 + A1:1991  
IEC 801-2:1991 / EN 50082-1:1992 4 kV CD, 8 kV AD  
IEC 801-3:1984 / EN 50082-1:1992 3 V/m, {1kHz 80% AM, 27-1000 MHz}  
IEC 801-4:1988 / EN 50082-1:1992 0.5 kV Sig. Lines, 1kV Power Lines

## Supplementary Information:

The product herewith complies with the requirements of the Low Voltage Directive 73/23/EEC and the EMC Directive 89/336/EEC and carries the CE marking accordingly.

This product was tested in a typical configuration with Hewlett-Packard test systems.

Colorado Springs, 08/18/98

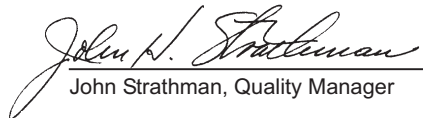
  
John Strathman, Quality Manager

European Contact: Your local Hewlett-Packard Sales and Service Office or Hewlett-Packard GmbH, Department ZQ / Standards  
Europe, Herrenberger Strasse 130, D-71034 Böblingen Germany (FAX: +49-7031-14-3143)

## Product Regulations

**Safety** IEC 1010-1:1990+A1 / EN 61010-1:1993  
UL 3111  
CSA-C22.2 No.1010.1:1993

**EMC** This Product meets the requirement of the European Communities (EC)  
EMC Directive 89/336/EEC.

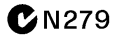

**Emissions** EN55011/CISPR 11 (ISM, Group 1, Class A equipment),  
IEC 555-2 and IEC 555-3

<b>Immunity</b>		Code	Notes
	EN50082-1		
	IEC 801-2 (ESD) 8kV AD	2	
	IEC 801-3 (Rad.) 3 V/m	1	
	IEC 801-4 (EFT) 1kV	1	

### Performance Codes:

- 1 PASS - Normal operation, no effect.
- 2 PASS - Temporary degradation, self recoverable.
- 3 PASS - Temporary degradation, operator intervention required.
- 4 FAIL - Not recoverable, component damage.

**Sound Pressure Level** Less than 60 dBA

**Definitions** Installation category (overvoltage category) I: Signal level, special equipment or parts of equipment, telecommunication, electronic etc., with smaller transient overvoltages than installation (overvoltage category) II.

Installation category (overvoltage category) II: Local level, appliances, portable equipment etc., with smaller transient overvoltages than installation category III.

**Environmental Conditions** Indoor use only.  
Altitude up to 3000 m. (10,000 ft.)

**Temperature** Instrument - 0 degrees C to 50 degrees C (32 degrees F to 122 degrees F)  
Disk Media - 10 degrees C to 40 degrees C (50 degrees F to 104 degrees F)  
Probes/cables - 0 degrees C to 65 degrees C (32 degrees F to 149 degrees F)

**Humidity** Relative humidity 8 to 80% at 40 degrees C (104 degrees F)

**Power** CAT II, Pollution degree 2  
HP 16600A - HP 16603A: ~Line 115/230 volts  $\pm$  20%, 48-66 Hz, 190 Watts max.

# DECLARATION OF CONFORMITY

according to ISO/IEC Guide 22 and EN 45014

**Manufacturer's Name:** Hewlett-Packard Company

**Manufacturer's Address:** Colorado Springs Division  
1900 Garden of the Gods Road  
Colorado Springs, CO 80907 USA

declares, that the product

**Product Name:** Logic Analyzer Mainframe

**Model Number(s):** HP 16700A

**Product Options(s):** All

conforms to the following Product Specifications:

**Safety:** IEC 1010-1:1990+A1 / EN 61010-1:1993  
UL 3111  
CSA-C22.2 No. 1010.1:1993

**EMC:** CISPR 11:1990 / EN 55011:1991 Group 1, Class A  
IEC 555-3:1982 + A1:1990 / EN 60555-3:1987 + A1:1991  
IEC 801-2:1991 / EN 50082-1:1992 4 kV CD, 8 kV AD  
IEC 801-3:1984 / EN 50082-1:1992 3 V/m, {1kHz 80% AM, 27-1000 MHz}  
IEC 801-4:1988 / EN 50082-1:1992 0.5 kV Sig. Lines, 1kV Power Lines

## Supplementary Information:

The product herewith complies with the requirements of the Low Voltage Directive 73/23/EEC and the EMC Directive 89/336/EEC and carries the CE marking accordingly.

This product was tested in a typical configuration with Hewlett-Packard test systems.

Colorado Springs, 9/22/97.

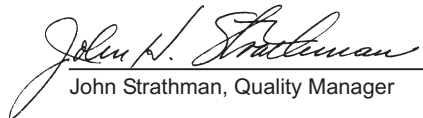
  
John Strathman, Quality Manager

European Contact: Your local Hewlett-Packard Sales and Service Office or Hewlett-Packard GmbH, Department ZQ / Standards  
Europe, Herrenberger Strasse 130, D-71034 Böblingen Germany (FAX: +49-7031-14-3143)

## Product Regulations

**Safety** IEC 1010-1:1990+A1 / EN 61010-1:1993  
UL 3111  
CSA-C22.2 No.1010.1:1993

**EMC** This Product meets the requirement of the European Communities (EC)  
EMC Directive 89/336/EEC.

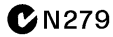

**Emissions** EN55011/CISPR 11 (ISM, Group 1, Class A equipment),  
IEC 555-2 and IEC 555-3

<b>Immunity</b>		Code	Notes
	EN50082-1		
	IEC 801-2 (ESD) 8kV AD	2	
	IEC 801-3 (Rad.) 3 V/m	1	
	IEC 801-4 (EFT) 1kV	1	

### Performance Codes:

- 1 PASS - Normal operation, no effect.
- 2 PASS - Temporary degradation, self recoverable.
- 3 PASS - Temporary degradation, operator intervention required.
- 4 FAIL - Not recoverable, component damage.

**Sound Pressure Level** Less than 60 dBA

**Definitions** Installation category (overvoltage category) I: Signal level, special equipment or parts of equipment, telecommunication, electronic etc., with smaller transient overvoltages than installation (overvoltage category) II.

Installation category (overvoltage category) II: Local level, appliances, portable equipment etc., with smaller transient overvoltages than installation category III.

**Environmental Conditions** Indoor use only.  
Altitude up to 3000 m. (10,000 ft.)

**Temperature** Instrument - 0 degrees C to 50 degrees C (32 degrees F to 122 degrees F)  
Disk Media - 10 degrees C to 40 degrees C (50 degrees F to 104 degrees F)  
Probes/cables - 0 degrees C to 65 degrees C (32 degrees F to 149 degrees F)

**Humidity** Relative humidity 8 to 80% at 40 degrees C (104 degrees F)

**Power** CAT II, Pollution degree 2  
HP 16700A : ~Line 115/230 volts  $\pm$  20%, 48-66 Hz, 610 Watts max.

# DECLARATION OF CONFORMITY

according to ISO/IEC Guide 22 and EN 45014

**Manufacturer's Name:** Hewlett-Packard Company

**Manufacturer's Address:** Colorado Springs Division  
1900 Garden of the Gods Road  
Colorado Springs, CO 80907 USA

declares, that the product

**Product Name:** Logic Analyzer Mainframe

**Model Number(s):** HP 16702A

**Product Options(s):** All

conforms to the following Product Specifications:

**Safety:** IEC 1010-1:1990+A1 / EN 61010-1:1993  
UL 3111  
CSA-C22.2 No. 1010.1:1993

**EMC:** CISPR 11:1990 / EN 55011:1991 Group 1, Class A  
IEC 555-2:1982 + A1:1985 / EN 60555-2:1987  
IEC 555-3:1982 + A1:1990 / EN 60555-3:1987 + A1:1991  
IEC 801-2:1991 / EN 50082-1:1992 4 kV CD, 8 kV AD  
IEC 801-3:1984 / EN 50082-1:1992 3 V/m, {1kHz 80% AM, 27-1000 MHz}  
IEC 801-4:1988 / EN 50082-1:1992 0.5 kV Sig. Lines, 1kV Power Lines

## Supplementary Information:

The product herewith complies with the requirements of the Low Voltage Directive 73/23/EEC and the EMC Directive 89/336/EEC and carries the CE marking accordingly.

This product was tested in a typical configuration with Hewlett-Packard test systems.

Colorado Springs, 04/16/98



Ken Wyatt / Product Regulations Manager

European Contact: Your local Hewlett-Packard Sales and Service Office or Hewlett-Packard GmbH, Department ZQ / Standards  
Europe, Herrenberger Strasse 130, D-71034 Böblingen Germany (FAX: +49-7031-14-3143)

## Product Regulations

**Safety** IEC 1010-1:1990+A1 / EN 61010-1:1993  
UL 3111  
CSA-C22.2 No.1010.1:1993

**EMC** This Product meets the requirement of the European Communities (EC)  
EMC Directive 89/336/EEC.

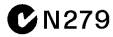

**Emissions** EN55011/CISPR 11 (ISM, Group 1, Class A equipment),  
IEC 555-2 and IEC 555-3

<b>Immunity</b>		Code	Notes
	EN50082-1		
	IEC 801-2 (ESD) 8kV AD	2	
	IEC 801-3 (Rad.) 3 V/m	1	
	IEC 801-4 (EFT) 1kV	1	

### Performance Codes:

- 1 PASS - Normal operation, no effect.
- 2 PASS - Temporary degradation, self recoverable.
- 3 PASS - Temporary degradation, operator intervention required.
- 4 FAIL - Not recoverable, component damage.

**Sound Pressure Level** Less than 60 dBA

**Definitions** Installation category (overvoltage category) I: Signal level, special equipment or parts of equipment, telecommunication, electronic etc., with smaller transient overvoltages than installation (overvoltage category) II.

Installation category (overvoltage category) II: Local level, appliances, portable equipment etc., with smaller transient overvoltages than installation category III.

**Environmental Conditions** Indoor use only.  
Altitude up to 3000 m. (10,000 ft.)

**Temperature** Instrument - 0 degrees C to 50 degrees C (32 degrees F to 122 degrees F)  
Disk Media - 10 degrees C to 40 degrees C (50 degrees F to 104 degrees F)  
Probes/cables - 0 degrees C to 65 degrees C (32 degrees F to 149 degrees F)

**Humidity** Relative humidity 8 to 80% at 40 degrees C (104 degrees F)

**Power** CAT II, Pollution degree 2  
HP 16702A: ~Line 115/230 volts  $\pm$  20%, 48-66 Hz, 610 Watts max.



# DECLARATION OF CONFORMITY

according to ISO/IEC Guide 22 and EN 45014

**Manufacturer's Name:** Hewlett-Packard Company

**Manufacturer's Address:** Colorado Springs Division  
1900 Garden of the Gods Road  
Colorado Springs, CO 80907 USA

declares, that the product

**Product Name:** Logic Analyzer Module

**Model Number(s):** HP 16517A and 16518A

**Product Options(s):** All

conforms to the following Product Specifications:

**Safety:** IEC 1010-1:1990+A1 / EN 61010-1:1993  
UL 3111  
CSA-C22.2 No. 1010.1:1993

**EMC:** CISPR 11:1990 / EN 55011:1991 Group 1, Class A  
IEC 555-2:1982 +A1:1985 / EN 60555-2:1987  
IEC 555-3:1982 +A1:1990 / EN 60555-3:1987 + A1:1991  
IEC 801-2:1991 / EN 50082-1:1992 4 kV CD, 8 kV AD  
IEC 801-3:1984 / EN 50082-1:1992 3 V/m, {1kHz 80% AM, 27-1000 MHz}  
IEC 801-4:1988 / EN 50082-1:1992 0.5 kV Sig. Lines, 1kV Power Lines

## Supplementary Information:

The product herewith complies with the requirements of the Low Voltage Directive 73/23/EEC and the EMC Directive 89/336/EEC, and carries the CE marking accordingly.

This product was tested in a typical configuration with Hewlett-Packard test systems.

Colorado Springs, 10/03/96

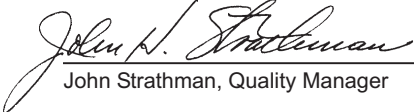
  
John Strathman, Quality Manager

European Contact: Your local Hewlett-Packard Sales and Service Office or Hewlett-Packard GmbH, Department ZQ / Standards  
Europe, Herrenberger Strasse 130, D-71034 Böblingen Germany (FAX: +49-7031-14-3143)

## Product Regulations

**Safety** IEC 348:1978 / HD 401 S1:1981  
UL 1244  
CSA-C22.2 No. 231 (Series M-89)

**EMC** This Product meets the requirements of the European Communities (EC)  
EMC Directive 89/336/EEC.

**Emissions** EN55011/CISPR 11 (ISM, Group 1, Class A equipment)

<b>Immunity</b>	EN50082-1	Code	Notes
	IEC 555-2	1	
	IEC 555-3	1	
	IEC 801-2 (ESD) 8kV AD	2	
	IEC 801-3 (Rad.) 3V/m	1	
	IEC 801-4 (EFT) 1kV	1	

### Performance Codes:

- 1 Pass - Normal operation, no effect.
- 2 Pass - Temporary degradation, self recoverable.
- 3 Pass - Temporary degradation, operator intervention required.
- 4 Fail - Not recoverable, component damage.

Notes: (none)

**Sound Pressure Level** N/A

**Definitions** Installation category (overvoltage category) I: Signal level, special equipment or parts of equipment, telecommunication, electronic etc., with smaller transient overvoltages than installation (overvoltage category) II.

Installation category (overvoltage category) II: Local level, appliances, portable equipment etc., with smaller transient overvoltages than installation category III.

**Environmental Conditions** Indoor use only.  
Altitude up to 3000 m. (10,000 ft.)

**Temperature** Instrument - 0 degrees C to 50 degrees C (32 degrees F to 122 degrees F)  
Disk Media - 10 degrees C to 40 degrees C (50 degrees F to 104 degrees F)  
Probes/cables - 0 degrees C to 65 degrees C (32 degrees F to 149 degrees F)

**Humidity** Relative humidity 8 to 80% at 40 degrees C (104 degrees F)

**Power** (From host frame.)

# DECLARATION OF CONFORMITY

according to ISO/IEC Guide 22 and EN 45014

**Manufacturer's Name:** Hewlett-Packard Company

**Manufacturer's Address:** Colorado Springs Division  
1900 Garden of the Gods Road  
Colorado Springs, CO 80907 USA

declares, that the product

**Product Name:** Pattern Generator Module

**Model Number(s):** HP 16522A

**Product Options(s):** All

conforms to the following Product Specifications:

**Safety:** IEC 1010-1:1990+A1 / EN 61010-1:1993  
UL 3111  
CSA-C22.2 No. 1010.1:1993

**EMC:** CISPR 11:1990 / EN 55011:1991 Group 1, Class A  
IEC 555-2:1982 +A1:1985 / EN 60555-2:1987  
IEC 555-3:1982 +A1:1990 / EN 60555-3:1987 + A1:1991  
IEC 801-2:1991 / EN 50082-1:1992 4 kV CD, 8 kV AD  
IEC 801-3:1984 / EN 50082-1:1992 3 V/m, {1kHz 80% AM, 27-1000 MHz}  
IEC 801-4:1988 / EN 50082-1:1992 0.5 kV Sig. Lines, 1kV Power Lines

## Supplementary Information:

The product herewith complies with the requirements of the Low Voltage Directive 73/23/EEC and the EMC Directive 89/336/EEC, and carries the CE marking accordingly.

This product was tested in a typical configuration with Hewlett-Packard test systems.

Colorado Springs, 4/03/95

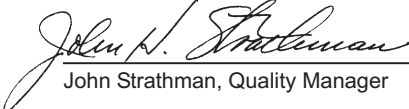
  
John Strathman, Quality Manager

European Contact: Your local Hewlett-Packard Sales and Service Office or Hewlett-Packard GmbH, Department ZQ / Standards  
Europe, Herrenberger Strasse 130, D-71034 Böblingen Germany (FAX: +49-7031-14-3143)

## Product Regulations

**Safety** IEC 1010-1: 1990+A1 / EN 61010-1: 1993  
UL 3111  
CSA-C22.2 No.1010.1:1993

**EMC** This Product meets the requirements of the European Communities (EC) EMC Directive 89/336/EEC.

**Emissions** EN55011/CISPR 11 (ISM, Group 1, Class A equipment)

<b>Immunity</b>	EN50082-1	Code	Notes
	IEC 555-2	1	
	IEC 555-3	1	
	IEC 801-2 (ESD) 8kV AD	1	
	IEC 801-3 (Rad.) 3V/m	1	
	IEC 801-4 (EFT) 1kV	1	

### Performance Codes:

- 1 Pass - Normal operation, no effect.
- 2 Pass - Temporary degradation, self recoverable.
- 3 Pass - Temporary degradation, operator intervention required.
- 4 Fail - Not recoverable, component damage.

Notes: (none)

**Sound Pressure Level** N/A

**Definitions** Installation category (overvoltage category) I: Signal level, special equipment or parts of equipment, telecommunication, electronic etc., with smaller transient overvoltages than installation (overvoltage category) II.

Installation category (overvoltage category) II: Local level, appliances, portable equipment etc., with smaller transient overvoltages than installation category III.

**Environmental Conditions** Indoor use only.  
Altitude up to 3000 m. (10,000 ft.)

**Temperature** Instrument - 0 degrees C to 50 degrees C (32 degrees F to 122 degrees F)  
Disk Media - 10 degrees C to 40 degrees C (50 degrees F to 104 degrees F)  
Probes/cables - 0 degrees C to 65 degrees C (32 degrees F to 149 degrees F)

**Humidity** Relative humidity 8 to 80% at 40 degrees C (104 degrees F)

**Power** (From host frame.)

# DECLARATION OF CONFORMITY

according to ISO/IEC Guide 22 and EN 45014

**Manufacturer's Name:** Hewlett-Packard Company

**Manufacturer's Address:** Colorado Springs Division  
1900 Garden of the Gods Road  
Colorado Springs, CO 80907 USA

declares, that the product

**Product Name:** Digitizing Oscilloscope Module

**Model Number(s):** HP 16533A and 16534A

**Product Options(s):** All

conforms to the following Product Specifications:

**Safety:** IEC 1010-1:1990+A1 / EN 61010-1:1993  
UL 3111  
CSA-C22.2 No. 1010.1:1993

**EMC:** CISPR 11:1990 / EN 55011:1991 Group 1, Class A  
IEC 555-2:1982 +A1:1985 / EN 60555-2:1987  
IEC 555-3:1982 +A1:1990 / EN 60555-3:1987 + A1:1991  
IEC 801-2:1991 / EN 50082-1:1992 4 kV CD, 8 kV AD  
IEC 801-3:1984 / EN 50082-1:1992 3 V/m, {1kHz 80% AM, 27-1000 MHz}  
IEC 801-4:1988 / EN 50082-1:1992 0.5 kV Sig. Lines, 1kV Power Lines

## Supplementary Information:

The product herewith complies with the requirements of the Low Voltage Directive 73/23/EEC and the EMC Directive 89/336/EEC and carries the CE marking accordingly.

This product was tested in a typical configuration with Hewlett-Packard test systems.

Colorado Springs, 4/03/95

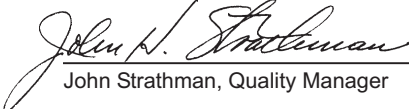
  
John Strathman, Quality Manager

European Contact: Your local Hewlett-Packard Sales and Service Office or Hewlett-Packard GmbH, Department ZQ / Standards  
Europe, Herrenberger Strasse 130, D-71034 Böblingen Germany (FAX: +49-7031-14-3143)

## Product Regulations

**Safety** IEC 1010-1: 1990+A1 / EN 61010-1: 1993  
UL 3111  
CSA-C22.2 No.1010.1:1993

**EMC** This Product meets the requirements of the European Communities (EC)  
EMC Directive 89/336/EEC.

**Emissions** EN55011/CISPR 11 (ISM, Group 1, Class A equipment)

<b>Immunity</b>	EN50082-1	Code	Notes
	IEC 555-2	1	
	IEC 555-3	1	
	IEC 801-2 (ESD) 8kV AD	1	
	IEC 801-3 (Rad.) 3V/m	1	
	IEC 801-4 (EFT) 1kV	1	

### Performance Codes:

- 1 Pass - Normal operation, no effect.
- 2 Pass - Temporary degradation, self recoverable.
- 3 Pass - Temporary degradation, operator intervention required.
- 4 Fail - Not recoverable, component damage.

Notes: (none)

**Sound Pressure Level** N/A

**Definitions** Installation category (overvoltage category) I: Signal level, special equipment or parts of equipment, telecommunication, electronic etc., with smaller transient overvoltages than installation (overvoltage category) II.

Installation category (overvoltage category) II: Local level, appliances, portable equipment etc., with smaller transient overvoltages than installation category III.

**Environmental Conditions** Indoor use only.  
Altitude up to 3000 m. (10,000 ft.)

**Temperature** Instrument - 0 degrees C to 50 degrees C (32 degrees F to 122 degrees F)  
Disk Media - 10 degrees C to 40 degrees C (50 degrees F to 104 degrees F)  
Probes/cables - 0 degrees C to 65 degrees C (32 degrees F to 149 degrees F)

**Humidity** Relative humidity 8 to 80% at 40 degrees C (104 degrees F)

**Power** (From host frame.)

# DECLARATION OF CONFORMITY

according to ISO/IEC Guide 22 and EN 45014

**Manufacturer's Name:** Hewlett-Packard Company

**Manufacturer's Address:** Colorado Springs Division  
1900 Garden of the Gods Road  
Colorado Springs, CO 80907 USA

declares, that the product

**Product Name:** Logic Analyzer Module

**Model Number(s):** HP 16550A

**Product Options(s):** All

conforms to the following Product Specifications:

**Safety:** IEC 1010-1:1990+A1 / EN 61010-1:1993  
UL 3111  
CSA-C22.2 No. 1010.1:1993

**EMC:** CISPR 11:1990 / EN 55011:1991 Group 1, Class A  
IEC 555-2:1982 +A1:1985 / EN 60555-2:1987  
IEC 555-3:1982 +A1:1990 / EN 60555-3:1987 + A1:1991  
IEC 801-2:1991 / EN 50082-1:1992 4 kV CD, 8 kV AD  
IEC 801-3:1984 / EN 50082-1:1992 3 V/m, {1kHz 80% AM, 27-1000 MHz}  
IEC 801-4:1988 / EN 50082-1:1992 0.5 kV Sig. Lines, 1kV Power Lines

## Supplementary Information:

The product herewith complies with the requirements of the Low Voltage Directive 73/23/EEC and the EMC Directive 89/336/EEC and carries the CE marking accordingly.

This product was tested in a typical configuration with Hewlett-Packard test systems.

Colorado Springs, 10/14/96

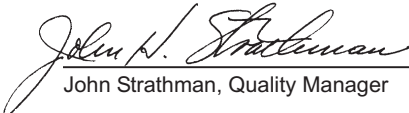
  
John Strathman, Quality Manager

European Contact: Your local Hewlett-Packard Sales and Service Office or Hewlett-Packard GmbH, Department ZQ / Standards  
Europe, Herrenberger Strasse 130, D-71034 Böblingen Germany (FAX: +49-7031-14-3143)

## Product Regulations

**Safety** IEC 348:1978 / HD 401 S1:1981  
UL 1244  
CSA-C22.2 No. 231 (Series M-89)

**EMC** This Product meets the requirements of the European Communities (EC)  
EMC Directive 89/336/EEC.

**Emissions** EN55011/CISPR 11 (ISM, Group 1, Class A equipment)

<b>Immunity</b>	EN50082-1	Code	Notes
	IEC 555-2	1	
	IEC 555-3	1	
	IEC 801-2 (ESD) 8kV AD	3	
	IEC 801-3 (Rad.) 3V/m	1	
	IEC 801-4 (EFT) 1kV	3	

### Performance Codes:

- 1 Pass - Normal operation, no effect.
- 2 Pass - Temporary degradation, self recoverable.
- 3 Pass - Temporary degradation, operator intervention required.
- 4 Fail - Not recoverable, component damage.

Notes: (none)

**Sound Pressure Level** N/A

**Definitions** Installation category (overvoltage category) I: Signal level, special equipment or parts of equipment, telecommunication, electronic etc., with smaller transient overvoltages than installation (overvoltage category) II.

Installation category (overvoltage category) II: Local level, appliances, portable equipment etc., with smaller transient overvoltages than installation category III.

**Environmental Conditions** Indoor use only.  
Altitude up to 3000 m. (10,000 ft.)

**Temperature** Instrument - 0 degrees C to 50 degrees C (32 degrees F to 122 degrees F)  
Disk Media - 10 degrees C to 40 degrees C (50 degrees F to 104 degrees F)  
Probes/cables - 0 degrees C to 65 degrees C (32 degrees F to 149 degrees F)

**Humidity** Relative humidity 8 to 80% at 40 degrees C (104 degrees F)

**Power** (From host frame.)



# DECLARATION OF CONFORMITY

according to ISO/IEC Guide 22 and EN 45014

**Manufacturer's Name:** Hewlett-Packard Company

**Manufacturer's Address:** Colorado Springs Division  
1900 Garden of the Gods Road  
Colorado Springs, CO 80907 USA

declares, that the product

**Product Name:** Digitizing Oscilloscope Module

**Model Number(s):** HP 16554A

**Product Options(s):** All

conforms to the following Product Specifications:

**Safety:** IEC 1010-1:1990+A1 / EN 61010-1:1993  
UL 3111  
CSA-C22.2 No. 1010.1:1993

**EMC:** CISPR 11:1990 / EN 55011:1991 Group 1, Class A  
IEC 555-2:1982 +A1:1985 / EN 60555-2:1987  
IEC 555-3:1982 +A1:1990 / EN 60555-3:1987 + A1:1991  
IEC 801-2:1991 / EN 50082-1:1992 4 kV CD, 8 kV AD  
IEC 801-3:1984 / EN 50082-1:1992 3 V/m, {1kHz 80% AM, 27-1000 MHz}  
IEC 801-4:1988 / EN 50082-1:1992 0.5 kV Sig. Lines, 1kV Power Lines

## Supplementary Information:

The product herewith complies with the requirements of the Low Voltage Directive 73/23/EEC and the EMC Directive 89/336/EEC and carries the CE marking accordingly.

This product was tested in a typical configuration with Hewlett-Packard test systems.

Colorado Springs, 10/27/94

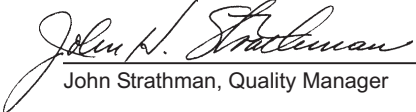
  
John Strathman, Quality Manager

European Contact: Your local Hewlett-Packard Sales and Service Office or Hewlett-Packard GmbH, Department ZQ / Standards  
Europe, Herrenberger Strasse 130, D-71034 Böblingen Germany (FAX: +49-7031-14-3143)

## Product Regulations

**Safety** IEC 1010-1: 1990+A1 / EN 61010-1: 1993  
UL 3111  
CSA-C22.2 No.1010.1:1993

**EMC** This Product meets the requirements of the European Communities (EC)  
EMC Directive 89/336/EEC.

**Emissions** EN55011/CISPR 11 (ISM, Group 1, Class A equipment)

<b>Immunity</b>	EN50082-1	Code	Notes
	IEC 555-2	1	
	IEC 555-3	1	
	IEC 801-2 (ESD) 8kV AD	1	
	IEC 801-3 (Rad.) 3V/m	1	
	IEC 801-4 (EFT) 1kV	1	

### Performance Codes:

- 1 Pass - Normal operation, no effect.
- 2 Pass - Temporary degradation, self recoverable.
- 3 Pass - Temporary degradation, operator intervention required.
- 4 Fail - Not recoverable, component damage.

Notes: (none)

**Sound Pressure Level** N/A

**Definitions** Installation category (overvoltage category) I: Signal level, special equipment or parts of equipment, telecommunication, electronic etc., with smaller transient overvoltages than installation (overvoltage category) II.

Installation category (overvoltage category) II: Local level, appliances, portable equipment etc., with smaller transient overvoltages than installation category III.

**Environmental Conditions** Indoor use only.  
Altitude up to 3000 m. (10,000 ft.)

**Temperature** Instrument - 0 degrees C to 50 degrees C (32 degrees F to 122 degrees F)  
Disk Media - 10 degrees C to 40 degrees C (50 degrees F to 104 degrees F)  
Probes/cables - 0 degrees C to 65 degrees C (32 degrees F to 149 degrees F)

**Humidity** Relative humidity 8 to 80% at 40 degrees C (104 degrees F)

**Power** (From host frame.)

# DECLARATION OF CONFORMITY

according to ISO/IEC Guide 22 and EN 45014

**Manufacturer's Name:** Hewlett-Packard Company

**Manufacturer's Address:** Colorado Springs Division  
1900 Garden of the Gods Road  
Colorado Springs, CO 80907 USA

declares, that the product

**Product Name:** Logic Analyzer Module

**Model Number(s):** HP 16557D

**Product Options(s):** All

conforms to the following Product Specifications:

**Safety:** IEC 1010-1:1990+A1 / EN 61010-1:1993  
UL 3111  
CSA-C22.2 No. 1010.1:1993

**EMC:** CISPR 11:1990 / EN 55011:1991 Group 1, Class A  
IEC 555-2:1982 +A1:1985 / EN 60555-2:1987  
IEC 555-3:1982 +A1:1990 / EN 60555-3:1987 + A1:1991  
IEC 801-2:1991 / EN 50082-1:1992 4 kV CD, 8 kV AD  
IEC 801-3:1984 / EN 50082-1:1992 3 V/m, {1kHz 80% AM, 27-1000 MHz}  
IEC 801-4:1988 / EN 50082-1:1992 0.5 kV Sig. Lines, 1kV Power Lines

## Supplementary Information:

The product herewith complies with the requirements of the Low Voltage Directive 73/23/EEC and the EMC Directive 89/336/EEC, and carries the CE marking accordingly.

This product was tested in a typical configuration with Hewlett-Packard test systems.

Colorado Springs, 7/02/97

  
John Strathman, Quality Manager

European Contact: Your local Hewlett-Packard Sales and Service Office or Hewlett-Packard GmbH, Department ZQ / Standards Europe, Herrenberger Strasse 130, D-71034 Böblingen Germany (FAX: +49-7031-14-3143)

## Product Regulations

**Safety** IEC 1010-1: 1990+A1 / EN 61010-1: 1993  
UL 3111  
CSA-C22.2 No.1010.1:1993

**EMC** This Product meets the requirements of the European Communities (EC)  
EMC Directive 89/336/EEC.

**Emissions** EN55011/CISPR 11 (ISM, Group 1, Class A equipment)

<b>Immunity</b>	EN50082-1	Code	Notes
	IEC 555-2	1	
	IEC 555-3	1	
	IEC 801-2 (ESD) 8kV AD	1	
	IEC 801-3 (Rad.) 3V/m	1	
	IEC 801-4 (EFT) 1kV	1	

### Performance Codes:

- 1 Pass - Normal operation, no effect.
- 2 Pass - Temporary degradation, self recoverable.
- 3 Pass - Temporary degradation, operator intervention required.
- 4 Fail - Not recoverable, component damage.

Notes: (none)

**Sound Pressure Level** N/A

**Definitions** Installation category (overvoltage category) I: Signal level, special equipment or parts of equipment, telecommunication, electronic etc., with smaller transient overvoltages than installation (overvoltage category) II.

Installation category (overvoltage category) II: Local level, appliances, portable equipment etc., with smaller transient overvoltages than installation category III.

**Environmental Conditions** Indoor use only.  
Altitude up to 3000 m. (10,000 ft.)

**Temperature** Instrument - 0 degrees C to 50 degrees C (32 degrees F to 122 degrees F)  
Disk Media - 10 degrees C to 40 degrees C (50 degrees F to 104 degrees F)  
Probes/cables - 0 degrees C to 65 degrees C (32 degrees F to 149 degrees F)

**Humidity** Relative humidity 8 to 80% at 40 degrees C (104 degrees F)

**Power** (From host frame.)

# DECLARATION OF CONFORMITY

according to ISO/IEC Guide 22 and EN 45014

**Manufacturer's Name:** Hewlett-Packard Company

**Manufacturer's Address:** Colorado Springs Division  
1900 Garden of the Gods Road  
Colorado Springs, CO 80907 USA

declares, that the product

**Product Name:** Logic Analyzer Module

**Model Number(s):** HP 16710A, 16711A and 16712A

**Product Options(s):** All

conforms to the following Product Specifications:

**Safety:** IEC 1010-1:1990+A1 / EN 61010-1:1993  
UL 3111  
CSA-C22.2 No. 1010.1:1993

**EMC:** CISPR 11:1990 / EN 55011:1991 Group 1, Class A  
IEC 555-2:1982 + A1:1985 / EN 60555-2:1987  
IEC 555-3:1982 + A1:1990 / EN 60555-3:1987 + A1:1991  
IEC 801-2:1991 / EN 50082-1:1992 4 kV CD, 8 kV AD  
IEC 801-3:1984 / EN 50082-1:1992 3 V/m, {1kHz 80% AM, 27-1000 MHz}  
IEC 801-4:1988 / EN 50082-1:1992 0.5 kV Sig. Lines, 1kV Power Lines

## Supplementary Information:

The product herewith complies with the requirements of the Low Voltage Directive 73/23/EEC and the EMC Directive 89/336/EEC and carries the CE marking accordingly.

This product was tested in a typical configuration with Hewlett-Packard test systems.

Colorado Springs, 09/01/98



Ken Wyatt / Product Regulations Manager

European Contact: Your local Hewlett-Packard Sales and Service Office or Hewlett-Packard GmbH, Department ZQ / Standards  
Europe, Herrenberger Strasse 130, D-71034 Böblingen Germany (FAX: +49-7031-14-3143)

## Product Regulations

**Safety** IEC 1010-1:1990+A1 / EN 61010-1:1993  
UL 3111  
CSA-C22.2 No.1010.1:1993

**EMC** This Product meets the requirement of the European Communities (EC)  
EMC Directive 89/336/EEC.

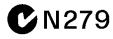

**Emissions** EN55011/CISPR 11 (ISM, Group 1, Class A equipment),  
IEC 555-2 and IEC 555-3

<b>Immunity</b>		Code	Notes
	EN50082-1		
	IEC 801-2 (ESD) 8kV AD	2	
	IEC 801-3 (Rad.) 3 V/m	1	
	IEC 801-4 (EFT) 1kV	1	

### Performance Codes:

- 1 PASS - Normal operation, no effect.
- 2 PASS - Temporary degradation, self recoverable.
- 3 PASS - Temporary degradation, operator intervention required.
- 4 FAIL - Not recoverable, component damage.

**Sound Pressure Level** Less than 60 dBA

**Definitions** Installation category (overvoltage category) I: Signal level, special equipment or parts of equipment, telecommunication, electronic etc., with smaller transient overvoltages than installation (overvoltage category) II.

Installation category (overvoltage category) II: Local level, appliances, portable equipment etc., with smaller transient overvoltages than installation category III.

**Environmental Conditions** Indoor use only.  
Altitude up to 3000 m. (10,000 ft.)

**Temperature** Instrument - 0 degrees C to 50 degrees C (32 degrees F to 122 degrees F)  
Disk Media - 10 degrees C to 40 degrees C (50 degrees F to 104 degrees F)  
Probes/cables - 0 degrees C to 65 degrees C (32 degrees F to 149 degrees F)

**Humidity** Relative humidity 8 to 80% at 40 degrees C (104 degrees F)

**Power** (From host frame.)

# DECLARATION OF CONFORMITY

according to ISO/IEC Guide 22 and EN 45014

**Manufacturer's Name:** Hewlett-Packard Company

**Manufacturer's Address:** Colorado Springs Division  
1900 Garden of the Gods Road  
Colorado Springs, CO 80907 USA

declares, that the product

**Product Name:** Logic Analyzer Module

**Model Number(s):** HP 16715A, 16716A, and 16717A

**Product Options(s):** All

conforms to the following Product Specifications:

**Safety:** IEC 1010-1:1990+A1 / EN 61010-1:1993  
UL 3111  
CSA-C22.2 No. 1010.1:1993

**EMC:** CISPR 11:1990 / EN 55011:1991 Group 1, Class A  
IEC 555-2:1982 +A1:1985 / EN 60555-2:1987  
IEC 555-3:1982 +A1:1990 / EN 60555-3:1987 + A1:1991  
IEC 801-2:1991 / EN 50082-1:1992 4 kV CD, 8 kV AD  
IEC 801-3:1984 / EN 50082-1:1992 3 V/m, {1kHz 80% AM, 27-1000 MHz}  
IEC 801-4:1988 / EN 50082-1:1992 0.5 kV Sig. Lines, 1kV Power Lines

## Supplementary Information:

The product herewith complies with the requirements of the Low Voltage Directive 73/23/EEC and the EMC Directive 89/336/EEC, and carries the CE marking accordingly.

This product was tested in a typical configuration with Hewlett-Packard test systems.

Colorado Springs, 3/19/99



Ken Wyatt / Product Regulations Manager

European Contact: Your local Hewlett-Packard Sales and Service Office or Hewlett-Packard GmbH, Department ZQ / Standards Europe, Herrenberger Strasse 130, D-71034 Böblingen Germany (FAX: +49-7031-14-3143)

## Product Regulations

**Safety** IEC 1010-1:1990+A1 / EN 61010-1:1993  
UL 3111  
CSA-C22.2 No.1010.1:1993

**EMC** This Product meets the requirement of the European Communities (EC)  
EMC Directive 89/336/EEC.

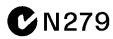

**Emissions** EN55011/CISPR 11 (ISM, Group 1, Class A equipment),  
IEC 555-2 and IEC 555-3

<b>Immunity</b>		Code	Notes
	EN50082-1		
	IEC 801-2 (ESD) 8kV AD	2	
	IEC 801-3 (Rad.) 3 V/m	1	
	IEC 801-4 (EFT) 1kV	1	

### Performance Codes:

- 1 PASS - Normal operation, no effect.
- 2 PASS - Temporary degradation, self recoverable.
- 3 PASS - Temporary degradation, operator intervention required.
- 4 FAIL - Not recoverable, component damage.

**Sound Pressure Level** N/A

**Definitions** Installation category (overvoltage category) I: Signal level, special equipment or parts of equipment, telecommunication, electronic etc., with smaller transient overvoltages than installation (overvoltage category) II.

Installation category (overvoltage category) II: Local level, appliances, portable equipment etc., with smaller transient overvoltages than installation category III.

**Environmental Conditions** Indoor use only.  
Altitude up to 3000 m. (10,000 ft.)

**Temperature** Instrument - 0 degrees C to 50 degrees C (32 degrees F to 122 degrees F)  
Disk Media - 10 degrees C to 40 degrees C (50 degrees F to 104 degrees F)  
Probes/cables - 0 degrees C to 65 degrees C (32 degrees F to 149 degrees F)

**Humidity** Relative humidity 8 to 80% at 40 degrees C (104 degrees F)

**Power** (From host frame.)



# DECLARATION OF CONFORMITY

according to ISO/IEC Guide 22 and EN 45014

**Manufacturer's Name:** Hewlett-Packard Company

**Manufacturer's Address:** Colorado Springs Division  
1900 Garden of the Gods Road  
Colorado Springs, CO 80907 USA

declares, that the product

**Product Name:** Logic Analyzer Module

**Model Number(s):** HP 16718A, and 16719A

**Product Options(s):** All

conforms to the following Product Specifications:

**Safety:** IEC 1010-1:1990+A1 / EN 61010-1:1993  
UL 3111  
CSA-C22.2 No. 1010.1:1993

**EMC:** CISPR 11:1990 / EN 55011:1991 Group 1, Class A  
IEC 555-2:1982 +A1:1985 / EN 60555-2:1987  
IEC 555-3:1982 +A1:1990 / EN 60555-3:1987 + A1:1991  
IEC 801-2:1991 / EN 50082-1:1992 4 kV CD, 8 kV AD  
IEC 801-3:1984 / EN 50082-1:1992 3 V/m, {1kHz 80% AM, 27-1000 MHz}  
IEC 801-4:1988 / EN 50082-1:1992 0.5 kV Sig. Lines, 1kV Power Lines

## Supplementary Information:

The product herewith complies with the requirements of the Low Voltage Directive 73/23/EEC and the EMC Directive 89/336/EEC, and carries the CE marking accordingly.

This product was tested in a typical configuration with Hewlett-Packard test systems.

Colorado Springs, 06/16/99



Ken Wyatt / Product Regulations Manager

European Contact: Your local Hewlett-Packard Sales and Service Office or Hewlett-Packard GmbH, Department ZQ / Standards Europe, Herrenberger Strasse 130, D-71034 Böblingen Germany (FAX: +49-7031-14-3143)

## Product Regulations

**Safety** IEC 1010-1:1990+A1 / EN 61010-1:1993  
UL 3111  
CSA-C22.2 No.1010.1:1993

**EMC** This Product meets the requirement of the European Communities (EC)  
EMC Directive 89/336/EEC.

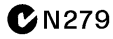

**Emissions** EN55011/CISPR 11 (ISM, Group 1, Class A equipment),  
IEC 555-2 and IEC 555-3

<b>Immunity</b>		Code	Notes
	EN50082-1		
	IEC 801-2 (ESD) 8kV AD	2	
	IEC 801-3 (Rad.) 3 V/m	1	
	IEC 801-4 (EFT) 1kV	1	

### Performance Codes:

- 1 PASS - Normal operation, no effect.
- 2 PASS - Temporary degradation, self recoverable.
- 3 PASS - Temporary degradation, operator intervention required.
- 4 FAIL - Not recoverable, component damage.

**Sound Pressure Level** N/A

**Definitions** Installation category (overvoltage category) I: Signal level, special equipment or parts of equipment, telecommunication, electronic etc., with smaller transient overvoltages than installation (overvoltage category) II.

Installation category (overvoltage category) II: Local level, appliances, portable equipment etc., with smaller transient overvoltages than installation category III.

**Environmental Conditions** Indoor use only.  
Altitude up to 3000 m. (10,000 ft.)

**Temperature** Instrument - 0 degrees C to 50 degrees C (32 degrees F to 122 degrees F)  
Disk Media - 10 degrees C to 40 degrees C (50 degrees F to 104 degrees F)  
Probes/cables - 0 degrees C to 65 degrees C (32 degrees F to 149 degrees F)

**Humidity** Relative humidity 8 to 80% at 40 degrees C (104 degrees F)

**Power** (From host frame.)

# DECLARATION OF CONFORMITY

according to ISO/IEC Guide 22 and EN 45014

**Manufacturer's Name:** Hewlett-Packard Company

**Manufacturer's Address:** Colorado Springs Division  
1900 Garden of the Gods Road  
Colorado Springs, CO 80907 USA

declares, that the product

**Product Name:** Logic Analyzer Memory Expansion

**Model Number(s):** HP E2485A

**Product Options(s):** All

conforms to the following Product Specifications:

**Safety:** IEC 1010-1:1990+A1 / EN 61010-1:1993  
UL 3111  
CSA-C22.2 No. 1010.1:1993

**EMC:** CISPR 11:1990 / EN 55011:1991 Group 1, Class A  
IEC 555-2:1982 +A1:1985 / EN 60555-2:1987  
IEC 555-3:1982 +A1:1990 / EN 60555-3:1987 + A1:1991  
IEC 801-2:1991 / EN 50082-1:1992 4 kV CD, 8 kV AD  
IEC 801-3:1984 / EN 50082-1:1992 3 V/m, {1kHz 80% AM, 27-1000 MHz}  
IEC 801-4:1988 / EN 50082-1:1992 0.5 kV Sig. Lines, 1kV Power Lines

## Supplementary Information:

The product herewith complies with the requirements of the Low Voltage Directive 73/23/EEC and the EMC Directive 89/336/EEC and carries the CE marking accordingly.

This product was tested in a typical configuration with Hewlett-Packard test systems.

Colorado Springs, 06/11/97.

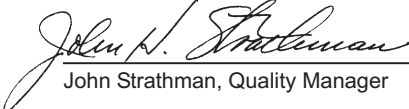
  
John Strathman, Quality Manager

European Contact: Your local Hewlett-Packard Sales and Service Office or Hewlett-Packard GmbH, Department ZQ / Standards  
Europe, Herrenberger Strasse 130, D-71034 Böblingen Germany (FAX: +49-7031-14-3143)

## Product Regulations

**Safety** IEC 1010-1:1990+A1 / EN 61010-1:1993  
UL 3111  
CSA-C22.2 No.1010.1:1993

**EMC** This Product meets the requirement of the European Communities (EC)  
EMC Directive 89/336/EEC.



**Emissions** EN55011/CISPR 11 (ISM, Group 1, Class A equipment)  
IEC 555-2 and IEC 555-3



<b>Immunity</b>		Code	Notes
EN50082-1			
IEC 801-2 (ESD) 8kV AD		3	
IEC 801-3 (Rad.) 3 V/m		3	
IEC 801-4 (EFT) 1kV		3	

### Performance Codes:

- 1 PASS - Normal operation, no effect.
- 2 PASS - Temporary degradation, self recoverable.
- 3 PASS - Temporary degradation, operator intervention required.
- 4 FAIL - Not recoverable, component damage.

**Sound Pressure Level** N/A

**Definitions** Installation category (overvoltage category) I: Signal level, special equipment or parts of equipment, telecommunication, electronic etc., with smaller transient overvoltages than installation (overvoltage category) II.

Installation category (overvoltage category) II: Local level, appliances, portable equipment etc., with smaller transient overvoltages than installation category III.

**Environmental Conditions** Indoor use only.  
Altitude up to 3000 m. (10,000 ft.)

**Temperature** Instrument - 0 degrees C to 50 degrees C (32 degrees F to 122 degrees F)  
Probes/cables - 0 degrees C to 65 degrees C (32 degrees F to 149 degrees F)

**Humidity** Relative humidity 8 to 80% at 40 degrees C (104 degrees F)

**Power** CAT II, Pollution degree 2  
HP E2485A: ~Line 100-240 volts  $\pm$  20%, 50-60 Hz, 40 Watts max.

© Copyright Hewlett-Packard Company 1998  
All Rights Reserved.

Reproduction, adaptation, or translation without prior written permission is prohibited, except as allowed under the copyright laws.

#### Restricted Rights Legend.

Use, duplication or disclosure by the U.S. Government is subject to restrictions as set forth in subparagraph (c)(1)(ii) of the Rights in Technical Data and Computer Software clause at DFARS 252.227-7013 for DOD agencies, and subparagraphs (c)(1) and (c)(2) of the Commercial Computer Software Restricted Rights clause at FAR 52.227-19 for other agencies.

Hewlett-Packard Company  
3000 Hanover Street  
Palo Alto, California 94304  
U.S.A.

#### Document Warranty

The information contained in this document is subject to change without notice.

**Hewlett-Packard makes no warranty of any kind with regard to this material, including, but not limited to, the implied warranties of merchantability or fitness for a particular purpose.**

Hewlett-Packard shall not be liable for errors contained herein or for damages in connection with the furnishing, performance, or use of this material.

#### Safety

This apparatus has been designed and tested in accordance with IEC Publication 1010, Safety Requirements for Measuring Apparatus, and has been supplied in a safe condition. This is a Safety Class I instrument (provided with terminal for protective earthing). Before applying power, verify that the correct safety precautions are taken (see the following warnings). In addition, note the external markings on the instrument that are described under "Safety Symbols."

#### Warning

- Before turning on the instrument, you must connect the protective earth terminal of the instrument to the protective conductor of the (mains) power cord. The mains plug shall only be inserted in a socket outlet provided with a protective earth contact. You must not negate the protective action by using an extension cord (power cable) without a protective conductor (grounding). Grounding one conductor of a two-conductor outlet is not sufficient protection.
- Only fuses with the required rated current, voltage, and specified type (normal blow, time delay, etc.) should be used. Do not use repaired fuses or short-circuited fuseholders. To do so could cause a shock or fire hazard.
- Service instructions are for trained service personnel. To avoid dangerous electric shock, do not perform any service unless qualified to do so. Do not attempt internal service or adjustment unless another person, capable of rendering first aid and resuscitation, is present.
- If you energize this instrument by an auto transformer (for voltage reduction), make sure the common terminal is connected to the earth terminal of the power source.
- Whenever it is likely that the ground protection is impaired, you must make the instrument inoperative and secure it against any unintended operation.
- Do not operate the instrument in the presence of flammable gasses or fumes. Operation of any electrical instrument in such an environment constitutes a definite safety hazard.
- Do not install substitute parts or perform any unauthorized modification to the instrument.
- Capacitors inside the instrument may retain a charge even if the instrument is disconnected from its source of supply.
- Use caution when exposing or handling the CRT. Handling or replacing the CRT shall be done only by qualified maintenance personnel.

#### Safety Symbols



Instruction manual symbol: the product is marked with this symbol when it is necessary for you to refer to the instruction manual in order to protect against damage to the product.



Hazardous voltage symbol.



Earth terminal symbol: Used to indicate a circuit common connected to grounded chassis.

#### WARNING

The Warning sign denotes a hazard. It calls attention to a procedure, practice, or the like, which, if not correctly performed or adhered to, could result in personal injury. Do not proceed beyond a Warning sign until the indicated conditions are fully understood and met.

#### CAUTION

The Caution sign denotes a hazard. It calls attention to an operating procedure, practice, or the like, which, if not correctly performed or adhered to, could result in damage to or destruction of part or all of the product. Do not proceed beyond a Caution symbol until the indicated conditions are fully understood or met.

Hewlett-Packard  
P.O. Box 2197  
1900 Garden of the Gods Road  
Colorado Springs, CO. 80901

### **Product Warranty**

This Hewlett-Packard product has a warranty against defects in material and workmanship for a period of one year from date of shipment. Some newly manufactured HP products may contain remanufactured parts which are equivalent to new in performance. During the warranty period, Hewlett-Packard Company will, at its option, either repair or replace products that prove to be defective.

For warranty service or repair, this product must be returned to a service facility designated by Hewlett-Packard.

For products returned to Hewlett-Packard for warranty service, the Buyer shall prepay shipping charges to Hewlett-Packard and Hewlett-Packard shall pay shipping charges to return the product to the Buyer. However, the Buyer shall pay all shipping charges, duties, and taxes for products returned to Hewlett-Packard from another country.

Hewlett-Packard warrants that its software and firmware designated by Hewlett-Packard for use with an instrument will execute its programming instructions when properly installed on that instrument. Hewlett-Packard does not warrant that the operation of the instrument software, or firmware will be uninterrupted or error free.

### **Limitation of Warranty**

The foregoing warranty shall not apply to defects resulting from improper or inadequate maintenance by the Buyer, Buyer-supplied software or interfacing, unauthorized modification or misuse, operation outside of the environmental specifications for the product, or improper site preparation or maintenance.

**No other warranty is expressed or implied. Hewlett-Packard specifically disclaims the implied warranties of merchantability or fitness for**

### **Exclusive Remedies**

The remedies provided herein are the buyer's sole and exclusive remedies. Hewlett-Packard shall not be liable for any direct, indirect, special, incidental, or consequential damages, whether based on contract, tort, or any other legal theory.

### **Assistance**

Product maintenance agreements and other customer assistance agreements are available for Hewlett-Packard products. For any assistance, contact your nearest Hewlett-Packard Sales Office.

### **Certification**

Hewlett-Packard Company certifies that this product met its published specifications at the time of shipment from the factory. Hewlett-Packard further certifies that its calibration measurements are traceable to the United States National Institute of Standards and Technology, to the extent allowed by the Institute's calibration facility, and to the calibration facilities of other International Standards Organization members.

### **About this edition**

This is the third edition of the HP 16600A Series, 16700A, 16702A, and Measurement Modules Installation Guide.

Publication number  
16700-97012, Nov. 1999  
Printed in USA.

Print history as follows:  
16700-97008, Nov. 1998  
16700-97010, May 1999  
16700-97012, Nov. 1999

New editions are complete revisions of the manual. Many product updates do not require manual changes; and, conversely, manual corrections may be done without accompanying product changes. Therefore, do not expect a one-to-one correspondence between product updates and manual updates.