
Programmer's Guide

Publication number 16555-97011
First edition, January 1997

For Safety information, Warranties, and Regulatory
information, see the pages behind the Index

© Copyright Hewlett-Packard Company 1987, 1990, 1993, 1994, 1997
All Rights Reserved

HP 16554A, HP 16555A, and HP 16555D State/Timing Logic Analyzers

In This Book

This guide, combined with the *HP 16500/16501A Programmer's Guide*, provides you with the information needed to program the HP 16554A and HP 16555A/D logic analyzer modules. Each module has its own reference to supplement the mainframe manual since not all mainframes will be configured with the same modules.

This manual is organized in three parts. Part 1 consists of chapters 1 and 2 which contain general information and instructions to help you get started.

Chapter 1 also contains:

- Mainframe system commands that are frequently used with the logic analyzer module
- HP 16554A/HP 16555A/HP 16555D logic analyzer command tree
- Alphabetic command-to-subsystem directory

Chapter 2 contains module-level commands.

Part 2 consists of chapters 3 through 16 which contain the subsystem commands for the logic analyzer and chapter 17 which contains information on the SYSTEM:DATA and SYSTEM:SETup commands for this module.

1	Programming the HP 16554A/ HP 16555A/HP 16555D	
2	Module Level Commands	
3	MACHine Subsystem	
4	WLISt Subsystem	
5	SFORmat Subsystem	
6	STRigger (STRace) Subsystem	
7	SLISt Subsystem	
8	SWAVEform Subsystem	
9	SCHart Subsystem	
10	COM Pare Subsystem	
11	TFORmat Subsystem	
12	TTRigger (TTRace) Subsystem	
13	TWAVEform Subsystem	
14	TLISt Subsystem	

Part 3, chapter 18, contains program examples of actual tasks that show you how to get started in programming the HP 16554A and HP 16555A/D logic analyzers. These examples are written in HP BASIC 6.2; however, the program concepts can be used in any other popular programming language. Error messages for the HP 16554A and HP 16555A/D are included in generic system error messages and are in the *HP 16500/16501A Programmer's Guide*.

15	SYMBOL Subsystem	
16	SPA Subsystem	
17	DATA and SETUP Commands	
18	Programming Examples	
	Index	

Contents

Part 1 General Information

1 Programming the HP 16554A/ HP 16555A/HP 16555D

Selecting the Module 1-3
Programming the Logic Analyzer 1-3
Mainframe Commands 1-5
Command Set Organization 1-8
Module Status Reporting 1-12
MESE<N> 1-13
MESR<N> 1-15

2 Module Level Commands

ARMLine 2-5
DBLock 2-5
MACHine 2-6
SPA 2-7
WLISt 2-7

Part 2 Commands

3 MACHine Subsystem

MACHine 3-4
ARM 3-5
ASSign 3-6
LEVelarm 3-7
NAME 3-8
REName 3-8
RESource 3-9
TYPE 3-10

4 WLISt Subsystem

WLISt	4-4
DELaY	4-5
INSert	4-6
LINE	4-7
MINus	4-8
OSTate	4-9
OTIME	4-9
OVERlay	4-10
PLUS	4-11
RANGe	4-12
REMOve	4-12
XOTime	4-13
XSTate	4-13
XTIME	4-14

5 SFORmat Subsystem

SFORmat	5-6
CLOCK	5-6
LABel	5-7
MASTer	5-9
MODE	5-10
MOPQual	5-11
MQUal	5-12
REMOve	5-13
SETHold	5-13
SLAVe	5-15
SOPQual	5-16
SQUal	5-17
THREshold	5-18

6 STRigger (STRace) Subsystem

Qualifier 6-6
STRigger (STRace) 6-8
ACQuisition 6-8
BRANch 6-9
CLEar 6-11
FIND 6-12
MLENght 6-13
RANGE 6-14
SEQuence 6-15
STORe 6-16
TAG 6-17
TAKenbranch 6-18
TCONtrol 6-19
TERM 6-20
TIMER 6-21
TPOsition 6-22

7 SLISt Subsystem

SLISt 7-7
COLumn 7-7
CLRPattern 7-8
DATA 7-9
LINE 7-9
MMODE 7-10
OPATtern 7-11
OSEarch 7-12
OSTate 7-13
OTAG 7-14
OVERlay 7-15
REMove 7-15
RUNTil 7-16
TAVerage 7-17
TMAXimum 7-17
TMINimum 7-18
VRUNs 7-18

Contents

XOTag 7-19
XOTime 7-19
XPATtern 7-20
XSEarch 7-21
XState 7-22
XTAG 7-22

8 SWAVeform Subsystem

SWAVeform 8-4
ACCumulate 8-5
ACQuisition 8-5
CENTer 8-6
CLRPattern 8-6
CLRStat 8-7
DELay 8-7
INSert 8-8
MLENght 8-8
RANGe 8-9
REMove 8-10
TAKenbranch 8-10
TPOSition 8-11

9 SCHart Subsystem

SCHart 9-4
ACCumulate 9-4
CENTer 9-5
HAXis 9-5
VAXis 9-6

10 COMPare Subsystem

COMPare 10-4
CLEar 10-5
CMASK 10-5
COPY 10-6
DATA 10-6

FIND 10-8
LINE 10-9
MENU 10-9
RANGe 10-10
RUNTil 10-11
SET 10-12

11 TFormat Subsystem

TFormat 11-4
ACQMode 11-5
LABel 11-6
REMove 11-7
THReshold 11-8

12 TRigger (TRace) Subsystem

Qualifier 12-6
TRigger (TRace) 12-8
ACQuisition 12-9
BRANch 12-9
CLEar 12-12
EDGE 12-13
FIND 12-14
MLENght 12-16
RANGe 12-17
SEQuence 12-18
SPERiod 12-19
TCONtrol 12-20
TERM 12-21
TIMER 12-22
TPOsition 12-23

13 TWAVeform Subsystem

TWAVeform	13-7
ACCumulate	13-7
ACQuisition	13-8
CENTer	13-9
CLRPattern	13-9
CLRStat	13-9
DELay	13-10
INSert	13-11
MLENght	13-12
MINus	13-13
MMODE	13-14
OCONdition	13-15
OPATtern	13-16
OSEarch	13-17
OTIME	13-18
OVERlay	13-18
PLUS	13-19
RANGE	13-20
REMove	13-20
RUNTil	13-21
SPERiod	13-22
TAVerage	13-23
TMAXimum	13-23
TMINimum	13-24
TPOSition	13-24
VRUNs	13-25
XCONdition	13-26
XOTime	13-26
XPATtern	13-27
XSEarch	13-28
XTIME	13-29

14 TLISt Subsystem

TLISt 14-7
COLumn 14-7
CLRPattern 14-8
DATA 14-9
LINE 14-9
MMODE 14-10
OCONdition 14-11
OPATtern 14-12
OSEarch 14-13
OSTate 14-14
OTAG 14-14
REMove 14-15
RUNTil 14-16
TAVerage 14-17
TMAXimum 14-17
TMINimum 14-18
VRUNs 14-18
XCONdition 14-19
XOTag 14-19
XOTime 14-20
XPATtern 14-20
XSEarch 14-21
XState 14-22
XTAG 14-23

15 SYMBol Subsystem

SYMBol 15-5
BASE 15-5
PATTErn 15-6
RANGe 15-7
REMove 15-8
WIDTh 15-8

16 SPA Subsystem

MODE	16-7
OVERView:BUCKet	16-8
OVERView:HIGH	16-9
OVERView:LABel	16-10
OVERView:LOW	16-11
OVERView:MLENgtH	16-12
OVERView:OMARker	16-13
OVERView:OVSTATistic	16-14
OVERView:XMARker	16-15
HISTogram:HSTATistic	16-16
HISTogram:LABel	16-17
HISTogram:OTHer	16-18
HISTogram:QUALifier	16-19
HISTogram:RANGe	16-20
HISTogram:TTYPe	16-21
TINTerval:AUTorange	16-22
TINTerval:QUALifier	16-23
TINTerval:TINTerval	16-24
TINTerval:TSTATistic	16-25

17 DATA and SETUp Commands

Introduction	17-2
Data Format	17-3
SYSTem:DATA	17-4
Section Header Description	17-6
Section Data	17-6
Data Preamble Description	17-7
Acquisition Data Description	17-11
Time Tag Data Description	17-13
SYSTem:SETUp	17-13

Part 3 Programming Examples

18 Programming Examples

- Making a Timing Analyzer Measurement 18-3
- Making a State Analyzer Measurement 18-5
- Making a State Compare Analyzer Measurement 18-9
- Transferring the Logic Analyzer Configuration 18-14
- Checking for Measurement Completion 18-18
- Sending Queries to the Logic Analyzer 18-19

Index

Contents-10

Part 1

- 1** Introduction to Programming
- 2** Module Level Commands

General Information



Programming the HP 16554A/ HP 16555A/HP 16555D

Introduction

This chapter introduces you to the basic command structure used to program the logic analyzer. Also included is an example program that sets up the timing analyzer for a basic timing measurement. Additional program examples are in chapter 18.



Selecting the Module

Before you can program the logic analyzer, you must first "select" it. This directs your commands to the logic analyzer.

To select the module, use the system command :SElect followed by the numeric reference for the slot location of the logic analyzer (1 through 10 referring to slots A through J respectively). For example, if the logic analyzer is in slot E, then the command:

```
:SElect 5
```

would select this module. For more information on the select command, refer to the *HP 16500/16501A Programmer's Guide*. It is available through your HP Sales Office.

Programming the Logic Analyzer

A typical logic analyzer program will do the following:

- select the appropriate module
- name a specified analyzer
- specify the analyzer type
- assign pods
- assign labels
- sets pod thresholds
- specify a trigger condition
- set up the display
- specify acquisition type
- start acquiring data

The following example program sets up the logic analyzer to make a simple timing analyzer measurement.

Example

```
10  OUTPUT XXX;":SELECT 3"
20  OUTPUT XXX;":MACH1:NAME 'TIMING' "
30  OUTPUT XXX;":MACH1:TYPE TIMING"
40  OUTPUT XXX;":MACH1:ASSIGN 1"
50  OUTPUT XXX;":MACH1:TFORMAT:LABEL 'COUNT',POS,0,0,255"
60  OUTPUT XXX;":MACH1:TTRIGGER:TERM A, 'COUNT', '#HFF' "
70  OUTPUT XXX;":MACH1:TWAVEFORM:RANGE 1E-6"
80  OUTPUT XXX;":MENU 3,5"
90  OUTPUT XXX;":MACH1:TWAVEFORM:INSERT 'COUNT' "
100 OUTPUT XXX;":RMODE SINGLE"
110 OUTPUT XXX;":START"
120  END
```

The three Xs (XXX) after the "OUTPUT" statements in the previous example refer to the device address required for programming over either HP-IB or RS-232-C. Refer to your controller manual and programming language reference manual for information on initializing the interface.

Program Comments

Line 10 selects the logic analyzer in slot C.

Line 20 names machine (analyzer) 1 "TIMING".

Line 30 specifies machine 1 is a timing analyzer.

Line 40 assigns pods 1 and 2 to machine 1.

Line 50 sets up the Timing Format menu by assigning the label COUNT, and assigning a polarity and channels to the label.

Line 60 selects the trigger pattern for the timing analyzer.

Line 70 sets the range to 100 ns (10 times s/div).

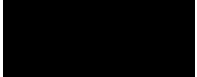
Line 80 changes the onscreen display to the Timing Waveforms menu.

Line 90 inserts the label "COUNT" in the Timing Waveform menu.

Line 100 specifies the Single run mode.

Line 110 starts data acquisition.

For more information on the specific logic analyzer commands, refer to chapters 2 through 17.



Mainframe Commands

These commands are part of the HP 16500/16501A mainframe system and are mentioned here only for reference. For more information on these commands, refer to the *HP 16500/16501A Programmer's Guide*.

CARDcage? Query

The CARDcage query returns a string of integers which identifies the modules that are installed in the mainframe. The returned string is in two parts. The first five two-digit numbers identify the card type. The identification number for the HP 16554A and HP 16555A/D logic analyzers is 34. A "-1" in the first part of the string indicates no card is installed in the slot.

The five single-digit numbers in the second part of the string indicate which card has the controlling software for the module; that is, where the master card is located.

Example

12, 11, -1, -1, 34, 2, 2, 0, 0, 5

A returned string of 12, 11, -1, -1, 34, 2, 2, 0, 0, 5 means that an oscilloscope time base card (ID number 11) is loaded in slot B and the oscilloscope acquisition card (ID number 12) is loaded in slot A. The next two slots (C and D) are empty (-1). Slot E contains a logic analyzer module (ID number 34).

The next group of numbers (2, 2, 0, 0, 5) indicate that a two-card module is installed in slots A and B with the master card in slot B. The "0" indicates an empty slot, or the module software is not recognized or is not loaded. The last digit (5) in this group indicates a one-card module is loaded in slot E. Complete information for the CARDcage query is in the *HP 16500/16501A Programmer's Guide*.

MENU Command/query

The MENU command selects a new displayed menu. The first parameter (X) specifies the desired module. The optional, second parameter specifies the desired menu in the module. The second parameter defaults to 0 if it is not specified. The query returns the currently selected and displayed menu.

For the HP 16554A/HP 16555A/HP 16555D Logic Analyzers:

- X,0 — State/Timing Configuration
- X,1 — Format 1
- X,2 — Format 2
- X,3 — Trigger 1
- X,4 — Trigger 2
- X,5 — Waveform 1
- X,6 — Waveform 2
- X,7 — Listing 1
- X,8 — Listing 2
- X,9 — Mixed Display
- X,10 — Compare 1
- X,11 — Compare 2
- X,12 — Chart 1
- X,13 — Chart 2
- X,14 — SPA 1
- X,15 — SPA 2

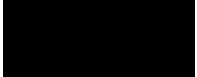
If a machine is turned off, its menus are not available. The Mixed Display is available only when one or both analyzers are state analyzers.

SElect Command/query

The SElect command selects which module or intermodule will have parser control. SElect 0 selects the intermodule, SElect 1 through 5 selects modules A through E respectively. Values -1 and -2 select software options 1 and 2. The SElect query returns the currently selected module.

STARt Command

The STARt command starts the specified module. If the specified module is configured for intermodule (group run), STARt will start all modules configured as part of the intermodule run.



STOP Command

The STOP command stops the specified module. If the specified module is configured as part of an intermodule run, STOP will stop all associated modules.

START and STOP are overlapped commands. Overlapped commands allow execution of subsequent commands while the logic analyzer operations initiated by the overlapped command are still in progress. For more information, see *OPC and *WAI commands in Chapter 5 of the *HP 16500/16501A Programmer's Guide*.

RMODE Command/query

The RMODE command specifies the run mode (single or repetitive) for a module. If the selected module is configured for intermodule, the intermodule run mode will be set by this command. The RMODE query returns the current setting.

SYSTEM:ERROR? Query

The SYSTEM:ERROR query returns the oldest error in the error queue. In order to return all the errors in the error queue, a simple FOR/NEXT loop can be written to query the queue until all errors are returned. Once all errors are returned, the query will return zeros.

SYSTEM:PRINT Command/query

The SYSTEM:PRINT command initiates a print of the screen or listing buffer over the current printer communication interface. The SYSTEM:PRINT query sends the screen or listing buffer data over the current controller communication interface.

MMEMORY Subsystem

The MMEMORY Subsystem provides access to both internal disc drives for loading and storing configurations.

INTERMODULE Subsystem

The INTERMODULE Subsystem commands are used to specify intermodule arming between multiple modules.

Command Set Organization

The command set for the HP 16554A/HP 16555A/HP 16555D is divided into module-level commands and subsystem commands. Module-level commands are listed in Chapter 2, "Module Level Commands" and each of the subsystem commands are covered in their individual chapters starting with Chapter 3, "MACHine Subsystem."

Each of these chapters contains a description of the subsystem, syntax diagrams, and the commands in alphabetical order. The commands are shown in long form and short form using upper and lowercase letters. For example, LABEL indicates that the long form of the command is LABEL and the short form is LAB. Each of the commands contain a description of the command and its arguments, the command syntax, and a programming example.

Figure 1-1 on the following page shows the command tree for the HP 16554A/HP 16555A/HP 16555D logic analyzer module. The (x) following the SElect command at the top of the tree represents the slot number where the logic analyzer module is installed. The number may range from 1 through 10, representing slots A through J, respectively.

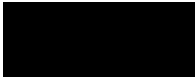
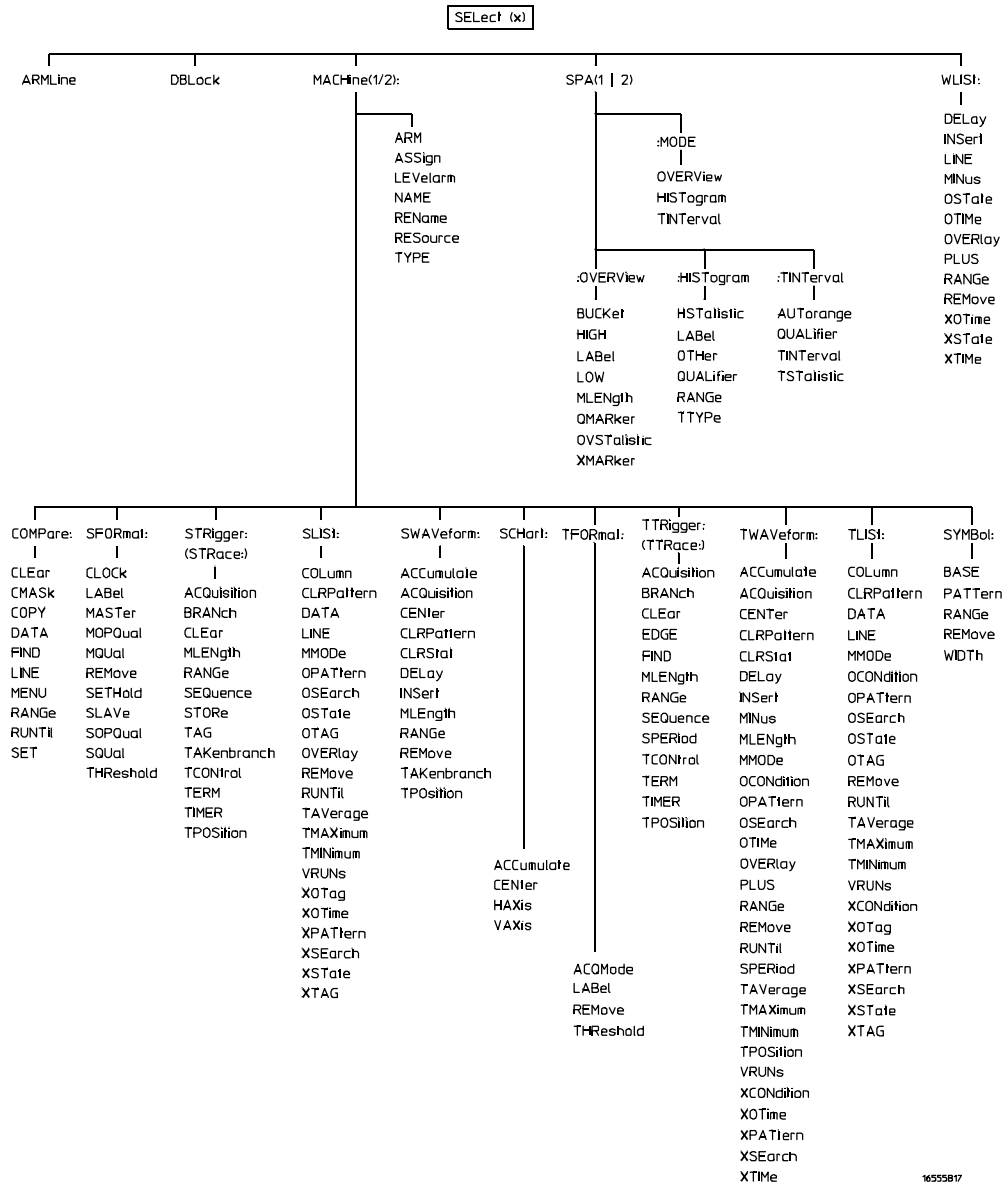


Figure 1-1



HP 16554A/HP 16555A/HP 16555D Command Tree

Table 1-1

Alphabetical Command-to-Subsystem Directory

Command	Where Used	Command	Where Used
ACCumulate	SCHart, SWAVeform, TWAVeform	MOPQual	SFORmat
ACQMode	TFORmat	MQUal	SFORmat
ACQquisition	STRigger, SWAVeform, TTRigger, TWAVeform	NAME	MACHine
ARM	MACHine	OCONdition	TLISt, TWAVeform
ARMLine	Module Level Commands	OMARker	SPA
ASSign	MACHine	OPATtern	SLISt, TLISt, TWAVeform
AUTorange	SPA	OSEarch	SLISt, TLISt, TWAVeform
BASE	SYMBol	OSTate	SLISt, TLISt, WLISt
BRANch	STRigger, TTRigger	OTAG	SLISt, TLISt
BUCKet	SPA	OTHer	SPA
CENter	SCHart, SWAVeform, TWAVeform	OTIMe	TWAVeform, WLISt
CLEar	COMParE, STRigger, TTRigger	OVERlay	SLISt, TWAVeform, WLISt
CLOCK	SFORmat	OVERView	SPA
CLRPattern	SLISt, SWAVeform, TLISt, TWAVeform	OVStatistic	SPA
CLRStat	SWAVeform, TWAVeform	PATtern	SYMBol
CMASK	COMParE	PLUS	TWAVeform, WLISt
COLumn	SLISt, TLISt	QUALifier	SPA
COPY	COMParE	RANGe	COMParE, SPA, STRigger, SWAVeform, SYMBol, TFORmat, TWAVeform, WLISt
DATA	COMParE, SLISt, TLISt	REMOve	SFORmat, SLISt, SWAVeform, SYMBol, TFORmat, TLISt, TWAVeform, WLISt
DBLock	Module Level Commands	REName	MACHine
DELay	SWAVeform, TWAVeform, WLISt	RESourCe	MACHine
EDGE	TTRigger	RUNtil	COMParE, SLISt, TLISt, TWAVeform
FIND	COMParE, STRigger, TTRigger	SEQuence	STRigger, TTRigger
HAXis	SCHart	SET	COMParE
HIGH	SPA	SETHold	SFORmat
HISTatistic	SPA	SLAVe	SFORmat
HISTogram	SPA	SOPQual	SFORmat
INSert	SWAVeform, TWAVeform, WLISt	SPERiod	TFORmat, TWAVeform
LABel	SFORmat, SPA, TFORmat	SETHold	SFORmat
LEVelarm	MACHine	SLAVe	SFORmat
LINE	COMParE, SLISt, TLISt, WLISt	SOPQual	SFORmat
LOW	SPA	SPERiod	TFORmat, TWAVeform
MASTer	SFORmat	SQUal	SFORmat
MENU	COMParE	STORe	STRigger
MINus	TWAVeform, WLISt	TAG	STRigger
MLENgth	SPA, STRigger, SWAVeform, TTRigger, TWAVeform	TAKenbranch	STRigger, SWAVeform
MMODE	SLISt, TLISt, TWAVeform	TAVerage	SLISt, TLISt, TWAVeform
MODE	SPA		

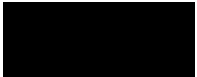


Table 1-1, continued

Alphabetical Command-to-Subsystem Directory, continued

Command	Where Used	Command	Where Used
TCONtrol	STRigger, TTRigger	VAXis	SCHart
TERM	STRigger, TTRigger	VRUNs	SLISt, TLISt, TWAVeform
THReshold	SFORmat, TFORmat	WIDTh	SYMBol
TIMER	STRigger, TTRigger	XCONdition	TLISt, TWAVeform
TINTerval	SPA	XMARker	SPA
TMAXimum	SLISt, TLISt, TWAVeform	XOTag	SLISt, TLISt
TMINimum	SLISt, TLISt, TWAVeform	XOTime	SLISt, TLISt, TWAVeform, WLISt
TPOStion	STRigger, SWAVeform, TTRigger, TWAVeform	XPATtern	SLISt, TLISt, TWAVeform
TStatistic	SPA	XSEarch	SLISt, TLISt, TWAVeform
TTYPe	SPA	XState	SLISt, TLISt, WLISt
TYPE	MACHine	XTAG	SLISt, TLISt
		XTIMe	TWAVeform, WLISt

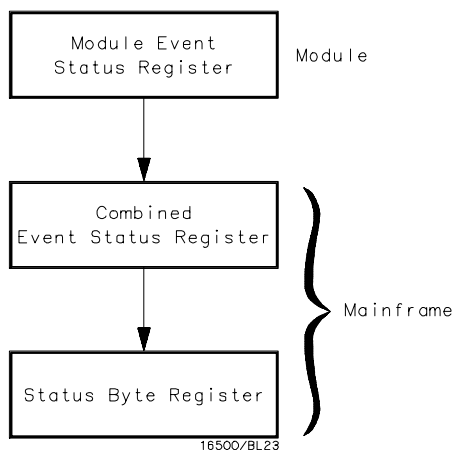
Module Status Reporting

Each module reports its status to the Module Event Status Register (MESR<N>), which in turn reports to the Combined Event Status Register (CESR) in the HP 16500/16501A mainframe (see *HP 16500/16501A Programmer's Guide* chapter 6). The Module Event Status Register is enabled by the Module Event Status Enable Register (MESE<N>).

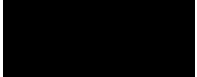
The MESE<N> and MESR<N> instructions are not used in conjunction with the SElect command, so they are not listed in the HP 16554A/HP 16555A/HP 16555D's command tree.

The following descriptions of the MESE<N> and MESR<N> instructions provide the module specific information needed to enable and interpret the contents of the registers.

Figure 1-2



Module Status Reporting



MESE<N>

Command :MESE<N><enable_mask>

The MESE<N> command sets the Module Event Status Enable register bits. The MESE register contains a mask value for the bits enabled in the MESR register. A one in the MESE will enable the corresponding bit in the MESR, a zero will disable the bit.

The first parameter <N> specifies the module. The second parameter specifies the enable value.

Refer to table 1-2 for information about the Module Event Status register bits, bit weights, and what each bit masks for the module. Complete information for status reporting is in chapter 6 of the *HP 16500/16501A Programmer's Guide* manual.

<N> { 1 | 2 | 3 | 4 | 5 | 6 | 7 | 8 | 9 | 10 } number of slot in which the module resides. 1 refers to slot A, and so on.

<enable_mask> integer from 0 to 255

Example OUTPUT XXX; ":MESE5 1"

Query :MESE<N>?

The MESE query returns the current setting.

Returned Format [:MESE<N>] <enable_mask> <NL>

Example 10 OUTPUT XXX; ":MESE5?"
 20 ENTER XXX; Mes
 30 PRINT Mes
 40 END

Table 1-2

Module Event Status Enable Register (A "1" enables the M ESR bit)

Bit	Weight	Enables
7	128	Not used
6	64	Not used
5	32	Not used
4	16	Not used
3	8	Pattern searches failed
2	4	Trigger found
1	2	RNT-Run until satisfied
0	1	MC-Measurement complete

The Module Event Status Enable Register contains a mask value for the bits to be enabled in the Module Event Status Register (MESR). A one in the MESE enables the corresponding bit in the MESR, and a zero disables the bit.



MESR<N>

Query :MESR<N>?

The MESR<N> query returns the contents of the Module Event Status register. When you read the MESR, the value returned is the total bit weights of all bits that are set at the time the register is read. Reading the register clears the Module Event Status Register.

Table 1-3 shows each bit in the Module Event Status Register and its bit weight for this module.

The parameter 1 through 10 refers to the module in slot A through J respectively.

Returned Format [MESR<N>]<status><NL>

<N> {1|2|3|4|5|6|7|8|9|10} number of slot in which the module resides

<status> integer from 0 to 255

Example

```
10 OUTPUT XXX; ":MESR5?"
20 ENTER XXX; Mer
30 PRINT Mer
40 END
```

Table 1-3

Module Event Status Register

Bit	Weight	Condition
7	128	Not used
6	64	Not used
5	32	Not used
4	16	Not used
3	8	1 = One or more pattern searches failed 0 = Pattern searches did not fail
2	4	1 = Trigger found 0 = Trigger not found
1	2	1 = Run until satisfied 0 = Run until not satisfied
0	1	1 = Measurement complete 0 = Measurement not complete



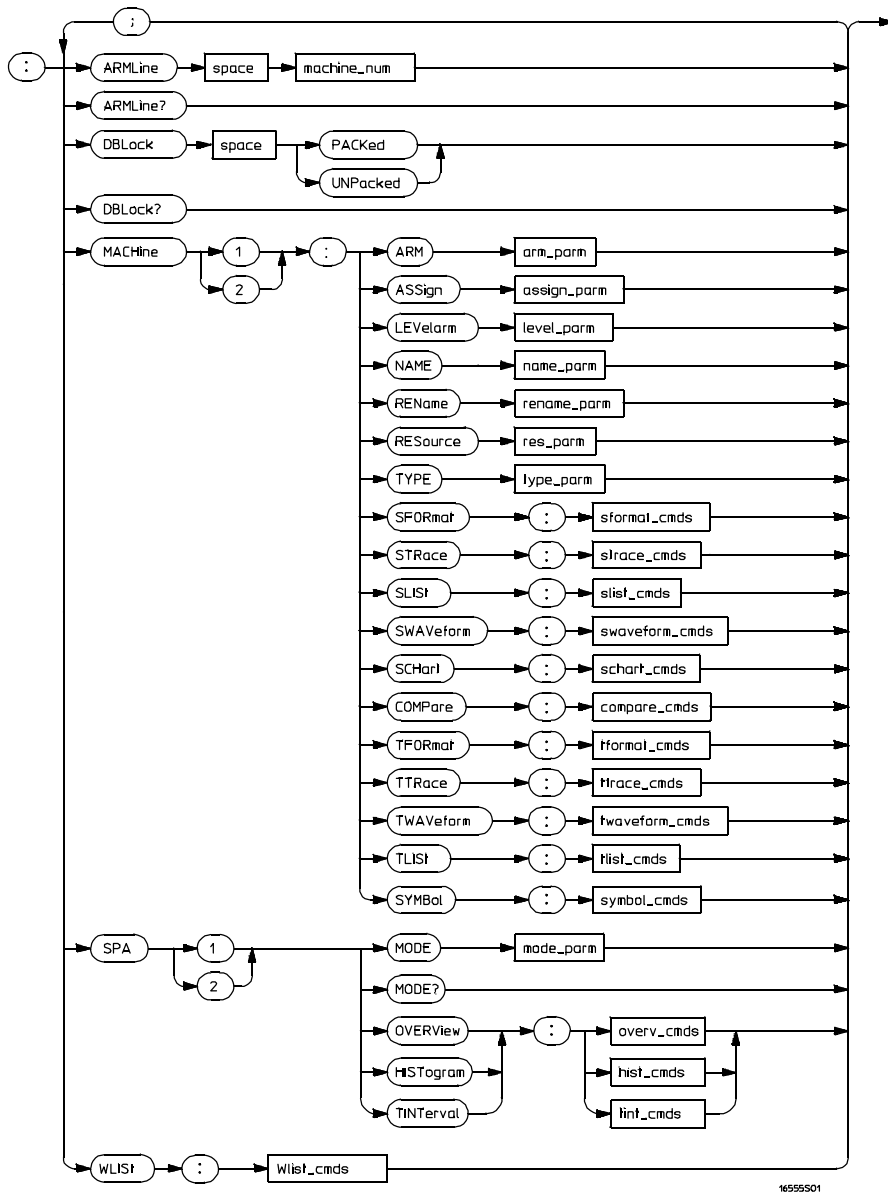
Module Level Commands

Introduction

The logic analyzer module level commands access the global functions of the HP 16554A/HP 16555A/HP 16555D logic analyzer module. These commands are:

- ARMLine
- DBLock
- MACHine
- SPA
- WLISt

Figure 2-1



Module Level Syntax Diagram



Table 2-1

Module Level Parameter Values

Parameter	Type of Parameter or Command	Reference
machine_num	MACHine{1 2}	
arm_parm	arm parameters	see chapter 3
assign_parm	assignment parameters	see chapter 3
level_parm	level parameters	see chapter 3
name_parm	name parameters	see chapter 3
rename_parm	rename parameters	see chapter 3
res_parm	resource parameters	see chapter 3
type_parm	type parameters	see chapter 3
sformat_cmds	state format subsystem commands	see chapter 5
strace_cmds	state trace subsystem commands	see chapter 6
slist_cmds	state list subsystem commands	see chapter 7
swaveform_cmds	state waveform subsystem commands	see chapter 8
schart_cmds	state chart subsystem commands	see chapter 9
compare_cmds	compare subsystem commands	see chapter 10
tformat_cmds	timing format subsystem commands	see chapter 11
ttrace_cmds	timing trace subsystem commands	see chapter 12
twaveform_cmds	timing waveform subsystem commands	see chapter 13
tlist_cmds	timing listing subsystem commands	see chapter 14
symbol_cmds	symbol subsystem commands	see chapter 15
mode_parm	SPA mode parameters	see chapter 16
overv_cmds	SPA overview commands	see chapter 16
hist_cmds	SPA histogram commands	see chapter 16
tint_cmds	SPA time interval commands	see chapter 16
Wlist_cmds	waveforms/listing commands	see chapter 4



ARMLine

Command :ARMLine MACHine<N>

The ARMLine command selects which machine generates the arm out signal on the IMB (intermodule bus). This command is only valid when two analyzers are on. However, the query is always valid.

<N> { 1 | 2 }

Example OUTPUT XXX; ":ARMLINE MACHINE1"

Query :ARMLine?

If the analyzer is set up for OR'd triggering, then the ARMLine query returns an empty string. This cannot be used for setting up OR'd triggering.

Returned Format [:ARMLine] { MACHine<N> | } <NL>

Example OUTPUT XXX; ":ARMLine?"

DBLock

Command :DBLock { PACKed | UNPACKed }

The DBLock command specifies the data block format that is contained in the response from a :SYSTEM:DATA? query. See Chapter 17 for more information on the :SYSTEM:DATA command and query.

The PACKed option (default) uploads data in a compressed format. This option is used to upload data for archiving, or for reloading back into the analyzer. When an analyzer configuration is saved to disk, the PACKed data format is always used (regardless of the current DBLock selection).

The UNPacked option uploads data in a format that is easy to interpret and process. The UNPacked format cannot be downloaded back into the analyzer.

Example

OUTPUT XXX; ":DBLOCK PACKED"

Query

:DBLock?

Returned Format

The DBLock query returns the current data block format selection.
[:DBLock]{PACKed | UNPacked}<NL>

Example

OUTPUT XXX; ":DBLock?"

MACHine

Command

:MACHine<N>

The MACHine command selects which of the two machines (analyzers) the subsequent commands or queries will refer to. MACHine is also a subsystem containing commands that control the logic analyzer system level functions. Examples include pod assignments, analyzer names, and analyzer type. See chapter 3 for details about the MACHine subsystem.

<N> {1|2}

Example

OUTPUT XXX; ":MACHINE1:NAME 'DRAMTEST' "



SPA

Command : SPA<N>

The SPA command selects which of the two analyzers the subsequent commands or queries will refer to. SPA is also a subsystem containing commands that control the logic analyzer SPA functions. See chapter 16 for details about the SPA subsystem.

<N> { 1 | 2 }

Example

OUTPUT XXX; ":SPA1:MODE OVERVIEW"

WLISt

Command : WLISt

The WLISt selector accesses the commands used to place markers and query marker positions in Timing/State Mixed mode. The WLISt subsystem also contains commands that allows you to insert waveforms from other time-correlated machines and modules. The details of the WLISt subsystem are in chapter 4.

Example

OUTPUT XXX; ":WLISt:OTIME 40.0E-6"

Part 2

- 3** MACHine Subsystem
- 4** WLISt Subsystem
- 5** SFORmat Subsystem
- 6** STRigger (STRace) Subsystem
- 7** SLISt Subsystem
- 8** SWAVeform Subsystem
- 9** SCHart Subsystem
- 10** COMPare
- 11** TFORmat Subsystem
- 12** TTRigger (TTRace) Subsystem
- 13** TWAVeform Subsystem
- 14** TLISt Subsystem
- 15** SYMBol Subsystem
- 16** SPA Subsystem
- 17** DATA and SETup Commands

Commands



MACHine Subsystem

Introduction

The MACHine subsystem contains the commands that control the machine level of operation of the logic analyzer. Some of the functions are normally found in the Trigger menu. These commands are:

- ARM
- LEValarm

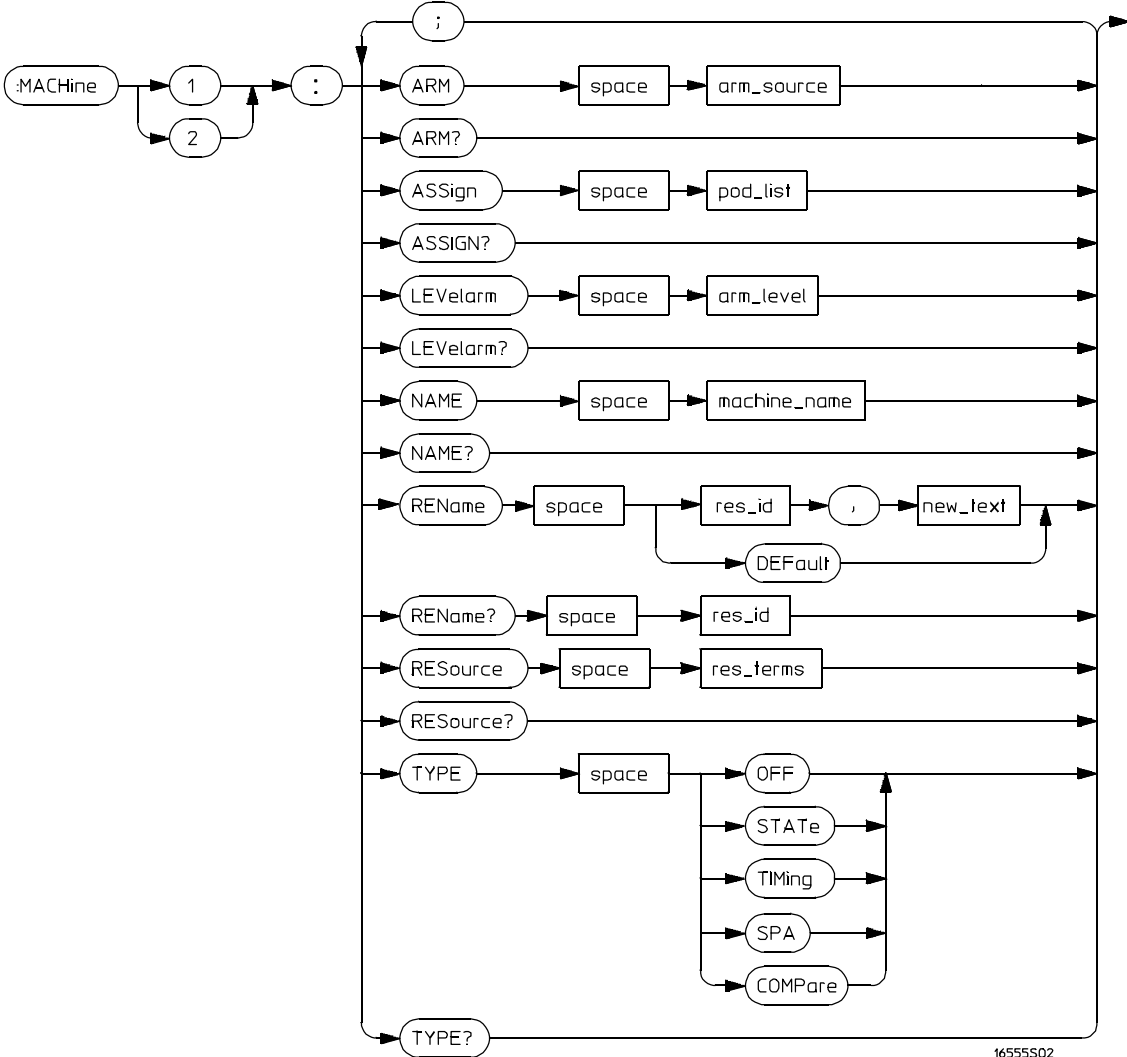
The functions of three of these commands reside in the State/Timing Configuration menu. These commands are:

- ASSign
- NAME
- TYPE

Even though the functions of the following commands reside in the Format menu they are at the machine level of the command tree and are therefore located in the MACHine subsystem. These commands are:

- REName
- RESource

Figure 3-1



Machine Subsystem Syntax Diagram

Table 3-1

Machine Subsystem Parameter Values

Parameter	Value
arm_source	{RUN INTermodule MACHine {1 2}}
pod_list	{NONE <pod_num>[, <pod_num>]...}
pod_num	integer from 1 to 12
arm_level	integer from 1 to 11 representing sequence level
machine_name	string of up to 10 alphanumeric characters
res_id	{<state_terms> H J} for state analyzer or {<state_terms> EDGE{1 2}} for timing analyzer
new_text	string of up to 8 alphanumeric characters
state_terms	{A B C D E F G I RANGE{1 2} TIMER{1 2}}
res_terms	{<res_id>[, <res_id>]...}

MACHine

Selector :MACHine<N>

The MACHine <N> selector specifies which of the two analyzers (machines) available in the module the commands or queries following will refer to. Because the MACHine<N> command is a root level command, it will normally appear as the first element of a compound header.

<N> {1|2} (the machine number)

Example

```
OUTPUT XXX; ":MACHINE1:NAME 'TIMING' "
```

ARM

Command :MACHine{1|2}:ARM <arm_source>

The ARM command specifies the arming source of the specified analyzer (machine). The RUN option disables the arm source. For example, if you do not want to use either the intermodule bus or the other machine to arm the current machine, you specify the RUN option.

If you are using an HP 16500C mainframe, you can set up OR'd Triggering by arming the module from INTermodule when intermodule is set to Group Run with OR TRIGGER. See the *HP 16500C Programmer's Guide* for details.

<arm_source> {RUN|INTermodule|MACHine{1|2}}

Example OUTPUT XXX; ":MACHINE1:ARM MACHINE2"

Query :MACHine{1|2}:ARM?

The ARM query returns the source that the current analyzer (machine) will be armed by.

Returned Format [:MACHine{1|2}:ARM] <arm_source>

Example OUTPUT XXX; ":MACHINE1:ARM?"



ASSign

Command `:MACHine{1|2}:ASSign <pod_list>`

The ASSign command assigns pods to a particular analyzer (machine). The ASSign command will assign two pods for each pod number you specify because pods must be assigned to analyzers in pairs. NONE clears all pods from the specified analyzer (machine) and places them in the "unassigned" category.

If you specify a pod number greater than currently available, the logic analysis system generates an "Argument out of range" error.

`<pod_list>` {NONE | <pod >#[, <pod >#]...}

`<pod>#` an integer from 1 to 12

Example

This example assigns pod pairs 1/2 and 5/6 to machine 1:

OUTPUT XXX;":MACHINE1:ASSIGN 5, 2, 1"

Query `:MACHine{1|2}:ASSign?`

The ASSign query returns which pods are assigned to the current analyzer (machine).

Returned Format `[:MACHine{1|2}:ASSign] <pod_list><NL>`

Example

OUTPUT XXX;":MACHINE1:ASSIGN?"

LEVelarm

Command :MACHine{1|2}:LEVelarm <arm_level>

The LEVelarm command allows you to specify the sequence level for a specified machine that will be armed by the Intermodule Bus or the other machine. This command is only valid if the specified machine is on and the arming source is not set to RUN with the ARM command.

<arm_level> integer from 1 to 11 representing sequence level

Example OUTPUT XXX; ":MACHINE1:LEVELARM 2"

Query :MACHine{1|2}:LEVelarm?

The LEVelarm query returns the current sequence level receiving the arming for a specified machine.

Returned Format [:MACHine{1|2}:LEVelarm] <arm_level><NL>

Example OUTPUT XXX; ":MACHINE1:LEVELARM?"



NAME

Command :MACHine{1|2}:NAME <machine_name>

The NAME command allows you to assign a name of up to 10 characters to a particular analyzer (machine) for easier identification. Spaces are valid characters.

<machine_name> string of up to 10 alphanumeric characters

Example OUTPUT XXX; ":MACHINE1:NAME 'DRAM TEST' "

Query :MACHine{1|2}:NAME?

The NAME query returns the current analyzer name as an ASCII string.

Returned Format [:MACHine{1|2}:NAME] <machine name><NL>

Example OUTPUT XXX; ":MACHINE1:NAME?"

REName

Command :MACHine{1|2}:REName {{<res_id>, <new_text>} | DEFault }

The REName command allows you to assign a specific name of up to eight characters to terms A through J, Range 1 and 2, Timer 1 and 2, and Edge 1 and 2. The terms do not have to be assigned to the specified machine. The DEFault option sets all resource term names to the default names assigned when turning on the instrument.

<res_id> {<state_terms>|H|J} for state analyzer
 {<state_terms>|EDGE{1|2}} for timing analyzer

<new_text> string of up to 8 alphanumeric characters

<state_terms> {A|B|C|D|E|F|G|I| RANGE1 | RANGE2 | TIMer1 | TIMer2}

Example

OUTPUT XXX; ":MACHINE1:RENAME A, 'DATA' "

Query

:MACHine{1|2}:RENAME? <res_id>

The REName query returns the current names for specified terms assigned to the specified analyzer.

Returned Format

[:MACHine{1|2}:RENAME] <res_id>, <new_text><NL>

Example

OUTPUT XXX; ":MACHINE1:RENAME? D"

RESource

Command

:MACHine{1|2}:RESource {<res_id>[, <res_id>]...}

The RESource command allows you to assign resource terms A through G and I, Range 1 and 2, and Timer 1 and 2 to a particular analyzer.

In the timing analyzer only, two additional resource terms are available. These terms are Edge 1 and 2. These terms are always assigned to the machine that is configured as the timing analyzer.

In state analyzers that are not configured for high speed, terms H and J are also available. H and J are not available to timing or high-speed analyzers.

<res_id> <state_terms> for high-speed state analyzer or
 {<state_terms>|H|J} for 100-MHz state analyzer or
 {<state_terms>|EDGE{1|2}} for timing analyzer

<state_terms> {A|B|C|D|E|F|G|I|RANGE1| RANGE2 | TIMer1|TIMer2}



MACHine Subsystem TYPE

Example

```
OUTPUT XXX; ":MACHINE1:RESOURCE A,C,RANGE1 "
```

Query

```
:MACHine{1|2}:RESOURCE?
```

Returned Format

The RESource query returns the current resource terms assigned to the specified analyzer. If no resource terms are assigned, no <res_id> is returned.

```
[ :MACHine{1|2}:RESOURCE ] <res_id> [, <res_id>, ... ] <NL>
```

Example

```
OUTPUT XXX; ":MACHINE1:RESOURCE?"
```

TYPE

Command

```
:MACHine{1|2}:TYPE <analyzer type>
```

The TYPE command specifies what type a specified analyzer (machine) will be. The analyzer types are state or timing. State Compare (COMPare) and SPA are considered to be state analyzers because they use an external clock, but need to be specified as COMPare or SPA.

The TYPE command also allows you to turn off a particular machine.

Only one timing analyzer can be specified at a time.

```
<analyzer type> {OFF|COMPare|SPA|STATe|TIMing}
```

Example

```
OUTPUT XXX; ":MACHINE1:TYPE STATE"
```

Query :MACHine{1|2}:TYPE?

Returned Format The TYPE query returns the current analyzer type for the specified analyzer.
 [:MACHine{1|2}:TYPE] <analyzer type><NL>

Example OUTPUT XXX; ":MACHINE1:TYPE?"





WLISt Subsystem

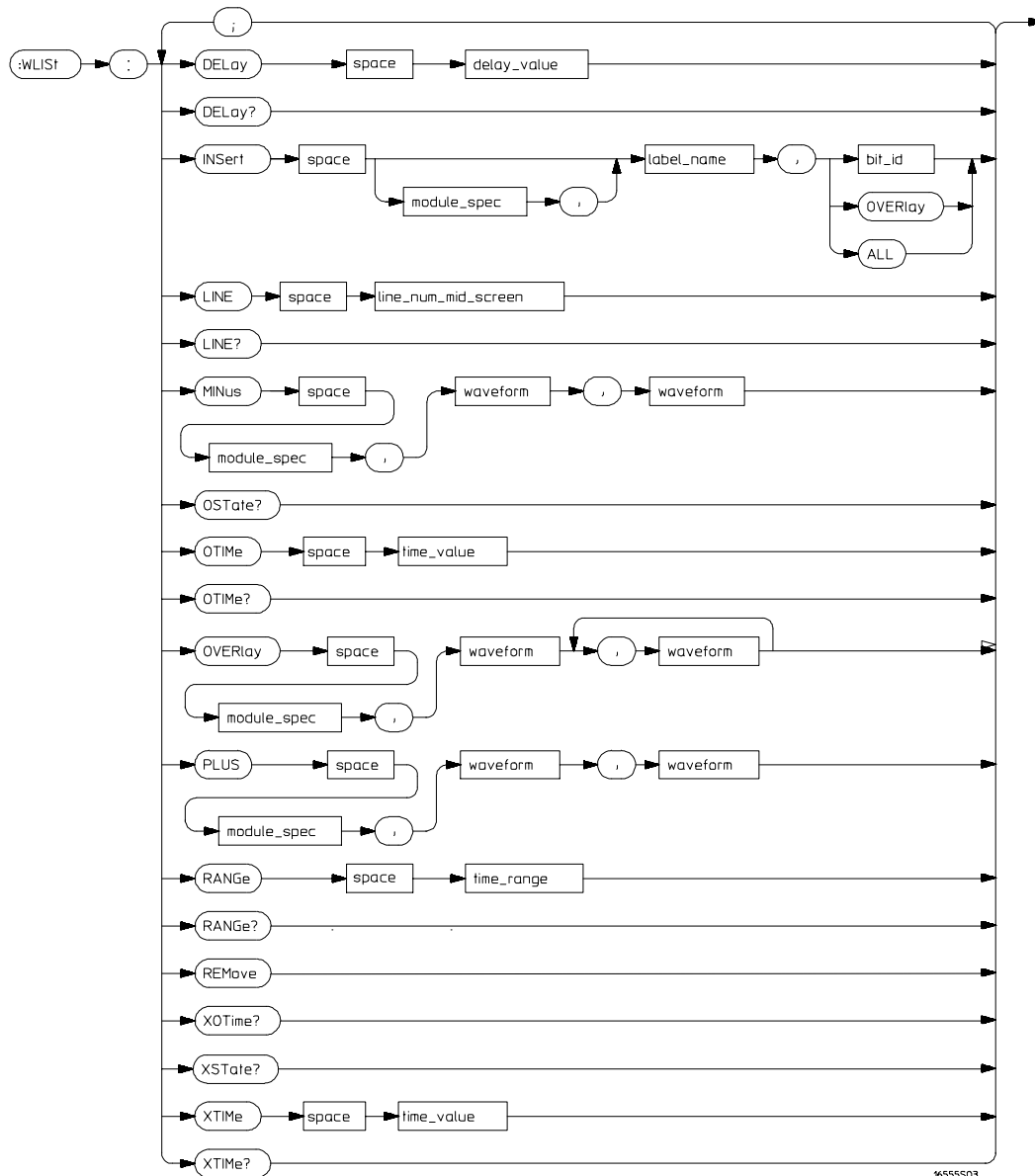
Introduction

The commands in the WLISt (Waveforms/LISting) subsystem control the X and O marker placement on the waveforms portion of the Timing/State mixed mode display. The XState and OState queries return what states the X and O markers are on. Because the markers can only be placed on the timing waveforms, the queries return what state (state acquisition memory location) the marked pattern is stored in.

In order to have mixed mode, one machine must be a state analyzer with time tagging on (use MACHine<N>:STRigger:TAG TIME).

- DELay
- INSert
- LINE
- MINus
- OState
- OTIME
- OVERlay
- PLUS
- RANGE
- REMove
- XOTime
- XState
- XTIME

Figure 4-1



WLISt Subsystem Syntax Diagram

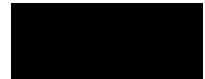


Table 4-1

WLISt Subsystem Parameter Values

Parameter	Value
delay_value	real number between -2500 s and +2500 s
module_spec	{1 2 3 4 5 6 7 8 9 10} (slot where master card is installed)
bit_id	integer from 0 to 31
label_name	string of up to 6 alphanumeric characters
line_num_mid_screen	integer from -516096 to +516096 (HP 16554A) or -1040384 to +1040384 (HP 16555A) or -2080768 to +2080768 (HP 16555D)
waveform	string containing <acquisition_spec>{1 2}
acquisition_spec	{A B C D E F G H I J}
time_value	real number
time_range	real number between 10 ns and 10 ks

WLISt

Selector

:WLISt

The WLISt (Waveforms/LISting) selector is used as a part of a compound header to access the settings normally found in the Mixed Mode menu. Because the WLISt command is a root-level command, it will always appear as the first element of a compound header.

The WLISt subsystem is only available when one or more state analyzers with time tagging on are specified.

Example

```
OUTPUT XXX; ":WLISt:XTIME 40.0E-6"
```

DElay

Command :WLISt:DElay <delay_value>

The DElay command specifies the amount of time between the timing trigger and the horizontal center of the the timing waveform display. The allowable values for delay are -2500 s to +2500 s.

<delay_value> real number between -2500 s and +2500 s

Example OUTPUT XXX; ":WLISt:DElay 100E-6"

Query :WLISt:DElay?

The DElay query returns the current time offset (delay) value from the trigger.

Returned Format [:WLISt:DElay] <delay_value><NL>

Example OUTPUT XXX; ":WLISt:DElay?"



INSert

Command :WLISt:INSert [<module_spec>,]<label_name>
 [, {<bit_id>|OVERlay|ALL}]

The INSert command inserts waveforms in the timing waveform display. The waveforms are added from top to bottom up to a maximum of 96 waveforms. Once 96 waveforms are present, each time you insert another waveform, it replaces the last waveform.

Time-correlated waveforms from the oscilloscope and another logic analyzer module can also be inserted in the logic analyzer's timing waveforms display. Oscilloscope waveforms occupy the same display space as three logic analyzer waveforms. When inserting waveforms from the oscilloscope or another logic analyzer module, the optional first parameter must be used, which is the module specifier. 1 through 10 corresponds to modules A through J. If you do not specify the module, the selected module is assumed.

The second parameter specifies the label name that will be inserted. The optional third parameter specifies the label bit number, overlay, or all. If a number is specified, only the waveform for that bit number is added to the screen.

If you specify OVERlay, all the bits of the label are displayed as a composite overlaid waveform. If you specify ALL, all the bits are displayed sequentially. If you do not specify the third parameter, ALL is assumed.

<module_spec> {1|2|3|4|5|6|7|8|9|10}
<label_name> string of up to 6 alphanumeric characters
<bit_id> integer from 0 to 31

Example OUTPUT XXX;":WLISt:INSERT 3, 'WAVE',9"

Inserting Oscilloscope Waveforms

Command :WLISt:INSert <module_spec>,<label_name>

This inserts a waveform from an oscilloscope to the timing waveforms display.

<module_spec> {1|2|3|4|5|6|7|8|9|10} slot in which master card is installed

<label_name> string of one alpha and one numeric character, identical to that on the oscilloscope waveform display.

Example

OUTPUT XXX;":WLIST:INSERT 3, 'C1'"

LINE

Command :WLISt:LINE <line_num_mid_screen>

The LINE command allows you to scroll the timing analyzer listing vertically. The command specifies the state line number relative to the trigger. The analyzer then highlights the specified line at the center of the screen.

<line_num_mid_screen> integer from -516096 to +516096 (HP 16554A)
or -1040384 to +1040384 (HP 16555A)
or -2080768 to +2080768 (HP 16555D).

Example

OUTPUT XXX;":WLIST:LINE 0"

Query :WLISt:LINE?

The LINE query returns the line number for the state currently in the data listing roll box at center screen.

Returned Format [:WLISt:LINE] <line_num_mid_screen><NL>

Example OUTPUT XXX; ":WLISt:LINE?"

MINus

Command :WLISt:MINus <module_spec>, <waveform>, <waveform>

The MINus command inserts time-correlated A-B (A minus B) oscilloscope waveforms on the screen. The first parameter is the module specifier where the oscilloscope module resides, where 1 through 10 refers to slots A through J. The next two parameters specify which waveforms will be subtracted from each other.

MINus only inserts oscilloscope waveforms. It cannot be used with analyzer waveforms.

<module_spec> {1|2|3|4|5|6|7|8|9|10} (slot where master card is located)

<waveform> string containing <acquisition_spec>{1|2}

<acquisition_spec> {A|B|C|D|E|F|G|H|I|J} (slot where acquisition card is located)

Example OUTPUT XXX; ":WLISt:MINUS 1, 'A1', 'A2' "

OSTate

Query :WLISt:OSTate?

The OSTate query returns the state where the O Marker is positioned. If data is not valid, the query returns 2147483647.

Returned Format [:WLISt:OSTate] <state_num><NL>
 <state_num> integer

Example OUTPUT XXX; ":WLISt:OSTATE?"

OTIME

Command :WLISt:OTIME <time_value>

The OTIME command positions the O Marker on the timing waveforms in the mixed mode display. If the data is not valid, the command performs no action.

<time_value> real number

Example OUTPUT XXX; ":WLISt:OTIME 40.0E-6"



Query :WLISt:OTIME?

The OTIME query returns the O Marker position in time. If data is not valid, the query returns 9.9E37.

Returned Format [:WLISt:OTIME] <time_value><NL>

Example OUTPUT XXX; ":WLIST:OTIME?"

OVERlay

Command :WLISt:OVERlay <module_number>, <label>
[, <label>]...

The OVERlay command overlays two or more oscilloscope waveforms and adds the resultant waveform to the current waveform display. The first parameter of the command syntax specifies which slot contains the oscilloscope time base card. The next parameters are the labels of the waveforms that are to be overlaid.

Overlay only inserts oscilloscope waveforms. It cannot be used with analyzer waveforms.

<module_spec> {1|2|3|4|5|6|7|8|9|10} (slot where master card is located)

<waveform> string containing <acquisition_spec>{1|2}

<acquisition_spec> {A|B|C|D|E|F|G|H|I|J} (slot where acquisition card is located)

Example OUTPUT XXX; ":WLIST:OVERLAY 3, 'C1', 'B1'"

PLUS

Command :WLISt:PLUS <module_spec>, <waveform>, <waveform>

The PLUS command inserts time-correlated A+B oscilloscope waveforms on the screen. The first parameter specifies which slot is the oscilloscope module. 1 through 10 refers to slots A through J. The next two parameters specify which waveforms will be added to each other.

PLUS only inserts oscilloscope waveforms. It cannot be used with analyzer waveforms.

<module_spec> {1|2|3|4|5|6|7|8|9|10} (slot where master card is located)
 <waveform> string containing <acquisition_spec>{1|2}
 <acquisition_ {A|B|C|D|E|F|G|H|I|J} (slot where acquisition card is located)
 spec>

Example OUTPUT XXX; ":WLISt:PLUS 1,'A1','A2'"

RANGe

Command :WLISt:RANGe <time_value>

The RANGe command specifies the full-screen time in the timing waveform menu. It is equivalent to ten times the seconds per division setting on the display. The allowable values for RANGe are from 10 ns to 10 ks.

<time_range> real number between 10 ns and 10 ks

Example OUTPUT XXX; ":WLISt:RANGe 100E-9"

Query :WLISt:RANGe?

The RANGe query returns the current full-screen time.

Returned Format [:WLISt:RANGe] <time_value><NL>

Example OUTPUT XXX; ":WLISt:RANGe?"

REMOve

Command :WLISt:REMOve

The REMOve command deletes all waveforms from the display.

Example OUTPUT XXX; ":WLISt:REMOve"

XOTime

Query :WLISt:XOTime?

The XOTime query returns the time from the X marker to the O marker. If data is not valid, the query returns 9.9E37.

Returned Format [:WLISt:XOTime] <time_value><NL>

<time_value> real number

Example OUTPUT XXX; ":WLISt:XOTime?"

XState

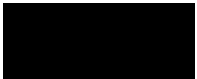
Query :WLISt:XState?

The XState query returns the state where the X Marker is positioned. If data is not valid, the query returns 2147483647.

Returned Format [:WLISt:XState] <state_num><NL>

<state_num> integer

Example OUTPUT XXX; ":WLISt:XState?"



XTIME

Command :WLISt:XTIME <time_value>

The XTIME command positions the X Marker on the timing waveforms in the mixed mode display. If the data is not valid, the command performs no action.

<time_value> real number

Example OUTPUT XXX; ":WLISt:XTIME 40.0E-6"

Query :WLISt:XTIME?

The XTIME query returns the X Marker position in time. If data is not valid, the query returns 9.9E37.

Returned Format [:WLISt:XTIME] <time_value><NL>

Example OUTPUT XXX; ":WLISt:XTIME?"



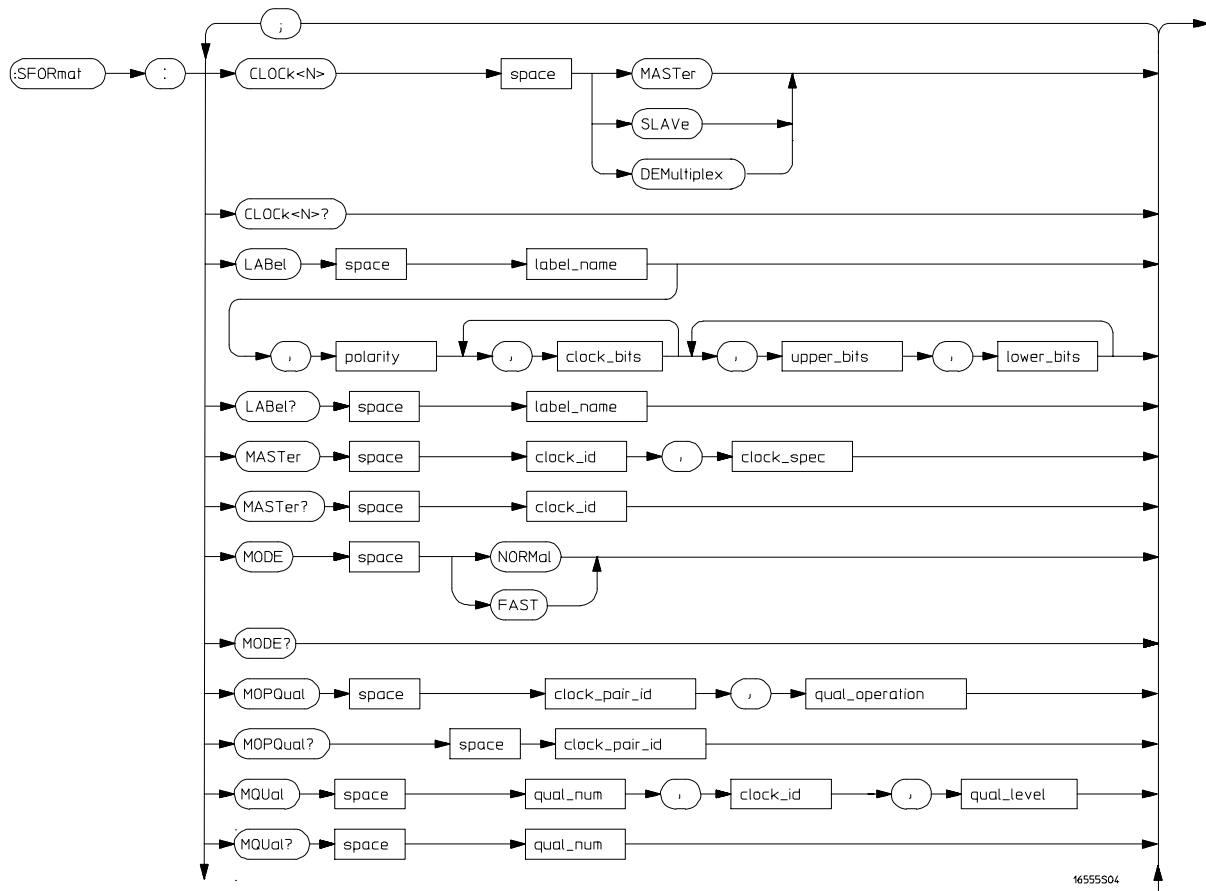
SFORmat Subsystem

Introduction

The SFORmat subsystem contains the commands available for the State Format menu in the HP 16554A/HP 16555A/HP 16555D logic analyzer modules. These commands are:

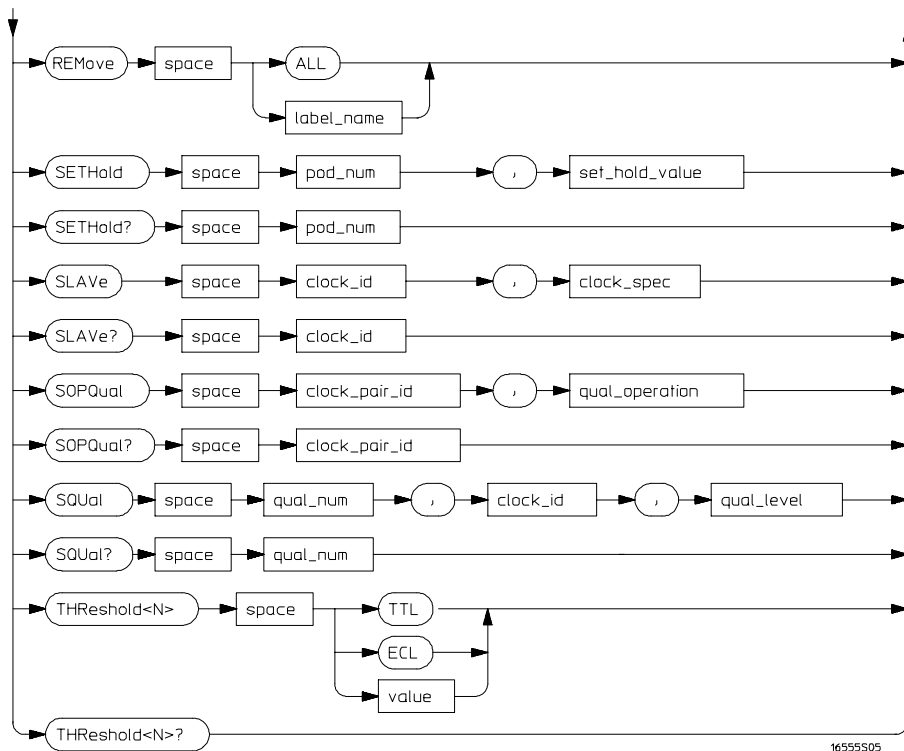
- CLOCK
- LABel
- MASTer
- MODE
- MOPQual
- MQUal
- REMove
- SETHold
- SLAVe
- SOPQual
- SQUal
- THReshold

Figure 5-1



SFORmat Subsystem Syntax Diagram

Figure 5-1 (continued)



SFOrmat Subsystem Syntax Diagram (continued)

Table 5-1

SFORmat Subsystem Parameter Values

Parameter	Value
<N>	an integer from 1 to 12
label_name	string of up to 6 alphanumeric characters
polarity	{POSitive NEGative}
clock_bits	format (integer from 0 to 65535) for a clock (clocks are assigned in decreasing order)
upper_bits	format (integer from 0 to 65535) for a pod (pods are assigned in decreasing order)
lower_bits	format (integer from 0 to 65535) for a pod (pods are assigned in decreasing order)
clock_id	{J K L M}
clock_spec	{OFF RISing FALLing BOTH}
clock_pair_id	{1 2}
qual_operation	{AND OR}
qual_num	{1 2 3 4}
qual_level	{OFF LOW HIGH}
pod_num	an integer from 1 to 12
set_hold_value	{0 1 2 3 4 5 6 7 8 9}
value	voltage (real number) -6.00 to +6.00



SFOrmat

Selector :MACHine{1|2}:SFOrmat

The SFOrmat (State Format) selector is used as a part of a compound header to access the settings in the State Format menu. It always follows the MACHine selector because it selects a branch directly below the MACHine level in the command tree.

Example OUTPUT XXX; ":MACHINE2:SFOrmat:MASTER J, RISING"

CLOCK

Command :MACHine{1|2}:SFOrmat:CLOCK<N> <clock_mode>

The CLOCK command selects the clocking mode for a given pod when the pod is assigned to the state analyzer. When the MASTer option is specified, the pod will sample all channels on the master clock. When the SLAVe option is specified, the pod will sample all channels on the slave clock. When the DEMultiplex option is specified, only one pod of a pod pair can acquire data. The bits of the selected pod will be clocked by the demultiplex master for labels with bits assigned under the Master pod. The same bits will be clocked by the demultiplex slave for labels with bits assigned under the Slave pod. The master clock always follows the slave clock when both are used.

<N> an integer from 1 to 12

<clock_mode> {MASTer | SLAVe | DEMultiplex}

Example OUTPUT XXX; ":MACHINE1:SFOrmat:CLOCK2 MASTER"

Query `:MACHine{1|2}:SFORmat:CLOCK<N>?`

The CLOCK query returns the current clocking mode for a given pod.

Returned Format `[:MACHine{1|2}:SFORmat:CLOCK<N>] <clock_mode><NL>`

Example `OUTPUT XXX; ":MACHINE1:SFORMAT:CLOCK2?"`

LABel

Command `:MACHine{1|2}:SFORmat:LABel <name>[,<polarity>,<clock_bits>,<upper_bits>,<lower_bits>[,<upper_bits>,<lower_bits>]...]`

The LABel command allows you to specify polarity and assign channels to new or existing labels. If the specified label name does not match an existing label name, a new label will be created.

The order of the pod-specification parameters is significant. The first one listed will match the highest-numbered pod assigned to the machine you're using. Each pod specification after that is assigned to the next highest-numbered pod. This way the specifications match the left-to-right descending order of the pods you see on the Format display. Not including enough pod specifications results in the lowest numbered pod(s) being assigned a value of zero (all channels excluded). If you include more pod specifications than there are pods for that machine, the extra ones will be ignored. However, an error is reported any time more than 22 pod specifications are listed.

The polarity can be specified at any point after the label name.

Because pods contain 16 channels, the format value for a pod must be between 0 and 65535 ($2^{16}-1$). When giving the pod assignment in binary, each bit will correspond to a single channel. A "1" in a bit position means the associated channel in that pod is assigned to the label. A "0" in a bit position means the associated channel in that pod is excluded from the label. Leading zeroes may be omitted. For example, assigning #B1111001100 is equivalent to entering ".....****..**.." through the touchscreen.

A label can not have a total of more than 32 channels assigned to it.



SFOrmat Subsystem
LABel

<name> string of up to 6 alphanumeric characters

<polarity> {POSitive | NEGative}

<clock_bits> format (integer from 0 to 65535) for a clock (clocks are assigned in decreasing order)

<upper_bits> format (integer from 0 to 65535) for a pod (pods are assigned in decreasing order)

<lower_bits>

Example

```
510 OUTPUT XXX;":MACHINE2:SFORMAT:LABEL 'STAT', POSITIVE, 0,127,40312"  
520 OUTPUT XXX;":MACHINE2:SFORMAT:LABEL 'SIG 1', #B11,#B0000000011111111,  
#B0000000000000000 "
```

Query :MACHine{1|2}:SFOrmat:LABel? <name>

The LABel query returns the current specification for the selected (by name) label. If the label does not exist, nothing is returned. The polarity is always returned as the first parameter. Numbers are always returned in decimal format. Label names are case-sensitive.

Returned Format [:MACHine{1|2}:SFOrmat:LABel] <name>,<polarity>
[, <assignment>]...<NL>

Example

```
OUTPUT XXX;":MACHINE2:SFORMAT:LABEL? 'DATA' "
```

MASTER

Command :MACHine{1|2}:SFORmat:MASTER <clock_id>,
 <clock_spec>

The MASTER clock command allows you to specify a master clock for a given machine. The master clock is used in all clocking modes (Master, Slave, and Demultiplexed). Each command deals with only one clock (J,K,L,M); therefore, a complete clock specification requires four commands, one for each clock. Edge specifications (RISing, FALLing, or BOTH) are ORed.

At least one clock edge must be specified.

<clock_id> {J|K|L|M}

<clock_spec> {OFF|RISing|FALLing|BOTH}

Example

OUTPUT XXX; ":MACHINE2:SFORMAT:MASTER J, RISING"

Query :MACHine{1|2}:SFORmat:MASTER? <clock_id>

The MASTER query returns the clock specification for the specified clock.

Returned Format [:MACHine{1|2}:SFORmat:MASTER] <clock_id>,<clock_spec><NL>

Example

OUTPUT XXX; ":MACHINE2:SFORMAT:MASTER? <clock_id>"



MODE

Command :MAChine{1|2}:SFOrmat:MODE {NORMal|FAST}

The MODE command places an HP 16555 state analyzer in either 100 MHz (normal) or 110 MHz (fast) mode. The HP 16554A has only one state analysis mode, 70 MHz. In 110-MHz mode, the h and j resource terms are not available.

Example OUTPUT XXX; ":MACHINE2:SFOrmat:MODE NORM"

Query :MAChine{1|2}:SFOrmat:MODE?

The MODE query is valid for both the HP 16554 and HP 16555.

Returned Format [:MAChine{1|2}:SFOrmat:MODE] {NORMal|FAST}<NL>

Example OUTPUT XXX; ":MACHINE2:SFOrmat:MODE?"

MOPQual

Command :MAChine{1|2}:SFOrmat:MOPQual <clock_pair_id>,
 <qual_operation>

The MOPQual (master operation qualifier) command allows you to specify either the AND or the OR operation between master clock qualifier pair 1/2, or between master clock qualifier pair 3/4. For example, you can specify a master clock operation qualifier 1 AND 2.

<clock_pair_id> {1|2} where 2 indicates qualifier pair 3/4.

<qual_operation> {AND|OR}

Example OUTPUT XXX; ":MACHine1:SFOrmat:MOPQUAL 1,AND"

Query :MAChine{1|2}:SFOrmat:MOPQual? <clock_pair_id>

The MOPQual query returns the operation qualifier specified for the master clock.

Returned Format [:MAChine{1|2}:SFOrmat:MOPQUAL <clock_pair_id>]
 <qual_operation><NL>

Example OUTPUT XXX; ":MACHine1:SFOrmat:MOPQUAL? 1"



MQUal

Command `:MACHine{1|2}:SFORmat:MQUal <qual_num>,
<clock_id>,<qual_level>`

The MQUal (master qualifier) command allows you to specify the level qualifier for the master clock.

`<qual_num>` {1|2|3|4}
`<clock_id>` {J|K|L|M}
`<qual_level>` {OFF|LOW|HIGH}

Example `OUTPUT XXX; ":MACHINE2:SFORmat:MQUAL 1,J,LOW"`

Query `:MACHine{1|2}:SFORmat:MQUal? <qual_num>`

The MQUal query returns the qualifier specified for the master clock.

Returned Format `[:MACHine{1|2}:SFORmat:MQUal] <qual_level><NL>`

Example `OUTPUT XXX; ":MACHINE2:SFORmat:MQUAL? 1"`

REMove

Command `:MACHine{1|2}:SFORmat:REMove {<name>|ALL}`

The REMove command allows you to delete all labels or any one label for a given machine.

<name> string of up to 6 alphanumeric characters

Example

```
OUTPUT XXX;":MACHINE1:SFORMAT:REMOVE 'A'"
OUTPUT XXX;":MACHINE2:SFORMAT:REMOVE ALL"
```

SETHold

Command `:MACHine{1|2}:SFORmat:SETHold
<pod_num>,<set_hold_value>`

The SETHold (setup/hold) command allows you to set the setup and hold specification for the state analyzer.

Even though the command requires integers to specify the setup and hold, the query returns the current settings in a string. For example, if you send the integer 0 for the setup and hold value, the query will return 3.5/0.0 ns as an ASCII string when you have one clock and one edge specified.



<pod_num> an integer from 1 to 12

<set_hold_value> integer {0|1|2|3|4|5|6|7|8|9} representing the following setup and hold values:

Table 5-2

Setup and hold values

For one clock and one edge	For one clock and both edges	Multiple Clocks
0 = 3.5/0.0 ns	0 = 4.0/0.0	0 = 4.5/0.0
1 = 3.0/0.5 ns	1 = 3.5/0.5	1 = 4.0/0.5
2 = 2.5/1.0 ns	2 = 3.0/1.0	2 = 3.5/1.0
3 = 2.0/1.5 ns	3 = 2.5/1.5	3 = 3.0/1.5
4 = 1.5/2.0 ns	4 = 2.0/2.0	4 = 2.5/2.0
5 = 1.0/2.5 ns	5 = 1.5/2.5	5 = 2.0/2.5
6 = 0.5/3.0 ns	6 = 1.0/3.0	6 = 1.5/3.0
7 = 0.0/3.5 ns	7 = 0.5/3.5	7 = 1.0/3.5
N/A	8 = 0.0/4.0	8 = 0.5/4.0
N/A	N/A	9 = 0.0/4.5

Example

OUTPUT XXX; ":MACHINE2:SFOrmat:SETHOLD 1,2"

Query

:MACHine{1|2}:SFOrmat:SETHOLD? <pod_num>

Returned Format

The SETHold query returns the current setup and hold settings.

[:MACHine{1|2}:SFOrmat:SETHold <pod_num>]
 <setup_and_hold_string><NL>

Example

OUTPUT XXX; ":MACHINE2:SFOrmat:SETHOLD? 3"

SLAVe

Command :MAChine{1|2}:SFOrmat:SLAVe <clock_id>,
 <clock_spec>

The SLAVe clock command allows you to specify a slave clock for a given machine. The slave clock is only used in the Slave and Demultiplexed clocking modes. Each command deals with only one clock (J,K,L,M); therefore, a complete clock specification requires four commands, one for each clock. Edge specifications (RISing, FALLing, or BOTH) are ORed.

When slave clock is being used at least one edge must be specified.

<clock_id> {J|K|L|M}

<clock_spec> {OFF|RISing|FALLing|BOTH}

Example

OUTPUT XXX; ":MACHINE2:SFOrmat:SLAVE J, RISING"

Query :MAChine{1|2}:SFOrmat:SLAVe?<clock_id>

The SLAVe query returns the clock specification for the specified clock.

Returned Format [:MAChine{1|2}:SFOrmat:SLAVe] <clock_id>,<clock_spec><NL>

Example

OUTPUT XXX; ":MACHINE2:SFOrmat:SLAVE? K"



SOPQual

Command `:MACHine{1|2}:SFOrmat:SOPQual <clock_pair_id>,
<qual_operation>`

The SOPQual (slave operation qualifier) command allows you to specify either the AND or the OR operation between slave clock qualifier pair 1/2, or between slave clock qualifier pair 3/4. For example you can specify a slave clock operation qualifier 1 AND 2.

`<clock_pair_id>` {1|2} where 2 specifies qualifier pair 3/4
`<qual_operation>` {AND|OR}

Example `OUTPUT XXX; ":MACHine2:SFOrmat:SOPQUAL 1,AND"`

Query `:MACHine{1|2}:SFOrmat:SOPQual? <clock_pair_id>`

The SOPQual query returns the operation qualifier specified for the slave clock.

Returned Format `[:MACHine{1|2}:SFOrmat:SOPQual <clock_pair_id>]
<qual_operation><NL>`

Example `OUTPUT XXX; ":MACHine2:SFOrmat:SOPQUAL? 1"`

SQUal

Command :MACHine{1|2}:SFORmat:SQUal
 <qual_num>, <clock_id>, <qual_level>

The SQUal (slave qualifier) command allows you to specify the level qualifier for the slave clock.

<qual_num> {1|2|3|4}
 <clock_id> {J|K|L|M}
 <qual_level> {OFF|LOW|HIGH}

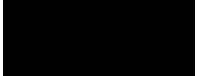
Example OUTPUT XXX; ":MACHINE2:SFORmat:SQUAL 1,J,LOW"

Query :MACHine{1|2}:SFORmat:SQUal?<qual_num>

The SQUal query returns the qualifier specified for the slave clock.

Returned Format [:MACHine{1|2}:SFORmat:SQUal] <clock_id>, <qual_level><NL>

Example OUTPUT XXX; ":MACHINE2:SFORmat:SQUAL? 1"



THReshold

Command :MACHine{1|2}:SFORmat:THReshold<N>
 {TTL|ECL|<voltage>}

The THReshold command allows you to set the voltage threshold for a given pod to ECL, TTL, or a specific voltage from -6.00 V to +6.00 V in 0.05 volt increments.

<N> an integer from 1 to 12 indicating pod number

<voltage> real number between -6.00 to +6.00

TTL default value of +1.6 V

ECL default value of -1.3 V

Example

OUTPUT XXX; ":MACHINE1:SFORmat:THRESHOLD1 4.0"

Query :MACHine{1|2}:SFORmat:THReshold<N>?

The THReshold query returns the current threshold for a given pod.

Returned Format [:MACHine{1|2}:SFORmat:THReshold<N>] <value><NL>

Example

OUTPUT XXX; ":MACHINE1:SFORmat:THRESHOLD4?"



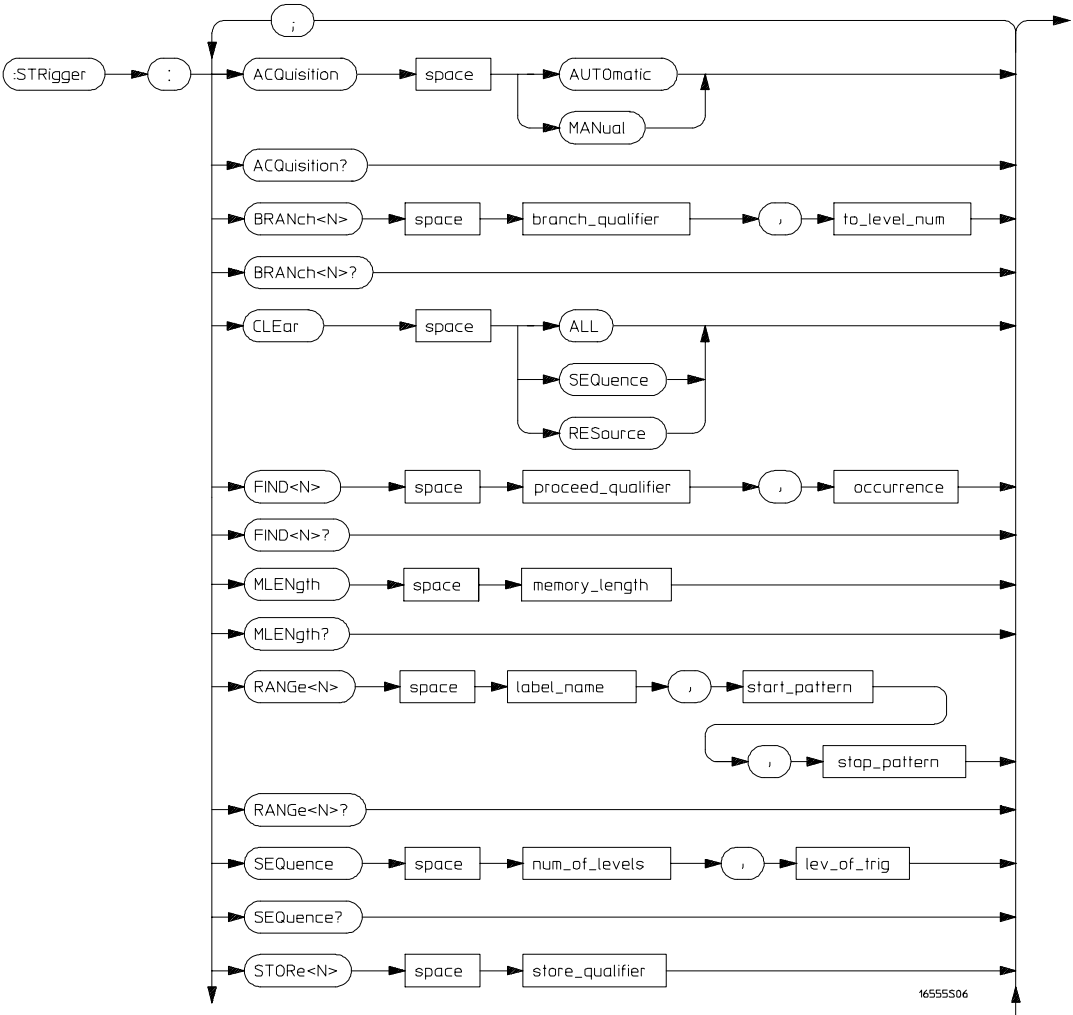
STRigger (STRace) Subsystem

Introduction

The STRigger subsystem contains the commands available for the State Trigger menu in the HP 16554A/HP 16555A/HP 16555D logic analyzer modules. The State Trigger subsystem will also accept the STRace selector as used in previous HP 16500-Series logic analyzer modules to eliminate the need to rewrite programs containing STRace as the selector keyword. The STRigger subsystem commands are:

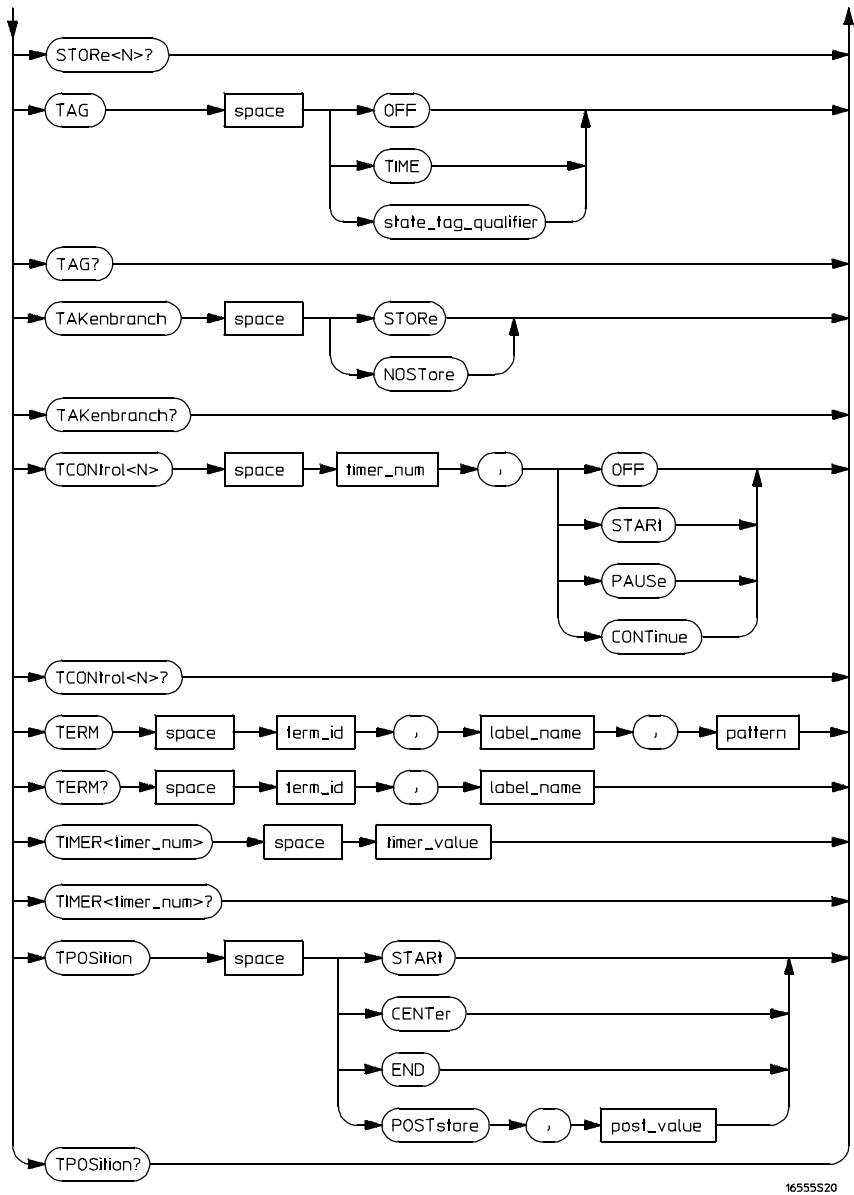
- ACQuisition
- BRANch
- CLEar
- FIND
- MLENgth
- RANGe
- SEQuence
- STORe
- TAG
- TAKenbranch
- TCONtrol
- TERM
- TIMER
- TPOStion

Figure 6-1



STRigger Subsystem Syntax Diagram

Figure 6-1 (continued)



16555520

STRigger Subsystem Syntax Diagram (continued)

Table 6-1

STRigger Subsystem Parameter Values

Parameter	Value
branch_qualifier	<qualifier>
qualifier	see "Qualifier" on page 6-6
to_lev_num	integer from 1 to last level
proceed_qualifier	<qualifier>
occurrence	number from 1 to 1048575
label_name	string of up to 6 alphanumeric characters
start_pattern	"{#B{0 1}...
stop_pattern	#Q{0 1 2 3 4 5 6 7}... #H{0 1 2 3 4 5 6 7 8 9 A B C D E F}... {0 1 2 3 4 5 6 7 8 9}...}"
num_of_levels	integer from 2 to 12
lev_of_trig	integer from 1 to (number of existing sequence levels - 1)
store_qualifier	<qualifier>
state_tag_qualifier	<qualifier>
timer_num	{1 2}
timer_value	400 ns to 500 seconds
term_id	{A B C D E F G H I J} (H and J not available in 110 MHz mode)
pattern	"{#B{0 1 X}... #Q{0 1 2 3 4 5 6 7 X}... #H{0 1 2 3 4 5 6 7 8 9 A B C D E F X}... {0 1 2 3 4 5 6 7 8 9}...}"
post_value	integer from 0 to 100 representing percentage
memory_length	{4096 8192 16384 32768 65536 131072 262144 516096 (HP 16554A only) 524288 1040384 (HP 16555A only) 524288 1048576 2080768 (HP 16555D only)}

Qualifier

The qualifier for the state trigger subsystem can be terms A through J, Timer 1 and 2, and Range 1 and 2. In addition, qualifiers can be the NOT boolean function of terms, timers, and ranges. The qualifier can also be an expression or combination of expressions as shown below and figure 6-2, "Complex Qualifier," on page 6-10.

The following parameters show how qualifiers are specified in all commands of the STRigger subsystem that use <qualifier>.

```

<qualifier> { "ANYSTATE" | "NOSTATE" | "<expression>" }
<expression> {<expression1a>|<expression1b>|<expression1a> OR
               <expression1b>|<expression1a> AND <expression1b>}
<expression1a> {<expression1a_term>|(<expression1a_term>[ OR
               <expression1a_term>]* )|(<expression1a_term>[ AND
               <expression1a_term>]* )}
<expression1a_term> { <expression2a>|<expression2b>|<expression2c>|<expression2d>}
<expression1b> {<expression1b_term>| ( <expression1b_term>[ OR
               <expression1b_term>]* )|(<expression1b_term>[ AND
               <expression1b_term>]* )}
<expression1b_term> {<expression2e>|<expression2f>|<expression2g>|<expression2h>}
<expression2a> {<term3a>|<term3b>|(<term3a> <boolean_op> <term3b>)}
<expression2b> {<term3c>|<range3a>|(<term3c> <boolean_op> <range3a>)}
<expression2c> {<term3d>}
<expression2d> {<term3e>|<timer3a>|(<term3e> <boolean_op> <timer3a>)}
<expression2e> {<term3f>|<term3g>|(<term3f> <boolean_op> <term3g>)}
<expression2f> {<term3h>|<range3b>|(<term3h> <boolean_op> <range3b>)}
<expression2g> {<term3i>}
<expression2h> {<term3j>|<timer3b>|(<term3j> <boolean_op> <timer3b>)}
<boolean_op> {AND | NAND | OR | NOR | XOR | NXOR}

```

```

<term3a> { A | NOTA }
<term3b> { B | NOTB }
<term3c> { C | NOTC }
<term3d> { D | NOTD }
<term3e> { E | NOTE }
<term3f> { F | NOTF }
<term3g> { G | NOTG }
<term3h> { H | NOTH }
<term3i> { I | NOTI }
<term3j> { J | NOTJ }
<range3a> { IN_RANGE1 | OUT_RANGE1 }
<range3b> { IN_RANGE2 | OUT_RANGE2 }
<timer3a> { TIMER1< | TIMER1>}
<timer3b> { TIMER2< | TIMER2>}

```

H, NOTH, J, and NOTJ are not available in 110-MHz mode.

Qualifier Rules

The following rules apply to qualifiers:

- Qualifiers are quoted strings and, therefore, need quotes.
- Expressions are evaluated from left to right.
- Parentheses are used to change the order evaluation and are optional.
- An expression must map into the combination logic presented in the combination pop-up menu (see figure 6-2 on page 6-10).

Examples

```

'A'
'( A OR B )'
'(( A OR B ) AND C )'
'(( A OR B ) AND C AND IN_RANGE2 )'
'(( A OR B ) AND ( C AND IN_RANGE1 ))'
'IN_RANGE1 AND ( A OR B ) AND C'

```



STRigger (STRace)

Selector :MACHine{1|2}:STRigger

The STRigger (STRace) (State Trigger) selector is used as a part of a compound header to access the settings found in the State Trace menu. It always follows the MACHine selector because it selects a branch directly below the MACHine level in the command tree.

Example OUTPUT XXX; ":MACHINE1:STRIGGER:TAG TIME"

ACQuisition

Command :MACHine{1|2}:STRigger:ACQuisition
{AUTOMATIC|MANual}

The ACQuisition command allows you to specify the acquisition mode for the State analyzer.

Example OUTPUT XXX; ":MACHINE1:STRIGGER:ACQUISITION AUTOMATIC"

Query :MACHine{1|2}:STRigger:ACQuisition?

The ACQuisition query returns the current acquisition mode.

Returned Format [:MACHine{1|2}:STRigger:ACQuisition] {AUTOMATIC|MANual}<NL>

Example OUTPUT XXX; ":MACHINE1:STRIGGER:ACQUISITION?"

BRANch

Command :MACHine{1|2}:STRigger:BRANch<N>
<branch_qualifier>, <to_level_number>

The BRANch command defines the branch qualifier for a given sequence level. When this branch qualifier is matched, it will cause the sequencer to jump to the specified sequence level. The branch qualifier functions like the "else on" branch of a sequence level.

The terms used by the branch qualifier (A through J, except in 110-MHz mode) are defined by the TERM command. The meaning of IN_RANGE and OUT_RANGE is determined by the RANGE command.

Within the limitations shown by the syntax definitions, complex expressions may be formed using the AND and OR operators. Expressions are limited to what you could manually enter through the State Trigger menu. Regarding parentheses, the syntax definitions on the next page show only the required ones. Additional parentheses are allowed as long as the meaning of the expression is not changed. Figure 6-2 shows a complex expression as seen in the State Trigger menu.

Example

The following statements are all correct and have the same meaning. Notice that the conventional rules for precedence are not followed. The expressions are evaluated from left to right.

```
OUTPUT XXX;":MACHINE1:STRIGGER:BRANCH1 'C AND D OR F OR G', 1"
OUTPUT XXX;":MACHINE1:STRIGGER:BRANCH1 '( (C AND D) OR (F OR G))', 1"
OUTPUT XXX;":MACHINE1:STRIGGER:BRANCH1 'F OR (C AND D) OR G', 1"
```

<N> integer from 1 to <number_of_levels>

<to_level_number> integer from 1 to <number_of_levels>

<number_of_levels> integer from 2 to the number of existing sequence levels (maximum 12)

<branch_qualifier> <qualifier> see "Qualifier" on page 6-6



Example

```
OUTPUT XXX; ":MACHINE1:STRIGGER:BRANCH1 'ANYSATE', 3"
OUTPUT XXX; ":MACHINE1:STRIGGER:BRANCH2 'A', 7"
OUTPUT XXX; ":MACHINE1:STRIGGER:BRANCH3 '((A OR B) OR NOTG)', 1"
```

Query

```
:MACHine{1|2}:STRigger:BRANch<N>?
```

The BRANch query returns the current branch qualifier specification for a given sequence level.

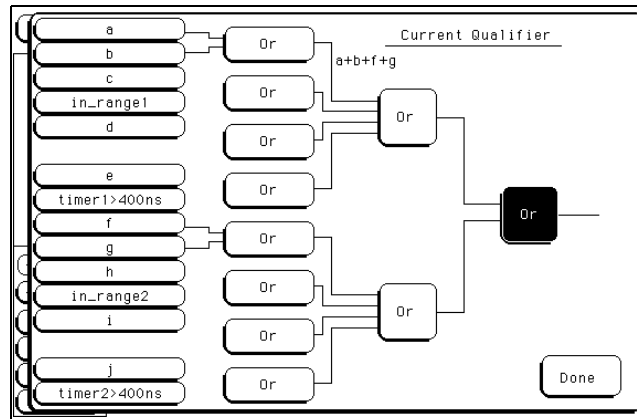
Returned Format

```
[ :MACHine{1|2}:STRigger:BRANch<N>]
<branch_qualifier>, <to_level_num><NL>
```

Example

```
OUTPUT XXX; ":MACHINE1:STRIGGER:BRANCH3?"
```

Figure 6-2



Complex qualifier

Figure 6-2 is a front panel representation of the complex qualifier (a Or b) Or (f Or g).

Example

The following example would be used to specify the complex qualifier shown in figure 6-2.

```
OUTPUT XXX; ":MACHINE1:STRIGGER:BRANCH1 '( (A OR B) AND (F OR G) )', 2"
```

Terms A through E, RANGE 1, and TIMER 1 must be grouped together and terms F through J, RANGE 2, and TIMER 2 must be grouped together. In the first level, terms from one group may not be mixed with terms from the other. For example, the expression ((A OR IN_RANGE2) AND (C OR G)) is not allowed because the term C cannot be specified in the F, G, and I group.

In the first level, the operators you can use are AND, NAND, OR, NOR, XOR, NXOR. Either AND or OR may be used at the second level to join the two groups together. It is acceptable for a group to consist of a single term. Thus, an expression like (B AND G) is legal, since the two operands are both simple terms from separate groups.

CLEar**Command**

```
:MACHINE{1|2}:STRigger:CLEar  
{All|SEquence|RESource}
```

The CLEar command allows you to clear all settings in the State Trigger menu, clear only the Sequence levels, or clear only the resource term patterns. Cleared settings are replaced with the defaults.

Example

```
OUTPUT XXX; ":MACHINE1:STRIGGER:CLEAR RESOURCE"
```



FIND

Command :MACHine{1|2}:STRigger:FIND<N>
<proceed_qualifier>, <occurrence>

The FIND command defines the proceed qualifier for a given sequence level. The qualifier tells the state analyzer when to proceed to the next sequence level. When this proceed qualifier is matched the specified number of times, the sequencer will proceed to the next sequence level. In the sequence level where the trigger is specified, the FIND command specifies the trigger qualifier (see SEquence command).

The terms A through J are defined by the TERM command. The meaning of IN_RANGE and OUT_RANGE is determined by the RANGE command. Expressions are limited to what you could manually enter through the State Trigger menu. Regarding parentheses, the syntax definitions below show only the required ones. Additional parentheses are allowed as long as the meaning of the expression is not changed. See page 6-9 for a detailed example.

<N> integer from 1 to (number of existing sequence levels -1)

<occurrence> integer from 1 to 1048575

<proceed_qualifier> <qualifier> see "Qualifier" on page 6-6

Example

```
OUTPUT XXX; ":MACHINE1:STRIGGER:FIND1 'ANYSSTATE', 1"  
OUTPUT XXX; ":MACHINE1:STRIGGER:FIND3 '( (NOTA AND NOTB) OR  
G)', 1"
```

Query :MACHine{1|2}:STRigger:FIND4?

The FIND query returns the current proceed qualifier specification for a given sequence level.

Returned Format [:MACHine{1|2}:STRigger:FIND<N>]
 <proceed_qualifier>,<occurrence><NL>

Example OUTPUT XXX; ":MACHINE1:STRIGGER:FIND<N>?"

MLENgth

Command :MACHine{1|2}:STRigger:MLENgth <memory_length>

The MLENgth command allows you to specify the analyzer memory depth. Valid memory depths range from 4096 states (or samples) through the maximum system memory depth minus 8192 states (HP 16554A or HP 16555A) or minus 16384 states (HP 16555D). Memory depth is affected by acquisition mode. If the <memory_length> value sent with the command is not a legal value, the closest legal setting will be used.

<memory_length> {4096 | 8192 | 16384 | 32768 | 65536 | 131072 | 262144
 | 516096 (HP 16554A only)
 | 524288 | 1040384 (HP 16555A only)
 | 524288 | 1048576 | 2080768 (HP 16555D only)}

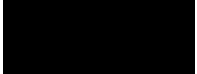
Example OUTPUT XXX; ":MACHINE1:STRIGGER:MLENGTH 262144"

Query :MACHine{1|2}:STRigger:MLENgth?

The MLENgth query returns the current analyzer memory depth selection.

Returned Format [:MACHine{1|2}:STRigger:MLENgth] <memory_length><NL>

Example OUTPUT XXX; ":MACHINE1:STRIGGER:MLENGTH?"



RANGe

Command :MAChine{1|2}:STRigger:RANGe<N> <label_name>,
 <start_pattern>,<stop_pattern>

The RANGe command allows you to specify a range recognizer term for the specified machine. Since a range can only be defined across one label and since a label must contain 32 or fewer bits, the value of the start pattern or stop pattern will be between $(2^{32})-1$ and 0.

When these values are expressed in binary, they represent the bit values for the label at one of the range recognizers' end points. Don't cares are not allowed in the end point pattern specifications.

<label_name> string of up to 6 alphanumeric characters

<start_pattern> "{#B{0|1} . . . |
 #Q{0|1|2|3|4|5|6|7} . . . |

<stop_pattern> #H{0|1|2|3|4|5|6|7|8|9|A|B|C|D|E|F} . . . |
 {0|1|2|3|4|5|6|7|8|9} . . . }"

<N> {1 | 2}

Example

OUTPUT XXX;":MACHINE1:STRIGGER:RANGE1 'DATA', '127', '255' "
OUTPUT XXX;":MACHINE1:STRIGGER:RANGE2 'ABC', '#B00001111',
'#HCF' "

Query :MACHine{1|2}:STRigger:RANGe<N>?

The RANGe query returns the range recognizer end point specifications for the range.

Returned Format [:MACHine{1|2}:STRigger:RANGe<N>]
 <label_name>, <start_pattern>, <stop_pattern><NL>

Example OUTPUT XXX; ":MACHINE1:STRIGGER:RANGE1?"

SEQuence

Command :MACHine{1|2}:STRigger:SEQuence <num_levels>,
 <trig_level>

The SEQuence command redefines the state analyzer trigger sequence. First, it deletes the current sequence. Then it inserts the number of levels specified, with default settings, and assigns the trigger to be at a specified sequence level. The number of levels may be between 2 and 12.

<num_levels> integer from 2 to 12

<trig_level> integer from 1 to (number of existing sequence levels - 1)

Example OUTPUT XXX; ":MACHINE1:STRIGGER:SEQUENCE 4,3"

Query :MACHine{1|2}:STRigger:SEQuence?

The SEQuence query returns the current sequence specification.

Returned Format [:MACHine{1|2}:STRigger:SEQuence] <num_levels>,
 <trig_level><NL>

Example OUTPUT XXX; ":MACHINE1:STRIGGER:SEQUENCE?"



STORE

Command `:MACHine{1|2}:STRigger:STORE<N> <store_qualifier>`

The STORE command defines the store qualifier for a given sequence level. Any data matching the STORE qualifier will be stored in memory as part of the current trace data. The qualifier may be a single term or a complex expression. The terms A through J are defined by the TERM command. The meaning of IN_RANGE1 and 2 and OUT_RANGE1 and 2 is determined by the RANGE command.

Expressions are limited to what you could manually enter through the State Trigger menu. Regarding parentheses, the syntax definitions below show only the required ones. Additional parentheses are allowed as long as the meaning of the expression is not changed.

A detailed example is provided starting on page 6-10.

<N> an integer from 1 to the number of existing sequence levels (maximum 12)

<store_qualifier> <qualifier> see "Qualifier" on page 6-6

Example

```
OUTPUT XXX; ":MACHINE1:STRIGGER:STORE1 'ANYSSTATE' "  
OUTPUT XXX; ":MACHINE1:STRIGGER:STORE2 'OUT_RANGE1' "  
OUTPUT XXX; ":MACHINE1:STRIGGER:STORE3 '(NOTC AND NOTD AND  
NOTI) ' "
```

Query `:MACHine{1|2}:STRigger:STORE<N>?`

The STORE query returns the current store qualifier specification for a given sequence level <N>.

Returned Format `[:MACHine{1|2}:STRigger:STORE<N>] <store_qualifier><NL>`

Example

```
OUTPUT XXX; ":MACHINE1:STRIGGER:STORE4? "
```

TAG

Command :MACHine{1|2}:STRigger:TAG
 {OFF|TIME|<state_tag_qualifier>}

The TAG command selects the type of count tagging (state or time) to be performed during data acquisition. State tagging is indicated when the parameter is the state tag qualifier, which will be counted in the qualified state mode. The qualifier may be a single term or a complex expression. The terms A through J are defined by the TERM command. The terms IN_RANGE1 and 2 and OUT_RANGE1 and 2 are defined by the RANGE command.

Expressions are limited to what you could manually enter through the State Trigger menu. Regarding parentheses, the syntax definitions below show only the required ones. Additional parentheses are allowed as long as the meaning of the expression is not changed. A detailed example is provided starting on page 6-10.

<state_tag_qualifier> <qualifier> see "Qualifier" on page 6-6

Example

```
OUTPUT XXX; ":MACHINE1:STRIGGER:TAG OFF"
OUTPUT XXX; ":MACHINE1:STRIGGER:TAG TIME"
OUTPUT XXX; ":MACHINE1:STRIGGER:TAG '(IN_RANGE OR NOTF)'"
OUTPUT XXX; ":MACHINE1:STRIGGER:TAG '((IN_RANGE OR A) AND E)'"
```

Query :MACHine{1|2} :STRigger:TAG?

The TAG query returns the current count tag specification.

Returned Format [:MACHine{1|2}:STRigger:TAG]
 {OFF|TIME|<state_tag_qualifier>}<NL>

Example

```
OUTPUT XXX; ":MACHINE1:STRIGGER:TAG?"
```



TAKenbranch

Command `:MACHine{1|2}:STRigger:TAKenbranch {STORe|NOSTore}`

The TAKenbranch command allows you to specify whether the state causing the branch is stored or not stored for the specified machine. The states causing the branch are defined by the BRANCh and FIND commands.

Example `OUTPUT XXX; ":MACHINE2:STRIGGER:TAKENBRANCH STORE"`

Query `:MACHine{1|2}:STRigger:TAKenbranch?`

The TAKenbranch query returns the current setting.

Returned Format `[:MACHine{1|2}:STRigger:TAKenbranch] {STORe|NOSTore}<NL>`

Example `OUTPUT XXX; ":MACHINE2:STRIGGER:TAKENBRANCH?"`

TCONtrol

Command :MAChine{1|2}:STRigger:TCONtrol<N> <timer_num>,
 {OFF|START|PAUSE|CONTInue}

The TCONtrol (timer control) command allows you to turn off, start, pause, or continue the timer for the specified level. The time value of the timer is defined by the TIMER command. There are two timers and they are available for either machine but not both machines simultaneously.

<N> integer from 1 to the number of existing sequence levels (maximum 12)

<timer_num> {1|2}

Example OUTPUT XXX; ":MACHINE2:STRIGGER:TCONTROL6 1, PAUSE"

Query :MAChine{1|2}:STRigger:TCONTROL<N>? <timer_num>

The TCONtrol query returns the current TCONtrol setting of the specified level.

Returned Format [:MAChine{1|2}:STRigger:TCONTROL<N> <timer_num>]
 {OFF|START|PAUSE|CONTInue}<NL>

Example OUTPUT XXX; ":MACHINE2:STRIGGER:TCONTROL6? 1"



TERM

Command :MACHine{1|2}:STRigger:TERM <term_id>,
<label_name>,<pattern>

The TERM command allows you to specify a pattern recognizer term in the specified machine. Each command deals with only one label in the given term; therefore, a complete specification could require several commands. Since a label can contain 32 or fewer bits, the range of the pattern value will be between $2^{32} - 1$ and 0. When the value of a pattern is expressed in binary, it represents the bit values for the label inside the pattern recognizer term. Because the pattern parameter may contain don't cares and be represented in several bases, it is handled as a string of characters rather than a number. Eight of the 10 terms (A through G and I) are always available for either machine but not both simultaneously. Terms H and J are not available unless the machine is configured as a state analyzer running in NORMal mode. If you send the TERM command to a machine with a term that has not been assigned to that machine, an error message "Legal command but settings conflict" is returned.

<term_id> {A|B|C|D|E|F|G|H|I|J}
<label_name> string of up to 6 alphanumeric characters
<pattern> "#B{0|1|X} . . . |
#Q{0|1|2|3|4|5|6|7|X} . . . |
#H{0|1|2|3|4|5|6|7|8|9|A|B|C|D|E|F|X} . . . |
{0|1|2|3|4|5|6|7|8|9} . . . }"

Example

OUTPUT XXX; ":MACHINE1:STRIGGER:TERM A,'DATA','255' "
OUTPUT XXX; ":MACHINE1:STRIGGER:TERM B,'ABC','#BXXXX1101' "

Query :MACHine{1|2}:STRigger:TERM? <term_id>,<label_name>

The TERM query returns the specification of the term specified by term identification and label name.

Returned Format [:MACHine{1|2}:STRace:TERM]<term_id>,<label_name>,<pattern><NL>

Example OUTPUT XXX;":MACHINE1:STRIGGER:TERM? B,'DATA' "

TIMER

Command :MACHine{1|2}:STRigger:TIMER{1|2} <time_value>

The TIMER command sets the time value for the specified timer. The limits of the timer are 400 ns to 500 seconds in 16 ns to 500 μ s increments. The increment value varies with the time value of the specified timer. There are two timers and they are available for either machine but not both machines simultaneously.

<time_value> real number from 400 ns to 500 seconds in increments which vary from 16 ns to 500 μ s.

Example OUTPUT XXX;":MACHINE1:STRIGGER:TIMER1 100E-6"

Query :MACHine{1|2}:STRigger:TIMER{1|2}?

The TIMER query returns the current time value for the specified timer.

Returned Format [:MACHine{1|2}:STRigger:TIMER{1|2}] <time_value><NL>

Example OUTPUT XXX;":MACHINE1:STRIGGER:TIMER1?"



TPOsition

Command :MACHine{1|2}:STRigger:TPOsition
 {START|CENTer|END| POSTstore, <poststore>}

The TPOsition (trigger position) command allows you to set the trigger at the start, center, end or at any position in the trace (poststore). Poststore is defined as 0 to 100 percent with a poststore of 100 percent being the same as start position and a poststore of 0 percent being the same as an end trace.

<poststore> integer from 0 to 100 representing percentage of poststore.

Example OUTPUT XXX; ":MACHINE1:STRIGGER:TPOSITION END"
 OUTPUT XXX; ":MACHINE2:STRIGGER:TPOSITION POSTstore, 75"

Query :MACHine{1|2}:STRigger:TPOsition?

The TPOsition query returns the current trigger position setting.

Returned Format [:MACHine{1|2}:STRigger:TPOsition] {START|CENTer|END|
 POSTstore, <poststore>}<NL>

Example OUTPUT XXX; ":MACHINE1:STRIGGER:TPOSITION?"



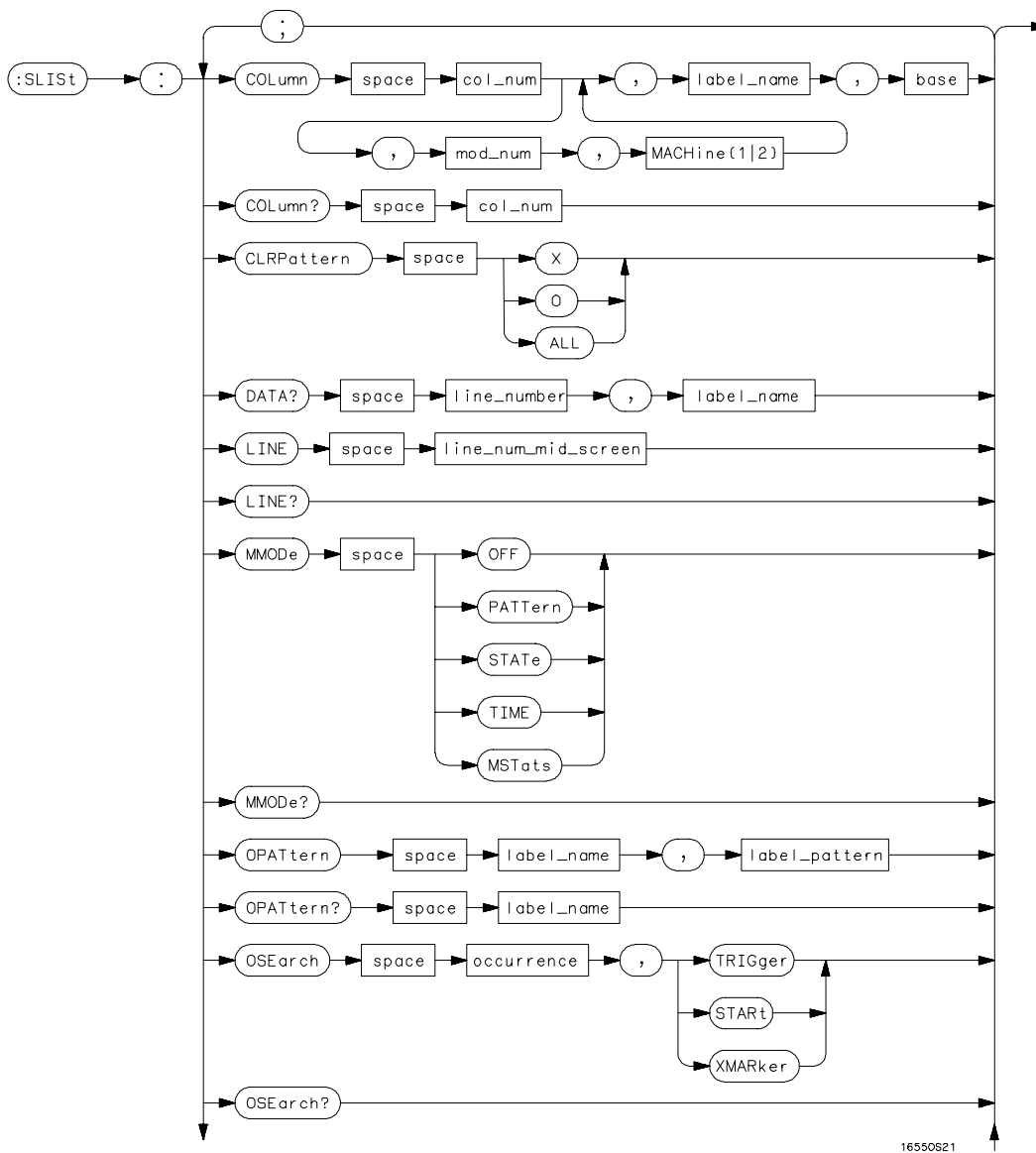
SLISt Subsystem

Introduction

The SLISt subsystem contains the commands available for the State Listing menu in the HP 16554A/HP 16555A/HP 16555D logic analyzer modules. These commands are:

- COLumn
- CLRPattern
- DATA
- LINE
- MMODE
- OPATtern
- OSEarch
- OSTate
- OTAG
- OVERlay
- REMove
- RUNTil
- TAVERAGE
- TMAXimum
- TMINimum
- VRUNs
- XOTag
- XOTime
- XPATtern
- XSEarch
- XSTate
- XTAG

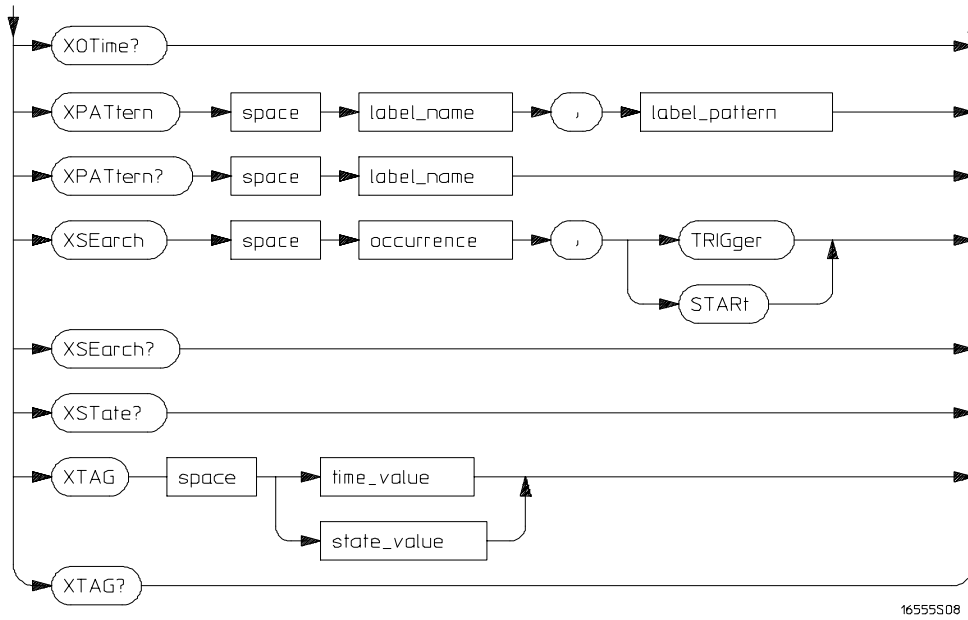
Figure 7-1



SLISt Subsystem Syntax Diagram



Figure 7-1 (continued)



SLISr Subsystem Syntax Diagram (continued)



Table 7-1

SLISSt Subsystem Parameter Values

Parameter	Value
mod_num	{1 2 3 4 5 6 7 8 9 10}
col_num	integer from 1 to 61
line_number	integer from -516096 to +516096 (HP 16554A) or from -1040384 to +1040384 (HP 16555A) or from -2080768 to +2080768 (HP 16555D)
label_name	a string of up to 6 alphanumeric characters
base	{BINary HEXadecimal OCTal DECimal TWOS ASCii SYMBOL IASsembler} for labels or {ABSolute RELative} for tags
line_num_mid_screen	integer from -516096 to +516096 (HP 16554A) or from -1040384 to +1040384 (HP 16555A) or from -2080768 to +2080768 (HP 16555D)
label_pattern	"#{B{0 1 X}... #Q{0 1 2 3 4 5 6 7 X}... #H{0 1 2 3 4 5 6 7 8 9 A B C D E F X}... {0 1 2 3 4 5 6 7 8 9}...}"
occurrence	integer from -516096 to +516096 (HP 16554A) or from -1040384 to +1040384 (HP 16555A) or from -2080768 to +2080768 (HP 16555D)
time_value	real number
state_value	real number
run_until_spec	{OFF LT,<value> GT,<value> INRange,<value>,<value> OUTRange,<value>,<value>}
value	real number

SLISt

Selector :MACHine{1|2}:SLISt

The SLISt selector is used as part of a compound header to access those settings normally found in the State Listing menu. It always follows the MACHine selector because it selects a branch directly below the MACHine level in the command tree.

Example OUTPUT XXX; ":MACHINE1:SLIST:LINE 256"

COLumn

Command :MACHine{1|2}:SLISt:COLumn <col_num>
[, <module_num>, MACHine{1|2}], <label_name>, <base>

The COLumn command allows you to configure the state analyzer listing by assigning a label name and base to one of the 61 vertical columns in the menu. A column number of 1 refers to the leftmost column. When a label is assigned to a column it replaces the original label in that column.

When the label name is "TAGS," the TAGS column is assumed and the next parameter must specify RELative or ABSolute.

<col_num> integer from 1 to 61

<module_num> {1|2|3|4|5|6|7|8|9|10}

<label_name> a string of up to 6 alphanumeric characters; "TAGS" to insert state or time tags.

<base> {BINary|HEXadecimal|OCTal|DECimal|TWOS|ASCii|SYMBOL|IASSEMBler} for labels or
{ABSolute|RELative} for tags

Example OUTPUT XXX; ":MACHINE1:SLIST:COLUMN 4, 'ADDR', HEX"



SLISL Subsystem CLRPattern

Query `:MACHine{1|2}:SLISL:COLumn? <col_num>`

The COLumn query returns the column number, module slot, machine, label name, and base for the specified column.

Returned Format `[:MACHine{1|2}:SLISL:COLumn]
<col_num>, <module_num>, MACHine{1|2}, <label_name>, <base><NL>`

Example `OUTPUT XXX; ":MACHINE1:SLISL:COLUMN? 4"`

CLRPattern

Command `:MACHine{1|2}:SLISL:CLRPattern {X|O|ALL}`

The CLRPattern command allows you to clear the marker patterns in the Specify Patterns menu.

Example `OUTPUT XXX; ":MACHINE1:SLISL:CLRPATTERN X"`

DATA

Query `:MACHine{1|2}:SLIST:DATA? <line_number>, <label_name>`

The DATA query returns the value at a specified line number for a given label. The format will be the same as the one shown in the listing display.

Returned Format `[:MACHine{1|2}:SLIST:DATA] <line_number>, <label_name>, <pattern_string><NL>`

`<line_number>` integer from -516096 to +516096 (HP 16554A) or from -1040384 to +1040384 (HP 16555A) or from -2080768 to +2080768 (HP 16555D)

`<label_name>` string of up to 6 alphanumeric characters

`<pattern_string>` `"{#B{0|1|X} . . . | #Q{0|1|2|3|4|5|6|7|X} . . . | #H{0|1|2|3|4|5|6|7|8|9|A|B|C|D|E|F|X} . . . | {0|1|2|3|4|5|6|7|8|9} . . . }"`

Example `OUTPUT XXX; ":MACHINE1:SLIST:DATA? 512, 'RAS' "`

LINE

Command `:MACHine{1|2}:SLIST:LINE <line_num_mid_screen>`

The LINE command allows you to scroll the state analyzer listing vertically. The command specifies the state line number relative to the trigger. The analyzer highlights the specified line at the center of the screen.

`<line_num_mid_screen>` integer from -516096 to +516096 (HP 16554A) or from -1040384 to +1040384 (HP 16555A) or from -2080768 to +2080768 (HP 16555D)

Example `OUTPUT XXX; ":MACHINE1:SLIST:LINE 0 "`



SLIS_t Subsystem
MMODE

Query `:MACHine{1|2}:SLISt:LINE?`

The LINE query returns the line number for the state currently in the box at the center of the screen.

Returned Format `[:MACHine{1|2}:SLISt:LINE] <line_num_mid_screen><NL>`

Example `OUTPUT XXX; ":MACHINE1:SLIST:LINE?"`

MMODE

Command `:MACHine{1|2}:SLISt:MMODE <marker_mode>`

The MMODE command (Marker Mode) selects the mode controlling the marker movement and the display of marker readouts. When PAT_Tern is selected, the markers will be placed on patterns. When STA_Te is selected and state tagging is on, the markers move on qualified states counted between normally stored states. When TIME is selected and time tagging is enabled, the markers move on time between stored states. When MS_Tats is selected and time tagging is on, the markers are placed on patterns, but the readouts will be time statistics.

`<marker_mode> {OFF|PATTern|STATe|TIME|MSTats}`

Example `OUTPUT XXX; ":MACHINE1:SLIST:MMODE TIME"`

Query :MACHine{1|2}:SLISt:MMODE?

The MMODE query returns the current marker mode selected.

Returned Format [:MACHine{1|2}:SLISt:MMODE] <marker_mode><NL>

Example OUTPUT XXX; ":MACHINE1:SLIST:MMODE?"

OPATtern

Command :MACHine{1|2}:SLISt:OPATtern
<label_name>, <label_pattern>

The OPATtern command allows you to construct a pattern recognizer term for the O Marker which is then used with the OSEarch criteria when moving the marker on patterns. Because this command deals with only one label at a time, a complete specification could require several invocations.

When the value of a pattern is expressed in binary, it represents the bit values for the label inside the pattern recognizer term. In whatever base is used, the value must be between 0 and $2^{32} - 1$, since a label may not have more than 32 bits. Because the <label_pattern> parameter may contain don't cares, it is handled as a string of characters rather than a number.

<label_name> string of up to 6 alphanumeric characters

<label_pattern> "{#B{0|1|X} . . . |
#Q{0|1|2|3|4|5|6|7|X} . . . |
#H{0|1|2|3|4|5|6|7|8|9|A|B|C|D|E|F|X} . . . |
{0|1|2|3|4|5|6|7|8|9} . . . }"

Example OUTPUT XXX; ":MACHINE1:SLIST:OPATTERN 'DATA', '255' "
OUTPUT XXX; ":MACHINE2:SLIST:OPATTERN 'ABC', '#BXXXX1101' "



Query :MACHine{1|2}:SLIS_t:OPATtern? <label_name>

Returned Format The OPATtern query returns the pattern specification for a given label name.
[:MACHine{1|2}:SLIS_t:OPATtern]
<label_name>,<label_pattern><NL>

Example OUTPUT XXX; ":MACHINE1:SLIST:OPATTERN? 'A' "

OSEarch

Command :MACHine{1|2}:SLIS_t:OSEarch <occurrence>,<origin>

The OSEarch command defines the search criteria for the O marker, which is then used with associated OPATtern recognizer specification when moving the markers on patterns. The origin parameter tells the marker to begin a search with the trigger, the start of data, or with the X marker. The actual occurrence the marker searches for is determined by the occurrence parameter of the OSEarch recognizer specification, relative to the origin. An occurrence of 0 places the marker on the selected origin. With a negative occurrence, the marker searches before the origin. With a positive occurrence, the marker searches after the origin.

<occurrence> integer from -516096 to +516096 (HP 16554A) or from -1040384 to +1040384 (HP 16555A) or from -2080768 to +2080768 (HP 16555D)

<origin> {TRIGger|START|XMARKer}

Example OUTPUT XXX; ":MACHINE1:SLIST:OSEARCH +10,TRIGGER "

Query :MACHine{1|2}:SLISt:OSEarch?

The OSEarch query returns the search criteria for the O marker.
Returned Format [:MACHine{1|2}:SLISt:OSEarch] <occurrence>, <origin><NL>

Example OUTPUT XXX; ":MACHINE1:SLIST:OSEARCH?"

OSTate

Query :MACHine{1|2}:SLISt:OSTate?

The OSTate query returns the line number in the listing where the O marker resides. If data is not valid, the query returns 2147483647.

Returned Format [:MACHine{1|2}:SLISt:OSTate] <state_num><NL>

<state_num> integer from -516096 to +516096 or 2147483647 (HP 16554A), or from -1040384 to +1040384 or 2147483647 (HP 16555A) or from -2080768 to +2080768 or 2147483647 (HP 16555D)

Example OUTPUT XXX; ":MACHINE1:SLIST:OSTATE?"



OTAG

Command :MAChine{1|2}:SLISt:OTAG
 {<time_value>|<state_value>}

The OTAG command specifies the tag value on which the O Marker should be placed. The tag value is time when time tagging is on, or states when state tagging is on. If the data is not valid tagged data, no action is performed.

<time_value> real number

<state_value> real number

Example :OUTPUT XXX;":MACHINE1:SLIST:OTAG 40.0E-6"

Query :MAChine{1|2}:SLISt:OTAG?

The OTAG query returns the O Marker position in time when time tagging is on or in states when state tagging is on, regardless of whether the marker was positioned in time or through a pattern search. If data is not valid, the query returns 9.9E37 for time tagging, or returns 2147483647 for state tagging.

Returned Format [:MAChine{1|2}:SLISt:OTAG] {<time_value>|<state_value>}<NL>

Example OUTPUT XXX;":MACHINE1:SLIST:OTAG?"

OVERlay

Command :MAChine{1|2}:SLIST:OVERlay <col_num>,
 <module_num>,MAChine{1|2},<label_name>

The OVERlay command allows you to add time-correlated labels from other modules or machines to the state listing. The added labels are interleaved with the column specified. The column must already contain a label.

<col_num> integer from 1 to 61

<Module_num> {1|2|3|4|5|6|7|8|9|10}

<label_name> a string of up to 6 alphanumeric characters

Example OUTPUT XXX; ":MACHINE1:SLIST:OVERlay,25,5,MACHINE2,'DATA' "

REMOve

Command :MAChine{1|2}:SLIST:REMOve

The REMOve command removes all labels, except the leftmost label, from the listing menu.

Example OUTPUT XXX; ":MACHINE1:SLIST:REMOVE"



RUNTiI

Command :MACHine{1|2}:SLISt:RUNTiI <run_until_spec>

The RUNTiI (run until) command allows you to define a stop condition when the trace mode is repetitive. Specifying OFF causes the analyzer to make runs until either the display's STOP field is touched or the STOP command is issued.

There are four conditions based on the time between the X and O markers. Using this difference in the condition is effective only when time tags have been turned on (see the TAG command in the STRace subsystem). These four conditions are as follows:

- The difference is less than (LT) some value.
- The difference is greater than (GT) some value.
- The difference is inside some range (INRange).
- The difference is outside some range (OUTRange).

End points for the INRange and OUTRange should be at least 8 ns apart since this is the minimum time resolution of the time tag counter.

<run_until_spec> {OFF|LT, <value>|GT, <value>|INRange, <value>, <value>|OUTRange, <value>, <value>}

<value> real number from -9E9 to +9E9

Example OUTPUT XXX; ":MACHINE1:SLIST:RUNTIL GT,800.0E-6"

Query :MACHine{1|2}:SLISt:RUNTiI?

The RUNTiI query returns the current stop criteria.

Returned Format [:MACHine{1|2}:SLISt:RUNTiI] <run_until_spec><NL>

Example OUTPUT XXX; ":MACHINE1:SLIST:RUNTIL?"

TAVerage

Query :MACHine{1|2}:SLISt:TAVerage?

The TAVerage query returns the value of the average time between the X and O Markers. If the number of valid runs is zero, the query returns 9.9E37. Valid runs are those where the pattern search for both the X and O markers was successful, resulting in valid time measurements.

Returned Format [:MACHine{1|2}:SLISt:TAVerage] <time_value><NL>
 <time_value> real number

Example OUTPUT XXX; ":MACHINE1:SLIST:TAVERAGE?"

TMAXimum

Query :MACHine{1|2}:SLISt:TMAXimum?

The TMAXimum query returns the value of the maximum time between the X and O Markers. If data is not valid, the query returns 9.9E37.

Returned Format [:MACHine{1|2}:SLISt:TMAXimum] <time_value><NL>
 <time_value> real number

Example OUTPUT XXX; ":MACHINE1:SLIST:TMAXIMUM?"



TMINimum

Query :MACHine{1|2}:SLISt:TMINimum?

The TMINimum query returns the value of the minimum time between the X and O Markers. If data is not valid, the query returns 9.9E37.

Returned Format [:MACHine{1|2}:SLISt:TMINimum] <time_value><NL>
<time_value> real number

Example OUTPUT XXX; ":MACHINE1:SLIST:TMINIMUM?"

VRUNs

Query :MACHine{1|2}:SLISt:VRUNs?

The VRUNs query returns the number of valid runs and total number of runs made. Valid runs are those where the pattern search for both the X and O markers was successful, resulting in valid time measurements.

Returned Format [:MACHine{1|2}:SLISt:VRUNs] <valid_runs>,<total_runs><NL>
<valid_runs> zero or positive integer
<total_runs> zero or positive integer

Example OUTPUT XXX; ":MACHINE1:SLIST:VRUNs?"

XOTag

Query :MACHine{1|2}:SLISt:XOTag?

The XOTag query returns the time from the X to O markers when the marker mode is time, or number of states from the X to O markers when the marker mode is state. If there is no data in the time mode the query returns 9.9E37. If there is no data in the state mode, the query returns 2147483647.

Returned Format [:MACHine{1|2}:SLISt:XOTag] {<XO_time>|<XO_states>}<NL>

<XO_time> real number

<XO_states> integer

Example OUTPUT XXX; ":MACHINE1:SLIST:XOTAG?"

XOTime

Query :MACHine{1|2}:SLISt:XOTime?

The XOTime query returns the time from the X to O markers when the marker mode is time, or number of states from the X to O markers when the marker mode is state. If there is no data in the time mode the query returns 9.9E37. If there is no data in the state mode, the query returns 2147483647.

Returned Format [:MACHine{1|2}:SLISt:XOTime] {<XO_time>|<XO_states>}<NL>

<XO_time> real number

<XO_states> integer

Example OUTPUT XXX; ":MACHINE1:SLIST:XOTIME?"



XPATtern

Command :MAChine{1|2}:SLIST:XPATtern
 <label_name>, <label_pattern>

The XPATtern command allows you to construct a pattern recognizer term for the X marker which is then used with the XSEarch criteria when moving the marker on patterns. Since this command deals with only one label at a time, a complete specification could require several invocations.

When the value of a pattern is expressed in binary, it represents the bit values for the label inside the pattern recognizer term. In whatever base is used, the value must be between 0 and $2^{32} - 1$, since a label may not have more than 32 bits. Because the <label_pattern> parameter may contain don't cares, it is handled as a string of characters rather than a number.

<label_name> string of up to 6 alphanumeric characters

<label_pattern> "#{B{0|1|X} . . . |
 #Q{0|1|2|3|4|5|6|7|X} . . . |
 #H{0|1|2|3|4|5|6|7|8|9|A|B|C|D|E|F|X} . . . |
 {0|1|2|3|4|5|6|7|8|9} . . . }"

Examples

OUTPUT XXX;":MACHINE1:SLIST:XPATTERN 'DATA','255' "
OUTPUT XXX;":MACHINE1:SLIST:XPATTERN 'ABC','#BXXXX1101' "

Query :MAChine{1|2}:SLIST:XPATtern? <label_name>

The XPATtern query returns the pattern specification for a given label name.

Returned Format [:MAChine{1|2}:SLIST:XPATtern]
 <label_name>,<label_pattern><NL>

Example

OUTPUT XXX;":MACHINE1:SLIST:XPATTERN? 'A' "

XSEarch

Command :MAChine{1|2}:SLISt:XSEarch <occurrence>,<origin>

The XSEarch command defines the search criteria for the X marker, which is then with associated XPATtern recognizer specification when moving the markers on patterns. The origin parameter tells the marker to begin a search from the trigger or from the start of data. The occurrence parameter determines which occurrence of the XPATtern recognizer specification, relative to the origin, the marker actually searches for. An occurrence of 0 places a marker on the selected origin.

<occurrence> integer from -516096 to +516096 (HP 16554A), or from -1040384 to +1040384 (HP 16555A) or from -2080768 to +2080768 (HP 16555D)

<origin> { TRIGger | START }

Example OUTPUT XXX; ":MACHINE1:SLIST:XSEARCH +10,TRIGGER"

Query :MAChine{1|2}:SLISt:XSEarch?

The XSEarch query returns the search criteria for the X marker.

Returned Format [:MAChine{1|2}:SLISt:XSEarch] <occurrence>,<origin><NL>

Example OUTPUT XXX; ":MACHINE1:SLIST:XSEARCH?"



XState

Query :MACHine{1|2}:SLISt:XState?

The XState query returns the line number in the listing where the X marker resides. If data is not valid, the query returns 2147483647.

Returned Format [:MACHine{1|2}:SLISt:XState] <state_num><NL>

<state_num> integer from -516096 to +516096 or 2147483647 (HP 16554A), or from -1040384 to +1040384 or 2147483647 (HP 16555A) or from -2080768 to +2080768 or 2147483647 (HP 16555D)

Example OUTPUT XXX; ":MACHINE1:SLIST:XSTATE?"

XTAG

Command :MACHine{1|2}:SLISt:XTAG
{<time_value>|<state_value>}

The XTAG command specifies the tag value on which the X marker should be placed. The tag value is time when time tagging is on, and states when state tagging is on. If the data is not valid tagged data, no action is performed.

<time_value> real number

<state_value> integer

Example OUTPUT XXX; ":MACHINE1:SLIST:XTAG 40.0E-6"

Query :MACHine{1|2}:SLISt:XTAG?

The XTAG query returns the X marker position in time when time tagging is on or in states when state tagging is on, regardless of whether the marker was positioned in time or through a pattern search. If data is not valid tagged data, the query returns 9.9E37 for time tagging, or returns 2147483647 for state tagging.

Returned Format [:MACHine{1|2}:SLISt:XTAG] {<time_value>|<state_value>}<NL>

Example OUTPUT XXX; ":MACHINE1:SLIST:XTAG?"





SWAVEform Subsystem

Introduction

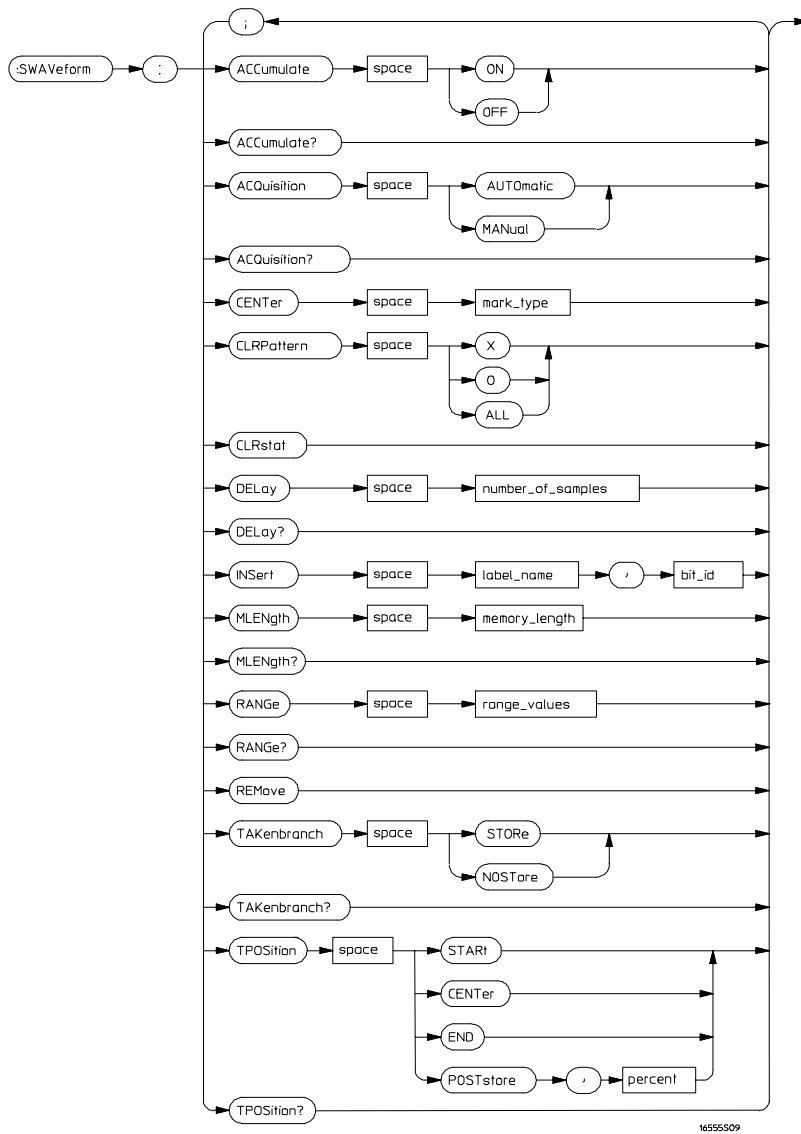
The commands in the State Waveform subsystem allow you to configure the display so that you can view state data as waveforms. Up to 96 channels, identified by label name and bit number, can be displayed at a time. The 12 commands in this subsystem are analogous to their counterparts in the Timing Waveform subsystem. In this subsystem the X axis is restricted to representing only samples (states), regardless of whether time tagging is on or off. As a result, the only commands which can be used for scaling are DELay and RANge.

The way to manipulate the X and O markers on the Waveform display is through the State Listing (SLISt) subsystem. Using the marker commands from the SLISt subsystem will affect the markers on the Waveform display.

The commands in the SWAVEform subsystem are:

- ACCumulate
- ACQuisition
- CENter
- CLRPattern
- CLRStat
- DELay
- INSert
- MLENgth
- RANge
- REMove
- TAKenbranch
- TPOsition

Figure 8-1



SWAVeform Subsystem Syntax Diagram

Table 8-1

SWAVeform Subsystem Parameter Values

Parameter	Value
number_of_samples	integer from -516096 to +516096 (HP 16554A) or from -1040384 to +1040384 (HP 16555A) or from -2080768 to +2080768 (HP 16555D)
label_name	string of up to 6 alphanumeric characters
bit_id	{OVERlay <bit_num> ALL}
bit_num	integer representing a label bit from 0 to 31
range_values	integer from 10 to 5000 (representing (10× states/Division))
mark_type	{X O XO TRIGger}
percent	integer from 0 to 100
memory_length	{4096 8192 16384 32768 65536 131072 262144 516096 (HP 16554A only) 524288 1040384 (HP 16555A only) 524288 1048576 2080768 (HP 16555D only)}

SWAVeform

Selector :MACHine{1|2}:SWAVeform

The SWAVeform (State Waveform) selector is used as part of a compound header to access the settings in the State Waveform menu. It always follows the MACHine selector because it selects a branch directly below the MACHine level in the command tree.

Example OUTPUT XXX; ":MACHINE2:SWAVEFORM:RANGE 40"

ACCumulate

Command :MACHine{1|2}:SWAVeform:ACCumulate
 {{ON|1}|{OFF|0}}

The ACCumulate command allows you to control whether the waveform display gets erased between individual runs or whether subsequent waveforms are allowed to be displayed over the previous waveforms.

Example OUTPUT XXX; ":MACHINE1:SWAVEFORM:ACCUMULATE ON"

Query MACHine{1|2}:SWAVeform:ACCumulate?

The ACCumulate query returns the current setting. The query always shows the setting as the characters, "0" (off) or "1" (on).

Returned Format [MACHine{1|2}:SWAVeform:ACCumulate] {0|1}<NL>

Example OUTPUT XXX; ":MACHINE1:SWAVEFORM:ACCUMULATE?"

ACQquisition

Command :MACHine{1|2}:SWAVeform:ACQquisition {AUTOMatic|MANual}

The ACQquisition command allows you to specify the acquisition mode for the state analyzer. The acquisition modes are automatic and manual.

Example OUTPUT XXX; ":MACHINE2:SWAVEFORM:ACQUISITION AUTOMATIC"



SWAVeform Subsystem CENTer

Query	<code>MACHine{1 2}:SWAVeform:ACQuisition?</code>
Returned Format	The ACQuisition query returns the current acquisition mode. <code>[MACHine{1 2}:SWAVeform:ACQuisition] {AUTOMatic MANual}<NL></code>
Example	<code>OUTPUT XXX; ":MACHINE2:SWAVEFORM:ACQUISITION?"</code>

CENTer

Command	<code>:MACHine{1 2}:SWAVeform:CENTer <marker_type></code>
	The CENTer command allows you to center the waveform display about the specified markers. The markers are placed on the waveform in the SLIST subsystem.
<code><marker_type></code>	<code>{X O XO TRIGger}</code>
Example	<code>OUTPUT XXX; ":MACHINE1:SWAVEFORM:CENTER X"</code>

CLRPattern

Command	<code>:MACHine{1 2}:SWAVeform:CLRPattern {X O ALL}</code>
	The CLRPattern command allows you to clear the marker patterns in the selected Specify Patterns menu.
Example	<code>OUTPUT XXX; ":MACHINE1:SWAVEFORM:CLRPATTERN"</code>

CLRStat

Command :MACHine{1|2}:SWAVeform:CLRStat

The CLRStat command allows you to clear the waveform statistics without having to stop and restart the acquisition.

Example OUTPUT XXX; ":MACHINE1:SWAVEFORM:CLRSTAT"

DElay

Command :MACHine{1|2}:SWAVeform:DElay <number_of_samples>

The DElay command allows you to specify the number of samples between the State trigger and the horizontal center of the screen for the waveform display.

<number_of_samples> integer from -516096 to +516096 (HP 16554A) or from -1040384 to +1040384 (HP 16555A) or from -2080768 to +2080768 (HP 16555D)

Example OUTPUT XXX; ":MACHINE2:SWAVEFORM:DELAY 127"

Query MACHine{1|2}:SWAVeform:DElay?

The DElay query returns the current sample offset value.

Returned Format [MACHine{1|2}:SWAVeform:DElay] <number_of_samples><NL>

Example OUTPUT XXX; ":MACHINE1:SWAVEFORM:DELAY?"



INSert

Command MACHine{1|2}:SWAVEform:INSert <label_name>,
 <bit_id>

The INSert command allows you to add waveforms to the state waveform display. Waveforms are added from top to bottom on the screen. When 96 waveforms are present, inserting additional waveforms replaces the last waveform. Bit numbers are zero-based, so a label with 8 bits is referenced as bits 0 through 7. Specifying OVERlay causes a composite waveform display of all bits or channels for the specified label.

<label_name> string of up to 6 alphanumeric characters

 <bit_id> {OVERlay | <bit_num> | ALL}

 <bit_num> integer representing a label bit from 0 to 31

Example

```
OUTPUT XXX;":MACHINE1:SWAVEFORM:INSERT 'WAVE', 19"  
OUTPUT XXX;":MACHINE1:SWAVEFORM:INSERT 'ABC', OVERLAY"  
OUTPUT XXX;":MACH1:SWAV:INSERT 'POD1', #B1001"
```

MLENgth

Command :MACHine{1|2}:SWAVEform:MLENgth <memory_length>

The MLENgth command allows you to specify the analyzer memory depth. Valid memory depths range from 4096 states (or samples) through the maximum system memory depth minus 8192 states. Memory depth is affected by acquisition mode. If the <memory_depth> value sent with the command is not a legal value, the closest legal setting will be used.

<memory_length> {4096 | 8192 | 16384 | 32768 | 65536 | 131072 | 262144
 | 516096 (HP 16554A)
 | 524288 | 1040384 (HP 16555A)
 | 524288 | 1048576 | 2080768 (HP 16555D)}

Example OUTPUT XXX; ":MACHINE1:SWAVEFORM:MLENGTH 262144"

Query :MACHine{1|2}:SWAVEform:MLENgtH?

Returned Format The MLENgth query returns the current analyzer memory depth selection.
 [:MACHine{1|2}:SWAVEform:MLENgtH] <memory_length><NL>

Example OUTPUT XXX; ":MACHINE1:SWAVEFORM:MLENGTH?"

RANGe

Command MACHine{1|2}:SWAVEform:RANGe <number_of_samples>

The RANGe command allows you to specify the number of samples across the screen on the State Waveform display. It is equivalent to ten times the states per division setting (states/Div) on the front panel. A number between 10 and 5000 may be entered.

<number_of_ integer from 10 to 5000
 samples>

Example OUTPUT XXX; ":MACHINE2:SWAVEFORM:RANGE 80"

Query MACHine{1|2}:SWAVEform:RANGe?

Returned Format The RANGe query returns the current range value.
 [MACHine{1|2}:SWAVEform:RANGe] <number_of_samples><NL>

Example OUTPUT XXX; ":MACHINE2:SWAVEFORM:RANGE?"



REMove

Command `:MACHine{1|2}:SWAVEform:REMove`

The REMove command clears the waveform display before building a new display.

Example `OUTPUT XXX; ":MACHINE1:SWAVEFORM:REMOVE"`

TAKenbranch

Command `MACHine{1|2}:SWAVEform:TAKenbranch {STORE|NOSTore}`

The TAKenbranch command allows you to control whether the states that cause branching are stored or not stored. This command is only available when the acquisition mode is set to manual.

Example `OUTPUT XXX; ":MACHINE2:SWAVEFORM:TAKENBRANCH STORE"`

Query `MACHine{1|2}:SWAVEform:TAKenbranch?`

The TAKenbranch query returns the current setting.

Returned Format `[MACHine{1|2}:SWAVEform:TAKenbranch] {STORE|NOSTore}<NL>`

Example `OUTPUT XXX; ":MACHINE2:SWAVEFORM:TAKENBRANCH?"`

TPOsition

Command MACHine{1|2}:SWAVeform:TPOsition
 {START|CENTer|END|POSTstore,<percent>}

The TPOsition command allows you to control where the trigger point is placed. The trigger point can be placed at the start, center, end, or at a percentage of post store. The post store option is the same as the User Defined option when setting the trigger point from the front panel.

The TPOsition command is only available when the acquisition mode is set to manual.

<percent> integer from 1 to 100

Example OUTPUT XXX; ":MACHINE2:SWAVEFORM:TPOSITION CENTER"

Query MACHine{1|2}:SWAVeform:TPOsition?

The TPOsition query returns the current trigger setting.

Returned Format [MACHine{1|2}:SWAVeform:TPOsition]
 {START|CENTer|END|POSTstore,<percent>}<NL>

Example OUTPUT XXX; ":MACHINE2:SWAVEFORM:TPOsition?"





SCHart Subsystem

Introduction

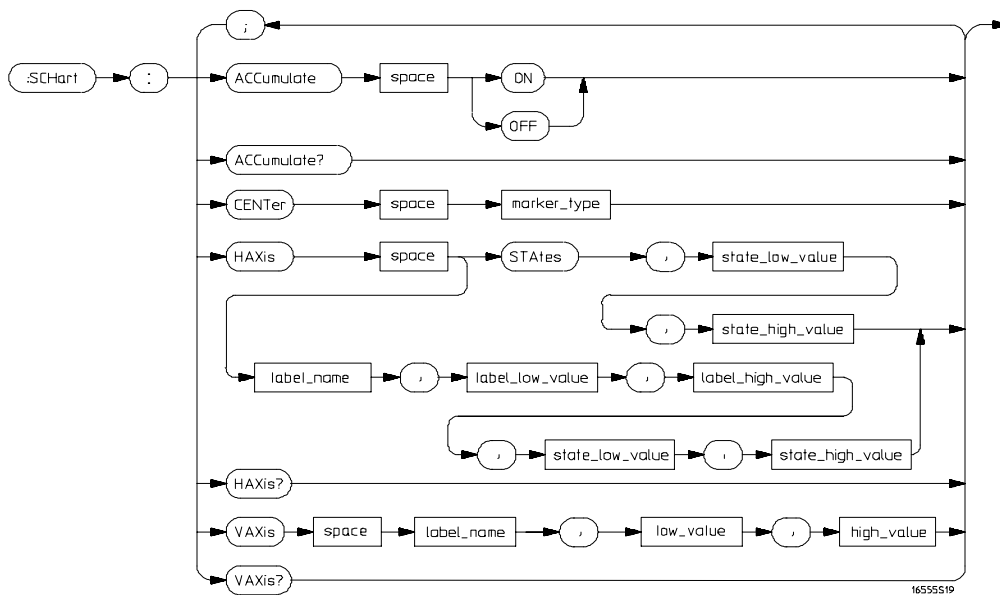
The State Chart subsystem provides the commands necessary for programming the HP 16554A/HP 16555A/HP 16555D's Chart display. The commands allow you to build charts of label activity, using data normally found in the Listing display. The chart's Y axis is used to show data values for the label of your choice. The X axis can be used in two different ways. In one, the X axis represents states (shown as rows in the State Listing display). In the other, the X axis represents the data values for another label.

When states are plotted along the X axis, X and O markers are available. Because the State Chart display is simply an alternative way of looking at the data in the State Listing, the X and O markers are manipulated through the SLISt subsystem. Because the programming commands do not force the menus to switch, you can position the markers in the SLISt subsystem and see the effects in the State Chart display.

The commands in the SCHart subsystem are:

- ACCumulate
- CENTer
- HAXis
- VAXis

Figure 9-1



SCHart Subsystem Syntax Diagram

Table 9-1

SCHart Subsystem Parameter Values

Parameter	Value
state_low_value	integer between ± 516096 (HP 16554A), ± 1040384 (HP 16555A), or ± 2080768 (HP 16555D)
state_high_value	integer from $\langle \text{state_low_value} \rangle$ to 516096 (HP 16554A), 1040384 (HP 16555A), or 2080768 (HP 16555D)
label_name	a string of up to 6 alphanumeric characters
label_low_value	string from 0 to $2^{32} - 1$ (#HFFFFFFF)
label_high_value	string from $\langle \text{label_low_value} \rangle$ to $2^{32} - 1$ (#HFFFFFFF)
low_value	string from 0 to $2^{32} - 1$ (#HFFFFFFF)
high_value	string from low_value to $2^{32} - 1$ (#HFFFFFFF)
marker_type	{X O XO TRIGger}

SCHart

Selector :MACHine{1|2}:SCHart

The SCHart selector is used as part of a compound header to access the settings found in the State Chart menu. It always follows the MACHine selector because it selects a branch below the MACHine level in the command tree.

Example OUTPUT XXX;":MACHINE1:SCHART:VAXIS 'A', '0', '9'"

ACCumulate

Command MACHine{1|2}:SCHart:ACCumulate {{ON|1} | {OFF|0}}

The ACCumulate command controls whether the chart display gets erased between each individual run or whether subsequent waveforms are displayed over the previous waveforms.

Example OUTPUT XXX;":MACHINE1:SCHART:ACCUMULATE OFF"

Query MACHine{1|2}:SCHart:ACCumulate?

The ACCumulate query returns the current setting. The query always shows the setting as the character "0" (off) or "1" (on).

Returned Format [:MACHine{1|2}:SCHart:ACCumulate] {0|1}<NL>

Example OUTPUT XXX;":MACHINE1:SCHART:ACCUMULATE?"

CENTer

Command MACHine{1|2}:SCHart:CENTer <marker_type>

The CENTer command centers the chart display about the specified markers. The markers are placed in the SLISt subsystem.

<marker_type> {X | O | XO | TRIGger}

Example

OUTPUT XXX; ":MACHINE1:SCHART:CENTER XO"

HAXis

Command MACHine{1|2}:SCHart:HAXis
 { STATES, <state_low_value>, <state_high_value> |
 <label_name>, <label_low_value>, <label_high_value>,
 <state_low_value>, <state_high_value> }

The HAXis command allows you to select whether states or a label's values will be plotted on the horizontal axis of the chart. The axis is scaled by specifying the high and low values. The shortform for STATES is STA. This is an intentional deviation from the normal truncation rule.

<state_low_value> integer from -516096 to +516096 (HP 16554A), or from -1040384 to +1040384 (HP 16555A), or from -2080768 to +2080768 (HP 16555D)

<state_high_value> integer from <state_low_value> to +516096 (HP 16554A), +1040384 (HP 16555A), or +2080768 (HP 16555D)

<label_name> a string of up to 6 alphanumeric characters

<label_low_value> string from 0 to $2^{32}-1$ (#HFFFFFFF)

<label_high_value> string from <label_low_value> to $2^{32}-1$ (#HFFFFFFF)



Example

```
OUTPUT XXX;":MACHINE1:SCHART:HAXIS STATES, -100, 100"  
OUTPUT XXX;":MACHINE1:SCHART:HAXIS 'READ', '-511', '511',  
0,300"
```

Query

```
MACHine{1|2}:SCHart:HAXis?
```

Returned Format

The HAXis query returns the current horizontal axis label and scaling.

```
[:MACHine{1|2}:SCHart:HAXis] {STates,<state_low_value>,  
<state_high_value>|<label_name>,<label_low_value>,  
<label_high_value><state_low_value>,<state_high_value>}
```

Example

```
OUTPUT XXX;":MACHINE1:SCHART:HAXIS?"
```

VAXis

Command

```
MACHine{1|2}:SCHart:VAXis  
<label_name>,<low_value>,<high_value>
```

The VAXis command allows you to choose which label will be plotted on the vertical axis of the chart and scales the vertical axis by specifying the high value and low value.

<label_name> a string of up to 6 alphanumeric characters

<low_value> string from 0 to $2^{32}-1$ (#FFFFFFFF)

<high_value> string from <low_value> to $2^{32}-1$ (#FFFFFFFF)

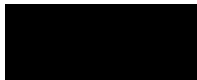
Example

```
OUTPUT XXX;":MACHINE2:SCHART:VAXIS 'SUM1', '0', '99'"  
OUTPUT XXX;":MACHINE1:SCHART:VAXIS 'BUS', '#H00FF', '#H0500'"
```

Query MACHine{1|2}:SCHart:VAXis?

Returned Format The VAXis query returns the current vertical axis label and scaling.
 [:MACHine{1|2}:SCHart:VAXis] <label_name>,<low_value>,
 <high_value><NL>

Example OUTPUT XXX; ":MACHINE1:SCART:VAXIS?"





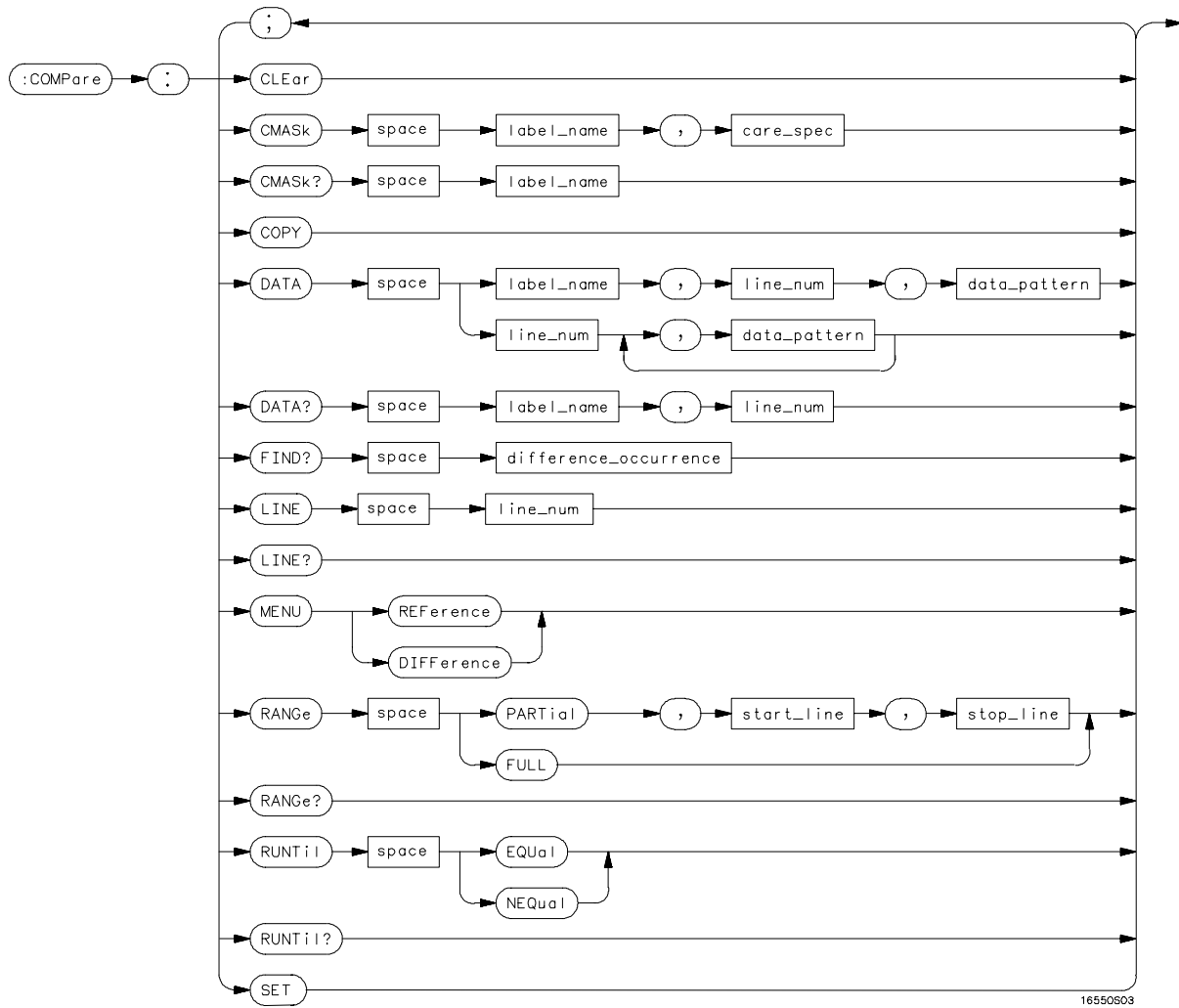
COMPare Subsystem

Introduction

Commands in the state COMPare subsystem provide the ability to do a bit-by-bit comparison between the acquired state data listing and a compare data image. The commands are:

- CLEAr
- CMASk
- COPY
- DATA
- FIND
- LINE
- MENU
- RANGe
- RUNTil
- SET

Figure 10-1



COM Pare Subsystem Syntax Diagram



Table 10-1

COM Pare Subsystem Parameter Values

Parameter	Value
label_name	string of up to 6 characters
care_spec	string of characters "{* .}..."
*	care
.	don't care
line_num	integer from -122880 to +122880 (HP 16554A) or -253951 to +253951 (HP 16555A) or -507903 to +507903 (HP 16555D)
data_pattern	"#{B{0 1 X} ... #Q{0 1 2 3 4 5 6 7 X} ... #H{0 1 2 3 4 5 6 7 8 9 A B C D E F X} ... {0 1 2 3 4 5 6 7 8 9} ... }"
difference_occurrence	integer from 1 to 122880 (HP 16554A) or 253951 (HP 16555A) or 507903 (HP 16555D)
start_line	integer from -122880 to +122880 (HP 16554A) or -253951 to +253951 (HP 16555A) or -507,903 to +507903 (HP 16555D)
stop_line	integer from <start_line> to +122880 (HP 16554A) or +253951 (HP 16555A) or +507903 (HP 16555D)

COMPare

Selector

:MACHine{1|2}:COMPare

The COMPare selector is used as part of a compound header to access the settings found in the Compare menu. It always follows the MACHine selector because it selects a branch directly below the MACHine level in the command tree.

Example

OUTPUT XXX; ":MACHINE1:COMPARE:FIND? 819"

CLEar

Command :MACHine{1|2}:COMPare:CLEar

The CLEar command clears all "don't cares" in the reference listing and replaces them with zeros except when the CLEar command immediately follows the SET command (see SET command).

Example

OUTPUT XXX;":MACHINE2:COMPARE:CLEAR

CMASk

Command :MACHine{1|2}:COMPare:CMASk <label_name>,
<care__spec>

The CMASk (Compare Mask) command allows you to set the bits in the channel mask for a given label in the compare listing image to "compares" or "don't compares."

The CMASk query returns the state of the bits in the channel mask for a given label in the compare listing image.

<label_name> a string of up to 6 alphanumeric characters

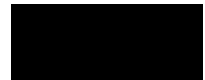
<care_spec> string of characters "{*|.}..." (32 characters maximum)

* care

. don't care

Example

OUTPUT XXX;":MACHINE2:COMPARE:CMASK 'DATA', '*.**..**'



COPY

Command :MACHine{1|2}:COMPare:COPY

The COPY command copies the current acquired State Listing for the specified machine into the Compare Listing template. This makes the current acquisition the reference listing. It does not affect the compare range or channel mask settings.

Example OUTPUT XXX; ":MACHINE2:COMPARE:COPY"

DATA

Command :MACHine{1|2}:COMPare:DATA
{<label_name>,<line_num>,<data_pattern>|
<line_num>,<data_pattern>[, <data_pattern>]... }

The DATA command allows you to edit the compare listing image for a given label and state row. When DATA is sent to an instrument where no compare image is defined (such as at power-up) all other data in the image is set to don't cares.

Not specifying the <label_name> parameter allows you to write data patterns to more than one label for the given line number. The first pattern is placed in the leftmost label, with the following patterns being placed in a left-to-right fashion as seen on the Compare display. Specifying more patterns than there are labels simply results in the extra patterns being ignored.

Because don't cares (Xs) are allowed in the data pattern, it must always be expressed as a string. You may still use different bases, but don't cares cannot be used in a decimal number.

<label_name> a string of up to 6 alphanumeric characters

<line_num> integer from -122880 to +122880 (HP 16554A) or -253951 to +253951 (HP 16555A) or -507903 to +507903 (HP 16555D)

<data_pattern> "{#B{0|1|X} . . . |
#Q{0|1|2|3|4|5|6|7|X} . . . |
#H{0|1|2|3|4|5|6|7|8|9|A|B|C|D|E|F|X} . . . |
{0|1|2|3|4|5|6|7|8|9} . . . }"

Example

```
OUTPUT XXX;":MACHINE2:COMPARE:DATA 'CLOCK', 42, '#B011X101X'"
OUTPUT XXX;":MACHINE2:COMPARE:DATA 'OUT3', 0, '#HFF40'"
OUTPUT XXX;":MACH1:COMP:DATA 129, '#BXX00', '#B1101', '#B10XX'"
OUTPUT XXX;":MACH1:COMP:DATA -511, '4', '64', '16', '256', '8', '6'"
```

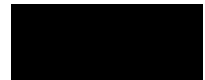
Query :MACHine{1|2}:COMPare:DATA? <label_name>,
<line_num>

The DATA query returns the value of the compare listing image for a given label and state row.

Returned Format [:MACHine{1|2}:COMPare:DATA] <label_name>,<line_num>,
<data_pattern><NL>

Example

```
10 DIM Label$(6), Response$(80)
15 PRINT "This program shows the values for a signal's Compare listing"
20 INPUT "Enter signal label: ", Label$
25 OUTPUT XXX;":SYSTEM:HEADER OFF" !Turn headers off (from responses)
30 OUTPUT XXX;":MACHINE2:COMPARE:RANGE?"
35 ENTER XXX; First, Last !Read in the range's end-points
40 PRINT "LINE #", "VALUE of "; Label$
45 FOR State = First TO Last !Print compare value for each state
50 OUTPUT XXX;":MACH2:COMPARE:DATA? '" Label$ "' , " VAL$(State)
55 ENTER XXX; Response$
60 PRINT State, Response$
65 NEXT State
70 END
```



FIND

Query	<code>:MACHine{1 2}:COMPare:FIND? <diff_occurrence></code>
	<p>The FIND query is used to get the line number of a specified difference occurrence (first, second, third, etc.) within the current compare range, as dictated by the RANGE command. A difference is counted for each line where at least one of the current labels has a discrepancy between its acquired state data listing (difference listing) and its compare data image (reference listing).</p> <p>Invoking the FIND query updates both the Listing and Compare displays so that the line number returned is in the center of the screen.</p> <p>If <diff_occurrence> is greater than the number of differences, the query returns the last difference and the associated line number.</p>
Returned Format	<code>[:MACHine{1 2}:COMPare:FIND] <difference_occurrence>, <line_number><NL></code>
<code><diff_occurrence></code>	integer from 1 to 122880 (HP 16554A) or 253952 (HP 16555A) or 507904 (HP 16555D).
<code><line_number></code>	integer from -122880 to +122880 (HP 16554A) or -253951 to +253951 (HP 16555A) or -507903 to +507903 (HP 16555D).
<hr/> Example <hr/>	OUTPUT XXX; ":MACHINE2:COMPARE:FIND? 26"

LINE

Command :MACHine{1|2}:COMPare:LINE <line_num>

The LINE command allows you to center the compare listing display about a specified line number. The Listing menu also changes so that the specified line is displayed midscreen.

<line_num> integer from -122880 to +122880 (HP 16554A) or -253951 to +253951 (HP 16555A) or -507903 to +507903 (HP 16555D).

Example OUTPUT XXX; ":MACHINE2:COMPARE:LINE -511"

Query :MACHine{1|2}:COMPare:LINE?

The LINE query returns the current line number specified.

Returned Format [:MACHine{1|2}:COMPare:LINE] <line_num><NL>

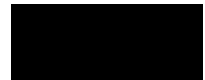
Example OUTPUT XXX; ":MACHINE4:COMPARE:LINE?"

MENU

Command :MACHine{1|2}:COMPare:MENU {REFerence|DIFFerence}

The MENU command allows you to display the reference or the difference listings in the Compare menu.

Example OUTPUT XXX; ":MACHINE2:COMPARE:MENU REFERENCE"



RANGe

Command :MAChine{1|2}:COMParE:RANGe {FULL | PARTial,<start_line>,<stop_line>}

The RANGe command allows you to define the boundaries for the comparison. The range entered must be a subset of the lines in the acquisition memory.

<start_line> integer from -122880 to +122880 (HP 16554A) or -253951 to +253951 (HP 16555A) or -507904 to +507904 (HP 16555D)

<stop_line> integer from <start_line> to +122880 (HP 16554A) or +253951 (HP 16555A) or +507904 (HP 16555D)

Example OUTPUT XXX;":MACHINE1:COMPARE:RANGE PARTIAL, -511, 512"
OUTPUT XXX;":MACHINE2:COMPARE:RANGE FULL"

Query :MAChine{1|2}:COMParE:RANGe?

The RANGe query returns the current boundaries for the comparison.

Returned Format [:MAChine{1|2}:COMParE:RANGe] {FULL|PARTial,<start_line>,<stop_line>}<NL>

Example 10 DIM String\$(100)
20 OUTPUT 707;":SELECT 2"
30 OUTPUT 707;":MACHINE1:COMPARE:RANGE?"
40 ENTER 707;String\$
50 PRINT "RANGE IS ";String\$
60 END

RUNTil

Command :MAChine{1|2}:COMPare:RUNTil {OFF | LT,<value> | GT,<value> | INRange,<value>,<value> | OUTRange,<value>,<value> | EQUal | NEQual}

The RUNTil (run until) command allows you to define a stop condition when the trace mode is repetitive. Specifying OFF causes the analyzer to make runs until either the display's STOP field is touched or the STOP command is issued.

There are four conditions based on the time between the X and O markers. Using this difference in the condition is effective only when time tags have been turned on (see the TAG command in the STRigger subsystem). These four conditions are as follows:

- The difference is less than (LT) some value.
- The difference is greater than (GT) some value.
- The difference is inside some range (INRange).
- The difference is outside some range (OUTRange).

End points for the INRange and OUTRange should be at least 8 ns apart since this is the minimum time resolution of the time tag counter.

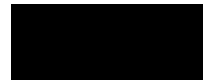
There are two conditions which are based on a comparison of the acquired state data and the reference listing. You can run until one of the following conditions is true:

- Every channel of every label has the same value (EQUal).
- Any channel of any label has a different value (NEQual).

<value> real number from -9E9 to +9E9

Example

OUTPUT XXX; ":MACHINE2:COMPARE:RUNTIL EQUAL"



COMParE Subsystem SET

Query :MACHine{1|2}:COMPare:RUNTil?

The RUNTil query returns the current stop criteria for the comparison when running in repetitive trace mode.

Returned Format [:MACHine{1|2}:COMPare:RUNTil] {OFF| LT,<value>|GT,<value>| INRange,<value>,<value>|OUTRange,<value>,<value>|EQUal|NEQual} <NL>

Example OUTPUT XXX; ":MACHINE2:COMPARE:RUNTIL?"

SET

Command :MACHine{1|2}:COMPare:SET

The SET command sets every state in the reference listing to "don't cares." If you send the SET command by mistake you can immediately send the CLear command to restore the previous data. This is the only time the CLear command will not replace "don't cares" with zeros.

Example OUTPUT XXX; ":MACHINE2:COMPARE:SET"



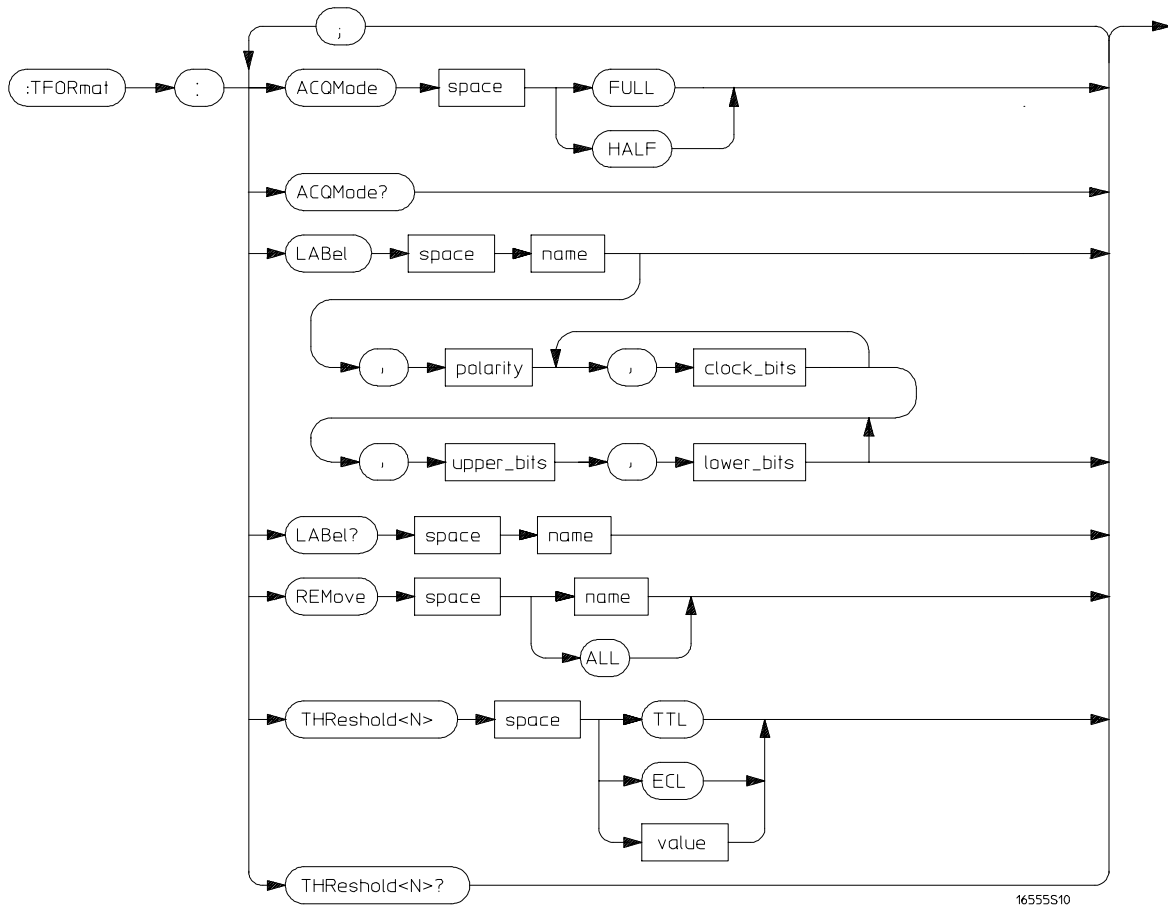
TFORmat Subsystem

Introduction

The TFOFormat subsystem contains the commands available for the Timing Format menu in the HP 16554A/HP 16555A/HP 16555D logic analyzer module. These commands are:

- ACQMode
- LABEL
- REMove
- THReshold

Figure 11-1



TFORmat Subsystem Syntax Diagram



Table 11-1

TFormat Subsystem Parameter Values

Parameter	Value
<N>	an integer from 1 to 12
name	string of up to 6 alphanumeric characters
polarity	{POSitive NEGative}
upper_bits	format (integer from 0 to 65535) for a pod (pods are assigned in decreasing order)
lower_bits	format (integer from 0 to 65535) for a pod (pods are assigned in decreasing order)
value	voltage (real number) -6.00 to +6.00
clock_bits	format (integer from 0 to 65535) for a clock (clocks are assigned in decreasing order)

TFormat

Selector

:MACHine{ 1 | 2 } :TFormat

The TFormat selector is used as part of a compound header to access those settings normally found in the Timing Format menu. It always follows the MACHine selector because it selects a branch directly below the MACHine level in the language tree.

Example

OUTPUT XXX; " :MACHINE1 :TFORMAT :ACQMODE? "

ACQMode

Command :MACHine{1|2}:TFormat:ACQMode {FULL | HALF}

The ACQMode (acquisition mode) command allows you to select the acquisition mode for the timing analyzer. The options are:

- conventional mode at full-channel 125 MHz (HP 16554A) or 250 MHz (HP 16555A/D)
- conventional mode at half-channel 250 MHz (HP 16554A) or 500 MHz (HP 16555A/D).

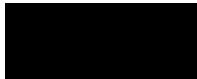
Example OUTPUT XXX; ":MACHINE2:TFORMAT:ACQMODE HALF"

Query :MACHine{1|2}:TFormat:ACQMode?

The ACQMode query returns the current acquisition mode.

Returned Format [:MACHine{1|2}:TFormat:ACQMode] {FULL | HALF}<NL>

Example OUTPUT XXX; ":MACHINE2:TFORMAT:ACQMODE?"



LABel

Command :MAChine{1|2}:TFormat:LABel <name>[,<polarity>,
 <clock_bits>,[<clock_bits>,<upper_bits>,
 <lower_bits>[,<upper_bits>,<lower_bits>]...]

The LABel command allows you to specify polarity and to assign channels to new or existing labels. If the specified label name does not match an existing label name, a new label will be created.

The order of the pod-specification parameters is significant. The first one listed will match the highest numbered pod assigned to the machine you're using. Each pod specification after that is assigned to the next highest numbered pod. This way they match the left-to-right descending order of the pods you see on the Format display. Not including enough pod specifications results in the lowest numbered pods being assigned a value of zero (all channels excluded). If you include more pod specifications than there are pods for that machine, the extra ones will be ignored. However, an error is reported any time more than 22 pod specifications are listed.

The polarity can be specified at any point after the label name.

Because pods contain 16 channels, the format value for a pod must be between 0 and 65535 ($2^{16}-1$). When giving the pod assignment in binary, each bit will correspond to a single channel. A "1" in a bit position means the associated channel in that pod is assigned to the label. A "0" in a bit position means the associated channel in that pod is excluded from the label. Leading zeroes may be omitted. For example, assigning #B1111001100 is equivalent to entering ".....****..**.." through the touchscreen.

A label can not have a total of more than 32 channels assigned to it.

<name> string of up to 6 alphanumeric characters

<polarity> {POSitive | NEGative}

<clock_bits> format (integer from 0 to 65535) for a clock (clocks are assigned in decreasing order)

<upper_bits> format (integer from 0 to 65535) for a pod (pods are assigned in decreasing order)
 <lower_bits> format (integer from 0 to 65535) for a pod (pods are assigned in decreasing order)

Example OUTPUT XXX;":MACHINE2:TFORMAT:LABEL 'STAT', POSITIVE, 0, 127, 40312"
 OUTPUT XXX;":MACHINE2:TFORMAT:LABEL 'SIG 1', #B11, #B0000000011111111, #B000000000000000000 "

Query :MACHine{1|2}:TFORMat:LABel? <name>

The LABEL query returns the current specification for the selected (by name) label. If the label does not exist, nothing is returned. Numbers are always returned in decimal format.

Returned Format [:MACHine{1|2}:TFORMat:LABel] <name>, <polarity>
 [, <assignment>] ...<NL>

<assignment> format (integer from 0 to 65535) for a pod (pods are assigned in decreasing order)

Example OUTPUT XXX;":MACHINE2:TFORMAT:LABEL? 'DATA' "

REMove

Command :MACHine{1|2}:TFORMat:REMove {<name>|ALL}

The REMove command allows you to delete all labels or any one label specified by name for a given machine.

<name> string of up to 6 alphanumeric characters

Example OUTPUT XXX;":MACHINE1:TFORMAT:REMOVE 'A' "



THReshold

Command :MACHine{1|2}:TFOrmat:THReshold<N>
 {TTL|ECL|<value>}

The THReshold command allows you to set the voltage threshold for a given pod to ECL, TTL, or a specific voltage from -6.00 V to +6.00 V in 0.05 volt increments.

<N> pod number (integer from 1 to 12)

<value> voltage (real number) -6.00 to +6.00

TTL default value of +1.6 V

ECL default value of -1.3 V

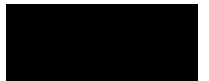
Example OUTPUT XXX;":MACHINE1:TFORMAT:THRESHOLD1 4.0"

Query :MACHine{1|2}:TFOrmat:THReshold<N>?

The THReshold query returns the current threshold for a given pod.

Returned Format [:MACHine{1|2}:TFOrmat:THReshold<N>] <value><NL>

Example OUTPUT XXX;":MACHINE1:TFORMAT:THRESHOLD2?"



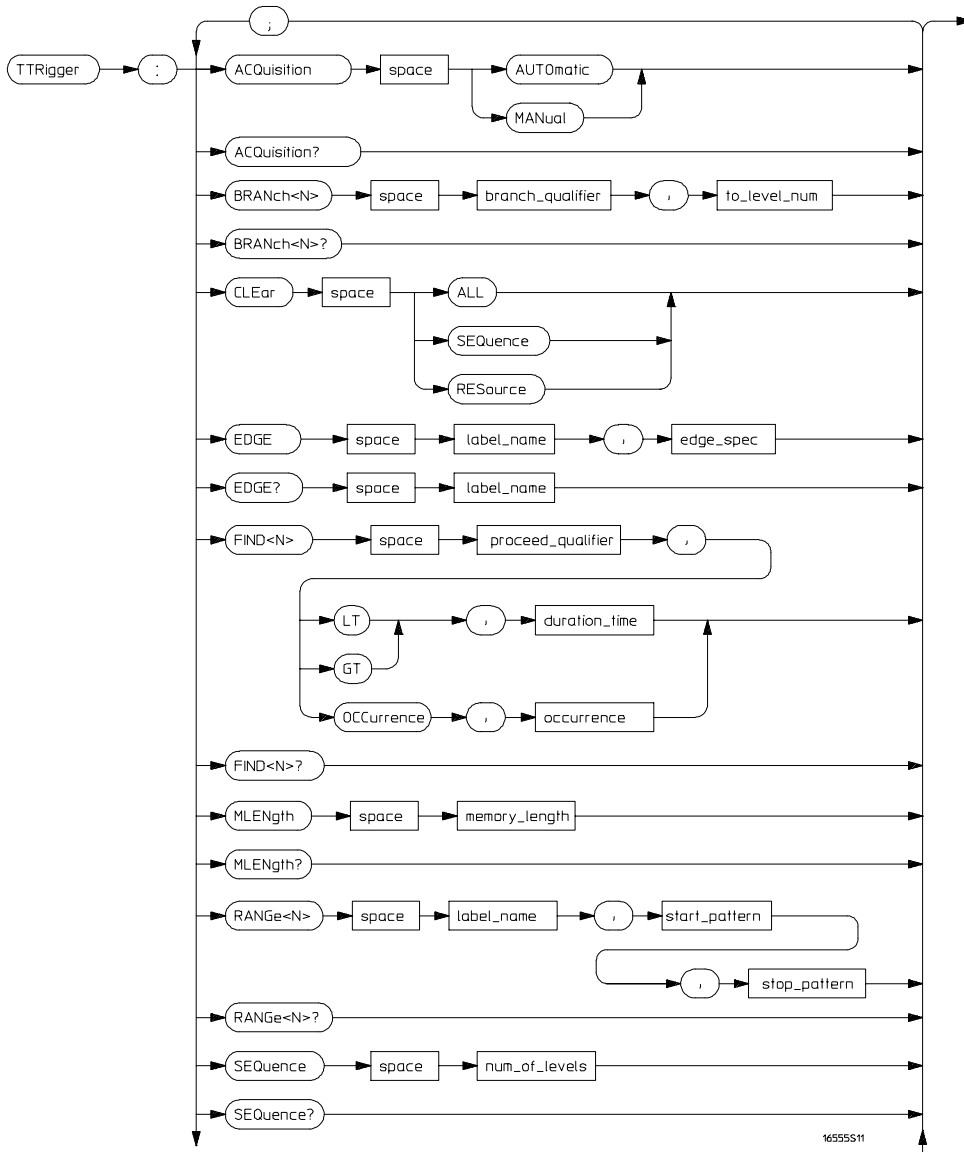
TTRigger (TTRace) Subsystem

Introduction

The TTRigger subsystem contains the commands available for the Timing Trigger menu in the HP 16554A/HP 16555A/HP 16555D logic analyzer module. The Timing Trigger subsystem will also accept the TTRace selector as used in previous HP 16500-series logic analyzer modules to eliminate the need to rewrite programs containing TTRace as the selector keyword. The TTRigger subsystem commands are:

- ACQuisition
- BRANch
- CLear
- EDGE
- FIND
- MLENgth
- RANGe
- SEQuence
- SPERiod
- TCONtrol
- TERM
- TIMER
- TPOStion

Figure 12-1



TTRigger Subsystem Syntax Diagram

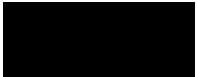
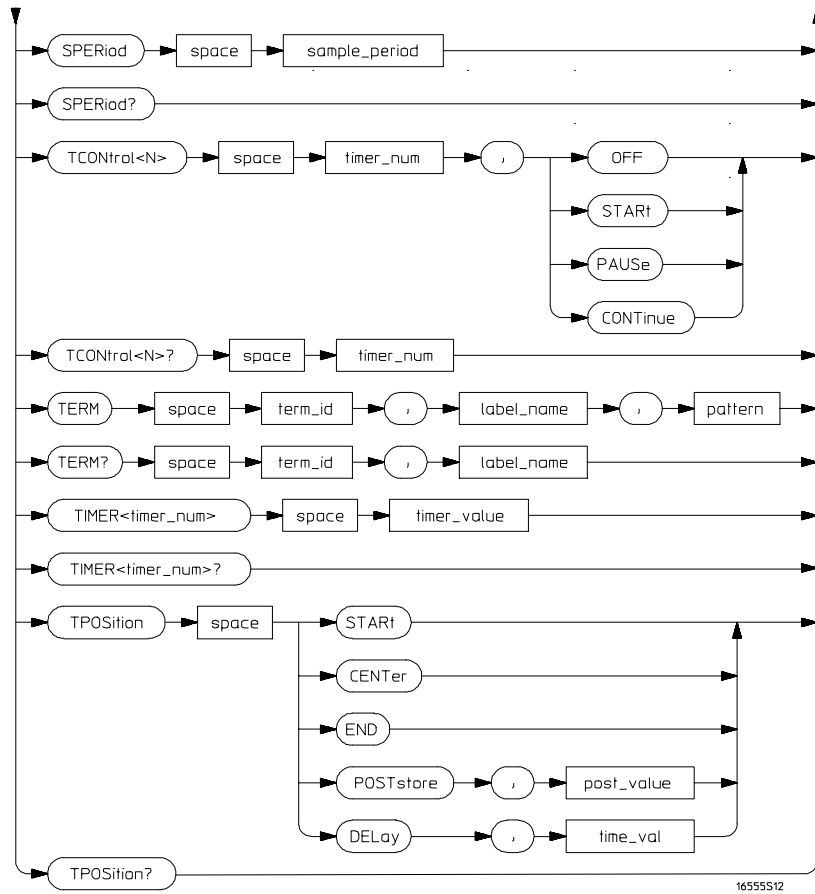


Figure 12-1 (continued)



TTRigger Subsystem Syntax Diagram (continued)

Table 12-1

TTRigger Parameter Values

Parameter	Value
branch_qualifier	<qualifier>
to_level_num	integer from 1 to last sequence level
proceed_qualifier	<qualifier>
occurrence	number from 1 to 1048575
label_name	string of up to 6 alphanumeric characters
start_pattern	"#{B{0 1}...
stop_pattern	#Q{0 1 2 3 4 5 6 7}... #H{0 1 2 3 4 5 6 7 8 9 A B C D E F}... {0 1 2 3 4 5 6 7 8 9}...}"
num_of_levels	integer from 1 to 10
timer_num	{1 2}
timer_value	400 ns to 500 seconds
term_id	{A B C D E F G I}
pattern	"#{B{0 1 X}... #Q{0 1 2 3 4 5 6 7 X}... #H{0 1 2 3 4 5 6 7 8 9 A B C D E F X}... {0 1 2 3 4 5 6 7 8 9}...}"
qualifier	see "Qualifier" on page 12-6
post_value	integer from 0 to 100 representing percentage
time_val	real number
duration_time	real number from 8 ns to 5 s based on the sample period
sample_period	real number from 4 ns (HP 16554A) or 2 ns (HP 16555A/D) to 8 ms
edge_spec	string consisting of {E F R .}
memory_length	{4096 8192 16384 32768 65536 131072 262144 516096 1040384 (HP 16554A) 524288 1048576 2088960 (HP 16555A) 524288 1048576 2097152 4177920 (HP 16555D only)}

Qualifier

The qualifier for the timing trigger subsystem can be terms A through G and I, Timer 1 and 2, Range 1 and 2, and Edge 1 and 2. In addition, qualifiers can be the NOT boolean function of terms, timers, and ranges. The qualifier can also be an expression or combination of expressions as shown below and figure 12-2, "Complex Qualifier," on page 12-11.

The following parameters show how qualifiers are specified in all commands of the TTRigger subsystem that use <qualifier>.

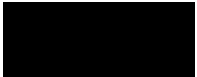
```

<qualifier> { "ANYSATE" | "NOSTATE" | "<expression>" }
<expression> {<expression1a>|<expression1b>|<expression1a> OR
               <expression1b>|<expression1a> AND <expression1b>}
<expression1a> {<expression1a_term>|(<expression1a_term>[ OR
               <expression1a_term>]* )|(<expression1a_term>[ AND
               <expression1a_term>]* )}
<expression1b> {<expression1b_term>|(<expression1b_term>[ OR
               <expression1b_term>]* )|(<expression1b_term>[ AND
               <expression1b_term>]* )}
<expression1a_term> {<expression2a>|<expression2b>|<expression2c>| <expression2d>}
<expression1b_term> {<expression2e>|<expression2f>|<expression2g>| <expression2h>}
<expression2a> {<term3a>|<term3b>|(<term3a> <boolean_op> <term3b>)}
<expression2b> {<term3c>|<range3a>|(<term3c> <boolean_op> <range3a>)}
<expression2c> {<term3d>|<edge3a>|(<term3d> <boolean_op> <edge3a>)}
<expression2d> {<term3e>|<timer3a>|(<term3e> <boolean_op> <timer3a>)}
<expression2e> {<term3f>|<term3g>|(<term3f> <boolean_op> <term3g>)}
<expression2f> {<range3b>}
<expression2g> {<term3i>|<edge3b>|(<term3i> <boolean_op> <edge3b>)}
<expression2h> {<timer3b>}
<boolean_op> {AND | NAND | OR | NOR | XOR | NXOR}

```

<term3a> { A | NOTA }
<term3b> { B | NOTB }
<term3c> { C | NOTC }
<term3d> { D | NOTD }
<term3e> { E | NOTE }
<term3f> { F | NOTF }
<term3g> { G | NOTG }
<term3i> { I | NOTI }
<range3a> { IN_RANGE1 | OUT_RANGE1 }
<range3b> { IN_RANGE2 | OUT_RANGE2 }
<edge3a> { EDGE1 | NOT EDGE1 }
<edge3b> { EDGE2 | NOT EDGE2 }
<timer3a> { TIMER1< | TIMER1> }
<timer3b> { TIMER2< | TIMER2> }

* = is optional such that it can be used zero or more times
+ = must be used at least once and can be repeated



Qualifier Rules

The following rules apply to qualifiers:

- Qualifiers are quoted strings and, therefore, need quotes.
- Expressions are evaluated from left to right.
- Parentheses are used to change the order evaluation and, therefore, are optional.
- An expression must map into the combination logic presented in the combination pop-up menu within the TTRigger menu.

Examples

```
'A'  
'( A OR B )'  
'(( A OR B ) AND C )'  
'(( A OR B ) AND C AND IN_RANGE2 )'  
'(( A OR B ) AND ( C AND IN_RANGE1 ))'  
'IN_RANGE1 AND ( A OR B ) AND C'
```

TTRigger (TTRace)

Selector

```
:MACHine{1|2}:TTRigger
```

The TTRigger (TTRace) (Timing Trigger) selector is used as a part of a compound header to access the settings found in the Timing Trigger menu. It always follows the MACHine selector because it selects a branch directly below the MACHine level in the command tree.

Example

```
OUTPUT XXX; ":MACHINE1:TTRIGGER:TAG TIME"
```

ACQuisition

Command :MACHine{1|2}:TTRigger:ACQuisition
{AUTOMATIC|MANual}

The ACQuisition command allows you to specify the acquisition mode for the timing analyzer.

Example OUTPUT XXX; ":MACHINE1:TTRIGGER:ACQUISITION AUTOMATIC"

Query :MACHine{1|2}:TTRigger:ACQuisition?

The ACQuisition query returns the current acquisition mode specified.

Returned Format [:MACHine{1|2}:TTRigger:ACQuisition] {AUTOMATIC|MANual}<NL>

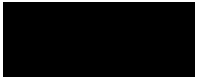
Example OUTPUT XXX; ":MACHINE1:TTRIGGER:ACQUISITION?"

BRANCh

Command :MACHine{1|2}:TTRigger:BRANCh<N>
<branch_qualifier>, <to_level_number>

The BRANCh command defines the branch qualifier for a given sequence level. When this branch qualifier is matched, it will cause the sequencer to jump to the specified sequence level. BRANCh functions like the "else on" branch of the front-panel sequence level.

The terms used by the branch qualifier (A through G and I) are defined by the TERM command. The meaning of IN_RANGE and OUT_RANGE is determined by the RANGE command. The edge terms are defined by the EDGE command.



Within the limitations shown by the syntax definitions, complex expressions may be formed using the AND and OR operators. Expressions are limited to what you could manually enter through the Timing Trigger menu. Regarding parentheses, the syntax definitions on the next page show only the required ones. Additional parentheses are allowed as long as the meaning of the expression is not changed. Figure 12-2, on page 12-11, shows a complex expression as seen in the Timing Trigger menu.

Example

The following statements are all correct and have the same meaning. Notice that the conventional rules for precedence are not followed. The expressions are evaluated from left to right.

```
OUTPUT XXX; ":MACHINE1:TTRIGGER:BRANCH1 'C AND D OR F OR G', 1"  
OUTPUT XXX; ":MACHINE1:TTRIGGER:BRANCH1 '((C AND D) OR (F OR  
G))', 1"  
OUTPUT XXX; ":MACHINE1:TTRIGGER:BRANCH1 'F OR (C AND D) OR  
G', 1"
```

<N>	integer from 1 to <number_of_levels>
<to_level_ number>	integer from 1 to <number_of_levels>
<number_of_ levels>	integer from 1 to the number of existing sequence levels (maximum 10)
<branch_ qualifier>	<qualifier> see "Qualifier" on page 12-6

Example

```
OUTPUT XXX; ":MACHINE1:TTRIGGER:BRANCH1 'ANYSATE', 3"  
OUTPUT XXX; ":MACHINE2:TTRIGGER:BRANCH2 'A', 7"  
OUTPUT XXX; ":MACHINE1:TTRIGGER:BRANCH3 '((A OR B) OR NOTG)',  
1"
```

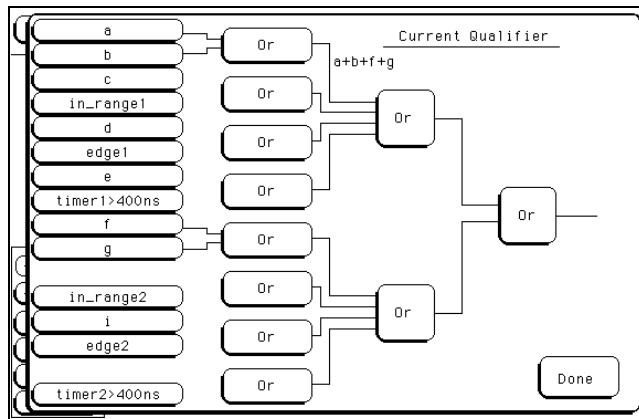
Query :MACHINE{1|2}:TTRigger:BRANch<N>?

The BRANch query returns the current branch qualifier specification for a given sequence level.

Returned Format [:MACHINE{1|2}:TTRigger:BRANch<N>]
 <branch_qualifier>, <to_level_num><NL>

Example OUTPUT XXX; ":MACHINE1:TTRIGGER:BRANCH3?"

Figure 12-2



Complex Qualifier

Figure 12-2 is a front-panel representation of the complex qualifier (a Or b) Or (f Or g).

Example This example would be used to specify this complex qualifier.

OUTPUT XXX; ":MACHINE1:TTRIGGER:BRANCH1 '((A OR B) AND (F OR G))', 2"



Terms **A** through **E**, **RANGE 1**, **EDGE1**, and **TIMER 1** must be grouped together and terms **F**, **G**, and **I**, **RANGE 2**, **EDGE2**, and **TIMER 2** must be grouped together. In the first level, terms from one group may not be mixed with terms from the other. For example, the expression `((A OR IN_RANGE2) AND (C OR G))` is not allowed because the term **C** cannot be specified in the **F**, **G**, and **I** group.

In the first level, the operators you can use are `AND`, `NAND`, `OR`, `NOR`, `XOR`, `NXOR`. Either `AND` or `OR` may be used at the second level to join the two groups together. It is acceptable for a group to consist of a single term. Thus, an expression like `(B AND G)` is legal since the two operands are both simple terms from separate groups.

CLear

Command `:MACHINE{1|2}:TTRigger:CLear
{All|SEquence|RESource}`

The `CLear` command allows you to clear all settings in the Timing Trigger menu, clear only the sequence levels, or clear only the resource term patterns. Cleared values are set to their defaults.

Example `OUTPUT XXX; ":MACHINE1:TTRIGGER:CLEAR RESOURCE"`

EDGE

Command `:MACHine{1|2}:TTRigger:EDGE<N> <label_name>, <edge_spec>`

The EDGE command allows you to define edge specifications for a given label. Edge specifications can be R (rising), F (falling), E (either), or "." (don't care). Edges are sent in the same string with the rightmost string character specifying what the rightmost bit will be.

The `<edge_spec>` string length must match the exact number of bits assigned to the specified label. If the string length does not match the number of bits, the "Parameter string invalid" message is displayed.

`<N>` {1|2}

`<label_name>` string of up to 6 alphanumeric characters

`<edge_spec>` string consisting of {R|F|E|.}[to total number of bits]

Example

For 8 bits assigned:

```
OUTPUT XXX;":MACHINE1:TTRIGGER:EDGE1 'DATA', '....F..E'
```

For 16 bits assigned:

```
OUTPUT XXX;":MACHINE1:TTRIGGER:EDGE1 'DATA',  
'....EEE.....F..R'
```



Query :MACHine{1|2}:TTRigger:EDGE<N>? <label_name>

Returned Format The EDGE query returns the current specification for the given label.
[:MACHine{1|2}:TTRigger:EDGE<N>] <label_name>,<edge_spec><NL>

Example OUTPUT XXX; ":MACHINE1:TTRIGGER:EDGE1? 'DATA' "

FIND

Command :MACHine{1|2}:TTRigger:FIND<N> <time_qualifier>,<condition_mode>

The FIND command defines the qualifier for a given sequence level. The qualifier tells the timing analyzer when to proceed to the next sequence level. When this proceed qualifier is matched for either the specified time or occurrence, the sequencer will proceed to the next sequence level. In the sequence level where the trigger is specified, the FIND command specifies the trigger qualifier (see SEQUENCE command).

The terms A through G and I are defined by the TERM command. The meaning of IN_RANGE and OUT_RANGE is determined by the RANGE command. The edge terms are defined by the EDGE command. Expressions are limited to what you could manually enter through the Timing Trigger menu. Regarding parentheses, the syntax definitions below show only the required ones. Additional parentheses are allowed as long as the meaning of the expression is not changed. See figure 12-2 on page 12-11 for a detailed example.

<N> integer from 1 to the number of existing sequence levels (maximum 10)

<time_qualifier> <qualifier> see "Qualifier" on page 12-6

<condition_mode> {{GT|LT}, <duration_time>|OCCurrence, <occurrence>}

GT greater than

LT less than

<duration_
time> real number from 8 ns to 5.00 seconds depending on sample period

<occurrence> integer from 1 to 1048575

Example

OUTPUT XXX;":MACHINE1:TTRIGGER:FIND1 'ANYSATE', GT, 10E-6"
OUTPUT XXX;":MACHINE1:TTRIGGER:FIND3 '(NOTA AND NOTB) OR
G)', OCCURRENCE, 10"

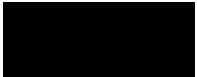
Query :MACHine{1|2}:TTRigger:FIND4?

The FIND query returns the current time qualifier specification for a given sequence level.

Returned Format [:MACHine{1|2}:TTRigger:FIND<N>]
<time_qualifier>, <condition_mode><NL>

Example

OUTPUT XXX;":MACHINE1:TTRIGGER:FIND<N>?"



MLENgtH

Command :MACHine{1|2}:TTRigger:MLENgtH <memory_length>

The MLENgtH command allows you to specify the analyzer memory depth. Valid memory depths range from 4096 samples through the maximum system memory depth minus 8192 samples (HP 16554A/HP 16555A) or minus 16384 samples (HP 16555D). Memory depth is affected by acquisition mode. If the <memory_depth> value sent with the command is not a legal value, the closest legal setting will be used.

<memory_length> {4096 | 8192 | 16384 | 32768 | 65536 | 131072 | 262144 | 516096 | 524288 | 1040384 (HP 16554A) | 524288 | 1040384 | 1048576 | 2088960 (HP 16555A) | 524288 | 1048576 | 2080768 | 2097152 | 4177920 (HP 16555D)}

Example OUTPUT XXX; ":MACHINE1:TTRIGGER:MLENGTH 262144"

Query :MACHine{1|2}:TTRigger:MLENgtH?

The MLENgtH query returns the current analyzer memory depth selection.

Returned Format [:MACHine{1|2}:TTRigger:MLENgtH] <memory_length><NL>

Example OUTPUT XXX; ":MACHINE1:TTRIGGER:MLENGTH?"

RANGe

Command :MACHine{1|2}:TTRigger:RANGe<N> <label_name>,
 <start_pattern>,<stop_pattern>

The RANGe command allows you to specify a range recognizer term for the specified machine. Since a range can only be defined across one label and, since a label must contain 32 or fewer bits, the value of the start pattern or stop pattern will be between $2^{32}-1$ and 0.

When these values are expressed in binary, they represent the bit values for the label at one of the range recognizers' end points. Don't cares are not allowed in the end point pattern specifications.

<label_name> string of up to 6 alphanumeric characters

<N> {1|2}

<start_pattern> "{#B{0|1} . . . |
<stop_pattern> #Q{0|1|2|3|4|5|6|7} . . . |
 #H{0|1|2|3|4|5|6|7|8|9|A|B|C|D|E|F} . . . |
 {0|1|2|3|4|5|6|7|8|9} . . . }"

Example

```
OUTPUT XXX;":MACHINE1:TTRIGGER:RANGE1 'DATA', '127', '255' "
OUTPUT XXX;":MACHINE1:TTRIGGER:RANGE2 'ABC', '#B00001111',
'#HCF' "
```

Query :MACHine{1|2}:TTRigger:RANGe<N>?

The RANGe query returns the range recognizer end point specifications for the range.

Returned Format [:MACHine{1|2}:TTRiger:RANGe<N>] <label_name>,<start_pattern>,
 <stop_pattern><NL>

Example

```
OUTPUT XXX;":MACHINE1:TTRIGGER:RANGE1?"
```



SEquence

Command `:MACHine{1|2}:TTRigger:SEquence <number_of_levels>`

The SEquence command defines the timing analyzer trigger sequence. First it deletes the current sequence, then it inserts the number of levels specified, with default settings. The number of levels can be between 1 and 10 when the analyzer is armed by the RUN key.

In timing analyzers, the trigger is always the last level.

`<number_of_levels>`
integer from 1 to 10

Example `OUTPUT XXX; ":MACHINE1:TTRIGGER:SEQUENCE 4 "`

Query `:MACHine{1|2}:TTRigger:SEquence?`

The SEquence query returns the current sequence specification.

Returned Format `[:MACHine{1|2}:TTRigger:SEquence] <number_of_levels>, <level_of_trigger><NL>`

Example `OUTPUT XXX; ":MACHINE1:TTRIGGER:SEQUENCE?"`

SPERiod

Command :MACHine{1|2}:TTRigger:SPERiod <sample_period>

The SPERiod command allows you to set the sample period of the timing analyzer.

<sample_period> real number from 4 ns (HP 16554A) or 2 ns (HP 16555A/D) to 8 ms

Example

OUTPUT XXX; ":MACHINE1:TTRIGGER:SPERIOD 50E-9"

Query :MACHine{1|2}:TTRigger:SPERiod?

The SPERiod query returns the current sample period.

Returned Format [:MACHine{1|2}:TTRigger:SPERiod] <sample_period><NL>

Example

OUTPUT XXX; ":MACHINE1:TTRIGGER:SPERIOD?"

TCONtrol

Command `:MACHine{1|2}:TTRigger:TCONtrol<N> <timer_num>,
{OFF|START|PAUSE|CONTInue}`

The TCONtrol (timer control) command allows you to turn off, start, pause, or continue the timer for the specified level. The time value of the timer is defined by the TIMER command.

<N> integer from 1 to the number of existing sequence levels (maximum 10)

<timer_num> {1|2}

Example `OUTPUT XXX; ":MACHINE2:TTRIGGER:TCONTROL6 1, PAUSE"`

Query `:MACHine{1|2}:TTRigger:TCONTROL<N>? <timer_num>`

The TCONtrol query returns the current TCONtrol setting of the specified level.

Returned Format `[:MACHine{1|2}:TTRigger:TCONTROL<N> <timer_num>]
{OFF|START|PAUSE|CONTInue}<NL>`

Example `OUTPUT XXX; ":MACHINE2:TTRIGGER:TCONTROL6? 1"`

TERM

Command :MACHine{1|2}:TTRigger:TERM <term_id>, <label_name>, <pattern>

The TERM command allows you to specify a pattern recognizer term in the specified machine. Each command deals with only one label in the given term; therefore, a complete specification could require several commands. Since a label can contain 32 or fewer bits, the range of the pattern value will be between $2^{32} - 1$ and 0. When the value of a pattern is expressed in binary, it represents the bit values for the label inside the pattern recognizer term. Since the pattern parameter may contain don't cares and be represented in several bases, it is handled as a string of characters rather than a number.

Eight of the 10 terms (A through G and I) are available (terms H and J are not available) to either machine but not both simultaneously. If you send the TERM command to a machine with a term that has not been assigned to that machine, an error message "Legal command but settings conflict" is returned.

<term_id> {A|B|C|D|E|F|G|I}

<label_name> string of up to 6 alphanumeric characters

<pattern> "#B{0|1|X} . . . |
#Q{0|1|2|3|4|5|6|7|X} . . . |
#H{0|1|2|3|4|5|6|7|8|9|A|B|C|D|E|F|X} . . . |
{0|1|2|3|4|5|6|7|8|9} . . . }"

Example

OUTPUT XXX;":MACHINE1:TTRIGGER:TERM A,'DATA','255' "
OUTPUT XXX;":MACHINE1:TTRIGGER:TERM B,'ABC','#BXXXX1101' "



TTRigger (TTRace) Subsystem TIMER

Query `:MACHine{1|2}:TTRigger:TERM?
<term_id>,<label_name>`

The TERM query returns the specification of the term indicated by term identification and label name.

Returned Format `[:MACHine{1|2}:TTRigger:TERM]
<term_id>,<label_name>,<pattern><NL>`

Example `OUTPUT XXX; ":MACHINE1:TTRIGGER:TERM? B,'DATA' "`

TIMER

Command `:MACHine{1|2}:TTRigger:TIMER{1|2} <time_value>`

The TIMER command sets the time value for the specified timer. The limits of the timer are 400 ns to 500 seconds in 16 ns to 500 μ s increments. The increment value varies with the time value of the specified timer.

`<time_value>` real number from 400 ns to 500 seconds in increments which vary from 16 ns to 500 μ s.

Example `OUTPUT XXX; ":MACHINE1:TTRIGGER:TIMER1 100E-6"`

Query `:MACHine{1|2}:TTRigger:TIMER{1|2}?`

The TIMER query returns the current time value for the specified timer.

Returned Format `[:MACHine{1|2}:TTRigger:TIMER{1|2}] <time_value><NL>`

Example `OUTPUT XXX; ":MACHINE1:TTRIGGER:TIMER1?"`

TPOStion

Command :MACHine{1|2}:TTRigger:TPOStion
 {START|CENTer|END|DELay, <time_val>|
 POSTstore,<poststore>}

The TPOStion (trigger position) command allows you to set the trigger at the start, center, end or at any position in the trace (poststore). Poststore is defined as 0 to 100 percent with a poststore of 100 percent being the same as start position and a poststore of 0 percent being the same as an end trace.

The DELay mode can be used to set the time between the trigger point and the start of the trace, causing the trace to begin after the trigger point.

<time_val> real number from either (2 × sample period) or 16 ns, whichever is greater, to (516096 × sample period)(HP 16554A) or (1040384 × sample period) (HP 16555A/D).

<poststore> integer from 0 to 100 representing percentage of poststore.

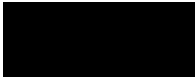
Example OUTPUT XXX; ":MACHINE1:TTRIGGER:TPOSITION END"
 OUTPUT XXX; ":MACHINE1:TTRIGGER:TPOSITION POSTstore,75"

Query :MACHine{1|2}:TTRigger:TPOStion?

The TPOStion query returns the current trigger position setting.

Returned Format [:MACHine{1|2}:TTRigger:TPOStion] {START|CENTer|END|DELay,
 <time_val>|POSTstore,<poststore>}<NL>

Example OUTPUT XXX; ":MACHINE1:TTRIGGER:TPOSITION?"





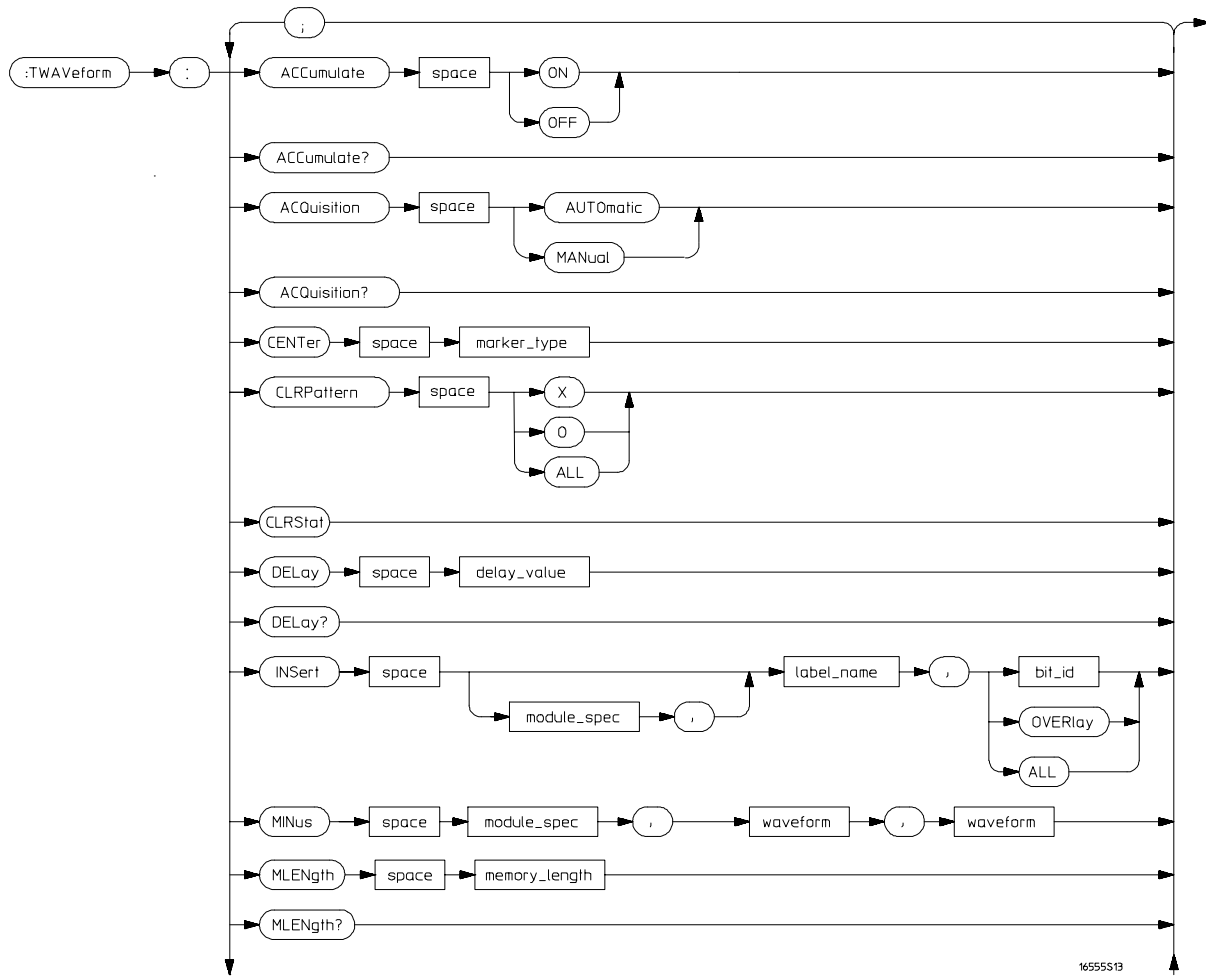
TWAVEform Subsystem

Introduction

The TWAVEform subsystem contains the commands available for the Timing Waveforms menu in the HP 16554A/HP 16555A/HP 16555D logic analyzer module. These commands are:

- ACCumulate
- ACQuisition
- CENTer
- CLRPattern
- CLRStat
- DELay
- INSert
- MINus
- MLENgth
- MMODE
- OCONdition
- OPATtern
- OSEarch
- OTIME
- OVERlay
- PLUS
- RANGe
- REMove
- RUNTil
- SPERiod
- TAVerage
- TMAXimum
- TMINimum
- TPOStion
- VRUNs
- XCONdition
- XOTime
- XPATtern
- XSEarch
- XTIME

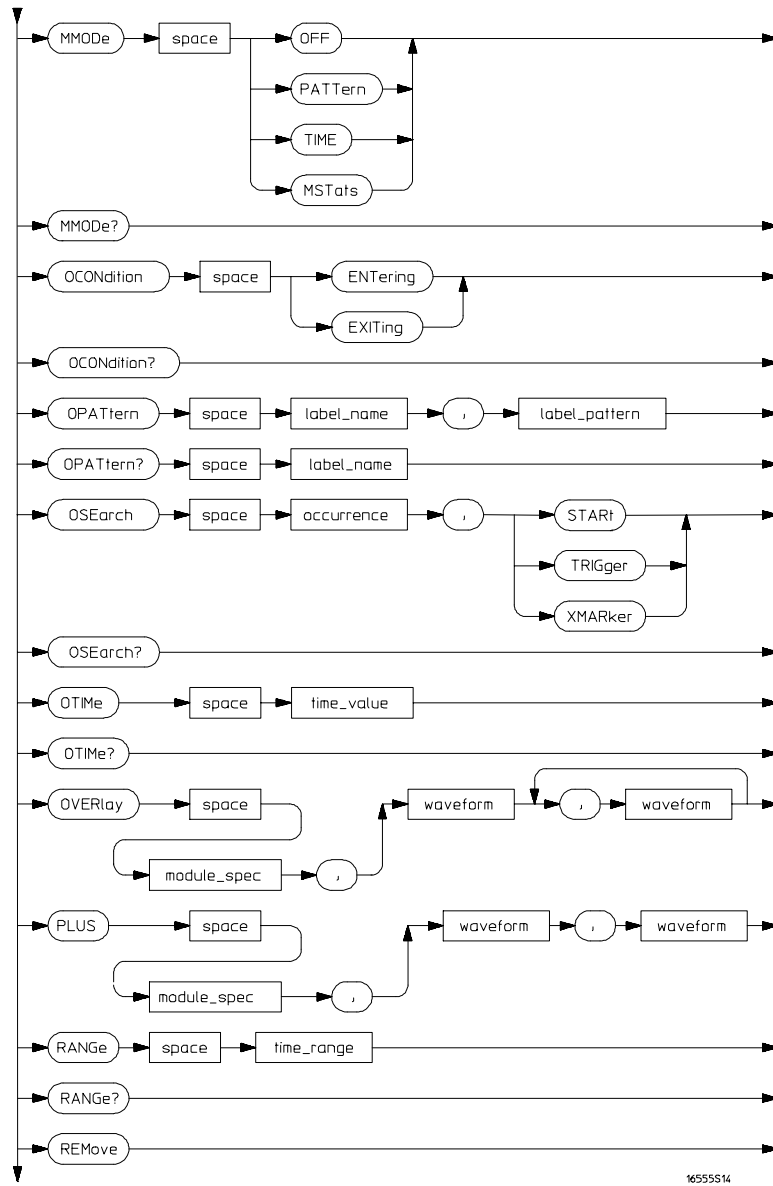
Figure 13-1



TWAVEform Subsystem Syntax Diagram

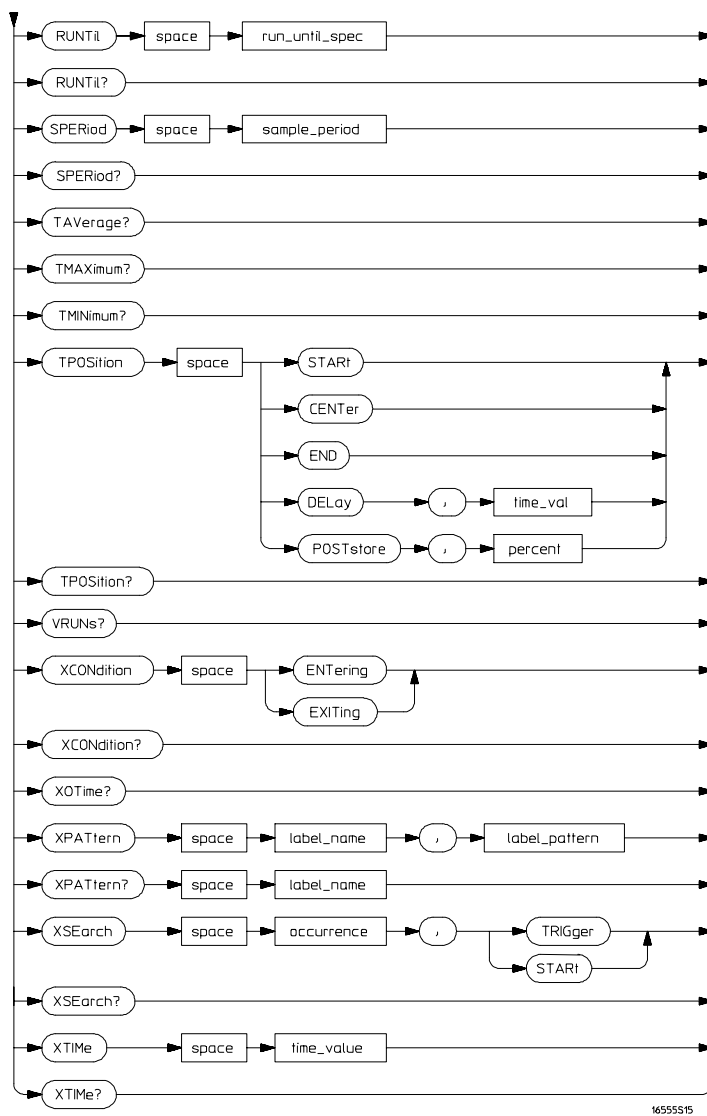


Figure 13-1 (continued)



TWAVEform Subsystem Syntax Diagram (continued)

Figure 13-1 (continued)



TWAVeform Subsystem Syntax Diagram (continued)



Table 13-1

TWAVEform Parameter Values

Parameter	Value
delay_value	real number between -2500 s and +2500 s
module_spec	{1 2 3 4 5 6 7 8 9 10}
bit_id	integer from 0 to 31
waveform	string containing <acquisition_spec>{1 2}
acquisition_spec	{A B C D E F G H I J} (slot where acquisition card is located)
label_name	string of up to 6 alphanumeric characters
label_pattern	"{#B{0 1 X}... #Q{0 1 2 3 4 5 6 7 X}... #H{0 1 2 3 4 5 6 7 8 9 A B C D E F X}... {0 1 2 3 4 5 6 7 8 9}...}"
occurrence	integer
time_value	real number
time_range	real number between 10 ns and 10 ks
run_until_spec	{OFF LT, <value> GT, <value> INRange, <value>, <value> OUTRange, <value>, <value>}
GT	greater than
LT	less than
value	real number
time_val	real number
sample_period	real number from 4 ns (HP 16554A) or 2 ns (HP 16555A/D) to 8 ms
marker_type	{X O XO TRIGger}
memory_length	{4096 8192 16384 32768 65536 131072 262144 516096 524288 1040384 (HP 16554A) 524288 1040384 1048576 2088960 (HP 16555A) 524288 1048576 2080768 4177920 (HP 16555D)}

TWAVeform

Selector `:MACHine{1|2}:TWAVeform`

The TWAVeform selector is used as part of a compound header to access the settings found in the Timing Waveforms menu. It always follows the MACHine selector because it selects a branch below the MACHine level in the command tree.

Example

```
OUTPUT XXX; ":MACHINE1:TWAVEFORM:DELAY 100E-9"
```

ACCumulate

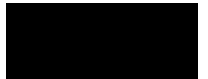
Command `:MACHine{1|2}:TWAVeform:ACCumulate <setting>`

The ACCumulate command allows you to control whether the waveform display gets erased between each individual run or whether subsequent waveforms are allowed to be displayed over the previous ones.

`<setting>` {0|OFF} or {1|ON}

Example

```
OUTPUT XXX; ":MACHINE1:TWAVEFORM:ACCUMULATE ON"
```



Query :MACHine{1|2}:TWAVEform:ACCumulate?

The ACCumulate query returns the current setting. The query always shows the setting as the characters, "0" (off) or "1" (on).

Returned Format [:MACHine{1|2}:TWAVEform:ACCumulate] {0|1}<NL>

Example OUTPUT XXX; ":MACHINE1:TWAVEFORM:ACCUMULATE?"

ACQuisition

Command :MACHine{1|2}:TWAVEform:ACQuisition
{AUTOMatic|MANual}

The ACQuisition command allows you to specify the acquisition mode for the timing analyzer. The acquisition modes are automatic and manual.

Query MACHine{1|2}:TWAVEform:ACQuisition?

The ACQuisition query returns the current acquisition mode.

Returned Format [MACHine{1|2}:TWAVEform:ACQuisition] {AUTOMatic|MANual}<NL>

Example OUTPUT XXX; ":MACHINE2:TWAVEFORM:ACQUISITION?"

CENTer

Command `:MACHine{1|2}:TWAVEform:CENTer <marker_type>`

The CENTer command allows you to center the waveform display about the specified markers.

<marker_type> {X|O|XO|TRIGger}

Example

OUTPUT XXX; ":MACHINE1:TWAVEFORM:CENTER X"

CLRPattern

Command `:MACHine{1|2}:TWAVEform:CLRPattern {X|O|ALL}`

The CLRPattern command allows you to clear the patterns in the selected Specify Patterns menu.

Example

OUTPUT XXX; ":MACHINE1:TWAVEFORM:CLRPATTERN ALL"

CLRStat

Command `:MACHine{1|2}:TWAVEform:CLRStat`

The CLRStat command allows you to clear the waveform statistics without having to stop and restart the acquisition.

Example

OUTPUT XXX; ":MACHINE1:TWAVEFORM:CLRSTAT"



DELaY

Command `:MACHine{1|2}:TWAVEform:DELaY <delay_value>`

The DELaY command specifies the amount of time between the timing trigger and the horizontal center of the the timing waveform display. The allowable values for delay are -2500 s to +2500 s.

`<delay_value>` real number between -2500 s and +2500 s

Example

OUTPUT XXX; ":MACHINE1:TWAVEFORM:DELAY 100E-6"

Query `:MACHine{1|2}:TWAVEform:DELaY?`

The DELaY query returns the current time offset (delay) value from the trigger.

Returned Format `[:MACHine{1|2}:TWAVEform:DELaY] <time_value><NL>`

Example

OUTPUT XXX; ":MACHINE1:TWAVEFORM:DELAY?"

INSert

Command :MACHine{1|2}:TWAVeform:INSert [<module_spec>,]
 <label_name>[, {<bit_id>|OVERlay|ALL}]

The INSert command inserts waveforms in the timing waveform display. The waveforms are added from top to bottom up to 96 waveforms. Once 96 waveforms are present, each time you insert another waveform, it replaces the last waveform.

Time-correlated waveforms from an oscilloscope or another logic analyzer module can also be inserted in the logic analyzer's timing waveforms display. Oscilloscope waveforms occupy the same display space as three logic analyzer waveforms. When inserting waveforms from an oscilloscope or another logic analyzer module, the optional module specifier must be used. 1 through 10 corresponds to modules A through J. If you do not specify the module, the selected module is assumed.

The second parameter specifies the label name that will be inserted. The optional third parameter specifies the label bit number, overlay, or all. If a number is specified, only the waveform for that bit number is added to the screen.

If you specify OVERlay, all the bits of the label are displayed as a composite overlaid waveform. If you specify ALL, all the bits are displayed sequentially. If you do not specify the third parameter, ALL is assumed.

<module_spec> {1|2|3|4|5|6|7|8|9|10}
 <label_name> string of up to 6 alphanumeric characters
 <bit_id> integer from 0 to 31

Example OUTPUT XXX;":MACHINE1:TWAVEFORM:INSERT 3, 'WAVE',9"



Inserting Oscilloscope Waveforms

Command :MACHine{1|2}:TWAVEform:INSert <module_spec>,
<label_name>

This inserts a waveform from an oscilloscope to the timing waveforms display.

<module_spec> {1|2|3|4|5|6|7|8|9|10} slot in which the oscilloscope master card is installed

<label_name> string of one alpha and one numeric character

Example

OUTPUT XXX;":MACHINE1:TWAVEFORM:INSERT 3, 'C1'"

MLENgtH

Command :MACHine{1|2}:TWAVEform:MLENgtH <memory_length>

The MLENgtH command allows you to specify the analyzer memory depth. Valid memory depths range from 4096 samples through the maximum system memory depth minus 8192 samples (HP 16554A/HP 16555A) or the maximum system memory depth minus 16384 (HP 16555D). Memory depth is affected by acquisition mode. If the <memory_depth> value sent with the command is not a legal value, the closest legal setting will be used.

<memory_length> {4096 | 8192 | 16384 | 32768 | 65536 | 131072 | 262144
| 516096 | 524288 | 1040384 (HP 16554A)
| 524288 | 1040384 | 1048576 | 2088960 (HP 16555A)
| 524288 | 1048576 | 2080768 | 2088960 | 4177920
(HP 16555D)}

Example

OUTPUT XXX;":MACHINE1:TWAVEFORM:MLENGTH 262144"

Query :MACHine{1|2}:TWAVeform:MLENgtH?

The MLENgth query returns the current analyzer memory depth selection.

Returned Format [:MACHine{1|2}:TWAVeform:MLENgtH] <memory_length><NL>

Example OUTPUT XXX; ":MACHINE1:TWAVEFORM:MLENGTH?"

MINus

Command :MACHine{1|2}:TWAVeform:MINus
 <module_spec>, <waveform>, <waveform>

The MINus command inserts time-correlated A-B (A minus B) oscilloscope waveforms on the display. The first parameter specifies where the oscilloscope master card resides, where 1 through 10 refers to slots A through J. The next two parameters specify which waveforms will be subtracted from each other.

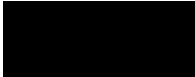
MINus is only available for oscilloscope waveforms.

<module_spec> {1|2|3|4|5|6|7|8|9|10}

<waveform> string containing <acquisition_spec>{1|2}

<acquisition_spec> {A|B|C|D|E|F|G|H|I|J} (slot where acquisition card is located)

Example OUTPUT XXX; ":MACHINE1:TWAVEFORM:MINUS 1,'A1','A2'"



MMODE

Command :MAChine{1|2}:TWAVEform:MMODE
 {OFF|PATTern|TIME|MSTats}

The MMODE (Marker Mode) command selects the mode controlling marker movement and the display of the marker readouts. When PATTern is selected, the markers will be placed on patterns. When TIME is selected, the markers move on time. In MSTats, the markers are placed on patterns, but the readouts will be time statistics.

Example OUTPUT XXX; ":MACHINE1:TWAVEFORM:MMODE TIME"

Query :MAChine{1|2}:TWAVEform:MMODE?

The MMODE query returns the current marker mode.

Returned Format [:MAChine{1|2}:TWAVEform:MMODE] <marker_mode><NL>
 <marker_mode> {OFF|PATTern|TIME|MSTats}

Example OUTPUT XXX; ":MACHINE1:TWAVEFORM:MMODE?"

OCONdition

Command :MAChine{1|2}:TWAVeform:OCONdition
 {ENTerInG|EXITInG}

The OCONdition command specifies where the O marker is placed. The O marker can be placed on the entry or exit point of the OPATtern when in the PATtern marker mode.

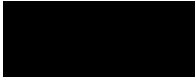
Example OUTPUT XXX; ":MACHINE1:TWAVEFORM:OCONDITION ENTERING"

Query :MAChine{1|2}:TWAVeform:OCONdition?

The OCONdition query returns the current setting.

Returned Format [:MAChine{1|2}:TWAVeform:OCONdition] {ENTerInG|EXITInG}<NL>

Example OUTPUT XXX; ":MACHINE1:TWAVEFORM:OCONDITION?"



OPATtern

Command :MAChine{1|2}:TWAVEform:OPATtern <label_name>,
 <label_pattern>

The OPATtern command allows you to construct a pattern recognizer term for the O marker which is then used with the OSEarch criteria and OCONdition when moving the marker on patterns. Since this command deals with only one label at a time, a complete specification could require several invocations.

When the value of a pattern is expressed in binary, it represents the bit values for the label inside the pattern recognizer term. In whatever base is used, the value must be between 0 and $2^{32} - 1$, since a label may not have more than 32 bits. Because the <label_pattern> parameter may contain don't cares, it is handled as a string of characters rather than a number.

<label_name> string of up to 6 alphanumeric characters

<label_pattern> "#{B{0|1|X} . . . |
 #Q{0|1|2|3|4|5|6|7|X} . . . |
 #H{0|1|2|3|4|5|6|7|8|9|A|B|C|D|E|F|X} . . . |
 {0|1|2|3|4|5|6|7|8|9} . . . }"

Example

OUTPUT XXX; ":MACHINE1:TWAVEFORM:OPATTERN 'A','511' "

Query :MAChine{1|2}:TWAVEform:OPATtern? <label_name>

The OPATtern query, in pattern marker mode, returns the pattern specification for a given label name. In the time marker mode, the query returns the pattern under the O marker for a given label. If the O marker is not placed on valid data, don't cares (X) are returned.

Returned Format [:MAChine{1|2}:TWAVEform:OPATtern]
 <label_name>,<label_pattern><NL>

Example

OUTPUT XXX; ":MACHINE1:TWAVEFORM:OPATTERN? 'A' "

OSearch

Command :MACHine{1|2}:TWAVEform:OSearch <occurrence>,
 <origin>

The OSearch command defines the search criteria for the O marker which is then used with the associated OPATtern specification and the OCONDition when moving markers on patterns. The origin parameter tells the marker to begin a search from the start of the acquisition, the trigger, or the X marker. The actual occurrence the marker searches for is determined by the occurrence parameter of the OSEArch specification, relative to the origin. An occurrence of 0 places a marker on the selected origin. With a negative occurrence, the marker searches before the origin. With a positive occurrence, the marker searches after the origin.

<origin> {START|TRIGger|XMARKer}

<occurrence> integer from -1040384 to +1040384 (HP 16554A) or from -2088960 to +2088960 (HP 16555A) or from -4177920 to +4177920 (HP 16555D)

Example OUTPUT XXX; ":MACHINE1:TWAVEFORM:OSEARCH +10, TRIGGER"

Query :MACHine{1|2}:TWAVEform:OSearch?

The OSearch query returns the search criteria for the O marker.

Returned Format [:MACHine{1|2}:TWAVEform:OSearch] <occurrence>,<origin><NL>

Example OUTPUT XXX; ":MACHINE1:TWAVEFORM:OSEARCH?"



OTIME

Command :MAChine{1|2}:TWAVEform:OTIME <time_value>

The OTIME command positions the O marker in time when the marker mode is TIME. If data is not valid, the command performs no action.

<time_value> real number -2.5 ks to +2.5 ks

Example

OUTPUT XXX; ":MACHINE1:TWAVEFORM:OTIME 30.0E-6"

Query :MAChine{1|2}:TWAVEform:OTIME?

The OTIME query returns the O marker position in time. If data is not valid, the query returns 9.9E37.

Returned Format [:MAChine{1|2}:TWAVEform:OTIME] <time_value><NL>

Example

OUTPUT XXX; ":MACHINE1:TWAVEFORM:OTIME?"

OVERlay

Command :MAChine{1|2}:TWAVEform:OVERlay <module_number>,
<label>,<label> [,<label>] ...

The OVERlay command overlays two or more oscilloscope waveforms and adds the resultant waveform to the current waveforms display. The first parameter of the command specifies which slot contains the oscilloscope master card. The next parameters are the labels of the waveforms that are to be overlaid.

The OVERlay command only works on oscilloscopes. To overlay analyzer waveforms, use the INSert command with OVERlay option.

<module_spec> {1|2|3|4|5|6|7|8|9|10}
 <waveform> string containing <acquisition_spec>{1|2}
 <acquisition_spec> {A|B|C|D|E|F|G|H|I|J} (slot where acquisition card is located)

Example

OUTPUT XXX; ":MACHINE1:TWAVEFORM:OVERLAY 3, 'C1','C2'"

PLUS

Command

:MACHine{1|2}:TWAVEform:PLUS
 <module_spec>, <waveform>, <waveform>

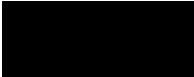
The PLUS command inserts time-correlated A+B oscilloscope waveforms on the screen. The first parameter specifies the slot where the oscilloscope module resides. 1 through 10 refers to slots A through J. The next two parameters specify which waveforms will be added to each other.

PLUS is only available for oscilloscope waveforms.

<module_spec> {1|2|3|4|5|6|7|8|9|10}
 <waveform> string containing <acquisition_spec>{1|2}
 <acquisition_spec> {A|B|C|D|E|F|G|H|I|J} (slot where acquisition card is located)

Example

OUTPUT XXX; ":MACHINE1:TWAVEFORM:PLUS 1,'A1','A2'"



RANGe

Command :MACHine{1|2}:TWAVeform:RANGe <time_value>

The RANGe command specifies the full-screen time in the timing waveform menu. It is equivalent to ten times the sec/Div setting on the display. The allowable values for RANGe are from 10 ns to 10 ks.

<time_range> real number between 10 ns and 10 ks

Example

OUTPUT XXX; ":MACHINE1:TWAVEFORM:RANGE 100E-9"

Query :MACHine{1|2}:TWAVeform:RANGe?

The RANGe query returns the current full-screen time.

Returned Format [:MACHine{1|2}:TWAVeform:RANGe] <time_value><NL>

Example

OUTPUT XXX; ":MACHINE1:TWAVEFORM:RANGE?"

REMOve

Command :MACHine{1|2}:TWAVeform:REMOve

The REMOve command deletes all waveforms from the display.

Example

OUTPUT XXX; ":MACHINE1:TWAVEFORM:REMOVE"

RUNTiI

Command `:MACHine{1|2}:TWAVEform:RUNTiI <run_until_spec>`

The RUNTiI (run until) command defines stop criteria based on the time between the X and O markers when the trace mode is in repetitive. When OFF is selected, the analyzer will run until either the STOP touch screen field is touched, or, the STOP command is sent. Run until time between X and O marker options are:

- Less Than (LT) a specified time value.
- Greater Than (GT) a specified time value.
- In range (INRange) between two time values.
- Out of range (OUTRange) between two time values.

End points for INRange and OUTRange should be at least 2 ns apart since this is the minimum time at which data is sampled.

This command affects the timing analyzer only, and has no relation to the RUNTiI commands in the SLISt and COMPare subsystems.

```
<run_until_spec> {OFF | LT,<value> | GT,<value> | INRange,<value>,<value>| OUTRange,<value>,<value>}
<value> real number
```

Example

```
OUTPUT XXX;":MACHINE1:TWAVEFORM:RUNTiI GT, 800.0E-6"
OUTPUT XXX;":MACHINE1:TWAVEFORM:RUNTiI INRANGE, 4.5, 5.5"
```

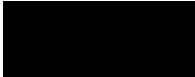
Query `:MACHine{1|2}:TWAVEform:RUNTiI?`

The RUNTiI query returns the current stop criteria.

Returned Format `[:MACHine{1|2}:TWAVEform:RUNTiI] <run_until_spec><NL>`

Example

```
OUTPUT XXX;":MACHINE1:TWAVEFORM:RUNTiI?"
```



SPERiod

Command `:MACHine{1|2}:TWAVeform:SPERiod <sample_period>`

The SPERiod command allows you to set the sample period of the timing analyzer.

<sample_period> real number from 4 ns (HP 16554A) or 2 ns (HP 16555A/D) to 8 ms

Example

OUTPUT XXX; ":MACHINE1:TWAVEFORM:SPERIOD 50E-9"

Query `:MACHine{1|2}:TWAVeform:SPERiod?`

The SPERiod query returns the current sample period.

Returned Format `[:MACHine{1|2}:TWAVeform:SPERiod] <sample_period><NL>`

Example

OUTPUT XXX; ":MACHINE1:TWAVEFORM:SPERIOD?"

TAVerage

Query :MACHine{1|2}:TWAVEform:TAVerage?

The TAVerage query returns the value of the average time between the X and O markers. If there is no valid data, the query returns 9.9E37.

Returned Format [:MACHine{1|2}:TWAVEform:TAVerage] <time_value><NL>
 <time_value> real number

Example OUTPUT XXX; ":MACHINE1:TWAVEFORM:TAVERAGE?"

TMAXimum

Query :MACHine{1|2}:TWAVEform:TMAXimum?

The TMAXimum query returns the value of the maximum time between the X and O markers. If there is no valid data, the query returns 9.9E37.

Returned Format [:MACHine{1|2}:TWAVEform:TMAXimum] <time_value><NL>
 <time_value> real number

Example OUTPUT XXX; ":MACHINE1:TWAVEFORM:TMAXIMUM?"



TMINimum

Query `:MACHine{1|2}:TWAVEform:TMINimum?`

The TMINimum query returns the value of the minimum time between the X and O markers. If there is no valid data, the query returns 9.9E37.

Returned Format `[:MACHine{1|2}:TWAVEform:TMINimum] <time_value><NL>`
`<time_value>` real number

Example `OUTPUT XXX; ":MACHINE1:TWAVEFORM:TMINIMUM?"`

TPOSITION

Command `MACHine{1|2}:TWAVEform:TPOSITION
{START |CENTer | END | DELay, <time_val> |
POSTstore, <percent>}`

The TPOSITION command allows you to control where the trigger point is placed in the acquisition. The trigger point can be placed at the start, center, end, at a percentage of post store, or at a value specified by delay. The post store option is the same as the User Defined option when setting the trigger point from the front panel.

The TPOSITION command is only available when the acquisition mode is set to manual.

`<time_val>` real number that varies by sample period

`<percent>` integer from 1 to 100

Example `OUTPUT XXX; ":MACHINE2:TWAVEFORM:TPOSITION CENTER"`

Query MACHine{1|2}:TWAVEform:TPOStion?

Returned Format The TPOStion query returns the current trigger setting.
 [MACHine{1|2}:TWAVEform:TPOStion] {START|CENTer|END|DELay,
 <time_val>| POSTstore,<percent>}<NL>

Example OUTPUT XXX; ":MACHINE2:TWAVEFORM:TPOStion?"

VRUNs

Query :MACHine{1|2}:TWAVEform:VRUNs?

The VRUNs query returns the number of valid runs and total number of runs made. Valid runs are those where the pattern search for both the X and O markers was successful resulting in valid time measurements.

Returned Format [:MACHine{1|2}:TWAVEform:VRUNs] <valid_runs>,<total_runs><NL>

<valid_runs> zero or positive integer

<total_runs> zero or positive integer

Example OUTPUT XXX; ":MACHINE1:TWAVEFORM:VRUNs?"



XCONdition

Command `:MACHine{1|2}:TWAVEform:XCONdition
{ENTering | EXITing}`

The XCONdition command specifies where the X marker is placed. The X marker can be placed on the entry or exit point of the XPATtern when in the PATTern marker mode.

Example `OUTPUT XXX; ":MACHINE1:TWAVEFORM:XCONDITION ENTERING"`

Query `:MACHine{1|2}:TWAVEform:XCONdition?`

The XCONdition query returns the current setting.

Returned Format `[:MACHine{1|2}:TWAVEform:XCONdition] {ENTering|EXITing}<NL>`

Example `OUTPUT XXX; ":MACHINE1:TWAVEFORM:XCONDITION?"`

XOTime

Query `:MACHine{1|2}:TWAVEform:XOTime?`

The XOTime query returns the time from the X marker to the O marker. If data is not valid, the query returns 9.9E37.

Returned Format `[:MACHine{1|2}:TWAVEform:XOTime] <time_value><NL>`

<time_value> real number

Example `OUTPUT XXX; ":MACHINE1:TWAVEFORM:XOTIME?"`

XPATtern

Command :MACHine{1|2}:TWAVEform:XPATtern
 <label_name>, <label_pattern>

The XPATtern command allows you to construct a pattern for the X marker which is then used with the XSEarch criteria and XCONdition when moving the marker on patterns. Since this command deals with only one label at a time, a complete specification could require several iterations.

When the value of a pattern is expressed in binary, it represents the bit values for the label inside the pattern. In whatever base is used, the value must be between 0 and $2^{32} - 1$, since a label may not have more than 32 bits. Because the <label_pattern> parameter may contain don't cares, it is handled as a string of characters rather than a number.

<label_name> string of up to 6 alphanumeric characters

<label_pattern> "#B{0|1|X} . . . |
 #Q{0|1|2|3|4|5|6|7|X} . . . |
 #H{0|1|2|3|4|5|6|7|8|9|A|B|C|D|E|F|X} . . . |
 {0|1|2|3|4|5|6|7|8|9} . . . }"

Example OUTPUT XXX; ":MACHINE1:TWAVEFORM:XPATTERN 'A','511' "

Query :MACHine{1|2}:TWAVEform:XPATtern? <label_name>

The XPATtern query, in pattern marker mode, returns the pattern specification for a given label name. In the time marker mode, the query returns the pattern under the X marker for a given label. If the X marker is not placed on valid data, don't cares (X) are returned.

Returned Format [:MACHine{1|2}:TWAVEform:XPATtern]
 <label_name>,<label_pattern><NL>

Example OUTPUT XXX; ":MACHINE1:TWAVEFORM:XPATTERN? 'A' "



XSEarch

Command :MACHine{1|2}:TWAVEform:XSEarch
<occurrence>, <origin>

The XSEarch command defines the search criteria for the X marker. The criteria are then used with the associated XPATtern specification and the XCONdition when moving markers on patterns. The origin parameter tells the marker to begin a search from the trigger or start. The occurrence parameter determines which occurrence of the XPATtern recognizer specification, relative to the origin, the marker actually searches for. An occurrence of 0 places a marker on the origin.

<origin> {TRIGger|START}

<occurrence> integer from from -1040384 to +1040384 (HP 16554A) or from -2088960 to +2088960(HP 16555A) or from -4177920 to +4177920(HP 16555D)

Example OUTPUT XXX; ":MACHINE1:TWAVEFORM:XSEARCH,+10,TRIGGER"

Query :MACHine{1|2}:TWAVEform:XSEarch?
<occurrence>, <origin>

The XSEarch query returns the search criteria for the X marker.
Returned Format [:MACHine{1|2}:TWAVEform:XSEarch] <occurrence>, <origin><NL>

Example OUTPUT XXX; ":MACHINE1:TWAVEFORM:XSEARCH?"

XTIME

Command :MAChine{1|2}:TWAVeform:XTIME <time_value>

The XTIME command positions the X marker in time when the marker mode is time. If data is not valid, the command performs no action.

<time_value> real number from -2.5 ks to +2.5 ks

Example

OUTPUT XXX; ":MACHINE1:TWAVEFORM:XTIME 40.0E-6"

Query :MAChine{1|2}:TWAVeform:XTIME?

The XTIME query returns the X marker position in time. If data is not valid, the query returns 9.9E37.

Returned Format [:MAChine{1|2}:TWAVeform:XTIME] <time_value><NL>

Example

OUTPUT XXX; ":MACHINE1:TWAVEFORM:XTIME?"





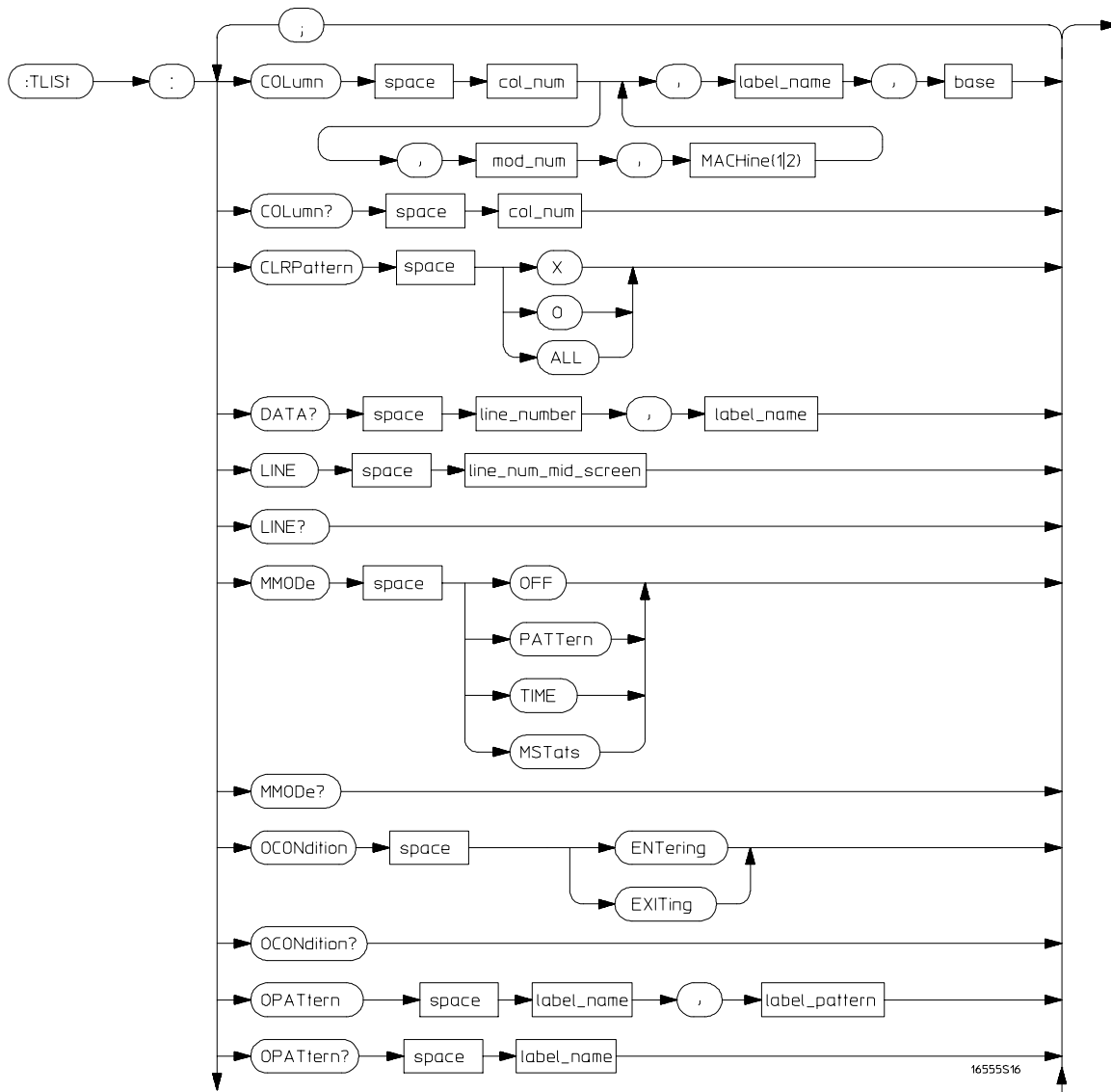
TLIS_t Subsystem

Introduction

The TLISt subsystem contains the commands available for the Timing Listing menu in the HP 16554A/HP 16555A/HP 16555D logic analyzer modules and is the same as the SLISt subsystem (except for the OCONdition and XCONdition commands). The TLISt subsystem commands are:

- COLumn
- CLRPattern
- DATA
- LINE
- MMODE
- OCONdition
- OPATtern
- OSEarch
- OSTate
- OTAG
- REMove
- RUNTil
- TAVerage
- TMAXimum
- TMINimum
- VRUNs
- XCONdition
- XOTag
- XOTime
- XPATtern
- XSEarch
- XSTate
- XTAG

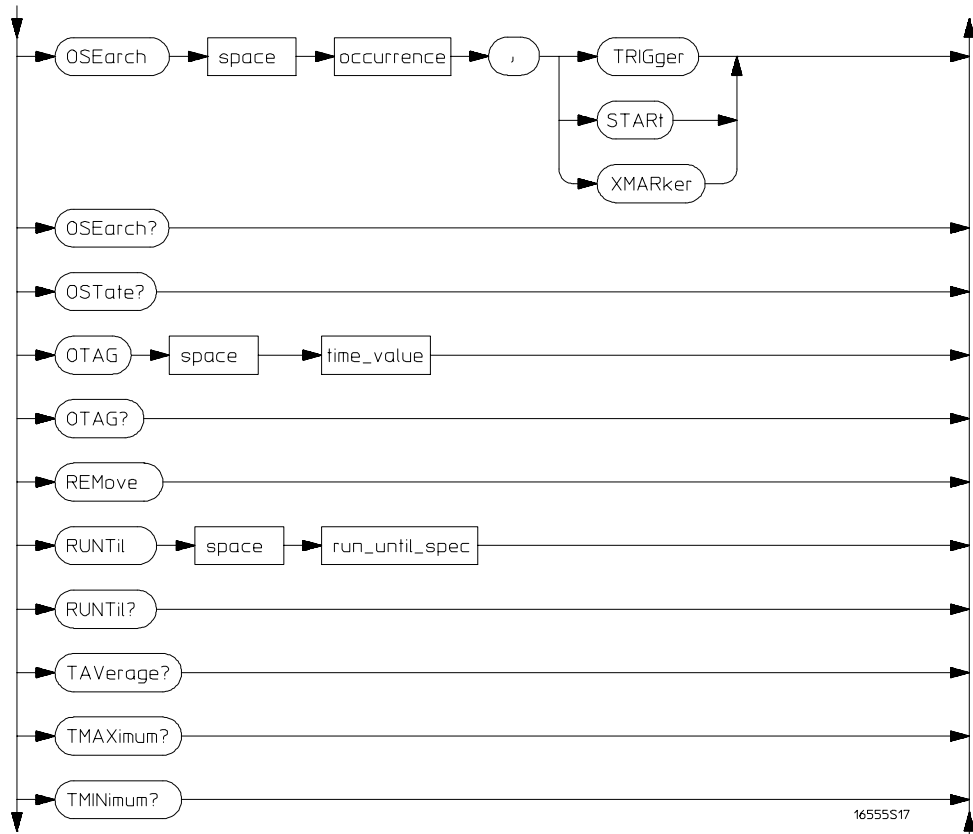
Figure 14-1



TLISt Subsystem Syntax Diagram

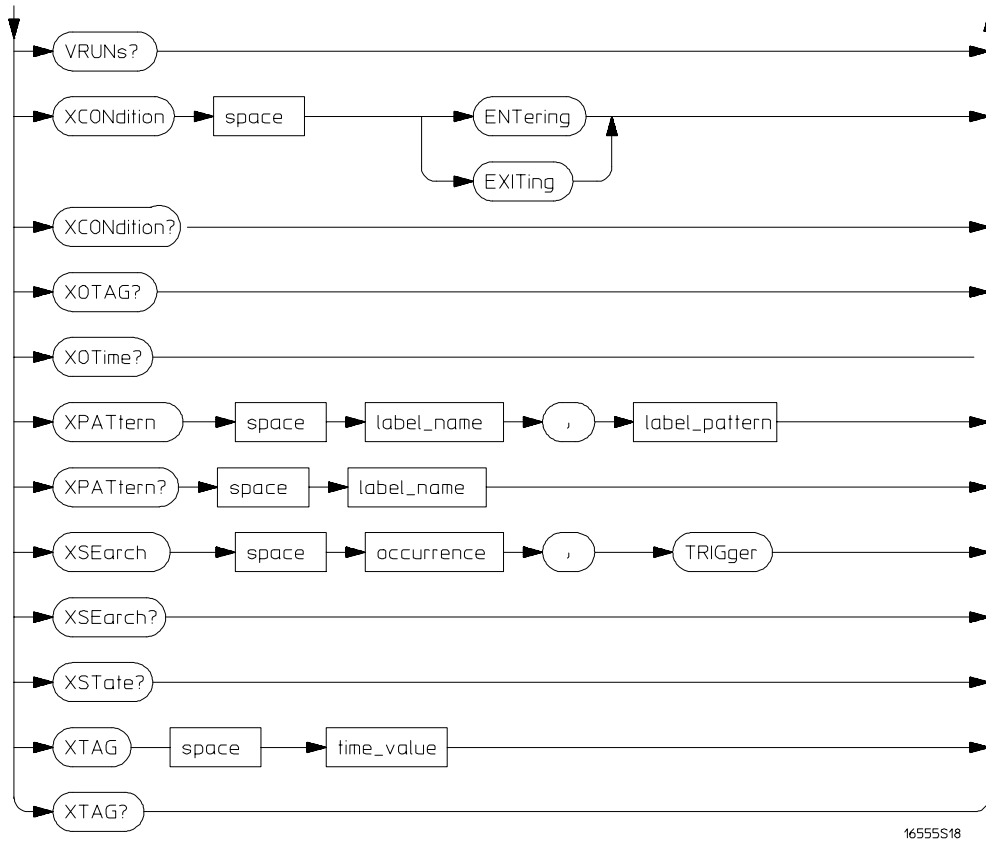


Figure 14-1 (continued)



TLISt Subsystem Syntax Diagram (continued)

Figure 14-1 (continued)



TLISt Subsystem Syntax Diagram (continued)



Table 14-1

TLISSt Parameter Values

Parameter	Value
mod_num	{1 2 3 4 5 6 7 8 9 10}
mach_num	{1 2}
col_num	integer from 1 to 61
line_number	integer between ± 1040384 (HP 16554A), or ± 2088960 (HP 16555A) or ± 4177920 (HP 16555D)
label_name	a string of up to 6 alphanumeric characters
base	{BINary HEXadecimal OCTal DECimal TWOS ASCii SYMBOL} for labels or {ABSolute RELative} for tags
line_num_mid_screen	integer between ± 1040384 (HP 16554A), or ± 2088960 (HP 16555A) or ± 4177920 (HP 16555D)
label_pattern	"#B{0 1 X}... #Q{0 1 2 3 4 5 6 7 X}... #H{0 1 2 3 4 5 6 7 8 9 A B C D E F X}... {0 1 2 3 4 5 6 7 8 9}..."
occurrence	integer between ± 1040384 (HP 16554A), or ± 2088960 (HP 16555A) or ± 4177920 (HP 16555D)
time_value	real number
run_until_spec	{OFF LT, <value> GT, <value> INRange, <value>, <value> OUTRange<value>, <value>}
value	real number

TLISt

Selector :MACHine{1|2}:TLISt

The TLISt selector is used as part of a compound header to access those settings normally found in the Timing Listing menu. It always follows the MACHine selector because it selects a branch directly below the MACHine level in the command tree.

Example OUTPUT XXX; ":MACHINE1:TLIST:LINE 256"

COLumn

Command :MACHine{1|2}:TLISt:COLumn <col_num>
 [, <module_num>, MACHine{1|2}], <label_name>, <base>

The COLumn command configures the timing analyzer listing by assigning a label name and base to one of the 61 vertical columns in the menu. A column number of 1 refers to the leftmost column. When a label is assigned to a column it replaces the original label in that column.

To insert time values, use the label name "TAGS". When the label name is "TAGS," the next parameter must specify RELative or ABSolute.

A label for tags must be assigned in order to use ABSolute or RELative time tagging.

<col_num> integer from 1 to 61

<module_num> {1|2|3|4|5|6|7|8|9|10}

<label_name> a string of up to 6 alphanumeric characters

<base> {BINary|HEXadecimal|OCTal|DECimal|TWOS|ASCii|SYMBOL} for labels or
 {ABSolute|RELative} for time



Example

OUTPUT XXX; ":MACHINE1:TLIST:COLUMN 4,2,'A',HEX"

Query

:MACHINE{1|2}:TLIST:COLumn? <col_num>

Returned Format

The COLumn query returns the column number, data source, label name, and base for the specified column.

[:MACHINE{1|2}:TLIST:COLumn]
<col_num>, <module_num>, MACHINE{1|2}, <label_name>, <base><NL>

Example

OUTPUT XXX; ":MACHINE1:TLIST:COLUMN? 4"

CLRPattern

Command

:MACHINE{1|2}:TLIST:CLRPattern {X|O|ALL}

The CLRPattern command allows you to clear the patterns for the selected markers in the Specify Patterns menu.

Example

OUTPUT XXX; ":MACHINE1:TLIST:CLRPATTERN O"

DATA

Query :MACHine{1|2}:TLISt:DATA? <line_number>,
<label_name>

The DATA query returns the value at a specified line number for a given label. The base will be the same as the one shown in the Listing display.

Returned Format [:MACHine{1|2}:TLISt:DATA] <line_number>,<label_name>,
<pattern_string><NL>

<line_number> integer from -1040384 to +1040384 (HP 16554A) or from -2088960 to +2088960 (HP 16555A) or from -4177920 to +4177920 (HP 16555D)

<label_name> string of up to 6 alphanumeric characters

<pattern_string> "{#B{0|1|X} . . . |
#Q{0|1|2|3|4|5|6|7|X} . . . |
#H{0|1|2|3|4|5|6|7|8|9|A|B|C|D|E|F|X} . . . |
{0|1|2|3|4|5|6|7|8|9} . . . }"

Example OUTPUT XXX;":MACHINE1:TLISt:DATA? 512, 'RAS' "

LINE

Command :MACHine{1|2}:TLISt:LINE <line_num_mid_screen>

The LINE command scrolls the timing analyzer listing vertically. The command specifies the state line number relative to the trigger. The analyzer then highlights the specified line at the center of the screen.

<line_num_mid_screen> integer from -1040384 to +1040384 (HP 16554A) or from -2088960 to +2088960 (HP 16555A) or from -4177920 to +4177920 (HP 16555D)

Example OUTPUT XXX;":MACHINE1:TLISt:LINE 0"



Query `:MACHine{1|2}:TLISt:LINE?`

The LINE query returns the line number for the state currently in the data roll box at the center of the screen.

Returned Format `[:MACHine{1|2}:TLISt:LINE] <line_num_mid_screen><NL>`

Example `OUTPUT XXX; ":MACHINE1:TLIST:LINE?"`

MMODE

Command `:MACHine{1|2}:TLISt:MMODE <marker_mode>`

The MMODE command (Marker Mode) selects the mode controlling the marker movement and the display of marker readouts. When PATTErn is selected, the markers will be placed on patterns. When TIME is selected the markers move on time between stored states. When MSTats is selected the markers are placed on patterns, but the readouts will be time statistics.

`<marker_mode>` {OFF|PATTErn|TIME|MSTats}

Example `OUTPUT XXX; ":MACHINE1:TLIST:MMODE TIME"`

Query `:MACHine{1|2}:TLISt:MMODE?`

The MMODE query returns the current marker mode selected.

Returned Format `[:MACHine{1|2}:TLISt:MMODE] <marker_mode><NL>`

Example `OUTPUT XXX; ":MACHINE1:TLIST:MMODE?"`

OCONdition

Command :MAChine{1|2}:TLISt:OCONdition {ENTering|EXITing}

The OCONdition command specifies where the O marker is placed. The O marker can be placed on the entry or exit point of the OPATtern when in the PATtern marker mode.

Example OUTPUT XXX; ":MACHINE1:TLIST:OCONDITION ENTERING"

Query :MAChine{1|2}:TLISt:OCONdition?

The OCONdition query returns the current setting.

Returned Format [:MAChine{1|2}:TLISt:OCONdition] {ENTering|EXITing}<NL>

Example OUTPUT XXX; ":MACHINE1:TLIST:OCONDITION?"



OPATtern

Command `:MACHine{1|2}:TLISt:OPATtern <label_name>,
<label_pattern>`

The OPATtern command allows you to construct a pattern for the O marker which is then used with the OSEarch criteria when moving the marker on patterns. Since this command deals with only one label at a time, a complete specification could require several iterations.

When the value of a pattern is expressed in binary, it represents the bit values for the label inside the pattern recognizer term. In whatever base is used, the value must be between 0 and $2^{32} - 1$, since a label may not have more than 32 bits. Because the <label_pattern> parameter may contain don't cares, it is handled as a string of characters rather than a number.

<label_name> string of up to 6 alphanumeric characters

<label_pattern> `"{#B{0|1|X} . . . |
#Q{0|1|2|3|4|5|6|7|X} . . . |
#H{0|1|2|3|4|5|6|7|8|9|A|B|C|D|E|F|X} . . . |
{0|1|2|3|4|5|6|7|8|9} . . . }"`

Example

```
OUTPUT XXX;":MACHINE1:TLISt:OPATtern 'DATA','255' "  
OUTPUT XXX;":MACHINE1:TLISt:OPATtern 'ABC','#BXXXX1101' "
```

Query `:MACHine{1|2}:TLISt:OPATtern? <label_name>`

The OPATtern query returns the pattern specification for a given label name.

Returned Format `[:MACHine{1|2}:TLISt:OPATtern] <label_name>,
<label_pattern><NL>`

Example

```
OUTPUT XXX;":MACHINE1:TLISt:OPATtern? 'A' "
```

OSearch

Command :MAChine{1|2}:TLISt:OSearch <occurrence>,<origin>

The OSearch command defines the search criteria for the O marker, which is then used with associated OPATtern recognizer specification when moving the markers on patterns. The origin parameter tells the marker to begin a search from the trigger, the start of data, or the X marker. The actual occurrence the marker searches for is determined by the occurrence parameter, relative to the origin. An occurrence of 0 places the marker on the selected origin. With a negative occurrence, the marker searches before the origin. With a positive occurrence, the marker searches after the origin.

<occurrence> integer from -1040384 to +1040384 (HP 16554A) or from -2088960 to +2088960 (HP 16555A) or from -4177920 to +4177920 (HP 16555D)

<origin> {TRIGger|START|XMARKer}

Example OUTPUT XXX; ":MACHINE1:TLIST:OSEARCH +10,TRIGGER"

Query :MAChine{1|2}:TLISt:OSearch?

The OSearch query returns the search criteria for the O marker.

Returned Format [:MAChine{1|2}:TLISt:OSearch] <occurrence>,<origin><NL>

Example OUTPUT XXX; ":MACHINE1:TLIST:OSEARCH?"



OSTate

Query :MACHine{1|2}:TLISt:OSTate?

The OSTate query returns the line number in the listing where the O marker resides. If data is not valid, the query returns 2147483647.

Returned Format [:MACHine{1|2}:TLISt:OSTate] <state_num><NL>
<state_num> 2147483647 or integer from -1040384 to +1040384 (HP 16554A) or from -2088960 to +2088960 (HP 16555A) or from -4177920 to +4177920 (HP 16555D)

Example OUTPUT XXX; ":MACHINE1:TLIST:OSTATE?"

OTAG

Command :MACHine{1|2}:TLISt:OTAG <time_value>

The OTAG command specifies the tag value on which the O marker should be placed. The tag value is always time for the timing analyzer. If the data is not valid tagged data, no action is performed.

<time_value> real number

Example :OUTPUT XXX; ":MACHINE1:TLIST:OTAG 40.0E-6"

Query `:MACHine{1|2}:TLISt:OTAG?`

The OTAG query returns the O marker position in time regardless of whether the marker was positioned in time or through a pattern search. If data is not valid, the query returns 9.9E37.

Returned Format `[:MACHine{1|2}:TLISt:OTAG] <time_value><NL>`

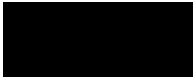
Example `OUTPUT XXX; ":MACHINE1:TLIST:OTAG?"`

REMove

Command `:MACHine{1|2}:TLISt:REMove`

The REMove command removes all labels, except the leftmost label, from the listing menu.

Example `OUTPUT XXX; ":MACHINE1:TLIST:REMOVE"`



RUNTiI

Command :MACHine{1|2}:TLISt:RUNTiI <run_until_spec>

The RUNTiI (run until) command allows you to define a stop condition when the run mode is repetitive. Specifying OFF causes the analyzer to make runs until either the display's STOP field is touched or the STOP command is issued.

There are four conditions based on the time between the X and O markers. These four conditions are as follows:

- The difference is less than (LT) some value.
- The difference is greater than (GT) some value.
- The difference is inside some range (INRange).
- The difference is outside some range (OUTRange).

End points for INRange and OUTRange should be at least 2 ns apart since this is the minimum time between samples.

<run_until_spec>	{OFF LT, <value> GT, <value> INRange, <value>, <value> OUTRange, <value>, <value>}
<value>	real number from -9E9 to +9E9

Example OUTPUT XXX; ":MACHINE1:TLISt:RUNTiI GT,800.0E-6"

Query :MACHine{1|2}:TLISt:RUNTiI?

The RUNTiI query returns the current stop criteria.

Returned Format [:MACHine{1|2}:TLISt:RUNTiI] <run_until_spec><NL>

Example OUTPUT XXX; ":MACHINE1:TLISt:RUNTiI?"

TAVerage

Query :MACHine{1|2}:TLISt:TAVerage?

The TAVerage query returns the value of the average time between the X and O markers. If the number of valid runs is zero, the query returns 9.9E37. Valid runs are those where the pattern search for both the X and O markers was successful, resulting in valid time measurements.

Returned Format [:MACHine{1|2}:TLISt:TAVerage] <time_value><NL>
 <time_value> real number

Example OUTPUT XXX; ":MACHINE1:TLIST:TAVERAGE?"

TMAXimum

Query :MACHine{1|2}:TLISt:TMAXimum?

The TMAXimum query returns the value of the maximum time between the X and O markers. If data is not valid, the query returns 9.9E37.

Returned Format [:MACHine{1|2}:TLISt:TMAXimum] <time_value><NL>
 <time_value> real number

Example OUTPUT XXX; ":MACHINE1:TLIST:TMAXIMUM?"



TMINimum

Query :MACHine{1|2}:TLISt:TMINimum?

The TMINimum query returns the value of the minimum time between the X and O markers. If data is not valid, the query returns 9.9E37.

Returned Format [:MACHine{1|2}:TLISt:TMINimum] <time_value><NL>
<time_value> real number

Example OUTPUT XXX; ":MACHINE1:TLIST:TMINIMUM?"

VRUNs

Query :MACHine{1|2}:TLISt:VRUNs?

The VRUNs query returns the number of valid runs and total number of runs made. Valid runs are those where the pattern search for both the X and O markers was successful resulting in valid time measurements.

Returned Format [:MACHine{1|2}:TLISt:VRUNs] <valid_runs>,<total_runs><NL>
<valid_runs> zero or positive integer
<total_runs> zero or positive integer

Example OUTPUT XXX; ":MACHINE1:TLIST:VRUNs?"

XCONdition

Command :MACHine{1|2}:TLISt:XCONdition {ENTering|EXITing}

The XCONdition command specifies where the X marker is placed. The X marker can be placed on the entry or exit point of the XPATtern when in the PATtern marker mode.

Example OUTPUT XXX; ":MACHINE1:TLIST:XCONDITION ENTERING"

Query :MACHine{1|2}:TLISt:XCONdition?

The XCONdition query returns the current setting.

Returned Format [:MACHine{1|2}:TLISt:XCONdition] {ENTering|EXITing}<NL>

Example OUTPUT XXX; ":MACHINE1:TLIST:XCONDITION?"

XOTag

Query :MACHine{1|2}:TLISt:XOTag?

The XOTag query returns the time from the X to the O marker. If there is no data the query returns 9.9E37.

Returned Format [:MACHine{1|2}:TLISt:XOTag] <XO_time><NL>

<XO_time> real number

Example OUTPUT XXX; ":MACHINE1:TLIST:XOTAG?"



XOTime

Query :MACHine{1|2}:TLISt:XOTime?

The XOTime query returns the time from the X to O markers. If there is no data the query returns 9.9E37.

Returned Format [:MACHine{1|2}:TLISt:XOTime] <XO_time><NL>
<XO_time> real number

Example OUTPUT XXX; ":MACHINE1:TLIST:XOTIME?"

XPATtern

Command :MACHine{1|2}:TLISt:XPATtern <label_name>,
<label_pattern>

The XPATtern command allows you to construct a pattern for the X marker which is then used with the XSEarch criteria when moving the marker on patterns. Since this command deals with only one label at a time, a complete specification could require several iterations.

When the value of a pattern is expressed in binary, it represents the bit values for the label inside the pattern recognizer term. In whatever base is used, the value must be between 0 and $2^{32} - 1$, since a label may not have more than 32 bits. Because the <label_pattern> parameter may contain don't cares, it is handled as a string of characters rather than a number.

<label_name> string of up to 6 alphanumeric characters

<label_pattern> "{#B{0|1|X} . . . |
#Q{0|1|2|3|4|5|6|7|X} . . . |
#H{0|1|2|3|4|5|6|7|8|9|A|B|C|D|E|F|X} . . . |
{0|1|2|3|4|5|6|7|8|9} . . . }"

Example OUTPUT XXX; ":MACHINE1:TLIST:XPATTERN 'DATA','255' "
 OUTPUT XXX; ":MACHINE1:TLIST:XPATTERN 'ABC','#BXXXX1101' "

Query :MACHine{1|2}:TLISt:XPATtern? <label_name>

Returned Format The XPATtern query returns the pattern specification for a given label name.
 [:MACHine{1|2}:TLISt:XPATtern] <label_name>,
 <label_pattern><NL>

Example OUTPUT XXX; ":MACHINE1:TLIST:XPATTERN? 'A' "

XSearch

Command :MACHine{1|2}:TLISt:XSEarch <occurrence>,<origin>

The XSearch command defines the search criteria for the X marker, which is then used with the associated XPATtern specification when moving the markers on patterns. The origin parameter tells the marker to begin a search from the trigger or the start of data. The occurrence parameter determines which occurrence of the X pattern, relative to the origin, the marker actually searches for. An occurrence of 0 places a marker on the selected origin.

<occurrence> integer from -1040384 to +1040384 (HP 16554A) or from -2088960 to
 +2088960 (HP 16555A) or from -4177920 to +4177920 (HP 16555D)
 <origin> { TRIGger | START }

Example OUTPUT XXX; ":MACHINE1:TLIST:XSEARCH +10,TRIGGER"



Query :MACHine{1|2}:TLISt:XSEarch?

Returned Format The XSEarch query returns the search criteria for the X marker.
[:MACHine{1|2}:TLISt:XSEarch] <occurrence>, <origin><NL>

Example OUTPUT XXX; ":MACHINE1:TLIST:XSEARCH?"

XState

Query :MACHine{1|2}:TLISt:XState?

Returned Format The XState query returns the line number in the listing where the X marker resides. If data is not valid, the query returns 2147483647.

Returned Format [:MACHine{1|2}:TLISt:XState] <state_num><NL>

<state_num> 2147483647 or integer from -1040384 to +1040384 (HP 16554A) or from -2088960 to +2088960 (HP 16555A) or from -4177920 to +4177920 (HP 16555D).

Example OUTPUT XXX; ":MACHINE1:TLIST:XSTATE?"

XTAG

Command :MAChine{1|2}:TLISt:XTAG <time_value>

The XTAG command specifies the tag value on which the X marker should be placed. The tag value is always time for the timing analyzer. If the data is not valid tagged data, no action is performed.

<time_value> real number

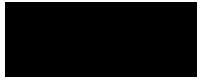
Example OUTPUT XXX; ":MACHINE1:TLISt:XTAG 40.0E-6"

Query :MAChine{1|2}:TLISt:XTAG?

The XTAG query returns the X marker position in time regardless of whether the marker was positioned in time or through a pattern search. If data is not valid tagged data, the query returns 9.9E37.

Returned Format [:MAChine{1|2}:TLISt:XTAG] <time_value><NL>

Example OUTPUT XXX; ":MACHINE1:TLISt:XTAG?"





SYMBOL Subsystem

Introduction

The SYMBol subsystem contains the commands that allow you to define symbols on the controller and download them to the HP 16554A/HP 16555A/HP 16555D logic analyzer modules. The commands in this subsystem are:

- BASE
- PATTern
- RANGe
- REMove
- WIDTh

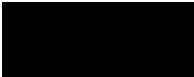
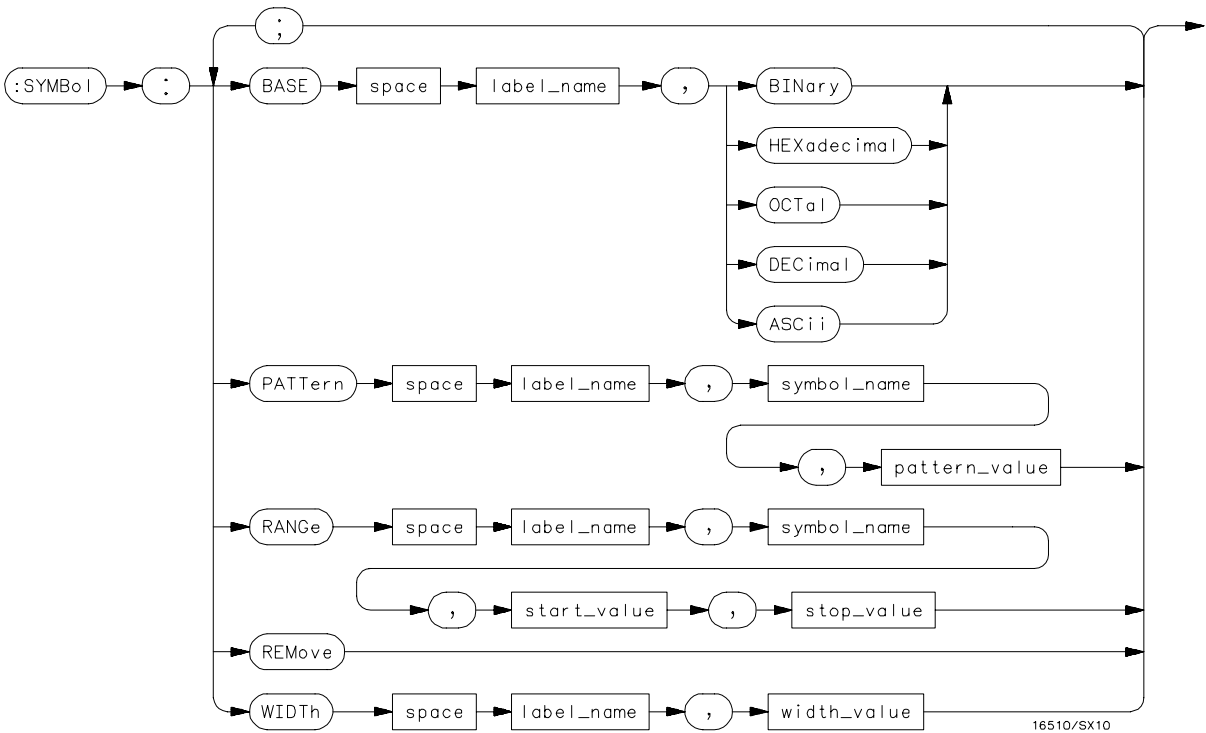


Figure 15-1



SYMBOL Subsystem Syntax Diagram

Table 15-1

SYMBOL Parameter Values

Parameter	Value
label_name	string of up to 6 alphanumeric characters
symbol_name	string of up to 16 alphanumeric characters
pattern_value	"{#B{0 1 X}... #Q{0 1 2 3 4 5 6 7 X}... #H{0 1 2 3 4 5 6 7 8 9 A B C D E F X}... {0 1 2 3 4 5 6 7 8 9}...}"
start_value	"{#B{0 1}...
stop_value	#Q{0 1 2 3 4 5 6 7}... #H{0 1 2 3 4 5 6 7 8 9 A B C D E F}... {0 1 2 3 4 5 6 7 8 9}...}"
width_value	integer from 1 to 16



SYM Bol

Selector :MACHine{1|2}:SYM Bol

The SYM Bol selector is used as a part of a compound header to access the commands used to create symbols. It always follows the MACHine selector because it selects a branch directly below the MACHine level in the command tree.

Example

```
OUTPUT XXX;":MACHINE1:SYMBOL:BASE 'DATA', BINARY"
```

BASE

Command :MACHine{1|2}:SYM Bol:BASE <label_name>,
<base_value>

The BASE command sets the base in which symbols for the specified label will be displayed in the symbol menu. It also specifies the base in which the symbol offsets are displayed when symbols are used.

BINARY is not available for labels with more than 20 bits assigned. In this case the base will default to HEXadecimal.

<label_name> string of up to 6 alphanumeric characters

<base_value> {BINARY | HEXadecimal | OCTal | DECimal | ASCii}

Example

```
OUTPUT XXX;":MACHINE1:SYMBOL:BASE 'DATA', HEXADECEIMAL"
```

PATTERN

Command :MACHINE{1|2}:SYMBOL:PATTERN <label_name>,
 <symbol_name>,<pattern_value>

The PATTERN command allows you to create a pattern symbol for the specified label.

Because don't cares (X) are allowed in the pattern value, it must always be expressed as a string. The values may be in binary (#B), octal (#Q), hexadecimal (#H), or decimal (default). Don't cares cannot be used in a decimal number.

<label_name> string of up to 6 alphanumeric characters
<symbol_name> string of up to 16 alphanumeric characters
<pattern_value> "{#B{0|1|X} . . . |
 #Q{0|1|2|3|4|5|6|7|X} . . . |
 #H{0|1|2|3|4|5|6|7|8|9|A|B|C|D|E|F|X} . . . |
 {0|1|2|3|4|5|6|7|8|9} . . . }"

Example

OUTPUT XXX; :MACHINE1:SYMBOL:PATTERN 'STAT',
'MEM_RD', '#H01XX'



RANGe

Command :MACHine{1|2}:SYMBOL:RANGe <label_name>,
 <symbol_name>,<start_value>,<stop_value>

The RANGe command allows you to create a range symbol containing a start value and a stop value for the specified label. The values may be in binary (#B), octal (#Q), hexadecimal (#H) or decimal (default). You can not use don't cares in any base.

<label_name> string of up to 6 alphanumeric characters

<symbol_name> string of up to 16 alphanumeric characters

<start_value> "{#B{0|1} . . . |

<stop_value> #Q{0|1|2|3|4|5|6|7} . . . |

 #H{0|1|2|3|4|5|6|7|8|9|A|B|C|D|E|F} . . . |

 {0|1|2|3|4|5|6|7|8|9} . . . }"

Example

OUTPUT XXX;":MACHINE1:SYMBOL:RANGE 'STAT',
'IO_ACC','0','H000F' "

REMOVe

Command `:MACHINE{1|2}:SYMBOL:REMOVe`

The REMOve command deletes all symbols from a specified machine.

Example

OUTPUT `XXX; ":MACHINE1:SYMBOL:REMOVE"`

WIDTh

Command `:MACHINE{1|2}:SYMBOL:WIDTh <label_name>,
<width_value>`

The WIDTh command specifies the width (number of characters) in which the symbol names will be displayed when symbols are used.

The WIDTh command does not affect the displayed length of the symbol offset value.

<label_name> string of up to 6 alphanumeric characters

<width_value> integer from 1 to 16

Example

OUTPUT `XXX; ":MACHINE1:SYMBOL:WIDTH 'DATA',9 "`



SPA Subsystem

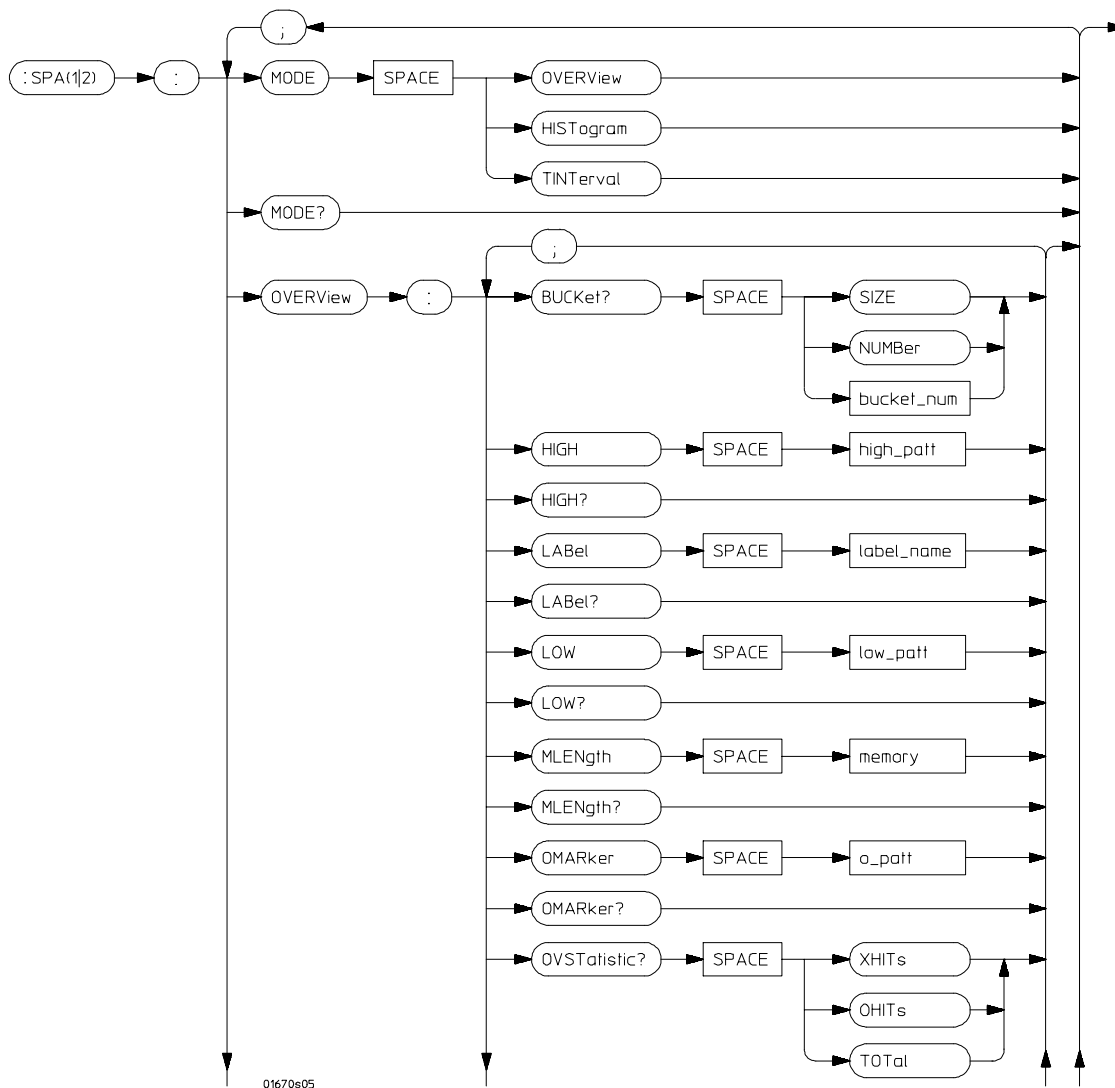
Introduction

This chapter provides you with information for programming the System Performance Analysis (SPA) features on the HP 16554A/HP 16555A/HP 16555D logic analyzer modules.

SPA commands have subsystems, indicated by the outdented items in the list. Indented commands must be prefaced with the outdented command above it unless MODE was previously used to set the mode. The SPA commands are:

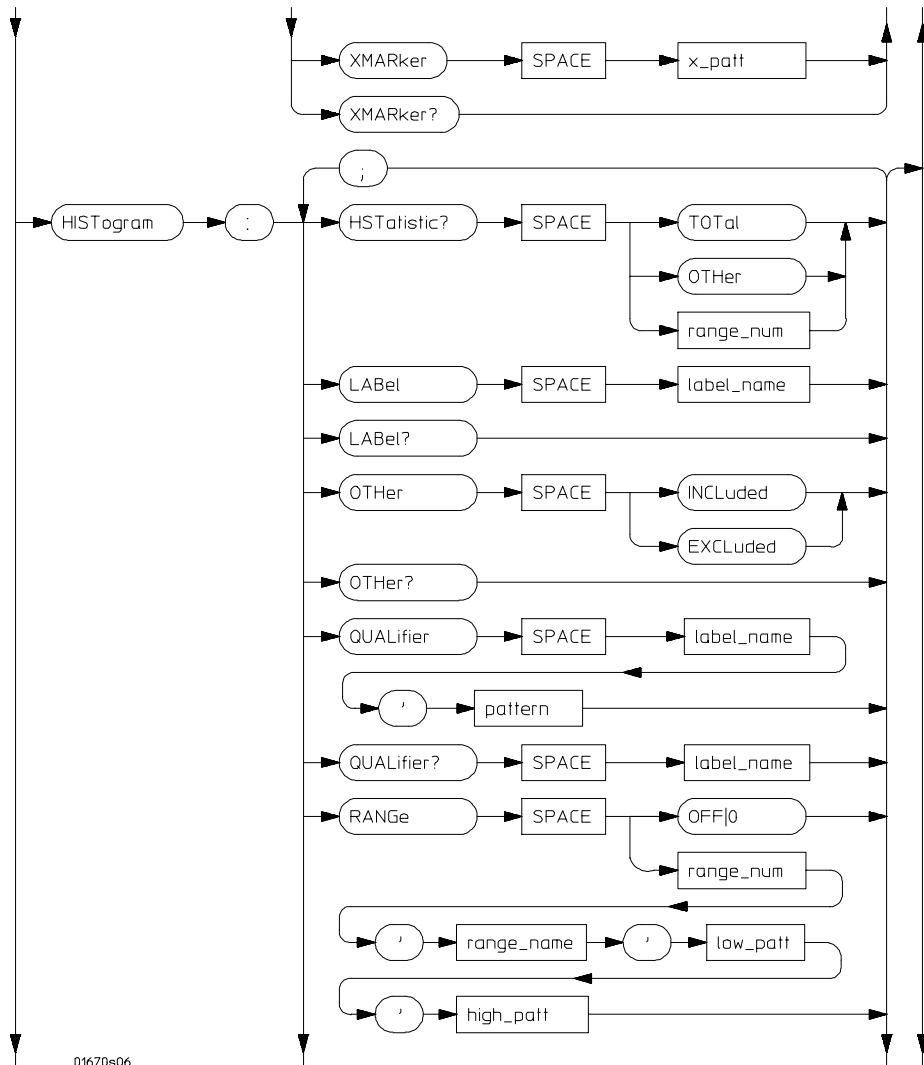
- OVERView
 - BUCKet
 - HIGH
 - LABEL
 - LOW
 - MLENgth
 - OMARKer
 - OVSTatistic
 - XMARKer
- HISTogram
 - HISTatistic
 - LABEL
 - OTHer
 - QUALifier
 - RANGe
 - TTYPe
- TINTerVal
 - AUTorange
 - QUALifier
 - TINTerVal
 - TSTatistic
- MODE

Figure 16-1



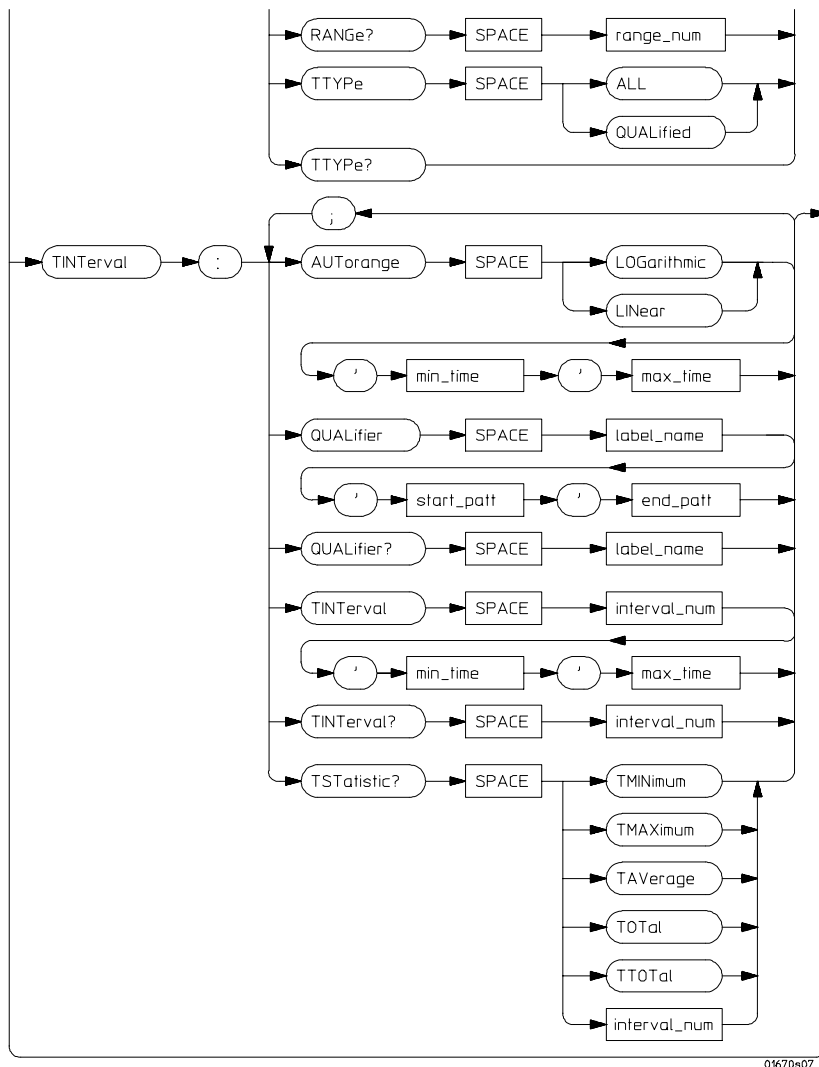
SPA Subsystem Syntax Diagram

Figure 16-1 (continued)



SPA Subsystem Syntax Diagram (continued)

Figure 16-1 (continued)



SPA Subsystem Syntax Diagram (continued)

Table 16-1

SPA Subsystem Parameter Values

Parameter	Value
bucket_num	0 to (number of valid buckets - 1)
high_patt	<pattern>
label_name	a string of up to 6 alphanumeric characters
low_patt	<pattern>
memory	{4096 8192 16384 32768 65536 131072 262144 516096 (HP 16554A) 524288 1040384 (HP 16555A) 524288 1048576 2080768 (HP 16555D)}
o_patt	<pattern>
x_patt	<pattern>
range_num	an integer from 0 to 10
range_name	a string of up to 16 alphanumeric characters
min_time	real number
max_time	real number
start_pattern	<pattern>
end_pattern	<pattern>
interval_num	an integer from 0 to 7
pattern	"{#B{0 1}... #Q{0 1 2 3 4 5 6 7}... #H{0 1 2 3 4 5 6 7 8 9 A B C D E F}... {0 1 2 3 4 5 6 7 8 9}...}"

MODE

Command : SPA{1|2}:MODE {OVERView|HISTogram|TINterval}

The MODE command selects which menu to display: State Overview, State Histogram, or Time Interval. A query returns the current menu mode.

Example

```
OUTPUT XXX; ":SPA1:MODE OVERView"  
OUTPUT XXX; ":SPA2:MODE HISTogram"  
OUTPUT XXX; ":SPA1:MODE TINterval"
```

Query : SPA{1|2}:MODE?

Returned Format [:SPA{1|2}:MODE] {OVERView|HISTogram|TINterval}<NL>

Example

```
10 DIM String$[100]  
20 OUTPUT XXX; ":SELECT 1"  
30 OUTPUT XXX; ":SPA1:MODE?"  
40 ENTER XXX;String$  
50 PRINT String$  
60 END
```



OVERView:BUCKet

Query : SPA{1|2}:OVERView:BUCKet?
 {SIZE|NUMBER|<bucket_num>}

The OVERView:BUCKet query returns data relating to the State Overview measurement. You specify SIZE for width of each bucket, NUMBER for number of buckets, or <bucket_num> for the number of hits in the specified bucket number

Returned Format [:SPA{1|2}:OVERView:BUCKet] {SIZE|NUMBER|<bucket_num>},
 <number><NL>

 <bucket_num> 0 to (number of valid buckets - 1)

 <number> integer number

Example

```
10 DIM String$(100)
20 OUTPUT XXX;":SELECT 1"
30 OUTPUT XXX;":SPA2:OVERView:BUCKet? 23"
40 ENTER XXX;String$
50 PRINT String$
60 END
```



OVERView:HIGH

Command :SPA{1|2}:OVERView:HIGH <high_pattern>

The OVERView:HIGH command sets the upper boundary of the State Overview measurement. A query returns the current setting of the upper boundary.

Setting the upper boundary defaults the data accumulators, statistic counters, and the number of buckets and their size.

<high_pattern> "{#B{0|1}...|
#Q{0|1|2|3|4|5|6|7}...|
#H{0|1|2|3|4|5|6|7|8|9|A|B|C|D|E|F}... .|
{0|1|2|3|4|5|6|7|8|9}...}"

Example

```
OUTPUT XXX;":SPA1:OVERView:HIGH '23394' "  
OUTPUT XXX;":SPA2:OVERView:HIGH '#Q4371' "
```

Query :SPA{1|2}:OVERView:HIGH?

Returned Format [:SPA{1|2}:OVERView:HIGH] <high_pattern><NL>

Example

```
10 DIM String$[100]  
20 OUTPUT XXX;":SELECT 1"  
30 OUTPUT XXX;":SPA1:OVERView:HIGH?"  
40 ENTER XXX;String$  
50 PRINT String$  
60 END
```

OVERView:LABel

Command : SPA{1|2}:OVERView:LABel <label_name>

The OVERView:LABel command selects a new label for collecting the SPA measurements. A query returns the name of the currently selected label. Selecting a new label defaults the State Overview data accumulators, statistic counters, and the number of buckets and their size.

<label_name> string of up to 6 alphanumeric characters

Example OUTPUT XXX; ":SPA2:OVERView:LABel 'A' "

Query : SPA{1|2}:OVERView:LABel?

Returned Format: [:SPA{1|2}:OVERView:LABel] <label_name><NL>

Example

```
10 DIM String$[100]
20 OUTPUT XXX; ":SELECT 1"
30 OUTPUT XXX; ":SPA2:OVERView:LABel?"
40 ENTER XXX;String$
50 PRINT String$
60 END
```

OVERView:LOW

Command :SPA{1|2}:OVERView:LOW <low_pattern>

The OVERView:LOW command sets the lower boundary of the State Overview measurement. A query returns the current setting of the lower boundary.

Setting the lower boundary defaults the data accumulators, statistic counters, and the number of buckets and their size.

```
<low_pattern> "#B{0|1}...|  
#Q{0|1|2|3|4|5|6|7}...|  
#H{0|1|2|3|4|5|6|7|8|9|A|B|C|D|E|F}...|  
{0|1|2|3|4|5|6|7|8|9}...}"
```

Example

```
OUTPUT XXX;":SPA2:OVERView:LOW '23394' "  
OUTPUT XXX;":SPA1:OVERView:LOW '#Q4371' "
```

Query :SPA{1|2}:OVERView:LOW?

Returned Format [:SPA{1|2}:OVERView:LOW] <low_pattern><NL>

Example

```
10 DIM String$[100]  
20 OUTPUT XXX;":SELECT 1"  
30 OUTPUT XXX;":SPA1:OVERView:LOW?"  
40 ENTER XXX;String$  
50 PRINT String$  
60 END
```



OVERView:MLENgtH

Command : SPA{1|2}:OVERView:MLENgtH <memory_length>

The MLENgtH command specifies the memory depth. Valid memory depths range from 4096 states (or samples) through the maximum system memory depth minus 8192 states (HP 16554A/HP 16555A) or minus 16384 states (HP 16555D). Memory depth is affected by acquisition mode. If the <memory_depth> value sent with the command is not a legal value, the closest legal setting will be used.

<memory_length> {4096 | 8192 | 16384 | 32768 | 65536 | 131072 | 262144
| 516096 (HP 16554A)
| 524288 | 1040384 (HP 16555A)
| 524288 | 1048576 | 2080768 (HP 16555D) }

Example OUTPUT XXX; ":SPA1:OVERVIEW:MLENGTH 262144"

Query : SPA{1|2}:OVERView:MLENgtH?

The MLENgtH query returns the current analyzer memory depth selection.

Returned Format [:SPA{1|2}:OVERView:MLENgtH] <memory_length><NL>

Example OUTPUT XXX; ":SPA1:OVERVIEW:MLENGTH?"

OVERView:OMARker

Command :SPA{1|2}:OVERView:OMARker <o_pattern>

The OVERView:OMARker command sends the O marker to the lower boundary of the bucket where the specified pattern is located. A request to place the marker outside the defined boundary forces the marker to the appropriate end bucket. A query returns the pattern associated with the lower end of the bucket where the marker is placed.

```
<o_pattern>  "#{B{0|1}...|  
             #Q{0|1|2|3|4|5|6|7}...|  
             #H{0|1|2|3|4|5|6|7|8|9|A|B|C|D|E|F}...|  
             {0|1|2|3|4|5|6|7|8|9}...}"
```

Example OUTPUT XXX;":SPA2:OVERView:OMARker '#H3C31'"

Query :SPA{1|2}:OVERView:OMARker?

Returned Format [:SPA{1|2}:OVERView:OMARker] <o_pattern><NL>

Example

```
10 DIM String$(100)  
20 OUTPUT XXX;":SELECT 1"  
30 OUTPUT XXX;":SPA1:OVERView:OMARker?"  
40 ENTER XXX;String$  
50 PRINT String$  
60 END
```



OVERView:OVStatistic

Query :SPA{1|2}:OVERView:OVStatistic?
{XHITs|OHITs|TOTal}

The OVERView:OVStatistic query returns the number of hits associated with the requested statistic or returns the number of hits in the specified bucket. XHITs requests the number of hits in the bucket where the X marker is located. OHITs requests the number of hits in the bucket where the O marker is located. TOTal requests the total number of hits.

Returned Format [:SPA{1|2}:OVERView:OVStatistic] {XHITs|OHITs|TOTal},
<number_hits><NL>

<number_hits> integer number

Example

```
10 DIM String$[100]
20 OUTPUT XXX;":SELECT 1"
30 OUTPUT XXX;":SPA2:OVERView:OVStatistic? OHITs"
40 ENTER XXX;String$
50 PRINT String$
60 END
```

OVERView:XMARker

Command :SPA{1|2}:OVERView:XMARker <x_pattern>

The OVERView:XMARker command sends the X marker to the lower boundary of the bucket where the specified pattern is located. A request to place the marker outside the defined boundary forces the marker to the appropriate end bucket. A query returns the pattern associated with the lower end of the bucket where the marker is placed.

```
<x_pattern>  "{#B{0|1}...|  
              #Q{0|1|2|3|4|5|6|7}...|  
              #H{0|1|2|3|4|5|6|7|8|9|A|B|C|D|E|F}...|  
              {0|1|2|3|4|5|6|7|8|9}...}"
```

Example OUTPUT XXX;":SPA2:OVERView:XMARker '#H3C31'"

Query :SPA{1|2}:OVERView:XMARker?

Returned Format [:SPA{1|2}:OVERView:XMARker] <x_pattern><NL>

Example

```
10 DIM String$(100)  
20 OUTPUT XXX;":SELECT 1"  
30 OUTPUT XXX;":SPA2:OVERView:XMARker?"  
40 ENTER XXX;String$  
50 PRINT String$  
60 END
```



HISTogram:HStatistic

Query :SPA{1|2}:HISTogram:HStatistic?
{TOTal|OTHer|<range_number>}

The HISTogram:HStatistic query returns the total number of samples or returns the number of samples in the specified range. Specify TOTal for the total number of samples, OTHer for the number of hits in "other" range, or <range_number> for the number of hits in that range.

Depending on whether the "other" range is on or off, the statistic TOTal includes or excludes the number of hits in the "other" range.

Returned Format [:SPA{1|2}:HISTogram:HStatistic] {TOTal|OTHer|<range_number>},<number_hits><NL>

<range_number> 0 to 10

<number_hits> integer number

Example

```
10 DIM String$(100)
20 OUTPUT XXX;" :SELECT 1"
30 OUTPUT XXX;" :SPA1:HISTogram:HStatistic? 7"
40 ENTER XXX;String$
50 PRINT String$
60 END
```

HISTogram:LABel

Command :SPA{1|2}:HISTogram:LABel <label_name>

The HISTogram:LABel command selects a new label for collecting SPA measurements. A query returns the name of the currently selected label. Selecting a new label defaults the State Histogram range names, bucket sizes, and hit accumulators.

<label_name> string of up to 6 alphanumeric characters

Example OUTPUT XXX;":SPA2:HISTogram:LABel 'A' "

Query :SPA{1|2}:HISTogram:LABel?

Returned Format [:SPA{1|2}:HISTogram:LABel] <label_name><NL>

Example

```
10 DIM String$[100]
20 OUTPUT XXX;":SELECT 1"
30 OUTPUT XXX;":SPA2:HISTogram:LABel?"
40 ENTER XXX;String$
50 PRINT String$
60 END
```



HISTogram:OTHer

Command : SPA{1|2}:HISTogram:OTHer {INCLuded|EXCLuded}

The HISTogram:OTHer command selects including or excluding the "other" histogram bucket. A query returns data indicating whether the "other" bucket is currently included or excluded.

Example OUTPUT XXX; ":SPA2:HISTogram:OTHer INCLuded"
OUTPUT XXX; ":SPA1:HISTogram:OTHer EXCLuded"

Query : SPA{1|2}:HISTogram:OTHer?

Returned Format [:SPA{1|2}:HISTogram:OTHer] {INCLuded|EXCLuded}<NL>

Example 10 DIM String\$(100)
20 OUTPUT XXX; ":SELECT 1"
30 OUTPUT XXX; ":SPA2:HISTogram:OTHer?"
40 ENTER XXX;String\$
50 PRINT String\$
60 END

HISTogram:QUALifier

Command :SPA{1|2}:HISTogram:QUALifier <label_name>,
<pattern>

The HISTogram:QUALifier command sets the pattern associated with the specified label. The pattern is a condition for triggering and storing the measurement. A query of a label returns the current pattern setting for that label.

<label_name> string of up to 6 alphanumeric characters

<pattern> "#B{0|1}...|
#Q{0|1|2|3|4|5|6|7}...|
#H{0|1|2|3|4|5|6|7|8|9|A|B|C|D|E|F}...|
{0|1|2|3|4|5|6|7|8|9}...}"

Example OUTPUT XXX;":SPA2:HISTogram:QUALifier 'A','255'"

Query :SPA{1|2}:HISTogram:QUALifier? <label_name>

Returned Format [:SPA{1|2}:HISTogram:QUALifier] <label_name>,<pattern><NL>

Example

```
10 DIM String$(100)
20 OUTPUT XXX;":SELECT 1"
30 OUTPUT XXX;":SPA1:HISTogram:QUALifier? 'A' "
40 ENTER XXX;String$
50 PRINT String$
60 END
```



HISTogram:RANGe

Command :SPA{1|2}:HISTogram:RANGe {OFF | <range_num>, <range_name>, <low_patt>, <high_patt>}

The HISTogram:RANGe command turns off all ranges or defines the range name, low boundary, and high boundary of the specified range. Defining a specified range turns on that range. For the specified range, a query returns the name, low boundary, high boundary, and whether the range is on or off.

<range_num> 0 to 10

<range_name> string of up to 16 alphanumeric characters

<low_patt> "{#B{0|1}...|

<high_patt> #Q{0|1|2|3|4|5|6|7}...|

#H{0|1|2|3|4|5|6|7|8|9|A|B|C|D|E|F}...|

{0|1|2|3|4|5|6|7|8|9}...}"

Example

OUTPUT XXX;":SPA1:HISTogram:RANGe OFF "

OUTPUT XXX;":SPA2:HISTogram:RANGe 5,'A','255','512' "

OUTPUT XXX;":SPA1:HISTogram:RANGe 8,'DATA','#B0100110','#H9F' "

Query :SPA{1|2}:HISTogram:RANGe? <range_num>

Returned Format [:SPA{1|2}:HISTogram:RANGe] <range_number>,<range_name>,<low_pattern>,<high_pattern>,<range_onoff><NL>

<range_onoff> {ON|OFF}

Example

10 DIM String\$[100]

20 OUTPUT XXX;":SELECT 1"

30 OUTPUT XXX;":SPA1:HISTogram:RANGe? 4"

40 ENTER XXX;String\$

50 PRINT String\$

60 END



HISTogram:TTYPe

Command :SPA{1|2}:HISTogram:TTYPe {ALL|QUALified}

The HISTogram:TTYPe command sets the trigger to trigger on anystate or on qualified state. A query returns the current trace type setting.

Example OUTPUT XXX;":SPA2:HISTogram:TTYPe ALL"

Query :SPA{1|2}:HISTogram:TTYPe?

Returned Format [:SPA{1|2}:HISTogram:TTYPe] {ALL|QUALified}<NL>

Example

```
10 DIM String$(100)
20 OUTPUT XXX;":SELECT 1"
30 OUTPUT XXX;":SPA1:HISTogram:TTYPe?"
40 ENTER XXX;String$
50 PRINT String$
60 END
```

TINterval:AUTorange

Command : SPA{1|2}:TINterval:AUTorange
{LOGarithmic|LINear}, <min_time>, <max_time>

The TINterval:AUTorange command automatically sets the Time Interval ranges in a logarithmic or linear distribution over the specified range of time. When the AUTorange command is executed, the data accumulators and statistic counters are reset.

<min_time> real number

<max_time> real number

Example

```
OUTPUT XXX; ":SPA2:TINterval:AUTorange LINear, 4.0E-3, 55.6E+2"  
OUTPUT XXX; ":SPA1:TINterval:AUTorange LOGarithmic, 3.3E+1, 8.6E+2"
```

TINTerval:QUALifier

Command :SPA{1|2}:TINTerval:QUALifier <label_name>,
<start_pattern>,<end_pattern>

The TINTerval:QUALifier command defines the start and stop patterns for a specified label. The start and stop patterns determine the time windows for collecting data. A query returns the currently defined start and stop patterns for a given label.

<label_name> string of up to 6 alphanumeric characters

<start_pattern> "{#B{0|1}...|
#Q{0|1|2|3|4|5|6|7}...|
#H{0|1|2|3|4|5|6|7|8|9|A|B|C|D|E|F}...|
{0|1|2|3|4|5|6|7|8|9}...}"

<end_pattern> "{#B{0|1}...|
#Q{0|1|2|3|4|5|6|7}...|
#H{0|1|2|3|4|5|6|7|8|9|A|B|C|D|E|F}...|
{0|1|2|3|4|5|6|7|8|9}...}"

Example

```
OUTPUT XXX;":SPA1:TINTerval:QUALifier 'A','#Q231','#Q455'"
OUTPUT XXX;":SPA2:TINTerval:QUALifier 'DATA','#H3A','#255'"
```

Query :SPA{1|2}:TINTerval:QUALifier? <label_name>

Returned Format [:SPA{1|2}:TINTerval:QUALifier] <label_name>,
<start_pattern>,<end_pattern><NL>

Example

```
10 DIM String$(100)
20 OUTPUT XXX;":SELECT 1"
30 OUTPUT XXX;":SPA1:TINTerval:QUALifier? 'A' "
40 ENTER XXX;String$
50 PRINT String$
60 END
```



TINterval:TINterval

Command :SPA{1|2}:TINterval:TINterval
<interval_number>,<min_time>,<max_time>

The TINterval:TINterval command specifies the minimum and maximum time limits for the given interval. A query returns these limits for a specified interval.

<interval_number> 0 to 7

<min_time> real number

<max_time> real number

Example

```
OUTPUT XXX;":SPA2:TINterval:TINterval 4,1.0E-3,47.0E5"
OUTPUT XXX;":SPA1:TINterval:TINterval 3,6.8E-7,4.90E2"
```

Query :SPA{1|2}:TINterval:TINterval? <interval_number>

Returned Format [:SPA{1|2}:TINterval:TINterval] <interval_number>,<min_time>,<max_time><NL>

Example

```
10 DIM String$(100)
20 OUTPUT XXX;":SELECT 1"
30 OUTPUT XXX;":SPA2:TINterval:TINterval? 6"
40 ENTER XXX;String$
50 PRINT String$
60 END
```

TINterval:TStatistic

Query :SPA{1|2}:TINterval:TStatistic? {TMINimum|TMAXimum|TAVerage|TOTal|TTOTal|<interval_number>}

The TINterval:TStatistic query returns either the time or the number of samples associated with the requested statistic. The statistics you can request are:

- TMINimum - overall minimum interval time
- TMAXimum - overall maximum interval time
- TAVerage - overall average interval time
- TOTal - total number of samples
- TTOTal - overall total time of all interval samples
- <interval_number> - number of hits in given interval

If TMINimum, TMAXimum, TAVerage, or TTOTal are not currently valid, the real value 9.9E37 is returned.

Returned Format [:SPA{1|2}:TINterval:TStatistic] { { {TMINimum | TMAXimum | TAVerage | TTOTal } <time_number>} | { {TOTal | <interval_number>}, <number_hits>} }<NL>

<interval_number> 0 to 7

<number_hits> integer number

<time_number> real number

Example

```
10 DIM String$[100]
20 OUTPUT XXX;":SELECT 1"
30 OUTPUT XXX;":SPA1:TINterval:TStatistic? 3"
40 ENTER XXX;String$
50 PRINT String$
60 END
```





DATA and SETup Commands

Introduction

The DATA and SETup commands are SYSTem commands that allow you to send and receive block data between the HP 16554A, HP 16555A, or HP 16555D and a controller. Use the DATA instruction to transfer acquired timing and state data, and the SETup instruction to transfer instrument configuration data. This is useful for:

- Re-loading to the logic analyzer
- Processing data later
- Processing data in the controller

This chapter explains how to use these commands.

The format and length of block data depends on the instruction being used, the configuration of the instrument, and the amount of acquired data. The length of the data block can be as big as 20 Mbytes (HP 16554A), 40 Mbytes (HP 16555A), or 80 Mbytes (HP 16555D) in a three-card configuration.

The SYSTem:DATA section describes each part of the block data as it appears when used by the DATA instruction when DBLock is set to UNPacked. The beginning byte number, the length in bytes, and a short description is given for each part of the block data. This is intended to be used primarily for processing of data in the controller.

This description is for data downloaded in UNPacked format. Data sent to a controller with the DBLock mode set to PACKed can be reloaded into the analyzer. It is highly configuration dependent, and so is not documented for post-processing. Data sent to a controller with the DBLock mode set to UNPacked cannot be reloaded into the analyzer.

SYSTem:DATA

Command :SYSTem:DATA <block data>

The SYSTem:DATA command transmits the acquisition memory data from the controller to the HP 16554A/HP 16555A/HP 16555D logic analyzers.

The block data consists of a variable number of bytes containing information captured by the acquisition chips. Since no parameter checking is performed, out-of-range values could cause instrument lockup; therefore, care should be taken when transferring the data string into the HP 16554A/HP 16555A/HP 16555D.

The <block data> parameter can be broken down into a <block length specifier> and a variable number of <section>S.

The <block length specifier> always takes the form #8DDDDDDDD. Each D represents a digit (ASCII characters "0" through "9"). The value of the eight digits represents the total length of the block (all sections). For example, if the total length of the block is 14522 bytes, the block length specifier would be "#800014522".

Each <section> consists of a <section header> and <section data>.

The <section data> format varies for each section and may be any length. For the DATA instruction, there is only one <section>, which is composed of a data preamble followed by the acquisition data. This section has a variable number of bytes depending on configuration and amount of acquired data.

Example

OUTPUT XXX; ":SYSTEM:DATA" <block data>

Do not load UNPacked data into the instrument; it may cause the HP 16500 to lock up. If this happens, cycle power. Only data saved in PACKed mode can be reloaded back into a logic analyzer.

<block data> <block length specifier><section>...

<block length specifier> #8<length>

<length> the total length of all sections in byte format (must be represented with 8 digits)

<section> <section header><section data>

<section header> 16 bytes, described on the following page

<section data> format depends on the type of data

The total length of a section is 16 (for the section header) plus the length of the section data. So when calculating the value for <length>, don't forget to include the length of the section headers.

Query :SYSTem:DATA?

The SYSTem:DATA query sends block data to the controller. The data sent by the SYSTem:DATA query reflect the configuration of the machines when the last run was performed. Any changes made since then through either front-panel operations or programming commands do not affect the stored configuration. The format of the block data depends on the current setting of the DBLock parameter.

Returned Format [:SYSTem:DATA] <block data><NL>

See Also The DBLock command description in chapter 2, "Module Level Commands."



Section Header Description

Because block data may contain multiple sections, this description numbers bytes beginning at the section header. The initial 10 bytes of the block length specifier and any other sections are not included in the numbering.

The section header uses bytes 1 through 16 (this manual begins counting at 1; there is no byte 0). The 16 bytes of the section header are as follows:

Byte Position

- 1 10 bytes - Section name ("DATA space space space space space space" in ASCII for the DATA instruction).
- 11 1 byte - Reserved
- 12 1 byte - Module ID (34 decimal for the HP 16554A and HP 16555A/D master boards, and 35 for expander boards)
- 13 4 bytes - Length of block in bytes that when converted to decimal, specifies the number of bytes contained in the data block.

Section Data

For the SYSTem:DATA query when DBLock mode is UNPacked, the <section data> parameter consists of two parts: the data preamble and the acquisition data. These are described in the following two sections.

When DBLock mode is set to PACKed, the format is highly configuration dependent. Because of the complexity and because it may be changed without notice, it is not described here.

Use UNPacked format for data you wish to post-process, and PACKed data for measurements you may want to load back into the analyzer module later.

Data Preamble Description

The UNPacked block data is organized as 574 bytes of preamble information, followed by a variable number of bytes of data. The preamble gives information for each analyzer describing the amount and type of data captured, where the trace point occurred in the data, which pods are assigned to which analyzer, and other information.

The preamble (bytes 17 through 590) consists of the following 574 bytes:

Byte Position

- 17 4 bytes - Instrument ID (always 16500 decimal for both the HP 16554A and HP 16555A)
- 21 4 bytes - Revision Code
- 25 4 bytes - number of acquisition chips used in last acquisition
- 29 4 bytes - Analyzer ID (0 for HP 16554A, 1 for the HP 16555A/D)

The values stored in the preamble represent the captured data currently stored in this structure and not the current analyzer configuration. For example, the mode of the data (bytes 33 and 103) may be STATE with tagging, while the current setup of the analyzer is TIMING.

The next 70 bytes are for Analyzer 1 Data Information.

- 33 4 bytes - Machine data mode, one of the following decimal values:
 - 1 = off
 - 0 = 70 MHz (HP 16554A) or 100 MHz (HP 16555A/D) State data, no tags
 - 1 = 70 MHz (HP 16554A) or 100 MHz (HP 16555A/D) State data with tags
 - 2 = 70 MHz (HP 16554A) or 100 MHz (HP 16555A/D) State data with tags
 - 3 = Fast State data, no tags (HP 16555A/D)
 - 4 = Fast State data with tags (HP 16555A/D)
 - 5 = Fast State data with tags (HP 16555A/D)
 - 10 = conventional timing data on all channels
 - 13 = conventional timing data on half channels

State data includes data acquired by State Compare and SPA machine types. There is no change in the data format.



Byte Position

37	4 bytes - List of pods in this analyzer, where a binary 1 indicates that the corresponding pod is assigned to this analyzer							
	bit 31	bit 30	bit 29	bit 28	bit 27	bit 26	bit 25	bit 24
	unused	unused	unused	unused	unused	unused	unused	unused
	bit 23	bit 22	bit 21	bit 20	bit 19	bit 18	bit 17	bit 16
	unused	unused	clkpd1	unused	unused	unused	unused	unused
	bit 15	bit 14	bit 13	bit 12	bit 11	bit 10	bit 9	bit 8
	unused	unused	unused	Pod 12	Pod 11	Pod 10	Pod 9	Pod 8
	bit 7	bit 6	bit 5	bit 4	bit 3	bit 2	bit 1	bit 0
	Pod 7	Pod 6	Pod 5	Pod 4	Pod 3	Pod 2	Pod 1	unused

Example xxxx xxxx xx1x xxxx xxx0 0000 0001 111x indicates that data pods 1 through 4 and clock pod 1 are assigned to this analyzer (x = unused).

- 41 4 bytes - Master chip for this analyzer.
- 45 4 bytes - Maximum hardware memory depth available for this analyzer.
- 49 4 bytes - Unused.
- 53 8 bytes - Sample period in picoseconds (timing only).

Example The following 64 bits represent a sample period of 8,000 picoseconds (8 nanoseconds):

00000000 00000000 00000000 00000000 00000000 00000000 00011111 01000000

Byte Position

- 61 4 bytes - Tag type for state mode in one of the following decimal values:
 - 0 = off
 - 1 = time tags
 - 2 = state tags
- 65 8 bytes - Trigger offset. The time offset (in picoseconds) from when this analyzer is triggered and when this analyzer provides an output trigger to the IMB or port out. The value for one analyzer is always zero and the value for the other analyzer is the time between the triggers of the two analyzers.
- 73 30 bytes - Unused
- 103 70 bytes - The next 70 bytes are for Analyzer 2 Data Information. They are organized in the same manner as Analyzer 1 above, but they occupy bytes 103 through 172.
- 173 88 bytes - Number of valid rows of data (starting at byte 591) for each pod.

Bytes 173 through 212 Unused

Bytes 213 through 216 contain the number of valid rows of data for pod 4 of the highest card slot expansion card in a three-card module.

Bytes 217 through 220 contain the number of valid rows of data for pod 3 of the highest cardslot expansion card in a three-card module.

Bytes 221 through 224 contain the number of valid rows of data for pod 2 of the highest cardslot expansion card in a three-card module.

Bytes 225 through 228 contain the number of valid rows of data for pod 1 of the highest cardslot expansion card in a three-card module.

Bytes 229 through 232 contain the number of valid rows of data for pod 4 of either the expansion card in a two-card module, or a middle cardslot expansion card in a three-card module.

Bytes 233 through 236 contain the number of valid rows of data for pod 3 of either the expansion card in a two-card module, or a middle cardslot expansion card in a three-card module.

Bytes 237 through 240 contain the number of valid rows of data for pod 2 of either the expansion card in a two-card module, or a middle cardslot expansion card in a three-card module.



Byte Position **Bytes 241 through 244** contain the number of valid rows of data for pod 1 of either the expansion card in a two-card module, or a middle cardslot expansion card in a three-card module.

Bytes 245 through 248 contain the number of valid rows of data for pod 4 of the master card.

Bytes 249 through 252 contain the number of valid rows of data for pod 3 of the master card.

Bytes 253 through 256 contain the number of valid rows of data for pod 2 of the master card.

Bytes 257 through 260 contain the number of valid rows of data for pod 1 of the master card.

261 88 bytes - The trigger point location for each pod, organized in the same way as the data rows (bytes 173 – 260). These rows start at 0, which represents the first sample stored for a pod. Bytes 345 through 348 contain the trigger location for pod 1.

Example

If bytes 341 and 344 contain the value 101008, the data in row 101008 for that pod is the trigger. There are 101008 rows of pre-trigger data.

349 234 bytes - Unused

583 2 bytes - Real Time Clock (RTC) year at time of acquisition. Year value is equal to the year minus 1990.

585 2 bytes - RTC month (1 = January . . . 12 = December) at time of acquisition.

586 1 byte - RTC day of the month at time of acquisition.

587 1 byte - RTC day of the week at time of acquisition.

588 1 byte - RTC hour (0 through 23) at time of acquisition.

589 1 byte - RTC minutes at time of acquisition.

590 1 byte - RTC seconds at time of acquisition.

Acquisition Data Description

The acquisition data section consists of a variable number of bytes depending on the number of cards in the configuration, the acquisition mode, and the state tag setting. The data is grouped in rows of bytes with one sample from each pod in a single row. The width of the row is based on the number of cards in the system. Each card has four pods with two bytes of data per pod. The clock pod data (four bytes) is always first in the data row. The first two bytes of the clock pod data are unused. The total number of bytes in a data row for the various card count configurations is:

Cards	Clock Pod Bytes	Data Bytes	Total Bytes Per Row
1	4 bytes	8 bytes	12 bytes
2	4 bytes	16 bytes	20 bytes
3	4 bytes	24 bytes	28 bytes

The sequence of pod data within a row is the same as shown above for the number of valid rows per pod. The number of valid rows per pod can be determined by examining bytes 253 through 256 for pod pair 3/4 of the master card and bytes 257 through 260 for pod pair 1/2 of the master card. The number of valid rows for other pod pairs is contained in bytes 213 through 252.

A one-card configuration has the following data arrangement (per row):

```
<clk pod 1> <pod 4> <pod 3> <pod 2> <pod 1>
```

A two-card configuration has the following data arrangement (per row):

```
<-----expansion card -----><-----master card----->
<clk 1><pod 4><pod 3><pod 2><pod 1><pod 4><pod 3><pod 2><pod 1>
```

A three-card configuration has the following data arrangement per row:

```
<- high expander -><-lower expander -><---master card--->
<clk 1><pod 4>. . .<pod 1><pod 4>. . .<pod 1><pod 4>. . .<pod 1>
```

If the data block is unloaded without first using the DBLock command to specify UNPacked data, this data block description does not apply.

Unused pods always have data, however it is invalid and should be ignored.



DATA and SETUp Commands
Acquisition Data Description

The depth of the data array is equal to the pod with the greatest number of rows of valid data. If a pod has fewer rows of valid data than the data array, unused rows will contain invalid data that should be ignored.

The clock pod contains data mapped according to the clock designator and the board (see below). Unused clock lines should be ignored.

```
exp2 exp1 mstr  
Clock Pod 1 < xxxx MLKJ MLKJ MLKJ >
```

Where x = not used, mstr = master card, exp# = expander card number.

Byte Position

- 591 2 bytes - Not used (clock pod 2).
- 593 1 byte - MSB of clock pod 1.
- 594 1 byte - LSB of clock pod 1.
- 595 1 byte - MSB of data pod 4, board x.
- 596 1 byte - LSB of data pod 4, board x.
- 597 1 byte - MSB of data pod 3, board x.
- 598 1 byte - LSB of data pod 3, board x.
- 599 1 byte - MSB of data pod 2, board x.
- 600 1 byte - LSB of data pod 2, board x.
- 601 1 byte - MSB of data pod 1, board x.
- 602 1 byte - LSB of data pod 1, board x.
- .
- .
- Byte n where $n = 591 + (\text{bytes per row} \times \text{maximum number of valid rows}) - 1$

Example

A three-card configuration with 516096 valid rows

First data byte = byte 591

Last data byte = 14,451,278 [591 + (28 × 516096) - 1]

Time Tag Data Description

If tags are enabled for one or both analyzers, the tag data follows the acquisition data. The first byte of the tag data is determined as follows:

$$591 + (\text{bytes per row} \times \text{maximum number of valid rows})$$

Each row of the tag data array consists of one (single analyzer with state tags) or two (both analyzers with state tags) eight-byte tag values per row. When both analyzers have state tags enabled, the first tag value in a row belongs to Machine 1 and the second tag value belongs to Machine 2.

If the tag value is a time tag, the number is an integer representing time in picoseconds. If the tag value is a state tag, the number is an integer state count.

The total size of the tag array is 8 or 16 bytes per row times the greatest number of valid rows.

SYSTEM:SETup

Command

:SYStem:SETup <block data>

The SYStem:SETup command configures the logic analyzer module as defined by the block data sent by the controller. It is not affected by DBLock.

There are three data sections which are always returned. The strings which are included in the section header are:

```
"CONFIG      "  
"DISPLAY1   "  
"BIG_ATTRIB"
```



Additionally, the following sections may also be included, depending on what is available:

```
"SYMBOLS A "  
"SYMBOLS B "  
"INVASM A "  
"INVASM B "
```

<block data>	<block length specifier><section>...
<block length specifier>	#8<length>
<length>	the total length of all sections in byte format (must be represented with 8 digits)
<section>	<section header><section data>
<section header>	16 bytes in the following format: 10 bytes for the section name 1 byte reserved 1 byte for the module ID code (34 for the HP 16554A and HP 16555A/D logic analyzer) 4 bytes for the length of the section data in bytes
<section data>	format depends on the type of data. The total length of a section is 16 (for the section header) plus the length of the section data. So when calculating the value for <length>, don't forget to include the length of the section headers. The format of the setup block is not affected by the DBLock command setting.

Example

OUTPUT XXX; "SETUP" <block data>

Query :SYSTem:SETup?

The SYSTem:SETup query returns a block of data that contains the current configuration to the controller.

Returned Format [:SYSTem:SETup] <block data><NL>

Part 3

18 Programming Examples

Programming Examples



Programming Examples

Introduction

This chapter contains short, usable, and tested programs that cover the most asked for examples. The examples are written in HP BASIC 6.0.

- Making a timing analyzer measurement
- Making a state analyzer measurement
- Making a state compare analyzer measurement
- Transferring logic analyzer configuration between the logic analyzer and the controller
- Checking for measurement completion
- Sending queries to the logic analyzer

Making a Timing Analyzer Measurement

This program sets up the logic analyzer to make a simple timing analyzer measurement. This example can be used with E2422-60004 Logic Analyzer Training board to acquire and display the output of the ripple counter. It can also be modified to make any timing analyzer measurement.

```
10  ! ***** TIMING ANALYZER EXAMPLE *****
11  !                                     for the HP 16554A/HP 16555A/HP 16555D Logic Analyzer
12  !
13  ! *****
14  ! Select the module slot in which the HP 16554A/HP 16555A/D is installed.
15  ! In this example, it is in slot B of the mainframe.
16  !
17  !
18  OUTPUT 707;":SELECT 2"
19  !
20  ! *****
21  ! Name Machine 1 "TIMING," configure Machine 1 as a timing analyzer,
22  ! and assign pod 1 to Machine 1.
23  !
24  !
25  OUTPUT 707;":MACH1:NAME 'TIMING'"
26  OUTPUT 707;":MACH1:TYPE TIMING"
27  OUTPUT 707;":MACH1:ASSIGN 1"
28  !
29  ! *****
30  ! Make a label "COUNT," give the label a positive polarity, and
31  ! assign the lower 8 bits.
32  !
33  !
34  OUTPUT 707;":MACHINE1:TFORMAT:REMOVE ALL"
35  OUTPUT 707;":MACH1:TFORMAT:LABEL 'COUNT',POS,0,0,#B0000000011111111"
36  !
37  ! *****
38  ! Specify FF hex for resource term A, which is the default
39  ! trigger term for the timing analyzer.
40  !
41  !
42  OUTPUT 707;":MACH1:TTRACE:TERM A, 'COUNT', '#HFF'"
43  !
44  ! *****
45  ! Remove any previously inserted labels, insert the "COUNT"
46  ! label, change the seconds-per-division to 100 ns, and display the
47  ! waveform menu.
48  !
```



Programming Examples Making a Timing Analyzer Measurement

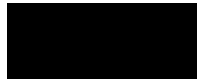
```
360 OUTPUT 707;":MACH1:TWAVEFORM:REMOVE"  
370 OUTPUT 707;":MACH1:TWAVEFORM:INSERT 'COUNT', ALL"  
380 OUTPUT 707;":MACH1:TWAVEFORM:RANGE 1E-6"  
390 OUTPUT 707;":MENU 2,5"  
400 !  
410 ! *****  
420 ! Run the timing analyzer in single mode.  
430 !  
440 OUTPUT 707;":RMODE SINGLE"  
450 OUTPUT 707;":START"  
460 !  
470 ! *****  
480 ! Set the marker mode (MMODE) to time so that patterns are available  
490 ! for marker measurements. Place the X-marker on 03 hex and the O-  
500 ! marker on 07 hex. Then tell the timing analyzer to find the first  
510 ! occurrence of 03h after the trigger and the first occurrence of 07h  
520 ! after the X-marker is found.  
530 !  
540 OUTPUT 707;":MACHINE1:TWAVEFORM:MMODE PATTERN"  
550 !  
560 OUTPUT 707;":MACHINE1:TWAVEFORM:XPATTERN 'COUNT','#H03' "  
570 OUTPUT 707;":MACHINE1:TWAVEFORM:OPATTERN 'COUNT','#H07' "  
580 !  
590 OUTPUT 707;":MACHINE1:TWAVEFORM:XCONDITION ENTERING"  
600 OUTPUT 707;":MACHINE1:TWAVEFORM:OCONDITION ENTERING"  
610 !  
620 OUTPUT 707;":MACHINE1:TWAVEFORM:XSEARCH +1, TRIGGER"  
625 WAIT 2  
630 OUTPUT 707;":MACHINE1:TWAVEFORM:OSEARCH +1, XMARKER"  
635 WAIT 2  
640 !  
650 ! *****  
660 ! Turn the longform and headers on, dimension a string for the query  
670 ! data, send the XOTIME query and print the string containing the  
680 ! XOTIME query data.  
690 !  
700 OUTPUT 707;":SYSTEM:LONGFORM ON"  
710 OUTPUT 707;":SYSTEM:HEADER ON"  
720 !  
730 DIM Mtime$[100]  
740 OUTPUT 707;":MACHINE1:TWAVEFORM:XOTIME?"  
750 ENTER 707;Mtime$  
760 PRINT Mtime$  
770 END
```

Making a State Analyzer Measurement

This state analyzer program selects the HP 16554A/HP 16555A/HP 16555D module, displays the configuration menu, defines a state machine, displays the state trigger menu, sets a state trigger for multilevel triggering. This program then starts a single acquisition measurement while checking for measurement completion.

This program is written so that you can run it with the HP E2433-60004 Logic Analyzer Training Board. This example is the same as the "Multilevel State Triggering" example in chapter 9 of the *HP E2433 Logic Analyzer Training Kit*.

```
10      ! ***** STATE ANALYZER EXAMPLE *****
20      !           for the HP 16554A/HP 16555A/HP 16555D Logic Analyzer
30      !
40      ! ***** SELECT THE HP 16554/HP 16555 MODULE *****
50      ! Select slot in which the HP 16554A/HP 16555A/HP 16555D is installed.
60      ! In this example, it is in slot B of the mainframe.
70      !
80      OUTPUT 707;":SELECT 2"
90      !
100     ! ***** CONFIGURE THE STATE ANALYZER *****
110     ! Name Machine 1 "STATE," configure Machine 1 as a state analyzer, assign
120     ! pod 1 to Machine 1, and display System Configuration menu of the
130     ! HP 16554A/HP 16555A/HP 16555D.
140     !
150     OUTPUT 707;":MACHINE1:NAME 'STATE'"
160     OUTPUT 707;":MACHINE1:TYPE STATE"
170     OUTPUT 707;":MACHINE1:ASSIGN 1"
180     OUTPUT 707;":MENU 2,0"
190     !
200     ! ***** SETUP THE FORMAT SPECIFICATION *****
210     ! Make a label "SCOUNT," give the label a positive polarity, and
220     ! assign the lower 8 bits.
230     !
240     OUTPUT 707;":MACHINE1:SFORMAT:REMOVE ALL"
250     OUTPUT 707;":MACHINE1:SFORMAT:LABEL 'SCOUNT', POS, 0,0,255"
260     !
```



Programming Examples Making a State Analyzer Measurement

```
270 ! ***** SETUP THE TRIGGER SPECIFICATION *****
280 ! The trigger specification will use five sequence levels with the trigger
290 ! level on level four. Resource terms A through E, and RANGE1 will be
300 ! used to store only desired counts from the 8-bit ripple counter.
310 !
320 ! Display the state trigger menu.
330 !
340 OUTPUT 707;":MENU 2,3"
350 !
360 ! Create a 5-level trigger specification with the trigger on the
370 ! fourth level.
380 !
390 OUTPUT 707;":MACHINE1:STRIGGER:SEQUENCE 5,4"
400 !
410 ! Define pattern terms A, B, C, D, and E to be 11, 22, 33, 44 and 59
420 ! decimal respectively.
430 !
440 OUTPUT 707;":MACHINE1:STRIGGER:TERM A,'SCOUNT','11'"
450 OUTPUT 707;":MACHINE1:STRIGGER:TERM B,'SCOUNT','22'"
460 OUTPUT 707;":MACHINE1:STRIGGER:TERM C,'SCOUNT','33'"
470 OUTPUT 707;":MACHINE1:STRIGGER:TERM D,'SCOUNT','44'"
480 OUTPUT 707;":MACHINE1:STRIGGER:TERM E,'SCOUNT','59'"
490 !
500 ! Define a Range having a lower limit of 50 and an upper limit of 58.
510 !
520 OUTPUT 707;":MACHINE1:STRIGGER:RANGE1 'SCOUNT','50','58'"
530 !
540 ! ***** CONFIGURE SEQUENCE LEVEL 1 *****
550 ! Store NOSTATE in level 1 and Then find resource term "A" once.
560 !
570 OUTPUT 707;":MACHINE1:STRIGGER:STORE1 'NOSTATE'"
580 OUTPUT 707;":MACHINE1:STRIGGER:FIND1 'A',1"
590 !
600 ! ***** CONFIGURE SEQUENCE LEVEL 2 *****
610 ! Store RANGE1 in level 2 and Then find resource term "E" once.
620 !
630 OUTPUT 707;":MACHINE1:STRIGGER:STORE2 'IN_RANGE1'"
640 OUTPUT 707;":MACHINE1:STRIGGER:FIND2 'E',1"
650 !
660 ! ***** CONFIGURE SEQUENCE LEVEL 3 *****
670 ! Store NOSTATE in level 3 and Then find term "B" once.
680 !
690 OUTPUT 707;":MACHINE1:STRIGGER:STORE3 'NOSTATE'"
700 OUTPUT 707;":MACHINE1:STRIGGER:FIND3 'B',1"
710 !
```

```
720 ! ***** CONFIGURE SEQUENCE LEVEL 4 *****
730 ! Store a combination of resource terms (C or D or RANGE1) in level 4 and
740 ! Then Trigger on resource term "E."
750 !
760 OUTPUT 707;":MACHINE1:STRIGGER:STORE4 '(C OR D OR IN_RANGE1)'"
770 !
780 ! ***** NOTE *****
790 ! The FIND command selects the trigger in the
800 ! sequence level specified as the trigger level.
810 ! *****
820 !
830 OUTPUT 707;":MACHINE1:STRIGGER:FIND4 'E',1"
840 !
850 ! ***** CONFIGURE SEQUENCE LEVEL 5 *****
860 ! Store anystate on level 5
870 !
880 OUTPUT 707;":MACHINE1:STRIGGER:STORE5 'ANystate'"
890 !
900 ! ***** START ACQUISITION *****
910 ! Place the logic analyzer in single acquisition mode, then determine when
920 ! the acquisition is complete.
930 !
940 OUTPUT 707;":RMODE SINGLE"
950 !OUTPUT 707;":*CLS"
960 OUTPUT 707;":START"
970 !
980 ! ***** CHECK FOR MEASUREMENT COMPLETE *****
990 ! Enable the MESR register and query the register for a measurement
1000 ! complete condition.
1010 !
1020 OUTPUT 707;":SYSTEM:HEADER OFF"
1030 OUTPUT 707;":SYSTEM:LONGFORM OFF"
1040 !
1050 Status=0
1060 OUTPUT 707;":MESE2 1"
1070 OUTPUT 707;":MESR2?"
1080 ENTER 707;Status
1090 !
1100 ! Print the MESR register status.
1110 !
1120 CLEAR SCREEN
1130 PRINT "Measurement complete status is ";Status AND 1
1140 PRINT "0 = not complete, 1 = complete"
1150 ! Repeat the MESR query until measurement is complete.
1160 WAIT 1
```



Programming Examples
Making a State Analyzer Measurement

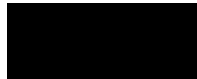
```
1170 IF (Status AND 1)=1 THEN GOTO 1190
1180 GOTO 1070
1190 PRINT TABXY(30,15);"Measurement is complete"
1200 !
1210 ! ***** VIEW THE RESULTS *****
1220 ! Display the State Listing and select a line number in the listing that
1230 ! allows you to see the beginning of the listing on the logic analyzer
1240 ! display.
1250 !
1260 OUTPUT 707;":MACHINE1:SLIST:COLUMN 1, 'SCOUNT', DECIMAL"
1270 OUTPUT 707;":MENU 2,7"
1280 OUTPUT 707;":MACHINE1:SLIST:LINE -16"
1290 !
1300 END
```

Making a State Compare Analyzer Measurement

This program example acquires a state listing, copies the listing to the compare listing, acquires another state listing, and compares both listings to find differences.

This program is written so that you can run it with the HP E2433-60004 Logic Analyzer Training Board. This example is the same as the "State Compare" example in chapter 3 of the *HP E2433 Logic Analyzer Training Kit*.

```
10      ! ***** STATE COMPARE EXAMPLE *****
20      !           for the HP 16554A/HP 16555A/HP 16555D Logic Analyzer
30      !
40      !
50      !***** SELECT THE HP 16554A/HP 16555A/HP 16555D MODULE *****
60      ! Select the slot in which the module is installed.
70      ! In this example, it is in slot B of the mainframe.
80      !
90      OUTPUT 707;":SELECT 2"
100     !
110     !***** CONFIGURE THE STATE ANALYZER *****
120     ! Name Machine 1 "STATE," configure Machine 1 as a compare state
130     ! analyzer, and assign pod 1 to Machine 1.
140     !
150     OUTPUT 707;":MACHINE1:NAME 'STATE' "
160     OUTPUT 707;":MACHINE1:TYPE COMPARE"
170     OUTPUT 707;":MACHINE1:ASSIGN 1"
180     !
190     ! *****
200     ! Remove all labels previously set up, make a label "SCOUNT," specify
210     ! positive logic, and assign the lower 8 bits of pod 1 to the label.
220     !
230     OUTPUT 707;":MACHINE1:SFORMAT:REMOVE ALL"
240     OUTPUT 707;":MACHINE1:SFORMAT:LABEL 'SCOUNT', POS, 0,0,255"
250     !
260     ! *****
270     ! Make the "J" clock the Master clock and specify the falling edge.
280     !
290     OUTPUT 707;":MACHINE1:SFORMAT:MASTER J, FALLING"
300     !
```



Programming Examples Making a State Compare Analyzer Measurement

```
310 ! *****
320 ! Specify two sequence levels, the trigger sequence level, specify
330 ! FF hex for the "a" term which will be the trigger term, and store
340 ! no states until the trigger is found.
350 !
360 OUTPUT 707;":MACHINE1:STRIGGER:SEQUENCE 2,1"
370 OUTPUT 707;":MACHINE1:STRIGGER:TERM A,'SCOUNT','#HFF'"
380 OUTPUT 707;":MACHINE1:STRIGGER:STORE1 'NOSTATE'"
390 OUTPUT 707;":MENU 2,3"
400 !
410 ! *****
420 ! Change the displayed menu to the state listing and start the state
430 ! analyzer in repetitive mode.
440 !
450 OUTPUT 707;":MENU 2,7"
460 OUTPUT 707;":RMODE REPETITIVE"
470 OUTPUT 707;":START"
480 !
490 ! *****
500 ! The logic analyzer is now running in the repetitive mode
510 ! and will remain in repetitive until the STOP command is sent.
520 !
530 PRINT "The logic analyzer is now running in the repetitive mode"
540 PRINT "and will remain in repetitive until the STOP command is sent."
550 PRINT
560 PRINT "Press CONTINUE"
570 PAUSE
580 !
590 !*****
600 ! Stop the acquisition and copy the acquired data to the compare reference
610 ! listing.
620 !
630 OUTPUT 707;":STOP"
640 OUTPUT 707;":MENU 2,10"
650 OUTPUT 707;":MACHINE1:COMPARE:MENU REFERENCE"
660 OUTPUT 707;":MACHINE1:COMPARE:COPY"
670 !
680 ! The logic analyzer acquisition is now stopped, the Compare menu
690 ! is displayed, and the data is now in the compare reference
700 ! listing.
710 !
```



```
720 !*****
730 ! Display line 4090 of the compare listing and start the analyzer
740 ! in a repetitive mode.
750 !
760 OUTPUT 707;":MACHINE1:COMPARE:LINE 4090"
770 OUTPUT 707;":START"
780 !
790 ! Line 4090 of the listing is now displayed at center screen.
810 ! In this example, the states are stable. However, in some
820 ! cases, the end points of the listing may vary thus causing
830 ! a false failure in compare. To eliminate this problem, a
840 ! partial compare can be specified to provide predictable end
850 ! points of the data.
860 !
870 PRINT "Press CONTINUE to send the STOP command."
880 PAUSE
890 OUTPUT 707;":STOP"
900 !
910 !*****
920 ! The end points of the compare can be fixed to prevent false failures.
930 ! In addition, you can use partial compare to compare only sections
940 ! of the state listing you are interested in comparing.
950 !
960 OUTPUT 707;":MACHINE1:COMPARE:RANGE PARTIAL, 0, 508"
970 !
980 ! The compare range is now from line 0 to +508
990 !
1000 !*****
1010 ! Change the Glitch jumper settings on the training board so that the
1020 ! data changes, reacquire the data and compare which states are different.
1030 PRINT "Change the glitch jumper settings on the training board so that "
1040 PRINT "the data changes, reacquire the data and compare which states are "
1041 PRINT "different."
1050 !
1060 PRINT "Press CONTINUE when you have finished changing the jumper."
1070 !
1080 PAUSE
1090 !
```



Programming Examples Making a State Compare Analyzer Measurement

```
1100 !*****
1110 ! Start the logic analyzer to acquire new data and then stop it to compare
1120 ! the data. When the acquisition is stopped, the Compare Listing Menu will
1130 ! be displayed.
1140 !
1150 OUTPUT 707;":START"
1155 WAIT 2
1160 OUTPUT 707;":STOP"
1170 OUTPUT 707;":MENU 2,10"
1180 !
1190 !*****
1200 ! Dimension strings in which the compare find query (COMPARE:FIND?)
1210 ! enters the line numbers and error numbers.
1220 !
1230 DIM Line$(20)
1240 DIM Error$(4)
1250 DIM Comma$(1)
1260 !
1270 ! *****
1280 ! Display the Difference listing.
1290 !
1300 OUTPUT 707;":MACHINE1:COMPARE:MENU DIFFERENCE"
1310 !
1320 ! *****
1330 ! Loop to query all 508 possible errors.
1340 !
1350 FOR Error=1 TO 508
1360 !
1370 ! Read the compare differences
1380 !
1390 OUTPUT 707;":MACHINE1:COMPARE:FIND? " & VAL$(Error)
1400 !
1410 ! *****
1420 ! Format the Error$ string data for display on the controller screen.
1430 !
1440 IF Error>99 THEN GOTO 1580
1450 IF Error>9 THEN GOTO 1550
1460 !
1470 ENTER 707 USING "#,1A";Error$
1480 ENTER 707 USING "#,1A";Comma$
1490 ENTER 707 USING "K";Line$
1500 Error_return=IVAL(Error$,10)
1510 IF Error_return=0 THEN GOTO 1820
1520 !
1530 GOTO 1610
```

```
1540 !
1550 ENTER 707 USING "#,2A";Error$
1555 ENTER 707 USING "#,1A";Comma$
1560 ENTER 707 USING "K";Line$
1570 GOTO 1610
1580 !
1590 ENTER 707 USING "#,3A";Error$
1595 ENTER 707 USING "#,1A";Comma$
1600 ENTER 707 USING "K";Line$
1610 !
1620 ! *****
1630 ! Test for the last error. The error number of the last error is the same
1640 ! as the error number of the first number after the last error.
1650 !
1660 Error_line=IVAL(Line$,10)
1670 IF Error_line=Error_line2 THEN GOTO 1780
1680 Error_line2=Error_line
1690 !
1700 ! *****
1710 ! Print the error numbers and the corresponding line numbers on the
1720 ! controller screen.
1730 !
1740 PRINT "Error number ",Error," is on line number ",Error_line
1750 !
1760 NEXT Error
1770 !
1780 PRINT
1790 PRINT
1800 PRINT "Last error found"
1810 GOTO 1850
1820 PRINT "No errors found"
1830 !
1840 !
1850 END
```



Transferring the Logic Analyzer Configuration

This program uses the `SYSTEM:SETup` query to transfer the configuration of the logic analyzer to your controller. This program also uses the `SYSTEM:SETup` command to transfer a logic analyzer configuration from the controller back to the logic analyzer. The configuration data will set up the logic analyzer according to the data. It is useful for getting configurations for setting up the logic analyzer by the controller. The `SYSTEM:SETup` command differs from the `SYSTEM:DATA` command because it only transfers the configuration and not acquired data.

```
10 ! ***** SETUP COMMAND AND QUERY EXAMPLE *****
20 !           for the HP 16554A/HP 16555A/HP 16555D
30 !
40 ! ***** CREATE TRANSFER BUFFER *****
50 ! Create a buffer large enough for the block data. See "Sending Queries
51 ! to the Logic Analyzer" for how to calculate buffer size for data. This
52 ! buffer is only big enough for setup information.
53 !
60 ASSIGN @Buff TO BUFFER [320000]
70 !
80 ! ***** INITIALIZE HPIB DEFAULT ADDRESS *****
90 !
100 REAL Address
110 Address=707
120 ASSIGN @Comm TO Address
130 !
140 CLEAR SCREEN
150 !
160 ! ***** INITIALIZE VARIABLE FOR NUMBER OF BYTES *****
170 ! The variable "Numbytes" contains the number of bytes in the buffer.
180 !
190 REAL Numbytes
200 Numbytes=0
210 !
220 ! ***** RE-INITIALIZE TRANSFER BUFFER POINTERS *****
230 !
240 CONTROL @Buff,3;1
250 CONTROL @Buff,4;0
260 !
```

```
270 ! ***** SEND THE SETUP QUERY *****
280 OUTPUT 707;":SYSTEM:HEADER ON"
290 OUTPUT 707;":SYSTEM:LONGFORM ON"
300 OUTPUT @Comm;":SELECT 2"
310 OUTPUT @Comm;":SYSTEM:SETUP?"
320 !
330 ! ***** ENTER THE BLOCK SETUP HEADER *****
340 ! Enter the block setup header in the proper format.
350 !
360 ENTER @Comm USING "#,B";Byte
370 PRINT CHR$(Byte);
380 WHILE Byte<>35
390     ENTER @Comm USING "#,B";Byte
400     PRINT CHR$(Byte);
410 END WHILE
420 ENTER @Comm USING "#,B";Byte
430 PRINT CHR$(Byte);
440 Byte=Byte-48
450 IF Byte=1 THEN ENTER @Comm USING "#,D";Numbytes
460 IF Byte=2 THEN ENTER @Comm USING "#,DD";Numbytes
470 IF Byte=3 THEN ENTER @Comm USING "#,DDD";Numbytes
480 IF Byte=4 THEN ENTER @Comm USING "#,DDDD";Numbytes
490 IF Byte=5 THEN ENTER @Comm USING "#,DDDDD";Numbytes
500 IF Byte=6 THEN ENTER @Comm USING "#,DDDDDD";Numbytes
510 IF Byte=7 THEN ENTER @Comm USING "#,DDDDDDD";Numbytes
520 IF Byte=8 THEN ENTER @Comm USING "#,DDDDDDDD";Numbytes
530 PRINT Numbytes
540 !
550 ! ***** TRANSFER THE SETUP *****
560 ! Transfer the setup from the logic analyzer to the buffer.
570 !
580 TRANSFER @Comm TO @Buff;COUNT Numbytes,WAIT
600 !
610 ENTER @Comm USING "-K";Length$
620 PRINT "LENGTH of Length string is";LEN(Length$)
630 !
640 PRINT "**** GOT THE SETUP ****  Press Continue when ready"
650 PAUSE
```



Programming Examples Transferring the Logic Analyzer Configuration

```
660 ! ***** SEND THE SETUP *****
670 ! Make sure buffer is not empty.
680 !
690 IF Numbytes=0 THEN
700     PRINT "BUFFER IS EMPTY"
710     GOTO 1170
720 END IF
730 !
740 ! ***** SEND THE SETUP COMMAND *****
750 ! Send the Setup command
760 !
770 OUTPUT @Comm USING "#,15A";":SYSTEM:SETUP #"
780 PRINT "SYSTEM:SETUP command has been sent.  Press Continue to send setup"
790 PAUSE
800 !
810 ! ***** SEND THE BLOCK SETUP *****
820 ! Send the block setup header to the module in the proper
821 ! format.
830 !
840 Byte=LEN(VAL$(Numbytes))
850 OUTPUT @Comm USING "#,B"; (Byte+48)
860 IF Byte=1 THEN OUTPUT @Comm USING "#,A";VAL$(Numbytes)
870 IF Byte=2 THEN OUTPUT @Comm USING "#,AA";VAL$(Numbytes)
880 IF Byte=3 THEN OUTPUT @Comm USING "#,AAA";VAL$(Numbytes)
890 IF Byte=4 THEN OUTPUT @Comm USING "#,AAAA";VAL$(Numbytes)
900 IF Byte=5 THEN OUTPUT @Comm USING "#,AAAAA";VAL$(Numbytes)
910 IF Byte=6 THEN OUTPUT @Comm USING "#,AAAAAA";VAL$(Numbytes)
920 IF Byte=7 THEN OUTPUT @Comm USING "#,AAAAAAA";VAL$(Numbytes)
930 IF Byte=8 THEN OUTPUT @Comm USING "#,AAAAA";VAL$(Numbytes)
940 !
950 ! ***** SAVE BUFFER POINTERS *****
960 ! Save the transfer buffer pointer so it can be restored after the
970 ! transfer.
980 !
990 STATUS @Buff,5;Streg
1000 !
1010 ! ***** TRANSFER SETUP TO THE MODULE *****
1020 ! Transfer the setup from the buffer to the HP 16554A/HP 16555A/HP 16555D.
1030 !
1040 TRANSFER @Buff TO @Comm;COUNT Numbytes, WAIT
1050 !
```

```
1060 ! ***** RESTORE BUFFER POINTERS *****
1070 ! Restore the transfer buffer pointer
1080 !
1090 CONTROL @Buff,5;Streg
1100 !
1110 ! ***** SEND TERMINATING LINE FEED *****
1120 ! Send the terminating linefeed to properly terminate the setup string.
1130 !
1140 OUTPUT @Comm;"
1150 !
1160 PRINT "**** SENT THE SETUP **** Program complete."
1170 END
```



Checking for Measurement Completion

This program can be appended to or inserted into another program when you need to know when a measurement is complete. If it is at the end of a program it will tell you when measurement is complete. If you insert it into a program, it will halt the program until the current measurement is complete. In this example, the module installed in slot B is being checked for measurement complete.

This program is also in the state analyzer example program in "Making a State Analyzer Measurement" on page 18-5. It is included in the state analyzer example program to show how it can be used in a program to halt the program until measurement is complete.

```
420 ! ***** CHECK FOR MEASUREMENT COMPLETE *****
430 ! Enable the MESR register and query the register for a measurement
440 ! complete condition.
450 !
460 OUTPUT 707;":SYSTEM:HEADER OFF"
470 OUTPUT 707;":SYSTEM:LONGFORM OFF"
480 !
490 Status=0
500 OUTPUT 707;":MESE2 1" ! Enables register for slot B
510 OUTPUT 707;":MESR2?" ! Queries register for slot B
520 ENTER 707;Status
530 !
540 ! Print the MESR register status.
550 !
560 CLEAR SCREEN
570 PRINT "Measurement complete status is ";Status AND 1
580 PRINT "0 = not complete, 1 = complete"
590 ! Repeat the MESR query until measurement is complete.
600 WAIT 1
610 IF (Status AND 1)=1 THEN GOTO 630
620 GOTO 510
630 PRINT TABXY(30,15);"Measurement is complete"
640 !
650 END
```

Sending Queries to the Logic Analyzer

This program example contains the steps required to send a query to the logic analyzer. Sending the query alone only puts the requested information in an output buffer of the logic analyzer. You must follow the query with an ENTER statement to transfer the query response to the controller. When the query response is sent to the logic analyzer, the query is properly terminated in the logic analyzer. If you send the query but fail to send an ENTER statement, the logic analyzer will display the error message "Query Interrupted" when it receives the next command from the controller, and the query response is lost.

```
10 ! ***** DATA COMMAND AND QUERY EXAMPLE *****
11 !
12 !           for the HP 16554A/HP 16555A/HP 16555D
13 !
14 ! ***** CREATE TRANSFER BUFFER *****
15 !
16 ! NOTE WELL! The data from the 16554A may be up to 19Mbytes long!
17 ! NOTE WELL! The data from the 16555A may be up to 38Mbytes long!
18 ! NOTE WELL! The data from the 16555D may be up to 76Mbytes long!
19 ! You may estimate the size of the buffer needed using the following
20 ! formula.
21 !
22 ! LET Cards = Number of 16554/16555 cards in your module.
23 ! LET Samples = Memory Length (see Acquisition Control in Trigger Menu)
24 ! LET BufferSize = (12 * Samples * Boards) + 1000
25 !
26 ! For example, a 1 board system with a full memory length of 1040384
27 ! requires (12 * 1040384) + 1000 = 12,485,608 bytes.
28 !
29 ! You may have to enlarge the workspace of your Basic environment
30 ! to accomodate this buffer.
31 ASSIGN @Buff TO BUFFER [3700000]
32 !
33 ! ***** INITIALIZE HPIB DEFAULT ADDRESS *****
34 !
35 REAL Address
36 Address=707
37 ASSIGN @Comm TO Address
38 !
39 CLEAR SCREEN
```



Programming Examples Sending Queries to the Logic Analyzer

```
150  !
160  ! ***** INITIALIZE VARIABLE FOR NUMBER OF BYTES *****
170  ! The variable "Numbytes" contains the number of bytes in the buffer.
180  !
190  REAL Numbytes
200  Numbytes=0
210  !
220  ! ***** RE-INITIALIZE TRANSFER BUFFER POINTERS *****
230  !
240  CONTROL @Buff,3;1
250  CONTROL @Buff,4;0
260  !
270  ! ***** SEND THE DATA QUERY *****
280  OUTPUT 707;":SYSTEM:HEADER ON"
290  OUTPUT 707;":SYSTEM:LONGFORM ON"
300  OUTPUT @Comm;"SELECT 2"
310  OUTPUT @Comm;":SYSTEM:DATA?"
320  !
330  ! ***** ENTER THE BLOCK DATA HEADER *****
340  ! Enter the block data header in the proper format.
350  !
360  ENTER @Comm USING "#,B";Byte
370  PRINT CHR$(Byte);
380  WHILE Byte<>35
390     ENTER @Comm USING "#,B";Byte
400     PRINT CHR$(Byte);
410  END WHILE
420  ENTER @Comm USING "#,B";Byte
430  PRINT CHR$(Byte);
440  Byte=Byte-48
450  IF Byte=1 THEN ENTER @Comm USING "#,D";Numbytes
460  IF Byte=2 THEN ENTER @Comm USING "#,DD";Numbytes
470  IF Byte=3 THEN ENTER @Comm USING "#,DDD";Numbytes
480  IF Byte=4 THEN ENTER @Comm USING "#,DDDD";Numbytes
490  IF Byte=5 THEN ENTER @Comm USING "#,DDDDD";Numbytes
500  IF Byte=6 THEN ENTER @Comm USING "#,DDDDDD";Numbytes
510  IF Byte=7 THEN ENTER @Comm USING "#,DDDDDDD";Numbytes
520  IF Byte=8 THEN ENTER @Comm USING "#,DDDDDDDD";Numbytes
530  Str1$=DVAL$(Numbytes,10)
531  ! DVAL$ returns an 11 character string
532  PRINT Str1$[12-Byte]
540  !
```

```
550 ! ***** TRANSFER THE DATA *****
560 ! Transfer the data from the logic analyzer to the buffer.
570 !
580 TRANSFER @Comm TO @Buff;COUNT Numbytes, WAIT
590 !
600 ENTER @Comm USING "-K";Length$
610 PRINT "LENGTH of Length string is ";Byte
620 !
630 PRINT "**** GOT THE DATA **** Press continue."
640 PAUSE
650 ! ***** SEND THE DATA *****
660 ! Make sure buffer is not empty.
670 !
680 IF Numbytes=0 THEN
690     PRINT "BUFFER IS EMPTY"
700     GOTO 1170
710 END IF
720 !
730 ! ***** SEND THE DATA COMMAND *****
740 ! Send the Setup command
750 !
760 OUTPUT @Comm USING "#,14A";":SYSTEM:DATA #"
770 PRINT "SYSTEM:DATA command has been sent. Press continue."
780 PAUSE
790 !
800 ! ***** SEND THE BLOCK DATA *****
810 ! Send the block data header to the HP 16554A/HP 16555A in the proper
820 ! format.
830 !
840 OUTPUT @Comm USING "#,A";"8"
850 Str1$=DVAL$(Numbytes,10)
860 Byte=1
870 PRINT USING "AAAAAAA";Str1$(4)
880 OUTPUT @Comm USING "#,AAAAAAA";Str1$(4)
890 !
900 ! ***** SAVE BUFFER POINTERS *****
910 ! Save the transfer buffer pointer so it can be restored after the
920 ! transfer.
930 !
940 STATUS @Buff,5;Streg
950 !
1000 !
```



Programming Examples
Sending Queries to the Logic Analyzer

```
1010 ! ***** TRANSFER DATA TO THE HP 16554A/HP 16555 *****
1020 ! Transfer the data from the buffer to the HP 16554A/HP 16555A.
1030 !
1040 TRANSFER @Buff TO @Comm;COUNT Numbytes, WAIT
1050 !
1060 ! ***** RESTORE BUFFER POINTERS *****
1070 ! Restore the transfer buffer pointer
1080 !
1090 CONTROL @Buff,5;Streg
1100 !
1110 ! ***** SEND TERMINATING LINE FEED *****
1120 ! Send the terminating linefeed to properly terminate the data string.
1130 !
1140 OUTPUT @Comm;"
1150 !
1160 PRINT "**** SENT THE DATA **** Program complete."
1170 END
```

Index

A

A+B, 4-11, 13-19
A,B, 13-18
A-B, 13-13
ACCumulate command/query, 8-5, 9-4, 13-7
ACQMode command/query, 11-5
ACquisition command/query, 6-8, 8-5, 12-9, 13-8
acquisition size, 8-8, 12-16, 13-12
analyzer 1 data information, 17-7
analyzer 2 data information, 17-9
ARM command/query, 3-5
ARMLine selector, 2-5
ASSign command/query, 3-6
AUTorange command, 16-22
average time, 13-23, 14-17, 16-25

B

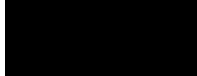
BASE command, 15-5
block data, 17-4
block length specifier, 17-4, , 17-5, 17-14
BRANch command/query, 6-9 to 6-10, 12-9 to 12-11
BUCKet query, 16-8

C

CARDcage query, 1-5
CENTer command, 8-6, 9-5, 13-9
chart display, 9-2
Chart menu, 9-2
CLEar command, 6-11, 10-5, 12-12
clock, 5-9
CLOCK command/query, 5-6
CLRPattern command, 7-8, 8-6, 13-9, 14-8
CLRStat command, 8-7, 13-9
CMASK command/query, 10-5
COLUMN command/query, 7-7, 14-7
command
 ACCumulate, 8-5, 9-4, 13-7
 ACQMode, 11-5
 ACquisition, 6-8, 12-9, 13-8
 ARM, 3-5
 ARMLine, 2-5
 ASSign, 3-6
 AUTorange, 16-22
 BASE, 15-5
 BRANch, 6-9, 12-9

CENTer, 8-6, 9-5, 13-9
CLEar, 6-11, 10-5
CLOCK, 5-6
CLRPattern, 7-8, 8-6, 13-9, 14-8
CLRStat, 8-7, 13-9
CMASK, 10-5
COLUMN, 7-7, 14-7
COMPARE, 10-4
COPY, 10-6
DATA, 10-6, 17-4
DBLOCK, 2-5
DELAY, 4-5, 8-7, 13-10
EDGE, 12-13
FIND, 6-12, 12-14
HAXIS, 9-5
HIGH, 16-9
HISTogram:LABEL, 16-17
HISTogram:OTHER, 16-18
HISTogram:QUALifier, 16-19
HISTogram:RANGE, 16-20
HISTogram:TTYPe, 16-21
INSERT, 4-6, 8-8, 13-11
LABEL, 5-7, 11-6, 16-10, 16-17
LEVELarm, 3-7
LINE, 4-7, 7-9, 10-9, 14-9
LOW, 16-11
MACHINE, 2-6, 3-4
MASTER, 5-9
MENU, 1-6, 10-9
MESE, 1-13
MINUS, 4-8, 13-13
MLENght, 6-13, 8-8, 12-16, 13-12, 16-12
MMODE, 7-10, 13-14, 14-10
MODE, 5-10
Module Level, 2-2
MOPQual, 5-11
MQual, 5-12
NAME, 3-8
OCONDITION, 13-15, 14-11
OMARKer, 16-13
OPATtern, 7-11, 13-16, 14-12
OSEarch, 7-12, 13-17, 14-13
OTAG, 7-14, 14-14
OTHER, 16-18
OTIME, 4-9, 13-18
OVERlay, 4-10, 7-15, 13-18
OVERView:HIGH, 16-9
OVERView:LABEL, 16-10
OVERView:LOW, 16-11

OVERView:MLENght, 16-12
OVERView:OMARKer, 16-13
OVERView:XMARKer, 16-15
PATTERN, 15-6
PLUS, 4-11, 13-19
PRINT, 1-7
QUALifier, 16-19, 16-23
RANGE, 4-12, 6-14, 8-9, 10-10, 12-17, 13-20, 15-7, 16-20
REMOVe, 4-12, 5-13, 7-15, 8-10, 11-7, 13-20, 14-15, 15-8
REName, 3-8
RESource, 3-9
RMODE, 1-7
RUNTil, 7-16, 10-11, 13-21, 14-16
SCHart, 9-4
SElect, 1-3, 1-6
SEquence, 6-15, 12-18
SET, 10-12
SETup, 17-13
SFORMAT, 5-6
SLAVE, 5-15
SLIST, 7-7
SOPQual, 5-16
SPA, 2-7
SPERiod, 12-19, 13-22
SQUAL, 5-17
START, 1-6
STOP, 1-7
STORE, 6-16
SWAVEform, 8-4
SYMBOL, 15-5
SYSTEM:DATA, 17-2, 17-4
SYSTEM:PRINT, 1-7
SYSTEM:SETup, 17-2, 17-13
TAKenbranch, 6-18, 8-10
TCONtrol, 6-19, 12-20
TERM, 6-20, 12-21
TFORmat, 11-4
THReshold, 5-18, 11-8
TIMER, 6-21, 12-22
TINTerval:AUTorange, 16-22
TINTerval:QUALifier, 16-23
TINTerval:TINTInterval, 16-24
TLIST, 14-7
TPOSITION, 6-22, 8-11, 12-23, 13-24
TTYPe, 16-21
TYPE, 3-10
VAXis, 9-6



-
- WIDTH, 15-8
 WLIST, 2-7, 4-4
 XCONdition, 13-26, 14-19
 XMARKer, 16-15
 XPATtern, 7-20, 13-27, 14-20
 XSEArch, 7-21, 13-28, 14-21
 XTAG, 7-22, 14-23
 XTIME, 4-14, 13-29
 command set organization, 1-8 to 1-11
 compare full, 10-10
 compare partial, 10-10
 COMPare selector, 10-4
 COMPare subsystem, 10-1, 10-3 to 10-12
 complex expression, 12-10
 complex qualifier, 6-10, 12-11
 configuration menu, 3-2
 COPY command, 10-6
 count states, 6-17
 count time, 6-17
- D**
- DATA, 17-4
 State 17-11 to 17-12
 DATA and SETup Commands, 17-1,
 17-3 to 17-14
 data block
 analyzer 1 data, 17-7
 analyzer 2 data, 17-9
 data preamble, 17-7
 section data, 17-6
 section header, 17-6
 DATA command/query, 10-6 to 10-7
 data preamble, 17-7 to 17-10
 DATA query, 7-9, 14-9
 DBLock selector, 2-5
 DELay command/query, 4-5, 8-7, 13-10
 delete symbols, 15-8
 demux clock, 5-6, 5-15
 difference listing, 10-9
 display, 8-6, 8-9, 9-5, 10-9, 13-10,
 14-7, 14-9
 deleting waveforms, 13-20
- E**
- EDGE command/query, 12-13
 else branch, 6-9
 else on, 12-9
 entering, 14-11
 examples, 16-8
 program, 1-4, 10-7, 10-10, 18-1 to 18-6
 exiting, 14-11
- F**
- FIND command/query, 6-12,
 12-14 to 12-15
 find error, 10-8
 FIND query, 10-8
 from Start/Trigger, 13-28, 14-21
 from Start/Trigger/X marker, 13-17, 14-13
 full channel mode, 11-5
- H**
- half channel mode, 11-5
 HAXis command/query, 9-5
 HIGH command/query, 16-9
 HISTogram:HStatistic query, 16-16
 HISTogram:LABel command/query, 16-17
 HISTogram:OTHer command/query, 16-18
 HISTogram:QUALifier command/query,
 16-19
 HISTogram:RANGe command/query, 16-20
 HISTogram:TTYPE command/query, 16-21
 HStatistic query, 16-16
- I**
- INSert command, 4-6, 8-8, 13-11
 interleave, 7-15
 INTermodule Subsystem, 1-7
 internal clock, 12-19
- L**
- label, 5-13
 LABel command/query, 5-7 to 5-8, 11-6,
 16-10, 16-17
 LEVelarm command/query, 3-7
 LINE command/query, 4-7, 7-9, 10-9, 14-9
 listing menu, 7-2
 LOW command/query, 16-11
- M**
- MACHine selector, 2-6, 3-4
 MACHine subsystem, 3-1, 3-3 to 3-11
 markers, 4-2, 7-8, 7-10, 7-17, 13-21,
 14-8, 14-10, 14-17 to 14-20, 16-14
 Chart, 9-2
 O, 4-9, 7-11 to 7-12, 13-15 to 13-16,
 13-17, 14-11, 14-14, 16-13
 occurrence, 7-14, 7-22
 pattern, 8-6, 13-15, 14-12, 14-19
 searching, 7-21
 setting type, 13-14
 statistics, 7-17 to 7-18, 8-7, 13-23 to
 13-25
 waveform, 8-2
 X, 7-20, 7-22, 13-26 to 13-29, 14-20,
 14-22 to 14-23, 16-15
 X-O, 13-26
 mask bits, 10-5
 master clock, 5-6
 MASTer command/query, 5-9
 maximum time, 13-23, 14-17
 measurement complete program example,
 18-18
 memory depth, 8-8, 12-16, 13-12
 MENU, 1-6
 MENU command, 10-9
 MESE command/query, 1-13
 MESR query, 1-15
 minimum time, 13-24, 14-18
 MINus command, 4-8, 13-13
 mixed mode, 4-2
 MLENgth command/query, 6-13, 8-8,
 12-16, 13-12, 16-12
 MMEMory Subsystem, 1-7
 MMODE command/query, 7-10, 13-14,
 14-10
 MODE command/query, 5-10, 16-7
 module level commands, 2-1, 2-3 to 2-7
 module status reporting, 1-12
 MOPQual command/query, 5-11
 most significant bit, 17-3
 MQual command/query, 5-12
- N**
- NAME command/query, 3-8
 number of runs, 13-25, 14-18
 number of samples, 16-25
-

O

OCONdition command/query, 13-15, 14-11
 offset, 4-5
 OMARKer command/query, 16-13
 OPATtern command/query, 7-11, 13-16, 14-12
 OR'd trigger, 3-5
 OSEArch command/query, 7-12, 13-17, 14-13
 OSTate query, 4-9, 7-13, 14-14
 OTAG command/query, 7-14, 14-14
 OTHER command/query, 16-18
 OTIME command/query, 4-9, 13-18
 OVERlay command/query, 4-10, 7-15, 13-18
 OVERView:BUCKet query, 16-8
 OVERView:HIGH command/query, 16-9
 OVERView:LABel command/query, 16-10
 OVERView:LOW command/query, 16-11
 OVERview:MLENght command/query, 16-12
 OVERView:OMARker command/query, 16-13
 OVERView:OVStatistic query, 16-14
 OVERView:XMARker command/query, 16-15
 OVStatistic query, 16-14

P

PATtern command, 15-6
 pattern markers, 7-8, 7-10 to 7-11, 8-6, 13-14, 13-26 to 13-27, 14-10 to 14-12
 PLUS command, 4-11, 13-19
 pod clock, 5-7
 poststore, 8-11
 preamble description, 17-7
 prestore, 8-11
 program examples

- checking for measurement complete, 18-18
- sending queries to the logic analyzer, 18-19
- state analyzer, 18-5
- state compare, 18-9
- SYSTEM:SETup command, 18-14
- SYSTEM:SETup query, 18-14
- timing analyzer, 18-3

transferring configuration to analyzer, 18-14
 transferring configuration to the controller, 18-14

Q

QUALifier command/query, 16-19, 16-23
 Query

- ACCumulate, 8-5, 9-4, 13-8
- ACQMode, 11-5
- ACQuisition, 6-8, 12-9, 13-8
- ARM, 3-5
- ASSign, 3-6
- BRANCh, 6-10, 12-11
- BUCKet, 16-8
- CARDcage, 1-5
- CLOCK, 5-7
- CMASK, 10-5
- COLUMN, 7-8, 14-8
- DATA, 7-9, 10-7, 14-9, 17-5
- DELAy, 4-5, 8-7, 13-10
- EDGE, 12-14
- ERRor, 1-7
- FIND, 6-13, 10-8, 12-15
- HAXis, 9-6
- HIGH, 16-9
- HISTogram:HStatistic, 16-16
- HISTogram:LABel, 16-17
- HISTogram:OTHER, 16-18
- HISTogram:QUALifier, 16-19
- HISTogram:RANGE, 16-20
- HISTogram:TTYpe, 16-21
- HStatistic, 16-16
- LABel, 5-8, 11-7, 16-10, 16-17
- LEVelarm, 3-7
- LINE, 4-8, 7-10, 10-9, 14-10
- LOW, 16-11
- MASTer, 5-9
- MENU, 1-6
- MESE, 1-13
- MESR, 1-15
- MLENght, 6-13, 8-9, 12-16, 13-13, 16-12
- MMODE, 7-11, 13-14, 14-10
- MODE, 5-10, 16-7
- MOPQual, 5-11
- MQQual, 5-12
- NAME, 3-8
- OCONdition, 13-15, 14-11
- OMARker, 16-13
- OPATtern, 7-12, 13-16, 14-12
- OSEArch, 7-13, 13-17, 14-13
- OSTate, 4-9, 7-13, 14-14
- OTAG, 7-14, 14-15
- OTHER, 16-18
- OTIME, 4-10, 13-18
- OVERView:BUCKet, 16-8
- OVERView:HIGH, 16-9
- OVERView:LABel, 16-10
- OVERView:LOW, 16-11
- OVERview:MLENght, 16-12
- OVERView:OMARker, 16-13
- OVERView:OVStatistic, 16-14
- OVERView:XMARker, 16-15
- OVStatistic, 16-14
- PRINT, 1-7
- QUALifier, 16-19, 16-23
- RANGE, 4-12, 6-15, 8-9, 10-10, 12-17, 13-20, 16-20
- REName, 3-9
- RESource, 3-10
- RMODE, 1-7
- RUNTil, 7-16, 10-12, 13-21, 14-16
- SEQuence, 6-15, 12-18
- SETup, 17-14
- SLAVE, 5-15
- SOPQual, 5-16
- SPERiod, 12-19, 13-22
- SQQual, 5-17
- STORE, 6-16
- SYSTEM:DATA, 17-5
- SYSTEM:ERRor, 1-7
- SYSTEM:PRINT, 1-7
- SYSTEM:SETup, 17-14
- TAG, 6-17
- TAKenbranch, 6-18, 8-10
- TAVerage, 7-17, 13-23, 14-17
- TCONtrol, 6-19, 12-20
- TERM, 6-21, 12-22
- THReshold, 5-18, 11-8
- TIMER, 6-21, 12-22
- TINTerval:QUALifier, 16-23
- TINTerval:TINTerval, 16-24
- TINTerval:TStatistic, 16-25
- TMAXimum, 7-17, 13-23, 14-17
- TMINimum, 7-18, 13-24, 14-18
- TPOSITION, 6-22, 8-11, 12-23, 13-25



-
- TStatistic, 16–25
 TTYPe, 16–21
 TYPE, 3–11
 VAXis, 9–7
 VRUNs, 7–18, 13–25, 14–18
 XCONdition, 13–26, 14–19
 XMARker, 16–15
 XOTag, 7–19, 14–19
 XOTime, 4–13, 7–19, 13–26, 14–20
 XPATtern, 7–20, 13–27, 14–21
 XSEarch, 7–21, 13–28, 14–22
 XState, 4–13, 7–22, 14–22
 XTAG, 7–23, 14–23
 XTIME, 4–14, 13–29
 query program example, 18–19
- R**
- RANGE command/query, 4–12, 6–14, 8–9,
 10–10, 12–17, 13–20, 15–7, 16–20
 reference listing, 10–6, 10–9
 REMove command, 4–12, 5–13, 7–15,
 8–10, 11–7, 13–20, 14–15, 15–8
 REName command/query, 3–8
 RESource command/query, 3–9
 RMODE, 1–7
 RUNTil command/query, 7–16, 10–11,
 13–21, 14–16
- S**
- s/Div, 4–12
 sample period, 13–22
 sample rate, 12–19
 SCHart selector, 9–4
 SCHart subsystem, 9–1, 9–3 to 9–7
 scroll listing, 14–9
 search, 7–12, 7–21
 searching, 14–13
 sec/Div, 13–20
 section data, 17–6
 section data format, 17–4
 section header, 17–6
 SElect command, 1–3, 1–6
 SEquence command/query, 6–15, 12–18
 SET command, 10–12
 SETup, 17–13
 SFORmat selector, 5–6
 SFORmat subsystem, 5–1, 5–3 to 5–18
 slave clock, 5–6
 SLAVE command/query, 5–15
 SLISt selector, 7–7
 SLISt subsystem, 7–1, 7–3 to 7–23
 SOPQual command/query, 5–16
 SPA selector, 2–7
 specify patterns, 13–9, 14–8, 14–12, 14–19
 SPERiod command/query, 12–19, 13–22
 SQUal command/query, 5–17
 START, 1–6
 state analyzer
 program example, 18–5
 state markers, 7–10
 states/Div, 8–9
 statistics, 7–10, 13–23 to 13–25, 16–14,
 16–16, 16–22, 16–25
 statistics markers, 7–18, 8–7, 13–14,
 14–10, 14–17 to 14–18
 STOP, 1–7
 stop measurement, 7–16, 10–11, 13–21,
 14–16
 STORe command/query, 6–16
 STRace selector, 6–8
 STRigger selector, 6–8
 STRigger/STRace subsystem, 6–1, 6–3 to
 6–22
 Subsystem
 COMPare, 10–2
 MACHine, 3–2
 SCHart, 9–2
 SFORmat, 5–1, 5–3 to 5–18
 SLISt, 7–1, 7–3 to 7–23
 STRigger/STRace, 6–1, 6–3 to 6–22
 SWAVeform, 8–2
 SYMBOL, 15–1, 15–3 to 15–8
 TFORmat, 11–1, 11–3 to 11–8
 TLISt, 14–1, 14–3 to 14–23
 TTRigger/TTRace, 12–1, 12–3 to 12–23
 TWAVeform, 13–1, 13–3 to 13–29
 WLISt, 4–1, 4–3 to 4–14
 SWAVeform selector, 8–4
 SWAVeform subsystem, 8–1, 8–3 to 8–11
 SYMBOL selector, 15–5
 SYMBOL subsystem, 15–1, 15–3 to 15–8
 syntax diagram
 COMPare Subsystem, 10–3
 MACHine Subsystem, 3–3
 SCHart Subsystem, 9–3
 SFORmat Subsystem, 5–3
 SLISt Subsystem, 7–3
 STRigger Subsystem, 6–3 to 6–4
 SWAVeform Subsystem, 8–3
 SYMBOL Subsystem, 15–3
 TFORmat Subsystem, 11–3
 TLISt Subsystem, 14–3
 TTRigger Subsystem, 12–3
 TWAVeform Subsystem, 13–3 to 13–4
 WLISt Subsystem, 4–3
 SYSTem:DATA, 17–4 to 17–5
 SYSTem:ERRor, 1–7
 SYSTem:PRINt, 1–7
 SYSTem:SETup, 17–13 to 17–14
 SYSTem:SETup program example, 18–14
- T**
- TAG command/query, 6–17
 TAKenbranch command/query, 6–18, 8–10
 TAVerage query, 7–17, 13–23, 14–17
 TCONtrol command/query, 6–19, 12–20
 TERM command/query, 6–20, 12–21
 TFORmat selector, 11–4
 TFORmat subsystem, 11–1, 11–3 to 11–8
 THReshold command/query, 5–18, 11–8
 time markers, 7–10, 13–14, 13–18, 13–26,
 13–29, 14–10
 time tag data description, 17–13
 time tags, 14–7
 timer, 6–19, 6–21, 12–20
 TIMER command/query, 6–21, 12–22
 timing analyzer
 program example, 18–3
 TINTerval:AUTorange command, 16–22
 TINTerval:QUALifier command/query,
 16–23
 TINTerval:TINTerval command/query,
 16–24
 TINTerval:TStatistic query, 16–25
 TLISt selector, 14–7
 TLISt subsystem, 14–1, 14–3 to 14–23
 TMAXimum query, 7–17, 13–23, 14–17
 TMINimum query, 7–18, 13–24, 14–18
 TPOSITION command/query, 6–22, 8–11,
 12–23, 13–24
 trace size, 8–8, 12–16
 trigger, 8–11, 12–14
 SPA, 16–21
 trigger position, 13–24
-

TStatistic query, 16-25
TTRace selector, 12-8
TTRigger selector, 12-8
TTRigger/TTRace subsystem, 12-1, 12-3
to 12-23
TTYPe command/query, 16-21
TWAVeform selector, 13-7
TWAVeform Subsystem, 13-1, 13-3 to
13-29
TYPE command/query, 3-10 to 3-11

V

VAXis command/query, 9-6 to 9-7
vertical scroll, 4-7
VRUNs query, 7-18, 13-25, 14-18

W

WIDTh command, 15-8
WLISt selector, 2-7, 4-4
WLISt subsystem, 4-1, 4-3 to 4-14

X

X entering, 14-19
X exiting, 14-19
XCONdition command/query, 13-26, 14-19
XMARKer command/query, 16-15
XOTag query, 7-19, 14-19
XOTime query, 4-13, 7-19, 13-26, 14-20
XPATtern command/query, 7-20, 13-27,
14-20
XSEarch command/query, 7-21, 13-28,
14-21
XState query, 4-13, 7-22, 14-22
XTAG command/query, 7-22 to 7-23,
14-23
XTIME command/query, 4-14, 13-29



Index-6

© Copyright Hewlett-Packard Company 1987, 1990, 1993, 1994, 1997
All Rights Reserved.

Reproduction, adaptation, or translation without prior written permission is prohibited, except as allowed under the copyright laws.

Document Warranty

The information contained in this document is subject to change without notice.

Hewlett-Packard makes no warranty of any kind with regard to this material, including, but not limited to, the implied warranties of merchantability or fitness for a particular purpose.

Hewlett-Packard shall not be liable for errors contained herein or for damages in connection with the furnishing, performance, or use of this material.

Safety

This apparatus has been designed and tested in accordance with IEC Publication 348, Safety Requirements for Measuring Apparatus, and has been supplied in a safe condition. This is a Safety Class I instrument (provided with terminal for protective earthing). Before applying power, verify that the correct safety precautions are taken (see the following warnings). In addition, note the external markings on the instrument that are described under "Safety Symbols."

Warning

- Before turning on the instrument, you must connect the protective earth terminal of the instrument to the protective conductor of the (mains) power cord. The mains plug shall only be inserted in a socket outlet provided with a protective earth contact. You must not negate the protective action by using an extension cord (power cable) without a protective conductor (grounding). Grounding one conductor of a two-conductor outlet is not sufficient protection.
- Only fuses with the required rated current, voltage, and specified type (normal blow, time delay, etc.) should be used. Do not use repaired fuses or short-circuited fuseholders. To do so could cause a shock or fire hazard.

- Service instructions are for trained service personnel. To avoid dangerous electric shock, do not perform any service unless qualified to do so. Do not attempt internal service or adjustment unless another person, capable of rendering first aid and resuscitation, is present.

- If you energize this instrument by an auto transformer (for voltage reduction), make sure the common terminal is connected to the earth terminal of the power source.

- Whenever it is likely that the ground protection is impaired, you must make the instrument inoperative and secure it against any unintended operation.

- Do not operate the instrument in the presence of flammable gasses or fumes. Operation of any electrical instrument in such an environment constitutes a definite safety hazard.

- Do not install substitute parts or perform any unauthorized modification to the instrument.

- Capacitors inside the instrument may retain a charge even if the instrument is disconnected from its source of supply.

- Use caution when exposing or handling the CRT. Handling or replacing the CRT shall be done only by qualified maintenance personnel.

Safety Symbols



Instruction manual symbol: the product is marked with this symbol when it is necessary for you to refer to the instruction manual in order to protect against damage to the product.



Hazardous voltage symbol.



Earth terminal symbol: Used to indicate a circuit common connected to grounded chassis.

WARNING

The Warning sign denotes a hazard. It calls attention to a procedure, practice, or the like, which, if not correctly performed or adhered to, could result in personal injury. Do not proceed beyond a Warning sign until the indicated conditions are fully understood and met.

CAUTION

The Caution sign denotes a hazard. It calls attention to an operating procedure, practice, or the like, which, if not correctly performed or adhered to, could result in damage to or destruction of part or all of the product. Do not proceed beyond a Caution symbol until the indicated conditions are fully understood or met.

Hewlett-Packard
P.O. Box 2197
1900 Garden of the Gods Road
Colorado Springs, CO 80901

Product Warranty

This Hewlett-Packard product has a warranty against defects in material and workmanship for a period of one year from date of shipment. During the warranty period, Hewlett-Packard Company will, at its option, either repair or replace products that prove to be defective. For warranty service or repair, this product must be returned to a service facility designated by Hewlett-Packard.

For products returned to Hewlett-Packard for warranty service, the Buyer shall prepay shipping charges to Hewlett-Packard and Hewlett-Packard shall pay shipping charges to return the product to the Buyer. However, the Buyer shall pay all shipping charges, duties, and taxes for products returned to Hewlett-Packard from another country.

Hewlett-Packard warrants that its software and firmware designated by Hewlett-Packard for use with an instrument will execute its programming instructions when properly installed on that instrument.

Hewlett-Packard does not warrant that the operation of the instrument software, or firmware will be uninterrupted or error free.

Limitation of Warranty

The foregoing warranty shall not apply to defects resulting from improper or inadequate maintenance by the Buyer, Buyer-supplied software or interfacing, unauthorized modification or misuse, operation outside of the environmental specifications for the product, or improper site preparation or maintenance.

No other warranty is expressed or implied. Hewlett-Packard specifically disclaims the implied warranties of merchantability or fitness for a particular purpose.

Exclusive Remedies

The remedies provided herein are the buyer's sole and exclusive remedies. Hewlett-Packard shall not be liable for any direct, indirect, special, incidental, or consequential damages, whether based on contract, tort, or any other legal theory.

Assistance

Product maintenance agreements and other customer assistance agreements are available for Hewlett-Packard products. For any assistance, contact your nearest Hewlett-Packard Sales Office.

Certification

Hewlett-Packard Company certifies that this product met its published specifications at the time of shipment from the factory. Hewlett-Packard further certifies that its calibration measurements are traceable to the United States National Institute of Standards and Technology, to the extent allowed by the Institute's calibration facility, and to the calibration facilities of other International Standards Organization members.

About this edition

This is the first edition of the *HP 16554A/HP 16555A/HP 16555D Programmer's Guide*.

Publication number
16555-97011

Printed in USA.

Edition dates are as follows:
First edition, January 1997

New editions are complete revisions of the manual. Update packages, which are issued between editions, contain additional and replacement pages to be merged into the manual by you. The dates on the title page change only when a new edition is published.

A software or firmware code may be printed before the date. This code indicates the version level of the software or firmware of this product at the time the manual or update was issued. Many product updates do not require manual changes; and, conversely, manual corrections may be done without accompanying product changes. Therefore, do not expect a one-to-one correspondence between product updates and manual updates.

The following list of pages gives the date of the current edition and of any changed pages to that edition.

All pages original edition