Front-Panel Operation Reference

Volume 1 of 2

**HP 1652B/HP 1653B
Logic Analyzers**



©Copyright Hewlett-Packard Company 1989

Manual Set Part Number 01652-90902

Printed in the U.S.A. November 1989

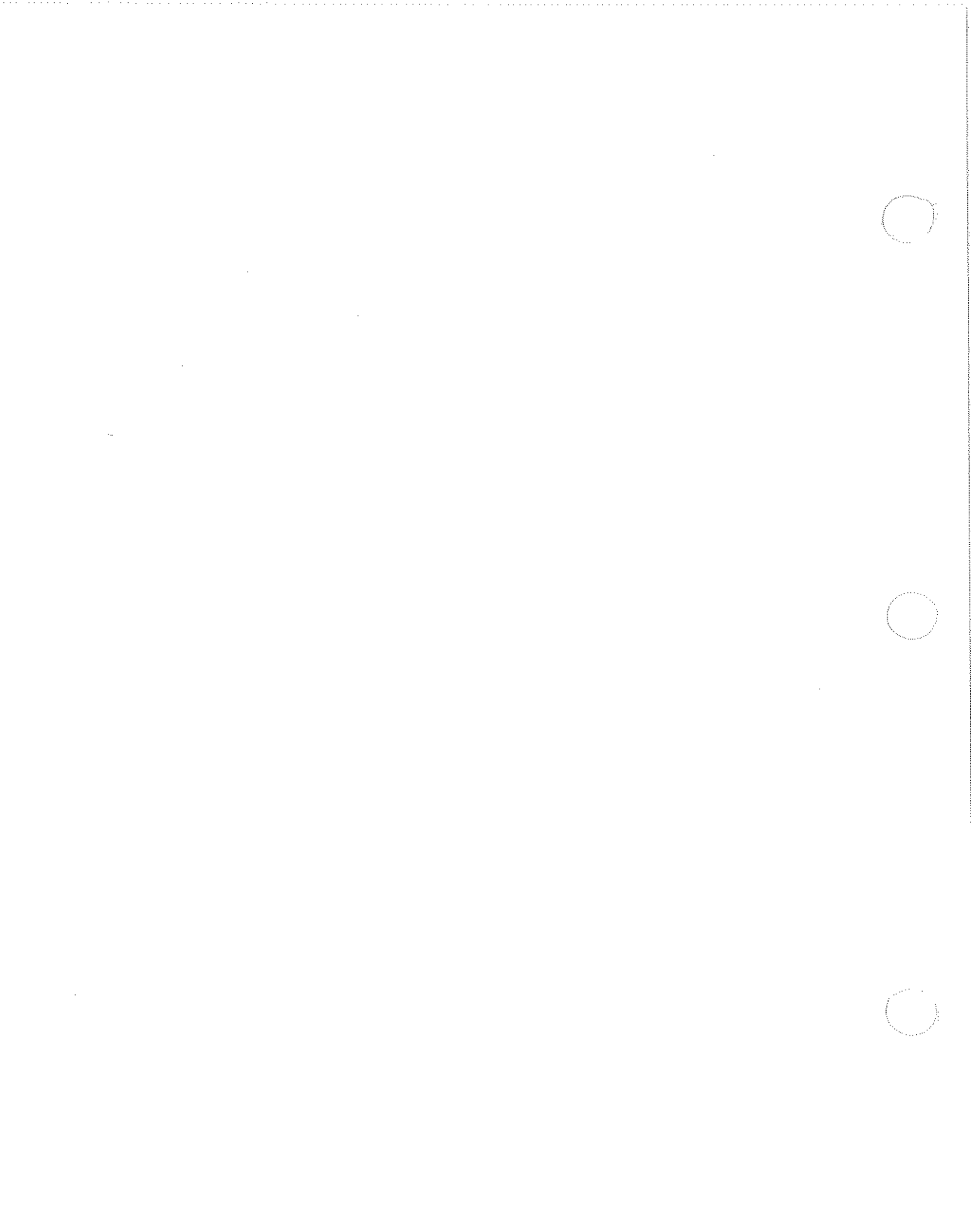

Contents Volume 1

Chapter 1:

General Information

Logic Analyzer Description	1-1
User Interface	1-1
Configuration Capabilities	1-2
Key Features	1-4
Accessories Supplied	1-5
Available Accessories	1-7
Manuals Supplied	1-7
Turning On the Logic Analyzer	1-7

Chapter 2:

Probing

Introduction	2-1
Probing Options	2-1
The HP 10320C User-Definable Interface	2-1
The HP 10269C General Purpose Probe Interface	2-2
General Purpose Probing	2-3
The Termination Adapter	2-3
The HP1652B/53B Probing System	2-4
Probe Pod Assemblies	2-4
Pod Grounding	2-5
Probes	2-5
Probe Grounding	2-6
Grabbers	2-6
Probe Cable	2-6
Oscilloscope Probes	2-7
Probe Inputs	2-7
External Trigger Inputs	2-7
Compensation Signal Output	2-7
Signal Line Loading	2-8
Maximum Probe Input Voltage	2-8
Pod Thresholds	2-8
Connecting the Logic Analyzer to the Target System	2-8
Connecting the Probe Cables to the Logic Analyzer	2-9
Connecting the Pods to the Probe Cable	2-10

Disconnecting the Probes from the Pods	2-11
Connecting the Grabbers to the Probes	2-12
Connecting the Grabbers to the Test Points	2-12
Labeling Pods, Probes, and Cables	2-13

Chapter 3:

Using the Front-Panel User Interface

Introduction	3-1
Front-Panel Controls	3-2
Rear-Panel Controls and Connectors	3-6
The Cursor	3-7
How to Select Menu	3-7
How to Switch between the Analyzers and Oscilloscope	3-8
Returning to the System Configuration Menu	3-8
How to Select Fields	3-9
Pop-up Menu	3-9
How to Close Pop-up Menu	3-9
How to Select Options	3-10
Toggle Fields	3-11
How to Enter Numeric Data	3-11
How to Enter Alpha Data	3-14
Changing Alpha Entries	3-15
How to Roll Data	3-16
Assignment/Specification Menu	3-17
Assigning Pod Bits to Labels	3-17
Specifying Patterns	3-18
Specifying Edges	3-19

Chapter 4:

System Configuration Menu

Introduction	4-1
System Configuration Menu	4-1
Accessing the System Configuration Menu	4-2
System Configuration Menu Fields	4-3
Name	4-3
Type	4-4
Scope On/Off	4-5
Autoscale	4-5
Pods	4-6
Where to Go Next	4-7

Introduction

About this manual...

Welcome to Hewlett-Packard logic analyzers. The HP 1652B/HP 1653B Logic Analyzer is more than just a logic analyzer. It is an analyzer and oscilloscope in one instrument. With this combination, you have expanded measurement capabilities.

This manual has been split into two volumes for better accessibility. Volume one contains general instrument information and operating reference information for the state analyzer. Also included is a state analyzer measurement example.

Volume two contains operating reference information and measurement examples for the timing analyzer and oscilloscope. To help put the total functionality of the instrument together, a measurement example for mixed mode operation (timing/state/scope) is included. Located in the back of volume two is the appendices which contain the seldom used information.

Information in both volumes is accessed easily by major tabs. All menu and field definitions are arranged by major function within each measurement type. In addition, both volumes have a master index.

The user interface of the HP 1652B/1653B was designed for the most intuitive operation as possible. Pop-up windows help lead you through setups and measurements so you won't have to memorize a lot of steps. As you read this manual and the other manuals about this logic analyzer, you will see just how easy the HP 1652B/1653B is to use.

If you aren't familiar with the HP 1652B/1653B Logic Analyzers, we suggest you read the HP 1652B/1653B Getting Started Guide. This guide contains tutorial examples on the basic functions of the logic analyzer and digitizing oscilloscope.

If you are new to logic analyzers and digitizing oscilloscopes, or just need a refresher, we think you'll find *Feeling Comfortable with Logic Analyzers* and *Feeling Comfortable with Digitizing Oscilloscopes* valuable reading. It will eliminate any misconceptions or confusion you may have about their application, and will show you how to get the most out of the measurement functions.

Please take time to fill out the "Your Comments Please" questionnaire. If it has already been used and you have any comments, address them to:

Hewlett-Packard
Atten: Publications Dept.
P.O. Box 2197
Colorado Springs, CO 80901-2197

Product Warranty

This Hewlett-Packard product has a warranty against defects in material and workmanship for a period of one year from date of shipment. During warranty period, Hewlett-Packard Company will, at its option, either repair or replace products that prove to be defective.

For warranty service or repair, this product must be returned to a service facility designated by Hewlett-Packard. However, warranty service for products installed by Hewlett-Packard and certain other products designated by Hewlett-Packard will be performed at the Buyer's facility at no charge within the Hewlett-Packard service travel area. Outside Hewlett-Packard service travel areas, warranty service will be performed at the Buyer's facility only upon Hewlett-Packard's prior agreement and the Buyer shall pay Hewlett-Packard's round trip travel expenses.

For products returned to Hewlett-Packard for warranty service, the Buyer shall prepay shipping charges to Hewlett-Packard and Hewlett-Packard shall pay shipping charges to return the product to the Buyer. However, the Buyer shall pay all shipping charges, duties, and taxes for products returned to Hewlett-Packard from another country.

Hewlett-Packard warrants that its software and firmware designated by Hewlett-Packard for use with an instrument will execute its programming instructions when properly installed on that instrument. Hewlett-Packard does not warrant that the operation of the instrument, software, or firmware will be uninterrupted or error free.

**Limitation of
Warranty**

The foregoing warranty shall not apply to defects resulting from improper or inadequate maintenance by the Buyer, Buyer-supplied software, or interfacing, unauthorized modification or misuse, operation outside of the environmental specifications for the product, or improper site preparation or maintenance.

**NO OTHER WARRANTY IS EXPRESSED OR IMPLIED.
HEWLETT-PACKARD SPECIFICALLY DISCLAIMS THE
IMPLIED WARRANTIES OR MERCHANTABILITY AND
FITNESS FOR A PARTICULAR PURPOSE.**

Exclusive Remedies THE REMEDIES PROVIDED HEREIN ARE THE BUYER'S SOLE AND EXCLUSIVE REMEDIES. HEWLETT-PACKARD SHALL NOT BE LIABLE FOR ANY DIRECT, INDIRECT, SPECIAL INCIDENTAL, OR CONSEQUENTIAL DAMAGES, WHETHER BASED ON CONTRACT, TORT, OR ANY OTHER LEGAL THEORY.

Assistance Product maintenance agreements and other customer assistance agreements are available for Hewlett-Packard products.

For any assistance, contact your nearest Hewlett-Packard Sales and Service Office. Addresses are provided at the back of this manual.

Certification Hewlett-Packard Company certifies that this product met its published specifications at the time of shipment from the factory. Hewlett-Packard further certifies that its calibration measurements are traceable to the United States National Bureau of Standards, to the extent allowed by the Bureau's calibration facility, and to the calibration facilities of other International Standards Organization members.

Safety This product has been designed and tested according to International Safety Requirements. To ensure safe operation and to keep the product safe, the information, cautions, and warnings in this manual must be heeded.

Printing History

New editions are complete revisions of the manual. Update packages, which are issued between editions, contain additional and replacement pages to be merged into the manual by the customer. The dates on the title page change only when a new edition or a new update is published.

A software code may be printed before the date; this indicates the version level of the software product at the time of the manual or update was issued. Many product updates and fixes do not require manual changes and, conversely, manual corrections may be done without accompanying product changes. Therefore, do not expect a one to one correspondence between product updates and manual updates.

Edition 1

November 1989

01652-90902

List of Effective Pages

The List of Effective Pages gives the date of the current edition and of any pages changed in updates to that edition. Within the manual, any page changed since the last edition is indicated by printing the date the changes were made on the bottom of the page. If an update is incorporated when a new edition of the manual is printed, the change dates are removed from the bottom of the pages and the new edition date is listed in Printing History and on the title page.

Pages	Effective Date
All	November 1989

Chapter 5:**I/O Menu**

Introduction	5-1
Accessing the I/O Menu	5-1
Print Screen	5-2
Print All	5-2
Disk Operations	5-3
Load	5-5
Store	5-5
Autoload	5-6
Copy	5-7
Duplicate Disk	5-8
Pack Disk	5-9
Rename	5-9
Purge	5-10
Format Disk	5-11
I/O Port Configuration	5-12
Configuring the Interfaces	5-13
The HP-IB Interface	5-13
The RS-232C Interface	5-14
External BNC Configuration	5-17
Self Test	5-18

Chapter 6:**Disk Drive Operations**

Introduction	6-1
The Disk Operations Available	6-1
Accessing the Disk Menu	6-3
Selecting a Disk Operation	6-4
Disk Operation Parameters	6-5
Installing a Blank Disk	6-6
Formatting a Disk	6-7
Storing to a Disk	6-9
The Load Operation	6-11
Renaming a File	6-12
The Autoload Operation	6-13
Purging a File	6-14
Copying a File	6-15
The Pack Disk Operation	6-17
Duplicating the Operating System Disk	6-18

Chapter 7:**Making Hardcopy Prints**

Introduction	7-1
Supported Printers	7-1
Alternate Printers	7-2
Hooking Up Your Printer	7-2
HP-IB Printer Cables	7-3
RS-232C Printer Cables	7-3
HP 13242G Cable	7-3
HP 92219H Cable	7-4
Setting HP-IB for HP Printers	7-4
Setting RS-232C for HP Printers	7-5
Setting RS-232C for Your Non-HP Printer	7-5
Setting Paper Width	7-6
RS-232C Default Configuration	7-6
Recommended Protocol	7-6
Starting the Printout	7-7
Print Screen	7-7
Print All	7-7
What Happens during a Printout?	7-8
Connecting to Other HP Printers	7-9

Chapter 8:**The State Analyzer**

Introduction	8-1
The State Analyzer: An Overview	8-1
State Analyzer Menu Maps	8-1
State Format Menu Map	8-2
State Trace Menu Map	8-3
State Listing Menu Map	8-5
State Compare Menu Map	8-6
State Waveform Menu Map	8-7
State Chart Menu Map	8-9

Chapter 9:**State Format Specification Menu**

Introduction	9-1
Accessing the State Format Specification Menu	9-1
State Format Specification Menu	9-1
State Format Specification Menu Fields	9-3
Label	9-3
Turn Label On	9-4
Modify Label	9-4
Turn Label Off	9-4
Polarity (Pol)	9-4
Bit Assignment	9-4
Pod Threshold	9-6
Specify Symbols	9-7
Clock	9-7
Pod Clock	9-9
Normal	9-9
Demultiplex	9-10
Mixed Clocks	9-11
Clock Period	9-12
Specify Symbols Menu	9-12
Specify Symbols Menu Fields	9-13
Label	9-13
Base	9-14
Symbol View Size	9-15
Symbol Name	9-15
Leaving the Symbol Table Menu	9-17

Chapter 10:**State Trace Menu**

Introduction	10-1
Accessing the State Trace Menu	10-2
State Trace Menu Fields	10-2
Sequence Levels	10-6
Insert Level	10-7
Delete Level	10-7
Storage Qualifier	10-8
Branching Qualifier	10-8
Occurrence Counter	10-9

Storage Macro	10-9
Reading the Sequence Level Display	10-11
Acquisition Fields	10-13
Trace Mode	10-13
Armed By	10-13
Branches	10-14
Off	10-14
Restart	10-14
Per Level	10-15
Count	10-18
Off	10-18
Time	10-18
States	10-20
Prestore	10-21
Qualifier and Pattern Fields	10-22
Label	10-22
Base	10-22
Qualifier Field	10-23
Patterns	10-23
Ranges	10-24
Pattern Fields	10-24

Chapter 11:

State Listing Menu

Introduction	11-1
Accessing the State Listing Menu	11-2
State Listing Menu Fields	11-3
Markers	11-3
Markers: Off	11-4
Markers: Patterns	11-4
Stop Measurement	11-5
Markers: Time	11-6
Markers: Statistics	11-6
Pattern ___ Field	11-7

Chapter 12:**State Compare Menu**

Introduction	12-1
Accessing the Compare Menu	12-2
The Compare and Difference Listing Displays	12-2
The Compare Listing	12-2
The Difference Listing	12-2
Creating a Compare Image	12-3
Bit Editing of the Compare Image	12-4
Masking Channels in the Compare Image	12-5
Specifying a Compare Range	12-6
Repetitive Comparisons with a Stop Condition	12-7
Locating Mismatches in the Difference Listing	12-8
Saving Compare Images	12-8

Chapter 13:**State Chart Menu**

Introduction	13-1
Accessing the State Chart Menu	13-1
Selecting the Axes for the Chart	13-1
Scaling the Axes	13-2
The Label Value vs. States Chart	13-3
The Label Value vs. Label Value Chart	13-4
X & O Markers and Readouts for Chart	13-5
Marker Options	13-6

Chapter 14:**State Waveforms Menu**

Introduction	14-1
Accessing the State Waveforms Menu	14-1
Selecting a Waveform	14-2
Replacing Waveforms	14-3
Deleting Waveforms	14-4
Selecting States per Division	14-4
Delay from Trigger	14-5
State Waveform Display Features	14-5
X and O Markers for State Waveform	14-5

Chapter 15:**State Analyzer Measurement Example**

Introduction	15-1
Problem Solving with the State Analyzer	15-2
What Am I Going to Measure?	15-2
How Do I Configure the Logic Analyzer?	15-4
Connecting the Probes	15-6
Activity Indicators	15-6
Configuring the State Analyzer	15-7
Specifying the J Clock	15-9
Specifying a Trigger Condition	15-10
Acquiring the Data	15-12
The State Listing	15-13
Finding the Answer	15-14
Summary	15-16

Index

General Information

Logic Analyzer Description

The HP 1652B/1653B logic analyzers are general purpose logic analyzers with oscilloscope measurement capabilities. These analyzers are designed as stand alone instruments for use by digital and microprocessor designers. Both the HP 1652B and HP 1653B have HP-IB and RS-232C interfaces for hardcopy printouts and control by a host computer. With faster state analysis, oscilloscope measurement capabilities and the improved features, the HP 1652B\53B analyzers will accommodate next generation design tasks.

The HP 1652B, is capable of 100 MHz timing and 35 MHz state analysis on 80 channels. The HP 1653B, is capable of 100 MHz timing and 25 MHz state analysis on 32 channels . You will use the same manual set regardless of whether you have an HP 1652B or an HP 1653B.

Both analyzers have the same 2-channel, 400-megasample/second, 100 MHz single-shot and repetitive single-shot digitizing oscilloscope measurement capabilities.

User Interface

First-time and casual users as well as experienced logic analyzer users will find the user interface easier to use than in previous generations.

The front panel is controlled by a front-panel keyboard, and the addition of a "KNOB" allows you to move the cursor or change settings more quickly than before. The timing analyzer (a close cousin of the oscilloscope) now has oscilloscope-type controls which more closely match the type of measurements you make with the timing analyzer. Information is displayed on a nine-inch white phosphor CRT.

Configuration Capabilities

The HP 1652B/1653B can be configured either as two independent machines (analyzers) or as two interactive machines. No matter how the analyzers are configured, up to two channels of oscilloscope measurement can be added. The configurations for each analyzer includes the following:

HP 1652B:

- Up to 80 channels state and up to two channels oscilloscope.
- Up to 80 channels timing and up to two channels oscilloscope.
- Two state machines with multiples of 16 channels per machine, with a combined maximum of 80 channels and up to two channels oscilloscope.
- One state and one timing machine with multiples of 16 channels per machine, with a combined maximum of 80 channels and up to two channels oscilloscope.
- Up to two channels of oscilloscope.

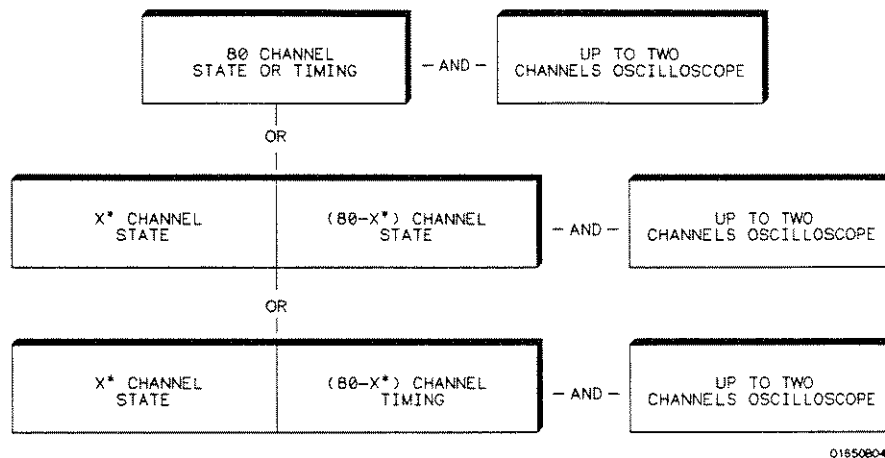

Figure 1-1. HP 1652B Configuration Capabilities

*multiples of 16 channels

HP 1653B:

- Up to 32 channels state and up to two channels oscilloscope.
- Up to 32 channels timing and up to two channels oscilloscope.
- Two state machines with multiples of 16 channels per machine, with a combined maximum of 32 channels and up to two channels oscilloscope.
- One state and one timing machine with multiples of 16 channels per machine, with a combined maximum of 32 channels and up to two channels oscilloscope.
- Up to two channels of oscilloscope.

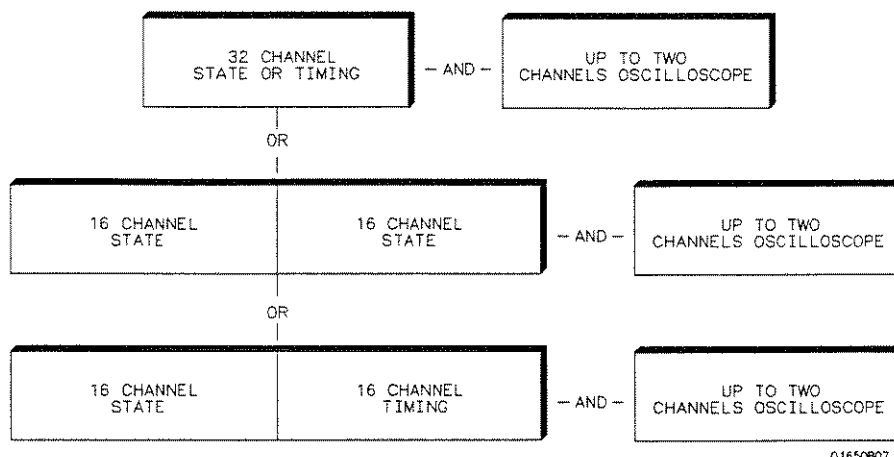

Figure 1-2. HP 1653B Configuration Capabilities

Key Features

A 3.5-inch disk drive is built into the instrument for storing logic analyzer and oscilloscope configurations and acquired data. The disk drive also provides a way of loading inverse assembly configuration files into the logic analyzer for easy configuring. Some common features of the logic analyzer and oscilloscope include lightweight passive probes for easy hook-up, mixed-mode display, HP-IB and RS-232C interfaces for programming and printer output.

Logic analyzer key features include:

- Transitional timing for extended timing analyzer memory.
- All channels can be used for state or timing.
- An external trigger BNC connector.
- Transitional or glitch timing modes.
- 1 k deep memory on all channels.
- Glitch detection.
- Marker measurements.
- Triggering and pattern qualification.
- Overlapping of timing waveforms.
- Eight sequence levels.
- Eight pattern recognizers.
- One range recognizer.
- Time and number-of-states tagging.
- Pre-store.
- Autoscale.
- Programmability.
- Cross-domain triggering.
- Interactive measurements.
- Oscilloscope-type controls in the timing analyzer.
- State Compare, Chart, and Waveform modes.

Oscilloscope key features include:

- 400 Megasample/second digitizing rate.
- 100 MHz single-shot (real-time) bandwidth.
- 4 ksamples per measurement per channel.
- Automatic waveform scaling.

- ECL and TTL presets.
- Automatic pulse parameter measurements.
- Channel-to-channel time interval measurements.
- Markers for time and voltage readouts.
- 6-bit resolution.
- Probe attenuation from 1:1 to 1000:1.
- 50 Ω dc or 1 M Ω dc input coupling.
- Edge or immediate triggering.
- Delayed trigger by events and/or time.
- Trigger point marker displayed.
- Normal, average, or cumulative acquisitions.
- Connect-the-dots.
- Chan + Chan, Chan-Chan, and waveform overlay.

Accessories Supplied

Table 1-1 lists the accessories supplied with your HP 1652B/53B. If any of these accessories were missing when you received the logic analyzer from the factory, contact your nearest Hewlett-Packard office.

Accessory	HP Part No.	Quantity	
		1652B	1653B
Probe assemblies	01650-61608	5	2
Probe cables	01650-61607	5	2
BNC Adapter 90°	1250-0076	2	2
BNC-to-mini probe adapter	1250-1454	1	1
Grabbers (Note 1)	5959-0288	100	40
Probe Leads (Note 2)	5959-9333	85	34
Ground leads (long) (Note 2)	5959-9335	5	2
Ground leads (short) (Note 2)	5959-9334	10	4
RS-232C loop back adapter	01650-63202	1	1
Probe and probe cable numbering label card	01650-94303	1	1
Mini-probes 10:1, 1 MΩ, 6.5 pF, 1 m	HP 10430A	2	2
AC power cable	See Note 3	1	1
Operating system disk	Call	2	2
Operating and Programming manual set	01652-90902	1	1
Service Manual	01652-90905	1	1

Table 1-1. Accessories Supplied

Notes:

1. Package of 20 per part number. The quantity in the table only indicates what is shipped with the instrument.
2. Package of 5 per part number. These items are shipped assembled as a 01650-61608. The part numbers are provided for replacement orders. The quantity in the above table only indicates what is sent with the instrument.
3. The type of power cord you receive with your logic analyzer depends on your country. Complete information about power cord options is in Appendix D of this manual.

Available Accessories

In addition to the accessories supplied, there are a number of accessories available that will make your measurement tasks easier and more accurate. You will find these listed in *Accessories for HP Logic Analyzers*.

Manuals Supplied

The manuals supplied with your logic analyzer are as follows:

- *Feeling Comfortable with Logic Analyzers* - A primer on logic analyzers.
- *Feeling Comfortable with Digitizing Oscilloscopes* - A primer on digitizing oscilloscopes.
- *Getting Started with the HP 1652B/1653B Logic Analyzer* - A tutorial for new and casual users.
- *HP 1652B/1653B Front Panel Operation Reference Manual* - A complete operating manual.
- *HP 1652B/1653B Programming Reference* - A complete reference to programming commands.
- *Service Manual* - A guide to troubleshooting and module-level repair.

Turning On the Logic Analyzer

Before you turn your logic analyzer on, refer to Appendix D for information covering installation and set up of your logic analyzer.

Note 

Do not turn on the logic analyzer before you remove the yellow shipping disk from the disk drive.

If you are unfamiliar with how to use the HP 1652B/1653B logic analyzers, refer to chapter 1 of the *Getting Started with the HP 1652B/1653B Logic Analyzer*.

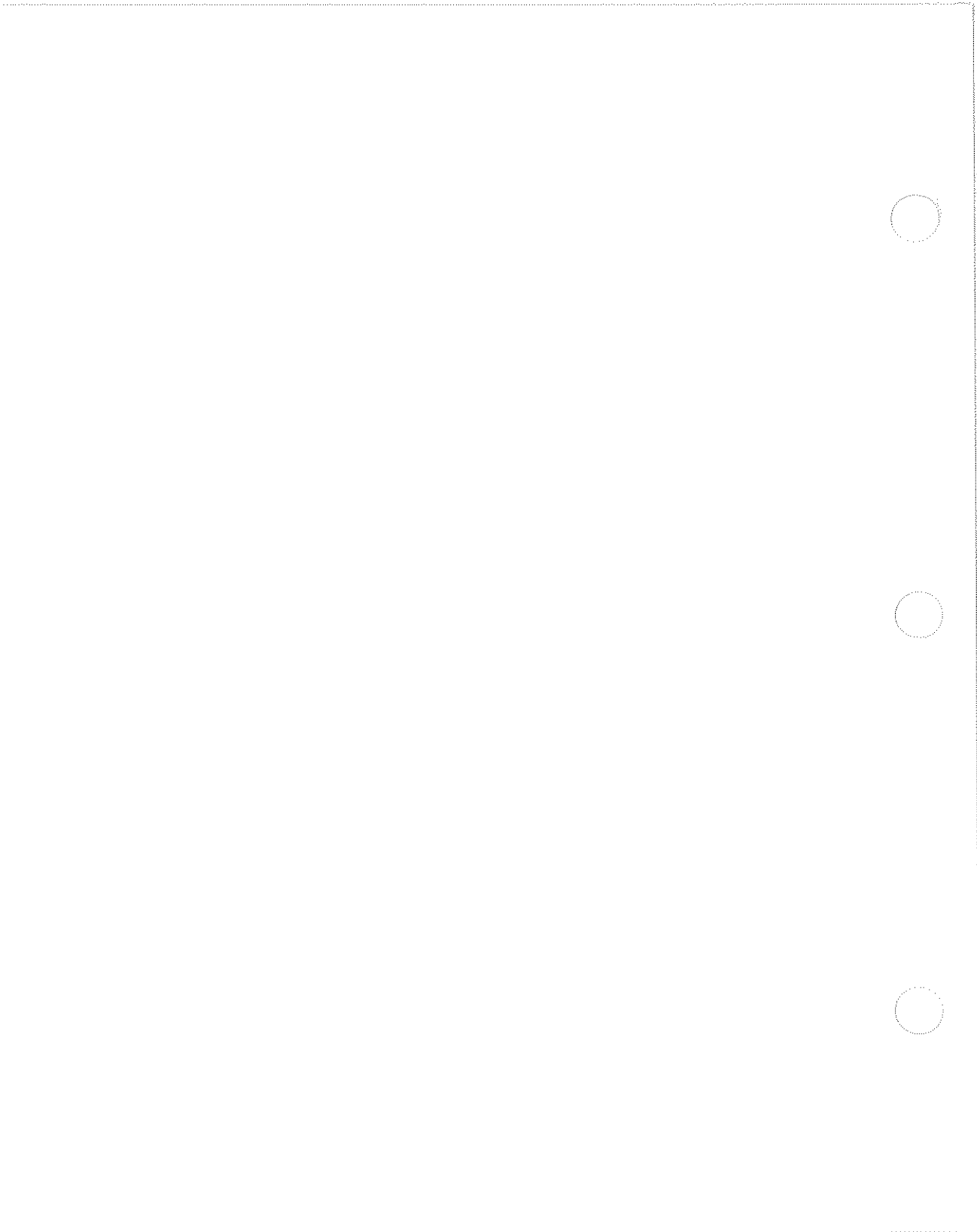

Probing

Introduction

This chapter contains a description of the probing system of the HP 1652B/1653B logic analyzers. It also contains the information you need for connecting the probe system components to each other, to the logic analyzer and oscilloscope, and to the system under test.

Probing Options

You can connect the HP 1652B/1653B logic analyzers to your system under test in one of the following ways:

- HP 10320C User-Definable Interface (optional).
- HP 10269C with microprocessor specific modules (optional).
- The standard HP 1652B/53B probes (general purpose probing.)
- Direct connection to a 20-pin 3M[®] Series type header connector using the optional termination adapter (HP part number 01650-63201).

The HP 10320C User-Definable Interface

The optional HP 10320C User-Definable Interface module combined with the optional HP 10269C General Purpose Probe Interface allows you to connect the HP 1652B/1653B logic analyzers to the microprocessor in your target system. The HP 10320C includes a breadboard (HP 64651B) which you custom wire for your system.

Another option for use with the HP 10320C is the HP 10321A Microprocessor Interface Kit. This kit includes sockets, bypass capacitors and a fuse for power distribution. Also included are wire-wrap headers to simplify wiring of your interface when you need active devices to support the connection requirements of your system.

You will find additional information about the HP 10320C and HP 10321A in the *Accessories for HP Logic Analyzers* data sheet.

The HP 10269C General Purpose Probe Interface

Instead of connecting the analyzer probe tips directly to the signal lines, you may use the optional HP 10269C General Purpose Probe Interface. The HP 10269C allows you to connect the probe cables, without the probes, to connectors on the interface. When the appropriate preprocessor is installed in the interface, you will have a direct connection between the logic analyzer and the microprocessor under test. See figure 2-1 for a basic block diagram.

There are a number of microprocessor specific preprocessors available as optional accessories which are listed in the *Accessories for HP Logic Analyzers* data sheet. Appendix A of this manual also introduces you to preprocessors and inverse assemblers.

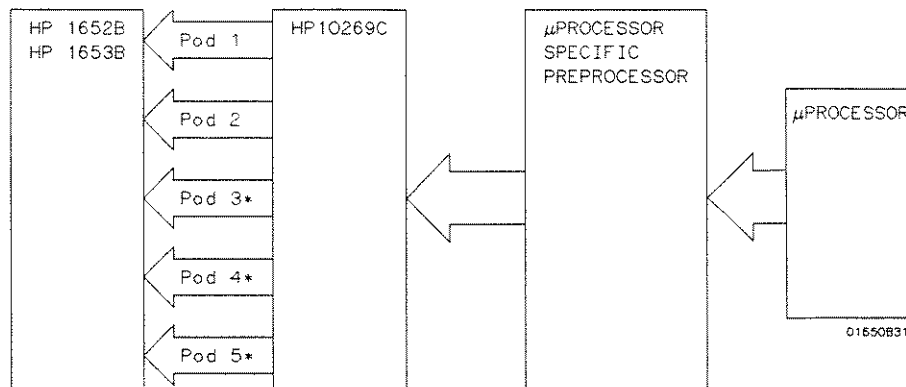

* Not available on HP1653B

Figure 2-1. HP 10269C with Preprocessor

General Purpose Probing

General purpose probing involves connecting the logic analyzer and oscilloscope probes directly to your target system without using any interface. General purpose probing does not limit you to specific hook up schemes, for an example, as the probe interface does.

The Termination Adapter

The optional termination adapter (HP part number 01650-63201) allows you to connect the logic analyzer probe cables directly to test ports on your target system without the probes. However, since the probes contain the proper termination for the logic analyzer inputs, a termination must be provided.

The termination adapter shown below, is designed to connect to a 20 (2x10) position, 4-wall, low profile header connector, 3M[®] Series 3592 or equivalent.

To hook up the adapter, connect the termination adapter to the analyzer probe cable. Connect the other end of the adapter directly to your test port.

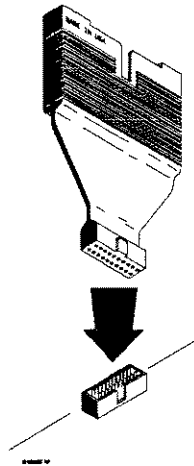

Figure 2-2. Termination Adapter

The HP1652B/1653B Probing System

The standard HP 1652B/53B probing system consists of logic analyzer probes and oscilloscope probes. Both have a passive design which means there are no active circuits at the outer end of the cable. The passive design also enables the pods and probes to be smaller and lighter, there by making them easier to use.

The logic analyzer probing system consists of flat ribbon probe cables, a probe housing, probe leads, ground leads and grabbers. This passive probing system is similar to the probing system used with high frequency oscilloscopes. It consists of a series R-C network (100 k Ω in parallel with 8 pF) at the probe tip, and a shielded resistive transmission line. The advantages of this system include the following:

- 2 ns risetime with $\pm 5\%$ perturbations
- 8 pF input capacitance at the probe tip
- Signal ground at the probe tip for higher speed timing signals
- Inexpensive removable probe tip assemblies

Probe Pod Assemblies

Probes and probe pod assemblies allow you to connect the logic analyzer to your system under test without the HP 10269C Probe Interface. This general purpose probing is useful for discrete digital circuits. Each pod, as they will be referred to for consistency, contains, 16 probes (data channels), one clock channel, and a pod ground. See the figure below.

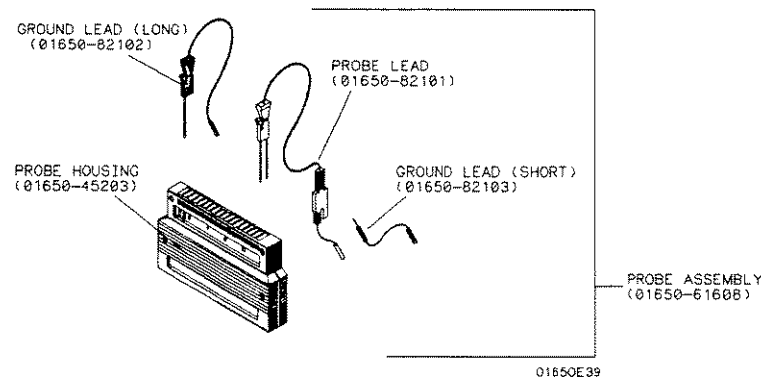

Figure 2-3. Probe Pod Assembly

Pod Grounding

Each pod is grounded by a pod ground lead that should always be used. You can connect the ground lead directly to a ground pin on your target system or use a grabber. The grabber connects to the ground lead the same way it connects to the probe lead. To connect the ground lead to grounded pins on your target system, you must use 0.63 mm (0.025 in.) square pins or round pins with a diameter of 0.66 mm (0.026 in) to 0.84 mm (0.033 in).

Probes

The probe consists of a 12-inch twisted pair cable and one grabber. The probe tip, which connects to the target system, has an integrated R-C network with an input impedance of 100 k Ω in parallel with approximately 8 pF. See figure 2-4 below.

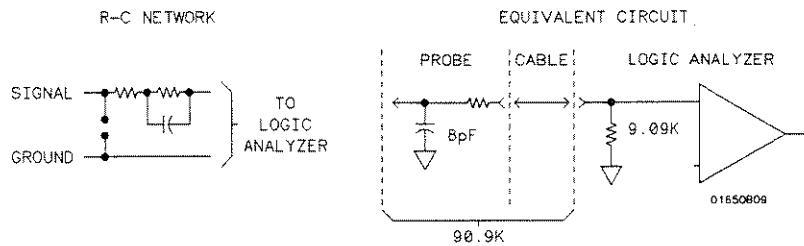
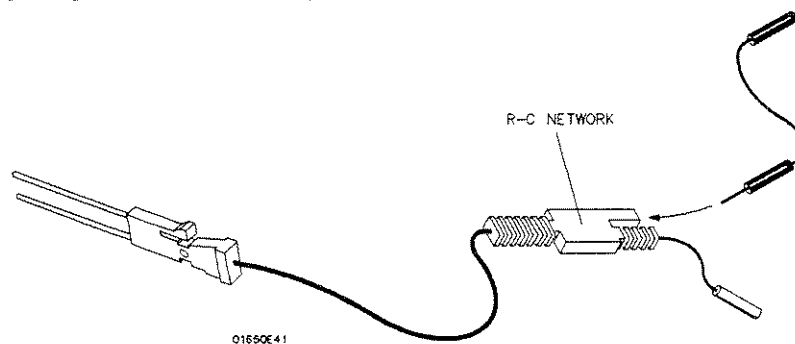

Figure 2-4. Probe Input Circuit

The other end of the probe has a two-pin connector that snaps into the pod's probe housing. See figure 2-5.



2-5. Probe

Probe Grounding

You can ground the probes in one of two ways. You can ground the probes with the pod ground only; however, the ground path won't be the same length as the signal path through the probe. If your probe ground path must be the same as your signal path, use the short ground lead (probe ground). The probe ground lead connects to the molded probe body via a pin and socket. You can then use a grabber or grounded pins on your target system the same way as the pod ground.



For improved signal fidelity, use a probe ground for every four probes in addition to the pod ground.

If you need additional probe ground leads, order HP part number 5959-9334 from your nearest Hewlett-Packard sales office.

Grabbers

The grabbers have a hook that fits around IC pins and component leads and connects to the probes and the ground leads. The grabbers have been designed to fit on adjacent IC pins.

Probe Cable

The probe cable contains 17 signal lines, 17 chassis ground lines and two power lines (for preprocessor use) that are woven together into a flat ribbon that is 4.5 feet long. The probe cable connects the logic analyzer to the pods, termination adapter, or the HP 10269C General Purpose Probe Interface.

Both ends of the cable are alike, so you can connect either end to the pods or logic analyzer. Each cable is capable of carrying 0.60 amps for preprocessor power.



DO NOT exceed this 0.60 amps per cable or the cable will be damaged. Also, the maximum power available from the logic analyzer (all cables) is 2 amps at 5 volts.



Preprocessor power is protected by a current limiting circuit. If current exceeds 2.3 amps, the circuit will open. The current limiting circuit will try to reset itself every 20 ms until the shorted condition is fixed.

Oscilloscope Probes

The two oscilloscope probes supplied with the HP 1652B/1653B Logic Analyzer are the HP 10433A Miniature Passive Probes. These small, lightweight probes allow measurements that were previously very difficult in densely populated circuits.

For complete information on the operation, maintenance, and adjustments of the miniature passive probes, be sure to read the operating note that is packaged with the probes.

Probe Inputs

Probe inputs are located on the front panel below the Knob. Input 1 (CH 1) is on the left. The probes may be connected directly to the BNC input connectors. The signal is dc coupled to the oscilloscope.

BNC cables can be connected directly to the BNC connectors. The HP 10503A 1.2 meter BNC-to-BNC cable is not provided with the instrument, but, you can order it, separately.

External Trigger BNCs

Inputs. The External Trigger Input allows the analyzer/scope trigger to be armed from an external TTL compatible source. Arming occurs when the normally active high status of the BNC is pulled low.

Outputs. The External Trigger Output provides the user access to the analyzer/scope trigger output pulse. The output pulse is a TTL compatible positive going pulse, that remains high from the time of trigger until the acquisition cycle is complete.

BNC cables can be connected directly to the BNC connectors. The HP 10503A 1.2 meter BNC-to-BNC cable is not provided with the instrument, but, you can order it, separately.

Compensation Signal Output

The Compensation Signal Output BNC is located on the rear panel. The Compensation Signal 50Ω output is ~1.2 kHz square wave with high amplitude near -200 mV and low amplitude near -400 mV when connected to a 50Ω load. This square wave is used for probe compensation adjustment (see your operating note for more information about probing) and is used in examples throughout this manual.

Signal Line Loading

Any signal line you intend to probe with the logic analyzer probes, must supply a minimum of 600 mV to the probe tip. The probes have an input impedance of 100 k Ω shunted by 8 pF. If the signal line is incapable of this minimum voltage, you will not only have an incorrect measurement, but the system under test may also malfunction.

Maximum Probe Input Voltage

The maximum input voltage of each logic analyzer probe is ± 40 volts peak.

The maximum input voltage of the oscilloscope probes is ± 250 volts dc at 1 M Ω setting and 5 volts rms at 50 Ω setting.

Pod Thresholds

Logic analyzer pods have two preset thresholds and a user-definable pod threshold. The two preset thresholds are ECL (- 1.3 V) and TTL (+ 1.6 V). The user-definable threshold can be set anywhere between - 9.9 volts and + 9.9 volts in 0.1 volt increments.

The pod thresholds of pods 1 and 2 in the HP 1653B and of pods 1, 2, and 3 in the HP 1652B can be set independently. The pod thresholds of pods 4 and 5 in the HP 1652B are slaved together. Therefore, when you set the threshold on either pod 4 or 5, both thresholds will be the same.

Connecting the Logic Analyzer to the Target System

There are four ways you can connect the logic analyzer to your target system: the probes (general purpose probing); the HP 10320C User-definable Interface; the HP 10269C with microprocessor specific preprocessor modules; and direct connection to a 20 pin 3M[®] Series type header connector using the optional termination adapter (HP part number 01650-63201).

Since the probe interface hookups are microprocessor specific, they will be explained in their respective microprocessor operating notes. The rest of this chapter is dedicated to general purpose probing with the logic analyzer probes.

Connecting the Probe Cables to the Logic Analyzer

You connect the probe cables to the probe cable connectors located on the rear panel of the logic analyzer. The probe cable connectors are keyed for proper orientation. You can connect either end of the cable to the rear panel since both ends of the cables are alike.

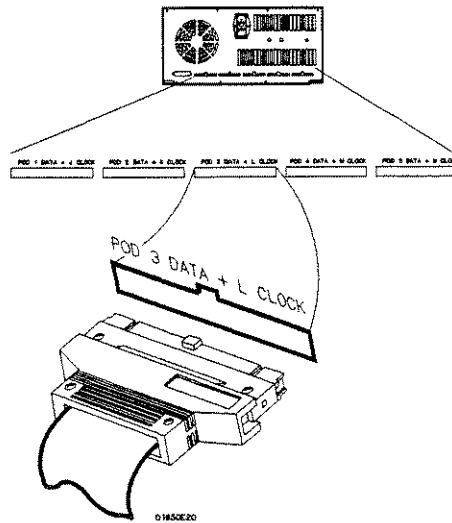

Figure 2-6. Probe Cable to Analyzer Connection

Connecting the Pods to the Probe Cable

The analyzer pods of the HP 1652B/53B differ from other logic analyzers in that they are passive (have no active circuits at the outer end of the cable). The pods, are the connector bodies (as shown below) that the probes are installed in when you receive your logic analyzer.

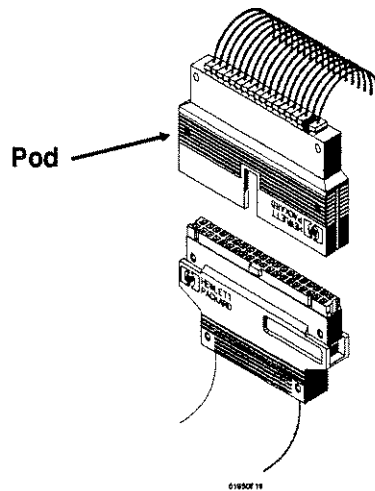

Figure 2-7. Connecting Pods to Probe Cables

To connect a pod to a cable, align the key on the cable connector with the slot on the pod connector and press together.

Disconnecting the Probes from the Pods

When you receive the logic analyzer, the probes are already installed in the pods. To keep them out of your way, disconnect them from the pod.

To disconnect a probe, insert the tip of a ball-point pen into the latch opening. Push on the latch while gently pulling the probe out of the pod connector as shown below.

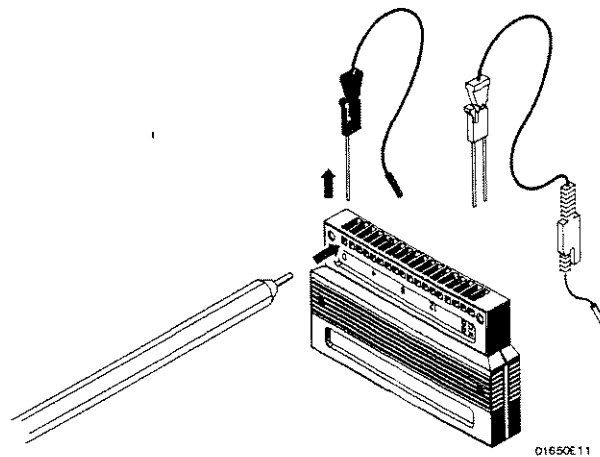

Figure 2-8. Disconnecting Probes From Pods

You connect the probes to the pods by inserting the double pin end of the probe into the pod. The probes and pod connector body are both keyed (beveled) so that they will fit together only one way.

Connecting the Grabbers to the Probes

Connect the grabbers to the probes by slipping the connector at the end of the probe onto the recessed pin located in the side of the grabber. If you need to use grabbers for either the pod or the probe grounds, connect the grabbers to the ground leads in the same manner.

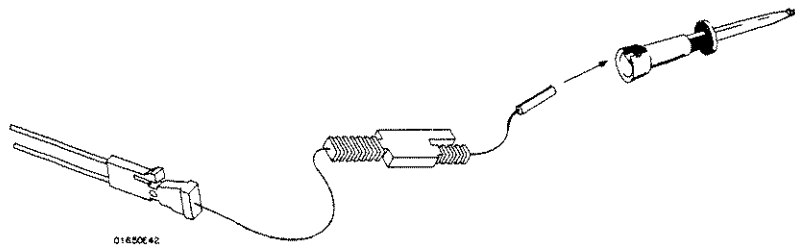

Figure 2-9. Connecting Grabbers to Probes

Connecting the Grabbers to the Test Points

The grabbers have a hook that fits around the IC pins and component leads. Connect the grabber to the test point by pushing the rear of the grabber to expose the hook. Hook the lead and release your thumb as shown below.

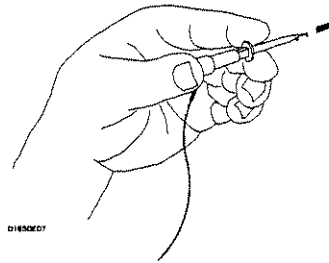

Figure 2-10. Connecting Grabbers to Test Points

Labeling Pods, Probes, and Cables

Included with your logic analyzer are self-adhesive labels for each pod, cable and probe. Use these sets of labels for identification.

Each set has labels for each end of the cable, a label for the probe housing, a label for the clock probe and 15 labels for each of the channels. The figure below, shows the correct placement of the labels.

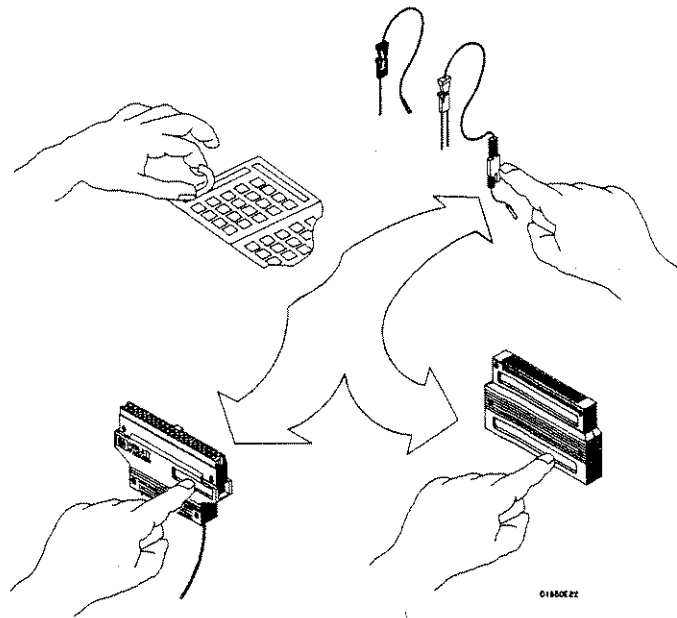
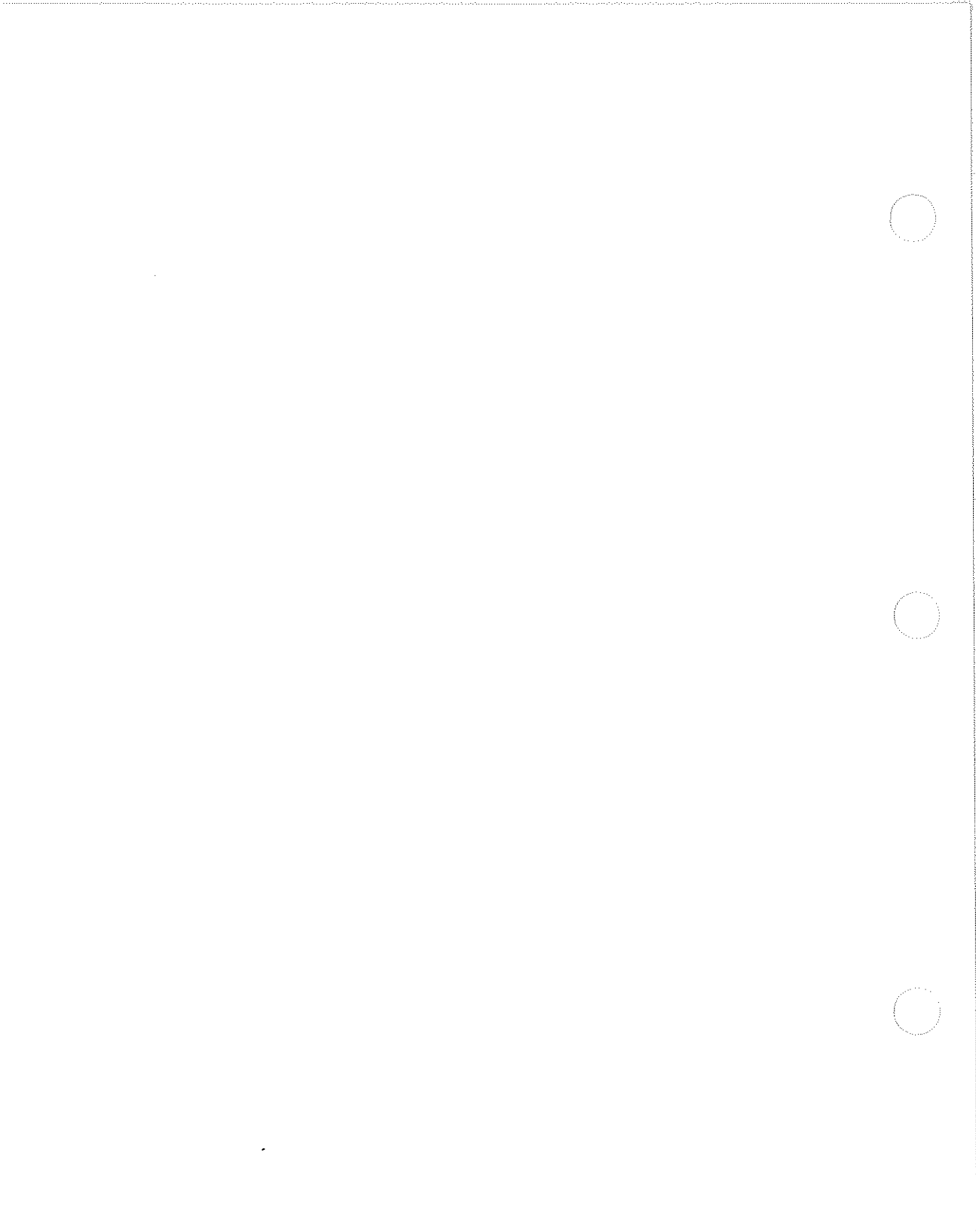

Figure 2-11. Labeling Pods, Probes and Cables



Using the Front-Panel User Interface

Introduction

This chapter explains how to use the front-panel user interface. The front and rear-panel controls and connectors are explained in the first part of this chapter followed by "How to use..." explanations of the front-panel user interface.

The front-panel user interface consists of front-panel keys, the KNOB, and display. The interface allows you to configure the logic analyzer, oscilloscope and each analyzer (machine) within the logic analyzer. It also displays acquired data and measurement results.

Using the front-panel user interface involves the following processes:

- Selecting the desired menu with the menu keys.
- Placing the cursor on the desired field within the menu by rotating the KNOB.
- Displaying the field options or current data by pressing the SELECT key.
- Selecting the desired option by rotating the KNOB or entering new data by using the KNOB or the keypad.
- Starting and stopping data acquisition by using the RUN and STOP keys.

Front-Panel Controls

In order to apply the user interface quickly, you should know what the front-panel controls do.

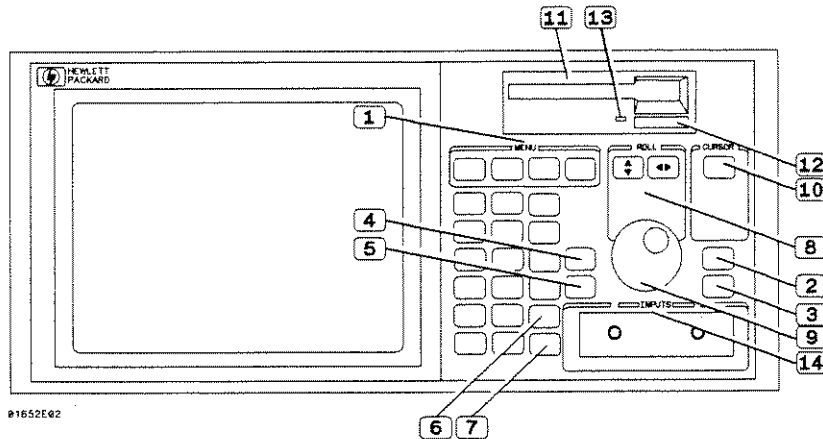

Figure 3-1. HP 1652B/53B Front Panel

- 1 Menu Keys.** The menu keys allow you to select the main menus in the logic analyzer. These keys are **FORMAT/CHAN**, **TRACE/TRIG**, **DISPLAY**, and **I/O**. The Format/Channel, Trace/Trigger, and Display keys will display the menus of either analyzer (machine) 1 or 2 respectively or the oscilloscope depending on what menu was last displayed or what you did in the System Configuration menu.

Format/Channel Menu Key. The **FORMAT/CHAN** menu key allows you to access either the Timing Format Specification, State Format Specification, or Oscilloscope Channel menus. You exit the Format/Channel menu by pressing another menu key or by returning to the System Configuration menu from this menu.

Trace/Trigger Menu Key. The **TRACE/TRIG** menu key allows you to access either the Timing Trace, State Trace, or Oscilloscope Trigger menus. You exit the Trace/Trigger menu by pressing another menu key or by returning to the System Configuration menu from this menu.

Display Menu Key. The DISPLAY menu key allows you to access either the Timing Waveforms display, State Listing display, or the Oscilloscope Waveforms display. You exit the Timing Waveforms, State Listing, and Oscilloscope Waveforms menus by pressing another menu key or by returning to the System Configuration menu.

I/O Menu Key. The I/O menu key allows you to access the I/O menu. You can access the I/O menu from any menu in either analyzer (timing or state) or oscilloscope, and at any time. Pressing the I/O menu key causes the I/O menu to pop up over any current menu on the display.

- ② **Run Key.** The RUN key allows you to initiate a data acquisition and display cycle. The analyzer (state or timing) is automatically forced into its display menu when a run is initiated. The oscilloscope will stay in its current menu when a run is initiated. The trace mode or run mode you select (in the Trace/Trigger menu) determines whether a single or multiple (repetitive) run occurs.
- ③ **Stop key.** The STOP key allows you to stop data acquisition or printing. A single press always stops the data acquisition. The data displayed on screen depends on which acquisition mode (single or repetitive) was used to acquire the data. In the repetitive mode, STOP causes the old display to remain unchanged as long as the old data is not corrupt. In single mode, STOP causes any new data to be displayed. If printing a hardcopy, the STOP key stops the print.
- ④ **Don't Care Key.** The DON'T CARE key allows you to enter don't cares in binary octal, and hexadecimal pattern specification fields. In Alpha Entry fields, this key enters a space and moves the underscore marker to the next space.
- ⑤ **Clear Entry Key.** The CLEAR ENTRY key allows you to perform the following tasks:
 - Return decimal values to the previous value in the decimal menu fields.
 - Return values to don't cares in menu fields with number bases other than decimal.
 - Clear Alpha Entry menus.
 - Move the underscore marker or cursor to its original position in the menu fields.

⑥ **Hex(adecimal) Keypad.** The HEX keypad allows you to enter numeric values in numeric entry fields. You enter values in the four number bases below:

- Binary
- Octal
- Decimal
- Hexadecimal

The A through F keys are used for both hexadecimal and alpha character entries.

⑦ **CHS Key.** The CHS (change sign) key allows you to change the sign (\pm) of numeric variables.

⑧ **Roll Keys.** When part of the data display is off screen, the ROLL keys define which way the KNOB will move the displayed data. These keys and the KNOB roll displayed data up/down or left/right so you can view off-screen data.

⑨ **Knob.** The KNOB has four major functions depending on what menu or pop-up menu you are in. The KNOB allows you to do the following:

- Move the cursor from field to field within the System Configuration and main menus.
- Roll the display left or right and up or down.
- Position the cursor on options within pop-up menus.
- Increment/decrement numeric values in numeric pop-up menus.

⑩ **Select Key.** The SELECT key allows you to open pop-up menus, choose options in them, cancel selections, and close pop-up menus. When the cursor is in a main menu (i.e. Format Specification) pressing the SELECT key either opens a pop-up, or toggles options (when there are only two options possible) in that field.

When a pop-up menu appears, the cursor will be on the current option. You use the KNOB to move the cursor to your desired option. Pressing the SELECT key tells the logic analyzer this is the option you want. This either automatically selects the option and closes the pop-up, opens another pop-up, or changes options. If the pop-up doesn't automatically close, it will contain the Done field. In this case you close the pop-up by placing the cursor on Done and pressing SELECT.

- ⑪ **Disk Drive.** A 3.5 inch, double-sided, double density drive. Besides loading the operating system, it allows you to store and load logic analyzer configurations and inverse assembler files.
- ⑫ **Disk Eject Button.** Press this button to eject a flexible disk from the disk drive.
- ⑬ **Indicator Light.** This light is illuminated when the disk drive is operating. Wait until this light is out before removing or inserting disks.
- ⑭ **Inputs 1 and 2.** Two BNC connectors allow the connection of oscilloscope probes and BNC cables for signal input to the oscilloscope.

Rear-Panel Controls and Connectors

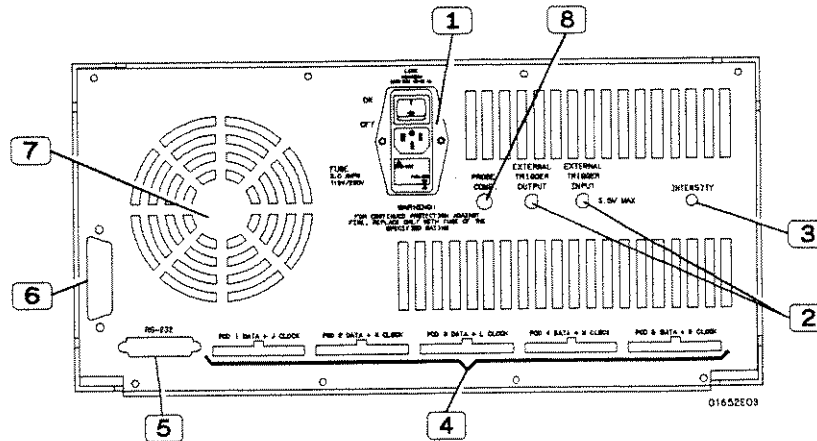

Figure 3-2. HP 1652B/53B Rear Panel

- ① **Line Power Module.** Permits selection of 110-120 or 220-240 Vac and contains the fuses for each of these voltage ranges. The On/Off switch is also part of the module.
- ② **External Trigger BNCs.** Provide arm out and arm in connections.
- ③ **Intensity Control.** Allows you to set the display intensity to a comfortable level.
- ④ **Pod Cable Connectors.** Keyed connectors for connecting the pod cables.



The HP 1653B rear panel has connectors for pods 1 and 2 only.

- ⑤ **RS-232C Interface Connector.** Standard DB-25 type connector for connecting an RS-232C printer or controller.

- ⑥ **HP-IB Interface Connector.** Standard HP-IB connector for connecting an HP-IB printer or controller.
- ⑦ **Fan.** Provides cooling for the logic analyzer. Make sure air is not restricted from the fan and rear-panel openings.
- ⑧ **Probe Compensation Signal Output.** Provides a signal for probe compensation adjustment.

The Cursor

The cursor (inverse video) highlights interactive fields within the menus that you want to use. Interactive fields are enclosed in boxes in each menu. When you rotate the KNOB, the cursor moves from one field to another.

How to Select Menus

You select the main menus by pressing the appropriate menu key. The main menu keys are:

- FORMAT/CHAN
- TRACE/TRIG
- DISPLAY
- I/O

When the menu is displayed, you can access fields within the menus.

The FORMAT/CHAN, TRACE/TRIG, and DISPLAY menu keys provide access to their respective menus. If more than one analyzer (machine) is on, or the oscilloscope is on, you see the selected menu of either analyzer 1, analyzer 2 or the oscilloscope depending on what type menu was last displayed (analyzer or scope), or what you did in the System Configuration menu. To switch from the machine 1 menu set to machine 2 (same analyzer) menu set or the oscilloscope menu set, select the desired analyzer or scope from the pop-up that appears when the field in the upper left corner of the main menu is selected. This pop-up is available in all main menus except the I/O menu.

The I/O menu differs from the other three main menus in that it is a pop-up menu that appears on top of the currently displayed menu when you press the I/O key.

How to Switch between the Analyzers and Oscilloscope

You can switch between the analyzers and oscilloscope in any main menu except the I/O menu. To switch between analyzers and scope, place the cursor on the field in the upper left corner of the FORMAT/CHAN, TRACE/TRIG, or DISPLAY (timing, state or scope) menu and press SELECT. A pop-up menu appears with the following options:

- System
- MACHINE 1 (or your analyzer name)
- MACHINE 2 (or your analyzer name)
- Mixed Mode (if two or more are on)
- Scope

Place the cursor on the opposite analyzer (machine), or scope and press SELECT. The logic analyzer will display the same menu type (i.e. format, trace, etc.) in the other analyzer (machine) or the scope menu. For example, if you were in the TRACE menu of machine 1, you will now see the TRIGGER menu of the scope or the TRACE menu of machine 2.

Returning to the System Configuration Menu

You can return to the System Configuration menu directly from the FORMAT, TRACE, or DISPLAY menus. To return to the System Configuration menu, place the cursor on the field in the upper left corner of any of these menus and press SELECT. The same pop-up menu appears with the following options:

- System
- MACHINE 1 (or your analyzer name)
- MACHINE 2 (or your analyzer name)
- Mixed Mode (if two or more are on)
- Scope

Place the cursor on System and press SELECT. The System Configuration menu is displayed.

How to Select Fields

You select fields within the main menu by placing the cursor on the desired field and pressing SELECT. Depending on what type of field you select, you will either see a pop-up menu or a new option in fields that toggle.

Pop-up Menu

The pop-up menu is the most common type of menu you see when you select a field. When a pop-up appears, you will see a list of two or more options. Two pop-up menu types are described in "How to Select Options" in this chapter.

How to Close Pop-up Menu

Pop-up menus without the Done option automatically close when you place the cursor on an option and press SELECT. After closing, the logic analyzer places your choice in the main menu field from which you opened the pop-up.

Pop-up menus that contain the Done option do not automatically close when you make your selection. To close the pop-up, you place the cursor on the Done option and press SELECT.

These two pop-up menu types are described in "How to Select Options" in this chapter.

How to Select Options

How to select options depends on what type of pop-up menu appears when you press select. When the pop-up appears, you will see a list of options. You select the option you want by placing the cursor on it and pressing SELECT. In most cases the pop-up menu closes and your desired option is now displayed in the field in the main menu.

There are also pop-up menus where each option within the pop-up menu has more than one option available. In these cases, when you place the cursor on one of the options and press SELECT, another pop-up will appear.

An example of one of these is the clock field in the State Format Specification menu. When you select the clock field in this menu it will pop-up and show you all five clocks (J, K, L, M, and N) for an HP 1652B or both clocks (J and K) for an HP 1653B.

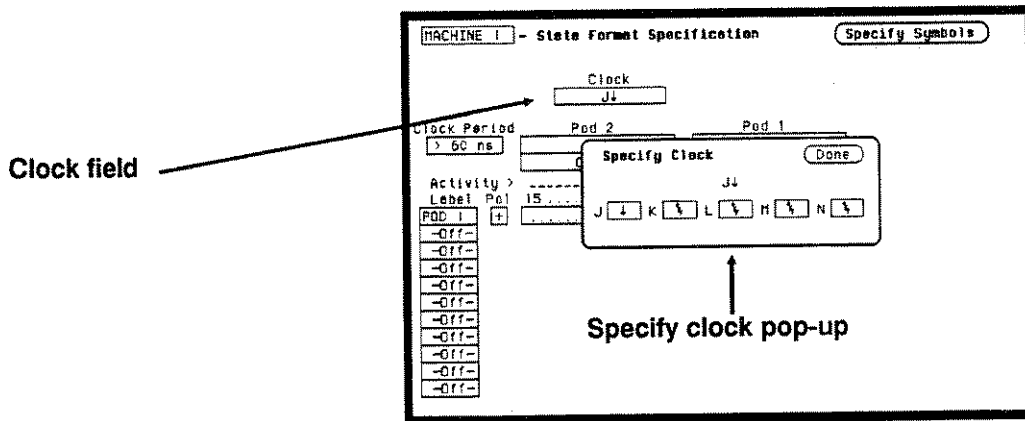

Figure 3-3. State Clock Pop-up Menu

When you place the cursor on one of the clocks and press SELECT, another pop-up appears, showing you the choices of clock specifications available.

Clock specification pop-up

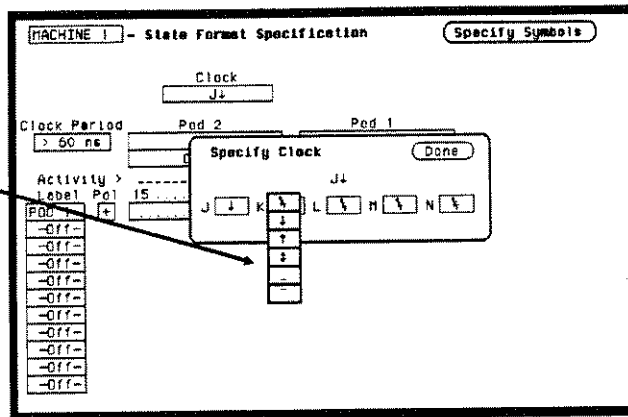

Figure 3-4. State Clock Pop-up with K Pop-up Open

When you choose one of these specifications and press SELECT, this pop-up will close, however, the original clock pop-up still remains open. When finished specifying the choices for the clocks, you close the original pop-up menu by selecting Done and pressing SELECT.

Toggle Fields

Some fields will toggle between two options "off" and "on". When you place the cursor on one of these fields and press SELECT, the displayed option toggles to the other choice and no additional pop-up appears.

How to Enter Numeric Data

There are a number of pop-up menus in which you enter numeric data. The two major types are as follows:

- Numeric entry with fixed units (i.e. volts).
- Numeric entry with variable units (i.e. ms, μ s, etc.).

An example of a numeric entry menu in which you only enter the value with fixed units is the pod threshold pop-up menu.

You can set the pod thresholds to either of the preset thresholds (TTL or ECL) or to a specific voltage from - 9.9 V to + 9.9 V.

To set pod thresholds to a specific voltage, place the cursor in the threshold portion of the pod field (TTL, ECL, or User-defined) of any pod and press SELECT.

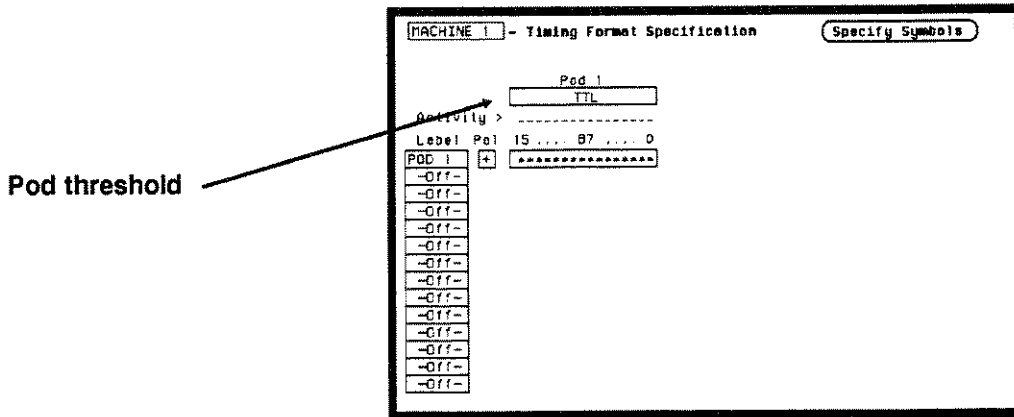

Figure 3-5. Pod Threshold

Select the **User-defined** option and another pop-up appears for you to specify the pod threshold voltage.

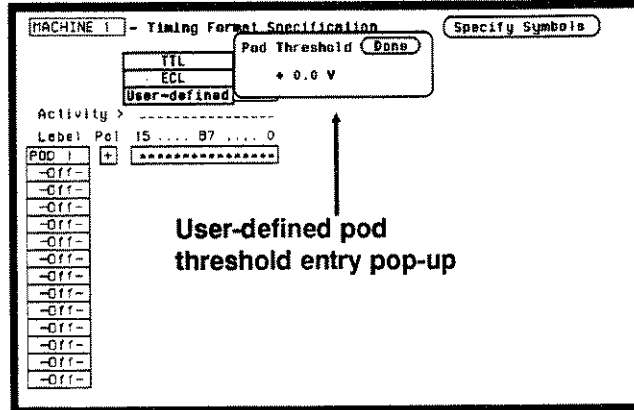

Figure 3-6. User-Defined Pop-up

You can select your desired threshold by rotating the KNOB until your desired threshold voltage is displayed. Rotating the KNOB increments or decrements the value in small steps. Or you can change the value with the keypad. It allows you to make large value changes quickly. Entering the new value from the keypad replaces the previous value.

If you want a negative voltage for the threshold, press the CHS (change sign) key on the front panel. The minus (–) sign will appear in the pop-up.

Notice, the cursor stays in the upper right corner of the pop-up over Done. When you press SELECT, the pop-up will close and your new threshold will be placed in the Pod field.

In another type of numeric entry pop-up menu you must specify the units as well as the numeric value. The pattern duration specification in the Timing Trace Specification menu is an example. When you place the cursor on the value in the present for _____ field and press SELECT, you will see the following pop-up:

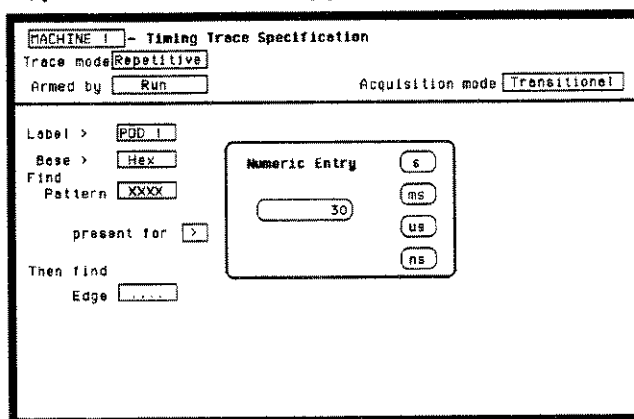

Figure 3-7. Numeric Entry Pop-up

You enter a new value from the keypad. When you have entered your desired value, you can change the units (i.e., ns, μ s, ms, s) by rotating the KNOB.

Once you select the new value and the units, close the pop-up by pressing SELECT. The new value and the units will be displayed in the present for _____ field.

In all numeric entry fields except the pod threshold field, you can open the pop-up without pressing SELECT. To open the pop-up without pressing SELECT, place the cursor on the field and press any number that particular field accepts. The pop-up will appear with the new number in the pop-up.



Any time the cursor is on one of the numeric entry fields and you unintentionally press a key that the field accepts, the pop-up will appear and the number you pressed will replace your current value. To close the pop-up and return the original value, press the CLEAR ENTRY key.

How to Enter Alpha Data

You can customize your analyzer configuration by giving names to several items:

- The name of each analyzer.
- Labels.
- Symbols.
- Filenames.
- File descriptions.

For example, you can give each analyzer a name that is representative of your measurement. The default names for the analyzers within the logic analyzer are MACHINE 1 and MACHINE 2. To rename an analyzer, place the cursor on the name you wish to change in the System Configuration menu and press SELECT. You will see the Alpha Entry pop-up menu:

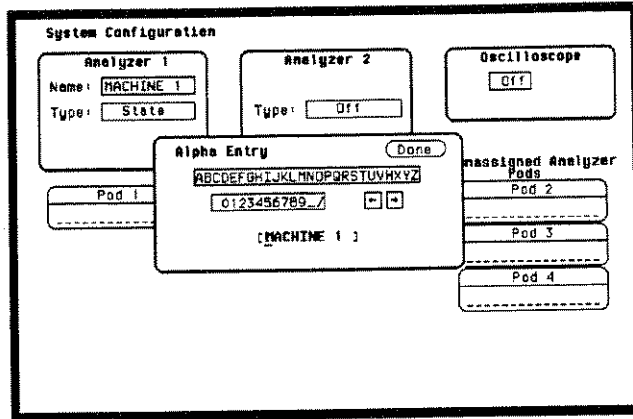

Figure 3-8. Alpha Entry Pop-up

The top two lines enclosed in boxes in the pop-up contain the complete alphanumeric set you use for names in these types of fields. The bottom line (enclosed in brackets) contains the name that existed when you opened the Alpha Entry pop-up. To enter alpha characters in the brackets (where the default or old name appears) position the cursor on the desired character and press SELECT. The new character will be placed in the brackets where the underscore marker is located. If you want to place a new character in the brackets at a location not marked by the underscore marker, move the underscore marker to where you want the new character to be placed. Moving the underscore marker is explained in "Changing Alpha Entries."

Note 

You can also make direct keypad entries. Your selection will be placed where the underscore marker is in the box.

Changing Alpha Entries

To make changes or corrections in the Alpha Entry field, position the underscore marker under the character you want to change.

To move the underscore marker to the left, place the cursor over the left arrow and press SELECT once for each backspace.

To move the underscore marker to the right, you either place the cursor on a desired character and press SELECT, or place it on the right arrow and press SELECT.

You can also use the ROLL keys and the KNOB to move the underscore marker. To use this alternate method press the left/right ROLL key and rotate the KNOB until the underscore marker is under the desired character. To return the KNOB to controlling the cursor's movement, press the left/right ROLL key again or press SELECT.

If you want to erase the entire entry and place the underscore marker at the beginning of the name box, press the CLEAR ENTRY key on the front panel.

If you want to replace a character with a space, place the underscore marker under that character and press the DON'T CARE key on the front panel.

How to Roll Data

To roll data, you press either the left/right or up/down ROLL keys and rotate the KNOB. The roll function is only available when there is more data in the menu than can fit on screen. If there is off-screen data, pressing the ROLL keys causes an indicator to appear in the upper left corner of the display and activates the roll function of the KNOB. If there is no off-screen data, the indicator will not appear.

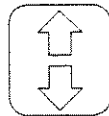

Up/Down

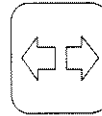

Left/Right

01650M06

Figure 3-9. Roll Function Keys

One example of a menu with off-screen data is the STATE LISTING menu. The state listing can contain up to 1024 lines; however, the display is only capable of showing you 16 lines at a time. To roll the off-screen data, press the up/down ROLL key and then rotate the KNOB to view the off-screen data.

68000STATE - State Listing		
Markers	011	
Label >	ADDR	DATA
Base >	Hex	Hex
-0007	0088C4	4E75
-0006	0088C5	51E6
-0005	0004FC	0000
-0004	0004F2	88C8
-0003	0088CB	B03C
-0002	0088CA	00FF
-0001	0088CC	5730
*0000	000000	0000
+0001	000002	04FC
+0002	000004	0000
+0003	000006	804E
+0004	00804B	2E7C
+0005	00804A	0000
+0006	00804C	04FC
+0007	00804E	51D8
+0008	008050	5100

Figure 3-10. Typical State Listing Menu

Assignment/ Specification Menus

There are a number of pop-up menus in which you assign or specify what you want the logic analyzer to do. The basic menus of this type are as follows:

- Assigning pod bits to labels
- Specifying patterns
- Specifying edges

Assigning Pod Bits to Labels

The bit assignment fields in both state and timing analyzers work identically. The convention for bit assignment is as follows:

- * (asterisk) indicates assigned bits
- . (period) indicates un-assigned bits

Note 

If you don't see any bit assignment fields, it merely means you do not have any pods assigned to this analyzer. Either switch analyzers or assign a pod to the analyzer you are working with.

To assign bits in these menus, place the cursor on one of the bit assignment fields and press SELECT. You will see the following pop-up menu:

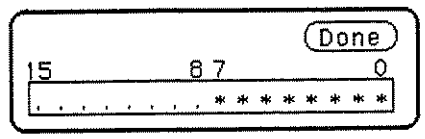

Figure 3-11. Bit Assignment Pop-up

Place the cursor on the left-most asterisk or period in the pop-up that you want to change and press SELECT. The bit assignment toggles to the opposite state of what it was when the pop-up first opened. Move the cursor one bit to the right. Holding the SELECT key, repeats the bit assignment. You close the pop-up by placing the cursor on Done and pressing SELECT.

Specifying Patterns

The Specify Patterns fields appear in several menus in both the timing and state analyzers. Patterns can be specified in one of the available number bases, except ASCII.

The convention for "don't cares" in these menus is an "X" except in the decimal base. If the base is set to decimal after a "don't care" is specified, a \$ character is displayed.

An example of a Specify Patterns field is the **Find Pattern** _____ field in the Timing Trace Specification menu.

When you place the cursor on the **Find Pattern** _____ field and press **SELECT**, you will see the following pop-up menu appear.



Figure 3-12. Find Pattern _____ field Pop-up

When the pop-up is open, enter your desired pattern from the keypad (including don't cares). When you finish entering your pattern, close the pop-up by pressing **SELECT**.

Specifying Edges

You can select positive-going (\uparrow), negative-going (\downarrow), or either edge (\updownarrow) as part of your trigger specification. You specify edges in the **Timing Trace Specification** menu by placing the cursor on the **Then find Edge** field under the desired label and pressing **SELECT**. You will see the following menu.

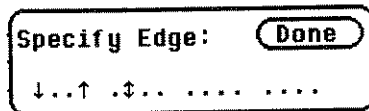

Figure 3-13. Edge Pop-up

You will notice a number of periods in the pop-up menu. Each period represents an unassigned bit for each bit assigned to the label. Don't be alarmed if you see a different number of unassigned bits, it merely means the number of bits in your label is different than the number in the label for this example.

To select a desired edge, place the cursor on your desired bit position in the pop-up and press **SELECT** until you see the desired edge, or unassign (.) the bit. Pressing **SELECT** changes the bit sequentially from (.) to \downarrow to \uparrow to \updownarrow and back to (.).



System Configuration Menu

Introduction

This chapter describes the System Configuration menu and pop-up menus within the System Configuration menu.

The purpose and functions of each field are explained in detail, and we have included illustrations and examples to make the explanations clearer.

System Configuration Menu

The System Configuration menu can be considered a system level menu in that it contains fields that you use to turn the scope on or off and start the configuration process for both analyzer 1 and analyzer 2. You use this menu to do the following:

- Turn analyzer machines and scope on or off.
- Specify analyzer type (timing and state).
- Assign pods to the individual machines within the logic analyzer.
- Initiate Autoscale in both the oscilloscope and timing analyzer.
- Name each analyzer.

In this menu, you configure your logic analyzer in one of nine ways:

- Timing analyzer only.
- State analyzer only.
- Up to two scope channels.
- Two state analyzers.
- One timing analyzer and one state analyzer.
- Timing analyzer with up to two scope channels.
- State analyzer with up to two scope channels.
- Two state analyzers with up to two scope channels.
- One timing analyzer, one state analyzer and up to two scope channels.

The System Configuration menu for the HP 1652B Logic Analyzer is shown below.

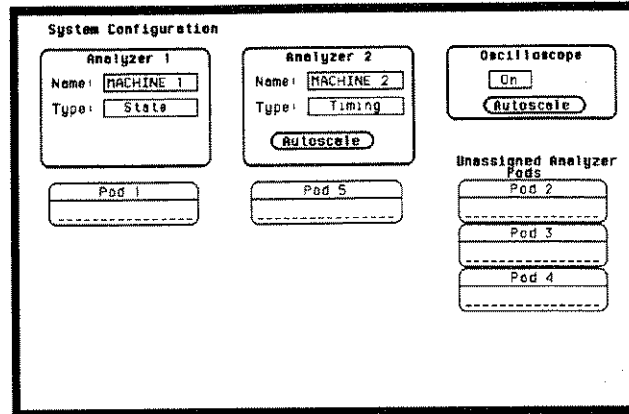

Figure 4-1. System Configuration Menu For HP 1652B

Accessing the System Configuration Menu

The System Configuration menu is the default display when the logic analyzer is turned on and the operating system has loaded. Once the logic analyzer or scope is on and you are in a menu other than the System Configuration menu, you access the System Configuration menu by placing the cursor in the system access field in the upper left corner and press SELECT. This field will be displaying either the scope, Machine 1, Machine 2, or a user-defined name for the current analyzer machine before you press SELECT.

You then place the cursor on System in the pop-up menu and press SELECT. When the pop-up closes the System Configuration menu will be displayed.

System Configuration Menu Fields

The System Configuration menu fields are described in the following paragraphs.

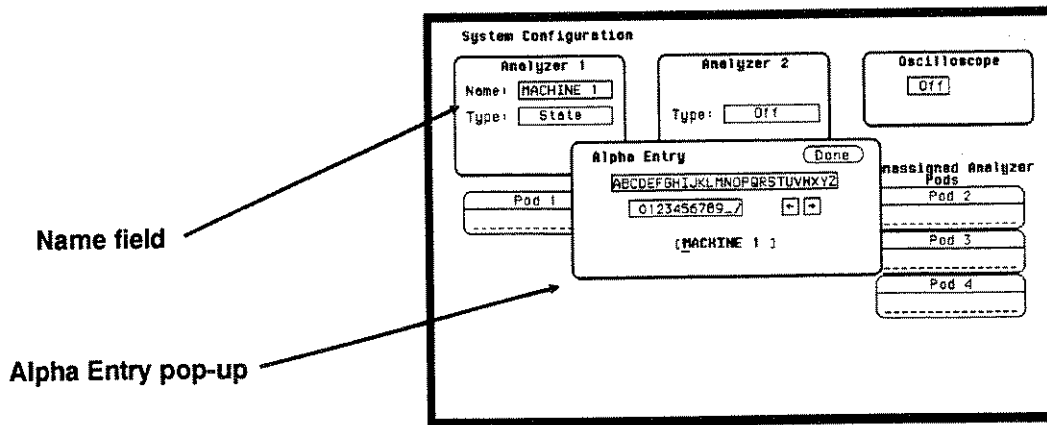

Figure 4-2. Alpha Entry Pop-up Menu

Name You name an analyzer by selecting the Name field under it. An Alpha Entry pop-up menu will open as shown above. The pop-up contains a row of alpha characters, a row of numeric characters, two arrows, and a box at the bottom of the menu in which the name appears. In the name box is an underscore marker. This marker indicates in what space your next selection will be placed.

You can name the analyzer in one of two ways. The first way is to position the cursor over the desired character in the pop-up using the KNOB, then press SELECT. The character appears in the name box.

The second method is to use the keypad on the front panel. With this keypad you can enter the letters A through F and the numbers 0 through 9 instead of using the characters in the pop-up.

The arrows in the pop-up move the underscore marker forward or backward. To move the marker forward, position the cursor over the right-pointing arrow and press SELECT. To backspace the marker position the cursor over the left-pointing arrow and press SELECT.

You can also move the underscore marker with the ROLL keys and the KNOB. Pressing the left/right ROLL key activates the marker. Rotating the KNOB places the marker under the desired character.

You can replace a character with a space in one of two ways. Position the cursor over the space in the pop-up and press SELECT, or press the DON'T CARE key on the front panel.

If you want to erase the entire entry and place the underscore marker at the beginning of the name box, press the CLEAR ENTRY key on the front panel. When you have entered the correct name, position the cursor over Done and press SELECT.

Type The **Type** field defines the machine as either a state analyzer or a timing analyzer. When this field is selected, a pop-up selector menu appears. You choose the machine type by using the KNOB to move the cursor within the menu to the desired selection and pressing SELECT.

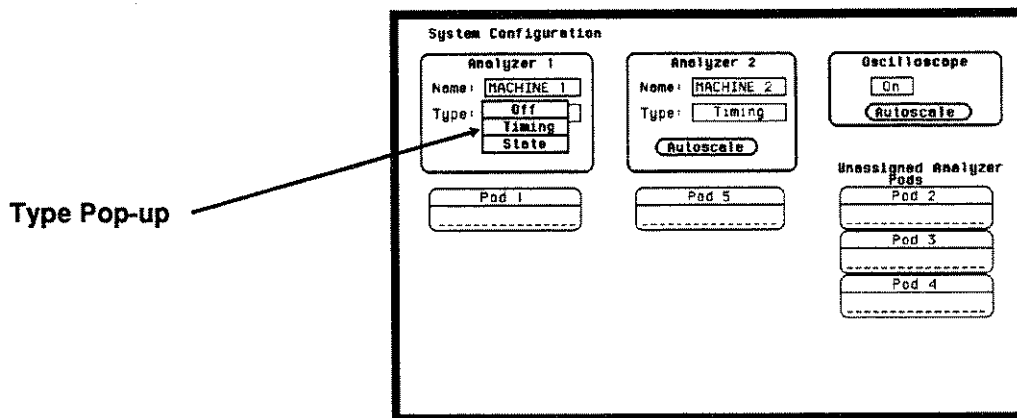

Figure 4-3. Type Pop-up Menu

Scope On/Off The scope defaults to Off. To turn the scope on or off, simply move the cursor over the **On/Off** field and press select. Scope measurement may be added to any analyzer configuration.

Autoscale Autoscale provides a starting point for setting up a measurement. The **Autoscale** field appears for the timing analyzer in the System Configuration menu only. When you select Autoscale, a pop-up appears with two options: **Cancel** and **Continue**. If you select **Cancel**, the autoscale is cancelled and control is returned to the System Configuration menu.

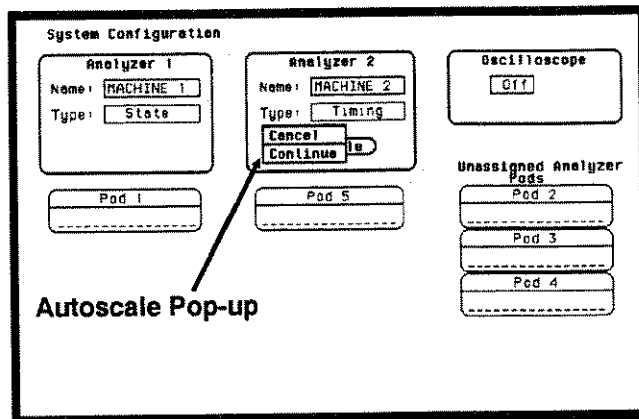

Figure 4-4. Autoscale Pop-up Menu

If you choose **Continue**, autoscale configures the Timing Format, Trace Specification, and the Timing Waveforms menus. Autoscale searches for channels with activity on the assigned pods and displays them in the Waveforms menu.

Autoscale for the scope is located in all main menus. When **Continue** is selected, the Channel, Trigger, and Waveforms displays are automatically configured. More information on scope autoscale is located in chapter 23, "Channel Menu."

Note 

Choosing Autoscale erases all previous configurations in the timing analyzer and scope, and turns the other analyzer (state) off if it was on. If you don't want this to happen, select Cancel in the pop-up.

Pods Each pod can be assigned to one of the analyzers. When the HP 1652B Logic Analyzer is powered up, Pod 1 is assigned to Analyzer 1 and Pod 5 is assigned to Analyzer 2. When the HP 1653B is powered up, Pod 1 is assigned to Analyzer 1 and Pod 2 is assigned to Analyzer 2.

To assign a pod, position the cursor on one of the pod fields and press SELECT. With the pop-up that appears, you can assign the pod to Analyzer 1, Analyzer 2, or Unassign it. Pressing the SELECT key closes the pop-up.

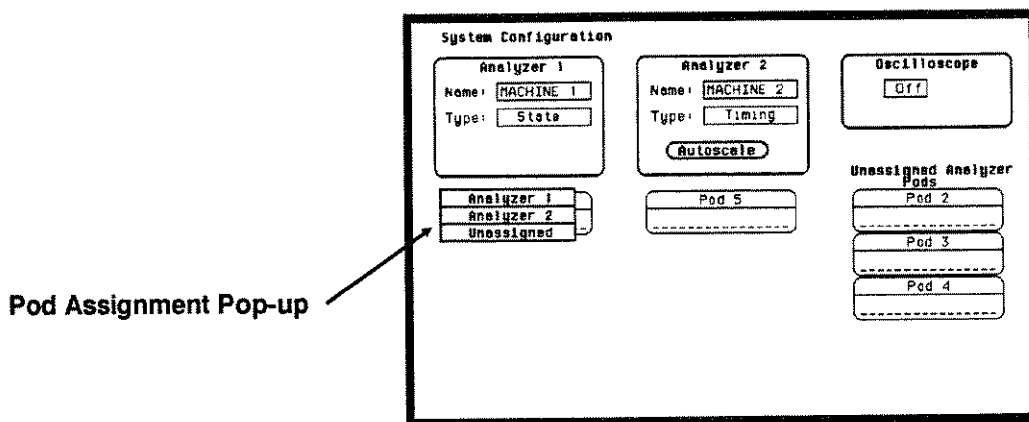

Figure 4-5. Pod Assignment Pop-up Menu

Where to Go Next

When you complete the system level configuration for the logic analyzer in this menu, you need to complete the individual analyzer configurations for analyzer 1, analyzer 2, or scope. To configure an individual analyzer you will normally configure the Format menu first and then the Trace menu. For the scope you configure the Channel menu first and then the Trigger menu.

Configuration menus for the timing analyzer start at chapter 16. For the state analyzer, menus start at chapter 8 and for the scope, start at chapter 22.

I/O Menu

Introduction

This chapter describes the I/O and pop-up menus that you will use on your logic analyzer. The purpose and functions of each menu are explained in detail, and we have included many illustrations and examples to make the explanations clearer.

The I/O menu allows you to perform I/O tasks with your logic analyzer. The tasks you can do with this menu areas follows:

- Print screens.
- Perform disk operations.
- Configure the HP-IB Interface.
- Configure the RS-232C Interface.
- Enable the analyzer to perform external triggering.
- Run self tests on the analyzer.

Accessing the I/O Menu

You can access the I/O menu from any other menu in the system by pressing the I/O key on the front panel. Use the KNOB to roll the cursor through the menu. When the cursor is positioned over the option you desire, press SELECT. It lists the following options:

- Done
- Print Screen
- Print All
- Disk Operations
- I/O Port Configuration
- External BNC Configuration
- Self Test

To exit the I/O menu, position the cursor over the **Done** option and press SELECT. This returns you to the menu you were in before you pressed the I/O key.

Print Screen

When you select the **Print Screen** option, the information on the screen is frozen and the message "PRINT in progress" appears at the top of the display. This message will not print. Only the STOP key is operational while data is being transferred to the printer. If you wish to stop a printout before it is completed, press the STOP key.

Print All

The **Print All** option prints not only what is displayed on screen but what is below, and, in the Format Specification, what is to the right of the screen at the time you initiate the printout.



Make sure the first line you wish to print is on screen when you select Print All. Lines above screen will not print.

Use this option when you want to print all the data in menus like:

- Timing Format Specification
- State Format Specification
- State Trace Specification
- State Listing
- Disk Directory
- Symbols

If there is information below the screen, the information will be printed on multiple pages. In Timing and State Format Specifications, the print will be compressed when necessary to print data that is off-screen to the right.

When you select the Print All option, the information on the screen is frozen, and the message "PRINT in progress" appears at the top of the display. This message will not print. If you wish to stop the printout before it is completed, press the STOP key on the front panel.

Disk Operations

The Disk Operations option allows you to perform operations on your disk and with the files on your disk. For example, you can load a file from your disk, store a file to your disk, or format a disk. The following pages describe the disk operations. For additional information on the disk operations, refer to Chapter 6, "Disk Drive Operations."

When you select Disk Operations, a new menu pops up. This menu is divided in two sections separated by a horizontal line. The top section displays the disk operation that is to be performed and the file or files that will be affected.

The bottom section displays the files on the disk in alphabetical order. It also states the type of the file and a description, if one was specified at storage. If no disk is in the disk drive or if the disk is not a supported format, the appropriate message will be displayed.

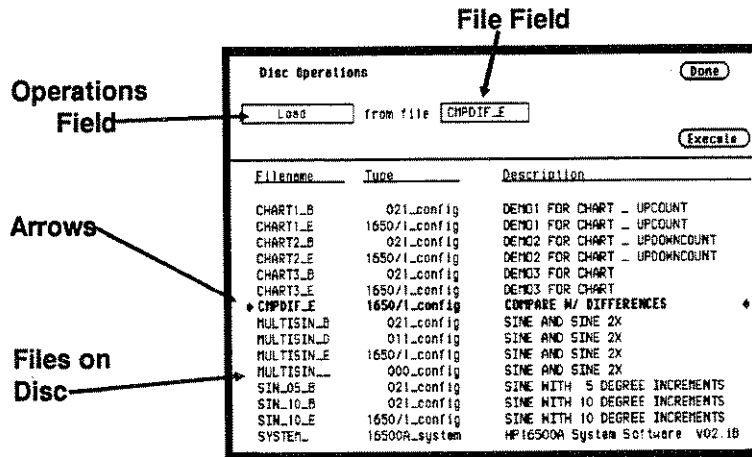

Halfway down the bottom display are arrows at each side of the screen. These arrows tell you which file is to be operated on. To roll through the list of files, press the up/down ROLL key and rotate the KNOB. The file that is between the arrows in boldface type also appears in the FILE field in the top section of the display.

The top section of the menu contains different types of fields. Pressing the Done field exits the Disk Operations menu and the I/O menu, returning you to the menu you were in before you pressed the I/O key. The field on the left-most side of the display is the operations field. It tells you which disk operation is to be performed. Next to that will usually be one or two file fields that tell you which file or files are to be acted upon. For several operations another field will appear in the top section.

The Execute field executes the disk operation appearing in the operations field. For non-destructive operations, when Execute is selected the operation is immediately performed. For destructive operations a pop-up appears with two options: Cancel and Continue. Cancel lets you change your mind before the action is taken preventing any data from being lost mistakenly. Continue executes the operation.

If you select the operations field, you will see a pop-up menu with nine options for disk operations, as shown. Each operation will now be discussed in detail.

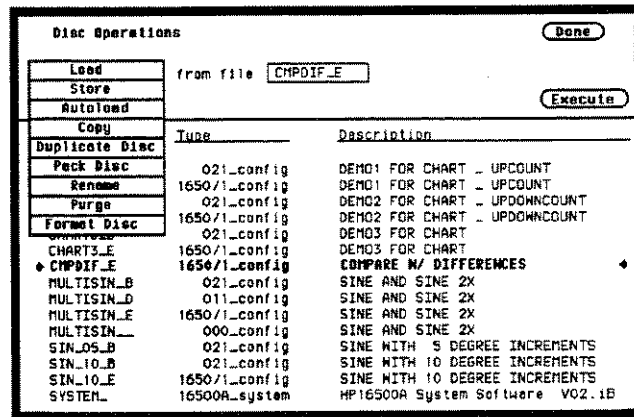

Figure 5-2. Disk Operations Pop-up Menu

Load The Load operation allows you to load configuration files (including symbol tables), and inverse assemblers from a disk. Executing a Load operation loads the logic analyzer with the file whose name appears in the File field in the top section of the Disk Operations menu. Loading symbol or inverse assembler replaces those that are linked to the current configuration.

When a Load operation is executed, a message "Loading file from disk" appears at the top of the display. After the file has been loaded, this message is replaced by "Load operation complete."

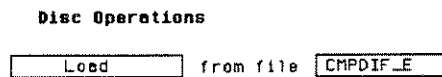

Figure 5-3. Load Operation

Store The Store operation allows you to store all the setup information, data and inverse assembler links for the analyzer in a configuration file. You cannot store information for only one of the internal analyzers. The information and data present in the logic analyzer at the time the Store is initiated is stored on the disk.

When you select Store from the operations pop-up menu, the top section of the Disk Operations menu looks similar to that shown in figure 5-4. In addition to the operations and file fields, there is a File description field. You can write an optional description of the file you are storing in this field. A file description is not necessary but may help identify a file in the future.

When you name the file that you are storing, you must begin the file name with a letter. The name can contain up to ten characters. It can be any combination of letters and numbers, but it cannot contain any spaces.

Entering a file description is similar to naming a file with three exceptions: you can enter up to 32 characters, start the description with a number, and enter spaces.

When you Execute the Store operation, the message "Storing configuration to disk" appears at the top of the display. After the file has been stored, the message is replaced with "Store operation complete" and the file name appears in the bottom section of the Disk Operations menu with its file type and a description, if you gave it one.



Figure 5-4. Store Operation

Autoload The Autoload operation allows a specified configuration file to be loaded at power up. When you select Autoload, the top section of the Disk Operations menu looks similar to that shown below. A field appears next to the operation field. When you select this field, a pop-up menu appears with the choices Enable and Disable. Enable causes the specified file to be automatically loaded at power up. Disable prevents any file from being loaded at power up.

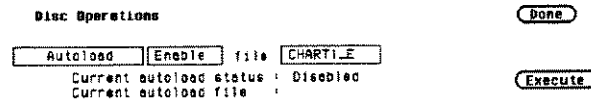

Figure 5-5. Autoload Operation

The file name in the file field can be changed with one of two methods. One method is to press the up/down ROLL key and rotate the KNOB to scroll through the list of files until the name of the desired file appears in the file field. The other method is to select the file field and use the Alpha Entry pop-up menu and the front-panel keypad to enter the name.

Below the operations and file fields are two information lines. The first line indicates the status of autoload (Enable or Disable), and the second line tells you which file, if any, is enabled for autoload. When you select either Enable or Disable the autoload status of a file will not change until you select Execute.

When you select Execute, after selecting Enable, the file whose name appears in the file field is selected for autoloading. The autoload status line will say Enable, and the autoload file line will state the name of the file.

Also, a file labeled AUTOLOAD is added to the bottom section of the display. This file is not a configuration file. It contains information the logic analyzer needs to load the chosen file at power up. If you disable autoloading, the file labeled AUTOLOAD does not disappear. You must Purge it to erase it from your disk. The Purge disk operation is covered later in this chapter. If Autoload is disabled, the logic analyzer will load the default configuration at power up.

Copy The Copy operation allows you to copy a file to the same disk or to another disk. When you select Copy, the top section of the Disk Operations menu will look similar to that below.

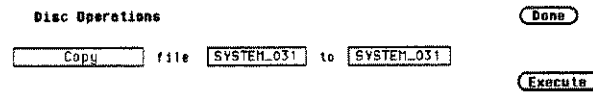

Figure 5-6. Copy Operation

Notice that there are two file fields. You can specify the file you are copying from and the file you are copying to. When you select either file field, you will get an Alpha Entry pop-up menu. You can use this menu and the keypad on the front panel to enter the name of the file. For the file that you are copying from, it is usually easier to use the up/down ROLL key and the KNOB to select one of the files on the disk rather than to use the Alpha Entry menu.

When you select Execute you will see a pop-up that tells you to insert the disk onto which you want to copy the file. There are also two fields in the pop-up. One is labeled **Continue**. You select **Continue** after you have inserted the disk and are ready to copy the file. The other field is labeled **Stop**. Selecting the **Stop** field halts the copy and returns you to the Disk Operations menu.

If you insert the destination disk and select **Continue**, the file will be copied. If the file is long, you might have to swap the source and destination disks again. The logic analyzer tells you if you need to reinsert the source disk to continue copying the file. You can also copy to the same disk, making the source and destination disk the same.

Duplicate Disk

The Duplicate Disk operation allows you to duplicate all the files on one disk to another. When you select this option, only the operations field appears in the top section of the Disk Operations menu. The disk is automatically formatted in this operation.



Figure 5-7. Duplicate Disk Operation

When you select Execute, you will see a pop-up with a message telling you what occurs when a disk is duplicated. The pop-up also contains two fields: Cancel and Continue. Cancel stops the duplicating process and returns you to the Disk Operations menu. Continue executes the operation. If you select **Continue**, the display goes blank except for the message "Insert source disk - hit select when ready." Insert the disk you want to duplicate and press SELECT. After the logic analyzer reads the disk, it displays the message "Insert destination disk - hit select when ready." Insert the disk to which you want to copy and press SELECT. The analyzer will tell you that it's writing to the disk.

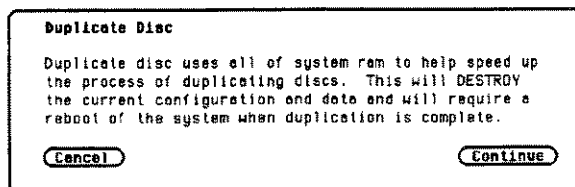

Figure 5-8. Duplicate Disk Pop-up Menu

The process of duplicating a disk is an iterative one; i.e., more than one swapping of disks may be necessary before all files are transferred. If this is the case the logic analyzer will repeat the message telling you to insert the source disk. Insert the source disk and press SELECT. The analyzer remembers where it stopped duplicating the first time and starts reading from that location. When the analyzer is ready, insert the destination disk and press SELECT. You will never have to swap disks more than three times.

After the duplication process is complete, the logic analyzer displays a message telling you what to do next. If you want to copy another disk, press the FORMAT key on the front panel. The analyzer will repeat its message to insert the source disk. If you do not want to copy any more disks, insert the system disk and press the SELECT key. This reboots the system.

Note 

Duplicating a disk destroys any existing configurations and data on the destination disk. Make sure that the disk to which you are duplicating is the correct disk.

Pack Disk

The Pack Disk operation reorganizes the files on the disk, making room for more. When a file is purged, it is not removed from the disk even though it doesn't appear in the Disk Operations menu. Packing a disk moves files up, creating space at the bottom of the disk memory.

When you select **Pack Disk**, the top section of the Disk Operations menu looks similar to that shown below. Selecting Execute starts the process. After the packing is completed, the message "Disk packing complete" appears at the top of the screen.



Figure 5-9. Pack Disk Operation

Rename

The Rename operation lets you rename a file. When you select this option, the display will look similar to that shown in figure 5-10.

You will see a file field that tells you what the old name of the file is, and a file field that tells you what the new name will be. If you select either one of the file fields, an Alpha Entry pop-up menu appears. You can use this menu and the keypad on the front panel to enter the name of the file. For the field with the old file name, it is usually easier to use the up/down ROLL key and the KNOB to select the desired file rather than to use the Alpha Entry pop-up menu.

To start the rename operation, select **Execute**. The file will be renamed and relocated alphabetically in the file list in the bottom section of the Disk Operations menu.

If you try to rename a file with a name that already exists, a message will tell you that a file already exists with that name, and the file will not be renamed.

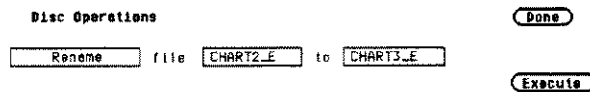

Figure 5-10. Rename Operation

Purge The Purge operation allows you to delete a file from a disk. When you select this option, the display will look similar to that shown below.

The file field contains the name of the file to be purged. You can change the file in this field either by positioning the cursor on the field and selecting it to access an Alpha Entry pop-up menu, or by using the up/down ROLL key and the KNOB to move among the files.

When you select **Execute** you will see a pop-up with the choices **Cancel** and **Continue**. **Cancel** lets you stop the Purge operation and returns you to the Disk Operations field menu. **Continue** purges the file whose name appears in the file field.



A purged file cannot be recovered. Make sure the file that is being purged is the correct one.

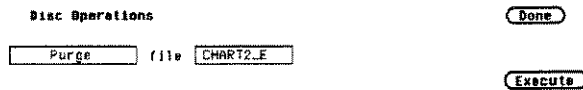

Figure 5-11. Purge Operation

Format Disk The Format Disk operation formats a disk, purging all previous files on the disk. When you select this option, the display will look similar to that shown in figure 5-12.

Selecting **Execute** gives you a pop-up with the choices **Cancel** and **Continue**. **Cancel** stops the format operation and returns you to the Disk Operation menu. If you select **Continue**, the disk will be formatted. The message "Disk format in progress" will appear at the top of the screen. When the formatting is complete, all the files will be deleted.



Formatting a disk purges all the files on the disk. Make sure the disk is the correct one to be formatted because purged files cannot be recovered.



Figure 5-12. Format Disk Operation

I/O Port Configuration

The I/O Port Configuration option in the I/O menu enables you to configure the logic analyzer for sending configuration, waveforms and listings to a printer or controller via HP-IB or RS-232C.

When you place the cursor on the External I/O Configuration option and press SELECT, you will see the menu shown in figure 5-13.

```
External I/O Port Configuration [Done]
Printer connected to [RS-232-C] Controller connected to [HP-IB]

RS-232-C Configuration          HP-IB Configuration
Protocol : [XON/XOFF]          HP-IB Address : [7]
Stop Bits : [1]
Parity : [None]
Baud rate : [2400]
Data Bits : [8]

Printer Information
Printer : [LaserJet] Paper width : [8.5"]
```

Figure 5-13. External I/O Port Configuration Menu

The HP 1652B/53B is equipped with a standard RS-232C interface and an HP-IB interface that allows you to connect to a printer or controller. Connecting a controller gives you remote access for running measurements, up-loading and down-loading configurations and data, and outputting to a printer. The controller interface is explained in more detail in the *HP 1652B/1653B Programming Reference Manual*.

Various HP-IB and RS-232C graphics printers can be connected to the logic analyzer. Configured menus as well as waveforms and other data can be printed for complete measurement documentation. The printer interface is explained in more detail in Chapter 7.

Configuring the Interfaces

You configure the HP-IB or RS-232C interfaces for a controller or a printer by first selecting the I/O menu. Then you select the **I/O Port Configuration** field to display the External I/O Port Configuration menu. When the menu appears, select either field at the top of the menu to switch the interfaces between a printer and a controller. Whenever you change the configuration for one interface, the other interface automatically changes to the opposite configuration.

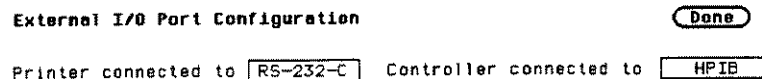

Figure 5-14. Interface Configurations

The HP-IB printer must be set to **Listen Always** for the HP-IB interface. In this mode, no HP-IB addressing is necessary. There are two fields at the bottom of the menu that allow you to select the printer type and paper width.

The HP-IB Interface

The Hewlett-Packard Interface Bus (HP-IB) is Hewlett-Packard's implementation of IEEE Standard 488-1978, "Standard Digital Interface for Programmable Instrumentation." The HP-IB is a carefully defined interface that simplifies the integration of various instruments and computers into systems. It uses an addressing technique to ensure that each device on the bus (interconnected by HP-IB cables) receives only the data intended for it. To accomplish this, each device is set to a different address and this address is used to communicate with other devices on the bus.

Selecting an Address. The HP-IB address can be set to 32 different HP-IB addresses, from 0 to 31. Simply choose an address that is compatible with your device and/or software. The default is 7.

To select an address:

1. Select the External I/O Port Configuration menu and place the cursor in the field directly to the right of **HP-IB Address:**. Press **SELECT** and an Integer Entry pop-up appears. See figure 5-15.

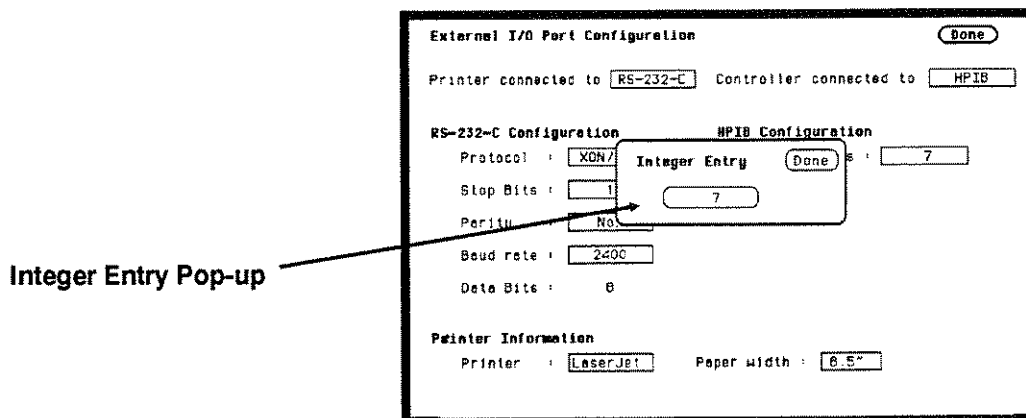

Figure 5-15. Integer Entry Pop-up

2. When the pop-up appears, either rotate the knob or use the keypad to enter the address. If you enter an address greater than 31, the address will default to 31 when you select **Done**.
3. When you are finished entering the HP-IB address, select **Done**. The pop-up closes, placing your selection in the appropriate field.

The RS-232C Interface

The RS-232C interface is Hewlett-Packard's implementation of EIA Recommended Standard RS-232C, "Interface Between Data Terminal Equipment and Data Communications Equipment Employing Serial Binary Data Interchange." With this interface, data is sent one bit at a time and characters are not synchronized with preceding or subsequent data characters. Each character is sent as a complete entity without relationship to other events.

Protocol. Protocol governs the flow of data between the instrument and the external device. The protocol options are **None** and **XON/XOFF**. The default setting is **XON/XOFF**.

None
XON/XOFF

Figure 5-16. Protocol Pop-up Menu

With less than a 5-wire interface, selecting **None** does not allow the sending or receiving device to control how fast the data is being sent. No control over the data flow increases the possibility of missing data or transferring incomplete data. With a full 5-wire interface, selecting **None** allows a hardware handshake to occur. With a hardware handshake, hardware signals control data flow. The HP 13242G cable allows the HP 1652B/1653BA to support hardware handshake.

With **XON/XOFF**, the receiver controls the data flow. By sending **XOFF** (ASCII decimal 19) over its transmit data line, the receiver requests that the sender disables data transmission. A subsequent **XON** (ASCII decimal 17) allows the sending device to resume data transmission

Data Bits. Data bits are the number of bits sent and received per character that represent the binary code of that character. The HP 1652B/53B supports 8-bit only.

Stop Bits. Stop bits are used to identify the end of the character. The number of stop bits must be the same for both the controller and the logic analyzer. The options are 1, 1.5, or 2 stop bits per character. The default setting is 1.

1
1 1/2
2

Figure 5-17. Stop Bits Pop-up Menu

Parity. The parity bit detects errors as incoming characters are received. If the parity bit does not match the expected value, the character is assumed to be incorrectly received. The action taken when an error is detected depends on how the interface and the device program are configured.

Parity is determined by the requirements of the system. The parity bit may be included or omitted from each character by enabling or disabling the parity function. The options are **None**, **Odd**, or **Even**. The default setting is **None**.

None
Odd
Even

Figure 5-18. Parity Pop-up Menu

Baud Rate. The baud rate is the rate at which bits are transferred between the interface and the peripheral. The baud rate must be set to transmit and receive at the same rate as the peripheral, or data cannot be successfully transferred. The available baud rates are 110 to 19.2k. The default setting is 9600.

110
300
600
1200
2400
4800
9600
19200

Figure 5-19. Baud Rate Pop-up Menu

Printer. You can specify which printer you are using by selecting the **Printer** attribute field and choosing one of the options in the pop-up. The options are **ThinkJet**, **QuietJet**, **LaserJet**, and **Alternate**. **Alternate** allows you to use an Epson[®] compatible printer. The default printer option is **ThinkJet**.

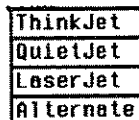

Figure 5-20. Printer Pop-up Menu

Paper Width. The logic analyzer offers two options for paper width: 8.5 and 13.5 inches. Selecting the **Paper Width** attribute field gives you a pop-up with which you can make your choice.

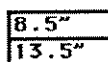

Figure 5-21. Paper Width Pop-up Menu

The HP ThinkJet and HP LaserJet series printers require a paper width of 8.5 inches and the HP QuietJet series printers require a paper width of 13.5 inches. If you have an HP ThinkJet or HP LaserJet printer but have set the paper width to 13.5 inches, the logic analyzer tells the printer to compress the print so it will fit on a page. The results may not be satisfactory. If you have an Epson® compatible printer, check your printer manual to see which size is required.

External BNC Configuration

On the rear panel of the logic analyzer are two BNC connectors. One BNC is an input for an external trigger source. The other is used to output a trigger source. The **External BNC Configuration** option in the I/O menu identifies one of the two internal machines or scope to be the trigger source for an external instrument.

When you select this option you will see a field next to the words "BNC output armed by." Selecting this field gives you a pop-up with either two or three options. One option is **Off**. This indicates that the logic analyzer will not trigger an external instrument. The other options are the internal analyzers, listed by name. You can select the analyzer for triggering your external instrument by using the **KNÖB** to position the cursor on the appropriate name and pressing **SELECT**.

If for some reason both of the internal analyzers are off, selecting the **External BNC Configuration** option gives you the message "BNC output armed by : Off (note: both machines are off)."

Self Test

The **Self Test** option in the I/O menu allows you to run a self test on the logic analyzer. The self test is on the PV disk. Selecting this option gives you a pop-up telling you what effect the self test has on the analyzer. The pop-up also contains two fields: **Cancel** and **Start Self Test**. **Cancel** lets you change your mind about running the self test. Selecting this field returns you to the I/O menu. Selecting the **Start Self Test** field causes your logic analyzer to load the self test from the disk and run through it. Before selecting this field you must insert the master disk with the self test on it.

Note

Running the self test destroys all current configurations and data. Make sure that you save any important configurations on a disk before running any of the self tests.

For a description of the individual self tests, refer to appendix E, in volume 2 of this manual.

Disk Drive Operations

Introduction

This chapter describes the disk operations of the HP 1652B/53B in a task format. The disk operations are described in detail in chapter 5.

The Disk Operations Available

Nine disk operations are available:

- **Load** - Instrument configurations and data can be loaded from the disk. Inverse assemblers can be loaded.
- **Store** - Instrument configurations and data can be stored on disk. System files cannot be stored.
- **Autoload** - Designates a configuration file to be loaded automatically the next time the HP 1652B/53B is turned on.
- **Copy** - Any file on the disk can be copied from one disk to another or to the same disk.
- **Duplicate Disk** - All files from one disk are copied to another disk. The directory and all files on the destination disk will be destroyed with this operation. The copied files are packed on the new disk as they are copied.
- **Pack Disk** - This function packs files on a disk. Packing removes all empty or unused sectors between files on a disk so that more space is available for files at the end of the disk.
- **Rename** - Any filename on a disk can be changed to another name.
- **Purge** - Any file on a disk can be purged (deleted) from the disk.
- **Format Disk** - Any two-sided 3.5-inch floppy disk can be formatted or initialized. The directory and all files on the disk will be destroyed with this operation.

Although default values are provided for these disk operations, you may have to specify additional information. This information is entered by selecting the appropriate fields displayed for each disk operation. Disk operations are initiated by selecting the Execute field. If there is a problem or additional information is needed to execute an operation, an advisory appears near the top center of the screen displaying the status of the operation (an error message prompts to swap disks, etc.).

If executing a disk operation could destroy or damage a file, another pop-up appears with the options Cancel and Continue when you select Execute. If you don't want to complete the operation, select Cancel to cancel the operation. Otherwise, select Continue and the operation will be executed.

Accessing the Disk Menu

To display the Disk Operations menu, press the I/O menu key.

When the I/O pop-up menu appears, place the cursor on Disk Operations and press SELECT. You will see the Disk Operations menu.

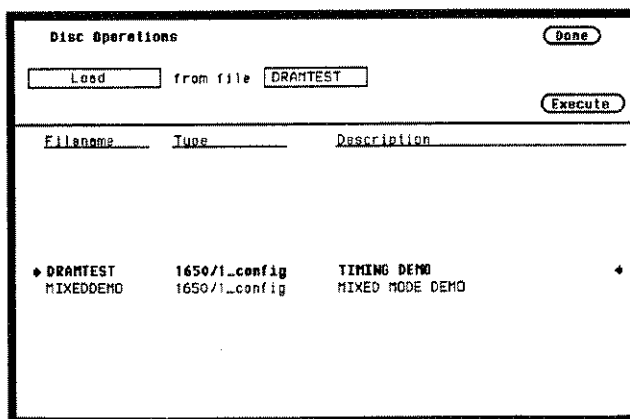

Figure 6-1. Disk Operation Menu

Selecting a Disk Operation

To select a disk operation, place the cursor on the field directly below Disk Operations and press SELECT. You will see the following pop-up:

Load
Store
Autoload
Copy
Duplicate Disc
Pack Disc
Rename
Purge
Format Disc

Figure 6 - 2. Disk Operations Pop-up Menu

When the pop-up appears, place the cursor on the operation you want and press SELECT. After you select an option, the pop-up closes and displays the fields required for your operation. For example, select Store. The Disk Operations menu now looks like this:

Disc Operations Done

Store to file

File description Execute

Filename	Type	Description
• DRAMTEST	1650/1_config	TIMING DEMO
MIXEDDEMO	1650/1_config	MIXED MODE DEMO

Figure 6-3. Store Operation

Disk Operation Parameters

The disk operation parameters consist of the information that the disk operation acts upon. They tell the logic analyzer the names, types, and descriptions of files. To change these parameters, select the appropriate field and the field will either toggle to the opposite function or a pop-up will appear. If a pop-up appears, select the appropriate option or enter data with the keypad.

To initiate the disk operation function you have selected, place the cursor on Execute. A pop-up appears with Continue and Cancel. To continue, place the cursor on Continue and press SELECT. To cancel place the cursor on Cancel and press SELECT. The Autoload, Pack Disk, and Rename functions immediately execute because they are not destructive to the files. These functions do not give you the Cancel and Continue options.

The screenshot shows a menu titled "Disk Operations" with a "Done" button in the top right. Below the title, there are two input fields: "Copy" and "file", followed by "DRAMTEST" and "to", followed by another "DRAMTEST" field. There is an "Execute" button in the top right of the menu area. Below these fields is a table with three columns: "Filename", "Type", and "Description".

Filename	Type	Description
• DRAMTEST	1650/1_config	TIMING DEMO
MIXEDDEMO	1650/1_config	MIXED MODE DEMO

Figure 6-4. Disk Operation Parameters

Installing a Blank Disk

Included with the HP 1652B/53B is a blank 3.5-inch flexible disk for your own use. To install the blank disk, hold the disk so that the Hewlett-Packard label is on top and the metal auto-shutter is away from you. Push the disk gently, but firmly, into the front disk drive until it clicks into place.

Note



The HP 1652B/53B disk drives use the gray Hewlett-Packard double-sided disks, which can be ordered in a package of ten with the Hewlett-Packard part number 92192A. **DO NOT** use single-sided disks with the HP 1652B/53B.

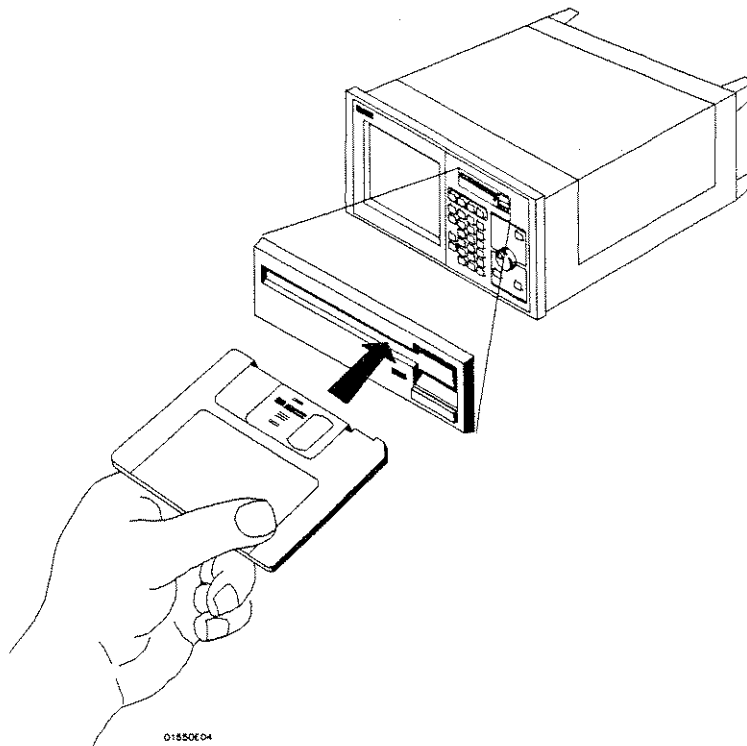

Figure 6-5. Installing a Disk

Formatting a Disk

Before any information can be stored on a new disk, you must first format it. Formatting marks off the sectors of the disk and creates the LIF (Logical Interchange Format) directory on the disk. If you initiate a Duplicate Disk operation, the logic analyzer will automatically format the destination disk.

Note

The HP 1652B/53B does not support track sparing. If a bad track is found, the disk is considered bad. If a disk has been formatted elsewhere with track sparing, the HP 1652B/53B will only read up to the first spared track.

Select the Format Disk operation.

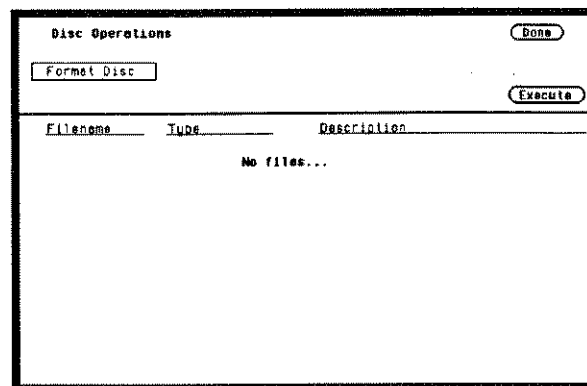

Figure 6-6. Format Disk Operation

After the Format Disk operation menu appears, the instrument reads the disk and shows its condition. One of three conditions can exist:

- If this is a new disk, or a disk formatted by a disk drive not using the LIF format, the menu will display UNSUPPORTED DISK FORMAT on the lower portion of the menu.
- If the disk is already formatted, but has no files, the menu will display No Files.

- If the disk already has files, a list of file names appear on the lower portion of the menu along with a file type and description.

If any of the listed files need to be saved, copy them to another disk before initiating the Format Disk function. To initiate the Format Disk function, select Execute. When the pop-up appears, select Continue and the instrument will format the disk. Otherwise, select Cancel to cancel the Format Disk operation.

Caution 

Once you press Continue, the Format Disk operation starts and permanently erases all the existing information from the disk. After that, there is no way to retrieve the original information.

Storing to a Disk

The Store operation allows you to store your configurations and data to a file with a description of its contents. You must assign a file name for each file in which you wish to store data.

Select the Store operation.

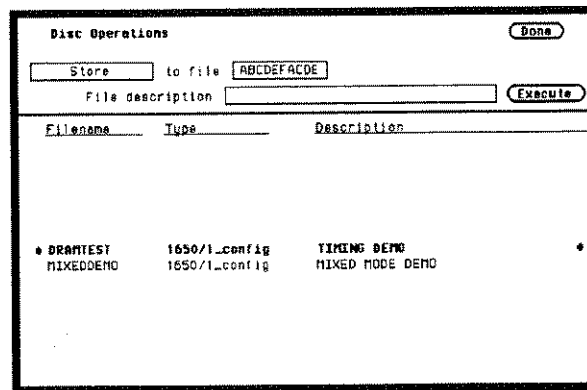

Filename	Type	Description
• DRAMTEST	1650/1_config	TIMING DEMO
• MIXEDDEMO	1650/1_config	MIXED MODE DEMO

Figure 6-7. The Store Operation

To name your file, place the cursor on the field to the right of "to file" and press SELECT. The Alpha Entry pop-up appears.

Enter a filename that starts with a letter and contains up to ten characters. It can be any combination of letters and numbers, but there can be no blank spaces between any of the characters.

Entering a file description is the same process as naming a file except you can enter up to 32 characters, start the description with a number, and enter spaces between characters.

Note 

The field for "file description" makes it easier to identify the type of data in each file. This is for your convenience but you can leave this field blank.

When you have completed entering the file name and file description, you initiate the store operation by placing the cursor on Execute and pressing SELECT. A pop-up appears with Continue and Cancel. To continue, place the cursor on Continue and press SELECT. To cancel, place the cursor on Cancel and press SELECT.

Caution 

If you store a new configuration and data to an existing file, they are written over the original information "DESTROYING" the original information in that file.

The Load Operation

The Load operation allows you to load previously stored configuration and data from a file on the disk.

Select the Load operation.

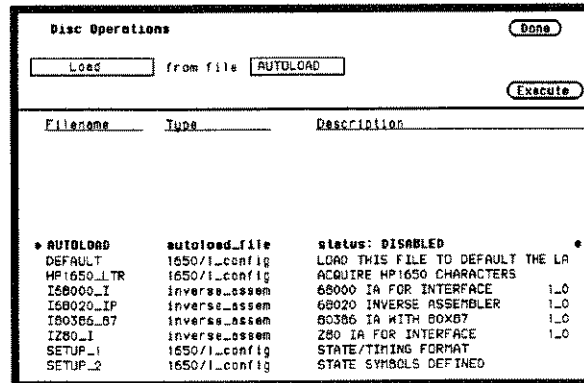

Figure 6-8. The Load Operation



The Load operation is type dependent. This means that you cannot load a system file. For example, if you try to load the file "SYSTEM_," an advisory "Warning: Invalid file type" appears in the top center of the display.

To load the desired file, press the up/down ROLL key and rotate the KNOB until the desired file appears in the field to the right of "from file."

Another way to enter the name of the file in the field to the right of "from file" is to select this field. When the Alpha Entry pop-up appears, enter the correct filename.

Renaming a File

The Rename operation allows you to change the name of a file. The only restriction is that you cannot rename a file to an already existing filename.

Select the Rename operation. When you have completed entering a new file name and description, you initiate the Rename operation by placing the cursor on Execute and pressing SELECT.

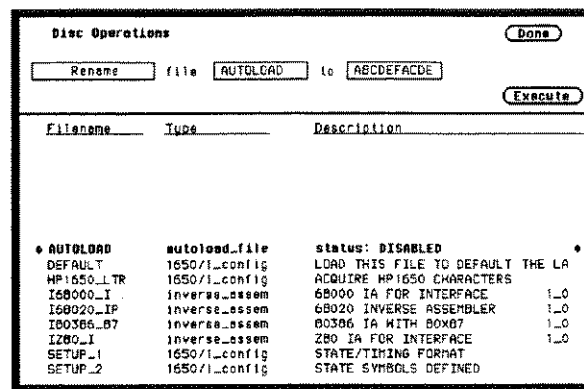

Disc Operations Done

Rename file to Execute

Filename	Type	Description
• AUTLOAD	autoload..file	status: DISABLED •
DEFAULT	1650/I_config	LOAD THIS FILE TO DEFAULT THE LA
HP1650_LTR	1650/I_config	ACQUIRE HP1650 CHARACTERS
I60000_I	inverse_essem	60000 IA FOR INTERFACE 1_0
I60020_IP	inverse_essem	60020 INVERSE ASSEMBLER 1_0
I00366_B7	inverse_essem	00366 IA WITH BOX67 1_0
I200_I	inverse_essem	200 IA FOR INTERFACE 1_0
SETUP_1	1650/I_config	STATE/TIMING FORMAT
SETUP_2	1650/I_config	STATE SYMBOLS DEFINED

Figure 6-9. Renaming a File

Use either the KNOB or the Alpha Entry pop-up to enter the filename you wish to change in the field to the right of "file."

Move the cursor to the field to the right of "to" and press SELECT. When the Alpha Entry pop-up appears, enter the new file name. When you have completed entering the new file name, you initiate the rename operation by placing the cursor on Execute and pressing SELECT. The rename operation immediately executes and when it is completed, an advisory "Rename operation complete" is displayed.

The Autoload Operation

Autoload allows you to designate a configuration file to be loaded automatically the next time the HP 1652B/53B is turned on. When the Autoload operation is enabled, your designated configuration file is loaded instead of the default configuration file. This process allows you to change the default configuration of certain menus to a configuration that better fits your needs.

Select the Autoload operation. To enable Autoload, select the Disable field and when the pop-up appears, select Enable.

With the up/down ROLL key and KNOB or the Alpha Entry pop-up enter the name of the configuration file you wish to load in the field to the right of "File" and select Execute. The Autoload function is Enabled as shown after "Current Autoload status:" on the display.

Note

When power is applied to the logic analyzer, Autoload On or Off is determined by the presence of an enabled autoload file on the disk. If an enabled autoload file is present on the disk, the logic analyzer will load this configuration file instead of the standard configuration file.

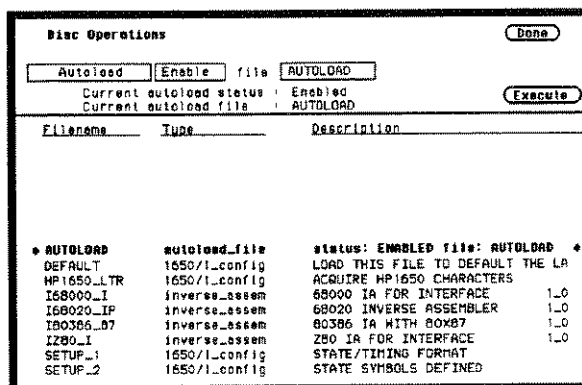

Figure 6-10. Autoload Operation Enabled

To disable the Autoload operation, select enable and when the pop-up appears, select disable. When the pop-up closes, select Execute and the Autoload function is disabled.

Purging a File

Select the Purge operation to Purge (delete) a file. With either the up/down ROLL key and KNOB or the Alpha Entry pop-up enter the file you wish to purge in the field to the right of "file." Select Execute and when the pop-up appears, select Continue and the file is purged from the disk.



Once EXECUTED, the Purge operation permanently erases the file. After that, there is no way to retrieve the original information.

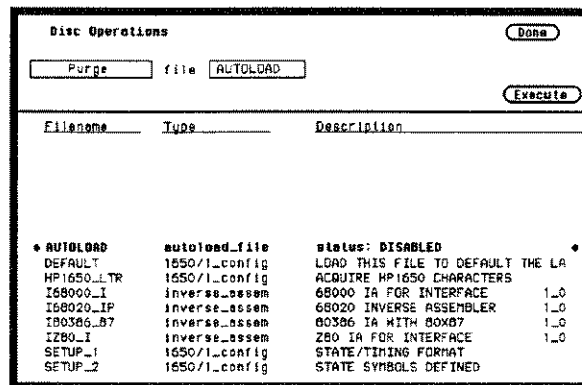

Figure 6-11. Purging a File

Copying a File

The Copy operation allows you to copy a file to the same disk or another disk. Select the Copy operation. With either the up/down ROLL key and the KNOB or the Alpha Entry pop-up, enter the filename you wish to copy in the field to the right of "file." Select the field to the right of "to" and when the Alpha Entry pop-up appears, enter the name of the file you want to "copy to."

You can also copy a file to the same filename on another disk. To do this, select the "To" filename field, press the CLEAR ENTRY key place the cursor on Done and press SELECT. This copies the original filename in the "To" filename field.

Select Execute to start the copy operation. A pop-up appears with instructions on what to do with the disks. Since you can copy a file to the same disk or another disk, simply follow the instructions as they apply to your situation and select Continue to continue.

- When "Insert the source disk" appears, remove the source disk and insert the destination disk into the disk drive if you are copying the file to another disk. The cursor is located on "Continue," so to continue, press SELECT; otherwise, place the cursor on "Stop" and press SELECT. If you are copying to the same disk, press "Continue" without moving the disk.

If the file cannot be copied in a single operation, the instruction "Insert the source disk" will appear in the pop-up. Remove the destination disk, re-insert the source disk and select Continue. The logic analyzer reads another segment of the source file. It will then tell you when to re-insert the destination disk and continue.

Note



If the source file is large (ie. System file) you should use the Duplicate Disk operation. Duplicating large files using the Copy operation requires changing disks many times. This invites the possibility of losing track of the disk changes, which will destroy part or all of the files on the source disk.

When the copy operation is complete, you will see the new file name in the directory. The new file name will be inserted in the directory in alphabetical order.

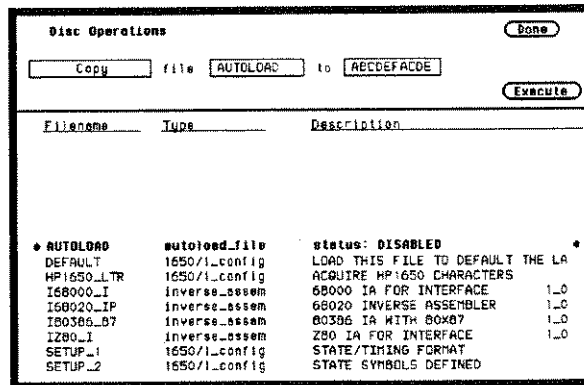

Figure 6-12. Copy File Operation

The Pack Disk Operation

By deleting files from the disk and adding other files, you end up with blank areas on the disk (between files) that are too small for the new files you are creating. The Pack Disk operation packs the current files together, removing unused areas from between the files so that more space is available for files at the end of the disk.

Select the Pack Disk operation. To pack the disk, select Execute.

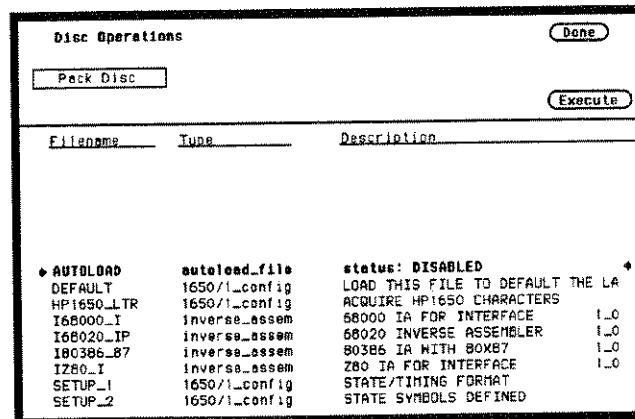

Figure 6-13. The Pack Disk Operation

Duplicating the Operating System Disk

The Duplicate Disk operation allows you to duplicate all the files on one disk to another disk. You use this operation to make a back-up copy of your important disks so you won't lose important data in the event the disk wears out, is damaged, or a file is accidentally deleted.

Select the Duplicate Disk operation and press Execute. When the pop-up appears you will see the following advisory:

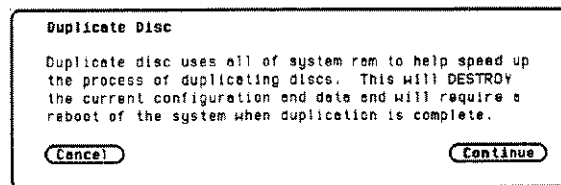

Figure 6-14. Duplicate Disk Pop-up

Caution

The original directory and files on the destination disk are destroyed by the DUPLICATE DISK operation.

To continue, select Continue. The instruction "Insert disk to be copied-hit select when ready" will be displayed. Insert the source disk and press SELECT. The logic analyzer reads the source disk and displays "Reading from source disk. Please wait..."

When the logic analyzer has filled memory or has read the entire source disk, it displays "Insert destination disk-hit select when ready." Remove the source disk, insert the destination disk and press SELECT. When the logic analyzer starts writing to the destination disk, you will see "Writing to destination disk. Please wait..."

Note

If the destination disk has not been formatted, the logic analyzer will automatically format the disk before it writes to it.

If the amount of data on the source disk exceeds the available memory in the logic analyzer, the logic analyzer will display "Insert the source disk-hit select when ready" again, and you will need to repeat the process of inserting the source disk, then the destination disk. Follow the directions on screen until the entire disk is duplicated.

When the entire disk is duplicated, you will see "Hit FORMAT key to copy another disk or insert system disk and hit SELECT to reboot." If you are finished duplicating disks, insert the system disk and press SELECT. The logic analyzer will load the system file and return you to the System Configuration menu.

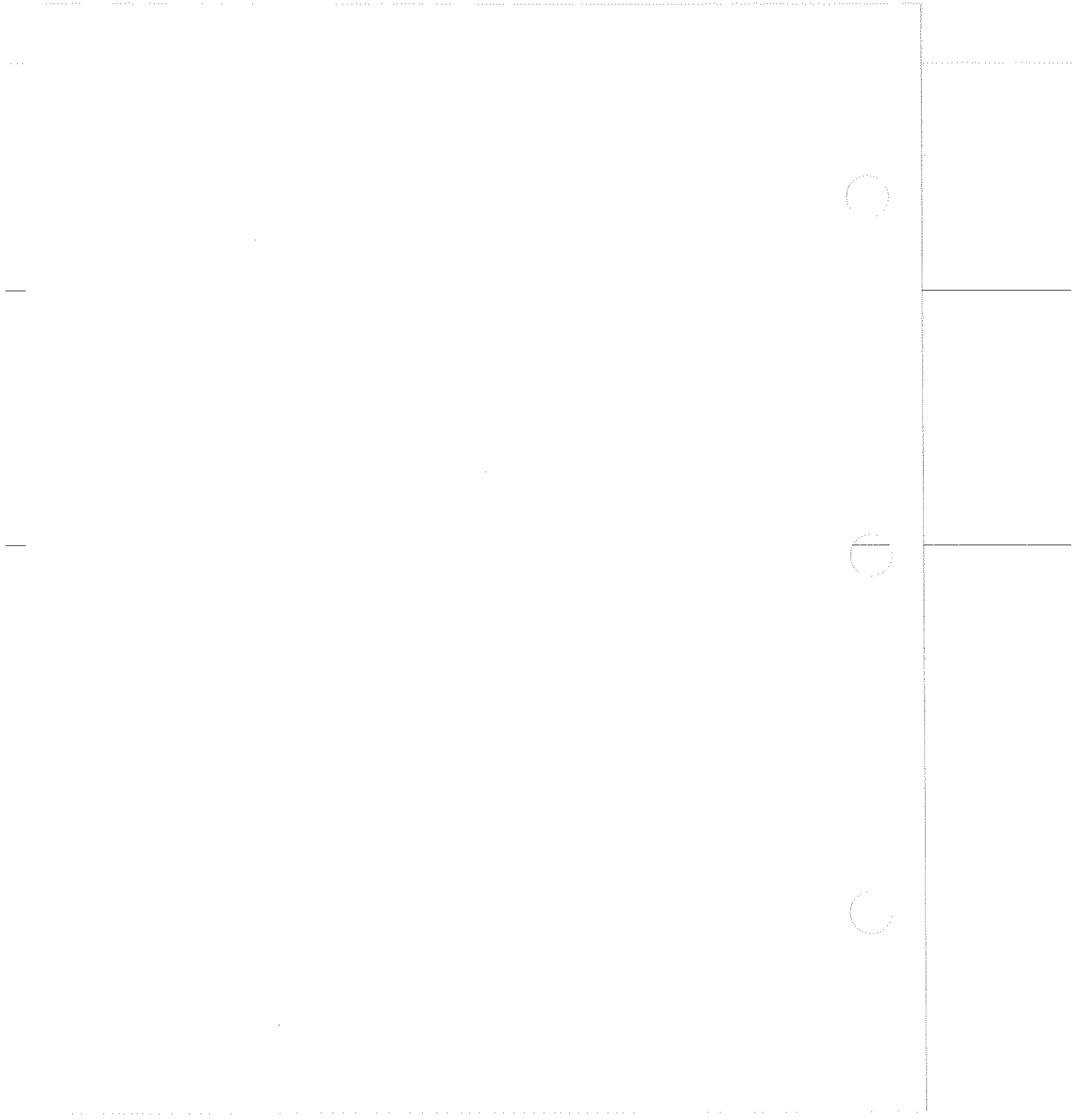

Making Hardcopy Prints

Introduction

The HP 1652B/1653B Logic Analyzers allow you to print configurations, waveforms, and listings. Whenever your printer is connected to the logic analyzer and you instruct it to do so, it will print what is currently displayed on screen or all data in the menus having off-screen data.

This chapter shows you how to set up the logic analyzer's HP-IB and RS-232C interfaces for printers. If you have a Hewlett-Packard ThinkJet, QuietJet, or LaserJet series printer with the RS-232C interface, the RS-232C interface is already set up for you with the exception of the printer type and page width.

If you have another kind of printer, refer to your printer manual for its interface requirements and change the logic analyzer's interface configuration as instructed.

Supported Printers

The HP 1652B/1653B logic analyzers will support the following printers with HP-IB or RS-232C capabilities. For the following RS-232C printers, these configurations should be used:

- HP ThinkJet (RS-232C switches set for HP controllers)
- HP QuietJet (factory settings)
- HP LaserJet (factory settings)
- Alternate

Alternate Printers

In addition to HP printers, the logic analyzers support Epson[®] compatible RS-232C printers. These alternate printers must support graphics.

When the logic analyzer's RS-232C configuration is set for alternate printers, it transmits data to the printer in the Epson[®] format.

Printers incompatible with either HP or Epson data transfer formats will not work with the HP 1652B/1653B logic analyzers.

Hooking Up Your Printer

If your printer is already connected to the logic analyzer, skip to "Setting the RS-232C for HP Printers" or "Setting the HP-IB for HP Printers" in this chapter. Otherwise hooking up your HP printer is just a matter of having the correct HP-IB or RS-232C interface cable. Refer to the figure below.

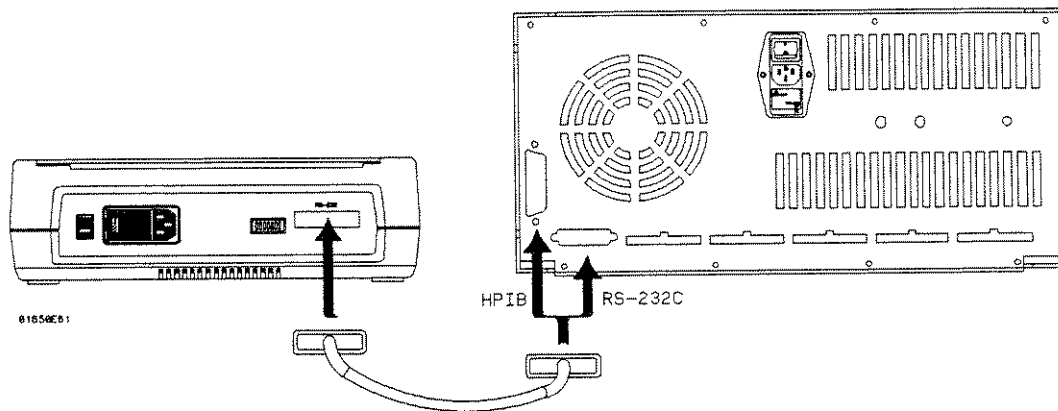

Figure 7-1. Logic Analyzer to Printer Hook-up

The type of connector on the printer end of the interface cable is determined by the kind of printer.

HP-IB Printer Cables

You can use any standard HP-IB cable to connect the logic analyzer to the printer. The specific HP-IB cable only depends on the length you need.

RS-232C Printer Cables

You can use either an HP 13242G or HP 92219H cable to connect the logic analyzer to the printer. However, the HP 13242G is the preferred cable since it can be used with either no protocol (hardware handshake) or XON/XOFF.

HP 13242G Cable The HP 13242G cable has standard DB-25 connectors on each end and is wired for hardware handshake. The cable schematic is shown below.

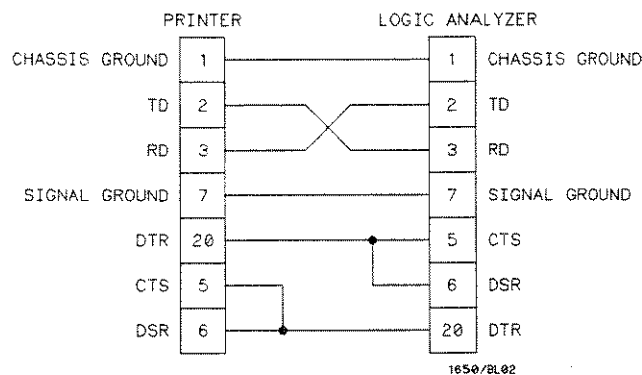

Figure 7-2. HP 13242G Cable Schematic

Note 

HP 13242G cable ends are the same, therefore it doesn't matter which end of the cable is connected to which piece of equipment.

HP 92219H Cable The HP 92219H cable has standard DB-25 connectors on each end and is wired for XON/XOFF handshake. The cable schematic is shown below.

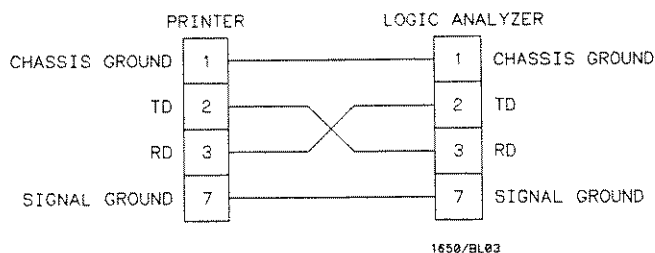

Figure 7-3. HP 92219H Cable Schematic

Setting HP-IB for HP Printers

The HP 1652B/53B interfaces directly with HP PCL printers supporting the printer command language. These printers must also support HP-IB and "Listen Always." Printers currently available from Hewlett-Packard with these features include:

- HP 2225A ThinkJet
- HP 2227B QuietJet
- HP 3630A option 002 PaintJet

Note

The printer must be in "Listen Always" when HP-IB is the printer interface. The HP 1652B/53B HP-IB port does not respond to service requests (SRQ) when controlling a printer. The SRQ enable setting for the HP-IB printer has no effect on the HP 1652B/53B operation.

For HP-IB printers, the Printer connected to field must be set to HP-IB in the I/O Port Configuration menu. You access the I/O Port Configuration menu by first accessing the I/O menu, then the I/O Port Configuration.

Setting RS-232C for HP Printers

All three series of HP printers (HP ThinkJet, HP LaserJet, and HP QuietJet) use the logic analyzer's RS-232C default configuration with only one or two changes depending on which printer you have.

Since the logic analyzer's default RS-232C configuration is set for the HP ThinkJet printer, no changes are needed for the HP ThinkJet.

For RS-232C printers, the Printer connected to field must be set to RS-232C in the I/O Port Configuration menu. You access the I/O Port Configuration menu by first accessing the I/O menu, then the I/O Port Configuration.

Listed below, are the changes you need to make for other HP printers:

- Printer type for the HP LaserJet and HP QuietJet.
- Paper width for the HP QuietJet.

You access the printer type and page width fields by first accessing the I/O menu, then the I/O Port Configuration menu.

Setting RS-232C for Your Non-HP Printer

The following attributes of the RS-232C interface must be set to the correct configuration for your printer:

- Protocol.
- Number of data bits.
- Number of stop bits.
- Parity type.
- Baud rate.
- Paper width.

You access these fields by first accessing the I/O menu then the I/O Port Configuration menu.

Setting Paper Width

Paper width is set by toggling the **Paper width : ____** field in the I/O Port Configuration menu. It tells the printer that you are sending up to 80 or 132 characters per line (only when you Print All) and is totally independent of the printer itself.

- If you select 132 characters per line (13.5 inches) when using other than an HP QuietJet selection, the listings are printed in a compressed mode. Compressed mode uses smaller characters to allow the printer to print more characters in a given width.
- If you select 132 characters per line (13.5 inches) on an HP QuietJet, it will print a full 132 characters per line.
- If you select 80 characters per line for any printer, a maximum of 80 characters are printed per line.

RS-232C Default Configuration

You can use the logic analyzer's default configuration (except for printer type and paper width) for all supported printers if you haven't changed the printer's RS-232C configuration.

The logic analyzer's default configuration is:

Protocol: XON/XOFF
Data Bits: 8
Stop Bits: 1
Parity: none
Baud rate: 9600
Printer: ThinkJet
Paper width: 8.5 inches

Recommended Protocol

The recommended protocol is XON/XOFF. This allows you to use the simpler three-wire hook-ups.

Starting the Printout

When you are ready to print, you need to know whether there is more data than is displayed on screen. In cases where data is off screen (i.e., format specifications with all pods assigned to a single analyzer), you need to decide whether you want just the data that is on screen or all the data.

If you want just what is on screen, start the printout with the Print Screen option. If you want all the data, use the Print All option. Both options are in the I/O menu. Once you decide which option to use, start the printout by placing the cursor on the print option (screen or all) and pressing SELECT.

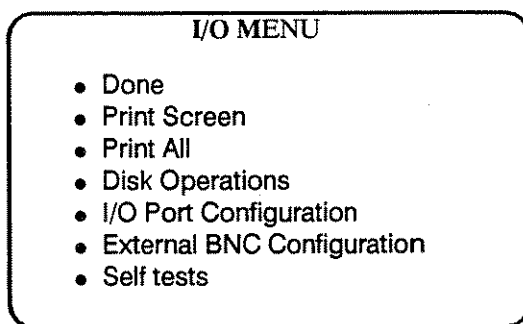

Figure 7 - 4. I/O Menu

Print Screen The Print Screen option prints only what is displayed on screen at the time you initiate the printout. In the Print Screen mode, the printer uses its graphics capabilities and the printout will look just like the logic analyzer screen with only one exception: the cursor will not print.

Print All The Print All option prints not only what is displayed on screen, but also what is below, and, in the Format Specification, what is to the right of the screen at the time you initiate the printout.



Make sure the first line you wish to print is at the top of the screen when you select Print All. Lines above the screen will not print.

Use this option when you want to print all the data in the following menus:

- Timing Format Specifications.
- State Format Specifications.
- State Trace Specifications.
- State Listing.
- Symbols.
- Disk Directory.

What Happens During a Printout?

When you press SELECT to start the printout, the I/O menu pop-up disappears and an advisory "PRINT in progress" appears in the top center of the display. While the data is transferred to the printer, the only useable key is the STOP key. When the logic analyzer has completed the data transfer to the printer, the advisory "PRINT complete" appears and the keyboard becomes useable again.

The PRINT in progress advisory won't appear in your printout. If you press STOP while the data is being transferred to the printer the transfer stops and the data already sent will print out. This causes an incomplete printout.

Connecting to Other HP Printers

The HP 1652B/53B can also be used with Hewlett-Packard printers that have RS-232C interface options. Simply connect the printer with the HP 13242G cable. Refer to table 7-1 for the appropriate selection for the RS-232C configuration of the HP 1652B/53B.

Table 7-1. HP Printer Selection

For this HP Printer	Select this Printer in I/O Port Configuration menu
HP 2631	QuietJet
HP 2671	ThinkJet
HP 2673	ThinkJet

The above printers should work with the HP 1652B/53B logic analyzers. However, no tests have been made to verify that they will work completely. Therefore, proper operation is neither promised nor supported by Hewlett-Packard.



The State Analyzer

Introduction

This chapter introduces the state analyzer and contains the state analyzer menu maps.

- Chapter 9 explains the State Format menu
- Chapter 10 explains the State Trace menu
- Chapter 11 explains the State Listing menu
- Chapter 12 explains the State Compare menu
- Chapter 13 explains the State Chart menu
- Chapter 14 explains the State Waveform menu
- Chapter 15 gives you a basic State Analyzer Measurement example

The State Analyzer (An Overview)

The state analyzer acquires data synchronously using the system-under-test to clock the acquired data. The acquired data is displayed in a list form in the State Listing menu and in waveform form in the State Waveform menu. The state analyzer differs from the timing analyzer in that the acquisition clock is provided by the system-under-test instead of the internal acquisition clock used by the timing analyzer. Therefore, the State Waveform menu displays the state waveforms referenced by states per division and not seconds per division as in the timing analyzer.

State Analyzer Menu Maps

The State Analyzer menu maps show you the fields and the available options of each field within the six menus. The menu maps will help you get an overview of each menu as well as provide you with a quick reference of what each menu contains.

State Format Menu Map

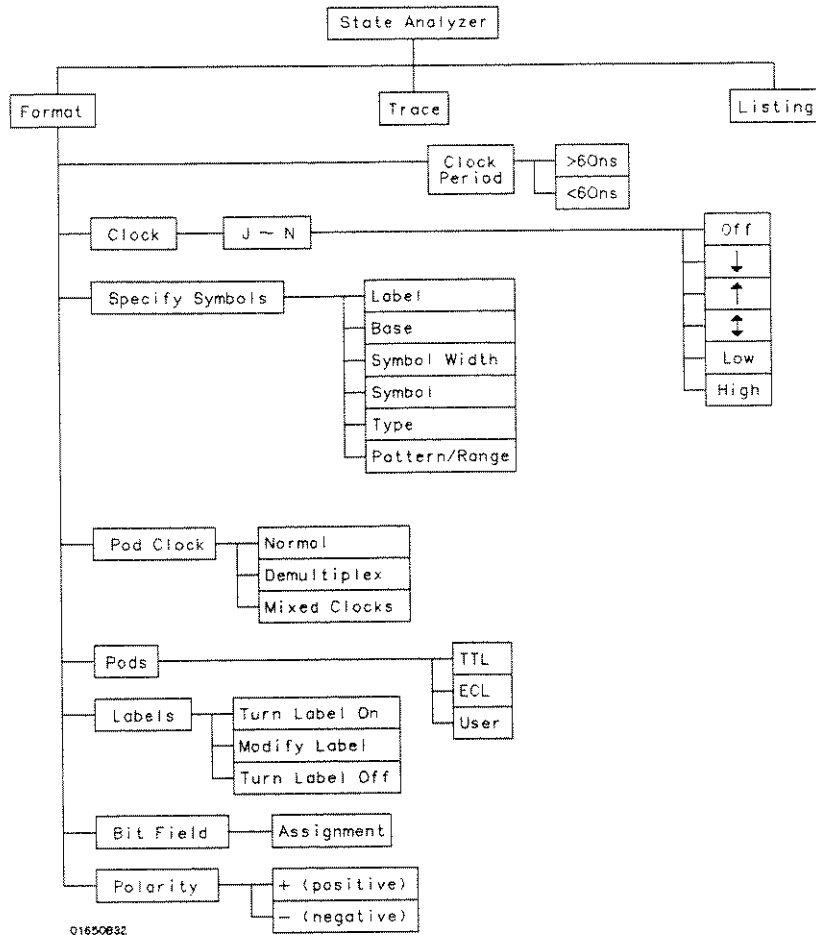

01650832

Figure 8-1. State Format Menu Map

State Trace Menu Map

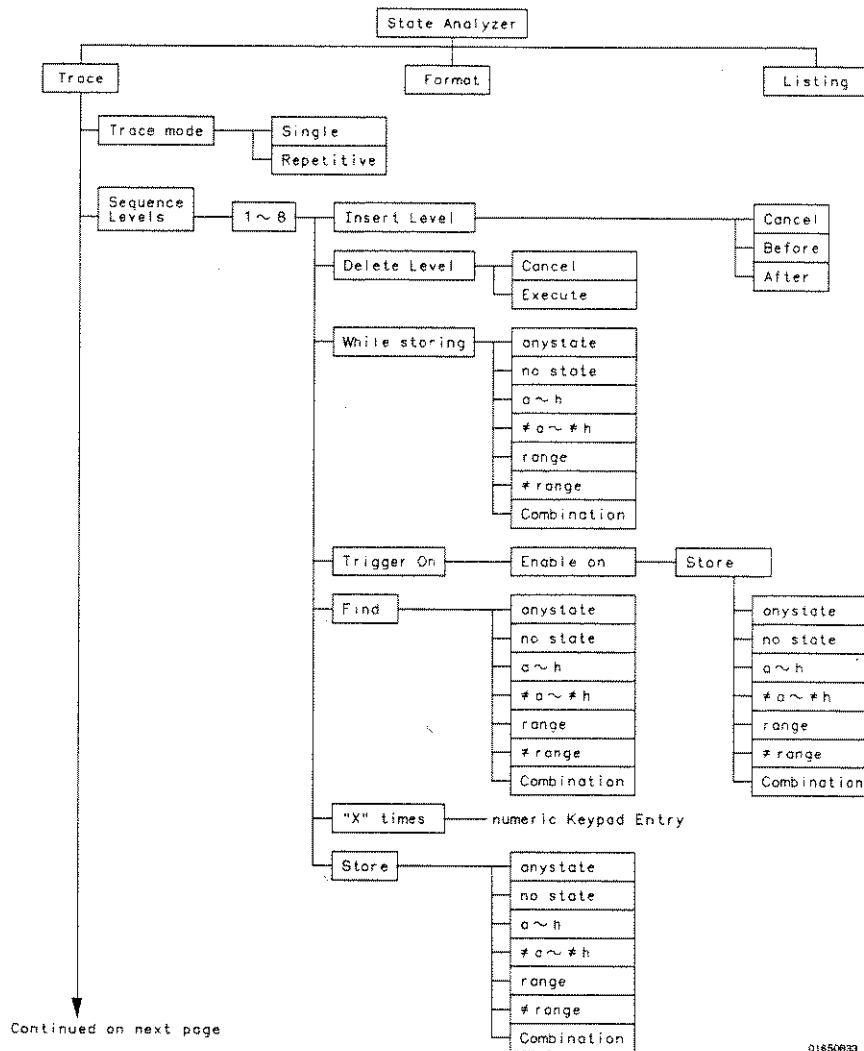
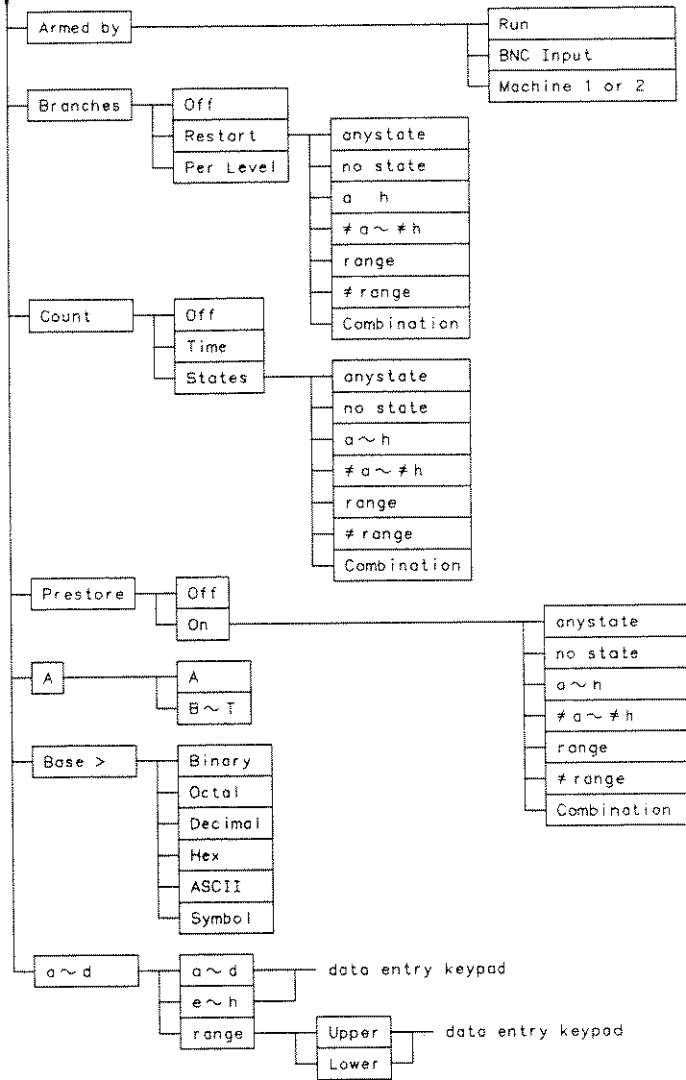

Figure 8-2. State Trace Menu Map

Continued from previous page



01650B34

Figure 8-2. State Trace Menu Map (continued)

State Listing Menu Map

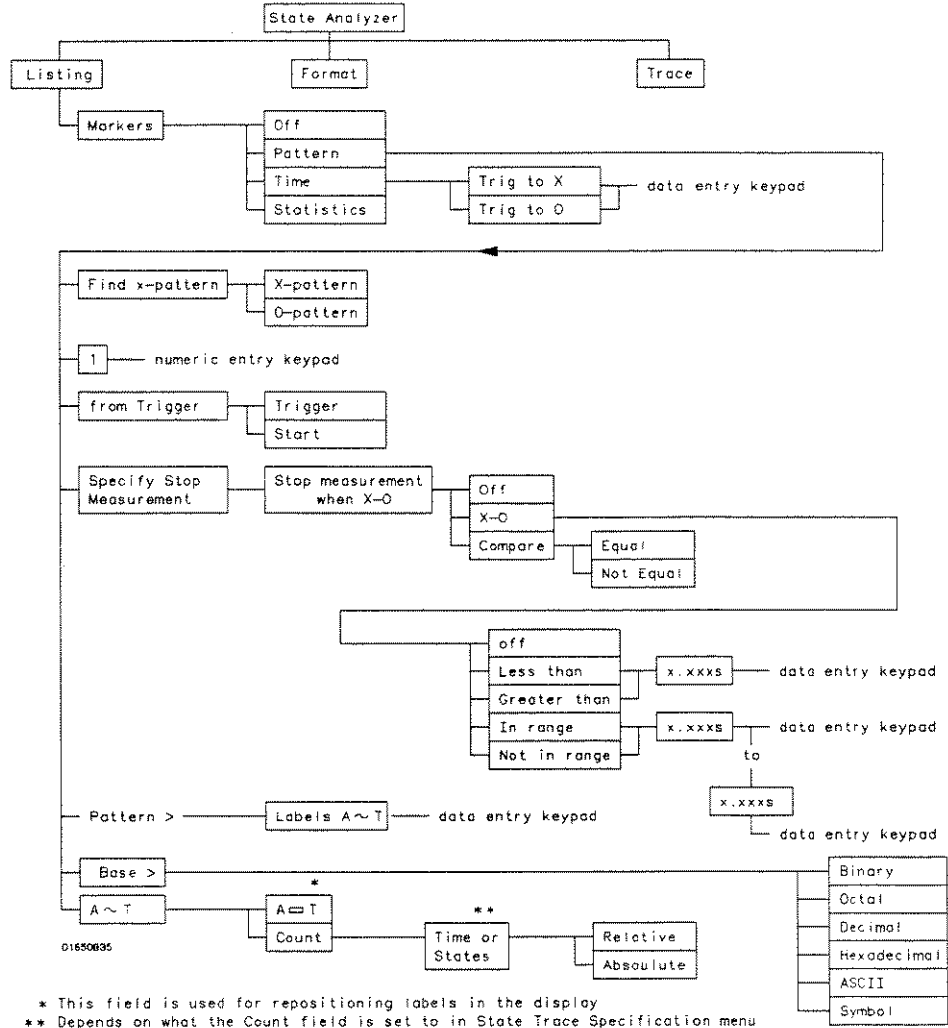

Figure 8-3. State Listing Menu Map

State Compare Menu Map

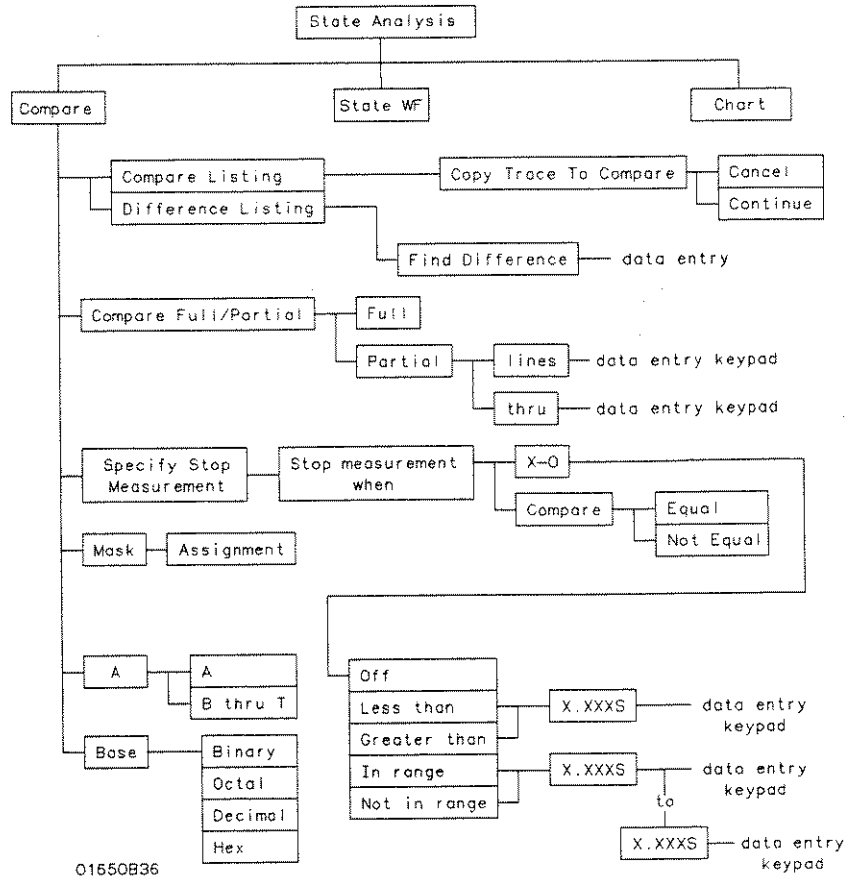
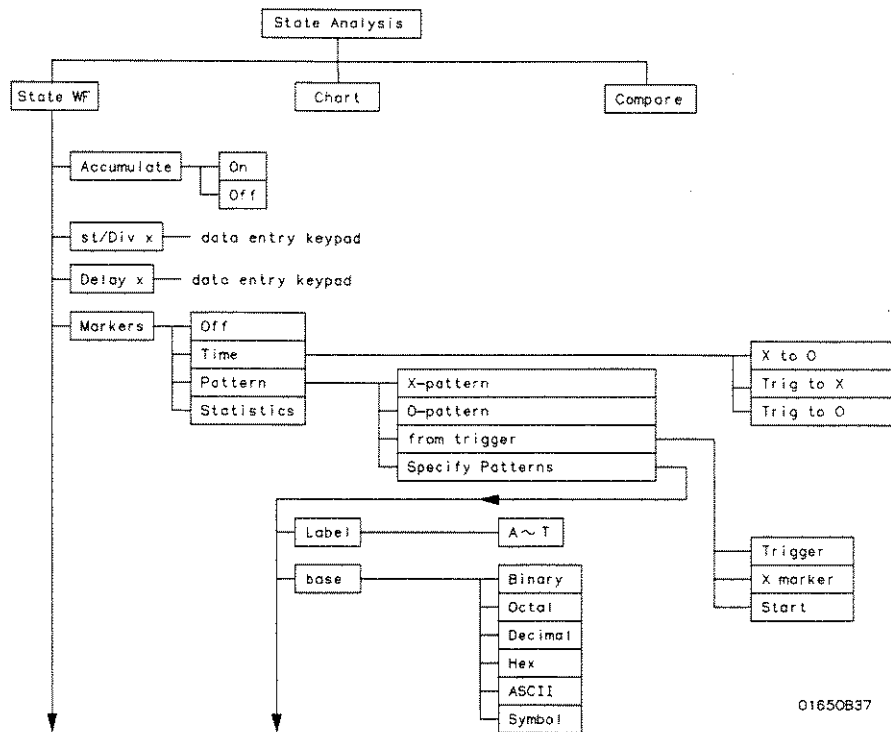

Figure 8-4. State Compare Menu Map

State Waveform Menu Map



01650B37

Figure 8-5. State Waveform Menu Map

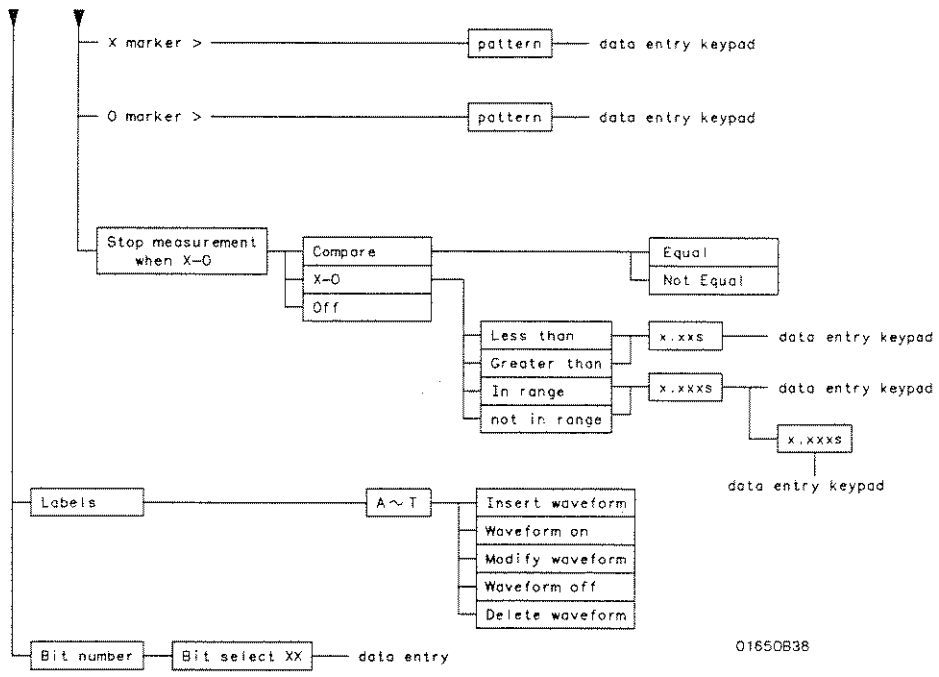

01650B38

Figure 8-5. State Waveform Menu Map (continued)

State Chart Menu Map

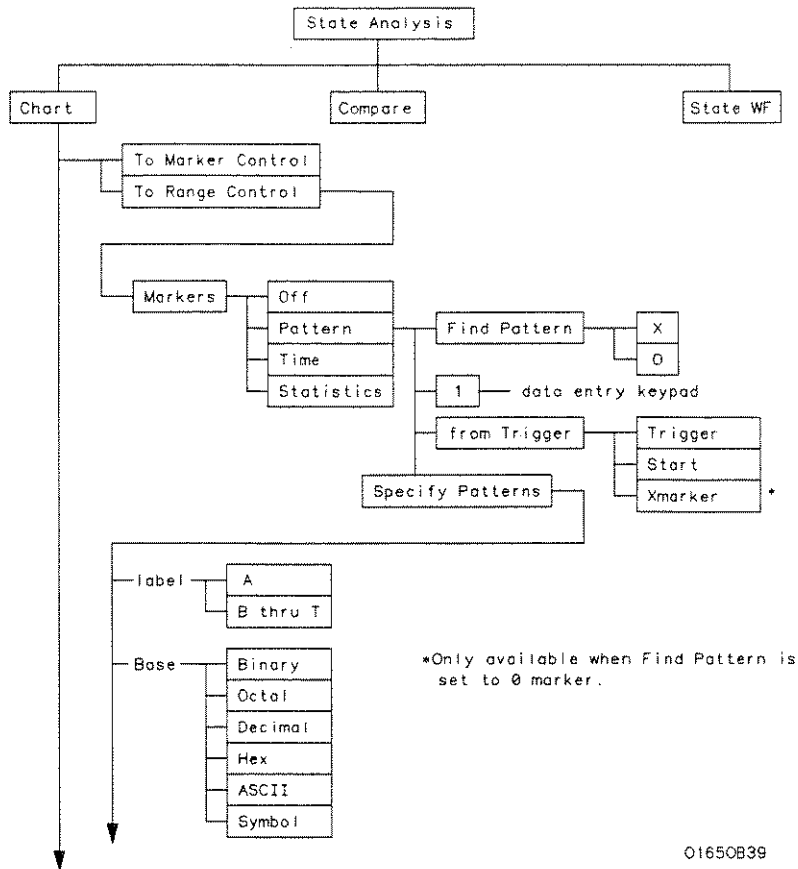

Figure 8-6. State Chart Menu Map

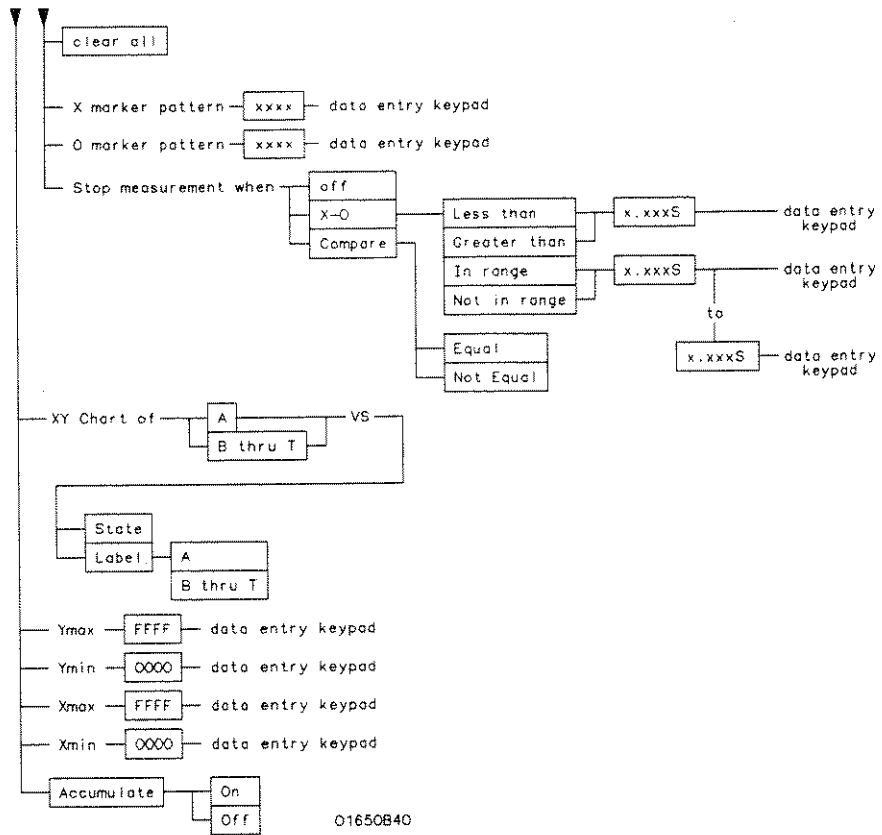

Figure 8-6. State Chart Menu Map (continued)

State Format Specification Menu

Introduction

This chapter describes the State Format Specification menu and all pop-up menus that you will use on your state analyzer. The purpose and functions of each menu are explained in detail, and we have included many illustrations and examples to make the explanations clearer.

Accessing the State Format Specification Menu

The State Format Specification menu can be accessed by pressing the FORMAT key on the front panel. If the Timing Format Specification Menu is displayed when you press the FORMAT key, you will have to switch analyzers. This is not a problem, it merely indicates that the last action you performed in the System Configuration Menu was on the timing analyzer.

State Format Specification Menu

The State Format Specification menu lets you configure the logic analyzer to group channels from your microprocessor into labels you assign for your measurements. You can set the threshold levels of the pods assigned to the state analyzer, assign labels and channels, specify symbols, and set clocks for triggering.

At power up, the logic analyzer is configured with a default setting. You can use this default setting to make a test measurement on the system under test. It can give you an idea of where to start your measurement. For an example of setting up configurations for the state analyzer, refer to your *Getting Started Guide* or "State Analyzer Measurement Example" in Chapter 15 of this manual.

At power up the State Format Specification menu looks like that shown below:

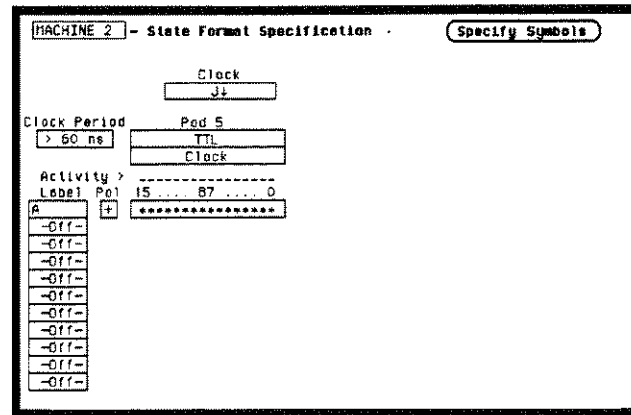

Figure 9-1. State Format Specification Menu

The State Format Specification menu for the HP 1653B is similar to that for the HP 1652B except that Pod 2 appears in the menu instead of Pod 5.

This menu shows only one pod assigned to each analyzer, which is the case at power up. Any number of pods can be assigned to one analyzer, from none to all five for the HP 1652B, and from none to two for the HP 1653B. In the State Format Specification menu, only three pods appear at a time in the display. To view any pods that are off screen, press the left/right ROLL key and rotate the KNOB. The pods are always positioned so that the lowest numbered pod is on the right and the highest numbered pod is on the left.

State Format Specification Menu Fields

Seven types of fields are present in the menus:

- Label
- Polarity (Pol)
- Bit assignments
- Pod threshold
- Specify Symbols
- Clock
- Pod Clock
- Clock Period

A portion of the menu that is not a field is the Activity Indicators display. The indicators appear under the active bits of each pod, next to "Activity > ." When the logic analyzer is connected to your target system and the system is running, you will see ↓ in the Activity Indicators display for each channel that has activity. These tell you that the signals on the channels are transitioning.

The fields in the Format menus are described in the following sections.

Label The label column contains 20 Label fields that you can define. Of the 20 labels, the state analyzer displays only 11 labels at one time. To view the labels that are off screen, press the up/down ROLL key and rotate the KNOB. The labels scroll up and down. To deactivate the scrolling, press the ROLL key again.

To access one of the Label fields, place the cursor on the field and press SELECT. You will see a pop-up menu like that shown below.

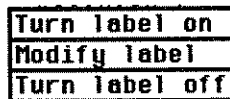

Figure 9-2. Label Pop-Up Menu

Turn Label On

Selecting this option turns the label on and gives it a default letter name. If you turned all the labels on they would be named A through T from top to bottom. When a label is turned on, bit assignment fields for the label appear to the right of the label under the pods.

Modify Label

If you want to change the name of a label, or want to turn a label on and give it a specific name, you would select the Modify label option. When you do, an Alpha Entry pop-up menu appears. You can use the pop-up menu and the keypad on the front panel to name the label. A label name can be a maximum of six characters.

Turn Label Off

Selecting this option turns the label off. When a label is turned off, the bit assignments are saved by the logic analyzer. This gives you the option of turning the label back on and still having the bit assignments if you need them. The waveforms and state listings are also saved.

You can give the same name to a label in the state analyzer as in the timing analyzer without causing an error. The logic analyzer distinguishes between them. An example of this appears in the *Getting Started Guide* and in chapter 15 of this manual.

Polarity (Pol) Each label has a polarity assigned to it. The default for all the labels is positive (+) polarity. You can change the polarity of a label by placing the cursor on the polarity field and pressing SELECT. This toggles the polarity between positive (+) and negative (-).

In the state analyzer, negative polarity inverts the data.

Bit Assignment The bit assignment fields allow you to assign bits (channels) to labels. Above each column of bit assignment fields is a line that tells you the bit numbers from 0 to 15, with the left bit numbered 15 and the right bit numbered 0. This line helps you know exactly which bits you are assigning.

The convention for bit assignment is as follows:

- * (asterisk) indicates assigned bit
- . (period) indicates unassigned bit

At power up the 16 bits of Pod 1 are assigned to the timing analyzer and the 16 bits of Pod 5 are assigned to the state analyzer.

To change a bit assignment configuration, place the cursor on a bit assignment field and press SELECT. You will see the following pop-up menu.

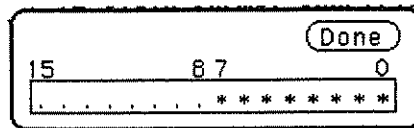

Figure 9-3. Bit Assignment Pop-Up Menu

Use the KNOB to move the cursor to an asterisk or a period and press SELECT. The bit assignment toggles to the opposite state of what it was before. When the bits (channels) are assigned as desired, place the cursor on Done and press SELECT. This closes the pop-up and displays the new bit assignment.

Assigning one channel per label may be handy in some applications. This is illustrated in chapter 8 of the *Getting Started Guide*. Also, you can assign a channel to more than one label, but this usually isn't desired.

Labels may have from 1 to 32 channels assigned to them. If you try to assign more than 32 channels to a label, the logic analyzer will beep, indicating an error, and a message will appear at the top of the screen telling you that 32 channels per label is the maximum.

Channels assigned to a label are numbered from right to left by the logic analyzer. The least significant assigned bit (LSB) on the far right is numbered 0, the next assigned bit is numbered 1, and so on. Since 32 channels can be assigned to one label at most, the highest number that can be given to a channel is 31.

Although labels can contain split fields, assigned channels are always numbered consecutively within a label. The numbering of channels is illustrated with the figure below.

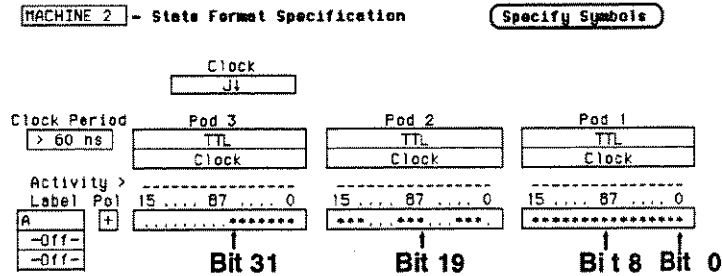

Figure 9-4. Numbering of Assigning Bits

Pod Threshold

Each pod has a threshold level assigned to it. For the HP 1653B Logic Analyzer, threshold levels may be defined for Pods 1 and 2 individually. For the HP 1652B Logic Analyzer, threshold levels may be defined for Pods 1, 2 and 3 individually, and one threshold for Pods 4 and 5. It does not matter if Pods 4 and 5 are assigned to different analyzers. Changing the threshold of one will change the threshold of the other.

If you place the cursor on one of the pod threshold fields and press SELECT, you will see the following pop-up menu.

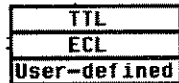

Figure 9-5. Pod Threshold Pop-Up Menu

TTL sets the threshold at + 1.6 volts, and ECL sets the threshold at - 1.3 volts.

The User-defined option lets you set the threshold to a specific voltage between -9.9 V and $+9.9\text{ V}$. If you select this option you will see a Numeric Entry pop-up menu as shown.

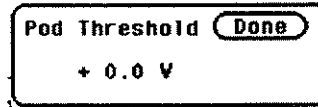

Figure 9-6. User-defined Numeric Entry Pop-Up Menu

You can change the value in the pop-up either with the keypad on the front panel or with the KNOB, which you rotate until you get the desired voltage. When the correct voltage is displayed, press SELECT. The pop-up will close and your new threshold will be placed in the pod threshold field.

The threshold level you specify for the 16 data bits also applies to a pod's clock threshold.

Specify Symbols

This field provides access to the Specify Symbols menu. It differs from the other fields in the State Format Specification menu in that it displays a complete menu instead of a pop-up. The complete description of the Specify Symbols Menu follows the State Format Specification Menu fields later in this chapter.

Clock

The Clock field in the Format Specification menu displays the clocks for clocking your system. The display will be referred to as the "clocking arrangement."

The HP 1652B Logic Analyzer has five clock channels, each of which is on a pod. The clocks are connected through the pods simply for convenience. The clock channels are labeled J, K, L, M, and N and are on pods 1 through 5, respectively. The clocking of the state analyzer is synchronous with your system because your analyzer uses the signals present in your system. The signal you use must clock the analyzer when the data you want to acquire is valid.

The HP 1653B Logic Analyzer has two clock channels, each on one of the pods. The J clock is on pod 1 and the K clock is on pod 2.

When you select the **Clock** field, you will see the following pop-up menu with which you specify the clock.

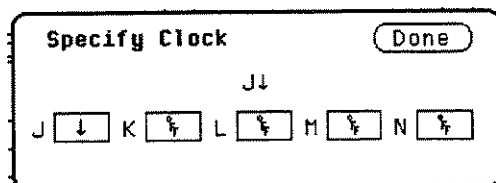

Figure 9-7. Clock Pop-Up Menu

You can use one of the clocks alone or combine them to build one clocking arrangement. If you select a field to the right of one of the clocks in the pop-up you will see another pop-up menu:

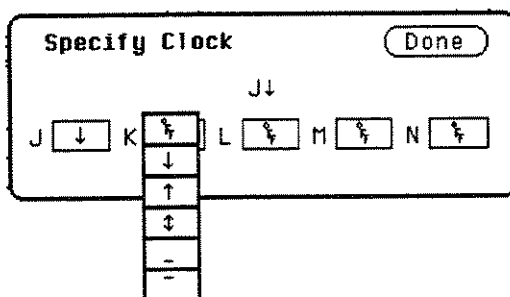

Figure 9-8. Single Clock Pop-Up Menu

You can specify the negative edge of the clock, the positive edge, either edge, a high level, a low level, or the clock to be off.

The clocks are combined by ORing and ANDing them. Clock edges are ORed to clock edges, clock levels are ORed to clock levels, and clock edges are ANDED to clock levels.

For example, if you select ↓ for the J clock, ↑ for the K clock, _ for the M clock, and — for the N clock, the resulting clocking arrangement will appear in the display as:

$$\text{Clock} \\ (J\downarrow + K\uparrow) \cdot (M_ + N^-)$$

Figure 9-9. Example of a Clocking Arrangement

With this arrangement, the state analyzer will clock the data when there is a negative edge of the J clock OR a positive edge of the K clock, AND when there is a low level on the M clock OR a high level on the N clock.

You must always specify at least one clock edge. If you try to use only clock levels, the logic analyzer will display a message telling you that at least one edge is required.

Pod Clock Your logic analyzer has the capability of clocking data in three different ways. The pod Clock fields in the State Format Specification menu allow you to specify which of the three ways you want to clock the data.

Each pod assigned to the state analyzer has a pod Clock field associated with it. Selecting one of the pod Clock fields gives you the following pop-up menu:

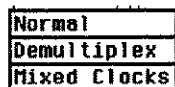

Figure 9-10. Pod clock Field Pop-Up Menu

Normal

This option specifies that clocking will be done in single phase. That is the clocking arrangement located in the Clock field above the pods in the State Format Specification menu will be used to clock all the pods assigned to this machine.

For example, suppose that the Clock field looks like the following:

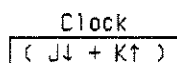

Figure 9-11. Example of a Clocking Arrangement

In Normal mode the state analyzer will sample the data on any assigned pods on a negative edge of the J clock OR on a positive edge of the K clock.

Demultiplex

With the HP 1652B/1653B Logic Analyzers, you can clock two different types of data that occur on the same lines. For instance, lines that transfer both address and data information need to be clocked at different times in order to get the right information at the right time.

When you select the Demultiplex option, the pod Clock field changes to "Master | Slave," and two clock fields appear above the pods where just one Clock field used to be. These fields are the Master Clock and Slave Clock, as shown:

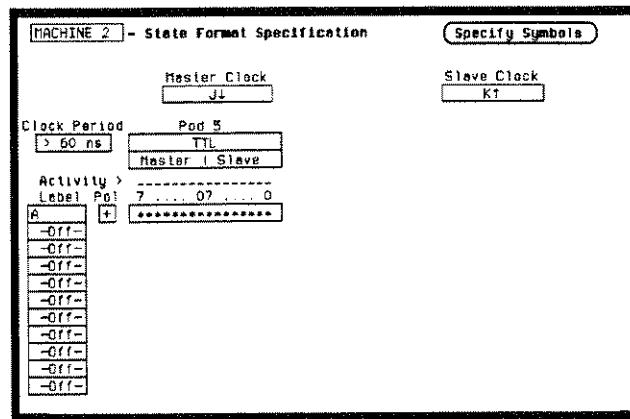

Figure 9-12. Master Clock and Slave Clock

Demultiplexing is done on the data lines of the specified pod to read only the lower eight bits. This is two-phase clocking, with the Master Clock following the Slave Clock. The analyzer first looks for the clocking arrangement that you specify in the Slave Clock. When it sees this arrangement, the analyzer clocks the data present on bits 0-7 of the pod, then waits for the clocking arrangement that you specify in the Master Clock. When it sees this arrangement, it again clocks the data present on bits 0-7 of the pod. The upper eight bits of the pods are ignored and don't need to be connected to your system.

Notice, the bit numbers that appear above the bit assignment field have changed. The bits are now numbered 7...07...0 instead of 15...87...0. This helps you set up the analyzer to clock the right information at the right time.

The address/data lines AD0-AD7 on the 8085 microprocessor are an example of Demultiplex. During part of the operating time the lines have an address on them, and during other times they have data on them. Hook the lower eight bits of one of the pods to these eight lines and set the Slave and Master Clocks so that they clock the data and the address at the proper time.

In this example, you may choose to assign the bits in the State Format Specification menu similarly to that shown below. In this case you would want to clock the address with the Slave Clock and the data with the Master Clock.

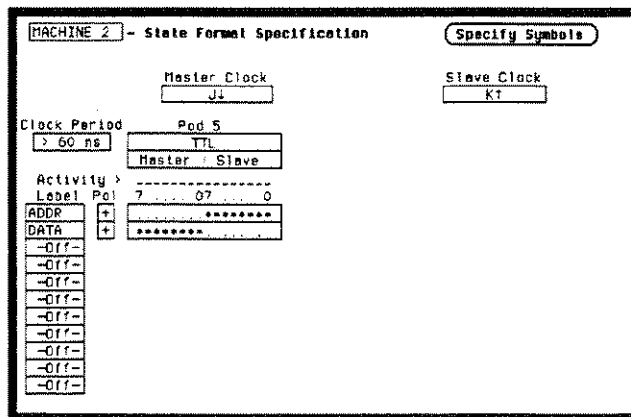

Figure 9-13. Master and Slave Clock Bit Assignments

The Master and Slave Clocks can have the same clocking arrangements. The clocking is still done the same way, with the lower eight bits being clocked first on the Slave Clock, then on the Master Clock.

Mixed Clocks

The Mixed Clocks option allows you to clock the lower eight bits of a pod separately from the upper eight bits. The state analyzer uses Master and Slave Clocks to do this. If you select this option from the pod Clock pop-up, the pod Clock field changes to "Master | Slave," and two Clock fields, Master and Slave, appear above the pods.

As in Demultiplex, the Master Clock follows the Slave Clock. The state analyzer looks for the clocking arrangement given by the Slave Clock and clocks the lower eight bits. Then it looks for the clock arrangement given by the Master Clock and clocks the upper eight bits. Unlike Demultiplex, all 16 bits of a pod are sampled.

The Master and Slave Clocks can have the same clocking arrangements. The clocking is still done the same way, with the lower eight bits clocked on the Slave Clock and the upper eight bits clocked on the Master Clock.

Clock Period This field provides greater measurement accuracy when your state input clock period is greater than 60 ns. When you select > 60 ns, the state analyzer provides greater immunity against noise or ringing in the state input clock signal; also, the logic analyzer provides greater accuracy when triggering another state or timing analyzer or the BNC trigger out.

If your State input clock period is less than 60 ns, you should select < 60 ns. This disables the Count field in the State Trace Specification menu because the maximum clock rate when counting is 16.67 MHz (60 ns clock period). This also turns Prestore off.

Specify Symbols Menu

The logic analyzer supplies Timing and State Symbol Tables in which you can define a mnemonic for a specific bit pattern of a label. When measurements are made by the state analyzer, the mnemonic is displayed where the bit pattern occurs if the Symbol base is selected.

It is possible for you to specify up to 200 symbols in the logic analyzer. If you have only one of the internal analyzers on, all 200 symbols can be defined in it. If both analyzers are on, the 200 symbols are split between the two. For example, analyzer 1 may have 150, leaving 50 available for analyzer 2.

To access the Symbol Table in the State Format Specification menu, place the cursor on the **Specify Symbols** field and press SELECT. You will see a new menu as shown. This is the default setting for the Symbol Table in both the timing and state analyzers.

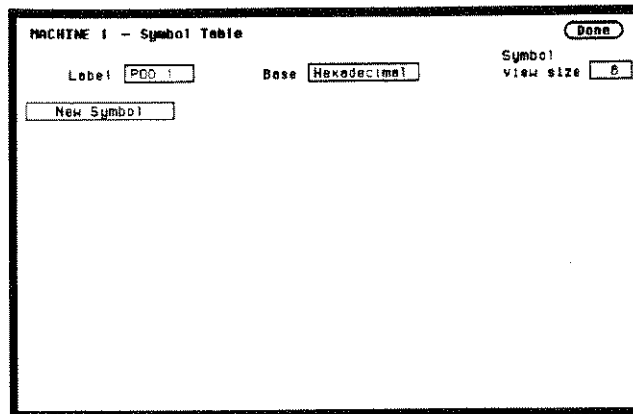

Figure 9-14. Symbol Table Menu

Specify Symbols Menu Fields There are four fields in the Symbol Table menu. They are:

- Label
- Base
- Symbol view size
- Symbol name

Label The **Label** field identifies the label for which you are specifying symbols. If you select this field, you will get a pop-up that lists all the labels turned on for that analyzer.

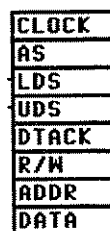

Figure 9-15. Label Pop-Up Menu

Each label has a separate symbol table. This allows you to give the same name to symbols defined under different labels. In the Label pop-up select the label for which you wish to specify symbols.

Base The **Base** field tells you the numeric base in which the pattern will be specified. The base you choose here will affect the pattern field of the State Trace Specification menu. This is covered later in this chapter.

To change the base, place the cursor on the field and press SELECT. You will see the following pop-up menu.

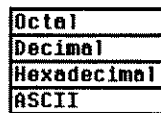

Figure 9-16. Base Pop-Up Menu

If more than 20 channels are assigned to a label, the Binary option is not offered in the pop-up. The reason for this is that when a symbol is specified as a range, there is only enough room for 20 bits to be displayed on the screen.

Decide which base you want to work in and choose that option from the numeric Base pop-up menu.

If you choose the ASCII option, you can see what ASCII characters the patterns and ranges defined by your symbols represent. ASCII characters represented by the decimal numbers 0 to 127 (hex 00 to 7F) are offered on your logic analyzer. Specifying patterns and ranges for symbols is discussed in the next section.

Note



You cannot specify a pattern or range when the base is ASCII. First define the pattern or range in one of the other bases, then switch to ASCII to see the ASCII characters.

Symbol View Size

The **Symbol view size** field lets you specify how many characters of the symbol name will be displayed when the symbol is referenced in the State Trace Specification menu and the State Listing menu. Selecting this field gives you the following pop-up.

3
4
5
6
7
8
9
10
11
12
13
14
15
16

Figure 9-17. Symbol View Size Pop-Up Menu

You can have the logic analyzer display from 3 to all 16 of the characters in the symbol name. For more information see "State Trace Specification Menu" and "State Listing Menu" later in this chapter.

Symbol Name

When you first access the Symbol Table, there are no symbols specified. The symbol name field reads "New Symbol." If you select this field, you will see an Alpha Entry pop-up menu on the display. Use the pop-up menu and the keypad on the front panel to enter the name of your symbol. A maximum of 16 characters can be used in a symbol name.

When you select the Done field in the Alpha Entry pop-up menu the name that appears in the symbol name field is assigned and two more fields appear in the display.

MACHINE 1 - Symbol Table Done

Label Base Symbol view size

Pattern

Figure 9-18. Symbol Defined as a Pattern

The first of these fields defines the symbol as either a Pattern or a Range. If you place the cursor on this field and press SELECT, it will toggle between Pattern and Range.

When the symbol is defined as a pattern, one field appears to specify what the pattern is. Selecting this field gives you a pop-up with which you can specify the pattern. Use the keypad and the DON'T CARE key on the front panel to enter the pattern. Be sure to enter the pattern in the numeric base that you specified in the Base field.

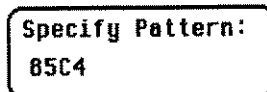

Figure 9-19. Specify Pattern Pop-Up Menu

If the symbol is defined as a range, two fields appear in which you specify the upper and lower boundaries of the range.

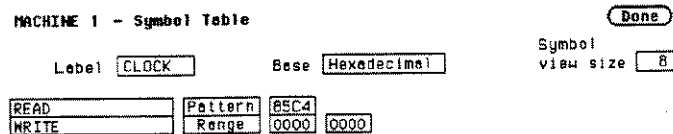

Figure 9-20. Symbol Defined as a Range

Selecting either of these fields gives you a pop-up with which you can specify the boundary of the range.

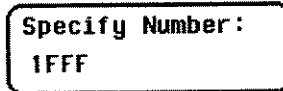

Figure 9-21. Specify Range Pop-Up Menu

You can specify ranges that overlap or are nested within each other. Don't cares are not allowed.

To add more symbols to your symbol table, place the cursor on the last symbol defined and press SELECT. A pop-up menu appears as shown.

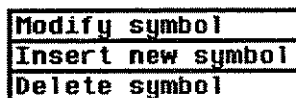

Figure 9-22. Symbol Pop-Up Menu

The first option in the pop-up is Modify symbol. If you select this option, you will see an Alpha Entry pop-up menu with which you can change the name of the symbol.

The second option in the pop-up is Insert new symbol. It allows you to specify another symbol. When you select it, you will see an Alpha Entry pop-up menu. Use the menu and the keypad on the front panel to enter the name of your new symbol. When you select Done, your new symbol will appear in the Symbol Table. The third option in the pop-up is Delete symbol. If you select this option, the symbol will be deleted from the Symbol Table.

Leaving the Symbol Table Menu

When you have specified all your symbols, you can leave the Symbol Table menu in one of two ways. One method is to place the cursor on the Done field and press SELECT. This puts you back in the Format Specification menu that you were in before entering the Symbol Table. The other method is to press the FORMAT, TRACE, or DISPLAY keys on the front panel to get you into the respective menu.

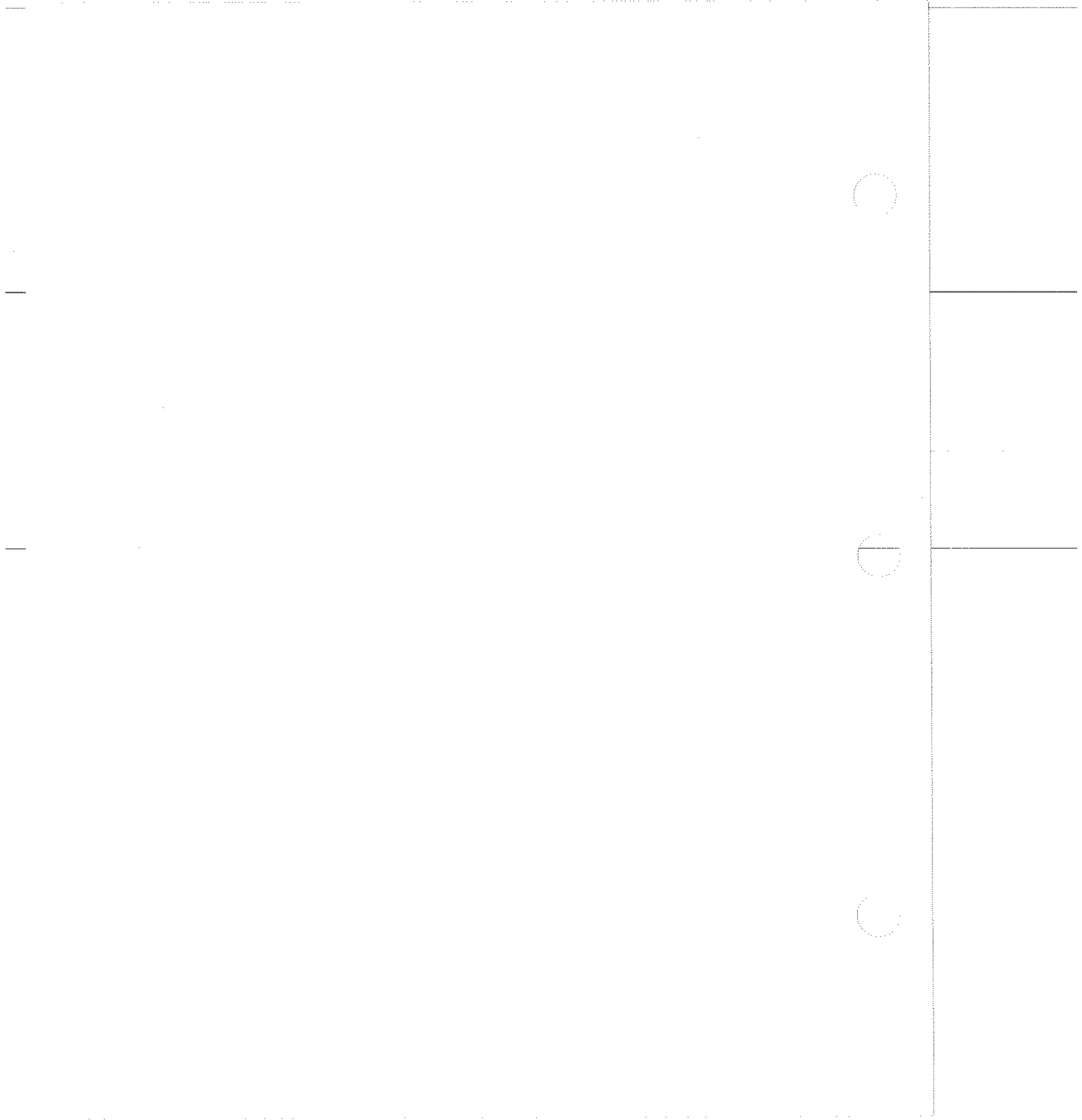

State Trace Menu

Introduction

This chapter describes the State Trace menu and the pop-up menus that you will use on your state analyzer. The purpose and functions are described in detail, and we have included many illustrations and examples to make the explanations clearer.

The Trace Specification menu allows you to configure the state analyzer to capture only the data of interest for your measurement. In the state analyzer you can configure the analyzer to trigger on a sequence of states. The default setting is shown in figure 10-1 below.

For an example of setting up a trace configuration for a State analyzer, refer to your *Getting Started Guide* or "State Analyzer Measurement Example" in Chapter 15 of this manual.

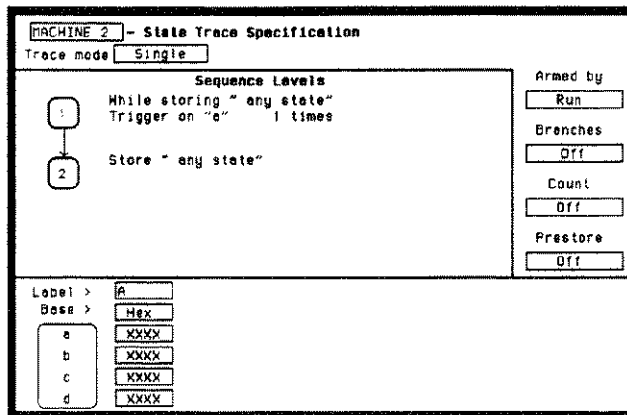

Figure 10-1. State Trace Specification Menu

Accessing the State Trace Menu

The State Trace menu can be accessed by pressing the TRACE key on the front panel. If the Timing Trace Specification menu is displayed when you press the TRACE key, you will have to switch analyzers. This is not a problem, it merely indicates that the last action you performed in the System Configuration Menus was on the timing analyzer.

State Trace Menu Fields

The menu is divided into three sections: the Sequence Levels in the large center box, the acquisition fields at the top and right of the screen, and the qualifier and pattern fields at the bottom of the screen.

Before describing the fields in the menu, we need to define a few terms. These terms will be used in the discussions of the fields, so understanding their meanings is essential.

Pattern Recognizers: a pattern of bits (0, 1, or X) in each label. There are eight recognizers available when one state analyzer is on. Four are available to each analyzer when two state analyzers are on. The pattern recognizers are given the names a through h and are partitioned into groups of four, a-d and e-h.

Range Recognizer: recognizes data which is numerically between or on two specified patterns. One range term is available and is assigned to the first state analyzer created by assigning pods to it or if only one analyzer is on, then the range term is assigned to it.

Qualifier: user-specified term that can be anystate, nostate, a single pattern recognizer, a range recognizer, the complement of a pattern or range recognizer, or a logical combination of pattern and range recognizers. To specify a qualifier, you will use the pop-up shown in figure 10-2. This pop-up appears when accessed through the five different fields encountered when setting qualifiers throughout the State Trace menu.

any state
no state
a
b
c
d
e
f
g
h
≠a
≠b
≠c
≠d
≠e
≠f
≠g
≠h
range
≠range
Combination

Figure 10-2. Qualifier Pop-Up Menu

If you select the **Combination** option in the pop-up, you will see a pop-up similar to that shown below.

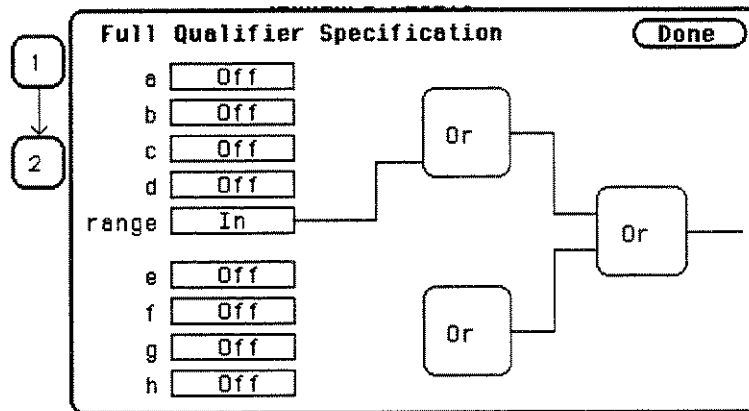

Figure 10-3. Full Qualifier Specification Pop-Up

Note 

If two multi-pod state analyzers are on, the qualifier pop-up menu will show that only four pattern recognizers are available to each analyzer. Pattern recognizers a-d and the range recognizer are assigned to the first analyzer created, and pattern recognizers e-h go with the second analyzer. In the Full Qualifier Specification pop-up there will be only one OR gate and one set of pattern recognizers.

With this Full Qualifier Specification pop-up, you specify a logical combination of patterns or ranges as the qualifier. The pattern recognizers are always partitioned into the groups of four shown. Only one operator is allowed between the patterns in a group. Patterns in uncomplimented form (a, b, etc.) can only be ORed.

The complements of patterns ($\neq a$, $\neq b$, etc.) can only be ANDED. For example, if the first OR field (gate) is changed to AND, all the patterns for that gate are complemented, as shown below.

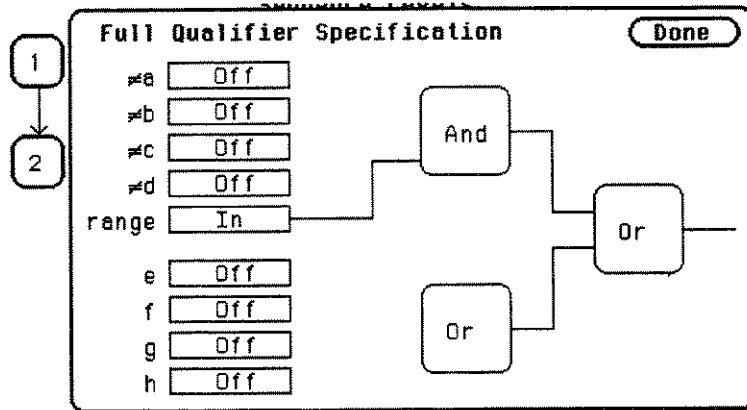

Figure 10-4. Complemented Patterns

To specify a pattern to be used in the combination, place the cursor on the pattern recognizer field and press SELECT. The field toggles from Off to On and a connection is drawn from the pattern field to the gate. In figure 10-5, patterns b, c and d and the range are ORed together, and e and g are ANDed together.

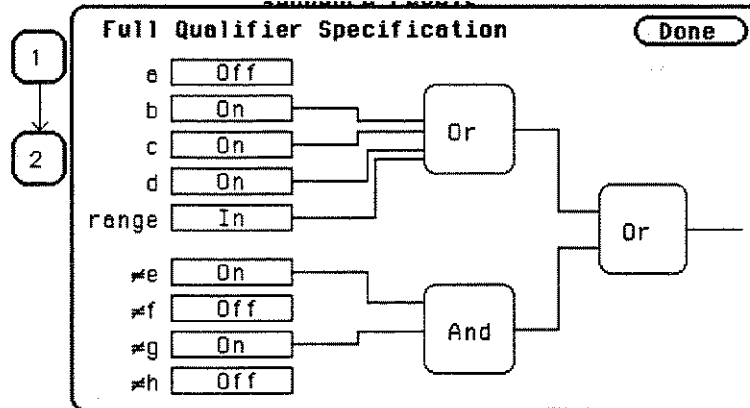

Figure 10-5. Patterns Assigned for Logical Combinations

As shown in the previous figures, the range is included with the first group of patterns (a-d). If you select the range field, you will see the following pop-up menu.

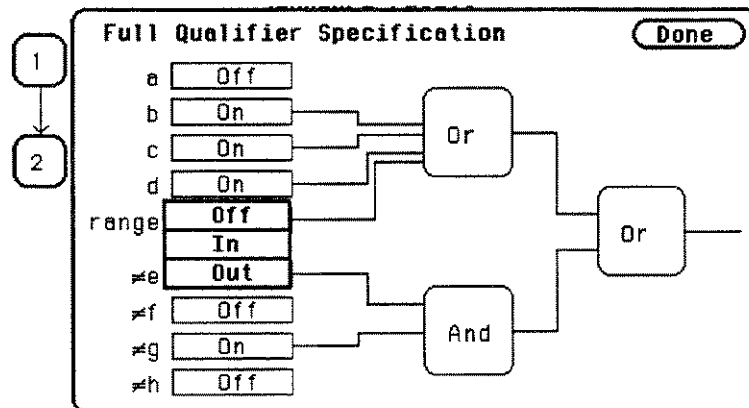

Figure 10-6. Range Specification Pop-Up Menu

Off disconnects the range from the qualifier specification. **In** indicates that the contents of the range are to be in the qualifier specification, and **Out** indicates that the complement of the range is to be in the qualifier specification.

When you have specified your combination qualifier, select **Done**. The **Full Qualifier Specification** pop-up closes and the Boolean expression for your qualifier appears in the field for which you specified it.

While storing

Figure 10-7. Boolean Expression for Qualifier

Sequence Levels

There are eight trigger sequence levels available in the state analyzer. You can add and delete levels so that you have from two to eight levels at a time.

Only three levels appear in the Sequence Levels display at one time. To display other levels so that they can be accessed, press the up/down ROLL key and rotate the KNOB.

If you select level 1 shown in figure 10-1, you will see the following pop-up menu:

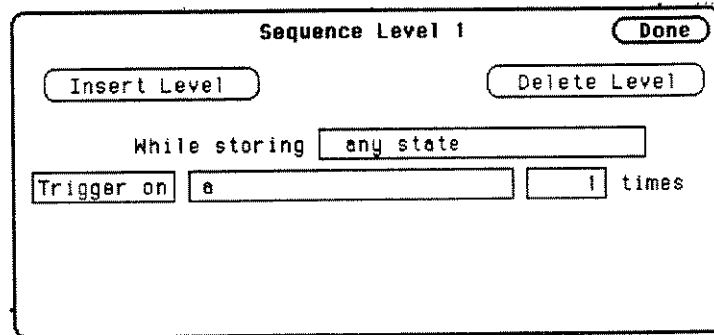

The image shows a pop-up menu titled "Sequence Level 1" with a "Done" button in the top right corner. Inside the menu, there are two buttons: "Insert Level" on the left and "Delete Level" on the right. Below these buttons, the text "While storing" is followed by a text input field containing "any state". Underneath that, the text "Trigger on" is followed by a text input field containing "a" and a numeric input field containing "1", with the word "times" to the right of the numeric field.

Figure 10-8. Sequence Level Pop-Up Menu

Not all sequence level pop-up menus look like this one. This happens to be the trigger sequence level in which you specify the state on which the analyzer is to trigger. The trigger term can occur in any of the first seven levels, and it is not necessarily a selectable field. The fields in the menu of figure 10-8 are described on the following pages.

Insert Level To insert a level, place the cursor on the field labeled **Insert Level** and press SELECT. You will see the following pop-up menu.

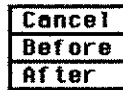



Figure 10-9. Insert Level Pop-Up Menu

Cancel returns you to the sequence level pop-up without inserting a level. **Before** inserts a level before the present level. **After** inserts a level after the present level. If there are eight levels, the **Insert Level** field doesn't appear in the sequence level pop-ups.

Delete Level If you want to delete the present level, select the field labeled **Delete Level**. You will see a pop-up menu with the choices **Cancel** and **Execute**. **Cancel** returns you to the sequence level pop-up without deleting the level. **Execute** deletes the present level and returns you to the State Trace Specification menu.

Note  If there are only two levels, neither field can be deleted even though the **Delete Level** field still appears in the menu. There will always be a trigger term level and a store term level in Sequence Levels. Therefore, if you try to delete either of these, all terms you have specified in these levels will be set to default terms, and, the trigger and store term levels will remain.

Storage Qualifier

Each sequence level has a storage qualifier. The storage qualifier specifies the states that are to be stored and displayed in the State Listing. Selecting this field gives you the qualifier pop-up menu shown in figure 10-2, with which you specify the qualifier.

As an example, suppose you specify the storage qualifier in a sequence level as shown below.

While storing

Figure 10-10. Storage Qualifier Example

The only states that will be stored and displayed are the states given by pattern recognizers a and d.

Branching Qualifier

Every sequence level except the last has a primary branching qualifier. With the branching qualifier, you tell the analyzer to look for a specific state or states. The primary branching qualifier advances the sequencer to the next level if its qualifier is satisfied.

In the example of figure 10-8, the branching qualifier tells the analyzer when to trigger. In other sequence levels, the qualifier may simply specify a state that the analyzer is to look for before continuing to the next level.

Some sequence levels also have a secondary branching qualifier. The secondary branch will, if satisfied, route the sequencer to a level that you define. This is covered in more detail in "Branches" later in this chapter.

Occurrence Counter

The primary branching qualifier has an occurrence counter. With the occurrence counter field you specify the number of times the branching qualifier is to occur before moving to the next level.

To change the value of the occurrence counter, position the cursor on the field and either press SELECT or press a numeric key on the front-panel keypad. You will see a pop-up similar to that shown below.

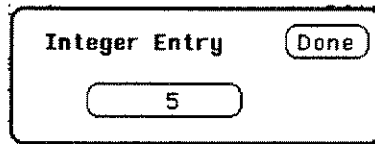

Figure 10-11. Occurrence Counter Pop-Up Menu

You can change the value by either rotating the KNOB or pressing the appropriate numeric keys. The qualifier can be specified to occur from one to 65535 times.

Storage Macro

Your logic analyzer has the capability of post-trigger storage through a storage macro. The storage macro is available only in the second to last level, and it consumes both that level and the last level. The field in figure 10-8 allows you to configure the state analyzer for post-trigger storage. This field does not always say Trigger on. If the sequence level is not a trigger level, the field will say Then find, as shown below.

Then find any state 1 times

Figure 10-12. Then Find Branching Qualifier

Selecting the field gives you a pop-up with two options. One option is what the field said previously. The other option is Enable on. If you select this option, the Sequence Level pop-up changes to look similar to that shown below.

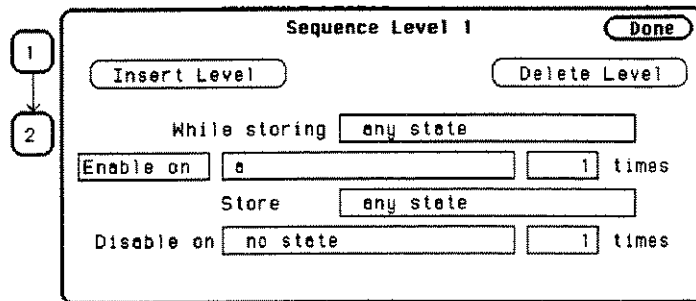

Figure 10-13. Storage Macro Sequence Level Example

Note 

Enable on can only be the next to last term, and when on, the last term is combined with the Enable term.

You specify qualifiers for the states on which you want the macro to enable, the states you want to store, and the states on which you want the macro to disable. The storage macro is a loop that keeps repeating itself until memory is full. The loop is repeated when the disable qualifier is satisfied. As an example, suppose you configure the sequence level of figure 10-13 to look like that shown below.

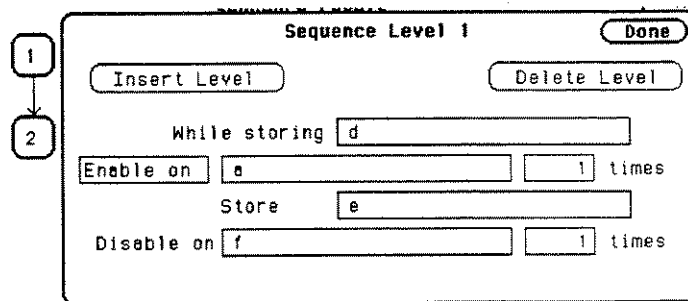

Figure 10-14. Sequence Level Pop-up with Storage Macro

The logic analyzer will store the state given by pattern recognizer **d** until it comes across the state given by **a**. When it sees state **a**, the logic analyzer starts to store the state given by pattern recognizer **e**. It stores that state until it sees the state given by **f**, at which time it disables and starts the process all over again. The analyzer repeats this process until its memory is full.

Reading the Sequence Level Display

Reading the display is fairly straightforward. For example, suppose your display looks like that shown below.

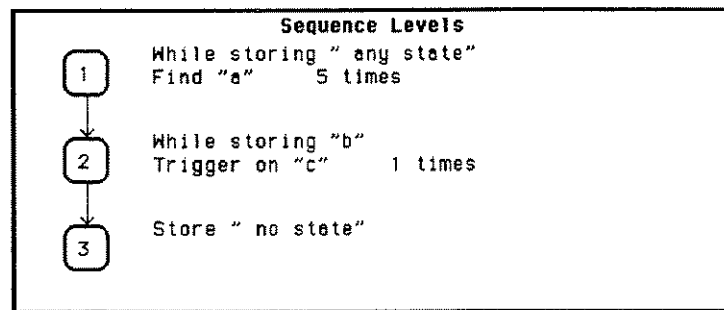

Figure 10-15. Sequence Level Display Example

In level 1 any state is stored while the logic analyzer searches for five occurrences of the pattern given by pattern recognizer **a**. When the five occurrences are found, the sequencer moves on to level 2. In level 2 the state given by pattern recognizer **b** is stored until one occurrence of the pattern given by pattern recognizer **c** is found and the logic analyzer triggers. In level 3 no state is stored, so the last state stored is the trigger state.

An example of a state listing for the previous State Trace configuration is shown below. The state patterns specified are:

a = B03C
b = 0000
c = 8930

MACHINE 2		-	STATE LISTING
Label	>	A	
Base	>	Hex	
-0028		4E75	
-0027		61E6	
-0026		0000	
-0025		88C8	
-0024		B03C	
-0023		00FF	
-0022		6730	
-0021		48E7	
-0020		4E75	
-0019		3000	
-0018		0000	
-0017		8930	
-0016		B03C	
-0015		00FF	
-0014		67F8	
-0013		B03C	
-0012		61FA	
-0011		B03C	
-0010		0000	
-0009		8930	
-0008		4EFA	
-0007		FF9A	
-0006		61E6	
-0005		B03C	
-0004		0000	
-0003		0000	
-0002		0000	
-0001		0000	
+0000		8930	

Figure 10-16. State Listing Example

Anystate was stored while the analyzer looked for five occurrences of the state B03C. After the fifth occurrence was found, only state 0000 was stored until state 8930 was found, and the analyzer triggered. After the trigger, no states were stored.

Acquisition Fields

The acquisition fields are comprised of the Trace mode, Armed by Branches, Count, and Prestore fields, as shown below.

MACHINE 2 - State Trace Specification

Trace mode

Sequence Levels	
1	While storing "any state" Trigger on "a" 1 times
2	Store "any state"

Armed by

Branches

Count

Prestore

Figure 10-17. State Trace Acquisition Fields

Trace Mode You specify the mode in which the state analyzer will trace with the **Trace mode** field. You have two choices for trace mode: **Single** and **Repetitive**. If you place the cursor on the field and press **SELECT** the field toggles from one mode to the other.

Single Trace mode acquires data once per trace. Repetitive Trace mode repeats single acquisitions until the **STOP** key on the front panel is pressed, or if Stop measurement is on, until conditions specified with the **X** and **O** markers in the State Listing menu are met.

If both analyzers are on, only one trace mode can be specified. Specifying one trace mode for one analyzer sets the same trace mode for the other analyzer.

Armed By The **Armed by** field lets you specify how your state analyzer is to be armed. The analyzer can be armed by the **RUN** key, the other analyzer, the scope or an external instrument through the **BNC** Input port. Any of these can tell the analyzer when to start capturing data.

When you select the **Armed by** field, a pop-up menu appears like that shown below. The first two options always appear in the pop-up. The third and fourth options will give the name of the other analyzer and scope. If the other analyzer or scope is off, or if the other machine or scope is being armed by this machine, these options will not be available.

Armed by

Run
BNC Input
Machine 1
Scope

Figure 10-18. Armed By Pop-Up Menu

Branches The **Branches** field allows you to configure the sequencer of the state analyzer to branch from one sequence level to another with secondary branching qualifiers, or to restart when a certain condition is met. Selecting this field gives you the following pop-up menu.

Branches

Off
Restart
Per level

Figure 10-19. Branches Pop-Up Menu

Off

If you select **Off**, all secondary branching qualifiers are deleted from the sequence levels. Only the primary branches remain.

Restart

The **Restart** option allows you to start over from sequence level 1 when a specified condition is met. This can be handy if you have code that branches off in several paths and you want the analyzer to follow one certain path. If the analyzer goes off on an undesired path, you would want the analyzer to stop and go back to the beginning and take the correct path.

If you select the Restart option, you will see a qualifier pop-up menu like that shown in figure 10-2. With the pop-up you select the qualifier for the pattern on which you want your analyzer to start over.

When your state analyzer is reading data it proceeds through the sequence. If a term doesn't match the branching qualifier, it is then checked against Restart. If the term matches, the state analyzer jumps back the sequence level 1.

Per Level

Selecting the Per level option allows you to define a secondary branching qualifier for each sequence level. A statement is added in each level so that you can configure the analyzer to move to a different level when a specified condition is met. An example of a sequence level with a secondary branching qualifier is shown in the figure below.

The screenshot shows a window titled "Sequence Level 2" with a "Done" button in the top right corner. Inside the window, there are two buttons: "Insert Level" on the left and "Delete Level" on the right. Below these buttons, the configuration is as follows:
While storing
Then find times
Else on goto level

Figure 10-20. Secondary Branching Qualifier

With this configuration, the state analyzer will store b until it finds c. If it finds f before it finds c, it will branch to sequence level 4. If you have specified a storage macro in the next to last sequence level the Else on statement will not appear in that level since a secondary branching qualifier already exists for that level.

In the last sequence level, which only specifies states that are to be stored, the secondary branching qualifier statement looks like that shown below.

Sequence Level 7 Done

Insert Level Delete Level

Store any state

On a goto level 6

Figure 10-21. Secondary Branch Qualifier in Last Level

In this example, as the state analyzer stores any state, it will branch to sequence level 6 if it finds the state given by qualifier a.

The trigger sequence level is used as a boundary for branching between levels. This level and the levels that occur before it cannot branch to levels that occur after the trigger level, and vice versa. Therefore, if there are eight sequence levels and level 5 is the trigger sequence level, then levels 1 through 5 can branch to levels 1 through 5 only, and levels 6 through 8 can branch to levels 6 through 8 only.

You can tell if secondary branch qualifiers have been specified by looking at the Sequence Levels display. Figure 10-22 shows how the display looks with the configuration that was given in figure 10-20. An arrow is drawn out of level 2, indicating that branching originates from that level, and an arrow is drawn to level 4 to indicate that a branch is going to that level.

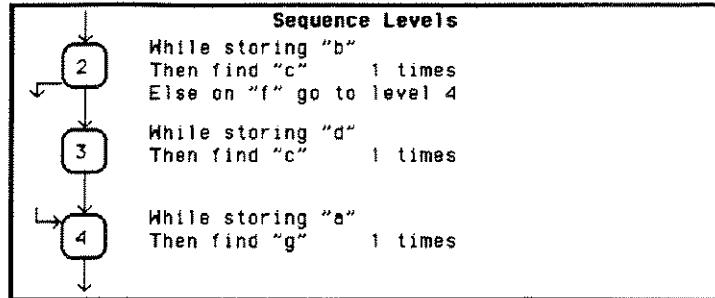

Figure 10-22. Branching Between Sequence Levels

Each sequence level can branch to only one level through a secondary branching qualifier. However, the number of times to which a level can be branched is limited only by the number of levels present. A level can have only one arrow pointing away from it, but it can have two pointing to it if more than one other level is branching to it. An example of this is shown in the figure below. The arrow with two tails indicates that a level above and a level below branch to this level.

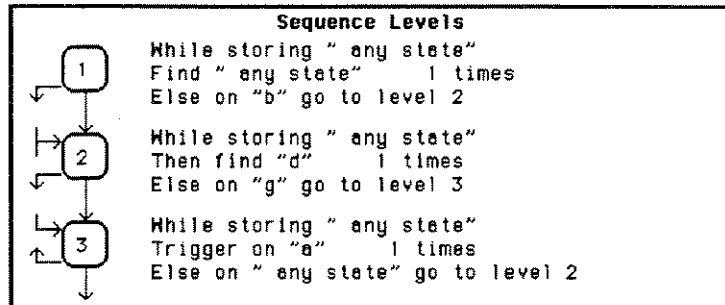



Figure 10-23. Multiple Branching Between Levels

Count The Count field allows you to place tags on states so you can count them. Counting cuts the acquisition memory in half from 1k to 512 and the maximum clock rate is reduced to 16.67 MHz.

Note  Count (State Trace menu) is turned off when "Clock Period" is set to < 60 ns in the State Format Specification menu since the clock rate is greater than 16.67 MHz. If you select Count, the clock period automatically changes to > 60 ns.

Selecting this field gives you the following pop-up menu.

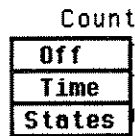

Figure 10-24. Count Pop-Up Menu

Off

If you select Off, the states are not counted in the next measurement.

Time

If you select Time counting, the time between stored states is measured and displayed (after the next run) in the State Listing under the label Time. The time displayed can be either relative to the previous state or to the trigger. The maximum time between states is 48 hours.

An example of a state listing with time tagging relative to the previous state is shown in figure 10-25.

68000STATE - State Listing		
Markers <input type="checkbox"/> Off		
Label >	DATA	Time
Base >	Hex	Rel
-0007	00FF	1.24 us
-0006	6730	1.28 us
-0005	4BE7	1.24 us
-0004	4E75	1.72 us
-0003	3000	1.28 us
-0002	0000	1.24 us
-0001	8930	1.24 us
+0000	803C	1.24 us
+0001	00FF	1.24 us
+0002	67FB	1.28 us
+0003	803C	1.24 us
+0004	61FA	1.72 us
+0005	803C	1.28 us
+0006	0000	1.96 us
+0007	8930	1.52 us
+0008	4EFA	1.24 us

Figure 10-25. Relative Time Tagging

An example of a state listing with time tagging relative to the trigger is shown below.

68000STATE - State Listing		
Markers <input type="checkbox"/> Off		
Label >	DATA	Time
Base >	Hex	Abs
-0007	00FF	-9.24 us
-0006	6730	-7.96 us
-0005	4BE7	-6.72 us
-0004	4E75	-5.00 us
-0003	3000	-3.72 us
-0002	0000	-2.48 us
-0001	8930	-1.24 us
+0000	803C	0 s
+0001	00FF	1.24 us
+0002	67FB	2.52 us
+0003	803C	3.76 us
+0004	61FA	5.48 us
+0005	803C	6.76 us
+0006	0000	8.72 us
+0007	8930	10.24 us
+0008	4EFA	11.48 us

Figure 10-26. Absolute Time Tagging

States

State tagging counts the number of qualified states between each stored state. If you select this option, you will see a qualifier pop-up menu like that shown in figure 10-2. You select the qualifier for the state that you want to count.

In the State Listing, the state count is displayed (after the next run) under the label States. The count can be relative to the previous stored state or to the trigger. The maximum count is 4.4×10^{12} .

An example of a state listing with state tagging relative to the previous state is shown below.

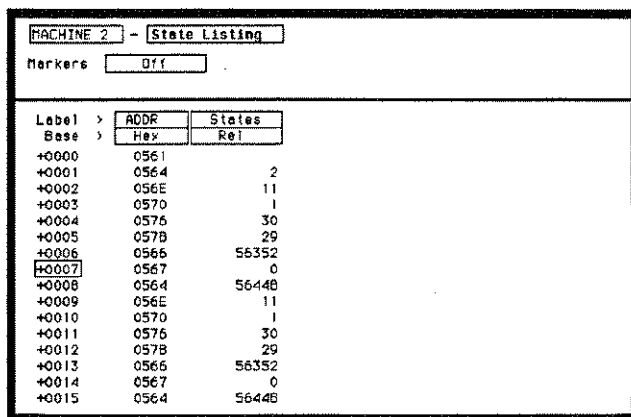

Label	>	ADDR	States
Base	>	Hex	Rel
+0000		0561	
+0001		0564	2
+0002		056E	11
+0003		0570	1
+0004		0575	30
+0005		057B	29
+0006		0566	56352
+0007		0567	0
+0008		0564	56448
+0009		056E	11
+0010		0570	1
+0011		0576	30
+0012		0578	29
+0013		0566	56352
+0014		0567	0
+0015		0564	56448

Figure 10-27. Relative State Tagging

An example of a state listing with state tagging relative to the trigger is shown below.

Label	Base	States	
		Hex	Abs
+0000		0561	0
+0001		0564	2
+0002		056E	13
+0003		0570	14
+0004		0576	44
+0005		057B	73
+0006		0565	56425
+0007		0567	56425
+0008		0564	112873
+0009		056E	112884
+0010		0570	112885
+0011		0576	112915
+0012		057B	112944
+0013		0565	169296
+0014		0567	169296
+0015		0564	225744

Figure 10-28. Absolute State Tagging

Prestore Prestore allows you to store two qualified states before each state that is stored. There is only one qualifier that enables prestore for each sequence level. If you select this field, you will see a pop-up with the options **Off** and **On**. Selecting **On** gives you a qualifier pop-up menu like that in figure 10-2, from which you choose the pattern range or combination of patterns and ranges that you want to prestore.

Note 

Prestore is only available when clock period is > 60 ns. If you select Prestore, the clock period automatically changes to > 60ns if it was previously set to < 60 ns.

During a measurement, the state analyzer stores in prestore memory occurrences of the states you specify for prestore. A maximum of two occurrences can be stored. If there are more than two occurrences previous ones are pushed out. When the analyzer finds a state that has been specified for storage, the prestore states are pushed on top of the stored state in memory and are displayed in the State Listing.

Qualifier and Pattern Fields

The qualifier and pattern fields appear at the bottom of the State Trace Specification menu. They allow you to specify patterns for the qualifiers that are used in the sequence levels.

Label >	A
Base >	Hex
a	XXXX
b	XXXX
c	XXXX
d	XXXX

Figure 10-29. Qualifier and Pattern Fields

Label The **Label** fields display the labels that you specified in the State Format Specification menu. The labels appear in the order that you specified them; however, you can change the order. Select one of the label fields and you will see a pop-up menu with all the labels. Decide which label you want to appear in the label field and select that label. The label that was there previously switches positions with the label you selected from the pop-up.

Base The **base** fields allow you to specify the numeric base in which you want to define a pattern for a label. The base fields also let you use a symbol that was specified in the State Symbol Table for the pattern. Each label has its own base defined separately from the other labels. If you select one of the base fields, you will see the following pop-up menu. Decide which base you want to define your pattern in and select that option.

Binary
Octal
Decimal
Hexadecimal
ASCII
Symbol

Figure 10-30. Numeric Base Pop-Up Menu

One of the options in the Base pop-up is ASCII . It allows you to see the ASCII characters that are represented by the pattern you specify in the pattern fields.

Note 

You cannot define ASCII characters directly. You must first define the pattern in one of the other numeric bases; then you can switch the base to ASCII to see the ASCII characters.

The Symbol option in the Base pop-up allows you to use a symbol that has been specified in the State Symbol Tables as a pattern. In the pattern fields you specify the symbols you want to use.

Qualifier Field If you select the qualifier field, you will see the following pop-up menu.

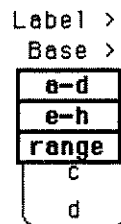

Figure 10-31. Qualifier Field Pop-Up Menu

Patterns

The pattern recognizers are in two groups of four: a-d and e-h. If you select one of these two options, the qualifier field will contain only those pattern recognizers. For instance, the qualifier field in figure 10-29 contains only the recognizers a-d.

Ranges

If you select the range option, the qualifier and pattern fields look similar to that shown below.

Label >	A
Base >	Hex
Range	
lower	0000
upper	FFFF

Figure 10-32. Range Qualifier and Pattern Fields

Only one range can be defined, and it can be defined over only one label, hence over only 32 channels. The channels do not have to be adjacent to each other. The logic analyzer selects the label over which the range will be defined by looking at the labels in order and choosing the first one that has channels assigned under only two pods. A label that contains channels from more than two pods cannot be selected for range definition. If all the labels have channels assigned under more than two pods, the range option is not offered in the qualifier field pop-up menu. However, in the HP 1653B, the range option will always be offered since the analyzer has only two pods.

Pattern Fields The pattern fields allow you to specify the states that you want the state analyzer to search for and store. Each label has its own pattern field that you use to specify a pattern for that label (if you are defining a pattern for a pattern recognizer).

During a run, the state analyzer looks for a specified pattern in the data. When it finds the pattern, it either stores the state or states or it triggers, depending on the step that the sequencer is on.

State Listing Menu

Introduction

This chapter describes the State Listing menus and how to interpret it. It also tells you how to use the fields to manipulate the displayed data so you can find your measurement answers. The State Listing menu is the display menu of the state analyzer.

There are two different areas of the state listing display, the menu area and the listing area. The menu area is in the top one-fourth of the screen and the listing area is the bottom three-fourths of the screen.

The listing area displays the data that the state analyzer acquires. The data is displayed in a listing format as shown below.

Label	ADDR	DATA	Time
Case	Hex	Hex	Rel
-0007	0088CA	00FF	1.24 us
-0006	0088CC	6730	1.28 us
-0005	0088CE	48E7	1.24 us
-0004	0088FE	4E75	1.72 us
-0003	008900	3000	1.28 us
-0002	0004F4	0000	1.24 us
-0001	0004F6	8930	1.24 us
+0000	008930	803C	1.24 us
+0001	008932	00FF	1.24 us
+0002	008934	67FE	1.28 us
+0003	008936	803C	1.24 us
+0004	00892E	61FA	1.72 us
+0005	008930	803C	1.28 us
+0006	0004F4	0000	1.96 us
+0007	0004F6	8930	1.52 us
+0008	00892A	4EFA	1.24 us

Figure 11-1. State Listing Menu

This listing display shows you 16 of the possible 1024 lines of data at one time. You can use the ROLL keys and the KNOB to roll the listing to the lines of interest.

The column of numbers at the far left represents the location of the acquired data in the state analyzer's memory. The trigger state is always 0000. At the vertical center of this column you will see a box containing a number. The box is used to quickly select another location in the state listing. The rest of the columns (except the Time/States column) represent the data acquired by the state analyzer. The data is grouped by label and displayed in the number base you have selected (hexadecimal is the default base).

When the Time or States option is selected in the Count field (State Trace Specification Menu), the acquired data will be displayed with time or state tags.

The Time column displays either the Rel(ative) time (time from one state to the next) or Abs(olute) time (time from each state to the trigger).

The States column displays the number of qualified states Rel(ative) to the previously stored state or the trigger (absolute).

Accessing the State Listing Menu

The State Listing Menu is accessed by pressing the DISPLAY key on the front panel when the state analyzer is on. It will automatically be displayed when you press RUN. If the Timing Waveforms is displayed when you press the DISPLAY key, you will have to switch analyzers. This is not a problem, it merely indicates that you were in the timing analyzer or you had performed an action to the timing analyzer in the System Configuration Menu.

State Listing Menu Fields

The menu area contains fields that allow you to change the display parameters, place markers, and display listing measurement parameters.

68000STATE	-	State Listing	
Markers		Time	
		Time X to Trigger	-2.48 us
		Time O to Trigger	3.76 us
		Time X to O	6.24 us

Figure 11-2. State Listing Menu Fields

Markers The Markers field allows you to specify how the X and O markers will be positioned on the state listing. The State Trace Specifications menu options are:

If Count in the State Trace menu is Off, the marker options are:

- Off
- Pattern

If Count in the State Trace menu is set to Time, the marker options are:

- Off
- Pattern
- Time
- Statistics

If Count in the State Trace menu is set to State, the marker options are:

- Off
- Pattern
- State

Markers Off When the markers are off they are not displayed, but are still placed at the specified points in the data. If Stop measurement is on and the Stop measurement criteria are present in the data, the measurement will stop even though the markers are off.

Markers Patterns When the markers are set to patterns, you can specify patterns on which the logic analyzer will place the markers. You can also specify how many occurrences of each marker pattern the logic analyzer looks for. This use of the markers allows you to find a specific pattern for each label in the acquired data.

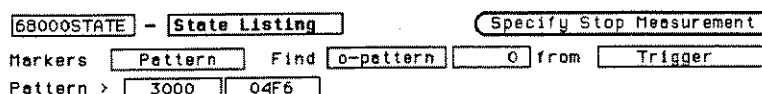

Figure 11-3. Markers Set to Patterns

Patterns for each marker (X and O) can be specified. They can be specified for both markers in each label. The logic analyzer searches for the logical "and" of patterns in all labels.

In the Find X (O)-pattern 0 from Trigger field you specify how many occurrences of the marked pattern from a reference point you want the logic analyzer to search for. The reference points are:

- Trigger
- Start (of a trace)
- X Marker (only available in O marker pattern specification)

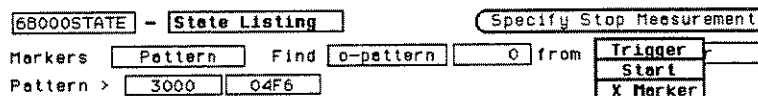

Figure 11-4. Search Reference Pop-Up Menu

Stop Measurement

Another feature of markers set to patterns is Stop Measurement. You can specify either stop measurement when X-O is ____ or Compare is ____ . The options for X-O are: Less than, Greater than, In range, Not in range. The options for Compare are: Equal and Not Equal (see figure 11-5).

Stop Measurement Parameters Done

Stop measurement: X-O is Less than 10 ns

Store exception to disk: On File name EXCEPTION

File description

Figure 11-5. Markers Patterns Pop-Up Menu

With this feature you can use the logic analyzer to look for a specified time or range of time between the marked patterns and to stop acquiring data when it finds this time between markers. The X marker must precede the O marker.

Also available is **Store exception to disk** which allows you to specify a file on the disk that exceptions can be stored in. The default filename is EXCEPTION. When the trace mode is repetitive and Store exception to disk is on, the following process takes place: data is acquired until the stop criteria is met, data acquisition will stop, data in the acquisition memory will be stored on the disk, and data acquisition will resume when the data is stored. This process continues until the disk is full. The data is stored in the same file name; however, the last three characters will automatically be replaced with a numerical serial number. For example, EXCEPTION will change to EXCEPT001 the second time memory is stored.

Note

The upper and lower range boundaries must not be the same value. For example, if you want to stop a measurement when the X and O markers are in range of 200 ns, you should set the range values to 190 ns and 210 ns. This eliminates erroneous measurement termination.

Markers Time

When the markers are set to Time, you can place the markers on states in the listing of interest and the logic analyzer will show the following:

- Time X to Trig(ger).
- Time O to Trig(ger).
- Time X to O.

To position the markers, move the cursor to the field of the marker you wish to position and press SELECT. A pop-up will appear showing the current time for that marker. Either rotate the KNOB or enter a numeric value from the keypad to change the position of that marker. Pressing SELECT when you are finished positions the marker and closes the pop-up.

```
68000STATE - State Listing
Markers Time
Time X to Trigger 6.76 us
Time O to Trigger 3.76 us
Time X to O -3.00 us
```

Figure 11-6. Markers Set to Time

The Time X to O field will change according to the position of the X and O markers. It displays the total time between the states marked by the X and O markers.

Markers Statistics

When statistics are specified for markers, the logic analyzer will display the following:

- Number of total runs.
- Number of valid runs (runs where markers were able to be placed on specified patterns).
- Minimum time between the X and O markers * Maximum time between the X and O markers.
- Average time between the X and O markers.

```
68000STATE - State Listing
Markers Statistics Valid runs: 1 of 4
Minimum X-O: 0 s
Maximum X-O: 0 s
Average X-O: 0 s
```

Figure 11-7. Markers Set to Statistics

How the statistics will be updated depends on the state trace mode (repetitive or single).

In repetitive, statistics will be updated each time a valid run occurs until you press STOP. When you press RUN after STOP, the statistics will be cleared and will restart from zero.

In single, each time you press RUN an additional valid run will be added to the data and the statistics will be updated. This will continue unless you change the placement of the X and O markers between runs.

Pattern _____ Field You use the **Pattern _____** field to specify the patterns for the X and O markers for each label.

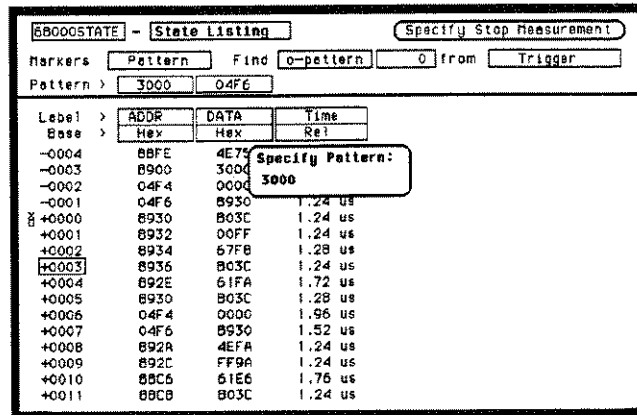

Figure 11-8. Pattern _____ Field Pop-Up Menu

When x-pattern is specified in the Find _____ from _____ field, the pop-ups in the Pattern _____ field allow you to specify a pattern for the X marker in each label.

When the O-pattern is specified, the pop-ups in the Pattern _____ field allow you to specify the patterns for the O marker in each label.

State Compare Menu

Introduction

State compare is a software post-processing feature that provides the ability to do a bit by bit comparison between the acquired state data listing and a compare data image. You can view the acquired data and the compare image separately. In addition, there is a separate difference listing that highlights the bits in the acquired data that do not match the corresponding bits in the compare image. Each state machine has its own Compare and Difference listings.

You can use the editing capabilities to modify the compare image. Masking capabilities are provided for you to specify the bits that you do not want to compare. "Don't compare" bits can be specified individually for a given label and state row, or specified by channel across all state rows. A range of states can be selected for a comparison. When a range is selected, only the bits in states on or between the specified boundaries are compared.

The comparison between the acquired state listing data and the compare image data is done relative to the trigger points. This means that the two data records are aligned at the trigger points and then compared bit by bit. Any bits in the acquired data that do not match the bits in the compare image are treated as unequal. The don't compare bits in the compare image are ignored for the comparison.

When a logic analyzer configuration is saved to or loaded from a disk, any valid compare data including the data image, etc. is also saved or loaded.

Accessing the Compare Menu

The Compare menu is accessed from the State Listing menu. To access the Compare menu place the cursor on the field **State Listing** and press SELECT. A pop-up appears with the following options:

- State Listing
- State Waveforms
- State Chart
- State Compare

Place the cursor on **State Compare** and press SELECT. The pop-up will close and display the State Compare menu.

The Compare and Difference Listing Displays

Two menus (or displays) in addition to the normal State Listing, are available for making comparison measurements: the Compare Listing and the Difference Listing.

The Compare Listing

The Compare Listing contains the image (or template) that acquired data is compared to during a comparison measurement. The boundaries of the image (or size of the template) can be controlled by using the channel masking and compare range functions described below. Any bits inside the image displayed as "X" have been set to don't compare bits.

The Difference Listing

The Difference Listing highlights the entire row with inverse video, if any, in the acquired data that differs from those in the compare image. In addition, when the base is hexadecimal, octal, or binary, the bit (or digit containing the bit) that differs from the compare image is underlined (see figures 12-2 and 12-3). If the base is inverse assembled symbols, the display does not change; however, the stop measurement functions still function.

To display the Compare Listing or the Difference Listing, place the cursor on the field directly to the right of **Show** in the upper left part of the display and press SELECT. The field will toggle between **Compare Listing** and **Difference Listing**.

The controls that roll the listing in all three menus, the normal State Listing, the Compare Listing, and the Difference Listing are synchronized unless the number of pre-trigger states differ between the Compare listing and the acquired data. This means that when you change the current row position in the Difference Listing, the logic analyzer automatically updates the current row in the acquired State Listing, Compare Listing and vice-versa.

If the three listings are synchronized and you re-acquire data, the Compare Listing may have a different number of pre-trigger states depending on the state trace trigger criteria. The Compare Listing can be resynchronized to the State and Difference Listings (if different) by entering the desired state (acquisition memory) location from the front-panel keypad.

This allows you to view corresponding areas of the two lists, to cross check the alignment, and analyze the bits that do not match.

Since time tags are not required to perform the compare, they do not appear in either the compare image or difference displays. However, correlation is possible since the displays are locked together.

To move between the State Listing and Compare Listing in the HP 1652B/53B, select the field directly to the right of your state machine's label, in the upper left most part of the screen and press SELECT. When this field is selected, a pop-up will appear. Select the State Listing field from this pop-up.

Creating a Compare Image

An initial compare image can be generated by copying acquired data into the compare image buffer. When you place the cursor on the **Copy Trace to Compare** field in the Compare Listing menu a pop-up appears with the options **Cancel** and **Continue**. If the **Continue** is selected, the contents of the acquisition data structure for the current machine are copied to the compare image buffer. The previous compare image is lost if it has not been saved to a disk. If you select **Cancel** the current compare image remains unchanged.

Bit Editing of the Compare Image

Bit editing allows you to modify the values of individual bits in the compare image or specify them as don't compare bits. The bit editing fields are located in the center of the Compare Listing display to the right of the listing number field (see figure 12-1). A bit editing field exists for every label in the display unless the label's base is ASCII or inverse assembled symbols. You can access any data in the Compare Listing by rolling the desired row vertically until it is located in the bit editing field for that label (column).

When you select one of the bit editing fields a pop-up appears in which you enter your desired pattern or don't compare for each bit.

The screenshot shows the State Compare menu interface. At the top, it displays '8085 - State Compare' and a 'Specify Stop Measurement' button. Below this are three buttons: 'Compare Listing', 'Copy Trace To Compare', and 'Full Compare'. A 'Mask' field is present with a right-pointing arrow. The main display is a table with columns for 'Label', 'Base', 'ADDR', 'DATA', and 'STAT'. The 'ADDR' and 'DATA' columns are labeled 'Hex', and the 'STAT' column is labeled 'Hex'. The table contains the following data:

Label	Base	ADDR	DATA	STAT
	Hex	Hex	Hex	Hex
+0065		0404	03	
+0066		0404	02	
+0067		0404	03	
+0068		0404	02	2
+0069		0404	03	3
+0070		0404	02	2
+0071		0404	03	3
+0072		0404	02	2
+0073		0404	03	3
+0074		0404	02	2
+0075		0404	03	3
+0076		0404	02	2
+0077		0404	03	3
+0078		0404	02	2
+0079		0404	03	3
+0080		0404	02	2

A pop-up window titled 'Specify Pattern:' is overlaid on the row for label '+0072', showing the value '752F'.

Figure 12-1. Bit Editing Fields

Masking Channels in the Compare Image

The channel masking function allows you to specify a bit, or bits in each label that you do not want compared. This causes the corresponding bits in all states to be ignored in the comparison. The compare data image itself remains unchanged on the display. The Mask fields are directly above the label and base fields at the top of both the Compare and Difference listings (see figure 12-2). When you select one of these fields a pop-up appears in which you specify which channels are to be compared and which channels are to be masked. A "." (period) indicates a don't compare mask for that channel and an "*" (asterisk) indicates that channel is to be compared.

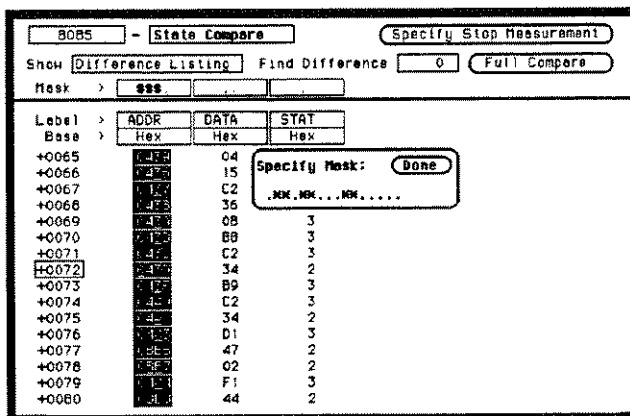

Figure 12-2. Bit Masking Fields

Specifying a Compare Range

The Compare Range function allows you to define a subset of the total number of states in the compare image to be used in the comparison. The range is specified by setting start and stop boundaries. Only bits in states (lines) on or between the boundaries are compared against the acquired data.

The Compare mode is accessed by selecting the **Full Compare/Partial Compare** field in either the Compare or Difference listing menus. When selected, a pop-up appears in which you select either the **Full** or **Partial** option. When you select the Partial option, fields for setting the start state and stop state values appear (see figure 12-3).

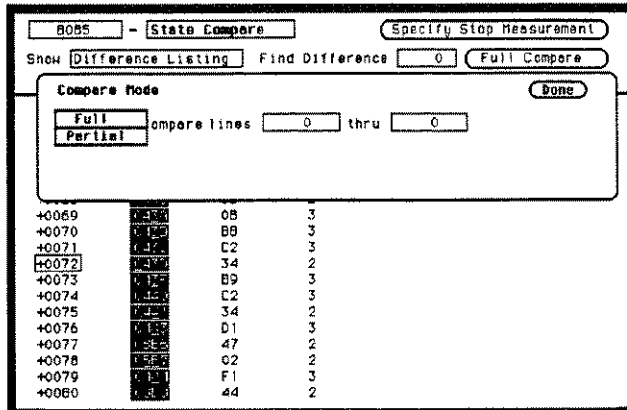

Figure 12-3. Compare Full/Compare Partial Field

Repetitive Comparisons with a Stop Condition

When you do a comparison in the repetitive trace mode, a stop condition may be specified. The stop condition is either **Stop Measurement when Compare is Equal** or **Not Equal**. In the case of **Equal**, bits in the compare image must match the corresponding bits in the acquired data image for the stop condition to be a true. In the case of **Not Equal**, a mismatch on a single bit will cause the stop condition to be true. When stop conditions are specified in two analyzers, both analyzers stop when the stop condition of either analyzer is satisfied. It is an OR function.

You access the stop measurement function by selecting the **Specify Stop Measurement** field in either the Compare or Difference Listing menus. When you select this field, the Stop Measurement Parameters pop-up appears (see figure 12-4). The first field in this pop-up, just to the right of Stop measurement contains either **Off**, **X-O** or **Compare**.

When this field is selected, a pop-up appears in which you select **Compare**. When you select the Compare option, you can access and select either the **Equal** or **Not Equal** option in the next field to the right.

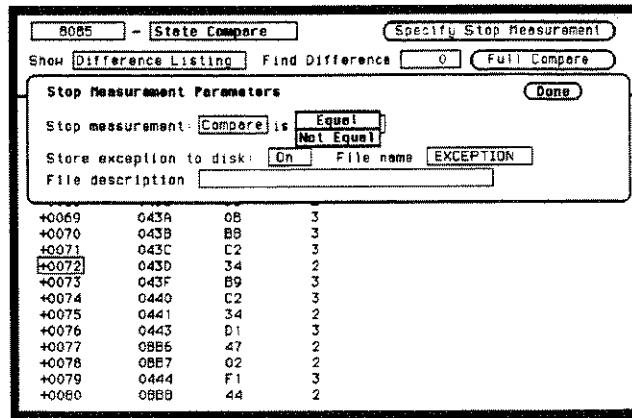

Figure 12-4. Specify Stop Measurement Field

Also available is **Store exception to disk** which allows you to specify a file on the disk that exceptions can be stored in. The default filename is **EXCEPTION**.

When the trace mode is repetitive and Store exception to disk is on, the following process takes place: data is acquired until the stop criteria is met, data acquisition will stop, data in the acquisition memory will be stored on the disk, and data acquisition will resume when the data is stored. This process continues until the disk is full. The data is stored in the same file name; however, the last three characters will automatically be replaced with a numerical serial number. For example, EXCEPTION will change to EXCEPT001 the second time memory is stored.

Note 

You may also specify a stop measurement based on time between the X and O markers in the Compare or Difference Listing menus. This is available only when Count is set to Time in the State Trace menu. If the Stop Measurement is set to run until Compare Equal or Compare Not Equal in the Compare or Difference Listings, the Stop Measurement on time X to O will change to run until Compare Equal or Compare Not Equal in the other state display menus (i.e. State Listing).

Locating Mismatches in the Difference Listing

The **Find Difference** feature allows you to easily locate any patterns that did not match in the last comparison. Occurrences of differences are found in numerical ascending order from the start of the listing. The first occurrence of an error has the numerical value of one.

This feature is controlled by the **Find Difference** ___ field in the Difference Listing menu. When you select this field an Integer Entry pop-up appears in which you enter a number indicating which difference you want to find. The listing is then scanned sequentially until the specified occurrence is found and rolled into view.

Saving Compare Images

When you save a logic analyzer configuration to a disk, the compare images for both state analyzers are saved with it. The compare data is compacted to conserve disk space. Likewise, when you load a configuration from disk, valid compare data will also be loaded.

State Chart Menu

Introduction

The State Chart Menu allows you to build X-Y plots of label activity using state data. The Y-axis always represents data values for a specified label. You can select whether the X-axis represents states (ie. rows in the State List) or the data values for another label. You can scale both the axes to selectively view data of interest. An accumulate mode is available that allows the chart display to build up over several runs. When **State** is selected for the X-axis, X & O markers are available which allows the current sample (state or time) relative to trace point and the corresponding Y-axis data value to be displayed. Marker placement is synchronized with the normal State Listing.

Accessing the State Chart Menu

The Chart menu is accessed from the State Listing menu. To access the Chart menu place the cursor on the field **State Listing** and press SELECT. A pop-up appears with the following options:

- State Listing.
- State Waveforms.
- State Chart.
- State Compare.

Place the cursor on State Chart and press SELECT. The pop-up will close and display the State Chart menu.

Selecting the Axes for the Chart

When using the State Chart display, you first select what data you want plotted on each axis. To assign the vertical axis label, position the cursor on the Y-axis **Label** field in the menu. This is the field just to the right of "XY Chart of Label". When selected, a pop up appears in which you select one of the labels that were defined in the State Format Specification Menu. The X-axis assignment field is just to the right of "Versus", and toggles between **State** and **Label** when selected. When label is selected, a third field appears to the right of **Label** that pops up when selected in which you select one of the defined state labels.

Scaling the Axes

Either axis of the X - Y chart can be scaled by using the associated vertical or horizontal **min** (minimum) or **max** (maximum) value fields. When selected, a **Specify Number** pop up appears in which you specify the actual minimum and maximum values that will be displayed on the chart.

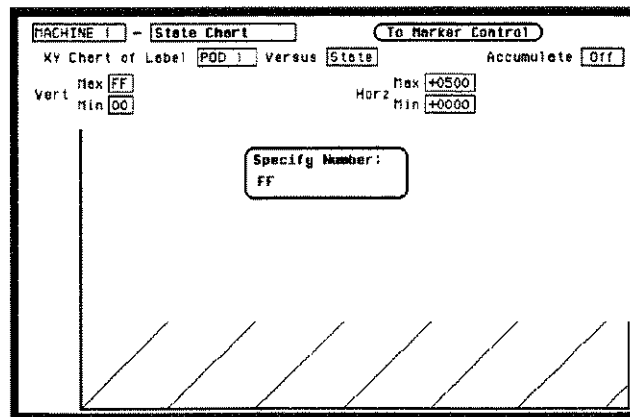

Figure 13-1. Axis Scaling Pop-up Menu

When **State** is selected for the X-axis, state acquisition memory locations are plotted on the X-axis. The minimum and maximum values can range from -1023 to +1023 depending on the trace point location. The minimum and maximum values for labels can range from 00000000H to FFFFFFFFH (0 to 2^{32-1}) regardless of axis, since labels are restricted to 32 bits.

The Label Value vs. States Chart

The Label Value versus State chart is a plot of label activity versus the memory location in which the label data is stored. The label value is plotted against successive analyzer memory locations. For example, in the following figure, label activity of POD 1 is plotted on the Y axis and the memory locations (State) are plotted on the X axis.

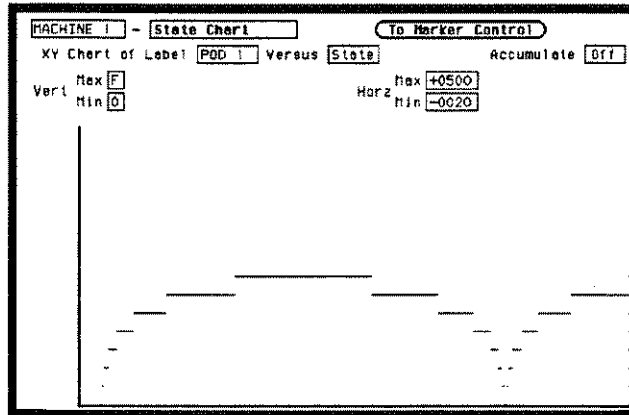

Figure 13-2. Label vs. State Chart

The Label Value vs. Label Value Chart

When labels are assigned to both axis, the chart shows how one label varies in relation to the other for a particular state trace record. Label values are always plotted in ascending order from the bottom to the top of the chart and in ascending order from left to right across the chart. Plotting a label against itself will result in a diagonal line from the lower left to upper right corner. X & O markers are disabled when operating in this mode.

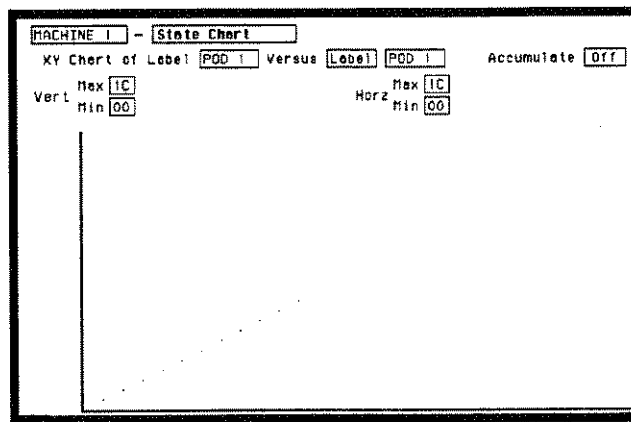

Figure 13-3. Label vs. Label Chart

X & O Markers and Readouts for Chart

When **State** is specified for the X-axis, X & O markers are available which can be moved horizontally. The markers are synchronized with the X and O markers in the normal State Listing.

To select the marker mode for Chart (if it is not presently displayed), place the cursor on the **To Marker Control** field and press **SELECT**. This field will toggle to **To Range Control** and the marker fields will be displayed (see figure 13-4).

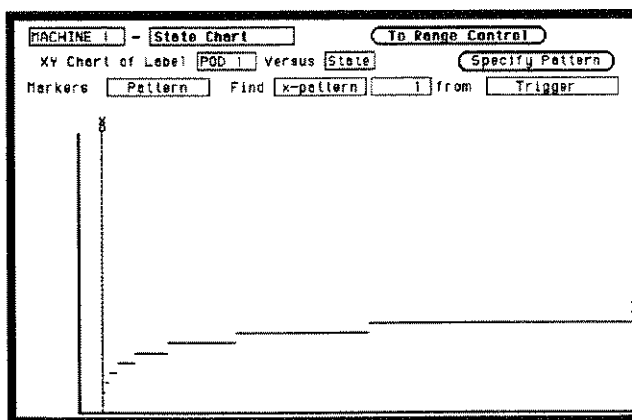

Figure 13-4. Marker Fields

When a marker is positioned in the State Chart menu, it is also positioned in the State Listing menu and vice-versa. The Chart marker operation is identical to the markers in the State Listing menu (see chapter 11).

Marker Options The marker options in the State Chart menu depend on what **Count** is set to in the State Listing menu.

When **Count** is set to **Off**, the Chart markers can be set to:

- Off.
- Pattern.

When **Count** is set to **Time**, the Chart markers can be set to:

- Off.
- Pattern.
- Time.
- Statistics.

When **Count** is set to **States**, the Chart markers can be set to:

- Pattern.
- States.
- Off.

State Waveforms Menu

Introduction

The State Waveforms Menu allows you to view state data in the form of waveforms identified by label name and bit number. Up to 24 waveforms can be displayed simultaneously. Only state data from the current state machine can be displayed as waveforms in the State Waveforms menu.

The presentation and user interface is generally the same as the Timing Waveform menu, except the X-axis of the state waveform display represents only samples, or states instead of time (seconds). This is true regardless of whether **Count** (in the State Trace menu) is set to **Time** or **Off**. As a result, the horizontal axis of the display is scaled by States/Div and Delay in terms of samples from trigger. Marker features are the same as for State List in that Time or States will only be available when **Count** is set to **Time** or **States**. The Sample Rate display is not available in State Waveform even when markers are off.

Accessing the State Waveforms Menu

The State Waveforms menu is accessed from the State Listing menu. To access the State Waveforms menu place the cursor on the State Listing field and press SELECT. A pop-up appears with the following options:

- State Listing.
- State Waveforms.
- State Chart.
- State Compare.

Place the cursor on State Waveforms and press SELECT. The pop-up will close and display the State Waveforms menu.

Selecting a Waveform

You can display up to 24 waveforms on screen at one time. Each waveform is a representation of a predefined label. To select a waveform, place the cursor on a label name on the left side of the display and press SELECT. A pop-up appears in which you:

- Insert waveforms.
- Turn on waveforms.
- Modify waveforms (waveform labels).
- Turn off waveforms.
- Delete waveforms.

Just to the right of each label name is a two-digit number or the word "all." The number indicates which bit of the label the waveform represents; or, all the bits of the label when "all" is displayed (see figure 14-1).

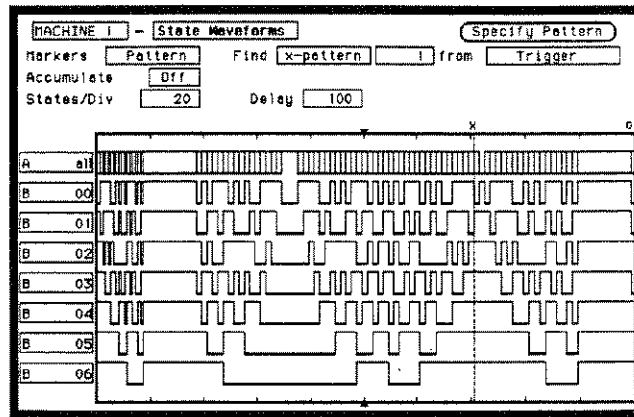

Figure 14-1. State Waveforms Menu

In the above figure, label A has "all" specified displaying all the bits overlaid in a single waveform. Label B however, has seven of its bits displayed individually (bits 0 through 6).

Replacing Waveforms

You can replace a currently displayed waveform (label) with another one of the predefined waveforms (labels). To replace one waveform with another, place the cursor on the waveform you wish to replace and press SELECT. A pop-up appears in which you select **Modify Waveform** as shown in the following figure.

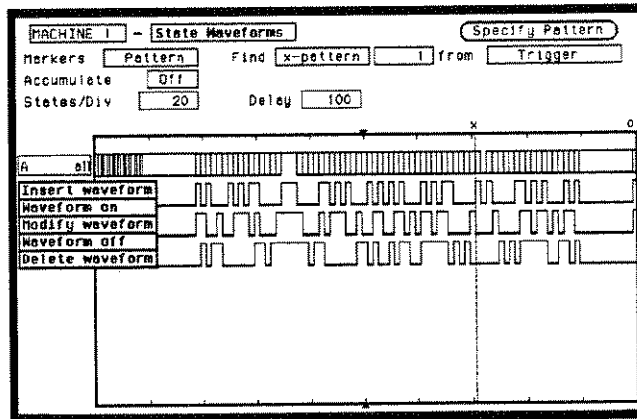

Figure 14-2. Waveform Selection Pop-up Menu

Another pop-up appears in which you select the waveform (label) you wish to display (see figure 14-3). When you place the cursor on the new waveform (label) and press SELECT the new waveform replaces the old waveform.

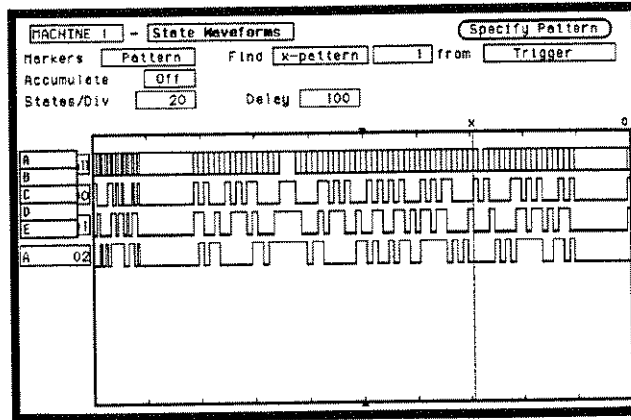

Figure 14-3. Available Waveforms Pop-up Menu

Deleting Waveforms

You can delete any of the currently displayed waveforms by placing the cursor on the waveform you wish to delete and pressing SELECT. When the pop-up appears place the cursor on **Delete waveform** and press SELECT.

Selecting States per Division

You can specify the states per division by placing the cursor on the field just to the right of **States/Div**, pressing SELECT, and either entering the number of states per division with the keypad or the knob. The range is from 1 to 1024 per division.

Delay from Trigger

You can specify the delay from trigger by specifying the number of states from the trigger. The delay will affect only the position of the State Waveforms display. It does not affect data acquisition. The minimum is -1024 and the maximum is 1024 independent of trace position in the record. Delay is not limited to the window containing data.

State Waveform Display Features

The waveform display features of the State Waveform menu are the same as the Timing Waveform menu with regard to:

- Low levels (below threshold) are represented by darker line.
- Dotted lines representing the X and O markers.
- Inverted triangle representing the trigger point.
- Accumulate Mode.
- Graticule frame with 10 horizontal divisions.

X and O Markers for State Waveform

Markers can be placed on the waveform display by specifying the number of states from trigger in the case of the X marker or number of states from either the trigger or X marker in the case of the O marker.

Markers can be automatically placed on the waveform by searching for specific patterns assigned to each marker.

The X and O marker operation is identical to the marker operation in the Timing Waveform Menu.

State Analyzer Measurement Example

Introduction

In this chapter you learn how to use the state analyzer by setting up the logic analyzer to simulate a simple state measurement. Since you may not have the same test circuit available, we will give you the measurement results as actually measured by the logic analyzer,

The exercise in this chapter is organized in a task format. The tasks are in the same order you will most likely use them once you become experienced. The steps in this format are both numbered and lettered. The numbered steps state the step objective. The lettered steps explain how to accomplish each step objective. There is also an example of each menu after it has been properly set up.

How you use the steps depends on how much you remember from chapters 1 through 4 of the *Getting Started Guide*. If you can set up each menu by just looking at the menu picture, go ahead and do so. If you need a reminder of what steps to perform, follow the numbered steps. If you still need more information about "how," use the lettered steps.

To gain confidence using your logic analyzer, we recommend that you configure the menus as you follow the simulated measurement example up to the section "Acquiring the Data." From that section to the end, you will see the measurement results on the State Listing screen as if you had the real test circuit connected, and as if you had selected RUN.

Problem Solving with the State Analyzer

In this example assume you have designed a microprocessor controlled circuit. You have completed the hardware, and the software designer has completed the software and programmed the ROM (read-only memory). When you turn your circuit on for the first time, your circuit doesn't work properly. You have checked the power supply voltages and the system clock and they are working properly.

Since the circuit has never worked before, you and the software engineer aren't sure if it is a hardware or software problem. You need to do some testing to find a solution.

What Am I Going to Measure?

You decide to start where the microprocessor starts when power is applied. We will describe a 68000 microprocessor; however, every processor has similar start-up routines.

When you power up a 68000 microprocessor, it is held in reset for a specific length of time before it starts doing anything to stabilize the power supplies. The time the microprocessor is held in reset ensures stable levels (states) on all the devices and buses in your circuit. When this reset period has ended, the 68000 performs a specific routine called "fetching the reset vector."

The first thing you check is the time the microprocessor is held in reset. You find the time is correct. The next thing to check is whether the microprocessor fetches the reset vector properly.

The steps of the 68000 reset vector fetch are:

1. Set the stack pointer to a location you specify, which is in ROM at address locations 0 and 2.
2. Find the first address location in memory where the microprocessor fetches its first instruction. This is also specified by you and stored in ROM at address locations 4 and 6.

What you decide to find out is:

1. What ROM address does the microprocessor look at for the location of the stack pointer, and what is the stack pointer location stored in ROM?
2. What ROM address does the microprocessor look at for the address where its first instruction is stored in ROM, and is the instruction correct?
3. Does the microprocessor then go to the address where its first instruction is stored?
4. Is the executable instruction stored in the first instruction location correct?

Your measurement, then, requires verification of the sequential addresses the microprocessor looks at, and of the data in ROM at these addresses. If the reset vector fetch is correct (in this example) you will see the following list of numbers in HEX (default base) when your measurement results are displayed.

```
+ 0000 000000 0000
+ 0001 000002 04FC
+ 0002 000004 0000
+ 0003 000006 8048
+ 0004 008048 3E7C
```

This list of numbers will be explained in detail later in this chapter in "The State Listing."

How Do I Configure the Logic Analyzer?

In order to make this state measurement, you must configure the logic analyzer as a state analyzer. By following these steps you will configure Analyzer 1 as the state analyzer.

If you are in the System Configuration menu you are in the right place to get started and you can start with step 2; otherwise, start with step 1.

1. Using the field in the upper left corner of the display, get the System Configuration menu on screen.
 - a. Place the cursor on the field in the upper left corner of the display and press SELECT.
 - b. Place the cursor on System and press SELECT.
2. In the System Configuration menu, change the Analyzer 1 type to State. If Analyzer 1 is already a state analyzer, go on to step 3.

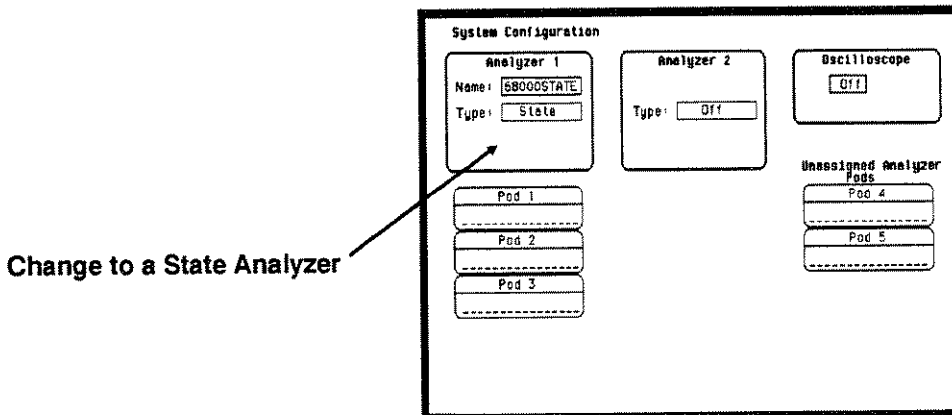

Figure 15-1. System Configuration Menu

- a. Place the cursor on the **Type: ____** and press SELECT.
- b. Place the cursor on State and press SELECT.

3. Name Analyzer 1 68000STATE (optional).
 - a. Place the cursor on the Name: ____ field of Analyzer 1 and press SELECT.
 - b. With the Alpha Entry pop-up, change the name to 68000STATE.
4. Assign pods 1, 2, and 3 to the state analyzer.
 - a. Place the cursor on the Pod 1 field and press SELECT.
 - b. In the Pod 1 pop-up, place the cursor on Analyzer 1 and press SELECT.
 - c. Repeat steps a and b for pods 2 and 3.

Connecting the Probes

At this point, if you had a target system with a 68000 microprocessor, you would connect the logic analyzer to your system. Since you will be assigning labels ADDR and DATA, you hook the probes to your system accordingly.

- Pod 1 probes 0 through 15 to the data bus lines D0 through D15.
- Pod 2 probes 0 through 15 to the address bus lines A0 through A15.
- Pod 3 probes 0 through 7 to the address bus lines A16 through A23.
- Pod 1, CLK (J clock) to the address strobe (LAS).

Activity Indicators

When the logic analyzer is connected and your target system is running, you will see **Activity Indicators** in the Pod 1, 2, and 3 fields of the System Configuration menu. This indicates which signal lines are transitioning.

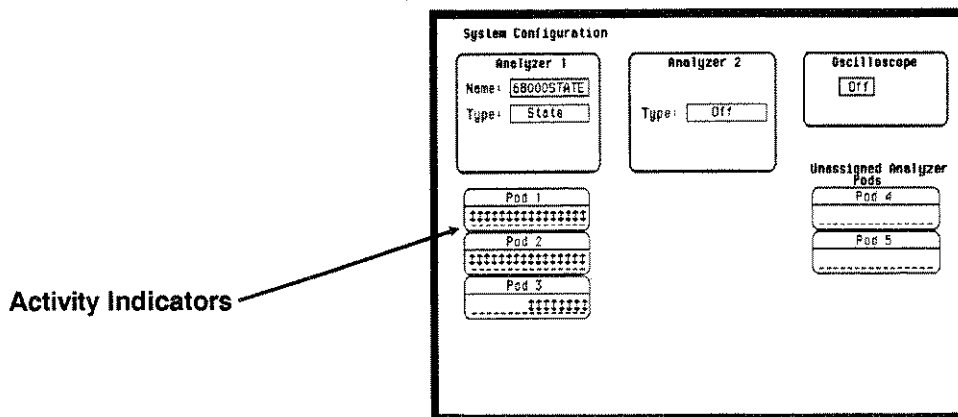

Figure 15-2. Activity Indicators

Configuring the State Analyzer

Now that you have configured the system, you are ready to configure the state analyzer. You will be:

- Creating two names (labels) for the input signals
- Assigning the channels connected to the input signals
- Specifying the State (J) clock
- Specifying a trigger condition

1. Display the State Format Specification menu.
 - a. Press the FORMAT key on the front panel.
2. Name two labels, one ADDR and one DATA.

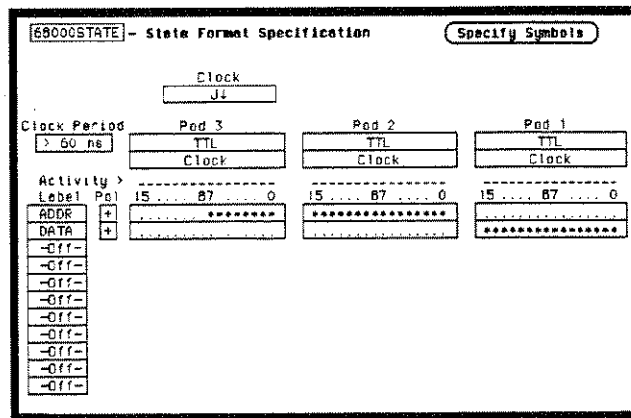

Figure 15-3. State Format Specification Menu

- a. Place the cursor on the top field in the label column and press SELECT.
- b. Place the cursor on Modify label and press SELECT.

- c. With the Alpha Entry pop-up, change the name of the label to ADDR.
 - d. Name the second label DATA by repeating steps a through c.
 3. Assign Pod 1 bits 0 through 15 to the label DATA.
 - a. Place the cursor on the bit assignment field below Pod 1 and to the right of DATA and press SELECT.
 - b. Any combination of bits may already be assigned to this pod; however, you will want all 16 bits assigned to the DATA label. The easiest way to assign is to press the CLEAR ENTRY key to un-assign any assigned bits before you start.
 - c. Place the cursor on the period under the 15 in the bit assignment pop-up and press SELECT. This will place an asterisk in the pop-up for bit 15, indicating Pod 1 bit 15 is now assigned to the DATA label. Repeat this procedure until all 16 bits have an asterisk under each bit number. Place the cursor on Done and press SELECT to close the pop-up.
 - d. Repeat step c for Pod 2 and the ADDR label to assign all 16 bits.
 - e. Repeat step c except you will assign the lower eight bits (0 - 7) of Pod 3 to the ADDR label.

Specifying the J Clock

If you remember from "What's a State Analyzer" in *Feeling Comfortable With Logic Analyzers*, the state analyzer samples the data under the control of an external clock, which is "synchronous" with your circuit under test. Therefore, you must specify which clock probe you will use for your measurement. In this exercise, you will use the J clock, which is accessible through pod 1.

1. Select the State Format Specification menu by pressing the FORMAT key.
2. Set the J Clock to sample on a negative-going edge.

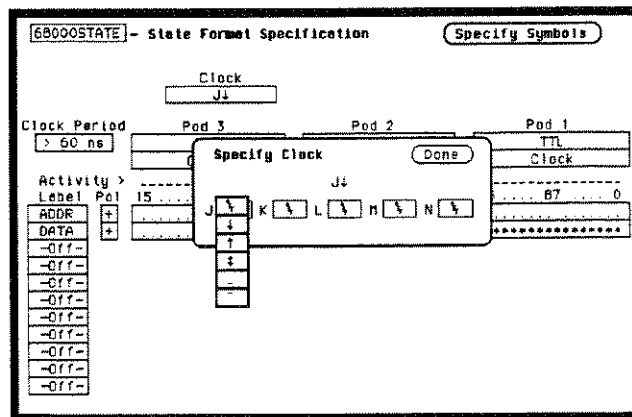

Figure 15-4. Specifying the J Clock

- a. Place the cursor on the CLOCK field and press SELECT.
- b. Place the cursor on the box just to the right of J in the pop-up (labeled OFF) and press SELECT.
- c. Place the cursor on ↓ and press SELECT.
- d. Place the cursor on Done and press SELECT.

Specifying a Trigger Condition

To capture the data and place the data of interest in the center of the display of the State Listing menu, you need to tell the state analyzer when to trigger. Since the first event of interest is address 0000, you need to tell the state analyzer to trigger when it detects address 0000 on the address bus.

1. Select the State Trace Specification menu by pressing the TRACE key.
2. Set the trigger so that the state analyzer triggers on address 0000. If the Trigger on option is not already perform steps a through d. If the option is a skip to step e.
 - a. Place the cursor on the 1 in the Sequence Levels field of the menu and press SELECT.
 - b. Place the cursor on the field to the right of the Trigger on field

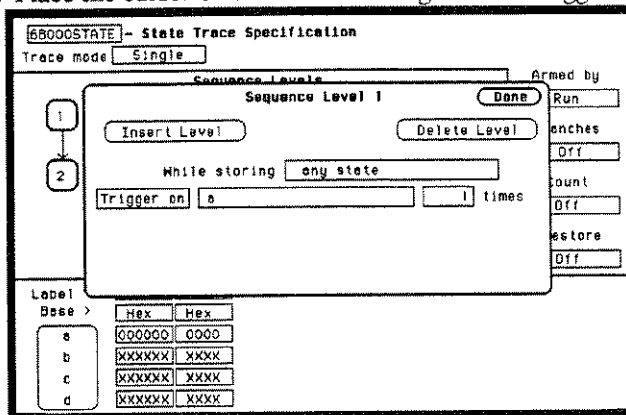

Figure 15-5. State Trace Specification Menu

and press SELECT. Another pop-up appears showing you a list of "trigger on" options. Options *a* through *h* are qualifiers. You can assign them a pattern for the trigger specification.

- c. Place the cursor on the a option and press SELECT.
- d. Place the cursor on Done in the Sequence Levels pop-up and press SELECT.
- e. Place the cursor on the field to the right of the a under the label ADDR and press SELECT.
- f. With the keypad, press 0 (zero) until there are all zeros in the Specify Pattern: pop-up and then press SELECT.

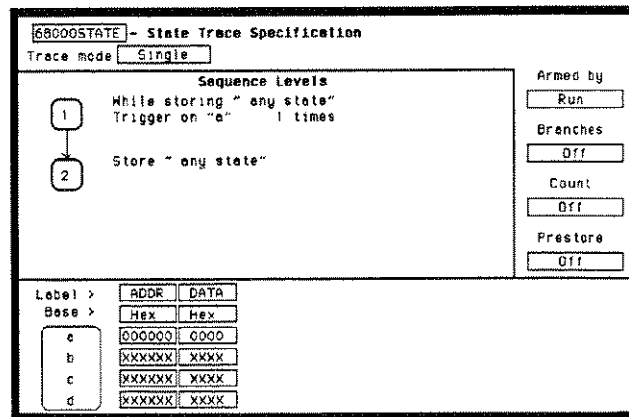

Figure 15-6. State Trace Specification

Your trigger specification now states: "While storing anystate trigger on "a" once and then store anystate."

When the state analyzer is connected to your circuit and is acquiring data, it continuously stores until it sees 0000 on the address bus, then it will store anystate until the analyzer memory is filled.

Acquiring the Data

Since you want to capture the data when the microprocessor sends address 0000 on the bus after power-up, you press the RUN key to arm the state analyzer and then force a reset of your circuit. When the reset cycle ends, the microprocessor should send address 0000 trigger the state analyzer and switch the display to the State Listing menu.

Note 

From this point in the exercise unto the end, we will give you the measurement results. This way, you will not have to obtain and use an identical circuit.

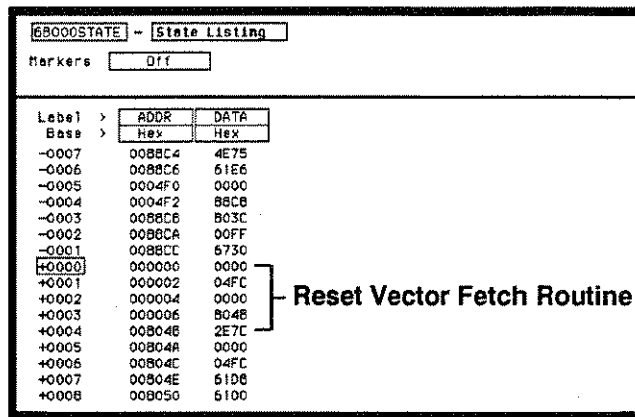

Label >	ADDR	DATA
Base >	Hex	Hex
-0007	00B8C4	4E75
-0006	00B8C6	61E6
-0005	0004F0	0000
-0004	0004F2	88C8
-0003	00B8C6	B03C
-0002	00B8CA	00FF
-0001	00B8CC	6730
+0000	000006	0000
+0001	000002	04FC
+0002	000004	0000
+0003	000006	B048
+0004	00B04E	2E7C
+0005	00B04A	0000
+0006	00B04C	04FC
+0007	00B04E	61D8
+0008	00B050	6100

Figure 15-7. Reset Vector Fetch Routine

The State Listing

The state listing displays three columns of numbers as shown:

State Locations

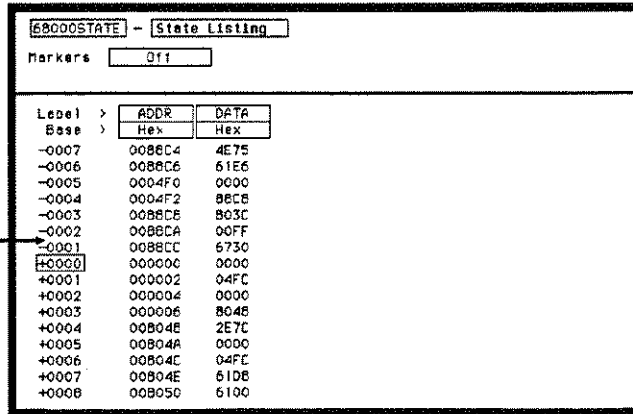

Level	ADDR	DATA
Base	Hex	Hex
-0007	00BEC4	4E75
-0006	00BEC6	61E6
-0005	0004F0	0000
-0004	0004F2	88CB
-0003	00BEC6	803C
-0002	00BEC4	00FF
-0001	00BEC4	6730
+0000	000000	0000
+0001	000002	04FC
+0002	000004	0000
+0003	000006	8048
+0004	00B04E	2E7C
+0005	00B04A	00D0
+0006	00B04C	04FE
+0007	00B04E	61DB
+0008	00B050	6100

Figure 15-8. State Locations

The first column of numbers are the state line number locations as they relate to the trigger point. The trigger state is on line + 0000 in the vertical center of the list area. The negative numbers indicate states occurring before the trigger and the positive numbers indicate states occurring after the trigger.

The second column of numbers are the states (listed in HEX) the state analyzer sees on the address bus. This column is labeled ADDR.

The third column of numbers are the states (listed in HEX) the state analyzer sees on the data bus. This column is labeled DATA.

Finding the Answer

Your answer is now found in the listing of states + 0000 through + 0004.

The 68000 always reads address locations 0, 2, 4, and 6 to find the stack pointer location and memory location for the instruction it fetches after power-up. The 68000 uses two words for each of the locations that it is looking for, a high word and a low word. When the software designer programs the ROM, he must put the stack pointer location at address locations 0 and 2. 0 is the high word location and 2 is the low word location. Similarly, the high word of the instruction fetch location must be in address location 4 and the low word in location 6.

Since the software design calls for the reset vector to set the stack pointer to 04FC and read memory address location 8048 for its first instruction fetch, you are interested in what is on both the address bus and the data bus in states 0 through 3.

The state listing below lists the codes reset vector search, in states 0 through 3 and the correct first microprocessor instruction in state 4.

```
+ 0000 000000 0000
+ 0001 000002 04FC
+ 0002 000004 0000
+ 0003 000006 8048
+ 0004 008048 3E7C
```

You see that states 0 and 1 do contain address locations 0 and 2 under the ADDR label, indicating the microprocessor did look at the correct locations for the stack pointer data. You also see that the data contained in these ROM locations are 0000 and 04FC, which are correct.

You then look at states 2 and 3. You see that the next two address locations are 4 and 6, which is correct, and the data found at these locations is 0000 and 8048, which is also correct.

So far you have verified that the microprocessor has correctly performed the reset vector search. The next thing you must verify is whether the microprocessor addresses the correct location in ROM that it was instructed to address in state 4 and whether the data is correct in this ROM location. From the listing on your machine, you see that the address in state 4 is 008048, which is correct, but the instruction found in this location is 2E7C, which is not correct. You have found your problem: incorrect data stored in ROM for the microprocessor's first instruction.

- + 0000 000000 0000 (high word of stack pointer location)
- + 0001 000002 04FC (low word of stack pointer location)
- + 0002 000004 0000 (high word of instruction fetch location)
- + 0003 000006 8048 (low word of instruction fetch location)
- + 0004 008048 2E7C (first microprocessor instruction)

68000STATE - State Listing

Markers

Label >	ADDR	DATA
Base >	Hex	Hex
-0007	0088C4	4E75
-0006	0088C6	61E6
-0005	0004F0	0000
-0004	0004F2	88CB
-0003	0088C8	803C
-0002	0088CA	00FF
-0001	0088CC	6730
+0000	000000	0000
+0001	000002	04FC
+0002	000004	0000
+0003	000006	8048
+0004	008048	2E7C ← Incorrect Data
+0005	00804A	0000
+0006	00804C	04FC
+0007	00804E	61D8
+0008	008050	6100

Figure 15-9. Incorrect Data

Summary

You have just learned how to make a simple state measurement with the HP 1652B Logic Analyzer. You have:

- specified a state analyzer
- learned which probes to connect
- assigned pods 1, 2, and 3
- assigned labels
- assigned bits
- specified the J clock
- specified a trigger condition
- acquired the data
- interpreted the state listing

You have seen how easy it is to use the state analyzer to capture the data on the address and data buses. You can use this same technique to capture and display related data on the microprocessor status control, and various strobe lines. You are not limited to using this technique on microprocessors. You can use this technique any time you need to capture data on multiple lines and need to sample the data relative to a system clock.

Chapter 21 shows you how to use the logic analyzer as an interactive timing and state analyzer. You will see a simple measurement that shows you both timing waveforms and state listings and how they are correlated.

If you have an HP 1653B, you do not have enough channels to simultaneously capture all the data for a 68000. But, since you probably aren't working with 16-bit microprocessors, this example is still valuable because it shows you how to make the same kind of measurement on an eight-bit microprocessor.

Index

A

absolute	18-9	Specifying Patterns	3-18
Accessing System Configuration Menu	4-2	Auto-Measure	
Accessories		+ Width and -Width	25-9
available	1-7	Fall Time	25-6
manuals	1-7	Measurement Example	25-4
supplied	1-5	Period and Frequency	25-8
Accessories for HP 1652B/53B	1-5	Preshoot and Overshoot	25-10
accumulate	19-6	Rise Time	25-5
acquisition		Top and Base Voltages	25-3
fields (state trace)	10-13	Vp-p	25-7
acquisition modes		Auto-Measure Field	25-1
glitch	18-5	Auto-Trig Field	24-6
state	10-13	Autoload	5-6, 6-1
timing	18-3	disable	5-6
transitional	18-4	enable	5-6
activity indicators	20-5	autoloading a file	6-13
alternate printers	7-2	Automatic Measurement	
armed by		Algorithms	B-1
BNC	24-4	Autoscale	23-19
Machine 1 or 2	24-4	Autoscale Field	4-5
Run	24-4	Axes (State Chart)	
state	10-13	Scaling the	13-2
timing	18-3	Selecting the	13-1
Armed by Field	24-3		
ASCII	17-9	B	
Assignment/Specification Menus		base	17-8, 18-6
Assigning Pod Bits to Labels	3-17	ASCII	17-9
description	3-17	State Trace	10-22
Specifying Edges	3-19	baud rate	5-16
		bit assignment	9-4, 17-4
		branches	10-14
		per level	10-15

restart	10-14
branching	
multiple levels	10-17
secondary	10-15
branching qualifier	10-8

C

cables for printer	7-3
Calibration	24-1, D-1
Cancel field	5-4
Changing Alpha Entries	3-15
Channel Menu	23-1
Channel Menu Fields	
Impedance	23-5
Input	23-1
Offset	23-3
Preset	23-5
Probe	23-4
V/Div	23-2
CHS Key	3-4
Clear Entry Key	3-3
clock	
demultiplex	9-10
master	9-10
mixed	9-11
normal	9-9
period (state)	9-12
slave	9-10
state	9-7
Closing Pop-up Menus	3-9
Compare Image	12-3
Bit Editing of the	12-4
Creating a	12-3
Masking Channels in the	12-5
Saving	12-8
Compare Listing Display	12-2
Compare Range	12-6
Specifying a	12-6
Compensation Signal	2-7

Configuration Capabilities	
HP 1652B capabilities	1-2
HP 1653B capabilities	1-3
Connect dots Field	25-31
Connecting	
analyzer to target system	2-8
Grabbers to probes	2-12
Grabbers to test points	2-12
Labels to pods, probes, cables	2-13
Other HP Printers	7-9
Pods to probe cables	2-10
probe cables to analyzer	2-9
Continue field	5-4
Copy	5-7, 6-1
Copying a File	6-15
count	10-18
States	10-20
Time	10-18
Cursor	3-7

D

data	
bits	5-15
time-correlating	21-11, 27-12
Delay	23-17
from Trigger (State)	14-5
Delay (timing)	19-9
Deleting Waveforms (State)	14-4
Demultiplex (clock)	9-10
Difference Listing	
Locating Mismatches in	12-8
Difference Listing Display	12-2
disk	
drive operations	6-1
format (LIF)	6-7
Installing a Blank Disk	6-6
operations	5-3
Disk Drive	3-5
Disk Eject Button	3-5

disk operation parameters	6-5	Auto-Trig Field	24-6
disk operations		Level Field	24-5
Autoload	5-6, 6-1, 6-13	Source Field	24-4, 24-6
Copy	5-7, 6-1	edges	
Copying a File	6-15	Then Find	18-11
Duplicate Disk	5-8, 6-1	Entering Alpha Data	3-14
Format Disk	5-11, 6-1	Entering Numeric Data	3-11
Formatting a Disk	6-7	Error Messages	C-1
load	5-5, 6-1, 6-11	Execute field	5-4
Pack Disk	5-9, 6-1	External Trigger (arming)	
Pack Disk Operation	6-17	for Scope	2-7
Purge	5-10, 6-1	external trigger BNCs	
Purging a File	6-14	configuration	5-17
Rename	5-9, 6-1		
Renaming a File	6-12		
Selecting a	6-4		
store	5-5, 6-1		
Storing to a Disk	6-9		
Disk Operations menu			
Accessing the	6-3		
display			
mixed mode	21-12, 27-13		
resolution (Timing Waveforms)	20-12		
Display Field			
Accumulate Mode	25-31		
Average Mode	25-30		
Normal	25-29		
display icons			
The Inverted Triangle	20-11		
Vertical Dotted Line	20-11		
Don't Care Key	3-3		
Duplicate Disk	5-8, 6-1		
Duplicating Operating System Disk	6-18		

F

Features of HP 1652B/1653B	1-4		
file description	5-5, 6-9		
filename	5-5, 6-9		
Find Pattern	18-7		
Format Disk	5-11, 6-1		
Format/Channel Menu Key	3-2		
Formatting a Disk	6-7		
Front-Panel Controls			
CHS Key	3-4		
Clear Entry Key	3-3		
Display Menu Key	3-3		
Don't Care Key	3-3		
Format/Channel Menu Key	3-2		
Hex(adecimal) Keypad	3-4		
I/O Menu Key	3-3		
Knob	3-4		
Menu Keys	3-2		
Roll Keys	3-4		
Run Key	3-3		
Select Key	3-4		
Stop Key	3-3		
Trace/Trigger Menu Key	3-2		
Full Qualifier Specification	10-4		
Fuse	D-8		

E

ECL	9-6		
Edge Trigger Mode			

HP 1652B/1653B
Front-Panel Reference

Index-3

G		Setting RS-232C for HP Printers	7-5
General Purpose Probe Interface	2-2	for Non-HP Printers	7-5
glitch triggering	18-13	inverse assembled data	
Glitch Acquisition mode	18-5	How to Display	A-19
Grabbers	2-6	inverse assembler files	
		loading	A-18
H		K	
Hooking Up Your Printer	7-2	Knob	3-4
HP-IB			
printer cables	7-3		
I		L	
I/O menu	5-1	Label Value vs. Label Value	
Accessing the	5-1	(State Chart)	13-4
I/O Menu Key	3-3	Label Value vs. States	
I/O Port Configuration menu	5-12	(State Chart)	13-3
Immediate Trigger Mode		labels	17-3
Armed by	24-3	State Format menu	9-3
Impedance Field	23-5	State Trace	10-22
Indicator Light	3-5	symbols	17-8
indicators		Timing Format menu	17-3
activity	20-5	Timing Trace menu	18-6
Input Field	23-1	Level Field	24-5
Input Voltage for Probes	2-8	Line Switch	D-10
Inputs 1 and 2	3-5	Line Voltage Selection	D-7
Installation	D-1	Load	5-5, 6-1
Installing a Blank Disk	6-6	loading a file	6-11
Intensity Control	D-10	Logic Analyzer	
interface		description	1-1
Configuring	5-13	key features	1-4
HP-IB	5-13, 7-1	turning it on	1-7
RS-232C	5-14, 7-1		
Setting HP-IB for HP Printers	7-4	M	
		Maintenance	D-1
		Making Hardcopy Prints	7-1

Marker Measurements	25-12	State Chart	8-9 - 8-10
markers		State Compare	8-6
Pattern (state)	11-4	State Format	8-2
Pattern (timing)	19-5	State Listing	8-5
Statistics (state)	11-6	State Trace	8-3
Statistics (timing)	19-6	State Waveform	8-7 - 8-8
Time (state)	11-6	timing analyzer	16-1
Time (timing)	19-4	Timing Format	16-2
Timing Waveforms menu	19-3	Timing Trace	16-3
X and O	20-10	Timing Waveform	16-4
Markers Field for Scope		Trigger Menu	22-3
Sample Period Display	25-14	Waveform Selection	22-5
Search	25-16	Waveforms Menu	22-4
Specify Search Markers	25-16	menus	
Statistics	25-23	Disk Operations	5-3, 6-1
Time	25-14	I/O	5-1
X-O Pattern from start	25-22	I/O Port Configuration	5-12
master clock	9-10	Specify Symbols (state)	9-7, 9-12
measurement example		Specify Symbols (timing)	17-7
state analyzer	15-1	State Chart	13-1
timing analyzer	20-1	State Compare	12-1
timing/state analyzer	21-1	State Format Specification	9-1
measurements		State Listing	11-1
microprocessor	A-1	State Trace	10-1
memory		State Waveform	14-1
acquisition	18-4 - 18-5	State Waveforms	14-1
menu fields		Timing Format Specification	17-1
Specify Symbols (state)	9-13	Timing Trace Specification	18-1
Specify Symbols (timing)	17-8	Timing Waveforms	19-1
st/Div (states-per-division)	14-4	Microprocessor Specific	
State Format Specification	9-3	Measurements	A-1
State Listing menu	11-3	Microprocessors Supported	A-3
State Trace menu	10-2	mixed clocks	9-11
Timing Format Specification	17-3	Mixed Mode Displays	26-1
Timing Trace Specification	18-2	Arming the Scope	26-4
Timing Waveforms menu	19-3	Displaying Timing Waveforms	26-5
Menu Keys	3-2	State/State	26-3
menu maps		State/Timing/Scope Mixed	
Channel Menu	22-2	Mode Display	26-8
Specify Markers	22-5	Time-Correlated Displays	26-9
state analyzer	8-1	Timing/Scope	26-4

Timing/State	26-2	find	18-7
Mixed Mode Field	26-1	Pod Clock	9-9
Mode Field	24-2	Pod Fields	4-6
Edge	24-4	Pod Grounding	2-5
Immediate	24-3	pod threshold	
		ECL	17-6
		TTL	17-6
		user-defined	17-6
		Pod Thresholds	2-8
		Pods	
		clock	9-9
		threshold	9-6, 17-6
		Polarity (Pol)	9-4, 17-4
		Pop-up Menus	3-9
		Power Cord Configurations	D-4
		preprocessors	A-2
		Preset Field	23-5
		prestore	10-21
		print	
		All	5-2, 7-7
		Screen	5-2, 7-7
		Starting the Printout	7-7
		Print All	5-2, 7-7
		Print Screen	5-2, 7-7
		printer	5-16
		printers	
		alternate	7-2
		Hooking Up	7-2
		Other HP Printers	7-9
		supported	7-1
		Probe Cables	2-6
		Probe Connecting	
		Analyzer to Target System	2-8
		Disconnecting Probes from Pods	2-11
		Grabbers to Probes	2-12
		Grabbers to Test Points	2-12
		Labels to Pods, Probes, Cables	2-13
		Pods to Probe Cables	2-10
		Probe Cables to Analyzer	2-9
		Probe Field	23-4
		Probe Grounding	2-6
N			
name			
label	9-4, 17-4		
symbol	17-10		
Name Field	4-3		
O			
O to Trig(ger)	19-4		
occurrence counter	10-9		
Offset Field	23-3		
Operating Characteristics	F-1		
Operating System Disk	6-18		
Duplicating the	6-18		
Operating System-loading	D-9		
Overlapping Timing Waveforms	21-14		
P			
Pack Disk	5-9, 6-1		
Packing a Disk	6-17		
paper width	5-17		
Setting the	7-6		
parity	5-15		
pattern			
recognizers	10-2		
Pattern Fields (state)	10-24		
patterns	10-23		
Duration (present for ____)	18-9		
fields	10-22		

Probe Inputs for Scope 2-7
 Probe Pod Assemblies 2-4
 Probes 2-5

Probing Options
 General Purpose Probing 2-3
 HP 10269C General Purpose
 Probe Interface 2-2
 HP 10320C User-Definable
 Interface 2-1
 Termination Adapter 2-3

Probing System for Analyzer
 description 2-4
 Grabbers 2-6
 Maximum Probe Input Voltage 2-8
 Pod Grounding 2-5
 Probe Cable 2-6
 Probe Grounding 2-6
 Probe Pod Assemblies 2-4
 Probes 2-5
 Signal Line Loading 2-8

Probing System for Scope
 Compensation Signal Outputs 2-7
 description 2-7
 External Trigger Inputs 2-7
 Maximum Probe Input Voltage 2-8
 Probe Inputs 2-7
 protocol 5-14
 Purge 5-10, 6-1
 Purging a File 6-14

Q

Qualifier Field (state) 10-23
 qualifier 10-2
 branching 10-8
 fields 10-22
 storage 10-8

R

range
 recognizers 10-2
 ranges 10-24
 Rear-Panel Controls and Connectors
 External Trigger BNCs 3-6
 Fan 3-7
 HP-IB Interface Connector 3-7
 Intensity Control 3-6
 Line Power Module 3-6
 Pod Cable Connectors 3-6
 Probe Compensation Signal 3-7
 RS-232C Interface Connector 3-6
 Recommended Protocol (RS-232C) 7-6
 Rename 5-9, 6-1
 repetitive
 trace mode (state) 10-13
 trace mode (timing) 18-3
 Repetitive Run Mode 24-7
 Replacing Waveforms (State) 14-3
 Returning to system configuration 3-8
 Roll Data 3-16
 Roll Keys 3-4
 RS-232C
 default configuration 7-6
 printer cables 7-3
 recommended protocol 7-6
 setting for HP printers 7-5
 setting for non-HP printers 7-5
 Run Key 3-3
 Run Mode Field 24-7
 Repetitive Mode Run 24-7
 Single Mode Run 24-7

S

sample period	19-3	An Overview	8-1
Scope		menu maps	8-1
Introduction	22-1	State Chart menu	13-1
Scope Field	25-1	Accessing the	13-1
Scope Menus Overview	22-6	state clock	9-7
Scope On/Off Field	4-5	State Compare menu	
Select Key	3-4	Accessing the	12-2
Selecting a Waveform (State)	14-2	State Format Specification menu	9-1
Selecting an Address (HPIB)	5-13	Accessing the	9-1
Selecting Fields	3-9	fields	9-3
Selecting Menus	3-7	State Listing menu	11-1
Selecting Options	3-10	Accessing the	11-2
self test	5-18	fields	11-3
Self Tests-powerup	E-1	state tagging	10-20
sequence levels	10-6	State Trace menu	10-1
Delete Level	10-7	Accessing the	10-2
Insert Level	10-7	fields	10-2
Reading the Display	10-11	State Waveforms menu	14-1
Signal Line Loading	2-8	Accessing the	14-1
single		State/State Mixed Mode Display	26-3
trace mode (state)	10-13	Statistics	25-23
trace mode (timing)	18-3	Stop bits	5-15
Single Run Mode	24-7	Stop Key	3-3
slave clock	9-10	Stop Measurement	
Slope Field	24-6	state	11-5
Source Field	24-4	Stop Measurement (timing)	19-5
Specifications	F-1	storage macro	10-9
Specify Search Markers		storage qualifier	10-8
Greater than	25-20	Store	5-5, 6-1
In/Not IN Range	25-21	Store exception to disk	
Less than	25-19	state	11-5
Type	25-17	State Compare	12-7
X-O Marker set on	25-17	timing	19-6
Specifying Edges	3-19	Storing to a Disk	6-9
Specifying Patterns	3-18	supported printers	7-1
st/Div (states-per-division)	14-1, 14-4	Switching Between Analyzer	
state analyzer	8-1	and Scope	3-8
		symbols	17-7
		base	9-14, 17-8
		label	9-13, 17-8
		name	9-15, 17-10

Toggle Fields 3-11
User-Definable Interface 2-1

V

V/Div Field 23-2
view size
symbol 17-10

W

Waveform Selection 23-6
Insert/Delete 23-9
Math 23-12
Modify 23-10
Overlay 23-11
Turning them ON/OFF 23-8

Waveforms Menu

Auto-Measure Field 25-1
Connect dots Field 25-31
Description 25-1
Display Field 25-29
Marker Measurements 25-12
Markers Field 25-13
Scope Field 25-1
Search Marker Measurement
Example 25-24

X

X and O markers
State Chart 13-5
State Waveform 14-5
Timing Waveforms 20-10
X to Trig(ger) 19-4

Index-10

HP 1652B/1653B
Front-Panel Reference