

# TEST FIXTURE

## 16058A

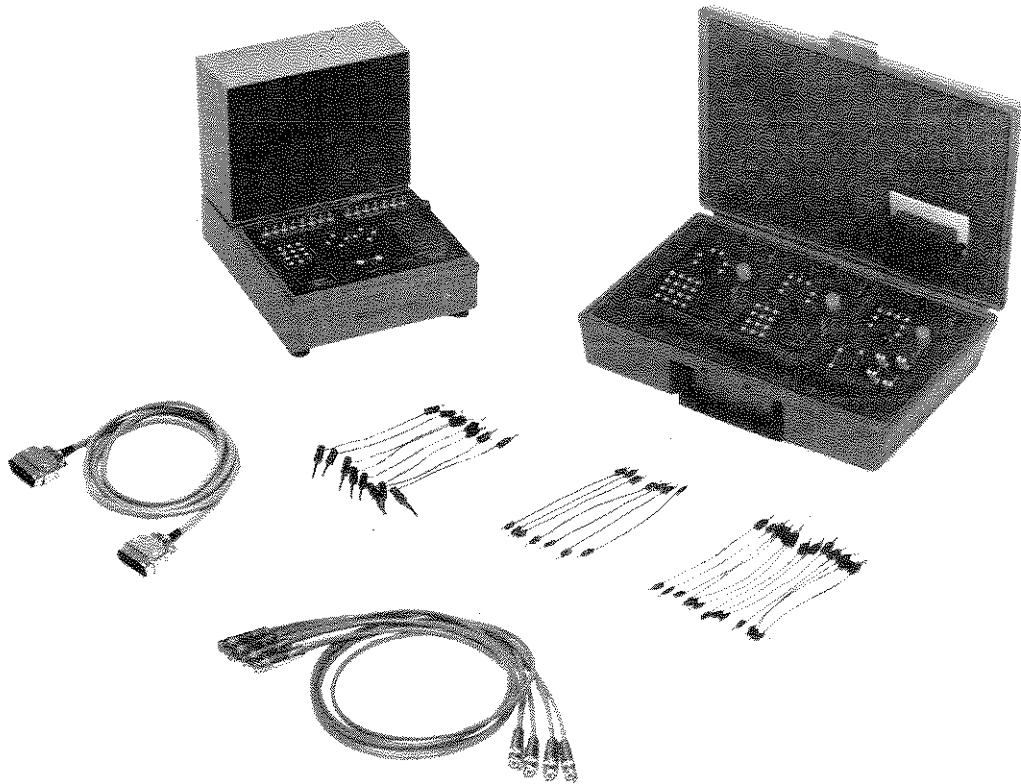

NOV. 1983



**HEWLETT  
PACKARD**

## **WARRANTY AND ASSISTANCE**

All Hewlett-Packard products are warranted against defects in materials and workmanship. This warranty applies for one year from the date of delivery, or, in the case of certain major components listed in the operating manual, for the specified period. We will repair or replace products which prove to be defective during the warranty period provided they are returned to Hewlett-Packard. No other warranty is expressed or implied. We are not liable for consequential damages.

For any assistance, contact your nearest Hewlett-Packard Sales and Service Office. Addresses are provided at the back of this manual.

# GENERAL INFORMATION

## 1. INTRODUCTION

This operating note provides the information required for operation and maintenance of the Hewlett-Packard Model 16058A Test Fixture shown on the front cover. It covers DESCRIPTION, OPERATION, and MAINTENANCE of the 16058A. To order additional copies of this operating note, contact the nearest Hewlett-Packard Sales and Service Office and specify the part number given on the rear cover.

## 2. DESCRIPTION

The Model 16058A Test Fixture is designed for use with the Hewlett-Packard Model 4145A Semiconductor Parameter Analyzer. The 16058A holds the device to be tested with the

4145A, and provides all necessary connections to the test input/output terminals of the 4145A. For stable and accurate measurements at extremely low current levels, the 16058A is equipped with an electrostatic light-shielding cover. To facilitate testing various types of devices, eight interchangeable socket boards and three types of special plug leads are furnished with the 16058A. The accessories furnished are listed in Table 1, and a brief description of each is given in Table 3. Other specifications of the 16058A are also given in Table 1. Table 2 lists typical performance characteristics, which are not specifications but typical characteristics included as additional information for the operator.

Table 1. 16058A Specifications (Sheet 1 of 2)

**FUNCTION:** Test fixture for use with the Hewlett-Packard Model 4145A Semiconductor Parameter Analyzer. Connects DUT to the SMU, Vs and Vm channels of the 4145A.

**ACCESSORIES FURNISHED:**

HP Part Number	Accessory Name
16058-60003	Personality Board
16058-61603	Triaxial Cable (4)
16058-61604	System Cable
16058-60004	Teflon Blank Board
16058-60005	Socket Board (for transistors)
16058-60006	Socket Board (24 pin dual in-line socket)
16058-60007	Socket Board (18 pin dual in-line socket)
16058-60008	Socket Board (for diodes)
16058-60009	Socket Board (8 pin socket)
16058-60010	Socket Board (10 pin socket)
16058-60011	Socket Board (12 pin socket)
16058-61600	Connection Cable (miniature banana--pin plug)
16058-61601	Connection Cable (pin plug--pin plug)
16058-61602	Connection Cable (miniature clip--pin plug)
16058-60100	Carrying Case

**WEIGHT:** 4.35 kilograms (including all accessories furnished)

Table 1. 16058A Specifications (Sheet 2 of 2)

DIMENSIONS : See figure below. (Unit : mm)

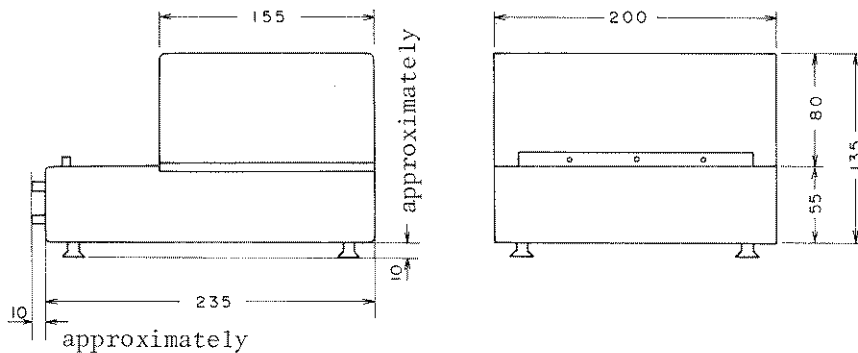

Table 2. 16058A Typical Performance Characteristics

The following characteristic data applies at operating temperatures of  $23^{\circ}\text{C} \pm 5^{\circ}\text{C}$ . Unless otherwise noted, the characteristic values are typical values under operation with the Personality Board and Socket Board installed.

1. Leakage Current

- (1) SMU channel --other SMU channel : Less than 5pA at 100V
- (2) SMU channel --COMMON : Less than 5pA at 100V
- (3) SMU channel --COMMON (when using CONNECTION SWITCH) : Less than 40pA at 100V

2. Stray Capacitance

- (1) SMU channel --COMMON : Less than 15pF
- (2) SMU channel --COMMON (when using CONNECTION SWITCH) : Less than 30pF
- (3) SMU channel --other SMU channels : Less than 3pF
- (4) SMU channel --other SMU channels (when using CONNECTION SWITCH) : Less than 10pF

3. Residual Resistance

- (1) Center conductor of triaxial cable : Less than 200m $\Omega$
- (2) Triaxial SMU terminal -- DUT socket : Less than 100m $\Omega$
- (3) Triaxial SMU terminal -- DUT socket (when using CONNECTION SWITCH) : Less than 200m $\Omega$

4. Guard Capacitance

- (1) SMU channel -- Guard (per channel, inclusive of triaxial cable) : Less than 140pF

Table 3. 16058A Furnished Accessories (Sheet 1 of 4)

**16058-60003 :**  
**Personality Board**

Main test fixture board providing measurement connection terminals and Connection Switch.

The board permits installation of one of the replaceable socket boards and construction of circuit connections necessary for the desired measurement. The Connection Switch allows selection of one of two different DUT connections (for two or three lead component measurements).

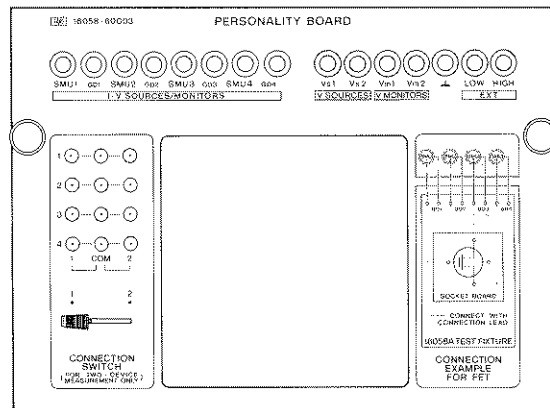

Accessory	Description
 <p>Cable length : Approximately 1.5m</p>	<p><b>16058-61603 :</b>  <b>Triaxial Cable (1ea.)</b></p> <p>The triaxial cable used to connect the 16058A to an SMU channel of the 4145A. Four cables are furnished.</p> <p>The triaxial cables ensure a complete shield against external noise interference.</p>
 <p>Cable length : Approximately 1.5m</p>	<p><b>16058-61604 :</b>  <b>System Cable</b></p> <p>Cable assembly with 24 pin male connectors used to connect the Vm and Vs channels of the 4145A to the 16058A.</p> <p>The cable also enables the 4145A to detect whether the fixture lid (shield cover) is open or closed.</p>

Table 3. 16058A Furnished Accessories (Sheet 2 of 4)

Accessory	Description
	<p>16058-60004 : Blank Teflon Board</p> <p>Insulation board used to minimize leakage current for extremely low-current measurements.</p>
	<p>16058-60005 : Socket Board (transistor sockets)</p> <p>Socket Board with two transistor sockets for measurement of three lead or four lead bipolar transistors and FETs.</p> <p>Either of the devices connected to the sockets can be selected by the Connection Switch on the Personality Board. Dimensions of the sockets are shown in the figure.</p>
	<p>16058-60006 : Socket Board (24-pin dual-in-line socket)</p> <p>Socket Board with a 24 pin dual-in-line socket.</p> <p>Dimensions of the socket are shown in the figure.</p>
	<p>16058-60007 : Socket Board (18-pin dual-in-line socket)</p> <p>Socket Board installed with a 18 pin dual in-line socket.</p> <p>Dimensions of the socket are shown in the figure.</p>

Table 3. 16058A Furnished Accessories (Sheet 3 of 4)

Accessory	Description
	<p>16058-60008 : Socket Board (diode sockets)</p> <p>Socket Board with two pairs of contacts for measurement of two-lead devices (such as diodes).</p> <p>The NARROW and WIDE contacts fit devices shorter than 20mm and 30mm, respectively.</p> <p>Dimensions of the socket are shown in the figure.</p>
	<p>16058-60009 : Socket Board (8-pin socket)</p> <p>Socket Board for measurement of 8-pin package devices.</p> <p>Dimensions of the socket are shown in the figure.</p>
	<p>16058-60010 : Socket Board (10-pin socket)</p> <p>Socket Board for measurement of 10-pin package devices.</p> <p>Dimensions of the socket are shown in the figure.</p>
	<p>16058-60011 : Socket Board (12-pin socket)</p> <p>Socket Board for measurement of 12-pin package devices.</p> <p>Dimensions of the socket are shown in the figure.</p>

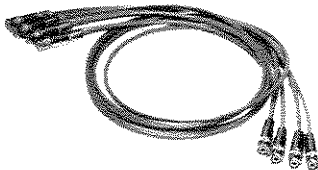
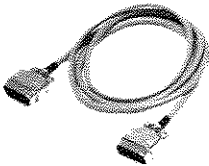
Table 3. 16058A Furnished Accessories (Sheet 4 of 4)

Accessory	Description
 <p>Cable length : Approximately 115mm</p>	<p>16058-61600: Connection Cable (1ea.)</p> <p>A miniature banana plug-pin plug lead for connecting measurement terminals to the Connection Switch on the Personality Board, or for connecting measurement terminals to the Socket Board. Twelve cables are furnished.</p>
 <p>Cable length : Approximately 115mm</p>	<p>16058-61601: Connection Cable (1ea.)</p> <p>A miniature pin plug-pin plug lead for connecting the Socket Board to the Connection Switch. Eight cables are furnished.</p>
 <p>Cable length : Approximately 115mm</p>	<p>16058-61602: Miniature Clip Lead (1ea.)</p> <p>A miniature pin plug-miniature clip lead for connecting a DUT to the measurement terminals on the Personality Board without using a DUT socket.</p> <p>The miniature clips permit connection of devices with non-standard shapes or lead arrangements. Eight leads are furnished.</p>
	<p>16058-60100: Accessory Case</p> <p>Carrying case for the Blank Teflon Board, six Socket Boards, and Connection Cables.</p>

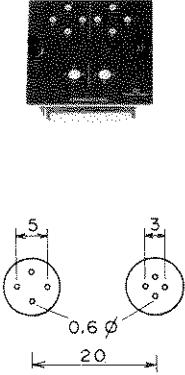
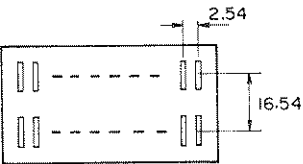
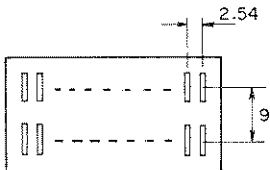

# OPERATION

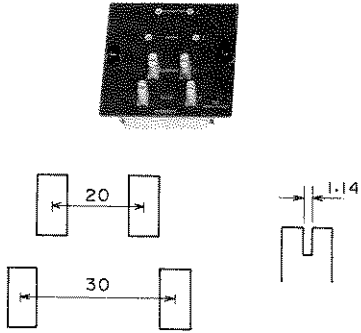
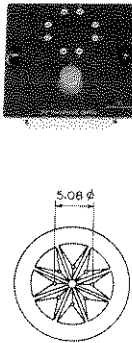
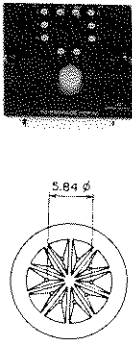
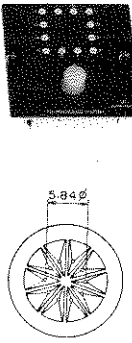
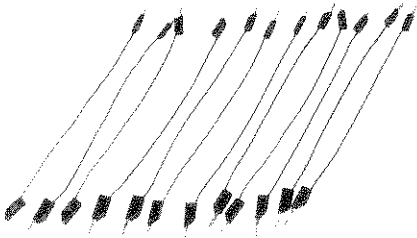
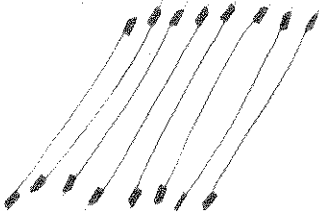
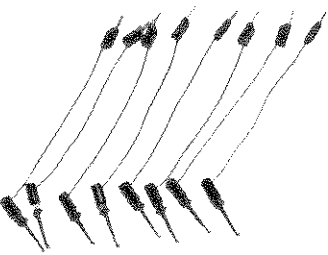
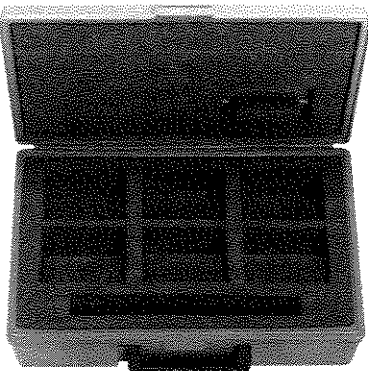
## 3. OPERATION

### 3-1. 16058A Connection

3-2. To connect the 16058A Test Fixture to the 4145A Semiconductor Parameter Analyzer, perform the following procedure :

- 1) Turn off the 4145A. If the 24 pin connector (labeled "TO 16058A TEST FIXTURE") on the rear panel is terminated with a shorting connector, disconnect the shorting connector from the 4145A.
- 2) Connect the triaxial cables (Part Number: 16058-61603) to the triaxial SMU terminals (SMU1 to SMU4) of the 16058A and the appropriate SMU terminals on the rear panel of the 4145A as shown in Figure 1.
- 3) Connect the system cable (Part Number : 16058-61604) to the 24-pin connector of the 16058A and the connector labeled "To 16058A TEST FIXTURE" on the rear panel of the 4145A. See Figure 1.

Figure 2 shows the circuit connection configuration between the 16058A and 4145A. The system cable provides connections necessary for the  $V_s$ ,  $V_m$  and fixture lid open/closed signals.

### 3-3. DUT Connection

3-4. The Socket Board installation procedure and examples of typical cable connections are described below :

- 1) First, select the appropriate Socket Board. Refer to Table 3 for the characteristics of individual Socket Board. If the DUT fits none of the Socket Boards, use the Blank Teflon Board (Part Number : 16058-60004) and the miniature clip leads (Part Number : 16058-61602) to connect the DUT.
- 2) Check that the black plastic fasteners of the Socket Board are unlocked.
- 3) Insert the Socket Board into the Personality Board. Press the fasteners to lock the Socket Board in place.
- 4) Connect the connection leads for the desired measurement. Figure 3 shows examples of typical connections.

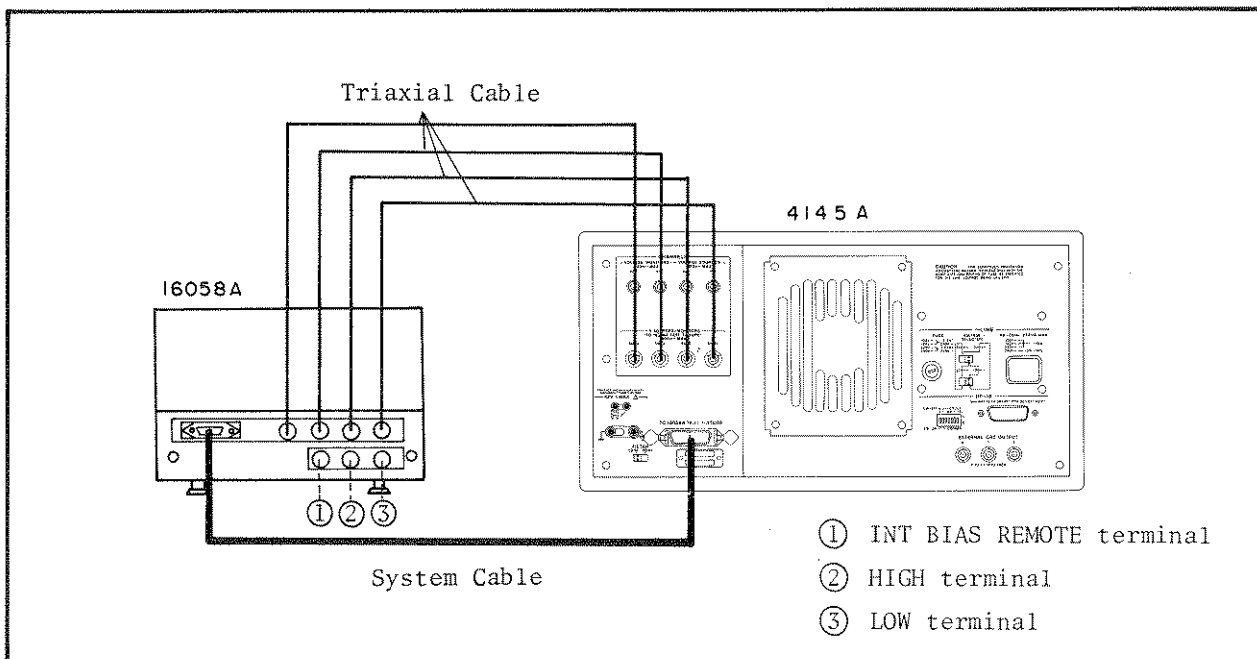

Figure 1. Connection between the 16058A and 4145A.

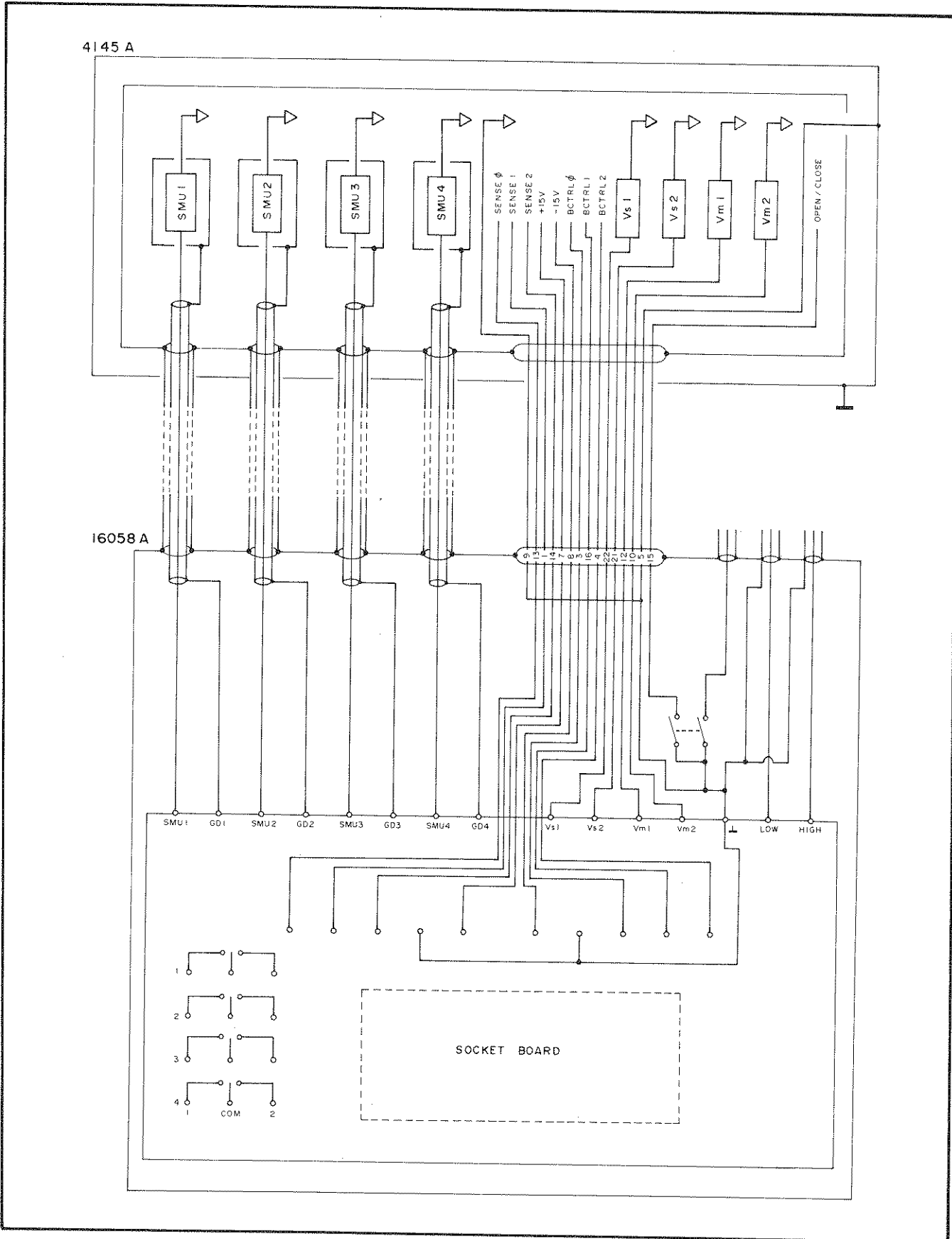
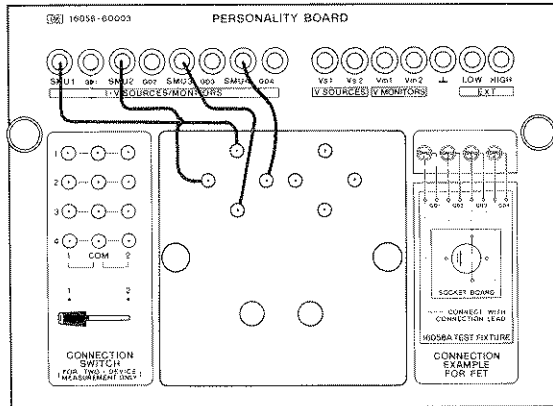

Figure 2. 16058A Circuit Schematic.

(1) Transistor measurements



Attach the transistor socket board (Part Number : 16058-60005) to the Personality Board.

Connect the miniature banana plug — pin plug cables to the SMU terminals on the Personality Board and the plug sockets on the Socket Board as shown in the figure.

Device socket : left socket

Connections :	SMU1	pin 1
	SMU2	pin 2
	SMU3	pin 3
	SMU4	pin 4

(2) Diode measurements

When alternately measuring two diodes, perform as follows :

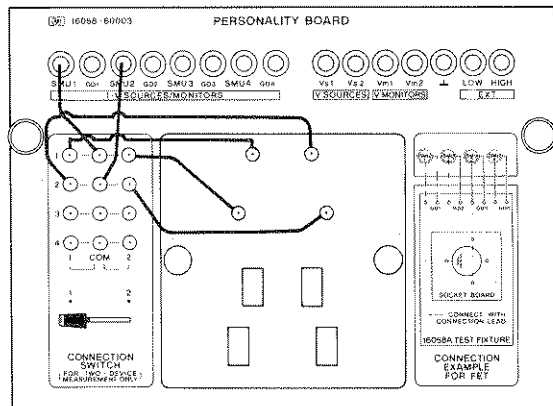

Attach the diode socket board (Part Number: 16058-60008) to the Personality Board. Connect the miniature banana plug — pin plug cables to the plug sockets of the Connection Switch and the SMU terminals on the Personality Board as shown in the figure. Connect the pin plug — pin plug cables to the plug sockets of the Connection Switch and those on the Socket Board.

Device socket : Both NARROW and WIDE

Connections :

NARROW	SMU1	pin 1
	SMU2	pin 2
WIDE	SMU1	pin 1
	SMU2	pin 2

Note

In the above figure, the NARROW socket is used when the Connection Switch is set to position 1 and the WIDE socket is used when set to position 2. When the switch is set to center, no connection is provided for the SMU channels.

Figure 3. DUT Connection Examples (Sheet 1 of 2).

### (3) Measurement of unique devices

When the DUT fits none of the Socket Boards, or when the measurement requires optimum insulation, perform as follows :

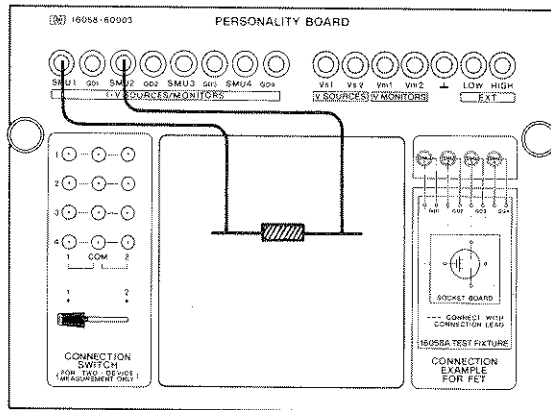

Attach the blank teflon board (Part Number: 16058-60004) to the Personality Board. Connect the miniature pin plug-miniature clip leads to the SMU terminals on the Personality Board and the DUT leads as shown in the figure.

Figure 3. DUT Connection Examples (Sheet 2 of 2).

### 3-4. Considerations for Accurate Measurement

3-5. To ensure accurate measurements, ample consideration should be given to the following points :

1. When connecting cables between the Socket Board and the Personality Board, separate the cables as much as possible to minimize the effects of stray admittances.
2. When using the miniature clip-pin plug leads, separate the leads as much as possible to minimize the effects of stray admittances.
3. When using the Teflon Blank Board, be sure to place the DUT on (or above) the board.
4. Never allow vibration or shock to the cables or test fixture during measurement. Use the 16058A and the 4145A in operating environments free from vibration and shock.
5. For low-current measurements (less than 1nA) which require that the leakage current be kept low, do not use the Connection Switch on the Personality Board.

6. To ensure operator safety in measurements which require high test voltage, the 4145A checks whether the fixture lid of the 16058A is open or closed. If a test voltage exceeding  $\pm 42V$  (including voltage sweep parameter setting) is applied to the 4145A when the fixture lid of the 16058A is open, the measurement will not be initiated and the 4145A will display "Close the fixture lid" on the CRT. Also, if the fixture lid is opened during a measurement applying a test voltage over  $\pm 42V$ , the measurement will automatically be discontinued and the 4145A will display "Output is disabled, close the fixture lid" on the CRT.

If there is no reason to open the fixture lid, keep the lid closed during measurement.

### 3-6. 16058A FOR SYSTEM USE

3-7. The 16058A is also designed for systems applications of the 4145A. When an additional power supply is required, or when another measuring instrument such as capacitance meter (Hewlett-Packard Model 4275A, for example) is required, the HIGH and LOW terminals at the rear of the 16058A (see Figure 1) can be used for connection between the instrument and the 16058A. The fixture lid open/closed signal is provided from the INT BIAS REMOTE terminal (see Figure 1). Refer to Figure 2 for details on the 16058A's internal circuit.

## MAINTENANCE

### 4. MAINTENANCE

#### 4-1. Preventive Maintenance

4-2. To maintain insulation between test channels (and guards) and contact of plug, pin and socket connections, it is recommended that the user perform cleaning on a regular basis. Clean the surface of the fixture and accessories, except sockets and contacts, with a lint-free cloth. Do not use cleaning fluids.

#### 4-3. Replaceable Parts

4-4. An exploded view of the 16058A is shown in Figure 4 for parts identification. Do not disassemble any further than shown. To order replacement parts, use the Hewlett-Packard part numbers listed in Table 4. If a faulty part is located in an assembly that cannot be disassembled, order the next higher assembly or return the whole device to the nearest Hewlett-Packard Sales/Service Office for repair or replacement.

Table 4. Replaceable Parts (Sheet 1 of 3)

Ref.	HP Part No.	Qty.	Description
1	2360-0113	2	SCREW
2	2360-0192	2	SCREW
3	16015-8522	4	FOOT (SUCTION CUP)
4	2190-0226	4	WASHER
5	0570-0394	4	SCREW
6	16058-25002	1	TEFLON SHEET
7	3050-0229	3	WASHER
8	2190-0108	3	WASHER
9	2200-0145	3	SCREW
10	2360-0192	2	SCREW
11	2950-0001	1	NUT
12	0360-1190	1	TERMINAL-SOLDER LUG
13	2190-0016	2	WASHER
14	2950-0054	2	NUT
15	2190-0054	2	WASHER
16	3101-0302	2	SWITCH (ROTARY)
17	16058-01200	1	ANGLE
18	16058-00202	1	PANEL (RIGHT SIDE)
19	16058-00200	1	PANEL (TOP)
20	2360-0192	2	SCREW
21	16058-61611	1	CABLE ASSEMBLY
22	0520-0128	2	SCREW
23	2190-0112	2	WASHER
24	1250-0118	1	CONNECTOR-BNC (FEMALE)
25	2360-0194	3	SCREW
26	1250-0687	4	CONNECTOR-TRIAxIAL (FEMALE)
27	1250-0102	2	CONNECTOR-BNC (FEMALE)
28	0403-0316	2	BMPER FOOT - RUBBER
29	16047-09000	1	HINGE
30	16058-60012	1	COVER ASSEMBLY
31	16058-00203	1	PANEL (LEFT SIDE)
32	2360-0192	2	SCREW
33	2200-0139	4	SCREW
34	2190-0108	4	WASHER
35	3050-0105	4	WASHER
36	2360-0192	2	SCREW
37	16058-00101	1	MAIN CHASSIS
38	16058-40000	1	TRIM
39	0360-2066	25	CONTACT - SPRING
40	0360-2082	25	SINGLE CONTACT CONNECTOR
41	16058-00100	1	CHASSIS
42	16058-00201	1	PANEL (BOTTOM)

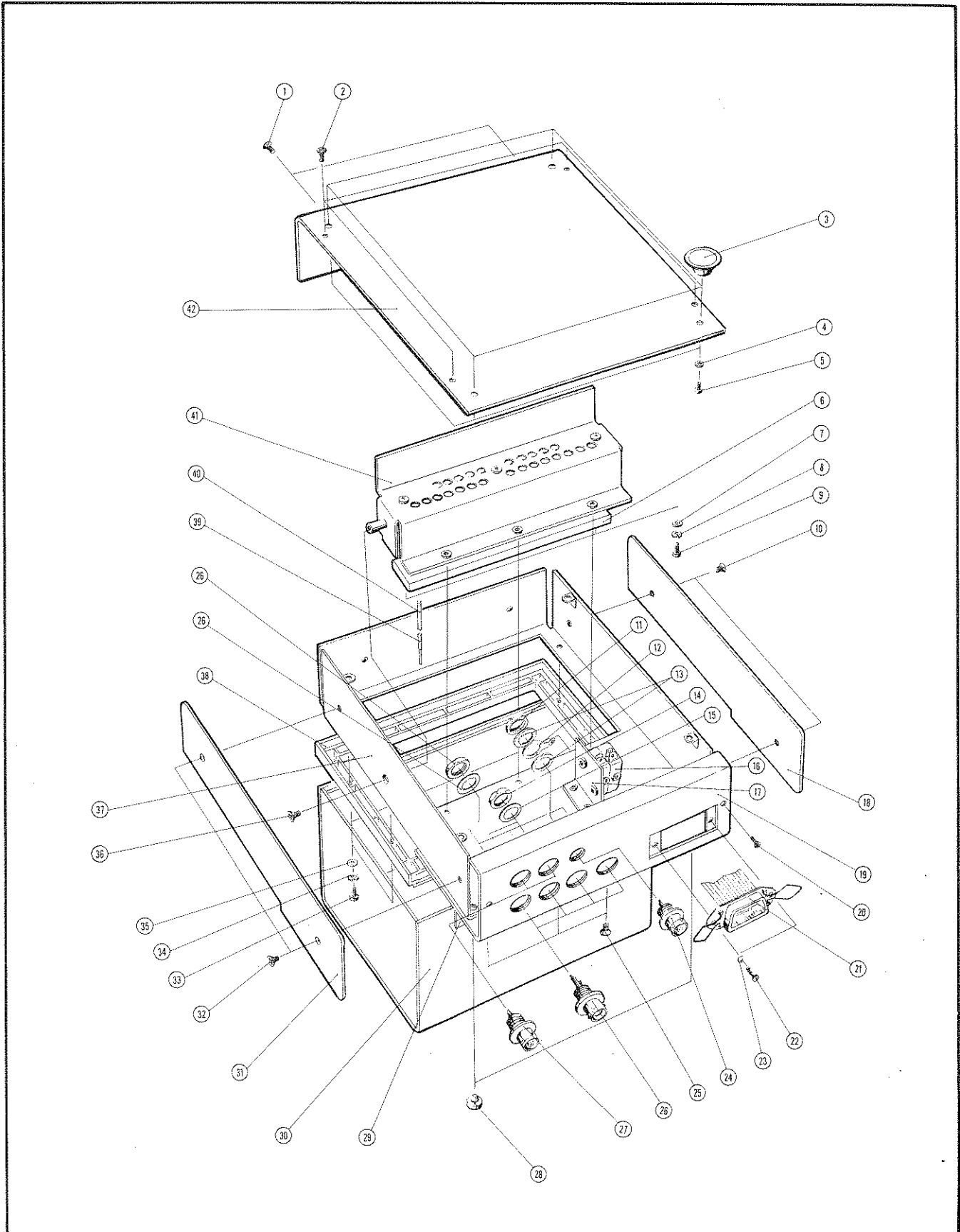

Figure 4. 16058A Exploded View (Sheet 1 of 2).

Table 4. Replaceable Parts (Sheet 2 of 3)

Ref.	HP Part No.	Qty.	Description
43	2580-0002	15	NUT
44	2190-0017	15	WASHER
45	2190-0749	15	WASHER
46	16058-25001	30	INSULATOR
47	0370-1123	2	KNOB
48	3050-0399	2	WASHER
49	3050-0647	4	WASHER
50	16058-00600	1	PLATE
	16058-08001	2	SPRING
51	16058-00204	1	PANEL (PERSONALITY BOARD)
	16058-00214	1	CHASSIS (PERSONALITY BOARD)
52	3050-0105	2	WASHER
53	16058-24001	2	SCREW
54	3100-1681	1	SWITCH (ROTARY)
55	2190-0108	2	WASHER
56	2260-0002	2	NUT
57	16058-24000	15	CONTACT
58	0360-0005	15	TERMINAL - SOLDER LUG
59	0360-2081	12	TEST PIN JACK
60	16058-60003	1	PERSONALITY BOARD
61	16058-60006	1	SOCKET BOARD (24-PIN DUAL IN LINE PACKAGE)
62 *1	2360-0190	3	SCREW
63 *2	16058-04000	1	COVER
64 *1	0360-2081	- *3	TEST PIN JACK
65 *4	1390-0365	2	SNAP-IN PLUNGER
66 *4	1390-0366	2	SNAP-IN GROMMET
67 *5	16058-00104	1	CHASSIS
	16058-00206	1	PANEL
68 *5	1200-0979	1	SOCKET
*1 :	Common to all Socket Boards, except the Blank Teflon Board (HP P/N : 16058-60004)		
*2 :	Common to all Socket Boards, except the transistor socket board (HP P/N: 16058-60005)		
*3 :	Quantity differs depending on the socket board.		
*4 :	Common to all Socket Boards.		
*5 :	Quantity differs depending on the Socket Board.		



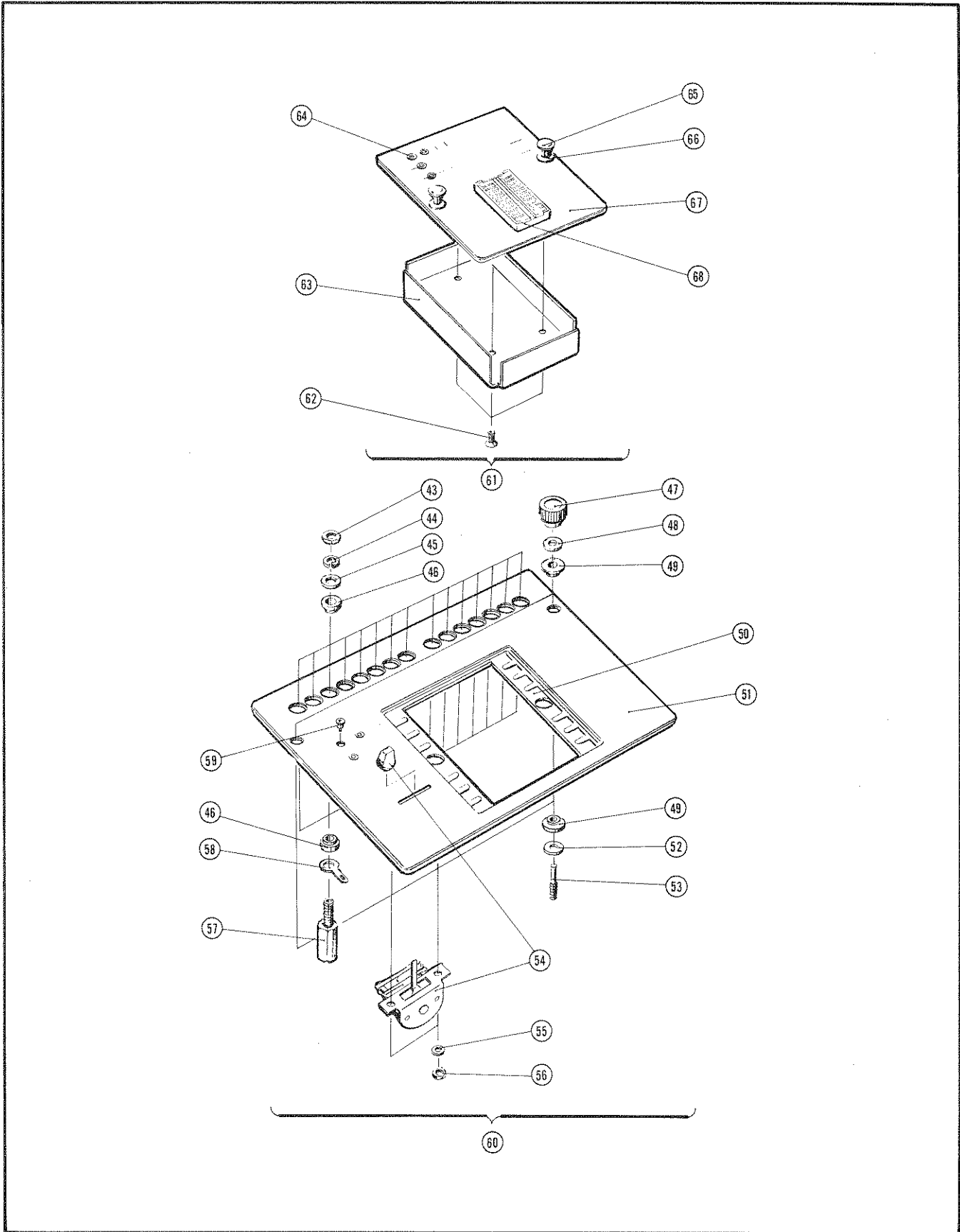

Figure 4. 16058A Exploded View (Sheet 2 of 2).

Table 4. Replaceable Parts (Sheet 3 of 3)

Ref.	HP Part No.	Qty.	Description
61	16058-60004	1	BLANK TEFLON BOARD
67	16058-25000	1	TEFLON PLATE
61	16058-60005	1	SOCKET BOARD (TRANSISTOR)
67	16058-00102	1	CHASSIS
	16058-00205	1	PLATE
68	1200-0976	1	SOCKET (Large)
	1200-0977	1	SOCKET (Small)
61	16058-60007	1	SOCKET BOARD (18-PIN DUAL IN LINE PACKAGE)
67	16058-00103	1	CHASSIS
	16058-00207	1	PANEL
68	1200-0978	1	SOCKET
61	16058-60008	1	SOCKET BOARD (DIODE)
67	16058-00105	1	CHASSIS
	16058-00208	1	PANEL
68	1200-0980	4	
61	16058-60009	1	SOCKET BOARD (8-PIN TO PACKAGE)
67	16058-00106	1	CHASSIS
	16058-00209	1	PANEL
68	1200-0238	1	SOCKET
61	16058-60010	1	SOCKET BOARD (10-PIN TO PACKAGE)
67	16058-00107	1	CHASSIS
	16058-00210	1	PANEL
68	1200-0239	1	SOCKET
61	16058-60011	1	SOCKET BOARD (12-PIN TO PACKAGE)
67	16058-00108	1	CHASSIS
	16058-00211	1	PANEL
68	1200-0240	1	SOCKET









Part No. 16058-90000

Printed in JAPAN

[www.valuetronics.com](http://www.valuetronics.com)