

**6060B/  
6061A**

**SYNTHESIZED RF  
SIGNAL GENERATOR**

***Giga-tronics***



# CONTENTS

THIS MANUAL introduces you to the Fluke 6060B Signal Generator and gives a brief introduction to remote programming using the IEEE-488 Interface option.

Introductory information for both the 6060B and the 6061A are provided here. Wherever "6060B" is mentioned, remember that the related descriptions also pertain to the 6061A.

THE 6060B SYNTHESIZED SIGNAL GENERATOR	3
OPTIONS	5
ACCESSORIES	6
SETTING UP THE 6060B	7
FRONT PANEL	12
REAR PANEL	13
EXAMPLES OF LOCAL OPERATION	14
IEEE-488 PROGRAMMING	
INSTRUCTIONS	20
OPERATION	22
REJECT ENTRY CODES	27

P/N 812503

OCTOBER 1986

©1986, John Fluke Mfg. Co., Inc., all rights reserved. Litho in U.S.A.

# THE 6060B SYNTHESIZED SIGNAL GENERATOR



## Introduction

The Fluke 6060B is a fully programmable, synthesized signal generator covering frequencies from 0.01 to 1050 MHz and amplitudes from -127 to +13 dBm. Special features include flexible parameter programming, responsive performance, built-in self tests, and as an option, an IEEE-488 Interface.

The 6060B is designed for RF applications that require good frequency accuracy, flexible modulation ability, and moderate spectral purity. The 6060B is well suited for testing a wide variety of RF receivers (particularly in-band) and RF devices, such as filters, amplifiers, and mixers.

# THE 6060B SYNTHESIZED SIGNAL GENERATOR

## Where to Get Help

If you have any questions about applications of the 6060B, refer to the 6060B Instruction Manual or contact:

**John Fluke Mfg. Co., Inc.**  
P.O. Box C9090  
Everett, WA 98206  
1-800-426-0361 (toll free) in most of U.S.A.  
206-356-5400 from AK, HI, WA  
206-356-5500 from other countries

**Fluke (Holland)B.V.**  
P.O. Box 5053,5004 EB, Tilburg,  
The Netherlands  
Tel. (013)673973, Tlx. 52237

For questions regarding service and calibration, see the list of Technical Service Centers in the 6060B Instruction Manual.

# OPTIONS

Options available for each instrument are summarized in the following table. To see what options are actually installed, check the list of options near the center of the rear panel. If the white bar adjacent to the option name has a black dot, that option is installed.

OPTION	DESCRIPTION
-130	<b>High-Stability Reference</b> Oven stabilized, crystal controlled reference oscillator with a $\pm 5 \times 10^{-10}$ /day aging rate.
-132	<b>Medium-Stability Reference</b> Oven stabilized, crystal controlled reference oscillator with a $\pm 1 \times 10^{-7}$ /mo aging rate.
-488	<b>IEEE-488 Interface (Standard on 6061A)</b> Talk and listen IEEE-488 interface capability for remote programming.
-651	<b>Low-Rate FM</b> Extends the bandwidth of the external modulation input down to 0.5 Hz typical for FM.
-830	<b>Rear Panel RF Output</b> Moves both RF OUTPUT and MOD INPUT connectors RF Output from the front panel to the rear panel.

# ACCESSORIES

The following accessories are available for the 6060B:

ACCESSORY NO.	DESCRIPTION
Y6001	Rack Mount Kit. Includes M05-205-600 (5-1/4 inch Rack Mount Ears) and M00-280-610 (24-inch Rack Slides)
Y8001	IEEE-488 Standard Cable, 1 meter
Y8002	IEEE-488 Standard Cable, 2 meters
Y8003	IEEE-488 Standard Cable, 4 meters
Y8021	IEEE-488 Shielded Cable, 1 meter
Y8022	IEEE-488 Shielded Cable, 2 meters
Y8023	IEEE-488 Shielded Cable, 4 meters
Y9111	Coaxial Cable, 50 ohm, 3 feet, BNC (m) both ends
Y9112	Coaxial Cable, 50 ohm, 6 feet, BNC (m) both ends

# SETTING UP THE 6060B

## Safety Instructions

### WARNING

TO AVOID ELECTRIC SHOCK, USE A POWER CORD THAT HAS A THREE-PRONG PLUG. IF YOU DO NOT USE A PROPER POWER CORD, THE 6060B CASE CAN DEVELOP AN ELECTRICAL POTENTIAL ABOVE EARTH GROUND.

### CAUTION

To avoid damage to the 6060B, check that the rear panel line voltage selection card and fuse are correct for the line voltage in your area. The correct line voltage and fuse combinations are:

LINE VOLTAGE	FUSE
100/120V $\pm$ 10%, 47 - 63 Hz	1.5 AMP SLO-BLO
220/240V $\pm$ 10%, 47 - 63 Hz	.75 AMP SLO-BLO



# SETTING UP THE 6060B

## **Connecting to Line Power**

Before you connect the 6060B to line power, be sure the 6060B POWER switch is in the OFF position. Then use three-prong power cord shipped with the 6060B to connect it to line power.

## **Bench Top Operation**

If the 6060B is stacked with other instruments, we recommend you place it on the bottom of the stack. The case is designed to support a reasonable amount of weight. Allow at least 3 inches of clearance behind and on each side of the 6060B to ensure proper air circulation.

# SETTING UP THE 6060B

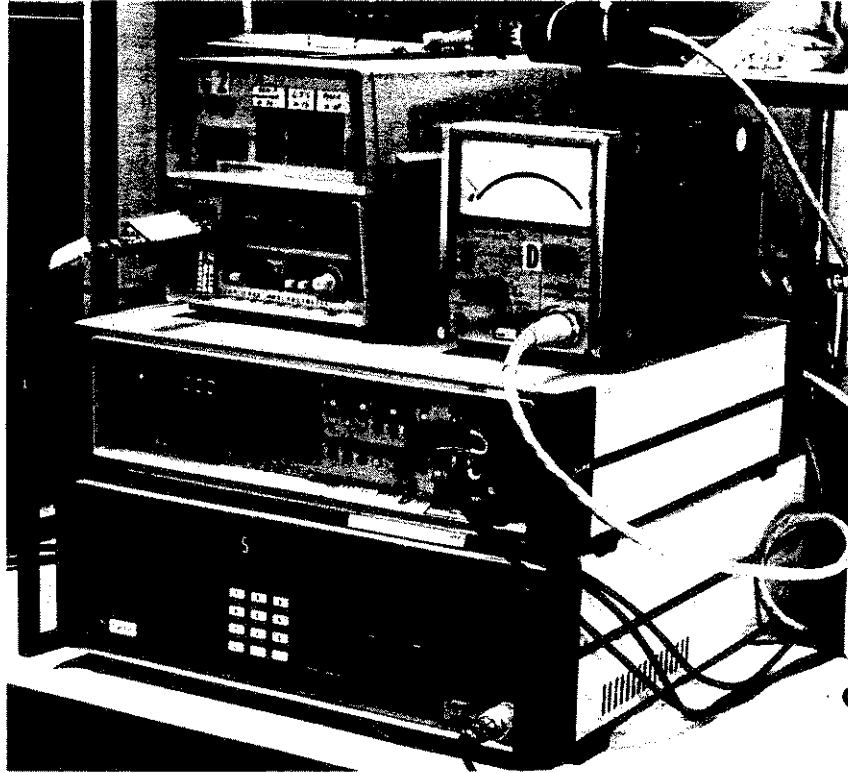

# SETTING UP THE 6060B

## Rack Mounting the 6060B

If you install your 6060B in a rack, do not cover the ventilation openings on the instrument. Fan clearance requirements are the same as for bench top operation. Instructions on how to install the 6060B in a rack are included with the Y6001 Rack Mount Kit.

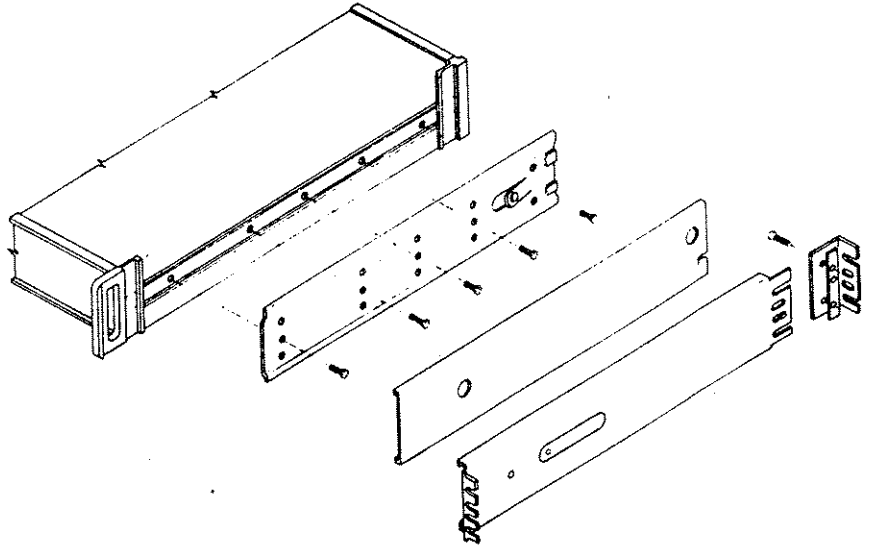

# SETTING UP THE 6060B

## Turning On the 6060B

To turn the 6060B on, press the green POWER switch on the right side of the front panel. When the 6060B is first turned on, all display segments light up for about 5 seconds while the instrument performs an internal self test. If a problem is found during the self test, it is noted with a numeric code in the display at the end of the test.

After the self test is completed, the instrument returns to the front panel state it was in when last turned off.

# FRONT PANEL

MODULATION  
ON/OFF

FUNCTION

DATA

UNITS

EDIT

STATUS

STATUS DISPLAY FIELD

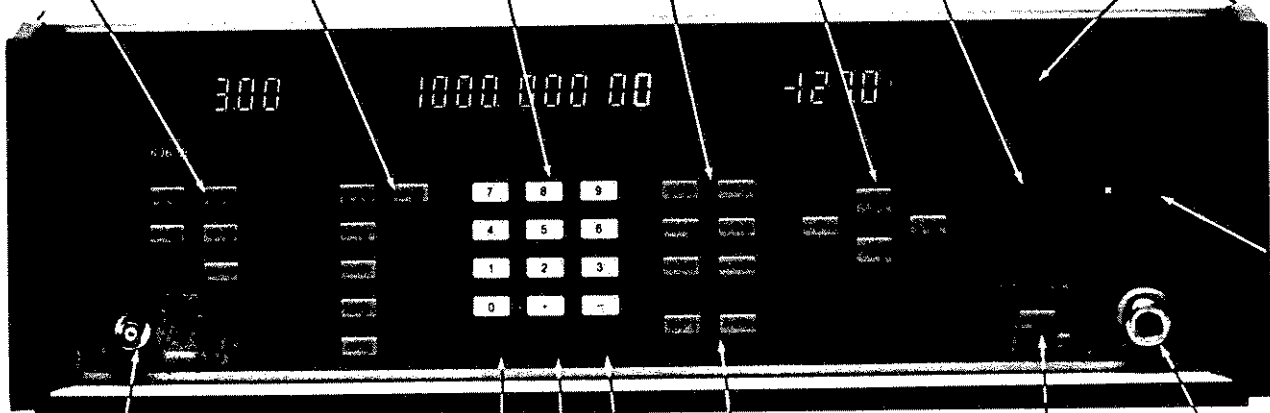

POWER

MOD INPUT

STO RCL SEQ

STEP

RF OUTPUT  
ON/OFF

RF OUTPUT Connector

# REAR PANEL

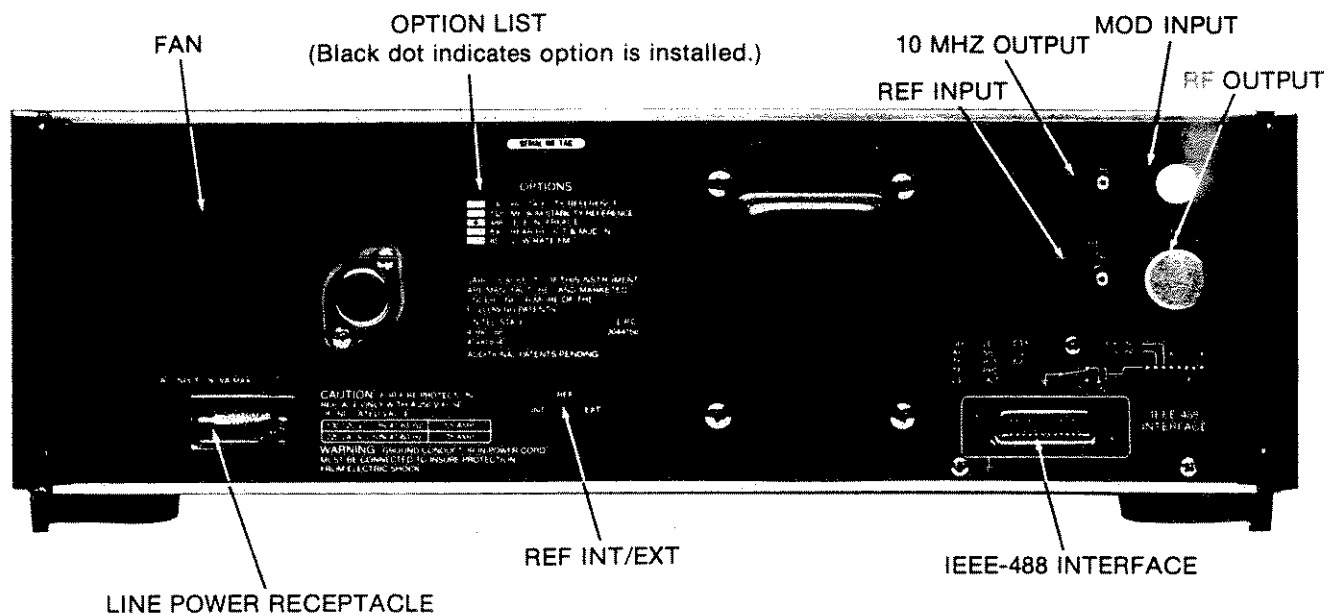

# EXAMPLES OF LOCAL OPERATION

The 6060B is operated from the the front panel using a FUNCTION - DATA -UNITS entry sequence. Select a parameter from the FUNCTION group, set the value with the DATA keys, and select the units with a key from the UNITS group. Here are some examples of how to enter frequency, amplitude, and modulation:

## Example 1

To set the 6060B to 45 MHz, +13 dBm, and FM deviation of 7 kHz, press:

FREQ 4 5 MHz/V

Then Press: AMPL 1 3 dBm

Then Press: FM 7 kHz/mV

### NOTE

*If your 6060B does not accept an entry, press the [STATUS] key while the 'REJ ENTRY' annunciator is lit and a numeric Reject Entry Code will be displayed. A complete list of the Reject Entry Codes is presented at the back of this manual.*

# EXAMPLES OF LOCAL OPERATION

## Example 2

To set the 6060B to 150,320 kHz, 25-kHz frequency step size, and amplitude of 0.1  $\mu$ V, press:

FREQ 1 5 0 3 2 0 kHz/mV

Then Press: FREQ STEP 2 5 kHz/mV

Then Press: AMPL . 1 Hz/ $\mu$ V

MODULATION	FREQUENCY	AMPLITUDE
	150 320 00	.100
	STEP	



# EXAMPLES OF LOCAL OPERATION

## Example 3

To have the 6060B display the results of the last self test, press:

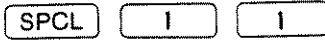

The display fields show all zeros if there are no errors.

# EXAMPLES OF LOCAL OPERATION

## Example 4

To frequency modulate the carrier, you have to set the FM deviation and the internal modulation rate (400 Hz or 1000 Hz) and then select the modulation source (internal and/or external). Here is how to select 3.5 kHz of FM deviation at the 400 Hz rate and internally modulate the carrier frequency:

FM 3 . 5 kHz/mV INT FM 400/1000

### NOTE

*The [400/1000] Hz key is a toggle type. Check the MODULATION display field to be sure the 400 Hz annunciator is lit. If it is not lit, press the [400/1000] Hz key again. The 400 Hz and 1000 Hz annunciators are lit only when INT FM or INT AM is selected.*

# EXAMPLES OF LOCAL OPERATION

## Example 5

You can use the bright digit in the display to change frequency, amplitude, or modulation indices. Here is how:

First select the display field with a FUNCTION key. Position the bright digit in the display using the ← and → EDIT keys. Change the value of the parameter by pressing the ↑ or ↓ EDIT keys.

FREQ -- [←] / [→] EDIT key -- [↑] / [↓] EDIT key

AMPL -- [←] / [→] EDIT key -- [↑] / [↓] EDIT key

FM -- [←] / [→] EDIT key -- [↑] / [↓] EDIT key

AM -- [←] / [→] EDIT key -- [↑] / [↓] EDIT key

# EXAMPLES OF LOCAL OPERATION

## Example 5a

To edit the displayed amplitude of 9.7 dBm to 10.0 dBm, press:

EDIT key or

To increase the value of the .1 dBm digit, press:

EDIT key three times

## Example 5b

To edit the displayed FM Deviation from 5.0 kHz to 3.0 kHz, press:

EDIT key or  EDIT key

To reduce or increase the value of the 1-kHz digit, press,

EDIT key two times

# IEEE-488 PROGRAMMING INSTRUCTIONS

## Introduction

The IEEE-488 Interface option makes the 6060B a fully programmable system instrument, capable of remote operation over the IEEE Standard 488-1978 interface bus. All instrument functions (with the exception of the front panel POWER switch and the rear panel REF INT/EXT switch) can be programmed via the IEEE-488 bus.

The following pages introduce you to programming the 6060B. For more detailed programming instructions, read the paragraphs under Remote Operation in Section 2 of the 6060B Instruction Manual.

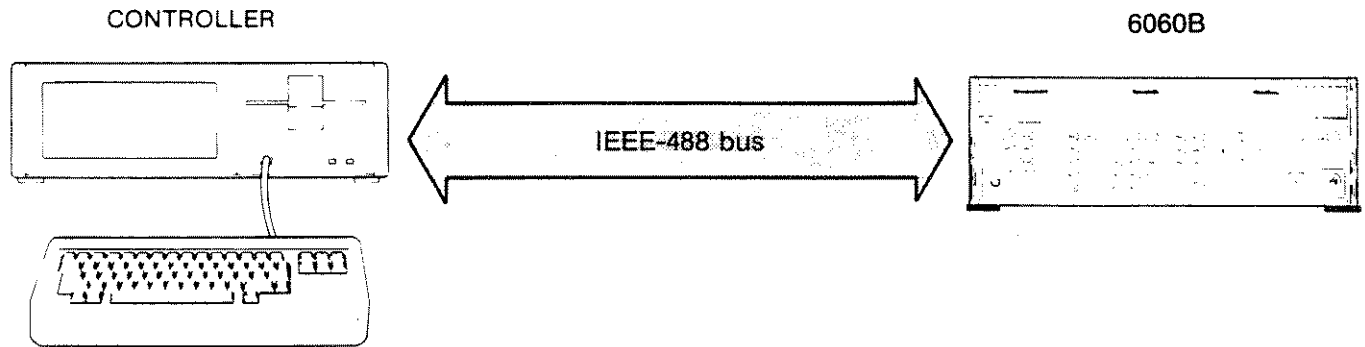

# OPERATION

## Setting Up the 6060B for Remote Operation

To set up the 6060B on the IEEE-488 interface bus:

1. Connect a standard IEEE-488 interface cable between the 6060B and the instrument controller with a Fluke Y8001 Interface Cable or a Y8021 Shielded Cable.
2. Using the address and mode switches on the rear panel, select the instrument IEEE-488 address and mode (Talk/Listen, Talk-Only, or Listen-Only).
3. To verify the address and mode, press:

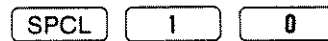

The selected address and mode appears in the FREQUENCY display. This selected address will be a decimal number from 0 to 30. The mode will be indicated by  $\overline{L}0$  or  $\overline{L}1$  for the Talk-Only or Listen-Only. The display will be blank, otherwise.

To return the 6060B to local control, press the [CLR/LCL] key on the front panel.

# OPERATION

## Remote Programming

The IEEE-488 interface commands use syntax similar to front panel operation. The most often used commands are listed below. A complete list of commands is given in Section 2 of the 6060B Instruction Manual.

**IEEE-488 INTERFACE COMMAND SET**

<b>FUNCTION</b>	<b>COMMAND</b>	<b>DATA</b>	<b>UNITS</b>
Frequency	FR	(Floating Point)	HZ, KZ, MZ, GZ*
Amplitude	AP	"	V, MV, UV, DB
Modulation			
AM	AM	"	PC
INT	AI	0 or 1	---
EXT	AE	"	---
FM	FM	(Floating Point)	HZ, KZ, MZ, GZ*
INT	FI	0 or 1	---
EXT	FE	0 or 1	---
400/1000	MR	0 or 1	---
Clear Instruction	CL	---	---
RF On/Off	RO	0 or 1	---

\*You can program the 6060B to tenths of GHz.

# OPERATION

## Typical Command String

Here is a typical command string as it might be sent from a Fluke 1722A Instrument Controller. (The 6060B bus address is set to 2.)

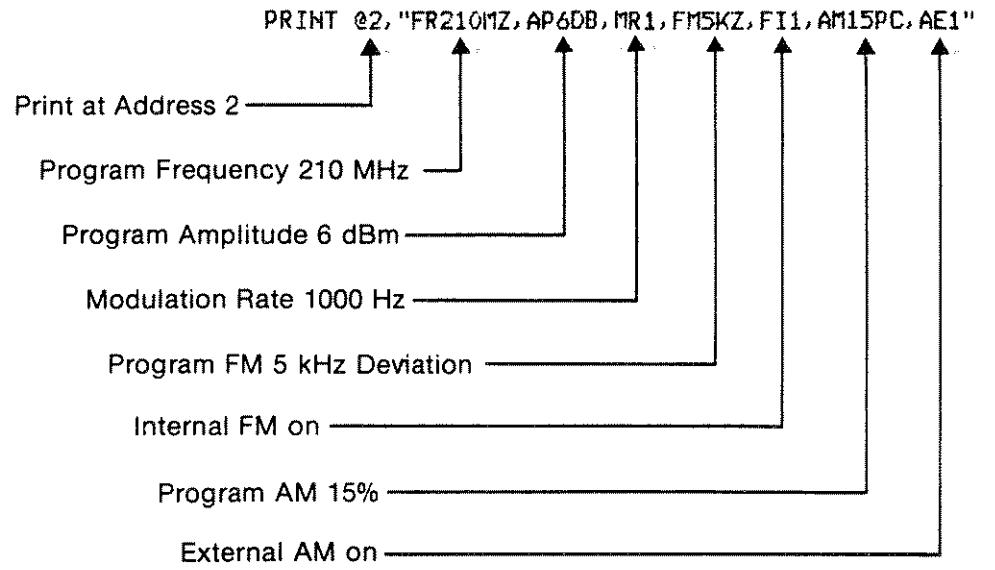



# OPERATION

## Programming Example

Here is a simple program using Fluke Basic on the Fluke 1722A Instrument Controller:

```
1  ! FLUKE 1722A BASIC PROGRAM TO CONTROL A 6060B
2  ! THE ADDRESS OF THE 6060B IS 2.
10 ! CLEAR THE 6060B SO THAT IT IS IN A KNOWN STATE.
15 INIT PORT 0
20 REMOTE @2 \ CLEAR @2
100 ! SET THE 6060B.
110 PRINT @2, "FR210MZ, AP60B, MR1, FMSKZ, FI1, AM15PC, AE1"
999 END
```

## Other Controllers

Every controller handles IEEE-488 commands somewhat differently. If you are using a controller other than the 1722A, refer to your controller's programming manual for details.

# OPERATION

## Talk-Only and Listen-Only Operation

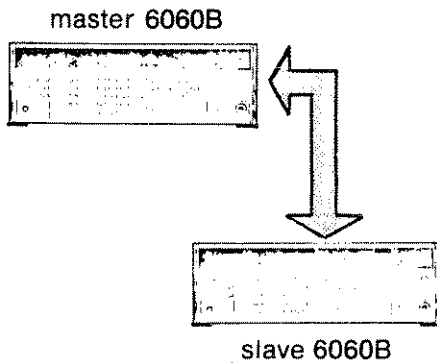

The Talk-Only and Listen-Only feature lets you use two or more 6060Bs in a master-slave configuration. By using the Talk-Only feature, you can use the master 6060B to give instructions to the slave 6060B. With the Listen-Only feature, the slave 6060B tracks the output of the master 6060B. Here is how to set up and operate the master-slave configuration:

1. Turn the POWER switches off on the master and slave 6060Bs.
2. Connect an IEEE-488 interface cable from the master 6060B to the slave 6060B.
3. Set the master 6060B rear panel TALK ONLY switch to 1.
4. Set the slave 6060B rear panel LISTEN ONLY switch to 1.
5. Turn on the 6060Bs.
6. Set the step capability of the master 6060B to the desired values. (Example: 25 kHz frequency step at 150 MHz carrier frequency.)
7. Set the step capability of the slave 6060B to the desired value. (Example: 25 kHz frequency at 175 MHz carrier frequency.)
8. Press the  $\uparrow$  STEP key on the master. The master will increase by 25 kHz and the slave will also increase by 25 kHz.

# REJECT ENTRY CODES

If your 6060B does not accept an entry, press the [STATUS] key while the 'REJ ENTRY' annunciator is lit and a numeric Reject Entry Code will be displayed. A complete list of the Reject Entry Codes follows:

CODE	DESCRIPTION
001 000 000	FM Deviation not between 0 and 99.9 kHz (9.99 kHz with option -651)
002 000 000	FM Deviation Step not between 0 and 99.9 kHz (9.99 kHz with option -651)
004 000 000	AM Depth not between 0 and 99%
010 000 000	AM Depth Step not between 0 and 99%
020 000 000	IEEE-488 command syntax error
040 000 000	IEEE-488 input value out of range
100 000 000	Special function requires IEEE option
200 000 000	IEEE edit or step operation beyond allowed range
000 001 000	Frequency not between 0.01 and 1050 MHz

# REJECT ENTRY CODES

000 004 000	Frequency Step not between 0 and 1050 MHz
000 040 000	Invalid memory location
000 100 000	Invalid data in memory
000 200 000	Special function not allowed
000 000 001	Output amplitude not between 10 nV and 2V
000 000 002	Insufficient resolution for units conversion
000 000 004	Units conversion to volts not allowed with reference in volts
000 000 010	Units conversion to dB not allowed with reference in volts
000 000 020	Amplitude Step not between 0 and 166 dB or 0 and 1999V
000 000 040	Units conversion on Amplitude Step not allowed
000 000 100	Amplitude step and current amplitude display not in same units



