

5500A

Multi-Product Calibrator

Operator Reference Guide

FLUKE

5500A

Multi-Product Calibrator

Operator Reference Guide

PN 945097

December, 1994

© 1994 Fluke Corporation, Inc.

All rights reserved. Printed in U.S.A.

FLUKE®

Table of Contents

Replacing the Fuse	4
Selecting Line Voltage	5
Front Panel Features	5
Rear Panel Features	10
Setup Menu	12
Instrument Setup Menu	12
Selecting an External Amplifier	12
Utility Functions Menu	13
Format EEPROM Menu	13
Zeroing the Calibrator	15
Operate and Standby	16
Connecting the Calibrator to a UUT	16
When to Use EARTH	16
Four-Wire versus Two-Wire Connections	16
Cable Connections	17
Setting the Output	20
Setting DC Voltage Output	20
Setting AC Voltage Output	21
Setting DC Current Output	23
Setting AC Current Output	24
Setting DC Power Output	25
Setting AC Power Output	27
Setting a Dual DC Voltage Output	29
Setting a Dual AC Voltage Output	30
Setting Resistance Output	33
Setting Capacitance Output	34
Setting Temperature Simulation (Thermocouple)	35
Setting Temperature Simulation (RTD)	37
Measuring Thermocouple Temperatures	38

Waveform Types	41
Sinewave	41
Triangewave	41
Squarewave	42
Truncated Sinewave	42
Setting Harmonics	43
Adjusting the Phase	44
Entering a Phase Angle	45
Entering a Power Factor	45
Entering a DC Offset	46
Using the 5725A Amplifier	47
5725A Amplifier Output	48
Editing and Error Output Settings	49
Editing the Output Setting	49
Displaying the Output Error	50
Using Multiply and Divide	50
Setting Output Limits	50
Setting Voltage and Current Limits	50

Safety Symbols



WARNING Risk of electric shock. Refer to the manual (see the Index for references).



GROUND Ground terminal to chassis (earth).



Attention Refer to the manual (see the Index for references). This symbol indicates that information about usage of a feature is contained in the manual. This symbol appears on the rear panel ground terminal and by the fuse compartment.

AC Power Source

The instrument is intended to operate from an ac power source that will not apply more than 264V ac rms between the supply conductors or between either supply conductor and ground.

Use the Proper Fuse

For fuse replacement use: 110 or 120 V operation, 2.5 ampere/250 volt time delay; 220 or 240 V operation, 1.25 ampere/250 volt time delay.

Grounding the instrument

The enclosure must be grounded through the grounding conductor of the power cord, or through the rear panel ground binding post.

Use the Proper Power Cord

Use only the power cord and connector appropriate for the voltage and plug configuration in your country. Use only a power cord that is in good condition. Refer power cord and connector changes to qualified service personnel.

 CAUTION

Verify applied voltage to the UUT does not exceed the UUT insulation rating.

Replacing the Fuse

Disconnect line power. Follow the figure below for fuse replacement.

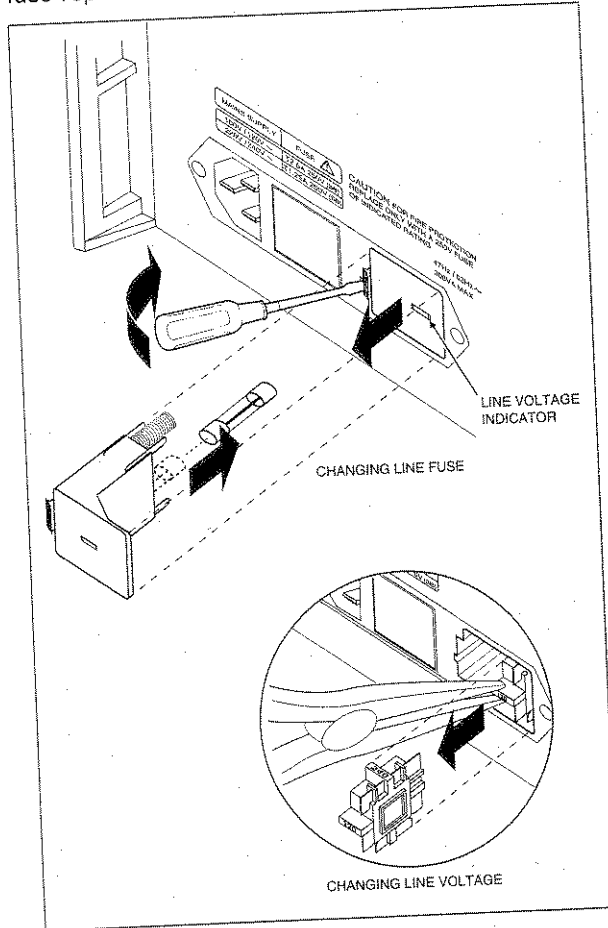

Selecting Line Voltage

There are four line voltage settings: 100V, 120V, 200V, and 240V (47 to 63 Hz). To check the setting, note the voltage setting visible through the window in the power line fuse compartment cover. To change the line voltage setting, follow the figure above for Changing Line Voltage.

Front Panel Features

Front panel features include all controls, displays, indicators, and terminals.

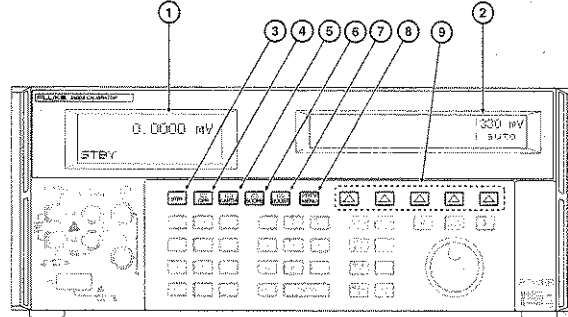

① Output Display

Two-line backlit LCD showing output amplitudes, frequency and calibrator status.

② Control Display

Multipurpose backlit LCD used for displaying data entries, UUT error adjustments, softkey labels, phase angles, watts, power factors, and other prompts and messages.

3

STBY

Places the 5500A in the standby mode. The NORMAL and AUX output terminals are internally disconnected from the 5500A.

4

OPR

Places the 5500A in the operate mode and lights the indicator on the key.

5

EARTH

Opens/closes a connection between the NORMAL LO terminal and earth ground, and lights the indicator on the key.

6

SCOPE

Enables or disables the ScopeCal option if it is present. An annunciator on the key indicates when the option is enabled.

7

BOOST

Enables or disables output from an amplifier. An annunciator on the key indicates when the 5725A is being used.

8

PREV
MENU

Recalls the previous set of menu choices. Each press of this key backs up one level of the menu tree.

9

Softkeys

Softkeys are identified by labels on the Control Display directly above each key.

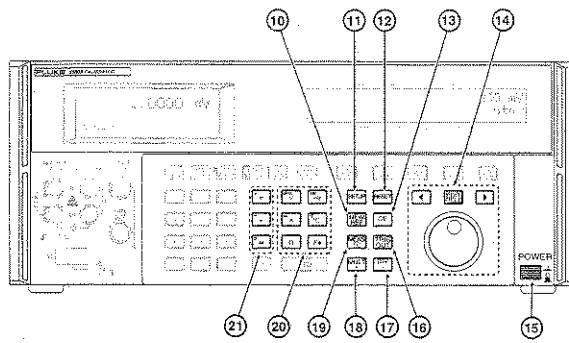

10 NEW REF

Active during error mode operation, and establishes the present output value as a new reference for meter error computation.

11 SETUP

Displays the setup menu in the control display. Setup options can be selected using the softkeys.

12 RESET

Aborts the current operating state of the 5500A and returns it to the power-up default state, except during remote control.

13 CE

Clears a partially completed keypad entry from the Control Display.

14   

Provide step adjustment of the output magnitude by selecting digits, provides means of adjustment and selection.

15 Turns the power on and off. The switch is a latching push-push type.

16 

Sets the external trigger when in the Scope mode.

17 

Changes the output to one tenth the reference value (not necessarily the present output value).

18 



Changes the output to ten times the reference value (not necessarily the present output value).

19 

Enables the TC (Thermocouple) input connection and causes the 5500A to compute a temperature based on the input.

20 **Output Units Keys**

Determine the function of the 5500A. Some keys have a second unit if the SHIFT key is pressed just before the units key.

21    **Multiplier Keys**

Select output value multipliers. Some keys have a second function using SHIFT.

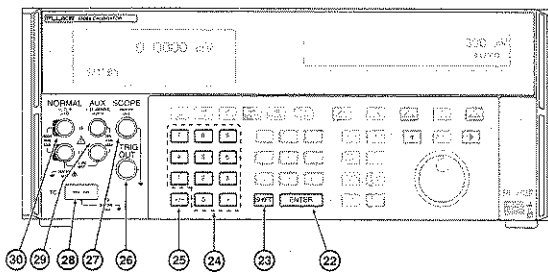

22 **ENTER**

Loads a newly entered output value shown on the Control Display into the 5500A, which appears on the Output Display.

23 **SHIFT**

Selects alternate functions of the units keys and alternate multipliers of the multiplier keys.

24 **Numeric Keypad**

Used to enter the digits of the output amplitude and frequency

25 **+/-**

Changes the polarity of the output for dc voltage or dc current functions.

26 Used to trigger the oscilloscope during oscilloscope calibration.

27 Used for outputs during oscilloscope calibration.

28 Used for thermocouple simulation during temperature meter calibration, and thermocouple measurements.

- ②⑨ **AUX** Used for ac and dc current outputs, the second voltage output in dual voltage modes, and ohms sense for 2-wire and 4-wire compensated resistance and capacitance measurements, and RTD simulation.
- ③⑩ **NORMAL** Used for ac and dc voltage, ohms and capacitance sourcing, and Resistance Temperature Detector (RTD) simulation.

Rear Panel Features

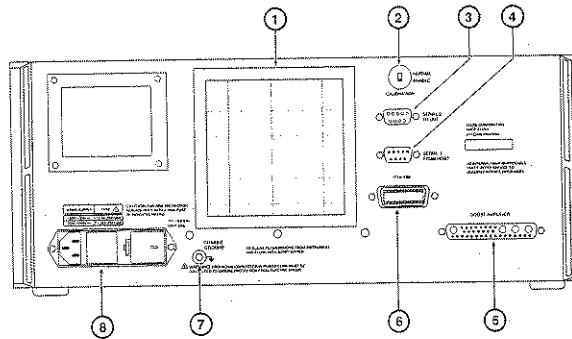

- ① **Fan Filter** Covers the air intake to keep dust and debris out of the chassis air baffles.
- ② **CALIBRATION SWITCH** Used to write enable/disable nonvolatile memory that stores calibration constants.
- ③ **SERIAL 2 TO UUT** Connector used for transmitting/receiving serial data between the 5500A and a Unit Under Test (UUT).
- ④ **SERIAL 1 FROM HOST** Connector used for remote control of the 5500A with a host, printer, or terminal.

⑤ **BOOST AMPLIFIER** Connector provides the analog and digital interface for the Fluke 5725A Amplifier.

⑥ **IEEE-488** Connector is a standard parallel interface for operating the 5500A in remote control on the IEEE-488 bus.

⑦



WARNING

To avoid shock hazard, connect the factory supplied three-conductor line power cord to a properly grounded power outlet. Do not use a two-conductor adapter or extension cord; this will break the protective ground connection.

Use the rear-panel ground terminal for a protective grounding wire if there is any question as to instrument earth grounding.

CHASSIS GROUND Binding post is internally grounded to the chassis.

⑧ **AC Power Input Module** Provides a grounded three-prong connector that accepts the line power cord, a switch mechanism to select the operating line voltage, and a line power fuse.

Setup Menu

Press **SETUP** for the SETUP menu.

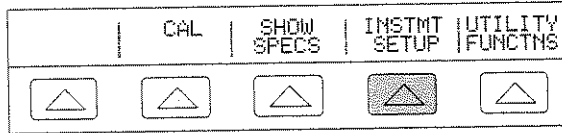

Instrument Setup Menu

Press the INSTMT SETUP softkey in the Setup to open the Instrument Setup Menu.

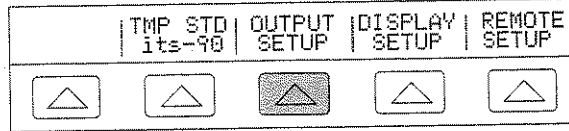

its-90
ipts-68

Selecting an External Amplifier

Press OUTPUT SETUP softkey in Instrument Setup Menu to open menu for SOURCE PREFERENCE softkey.



5500
5725

Utility Functions Menu

Press the UTILITY FUNCTNS softkey in the Instrument setup Menu to open the utility menus.

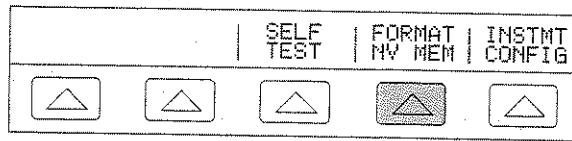

Format EEPROM Menu



Use with extreme care. The format nonvolatile memory menu softkeys permanently erase calibration constants. Pressing ALL or CAL invalidates the state of calibration of the 5500A.

Pressing FORMAT NV MEM in the utility functions menu opens the following:



The softkeys in this menu require the rear panel CALIBRATION switch to be in the ENABLE position, except for SETUP.

- **ALL** Replaces the entire contents of the EEPROM with factory defaults.
- **CAL** Replaces all calibration constants with factory defaults.
- **SETUP** Replaces the setup parameters with factory defaults (see Defaults table).

Factory Defaults for SETUP

Features	
Temperature Standard	its-90
Host Connection	gpiB (IEEE-488)
GPIB Port Address	4
Serial Ports	8 bits, 1 stop bit, xon/xoff, parity none, 9600 baud, wait 30 sec.
EOL (end of line)	CRLF
EOF (end of file)	012,000
Remote I/F	term
Display Contrast*	level 7,7
Display Brightness*	level 1,0
RTD Power Up Default Type	pt385
Thermocouple Power Up Default Type	K
Source Preference	5500
Current Limits	±11 A
Voltage Limits	±1000 V
Remote commands	
SRQSTR	SRQ: %02x %02x %04x %04x
*PUD string	cleared
* Output Display and Control Display, respectively. There are 8 levels: 0,1,2,3,4,5,6,7.	

Zeroing the Calibrator

To meet the specifications, zeroing is required every 7 days, or when the 5500A Calibrator ambient temperature changes by more than 5 °C. Choose from complete instrument zeroing (ZERO) or ohms-only zeroing (OHMS ZERO).

1. Turn on Calibrator and warmup (30 minutes).
2. Press **RESET** key.
3. Install copper short circuit in TC connector (complete instrument zeroing only).
4. Press **SETUP** key, opening setup menu.



5. Press CAL softkey in setup menu.



6. Press CAL softkey in calibration menu.

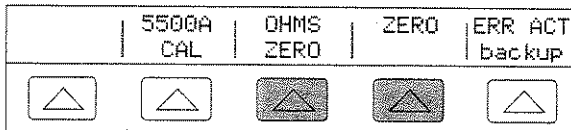

7. Press ZERO softkey for complete instrument zeroing or OHMS ZERO for ohms-only zeroing. After zeroing routine is complete (several minutes), press **RESET**.

Operate and Standby

To enable the operate mode, press **OPR**. To place the calibrator in standby, press **STBY**.

The calibrator goes into the standby if:

- The **RESET** key is pressed.
- A voltage $\geq 33V$ is selected when the previous output voltage was less than 33V.
- Function changed.
- Output location is changed.
- Overload condition is detected.

Connecting the Calibrator to a UUT

WARNING

The 5500A Calibrator is capable of supplying lethal voltages. Do not make connections to the output terminals when a voltage is present. Placing the instrument in standby may not be enough to avoid shock hazard, since the **OPR** key could be pressed accidentally. Press reset and verify that the **STBY** annunciator is lit before making connections to the output terminals.

When to Use EARTH

The **EARTH** key makes a connection between the NORMAL LO terminal and earth ground. When the common ground is not at the UUT, use **EARTH** to make a common ground at the calibrator.

Four-Wire versus Two-Wire Connections

The external sensing capability of the four- and two-wire compensated connections provides increased precision for resistance values below 110 k Ω and capacitance values 110 nf and above.

Cable Connections

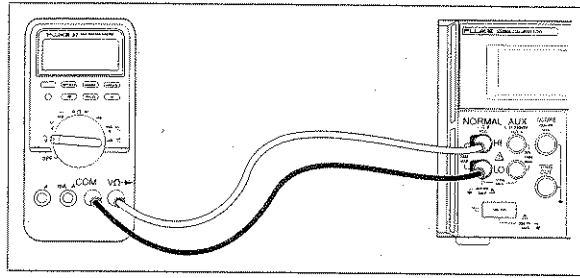

UUT Connection: DC Voltage/AC Voltage

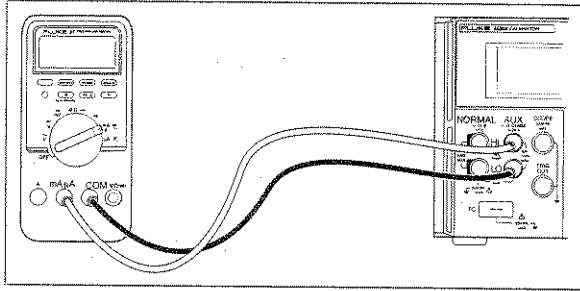

UUT Connection: DC Current/AC Current

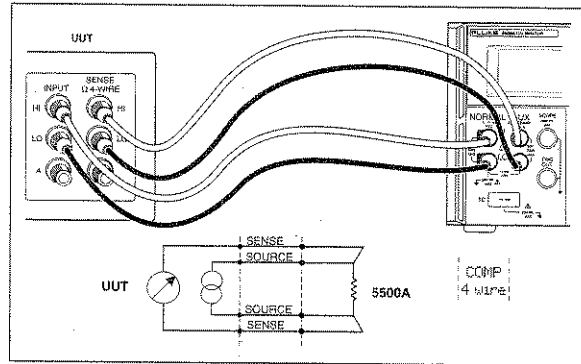

UUT Connection: Resistance (4-Wire Comp)

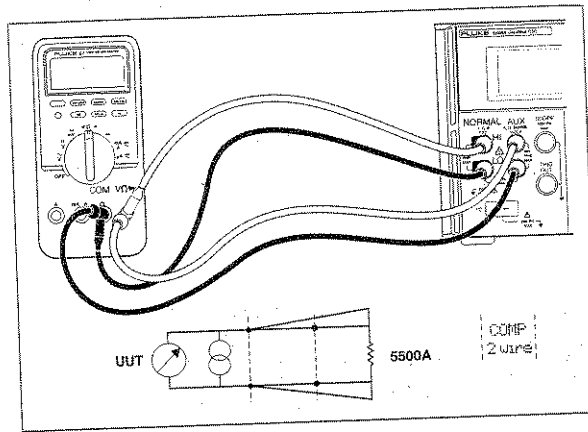

UUT Connection: Resistance (2-Wire Comp)

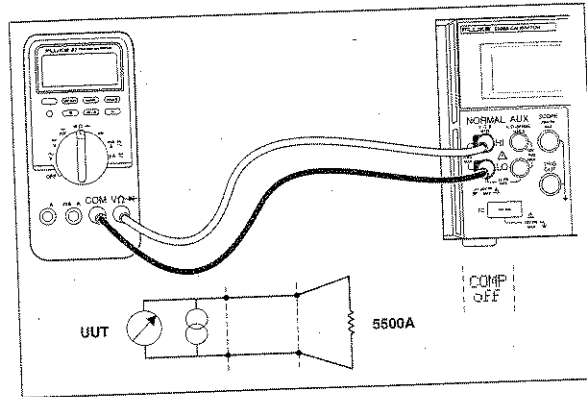

UUT Connection: Resistance (Comp Off)

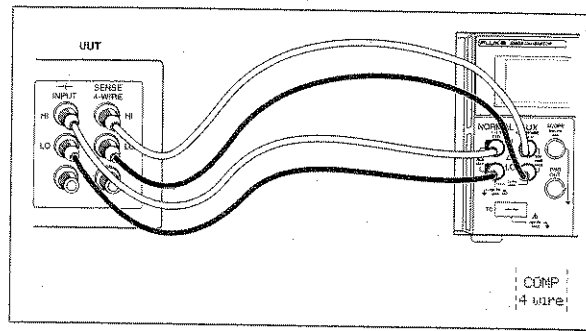

UUT Connection: Capacitance (4-Wire Comp)

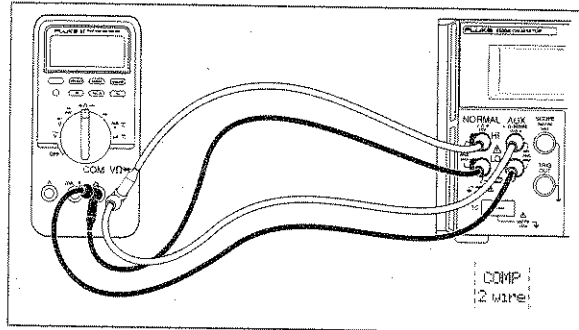

UUT Connection: Capacitance (2-Wire Comp)

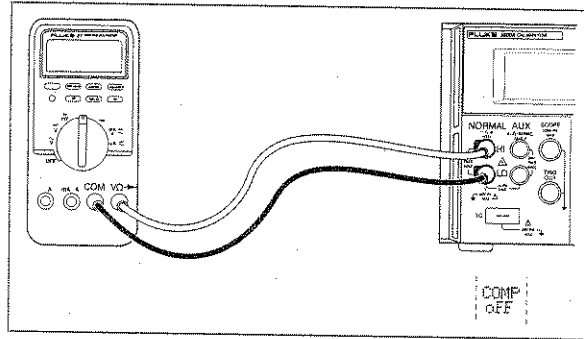

UUT Connection: Capacitance (Comp Off)

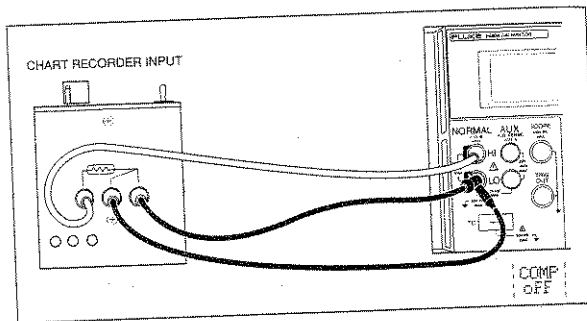

UUT Connection: Temperature (RTD)

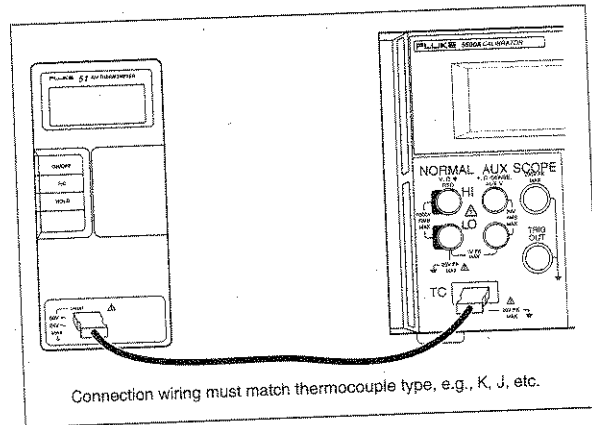

UUT Connection: Temperature (Thermocouple)

Setting the Output

Setting DC Voltage Output

Sets dc voltage output at 5500A NORMAL terminals.

1. Press **RESET** to clear 5500A output.
2. Connect UUT.
3. Set UUT to measure dc voltage.
4. Enter desired voltage output (7 digits).
5. Press **+/-** to select polarity.

6. Press a multiplier key, if necessary.
7. Press **V**.
8. Control Display shows entered value. For example, 123.4567 mV.

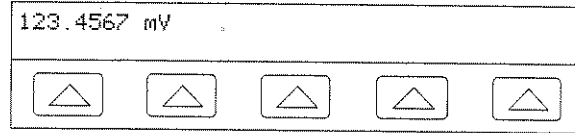

9. Press **ENTER**. Output appears in Output Display.

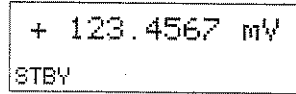

10. Press **OPR** to activate calibrator output.

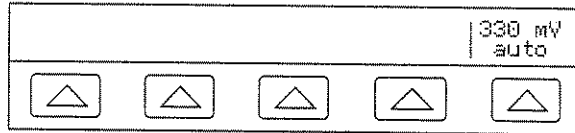

auto
locked

Range (Operating Range) Selects autorange (auto) or lock (locked) present range.

Setting AC Voltage Output

Sets ac voltage output in volts or as a power output in dBm (referenced to a 600 Ω load) at 5500A NORMAL terminals.

1. Press **RESET** to clear 5500A output.
2. Connect UUT.
3. Set UUT to measure ac voltage.
4. Enter desired voltage output (6 digits).
5. Press a multiplier key, if necessary.

6. Press $\overline{\text{V}}$ (volts) or $\overline{\text{SHIFT}} \overline{\text{V}}$ (dBm).
7. Control Display shows entered value. For example, 2.44949 V.

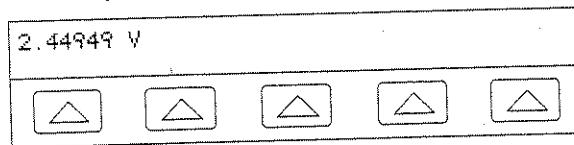

8. Enter desired frequency output (5 digits).
9. Press a multiplier key, if necessary.
10. Press $\overline{\text{Hz}}$ key.
11. Control Display shows entered value. For example, 1.1234 kHz (below).

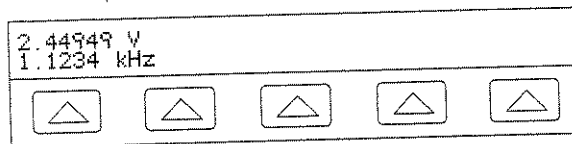

12. Press $\overline{\text{ENTER}}$ for output in Output Display.

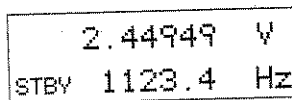

13. Press $\overline{\text{OPR}}$ to activate calibrator output.

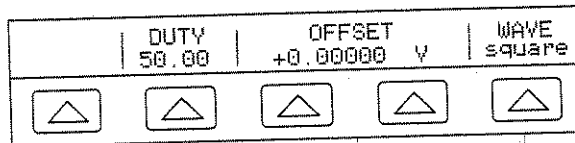

1.00 to 99.00% See specifications. sine tri square truncs

DUTY (Duty Cycle) Set squarewave duty cycle (1.00 to 99.00%).

OFFSET (Voltage Offset) Add positive or negative dc offset voltage.

WAVE (Waveform) Select type of waveform.

Setting DC Current Output

Sets dc current output at 5500A AUX terminals (or 5725A BOOST terminals).

1. Press **RESET** to clear 5500A output.
2. Connect UUT.
3. Set UUT to measure dc current.
4. Enter desired current output (6 digits).
5. Press **+/-** to select polarity.
6. Press a multiplier key, if necessary.
7. Press **A**.
8. Control Display shows entered value. For example, 234.567 mA.

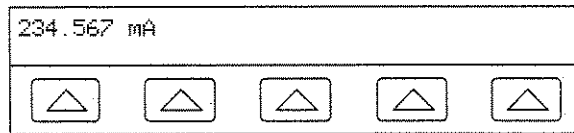

9. Press **ENTER** for output in Output Display.

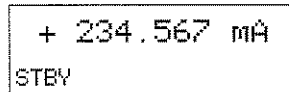

10. Press **OPR** to activate calibrator output.

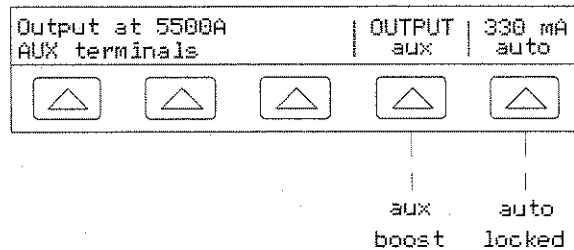

OUTPUT (Output Location) Selects 5500A (aux) or 5725A (boost). If 5725A not connected, OUTPUT softkey does not appear.

Range (Operating Range) Selects autorange (auto) or lock (locked) present range.

Setting AC Current Output

Sets ac current output at 5500A AUX terminals (or 5725A BOOST terminals).

1. Press **RESET** to clear 5500A output.
2. Connect UUT.
3. Set UUT to measure ac current.
4. Enter desired current output (6 digits).
5. Press a multiplier key, if necessary.
6. Press **A**.
7. Enter desired frequency (5 digits).
8. Press a multiplier key, if necessary.
9. Press **Hz**.
10. Control Display shows entered value. For example, 123.456 mA and 1.1234 kHz.

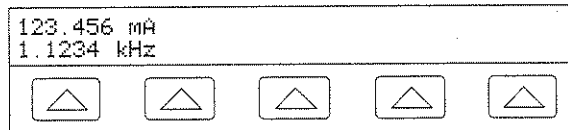

11. Press **ENTER** for output in Output Display.

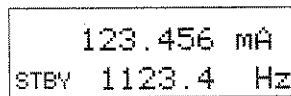

12. Press **OPR** to activate calibrator output.

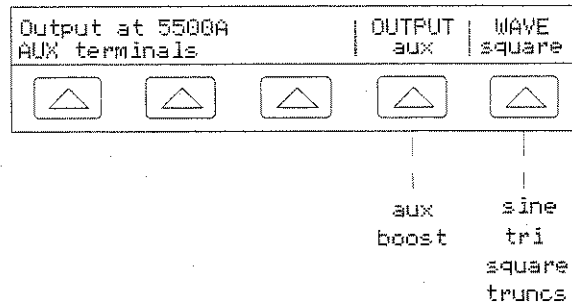

OUTPUT (Output Location) Selects 5500A (aux) or 5725A (boost). If 5725A not connected, OUTPUT softkey does not appear.

WAVE (Waveform) Selects one of four different types of waveforms.

Setting DC Power Output

NOTE

Tie the terminals NORMAL LO and AUX LO together at the UUT or at the 5500A, via the "LO"s softkey selection "tied."

Sets dc voltage at 5500A NORMAL terminals and dc current on AUX terminals (or 5725A boost terminals).

1. Press **RESET** to clear 5500A output.
2. Connect UUT
3. Set UUT to measure dc power.
4. Enter desired voltage output (7 digits).
5. Press **+/-** to select polarity.
6. Press a multiplier key, if necessary.
7. Press **$\overline{\text{V}}$** .
8. Enter desired current output (6 digits).
9. Press **+/-** to select polarity.

10. Press a multiplier key, if necessary.
11. Press V A .
12. Control Display shows entered value. For example, 123.4567 mV and 234.567 mA.

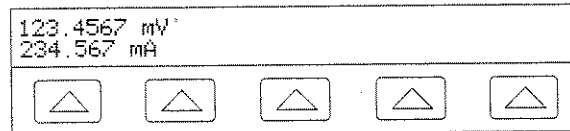

13. Press **ENTER** for output in Output Display.

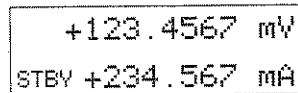

14. Press **OPR** to activate calibrator output.

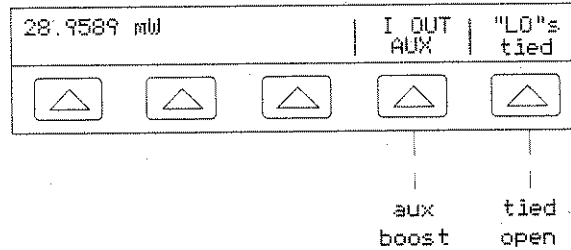

(Hint: Enter voltage or current and then a watts entry value using **SHIFT V A**. The remaining volts or current value is calculated and displayed.)

I OUT (Current Output) Selects 5500A (aux) or 5725A (boost). If 5725A not connected, AUX is in upper case letters.

"LO"s (Low Potential Output Terminals) Ties or opens a connection between front panel NORMAL LO and AUX LO terminals.

Setting AC Power Output

NOTE

Tie the terminals NORMAL LO and AUX LO together at the UUT, or at the 5500A via the "LO"s softkey selection "tied." For optimum phase performance, tie the LO terminals at the UUT. At current levels ≥ 2.2 A, tie the terminals at the UUT using heavy gage wire < 10 m Ω resistance.

Sets ac voltage at 5500A NORMAL terminals and ac current on AUX terminals (or 5725A boost terminals).

1. Press **RESET** to clear 5500A output.
2. Connect UUT.
3. Set UUT to measure ac power.
4. Enter desired voltage output (6 digits).
5. Press a multiplier key, if necessary.
6. Press **mV**.
7. Enter desired current output (6 digits).
8. Press a multiplier key, if necessary.
9. Press **μ A**.
10. Enter desired frequency output (5 digits).
11. Press a multiplier key, if necessary.
12. Press **kHz**.
13. Control Display shows entered value. For example, 123.456 mV, 234.567 mA, and 1.1234 kHz.

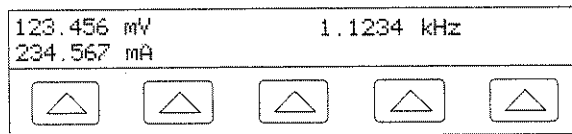

14. Press **ENTER** for output in Output Display.

```

123.456 mV
STBY 234.567 mA
  
```

15. Press **OPR** to activate calibrator output.

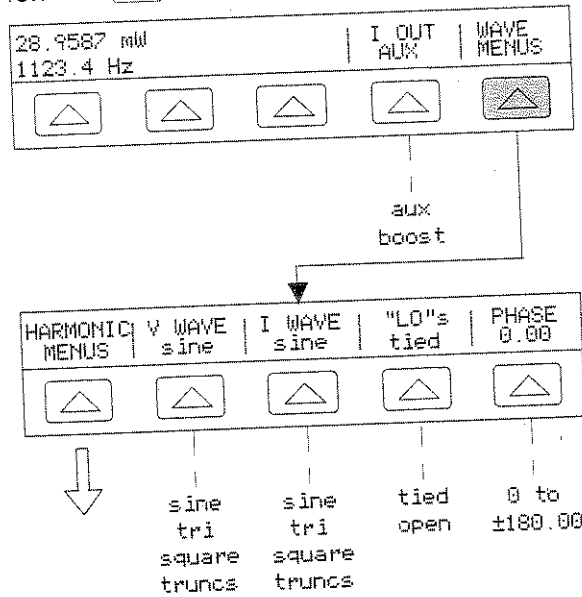

(Hint: Enter voltage or current and then a watts entry value using **SHIFT** **A**. The remaining volts or current value is calculated and displayed.)

I OUT (Current Output) Selects 5500A (aux) or 5725A (boost). If 5725A not connected, AUX is in upper case letters.

WAVE MENU (Waveform Menu) Selects type of harmonic, waveform, front panel LO terminal condition, and phase.

HARMONIC MENU (Harmonic Frequency Menu) Selects harmonic outputs.

V WAVE (Voltage Waveform) Selects voltage waveform.

I WAVE (Current Waveform) Selects current waveform.

"LO"s (Low Potential Output Terminals) Ties or opens a connection between front panel NORMAL LO and AUX LO terminals.

PHASE (Phase Difference) Selects phase difference between NORMAL and AUX outputs.

Setting a Dual DC Voltage Output

NOTE

Tie the terminals NORMAL LO and AUX LO together at the UUT or at the 5500A, via the "LO"s softkey selection "tied."

Sets dual dc voltages at 5500A NORMAL terminals and AUX terminals.

1. Press **RESET** to clear 5500A output.
2. Connect UUT.
3. Set UUT to measure dual dc voltage.
4. Enter desired voltage output at NORMAL terminals (7 digits).
5. Press **+/-** to select polarity.
6. Press a multiplier key, if necessary.
7. Press **dBmV**.

NOTE

Voltage on the AUX output is limited to 3.3V maximum.

8. Enter desired voltage output at AUX terminals (6 digits).
9. Press **+/-** to select polarity.
10. Press a multiplier key, if necessary.
11. Press **dBmV**.

12. Control Display shows entries. For example, 123.4567 mV and 234.567 mV.

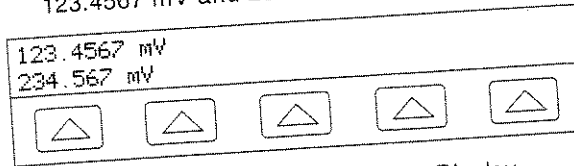

13. Press **ENTER** for output in Output Display.

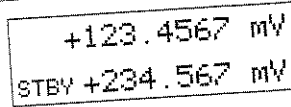

14. Press **OPR** to activate calibrator output.

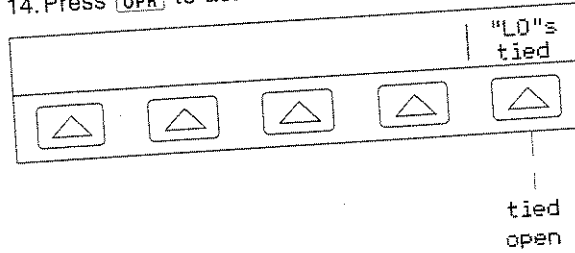

"LO"s (Low Potential Output Terminals) Ties or opens a connection between front panel NORMAL LO and AUX LO terminals.

Setting a Dual AC Voltage Output

NOTE

Tie the terminals NORMAL LO and AUX LO together at the UUT or at the 5500A, via the "LO"s softkey selection "tied."

Sets dual ac voltages at 5500A NORMAL terminals and AUX terminals.

1. Press **RESET** to clear 5500A output.
2. Connect UUT.
3. Set UUT to measure dual ac voltage.

4. Enter desired voltage output at NORMAL terminals (6 digits).
5. Press a multiplier key, if necessary. For example, press μ m.
6. Press \overline{V} .

NOTE

The AUX output is limited to 3.3V rms for sinewaves, 6.6 V peak-to-peak for squarewaves, 9.3 V peak-to-peak for triangle and truncated sinewaves.

7. Enter desired voltage output at AUX terminals (6 digits).
8. Press a multiplier key, if necessary.
9. Press \overline{V} .
10. Enter desired frequency output (5 digits).
11. Press a multiplier key, if necessary.
12. Press \overline{Hz} .
13. Control Display shows entries. For example, 123.456 mV, 234.567 mV at 1.1234 kHz.

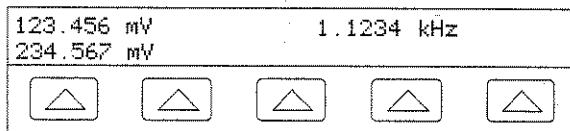

14. Press \overline{ENTER} for output in Output Display.

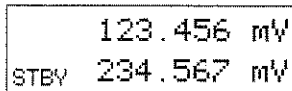

15. Press **OPR** to activate calibrator output.

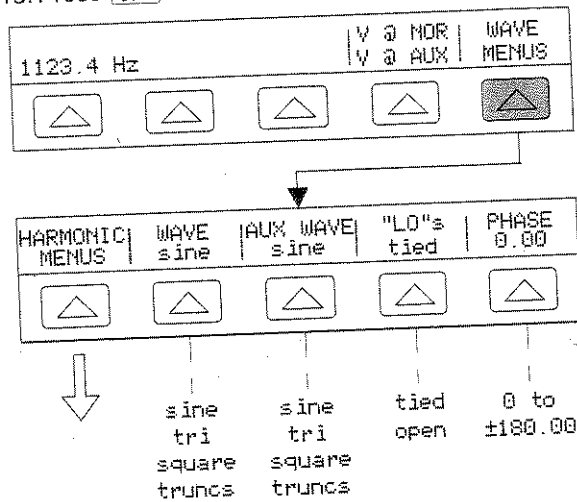

- V @ NOR** (Voltage at NORMAL Terminals) **V @ AUX** (Voltage at AUX Terminals) Not softkeys.
- WAVE MENU** (Waveform Menu) Selects type of harmonic, waveform, front panel LO terminal condition, and phase.
- HARMONIC MENU** (Harmonic Frequency Menu) Selects harmonic outputs.
- WAVE** (Waveform) Selects one of four different waveforms at NORMAL terminals.
- AUX WAVE** (Auxiliary Waveform) Selects one of four different waveforms at AUX terminals.
- "LO"s** (Low Potential Output Terminals) Ties or opens a connection between front panel NORMAL and AUX LO terminals.
- PHASE** (Phase Difference) Selects phase difference between NORMAL and AUX outputs.

Setting Resistance Output

Sets synthesized resistance output at 5500A NORMAL terminals.

1. Press **RESET** to clear 5500A output.
2. Connect UUT.

NOTE

Be sure terminal connections from 5500A to UUT are LO to LO and HI to HI.

3. Set UUT to measure resistance.
4. Enter desired resistance (6 digits).
5. Press a multiplier key, if necessary.
6. Press **Ω**.
7. Control Display shows entered value. For example, 12.3456 kΩ.

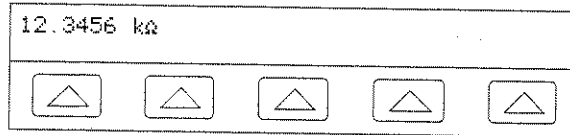

8. Press **ENTER** for output in Output Display.

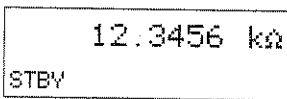

9. Press **OPR** to activate calibrator output.

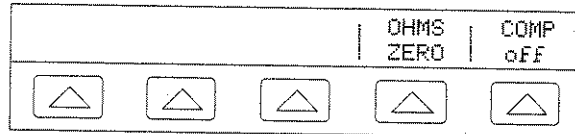

off
2 wire
4 wire

OHMS ZERO Zeros the ohms-only function.

COMP (Compensation) Applies 4-wire, 2-wire or compensation off (<110 kΩ only).

Setting Capacitance Output

Sets synthesized capacitance output at 5500A NORMAL terminals.

1. Press **RESET** to clear 5500A output.
2. Connect UUT.

NOTE

Since this is a synthesized output, be sure the terminal connections from the 5500A to the UUT are LO to LO and HI to HI.

3. Set UUT to measure capacitance.
4. Enter desired capacitance output (5 digits).
5. Press a multiplier key. For example, **SHIFT** then **m** for μf .
6. Press **F \pm** .
7. Control Display shows entered value. For example, 123.45 μf (below).

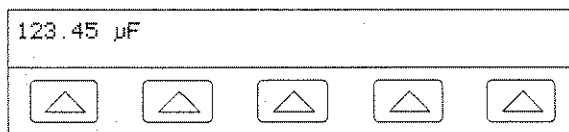

8. Press **ENTER** for output in Output Display.

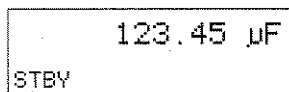

9. Press **OPR** to activate calibrator output.



off
2 wire
4 wire

COMP (Compensation) Applies 4-wire compensation, 2-wire compensation or turns compensation off (≥ 110 nF).

Setting Temperature Simulation (Thermocouple)

NOTE

Make sure the thermocouple wire and plug are not affected by extraneous temperature sources. For example, do not place your fingers on the thermocouple plug or wire when simulating a temperature.

Sets a simulated thermocouple temperature output at 5500A front panel TC connector.

1. Press **RESET** to clear 5500A output.
2. Connect UUT.

NOTE

Use thermocouple wire and miniconnectors that match the type of thermocouple.

3. Set UUT to measure temperature.
4. Enter desired temperature output (6 digits).
5. Press **°C** key or for °F, **SHIFT** **°C** keys.
6. Control Display shows entered value. For example, 123.456 °C.

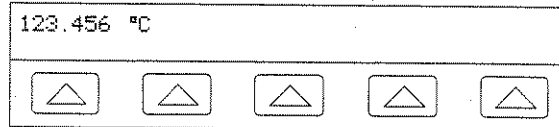

7. Press **ENTER** for output in Output Display.

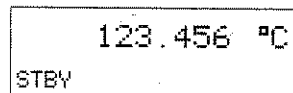

8. Press **OPR** to activate calibrator output.

NOTE

The temperature is cleared to 0 °C (32 °F) if you change between rtd and tc, or change the type of thermocouple (except a B-type thermocouple is 600 °C).

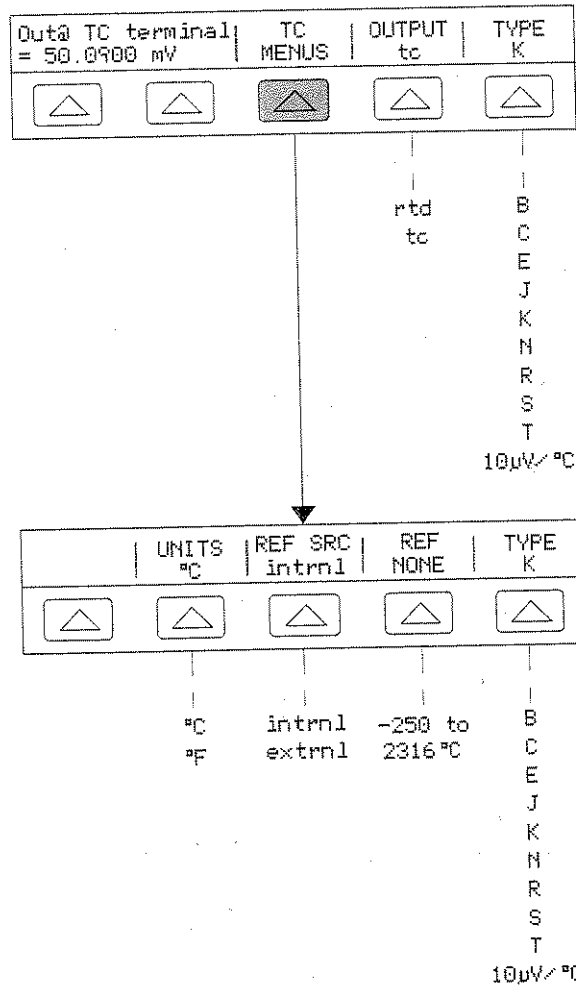

Out@TC terminal (Output at front panel TC terminals) Displays dc voltage at TC terminals.

TC MENUS (Thermocouple Menu) Shows submenus for thermocouple outputs.

UNITS (Temperature Units) Selects °C or °F temperature unit.

REF SRC (Reference Source) Selects intrnl (Internal) or extrnl (External) reference source.

TYPE (Thermocouple Type) Selects emulated thermocouple type.

OUTPUT (Temperature Output Device) Selects temperature device: thermocouple (tc) or resistance temperature detector (rtd).

TYPE (Thermocouple Type) Selects emulated thermocouple type.

Setting Temperature Simulation (RTD)

Sets a simulated RTD temperature output at 5500A NORMAL terminals.

1. Press **RESET** to clear 5500A output.
2. Connect UUT.
3. Set UUT to measure temperature.
4. Enter desired temperature output (6 digits).
5. Press **°C** key or for °F, **SHIFT** **°C** keys.
6. Control Display shows entered value. For example, 123.456 °C.

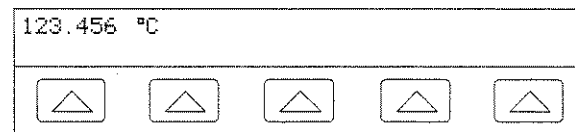



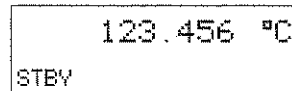

7. Press **ENTER** to output in Output Display.



- Press **OPR** to activate calibrator output.

NOTE

The temperature is cleared to 0 °C (32 °F) if you change between tc and rtd, or change the type of rtd.

Output at 5500A NORMAL terminals	TYPE pt385	OUTPUT rtd	COMP off
			
	pt385 pt3926 ni120	rtd tc	off 2 wire 4 wire

Output at 5500A NORMAL terminal. Displays location of output terminals (always NORMAL).

TYPE (RTD Type) Selects rtd curve pt385, pt3926, or ni120.

OUTPUT (Temperature Output Device) Selects temperature device: thermocouple (tc) or resistance temperature detector (rtd).

COMP (Compensation) Applies 4-wire compensation, 2-wire compensation or turns compensation off.

Measuring Thermocouple Temperatures





Measures a thermocouple temperature output at 5500A front panel TC connector.

- Press **RESET** to clear 5500A output.
- Connect thermocouple to TC connector.

NOTE

Use thermocouple wire and miniconnectors that match the type of thermocouple.

3. Press  to display TC menus.

MeasTC terminal = ----- V	TC MENUS	OFFSET 0.00	TYPE K
			

-500 to
+500 °C

B
C
E
J
K
N
R
S
T

10µW/°C

OpenTCD on	UNITS °C	REF SRC intrnl	REF 27.75	TYPE K
				

on
off

°C
°F

intrnl
extrnl

-250 to
2316 °C

B
C
E
J
K
N
R
S
T

10µW/°C

4. Measured temperature is in Output Display. A small m blinks during a measurement.

m	22.58 °C
Measured Value	

Meas@TC terminal (Measurement at TC terminals) Displays dc voltage at TC terminals.

TC MENUS (Thermocouple Menus) Opens submenus supporting thermocouple outputs.

Open TCD (Open Thermocouple Detect) Selects on or off for Open TCD feature.

UNITS (Temperature Units) Selects °C or °F temperature unit.

REF SRC (Reference Source) Selects intrnl (Internal) or extrnl (External) reference source.

REF (Temperature Reference) Displays value of temperature reference.

TYPE (Thermocouple Type) Selects emulated thermocouple type.

OFFSET (Measurement Display Offset) Selects temperature offset value to be added or subtracted from actual measurement.

TYPE (Thermocouple Type) Selects emulated thermocouple type.

Waveform Types

For AC voltage, ac current, dual ac voltage, and ac power, select between four waveforms.

Sinewave

For sine, a sinewave is present on calibrator outputs. Variables are amplitude, frequency, and dc offset voltage.

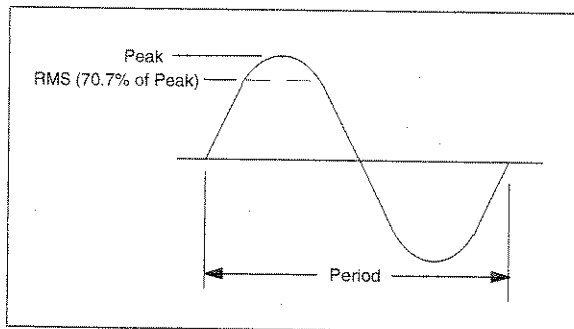

Sinewave

Trianglewave

For tri, a trianglewave is present on calibrator outputs. Variables are amplitude, frequency, and dc offset voltage.

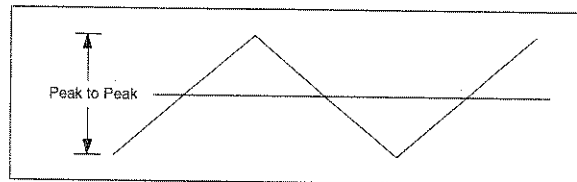

Trianglewave

Squarewave

For square, a squarewave is present on calibrator outputs. Variables are duty cycle, amplitude, frequency, and dc offset voltage.

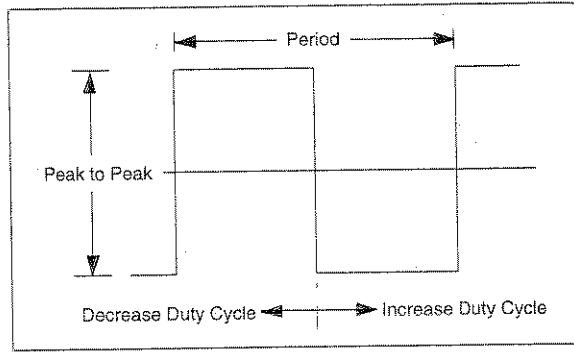

Squarewave and Duty Cycle

Truncated Sinewave

For trunks, a truncated sinewave is present on calibrator outputs. Variables are amplitude and frequency.

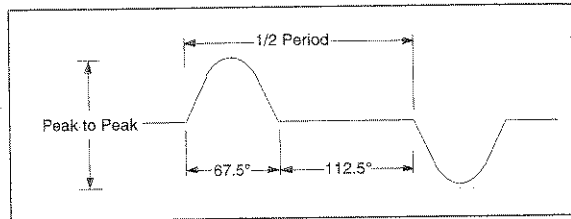

Truncated Sinewave

Setting Harmonics

For dual ac voltages or ac power (sinewaves only), source two signals with adjustable harmonic difference. Fundamentals can be configured on either NORMAL or AUX terminals.

1. Press softkey WAVE MENUS to open waveform menu.
2. Press softkey HARMONIC MENUS to open harmonic menu.

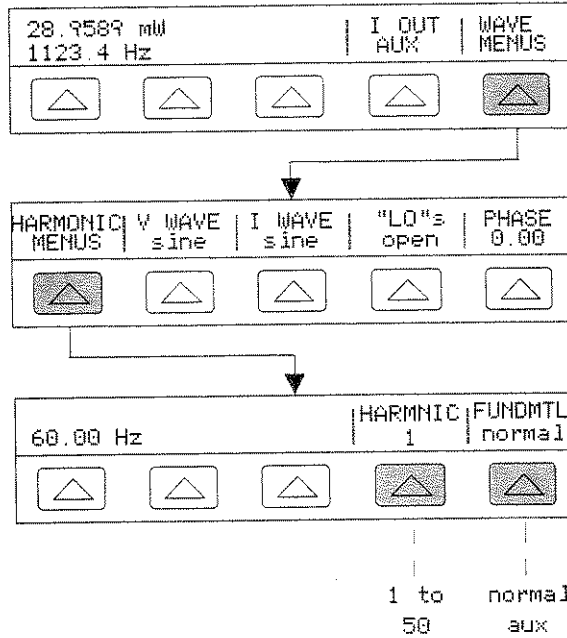

3. Press softkey FUNDMTL to select NORMAL or AUX terminals (or BOOST when 5725A connected) for fundamental.

- Press softkey HARMNIC to enter desired harmonic (1 to 50). For example, 7th harmonic. Press **ENTER**.

Harmonic = 1				
New harmonic = 7				

- Press **PREV** **MENU** one or more times to return to previous menus.

Adjusting the Phase

Sets a phase difference between outputs in dual ac voltage and ac power output modes.

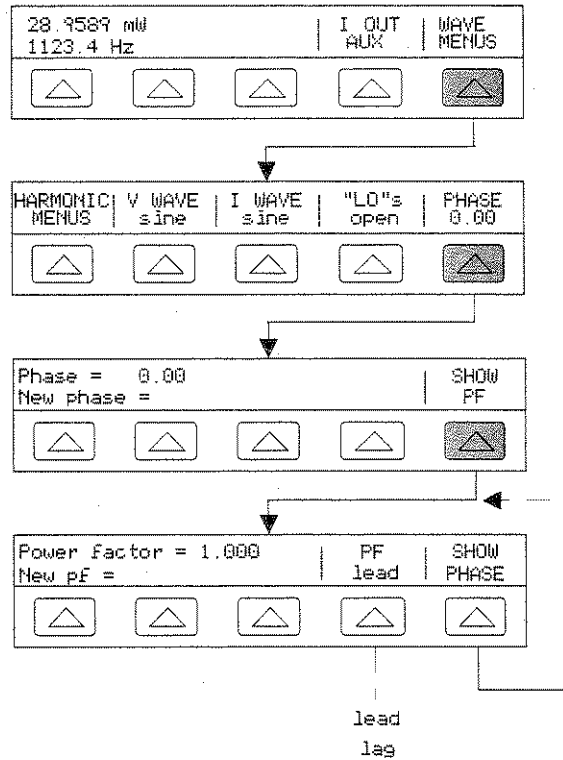

Entering a Phase Angle

Sets a phase shift in degrees for dual ac voltage or ac power output.

1. Press softkey WAVE MENUS to open waveform menu.
2. Press softkey PHASE to open phase entry menu.
3. Enter desired phase angle (5 digits).
4. Press **+/-** to select leading (+) or lagging (-) phase shift.
5. Control Display shows entries. For example, a leading phase angle of 123.45 degrees. Press **ENTER**.

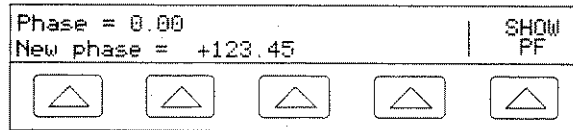

6. Press **PREV MENU** one or more times to return to previous menus.

Entering a Power Factor

Sets a phase shift as a power factor (PF), where $PF = \text{Cosine } \Phi$, and Φ is phase shift.

1. Press softkey WAVE MENUS to open waveform menu.
2. Press softkey PHASE to open phase entry menu.
3. Press softkey SHOW PF to open power factor entry menu.
4. Enter desired power factor (3 digits).

- Press softkey PF to toggle a leading (lead) or lagging (lag) power factor. For example, a leading power factor of .678. Press **ENTER**.

Power Factor = 1.000	PF	SHOW
New pf = .678	lead	PHASE

lead
lag

- Press **PREV/MENU** one or more times to return to previous menus.

Entering a DC Offset

Sets a dc offset for single ac voltage outputs.

	OFFSET	WAVE
	+0.00000 V	sine

sine
tri
square
truncs

- Press softkey WAVE to select desired waveform.
- Press softkey OFFSET to open offset entry menu.
- Enter desired offset. For example, 0.123 V. Press **ENTER**.

Offset = +0.0000 V
New offset = 0.123 V

4. Press **PREV** **MENU** one or more times to return to previous menus.

Using the 5725A Amplifier

In voltage boost mode, 5725A output appears on 5500A NORMAL terminals. In current boost mode, 5725A output appears on 5725A terminals. Redirected 5500A current to 5725A output terminals is 0 - 2.2 A dc, and 300 μ A - 2.2 A ac.

Rules of Operation

Whenever **BOOST** key annunciator is on, 5725A voltage boost or current boost amplifier is in use.

If 5725A Current Amplifier indicator is on, while **BOOST** annunciator is off, 5500A current is being redirected to 5725A.

When sourcing current, OUTPUT softkey choice AUX or BOOST takes precedence over Source Preference softkey and front panel **BOOST** key. Exception: When selected current cannot be sourced by 5500A, output automatically switches to BOOST and displays Current OUTPUT moved to 5725A in Control Display.

Source Preference softkey chooses 5500A or 5725A when either can source output. **BOOST** key is a temporary Source Preference selection.

Any current or voltage combination outside capabilities of 5500A but within capabilities of 5725A will activate 5725A output.



Boosted voltage operation produces high voltage at higher current levels than normally available from the calibrator. During boosted voltage operation, the potential risk of injury or fatal accident is greater than during normal operation.

Set a boosted output from 5725A Amplifier:





1. Press **RESET** to clear 5500A output.
2. Install 5725A, as described in 5725A manual.
3. Connect UUT. For boosted current, connect to 5725A terminals; for boosted voltage, connect to 5500A NORMAL terminals.
4. Set UUT to measure output.
5. Set source preference to 5725: press front panel **SETUP** key; softkey INSTMT SETUP; softkey OUTPUT SETUP; softkey SOURCE PREFERENCE to select 5725.
6. Press **PREV MENU** key one or more times to return to previous menus.
7. Enter desired output value described under "Setting the Output."

NOTE









*You can have the 5725A source a dc current below 1.5 A to take advantage of the amplifier's higher compliance voltage. To do so, press the RANGE softkey to lock onto the 11 A range when the 5500A is set for over 2.2 A, or set the lower current and press **BOOST** **OPR** to turn on the amplifier.*

8. Press **BOOST** key.



Editing and Error Output Settings

Edit outputs using Edit Field knob and associated , , and  keys. In addition, multiply  and divide  keys edit output by decades.

Keys That Exit Error Mode

Keys	Action
	Returns to previous reference value.
 + 	New reference.
Keypad entry + 	New reference.
	Present output as new reference.
	Sets calibrator to x10 reference value and new reference.
	Sets calibrator to 1/10 reference value and new reference.
	Returns to power-up state.

Editing the Output Setting

Turn Edit Field knob clockwise to increase output value or counter-clockwise to decrease output value. To select higher order digit, use Edit Field cursor key  or . Output digit in edit is always underlined.

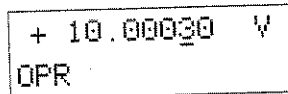

+ 10.00030 V
OPR

Displaying the Output Error

Edit output so UUT displays expected value and thus indicates UUT accuracy.

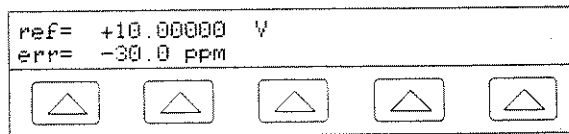

For example, edited difference of .00030 volts for output of 10.00000 V represents $.00030/10.00000=.000030$, or 30 parts per million.

Using Multiply and Divide

Press **MULT** key to multiply output by x10. Press **DIV** key to divide output by 1/10. If multiplied output exceeds 33V, 5500A is placed in STBY (Standby).

Setting Output Limits

Output limits help prevent accidental damage to UUTs from overcurrent or overvoltage. Selections are saved in nonvolatile memory. Voltage limits are expressed in rms.

Setting Voltage and Current Limits

Sets voltage and current limits.

1. Press **RESET** to clear 5500A output.
2. Press **SETUP**. Press softkey INSTMT SETUP to open setup submenus.
3. Press softkey OUTPUT SETUP to open output setup submenus.

4. Press softkey SET LIMITS to open set limits menu.



5. **To Limit Voltage** (applies to both dc and ac voltages) Press softkey under VOLTAGE.

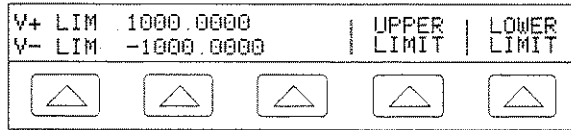

- a. Press "Upper Limit" or "Lower Limit" softkey, as desired, and enter new limit.
- b. Press **ENTER** then **PREV MENU** one or more times to return to previous menus.
6. **To Limit Current** (applies to both dc and ac currents) Press softkey under CURRENT.

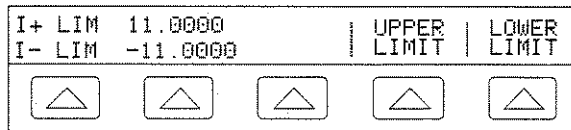

- a. Press "Upper Limit" or "Lower Limit" softkey, as desired, and enter new limit.
- b. Press **ENTER** then **PREV MENU** one or more times to return to previous menus.