

For the benefit and convenience of its customers, Fluke Corporation (Fluke) has reproduced this copy of a manual which is no longer in production. This manual has not been edited or updated since the revision date shown on the *lower left hand corner of the first page*. Fluke will not be liable for any claims, losses or damages of any kind incurred by any user arising from use of this manual.

5100B Series

CALIBRATORS

Instruction Manual

PN 926634

October 1992 Rev. 1 1/94

©1994 Fluke Corporation. All rights reserved. Printed in U.S.A.
All product names are trademarks of their respective companies

FLUKE®

WARRANTY

Fluke Corporation (Fluke) warrants this product to be free from defects in material and workmanship under normal use and service for a period of 1 year from date of shipment. Software is warranted to operate in accordance with its programmed instructions on appropriate Fluke products. It is not warranted to be error free. This warranty extends only to the original purchaser and shall not apply to fuses, computer media, batteries or any product which, in Fluke's sole opinion, has been subject to misuse, alteration, abuse or abnormal conditions of operation or handling.

Fluke's obligation under this warranty is limited to repair or replacement of a product which is returned to an authorized service center within the warranty period and is determined, upon examination by Fluke, to be defective. If Fluke determines that the defect or malfunction has been caused by misuse, alteration, abuse, or abnormal conditions of operation or handling, Fluke will repair the product and bill the purchaser for the reasonable cost of repair. If the product is not covered by this warranty, Fluke will, if requested by purchaser, submit an estimate of the repair costs before work is started.

To obtain repair service under this warranty purchaser must forward the product, (transportation prepaid) and a description of the malfunction to the nearest Fluke Service Center. The product shall be repaired at the Service Center or at the factory, at Fluke's option, and returned to purchaser, transportation prepaid. The product should be shipped in the original packing carton or a rigid container padded with at least four inches of shock absorbing material. **FLUKE ASSUMES NO RISK FOR IN-TRANSIT DAMAGE.**

THE FOREGOING WARRANTY IS PURCHASER'S SOLE AND EXCLUSIVE REMEDY AND IS IN LIEU OF ALL OTHER WARRANTIES, EXPRESS OR IMPLIED, INCLUDING BUT NOT LIMITED TO ANY IMPLIED WARRANTY OF MERCHANTABILITY, OR FITNESS FOR ANY PARTICULAR PURPOSE OR USE. FLUKE SHALL NOT BE LIABLE FOR ANY SPECIAL, INDIRECT, INCIDENTAL, OR CONSEQUENTIAL DAMAGES OR LOSS WHETHER IN CONTRACT, TORT, OR OTHERWISE.

CLAIMS

Immediately upon arrival, purchaser shall check the packing container against the enclosed packing list and shall, within thirty (30) days of arrival, give Fluke notice of shortages or any nonconformity with the terms of the order. If purchaser fails to give notice, the delivery shall be deemed to conform with the terms of the order.

The purchaser assumes all risk of loss or damage to products upon delivery by Fluke to the carrier. If a product is damaged in transit, **PURCHASER MUST FILE ALL CLAIMS FOR DAMAGE WITH THE CARRIER** to obtain compensation. Upon request by purchaser, Fluke will submit an estimate of the cost to repair shipment damage.

Fluke will be happy to answer all questions to enhance the use of this product. Please address your requests or correspondence to: Fluke Corporation, P.O. Box 9090, Everett, WA 98206-9090, Attn: Sales Department. For European Customers: Fluke Europe B.V., P.O. Box 1186, 5602 B.D., Eindhoven, The Netherlands.

OPERATOR SAFETY SUMMARY

WARNING

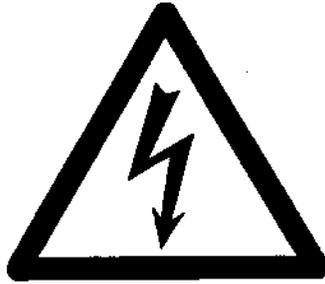

HIGH VOLTAGE

is used in the operation of this equipment

LETHAL VOLTAGE

MAY BE PRESENT ON THE TERMINALS. OBSERVE ALL SAFETY PRECAUTIONS!

TO AVOID ELECTRICAL SHOCK HAZARD, THE OPERATOR SHOULD NOT ELECTRICALLY CONTACT THE OUTPUT HI OR SENSE HI BINDING POSTS. DURING OPERATION, LETHAL VOLTAGES OF UP TO 1100V AC OR DC MAY BE PRESENT ON THESE TERMINALS.

WHENEVER THE NATURE OF THE OPERATION PERMITS, KEEP ONE HAND AWAY FROM EQUIPMENT TO REDUCE THE HAZARD OF CURRENT FLOWING THROUGH VITAL ORGANS OF THE BODY.

SAFETY TERMS IN THIS MANUAL

This instrument has been designed and tested in accordance with IEC Publication 348, Safety Requirements for Electronic Measuring Apparatus. This Operator Manual contains information, warnings, and cautions that must be followed to ensure safe operation and to maintain the 5100B in a safe condition. Use of this equipment in a manner not specified herein may impair the protection provided by the equipment.

WARNING statements identify conditions or practices that could result in personal injury or loss of life.

CAUTION statements identify conditions or practices that could result in damage to equipment.

SAFETY

SYMBOLS MARKED ON EQUIPMENT



DANGER — High voltage



Power on



Ground (earth) terminal



Power off



Attention — refer to the manual. This symbol indicates that information about the use of a feature is contained in the manual.

POWER SOURCE

The 5100B is intended to operate from a power source that will not apply more than 264V ac rms between the supply conductors or between either supply conductor and ground. A protective ground connection by way of the grounding conductor in the power cord is essential for safe operation.

USE THE PROPER FUSE

To avoid fire hazard, use only a fuse specified on the line voltage selection switch label, and which is identical in type, voltage rating, and current rating. Never bypass a fuse by shorting across the fuse terminals.

GROUNDING THE 5100B

The 5100B is a Safety Class I (grounded enclosure) instrument as defined in IEC 348. The enclosure is grounded through the grounding conductor of the power cord. To avoid electrical shock, plug the power cord into a properly wired earth grounded receptacle before connecting anything to any of the binding posts, terminals, or connectors. A protective ground connection by way of the grounding conductor in the power cord is essential for safe operation.

USE THE PROPER POWER CORD

Use only the power cord and connector appropriate for proper operation of a 5100B Series in your country.

Use only a power cord that is in good condition.

Refer cord and connector changes to qualified service personnel.

DO NOT OPERATE IN EXPLOSIVE ATMOSPHERES

To avoid explosion, do not operate the 5100B in an atmosphere of explosive gas.

DO NOT REMOVE COVER

To avoid personal injury, do not remove the 5100B cover. Do not operate the 5100B without the cover properly installed. There are no user-serviceable parts inside the 5100B, so there is no need for the operator to ever remove the cover.

DO NOT ATTEMPT TO OPERATE IF PROTECTION MAY BE IMPAIRED

If the 5100B appears damaged or operates abnormally, protection may be impaired. Do not attempt to operate it. When in doubt, have the instrument serviced.

Table of Contents

SECTION	TITLE	PAGE
1	INTRODUCTION AND SPECIFICATION	1-1
1-1.	INTRODUCTION	1-1
1-7.	BASIC CALIBRATION	1-1
1-8.	Series Common Features	1-1
1-14.	Storage System Models	1-2
1-16.	Element Resistant Models	1-2
1-18.	OPTIONS	1-2
1-19.	Analog Options	1-2
1-21.	Interface Options	1-2
1-24.	Boost Mode Accessories	1-2
1-25.	SPECIFICATIONS	1-2
1-26.	Summarized Specifications	1-2
1-28.	Complete Specifications	1-3
2	OPERATING INSTRUCTIONS	2-1
2-1.	INTRODUCTION	2-1
2-3.	SHIPPING INFORMATION	2-1
2-5.	OPTIONS AND ACCESSORIES	2-1
2-7.	INSTALLATION	2-1
2-9.	OPERATING FEATURES	2-2
2-10.	Front Panel Controls	2-2
2-31.	Rear Panel	2-2
2-33.	Error Messages	2-2
2-35.	List (Storage Only)	2-2
2-40.	Program Write-Protect (Storage Only)	2-13
2-42.	LOCAL OPERATION	2-15
2-43.	Initialization	2-15
2-45.	Status During Function Change	2-15
2-47.	Meter Connection Procedure	2-15
2-49.	DC Voltage Output	2-15
2-51.	AC Voltage Output	2-16
2-53.	Wideband Output	2-17
2-55.	Direct Current Output	2-17
2-57.	Alternating Current Output	2-18
2-59.	Resistance Output	2-19
2-61.	dBm Output (AC Volts Only)	2-19
2-63.	Boost Mode Operation	2-20
2-72.	Enter Entry Limit	2-21
2-74.	Tolerance Limit Entry	2-22
2-76.	Error Mode Operation	2-22
2-91.	NEW REF/CAL 1 Ω Operation	2-23

(continued on page ii)

TABLE OF CONTENTS, *continued*

SECTION	TITLE	PAGE
2-97.	Fractional-Scale Operation	2-34
2-100.	External Oscillator Operation	2-24
2-104.	Recall Operations	2-25
2-107.	Storage System Operations (Storage Only)	2-25
2-133.	REMOTE OPERATION	2-28
2-137.	Initiation Characters	2-29
2-148.	String Commands	2-30
3	THEORY OF OPERATION	3-1
3-1.	INTRODUCTION	3-1
3-4.	INSTRUMENT BLOCK DIAGRAM	3-1
3-9.	FUNCTIONAL BLOCK DIAGRAM	3-1
3-10.	DC Voltage Less Than 20 Volts	3-1
3-13.	AC Voltage	3-3
3-17.	AC and DC Voltage, 20 Volts and Higher	3-4
3-19.	AC Current Under 200 mA	3-4
3-22.	DC Current Under 200 mA	3-9
3-24.	Direct and Alternating Current >200 mA	3-9
3-26.	Resistance	3-9
3-28.	Control System	3-9
3-38.	DETAILED CIRCUIT ANALYSIS	3-14
3-40.	Power Supply Regulator	3-14
3-55.	Digital-to-Analog Converter (DAC)	3-14
3-68.	Analog Control	3-16
3-82.	Power Amplifier	3-17
3-99.	Extended High Voltage	3-18
3-105.	Oscillator	3-19
3-114.	Ranging Assembly	3-20
3-135.	Controller	3-21
3-145.	Front Panel	3-22
3-151.	Guard Isolator	3-22
3-155.	Tape Interface (Storage Only)	3-22
3-171.	Tape Drive Assembly	3-25
4	MAINTENANCE	4-1
4-1.	INTRODUCTION	4-1
4-3.	SERVICE INFORMATION	4-1
4-6.	GENERAL MAINTENANCE	4-1
4-7.	Cleaning	4-1
4-9.	Air Filter Maintenance	4-1
4-11.	Line Voltage Selection	4-2
4-13.	Fuse Replacement	4-2
4-15.	Instrument Assembly/Disassembly	4-2
4-39.	PERFORMANCE TEST	4-5
4-43.	Calibration Test Equipment Accuracy Considerations	4-5
4-47.	Equipment Preparation	4-6
4-49.	DC Offset Voltage	4-7
4-51.	DC Voltage Tests	4-8
4-53.	DC Ripple and Noise Tests	4-8
4-55.	DC Current Tests	4-11
4-57.	AC Voltage Tests	4-12
4-59.	AC Distortion and Noise Tests	4-14
4-61.	Frequency Accuracy Tests	4-14
4-63.	Resistance Tests	4-15
4-67.	AC Current Tests	4-17
4-70.	Overload Tests	4-18
4-73.	Storage System Test (Storage Only)	4-18
4-76.	CALIBRATION PROCEDURE	4-18
4-77.	Introduction	4-18
4-81.	Power Supply Calibration	4-19

(continued on page iii)

TABLE OF CONTENTS, *continued*

SECTION	TITLE	PAGE
4-83.	Power Amplifier (A17) Calibration	4-19
4-90.	Reference Voltage Calibration	4-21
4-92.	Low Range Ohms Calibration	4-22
4-94.	DC Zero Calibration	4-22
4-96.	Current Gain Calibration	4-23
4-98.	High Range Ohms Calibration	4-23
4-101.	Millivolt Range Calibration	4-24
4-103.	AC Calibration	4-25
4-105.	Storage System Calibration (Storage Only)	4-25
4-106a.	Tape Drive Calibration	4-25
4-107.	Factory Selected Component Replacement	4-26
4-119.	TROUBLESHOOTING	4-29
5	LISTS OF REPLACEABLE PARTS	5-1
	TABLE OF CONTENTS	5-1
5-1.	INTRODUCTION	5-2
5-2.	HOW TO OBTAIN PARTS	5-2
5-3.	MANUAL STATUS INFORMATION	5-2
5-4.	NEWER INSTRUMENTS	5-2
5-5.	SERVICE CENTERS	5-3
6	OPTION AND ACCESSORY INFORMATION	6-1
	TABLE OF CONTENTS	6-1
7	SCHEMATIC DIAGRAMS	7-1
	TABLE OF CONTENTS	7-1

List of Tables

TABLE	TITLE	PAGE
1-1.	Summarized Specifications	1-3
1-2.	DC Volts Specifications	1-4
1-3.	AC Volts Specifications	1-5
1-4.	Current Specifications	1-6
1-5.	Resistance Specifications	1-8
1-6.	Wideband Option -03 Specifications	1-9
1-7.	General Specifications	1-10
1-8.	System Specifications for Power Amplifier Application (5100 Series B + Y5000, Y5001, 5205A/5215A Combination)	1-11
1-9.	System Specification for Transconductance Amplifier Application (5100 Series B + Y5000, Y5020, 5220A Combination)	1-12
2-1.	Option and Accessories	2-1
2-1.	Front Panel Display and Control	2-4
2-3.	Data Entry Group	2-5
2-4.	Main Output Group	2-7
2-5.	Output Display Group	2-8
2-6.	Central Display Group	2-9
2-7.	Error Mode Group	2-9
2-8.	Storage Group (Storage Only)	2-10
2-9.	Rear Panel	2-13
2-10.	Error Codes	2-13
2-11.	Standby/Operate Status Change	2-15
2-12.	External Frequency/Voltage Limitations	2-24
2-13.	External Oscillator Frequency Ranges	2-25
2-14.	Programming Codes	2-29
2-15.	Interface Interrupt Codes	2-30
2-16.	Interface Output Codes	2-30
2-17.	Status Register Message Assignments	2-32
2-18.	Status Message Function Codes	2-34
2-19.	Status Message Examples	2-34
3-1.	Power Amp Relay Controls	3-17
3-2.	I/O Header Interface Pin Assignments	3-27
4-1.	Input Line Voltage Switch Settings	4-2
4-2.	Test Equipment	4-6
4-3.	DC Voltage Tests	4-10
4-4.	DC Ripple and Noise Tests	4-11
4-5.	DC Current Test	4-12
4-6.	AC Voltage Tests	4-13
4-7.	AC Distortion and Noise Tests	4-15
4-8.	Frequency Accuracy Tests	4-15
4-9.	Resistance Tests	4-17
4-10.	PCB Reference Designators	4-19

(continued on page vi)

LIST OF TABLES, *continued*

TABLE	TITLE	PAGE
4-11.	Power Supply Regulator Adjustments	4-19
4-12.	Divider Resistor Selection	4-27
4-13.	High Frequency Capacitor Selection	4-28
4-14.	Display Troubleshooting	4-29
4-15.	Analog Circuitry Troubleshooting	4-32
4-16.	Power Supply Regulator Troubleshooting	4-38
4-17.	Power Amp Troubleshooting	4-45
4-18.	Extended High Voltage Troubleshooting	4-49
4-19.	Controller Troubleshooting	4-51
4-20.	Isolator Troubleshooting	4-52
4-21.	Tape Interface Troubleshooting	4-53
4-22.	Tape Drive Assembly Troubleshooting	4-57

List of Illustrations

FIGURE	TITLE	PAGE
2-1.	Front Panel	2-3
2-2.	Data Entry Group	2-4
2-3.	Main Output Group	2-6
2-4.	Output Display Group	2-8
2-5.	Central Display Group	2-8
2-6.	Error Mode Group	2-9
2-7.	Storage Group (Storage Only)	2-10
2-8.	Rear Panel	2-12
2-9.	LIST Program	2-14
2-10.	LIST Data (Storage Only)	2-14
2-11.	Tape Write-Protect Feature	2-15
2-12.	Meter Connections	2-16
3-1.	5100B Block Diagram	3-2
3-2.	2V dc to 19.9999V dc and 50 Ω Override Inputs	3-3
3-3.	Less than 2V dc Outputs Block Diagram	3-5
3-4.	AC Voltage Block Diagram	3-6
3-5.	AC and DC Voltage, 20V and Higher	3-7
3-6.	AC Current Under 200 mA	3-8
3-7.	DC Current Under 200 mA	3-10
3-8.	1 Ω - 10 k Ω Resistance	3-11
3-9.	100 k Ω - 10 M Ω Resistance	3-12
3-10.	Control System Block Diagram	3-12
3-11.	Controller Block Diagram	3-13
3-12.	Power Amp Relay Controls	3-17
3-13.	Isolator Block Diagram	3-23
3-14.	Write Timing Diagram (Storage Only)	3-24
3-15.	Read Timing Diagram (Storage Only)	3-25
3-16.	Tape Drive Functional Block Diagram	3-28
3-17.	Read/Write Electronic Block Diagram With Accompanying Waveforms	3-29
4-1.	Input Line Voltage Switches	4-2
4-2.	Accuracy Uncertainties	4-7
4-3.	Offset Voltage Checks	4-7
4-4.	DC Low Voltage Tests	4-8
4-5.	DC Voltage Tests	4-9
4-6.	DC Current Tests	4-10
4-7.	AC Voltage Tests	4-12
4-8.	AC Low Voltage Tests	4-13
4-9.	Current Source Transfer Connections	4-15
4-10.	Resistance Computation Examples	4-15
4-11.	Calibration Resistance Computation Examples	4-19
4-12.	Differential Connections	4-21

5100 B

Calibrator

5101 B

Calibrator

5102 B

Meter Calibrator

Section 1

Introduction & Specifications

1-1. INTRODUCTION

1-2. The microprocessor controlled 5100 Series B Calibrator outputs are programmable from the Front Panel or through an optional remote interface, through a wide range of DC voltages and current; AC voltages, current and dBm; and resistance. Connections on the Front Panel include terminals for output, sense, voltage guard, and current guard. A chassis binding post is available on the rear panel. Available on the Front Panel is a dedicated BNC output connector for use with the Wideband Option -03 which extends the frequency range of the instrument. The connector is installed in all instruments, allowing addition of the option at some later date, if desired.

1-3. The output can be modified using the Front Panel Error Mode controls or through an optional remote interface. This allows the operator, in all outputs except frequency, to modify the output and read the deviation from the base in percentage or digits on the Front Panel or the remote device. Frequency can be modified to step through the entire range of the meter under test with minimum amount of reprogramming by the operator.

1-4. The 5100 Series has three models of calibrators. The basic model is the 5100B which has all the features listed above. The Model 5101B has all the features of the 5100B plus an integral storage system consisting of a memory and tape cassette which allows the operator to enter or record a program to step the calibrator through a predetermined sequence. The 5102B is electronically identical to the 5100B with the addition of an environmental, element-resistant, fiberglass case plus all-position relays for operation at any angle. This permits safer and easier transport plus the ability to operate in any position.

1-5. Data (paragraphs, tables, or figures) pertaining to only a portion of the series, and not the entire series, is marked by following the title of the applicable item with a descriptive notation enclosed in parentheses. Instruments containing a storage memory and tape system, e.g., 5101B are identified by the notation (Storage Only). Those with the element-resistant case, e.g., 5102B, are identified by the notation (Fiberglass Case Only).

1-6. The 5100 Series B instruments are an extension of the preceding 5100 Series A instruments. They have all the capabilities of the "A" Series plus the following added features: the instrument now has the capability to output up to 1100V ac at 50 Hz through 1 kHz as opposed to the 400 Hz only, in the "A" Series. The boost capability has been activated allowing the "B" Series to slave power and/or current amplifiers to extend its limits. Special handling and equipment are no longer required to calibrate VOM's with a non-linear input impedance.

1-7. BASIC CALIBRATOR

1-8. Series Common Features

1-9. All models of the calibrator can provide dc voltage outputs from 0 to 1100 volts on six ranges with resolutions ranging from 0.1 microvolts to 10 millivolts. Direct current outputs are available from 10 microamps to 2 amps on five ranges with resolution between 1 nanoamp and 10 microamps.

1-10. AC voltage outputs between 1 millivolt and 1100 volts are available from the 50 Hz minimum frequency up to 1 kHz. From that point the maximum voltage available is 110 volts up to 20 kHz, dropping to a 20 volt maximum from 30 kHz to 50 kHz. Six ranges are available for ac voltage outputs with resolution varying from 0.1 microvolt to 10 millivolts. Five alternating current ranges control output from 10 microamps to 2 amps at frequencies of 50 Hz to 1 kHz, with resolution between 1 nanoamp and 10 milliamps.

1-11. All instruments in the series have the capability to extend their voltage (power) and current limits through the BOOST Function using the Y5000 Interface Accessory and selected external amplifiers. Loads up to 200 mA can be handled when a Fluke Model 5202A/5215A is connected through the interface accessory and the applicable cable. Output currents up to $\pm 19.9999A$ are available when a Fluke Model 5220A is connected through the interface and the applicable cable.

1-12. Resistance outputs at the cardinal values from 1 ohm to 10 Megohms are available. The outputs from 1 ohm to 10 kilohm have a four-terminal measurement capability. The 100 kilohm, 1 Megohm, and 10 Megohm outputs use two-terminal measurements with the OUTPUT HI and SENSE HI, and OUTPUT LO and SENSE LO terminals, respectively, connected internally.

1-13. Modification of the output to measure the deviation in a percent of error figure is displayed for each change of the output from the base. The frequency may be altered for AC outputs to cover a range of frequencies; however, there is no percent of error display. The modifications can be programmed from either the Front Panel or a remote source.

1-14. Storage System Models

1-15. The storage system consists of a storage memory and a mini-cassette type system. The storage memory holds up to 74 separate fixed length instructions. Any field not filled when an instruction is created is filled with the default condition; i.e., either the allowable maximum or minimum, as applicable. Data stored in the memory to form a test program for an instrument, or instruments, may be read out, as desired, or transferred, through the use of the integral tape system, to a tape for permanent record. The storage memory may be loaded from a prerecorded tape through the tape system to perform a standard calibration procedure. A program must be loaded into the storage memory to be run, the instrument is not able to operate directly from the prerecorded tape. A printed listing of the program or the data from the step in progress can be obtained from storage system models equipped with an optional remote interface. Use a printer that is compatible with the interface you are using.

CAUTION

Tapes used must be certified digital mini-cassettes that conform with ANSI standard X3B5/77-49. Audio quality tapes will not give acceptable results.

1-16. Element Resistant Models

1-17. The environmental, element-resistant case is a fiberglass shell with removable front and rear covers. The case has handles to provide ease of transportation and seals on the case openings to resist entrance of the elements when the case is closed. The covers must be removed to operate the system. The only change in internal circuitry is the substitution of all-position relays so that the instrument can be operated while sitting at any angle. Operation of the instrument is identical with the standard instrument.

1-18. OPTIONS

1-19. Analog Options

1-20. The Wideband Option (-03) allows outputs of 300 μV (-57.5 dBm) to 3.1623V rms (+23 dBm) at frequencies from 10 Hz to 10 MHz into a load impedance of 50 ohms. The output impedance is 50 ohms and 50 ohm coaxial cable should be used to transfer the output signal.

1-21. Interface Options

1-22. Two system interface options are available for the 5100 Series. Option -05 interfaces the instrument to the IEEE 488-1975 Bus System. Option -06 interfaces the instrument to a system using a RS-232-C Interface. Only one of the interface options can be installed at a time; however, they are easily exchanged with a minimum of operator training and time.

1-23. Boost Mode Accessories

1-24. The Boost Mode of Operation permits the operator to slave the Fluke Model 5205A/5215A and/or the Fluke Model 5220A to a 5100 Series Calibrator to extend the power and/or current capabilities of the instrument. Required are the Y5000 Interface and the applicable dedicated cable assembly, Y5001 to the Model 5205A/5215A, or Y5002 to the Model 5220A. Operation of the Models 5205A and 5215A is the same except that DC voltage outputs cannot be obtained from the Model 5215A.

1-25. SPECIFICATIONS

1-26. Summarized Specifications

1-27. Table 1-1 summarizes the 5100 Series accuracy specifications when they are used in a typical meter calibration service. The tolerances in the table are valid provided the ambient temperature is between 20 degrees and 30 degrees Celsius, the relative humidity is less than 85%, and the input line voltage is within 10% of nominal. In addition, they are applicable only when the instrument being calibrated is an analog voltmeter with more than

1000 ohms/volt sensitivities, a TVM or DVM with greater than 1 Megohm input impedance, or analog or digital ammeter with less than 1 volt total voltage drop.

1-28. Complete Specifications

1-29. The complete specifications for the 5100 Series Calibrators are listed in Table 1-2 through 1-9, with each

table covering a specific portion of the specification. Refer to Table 1-2 for detailed listing on DC volts; Table 1-3 for AC volts; Table 1-4 for Current, both direct and alternating; Table 1-5 for Resistance; Table 1-6 for the Wideband Option -03; Table 1-7, for the General Specifications, including environmental information; Table 1-8, for combined use with a Model 5205A/5215A and Table 1-9, with a Model 5220A.

Table 1-1. Summarized Specifications

PROGRAMMED OUTPUT	RANGE	ACCURACY +/- (% OF OUTPUT + % OF RANGE + FLOOR)
DC Voltage	All	.004 + .001 + 5 μ V
AC Voltage	50 Hz – 1 kHz (All ranges) 1 kHz – 10 kHz (Up to 110V)	.035 + .005 + 50 μ V
	10 kHz – 20 kHz (Up to 110V) 20 kHz – 50 kHz (Up to 19.9999V)	.06 + .008 + 50 μ V
Direct Current	All	.015 + .002 + .02 μ A
Alternating Current	50 Hz – 1 kHz (All ranges)	(.05 + .005) + .02 μ A
Resistance	Four terminal 1 ohm 10 ohm 100 ohm, 1 kilohm, 10 kilohm	.015% .01% .003%
	Two terminal 100 kilohm 1 Megohm 10 Megohm	.003% .01% .03%

Table 1-2. DC Volts Specifications

DC Volts				
RANGE	RESOLUTION	MAXIMUM CURRENT	RIPPLE AND NOISE (10 Hz to 3 kHz) NO LOAD TO MAXIMUM RATED LOAD	ACCURACY (6 months) (20°C to 30°C)
±(200V to 1100V)	10 mV	6 mA/400 pF max	<0.05% of setting rms	± (0.004% of setting + 0.001% of range + 5µV)
±(20V to 199.999V)	1 mV	10 mA/400 pF max	<0.05% of setting rms (open to 20k Ω) <0.1% of setting rms (20k Ω to max rated load)	
±(2V to 19.9999V)	100 µV	25 mA/1000 pF	<0.02% of setting +50 µV rms	
±(0.2V to 1.99999V)	10 µV	Limited by 50Ω output resistance	<0.01% of setting +25 µV rms	
±(20 mV to 199.999 mV)	1 µV		<0.01% of setting +25 µV rms	
±(0 to 19.9999 mV)	0.1 µV		<0.01% of setting +25 µV rms	
±(0 to 1.99999V) 50Ω OVERRIDE	100 µV	25 mA/1000 pF	<0.02% of setting +50 µV rms	± (-0.005% of setting +205 µV)

Temperature Coefficient

Above 30°C and Below 20°C add to accuracy limits ±(5 ppm of setting +1 ppm of range +1 µV)/°C. 200V to 1100V range add ±(5 ppm of setting +2 ppm of range)/°C.

Remote Sensing

Four wire remote sensing is available from 2V to 1100V and below 2V in 50Ω DIVIDER OVERRIDE mode. The three lowest ranges are normally internal sensed. Internal sense connections are made automatically inside the box.

Transient Recovery Time

2 seconds to settle within 50 ppm of final value following any change in output voltage or current for all ranges except 20 to 199.999V, 20 kΩ to 2 kΩ load and switching between two highest ranges which requires 4 seconds.

Short Term Stability (10 Minutes)

At any fixed temperature from 0°C to 50°C the short term stability is ±(10 ppm of setting +2 ppm of range +5 µV) except above 500V which is ±25 ppm of setting.

Load Regulation

EXTERNAL SENSE: 2V to 1100V ±10 ppm no load to full rated load. Same for 0V to 1.99999V using 50Ω DIVIDER OVERRIDE.

INTERNAL SENSE: (At output terminals) Same as external except max. Full load is 400Ω.

Overcurrent Protection

On all ranges current is limited to prevent damage due to an overload or short circuit at output terminals. The operator is alerted by a flashing "O.L." on the central display. After approximately 2 seconds the calibrator goes to standby.

Guard

The DC voltage section is guarded and a front panel terminal is provided labeled "V GUARD".

Table 1-3. AC Volts Specifications

AC Volts					
RANGE ¹	RESOLUTION	MAXIMUM CURRENT	FREQUENCY	AMPLITUDE ACCURACY (6 months) (20°C to 30°C)	TOTAL HARMONIC DISTORTION AND NOISE
200V to 1100V	10 mV	6 mA/400 pF max	(1 mV to 1100V) 50 Hz to 1 kHz	50 Hz to 10 kHz ±(.035% of setting +0.005% of range +50 μV)	Bandwidth of 10 Hz to 200 kHz. Distortion, line interference + noise including random spikes.
20V to 199.999V	1 mV	10 mA/400 pF max			
2V to 19.999V	100 μV	25 mA/400Ω/ 1000 pF max	(1 mV to 110V) 50 Hz to 20 kHz (Below 20V) 50 Hz to 50 kHz	>10 kHz to 50 kHz ±(0.06% of setting +0.008% of range +50 μV)	(20V and Higher) 50 Hz to 10 kHz: (0.08% of output) rms
0.2V to 1.99999V	10 μV	2 kΩ min./1000 pF max			
20 mV to 199.999 mV	1 μV	Limited by 50Ω source resistance	Accuracy: ±3% Resolution: 1 MSD	<i>NOTE</i> "Range" inaccuracy statement is 20V for 50Ω override	(Below 20V) 50 Hz to 10 kHz: (0.05% of output +10 μV) rms 10 kHz to 50 kHz: (0.08% of output + 20 μV) rms
1 mV ² to 19.9999 mV	0.1 μV				

(1) Can be set in dBm = 1 mW across 600Ω = .7746V

(2) 10% Lower voltage available using the Edit control

(3) When operating into 600Ω, for decibel levels below -11.76 dBm and above -31.76 dBm, use a .62847 dBm correction factor to compensate for the loading on the 50Ω divider output.

For Example: If a -20 dBm output level is necessary, program -20 dBm, .62847 dBm (-19.37 dBm) to compensate for loading and establish a true -20.00 dBm output across 600Ω. Note that any inaccuracy in the values of the internal 45Ω and the external 600Ω load resistance results in a commensurate error in the actual output across the load. You may assume that the internal 45Ω resistance is within .01Ω (.02%), so the greatest error is in the 600Ω load resistance.

To correct for errors below 20 mV (-31.76 dBm), use the correction based on 600/649.5, or .92378 that results in a dBm correction of .6886 dBm. For an output of -40 dBm, program -40 dBm, plus .6886 dBm (-39.31 dBm). Resistance errors as outlined in the previous paragraph apply to this example.

NOTE

The simplest way to insure accuracy is to monitor the output level across the 600Ω load using a high-impedance ac voltmeter.

Table 1-3. AC Volts Specifications (cont)

Temperature Coefficient (Above 30°C and Below 20°C)

AMPLITUDE: Accuracy limits increase by $\pm(20 \text{ ppm of setting} + 2 \text{ ppm of range})/^\circ\text{C}$

FREQUENCY: Accuracy limits increase by $\pm 0.1\%/^\circ\text{C}$

Remote Sensing

Four wire remote sensing is available from 2V to 1100V. The three lowest ranges are internally sensed. Internal sense connections are made automatically inside the box.

Transient Recovery Time

2 seconds to settle within 100 ppm of the final value for amplitude and within 0.3% for frequency following any change in output voltage, current, or frequency. Switching between two highest ranges requires 2.2 seconds.

Short Term Stability (10 Minutes)

At any fixed temperature from 0°C to 50°C the short term stability is $\pm(0.01\% \text{ of range} + 10 \mu\text{V})$.

Load Regulation

EXTERNAL SENSE: 0.2V to 1100V $\pm 200 \text{ ppm}$ no load to full rated load.

INTERNAL SENSE: (At output terminals) Same as external except voltages less than 0.2V have a load regulation expressed as an output impedance of 50Ω.

The above load regulations are met with reactive loads with power factors between 0.9 and 1.0.

Overcurrent Protection

On all ranges current is limited to prevent damage due to an overload or short circuit at output terminals. The operator is alerted by a flashing "O.L." on the central display. After approximately 2 seconds the calibrator goes to standby.

Guard

The AC voltage function is guarded and a front panel terminal labeled "V GUARD" is provided.

DISCRETE FREQUENCIES AVAILABLE

IN Hz	50	60	70	80	90	100	200	300	400	500	600	700	800	900
110V to 1100V	•	•	•	•	•	•	•	•	•	•	•	•	•	•
20V to 110V	•	•	•	•	•	•	•	•	•	•	•	•	•	•
1 mV to 20V	•	•	•	•	•	•	•	•	•	•	•	•	•	•
IN kHz	1	2	3	4	5	6	7	8	9	10	20	30	40	50
110V to 1100V	•										•			
20V to 110V	•	•	•	•	•	•	•	•	•	•	•			
1 mV to 20V	•	•	•	•	•	•	•	•	•	•	•	•	•	•

Table 1-4. Current Specifications

DC Current				
RANGE	RESOLUTION	COMPLIANCE VOLTAGE	ACCURACY (6 months) (20°C to 30°C)	RIPPLE AND NOISE
±(0.2A to 1.99999A)	10 μA	0 to 2.1V min	±(0.015% of output +0.002% of range +0.02 μA) Compliance voltage: >1V add 0.002% setting/volt	(0.05% of output +0.01 μA) rms Measured with a bandwidth of 10 Hz to 10 kHz including random spikes
±(20 mA to 199.999 mA)	1 μA	0 to 10V min		
±(2 mA to 19.9999 mA)	100 nA	0 to 10V min		
±(0.2 mA to 1.99999 mA)	10 nA	0 to 10V min		
±(10 μA ¹ to 199.999 μA)	1 nA	0 to 10V min		

(1) 10% lower current available using the Edit Control.

Temperature Coefficient (Above 30°C and Below 20°C)

The accuracy limits increase by ±(10 ppm of setting + 2 ppm of range)/°C

Transient Recovery Time

1 Second to settle to within 0.01% of final value following any change in current or compliance voltage.

Short Term Stability (10 Minutes)

At any fixed temperature from 0°C to 50°C the short term stability is ±(50 ppm of setting + 5 ppm of range + 0.002 μA).

Load Regulation

±20 ppm/volt for a change in the output voltage from 1 volt to maximum rated compliance voltage.

Overvoltage Protection

On all ranges voltage is limited to not more than 2V greater than maximum rated compliance voltage due to an open circuit condition. The operator is alerted by a flashing "O.L." on the central display. After approximately 2 seconds the calibrator goes to standby.

Guard

The DC current section is guarded and a front panel terminal labeled "I GUARD" is provided.

Table 1-4. Current Specifications (cont)

AC Current					
RANGE	RESOLUTION	COMPLIANCE VOLTAGE	ACCURACY (6 months) (20°C to 30°C)	FREQUENCY	TOTAL HARMONIC DISTORTION AND NOISE
0.2A to 1.99999A	10 μ A	0 to 1.4V rms min.	$\pm(0.05\%$ of setting + $+ .005\%$ of range +0.02 μ A) Compliance voltage: >1V rms add 0.005% of setting/volt	50 Hz to 1 kHz	Distortion, line interference + noise including random spikes (0.05% of output + μ A) rms + (>1V rms) add 0.01% of distortion/volt
20 mA to 199.999 mA	1 μ A	0 to 7V rms min.		Accuracy: $\pm 3\%$ Resolution: 1 MSD	
2 mA to 19.9999 mA	100 nA	0 to 7V rms min.		Although no accuracy specifications apply above 1 kHz, output is usable to 5 kHz.	
0.2 mA to 1.99999 mA	10 nA	0 to 7V rms min.			
10 μ A ¹ to 199.999 μ A	1 nA	0 to 7V rms min.			

(1) 10% lower current available using the Edit Control.

Temperature Coefficient (Above 30°C and Below 20°C)

CURRENT: Accuracy limits increase by $\pm(25$ ppm of setting + 10 ppm of range+0.2 nA)/°C.

FREQUENCY: Accuracy limits increase by $\pm 0.1\%$ /°C.

Transient Recovery Time

4 seconds to settle within 0.2% of final value for current and within 0.3% for frequency following any change in output current, voltage, or frequency.

Short Term Stability (10 Minutes)

At any fixed temperature from 0°C to 50°C the short term stability is $\pm(0.014\%$ of setting + 0.002% of range + 0.4 μ A).

Load Regulation

± 50 ppm +20 nA/volt for a change in the output voltage from 1V to maximum rated compliance voltage. Load regulation is met with reactive loads with power factors between 0.9 and 1.0.

Overvoltage Protection

On all ranges voltage is limited to not more than 2V peak greater than maximum rated compliance voltage due to an open circuit condition. The operator is alerted by a flashing "O.L." on the central display. After approximately 2 seconds the calibrator goes to standby.

Guard

The AC current section is guarded and a front panel terminal labeled "I GUARD" is provided.

Table 1-5. Resistance Specifications

Resistance						
RANGE	POWER DISSIPATION	MAXIMUM CURRENT	PEAK VOLTAGE	ACCURACY (6 Months) (20°C to 30°C)	TEMPERATURE COEFFICIENT >30°C and <20°C ACCURACY LIMITS INCREASE BY	POWER COEFFICIENT
1Ω	1W	1A	1V	0.015%	10 ppm/°C	0.1 ppm/mW
10Ω		300 mA	3V	0.010%		
100Ω		100 mA	10V	0.003%	5 ppm/°C	0.3 ppm/mW
1 kΩ		30 mA	30V			
10 kΩ		10 mA	100V			
100 kΩ		3 mA	300V			
1 MΩ	100 mW	0.3 mA		0.010%	0.2 ppm/mW	
10 MΩ	10 mW	0.03 mA		0.030%	10 ppm/°C up to 40°C 50 ppm/°C above 40°C	0.02 ppm/mW

Two or Four Terminal Ohms Below 100 kΩ

The maximum residual resistance that can be compensated for using the Cal 1Ω function is 0.99999Ω.

The accuracy specification given above is for a 4-terminal connection below 100 kΩ. The accuracy specification is valid if the CAL 1Ω function is performed within the last 8 hours and the instrument is continually powered during that period. The 2-terminal connection is made to the OUTPUT terminals.

RANGE	ACCURACY	} + Ohmmeter Error (see note)
10Ω	0.4%	
100Ω	0.05%	
1 kΩ	0.0125%	
10 kΩ	0.0075%	

NOTE

The "Ohmmeter Error" is the error the Ohmmeter has in measuring the 1 Ohm function expressed in Ohms.

Table 1-6. Wideband Option -03 Specifications

Wideband Option -03			
RANGE VOLTS	RANGE APPROX dBm*	AMPLITUDE ACCURACY AT 1 kHz TERMINATED IN 50Ω (6 Months 20°C to 30°C)	FREQUENCY VS. AMPLITUDE FLATNESS TERMINATED WITH **50Ω AND 1 FT OF RG58/AU
1V to 3.1623V	+13 to +23	±(0.25% of setting + 0.25% of range)	10 Hz to 30 Hz: ±0.3%
0.31624V to 0.99999V	+3 to +13	±(0.50% of setting + 0.25% of range)	>30 Hz to 1 MHz: ±0.25%
0.1V to 0.31623V	-7 to +3	±(0.75% of setting + 0.25% of range)	>1 MHz to 5 MHz ±0.25% above 1 mV ±0.6% at 1 mV and lower
31.624 mV to 99.999 mV	-17 to -7	±(1.00% of setting + 0.25% of range)	
10 mV to 31.623 mV	-27 to -17	±(1.25% of setting + 0.25% of range)	
3.1624 mV to 9.9999 mV	-37 to -27	±(1.50% of setting + 0.25% of range)	>5 MHz to 10 MHz: ±0.6%
1 mV to 3.1623 mV	-47 to -37	±(1.75% of setting + 0.25% of range)	Frequency Resolution: 1 MSD
300 μV to 0.99999 mV	-57 to -47	±(2.00% of setting + 0.25% of range)	Frequency Accuracy: ±3%

(*) 0 dBm = mW across 50Ω = 0.22361V.

(**) Frequency vs amplitude flatness with respect to 1 kHz.

Temperature Coefficient (Above 30° and Below 20°C)

AMPLITUDE: Accuracy limits increase by 0.1 times the accuracies listed in the amplitude accuracy column/°C.

FREQUENCY: Accuracy limits increase by 0.25%/°C.

Transient Recovery Time

2 seconds to settle within 500 ppm of final value for amplitude and within 0.3% for frequency following any change in voltage, current, or frequency.

Harmonics

-40 dB or lower relative to fundamental for each frequency except -32 dB above 5 MHz.

Spurious Outputs

-50 dB or lower relative to fundamental for each frequency.

Overload Protection

A short circuit on the wideband output will not damage the calibrator. Normal operation is restored upon removal.

5100 SERIES WIDEBAND FREQUENCY RESPONSE

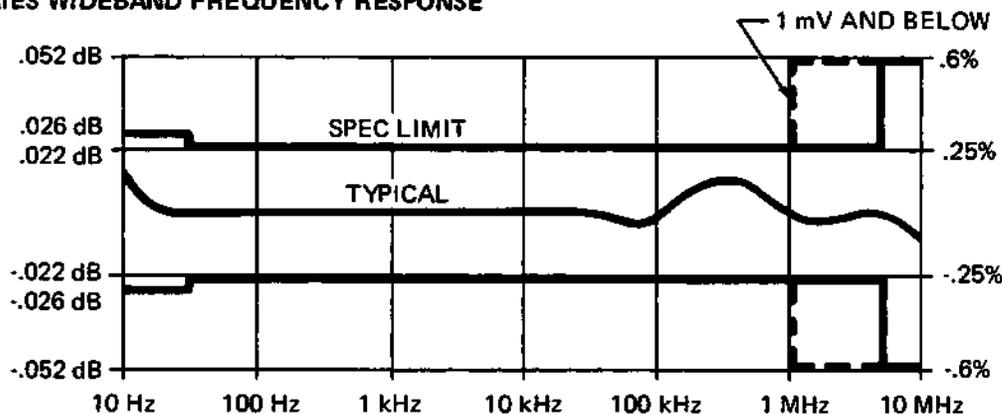

Table 1-7. General Specifications

Stability/Environmental

All specifications have been stated with the following conditions:

Time: Six months
Temp: 25°C ±5°C
R.H.: < 85%

Temperature Range

5100B/5101B: Operating 0°C to +50°C
 Non Operating -20°C to +65°C
5101A w/tape: Operating +10°C to +40°C
 Non Operating +4°C to +50°C

Humidity Range

0°C to 35°C: 85% RH (Non-Condensing)
 35°C to 40°C: 70% RH
 40°C to 50°C: 50% RH

Shock and Vibration

Meets requirements of MIL-T-28800 for class 5 style E equipment.

Operating Power

(100V, 110V, 115V, 120V, 200V, 220V, 230V, 240V ± 10%; 50 - 60 Hz)

5100B: 200 VA Fully Loaded
5101B: 220 VA Fully Loaded

Warmup

30 Minutes to rated accuracy

Dimensions

22.23 cm H X 43.18 cm L X 60.33 Cm W
 (8.75 in H X 17.00 in L X 23.75 in W)

Weight

5100B: 30.4 kgm (67 lbs.) basic.
 32.7 kgm (72 lbs.) fully loaded.
5101B: 32.7 kgm (72 lbs.) basic.
 34.9 kgm (77 lbs.) fully loaded.
5102B: 35.8 kgm (79 lbs.) basic.
 38.1 kgm (84 lbs.) fully loaded.

Safety

Safety Class I as defined in IEC 348.

Line Regulation

Output changes less than 5% of Load Regulations.

**Table 1-8. System Specifications for Power Amplifier Application
(5100 Series B + Y500, Y5001, 5205A/5215A Combination)**

DC Operation (with 5205A)

Output Voltage

±(100 to 1100) volts

Output Current

100 mA maximum

Accuracy

(90-Day) ±(0.06% of output + 20 mV)

(180-Day) ±(0.07% of output + 20 mV)

Maximum Capacitive

Load: < 1500 pF

Temperature Coefficient

±(25 ppm of output +3 mV)/°C

Ripple and Noise

Random noise, in a 1 MHz bandwidth shall not exceed 100 mV rms. Line-related noise shall be less than 50 mV rms.

AC Operation (with 5205A or 5215A)

Output Voltage

100 to 110V rms

Output Current

200 mA from 100 Hz to 50 kHz linearly decreasing to 140 mA in the region 100 Hz to 50 Hz.

Amplitude Accuracy (180-Day, 23°C ±5°C)

50 Hz to 10 kHz ±(.08% Eo + .1 volt)

10 kHz to 50 kHz ±(.12% Eo + .15 volt)

Total Distortion and Noise, (in the band 10 Hz to 1 MHz)

50 Hz to 20 kHz 0.1% of output

20 kHz to 50 kHz 0.2% of output

Maximum Capacitive Load

1500 pF or that value which draws the maximum rated load current, whichever is less.

Amplitude Temperature Coefficient

Above 30°C and below 20°C the accuracy limit increases by ±(30 ppm of output +3 mV)/°C for 50 Hz to 10 kHz; and ±(50 ppm of output +5mV)/°C for 10 kHz to 50 kHz.

Table 1-9. System Specifications for Transconductance Amplifier Application
(5100 Series B + Y5000, Y5002, 5220A Combination)

DC Mode

Output Range

± 1 to ± 19.9999 A

Accuracy of Output

$\pm(0.025\%$ of selected output + 1 mA)

Resolution

± 0.1 mA

Temperature Coefficient

$\pm(0.003\%$ of selected output + $100\ \mu\text{A}$) in ten minutes, with constant line, load, and temperature.

Line Regulation

Output changes less than 0.001% for a $\pm 10\%$ in line voltage.

Load Regulation

Output changes less than $\pm(0.005\% + 100\ \mu\text{A})$ for a full load change of 4 volts of compliance.

AC Mode

Output Range

1A rms to 19.9999A rms

Accuracy of Output

$\pm(0.07\%$ of selected output + 1 mA rms) from 50 Hz to 1 kHz, and $\pm(0.07\%$ of selected output + 1 mA rms) $\times f$ from 1 kHz to 5 kHz, where f = frequency in kHz.

Resolution

± 0.1 mA rms

Temperature Coefficient

$\pm(0.003\%$ of selected output + $100\ \mu\text{A}$ rms) per degree C, above 30°C and below 20°C .

Short Term Stability

Output changes less than $\pm(0.02\% + 500\ \mu\text{A}$ rms) in 10 minutes, with constant line, load, and temperature.

Section 2

Operating Instructions

2-1. INTRODUCTION

2-2. This section contains information regarding installation and operation of the Model 5100 Series Calibrators. It is recommended that the contents of this section be read and understood before any attempt is made to operate the instrument. Should any difficulties arise during operation, contact your nearest Fluke Sales Representative, or the Fluke Corporation, P.O. Box 9090, Everett, WA 98206-9090, Tel (206) 356-5400.

2-3. SHIPPING INFORMATION

2-4. The instrument is packed and shipped in a foampacked cardboard carton. If reshipment is required use the original container or request a new container from the Fluke Corporation. Please include the instrument model number with your request.

2-5. OPTIONS AND ACCESSORIES

2-6. Listed in Table 2-1 are the options and accessories available for the 5100 Series B Calibrators. A detailed description of each is included in Section 6 of the instruction manual.

2-7. INSTALLATION

2-8. The 5100 instruments are designed for bench-top use (all) or for installation in a standard 19-inch equipment rack (5100B and 5101B) using the optional accessory rack mounting kit. If desired, accessory chassis slides may be installed to facilitate access to the rack-installed equipment. Information on the installation of

rack mounting accessories is given in Section 6 of the instruction manual.

Table 2-1. Options and Accessories

OPTION OR MODEL NO.	TITLE
Option -03	Wideband (10Hz to 10 MHz)
Option -05	IEEE-488 Standard Interface
Option -06	Bit Serial Asynchronous Interface (RS-232-C)
5100A-7003K	Transit Case
5100A-7005K	Extender Accessory Kit
MIS-7190K	Static Controller
M08-205-600	Rack Mounting Kit
M00-280-610	Chassis Slides
Y5000	5100 Series Interface
Y5001	Cable Assembly (Y5000 to Model 5205A/5215A)
Y5002	Cable Assembly (Y5000 to Model 5220A)
Y8021	1 Meter IEEE Cable
Y8022	2 Meter IEEE Cable
Y8023	4 Meter IEEE Cable
Y8007	10-Pack of Minicassettes for Storage System Instruments

2-9. OPERATING FEATURES

2-10. Front Panel Controls

2-11. The 5100 Series Front Panels are divided into nine major groupings. The groupings and their general use are shown and explained in Figure 2-1 and Table 2-2. The individual groupings are explained and illustrated in greater detail in later paragraphs of this section.

2-12. The first eight groupings are identical in operation and positioning for all models in the series. The ninth grouping, the Storage System, is present only in the Model 5101B and any material dealing with it is peculiar to the 5101B only.

2-13. POWER

2-14. The Power Group consists of the POWER switch. The switch is in to apply line power to the instrument and out to remove power.

2-15. DATA ENTRY

2-16. Individual items or groupings on the Data Entry keyboard are explained in Figure 2-2 and Table 2-3. In addition, a voltage (V), dBm entry, WIDEBAND, or EXT OSC selection will lock the keyboard from further entries until either the ENTER, RECALL, or CLEAR switch is depressed. If either "Err3" or "Err4" results when ENTER is depressed, the original entry is not changed and the KEYBOARD indicator remains illuminated.

2-17. CONTROL

2-18. Two switches in the Control Group select the Operating mode (OPR/STDBY) and Controlling device (LOCAL/REM). Both switches are push-push type switches that illuminate the applicable indicator to show the selected mode. To change from STDBY to OPR, depress the switch and the OPR indicator will illuminate and the STDBY indicator extinguish. To return to STDBY depress the switch again and the condition will reverse, i.e., the OPR indicator extinguish and the STDBY indicator illuminate. The LOCAL/REM pushbutton switch operates in the same manner.

2-19. WIDEBAND OUTPUT

2-20. When the Wideband -03 Option is installed and selected, the output is present at the BNC type connector with an output impedance of 50 ohms. The maximum output is 3.1623 volts rms (+23 dBm) into 50 ohms.

2-21. MAIN OUTPUT

2-22. An explanation of the terminals, controls, and indicators are given in Figure 2-3 and Table 2-4.

2-23. OUTPUT DISPLAY

2-24. An explanation of the Output Display and indicators is given in Figure 2-4 and Table 2-5.

2-25. CENTRAL DISPLAY

2-26. An explanation of the Central Display and indicators is given in Figure 2-5 and Table 2-6.

2-27. ERROR MODE

2-28. An explanation of the Error Mode Controls and indicator are given in Figure 2-6 and Table 2-7. The use of any control automatically places the instrument in the Error Mode if it has not been selected previously.

2-29. STORAGE SYSTEM (Storage Only)

2-30. An explanation of the Storage System controls and indicators is given in Figure 2-7 and Table 2-8.

2-31. Rear Panel

2-32. The 5100 Series Rear Panel is shown and explained in Figure 2-8 and Table 2-9, respectively.

2-33. Error Messages

2-34. The Central Display and the optional interface output device will indicate an error by displaying an error code. The codes and errors causing them are shown in Table 2-10.

2-35. List (Storage Only)

2-36. The LIST switch in the Storage Group allows the operator to print a hard copy of a stored program or a test in progress, provided the instrument is equipped with one of the optional remote interfaces. The instrument must be in the Store Mode, the first desired step of the program selected, and LIST selected to output a listing of the stored program. The printed output starts with the selected program step and continues to the end of the stored program. The printed output includes the step number; the 5100 output (programmed nominal and full-scale as modified by the Error Mode and/or Fractional-Scale Operations); tolerance and entry limits; and the status, to include Standby/Operate, Sensing, External Oscillator, Wideband, 50 ohm divider override, Boost, and the position of the Error Mode Digit. The placement of the data in the print format is shown in Figure 2-9. Entering any command during a list operation terminates the listing. During a program list the instrument automatically goes to standby.

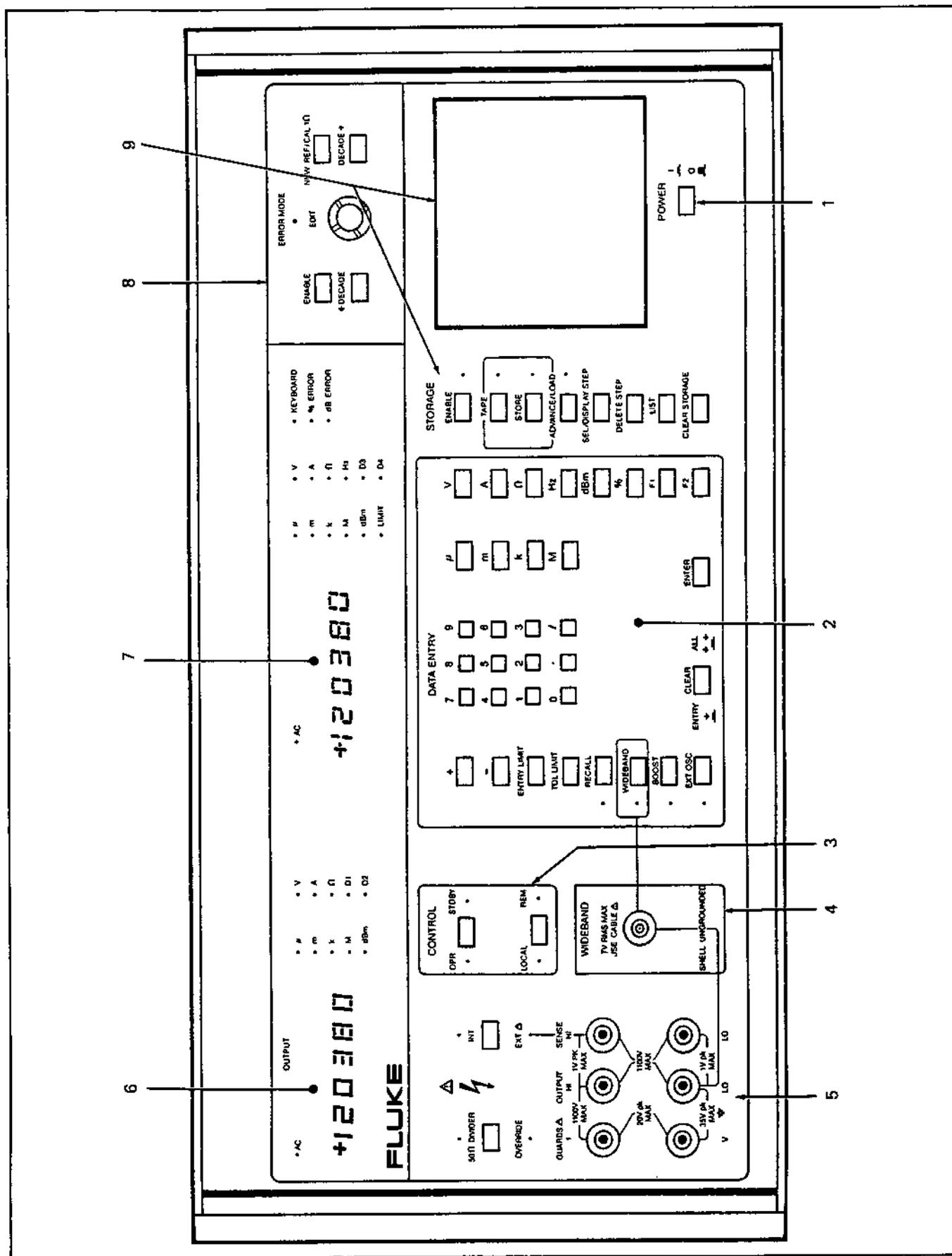

Figure 2-1. Front Panel

Table 2-2. Front Panel Display and Controls

1. POWER	Controls the application and removal of input power.
2. DATA ENTRY	This portion of the Keyboard allows the operator to enter the data desired into the input registers for display, and upon completion places the data into memory.
3. CONTROL	Selects the operational status and mode.
4. WIDEBAND OUTPUT	(10 Hz - 10 MHz) Output terminal for the wideband frequency option. Operational only with Option -03 installed.
5. MAIN OUTPUT	(DC, 50 Hz - 50 kHz) Sense controls and output terminals for the main output.
6. OUTPUT DISPLAY	Displays the output value and function.
7. CENTRAL DISPLAY	Displays the data entered from the data entry section, the error in a percentage figure, the error in dB's, the output frequency when an AC output is selected and the limits, when recalled.
8. ERROR MODE	When enabled, the output may be modified at any decade and the percent of error or dB error deviation from the original figure displayed in percentage or dB respectively.
9. STORAGE SYSTEM (STORAGE ONLY)	When enabled, operates the instrument from a stored program. The program may be entered manually or from a previously recorded tape, read by the integral tape system.

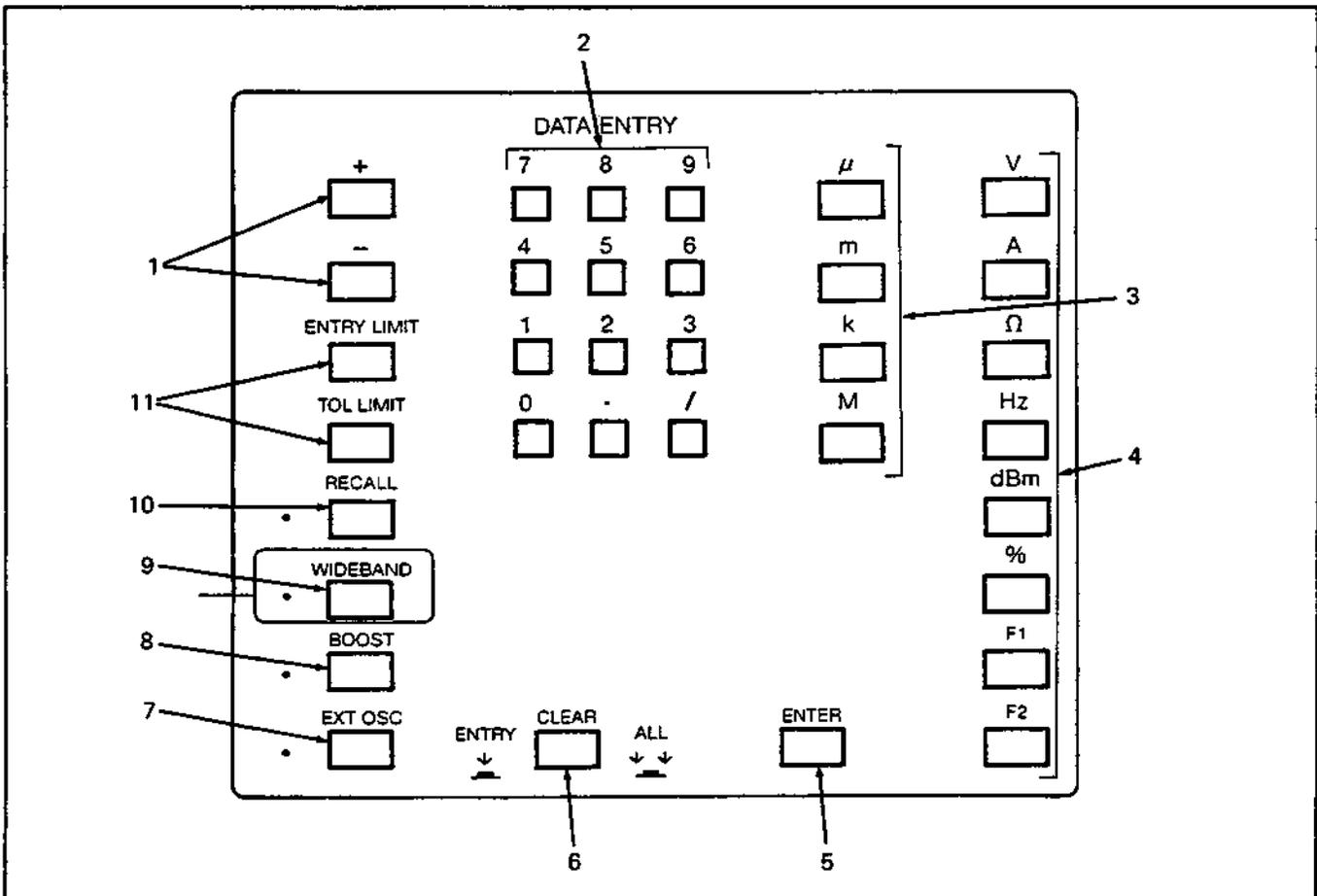

Figure 2-2. Data Entry Group

Table 2-3. Data Entry Group

1.	POLARITY	Depress the applicable keyswitch (+ or -) for the desired polarity with any DC Volts or Amps entry. If an entry is not made positive polarity is assumed, if the DC mode is selected.
2.	NUMERICAL	Depress the applicable keyswitch to enter the numerical data desired. Characters available are 0 through 9, the decimal point (.), and the slash (/) used for ratio. Data is entered by depressing the keys in sequence, beginning with the most significant digit. Restrictions are placed on the numerical entries for frequency and resistance. Only the first digit (the MSD) is variable with a frequency entry. Resistance is variable only in decades from 1 ohm through 10 megohms.
3.	MULTIPLIER	Select the multiplier for the numerical data entered. Available are u(10^{-6}), m(10^{-3}), k(10^3) and M(10^6). No entry assumes a value of units (10^0).
4.	FUNCTION	Designates the function of the numerical data entered. Depress "V" to select Volts, "A" for Amps, "Ω" for Ohms, "Hz" for Frequency, "dBm" for decibels milliwatt and "%" for percentage. Once Volts, Amps, Ohms, Hertz, or dBm have been selected, the instrument is locked into the Keyboard Mode until the data is entered into the instrument with the "ENTER" switch. Switches "F1" and "F2" are not used at this time.
5.	ENTER	When the correct entry has been completed (both magnitude and frequency, if applicable) and is shown on the Central Display (frequency only is displayed for AC entries) or Indicators, as applicable, the ENTER switch is depressed to enter the data into memory and perform the selected action. If an Error display results, the data entered in the keyboard memory is retained until correctly entered or cleared.
WARNING		
IF A KEYBOARD ENTRY IS TERMINATED WITH EITHER A CLEAR OR ERROR MESSAGE THE INSTRUMENT RETAINS ITS PREVIOUS STATUS. IF TWO NEW PARAMETERS ARE ENTERED, E.G., FREQUENCY AND MAGNITUDE, AND ONE IS ILLEGAL THE INSTRUMENT REJECTS THE ILLEGAL ENTRY, WHILE ACCEPTING THE LEGAL ENTRY, SOMETIMES RESULTING IN AN UNPLANNED OUTPUT. FOR SAFETY, ALWAYS VERIFY THE OUTPUT MAGNITUDE OF THE INSTRUMENT, AS SHOWN ON THE OUTPUT DISPLAY, AFTER AN ILLEGAL ENTRY.		
6.	CLEAR	Depress the CLEAR switch once to clear the display (CLEAR ENTRY). A second consecutive depression clears memory and resets the instrument (CLEAR-ALL).
7.	EXTERNAL OSCILLATOR	An external input can be used to obtain a desired frequency not available internally. The Source input must be 1.2V +/-5% and the impedance must be less the 50 ohms. In addition the output frequency must be within the allowable range for the output voltage selected. Only the frequency range is shown on the Central Display, the frequency magnitude is blanked. The function is not active until the ENTER switch is depressed.
8.	BOOST	Selects the Boost Function which extends the Voltage (Power) and Current Capabilities of the instrument. This is accomplished by routing the 5100 B output through an accessory interface to a Fluke Model 5205A/5215A Power Amplifier and/or a Fluke Model 5220A Transconductance Amplifier. The Output is available at the terminals of the applicable Amplifier instrument, rather than the Calibrator terminals, once the Boost Function is selected the output value data keyed in, and the ENTER Switch depressed.
9.	WIDEBAND	Selects the Wideband -03 Option with its greater frequency range (10 Hz to 10 MHz) and its dedicated output connector. The function is not active until the ENTER switch is depressed.

Table 2-3. Data Entry Group (cont)

10. RECALL	<p>The RECALL switch can be used to restore to the Central Display the stored limit values (output magnitude), voltage (e.g., when the output display reads in dBm), and frequency. The RECALL switch will also clear the keyboard memory and the keyboard indicator.</p>
11. LIMITS	<p>Depression of the applicable limit switch enables entry into memory of a limit value, including polarity if applicable for that function. If the polarity is not specified, but is applicable, the entered value is applied as both positive and negative limits. When the polarity is entered the unnamed polarity is unchanged. When programmed data exceeds the ENTRY LIMIT previously entered the entry is refused and the message "Err3" is displayed on the Central Display and the LIMIT indicator illuminated. If the error shown on the Central Display during Error Mode Operations exceeds the figure set with TOL LIMIT the LIMIT indicator illuminates and the Central Display numerics flash. This is for information only, it does not effect the operation of the instrument. The tolerance limit is normally set as a percentage of dB limit. If it is set using any other function, i.e. volts, amps, etc. the value is automatically changed to a percentage of the current output value by the instrument controller.</p>

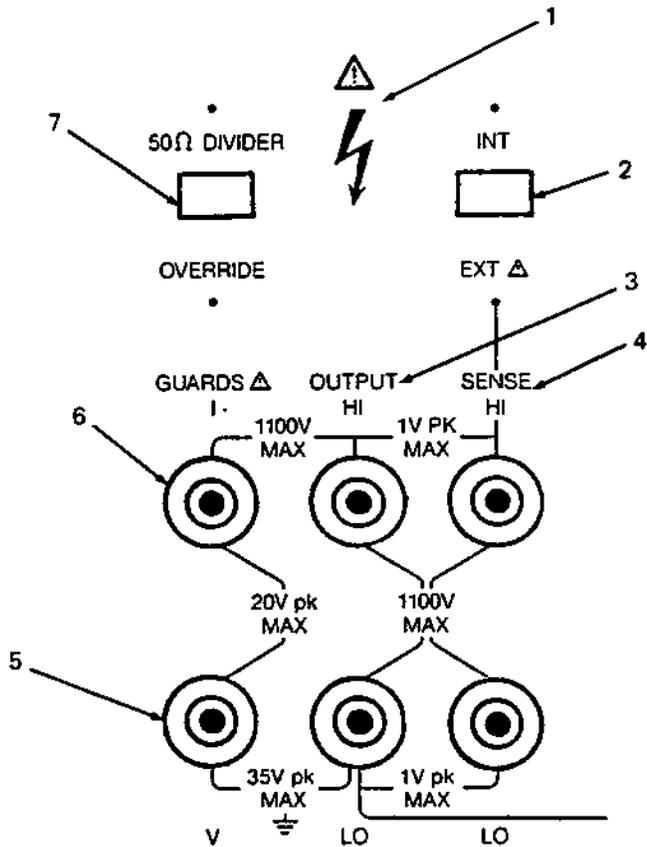

Figure 2-3. Main Output Group

Table 2-4. Main Output Group

- | | | |
|----|------------------|--|
| 1. | WARNING DECAL | Warning that lethal voltages may be present at the output terminals. |
| 2. | SENSE SWITCH | Push-Push toggle switch to select internal (2-wire) or external (4-wire) sensing. The indicator illuminated signifies the type of sensing selected. To change types depress the switch one time and the indicators will reverse. |
| 3. | OUTPUT TERMINALS | The HI and LO output terminals. All standard Voltage, Current, and Resistance outputs are available on these terminals. The maximum difference between the HI and LO terminals is 1100 Volts rms. |

CAUTION

Do not connect the Output HI terminal to chassis, or an earth ground, at any time. Damage to the instrument may result. Do not connect either guard terminal to the Output HI terminal, component failure occurs within the instrument at output voltages above 15 volts. When using the instrument always set the calibrator to STDBY before connecting or disconnecting a load. Arcing may result if the connections are broken while a high voltage output is selected. The arcing may cause logic interruptions that could result in calibrator damage.

- | | | |
|----|-----------------|---|
| 4. | SENSE TERMINALS | Used for 4-wire resistance and remote voltage sensing. The allowable difference between Output HI and Sense HI or Output LO and Sense LO is 0.3 Volts. |
| 5. | V GUARD | Connects to the inner shield surrounding the analog sections of the 5100B to isolate them from the chassis, I/O connections and digital section. Normally connected to Output Lo at either the Front Panel or the Voltmeter under test. |
| 6. | I GUARD | Provides a driven shield "guard" around output HI in the AC and DC Current modes. Held at the same voltage as Output HI by a unity gain amplifier, is used to minimize the degradation of accuracy caused by stray capacitance between Output Hi and Output LO. |

CAUTION

Output Current inaccuracies will result if the I-Guard terminal is connected to the V-Guard, Output LO, Chassis, or Sense terminal.

- | | | |
|----|--------------------------|--|
| 7. | 50Ω DIVIDER/
OVERRIDE | The 50Ω DIVIDER indicator illuminates when an output voltage between 0 and 1.99999V dc or between 1 and 199.99 mV ac is selected, with the exception of the 200 mV to 1.9999V ac range. The illumination of the indicator verifies that the calibrator has automatically changed to an internal precision 50Ω divider. |
|----|--------------------------|--|

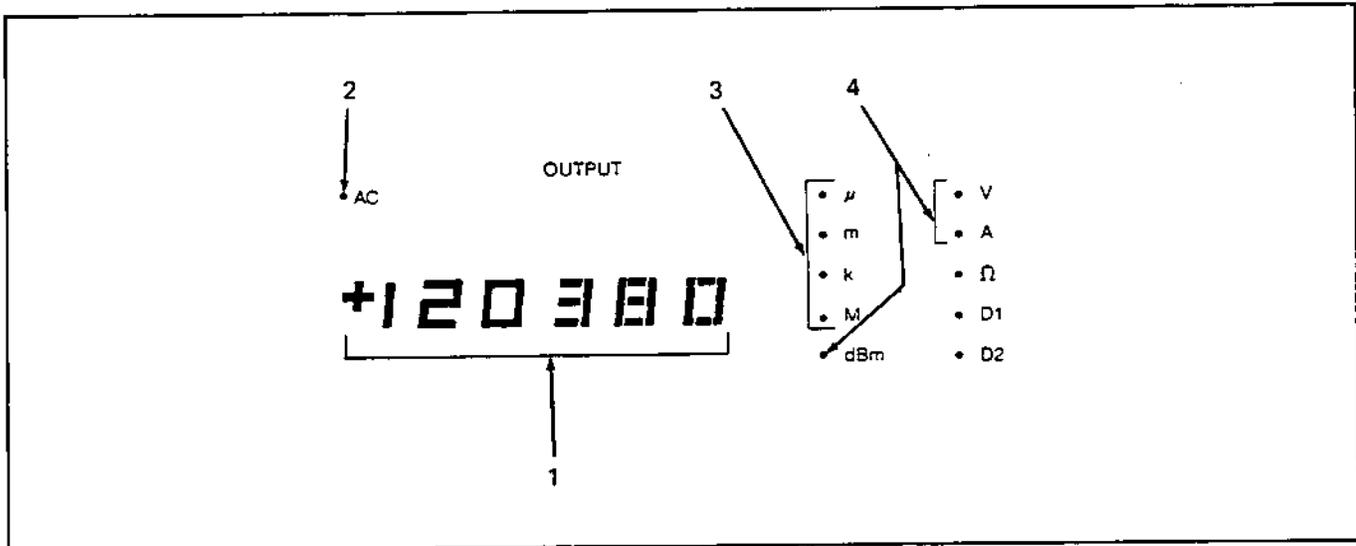

Figure 2-4. Output Display Group

Table 2-5. Output Display Group

1. NUMERIC DISPLAY	The absolute numeric value with decimal point and polarity, if applicable, of the signal present at the output terminals.
2. AC INDICATOR	Illuminated when the output signal is an AC Voltage of Current.
3. MULTIPLIER	Indicator illuminates to show the multiplier of the numeric display. The multipliers are $\mu(10^{-6})$, $m(10^{-3})$, $k(10^3)$ and $M(10^6)$. Units (10^0) are the default condition with no indicator illuminated.
4. FUNCTION	Illuminated to show whether the function displayed is Voltage (V), Current (A), Resistance (Ω), or decibel milliwatts (dBm). Indicators D1 and D2 are not used at this time.

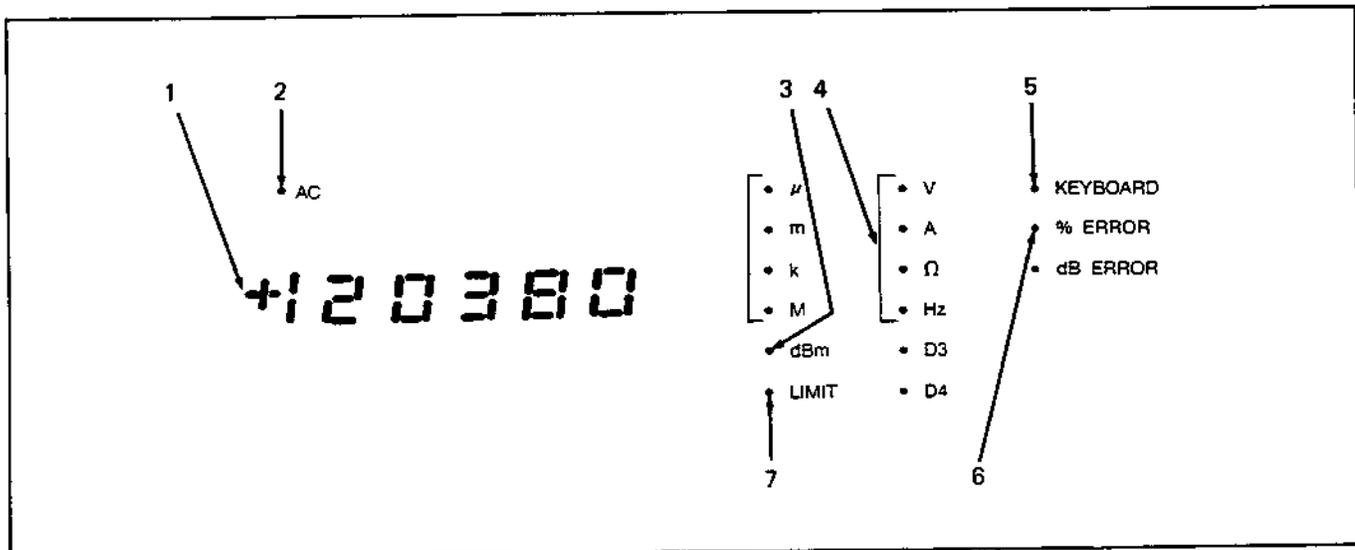

Figure 2-5. Central Display Group

Table 2-6. Central Display Group

1. NUMERIC DISPLAY	The absolute numeric value and polarity, if applicable, of the signal displayed.
2. AC INDICATOR	Illuminated when the displayed signal is an AC Voltage or Current.
3. MULTIPLIER	Indicator illuminates to show the multiplier of the numeric display. The exponents are $\mu(10^{-6})$, $m(10^{-3})$, $k(10^3)$ and $M(10^6)$. Units (10^0) are the default condition with no indicator illuminated.
4. FUNCTION	Illuminates to show whether the function displayed is Voltage (V), Current (A), Resistance (Ω), Frequency (Hz), or decibel milliwatts (dBm). Indicators D3 and D4 are not used at this time.
5. KEYBOARD	Illuminates when a "V", "A", " Ω " dBm, Hz, WIDEBAND, or EXT OSC entry is made from the DATA ENTRY group keyboard. Extinguishes when the data is entered into memory.
6. ERROR MODE INDICATORS	When the Output is modified to select the ERROR MODE the applicable indicator illuminates to define whether the displayed numeric is a percentage error or a dB error. The error is the difference between the original output as shown on the output display and the present output display, as modified by the error controls.
7. LIMIT INDICATORS	Illuminates when the displayed error exceeds the tolerance limit stored for that function. The indicator is a warning to the operator only. It does not effect operation of the instrument. The indicator also illuminates when either ENTRY LIMIT or TOL LIMIT is keyed as the initial step in storing a limit value or when the stored limits are recalled for observation.

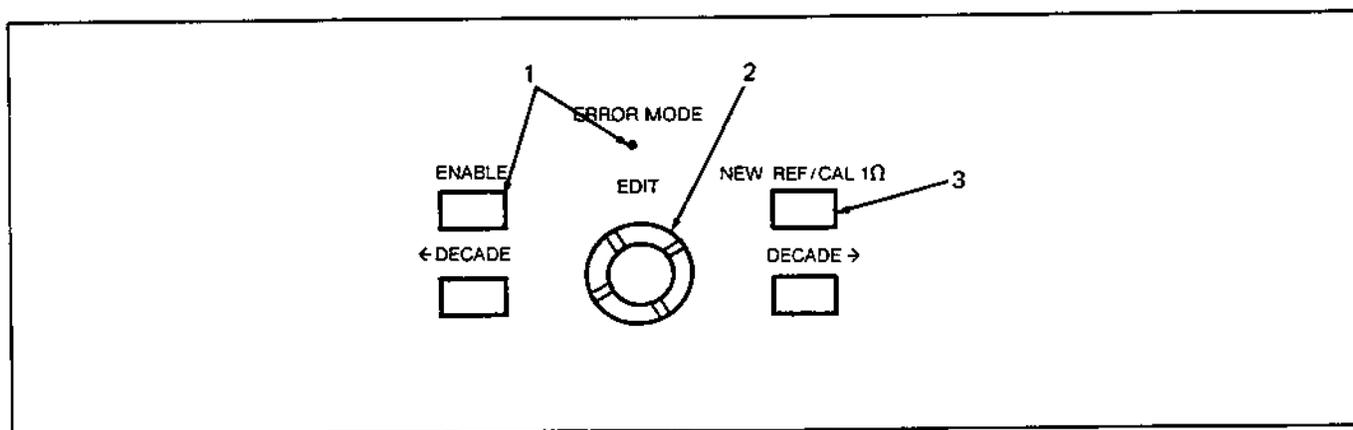

Figure 2-6. Error Mode Group

Table 2-7. Error Mode Group

1. ENABLE	The ENABLE switch toggles the instrument into or out of the Error Mode. When in the Error Mode the indicator illuminates. The Error Mode cannot be entered if the keyboard indicator is illuminated.
2. CONTROLS	The edit switch increments the absolute value (clockwise rotation) or decrements the absolute value (counterclockwise rotation) of the intensified digit on the output display (Central Display for Frequency modifications) when the error mode is selected. For example, a clockwise rotation will make a positive number more positive and a negative number more negative.

Table 2-7. Error Mode Group (cont)

<p>3. NEW REF/CAL 1 OHM</p>	<p>The left decade switch moves the intensified digit one decade to the left (toward the MSD) each time it is depressed. The right decade switch moves the intensified digit one position to the right (toward the LSD) with each depression. Continuing switch depressions when the digit has reached one extreme have no further effect.</p> <p>Changes the reference used in the computation of %ERROR or dB ERROR to the Value in the Output Display and resets the displayed error to zero. If the instrument is in the fractional scale mode, the full scale reference value is not changed. Used during internal sensed (2-wire) resistance measurements in the 1 ohm range to compensate the display resistance value for residual resistance.</p>
---------------------------------	--

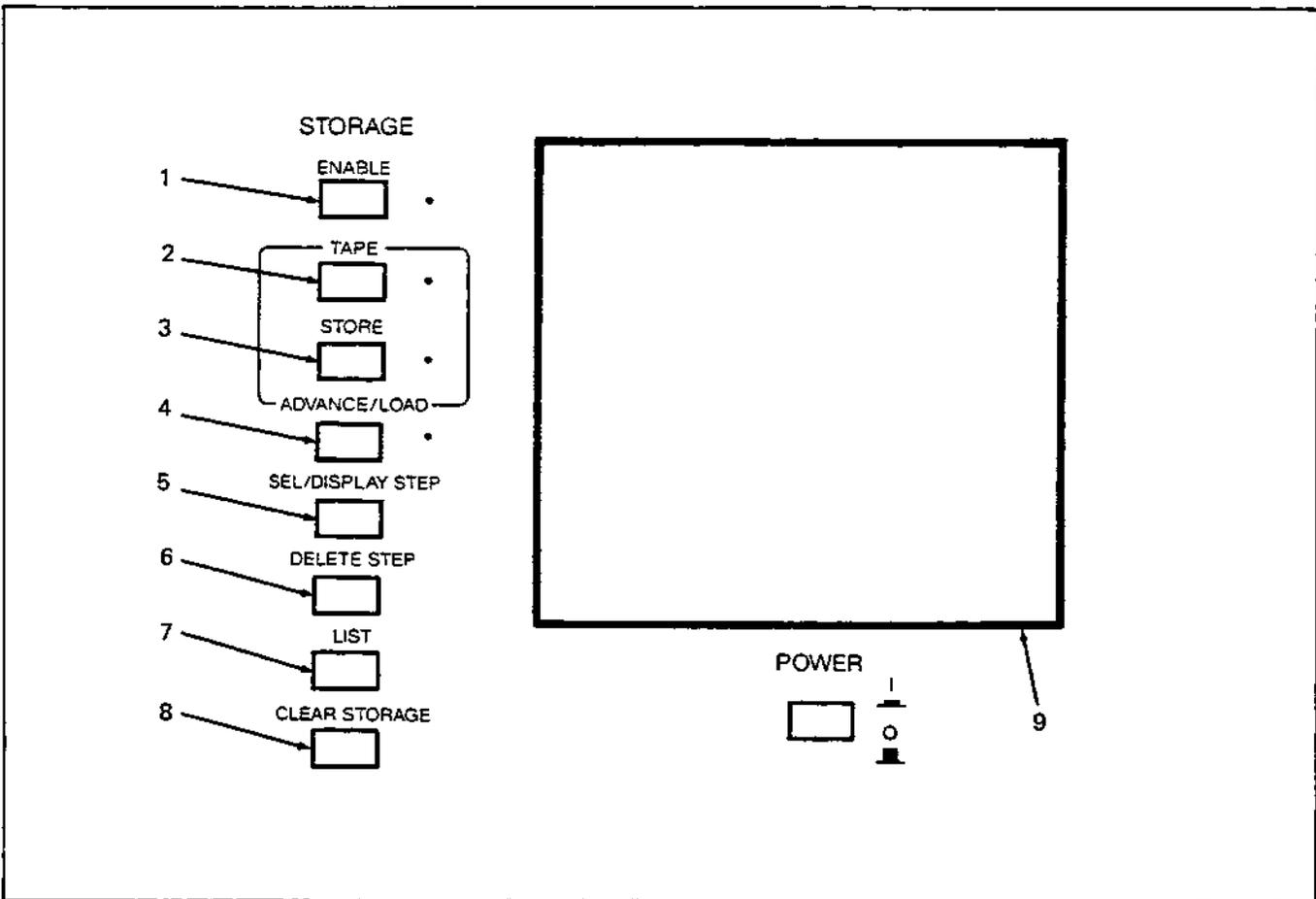

Figure 2-7. Storage Group (Storage Only)

Table 2-8. Storage Group (Storage Only)

<p>1. ENABLE</p>	<p>The ENABLE switch toggles the instrument into or out of, the storage mode of operation. The ENABLE indicator illuminates with the storage mode selected. Neither the tape system nor the memory can be used until the storage mode is selected.</p>
<p>2. TAPE</p>	<p>The TAPE switch is a toggle, enabling or disabling the Tape Mode. The TAPE indicator illuminates when the Tape Mode is selected.</p>

Table 2-8. Storage Group (Storage Only) (cont)

- | | |
|---------------------|---|
| 3. STORE | The STORE switch toggles the instrument between the Read and Store Modes. The Store Mode is selected when the indicator is illuminated. When the Store Mode is selected, data may be transferred from the instrument output to the Storage Memory or from the Storage Memory to Tape. The Read Mode is used to transfer data from a tape to the Storage Memory or from the Storage Memory to the instrument output. |
| 4. ADVANCE/LOAD | Operation of the ADVANCE/LOAD switch differs for the Read Mode, and Store Mode. When the Read Mode is selected and the switch is depressed, the next step in storage is transferred to the instrument output and the step number increments. When the final step has been selected, "End P", is displayed when the final step is loaded into the last step location. In the Store Mode, when the switch is depressed the output state is transferred to memory at the current step then the step number is incremented. After entering the final step for the capacity of memory, "End P" is displayed. If "FULL" is displayed, the memory buffer capacity would be exceeded and additional commands cannot be accepted. |
| 5. SEL/DISPLAY STEP | Operation of the SEL/DISPLAY STEP switch is controlled by the operation preceding depression of the switch. If the operation is not preceded by the entry of a numerical value, the step number of the selected step is flashed on the Central Display. If preceded by a numerical entry, the action taken is dependent upon whether the Read or Store Mode is selected, if there is a program entered and whether or not the step selected is within an existing program. When the Read Mode is selected, the step number flashes, then the stored output state is transferred to the instrument output. If the number selected is greater than the last step in the program, "End P", is displayed. In the Store Mode, the number selected is displayed, and that becomes the step referenced in storage operation. If the selected number is greater than the last step in the program the number of the first unused step is displayed and the final step is referenced. In the Store Mode the Output does not change when selecting or displaying steps. |
| 6. DELETE STEP | The step selected for operation is deleted when the DELETE STEP switch is depressed with the Store Mode selected. The step numbers of any subsequent steps are automatically decremented so there are no gaps in the sequence. The data replacing the deleted instruction is displayed. "Err 1", is displayed if the DELETE STEP switch is depressed with the Read Mode selected. |
| 7. LIST | Used with one of the Optional Interfaces to print an 80 column listing of of either all or part of the stored program (Store Mode) or the results of an individual test (Read Mode). |
| 8. CLEAR STORAGE | In the Store Mode all data in the storage memory is deleted and "End P", is displayed when the CLEAR STORAGE switch is depressed. If the switch is depressed in the Read Mode "Err 1", is displayed and no clearing action results. |
| 9. TAPE SYSTEM | Tape Unit to Read/Store data using a mini-cassette system, providing a permanent record of test programs. |

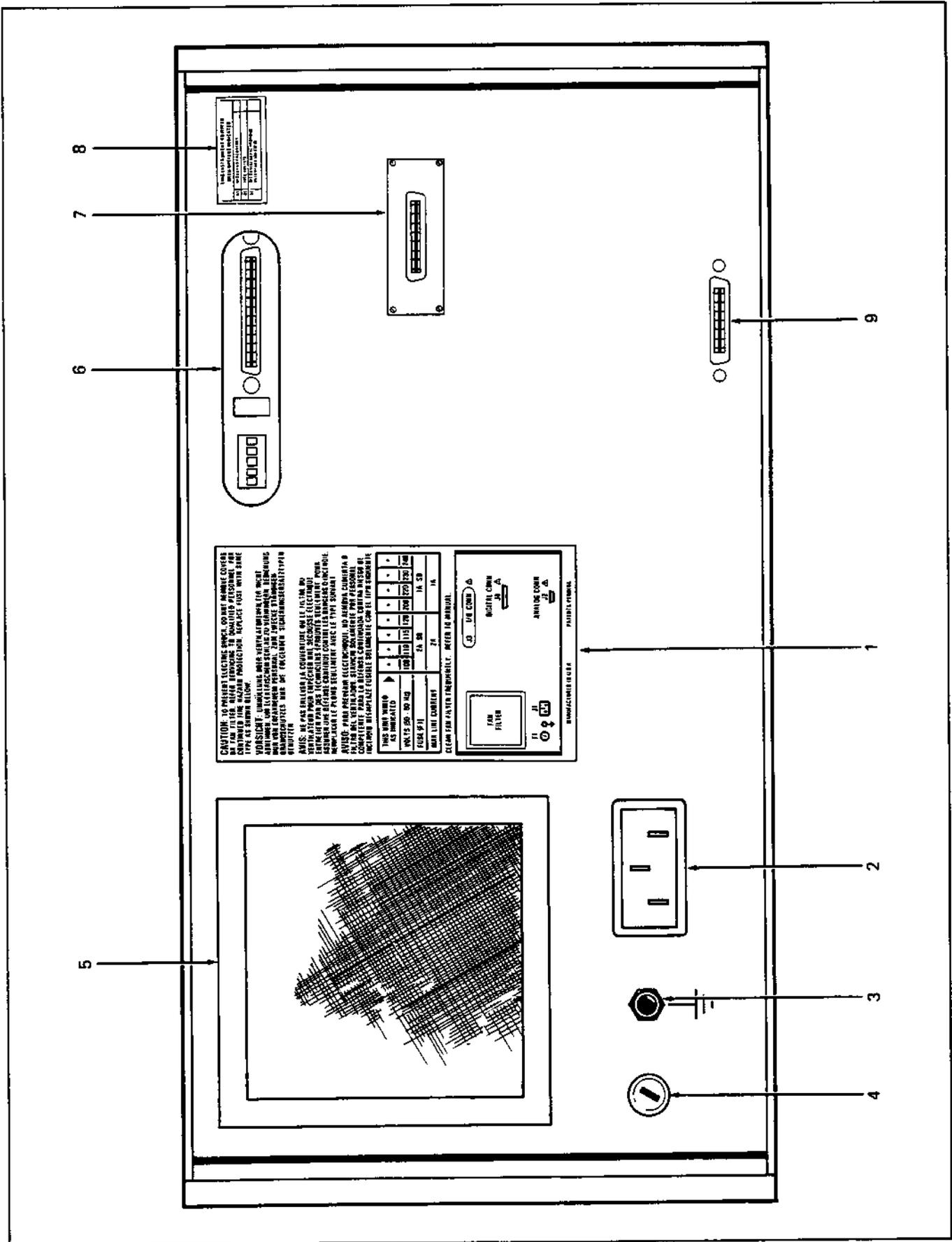

Figure 2-8. Rear Panel

Table 2-9. Rear Panel

1. Explanatory Decal lists set line voltage and nomenclature and/or identifiers for rear panel items
2. Input line power connector, J1
3. Chassis ground lug
4. Line power fuse, F 1
5. Fan Filter. Refer to Section 4 for maintenance procedure
6. Interface Access slot. If one of the option interfaces is installed in the instrument, access to the connector and address controls, if any, will be available here
7. MIS Bus Connector
8. Explanatory Decal lists Options installed in instrument
9. Analog Bus Connector. Inputs for the External Oscillator Signal, Oscillator Output, and Oscillator Output 90° are applied through the Analog Bus Connector, if required.

Table 2-10. Error Codes

Err0	No error (status message only)
Err1	Invalid character or sequence
Err2	Invalid frequency or resistance entry
Err3	Programmed output exceeds entry limits or instrument capabilities
Err4	Invalid frequency/output combination
Err5 (Msg) O.L. (display)	Overload or overcompliance voltage
Err6	Module accessed inoperative or not installed—voltage greater than 20V programmed with high voltage output not installed
Err7	String command exceeds 32 characters
Err8	Tape load/feed problem or write protected
Err9	Unable to read the tape

2-37. To obtain a listing of the current output, select the Read Mode and List. The printed output includes the step number, programmed nominal output, tolerance programmed, the actual output error, and if that exceeds the programmed tolerance, the word FAIL. The placement of this data in the print format is shown in Figure 2-10.

2-38. Both types of listing(s) are preceded by a heading (see Figures 2-9 and 2-10). A heading may be obtained, subsequent to completion of the current line, by toggling the ENABLE pushbutton (two depressions), then depressing the last switch. A heading in progress can be terminated by entering a command.

2-39. All numeric data, except the tolerance limits for

both List Program and List Data, are printed in engineering notation. Only the exponents E-6, E-3, E3 and E6 are printed, the E0 entry is blanked.

2-40. Program Write-Protect (Storage Only)

2-41. Tapes recorded with a program destined for permanent storage may be protected from accidental erasure with the tape cassette write-protect feature. To obtain this feature, punch out the cross shaped plug (Figure 2-11) on the top back of the cassette as it is placed in the tape reader. After the plug has been removed an "Err8" results if an attempt is made to write additional data, or, write over the existing data on that side of the tape cassette.

HEADING			
DATA			
INSTRUMENT			
.			
STEP	OUTPUT & REFERENCE	LIMITS	STATUS
1.	2.	3.	4.
1. Program Step Number	2. OUT: Actual Output NOM: Programmed Output (nominal) FS REF: Full Scale value if the nominal is a fractional scale	3. TOL: Tolerance limits in percent of dB ENT: Positive entry limit Negative entry limit (printed only if applicable)	4. STDBY or OPR, EXT SENSE or INT SENSE EXT OSC or WIDEBAND or 50Ω DIV OVRD (mutually exclusive) and BOOST Position of the Error Cursor (1 for Output Display MSD down to 6 for the LSD and FREQ for frequency)
<p><i>NOTE</i></p> <p><i>If the second entry within a field is not used, subsequent entries within the field fill the vacated space.</i></p>			

Figure 2-9. LIST Program (Storage Only)

INSTRUMENT		SERIAL NO		
DATE		OPERATOR		
STEP	NOMINAL OUTPUT	TOLERANCE	ERROR	
1.	2.	3.	4.	5.
1. Step number of the program (Blank without a program in memory)	2. Nominal Programmed Output	3. Tolerance in Percent or dB	4. Actual Value of Error in Percent or dB	5. Prints **Fail** if the Actual Error Exceeds the Tolerance

Figure 2-10. LIST Data (Storage Only)

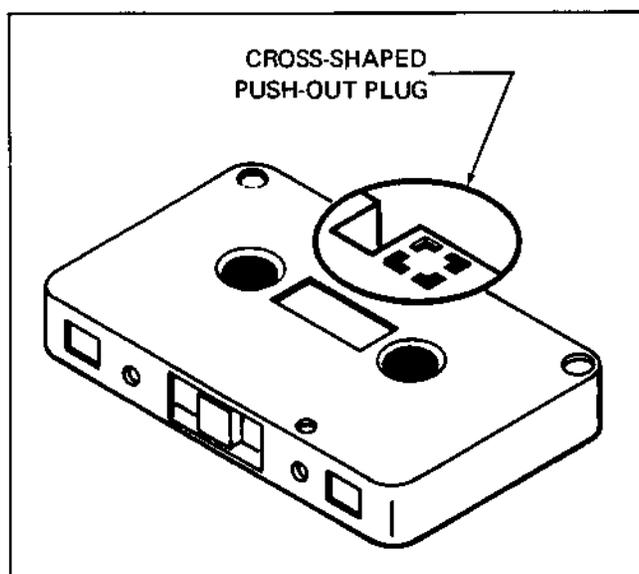

Figure 2-11. Tape Write-Protect Feature

2-42. LOCAL OPERATION

2-43. Initialization

2-44. The instrument is initialized when power is applied with the power switch, after having been removed, or when the CLEAR switch is depressed twice successively. This clears the registers and memory, extinguishing all the indicators except the following: STDBY, LOCAL, INT, AND 50Ω DIVIDER. In addition, the OUTPUT display reads 0.0000 mV and the Central Display flashes the number of the software revision, e.g., 1.0.5. The storage system, if installed, is not cleared by the CLEAR switch depressions.

2-45. Status During Function Change

2-46. In some cases the instrument automatically drops in status from Operate to Standby when the function is changed. These cases are listed in Table 2-11. When the status changes during a function change, depress the OPR/STDBY keyswitch to toggle the instrument back into Operate and continue with the procedure.

2-47. Meter Connection Procedure

2-48. Verify the instrument is in STDBY, then connect the meter to be calibrated to the Output terminals using the applicable configuration from Figure 2-12.

NOTE

Wideband AC Voltmeters (bandwidths exceeding 1 MHz) are susceptible to high-frequency noise on the low ranges and should be calibrated at levels below 10 mV using the Wideband (10 Hz-10 MHz) Output (Option -03).

Table 2-11. Standby/Operate Status Change

PRESENT FUNCTION	INSTRUMENT DROPS FROM OPR TO STDBY GOING TO THE FOLLOWING FUNCTIONS:
<20V dc	$\geq 20V$ dc, $\geq 20V$ ac, A dc, A ac, Ohms
$\geq 20V$ dc	$\geq 20V$ ac, A dc, A ac, Ohms
<20V ac	$\geq 20V$ dc, $\geq V$ ac, A dc, A ac, Ohms
$\geq 20V$ ac	$\geq 20V$ dc A dc, A ac, Ohms
A dc	V dc, V ac, Ohms
A ac	V dc, V ac, Ohms
Ohms	$\geq 20V$ dc, $\geq 20V$ ac, <20V dc, A dc, A ac
Wideband	$\geq 20V$ dc, $\geq 20V$ ac, A dc, A ac
<20V dc, <20V ac:	Selected Output is less than 20V
$\geq 20V$ dc, $\geq 20V$ ac:	Selected Output is equal to or greater than 20V

2-49. DC Voltage Output

2-50. Obtain a DC voltage output using the following procedure:

1. If the meter being tested is not connected, perform the connection procedure above.
2. Select the desired polarity and depress the applicable keyswitch.
3. Visible on the Central Display is the correct polarity.

NOTE

If a polarity is not selected, during DC operations, the instrument defaults to a positive polarity when the command is entered into memory.

4. Depress the numerical keyswitches required to obtain the absolute value of the desired voltage. Select in the normal sequence, i.e., from MSD (left) to the LSD (right).
5. The digits appear in the Central Display as they are entered with the LSD added on the right.
6. Select a multiplier, if required. If none is selected the instrument assumes units.
7. The selected multiplier indicator, if any, illuminates.

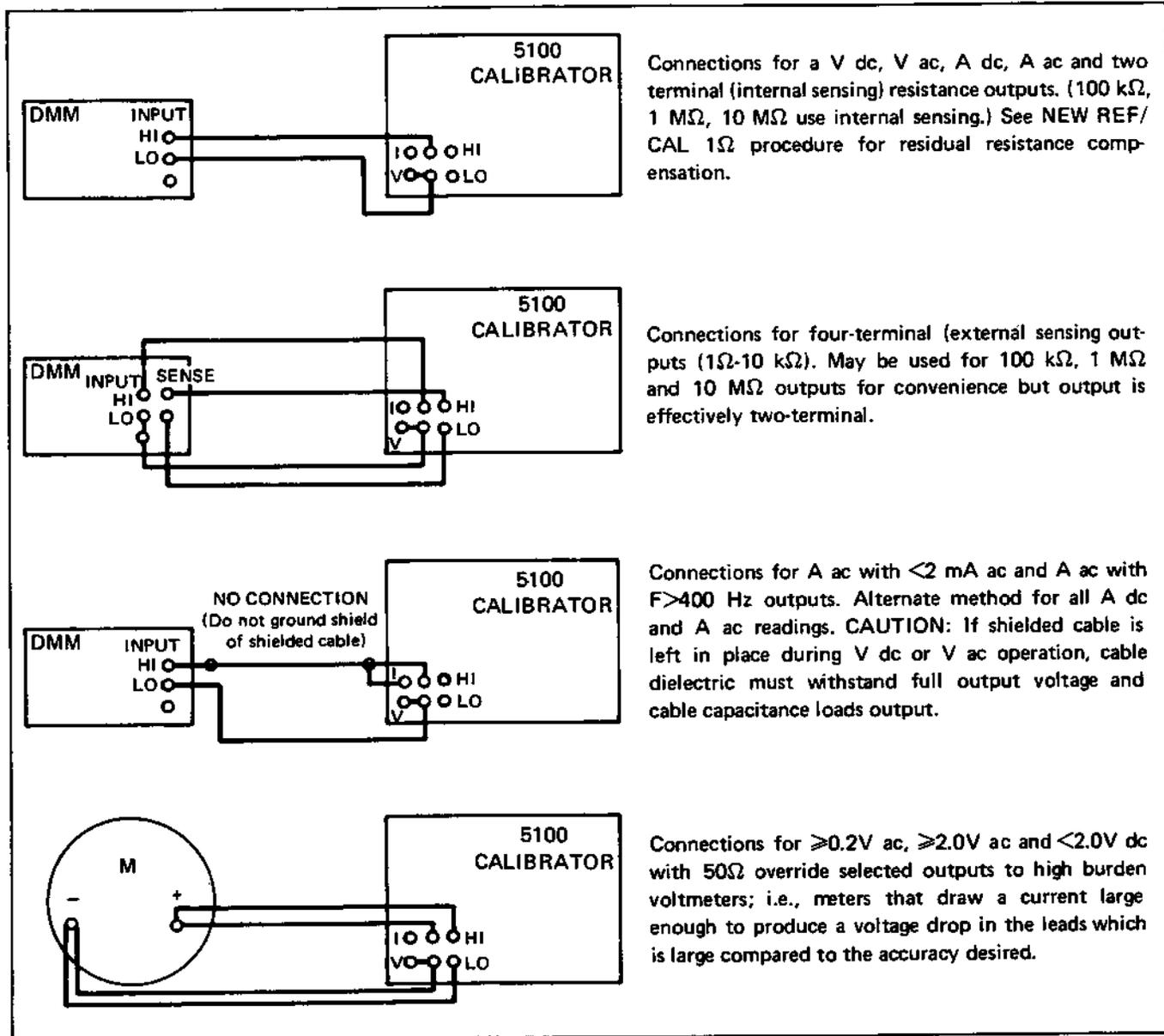

Figure 2-12. Meter Connections

8. Depress the V keyswitch to select volts.
9. The KEYBOARD and V indicators illuminate.
10. Depress the ENTER keyswitch.
11. The data visible on the Central Display transfers to the Output Display, blanking the Central Display.

NOTE

If the programmed output is 2.0 volts or greater the 50 OHM DIVIDER indicator automatically extinguishes.

12. Select OPR on the instrument, if required.

NOTE

If the current exceeds the capability of the calibrator, the Central Display flashes "O.L." and the instrument goes into STDBY.

13. The DC output may be altered by repeating the procedure starting at step 2.

2-51. AC Voltage Output

2-52. Obtain an AC voltage output using the following procedure:

1. If the meter being tested is not connected, perform the connection procedure above.

2. Depress the numerical keyswitches required to obtain the absolute value of the desired AC voltage. Select in the normal sequence, i.e., from the MSD (left) to the LSD (right).
3. The digits appear in the Central Display as they are entered, with the LSD being added on the right.
4. Select a multiplier, if required. If none is selected the instrument assumes units.
5. The selected multiplier indicator, if any, illuminates.
6. Depress the "V" keyswitch to select volts.
7. The KEYBOARD and V indicators illuminate.

NOTE

The output will be a DC voltage until a frequency is entered. The AC voltage may be altered without effecting the frequency by depressing ENTER and deleting the remaining steps of the procedure.

8. Depress the numeric keyswitches required to obtain the absolute value of the desired frequency. Select in the normal sequence, i.e., from the MSD (left) to the LSD (right).

NOTE

For a frequency entry the MSD is the only allowable significant digit.

9. The frequency entry appears on the Central Display.
10. Select a multiplier, if required. If none is selected the instrument assumes units.
11. The selected multiplier indicator, if any, illuminates.
12. Depress the Hz keyswitch.
13. The Central Display AC and Hz indicators illuminate.
14. Depress the ENTER keyswitch.
15. The frequency is displayed on the Central Display and the AC indicator on the Output Display illuminates.

NOTE

The frequency may be altered without entering the voltage into the instrument by deleting steps 1 through 7.

16. Select OPR on the instrument, if required, to obtain an output.

NOTE

If the output current exceeds the capability of the calibrator the Central Display flashes "O.L." and the instrument goes into STDBY.

17. Either the voltage or frequency can subsequently be altered without effecting the other.

2-53. Wideband Output

2-54. If the Wideband Option -03 is installed obtain an output at the wideband connector using the following procedure:

1. Depress the WIDEBAND switch.
2. The WIDEBAND indicator illuminates.

NOTE

Any voltage and frequency combination, within the specified limits of the Wideband Option, previously entered will be available for output. Any limits previously entered are still applicable.

3. Connect a 1 foot RG58/AU cable with BNC connectors between the wideband output connector and the receiving instrument.

NOTE

Any cable length greater than 1 foot will have an effect on the accuracy specifications. Refer to Section 6 of the instruction manual.

4. Select an AC voltage and frequency output, if required, as described above.

NOTE

Toggling the WIDEBAND switch and depressing the ENTER switch returns the instrument to standard operation.

2-55. Direct Current Output

2-56. Obtain a Direct Current Output using the following procedure:

1. If the meter being tested is not connected to the

instrument output terminals perform the connection procedure above.

2. Select the desired polarity and depress the applicable keyswitch.
3. Visible on the Central Display is the correct polarity.

NOTE

If a polarity is not selected the instrument defaults to a positive polarity when the command is entered into memory.

4. Depress the numerical keyswitches required to obtain the absolute value of the desired DC amps setting. Select in the normal sequence, i.e., from the MSD (left) to the LSD (right).
5. The digits appear in the Central Display as they are entered, with the LSD added on the right.
6. Select a multiplier, if required. If none is selected the instrument assumes units.
7. The selected multiplier indicator, if any, illuminates.
8. Depress the A keyswitch to select Current (Amps).
9. The KEYBOARD and A indicators illuminate.
10. Depress the ENTER keyswitch.
11. The command string visible on the Central Display transfers to the Output Display, blanking the Central Display. If the 50Ω indicator was illuminated from a prior setting it extinguishes.
12. Select OPR in the instrument, if required, to obtain an output.

NOTE

If the required compliance voltage exceeds the calibrator's capacity, the Central Display flashes "O.L." and the instrument goes into STDBY.

2-57. Alternating Current Output

2-58. Obtain an Alternating Current Output using the following procedure:

1. If the meter being tested is not connected to the instrument output terminals perform the connection procedure above.

2. Depress the numerical keyswitches required to obtain the absolute value of the desired AC amps setting. Select in the normal sequence, i.e., from the MSD (left) to the LSD (right).
3. The digits appear in the Central Display as they are entered, with the LSD added on the right.
4. Select a multiplier, if required. If none is selected the instrument assumes units.
5. The selected multiplier indicator, if any, illuminates.
6. Depress the A keyswitch to select Current (Amps).
7. The KEYBOARD and A indicators illuminate.

NOTE

The output will be in direct current until a frequency is entered. The alternating current may be altered without effecting the frequency by depressing ENTER and deleting the remaining steps of this procedure.

8. Depress the numeric keyswitches required to obtain the absolute value of the desired frequency. Select in the normal sequence, i.e., from the MSD (left) to the LSD (right).

NOTE

For a frequency entry the MSD is the only allowable significant digit.

9. The frequency entry appears on the Central Display.
10. Select a multiplier, if required. If none is selected the instrument assumes units.
11. The selected multiplier indicator, if any, illuminates.
12. Depress the Hz keyswitch.
13. The Central Display, KEYBOARD, AC, and Hz indicators illuminate.
14. Depress the ENTER keyswitch.
15. The frequency remains on the Central Display and the AC indicator on the Output Display illuminates.

NOTE

The frequency may be selected without entering the current into the instrument by deleting steps 1 through 7.

16. Select OPR on the instrument if required, to obtain an output.

NOTE

If the required compliance voltage exceeds the calibrator's capacity, the Central Display flashes "O.L." and the instrument goes into STDBY.

2-59. Resistance Output

2-60. Obtain a Resistance Output using the following procedure:

1. If the meter being tested is not connected to the instrument output terminals perform the connection procedure above.
2. Depress the numeric keyswitches required to obtain the absolute value of the desired resistance setting. Select in the normal sequence, i.e., from the MSD (left) to the LSD (right).

NOTE

Resistance entries may only be made from 1 ohm through 10 Megohms in multiples of power of ten (e.g., 10^0 , 10^1 , 10^2 , ..., 10^7).

3. The digits selected appear on the Central Display as they are entered.
4. Select a multiplier, if required. If none is selected the instrument assumes units.
5. The selected multiplier indicator, if any, illuminates.
6. Depress the Ω keyswitch to select Resistance (ohms).
7. The OHM indicator illuminates.

NOTE

If a low ohms value (10 kilohms and below) and internal sensing (two terminal) is selected, the Central Display flashes for one-half second "CAL Ω " when the ENTER switch is depressed. This display notifies the operator that he may compensate for the residual resistance encountered in low resistance, two-terminal calibration by performing the CAL 1 OHM procedure. This message is only displayed the first time low ohms is selected

after initial power applications or a RESET command. The CAL Ω display is blanked when the Resistance Value is entered into memory.

8. Depress the ENTER keyswitch.
9. The data visible on the Central Display transfers to the Output Display, blanking the Central Display.
10. Select OPR on the instrument, if required, to obtain an output.

2-61. dBm Output (AC Volts Only)

2-62. Obtain an output in decibels (i.e., 0 dBm is equal to 1 mW across 600 ohms for the main output terminals or across 50 ohms for the Wideband Option output) using the following procedure:

1. If the meter being tested is not connected to the instrument output terminals, perform the connection procedure above.
2. Obtain an AC output using the procedure above.

NOTE

The dBm entry below can be substituted for AC volts when obtaining an output.

3. Depress the numeric keyswitches required to enter the value of the desired dBm setting. Select in the normal sequence, i.e., from the MSD (left) to the LSD (right).
4. The frequency on the Central Display is blanked and the digits appear on the Central Display as they are entered, with the LSD added on the right.
5. Depress the dBm keyswitch.
6. The KEYBOARD and dBm indicators illuminate.
7. Depress the ENTER keyswitch.
8. The dBm value selected transfers to the Output Display and the frequency reappears on the Central Display.

NOTE

To determine the dBm output level in voltage, depress RECALL, V, ENTER, and the value will be displayed on the Central Display. Depress RECALL to toggle the instrument out of the Recall Mode.

2-63. Boost Mode Operation

2-64. Outputs can be obtained from either a Fluke Model 5205A/5215A Power Amplifier or 5220A Transconductance Amplifier to augment the calibrator capabilities by selecting the boost Mode. In addition to the Amplifiers named, a Y5000 5100 Series Interface Accessory and a cable for the applicable amplifier (Y5001 for the 5205A/5215A and/or Y5002 for the 5220A) are required.

2-65. The sequence of operations for the boost mode, using the Power or Current Amplifiers are listed below. Both amplifiers may remain connected to the calibrator, through the interface, while the calibrator is operating, however, only one can be selected and, therefore, operational, at a time.

2-66. POWER AMPLIFIER OPERATION

2-67. The Power Amplifier used may be either a Fluke Model 5205A or a Fluke Model 5215A. Either amplifier may be used to obtain AC voltage output, however, DC output can be obtained only from the Model 5205A.

2-68. Obtain a Boost Mode Power Amplifier output using the following procedure:

1. Insure power has been remove from both the calibrator and amplifier.
2. Connect the Y5000 Interface to the calibrator.
3. Connect the amplifier to the Calibrator Interface using the Y5001 Cable Assembly.
4. Apply power to both instruments and allow an adequate warmup period.
5. If the Model 5205A is used, select the REMOTE/5200 position.
6. Program a Boost Mode output from the calibrator by selecting in turn boost, output value data (100 to 1100 volts, and a frequency from 50 Hz to 50 kHz if AC), and ENTER.

NOTE

Selection of the BOOST keyswitch may either precede or follow entry of the Output Value Data without effecting operations, provided it precedes the selection of ENTER.

7. The BOOST indicator illuminates when the BOOST keyswitch is depressed, the voltage selected appears on the Calibrator Output Display, and the

frequency, if applicable, appears on the Central Display when the ENTER keyswitch is depressed. If a Model 5205A is used the 5200 indicator on the amplifier illuminates.

NOTE

If both the 5205A/5215A and 5220A are connected through the Y5000 the 5220A goes into REMOTE, STANDBY, and LOCAL LOCKOUT when ENTER is selected. This prevents accidental operation of the 5220A from the power amplifier drive signal on the 5205A/5215A rear panel.

8. Select OPR (operate) on the calibrator.

NOTE

When operating in the AC Mode the AC drive signal (up to 20V ac) for the Boost Amplifier is present on the Calibrator Output Terminals.

9. The OPERATE indicators of both the calibrator and amplifier illuminate and the programmed output value is available at the amplifier output terminals.

NOTE

Depressing BOOST, ENTER, while in the BOOST Mode will toggle the calibrator out of the Boost Mode, and return the output to the calibrator; however, at the greatly reduced power specifications of the basic instrument.

2-69. TRANSCONDUCTANCE AMPLIFIER OPERATION

2-70. The Fluke Model 5220A Transconductance (current) Amplifier is used to expand the capabilities of the calibrator up to 20 (19.9999) Amps. When connected to a 5100 Series B Calibrator through a Y5000 Interface and Y5002 Cable Assembly outputs can be programmed directly from the calibrator front panel.

2-71. Obtain a Boost Mode Current Amplifier Output using the following procedure:

1. Insure power has been removed from both the calibrator and amplifier.
2. Connect the Y5000 Interface to the calibrator.
3. Connect the amplifier to the Calibrator Interface using the Y5002 Cable Assembly.
4. Connect a load or current meter to the 5220A Outputs.

NOTE

The current selected multiplied by the load resistance must equal less than 3Vrms or 4.2V dc to prevent a compliance trip of the equipment.

5. Apply power to both instruments and allow an adequate warmup period.
6. Program a Boost Mode Output from the calibrator by selecting in turn BOOST, Output Value Data (from a 0A dc or 2A ac to a maximum of 19.9999 Amps), and ENTER.

NOTE

Selection of the BOOST keyswitch may either precede or follow entry of the Output Value Data without effecting operation, provided it precedes the selection of ENTER.

7. The BOOST indicator illuminates when the BOOST keyswitch is depressed. The current selected appears on the Calibrator Output Display, and the frequency, if applicable, appears on the Central Display, when the ENTER keyswitch is depressed. The REMOTE and REAR INPUT indicators illuminate on the Current Amplifier front panel when the calibrator ENTER keyswitch is depressed.

8. Select OPR (operate) on the calibrator.

NOTE

When operating in the AC Mode the AC drive signal (up to 20V ac) for the BOOST Amplifier is also present on the calibrator Output Terminals.

9. The OPERATE indicators of both the calibrator and amplifier illuminate and the programmed output value is available at the amplifier output terminals.

NOTE

Depressing BOOST, ENTER while in the Boost Mode will toggle the calibrator out of the Boost Mode and return the output to the calibrator terminals; however, if an output greater than the capability of the calibrator, i.e. >1.99999A, has been programmed, an error results and an error message is displayed.

2-72. Enter Entry Limit

2-73. Place an Entry Limit in memory using the following procedure:

1. Depress the ENTRY LIMIT keyswitch.
2. The LIMIT indicator illuminates.

NOTE

Entry Limits may be set in either volts or amps at any value; however, the instrument will not exceed the values listed in the specifications. If a polarity is not assigned, the entry will be both positive and negative limits. If a polarity is specified, the other polarity remains unspecified until an entry is made.

3. Select the polarity, if desired, and depress the applicable keyswitch.
4. Visible on the Central Display is the correct polarity.
5. Depress the numeric keyswitches required to obtain the absolute value of the desired entry limits. Select in the normal sequence, i.e., from the MSD (left) to the LSD (right).
6. The digits appear on the Central Display as they are entered, with the LSD added on the right.
7. Select a multiplier, if required. If none is selected the instrument assumes units.
8. Select either volts (V) or amps (A).
9. The applicable indicator illuminates.

NOTE

The value of the Entry Limit is stored at this time; however, it is not compared against an existing value until the ENTER switch is depressed.

10. A value higher than the Entry Limit in memory cannot be entered until the Entry Limit is changed or cleared. Any attempt results in an Err3 display, which has no effect on the existing output. The value stored can be verified by using the Recall procedure described in a subsequent paragraph. In addition, if an entry limit is entered that is smaller than the programmed output, Err3 results. The error signal can be cleared by reprogramming the entry limit or the output, or by resetting (depressing CLEAR twice successively) the instrument.

2-74. Tolerance Limit Entry

2-75. Place the Tolerance Limit in memory using the following procedure:

1. Depress the TOL LIMIT keyswitch.
2. The LIMIT indicator illuminates.
3. Depress the numerical keyswitches required to obtain the absolute value of the limit percentage. Select in the normal sequence, i.e., from the MSD (left) to the LSD (right).
4. The digits appear on the Central Display as they are entered, with the LSD added on the right.
5. Depress the % keyswitch.
6. The % ERROR indicator illuminates.

NOTE

The tolerance limit is now entered into memory; however, it is not compared against an existing value until the Error Mode is entered. A percent of error greater than the entry during Error Mode operations causes the LIMIT indicator to illuminate and the numeric value on the Central Display to flash. This is a notice to the operator that the preset error limit has been exceeded. It does not effect the operation of the instrument.

2-76. Error Mode Operation

2-77. The Error Mode is used to find the deviation from a previously obtained output. This output may be in volts (DC or AC), Amps (DC or AC), ohms, Hertz, or decibels.

2-78. The Error Mode is entered by activating any of the rotary or keyswitches in the Error Mode Group. The Central Display immediately blanks any data displayed and substitutes zero error if the EDIT switch is rotated, if the NEW REF/CAL I OHM keyswitch is toggled, or if the ENABLE, ◀DECADE or DECADE▶ keyswitches are toggled (if cursor right decade is depressed to enter the Error Mode the frequency is displayed). If an internal calculation overflow results from exceeding the instrument's calculating ability or from a tolerance limit entry the Central Display will show "L Err" for large error. The data blanked from the Central Display is placed in temporary storage and redisplayed with the return to the normal mode. The instrument can be returned to the normal mode of operation by toggling the ENABLE keyswitch or by depressing any Front Panel keyswitch except the remaining Error Mode Group or OPR/STDBY.

2-79. VOLTS/AMPS ERROR MODE OPERATION

2-80. With the Volts/Amps measurements the output

signal is altered until the meter under test reads correctly. Therefore as the output magnitude goes higher it shows that a larger change is required to bring the test meter to the correct display and the percent of error is negative. The change in magnitude of the output is the inverse polarity of the percent of error.

2-81. Check the Volts/Amps Error Mode operation using the following procedure:

1. If the meter being tested is not connected to the instrument output terminals, perform the connection procedure above.
2. Obtain the desired base output using the applicable preceding procedure.
3. Place the instrument in the Error Mode using the procedure described in the preceding paragraph.
4. With the EDIT switch, modify the output until the meter under test reads the base setting of the output.
5. The Output Display reads the output required in volts or amps to obtain the required reading and the Central Display shows the difference from the base as a percentage.

2-82. OHMS ERROR MODE OPERATION

2-83. For an Ohms Error the Output Display is altered to match the reading of the test meter, and, as a result, the percentage of error is displayed. In this case, the percent increases or decreases with the change from the base and the display polarity has a direct relationship to the change of the output reading.

2-84. Check the Ohms Error Mode operation using the following procedure:

1. If the meter under test is not connected to the instrument output terminals perform the connection procedure above.
2. Obtain the desired base output using the applicable preceding procedures.
3. Place the instrument in the Error Mode using the procedure previously described.
4. With the EDIT switch, modify the Output Display until it corresponds to the reading of the meter under test.
5. The Central Display shows the percent of error in the meter under test.

2-85. FREQUENCY ERROR MODE OPERATION

2-86. The calibrator does not provide frequency error percentages. However, the Error Mode does allow the operator to quickly step through the frequency range of the instrument, checking the frequency response of the meter under test.

2-87. Check the Frequency Error Mode operations using the following procedure:

1. If the meter under test is not connected to the instrument output terminals perform the connection procedure above.
2. Obtain the desired base frequency using the applicable procedure.
3. Depress the DECADE ► keyswitch to place the instrument in the Error Mode and move the cursor over the MSD (only digit accessible for modification) of the frequency.
4. With the EDIT switch modify the frequency as desired.

2-88. dBm ERROR MODE OPERATION

2-89. In the dBm Error Mode the displayed error is in dB rather than a percentage. Modification to the base figure is in dBm and the error on the Central Display is changed accordingly.

2-90. Check the dBm Error Mode operation using the following procedure:

1. If the meter under test is not connected to the instrument output terminals, perform the connection procedure above.
2. Obtain the desired base output in dBm using the applicable procedure.
3. Place the instrument in the Error Mode using the procedure described above.
4. With the EDIT switch, modify the base output until the meter under test reads the desired setting.
5. The Output Display reads the dBm required to obtain the proper reading and the Central Display shows the difference from the base in dB.

2-91. NEW REF/CAL 1Ω Operation

2-92. This switch performs two different functions, dependent upon the status of the instrument. The New Reference function is available any time the instrument is

in the Error Mode, while the CAL 1 OHM function requires that 1 ohm resistance be selected also. The sequence of operations for each is given below.

2-93. NEW REFERENCE OPERATION

2-94. If the keyswitch is depressed when the instrument is in the Error Mode, the output, as modified by the edit feature of the error mode, becomes the new base except in the Fractional-Scale Mode when the full-scale reference is not changed. Error Mode modifications and percent of error figures will be on the new base established with the NEW REF/CAL 1Ω keyswitch.

2-95. CAL 1Ω OPERATION

2-96. This feature is used to compensate for the residual resistance during two-terminal (internal sensing) operations. Use the following procedure for the CAL 1Ω sequence:

1. Connect the test ohmmeter using the two-terminal method.
2. Select internal sensing and program a 1Ω output from the instrument.
3. Use the Error Mode and modify the instrument output until it reads the same as the meter under test.

NOTE

The meter under test must be reasonably accurate ($\pm 1\%$) and must read between 1.00000 and 1.99999 ohms for the CAL 1Ω feature to operate.

4. When the instrument output and the meter under test read the same, depress the NEW REF/1 OHM CAL keyswitch.
5. The residual resistance is automatically added to any resistance range selected up to 10 kilohms, as long as the resistance function is selected, it remains on internal sense, and the instrument is not reset by either removing power or a CLEAR ALL command, or until a new value of residual resistance is entered.

NOTE

If the switch is depressed when the instrument display is greater than 1.99999 ohms, a correction of zero ohms is stored. In addition, the instrument operates as in the NEW REF mode described above.

2-97. Fractional-Scale Operation

2-98. Fractional-Scale Operations allow the operator to output and modify for Error Mode operations some fractional value of the base output while the displayed error is computed on the original value. (Fractional scale entries must be in units; multiplier, i.e., exponents cannot be used.) It is intended for use with a meter under test that has its accuracy at fractional-scale magnitudes specified as a percent of full-scale. When a fractional-scale entry results in a Err3 or Err4 an erroneous output value results from the programmed fraction. Programming a valid output or resetting the instrument will remove the error. The procedure in the following example demonstrates how the percentage of error is computed on a 12 volt base rather than on a 9 volt output obtained with the 1/4 fractional-scale entry. The fractional-scale feature cannot be used when the instrument is in the Keyboard Mode.

1. Obtain an output of 12 volts using the DC volts output.
2. Depress the Data Entry Group keyswitches "3,/4," to make the fractional-scale entry.
3. The Central Display shows "3-4".
4. Depress the ENTER keyswitch.
5. The Central Display blanks and the Output Display is altered to read +9.0000 volts.
6. Rotate the EDIT switch clockwise for an Output Display of +9.0001.
7. The Central Display reads -.0008 and the %ERROR indicator is illuminated.

NOTE

A change of .0001 at 9 volts base would read -.00111 (0.0001/9 = -.0011%) while the same change with a 12 volt base would read the -.0008 displayed.

2-99. Entries can be made for any function except dBm or ohms. The entries may also be altered by making a new fractional-scale entry. For example: using the above example if 1/2 was entered the output display would change to 6.000, 1/4 would change it to 3.000 and 1/1 would change it back to 12.000. As you can see, all entries have made their change based on the original 12 volts, not on the current output. If at some time during the procedure it is desired to change the base to the current output, it can be accomplished by depressing the NEW REF/CAL 1 OHM keyswitch. If the ENTER switch is depressed without entering a valid fraction, the instrument drops out of the Fractional Scale Mode.

2-100. External Oscillator Operation

2-101. Desired frequencies that are outside the capability of the instrument, i.e., more than one significant digit or more accurate, can be obtained using the External Oscillator feature. The external frequency must be within the range of the standard 5100 Series (50 Hz to 50 kHz) at 1.2V rms +/-5% and an output impedance no greater than 50 ohms. The signal is input to the instrument at pin 4 (EXT OSC) and 7 (OSC COM) of J2, the Analog Connector on the Rear Panel.

NOTE

Matching connectors to meet the customer's particular needs are available from Fluke or the manufacturer. For example, a straight-in hooded 14-pin male connector can be ordered from Fluke using Part Number 272443. The Federal Supply Code is 02660 and the Manufacturer's Part Number is 57-30140.

2-102. Certain limitations are placed on external frequency/programmed voltage combinations when maximum performance is required. These limits are listed in Table 2-12. Other combinations may be programmed, at the user's discretion; however, the performance will be degraded and the instrument may go into Overload ("O.L."). No damage will result to the instrument from the overload condition.

NOTE

Amplitude instabilities, distortion, noise, etc., of the external oscillator can appear at the instrument output.

Table 2-12. External Frequency/Voltage Limitations

EXTERNAL FREQUENCY	PROGRAMMED AC VOLTAGE
50 Hz – 1 kHz	1100V
> 1 kHz – 20 kHz	110V
> 20 kHz – 50 kHz	19.9999V

2-103. Operate with the external oscillator using the following procedure:

1. Connect the external oscillator signal to J2 on the rear panel, insuring it is within the frequency, voltage, and impedance limits as stated above.
2. Depress the EXT OSC keyswitch to select the external oscillator function.
3. The KEYBOARD and EXT OSC indicators illuminate.

4. Program the desired output voltage or current.
 5. Program a frequency within one of the brackets in Table 2-13 to match the input frequency.
 6. Depress the ENTER switch.
 7. The programmed voltage and frequency are displayed and the KEYBOARD indicator extinguishes.
 8. Select OPR, if required.
5. Depress the keyswitch for the applicable function, i.e., V, A, Hz, etc.
 6. The recalled data is displayed on the Central Display with any previously displayed data stored and blanked from the display.
 7. Toggling the instrument out of the Recall Mode, by depressing the RECALL keyswitch, blanks the recalled data and returns the stored, previously displayed, data to the Central Display.

Table 2-13. External Oscillator Frequency Ranges

OUTPUT	INPUT FREQUENCY	PROGRAM THE FREQUENCY BETWEEN
Volts	50 Hz to 1999 Hz	50 Hz to 1000 Hz
Volts	2 kHz to 20 kHz	2 kHz to 20 kHz
Volts	20 kHz to 50 kHz	30 kHz to 50 kHz
Amps	50 Hz to 1000 Hz	50 Hz to 1000 Hz

2-104. Recall Operations

2-105. With the instrument toggled into the Recall Mode, data stored in memory can be recalled and displayed on the Central Display. The stored values for voltages (V), current (A), frequency (Hz), resistance (Ω), decibels (dBm), dBm equivalent voltage, Entry Limits, or Tolerance Limits, in the applicable polarity, can be displayed. Depression of an illegal keyswitch toggles the instrument out of the Recall Mode. If a numeric key is depressed, "Err1" is displayed and the entry is ignored; however, the instrument is toggled out of Recall. Toggle the RECALL key prior to a numeric entry to preclude the error message, or, if already displayed, reenter the numeric or depress CLEAR one time to resume operations.

2-106. Perform the Recall operation using the following procedure:

1. Toggle the instrument into the Recall Mode with the RECALL keyswitch.
2. The RECALL indicator illuminates.
3. If a Limit value (ENTRY LIMIT or TOL LIMIT) is to be recalled, depress the applicable keyswitch(s). The appropriate indicator illuminates. The tolerance limit is displayed, if selected.
4. If a polarity is required depress the applicable keyswitch. The polarity indication appears on the Central Display.

NOTE

Depressing RECALL clears the keyboard memory of any data stored and extinguishes the KEYBOARD indicator, if illuminated.

2-107. Storage System Operations (Storage Only)

2-108. The following set of procedures are for the operation of the Storage System and its integral Tape System. In all cases, the Storage Mode must be selected by depressing the ENABLE switch so that the ENABLE indicator illuminates. If the Tape System is to be used, a tape cassette must be loaded into the Tape System.

CAUTION

Tapes used must be certified digital mini-cassettes that conform with the ANSI Standard X3B5/77-49. Audio tapes will not give acceptable results.

NOTE

Do not attempt to load a tape with any Standard Analog PCB Assemblies removed, except the Extended High Voltage Assembly. The display will blank and the instrument must be reset.

2-109. CREATING A STORAGE SYSTEM PROGRAM (STORAGE ONLY)

2-110. The following routine is an example of a simple program that can be used to become familiar with the procedures required to enter a program into memory and then transfer it to tape storage. A detailed description of all the routines available follows in the ensuing paragraphs. Load the example program using the following procedure:

1. Insert the tape, on which the program is to be written, into the tape system.
2. Select the ENABLE and STORE keyswitches.

3. The ENABLE and STORE indicators illuminate.

4. Select, in turn, the 1, V, ENTER, ADVANCE/LOAD keyswitches.

NOTE

Any legal function or control can be included in the command, e.g., Standby/Operate, Internal/External Sense, etc; however, for safety reasons step 001 always comes up in STANDBY.

5. The Output Display reads 1.00000V and the Central Display flashes the number "002" to indicate that new data will be placed in step 2.

6. Select the 2, V, ENTER, ADVANCE/LOAD keyswitches.

7. The Output Display reads 2.00000V and the Central Display flashes 003.

8. Continue the sequence using 3, 4, 5, etc, volt entries for as many steps as desired.

9. Select the TAPE keyswitch.

10. The TAPE indicator illuminates.

11. Select ADVANCE/LOAD.

12. The loaded tape rewinds, runs forward to load the data, and rewinds again.

13. The Output Display reads 1.00000V, the Central Display flashes 001 and the TAPE and STORE indicators extinguish.

14. Select the 3, SEL DISPLAY STEP keyswitches.

15. The Output Display reads 3.00000V, i.e., the programmed output for step 3 and the Central Display flashes 003.

16. Select ADVANCE/LOAD.

17. The Central Display flashes the number of the next step in sequence and the Output Display reads the value of the of the step, i.e., 4.00000V.

18. Step through the program until the Central Display reads "END P" signaling the end of the program. At each step the Central Display should flash the number of the step and the Output Display read the value stored.

19. Select the ENABLE keyswitch to toggle out of the Enable Mode and disable the storage system, and return to standard operations when desired.

2-111. DISPLAY THE STEP LOCATION SELECTED (STORAGE ONLY)

2-112. Use the following procedure to display the number of the selected step on the Central Display:

1. Depress the SEL/DISPLAY step switch.
2. The number of the step selected flashes on the Central Display, holds for approximately one second, then the display returns to its prior state.

2-113. SELECT A STEP-READ MODE (STORAGE ONLY)

2-114. Use the following procedure to select a predetermined step while in the Read Mode:

1. Verify the Read Mode is selected, i.e., the STORE indicator is extinguished.
2. Select the number of the desired step with the numeric switches in the data entry group.
3. The number entered appears on the Central Display.
4. Depress the SEL/DISPLAY STEP switch.
5. The number of the step selected flashes on the Central Display for approximately one second, then the state stored in that location is transferred to the instrument output. "End P" is displayed if the selected step is beyond the end of the current program.

NOTE

The instrument status might drop from OPR to STDBY with the change in state of the selected output. Refer to Table 2-11 for a list of the operational status requiring a change in status.

2-115. SELECT A STEP - STORE MODE (STORAGE ONLY)

2-116. Use the following procedure to select a predetermined step while in the Store Mode:

1. Select the Store Mode with the STORE switch.
2. The STORE indicator illuminates.

3. Select the number of the desired step with the numeric switches in the Data Entry Group.
4. The number entered appears on the Central Display.
5. Depress the SEL/DISPLAY STEP switch.
6. The memory moves to the step location selected, provided it is within the existing program. If not, it steps to the first location available for data entry. The selected step number is flashed on the Central Display for approximately one second, then the output returns to its original state.

2-117. READ OUTPUT STATE (STORAGE ONLY)

2-118. Read an output state previously stored in memory using the following procedure:

1. Perform the Select a Step (Read Mode) procedure previously described, using the number of the step to be read.
2. Depress the ADVANCE/LOAD switch.
3. The state is transferred to the output of the instrument and its appropriate step number is displayed for approximately one second, followed by the display of the output condition.

2-119. STORAGE OUTPUT STATE (STORAGE ONLY)

2-120. Store an output state in memory using the following procedure:

1. Select the Store Mode with the STORE switch.
2. The STORE indicator illuminates.
3. Verify the state to be stored has been programmed into the instrument.

NOTE

The desired state can be programmed into the instrument at this time or at any time prior to selecting the storage mode of operation.

4. Depress the ADVANCE/LOAD switch.
5. The number of the next step in sequence flashes on the Central Display for approximately one second, then the display returns to its previous state. "End P" is displayed if the step stored fills the memory.

NOTE

"FULL" is displayed when the memory is full and the step cannot be loaded.

2-121. DELETE INSTRUCTION (STORAGE ONLY)

2-122. Use the following procedure to delete a previously entered instruction:

1. Perform the Select a Step (Store Mode) procedure previously described using the number of the step to be deleted.

NOTE

Instrument must be in the Store Mode.

2. Depress the DELETE switch.
3. The step number deleted flashes on the Central Display for approximately one second. All subsequent steps move up one number and the step moved into the step just deleted is transferred to the output.

2-123. TRANSFER STORAGE MEMORY TO TAPE (STORAGE ONLY)

2-124. Transfer the instructions stored in memory to a tape for a permanent record using the following procedure:

1. Insure a tape cassette is loaded in the Tape Reader then select the Tape Mode with the TAPE switch.
2. The TAPE indicator illuminates.
3. Select the Store Mode with the STORE switch.
4. The STORE indicator illuminates.
5. Depress the ADVANCE/LOAD switch.

NOTE

If the unit was in OPR (Operate), it will drop in status to STDBY (Standby).

6. The tape advances.
7. When the transfer of data is complete, the TAPE and STORE indicators automatically extinguish and the tape stops. There is no change in the data displayed or stored in memory except the instrument remains in STDBY.

2-125. TRANSFER TAPE RECORD TO STORAGE MEMORY (STORAGE ONLY)

2-126. Transfer the data stored on a tape to the storage group memory using the following procedure:

1. Insure the tape cassette containing the program to be transferred is loaded in the Tape Reader, then select the Tape Mode with the TAPE switch.
2. The TAPE indicator illuminates.
3. Verify the Read Mode is selected, i.e., the STORE indicator is extinguished.
4. Depress the ADVANCE/LOAD switch.

NOTE

If the unit was in OPR it will drop in status to STDBY.

5. The tape advances.
6. When the transfer of data is complete, the TAPE indicator extinguishes automatically, the tape drive stops. Step 1 is transferred to the output, and step "1" flashes on the Central Display, followed by display of the data in Step 1 on the Output Display and the Central Display, if applicable.

2-127. LIST PROGRAM STEPS (STORAGE ONLY)

2-128. Use the following procedure to obtain a permanent printed copy of a program entered into storage memory. An optional remote interface must be installed in the instrument to use this feature.

1. Perform the Select a Step (Store Mode) procedure previously described, using the first number of the desired listing.
2. Depress the LIST switch.

NOTE

If the unit was in OPR it will drop in status to STDBY.

3. The program, or selected portion, is transferred through the optional remote interface to a printing device.

NOTE

The listing is terminated if a front panel switch is depressed or a command is input through the remote interface.

2-129. LIST DATA (STORAGE ONLY)

2-130. Use the following procedure to obtain a permanent printed copy of the test data. An optional remote interface must be installed in the instrument to use this feature.

1. Verify the Read Mode is selected, i.e., the STORE indicator is extinguished.
2. Depress the LIST switch.
3. The single test step at the output is transferred through the remote interface to the printing device.

2-131. CLEAR STORAGE MEMORY (STORAGE ONLY)

2-132. Use the following procedure to clear the storage memory:

1. Select the Store Mode with the STORE switch.
2. The STORE indicator illuminates.
3. Depress the CLEAR STORAGE switch.
4. Any data stored in memory is erased and the Central Display flashes "End P" then returns to its prior state.

2-133. REMOTE OPERATION

2-134. The 5100 Series B can be remotely programmed through either the IEEE 488-1975 Standard Interface Option (-05) or the Bit Serial Asynchronous (RS-232-C) Interface Option (-06), described in Section 6 of the instruction manual. Communication between the controlling device and the instrument interface must be in the standard ASCII codes. The codes accepted by the instrument and a brief explanation of each is given in Table 2-14.

2-135. When one of the optional interface modules is installed in the instrument the Remote Mode can be activated either manually or from the Control Device. The instrument can be placed in remote through the IEEE-488 Interface by addressing it with the address assigned to the instrument. Remote can be accomplished through the Bit Serial Interface by programming the character "J" as described in later paragraphs. The instrument is put in remote from the front panel by toggling the REMOTE switch. Unless the front panel is disabled or "locked out" by a remote command it can return the instrument to local operation by toggling the REMOTE switch on the front panel.

Table 2-14. Programming Codes

CODE	EXPLANATION	CODE	EXPLANATION
	INITIATION CHARACTERS		STORAGE COMMANDS (Storage Only)
*	Reset – go to local	Q1	Enable Storage Mode
C	Clear Entry	Q0	Disable Storage Mode
CC	Reset – stay in remote	[1	Enable Tape Mode
LC	Clear entry limits	[0	Disable Tape Mode
TC	Clear tolerance limits	W1	Select Store Mode
I0-3	Interface Interrupt Enable Codes	W0	Select Read Mode
Y0-7	Interface Output Enable Codes	&	Advance/Load
.	Termination Character	(Select/Display Step
	CONTROL COMMANDS)	Delete Step
J	Go to Remote - RS232	K	List
#	Go to local – RS232	=	Clear Storage
U1	Enable Local Lockout		DATA INSTRUCTIONS
U0	Disable Local Lockout	+,–	Polarity entry
S	Go to Standby	0–9	Magnitude entry
N	Go to Operate	.	Decimal point
X1	* Select external sensing	/	Fractional scale entry
X0	* Select internal sensing	E	Exponent entry follows
F1	* Enable external oscillator mode	V	* Volts entry
F0	* Disable external oscillator mode	A	* Amps entry
R1	* Select 50 ohm divider override	Z	* Ohms entry
R0	* Disable 50 ohm divider override	H	* Hertz entry
@	Error Mode toggle	D	* dBm entry
<	Error Mode Cursor one position left	%	Percentage entry
>	Error Mode Cursor one position right		STATUS
:	Increment digit under cursor	!?"'	Print Status message
:	Decrement digit under cursor	?	Print Central Display
\$ or '	Store NEW REF/CAL 1 ohm reference		
G	Recall		
L	Enable Entry Limit entry		
T	Enable Tolerance Limit entry		
P1	* Enable Wideband option		
P0	* Disable Wideband option		
B1	* Enable Boost Mode		
B0	* Disable Boost Mode		
			*Terminator required for action

2-136. Programming instructions may be either initiation or string commands. The initiation commands are one or two character messages that are operated on as soon as they arrive unless they are part of a string, in which case they are executed in sequence within the string. The only exception is reset, which has an immediate response. String Commands can be Control Commands, Storage Command (used with the 5101B only), Data Instructions, Status requests, or a combination of the first three, and are sent in a series of 1-to-32 characters that are, with the exceptions noted in the text, concluded with a terminator character.

2-137. Initiation Characters

2-138. RESET "*"

2-139. The instrument is reset to the initial sequence and Local Mode with this instruction. It assumes the default condition, i.e., all registers reset. The visible effect on the instrument is the STDBY, LOCAL, INT, and 50Ω DIVIDER indicators illuminated and the Output Display set to 0.0000 mV dc. In addition, the Wideband, External Oscillator, Echo Capability, and Line Feed Suppression features are disabled and the IEEE-488 Service Request disabled.

NOTE

Allow a 500 ms interval between a Reset command "" and any subsequent command.*

2-140. CLEAR "C"

2-141. A single "C" entry during a numeric entry while in the Keyboard Mode clears that entry. A second successive "C" entry clears the instrument to its initial state except it remains in remote. When the "C" is directly preceded by an "L" entry the programmed entry limits are set to their maximum setting. The entry "TC" sets the tolerance limits to maximum tolerance.

2-142. INTERFACE INTERRUPT ENABLE CODES

2-143. Interrupts for the interface system are generated using the alpha character I followed by an octal number between 0 and 3, inclusive. The numeric is based on the three binary bits of an octal number with bit 0 high if the interrupt (Service Request SRQ in the IEEE-488 Interface) is enabled with a "Ready", and bit 1 high if enabled with an "Error". "Ready" interrupt refers to a SRQ at the end of a timeout which represents the maximum settling time required in the programmed range. They are generated after a command which causes a change in output, e.g., a terminator or Standby/Operate Command. Bit 2 is not used at this time so the available codes extend only to an octal 3. The possible combinations are given in Table 2-15.

Table 2-15. Interface Interrupt Codes

NUMERIC	INTERRUPT ON	
	READY	ERROR
0	Disabled	Disabled
1	Enabled	Disabled
2	Disabled	Enabled
3	Enabled	Enabled

2-144. INTERFACE OUTPUT CODES

2-145. Outputs for the interface system are generated using the alpha character I followed by an octal numeric between 0 and 7, inclusive. The numeric is based on the three binary bits of an octal number with bit 0 high to suppress alphabetic character output, bit 1 high to enable the echo feature of the RS-232-C Interface, and bit 2 high to disable the automatic line feed following a carriage return. The possible combinations are given in Table 2-16.

Table 2-16. Interface Output Codes

NUMERIC	ALPHA CHARACTER OUTPUT	RS232 ECHO CAPABILITY	AUTO LINE FEED AFTER CARRIAGE RETURN
0	Active	Disabled	Enabled
1	Suppressed	Disabled	Enabled
2	Active	Enabled	Enabled
3	Suppressed	Enabled	Enabled
4	Active	Disabled	Disabled
5	Suppressed	Disabled	Disabled
6	Active	Enabled	Disabled
7	Suppressed	Enabled	Disabled

2-146. TERMINATOR ",",

2-147. The character "," (comma) is entered to complete a string of commands and is notice to the controller to execute the preceding commands back to the previous terminator.

2-148. String Commands

2-149. There are four types of commands that can be used within a string. They consist of entries to program Control Commands, Tape Commands (used with Storage Units only), Data Instructions, or to request a return statement on Status. The Control Commands, Tape Commands, and Data Instructions can be combined in a single string, provided the string does not exceed 32 characters in length, including the terminator.

2-150. CONTROL COMMANDS

2-151. Control Commands are used to program the modes of operation. The codes are used to enable or disable the modes of operation. Multiple modes may be enabled in one command string. The Control Commands are given in the following paragraphs.

2-152. Interface Commands

2-153. The IEEE 488-1975 Interface is enabled with an address character which is further defined in the Standard and Section 6 of the instruction manual. The RS-232-C Interface is enabled with the character "J" and disabled and returned to Local control with the character "#". The characters "UI" lockout the LOCAL/REM switch on the Front Panel for a Local Lockout condition, preventing a return to Local from the Front Panel. The Local Lockout is disabled, allowing free use of the Front Panel with the instruction "U0". The Local/Remote commands are acted on immediately, not requiring a terminator.

2-154. Standby/Operate

2-155. Standby is enabled with the character "S". Operate is enabled with the character "N". The modes are mutually exclusive so the opposite mode is automatically disabled. The Standby/Operate commands do not require a terminator for action.

2-156. Sensing

2-157. External sensing is selected with the instruction "X1". Internal sensing with "X0". A terminator is required for execution.

2-158. External Oscillator

2-159. The External Oscillator Mode is selected with the instruction "F1". To return to the internal oscillator, program "F0". A terminator is required for execution.

2-160. 50Ω Divider Override

2-161. The Override Mode is programmed with the characters "R1". This mode does not allow the instrument to go into DC voltage ranges below 20 volts (minimum normal reading 2.0000). An output of 1.00000 or less has a normal output impedance of 50 ohms. The override may be disabled while remaining in the DC Volts with the instruction "R0". Programming a reading above 2.0000V dc, or an output with any function except DC volts selected automatically, disables the override. A terminator is required for execution.

2-162. Error Mode Instructions

2-163. Programming any of the six Error Mode instructions puts the instrument into the Error Mode unless the instrument is in the Keyboard Mode. The character "@" toggles the instrument, enabling and disabling the Error Mode. The cursor (intensified digit) can be moved to the left by programming "<" or to the right, by ">". The digit under the cursor is made more positive with the character ";" and made more negative with ":". The character "C" stores the NEW/REF CAL 1 OHM reference. Programming any instruction not legal for the Error Mode (Error Mode Codes, Standby or Operate) while in the Error Mode toggles the instrument out of the Error Mode. The Error Mode instructions do not require a terminator for action.

2-164. Recall

2-165. The instruction "G" (GET) places the instrument in the Recall Mode. When in the Recall Mode a legal instruction (G, +, -, V, A, H, D, M, T, L, ?) displays the stored data. Any instruction not legal for recall will toggle the instrument out of Recall, if it had been in that mode of operation. If a numeric is programmed while in the Recall

Mode an "Err1" results. Programming a terminator (.) prior to the numeric prevents the error message, as will a Clear (C), which also removes any error message inadvertently acquired. Programming Recall M (GM) or Recall followed by a function not selected, displays on the Central Display the magnitude of the function selected. The message must be followed by the Central Display Access Instruction (?) to place the data on an output device. The Recall instructions do not require a terminator for action.

2-166. Limits

2-167. The Entry Limit is programmed with the character "L" followed by the applicable magnitude entry. For example, the instruction L12.3456V would enter a limit of +/-12.3456V dc and any entry exceeding that figure would be rejected with an "Err3" display. The instruction "T" followed by the applicable magnitude entry sets the tolerance limits. The typical instruction T.05% would program a limit of 0.05% and any error exceeding that during Error Mode operation would illuminate the LIMIT indicator and flash the display, warning the operator the preset limits has been exceeded. Both limit entries may be set to their maximum figure, effectively disabling them, by entering the applicable instruction followed by the character "C" (LC or TC).

2-168. Wideband Option

2-169. When installed, the Wideband Option is enabled with the instruction "P1". It is disabled with the instruction "P0". When enabled the output is available at the dedicated connector and the applicable voltage and frequency specifications apply. A terminator is required for execution.

2-170. Boost Mode

2-171. The Boost Mode is programmed with the characters "B1". To obtain the output from the applicable amplifier (5205A/5215A for power or 5220A for current) program the desired output data followed, preceded, by the Boost Mode Command, and completed with a terminator. The output is on the terminals of the selected amplifier, and not on the calibrator output terminals. The Boost Mode is disabled with the instruction "B0". In both cases, enable and disable, the programmed instruction requires a terminator before it can be executed.

**2-172. STORAGE COMMANDS
(STORAGE ONLY)**

2-173. The Storage Commands are only used by instruments in the 5100 Series that are equipped with a Storage System and Tape Drive.

2-174. Storage Enable

2-175. The Storage Mode is enabled with the instruction "Q1" and disabled with "Q0". Until the Storage Mode is enabled with this instruction, the remaining storage commands are ignored.

2-176. Tape System

2-177. Enable the Tape Mode for a Read or Store operation on the tape with the instruction "I". Disable the Tape Mode with the instruction "0".

2-178. Store

2-179. Program the instruction "W1" to select the Store Mode and write data either in the storage memory or on tape. Select the Read Mode with the instruction "W0". This disables the store capability and permits the reading of data from either the storage memory or the tape system.

2-180. Advance/Load

2-181. The instruction "&" performs remotely the functions of the ADVANCE/LOAD switch. The actual function and performance varies with the state of the Tape, Read and Store Modes. With the Tape Mode disabled and the Read Mode selected, the program in the storage memory advances one step. Selecting the Store Mode with the Tape Mode remaining disabled results in the programming data being written into the storage location selected and then advancing the program one step. When the Tape Mode is selected the instruction starts the tape drive motor, which automatically advances until it reaches the end of the program.

2-182. Select/Display Step

2-183. The instruction "(" performs the same function as the Front Panel SEL/Display switch. The instruction, directly preceded by a numeric entry, displays the data in the program step corresponding to the numeric entry on the Central Display, after flashing the step number. The same instruction, without a directly preceding numeric entry, results in the flashing display on the Central Display of the current step number.

2-184. Delete Step

2-185. With the Store Mode selected the instruction ")" causes the program step presently selected to be deleted from the program. Insure the step counter is at the correct position before transmitting this instruction.

2-186. List Instruction

2-187. The instruction "K" lists the present program or the data for the current test as determined by the

Read/Store Mode status. When the Store Mode (W1) is selected, the optional remote interface outputs to a printing device the stored program, starting with the program step selected. In the Read Mode (W0) a list data function results, with the data pertaining to the instruction on the instrument output transmitted through the optional remote interface to a printing device.

2-188. The transmission of any character, including carriage return and/or line feed, after the "K" terminates the output, deleting the listing. Any characters used by the system controller should be suppressed prior to transmission to assure an output of the listing.

2-189. Clear Storage Instruction

2-190. When the Store Mode has been selected the instruction "=" clears the program previously written in the storage memory.

2-191. DATA INSTRUCTIONS

2-192. The Data Instructions are required to select or change the output from the instrument. They set the polarity, magnitude, multiplier, and function of the 5100 Series output. The instructions required for each are listed in the following paragraphs.

2-193. Polarity Instructions

2-194. A positive or negative polarity can be entered with the characters "+" or "-", respectively. A positive polarity is assumed by the instrument if no polarity entry is made.

2-195. Magnitude Instructions

2-196. These instructions include the numeric characters "0" through "9", the decimal point "." and the slash "/" used for the fractional-scale divider.

2-197. Multiplier Instructions

2-198. The multiplier for the numeric value is entered into the string using the scientific notation method. The character "E" is programmed followed by the numeric value of the power of ten desired, i.e., for 10^2 program E2, $10^3 = E3$, $10^4 = E4$, etc. If there is no entry the instrument assumes units (10^0) for the instruction.

2-199. Function Instruction

2-200. The Function Commands define the output selected by the Magnitude Commands. The character "V" is programmed to select volts, "A" for amps, "Z" for ohms, "H" for Hertz, "D" for dBm, and "%" for percentage.

2-201. STATUS

2-202. Status Messages can with draw from the instrument and decode information in the status registers and the central display. The displayed data contains both alphabetic and numeric characters, unless the alphabetic characters have been suppressed using the applicable Interface Output Code. The Output Display is not directly accessible but may be placed on the Central Display with a recall instruction and then withdrawn with a status request. With any Status Message, all characters in the message must be accepted by the controlling device before any other operation can be performed by the instrument.

2-203. Status Register Message Instruction "!" or "?"

2-204. Entry of the characters "!" results in an immediate response of a nine-character message followed

by a carriage return and line feed to the interface. A terminator is not required for this control character. Characters 1 and 9 of the message are coded 0 through 9, and character 2 through 8 are coded 0 through 7. Since some functions or operations are mutually exclusive, not all code combinations are used in some characters. The characters, their position and the data provided are given in Table 2-17 and examples of status register messages are given in a subsequent paragraph titled PROGRAM EXAMPLES. When the indicated bit is true the data listed in the table is present, or selected. Conversely, in cases where two conditions are mutually exclusive (e.g., Operate and Standby, External Sense and Internal Sense, or Storage Mode and Read Mode) the false condition automatically selects the opposite of the listed condition. Bits 4 through 7 are always in the state indicated, which creates the ASCII number required for printing when joined with the variable four-low-order bits.

Table 2-17. Status Register Message Assignments

NO.	BITS 7-4	BIT 3	BIT 2	BIT 1	BIT 0	COMMENTS
1	0011	X	X	X	X	Decoded binary number corresponding to the Error Codes in Table 2-9. <i>NOTE</i> <i>Only error codes 4, 5, 6, 8, and 9 appear in character 1 of the Status Register Message. Actions that prompt the remaining codes clear themselves and therefore are transient. If an IEEE Interface is installed all error codes may be accessed using the SRQ line.</i>
2	0011	0	Ready	Overload	High Voltage	WARNING The High Voltage bit is set for a programmed voltage output above 20 Volts.
3	0011	0	Volts	Amps	Ohms	Only one function may be present at a time.
4	0011	0	dBm	AC	Operate	AC must be selected if dBm is present. Standby present if Operate is not selected.
5	0011	0	50Ω Override	50Ω Divider	External	50Ω Override and 50Ω Divider cannot be selected at the same time. Internal sense present if External Sense not selected.
6	0011	0	External Osc	Boost	Wideband	External Oscillator and Wideband cannot be selected at the same time.
7	0011	0	Recall	Error Mode	Keyboard	Recall and Error Mode cannot be selected at the same time.
8	0011	0	Storage Mode	Tape Mode	Storage System Enable	Applicable only to models with a storage system installed. Automatically zero for all other. Bit 0 must be true before either Bit 1 or Bit 2 can be enabled.
9	0011	X	X	X	X	Cursor position. Always 9 if Bit 1 of character 7 False. MSD digit position of Output Display is 0, increasing to 7 at second digit position of Central Display. In Error Mode 9 signifies off scale to left.

2-205. Central Display Access Instruction “?”

2-206. Entry of the character “?” results in the immediate response of a 5½ digit scientific notation number. The first digit will always be a 1 or 0 followed by a decimal point, five digits, “E” for exponent, the exponent sign, and the exponent digit. The sign of the exponent is transmitted only when it is negative. The sign for the number is transmitted only when it is relevant, i.e., it is not sent for AC amplitudes or frequencies.

2-207. The numeric message is followed by the character “L” if the LIMIT indicator on the Front Panel is illuminated. A character (Table 2-18) representing any illuminated function indicator on the Central Display follows the numeric portion of the message. When all data has been transmitted the message concludes with a Carriage Return and Line Feed.

Table 2-18. Status Message Function Codes

CHARACTER	INDICATOR ILLUMINATED
L	Limit
V	V – Volts
A	A – Amps
Z	Ω – Ohms
H	Hz – Hertz
D	dBm – Decibal Milliwatts
%	% ERROR
G	dB ERROR

2-208. Only the data on the Central Display is transmitted with the character “?”; however, the data can be frequency from an AC operation, a percentage during Error Mode operations or any data available on the Central Display during Recall operations. Examples of each of the above are given in the following paragraphs.

2-209. When the instrument is operating in the AC Mode the frequency selected is displayed on the Central Display. If this frequency was 400 Hz and the Central Display was requested with the character “?”, the response would be 0.40000E3H CR LF. A frequency of 10 kHz would be transmitted as 1.00000E4H CR LF. Any other frequency would result in status message in the same format.

2-210. In the Error Mode, the frequency for editing, the percentage of error calculated, and the dB error calculated can be transmitted in a status message when they are present on the Central Display. If the message is a percentage of error or dB figure and it exceeds the preset tolerance limits so that the LIMIT indicator is illuminated, the message ends with the character “L”.

2-211. A frequency transmission is transmitted as described above.

2-212. A percentage error is transmitted as shown on the Central Display, i.e., a reading of 0.0031 would be transmitted as 0.0031E0% CR LF.

2-213. In the Recall Mode, any data that can be recalled to the Central Display can be transmitted in the status message. This includes programmed values for volts, amps, ohms, dBm, the voltage when dBm is programmed, the tolerance limits and the entry limits, both voltage and current.

2-214. Recalled programmed entry limits of +750V dc would be transmitted as +0.75000E3VL CR LF.

2-215. An output of +150 μ A dc recalled and transmitted would be +1.50000E-04A CR LF.

2-216. Program Examples

2-217. The following paragraphs contain several programming examples to aid the operator in using the calibrator.

2-218. Use the following instructions to obtain the output listed:

1. +6E-3A, N-In operate with an output of +6mA dc.
2. 5V1E3H, N-In operate with an output of 5V ac at 1 kHz.
3. L+300VL-250V - Set the entry limits at +1300V dc and -250V dc.
4. <T.01% - Sets the tolerance limit to $\pm 0.01\%$.
5. 1.5VX1R1, N-In operate with an output of +1.5V dc and the instrument prepared for four-terminal sensing with the 50 ohm divider overridden.
6. GL+V?- Recall the positive voltage entry limit and output it in a Central Display Access Word.

2-219. Some typical status register messages and their decoded explanation are given in Table 2-19.

Table 2-19. Status Message Examples

1. 004210019	No. 1 = 0 = 0000 = No errors
	No. 2 = 0 = 0000 = None selected
	No. 3 = 4 = 0100 = Volts selected
	No. 4 = 2 = 0010 = AC and Standby selected
	No. 5 = 1 = 0001 = External Sensing selected
	No. 6 = 0 = 0000 = None selected
	No. 7 = 0 = 0000 = None selected
	No. 8 = 1 = 0001 = Storage system enabled and Read Mode (default)
	No. 9 = 9 = 1001 = Error Mode not selected
2. 61410109	No. 1 = 6 = 0110 = Module missing (error code 6)
	No. 2 = 1 = 0001 = High voltage dc programmed
	No. 3 = 4 = 0100 = Voltage selected
	No. 4 = 0 = 0000 = DC and standby selected
	No. 5 = 1 = 0001 = External sensing selected
	No. 6 = 0 = 0000 = None selected
	No. 7 = 1 = 0001 = Keyboard Mode selected
	No. 8 = 0 = 0000 = Storage system not selected
	No. 9 = 9 = 1001 = Error Mode not selected
3. 001100275	No. 1 = 0 = 0000 = No errors
	No. 2 = 0 = 0000 = None selected
	No. 3 = 1 = 0001 = Ohms selected
	No. 4 = 1 = 0001 = Operate selected
	No. 5 = 0 = 0000 = Internal sensing selected
	No. 6 = 0 = 0000 = None selected
	No. 7 = 2 = 0010 = Error Mode selected
	No. 8 = 7 = 0111 = Storage system enabled, Store Mode & Tape Mode
	No. 9 = 5 = 0101 = Cursor on LSD of output display

Section 3

Theory of Operation

3-1. INTRODUCTION

3-2. The 5100 Series B Calibrators are a controllable source of AC and DC voltage, AC and DC current, and a set of precision resistors. The control of the voltage and current magnitude is provided by an analog control system. A Digital Controller responding to either Front Panel or remote digital commands chooses the desired output (i.e., AC volts, DC current, etc.), sets the desired magnitude and operates the front panel displays.

3-3. Explanations at an instrument block diagram, functional block diagram, and detailed circuit analysis level are contained in the following paragraphs. The functional block diagram section is divided according to the function performed, i.e., DC voltage, AC current, etc., followed by the Digital Controller System. The detailed circuit analysis deals with the individual pcb assemblies.

3-4. INSTRUMENT BLOCK DIAGRAM

3-5. The block diagram of the 5100 Series B in Figure 3-1 shows the major function of the instrument. An explanation of the operation is given in these paragraphs followed in subsequent paragraphs by an explanation and block of each operating function within the instrument.

3-6. The Digital Controller receives all commands to the calibrator via the Front Panel from an operator or from a remote location by either the IEEE-488-1975 (Option -05) or RS-232-C (Option -06) Interface Assembly. The Digital Controller in turn transmits digital signals to a DAC (digital-to-analog converter), block A in Figure 3-1, relays and FET switches in block B, relays and FET switches in block C, and the Front Panel indicators in block D. The commands received by the Digital Controller are displayed thereon as well as Error Messages in the event of an out-of-range or incorrect command, and other status indications.

3-7. The analog control system senses the output voltage or current, by using precision voltage dividers, current shunts, and AC converter, as is appropriate, block B, Figure 3-1, and presents the resulting DC voltage to one input of a precision Integrator-Comparator, block E.

3-8. The other input is supplied with a precision voltage from the DAC, proportional to the desired voltage or current output of the calibrator. Any difference between the two inputs is amplified by the Integrator-Comparator to produce a controlling signal for the controllable source. The Integrator-Comparator also provides the phase and frequency compensation that establishes the control-loop time response.

3-9. FUNCTIONAL BLOCK DIAGRAM

3-10. DC Voltage Less Than 20 Volts

3-11. There are three power amplifiers on the Power Amplifier Assembly to provide the output voltage and current levels needed at the output terminals in the DC Voltage and other modes. The isolation circuitry in the Current Modes is also contained on the assembly. Figure 3-2 is a simplified diagram for 0 to ± 19.9999 V DC. The High Frequency Amplifier, A1, drives the output high terminal directly. The high sense terminal feeds this voltage to the voltage ranging resistors and switches where it is divided by two before being applied to the Integrator-Comparator for comparison to a precision voltage supplied by the DAC. The DAC is programmed via the Digital Bus to produce one-half of the desired calibrator output voltage with the desired polarity. When there is a difference between the DAC voltage and that from the voltage ranging, the integrator produces a voltage, "Control", that drives the input to A1 so as to correct the calibrator output.

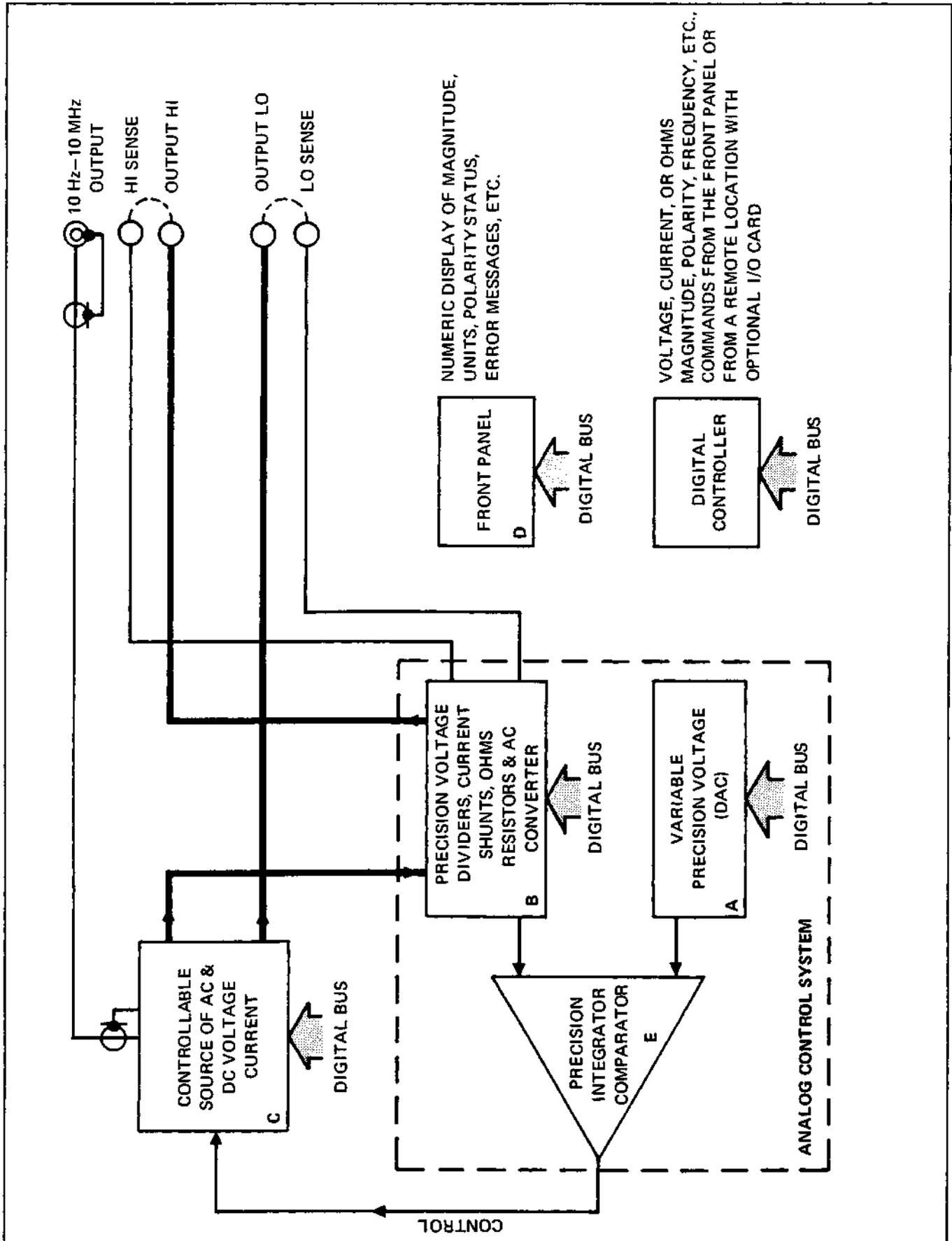

Figure 3-1. 5100B Block Diagram

AC current mode, F common is the power amplifier output voltage, and S common is the power amplifier common. The voltage between F common and S common is the power amplifier output voltage.

3-14b. The amplitude control function is provided primarily by the amplifier composed of Q104, Q105, U111, and Q106. This amplifier functions as a variable gain amplifier whose gain is controlled by the channel resistance of Q106. With 1.2V rms at P81-37, the voltage at the output of U111 varies between .3 and 3V rms depending on the channel resistance of Q106. The channel resistance of Q106 depends upon the output voltage selected. The amplifier composed of U114-1, -2, and -3 serves as a gain-determining and level-shift network between the control voltage at P81-17 and the gate of Q106. As the control voltage varies from 0 to 10 volts dc, the gate voltage of Q106 varies from approximately -6 volts to 0 volts dc. The voltage channel resistance varies at the gate of Q106 and thereby the voltage gain of the variable gain amplifier controls the output voltage.

3-14c. U112 and U113 serve to provide the F common and S common isolation required when the AC current mode is selected. U113 is composed of four FET switches. The FET switches are on and off in pairs. (When one pair of the FET switches are on, the other pair is off.) There is a relatively short time when no switches are on. U113 operates first by turning on two switches and charging C33 to the control voltage at U101-1. During this time, one end of C33 is connected to F common. Next, the first pair of switches opens and the other pair closes. During this time, the voltage across C33 is transferred across C34.

NOTE

C34 is connected to S common. Therefore, the isolation required in AC current mode is provided by two off FET switches.

3-14d. U112 is a 1 kHz multivibrator. The duty cycle of the multivibrator is very close to 50%. The output of U112 controls the state of conductance of the FET switches in U113.

3-15. Figure 3-4 also shows the transformer, T2, that is used to obtain 20 to 110V from 1 kHz to the specified maximum frequency of 20 kHz for this range. The voltage ranging now divides by 100.

3-16. For AC voltages below 2V, the output from the A1 is reduced by the Millivolt Divider in the same manner as for lower DC volts, Figure 3-3. The AC Buffer is connected to the 2V tap on the Millivolt Divider instead of to the top end as is done in the case of DC volts.

3-17. AC and DC Voltage, 20 Volts & Higher

3-18. The block diagram for AC and DC voltages of 20V through 1100V and below 1 kHz is in Figure 3-5. The

High Frequency Amplifier, A1, drives a higher power amplifier, A2, (Low Frequency Amplifier) which in turn drives step-up transformer, T1. The High Frequency Amplifier receives a controlled input from the oscillator through Q106, as described above. The integrator, DAC, etc., have been omitted because they are connected in the same way as shown in Figure 3-4. The connections shown in Figure 3-5, are for the 20 to 250V ac output. Amplifier A2 supplies approximately 2.8 to 35V ac to a tap on the primary of T1, the low frequency output transformer. For an output of 20 to 1100V dc, rectifiers and active filters are switched in between the transformer and the output terminals. Also, the oscillator is set to 1 kHz and its waveform is modified to minimize the peak currents that A2 must supply to the transformer, T1.

3-19. AC Current Under 200 mA

3-20. Figure 3-6 is the block diagram illustrating the AC Current Mode below 200 mA. The current ranging resistors (current shunts) are switched for each 10 to 1 change in output current magnitude. This maintains an input voltage between 0.2 and 2 volts to the AC Buffer as in the AC Voltage Mode described above. Notice an important difference. In AC volts, Figure 3-4, the common for the DAC, AC Buffer, etc., ∇ F, was connected to LO sense and output LO which is the common for A1, oscillator, etc. In the AC Current Mode, the ∇ F common is connected to the A2 end of the current ranging. It is a "floating" ground. All circuits including power supplies, that are connected to this common are floating and shielded. A transformer and optical-isolators in the DAC transfer Digital Bus signals to the ∇ common. J-FET Q106 isolates the output of the integrator, "Control", from the input of A1. Without this isolation, the input to A1 would vary, not only with the "Control", but also with the calibrator output voltage (compliance voltage).

3-21. There is an additional amplifier used in the Current Modes: the Current-Guard Driver. It is a non-inverting, unity gain operation amplifier that drives the I-Guard terminal on the panel and shields placed around the current ranging resistors. In this way, stray capacity for output high to output low (common ground \neq 1 and \neq 2) is isolated and driven by the I-Guard Driver. If it were not, the capacity would be driven by A2 with the resulting current flowing through the current ranging resistors. Since this is in addition to the actual calibrator output current, it would cause an error, especially at the higher frequencies and lower currents. The I-Guard terminal permits the user to extend this guard to enclose the lead from the output high terminal to the meter under test. The operation above 200 mA is explained in the following paragraph.

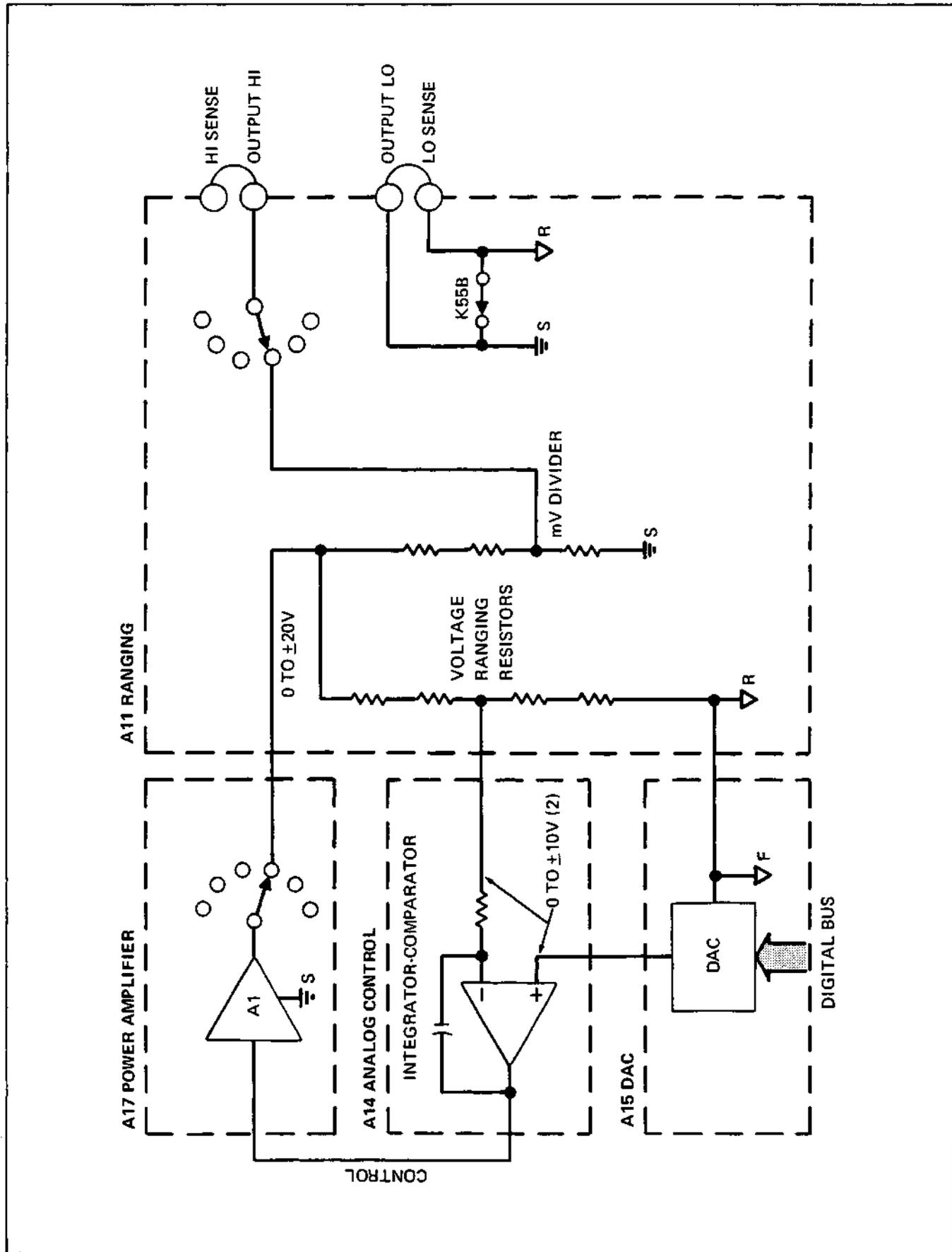

Figure 3-3. Less than 2V dc Outputs Block Diagram

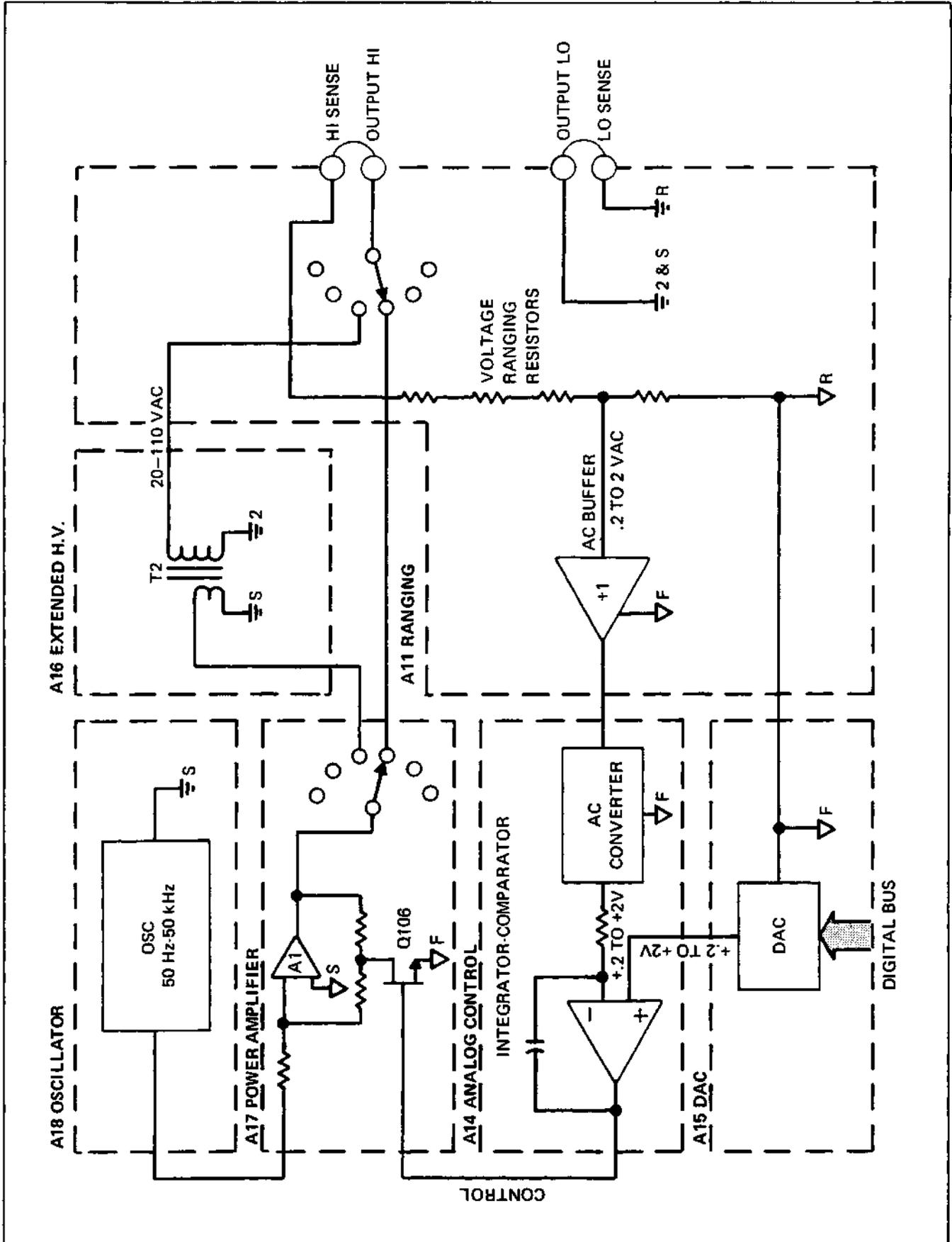

Figure 3-4. AC Voltage Block Diagram

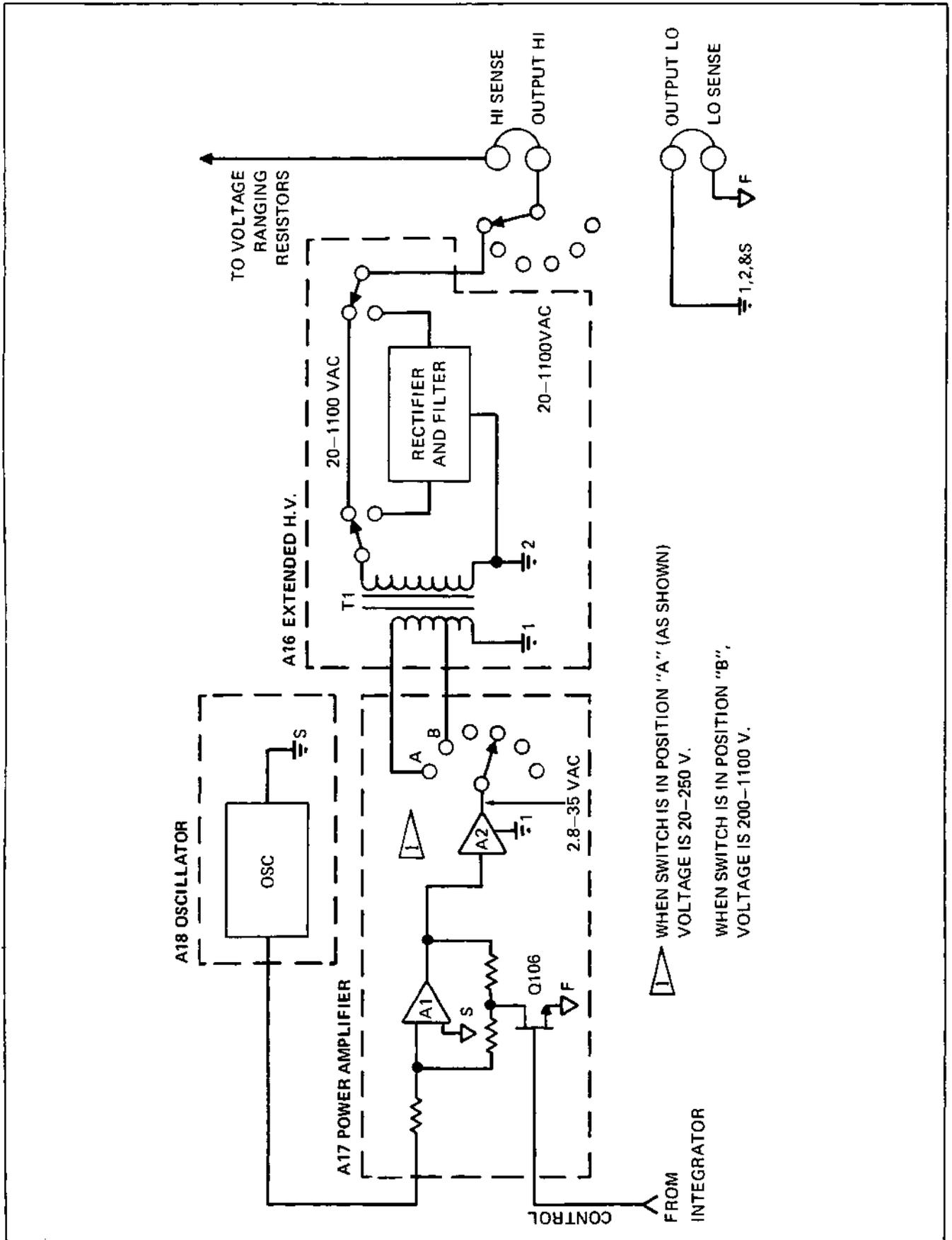

Figure 3-5. AC and DC Voltage, 20V and Higher

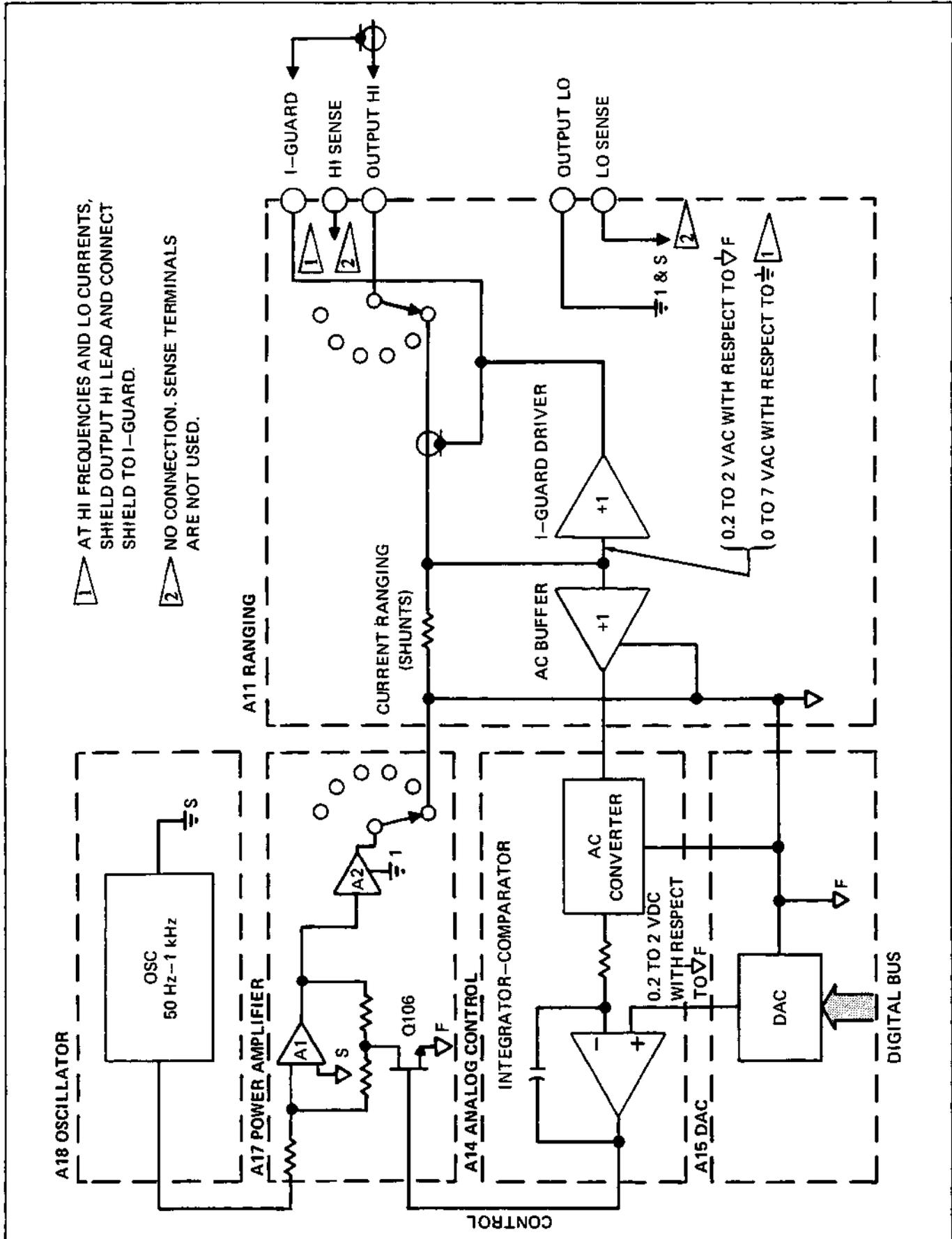

Figure 3-6. AC Current Under 200 mA

3-22. DC Current Under 200 mA

3-23. The Direct Current Mode under 200 mA is similar to the AC Mode. See Figure 3-7. The ∇ F common "floats", the same current ranging resistors are used, etc., but the isolation between the integrator output ("Control") and the AI input is different. In place of Q106 are U108 and U109. The "Control" voltage drives the LED in U108 or U109 through amplifiers (omitted for clarity). When U108 is driven, varying positive current is supplied to AI. When U109 is driven, the current to AI is negative. Thus, the input to AI amplifier is proportional only to the "Control" voltage as in the case of ac current above; but, in this case, the input is dc.

3-24. Direct and Alternating Current >200 mA

3-25. For Alternating or direct currents above 200 mA a third, high current, low voltage amplifier, the High Current Amplifier, is used in place of A2 shown in Figures 3-6 and 3-7. Otherwise, there is no difference.

3-26. Resistance

3-27. Figure 3-8 and 3-9 show the connections in simplified form for Low and High Ohms Mode. Four-terminal (EXT Sense) and two-terminal (INT Sense) connection is provided for values of 10,000 ohms and lower. Notice that all the resistors, except one, have dual usage: 1 ohm through 10 kilohms are also used for current ranging and 100 kilohms and 1 Megohm are used for voltage ranging. This saves space, cost, and calibration time since two separate sets of precision resistors are not needed.

3-28. Control System

3-29. The internal control of all aspects of the calibrator is centered in a Digital Controller (Figure 3-10). It is connected to all of the pcb modules (except the power supply) by the Internal Digital Bus. Each pcb has one or more addresses. The Controller directs commands to specific pcbs or section of pcbs by preceding each command with the appropriate address. Each module transmits an acknowledge signal to the Controller after receipt of the command data. In addition, some modules transmit data to the Controller.

3-30. CONTROLLER

3-31. The Controller (Figure 3-11) is a small, specially programmed digital computer, consisting of: a microprocessor (μ P) with timing, interface, and logic that

constitutes a Central Processing Unit (CPU); Read Only Memory (ROM), and Random Access (Read/Write) Memory (RAM); and buffers to interface the controller to the Internal Digital Bus. All control is by solid-state switches and mechanical relays optimally located on pcbs throughout the calibrator. They respond to commands from the Controller. Commands to the Controller, in turn, originate from an operator using the Front Panel or from an external (remote) source via the IEEE-488-1975 or RS-232-C Bit-Serial Interfaces. The Controller also transmits to the displays on the Front Panel the commands it has received and error messages.

3-32. FRONT PANEL

3-33. The operator controls and monitors the calibrator operation from the Front Panel. Voltage, frequency, etc., are entered via a keyboard, similar to an electronic calculator, or via rotary switch. As each key is depressed, the Controller, which periodically scans all keys and the rotary switch positions, decodes its function through the use of the μ P and data stored in the ROM, places the result in the RAM, and lights the appropriate Front Panel indicator in the Central Display. When a complete group of numbers, units, and/or a function has been entered, the operator presses the ENTER key. The Controller now checks to determine if the group is a valid entry by comparing it to data stored in the ROM. If invalid, an Error Message is displayed on the panel and no further action takes place. If valid, the group is manipulated and encoded for transmission via the Internal Digital Bus to the appropriate analog pcb modules and on the Front Panel the display is shifted from the central to the output display on the left side.

3-34. INPUT/OUTPUT

3-35. This module operates with the Controller through the use of a handler program stored in the ROM. It interfaces the Internal Digital Bus (which is optimum for internal data handling and is common to other Fluke instruments) to the IEEE-488-1975 or RS-232-C Interface. Details on the respective I/O options are found in the applicable portion of Section 6.

3-36. GUARD ISOLATOR

3-37. This module transmits data both ways between the unguarded and guarded sections of the calibrator while maintaining the required isolation.

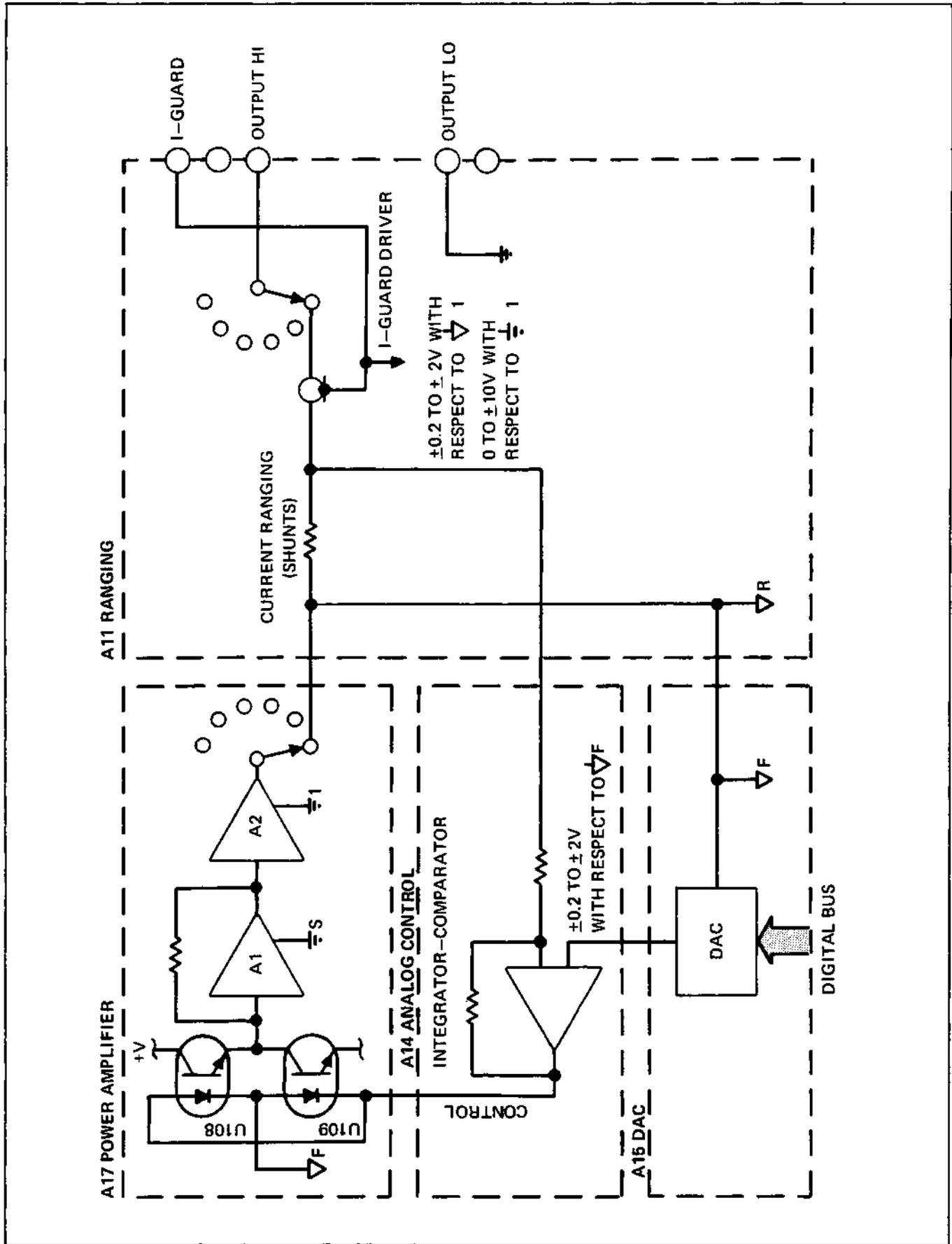
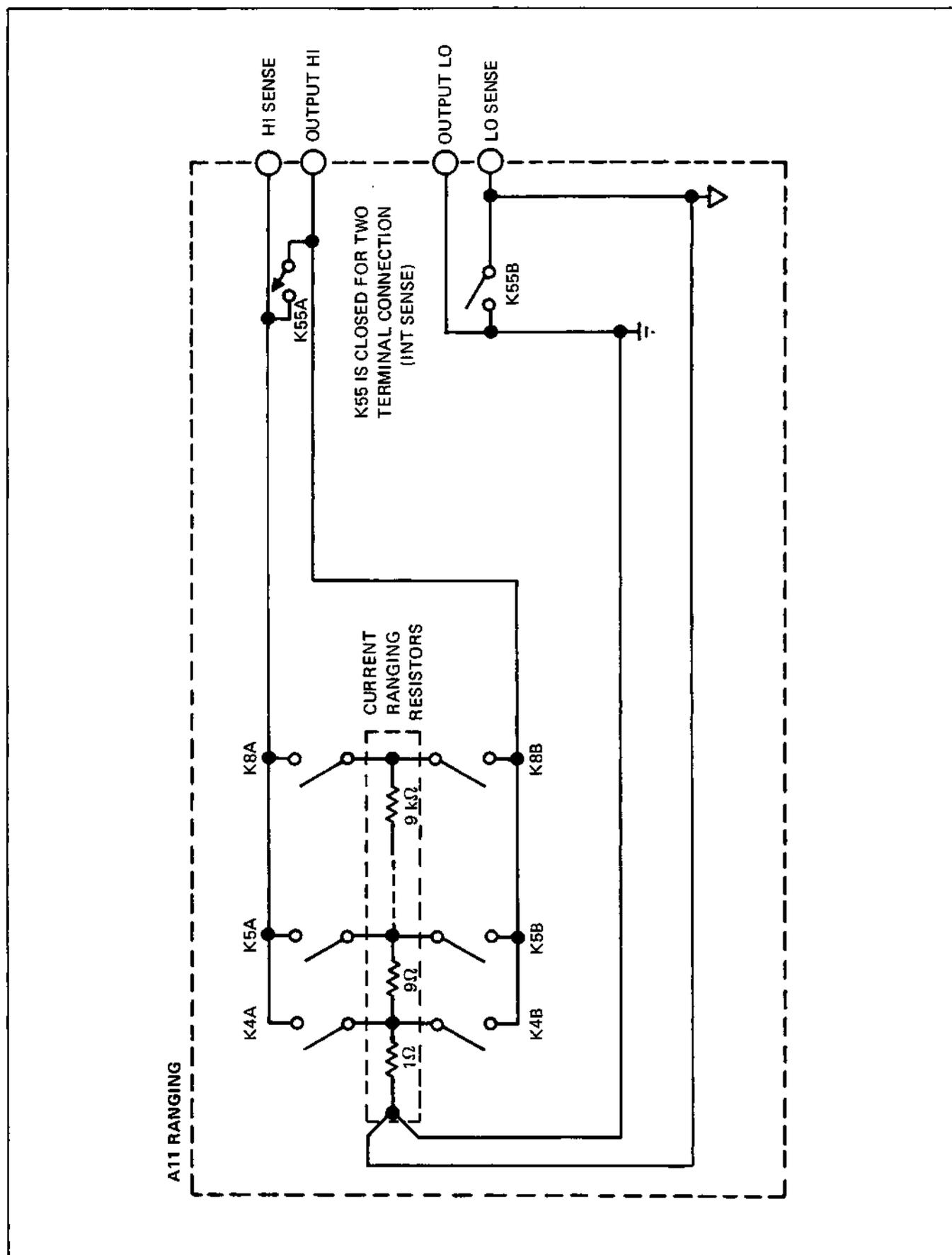

Figure 3-7. DC Current Under 200 mA

Figure 3-8. 1Ω - $10\text{ k}\Omega$ Resistance

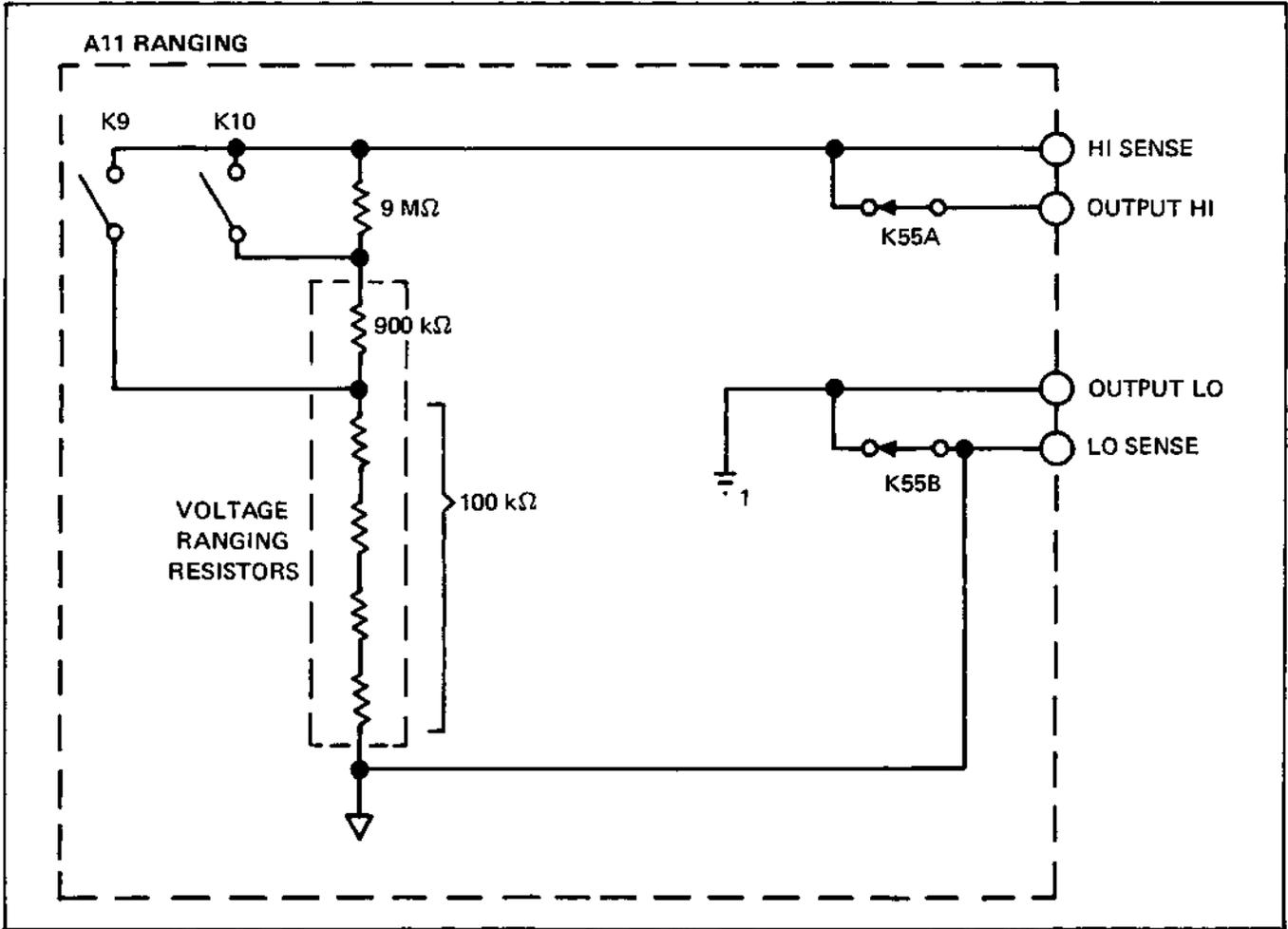

Figure 3-9. 100 kΩ - 10 MΩ Resistance

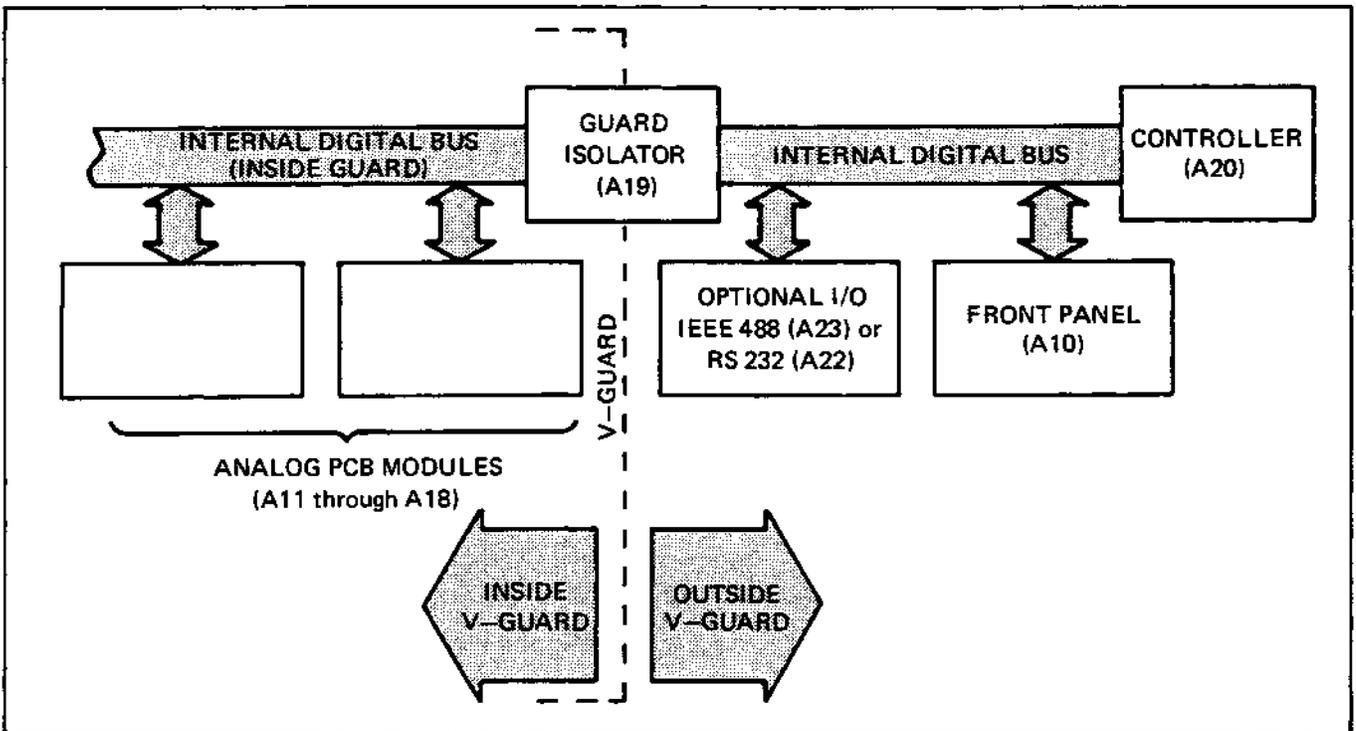

Figure 3-10. Control System Block Diagram

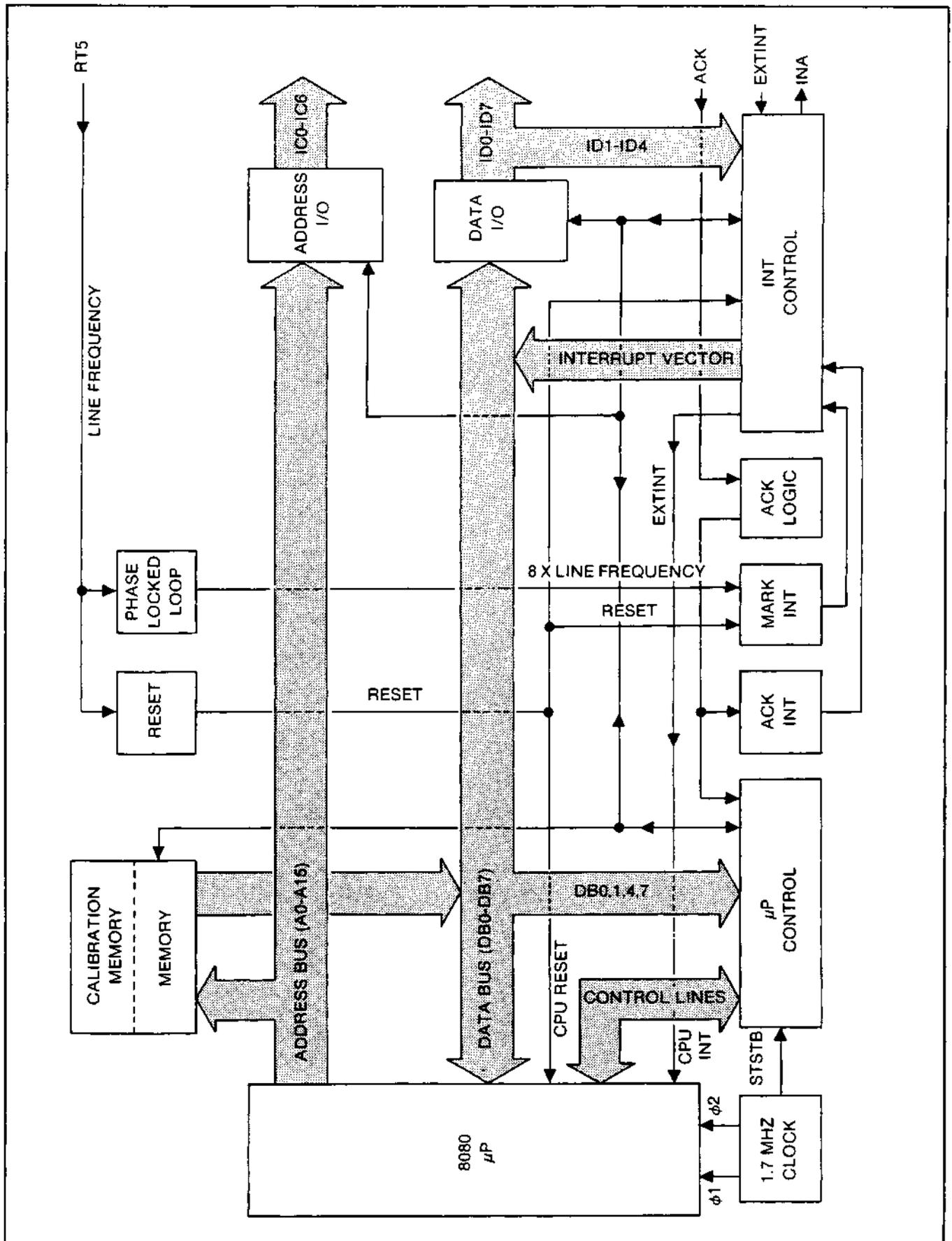

Figure 3-11. Controller Block Diagram

3-38. DETAILED CIRCUIT ANALYSIS

3-39. The following paragraphs contain a detailed circuit analysis of the individual pcb assemblies. Consult the schematic drawings in Section 8 when components are referred during the discussion.

3-40. Power Supply Regulator

3-41. The Power Supply Regulator supplies the calibrator with guarded, unguarded, and floating voltage outputs, in addition to a real time clock (approximately 60 Hz) and a power on preset generator.

3-42. UNGUARDED SUPPLIES

3-43. The three DC outputs from the unguarded supplies are +5 volts, +12 volts, and -12 volts. The +5V supply is regulated by U3 with transistors Q1 and Q22 to increase the output current capacity. Current is limited by R3 and R77 to approximately 4.5A. The triac, Q19, provides overvoltage protection. If the output exceeds 5.6 volts, VR1 conducts, firing Q19, clamping the input voltage to less than 1 volt, and opening the fuse, F1. The output voltage can be adjusted, over a limited range, underload with the variable resistor, R93. The +12V and -12V supplies are controlled by the fixed voltage, three-terminal regulators, U1 and U2, respectively.

3-44. FLOATING SUPPLIES

3-45. The floating supplies provide regulated +5 volts, +15 volts, and -15 volts from unregulated inputs of +5 volts and ± 40 volts. The ± 40 volts, which is required elsewhere in the instrument, is dropped to manageable levels by the zeners, VR12 and VR13, for +15V regulator, U6. The +5V supply is regulated by the three-terminal regulator U4.

3-46. GUARDED SUPPLIES

3-47. Outputs of +15V, -15V, +62V, -62V, +39V, -39V, and -20V are obtained from the guarded supplies. The +15V is obtained from the regulator U7, augmented by the series pass transistor Q2. Output current is sensed by RT1 for overload limiting. The supply is adjusted with the variable resistor R6.

3-48. The +15V is used as a reference for the remaining outputs of the guarded supplies, either directly, indirectly through the -15V supply, or both. The divider R9 and R10, and the the operation amplifier, U8, detect any difference between the plus and minus 15V supplies to drive the series pass transistor Q3 and reduce the difference to near zero. RT2 samples the output current and, if it exceeds 0.6 volts, Q4 conducts to reduce the base current of Q3 and reduce output current.

Q21, CR16, CR17, CR18, and R74 provide a constant current sink to the base of Q3 and the output of U8. The zener VR2 provides voltage translation from the base of Q3, at -15.6 volts to the output of the op-amp or near zero volts.

3-49. The -20 volt supply provides the +5 volt logic supply by connecting the high side of the -20 volt supply to the regulated -15 volt supply so the low side, logic common, is at -20 volts with respect to the grounds ($\frac{+}{-}$ and 1). The supply is regulated by U11 with transistors Q15 and Q23 to increase the output current capacity. Current is limited by R31 and R73 to approximately 4.5A. The triac, Q20, provides overvoltage protection. If the output exceeds 5.6 volts, VR11 conducts, firing Q20, clamping the input voltage to less than 1 volt, and opening the fuse, F1. The output voltage can be adjusted over a limited range, under load, with the variable resistor, R84.

3-50. The plus and minus 62 volt supplies operate essentially the same as the -15 volt supply with the exception of component values. The +15 volt supply provides a reference for the +62 volt supply and the -15 volt supply to the -62 volt supply. The 30 volt zeners, VR5 and VR6, are used to regulate the input voltages to the proper level for the operational amplifiers. The ± 62 volt supplies are further regulated to provide ± 39 volt supplies. The regulating circuitry is essentially the same as the ± 62 volt and -15 volt regulators. The ± 15 volt supplies are used as the references.

3-51. REAL TIME CLOCK

3-52. The real time clock generator provides a square wave output at approximately 60 Hz to synchronize timing functions in the Controller. The frequency is derived from U16 which operates as a free-running multivibrator with the frequency set by the values of R80 and C62.

3-53. POWER ON PRESET GENERATOR

3-54. The Power On Preset (POP) Generator provides a low-going pulse (POP) upon the application of power to the instrument. The pulse provides a clear signal to the logic, preventing the latches from turning on relays, switches, etc., in a random manner, possibly resulting in damage to the equipment or operator.

3-55. Digital-to-Analog Converter (DAC)

3-56. The DAC consists of digital and analog sections, each individually guarded, that are optically coupled. The digital section consists of a clock, two counters, one an increment by ten-to-two hundred thousand and the other an increment by one-to-ten, latches to hold the preset

data, and addressing circuitry. The analog section converts the digital output into a square wave with the duty cycle representing the output voltage. Each of the sections is described in greater detail below.

3-57. DIGITAL SECTION

3-58. The +5V logic signal for the digital section is derived by using the -15V for the logic high and -20V as common. This procedure is common with the guarded portion of the instrument. The high negative levels are required to turn off FETs in the analog circuitry.

3-59. The programmed output value is loaded into five quad latches (U26, U6, U11, U14, U20) and a single latch for the overrange digit (U15). The data entered is compared with two separate free-running counters, a major counter (U4, U9, U12, U18, and U17-3) which increments by tens up to two hundred thousand, and minor counter (U24) which increments by one up to ten. Both counters automatically reset to zero and restart when the maximum count is reached. The major counter is clocked by the 4 MHz clock at U17-5, which is a divide-by-two circuit for the 8 MHz output of the free-running clock formed by Y1 and its associated components. The programmed data is clocked into the latches from the data lines (ID0 through ID7) on commands decoded from the control lines (IC0 through IC4).

3-60. The programmed output two MSD digits are clocked into U15-8 and U20 when the first address is decoded at U8-9. In addition, a preset signal at U15-4 sets U15-5 high to enable the second and last address gates. The second address gate at U8-6 loads the third and fourth MSD digits at U14 and U11, respectively, and the fifth MSD and LSD are loaded into U6 and U26, respectively, with the last address at U8-10. The last address also clocks U15-3 for a low at U15-5, disabling the second and last address gates.

3-61. When the programmed data and both counters contain the same count, the latches \bar{Q} are set high (U29-10 for the major counter and U29-14 for the minor) to control the duty cycle, and through it, the analog output. The comparator (U5, U10, U13, U19, U25) compares each \bar{Q} output from the counters against the equivalent Q of the data latches with an exclusive OR circuit and the output of the comparator is wire ORed to set the U29 latches.

3-62. The number actually stored in the latches for comparison with the major and minor counters is one digit less than the figure keyed in at the Front Panel. For example, if 19999 is keyed in on the Front Panel (the DAC scales the figure, ignoring decimal placement), the latches corresponding to the major counter would be

loaded with 19998 by the microprocessor and the latch matching the minor counter would be loaded with 8. The same holds true for zero. Loaded would be 19999 and 9 for the major and minor counters, respectively.

3-63. Since the major counter MSD only requires one of the four bits available on the data lines, the first address loads the remaining three bits into U35 to operate relays which control the analog circuitry.

3-64. ANALOG SECTION

3-65. The analog section takes the square wave created by the digital section and outputs a percentage of the full-scale value available as determined by the duty cycle of the waveform. For example, if the programmed count was at 50,000 the duty cycle would be 25% of the total count and the output would be 25% of the available full-scale output.

3-66. The clock is transferred across the guard to the analog circuitry for use on U34 with pulse transformer T1. The signal at U34 is synchronous but is one clock behind due to the transferring action. The remaining data is transferred using opto-couplers. The output from the matching counters and latches is transferred to U34, summed, filtered, and output from the DAC in ranges of either zero to 10 volts or zero to 2 volts, as determined by the status of relay K3 and U35-15. The major cycle uses the output at U34-5 and -6 to operate the common base drivers, Q10 and Q11, which in turn drive the FETs, Q2 and Q4, which are fast-switching devices with precise known resistance. The output is filtered at U39, and with the bootstrap capacitor C11 (which is completed by the follower amplifier on the Analog Control PCB). The two values are summed and divided by R35 in parallel with the series resistors R36, R37, R42, and R40, to give an output between zero and 10 volts, proportional to the duty cycle. For DC current and AC measurements, K3 is energized, and Q6 through Q9 enabled to change the network by inserting R38 and R41 to VR CIM into the circuit of an output between zero and two volts, proportional to the input duty cycle. The input to these dividers comes from the regulator on the Analog Control PCB as either +VR (+10.0005V dc) or -VR (-10.00004V dc) as determined by the status of K1 and K2.

3-67. The analog section uses a floating 5V supply for part of the circuit. These are identified as +5V (FH) for floating high and +5V (FC) for floating common. Floating common is tied to either -15V for +VR switching or the output of U33, which is approximately -24V for -VR switching, as determined by the status of K1 (energized with +VR selected) and K2 (-VR selected). The lower common is required to turn off the FETs in the applicable circuit because the switching voltage could exceed the breakdown voltage to the FETs if left at -24V when +VR is switched.

3-68. Analog Control

3-69. The Analog Control PCB Assembly has four individual sections. Included are the reference voltage circuit, which provides the plus and minus 10 volt references from the reference amplifier and inverter. The main DC amplifier, or integrator, where the input is compared to the reference and the difference amplified to generate an error signal for the power amp to use to zero the error. The AC Converter is an averaging converter and full-wave rectifier, and the control section, with the compliance voltage limiter and detector.

3-70. REFERENCE VOLTAGE SECTION

3-71. The reference voltage section is based on the action of the accurate and stable reference amplifier U10. Low frequency ripple is removed with the circuit formed by U2, Q2, and their associated components, and high frequency ripple with Q1, Q16, and their associated components. Output spikes are removed by C9, and C22 is for spike suppression. To reduce errors the circuit common (VR COM) is independent, and connected to the floating ground on the DAC.

3-72. Negative output is obtained by using a unity gain inverter, op amp U3. Q10 and CR2 are installed in the circuit to prevent it from stabilizing at some voltage other than -10V. Without them it would be possible for the circuit to stabilize at 0.6V.

3-73. The ref amp circuit has several components that require special selection. U10, R9, and R10 are selected as a set after TC checks. They must always be replaced as a set. R17 and R20 are also matched for TC and must be replaced as a set. R13 and R14 are selected from values determined with a decade box using the procedure found later in this manual.

3-74. INTEGRATOR

3-75. The DAC output is integrated with the selected of three feedback paths. The feedback input is through Q73 when input for the dc attenuator, through Q74 when from the AC Converter, or through K3B when from an external source, e.g., the Wideband Option. An op amp is formed by Q65, Q68, U67, and their associated components with the DAC output at P53 to the non-inverting input and the feedback signal supplying the other op amp input. U61 and its associated components provide the bootstrap circuit for the signal from the DAC output at P37-51. The output of U61 also goes to the zeners VR60 (3.9V) and VR61 (6.2V) for 1 mA current flow through the diodes, CR60 and CR61. The maximum signal applied will be limited to 13 volts due to the back-to-back zeners VR62 and VR63. Q62, Q63, Q69, and

CR70 provide additional protection by clamping the bases of Q68. R71 (DC BIAS) is adjusted for zero drift, with TP13 and and TP14 shorted, to balance the input to the integrator.

3-76. The resistors R65 and R67 are a matched pair and must be replaced as such. R64 and R66 are selected to go with the op amp formed by the Q65, Q68, U67 combination. One will be a selected value and the other replaced with a piece of bus wire. Refer to the procedure later in the manual when reselection is required due to replacement of the installed resistor or one of the op amp components, Q65, Q68, or U67.

3-77. AC CONVERTER

3-78. Buffered AC is input at P51-21, routed through R32 and R36 to the op amp made up of Q36, U37, and the output stage Q45, Q46. The high impedance output goes to the two feedback diodes CR46 and CR47 and their 22k plus resistors, R35 and R33, respectively. The output is filtered by the active three-pole filter, U51 and associated components. The time constant of the integrator (U42) also effects the filtering. U42 integrates the signal at the summing-junction of the main amplifier and applies it to the non-inverting terminal of U37. The result is a high impedance input to Q36 which forms a unity gain high impedance buffer with U37. The ferrite beads, L45 and L46, on the bases of Q45 and Q46, respectively, keep the transistors from oscillating. The AC Converter output replaces the DC attenuator output to the integrator when the AC Mode is selected. The signal path is through Q74 and Q73, and into the integrator.

3-79. COMPLIANCE VOLTAGE LIMITER AND DETECTOR

3-80. This circuit operates when the instrument operates in the Current Mode. If the compliance voltage exceeds a 10 volt (2 volt on the 2A range) DC or peak AC preset limit, the voltage is clamped at that point and a visual indication (O.L. or Overload) is provided on the Central Display.

3-81. If the compliance voltage exceeds 10 volts, it is sensed at U84, which sets U96-5 and ID7 high to signal the instrument Controller an overload condition exists. At the same time, U100 is activated, turning on Q55, which turns on Q73, thereby disconnecting the feedback signal to the integrator and holding the output level until the overload is removed or the output switched to Standby. The clamping takes effect when CR81 (CR82) conducts, immediately after U84 turns on, dumping current into the power transistor Q81 (Q82). When the 2A range is selected, Q88 is turned on to shunt R88 and change the compliance sense voltage to approximately 2V dc or peak AC.

3-82. Power Amplifier

3-83. The Power Amplifier Assembly is made up of four independent amplifiers and a control logic section. The amplifiers are the high frequency, which may be used alone or in combination with one of the other amplifiers as determined by the output mode; the low frequency; the high current; and the isolation. The control logic energizes or de-energizes relays to control the output path as determined by the operating mode selected. Figure 3-12 and Table 3-1 are a simplified block diagram and

relay truth table showing the amplifier combination required for the various operating modes. The complete relay truth table for the Power Amplifier Assembly is in Section 8, located adjacent to the schematic.

3-84. HIGH FREQUENCY AMPLIFIER

3-85. The input stage of the high frequency amplifier is the op amp U102. This is followed by a transistor amplifier with a local feedback for voltage gain and low output impedance. The output stage consists of

Table 3-1. Power Amp Relay Controls

	K3	K4	K7	K8	K11	K10
AC Volts less than 20 Volts	0	1	0	0	0	0
AC Volts 20–110 Volts 1 kHz to 20 kHz	0	1	0	0	0	0
AC Volts 20–110 Volts 50 Hz to 1 kHz	0	1	1	1	0	0
DC Volts less than 20 Volts	1	0	0	0	1	0
DC Volts 20–1100 Volts	0	1	1	1	0	0
AC Current less than 200 mA	0	1	1	1	0	0
AC Current more than 200 mA	0	1	0	1	0	0
DC Current less than 200 mA	1	0	1	1	1	0
DC Current more than 200 mA	1	0	0	1	1	0
AC Boost Mode	0	1	0	0	0	1
DC Boost Mode	1	0	0	0	1	1

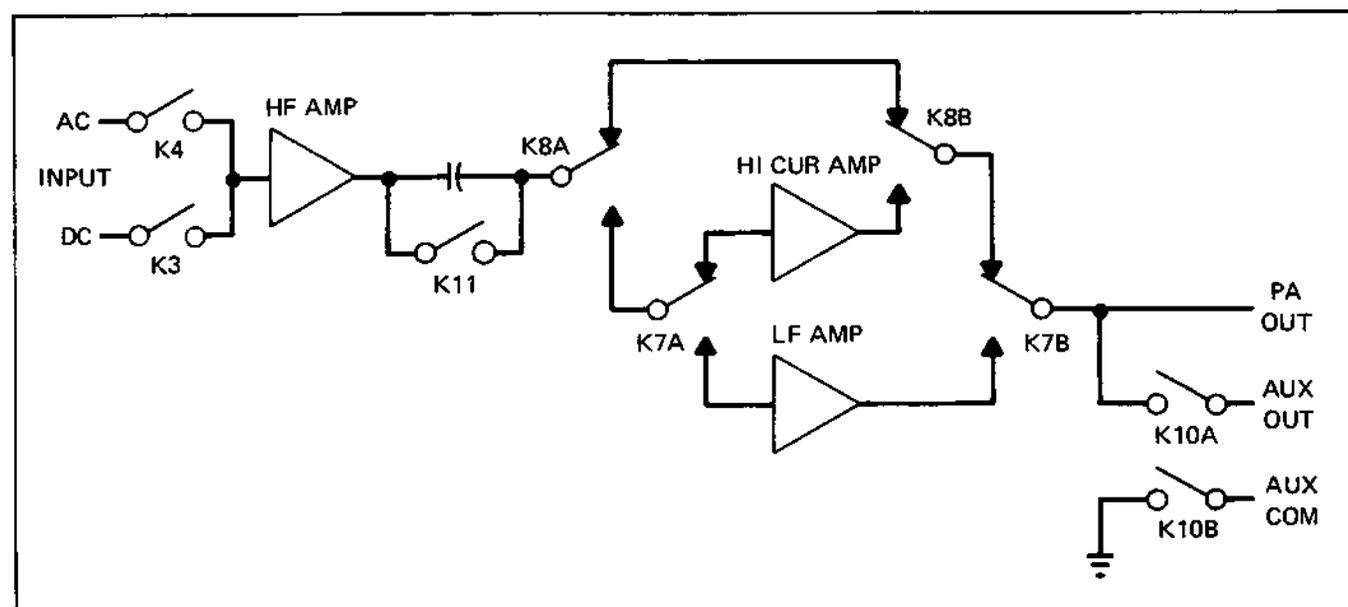

Figure 3-12. Power Amp Relay Controls

Darlington connected Q117/Q119 and Q118/Q120. Q115 and Q116 provide current limiting by monitoring R140 and R141. When the shunt voltage reaches approximately 0.6 volts, the transistors conduct by passing the base current from the Darlington pairs. A current limit condition also turns on the overload flag for the Controller by directing base current to Q2 through Q114. VR108 and VR109 provide a negative feedback clamp around U102 to prevent amplifier saturation during limit conditions.

3-86. LOW FREQUENCY AMPLIFIER

3-87. The low frequency amplifier may be used as either a voltage amplifier with low output impedance (e.g., to drive a transformer) or as a current source with high output impedance.

3-88. The input stage is the op amp U104 with the signal applied to the non-inverting input. A feedback path is provided through R186 to the inverting input. In the Voltage Mode (K5 energized, K2 de-energized) the contacts of K5 are closed, applying ground to one side of R151, resulting in a gain of approximately five. In the Current Mode (K2 energized, K5 de-energized) a positive feedback signal (PAFB) is applied through U105 to reduce the negative feedback.

3-89. The output stage is quasi-complementary with the driver transistor Q131 and Q133 the complementary pair. Current limiting is provided by Q129 and Q130 when the drop across R182 and R183 reaches approximately 0.6 volts. At the same time, the instrument Controller is notified of the overload when P82-23 goes low as a result of Q1/Q135 conducting through the action of Q128 and/or Q127. The zeners VR110 and VR111 provide negative feedback clamping for the input op amp to prevent amplifier saturation during the current limit conditions.

3-90. HIGH CURRENT AMPLIFIER

3-91. The High Current Amplifier is used only for current outputs equal to or greater than 200 mA. The op amp U106 is the input stage and the output stages are the complementary Darlington output transistors Q142 and Q143. Q140 and Q141 provide current limit protection and turn on the overload flag (Q2 and Q135) for Controller notification.

3-92. ISOLATION AMPLIFIER

3-93. Isolation between the Analog Control Assembly floating ground and the High Frequency Amplifier S-ground is maintained by the Isolation Amplifier. The input signal, either AC or DC, from the Analog Control Assembly is applied to U101-1, which is connected, as determined by the state of the FET switches Q101/Q102,

as either a unity gain follower amplifier (switches open) or unity gain inverter (switches closed). The relay configuration for each function can be found in the table adjacent to the schematic in Section 8.

3-94. For DC signals the output of U101-1 goes to U101-4 through the contacts of K3B. U101-4 is connected as a voltage-to-current converter and produces a current in the LED sections of U108 (positive) or U109 (negative) proportional to the input voltage. If U108 is turned on, the phototransistor section conducts a current from the +15V supply through K3A into the summing network of the high frequency amplifier input, U102. In the reverse condition, U109 conducts from the -215V supply to the summing network. As a result, the analog control output signal referenced to F-ground is able to produce a proportional input current to the High Frequency Amplifier, which is referenced to S-ground.

3-95. When the High Frequency Amplifier inputs are AC signals, the output of U101-1 is connected through K4B to the bilateral switch (U113). The flip/flop (U112) sets the frequency that cycles U113. The input signal is sent to U114-1, -2, and -3, creating a network that controls Q106. The circuit containing U-111; Q10 and Q105 create a feedback network for Q106, converting the input to a proportional change in the magnitude of the AC signal input to the High Frequency Amplifier.

3-96. The variable resistor, R17, sets the gain of the Isolation Amplifier. Negative feed back is provided by C6 and R20 for transient conditions to avoid saturation and overshoot in the amplifier.

3-97. CONTROL LOGIC

3-98. The control logic decodes the microprocessor commands to the power amplifier and energizes the relays that direct the signal path with the decoded commands. The control lines plus ID0 or ID1 are decoded by U1-6 or U1-8 to clock U3 or U4 respectively and latch the data line information. The data lines contain the configuration to energize or de-energize the relays required, as determined by the microprocessor program for the function selected.

3-99. Extended High Voltage

3-100. Outputs of the power amplifier higher than 20 volts are routed to the Extended High Voltage Assembly. The assembly contains a high voltage transformer, a rectifier, and filter circuit, and the relay control logic for the relay contacts that control the signal path.

3-101. AC outputs between 20 and 100 volts at frequencies greater than 1 kHz are routed through K3A to the high frequency transformer, T2, and then directly to the high voltage output.

3-102. AC outputs up to 265 volts at frequencies of 1 kHz or less, are routed through K1 to the high voltage transformer, T1, then through the energized contacts of K4 to the high voltage output. Outputs between 265 and 1000 volts go through K2 to reduce the number of primary windings and then output on the same path.

3-103. DC output voltages are input to the assembly as a modified 2 kHz square wave. For outputs between 20 and 200 volts the signal goes to T1 through K1, and then through the de-energized contacts of K4 to the rectifier, CR8 through CR11. Polarity is established by the condition of K5, de-energized for positive outputs and energized for negative. The signal is then filtered by an active filter, U1, and output through K6 and K7. Outputs between 200 and 1000 volts dc are routed to T1 through K2 to reduce the primary coils and increase the secondary output. All other steps are the same.

3-104. Control lines 0, 3, and 4 high are decoded at U7-8 to clock the information from the microprocessor on the data lines into U3. The latched data controls the energizing and/or de-energizing of the relays that control signal paths. Relay status for each possible function is given on the Extended High Voltage Assembly schematic in Section 8. In addition to latching the data for the relays, the signal at U7-8 performs several other functions. One of these is the generation of the ACK signal so that the Controller knows the data has been received. The first time the signal is generated at power application, U7-6 is set to enable U8-2. Each signal after that fires the retriggerable one-shot, U9. If the pulse period of approximately 4.5 seconds passes without the assembly being accessed again to retrigger the one-shot, the trailing edge of the U9 pulse will clock U8-3 to generate POP (through U6-6) and reset the analog control circuits. This insures no dangerous outputs are present if the Controller becomes inactive.

3-105. Oscillator

3-106. The Oscillator Assembly uses 360 degrees of phase shift, obtained through two integrators and an inverter, to obtain their required oscillation. The frequency is selected by varying the resistors and capacitors on the integrators with FET switches controlled by the microprocessor. The range of oscillation is selected by the state of relays K1, K2, and K3 which add capacitance and resistance, through the selected FET switched, to the circuit. The range multiplier selection is controlled by the microprocessor which activates the applicable FET switches. The schematic in Section 8 includes a table giving the relay and FET switch control lines for each frequency combination. For example, a programmed output of 20V dc or greater would result in K2 and K5 energized and signals LF, F1, F4A, and F4B high; a programmed output of 5 kHz would result in K3 and K5 energized, and signals (not)LF and F4A high.

3-107. Feedback, through R11, makes U1 a unity gain inverter. U4 provides an additional 90 degrees of phase shift and the feedback is added to U1 through R1, R4, R8, and Q1, which acts as a variable voltage controller resistor. The output signal is added to the feedback through R2.

3-108. The oscillator operates with a fixed output amplitude. A four-phase signal is formed with the input and output of U1, the 90 degree shifted output of U4 (available at TP5), and the output of the U2, which inverts the output of U4. These outputs, when rectified by the four-phase rectifier, CR1 through CR4, and integrated by U3, provide a low ripple signal to compare against the voltage reference VR1. The circuit uses U3 as an amplifier, set so that above 1 kHz the gain is rolled off by Q3 and below 1 kHz, through Q2, the gain climbs to keep the loop stable and to prevent oscillator ringing.

3-109. To prevent long delay times, waiting for settling in the low frequency ranges, C10 and C17 are precharged to zero and -1.7 volts, respectively. This allows the oscillator to start oscillating immediately when the lower frequency ranges are selected.

3-110. Capacitors C40 and C41, compensate for phase errors from U1 at high frequencies. The integrators U4 and U5 use C42 and C43, respectively, for a signal capacitor feedback to add a compensating signal at a frequency approximately equal to the break frequency of the amplifier. R50 adjusts the total phase error of the oscillator at high frequencies and is set so the control voltage at TP2 remains approximately constant at frequencies above 20 kHz.

3-111. To obtain the symmetrical square wave output required by the Extended High Voltage Assembly for high voltage DC outputs, K5A is energized and the signal routed through U14 and its associated components where it is clipped and rectified. From there it goes out through K5B to the power amplifier input.

3-112. When EXT OSC is selected on the front panel, K6 is energized and K4 is de-energized. This routes the external oscillator input at P91-39, which originates on the rear panel, directly out to the power amp on P91-37.

3-113. Digital control of the circuit originates when U10-12 decodes the proper information on the control lines and clocks the data on the data lines into U8 and U9. The data in U8 controls relay and rectifier operation and in U9 the FET switches for frequency range multipliers.

3-114. Ranging Assembly

3-115. The Ranging Assembly provides the path for the output signal from the power amplifier or high voltage output to the output and sense terminals. The data on the Digital Bus from the microprocessor is decoded by the logic circuitry (U5 through U18) to operate a series of relays and photocouplers which direct the path of the analog output through the assembly. The relays and photocouplers energized for a function and range are given in the chart on the Ranging Assembly schematic in Section 8.

3-116. The analog circuitry controls the output signal, steering it, either directly to the output and sense terminals, or through a divider network. The path is through the relay contacts controlled by the digital section. The paths for the various output ranges are detailed in the following paragraphs.

3-117. READINGS OF THE 2V TO 19.9999V RANGE

3-118. The power amp output is input at P41-16/36, is routed through the energized contacts of K18 and the de-energized contacts of K56B to the OUTPUT HI terminal. OUTPUT LO is tied directly to ∇ s. External sensing is from the HI terminal through de-energized K56A and K1D, energized K12, the resistor network to ∇ R and back to the LO terminal. Part of the signal is picked off through K14 and sent to the Analog Control Assembly via P44, the DC ATTN cable. If internal sensing is selected, the HI and LO SENSE terminals are connected directly to the applicable OUTPUT terminal through the energized contacts of K55.

3-119. The AC path is the same to the output terminals. The path for external sensing is through K13A instead of K12, used with the DC. A portion of the sensing is picked off through K13A and routed to U2 for the buffered AC signal at P41-21. Internal sensing is through the contacts of K55 as in DC.

3-120. If external sensing and the 50 ohm override are selected for DC outputs less than 2 volts or AC output less than 200 mV, sensing is as described in the preceding paragraphs.

3-121. READINGS OF LESS THAN 1.99999V

3-122. DC outputs on the 2V, 200 mV, and 20 mV ranges are routed through either the energized contacts of K50, K51, or K52, respectively, the energized contacts of K57, the de-energized contacts of K56B to the OUTPUT terminal. OUTPUT LO is connected to ∇ s at the bottom of the mV divider. Sensing is internally, through the contacts of K55, with the pick-off for U2 through K53

and K54, respectively. The 2V ac range path to the output terminal is the same as the dc path for the 2V range. The pick-off for U2 and the buffered AC is through K16 and external sensing is available.

3-124. GREATER THAN 20V RANGES

3-125. Both the 200V dc and 1100V dc range outputs originate at the Extended High Voltage Assembly and are routed to the OUTPUT HI terminal through the energized contacts of K56B. SENSE HI is through the energized contacts of K56A and K10, the divider, and back to SENSE LO. The DC ATTN pick-off is through the energized contacts of K14 for the 20V dc range and through the FET switch Q1 (enabled by photocoupler U20B and Q4) for the 1100V dc range.

3-126. The 200V dc and 1100V dc range outputs use the same path to the OUTPUT terminals. The sense lines use K9 for the 200V ac range. K10 for the 1100V dc range with Q2 (enabled by U20A) providing the input for U2.

3-127. OHMS

3-128. The low ohms outputs use the energized contacts of K3 to provide a path from the bottom of the divider to SENSE LO through ∇ R. The bottom of the divider is also connected to OUTPUT LO through K1B and a ground. The paths from the top of the divider to OUTPUT and SENSE HI are through the energized contacts of the applicable relay (A for output, B for sense). Relays K4, K5, K6, K7, and K8 are energized individually for ohms ranges 1, 10, 100, 1k, and 10 kohms, respectively.

3-129. Internal sensing is automatically selected from the microprocessor through K55 when the 100k, 1M, and 10M ranges are selected. The high ohm divider (R21 through R39, less R32) outputs 100k with K9, K55, and K56 energized, 1M with K10, K55, and K56 energized, and 10M with K55 and K56 energized.

3-130. CURRENT

3-131. The current ranges use the low ohm shunts as current shunts in series between the power amp output and OUTPUT HI. Relay K3 connects the floating ground ∇ R to the PA output (P41-16) so that it floats above OUTPUT LO by the output of the power amp. Relays, K4, K5, K6, K7, and K8 are energized for the 2A, 100 mA, 20 mA, 2 mA, and 200 μ A ranges, respectively, to connect the "A" contacts to OUTPUT HI and the "B" contacts to SENSE HI.

3-132. For DC current, K19 is enabled to provide a path for the sense to DC ATTN on P44. K16 provides the path to U2 when AC current is selected. With K1 energized, contacts "C" enable the I Guard Driver U1, which is a follower, for the PAFB output (P41-35) for current feed back to maintain the approximately constant loop gain of the power amp. It also assists in the power amp operation as a relatively high impedance current source and can be used from the front panel to reduce high frequency errors.

3-133. DIGITAL CIRCUITRY

3-134. When directly addressed with the correct output from the microprocessor on the IC line, U5-12 clocks the data on line ID0 through ID4 into U6. Relays K57, K55, K17, and K18 may be energized from U6, provided the required data is the ID line. If ID0 is high, U5-5 and U5-9 are enabled for indirect addressing. With the indirect address from the microprocessor, U5-9 latches the data on line ID0 through ID8 into U7 and U8 and/or U5-6 latches, then into U9 and U10. The data in the latches is decoded to energize the relays required (as shown in the chart) for the range and function selected. The data stays latched until the function and/or range is altered.

3-135. Controller

3-136. Under the direction of the software program, the Controller addresses and sets up each of the modules necessary to perform a function. Two types of addresses are used: direct and indirect. An indirect address requires a previous direct address to set up the indirect address response logic. Data transfers are accomplished with a handshake between the address (IC) lines and the acknowledge (ACK) line. When the Controller addresses a module, it places data on the data (ID) lines or receives data from the addressed module. The addressed module responds with an ACK signal, signifying that it is receiving or sending data. On initial power-up, the Controller checks the ACK signal from each module to insure that module is installed. If any fail to respond, due to either absence or a failure, error message (ERR6) is displayed.

3-137. The Controller is structured around the Intel 8080 microprocessor. Figure 3-11 is a block diagram of the Controller module. Hardware control functions have been minimized by careful software design. Sequences of events are timed from two sources. Basic operations of the microprocessor are run from a 1.7 MHz clock. The other source is generated by real time clock pulses at approximately 60 Hz, which are applied to a phase-locked loop. The phase-locked loop multiplies the real time clock frequency by eight. This signal is used to generate mark interrupts which time the background process.

3-138. The Controller has two 2016-bit RAMs installed on the PCB for use as temporary storage of data by the microprocessor. The amount and location of the memory devoted to the software varies with the model within the series and is covered later in this paragraph. Data lines (DB0-DB7) are used for bidirectional data flow. Address lines (A0-A15) determine the source or storage location of data. Since other modules of the 5100 Series B are addressed as memory locations, address and data I/O controls are used for access to the external bus structure.

3-139. Interrupts are used to divert the microprocessor from the main program to service other routines. Interrupts are synchronized to an appropriate time in the microprocessor cycle through interrupt control, where assigned priorities vector module identity data onto the Data Bus. Module identity data words direct the microprocessor to the memory location containing the next instruction. Two interrupts are internally generated: ACK INT and MARK INT (priorities one and six, respectively).

3-140. An interrupt may be externally requested by pulling the INT line lower. When the microprocessor is ready to accept the interrupt, the interrupt acknowledge (INA) signal is generated. The requesting module must respond with an ACK and a data bit (on ID1-ID4) which is used as a priority vector by INT CONTROL.

3-141. Two types of resets may occur: software and hardware. Software resets are a result of a remote request. Hardware resets occur at power-up or power-down. Real time clock pulses from RT5 are sensed by the reset logic. At power-up the reset signal assures the microprocessor will start from program location zero. At power-down the reset signal assures the Controller will not call up wrong modules.

3-142. The microprocessor control logic is responsible for latching up a status word at the beginning of each instruction cycle and for telling the microprocessor when to enter and exit wait states. Microprocessor sequences are divided into machine states (one clock period, 588 ns), machine cycles (from three to five states), and instruction cycles (from one to five machine cycles). Status words are used to control and synchronize data I/O, memory read/write, and some of the interrupt control signals. The microprocessor must be instructed to enter a wait state after addressing an external module and after being interrupted to allow the external module time to respond.

3-143. Memory for non-storage instruments (5100B, and 5102B) consists of two ROMs (U23 and U24).

3-144. Memory for the storage instrument (5101B) consists of two ROMs (U23 and U24) and two RAMs (U20 and U22).

3-145. Front Panel

3-146. The control lines from the Controller microprocessor (IC0 through IC6) are decoded by U22 and U23 to set up a series of control operations within the Front Panel. The output of U23-10 (LD DIG) loads the contents of the data lines into U1 and U9 to enable, if at the correct level, Q1 through Q8, and through them, enable the LED indicators, at the same time U1 and U9 via output lines B0 through B6, enable the Front Panel key switches. The one-shot U12 clears U1 and U9 when the clock is removed.

3-147. The decoded signals at U23-9, U23-6, and U23-10 clock the contents of the data lines into U2 and U3, U4 and U5, and U6, respectively. These provide the low required to illuminate the LED indicators, provided the data on the lines selected the indicator.

3-148. A decoded signal at U22-9 (RSDW) enables the output of the key switch matrix. A depressed key switch in an enabled bank causes an output on the applicable data line.

3-149. The edit circuit is enabled with a low at U22-6. Movement of the EDIT switch (S51) outputs a signal on the data lines.

3-150. Any decoded signal at U22 or U23 generates ACK signal to the microprocessor through U28 and Q9. This informs the Controller that the Front Panel has received the instructions.

3-151. Guard Isolator

3-152. The isolator accepts parallel data, shifts it to serial format for transfer across isolation transformers, and converts it back to the parallel format. The module reads the address on the Unguarded Control Lines (IC0 through IC6) and, if the data is destined for one of the analog modules, shifts it across the isolation transformers and places it on the Analog Bus. When the Controller requests data, the address on the Guarded Control Lines is decoded and the data bit from the analog module transmitted on ID7 to the Controller. A more detailed explanation using the block diagram in Figure 3-13 follows.

3-153. When data (ID0 through ID7) is destined for an analog module the address is decoded by the control logic circuitry which disables the clock (7.5 MHz), clears the guarded shift registers, and enables the unguarded shift register to load the parallel data. After a built-in time

delay the clock resumes and begins shifting the data through the isolation transformers into the guarded shift registers to the output. Completion of the transfer is decoded by the return logic to enable and pass through the isolation transformer to the control logic, the ACK (Acknowledge) signal generated by the receiving analog module.

3-154. When the Controller requests data from an analog module, the same sequence repeats itself through the output of the address. The address output is decoded by the return logic, returning the status of the addressed module through the return logic and isolation transformer to the control logic and, on the Unguarded Bus, to the Controller.

3-155. Tape Interface (Storage Only)

3-156. The Tape Interface Assembly links the Raymond mini-cassette tape system and the instrument Controller, through the Internal Bus. It sends to the cassette system operational commands originating from the Controller, and accepts and transmits to the Controller system any data transfer status information. The interface also converts and coordinates data flow between the cassette system, with its serial format, and the Controller, with its parallel format. Operation of the interface is divided into the control, status, write, read, and interrupt circuits, each of which is discussed further below.

3-157. CONTROL CIRCUIT

3-158. The interface responds to four control commands: interrupt enable, move, rewind, and write. The cassette system responds to the control line MOTION (move), FWD/RWND (Rewind), and READ/WRITE (Write) to perform the indicated operation. The interrupt enable command controls the operation of the interrupt circuit. The commands are received by the interface on the Data Bus and latched into U23.

3-159. STATUS CIRCUIT

3-160. These circuits return the cassette system and interface operational status to the Controller. The cassette system status returned is CASSETTE LOADED, SIDE A/B, WRITE INHIBIT, and TAPE POSITION. The interface status returned is EOR (End Of Record), DAV (Data Valid), RFD (Ready For Data), and BSY (Interface Busy). The data is encoded in eight parallel-bits and transferred to the Data Bus when the correct address is decoded.

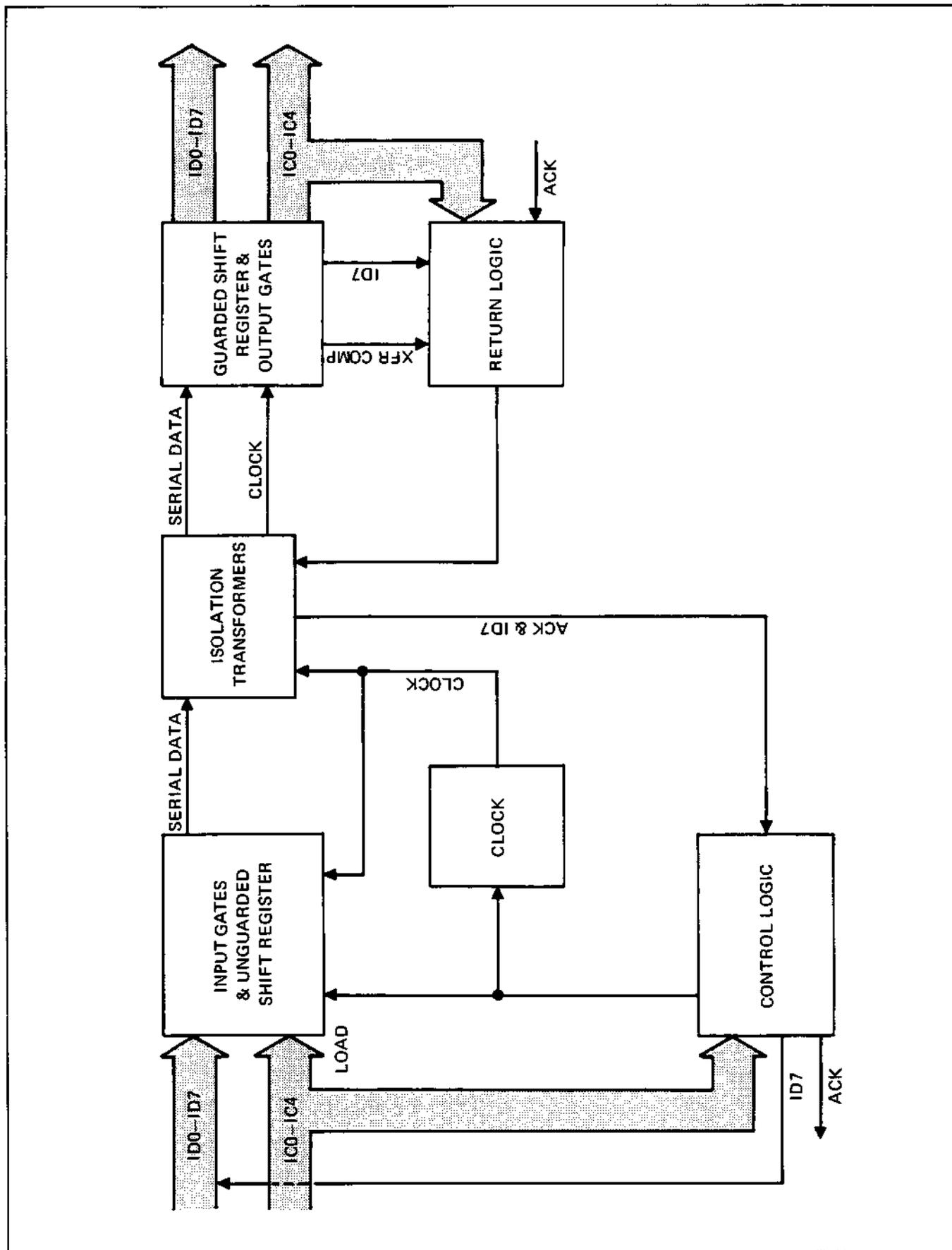

Figure 3-13. Isolator Block Diagram

3-161. WRITE CIRCUIT

3-162. The write circuit converts the data destined for tape storage from the parallel format of the Controller to the phase-encoded bit-serial format of the cassette system.

3-163. The free-running oscillator, U1, provides timing at 9.6 kHz, which is divided twice by U25 to produce clocks at 4.8 kHz and 2.4 kHz. The two are combined to generate two clocks to either load the shift register (U6) from the parallel input (U7, U8) or shift the data out of the register in the phase-encoded serial format.

3-164. At time T1 (Figure 3-14), the Controller generated address is decoded at U9-6 to set \overline{RFD} (U5-9), not ready for data, high and to move ID0 through ID7 into the latches U7 and U8. Transfer to the shift register is accomplished by a pulse at U3-4 and is synchronized with the master clock by U2. BSY (Busy), at time T2, sets U2-1 to indicate the data is being clocked out of the register and resets \overline{RFD} to signal the Controller that it is ready to accept the next data byte. Each bit shifted out is latched, in turn, into U5 and then phase-encoded in U10. At time T3 the Controller outputs the next data byte to the interface for loading into the latches U7 and U8, and to set RFD high. The number of bits shifted is counted by U11, and when it reaches eight, BSY is reset and a new load

pulse is generated at time T4. The sequence continues until the final bit is shifted out so that BSY remains low and there are no additional shift pulses generated, as in T5.

3-165. READ CIRCUIT

3-166. Operation of the read circuit is the reverse of the write circuit. Data is read from the tape in a phase-encoded bit-serial format, decoded, and then output to the Controller in the parallel format required.

3-167. When the data read from the tape at U10-13 changes, a spike is generated at U10-11, causing a 1 us pulse at U12-5 (Figure 3-15). The approximately 301 us clock from U13 clocks the tape data into U18. The trailing edge of the pulse clocks the counter U14 to count the number of data bits read. When eight bits have been read U14-2 goes high, resetting the counter, loading the latches U19 and U20 from the shift register, and setting the DAV latch (U4-10/ U4-11) to signify data is available (DAV). When the Controller inputs the data from the tape interface, the DAV latch is reset, enabling the interface, for when the next eight bits of data are available. The output at U12-4 has been held low from the first data transition of a tape reading operation. After data transfer is complete the point goes high, signaling the Controller the completion of data transfer.

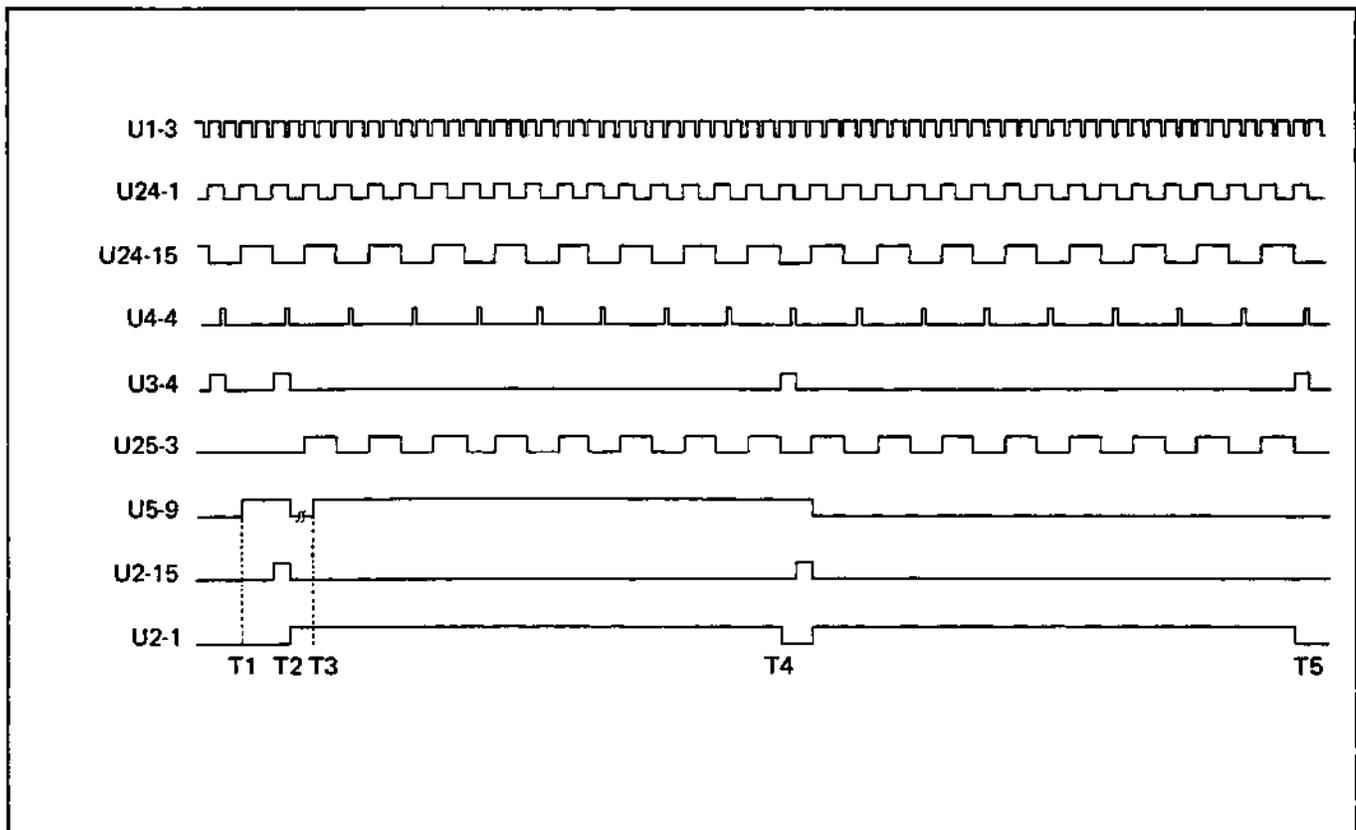

Figure 3-14. Write Timing Diagram (Storage Only)

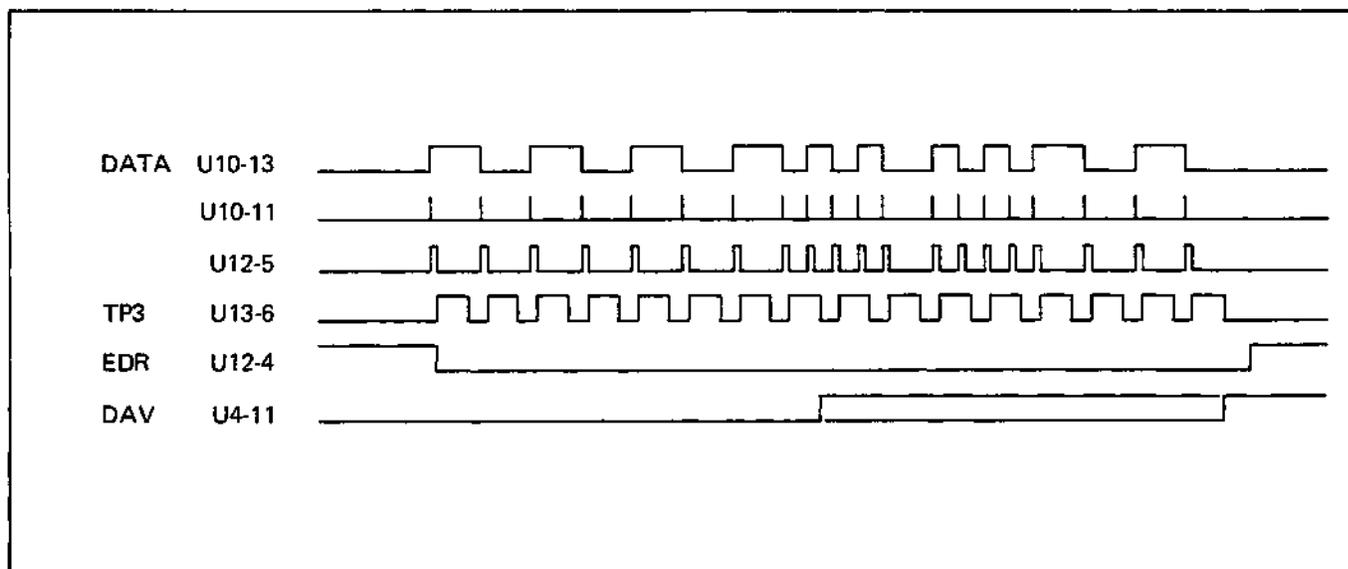

Figure 3-15. Read Timing Diagram (Storage Only)

3-168. INTERRUPT CIRCUIT

3-169. The interrupt circuit notifies the instrument Controller when the interface is ready to input data or accept additional output data. An interrupt enable ($\overline{\text{INT}}$) control signal is generated at the start of an interrupt and removed when a valid input data address is decoded.

3-170. Generation of either a DAV (Read Cycle) or $\overline{\text{RFD}}$ (Write Cycle) resets the applicable portion of U26 to generate an $\overline{\text{INT}}$ for transmission to the Controller. When the interface receives an interrupt acknowledge (INA) in return and $\overline{\text{INT}}$ is valid, it sets data line ID1 high and generates acknowledge (ACK) for the Controller. Setting ID1 high signifies the interrupt is from the tape interface. The interrupt is removed on signal from the Controller. The interrupt is also automatically reset at power on from U10-3 to insure the instrument does not come up with the interrupt active.

3-171. Tape Drive Assembly

3-172. INTRODUCTION

3-173. The Tape Drive Assembly is a reel drive, solenoid operated, mini-cassette transport. The drive is intended for use with an electronic motor speed controller for constant reel speed (varying tape speed) in the read and write modes. REWIND is accomplished by applying, to the motor, full voltage in the opposite polarity and engaging the solenoid, Table 3-2. The functional block diagram is found in Figure 3-16.

3-174. The recording media is to track digital magnetic tape in a certified mini-cassette, JFP/N 446997. This is used with a single channel head and saturation recording techniques.

3-175. End-of-Tape, (EOT) is detected by an IR LED and IR photo transistor detecting clear leader or EOT/BOT hole. WRITE INHIBIT is detected by switch closure. The cassette is file protected when switch is open. Cassette presence is detected by switch closure.

3-176. The Tape Drive Assembly transfers data at a constant reel speed, (variable tape speed), of three inches per second at the beginning of the tape, in the forward direction and rewinds at an average, (but variable), speed of 9 inches per second.

3-177. TAPE DRIVE MOTOR CONTROL

3-178. A speed-regulated reel-drive motor moves the magnetic tape over the read/write head. To operate the motor in the forward direction, a "low" signal is output to the FWD / RWND line and to the MOTION line. These signals operate the switch formed by U7B to connect the positive side of the tape drive motor to the +5 volt supply. As a result, motor current flows through U7B, through the motor and out through back-EMF regulator, U8. The back-EMF regulator senses the voltage across the motor, which is proportional to motor speed and provides the feedback necessary to maintain a constant motor speed. Potentiometer R27 provides a means of setting motor speed.

3-179. To operate the motor in the rewind direction, a "high" signal is output to the FWD / RWND line and a "low" to the MOTION line. The REWIND signal turns on the solenoid driver, U7B, to actuate the rewind solenoid, closes the switch formed by U7C, bypasses U8, flows through the motor and through Q1 to ground, (MOTR). Since regulator U8 is bypassed, motor rewind speed is uncontrolled and is the maximum provided by five volts.

3-180. READ/WRITE CIRCUIT DESCRIPTION

3-181. The read/write electronics conditions and processes the read/write signals at the recording head. The system consists of write power control, write drivers, read signal conditioning, peak detector, threshold detectors and data latch. Figure 3-17 is the functional block diagram of the system with accompanying waveforms. The following paragraphs describe the block diagram and each of the areas listed above.

3-182. Write Drivers

3-183. The write drivers convert the bi-phase TTL input data into the properly phased WRITE current through the recording head. The entire write circuit is interlocked to the READ /WRITE command and the WRITE INHIBIT status signal through write power control, Q1.

3-184. Write Power Control

3-185. The write power control, controls the application of power to the write drivers. Write power is not applied until a WRITE command is present and the WRITE INHIBIT status is off, in order to prevent interference with the read process. This also ensures that a write protected cassette is not erased or overwritten.

3-186. Read Signal Conditioning

3-187. The read signal conditioning circuit consists of the read preamplifier and low pass filter. The data signal from recording head is input to the differential preamplifier where

it is amplified (see waveform U9, pin 1, in Figure 3-17). The amplified data signal is routed to the low pass filter which eliminates high frequency noise above 5 kHz and provides an adjustable second stage amplification. The output of the read signal conditioning circuits, (waveform TP6), is then routed to the data peak detector and threshold detectors.

3-188. Data Peak Detection

3-189. This circuit consists of two circuits, a differentiator with diode clamping and a high speed logic converter. The first circuit differentiates the signal to provide a 90 degree phase shift (see waveform U10, pin 1, in Figure 3-17) and routes it to the data latch.

3-190. Threshold Detector

3-191. The threshold detectors are open loop level comparators with detection levels set at $\pm 15\%$. This detection gating logic helps eliminate the possibility of noise in the gap being translated into false data and provides a signal polarity indication (see waveforms U10, pin 7 and pin 14 in Figure 3-17) to the data latch.

3-192. Data Latch

3-193. The data latch combines the peak detection output with the threshold detection gating logic outputs to form the biphasic data stream (see waveform TP5 in Figure 3-17). The data output is clamped during WRITE mode to prevent transmission of erroneous data.

Table 3-2. Pin Assignments at I/O Header Interface Connector J33

PIN NUMBER	SIGNAL NAME	WAVEFORM	REMARKS
1	MOTOR +5 VDC		$\pm .25V$
2	+5 VDC		$\pm .25V$
3	MOTOR GND		
4	SIGNAL GND		
9	DATA IN		
10	READ/WRITE		
12	TAPE POSITION		
13	FWD/RWIND		ENABLED WHEN MOTION COMMAND APPLIED.
15	CASSETTE LOADED		
17	CHASSIS GND		
19	KEYING POSITION		
22	DATA OUT		
23	WRITE INHIBIT		
24	MOTION		

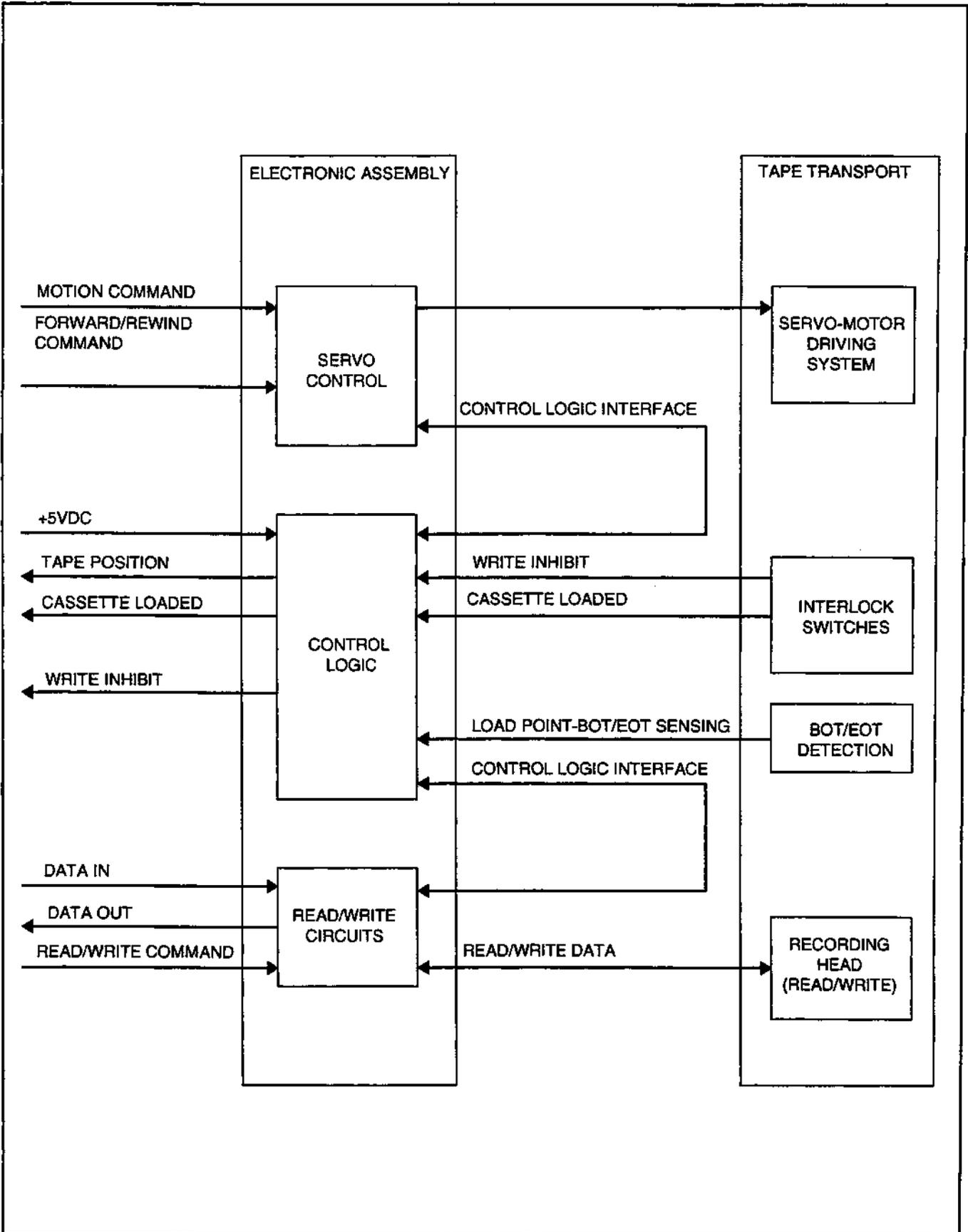

Figure 3-16. Tape Drive Functional Block Diagram

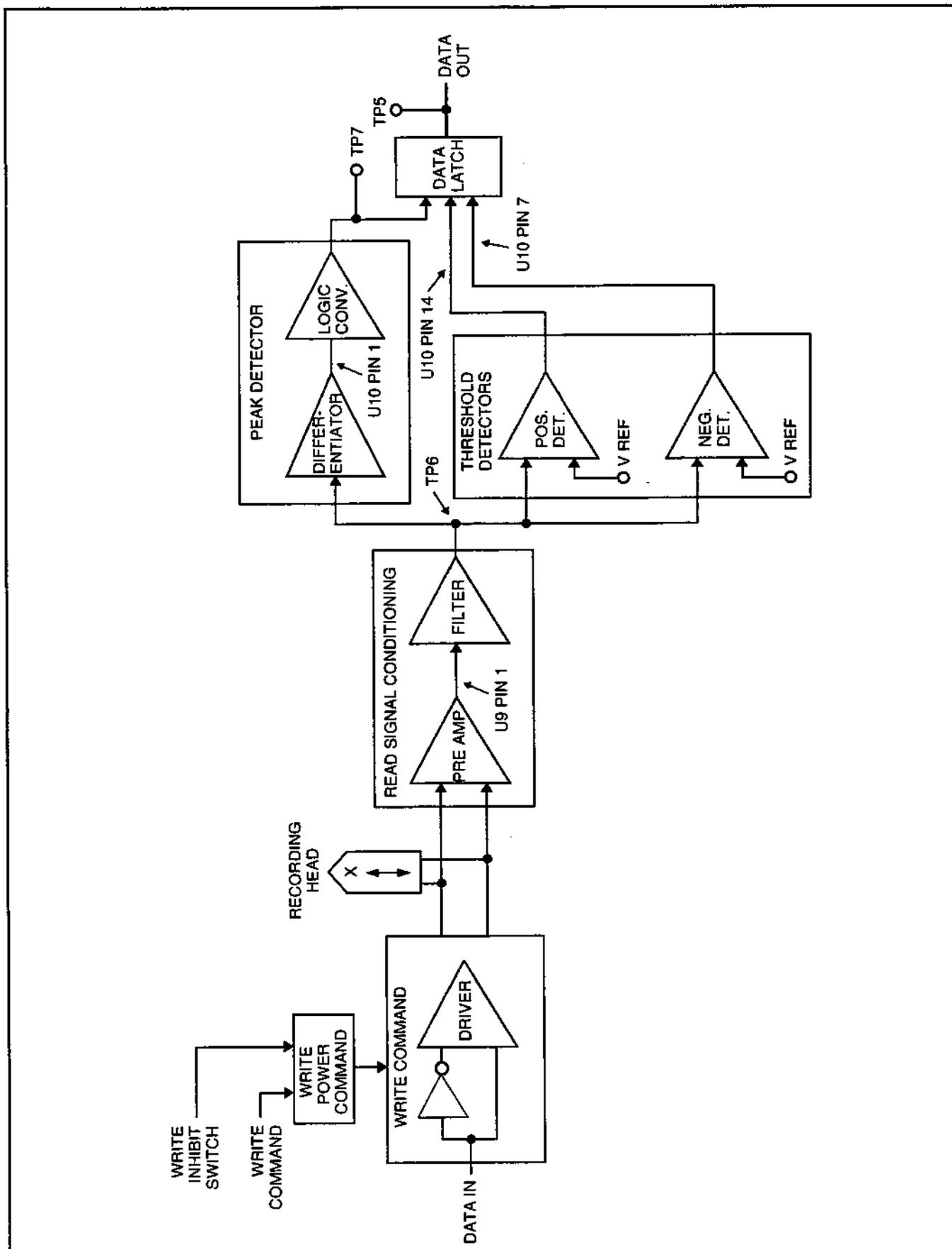

Figure 3-17. Read/Write Electronic Block Diagram with Accompanying Waveforms

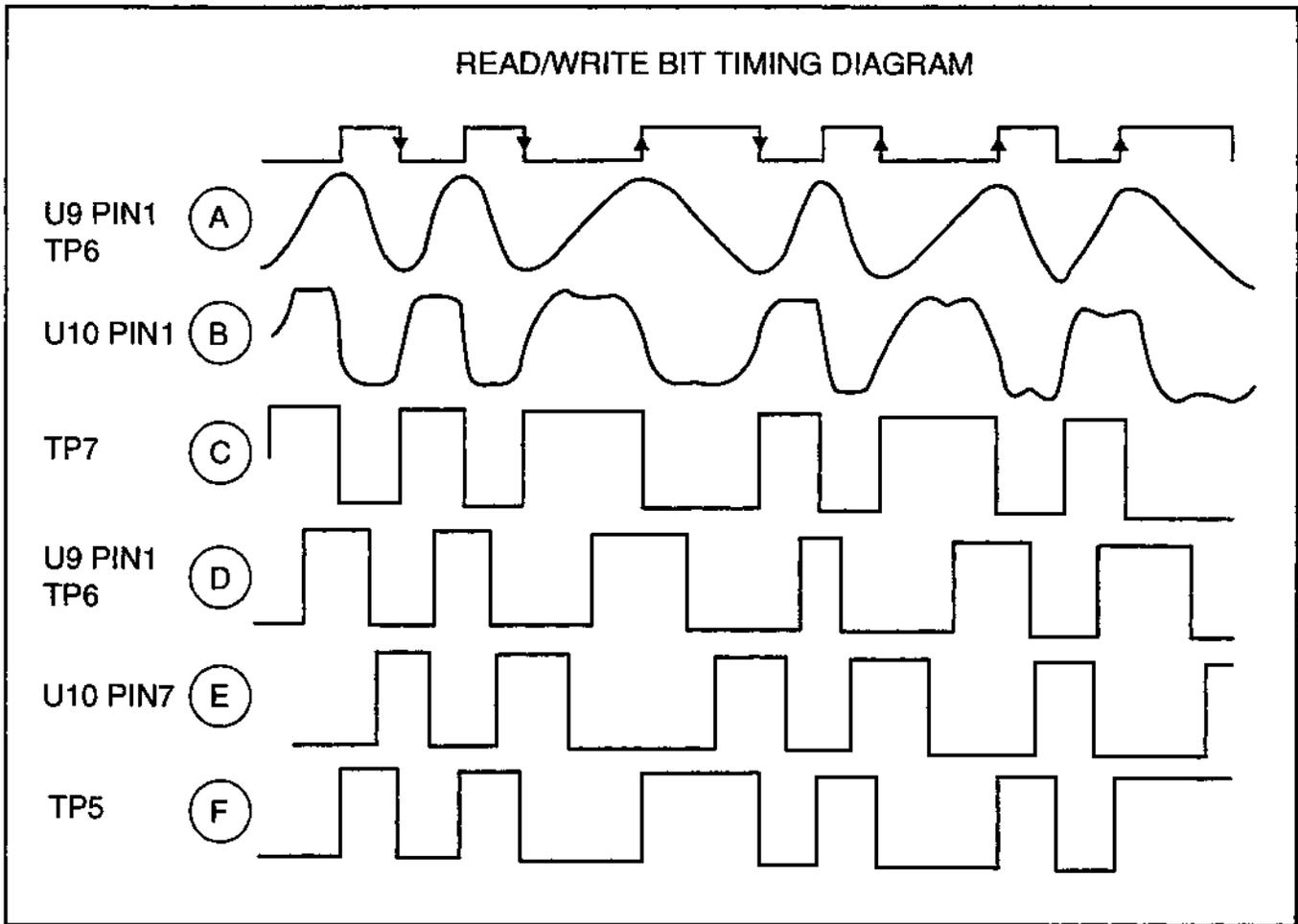

Figure 3-17. Read/Write Electronic Block Diagram with Accompanying Waveforms (cont)



static awareness



A Message From
Fluke Corporation

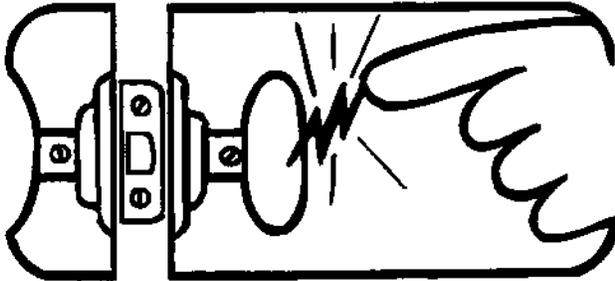

Some semiconductors and custom IC's can be damaged by electrostatic discharge during handling. This notice explains how you can minimize the chances of destroying such devices by:

1. Knowing that there is a problem.
2. Learning the guidelines for handling them.
3. Using the procedures, packaging, and bench techniques that are recommended.

The following practices should be followed to minimize damage to S.S. (static sensitive) devices.

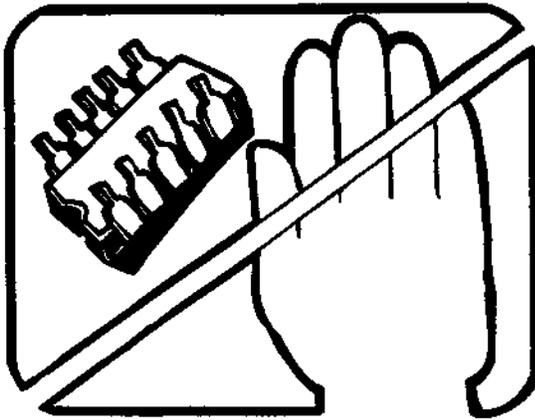

1. MINIMIZE HANDLING

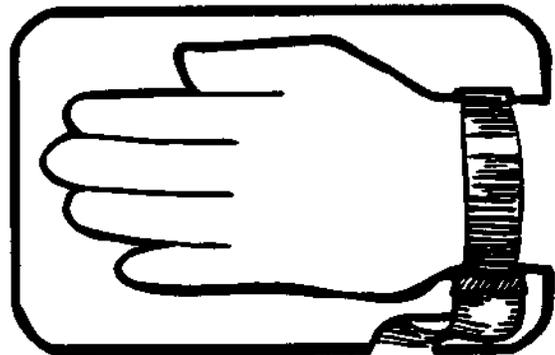

3. DISCHARGE PERSONAL STATIC BEFORE HANDLING DEVICES. USE A HIGH RESISTANCE GROUNDING WRIST STRAP.

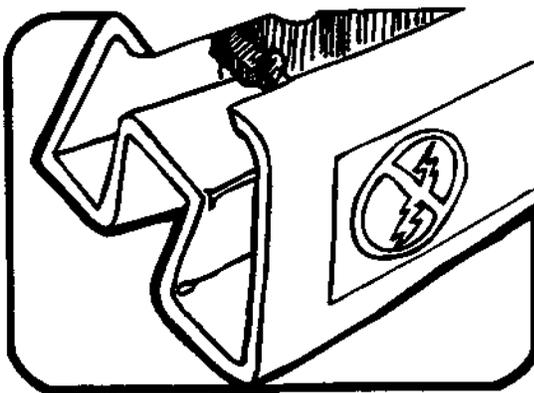

2. KEEP PARTS IN ORIGINAL CONTAINERS UNTIL READY FOR USE.

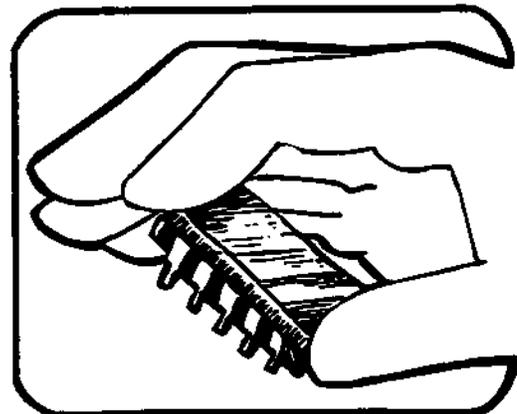

4. HANDLE S.S. DEVICES BY THE BODY.

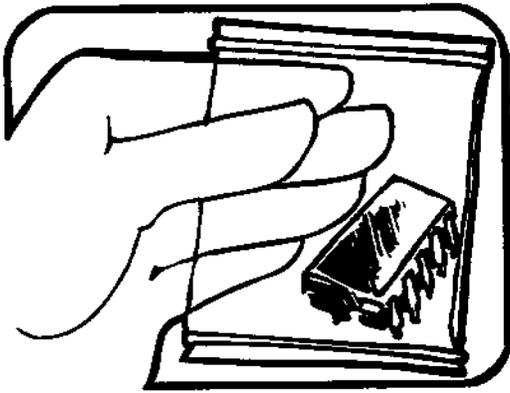

5. USE STATIC SHIELDING CONTAINERS FOR HANDLING AND TRANSPORT.

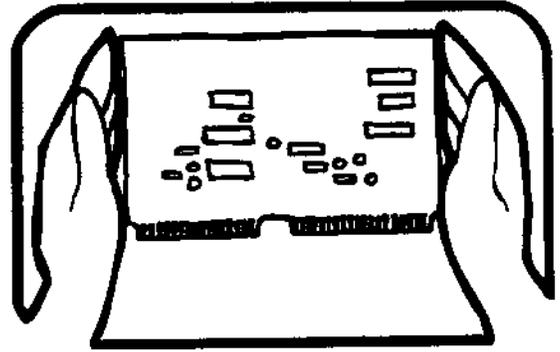

8. WHEN REMOVING PLUG-IN ASSEMBLIES HANDLE ONLY BY NON-CONDUCTIVE EDGES AND NEVER TOUCH OPEN EDGE CONNECTOR EXCEPT AT STATIC-FREE WORK STATION. PLACING SHORTING STRIPS ON EDGE CONNECTOR HELPS PROTECT INSTALLED S.S. DEVICES.

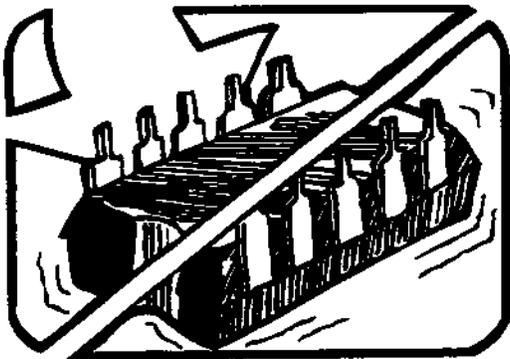

6. DO NOT SLIDE S.S. DEVICES OVER ANY SURFACE.

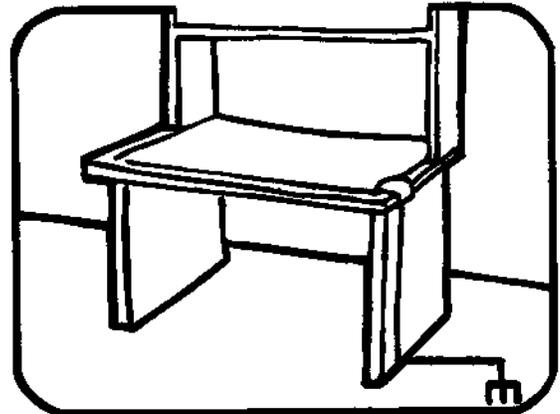

9. HANDLE S.S. DEVICES ONLY AT A STATIC-FREE WORK STATION.

10. ONLY ANTI-STATIC TYPE SOLDER-SUCKERS SHOULD BE USED.

11. ONLY GROUNDED-TIP SOLDERING IRONS SHOULD BE USED.

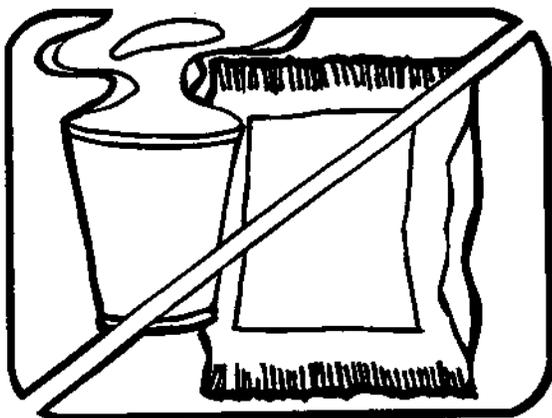

7. AVOID PLASTIC, VINYL AND STYROFOAM® IN WORK AREA.

PORTIONS REPRINTED
WITH PERMISSION FROM TEKTRONIX INC.
AND GENERAL DYNAMICS, POMONA DIV.

Section 4

Maintenance

WARNING

THESE SERVICING INSTRUCTIONS ARE FOR USE BY QUALIFIED PERSONNEL ONLY. TO AVOID ELECTRIC SHOCK, DO NOT PERFORM ANY SERVICING OTHER THAN THAT CONTAINED IN THE OPERATING INSTRUCTIONS UNLESS YOU ARE QUALIFIED TO DO SO.

4-1. INTRODUCTION

4-2. This section contains information on general maintenance, troubleshooting, selected component replacement, calibration procedures, and a performance test. The performance test can be used upon receipt of the calibrator as an acceptance test or at any other time, to verify the correct operation of the instrument.

4-3. SERVICE INFORMATION

4-4. Each instrument manufactured by the Fluke Corporation is warranted for a period of 1-year upon delivery to the original purchaser. The WARRANTY is located at the front of the manual.

4-5. Factory authorized calibration and service for each Fluke product is available at various worldwide locations. A complete list of domestic service centers is located at the rear of the manual. Shipping information is given in Section 2, if requested, the customer will be provided an estimate before any work begins on instruments that are beyond the Warranty period.

4-6. GENERAL MAINTENANCE

4-7. CLEANING

4-8. Periodically (at least every 180 days) clean the instrument using the following procedure:

1. Insure that power is removed from the instrument.
2. Remove the top and bottom covers from the instrument.

3. Disconnect the PCB assemblies from the motherboard and remove them from the instrument.

4. Clean the interior of the instrument using low pressure, clean, dry air, or a vacuum cleaner.

5. Clean the Front Panel and exterior surfaces with anhydrous ethyl alcohol or a soft cloth dampened with a mild solution of detergent and water.

6. Replace the PCB assemblies and covers if access to the instrument interior is no longer required.

4-9. Air Filter Maintenance and Cooling Considerations

4-10. Visually inspect the air filter at the rear of the fan compartment periodically for dirt and contaminants. If cleaning is required, use the following procedure:

1. Insure that power is removed from the instrument and the fan is not operating.
2. Apply inward pressure to the top and bottom of the filter bracket then pull to the rear until the filter and bracket are free from the instrument.
3. Clean the filter using either low pressure, clean, dry air, or a water and mild detergent solution.

NOTE

If water is used for cleaning, insure that the filter is dried thoroughly before reinstalling.

4. Reinstall the filter by inserting the bottom into the frame first then pushing in on the top of the filter.

4-10a. A hidden but important feature of the 5100 Series B is its internal cooling system. Baffles direct cooling air from the fans throughout the chassis to internally dissipate heat during operation. The accuracy and dependability of all internal parts of the 5100 Series B are enhanced by maintaining the coolest possible internal temperature. By observing the following rules, you can lengthen the life of the 5100 Series B and enhance its performance:

CAUTION

Damage caused by overheating may occur if the area around the air intake is restricted, the intake air is too warm, or the air filter becomes clogged.

- The area around the air filter must be at least 3 inches from nearby walls or rack enclosures.
- The exhaust perforations on the sides of the 5100 Series B must be clear of obstructions.
- The air entering the instrument must be room temperature. Make sure that exhaust from another instrument is not directed into the fan inlet.
- Clean the air filter every 30 days as described earlier in this section, or more frequently if the 5100 Series B is operated in a dusty environment.

4-11. Line Voltage Selection

4-12. The calibrator is set at the factory to operate at a line voltage of 115 volts $\pm 10\%$ with a frequency of 50 to 60 Hz. Three switches in the power supply (Figure 4-1) permit the selection of one-of-eight possible input line voltage ranges shown in Table 4-1. (The switch position settings are also screened on the calibrator inner cover.) The table gives each possible voltage and its high and low tolerance. Select the setting for use with the local line voltage that includes the expected fluctuations in the local line voltage.

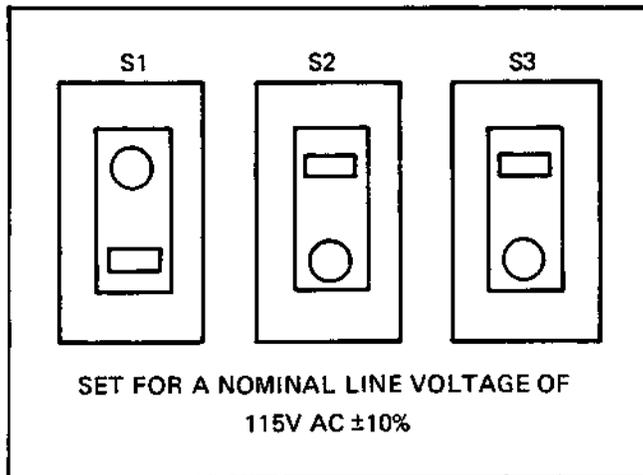

Figure 4-1. Input Line Voltage Switches

4-13. Fuse Replacement

4-14. Insure that the proper fuse is installed for the input line voltage selected from the values below:

110 to 120 volt range selected - MDX 2A

200 to 240 volt range selected - MDL 1A

4-15. Instrument Assembly/Disassembly

4-16. The 5100 Series B instruments can be easily disassembled by sections to gain access to any component within the instrument. In most cases, some previous step in the disassembly process will be required and the procedure will refer to that step. Removal of the top cover is the first step in disassembly for instruments with standard cases. Instructions for assembly/disassembly of instruments with the fiberglass case are in later subparagraphs of this procedure.

CAUTION

Use static awareness precautions during instrument disassembly or assembly. Do not allow the PCB card-edge connectors or the cable connector pins to come in contact with any ungrounded object, including personnel, since static charges in excess of the damage point (approximately 60 volts) can build up on these objects. The damage incurred may not be apparent immediately, it may appear up to three months after the incident occurs. The PCB digital input card-edge connector should be inserted into a connector with all pins shorted to make all points common any time the assembly is removed from the instrument. Refer to the yellow insert sheet on static awareness in an earlier section of this manual for further details.

4-17. Reassembly of the instrument should be performed in the reverse order, as required, unless noted otherwise.

Table 4-1. Input Line Voltage Switch Settings

LINE VOLTAGE			POSITION OF COLOR DOT		
-10%	NOMINAL	+10%	S1	S2	S3
90	100	110	Up	Up	Down
99	110	121	Up	Up	Up
103.5	115	126.5	Up	Down	Down
108	120	132	Up	Down	Up
180	200	220	Down	Up	Down
198	220	242	Down	Up	Up
207	230	253	Down	Down	Down
216	240	264	Down	Down	Up

4-18. FRONT PANEL PCB REMOVAL AND LED REPLACEMENT

4-19. Perform the disassembly of the Front Panel using the following procedure:

1. Remove any shorting links on the output terminals.
2. Remove the screws securing the bottom cover to the front panel.
3. Loosen or remove the screws on each side, directly to the rear of the front handles and, if applicable, the screws attaching the side bars to the inner frame (fiber-glass case only).
4. Slide the Front Panel and attached PCBs forward, insuring they clear the output terminals.

NOTE

Disassembly operations requiring only the forward movement of the Front Panel to free the output terminals cease at this point.

5. Disconnect the ribbon cables connecting the Front Panel to the power supply interconnect board when the connectors become accessible.
6. The front panel, Front Panel PCB, and shield are now free and may be lifted away from the instrument, allowing removal of the Front Panel to gain access to the LEDs on the Front Panel PCB.
7. Defective LEDs on the Output and Central Display may be replaced without removing the shield by lifting the small pcb assembly containing these indicators away from the Front Panel PCB. The shield must be removed from the rear of the PCB for access to the remainder of the LEDs.

4-20. TRANSFORMER AND PCB ASSEMBLY REMOVAL

4-21. Remove the transformer and its associated PCB assembly using the following procedure:

1. Remove the bottom cover.
2. Remove the screws (in a trapezoidal pattern) securing the transformer frame to the inner bottom.
3. Remove the screws (in a square pattern) securing the transformer frame to the side of the instrument.
4. Grasp the transformer firmly and lift the assembly straight up and out of the power supply compartment.

4-22. PCB ASSEMBLY REMOVAL

4-23. Remove the PCB assemblies using the following procedure:

1. If the Ranging PCB requires removal from the analog (main) compartment, slide the Front Panel forward to clear the output terminals using the procedure described above.

2. To remove any PCB in the analog compartment, or the Power Supply Regulator PCB, insert the card puller (provided with the instrument) into the hole provided at the top center of the PCB and lift straight up.

NOTE

The card puller is required since the space between the PCBs is insufficient to grasp the boards firmly.

3. Remove the PCBs from the digital (rear) compartment by grasping the boards firmly at each corner and pulling straight up.

NOTE

If the four section shield must be removed from the DAC PCB Assembly insure the cutaway portions for the photocoupler and pulse transformer are to the center on the component side and the two cutaway corners are to the center on the non-component side.

4-24. POWER SUPPLY COMPARTMENT SIDE PANEL REMOVAL

4-25. Remove the outside panel from the power supply compartment using the following procedure:

1. Remove the front Panel using the procedure described above.
2. Remove the screws connecting the side panel to the rear panel.
3. Remove the screws attaching the front bulkhead, the center brace the capacitor bracket, and the transformer assembly to the side panel.
4. Remove the screws attaching the bottom flange of the side panel to the inner bottom.
5. Slide the side panel forward, away from the rear panel, and lift it away from the instrument.

4-26. REAR PANEL REMOVAL

4-27. Remove the rear panel from the instrument using the following procedure:

1. Remove the plates around the DIGITAL CONNECTOR (J4) and the outboard screws around the ANALOG CONNECTOR (J2) cover.

2. Remove the screws attaching the bottom cover to the rear panel.
3. Remove the two screws on each side attaching the rear panel to the side panels, located directly in front of the corner braces with the decals. It is not necessary to remove the decals to remove the rear panel.
4. Disconnect the power cord connecting the fan to the power supply motherboard.
5. Move the rear panel straight back until the digital connector is free, then lift the rear panel away from the instrument.

4-28. MIS MOTHERBOARD REMOVAL

4-29. Remove the MIS Motherboard from the digital compartment of the instrument using the following procedure:

1. Remove the PCB assemblies from the digital compartment using the procedure described earlier.
2. Remove the rear panel from the instrument using the procedure described above.
3. Remove the two screws in the capacitor chamber (beneath the MIS Motherboard and only accessible with the rear panel removed) attaching the MIS Motherboard bracket to the frame.
4. Remove the left side screws and panel, then lift the MIS Motherboard, its bracket, and the connector PCB free from the instrument compartment.

4-30. MAIN MOTHERBOARD REMOVAL

4-31. Remove the main motherboard from the instrument using the following procedure:

1. Remove the PCB assemblies from the analog and digital compartments using the procedure described earlier.
2. Remove the MIS Motherboard from the instrument using the procedure described above.
3. Remove the twelve screws within the square pattern attaching the main motherboard to the instrument.

NOTE

Do not remove the screws in the round patterns from the main motherboard. These attach the bottom shield to the motherboard.

4. Remove the left side panel and lift the motherboard away from the instrument.

4-32. POWER SUPPLY REMOVAL

4-33. Remove the power supply from the instrument using the following procedure:

1. Remove the Power Supply Regulator PCB Assembly as described above.
2. Remove the rear panel from the instrument using the procedure described above.
3. Remove the Transformer and PCB Assembly using the procedure described above.
4. Remove the Power Supply Interconnect PCB from the front of the power supply motherboard by removing the two screws on the top and lifting the PCB straight up.
5. Remove the capacitor bracket (rear) and stud (front) from the power supply chamber of the instrument.
6. Disconnect J14 and J15 that connect the main motherboard to the power supply motherboard.
7. Remove the screws fastening the power supply motherboard to the frame.
8. Slide the power supply mother board out the rear of the instrument.
9. The capacitors in the capacitor chamber are an electrical part of the power supply and are accessible for inspection or maintenance with the rear panel removed.

4-34. ENVIRONMENTAL RESISTIVE CASE ASSEMBLY/DISASSEMBLY (FIBERGLASS CASE ONLY)

NOTE

All sections of the fiberglass case and covers are part of a serial numbered matched set that must be kept intact for maximum protection.

4-35. Remove the fiberglass case using the following procedure:

1. Insure the front cover is attached to the instrument then stand the instrument upright on its front cover.

2. Remove the line cord and the hex (Allenhead) screws along the side of the back panel.
3. Set the instrument upright on its rear panel.
4. Remove the front cover, the hex screws and associated plates, and the vent screen.
5. Lift off the front half of the fiberglass case.
6. Place the instrument flat; i.e., the normal operating position.
7. Support the inner chassis and slide the rear half of the fiberglass case off the instrument.

4-36. Replace the fiberglass case using the following procedure:

1. Set the instrument upright, on its rear panel.
2. Slide the front half of the case over the chassis, insuring the feet are on the correct side.
3. Install the vent screen (left side) and the plates using the hex screws previously removed. Install the washers on the screws holding the screen.
4. Install the front cover on the instrument and set the instrument upright on the front cover.
5. Slide the rear half of the case over the chassis, insuring the feet are on the correct side.
6. Install the case with hex screws, using the washers on the screws through the vent screen.

4-37. TAPE SYSTEM REMOVAL (STORAGE ONLY)

4-38. Remove the tape system from the calibrator using the following procedure:

1. Slide the Front Panel forward to gain access to the tape system using the procedure described previously.
2. Lift the tape access door on the Front Panel and remove the four screws securing the tape system to the Front Panel.
3. Disconnect the ribbon cable from the Tape Drive PCB and lift the tape system clear of the instrument.

NOTE

The Front Panel must be at its extreme forward limit for the tape system to clear the rear of the EDIT switch.

4. The tape drive may be separated from the Tape Drive PCB, if desired, by disconnecting the cable connecting the drive to the PCB and removing the four screws securing the drive to the PCB.

4-39. PERFORMANCE TEST

4-40. The following paragraphs contain a performance verification test which compares the outputs of the instrument to the specifications in Section 1 of this manual. The test may be used to verify calibration of the instrument between scheduled calibration periods, as an acceptance test, or as an aid in troubleshooting.

4-41. The test equipment required for the performance test is listed in Table 4-2. If the recommended equipment is not available, replacements with equivalent specifications may be substituted. The test must be performed when the ambient temperature is between 22 and 24 degrees Celsius, with the relative humidity less than 85%, to attain maximum accuracy.

4-42. If the instrument does not meet the error limits listed in the performance test either the calibration procedure or corrective maintenance should be performed, as determined by the symptoms.

4-43. Calibration Test Equipment Accuracy Considerations

4-44. Accurate calibration of the 5100 Series B Calibrators requires precision calibration standards and test equipment often accessible only in a standards lab. Calibration is normally performed using test equipment with accuracies four to ten times better than the instrument being calibrated. This criteria allows the errors of the test equipment to be ignored even though the possibility exists that the inherent errors of the test equipment could make the instrument read out of tolerance when good, or in tolerance when bad. An example of this problem using a four to one ratio and the uncertain area is shown in Figure 4-2.

4-45. The performance test for the 5100 Series B Calibrators contains tables used to verify the accuracy of the DC voltage and current, and the AC voltage. These tables have columns for the programmed output, both calibrator and test equipment, and the specified maximum allowable \pm error of the calibrator for the programmed output, in percent. In addition, highlighted columns have been added which list the maximum specified error in percent of the test equipment called out in the procedure; the summed errors of the calibrator and test equipment, and the difference when the possible test equipment error is subtracted from the possible calibrator error.

4-46. These last three columns, which are highlighted, are given as a convenience to the individual to use or not

use, as he determines, depending on the circumstances involved, and the desired degree of accuracy. In all cases, if any test equipment is replaced with a different model, the three columns must be recomputed.

4-47. Equipment Preparation

4-48. Perform the following procedure prior to beginning any operation. The equipment should have a

warmup period of at least 30 minutes prior to performing any test.

1. Verify that the instrument is set for the correct input line voltage range, using the procedure outlined earlier in this section.
2. Connect the calibrator to the input line power.

Table 4-2. Test Equipment

ITEM	SPECIFICATIONS (minimum)	NOMENCLATURE
DC Voltage Standard	0.001% Accuracy	Fluke 5700A
Current Calibrator	25 ppm/hr Stability	Fluke 5700A
Voltage Divider	0.1 ppm Resolution, 1 ppm Terminal Linearity	Fluke 720A
Ratio Transformer	0.5 ppm Terminal Linearity at 400 Hz	ESI DT72A
Null Detector	1 μ V Range	Fluke 845AB
Thermal Transfer Standard	0.02% @ 1000V Range, 0.01% @ other ranges	Fluke 5790A
DC Differential Voltmeter	NMRR > 100 dB @ 400 Hz	Fluke 885A
RMS Differential Voltmeter	1 μ V Resolution	Fluke 931B
Digital Multimeter	5½ Digit 100 μ Ω /1 μ V Resolution	Fluke 8500A/8505A/8506A
Digital Multimeter	Current Reading 1%	Fluke 8500A/8502A/8505A/ with -01 and -03 options
Frequency Counter	50 Hz to 50 kHz >0.5 Accuracy (10 Hz to 10 MHz with -03 Option)	Fluke 1900A
Oscilloscope	>60 MHz Dual Trace at .5 mV/cm Sensitivity Amplifier	Tektronix w/Dual Trace Plug-In w/5A22N
Distortion Analyzer	50 Hz to 50 kHz >0.01% Accuracy	HP 339A
Resistive Loads	100 Ω \pm 1%, ½W	Metal Film Type Carbon Composition Type Carbon Composition Type Carbon Composition Type Carbon Composition Type Wire Wound Type Carbon Composition Type
	33 Ω \pm 5%, 2W	
	2 k Ω \pm 5%, 2W	
	20 k Ω \pm 5%, 2W	
	33 k Ω \pm 5%, 2W	
Standard Resistor w/ Accessories	1 Ω \pm 1%, 5W 2 ea. 1 Ω \pm 5%, 2W in parallel = 0.5 Ω 4W	Fluke 742A-1
	1 Ω at 50 ppm minimum	Fluke 5450A
	10 Ω and 1 M Ω at 25 ppm minimum 100 Ω , 1 k Ω , 10 k Ω , 100 k Ω at 10 ppm minimum 10 M Ω at 100 ppm minimum	
Lowpass Filter	Construct of 1 k Ω resistor and 0.05 μ F capacitor in series	Metal Film Type Non-polarized
Extender PCB		Fluke 5100A-7005K

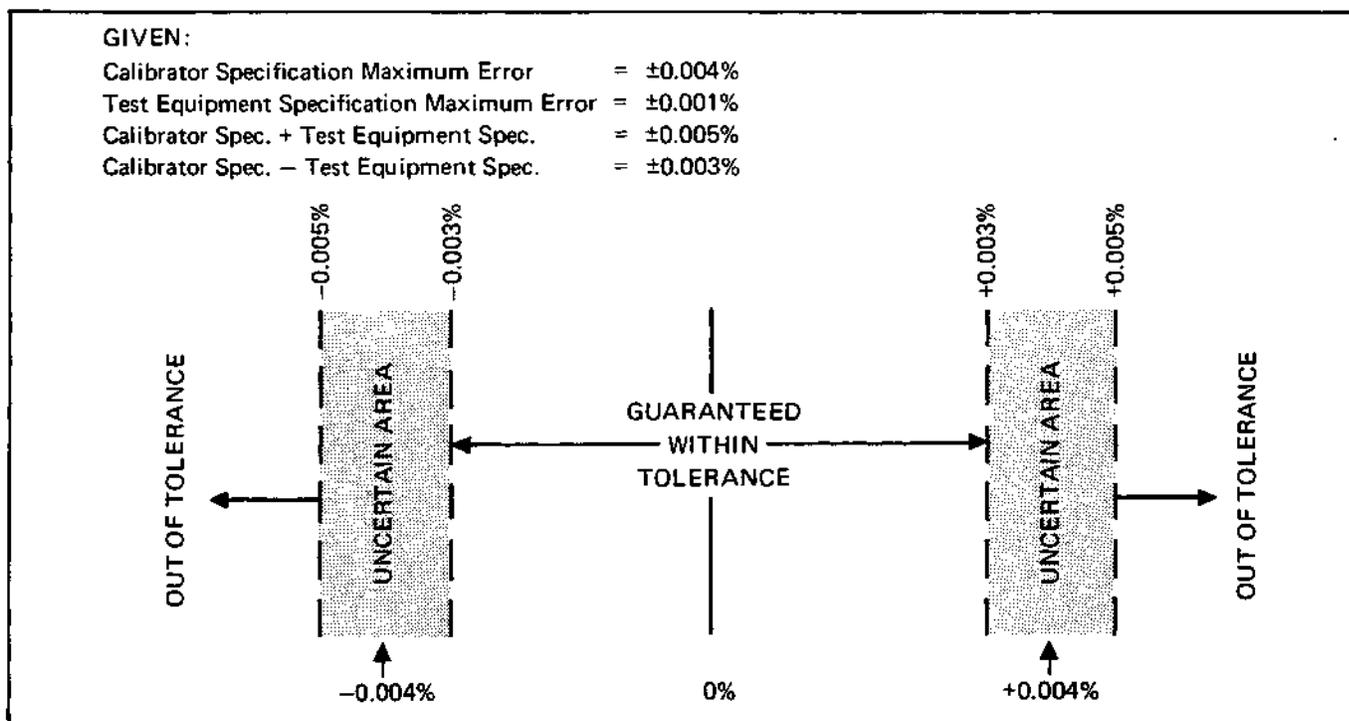

Figure 4-2. Accuracy Uncertainties

- Depress the POWER switch to apply power to the instrument.
- The Output Display reads $+0.0000$ mV and the STDBY, LOCAL, INT, and 50Ω DIVIDER indicators illuminate.
- Make all interequipment connections, during the test, using low thermal EMF copper leads or coaxial cable, as applicable.

4-49. DC Offset Voltage

4-50. Perform the DC offset voltage test using the following procedure:

- Depress the CLEAR keyswitch twice in succession.
- The Front Panel indications blink, then read $+0.0000$ mV with only the STDBY, LOCAL, INT, and 50Ω DIVIDER indicators illuminated.
- Prepare the test null detector to read a null ± 5 μ V, then connect the equipment as shown in Figure 4-3.
- Select OPR on the calibrator.
- Verify the null detector reads 0 ± 5 μ V.

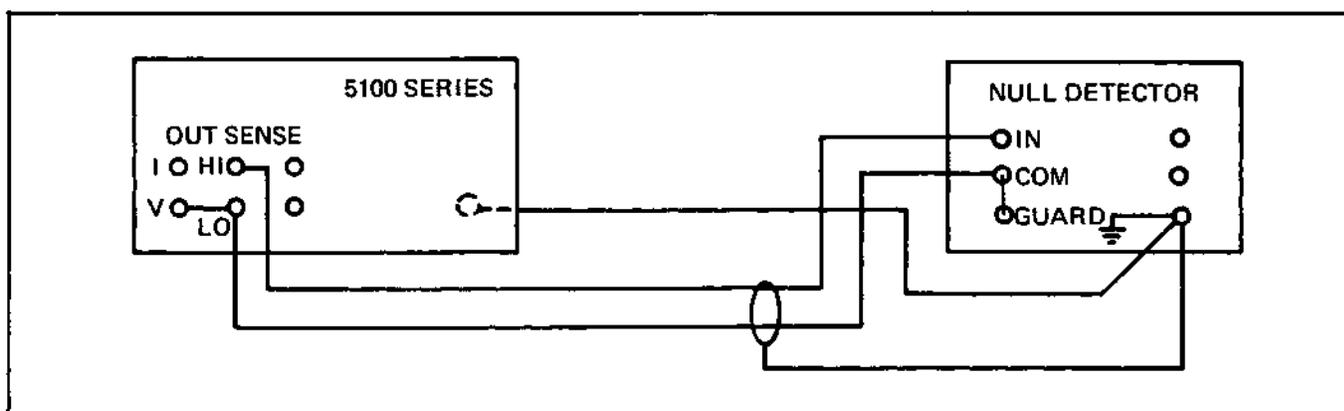

Figure 4-3. Offset Voltage Checks

6. Depress the 50 Ω DIVIDER OVERRIDE keyswitch.
7. The OVERRIDE indicator illuminates.
8. Verify the null detector reads $0 \pm 205 \mu\text{V}$.
9. Select STDBY on the calibrator.

4-51. DC Voltage Tests

4-52. Perform the DC voltage tests using the following procedure:

1. Select STDBY on the calibrator.
2. Connect the equipment as shown in Figure 4-4. Do not use the null detector built into the DC Voltage Standard.
3. Select the setting in step 1 of Table 4-3, for each of the instruments listed.
4. Select OPR on the test equipment and calibrator.
5. Enable the calibrator Error Mode and modify the calibrator output until a null is obtained on the null meter.
6. Verify the displayed error is no greater than the allowable error for the programmed calibrator output of the applicable step.
7. Select STDBY on the calibrator and test equipment.
8. Repeat steps 3 through 7 for steps 2 through 4 of Table 4-3.
9. Connect the equipment as shown in Figure 4-12. If the DC Voltage Standard cannot be connected in the differential mode proceed to step 16.
10. Select the setting, in step 5 of Table 4-3, for each of the instruments listed.
11. Select OPR on the test equipment and calibrator.
12. Select the calibrator Error Mode and modify the calibrator output until a null is obtained on the null meter.
13. Verify the displayed error is no greater than the allowable error for the programmed calibrator output of the applicable step.

14. Select STDBY on the calibrator and test equipment.

15. Repeat steps 10 through 14 for the remaining steps of Table 4-3.

16. Connect the test DC voltmeter (5 $\frac{1}{2}$ digit DMM or DC Differential voltmeter) to the DC Voltage Standard.

17. Set the DC Voltage Standard to the value called out in step 5 of Table 4-3.

18. Record the voltmeter reading.

19. Repeat steps 17 and 18 for the remaining values in Table 4-3.

20. Select STDBY on the calibrator.

21. Connect the DC voltmeter to the calibrator output terminals.

22. Program the calibrator for an output voltage equal to the value recorded in step 18 then select OPR on the calibrator.

23. Select the calibrator Error Mode and modify the calibrator until the DC voltmeter reads the voltage recorded in step 18.

24. Verify the displayed error is no greater than the allowable error for the programmed calibrator output of the applicable step.

25. Repeat steps 22 through 24 for the remaining steps on Table 4-3.

26. Select STDBY on the calibrator and the test equipment.

4-53. DC Ripple and Noise Tests

4-54. Perform the DC ripple and noise tests using the following procedure:

1. Insure STDBY is selected on the calibrator.
2. Construct a 10 Hz to 3 kHz bandpass filter from a 1 k Ω metal film resistor in series with a 0.05 μF capacitor. Connect the resistor to the calibrator HI output terminal and the capacitor to the LO terminal.
3. Connect the oscilloscope HI input to the common point on the filter's resistor and capacitor, and the LO input to the calibrator LO terminal.

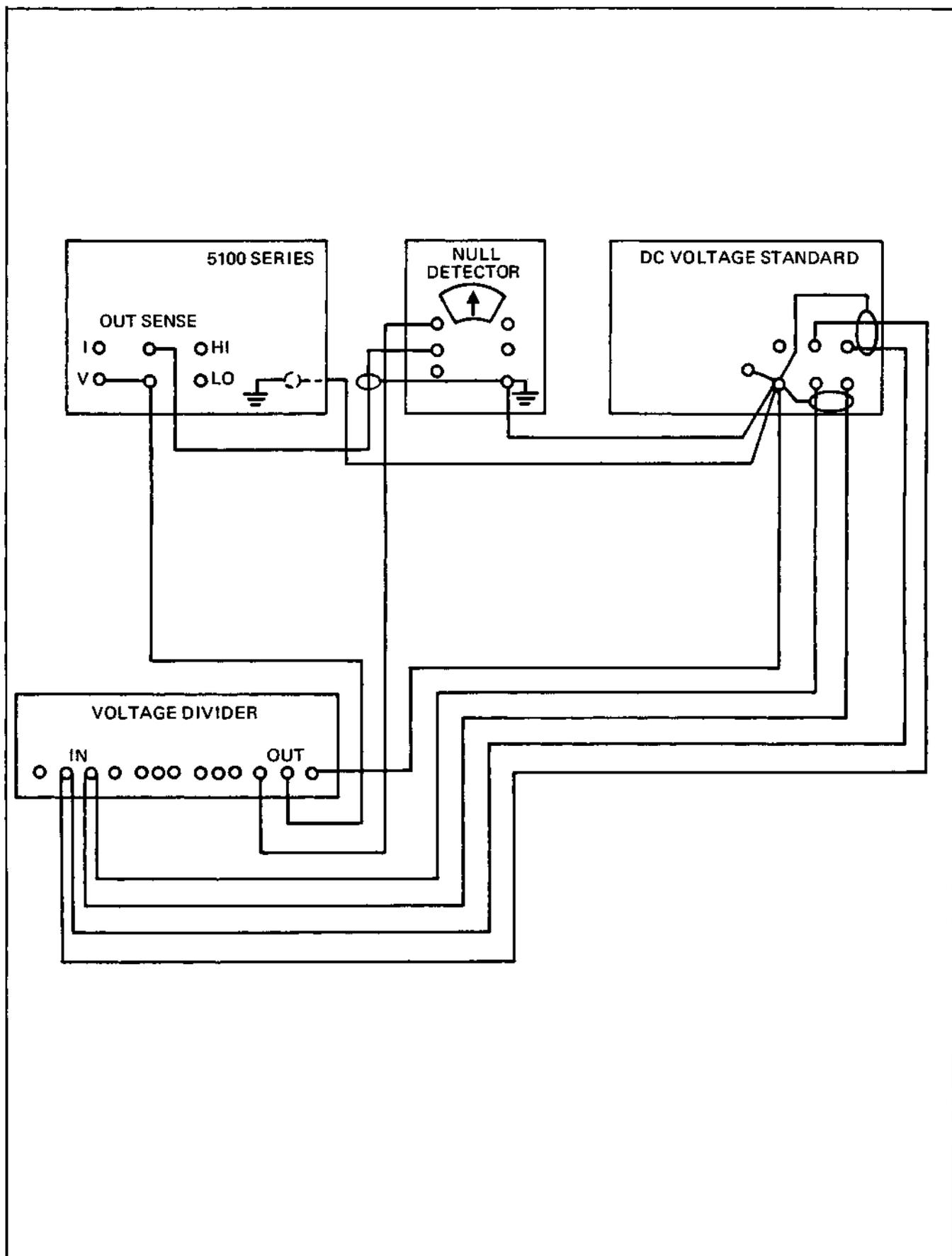

Figure 4-4. DC Low Voltage Tests

Table 4-3. DC Voltage Tests

STEP	5100 PROGRAMMED OUTPUT	DC VOLTAGE STANDARD OUTPUT	VOLTAGE DIVIDER RATIO	NULL DETECTOR STARTING RANGE	MAXIMUM 5100 % ERROR	TEST EQUIPMENT % ERROR †	TOTAL % OF ERROR (Sum) †	TOTAL % OF ERROR (Difference)†
1	+19.9900 mV	+1.000000	0.0199900	10 μ V	± 0.0300	± 0.0025	± 0.0325	± 0.0275
2*	-19.9900 mV	-1.000000	0.0199900	10 μ V	± 0.0300	± 0.0025	± 0.0325	± 0.0275
3	+199.900 mV	+1.000000	0.1999000	30 μ V	± 0.0075	± 0.0021	± 0.0096	± 0.0054
4	+1.99900V	+10.00000	0.1999000	300 μ V	± 0.0053	± 0.0012	± 0.0065	± 0.0041
5	+19.9900V	+19.99000		3 mV	± 0.0050	± 0.0011	± 0.0061	± 0.0039
6*	-19.9900V	-19.99000		3 mV	± 0.0050	± 0.0011	± 0.0061	± 0.0039
7	+199.900V	+199.90000		30 mV	± 0.0050	± 0.0016	± 0.0066	± 0.0034
8*	-199.900V	-199.90000		30 mV	± 0.0050	± 0.0016	± 0.0066	± 0.0034
9	+1000V	1000.000		300 mV	± 0.0051	± 0.0015	± 0.0066	± 0.0036
10*	-1000V	1000.000		300 mV	± 0.0051	± 0.0015	± 0.0066	± 0.0036

*Negative outputs from the DC Voltage Standard may be obtained by reversing the leads at the output + and - terminals.
 †Read paragraphs 4-41 through 4-44, before using these columns.

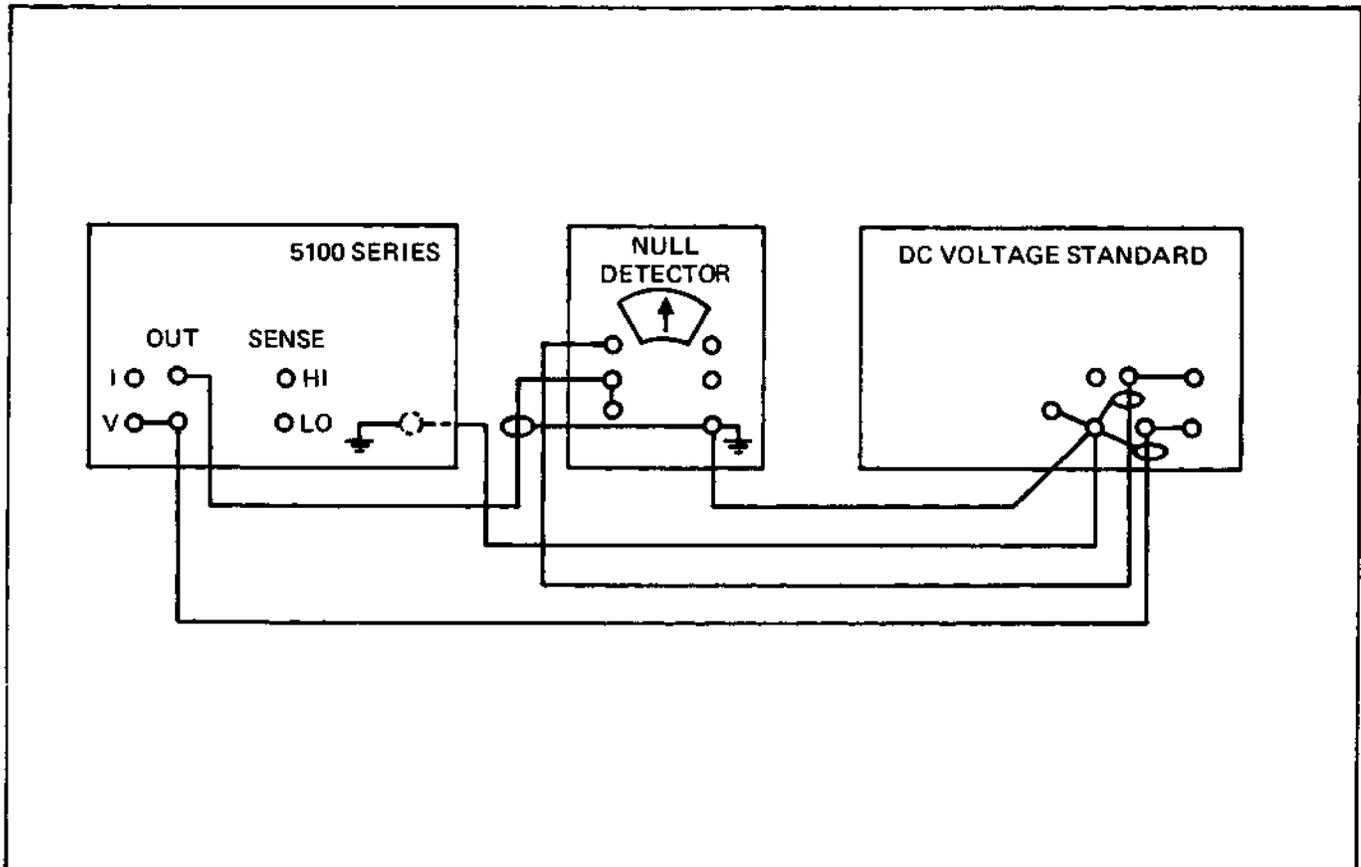

Figure 4-5. DC Voltage Tests

NOTE

If available, an oscilloscope plug-in filtering module with a 10 Hz to 3 Hz bandpass capability (e.g., Tektronix 5A22N) may be used.

4. Program, in turn, the DC voltage outputs in Table 4-4, applying the load, when applicable, and verify the oscilloscope display is within the listed tolerance.

NOTE

The peak-to-peak column is an approximation of the rms voltage and is not an exact equivalent.

5. When all steps in the table have been completed, select STDBY on the calibrator and remove the filter.

4-55. DC Current Tests

4-56. Perform the DC current test using the following procedure:

1. Select STDBY on the calibrator.
2. Connect the equipment as shown in Figure 4-6 using the 1.00000 kilohm shunt.

NOTE

If the actual value of the shunt is known, e.g., 1.00010 kilohms, accuracy can be improved by entering the value as a fractional-scale into the calibrator prior to programming a current output. Make the following entry: "1.00010 ENTER".

3. Select the setting in step 1 of Table 4-5 for each of the instruments listed. Insure the correct null meter polarity is selected for the programmed calibrator output.

NOTE

The DC voltage Standard, as shown in Figure 4-6, is used as a differential voltmeter in this test to obtain the added accuracy. A standard DC differential voltmeter may be substituted; however, the test equipment % of error figures in Table 4-5 must be adjusted accordingly.

Table 4-4. DC Ripple and Noise Tests

PROGRAMMED OUTPUT	APPLIED LOAD	APPROXIMATE PEAK-TO-PEAK	ALLOWABLE RIPPLE (Vrms)*
19.9999	None	12 mV	4 mV
20.000	None	30 mV	10 mV
20.000	2 kΩ	60 mV	20 mV
199.999	20 kΩ	0.6 mV	.2V
200.000	33 kΩ	0.3 mV	.1V

* Applicable when using a true-rms voltmeter

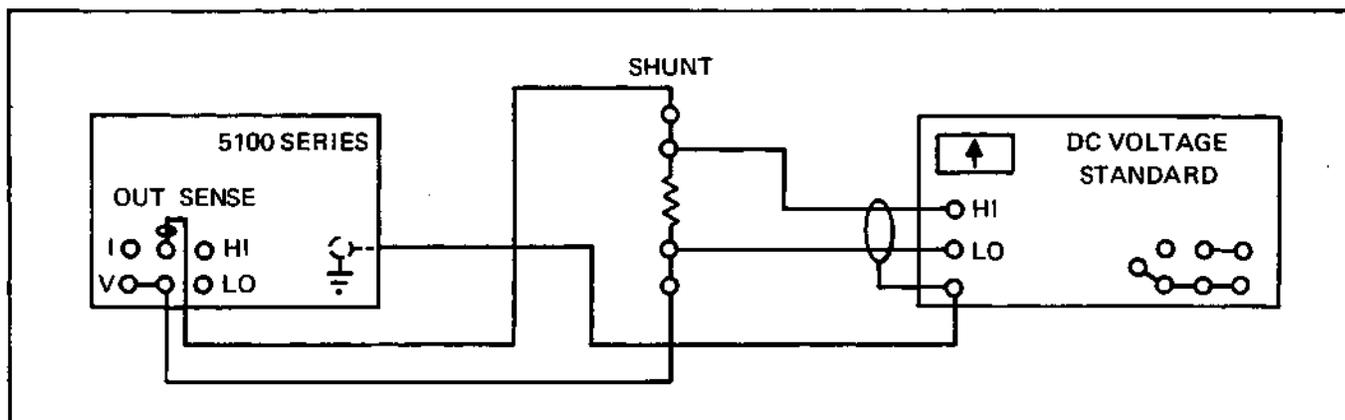

Figure 4-6. DC Current Tests

Table 4-5. DC Current Test

STEP	5100 PROGRAMMED OUTPUT	DC VOLTAGE STANDARD SETTING	MAXIMUM 5100 % ERROR	TEST EQUIPMENT % ERROR	TOTAL % OF ERROR (SUM)	TOTAL % OF ERROR (DIFFERENCE)
1	+1.90000 mA	+1.900000V	± 0.018	±0.0065	± 0.025	± 0.012
2*	-1.90000 mA	+1.900000V	± 0.018	±0.0065	± 0.025	± 0.012
3	+2.10000 mA	+2.100000V	± 0.035	±0.0065	± 0.042	± 0.029
4*	-2.10000 mA	+2.100000V	± 0.035	±0.0065	± 0.042	± 0.029
5	+1.00000A	+1.000000V	± 0.019	±0.0070	± 0.026	± 0.012
6*	-1.00000A	+1.000000V	± 0.019	±0.0070	± 0.026	± 0.012

*Select a negative reading on the null detector.

4. Select OPR on the calibrator.
5. Select the calibrator Error Mode and modify the calibrator output until a null is obtained on the null meter.
6. Verify the displayed error is no greater than the allowable error for the programmed calibrator output of the applicable step.
7. Select STDBY on the calibrator.
8. Repeat steps 3 through 7 for steps 2 through 4 of Table 4-5.
9. Verify all instruments are in Standby.
10. Replace the 1.00000 kilohm shunt with the 1.00000 ohm shunt, using the parallel compensation network.
11. Select the setting in step 5 of Table 4-5 for each of the instruments listed.
12. Select OPR on all instruments.

NOTE

Heat build up in the 1 ohm shunt can effect accuracy. If the test requires more than one minute, return to STDBY after that time, wait five minutes for cooling, then resume the test.

13. Select the calibrator Error Mode and modify the calibrator output until a null is obtained on the null meter.
14. Verify the displayed error is no greater than the allowable error for the programmed calibrator output of the applicable step.
15. Select STDBY on the calibrator.

16. Repeat steps 11 through 15 for step 6 of Table 4-5.

4-57. AC Voltage Tests

4-58. Perform the AC voltage tests using the following procedure:

1. Select STDBY on the calibrator.
2. Connect the equipment as shown in Figure 4-7.
3. Select the setting in step 1 of Table 4-6 for each of the instruments listed.
4. Select EXT Sensing on the calibrator.
5. Select OPR of the calibrator.
6. Perform the thermal transfer. Use the Error Mode to modify the calibrator output to obtain the null on the thermal transfer standard.
7. Verify the displayed error is no greater than the allowable error for the programmed calibrator output of the applicable step.
8. Select STDBY on the calibrator.
9. Repeat steps 3 through 8 for the remaining steps of Table 4-6.
10. Program an output of 10V dc from the DC voltage calibrator and of 10V ac at 400 Hz from the 5100 Series B Calibrator.
11. Perform the thermal transfer test. Use the Error Mode to modify the 5100 Series B Calibrator output to obtain the null on the thermal transfer standard.

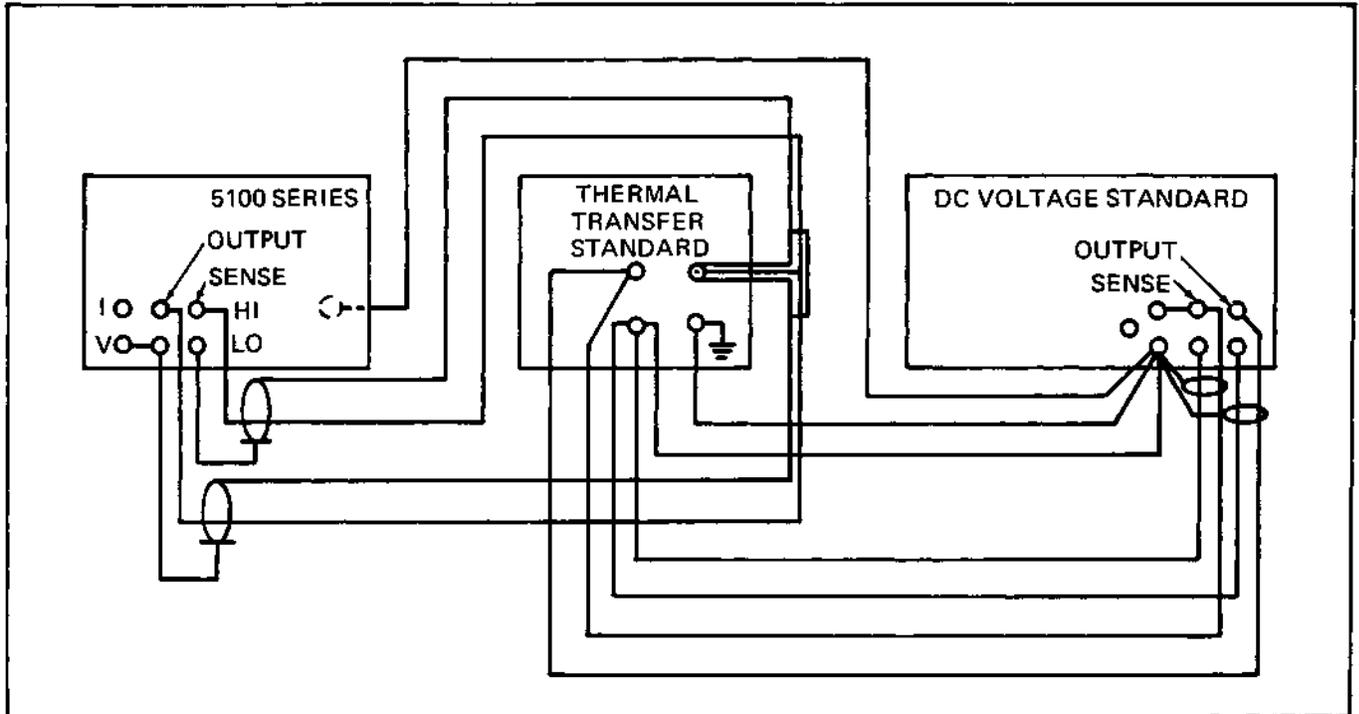

Figure 4-7. AC Voltage Tests

Table 4-6. AC Voltage Tests

STEP	PROGRAMMED 5100		DC VOLTAGE STANDARD OUTPUT	MAXIMUM 5100 % ERROR	TEST EQUIPMENT % ERROR	TOTAL % OF ERROR (Sum)	TOTAL % OF ERROR (Difference)
	VOLTAGE RMS	FREQUENCY					
1	19.9900V	400 Hz	19.99000	±0.040	±0.011	±0.051	±0.029
2	19.9900V	10 kHz	19.99000	±0.040	±0.011	±0.051	±0.029
3	19.9900V	50 kHz	19.99000	±0.068	±0.011	±0.079	±0.057
4	2.1000V	400 Hz	2.10000V	±0.085	±0.012	±0.097	±0.073
5	2.1000V	10 kHz	2.10000V	±0.085	±0.012	±0.097	±0.073
6	2.1000V	50 kHz	2.10000V	±0.139	±0.012	±0.151	±0.127
7	199.900V	1 kHz	199.9000V	±0.040	±0.012	±0.052	±0.028
8	105.000V	20 kHz	105.0000V	±0.075	±0.012	±0.087	±0.083
9	1000.00V	400 Hz	1000.000V	±0.041	±0.022	±0.063	±0.019
10	1000.00V	50 Hz	1000.000V	±0.041	±0.022	±0.063	±0.019
11	1000.00V	1 kHz	1000.000V	±0.041	±0.022	±0.063	±0.019

12. Select STDBY on the calibrators. Do not change the output settings of the 5100 Series B Calibrator.

13. Connect the equipment as shown with the solid lines in Figure 4-8.

14. Select OPR on the calibrator.

15. Set the AC ratio transformer to 0.1000000, adjust the rms differential voltmeter for a null, and record the dial setting of the rms differential voltmeter.

16. Repeat step 15 with a ratio transformer setting of 0.0100000 and record the rms differential voltmeter setting required to obtain a null.

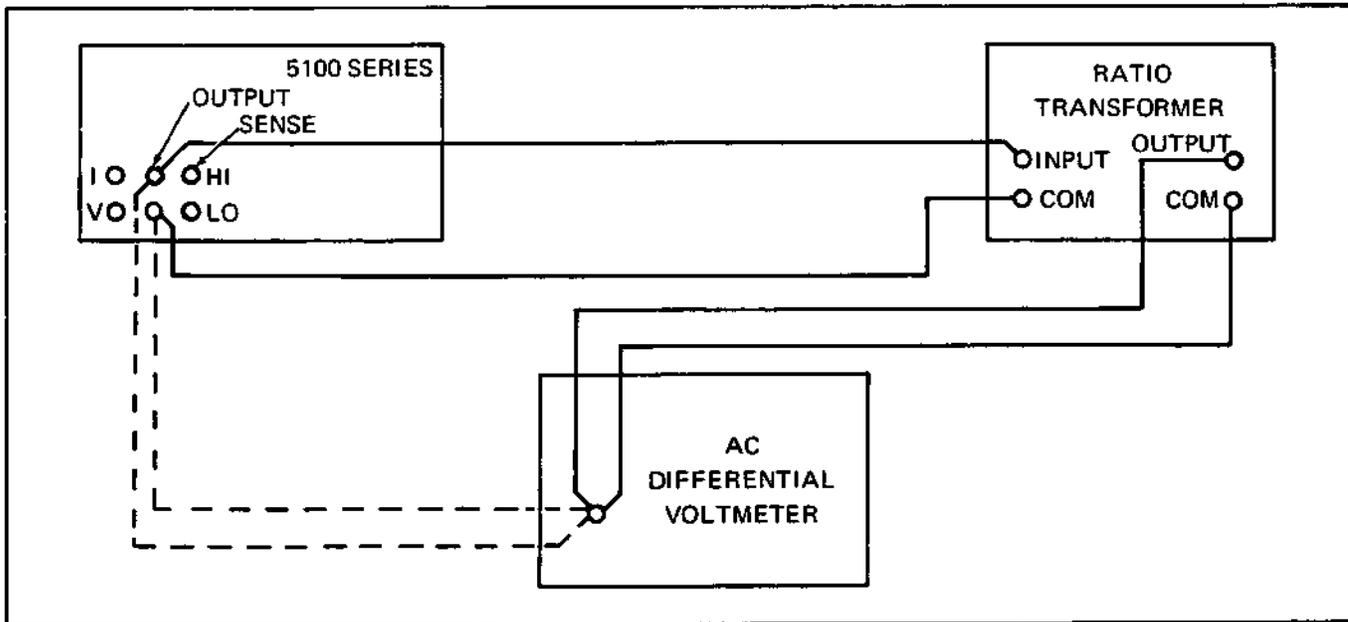

Figure 4-8. AC Low Voltage Tests

17. Repeat step 15 with a ratio transformer setting of 0.0010000 and record the rms differential voltmeter setting required to obtain a null.

18. Select STDBY on the calibrator.

19. Connect the equipment as shown with the broken line in Figure 4-8.

20. Select OPR on the calibrator.

21. Program a calibrator output of 1V ac at 400 Hz.

22. Set the rms differential voltmeter to the setting recorded in step 15 and verify the error is less than $\pm 0.065\%$.

23. Program a calibrator output of 100 mV ac at 400 Hz.

24. Set the rms differential voltmeter to the setting recorded in step 16 and verify the error is less than $\pm 0.11\%$.

25. Program a calibrator output of 10 mV ac at 400 Hz.

26. Set the rms differential voltmeter to the setting recorded in step 17 and verify the error is less than $\pm 0.56\%$.

27. Select STDBY on the calibrator.

4-59. AC Distortion and Noise Tests

4-60. Perform the AC distortion tests using the following procedure:

1. Select STDBY on the calibrator.
2. Connect the distortion analyzer to the calibrator output terminals.

NOTE

Broadband total distortion analyzers, such as the HP330 Series, may give readings above the specification limit unless used with a 200 kHz low pass filter between the calibrator output and the distortion analyzer.

3. Program an output with each voltage/frequency combination in Table 4-7 and verify the reading on the distortion analyzer does not exceed the listed tolerance.

4. When all steps in the table have been completed, select STDBY on the calibrator.

4-61. Frequency Accuracy Tests

4-62. Perform the frequency accuracy test using the following procedure:

1. Connect the calibrator output terminals to the frequency counter input.

Table 4-7. AC Distortion and Noise Tests

PROGRAMMED VOLTAGE	OUTPUT FREQUENCY	TOTAL DISTORTION AND NOISE (rms)	TOTAL DISTORTION AND NOISE %
0.3	50 Hz	0.16 mV	0.053%
0.3	1 kHz	0.16 mV	0.053%
0.3	50 kHz	0.26 mV	0.087%
10	50 kHz	8 mV	0.08%
200	1 kHz	160 mV	0.08%
200	50 Hz	160 mV	0.08%
1000	50 Hz	800 mV	0.08%

2. Program an output at each frequency in Table 4-8 at 1V rms and verify the counter reads within the frequency range listed for the programmed frequency.

Table 4-8. Frequency Accuracy Tests

CALIBRATOR FREQUENCY OUTPUT	COUNTER READING	
	MINIMUM	MAXIMUM
50 Hz	48.5 Hz	51.5 Hz
400 Hz	388 Hz	412 Hz
2 kHz	1.94 kHz	2.06 kHz
3 kHz	2.91 kHz	3.09 kHz
4 kHz	3.88 kHz	4.12 kHz
5 kHz	4.85 kHz	5.15 kHz
6 kHz	5.82 kHz	6.18 kHz
7 kHz	6.79 kHz	7.21 kHz
8 kHz	7.76 kHz	8.24 kHz
9 kHz	8.73 kHz	9.27 kHz
10 kHz	9.7 kHz	10.3 kHz
50 kHz	48.5 kHz	51.5 kHz

4-63. Resistance Tests

4-64. The adjustment of the ohms function of the 5100 Series B Calibrators requires four separate test procedures. The first two test procedures are part of the Two-Terminal Resistance Accuracy Verification. The first test procedure is the Repeatability test. This test procedure verifies that each reading is consistent when changing the range using the ohms function. The test procedure compares the reading on the calibrator to that of a DMM. The second test procedure is the Accuracy test. This test procedure adjusts and verifies the accuracy

of each setting. It also compares the reading of the calibrator to a DMM. These two test procedures should be completed before the next two test procedures to ensure accurate results. The third test procedure is the Current Source Transfer test. This test procedure is required for the 1 Ω range and may be used for the 10 and 100 Ω outputs. The test procedure uses the current reading stability of a constant current source and a digital voltmeter to perform the transfer test. The fourth test procedure is the Resistance Transfer test. This test procedure performs a transfer for the higher ohms values from a certified standard resistor using a 5 $\frac{1}{2}$ -digit DMM with a 1 M Ω resolution and checks outputs of 1 k Ω or higher. The 10 and 100 Ω outputs can also be checked if not already done so by the Current Source Transfer test.

NOTE

Do not use a Kelvin bridge in lieu of the DMM for the following test. Erroneous readings will result for values ≤ 1 k Ω .

4-64a. TWO TERMINAL RESISTANCE ACCURACY VERIFICATION

1. Connect an ohmmeter capable of measuring 1 Ω to an accuracy of at least 10 m Ω (see note) to the calibrator OUTPUT terminals. Use the two-terminal mode on both instruments.

NOTE

Suitable ohmmeters are the Fluke 8800A, 8810A, or any 8500 series. If the ohmmeter used has an accuracy of 10 m Ω or better, the "Ohmmeter Error" in the two-terminal specification may be ignored.

2. Call 1 Ω on the Calibrator. The center display should flash CALI.

- Adjust the calibrator error dial until the output display is the same as the ohmmeter display. Depress the NEW REF/CAL 1Ω button and verify that the center display goes to .0000%.

4-64b. Repeatability Test

- Place the calibrator to standby then back to operate.
- Call 10Ω, 100kΩ, 10kΩ, and 100kΩ, then return to 1Ω.
- Verify that the ohmmeter reading remains within ±10 mΩ of that noted in step 3 of the Two-Terminal Resistance Accuracy Verification.

NOTE

Failure to achieve the required repeatability may be due to a defective relay related to the 1Ω to 100 kΩ resistors.

- Call 1MΩ; then return to 1Ω. The ohmmeter must again return to within ±10 MΩ of the previous reading.

NOTE

Failure to achieve repeatability when going over 100 kΩ and back is due to K56. This is a high voltage rated button relay and operates when going to 1 MΩ and 10 MΩ. There are two choices if K56 malfunctions: clean the contacts, or replace the relay. The contacts can be cleaned with a strip of business card soaked in alcohol.

4-64c. Accuracy Test

- Call 1Ω, and repeat step 3 of the Two-Terminal Resistance Accuracy Verification to achieve a precise reading.
- Call each of the ohm values tabulated below and verify that when the error dial is adjusted to cause the output display to equal the ohmmeter reading, the center display reads less than the value shown in the accuracy column below.

RANGE	ACCURACY
10Ω	0.4%
100Ω	0.05%
1 kΩ	0.0125%
10kΩ	0.0075%

4-65. CURRENT SOURCE TRANSFER TEST

CAUTION

Set voltage limit controls on the current source to the lowest voltage possible while still providing the current required for the test. In addition, to prevent damage to the equipment, set the current source to STDBY before either setting the 5100 Series B Calibrator to STDBY or disconnecting the leads between the instruments.

- Connect the equipment as shown in Figure 4-9.
- Program a calibrator output of 1 ohm with EXT sensing selected and select DC volts on the DMM.
- Multiply the certified value of the 1 ohm standard resistor by 0.1 and record the results as volts, e.g., a 1 ohm standard resistor certified at a -100 ppm error would be 0.999900 X 0.1, equaling 0.0999900, or 99.99 mV.
- Adjust the output of the current source (approximately 100 mA) until the DMM reads the computed value.
- Transfer the DMM leads from the standard resistor to the calibrator sense terminals.
- Verify the DMM reads between 0.09998 and 0.10002 volts (99.98-100.02 mV), i.e., 0.10000 ±0.02%.

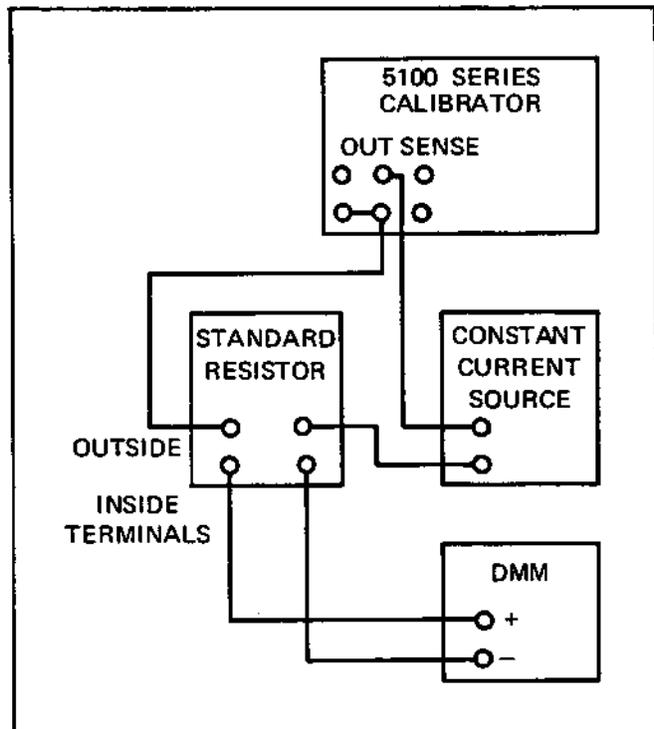

Figure 4-9. Current Source Transfer Connections

7. If the current source transfer test is used for the 10- and 100-ohm test, repeat steps 2 through 6, using calibrator settings of 10 and 100 ohms, current source settings of approximately 10 mA and 1mA, and readings of $.10000 \pm 0.01\%$ and $.100000V \pm 0.005\%$, respectively.

4-66. RESISTANCE TRANSFER TEST

1. Algebraically subtract the nominal value of the standard resistor (e.g., 10 ohm, 100 ohm, etc) from the certified value of the standard resistor. Record the computed difference. A computation example is shown in Figure 4-10, using 1 ohm as an example.

2. Connect the 5½ digit test DMM to the 10 ohm standard resistor, using the four-terminal configuration.

3. Measure the resistance of the standard resistor with the test DMM and record the value displayed.

4. Transfer the test DMM input leads from the standard resistor to the calibrator output terminals.

5. Program a calibrator output of 10 ohm, with EXT sensing selected.

6. Algebraically subtract the value recorded in step 1 from the value recorded in step 3 and verify the displayed value, when compared to the computed difference is within the resistance and tolerance listed in Table 4-9.

7. Repeat steps 1 through 6 for the remaining calibrator resistance outputs, insuring the deviation from the computed value is within the tolerance listed in Table 4-9.

NOTE

The test DMM may be left in the four-terminal configuration for the 100k, 1M, and 10M readings, if desired; however, the actual reading will be based on two-terminal operation.

4-67. AC Current Tests

4-68. The accuracy of the alternating current networks was verified with the direct current tests, however, the following tests are included to verify the proper operation of the AC relays required within the circuit. In all cases, the tolerances of the calibrator far exceed the DMM specification and the test must be considered an operational test rather than an accuracy test.

	CERTIFIED VALUE GREATER THAN NOMINAL	CERTIFIED VALUE LESS THAN NOMINAL
Step 1:		
Nominal Value	+1.000000	+1.000000
Certified Value	+1.000033	+0.999977
Computation:	+1.000033	+0.999977
Change sign & add	-1.000000	-1.000000
Difference	+0.000033	-0.000023
Step 3:		
Measured Value	+1.00005	+0.99995
Step 6:		
Recorded Step 1	+0.000033	-0.000023
Recorded Step 3	+1.00005	+0.99995
Computation:	+1.000050	+0.999950
Change sign & add	-0.000033	+0.000023
Difference	+1.000017	+0.999973
Rounded	+1.00002	+0.99997

Figure 4-10. Resistance Computation Examples

Table 4-9. Resistance Tests

RESISTANCE	TOLERANCE
10Ω	±1 mΩ
100Ω	±5 mΩ
1 kΩ	±50 mΩ
10 kΩ	±500 mΩ
100 kΩ	±5Ω
1 MΩ	±100Ω
10 MΩ	±5 kΩ

4-69. Verify the AC current operation with the following procedure:

1. Connect a DMM to the calibrator output terminals and prepare it to read alternating current.
2. Program a 190 μA, 400 Hz output from the calibrator.
3. The DMM reads between 187 μA and 193 μA.
4. Program a 1.9 mA, 400 Hz output from the calibrator.

5. The DMM reads between 1.88 mA and 1.92 mA.
6. Program a 19 mA, 400 Hz output from the calibrator.
7. The DMM reads between 18.9 mA and 19.1 mA.
8. Program a 190 mA, 400 Hz output from the calibrator.
9. The DMM reads between 189 mA and 191 mA.
10. Program a 1.9 A, 400 Hz output from the calibrator.
11. The DMM reads between 1.89 A and 1.91 A.

4-70. Overload Tests

4-71. These tests check the capability of the instrument to detect and react to an overload condition. The overload signal is the symbol "O.L." on the Central Display.

4-72. Perform the overload tests using the following procedure:

1. Verify the calibrator is in Standby.
2. Connect the 100 ohm, $\frac{1}{2}$ W load to the calibrator output terminals.
3. Select a 70.000 mA, 400 Hz output from the calibrator.
4. Select OPR on the calibrator.
5. The calibrator does not go into overload.
6. Remove the load from the calibrator.
7. The Central Display shows the symbol "O.L.". After a delay of approximately two seconds, the calibrator automatically drops into Standby.
8. Connect the 1 ohm, 5W load to the calibrator output terminals.
9. Select a 1.40000A, 400 Hz output from the calibrator.
10. Repeat steps 4 through 8 for the 1 ohm load.

4-73. Storage System Test (Storage Only)

4-74. Operation of the storage system may be verified by loading the storage memory with random instructions, transferring the data loaded in the memory to the tape, and reading the tape back to the instrument, using the applicable operating instructions given in Section 2 of this manual.

CAUTION

As a safety precaution, none of the random instructions should exceed 30 volts in value.

4-75. The calibration procedure requires a tape loaded with 74 instructions. The data in each instruction is irrelevant as long as each available instruction slot of the 74 available is used. The tape created during the verification test may be set aside for use during the calibration, provided all 74 instruction slots were used.

CAUTION

Tapes used must be certified digital mini-cassettes that conform with ANSI Standard X3B35/77-49. Audio quality tapes will not give acceptable results.

4-76. CALIBRATION PROCEDURE

4-77. Introduction

4-78. The normal calibration interval for the 5100 Series B Calibrator is 180 days, however, the instrument should be recalibrated any time repairs are made regardless of the time since the last calibration. The ambient temperature should be between 22 and 24 degrees Celsius, with the relative humidity less than 85%. Refer to Table 4-2 for the test equipment recommended for use during calibration. Verify the instrument is set to operate at the local input line voltage using the procedure given earlier in this section. The calibrator should have a warmup of at least 1-hour before starting the calibration procedure.

4-79. Test points and adjustments for all assemblies except the Power Supply Regulator (R83 only) and the Power Amplifier are accessible along the top edge of the applicable pcb assembly. Since there is an air space between the Power Amplifier and the Extended High Voltage assemblies, the power amp test points are accessible, however, they may be more easily accessed if the connections are made with the assembly partially withdrawn from the instrument. When a test point is called out in the procedure, turn power OFF, remove the assembly, attach the test equipment to the applicable test points, insert the assembly, and turn power ON. An

optional extender pcb is available as an accessory if this alternative is desired. Adjustments and test points are listed by their reference designator, followed by the reference designator, in parentheses, of the pcb assembly on which it is located; e.g., R84 (A9), TP21 (A17), C14 (A18); which are R84 on the Power Supply Regulator, Test Point 21 on the Power Amplifier, and C14 on the Oscillator, respectively. The assemblies containing calibration adjustments and their reference designators are listed in Table 4-10.

Table 4-10. PCB Reference Designators

REFERENCE DESIGNATOR	NOMENCLATURE
A9	Power Supply Regulator
A11	Ranging Assembly
A14	Analog Control Assembly
A15	DAC Assembly
A16	Extended High Voltage Assembly
A17	Power Amplifier Assembly
A18	Oscillator Assembly

4-80. The instrument should be placed in STDBY (standby) prior to connecting or transferring any test leads and returned to OPR (operate) as the last step in the sequence when programming an output.

4-81. Power Supply Calibration

4-82. Calibrate the Power Supply Regulator using the following procedure. For non-adjustable voltages outside their tolerance, refer to the troubleshooting portion of this section.

1. Connect the test DMM to the test points listed in the first step of Table 4-11.
2. Apply power to the calibrator.
3. Adjust the voltage for the listed tolerance with the adjustment listed.
4. Repeat step 3 for the remaining steps of Table 4-11. If no adjustment is listed, verify the voltage is between the listed tolerances.

4-83. Power Amplifier A17 (4083) Calibration

4-84. Calibration of the Power Amplifier requires adjustments for loop gain, zero, and bias. Prior to beginning the procedure below, prepare the instrument using the applicable procedure described in the introduction, then reapply power. Perform the Power Amp calibration using the following procedure:

Table 4-11. Power Supply Regulator Adjustments

TEST LEADS		VOLTAGE READING		ADJUSTMENT
HI	LO	LO	HI	
TP17	TP18	+4.9	+5.3	R83
TP16	TP18	+11.25	+12.75	None
TP15	TP18	-12.75	-11.25	None
TP14	TP13	+14.99	+15.01	R6
TP12	TP13	-15.15	-14.85	None
TP12	TP1	+4.9	+5.3	R84
TP4	TP6	+60.0	+64.0	None
TP2	TP6	-64.0	-60.0	None
TP3	TP6	+37.5	+40.5	None
TP5	TP6	-40.5	-37.5	None
TP11	TP10	+14.25	+15.75	None
TP7	TP10	-15.75	-14.25	None
TP8	TP9	+4.75	+5.25	None

NOTE

Connect the test leads to the Power Amp test points using one of the three procedures described in the Calibration Procedure Introduction. Since some of the test points called out are located on other assemblies, verify the assembly location prior to connecting test equipment.

4-85. LOOP GAIN CALIBRATION

1. Center R52.
2. Connect a test DVM, prepared for approximately 10V dc, high input lead to TP24 (A17) and the low lead to TP29 (A17).
3. Program the calibrator for an output of 2V ac at 1k Hz.
4. Turn R17 completely CCW. The DVM should be reading -1 to -3V dc. If not see section 4-118.
5. Program the calibrator for an output of +20V dc.
6. Adjust R17 (A17) for a reading of +1V \pm 0.02V dc.
7. Program the calibrator for an output of 2V ac at 1k Hz.
8. The DVM should read 1.25 \pm 0.5V dc.
9. Program the calibrator for an output of 19.999V ac at 50k Hz.
10. With a 2k ohm load the DVM should read between 7.5V and 11.5V dc.

4-86. ZERO CALIBRATION

NOTE

In the remaining portion of the Power Amp Calibration, the DC meter used must make a zero measurement in the presence of up to 35V rms normal mode AC signal. This requires excellent normal mode rejection. In addition to the Fluke 885A Differential Voltmeter called out, a Fluke 845AB Null Detector, a Fluke 79 Multimeter, or equivalent differential voltmeter may be used.

1. Connect the DC differential voltmeter high input lead to TP4 (A17) and the low to TP23 (A17). Connect a jumper from TP27 (A17) to TP23 (A17).
2. Adjust R114 (A17) for a reading of 0 ± 0.5 mV.
3. Remove jumper from TP27 (A17) and TP23 (A17).

CAUTION

High Voltage present at the output of calibrator. Do not have any connections to output terminals at this time.

4. Program the calibrator for an output of +1100V dc.
5. Select OPR on the calibrator.
6. Adjust R52 for 0 ± 30 mV.
7. Select STDBY on the calibrator.
8. Transfer to DC differential high lead to TP21 (A17).
9. Adjust R155 (A17) for a reading of 0 ± 0.5 mV dc.
10. Program STDBY on the calibrator.
11. Connect a 33Ω , 2W load to the calibrator output terminals.
12. Program the calibrator for an output of 199 mA at 400 Hz.
13. Select OPR on the calibrator.
14. Adjust R150 (A17) for a reading 0 ± 0.5 mV dc.
15. Program STDBY on the calibrator.
16. Connect a 0.5Ω , 4W load to the calibrator output terminals.

NOTE

The load must be stable and the connections tight.

17. Program the calibrator for an output of 1.999A at 400 Hz.
18. Select OPR on the calibrator.

19. Adjust F193(A17) for a reading of 0 ± 0.5 mV dc.

20. Program STDBY on the calibrator.

21. Remove the 0.5Ω load from the output terminals.

4-87. BIAS CALIBRATION

1. Transfer the DC differential high input lead to TP3 (A17) and the low to TP5 (A17).
2. Program the calibrator for an output of 190V ac at 400 Hz.
3. Adjust R123(A17) for a reading between 149 and 151 mV dc.
4. Program the calibrator for an output of 25V ac at 400 Hz.
5. Transfer the DC differential high input lead to TP8 (A17) and the low to TP9 (A17).
6. Adjust R165 (A17) for a reading between 44.9 and 45.1 mV dc.
7. Program STDBY on the calibrator.
8. Connect 0.5 ohm, 4W load to the calibrator output terminals.
9. Transfer the test DMM high input lead to TP18 (A17) and the low to TP19 (A17).
10. Program the calibrator for an output of 200 mA at 400 Hz.
11. Adjust R203 (A17) for a reading between 17.9 and 18.1 mV dc.
12. Program STDBY on the calibrator.
13. Remove the 0.5 ohm load from the output terminals.
14. If the Power Amp Assembly is installed on an extender PCB, remove power from the instrument, remove the assembly and extender PCB, insert the assembly into the motherboard and reapply power to the instrument.
15. Install the top inner guard cover on the instrument.

4-88. OSCILLATOR (A18) CALIBRATION

4-89. Calibrate the Oscillator Assembly using the following procedure:

1. Connect the probe tip of one channel of a dual trace oscilloscope to TP3 (A18) and ground to TP10 (A18) to monitor oscillation.
2. Connect the probe of the second channel to TP2 (A18) and ground to TP10 (A18). Set the scope controls for 1V dc, 1 ms/cm, DC coupling, and use a 10:1 probe.
3. Connect a test DMM, prepared for 2V ac, high input lead to TP3 (A18) and the low to TP10 (A18).
4. Connect a frequency counter to the instrument output terminals (wideband connector if the Wideband Option is installed).
5. Program an output of 1V ac at 1 kHz with WIDEBAND selected, if the option is installed. Press ENTER after selecting WIDEBAND.
6. If no oscillation is present at first channel of the scope, adjust R1 (A18) until oscillation begins.
7. Program a 50 Hz output (10 Hz if the wideband option is installed).
8. Adjust R1 (A18) so the positive peaks of the waveform at TP2 (A18) are at the DC zero level (between the 0V dc and -0.5V dc level).
9. Program a 50 kHz output (90 kHz if the Wideband Option is installed).
10. Adjust C14 (A18) and C21 (A18) equal amounts in the same direction for a counter reading of 50 ± 0.1 kHz (90 ± 0.1 kHz with the Wideband Option installed).
11. Record the DMM reading at the completion of the frequency adjustment, then transfer the DMM high input lead to TP5 (A18) from TP3 (A18).
12. Adjust C14 (A18) and C21 (A18) equal amounts in opposite directions until the same DMM reading ± 0.05 V rms is obtained as recorded in the step above.
13. Repeat steps 10, 11, and 12 until the two readings are within the stated tolerance without further adjustments.

14. With 50 kHz (90 kHz) programmed, note the DC level of the signal on the oscilloscope at TP2 (A18).

15. Program the calibrator output frequency of 20 kHz and note the DC level of the signal at TP2 (A18).

16. Adjust R50(A18) for a minimum difference in the displayed DC level at the two frequencies. Reprogram the frequencies, as required, to obtain the minimum difference in DC levels while still maintaining oscillation.

4-90. Reference Voltage Calibration

4-91. The Analog Control Assembly (A14) reference voltage is set using the DC voltage standard/null detector as a differential voltmeter (Figure 4-11). Perform the reference voltage calibration using the following procedure:

1. Prepare the DC voltage standard/null detector for use as a differential voltmeter at +10.0005V dc.
2. Connect TP1 (A14) to the null detector input HI and TP3 (A14) to input LO.
3. Adjust R11 (A14) for a null of $0 \pm 50 \mu\text{V}$ dc.

	CERTIFIED VALUE GREATER THAN NOMINAL	CERTIFIED VALUE LESS THAN NOMINAL
Step 7:		
Nominal Value	+1.000000	+1.000000
Certified Value	+1.000033	+0.999977
Computation:	+1.000033	+0.999977
Change sign & add	-1.000000	-1.000000
Difference	+0.000033	-0.000023
Step 9:		
Measured Value	+1.00005	+0.99995
Step 12:		
Recorded Step 1	+0.000033	-0.000023
Recorded Step 3	+1.00005	+0.99995
Computation:	+1.000050	+0.999950
Change sign & add	-0.000033	+0.000023
Difference	+1.000017	+0.999973
Rounded	+1.00002	+0.99997

Figure 4-11. Calibration Resistance Computation Examples

4. Remove the connection between TP1 (A14) and the input HI terminal, at TP1.
5. Prepare the DC voltage standard/ null detector for use as a differential voltmeter at -10.0005V dc.
6. Connect TP4 (A14) to the input HI terminal.
7. Adjust R23 (A14) for a null of $0 \pm 50 \mu\text{V}$ dc.
8. Remove the test equipment from the Analog Control PCB.

4-92. Low Range Ohms Calibration

CAUTION

Set the voltage limit controls on the current source to the lowest voltage possible while still providing the current required for the test. To prevent damage to the equipment, set the current source to STDBY before either setting the calibrator to STDBY or disconnecting the leads between the instruments.

4-93. The low ohms calibration is performed by relying on the short term stability of a test DMM and using it as a transfer device. The accuracy is not critical as long as the short term stability is present, but the DMM must have a resolution of $10 \mu\Omega$. Perform the low ohms calibration using the following procedure:

1. Connect the equipment as shown in Figure 4-9.
2. Program a calibrator output of 1 ohm with EXT sensing selected and select DC volts on the DMM.
3. Multiply the certified value of the 1 ohm standard resistor by 0.1 and record the result as volts (see Resistance Performance Test for example).
4. Adjust the output of the current source (approximately 100 mA) until the DMM reads the computed value.
5. Transfer the DMM leads from the standard resistor to the calibrator sense terminals.
6. Adjust R2 (A11) for a DMM reading between 0.09999 and 0.10001 V dc.
7. Algebraically subtract the nominal value of the standard resistor (e.g., 10 ohm, 100 ohm, etc.) from the certified value of the standard resistor. Record the computed difference. Computation examples are shown in Figure 4-11.

8. Connect the $5\frac{1}{2}$ digit test DMM to the 1 ohm standard resistor, using the four-terminal configuration.

NOTE

Do not use a Kelvin bridge in lieu of the DMM. Erroneous readings will result for values $\leq k\Omega$.

9. Measure the resistance of the standard resistor with the test DMM and record the value displayed.
10. Transfer the test DMM input leads from the standard resistor to the calibrator output terminals.
11. Program a calibrator output of 10 ohm, with EXT sensing selected.
12. Algebraically subtract the value recorded in step 7 from the value recorded in step 9 and adjust R5 (A11) for a test DMM display equal to the computed difference ± 1 digit.
13. Repeat steps 7 through 10 using a 100 ohm standard resistor and calibrator output, adjusting R8 (A11) to the value computed in step 12 ± 1 digit.
14. Repeat steps 7 through 10 using a 1K ohm standard resistor and calibrator output, adjusting R11 (A11) to the value computed in step 12 ± 1 digit.
15. Repeat steps 7 through 10 using a 10K ohm standard resistor and calibrator output, adjusting R14 (A11) to the value computed in step 12 ± 1 digit.

4-94. DC Zero Calibration

4-95. Set the DC zero circuits using the following procedure:

1. Connect the equipment as shown in Figure 4-12.
2. Program the calibrator for a 0V dc output with the 50 OHM OVERRIDE selected.
3. Set the NULL meter for the $30\mu\text{V}$ range.
4. Adjust R63 (A14) for a null of $0 \pm 10 \mu\text{V}$ dc.
5. Connect an oscilloscope set to 50 mV/cm with a 10:1 probe to TP5 (A14) and ground to TP14 (A14).
6. Connect a jumper between TP13 (A14) and TP14 (A14).
7. Adjust R71 (A14) for an oscilloscope display that does not constantly drift toward the same polarity.
8. Remove the jumper connecting TP13 (A14) and TP14 (A14) and readjust R63 (A14) for a null of $0 \pm 10 \mu\text{V}$ dc, if required.

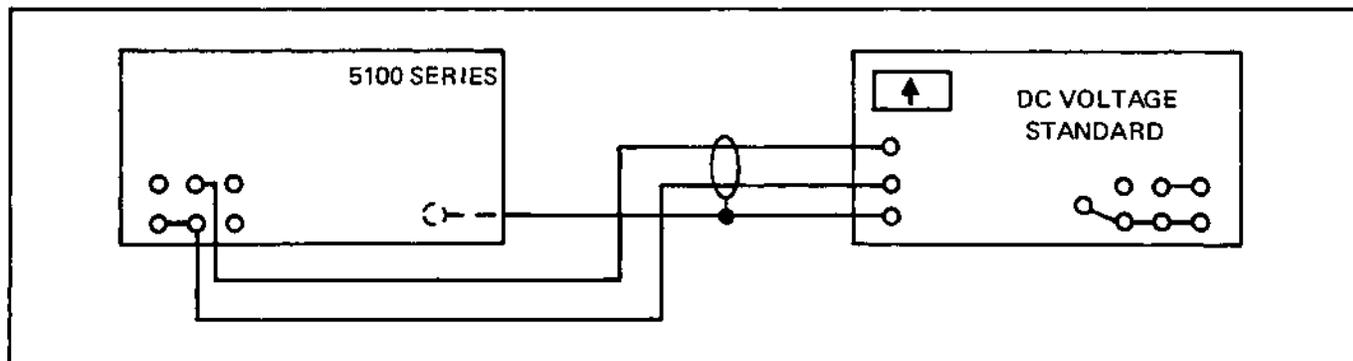

Figure 4-12. Differential Connections

4-96. Current Gain Calibration

4-97. Perform the current gain calibration using the following procedure:

1. Connect the equipment as shown in Figure 4-6 using the 1k ohm precision shunt.
2. Prepare the DC voltage standard/null detector for use as a differential voltmeter at 1.9V dc.
3. Program the calibrator for an output of 1.9 mA dc and adjust R42 (A15) for a null at $0 \pm 20 \mu\text{V}$ dc.
4. Place the calibrator and DC voltage standard in the Standby Mode.
5. Replace the 1 kilohm precision shunt with the 1 ohm precision shunt.
6. Enter 1.9A dc into the calibrator.
7. Place the calibrator and DC voltage standard in the Operate Mode.

NOTE

Heat build up in the 1 ohm shunt can effect accuracy. If the test requires more than one minute return to STDBY after that time, wait five minutes for cooling, then resume the test.

8. Check for a null of $0 \pm 285 \mu\text{V}$ (0.015%) on the voltage standard (differential).
9. If the reading is within tolerance proceed to the next procedure. If it is out of tolerance, perform the remainder of the subparagraph.
10. Adjust R2 (A11) for a null of $0 \pm 285 \mu\text{V}$.
11. Repeat the R2 (A11) adjustment of the Low Range Ohms Calibration (steps 1 through 6) and adjust, if required, for the listed tolerance.
12. Repeat steps 10 and 11 until both readings are within tolerance.

NOTE

Since R2 (A11) is part off the divider networks for both the 1 ohms and 1 amp ranges, it must be adjusted to meet both requirements. If this cannot be accomplished the circuit requires troubleshooting to define the problem.

4-98. High Range Ohms Calibration

4-99. Portions of the high range calibration require the computation of a resistance value prior to making an adjustment. The computation is based on the nominal value of a standard resistor (e.g., 1 kohm 100 kohm, etc.) and the certified value of the same standard resistor (Figure 4-10). Use the following procedure to obtain this value.

1. Algebraically subtract the nominal value of the standard resistor (e.g., 1 k Ω , 100 k Ω , etc.) from the certified value of the standard resistor. Record the computed difference. Connect the equipment using the four-terminal configuration.
2. Connect the 5½ digit test DMM to the standard resistor in use.
3. Measure the resistance of the standard resistor with the test DMM and record the value displayed.
4. Transfer the test DMM input leads from the standard resistor to the designated test points or terminals.
5. Program the designated calibrator output, with EXT sensing selected.
6. Algebraically subtract the value recorded in step 1 from the value recorded in step 3 and adjust the designated point for a test DMM display equal to the computed difference \pm the stated tolerance.

4-100. Perform the high range ohms calibration using the following procedure:

1. Perform steps 1 through 4 of the resistance procedure above using a 1 k Ω standard resistor.

2. Program a 100 k Ω calibrator output.

NOTE

The test is made with a 1 k Ω standard resistor while the calibrator is programmed for 100 k Ω to set the lower portion of the high ohm and voltage ranging ladder.

3. Perform step 6 of the resistance procedure above, connecting the test DMM HI to TP8 (A11) and the LO to TP9 (A11) and adjusting R38 (A11) for the computed value ± 1 digit.

NOTE

The remaining resistance measurements may be performed in the four-terminal configuration if desired; however, the instrument automatically selects internal sensing.

4. Perform the resistance procedure above, using 100 k Ω , connecting the test DMM to the calibrator output terminals and adjusting R30 (A11) and R33 (A11) equal amounts in the same direction for the computed value in step 6 ± 1 digit.
5. Connect the equipment as shown in Figure 4-12.
6. Prepare the DC voltage standard/null detector for use as a differential voltmeter at 19.00000V dc.
7. Program the calibrator for an output of 19V dc.
8. Adjust R30 (A11) and R33 (A11) equal amounts in opposite directions for a null at $0 \pm 190 \mu\text{V}$ dc.
9. Program the calibrator for an output of -19.0000V dc, then adjust R23(A14) for precisely -19.0000V dc on the differential voltmeter.
10. Prepare the DC voltage standard/null detector for use as a differential voltmeter at 190.0000V dc.
11. Program the calibrator for an output of 190V dc.
12. Adjust R27(A11) for a null of $0 \pm 1.9 \text{ mV}$ dc.
13. Prepare the DC voltage standard/null detector for use as a differential voltmeter at 1000.0000V dc.
14. Program the calibrator for an output of 1000V dc.
15. Adjust R37(A11) for a null of $0 \pm 10 \text{ mV}$ dc.

16. Repeat steps 4 through 16 until all measurements are within tolerance without an adjustment.

17. Perform the resistance procedure above using 1 M Ω , connecting the test DMM to the calibrator output terminals and checking for the computed value $\pm 40\Omega$. There is no adjustment for this step; however, if the error is not gross it may be brought within tolerance by restarting the procedure at step 1. If the reading is still out of tolerance after repeating the procedure, troubleshoot the circuit.

18. Perform the resistance procedure above using 10 M Ω , connect the test DMM to the calibrator output terminals, and adjusting R22(A11) for the computed value $\pm 400\Omega$.

4-101. Millivolt Range Calibration

- 4-102. Perform the millivolt range calibration using the following procedure:

1. Connect the equipment as shown in Figure 4-4. Do not use the null detector built into the DC voltage standard.
2. Set the voltage divider ratio to .19.
3. Prepare the dc voltage standard/null detector for an output of +10.000000V dc.
4. Program the calibrator for an output of 1.9V dc.
5. Adjust R19 (A11) for a null of $0 \pm 19 \mu\text{V}$ dc.
6. Reverse the leads at the DC voltage standard output terminals to obtain a negative output.
7. Program the calibrator for an output of -1.9V dc.
8. Adjust R19 (A11) to balance the null error of the $\pm 1.9\text{V}$ dc inputs.
9. Repeat steps 3 through 8 until the error is balanced (the same at both plus and minus 1.9V dc) and within the listed tolerances.
10. Set the voltage divider to .00190000 and repeat the procedure in steps 3 through 8, using R16(A11) to obtain a balance for the $\pm 190 \text{ mV}$ dc input with a tolerance of $\pm 5 \mu\text{V}$ dc.
11. Set the voltage divider to .00190000 and repeat the procedure in steps 3 through 8, using R55 (A11) to obtain a balance for the 19 mV dc input with a tolerance of $\pm 5 \mu\text{V}$ dc.

4-103. AC Calibration

4-104. Perform the AC Calibration using the following procedure:

1. Connect the equipment as shown in Figure 4-7.
2. Set the thermal transfer standard to the 2 volt range.
3. Set the DC Voltage Standard controls for an output of 2.000000V dc.
4. Program the calibrator for an EXT sensed output of 2V ac at 1 kHz.
5. Perform the thermal transfer, adjusting R39 (A14) for a null $\pm 0.01\%$.
6. Set the thermal transfer standard to the 20 volt range.
7. Set the DC Voltage Standard controls for an output of 19.9999V dc.
8. Program the calibrator for an output of 19.999V dc at 1 kHz.
9. Perform the thermal transfer, adjusting R32 (A14) for a null $\pm 0.005\%$.
10. Repeat steps 3 through 9 until both tests are within tolerance without an adjustment.
11. Program the calibrator for an output of 19.9999V ac at 50 kHz.
12. Perform the thermal transfer, adjusting C15 (A11) for a null $\pm 0.01\%$.
13. Set the thermal transfer standard to the 100 volt range.
14. Set the DC Voltage Standard controls for an output of 100.0000V dc.
15. Program the calibrator for an output of 100V ac at 20 kHz.
16. Perform the thermal transfer, adjusting C1 (A11) for a null $\pm 0.01\%$.

4-105. Storage System Calibration (Storage Only)

4-106. Calibrate the storage system using the following procedure:

CAUTION

Tapes used must be certified digital mini-cassettes that conform with ANSI Standard X3B5/77-49. Audio quality tapes will not give acceptable results.

1. Select STDBY on the calibrator.
2. Connect a frequency counter between TP2 (A8) (HI) and TP1 (A8) (LO).
3. Adjust R2 (A8) for a reading on the frequency counter between 9.55 kHz and 9.65 kHz.
4. Place a prepared tape with data loaded into all 74 addresses into the tape reader.

NOTE

The prepared tape must have all 74 address locations filled; however the data is immaterial. For example, all 74 locations could be filled with the same instructions, ie., 1V dc or 100 mV, 400 Hz or 100 Ω .

5. Disconnect the frequency counter and connect an oscilloscope between TP3 (A8) (HI) and TP1 (A8) (LO). Set the scope to read 50 $\mu\text{s}/\text{cm}$.
6. Select STORAGE ENABLE, TAPE, and READ (STORE indicator extinguished) on the calibrator.
7. When the tape begins to run forward, adjust R13 (A8) for a waveform high period between 295 and 305 μs .
8. Select STORAGE and TAPE disable, and disconnect the test equipment.

4-106a. Tape Drive Calibration

4-106b. Perform the tape drive calibration using the following procedure:

1. With the 5101B off, connect the UUT to cable P33.

NOTE

Be sure the bottom of the UUT is insulated from any metal surface.

2. Turn on the 5101B.
3. Using the DMM, verify 5 VDC, ± 0.25 , from +5V to GND and from MOTV to MOTR.
4. Load Test Tape in tape drive.

NOTE

A test tape can be created by writing a string of commands to the tape. The write cycle requires no calibration.

5. Connect the DMM to GND and TP8. Set DMM for DCV.

6. Connect the Scope to TP6. Set Scope for 0.2V/div and .2E-3s/div.
7. Press ENABLE, TAPE, and ADVANCE/LOAD. This initiates the READ cycle.
8. Adjust R27 until DMM reads 4.08VDC, $\pm 0.02V$, at TP8.
9. Adjust R39 until the UNIFORM wave form is 0.6V, $\pm 0.01V$, peak to peak.
10. Verify correct read cycle of tape.
11. If ERR 9 is displayed, read the tape again without further adjustment. Since the UUT was not calibrated at the beginning of the tape, it may not read the tape the first time.
12. The tape drive may now be attached to the controller pca. These are now a set. If they become separated, the calibration procedure will need to be repeated.

4-107. Factory Selected Component Replacement

4-108. Some components are factory selected at the time of manufacture. None are high failure items; however, if replacement is required, use the applicable portion of the following procedure, or return the assembly to your local Fluke Service Center. Failure to use the correct replacement procedure may affect the calibration of the instrument. The instrument should be recalibrated any time that one of the following component selection procedures is used.

4-109. ANALOG CONTROL ASSEMBLY - R64/R66

4-110. Either R64 or R66 will be installed in the instrument with a jumper wire installed in the other position. If the installed resistor fails, use the following procedure to replace the resistor/wire combination:

1. With power removed from the instrument and the Analog Control Assembly removed, replace the defective resistor with a jumper so that both the R64 and R66 positions are jumpered.
2. Replace the assembly and apply power to the instrument.
3. Place a test DMM across the output terminals, high to high and low to low.
4. Program a calibrator output of 0V with 50 Ω OVERRIDE selected.
5. If the DMM reading is positive, remove power and the assembly, then replace the jumper in the R66 position with a decade box. If the reading is negative, replace the R64 jumper with the decade box.
6. Restore the assembly and power, then adjust the decade box for a DMM reading of $0.0 \pm 5 \mu V$.

7. Replace the decade box with a resistor the value of the decade box setting $\pm 3\%$. Determine the actual value of the decade box setting with the 5 $\frac{1}{2}$ digit test DMM. Use a T9 type, metal film, 1%, 1/8 watt resistor to replace the jumper wire.

4-111. ANALOG CONTROL ASSEMBLY R13/R14

4-112. The resistance value of R13 and R14 in the analog control regulator circuit is critical to the accuracy of the output. If either component fails or the regulator (U10) is replaced, new values should be selected using the following procedure:

1. Remove R13 (A14) and R14 (A14) from the circuit and temporarily replace them with a 20-turn, 1 k Ω , $\frac{1}{2}$ watt potentiometer (Fluke Stock No. 267856).
2. Connect the 5 $\frac{1}{2}$ digit test DMM between TP1 (A14) HI and TP3 (A14) LO.
3. Apply power to the instrument, allow it to warmup, then adjust the 1 k Ω potentiometer, installed in step 1, for a DMM reading of +10.005V dc.
4. Remove power, then remove the potentiometer from the instrument, taking care not to change the potentiometer setting.
5. Measure the resistance of the potentiometer using the 5 $\frac{1}{2}$ digit test DMM and select the precision resistors required from Table 4-12. If the value required is less than 200 ohms, install the selected resistor in R13 and a jumper wire in R14. For value in excess of 200 ohms place the required 100's value in R13 and the 10's value in R14.

4-113. RANGING ASSEMBLY C2/C18/C20

4-114. On the Ranging Assembly, capacitors, C2, C18, and C20, are selected for high frequency performance. Use the following procedure for component selection when required by component failure or a fault in the high frequency adjustment.

NOTE

This procedure requires a DMM certified for 20V ac at 50 kHz. Subtract, algebraically, the supplied correction factor before using the replacement table.

1. Remove any components presently installed in the C2, C18, and C20 positions.
2. Connect the test DMM to the output terminals; high to output high and low to output low.
3. Rotate C15 through its range and record the maximum and minimum readings.
4. Set C15 for a reading at the midpoint between the maximum and minimum readings.

Table 4-12. Divider Resistor Selection

RESISTOR VALUE	FLUKE STOCK NO.	RESISTOR VALUE	FLUKE STOCK NO.	RESISTOR VALUE	FLUKE STOCK NO.	RESISTOR VALUE	FLUKE STOCK NO.
15	215038	65	214536	114	214049	164	213546
16	215020	66	214528	115	214031	165	213538
17	215012	67	214510	116	214023	166	213520
18	215004	68	214502	117	214015	167	213512
19	214999	69	214494	118	214007	168	213504
20	214981	70	214486	119	213991	169	213496
21	214973	71	214478	120	213983	170	213488
22	214965	72	214460	121	213975	171	213470
23	214957	73	214452	122	213967	172	213462
24	214940	74	214445	123	213959	173	213454
25	214932	75	214437	124	213942	174	213447
26	214924	76	214429	125	213934	175	213439
27	214916	77	214411	126	213926	176	213421
28	214908	78	214403	127	213918	177	213413
29	214890	79	214395	128	213900	178	213405
30	214882	80	214387	129	213892	179	213397
31	214874	81	214379	130	213884	180	213389
32	214866	82	214361	131	213876	181	213371
33	214858	83	214353	132	213868	182	213363
34	214841	84	214346	133	213850	183	213355
35	214833	85	214338	134	213843	184	213348
36	214825	86	214320	135	213835	185	213330
37	214817	87	214312	136	213827	186	213322
38	214809	88	214304	137	213819	187	213314
39	214791	89	214296	138	213801	188	213306
40	214783	90	214288	139	213793	189	213298
41	214775	91	214270	140	213785	190	213280
42	214767	92	214262	141	213777	191	213272
43	214759	93	214254	142	213769	192	213264
44	214742	94	214247	143	213751	193	213256
45	214734	95	214239	144	213744	194	213249
46	214726	96	214221	145	213736	195	213231
47	214718	97	214213	146	213728	196	213223
48	214700	98	214205	147	213710	197	213215
49	214692	99	214197	148	213702	198	213207
50	214684	100	214189	149	213694	199	213199
51	214676	101	214171	150	213686	200	213181
52	214668	102	214163	151	213678	300	227686
53	214650	103	214155	152	213660	400	131698
54	214643	104	214148	153	213652	500	195388
55	214635	105	214130	154	213645	600	279711
56	214627	106	214122	155	213637	700	279703
57	214619	107	214114	156	213629	800	341701
58	214601	108	214106	157	213611	900	228742
59	214593	109	214098	158	213603	1000	131706
60	214585	110	214080	159	213595	1100	238949
61	214577	111	214072	160	213587	1200	278077
62	214569	112	214064	161	213579	1300	278069
63	214551	113	214056	162	213561	1400	278051
64	214544			163	213553		

Table 4-13. High Frequency Capacitor Selection

DMM INDICATION	C18	C2	C20	FLUKE STOCK NO.
19.900-19.953			2pF	148536
19.954-19.999			3pF	148551
20.000-20.068	2pF			175208
20.069-20.096	3pF			460436
20.097-20.124	4pF			190397
20.125-20.152	5pF			148577
20.153-20.180	4pF	2pF		190397,175208
20.181-20.208	4pF	3pF		190397,460436

5. Program a calibrator output of 19.9999V ac at 50 kHz.

6. Subtract, algebraically, the correction factor from the DMM reading, then install the capacitors listed for that voltage range in Table 4-13. The capacitors are dipped mica, $\pm 5\%$ tolerance, with a voltage rating of 500V dc.

NOTE

The DMM reading will be 100 through 150 digits lower with shield removed from the Ranging Assembly.

7. Adjust C15 for a DMM reading of 19.9999V ac, after taking into account the correction factor.

5. If the reading is a null $\pm 0.29\%$ on the 1% null scale the present arrangement is correct and no further checks are needed. This is generally the case. If the null reading exceeds $+0.29\%$, perform the applicable of steps 6, 7, or 8. If the reading exceeds -0.29% go to step 10.

6. For readings greater than the null between $+0.29\%$ and $+0.45\%$, install the 10 pF capacitor in C32 and perform step 9.

7. For readings greater than the null between $+0.45\%$ and $+0.6\%$, install the 15 pF capacitor in C32 and perform step 9.

8. For readings greater than the null of $+0.6\%$, install the 22 pF capacitor in C32 and perform step 9.

9. Retaining the original calibrator and differential voltmeter settings, recheck for a null $\pm 0.29\%$. If the reading is within the listed tolerance the present arrangement is correct and no further checks are needed.

10. If the reading is below the bottom tolerance on the initial reading, or one pass through the selection procedure, does not bring it within tolerance the assembly is defective. Check the voltage divider circuit or return the assembly to you local Fluke service center.

4-115. RANGING ASSEMBLY C31/C32

4-116. Capacitor C31 or C32, or possibly neither, are installed in the Ranging Assembly to compensate for PCB variances that effect the millivolt divider. The procedure in the subsequent subparagraphs should be performed any time the installed capacitor, or any of the fixed wirewound resistors in the millivolt divider (R66, R67, R68, R69, R70, R71), are replaced. Three parts are possible for installation and the follow in the sequence; Description, Fluke Stock Number; Manufacturers Federal Supply Code, and Manufacturers Part Number:

Cap, Mica, 2 pf ± 5 pF, 500V; 175208; 72136; DM15C020E

Cap, Mica, 10 pf $\pm 10\%$, 500V; 175216; 72136; DM15C100K

Cap, Mica, 22 pf $\pm 5\%$, 500V; 148551; 72136; DM15C220J

Cap, Mica, 15 pf $\pm 5\%$, 500V; 148569; 72136; DM15C150J

1. Verify a 2 pF capacitor is installed in the C31 position and the C32 position is vacant.

2. Connect an AC differential voltmeter to the calibrator output terminals using coaxial cable.

3. Prepare the differential to read a null (1% scale minimum) at 20 mV.

4. Program a calibrator output of 19.9999 mV at 50 kHz.

4-117. POWER AMPLIFIER ASSEMBLY (R70)

4-118. If Q106 and/or Q107 are replaced and Loop Gain Calibration is incorrect, use the following procedure to select R70.

1. Center R52.

2. Connect a test DVM, set for approximately 10V dc. Place the high input lead to TP24(A17) and the low input input lead to TP29(A17).

3. Program the calibrator for an output of 2V ac at 1 kHz.

4. Turn R17 completely CCW. If the DVM reads between -1 and -3V dc, then R70 need not be changed. If the reading does not fall within the -2 and -3V dc range, continue to step 5.

5. Note the DVM reading.

6. If the reading is greater than -1V, then select a lower value of resistor (300 k Ω , 330 k Ω , 360 k Ω , 390 k Ω (installed), or 420 k Ω). If the reading is less than -3V, then select a resistance value higher than 420 k Ω . For each change of 30 k Ω , the DVM can be expected to change approximately -1V.

7. Install the new resistor.

4-119. TROUBLESHOOTING

4-120. Troubleshooting for the analog circuitry in the instrument is covered in the tabular flow charts beginning

with Table 4-14. When a step on the flow chart is completed, check for a decision transfer. If not decision is required, perform the next step of the table in sequence.

NOTE

If any question arises during the troubleshooting procedure on a reading by a DMM, verify the signal present with an oscilloscope.

Table 4-14. Display Troubleshooting

STEP NO.	ACTION	Go to the step number given for correct response	
		YES	NO
1	Apply power to the instrument and select POWER ON.		
2	Does the Output Display read +0.0000 mV, with the STDBY, LOCAL, INT (Sense), and 50 Ω DIVIDER indicators illuminated?	7	3
3	Check for voltages on the Power Supply Regulator (A9). With the DMM low at TP18, check with the high lead at TP15 for -12 \pm 0.5V dc, at TP16 for +12 \pm 0.5V dc and at TP17 for +5.2 \pm .25V dc.		
4	Are all voltages present and within their listed tolerance?	6	5
5	Check out the Power Supply Regulator (A9) using the applicable table. Repair as required, then resume at step 1.		
6	Check the Controller and Memory Assemblies (A20 and A21), bus lines, and connectors. Replace or repair as required, then resume at step 1.		
	<p><i>NOTE</i></p> <p><i>The following series of tests check out a section of the Front Panel indicators. If any indicators are not operational, perform the fault location subroutine, then return to the main program at the step initiating the transfer.</i></p>		
7	Key -in +188.88 μ A, but do not depress ENTER.		
8	Does the Central Display read +188.88 with the μ A and KEYBOARD indicators illuminated?	9	58
9	Depress ENTER.		
10	Does the +188.888, μ , and A indicators transfer to the Output Display and the KEYBOARD indicator extinguish?	11	58
11	Toggle the SENSE switch.		
12	Does the EXT indicator illuminate and the INT indicator extinguish?	13	58
13	Toggle the SENSE switch again.		
14	Does the INT indicator illuminate and the EXT indicator extinguish?	15	58
15	Depress the CLEAR switch, then repeat steps 11 through 14 for the LOCAL/REM and 50 Ω DIVIDER/OVERRIDE indicators.		

Table 4-14. Display Troubleshooting (cont)

STEP NO.	ACTION	Go to the step number given for correct response	
		YES	NO
16	Did both operations perform correctly?	17	58
17	Toggle the RECALL switch.		
18	Does the RECALL indicator illuminate?	19	58
19	Toggle the RECALL switch again.		
20	Does the RECALL indicator extinguish?	21	58
21	Repeat steps 17 through 20 for the EXT OSC, BOOST, and WIDEBAND switches.		
22	Did all of the operations perform correctly?	23	58
23	Depress the following switches in the sequence listed: CLEAR, 1, /, 2.		
24	Does the Central Display read 1–2, with the KEYBOARD indicator illuminated?	25	58
25	Depress the following switches in the sequence listed: CLEAR, ENTRY LIMIT, 1, μ , V.		
26	Does the Central Display read 1, with the μ , V, and LIMIT indicator illuminated?	27	58
27	Depress the following switches in the sequence listed: CLEAR, TOL LIMIT, 1, %.		
28	Does the Central Display read 1, with the LIMIT and % ERROR indicators illuminated?	29	58
29	Depress the following switches in the sequence listed: CLEAR, CLEAR, 1, K, Hz.		
30	Does the Central Display read 1, with the AC, k, Hz, and KEYBOARD indicators illuminated?	31	58
31	Depress the following switches in the sequence listed: 1, m, A, ENTER.		
32	Does the Output Display read 1.0000, with the AC, m, and A indicators illuminated and the Central Display reads 1000.0 with the AC and Hz indicators illuminated?	33	58
33	Depress the following switches in the sequence listed: -, 1, ., 1, dBm		
34	Does the Central Display read -1.1, with the Ac, dBm, and KEYBOARD indicators illuminated?	35	58
35	Depress the ENTER switch.		
36	Does the Output Display read -1.10000, with the AC and dBm indicators illuminated?	37	58
37	Depress the ERROR MODE-ENABLE switch.		
38	Does the Central Display read +0.00000 with dB ERROR and ERROR MODE indicators illuminated?	39	58
39	Depress the following switches in the sequence listed: 1, M, Ω .		
40	Does the Central Display read 1, with the M, Ω , and KEYBOARD indicators illuminated?	41	58
41	Depress the ENTER switch.		
42	Does the Output Display read 1.00000 with the M and Ω indicators illuminated and does the Central Display and indicators extinguish?	43	58
	<i>NOTE</i> <i>The D1, D2, D3, and D4 indicators are inoperative and have no function at this time.</i>		
43	Depress the following switches in the sequence listed: 2, 3, 4, 5, 6.		
44	Does the Central Display read 23456?	45	59
45	Depress the following switches in the sequence listed: CLEAR, 7, 8, 9, 1.		
46	Does the Central Display read 7891?	47	59

Table 4-14. Display Troubleshooting (cont)

STEP NO.	ACTION	Go to the step number given for correct response	
		YES	NO
47	Depress the following switches in the sequence listed: m, V, ENTER, ERROR MODE ENABLE.		
48	Does the Output Display read 7.8910 with the zero intensified and illuminated? Does the Central Display read +.0000, the % ERROR and ERROR MODE indicator illuminate?	49	59
49	Depress the left DECADE switch four times.		
50	Did the intensified digit move to the left from the zero to the one, to the nine, to the eight, to the seven?	51	59
51	Depress the right DECADE switch four times.		
52	Did the intensified digit move to the right and back to zero?	53	59
53	Turn the EDIT switch knob clockwise until the Output Display reads 7.8920.		
54	Does the EDIT switch change the Output Display and the error percentage on the Central Display?	56	55
55	For no movement, check U22-6; for periodic skips, check U26; for extra counts, check R4, R5, and R6. Repair as required, then resume at step 53.		
56	Depress the NEWREF/CAL 1Ω switch.		
57	Does the Central Display error display change to +.0000 and the % ERROR indicator remain illuminated?	60	59
58	Front Panel Indicator Subroutine. Each indicator on the Front Panel, including segments on the numerical LED assemblies, are controlled on both the anode and cathode. All anodes are connected in one-of-eight groups, each group is controlled by power transistors Q1 through Q8. U1 and U9 are latches, which in conjunction with U10, U11, and RN1 cycle the transistors Q1 through Q8 for 2 ms periods with one rest period at the ninth interval. The emitter voltage of the selected transistor should be $+5 \pm 0.7V$ dc during the 2 ms period, while all other emitter voltages should be less than 2V dc. Check CR44 and U21 for incorrect voltages. Commands from the instrument Controller into latches U2 through U6 and their drivers (U7, U8, U13 through 20), apply common to the indicators. Failure of the resistors (R9, R10, R11, R12) or the resistor networks (RN3, RN4) can cause the indications under the control of that resistor to be excessively bright, dim, or not illuminate. If the problem is located, repair as required, then return to the main program at the step initiating the transfer to the subroutine. If the fault cannot be isolated to the indicator control circuits, it might be in a defective key. In this case continue with step 59.		
59	All the Front Panel key switches are wired into a seven column, eight row matrix. The instrument Controller periodically activates the columns through latches U1 and U9 and, therefore, synchronized with the power transistors, Q1 through Q8. Failure of any latch in U1 or U9 will disable a column of key switches (refer to the matrix chart on the schematic). The key switch outputs are held low by RN2 until a switch is depressed. An open resistor in RN2 can result in noise resulting in spurious data entries. A shorted resistor in RN2 disables all the switches in that row. The Controller reads switch closures on data lines ID0 through ID7. These data lines are isolated by the buffers U26 and U27 which are held disabled by RDSW high at U22-9 from the Controller. Repair as required, then return to the step in the main program that initiated the transfer.		
60	Troubleshooting of the Front Panel is now completed.		

Table 4-15. Analog Circuitry Troubleshooting

STEP NO.	ACTION	Go to the step number given for correct response	
		YES	NO
1	Remove power from the instrument, wait at least 30 seconds, and then remove the Analog Control Assembly from the instrument. Install it into an Extender Assembly and install the combination in the calibrator. Reapply power to the instrument and program an output of +1.9V dc.		
2	Check with an oscilloscope HI lead at P52; pins 14, 15, 17, 18, 19, 20, 32, 35, 36, 37, 38, 39, and 40 for a pulse train with high levels at -15V and low levels at -20V. Use TP9 (A14) or ∇_s for scope low.		
3	Is the pulse train present at all pins, at the proper levels?	5	4
4	One at a time, remove the PCB assemblies from the analog compartment until the pulse train returns to normal. When the PCB causing the problem is identified, refer to the procedures for troubleshooting that board. If all boards in the analog compartment have been removed and the trouble remains, check the buffer/drivers on the Isolator Assembly (A19). Repair as required, then resume at step 2.		
5	Connect the test 5½ digit DMM to the output terminals of the calibrator in a four-terminal ohms configuration.		
6	Program, in turn; 1, 10, 100, 1k, 10k, 100k, 1M, and 10M ohms from the calibrator. Check the outputs with the test DMM for readings of 1 ± 0.05 , 10 ± 0.1 , $1k \pm 1$, $100k \pm 50$, $1M \pm 1k$, and $10M \pm 10k$ ohms, respectively.		
7	Are all of the resistance readings within the stated tolerances?	9	8
8	Check the relay circuits and their associated logic components on the Ranging Assembly (A11). Relay K55 is applicable to all ranges; K56 to the 100k, 1M, and 10M ohm ranges only; and K4 through K10 each applicable to a single range, 1 ohm through 10M ohms, respectively. The relays are controlled by logic circuits in U3 through U8, U10 through U14, U16, and U18. Repair as required, then resume at step 5.		
9	Prepare the test DMM connected to the output terminals to read approximately 10V dc.		
10	Program a +10V dc Calibrator output and observe the display.		
11	Program a -10V dc Calibrator output and observe the display.		
12	Are both readings within 1.0 mV of the programmed outputs?	28	13
13	Connect the DMM between TP5 (High) and TP8 (Low) on the Analog Control PCB and program the first incorrect voltage.		
14	Is a reading greater than the DMM floor but less than 10 volts present?	15	27
15	The control loop is closed but inaccurate. Check for one-half the programmed output ($+5V \pm 0.01$ or -5 ± 0.01 volts) between the junction of R74, R77, R78, Q73 (High) and TP8 (Low).		
16	Is the reading correct?	18	17
	<p style="text-align: center;"><i>NOTE</i></p> <p style="text-align: center;"><i>The ranging divider is not easily loaded by the integrator circuit; however, the possibility of loading does exist and it can be checked using the following procedure:</i></p> <p style="text-align: center;"><i>a) Turn off power and remove the Analog PCB.</i></p> <p style="text-align: center;"><i>b) Install the Power Amp on an Extender PCB and connect a variable isolated DC power supply between TP24 (+) and TP29 (-).</i></p>		

Table 4-15. Analog Circuitry Troubleshooting (cont)

STEP NO.	ACTION	Go to the step number given for correct response	
		YES	NO
	<p><i>c) With a programmed output of 10V, increase the power supply output while monitoring the output terminals. For a swing of less than 10V from the supply the output terminals should swing from zero to approximately 35V. If the input polarity is reversed the swing should also reverse.</i></p> <p><i>d) The voltage at the coaxial connector, J54, in the Analog Control slot should be precisely one-half the measured output voltage.</i></p>		
17	Check Q1, U19, and their associated drive circuits on the Ranging PCB. Repair as required, then resume at step 9.		
18	With a high impedance DVM check for 5 ± 0.01 volts between U61-3 and TP8 (Low).		
19	Is the reading correct?	26	20
20	Check the reference voltage input to the DAC from common at A14 TP3 to A14 TP1 (+10V) and A14 TP4 (-10V).		
21	Is the reading correct?	23	22
22	Check the voltage reference circuit on the Analog Control PCB. Repair as required, then resume at step 9.		
23	Check the DAC for a 50% duty cycle drive waveform on TP10, TP7, and TP5. If the waveform is not present at TP5 check for the proper logic drive signals to the digital section. Check for the proper relay action using the schematic chart. Repair or replace as required.		
	<p style="text-align: center;">NOTE</p> <p style="text-align: center;"><i>To eliminate the possibility of loading the DAC from the Analog Control Integrator circuit the input may be removed by desoldering the integrator input line at the junction of Q62 and Q63.</i></p>		
24	Is the programmed output voltage present at the output terminals?	9	25
25	Check the Power Amp (A17) using the applicable Table. Repair as required, then resume at step 9.		
26	Check the Analog Control (A14) Integrator circuits Q68 (for excessive bias current), Q73, Q74, K3, and their associated components. Repair as required, then resume at step 9.		
27	The control loop is open. Check the Ranging (A11), Analog Control (A14), and Power Amp (A17) for proper closure of the relays and FETs using the applicable tables on the schematics. Repair as required, then resume at step 9.		
28	Prepare the test DMM connected to the output terminals to read approximately 1V dc, then program a calibrator output of +1V dc.		
29	Is the reading +1V dc $\pm 200 \mu\text{V}$?	31	30
30	Check K50, K14, and their associated logic circuits on the Ranging PCB. Repair as required, then resume at step 28.		
31	Program a calibrator output of +100 mV dc.		

Table 4-15. Analog Circuitry Troubleshooting (cont)

STEP NO.	ACTION	Go to the step number given for correct response	
		YES	NO
32	Does the test DMM read +100 mV dc $\pm 25 \mu\text{V}$?	34	33
33	Check K51, K14, and their associated logic circuits on the Ranging PCB. Repair as required, then resume at step 31.		
34	Program a calibrator output of +10 mV dc.		
35	Does the test DMM read +100 mV dc $\pm 10 \mu\text{V}$?	37	36
36	Check K52, K14, and their associated logic circuits on the Ranging PCB. Repair as required, then resume at step 34.		
37	Connect a test DMM prepared for DC current to the output terminals.		
38	Program a calibrator output of +100 mA dc and observe the DMM for a reading of +100 mA dc ± 0.1 mA.		
39	Program a calibrator output of -100 mA dc and observe the DMM for a reading of -100 mA dc ± 0.1 mA.		
40	Are both reading (steps 38 and 39) within the listed tolerances?	45	41
	CAUTION  F and  R float on the PA output during current operation. Do not short to any other ground in the system, i.e.,  S or  1 during the current tests." data-bbox="258 458 605 512"/>		
41	Check the control loop voltage between TP5 (high) and TP8 (low) on the Analog Control PCB.		
42	Is the absolute value greater than the DMM floor but less 10V?	44	43
43	The control loop is open. Check K1, K3, K5, K55, U19, and their associated logic circuits on the Ranging PCB. Check relay K2, K3, K7, K11, and their associated drivers on the Power Amp. If the fault is not located in the relays, check the Power Amp using the applicable table. Repair as required, then resume at step 37.		
44	The control loop is closed. Check the \pm reference voltage from the PS Regulator and Analog Control PCBs. The positive reference is called for negative current and vice versa. Check the DAC, beginning with the procedure in step 23, followed by checks of K2 (open) and Q6 through Q9 (on). With +100 mA programmed -1 +0.01V dc should be present at the junction C14/15 (high) and TP12 (low). Repair as required, then resume at step 37.		
45	Program a calibrator output of +1.9A dc.		
46	Does the test DMM read 1.9A dc ± 2 mA?	48	47
47	The only difference for the high current operation is the use of R1 (A11) and the high current amp (U106, Q142, Q143, and associated components) on the Power Amp. Repair as required, then resume at step 45.		
48	Program a calibrator output of 10V ac at 1 kHz.		
49	Does the test DMM read 10V ac ± 10 mV at the output terminals?	70	50
50	Check the control loop by measuring the DC voltage between TP5 (high) and TP8 (low) on the Analog Control PCB with 10V ac output programmed.		
51	Does the test DMM read more than its floor but less than 10V dc?	52	59
52	Measure the calibrator output voltage and the voltage between TP2 (high) and TP8 (low) on the Ranging PCB.		

Table 4-15. Analog Circuitry Troubleshooting (cont)

STEP NO.	ACTION	Go to the step number given for correct response	
		YES	NO
53	Is the voltage at the test points one-tenth (1/10) that of the output terminals?	56	54
54	Check the relay operation on the Ranging PCB using the table on the schematic. Check U8, Q2, and their associated circuits. Repair as required.		
55	Is 10V ac ± 10 mV present at the output terminals?	70	56
56	With the DMM low at TP8 on the Analog Control PCB, check the rms voltage at pin 38 P51 and the DC voltage at TP12.		
57	Is the positive value at TP12 equal to the rms voltage?	59	58
58	Check the AC Converter and/or Integrator on the Analog Control PCB for the following voltages from TP8 to the points given: 0 ± 1 mV at U42-2, $+1 \pm 0.5$ V at U37-2, and U37-3, and 8 ± 1 V at U37-6. Check the integrator input stages at Q74 with its drive circuits. Repair as required.		
59	Is 10V ac ± 10 mV present at the output terminals?	70	60
60	Check between TP3 (high and TP4 (low) on the Oscillator PCB (A18) with an oscilloscope for a sine wave with no offset, and at the programmed frequency $\pm 3\%$.		
61	Is the oscillator output correct?	68	62
62	Is the DC voltage between TP2 (high) and TP4 (low) on the Oscillator PCB between 0 and -3 V?	65	63
63	Check, in sequence, the following items, checking with a DMM for 1.2 ± 0.1 V rms between TP3 (high) and TP4 (low) on the oscillator PCB after each item: Check relays of the Oscillator PCB using the chart on the schematic. Check op amps, U1 through U5 (0 ± 20 mV dc at pin 2), and their associated components. Check CR1 through CR4, VR1, and their associated components.		
64	Does the test DMM read 1.2 ± 0.1 V rms between TP3 (high) and TP4 (low) on the Oscillator PCB?	60	67
65	For frequency errors greater than 3%, check the FETs Q4 through Q11, and Q14 through Q21, and their drive logic. Repair as required.		
66	Does the frequency equal the 1 kHz ± 30 Hz entered in step 48?	60	67
67	Since arrival at this point is dependent upon all previous checks being correct, there is a possibility that some component was damaged during testing and the test should be restarted at step 1.		
68	Is 10V ac ± 10 mV present at the output terminals?	70	69
69	Perform the Power Amp test using the applicable table. Repair as required, then resume at step 48.		
70	Program a calibrator output of 10V ac at 50 kHz.		
71	Does the test DMM read 10V ac ± 20 mV at the Calibrator output terminals?	74	72
72	Is the frequency equal to 50 kHz ± 1.5 kHz?	73	60
73	For amplitude errors, restart at step 48, placing special emphasis on correct amplitude of test in steps 56 and 57, and in the DAC output of the power amp of P53. Repair as required, then resume at step 70.		
<p>CAUTION</p> <p>∇F and ∇R float on the PA output in the current ranges. Do not short to any other ground in the system, i.e., $\frac{1}{2}$ S or $\frac{1}{2}$ 1 during the current tests.</p>			

Table 4-15. Analog Circuitry Troubleshooting (cont)

STEP NO.	ACTION	Go to the step number given for correct response	
		YES	NO
74	Program a calibrator output of 100 mA ac at 400 Hz.		
75	At the calibrator output terminals, does the test DMM read 100.000 mA \pm 0.5 mA?	90	76
76	Remove the test DMM connected to the calibrator output terminals.		
77	Does the instrument display flash overload (O.L.) and return to STDBY after approximately 2 seconds?	78	79
78	Check the Power Amp Assembly using the applicable table, with special emphasis on the high voltage amp circuit. Repair as required, then resume at step 74.		
79	On the Ranging Assembly, check relays K1, K3, K5, K16, K55, and their associated circuitry. Check the AC voltage between TP2 (high) and TP8 (low) for an output proportional to the current at the output terminals, i.e., 1.05 \pm .002V ac should be at TP2 when 105 mA is at the output terminals. Repair as required.		
80	Is 100 \pm 0.5 mA ac now present at the output terminals?	90	81
81	On the Ranging Assembly check the AC buffer amp (U2), Q2, and their associated circuits and drivers. Repair as required.		
82	Is 100 \pm 0.5 mA ac now present at the output terminals?	90	83
83	On the Analog Control Assembly recheck the AC Converter and Integrator circuits using the procedure in step 56, 57, and 58. Repair as required.		
84	Is 100 \pm 0.5 mA ac now present at the output terminals?	90	85
85	Check the Power Amp Assembly using the applicable table with emphasis on the AC Current Mode. Repair as required.		
86	Is 100 \pm 0.5 mA ac now present at the output terminals?	90	87
87	Check the Oscillator Assembly using the procedure in steps 60 through 64.		
88	Is 100 \pm 0.5 mA ac now present at the output terminals?	90	89
89	Since arrival at this point is dependent upon all previous checks being correct, there is a possibility that some component was damaged during testing and the test should be restarted at step 1.		
90	Program a calibrator output of 1.9A ac at 400 Hz.		
91	Does the test DMM read 1.9A ac \pm 4 mA at the calibrator output terminals?	93	92
92	Check the Power Amp Assembly using the applicable table with emphasis on the high current amplifier. Repair as required, then resume at step 90.		
93	Disconnect the test DMM from the calibrator output terminals.		
94	With no load, does the Central Display briefly show O.L., then return to the reading present before the test DMM was removed, and does the calibrator drop in status to STDBY?	96	95
95	Check the Compliance Voltage Limiter and Detector circuit on the Analog Control Assembly. When the output terminal compliance voltage goes above 2.1V dc or peak AC, at 200 mA or higher, Q81 and Q82 should be conducting heavily to cause the high current amplifier on the Power Amp Assembly to go into current limit and signal the Controller an overload is present. Check the level detectors, U83 and U84, R84 through R87, which set the plus and minus "trip" voltages. Q88 and Q89 should be turned "on" for currents over 200 mA and "off" for currents under 200 mA. Repair as required and resume at step 93.		

Table 4-15. Analog Circuitry Troubleshooting (cont)

STEP NO.	ACTION	Go to the step number given for correct response	
		YES	NO
	WARNING DURING THE REMAINDER OF THE TEST, LETHAL VOLTAGES MAY BE PRESENT AT THE OUTPUT TERMINALS AND ON THE HIGH VOLTAGE OUTPUT ASSEMBLY A16.		
96	Program a calibrator output of 100V ac at 20 kHz and check at the output terminals for a DMM reading of $100 \pm 0.1V$ ac.		
97	Program a calibrator output of a 100V ac at 400 Hz and check at the output terminals for a DMM reading of $100 \pm 0.1V$ ac.		
98	Program a calibrator output of a 1000V ac at 400 Hz and check at the output terminals for a DMM reading of $1000 \pm 1V$ ac.		
99	Are all of the high voltage AC readings within tolerance?	101	100
100	Check the high voltage output (A16) with emphasis on T2 and K3, if the fault is only with the 20 kHz output, on T1 and K7, for 400 Hz faults, on K1 for 100V faults and on K2 for 1000V faults. If the problem cannot be located in the A16 Assembly, refer to the low voltage AC procedure beginning at step 48, since the high voltage is dependent upon a correct output from the low voltage circuits. Repair as required, then resume at step 96 or step 48 determined by the component replaced.		
101	Program a calibrator output of +100V dc and check the output terminals for a DMM reading of $+100 \pm 0.1V$ dc.		
102	Program a calibrator output of 1000V dc and check the output $+1000 \pm 1V$ dc.		
103	Are both dc voltage readings within their stated tolerances?	114	104
104	Program the calibrator for the first incorrect output.		
105	Is the output voltage greater than 20V dc?	112	106
106	Check the Ranging PCB (A11) for relay operation using the chart on the schematic. Begin with K56 and its drive logic.		
107	Is the programmed output present at the output terminals?	101	108
108	Check the waveform at TP11 of the Oscillator Assembly (A18).		
109	Is the waveform as depicted? (See Oscillator Waveforms in Section 8).	110	113
110	Check the Power Amp Assembly (A17) using the applicable table with emphasis on the connections and the high voltage amplifier. Repair as required.		
111	Is the programmed output present at the output terminals?	101	112
112	Check the High Voltage Output Assembly (A16) with emphasis on the high voltage DC path (CR1 through CR4, K5, K6, R35, through R39, U1, and associated components) and T1. Repair as required, then resume at step 101.		
113	Check the Oscillator Assembly (A18) using the procedure in steps 59 through 65. Repair as required, then resume at step 101.		
114	Troubleshooting of the analog circuits is complete.		

Table 4-16. Power Supply Regulator Troubleshooting

STEP NO.	ACTION	Go to the step number given for correct response	
		YES	NO
	<p style="text-align: center;"><i>NOTE</i></p> <p><i>The test can be performed, if desired, without placing the PCB on an extender, since all test points and adjustments on the Power Supply Regulator Assembly (A9) are accessible. However, to continue the test when a reading is out of tolerance, remove power from the instrument, wait at least 30 seconds, remove the PCB, return the PCB to the instrument on an extender PCB and reapply power. The first supply checked is the +15V(s) dc which is used as a reference for the -15V(s), ±62V, and ±30V supplies. The -15V references the -30V and -62V supplies, but since it is regulated by the +15V supply, that supply effectively references them all and if it is out of tolerance all others will be also. It should also be noted the -15V(s) is logic high (LH) and -20V(s) is logic common (LC) providing +5V logic for some circuits. If any supply reads out of tolerance check for ripple with an oscilloscope as the first step in troubleshooting. Typical ripple values for the power supply regulator voltages are given at the end of the table. The common connection between ($\frac{1}{2}$ S) and ($\frac{1}{2}$ 1) is on the Ranging Assembly and if it is removed, a substitute connection must be made by connecting a jumper between TP13, and TP6.</i></p>		
1	With power removed from the instrument, remove the top and inner covers, then verify the correct placement of the line voltage selection switches and fuse valve.		
2	Reconnect the line cord and depress the POWER switch.		
3	Does the blower (fan) rotate?	5	4
4	Check the power source, line cord, line fuse, POWER switch, and line voltage selection switches. Repair as required and resume the test at step 2.		
5	Connect the test DVM, prepared for approximately +15V dc, between TP14 (high) and TP13 (low).		
6	Can the voltage be adjusted with R6 to between +14.99 and +15.01?	16	7
7	Is the reading more than +15.01?	8	9
8	Check Q2, U7, and their associated components. Repair as required, then resume the test at step 5.		
9	Transfer the voltmeter high input lead to the collector (center pin) of Q2.		
10	Is the reading greater than 17V?	12	11
11	Check the filtered DC V across C3 on the Aft Transformer Board (A8A2), the Bridge Rectifier (CR2), and the card-edge connectors on the Power Supply Motherboard. Repair as required, then resume at step 5.		
12	With the test DVM measure the voltage drops across R4 (1 ohm) on the P.S. Regulator.		
13	Is the reading greater than 0.65V?	15	14

Table 4-16. Power Supply Regulator Troubleshooting (cont)

STEP NO.	ACTION	Go to the step number given for correct response	
		YES	NO
14	Check Q2, U7, and their associated components. Repair as required, then resume at step 5.		
15	An excessive voltage drop is an indication of current limiting. Check CR14 and C13. If the trouble is not isolated, perform the subroutine beginning at step 154, then resume the test at step 5.		
16	Connect the test DVM, prepared for approximately -15V dc, between TP12 (high) and TP13 (low).		
17	Is the reading between -14.85 and -15.15V dc?	27	18
18	Is the reading greater than -15.15V dc?	19	20
19	Check Q3, Q21, U8, and their associated components. Repair as required, then resume at step 16.		
20	Transfer the high input lead of the DVM to the collector (center pin) of Q3.		
21	Is the reading greater than -17V?	23	22
22	Check the filtered DC across C4 on the Aft Transformer Board (A8A2), the Bridge Rectifier, CR2, and the card-edge connectors on the P.S. Motherboard. Repair as required and resume the test at step 16.		
23	With the test DVM measure the voltage drop across R12 (1 ohm) on the P.S. Regulator.		
24	Is the reading greater than 0.65V?	26	25
25	Check Q21, Q3, Q4, U8, and their associated components. Repair as required, then resume at step 16.		
26	An excessive voltage drop is an indication of current limiting. Check CR15 and C12. If the trouble is not isolated there, perform the subroutine beginning at step 154, then resume the test at step 16.		
27	Connect the test DVM, prepared for approximately +62V dc, between Tp4 (high) and TP6 (low).		
28	Is the reading between +60.0 and +64.0V dc?	38	29
29	Is the reading greater than +64.0V dc?	30	31
30	Check Q5, Q6, Q8, U9, and their associated components. Repair as required, then resume the test at step 27.		
31	Transfer the high input lead of the DVM to the collector (center pin) of Q5.		
32	Is the reading greater than 69V dc?	34	33
33	Check the Bridge Rectifier, CR1, on the Aft Transformer Board (A8A2), the transformer output, and the card-edge connectors on the P.S. Motherboard. Repair as required and resume at step 27.		
34	With the test DVM, measure the voltage drop across R15 (1.1 ohm) on the P.S. Regulator.		
35	Is the reading greater than 0.65V?	37	36
36	Check Q8, Q6, Q5, Q7, U9, and their associated components. Repair as required, then resume at step 27.		
37	An excessive voltage drop is an indication of current limiting. Remove the Power Amp Assembly from the instrument and recheck the voltage drop to isolate the problem to an assembly. If the problem remains, check C18, CR3, and the +39V regulator. Repair as required, then resume the test at step 27.		
38	Connect the test DVM, prepared for approximately +39V dc, between TP3 (high) and TP6 (low).		
39	Is the reading between +37.5 and +40.5V dc?	49	40

Table 4-16. Power Supply Regulator Troubleshooting (cont)

STEP NO.	ACTION	Go to the step number given for correct response	
		YES	NO
40	Is the reading greater than +40.5V dc?	41	42
41	Check Q14, U12, and their associated components.		
42	Transfer the high input lead of the DVM to the collector (center pin) of Q14.		
43	Is the reading between +60 and +64V dc?	45	44
44	Return to step 27 and test the +62V dc power supply.		
45	With the test DVM measure the voltage drop across R32 (4.7 ohm) on the P.S. Regulator.		
46	Is the reading greater than 0.65V dc?	48	47
47	Check Q14, Q16, VR9, U12, and their associated components. Repair as required, then resume the test at step 38.		
48	An excessive voltage drop is an indication of current limiting. Remove the Power Amp Assembly from the instrument and recheck the voltage drop to isolate the problem to an assembly. If the problem remains, check C23 and CR9. Repair as required, then resume at step 38.		
49	Connect the test DVM, prepared for approximately -65V dc, between TP2 (high) and TP6 (low).		
50	Is the reading between -60 and -64V dc?	50	51
51	Is the reading greater than -64V dc?	52	53
52	Check Q9, Q11, Q12, U10, and their associated components. Repair as required, then resume the test at step 49.		
53	Transfer the high input lead of the DVM to the emitter of Q12.		
54	Is the reading greater than -69V dc?	56	55
55	Check the output of the Bridge Rectifier CR1 on the Aft Transformer Board (A8A2), the transformer output, and the card-edge connectors on the P.S. Motherboard. Repair as required, then resume at step 49.		
56	With the test DVM, measure the voltage drop across R25 (1.1 ohm).		
57	Is the reading greater than 0.65V?	59	58
58	Check Q9, Q10, Q11, Q12, VR8, U10, and their associated components. Repair as required, then resume at step 49.		
59	An excessive voltage drop is an indication of current limiting. Remove the Power Amp Assembly from the instrument and recheck the voltage drop to isolate the problem to an assembly. If the problem remains, check C19, CR25, and the -39V regulator. Repair as required, then resume the test at step 49.		
60	Connect the test DVM, prepared for approximately -39V dc, between TP5 (high) and TP6 (low).		
61	Is the reading between -37.5 and -40.5V dc?	71	62
62	Is the reading greater than -40.5V dc?	63	64
63	Check Q13, U13, and their associated components. Repair as required, then resume at step 60.		
64	Transfer the high input lead of the DVM to the collector of Q13.		
65	Is the reading between 60 and 64V dc?		
66	Return to step 49 and test the -62V dc.		
67	With the test DVM measure the voltage drop across R40 (4.7 ohm) on the P.S. Regulator.		
68	Is the reading greater than 0.65V?	69	70

Table 4-16. Power Supply Regulator Troubleshooting (cont)

STEP NO.	ACTION	Go to the step number given for correct response	
		YES	NO
69	Check Q13, Q17, VR10, U13, and their associated components. Repair as required, then resume the test at step 60.		
70	An excessive voltage drop is an indication of current limiting. Remove the Power Amp Assembly from the instrument and recheck the voltage drop to isolate the problem to an assembly. If the problem remains, check C26 and CR7. Repair as required, then resume the test at step 60.		
71	Connect the test DVM, prepared for approximately +5V dc, between TP12 (high) and TP1 (low).		
72	Can the reading be adjusted with R84 to between +4.9 and +5.3V dc?	85	73
73	Is the reading greater than +5.3V dc?	74	75
74	Check Q23, Q15, U11, and their associated components. Repair as required then resume at step 71.		
75	Transfer the high input lead of the DVM to the collector of Q15.		
76	Is the reading greater than +6.5V dc?	81	77
77	Transfer the high input lead of the DVM to the input side of fuse F-2.		
78	Is the reading greater than +6.5V dc?	79	80
79	Check F2 and the fuse holder. If the fuse is replaced and blows again, check Q15, Q23, U11, the triac Q20 and VR11 for an overload. Repair as required, then resume at step 71.		
80	Check the input from the rectifiers on the transformer board and the card-edge connectors on the P.S. Motherboard. Repair as required, then resume at step 71.		
81	With the test DVM measure the voltage drop across R31 (0.27 ohms).		
82	Is the reading greater than 0.65?	84	83
83	Check Q15, Q23, U11, and associated components. Repair as required then resume at step 71.		
84	An excessive voltage drop is an indication of current limiting. Check C63. If the trouble is not isolated there, perform the subroutine beginning at step 154, then resume the test at step 71.		
85	Connect the test DVM, prepared for approximately +5V dc, between TP17 (high) and TP18 (low).		
86	Can the reading be adjusted with R83 to between +4.9 and +5.3V dc?	99	87
87	Is the reading greater than +5.3V?	88	89
89	Transfer the high input lead of the DVM to the collector of Q1.		
90	Is the reading greater than +6.5V?	95	91
91	Transfer the high input lead of the DVM to the input side of the fuse F1.		
92	Is the reading greater than +6.5V?	93	94
93	Check F1 and the fuse holder. If the fuse is replaced and blows again, check Q1, Q22, U3, traic U19, and VR1 for an overload. Repair as required, then resume at step 85.		
94	Check the input from the rectifiers on the Aft Transformer Board (A8A2), and the card-edge connectors on the P.S. Motherboard. Repair as required, then resume at step 85.		
95	With the test DVM measure the voltage drop across R3 (0.27 ohms).		
96	Is the reading greater than 0.65V?	98	97
97	Check Q1, Q22, U3, and their associated components. Repair as required then resume at step 85.		
98	An excessive voltage drop is an indication of current limiting. Check the PCBs using the +5 Digital Bus for the path of excessive current. Repair as required, then resume at step 85.		

Table 4-16. Power Supply Regulator Troubleshooting (cont)

STEP NO.	ACTION	Go to the step number given for correct response	
		YES	NO
99	Connect the test DVM, prepared for approximately +12V dc, between TP16 (high) and TP18 (low).		
100	Is the reading between +11.25 and +12.75V dc?	108	101
101	Is the reading greater than +12.75V?	102	103
102	Check U1 and its associated components. Repair as required, then resume at step 99.		
103	Transfer the high input lead of the DVM to U1-1.		
104	Is the reading greater than +14V?	105	107
105	Is the case of the regulator U1 excessively warm to the touch?	106	107
106	Check C1 and CR10. Check the PCBs using the +12 (Vdd) on the Digital Bus for current limiting. Repair as required, then resume at step 99.		
107	Check the input from the rectifier on the Aft Transformer Board (ABA2), and the card-edge connectors on the P.S. Motherboard. Repair as required, then resume at step 99.		
108	Connect the test DVM, prepared for approximately -12V dc, between TP15 (high) and TP18 (low).		
109	Is the reading between -11.25 and -12.75V dc?	117	110
110	Is the reading greater than -12.75V?	111	112
111	Check U2 and its associated components. Repair as required then resume at step 108.		
112	Transfer the high input lead of the DVM to U2-3.		
113	Is the reading greater than -14V?	114	116
114	Is the case of the regulator U2 excessively warm to the touch?	115	116
115	Check C2 and CR11. Check the PCBs using the -12V (VGG) on the Digital Bus for current limiting. Repair as required, then resume at step 108.		
116	Check the input from the rectifier on the Aft Transformer Board (ABA2), and the card-edge connectors on the P.S. Motherboard. Repair as required, then resume at step 108.		
117	Connect the test DVM, prepared for approximately +5V dc, between TP8 (high) and TP9 (low).		
118	Is the reading between +4.75 and +5.25V dc?	126	119
119	Is the reading greater than +5.25V?	120	121
120	Check U4 and its associated components. Repair as required then resume at step 117.		
121	Transfer the high input lead of the DVM to U4-1.		
122	Is the reading greater than +7V?	123	125
123	Is the case of the regulator U4 excessively warm to the touch?	124	125
124	Check C4 and the PCBs using the +5V (FH) on the Digital Bus for current limiting. Repair as required, then resume at the step 117.		
125	Check the input from the rectifier on the Aft Transformer Board (ABA2), and the card-edge connector on the P.S. Motherboard. Repair as required, then resume at step 117.		
126	Connect the test DVM, prepared for approximately +15V, between TP11 (high) and TP10 (low).		
127	Is the reading between +14.25 and +15.75V?	135	128
128	Is the reading greater than +15.75V?	129	130
129	Check U5 and its associated components. Repair as required, then resume at step 126.		

Table 4-16. Power Supply Regulator Troubleshooting (cont)

STEP NO.	ACTION	Go to the step number given for correct response	
		YES	NO
130	Transfer the high input lead of the DVM to U5-1.		
131	Is the reading greater than +17V?	132	134
132	Is the case of the regulator U5 excessively warm to the touch?	133	134
133	Check C5 and CR12. Check the PCBs using the +15V (F) on the Digital Bus for current limiting. Repair as required, then resume at step 126.		
134	Check the input from the rectifiers on the Aft Transformer Board (A8A2), and the card-edge connector on the P.S. Motherboard. Repair as required, then resume at step 126.		
135	Connect the test DVM, prepared for approximately -15V, between TP7 (high) and TP10 (low).		
136	Is the reading between -14.25 and -15.75V dc?	144	137
137	Is the reading greater than -15.75V?	138	139
138	Check U6 and its associated components. Repair as required, then resume at step 135.		
139	Transfer the high input lead of the DVM to U6-3.		
140	Is the reading greater than -17V?	141	143
141	Is the case of the regulator U6 excessively warm to the touch?	142	143
142	Check C6 and CR13. Check the PCBs using the -15V (F) on the Digital Bus for current limiting. Repair as required, then resume at step 135.		
143	Check the input from the rectifiers on the Aft Transformer Board (A8A2), and the card-edge connectors on the P.S. Motherboard. Repair as required, then resume at step 135.		
144	Connect a scope prepared for a 60 Hz 5V square wave to U16-3 (high) and U16-1 (low).		
145	Is the scope amplitude between 4 and 5V and the period between 15.7 and 17.7 msec?	146	147
146	Check U16 and its associated components. Repair as required, then resume at step 144.		
147	Prepare a scope for triggered sweep, 50 ms per division, and 2V per division vertical sensitivity.		
148	Connect the scope between TP1 (low) and the junction point of the collector of Q18 and the bottom of R48 (high).		
149	Turn the calibrator POWER switch ON and OFF several times while observing the scope display.		
150	Does the display match either waveform 1 or 2 below?	158	151
	<p>WAVEFORM 1 </p> <p>WAVEFORM 2 </p> <p>WAVEFORM 3 </p>		

Table 4-17. Power Amp Troubleshooting

STEP NO.	ACTION	Go to the step number given for correct response	
		YES	NO
	<i>NOTE</i> <i>All test points listed in this table are on the Power Amplifier Assembly (A17).</i>		
1	Remove power from the instrument, wait at least 30 seconds, then remove the PCB assembly from the instrument. Install the assembly in an extender PCB and install the combination in the instrument.		
2	Use the test DVM to check the input voltages to the Power Amplifier. The first test point listed is for the high input lead. If any voltages are out of tolerance, perform the test on the Power Supply Regulator. +15 \pm 0.05V dc between TP11 and TP23 -15 \pm 0.2V dc between TP12 and TP23 +39 \pm 1.5V dc between TP2 and TP23 -39 \pm 1.5V dc between TP5 and TP23 -20 \pm 0.25V dc between TP14 and TP23 +62 \pm 2.0V dc between TP7 and TP22 -62 \pm 2.0V dc between TP10 and TP22 -12 \pm 0.75V dc between TP20 and TP22 +12 \pm 0.75V dc between TP17 and TP22 +15 \pm 0.75V dc between TP30 and TP29 -15 \pm 0.75V dc between TP31 and TP29		
3	With the calibrator in STDBY, ground the HF Amp input by connecting a jumper between TP27 and TP23. Connect the test DVM between TP4 (high) and TP23 (low).		
4	Is the voltmeter reading 0 +0.1V dc?		
4A	Remove jumper from TP23 and TP27.	4A	5
5	A large output from the High Frequency Amplifier with the input grounded is an indication of problems within the amplifier. Trace the signal through the circuit until the source is found. Repair as required, then resume at step 3.		
6	With the DVM remaining connected between TP4 (high) and TP23 (low), and prepared for approximately 10V dc, program a calibrator output of +10.0V dc.		
7	Is the voltmeter reading between 9.9 and 10.1V dc?	38	8
8	Is the reading greater than 10.1V dc?	13	9
9	Transfer the DVM leads to TP24 (high) and TP29 (low).		
10	Is the reading greater than 10V dc?	11	12
11	Check the Isolation Amplifier circuitry, beginning with K3 and its logic circuits. Repair as required, then resume at step 6.		
12	Perform tests on assemblies external to the Power Amp, beginning with the Analog Control and the Ranging PCBs. Repair as required, then return to the Power Amp test at step 6.		
13	Transfer the DVM high input lead to TP21.		
14	Is the DVM reading greater than 10V?	16	15
15	Check the relays K7 and K8 for continuity, and relay K11 with its logic circuits. Repairs as required, then resume at step 6.		
16	Transfer the DVM high input lead to TP24.		

Table 4-17. Power Amp Troubleshooting (cont)

STEP NO.	ACTION	Go to the step number given for correct response	
		YES	NO
17	Is the DVM reading greater than +10V dc?	18	19
18	The Isolation Amplifier is responding correctly to the stimulus. Perform test on assemblies external to the Power Amp, beginning with the Analog Control and Ranging Assembly. Repair as required, then return to the Power Amp test at step 6.		
19	Is the DVM reading greater than -10V?	20	21
20	A negative control signal is an indication that the control loop is attempting to reduce the excessive output. Check the Isolation Amplifier circuit using standard signal tracing procedures. Repair as required, then resume at step 6.		
21	A low control voltage is an indication of trouble within another assembly. Perform tests on assemblies external to the Power Amp, beginning with Ranging and the Analog Control. Repair as required, then return to the Power Amp test at step 6.		
22	Set the calibrator to Standby. Attach probes to TP29 and TP41.		
23	Adjust R17 from CCW to CW. The voltage should swing from -4 to -10V dc.	25	24
24	Examine U113, U114, and related circuitry.		
25	Check TP40 and U112-10 for voltage and frequency.		
26	Is the voltage displaying a 0 through 15V symmetrical square wave?	27	28
27	Is the frequency 3.3 kHz?	29	28
28	Examine U112 and related circuitry.		
29	Verify oscillator input at connector pin P81-37.		
30	Call 2V at 1 kHz.		
31	Does TP41 read -6V?	32	37
32	Does TP24 read 0V?	33	37
33	Is the voltmeter reading approximately 1.2V ac?	35	34
34	Check K4 contacts, coil, and logic circuits. Repair as required, then resume at step 25.		
35	Does the cathode of VR113 read 22V?	38	36
36	Examine VR113 and related circuit or the 40V power supply.		
37	Check the High Frequency Isolation Amplifier to isolate the faulty components using normal signal tracing techniques. The Isolation Amplifier includes U111, U112, U113, U114, Q104, Q105, and related circuitry. Repair as required, then return to step 25.		
38	Prepare test DVM to read approximately 25V ac, then connect it between TP9 (high) and TP23 (low).		

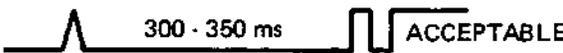
Table 4-17. Power Amp Troubleshooting (cont)

STEP NO.	ACTION	Go to the step number given for correct response	
		YES	NO
39	Program the calibrator for an output of 20V ac 400 Hz.		
40	Is the DVM reading between 3.0 and 4.0V ac?	50	41
41	Is the DVM reading greater than 4V ac?	42	46
42	Transfer the DVM high input lead to TP21.		
43	Is the DVM reading still greater than 4V ac?	45	44
44	Check the K7A relay contacts and the associated circuitry. Repair as required, then resume at step 38.		
45	Perform tests on assemblies external to the Power Amp, beginning with the High Voltage and Ranging Assemblies and the signal path connecting those assemblies to the Power Amp. Repair as required, then return to the Power Amp test at step 38.		
46	Change the DVM settings to read a low DC voltage.		
47	Is the DVM reading greater than $0 \pm 0.2V$ dc?	48	49
48	Check the Low Frequency Amplifier, its input/output signals and the signal path through the circuit. Repair as required, then resume at step 38.		
49	Check the signal path for the High Frequency Amplifier output (TP4) through relays K7 and K8. Repair as required, then resume at step 38.		
50	Connect a test DVM, prepared to read approximately 15V ac, between TP4 (high) and TP23 (low). Connect a shorting link across the output terminals and program an output of 199 mA at 400 Hz.		
51	Is the DVM reading between 8 and 10V ac?	55	52
52	Is the DVM reading greater than 15V ac?	53	54
53	Check for an excessive voltage drop in the contacts of K7 and the card-edge connectors. Repair as required, then resume at step 50.		
54	Check relays K2, K5, and their logic circuits. Repair as required, then resume at step 50.		
55	Transfer the DVM high input lead to TP19. Then, with the output terminals still shorted, program an output of 1.99A at 400 Hz.		
56	Is the DVM reading between 1.5 and 3.5V ac?		
57	Is the DVM reading greater than 3.5V ac?		
58	Check for an excess voltage drop in the contacts of K7A and K8B, or in the card-edge connectors for the Power Amp and Ranging Assemblies. Repair as required, then resume at step 55.		
59	Check the High Current Amplifier (normal reading at TP4 w/1.99A programmed would be $11.5 \pm 1V$ ac). Trace the signal path through K7B, K8A, and the op amp U106. Repair as required, then resume at step 55.		
60	Connect a 10Ω resistor across the calibrator output terminals. Connect the test DVM, prepared for approximately 2V ac, between PAFB at J81-35 (high) and TP23 (low). Program an output of 199 mA at 400 Hz.		
61	Is the DVM reading between 1.98 and 2.00V ac?	63	62
62	Check the I-Guard Driver op amp (U1) and its associated components on the Ranging Assembly. Repair as required, then resume at step 60.		
63	Transfer the DVM high input lead to U105-6.		
64	Is the DVM reading between 1.98 and 2.00V ac?	66	65
65	Check the op amp U105 and its associated components. Repair as required then resume at step 63.		

Table 4-17. Power Amp Troubleshooting (cont)

STEP NO.	ACTION	Go to the step number given for correct response													
		YES	NO												
66	<p>The test of the Power Amplifier Assembly is complete.</p> <p style="text-align: center;"><i>NOTE</i></p> <p style="text-align: center;"><i>The four separate amplifiers on the Power Amp are checked using portions of the procedure above. If the problem has been isolated to a single amplifier the applicable steps are given below. If a test is made on only one amplifier, insure that all voltages are present, correct, and all prior equipment procedures have been previously performed.</i></p> <table border="0" style="width: 100%;"> <thead> <tr> <th style="text-align: left;">POWER AMP SECTION</th> <th style="text-align: left;">PROCEDURE STEPS</th> <th style="text-align: left;">FAILURE MODE</th> </tr> </thead> <tbody> <tr> <td>Isolation & H.F. Amps</td> <td>3-32</td> <td>DC V <20V AC & DC I <20 mA AC V <110V, 20 kHz AC V <20V, 50 kHz</td> </tr> <tr> <td>L.F. Amp</td> <td>33-50, 56-62</td> <td>AC V > 20V <1 kHz DC V >20V AC & DC I <200 mA</td> </tr> <tr> <td>High Current Amp (Incl. I-Guard on Ranging)</td> <td>51-62</td> <td>AC & DC I >200 mA</td> </tr> </tbody> </table>	POWER AMP SECTION	PROCEDURE STEPS	FAILURE MODE	Isolation & H.F. Amps	3-32	DC V <20V AC & DC I <20 mA AC V <110V, 20 kHz AC V <20V, 50 kHz	L.F. Amp	33-50, 56-62	AC V > 20V <1 kHz DC V >20V AC & DC I <200 mA	High Current Amp (Incl. I-Guard on Ranging)	51-62	AC & DC I >200 mA		
POWER AMP SECTION	PROCEDURE STEPS	FAILURE MODE													
Isolation & H.F. Amps	3-32	DC V <20V AC & DC I <20 mA AC V <110V, 20 kHz AC V <20V, 50 kHz													
L.F. Amp	33-50, 56-62	AC V > 20V <1 kHz DC V >20V AC & DC I <200 mA													
High Current Amp (Incl. I-Guard on Ranging)	51-62	AC & DC I >200 mA													

Table 4-18. Extended High Voltage Troubleshooting

STEP NO.	ACTION	Go to the step number given for correct response	
		YES	NO
	WARNING VOLTAGE UP TO 1600V MAY BE PRESENT ON THIS ASSEMBLY. PLACE THE 5100 SERIES B CALIBRATOR IN STDBY BEFORE ATTACHING OR TRANSFERRING TEST LEADS. <i>NOTE</i> <i>All test points in this table are on the High Voltage Output Assembly (A16).</i>		
1	Remove power from the instrument, wait at least 30 seconds, then remove the PCB assembly from the instrument. Remove the Control PCB from its mounting spacers and remount it on the transformer brackets so that it is at a 90° angle from its normal position. Install the assembly on an extender PCB and reinstall it in the equipment, insuring that the High Voltage Transformer has support and is not suspended in space.		
2	Connect the high input of a test voltmeter, prepared for AC volts, to the high terminal of P73 and the low input to TP10.		
3	Apply power to the instrument and program an output of 20V ac at 2 kHz.		
4	Voltmeter reads between 19.5 and 20.5V ac?	11	5
5	Voltmeter reads approximately zero?	6	10
6	Select STDBY, transfer the high lead to TP5 and select OPR.		
7	Voltmeter reading 3.5V or greater?	8	9
8	Check the relays K3 and K7, and their logic circuits. Repair as required, then resume at step 2.		
9	Check the connectors and the input from the Power Amplifier. Repair as required, then resume at step 2.		
10	For a non-zero, but out of tolerance reading, check the Ranging Assembly and/or Power Amplifier Assembly. When complete, resume the test at step 2.		
11	Program an output of 20V ac at 400 Hz. The high test lead is at P73.		
12	Voltmeter reads between 19.5 and 20.5V ac?	19	13
13	Voltmeter reads approximately zero?	14	18
14	Select STDBY, transfer the high lead to TP5, and select OPR.		
15	Voltmeter reads 2.8V ac or greater?	16	17
16	Check relays K1, K4, K7, and their logic circuits. Repair as required, then resume step 11.		
17	Check the connectors and the input from the Power Amplifier. Repair as required, then resume at step 11.		
18	For a non-zero but out of tolerance reading, check the Ranging Assembly and/or Power Amplifier Assembly. When complete, resume the test at step 11.		
19	With the high test lead at P73 HIGH and the test voltmeter prepared for DC volts, program an output of +20V dc.		
20	Voltmeter reads between 19.5 and 20.5V dc?	26	21
21	Voltmeter reads approximately zero?	22	26
22	Select STDBY, transfer the high lead to TP3, then select OPR.		

Table 4-18. Extended High Voltage Troubleshooting (cont)

STEP NO.	ACTION	Go to the step number given for correct response	
		YES	NO
23	Voltmeter reads between 18 and 22V dc?	24	25
24	Check relays K6, K7, and their logic circuits. Repair as required, then resume at step 19.		
25	Check the normally closed contacts of K4 and K5 and its logic circuit, rectifier CR1 through CR4, and the input from the Power Amplifier. Repair as required, then resume at step 19.		
26	With the high test lead at P73 HIGH, program an output of +300V dc.		
27	Voltmeter reads between 299.5 and 300.5V dc?	34	28
28	Voltmeter reads approximately zero?	29	33
29	Select STDBY, transfer the high lead to TP5 then select OPR.		
30	Voltmeter reads 9V or greater?	31	32
31	Check the relays K2, K6, K7, and their control logic, rectifier CR1 through CR4, and U1 with its associated circuitry. Repair as required, then resume at step 26.		
32	Check continuity and the input from the Power Amplifier. Repair as required, then resume at step 26.		
33	For a non-zero but out of tolerance reading, check the Ranging Assembly and/or Power Amplifier Assembly. When complete, resume the test at step 26.		
34	With the high test lead at P73 HIGH, program an output of +1100V dc.		
35	Voltmeter reads between 1099.5 and 1100.5V dc?	39	36
36	Does the Central Display flash overload (O.L.) and/or the calibrator return to standby?	37	38
37	Perform the Power Amplifier zero adjustment calibrator procedure. Repair as required, then resume the test at step 34.		
38	Check at TP5 with an oscilloscope (low to TP10) for a symmetric rounded square wave with an amplitude of approximately 35 volts. Check the Power Amp Assembly for low amplitude or an unsymmetrical waveform. Repair as required, then resume at step 34.		
39	With the voltmeter high test lead at P73 HIGH, program an output of 300V dc.		
40	Voltmeter reads between -299.5 and 300.5V dc?	42	41
41	Check relay K5, its logic circuit, the rectifier, and filter circuits. Repair as required, then resume at step 39.		
42	Connect a 2k ohm resistor to the output terminals of the calibrator. Connect an oscilloscope across the resistor.		
43	Program an output of +20V dc. With AC coupling selected, adjust the scope to display the ripple waveform.		
44	Is the displayed ripple waveform less than 30 mV peak-to-peak?	46	45
45	Check the filter circuit U1 and its associated circuitry. Repair as required, then resume the test at step 42.		
46	The test of the High Voltage Assembly is complete.		

Table 4-19. Controller Troubleshooting

STEP NO.	ACTION	Go to the step number given for correct response	
		YES	NO
	<p style="text-align: center;"><i>NOTE</i></p> <p><i>Due to the speed and complexity of the Controller, it is recommended that, when a problem is isolated to the Controller, the unit be sent to the nearest Service Center for repair. The following information will assist in verifying Controller operation. Many problems require the use of an in-circuit tester.</i></p> <p>Troubleshoot the Controller with only the Controller, Front Panel, and Power Supply installed. The most common symptom of Controller failure is a blank display. Other symptoms include an improper display, a failure to read switches or respond to external interrupts, or an initialization display ("CXXXXXX") improperly indication all optional modules present. The following checks verify basic Controller operation:</p> <ol style="list-style-type: none"> 1. Check power supply voltages at the Controller. Test Points are located on the circuit board top edge and are identified on the inside of the hinged module top. <p>Test DMM LO: TP1 (VSS)</p> <p>Test DMM HI: TP3 (VCC +5V) TP5 (VBB -5V) TP6 (VDD +12V)</p> <p>If any of these voltages are more than 5% out of tolerance, proceed to "Power Supply Troubleshooting" in this section.</p> 2. If the power supply checks good, verify the presence of the following signals in sequence. If a signal is present go on to the next check. If a signal is not present, the Controller may be faulty. Although probable fault causing components or circuits may be mentioned, the Controller will probably require repair at a Service Center. <p>SYNC pulse at TP7</p> <p>If not SYNC pulse, check O1 at U15-22; O2 at U15-15. (Test failure suggests U19.)</p> <p>RESET signal at U10-2 on power-up; check for 0.1 sec low-going pulse. (Test failure suggests reset circuit.)</p> <p>CPUNIT at TP4</p> <p>DLDAK at TP2</p> 		

Table 4-20. Isolator Troubleshooting

STEP NO.	ACTION	Go to the step number given for correct response	
		YES	NO
1	When power is applied does the display illuminate?	3	2
2	Check the address and data line inputs to the shift register. Repair as required, then resume at step 1.		
3	Does the display read "Err6"?	4	5
4	Check the address lines (IC0-IC6) through the input gates and unguarded shift register, the isolation transformer, and the guarded shift register and output gates. Check the ACK signal path through the assembly. Repair as required, then resume at step 1.		
5	Program various types of outputs and check the instrument output terminals after each programmed output for the correct value.		
6	Is the display of the programmed output correct and variable?	8	7
7	Check the data return (ID7), the applicable isolation transformer and the output latch and gates.		
8	Does the output match the programmed display?	10	9
9	Check the data lines (ID0-ID7) through the input gates and unguarded shift register, the isolation transformer, and the guarded shift register and output gates. Repair as required, then resume at step 5.		
10	Troubleshooting of the Isolator Assembly is complete.		

Table 4-21. Tape Interface Troubleshooting

STEP NO.	ACTION	Go to the step number given for correct response	
		YES	NO
	<i>NOTE</i> <i>During this procedure, the assumption is made that the Static Controller Assembly is operating correctly.</i>		
1	Remove power from the instrument, wait at least 30 seconds, then remove the instrument covers and guards. Mechanically detach and slide forward the Front Panel, using the applicable procedure in Section 4, to gain access to the component side of the Tape Interface Assembly (A8). Lay the Front Panel face down on the work area, leaving the ribbon cables connected, then remove all other PCB assemblies from the instrument except for the Tape Interface, Tape Drive, and Power Supply Regulator.		
2	Insert the Static Controller into the card-edge connector, from which the Controller was removed.		
3	Apply power to the instrument.		
4	Check between TP4 (HI) and TP1 (LO) with a test DVM.		
5	Is the voltage present between 4.75 and 5.25V dc?	7	6
6	Check the Power Supply Regulator using the applicable troubleshooting table and the cables connecting the Tape Interface Assembly to the Power Supply Regulator. Repair as required, then, resume at step 4.		
7	Place all switches on the Static Controller in the down position.		
8	Are any of the Static Controller LEDs illuminated?	9	10
9	Check the circuitry dealing with indicator illuminated (i.e., INT, ACK, ID0-7). Repair as required, then resume at step 7.		
10	Insure the DATA IN switch is down, then place the CONTROL OUT switch in the up position.		
11	One at a time, put IC3, IC5, and IC6 switches up, and check that the ACK indicator illuminates when the third switch goes up. Ignore the ID indicators.		
12	Return all IC switches to down.		
13	One at a time, put IC1, IC5, and IC6 switches up, and check that the ACK indicator illuminates when the third switch goes up. Ignore the ID indicators.		
14	Return all IC switches to down.		
15	Select DATA OUT with the CONTROL OUT switch in the up position.		
16	One at a time, put IC0, IC5, and IC6 switches up and check that the ACK indicator illuminates when the third switch goes up.		
17	Return all IC switches to down.		
18	One at a time, put IC2, IC3, and IC6 switches up, and check that the ACK indicator illuminates when the third switch goes up.		
19	Does the ACK indicator illuminate after the third switch for all four tests?	21	20
20	If the indicator fails to illuminate, check the ACK circuit between U16-13 and the connector. If it illuminates for one or more test, check the applicable input to U16-13. Repair as required then resume at step 10.		
21	Place a previously prepared, not completely rewound, tape in the tape drive unit. Use a scratch tape so operation will not be affected if the contents of the tape are lost.		

Table 4-21. Tape Interface Troubleshooting (cont)

STEP NO.	ACTION	Go to the step number given for correct response	
		YES	NO
22	Does the tape stay stationary; not moving in either direction?	26	23
23	Is the MOTION CMD signal (P33-17 or U21-11) at logic high level?	25	24
24	Check the logic generating the MOTION CMD signal. Repair as required, then resume at step 21.		
25	Repair or replace the tape drive unit, then resume at step 21.		
26	Place the DATA OUT, IC0, IC5, and IC6 switches up and all other switches down.		
27	Monitor the MOTION CMD with a scope and check for a high logic level when the CONTROL OUT switch is placed up and then down.		
28	Repeat step 27 with ID switches, ID0, ID1, ID2, and ID3, set up in turn, and check for the logic level listed at MOTION CMD when CONTROL OUT is toggled. ID0 – High ID1 – High ID2 – Low ID3 – High		
29	Is the correct logic level present at MOTION CMD for all tests?	31	30
30	Check the MOTION CMD generation circuitry and the control gates. Repair as required, then resume at step 26.		
31	Check the FWD/RWND CMD with the ID switches None (all down), ID0, ID1, ID2, and ID3 set to the up position, in turn, and check for the logic level listed at FWD/RWND CMD when CONTROL OUT is toggled. None – Low ID0 – Low ID1 – High ID2 – Low ID3 – Low		
32	Is the correct logic level present at FWD/RWND CMD for all tests?	34	33
33	Check the FWD/RWND CMD generation circuitry and the control gates. Repair as required, then resume at step 31.		
34	Check the READ/WRITE signal with the ID switches None, ID0, ID1, ID2, and ID3, set to the up position, in turn, and check for the logic level listed at READ/WRITE when CONTROL OUT is toggled. None – Low ID0 – High ID1 – Low ID2 – Low ID3 – Low		
35	Is the correct logic level present at READ/WRITE for all tests?	37	36
36	Check the READ/WRITE generation circuitry and the control gates. Repair as required, then resume at step 34.		
37	Check the signal at U23-2 with the ID switches None, ID0, ID1, ID2, and ID3 set to the up position in turn, and check for logic level listed at U25-13 when CONTROL OUT is toggled.		

Table 4-21. Tape Interface Troubleshooting (cont)

STEP NO.	ACTION	Go to the step number given for correct response	
		YES	NO
	None – Low ID0 – Low ID1 – Low ID2 – Low ID3 – High		
38	Is the correct logic level present at U25-13 for all tests?	40	39
39	Check the inputs and output to U23. Repair as required, then resume at step 37.		
40	Select the DATA IN Mode with switches CONTROL OUT, IC1, IC5, and IC6 up and all remaining switches down.		
41	Monitor the ID4 indicator (ignore other indicators) while inserting and removing a fully rewound tape into the tape drive unit.		
42	Does ID4 indicator illuminate and extinguish as the tape is inserted and removed?	44	43
43	Check the TAPE POSITION signal (P33-2) circuitry. Repair as required, then resume at step 44.		
44	Toggle the top-left sense switch on the face of the tape drive unit.		
45	Does the ID5 indicator toggle with the sense switch?	47	46
46	Check the WRITE INHIBIT signal (P33-18) circuitry. Repair as required, then resume at step 44.		
47	Toggle the top-right sense switch on the face of the tape drive unit.		
48	Does the ID6 indicator toggle with the sense switch?	50	49
49	Check the SIDE A/B signal (P33-25) circuitry. Repair as required, then resume at step 47.		
50	Toggle the center sense switch on the face of the tape drive unit.		
51	Does the ID7 indicator toggle with the sense switch?	53	52
52	Check the CASSETTE LOADED signal (P33-26) circuitry. Repair as required, then resume at step 51.		
53	Remove power from the instrument, wait at least 30 seconds then disconnect P33 from the tape drive unit. When completed, reapply power to the instrument.		
54	Place switches IC0, IC5, IC6, ID0, ID1, ID3, and DATA OUT in the up position with all other switches down. Toggle the CONTROL OUT switch up then down, disregarding the indicators. This step prepares the interface.		
55	Place switches IC3, IC5, IC6, and CONTROL OUT up and all others down.		
56	Is the ACK indicator illuminated and the INT indicator extinguished? Disregard the ID indicators.	58	57
57	Check the bus line and driving signal of the incorrect indicator. Repair as required, then resume at step 55.		
58	Place all switches down, then place IC2, IC3, IC6, and DATA OUT switches in the up position.		
59	Place the CONTROL OUT switch up, then down.		
60	Does the INT indicator illuminate?	66	61
61	Is there a low logic level at U2-5?	65	62
62	Is there a low logic level at U26-1?	64	63
63	Check the write circuitry (refer to the Theory of Operation). Repair as required, then resume at step 55.		

Table 4-21. Tape Interface Troubleshooting (cont)

STEP NO.	ACTION	Go to the step number given for correct response	
		YES	NO
64	Check the circuitry controlling the signal at U27-10. Repair as required, then resume at step 55.		
65	Check the INT signal and its control logic. Repair as required, then resume at step 55.		
66	Connect with a jumper pins 5 and 19 of P33. Place switches IC3, IC5, and IC6 up and all others down.		
67	Place the CONTROL OUT switch up.		
68	Is the INT indicator extinguished?	70	69
69	Check the bus line and the logic signal controlling the INT line. Repair as required, then resume at step 67.		
70	Place all switches down, then place the DATA OUT, ID0, ID3, IC0, IC5, and IC6 in the up position.		
71	Toggle the CONTROL OUT switch up, then down (this step prepares the instrument for the next test).		
72	Place switches IC2, IC3, IC6, ID1, ID3, ID5, and ID7 up and all other switches down.		
73	Toggle the CONTROL OUT switch up then down.		
74	Does the INT indicator illuminate?	76	75
75	Check the bus line and the logic signal controlling the INT line. Repair as required, the resume at step 55.		
76	Is a low logic level present at U27-6?	79	77
77	Is a low logic level present at U26-13?	64	78
78	Check the read circuitry (refer to the Theory of Operation). Repair as required, then resume at step 55.		
79	Toggle the DATA IN switch up and down, then place the INA switch in the up position.		
80	Do the INT, ACK, and ID1 indicators illuminate?	82	81
81	Check the interrupt circuitry (refer to the Theory of Operation). Repair as required, then resume at step 55.		
82	Place all switches down, then place IC3, IC5, and IC6 in the up position.		
83	Place the CONTROL OUT switch in the up position.		
84	Do indicators ID1, ID3, ID5, and ID7 illuminate and ID0, ID2, ID4, and ID6 remain extinguished?	85	78
85	Is the INT indicator extinguished?	86	81
86	Is the ACK indicator extinguished?	87	88
87	Check acknowledge circuitry (refer to the Theory of Operation). Repair as required, then resume at step 55.		
88	Place the CONTROL OUT switch down.		
89	Remove power from the instrument, disconnect the jumper from P33 and reconnect P33 to the tape drive unit.		
90	Troubleshooting of the Tape Interface Assembly is complete.		

Table 4-22. Tape Drive Assembly Troubleshooting

STEP NO.	ACTION	Go to the step number given for correct response	
		YES	NO
	NOTE		
	<i>During this procedure, the assumption is made that the Tape Interface Assembly is operating correctly.</i>		
1	Remove power from the instrument, wait at least 30 seconds, then remove the instrument cover and guards. Mechanically detach and slide forward the Front Panel, using the applicable procedure in Section 4, to gain access to the Tape Drive. Remove the cable from the upper edge of the Tape Drive. Lower the dust cover on the Front Panel and remove the four mounting screws. Remove the Tape Drive and place on top of the unit. Reconnect the cable. Be sure the bottom of the board is insulated from any metal. Remove all other PCAs from the instrument except for the Tape Interface and Power Supply Regulator.		
2	Apply power to the instrument.		
3	Check +5 and GND with a test DVM.		
4	Is the voltage present between 4.75 and 5.25V dc?	6	5
5	Check the Power Supply Regulator using the applicable troubleshooting table. Repair as required, resume at step 4.		
6	Check MOTV and MOTR with a DVM.		
7	Is the voltage present between 4.75 and 5.25V dc?	9	8
8	Check the Power Supply Regulator using the applicable troubleshooting table. Repair as required, then resume at step 7.		
9	Place a previously prepared, not completely rewound, tape in the tape drive unit. Use a scratch tape so operation will not be affected if the contents of the tape are lost.		
10	Press ENABLE, TAPE, ADVANCE/LOAD.		
11	The tape should rewind, stop at the BOT and go forward.		
12	Does the tape rewind?	14	13
13	Verify the logic levels of U2 and U7 and output levels of U7. Repair as needed. Resume at step 10.		
14	Does the tape go forward?	16	15
15	Verify the logic levels of U2 and U7 and output levels of U7. Repair as needed. Resume at step 10.		
16	Verify the correct reading of the tape.	20	17
17	Recalibrate per TAPE DRIVE CONTROLLER TEST PROCEDURE.		
18	Verify the correct reading of the tape.	20	19
19	Examine waveform provided in the Theory of Operation, section 3-180. Repair as necessary. Resume at step 10.		
20	This completes the read cycle testing.		
21	Call 1V dc.		
22	Press ENABLE, STORE, and press ADVANCE/LOAD until the display reads FULL.		
23	Press TAPE, ADVANCE/LOAD. This stores the program on the tape.		

Table 4-22. Tape Drive Assembly Troubleshooting (cont)

STEP NO.	ACTION	Go to the step number given for correct response	
		YES	NO
24	Did the tape drive accept the program?	26	25
25	Check the logic levels of U4A, U6 and Q1. Repair as needed. Resume at step 22.		
26	This completes the maintenance testing.		

Section 5

List of Replaceable Parts

TABLE OF CONTENTS

ASSEMBLY NAME	DRAWING NO.	TABLE NO.	PAGE	FIGURE NO.	PAGE
5100B Final Assembly	5100B T&B	5-1	5-4	5-1	5-6
5101B Final Assembly	5101B T&B	5-2	5-13	5-2	5-15
5102B Final Assembly	5102B T&B	5-3	5-23	5-3	5-25
A1 Main Motherboard PCA.....	5100A-4001T	5-4	5-34	5-4	5-35
A2 MIS Motherboard PCA	5100A-4002T	5-5	5-36	5-5	5-37
A3 Power Supply Motherboard PCA.....	5100A-4003T	5-6	5-38	5-6	5-39
A4 Diagonal Bus PCA.....	5100A-4004	5-7	5-40	-	-
A5 Main Interconnect PCA.....	5100A-4005S	5-8	5-40	-	-
A6 MIS Interconnect PCA.....	5100A-4006S	5-9	5-40	-	-
A7 Power Supply Termination Assembly	5100A-6521	5-10	5-40	-	-
A7A1 Forward Transformer Termination PCA	5100A-4011S	5-11	5-41	5-7	5-42
A7A2 Aft Transformer Termination PCA	5100A-4012S	5-12	5-43	5-8	5-44
A8 Power Supply Interconnect PCA	5100A-4130S	5-13	5-45	-	-
(5100B & 5102B)					
A8 Tape Interface PCA (5101B).....	5101A-4030S	5-14	5-45	5-9	5-46
A9 Power Supply Regulator PCA.....	5100A-4010T	5-15	5-47	5-10	5-49
A10 Front Panel PCA (5100B & 5102B)....	5100A-4020T	5-16	5-50	5-11	5-51
A10 Front Panel PCA (5101B).....	5101A-4020T	5-17	5-52	5-12	5-53
A10A1 Display PCA.....	5100A-4021	5-18	5-54	5-13	5-55
A11 Ranging PCA	5100A-4040T	5-19	5-56	5-14	5-58
A14 Analog Control PCA	5100A-4050T	5-20	5-59	5-15	5-61
A15 Digital-to-Analog PCA.....	5100A-4060T	5-21	5-62	5-16	5-64
A16 Extended High Voltage PCA	5100A-4071T	5-22	5-65	5-17	5-66
A16A1 High Voltage Control PCA	5100A-4072S	5-23	5-67	5-18	5-68
A17 Power Amplifier PCA	5100A-4083T	5-24	5-69	5-19	5-72
A17A1 Power Transistor PCA.....	5100A-4180	5-25	5-73	5-20	5-74
A18 Oscillator PCA	5100A-4090T	5-26	5-75	5-21	5-76
A19 Isolator PCA	5100A-4181T	5-27	5-77	5-22	5-78
A20 Controller PCA.....	5101B-4187T	5-28	5-79	5-23	5-80
A21 Tape Drive PCA.....	5101B-4030T	5-29	5-81	5-24	5-82

5-1. INTRODUCTION

This section contains an illustrated list of replaceable parts for the 5100B, 5102B and 5200B. Parts are listed by assembly; alphabetized by reference designator. Each assembly is accompanied by an illustration showing the location of each part and its reference designator. The parts lists give the following information:

- Reference designator
- An indication if the part is subject to damage by static discharge
- Description
- Fluke stock number
- Manufacturers supply code (code-to-name list at the end of this section)
- Manufacturers part number or generic type
- Total quantity
- Any special notes (i.e., factory-selected part)

CAUTION

A ⚡ symbol indicates a device that may be damaged by static discharge.

5-2. HOW TO OBTAIN PARTS

Electrical components may be ordered directly from the manufacturer by using the manufacturers part number, or from the Fluke Corporation and its authorized representatives by using the part number under the heading FLUKE STOCK NO. In the U.S., order directly from the Fluke Parts Dept. by calling 1-800-526-4731. Parts price information is available from the Fluke Corporation or its representatives. Prices are also available in a Fluke Replacement Parts Catalog which is available on request.

In the event that the part ordered has been replaced by a new or improved part, the replacement will be accompanied by an explanatory note and installation instructions, if necessary.

To ensure prompt delivery of the correct part, include the following information when you place an order:

- Instrument model and serial number
- Part number and revision level of the pca containing the part.
- Reference designator
- Fluke stock number
- Description (as given under the DESCRIPTION heading)
- Quantity

5-3. MANUAL STATUS INFORMATION

The Manual Status Information table that precedes the parts list defines the assembly revision levels that are documented in the manual. Revision levels are printed on the component side of each pca.

5-4. NEWER INSTRUMENTS

Changes and improvements made to the instrument are identified by incrementing the revision letter marked on the affected pca. These changes are documented on a supplemental change/errata sheet which, when applicable, is included with the manual.

5-5. SERVICE CENTERS

A list of service centers is located at the end of this section.

NOTE 

This instrument may contain a Nickel-Cadmium battery. Do not mix with the solid waste stream. Spent batteries should be disposed of by a qualified recycler or hazardous materials handler. Contact your authorized Fluke service center for recycling information.

MANUAL STATUS INFORMATION

REF OR OPTION NO.	ASSEMBLY NAME	FLUKE PART NO.	REVISION LEVEL
A1	Main Motherboard	420315	T
A2	MIS Motherboard PCA	455725	B
A3	Power Supply Motherboard PCA	433003	T
A4	Diagonal Bus PCA	420281	D
A5	Main Interconnect PCA	420299	A
A6	MIS Interconnect PCA	420307	B
A7	Power Supply Termination Assembly	803288	B
A7A1	Forward Transformer Terminator PCA	700435	L
A7A2	After Transformer Terminator PCA	700484	K
A8	Power Supply Interconnect PCA (5100B and 5102B)	457226	F
A8	Tape Interface PCA (5101B)	458794	L
A9	Power Supply Regulator PCA	458398	AU
A10	Front Panel Assembly (5100B and 5102B)	458406	H
A10	Front Panel Assembly (5101B)	459537	G
A10A1	Display PCA	456004	F
A11	Ranging PCA	862420	BL
A12	Wideband Output PCA (Opt. -03)	427443	AL
A13	Wideband Oscillator PCA (Opt. -03)	427450	AC
A14	Analog Control PCA	457705	AH
A15	Digital-to-Analog PCA	458422	AC
A16	Extended High Voltage PCA	514976	U
A16A1	High Voltage Control PCA	700526	H
A17	Power Amplifier PCA	803866	AB
A17A1	Power Transistor PCA	438606	G
A18	Oscillator PCA	458455	W
A19	Isolator Pca	455832	AB
A20	Controller PCA	661231	H
A21	Tape Drive PCA	885418	A
A22	Bit Serial Interface (Opt. -06)	468520	M
A23	IEEE-488 Interface Main PCA (Opt. -05)	632877	R
A23A1	IEEE-488 Piggyback PCA (Opt. -05)	503532	M

Table 5-1. 5100B Final Assembly

REFERENCE DESIGNATOR	DESCRIPTION	FLUKE STOCK NO	MFRS SPLY CODE	MANUFACTURERS PART NUMBER OR GENERIC TYPE	TOT QTY	NOTES
A 1	† MAIN MOTHERBOARD PCA	420315	89536	420315	1	
A 2	† MIS MOTHERBOARD PCA	455725	89536	455725	1	
A 3	† POWER SUPPLY MOTHERBOARD PCA	433003	89536	433003	1	
A 4	† DIAGONAL BUS PCA	420281	89536	420281	1	
A 5	† MAIN INTERCONNECT PCA	420299	89536	420299	1	
A 6	† MIS INTERCONNECT PCA	420307	89536	420307	1	
A 7	† POWER SUPPLY TERMINATION ASSEMBLY	803288	89536	803288	1	
A 8	† POWER SUPPLY INTERCONNECT PCA	457226	89536	457226	1	
A 9	† POWER SUPPLY REGULATOR PCA	458398	89536	458398	1	
A 10	† FRONT PANEL PCA	458406	89536	458406	1	
A 11	† RANGING PCA	862420	89536	862420	1	
A 14	† ANALOG CONTROL PCA	457705	89536	457705	1	
A 15	† DIGITAL-TO-ANALOG PCA	458422	89536	458422	1	
A 16	† EXTENDED HI VOLTAGE PCA	514976	89536	514976	1	
A 17	† POWER AMPLIFIER PCA	803866	89536	803866	1	
A 18	† OSCILLATOR PCA	458455	89536	458455	1	
A 19	† ISOLATOR PCA	455832	89536	455832	1	
A 20	† CONTROLLER PCA	661231	89536	661231	1	
H 1, 8	SCREW, PH, P, LOCK, STL, 8-32, .375	114116	74594	114116	16	
H 2	SCREW, CAP, SCKT, SS, 8-32, .375	295105	74594	295105	4	
H 3, 11, 20	SCREW, PH, P, LOCK, STL, 4-40, .250	129890	74594	129890	25	
H 4, 15, 28	SCREW, FHU, P, LOCK, SS, 6-32, .250	320093	74594	320093	24	
H 5	SCREW, PH, P, LOCK, STL, 6-32, .438	436584	26233	P37	9	
H 6	NUT, HEX, STL, 10-32	110536		COMMERCIAL	4	
H 7, 18	SCREW, FH, P, LOCK, STL, 8-32, .312	281725	74594	281725	9	
H 9	WASHER, FLAT, STL, .203, .434, .031	110262		COMMERCIAL	4	
H 10	WASHER, LOCK, INTRNL, STL, .204ID	110312	73734	1306	4	
H 12	SCREW, PH, P SEMS, STL, 4-40, .375	281196		COMMERCIAL	2	
H 13, 21	SCREW, PH, P, SEMS, STL, 6-32, .250	178533		COMMERCIAL	31	
H 14	SCREW, PH, P, SEMS, STL, 6-32, .625	272591		COMMERCIAL	4	
H 16	SCREW, PH, P, LOCK, STL, 4-40, .500	152132	74594	152132	1	
H 17	WASHER, SHLDR, NYLON, .113, .245	485417	86928	5607-50	1	
H 19	SCREW, PH, P, LOCK, STL, 4-40, .375	152124	74594	152124	19	
H 22	SCREW, PH, P, LOCK, STL, 8-32, .312	807123	74594	807123	4	
H 23, 34	WASHER, FLAT, STL, .170, .375, .031	110288		COMMERCIAL	6	
H 24	SCREW, FHU, P, LOCK, SS, 8-32, .312	855189	74594	855189	8	
H 25, 33	SCREW, PH, P, SEMS, STL, 4-40, .250	185918		COMMERCIAL	8	
H 26	SCREW, PH, P, LOCK, STL, 8-32, .625	184994	74594	184994	1	
H 27	WASHER, FLAT, BR, .119, .281, .025	110775	86928	5714-23-25-N	2	
H 29	SCREW, PH, P, LOCK, STL, 6-32, .375	152165	74594	152165	2	
H 30	NUT, HEX, MINI, SS, 6-32	110569		COMMERCIAL	3	
H 31	SCREW, PH, P, LOCK, STL, 6-32, .250	152140	74594	152140	2	
H 32	SCREW, PH, P, LOCK, STL, 2-56, .250	149534	74594	149534	2	
H 35	WASHER, LOCK, SPLIT, STL, .141, .266, .031	110692	86928	5850-13-22	2	
H 36	SCREW, PH, P, SEMS, STL, 6-32, .500	177030		COMMERCIAL	10	
MP 1	FRONT PANEL-PACKAGE UPGRADE	856492	89536	856492	1	
MP 2	BRACKET, FRONT PANEL	421743	89536	421743	1	
MP 3	PARTITION & SHIELD ASSY	426221	89536	426221	2	
MP 4	ASSY, DK GRAPHITE KNURLED KNOB/DECAL	856737	89536	856737	1	
MP 5	CORNER, HANDLE FRONT PLASTIC-8 3/4	856724	89536	856724	2	
MP 6	LENS/DECAL, FRONT PANEL	845875	89536	845875	1	
MP 7	NAMEPLATE	856575	89536	856575	1	
MP 8	REAR PANEL, MED PEWTER	856687	89536	856687	1	
MP 9	FRAME, FILTER, MEDIUM PENTER	856690	89536	856690	1	
MP 10	FAN ACC.FILTER, AL W/FOAM	542118	48672	T-3500	1	
MP 11	ROTRON #271016	422535	82877	271016	1	
MP 12	FAN, MUFFIN VENTURI, 4 1/2 IN	103374	82877	MU2A1-028021	2	
MP 13	REAR CORNER-PAINTED, DK GRAPHITE	856682	89536	856682	2	
MP 14	SHIM, REAR CORNER	421784	89536	421784	2	
MP 15	DECAL, REAR PANEL	455683	89536	455683	1	
MP 16	DECAL, OPTION	582320	89536	582320	1	
MP 17	BRACKET, MIS MOUNTING	421735	89536	421735	1	
MP 18	BULKHEAD, FRONT	421685	89536	421685	1	
MP 19	JUMPER, LINK, BINDING POST	190728	18310	01-111-035	1	
MP 20	BRACKET, CARD SLIDE	426213	89536	426213	1	
MP 21	BOTTOM COVER-PACKAGE UPGRADE	856679	89536	856679	1	
MP 22	GUIDE PLATE, LO FREQ XFMR	425124	89536	425124	1	
MP 23	BRACKET, CAPACITOR MOUNTING	426197	89536	426197	1	
MP 24	CHASSIS ASSY, LEFT SIDE	443929	89536	443929	1	
MP 25	CHASSIS INTERIOR, BOTTOM	421701	89536	421701	1	
MP 26	GROMMET, EXTRUDED, POLYETHYLENE, .036	441782	06915	PGS-1	1	
MP 27	GROMMET, SLOT, RUBBER, .875, .062	380782		1117	2	
MP 28	CHASSIS ASSY, RIGHT SIDE	443937	89536	443937	1	
MP 29	BOTTOM FOOT, MOLDED	775791	89536	775791	4	
MP 30	SPACER, .312 RND, NYL, 6-32, 1.063	104174	55566	1760632N	2	

Table 5-1. 5100B Final Assembly (cont)

REFERENCE DESIGNATOR	DESCRIPTION	FLUKE STOCK NO	MFRS SPLY CODE	MANUFACTURERS PART NUMBER OR GENERIC TYPE	TOT QTY	NOTES
MP 31	COVER, TOP	525881	89536	525881	1	
MP 32	DORCAS, PLASTIC SPACER	421776	89536	421776	17	
MP 33	COVER, INNER	421727	89536	421727	1	
MP 34	PLATE, MIS BUS CONNECTOR, MED PEWTER	857961	89536	857961	2	
MP 35	DECAL, CORNER REAR-8 3/4, DK GRAPHITE	856567	89536	856567	2	
MP 36	SIDE TRIM-21", PUTTY GREY	526004	89536	526004	2	
MP 37	PLATE, I/O ACCESS, MED PEWTER	864843	89536	864843	1	
MP 38	COVER PLATE, DIGITAL CONN, MED PEWTER	857966	89536	857966	1	
MP 39	DECAL, CORNER FRONT-8 3/4, DK GRAPHITE	856539	89536	856539	2	
MP 40	ACCESSORY CARD PULLER	170951	89536	170951	1	
MP 41	PARTITION, POWER SUPPLY	421693	89536	421693	1	
MP 52	‡ MIS SHIELD ASSEMBLY	653857	89536	653857	1	
TM 1	INSTRUCTION MANUAL (SN 4685001 & UP)	926634	89536	926634		
TM 2	GETTING STARTED MANUAL	732586	89536	732586	1	
TM 3	5100B SERIES OPERATOR MANUAL	523100	89536	523100	1	
W 1, 2	CABLE ASSY, FLAT, 16 COND, 3.50, DIP CONN	380576	52072	CAD16P-02-261TT-003.5	2	
W 3	CORD, LINE, 5-15/IEC, RT ANG, 3-18AWG, SVT	363481	70903	CH-8339	1	
NOTES:	‡ Static sensitive part.					

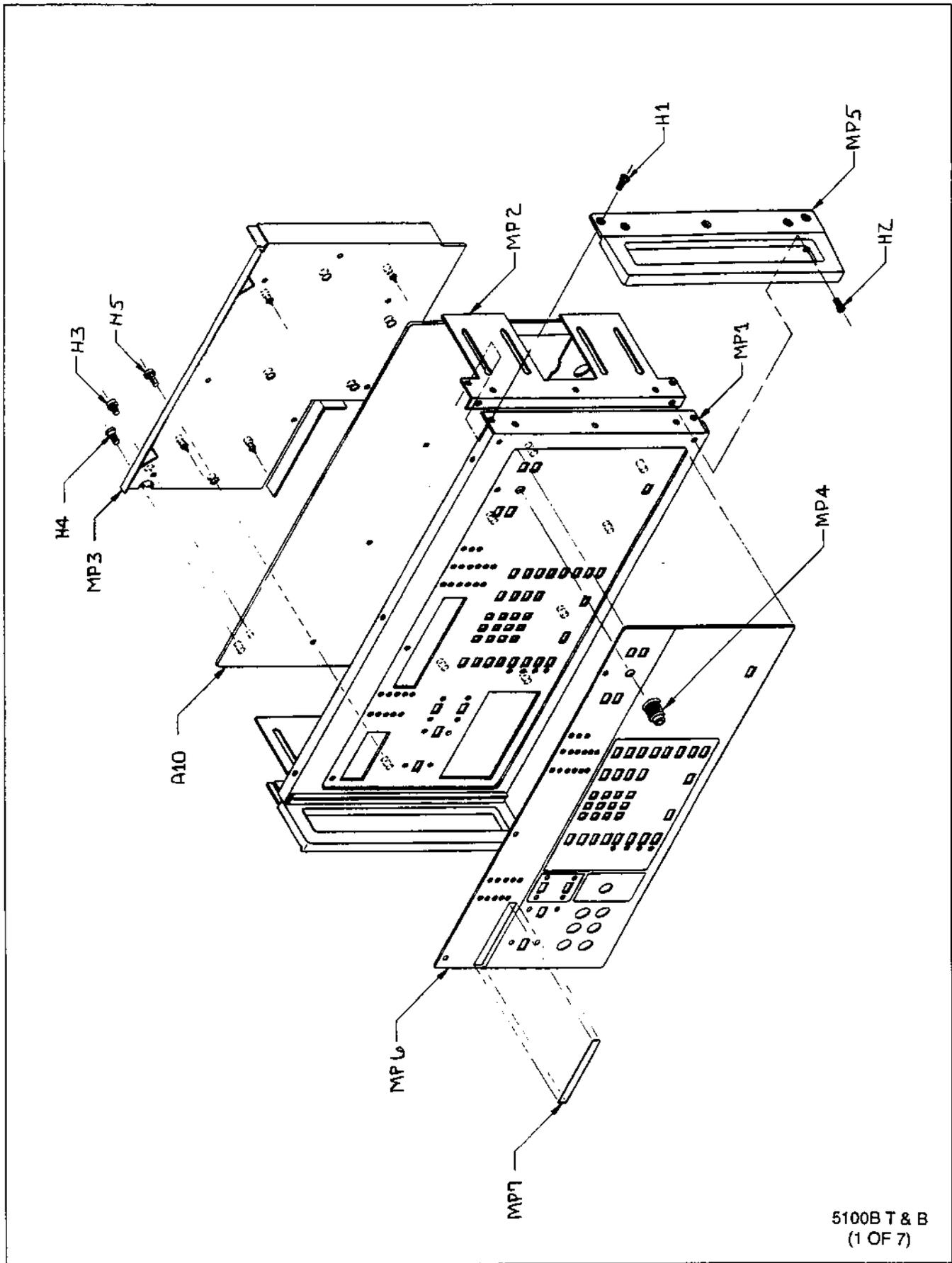

5100B T & B
(1 OF 7)

Figure 5-1. 5100B Final Assembly

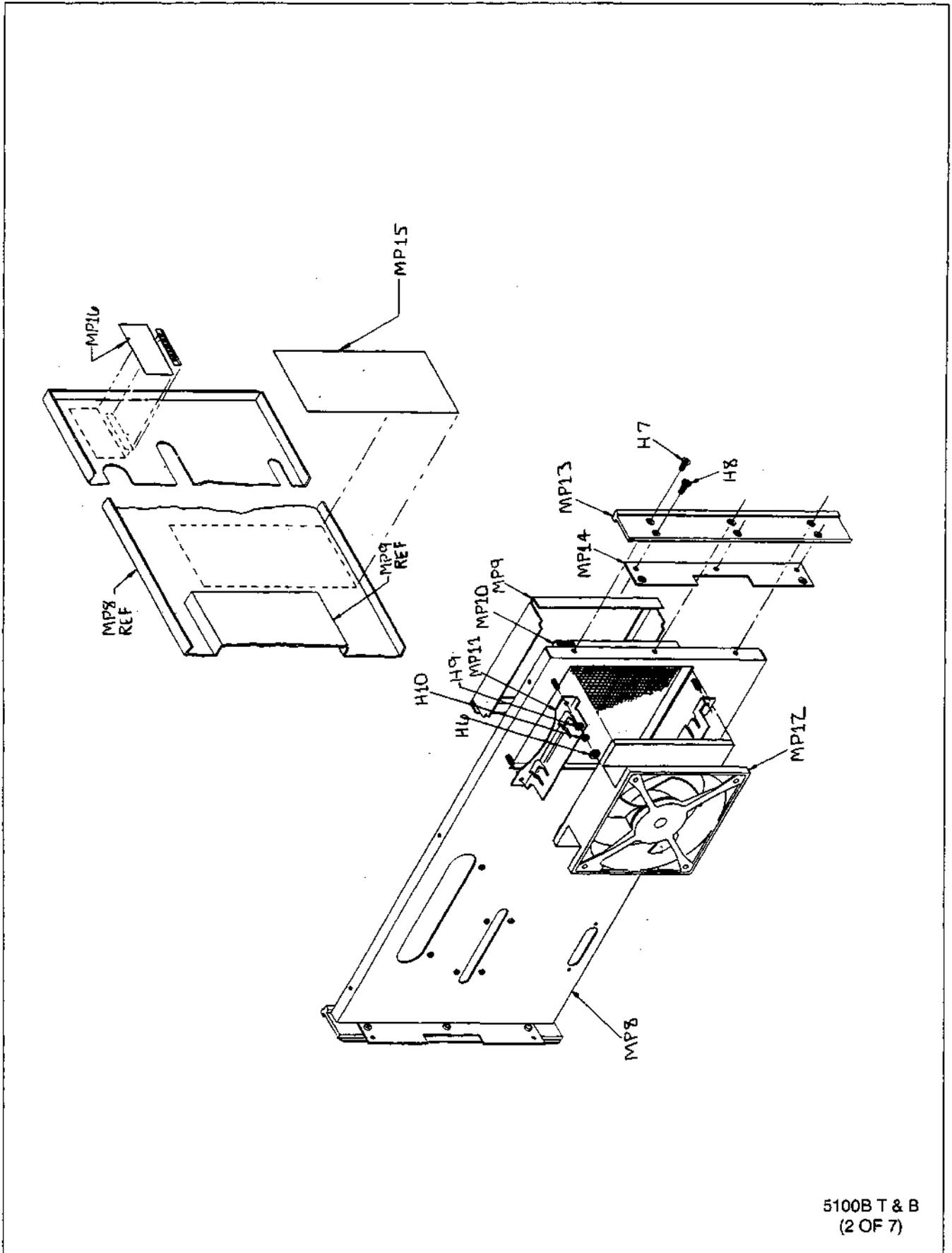

5100B T & B
(2 OF 7)

Figure 5-1. 5100B Final Assembly (cont)

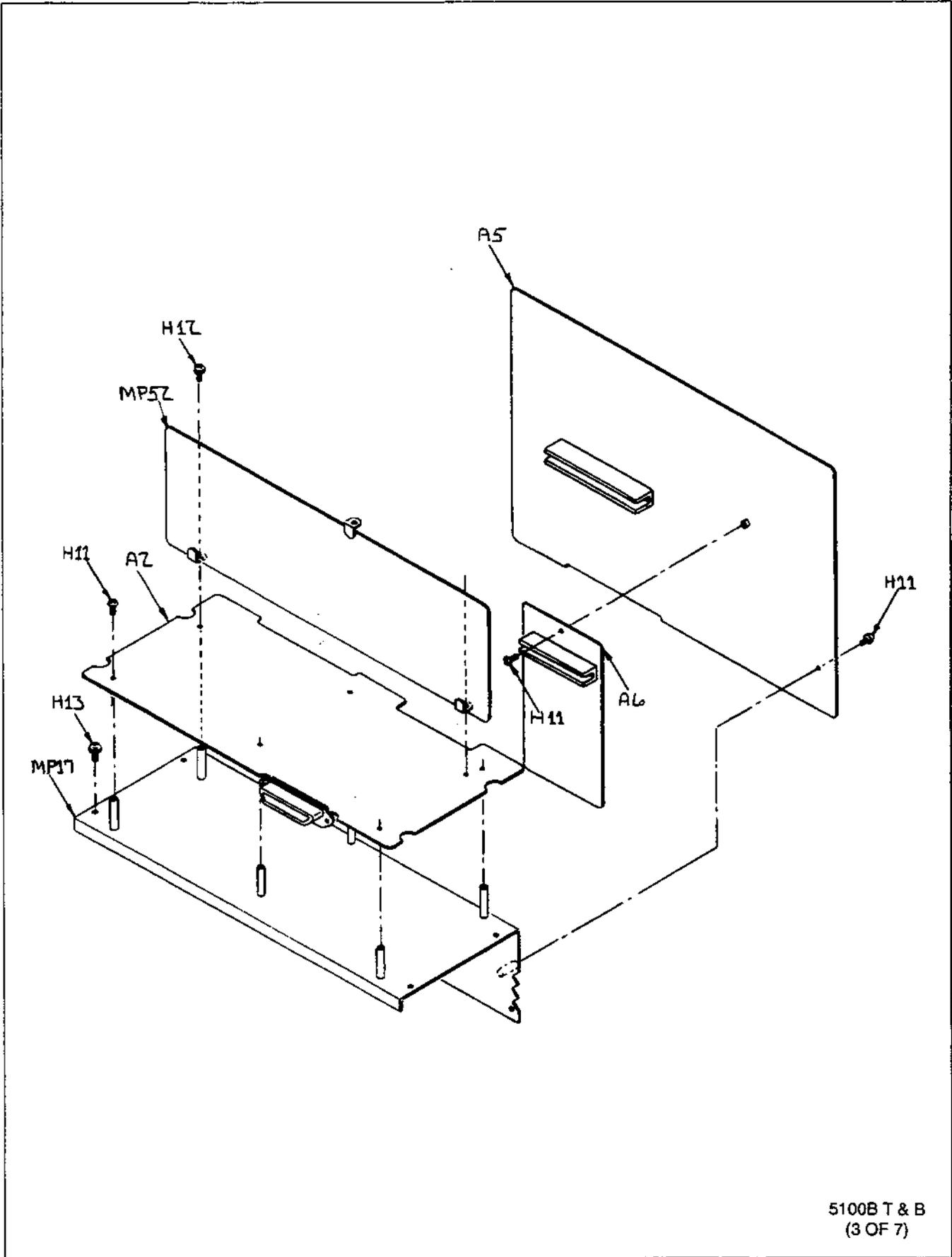

5100B T & B
(3 OF 7)

Figure 5-1. 5100B Final Assembly (cont)

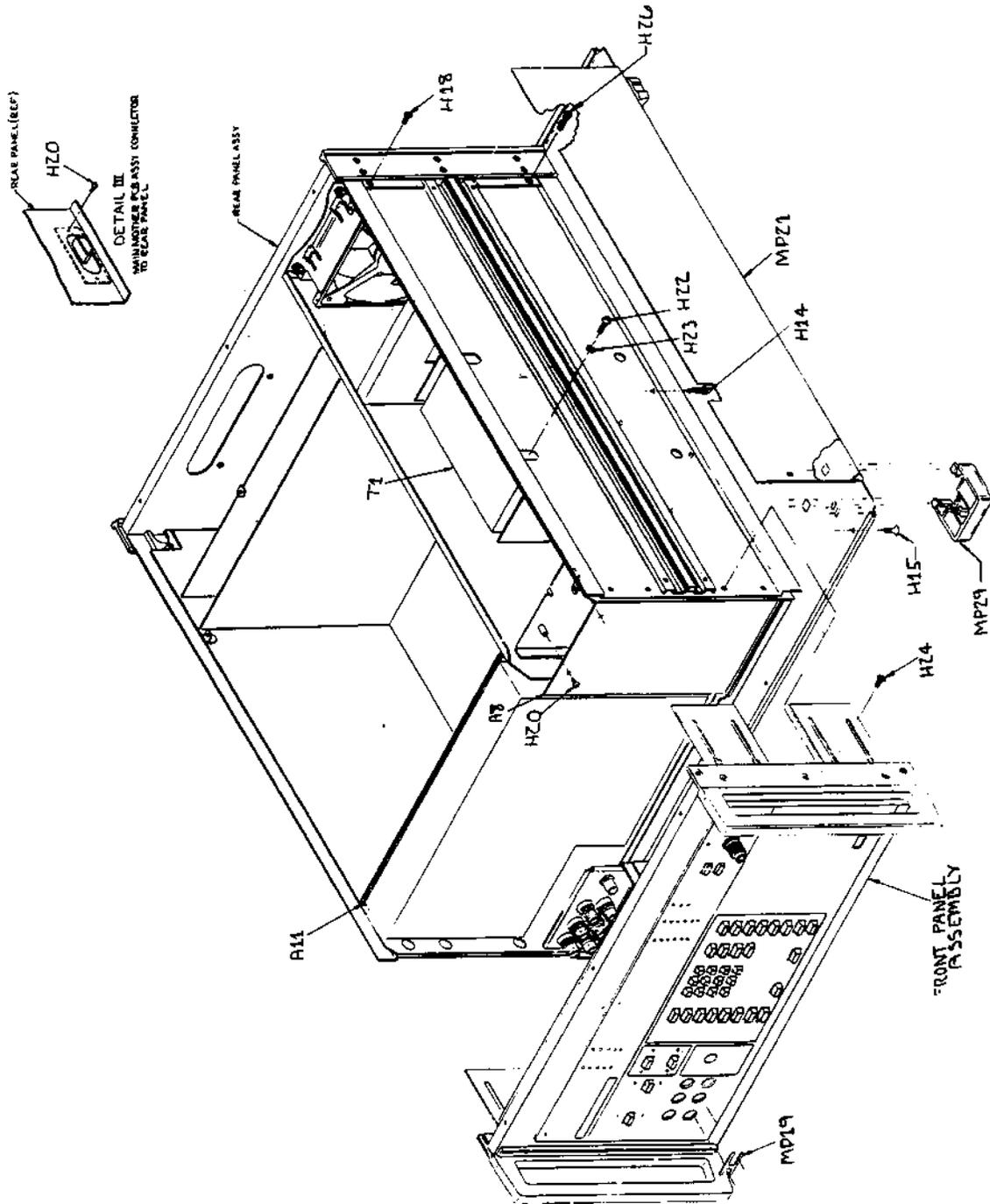

5100B T & B
(5 OF 7)

Figure 5-1. 5100B Final Assembly (cont)

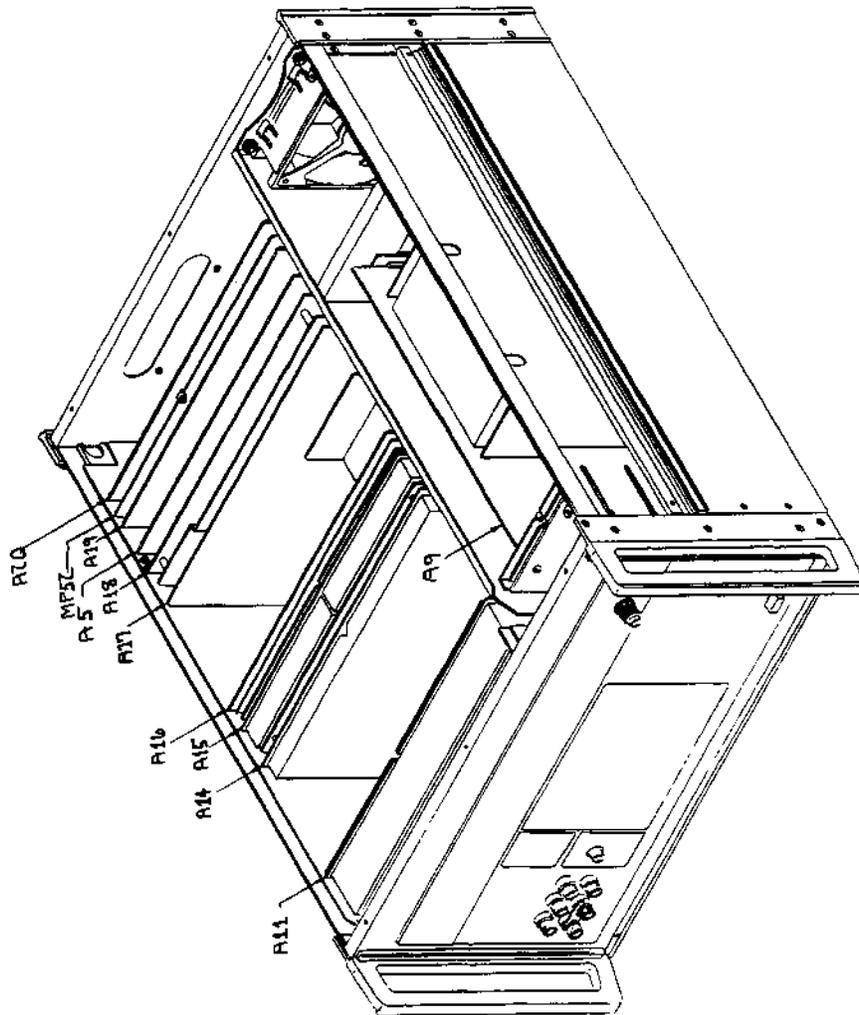

5100B T & B
(6 OF 7)

Figure 5-1. 5100B Final Assembly (cont)

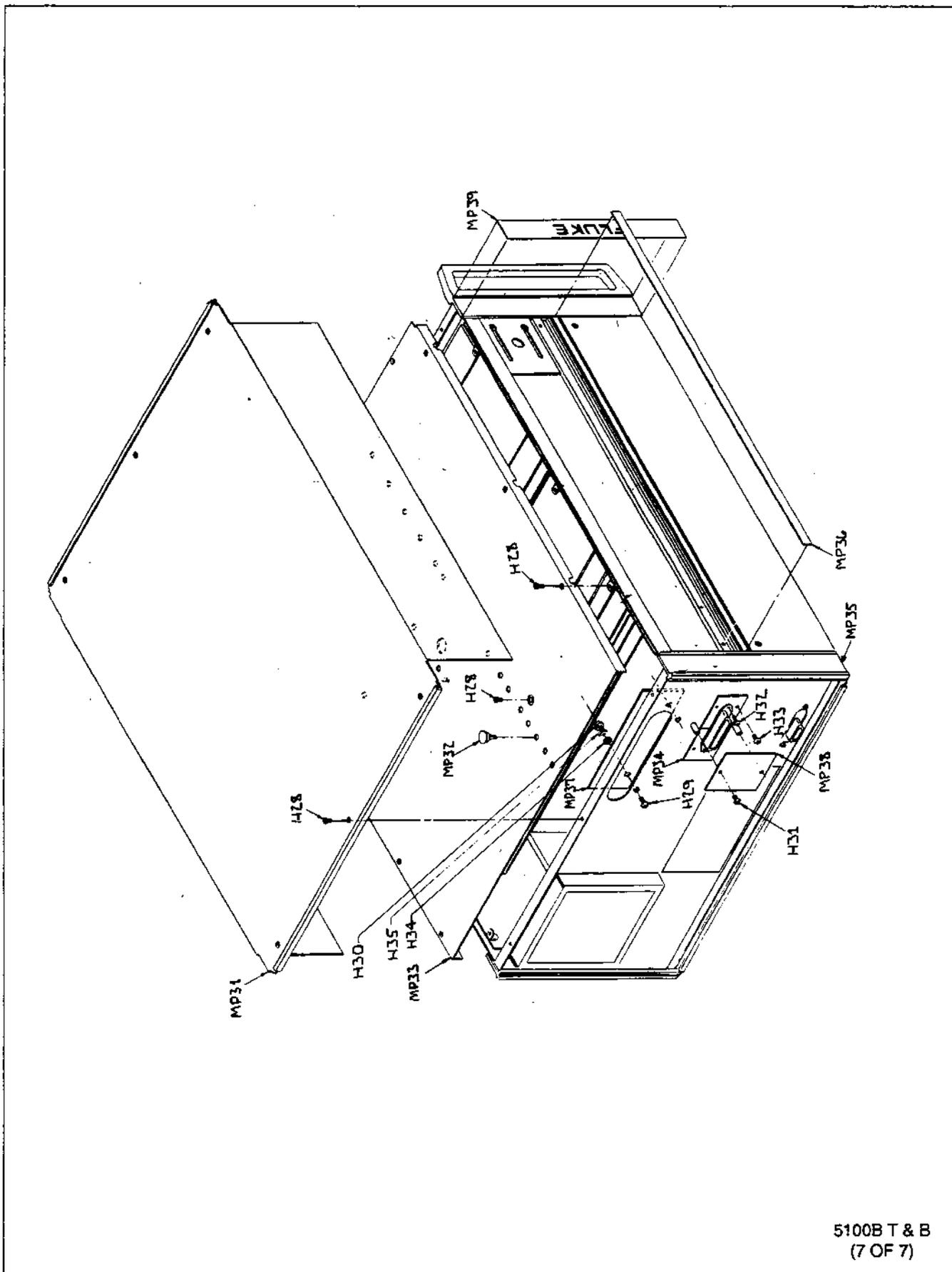

5100B T & B
(7 OF 7)

Figure 5-1. 5100B Final Assembly (cont)

Table 5-2. 5101B Final Assembly

REFERENCE DESIGNATOR	DESCRIPTION	FLUKE STOCK NO	MFRS SPLY CODE	MANUFACTURERS PART NUMBER OR GENERIC TYPE	TOT QTY	NOTES
A 1	† MAIN MOTHERBOARD PCA	420315	89536	420315	1	
A 2	† MIS MOTHERBOARD PCA	455725	89536	455725	1	
A 3	† POWER SUPPLY MOTHERBOARD PCA	433003	89536	433003	1	
A 4	† DIAGONAL BUS PCA	420281	89536	420281	1	
A 5	† MAIN INTERCONNECT PCA	420299	89536	420299	1	
A 6	† MIS INTERCONNECT PCA	420307	89536	420307	1	
A 7	† POWER SUPPLY TERMINATION ASSEMBLY	803288	89536	803288	1	
A 8	† TAPE INTERFACE PCA	458794	89536	458794	1	
A 9	† POWER SUPPLY REGULATOR PCA	458398	89536	458398	1	
A 10	† FRONT PANEL PCA	458406	89536	458406	1	
A 11	† RANGING PCA	458414	89536	458414	1	
A 14	† ANALOG CONTROL PCA	457705	89536	457705	1	
A 15	† DIGITAL-TO-ANALOG PCA	458422	89536	458422	1	
A 16	† EXTENDED HI VOLTAGE PCA I VOLTAGE	514976	89536	514976	1	
A 17	† POWER AMPLIFIER PCA	803866	89536	803866	1	
A 18	† OSCILLATOR PCA	458455	89536	458455	1	
A 19	† ISOLATOR PCA	455832	89536	455832	1	
A 20	† CONTROLLER PCA	661231	89536	661231	1	
A 21	† TAPE DRIVE PCA	885418	89536	885418	1	
E 1	JUMPER, LINK, BINDING POST	190728	18310	01-111-035	1	
H 1, 13	SCREW, FH, P, LOCK, STL, 8-32, .375	114116	74594	114116	16	
H 2	SCREW, CAP, SCKT, SS, 8-32, .375	295105	74594	295105	4	
H 3, 17, 23	SCREW, PH, P, LOCK, STL, 4-40, .250	129890	74594	129890	25	
H 4, 19, 33	SCREW, FHU, P, LOCK, SS, 6-32, .250	320093	74594	320093	24	
H 5	SCREW, PH, P, LOCK, STL, 6-32, .438	436584	26233	P37	9	
H 7	SCREW, PH, P, LOCK, SS, 4-40, .375	256164	74594	256164	8	
H 8	SCREW, FH, P, SS, 4-40, .250	375469		COMMERCIAL	6	
H 9	SPRING, COIL, COMP, SS, .250, .240	876904	84830	LC-020C-1-SS	1	
H 10	SCREW, PH, P, THD CUT, STL, 4-40, .250	178590		COMMERCIAL	1	
H 11	NUT, HEX, STL, 10-32	110536		COMMERCIAL	4	
H 12, 26	SCREW, FH, P, LOCK, STL, 8-32, .312	281725	74594	281725	9	
H 14	WASHER, FLAT, STL, .203, .434, .031	110262		COMMERCIAL	4	
H 15	WASHER, LOCK, INTRNL, STL, .204 ID	110312	73734	1306	4	
H 16, 29	SCREW, PH, P, SEMS, STL, 6-32, .250	178533		COMMERCIAL	31	
H 18	SCREW, PH, P, SEMS, STL, 4-40, .375	281196		COMMERCIAL	2	
H 20	SCREW, PH, P, LOCK, STL, 4-40, .500	152132	74594	152132	2	
H 21	WASHER, SHLDR, NYLON, .113, .245	485417	86928	5607-50	1	
H 22	SCREW, PH, P, SEMS, STL, 6-32, .625	272591		COMMERCIAL	4	
H 24	SCREW, PH, P, LOCK, STL, 4-40, .375	152124	74594	152124	19	
H 25, 38	WASHER, FLAT, STL, .170, .375, .031	110288		COMMERCIAL	6	
H 27	SCREW, FHU, P, LOCK, SS, 8-32, .312	855189	74594	855189	8	
H 28, 37	SCREW, PH, P, SEMS, STL, 4-40, .250	185918		COMMERCIAL	8	
H 30	SCREW, PH, P, LOCK, STL, 8-32, .312	807123	74594	807123	4	
H 31	SCREW, PH, P, LOCK, STL, 8-32, .625	184994	74594	184994	1	
H 32	WASHER, FLAT, BR, .119, .281, .025	110775	86928	5714-23-25-N	2	
H 34	SCREW, PH, P, LOCK, STL, 6-32, .375	152165	74594	152165	2	
H 35	NUT, HEX, MINI, SS, 6-32	110569		COMMERCIAL	3	
H 36	SCREW, PH, P, LOCK, STL, 2-56, .250	149534	74594	149534	2	
H 39	SCREW, PH, P, LOCK, STL, 6-32, .250	152140	74594	152140	2	
H 40	WASHER, LOCK, SPLIT, STL, .141, .266, .031	110692	86928	5850-13-22	2	
MP 1	FRONT PANEL	856497	89536	856497	1	
MP 2	BRACKET, FRONT PANEL	421743	89536	421743	2	
MP 3	PARTITION & SHIELD ASSY	426221	89536	426221	1	
MP 4	ASSY, DK GRAPHITE KNULED KNOB/DECAL	856737	89536	856737	1	
MP 5	LENS/DECAL, FRONT PANEL-PACKAGE UPDATE	856505	89536	856505	1	
MP 6	NAMEPLATE	856583	89536	856583	1	
MP 7	MOUNTING RAIL, TAPE DECK, LEFT, M PEWTER	856708	89536	856708	1	
MP 8	MOUNTING RAIL, TAPE DECK, RT, MED PEWTER	856703	89536	856703	1	
MP 9	DOOR, TAPE DECK	891689	89536	891689	1	
MP 10	MOUNTING BRACKET / TAPEDECK	885454	89536	885454	1	
MP 11	HINGE PIN, TAPE DECK	455626	89536	455626	1	
MP 12	SUPPORT, LATCH BUTTON	885426	89536	885426	1	
MP 13	BUTTON, LATCH	885421	89536	885421	1	
MP 14	CORNER, HANDLE FRONT PLASTIC-8 3/4	856724	89536	856724	2	
MP 15	SPRING, HINGE, LEFT	453712	89536	453712	1	
MP 16	SPRING, HINGE, RIGHT	453720	89536	453720	1	
MP 17	REAR PANEL, MED PEWTER	856687	89536	856687	1	
MP 18	FRAME, FILTER, MEDIUM PEWTER	856690	89536	856690	1	
MP 19	FAN ACC, FILTER, AL W/FOAM	542118	48672	T-3500	1	
MP 20	ROTRON #271016	422535	82877	271016	2	
MP 21	FAN, MUFFIN VENTURI, 4 1/2 IN	103374	82877	MU2A1-02B021	1	
MP 22	REAR CORNER-PAINTED, DK GRAPHITE	856682	89536	856682	2	
MP 23	SHIM, REAR CORNER	421784	89536	421784	2	
MP 24	DECAL, REAR PANEL	455683	89536	455683	1	
MP 25	DECAL, OPTION	582320	89536	582320	1	

Table 5-2. 5101B Final Assembly (cont)

REFERENCE DESIGNATOR	DESCRIPTION	FLUKE STOCK NO	MFRS SPLY CODE	MANUFACTURERS PART NUMBER OR GENERIC TYPE	TOT QTY	NOTES
MP 26	BRACKET, MIS MOUNTING	421735	89536	421735	1	
MP 27	BULKHEAD, FRONT	421685	89536	421685	1	
MP 28	BRACKET, CARD SLIDE	426213	89536	426213	1	
MP 29	BOTTOM, COVER-PACKAGE UPGRADE	856679	89536	856679	1	
MP 30	GUIDE PLATE, LO FREQ XFMR	425124	89536	425124	1	
MP 31	BRACKET, CAPACITOR MOUNTING	426197	89536	426197	1	
MP 32	CHASSIS ASSY, LEFT SIDE	443929	89536	443929	1	
MP 33	CHASSIS INTERIOR, BOTTOM	421701	89536	421701	1	
MP 34	GROMMET, EXTRUDED, POLYETHYLENE, .036	441782	06915	PGS-1	1	
MP 35	PARTITION, POWER SUPPLY	421693	89536	421693	1	
MP 36	GROMMET, SLOT, RUBBER, .875, .062	380782	2K262	1117	2	
MP 37	CHASSIS ASSY, RIGHT SIDE	443937	89536	443937	1	
MP 38	BOTTOM FOOT, MOLDED	775791	89536	775791	4	
MP 39	SPACER, .312 RND, NYL, 6-32, 1.063	104174	55566	1760632N	2	
MP 40	COVER, TOP	525881	89536	525881	1	
MP 41	DORCAS, PLASTIC SPACER	421776	89536	421776	14	
MP 42	COVER, INNER	421727	89536	421727	1	
MP 43	DECAL, CORNER REAR-8 3/4, DK GRAPHITE	856567	89536	856567	2	
MP 44	SIDE TRIM-21", PUTTY GREY	526004	89536	526004	2	
MP 45	PLATE, I/O ACCESS, MED PEWTER	864843	89536	864843	1	
MP 46	PLATE, MIS BUS CONNECTOR, MED PEWTER	857961	89536	857961	2	
MP 47	DECAL, CORNER FRONT-8 3/4, DK GRAPHITE	856539	89536	856539	2	
MP 48	TAPE, CASSETTE	446997	51372	006521	1	
MP 49	COVER PLATE, DIGITAL CONN, MED PEWTER	857966	89536	857966	1	
MP 50	ACCESSORY CARD FULLER	170951	89536	170951	1	
MP 52	† MIS SHIELD ASSEMBLY	653857	89536	653857	1	
TM 1	INSTRUCTION MANUAL (SN 4685001 & UP)	926634	89536	926634	1	
TM 2	GETTING STARTED MANUAL	732586	89536	732586	1	
TM 3	5100B SERIES OPERATOR MANUAL	523100	89536	523100	1	
W 1, 2	CABLE ASSY, FLAT, 16 COND, 3.50, DIP CONN	380576	52072	CAD16P-D2-261TT-003.5	2	
W 3	CORD, LINE, 5-15/IEC, RT ANG, 3-18AWG, SVT	363481	70903	CH-8339	1	
NOTES:	† Static sensitive part.					

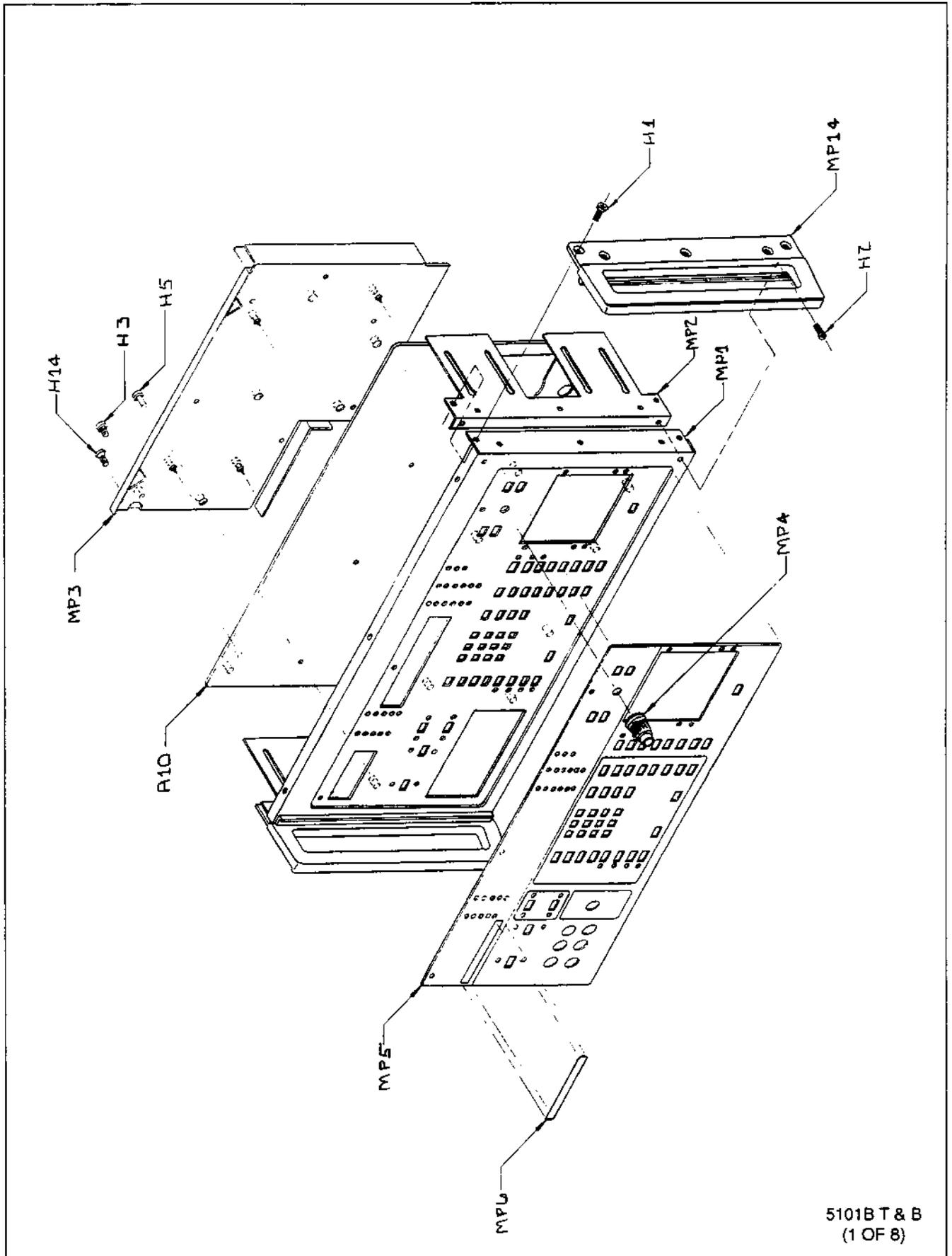

5101B T & B
(1 OF 8)

Figure 5-2. 5101B Final Assembly

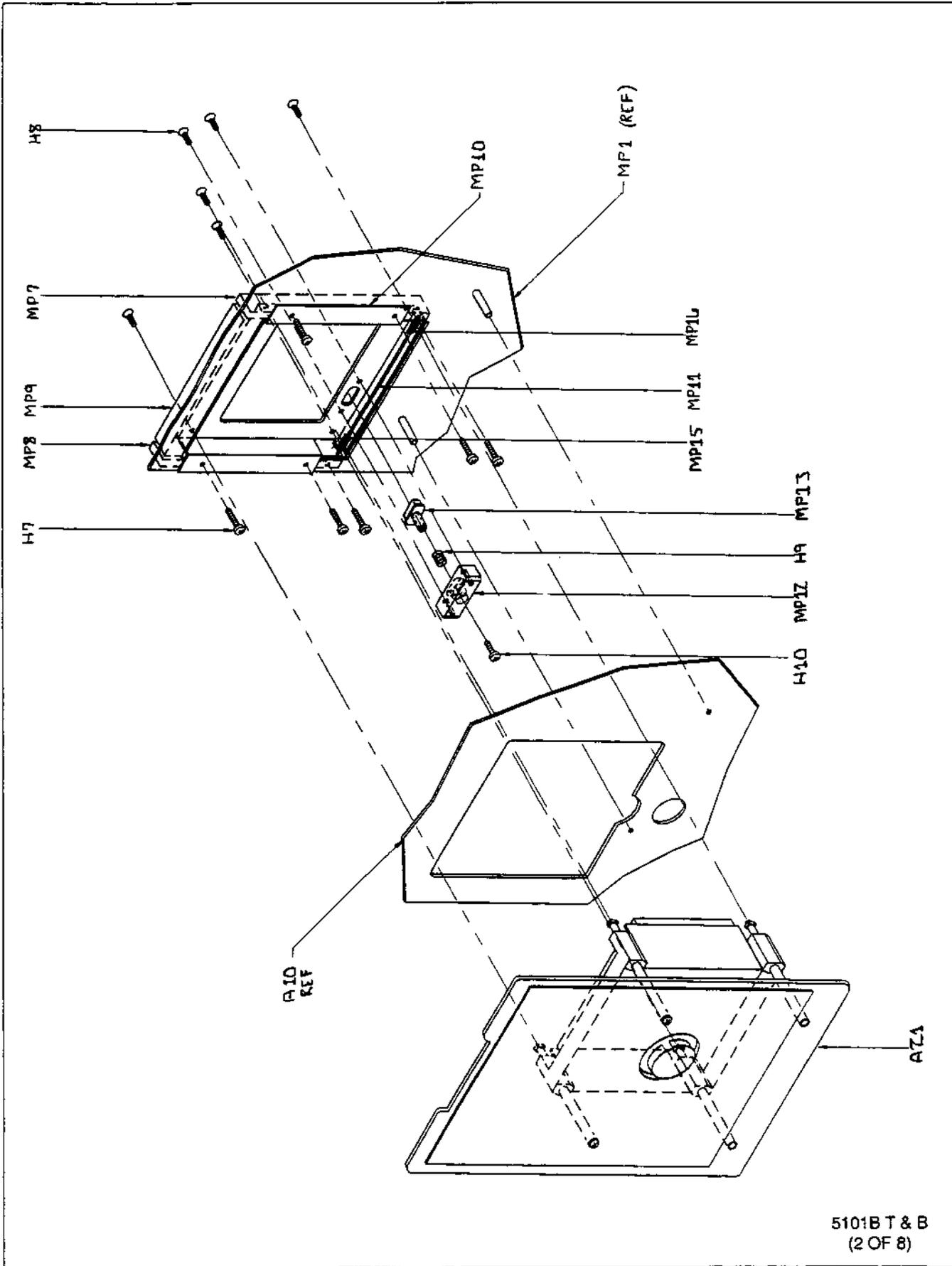

5101B T & B
(2 OF 8)

Figure 5-2. 5101B Final Assembly (cont)

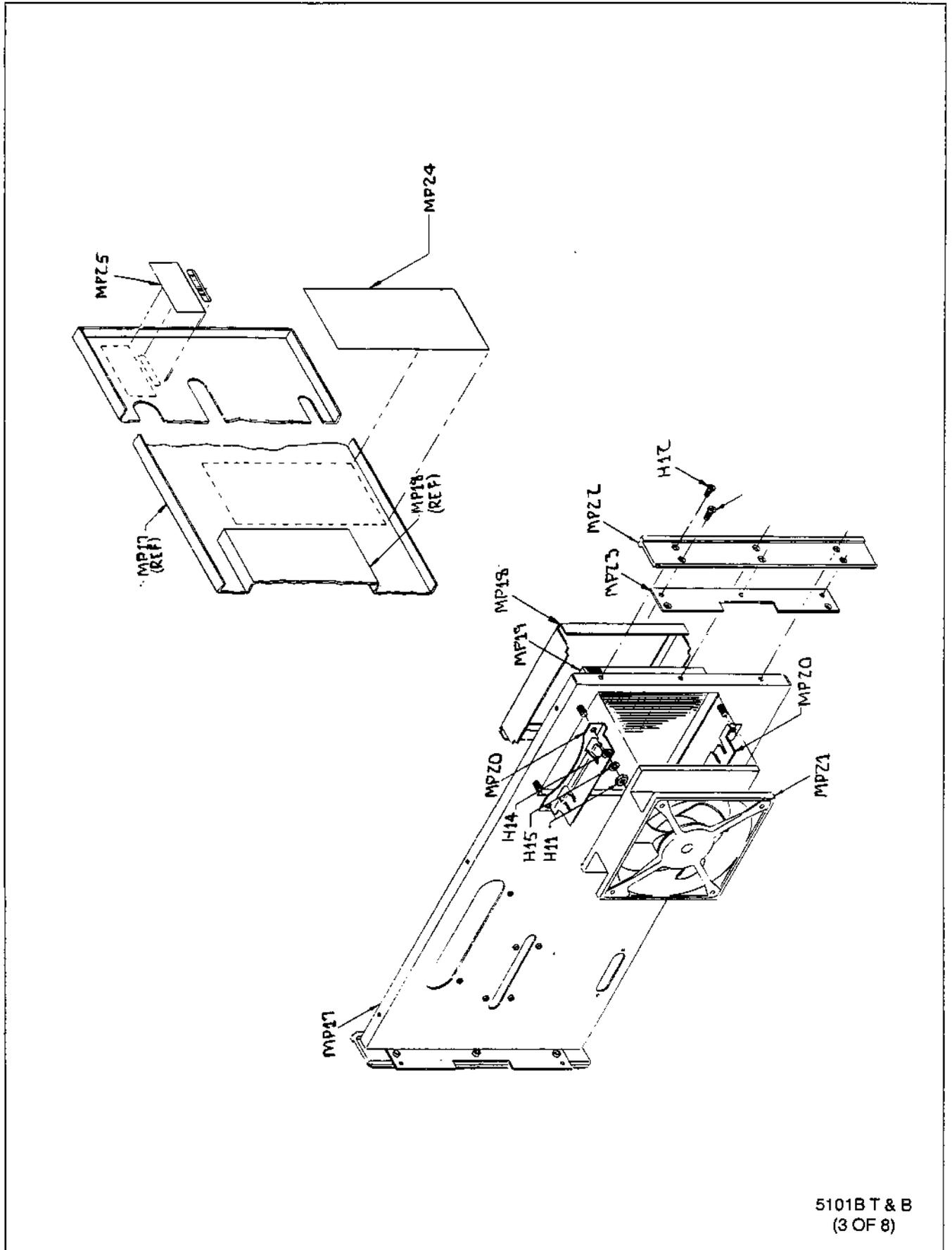

5101B T & B
(3 OF 8)

Figure 5-2. 5101B Final Assembly (cont)

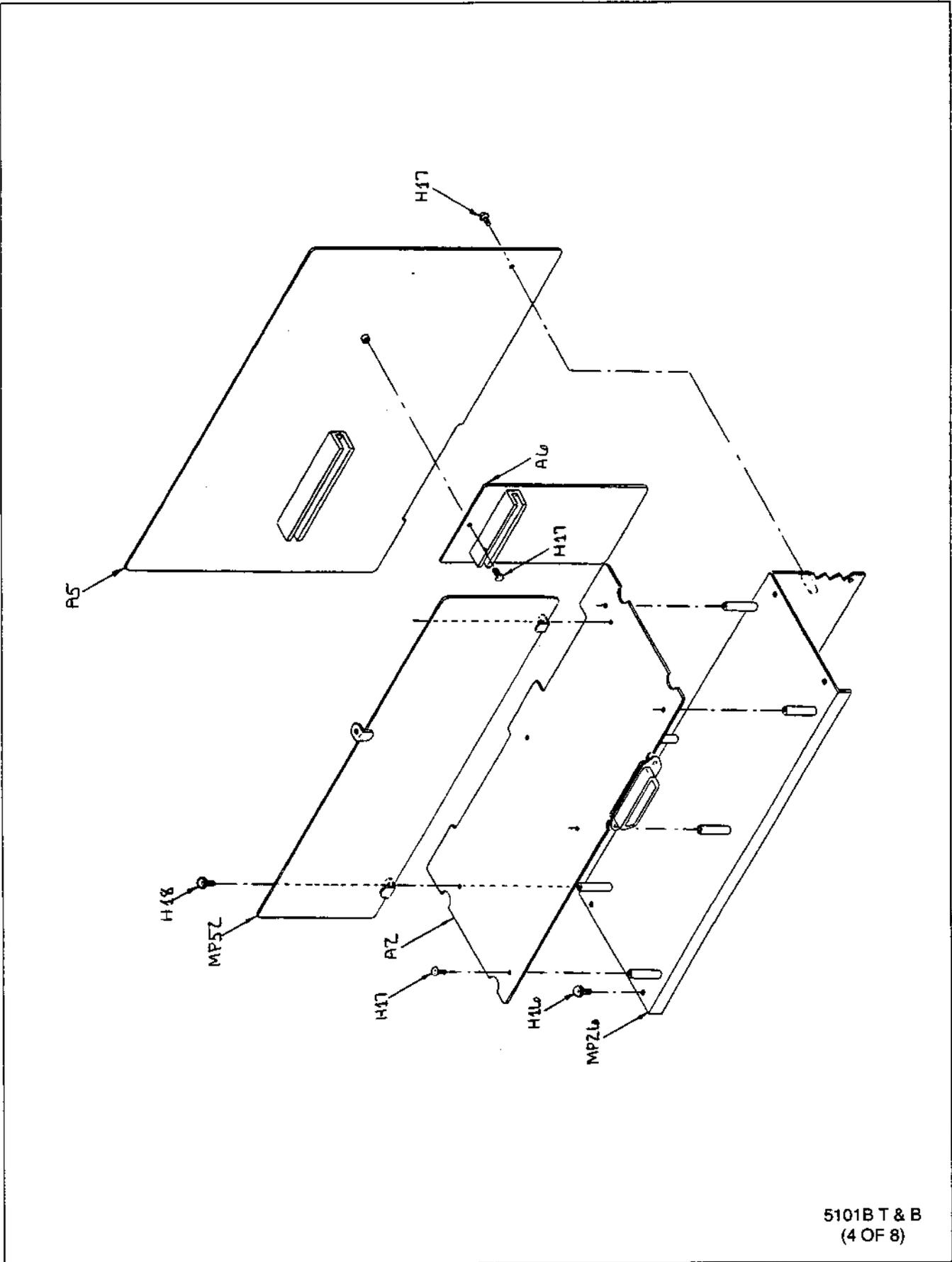

Figure 5-2. 5101B Final Assembly (cont)

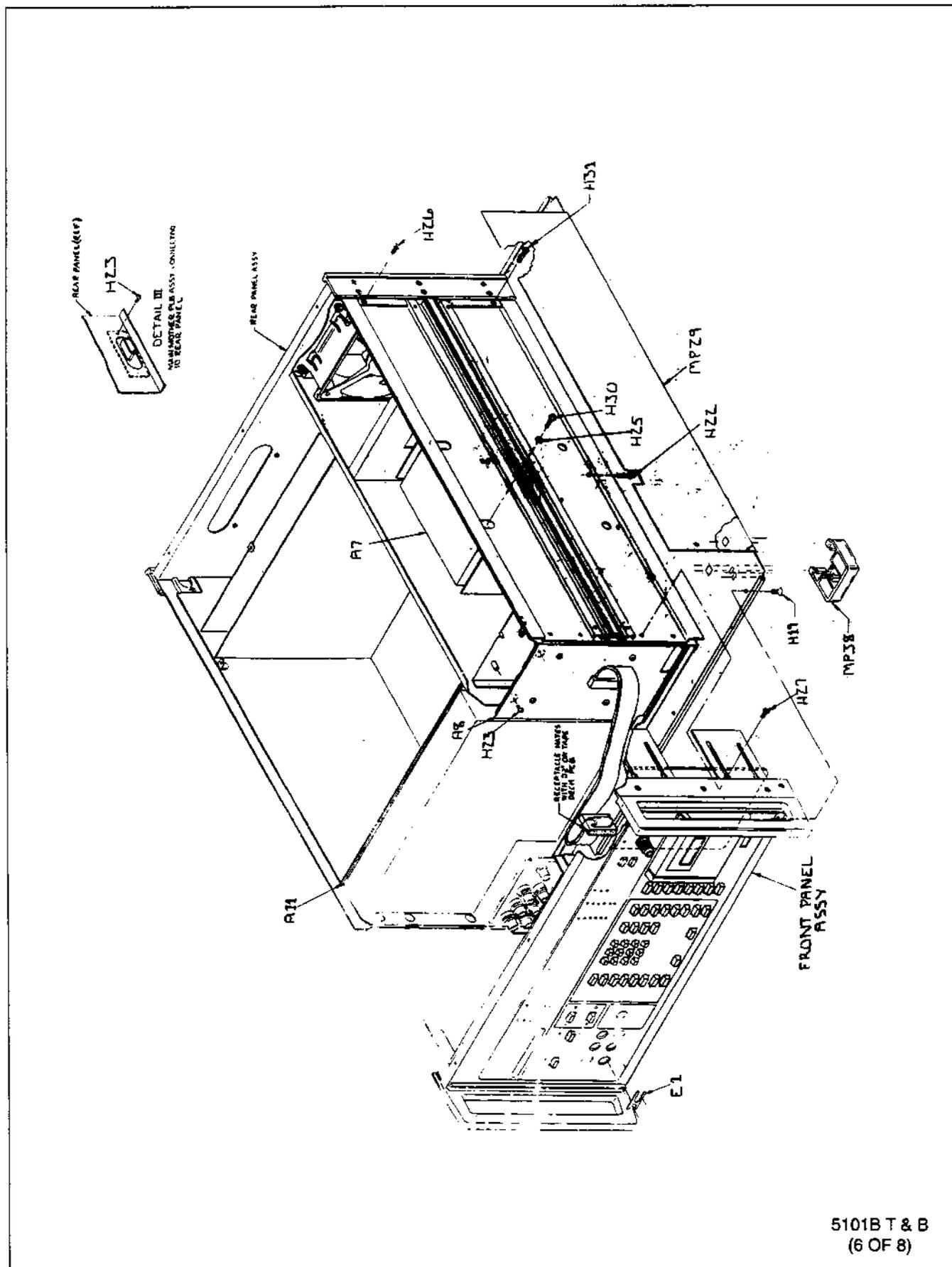

Figure 5-2. 5101B Final Assembly (cont)

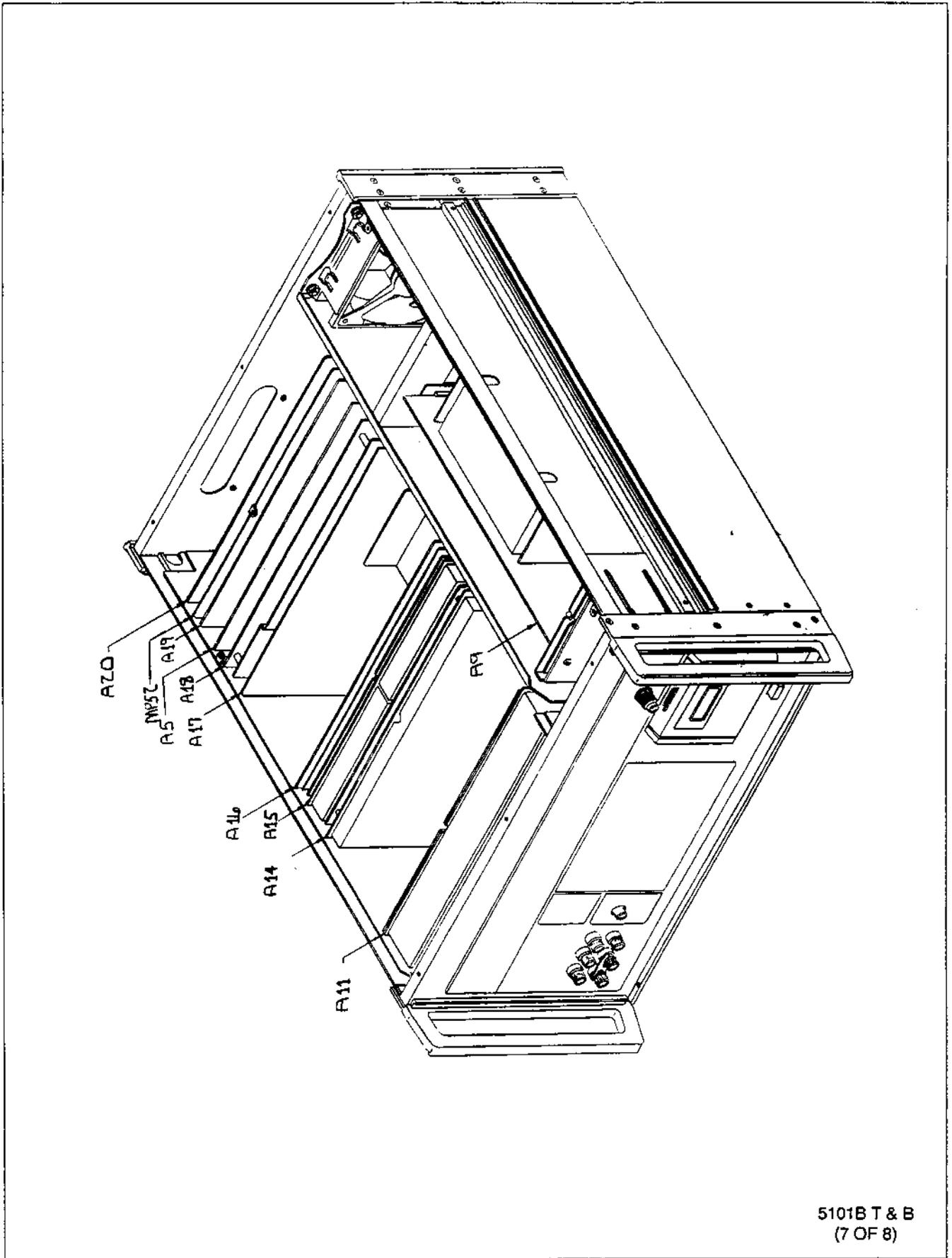
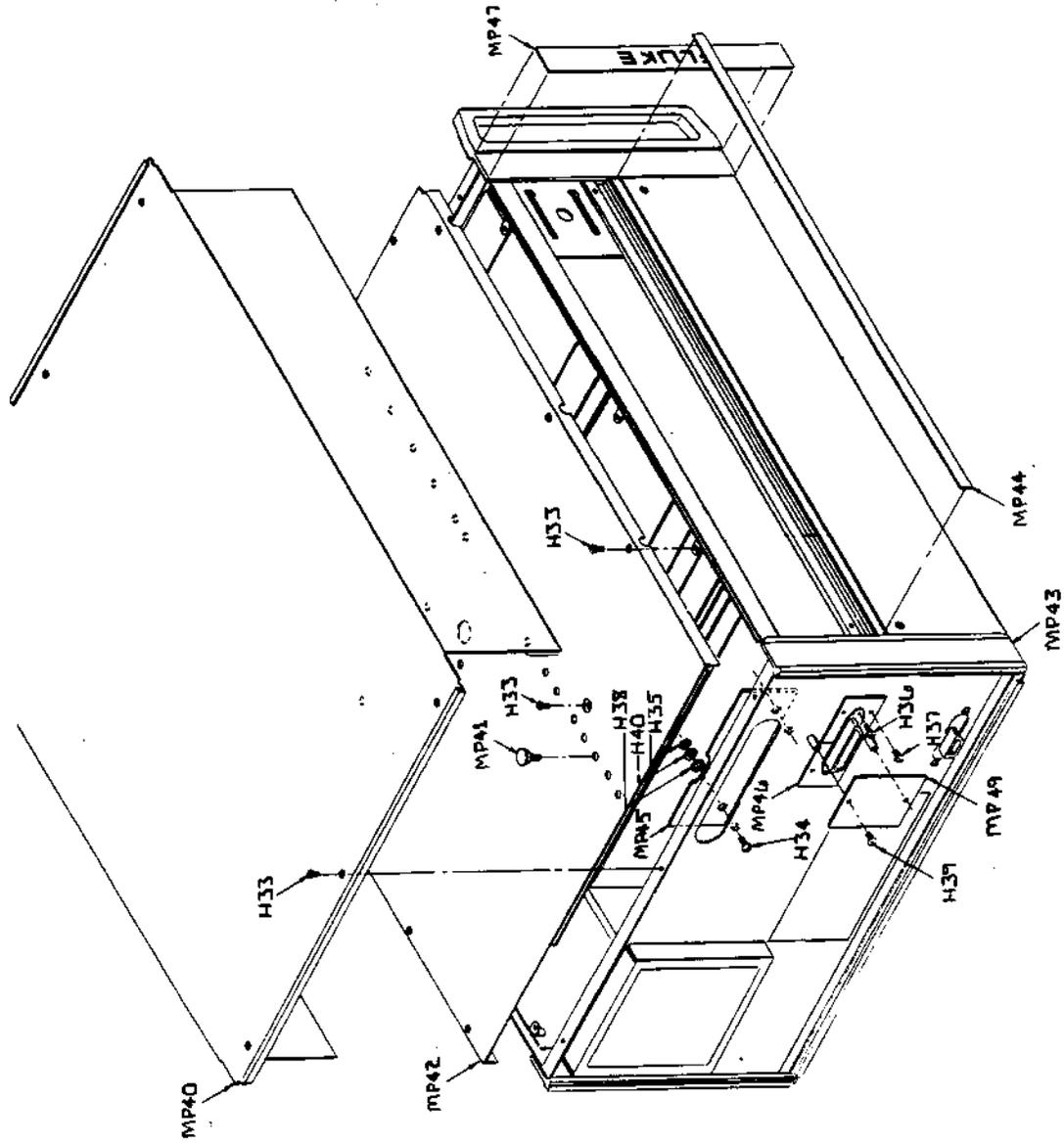

Figure 5-2. 5101B Final Assembly (cont)



5101B T & B
(8 OF 8)

Figure 5-2. 5101B Final Assembly (cont)

Table 5-3. 5102B Final Assembly

REFERENCE DESIGNATOR	DESCRIPTION	FLUKE STOCK NO	MFRS SPLY CODE	MANUFACTURERS PART NUMBER OR GENERIC TYPE	TOT QTY	NOTES
A 1	† MAIN MOTHERBOARD PCA	420315	89536	420315	1	
A 2	† MIS MOTHERBOARD PCA	455725	89536	455725	1	
A 3	† POWER SUPPLY MOTHERBOARD PCA	433003	89536	433003	1	
A 4	† DIAGONAL BUS PCA	420281	89536	420281	1	
A 5	† MAIN INTERCONNECT PCA	420299	89536	420299	1	
A 6	† MIS INTERCONNECT PCA	420307	89536	420307	1	
A 7	POWER SUPPLY TERMINATION ASSEMBLY	803288	89536	803288	1	
A 8	† POWER SUPPLY INTERCONNECT PCA	457226	89536	457226	1	
A 9	† POWER SUPPLY REGULATOR PCA	458398	89536	458398	1	
A 10	† FRONT PANEL PCA	458406	89536	458406	1	
A 11	† RANGING PCA	458414	89536	458414	1	
A 14	† ANALOG CONTROL PCA	457705	89536	457705	1	
A 15	† DIGITAL-TO-ANALOG PCA	458422	89536	458422	1	
A 16	† EXTENDED HI VOLTAGE PCA	514976	89536	514976	1	
A 17	† POWER AMPLIFIER PCA	803866	89536	803866	1	
A 18	† OSCILLATOR PCA	458455	89536	458455	1	
A 19	† ISOLATOR PCA	455832	89536	455832	1	
A 20	† CONTROLLER PCA	661231	89536	661231	1	
E 1	JUMPER, LINK, BINDING POST	190728	18310	01-111-035	1	
H 1, 6	SCREW, FH, P, LOCK, STL, 8-32, .312	281725	74594	281725	16	
H 2, 10, 18	SCREW, PH, P, LOCK, STL, 4-40, .250	129890	74594	129890	30	
H 3, 35	SCREW, FH, P, LOCK, SS, 6-32, .250	320093	74594	320093	18	
H 4	SCREW, FH, P, LOCK, STL, 6-32, .438	436584	26233	P37	9	
H 5	NUT, HEX, STL, 10-32	110536		COMMERCIAL	4	
H 7	WASHER, FLAT, STL, .203, .434, .031	110262		COMMERCIAL	4	
H 8	WASHER, LOCK, INTRNL, STL, .204ID	110312	73734	1306	4	
H 9, 19	SCREW, PH, P, SEMS, STL, 6-32, .250	178533		COMMERCIAL	31	
H 11	SCREW, PH, P SEMS, STL, 4-40, .375	281196		COMMERCIAL	2	
H 12	SCREW, FH, P, LOCK, STL, 8-32, .375	114116	74594	114116	3	
H 13	SCREW, FH, SL, LOCK, STL, 8-32, 1.750	474031	74594	474031	4	
H 14	SCREW, PH, P, LOCK, STL, 4-40, .500	152132	74594	152132	1	
H 15	WASHER, SHLDR, NYLON, .113, .245	485417	86928	5607-50	1	
H 16	SCREW, PH, P, SEMS, STL, 6-32, .500	177030		COMMERCIAL	10	
H 17	SCREW, PH, P, SEMS, STL, 6-32, .625	272591		COMMERCIAL	4	
H 20	SCREW, PH, P, LOCK, STL, 8-32, .312	807123	74594	807123	4	
H 21, 33	WASHER, FLAT, STL, .170, .375, .031	110288		COMMERCIAL	6	
H 22	SCREW, FH, P, LOCK, STL, 8-32, .437	306159	74594	306159	8	
H 23	SCREW, FH, P, LOCK, STL, 8-32, .625	184994	74594	184994	5	
H 24	WASHER, FLAT, BR, .119, .281, .025	110775		COMMERCIAL	2	
H 25, 31	SCREW, PH, P, SEMS, STL, 4-40, .250	185918		COMMERCIAL	8	
H 26	SCREW, PH, P, LOCK, STL, 4-40, .375	152124	74594	152124	19	
H 27	SCREW, PH, P, LOCK, STL, 6-32, .375	152165	74594	152165	2	
H 28	NUT, HEX, MINI, SS, 6-32	110569		COMMERCIAL	2	
H 29	SCREW, PH, P, LOCK, SS, 8-32, .625	293324	74594	293324	12	
H 30	WASHER, FLAT, SS, BLK, .171, .312, .030	474650	89536	474650	12	
H 32	SCREW, PH, P, LOCK, STL, 6-32, .250	152140	74594	152140	2	
H 34	SCREW, PH, P, LOCK, STL, 2-56, .250	149534	74594	149534	2	
H 36	SCREW, PH, P, THD CUT, SS, 4-24, .375	183574		COMMERCIAL	16	
H 37	WASHER, LOCK, SPLIT, STL, .141, .266, .031	110692	86928	5850-13-22	2	
MP 1	FRONT PANEL-PACKAGE UPGRADE	856492	89536	856492	1	
MP 2	BRACKET, FRONT PANEL MOUNTING	468215	89536	468215	2	
MP 3	PARTITION & SHIELD ASSY	426221	89536	426221	1	
MP 4	ASSY, DK GRAPHITE KNURLED KNOB/DECAL	856737	89536	856737	1	
MP 5	BRACKET, SLIDE FRONT PANEL	468389	89536	468389	2	
MP 6	LENS/DECAL, FRONT PANEL	845875	89536	845875	1	
MP 7	NAMEPLATE	856588	89536	856588	1	
MP 8	REAR PANEL, MED PEWTER	857128	89536	857128	1	
MP 9	FRAME, FILTER, MEDIUM PEWTER	856690	89536	856690	1	
MP 10	FAN ACC, FILTER, AL W/FOAM	542118	48672	T-3500	1	
MP 11	ROTRON #271016	422535	82877	271016	2	
MP 12	FAN, MUFFIN VENTURI, 4 1/2 IN	103374	82877	MU2A1-028021	1	
MP 13	FLATE, REAR CORNER	468397	89536	468397	2	
MP 14	DECAL, REAR PANEL	455683	89536	455683	1	
MP 15	DECAL, OPTION	582320	89536	582320	1	
MP 16	BRACKET, MIS MOUNTING	468207	89536	468207	1	
MP 17	BULKHEAD, FRONT	468173	89536	468173	1	
MP 18	BRACKET, CARD SLIDE	468223	89536	468223	1	
MP 19	CHASSIS ASSY, LEFT SIDE	468355	89536	468355	1	
MP 20	CHASSIS ASSY, RIGHT SIDE	468363	89536	468363	1	
MP 21	GUIDE PLATE, LO FREQ XFMR	425124	89536	425124	1	
MP 22	BRACKET, CAPACITOR MOUNTING	426197	89536	426197	1	
MP 23	CHASSIS, BOTTOM	468181	89536	468181	1	
MP 24	SPACER, RND, NYL, .187ID, 1.125	474023	55666	126210N	4	
MP 25	BAR, CASE	469072	89536	469072	4	
MP 26	PARTITION, POWER SUPPLY	421693	89536	421693	1	

Table 5-3. 5102B Final Assembly (cont)

REFERENCE DESIGNATOR	DESCRIPTION	FLUKE STOCK NO	MFRS SPLY CODE	MANUFACTURERS PART NUMBER OR GENERIC TYPE	TOT QTY	NOTES
MP 27	GROMMET, EXTRUDED, POLYETHYLENE, .105	435974	06915	PG5-2	1	
MP 28	GROMMET, SLOT, RUBBER, .875, .062	380782	2K262	1117	2	
MP 29	SPACER, .312 RND, NYL, 6-32, 1.063	104174	55566	1760632N	2	
MP 30	DORCAS, PLASTIC SPACER	421776	89536	421776	14	
MP 31	COVER, INNER	468199	89536	468199	1	
MP 32	PLATE, MIS BUS CONNECTOR, MED PEWTER	857961	89536	857961	2	
MP 33	INSULATOR, INNER COVER	469098	89536	469098	1	
MP 34	RETAINER, LEFT	856815	89536	856815	1	
MP 35	RETAINER, RIGHT	856823	89536	856823	1	
MP 36	COVER PLATE, DIGITAL CONN, MED PEWTER	857966	89536	857966	1	
MP 37	SCREEN, FRONT EXHAUST	856810	89536	856810	1	
MP 38	SCREEN, REAR EXHAUST	856807	89536	856807	1	
MP 39	FOOT, CASE REAR	468348	89536	468348	4	
MP 40	CASE, COMBNTN, FIBERGLASS, 22X19X9	461749	24995	CR391-4661	1	
MP 41	TAPE, FOAM, VINYL, 1/2 W, 1/16 THK	282152	26066	4516	3	
MP 42	ACCESSORY CARD PULLER	170951	89536	170951	1	
MP 43	BAG, VINYL, 7.0X12.375	474056	4F434	7.0X12.375	1	
MP 52	† MIS SHIELD ASSEMBLY	653857	89536	653857	1	
TM 1	INSTRUCTION MANUAL (SN 4685001 & UP)	926634	89536	926634	1	
TM 2	5100B SERIES OPERATOR MANUAL	523100	89536	523100	1	
TM 3	GETTING STARTED MANUAL	732586	89536	732586	1	
W 1, 2	CABLE ASSY, FLAT, 16 COND, 3.50, DIP CONN	380576	52072	CAD15P-02-261TT-003.5	2	
W 3	CORD, LINE, 5-15/IEC, RT ANG, 3-18AWG, SVT	363481	70903	CH-8339	1	
NOTES:	† Static sensitive part.					

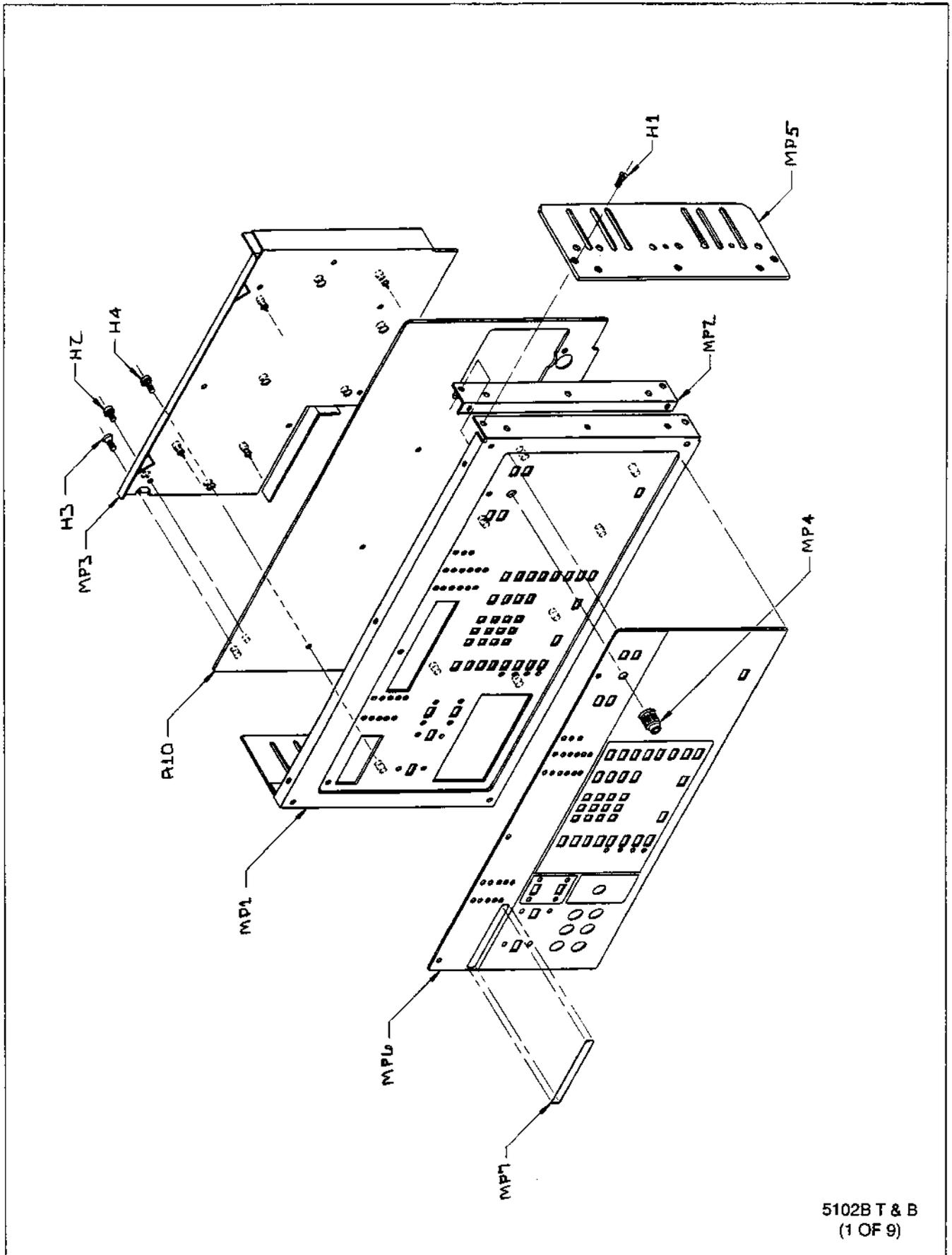

5102B T & B
(1 OF 9)

Figure 5-3. 5102B Final Assembly

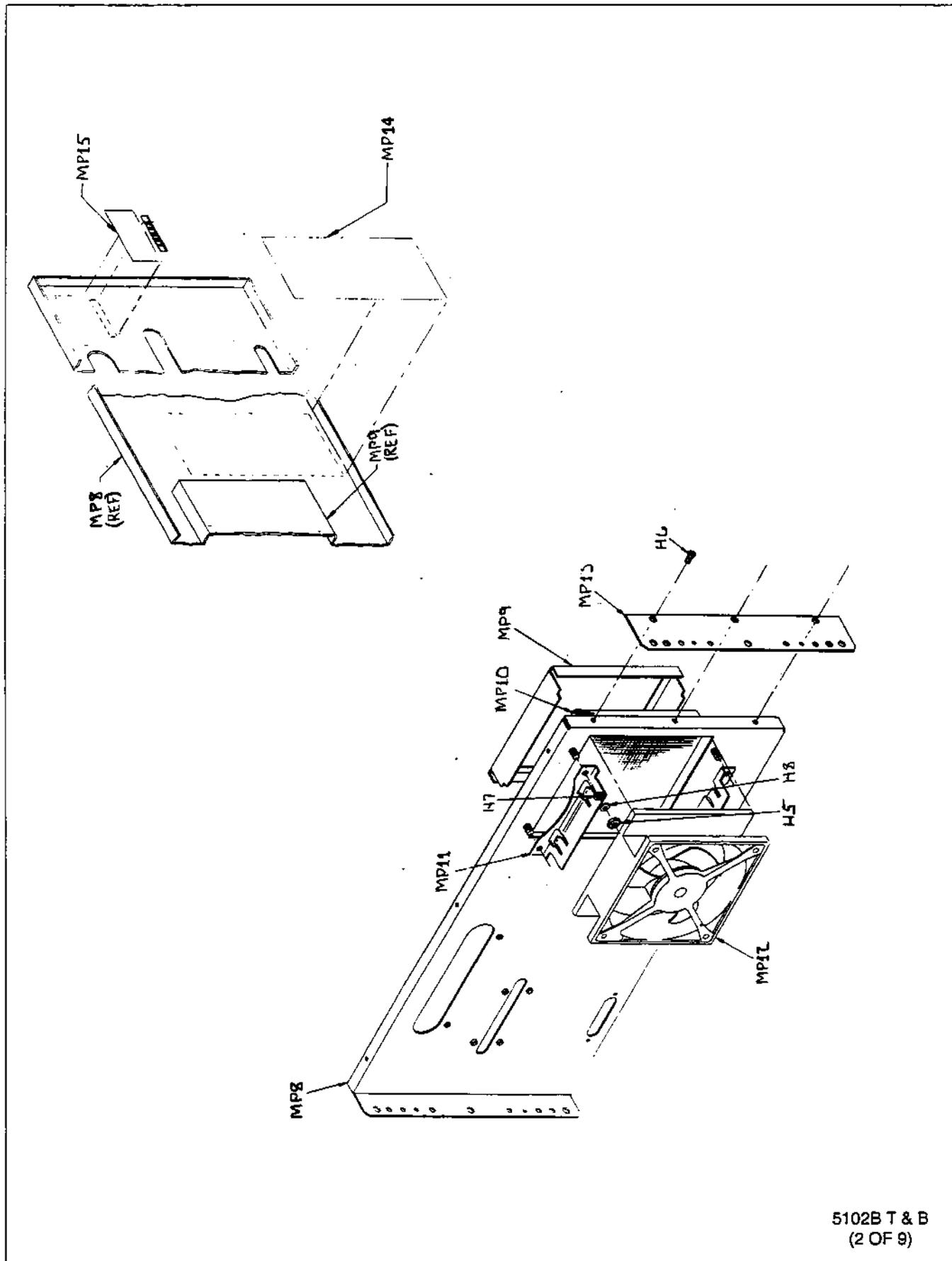

5102B T & B
(2 OF 9)

Figure 5-3. 5102B Final Assembly (cont)

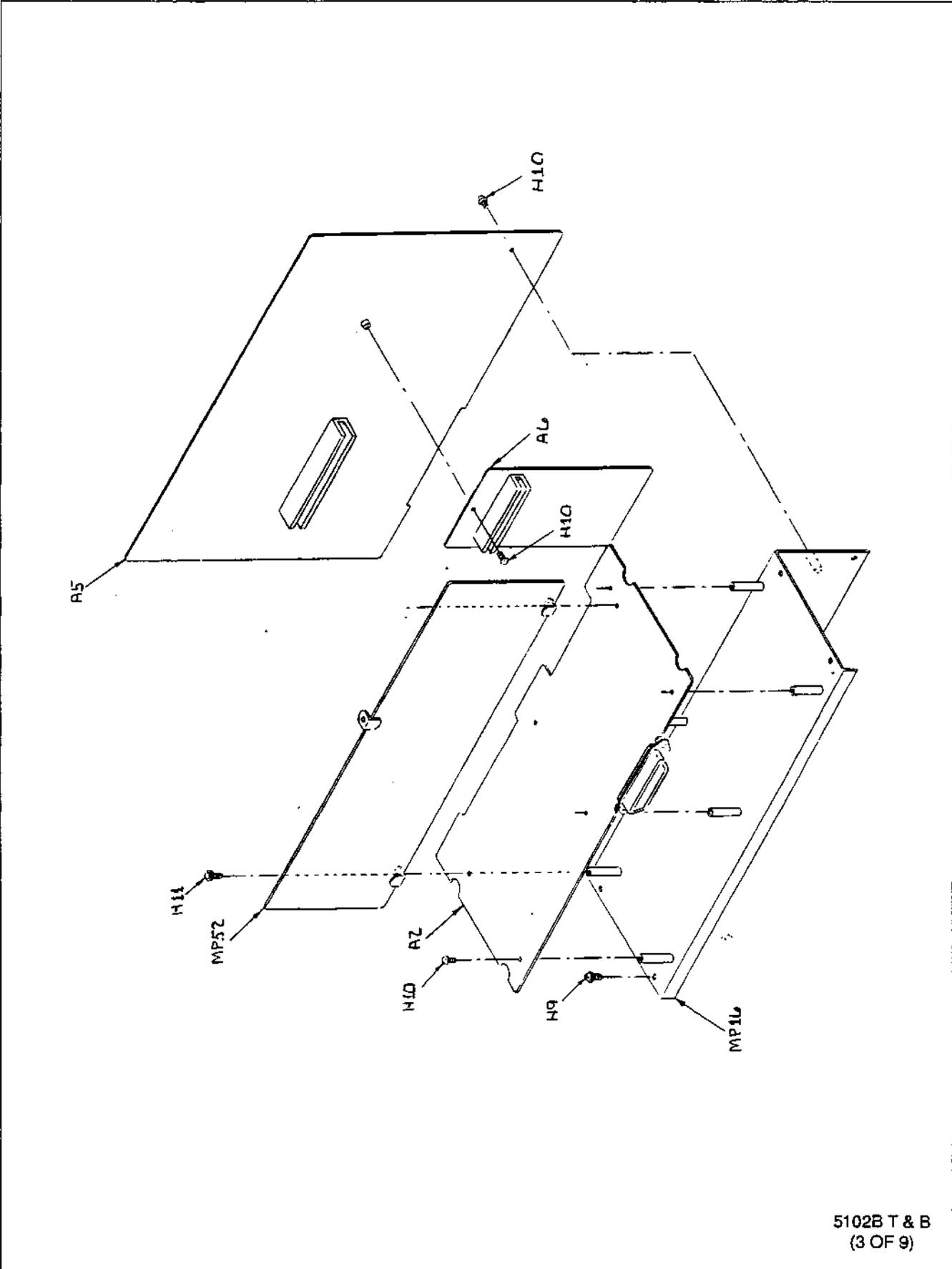

5102B T & B
(3 OF 9)

Figure 5-3. 5102B Final Assembly (cont)

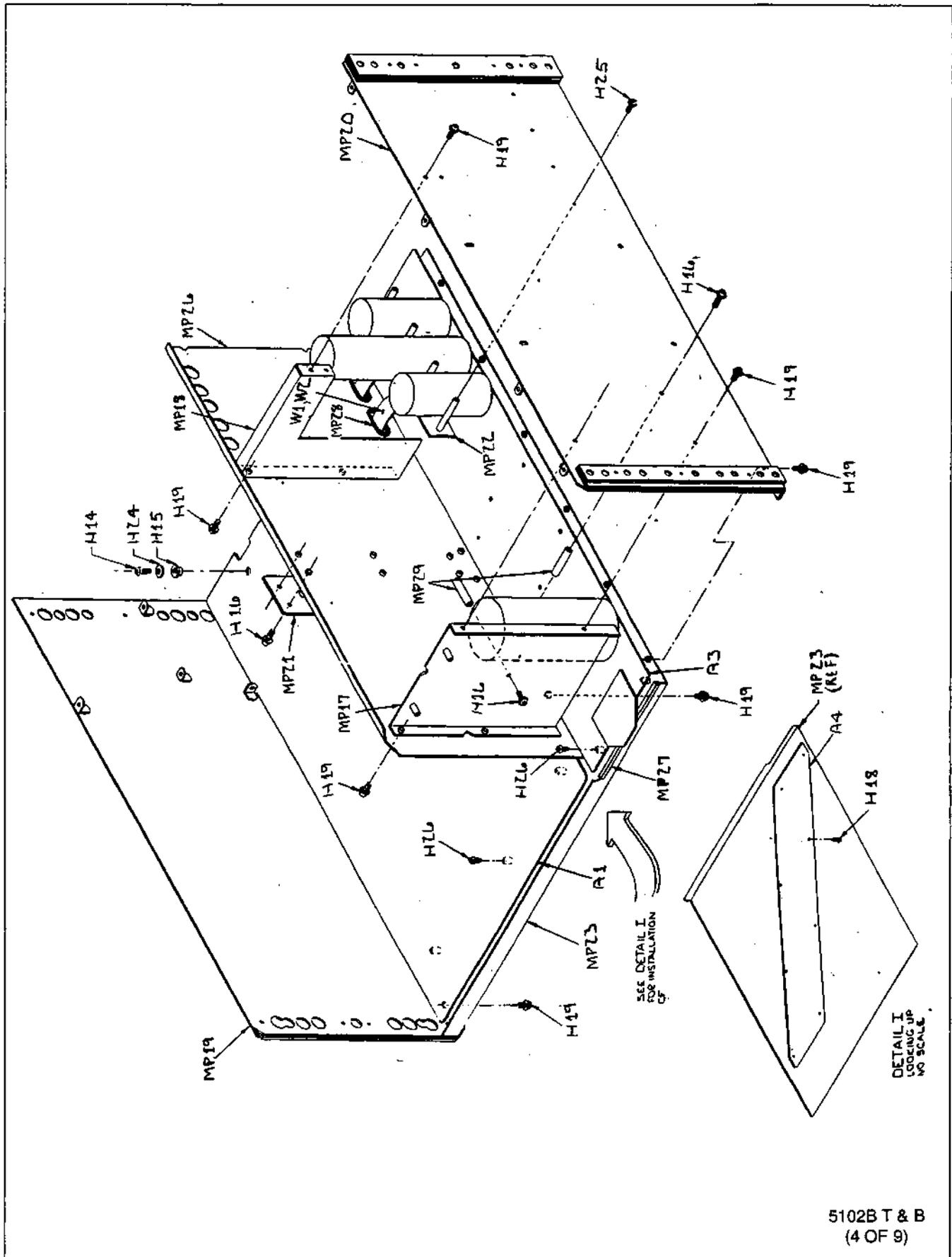

Figure 5-3. 5102B Final Assembly (cont)

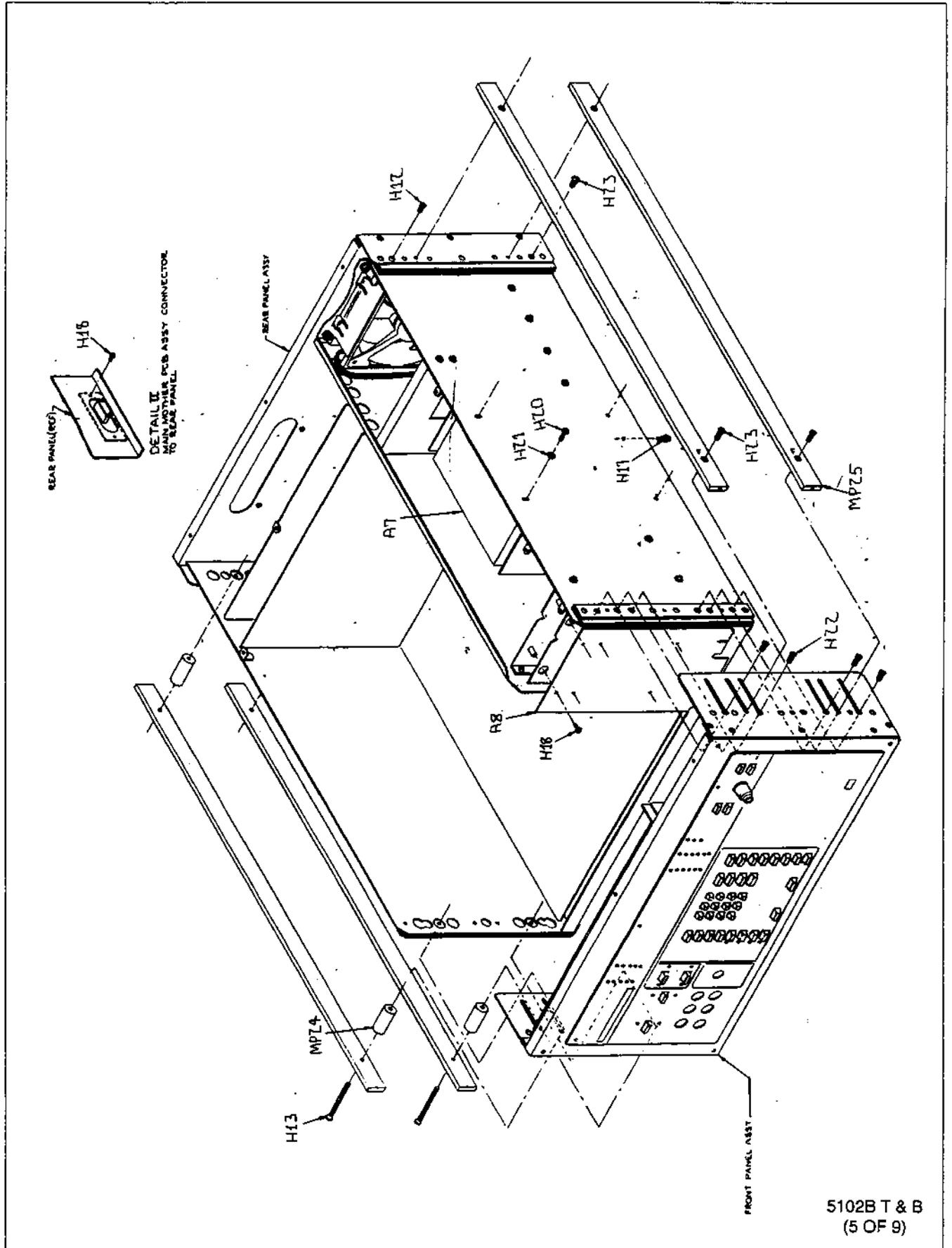
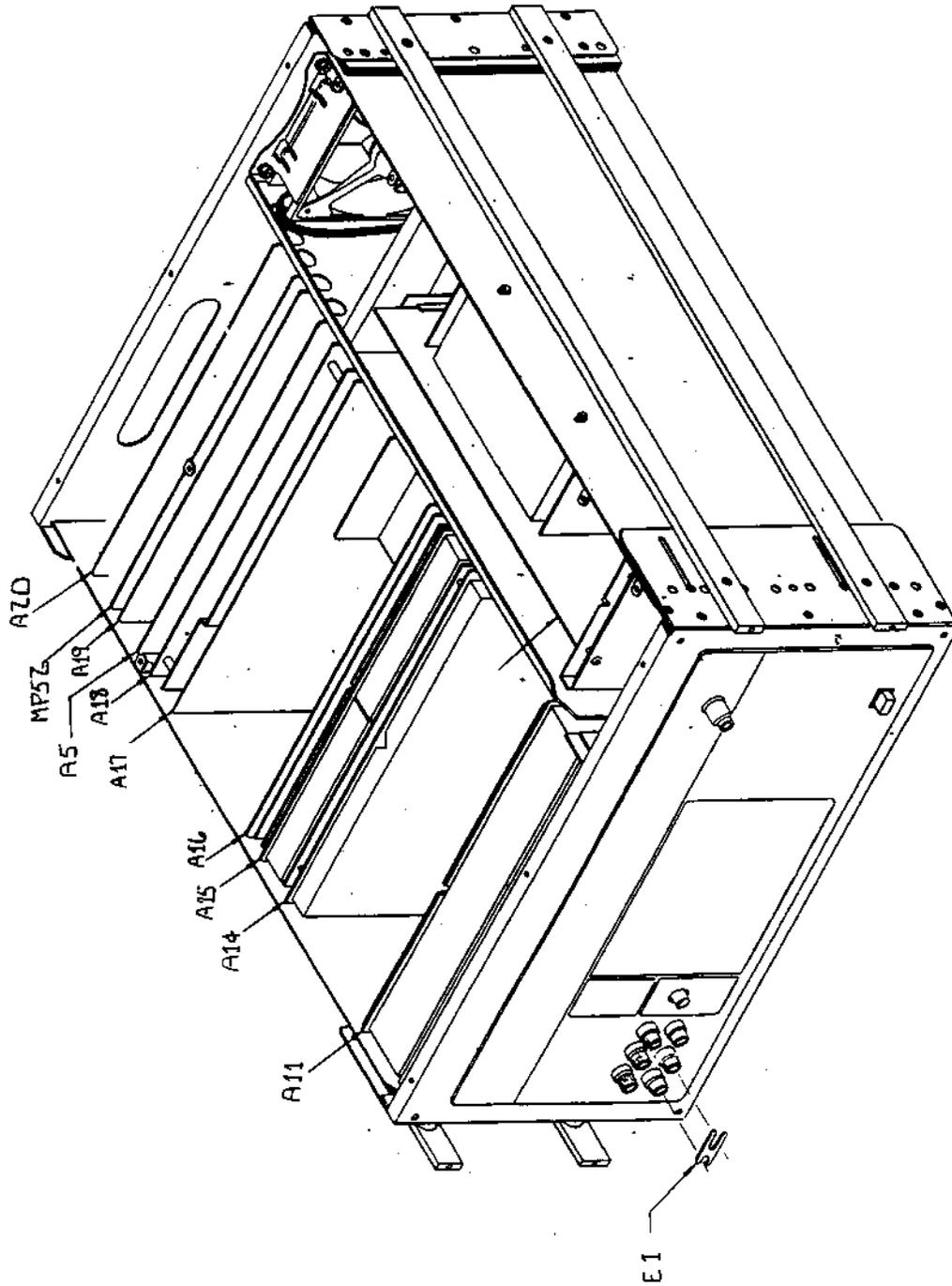
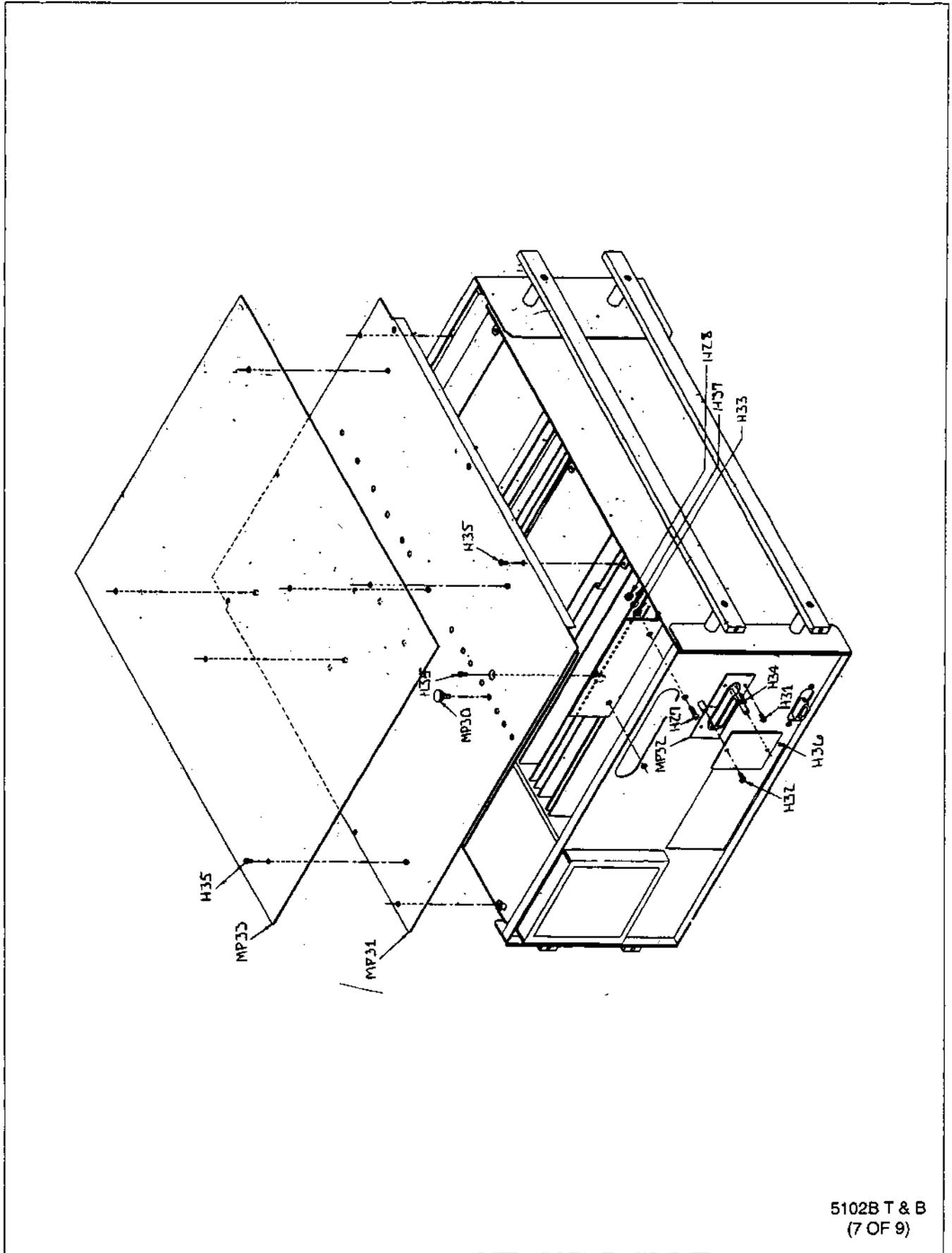

Figure 5-3. 5102B Final Assembly (cont)



5102B T & B
(6 OF 9)

Figure 5-3. 5102B Final Assembly (cont)



5102B T & B
(7 OF 9)

Figure 5-3. 5102B Final Assembly (cont)

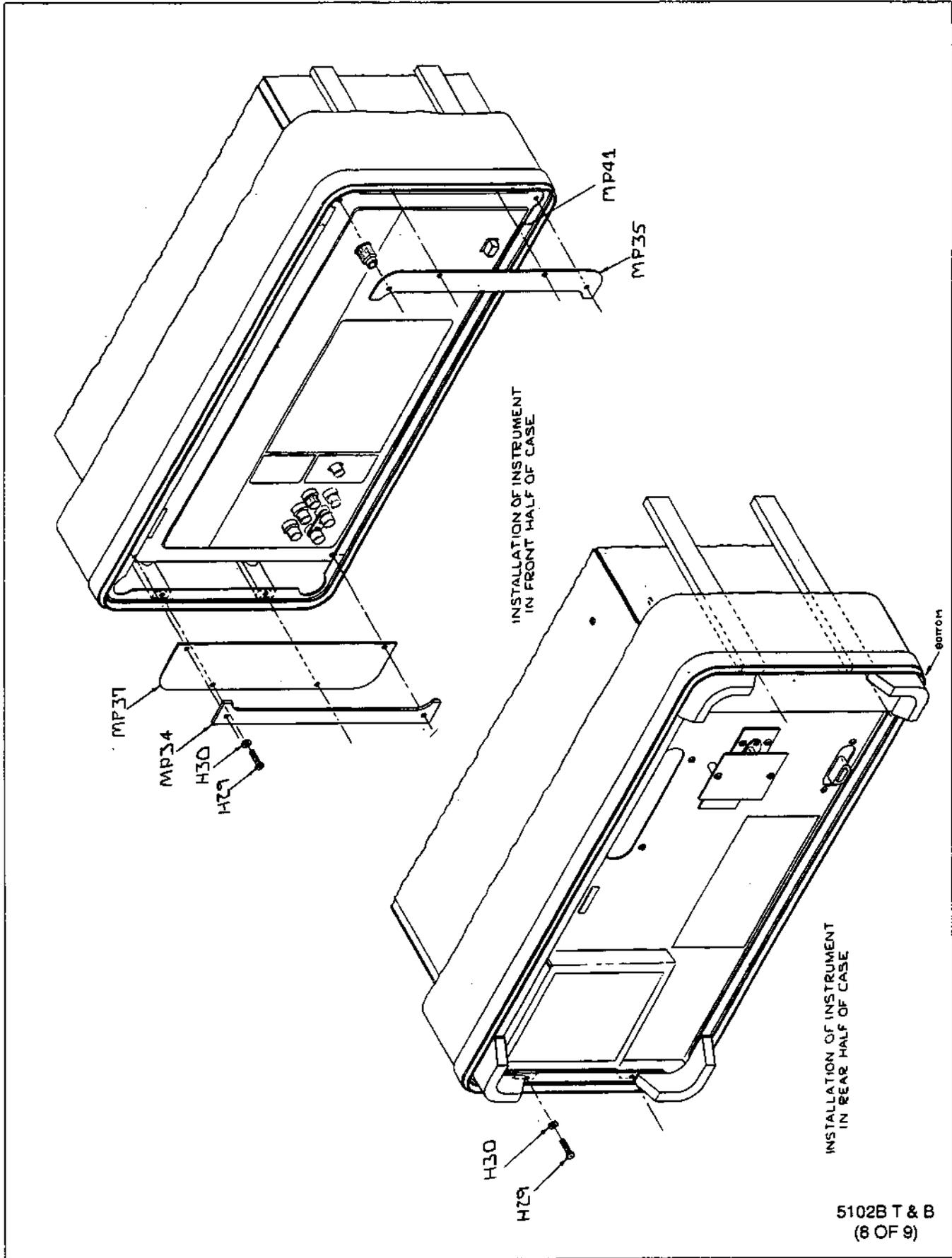
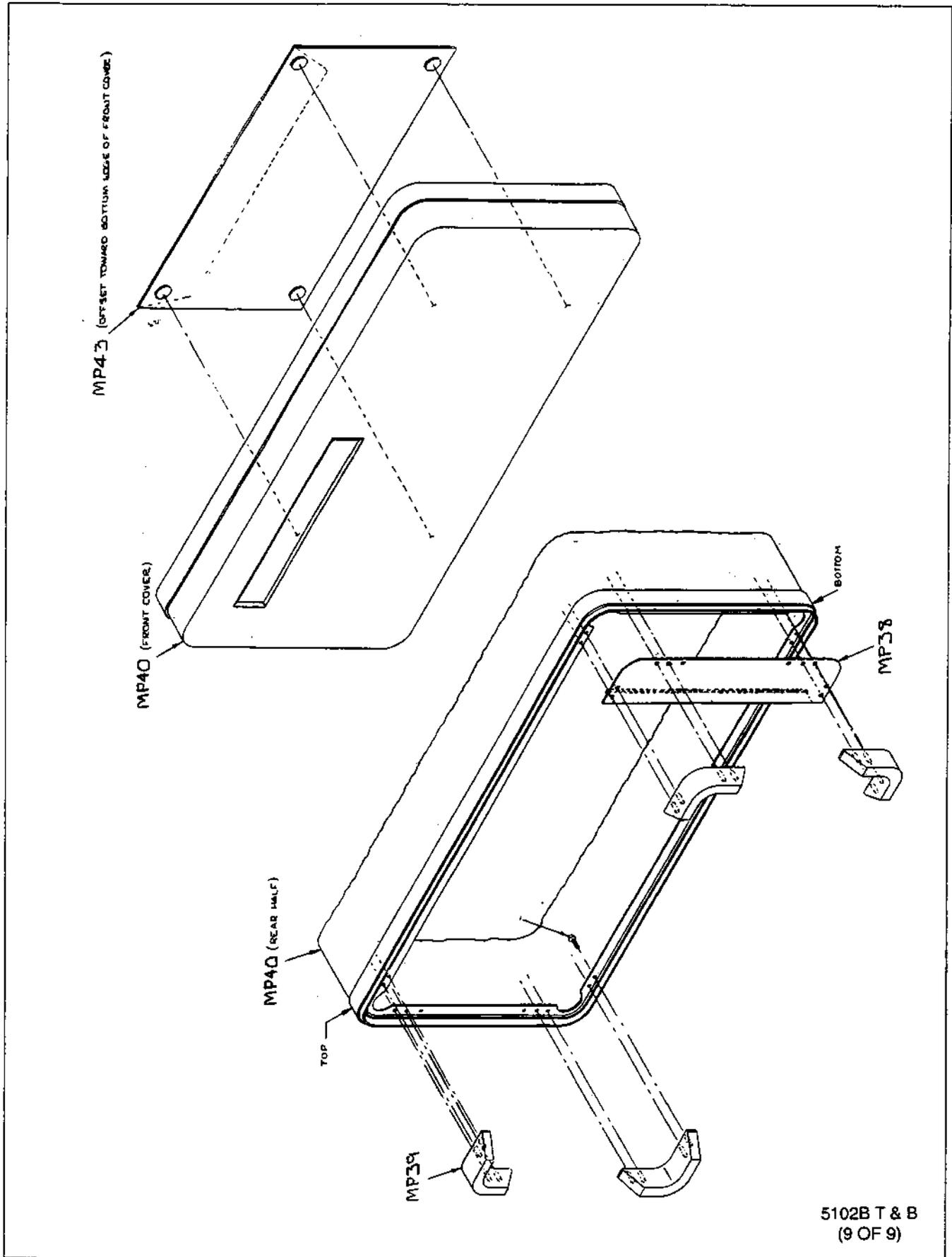

Figure 5-3. 5102B Final Assembly (cont)



5102B T & B
(9 OF 9)

Figure 5-3. 5102B Final Assembly (cont)

Table 5-4. A1 Main Motherboard PCA

REFERENCE DESIGNATOR	DESCRIPTION	FLUKE STOCK NO	MFRS SPLY CODE	MANUFACTURERS PART NUMBER OR GENERIC TYPE	TOT QTY	NOTES
C 1, 2	CAP, AL, 45000UF, +75-10%, 25V, LO TERM	446864	56289	36DX453G025BF2A	2	
H 1	SCREW, PH, P, LOCK, STL, 2-56, .250	149534	74594	149534	6	
H 2	SCREW, PH, P, LOCK, STL, 2-56, .375	146803	74594	146803	2	
H 3	SCREW, PH, P, SS, 10-32, .250	855184		COMMERCIAL	4	
H 4	SCREW, PH, P, SEMS, STL, 6-32, .500	177030		COMMERCIAL	8	
H 5	TERM, RING 5/64 & .196, SOLDR	101014	79963	123	2	
H 6	TERM, RING .087 & .196, SOLDR	101048	79963	46.196/.087.020 BRASS	2	
H 7	WASHER, LOCK, INTRNL, STL, .204ID	110312	73734	1306	4	
H 8	SCREW, PH, P, LOCK, STL, 4-40, .250	129890	74594	129890	11	
H 9	SCREW, PH, P, LOCK, STL, 4-40, .375	152124	89536	152124	1	
H 10	WASHER, FLAT, BR, .119, .281, .025	110775		COMMERCIAL	1	
J 2	CONN, MICRO-RIBBON, REC, CABLE, 14 POS	272450	02660	57-40140	1	
J 23, 41, 42,	CONN, PWB EDGE, REC, .150CTR, 40 POS	422550	00779	2-583407-0	17	
J 51, 52, 61,		422550				
J 62, 71, 72,		422550				
J 81, 82, 91,		422550				
J 92, 111, 112,		422550				
J 121, 122		422550				
J 43, 73	CONN, HV, CABLE, REC, 2 CONTACT	442889	81312	JFA25	2	
J 44, 53, 54,	CONN, COAX (F), PWB, SLIDE-ON	423020	98291	052-052-0000-220	4	
J 63		423020				
MP 2	PLATE, ANALOG CONNECTOR	425694	89536	425694	1	
MP 3	PLATE, CAPACITOR MOUNTING	425181	89536	425181	1	
MP 4	ANGLE, HV CONNECTOR	445015	89536	445015	2	
MP 5	CONN ACC, PWB EDGE, POLARIZING INSERT	293498	00779	530030-1	9	
MP 6	SPACER, .375 RND, NYL, 6-32, 2.000	446302	55866	1816632N	4	
MP 7	CABLE ACCESS, TIE, 4.00L, .10W, .75 DIA	172080	06383	SST-1M	3	
MP 8	BUSHING	846584	89536	846584	4	
MP 9	SHIELD, MAIN MOTHER PCB	425686	89536	425686	1	
MP 10	WASHER, SHLDR, NYLON, .113, .245	485417	86928	5607-50	1	
R 1, 2	RES, CC, 680, +-5%, 1W	180349	01121	GB6815	2	
W 1	CABLE ASSY, DC ATTENUATOR	432823	89536	432823	1	
W 2	CABLE ASSY, HIGH VOLTAGE	426924	89536	426924	1	
W 3	WIRE, KYN, UL1422/1423, 24AWG, SOLID, WHT	343798	89536	343798	1	
W 4	WIRE, TEF, UL1180, 22AWG, STRN, BLK	115774	89536	115774	1	
XP 14, 15, 16	SOCKET, IC, 16 PIN	276535	00779	2-640358-1	3	
NOTES:	† Static sensitive part.					

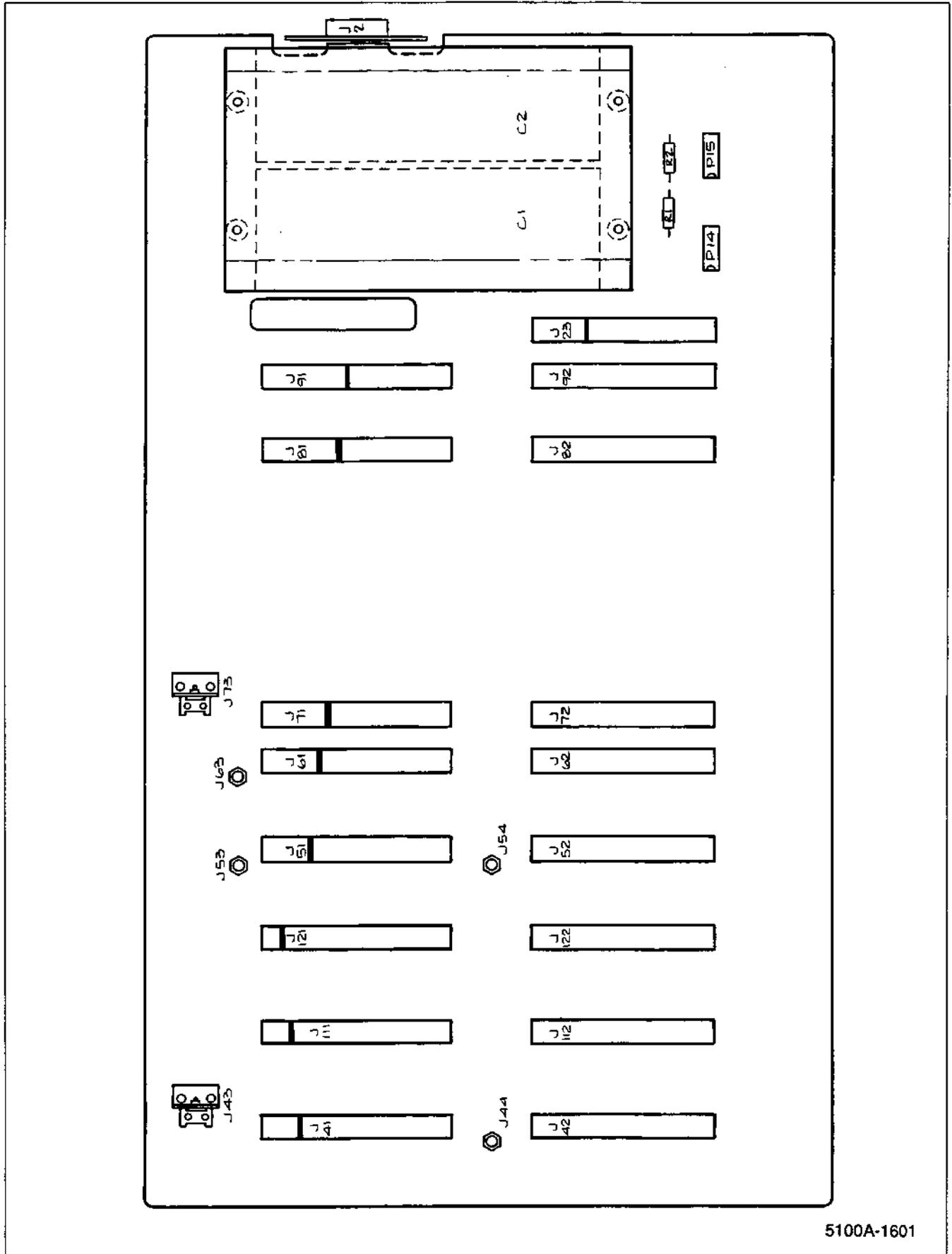
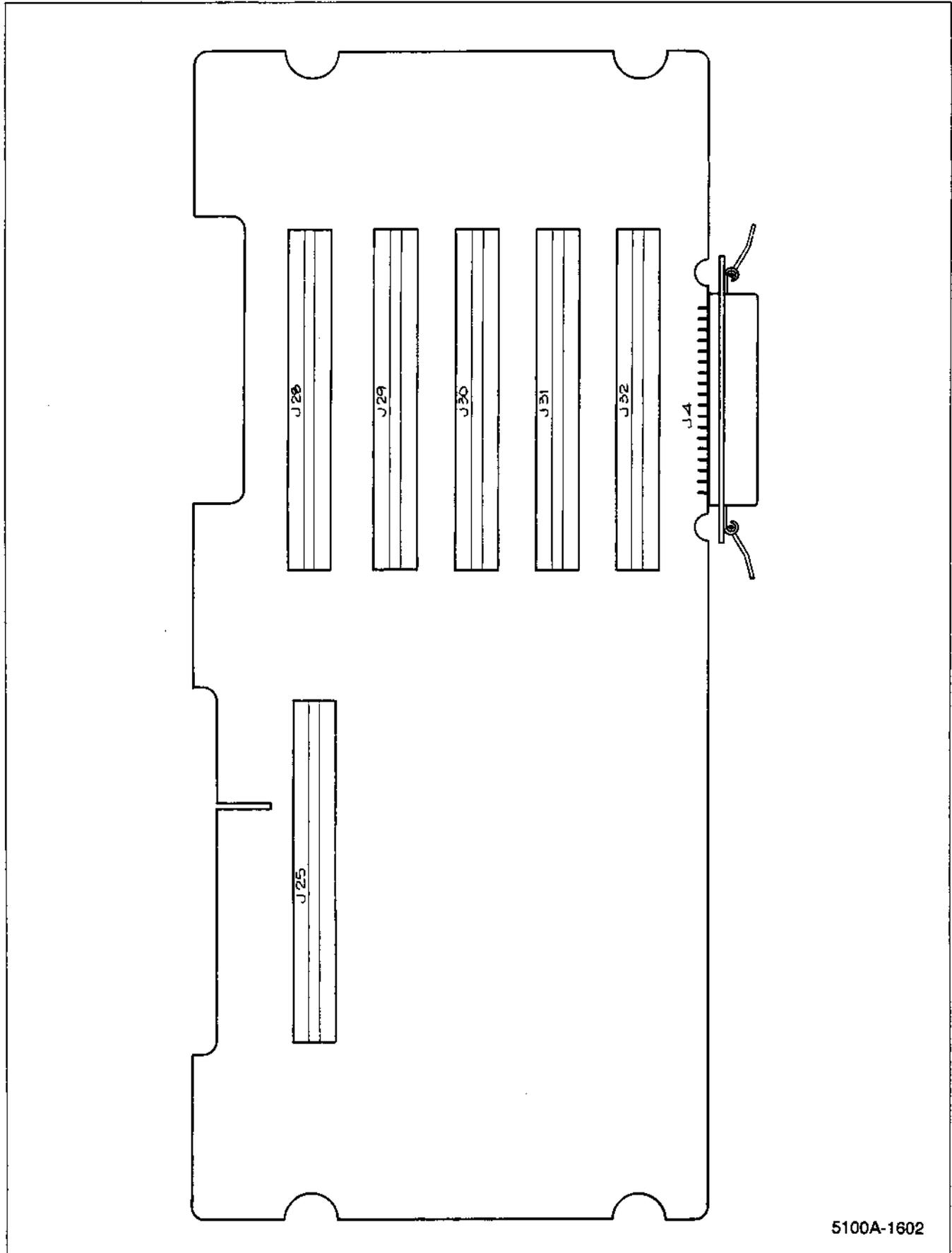

Figure 5-4. A1 Main MotherBoard PCA

Table 5-5. A2 MIS Motherboard PCA

REFERENCE DESIGNATOR	DESCRIPTION	FLUKE STOCK NO	MFRS SPLY CODE	MANUFACTURERS PART NUMBER OR GENERIC TYPE	TOT QTY	NOTES
J 4	CONN, MICRO-RIBBON, REC. CABLE, 36 POS	158469	02660	57-40360	1	
J 25, 28- 32	CONN, PWB EDGE, REC. .150CTR, 40 POS	422550	00779	2-583407-0	6	
MP 1- 5	CONN ACC, PWB EDGE, POLARIZING INSERT	293498	00779	530030-1	5	
MP 6	SPACER, SWAGE, .250 RND, BR. 4-40, .125	335596	55566	3045B440B14-MOD.-.125	1	
NOTES:	† Static sensitive part.					



5100A-1602

Figure 5-5. A2 MIS Motherboard PCA

Table 5-6. A3 Power Supply Motherboard PCA

REFERENCE DESIGNATOR	DESCRIPTION	FLUKE STOCK NO	MFRS SPLY CODE	MANUFACTURERS PART NUMBER OR GENERIC TYPE	TOT QTY	NOTES
C 1, 2	CAP, AL, 1700UF, +75-10%, 100V, HI TERM	423541	56289	36DX172G100AB2B	2	
C 7	CAP, AL, 34000UF, +100-10%, 15V, HI TERM	423533	56289	36DX343G015AF2B	1	
C 9, 10	CAP, AL, 750UF, +75-10%, 50V	424266	56289	601D757G050HL	2	
C 11	CAP, AL, 50000UF, +100-10%, 15V, HI TERM	423525	56289	36DX503G015BC2B	1	
F 1	FUSE, .25X1.25, 2A, 250V, SLOW	109181	71400	MDA-2	1	
H 1	NUT, HEX, STL, 4-40	110635		COMMERCIAL	2	
H 2	NUT, HEX, BR, 1/4-28	110619		COMMERCIAL	1	
H 3	SCREW, FH, P, STL, M2.5X6	380626	2M530	7985-M2.5X6	2	
H 4	SCREW, PH, P, SEMS, STL, 6-32, .250	178533		COMMERCIAL	3	
H 5	SPACER, SWAGE, .250 RND, BR, 4-40, .070	343996	55566	3045B440B14-MOD.-.070	3	
H 6	TERM, RING 1/4 & 1/32, SOLDR	102566	79963	813	2	
H 7	SCREW, PH, P, SEMS, STL, 4-40, .250	185918		COMMERCIAL	3	
H 8	SCREW, PH, P, SS, 10-32, .375	855176		COMMERCIAL	8	
H 9	WASHER, LOCK, SPLIT, STL, .194, .350, .047	111484	86928	5850-17-22	8	
H 10	WASHER, FLAT, COPPER, #8, .020	721688		COMMERCIAL	8	
H 11	TERM, RING #6, 3/32 - 2 PLACES, SOLDRD	132399	78189	2104-06-00	1	
J 1	PWR PLUG, PANEL, 6A, 250V, 3 WIRE	284166	82389	EAC-309	1	
J 11, 12	CONN, PWB EDGE, REC, .150CTR, 40 POS	422550	00779	2-583407-0	2	
J 13	CONN, PWB EDGE, REC, .150CTR, 16 POS	408484	00779	583407-9	1	
J 14, 15	SOCKET, IC, 16 PIN	276535	00779	2-640358-1	2	
J 16	CONN, PWB EDGE, REC, .150CTR, 28 POS	291930	00779	1-583407-4	1	
J 17	CONN, PWB EDGE, REC, .150CTR, 22 POS	459883	00779	1-583694-4	1	
MP 1	BINDING POST, STUD, PLATED	102707	89536	102707	1	
MP 2	BRACKET, FUSE/LINE	425173	89536	425173	1	
MP 3	BINDING HEAD, PLATED	102889	89536	102889	1	
MP 4	BRACKET, POWER SWITCH	425678	89536	425678	1	
MP 5	CONN ACC, PWB EDGE, POLARIZING INSERT	293498	00779	530030-1	4	
MP 6	INSULATOR POWER SWITCH	438564	89536	438564	1	
MP 7	CABLE ACCESS, TIE, 4.00L, .10W, .75 DIA	172080	06383	SST-1M	6	
R 1, 2, 7	RES, CC, 18K, +-10%, 1W	109447	01121	GB1831	3	
R 3, 4	RES, CF, 39K, +-5%, 0.25W	442400	59124	CF1/4 393J	2	
R 11	RES, CC, 680, +-5%, 1W	180349	01121	GB6815	1	
RV 3	VARISTOR, 430V, +-10%, 1.0MA	519355	34371	V275LA20A	1	
S 1	POWER SWITCH	291526	89536	291526	1	
S 4	PUSHBUTTON SML RECT C L REPL GREEN	419747	89536	419747	1	
W 1	WIRE, TEF, UL1180, 18AWG, STRN, GRN/YEL	386177	89536	386177	1	
W 2	WIRE, TEF, UL1180, 18AWG, STRN, BLK	135814	04946	135814	1	
W 3	WIRE, TEF, UL1180, 22AWG, STRN, WHT	115667	89536	115667	1	
W 4	CABLE ASSY, POWER & FAN	426858	89536	426858	1	
W 5	CORD SET, FAN	438424	89536	438424	1	
XF 1	HDR, FUSE, 1/4 X 1-1/4 HI PROFILE	658344	75915	345-612	1	
NOTES:	† Static sensitive part.					

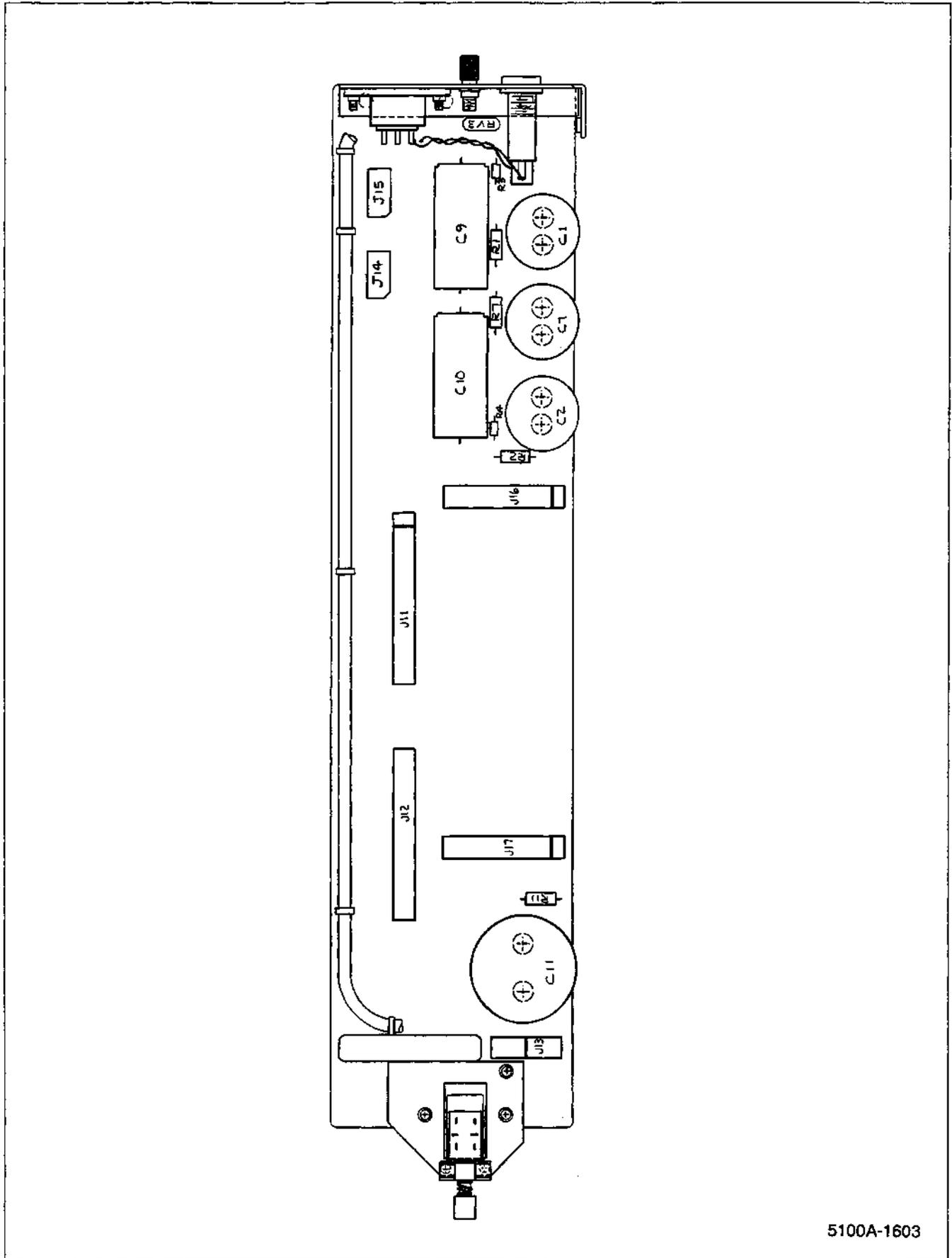

5100A-1603

Figure 5-6. A3 Power Supply Motherboard PCA

Table 5-7. A4 Diagonal Bus PCA

REFERENCE DESIGNATOR	DESCRIPTION	FLUKE STOCK NO	MFRS SPLY CODE	MANUFACTURERS PART NUMBER OR GENERIC TYPE	TOT QTY	NOTES
J 22	CONN, FWB EDGE, REC, .150CTR, 32 POS	448050	00779	1-583407-6	1	
J 27	CONN, FWB EDGE, REC, .150CTR, 30 POS	291948	00779	1-583407-5	1	
MP 1- 3	CONN ACC, FWB EDGE, POLARIZING INSERT	293498	00779	530030-1	3	
MP 4	PLASTIC PART, HOLE PLUG, POLYETH, .312	187799	82240	B-2328	8	
NOTES:	† Static sensitive part.					

Table 5-8. A5 Main Interconnect PCA

REFERENCE DESIGNATOR	DESCRIPTION	FLUKE STOCK NO	MFRS SPLY CODE	MANUFACTURERS PART NUMBER OR GENERIC TYPE	TOT QTY	NOTES
MP 1	CONN ACC, FWB EDGE, POLARIZING INSERT	293498	00779	530030-1	1	
MP 2	SPACER, SWAGE, .250 RND, BR, 4-40, .187	330498	55566	3046B440B5	1	
P 24	CONN, FWB EDGE, REC, .150CTR, 40 POS	422550	00779	2-583407-0	1	
NOTES:	† Static sensitive part.					

Table 5-9. A6 MIS Interconnect PCA

REFERENCE DESIGNATOR	DESCRIPTION	FLUKE STOCK NO	MFRS SPLY CODE	MANUFACTURERS PART NUMBER OR GENERIC TYPE	TOT QTY	NOTES
J 26	CONN, FWB EDGE, REC, .150CTR, 30 POS	291948	00779	1-583407-5	1	
NOTES:	† Static sensitive part.					

Table 5-10. A7 Power Supply Termination Assembly

REFERENCE DESIGNATOR	DESCRIPTION	FLUKE STOCK NO	MFRS SPLY CODE	MANUFACTURERS PART NUMBER OR GENERIC TYPE	TOT QTY	NOTES
A 1	† FWD TRANSFORMER TERMINATION PCA	700435	89536	700435	1	
A 2	† APT TRANSFORMER TERMINATION PCA	700484	89536	700484	1	
H 1	SCREW, PH, P, LOCK, STL, 4-40, .312	152116	74594	152116	8	
H 2	WASHER, FLAT, STL, .123, .250, .032	195909		COMMERCIAL	4	
H 3	SCREW, PH, P, LOCK, STL, 8-32, .375	114124	74594	114124	16	
H 4	WASHER, FLAT, STL, .170, .375, .031	110288		COMMERCIAL	16	
H 5	SCREW, PH, P, LOCK, STL, 4-40, .500	152132	74594	152132	8	
H 6	SCREW, PH, P, LOCK, STL, 6-32, .312	152157	74594	152157	4	
H 7	SCREW, PH, P, LOCK, STL, 8-32, .250	228890	74594	228890	8	
H 8	SCREW, PH, P, LOCK, STL, 8-32, 1.625	772863	74594	772863	4	
H 9	NUT, HEX, STL, 8-32	110544		COMMERCIAL	4	
H 10	WASHER, LOCK, SPLIT, STL, .168, .307, .040	111070	86928	5850-15-22	4	
MP 1	BRACKET, TRANSFORMER	803296	89536	803296	4	
MP 2	MTG PLATE, UPPER, POWER XFMR	426486	89536	426486	1	
MP 3	MTG PLATE, LOWER, POWER XFMR	426494	89536	426494	1	
MP 4	SHIELD MAGNETIC	453795	89536	453795	1	
NOTES:	† Static sensitive part.					

Table 5-11. A7A1 Forward Transformer Termination PCA

REFERENCE DESIGNATOR	DESCRIPTION	FLUKE STOCK NO	MFRS SPLY CODE	MANUFACTURERS PART NUMBER OR GENERIC TYPE	TOT QTY	NOTES
C 1	CAP. POLYES. 0.47UF, +-10%, 50V	697409	37942	185-2-474K50AA	1	
C 2, 3	CAP. POLYES. 0.1UF, +-20%, 250VAC	542233	72347	PME271M610	2	
C 12, 13	CAP. AL, 2200UF, +75-20%, 25V	392720	62643	SM25T-2200	2	
CR 5	DIODE, SI, RECT, BRIDGE, BV=200V, IO=1.5A	296509	30800	KBP 02M	1	
CR 11, 12	DIODE, SI, 100 PIV, 22.0 AMP	325746	04713	MR751	2	
CR 16, 17	DIODE, SI, 100 PIV, 1.0 AMP	698555	04713	1N4002	2	
E 1- 21	TERM, UNINSUL, FEEDTHRU, HOLE, TURRET	101741	03445	3505-B	21	
MP 1	CABLE TIE, 5", 1.375"DIA	807230	SU802	08350	2	
R 9, 10	RES. CC, 4.3K, +-5%, 0.5W	403337	01121	EB4325	2	
RV 2	VARISTOR, 68V, +21, -26%, 1.0MA	460394	09214	V68MA3A	1	
S 1- 3	SWITCH, SLIDE, DPDT, POWER	234278	82389	11A1297A	3	
NOTES:	† Static sensitive part.					

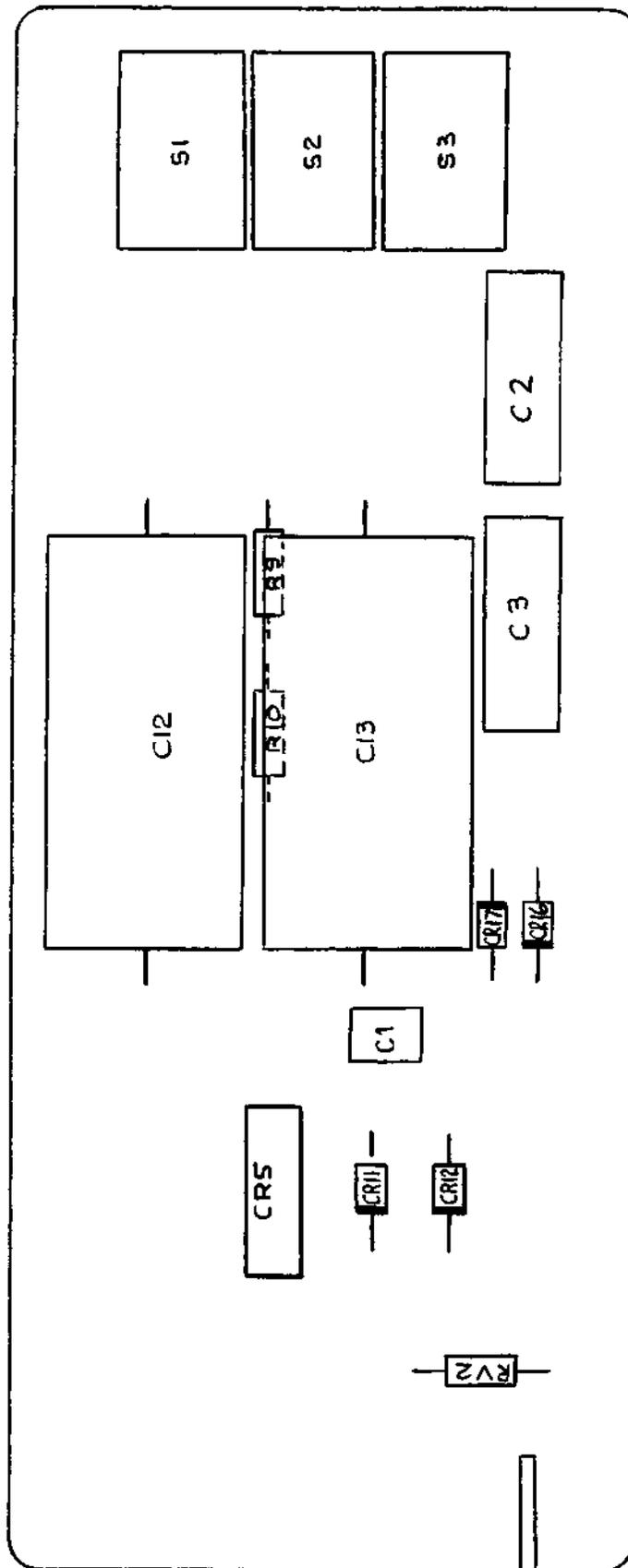

5100A-1611

Figure 5-7. A7A1 Forward Transformer Termination PCA

Table 5-12. A7A2 Aft Transformer Termination PCA

REFERENCE DESIGNATOR	DESCRIPTION	FLUKE STOCK NO	MFRS SPLY CODE	MANUFACTURERS PART NUMBER OR GENERIC TYPE	TOT QTY	NOTES
C 3, 4	CAP, AL, 2200UF, +75-20%, 35V	370742	62643	SM35T-2200	2	
C 8	CAP, AL, 2200UF, +75-20%, 16V	364182	62643	SM16T-2200	1	
CR 1, 2, 4	DIODE, SI, RECT, BRIDGE, BV=200V, IO=1.5A	296509	30800	KBP 02M	3	
CR 6- 9, 12- CR 15	DIODE, SI, 200 PIV, 3.0 AMP	331090	14099	SS6252	8	
E 1- 23	TERM, UNINSUL, FEEDTHRU, HOLE, TURRET	101741	03445	3505-B	23	
F 1, 2	FUSE, .25X1.25, 3A, 250V, SLOW	109280	71400	MDA-3	2	
F 3, 4	FUSE, 8X8.5MM, 2A, 250V, SLOW, RADIAL	806331	0JR59	19372-TPRL-2.000	2	
MP 1- 4	FUSE, CLIP, PCB, 1/4X1-1/4	756460	75915	122088	4	
MP 5	CABLE TIE, 5", 1.375"DIA	807230	5U802	08350	3	
R 5, 6, 8	RES, CC, 4.3K, +-5%, 0.5W	403337	01121	EB4325	3	
RV 1	VARISTOR, 68V, +21, -26%, 1.0MA	460394	09214	V68MA3A	1	
NOTES:	† Static sensitive part.					

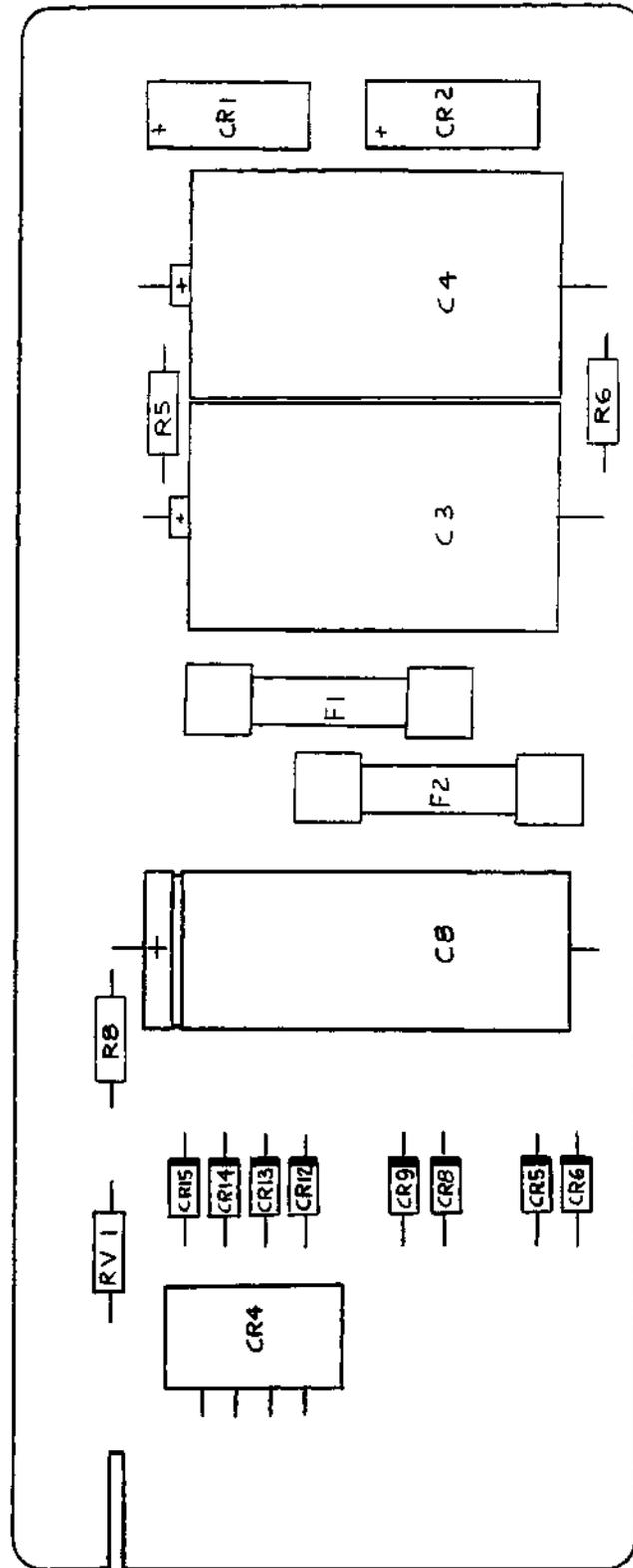

5100A-1612

Figure 5-8. A7A2 Aft Transformer Termination PCA

Table 5-13. A8 Power Supply Interconnect PCA (5100B & 5102B)

REFERENCE DESIGNATOR	DESCRIPTION	FLUKE STOCK NO	MFRS SPLY CODE	MANUFACTURERS PART NUMBER OR GENERIC TYPE	TOT QTY	NOTES
H 1	SCREW, PH. P, LOCK, STL, 4-40, .250	129890	74594	129890	4	
J 10, 21	SOCKET, IC, 16 PIN	276535	00779	2-640358-1	2	
MP 1	SHIELD, POWER SUPPLY INTERCONNECT	455634	89536	455634	1	
NOTES:	† Static sensitive part.					

Table 5-14. A8 Tape Interface PCA (5101B)

REFERENCE DESIGNATOR	DESCRIPTION	FLUKE STOCK NO	MFRS SPLY CODE	MANUFACTURERS PART NUMBER OR GENERIC TYPE	TOT QTY	NOTES
C 1, 13	CAP, POLYES, 0.1UF, +-10%, 100V	393439	68919	MKS4104K100	2	
C 2	CAP, POLYES, 0.01UF, +-10%, 250V	325548	68919	MKS4103K250	1	
C 3	CAP, TA, 22UF, +-20%, 15V	423012	56289	199D226X0015DA2	1	
C 4, 14	CAP, POLYES, 0.22UF, +-10%, 100V	436113	68919	MKS4224K100	2	
C 12	CAP, POLYES, 0.001UF, +-10%, 200V	159582	84411	JF-31 102 K 200	1	
C 15- 19	CAP, TA, 0.22UF, +-20%, 35V	161331	56289	199D224X0035AA2	5	
C 20	CAP, MICA, 240PF, +-5%, 500V	362863	93790	CD15FD241J03	1	
H 1	SCREW, PH. P, LOCK, STL, 4-40, .250	129890	74594	129890	4	
J 10, 21	SOCKET, IC, 16 PIN	276535	00779	2-640358-1	2	
MP 1	SHIELD, POWER SUPPLY INTERCONNECT	455634	89536	455634	1	
Q 10, 11	† TRANSISTOR, SI, PNP, SMALL SIGNAL	226290	04713	MP53640	2	
Q 12	† TRANSISTOR, SI, NPN, SMALL SIGNAL, TO-92	218396	04713	2N3904	1	
R 1	RES, MF, 750, +-1%, 0.125W, 100PPM	312801	91637	CMF-55 7500F T-1	1	
R 2	RES, VAR, CERM, 500, +-20%, 0.5W	267849	80294	3009P-1-S01	1	
R 3	RES, CF, 20K, +-5%, 0.25W	441477	59124	CF1/4 203J	1	
R 8, 19, 21	RES, CF, 150, +-5%, 0.25W	343442	59124	CF1/4 151J	3	
R 9, 20, 22	RES, CF, 22K, +-5%, 0.25W	348870	59124	CF1/4 223J	3	
R 11	RES, MF, 3.48K, +-1%, 0.125W, 100PPM	260687	91637	CMF-55 3481F T-1	1	
R 12, 15, 15,	RES, CF, 3K, +-5%, 0.25W	441527	59124	CF1/4 302J	4	
R 16		441527				
R 13	RES, VAR, CERM, 2K, +-20%, 0.5W	267864	80294	3009P-1-202	1	
R 14	RES, MF, 10K, +-1%, 0.125W, 100PPM	168260	91637	CMF-55 1002F T-1	1	
R 30	RES, CF, 510, +-5%, 0.25W	441600	59124	CF1/4 511J	1	
TP 1- 7	TERM, UNINSUL, FEEDTHRU, HOLE, TURRET	179283	88245	2010B-5	7	
U 1	† IC, BPLR, TIMER, 8 PIN DIP	402610	18324	NE555N	1	
U 2, 24	† IC, CMOS, DUAL JK F/F, +EDG TRIG	355230	27014	CD4027BCN	2	
U 3, 25	† IC, CMOS, QUAD 2 INPUT AND GATE	408401	04713	MC14081BCP	2	
U 4	† IC, CMOS, QUAD 2 INPUT NOR GATE	355172	27014	CD4001BCN	1	
U 5, 26	† IC, CMOS, DUAL D F/F, +EDG TRG	418830	27014	MM74C74J	2	
U 6	† IC, CMOS, 8BIT PAR/SER-I/O SHIFT RGS	380766	04713	MC14021BCP	1	
U 7, 8	† IC, CMOS, QUAD D LATCH, W/KOR ENABLE	355149	34371	CD4042BE	2	
U 9	† IC, CMOS, TRIPLE 3 INPUT NAND GATE	375147	27014	CD4023CN	1	
U 10	† IC, CMOS, QUAD KOR GATE	355222	34371	CD4030BE	1	
U 11, 14	† IC, CMOS, PRSET BIN/DEC UP/DOWN COUNTER	452904	04713	MC14029BCP	2	
U 12	† IC, LSTTL, RETRG MONOSTAB MULTIVIB W/CLR	404186	01295	SN74LS123N	1	
U 13	† IC, TTL, MONOSTABLE MULTIVIBRATOR	293050	27014	DM7412N	1	
U 15	† IC, CMOS, QUAD 2 INPUT OR GATE	408393	04713	MC14071BCP	1	
U 16	† IC, CMOS, DUAL 4 INPUT NAND GATE	355206	04713	MC14012BCP	1	
U 18	† IC, CMOS, DUAL 4BIT SER-IN, PAR-OUT SHFT	340125	04713	MC14015BCP	1	
U 19, 20	† IC, CMOS, QUAD D LATCH, +EDG TRG, W/RESET	412742	27014	MM74C173N	2	
U 21, 22	† IC, CMOS, HEX BUFFER W/3-STATE OUTPUT	407759	04713	MC14503BCP	2	
U 23	† IC, CMOS, QUAD D F/F, +EDG TRG, W/CLR	452912	27014	MM74C175N	1	
U 27	† IC, CMOS, QUAD 2 INPUT NAND GATE	355198	04713	MC14011UBCP	1	
W 1	CABLE ASSY, TAPE INTERFACE	463109	89536	463109	1	
XU 13	SOCKET, IC, 14 PIN	276527	00779	2-640357-1	1	
NOTES:	† Static sensitive part.					

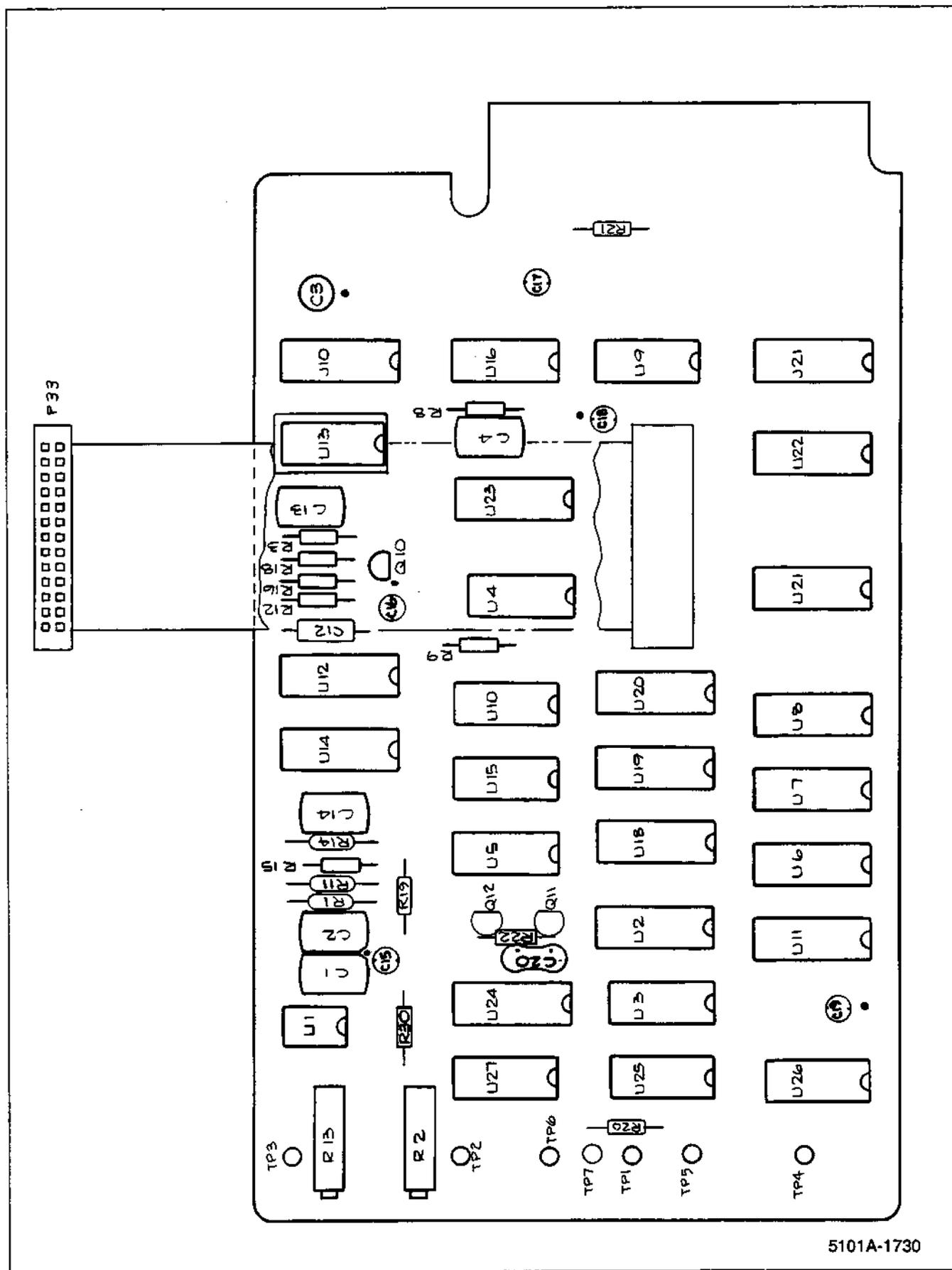

Figure 5-9. A8 Tape Interface PCA (5101B)

Table 5-15. A9 Power Supply Regulator PCA

REFERENCE DESIGNATOR	DESCRIPTION	FLUKE STOCK NO	MFRS SPLY CODE	MANUFACTURERS PART NUMBER OR GENERIC TYPE	TOT QTY	NOTES
C 1, 2, 4-	CAP, TA, 1UF, +-20%, 35V	697417	56289	199D105X0035AG2	6	
C 6, 40		697417				
C 3, 20	CAP, CER, 1500PF, +-10%, 50V, COG	832600	04222	SR215A152KAA	2	
C 7	CAP, CER, 100PF, +-5%, 50V, COG	831495	04222	SR595A101JAA	1	
C 8	CAP, CER, 2000PF, +-20%, 100V, 25U	757096	60705	562C25USE101EE202M	1	
C 9	CAP, AL, 2, 2UF, +-20%, 50V, SOLV PROOF	816868	62643	KME50T2R2M5X11RP	1	
C 10, 14, 15,	CAP, CER, 33PF, +-2%, 50V, COG	715292	04222	SR595A330GAA	5	
C 21, 24		715292				
C 11, 15, 17,	CAP, CER, 2700PF, +-5%, 50V, COG	832303	04222	SR595A272JAA	5	
C 22, 25		832303				
C 12, 13	CAP, AL, 47UF, +-20%, 50V, SOLV PROOF	822403	62643	KME50T47RM6X11RP	2	
C 18, 19	CAP, AL, 10UF, +75-10%, 150V	106251	56289	30D106-K-150	2	
C 23, 26	CAP, AL, 20UF, +75-10%, 50V	106229	56289	30D206-K-50	2	
C 27, 28, 64-	CAP, CER, 0.047UF, +-10%, 100V, X7R	844733	04222	SR595A473KAA	6	
C 67		844733				
C 29, 30, 32-	CAP, CER, 0.22UF, +80-20%, 50V, 25U	649939	04222	SR595E224ZAA	7	
C 36		649939				
C 31, 39	CAP, CER, 1UF, +-20%, 50V, 25U	436782	04222	SR305E105MAA	2	
C 37, 38	CAP, AL, 2UF, +75-10%, 150V	267310	56289	30D205-K-150	2	
C 41	CAP, TA, 150UF, +-20%, 15V	422576	56289	199D157X0015FA1	1	
C 42	CAP, TA, 5, 6UF, +-20%, 25V	368969	56289	199D565X0025CA2	1	
C 60, 63	CAP, AL, 100UF, +-20%, 16V, SOLV PROOF	816850	62643	KME16T101M6, 3X11RP	2	
C 61	CAP, POLYES, 0.01UF, +-10%, 50V	309906	56699	712A1BB103PK401SK	1	
C 62	CAP, POLYPS, 0.047UF, +-2%, 160V	929872	89536	929872	2	
CR 2-15, 19	DIODE, SI, 400 PIV, 1 AMP	831586	65940	1N4004A	15	
CR 16, 17	DIODE, SI, BV=75V, IO=150MA, 500MW	203323	65940	1N4448	2	
F 1, 7	FUSE, 8X8.5MM, 3.15A, 250V, SLOW, RADIAL	832253	0JR59	19372-TPRL-3.150	2	
F 2, 4	FUSE, 8X8.5MM, 0.125A, 250V, SLOW, RADIAL	832261	0JR59	19372-TPRL-0.125	2	
F 5	FUSE, 8X8.5MM, 2A, 250V, SLOW, RADIAL	806331	0JR59	19372-TPRL-2.000	1	
F 6	FUSE, 8X8.5MM, 1.0A, 250V, SLOW, RADIAL	845433	0JR59	19372-TPRL-1.000	1	
H 1	SPACER, SWAGE, .250 RND, BR, 6-32, .070	342824	55566	3045B632B14-MOD.-.070	17	
H 2	SCREW, PH, P, SEMS, STL, 6-32, .375	177022		COMMERCIAL	17	
H 3	SCREW, PH, P, SEMS, STL, 6-32, .250	178533		COMMERCIAL 3		
MP 1-8	SOCKET, SINGLE, PWB, FOR 0.018-0.040 PIN	284281	00779	380598-2	8	
MP 9	HEAT DIS, HORIZ, 1.18X1.00X0.50, TO-220	453878	13103	6106-B-14	4	
MP 10	HEAT DIS, VERT FINS, TO-3	342675	13103	6003-B-2	4	
MP 11	HEAT DIS, VERT FIN, 1.00X.71OX.50, BLACK	352765	13103	6107-B-14	4	
P 1-18	JUMPER, WIRE, NONINSUL, 0.200CTR	816090	91984	150T1	18	
Q 1, 15	TRANSISTOR, SI, BV=60V, 200W, TO-3	483230	04713	2N5885	2	
Q 2, 14	TRANSISTOR, SI, BV=70V, 90W, TO-127	325720	04713	MJE3055	2	
Q 3, 13	TRANSISTOR, SI, BV=70V, 90W, TO-127	325738	04713	MJE2955	2	
Q 5, 12	TRANSISTOR, SI, BV=375V, 100W, TO-3	313213	34371	2N5240	2	
Q 6	TRANSISTOR, SI, NPN, SMALL SIGNAL	333067	04713	2N3439	1	
Q 7, 18, 21	TRANSISTOR, SI, NPN, SMALL SIGNAL, TO-92	698225	27014	2N3904	3	
Q 8, 17	TRANSISTOR, SI, PNP, TO92	698274	04713	2N5401	2	
Q 9, 16	TRANSISTOR, SI, NPN, HI-VOLTAGE, TO-92	722934	27014	MPSA42	2	
Q 10, 24	TRANSISTOR, SI, PNP, TO92	698233	04713	2N3906	2	
Q 11	TRANSISTOR, SI, VB=200V, 10W, TO-5	276899	04713	2N5415	1	
Q 19, 20	THYRISTOR, SI, TRIAC, VBO=400V, 8.0A	271668	04713	SC146D	2	
Q 22, 23	TRANSISTOR, SI, BV=45V, 30W, TO-220	325761	34371	D44C5	2	
R 1, 29	RES, MF, 1.43K, +-1%, 0.125W, 100PPM	325662	91637	CMF-55 1431F T-1	2	
R 2, 30	RES, MF, 4.75K, +-1%, 0.125W, 100PPM	260679	91637	CMF-55 4751F T-1	2	
R 3, 31, 77	RES, WW, 0.27, +-5%, 2W	219428		SPH.27OHMS5%	3	
R 5	RES, MF, 5.11K, +-1%, 0.125W, 100PPM	294868	91637	CMF-55 5111F T-1	1	
R 6, 83, 84	RES, VAR, CERM, 1K, +-10%, 0.5W	285155	80294	33865-1-102	1	
R 7	RES, CF, 51K, +-5%, 0.25W	376434	59124	CF1/4 513J	3	
R 8	RES, MF, 2.32K, +-1%, 0.125W, 100PPM	260315	91637	CMF-55 2321F T-1	1	
R 9, 10	RES, MF, 7.5K, +-1%, 0.5W, 100PPM	192161	91637	CMF-65 7501F T-1	2	
R 11, 98	RES, CF, 100, +-5%, 0.25W	348771	59124	CF1/4 101J	2	
R 14, 34, 39	RES, MF, 110K, +-1%, 0.125W, 100PPM	234708	91637	CMF-55 1103F T-1	3	
R 15, 25	RES, CC, 1.1, +-5%, 0.5W	163717	01121	EB1R15	2	
R 16, 43, 81	RES, MF, 2K, +-1%, 0.125W, 100PPM	235226	91637	CMF-55 2001F T-1	3	
R 17, 50	RES, CF, 27K, +-5%, 0.25W	441501	59124	CF1/4 273J	2	
R 19, 24	RES, MF, 107K, +-1%, 0.125W, 100PPM	288399	91637	CMF-55 1073F T-1	2	
R 20, 23	RES, MF, 17.4K, +-1%, 0.125W, 100PPM	236802	91637	CMF-55 1742F T-1	2	
R 21, 22	RES, MF, 5.62K, +-1%, 0.125W, 100PPM	235168	91637	CMF-55 5621F T-1	2	
R 28, 42	RES, CC, 4.7K, +-10%, 2W	245308	01121	HB4721	2	
R 32, 40	RES, CC, 4.7, +-5%, 0.5W	188870	01121	EB4R75	2	
R 33, 41, 47	RES, CF, 3K, +-5%, 0.25W	441527	59124	CF1/4 302J	3	
R 35, 37	RES, MF, 15K, +-1%, 0.125W, 100PPM	285296	91637	CMF-55 1502F T-1	2	
R 36, 38	RES, MF, 9.09K, +-1%, 0.125W, 100PPM	221663	91637	CMF-55 9091F T-1	2	
R 44-46	RES, CF, 100K, +-5%, 0.25W	348920	59124	CF1/4 104J	3	
R 48	RES, CF, 300, +-5%, 0.25W	441519	59124	CF1/4 301J	3	
R 49, 53, 60-	RES, CF, 1K, +-5%, 0.25W	343426	59124	CF1/4 102J	12	
R 66, 72, 78,		343426				
R 82		343426				

Table 5-15. A9 Power Supply Regulator PCA (cont)

REFERENCE DESIGNATOR	DESCRIPTION	FLUKE STOCK NO	MFRS SPLY CODE	MANUFACTURERS PART NUMBER OR GENERIC TYPE	TOT QTY	NOTES
R 57	RES, MF, 4.22K, +-1%, 0.125W, 100PPM	168245	91637	CMF-55 4221F T-1	1	
R 67, 68	RES, CF, 5.1K, +-5%, 0.25W	368712	59124	CF1/4 512J	2	
R 69, 70	RES, CF, 2.2K, +-5%, 0.25W	343400	59124	CF1/4 222J	2	
R 73	RES, CF, 6.8K, +-5%, 0.25W	368761	59124	CF1/4 682J	1	
R 74	RES, MF, 100, +-1%, 0.125W, 100PPM	168195	91637	CMF-55 1000F T-1	1	
R 75, 76	RES, MF, 1.5K, +-1%, 0.125W, 100PPM	313098	91637	CMF-55 1501F T-1	2	
R 79	RES, WW, 0.47, +-5%, .2W	219360	23237	SPH2.47OHMS5%	1	
R 80	RES, MF, 255K, +-1%, 0.125W, 100PPM	221630	91637	CMF-55 2553F T-1	1	
R 85, 97	RES, CF, 10, +-5%, 0.25W	807669	59124	CF1/4 100J	2	
R 87, 88	RES, WW, .2, +-3%, .7W	255661	05347	MS2N101R200H	2	
R 89, 90	RES, CC, 51, +-5%, 1W	157586	01121	GB5105	2	
R 91, 92	RES, CF, 20K, +-5%, 0.25W	697110	59124	CF1/4 203J	2	
R 93, 94	RES, CF, 5.6K, +-5%, 0.25W	442350	59124	CF1/4 562J	2	
R 95, 96	RES, CF, 4.3K, +-5%, 0.25W	441576	59124	CF1/4 433J	2	
U 1	† IC, VOLT REG, FIXED, +12 VOLTS, 1.5 AMPS	413195	27014	LM340T-12	1	
U 2	† IC, VOLT REG, FIXED, -12 VOLTS, 1.5 AMPS	381665	04713	MC7912CT	1	
U 3, 7, 11	† IC, VOLT REG, ADJ, 2 TO 37 VOLT, 0.15 AMP	379420	04713	MC1723CP	3	
U 4, 5	† IC, VOLT REG, FIXED, +5 VOLTS, 1.5 AMPS	355107	27014	MC7805CT	2	
U 6	† IC, VOLT REG, FIXED, -5 VOLTS, 1.5 AMPS	394551	04713	MC7905CT	1	
U 8- 10, 12,	† IC, OP AMP, GEN PURPOSE, 8 PIN DIP	363515	27014	LM301AN	5	
U 13	†	363515				
U 14	† IC, CMOS, RETRIG/RESET MULTIVIBRATOR	393512	34371	CD4098BE	1	
U 15	† IC, CMOS, HEX INVERTER	381848	27014	CD4049CN	1	
U 16	† IC, BFLR, TIMER, SINGLE SOURCE, 8PDIP	928676	89536	928676	1	
VR 1, 11	† ZENER, UNCOMP, 5.1V, 5%, 20.0MA, 0.5W	535476	04713	1N5231B	2	
VR 2	† ZENER, UNCOMP, 16.0V, 5%, 7.8MA, 0.4W	325837	04713	1N966B	1	
VR 3, 7	† ZENER, UNCOMP, 4.3V, 5%, 20.0MA, 0.4W	180455	04713	1N749A	2	
VR 4, 8	† ZENER, UNCOMP, 51.0V, 5%, 2.5MA, 0.4W	418665	04713	1N978B	2	
VR 5, 6, 9,	† ZENER, UNCOMP, 24.0V, 5%, 5.2MA, 0.4W	267807	04713	1N970B	4	
VR 10	†	267807				
VR 12, 14	† ZENER, UNCOMP, 6.8V, 5%, 37.0MA, 1.0W	454595	04713	1N4736A	2	
VR 15, 16	† ZENER, UNCOMP, 10.0V, 5%, 12.5MA, 0.4W	810267	65940	1N961BT-88	2	
NOTES:	† Static sensitive part.					

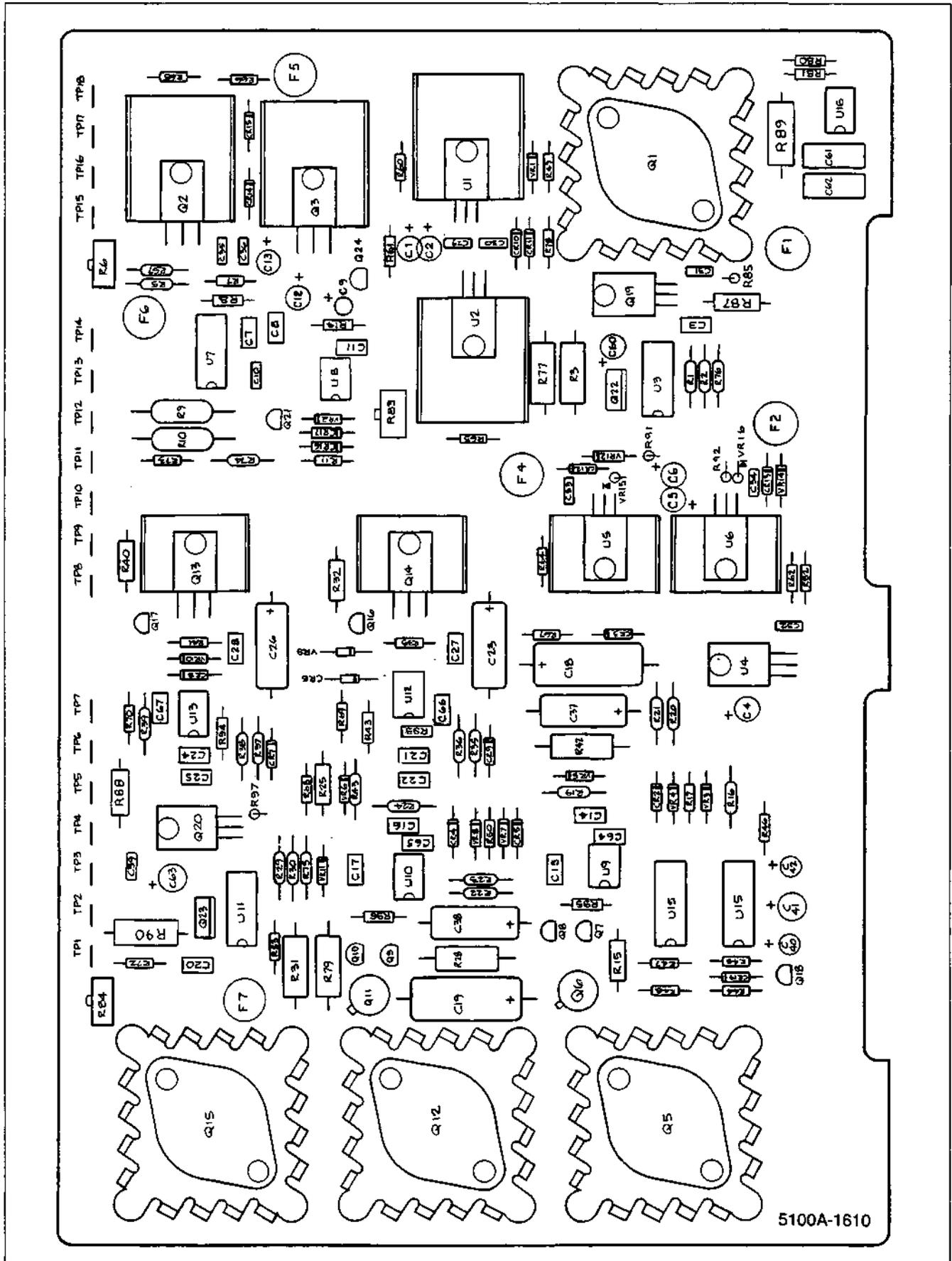

Figure 5-10. A9 Power Supply Regulator PCA

Table 5-16. A10 Front Panel PCA (5100B & 5102B)

REFERENCE DESIGNATOR	DESCRIPTION	FLUKE STOCK NO	MFRS SPLY CODE	MANUFACTURERS PART NUMBER OR GENERIC TYPE	TOT QTY	NOTES
A 1	† DISPLAY PCA	456004	89536	456004	1	
AS 1- 38, 47-	ACTUATOR, SWITCH	412106	89536	412106	42	
AS 50		412106				
C 1, 7	CAP, TA, 1UF, +-20%, 35V	697417	56289	199D105X0035AG2	2	
C 2- 6, 8,	CAP, CER, 0.047UF, +-20%, 50V, X7R	831487	04222	SR595C473MAA	7	
C 9		831487				
C 10	CAP, CER, 0.047UF, +-20%, 50V, Z5U	460733	04222	SR205E473MAA	1	
C 11, 12	CAP, TA, 6.8UF, +-20%, 35V	807602	56289	199D685X0035DE2	2	
CR 3- 15	LED, RED, PCB MNT, LUM INT=0.5MCD	369777	28480	HIMP-1000	13	
CR 44	DIODE, SI, 100 PIV, 1.0 AMP	742874	65940	1N4002A	1	
CR 45	DIODE, SI, 50 PIV, 2 AMP, SELECTED IR	347559	14936	P-300G-066	1	
CS 1- 38, 47-	COVER, PUSHBUTTON SWITCH	401299	89536	401299	42	
CS 50		401299				
H 1	WASHER, LOCK, INTRNL, STL, .387ID	129957	78189	1220-05	1	
H 2	WASHER, FLAT, STL, .390, .625, .031	110007		COMMERCIAL	1	
H 3	NUT, HEX, BR, 3/8-32	129718		COMMERCIAL	1	
H 4	NUT, HEX, STL, 4-40	110635		COMMERCIAL	8	
H 6	SCREW, PH, P, LOCK, STL, 4-40, .250	129890	74594	129890	6	
H 7	SCREW, PH, P, SEMS, STL, 4-40, .250	185918		COMMERCIAL	8	
H 8	SPACER, SWAGE, .250 RND, BR, 4-40, .187	335604	55566	3046B440B14-MOD.-.187	7	
H 9	SPACER, SWAGE, .250 RND, BR, 6-32, .325	296137	55566	3045B632B14-MOD.-.325	1	
MP 1, 2	PUSHBUTTON, MED, PTY GRAY	546382	89536	546382	2	
MP 4- 12, 27-	PUSHBUTTON SMALL RECTANGULAR/GRAPHITE	856732	89536	856732	22	
MP 38, 47		856732				
P 10, 21	CABLE ASSY, FLAT, 16 COND, 5.25, DIP CONN	428409	52072	CAD16P-02-261DT-005.25	2	
PS 3	PUSHBUTTON, SML RECTANGULAR GREEN	416230	89536	416230	1	
PS 13- 24	PUSHBUTTON-SQUARE-, WHITE	406744	89536	406744	12	
PS 25	PUSHBUTTON, RECT. LIGHT BLUE	406876	89536	406876	1	
PS 26	PUSHBUTTON, SMALL RECT. DK ORANGE	420620	89536	420620	1	
PS 48- 50	PUSHBUTTON SMALL RECTANG/DK GRAPHITE	856729	89536	856729	3	
PS 51	SWITCH, ROTARY, EDIT	429548	89536	429548	1	
Q 1- 8	† TRANSISTOR, SI, BV= 60V, 65W, TO-220	386128	04713	TIP120T	8	
Q 9	† TRANSISTOR, SI, PNP, SWITCHING, TO-92	831446	04713	MPS3640	1	
R 1	RES, CF, 22K, +-5%, 0.25W	573451	59124	CF1/4 223J	1	
R 2	RES, CF, 150, +-5%, 0.25W	343442	59124	CF1/4 151J	1	
R 3	RES, CF, 1K, +-5%, 0.25W	343426	59124	CF1/4 102J	1	
R 4- 7	RES, CF, 10K, +-5%, 0.25W	348839	59124	CF1/4 102J	4	
R 8	RES, CF, 47K, +-5%, 0.25W	348896	59124	CF1/4 473J	1	
R 9- 12	RES, CF, 33, +-5%, 0.25W	414524	59124	CF1/4 330J	4	
RN 1	RES, CERM, SIP, 10 PIN, 9 RES, 2K, +-2%	446880	91637	CSC10B-01-202G	1	
RN 2	RES, CERM, SIP, 10 PIN, 9 RES, 10K, +-2%	414003	91637	CSC10A-01-103G	1	
RN 3, 4	RES, CERM, DIP, 16 PIN, 8 RES, 39, +-5%	519348	91637	MDF16-03-390J	2	
TP 1- 3	JUMPER, WIRE, NONINSUL, 0.200CTR	816090	91984	150T1	3	
U 1- 6, 9	† IC, LSTTL, QUAD D F/F, +EDG TRG, W/CLR	393215	01295	SN74LS175N	7	
U 7, 8, 18,	† IC, TTL, DUAL NAND DRVR W/OPEN COLLECT	329706	27014	D575452N	4	
U 20	†	329706				
U 10, 11	† IC, LSTTL, QUAD 2 IN NAND W/OPEN COLLECT	453167	01295	SN74LS26N	2	
U 12	† IC, CMOS, RETRIG/RESET MULTIVIBRATOR	393512	34371	CD4098BE	1	
U 21	† IC, ARRAY, 8 DIODE, COMMON CATHODE	429464	31019	TND933	1	
U 22, 23	† IC, CMOS, TRIPLE 3 INPUT NAND GATE	375147	27014	CD4023CN	2	
U 24, 25	† IC, CMOS, HEX BUFFER	381830	27014	CD4050BCN	2	
U 26, 27	† IC, CMOS, HEX BUFFER W/3-STATE OUTPUT	407759	04713	MC14503BCP	2	
U 28	† IC, CMOS, DUAL 4 INPUT AND GATE	408799	04713	MC14082BCP	1	
NOTES:	† Static sensitive part.					

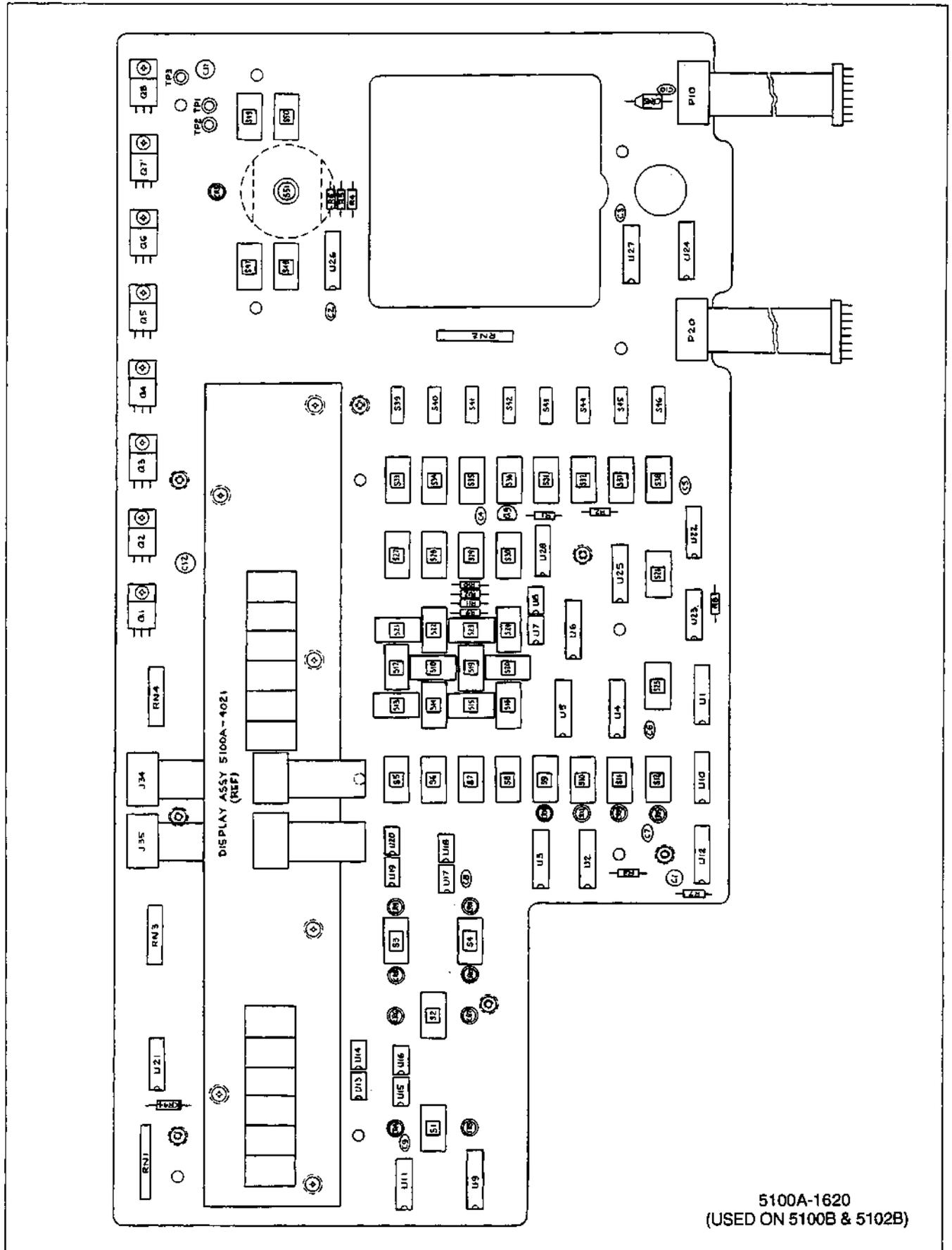

Figure 5-11. A10 Front Panel PCA (5100B and 5102B)

Table 5-17. A10 Front Panel PCA (5101B)

REFERENCE DESIGNATOR	DESCRIPTION	FLUKE STOCK NO	MFRS SPLY CODE	MANUFACTURERS PART NUMBER OR GENERIC TYPE	TOT QTY	NOTES
A 1	‡ DISPLAY PCA	456004	89536	456004	1	
C 1, 7	CAP, TA, 1UF, +-20%, 35V	697417	56289	199D105X0035AG2	2	
C 2- 6, 8, C 9	CAP, CER, 0.047UF, +-20%, 50V, X7R	831487	04222	SR595C473MAA	7	
C 10	CAP, CER, 0.047UF, +-20%, 50V, 25U	460733	04222	SR205E473MAA	1	
C 11, 12	CAP, TA, 6.8UF, +-20%, 35V	807602	56289	199D685X0035DE2	2	
CR 3- 18	LED, RED, PCB MNT, LUM INT=0.5MCD	369777	28480	HLMP-1000	16	
CR 44	DIODE, SI, 100 PIV, 1.0 AMP	742874	65940	1N4002A	1	
CR 45	DIODE, SI, 50 PIV, 2 AMP, SELECTED IR	347559	14936	F-300G-066	1	
CS 1- 50	COVER, PUSHBUTTON SWITCH	401299	89536	401299	50	
H 1	SCREW, PH, P, LOCK, STL, 4-40, .250	129890	74594	129890	6	
H 2	SCREW, PH, P, SEMS, STL, 4-40, .250	185918		COMMERCIAL	8	
H 3	NUT, HEX, STL, 4-40	110635		COMMERCIAL	8	
H 4	NUT, HEX, BR, 3/8-32	129718		COMMERCIAL	1	
H 5	WASHER, FLAT, STL, .390, .625, .031	110007		COMMERCIAL	1	
H 6	WASHER, LOCK, INTRNL, STL, .387ID	129957	78189	1220-05	1	
H 7	SPACER, SWAGE, .250 RND, BR, 4-40, .125	335596	55566	3045B440B14-MOD.-.125	6	
H 8	SPACER, SWAGE, .250 RND, BR, 4-40, .187	335604	55566	3046B440B14-MOD.-.187	7	
H 9	SPACER, SWAGE, .250 RND, BR, 6-32, .325	296137	55566	3045B632B14-MOD.-.325	1	
MP 1, 2, 39- MP 45, 47	PUSHBUTTON, MED, PTY GRAY	546382	89536	546382	10	
MP 4- 12, 27- MP 38	PUSHBUTTON SMALL RECTANGULAR/GRAPHITE	856732	89536	856732	21	
MP 48	5101A-8003 DECAL	856732				
P 10, 21	CABLE ASSY, FLAT, 16 COND, 5.25, DIP CONN	473397	89536	473397	1	
PS 3	PUSHBUTTON, SML RECTANGULAR GREEN	428409	52072	CAD16P-02-261DT-005.25	2	
PS 13- 24	PUSHBUTTON-SQUARE-, WHITE	416230	89536	416230	1	
PS 25, 46	PUSHBUTTON-SQUARE-, WHITE	406744	89536	406744	12	
PS 26	PUSHBUTTON, RECT. LIGHT BLUE	406876	89536	406876	2	
PS 48- 50	PUSHBUTTON, SMALL RECT. DK ORANGE	420620	89536	420620	1	
Q 1- 8	PUSHBUTTON SMALL RECTANG/DK GRAPHITE	856729	89536	856729	3	
Q 9	‡ TRANSISTOR, SI, BV= 60V, 65W, TO-220	386128	04713	TIP120T	8	
R 2	‡ TRANSISTOR, SI, PNP, SWITCHING, TO-92	831446	04713	MPS3640	1	
R 3	RES, CF, 150, +-5%, 0.25W	343442	59124	CF1/4 151J	1	
R 4- 7	RES, CF, 1K, +-5%, 0.25W	343426	59124	CF1/4 102J	1	
R 8	RES, CF, 10K, +-5%, 0.25W	348839	59124	CF1/4 102J	4	
R 9- 12	RES, CF, 47K, +-5%, 0.25W	348896	59124	CF1/4 473J	1	
RN 1	RES, CF, 33, +-5%, 0.25W	414524	59124	CF1/4 330J	4	
RN 2	RES, CERM, SIP, 10 PIN, 9 RES, 2K, +-2%	446880	91637	CSC10B-01-202G	1	
RN 3, 4	RES, CERM, SIP, 10 PIN, 9 RES, 10K, +-2%	414003	91637	CSC10A-01-103G	1	
RS 1- 50	RES, CERM, DIP, 16 PIN, 8 RES, 39, +-5%	519348	91637	MDF16-03-390J	2	
S 1- 50	SWITCH PART, SPST, FIXED CONTACT	416875	00779	62313-4	50	
S 51	ACTUATOR, SWITCH	412106	89536	412106	50	
SS 1- 50	SWITCH, ROTARY, EDIT	429548	89536	429548	1	
TP 1- 3	SWITCH PART, SPST, SPRING	414516	00779	62312-3	50	
U 1- 6, 9	JUMPER, WIRE, NONINSUL, 0.200CTR	816090	91984	150T1	3	
U 7, 8, 13- U 17, 19	‡ IC, LSTTL, QUAD D F/F, +EDG TRG, W/CLR	393215	01295	SN74LS175N	7	
U 10, 11	‡ IC, TTL, DUAL NAND DRVR W/OPEN COLLECT	329706	27014	DS75452N	8	
U 12	‡ IC, LSTTL, QUAD 2 IN NAND W/OPEN COLLECT	453167	01295	SN74LS26N	2	
U 21	‡ IC, CMOS, RETRIG/RESET MULTIVIBRATOR	393512	34371	CD4098BE	1	
U 22, 23	‡ IC, ARRAY, 8 DIODE, COMMON CATHODE	429464	31019	TND933	1	
U 24, 25	‡ IC, CMOS, TRIPLE 3 INPUT NAND GATE	375147	27014	CD4023CN	2	
U 26, 27	‡ IC, CMOS, HEX BUFFER	381830	27014	CD4050BCN	2	
	‡ IC, CMOS, HEX BUFFER W/3-STATE OUTPUT	407759	04713	MC14503BCP	2	
NOTES:	‡ Static sensitive part.					

Table 5-18. A10A1 Display PCA

REFERENCE DESIGNATOR	DESCRIPTION	FLUKE STOCK NO	MFRS SPLY CODE	MANUFACTURERS PART NUMBER OR GENERIC TYPE	TOT QTY	NOTES
CR 1, 7	LED, RED, OVERFLOW	472951	28480	QDSP-3011	2	
CR 2- 6, 8-	LED, RED, 7 SEGMENT	472944	28480	QDSP-3016	10	
CR 12		472944				
DS 1, 2, 19-	LED, RED, PCB MNT. LUM INT=0.5MCD	369777	28480	HLMP-1000	27	
DS 43		369777				
W 34, 35	CABLE ASSY, FLAT, 14 COND, 3.75, DIP CONN	447755	52072	CAD14P-02-261DD-003.75	2	
NOTES:	† Static sensitive part.					

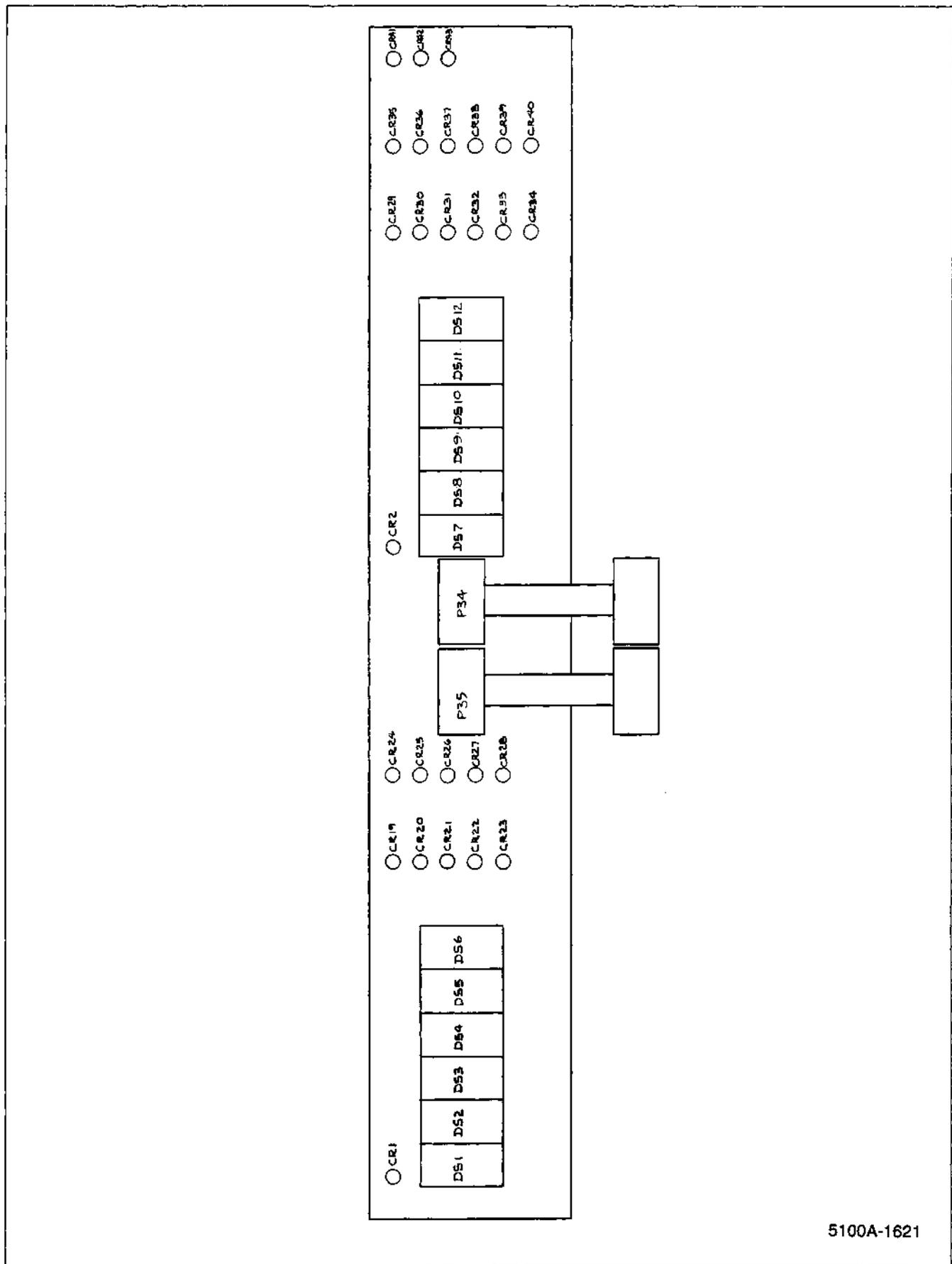

Figure 5-13. A10A1 Display PCA

Table 5-19. A11 Ranging PCA

REFERENCE DESIGNATOR	DESCRIPTION	FLUKE STOCK NO	MFRS SPLY CODE	MANUFACTURERS PART NUMBER OR GENERIC TYPE	TOT QTY	NOTES
C 1	CAP, VAR, 2-10PF, 250V, CER	375238	52769	GKC10000	1	
C 4	CAP, CER, 82PF, +-2%, 50V, COG	714857	04222	SR595A820GAA	1	
C 5, 6, 11- C 14, 16, 17	CAP, TA, 15UF, +-20%, 20V	807610 807610	56289	199D156X0020DE2	8	
C 7	CAP, CER, 5.0PF, +-10%, 1000V, COM	817015	60705	561CC0HRE102ECSROD	1	
C 8, 9	CAP, CER, 0.22UF, +-80-20%, 50V, Z5U	649939	04222	SR595E224ZAA	2	
C 10	CAP, TA, 47UF, +-20%, 20V	348516	56289	199D476X0020EA2	1	
C 15	CAP, VAR, 6-50PF, 250V, CER	404301	52769	GKS50000	1	
C 18	CAP, MICA, 3PF, +-0.5PF, 500V	469436	93790	CD15CDO30D03	1	
C 19, 21- 29	CAP, CER, 470PF, +-5%, 100V, COG	830836	04222	SR591A471JAA	10	
C 31	CAP, CER, 2.2PF, +-0.25PF, 100V, COJ	812099	04222	SRO71A2R2CAA	1	
C 33, 34	CAP, MICA, 27PF, +-5%, 500V	177998	93790	CD15ED270J03	2	
CR 1, 2	DIODE, SI, 400 FIV, 1.0 AMP	368738	04713	1N4004	2	
CR 3, 4	DIODE, SI, 50 PIV, 2 AMP, SELECTED IR	347559	14936	P-300G-066	2	
CR 5- 24, 27- CR 30, 50, 51	DIODE, SI, BV=75V, IO=150MA, 500MW	203323 203323	65940	1N4448	26	
CR 25, 26	DIODE, SI, BV=20V, IO=50MA, SELECTED IR	348177	07263	FD7223	2	
F 1	FUSE, 8X8.5MM, 3.15A, 250V, SLOW, RADIAL	832253	0JR59	19372-TPRL-3.150	1	
H 1	WASHER, FLAT, COPPER, #8, .032	631622	86928	5716-61-32	6	
H 2	WASHER, SHLDR, FIBER, .140, .312, .062	110387	86928	5604-47	3	
H 3, 11	SCREW, FHU, P, LOCK, SS, 6-32, .500	520585	74594	520585	4	
H 4	SCREW, PH, P, SEMS, STL, 6-32, .375	177022		COMMERCIAL	6	
H 5	NUT, #8 LOW THERMAL	850334	89536	850334	12	
H 6	SCREW, PH, P, LOCK, STL, 4-40, .250	129890	89536	129890	2	
H 7	WASHER, FLAT, COPPER, #8, .020	721688	86928	5716-64-20	12	
H 8	SCREW, PH, P, LOCK, STL, 2-56, .375	146803	74594	146803	3	
H 9	SPACER, .250 HEX, AL, 6-32, 2.362	417493	06540	8236-A-0632	1	
H 10	TERM, RING, #6, 26-22AWG, CRIMP, GOLD	832667	00779	1-331401-2	8	
H 12	SPACER, SWAGE, .250 RND, BR, 6-32, 1.450	460402	55566	3045B632B14-MOD.-1.450	4	
H 13	SPACER, SWAGE, .250 RND, BR, 4-40, .250	340547	55566	3047B440B14-MOD.-.250	2	
H 14	SCREW, PH, P, LOCK, STL, 4-40, .500	152132	74594	152132	6	
K 1	RELAY, ARMATURE, 4 FORM C, 4.5VDC	422931	26806	AZ421-14-201	1	
K 3, 55	RELAY, REED, 2 FORM A, 4.5VDC	442921	71707	CR2572	2	
K 4- 7	RELAY, ARMATURE, 2 FORM C, 4.5VDC	514240	26806	A2-420-12-203	4	
K 8, 13, 17, K 50- 52	RELAY, REED, 2 FORM A, 5VDC	340638 340638	71707	7002-5057	6	
K 9, 10	RELAY, REED, 1 FORM A, 4.5VDC	441949	71707	1240-0094	2	
K 12, 14	RELAY, REED, 1 FORM A, 4.5VDC	423707	71707	4000-0238	2	
K 16, 18	RELAY, REED, 1 FORM A, 4.5VDC	404590	71707	4000-0008	2	
K 19	RELAY, REED, 1 FORM A, 4.5VDC	357566	71707	1240-0069	1	
K 53, 54	RELAY, REED, 1 FORM A, 4.5VDC	357558	71707	1240-0068	2	
K 56	RELAY, ARMATURE, 2 FORM C, 4.5VDC	573956	26806	AZ420-13-202	1	
K 57	RELAY, REED, 1 FORM A, 5VDC	404061	71707	CR-3201-5-71	1	
L 1, 2, 4, L 5	CHOKE, 6TURN	320911 320911	89536	320911	4	
L 3	CHOKE, 3 TURN	452888	89536	452888	1	
L 9, 10	CORE, BALUN, FERRITE, .550X.290X1.130	414268	34899	2865006802	2	
MP 2	SLEEV, TEFLON, 0.027ID, NATURAL	196717	60495	TW-22-NATURAL	1	
MP 3	BRACKET, HV CONNECTOR	426205	89536	426205	1	
MP 4	FENCE, HIGH VOLTAGE, RANGING PCB	426916	2M021	426916	1	
MP 5	TERM, INSUL, STANDOFF, BIFURCATED	271650	12615	SI-890-823	3	
MP 6	MOUNTING PLATE, BINDING POST	856674	89536	856674	1	
MP 7	BINDING POST-RED	850292	89536	850292	2	
MP 8	BINDING POST, BLACK	850297	89536	850297	2	
MP 9	BINDING POST, BLUE	823203	89536	823203	1	
MP 10, 18	CABLE ACCESS, TIE, 4.00L, .10W, .75 DIA	172080	06383	SST-1M	6	
MP 11	BINDING POST, PURPLE	850321	89536	850321	1	
MP 12	SOCKET, SINGLE, PWB, FOR 0.018-0.040 PIN	348201	00779	1-380737-0	4	
MP 13	INSULATOR, BINDING POST, FRONT (MED P.)	823187	89536	823187	6	
MP 14	INSULATOR, REAR	823211	89536	823211	6	
MP 15	SHIELD, RANGING, FRONT	432781	89536	432781	1	
MP 16	SHIELD, RANGING, REAR	432799	89536	432799	1	
MP 17	CABLE TIE ANCHOR, ADHSV, .160TIE	407980	06383	ABMM-A-C	1	
MP 19	TERM, INSUL, FEEDTHRU, BIFURCATED	281865	12615	SL-841-777	14	
P 43	CONN, HV, CABLE, PLUG, 2 CONTACT	442897	81312	JFA2P	1	
P 44	CONN, COAX, SMB (M), PWB, RT ANG	353243	26805	5164-S003-09	1	
Q 1, 2	TRANSISTOR, SI, N-JFET, SWITCHING, TO-92	370072	17856	J2318	2	
Q 3	TRANSISTOR, SI, PNP, SWITCHING, TO-92	831446	04713	MP33640	1	
Q 4	TRANSISTOR, SI, NPN, SMALL SIGNAL, TO-92	698225	27014	2N3904	1	
Q 5, 6	TRANSISTOR, SI, N-JFET, TO-92	376475	27014	SF50072	2	
R 1	RES WW 1.0033 OHM	421131	89536	421131	1	
R 2	RES, VAR, CERM, 225, +-10%, 0.5W	267831	80294	3009P-1-225	1	
R 3	RES, MF, 232, +-14, 0.125W, 100PPM	289975	91637	CMF-55 2320F T-1	1	
R 4	RES WW 9.0286 OHM	421149	89536	421149	1	
R 5	RES, VAR, CERM, 2K, +-20%, 0.5W	267864	80294	3009P-1-202	1	

Table 5-19. A11 Ranging PCA (cont)

REFERENCE DESIGNATOR	DESCRIPTION	FLUKE STOCK NO	MFRS SPLY CODE	MANUFACTURERS PART NUMBER OR GENERIC TYPE	TOT QTY	NOTES
R 6	RES, MF, 1.96K, +-1%, 0.125W, 100PPM	288423	91637	CMF-55 1961F T-1	1	
R 7	RES WW 90.202 OHM	421156	89536	421156	1	
R 8	RES, VAR, CERM, 20K, +-20%, 0.5W	267898	80294	3009F-1-203	1	
R 9	RES, MF, 31.6K, +-1%, 0.125W, 100PPM	261610	91637	CMF-55 3162F T-1	1	
R 10	RES WW 901.28 OHM	421164	89536	421164	1	
R 11, 38	RES, VAR, CERM, 200K, +-20%, 0.5W	381509	80294	3009F-1-204	2	
R 12	RES, MF, 549K, +-1%, 0.125W, 100PPM	375964	91637	CMF-55 5493F T-1	1	
R 13	RES WW 9027.4 OHM	421172	89536	421172	1	
R 14, 16, 37	RES, VAR, CERM, 500K, +-20%, 0.5W	288753	80294	3009F-1-504	3	
R 15	RES, MF, 2.8M, +-1%, 0.5W, 100PPM	236703	91637	CMF-65 2804F T-1	1	
R 17	RES, MF, 806K, +-1%, 0.125W, 100PPM	217976	91637	CMF-55 8063F T-1	1	
R 18	RES, MF, 107K, +-1%, 0.125W, 100PPM	288399	91637	CMF-55 1073F T-1	1	
R 19	RES, VAR, CERM, 100K, +-20%, 0.5W	268581	80294	3009F-1-104	1	
R 20, 29, 58, R 59, 73, 74, R 100	RES, CF, 10K, +-5%, 0.25W	348839 348839 348839	59124	CF1/4 102J	7	
R 21	RES, MF, 8.987M, +-0.1%, 2W, 10PPM	417501	19647	TF050N-8.97M-0.1%-10PPM	1	
R 22	RES, VAR, CERM, 25K, +-20%, 0.5W	285213	80294	3009F-1-253	1	
R 23- 26	900K RESISTOR SET GROUPING CHART	425918	89536	425918	1	
R 27	RES, VAR, CERM, 1K, +-20%, 0.5W	267856	80294	3009F-1-102	1	
R 28, 31, 34, R 39	MATCHED RESISTOR SET	862149 862149	89536	862149	1	
R 30, 33	RES, VAR, CERM, 50, +-20%, 0.5W	267815	80294	3009F-1-500	2	
R 32, 47, 49, R 51	RES, CF, 1K, +-5%, 0.25W	343426 343426	59124	CF1/4 102J	4	
R 35	RES, MF, 1.13M, +-1%, 0.5W, 100PPM	221556	91637	CMF-65 1134F T-1	1	
R 36	RES, MF, 332K, +-1%, 0.125W, 100PPM	289504	91637	CMF-55 3323F T-1	1	
R 40, 53, 54, R 60	RES, CF, 22K, +-5%, 0.25W	348870 348870	59124	CF1/4 223J	4	
R 41	RES, CF, 62K, +-5%, 0.25W	348904	59124	CF1/4 623J	1	
R 42, 72	RES, CF, 4.7K, +-5%, 0.25W	348821	59124	CF1/4 472J	2	
R 43	RES, CF, 470, +-5%, 0.25W	343434	59124	CF1/4 471J	1	
R 44, 45	RES, CF, 47K, +-5%, 0.25W	348896	59124	CF1/4 473J	2	
R 46	RES, CF, 2.2K, +-5%, 0.25W	343400	59124	CF1/4 222J	1	
R 48	RES, CF, 820, +-5%, 0.25W	442327	59124	CF1/4 821J	1	
R 50	RES, CF, 220, +-5%, 0.25W	342626	59124	CF1/4 221J	1	
R 52	RES, CF, 110K, +-5%, 0.25W	442426	59124	CF1/4 114J	1	
R 55	RES, VAR, CERM, 200, +-20%, 0.5W	284711	80294	3009F-1-201	1	
R 57	RES, CF, 33K, +-5%, 0.25W	348888	59124	CF1/4 333J	1	
R 61	RES, CF, 150, +-5%, 0.25W	343442	59124	CF1/4 151J	1	
R 63, 64	RES, CF, 330, +-5%, 0.25W	368720	59124	CF1/4 331J	2	
R 65	RES, CF, 24K, +-5%, 0.25W	442384	59124	CF1/4 243J	1	
R 66	44.910K WWRES .05% 5PPMTC 1/2W HERM	468595	89536	468595	1	
R 67- 71	RESISTOR SET, VOLTAGE DIVIDER	422337	89536	422337	1	
TP 2- 6, 8, TP 9	JUMPER WIRE, NONINSUL, 0.200CTR	816090 816090	91984	150T1	7	
U 1	IC, OP AMP, JFET INPUT, TO-9 CASE	429837	27014	LF365BH	1	
U 2	IC, OP AMP, SELECTED 40V/US SLEW RATE	329912	27014	LM318H	1	
U 3, 4	IC, CMOS, HEX BUFFER	381830	27014	CD4050BCN	2	
U 5	IC, CMOS, TRIPLE 3 INPUT NAND GATE	418244	27014	MM74C10N	1	
U 6	IC, LSTTL, HEX D F/F, +EDG TRG, W/CLEAR	393207	01295	SN74LS174N	1	
U 7- 10	IC, LSTTL, QUAD D F/F, +EDG TRG, W/CLR	393215	01295	SN74LS175N	4	
U 11- 13	IC, TTL, DUAL NAND DRVR W/OPEN COLLECT	329706	27014	DS75452N	3	
U 14- 18	IC, TTL, QUAD 2 IN NAND GATE W/OPEN COL	310201	27014	DM7438N	5	
U 20	ISOLATOR, OPTO, LED TO TRANSISTOR, DUAL	454330	25088	ILCT-6-254	1	
VR 1	ZENER, UNCOMP, 24.0V, 5%, 5.2MA, 0.4W	267807	04713	1N970B	1	
VR 2, 3	ZENER, UNCOMP, 6.2V, 5%, 20.0MA, 0.4W	325811	04713	1N753A	2	
W 1	WIRE, TEF, UL1180, 22AWG, STRN, VIO	115808	89536	115808	1	
W 2	CABLE ASSY, RANGING MILIVOLT DIVIDER	444968	89536	444968	1	
W 3	CABLE ASSY, RANGING SENSE HIGH	444976	89536	444976	1	
W 4	WIRE, COPPER/TIN, BUS, 24AWG	115477	04946	302-10	1	
W 5	WIRE, TEF, UL1180, 22AWG, STRN, BLK	115774	89536	115774	1	
W 6	WIRE, TEF, UL1180, 22AWG, STRN, RED	115576	23172	2875-3	1	
W 7	WIRE, TEF, UL1180, 22AWG, STRN, GRN	115659	89536	115659	1	
W 8	RF CABLE ASSY	438226	89536	438226	1	
W 9	WIRE, TEF, UL1180, 22AWG, STRN, BRN	115782	89536	115782	1	
XK 1	RELAY SOCKET, 4 POLE	441964	77342	27E606	1	
XK 4- 7, 56	RELAY SOCKET, 2 POLE	376665	77342	27E501	5	
NOTES:	† Static sensitive part.					

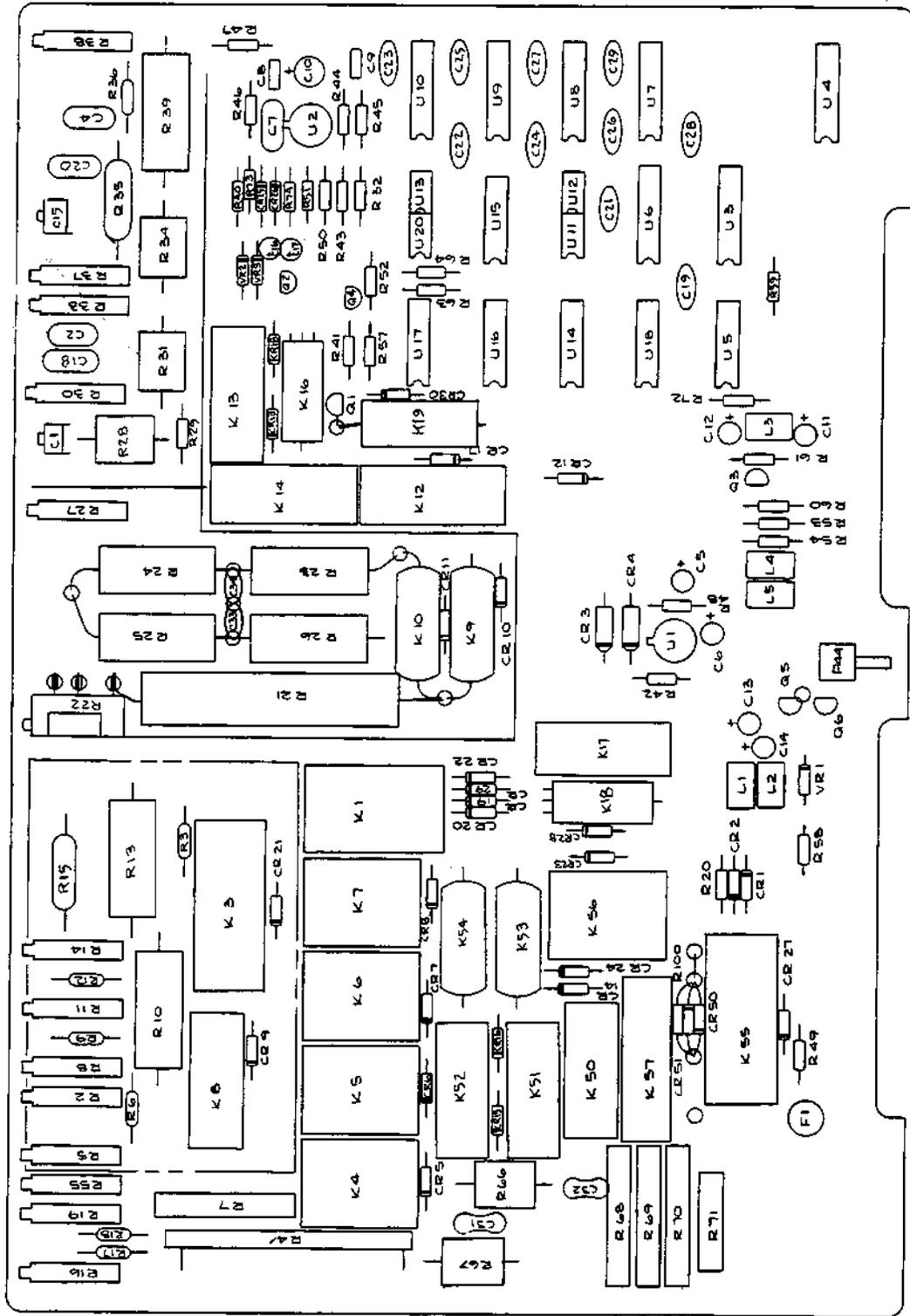

5100A-1640

Figure 5-14. A11 Ranging PCA

Table 5-20. A14 Analog Control PCA

REFERENCE DESIGNATOR	DESCRIPTION	FLUKE STOCK NO	MFRS SPLY CODE	MANUFACTURERS PART NUMBER OR GENERIC TYPE	TOT QTY	NOTES
C 1, 4	CAP, CER, 2700PF, +-5%, 50V, COG	832303	04222	SR595A272JAA	2	
C 2, 3, 6,	CAP, CER, 1000PF, +-2%, 50V, COG	807966	04222	SR595A102GAA	6	
C 7, 116, 117		807966				
C 5, 42, 51	CAP, CER, 33PF, +-5%, 50V, COG	714543	04222	SR595A330JAA	3	
C 8	CAP, CER, 5100PF, +-2%, 50V, COG	732651	04222	SR595A512GAA	1	
C 9, 23	CAP, CER, 1500PF, +-10%, 50V, COG	832600	04222	SR215A152KAA	2	
C 10, 65- 67	CAP, CER, 120PF, +-5%, 50V, COG	721142	04222	SR595A121JAA	4	
C 22	CAP, CER, 0.22UF, +-80-20%, 50V, 25V	649939	04222	SR595E2242AA	1	
C 30	CAP, POLYPR, 0.39UF, +-10%, 50V	424234	84411	JF-86 394 K 50	1	
C 31	CAP, TA, 68UF, +-10%, 15V	182824	56289	150D686X9015R2	1	
C 35, 37, 46	CAP, TA, 39UF, +-20%, 20V	358234	56289	199D396X0020EA2	3	
C 38	CAP, POLYPR, 0.039UF, +-10%, 50V	424218	84411	JF-86 333 K 50	1	
C 41, 100-104	CAP, TA, 15UF, +-20%, 20V	807610	56289	199D156X0020DE2	6	
C 43	CAP, CER, 0.01UF, +-80-20%, 50V, 25V	697284	60705	562C25USE051EE103M	1	
C 47, 52, 53	CAP, POLYCA, 1UF, +-10%, 50V	271619	84411	X463UW10510450V	3	
C 49, 50	CAP, TA, 1UF, +-20%, 35V	697417	56289	199D105X0035AG2	2	
C 70	CAP, CER, 2000PF, +-5%, 50V, COG	832618	04222	SR215A202JAA	1	
C 71	CAP, POLYCA, 0.68UF, +-10%, 50V	284695	84411	X463UW0.6810450V	1	
C 72, 76	CAP, POLYCA, 1UF, +-10%, 100V	313262	84411	X463UW1104100V	2	
C 73	CAP, POLYCA, 5UF, +-10%, 50V	313254	84411	JF-72 505 K 50	1	
C 74	CAP, POLYPR, 0.1UF, +-10%, 50V	413310	84411	JF-86 104 M 50	1	
C 110-115	CAP, CER, 100PF, +-5%, 50V, COG	831495	04222	SR595A101JAA	6	
CR 2, 4, 5,	DIODE, SI, BV=75V, IO=150MA, 500MW	203323	65940	1N4448	6	
CR 92, 93, 95		203323				
CR 37	DIODE, SI, N-JFET, CURRENT REG, IF=3.0 MA	832113	17856	J2901	1	
CR 46, 47	DIODE, SI, BV=20V, IO=50MA, SELECTED IR	348177	07263	FD7223	2	
CR 60, 61	DIODE, SI, N-JFET, CURRENT REG, IF=1.0 MA	832105	17856	J2900	2	
CR 70	DIODE, SI, BV= 90.0V, IO= 75MA, SELCTD IR	260554	14552	CD55105	1	
CR 81, 82	DIODE, SI, 50 PIV, 2 AMP, SELECTED IR	347559	14936	P-300G-066	2	
H 1	NUT, HEX, STL, 4-40	184044		COMMERCIAL	2	
H 2, 5	SCREW, PH, P, SEMS, STL, 4-40, .250	185918	89536	185918	4	
H 4	SCREW, PH, P, LOCK, STL, 4-40, 1.125	241331	74594	241331	4	
K 1, 4, 5	RELAY, REED, 1 FORM A, 4.5VDC	404590	71707	4000-0008	3	
K 2, 3	RELAY, REED, 2 FORM A, 5VDC	340638	71707	7002-9057	2	
L 37, 50, 100-	CHOKO, 6TURN	320911	89536	320911	5	
L 102		320911				
L 45, 46	CORE, TOROID, FERRITE, .047X.138X.118	321182	0LUA3	56-590-65-4B	2	
MP 1	CABLE ACCESS, TIE, 4.00L, .10W, .75 DIA	172080	06383	SST-1M	5	
MP 2	TERM, INSUL, FEEDTHRU, BIFURCATED	281865	12615	SL-841-777	1	
MP 3	SHIELD, ANALOG CONTROL, FRONT	432815	89536	432815	1	
MP 4	SHIELD, ANALOG CONTROL, REAR	432963	89536	432963	1	
MP 5	PLASTIC PART, SHELL, DP, 1.50, 1.50, .95	448324	19080	POS-5001000S1	2	
P 53, 54	CONN, COAX, SMB (M), PWB, RT ANG	353243	26805	S164-5003-09	2	
Q 1, 3, 16,	TRANSISTOR, SI, NPN, SMALL SIGNAL, TO-92	698225	27014	2N3904	5	
Q 55, 86		698225				
Q 2, 4, 5,	TRANSISTOR, SI, PNP, TO92	698233	04713	2N3906	5	
Q 44, 85		698233				
Q 10, 73, 74	TRANSISTOR, SI, N-JFET, TO-92	816314	17856	J2864	3	
Q 36	TRANSISTOR, SI, N-JFET, TO-92	832162	17856	J2908	1	
Q 45	TRANSISTOR, SI, PNP, SMALL SIGNAL	229898	65940	MPS6522	1	
Q 46	TRANSISTOR, SI, NPN, SMALL SIGNAL	218081	04713	MPS6520	1	
Q 61, 69	TRANSISTOR, SI, NPN, SMALL SIGNAL	329698	27014	2N2484	2	
Q 62, 63	TRANSISTOR, SI, N-JFET, HI-VOLTAGE, TO-92	832147	17856	J2907	2	
Q 65	TRANSISTOR, SI, NPN, DUAL, TO-52	295717	18786	MP312-60	1	
Q 68	TRANSISTOR, SI, NPN, DUAL, TO-78, HI-BETA	585109	34371	ITS31897	1	
Q 81	TRANSISTOR, SI, BV=45V, 27W, TO-220	325753	09214	D45C5	1	
Q 82	TRANSISTOR, SI, BV= 45V, 30W, TO-220	325761	34371	D44C5	1	
Q 88, 89	TRANSISTOR, SI, N-CHAN, TO-92, SWITCH	832139	17856	J2903	1	
Q 93	TRANSISTOR, SI, PNP, SWITCHING, TO-92	831446	04713	MPS3640	2	
R 1, 4	RES, CF, 1.3K, +-5%, 0.25W	441394	59124	CF1/4 132J	2	
R 2, 3, 92	RES, CF, 470, +-5%, 0.25W	343434	59124	CF1/4 471J	3	
R 5	RES, MF, 4.22K, +-1%, 0.125W, 100PPM	168245	91637	CMF-55 4221F T-1	1	
R 6, 12	RES, MF, 1.27K, +-1%, 0.125W, 100PPM	267369	91637	CMF-55 1271F T-1	2	
R 7, 61	RES, MF, 10K, +-1%, 0.125W, 100PPM	168260	91637	CMF-55 1002F T-1	2	
R 8	RES, MF, 4.99K, +-1%, 0.125W, 100PPM	168252	91637	CMF-55 4991F T-1	1	
R 9, 17, 20	REF AMP SET, 5100A-4503	425959	89536	425959	1	
R 11, 23	RES, VAR, CERM, 100, +-20%, 0.5W	267823	80294	3009P-1-101	2	
R 13	RES, WW 400< +- .5< 6PPM, .5W CARD	341669	89536	341669	1	
R 14	RES, WW 27< 0.5< TOL, 0.5W CARD,	214916	89536	214916	1	
R 15	RES, MF, 2.26K, +-1%, 0.125W, 100PPM	328294	89536	328294	1	
R 16, 26	RES, CC, 220, +-5%, 0.5W	186031	01121	EB2215	2	
R 18, 19, 24,	RES, MF, 10, +-1%, 0.125W, 100PPM	268789	91637	CMF-55 10R0F T-1	4	
R 101		268789				
R 22, 25	RESISTOR, MATCHED SET	291690	89536	291690	1	
R 27	RES, CF, 7.5K, +-5%, 0.25W	441667	59124	CF1/4 752J	1	
R 28	RES, CF, 5.1K, +-5%, 0.25W	368712	59124	CF1/4 512J	1	

Table 5-20. A14 Analog Control PCA (cont)

REFERENCE DESIGNATOR	DESCRIPTION	FLUKE STOCK NO	MFRS SPLY CODE	MANUFACTURERS PART NUMBER OR GENERIC TYPE	TOT QTY	NOTES
R 30	RES, MF, 26.7K, +-1%, 0.125W, 100PPM	245779	91637	CMF-55 2672F T-1	1	
R 31, 34	RES, MF, 562, +-0.1%, 0.125W, 25PPM	375519	91637	CMF-55 5620B T-9	2	
R 32	RES, VAR, CERM, 20, +-20%, 0.5W	261180	80294	3009P-1-200	1	
R 33, 36	RES, MF, SET, TOL/TC MATCHED	417709	91637	417709	1	
R 35	RES, MF, 22.1K, +-1%, 0.125W, 100PPM	235234	91637	CMF-55 2212F T-1	1	
R 37	RES, CF, 510, +-5%, 0.25W	441600	59124	CF1/4 511J	1	
R 38	RES, MF, 20K, +-1%, 0.125W, 100PPM	291872	91637	CMF-55 2002F T-1	1	
R 39	RES, VAR, CERM, 100K, +-20%, 0.5W	268581	80294	3009P-1-104	1	
R 40	RES, MF, 1M, +-1%, 0.125W, 100PPM	268797	91637	CMF-55 1004F T-1	1	
R 41	RES, MF, 100, +-1%, 0.125W, 100PPM	168195	91637	CMF-55 1000F T-1	1	
R 42	RES, MF, 41.2K, +-1%, 0.125W, 100PPM	289538	91637	CMF-55 4122F T-1	1	
R 43	RES, CF, 1K, +-5%, 0.25W	343426	59124	CF1/4 102J	1	
R 44	RES, MF, 215, +-1%, 0.5W, 100PPM	150862	91637	CMF-65 2150F T-1	1	
R 45	RES, MF, 237, +-1%, 0.125W, 100PPM	328005	91637	CMF-55 2370F T-1	1	
R 46	RES, MF, 499, +-1%, 0.125W, 100PPM	168211	91637	CMF-55 4990F T-1	1	
R 47, 74, 77, 78	RES, MF, 29.4K, +-0.1%, 0.125W, 25PPM	344473	91637	CMF-55 2942B T-9	4	
R 48, 50	RES, MF, 3.48K, +-1%, 0.125W, 100PPM	260687	91637	CMF-55 3481F T-1	2	
R 49	RES, MF, 7.50K, +-1%, 0.125W, 100PPM	223529	89536	223529	1	
R 51	RES, MF, 6.49K, +-1%, 0.125W, 100PPM	294900	91637	CMF-55 6491F T-1	1	
R 52	RES, MF, 15.8K, +-1%, 0.125W, 100PPM	293688	91637	CMF-55 1582F T-1	1	
R 53	RES, CF, 750, +-5%, 0.25W	441659	59124	CF1/4 751J	1	
R 54, 91	RES, CF, 2.2K, +-5%, 0.25W	343400	59124	CF1/4 222J	2	
R 55, 56, 62, 69, 100	RES, CF, 10K, +-5%, 0.25W	348839	59124	CF1/4 102J	5	
R 60	RES, MF, 309K, +-1%, 0.125W, 100PPM	235283	91637	CMF-55 3093F T-1	1	
R 63	RES, VAR, CERM, 5K, +-20%, 0.5W	267872	80294	3009P-1-502	1	
R 64, 66	RES JUMPER, 0.02, 0.25W	697060	59124	Z-25	2	
R 65, 67	RES. SET, 2M T.C. MATCHED	290320	89536	290320	1	
R 68	RES, MF, 2.8M, +-1%, 0.5W, 100PPM	236703	91637	CMF-65 2804F T-1	1	
R 70	RES, MF, 499K, +-1%, 0.125W, 100PPM	268813	91637	CMF-55 4993F T-1	1	
R 71	RES, VAR, CERM, 100K, +-10%, 0.5W	288308	80294	3386S-1-104	1	
R 72, 73	RES, CC, 100M, +-10%, 0.5W	190520	01121	EB1071	2	
R 75, 95, 97-99	RES, CF, 47K, +-5%, 0.25W	348896	59124	CF1/4 473J	5	
R 76	RES, MF, 40.2K, +-1%, 0.125W, 100PPM	235333	91637	CMF-55 4022F T-1	1	
R 79	RES, CF, 100, +-5%, 0.25W	348771	59124	CF1/4 101J	1	
R 80, 83	RES, CC, 1.3K, +-5%, 0.5W	109157	01121	EB1325	2	
R 81, 82	RES, CF, 33, +-5%, 0.25W	414524	59124	CF1/4 330J	2	
R 84, 87	RES, MF, 1.37K, +-1%, 0.5W, 100PPM	148874	91637	CMF-65 1371F T-1	2	
R 85, 86	RES, CF, 75, +-5%, 0.25W	441642	59124	CF1/4 750J	2	
R 88, 89	RES, MF, 2.15K, +-1%, 0.125W, 100PPM	293712	91637	CMF-55 2151F T-1	2	
R 90, 93	RES, CF, 22K, +-5%, 0.25W	348870	59124	CF1/4 223J	2	
R 94	RES, CF, 150, +-5%, 0.25W	343442	59124	CF1/4 151J	1	
R 96	RES, CF, 4.7K, +-5%, 0.25W	348821	59124	CF1/4 472J	1	
TP 1-14	JUMPER, WIRE, NONINSUL, 0.200CTR	816090	91984	150T1	14	
U 2, 67	† IC, OP AMP, GENERAL PURPOSE, TO-5 CASE	284760	27014	LM308H	2	
U 3, 42	† IC, OP AMP, SELECTED, GEN PURPOSE, TO-78	225961	24355	AD3092	2	
U 10	† REF AMP SET, 5100A-4503	425959	89536	425959	1	
U 37	† IC, OP AMP, GENERAL PURPOSE, TO-5 CASE	483495	27014	LM318H	1	
U 51	† IC, OP AMP, GEN PURPOSE, TO-99/TO-78	271502	27014	LM301AH	1	
U 61	† IC, OP AMP, JFET INPUT	357830	27014	NATSH63351	1	
U 75	† ISOLATOR, OPTO, LED TO TRANSISTOR	380014	14936	MCT2	1	
U 83, 84	† IC, COMPARATOR, 8 PIN DIP	352195	27014	LM311N	2	
U 92	† IC, TTL, HEX INVERTER W/OPEN COLLECTOR	288605	27014	DM7416N	1	
U 93	† IC, LSTTL, HEX D F/F, +EDG TRG, W/CLEAR	393207	01295	SN74LS174N	1	
U 94	† IC, CMOS, HEX INVERTER	381848	27014	CD4049CN	1	
U 95	† IC, CMOS, HEX BUFFER W/3-STATE OUTPUT	407759	04713	MC14503BCP	1	
U 96	† IC, CMOS, DUAL D F/F, +EDG TRG	418830	27014	MM74C74J	1	
U 97	† IC, CMOS, TRIPLE 3 INPUT NAND GATE	418244	27014	MM74C10N	1	
U 98	† IC, LSTTL, QUAD D F/F, +EDG TRG, W/CLR	393215	01295	SN74LS175N	1	
U 99	† IC, TTL, QUAD 2 INPUT NAND GATE	292953	27014	SN7400N	1	
U 100	† ISOLATOR, OPTO, HI-SPEED, 8 PIN DIP	354746	47379	6N135	1	
VR 60	† ZENER, UNCOMP, 3.9V, 10%, 20.0MA, 0.4W	113316	04713	1N748	1	
VR 61	† ZENER, UNCOMP, 6.2V, 5%, 20.0MA, 0.4W	325811	04713	1N753A	1	
VR 62, 63	† ZENER, UNCOMP, 12.0V, 5%, 20.0MA, 0.4W	203547	04713	1N759A	2	
W 1	WIRE, TEF, UL1180, 22AWG, STRN, YEL	115584	89536	115584	1	
NOTES:	† Static sensitive part. ‡ Matched set includes R9, R10, R20, U10.					

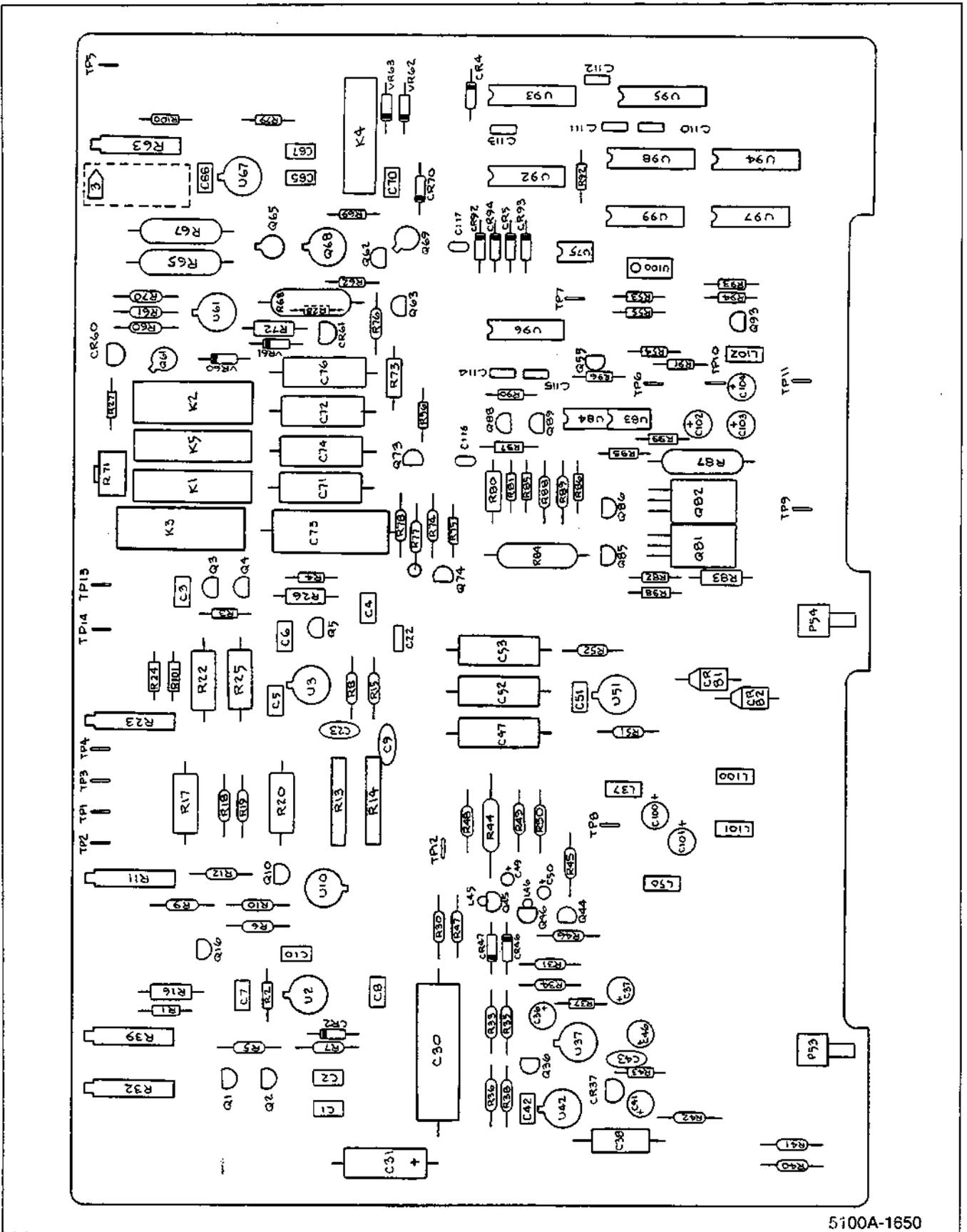

5100A-1650

Figure 5-15. A14 Analog Control PCA

Table 5-21. A15 Digital-to-Analog PCA

REFERENCE DESIGNATOR	DESCRIPTION	FLUKE STOCK NO	MFRS SPLY CODE	MANUFACTURERS PART NUMBER OR GENERIC TYPE	TOT QTY	NOTES
C 1, 2, 8, C 9, 21, 22, C 26, 27	CAP, TA, 15UF, +-20%, 20V	807610 807610 807610	56289	199D156X0020DE2	8	
C 3	CAP, CER, 47PF, +-2%, 100V, COG	832295	04222	SR591A470GAA	1	
C 4, 19	CAP, TA, 1UF, +-20%, 35V	697417	56289	199D105X0035AG2	2	
C 5- 7, 10, C 24, 28, 29, C 43- 46	CAP, CER, 0.22UF, +80-20%, 50V, 25U	649939 649939 649939	04222	SR595E2242AA	11	
C 11, 14, 15, C 17	CAP, POLYCA, 0.68UF, +-10%, 50V	284695 284695	84411	X463UWC.6810%50V	4	
C 12, 18, 23	CAP, CER, 0.01UF, +-20%, 50V, X7R	816249	04222	SR075C103MAA	3	
C 13	CAP, CER, 0.047UF, +-20%, 50V, X7R	831487	04222	SR595C473MAA	1	
C 16	CAP, CER, 33PF, +-5%, 50V, COG	714543	04222	SR595A330JAA	1	
C 20	CAP, TA, 6.8UF, +-20%, 35V	807602	56289	199D685X0035DE2	1	
C 31- 42	CAP, CER, 100PF, +-5%, 50V, COG	831495	04222	SR595A101JAA	12	
CR 1- 3, 6, CR 9- 13	DIODE, SI, BV=75V, IO=150MA, 500MW	203323 203323	65940	1N4448	9	
CR 4	DIODE, SI, 100 PIV, 1.5 AMP	116111	66967	1N5392	1	
CR 5, 7	DIODE, SI, N-JFET, CURRENT REG, IF=5.3 MA	334714	17856	J9010	2	
E 1- 19	JUMPER, WIRE, NONINSUL, 0.200CTR	816090	91984	150T1	19	
H 1	SCREW, PH, P, SEMS, STL, 4-40, .250	185918		COMMERCIAL	1	
H 2	NUT, HEX, STL, 4-40	184044		COMMERCIAL	1	
H 3	SCREW, PH, P, LOCK, STL, 4-40, 1-125	241331	74594	241331	8	
K 1, 2	RELAY, REED, 2 FORM A, 5VDC	340638	71707	7002-S057	2	
K 3	RELAY, REED, 1 FORM A, 4.5VDC	424408	71707	CR4000-001	1	
L 1	CHOKE, 3 TURN	452888	89536	452888	1	
L 2- 4	CHOKE, 6TURN	320911	89536	320911	3	
MP 1	BUSHING, SNAP-IN, NYLON, 0.251 ID	160507	96881	4L4-F	1	
MP 2	TERM, INSUL, FEEDTHRU, BIFURCATED	281865	12615	SL-841-777	3	
MP 3	DAC SHIELD, LEFT FRONT	421792	89536	421792	1	
MP 4	DAC SHIELD, RIGHT FRONT	421800	89536	421800	1	
MP 5	DAC SHIELD, LEFT REAR	421818	89536	421818	1	
MP 6	DAC SHIELD, RIGHT REAR	425199	89536	425199	1	
F 63	CONN, COAX, SMB (M), PWB, AT ANG	353243	26805	5164-5003-09	1	
Q 1	TRANSISTOR, SI, PNP, SWITCHING, TO-92	831446	04713	MPS3640	1	
Q 2, 4, 6- Q 9	FIELD EFFECT N-CHANNEL, GRP OF SIX	418657 418657	89536	418657	6	
Q 3, 5	TRANSISTOR, SI, N-CHAN, TO-92, SWITCH	832139	17856	J2903	2	
Q 10- 15	TRANSISTOR, SI, NPN, SMALL SIGNAL, TO-92	832212	04713	MPS2369RLRA	6	
R 1, 8, 10- R 12, 16, 25, R 49, 60, 61	RES, CF, 1K, +-5%, 0.25W	343426 343426 343426	59124	CF1/4 102J	10	
R 2, 33, 52, R 53	RES, CF, 4.7K, +-5%, 0.25W	348821 348821	59124	CF1/4 472J	4	
R 3- 6, 9, R 21, 26	RES, CF, 620, +-5%, 0.25W	442319 442319	59124	CF1/4 621J	7	
R 7, 17, 50	RES, CF, 470, +-5%, 0.25W	343434	59124	CF1/4 471J	3	
R 14	RES, CF, 22K, +-5%, 0.25W	348870	59124	CF1/4 223J	1	
R 15, 51	RES, CF, 150, +-5%, 0.25W	343442	59124	CF1/4 151J	2	
R 19, 20	RES, CF, 220, +-5%, 0.25W	342626	59124	CF1/4 221J	2	
R 22, 23	RES, CF, 330, +-5%, 0.25W	368720	59124	CF1/4 331J	2	
R 24	RES, CF, 33, +-5%, 0.25W	414524	59124	CF1/4 330J	1	
R 27, 28	RES, CF, 560, +-5%, 0.25W	385948	59124	CF1/4 561J	2	
R 29, 31	RES, CF, 3.3K, +-5%, 0.25W	348813	59124	CF1/4 332J	2	
R 30, 32	RES, CF, 2.7K, +-5%, 0.25W	386490	59124	CF1/4 272J	2	
R 34	RES, CF, 10K, +-5%, 0.25W	348839	59124	CF1/4 102J	1	
R 35	RES, WW, HERM, 1/4W, 100K, +-0.2%	299222	89536	299222	1	
R 36, 37	RES, MF, 3.24M, +-1%, 0.5W, 100PPM	381525	91637	CMF-65 3244F T-1	2	
R 38	RES, MF, 301, +-1%, 0.125W, 100PPM	267740	91637	CMF-55 3010F T-1	1	
R 40	RES WW 24.916K OHM	421180	89536	421180	1	
R 41	RES, MF, 64.9, +-1%, 0.125W, 100PPM	313338	91637	CMF-55 64R9F T-1	1	
R 42	RES, VAR, CERM, 50, +-20%, 0.5W	267815	80294	3009P-1-500	1	
R 43- 45	RES, MF, 20K, +-1%, 0.125W, 100PPM	291872	91637	CMF-55 2002F T-1	3	
R 46	RES, CF, 2.2K, +-5%, 0.25W	343400	59124	CF1/4 222J	1	
R 47, 48	RES, CF, 27K, +-5%, 0.25W	441501	59124	CF1/4 273J	2	
R 62	RES, MF, 27.4K, +-1%, 0.125W, 25PPM	484899	91637	CMF-55 2742F T-9	1	
T 1	PULSE TRANSFORMER	420901	89536	420901	1	
U 2, 3, 7	IC, CMOS, HEX BUFFER	381830	27014	CD4050BCN	3	
U 4, 9, 12, U 18, 24	IC, LSTTL, SYNC PRESET BCD DECADE CNTR	414227 414227	01295	SN74LS162AN	5	
U 5, 10, 13, U 19, 22, 25	IC, LSTTL, QUAD 2INPUT EXOR GATE W/OC	566083 566083	89536	566083	6	
U 6, 11, 14, U 20, 26, 35	IC, LSTTL, QUAD D F/F, +EDG TRG, W/CLR	393215 393215	01295	SN74LS175N	6	
U 8	IC, CMOS, TRIPLE 3 INPUT NAND GATE	375147	27014	CD4023CN	1	
U 15	IC, LSTTL, DUAL D F/F, +EDG TAG, W/CLR	393124	01295	SN74LS74AN	1	
U 16	IC, TTL, HEX INVERTER	292979	27014	DM7404N	1	

Table 5-21. A15 Digital-to-Analog PCA (cont)

REFERENCE DESIGNATOR	DESCRIPTION	FLUKE STOCK NO	MFRS SPLY CODE	MANUFACTURERS PART NUMBER OR GENERIC TYPE	TOT QTY	NOTES
U 17	† IC, LSTTL, DUAL JK F/F, W/SEP CLKS&CLRS	393157	01295	SN74LS107AN	1	
U 27	† IC, LSTTL, DUAL 4 INPUT AND GATE	408708	27014	DM74LS21N	1	
U 28	† IC, LSTTL, QUAD 2 INPUT NAND GATE	393033	01295	SN74LS00N	1	
U 29	† IC, TTL, DUAL JK M/S F/F, +EDG TRG, W/SET	369694	27014	DM7476N	1	
U 30, 37	† IC, TTL, QUAD 2 IN NAND GATE W/OPEN COL	310201	27014	DM7438N	2	
U 31	† IC, CMOS, TRIPLE 3 INPUT AND GATE	408807	04713	MC14073BCP	1	
U 32	† ISOLATOR, OPTO, DUAL, DTL/TTL COMPATABLE	418285	28480	HCPL-2630	1	
U 33	† IC, VOLT REG, FIXED, -12 VOLTS, 1.5 AMPS	381665	04713	MC7912CT	1	
U 34	† IC, STTL, DUAL D F/F, +EDG TRG, W/SET&CLR	418269	01295	SN74S74N	1	
U 36	† IC, OP AMP, SELECTED VOLTAGE FOLLOWER	288365	27014	LM310H	1	
U 38	† ISOLATOR, OPTO, LED TO TRANSISTOR, DUAL	454330	25088	ILCT-6-254	1	
U 39	† IC, OP AMP, GEN PURPOSE, TO-99/TO-78	271502	27014	LM301AH	1	
VR 1	† ZENER, UNCOMP, 12.0V, 5%, 20.0MA, 0.4W	203547	04713	1N759A	1	
VR 2	† ZENER, UNCOMP, 6.8V, 5%, 20.0MA, 0.4W	260695	04713	1N754A	1	
W 1	WIRE, TEF, UL1180, 22AWG, STRN, WHT	115667	89536	115667	1	
XY 1	SOCKET, CRYSTAL, PWB	148668	95146	8000-AG10	1	
Y 1	CRYSTAL, 8MHz, +/-0.5%, HC-6/U	422519	61429	422519	1	
NOTES:	† Static sensitive part.					

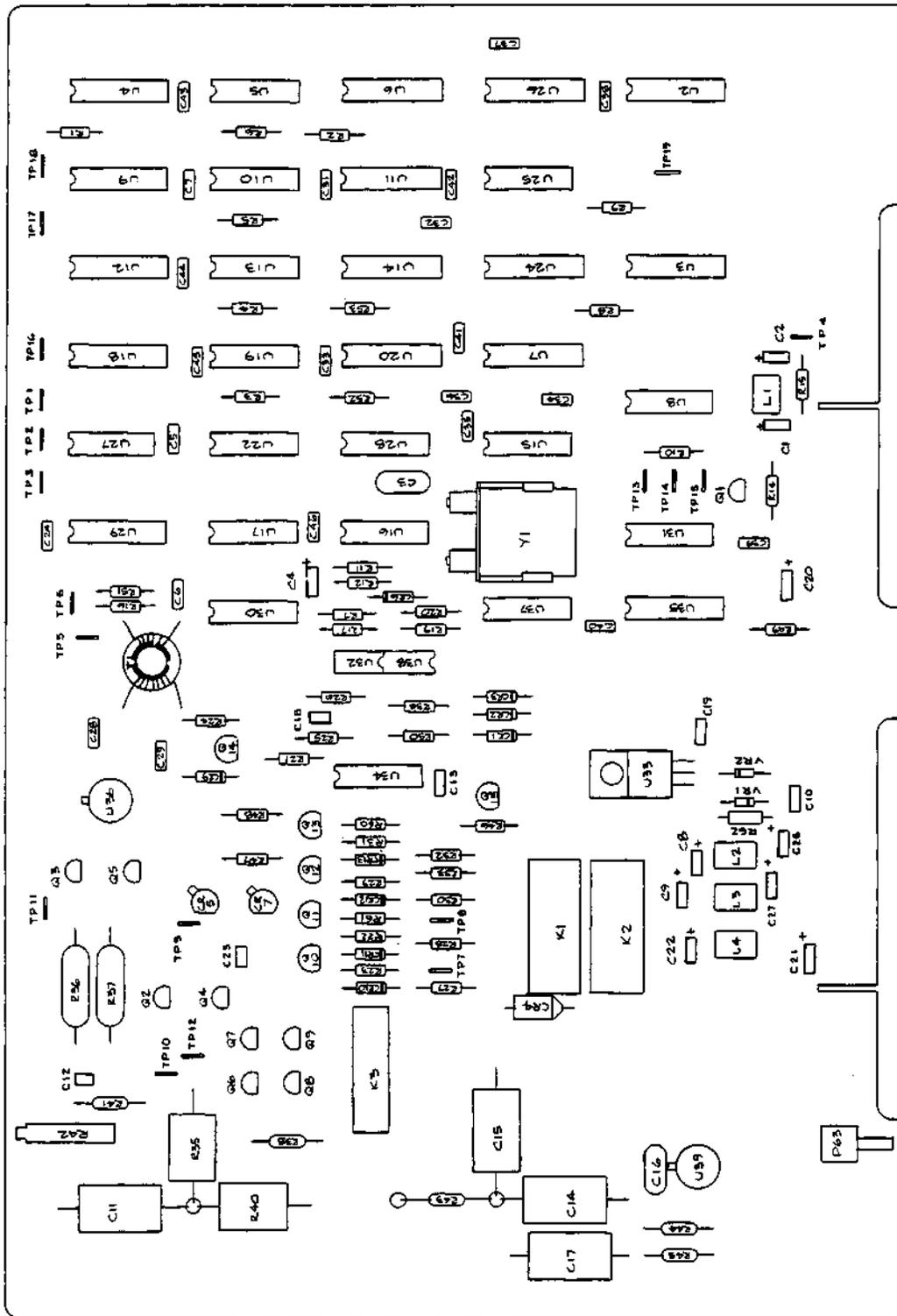

5100A-1660

Figure 5-16. A15 Digital-to-Analog PCA

Table 5-22. A16 Extended High Voltage PCA

REFERENCE DESIGNATOR	DESCRIPTION	FLUKE STOCK NO	MFRS SPLY CODE	MANUFACTURERS PART NUMBER OR GENERIC TYPE	TOT QTY	NOTES
A 1	† HIGH VOLTAGE CONTROL PCA	700526	89536	700526	1	
C 1- 6	CAP, TA, 15UF, +-20%, 20V	807610	56289	199D156X0020DE2	6	
C 10, 11	CAP, POLYES, 0.33UF, +-20%, 2000V	423301	84411	X675HV.3342042000V	2	
C 12, 13	CAP, CER, 0.047UF, +-20%, 50V, X7R	831487	04222	SR595C473MAA	2	
C 14	CAP, POLYCA, 0.33UF, +-10%, 400V	447623	56699	719B1MJ334K401SD	1	
C 15	CAP, CER, 10PF, +-20%, 50V, COG	721589	04222	SR595A100MAA	1	
CR 8- 11	DIODE, SI, HV STACK, FIV=2K, 40MA	418616	83003	VA20X-2	4	
CR 12, 13	† DIODE, SI, BV=75V, IO=150MA, 500MW	203323	65940	1N4448	2	
H 1	SCREW, FH, P, LOCK, STL, 2-56, .375	146803	74594	146803	1	
H 2	SCREW, FH, P, LOCK, STL, 4-40, .250	129890	74594	129890	8	
H 3	SCREW, FH, P, LOCK, STL, 6-32, .375	152165	74594	152165	3	
H 4	SPACER, .375 HEX, AL, 6-32, 1.750	246868	55566	2258632A7	4	
H 5	SCREW, FH, P, LOCK, STL, 6-32, .250	152140	74594	152140	8	
H 6	SPACER, SWAGE, .250 RND, BR, 4-40, .187	335604	55566	3046B440B14-MOD.-.187	6	
J 73	CONN, HV, CABLE, PLUG, 2 CONTACT	442897	81312	JFA2P	1	
K 1, 2	RELAY, ARMATURE, 2 FORM C, 5V	733063	89536	733063	2	
K 3	RELAY, REED, 2 FORM A, 4.5VDC	441931	71707	1235-0093	1	
K 4, 5	RELAY, ARMATURE, 2 FORM C, 4.5VDC	573956	26806	A2420-13-202	2	
K 6, 7	RELAY, REED, 1 FORM A, 4.5VDC	441949	71707	1240-0094	2	
L 1- 3	CHOKO, 6TURN	320911	89536	320911	3	
L 4	INDUCTOR, 3900UH, +-10%, 1.8MHZ, SHLD	363176	24759	MR-3900J&K	1	
MP 1	GUIDE BRKT, LO FREQ XFMR	425140	89536	425140	1	
MP 2	BRACKET, HV CONNECTOR	426205	89536	426205	1	
MP 3	TERM, INSUL, FEEDTHRU, BIFURCATED	281865	12615	SL-841-777	1	
MP 4, 5	RELAY SOCKET, ACCESSORY, SPRING, 2 POLE	376459	77342	20C249	2	
MP 6	CABLE TIE, 5", 1.375"DIA	807230	50802	08350	5	
MP 7	DECAL, 514968	508143	89536	508143	1	
MP 8	SHIELD, EXT HI VOLT	515411	89536	515411	1	
R 1- 3	RES, CC, 330K, +-5%, 1W	109777	01121	GB3345	3	
R 4, 5	RES, CC, 2.7K, +-5%, 1W	296442	01121	GB2725	2	
R 6	RES, CC, 2.2K, +-10%, 1W	109843	01121	GB2221	1	
R 7	RES, MF, 7.15K, +-1%, 0.5W, 100PPM	186072	91637	CMF-65 7151F T-1	1	
R 8	RES, MF, 1.91K, +-1%, 0.5W, 100PPM	245621	91637	CMF-65 1911F T-1	1	
R 9	RES, CC, 390, +-10%, 1W	109561	01121	GB3911	1	
RV 1	VARISTOR, 150V, +-10%, 1.0MA	474122	09214	V150MT2B	1	
T 1	XFORMER, EXTENDED HI VOLTAGE	510057	89536	510057	1	
T 2	HI FREQ XFORMER	432997	89536	432997	1	
TP 3, 5- 7, TP 10, 11	JUMPER, WIRE, NONINSUL, 0.200CTR	816090	91984	150T1	6	
U 1	† IC, OP AMP, JFET INPUT, TO-5 CASE	429837	27014	LF365BH	1	
VR 1, 2	† ZENER, UNCOMP, 9.1V, 5%, 28.0MA, 1.0W	459917	12969	U28709	2	
W 1	WIRE, TEF, UL1180, 22AWG, STRN, GRN	115659	89536	115659	1	
W 2	WIRE, TEF, UL1180, 22AWG, STRN, RED	115576	23172	2875-3	1	
W 3, 4	CABLE, FLAT, JUMPER, 18COND, .100SP, 2.5	418764	0FYL7	S-18-P-2.5-E-E	2	
XK 4, 5	RELAY SOCKET, 2 POLE	376665	77342	27E501	2	
NOTES:	† Static sensitive part.					

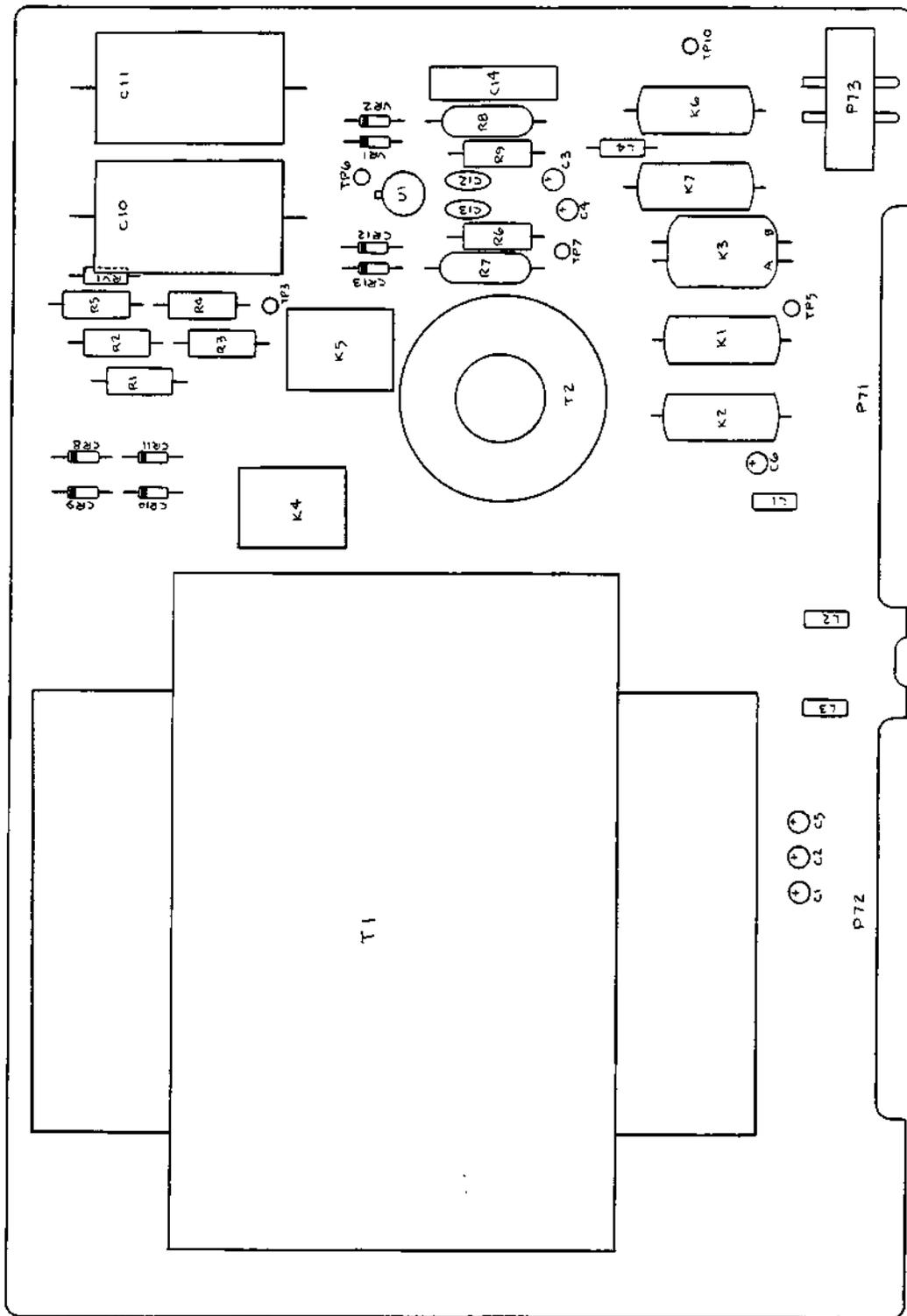

5100A-1671

Figure 5-17. A16 Extended High Voltage PCA

Table 5-23. A16A1 High Voltage Control PCA

REFERENCE DESIGNATOR	DESCRIPTION	FLUKE STOCK NO	MFRS SPLY CODE	MANUFACTURERS PART NUMBER OR GENERIC TYPE	TOT QTY	NOTES
C 7- 9	CAP, CER, 0.047UF, +-20%, 50V, X7R	831487	04222	SR595C473MAA	3	
C 15, 16	CAP, CER, 470PF, +-10%, 50V, C0G	733071	04222	SR595A471KAA	2	
C 17	CAP, TA, 22UF, +-20%, 10V	658971	56289	199D226X0010CG2	1	
C 18	CAP, TA, 1UF, +-20%, 35V	697417	56289	199D105X0035AG2	1	
CR 1- 7, 14	DIODE, SI, BV=75V, IO=150MA, 500MW	203323	65940	1N4448	8	
E 8, 9	JUMPER, WIRE, NONINSUL, 0.200CTR	816090	91984	150T1	2	
Q 1	TRANSISTOR, SI, PNP, SWITCHING, TO-92	831446	04713	MPS3640	1	
R 10	RES, CF, 47K, +-5%, 0.25W	348896	59124	CF1/4 473J	1	
R 11, 12	RES, CF, 22K, +-5%, 0.25W	348870	59124	CF1/4 223J	2	
R 13	RES, CF, 150, +-5%, 0.25W	343442	59124	CF1/4 151J	1	
R 14	RES, CF, 4.7K, +-5%, 0.25W	348821	59124	CF1/4 472J	1	
R 15	RES, MF, 200K, +-1%, 0.125W, 100PPM	261701	91637	CMF-55 2003F T-1	1	
R 16, 17	RES, CF, 10K, +-5%, 0.25W	348839	59124	CF1/4 102J	2	
U 2	IC, CMOS, HEX BUFFER	381830	27014	CD4050BCN	1	
U 3	IC, LSTTL, HEX D F/F, +EDG TRG, W/CLEAR	393207	01295	SN74LS174N	1	
U 4	IC, TTL, DUAL NAND DRVR W/OPEN COLLECT	329706	27014	DS75452N	1	
U 5, 6	IC, FTTL, QUAD 2 IN NAND W/OPEN COLLECT	854617	27014	74F38PC	2	
U 7	IC, CMOS, TRIPLE 3 INPUT NAND GATE	418244	27014	MM74C10N	1	
U 8	IC, CMOS, DUAL D F/F, +EDG TRG	418830	27014	MM74C74J	1	
U 9	IC, CMOS, DUAL MONOSTABLE MULTIBRATOR	454017	27014	CD4538BCN	1	
U 10	IC, LSTTL, QUAD 2 INPUT NAND GATE	393033	01295	SN74LS00N	1	
NOTES:	† Static sensitive part.					

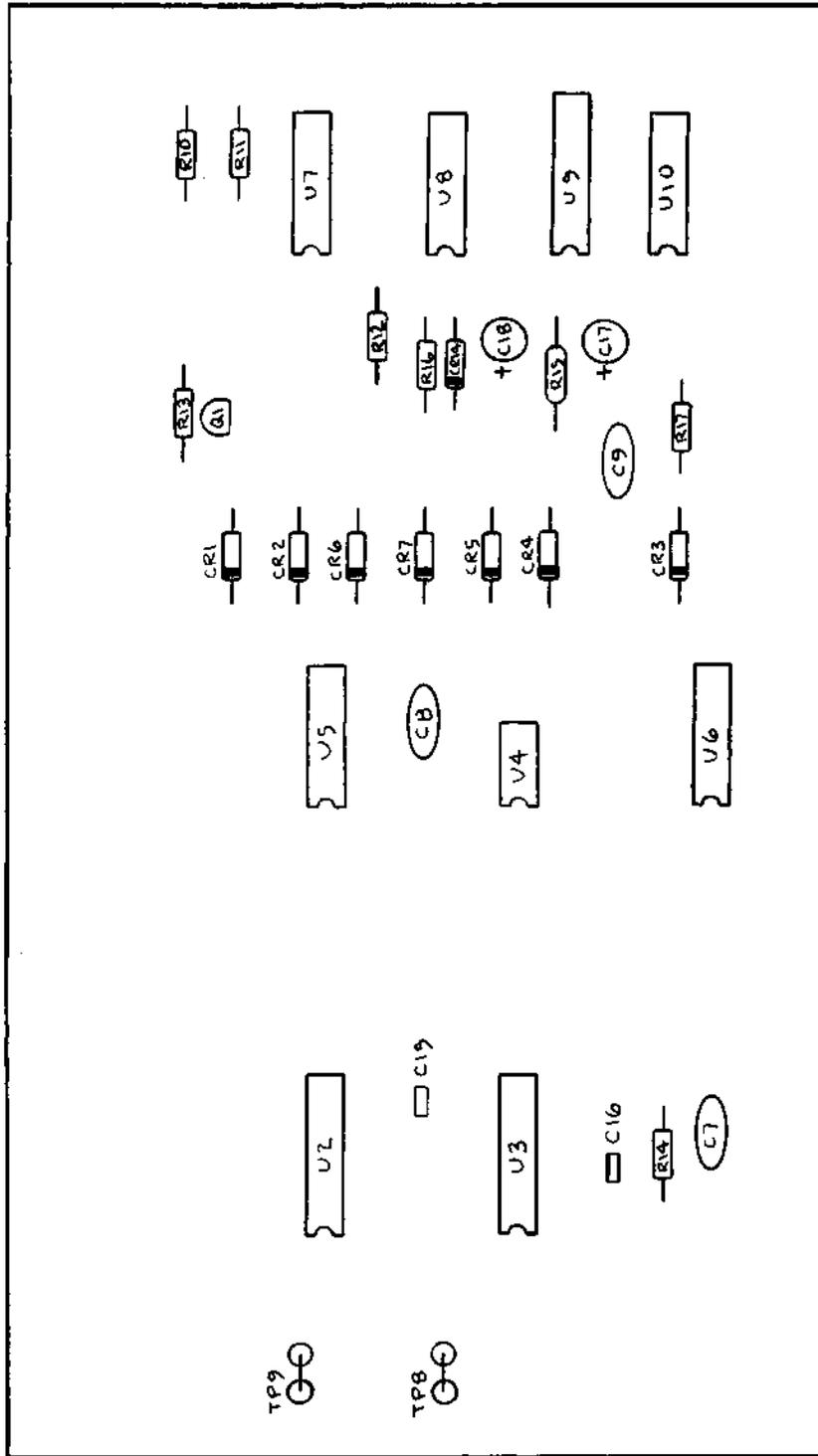

5100A-1672

Figure 5-18. A16A1 High Voltage Control PCA

Table 5-24. A17 Power Amplifier PCA

REFERENCE DESIGNATOR	DESCRIPTION	FLUKE STOCK NO	MFRS SPLY CODE	MANUFACTURERS PART NUMBER OR GENERIC TYPE	TOT QTY	NOTES
A 1	*POWER TRANSISTOR PCA	438606	89536	438606	1	
C 1, 2	CAP. TA, 6.8UF, +-20%, 35V	807602	56289	199D685X0035DE2	2	
C 3, 121, 127, C 140	CAP. CER, 33PF, +-5%, 50V, COG	714543	04222	SR595A330JAA	4	
C 4, 5, 19- C 21, 25, 26, C 28, 29, 31, C 32, 35, 36	CAP. CER, 0.22UF, +-20%, 50V, Z5U	831982	04222	SR295E224MAA	13	
C 8, 9, 104, C 105, 112, 117- C 119, 124, 125, C 141, 142, 146, C 147	CAP. CER, 0.05UF, +-20%, 100V, Z5V	149161	60705	565CBA101AR503MA05	14	
C 15- 18	CAP. CER, 100PF, +-5%, 50V, COG	831495	04222	SR595A101JAA	4	
C 22	CAP. POLYES, 0.01UF, +-10%, 50V	715037	37942	171-473K160B	1	
C 23, 24	CAP. CER, 33PF, +-2%, 100V, COG	838466	04222	SR071A330GAA	2	
C 27	CAP. CER, 0.0022UF, +-10%, 500V, Z5R	268425	60705	562CCK501EG222KA09	1	
C 30	CAP. POLYES, 0.001UF, +-10%, 50V	720938	68919	MKS1102K50	1	
C 33, 34	CAP. POLYPR, 0.033UF, +-10%, 63V	721050	68919	MKP20333K63	2	
C 37	CAP. POLYES, 1UF, +-10%, 50V	733089	68919	MKS2105K50	1	
C 38, 107, 114, C 129, 145	CAP. TA, 2.2UF, +-20%, 25V	697425	56289	199D225X0025AG2	5	
C 39	CAP. CER, 680PF, +-5%, 50V, COG	743351	04222	SR595A681JAA	1	
C 40	CAP. POLYES, 0.47UF, +-10%, 50V	697409	37942	185-2-474K50AA	1	
C 41	CAP. CER, 2200PF, +-10%, 500V, Z5R	817007	60705	562CRE501EG222KA09	1	
C 42, 43	CAPACITOR, MATCHED SET	855622	89536	855622	1	
C 46	CAP. TA, 10UF, +-20%, 25V	714774	56289	199D106X0025BE2	1	
C 102	CAP. CER, 470PF, +-5%, 50V, COG	830430	04222	SR595A471JAA	1	
C 103	CAP. CER, 56PF, +-2%, 50V, COG	714378	04222	SR595A560GAA	1	
C 106	CAP. CER, 220PF, +-2%, 100V, COG	812131	04222	SR291A221GAA	1	
C 108	CAP. CER, 100PF, +-2%, 100V, COG	812115	04222	SR291A101GAA	1	
C 109	CAP. CER, 1800PF, +-5%, 50V, COG	528547	04222	SR215A182JAA	1	
C 110	CAP. TA, 1UF, +-20%, 35V	161919	56289	199D105X0035AA2	1	
C 111, 113, 128, C 130	CAP. TA, 0.22UF, +-20%, 35V	161331	56289	199D224X0035AA2	4	
C 115, 116, 148, C 149	CAP. TA, 47UF, +-20%, 20V	348516	56289	199D476X0020EA2	4	
C 120	CAP. CER, 39PF, +-2%, 100V, COG	512962	04222	SR151A390GAA	1	
C 122	CAP. CER, 12PF, +-2%, 100V, COG	816124	04222	SR291A120GAA	1	
C 123	CAP. CER, 360PF, +-5%, 50V, COG	528471	04222	SR215A361JAA	1	
C 131, 134	CAP. CER, 0.01UF, +-80-20%, 500V, Z5U	816991	60705	562CZ5USE501AG103Z	2	
C 132, 133	CAP. TA, 39UF, +-20%, 6V	163915	56289	199D396X0006DA2	2	
C 135, 136	CAP. AL, 10UF, +75-10%, 150V	106351	0P569	30D106-K-150	2	
C 137	CAP. CER, 1500PF, +-10%, 1000V, Z5R	557496	60705	562CX5FCK102EG152K	1	
C 138, 139	CAP. AL, 150UF, +50-10%, 63V	170274	62643	SM63T-150	2	
C 144	CAP. CER, 1000PF, +-2%, 50V, COG	807966	04222	SR595A102GAA	1	
C 150	CAP. TA, 68UF, +-20%, 6.3V	821785	56289	199D685X06R3DG2	1	
C 152	CAP. CER, 100PF, +-10%, 1000V, S3N	816983	60705	561CR3LSE102EF101K	1	
CR 1- 5, 7- CR 10, 103-106, CR 109, 110, 112- CR 117, 120-124, CR 128, 129, 131- CR 133	* DIODE, SI, BV=75V, IO=150MA, 500MW	203323	65940	1N4448	31	
CR 107, 108, 118, CR 119, 125, 126	DIODE, SI, 100 PIV, 1 AMP	742874	65940	1N4002A	6	
CR 127, 130	* DIODE, SI, N-JFET, CURRENT REG, IF=3.0 MA	832113	17856	J2901	2	
E 1- 24, 26, E 27, 29- 31, E 40, 41	JUMPER, WIRE, NONINSUL, 0.200CTR	816090	91984	150T1	31	
H 1	SPACER, SWAGE, .250 RND, BR, 4-40, .531	355479	55566	3045B0440B14-MOD. = .531	4	
H 2	SCREW, PH, P, SEMS, STL, 4-40, .250	185918	89536	185918	6	
H 3	NUT, HEX, STL, 4-40	184044	89536	184044	2	
K 2, 5	RELAY, REED, 1 FORM A, 4.5VDC	404590	71707	4000-0008	2	
K 3, 4	RELAY, REED, 2 FORM A, 5VDC	340638	71707	7002-5057	2	
K 7, 8	RELAY, ARMATURE, 2 FORM C, 4.5VDC	514240	26806	AZ-420-12-203	2	
K 10	RELAY, REED, 2 FORM A, 4.5V	380725	71707	1235-0081	1	
K 11	RELAY, REED, 1 FORM A, 4.5VDC	441949	71707	1240-0094	1	
L 1	CHOKO, 6TURN	320911	89536	320911	1	
MP 1	HEAT DIS, PWB MTG, 1.380, 2.000, .500	386235	13103	6032D1.380-2.000-.500	2	
MP 2	HEAT DIS, PRESS ON, TO-5	418384	13103	2225B	5	
MP 3	INSUL PT, TRANSISTOR MOUNT, DAF, TO-5	152207	07047	10123-DAP	6	
Q 1	* TRANSISTOR, SI, PNP, SWITCHING, TO-92	831446	04713	MPS3640	1	
Q 2, 115	* TRANSISTOR, SI, NPN, HI-VOLTAGE, TO-92	722934	27014	MPS-A42	2	
Q 19, 20	* PREFERRED PART, TRANSISTOR SET	468926	89536	468926	1	
Q 101, 102	* TRANSISTOR, SI, N-JFET, TO-92	816314	17856	J2864	2	
Q 104, 105	* TRANSISTOR, SI, NPN, DUAL, TO-52, SELECTED	478321	0N0X0	ITS31771	2	

Table 5-24. A17 Power Amplifier PCA (cont)

REFERENCE DESIGNATOR	DESCRIPTION	FLUKE STOCK NO	MFRS SPLY CODE	MANUFACTURERS PART NUMBER OR GENERIC TYPE	TOT QTY	NOTES
Q 106,107	† TRANSISTOR, SI, N-JFET	742304	17856	PN4091	2	
Q 108,109	† TRANSISTOR, SI, PNP, 40V, 0.2W, TO-92	341081	27014	2N4121	2	
Q 110,123,133	† TRANSISTOR, SI, VB=200V, 10W, TO-5	275899	04713	2N5415	3	
Q 111	† TRANSISTOR, SI, NPN, SMALL SIGNAL, TO-92	832170	04713	MPS6520	1	
Q 112,117	† TRANSISTOR, SI, BV=80V, 10W, TO-202	343970	04713	SPS7104	2	
Q 113,128,129, Q 140	† TRANSISTOR, SI, NPN, SMALL SIGNAL, TO-92	698225	27014	2N3904	4	
Q 114,116,127, Q 139,141	† TRANSISTOR, SI, PNP, T092	698274	04713	2N5401	5	
Q 118	† TRANSISTOR, SI, BV= 80V, 10W, TO-202, SEL	343988	04713	SPS7025	1	
Q 121,122,125, Q 131	† TRANSISTOR, SI, NPN, SMALL SIGNAL	343967	04713	2N3439	4	
Q 130,135	† TRANSISTOR, SI, PNP, T092	698233	04713	2N3906	2	
R 1, 2	RES, CF, 22K, +-5%, 0.25W	348870	59124	CF1/4 223J	2	
R 3	RES, CF, 150, +-5%, 0.25W	343442	59124	CF1/4 151J	1	
R 4, 59,170, R 172,208,227	RES, CF, 4.7K, +-5%, 0.25W	348821	59124	CF1/4 472J	6	
R 5,139,142, R 228	RES, CF, 390, +-5%, 0.25W	441543	59124	CF1/4 391J	4	
R 8,229	RES, CF, 15K, +-5%, 0.25W	348854	59124	CF1/4 153J	2	
R 9, 24,171, R 191,201	RES, CF, 2K, +-5%, 0.25W	441469	59124	CF1/4 202J	5	
R 10	RES, CF, 9.1K, +-5%, 0.25W	441691	59124	CF1/4 912J	1	
R 11	RES, CF, 3.9K, +-5%, 0.25W	342600	59124	CF1/4 392J	1	
R 12	RES, CF, 12K, +-5%, 0.25W	348847	59124	CF1/4 123J	1	
R 13, 15	RES, MF, 20K, +-1%, 0.125W, 100PPM	291872	91637	CMF-55 2002F T-1	2	
R 14	RES, CF, 20K, +-5%, 0.25W	441477	59124	CF1/4 203J	1	
R 17	RES, VAR, CERM, 500K, +-10%, 0.5W	851683	80294	3386S-1-504	1	
R 22	RES, MF, 2K, +-1%, 0.5W, 100PPM	151266	91637	CMF-65 2001F T-1	1	
R 25- 35, 37- R 40,185	RES, CF, 10K, +-5%, 0.25W	348839	59124	CF1/4 102J	16	
R 41	RES, MF, 121K, +-1%, 0.125W, 100PPM	229369	91637	CMF-55 1213F T-1	1	
R 42, 47	RES, MF, 1.21K, +-1%, 0.125W, 100PPM	229146	91637	CMF-55 1211F T-1	2	
R 43, 44, 53	RES, MF, 2.61K, +-0.1%, 0.125W, 100PPM	851571	91637	CMF-55 2611B T-1	3	
R 45,133,209, R 211	RES, CF, 7.5K, +-5%, 0.25W	441667	59124	CF1/4 752J	4	
R 46, 60	RES, MF, 7.15K, +-1%, 0.125W, 100PPM	260356	91637	CMF-55 7151F T-1	2	
R 48	RES, MF, 7.32K, +-1%, 0.125W, 100PPM	294926	91637	CMF-55 7321F T-1	1	
R 49	RES, MF, 1.62K, +-1%, 0.125W, 100PPM	283697	91637	CMF-55 1621F T-1	1	
R 50, 51	RES, MF, 90.9K, +-1%, 0.125W, 100PPM	223537	91637	CMF-55 9092F T-1	2	
R 52	RES, VAR, CERM, 100, +-10%, 0.5W	285130	80294	3386S-1-101	1	
R 56,194	RES, MF, 2K, +-1%, 0.125W, 100PPM	235226	91637	CMF-55 2001F T-1	2	
R 57	RES, MF, 205, +-1%, 0.125W, 100PPM	325647	91637	CMF-55 2050F T-1	1	
R 58	RES, MF, 64.9K, +-1%, 0.125W, 100PPM	288530	91637	CMF-55 6492F T-1	1	
R 61	RES, MF, 49.9K, +-0.1%, 0.125W, 100PPM	291070	91637	CMF-55 4992B T-1	1	
R 62	RES, MF, 49.9K, +-1%, 0.125W, 100PPM	268821	91637	CMF-55 4992F T-1	1	
R 63	RES, CF, 39K, +-5%, 0.25W	442400	59124	CF1/4 393J	1	
R 64	RES, CF, 33K, +-5%, 0.25W	348888	59124	CF1/4 333J	1	
R 66	RES, CF, 18K, +-5%, 0.25W	348862	59124	CF1/4 183J	1	
R 67, 68, 70	RES, CF, 390K, +-5%, 0.25W	442475	59124	CF1/4 394J	3	
R 71	RES, MF, 3.16K, +-1%, 0.125W, 100PPM	235291	91637	CMF-55 3161F T-1	1	
R 72	RES, CF, 8.2K, +-5%, 0.25W	441675	59124	CF1/4 822J	1	
R 110	RES, MF, 5.9K, +-1%, 0.125W, 100PPM	267351	91637	CMF-55 5901F T-1	1	
R 111	RES, MF, 18.2K, +-1%, 0.125W, 100PPM	236810	91637	CMF-55 1822F T-1	1	
R 112	RES, MF, 12.7K, +-1%, 0.125W, 100PPM	217448	91637	CMF-55 1272F T-1	1	
R 113	RES, MF, 191, +-1%, 0.125W, 100PPM	325639	91637	CMF-55 1910F T-1	1	
R 114	RES, VAR, CERM, 200K, +-20%, 0.5W	381509	80294	3009P-EH1-204	1	
R 115,192	RES, CF, 200K, +-5%, 0.25W	441485	59124	CF1/4 204J	2	
R 116	RES, CF, 2.7K, +-5%, 0.25W	386490	59124	CF1/4 272J	1	
R 117	RES, MF, 61.9, +-1%, 0.125W, 100PPM	305961	91637	CMF-55 6199F T-1	1	
R 118	RES, MF, 953, +-1%, 0.125W, 100PPM	288555	91637	CMF-55 9530F T-1	1	
R 119	RES, MF, 365, +-1%, 0.125W, 100PPM	459859	91637	CMF-55 3650F T-1	1	
R 121	RES, MF, 61.9K, +-1%, 0.125W, 100PPM	237230	91637	CMF-55 6192F T-1	1	
R 122	RES, MF, 4.32K, +-1%, 0.125W, 100PPM	294819	91637	CMF-55 4321F T-1	1	
R 123,203	RES, VAR, CERM, 1K, +-10%, 0.5W	851555	80294	3386S-1-102	2	
R 124,166	RES, MF, 1.5K, +-1%, 0.125W, 100PPM	313098	91637	CMF-55 1501F T-1	2	
R 125	RES, CF, 33, +-5%, 0.25W	414524	59124	CF1/4 330J	1	
R 126	RES, MF, 453, +-1%, 0.125W, 100PPM	267393	91637	CMF-55 4530F T-1	1	
R 127,129	RES, CF, 6.8K, +-5%, 0.25W	368761	59124	CF1/4 682J	2	
R 128	RES, MF, 174, +-1%, 0.125W, 100PPM	343913	91637	CMF-55 1740F T-1	1	
R 130	RES, CF, 470K, +-5%, 0.25W	342634	59124	CF1/4 474J	1	
R 131	RES, CF, 150K, +-5%, 0.25W	348938	59124	CF1/4 154J	1	
R 132,216,221	RES, CF, 1K, +-5%, 0.25W	343426	59124	CF1/4 102J	3	
R 134,137,174, R 177	RES, CF, 470, +-5%, 0.25W	343434	59124	CF1/4 471J	4	
R 135,136	RES, CF, 180, +-5%, 0.25W	441436	59124	CF1/4 181J	2	

Table 5-24. A17 Power Amplifier PCA (cont)

REFERENCE DESIGNATOR	DESCRIPTION	FLUKE STOCK NO	MFRS SPLY CODE	MANUFACTURERS PART NUMBER OR GENERIC TYPE	TOT QTY	NOTES
R 138, 143	RES. CF, 10, +-5%, 0.25W	340075	59124	CF1/4 100J	2	
R 140, 141	RES. CF, 8.2, +-5%, 0.25W	442269	59124	CF1/4 8R2J	2	
R 144	RES. MF, 1.82K, +-1%, 0.125W, 100PPM	293670	91637	CMF-55 1821F T-1	1	
R 145	RES. MF, 1.43K, +-1%, 0.125W, 100PPM	325662	91637	CMF-55 1431F T-1	1	
R 146	RES. MF, 178, +-1%, 0.125W, 25PPM	501437	91637	CMF-55 1781F T-9	1	
R 147, 148	RES. MF, 4.99K, +-1%, 0.125W, 100PPM	168252	91637	CMF-55 4991F T-1	2	
R 149	RES. CF, 75K, +-5%, 0.25W	394130	59124	CF1/4 75J	1	
R 150, 155, 193	RES. VAR. CERM, 50K, +-10%, 0.5W	288290	80294	3386S-1-503	3	
R 151	RES. MF, 3.83K, +-1%, 0.125W, 100PPM	235143	91637	CMF-55 3831F T-1	1	
R 152	RES. MF, 12.1K, +-1%, 0.125W, 100PPM	234997	91637	CMF-55 1212F T-1	1	
R 153, 186	RES. MF, 15.4K, +-1%, 0.125W, 100PPM	261651	91637	CMF-55 1542F T-1	2	
R 154, 192	RES. CC, 5.1M, +-5%, 0.25W	658609	01121	CB5155	2	
R 156	RES. CF, 15, +-5%, 0.25W	348755	59124	CF1/4 150J	1	
R 157	RES. CC, 3.9K, +-10%, 2W	110213	01121	HB3921	1	
R 158	RES. MF, 2.05K, +-1%, 0.125W, 100PPM	293704	91637	CMF-55 2051F T-1	1	
R 159	RES. MF, 8.25K, +-1%, 0.5W, 100PPM	192492	91637	CMF-65 8251F T-1	1	
R 162	RES. MF, 464, +-1%, 0.125W, 100PPM	340810	91637	CMF-55 4640F T-1	1	
R 163, 168	RES. CC, 11K, +-5%, 0.5W	108613	01121	EB1135	2	
R 164	RES. MF, 4.53K, +-1%, 0.125W, 25PPM	376921	91637	CMF-55 4531F T-9	1	
R 165	RES. VAR. CERM, 500, +-10%, 0.5W	291120	80294	3386S-1-502	1	
R 167	RES. CF, 27, +-5%, 0.25W	348763	59124	CF1/4 270J	1	
R 169	RES. MF, 909, +-1%, 0.125W, 100PPM	312629	91637	CMF-55 9090F T-1	1	
R 173, 178	RES. CF, 91K, +-5%, 0.25W	441709	59124	CF1/4 91J	2	
R 175, 176, 222, R 223	RES. CF, 56, +-5%, 0.25W	342612	59124	CF1/4 560J	4	
R 154, 179, 195	RES. CF, 100K, +-5%, 0.25W	348920	59124	CF1/4 104J	3	
R 180	RES. CF, 51, +-5%, 0.25W	414540	59124	CF1/4 510J	1	
R 181, 184	RES. CF, 240, +-5%, 0.25W	376624	59124	CF1/4 241J	2	
R 182, 183	RES. CC, 1.6, +-5%, 0.5W	218727	01121	EB1865	2	
R 187	RES. CF, 56K, +-5%, 0.25W	441626	59124	CF1/4 563J	1	
R 188	RES. MF, 2.67K, +-1%, 0.125W, 100PPM	289587	91637	CMF-55 2671F T-1	1	
R 189	RES. MF, 1.4K, +-1%, 0.125W, 100PPM	344333	91637	CMF-55 1402F T-1	1	
R 190	RES. MF, 200, +-1%, 0.125W, 100PPM	245340	91637	CMF-55 2000F T-1	1	
R 196	RES. CF, 27K, +-5%, 0.25W	441501	59124	CF1/4 273J	1	
R 197	RES. CF, 750, +-5%, 0.25W	441659	59124	CF1/4 751J	1	
R 198, 199	RES. CF, 100, +-5%, 0.25W	348771	59124	CF1/4 101J	2	
R 200	RES. CF, 22, +-5%, 0.25W	381145	59124	CF1/4 220J	1	
R 202	RES. MF, 6.65K, +-1%, 0.125W, 100PPM	294918	91637	CMF-55 6651F T-1	1	
R 204	RES. MF, 2.37K, +-1%, 0.125W, 100PPM	293720	91637	CMF-55 2371F T-1	1	
R 205	RES. MF, 10, +-1%, 0.125W, 100PPM	260789	91637	CMF-55 10R0F T-1	1	
R 206, 207	RES. CF, 300K, +-5%, 0.25W	441535	59124	CF1/4 304J	2	
R 210, 212	RES. CF, 200, +-5%, 0.25W	441451	59124	CF1/4 201J	2	
R 213, 214	RES. WW, 0.15, +-5%, 2W	325712	23237	SPH2-.150HMS5%	2	
R 217, 220	RES. MF, 100, +-1%, 0.125W, 100PPM	168195	91637	CMF-55 1000F T-1	2	
R 218, 219	RES. MF, 12.1, +-1%, 0.125W, 100PPM	296608	91637	CMF-55 1211F T-1	2	
R 224	RES. CF, 300, +-5%, 0.25W	441519	59124	CF1/4 301J	1	
R 230	RES. MF, 3.01K, +-1%, 0.125W, 100PPM	312645	89536	312645	1	
R 231	RES. DF, 47K, +-5%, 0.25W	348896	89536	348896	1	
U 1	† IC, CMOS, DUAL 4 INPUT NAND GATE	429407	27014	MM74C20N	1	
U 2	† IC, CMOS, HEX BUFFER	381830	27014	CD4050BCN	1	
U 3	† IC, LSTTL, HEX D F/F, +EDG TRG, W/CLEAR	393207	01295	SN74LS174N	1	
U 4	† IC, LSTTL, QUAD D F/F, +EDG TRG, W/CLR	393215	01295	SN74LS175N	1	
U 5	† IC, TTL, QUAD 2 IN NAND GATE W/OPEN COL	310201	01295	SN7438N	1	
U 6, 7	† IC, TTL, DUAL NAND DRVR W/OPEN COLLECT	329706	27014	DS75452N	2	
U 8	† IC, TTL, QUAD 2 INPUT NOR GATE	288845	27014	DM7402N	1	
U 101	† IC, OP AMP, DUAL, JFET INPUT, 8 PIN DIP	454454	01295	TL082CP	1	
U 102	† IC, OP AMP, GENERAL PURPOSE, TO-5 CASE	483495	27014	LM318H	1	
U 104, 105	† IC, OP AMP, LO-NOISE, 8 PIN DIP	495051	89536	495051	2	
U 106	† IC, OP AMP, LO-OFFSET VOLTAGE, LO-NOISE	605980	89536	605980	1	
U 108-110, 115	† ISOLATOR, OPTO, LED TO TRANSISTOR	851790	25088	4N28-584	4	
U 111	† IC, OP AMP, HI-SLEW RATE, 8 PIN DIP	386268	27014	LM318N	1	
U 112	† IC, CMOS, MONOSTABL/ASTABL MULTIVIBRATR	535575	27014	CD4047BC	1	
U 113	† IC, CMOS, QUAD BILATERAL SWITCH	586735	17856	DG211CJ	1	
U 114	† IC, OP AMP, QUAD, JFET INPUT, 14 PIN DIP	483438	01295	TL084CN	1	
VR 101, 103, 108, VR 109	† ZENER, UNCOMP, 3.9V, 10%, 20.0MA, 0.4W	113316	04713	1N748A	4	
VR 104	† ZENER, UNCOMP, 4.3V, 5%, 20.0MA, 0.4W	180455	04713	1N749A	1	
VR 105, 106, 110, VR 111	† ZENER, UNCOMP, 6.2V, 2%, 20.0MA, 0.4W	325803	04713	1N753C	4	
VR 113	† ZENER, UNCOMP, 22.0V, 5%, 5.6MA, 0.4W	181073	04713	1N969B	1	
VR 114	† ZENER, UNCOMP, 5.6V, 5%, 20.0MA, 0.4W	277236	04713	1N752A	1	
XK 7, 8	RELAY SOCKET ACCESS, SPRING STRAP	376459	77342	20C249	2	
XK 7, 8	RELAY SOCKET, 2 POLE	376665	77342	27E501	2	
NOTES:	† Static sensitive part.					

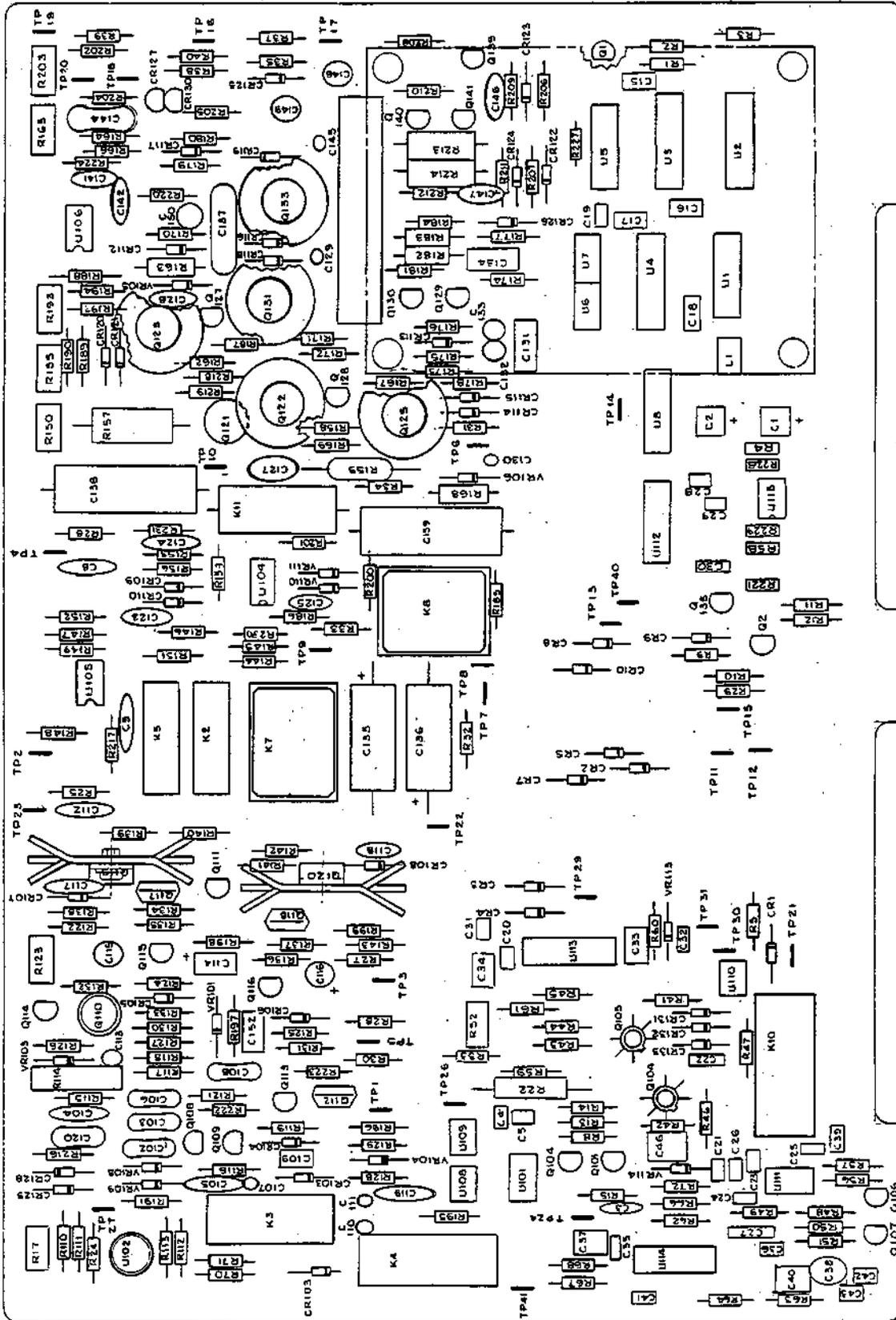

5100A-1683

Figure 5-19. A17 Power Amplifier PCA

Table 5-25. A17A1 Power Transistor PCA

REFERENCE DESIGNATOR	DESCRIPTION	FLUKE STOCK NO	MFRS SPLY CODE	MANUFACTURERS PART NUMBER OR GENERIC TYPE	TOT QTY	NOTES
C 10- 13	CAP, CER, 0.1UF, +-20%, 100V, 25V	149146	60705	565C25UBA101AW104M	4	
H 1	STUD, CLINCH, SOLDR, ST, 6-32, .500	806414	24347	SH52-632-8HS	8	
H 2	WASHER, SHLDR, NYL, .141, .320, .065	733345	86928	5607-72	8	
H 3	WASHER, FLAT, BR, .147, .312, .032	111310	86928	5714-33-32-N	8	
MP 1	HEATSINK	803858	89536	803858	1	
MP 2	INSUL PART, TO-3, SI, 1.650, 1.140	473165	55285	7403-09FR-05	4	
MP 3	HEAT DIS, PCB MT, 0.562X0.531	312413	98978	RU67B1U	2	
MP 4	SOCKET, SINGLE, PWB, FOR 0.018-0.040 PIN	284281	00779	380598-2	8	
MP 5	NUT, HEX, ELAST STOP, STL, 6-32, .125	110841	72962	F21NTM-62	8	
Q 124, 138	† TRANSISTOR, SI, NPN, SMALL SIGNAL	218081	04713	MP96520	2	
Q 132, 134	† TRANSISTOR, SI, BV-375V, 100W, TO-3	313213	34371	2N5240	2	
Q 142	† TRANSISTOR, SI, BV-60V, 100W, TO-3, DAR	429092	04713	2N6055	1	
Q 143	† TRANSISTOR, SI, BV-60V, 100W, TO-3, DAR	429084	04713	2N6053	1	
W 1	CABLE, FLAT, JUMPER, 18COND, .100SP, 2.5	418764	0FV17	S-18-P-2.5-E-E	1	
NOTES:	† Static sensitive part.					

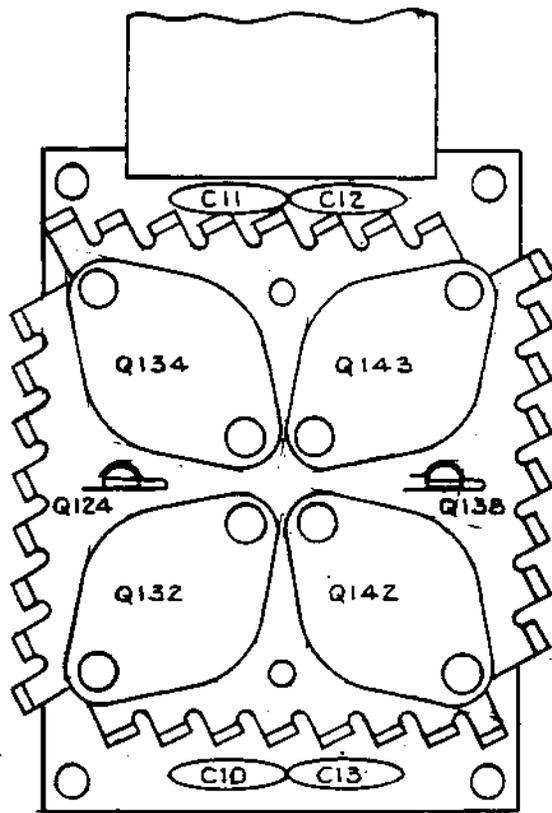

5100A-1680

Table 5-26. A18 Oscillator PCA

REFERENCE DESIGNATOR	DESCRIPTION	FLUKE STOCK NO	MFRS SPLY CODE	MANUFACTURERS PART NUMBER OR GENERIC TYPE	TOT QTY	NOTES
C 1- 4, 15, C 16, 22, 23 C 5, 9, 24- C 29	CAP, CER, 0.22UF, +80-20%, 50V, 25U	649939 649939	04222	SR595E2242AA	8	
C 7	CAP, TA, 15UF, +-20%, 20V	807610 807610	56289	199D156X0020DE2	8	
C 8	CAP, CER, 0.1UF, +-20%, 100V, 25V	149146	60705	565C25UBA101AW104M	1	
C 10, 17	CAP, CER, 33PF, +-5%, 50V, COG	714543	04222	SR595A330JAA	1	
C 11, 18	CAP, POLYPR, 0.783UF, +-1%, 50V	413591	84411	JF-86 7933 F 50	2	
C 12, 19	CAP, POLYPR, 0.0786UF, +-1%, 50V	422998	84411	JF-86 .0786 F 50	2	
C 13, 20	CAP, POLYPR, 7150PF, +-1%, 50V	422980	84411	JF-86 715 F 50	2	
C 14, 21	CAP, MICA, 768PF, +-1%, 300V	413609	93790	CD15FD768F03	2	
C 36	CAP, VAR, 6-50PF, 250V, CER	404301	52769	GKB50000	2	
C 40, 41	CAP, POLYES, 1UF, +-20%, 200V	106450	84411	X663F10520%200V	1	
C 42, 43	CAP, CER, 1.8PF, +-0.25PF, 100V, COX	816660	04222	SR591A1R8CAA	2	
C 44	CAP, MICA, 36PF, +-5%, 500V	320994	93790	CD15ED360J03	2	
C 45	CAP, TA, 68UF, +-20%, 15V	193615	56289	199D68X0015EA2	1	
CR 1- 4	DIODE, SI, SCHOTTKY BARRIER, SMALL SIGNAL	714378	04222	SR595A560GAA	1	
CR 5- 11	DIODE, SI, BV=75V, IO=150MA, 500MW	313247	28480	5082-6264	4	
CR 12	DIODE, SI, RECT, BRIDGE, BV=50V, IO=1A	203323	65940	1N4448	7	
H 1	SCREW, PH. P, LOCK, STL, 4-40, .250	418582	14936	DF01M	1	
K 1, 2	RELAY, REED, 1 FORM A/1 FORM C, 4.5VDC	129890	74594	129890	5	
K 3, 5	RELAY, REED, 2 FORM A, 5VDC	572529	71707	CR3400-0003	2	
K 4, 6	RELAY, REED, 1 FORM A, 4.5VDC	340638	71707	7002-5057	2	
L 1- 3	CHOKE, STURN	404590	71707	4000-0008	2	
MP 1	SHIELD, OSCILLATOR	320911	89536	320911	3	
Q 1- 11	TRANSISTOR, SI, N-JFET, TO-92	438333	89536	438333	1	
Q 12	TRANSISTOR, SI, PNP, SWITCHING, TO-92	832154	27014	SF50190	11	
Q 14- 21	TRANSISTOR, SI, P-MOS, 2 ZENER PROTECTED	831446	04713	MPS3640	1	
Q 23	TRANSISTOR, SI, PNP, TO92	306142	21845	MS141	8	
Q 24	TRANSISTOR, SI, NPN, SMALL SIGNAL, TO-92	698233	04713	2N3906	1	
R 1	RES, VAR, CERM, 5K, +-10%, 0.5W	698225	27014	2N3904	1	
R 2, 7, 9, R 11	RES, MF, 4.99K, +-1%, 0.125W, 100PPM	288282	80294	3386S-1-502	1	
R 3	RES, CF, 150K, +-5%, 0.25W	168252	91637	CMF-55 4991F T-1	4	
R 4, 10	RES, CF, 3.3K, +-5%, 0.25W	348938	59124	CF1/4 154J	1	
R 5, 6, 45, R 47	RES, CF, 100K, +-5%, 0.25W	348813	59124	CF1/4 332J	2	
R 8, 33	RES, CF, 150, +-5%, 0.25W	348920	59124	CF1/4 104J	4	
R 12, 42- 44	RES, MF, 3.65K, +-1%, 0.125W, 100PPM	343442	59124	CF1/4 151J	2	
R 13	RES, MF, 12.4K, +-1%, 0.125W, 100PPM	293779	91637	CMF-55 3651F T-1	4	
R 14, 15, 21, R 22	RES, MF, 4.87K, +-1%, 0.125W, 100PPM	261644	91637	CMF-55 1242F T-1	1	
R 16, 23	RES, MF, 10K, +-1%, 0.125W, 100PPM	294850	91637	CMF-55 4871F T-1	4	
R 17, 18, 24, R 25	RES, MF, 20K, +-1%, 0.125W, 100PPM	168260	91637	CMF-55 1002F T-1	2	
R 19	RES, CF, 36K, +-5%, 0.25W	291872	91637	CMF-55 2002F T-1	4	
R 20	RES, CF, 3.9K, +-5%, 0.25W	442392	59124	CF1/4 363J	1	
R 26- 31	RES, CF, 47K, +-5%, 0.25W	342600	59124	CF1/4 392J	1	
R 32, 54, 55	RES, CF, 10K, +-5%, 0.25W	348896	59124	CF1/4 473J	6	
R 37	RES, CF, 1K, +-5%, 0.25W	348839	59124	CF1/4 102J	3	
R 40	RES, VAR, CERM, 100K, +-10%, 0.5W	343426	59124	CF1/4 102J	1	
R 41	RES, MF, 953, +-1%, 0.125W, 100PPM	288308	80294	3386S-1-104	1	
R 46, 48	RES, CF, 470K, +-5%, 0.25W	288555	91637	CMF-55 9530F T-1	1	
R 49	RES, CF, 510, +-5%, 0.25W	342634	59124	CF1/4 474J	2	
R 50	RES, VAR, CERM, 1K, +-10%, 0.5W	441600	59124	CF1/4 511J	1	
R 51	RES, MF, 41.2K, +-1%, 0.125W, 100PPM	285155	80294	3386S-1-102	1	
R 52	RES, MF, 18.2K, +-1%, 0.125W, 100PPM	289538	91637	CMF-55 4122F T-1	1	
R 53	RES, MF, 1K, +-1%, 0.125W, 100PPM	236810	91637	CMF-55 1822F T-1	1	
R 56	RES, MF, 402, +-1%, 0.125W, 100PPM	168229	91637	CMF-55 1001F T-1	1	
R 57	RES, MF, 100, +-1%, 0.125W, 100PPM	285611	91637	CMF-55 4020F T-1	1	
R 58	RES, MF, 523K, +-1%, 0.125W, 100PPM	168195	91637	CMF-55 1000F T-1	1	
TF 1- 11	JUMPER, WIRE, NONINSUL, 0.200CTR	260752	91637	CMF-55 5233F T-1	1	
U 1, 2	IC, OP AMP, GENERAL PURPOSE, TO-5 CASE	816090	91984	150T1	11	
U 3, 14	IC, OP AMP, GEN PURPOSE, TO-99/TO-78	483495	27014	LM318H	2	
U 4, 5	IC, OP AMP, JFET INPUT, TO-5 CASE	271502	27014	LM301AH	2	
U 6, 13	IC, TTL, QUAD 2 IN NAND GATE W/OPEN COL	429837	27014	LF365BH	2	
U 7	IC, TTL, QUAD 2 IN NAND GATE W/OPEN COL	310201	27014	DM7438N	2	
U 8, 9	IC, TTL, QUAD D F/F, +EDG TRG, W/CLR	418236	27014	DM7407N	1	
U 10	IC, CMOS, TRIPLE 3 INPUT NAND GATE	393215	01295	SN74LS175N	2	
U 11, 12	IC, CMOS, HEX BUFFER	418244	27014	MM74C10N	1	
VR 1	ZENER, UNCOMP, 5.6V, 5%, 20.0MA, 0.4W	381830	27014	CD4050BCN	2	
VR 2	ZENER, UNCOMP, 5.1V, 5%, 20.0MA, 0.4W	277236	04713	1N752A	1	
		159798	04713	1N751A	1	
NOTES:	† Static sensitive part.					

Table 5-27. A19 Isolator PCA

REFERENCE DESIGNATOR	DESCRIPTION	FLUKE STOCK NO	MFRS SPLY CODE	MANUFACTURERS PART NUMBER OR GENERIC TYPE	TOT QTY	NOTES
C 1, 4	CAP, CER, 220PF, +-2%, 100V, COG	816728	04222	SR591A221GAA	2	
C 2	CAP, CER, 10PF, +-5%, 100V, COG	566042	04222	SR151A100JAA	1	
C 3	CAP, CER, 33PF, +-2%, 100V, COG	513226	04222	SR151A330GAA	1	
C 5	CAP, CER, 68PF, +-2%, 50V, COG	715300	04222	SR595A680GAA	1	
C 6	CAP, TA, 39UF, +-20%, 6.3V	835890	56289	199D396X06R3DG2	1	
C 7	CAP, AL, 150UF, +50-10%, 16V	186296	62643	SM16T-150	1	
C 8, 9	CAP, CER, 27PF, +-2%, 100V, COG	816652	04222	SR591A270GAA	2	
C 10, 12, 13	CAP, CER, 0.22UF, +80-20%, 50V, 25U	649939	04222	SR595E224ZAA	3	
C 11	CAP, CER, 0.0047UF, +-10%, 500V, Z5R	106724	60705	562CXSRCK501AJ472K	1	
C 14, 15	CAP, CER, 0.01UF, +-20%, 50V, X7R	816249	04222	SR075C103MAA	2	
CR 1- 3	DIODE, SI, BV=75V, IO=150MA, 500MW	203323	65940	1N4448	3	
CR 4, 5	DIODE, SI, SCHOTTKY BARRIER, SMALL SIGNAL	313247	28480	5082-6264	2	
H 1	SPACER, SWAGE, .250 RND, BR, 4-40, .500	380519	55566	3051B440B14-MOD.-.500	2	
L 1	CHOKE, 6TURN	320911	89536	320911	1	
MP 1	WIRE, COPPER/TIN, BUS, 20AWG	212704	04946	302-12	1	
MP 2	DECAL 455832	473488	89536	473488	1	
Q 1	TRANSISTOR, SI, FNP, SWITCHING, TO-92	831446	04713	MPS3640	1	
R 1	RES, CF, 220, +-5%, 0.25W	342626	59124	CF1/4 221J	1	
R 2	RES, CF, 5.1K, +-5%, 0.25W	368712	59124	CF1/4 512J	1	
R 3	RES, CF, 47K, +-5%, 0.25W	348896	59124	CF1/4 473J	1	
R 4, 7	RES, CF, 4.7K, +-5%, 0.25W	348821	59124	CF1/4 472J	2	
R 5, 8- 13, R 16, 17	RES, CF, 10K, +-5%, 0.25W	348839	59124	CF1/4 102J	9	
R 6	RES, CF, 1K, +-5%, 0.25W	343426	59124	CF1/4 102J	1	
R 14	RES, CF, 150, +-5%, 0.25W	343442	59124	CF1/4 151J	1	
R 15	RES, CF, 470, +-5%, 0.25W	343434	59124	CF1/4 471J	1	
R 18	RES, CF, 1.5K, +-5%, 0.25W	343418	59124	CF1/4 152J	1	
T 1, 3, 6, T 8	TORO, ISOLATOR	437608	89536	437608	4	
T 2, 4, 5, T 7	TORO, ISOLATOR	437590	89536	437590	4	
U 1, 2, 5	IC, CMOS, HEX BUFFER	381830	27014	CD4050BCN	3	
U 3, 7	IC, TTL, 8BIT PAR-IN, SER-OUT SHIFT RGS	293118	27014	DM74165N	2	
U 4, 15	IC, TTL, QUAD 2 INPUT NAND W/OPEN COL	408021	27014	DM7426N	2	
U 6, 24	IC, LSTTL, HEX INVERTER	393058	01295	SN74LS04N	2	
U 8, 14, 23	IC, LSTTL, RETRG MONOSTAB MULTIVIB W/CLR	404186	01295	SN74LS123N	3	
U 9	IC, STTL, QUAD 2 INPUT NAND GATE	363580	01295	SN74S00N	1	
U 10	IC, LSTTL, TRIPLE 3 INPUT NAND GATE	393074	27014	DM74LS10N	1	
U 11, 19	IC, LSTTL, QUAD 2 INPUT NOR GATE	393041	27014	SN74LS02N	2	
U 12, 22, 26	IC, CMOS, QUAD 2 INPUT NOR GATE	355172	27014	CD4001BCN	3	
U 13, 21	IC, CMOS, HEX BUFFER W/3-STATE OUTPUT	407759	04713	MC14503BCP	2	
U 16, 20	IC, TTL, 8BIT SER-IN, PAR-OUT R-SHFT RGS	272138	27014	DM74164N	2	
U 17	RES, CERM, DIP, 16 PIN, 15 RES, 10K, +-5%	355305	91637	MDF16-03-103J	1	
U 18	IC, CMOS, QUAD 2 INPUT AND GATE	408401	04713	MC14081BCP	1	
U 25	IC, CMOS, TRIPLE 3 INPUT NOR GATE	355180	27014	CD4025BCN	1	
W 1	WIRE, TEF, UL1180, 22AWG, STRN, GRN	115659	89536	115659	1	
NOTES:	† Static sensitive part.					

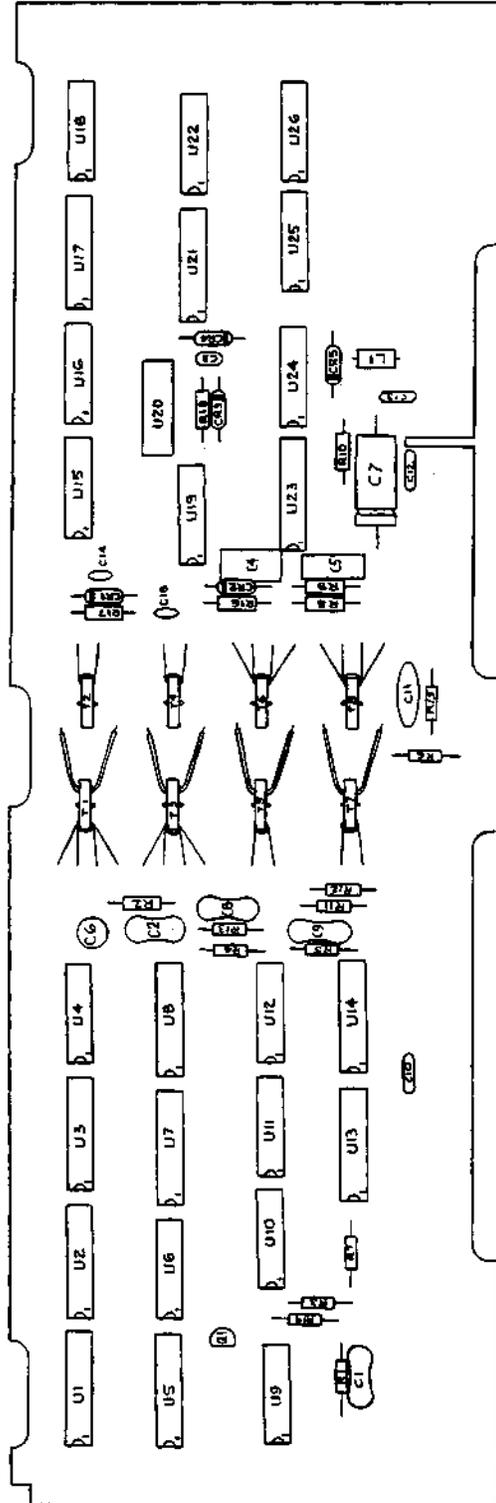

MIS-1781

Figure 5-22. A19 Isolator PCA

Table 5-28. A20 Controller PCA

REFERENCE DESIGNATOR	DESCRIPTION	FLUKE STOCK NO	MFRS SPLY CODE	MANUFACTURERS PART NUMBER OR GENERIC TYPE	TOT QTY	NOTES
C 1, 3, 5-0 C 7, 10- 12.0 C 15, 17- 20.0 C 22- 25, 27.0 C 28, 30	CAP,CER,0.22UF,+80-20%,50V,25U	649939 649939 649939 649939 649939	04222	SR595E224ZAA	20	
C 2	CAP,CER,1800PF,+5%,50V,COG	832717	04222	SR595A182JAA	1	
C 4	CAP,TA,6.8UF,+10%,35V	182782	56289	150D685X9035B2	1	
C 8	CAP,TA,39UF,+20%,6V	163915	56289	199D396X0006DA2	1	
C 9	CAP,POLYES,0.01UF,+10%,50V	715037	37942	171-473K160B	1	
C 13	CAP,CER,33PF,+5%,50V,COG	714543	04222	SR595A330JAA	1	
C 14	CAP,POLYES,0.1UF,+10%,50V	649913	68919	MKS2104K50	1	
C 16, 21, 25.0 C 29	CAP,AL,47UF,+75-20%,25V	655191 655191	62643	SM25T-47	4	
CR 1	‡ DIODE,SI,BV=75V,IO=150MA,500MW	203323	65940	1N4448	1	
CR 2, 3	‡ ZENER,UNCOMP,5.1V,5%,20.0MA,0.5W	535476	04713	IN5231B	2	
H 1	SPACER,SWAGE,.250 RND,BR,4-40,.187	335604	55566	3046B440B14-MOD.-.187	1	
L 1	CHOKE,6TURN	320911	89536	320911	1	
MP 1	PAD, ADHESIVE	735365	89536	735365	1	
R 1	RES,CF,200K,+5%,0.25W	441485	59124	CF1/4 204J	1	
R 2	RES,CF,1M,+5%,0.25W	348987	59124	CF1/4 105J	1	
R 3, 6	RES,CF,10K,+5%,0.25W	348839	59124	CF1/4 102J	2	
R 4, 5, 9	RES,CF,1.5K,+5%,0.25W	343418	59124	CF1/4 152J	3	
R 8	RES,CF,33K,+5%,0.25W	348888	59124	CF1/4 333J	1	
R 10	RES,CF,2.7K,+5%,0.25W	386490	59124	CF1/4 272J	1	
R 15	RES,CF,6.2K,+5%,0.25W	442366	59124	CF1/4 622J	1	
TP 1- 7	JUMPER,WIRE,NONINSUL,0.200CTR	816090	91984	150T1	8	
U 1	‡ IC,LSTTL,DUAL J-K F/F,+EDG TRIG	412999	27014	DM74LS109AN	1	
U 2	‡ IC,CMOS,DUAL MONOSTABLE MULTIBRATOR	454017	27014	CD4538BCN	1	
U 3	‡ IC,CMOS,DUAL SYNC BINRY UP CNTR	355164	04713	MC14520BCP	1	
U 4	‡ IC,CMOS,PHASE LOCKED LOOP,16 PIN DIP	403584	04713	MC14046BCP	1	
U 5, 27	‡ IC,LSTTL,QUAD 2 IN NAND W/SCHMT TRIG	504449	27014	DM74LS132N	2	
U 6	‡ IC,LSTTL,TRIPLE 3 INPUT AND GATE	393082	27014	DM74LS11N	1	
U 7, 9	‡ IC,CMOS,DUAL D F/F,+EDG TRG W/SET&RST	536433	04713	MC14013BCP	2	
U 8, 16	‡ IC,CMOS,TRIPLE 3 INPUT NOR GATE	586453	04713	MC14025BCP	2	
U 10	‡ IC,CMOS,HEX INVERTER	381848	27014	CD4049CN	1	
U 11	‡ IC,CMOS,TRIPLE 3 INPUT NAND GATE	375147	27014	CD4023CN	1	
U 12	‡ IC,LSTTL,QUAD D F/F,+EDG TRG,W/CLR	393215	01295	SN74LS175N	1	
U 13	‡ IC,LSTTL,OCTL INV LINE DRVR W/3-STATE	429480	27014	DM74LS240N	1	
U 14	‡ IC,CMOS,QUAD 2 INPUT NAND GATE	355198	04713	MC14011UBCP	1	
U 17, 26	‡ IC,CMOS,QUAD 2 INPUT NOR GATE	355172	27014	CD4001BCN	2	
U 18	‡ IC,256 X 4,PROM,PROGRAMMED	722744	27014	DM745387N	1	
U 19	‡ IC,STTL,CLOCK GENERATOR	586230	34649	P8224	1	
U 20, 22	‡ IC,2K X 8 STAT RAM	584144	49569	IDT6116SA-45P	2	
U 21	‡ IC,CMOS,8 BIT PRIORITY ENCODER	412973	04713	MC14532BCP	1	
U 23	‡ PROM,PROGRAMMED U23	661322	89536	661322	1	
U 24	‡ PROM,PROGRAMMED U24	661330	89536	661330	1	
U 25	‡ IC,CMOS,OCTAL BUS TRANSCEIVER	722017	27014	MM74HCT245N	1	
U 28	‡ IC,LSTTL,8BIT S-IN, P-OUT R-SHIFT RGS	408732	27014	DM74LS164N	1	
W 1, 2, 5	WIRE,JUMPER,TEF,22AWG,WHT,.500	484311	60386	J.TEFLON .500	3	
XU 15	SOCKET,IC,40 PIN	429282	00779	2-640379-1	1	
XU 18, 19	SOCKET,IC,16 PIN	276535	00779	2-640358-1	2	
XU 20, 22	SOCKET,IC,24 PIN	376236	00779	2-640361-1	2	
XU 23, 24	SOCKET,IC,28 PIN	448217	95146	228AG-39D	2	
Y 1	CRYSTAL,15.36MHZ,+0.05%,HC-18/U	642728	5W664	HC-18/U-15.36	1	
Z 1, 2, 4	RES,CERM,SIP,10 PIN,9 RES,6.2K,+2%	501536	91637	CSC10A-01-622G	3	
Z 3	RES,CERM,SIP,10 PIN,9 RES,2K,+2%	446880	91637	CSC10B-01-202G	1	
Z 5	RES,CERM,DIP,16 PIN,8 RES,2K,+5%	574905	91637	MDP16-03-202J	1	
NOTES:	‡ Static sensitive part.					

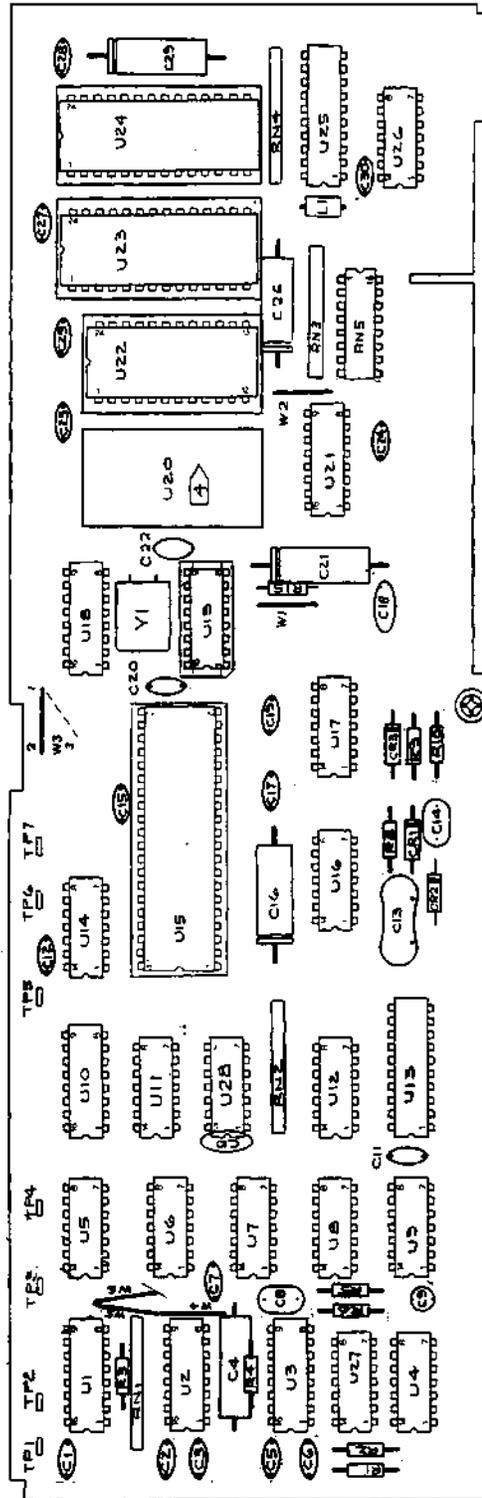

MIS-1687

Figure 5-23. A20 Controller PCA

Table 5-29. A21 Tape Drive PCA

REFERENCE DESIGNATOR	DESCRIPTION	FLUKE STOCK NO	MFRS SPLY CODE	MANUFACTURERS PART NUMBER OR GENERIC TYPE	TOT QTY	NOTES
C 1- 4, 16-1	CAP, TA, 10UF, +-20%, 10V	714766	56289	199D106X0010BE2	11	
C 22		714766				
C 5	CAP, TA, 6.8UF, +-20%, 10V	655043	56289	199D685X0010BG2	1	
C 6	CAP, CER, 4700PF, +-20%, 100V, COG	743427	04222	SR591A472MAA	1	
C 7, 23	CAP, TA, 2.2UF, +-20%, 25V	697425	56289	199D225X0025AG2	2	
C 8, 9	CAP, TA, 0.22UF, +-20%, 35V	161331	56289	199D224X0035AA2	2	
C 10	CAP, MICA, 1300PF, +-5%, 500V	182881	93790	CD19FD132J03	1	
C 11	CAP, CER, 680PF, +-5%, 50V, COG	743351	04222	SR595A681JAA	1	
C 12, 14	CAP, TA, 1UF, +-20%, 35V	697417	56289	199D105X0035AG2	2	
C 13	CAP, POLYEST, 0.01UF, +-10%, 50V	715037	37942	171-473K160B	1	
C 15	CAP, CER, 220PF, +-20%, 50V, COG	740654	04222	SR595A221MAA	1	
CR 1- 9	† DIODE, SI, BV-75V, IO-150MA, 500MW	203323	65940	1N4448	9	
E 1- 9	JUMPER, WIRE, NONINSUL, 0.200CTR	816090	91984	150T1	9	
H 1	SCREW, PH, P, LOCK, STL, 6-32, .375	152165	74594	152165	2	
H 2	WASHER, FLAT, DELRIN, .140, .215, .075	866541	89536	866541	2	
H 3	SPACER, SWAGE, .250 RND, BR, 6-32, 1.250	876821	55566	3063B632B14-MOD.-1.250	4	
J 18	HEADER, 2 ROW, .100CTR, 80 PIN	806273	00779	1-103186-0	1	
J 33	HEADER, 2 ROW, .100CTR, 26 PIN	756866	00779	1-102977-3	1	
MP 1	RECORDER, DIGITAL, CASSETTE, MINI	574459	0GBV1	600-0028-056	1	
MP 2	SPACER, TAPE CONTROLLER	885447	89536	885447	4	
MP 3	INSULATOR, CABLE	894212	89536	894212	1	
Q 1, 5	† TRANSISTOR, SI, PNP, 80V, 0.625W, TO-92	816272	04713	MP58599	2	
Q 2	† TRANSISTOR, SI, NPN, SMALL SIGNAL	330803	04713	MP56560	1	
Q 3	† TRANSISTOR, SI, PNP, SM SIG, DARLINGTON	524140	04713	MP5-A63	1	
Q 4	† TRANSISTOR, SI, NPN, SMALL SIGNAL, TO-92	698241	04713	2N4401	1	
R 2	RES, CF, 2.7, +-5%, 0.25W	442061	59124	CF1/4 2R7J	1	
R 4	RES, MF, 1.5K, +-1%, 0.125W, 100PPM	313098	91637	CMF-55 1501F T-1	1	
R 5	RES, MF, 1K, +-0.1%, 0.125W, 50PPM	474445	91637	CMF-55 1001B	1	
R 6, 12- 14, 1	RES, CF, 10K, +-5%, 0.25W	348839	59124	CF1/4 102J	7	
R 23, 42, 54		348839				
R 7	RES, CF, 2.7K, +-5%, 0.25W	386490	59124	CF1/4 272J	1	
R 8, 25	RES, CF, 100K, +-5%, 0.25W	348920	59124	CF1/4 104J	2	
R 9, 26	RES, CF, 110, +-5%, 0.25W	442285	59124	CF1/4 111J	2	
R 10, 18, 21	RES, CF, 2K, +-5%, 0.25W	441469	59124	CF1/4 202J	3	
R 15, 16, 38, 1	RES, CF, 1K, +-5%, 0.25W	343426	59124	CF1/4 102J	6	
R 41, 43, 52		343426				
R 17	RES, CF, 47, +-5%, 0.25W	441592	59124	CF1/4 470J	1	
R 19	RES, CF, 1.8K, +-5%, 0.25W	441444	59124	CF1/4 182J	1	
R 20	RES, CF, 360, +-5%, 0.25W	352286	59124	CF1/4 361J	1	
R 22, 24, 28	RES, CF, 200, +-5%, 0.25W	441451	59124	CF1/4 201J	3	
R 27	RES, VAR, CERM, 500, +-20%, 0.5W	267849	80294	3009P-1-501	1	
R 29	RES, CF, 100, +-5%, 0.25W	348771	59124	CF1/4 101J	1	
R 30, 31	RES, CF, 2.2K, +-5%, 0.25W	343400	59124	CF1/4 222J	2	
R 32, 33	RES, CF, 200K, +-5%, 0.25W	441485	59124	CF1/4 204J	2	
R 34, 45- 47	RES, CF, 20K, +-5%, 0.25W	441477	59124	CF1/4 203J	4	
R 35	RES, CF, 3.9K, +-5%, 0.25W	342600	59124	CF1/4 392J	1	
R 36, 37	RES, CF, 33K, +-5%, 0.25W	348888	59124	CF1/4 333J	2	
R 39	RES, VAR, CERM, 20K, +-20%, 0.5W	267898	80294	3009P-1-203	1	
R 40	RES, CF, 3.3K, +-5%, 0.25W	348813	59124	CF1/4 332J	1	
R 44	RES, CF, 6.2K, +-5%, 0.25W	442368	59124	CF1/4 622J	1	
R 48	RES, MF, 13.3K, +-0.5%, 0.125W, 100PPM	556977	91637	CMF-55 1332D T-1	1	
R 49, 51, 55	RES, MF, 10K, +-0.1%, 0.125W, 50PPM	343459	91637	CMF-55 1002B T-2	3	
R 50	RES, MF, 17.4K, +-1%, 0.125W, 100PPM	236802	91637	CMF-55 1742F T-1	1	
R 53	RES, CF, 27K, +-5%, 0.25W	441501	59124	CF1/4 273J	1	
U 1, 3	† IC, CMOS, HEX INVERTER	404699	27014	CD4069CN	2	
U 2, 5	† IC, LSTTL, TRIPLE 3 INPUT NAND GATE	393074	27014	DM74LS10N	2	
U 4	† IC, CMOS, QUAD 2 INPUT NAND GATE	418509	27014	MM74CC00N	1	
U 6	† IC, TTL, DUAL AND DRVR W/OPEN COLLECTOR	393959	27014	DS75451N	1	
U 7	† IC, ARRAY, 4 TRANS, PNP, MEMORY DRIVER	477828	27014	DH3467CN	2	
U 8	† IC, BPLR, DC MOTOR SPEED REGULATOR	536383	6X403	TD11151	1	
U 9, 10	† IC, OP AMP, QUAD, 14 PIN DIP	402669	27014	LM324N	2	
W 1	WIRE, JUMPER, TEF, 22AWG, WHT, .500	484311	89536	484311	1	
W 2	WIRE, JUMPER, TEF, 22AWG, WHT, .600	529826	89536	529826	1	
NOTES:	† Static sensitive part.					

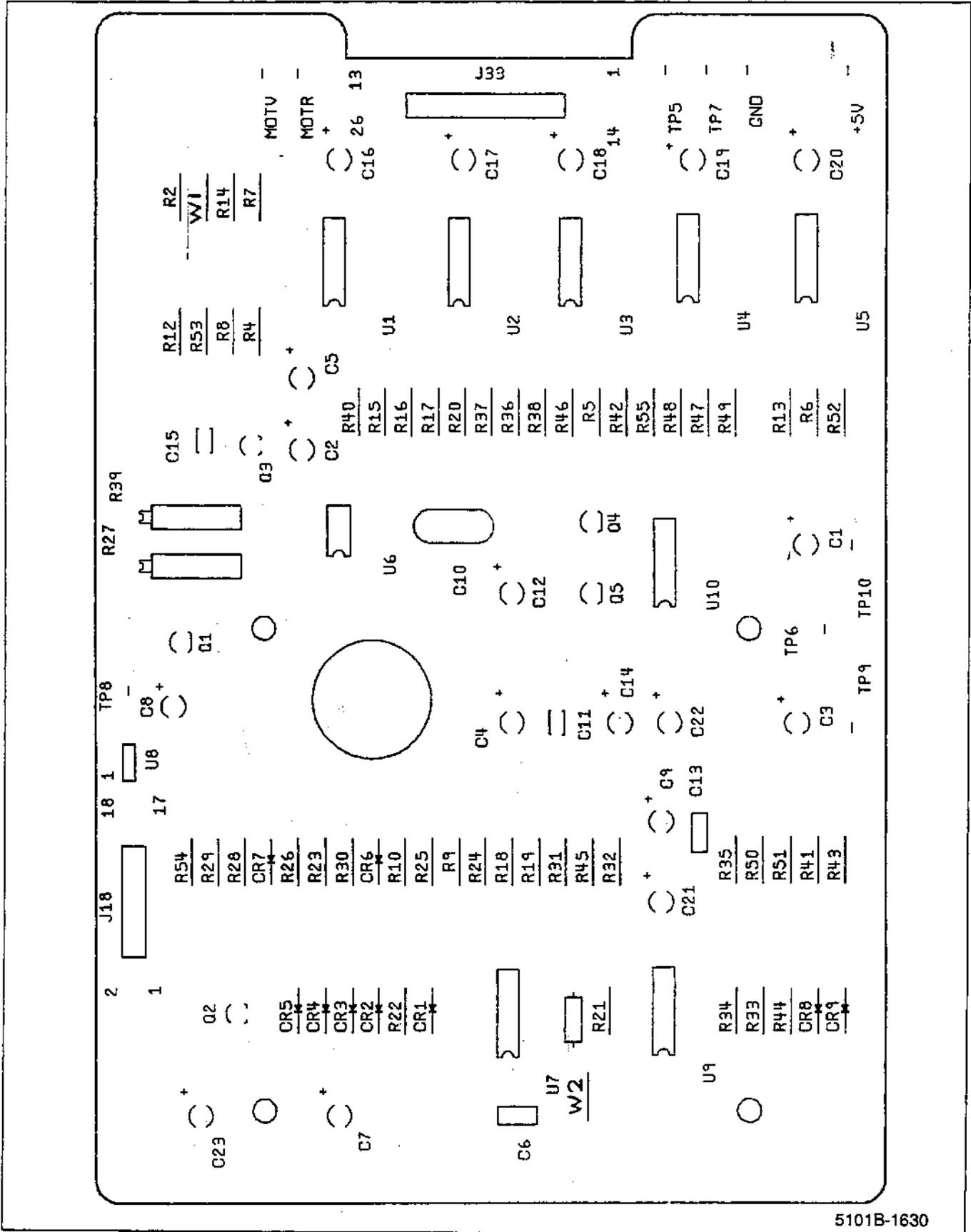

5101B-1630

Figure 5-24. A21 Tape Drive PCA

Supply Codes for Manufacturers

00779 AMP, Inc. Harrisburg, PA	0JR59 Wickmann USA Inc. Atlanta, GA	22526 DuPont, El DeNemours & Co. Inc. DuPont Connector Systems New Cumberland, PA	30035 Jolo Industries Inc. Garden Grove, CA
01121 Allen-Bradley Co. Milwaukee, WI	0LUA3 Philips Components Sistersville, RI	23172 Alpha Wire Corp. Torrance, CA	30800 General Instrument Corp. Capacitor Div. Hicksville, NY
01295 Texas Instruments Inc. Semiconductor Group Dallas, TX	0N0K0 Calogic Inc. Fremont, CA	23237 I R C, Inc. Microcircuits Div Philadelphia, PA	31019 Ailegro Microsystems Inc. Formerly Sprague Electric Co. Semiconductor Group Willow Grove, PA
02660 Amphenol Corp. Industrial Technology Div. Wallingford, CT	0P569 BMI (Barkers Microfarads Inc.) Hillsville, VA	24347 Penn Engineering Co. S. El Monte, CA	34371 Harris Corp. Semiconductor Sector Military & Aerospace Div. Melbourne, FL
03445 Lerco Electronics Inc Burbank, CA	11237 CTS Corp of California Pasa Robles Div. Pasa Robles, CA	24355 Analog Devices Inc. Norwood, MA	34649 Intel Corp. Santa Clara, CA
04222 AVX Kyocera Corp. Myrtle Beach, SC	12615 US Terminals Inc. Cincinnati, OH	24759 Lenox-Fugle Electronics Inc. South Plainfield, NJ	34899 Fair-rite Products Corp. Walkill, NY
04713 Motorola Inc. Semiconductor Products Sector Phoenix, AZ	12969 Unitrode Corp. Lexington, MA	24995 ECS Composites Grants Pass, OR	37942 North American Capacitor Co. Mallory Div. Greencastle, IN
04946 Standard Wire and Cable Rancho Dominguez, CA	13103 Thermalloy Co., Inc. Dallas, TX	25088 Siemens Corp. Iselin, NJ	43791 Datron Systems Wilkes Barre, PA
05347 Ultronix Inc (Tel Labs) Grand Junction, CO	14099 Semtech Corp. Newbury Park, CA	26066 Minnesota Mining & Mfg. Co. Industrial Tape Div. St. Paul, MN	47379 ISOCOM Campbell, CA
05820 EG & G Wakefield Engineering Wakefield, MA	14552 Microsemi Corp. (Formerly Micro-Semiconductor) Santa Ana, CA	26233 Nylok Fastener Corp. Carson, CA Replaced 18715 (United Shoe & Nylock Co.)	48672 Metal Masters Div. of Eco-Air Products Inc. San Diego, CA
06383 Panduit Corp. Tinley Park, IL	14936 General Instrument Corp. Power Semiconductor Div. Hicksville, NY	26805 M/A-COM Omni Spectra Inc. Microwave Connector Div. Sub of M/A-COM Inc. Waltham, MA Formerly Omni Spectra	49569 IDT (International Development & Trade) Dallas, TX
06540 Amatom Electronic Hardware Div. New Haven Mfg. Corp New Haven, CT	17856 Siliconix Inc. Santa Clara, CA	26806 American Zettler Inc. Aliso Viejo, CA	4F434 Plastic Sales Los Angeles, CA
06915 Richco Plastic Co. Chicago, IL	18310 Concord Electronics Corp. New York, NY	27014 National Semiconductor Corp. Santa Clara, CA	50738 Wire-Pro Salem, NJ
07047 Ross Milton Co., The Southampton, PA	18324 Signetics Corp. Military Products Div. Orem, UT	28480 Hewlett-Packard Co. Corporate HQ Palo Alto, CA	51372 Verbatim Corp. Sunnyvale, CA
07263 Fairchild Semiconductor North American Sales Cupertino, CA	18786 Micro-Power Inc. Long Island City, NY	2K262 Boyd Corp. Portland, OR	52072 Circuit Assembly Corp. Irvine, CA
09214 General Electric Co. Semiconductor Products Dept. Auburn, NY	19080 Robinson Electronics Inc. San Luis Obispo, CA	2M021 EFAB Mfg. Inc. Charlottesville, VA	52769 Sprague-Goodman Electronics Inc. Garden City Park, NY
0FYL7 Ansley Chicago, IL	19647 Caddock Electronics Inc. Riverside, CA	2M530 John Perine Seattle, WA	55285 Bercquist Co. Inc., The Minneapolis, MN
0GBV1 Zetaco Inc. Eden Prairie, MN	20584 Enochs Inc. Indianapolis, IN	21845 Solitron Devices Inc. Corp Hq & Semiconductor Mfg. Group Riviera Beach, FL	55408 STI-CO Industries Inc. Orchard Park, NY

Supply Codes for Manufacturers (cont)

55464 Central Semiconductor Corp. Div. of Central State Industries, Inc. Hauppauge, NY	65940 Rohm Corp Irvine, CA	77342 Potter & Brumfield Inc. A Siemens Co. Princeton, IN Formerly AMF Inc.	84830 Lee Spring Co. Inc. Brooklyn, NY
55566 RAF Electronic Hardware Inc. Seymour, CT	66967 Powerex Inc Auburn, NY	78189 Illinois Tool Works Inc. Shakeproof Div. Elgin, IL	86928 Seastrom Mfg. Co. Inc. Glendale, CA
56289 Sprague Electric Co. Nashua, NH	68919 Inter-Technical Group Inc., The Wima Division Elmsford, NY	79963 Zierick Mfg. Corp. Mount Kisco, NY	88245 Winchester Electronics Litton Systems-USeco Div. Van Nuys, CA
56699 Philips Components Discrete Products Div. (Formerly Mepco/Centralab) Columbia, SC	6X403 SGS/ATES Semiconductor Corp. Indianapolis, IN	80294 Bourns Instruments Inc. Riverside, CA	89536 John Fluke Mfg. Co., Inc. Everett, WA
59124 KOA Speer Electronics Inc. Bradford, PA	70903 Cooper Belden Electronic Wire & Cable Geneva, IL	81312 Div. of Litton Systems Inc. Winchester Electronics Watertown, CT	91637 Dale Electronics Inc. Columbus, NE
5U802 Dennison Mfg. Co. Fastener Div. Framingham, MA	71400 Bussman - Now Magnum Div. of Cooper Industries Inc. St. Louis, MO	82240 Simmons Fastener Corp. An Amfast Corp. Albany, NY	91833 Keystone Electronics Corp. Astoria, NY
5W664 NDK America Inc. Div. of Nihon Dempa Kogyo LTD Lynchburg, VA	71707 Coto Corp. Providence, RI	82389 Switchcraft Inc. Sub of Raytheon Chicago, IL	91984 Maida Development Co. Hampton, VA
60386 Squires Electronics Inc. Cornelius, OR	72347 Ericsson Components, Inc. (Formerly Rifa, Inc.) Richardson, TX	82877 Rotron Inc. Custom Div. Woodstock, NY	93790 Cornell-Dubilier Electronics New Bedford, MA
60495 Atlantic Tubing Paterson, NJ	72962 Elastic Stop Nut Div. of Harvard Industries Union, NJ	83003 Varo Electron Devices Garland, TX	95146 Augat Alcoswitch North Andover, MA
60705 Cera-Mite Corp. Grafton, WI	73734 Federal Screw Products Inc. Chicago, IL	83553 Associated Spring Barnes Group, Inc. Gardena, CA	96881 Thomson Industries Inc. Port Washington, NY
61429 Fox Electronics Fort Myers, FL	74594 Component Resources Inc. Div of EPI International Corp. Beaverton, OR	84411 American Shizuki Corp. Ogallala Opns Ogallala, NE	98291 ITT Seallectro New Britain, CT
62643 United Chemi-con Inc. Rosemont, IL	75915 Littelfuse Tracor, Inc. (Formerly: Tracor-Littelfuse) Des Plaines, IL		98978 IERC International Electronic Research Corp. Burbank, CA

Service Centers

USA	INTERNATIONAL			
<p>California Fluke Service Center 46610 Landing Parkway Framont, CA 94538 TEL: (510) 851-5112 FAX: (510) 851-4962</p> <p>Fluke Service Center 16715 Von Karman Avenue Suite 110 Irvine, CA 92714 TEL: (714) 863-8031 FAX: (714) 757-7556</p> <p>Illinois Fluke Service Center 1150 W. Euclid Avenue Palatine, IL 60067 TEL: (708) 705-0500 FAX: (708) 705-9989</p> <p>New Jersey Fluke Service Center W. 75 Century Rd Paramus, N.J. 07652-0930 TEL: (201) 599-9500 (599-0919) FAX: (201) 599-2083</p> <p>Texas Fluke Service Center - Dallas 2104 Hutton Drive Suite 112 Carrollton, TX 75006 TEL: (214) 406-1000 FAX: (214) 406-1072</p> <p>Washington Fluke Service Center Fluke Corporation Building #4 1420 - 75TH St. S.W. Everett WA 98203 TEL: (206) 356-5560 FAX: (206) 356-6390</p>	<p>Argentina Coasin S.A. Virrey del Pino 4071 1430 CAP FED Buenos Aires TEL: 54-1-552-5248 FAX: 54-1-555-3321</p> <p>Viditec S.A. Lacarra 234 Buenos Aires CP 1407 TEL: 54-1-836-1189 FAX: 54-1-636-2185</p> <p>Australia Phillips Sci. and Ind., Pty., L. 745 Springvale Road Mulgrave Victoria 3170 TEL: 61-3-881-3665 FAX: 61-3-881-3636</p> <p>Phil. Sci. & Ind. Bk F. Centrect. 34 Waterloo Road North Ryde, N.S.W. 2113 TEL: 61-2-888-0423 FAX: 61-2-888-0440</p> <p>Austria Fluke Vertriebsges. GMBH (GM) SudrandstraBe 7 P.O. Box 10, A-1232 Wien TEL: 43-1-614-1030 FAX: 43-1-614-1010</p> <p>Bahrain Mohammed Fakhro & Bros. P.O. Box 439 Bahrain TEL: 973-253529 FAX: 973-275996</p> <p>Belgium N.V. Fluke Belgium S.A. Sales & Service Dept. Langeveldpark - Unit 5 & 7 P.Basteleusstraat 2-4-6 1600 St. Pieters - Leeuw TEL: 218-2-331-2777 (ext 218) FAX: 32-2-331-1489</p> <p>Bolivia Coasin Bolivia S.R.L. Casilla 7295, Calle Ayacucho No. 208 Edificio Flores, 5to. Piso La Paz TEL: 591-2-317531 or 317173 FAX: 591-2-317545</p> <p>Brazil Phillips Medical Systems, LTDA Av. Interlagos North 3493 - Campo Grande 04661-200 Sao Paulo S.P. TEL: 55-11-523-4811 FAX: 55-11-524-4873</p> <p>Sigtron Instrumentos E. Servicos Rua Avaro Rodrigues 269 - Brooklin Sao Paulo, Sp TEL: 55-11-240-7359 FAX: 55-11-533-3749</p>	<p>Bulgaria Ac Sophilco, Cust. Supp. Serv. P.O. Box 42 1309 Sofia TEL: 359-2-200785 FAX: 359-2-220910</p> <p>C.S.F.R. Elso NA. Berance 2 16200 Prague 6 TEL: 42-2-316-4810 FAX: 42-2-364986</p> <p>Data Elektronik BRNO Jugoslavska 113 61300 Brno TEL: 42-5-57400-2 FAX: 42-5-574002</p> <p>Canada Fluke Electronics Canada Inc. 400 Britannia Rd East, Ut #1 Mississauga, Ontario L4Z 1X9 TEL: 905-880-7600 FAX: 905-880-6866</p> <p>Chile Intronica, Instrumen Electronica, S.A.C.I. Guardia Vieja 181 Of. 503 Casilla 18500, Santiago 9 TEL: 56-2-232-3888 FAX: 56-2-231-6700</p> <p>China Fluke S.C., Room 2111 Scite Tower Jiangumenwai Dajie Beijing 100004 TEL: 86-10-512-3436 or 3435 FAX: 86-10-512-3437</p> <p>Colombia Sistemas E Instrument., Ltda. Carrera 21, NO. 39A-21, OF. 101 Ap. Aereo 29583, Bogota TEL: 57-1-287-5424 FAX: 57-1-287-2248</p> <p>Costa Rica Electronic Engineering, S.A. Carretera de Circunvalacion Sabanilla Av. Novena P.O. Box 4300-1000, San Jose TEL: 506-253-3759 or 225-8793 FAX: 506-225-1286</p>	<p>Countries not listed Eastern Europe and Middle East Fluke Europe B.V., Exp. sales Science Park Eindhoven 5110 5692 EC Son The Netherlands TEL: 31-40-644265 FAX: 31-40-644260</p> <p>Croatia Kaktim - Zagreb Fluke Sis & Serv. Draga 6 41425 Sveta Jana TEL: 385-41-837115 FAX: 385-41-837237</p> <p>Denmark Fluke Danmark A/S, Cust. Supp. Ejby Industrivej 40 DK 2600 Glostrup TEL: 45-43-44-1900 or 1935 FAX: 45-43-43-9192</p> <p>Ecuador Proteco Coasin Cia., Ltda. Av. 12 de Octubre 2448 y Orellana P.O. Box 17-03-22B-A, Quito TEL: 593-2-230283 or 520005 FAX: 593-2-561980</p> <p>Egypt EEMCO Electronic Equipment Mking Co. 9 Hassan Mazher St. P.O. Box 2009 St. Heliopolis 11361 Cairo, Egypt TEL: 20-2-417-8296 FAX: 20-2-417-8296</p> <p>Fed. Rep. of Germany Fluke Deutschland GmbH Customer Support Services Servicestutzpunkt VFNS Oskar-Messter-Strasse 18 85737 Ismaning/Munich TEL: 49-89-9961-1260 FAX: 49-89-9961-1270</p> <p>Fluke Deutschland (CSS), Servicestutzpunkt VFNS Meiendorferstrasse 205 22145 Hamburg TEL: 49-40-679-7474 FAX: 49-40-679-7421</p> <p>Finland Fluke Finland Oy Sinkkalantie 3, P.O. Box 151 SF 02631 Espoo TEL: 358-0-6152-5620 or 5800 FAX: 358-0-6152-5630</p> <p>France Fluke France S.A. 37 Rue Voltaire BP 112, 93700 Drancy, TEL: 33-1-4896-6310 or 6361 FAX: 33-1-4896-6330</p>	<p>Greece Philips S.A. Heienique Fluke Sales & Service Manager 15, 25th March Street, P.O. Box 3153, 177 78 Tavros Athens TEL: 30-1-489-4911 or 4262 FAX: 30-1-481-8594</p> <p>Hong Kong Schmidt & Co, Ltd. 1st Floor 323 Jaffe Road Wanchai TEL: 852-9223-5623 FAX: 852 634-1848</p> <p>Hungary MTA MMSZ KFT, Srv. / Gen. Mgr Etele Ut. 59 -61 P.O. Box 58 H 1502 Budapest TEL: 361-186-9589 or 209-3444 FAX: 361-161-1021</p> <p>Iceland Tæknival HF P.O. Box 8294, Skeifunni 17 128 Reykjavik TEL: 354-1-681665 FAX: 354-1-680664</p> <p>India Philips India Limited Band Box House 254 Dr. Annie Besant Road Bombay 400 025 TEL: 91-22-483-0311 FAX: 91-22-495-0488</p> <p>Hinditron Services Pvt. Inc. 33/44A 8th Main Road Raj Mahal Vilas Extension Bengalore 560 080 TEL: 91-80-334-8266 or 0068 FAX: 91-80-334-5022</p> <p>Hinditron Services Pvt. Ltd Hinditron House, 23-B Mahal Industrial Estate Mahakali Caves Rd, Andheri East Bombay 400 093 TEL: 91-22-836-4745 or 832- 6590 FAX: 91-22-836-4682</p> <p>Hinditron Services Pvt. Ltd Casite House, 5th Floor 5/1 A, Hungerford Street Calcutta 700 017 TEL: 91-33-247-9094</p> <p>Hinditron Services Pvt. Ltd 204-206 Hemkunt Tower 98 Nehru Place New Delhi 110 019 TEL: 91-11-641-3675 FAX: 91-11-642-9118</p> <p>Hinditron Services Pvt. Ltd. Field Service Center Emerald House, 5th Floor 114 Sarojini Devi Road Secunderabad 500 003 TEL: 91 40-844033 or 843753 FAX: 91-40-847585</p>

Service Centers (cont)

Indonesia

P. T. Daeng Bro, Phillips House
Jln H.R. Rasuna Said Kav. 3-4
Jakarta 12950
TEL: 62-21-520-1122
FAX: 62-21-520-5189

Israel

R.D.T Equipment & Sys, Ltd.
P.O. Box 58013
Tel Aviv 61580
TEL: 972-3-645-0745
FAX: 972-3-647-8906

Italy

Fluke Italia S.R.L., CSS
Viale Delle Industrie, 11
20090 Vimodrone (MI)
TEL: 39-2-269-434-203 or 4341
FAX: 39-2-250-1645

Japan

Fluke Corp., Sumitomo Higashi
Shinbashi Bldg.
1-1-11 Hamamatsucho
Minato-ku, Tokyo 105
TEL: 81-3-3434-0188 or 0181
FAX: 81-3-3434-0170

Jordan

Jordan Med. Supp. & Services
P.O. Box 140415, Amman
TEL: 962-6-899353 or 699354
FAX: 962-6-663556

Kenya

Walterfang
P.O. Box 14887
Nairobi, Kenya
TEL: 254-2
FAX: 254-2

Korea

B&P International Co., Ltd.
Geopung Town A-303
203-1 Nonhyun-Dong
Kangnam-Ku
Seoul 135-010
TEL: 82 02 546-1457
FAX: 82 02 546-1458

IL MYOUNG, INC.

Youngdong P.O. Box 1486
780-46, Yeogamsam-Dong
Kangnam-Ku, Seoul
TEL: 82 2 552-8582-4
FAX: 82 2 553-0388

Kuwait

Yusuf A. Alghanim & Sons W.L.L.
P.O. Box 223 Safat
Alghanim Industries
Airport Road Shuwaikh
13003 Kuwait
TEL: 965-4842988
FAX: 965-4847244

Malaysia

GNN. SDN. BHD.
17D, 2nd Floor
Lebuhraya Batu Lintang
Taman Seri Damai
11600 Jelutong Penang
TEL: 60-4-657-8584
FAX: 60-4-657-0835

Mexico

Metro. Y Calibraciones Ind., S.A.
Diagonal No. 27
Entra Calle de Eugenia Y Ave.
Col. Del Valle
C.P. 03100, Mexico D.F.
TEL: 52-5-682-8040
FAX: 52-5-687-8895

Netherlands

Fluke Nederland B.V. (CSS)
Aldeling Service
Science Park Eindhoven 5108
5692 EC Son
TEL: 31-40-644300 or 644311
FAX: 31-40-644321

New Zealand

Phillips Scientific & Ind., Pty., L.
Private Bag 41904,
St. Lukes, 2 Wagener Place
Mt. Albert, Auckland 3
TEL: 64-9-894-4160
FAX: 64-9-849-7814

Nigeria

Philips Projects Centre
Resident Delegate / PMB 80065
8, Kolo Abayomi Street
Victoria Island, Nigeria
TEL: 234-1-262-0632
FAX: 234-1-262-0631

Norway

Fluke Norway A/S, Cust. Support
P.O. Box 8054 Etterstad
N-0601 Oslo
TEL: 47-22-653400
FAX: 47-22-653407

Pakistan (Philips)

Philips Elec. Ind. of Prof. Sys. Div.
Islamic Cham. of Commerce
St-2/A, Block 9, KDA Scheme 5,
Clifton, Karachi-75600
TEL: 92-21-587-4641 or 4649
FAX: 92-21-577-035

Peru

Impor. & Repres. Electronicas
S.A., JR. Pumacahua 955
Lima 11
TEL: 51-14-23-5099
FAX: 51-14-31-0707

Philippines

Spark Electronics Corp.
P.O. Box 610, Greenhills
Metro Manila 1502
TEL: 63-2-700-621
FAX: 63-2-721-0491 or 700-709

Poland

Elec. Instr. Srv. Philips Cons.
UL. Malachowska 6
60 188 Poznan
TEL: 48-61-681996
FAX: 48-61-682256

Portugal

Fluke Iberica S.L.
Sales Y Services Dept
Campo Grande 35 - 7b
1700 Lisboa
TEL: 351-1-795-1712
FAX: 351-1-795-1713

Romania

Ronex S.R.L., Cust. Supp. Serv.
Str. Transilvaniei Nr. 24
70778 Bucharest - I
TEL: 40-1-614-3597 or 3598
FAX: 40-1-659-4468

Russia

Infonedia
UL. Petrovsko Razumovsky
Proezd. 29
103287 Moscow
TEL: 7-95-212-3833
FAX: 7-95-212-3838

Saudi Arabia

A. Rajab & Salsilah Co. S&S Dept.
P.O. Box 203
21411 Jeddah
TEL: 966-2-661-0006
FAX: 966-2-661-0558

Singapore

Fluke Singapore Pte., Ltd.
Fluke ASEAN Regional Office
#27-03 PSA Building
460 Alexandra Road
Singapore 0511
TEL: 65-276-5161
FAX: 65-276-5759

South Africa

Spescom Measure. (PTY) Ltd.
Spescom Park
Cm. Alexandra Rd. & Second St.
Halfway House, Midrand 1685
TEL: 27-11-315-0757
FAX: 27-11-805-1193

Spain

Fluke Iberica S.L.
Centro Empresarial Euronora
c/Ronda de Poniente, 8
28760-Tres Cantos
Madrid, Spain
TEL: 34-1-804-2301
FAX: 34-1-804-2496

Sultan of Oman

Mustafa & Jawad Trdg Co. (CSS)
P.O. Box 1918, P.C. 112
Ruwi - Muscat
TEL: 968-709955
FAX: 968-564005

Sweden

Fluke Sverige AB, (CSS)
P.O. Box 61
S-164 94 Kista
TEL: 46-8-751-0235
FAX: 46-8-751-0480

Switzerland

Fluke Switzerland AG, (CSS)
Rutistrasse 28
8952 Schlieven
TEL: 41-1-730-3310
FAX: 41-1-730-3720

Taiwan

Schmidt Scientific Taiwan, Ltd.
5th Floor, No. 178, Section 2
Min Sheng East Road, Taipei
TEL: 886-2-501-3468
FAX: 886-2-502-9692

Thailand

Measuratronix Ltd.
2102/31 Ramkhamhang Road
Bangkok 10240
TEL: 66-2-375-2733 or 2734
FAX: 66-2-374-9965

Turkey

Pestas Prof. Elektr. Sist. Tic. V
Selcuklar Caddesi
Meydan Apt. No. 49, Daire 23
Akatlar 80630 Istanbul
TEL: 90-212-282-7838
FAX: 90-212-282-7839

U.A.E.

Haris Al Afaq Ltd.
P.O. Box 8141
Dubai
TEL: 971-4-283623 or 283624
FAX: 971-4-281285

United Kingdom

Fluke U.K. LTD. (CSS)
Colonial Way
Watford, Hertfordshire WD2 4TT
TEL: 44-923-240511
FAX: 44-923-225067

Uruguay

Cosin Uruguay S.A.
Casilla de Correo 1400
Libertad 2528, Montevideo
TEL: 598-2-789-015
FAX: 598-2-492-199

Venezuela

Cosin C.A.
Calle 9 Con Calle 4, Edif. Edinurbi
Apartado de Correos NR-70.136
Los Ruicas
Caracas 1070-A
Venezuela
TEL: 58-2-242-7466 or 1248
FAX: 58-2-241-1938

Vietnam

Schmidt-Vietnam Co., Ltd.
6/F1. Pedagogical College Bldg.
Dich Vong, KM 8 Highway 32
Tu Liem
Hanoi
Vietnam
TEL: 84-4-346186 or 346187
FAX: 84-4-346-188

Yugoslavia

Jugoelektro Beograd
T & M Customer Support
Services
Knez Mihailova 33
11070 Novi
TEL: 38-11-182470
FAX: 38-11-638209

Zimbabwe

Field Technical Sales
45, Kelvin Road North
P.O. Box Cy535 Causeway
Harare, Zimbabwe
TEL: 263-4-750381 or 750382
FAX: 263-4-729970

Section 6

Option & Accessory Information

TABLE OF CONTENTS

OPTION/ MODEL NO.	DESCRIPTION	PAGE
ACCESSORIES		
5100A-7003K	Transit Case	600-1
5100A-7005K	PCB Extender Assembly Kit	600-1
MIS-7190K	Static Controller	600-1
M08-205-600	Rack Mounting Kit	600-1
M00-280-610	Chassis Slides Kit	600-1
Y5000	5100 Series Interface	600-1
Y5001	Interface Cable Assembly	600-2
Y5002	Interface Cable Assembly	600-2
Y8021	Printer Cables IEEE (Storage Only)	600-3
Y8022	Printer Cables IEEE (Storage Only)	600-3
Y8023	Printer Cables IEEE (Storage Only)	600-3
Y8004	Printer Cables RS-232-C(Storage Only)	600-3
OPTIONS		
-03	Wideband Frequency	603-1
-05	IEEE-488 Interface	605-1
-06	Bit Serial Asynchronous Interface (RS-232-C)	606-1

6-1. INTRODUCTION

6-2. This section of the manual contains information on the accessories and options available for the 5100 Series B Calibrators.

6-3. ACCESSORY INFORMATION

6-4. The portion of this section dealing with accessories will contain the details of all accessories available for the 5100 Series B.

6-5. OPTION INFORMATION

6-6. Each of the options available for the 5100 Series B are described separately in a sub-section identified with the option name and number. The option description contains the information on the operating instructions and maintenance not covered in the main body of the text, plus a complete list of replaceable parts for the option.

Accessories

600-1. TRANSIT CASE 5100A-7003K

600-2. This kit contains a case designed to protect the 5100B and 5101B Calibrators while the instrument is in transit. The bottom portion of the case is two inches high, permitting the operator access to the instrument controls when the top cover is removed. This removes the necessity of lifting the instrument from the case and lessens the possibility of damage in transit. The transit case is illustrated in Figure 600-1.

NOTE

The transit case is not intended to be used as sole protection during shipping by common carrier or in airline baggage.

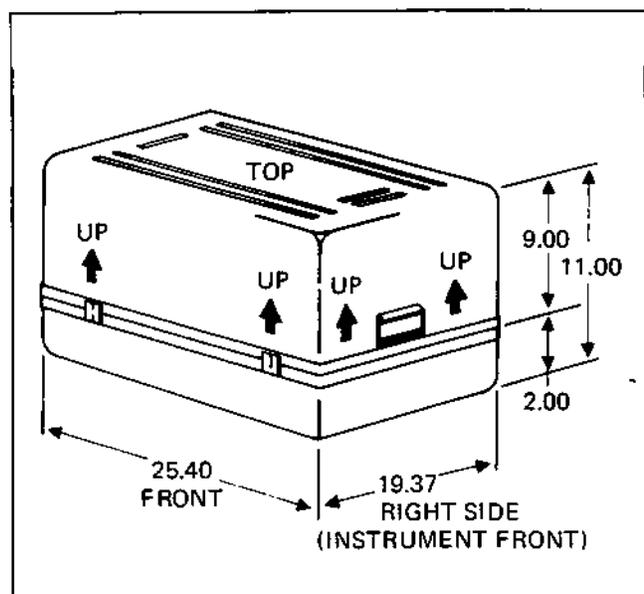

Figure 600-1. Transit Case

600-3. PCB EXTENDER ASSEMBLY KIT, 5100A-7005K

600-4. This kit contains the PCBs required for servicing the instrument. Component parts of the kit are listed in Table 600-1. Replacement items for the kit can be ordered using the Fluke Stock Number in the Table and the procedure in Section 5.

Table 600-1. Extender Kit

DESCRIPTION	FLUKE STOCK NO.
Analog Extender PCB	420323
Digital (MIS) Extender PCB	455758

600-5. STATIC CONTROLLER MIS-7190K

600-6. Replaces the Controller PCB in the digital compartment providing the operator switch control of the data and control lines. Operation of the Static Controller is covered in the manual that comes with the device.

600-7. RACK MOUNTING KIT M08-205-600

600-8. Instructions for the use and installation of the rack mounting accessory accompany the kit.

600-9. CHASSIS SLIDES KIT M00-280-610

600-10. Instructions for the installation and use of the chassis slides accessory accompany the kit.

600-11. Y5000 5100 SERIES INTERFACE

600-12. The Model Y5000 is an accessory that allows the calibrator operator to slave a Fluke Model 5205A/5215A Power Amplifier and/or a Fluke Model 5220A

Transconductance Amplifier to the calibrator to extend the voltage (power) and/or current limits of the instrument. Either the 5205A or 5215A may be used as a power amplifier. Operation is the same except that DC output cannot be obtained from the 5215A. Each amplifier must be connected to the interface with a dedicated cable assembly accessory designed specifically for that instrument combination. The cable accessories available are listed in subsequent paragraphs.

600-13. The accessory is a small box that mounts on the rear of the 5100 Series B calibrator. The front has two connectors that mate with the MIS Bus (Digital) Connector and Analog Bus Connector on the calibrator rear panel. It can be securely attached to the calibrator using the screws included with the assembly. The rear of the assembly has two digital (J1 and J3) and two analog (J2 and J4) connectors to provide simultaneous connection to two separate instruments.

600-14. For a description of the Y5000 Interface and further instructions on the installation and use refer to the instruction manual shipped with the accessory.

600-15. Y5001 INTERFACE CABLE ASSEMBLY

600-16. The Y5001 accessory is a dedicated cable assembly that connects a Fluke Model 5205A/5215A Power Amplifier to the Y5000 5100 Series Interface. It consists of a custom-built cable with a male 36-pin connector and a male 14-pin connector on one end to connect to the digital analog outputs, on the Y5000, respectively, and a female 25-pin connector on the other to mate with the connector labeled 5200 on the 5205A or 5215A rear panel.

CAUTION

Do not connect the analog and digital connectors on the Y5001 Cable Assembly directly to the 5100 Calibrator. They must be connected through the Y5000 interface or damage may result to the calibrator.

600-17. For a description of the Y5001 Cable Assembly and further instructions on installation, refer to the instruction sheet shipped with the assembly.

600-18. Y5002 INTERFACE CABLE ASSEMBLY

600-19. The Y5002 accessory is a dedicated cable assembly that connects a Fluke Model 5220A

Transconductance Amplifier to the Y5000 5100 Series Interface. It consists of a custom-built cable with a male 36-pin connector and a male 14-pin connector on one end to connect to the digital and analog outputs, on the Y5000, respectively, and a male 24-pin connector on the other to mate with the connector labeled P71 on the 5220A rear panel.

CAUTION

Do not connect the analog and digital connectors on the Y5002 directly to the 5100 Calibrator. They must be connected through the Y5000 interface or damage may result to the calibrator.

600-20. For a description of the Y5002 Cable Assembly and further instructions on installation refer to the instruction sheet shipped with the assembly.

600-21. PRINTER CABLES (STORAGE ONLY)

600-22. A cable applicable to a printer used in the system should be selected from Table 600-2. The cable connects the printer to the applicable remote interface at the rear panel.

Table 600-2. Printer Cables

ACCESSORY NO.	INTERFACE TYPE	LENGTH
Y8021	IEEE	1 meter
Y8022	IEEE	2 meters
Y8023	IEEE	4 meters
Y8004	RS-232-C	1.5 meters

600-23. Y8007 TAPE CASSETTES (STORAGE ONLY)

600-24. A pack of 10 blank, mini-cassettes for use with the tape storage system are available as accessory Y8007.

CAUTION

Tapes used must be certified digital mini-cassettes that conform with ANSI standard X3B5/77-49. Audio quality tapes will not give acceptable results.

-03 Option Wideband Frequency

603-1. INTRODUCTION

603-2. The Wideband (WB) Frequency Option increases the frequency capability of the 5100 Series B Calibrators from the standard 50 Hz-50 kHz to 10 Hz-10 MHz. The output voltage is limited to between 300 μ V (-57.5 dB) and 3.1623V ac rms (+23 dB) into 50 ohms with an output impedance of 50 ohms from the options dedicated BNC connector.

603-3. SPECIFICATIONS

603-4. Specifications for the wideband option are included with the instrument specifications in Section I. A chart showing the additional attenuation for output cables in excess of one (1) foot is included in Table 603-1.

603-5. INSTALLATION

603-6. The option may be installed at any time by inserting the option's two PCB assemblies into the applicable slots in the analog compartment and connecting the cables included.

603-7. OPERATING FEATURES

603-8. The control connector for this option is installed in all instruments; however, they do not operate until the optional PCB assemblies are installed.

603-9. The option is activated when the WIDEBAND switch in the Data Entry Group is toggled.

603-10. While activated all AC voltage outputs must be taken from the Wideband BNC connector output and the maximum voltage available is 3.1623V rms into 50 Ω .

603-11. OPERATING NOTES

603-12. Operation of the instrument for an AC voltage output with the wideband option installed is basically the same as with the standard calibrator. Before operation can begin the WIDEBAND function must be selected with the keyswitch or through a Remote Interface. The WIDEBAND indicator illuminated signals this has been done. The other major change is the requirement that all outputs must be taken from the dedicated 50 ohm output impedance wideband BNC connector.

Table 603-1. Additional Attenuation in dB and Percent for Additional Cable Length

Total Cable Length (1 Ft Std)	Frequency									
	100 KHz		500 KHz		1 MHz		5 MHz		10 MHz	
	dB	%	dB	%	dB	%	dB	%	dB	%
2 ft	0.0014	0.016	0.0025	0.029	0.0035	0.04	0.009	0.104	0.0132	0.15
3 ft	0.0028	0.032	0.0050	0.058	0.0070	0.08	0.018	0.208	0.0264	0.30
4 ft	0.0042	0.048	0.0075	0.087	0.0105	0.12	0.027	0.312	0.0396	0.45
5 ft	0.0056	0.064	0.0100	0.116	0.0140	0.16	0.036	0.416	0.0528	0.60
6 ft	0.0070	0.080	0.0125	0.145	0.0175	0.20	0.045	0.520	0.0660	0.75
7 ft	0.0084	0.096	0.0150	0.174	0.0210	0.24	0.054	0.624	0.0792	0.90

603-13. The remaining steps of the AC voltage operation in Section 2 remain the same, with the constraints of the new specifications, i.e., 300 μV rms (-57.5 dB) to 3.1623V rms (+23 dB), into 50 Ω .

NOTE

When the internal range is changed as part of Error Mode operations, discontinuities between the ranges can occur because the available resolution greatly exceeds the permissible difference between ranges. Tests should be performed at programmed values that allow the required tolerances without automatically changing internal ranges. The points at which a one-digit LSD increment of the output results in internal ranging are 0.99999 mV, 3.1623 mV, 9.9999 mV, 31.623 mV, 99.999 mV, 0.31623V and 0.99999V.

603-14. THEORY OF OPERATION

603-15. The wideband option, as shown in Figure 603-1, is a wideband (WB) generator which uses the WB Oscillator and WB Output Amplifier PCBs of the option plus various sections of the standard calibrator. The overall block, and each component block, is described in the following paragraphs.

603-16. WB Option

603-17. Frequencies from 100 kHz to 10 MHz are generated by the WB Oscillator while frequencies from 10 Hz to 90 kHz are generated by the oscillator described in Section 3. Either of the oscillators drives the WB Output, which amplifies the voltage to the 3.1623V level required by the output, and has output current sufficient to drive the 50 ohm load.

603-18. WB OSCILLATOR

603-19. The WB Oscillator generates frequencies from 100 kHz to 10 MHz. The frequencies are produced by mixing a 20 MHz reference with frequencies produced by the Voltage Controlled Oscillator (VCO) of 20.1 to 30 MHz. The corresponding difference signal from the mixer varies from 100 kHz to 10 MHz. The mixer output is filtered by a 10 MHz low pass filter and amplified to the level required by the WB Output Amplifier. The output from the WB Oscillator is varied over a range of a little over 3 to 1 by changing the amplitude of the 20 MHz reference input to the mixer. This amplitude variation is produced by a voltage controlled amplitude modulator whose gain changes as a function of a DC voltage "Control".

603-20. The 20 MHz reference signal is generated by an L-C Oscillator, and applied to the amplitude modulator and the 200:1 divider. The VCO, $\div N$ Divider, and Phase Detector form a phase-locked loop. The VCO output is divided by the $\div N$ Divider to produce a 100 kHz signal which is compared with a 100 kHz reference produced by dividing the 20 MHz reference by 200:1. The two 100 kHz signals are applied to the phase detector which produces a DC output proportional to the difference in phase. The phase detector output causes the VCO to produce a frequency which, when divided down by the $\div N$ Divider, is 100 kHz. The $\div N$ Divider is programmed such that it will divide by 201 to produce a 20.1 MHz VCO output and by 300 for a 30 MHz output. The VCO output is then mixed with the 20 MHz reference to produce the output frequencies explained above.

603-21. WB OUTPUT AMPLIFIER

603-22. This amplifier is used to produce the output voltage and current required for a 50 ohm load. It also contains the 50 ohm Attenuator and Thermal Converter. The output of the Power Amplifier varies from 1 to 3.1623V. Lower voltages are obtained from the 50 ohm Attenuator, which is programmed in seven 10 dB steps to reduce the output down to as low as 300 μV with 1V input and 70 dB of attenuation. The Thermal Converter produces a DC output that is proportional to the rms value of the power amplifier output voltages.

603-23. Amplitude Control Loop

603-24. The output amplitude is leveled to the required output voltage by the Amplitude Control Loop. The output voltage is converted by the Thermal Converter to a DC voltage. This voltage is compared with DAC output by the integrator in the same manner as explained previously in Section 3. The integrator output "Control" is applied to Q106, which acts as the current controller resistor, or to the amplitude modulator in the Wide Band Oscillator. If the output frequency required is in the range of 10 Hz to 90 kHz, Q106 varies the input to Power Amplifier A1 and thereby vary the input to the power amp in the WB Output Amplifier. If the output frequency is in the range of 100 kHz to 10 MHz, the amplitude modulator uses "Control" to vary the WB Oscillator output as explained above. Any difference between the Thermal Converter output and the DAC output causes the integrator to vary the signal into, and, therefore, signal out of, the WB Output Amplifier and bring the output voltage to the required value.

603-25. MAINTENANCE

603-26. The option consists of two PCBs installed in the analog compartment of the 5100 Series B Calibrators. For general maintenance procedures refer to Section 4 of this manual.

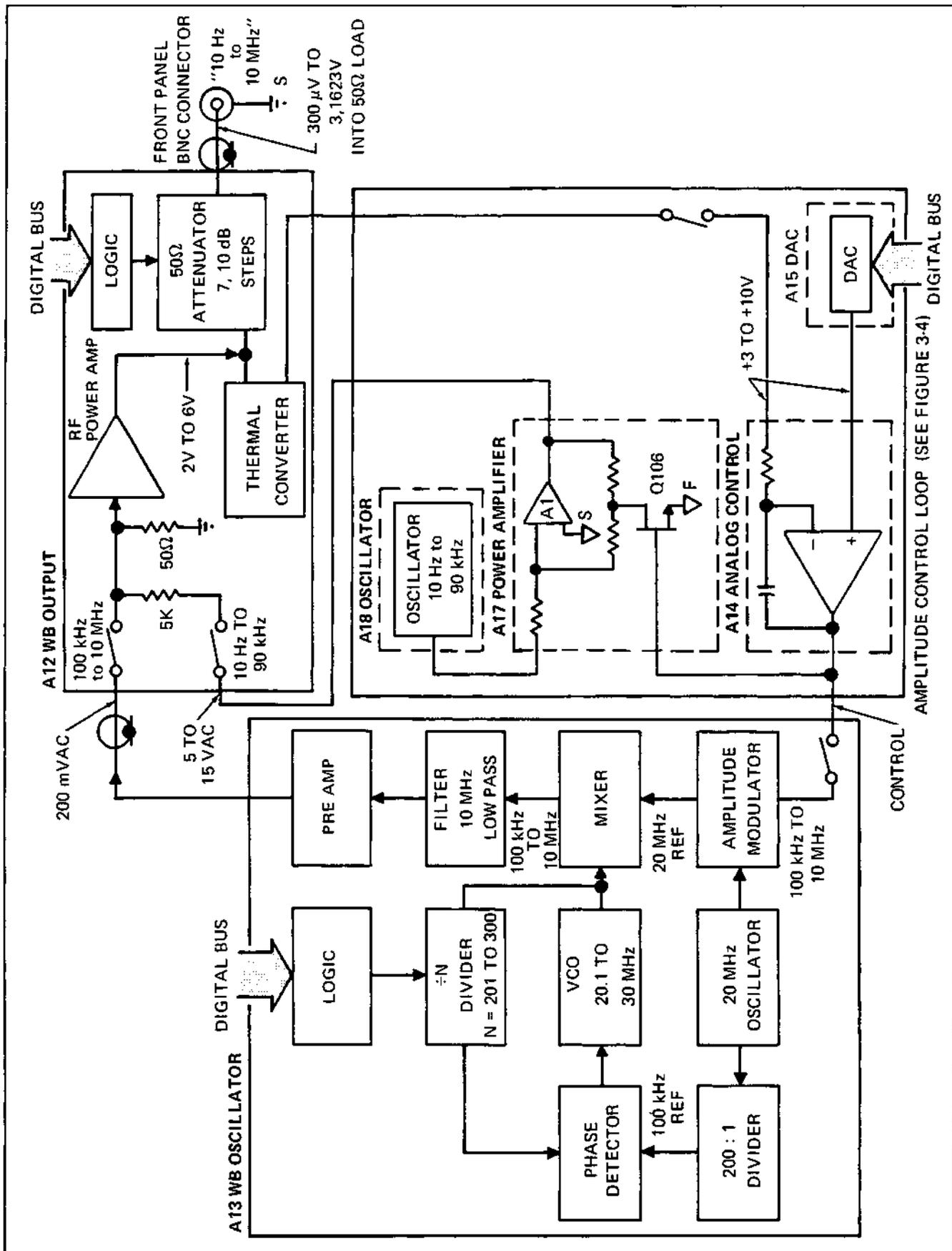

Figure 603-1. WB Option Block Diagram

603-27. PERFORMANCE TEST

603-28. The wideband performance test consists of tests for accuracy in voltage, flatness, and frequency. Test equipment required for the performance test, in addition to those listed in Section 4, are listed in Table 603-2. If the calibrator does not pass the performance test, perform the calibration or troubleshooting procedures, as is deemed applicable by the symptoms. Any repairs resulting from troubleshooting should be followed by a performance test and/or calibration procedure. Perform each of these tests using the applicable portion of the following procedures.

Table 603-2. Additional Test Equipment (Wideband)

ITEM	NOMENCLATURE
Oscilloscope	Tektronix Model 7613
Spectrum Analyzer	Tektronix Model 7L13 Plug-In
True RMS Voltmeter with dc analog output proportional to meter reading – 10 MHz minimum frequency response.	Fluke 8920A
Digital dc Voltmeter with 1 μ V sensitivity (this is a required second DMM)	Fluke 8800A
Standard Attenuators	3 ea. 20 dB GR874-G20L 1 ea. 10 dB GR874-G10L
20 dB (X10) "pad" 50 Ω Termination	Tektronix 011-0054-02 Tektronix 011-0049091
Thermal Converter and Accessories	
Thermal Converter	3V Fluke A55
Thermal Converter Cable	Fluke P/N 122325
Coaxial Tee	GR874-TL
RF 50 Ω Load	GR874-W50BL
Adapter	GR874-QBJL
Coaxial Cable	12" BNC to BNC RG58
Precision 50 Ω Load	2 each 100 Ω \pm 0.1% Metal Film in Parallel

603-29. Wideband Frequency Tests

1. Connect the wideband output connector to a frequency counter input with coaxial cable, terminate with 50 Ω .
2. Program an output at each frequency in Table 603-3 at 1V rms and verify the counter reads within the frequency range listed for the programmed frequency.

Table 603-3. Wideband Frequency Test

CALIBRATOR FREQUENCY OUTPUT	COUNTER READING	
	MINIMUM	MAXIMUM
10 Hz	9.7 Hz	10.3 Hz
20 Hz	19.4 Hz	20.6 Hz
50 Hz	48.5 Hz	51.5 Hz
100 Hz	97 Hz	103 Hz
1 kHz	970 Hz	1030 Hz
10 kHz	9.7 kHz	51.5 kHz
50 kHz	48.5 kHz	51.5 kHz
100 kHz	97 kHz	103 kHz
500 kHz	485 kHz	515 kHz
1 MHz	0.97 MHz	1.03 MHz
3 MHz	2.91 MHz	3.09 MHz
5 MHz	4.85 MHz	5.15 MHz
10 MHz	9.7 MHz	10.3 MHz

603-30. Wideband Voltage Tests

1. Select STDBY on the calibrator.
2. Connect the equipment as shown in Figure 603-2.
3. Select the voltage settings in step 1 of Table 603-4 for each of the instruments listed.
4. Select a calibrator output frequency of 1 kHz.
5. Select OPR on the calibrator.
6. Select the calibrator Error Mode and modify the output until a null is obtained on the RMS Differential Voltmeter.
7. Verify the displayed error is no greater than the allowable error for the programmed calibrator output of the applicable step.
8. Select STDBY on the calibrator.
9. Repeat steps 3 through 8 for the remainder of Table 603-4.

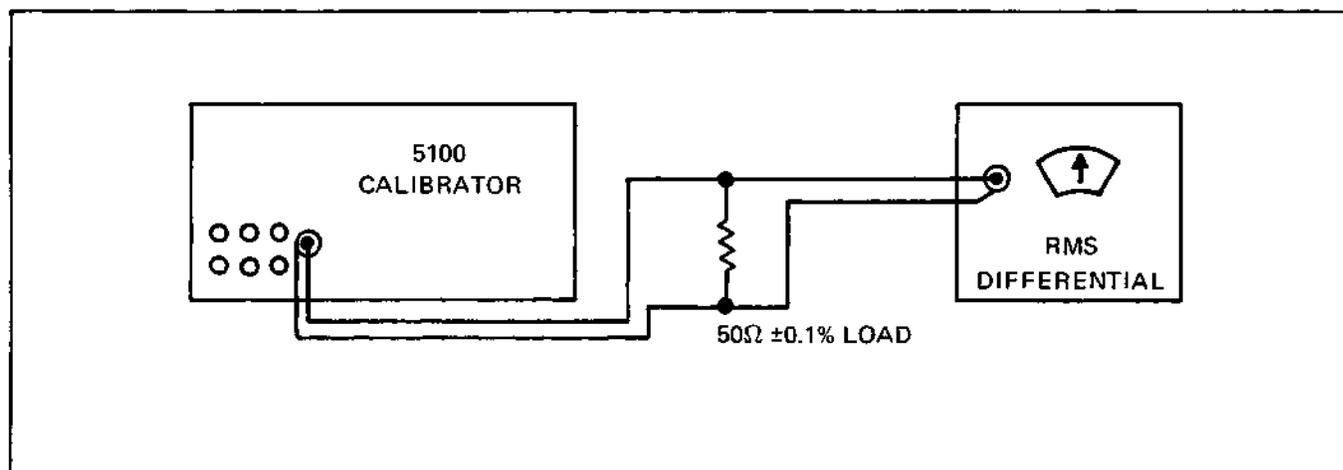

Figure 603-2. Wideband Accuracy Tests

Table 603-4. Wideband Accuracy Tests

STEP	CALIBRATOR PROGRAMMED OUTPUT VOLTAGE	RMS DIFFERENTIAL VOLTMETER SETTING	MAXIMUM CALIBRATOR % ERROR	TEST EQUIPMENT % ERROR	TOTAL PERMISSIBLE % ERROR ON CALIBRATOR DISPLAY
1	3.1585V	3.1585V	±0.5000	±0.1650	±0.6650
2	2.0000V	2.0000V	±0.6250	±0.1750	±0.8000
3	1.0000V	1.0000V	±1.0000	±0.1550	±1.1550
4	0.99999V	0.99999V	±0.7500	±0.1550	±0.9050
5	0.31623V	0.31623V	±1.0000	±0.1650	±1.1650
6	99.999 mV	99.999 mV	±1.2500	±0.1550	±1.4050
7	31.623 mV	31.623 mV	±1.5000	±0.1650	±1.6650
8	9.999 mV	9.999 mV	±1.7500	±0.2000	±1.9500

603-31. Wideband Flatness Tests**603-32. LOW FREQUENCY FLATNESS TESTS**

603-33. Perform the Low Frequency Flatness test using the following procedure:

1. Connect the equipment as shown in Figure 603-3.
2. Select autoranging on the DMM.
3. Program the calibrator for 2.9V rms 1 kHz wideband output.
4. Select OPR on the calibrator.
5. Record the reading on the DMM.
6. Program the calibrator for a 2.9V rms 100 Hz wideband output.
7. Select the calibrator Error Mode and modify the calibrator output until the DMM reads the value recorded in step 5 above.
8. Verify the displayed error is no greater than $0 \pm 0.25\%$.
9. Program the calibrator for a 2.9V rms 10 Hz wideband output.
10. Repeat step 7 above.
11. Verify the displayed error is no greater than $0 \pm 0.3\%$.
12. Select STDBY on the calibrator.

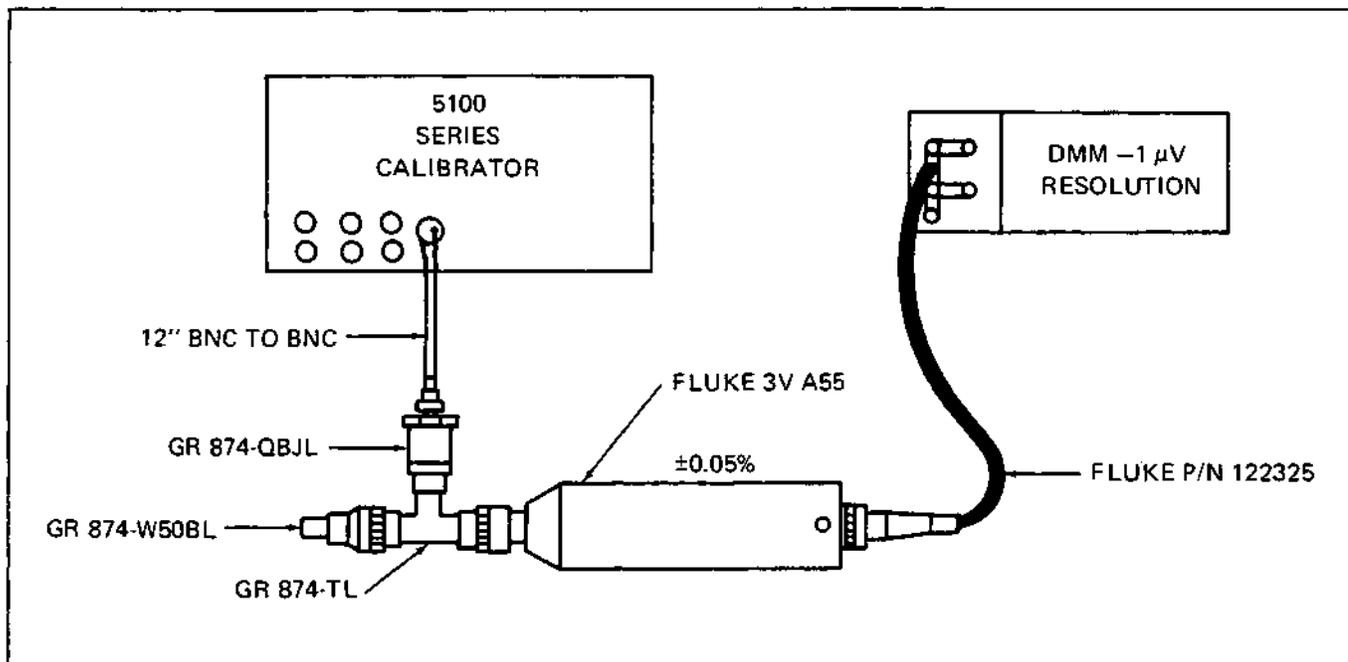

Figure 603-3. Wideband Low Frequency Flatness Tests

603-34. MEDIUM AND HIGH FREQUENCY; FLATNESS TESTS

603-35. Verification of the wideband flatness requires termination of the output with the specified 50 ohms. This can be accomplished by using either a 50 ohm input impedance thermal converter or, as in the case of the following procedure, a 50 ohms input impedance detector characterized for flatness using a non-50 ohm converter, i.e., the Fluke A55.

NOTE

The procedure does not cover attenuator flatness since this is not deemed necessary for routine verification. If such a test is desired refer to the attenuator flatness verification portion of the Calibration Procedure.

603-36. 50Ω Detector Characterization

603-37. Characterize the 50Ω detector using the following procedure:

1. Connect the equipment as shown in Figure 603-4.
2. Program a wideband calibrator output of 2.9V at 1 kHz.
3. Select the Error Mode and with the EDIT switch obtain a convenient reference reading (e.g., 0.2900V) on the DMM connected to the rf voltmeter analog output.

4. Allow approximately five minutes for stabilization, then record the display on the DMM connected to the rf voltmeter analog output and the DMM connected to the thermal converter (sample recording form in Figure 603-5).

5. Program in turn outputs of 100 kHz, 10 MHz, 3 MHz, 5 MHz, and 10 MHz. At each frequency use the Error Mode EDIT switch to obtain the Thermal Converter/DMM indication recorded in step 4 above, then record the reading displayed on the rf voltmeter/DMM.

NOTE

When the internal range is changed as part of Error mode operations, discontinuities between the ranges can occur because the available resolution greatly exceeds the permissible difference between ranges. The test should be performed at programmed values that allow the required tolerances without automatically changing internal ranges. The points at which a one digit LSD increment of the output results in internal ranging are 0.99999 mV, 3.1623 mV, 9.9999 mV, 31.623 mV, 99.999 mV, 0.31623V, and 0.99999V.

6. When all frequencies are tested, return to the 1 kHz setting and verify the reading on the Thermal Converter/DMM and rf voltmeter/DMM is the same as originally recorded. Repeat the test if required.

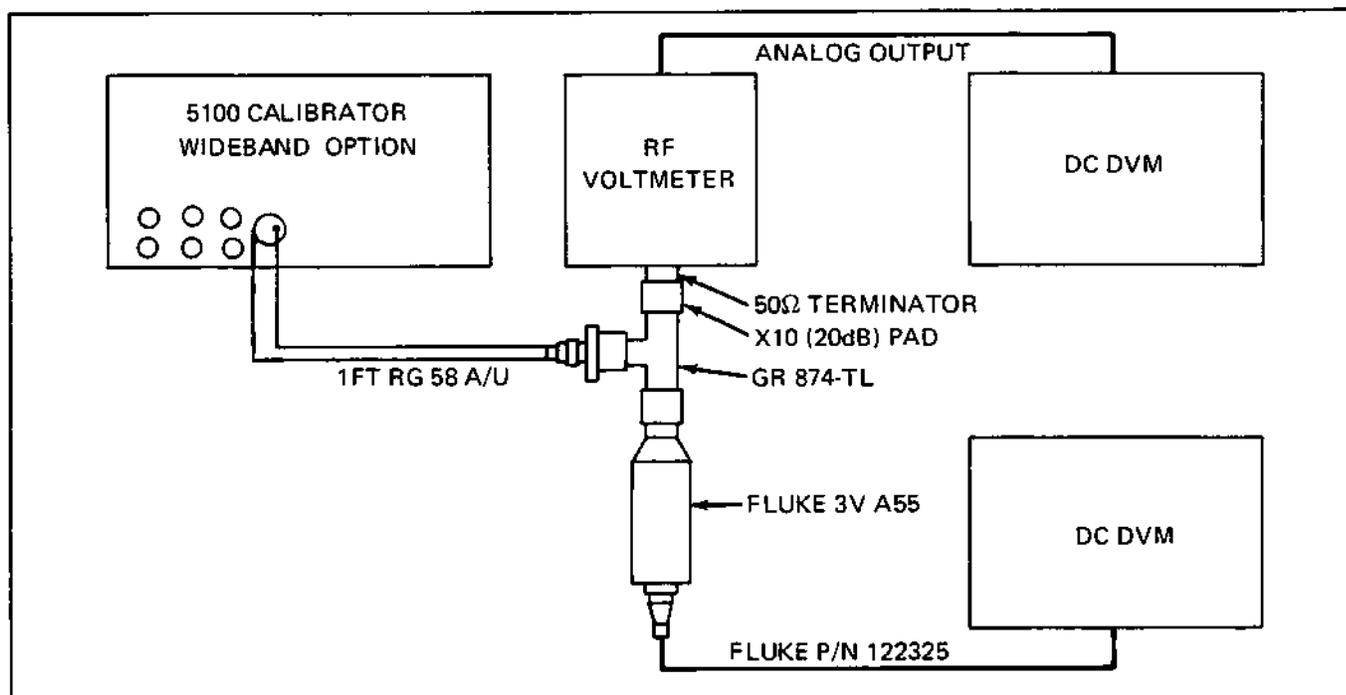

Figure 603-4. Wideband Flatness Tests Characterization

STEP	FREQUENCY	50Ω DETECTOR CHARACTERIZATION		FLATNESS TEST % OF ERROR DISPLAYED
		RF VOLTMETER/ DMM READING	THERMAL CONVERTER/ DMM READING	
1	1 kHz (Ref)	_____	_____	0.0000%
2	100 kHz	_____	_____	_____
3	1 MHz	_____	_____	_____
4	3 MHz	_____	_____	_____
5	5 MHz	_____	_____	_____
6	7 MHz	_____	_____	_____
7	10 MHz	_____	_____	_____
8	1 kHz	_____	_____	_____
		(Must be same as step 1)	(Must be same as step 1)	(0 ±0.02%)

Figure 603-5. Sample Form for 50Ω Flatness Tests

603-38. Medium and High Frequency Verification

603-39. Verify the flatness of the wideband at medium and high frequencies using the following procedure:

1. Connect the equipment as shown in Figure 603-6.
2. Program a wideband calibrator output of 2.9V at 1 kHz.
3. Select the Error Mode on the calibrator and with the EDIT switch obtain the reading on the rf voltmeter/DMM recorded during the characterization procedure at 1 kHz.

4. Depress the NEW REF/CAL IΩ switch on the calibrator and verify the Central Display reads .0000% error.

NOTE

To avoid changing the error reference level during the remainder of the test, all changes in voltage and frequency must be made with the Error Mode controls. Select the function to be changed, voltage or frequency, with the decade switches (◀ DECADE or DECADE ▶) and then alter the selected figure with the EDIT switch.

5. With the Error Mode EDIT switch obtain a 100 kHz output, then, with the EDIT switch, adjust the output voltage for a display on the DMM of the figure recorded at that frequency during characterization.
6. The Central Display should read no greater than $0 \pm 0.25\%$ ERROR at the recorded figure.
7. Repeat steps 5 and 6 for 1 MHz, 3 MHz, and 5 MHz.
8. Repeat steps 5 and 6 for 7 MHz and 10 MHz allowing an error of $0 \pm 0.6\%$.
9. Return to the 2.9V at 1 kHz initial setting using the EDIT switch and verify the Central Display read $0 \pm 0.02\%$. Repeat the test if this step is not within the stated tolerance.

603-40. CALIBRATION PROCEDURE

603-41. General Preparation

NOTE

Data acquired during the performance test is required to perform the calibration procedure. Complete the performance test immediately prior to starting the calibration procedure to insure the validity of the reference data.

603-42. If the instrument does not meet, or cannot be adjusted to meet, the listed tolerance in any step the instrument does not meet the calibration requirements and should be repaired.

603-43. During calibration of the 5100 B Series Calibrators all outputs should be manually programmed on the front panel.

603-44. Test equipment required, in addition to those listed in Table 4-1, is listed in Table 603-2.

603-45. Oscillator Calibration Procedure

603-46. EQUIPMENT PREPARATION

603-47. Perform the following steps prior to beginning calibration of the Wideband Oscillator:

1. Remove the Analog Control PCB (A14) from the calibrator.
2. Remove the Wideband Oscillator PCB (A13) from the calibrator. Remove the front shield and reinstall the PCB in the calibrator on an extender PCB.

NOTE

Refer to the reference designator WB Oscillator drawing to establish component locations during the calibration procedure.

3. Apply power to the instrument and select WIDEBAND.

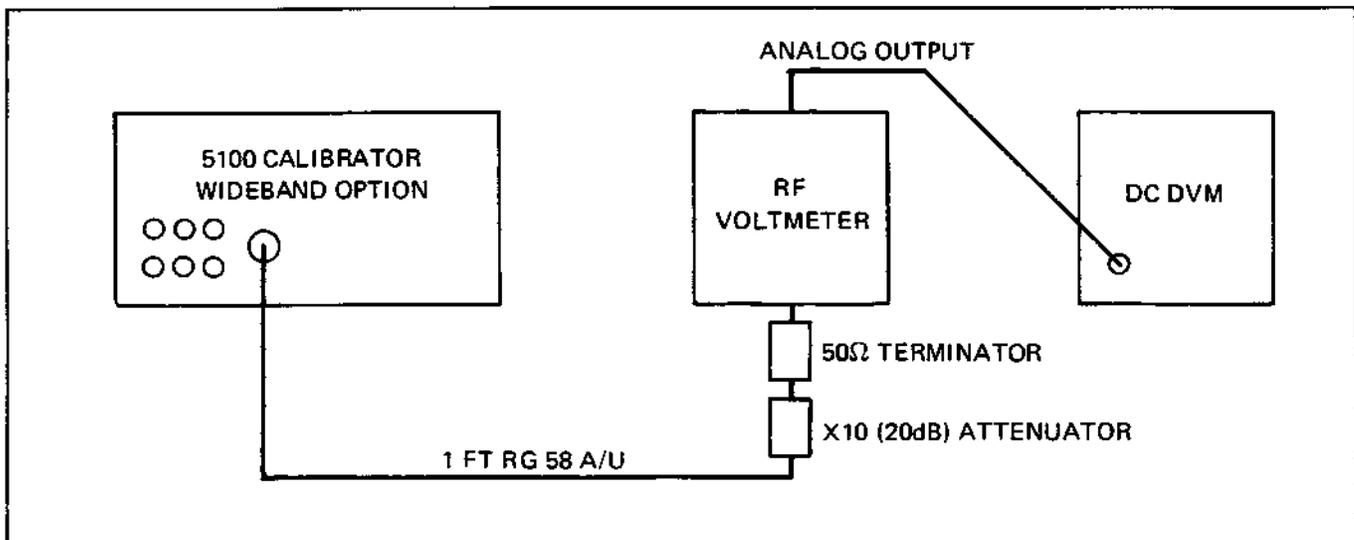

Figure 603-6. Wideband Medium and High Frequency Flatness Tests

603-48. OSCILLATOR ADJUSTMENTS

603-49. Adjust the Wideband 2 MHz Oscillator using the following procedure:

1. Connect a frequency counter between TP7 (HI) and TP9 (LO) on the Oscillator Assembly.
2. Program a calibrator wideband output of 1 volt at 200 kHz.
3. Adjust T1 for reading on the counter between 19.9800 and 20.0200 MHz.
4. Connect TP17 and TP15 (+5V) on the Oscillator Assembly with a jumper.
5. Connect the scope to TP13 and TP9 (ground).
6. Adjust L11 for a maximum signal.
7. Connect a short between TP9 and TP10.
8. Connect the spectrum analyzer to TP8.
9. Adjust L14 for a minimum 20 MHz signal.
10. Remove the short between TP9 and TP10.
11. Adjust L15 for a maximum 20 MHz signal.
12. Repeat steps 6 through 10 until the minimum and maximum are present without interaction.
13. Disconnect the frequency counter from the instrument.

NOTE

Offset errors can result in subsequent test if the frequency counter is not removed.

14. Connect the scope to TP2 and TP9 (ground).
15. Manually program the calibrator for an output of 1V ac at 100 kHz.
16. Adjust T2 for a 2.5V dc display on the scope.
17. Manually program the calibrator for an output of 1V ac at 10 MHz.
18. The DC voltage displayed on the scope should be between 9 and 11V dc.

603-50. DC OFFSET CALIBRATION

603-51. Perform the DC Offset Calibration using the following procedure:

1. Disconnect the jumper between TP15 and TP17.
2. Connect the scope to J123 output connector.
3. Adjust R59 for a scope display of less than 100 mV dc.

603-52. OUTPUT LEVEL PRE-CALIBRATION

603-53. Perform the Output Level Calibration using the following procedure:

1. Replace the Analog Control PCB (A14).
2. With the wideband output cable connect J123 to the Wideband Output (A12).
3. Connect a BNC "T" connector to the wideband output on the front panel. Connect the rms differential voltmeter to one side of the T and the 50 ohm precision termination to the other.
4. Manually program the calibrator for a wideband output of 3.1623V ac at 100 kHz.
5. Adjust R36 for an approximate 3 volt reading on the rms differential voltmeter.

603-54. HIGH FREQUENCY BALANCE AND ROLL-OFF CALIBRATION

603-55. Perform the HF Balance and Roll-Off Calibration using the following procedure:

1. Connect the spectrum analyzer to the wideband front panel output through a 20 dB attenuator.
2. Manually program the calibrator for a wideband output of 3.1623V ac at 9 MHz.
3. Tune the analyzer to observe the spurious signal at 11 MHz.
4. Adjust R53 for the minimum signal on the analyzer. It must be at least 56 dB down from the 9 MHz signal.
5. Manually program the calibrator for a wideband output of 3.1623V ac at 400 kHz.

6. Tune the analyzer to center the 20.4 MHz signal.

7. Adjust L23 counterclockwise until the 20.4 MHz signal increases; then turn L23 clockwise until the 20.4 MHz signal is minimum.

603-56. FREQUENCY RESPONSE CALIBRATION

603-57. Perform the Frequency Response Calibration using the following procedure:

1. Connect the test DMM between TP17 (HI) and TP9 (LO).
2. Manually program a calibrator wideband output of 3.1623V ac at 10 MHz.
3. Adjust R36 for a reading of 5.2V dc.
4. Vary the programmed frequency between 9 MHz and 1 MHz in 1 MHz steps; and from 900 kHz to 100 kHz in 100 kHz steps.
5. Verify the displayed voltage stays between 4.5 and 5.5V dc at all frequency steps.

603-58. Output Calibration Procedure

603-59. EQUIPMENT PREPARATION

603-60. Perform the following steps prior to beginning calibration of the wideband output:

1. Remove the Wideband Output PCB (A12) from the calibrator. Remove the front shield and reinstall the PCB in the calibrator on an extender PCB.

CAUTION

Insure the heat sink plate is properly installed and in place on the PCB before reapplying power. It is possible to remove the plate with the shield if all screws are not removed in conjunction with the shield removal.

2. Verify the cable connecting the WB Oscillator (A13) to the WB Output (A12) and the output to the front panel connector are in place and connected.

NOTE

Refer to the reference designator WB output drawing to establish component locations during the calibration procedure.

3. Verify that C6 is turned the maximum clockwise, with the screw adjustment all the way in.

603-61. BIAS AND DC OFFSET ADJUSTMENTS

603-62. Adjust the bias and DC offset voltage using the following procedure:

1. Connect the test DMM between TP1 (HI) and TP2 (LO) on the Output Assembly.
2. Adjust R36 for a reading between 0.73 and 0.77V dc.
3. Connect the test DMM between TP2 (HI) and ground.
4. Adjust R14 for a reading of 0 ± 10 mV dc.

603-63. RMS SENSOR ALIGNMENT

603-64. Align the rms sensor circuit using the following procedure:

1. Connect the rms differential voltmeter to the wideband Output terminal with the 50 ohm precision terminator.
2. Manually program a calibrator output of 3V ac at 1 kHz.
3. Set the rms differential voltmeter for 3.0000V ac.
4. Adjust R79 for a null on the voltmeter.
5. Manually program a calibrator output of 1V ac at 1 kHz.
6. Set the RMS differential voltmeter for 1.0000V ac.
7. Adjust R74 for a null on the voltmeter.
8. Repeat steps 2 through 7 until both outputs null without an adjustment.
9. Manually program a calibrator output of 2V ac at 1 kHz.
10. Set the RMS differential voltmeter for 2.0000V ac.
11. Verify the voltmeter reads a null $\pm 0.2\%$.
12. Manually program a calibrator output of .99999V ac at 1 kHz.

13. Set the rms differential voltmeter for 1.0000V ac.
14. Adjust R85 for a null on the voltmeter.

603-65. HIGH FREQUENCY OUTPUT CALIBRATION

603-66. Adjust the high frequency output using the following procedure:

1. Connect the test equipment as shown in Figure 603-6.
2. Program a calibrator output of 2.9999V ac at 1 kHz. Using the EDIT switch vary the calibrator output until the rf voltmeter/DMM reads the figure recorded for 1 kHz in Figure 603-5.
3. Program a calibrator frequency of 5 MHz.
4. Adjust C40 to obtain on the rf voltmeter/DMM the value recorded for 5 MHz in the rf voltmeter column of Figure 603-5.

603-67. Attenuator Flatness Verification

603-68. This procedure is not deemed necessary for routine recalibration, provided the flatness portion of the performance test was within the specified tolerances. However, it should be performed any time that repairs are made to the attenuator circuits, or output performance is questionable at low levels.

NOTE

Check the DC resistance of the standard attenuators when terminated with 50Ω for a tolerance of ±1% on both inputs.

603-69. Perform the attenuator flatness verification using the following procedure:

1. If not just completed, perform the wideband flatness portion of the performance test, insuring the data listed in the Flatness Test % of Error Displayed column in Figure 603-5, is recorded in Row 1 of Figure 603-7 for the 1 kHz, 100 kHz, 5 MHz, and 10 MHz columns.
2. Connect the equipment as shown in Figure 603-8.
3. Program the calibrator for a wideband output of 2.9V at 1 kHz.

4. Select the Error Mode and with the EDIT switch, adjust the calibrator output for a convenient reference level (e.g., 0.29000V) on the DMM connected to the rf voltmeter.

5. Record the reading on the DMM connected to the rf voltmeter. (See the sample form in Figure 603-7.)

6. Depress the NEW REF/CAL 1Ω switch.

7. The Central Display reads .0000.

NOTE

During the remainder of the test all changes in voltage or frequency must be made with the Error Mode controls. Select the function to be changed, voltage or frequency, with the decade switches (◀ DECADE or DECADE ▶) and then alter the selected figure with the EDIT switch.

8. With the Error Mode EDIT switch set the DMM to the reading recorded in step 5 at frequencies of 100 kHz, 5 MHz, 10 MHz, and 1 kHz, and record the % of error displayed at each frequency (see sample form in Figure 603-7, Row 2, Column 2, 3, 4, and 5, respectively). If the second error reading at 1 kHz is greater than 0.0000% repeat the test.

NOTE

The wideband flatness portion of the performance test is sufficient for low frequencies and no further tests are made during the attenuator flatness verification.

9. Repeat steps 3 through 8 for the remaining test (Rows 6, 9, 12, 15, 18) shown in Figure 603-7. Remove and insert the 10 dB and 20 dB standard attenuators as required to obtain the attenuation listed for that row in each column. Enter the Central Display reading in the applicable space on the form for each test.

NOTE

Complete all measurements before performing the computation to insure the reference (Row 2) remains valid.

10. Perform the computations listed subsequent to each test and compare the result in the double underlined rows (5, 8, 11, 14, 17, 20) to the applicable tolerance in Row 21 (0.25% for columns 2 and 3, and 0.6% for Column 4).

ROW	ACTION	COLUMN	COLUMN 1	COLUMN 2	COLUMN 3	COLUMN 4	COLUMN 5
		FREQ	1 kHz	100 kHz	5 MHz	10 MHz	1 kHz
Row 1	Flatness % of Error from Fig. 603-5		0.0000	_____	_____	_____	_____
Row 2	Reference Point 60 dB ≈ 2.9V		0.0000	_____	_____	_____	_____
Row 3	50 dB ≈ 0.9V		_____	_____	_____	_____	_____
Row 4	(Row 3) – (Row 2)		_____	_____	_____	_____	_____
Row 5	(Row 4)– (Row 1)		=====	=====	=====	=====	=====
Row 6	40 dB ≈ 290 mV		_____	_____	_____	_____	_____
Row 7	(Row 6) – (Row 2)		_____	_____	_____	_____	_____
Row 8	(Row 7) – (Row 1)		=====	=====	=====	=====	=====
Row 9	30 dB ≈ 90 mV		_____	_____	_____	_____	_____
Row 10	(Row 9) – (Row 2)		_____	_____	_____	_____	_____
Row 11	(Row 10) – (Row 2)		=====	=====	=====	=====	=====
Row 12	20 dB ≈ 29 mV		_____	_____	_____	_____	_____
Row 13	(Row 12) – (Row 2)		_____	_____	_____	_____	_____
Row 14	(Row 13) – (Row 1)		=====	=====	=====	=====	=====
Row 15	10 dB ≈ 9 mV		_____	_____	_____	_____	_____
Row 16	(Row 15) – (Row 2)		_____	_____	_____	_____	_____
Row 17	(Row 16) – (Row 1)		=====	=====	=====	=====	=====
Row 18	0 dB ≈ 2.9 mV		_____	_____	_____	_____	_____
Row 19	(Row 18) – (Row 2)		_____	_____	_____	_____	_____
Row 20	(Row 19) – (Row 1)		=====	=====	=====	=====	=====
Row 21	Tolerance		_____	0.2500%	0.2500%	0.6000%	_____

Figure 603-7. Attenuator Flatness Verification Sample Form

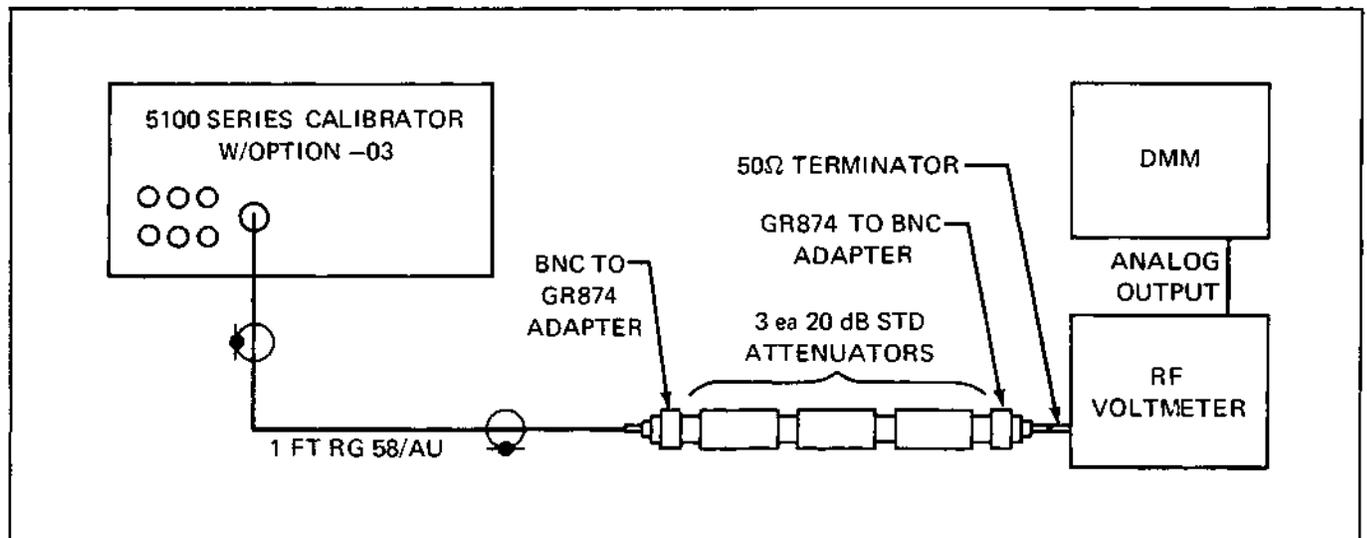

Figure 603-8. Attenuator Flatness Verification Connections

603-70. TROUBLESHOOTING

603-71. Troubleshooting for the -03 Wideband Frequency Option consists of the tabular flow chart in Table 603-5. When a step in the flow chart is completed, check for a decision transfer. If no decision is required, perform the next step of the table in sequence.

603-72. LIST OF REPLACEABLE PARTS

603-73. The wideband option consists of two assemblies and a connecting coaxial cable (J113, J123, Fluke and Mfg. Stock No. 205880 and Mfg. Supply Code 89536). Tables 603-6 and 603-7 contain lists of replaceable parts for the two assemblies. Refer to Section 5 for an explanation of the columnar entries.

Table 603-5. Wideband Option Troubleshooting

STEP NO.	ACTION	Go to the step number given for correct response	
		YES	NO
1	Select WIDEBAND and ENTER, then program an output of 3.1623V at 100 kHz.		
2	Check the voltage at the Wideband Output terminal with RMS differential voltmeter as shown in Figure 603-2.		
3	Does the differential voltmeter read 3.1623V ac $\pm 0.5\%$?	16	4
4	Check the input voltages at the following points: On the Oscillator Assembly with low at TP9 check at TP12 for $+15 \pm 0.05V$ dc, at TP11 for $-15 \pm 0.2V$ dc and at TP1 for $-20 \pm 0.25V$ dc. On the Output Assembly with low at the connector shield of J113 check TP4 for $+15 \pm 0.5V$ dc, at TP5 for $-15 \pm 0.2V$ dc and at TP6 for $-20 \pm 0.25V$ dc.		
5	Are all voltages present and within the stated tolerance?	7	6
6	Check the circuits and the input from the power supply regulator. Repair as required then resume at step 2.		
7	Is 9 volts peak-to-peak present at J114 on the Output Assembly with the output terminals terminated with 50 ohms?	9	8
8	Check the cable and connections between the Output Assembly output at J114 and the front panel output terminal. Repair as required then resume at step 2.		
9	Is 18V peak-to-peak present at TP2 on the Output Assembly?	11	10
10	Check the output attenuator circuit on the Output Assembly. Check Table 603-7, for the correct divider states with the frequency selected. Check Table 603-8, for the relay states for the output voltage selected. Check at U4-9 (A12), U7-6 (A13), and U7-8 (A13) for a clock pulse train with approximately 20 ms period. Repair as required then resume at step 2.		
11	Is 0.9 volts peak-to-peak present at TP3 on the Output Assembly?	13	12
12	Check the amplifier circuit on the Output Assembly. Repair as required then resume at step 2.		
13	Is 0.9 volts peak-to-peak present at J123 on the Oscillator Assembly?	14	15
14	Check K1, K2, and their associated circuitry on the Output Assembly plus the cabling and connectors between the Output and Oscillator Assemblies. Repair as required then resume at step 2.		
15	<p>The problem lies within the Oscillator Assembly. Isolate the fault to a stage by checking the signals at the points below with an Oscilloscope using a 10:1 probe. All signals voltages given are for peak-to-peak (p-p) waveforms in relation to TP9 with a programmed output 3.1623V at 100 kHz. The frequency given is the frequency of the waveform, not the programmed output.</p> <ul style="list-style-type: none"> Collector Q20 – 3V p-p at 100 kHz and Harmonics Base Q18 – 500 mV p-p at 100 kHz and Harmonics Collector Q17 – 1V p-p at 100 kHz and Harmonics Base Q15 – 190 mV p-p at 100 kHz and Harmonics U20-4 – 100 mV p-p at 20 MHz and Harmonics U20-8 – 1.2V p-p at 20.1 MHz and Harmonics TP10 – 0.9V p-p at 20 MHz TP8 – 100 mV p-p at 20 MHz and Harmonics TP13 – 1V p-p at 20 MHz and Harmonics TP3 – 4V p-p at 20.1 MHz and Harmonics TP7 – 4V p-p at 20 MHz <p>Repair as required then resume at step 2.</p>		

Table 603-5. Wideband Option Troubleshooting (cont)

STEP NO.	ACTION	Go to the step number given for correct response	
		YES	NO
16	Check the frequencies of the output signal with a Frequency Counter. The programmed output should be 3.1623V at 100 kHz.		
17	Is the frequency 100 kHz $\pm 3\%$?	34	18
	<i>NOTE</i> All of the following levels on the Oscillator Assembly are in relation to TP9.		
18	Is a 20 MHz signal present at TP7 of the Oscillator Assembly?	20	19
19	Check the 20 MHz Oscillator circuit on the Oscillator Assembly. Repair as required then resume at step 16.		
20	Is a 20-30 MHz signal present at TP3 of the Oscillator Assembly?	22	21
21	Check the VCO circuit on the Oscillator Assembly. Repair as required then resume at step 16.		
22	Is the following waveform present at TP4?	24	23
23	Check the 201-300:1 Divider Circuit on the Oscillator Assembly. Repair as required then resume at step 16.		
24	Is the following waveform present at TP5?	26	25
25	Check the 200:1 Divider Circuit on the Oscillator Assembly. Repair as required then resume at step 16.		

Table 603-6. A12 Wideband Output PCA

REFERENCE DESIGNATOR	DESCRIPTION	FLUKE STOCK NO	MFRS SPLY CODE	MANUFACTURERS PART NUMBER OR GENERIC TYPE	TOT QTY	NOTES
C 1, 5, 16- C 18, 39	CAP,CER,0.22UF,+-20%,50V,X7R	853648 853648	04222	SR325C224MAA	6	
C 2, 3	CAP,TA,68UF,+-20%,15V	193615	56289	199D686X0015EA2	2	
C 4	CAP,TA,4.7UF,+-20%,25V	807644	56289	199D475X0025BE2	1	
C 6	CAP,VAR,0.25-1.5PF,1700V,TEFLON	218206	52769	ER-530-000	1	
C 7, 10, 11, C 31	CAP,CER,0.01UF,+80-20%,500V,25U	816991 816991	60705	562C25USE501AG103Z	4	
C 8, 32, 35	CAP,CER,0.0012UF,+-10%,500V,Z5R	106732	60705	562CCK501EE122KA59	3	
C 9	CAP,CER,430PF,+-5%,50V,COG	732644	04222	SR595A431JAA	1	
C 12, 15	CAP,TA,6.8UF,+-20%,35V	807602	56289	199D685X0035DE2	2	
C 13, 14, 19, C 20	CAP,CER,0.047UF,+-20%,50V,X7R	831487 831487	04222	SR595C473HAA	4	
C 21- 24	CAP,TA,22UF,+-20%,25V	845149	56289	199D226X0025DG2	4	
C 25- 27, 37, C 38	CAP,TA,15UF,+-20%,20V	807610 807610	56289	199D156X0020DE2	5	
C 28	CAP,CER,33PF,+-5%,50V,COG	714543	89536	714543	1	
C 33, 36, 41, C 42	CAP,POLYES,0.33UF,+-10%,50V	715284 715284	37942	185-2-334K50AA	4	
C 34	CAP,CER,33PF,+-2%,50V,COG	715292	04222	SR595A330GAA	1	
C 40	CAP,VAR,2-10PF,250V,CER	375238	52769	GKC10000	1	
CR 1- 20	DIODE,SI,BV=75V,IO=150MA,500MW	203323	65940	1N4448	20	
H 1	SCREW,PH,P,LOCK,STL,4-40,.250	129890	74594	129890	7	
H 2, 4	SCREW,PH,P,LOCK,STL,4-40,.250	740746	74594	740746	24	
H 3	SCREW,PH,P,LOCK,STL,4-40,.375	152124	74594	152124	4	
H 5	SCREW,PH,P,LOCK,STL,4-40,.625	145813	74594	145813	6	
H 6	SCREW,PH,P,SS,4-40,.250	375469		COMMERCIAL	2	
J 113,114	CONN,COAX,SMB(M),PANEL	207639	98291	051-049-0000-990	2	
K 1, 2, 7	RELAY,REED,1 FORM A,4.5VDC	404590	71707	4000-0008	3	
K 3- 5, 8	RELAY,ARMATURE,2 FORM C,26.5VDC	641670	43791	50GE 5N-1-A-700	4	
K 6	RELAY,REED,2 FORM A,15VDC	341024	71707	7002-5050	1	
L 1, 2, 6, L 13, 14	CORE,TOROID,FERRITE,.047X.138X.118	321182 321182	0LUA3	56-590-65-4E	5	
L 3- 5, 7- L 12	CHOKO,6TURN	320911 320911	89536	320911	9	
MP 1	SPACER,SWAGE,.250 RND,BR,4-40,.875	436683	55566	3057B440B14-MOD.=875	6	
MP 2	SPACER,SWAGE,.250 RND,BR,4-40,.750	370528	55566	3055B440B14-MOD.=.750	6	
MP 3	SPACER,SWAGE,.250 RND,BR,4-40,.250	340547	55566	3047B440B14-MOD.=.250	4	
MP 4	HEATS DIS,W/BEO WASHER,TO-5	407262	13103	1130	7	
MP 5	SPACER,.156 RND,SOLUBLE,.062,.060	296319	89536	296319	18	
MP 6	BRACKET,CONN.MTG,RF OUTPUT	462069	89536	462069	1	
MP 7	PLATE,CONNECTOR MTG	438127	89536	438127	1	
MP 8	PLATE,TRANSISTOR CLAMP	438135	89536	438135	1	
MP 9	PLATE,TRANSISTOR MTG	438143	89536	438143	1	
MP 10	PLATE,HEATSINK MTG	438150	89536	438150	1	
MP 11	SHIELD,WB OUTPUT ATTENUATOR,FRONT	438168	89536	438168	1	
MP 12	SHIELD,WB OUTPUT ATTENUATOR,REAR	438176	89536	438176	1	
MP 13	SHIELD,WB OUTPUT,FRONT	438184	89536	438184	1	
MP 14	SHIELD,WB OUTPUT,REAR	438192	89536	438192	1	
Q 1, 2	TRANSISTOR,SI,NPN,SMALL SIGNAL	333898	04713	MPSH10	2	
Q 3	TRANSISTOR,SI,PNP,SMALL SIGNAL	343012	27014	PN4258	1	
Q 4	TRANSISTOR,SI,PNP,SMALL SIGNAL	402578	04713	2N5160	1	
Q 5, 11	TRANSISTOR,SI,NPN,SMALL SIGNAL	179374	04713	2N2218	2	
Q 6	TRANSISTOR,SI,NPN,HI-CURRENT	402602	04713	MRP531	1	
Q 7	TRANSISTOR,SI,PNP,SMALL SIGNAL	402586	04713	2N2905A	1	
Q 8	TRANSISTOR,SI,NPN,HI-FREQ,SMALL SIG	407965	04713	2N3553	1	
Q 9, 15	TRANSISTOR,SI,PNP,SMALL SIGNAL	844993	55464	MPS6522	2	
Q 10	TRANSISTOR,SI,PNP,SMALL SIG,HI-FREQ	402560	55408	MM4019-M	1	
Q 12	TRANSISTOR,SI,NPN,SMALL SIGNAL,TO-92	832170	04713	MPS6520	1	
Q 13	TRANSISTOR,SI,PNP,SWITCHING,TO-92	831446	04713	MPS3640	1	
Q 14	TRANSISTOR,SI,NPN,SMALL SIGNAL,TO-92	698225	27014	2N3904	1	
Q 16	TRANSISTOR,SI,ENP,TO92	698233	04713	2N3906	1	
R 1	RES,MF,2.49K,+-1%,0.125W,100PPM	226209	91637	CMF-55 2491F T-1	1	
R 2	RES,MF,52.3,+-1%,0.125W,100PPM	305912	91637	CMF-55 52R3F T-1	1	
R 3, 9, 16	RES,CF,1K,+-5%,0.25W	343426	59124	CF1/4 102J	3	
R 4, 12, 58	RES,CF,10K,+-5%,0.25W	348839	59124	CF1/4 102J	3	
R 5, 89, 90	RES,CF,100,+-5%,0.25W	348771	59124	CF1/4 101J	3	
R 6	RES,CC,27,+-10%,0.125W	266254	01121	BB2701	1	
R 7, 8	RES,CC,1.5K,+-5%,0.5W	266353	01121	EB1525	2	
R 10	RES,MF,49.9,+-1%,0.125W,100PPM	305896	91637	CMF-55 49R9F T-1	1	
R 11	RES,MF,953,+-1%,0.125W,100PPM	288555	91637	CMF-55 9530F T-1	1	
R 13	RES,CF,20K,+-5%,0.25W	441477	59124	CF1/4 203J	1	
R 14	RES,VAR,CERM,50K,+-10%,0.5W	335778	80294	3386R-1-503	1	
R 15	RES,CF,5.1K,+-5%,0.25W	368712	59124	CF1/4 512J	1	
R 17	RES,CF,18,+-5%,0.25W	441428	59124	CF1/4 18R0J	1	
R 18, 33, 41	RES,CF,10,+-5%,0.25W	340075	59124	CF1/4 100J	3	
R 19, 32	RES,CC,3.9,+-5%,0.5W	188490	01121	EB3R95	2	

Table 603-6. A12 Wideband Output PCA (cont)

REFERENCE DESIGNATOR	DESCRIPTION	FLUKE STOCK NO	MFRS SPLY CODE	MANUFACTURERS PART NUMBER OR GENERIC TYPE	TOT QTY	NOTES
R 20, 31	RES.MF,301,+/-1%,0.125W,100PPM	267740	91637	CMF-55 3010F T-1	2	
R 21, 30	RES.CC,1K,+/-5%,0.5W	108597	01121	EB1025	2	
R 22, 29	RES.MF,24.3K,+/-1%,0.125W,100PPM	236745	91637	CMF-55 2432F T-1	2	
R 23, 27	RES.MF,10,+/-0.25%,0.25W,50PPM	424192	91637	CMF-60 10R0C T-2	2	
R 24, 28	RES.MF,232,+/-1%,0.125W,100PPM	289975	91637	CMF-55 2320F T-1	2	
R 25, 26, 91, R 92	RES.MF,45.3,+/-1%,0.5W,25PPM	435560	91637	CMF-65 45R3F T-9	4	
R 34	RES.CF,4.3,+/-5%,0.25W	441550	59124	CF1/4 4R3J	1	
R 35	RES.CF,22,+/-5%,0.25W	381145	59124	CF1/4 220J	1	
R 36	RES.VAR,CERM,100,+/-20%,0.5W	193052	80294	3329H-1-101	1	
R 37	RES.MF,22.6,+/-1%,0.125W,100PPM	296640	91637	CMF-55 22R6F T-1	1	
R 38	RES.MF,221,+/-1%,0.125W,100PPM	340794	91637	CMF-55 2210F T-1	1	
R 39	RES.MF,2.55K,+/-1%,0.125W,100PPM	325498	91637	CMF-55 2551F T-1	1	
R 40	RES.CF,510,+/-5%,0.25W	441600	59124	CF1/4 511J	1	
R 42, 43	RES.CF,270,+/-5%,0.25W	348789	59124	CF1/4 271J	2	
R 44	RES.CF,430,+/-5%,0.25W	441568	59124	CF1/4 431J	1	
R 45	RES.MF,96.247,+/-0.1%,0.25W,25PPM	416727	91637	CMF-60 96R247B T-9	1	
R 46	RES.MF,71.151,+/-0.1%,0.125W,25PPM	416735	91637	CMF-55 71R151B T-9	1	
R 47	RES.MF,96.247,+/-0.1%,0.125W,25PPM	416743	91637	CMF-55 2470B T-9	1	
R 48, 51	RES.MF,61.111,+/-0.1%,0.5W,25PPM	408435	91637	CMF-65 61R111B T-9	2	
R 49, 52, 55	RES.MF,247.5,+/-0.1%,0.25W,25PPM	408427	91637	CMF-60 247R5B T-9	3	
R 50, 53, 54, R 56	RES.MF,61.111,+/-0.1%,0.25W,25PPM	408419	91637	CMF-60 61R111 T-9	4	
R 57	RES.CF,150,+/-5%,0.25W	343442	59124	CF1/4 151J	1	
R 61	RES.CF,360,+/-5%,0.25W	352286	59124	CF1/4 361J	1	
R 62, 63	RES.CF,75,+/-5%,0.25W	441642	59124	CF1/4 750J	2	
R 64	RES.CF,39,+/-5%,0.25W	340836	59124	CF1/4 390J	1	
R 65	RES.CF,1.5K,+/-5%,0.25W	343418	59124	CF1/4 152J	1	
R 66	RES.MF,1K,+/-1%,0.125W,100PPM	168229	91637	CMF-55 1001F T-1	1	
R 67	RES.MF,27.4K,+/-1%,0.125W,25PPM	484899	89536	484899	1	
R 69	RES.MF,357K,+/-1%,0.125W,100PPM	235002	91637	CMF-55 3573F T-1	1	
R 70, 71	RES.MF,619K,+/-0.1%,0.125W,25PPM	867903	91637	CMF-55 6193B T-9	2	
R 72, 73	RMS SENSOR & MATCHED COMPONENT	873641	89536	873641	1	
R 74	RES.VAR,CERM,5K,+/-10%,0.5W	288282	80294	3386S-1-502	1	
R 75, 76	RES.MF,75K,+/-1%,0.125W,100PPM	291443	91637	CMF-55 7502F T-1	2	
R 77	RES.MF,1.69K,+/-1%,0.125W,100PPM	321414	91637	CMF-55 1691F T-1	1	
R 78, 80	RES.CF,47,+/-5%,0.25W	441592	59124	CF1/4 470J	2	
R 79	RES.VAR,CERM,500,+/-10%,0.5W	291120	80294	3386S-1-502	1	
R 81	RES.MF,10K,+/-1%,0.125W,100PPM	168260	91637	CMF-55 1002F T-1	1	
R 82	RES.MF,90.9K,+/-1%,0.125W,100PPM	223537	91637	CMF-55 9092F T-1	1	
R 83, 84, 95, R 98	RES.MF,40.2K,+/-1%,0.125W,100PPM	235333	91637	CMF-55 4022F T-1	4	
R 85	RES.VAR,CERM,2K,+/-10%,0.5W	285163	80294	3386S-1-202	1	
R 86	RES.MF,32.4K,+/-1%,0.125W,25PPM	446674	91637	CMF-55 3242F T-9	1	
R 87	RES.MF,6.04K,+/-1%,0.125W,25PPM	446682	91637	CMF-55 6041F T-9	1	
R 88	RES.MF,25.5K,+/-1%,0.125W,25PPM	446666	91637	CMF-55 2552F T-9	1	
R 93	RES.MF,8.66K,+/-1%,0.125W,100PPM	260364	89536	260364	1	
R 94	RES.CF,4.7K,+/-5%,0.25W	348821	59124	CF1/4 472J	1	
R 96	RES.MF,1.96K,+/-1%,0.125W,100PPM	288423	91637	CMF-55 1961F T-1	1	
R 97	RES.MF,13K,+/-1%,0.125W,100PPM	335539	91637	CMF-55 1302F T-1	1	
TP 1- 7	JUMPER,WIRE,NONINSUL,0.200CTR	816090	91984	150T1	7	
U 1	IC,OP AMP,SELECTED 40V/US SLEW RATE	329912	27014	LM318H	1	
U 2	IC,CMOS,TRIPLE 3 INPUT NAND GATE	418244	27014	MM74C10N	1	
U 3	IC,CMOS,HEX BUFFER	381830	27014	CD4050BCN	1	
U 4	IC,LSTTL,HEX D F/F,+EDG TRG,W/CLEAR	393207	01295	SN74LS174N	1	
U 5	IC,TTL,HEX INVERTER W/OPEN COLLECTOR	407593	27014	DM7406N	1	
U 6	IC,OP AMP,GENERAL PURPOSE,TO-78 CASE	413732	27014	LM308N	1	
U 7	IC,OP AMP,GENERAL PURPOSE,8 PIN DIP	413740	27014	LM307N	1	
VR 1	ZENER,UNCOMP,13.0V,5%,9.SMA,0.4W	110726	04713	1N964B	1	
VR 2- 8	ZENER,UNCOMP,8.2V,5%,20.0MA,0.4W	386771	04713	1N756A	7	
VR 9	ZENER,UNCOMP,7.5V,5%,20.0MA,0.4W	256446	04713	1N755A	1	
VR 10	ZENER,UNCOMP,5.6V,5%,20.0MA,0.4W	277236	04713	1N752A	1	
VR 11	ZENER,UNCOMP,10.0V,5%,12.SMA,0.4W	246611	04713	1N961B	1	
W 1	WIRE,COPPER/TIN,BUS,22AWG	115469	04946	302-11	1	
XQ 4- 8, 10, XQ 11	SOCKET,TRANS,TO-5,3 PIN	836247	95146	8059-2G1	7	
NOTES:	† Static sensitive part.					

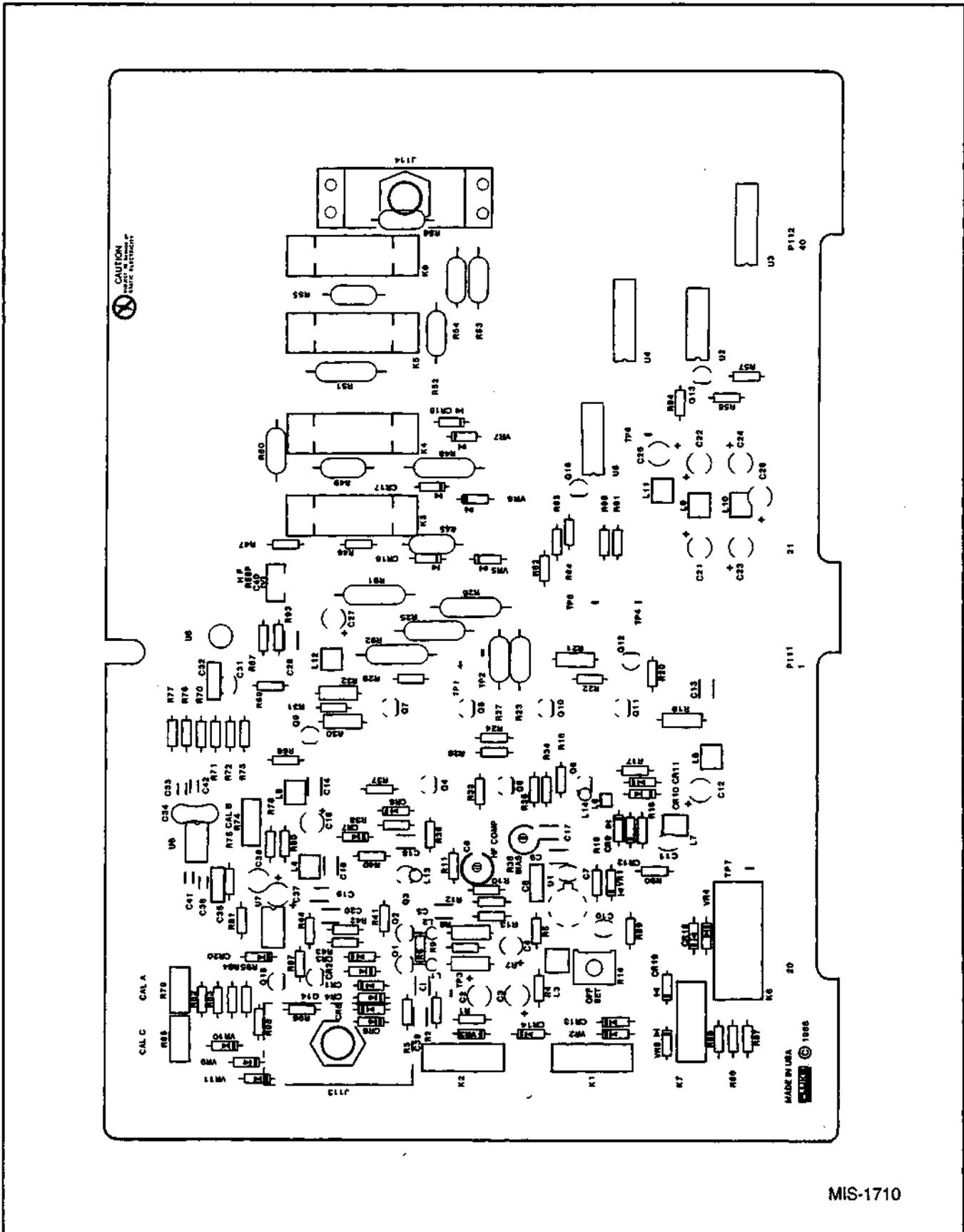

Figure 603-9. A12 Wideband Output PCA

MIS-1710

Table 603-7. A13 Wideband Oscillator PCA

REFERENCE DESIGNATOR	DESCRIPTION	FLUKE STOCK NO	MFRS SPLY CODE	MANUFACTURERS PART NUMBER OR GENERIC TYPE	TOT QTY	NOTES
C 1, 27, 36	CAP,CER,39PF,+-5%,1000V,COG	817031	60705	561CCOGRE102EG390J	3	
C 2, 4, 6-	CAP,TA,15UF,+-20%,20V	807610	56289	199D156X0020DE2	37	
C 9, 12- 14,		807610				
C 25, 26, 30,		807610				
C 32, 38, 46-		807610				
C 50, 61, 67,		807610				
C 68, 71- 73,		807610				
C 77- 84, 87-		807610				
C 89, 93		807610				
C 3, 23, 29,	CAP,CER,0.01UF,10%,100V,X7R	557587	89536	557587	10	
C 31, 74, 75,		557587				
C 90, 91, 94,		557587				
C 95		557587				
C 10	CAP,CER,33PF,+-5%,50V,COG	714543	04222	SR595A330JAA	1	
C 11	CAP,CER,300PF,+-10%,500V,X7W	105734	60705	562CX7WCK501AE301K	1	
C 15	CAP,POLYES,0.033UF,+-10%,50V	715276	68919	MKS2333K50	1	
C 16, 19, 37	CAP,CER,390PF,+-2%,50V,COG	820530	04222	SR595A391GAA	3	
C 17	CAP,CER,18PF,+-2%,100V,COG	830638	04222	SR591A180GAA	1	
C 18, 20	CAP,CER,1200PF,+-20%,100V,X7R	816223	04222	SR071C1222MAA	2	
C 21	CAP,CER,360PF,+-5%,50V,COG	528471	04222	SR215A361JAA	1	
C 22	CAP,CER,1000PF,+-2%,50V,COG	807966	04222	SR595A102GAA	1	
C 28	CAP,CER,510PF,+-5%,100V,COG	816645	04222	SR591A511JAA	1	
C 33, 34, 65,	CAP,CER,22PF,+-5%,50V,COG	714550	04222	SR595A220JAA	4	
C 98		714550				
C 35	CAP,CER,430PF,+-5%,50V,COG	732644	04222	SR595A431JAA	1	
C 39, 62	CAP,CER,120PF,+-5%,50V,COG	721142	04222	SR595A121JAA	2	
C 40, 59, 70	CAP,CER,5.0PF,+-10%,1000V,COH	817015	60705	561CCOHRE102EC5R0D	3	
C 41	CAP,CER,150PF,+-10%,50V,X7R	682377	04222	SR595C151KAA	3	
C 42, 54, 99	CAP,CER,12PF,+-2%,50V,COG	715169	04222	SR595A120GAA	1	
C 43	CAP,CER,100PF,+-2%,100V,COG	812115	04222	SR291A101GAA	1	
C 44, 45	CAP,CER,0.05UF,+-20%,100V,Z5V	149161	60705	565CBA101AR503MAD5	2	
C 51, 52	CAP,TA,4.7UF,+-20%,25V	807644	56289	199D475X0025BE2	2	
C 53	CAP,CER,47PF,+-2%,100V,COG	812123	04222	SR291A470GAA	1	
C 55	CAP,CER,56PF,+-2%,50V,COG	714378	04222	SR595A560GAA	1	
C 56, 60	CAP,TA,68UF,+-20%,20V	782680	56289	199D686X0020FA4	2	
C 57	CAP,CER,4.0PF,+-0.25PF,1500V,COJ	714535	91984	6010C0H4R0C1.5LVT14	1	
C 58, 69	CAP,CER,10PF,+-2%,50V,COG	713875	04222	SR595A100GAA	2	
C 63	CAP,CER,39PF,+-2%,100V,COG	816207	04222	SR291A390GAA	1	
C 64	CAP,CER,270PF,+-5%,50V,COG	658898	04222	SR595A271JAA	1	
C 66	CAP,CER,220PF,+-2%,100V,COG	816728	04222	SR591A221GAA	1	
C 76	CAP,CER,5000PF,+-20%,100V,Z5U	758201	60705	562C25USE101EE502M	1	
C 85	CAP,TA,22UF,+-20%,25V	845149	56289	199D226X0025DG2	1	
C 86	CAP,CER,1200PF,+-20%,100V,X7R	358283	04222	SR201C1222MAA	1	
C 92, 96	CAP,TA,10UF,+-20%,25V	714774	56289	199D106X0025BE2	2	
C 97	CAP,CER,47PF,+-2%,100V,COG	832295	04222	SR591A470GAA	1	
CR 1	DIODE,SI,VARACTOR,PiV= 12V	363812	04713	MV109	1	
CR 2, 5	DIODE,SI,BV=75V,IO=150MA,500MW	203323	65940	1N4448	2	
CR 3	DIODE,SI,SCHOTTKY BARRIER,SMALL SIGNAL	313247	28480	5082-6264	1	
CR 4	DIODE,SI,100 PIV,1.5 AMP	116111	66967	1N5392	1	
H 1	SCREW,PH,P,LOCK,STL,4-40,.250	740746	74594	740746	10	
H 2	SCREW,PH,P,LOCK,STL,4-40,.250	129890	89536	129890	2	
J 123	CONN,COAX,SMB(M),PANEL	207639	98291	051-049-0000-990	1	
K 1	RELAY,REED,1 FORM A,4.5VDC	404590	71707	4000-000E	1	
L 1, 2, 6-	CHOKES,6TURN	320911	89536	320911	23	
L 10, 13, 18-		320911				
L 20, 22, 25-		320911				
L 29, 31, 32,		320911				
L 35- 38		320911				
L 3- 5	INDUCTOR,6800UH,+-5%,1.5MHZ,SHLD	363184	24759	MR-6800J	3	
L 12	INDUCTOR,10UH,+-10%,53MHZ,SHLD	249078	24759	MR-10J&K	1	
L 16, 17	INDUCTOR,0.47UH,+-5%,264MHZ,SHLD	329664	24759	MR-0.47J	2	
L 21	INDUCTOR,3.9UH,+-5%,84MHZ,SHLD	413864	24759	MR-3.90J	1	
L 24	INDUCTOR,1.5UH,+-5%,128MHZ,SHLD	413856	24759	MR-1.5J	1	
L 30	INDUCTOR,27MH,+-10%,445KHZ,SHLD	363192	24759	MR-27000J&K	1	
L 33, 40	CORE,TOROID,FERRITE,.047X.138X.118	321182	0LUA3	56-590-65-4B	2	
L 39	INDUCTOR,2.2UH,+-10%,108MHZ,SHLD	413880	24759	MR-2.20J	1	
MP 1	SPACER,SWAGE,.250 RND,BR,4-40,.625	347526	55566	3053B440B14-MOD.=.625	2	
MP 2	SPACER,SWAGE,.250 RND,BR,4-40,.750	370528	55566	3055B440B14-MOD.=.750	5	
MP 3	SHIELD,WB OSC,FRONT	438200	89536	438200	1	
MP 4	SHIELD,WB OSC,REAR	438218	89536	438218	1	
MP 5	HEAT DIS,RAD FIN,.255 ID,.720 OD	104646	05820	207-AB	1	
MP 6	PLATE,CONNECTOR MTG	438127	89536	438127	1	
MP 7	SPACER,SWAGE,.250 RND,BR,4-40,.250	340547	55566	3047B440B14-MOD.=.250	5	
MP 8	INSUL PART,TRANSISTOR MOUNT,DAP,TO-5	152207	07047	10123-DAP	1	
MP 9	FENCE,WB OSCILLATOR PCB	450031	89536	450031	1	
Q 1- 3, 5,	TRANSISTOR,SI,NPN,SMALL SIGNAL	248351	04713	MPS918	7	
Q 9- 11		248351				

Table 603-7. A13 Wideband Oscillator PCA (cont)

REFERENCE DESIGNATOR	DESCRIPTION	FLUKE STOCK NO	MFRS SPLY CODE	MANUFACTURERS PART NUMBER OR GENERIC TYPE	TOT QTY	NOTES
Q 4, 22- 25	† TRANSISTOR, SI, PNP, SWITCHING, TO-92	831446	04713	MPS3640	5	
Q 6	† TRANSISTOR, SI, PNP, SMALL SIGNAL	195974	04713	2N3906	1	
Q 7	† TRANSISTOR, SI, PNP, SMALL SIGNAL	844993	55464	MPS6522	1	
Q 8	† TRANSISTOR, SI, NPN, SMALL SIGNAL, TO-92	698225	27014	2N3904	1	
Q 13, 14, 17, Q 20	† TRANSISTOR, SI, PNP, SMALL SIGNAL	844985	27014	PN4258	4	
Q 15, 16, 18, Q 19	† TRANSISTOR, SI, NPN, SMALL SIGNAL, TO-92	832170	89536	832170	4	
Q 21	† TRANSISTOR, SI, NPN, SMALL SIGNAL	346916	04713	2N2219A	1	
R 1, 27, 29, R 30	RES, CF, 10K, +-5%, 0.25W	348839	59124	CF1/4 102J	4	
R 2, 13, 20, R 21, 45, 66, R 70, 71, 95, R 101	RES, CF, 100, +-5%, 0.25W	348771	59124	CF1/4 101J	10	
R 5, 25	RES, CF, 3K, +-5%, 0.25W	441527	59124	CF1/4 302J	2	
R 6, 26, 62, R 104	RES, CF, 270, +-5%, 0.25W	348789	59124	CF1/4 271J	4	
R 7, 24, 105	RES, CF, 360, +-5%, 0.25W	352286	59124	CF1/4 361J	3	
R 8	RES, CF, 62, +-5%, 0.25W	441634	59124	CF1/4 620J	1	
R 9, 50	RES, MF, 750, +-1%, 0.125W, 100PPM	312801	91637	CMF-55 7500F T-1	2	
R 10	RES, MF, 3.83K, +-1%, 0.125W, 100PPM	235143	91637	CMF-55 3831F T-1	1	
R 11	RES, MF, 5.49K, +-1%, 0.125W, 100PPM	334565	91637	CMF-55 5491F T-1	1	
R 12	RES, MF, 9.09K, +-1%, 0.125W, 100PPM	720573	89536	720573	1	
R 14	RES, CF, 47K, +-5%, 0.25W	348896	59124	CF1/4 473J	1	
R 15	RES, MF, 1.78K, +-1%, 0.5W, 100PPM	247296	91637	CMF-65 1781F T-1	1	
R 16	RES, CF, 750, +-5%, 0.25W	441659	59124	CF1/4 751J	1	
R 17	RES, CF, 3.9K, +-5%, 0.25W	342600	59124	CF1/4 392J	1	
R 18, 42	RES, CF, 2K, +-5%, 0.25W	441469	59124	CF1/4 202J	2	
R 19	RES, CF, 560K, +-5%, 0.25W	342642	59124	CF1/4 564J	1	
R 3, 4, 22 R 23	RES, CF, 1.2K, +-5%, 0.25W	441378	59124	CF1/4 122J	4	
R 28	RES, CF, 4.7K, +-5%, 0.25W	348821	59124	CF1/4 472J	1	
R 31, 32	RES, CF, 150, +-5%, 0.25W	343442	59124	CF1/4 151J	2	
R 33	RES, MF, 3.01K, +-1%, 0.125W, 100PPM	312645	91637	CMF-55 3011F T-1	1	
R 34, 38	RES, MF, 182, +-1%, 0.125W, 100PPM	289579	91637	CMF-55 1820F T-1	2	
R 35	RES, MF, 4.02K, +-1%, 0.125W, 100PPM	235325	91637	CMF-55 4021F T-1	1	
R 36	RES, VAR, CERM, 500, +-10%, 0.5W	325613	80294	3386R-1-501	1	
R 37	RES, MF, 324, +-1%, 0.125W, 100PPM	443010	91637	CMF-55 3240F T-1	1	
R 47, 49	RES, MF, 49.9, +-1%, 0.125W, 100PPM	305896	91637	CMF-55 4989F T-1	2	
R 46	RES, MF, 422, +-1%, 0.125W, 100PPM	288506	91637	CMF-55 4220F T-1	1	
R 48, 86	RES, CF, 5.1, +-5%, 0.25W	441287	59124	CF1/4 5R1J	2	
R 51	RES, MF, 649, +-1%, 0.125W, 100PPM	720458	89536	720458	1	
R 52, 77	RES, MF, 732, +-1%, 0.125W, 100PPM	294884	91637	CMF-55 7320F T-1	2	
R 53	RES, VAR, CERM, 20, +-20%, 0.5W	275727	80294	3386R-1-200	1	
R 54	RES, MF, 634, +-1%, 0.125W, 100PPM	223560	91637	CMF-55 6340F T-1	1	
R 55	RES, MF, 301, +-1%, 0.125W, 100PPM	267740	91637	CMF-55 3010F T-1	1	
R 56	RES, CF, 10, +-5%, 0.25W	340075	59124	CF1/4 100J	1	
R 57	RES, CF, 240, +-5%, 0.25W	376624	59124	CF1/4 241J	1	
R 58, 60	RES, MF, 100, +-1%, 0.125W, 100PPM	168195	91637	CMF-55 1000F T-1	2	
R 59	RES, VAR, CERM, 1K, +-30%, 0.5W	193060	80294	3329R-1-102	1	
R 61	RES, MF, 453, +-1%, 0.125W, 100PPM	267393	91637	CMF-55 4530F T-1	1	
R 63, 65, 72, R 74	RES, CF, 1.3K, +-5%, 0.25W	441394	59124	CF1/4 132J	4	
R 64, 73	RES, CF, 4.7, +-5%, 0.25W	441584	59124	CF1/4 4R7J	2	
R 67, 76, 80	RES, CC, 680, +-5%, 0.5W	178392	01121	EB6815	3	
R 68	RES, CF, 510, +-5%, 0.25W	441600	59124	CF1/4 511J	1	
R 69, 78	RES, CF, 5.6, +-5%, 0.25W	441618	59124	CF1/4 5R6J	2	
R 75	RES, CF, 1K, +-5%, 0.25W	343426	59124	CF1/4 102J	1	
R 79, 81	RES, MF, 150, +-1%, 0.125W, 100PPM	448555	91637	CMF-FF 1500F T-1	2	
R 82	RES, CF, 1.8K, +-5%, 0.25W	441444	59124	CF1/4 182J	1	
R 83	RES, MF, 10K, +-1%, 0.125W, 100PPM	168260	91637	CMF-55 1002F T-1	1	
R 85	RES, MF, 3.57K, +-1%, 0.125W, 100PPM	226217	91637	CMF-55 3571F T-1	1	
R 89	RES, CF, 4.3K, +-5%, 0.25W	441576	59124	CF1/4 433J	1	
R 90	RES, CC, 510, +-5%, 0.5W	108951	01121	EB5115	1	
R 92, 98	RES, CF, 30K, +-5%, 0.25W	368753	59124	CF1/4 303J	2	
R 93, 99	RES, CF, 330, +-5%, 0.25W	368720	59124	CF1/4 331J	2	
R 94, 100	RES, CF, 160, +-5%, 0.25W	441410	59124	CF1/4 161J	2	
R 97, 103	RES, CF, 20K, +-5%, 0.25W	441477	59124	CF1/4 203J	2	
R 96, 102	RES, CF, 200, +-5%, 0.25W	441451	59124	CF1/4 201J	2	
R 106	RES, CF, 2, +-5%, 0.25W	442053	59124	CF1/4 2R00J	1	
T 1, 2, 11, T 14, 15, 23	RF COIL TREATED, ADJUSTABLE 1.4-1.9MH	345850	89536	345850	6	
TP 1- 17	JUMPER, WIRE, NONINSUL, 0.200CTR	816090	91984	150T1	17	
U 2	† IC, LSTTL, DUAL JK F/F, -EDG TRIG	414029	01295	SN74LS112N	1	
U 3	† IC, TTL, DUAL DIV BY 2, DIV BY 5 COUNTER	402552	01295	SN74390N	1	

Table 603-7. A13 Wideband Oscillator PCA (cont)

REFERENCE DESIGNATOR	DESCRIPTION	FLUKE STOCK NO	MFRS SPLY CODE	MANUFACTURERS PART NUMBER OR GENERIC TYPE	TOT QTY	NOTES
U 4	† IC, TTL, PHASE FREQUENCY DETECTOR	320721	04713	MC4044P	1	
U 5	† IC, OP AMP, GEN PURPOSE, TO-99/TO-78	271502	27014	LM301AH	1	
U 6, 17	† IC, STTL, TRIPLE 3 INPUT AND GATE	363457	27014	DM74S11N	2	
U 7	† IC, CMOS, DUAL 4 INPUT NAND GATE	429407	27014	MM74C20N	1	
U 9	† IC, CMOS, HEX BUFFER	381830	27014	CD4050BCN	1	
U 11, 12	† IC, LSTTL, HEX D F/F, +EDG TRG, W/CLEAR	393207	01295	SN74LS174N	2	
U 13	† IC, TTL, DIV BY 2, DIV BY 5 DEC CNTR	320754	01295	SN74196N	1	
U 14, 15	† IC, LSTTL, DIV BY 2, DIV BY 5 PRSET CNTR	393256	01295	SN74LS196N	2	
U 18	† IC, LSTTL, DUAL JK M/S F/F, +EDG, W/SET	875349	04713	SN74LS76AN	1	
U 19	† IC, STTL, DUAL JK F/F, +EDG TRIG	363440	01295	SN74S112N	1	
U 20	† IC, BPLR, BALANCED MODULATOR/DEMODULATR	344036	04713	MC1496P	1	
U 21	† IC, ARRAY, 5 TRANS, NPN, 3 ISO, 2 DIFF CON	248906	27014	LM3346N	1	
U 23	† IC, TTL, HEX INVERTER W/OPEN COLLECTOR	407593	27014	DM7406N	1	
VR 1, 2, 5	† ZENER, UNCOMP, 10.0V, 5%, 12.5MA, 0.4W	246611	04713	1N961B	3	
VR 3	† ZENER, UNCOMP, 4.3V, 5%, 20.0MA, 0.4W	180455	04713	1N749A	1	
VR 4	† ZENER, UNCOMP, 6.8V, 10%, 18.5MA, 0.4W	342527	14552	D2810702A	1	
VR 6	† ZENER, UNCOMP, 5.1V, 5%, 20.0MA, 0.4W	159798	04713	1N751A	1	
VR 7, 8	† ZENER, UNCOMP, 15.0V, 5%, 8.5MA, 0.4W	266601	04713	1N965B	2	
W 1	† WIRE, COPPER/TIN, BUS, 22AWG	115469	04946	302-11	1	
NOTES:	† Static sensitive part.					

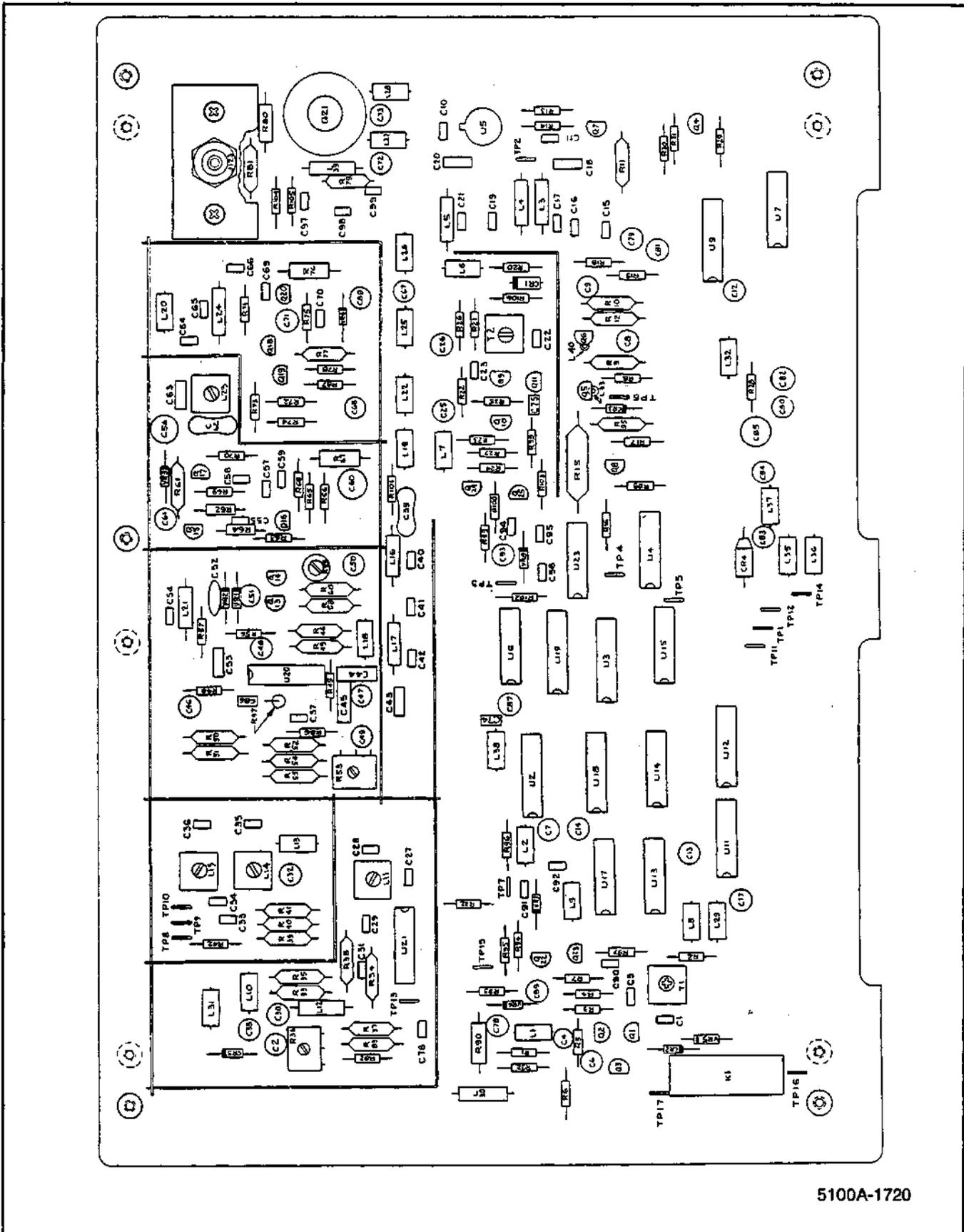

5100A-1720

Figure 603-10. A13 Wideband Oscillator PCA

-05 Option IEEE 488-1975 Standard Interface

605-1. INTRODUCTION

605-2. The IEEE 488-1875 Interface places the 5100 Series B Calibrator on an IEEE Bus, allowing it to be programmed through a system controller. The instrument outputs are available to the bus, at the direction of the controller, for routing to the instrument(s) under test. All controls and responses of the calibrator can be accessed with the system controller except the POWER switch.

CAUTION

There are protective diodes between the signal (logic) ground and equipment (chassis) ground. Damage to the equipment could result if the potential between these points exceeds 0.6V dc.

605-3. SPECIFICATIONS

605-4. Specifications for the IEEE 488-1975 Standard Interface, Option -05, conform to those established in the IEEE Standard Digital Interface for Programmable Instrumentation as published by the Institute of Electrical and Electronics Engineers; 345 E. 47th St.; N.Y., NY 10017. For an explanation of the IEEE 488-1975 Standard refer to the standard document.

605-5. INSTALLATION

605-6. The option may be installed at any time by inserting the option's pcb assembly into the rearmost connector in the digital compartment and removing the plate from the rear panel interface access port. All interface options go into this slot; however, only one can be installed at a time.

605-7. OPERATING FEATURES

605-8. Attached to the assembly and accessible through a port on the rear panel (Figure 605-1) are a standard specified connector, five address switches, and a Talk Only Mode switch. The connector is standard for the IEEE Bus and is specified by the standard document. The address of the instrument is set using the five address switches. The characters used to address the instrument in the Talk and Listen Modes are given in Table 605-1. The five low order bits of the message determine the address, the next two higher bits differentiate between the Talk and Listen Modes. Normal operation allows the calibrator to both talk and listen to the bus. The Listen Mode can be disabled with the Talk Only switch, if desired.

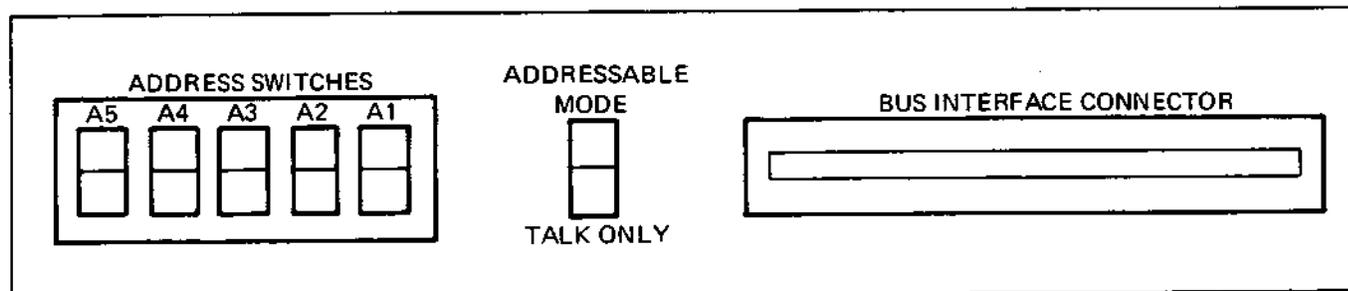

Figure 605-1. IEEE Access Port

Table 605-1. Allowable Listen and Talk Addresses

DECIMAL	5 4 3 2 1 BINARY	ASCII CHARACTER	
		LISTEN	TALK
0	0 0 0 0 0	SP	@
1	0 0 0 0 1	!	A
2	0 0 0 1 0	"	B
3	0 0 0 1 1	#	C
4	0 0 1 0 0	\$	D
5	0 0 1 0 1	%	E
6	0 0 1 1 0	&	F
7	0 0 1 1 1	'	G
8	0 1 0 0 0	(H
9	0 1 0 0 1)	I
10	0 1 0 1 0	*	J
11	0 1 0 1 1	+	K
12	0 1 1 0 0	,	L
13	0 1 1 0 1	-	M
14	0 1 1 1 0	.	N
15	0 1 1 1 1	/	O
16	1 0 0 0 0	0	P
17	1 0 0 0 1	1	Q
18	1 0 0 1 0	2	R
19	1 0 0 1 1	3	S
20	1 0 1 0 0	4	T
21	1 0 1 0 1	5	U
22	1 0 1 1 0	6	V
23	1 0 1 1 1	7	W
24	1 1 0 0 0	8	X
25	1 1 0 0 1	9	Y
26	1 1 0 1 0	:	Z
27	1 1 0 1 1	;	[
28	1 1 1 0 0	<	\
29	1 1 1 0 1	=]
30	1 1 1 1 0	>	^

605-9. OPERATING NOTES

605-10. Instrument Programming

605-11. The programming instructions required to operate the instrument are found in Section 2 of this manual.

605-12. Interface Control

605-13. Information is input to the interface from the controller on the System Bus, which contains eight data lines, three handshake lines, and five bus management lines. Control of the handshake and management lines is from the controller and will vary with the controller used. Refer to the instructions with the system controller for the information on how to obtain the correct level on these lines. The lines, and a brief explanation of their function, are given in Table 605-2. Refer to the IEEE 488-1975 Standard Manual for a further explanation of their function.

Table 605-2. Interface Control Lines

MNEMONIC	TITLE	EXPLANATION
EOI	End or Identify	Indicates end of multiple byte message.
DAV	Data Available	True with data on the bus.
NFRD	Not Ready For Data	True with all instruments on bus ready for data.
NDAC	Not Data Accepted	True with data accepted and can be removed.
IFC	Interface Clear	True places all interfaces in known quiescent state.
SRQ	Service Request	Draws attention of the controller to issuing device.
ATN	Attention	Differentiate between interface (True) and device dependent message (False).
REN	Remote Enable	Selects Remote (True) or Local (False).

605-14. Interface Messages

605-15. Multiple line messages are input to the interface from the controller using the data lines. The ones used within the instrument are listed with their codes in Table 605-3. Further information on the messages can be obtained from the IEEE 488-1975 Standard Manual.

605-16. Status Request Responses

605-17. A service request (SRQ) can be generated within the interface by either an error or ready condition, provided it was enabled by the applicable Interface

Table 605-3. Interface Messages

MNEMONIC	MESSAGE	CODING			ALL DEVICES RESPOND (Universal)	ADDRESSED DEVICES ONLY RESPOND	DEVICE IN LOCAL RESPONDS AND GOES TO REMOTE	NOTE
		BINARY	OCTAL	HEX				
MLA	My Listen Address	X F T A5 A4 A3 A2 A1				X	X	1
MTA	My Talk Address	X T F A5 A4 A3 A2 A1				X	X	1
UNL	Unlisten	X F T T T T T T	077	3F	X			
UNT	Untalk	X T F T T T T T	137	5F	X		X	
OTA	Other Talk Address	X X X X X X X X					X	2
SPE	Serial Poll Enable	X F F T T F F F	030	18	X		X	
SPD	Serial Poll	X F F T T F F T	031	19	X		X	
LLO	Local Lockout	X F F T F F F T	021	11	X		X	
GTL	Go To Local	X F F F F F F T	001	01		X		
DCL	Device Clear	X F F T F T F F	024	14	X			
SDO	Selected Clear	X F F F F T F F	004	04		X		

1. Setting of Address Switch
2. Any Address other than MTA

Interrupt Enable Code. When the instrument is addressed during a serial poll operation by the IEEE-488 Controller, and an interrupt was generated, the response byte will be a zero for ready or the numeric of the applicable Error Code. If the SRQ was not generated by the calibrator, the response is a null character (binary 00000000) to the controller.

605-18. THEORY OF OPERATION

605-19. General

605-20. The IEEE-488 interface assembly transfers data between the System Bus and the Internal Digital Bus. Signals on the system bus are fully defined in the IEEE-488 Standard with a brief description given in the paragraph on interface control.

605-21. The assembly consists of two PCBs that are fastened together electrically with a 56-pin post and connector set, and mechanically with screws and standoffs. The mainboard (MB) is numbered MIS-1172 and the secondary or piggyback board (PB) MIS-1072.

Refer to the schematics in Section 8 during the following discussion for the drawings of these two PCBs. Reference designators will be followed by the abbreviation for the applicable board, i.e., MB or PB, during the discussion.

605-22. Data Lines

605-23. Data is applied to the interface from the System Bus through the receiver/drivers U21 (MB) and U24 (MB) on lines DI01 through DI08 and is inverted and placed on the Digital Bus ID0 through ID7 from the Data Registers, U30 (MB) and U29 (MB). The data is latched in U26 (MB) and U29 (MB) to hold it after removal from the System Bus by the system controller, and at the same time the five low order bits are applied to the control register U11 (PB), U14 (PB) and U16 (PB). In addition, the data is decoded by S1, U3, U5, U6, U8, U12, and U19 (all on the mainboard) to obtain, if present, one of the signals in Table 605-3. In addition to the proper code, ATN must be low on the System Bus (J3-11) for any of the signals in Table 605-3 to be present. The signal GET (Group Execute Trigger) decoded at U8-11 (MB) is not used in the 5100 Series B.

605-24. Address Lines

605-25. The instrument address lines (IC0-IC6) are input on the Digital Bus and decoded to perform a series of internal functions, all of which generate an ACK at U6-1 (PB) for return to the instrument controller. IC1, 4, 5, high, are decoded at U12-6 (PB) to enable the response register, U26 (MB) and U29 (MB). IC3, 4, 6, high, are decoded at U12-10 (PB) to clock the control register; U11 (PB), U14 (PB) and U16 (PB). If ID0 is high at the same time, a Return to Local Signal is generated at U8-3 (PB). IC0, 3, 5, high, are decoded at U13-6 (PB) to provide a software reset at U8-8 (PB) to accompany the power-on reset at U8-9 (PB). IC0, 4, 6, high, are decoded at U13-10 (PB) to enable the data register U30 (MB) and U31 (MB).

605-26. Control Register

605-27. The control register consists of U11 (PB), U14 (PB) and U16 (PB). Four of the six latches are enabled from U12-10 (PB) described above. Of these INT (Interrupt) at U14-2 (PB) is controlled by ID3, SRQ at U14-13 (PB) by ID2, NFRD at U16-1 (PB) by ID2, and EOI at U11-13 (PB) by ID0. A NDAC is generated at U16 (PB) for the System Bus and to reset the NRFD previously generated. DAV is generated at U11-2 (PB), when clocked from U12-6 and addressed as a talker. INT is generated for an interrupt, with the proper input signals, except when the latch is held reset by the power-on reset routine. Refer to Table 605-2 for a brief explanation of the other signals.

605-28. Status Register

605-29. The status register in U28 (MB) and part of U31 (MB) stores signals decoded or input from the System Bus for placement on the Digital Bus. The register is clocked from U13-9 (PB) with IC0, IC4, and IC6, high. When the register has been enabled it reflects the status of the Talk Only Mode (high) on ID0, Remote Enable (REN) from the System Bus on ID1, GTL on ID2, MLA on ID3, INA for an interface message on ID4, device dependent message on ID5, serial-poll on ID6 and on ID7 when the system controller requests data.

605-30. Mode Register

605-31. Data that selects the operating mode is latched into the Mode Register by DAV. MLA will be at U11-1, if decoded, and MTA at U11-15. They are mutually exclusive and both points cannot be high simultaneously. U15-1 is clocked high when the instrument is in the Remote Mode and U15-15 when the serial-poll has been selected.

605-32. Reset

605-33. The instrument is automatically reset when power is reapplied after an interruption by the circuitry at U8-9 (PB). This prevents the instrument from coming up in an undesirable or unknown logic state. Software resets the instrument with a front panel RESET switch depression, system programming request or a momentary power interruption that is too short for the C3/R8 (PB) combination to discharge and cause a reset.

605-34. MAINTENANCE

605-35. Refer to Section 4 of the manual for instructions on the installation and cleaning of the assembly. The assembly is disassembled by removing the screws and standoffs that fasten the boards together, then pulling straight apart, to prevent damage to the electrical connectors.

650-36. PERFORMANCE TEST

605-37. Operation of the IEEE-488 interface may be verified by programming changes in range, output, and mode while observing the front panel for the proper indication. Operation of the calibrator should be verified before an attempt is made to program remotely.

605-38. CALIBRATION

605-39. The IEEE-488 interface assembly does not require any calibration.

605-40. TROUBLESHOOTING

605-41. Troubleshooting for the -05 Option IEEE 488-1975 Remote Interface consists of the tabular flow chart in Table 605-4. When a step in the flow chart is completed, check for a decision transfer. If no decision is required, perform the next step of the table in sequence.

605-42. LIST OF REPLACEABLE PARTS

605-43. Tables 605-5 and 605-6 are a list of replaceable parts for the IEEE-488 interface option. Refer to Section 5 for an explanation of the columnar entries.

Table 605-4. IEEE Remote Interface Troubleshooting

STEP NO.	ACTION	Go to the step number given for correct response	
		YES	NO
	<i>NOTE</i> <i>Due to the speed and complexity of the data on the bus system, it is recommended that when a problem is isolated to the interface, the pcb be sent to the nearest Fluke Service Center for repair. The following table will be some assistance troubleshooting simpler problems; however, many problems will require the use of a Fluke Trendar, or similar logic board tester. The instrument must be connected through a bus network to a system controller, e.g., the Fluke 1722A to operate.</i>		
1	This test is based on the assumption that the instrument was checked and found operational in all local aspects prior to installing the IEEE Remote Interface in the instrument.		
2	Install the IEEE Interface Assembly in the instrument and apply power from the front panel switch.		
3	Does the Output Display read 0.0000 mV dc?	5	4
4	If the display is blank check the ACK circuit on the Piggyback (PB) PCB. If the display is incorrect (garbled or wrong) check the input latches and output buffers on the Main (MB) PCB. Repair as required then resume at step 2.		
5	Address the instrument on the IEEE Bus with the applicable address.		
6	Does the instrument go into remote?	8	7
7	On the Main Board check the address lines through the Receiver/Driver, the address switches, the MLA circuitry, and the REN and DAV signals. On the Piggyback Board check the INT circuit. Repair as required then resume at step 5.		
8	Program an instruction from the remote controller.		
9	Is the output display as programmed?	11	10
10	Check the output latches and buffers, the UNL circuitry and the Receiver/Driver on the Main Board. Repair as required then resume at step 8.		
11	Does the instrument respond to a "SRQ" from an Interrupt Ready or Error?	13	12
12	Check the SRQ line in and the Receiver/Driver on the Main Board and the status latches on the Piggyback Board. Repair as required then resume at step 11.		
13	Does the interface clear from the system controller?	15	14
14	Check the IFC input and the IFC circuit. Repair as required then resume at step 13.		
15	Can the Front Panel be locked out from the system controller?	17	16
16	Check the LLO line and the decoder circuit. Repair as required then resume at step 15.		
17	Troubleshooting of the IEEE Interface, as applicable at this level, is complete.		

Table 605-5. A23 IEEE-488 Interface Main PCA

REFERENCE DESIGNATOR	DESCRIPTION	FLUKE STOCK NO	MFRS SPLY CODE	MANUFACTURERS PART NUMBER OR GENERIC TYPE	TOT QTY	NOTES
A 1	IEEE PIGGY BACK PCA	503532	89536	503532	1	
C 1, 2	CAP.CER. 270PF, +-5%, 50V, COG	658898	04222	SR595A271JAA	2	
C 3	CAP.TA. 10UF, +-20%, 25V	714774	56289	199D106X0025B2	1	
C 4- 8	CAP.CER. 0.22UF, +-20%, 50V, X7R	853648	04222	SR325C224MAA	5	
C 9	CAP.CER. 100PF, +-5%, 50V, COG	831495	04222	SR595A101JAA	1	
CR 1	DIODE, SI, BV=75V, IO=150MA, 500MW	203323	65940	1N4448	1	
E 1	WIRE, JUMPER, TEF, 22AWG, WHT, .300	528257	60386	J.TEFLON .300	1	
H 1	WASHER, LOCK, SPLIT, STL, .168, .307, .040	111070	86928	5850-15-22	2	
H 2	SCREW, CONNECTOR MOUNTING	429472	20584	429472	2	
H 3	SCREW, PH, P, LOCK, STL, 4-40, .375	152124	74594	152124	2	
J 2, 4, 5	HEADER, 1 ROW, .100CTR, 36 PIN	447813	22526	65501-136	3	
J 3	CONNECTOR MODIFIED	534107	89536	534107	1	
MP 1	SPACER, SWAGE, .250 RND, BR, 4-40, .187	335604	55566	3046B440B14-MOD.=.187	1	
MP 2	SPACER, SWAGE, .250 RND, BR, 4-40, .340	380329	55566	3045B440B14-MOD.=.340	2	
MP 3	SPACER, SWAGE, .250 RND, BR, 6-32, .550	312421	55566	3045B632B14-MOD.=.550	2	
MP 4	SPACER, SWAGE, .250 RND, BR, 6-32, .220	261727	55566	3045B632B14-MOD.=.220	2	
MP 5	DECAL 468538	473504	89536	473504	1	
Q 1	TRANSISTOR, SI, NPN, SMALL SIGNAL, TO-92	698225	27014	2N3904	1	
R 1	RES, CF, 18K, +-5%, 0.25W	348862	59124	CF1/4 183J	1	
R 2	RES, CF, 10K, +-5%, 0.25W	348839	59124	CF1/4 102J	1	
R 3	RES, CF, 1K, +-5%, 0.25W	343426	59124	CF1/4 102J	1	
R 4	RES, CF, 4.7K, +-5%, 0.25W	348821	59124	CF1/4 472J	1	
R 5	RES, CF, 15K, +-5%, 0.25W	348854	59124	CF1/4 153J	1	
S 1	SWITCH, DIP, SPDT, 5 POS	417766	11237	206-125	1	
S 2	SWITCH, SLIDE, SPDT	417287	95146	MSSA-104D-1	1	
U 1	IC, CMOS, QUAD 2 INPUT NAND GATE	355198	04713	MC14011UBCP	1	
U 2	IC, CMOS, DUAL 4 INPUT NOR GATE	363820	27014	CD4002BCN	1	
U 3, 6, 19	IC, CMOS, 8 INPUT NOR GATE	408781	04713	MC14078BCP	3	
U 4, 17	IC, CMOS, QUAD 2 INPUT AND GATE	408401	04713	MC14081BCP	2	
U 5, 8, 14	IC, CMOS, QUAD 2 INPUT NOR GATE	355172	27014	CD4001BCN	3	
U 7	IC, CMOS, TRIPLE 3 INPUT NOR GATE	355180	27014	CD4025BCN	1	
U 9	IC, CMOS, DUAL 8IN TO 1 OF 4 DCDR/MUX	408369	04713	MC14556BCP	1	
U 10	IC, CMOS, QUAD 2 INPUT OR GATE	408393	04713	MC14071BCP	1	
U 11, 15	IC, CMOS, DUAL JK F/F, +EDG TRIG	355230	27014	CD4027BCN	2	
U 12	IC, CMOS, TRIPLE 3 INPUT NAND GATE	375147	27014	CD4023CN	1	
U 13, 18	IC, CMOS, HEX INVERTER	404681	04713	MC14093BCP	2	
U 16	IC, CMOS, QUAD 2 IN NAND W/SCHMT TRIG	404632	04713	MC14093BCP	1	
U 20, 21, 24,	IC, LSTTL, QUAD INTERFACE BUS TRANSVR	428649	01295	MC3446N	4	
U 27		428649				
U 22, 25	IC, CMOS, HEX INVERTER	381848	27014	CD4049CN	2	
U 26, 29	IC, CMOS, QUAD D LATCH, W/KOR ENABLE	355149	34371	CD4042BE	2	
U 28, 30, 31	IC, CMOS, HEX BUFFER W/3-STATE OUTPUT	407759	04713	MC14503BCP	3	
U 32	IC, LSTTL, QUAD 2 INPUT NAND GATE	393033	01295	SN74LS00N	1	
U 33, 34	RES, CERM, SIP, 8 PIN, 7 RES, 4.7K, +-2%	412916	91637	CSC08A-01-472G	2	
NOTES:	Static sensitive part.					

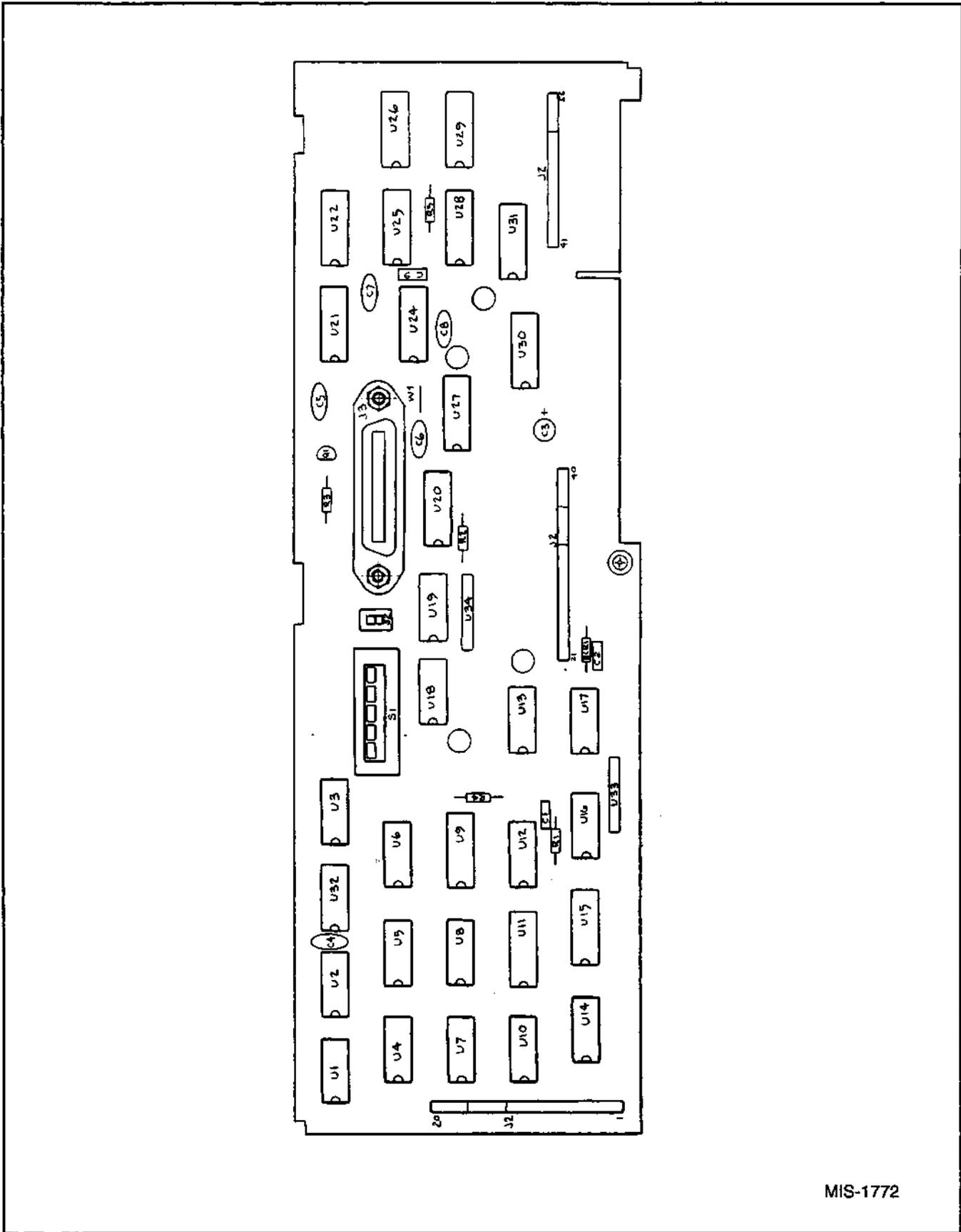

MIS-1772

Figure 605-2. A23 IEEE-488 Interface Main PCA

Table 605-6. A23A1 IEEE-488 Piggyback PCA

REFERENCE DESIGNATOR	DESCRIPTION	FLUKE STOCK NO	MFRS SPLY CODE	MANUFACTURERS PART NUMBER OR GENERIC TYPE	TOT QTY	NOTES
C 1, 4	CAP. CER, 270PF, +-5%, 50V, COG	658898	04222	SR595A271JAA	2	
C 2	CAP. CER, 100PF, +-5%, 50V, COG	831495	04222	SR595A101JAA	1	
C 3	CAP. TA, 1UF, +-20%, 35V	697417	56289	199D105X003SAG2	1	
CR 1	† DIODE, SI, BV=75V, IO=150MA, 500MW	203323	65940	1N4448	1	
H 1	WASHER, LOCK, INTRNL, STL, .267ID	110817	86928	5855-18-Z1	1	
H 2	WASHER, FLAT, SS, .251, .500, .016	200980		COMMERCIAL	1	
J 1, 2	SOCKET, 1 ROW, PWB, 0.100CTR, 20 POS	447110	30035	SS-109-1-20	2	
P 4	BANANA JACK, PANEL	441741	18310	01-2540-1-02	1	
Q 1	† TRANSISTOR, SI, NPN, SMALL SIGNAL, TO-92	698225	27014	2N3904	1	
Q 2	† TRANSISTOR, SI, PNP, SWITCHING, TO-92	831446	04713	MPS3640	1	
R 1, 5, 7	RES, CF, 10K, +-5%, 0.25W	348839	59124	CF1/4 102J	3	
R 2, 6	RES, CF, 47K, +-5%, 0.25W	348896	59124	CF1/4 473J	2	
R 3, 4	RES, CF, 150, +-5%, 0.25W	343442	59124	CF1/4 151J	2	
R 8	† RES, CF, 15K, +-5%, 0.25W	348854	59124	CF1/4 153J	1	
U 16, 18		340117				
U 2, 4	† IC, CMOS, QUAD 2 INPUT NOR GATE	355172	27014	CD4001BCN	2	
U 3	† IC, CMOS, QUAD 2 IN NAND W/SCHMT TRIG	404632	04713	MC14093BCP	1	
U 5, 7	† IC, CMOS, HEX INVERTER	404681	04713	MC14093BCP	2	
U 6	† IC, CMOS, DUAL 4 INPUT NOR GATE	363820	27014	CD4002BCN	1	
U 8, 9	† IC, CMOS, QUAD 2 INPUT NAND GATE	355198	04713	MC14011UBCP	2	
U 10	† IC, CMOS, HEX INVERTER	381848	27014	CD4049CN	1	
U 12	† IC, CMOS, TRIPLE 3 INPUT AND GATE	409807	04713	MC14073BCP	1	
U 13	† IC, CMOS, TRIPLE 3 INPUT NAND GATE	375147	27014	CD4023CN	1	
U 17	† IC, CMOS, TRIPLE 3 INPUT NOR GATE	355180	27014	CD4025BCN	1	
XP 2	SOCKET, 1 ROW, PWB, 0.100CTR, 16 POS	447102	30035	SS-109-1-16	1	
NOTES:	† Static sensitive part.					

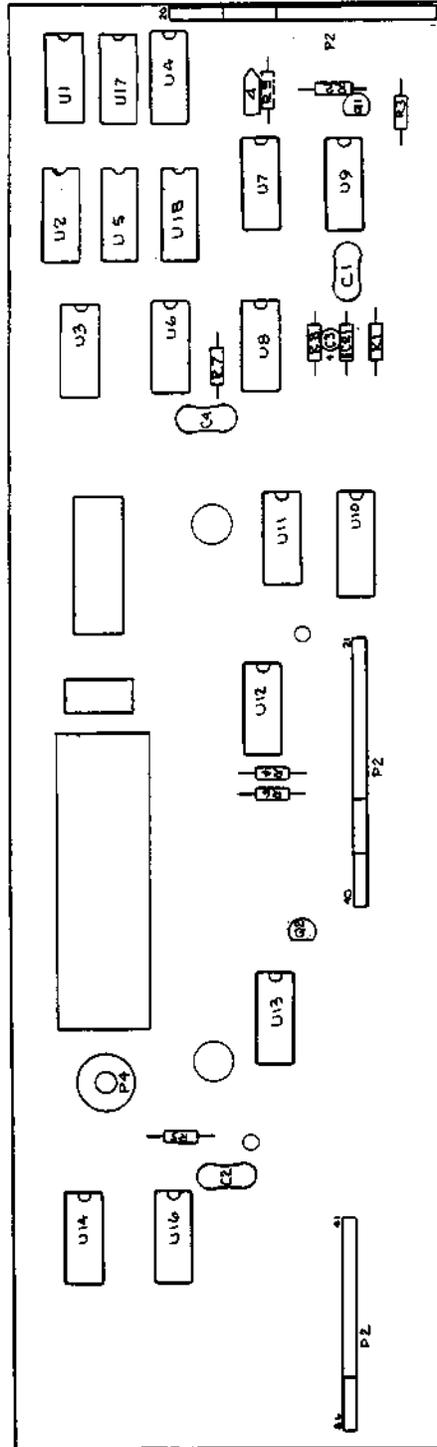

NOTE:  R9 may not be installed, selected in test.

MIS-1674

Figure 605-3. A23A1 IEEE-488 Piggyback PCA

-06 Option Bit Serial Asynchronous Interface (RS-232-C)

606-1. INTRODUCTION

606-2. The Bit Serial Asynchronous Interface takes the eight-bit parallel data in the calibrator, converts it to a bit serial format and outputs it to a system controller on a RS-232-C Bus. Data from the system controller is altered in the same way, allowing for full control of the instrument by a remote source. All controls and responses of the calibrator can be accessed with the system controller through the bit serial interface except the power switch.

CAUTION

There are protective diodes between the signal (logic) ground and equipment (chassis) ground. Damage to the equipment could result if the potential between these points exceeds 0.6V dc.

606-3. SPECIFICATIONS

606-4. The bit serial interface meets or exceeds the data transmission and receiving requirements of EIA Standard RS-232-C, RS-232-B, MIL-STD-188B, CCITT V24, and the 20 mA current loop. Baud rates of 50, 75, 110, 134.5, 150, 200, 300, 600, 1200, 1800, 2400, 4800, and 9600 are switch selectable.

606-5. INSTALLATION

606-6. The option may be installed at any time by inserting the option's single PCB into the rearmost connector in the digital compartment. All interface options go into the same slot; however, only one can be installed at a time.

606-7. OPERATING FEATURES

606-8. Attached to the PCB and accessible through a port on the rear panel (Figure 606-1) are a standard specified connector and a switch module with eight microswitches. The connector is standard for the RS-232-C interface and is specified by the standard document. The eight switches control the operating modes of the interface and the baud rate. The modes selected by the switches are shown in Tables 606-1 and Table 606-2. The selection of Odd or Even parity with switch 8 is applicable only if the parity feature has been selected using the jumpers described below.

606-9. The interface is shipped configured for an eight-bit character without parity. Selection of parity and five-, six-, or seven-bit characters can be accomplished by installing jumpers into the PCB as shown in Table 606-3

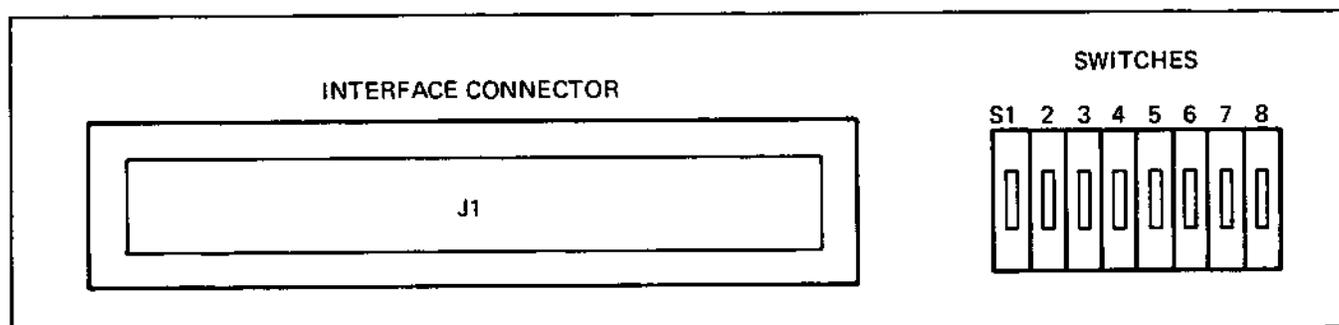

Figure 606-1. Bit Serial Access Port

Table 606-1. Switch Selection

SW#	SELECTION	SW ON	SW OFF
S1	Current Loop/ RS232	Current	RS232C
S2	RS232B/ RS232C	RS232B	RS232C
S3	Stop Bits	1 Bit	2 Bits
S4	Baud Rate	*	*
S5	Baud Rate	*	*
S6	Baud Rate	*	*
S7	Baud Rate	*	*
S8	Parity	Odd	Even

* Defined in Table 606-2

Table 606-2. Baud Rate

COUNT	S4	S5	S6	S7	BAUD RATE
0	OFF	OFF	OFF	OFF	110
1	OFF	OFF	OFF	ON	150
2	OFF	OFF	ON	OFF	300
3	OFF	OFF	ON	ON	2400
4	OFF	ON	OFF	OFF	1200
5	OFF	ON	OFF	ON	1800
6	OFF	ON	ON	OFF	4800
7	OFF	ON	ON	ON	9600
8	ON	OFF	OFF	OFF	2400
9	ON	OFF	OFF	ON	600
10	ON	OFF	ON	OFF	200
11	ON	OFF	ON	ON	134.5
12	ON	ON	OFF	OFF	75
13	ON	ON	OFF	ON	50

Table 606-3. Character Length and Parity

	JUMPER #1 INSTALLED	JUMPER #2 INSTALLED	JUMPER #3 INSTALLED
Bit 5	Yes	Yes	N/A
Bit 6	No	Yes	N/A
Bit 7	Yes	No	N/A
Bit 8	No	No	N/A
Parity	N/A	N/A	Yes
No Parity	N/A	N/A	No

606-10. OPERATING NOTES

606-11. Programming instructions required to operate the instrument are found in Section 2 of this manual.

606-12. THEORY OF OPERATION

606-13. General

606-14. The bit serial interface alters to the proper format and transmits data between the eight-bit (byte) parallel format used on the Instrument Bus and the bit serial format of the System Bus. As shown on the schematic in Section 8, data inputs from either the System Bus or the Instrument Bus are latched into a Universal Asynchronous Receiver Transmitter (UART) U9, which is driven by a programmable clock (U3) set at the selected baud rate. Data on the Instrument Bus (ID0-ID7) is latched into the UART on DBI through DB8 and output from the UART to the Instrument Bus on RDI through RD8. Four separate functions are decoded from the control lines and the receipt of any one generates a common acknowledge signal (ACK). An interrupt function can be generated to notify the instrument controller the received data is available, allowing polled or interrupt control of the interface.

606-15. Functions

606-16. An address of IC0, IC4, and IC6 high with the remaining lines low, generates the STATIN function. This generates ACK and enables the tri-state transmitters on the ID0-ID3 lines so that DA (received data available at RDI-RD8), OR (overrun, i.e., a new character received prior to final transmission of the previous character), TBMT (Transmitter Buffer Empty and ready for the next character), and/or FE (Framing Error; i.e., no stop-bit with received character) can be placed on the data lines.

606-17. The DATIN function (IC1, IC4, IC6, only high) strobes the RDE and RDA inputs to the UART. The UART is enabled to place data on the Instrument Bus by RDE and to receive another serial character from the System Bus by RDA.

606-18. With IC2, IC4, and IC5, only, high COUT is decoded to reset the UART and clock U5-3. If IC7 is high with COUT, the interrupt capability is disabled by enabling the reset at U5-10. This prevents an interrupt signal to the instrument controller until removed. If ID7 is low, the interrupt circuitry is enabled.

606-19. DATOUT is decoded, from IC3, IC4, and IC6, only, high, to strobe the DS input to the UART. The rising edge of DS initiates serial transmission of the character from SO onto the System Bus. It is available at both J1-2 for RS-232-C and J1-11 for the 20 mA current loop, for the user's selection.

606-20. Interrupt

606-21. When DA (received data available) goes high, an interrupt is generated unless it has been disabled by the COUT function, for a low at INT. The instrument controller responds with an INA, generating an ACK and enabling U8-15 to pass the output of the interrupt flip-flop to the instrument controller for interrupt vectoring. The removal of INA by the instrument controller causes the interrupt flip-flop to reset itself and prepare the circuit for the next interrupt.

606-22. MAINTENANCE

606-23. Refer to Section 4 of the manual for instructions on the cleaning and installation of the assembly.

606-24. PERFORMANCE TEST

606-25. Operation of the bit serial interface may be verified by programming changes in range, output and mode while observing the Front Panel for the proper

indications. If the echoing capability is selected, the instruction sent can be monitored on the output device. Operation of the calibrator should be verified before an attempt is made to program remotely.

606-26. CALIBRATION

606-27. The Bit Serial Asynchronous Interface does not require any calibration.

606-28. TROUBLESHOOTING

606-29. Troubleshooting for the -06 Bit Serial Asynchronous Interface Option consists of the tabular flow chart in Table 606-4. When a step in the flow chart is complete, check for a decision transfer. If no decision is required, perform the next step of the table in sequence.

606-30. LIST OF REPLACEABLE PARTS

606-31. Table 606-5 is a list of replaceable parts for the bit serial interface option. Refer to Section 5 for an explanation of the columnar entries.

Table 606-4. Bit Serial Remote Interface Troubleshooting

STEP NO.	ACTION	Go to the step number given for correct response	
		YES	NO
	<p><i>NOTE</i></p> <p><i>The instrument must be connected through a bus network to a system controller, e.g., the Tektronix 4051 or HP 9825, to operate.</i></p>		
1	This test is based on the assumption that the instrument was checked in local and found operational in all aspects prior to installing the Bit Serial Asynchronous (RS-232-C) Remote Interface in the Instrument.		
2	Install the Bit Serial Interface in the instrument and apply power from the Front Panel switch.		
3	Does the output display read 0.0000 mV dc?	7	4
4	Does the central display read "Err6"?	6	5
5	If the display is blank check for a high ACK line, check the address lines and the address decoders. If the display is incorrect (garbled or wrong) check the input data lines and gates. Repair as required then resume at step 2.		
6	Check the address decoder and ACK circuit. Repair as required then resume at step 2.		
7	Using the controller, instruct the program to go to remote (program the character "J").		
8	Does the instrument go to remote?	10	9
9	Check the input gates, the UART (U9), the BAUD rate (U3), the INT circuit, the INA circuit, and the status output circuit. Repair as required then resume at step 7.		
10	Program several instructions into the Calibrator from the remote controller.		
11	Did the instrument respond correctly to the programmed instruction?	13	12
12	Check the UART (U9), the output circuit (U4), and the data input gate (U7). Repair as required then resume at step 10.		
13	Troubleshooting of the Bit Serial Interface, as applicable at this level, is complete.		

Table 606-5. A22 Bit Serial Interface PCA

REFERENCE DESIGNATOR	DESCRIPTION	FLUKE STOCK NO	MFRS SPLY CODE	MANUFACTURERS PART NUMBER OR GENERIC TYPE	TOT QTY	NOTES
C 1 - 3	CAP, TA, 5.6UF, +-20%, 25V	368969	56289	199D565X0025CA2	3	
C 4, 5	CAP, MICA, 56PF, +-5%, 500V	148528	93790	CD15ED560J03	2	
C 6 - 9	CAP, CER, 0.22UF, +-20%, 50V, Z5U	309849	04222	SR215E224MAA	4	
CR 1	‡ DIODE, SI, BV=75V, IO=150MA, 500MW	203323	65940	1N4448	1	
E 1 - 3	TERM, UNINSUL, FEEDTHRU, HOLE, TURRET	179283	88245	2010B-5	3	
H 1	CONN, D-SUB, PWB, 25 PIN	413898	89536	413898	1	
H 2	SCREW, PH, P, LOCK, STL, 4-40, .250	129890	74594	129890	2	
H 3	CONN ACC, D-SUB, SPRING LATCH ASSEMBLY	330134	50738	17-529	1	
H 4	SCREW, PH, P, LOCK, SS, 4-40, .375	256164	74594	256164	1	
JP 1 - 3	TERM, UNINSUL, FEEDTHRU, BIFUR, HOLE	208363	91833	1526-2	6	
MP 1	DECAL 468520	473496	89536	473496	1	
MP 2	SPRING, COIL, COMP, M WIRE, .380, .120	424465	83553	C0121-014-0380M	1	
MP 3	SPACER, SWAGE, .250 RND, BR, 4-40, .187	335604	55566	3046B440B14-MOD.=.187	3	
MP 4	SPACER, SWAGE, .250 RND, BR, 6-32, .550	312421	55566	3045B632B14-MOD.=.550	2	
Q 1	‡ TRANSISTOR, SI, NPN, SMALL SIGNAL, TO-92	218396	04713	2N3904	1	
Q 2	‡ TRANSISTOR, SI, PNP, SMALL SIGNAL	226290	04713	MPS3640	1	
Q 3	‡ TRANSISTOR, SI, PNP, SMALL SIGNAL	195974	04713	2N3906	1	
R 1, 4	RES, CF, 150, +-5%, 0.25W	343442	59124	CF1/4 151J	2	
R 2	RES, CF, 47K, +-5%, 0.25W	348896	59124	CF1/4 473J	1	
R 3	RES, CF, 10K, +-5%, 0.25W	348839	59124	CF1/4 102J	1	
R 5	RES, CC, 10M, +-5%, 0.25W	194944	01121	CB1065	1	
R 6	RES, CF, 33K, +-5%, 0.25W	348888	59124	CF1/4 333J	1	
R 7, 14	RES, CF, 1K, +-5%, 0.25W	343426	59124	CF1/4 102J	2	
R 8	RES, CF, 2.2K, +-5%, 0.25W	343400	59124	CF1/4 222J	1	
R 9	RES, CF, 47, +-5%, 0.25W	441592	59124	CF1/4 470J	1	
R 10	RES, CF, 750, +-5%, 0.25W	441659	59124	CF1/4 751J	1	
R 11, 12, 15, R 38	RES, CF, 4.7K, +-5%, 0.25W	348821	59124	CF1/4 472J	4	
R 13	RES, CF, 620, +-5%, 0.25W	442319	59124	CF1/4 621J	1	
S 1	SWITCH, DIP, SPST, 8 POS	414490	00779	435166-5	1	
U 1	‡ IC, TTL, DUAL EIA/MIL LINE RECEIVER	354704	18324	NBT16	1	
U 2	‡ IC, CMOS, HEX INVERTER	381848	27014	CD4049CN	1	
U 3	‡ IC, CMOS, PROGRAMBLE BIT RATE GENERATOR	418731	34371	HD3-4702-9	1	
U 4	‡ IC, TTL, DUAL EIA/MIL LINE DRIVER	354696	18324	NBT15N	1	
U 5	‡ IC, CMOS, DUAL D F/F, +EDG TRIG	340117	04713	MC14013BCP	1	
U 5, 7	‡ IC, CMOS, TRIPLE 3 INPUT NAND GATE	375147	27014	CD4023CN	2	
U 8	‡ IC, CMOS, HEX BUFFER W/3-STATE OUTPUT	407759	04713	MC14503BCP	1	
U 9	‡ IC, CMOS, UNIV ASYNC RECEIVR/TRANSMITER	453464	34371	HD3-6402C-9	1	
U 10	‡ IC, CMOS, TRIPLE 3 INPUT AND GATE	408807	04713	MC14073BCP	1	
U 11	‡ IC, CMOS, QUAD 2 INPUT NAND GATE	355198	04713	MC14011UBCP	1	
U 12	‡ IC, CMOS, HEX BUFFER	381830	27014	CD4050BCN	1	
U 13	‡ IC, CMOS, OCTAL BUS TRANSCEIVER	722017	27014	MM74HCT245N	1	
V 1	CRYSTAL, 2.4576MHZ, +-0.01%, HC-33, 51/U	435370	61429	FOX024	1	
XU 9	SOCKET, IC, 40 PIN	429282	00779	2-640379-1	1	
Z 37	RES, CERM, SIP, 6 PIN, 5 RES, 10K, +-2%	500876	91637	CSC06A-01-103G	1	
NOTES:	‡ Static sensitive part.					

Section 7 Schematic Diagrams

TABLE OF CONTENTS

FIGURE NO.	TITLE	PAGE
7-1	Interconnect Diagram	7-3
7-2	A1 Main Motherboard & A2 MIS Motherboard PCA	7-7
7-3	A3 Power Supply Motherboard & A7 Power Supply Termination Assembly	7-9
7-4	A8 Power Supply Interconnect PCA (5100B & 5102B)	7-13
7-5	A8 Tape Interface PCA (5101B)	7-14
7-6	A9 Power Supply Regulator PCA	7-16
7-7	A10 Front Panel PCA and A10A1 Display PCA (5100B & 5102B)	7-18
7-8	A10 Front Panel PCA and A10A1 Display PCA (5101B)	7-22
7-9	A11 Ranging PCA	7-26
7-10	A12 Wideband Output PCA (Option -03)	7-29
7-11	A13 Wideband Oscillator PCA	7-32
7-12	A14 Analog Control PCA	7-35
7-13	A15 Digital-to-Analog PCA	7-37
7-14	A16 Extended High Voltage and A16A1 High Voltage Control PCAs	7-39
7-15	A17 Power Amplifier and A17A1 Power Transistor PCAs	7-42
7-16	A18 Oscillator PCA	7-46
7-17	A19 Isolator PCA	7-48
7-18	A20 Controller PCA	7-50
7-19	A21 Tape Drive PCA	7-53
7-20	A22 Bit Serial Interface PCA (Option -06)	7-55
7-21	A23 IEEE-488 Interface Main & A23A1 IEEE-488 Piggyback PCAs (Option -05)	7-57

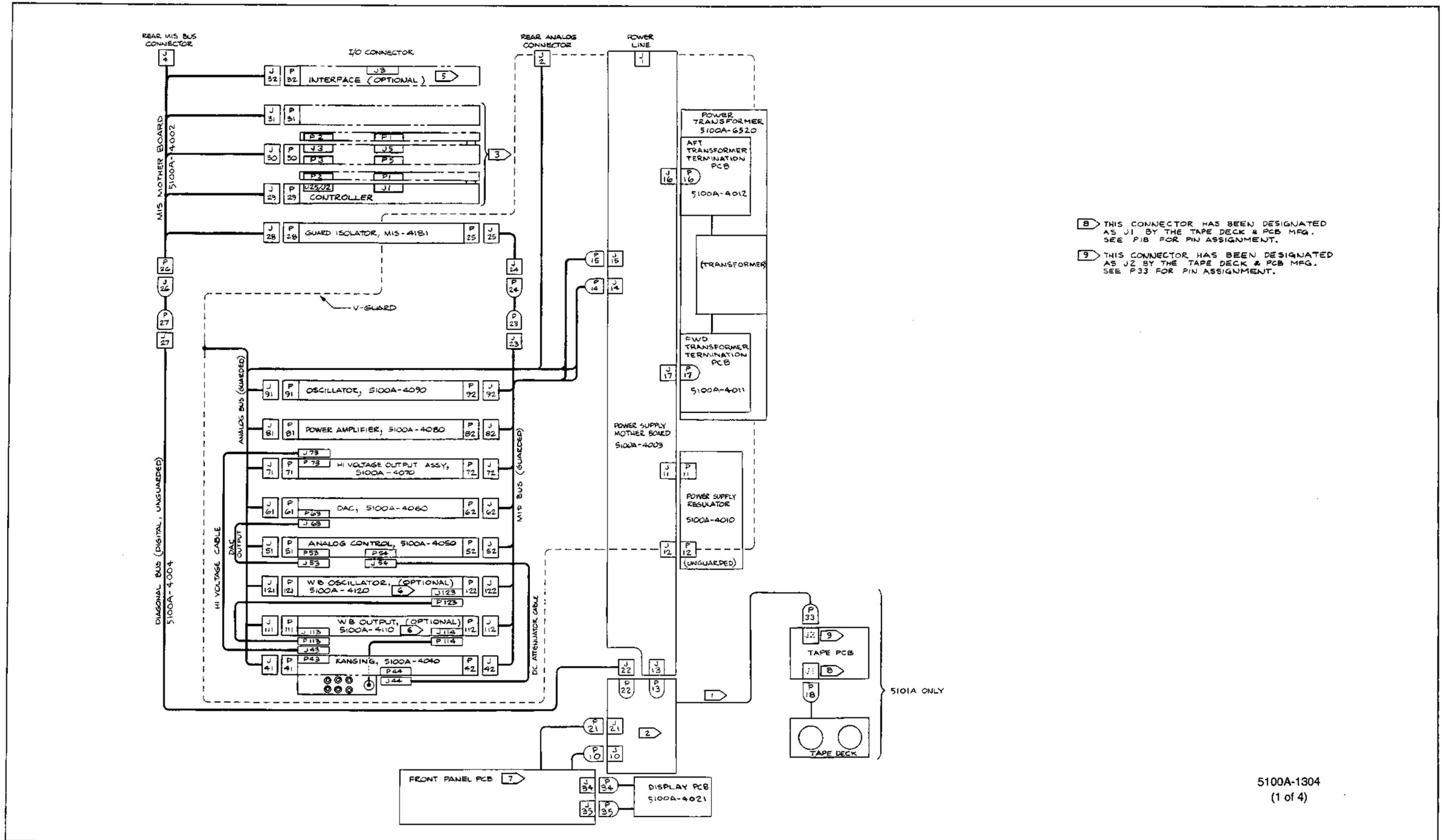

5100A-1304
(1 of 4)

Figure 7-1. Interconnect Diagram

REAR ANALOG J2		REAR HIS BUS J6		PS INTERCONNECT/TAPE INTERFACE J10		PS MOTHER J11		PS MOTHER J12		PS INTERCONNECT/TAPE INTERFACE J15		PS MOTHER J14		PS MOTHER J15		TAPE J18		PS INTERCONNECT/TAPE INTERFACE J21		PS INTERCONNECT J22		GUARDED BUS J23							
PIN	Mnemonic	PIN	Mnemonic	PIN	Mnemonic	PIN	Mnemonic	PIN	Mnemonic	PIN	Mnemonic	PIN	Mnemonic	PIN	Mnemonic	PIN	Mnemonic	PIN	Mnemonic	PIN	Mnemonic	PIN	Mnemonic						
1	V-GUARD	1	ID1	1	TNT	1	+5V (FH)	1	+5V (FH)	1	SPARE W	1	+15V (S) RET (⊕g)	1	R/W HD	1	IC3	1	SPARE RT3	1	IC1	1	IC1	1	IC1	1	IC1		
2	AC PHASE	2	ID3	2	INA	2	+5V (RET, FC)	2	+5V (RET, FC)	2	CHASSIS 5	2	+15V (S)	2	-15V (S)	2	HD SMLD RTN	2	IC2	2	REAL TIME CLK	2	IC2	2	IC2	2	IC2	2	IC2
3	OSC OUT	3	ID5	3	+5V (Vcc)	3	+62V RET (⊕g)	3	+62V RET (⊕g)	3	+5V RET (Vss)	3	+5V (S)	3	-15V (S)	3	POP	3	IC3	3	-12V (Vgg)	3	IC3	3	IC3	3	IC3	3	IC3
4	EXT OSC	4	ID7	4	SPARE Y	4	-62V (UNREG)	4	-62V (UNREG)	4	+8V	4	+8V	4	+8V	4	GND RTN	4	IC4	4	SPARE X	4	IC4	4	IC4	4	IC4	4	IC4
5		5	IC1	5	+8V	5	-39V	5	-39V	5	+5V (Vcc)	5	+5V (F)	5	+5V (F)	5	LED -	5	ID7	5	TNT	5	ID7	5	ID7	5	ID7	5	ID7
6		6	IC3	6	+8V RET	6	+62V	6	+62V	6	+5V (Vcc)	6	-15V (F)	6	-15V (F)	6	BUMB TACH	6	ID6	6	+5V RET (Vss)	6	ID6	6	ID6	6	ID6	6	ID6
7	OSC COM	7	IC5	7	SPARE U	7	+62V	7	+62V	7	+5V (FH)	7	-10V	7	-10V	7	FWD TACH RTN	7	ID5	7	+5V (Vcc)	7	ID5	7	ID5	7	ID5	7	ID5
8	PHASE LOCK	8	+5V (Vcc)	8	+5V RET (Vss)	8	+62V (UNREG)	8	+62V (UNREG)	8	+62V	8	+10V RET	8	+10V	8	+10V	8	RWHD TACH RTN	8	ID4	8	IC6	8	IC6	8	IC6	8	IC6
9	OSC 90°	9	ACK	9	+5V RET (Vss)	9	+39V	9	+39V	9	+5V (RET, FC)	9	+10V RET	9	+10V	9	FWD TACH	9	ID8	9	+5V RET (Vss)	9	ID8	9	ID8	9	ID8	9	ID8
10	AUX OUT	10	+5V RET (Vss)	10	CHASSIS 5	10	POP	10	POP	10	+40V (F, UNREG)	10	+10V	10	+10V	10	RWHD MOT (+)	10	ID1	10	IC2	10	IC2	10	IC2	10	IC2	10	IC2
11	V-GUARD	11	+8V RET	11	+8V RET	11	+8V	11	+8V	11	+40V (F, RET)	11	+10V	11	+10V	11	RWHD MOT RTN	11	ID2	11	IC8	11	IC8	11	IC8	11	IC8	11	IC8
12	EXT SENSE HI	12	INA	12	+8V	12		12		12	+40V (F, UNREG)	12	-10V	12	-10V	12	RWHD MOT	12	ID3	12	ID6	12	ID6	12	ID6	12	ID6		
13	EXT SENSE LO	13	SPARE V	13	SPARE V	13	+12V (UNREG)	13	+12V (UNREG)	13	+5V (Vcc)	13	+5V (Vcc)	13	+5V (Vcc)	13	RWHD MOT RTN	13	ID4	13	IC4	13	IC4	13	IC4	13	IC4		
14	AUX COM	14	+12V (Vdd)	14	+5V (Vcc)	14	-12V (UNREG)	14	-12V (UNREG)	14	+5V RET (Vss)	14	-20V (LC)	14	-20V (LC)	14	R/W HD	14	ID2	14	ID2	14	ID2	14	ID2	14	ID2		
15		15	REAL TIME CLK	15	-12V (Vgg)	15	POP	15	POP	15	+12V (Vdd)	15	+12V (Vdd)	15	+12V (Vdd)	15	SPARE AA	15	ID8	15	ID8	15	ID8	15	ID8	15	ID8		
16		16	RT3	16	+12V (Vdd)	16	+12V (Vdd)	16	+12V (Vdd)	16	REAL TIME CLK	16	-15V (LH)	16	-15V (LH)	16	SPARE AB	16	IC8	16	IC8	16	IC8	16	IC8	16	IC8		
17		17	RT1	17		17		17		17	+12V (Vdd)	17	+12V (Vdd)	17	SPARE AB	17	ID6	17	ID6	17	ID6	17	ID6	17	ID6				
18	V-GUARD	18	V-GUARD	18	-15V (LH)	18	-15V (LH)	18	-15V (LH)	18	+5V RET (Vss)	18	+5V RET (Vss)	18	+5V RET (Vss)	18	A/B SENS	18	ID4	18	ID4	18	ID4	18	ID4	18	ID4		
19	ID8	19	ID8	19	-20V (LC)	19	-20V (LC)	19	-20V (LC)	19	+5V (Vcc) & MOTV	19	+5V (Vcc) & MOTV	19	+5V (Vcc) & MOTV	19	CASS. SENS	19	ID2	19	ID2	19	ID2	19	ID2	19	ID2		
20	ID2	20	ID2	20	-15V (LH, UNREG)	20	-15V (LH, UNREG)	20	-15V (LH, UNREG)	20	+5V (UNREG)	20	+5V (UNREG)	20	+5V (UNREG)	20	WRT INTLK	20	ID8	20	ID8	20	ID8	20	ID8	20	ID8		
21	ID4	21	ID4	21	5V (FH)	21	5V (FH)	21	5V (FH)	21	-15V (S, UNREG)	21	-15V (S, UNREG)	21	-15V (S, UNREG)	21	SENS C	21	ID4	21	ID4	21	ID4	21	ID4	21	ID4		
22	ID6	22	ID6	22	-5V (F, UNREG)	22	-5V (F, UNREG)	22	-5V (F, UNREG)	22	-15V (S)	22	-15V (S)	22	-15V (S)	22	SENS E	22	ID6	22	ID6	22	ID6	22	ID6	22	ID6		
23	ID4	23	ID4	23	+62V RET (⊕g)	23	+62V RET (⊕g)	23	+62V RET (⊕g)	23	+15V (S) RET (⊕g)	23	+15V (S) RET (⊕g)	23	+15V (S) RET (⊕g)	23	SENS E	23	ID2	23	ID2	23	ID2	23	ID2	23	ID2		
24	ID2	24	ID2	24	-62V	24	-62V	24	-62V	24	+15V (S)	24	+15V (S)	24	+15V (S)	24	SENS E	24	ID4	24	ID4	24	ID4	24	ID4	24	ID4		
25	ID4	25	ID4	25	-62V (UNREG)	25	-62V (UNREG)	25	-62V (UNREG)	25	+15V (S, UNREG)	25	+15V (S, UNREG)	25	+15V (S, UNREG)	25	SENS E	25	ID6	25	ID6	25	ID6	25	ID6	25	ID6		
26	IC6	26	IC6	26	-39V	26	-39V	26	-39V	26	-15V (F)	26	-15V (F)	26	-15V (F)	26	SENS E	26	ID8	26	ID8	26	ID8	26	ID8	26	ID8		
27	+5V (Vcc)	27	+5V (Vcc)	27	+62V	27	+62V	27	+62V	27	+40V (F, UNREG)	27	+40V (F, UNREG)	27	+40V (F, UNREG)	27	SENS E	27	ID4	27	ID4	27	ID4	27	ID4	27	ID4		
28	+5V RET (Vss)	28	+5V RET (Vss)	28	+62V (UNREG)	28	+62V (UNREG)	28	+62V (UNREG)	28	+15V (F)	28	+15V (F)	28	+15V (F)	28	SENS E	28	ID6	28	ID6	28	ID6	28	ID6	28	ID6		
29	TNT	29	TNT	29	+39V	29	+39V	29	+39V	29	+40V (F, UNREG)	29	+40V (F, UNREG)	29	+40V (F, UNREG)	29	SENS E	29	ID8	29	ID8	29	ID8	29	ID8	29	ID8		
30		30		30		30		30		30	+40V (F, RET)	30	+40V (F, RET)	30	SENS E	30	ID4	30	ID4	30	ID4	30	ID4	30	ID4	30	ID4		
31	-12V (Vgg)	31	-12V (Vgg)	31		31		31		31	REAL TIME CLK	31	REAL TIME CLK	31	SENS E	31	ID6	31	ID6	31	ID6	31	ID6	31	ID6	31	ID6		
32	RT4	32	RT4	32	POP	32	POP	32	POP	32	REAL TIME CLK	32	REAL TIME CLK	32	SENS E	32	ID8	32	ID8	32	ID8	32	ID8	32	ID8	32	ID8		
33	RT2	33	RT2	33		33		33		33	+12V (UNREG)	33	+12V (UNREG)	33	SENS E	33	ID4	33	ID4	33	ID4	33	ID4	33	ID4	33	ID4		
34	RT8	34	RT8	34		34		34		34	-12V (UNREG)	34	-12V (UNREG)	34	SENS E	34	ID6	34	ID6	34	ID6	34	ID6	34	ID6	34	ID6		
35		35		35	POP	35	POP	35	POP	35	+12V RET	35	+12V RET	35	SENS E	35	ID8	35	ID8	35	ID8	35	ID8	35	ID8	35	ID8		
36		36		36	POP	36	POP	36	POP	36	-12V (Vgg)	36	-12V (Vgg)	36	SENS E	36	ID4	36	ID4	36	ID4	36	ID4	36	ID4	36	ID4		
37		37		37		37		37		37	+12V (Vdd)	37	+12V (Vdd)	37	SENS E	37	ID6	37	ID6	37	ID6	37	ID6	37	ID6	37	ID6		
38		38		38	-15V (LH)	38	-15V (LH)	38	-15V (LH)	38	+5V RET (Vss)	38	+5V RET (Vss)	38	SENS E	38	ID8	38	ID8	38	ID8	38	ID8	38	ID8	38	ID8		
39		39		39	-20V (LC)	39	-20V (LC)	39	-20V (LC)	39	+5V (Vcc) & MOTV	39	+5V (Vcc) & MOTV	39	SENS E	39	ID4	39	ID4	39	ID4	39	ID4	39	ID4	39	ID4	39	ID4
40		40		40	-15V (LH, UNREG)	40	-15V (LH, UNREG)	40	-15V (LH, UNREG)	40	+5V (UNREG)	40	+5V (UNREG)	40	SENS E	40	ID6	40	ID6	40	ID6	40	ID6	40	ID6	40	ID6	40	ID6

GUARDED BUS J24		ISOLATOR GUARDED J25		UNGUARDED BUS J26		UNGUARDED BUS J27		ISOLATOR UNGUARDED J28		CONTROLLER J29		INTERFACE J30		INTERFACE J31		INTERFACE J32		RANGING J41		RANGING J42							
PIN	Mnemonic	PIN	Mnemonic	PIN	Mnemonic	PIN	Mnemonic	PIN	Mnemonic	PIN	Mnemonic	PIN	Mnemonic	PIN	Mnemonic	PIN	Mnemonic	PIN	Mnemonic	PIN	Mnemonic						
1		1	SPARE RT3	1	SPARE RT3	1	SPARE RT3	1	V-GUARD	1	V-GUARD	1	V-GUARD	1	V-GUARD	1	V-GUARD	1	V-GUARD	1	V-GUARD	1	V-GUARD	1	V-GUARD		
2		2	REAL TIME CLK	2	REAL TIME CLK	2	REAL TIME CLK	2	REAL TIME CLK	2	RT8	2	RT8	2	RT8	2	RT8	2	RT8	2	RT8	2	RT8	2	RT8		
3		3	-12V (Vgg)	3	-12V (Vgg)	3	-12V (Vgg)	3	-12V (Vgg)	3	RT2	3	RT2	3	RT2	3	RT2	3	RT2	3	RT2	3	RT2	3	RT2		
4		4	SPARE X	4	SPARE X	4	SPARE X	4	SPARE X	4	RT4	4	RT4	4	RT4	4	RT4	4	RT4	4	RT4	4	RT4	4	RT4		
5		5	TNT	5	TNT	5	TNT	5	TNT	5	RT4	5	RT4	5	RT4	5	RT4	5	RT4	5	RT4	5	RT4	5	RT4		
6		6	+5V RET (Vss)	6	+5V RET (Vss)	6	+5V RET (Vss)	6	+5V RET (Vss)	6	-12V (Vgg)	6	-12V (Vgg)	6	-12V (Vgg)	6	-12V (Vgg)	6	-12V (Vgg)	6	-12V (Vgg)	6	-12V (Vgg)	6	-12V (Vgg)	6	-12V (Vgg)
7		7	+5V (Vcc)	7	+5V (Vcc)	7	+5V (Vcc)	7	+5V (Vcc)	7		7		7		7		7		7		7		7			
8	-15V (S)	8	-15V (S)	8	IC6	8	IC6	8	IC6	8	SPARE X	8	SPARE X	8	SPARE X	8	SPARE X	8	SPARE X	8	SPARE X	8	SPARE X	8	SPARE X		
9	⊕g	9	⊕g / AR	9	IC4	9	IC4	9	IC4	9	TNT	9	TNT	9	TNT	9	TNT	9	TNT	9	TNT	9	TNT	9	TNT		
10		10		10	IC2	10	IC2	10	IC2	10	+5V RET (Vss)	10	+5V RET (Vss)	10	+5V RET (Vss)	10	+5V RET (Vss)	10	+5V RET (Vss)	10	+5V RET (Vss)	10	+5V RET (Vss)	10	+5V RET (Vss)		
11	-20V (LC)	11	-20V (LC)	11	IC8	11	IC8	11	IC8	11	+5V (Vcc)	11	+5V (Vcc)	11	+5V (Vcc)	11	+5V (Vcc)	11	+5V (Vcc)	11	+5V (Vcc)	11	+5V (Vcc)	11	+5V (Vcc)		
12	-15V (LH)	12	-15V (LH)	12	IC6	12	IC6	12	IC6	12	+5V (Vcc)	12	+5V (Vcc)														

ANALOG CONTROL		ANALOG CONTROL		DAC		DAC		HV OUTPUT		HV OUTPUT		POWER AMPLIFIER		POWER AMPLIFIER		OSCILLATOR		OSCILLATOR		WB OUTPUT		WB OUTPUT	
J51		J52		J61		J62		J71		J72		J81		J82		J91		J92		J111		J112	
PIN	Mnemonic	PIN	Mnemonic	PIN	Mnemonic	PIN	Mnemonic	PIN	Mnemonic	PIN	Mnemonic	PIN	Mnemonic	PIN	Mnemonic	PIN	Mnemonic	PIN	Mnemonic	PIN	Mnemonic	PIN	Mnemonic
1		1		1		1		1		1		1	+62V	1		1		1		1		1	
2		2		2		2		2		2		2	+10V	2		2		2		2		2	
3		3		3	⊕	3		3	⊕	3		3	⊕	3		3		3		3		3	
4		4		4		4		4		4		4	-10V	4		4		4		4		4	
5		5		5		5		5		5		5	-62V	5		5		5		5		5	
6	AUX DC SENSE	6		6		6		6		6	-15V (LH)	6		6		6		6		6	AUX DC SENSE	6	-15V (LH)
7		7		7		7		7		7	-20V (LC)	7		7		7		7		7		7	-20V (LC)
8	-40V (F, UNREG)	8	-15V (S)	8	-40V (F, UNREG)	8		8		8	-15V (S)	8		8	-15V (S)	8		8		8		8	-15V (S)
9	+15V (F)	9	⊕	9	+15V (F)	9		9		9	⊕	9		9	⊕	9		9		9		9	⊕
10	VR COM	10		10	VR COM	10		10		10	+15V (F)	10		10		10		10		10		10	⊕
11		11	-20V (LC)	11		11	-20V (LC)	11		11		11		11	-20V (LC)	11		11		11		11	-20V (LC)
12		12	-15V (LH)	12		12	-15V (LH)	12		12		12		12	-15V (LH)	12		12		12		12	-15V (LH)
13		13		13		13		13		13		13		13		13		13		13		13	
14	I-GUARD	14	IC4	14	IC4	14	IC4	14		14	IC4	14		14	IC4	14		14		14		14	IC4
15	AUX DC RETURN	15	IC2	15	IC2	15	IC2	15		15		15		15		15		15		15	AUX DC SENSE RET	15	IC2
16		16		16		16		16	PA OUT	16	IC8	16		16	IC8	16		16		16	PA OUT	16	IC8
17	CONTROL	17	ID6	17	ID6	17	ID6	17		17	ID6	17		17	ID6	17		17		17		17	ID6
18		18	ID4	18	ID4	18	ID4	18		18	ID4	18		18	ID4	18		18		18		18	ID4
19		19	ID2	19	ID2	19	ID2	19		19	ID2	19		19	ID2	19		19		19		19	ID2
20		20	ID8	20	ID8	20	ID8	20		20	ID8	20		20	ID8	20	OSC. OUT	20		20		20	ID8
21	BUFFERED AC	21		21		21		21		21		21		21		21		21		21		21	
22		22		22		22		22		22		22		22		22		22		22		22	
23		23	OVERLOAD	23		23	⊕	23	⊕	23		23		23	OVERLOAD	23		23		23		23	
24		24		24		24		24		24		24		24		24		24		24		24	
25		25	POP	25		25	POP	25		25	POP	25		25	POP	25		25		25		25	POP
26		26		26		26		26		26		26		26		26		26		26		26	
27		27		27		27		27		27		27		27		27		27		27		27	
28	⊕F	28	+15V (S)	28	⊕F	28	+15V (F)	28		28	+15V (S)	28		28	+15V (S)	28		28		28		28	+15V (S)
29	-15V (F)	29		29		29		29		29		29		29		29		29		29		29	
30	+40V (F, UNREG)	30	⊕	30		30		30		30	⊕	30		30	⊕	30		30		30		30	⊕
31	-VR	31	-20V (LC)	31	-VR	31	-20V (LC)	31		31	-20V (LC)	31		31	-20V (LC)	31		31		31		31	-20V (LC)
32		32	ACK	32	ACK	32	ACK	32		32	ACK	32		32	ACK	32		32		32		32	ACK
33		33	-15V (LH)	33		33	-15V (LH)	33		33		33		33	-15V (LH)	33		33		33		33	
34	I-GUARD	34		34		34		34		34		34		34		34		34		34		34	
35		35	IC3	35	IC3	35	IC3	35		35	IC3	35		35	IC3	35		35		35		35	IC3
36		36	IC1	36	IC1	36	IC1	36	PA OUT	36	IC1	36		36	IC1	36		36		36	PA OUT	36	IC1
37	INT BOOTSTRAP	37	ID7	37	INT BOOTSTRAP	37	ID7	37		37	ID7	37		37	ID7	37	PA INP	37		37	PA INP	37	ID7
38		38	ID5	38		38	ID5	38		38	ID5	38		38	ID5	38		38		38		38	ID5
39		39	ID3	39		39	ID3	39		39	ID3	39		39	ID3	39		39		39		39	ID3
40		40	ID1	40		40	ID1	40		40	ID1	40		40	ID1	40		40		40		40	ID1

WB OSC		WB OSC	
J121		J122	
PIN	Mnemonic	PIN	Mnemonic
1		1	
2		2	
3		3	
4		4	
5		5	
6		6	-15V (LH)
7		7	-20V (LC)
8		8	-15V (S)
9		9	⊕
10		10	
11		11	
12		12	
13		13	
14		14	IC4
15		15	IC2
16		16	
17	CONTROL	17	ID6
18		18	ID4
19		19	ID2
20		20	ID8
21		21	
22		22	
23		23	
24		24	
25		25	POP
26		26	-15V (LH)
27		27	-20V (LC)
28		28	+15V (S)
29		29	
30		30	⊕
31		31	
32		32	ACK
33		33	
34		34	
35		35	
36		36	IC1
37		37	ID7
38		38	ID5
39		39	ID3
40		40	ID1

5100A-1304
(3 of 4)

Figure 7-1. Interconnect Diagram (cont)

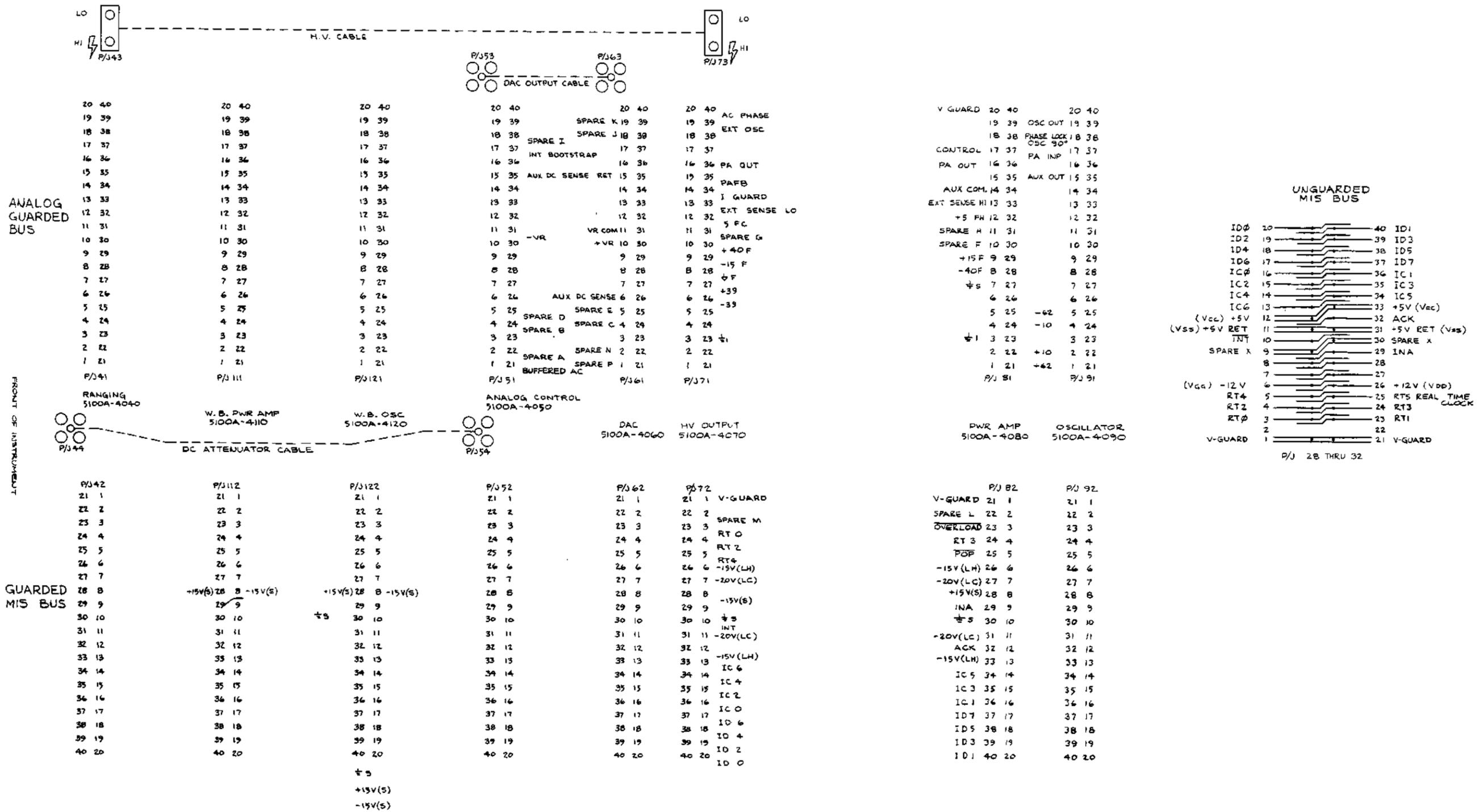
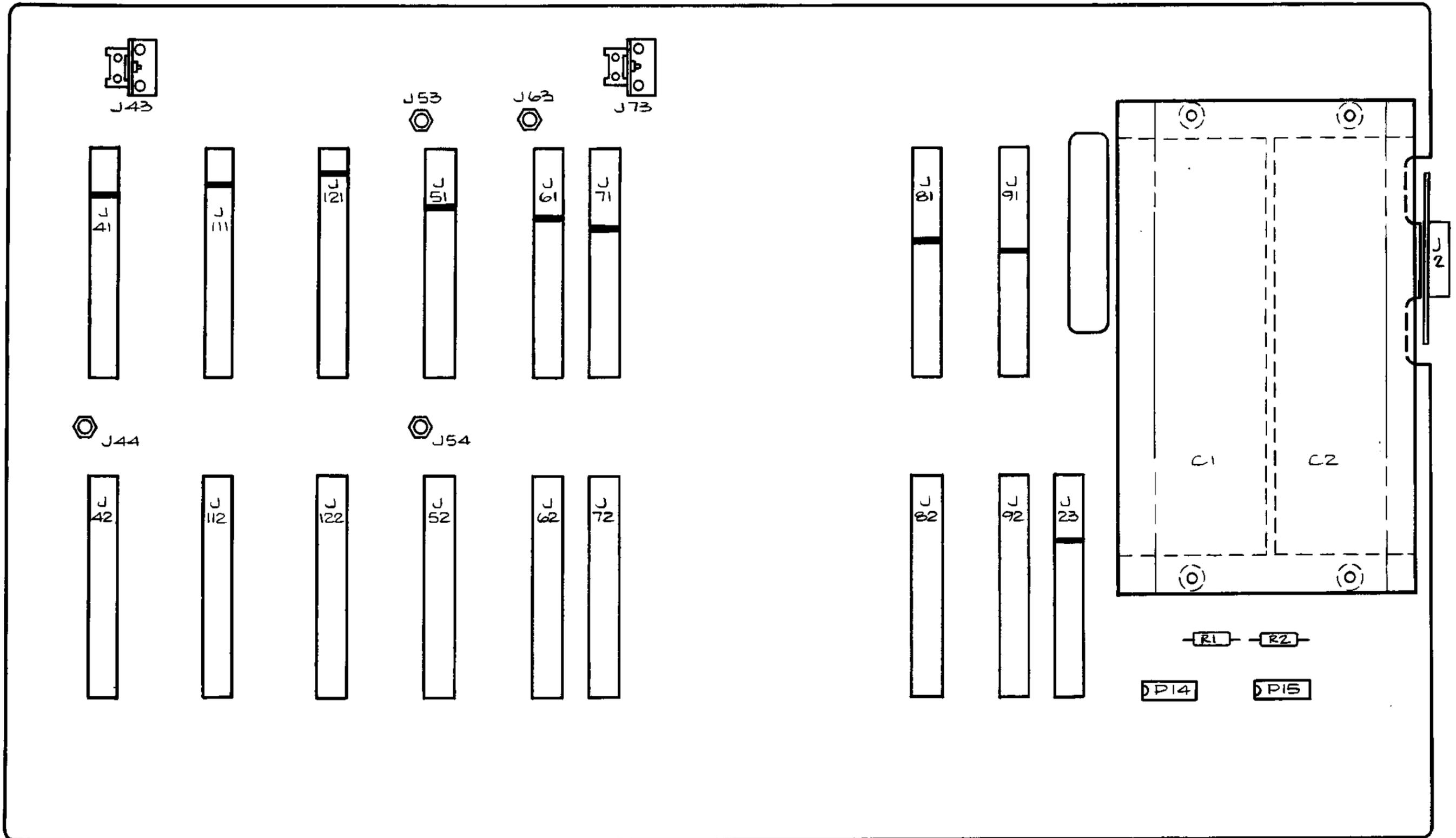
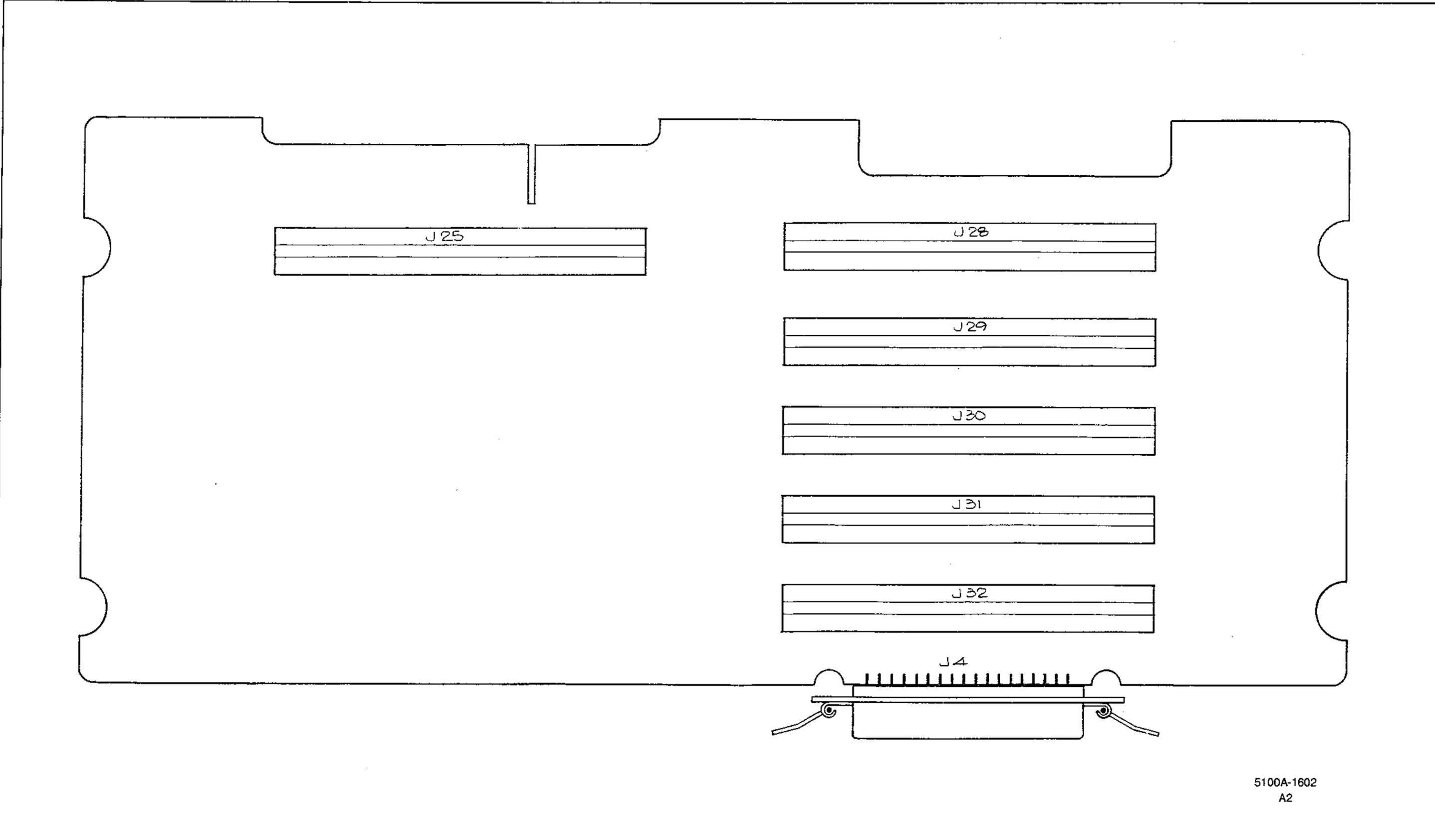

Figure 7-1. Interconnect Diagram (cont)



5100A-1601 A1

Figure 7-2. A1 Main Motherboard and A2 MIS Motherboard PCAs



5100A-1602
A2

Figure 7-2. A1 Main Motherboard and
A2 MIS Motherboard PCAs (cont)

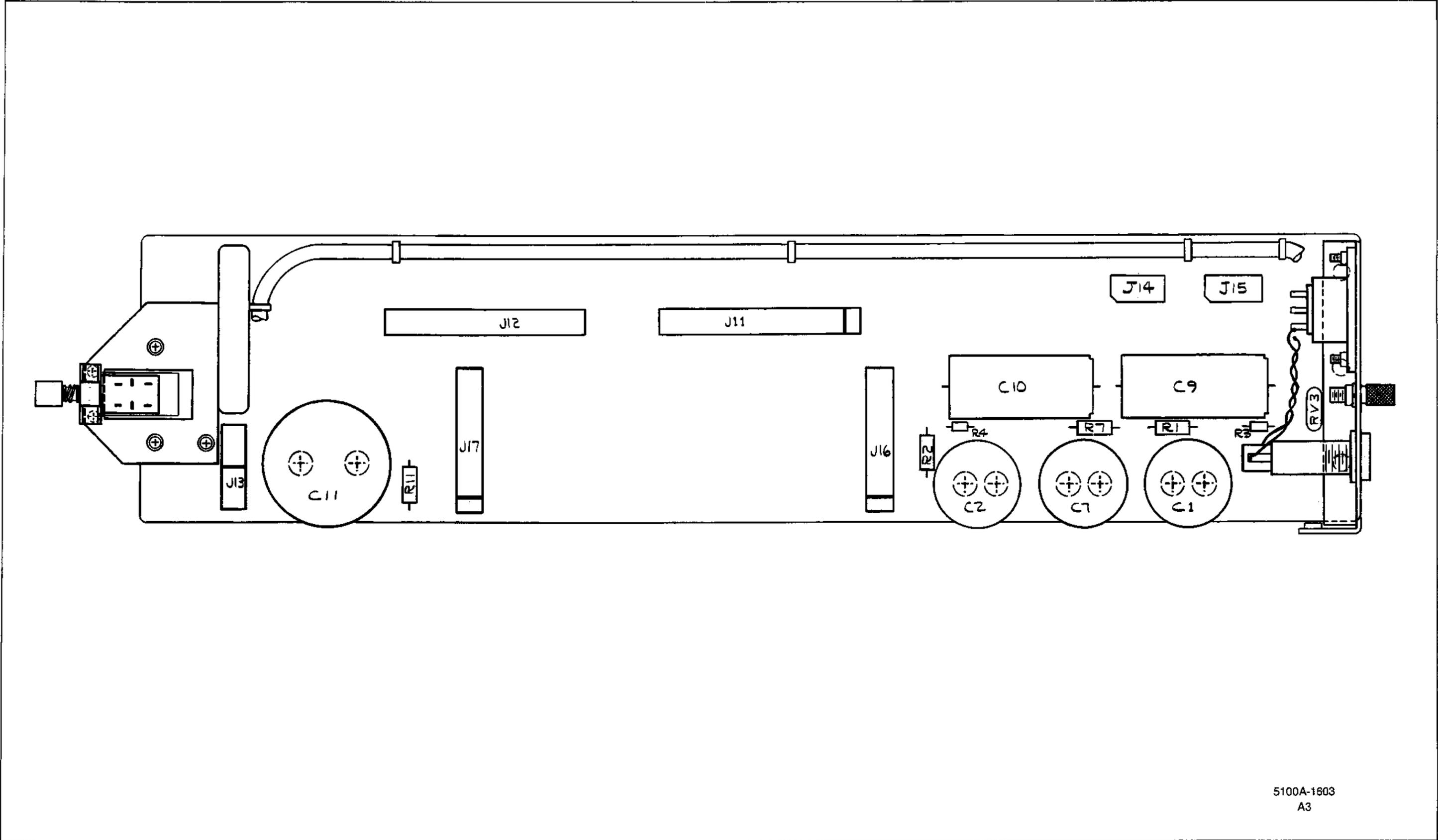

5100A-1603
A3

Figure 7-3. A3 Power Supply Motherboard PCA and A7 Power Supply Termination Assembly

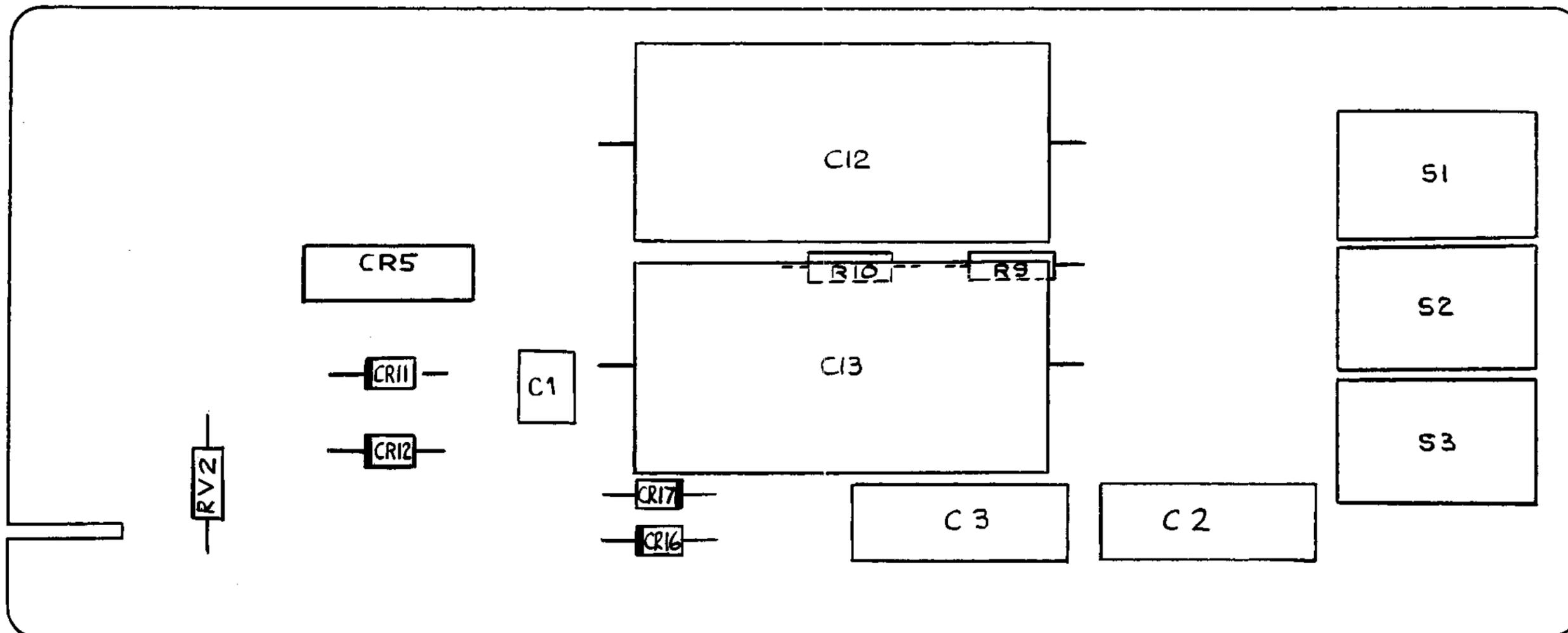

5100A-1611
A7A1

Figure 7-3. A3 Power Supply Motherboard PCA and A7 Power Supply Termination Assembly (cont)

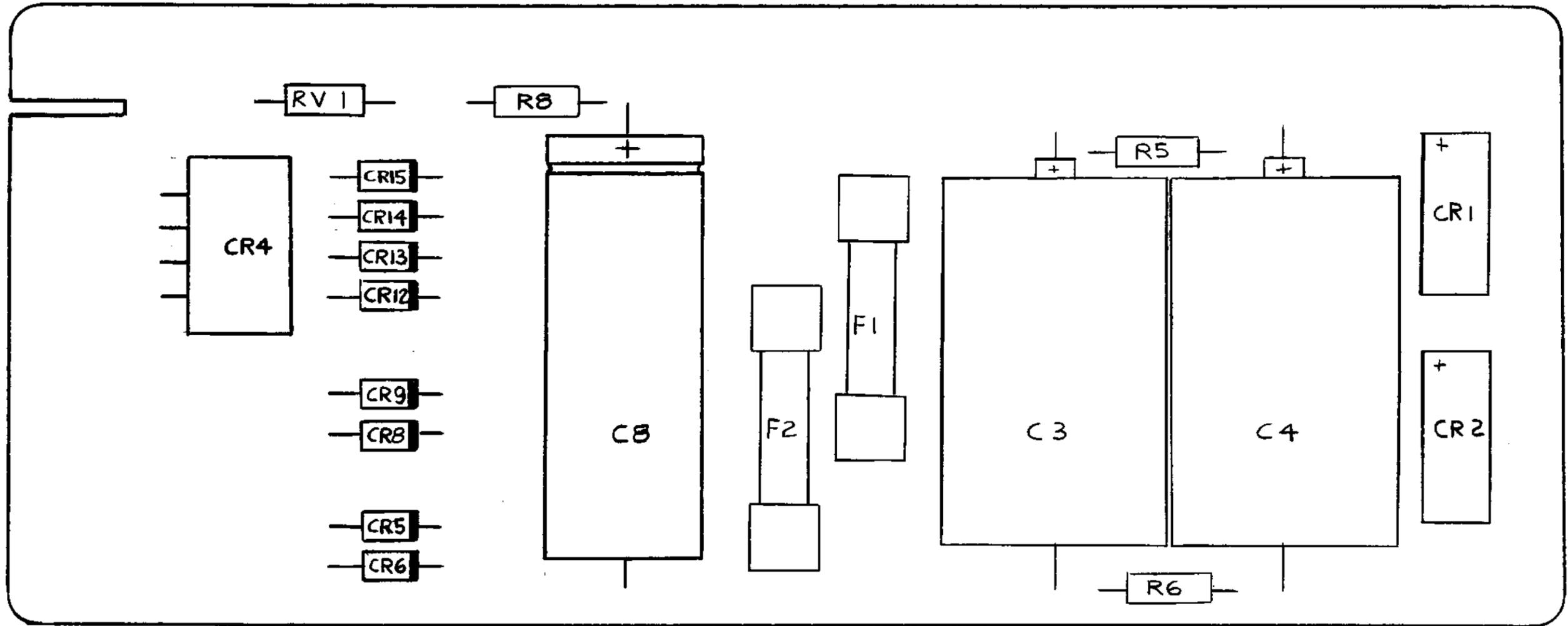

5100A-1612
A7A2

Figure 7-3. A3 Power Supply Motherboard PCA and A7 Power Supply Termination Assembly (cont)

VOLTAGE ± 10%	POSITION OF DOTS		
	S1	S2	S3
100	UP	UP	DOWN
110	UP	UP	UP
115	UP	DOWN	DOWN
120	UP	DOWN	UP
200	DOWN	UP	DOWN
220	DOWN	UP	UP
230	DOWN	DOWN	DOWN
240	DOWN	DOWN	UP

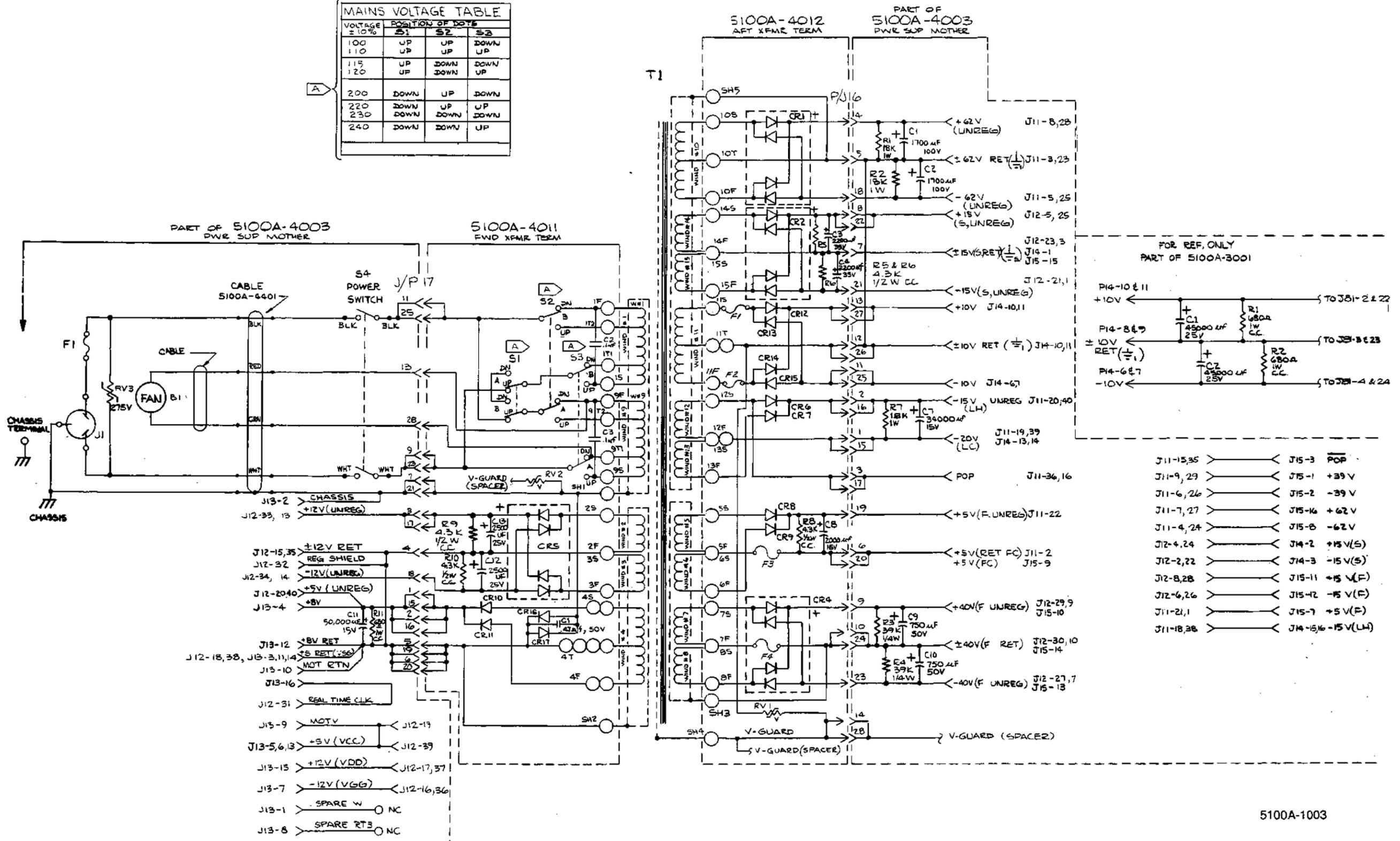

Pin	Signal	Pin	Signal
J11-15,35	POP	J15-3	POP
J11-9, 29	+39 V	J15-1	+39 V
J11-6, 26	-39 V	J15-2	-39 V
J11-7, 27	+62 V	J15-16	+62 V
J11-4, 24	-62 V	J15-8	-62 V
J12-4, 24	+15 V(S)	J14-2	+15 V(S)
J12-2, 22	-15 V(S)	J14-3	-15 V(S)
J12-8, 28	+15 V(F)	J15-11	+15 V(F)
J12-6, 26	-15 V(F)	J15-12	-15 V(F)
J11-21, 1	+5 V(F)	J15-7	+5 V(F)
J11-18, 38	-15 V(LH)	J14-15, 16	-15 V(LH)

Figure 7-3. A3 Power Supply Motherboard PCA and A7 Power Supply Termination Assembly (cont)

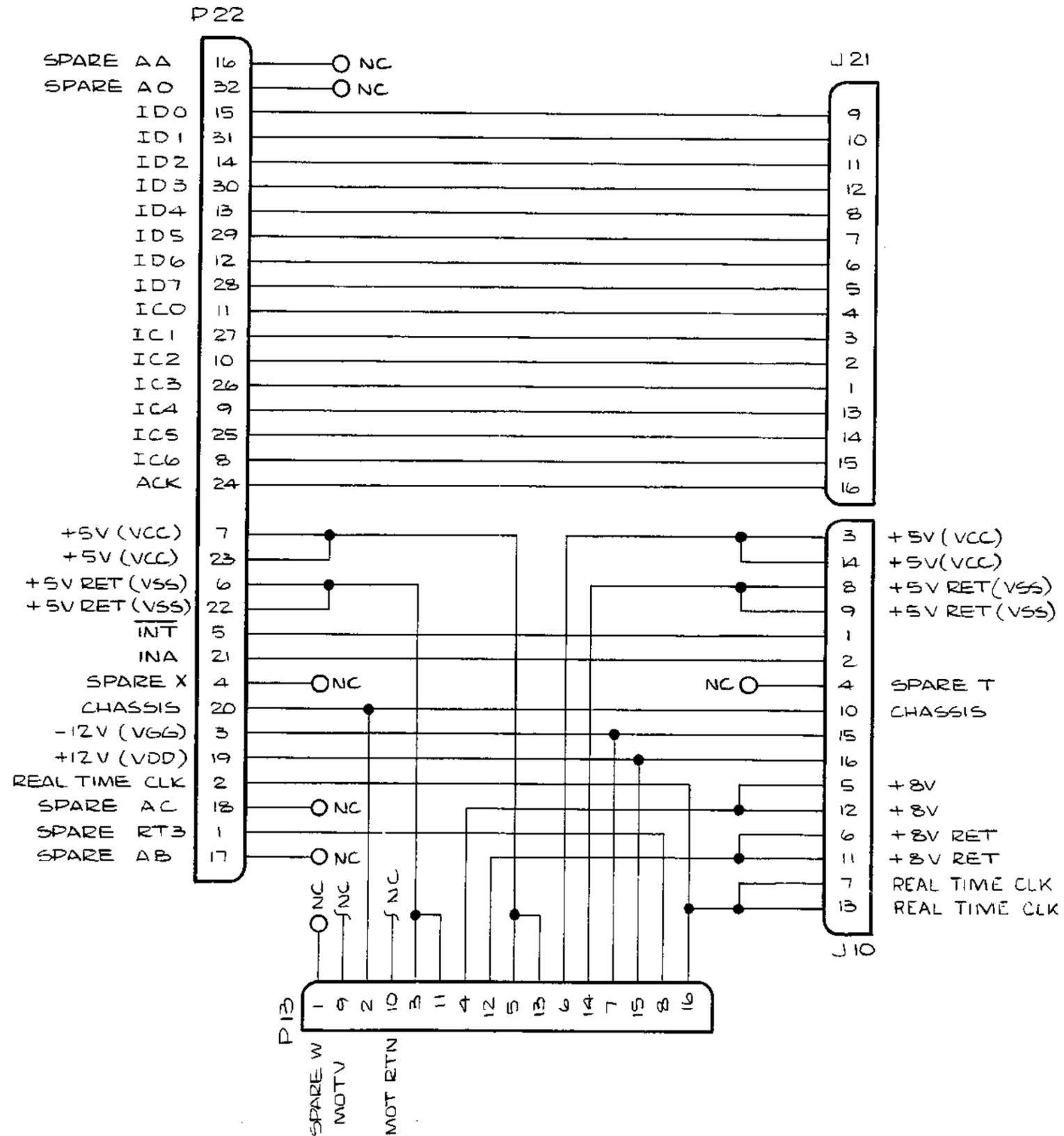

5100A-1130

Figure 7-4. A8 Power Supply Interconnect PCA (5100B & 5102B)

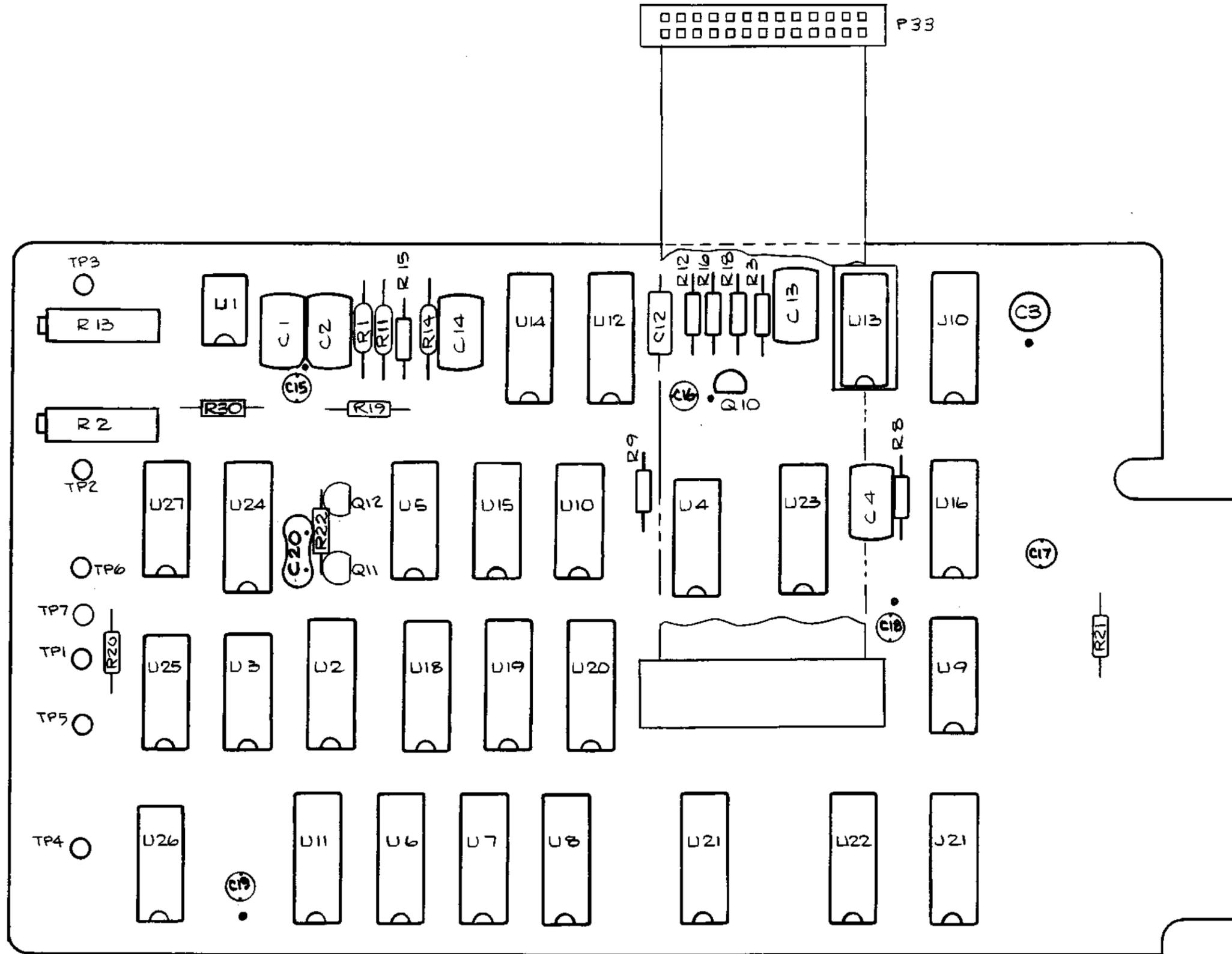

5101A-1730

Figure 7-5. A8 Tape Interface PCA (5100B)

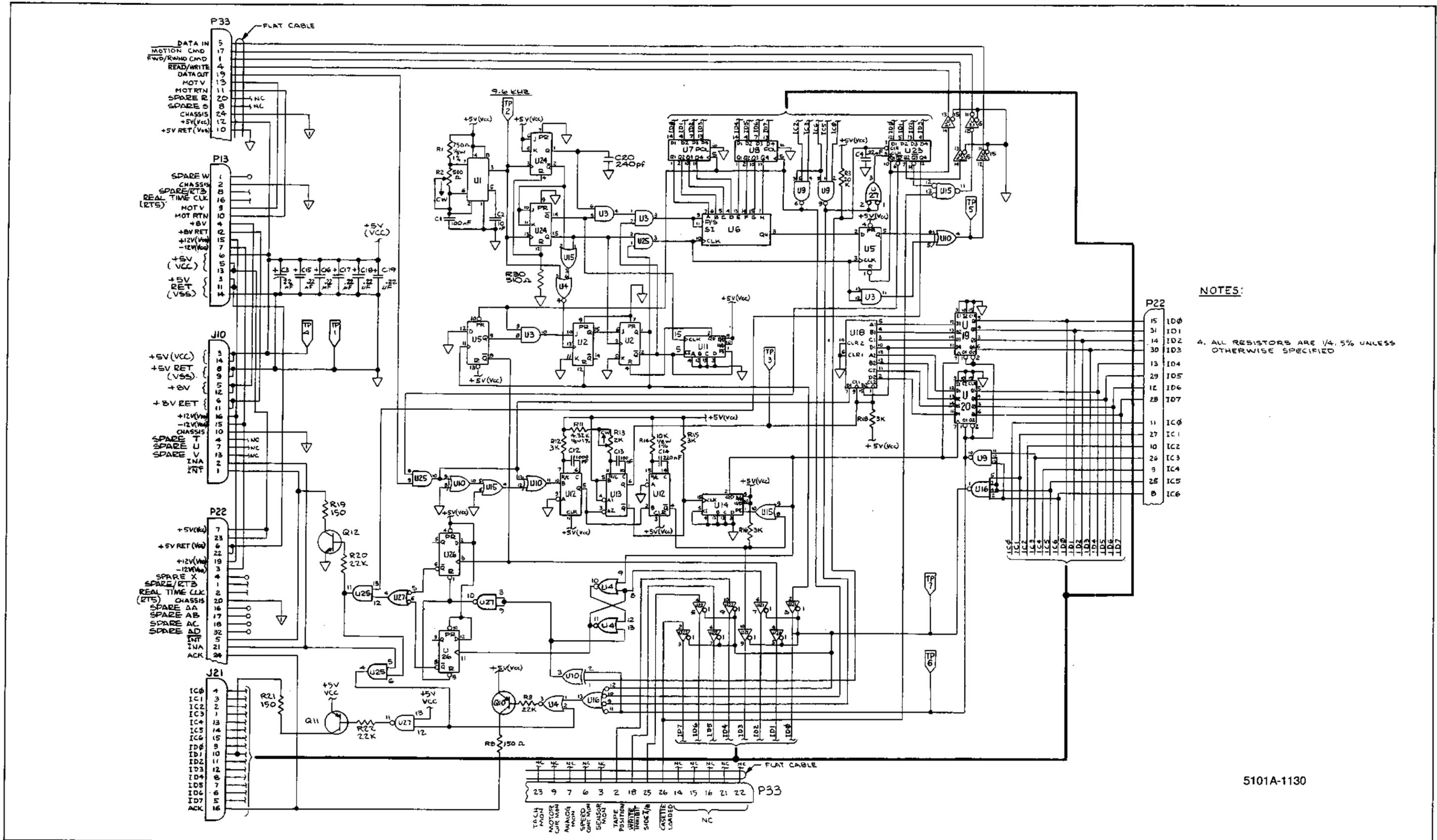

NOTES:
 4. ALL RESISTORS ARE 1/4, 5% UNLESS OTHERWISE SPECIFIED

5101A-1130

Figure 7-5. A8 Tape Interface PCA (5100B) (cont)

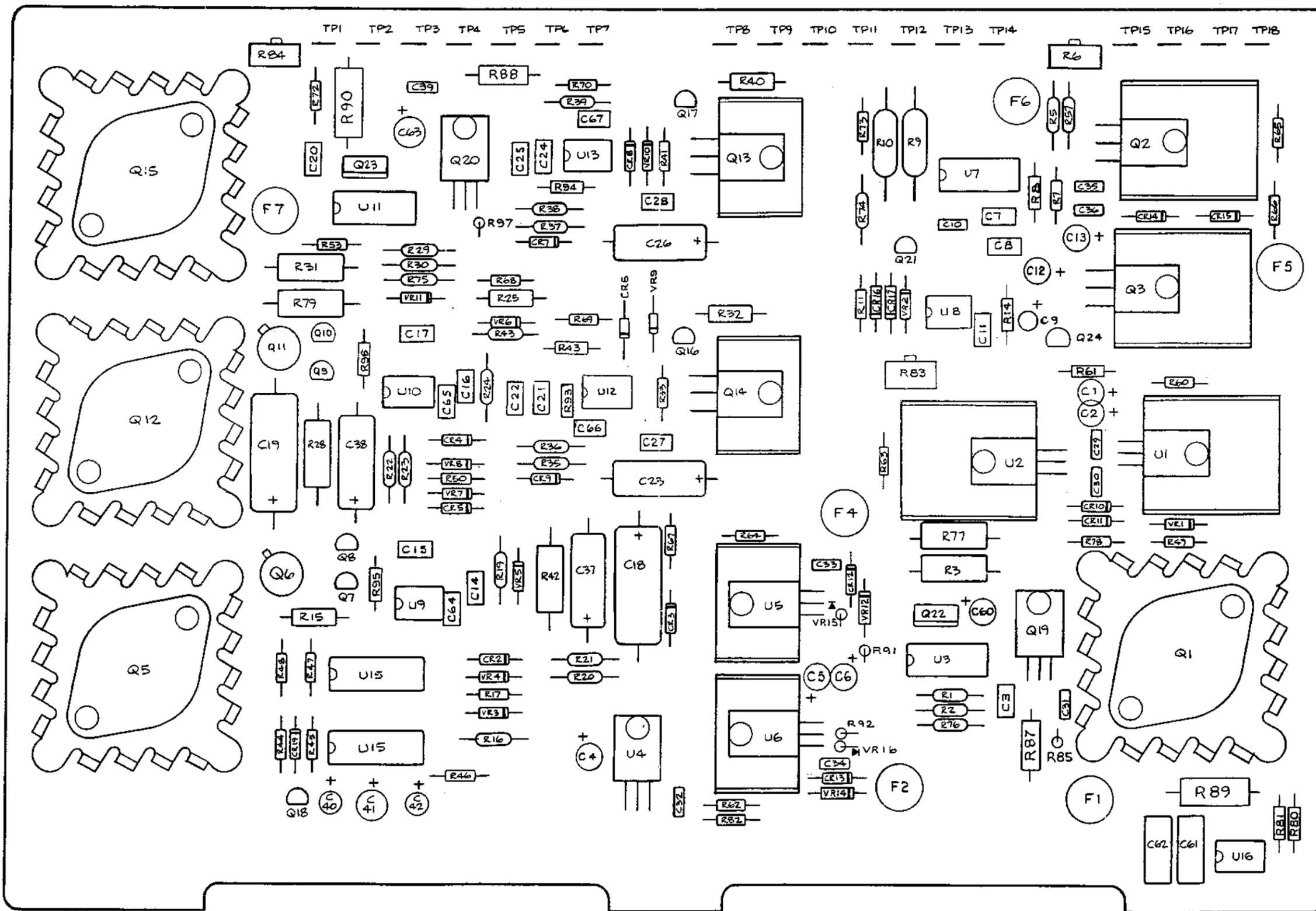
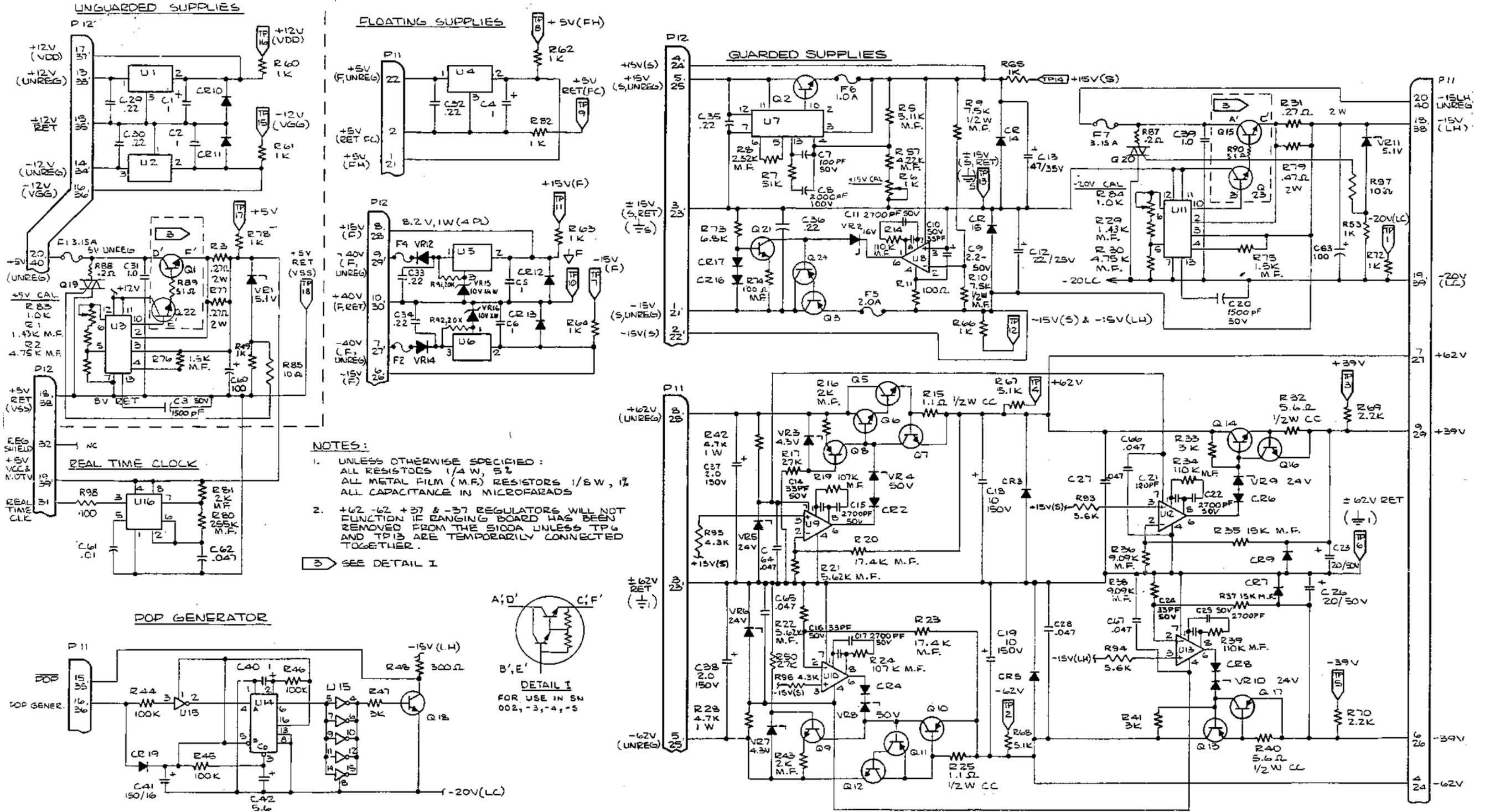

Figure 7-6. A9 Power Supply Regulator PCA



5100A-1010

Figure 7-6. A9 Power Supply Regulator PCA (cont)

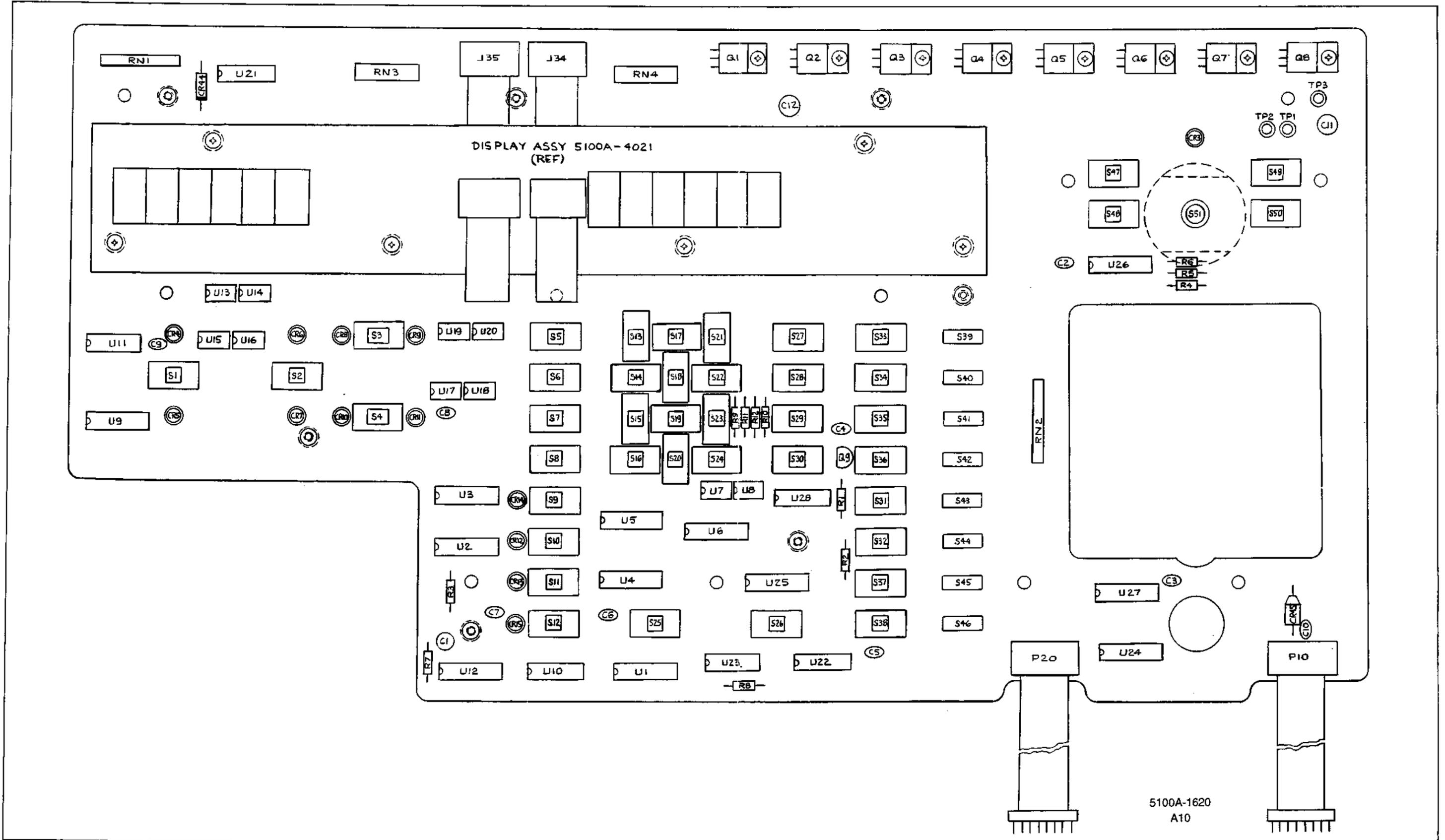
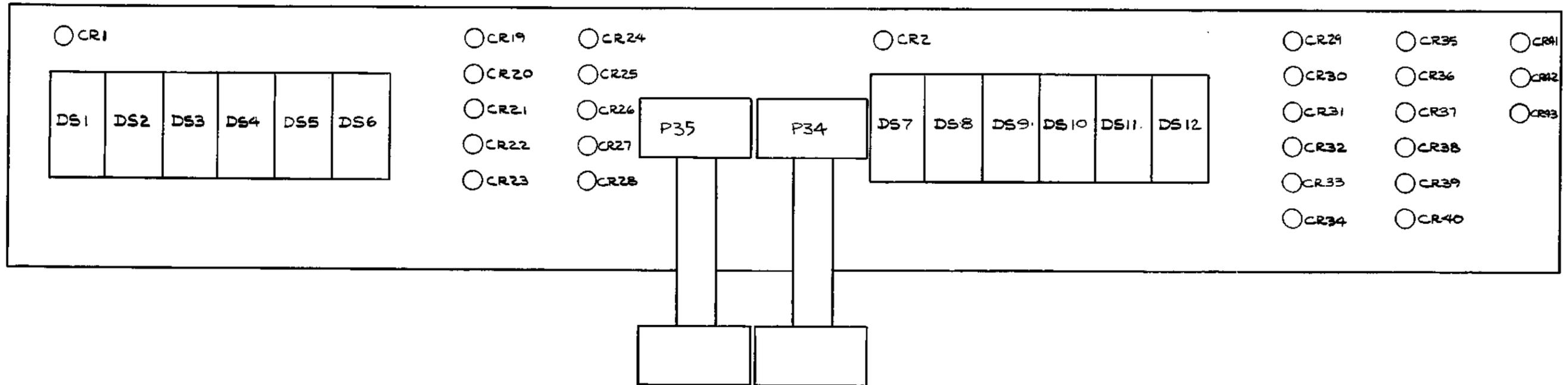
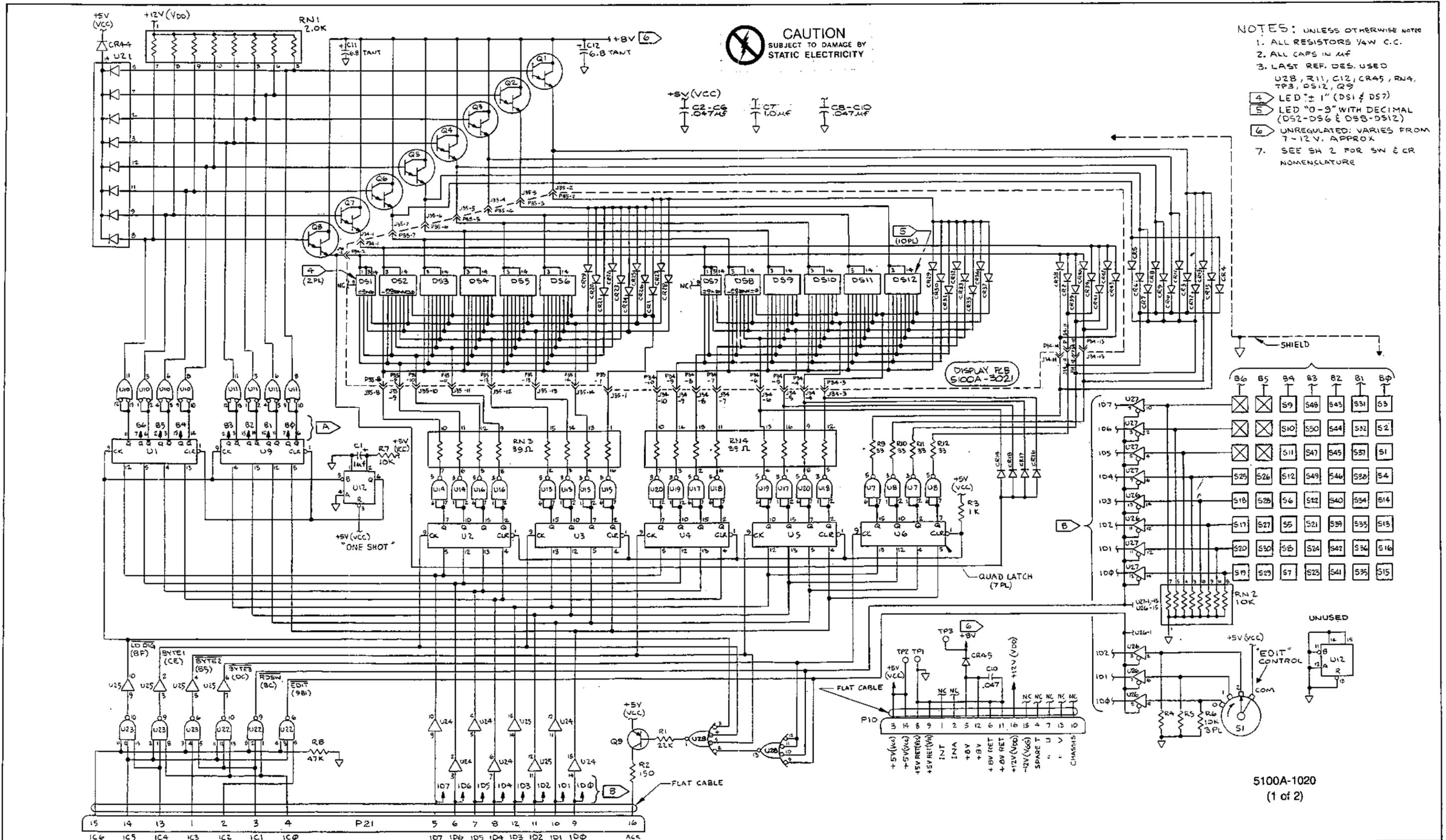

Figure 7-7. A10 Front Panel PCA and A10A1 Display PCA (5100B & 5102B)



5100A-1621
A10A1

Figure 7-7. A10 Front Panel PCA and A10A1 Display PCA (5100B & 5102B) (cont)



CAUTION
SUBJECT TO DAMAGE BY
STATIC ELECTRICITY

- NOTES: UNLESS OTHERWISE NOTED
1. ALL RESISTORS 1/4W C.C.
 2. ALL CAPS IN MF
 3. LAST REF. DES. USED
U28, R11, C12, CR45, RN4,
TP3, DS12, Q9
 4. LED "± 1" (DS1 & DS7)
 5. LED "0-9" WITH DECIMAL
(DS2-DS6 & DS8-DS12)
 6. UNREGULATED: VARIES FROM
7-12V. APPROX
 7. SEE SH 2 FOR SW & CR
NOMENCLATURE

Figure 7-7. A10 Front Panel PCA and A10A1 Display PCA (5100B & 5102B)

TABLE I

SW NO.	NOMENCLATURE
1	50Ω DIVIDER/OVERRIDE
2	INT/EXT Δ
3	OPR/STDBY
4	LOCAL/REM
5	+
6	-
7	ENTRY LIMIT
8	TOL LIMIT
9	RECALL
10	WIDE BAND
11	BOOST
12	EXT OSC
13	7
14	4
15	1
16	0
17	8
18	5
19	2
20	. (DECIMAL)
21	9
22	6
23	3
24	√
25	CLEAR
26	ENTER
27	M
28	M
29	K
30	M
31	dBm
32	%
33	V
34	A
35	Ω
36	Hz
37	F1
38	F2
39	ENABLE
40	TAPE
41	STORE
42	ADVANCE/LOAD
43	SEL/DISP STEP
44	DELETE STEP
45	LIST
46	CLEAR STORAGE
47	ERROR MODE ENABLE
48	Δ DECADE
49	NEW REF/CAL 1 Ω
50	DECADE D

} 5101A ONLY

TABLE II

CR NO.	NOMENCLATURE
1	AC (OUTPUT)
2	AC (CENTER)
3	ERROR MODE
4	50Ω DIVIDER
5	OVERRIDE
6	INT
7	EXT/Δ
8	OPR
9	STDBY
10	LOCAL
11	REMOTE
12	WIDE BAND
13	BOOST
14	RECALL
15	EXT OSC
16	ENABLE
17	TAPE
18	STORE
19	M (OUTPUT)
20	M
21	K
22	M
23	dBm
24	V
25	A
26	Ω
27	D1
28	D2 (OUTPUT)
29	M (CENTER)
30	M
31	K
32	M
33	dBm
34	LIMIT
35	V
36	A
37	Ω
38	Hz
39	D3
40	D4 (CENTER)
41	KEYBOARD
42	% ERROR
43	dB ERROR

} 5101A ONLY

5100A-1020
(2 of 2)

Figure 7-7. A10 Front Panel PCA and A10A1 Display PCA (5100B & 5102B)

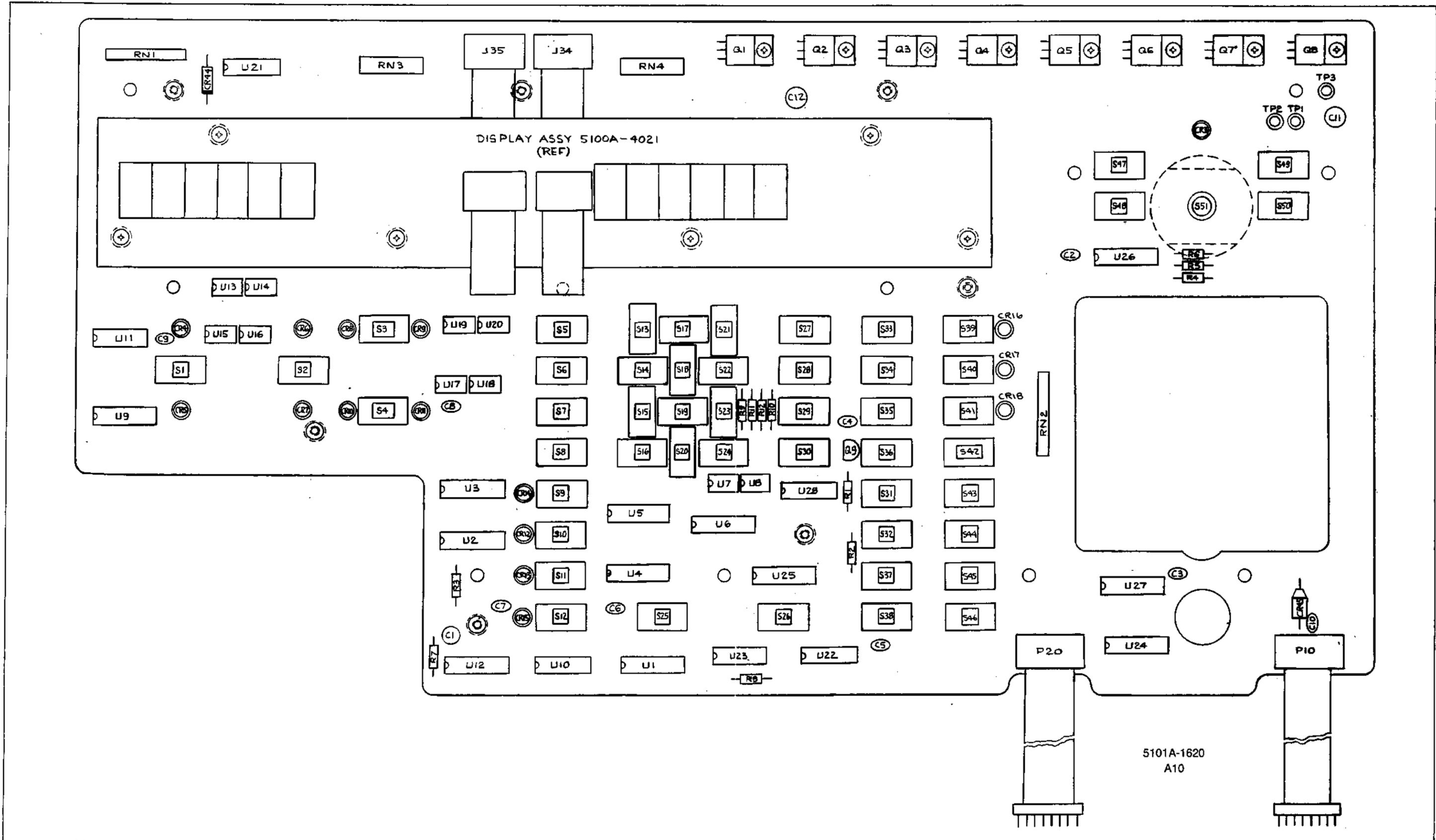
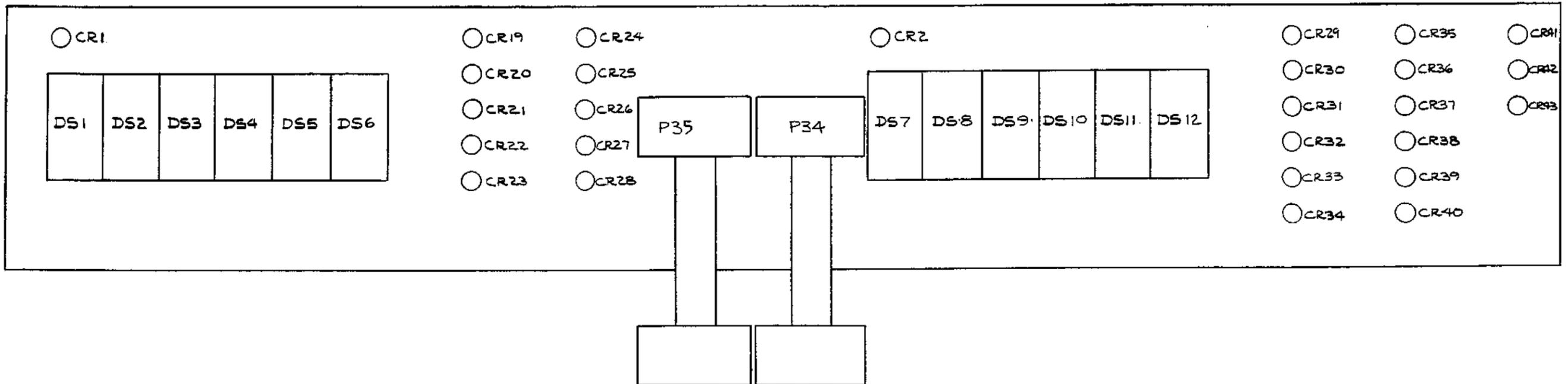

Figure 7-8. A10 Front Panel PCA and A10A1 Display PCA (5101B)



5100A-1621
A10A1

Figure 7-8. A10 Front Panel PCA and
A10A1 Display PCA (5101B) (cont)

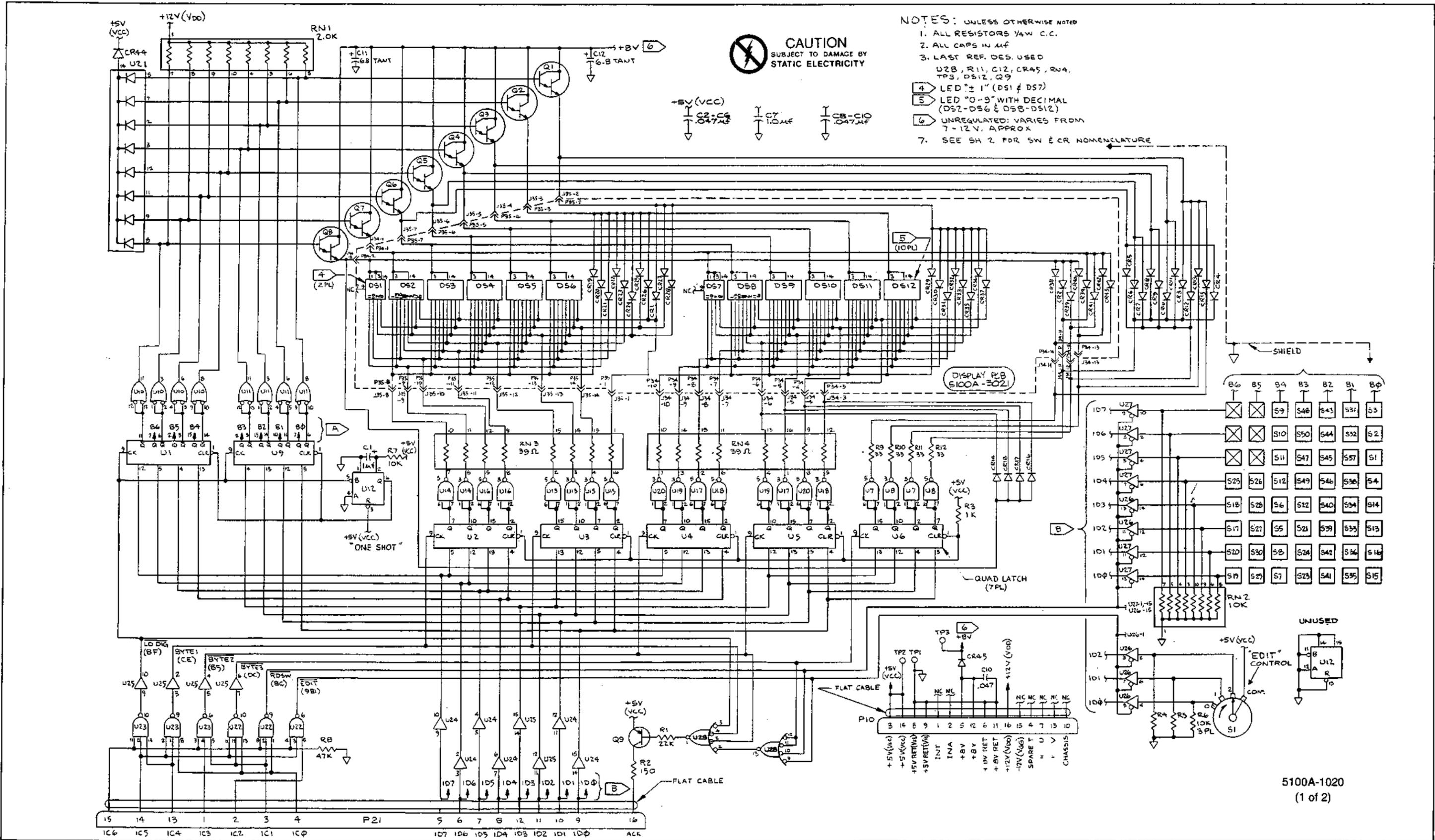

Figure 7-8. A10 Front Panel PCA and A10A1 Display PCA (5101B) (cont)

5100A-1020
(1 of 2)

TABLE I

SW NO.	NOMENCLATURE
1	50Ω DIVIDER/OVERRIDE
2	INT/EXT Δ
3	OPR/STDBY
4	LOCAL/REM
5	+
6	-
7	ENTRY LIMIT
8	TOL LIMIT
9	RECALL
10	WIDE BAND
11	BOOST
12	EXT OSC
13	7
14	4
15	1
16	∅
17	8
18	5
19	2
20	. (DECIMAL)
21	9
22	6
23	3
24	/
25	CLEAR
26	ENTER
27	M
28	m
29	K
30	M
31	dBm
32	%
33	V
34	A
35	Ω
36	Hz
37	F1
38	F2
39	ENABLE
40	TAPE
41	STORE
42	ADVANCE/LOAD
43	SEL/DISP STEP
44	DELETE STEP
45	LIST
46	CLEAR STORAGE
47	ERROR MODE ENABLE
48	Δ DECADE
49	NEW REF/CAL 1 Ω
50	DECADE D

} 5101A ONLY

TABLE II

CR NO.	NOMENCLATURE
1	AC (OUTPUT)
2	AC (CENTER)
3	ERROR MODE
4	50Ω DIVIDER
5	OVERRIDE
6	INT
7	EXT/Δ
8	OPR
9	STDBY
10	LOCAL
11	REMOTE
12	WIDE BAND
13	BOOST
14	RECALL
15	EXT OSC
16	ENABLE
17	TAPE
18	STORE
19	M (OUTPUT)
20	m
21	K
22	M
23	dBm
24	V
25	A
26	Ω
27	D1
28	D2 (OUTPUT)
29	M (CENTER)
30	m
31	K
32	M
33	dBm
34	LIMIT
35	V
36	A
37	Ω
38	Hz
39	D3
40	D4 (CENTER)
41	KEYBOARD
42	% ERROR
43	dB ERROR

} 5101A ONLY

5100A-1020
(2 of 2)Figure 7-8. A10 Front Panel PCA and
A10A1 Display PCA (5101B) (cont)

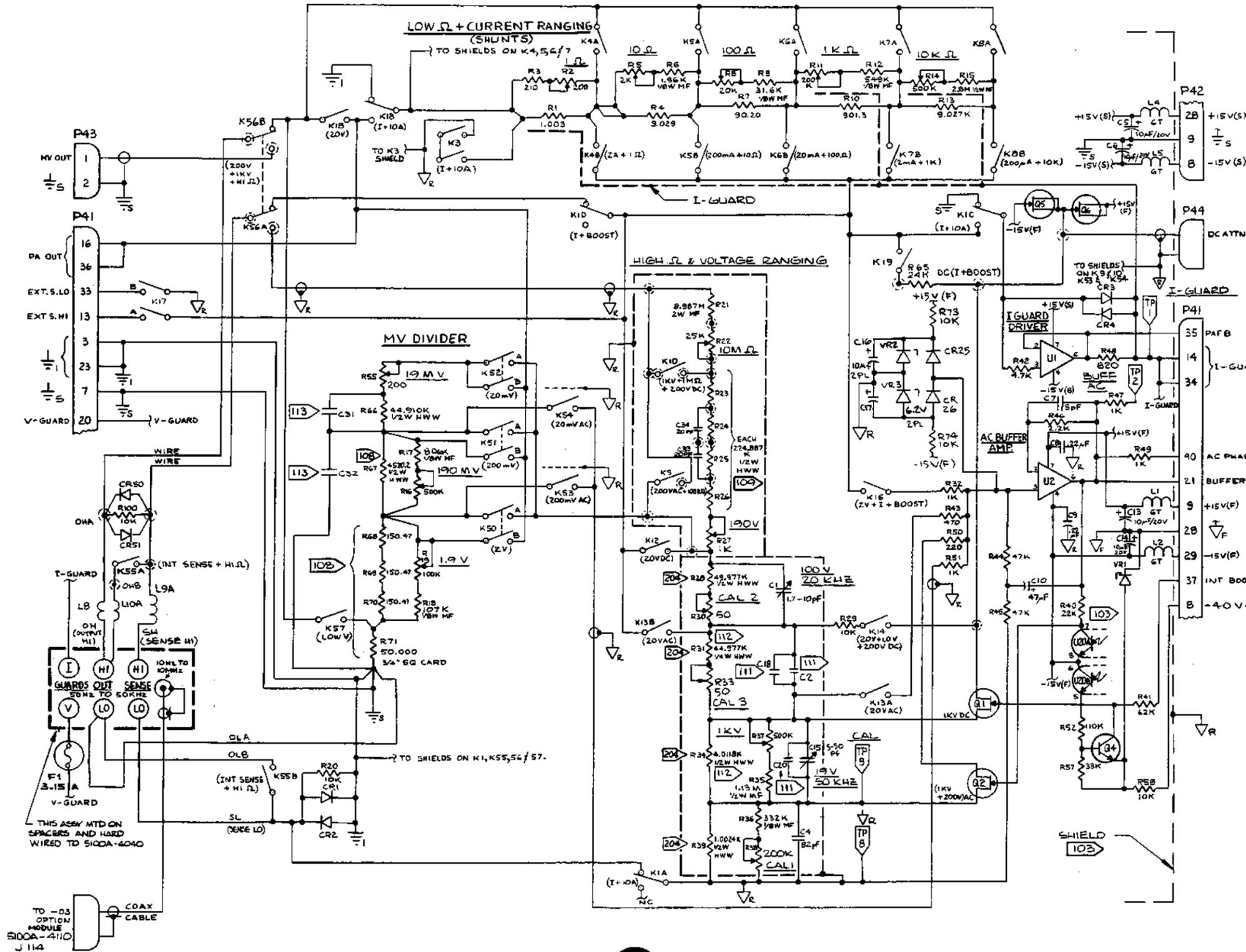

- NOTES: (UNLESS OTHERWISE SPECIFIED)**
- 101. ALL RESISTORS 1/4W, CC, AND ALL RESISTANCE IN OHMS.
 - 102. ALL RELAYS SHOWN IN DE-ENERGIZED POSITION
 - 103. (SHIELD) FLOATS IN CURRENT RANGES.
 - 107. \oplus DENOTES INTERCONNECTION ON TEFLON STANDOFF OR OFF PCB
 - 108. R67, 68, 69, 70 & 71 MUST BE REPLACED AS A COMPLETE SET.
 - 109. R23 - R26 MUST BE REPLACED AS A COMPLETE SET.
 - 110. ∇ CONNECTS TO ∇ VIA P44, DC ATTN CABLE AND P54 ON THE ANALOG CONTROL.
 - 111. SELECT IN TEST.
 - 112. REPLACEMENT MAY REQUIRE RESELECTION OF C2, C18 OR C20 (SEE 111)
 - 113. C31, C32 FACTORY SELECTED FOR OUTPUT AT 19,999 MV @ 50 KHZ.

CAUTION
SUBJECT TO DAMAGE BY
STATIC ELECTRICITY

5100A-1040
(1 of 2)

Figure 7-9. A11 Ranging PCA (cont)

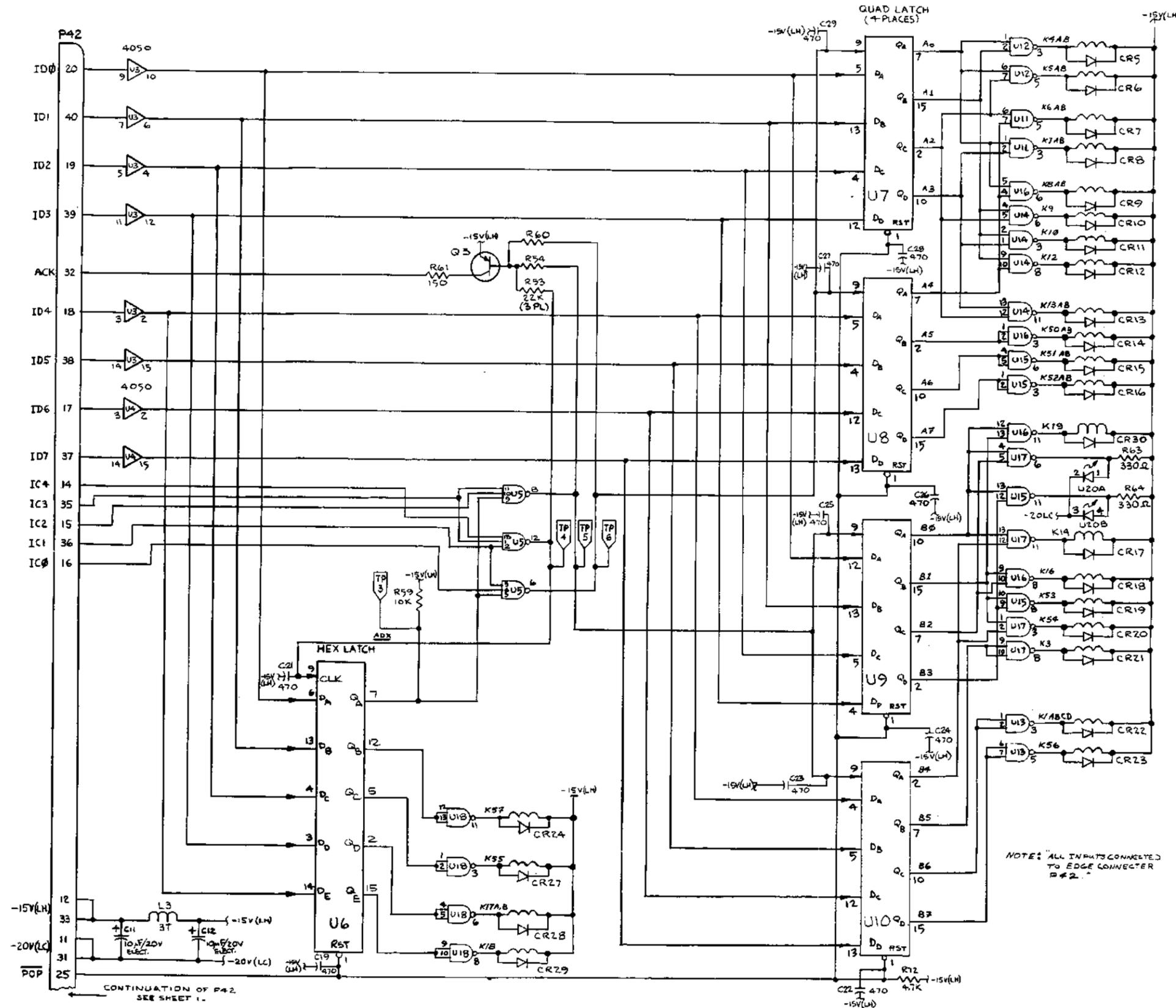

	DC VOLTAGE	AC VOLTAGE	DC CURRENT	AC CURRENT	OHMS
K1					
K3					
K4					
K5					
K6					
K7					
K8					
K9					
K10					
K12					
K13					
K14					
K16					
K17					
K18					
K50					
K51					
K52					
K53					
K54					
K55					
K56					
K57					
K19					
U20A					
U20B					

ALL BLANK POSITIONS ARE LOGIC "0" EXCEPT AS NOTED

NOTES

- 201. "1" = ENERGIZED, "0" = NOT ENERGIZED FOR ALL RELAYS
- "0" = LOW AT U16 PIN 11, "1" = HI AT U17 PIN 6 & U15 PIN 11
- 202. 1Ω THRU 10K SHOWN FOR 4-TERMINAL CONFIGURATION FOR 2-TERMINAL CONFIGURATION, K55 WILL BE ENERGIZED, "1", FOR 1Ω THRU 10K
- 203. ALL CAPACITORS CERAMIC & pF UNLESS MARKED OTHERWISE.
- 204. R28, 31, 34 & 39 SHOULD ALL BE REPLACED IF ANY ONE NEEDS REPLACING.

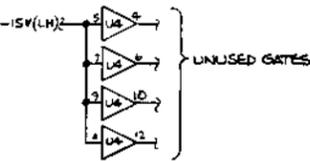

CAUTION
SUBJECT TO DAMAGE BY
STATIC ELECTRICITY

5100A-1040
(2 of 2)

Figure 7-9. A11 Ranging PCA (cont)

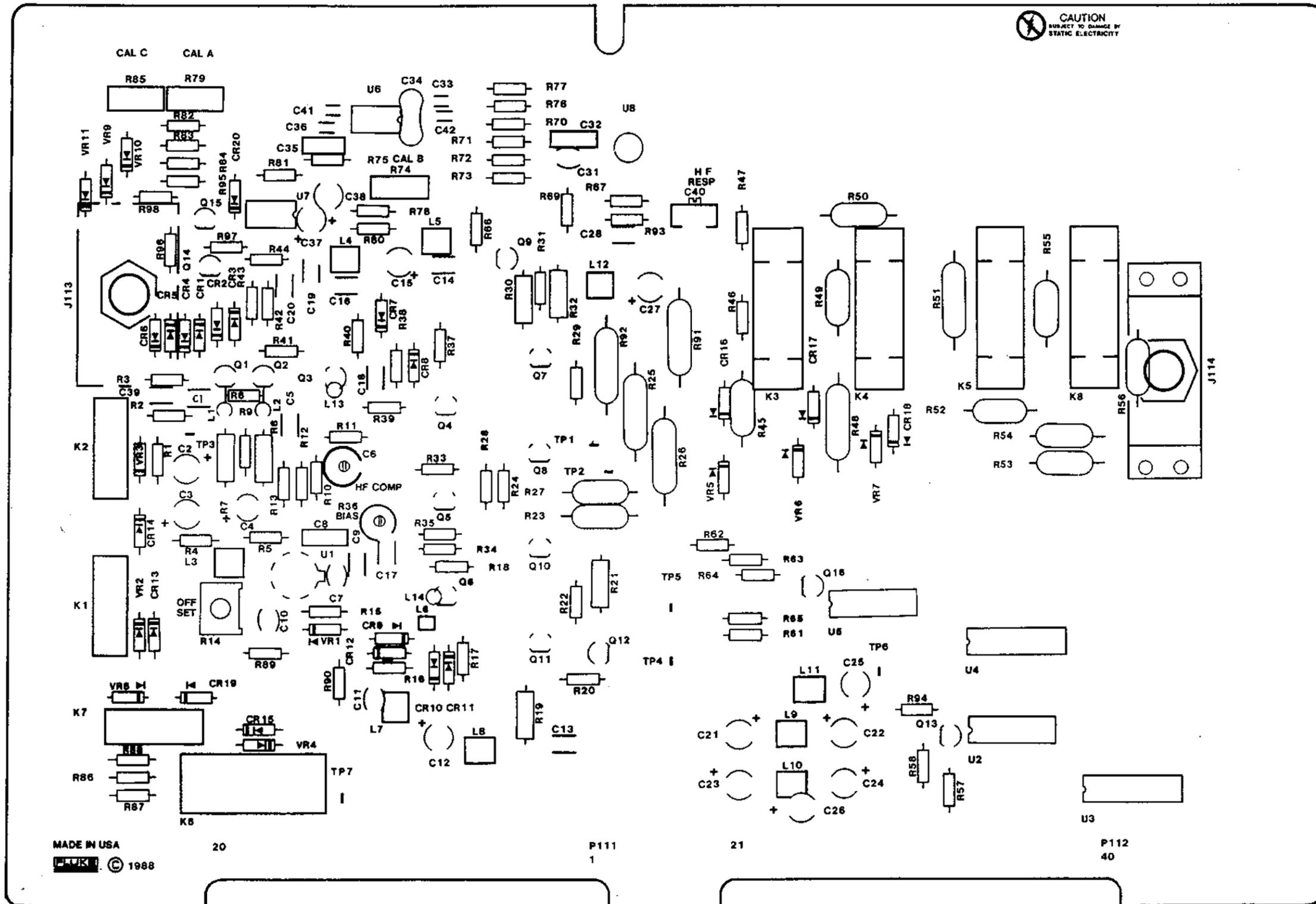
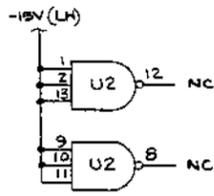

Figure 7-10. A12 Wideband Output PCA (Option -03)

UNUSED GATES



1 MATCHED SET 5100A-4504
U8, R72 AND R73
R73 MARKED WITH A BLACK DOT

TRUTH TABLE

RANGE	K1	K2	K3	K4	K5	K6	K7	K8
3.1623V - 1V	1	1	1	1	1	1	1	1
.99999V - 3.1624V	1	1	1	1	1	1	1	1
.31623V - 100mV	1	1	1	1	1	1	1	1
.99999mV - 3.1624mV	1	1	1	1	1	1	1	1
.31623mV - 10mV	1	1	1	1	1	1	1	1
.99999mV - 3.1624mV	1	1	1	1	1	1	1	1
.31623mV - 1mV	1	1	1	1	1	1	1	1
.99999mV - 3.1624mV	1	1	1	1	1	1	1	1

1 = RELAY CLOSED
-20V AT INPUT

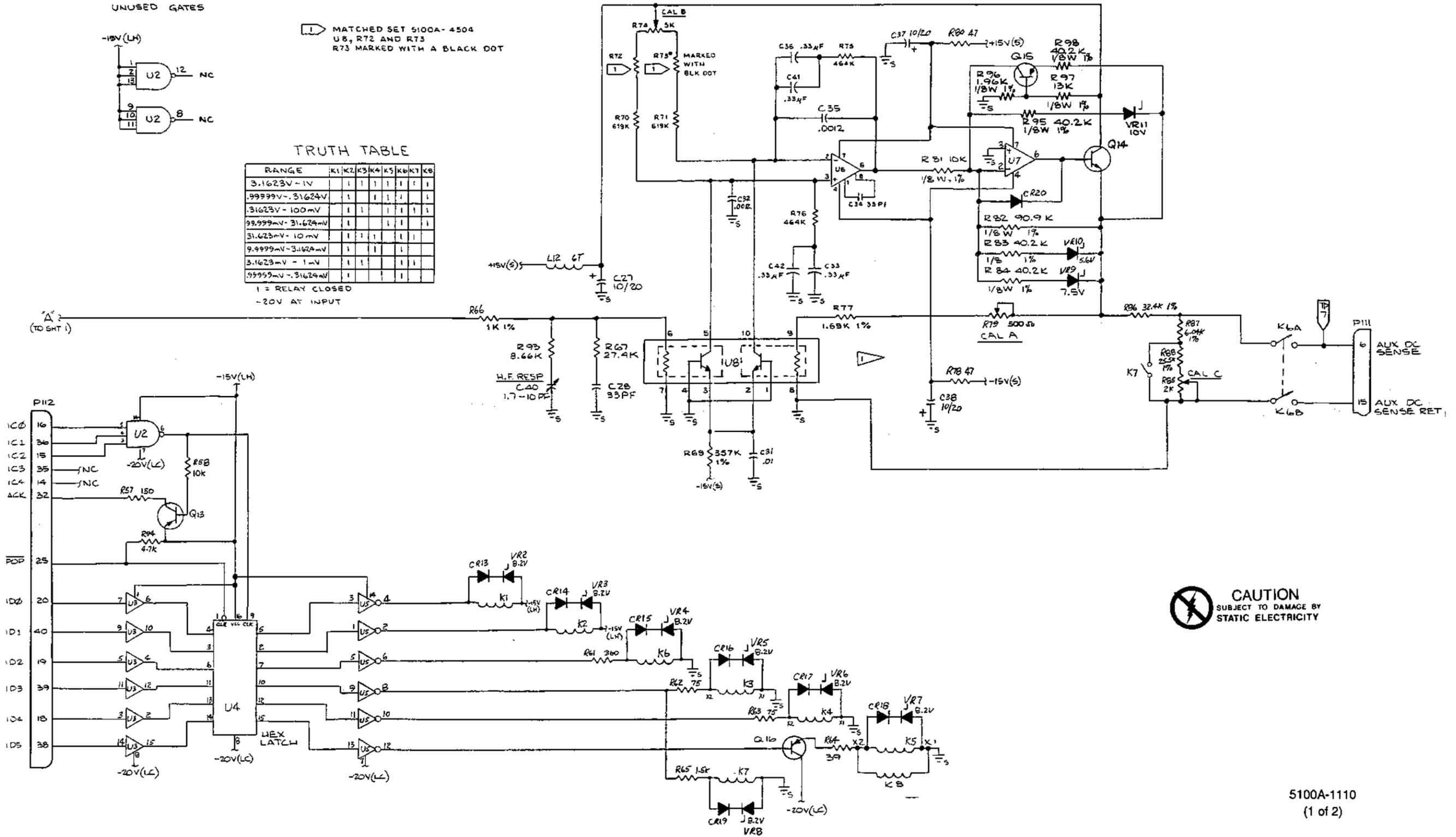

CAUTION
SUBJECT TO DAMAGE BY
STATIC ELECTRICITY

5100A-1110
(1 of 2)

Figure 7-10. A12 Wideband Output PCA
(Option -03) (cont)

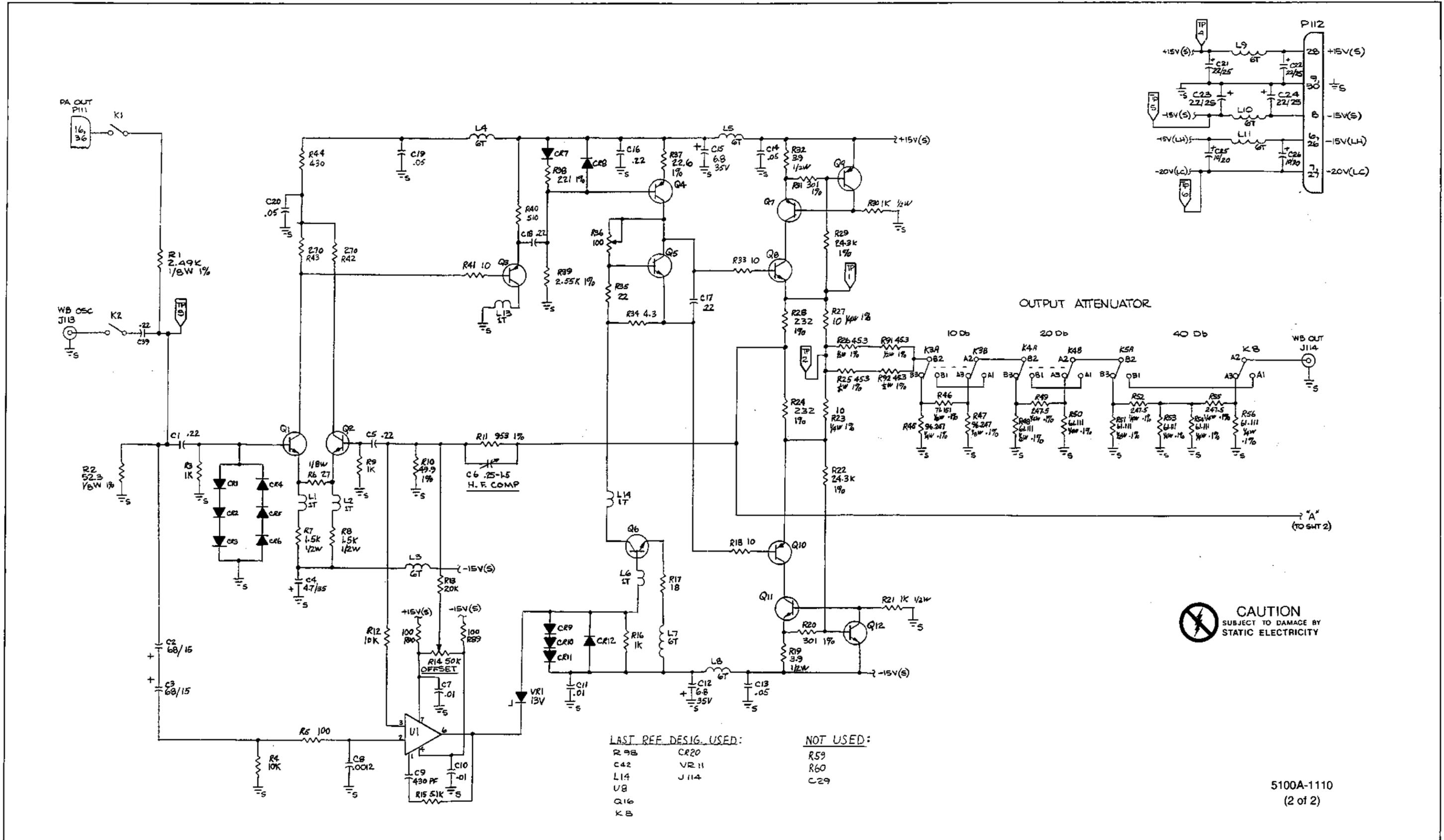

5100A-1110
(2 of 2)

Figure 7-10. A12 Wideband Output PCA
(Option -03) (cont)

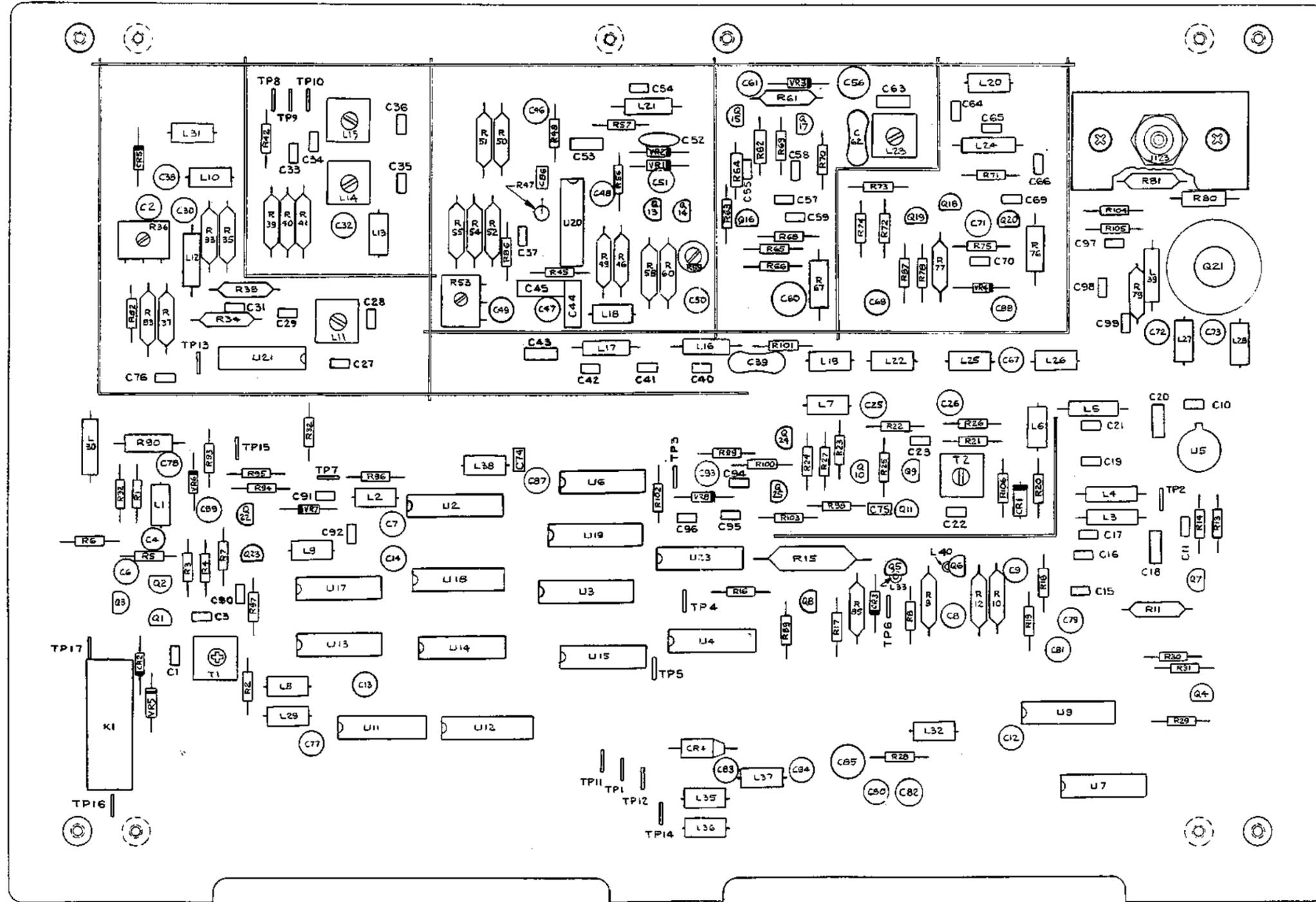

5100A-1720

Figure 7-11. A13 Wideband Oscillator PCA
(Option -03)

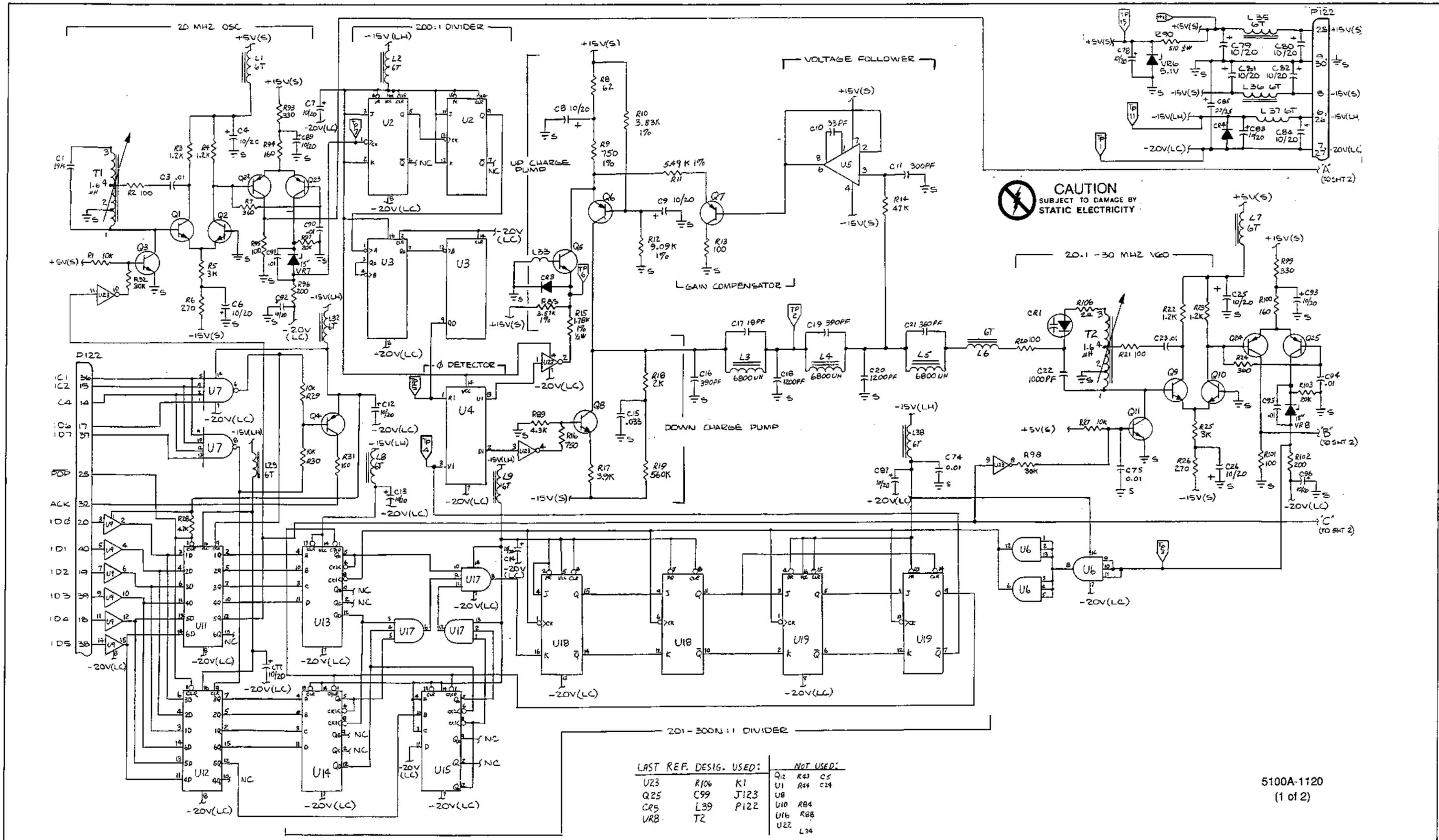

Figure 7-11. A13 Wideband Oscillator PCA (Option -03) (cont)

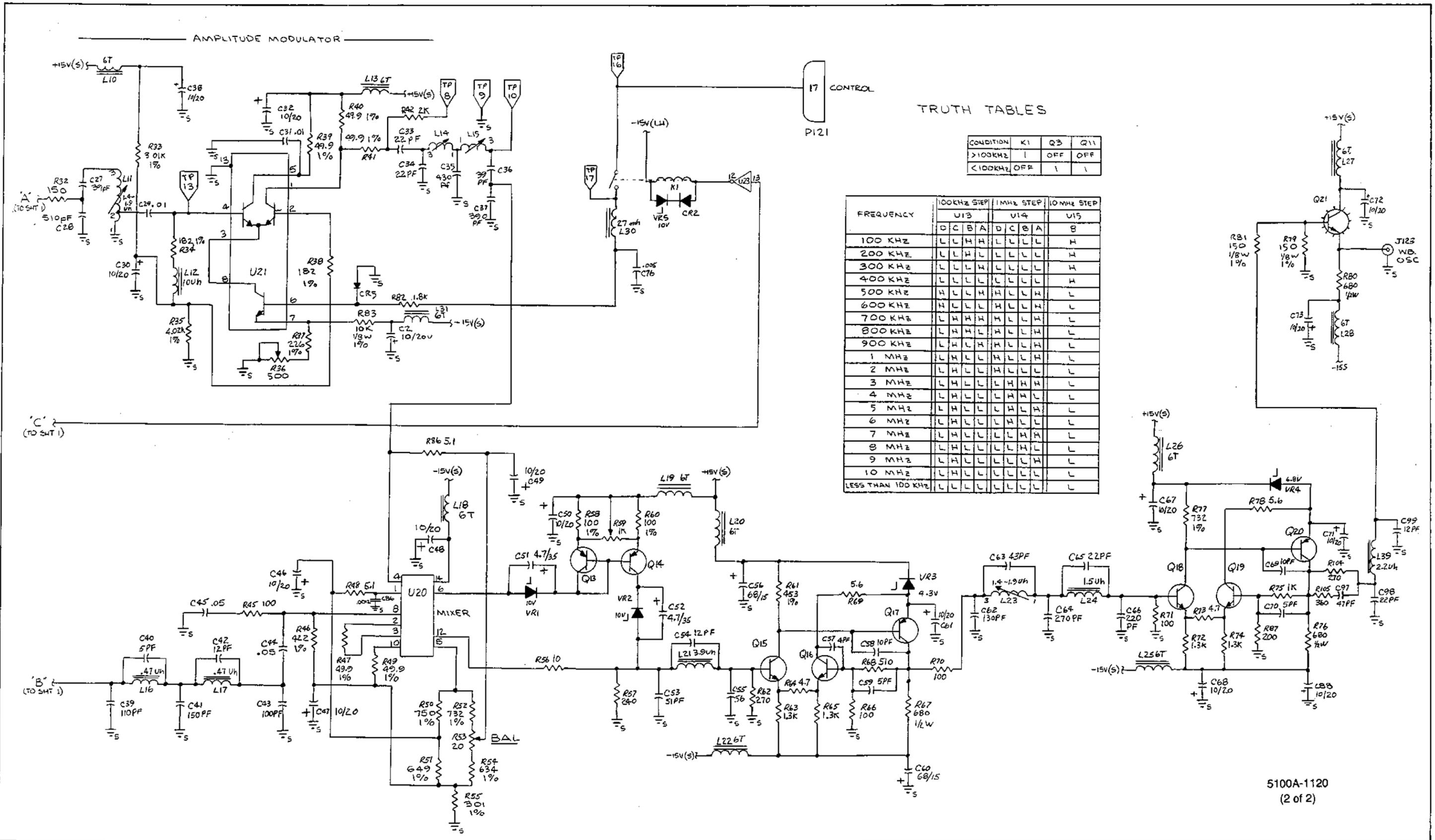
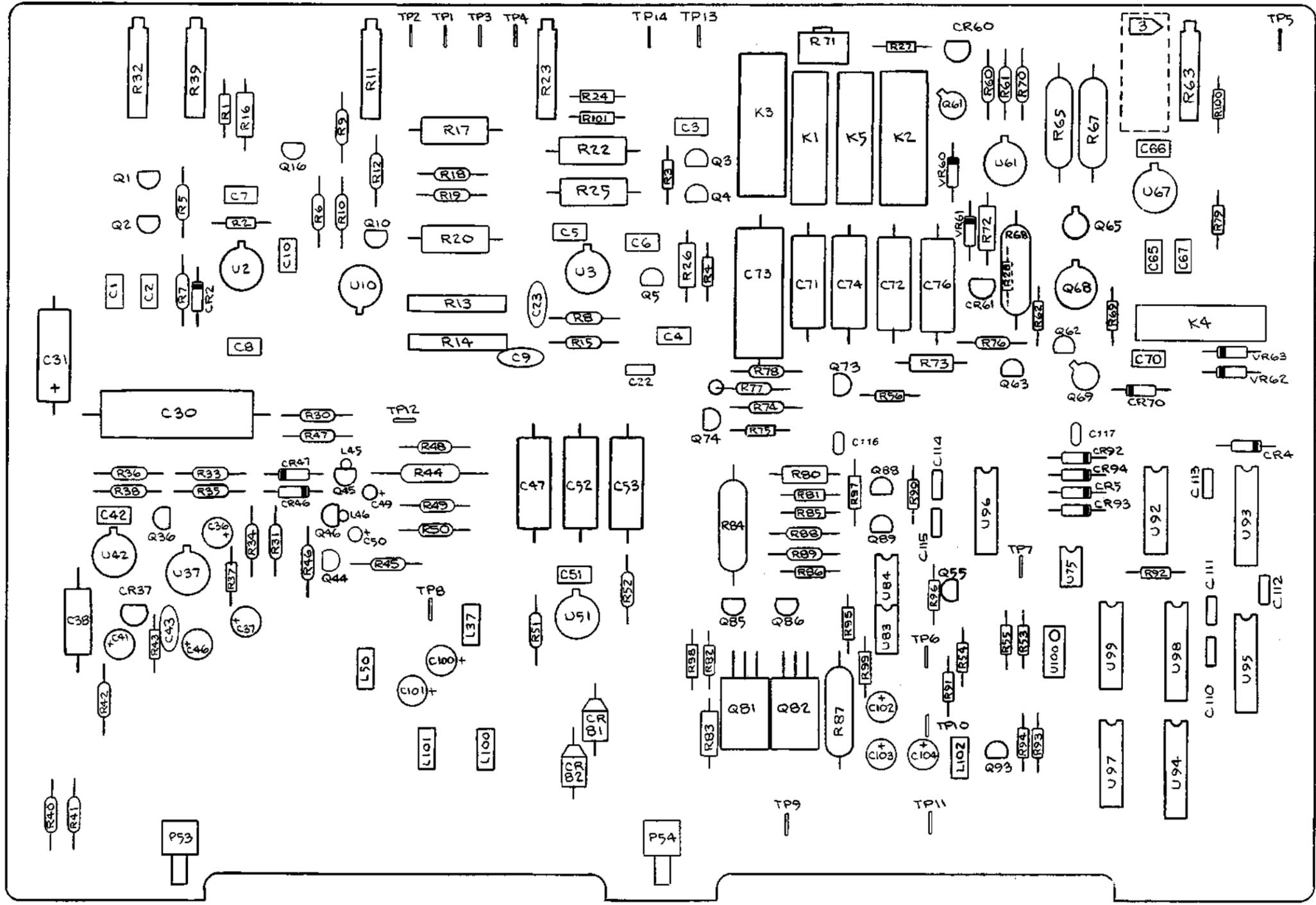

Figure 7-11. A13 Wideband Oscillator PCA (Option -03) (cont)

5100A-1120 (2 of 2)



NOTES :

3 THERE WILL BE ONE RESISTOR AND ONE BUSS WIRE JUMPER OR "0" OHM RESISTOR IN THIS LOCATION.

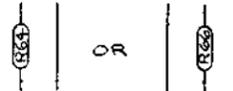

5100A-1650

Figure 7-12. A14 Analog Control PCA

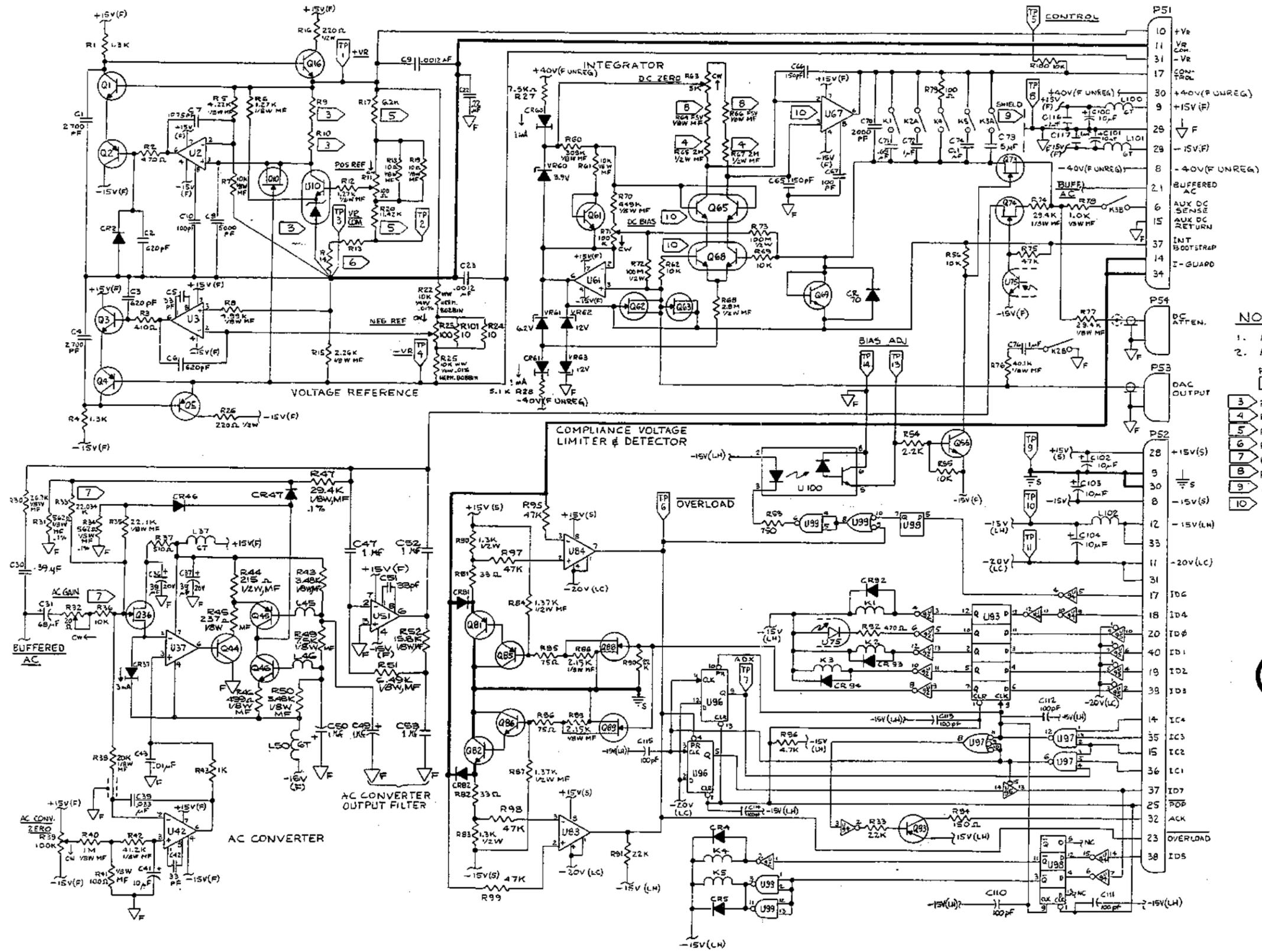

- NOTES: (UNLESS OTHERWISE SPECIFIED)**
1. ALL POLARIZED CAPS ARE TANTALUM
 2. ALL RESISTORS 1/4W CC IN OHMS
- FOR DETAILS OF MATCHING IN **3** THRU **10** SEE MANUAL
- 3** R9 & R10 SUPPLIED WITH REF AMP U10 AS A SET.
 - 4** R65 & R67 MATCHED SET
 - 5** R17 & R20 MATCHED SET 1/2W, HERM.
 - 6** R13 & R14 3/4" WW CARD, FACTORY SELECTED.
 - 7** R33 & R36 MATCHED SET, 1/8W MF.
 - 8** R64 & R66 SELECT IN TEST, (1 RESISTOR & 1 SHORTING WIRE).
 - 9** CAUTION: FLOATS IN CURRENT RANGES.
 - 10** MAY EFFECT VALUES OF R66 & R64.

RELAYS:
 I = ENERGIZED
 O = DE-ENERGIZED
 X = DON'T CARE, OR AS ALREADY DETERMINED, (AS IN O.L.)

CAUTION
 SUBJECT TO DAMAGE BY STATIC ELECTRICITY

5100A-1050

Figure 7-12. A14 Analog Control PCA (cont)

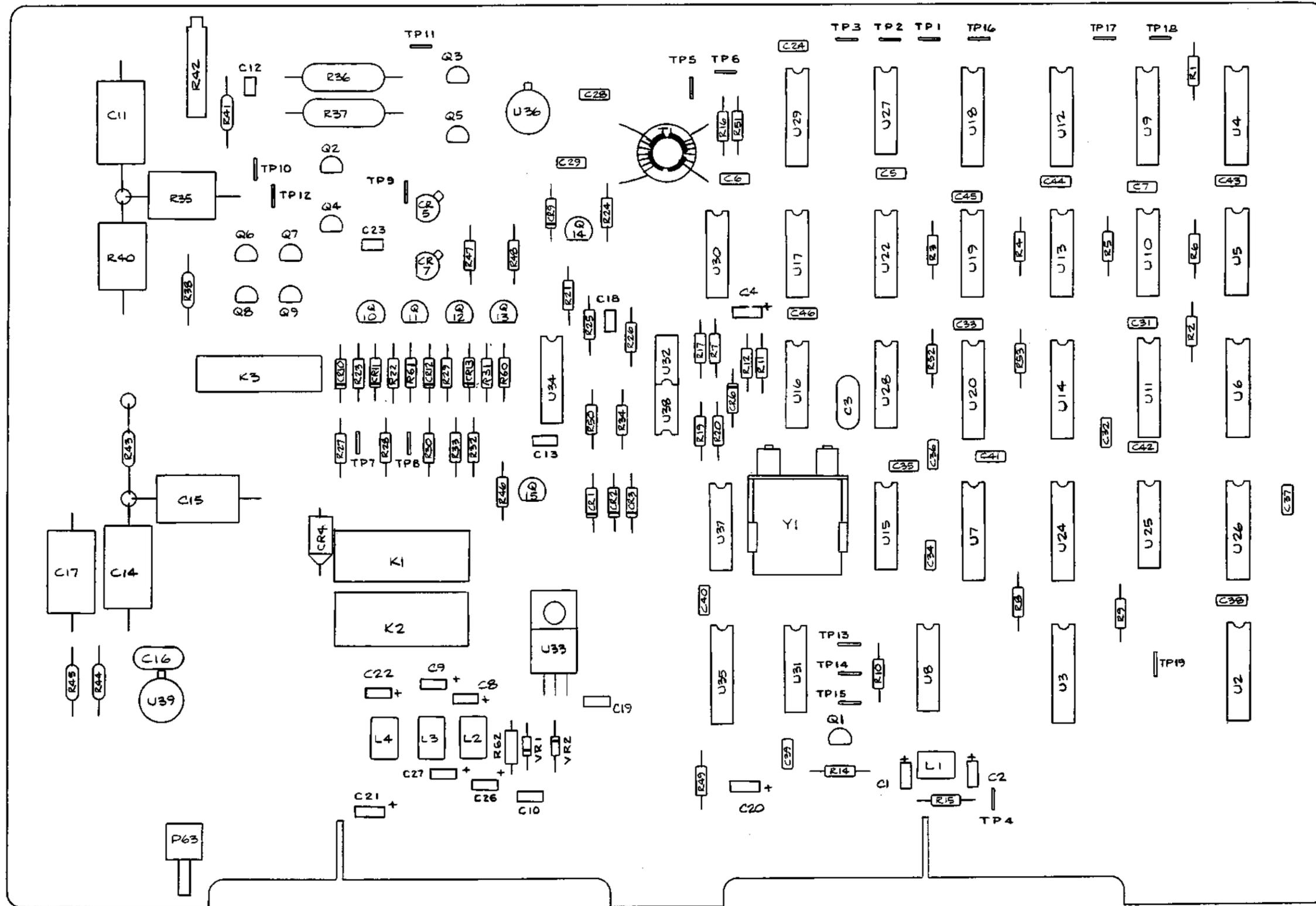

5100A-1660

Figure 7-13. A15 Digital-to-Analog PCA

CAUTION
SUBJECT TO DAMAGE BY
STATIC ELECTRICITY

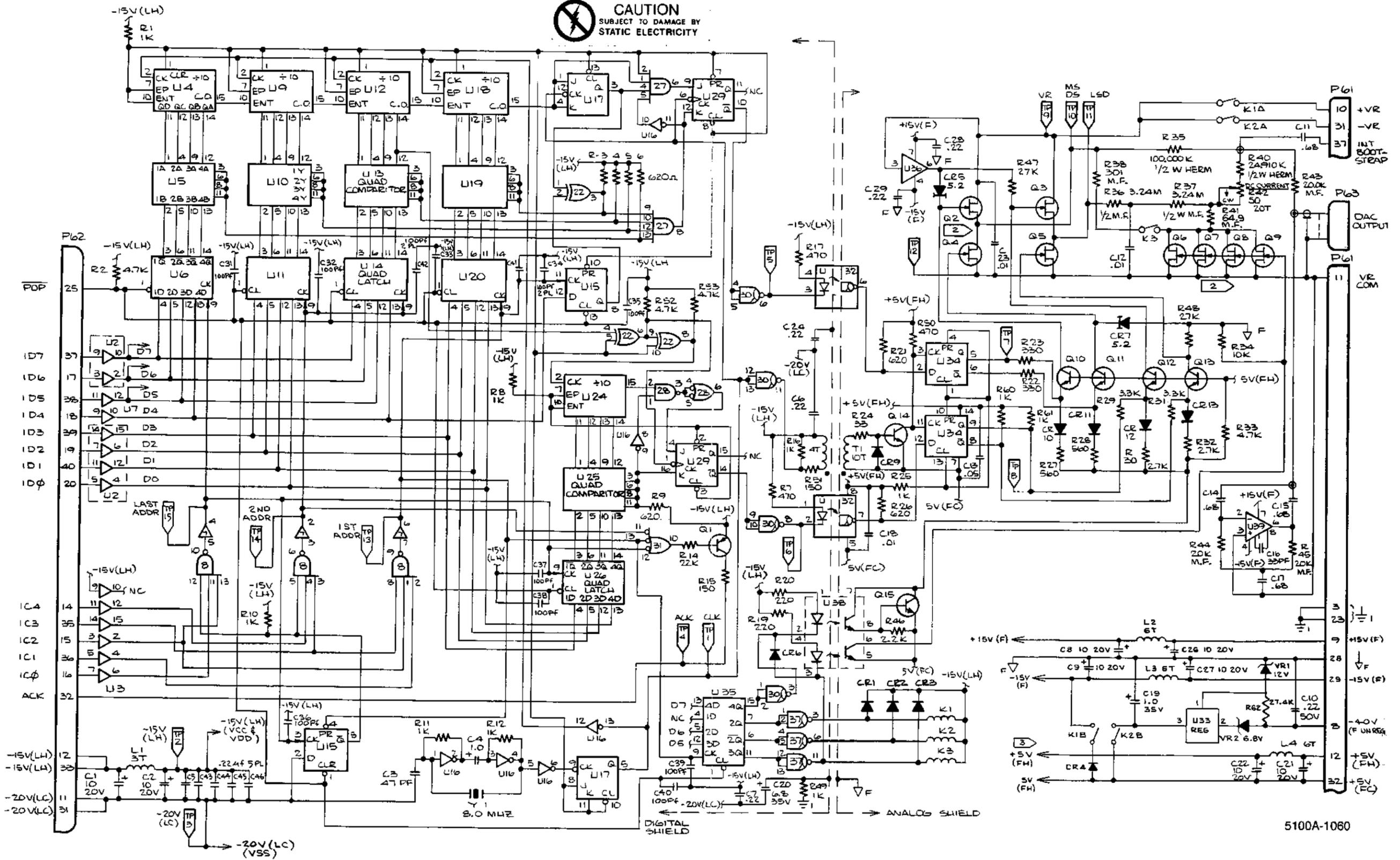
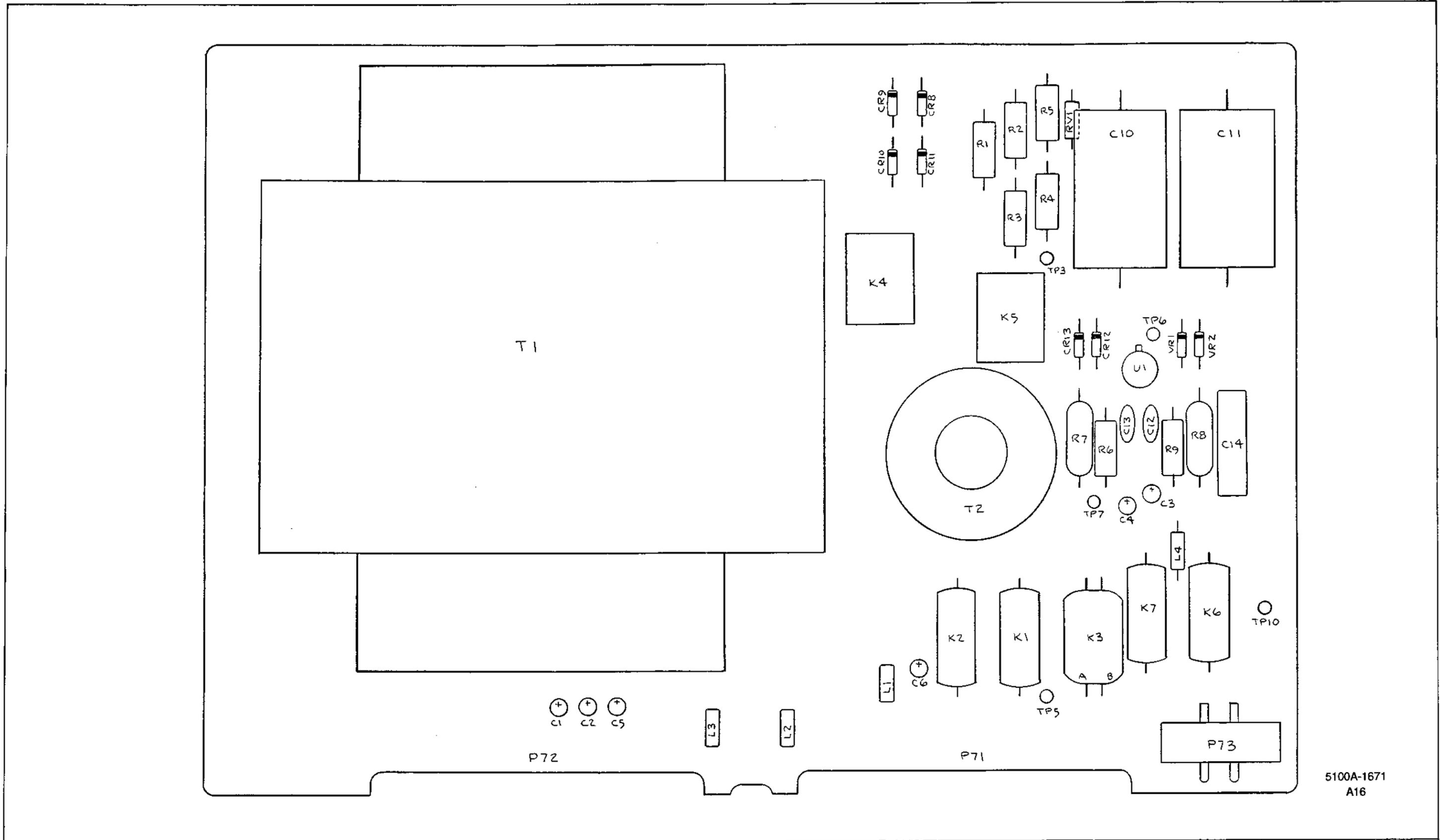

Figure 7-13. A15 Digital-to-Analog PCA (cont)

5100A-1060



5100A-1671
A16

Figure 7-14. A16 Extended High Voltage and A16A1 High Voltage Control PCAs

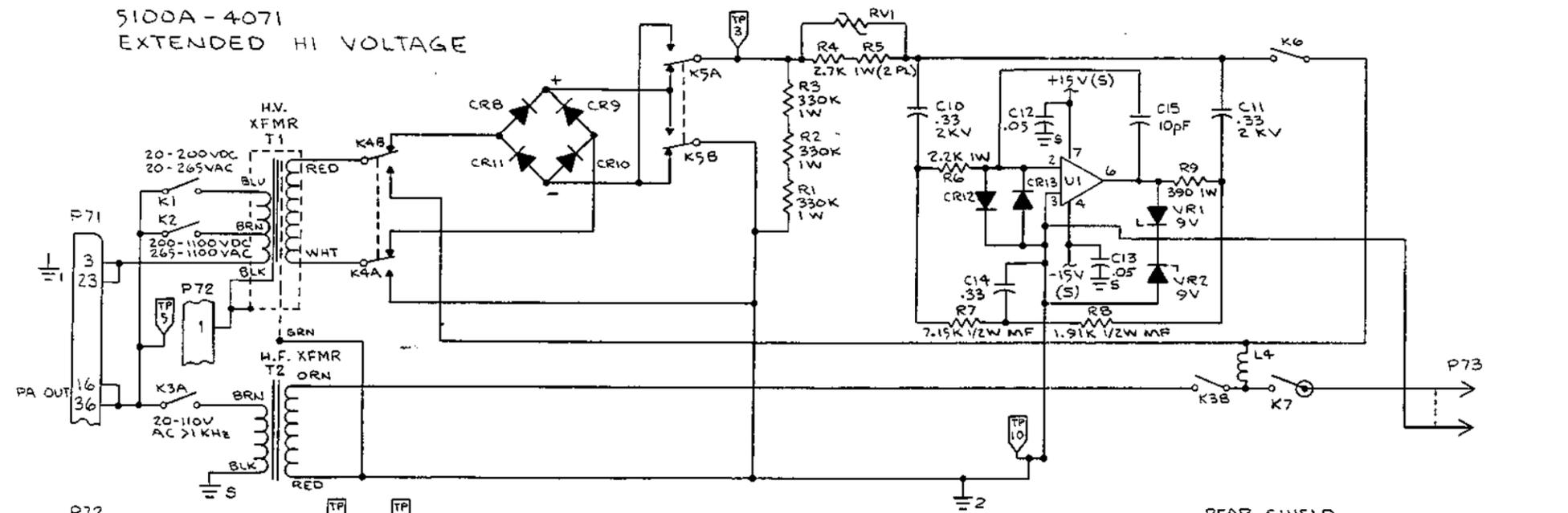

- NOTES: (UNLESS OTHERWISE SPECIFIED)
1. ALL RESISTORS ARE 1/4W 5%
 2. ALL RESISTOR VALUES IN OHMS
 3. ALL CAPACITOR VALUES IN MICROFARADS
 4. \odot TEFLON STAND OFF
 - 5 \rightarrow FRAME OR SHIELD CONNECTED TO \perp 2
 - 6 \rightarrow INSTALLED ON 5130A ONLY.

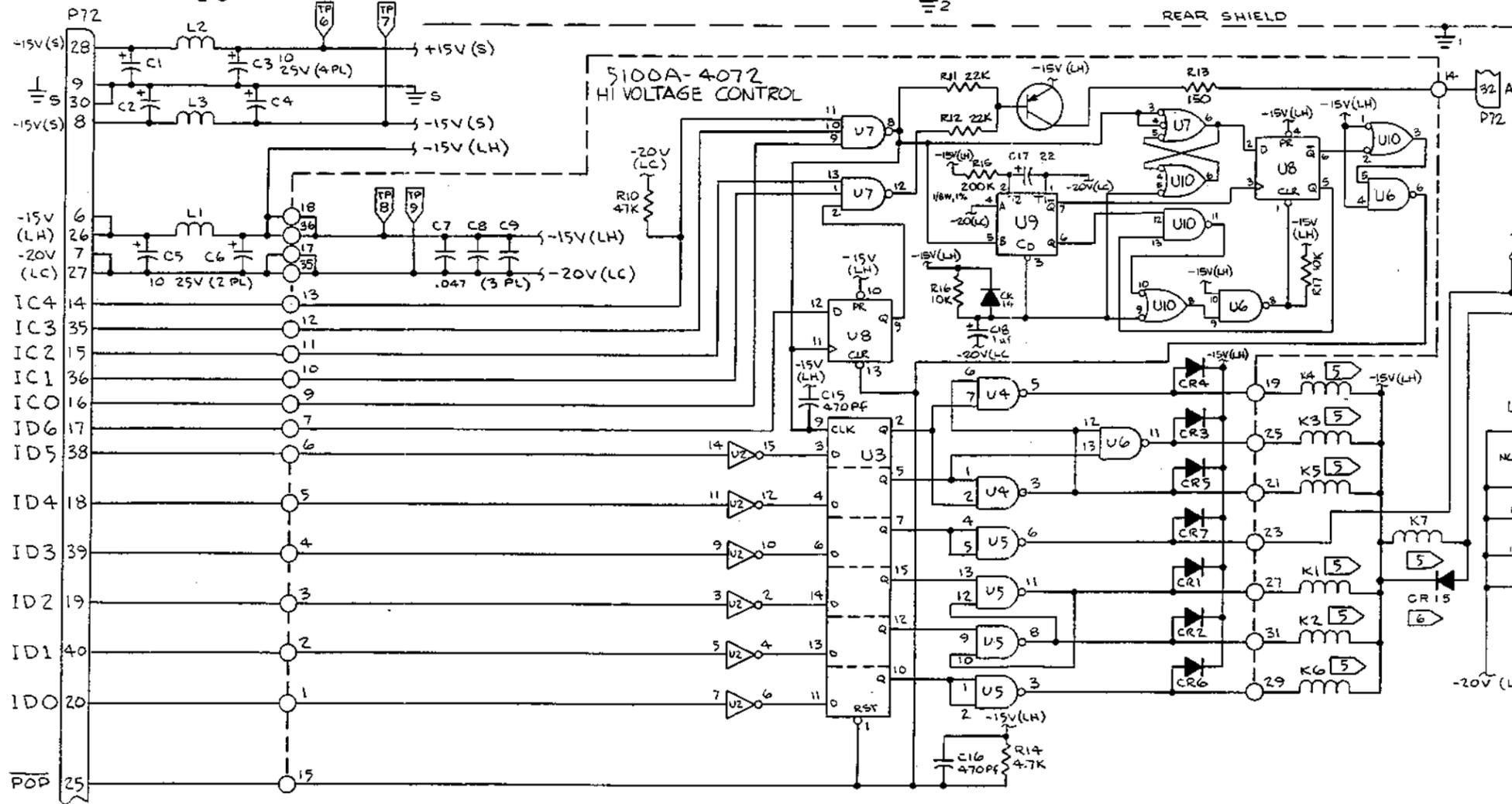

REF.	DES.
C18	
CR15	
K7	
L4	
Q1	
Q2	
Q3	
Q4	
Q5	
Q6	
Q7	
Q8	
Q9	
Q10	
Q11	
Q12	
Q13	
Q14	
Q15	
Q16	
Q17	
Q18	
Q19	
Q20	
Q21	
Q22	
Q23	
Q24	
Q25	
Q26	
Q27	
Q28	
Q29	
Q30	
Q31	
Q32	
Q33	
Q34	
Q35	
Q36	
Q37	
Q38	
Q39	
Q40	
Q41	
Q42	
Q43	
Q44	
Q45	
Q46	
Q47	
Q48	
Q49	
Q50	
Q51	
Q52	
Q53	
Q54	
Q55	
Q56	
Q57	
Q58	
Q59	
Q60	
Q61	
Q62	
Q63	
Q64	
Q65	
Q66	
Q67	
Q68	
Q69	
Q70	
Q71	
Q72	
Q73	
Q74	
Q75	
Q76	
Q77	
Q78	
Q79	
Q80	
Q81	
Q82	
Q83	
Q84	
Q85	
Q86	
Q87	
Q88	
Q89	
Q90	
Q91	
Q92	
Q93	
Q94	
Q95	
Q96	
Q97	
Q98	
Q99	
Q100	

	20-265V AC < 1KHz	265-1100V AC < 1KHz	20-110V AC > 1KHz	+20-200V DC	-20-200V DC	+200-1100V DC	-20-1100V DC	2-19.999V AC < 1KHz	2-19.999V AC > 1KHz	STANDBY	BOOST MODE
K1	1	0	0	0	0	0	0	0	0	0	0
K2	0	0	0	0	0	0	0	0	0	0	0
K3	0	0	0	0	0	0	0	0	0	0	0
K4	1	1	0	0	0	0	0	0	0	0	0
K5	X	X	0	0	0	0	0	0	0	0	0
K6	0	0	0	1	1	1	1	0	0	0	0
K7	1	1	1	1	1	1	1	0	0	0	0

5100A-1071

Figure 7-14. A16 Extended High Voltage and A16A1 High Voltage Control PCAs (cont)

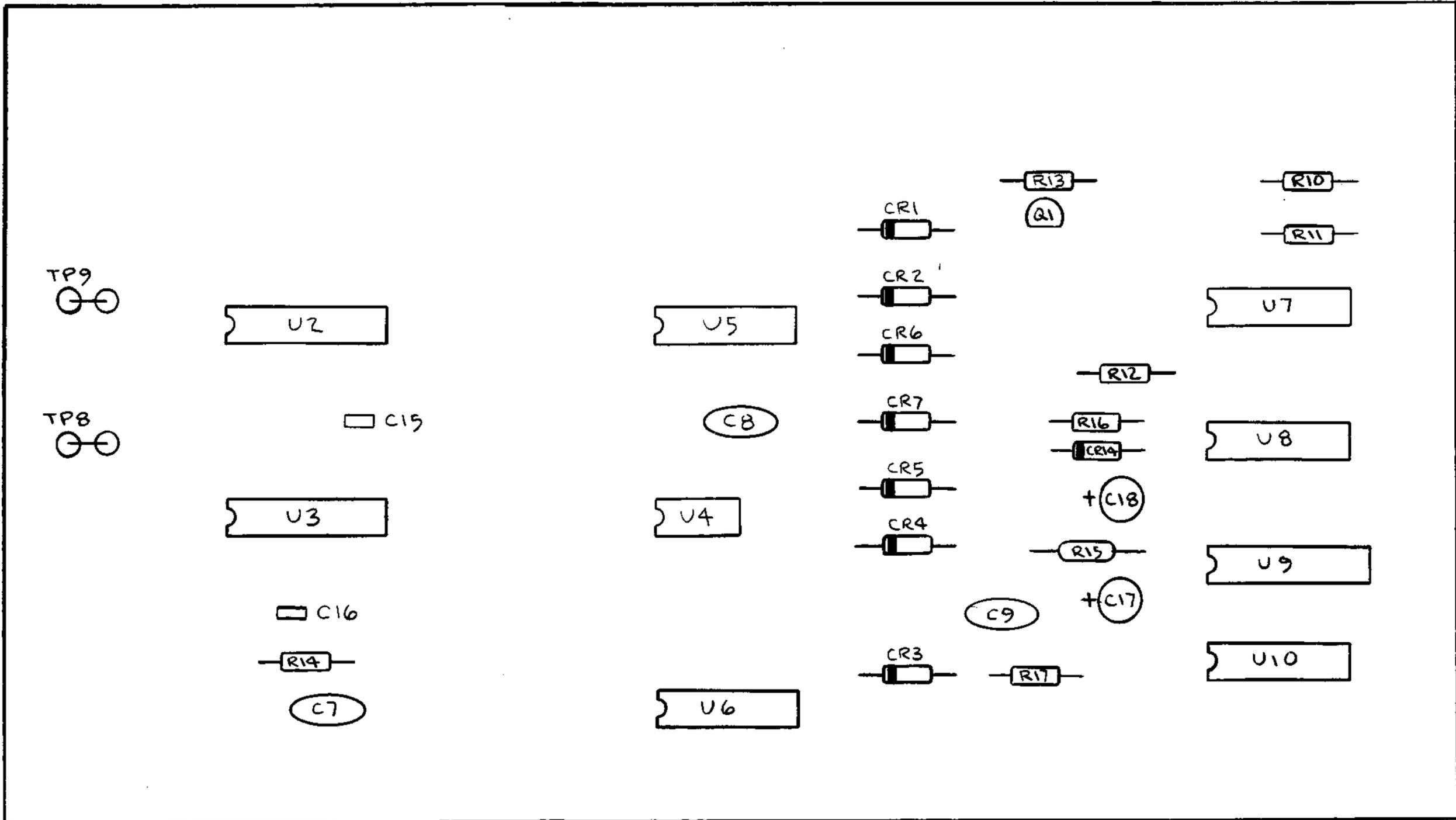

5100A-1672
A16A1

Figure 7-14. A16 Extended High Voltage and A16A1 High Voltage Control PCAs (cont)

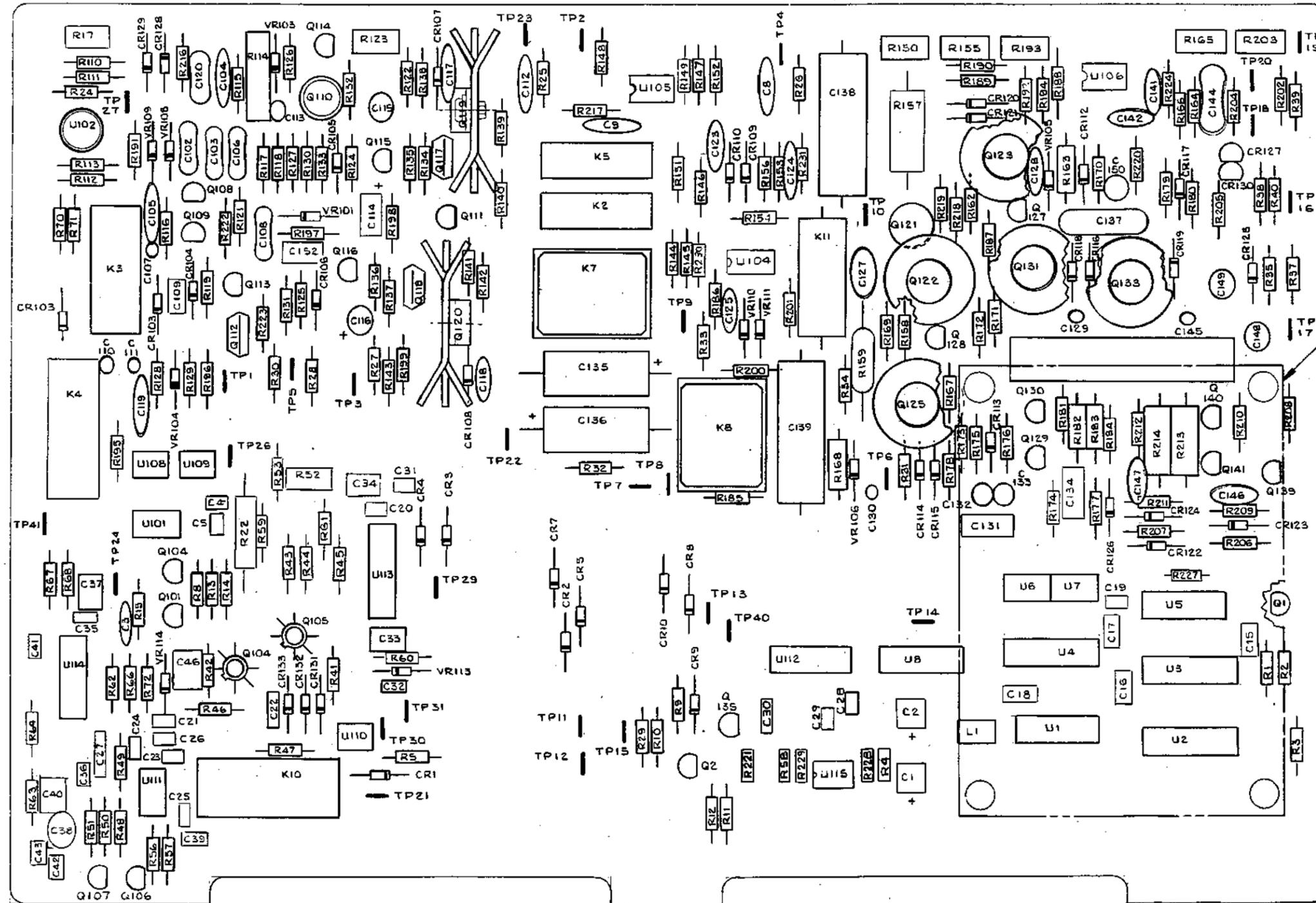

A17

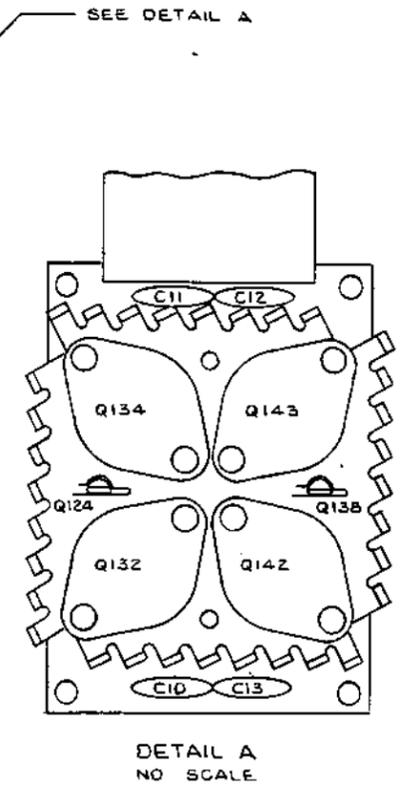

DETAIL A
NO SCALE

A17A1

5100A-1683

Figure 7-15. A17 Power Amplifier and A17A1 Power Transistor PCAs

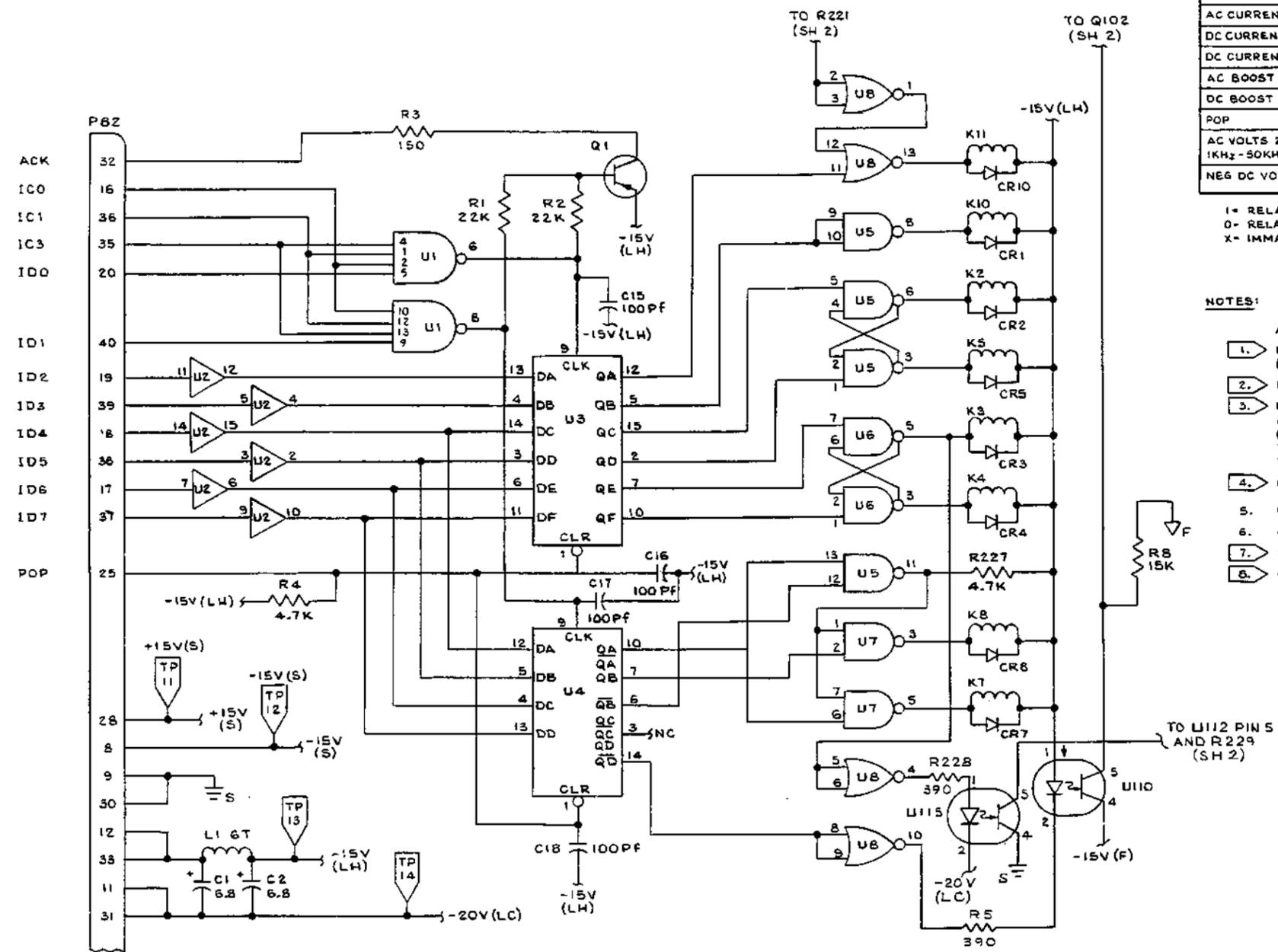

FUNCTION	K2	K3	K4	K5	K7	K8	K10	Q101 Q102	K11
AC VOLTS <20V	X	0	1	X	0	0	X	0	0
AC VOLTS 20-1100 50Hz-1KHz	0	0	1	1	1	1	0	0	0
DC VOLTS ≥ 20V	0	0	1	1	1	1	0	0	0
DC VOLTS <20V	X	1	0	X	0	0	X	1	1
AC CURRENT <200mA	1	0	1	0	1	1	0	0	0
AC CURRENT ≥ 200mA	X	0	1	X	0	1	0	0	0
DC CURRENT <200mA	1	1	0	0	1	1	0	0	1
DC CURRENT ≥ 200mA	X	1	0	1	0	1	0	0	1
AC BOOST	0	0	1	1	0	0	1	0	0
DC BOOST	0	1	0	1	0	0	1	1	1
POP	0	0	0	0	0	0	0	0	0
AC VOLTS 20-110V 1KHz-50KHz	X	0	1	X	0	0	0	0	0
NEG DC VOLTS ≥ 20V	0	0	1	1	1	0	0	1	0

1- RELAY ENERGIZED
0- RELAY DE-ENERGIZED
X- IMMATERIAL

NOTES:

- 1. ALL RESISTORS ARE 1/4 W C.F., UNLESS OTHERWISE INDICATED.
- 2. PART OF 5100A-4180 POWER TRANSISTOR ASSEMBLY (Q124, Q132, Q134, Q135, Q142, Q143, C10 THRU C13).
- 3. REQUIRES HEAT SINK.
- 4. MEASURED RELATIVE TO TP22.
- 5. ALL OTHER VOLTAGES ARE MEASURED RELATIVE TO TP23. (IF RANGING PCB IS REMOVED FROM CHASSIS, CONNECT TEMPORARY JUMPER ON POWER SUPPLY REGULATOR FROM TP6 TO TP13).
- 6. GROUND PLANE ON 5100A-4180 CONNECTS TO $\frac{1}{1}$.
- 7. RESISTORS ARE MEASURED IN OHMS.
- 8. CAPACITORS ARE MEASURED IN MICROFARADS.
- 9. SELECTED IN TEST FROM 300K TO 470K (390K NOMINAL).
- 10. C42 AND C43 ARE A MATCHED SET.

5100A-1083
(1 of 3)

Figure 7-15. A17 Power Amplifier and A17A1 Power Transistor PCAs (cont)

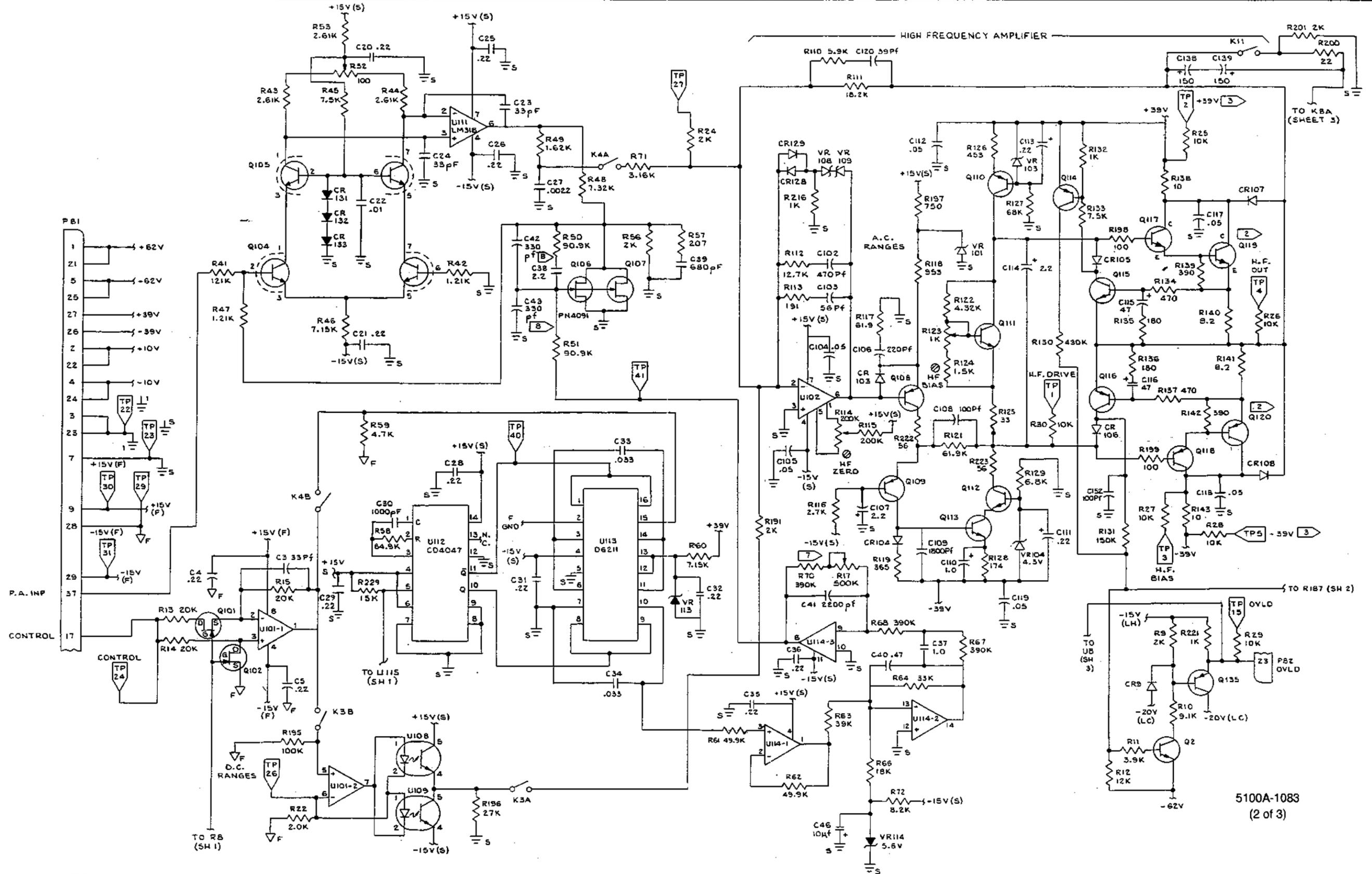
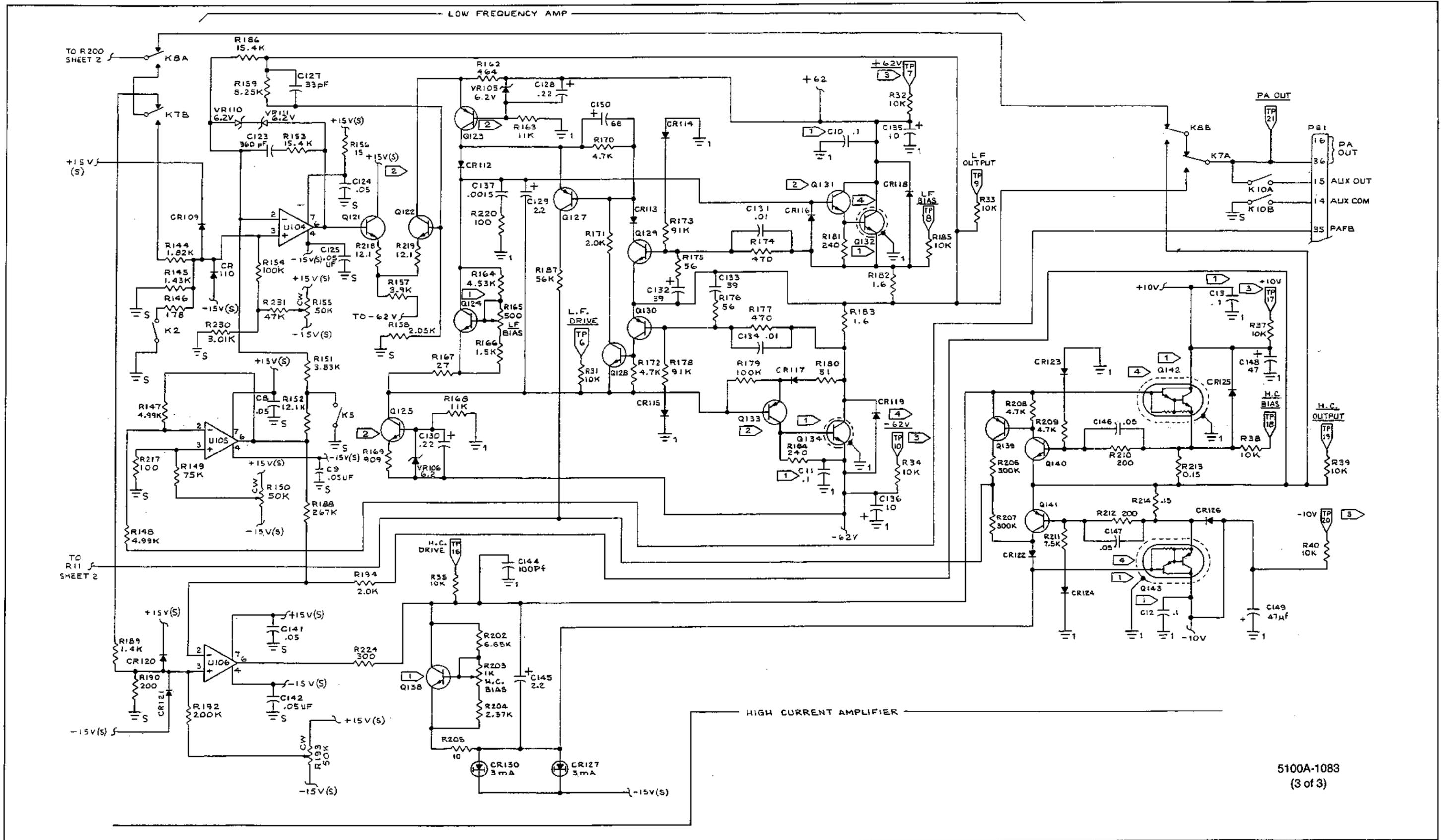

Figure 7-15. A17 Power Amplifier and A17A1 Power Transistor PCAs (cont)

5100A-1083
(2 of 3)



5100A-1083
(3 of 3)

Figure 7-15. A17 Power Amplifier and A17A1 Power Transistor PCAs (cont)

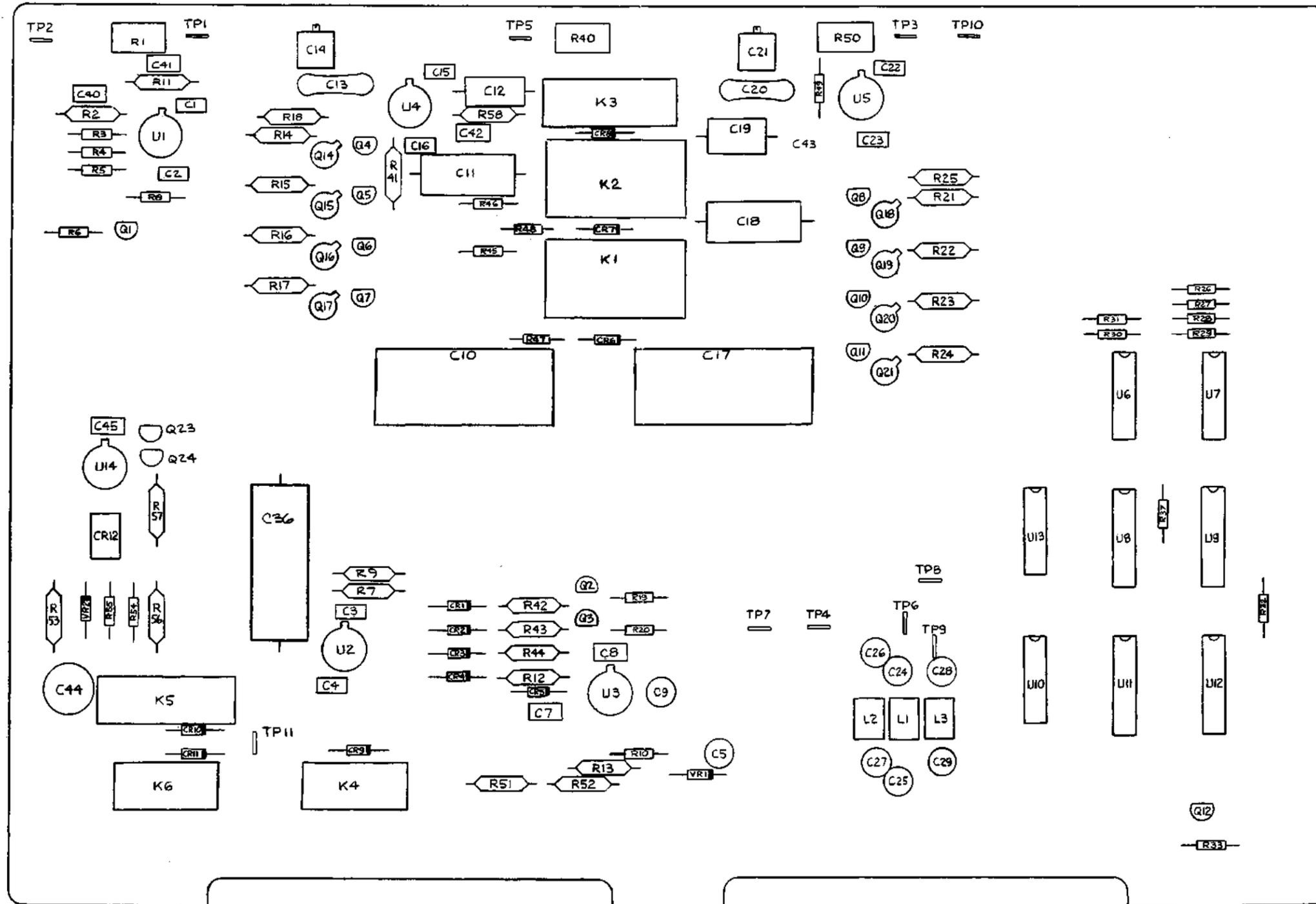

5100A-1690

Figure 7-16. A18 Oscillator PCA

NOTES: (UNLESS OTHERWISE SPECIFIED)

1. ALL RESISTORS 1/4 W CF ± 5%.
2. ALL M.F. RESISTORS 1/8 W ± 1%.
3. RELAYS ARE SHOWN DE-ENERGIZED.
4. 'H' = HIGH = RELAY ENERGIZED.
5. LAST REF. DES. NO'S USED: U14, Q21, VR2, CR12, L3, C45, K6, R58, TP10.
6. REF. DES. NO'S NOT USED: Q13, C6, C30-C35, C37-C39, R34-R36, R38, R39.

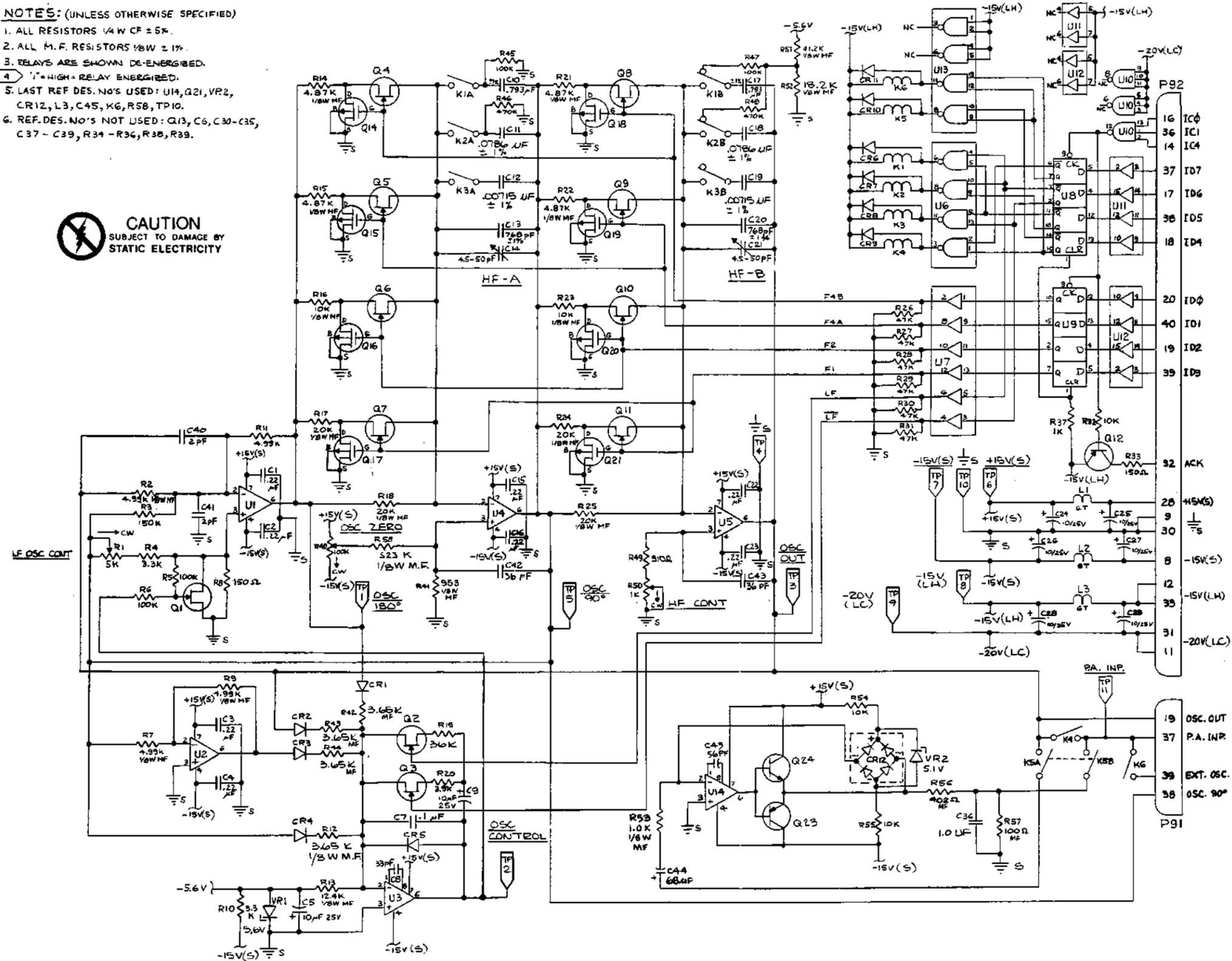

TRUTH TABLE

4	VDC & DC CUR		FREQ. RANGE (ACV & ACI)			
	≥ 20 VDC	≥ 20 VDC	104HZ	1004HZ	1K4HZ	10K4HZ
K1	1	0	1	0	0	0
K2	0	1	0	1	0	0
K3	0	0	0	0	1	0
K4	0	0	1	1	1	1
K5	0	1	0	0	0	0
K6	0	0	0	0	0	0
LF	1	1	1	1	0	0
HF	0	0	0	0	1	1

		FREQ. RANGE MULTIPLIER									
		1	2	3	4	5	6	7	8	9	10
F1	0	1	0	1	0	1	0	1	0	1	0
F2	0	0	0	0	1	1	0	0	1	1	0
F4A	1	1	0	0	0	0	1	1	1	1	1
F4B	1	1	0	0	0	0	0	0	0	0	1

5100A-1090

Figure 7-16. A18 Oscillator PCA (cont)

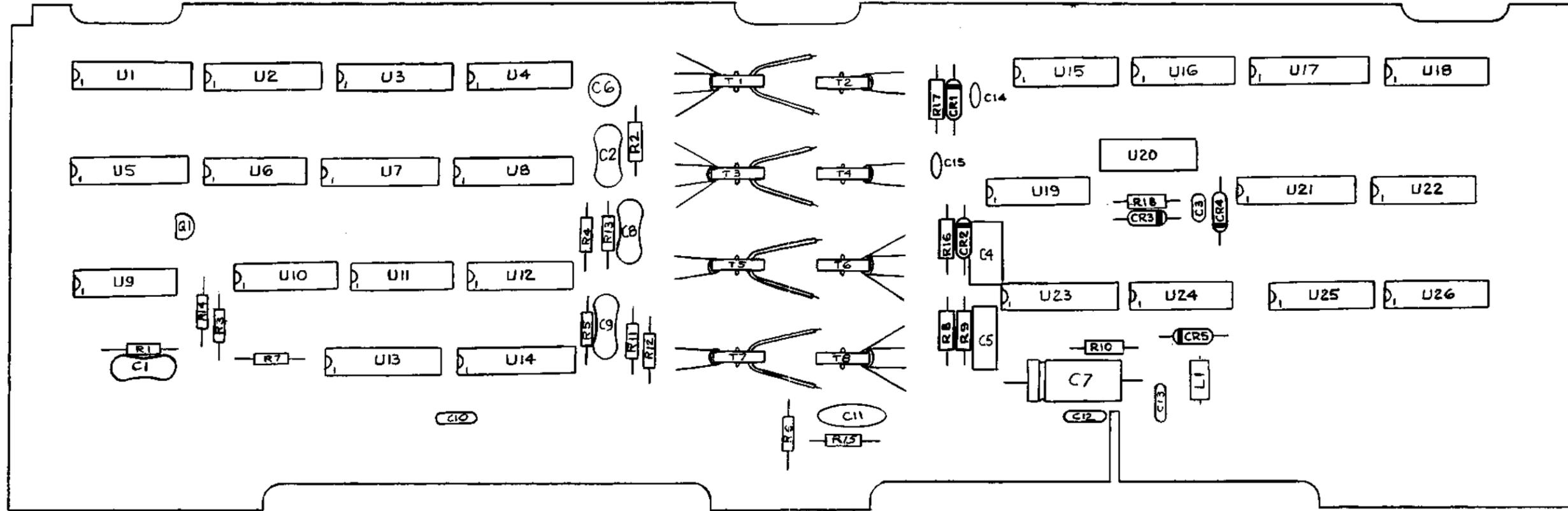

MIS-1781

Figure 7-17. A19 Isolator PCA

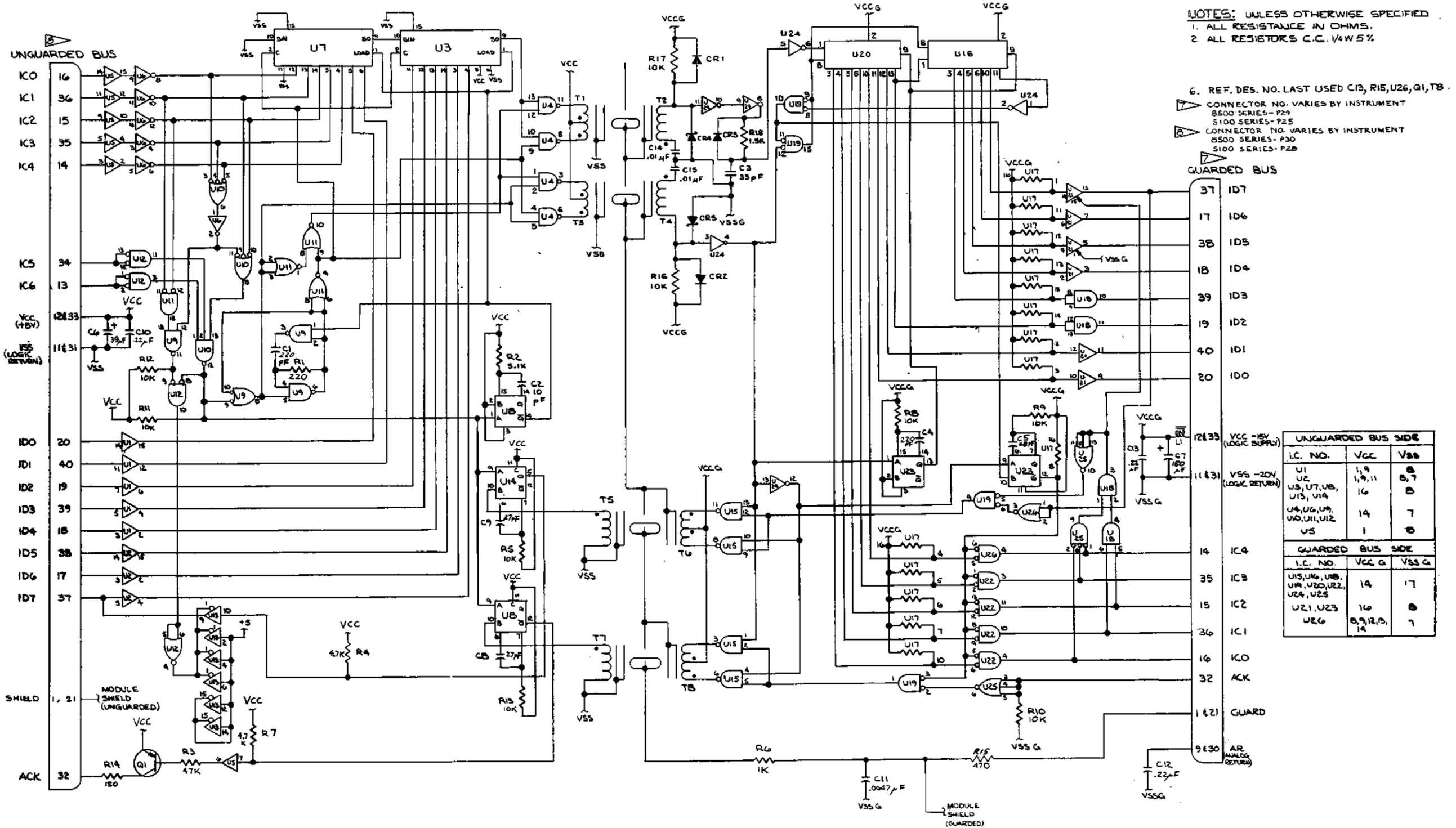

NOTES: UNLESS OTHERWISE SPECIFIED
 1. ALL RESISTANCE IN OHMS.
 2. ALL RESISTORS C.C. 1/4W 5%
 6. REF. DES. NO. LAST USED C13, R15, U26, Q1, T8.

CONNECTOR NO. VARIES BY INSTRUMENT
 8500 SERIES - P29
 5100 SERIES - P25
 CONNECTOR NO. VARIES BY INSTRUMENT
 8500 SERIES - P30
 5100 SERIES - P28

UNGUARDED BUS SIDE		
I.C. NO.	VCC	VSS
U1	1, 9, 11	8, 7
U2	1, 9, 11	8, 7
U3, U7, U8, U13, U14	16	8
U4, U6, U9, U10, U11, U12	14	7
U5	1	8

GUARDED BUS SIDE		
I.C. NO.	VCC G	VSS G
U15, U16, U18, U19, U20, U22, U24, U25	14	17
U21, U23	16	8
U26	8, 9, 12, 13, 14	7

MIS-1181

Figure 7-17. A19 Isolator PCA (cont)

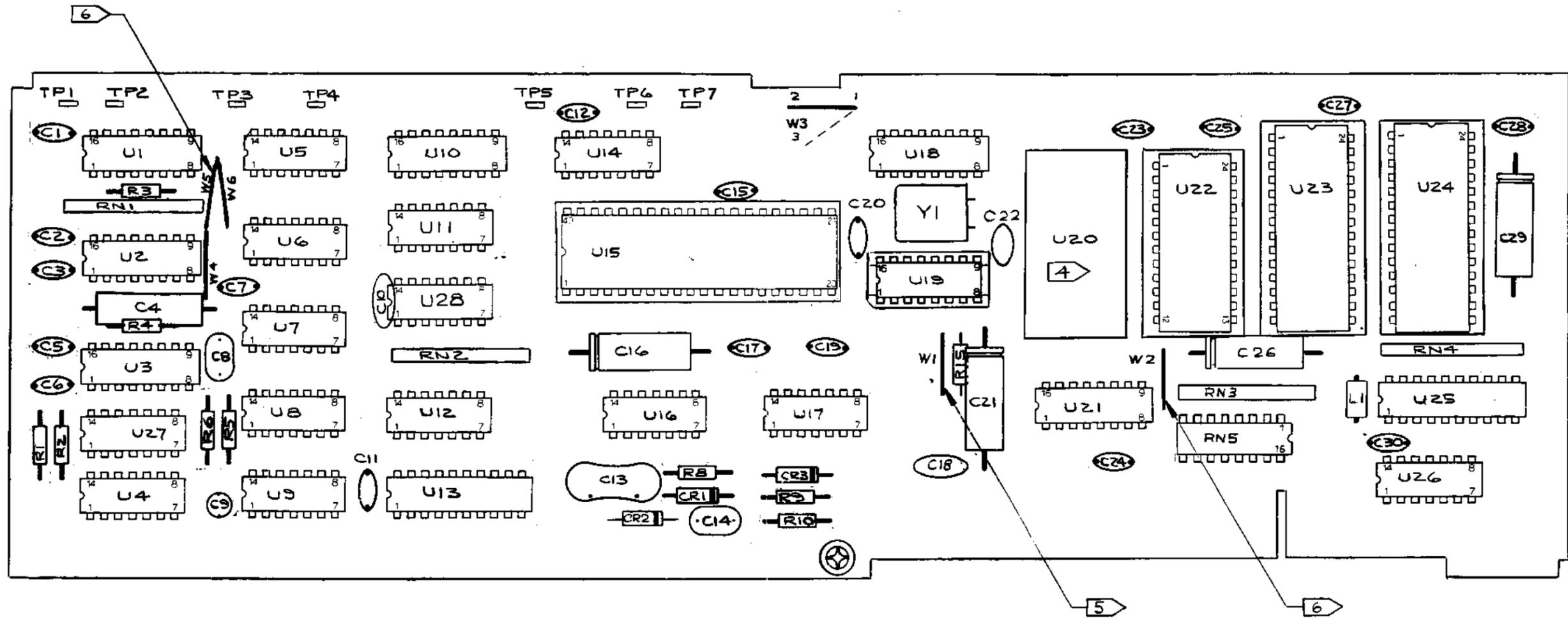

NOTES:-

- 4. U 20 INSTALLED ONLY ON 5101B.
- 5. JUMPER USED ON 5101B ONLY.
- 6. INSTALL JUMPER W2 ON 5100B PRODUCT LINE.

5100A-1687

Figure 7-18. A20 Controller PCA

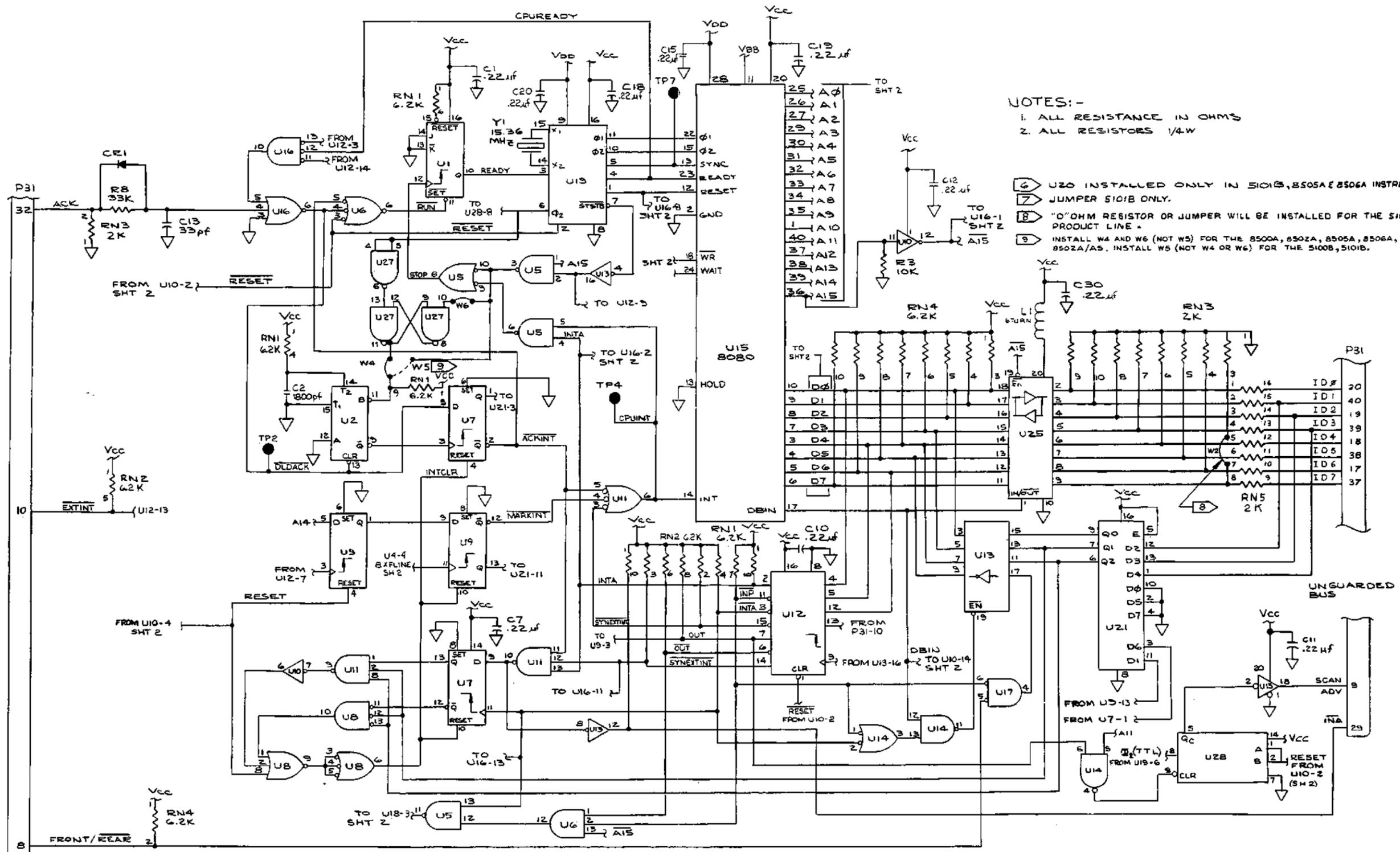

- NOTES:-**
1. ALL RESISTANCE IN OHMS
 2. ALL RESISTORS 1/4W
 - 6 U20 INSTALLED ONLY IN 5101B, 8505A & 8506A INSTRUMENT.
 - 7 JUMPER 5101B ONLY.
 - 8 "0" OHM RESISTOR OR JUMPER WILL BE INSTALLED FOR THE 5100 PRODUCT LINE.
 - 9 INSTALL W4 AND W6 (NOT W5) FOR THE 8500A, 8502A, 8505A, 8506A, 8502A/AS. INSTALL W5 (NOT W4 OR W6) FOR THE 5100B, 5101B.

MIS-1187
(1 of 2)

Figure 7-18. A20 Controller PCA (cont)

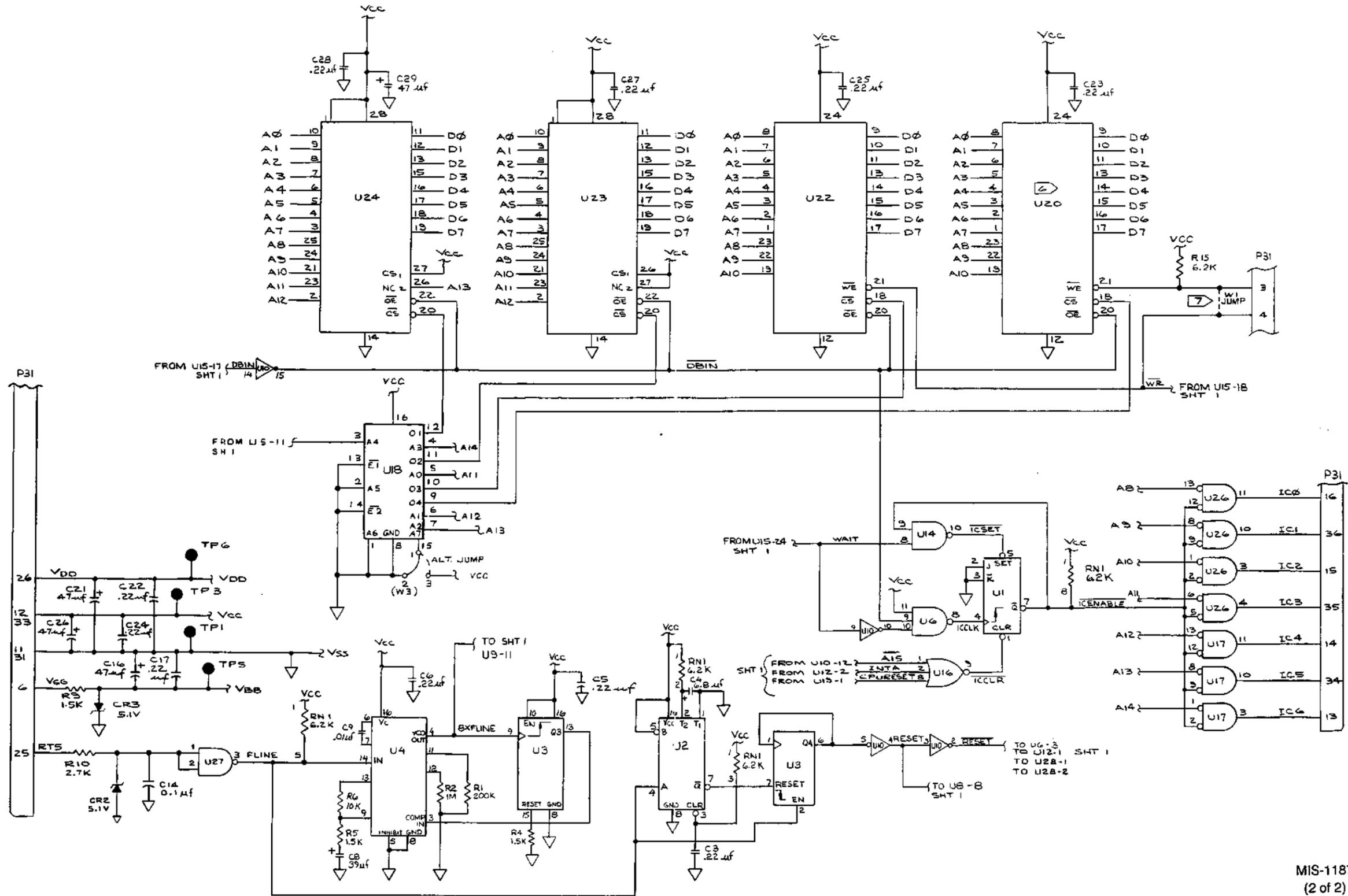

MIS-1187
(2 of 2)

Figure 7-18. A20 Controller PCA (cont)

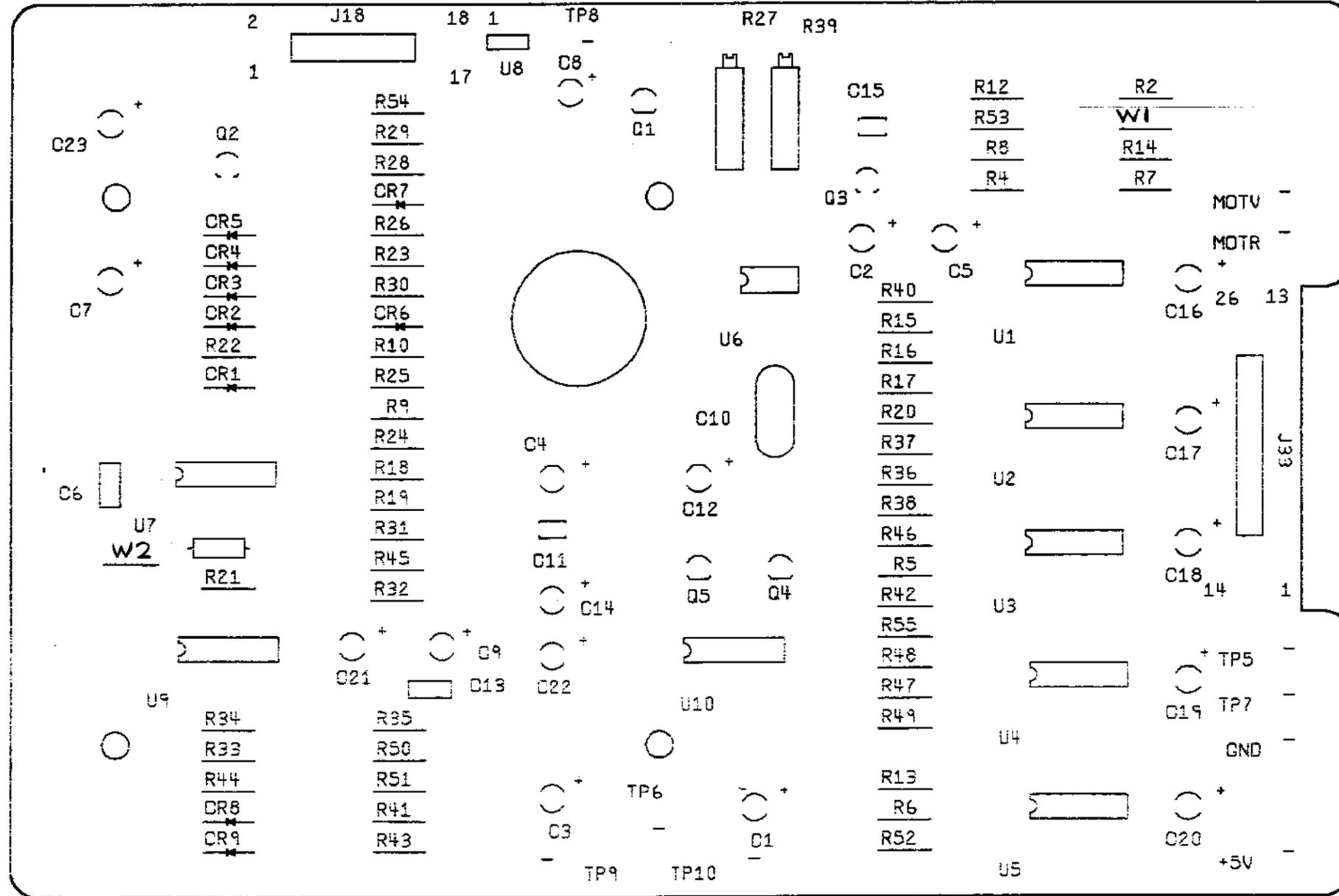

5101B-1630

Figure 7-19. A21 Tape Drive PCA

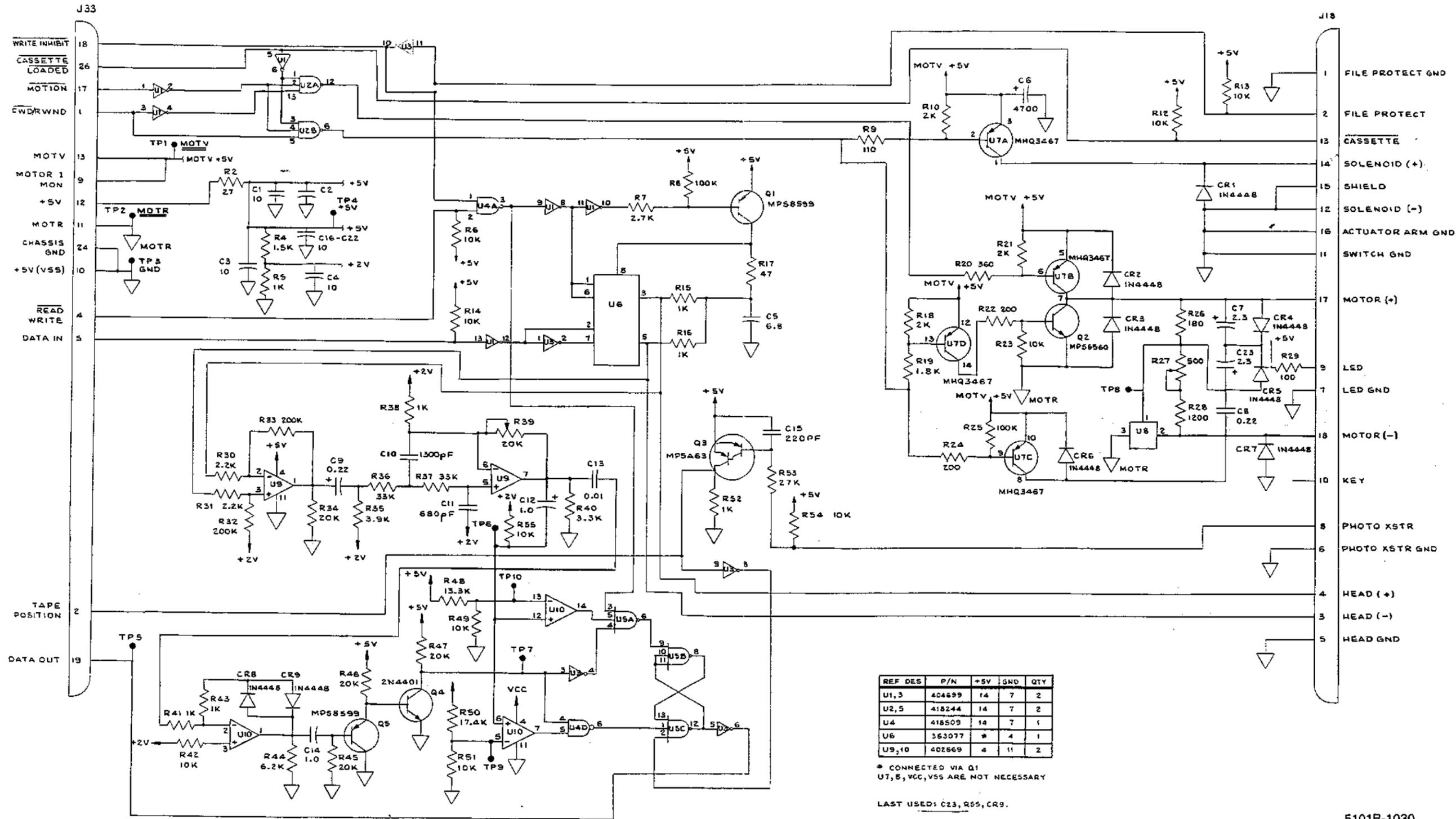

5101B-1030

Figure 7-19. A21 Tape Drive PCA (cont)

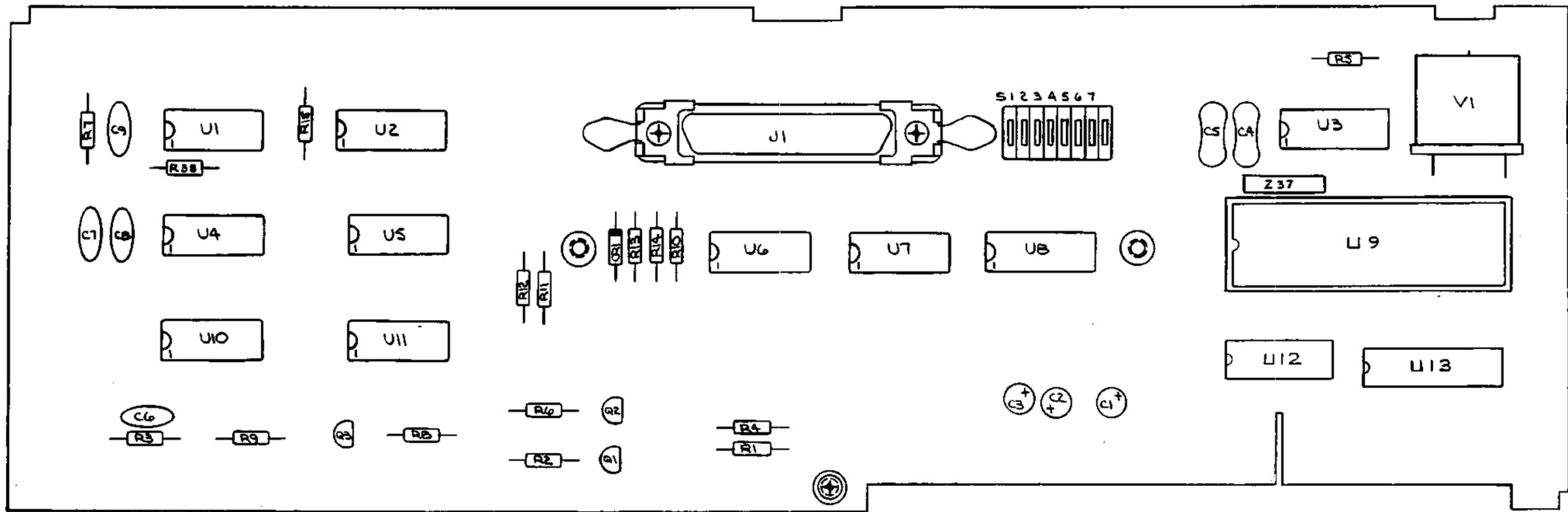

MIS-1770

Figure 7-20. A22 Bit Serial Interface PCA (Option -06)

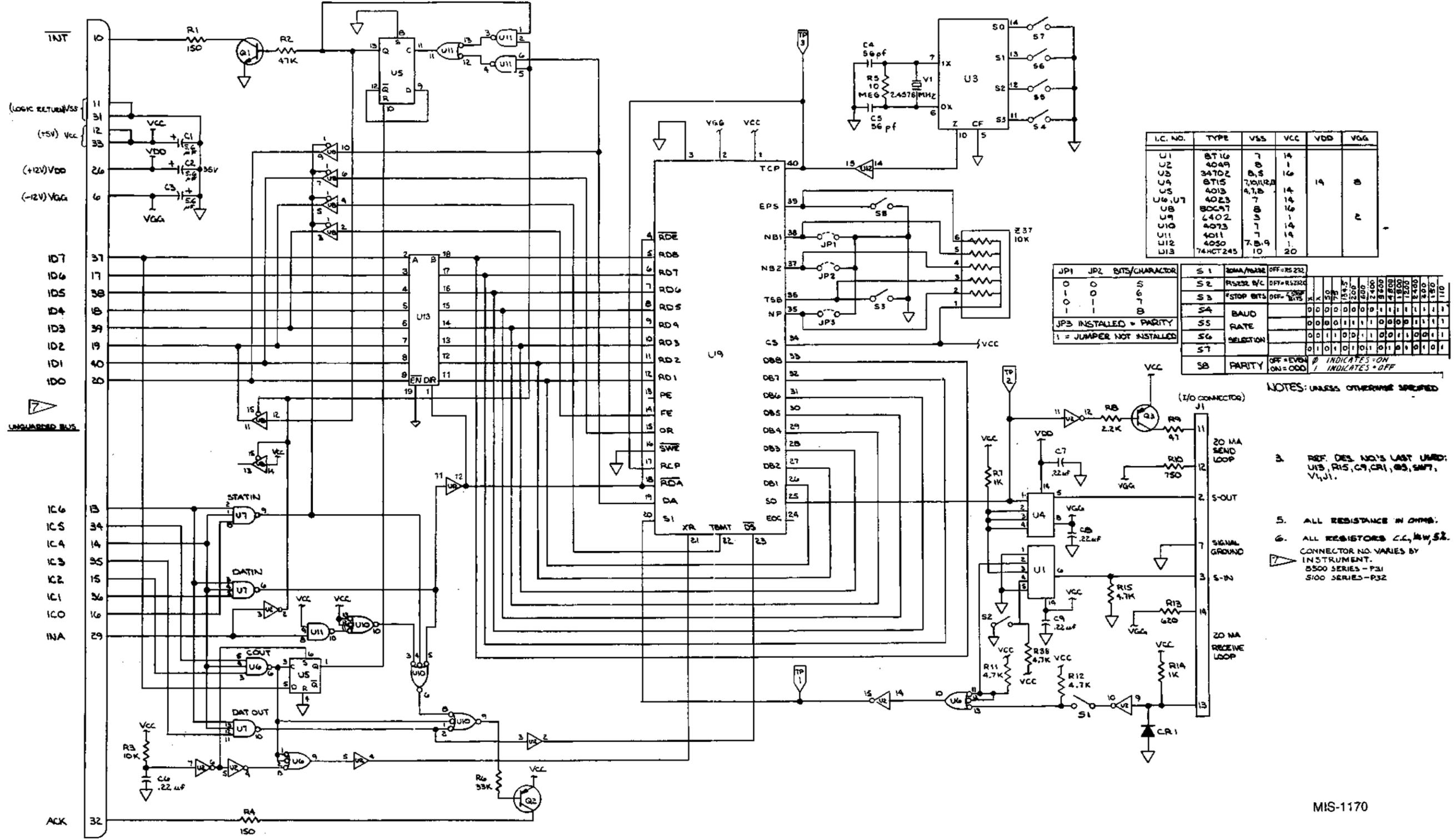

I.C. NO.	TYPE	VSS	VCC	VDD	VGG
U1	8T16	7	14		
U2	4049	8	1		
U3	34702	8,9	16		
U4	8T15	7,10,12,8		14	8
U5	4013	8,7,8	14		
U6, U7	4023	7	14		
U8	80C97	8	16		
U9	2402	3	14		2
U10	4073	7	14		
U11	4011	7	14		
U12	4050	7,8,9	1		
U13	74ACT245	10	20		

JP1	JP2	BITS/CHARACTER
0	0	5
1	0	6
0	1	7
1	1	8

JP3 INSTALLED = PARITY
1 = JUMPER NOT INSTALLED

S1	20MA/RECEIVE	OFF=RS232C
S2	RS232 B/C	OFF=RS232C
S3	*STOP BITS	OFF=2 STOP BITS
S4	BAUD	0 0 0 0 0 0 0 1 1 1 1 1 1 1 1 1
S5	RATE	0 0 0 0 1 1 1 1 0 0 0 0 1 1 1 1
S6	SELECTION	0 0 1 1 0 0 1 1 0 0 1 1 0 0 1 1
S7	PARITY	0 1 0 1 0 1 0 1 0 1 0 1 0 1 0 1
S8	PARITY	OFF=EVEN ON=ODD

INDICATES = ON
INDICATES = OFF

- NOTES: UNLESS OTHERWISE SPECIFIED
- REF. DES. NO.'S LAST USED: U13, R15, C9, C11, C13, S17, V1, J1.
 - ALL RESISTANCE IN OHMS.
 - ALL RESISTORS C1, R1, S2.
 - CONNECTOR NO. VARIES BY INSTRUMENT.
8500 SERIES - P31
5100 SERIES - P32

Figure 7-20. A22 Bit Serial Interface PCA (Option -06) (cont)

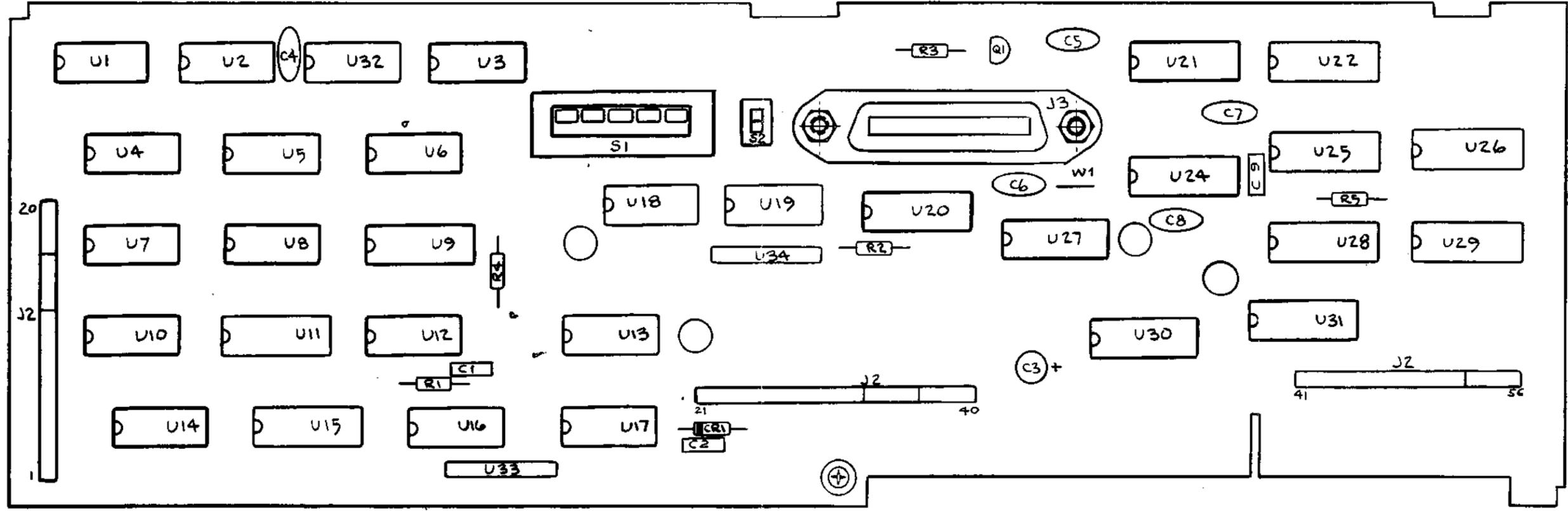

MIS-1772
A23

Figure 7-21. A23 IEEE-488 Interface Main and
A23A1 IEEE-488 Piggyback PCAs
(Option -05)

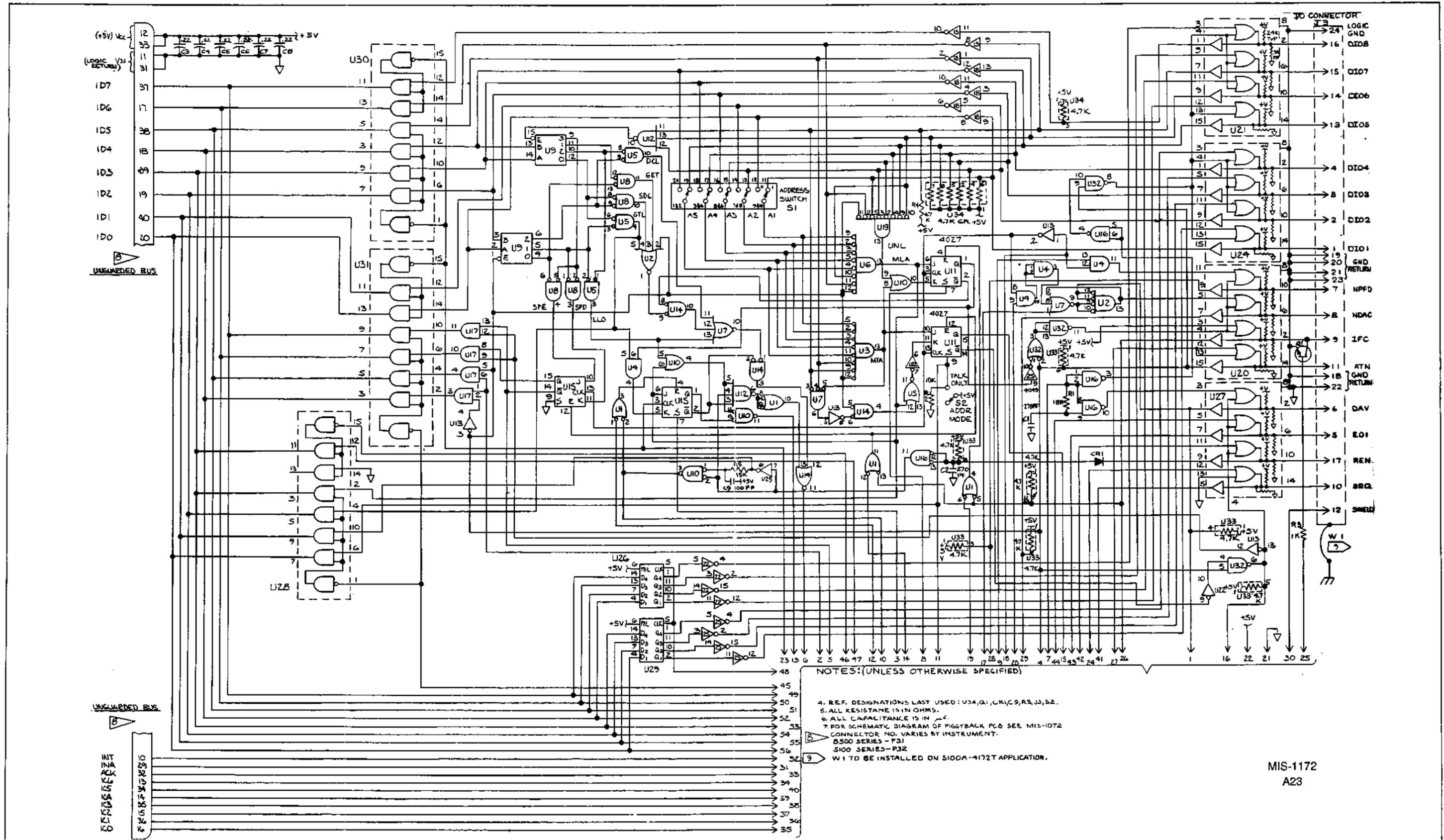

NOTES: (UNLESS OTHERWISE SPECIFIED)

4. REF. DESIGNATIONS LAST USED: U34, Q1, U1C, 9, R5, J3, S2.
5. ALL RESISTANCE IS IN OHMS.
6. ALL CAPACITANCE IS IN μ F.
7. FOR SCHEMATIC DIAGRAM OF PIGGYBACK PCB SEE MIS-1072 CONNECTOR NO. VARIES BY INSTRUMENT.
8. 5100 SERIES - P31
9. 5100 SERIES - P32
- W1 TO BE INSTALLED ON S100A-1172T APPLICATION.

MIS-1172
A23

Figure 7-21. A23 IEEE-488 Interface Main and A23A1 IEEE-488 Piggyback PCAs (Option -05) (cont)

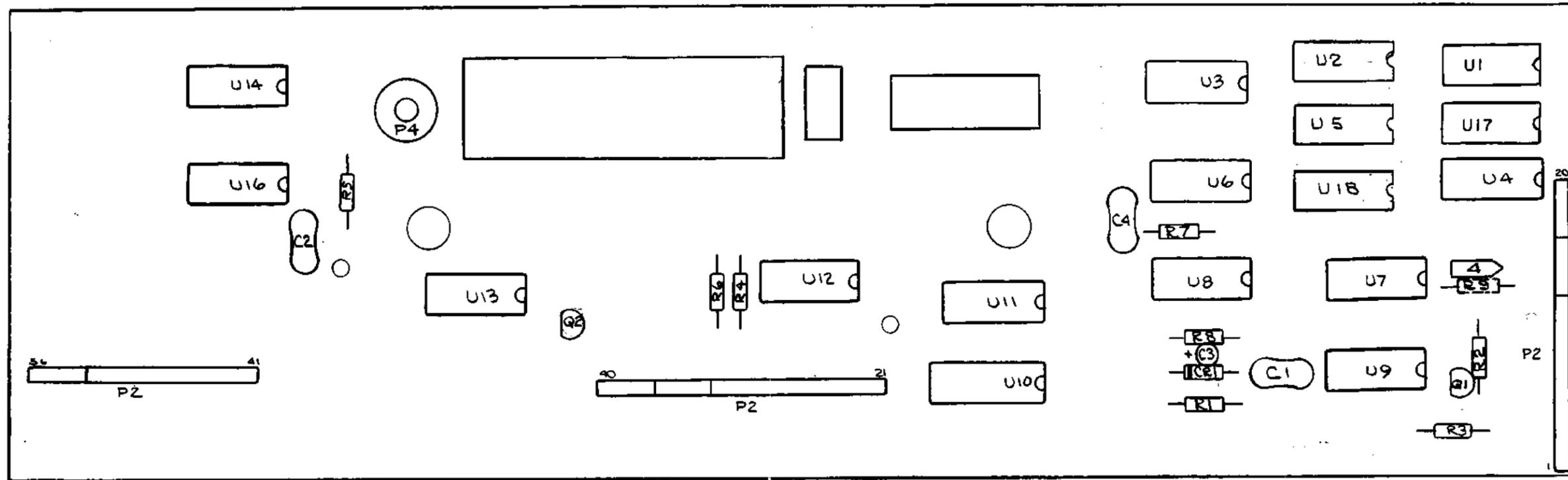

MIS-1674
A23A1

Figure 7-21. A23 IEEE-488 Interface Main and
A23A1 IEEE-488 Piggyback PCAs
(Option -05) (cont)

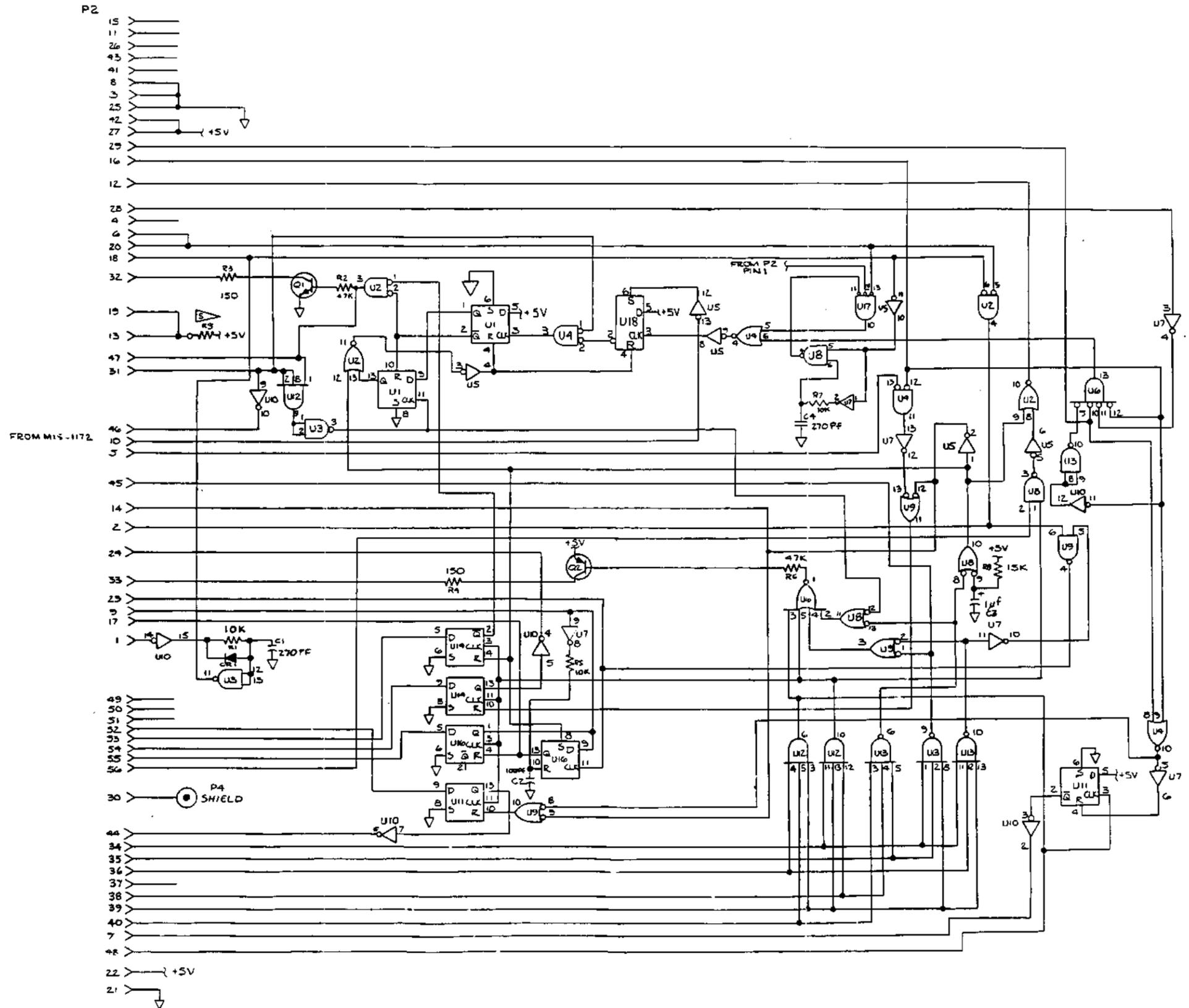

NOTES: (UNLESS OTHERWISE SPECIFIED).

- A. ALL RESISTORS ARE C.C. 1/4W AND RESISTANCE IS IN OHMS.
- B. R9 IS TO BE SELECTED AT TEST IF REQUIRED
- C. LAST REF. DES. USED: U8, Q2, C1, R9, C4, P4.
- D. REF. DES. NOT USED: U15, P1, P3.
- E. FOR SCHEMATIC DIAGRAM OF MAIN PCB SEE MIS-1172

UNUSED GATES

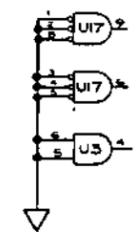

MIS-1074
A23A1

Figure 7-21. A23 IEEE-488 Interface Main and A23A1 IEEE-488 Piggyback PCAs (Option -05) (cont)