

# 37 MULTIMETER

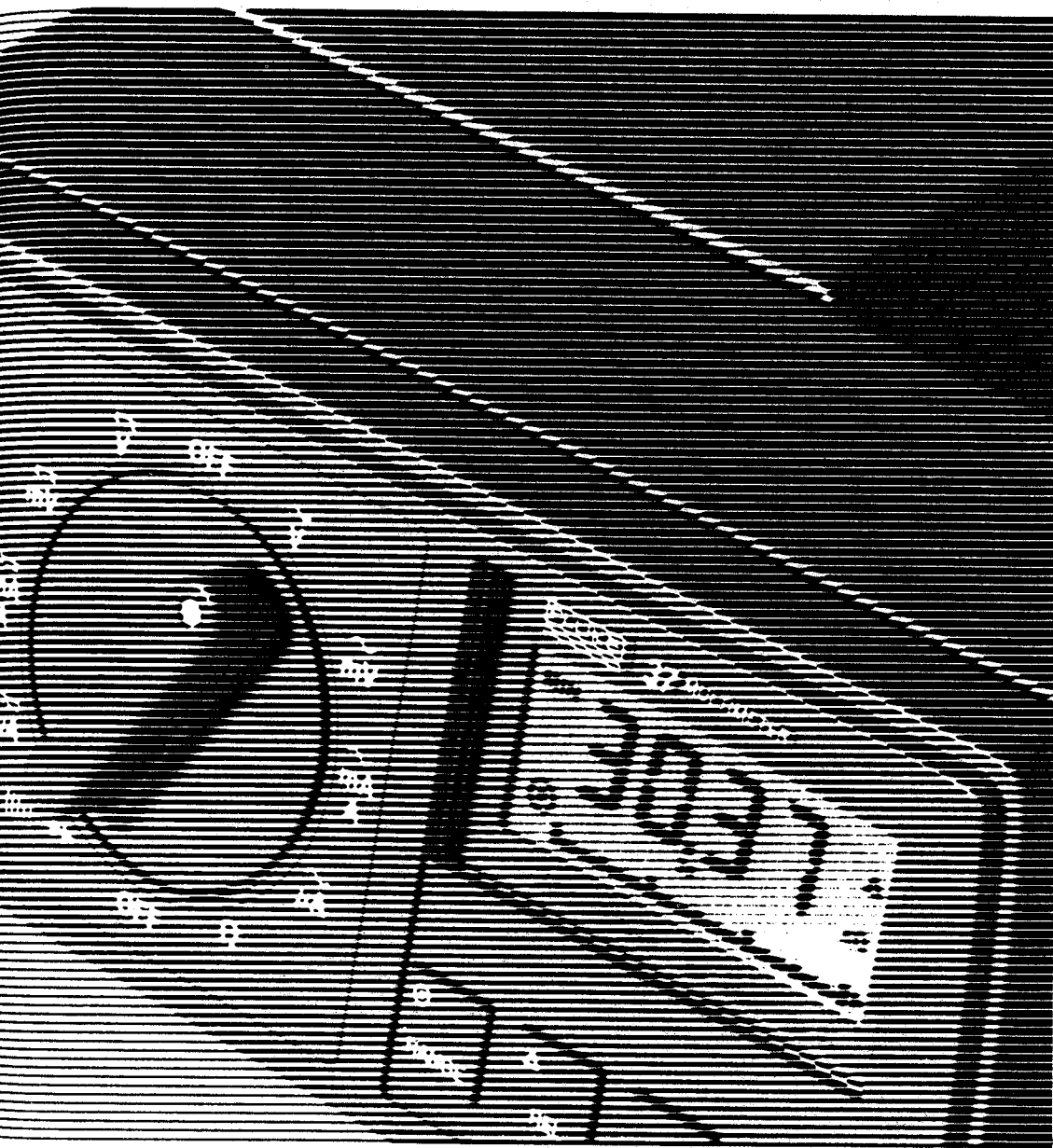

OPERATOR'S MANUAL  
MANUEL D'INSTRUCTION  
BEDIENUNGS-HANDBUCH  
MANUAL DE INSTRUCCIONES  
MANUALE D'IMPIEGO  
取扱説明書

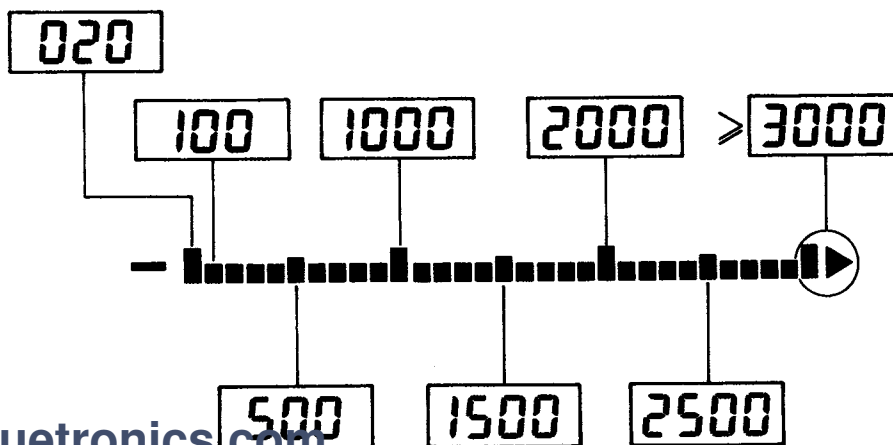
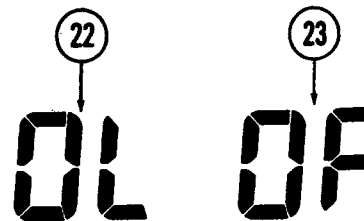
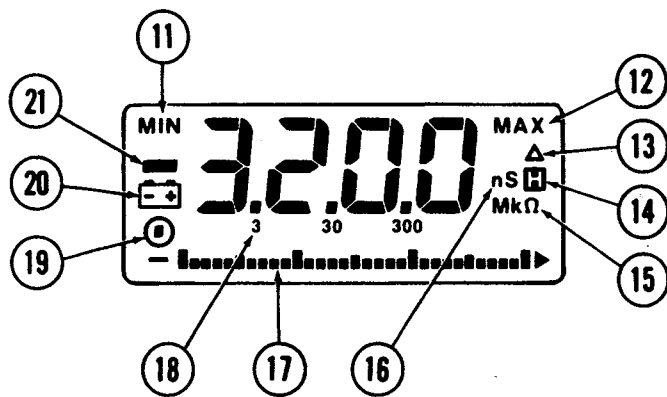
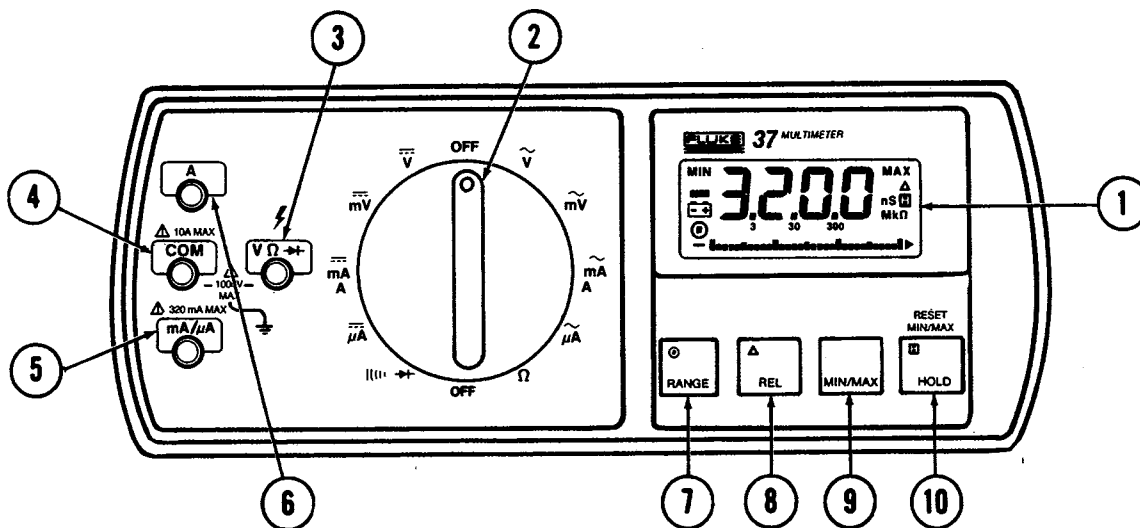

SEE PAGE 2  
 VOIR PAGE 16  
 SIEHE SEITE 30  
 VEDI PAGINA 46  
 VER PAGINA 60  
 74 ページ参照

# 37 MULTIMETER

---

English

Français

Deutsch

Italiano

Español

日本語



# Operating Instructions

This meter has been designed and tested according to IEC Publication 348. Safety Requirements for Electronic Measuring Apparatus. This manual contains information and warnings which must be followed to ensure safe operation and retain the meter in safe condition.

## INTRODUCTION

The Fluke 37 is a rugged, portable multimeter ideal for use on the bench or in the field. It provides unsurpassed performance and input protection in the most demanding working conditions.

The Fluke 37 combines the performance and accuracy of a digital meter with the speed and dynamic measurement capability of an analog meter. The 3200-count, digital display offers better resolution than a conventional 3½-digit, 2000-count display, and the 31-segment analog bar graph display provides quick and easy dynamic measurement indications. In addition, a unique Touch-Hold™ mode allows you to watch the probes during critical measurements. The Touch-Hold mode locks the measurement into the display for viewing and automatically updates the display when a new measurement is taken. These and other useful features of the Fluke 37 are explained in detail in this manual.

## MULTIMETER SAFETY

Read this information before using the meter. WARNINGS denote hazards to the operator. CAUTIONS denote hazards to the meter. The following safe practices and proper operating procedures should be followed when using any multimeter:











- Inspect the test leads for insulation damage or exposed metal. Damaged leads should be replaced.
- Check test lead continuity using the diode test (⎓ →) mode.
- Be certain the digital multimeter (DMM) itself is in good operating condition. During the continuity test, a meter reading that goes from overload (OL) to 0 generally means the meter is working properly.

- Select the proper function and range for your measurement.

## WARNING

**TO AVOID ELECTRICAL SHOCK, USE CAUTION WHEN WORKING ABOVE 60V DC OR 25V AC RMS. SUCH VOLTAGES POSE A SHOCK HAZARD.**

- Electrically disconnect the live, or hot, test lead before disconnecting the common test lead.
- Follow all equipment safety procedures. Disconnect the input power and discharge all high-voltage capacitors through a protective impedance before testing in  $\Omega$  and (⎓ →) with the multimeter.
- Avoid working alone.

	OFF (power) SWITCH POSITION		DANGEROUS VOLTAGE
	ON (power) SWITCH POSITION		GROUND
	AC— ALTERNATING CURRENT		SEE EXPLANATION IN MANUAL
	DC— DIRECT CURRENT		DOUBLE INSULATION (Protection Class II)
	EITHER DC OR AC		FUSE

International Electrical Symbols

\*Touch-Hold is a trademark of the John Fluke Manufacturing Company

- When making a current measurement, turn the power off before connecting the multimeter in the circuit. Overloading a current shunt will cause excessive heat.
- When measuring transformer secondary or motor winding current, check the multimeter fuses first. (See Fuse Test in the Operator Maintenance Section.) An open fuse will allow high voltage build-up, which is potentially hazardous.

**WARNING**

**TO AVOID ELECTRICAL SHOCK OR DAMAGE TO THE METER, DO NOT APPLY MORE THAN 1000V BETWEEN ANY TERMINAL AND EARTH GROUND.**

**OPERATING FEATURES**

The following features are keyed by number to the illustration inside the front cover.

**① Digital Display:**

3200 count, liquid crystal display with automatic decimal point positioning. Updated two times per second. When the meter is first turned on, all

display segments appear while the instrument performs a brief power-up self-test.

**② Function Selector Rotary Switch:**

Turn to select any of 10 different functions, or OFF. Refer to the Specifications for available ranges and to Table 1 for input terminals and limits.

- $\overline{\text{V}}$  Volts dc
- $\overline{\text{mV}}$  Millivolts dc
- $\sim \text{V}$  Volts ac
- $\sim \text{mV}$  Millivolts ac
- $\Omega$  Ohms (resistance), also conductance ( $1/\Omega$ ) in nanosiemens (nS)
- $\{\{\{\{\} \rightarrow\}$  Continuity or diode test

**Table 1. Input Terminals and Limits**

FUNCTION	INPUT TERMINALS		MIN DISPLAY READING	MAX DISPLAY READING	MAXIMUM INPUT
	Red Lead	Black Lead			
$\overline{\text{V}}$ $\sim \text{V}$	V $\Omega$ $\rightarrow\}$	COM	0.001V	1000V	1000V
$\overline{\text{mV}}$ $\sim \text{mV}$	V $\Omega$ $\rightarrow\}$	COM	0.1 mV	320.0 mV	500V
$\Omega$ (nS)	V $\Omega$ $\rightarrow\}$	COM	0.1 $\Omega$	32.00 M $\Omega$	500V
	V $\Omega$ $\rightarrow\}$	COM	0.01 nS	32.00 nS	500V
$\{\{\{\{\} \rightarrow\}$	V $\Omega$ $\rightarrow\}$	COM	0.001V	2.08V	500V
$\overline{\text{mA/A}}$ $\sim \text{mA/A}$	A	COM	0.01A	20.00A*	10A*    600V
	$\text{mA}$ $\mu\text{A}$	COM	0.01 mA	320.0 mA	320 mA    600V
$\overline{\mu\text{A}}$ $\sim \mu\text{A}$	$\text{mA}$ $\mu\text{A}$	COM	0.1 $\mu\text{A}$	3200 $\mu\text{A}$	320 mA    600V

\*10A continuous, 20A for 30 seconds maximum

$\tilde{\text{mA/A}}$	Milliamps or amperes ac
$\tilde{\mu\text{A}}$	Microamps ac
$\text{mA/A}$	Milliamps or amperes dc
$\mu\text{A}$	Microamps dc

**3** **V  $\Omega$   $\rightarrow$  Volt, Ohms, Diode Test Input Terminal:**

Input terminal used in conjunction with the volts, mV (ac or dc), ohms, or diode test position of the function selector rotary switch.

**4** **COM Common Terminal:**

Common or return terminal used for all measurements.

**5** **mA/ $\mu$ A Milliamp/Microamp Input Terminal:**

Input terminal used for current measurements up to 320 mA (ac or dc) with the function selector rotary switch in the mA or  $\mu$ A position.

**6** **A Amperes Input Terminal:**

Input terminal used for current measurements up to 10A continuous (20A for 30 seconds) with the function selector rotary switch in the mA/A position (ac or dc).

**7** **RANGE  $\odot$  Manual Range Mode Pushbutton:**

Press once to enter manual range mode, press again to increment range, press and hold for 2 seconds to return to autorange. Meter returns to autorange if the function selector is switched to any other position. There is no autorange annunciator; absence of the manual range annunciator indicates the meter is in autorange. If RANGE is depressed (>1 second) while the function switch is moved from OFF to any ON position, manual ranging will be selected in all functions.

**8** **REL  $\Delta$  Relative Mode Pushbutton:**

Press momentarily to enter the Relative mode and store the displayed reading. The display will read zero. Press again to update the stored digital reading. Press and hold for 2 seconds to exit the

Relative mode. The Relative mode stores a digital reading and displays the change (difference) between the stored reading and any following reading. For example, if the stored reading is 15.00V and the present reading is 14.10V, the display will indicate -0.90V. The analog bar graph continues to display the actual reading (14.10V). If the difference exceeds 3999 counts (without overloading the input), OF (overflow) is displayed. The Relative mode selects manual ranging; changing ranges automatically exits the Relative mode.

**9** **MIN/MAX MIN/MAX Mode Pushbutton:**

Press momentarily to enter MIN/MAX mode, press again to toggle between MIN and MAX indications. Press and hold for 2 seconds to exit MIN/MAX mode. The meter stores the minimum and maximum digital readings, and will display either reading as selected by the operator. Press the HOLD/RESET button to reset the MIN/MAX readings to the present input. The MIN/MAX mode selects manual ranging; use a range that can record the maximum anticipated input. Range changes reset previously recorded MIN/MAX readings. Exiting the MIN/MAX mode does not reset the previously recorded readings unless the range or function is changed. The MIN/MAX mode overrides the Touch-Hold mode.

**10** **HOLD  $\square$  Touch-Hold Mode Pushbutton:**

Press momentarily to enter Touch-Hold mode. In Touch-Hold, the meter captures a stable measurement and holds it in the display. The operator can watch the probes while taking measurements in difficult or hazardous circuits, then look at the display when convenient. The meter beeps and the display is automatically updated each time a new, stable measurement is made. Press momentarily to manually update reading. Press and hold for 2 seconds to exit Touch-Hold mode. If HOLD is depressed (>1 second) while the function switch is moved from OFF to any ON position, the Touch-Hold mode will only update to a new reading when the HOLD button is pressed. (Automatic Touch-Hold updates are defeated.) This is useful when you want to take a reading at a specific time and hold it.

**11** **MIN Minimum Annunciator:**

Indicates that the meter is in the MIN/MAX recording mode, and the value displayed is the minimum digital reading taken since reset or since entering MIN/MAX. Refer to item 9 for operation.

**12** **MAX Maximum Annunciator:**

Indicates that the meter is in the MIN/MAX recording mode, and the value displayed is the maximum digital reading taken since reset or since entering MIN/MAX. Refer to item 9 for operation.

**13** **△ Relative Annunciator:**

Indicates that the meter is in the Relative mode and that the value displayed is relative (the difference between the present measurement and the previously stored reading). Refer to item 8 for operation.

**14** **⏏ Touch-Hold Mode Annunciator:**

Displayed when the Touch-Hold mode is in use. Refer to item 10 for operation.

**15** **MkΩ Resistance Annunciators:**

The appropriate annunciator (Ω, k, or M) is displayed for the resistance range in use.

**16** **nS Conductance Range Annunciator (nS):**

Top range of the resistance function is the conductance range. Displays conductance in nS (nanosiemens). 1000/nS converts to megohms. (Example: 2 nS converts to 500 MΩ.) Use for measuring resistance above 32 megohms. Select Ω, open test leads, press RANGE button twice. (Refer to item 7 for manual range operation.)

**17** **▬ Analog Bar Graph Display:**

Analog representation of input. Composed of 31 segments which illuminate starting from the left as the input increases. (See display inside rear cover.) A minus sign (-) is displayed for reverse-polarity inputs. Updated 25 times per second.

**18** **· · · Decimal Point/Range Indicator:**

Decimal point position and the digits (3, 30, 300) under the decimal point indicate the range in use.

**19** **⊙ Manual Range Annunciator:**

Displayed in the Manual Range mode or if the selected function has only one range. Absence of the indicator implies autorange mode in use. The meter powers-up in autorange. In autorange, the meter automatically selects the measurement range. Refer to item 7 for operation.

**20** **🔋 Low Battery Annunciator:**

At least 60 hours of battery life remain when first displayed. Battery voltage is tested each time the function switch is moved to a new position.

**21** **— Negative Polarity Annunciator:**

Automatically indicates negative inputs.

**22** **⏏ Overload Indication:**

These symbols indicate the input is too large for the input circuitry. (The location of the decimal point depends on the measurement range.)

**23** **⏏ Overflow Indication:**

These symbols indicate the calculated difference in the Relative mode is too large to display (>3999 counts) and that the input is not overloaded.

**24** **Beeper (not illustrated):**

The beeper can produce beeps, clicks, or a continuous tone. It is used for audible indication in the diode test mode, when operating the push buttons, and when a new reading is displayed in the Touch-Hold mode.

**ACCESSORY COMPARTMENT**

The multimeter provides an easy-access compartment for storing test leads and other accessories. The compartment is large enough to accommodate certain temperature probes, current probes, and rf probes. The accessory compartment also provides access for battery and fuse replacement.



## BAIL ADJUSTMENT

The multimeter is shipped from the factory with a detachable bail stored in the accessory compartment. The bail allows the multimeter to rest in four convenient viewing positions, as shown in Figure 1.

To install the bail, slide the bail's mounting tabs into the two sets of mounting brackets on the case bottom as shown in position I or II. While installing the bail, keep the mounting tabs parallel to the case bottom. To remove the bail, simply slide the bail out of the mounting brackets.

To rest the multimeter on a bench (view A), install the bail as shown in position I. To rest the multimeter on a shelf (view B) or the floor (view C), install the bail as shown in position II. The multimeter can also be stood on end (view D).

## APPLICATIONS

### AC Measurement

The multimeter's ac ranges employ an average responding ac-coupled converter. This means that the multimeter measures the average value of the input and displays it as an equivalent rms value for a sine wave. As a result, measurement errors are introduced when the input waveform is non-sinusoidal. Further, any dc component of the input is blocked by the ac-coupled converter. Figure 2 shows some commonly encountered waveforms. If the waveform is known, multiply the reading displayed on the multimeter by the indicated factor for the desired conversion.

### Voltage, AC/DC

The multimeter features five ac voltage ranges and five dc voltage ranges. All ranges present an input impedance of approximately 10 megohms in parallel with less than 100 pF. Measurement errors, due to circuit loading, can result when making either ac or dc voltage measurements on circuits with high source resistance. However, in most cases the error is negligible (0.1% or less) if the measurement circuit source resistance is 10 kilohms or less. If circuit loading does present a problem, the percentage of error can be calculated using the appropriate formula from Figure 3.

When measuring voltages above 320V in Touch-Hold mode, use manual ranging to minimize readings of stray voltages.

## Current, AC/DC

### WARNING

**INSTRUMENT DAMAGE AND OPERATOR INJURY MAY RESULT IF THE FUSE BLOWS WHILE CURRENT IS BEING MEASURED IN A CIRCUIT WHICH EXHIBITS AN OPEN CIRCUIT VOLTAGE GREATER THAN 600V. DO NOT ATTEMPT AN IN-CIRCUIT CURRENT MEASUREMENT WHERE THE POTENTIAL IS GREATER THAN 600V.**

The multimeter features five ac current ranges and five dc current ranges. All current ranges are fuse protected. If a fuse opens, refer to the fuse replacement procedures in the Operator Maintenance section of this manual.

### Current Measurement Error Calculations

In an ac or dc current measurement, the voltage developed across the meter's terminals is called burden voltage. The burden voltage for a full-scale input is given for each range in the Specifications table. The burden voltage can affect the accuracy of a current measurement if the current source is unregulated and the terminal resistance represents a significant portion (1/1000th or more) of the source resistance. If burden voltage does present a problem, the percentage of error can be calculated using the formula in Figure 4. Approximate terminal resistances for the current ranges are: 0.05 ohms for A, 5.5 ohms for mA, and 500 ohms for  $\mu$ A.

### Resistance Measurement

### CAUTION

**Turn test circuit power off and discharge all capacitors before attempting in-circuit resistance measurements.**

The multimeter features six resistance ranges and a conductance range. All ranges employ a two-wire measurement technique. As a result, test lead resistance may influence measurement accuracy on the 320-ohm range. To determine the error, short the test leads together and read the lead resistance. Correct the measurement by subtracting the lead resistance from the measurement, or use the Relative (REL) mode to zero the display. The error is usually 0.1 to 0.2 ohms for a standard pair of test leads.



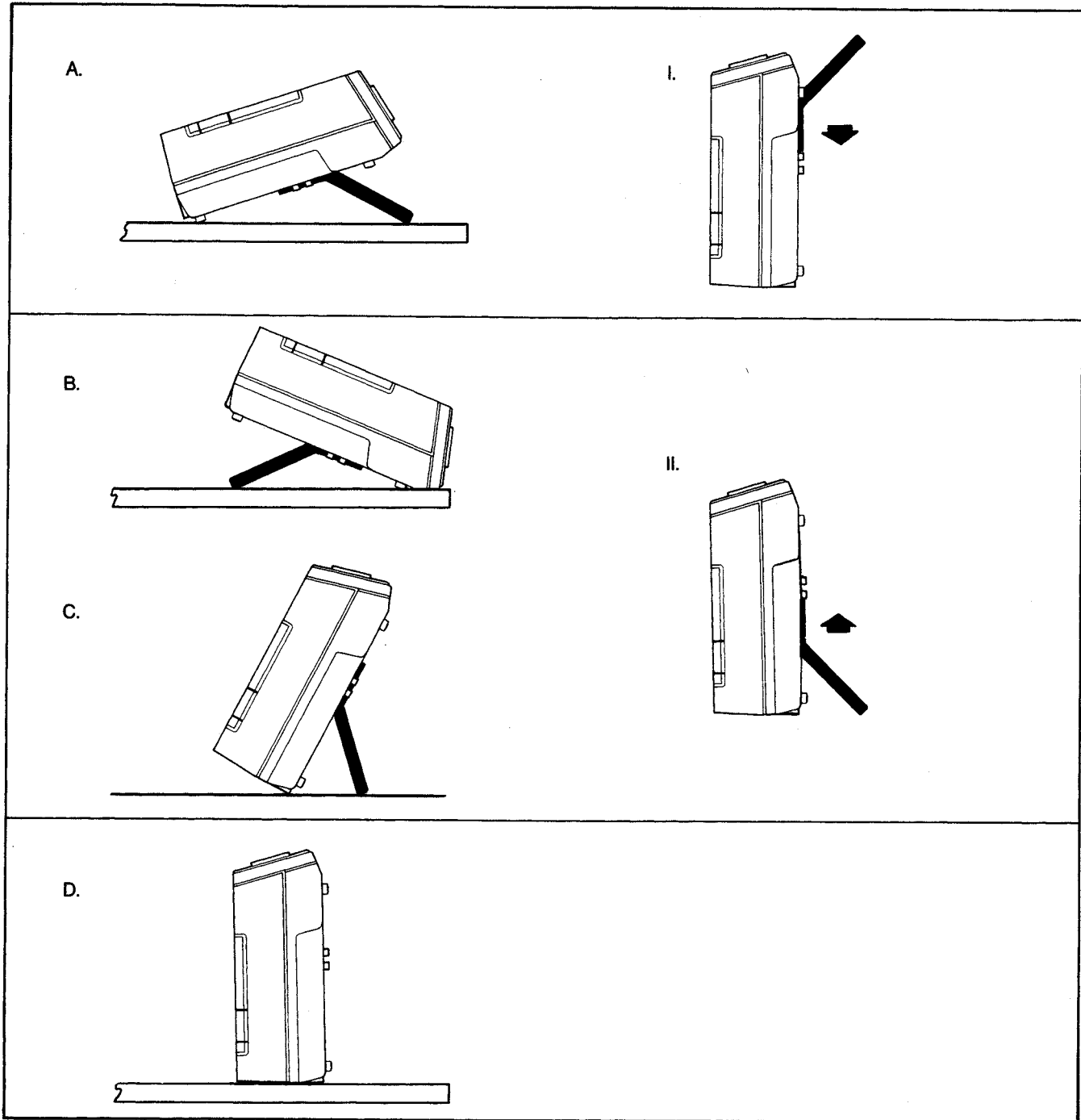

Figure 1. Bail Adjustment





AC COUPLED INPUT WAVEFORM	DISPLAY MULTIPLIER FOR MEASUREMENT CONVERSION				AC COUPLED INPUT WAVEFORM	DISPLAY MULTIPLIER FOR MEASUREMENT CONVERSION			
	RMS AC+DC	DC COMPONENT ONLY	0-PK	PK-PK		RMS AC+DC	DC COMPONENT ONLY	0-PK	PK-PK
SINE 	1.000	0.000	1.414	2.828	RECTIFIED SQUARE 	1.274	0.900	1.800	1.800
RECTIFIED SINE (FULL WAVE) 	2.375	2.138	3.359	3.359	RECTANGULAR PULSE 	$\frac{0.450}{\sqrt{D(I-D)}}$	$\frac{0.450}{(I-D)}$	$\frac{0.450}{D(I-D)}$	$\frac{0.450}{D(I-D)}$
RECTIFIED SINE (HALF WAVE) 	1.283	0.817	2.566	2.566	TRIANGLE SAWTOOTH 	1.040	0.000	1.800	3.600
SQUARE 	0.900	0.000	0.900	1.800					

Figure 2. Waveform Conversion

1. DC VOLTAGE MEASUREMENTS

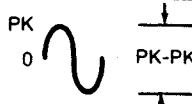
Loading Error in % =  $100 \times R_s \pm (R_s + 10^7)$   
 Where:  $R_s$  = Source resistance in ohms of circuit being measured.

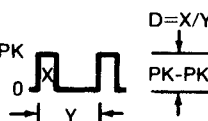
2. AC VOLTAGE MEASUREMENTS

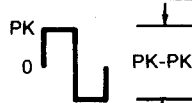
First, determine input impedance, as follows:

$$Z_{in} = \frac{10^7}{\sqrt{1 + (2 \pi F \cdot R_{in} \cdot C)^2}}$$

Where:  $Z_{in}$  = effective input impedance  
 $R_{in}$  =  $10^7$  ohms  
 $C_{in}$  =  $100 \times 10^{-12}$  Farads  
 $F$  = frequency in Hz

Then, determine source loading error as follows:  
 (Vector algebra required)

$$\text{Loading Error in \%} = \frac{100 \times Z_s}{R_s + Z_{in}}$$

Where:  $Z_s$  = source impedance  
 $Z_{in}$  = input impedance (calculated)  
 $R_s$  = source resistance

Figure 3. Voltage Measurement Error Calculations

Some in-circuit resistance measurements can be made without removing diodes and transistors from the circuit. The full-scale measurement voltage produced on ranges below 32 megohms does not strongly forward bias silicon diodes or transistor junctions. Use the highest range you can (except 32 megohm) to minimize the possibility of turning on diodes or transistor junctions. Full scale measurement voltage in the 32-megohm range does strongly forward bias a diode or transistor.

### Diode Test and Continuity

In diode test, there is only one range: 0 to +2.08 volts. Voltage is developed across the component(s) under test by a test current output from the multimeter. Voltages greater than 2.08V or open test leads produce an overload (OL) condition. Negative inputs produce a negative indication (they are not suppressed). In the diode test function (||||| →), the beeper produces a continuous tone if the input is less than 0.1V, and the beeper beeps once when the input descends through a 0.7V threshold.

Audible continuity testing is also performed with the function selector switch in the diode test/continuity position. A continuous tone sounds for test resistances below approximately 150 ohms. An intermittent connection produces erratic beeps, and can be a valuable troubleshooting aid.

Erratic beeps can also occur, due to environmental noise, if a test value is very close to the threshold (150 ohms). Test resistances from approximately 150 ohms to 1000 ohms produce a short tone similar to a forward biased diode. Test resistances less than approximately 20 kilohms will produce an on-scale reading.

**Conductance**

Conductance measurement is performed with the function selector switch in the ohms (Ω) function. The conductance range can only be entered using manual range selection; autorange cannot enter the conductance range. The conductance range can be used both to measure conductance (1/Ω, the inverse of resistance) and to measure very high resistances (greater than 32 megohms).

High value resistance measurements are susceptible to induced noise, and may require careful shielding. Conductance measurements are displayed in nanosiemens (nS). Calculate megohms by dividing 1000 by the nanosiemens displayed (1000/nS is equivalent to megohms). Example: 2 nS converts to 500 megohms (1000/2).

**Leakage Testing**

The conductance range effectively extends the resistance measurement capability of the multimeter to the point where it can provide useful leakage measurements on passive

components. For example, the operator can detect leaky diodes, cables, connectors, printed circuit boards, etc. In all cases, the test voltage is less than 2V dc.

Leakage testing on purely resistive components such as cables and printed circuit boards is straightforward. Select the ohms function and manually increment the range to conductance (nS). Connect the test leads to the test points on the unit under test, and read the leakage in terms of conductance.

**NOTE**

*There is normally a small residual reading with open test leads in the conductance range. To ensure accurate measurements, connect clean test leads to the multimeter and (with the leads open) read the residual leakage in nanosiemens. Correct subsequent measurements by subtracting the residual from the readings. This can be done automatically using the Relative mode (REL) in the multimeter.*

Diode leakage tests require that the diode junction be reverse biased when being measured. This is accomplished by connecting the anode of the diode to the COMMON input terminal and the cathode (ring) of the diode to the volts/ohms/diode test terminal. Leakage at the test voltage being applied can then be read in terms of conductance.

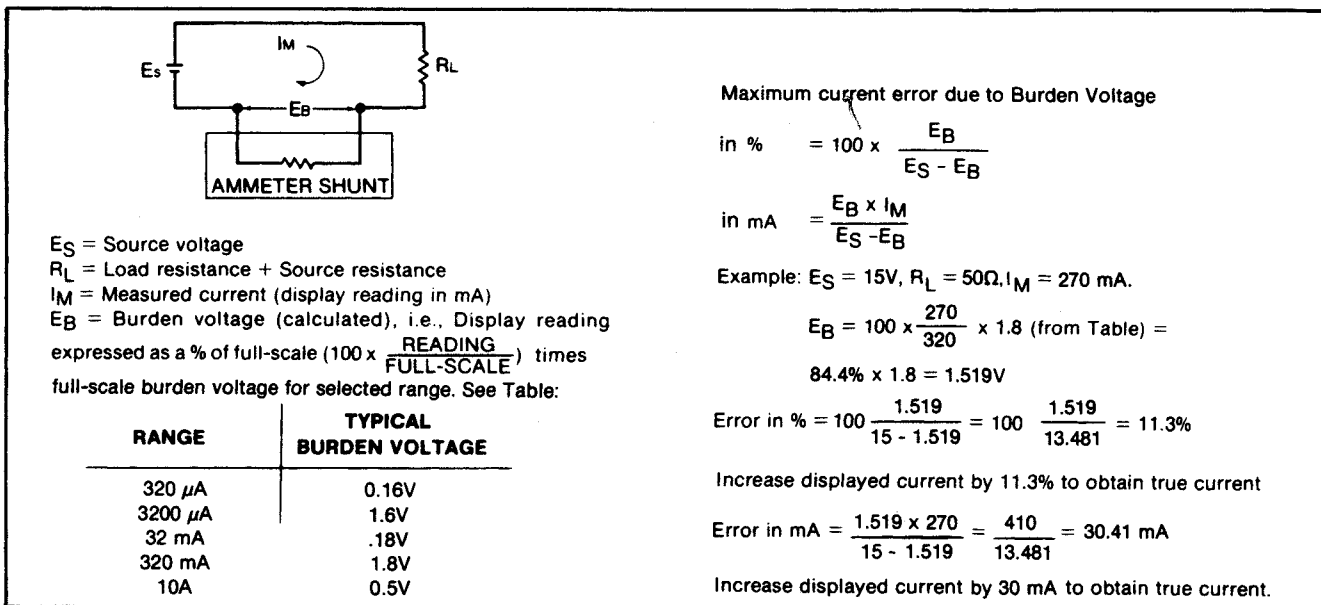

Maximum current error due to Burden Voltage

$$\text{in \%} = 100 \times \frac{E_B}{E_S - E_B}$$

$$\text{in mA} = \frac{E_B \times I_M}{E_S - E_B}$$

Example:  $E_S = 15V, R_L = 50\Omega, I_M = 270 \text{ mA}$ .

$$E_B = 100 \times \frac{270}{320} \times 1.8 \text{ (from Table)} =$$

$$84.4\% \times 1.8 = 1.519V$$

$$\text{Error in \%} = 100 \times \frac{1.519}{15 - 1.519} = 100 \times \frac{1.519}{13.481} = 11.3\%$$

Increase displayed current by 11.3% to obtain true current

$$\text{Error in mA} = \frac{1.519 \times 270}{15 - 1.519} = \frac{410}{13.481} = 30.41 \text{ mA}$$

Increase displayed current by 30 mA to obtain true current.

Figure 4. Current Measurement Error Calculations

High-voltage stacked diode assemblies can usually be tested for forward and reverse resistance changes using conductance. These assemblies typically have such high forward voltage drops that the diode test or resistance modes cannot test them.

### **ANALOG BAR GRAPH APPLICATIONS**

In looking at the analog bar graph, notice that it is composed of segments that simulate an analog needle. The bar graph performs the same function as an analog meter needle, but it eliminates the mechanical overshoot inherent in needle movements.

A negative (–) annunciator is displayed at the left end of the bar graph when taking a reverse polarity dc measurement. Assume that a slowly varying dc voltage is the input signal. As the input goes more positive (from zero), a bar graph segment is displayed, and additional segments are displayed from left to right, to indicate the input level as it increases. Now, assume that the input level slowly decreases. Fewer bar graph segments are displayed as the signal decreases, then the – annunciator flashes as the signal level passes through 0. As the signal goes more negative, the – annunciator is displayed, and additional bar graph segments are displayed from left to right, indicating a more negative input signal. The first segment is an indication greater than or equal to 20 counts.

Note that every fifth segment of the bar graph is slightly larger than those in between, and every tenth segment is larger yet. These larger segments provide a quick reference for bar graph indications. The largest segments (every 10th segment) divide the display into thirds. Thus, if the bar graph indicates 11 segments on the 32.00V range, the input voltage is 10 to 11 volts; if the bar graph indicates 11 segments on the 320.0V range, the input voltage is 100 to 110 volts. If the input equals or exceeds 3000 counts on the range selected, the bar graph displays an arrow at the far right of the display. If the manual range annunciator (  $\text{Ⓢ}$  ) is not displayed, the multimeter automatically switches to the next higher range if the input exceeds approximately 3260 counts. If the multimeter is in the manual range mode, the overrange arrow is displayed until the operator manually selects a range appropriate for the input value.

#### **Using the Analog Bar Graph**

The analog bar graph is most useful in making adjustments and performing limited diagnostics. Bar graph response is fast and precise, so it can be used to easily reach a setting within a few percent of the final adjustment. The bar graph can be used to make rough adjustments quickly; then the 3200-count digital display can be used for final adjustment.

The analog bar graph is useful for performing limited diagnostics in applications where rapidly fluctuating signal levels cause the flashing digits of a digital display to be useless. Like the traditional VOM needle, the analog bar graph excels at displaying trends, or slowly changing signals. In addition, autoranging on the multimeter allows monitoring the signal change through changing ranges.

Many diagnostic routines using the bar graph require practice. The operator is looking for good or bad signal patterns that occur over some span of time. Capacitance checks and noisy resistance measurements create such patterns. Therefore, familiarity with analog bar graph response and movement is necessary to accurately interpret a signal pattern. Compare the bar graph response when making measurements on a known-good unit to the bar graph response when making measurements on a faulty unit.

#### **Specific Applications—Nulling**

The multimeter bar graph is ideal for nulling adjustments. As an adjustment approaches zero, fewer bar graph segments are displayed, then no bar graph segments are displayed. The – annunciator flickers when the input level is within 10 counts of zero. The flickering null indication is displayed every time the input approaches zero or swings from one polarity to the other. The operator merely watches for the – annunciator indication, then reverses the direction of the adjustment when the polarity sign is displayed. In one or two passes, a near-zero input level is possible, then the digital display can be used for exact zero adjustment.

When using an analog VOM without a center scale, the operator must manually switch the polarity between each adjustment. Also, with the traditional analog VOM, there is no digital display to use for fine adjustment after the analog needle is at zero.

#### **Specific Applications—Contact Bounce**

When subject to vibration, relay contacts may begin to bounce open. Checking for this intermittent problem is a routine troubleshooting measure associated with many types of equipment, including computers. Since the bounce problem will worsen as the relay fatigues, early diagnosis is important.

When the contact bounces open, its resistance value changes momentarily from zero to infinity and back. Ordinary hand-held DMMs take more than 300 milliseconds to update their displays—much too long to detect a brief contact bounce. A traditional VOM needle will move slightly at the instant of contact bounce, but the inertia of the needle movement dampens the response.

The analog bar graph, however, will display at least one segment the moment the contact opens. The bar graph can detect contact bounce as brief as 0.2 milliseconds, while most analog needle movements require a 3 millisecond opening before they will respond.

Since the analog bar graph is ten times more sensitive to erratic signals than most analog needle movements, the bar graph can detect faulty contacts earlier than ever before. The severity of the problem is indicated by the number of segments displayed.

### Specific Applications—Checking Capacitors

Volt-ohm meters are often used as simple capacitor checkers. In the capacitor kick test, the needle of the VOM in the resistance mode moves quickly from open (infinite ohms) toward short (zero ohms) as the capacitor is placed across the VOM input. The VOM battery charges the capacitor and the needle slowly moves back to the open (infinite ohms) position. The higher resistance ranges offer increased sensitivity for checking smaller capacitors.

The analog bar graph can make similar checks in the resistance function, even in the autoranging mode. As a capacitor is placed across the inputs, the analog bar graph quickly shortens, then rapidly down-ranges, depending on the size of the capacitor. As the capacitor charges, the bar graph slowly extends back to its full 31-segment length, up-ranging if necessary. For capacitors as small as 0.02  $\mu\text{F}$ , only the 30-megohm range is involved, the last few segments blink off, then back on.

In a fixed range (using manual range mode), the time it takes for the bar graph to extend from zero to full scale indicates the approximate capacitance value. Table 2 gives typical capacitance values for various charge times on different resistance ranges. For very small capacitors, use the conductance (nS) mode.

### Specific Applications—Noisy Resistance Measurements

Most digital multimeters are so sensitive they cannot tolerate as much as 50 mV of line noise while making resistance measurements; their digital displays become unreadable due to the line noise. On the other hand, because of the mechanical inertia of the analog needle, the noise alternately pulls the needle to the left and then to the right, averaging out any movement and leaving a fairly stable resistance reading.

Table 2. Capacitance Vs. Time to Full Scale

Resistance Range	320 $\Omega$	3.2k $\Omega$	32k $\Omega$	320k $\Omega$	3.2M $\Omega$	32M $\Omega$
Capacitance Value						
10,000 $\mu\text{F}$	4 sec	33 sec	5 min	ext	ext	ext
1,000 $\mu\text{F}$	blink	4 sec	30 sec	ext	ext	ext
100 $\mu\text{F}$	nil	blink	4 sec	32 sec	ext	ext
10 $\mu\text{F}$	nil	nil	blink	4 sec	30 sec	ext
1 $\mu\text{F}$	nil	nil	nil	blink	3 sec	19 sec
0.1 $\mu\text{F}$	nil	nil	nil	nil	blink	2 sec
0.02 $\mu\text{F}$	nil	nil	nil	nil	nil	blink

ext = extended time, nil = no indication

The multimeter's resistance measurement circuit is designed to tolerate ac noise far better than the usual DMM. Readable 2-kilohm readings can be obtained even in the presence of 1V ac noise. Readings of 1 megohm may be obtained with up to 2V ac noise. The noise appears as about 50 counts of change and an oscillating bar graph.

## OPERATOR MAINTENANCE

### WARNING

**TO AVOID ELECTRICAL SHOCK, REMOVE THE TEST LEADS AND ANY INPUT SIGNALS BEFORE REPLACING THE BATTERY OR FUSES.**

### Battery Installation or Replacement

The multimeter is powered by a single 9V battery (NEDA 1604, 6F22, or 006P). Referring to Figure 5, use the following procedure to replace the battery:

1. Disconnect test leads from any live source, turn the rotary switch to OFF, and remove the test leads from the front terminals.
2. Open the hinged lid of the accessory compartment by pressing back and up on the button. Remove any stored accessories.
3. Using a slot-head screwdriver, car key, or other appropriate tool, pry open the top of the battery cover and lift the cover out.
4. Remove the battery from the battery cover and disconnect the battery connector leads.

5. Snap the battery connector leads to the terminals on a new battery and slide the battery into the battery cover.
6. Reinsert the battery cover in the multimeter.

#### Fuse Test

1. Turn the function selector switch to the  $\Omega$  position.
2. Connect a test lead from the  $V\Omega \rightarrow +$  input terminal to the A input terminal.
3. The display should indicate between 0.1 ohm and 0.3 ohm. This tests F3 (15A, 600V fast).
4. Move one end of the test lead from the A input terminal to the mA/ $\mu$ A input terminal.
5. The display should indicate between 5.3 ohms and 6.0 ohms. This tests F1 (2A, 600V fast) and F2 (630 mA, 250V fast).
6. If either of the above display indications is OL (overload), replace the appropriate fuse.

#### Fuse Replacement

##### WARNING

**TO PREVENT DAMAGE OR INJURY, INSTALL QUICK ACTING FUSES WITH THE AMP/VOLT RATINGS SHOWN IN FIGURE 5.**

Referring to Figure 5, use the following procedure to check or replace the multimeter's fuses:

1. Perform steps 1 through 3 of the battery replacement procedure.
2. Remove the battery from the battery cover and set the cover aside.
3. Remove the defective fuse by prying the fuse loose on one end and sliding the fuse out of the fuse bracket.
4. Install a new fuse of the same size and rating. (Note that there is a spare 630 mA, 250V fuse stored below the battery inside the battery cover.)
5. Reinstall the battery in the cover and insert the cover into the multimeter.

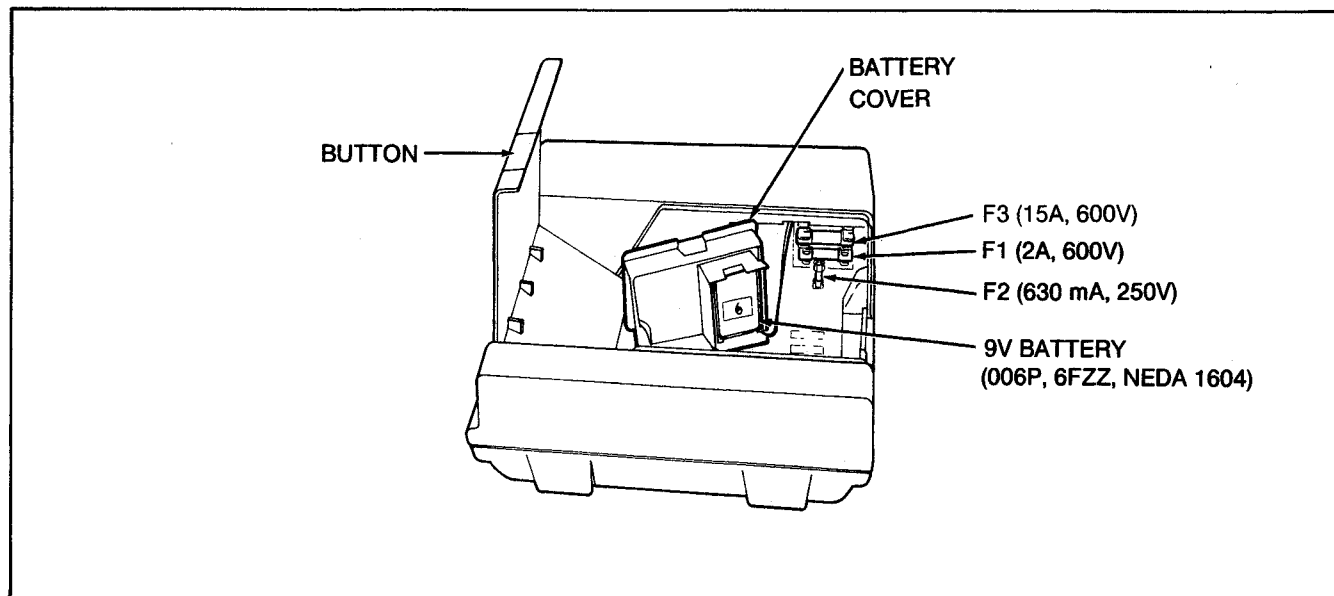

Figure 5. Battery and Fuse Replacement



**General Maintenance**

Clean the case with a damp cloth and detergent; do not use abrasives or solvents.

Have the meter calibrated by a qualified technician once a year to ensure specified performance. Contact the nearest Fluke Service Center or refer to the Fluke Service Manual (part number 785311) for calibration or repair. Refer to the parts list at the end of this manual for operator replaceable parts.

**BATTERY ELIMINATOR ACCESSORY**

Table 3 lists the battery eliminators available to provide power for operation of the Fluke 37 from 100V ac, 115V ac, 220V ac, or 240V ac line voltages.

**WARNING**

**TO PREVENT ELECTRICAL SHOCK OR DAMAGE, USE ONLY FLUKE MODEL A81 BATTERY ELIMINATORS.**

**SERVICE**

If the instrument fails, forward it, postage paid, to the nearest Fluke Service Center (refer to the list at the back of this manual). Include a description of the difficulty, and pack the instrument securely; Fluke shall assume NO responsibility for damage in transit.

**IN WARRANTY:** Instruments covered by the limited warranty will be promptly repaired or replaced, at Fluke's option, and returned, all at no charge. See the registration card for warranty terms.

**OUT OF WARRANTY (USA AND CANADA):** The instrument will be repaired and returned for a fixed fee. (Repairs needed because of abuse or accidental damage will be quoted.) Contact the nearest Service Center for current prices. Include a check, money order, or purchase order with the instrument.

**OUT OF WARRANTY (OUTSIDE USA AND CANADA):** Service programs may vary by country. Contact the nearest Service Center for information.

Table 3.

MODEL	INPUT	CONNECTOR	SAFETY
A81-100	100V ac 48-66 Hz	NEMA 1-15P	Designed to UL 1244
A81-115	120V ac 60 Hz	NEMA 1-15P	UL Listed CSA Cert
A81-220B	220V ac 50 Hz	CEE 7	VDE Pending
A81-230	220V ac 48-66 Hz	CEE 7	IEC 348 (Outside Europe)
A81-230-3	240V ac 50 Hz	BS-1363	IEC 348
<b>OUTPUT</b> All models 8.2V dc @ 2 mA, 5.8V dc @ 0.15A			



## Fluke 37 Specifications

FUNCTION	RANGE	RESOLUTION	ACCURACY *		
$\overline{\text{V}}$	3.200V	0.001V	$\pm(0.1\%+1)$		
	32.00V	0.01V	$\pm(0.1\%+1)$		
	320.0V	0.1V	$\pm(0.1\%+1)$		
	1000V	1V	$\pm(0.1\%+1)$		
$\overline{\text{mV}}$	320.0 mV	0.1 mV	$\pm(0.1\%+1)$		
$\Omega$ (nS)	320.0 $\Omega$	0.1 $\Omega$	$\pm(0.3\%+2)$		
	3.200 k $\Omega$	0.001 k $\Omega$	$\pm(0.2\%+1)$		
	32.00 k $\Omega$	0.01 k $\Omega$	$\pm(0.2\%+1)$		
	320.0 k $\Omega$	0.1 k $\Omega$	$\pm(0.2\%+1)$		
	3.200 M $\Omega$	0.001 M $\Omega$	$\pm(0.2\%+1)$		
	32.00 M $\Omega$	0.01 M $\Omega$	$\pm(1\%+1)$		
32.00 nS	0.01 nS	$\pm(2\%+10)$			
$\{\{\{\{\} \rightarrow\}$	2.080V	0.001V	$\pm(1\%+1)$ typical		
$\sim \text{V}$	3.200V 32.00V 320.0V 1000V	0.001V 0.01V 0.1V 1V	40 Hz-2 kHz	2 kHz-10 kHz	10 kHz-30 kHz
			$\pm(0.5\%+3)$	$\pm(2\%+3)$	$\pm(4\%+10)$
			$\pm(0.5\%+3)$	$\pm(2\%+3)$	$\pm(4\%+10)$
			$\pm(0.5\%+3)$	$\pm(2\%+3)$	$\pm(4\%+10)$
			$\pm(1\%+3)$	$\pm(3\%+3)$	Not Specified
$\sim \text{mV}$	320.0 mV	0.1 mV	$\pm(0.5\%+3)$	$\pm(2\%+3)$	$\pm(4\%+10)$

FUNCTION	RANGE	RESOLUTION	ACCURACY *	TYPICAL BURDEN VOLTAGE
$\overline{\text{mA/A}}$	32.00 mA	0.01 mA	$\pm(0.75\%+2)$	5.6 mV/mA
	320.0 mA	0.1 mA	$\pm(0.75\%+2)$	5.6 mV/mA
	10.00A	0.01A	$\pm(0.75\%+2)$	50 mV/A
$\overline{\mu\text{A}}$	320.0 $\mu\text{A}$	0.1 $\mu\text{A}$	$\pm(0.75\%+2)$	0.5 mV/ $\mu\text{A}$
	3200 $\mu\text{A}$	1 $\mu\text{A}$	$\pm(0.75\%+2)$	0.5 mV/ $\mu\text{A}$
$\sim \text{mA/A}$ 40-1000 Hz	32.00 mA	0.01 mA	$\pm(1.5\%+2)$	5.6 mV/mA
	320.0 mA	0.1 mA	$\pm(1.5\%+2)$	5.6 mV/mA
	10.00A	0.01A	$\pm(1.5\%+2)$	50 mV/A
$\sim \mu\text{A}$ 40-1000 Hz	320.0 $\mu\text{A}$	0.1 $\mu\text{A}$	$\pm(1.5\%+2)$	0.5 mV/ $\mu\text{A}$
	3200 $\mu\text{A}$	1 $\mu\text{A}$	$\pm(1.5\%+2)$	0.5 mV/ $\mu\text{A}$

\* Accuracy is specified as  $\pm([\% \text{ of reading}] + [\text{number of least significant digits}])$ .

Basic electrical accuracy is specified from 18°C to 28°C with relative humidity up to 90%, for a period of one year after calibration. All ac conversions are ac coupled, average responding, and calibrated to read the true rms value of a sine wave input.

Ranging is either automatic or manual in all functions with more than one range. Test resistance below approximately 150 $\Omega$  in the  $\{\{\{\{\} \rightarrow\}$  function produces a continuous audible tone.

Fluke 37 Specifications (cont)

FUNCTION	OVERLOAD PROTECTION	INPUT IMPEDANCE (nominal)	COMMON MODE REJECTION RATIO (1 kΩ unbalance)	NORMAL MODE REJECTION
$\overline{\overline{V}}$	1000V rms**	10 MΩ in // with <100 pF	>120 dB at dc, 50 Hz, or 60 Hz	>60 dB at 50 Hz or 60 Hz
$\overline{\overline{mV}}$	500V rms**	10 MΩ in // with <100 pF	>120 dB at dc, 50 Hz, or 60 Hz	>60 dB at 50 Hz or 60 Hz
$\sim V$	1000V rms (10 <sup>7</sup> V-Hz max)	10 MΩ in // with <100 pF (ac coupled)	>60 dB, dc to 60 Hz	
$\sim mV$	500V rms (10 <sup>7</sup> V-Hz max)	10 MΩ in // with <100 pF (ac coupled)	>60 dB, dc to 60 Hz	
Ω	500V rms	OPEN CIRCUIT TEST VOLTAGE	FULL SCALE VOLTAGE	
			Up to 3.2 MΩ	32 MΩ or nS
		<2.8V dc	<420 mV dc	<1.3V dc

\*\* 10<sup>7</sup> V- Hz max

MAXIMUM VOLTAGE BETWEEN ANY TERMINAL AND EARTH GROUND
1000V

FUNCTION	FUSE PROTECTION
mA or μA A	630 mA 250V FAST, 2A 600V FAST 15A 600V FAST

- Digital Display ..... 3200 counts, updates 2/sec
- Analog Display ..... 31 segments, updates 25/sec
- Operating Temperature ..... -15°C to 55°C, to -40°C for 20 minutes when taken from 20°C
- Storage Temperature ..... -40°C to +60°C
- Temperature Coefficient ..... 0.1 x (specified accuracy)/°C  
(<18°C or >28°C)
- Relative Humidity ..... 0% to 90% (0°C to 35°C)  
0% to 70% (35°C to 55°C)
- Battery Type ..... 9V, NEDA 1604 or 6F22 or 006P
- Battery Life ..... 1000 hrs typical
- Shock and Vibration ..... Per MIL-T-28800
- Size (HxWxL) ..... 3.5 in x 8.5 in x 8.9 in (8.9 cm x 21.6 cm x 22.6 cm)
- Weight ..... 2.5 pounds (0.94 kg)
- Safety ..... Protection Class II per IEC 348 and ANSI C39.5