

175, 177, 179

True-rms Multimeters

Users Manual

May 2003 Rev. 2, 10/15

© 2003-2015 Fluke Corporation. All rights reserved. Specifications are subject to change without notice.

All product names are trademarks of their respective companies.

Lifetime Limited Warranty

Each Fluke 20, 70, 80, 170 and 180 Series DMM will be free from defects in material and workmanship for its lifetime. As used herein, "lifetime" is defined as seven years after Fluke discontinues manufacturing the product, but the warranty period shall be at least ten years from the date of purchase. This warranty does not cover fuses, disposable batteries, damage from neglect, misuse, contamination, alteration, accident or abnormal conditions of operation or handling, including failures caused by use outside of the product's specifications, or normal wear and tear of mechanical components. This warranty covers the original purchaser only and is not transferable.

For ten years from the date of purchase, this warranty also covers the LCD. Thereafter, for the lifetime of the DMM, Fluke will replace the LCD for a fee based on then current component acquisition costs.

To establish original ownership and prove date of purchase, please complete and return the registration card accompanying the product, or register your product on <http://www.fluke.com>. Fluke will, at its option, repair at no charge, replace or refund the purchase price of a defective product purchased through a Fluke authorized sales outlet and at the applicable international price. Fluke reserves the right to charge for importation costs of repair/replacement parts if the product purchased in one country is sent for repair elsewhere.

If the product is defective, contact your nearest Fluke authorized service center to obtain return authorization information, then send the product to that service center, with a description of the difficulty, postage and insurance prepaid (FOB Destination). Fluke assumes no risk for damage in transit. Fluke will pay return transportation for product repaired or replaced in-warranty. Before making any non-warranty repair, Fluke will estimate cost and obtain authorization, then invoice you for repair and return transportation.

THIS WARRANTY IS YOUR ONLY REMEDY. NO OTHER WARRANTIES, SUCH AS FITNESS FOR A PARTICULAR PURPOSE, ARE EXPRESSED OR IMPLIED. FLUKE SHALL NOT BE LIABLE FOR ANY SPECIAL, INDIRECT, INCIDENTAL OR CONSEQUENTIAL DAMAGES OR LOSSES, INCLUDING LOSS OF DATA, ARISING FROM ANY CAUSE OR THEORY. AUTHORIZED RESELLERS ARE NOT AUTHORIZED TO EXTEND ANY DIFFERENT WARRANTY ON FLUKE'S BEHALF. Since some states do not allow the exclusion or limitation of an implied warranty or of incidental or consequential damages, this limitation of liability may not apply to you. If any provision of this warranty is held invalid or unenforceable by a court or other decision-maker of competent jurisdiction, such holding will not affect the validity or enforceability of any other provision.

Fluke Corporation
P.O. Box 9090
Everett, WA 98206-9090
U.S.A.

Fluke Europe B.V.
P.O. Box 1186
5602 BD Eindhoven
The Netherlands

Table of Contents

Title	Page
Introduction	1
How to Contact Fluke	1
Safety Information.....	1
Symbols	3
Unsafe Voltage	5
Test Lead Alert	5
Terminals	5
Product Buttons	6
Rotary Switch Positions	6
Display	7
Battery Saver (Sleep Mode)	9
MIN MAX AVG Recording Mode	9
Display HOLD and AutoHOLD Modes.....	10
Manual Range and Autorange.....	10
Power-Up Options	11
Basic Measurements	11
Measure AC and DC Voltage	12
Measure Resistance.....	12
Measure Capacitance.....	12
Test for Continuity.....	13
Measure Temperature (179 Only).....	13
Test Diodes.....	13
Measure AC or DC Current	14
AC Zero Input Behavior of True-rms Meters	14
Measure Frequency.....	15
AC/DC Voltage Frequency	15
AC Current Frequency.....	15
Use the Bar Graph.....	16

Maintenance	16
Clean the Product	17
Test the Fuses	17
Replace the Battery and Fuses	17
Specifications	18
Electrical Specifications	20

Introduction

The Fluke 175, 177, and 179 are battery-powered, True-rms multimeters (the Product) with a 6000-count, 3 3/4-digit display and a bar graph. This manual applies to all three models. All figures show the 179.

How to Contact Fluke

To contact Fluke, call one of the following telephone numbers:

- Technical Support USA: 1-800-44-FLUKE (1-800-443-5853)
- Calibration/Repair USA: 1-888-99-FLUKE (1-888-993-5853)
- Canada: 1-800-36-FLUKE (1-800-363-5853)
- Europe: +31-402-675-200
- Japan: +81-3-6714-3114
- Russia: +8-495-664-75-12
- Singapore: +65-6799-5566
- Anywhere in the world: +1-425-446-5500

Or, visit Fluke's website at www.fluke.com.

To register your product, visit <http://register.fluke.com>.

To view, print, or download the latest manual supplement, visit <http://us.fluke.com/usen/support/manuals>.

Safety Information

In this manual, a **Warning** identifies conditions and procedures that are dangerous to the user. A **Caution** identifies conditions and procedures that can cause damage to the Product or the equipment under test.

Warning

To prevent possible electrical shock, fire, or personal injury:

- **Read all safety information before you use the Product.**
- **Carefully read all instructions.**
- **Use the Product only as specified, or the protection supplied by the Product can be compromised.**

- Examine the case before you use the Product. Look for cracks or missing plastic. Carefully look at the insulation around the terminals.
- Do not use the Product around explosive gas, vapor, or in damp or wet environments.
- Do not work alone.
- Limit operation to the specified measurement category, voltage, or amperage ratings.
- Comply with local and national safety codes. Use personal protective equipment (approved rubber gloves, face protection, and flame-resistant clothes) to prevent shock and arc blast injury where hazardous live conductors are exposed.
- Use Product-approved measurement category (CAT), voltage, and amperage rated accessories (probes, test leads, and adapters) for all measurements.
- Do not exceed the Measurement Category (CAT) rating of the lowest rated individual component of a Product, probe, or accessory.
- Do not touch voltages >30 V ac rms, 42 V ac peak, or 60 V dc.
- Keep fingers behind the finger guards on the probes.
- Use only current probes, test leads, and adapters supplied with the Product.
- Connect the common test lead before the live test lead and remove the live test lead before the common test lead.
- Disable the Product if it is damaged.
- Do not use the Product if it is damaged.
- Do not use the Product if it operates incorrectly.
- Only use probes, test leads, and accessories that have the same measurement category, voltage, and amperage ratings as the Product.
- Remove the batteries if the Product is not used for an extended period of time, or if stored in temperatures above 50 °C. If the batteries are not removed, battery leakage can damage the Product.

- The battery door must be closed and locked before you operate the Product.
- Use only cables with correct voltage ratings.
- Remove all probes, test leads, and accessories before the battery door is opened.
- Replace the batteries when the low battery indicator shows to prevent incorrect measurements.
- Do not apply more than the rated voltage, between the terminals or between each terminal and earth ground.
- Measure a known voltage first to make sure that the Product operates correctly.
- Use the correct terminals, function, and range for measurements.
- Do not use test leads if they are damaged. Examine the test leads for damaged insulation, exposed metal, or if the wear indicator shows. Check test lead continuity.
- Do not touch the probes to a voltage source when the test leads are connected to the current terminals.

- Do not use test leads if they are damaged. Examine the test leads for damaged insulation and measure a known voltage.
- Do not use in CAT III or CAT IV environments without the protective cap installed on test probe. The protective cap decreases the exposed probe metal to <4 mm. This decreases the possibility of arc flash from short circuits.

Symbols

Table 1 is a list of the symbols used on the Product and in this manual.

Table 1. Symbols







Symbol	Description
	Consult user documentation.
	WARNING. RISK OF DANGER.
	WARNING. HAZARDOUS VOLTAGE. Risk of electric shock.
	Earth
	AC (Alternating Current)
	DC (Direct Current)
	Both direct and alternating current

Table 1. Symbols (cont.)













Symbol	Description
	Earth
	Capacitance
	Fuse
	Conforms to European Union directives.
	Double Insulated
	Low battery. Replace battery.
IR	Minimum fuse interrupt rating.
	Continuity test or continuity beeper tone.
	Conforms to European Union directives.
	Certified by CSA Group to North American safety standards.
	Certified by TÜV SÜD Product Service.
	Conforms to relevant Australian Safety and EMC standards.
	Conforms to relevant South Korean EMC Standards.

Table 1. Symbols (cont.)

Symbol	Description
CAT II	Measurement Category II is applicable to test and measuring circuits connected directly to utilization points (socket outlets and similar points) of the low-voltage MAINS installation.
CAT III	Measurement Category III is applicable to test and measuring circuits connected to the distribution part of the building's low-voltage MAINS installation.
CAT IV	Measurement Category IV is applicable to test and measuring circuits connected at the source of the building's low-voltage MAINS installation.
	This product complies with the WEEE Directive marking requirements. The affixed label indicates that you must not discard this electrical/electronic product in domestic household waste. Product Category: With reference to the equipment types in the WEEE Directive Annex I, this product is classed as category 9 "Monitoring and Control Instrumentation" product. Do not dispose of this product as unsorted municipal waste.

Unsafe Voltage

During a voltage measurement, the Product alerts you to the presence of a potentially hazardous voltage. When the Product detects a voltage ≥ 30 V or a voltage overload (OL), the ⚡ symbol shows on the display to alert you to the presence of a potentially hazardous voltage.

Test Lead Alert

To remind you to check that the test leads are in the correct terminals, LEAD momentarily shows on the display when you move the rotary switch to or from the mA or A position.

⚠️ Warning

Attempting to make a measurement with a test lead in an incorrect terminal might blow a fuse, damage the Product, and cause serious personal injury.

Terminals

Table 2 shows the terminals on the Product.

Table 2. Terminals

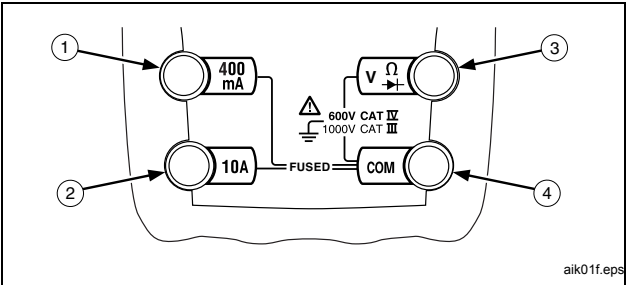

Item	Description
①	Input terminal for ac and dc milliamp measurements to 400 mA and frequency measurements.
②	Input terminal for ac and dc current measurements to 10 A and frequency measurements.
③	Input terminal for voltage, continuity, resistance, diode, capacitance, frequency, and temperature (179 only) measurements.
④	Common (return) terminal for all measurements.

Product Buttons

Table 3 identifies the basic functions of the buttons on the Product. The buttons have other functions described later in the manual.

Table 3. Product Buttons

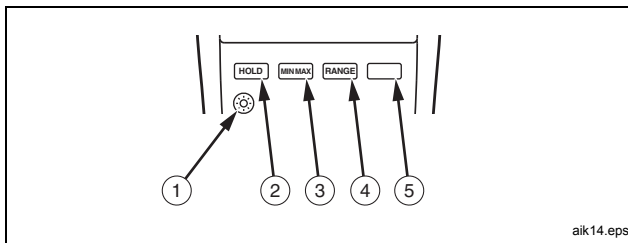

Item	Description
①	Toggles the backlight on and off. The backlight automatically turns off after 2 minutes (177 and 179 only).
②	In MIN MAX AVG mode, push to pause or continue MIN MAX AVG recording. In the Display HOLD mode, the Product holds the reading on the display. In the AutoHOLD mode, the Product holds the reading on the display until it detects a new stable reading. Then the Product beeps and displays the new reading.

Table 3. Product Buttons

Item	Description
③	Activates MIN MAX AVG mode.
④	Toggles between Auto Range and Manual Range modes. In Manual Range mode, increments the range. After the highest range, the Product wraps to the lowest range.
⑤	(Yellow button) Selects alternate measurement functions on a rotary switch setting, for example, to select dc mA, dc A, Hz, temperature (179 only), capacitance, diode test.

Rotary Switch Positions

Table 4 identifies the switch positions on the Product.

Table 4. Rotary Switch Positions

Switch Position	Measurement Function
\tilde{V}	AC voltage from 30.0 mV to 1000 V.
Hz	Frequency from 2 Hz to 99.99 kHz.
\bar{V}	DC voltage 1 mV to 1000 V.
Hz	Frequency from 2 Hz to 99.99 kHz.

Table 4. Rotary Switch Positions

Switch Position	Measurement Function
$\overline{\text{mV}}$	DC mV 0.1 mV to 600 mV.
	Temperature -40 °C to +400 °C. -40 °F to +752 °F.
	Beeper turns on at <25 Ω and turns off at >250 Ω .
	Diode test. Displays Ω above 2.4 V.
$\overline{\text{A}}$	AC A from 0.300 A to 10 A.
$\sim \text{A}$	DC A from 0.001 A to 10 A. >10.00, display flashes. >20 A, Ω is displayed.
Hz	Frequency of ac A 2 Hz to 30 kHz.
Ω	Ohms from 0.1 Ω to 50 M Ω .
	Farads from 1 nF to 9999 μF .
$\overline{\text{mA}}$	AC mA from 3.00 mA to 400 mA.
mA	DC mA from 0.01 mA to 400 mA.
Hz	Frequency of ac mA 2 Hz to 30 kHz.

Note: AC voltage and current AC-coupled, true-rms, up to 1 kHz.

Display

Table 5 shows the items on the Product display.

Table 5. Display

Item	Symbol	Description
①		Continuity test.
②		Diode test.
③		Negative readings.
④		Unsafe voltage. Voltage ≥ 30 V, or voltage overload (Ω).

aik02f.eps

Table 5. Display (cont.)

Item	Symbol	Description
⑤	HOLD A-Auto HOLD	Display HOLD is enabled. Display freezes present reading. In MIN MAX AVG mode, MIN MAX AVG recording is interrupted. AutoHOLD is enabled. Display holds present reading until it detects new stable input. Then the Product beeps and displays the new reading.
⑥	MIN MAX MAX, MIN, AVG	MIN MAX AVG enabled. Maximum, minimum, average or present reading.
⑦	nμ F, °F, °C mVA, MkΩ, kHz	Measurement units.
⑧	DC, AC	Direct current, alternating current.
⑨		Low battery. Replace battery.
⑩	61000mV	All possible ranges.
⑪	Bar graph	Analog display.

Table 5. Display (cont.)

Item	Symbol	Description
⑫	Auto Range Manual Range	The Product selects the range with the best resolution. The user selects the range.
⑬	±	Bar graph polarity.
⑭	OL	The input out of range.
⑮	LEAd	 Test lead alert. Displayed when the rotary switch is moved to or from the mA or A position.

Table 6 identifies error messages that can show on the display.

Table 6. Error Messages

Error	Description
bAt	Replace the battery immediately.
d, 5C	In the capacitance function, too much electrical charge is present on the capacitor being tested.
EEP Err	Invalid EEPROM data. Have Product serviced.
Cal Err	Invalid calibration data. Calibrate Product.
OPEn	Open thermocouple is detected.

Battery Saver (Sleep Mode)

The Product enters the Sleep mode and the display goes blank if there is no function change or button press for 20 minutes. To disable the Sleep mode, hold down **[]** while turning the Product on. The Sleep mode is always disabled in the MIN MAX AVG mode and the AutoHOLD mode.

MIN MAX AVG Recording Mode

The MIN MAX AVG recording mode captures the minimum and maximum input values and calculates a running average of all readings. When a new high or low is detected, the Product beeps.

Note

For dc functions, accuracy is the specified accuracy of the measurement function ± 12 counts for changes longer than 350 ms in duration.

For ac functions, accuracy is the specified accuracy of the measurement function ± 40 counts for changes longer than 900 ms in duration.

To use MIN MAX AVG recording:

1. Set the desired measurement function and range. (Autoranging is disabled in the MIN MAX AVG mode.)
2. Press **[MIN MAX]** to activate MIN MAX AVG mode.
MIN MAX and MAX come on, and the highest reading detected since entering MIN MAX AVG shows on the display.
3. To step through the low (MIN), average (AVG), and present readings, press **[MIN MAX]**.
4. To pause MIN MAX AVG recording without erasing stored values, press **[HOLD]**.
HOLD comes on.
5. To continue MIN MAX AVG recording, press **[HOLD]** again. **HOLD** turns off.
6. To erase stored readings and exit, press **[MIN MAX]** for 1 second or turn the rotary switch.

Display HOLD and AutoHOLD Modes

Warning

To avoid electric shock, fire, or personal injury, do not use the Display HOLD or AutoHOLD mode to determine if a circuit is live. Unstable or noisy readings will not be captured.

In the Display HOLD mode, the Product holds the reading on the display.

In the AutoHOLD mode, the Product holds the reading on the display until it detects a new stable reading. Then the Product beeps and displays the new reading.

1. Press **HOLD** to activate Display HOLD.

HOLD comes on.

2. Press **HOLD** again to activate AutoHOLD.

A-AutoHOLD shows on the display.

3. To continue normal operation at any time, press **HOLD** for 1 second or turn the rotary switch.

Manual Range and Autorange

The Product has both Manual range and Autorange modes.

- In the Autorange mode, the Product selects the range with the best resolution.
- In the Manual Range mode, override Autorange and select the range yourself.

When you turn the Product on, it defaults to Autorange and **Auto Range** shows.

1. To enter the Manual Range mode, press **RANGE**.

Manual Range shows.

2. In the Manual Range mode, press **RANGE** to increment the range. After the highest range, the Product wraps to the lowest range.

Note

You cannot manually change the range in the MIN MAX AVG, or Display HOLD modes.

*If you press **RANGE** while in MIN MAX AVG, or Display HOLD, the Product beeps twice, indicating an invalid operation, and the range does not change.*

3. To exit Manual Range, press **RANGE** for 1 second or turn the rotary switch.





The Product returns to Autorange and **Auto Range** shows.

Power-Up Options

Table 7 shows the Power-Up Options. To select a Power-Up Option, hold down the button indicated while turning the Product from OFF to any switch position.

Power-Up Options are cancelled when the Product is turned OFF.

Table 7. Power-Up Options

Button	Power-Up Options
AutoHOLD 	\checkmark switch position turns on all LCD segments. $\bar{\checkmark}$ switch position displays the software version number. $\overline{\checkmark}$ switch position displays the model number.
	Disables beeper. (bEEP)
	Enables "Smoothing" mode. (S---) Dampens display fluctuations of rapidly changing inputs by digital filtering.
	(Yellow button) Disables automatic power-down (Sleep mode). (PoFF) Sleep mode is also disabled while the Product is in a MIN MAX AVG Recording mode, or the AutoHOLD mode.
	Disables automatic 2-minute backlight timeout. (LoFF) (177 and 179 Only)

Basic Measurements

The figures on the following pages show how to make basic measurements.

⚠ Warning

To avoid electric shock, fire, or personal injury:

- Connect the common test lead before the live test lead and remove the live test lead before the common test lead.
- Disconnect power and discharge all high-voltage capacitors before you measure resistance, continuity, capacitance, or a diode junction.

Measure AC and DC Voltage

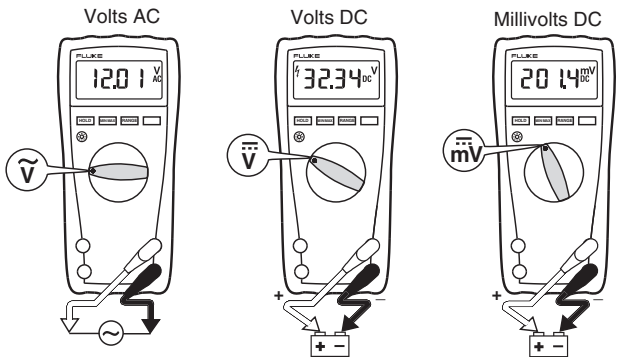

AIK03F.EPS

Measure Resistance

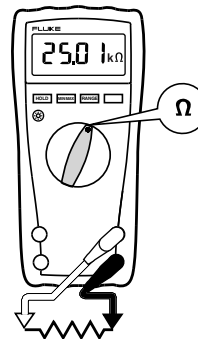

AIK04F.EPS

Measure Capacitance

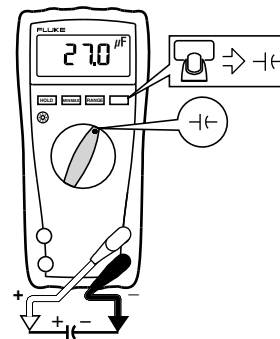

AIK05F.EPS

Test for Continuity

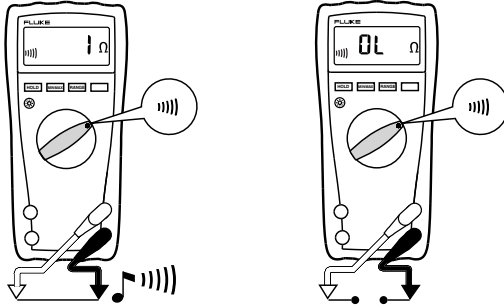

AIK06F.EPS

Test Diodes

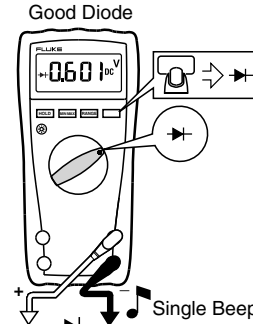

Good Diode
Forward Bias

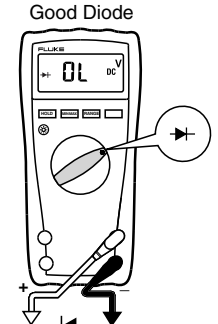

Good Diode
Reverse Bias

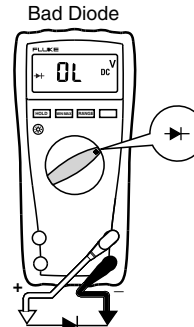

Bad Diode
Open

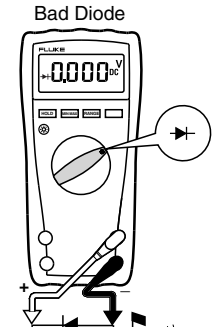

Bad Diode
Shorted

AIK07F.EPS

Measure Temperature (179 Only)

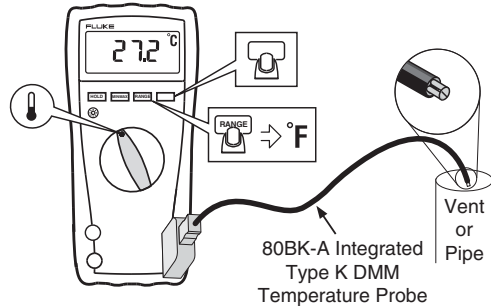

⚠️ Warning: Do not connect 80BK-A to live circuits.

AIK10F.EPS

Measure AC or DC Current

⚠ ⚠ Warning

To prevent possible electrical shock, fire, or personal injury:

- Never attempt to make an in-circuit current measurement when the open-circuit potential to earth is >1000 V.
- Check the Product's fuses before testing. (See *Test the Fuses.*)
- Use the proper terminals, switch position, and range for your measurement.
- Never place the probes in parallel with a circuit or component when the leads are plugged into the current terminals.

To measure current:

1. Turn power OFF.
2. Break circuit.
3. Insert Product in series.
4. Turn power on.

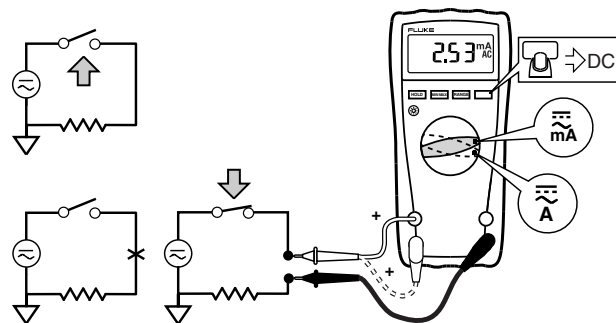

aik08f.eps

AC Zero Input Behavior of True-rms Meters

Unlike averaging meters, which can accurately measure only pure sinewaves, True-rms meters accurately measure distorted waveforms. Calculating True-rms converters require a certain level of input voltage to make a measurement. This is why ac voltage and current ranges are specified from 5 % of range to 100 % of range. Non-zero digits that are displayed on a True-rms meter when the test leads are open or are shorted are normal. They do not affect the specified ac accuracy above 5 % of range.

Unspecified input levels on the lowest ranges are:

- AC voltage: below 5 % of 600 mV ac, or 30 mV ac
- AC current: below 5 % of 60 mA ac, or 3 mA ac

Measure Frequency

⚠⚠ Warning

To prevent possible electrical shock, fire, or personal injury, disregard the bar graph for frequencies >1 kHz. If the frequency of the measured signal is >1 kHz, the bar graph is unspecified.

The Product measures the frequency of a signal. The trigger level is 0 V, 0 A ac for all ranges.

AC/DC Voltage Frequency

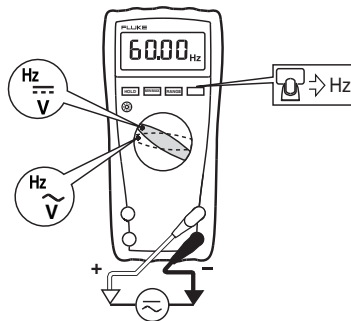

aik15.eps

AC Current Frequency

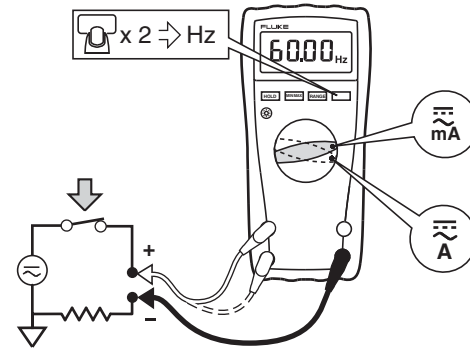

aik16.eps

- In frequency, the bar graph shows the ac/dc voltage or ac current accurately up to 1 kHz.
- Select progressively lower ranges using manual ranging for a stable reading.
- To exit frequency, press or turn the rotary switch.

Use the Bar Graph

The bar graph is like the needle on an analog meter. It has an overload indicator (▶) to the right and a polarity indicator (±) to the left.

Because the bar graph updates about 40 times per second, which is 10 times faster than the digital display, the bar graph is useful for making peak and null adjustments and for observing rapidly changing inputs.

The bar graph is disabled when measuring capacitance or temperature. In frequency, the bar graph accurately indicates the voltage or current up to 1 kHz.

The number of lit segments indicates the measured value and is relative to the full-scale value of the selected range.

In the 60 V range, for example (see below), the major divisions on the scale represent 0 V, 15 V, 30 V, 45 V, and 60 V. An input of -30 V lights the negative sign and the segments up to the middle of the scale.



AIK11F.EPS

Maintenance

⚠⚠ Warning

To prevent possible electrical shock, fire, personal injury, or damage to the Product:

- Repair the Product before use if the battery leaks.
- Do not operate the Product with covers removed or the case open. Hazardous voltage exposure is possible.
- Remove the input signals before you clean the Product.
- Use only specified replacement parts.
- Have an approved technician repair the Product.
- Use only specified replacement fuses.
- Replace a blown fuse with exact replacement only for continued protection against arc flash.

Clean the Product

Wipe the case with a damp cloth and mild detergent. Do not use abrasives or solvents. Dirt or moisture in the terminals can affect readings.

Test the Fuses

Test fuses as shown below.

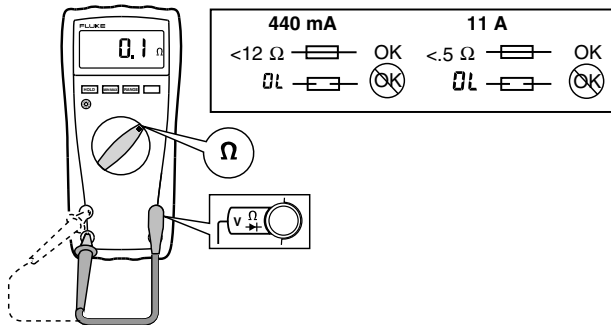

AIK12F.EPS

Replace the Battery and Fuses

⚠ ⚠ Warning

To prevent possible electrical shock, fire, personal injury, or damage to the Product:

- Remove the test leads and any input signals before replacing the fuse.
- Use **ONLY** fuses with the amperage, interrupt, voltage, and speed ratings specified.
- Replace the battery as soon as the low battery indicator (🔋) appears.

Table 8 lists the replacement battery and fuses.

Table 8. Replacement Battery and Fuses

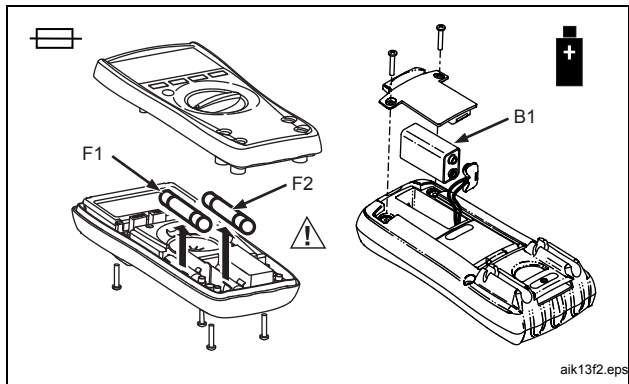

Item	Part Number
⚠ F1 Fuse, 440 mA, 1000 V, FAST	943121
⚠ F2 Fuse, 11 A, 1000 V, FAST	803293
B1 Battery, 9 V Alkaline NEDA 1604 / 1604A	614487

Specifications

Accuracy is specified for 1 yr after calibration, at operating temperatures of 18 °C to 28 °C, with relative humidity at 0 % to 90 %. Accuracy specifications take the form of: \pm ([% of Reading] + [Counts])

Maximum voltage between any terminal and earth ground 1000 V

⚠ **Fuse Protection for mA inputs** 0.44 A, 1000 V, IR 10 kA

⚠ **Fuse Protection for A input** 11 A, 1000 V, IR 17 kA

Display Digital: 6000 counts, updates 4/sec

Bar Graph 33 segments, Updates 40x/sec

Frequency 10,000 counts

Capacitance 1000 counts

Altitude

Operating 2000 m

Storage 12,000 m

Temperature

Operating -10 °C to +50 °C

Storage -40 °C to +60 °C

Temperature coefficient 0.1 X (specified accuracy / °C, (<18 °C or >28 °C))

Relative HumidityMaximum Non-condensing:
90 % to 35 °C,
75 % to 40 °C,
45 % to 50 °C

Battery LifeAlkaline: 400 hrs typical

Size (H x W x L)4.3 cm x 9 cm x 18.5 cm

Weight420 g

Safety

GeneralIEC 61010-1: Pollution Degree 2

MeasurementIEC 61010-2-033: CAT IV 600 V,
CAT III 1000 V

Electromagnetic Compatibility (EMC)

InternationalIEC 61326-1: Portable
Electromagnetic Environment
CISPR 11: Group 1, Class A,
IEC 61326-2-2

*Group 1: Equipment has intentionally generated and/or uses
conductively-coupled radio frequency energy that is necessary for the
internal function of the equipment itself.*

*Class A: Equipment is suitable for use in all establishments other than
domestic and those directly connected to a low-voltage power supply
network that supplies buildings used for domestic purposes. There
may be potential difficulties in ensuring electromagnetic compatibility
in other environments due to conducted and radiated disturbances.*

*Emissions that exceed the levels required by CISPR 11 can occur
when the equipment is connected to a test object. The equipment
may not meet the immunity requirements of this standard when test
leads and/or test probes are connected.*

Korea (KCC).....Class A Equipment (Industrial
Broadcasting & Communication
Equipment)

*Class A: Equipment meets requirements for industrial electromagnetic
wave equipment and the seller or user should take notice of it. This
equipment is intended for use in business environments and not to be
used in homes.*

USA (FCC)47 CFR 15 subpart B. This product is
considered an exempt device per
clause 15.103.

Electrical Specifications

Function	Range ^[1]	Resolution	Accuracy ±([% of Reading] + [Counts])		
			175	177	179
AC Volts ^{[2],[3]}	600.0 mV	0.1 mV	1.0 % + 3	1.0 % + 3	1.0 % + 3
	6.000 V	0.001 V	(45 Hz to 500 Hz)	(45 Hz to 500 Hz)	(45 Hz to 500 Hz)
	60.00 V	0.01 V			
	600.0 V	0.1 V			
	1000 V	1 V	2.0 % + 3	2.0 % + 3	2.0 % + 3
			(500 Hz to 1 kHz)	(500 Hz to 1 kHz)	(500 Hz to 1 kHz)
DC mV	600.0 mV	0.1 mV	0.15 % + 2	0.09 % + 2	0.09 % + 2
DC Volts	6.000 V	0.001 V			
	60.00 V	0.01 V	0.15 % + 2	0.09 % + 2	0.09 % + 2
	600.0 V	0.1 V			
	1000 V	1 V	0.15 % + 2	0.15 % + 2	0.15 % + 2
Continuity	600 Ω	1 Ω	Product beeps at <25 Ω, beeper turns off at >250 Ω; detects opens or shorts of 250 μs or longer.		
Ohms	600.0 Ω	0.1 Ω	0.9 % + 2	0.9 % + 2	0.9 % + 2
	6.000 kΩ	0.001 kΩ	0.9 % + 1	0.9 % + 1	0.9 % + 1
	60.00 kΩ	0.01 kΩ	0.9 % + 1	0.9 % + 1	0.9 % + 1
	600.0 kΩ	0.1 kΩ	0.9 % + 1	0.9 % + 1	0.9 % + 1
	6.000 MΩ	0.001 MΩ	0.9 % + 1	0.9 % + 1	0.9 % + 1
	50.00 MΩ	0.01 MΩ	1.5 % + 3	1.5 % + 3	1.5 % + 3

Function	Range ^[1]	Resolution	Accuracy ± ([% of Reading] + [Counts])		
			175	177	179
Diode test	2.400 V	0.001 V	1 % + 2		
Capacitance	1000 nF	1 nF	1.2 % + 2	1.2 % + 2	1.2 % + 2
	10.00 μF	0.01 μF	1.2 % + 2	1.2 % + 2	1.2 % + 2
	100.0 μF	0.1 μF	1.2 % + 2	1.2 % + 2	1.2 % + 2
	9999 μF ^[4]	1 μF	10 % typical	10 % typical	10 % typical
AC Amps ^[5] (True-rms) (45 Hz to 1 kHz)	60.00 mA	0.01 mA	1.5 % + 3	1.5 % + 3	1.5 % + 3
	400.0 mA ^[6]	0.1 mA			
	6.000 A	0.001 A			
	10.00 A ^[7]	0.01 A			
DC Amps ^[5]	60.00 mA	0.01 mA	1.0 % + 3	1.0 % + 3	1.0 % + 3
	400.0 mA ^[6]	0.1 mA			
	6.000 A	0.001 A			
	10.00 A ^[7]	0.01 A			
Hz (AC- or DC- coupled, V or A ^[8] ^[9] input)	99.99 Hz	0.01 Hz	0.1 % + 1	0.1 % + 1	0.1 % + 1
	999.9 Hz	0.1 Hz			
	9.999 kHz	0.001 kHz			
	99.99 kHz	0.01 kHz			

Function	Range ^[1]	Resolution	Accuracy ±([% of Reading] + [Counts])		
			175	177	179
Temperature ^[10]	-40 °C to +400 °C -40 °F to +752 °F	0.1 °C 0.1 °F	NA	NA	1 % + 10 ^[11] 1 % + 18 ^[10]
MIN MAX AVG	For dc functions, accuracy is the specified accuracy of the measurement function ±12 counts for changes longer than 350 ms in duration. For ac functions, accuracy is the specified accuracy of the measurement function ±40 counts for changes longer than 900 ms in duration.				
<p>[1] All ac voltage and ac current ranges are specified from 5 % of range to 100 % of range.</p> <p>[2] Crest factor of ≤3 at full scale up to 500 V, decreasing linearly to crest factor ≤1.5 at 1000 V.</p> <p>[3] For non-sinusoidal waveforms, add -(2 % reading + 2 % full scale) typical, for crest factors up to 3.</p> <p>[4] In the 9999 µF range for measurements to 1000 µF, the measurement accuracy is 1.2 % + 2 for all models.</p> <p>[5] Amps input burden voltage (typical): 400 mA input 2 mV/mA, 10 A input 37 mV/A.</p> <p>[6] 400.0 mA accuracy specified up to 600 mA overload.</p> <p>[7] >10 A unspecified.</p> <p>[8] Frequency is specified from 2 Hz to 99.99 kHz in Volts and from 2 Hz to 30 kHz in Amps.</p> <p>[9] Below 2 Hz, the display shows zero Hz.</p> <p>[10] In RF field of 3 V/m specified accuracy ±5 °C (9 °F).</p> <p>[11] Does not include error of the thermocouple probe.</p>					

Function	Overload Protection ^[1]	Input Impedance (Nominal)	Common Mode Rejection Ratio (1 k Ω Unbalanced)		Normal Mode Rejection
Volts ac	1000 V rms	>10 M Ω < 100 pF	>60 dB @ dc, 50 Hz or 60 Hz		
Volts dc	1000 V rms	>10 M Ω < 100 pF	>120 dB @ dc, 50 Hz or 60 Hz		>60 dB @ 50 Hz or 60 Hz
mV $\sqrt{\text{Hz}}$	1000 V rms ^[2]	>10 M Ω < 100 pF	>120 dB @ dc, 50 Hz or 60 Hz		>60 dB @ 50 Hz or 60 Hz
		Open Circuit Test Voltage	Full Scale Voltage To:		Short Circuit Current
			600 k Ω	50 M Ω	
Ohms/Capacitance	1000 V rms ^[2]	<8.0 V dc	<660 mV dc	<4.6 V dc	<1.1 mA
Continuity/Diode test	1000 V rms ^[2]	<8.0 V dc	2.4 V dc		<1.1 mA
[1] 10 ⁷ V-Hz maximum.					
[2] For circuits <0.3 A short circuit. 660 V for high energy circuits.					

Function	Overload Protection	Overload
mA	Fused, 44/100 A, 1000 V FAST Fuse	600 mA overload for 2 minutes maximum, 10 minutes rest minimum
A	Fused, 11 A, 1000 V FAST Fuse	20 A overload for 30 seconds maximum, 10 minutes rest minimum

Frequency Counter Sensitivity						
Input Range ^{[1][2]}		Typical Sensitivity (RMS Sine Wave)				
		2 Hz to 45 Hz	45 Hz to 10 kHz	10 kHz to 20 kHz	20 kHz to 50 kHz	50 kHz to 100 kHz
Volts ac	600 mV	Unspecified ^[3]	80 mV	150 mV	400 mV	Unspecified ^[3]
	6 V	0.5 V	0.6 V	1.0 V	2.8 V	Unspecified ^[3]
	60 V	5 V	3.8 V	4.1 V	5.6 V	9.6 V
	600 V	50 V	36 V	39 V	45 V	58 V
	1000 V	500 V	300 V	320 V	380 V	NA
Volts dc	6 V	0.5 V	0.75 V	1.4 V	4.0 V	Unspecified ^[3]
	60 V	4 V	3.8 V	4.3 V	6.6 V	13 V
	600 V	40 V	36 V	39 V	45 V	58 V
	1000 V	500 V	300 V	320 V	380 V	NA
AC/DC Amps	mA	5 mA	4 mA	4 mA	4 mA ^[4]	NA
	A	0.5 A	0.4 A	0.4 A	0.4 A ^[4]	NA

[1] Maximum input for specified accuracy = 10X Range or 1000 V.
[2] Noise at low frequency and amplitude may exceed the frequency accuracy specification.
[3] Unspecified but usable depending on quality and amplitude of signal.
[4] In mA and A ranges, frequency measurement is specified to 30 kHz.