

MODEL 121B
POWER SOURCE

www.valuetronics.com

SECTION I GENERAL DESCRIPTION

1-1. SCOPE OF MANUAL

1-2. This manual describes the Model 121B Power Source manufactured by Elgar Corporation. It provides operating, maintenance, and adjustment instructions; a circuit description, a schematic diagram; and a parts list.

1-3. INTRODUCTION

1-4. The Elgar Model 121B Power Source provides AC power at precise frequencies for testing, motor operation, and frequency conversion. The basic power amplifier consists of two DC supplies and a direct-coupled amplifier with a tapped output transformer. The output transformer provides nominal output voltages of 115 and 220 VAC that are adjustable between 0-125 and 0-250 VAC. The total available power is 120 volt-amperes at full rated output voltage. Power at less than full-rated output voltage is derated as illustrated in Figure 1-1. Shown in Figure 1-2 is a curve of typical harmonic distortion. Input power is 50-60 Hz. The power transformer may be wired for 230V at 50-60 Hz.

1-5. Output power frequency is established by a plug-in oscillator. Output frequency range is 45 to 10 KHz. A variety of plug-in oscillators is available with frequency accuracies up to .0001%.

1-6. The Elgar Power Source facilitates equipment tests to meet military specification operating requirements over the frequency range of 47 to 63 Hz or 47 to 425 Hz. The basic power source output is single-phase. Multiphase power can be obtained however, by stacking two or three power sources, all driven by the same multi-phase plug-in oscillator.

1-7. GENERAL DESCRIPTION

1-8. The Elgar Model 121B Power Source is contained in a rack mount enclosure. A meter for output voltage monitoring, a power-on Indicator, a voltage amplitude control and a power circuit breaker that applies line power to the unit are located on the front panel. Cooling air is drawn through a front-panel grill and exhausted at the rear of the enclosure.

1-9. The enclosure contains two heat-sink assemblies, which comprise a two-section power amplifier. Control circuitry is mounted on a circuit board with test points and adjustment controls available on the top side of the board. Output power is available at the rear panel terminal block and across the red and white binding posts located on the front panel.

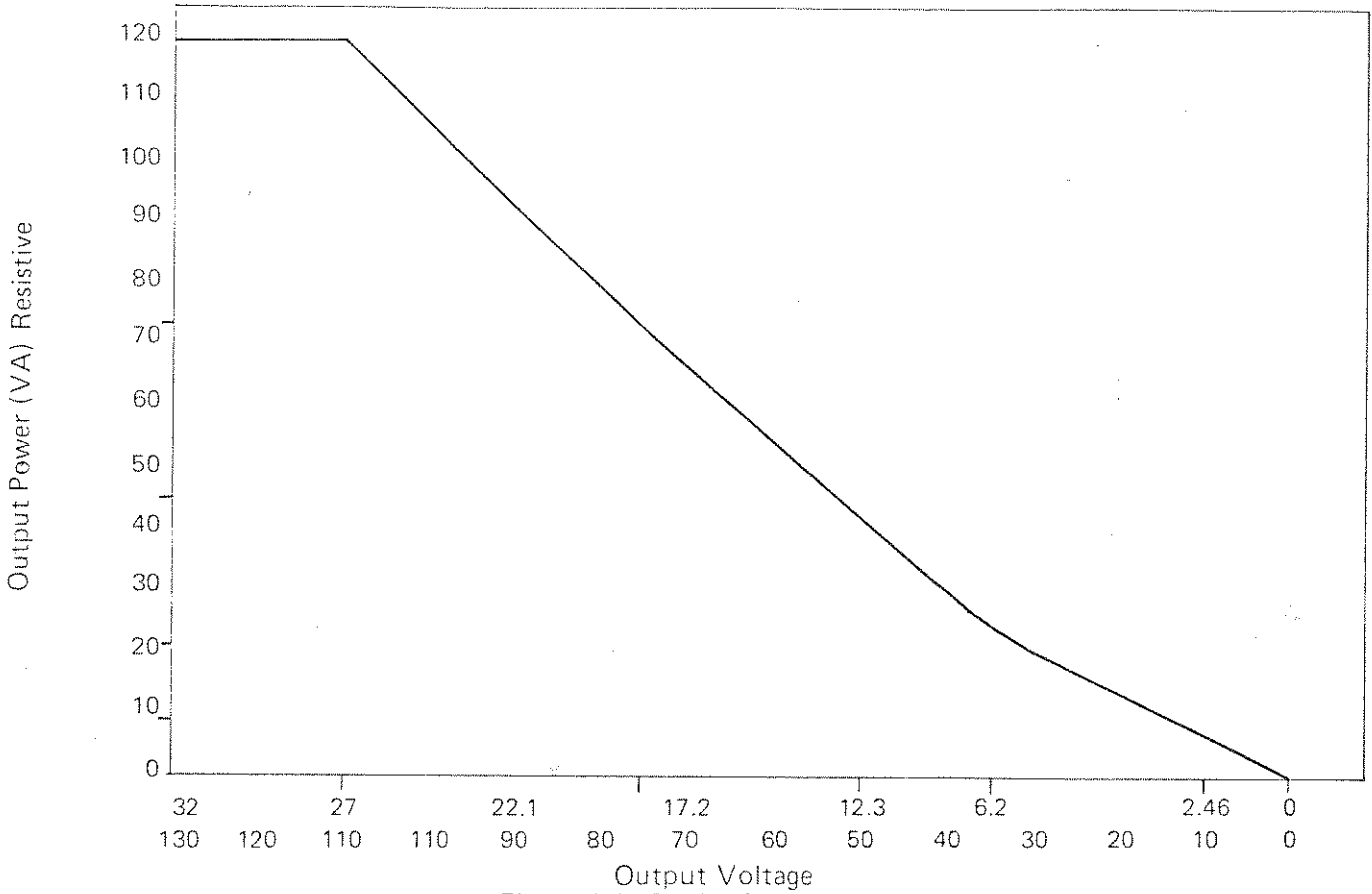

Figure 1-1. Power Output Derating

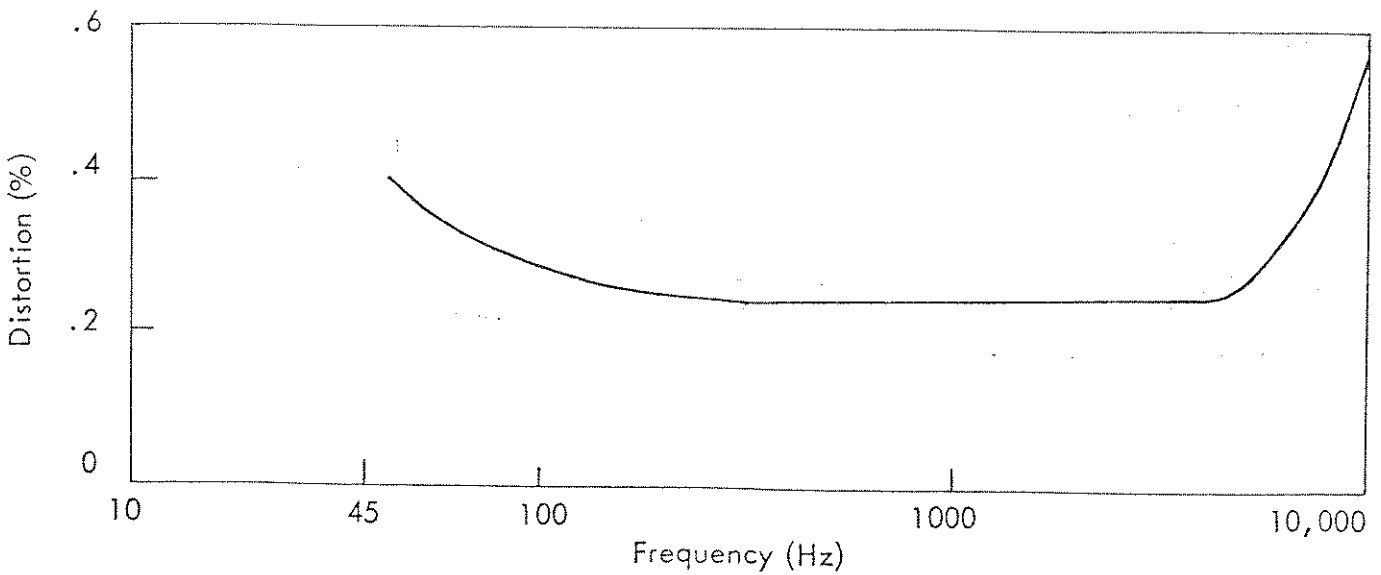

Figure 1-2. Typical Harmonic Distortion at 120 VA

SECTION II
SPECIFICATIONS

Output Power	0-120 VA
Power Factor	Unity to ± 0.7
Output Voltage	Adjustable 0-60, 0-125 VAC or 0-250 VAC
Output Frequency Range	45 Hz-10 KHz at full rated power
Distortion	Less than 0.9% (45 Hz - 10 KHz) Less than 0.5% (100 - 1000 Hz)
Output Noise	70 db below full output voltage
Load Regulation	$\pm 1\%$, no load to full load over full frequency range, adjustable to zero for specific load and frequency
Line Regulation	$\pm 0.25\%$ 115 VAC $\pm 10\%$ $\pm 0.25\%$ 230 VAC $\pm 10\%$
Short Circuit Protection	Output may be shorted and recovers immediately when short is removed.
Input Power	One phase 115 or 230 VAC, 45-65 Hz, 360 VA maximum
Temperature Range	0-50° C
Dimensions	3-1/2 x 19 inch relay rack panel by 14 inches deep overall
Weight	Approximately 45 pounds

www.valuetronics.com

SECTION III OPERATION

3-1. The Elgar Power Source has been aligned and tested prior to shipment. The instrument is therefore ready for immediate use upon receipt. The following checks should be made, however, to assure that the instrument has suffered no damage during shipment.

1. Inspect the shipping container before accepting it from the carrier. If damage to the container is evident, remove the instrument from the container and visually inspect for damage to the instrument parts.

2. If any damage to the instrument or container is evident, a description of the damage should be noted on the carrier's receipt, and signed by the driver or carrier agent. Save all shipping containers and filler material for inspection.

3. Forward a report of any damage to the Elgar Service Department, 8225 Mercury Ct., San Diego California, 92111. Elgar will provide instructions for repair or replacement of the instrument.

3-3. INSTALLATION AND OPERATION

1. The Elgar Power Source is designed for installation in a standard electrical equipment rack. Install the power source so that the flow of cooling

air into the front panel grill and out the rear panel grill is unobstructed.

2. Insert the plug-in oscillator.

3. Connect the load to the appropriate terminal of the rear panel power output terminal block (see Figure 3-1). For bench mounted applications, the front panel binding posts may be used for 220 or 115V output.

4. Connect the input power cord on the rear panel to an appropriate source of single phase power.*

5. Turn front panel power switch on. The pilot lamp will illuminate.

6. Adjust front panel AMPLITUDE control for the desired output voltage as indicated on the front panel voltmeter.

7. With the output wired for 0-125 VAC out, the meter indicates the supplied voltage. When the output is wired for 0-250 VAC out meter reads one half of the supplied voltage.

*See main schematic for 115V or 230V input connections.

NOTE

Certain Elgar plug-in oscillators do not require the use of the front panel AMPLITUDE control. Others are remotely programmed. Consult the oscillator instruction manual.

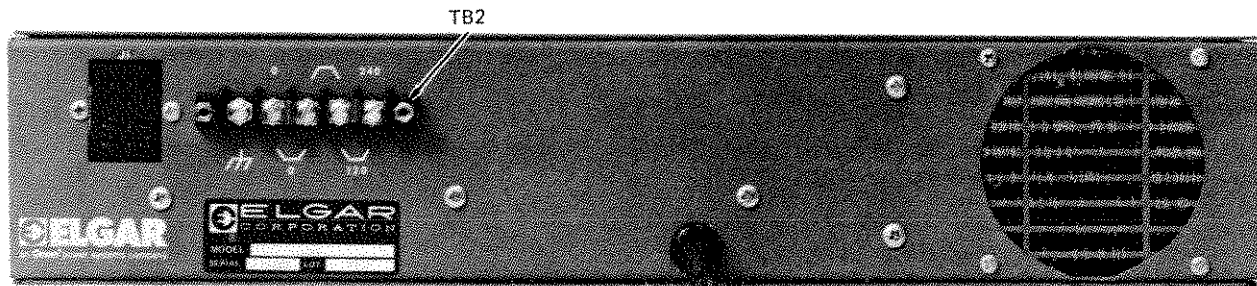

Figure 3-1. Rear Panel

SECTION IV THEORY OF OPERATION

4-1. CIRCUIT DESCRIPTION

4-2. The input signal, approximately 3 VRMS, is provided by the plug-in oscillator. For most oscillators, the input signal amplitude is controlled by front panel AMPLITUDE control, R1. The signal is applied to the first amplifier stage consisting of differential amplifier Q1 and Q2. The differential amplifier provides high DC stability. The emitter currents are supplied by R10 from a +12V supply regulated by CR1. The output of Q1 is coupled to the base Q3 which provides drive signals to the complementary driver stage, Q6 and Q7. Q7 operates as an emitter follower to drive emitter follower Q8 which provides base drive signals to the upper half of the push-pull class B power amplifier. Q6 is operated as a common emitter stage to provide phase inversion of the drive signals to the lower half of the power amplifier. The output of Q6 is applied to emitter follower Q11, which provides base drive signals to the lower half of the power amplifier.

4-3. The power amplifier consists of 4 power transistors mounted on two heat sinks. The .22 ohms emitter resistors ensure equal current sharing of the output transistors. The driver and output stages are operated from nominal ± 40 VDC supplies. Thermal switch shown on heatsink No. 1 turns drive signals off to the power amplifier in the event the power

amplifier overheats from excessive load or restricted air flow through the wind tunnel.

4-4. The power amplifier is also protected from overloads or short circuits on the output by current limit transistors Q4 and Q5. The current in the upper half of the power amplifier is sampled by R35 and applied to the base of Q5 through selected resistor R28. When the voltage at the base of Q5 reach Q5's conduction threshold (approximately .6V) drive signal is diverted from the base of Q7 thus preventing any further increase in output current. Simultaneously, the current in the lower half of the power amplifier is sampled by R31. This voltage is applied to the base of Q4 through selected resistor R29. When the voltage at the base of Q4 reaches Q4's conduction threshold, drive signal is diverted from the base of Q6 preventing any further increase in output current of the lower half of the power amplifier.

4-5. Amplifier output (TP2) is connected to output transformer T2, which steps up the amplifier voltage to the required output level. Negative AC feedback path is from TP2 through R16 to the base of Q1. Capacitor C7 across R16 is used to prevent high frequency oscillations in output. Load regulation is accomplished by passing the TP2 wire from the heat-sink plugs through

a current transformer T3. Positive current feedback is taken across the secondary through regulation adjustment potentiometer R7 and to the base Q1 through R5. R6 and C4 are used as high frequency regulation boost network.

4-6. POWER SUPPLIES

4-7. Plus and minus 40 VDC for the power amplifiers are developed by rectifier bridge from the secondary voltage of power transformer T1. C1-C2 are filter capacitors for these supplies and R2 and R3 are bleeder resistors.

4-8. INTERCONNECTIONS FOR MULTIPHASE OPERATION

4-9. Two or three Model 121B power Sources may be used to generate two-phase or three-phase AC power. Two-phase or three-phase signals are generated in a two-phase or three-phase oscillator installed in the master power amplifier. Signals from the oscillator are carried to tone or two slave power amplifiers (see Figure 4-1), each of which has a dummy oscillator plug-in which makes the required signal interconnections installed in it. The front panel AMPLITUDE control on the master amplifier controls the amplitude of all the amplifiers' outputs simultaneously. The front panel AMPLITUDE controls of the slave amplifier(s) however, must initially be set so that their output voltages equal the master amplifier output voltage.

4-10. Two-phase operation requires two power sources. Three-phase operation may be accomplished with three power sources in "wye" connection, or with two power sources in open-delta connection. The use of three Model 121B's for three-phase operation provides 360 VA total output, while the use of two power sources provides 240 VA total output. A more detailed circuit description of two-phase and three-phase power sources is provided in the oscillator instruction manuals.

4-11. The 400 SR plug-in is a universal signal routing plug-in used in multi-phase systems to route drive signal from a master plug-in oscillator or an external oscillator source. The routing is accomplished by the closing of specific switches on the 8 pole

single throw DIP Switch. Standard plug-ins are as follows (for special configurations refer to the addendum):

- Model 400—A External oscillator adaptor. Has front panel phone jack and routes signal to power amplifier input. DIP Switch not necessary. If present switches 7 & 8 must be ON connecting pins 14 to 21 and 16 to 12
- 400—B Blank plug-in used in 2nd amplifier (B phase) of multi-phase system. Routes appropriate signal from oscillator in 1st amplifier input switches 6 7 8 must be ON, connecting pins 22 to 11, 21 to 14, 16 to 12
- 400—C Blank plug-in used in 3rd amplifier (C phase) of 3 amplifier, 3 phase system. Routes appropriate signal from oscillator in 1st amplifier to 3rd amplifier input. Switches 5 7 8 must be ON, connecting pins 22-10, 21-14, 16 to 12
- 400 BT Blank plug-in used in 2nd amplifier(s) in a Tandem System such as 2000-1. Also used in single phase TG 704A systems or in phase A of multi-phase TG 704A-3 systems. Switches 4 7 8 must be ON connecting pins 22 to 9, 21 to 14 and 16 to 12
- 400—DPA Blank plug-in used in single phase DAP systems or in phase A of multi-phase DAP systems. Switch 3 8 must be ON connecting pins 14 to 9 and 16 to 12
- 400—DPB Blank plug-in used in phase B of multi-phase DAP systems.

Switches 1 8 must be ON connecting pins 14 to 11 and 16 to 12

400-DPC Blank plug-in used in phase C of multi-phase DAP systems. Switches 2 8 must be ON connecting pins 14 to 10 and 16 to 12

400-TGB Plug in used in single package 30 units such as 1753B when used with TG 704A-3. It has front panel B and C phase amplitude pots. Switches 4 7 8 must be ON connecting pins 22 to 9, 21 to 14 and 16 to 12

4-12. In the open delta configuration two power amplifiers of equal VA rating are driven by a standard three phase oscillator having 120° phase angle between $\emptyset A$, $\emptyset B$ and $\emptyset C$. An open delta requires that two amplifiers have a 60° phase angle between them and this is accomplished by inverting the second amplifier.

4-13. In these systems the amplifier containing the plug-in oscillator is referred to as the master or A phase source. The second amplifier is referred to as the slave or B phase source.

4-14. The open delta hook-up shown in Figure 4-2 page 4-4 is shown below as a vector diagram in Figure 4-1.

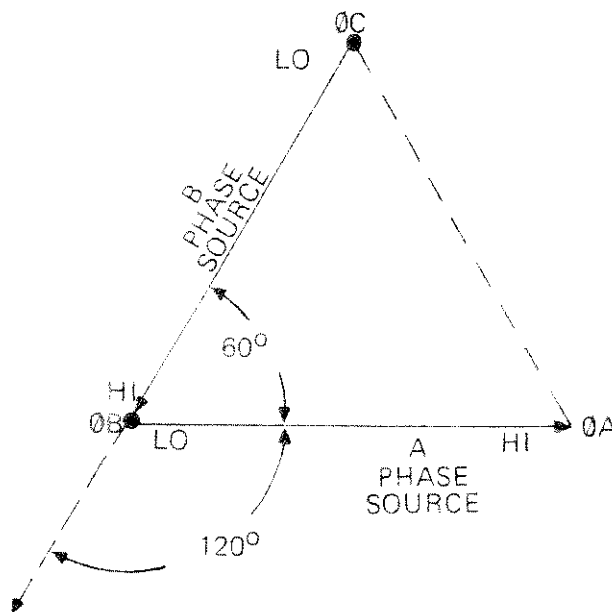

Figure 4-1.

4-15. Certain specialized oscillators such as the Super-Stable (SS) series and the Quasi-Square wave series are designed only for the open delta configurations using two amplifiers and have the phase and angle between the $\emptyset A$ and $\emptyset B$ drive

signals at 60° .

4-16. When using the SS series or quasi-square wave systems, the interconnections would be per Figure 4-2.

QUASI-SQUARE WAVE SUCH AS 443-1-111

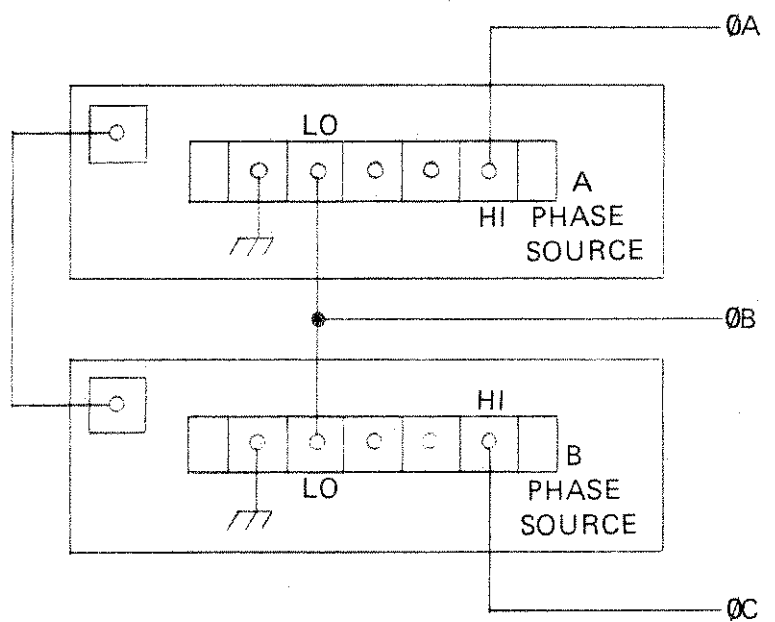
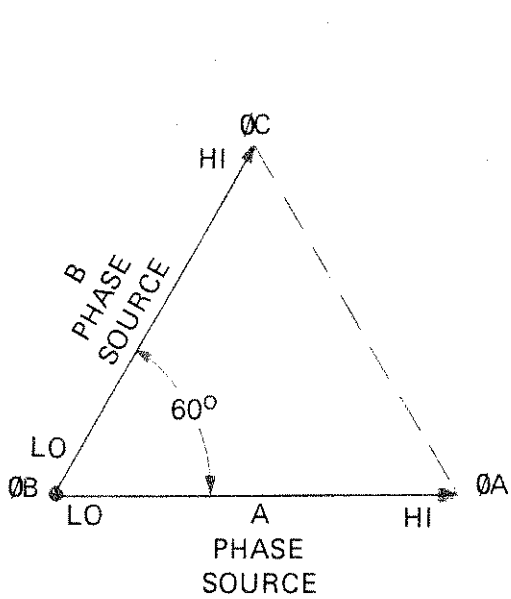

SUPER STABLE SUCH AS 443-.01SS

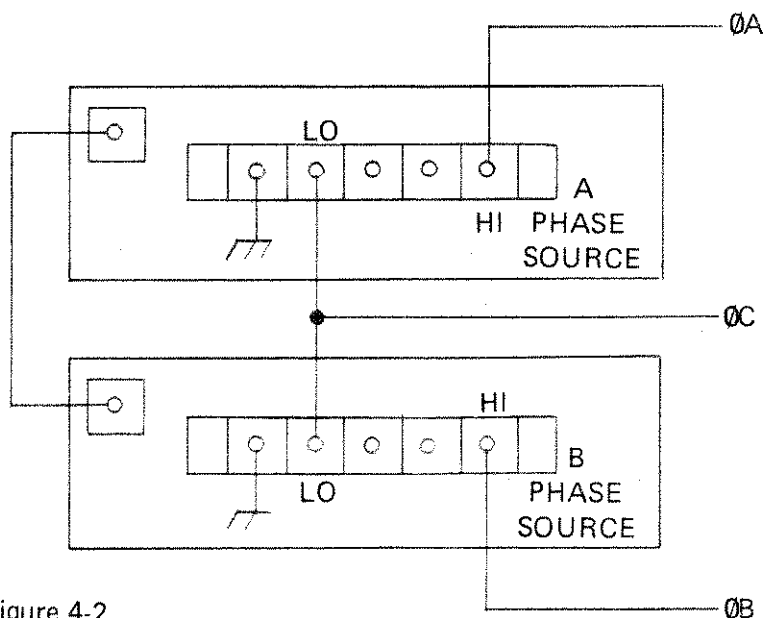
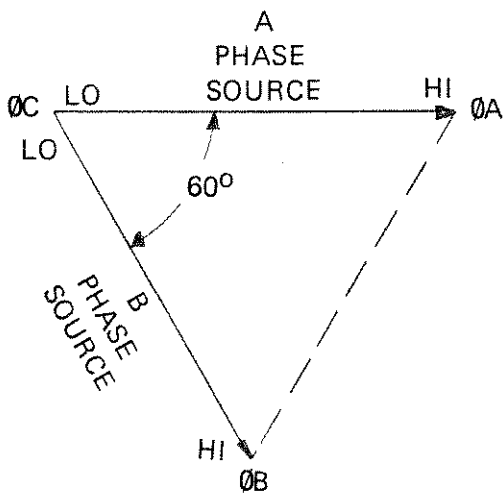

Figure 4-2

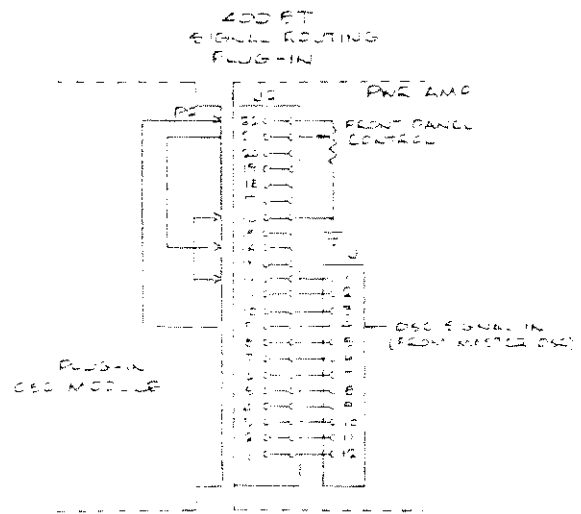
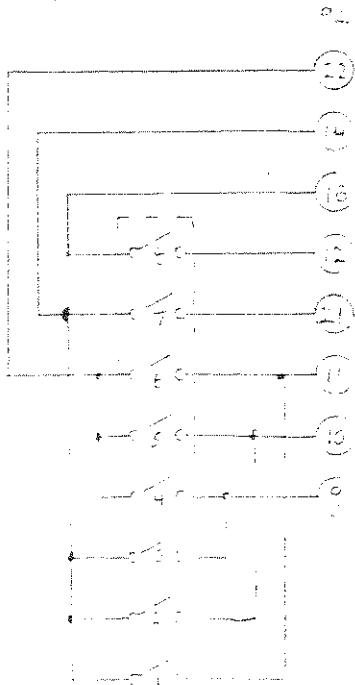
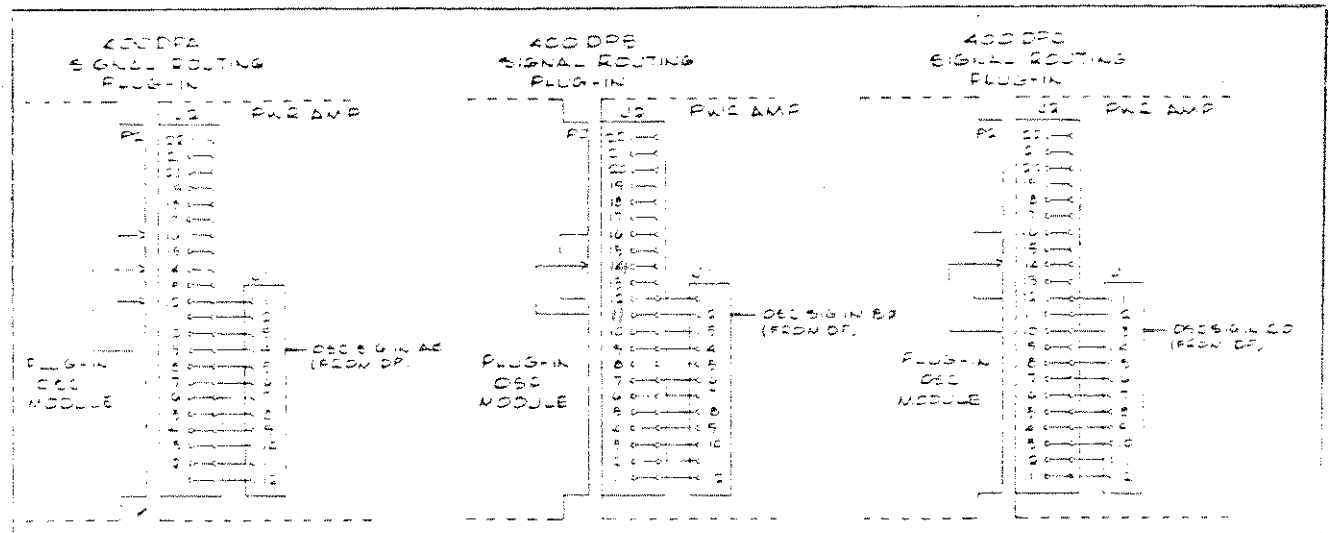
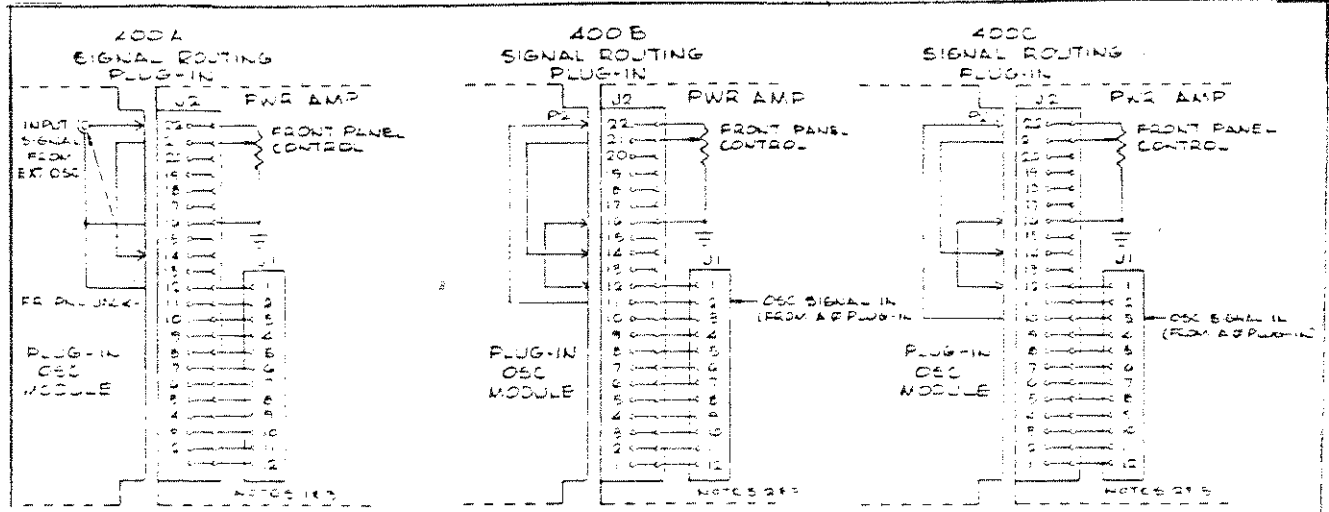

Figure 4-3. Signal Routing Plug-in Connections

OUTPUT CONFIGURATIONS FOR MODEL 121B

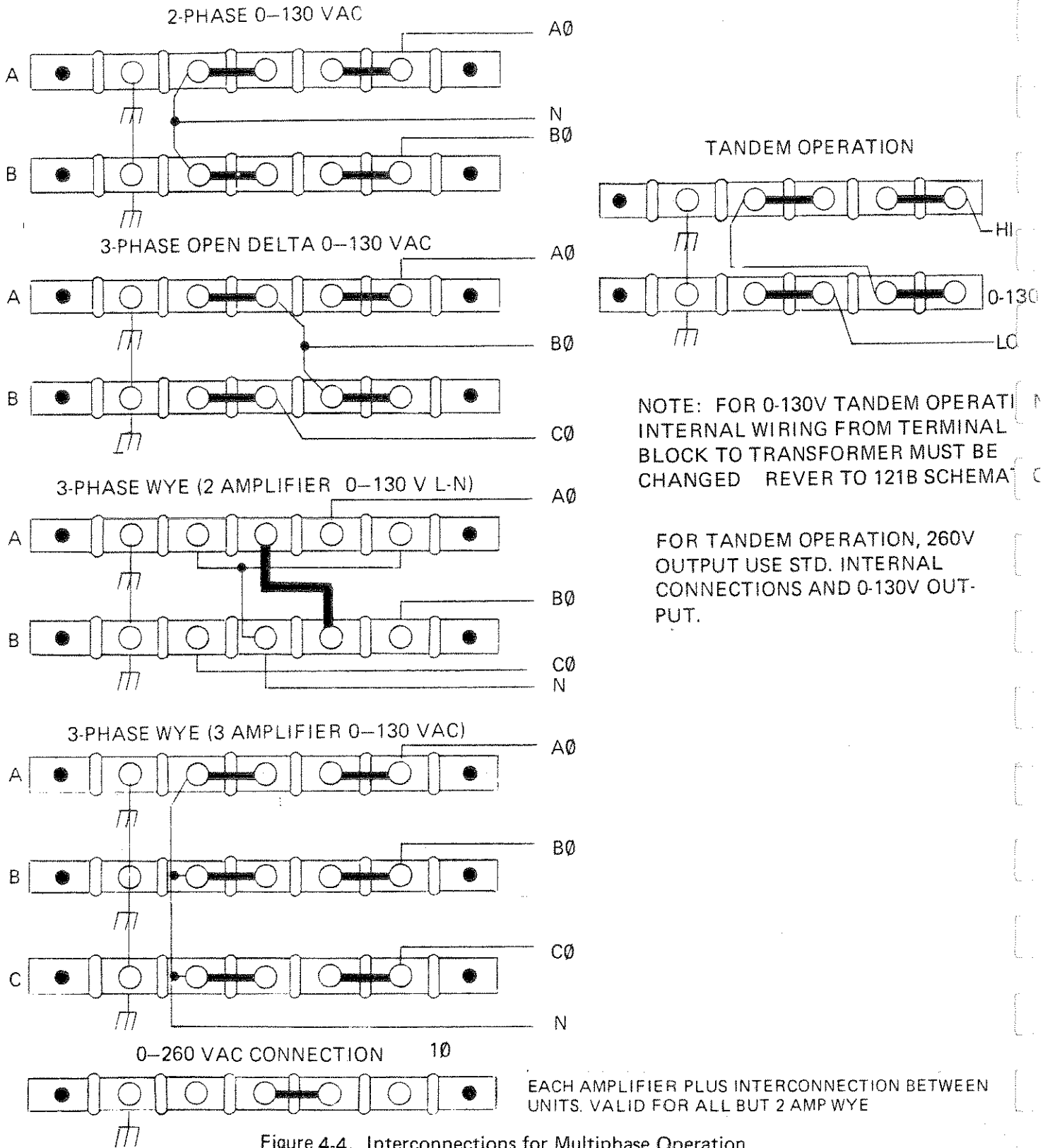

Figure 4-4. Interconnections for Multiphase Operation

SECTION V MAINTENANCE AND ADJUSTMENT

5-1. SERVICE INFORMATION

5-2. Questions concerning the operation, repair or servicing of this instrument should be directed to the nearest Elgar representative or to the Service Department, Elgar Corporation, 8225 Mercury Ct. San Diego, California 92111. Include the model number and serial number in any correspondence concerning this instrument.

5-3. FACTORY REPAIR

5-4. Should it be necessary to return an instrument to the factory for repair, please contact the Elgar Corporation Service Department for authorization to make shipment. Do not return the unit without authorization.

5-5. TEST POINTS

5-6. Test points and adjustment controls are conveniently provided at the top of the amplifier circuit board, accessible by removing the top cover of the instrument (see Figure 5-1.) The test points are as follows:

- TP1 – Circuit common
- TP2 – Amplifier output
- TP3 – Oscillator signal

5-7. OUTPUT REGULATION ADJUSTMENT

5-8. The regulation adjustment, R7, is set at the factory to give $\pm 1\%$ load regulation over the frequency range of the power source. The regulation may require re-adjustment if the load is highly reactive or if zero regulation is desired for a specific load and frequency. To make this adjustment, disconnect the load and read the output voltage. Connect the load and adjust R7 until the same reading is obtained.

NOTE

If the load is heavy enough to cause current limit transistors Q5 and Q4 to conduct, the output voltage will be reduced, giving an indication of poor load regulation. Load voltage fall-off due to current limiting action should not be compensated by the regulation adjustment.

5-9. CURRENT LIMIT ADJUSTMENT

5-10. Current limits are preset with selected components at the factory and therefore are not field adjustable.

5-11. PERIODIC MAINTENANCE

5-12 The only periodic maintenance required by the Model 121B power source is occasional cleaning of the heat sinks. The heat sinks may be inspected through the front panel air grill. If enough dust and dirt have accumulated to restrict the air flow an air jet should be directed through the front panel grill while the instrument is operating. If this does not dislodge the dirt, the heat sink must be removed to be cleaned.

5-13 TROUBLESHOOTING

5-14 CIRCUIT BREAKER TRIPS: If the circuit breaker trips at no load, a fault in either the power transistors or power rectifiers is indicated. Unplug both heatsinks and try the circuit breaker. If it does not trip, look for shorted power transistor,

(power transistors can be tested with an ohmmeter). If the circuit breaker still trips, look for a shorted rectifier bridge. If all diodes and filter capacitors are good, a fault in the power transformer or wiring harness is indicated.

5-15 OUTPUT DISTORTION. Output distortion may be caused by over loading. Check the load current waveform with an oscilloscope since some high crest factor loads may draw considerably more peak current than is indicated by a load ammeter.

5-16 OVERHEATING. If overheating causes thermostat S1 to close, the output voltage will fall to zero. Over heating may be caused by restricted air flow or excessive environmental temperature (greater than 50° C).

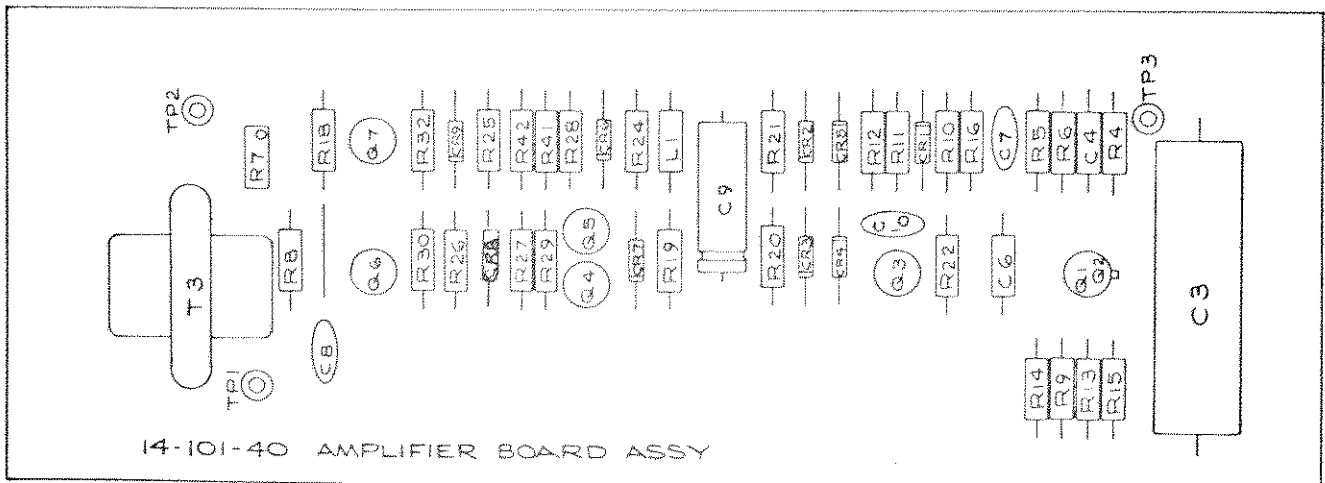
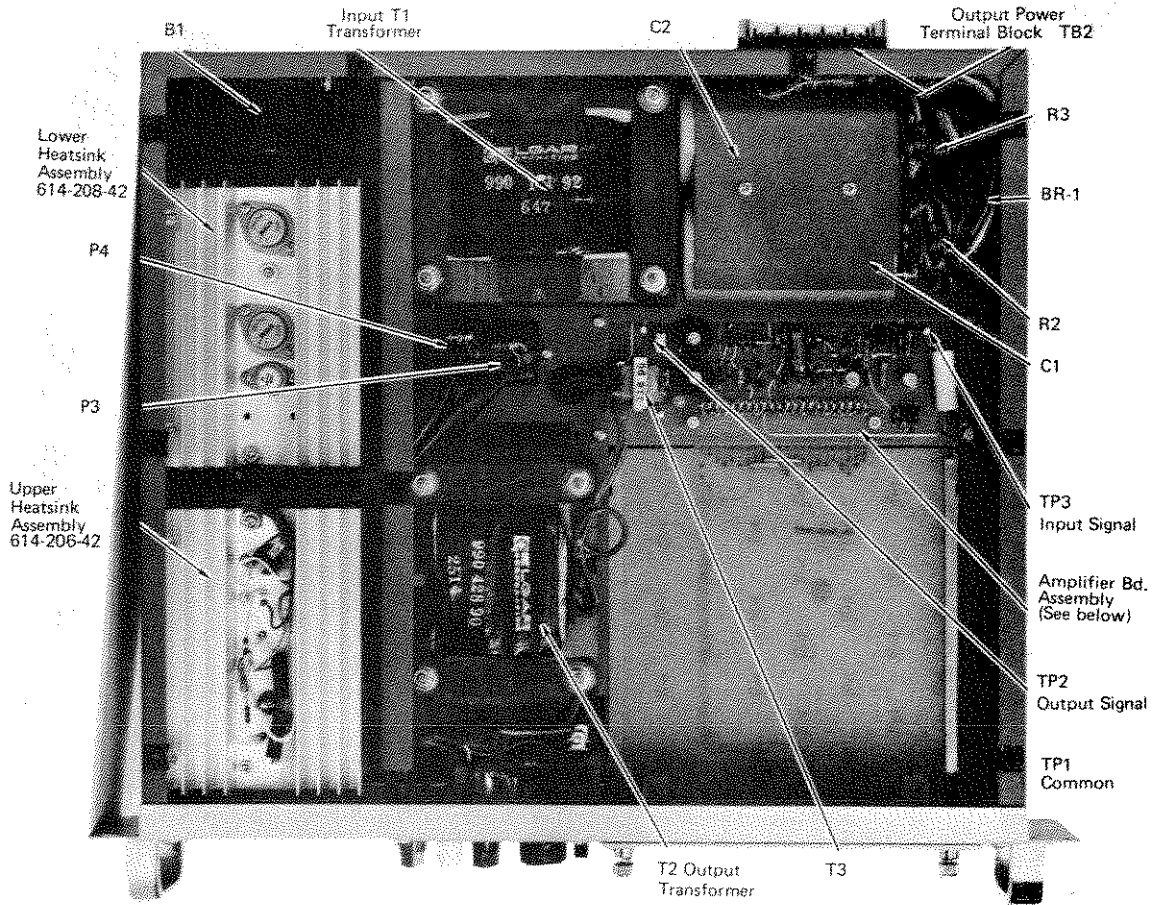

Figure 5-1. Top View

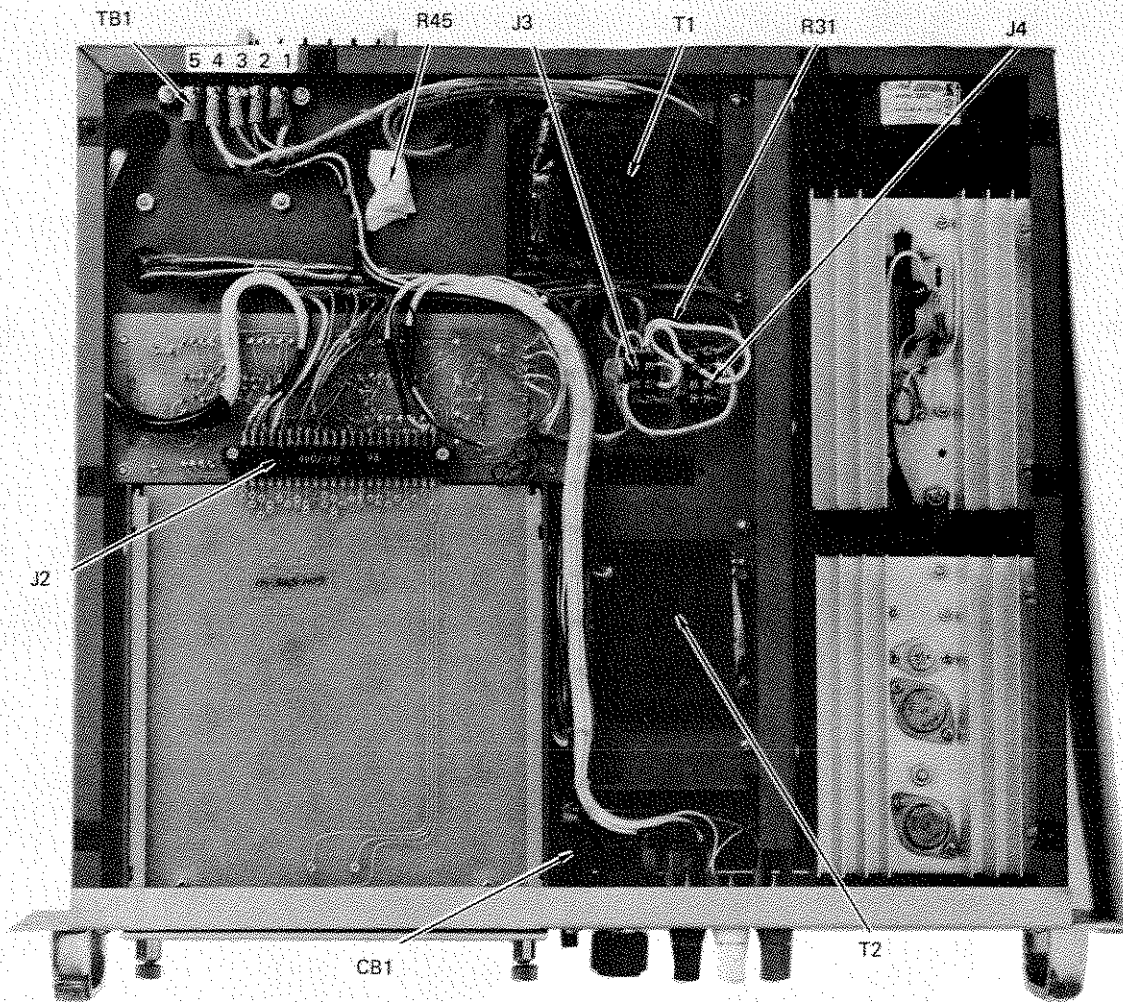

Figure 5-2. Bottom View

SECTION VI PARTS LIST

6-1. GENERAL

6-2. This section contains a listing of all parts necessary for factory-authorized repair for the Model 121B AC Power Source. Location of parts and assembly is given on an illustration accompanying each parts list. Parts are located on the illustration and correlated on the parts list by reference designators. Note that trimming capacitors are factory-selected parts and replacement of these parts is beyond the scope of customer maintenance. They are, therefore, not included in the following lists.

6-3. SPARE PARTS

6-4. When ordering spare parts, specify part name, part number, manufacturer, component value and rating. Where no specific manufacturer or part number is given, the replacement parts should conform to value, rating, and tolerance as listed. If complete assembly is desired, order assembly from Elgar Corporation, 8225 Mercury Court, San Diego 92111. Specify assembly number, instrument series number and instrument name.

CHASSIS PARTS LIST MODEL 121B

SCHEMATIC DESIGNATION	VALUE	DESCRIPTION OR TYPE	RATING	MANUFACTURER		ELGAR PART NUMBER
				NAME	PART NUMBER	
R1	0-10K	Potentiometer		Spectrol	534-9561-10	819-103-53
R2,R3	4.7K	Carbon	2W,5%	Speer	RC42GF472J	804-472-05
R31	.1 ohm	Wire Wound	10W,10%	Dale	CW 10.1	808-0R1-05
R45	4.7 ohm	Carbon	½W,5%	Speer	RC20GF4R7J	826-4R7-05
C1,C2	9300 uF	Alum. Elec.	50V	G.E.	86F168M	826-908-12
C13,14	.015 uF	Cer. Disc	1KV	Centralab	DDM202	821-153-10
BR1		Diode Bridge	25A	Motorola	MDA990-3	847-990-3X
B1		Fan		Rotron	SU2A1	853-SU2-A1
T1		Power Xfmr		Elgar		990-171-9X
T2		Output Xfmr		Elgar		990-428-9X
T3		Current Xfmr		Elgar		990-116-9X
DS1		Lamp		Eldema	BG02-RCS AIC-68K	854-86K-22
CB1		Circuit Breaker	6.5 Amp	Airpax	UPG1-1.6-1	852-652-51
M1		Voltmeter	0-150VAC	Jewell	82T	857-150-82
J1		Receptacle	12 Pin	Cinch Jones	S312AB	856-312-S1
J2		Receptacle	22 Pin	Cinch Jones		856-8B0-M2
J3,4		Receptacle		Cinch Jones	S308AB	856-308-S1
BP3		Blue Dinding Post			DF30BC	891-030-00
BP1		Red Binding Pose			DF30RC	891-030-02
BP2		White Binding Post			DF30WTC	891-030-09

SCHEMATIC DESIGNATION	VALUE	DESCRIPTION OR TYPE	RATING	MANUFACTURER		ELGAR PART NUMBER
				NAME	PART NUMBER	
R33,R34,R37,R38 R35,R36,R39,R40 CR11,CR12 C11,CR12	47 ohm .22 ohm .0047 uf	Carbon Wire Wound Diode Mylar	1/2w, 5% 5W, 5% 200V 18A 200V, 10%	Speer Dale G.E. Sprague	RC20GF470J CW5,22 A327B 19P47292	802-470-05 807-R22-05 845-368-DX 822-472-05
Q8,Q11 Q9,Q10,Q12,Q13		Transistor Transistor		Motorola RCA	2N4912 2N4348	839-491-2X 841-434-8X
P3,P4		Plug		Cinch Jones	P308CCT	856-308-P1
S1*		Thermost		Elmwood	3400	861-340-0X

* Used only on Assy. No. 14-206-40

AMPLIFIER BOARD ASSEMBLY 614-101-40

SCHEMATIC DESIGNATION	VALUE	DESCRIPTION OR TYPE	RATING	MANUFACTURER		ELGAR PART NUMBER
				NAME	PART NUMBER	
R4	3.32K	Metal Film	1/8W, 1%	Dale	RN60C3321F	813-332-1F
R5	4.75K	Metal Film	1/8W, 1%	Dale	RN60C4751F	813-475-1F
R6,14,24,41,42	FSV	Carbon	1/2W, 5%	Speer	RC20GF ---J	802-xxx-05
R7	1K	Potentiometer		Bourns	63WR1K	819-102-63
R8	33 ohm	Carbon	1/2W, 5%	Speer	RC20GF330J	802-330-05
R9, R18-20	4.7K	Carbon	1/2W, 5%	Speer	RC20GF472J	802-472-05
R10,25	6.2K	Carbon	1/2W, 5%	Speer	RC20GF622J	802-622-05
R11	3.9K	Carbon	1/2W, 5%	Speer	RC20GF392J	802-392-05
R12,30,32	100 ohm	Carbon	1/2W, 5%	Speer	RC20GF101J	802-101-05
R13	1.5K	Carbon	1/2W, 5%	Speer	RC20GF152J	802-152-05
R15	2.2K	Carbon	1/2W, 5%	Speer	RC20GF222J	802-222-05
R16	33.2K	Metal Film	1/8W, 1%	Dale	RN60C3322F	813-332-2F
R21,28,29	68 ohm	Carbon	1/2W, 5%	Speer	RC20GF680J	802-680-05
R22	200 ohm	Carbon	1/2W, 5%	Speer	RC20GF201J	802-201-05
R26	1.8K	Carbon	1/2W, 5%	Speer	RC20GF182J	802-182-05
R27	5.6K	Carbon	1/2W, 5%	Speer	RC20GF562J	802-562-05
C3	10 uf	Mylar	10V, 5%	IMB	SA9B106J	822-106-X0
C4,6	FSV	Paper	200V, 10%	Sprague	192P ----	822-xxx-05
C7	200 pf	Dip Mica	500V, 5%	Sangamo	DM15-201J	820-201-05
C8	220 uf	Tantalum	10V	Sprague	196D227X0010MA3	823-227-61
C9	50 uf	Alum Elec	50V	Sprague	500D506G050DD7	824-506-71
C10	220 pf	Dip Mica	500V, 5%	Sangamo	DM15-221J	820-221-05
CR1		Zener Diode	12V	Motorola	1N5242	843-524-2X
CR2-9		Diode		ITT	1N4004	845-400-4X
Q1,2		Diff. Amp. PNP		National	2N3810	849-381-0X
Q3,7		Transistor		RCA	2N3440	837-344-0X
Q4		Transistor		Fairchild	2N3638	834-363-8X
Q5		Transistor		Fairchild	2N3567	835-356-7X
Q6		Transistor		Motorola	2N4236 (SJ5109)	836-423-6X
L1	150 uH	Choke		Nytronics	SWD150	851-150-01

1
2
3
4
5
6
7
8
9
10
11
12
13
14
15
16
17
18
19
20
21
22
23
24
25
26
27
28
29
30
31
32
33
34
35
36
37
38
39
40
41
42
43
44
45
46
47
48
49
50
51
52
53
54
55
56
57
58
59
60
61
62
63
64
65
66
67
68
69
70
71
72
73
74
75
76
77
78
79
80
81
82
83
84
85
86
87
88
89
90
91
92
93
94
95
96
97
98
99
100