Technical Reference

Content

General Information, Safety Instructions	5
Warranty Information	5
Support	5
Printing History.....	5
Safety symbols in the manual	6
Safety instructions for all DEWETRON systems	7
Environmental Considerations	8
DEWE-3010	9
System specifications	9
Connectors	10
Instruction for battery exchange	12
A/D & D/A Conversion	A1
Internal Wiring	B1
EC-Certificate of conformity	C1

Technical Reference

The information contained in this document is subject to change without notice.

DEWETRON elektronische Messgeraete Ges.m.b.H. (DEWETRON) shall not be liable for any errors contained in this document. DEWETRON MAKES NO WARRANTIES OF ANY KIND WITH REGARD TO THIS DOCUMENT, WHETHER EXPRESS OR IMPLIED. DEWETRON SPECIFICALLY DISCLAIMS THE IMPLIED WARRANTIES OF MERCHANTABILITY AND FITNESS FOR A PARTICULAR PURPOSE. DEWETRON shall not be liable for any direct, indirect, special, incidental, or consequential damages, whether based on contract, tort, or any other legal theory, in connection with the furnishing of this document or the use of the information in this document.

Warranty Information

A copy of the specific warranty terms applicable to your DEWETRON product and replacement parts can be obtained from your local sales and service office.

Support

For any support please contact your local distributor first or DEWETRON directly.

For Asia and Europe, please contact:

DEWETRON Ges.m.b.H.
Parkring 4
A-8074 Graz-Grambach
AUSTRIA
Tel.: +43 316 3070
Fax: +43 316 307090
Email: support@dewetron.com
Web: <http://www.dewetron.com>

The telephone hotline is available
Monday to Friday between
08:00 and 17:00 CET (GMT +1:00)

For the Americas, please contact:

DEWETRON, Inc.
PO Box 1460
Charlestown, RI 02813
U.S.A.
Tel.: +1 401 364 9464
Toll-free: +1 877 431 5166
Fax: +1 401 364 8565
Email: support@dewamerica.com
Web: <http://www.dewamerica.com>

The telephone hotline is available
Monday to Friday between
08:00 and 17:00 GST (GMT -5:00)

Restricted Rights Legend

Use austrian law for duplication or disclosure.

DEWETRON GesmbH
Parkring 4
A-8074 Graz-Grambach / Austria

Printing History

Please refer to the page bottom for printing version.

Copyright © DEWETRON elektronische Messgeraete Ges.m.b.H.

This document contains information which is protected by copyright. All rights are reserved. Reproduction, adaptation, or translation without prior written permission is prohibited, except as allowed under the copyright laws.

All trademarks and registered trademarks are acknowledged to be the property of their owners.

Safety instructions

Safety symbols in the manual



Indicates hazardous voltages.

WARNING *Calls attention to a procedure, practice, or condition that could cause bodily injury or death.*

CAUTION *Calls attention to a procedure, practice, or condition that could possibly cause damage to equipment or permanent loss of data.*

WARNINGS

The following general safety precautions must be observed during all phases of operation, service, and repair of this product. Failure to comply with these precautions or with specific warnings elsewhere in this manual violates safety standards of design, manufacture, and intended use of the product. DEWETRON Elektronische Messgeraete Ges.m.b.H. assumes no liability for the customer's failure to comply with these requirements.

All accessories shown in this document are available as option and will not be shipped as standard parts.



*For safety reasons max. 50 V may be applied to the BNC input-connectors!
Refer to the regulation of maximum allowable touch potential.*

Safety instructions for all DEWETRON systems

- The DEWETRON data acquisition systems may only be installed by experts.
- Read your manual before operating the system.
- Observe local laws when using the instrument.
- Ground the equipment: For Safety Class 1 equipment (equipment having a protective earth terminal), a non interruptible safety earth ground must be provided from the mains power source to the product input wiring terminals or supplied power cable.
- DO NOT operate the product in an explosive atmosphere or in the presence of flammable gases or fumes and do not bring the system in contact with water.
- DO NOT operate damaged equipment: Whenever it is possible that the safety protection features built into this product have been impaired, either through physical damage, excessive moisture, or any other reason, REMOVE POWER and do not use the product until safe operation can be verified by service-trained personnel. If necessary, return the product to a DEWETRON sales and service office for service and repair to ensure that safety features are maintained.
- Keep away from live circuits: Operating personnel must not remove equipment covers or shields. Procedures involving the removal of covers or shields are for use by service-trained personnel only. Under certain conditions, dangerous voltages may exist even with the equipment switched off. To avoid dangerous electrical shock, DO NOT perform procedures involving cover or shield removal unless you are qualified to do so.
- No modifications are allowed at the instrument. The fuse in the power module has to be replaced by the same type. For continued protection against fire, replace the line fuse(s) only with fuse(s) of the same voltage and current rating and type. DO NOT use repaired fuses or short-circuited fuse holder labels and print on the power module may not be removed.
- DO NOT service or adjust alone. Do not attempt internal service or adjustment unless another person, capable of rendering first aid and resuscitation, is present.
- DO NOT substitute parts or modify equipment: Because of the danger of introducing additional hazards, do not install substitute parts or perform any unauthorized modification to the product. Return the product to a DEWETRON sales and service office for service and repair to ensure that safety features are maintained.
- Before opening the instrument (experts only) or exchanging the fuse in the power module disconnect power!
- Don't touch internal wiring!
- Don't use higher supply voltage than specified and take care of the correct polarity, otherwise the system will be damaged!
- Use only original plugs and cables for harnessing.
- Install filler-panels in unused slots.
- The power-cable and -connector serve as Power-Breaker. The cable must not exceed 10 feet, disconnect function must be possible without tools.
- Keep the ventilation slots free and check them frequently to avoid an overheating of the system. The cleaning interval of the filter pads depends on the environmental conditions.
- Safety of the operator and the unit depend on following these rules.
- DEWETRON is not responsible for any damage or injury that could result from improper connection or misuse!

General Information

CAUTION

- The system BIOS is protected by password. Any change in the BIOS may cause a system crash. When the system is booting, do not press ESC-button on keyboard. This may clear the BIOS settings and cause system faults.
- Any change in the file structure as deleting or adding files or directories might cause a system crash.
- Before installing software updates contact DEWETRON or your local distributor. Use only software packages which are released by DEWETRON. Further informations are also available in the internet (<http://www.dewetron.com>).
- After power off the system wait at least 10 seconds before switching the system on again. Otherwise the system may not boot correct. This prolongs also the life of all system components.

Environmental Considerations

Information about the environmental impact of the product.

Product End-of-Life Handling

Observe the following guidelines when recycling a DEWETRON system:

System and Components Recycling

Production of these components required the extraction and use of natural resources. The substances contained in the system could be harmful to your health and to the environment if the system is improperly handled at it's end of life! Please recycle this product in an appropriate way to avoid an unnecessary pollution of the environment and to keep natural resources.



This symbol indicates that this system complies with the European Union's requirements according to Directive 2002/96/EC on waste electrical and electronic equipment (WEEE). Please find further informations about recycling on the DEWETRON web site www.dewetron.com



Restriction of Hazardous Substances

This product has been classified as Monitoring and Control equipment, and is outside the scope of the 2002/95/EC RoHS Directive. This product is known to contain lead.

DEWE-3010 PC instrument

- Portable data acquisition system
- Up to 16 channel signal input
- Up to 8 channels with isolation
(in conjunction with DEWE-DAQ modules)
- A/D converter specs see appendix A

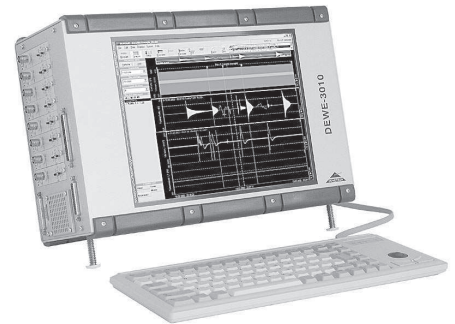

System specifications

	DEWE-3010
Power supply:	<input type="checkbox"/> AC power supply ACE-716A (for details see 1.1 on next page) <input type="checkbox"/> DC power supply NET-202 + Accu (for details see 1.2 on next page)
Operating temperature:	-5 °C to 50 °C (standard)
Storage temperature:	-20 °C to +60 °C
Humidity (operating):	10 % to 80 %, non condensing 5 % to 95 %, rel. humidity
Vibration:	MIL-STD 810F 514.5 procedure I operating test procedure frequency range: 5 to 200 to 5 Hz; 5 x 12 min each direction displacement amplitude ±3.5 mm (5 to 8.45 Hz) acceleration amplitude 1 g (8.45 to 92 Hz) displacement amplitude 92 to 113 Hz: ±0.029 mm acceleration amplitude 1.5 g (113 to 200 Hz)
Shock:	MIL-STD 810F 516.5 procedure I non operating test procedure ½ sinus 11 ms 10 g, 3 shocks positive, 3 shocks negative
Dimensions (W x H x D):	approx. 372 x 258 x 170 mm (14.6 x 10.2 x 6.7 in.)
Weight:	typ. 6 kg (12 lbs), depending on configuration

Main System

Connectors

Typical DEWE-3010 system

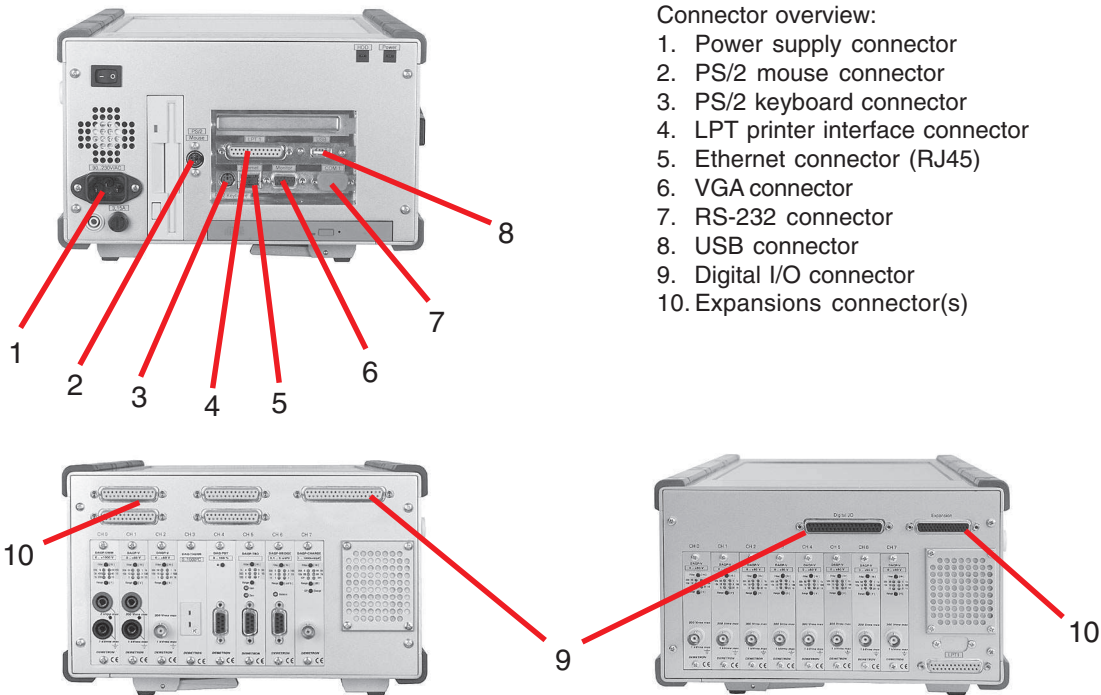

- Connector overview:
1. Power supply connector
 2. PS/2 mouse connector
 3. PS/2 keyboard connector
 4. LPT printer interface connector
 5. Ethernet connector (RJ45)
 6. VGA connector
 7. RS-232 connector
 8. USB connector
 9. Digital I/O connector
 10. Expansions connector(s)

Note: The location of the connectors might vary from system to system and depends on system configuration

1. Power supply connectors

1.1 AC power supply

AC Power supply	ACE-716A
Input:	
Input range:	85 to 135 V _{AC} and 180 to 265 V _{AC} (auto selecting)
Input frequency:	47 to 440 Hz
Max. input current:	5 A (115 V _{AC}) or 3 A (230 V _{AC})
Output:	
Output power:	150 W
Output voltages:	+5 V (max. 25 A)
	+12 V (max. 10 A)
	-5 V (max. 1 A)
	-12 V (max. 1 A)
The system fuse is located between connector and power switch.	
If the system doesn't work after switching on, disconnect the power cord and check the fuse.	

Note: The maximum load is 150 W, otherwise power supply can be damaged.

AC power supply connector

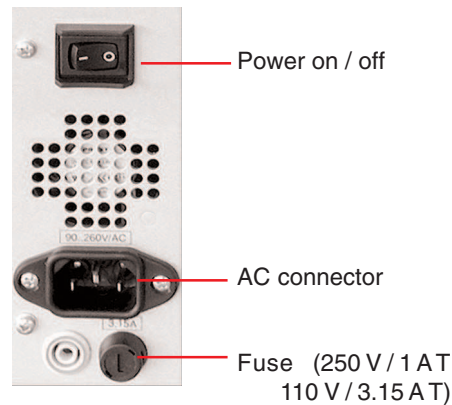

1.2 DC power supply

DC Power supply	NET-202 + Accu
Input:	
DC and battery input:	10 to 32 V _{DC}
Max. input current:	3.5 A (230 V _{AC}), startup peak up to 25 A
Input power:	160 W
Input voltage priority:	1. DC voltage 2. Battery
Battery type:	NiCd, 24 V _{DC} , 600 mAh
Output:	
Output power:	160 W
Output voltages:	+5 V (max. 20 A) -5 V (max. 0.3 A) +12 V (max. 5 A) -12 V (max. 0.4 A)
Power LED:	
dim green:	DC connected to system, system powered off
bright green:	DC connected to system, system powered on
orange:	system powered on, working via accu
red:	starts 30 sec. before accu is getting low together with beep signal

Note: The maximum load is 160 W, otherwise power supply can be damaged.

DC power supply connector

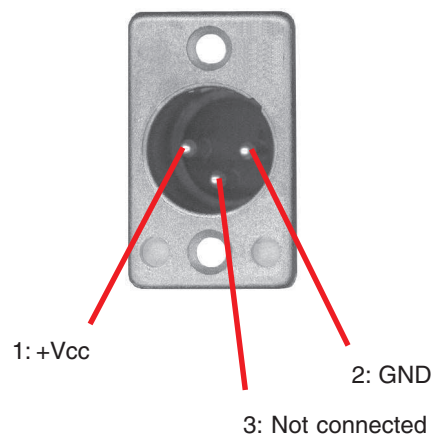

Main System

Instructions for battery exchange

The following part is only valid for systems with DC power supply:

WARNING Battery exchange has to be done by qualified persons only!

Power down system and disconnect from power supply. Remove four screws from bottom of the DEWE-3010 system to get access to the battery. Exchange battery and close battery compartment again with the four screws.

WARNING Do not touch any internal wiring expect of the battery connection cable!

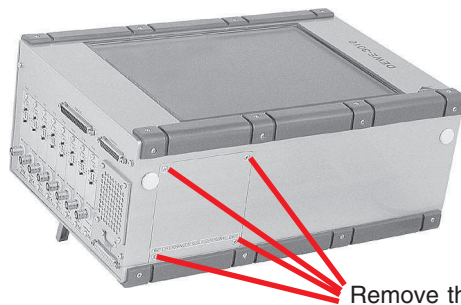

Remove this 4 screws for battery access

2. PS/2 mouse connector

The mouse / trackball connector is used to connect the trackball embedded in the keyboard or an external PS/2 mouse. The connector meets standard PS/2 pin assignment.

3. PS/2 keyboard connector

The keyboard connector is used to connect PS/2 keyboard to DEWE-3010 system. The connector meets standard PS/2 pin assignment.

4. LPT printer interface connector

The printer interface connector (female) is located on the right side of the DEWE-3010. It is configured as standard LPT interface.

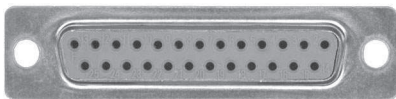

25-pin SUB-D connector (female)

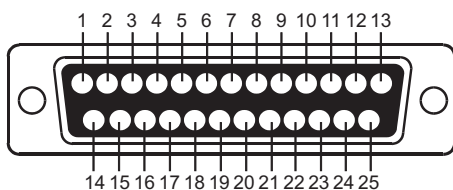

Schematic

Pin assignment

1: Strobe	14: Auto FD
2: Data 1	15: Error
3: Data 2	16: Init
4: Data 3	17: Select In
5: Data 4	18: GND
6: Data 5	19: GND
7: Data 6	20: GND
8: Data 7	21: GND
9: Data 8	22: GND
10: ACK	23: GND
11: Busy	24: GND
12: PE	25: GND
13: Select	

5. Ethernet connector

The DEWE-3010 system supports 10/100 BaseT Ethernet with standard RJ45 connector.

6. VGA connector

The VGA connector offers the possibility to connect an external CRT or other standard VGA displays to the system.

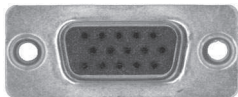

15-pin mini SUB-D connector

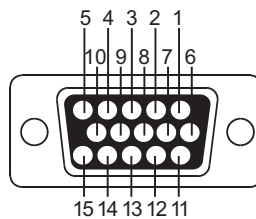

Schematic

Pin assignment

- 1: Red video
- 2: Green video / Sync on green
- 3: Blue video
- 4: -
- 5: -
- 6: Red video ground
- 7: Green video ground
- 8: Blue video ground
- 9: -
- 10: Ground
- 11: Ground
- 12: Data line
- 13: H-Sync / HV-Sync
- 14: V-Sync
- 15: Clock line

7. RS-232 interface connector (COM1)

The RS-232 interface connector (male) is located on the right side of the DEWE-3010. It is configured as standard RS-232 interface COM 1 and can be used for mouse or other peripheral units.

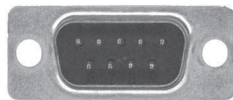

9-pin SUB-D connector (male)

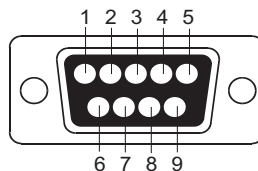

Schematic

Pin assignment

- 1: DCD (Data Carrier Detector)
- 2: RD (Received Data)
- 3: TD (Transmitted Data)
- 4: DTR (Data Terminal Ready)
- 5: GND (Ground)
- 6: DSR (Data Set Ready)
- 7: RTS (Request To Send)
- 8: CTS (Clear To Send)
- 9: RI (Ring Indicator)

8. USB interface connectors (Universal Serial Bus)

The USB interface connectors meets standard USB pin assignment.

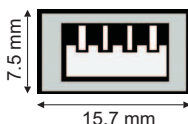

9. Digital I/O connector

This connector supports digital input and output lines of the built-in A/D board. If this board does not support digital I/O's, the connector is not available.

The pin assignment is depending on A/D board used - details are available in appendix B.

Main System

10. Expansion connector(s)

These connectors support analog input channel 8 to 15 of the built-in A/D board and power supply of the external 8 channel RACK (option) for all systems and the channel 16 - 63 expansion for the DEWE-3010-64 system.

The pin assignment depends on the used A/D board - details are available in appendix B.

A/D & D/A Conversion

A/D Conversion

Detailed information about the A/D card are not included in this manual.

For detailed information see the manufacturer's A/D card manual.

D/A Conversion

Detailed information about the D/A card are not included in this manual.

For detailed information see the manufacturer's D/A card manual.

A/D & D/A Conversion

Notes

8 slot DEWE-MOTHERBOARD

I/O connectors

Ixx: Analog input xx (leads to
DAQ-module pin 1 in slot xx)
Oxx: Analog output xx (leads to
DAQ-module pin 7 in slot xx)
G: GND (reference for A/D card)
68-pin high-density sub-D connector

Baud rate for onboard RS-232/485 converter

1	115000
2	57600
3	38400
4	19200
5	9600
6	4800
7	2400

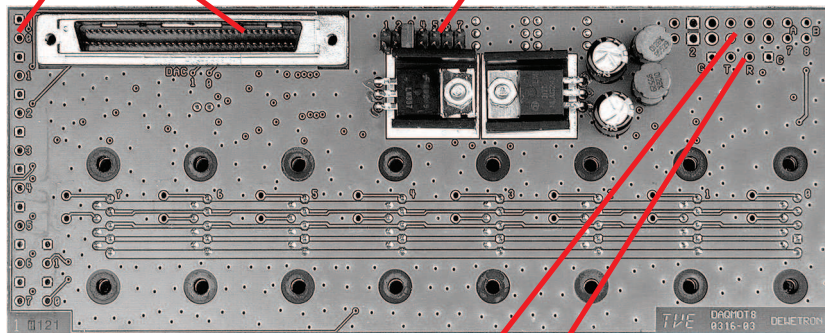

Rear view

Supply voltages, RS-485 connection

- 1 +12 V (supply voltage)
- 2 GND (system ground)
- 3 GND (referenced ground)
- 4 -12 V (supply voltage)
- 5 +Vcc (sensor supply, normally +12 V, leads to DAQ-module pin 6)
- 6 -Vcc (normally not connected, leads to DAQ-module pin 8)
- 7 A (RS-485)
- 8 B (RS-485)

RS-232 connection

- G GND
- T Transmit
- R Receive
- G GND

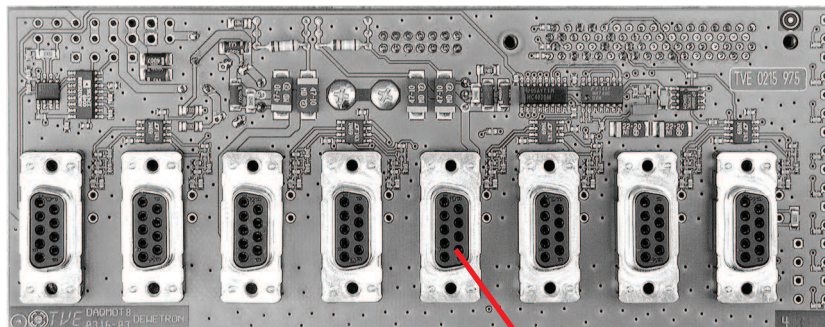

Front view (connectors for DAQ-modules)

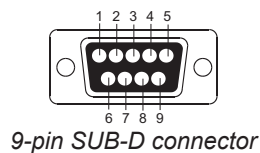

Interface pin assignment:

- 1 Module input (± 5 V)
- 2 RS-485 (A)
- 3 RS-485 (B)
- 4 GND
- 5 +9 V power supply
- 6 +12 V power / sensor supply
- 7 Module output (from A/D board)
- 8 reserved
- 9 -9 V power supply

The 8 slot DEWE-MOTHERBOARD receives the ± 12 V_{DC} power supply via a DC/DC converter from the internal power supply.

Internal Wiring

Notes

EC-Certificate of conformity

EC-Certificate of conformity

Manufacturer: **DEWETRON Elektronische Messgeraete Ges.m.b.H.**

Address: **Parkring 4
A-8074 Graz-Grambach Austria**

Tel.: +43 316 3070 0

Fax: +43 316 3070 90

e-mail: sales@dewetron.com

http://www.dewetron.com

Name of product: **DEWE-3010**

Kind of product: *Portable instrument*

The product meets the regulations of the following EC-directives:

73/23/EEC

"Directive on the approximation of the laws of the Member States relating to electrical equipment designed for use within certain voltage limits amended by the directive 93/68/EEC"

89/336/EEC

"Directive on the approximation of the laws of the Member States relating to electromagnetic compatibility amended by the directives 91/263/EEC, 92/31/EEC, 93/68/EEC and 93/97/EEC"

The accordance is proved by the observance of the following standards:

L V E M C	Safety	IEC/EN 61010-1:1992/93 IEC/EN 61010-2-031	IEC 61010-1:1992/300 V CATIII PoI. D. 2 IEC 1010-2-031
	Emissions	EN 61000-6-4	EN 55011 Class B
	Immunity	EN 61000-6-2	Group standard

Graz, Nov. 15th, 2004

Place / Date of the CE-marking

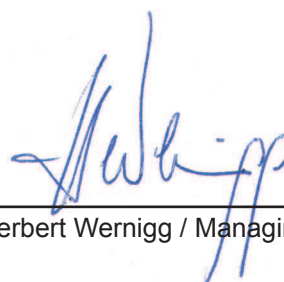

Ing. Herbert Wernigg / Managing director

Notes
