

# DHP Series Power Supplies

The DHP Series power supplies provide a wide range of power levels delivered from a thin rackmount profile. Individual models provide DC outputs from 2 kW to 30 kW. All models incorporate self-diagnostics that continually monitor critical parameters to assure maximum system uptime. For ease of use, the DHP has a front panel keypad control and standard analog remote programming as well as optional remote digital IEEE 488.2, RS 232 and isolated analog interface. Extensive programming capability allows storing both individual voltage and current settings and auto sequences. During power up the output of the supply is disabled for optimum safety. Also, a LAST SET button returns the supply to its last voltage and current setting prior to being powered down. Each model is backed by a five year warranty. This series is TUV recognized, and all models  $\leq 400V$  are CE marked.

## Features and Benefits

- **Modular Design:** The series incorporates a unique modular design that results in three thin rackmount profiles: 2U for 2 kW to 3 kW, 3U for most 5 kW to 15 kW and 6U for 16 kW to 30 kW.
- **Extensive Controls:** These supplies are programmable from a front panel keypad or remotely through operator selectable 5V or 10V analog inputs. Options include IEEE 488.2, RS 232 and isolated analog control.



- **Extensive Displays:** These digitally controlled supplies display a wide range of operational and diagnostic parameters. These include:
  - Power supply rating
  - Output power, voltage and current
  - All power, voltage and current set points and limits
  - Present and highest AC input voltage
  - Present and highest air inlet temperature
  - Lowest AC input voltage
  - Power and auto-step sequence settings
  - Calibration set-up
  - Remote operation set-up
  - Diagnostics fault status summary
- **Power-Off Memory:** Enabling the input power and pushing the LAST SET button will restore the supply to its last voltage and current settings during the last power-off cycle.
- **Power Monitors:** Operating output power can be displayed with the voltage and current.
- **Programmable Output:** Nine commonly used power supply set-ups can be stored. In addition, programmed sequences up to nine steps long can be stored.
- **Internal Diagnostics:** Internal operational parameters are displayed on command or in the event of a fault. These events are:
  - Watch-Dog Timer: Monitors the system's microprocessors
  - Controller: Checks control board integrity
  - Air Inlet Temperature: Monitors and records highest input cooling air temperature
  - AC High Line: Monitors and records highest AC input voltage
  - AC Low Line: Monitors the lowest AC input voltage
  - Power Module Status: Monitors integrity of each internal power module
- **Safe Power Up:** In the local mode the output is disabled for additional safety at power up.

**Sorensen**  
Division of **ELGAR**

- **Soft Calibration:** Calibration does not require removing chassis covers. The calibration of the supply's control board is checked at each power on cycle.
- **Operating Modes:** Constant current, constant voltage and constant power modes are standard with each supply. Front panel LEDs indicate what mode is active.

- **External Shutdown:** An external shutdown signal can be used to inhibit output.
- **Front Panel Lockout:** When operated remotely, front panel controls are disabled.
- **Protection:** The supplies have overvoltage, overtemperature, overcurrent, turn-on surge limit,

- slow start, brown out and short circuit protection. Overvoltage set points can be activated from the front panel without applying power to the load.
- **Agency Approvals:** TUV to IED 950, all models  $\leq 400V$  are CE marked
- **5-year Warranty**

## Specifications

### Input

#### Voltage and Frequency

**2-3 kW:** 190-253 VAC, 47-63 Hz, single-phase, 2-wire plus ground

**5-30 kW:** 190-253 VAC, 47-63 Hz, three-phase, 3-wire plus ground, Delta or Wye

### Output

**Voltage:** See table

**Current:** See table

#### Regulation (line or load)

**Voltage:** 0.1% of maximum rated output

**Current:** 0.1% of maximum rated output

**Transient Response:** A 30% step load will recover to within 2% of set value within 10 ms

**Stability:**  $\pm 0.05\%$  current or voltage rating 8 hours after warm-up and at fixed line, load and temperature

**Efficiency:** 80% minimum at full load

**Temperature Coefficient:** 0.02%/°C of rated output current

### General

**Operating Temperature:** 0 to 50°C; no derating

**Cooling:** Internal fan

**Controls (Front Panel):** Keypad to select/adjust voltage, current and power with non-volatile memories to store commonly used parameters

**Meters/Indicators:** Backlit LCD alphanumeric display and LEDs

**Built-in Protection:** Overcurrent, overtemperature, brown out, turn-on surge limit, slow start, overvoltage (OVP resettable without recycling power)

#### Remote Control/Monitor (Rear Panel):

On/Off control via contact closure, 6-120 VDC, 12-240 VAC, TTL or CMOS switch, output voltage and current monitor, (0-10 volt) OVP limit set, summary fault status

#### Auto-Step Sequencing and

**Programming:** Nine memories are on-board for auto-step sequencing. Auto-step sequences can be up to 27.75 hours long. Up to nine steps can be programmed in each sequence. In addition, nine memories can store commonly used power supply settings.

#### Remote Programming:

Voltage (0 to 100%)

<u>Resistive</u>	<u>Voltage</u>
0-5 k $\Omega$	0-5 VDC or 10 VDC

<u>Current</u>	<u>Resolution</u>
0-1 mA	0.1%

Current (0 to 100%)

<u>Resistive</u>	<u>Voltage</u>
0-5 k $\Omega$	0-5 VDC or 10 VDC

<u>Current</u>	<u>Resolution</u>
0-1 mA	0.1%

Computer: Optional internal IEEE 488.2 or RS 232 programmability using Standard Commands for Programmable Instruments (SCPI)

**Self Calibration:** Power supply calibration via front panel without removing chassis covers. Calibration is checked on control board at each power-on cycle.

#### Dimensions

**Case I:** 2U or 3-1/2" (88 mm) H x 19" (482 mm) W x 18" (457 mm) D  
**Case II:** 3U or 5-1/4" (133 mm) H x 19" (482 mm) W x 22" (558 mm) D  
**Case III:** 6U 10-1/2" (266 mm) H x 19" (482 mm) W x 22" (558 mm) D

#### Weight: Maximum

**Case I:** 45 lbs. (22 kg)

**Case II:** 80 lbs. (55 kg)

**Case III:** 160 lbs (73 kg)

#### Shipping Weight: Maximum

**2-3 kW:** 48 lbs. (23 kg)

**5-15 kW:** 120 lbs. (73 kg)

**16-30 kW:** 200 lbs. (91 kg)

### Options

#### Remote Control Options

**M8:** RS 232 remote serial interface

**M9D:** IEEE 488.2 interface features 12 bit resolution of programming and 12 bit readback resolution for voltage and current

**M10:** Both IEEE 488.2 and RS 232

**M11:** RS 232 and isolated analog programming

**M12:** IEEE-488.2 and isolated analog programming

**M14:** IEEE-488.2, RS 232 and isolated analog programming

**M17:** Down programming option for  $\geq 80V$  models. Program the output voltage from 100% to 10% (no load condition) in less than 1 second. One down programming cycle per 10 seconds.

**M51:** Isolated Analog Programming

#### Input Voltage Options

(only apply to 3 phase models  $\geq 5$  kW)

**M1:** 360-440 VAC, 47-63 Hz, three-phase, 3 wire plus ground, Delta or Wye may be used

**M2:** 432-528 VAC, 47-63 Hz, three-phase, 3 wire plus ground, Delta or Wye

**M3:** 190-253 VAC, 47-63 Hz, three-phase, 3 wire plus ground, Delta or Wye (3 kW only)

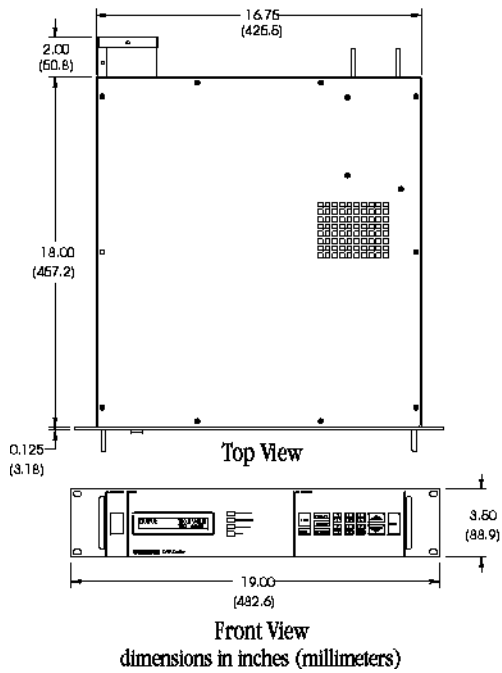

**Input Connections**

#8-32 Threaded Studs

**Output Connections**

5-60 Volt Models

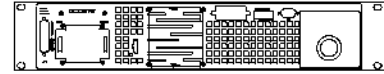

Copper Bus Bars, Nickel Plated  
 Dimensions: 1.5 in. x 0.75 in. x 0.18 in.  
 Space Between Bus Bars: 2.125 in.  
 Holes in Bus Bar: 0.375 in.

**Output Connections**

80-400 Volt Models

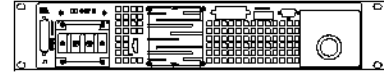

Two Position Terminal Block

Rear Panel Views

**Case Size I**

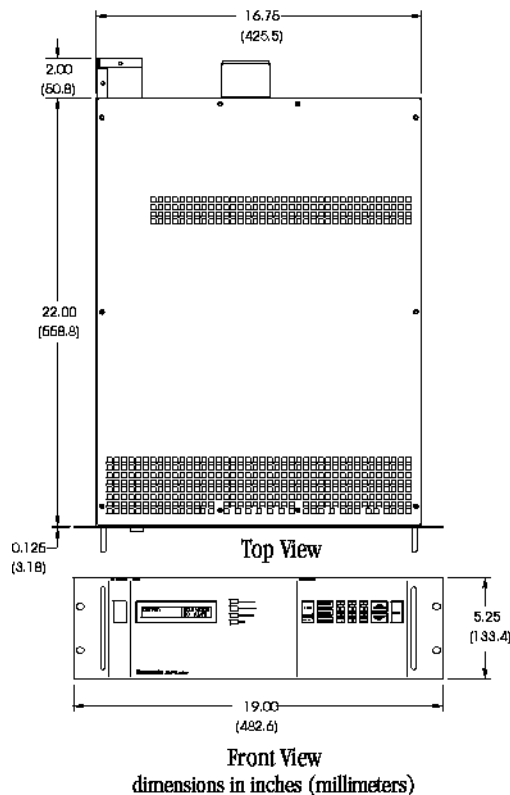

**Input Connections**

#10-32 Threaded Studs

**Output Connections**

5-60 Volt Models

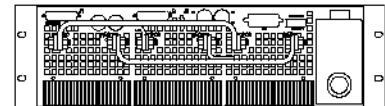

Copper Bus Bars, Nickel Plated  
 Holes in Bus Bar: 0.390 in.

**Output Connections**

80-600 Volt Models

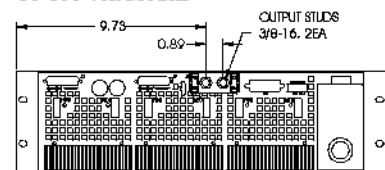

0.375 in. Bronze Threaded Studs

Rear Panel Views

**Case Size II**

**2 kW and 3 kW**

Model	Output		Ripple (RMS) Typical	Case Size	Model	Output		Ripple (RMS) Typical	Case Size
	Volts	Amps				Volts	Amps		
5-325	5	325	10 mV	I	60-50	60	50	25 mV	I
5-450	5	450	10 mV	I	80-25	80	25	25 mV	I
5-500	5	500	10 mV	I	80-37	80	37	25 mV	I
8-250	8	250	10 mV	I	100-20	100	20	25 mV	I
8-350	8	350	10 mV	I	100-30	100	30	25 mV	I
10-200	10	200	10 mV	I	120-16	120	16	25 mV	I
10-300	10	300	10 mV	I	120-25	120	25	25 mV	I
15-130	15	130	10 mV	I	150-13	150	13	25 mV	I
15-200	15	200	10 mV	I	150-20	150	20	25 mV	I
20-100	20	100	10 mV	I	200-10	200	10	25 mV	I
20-150	20	150	10 mV	I	200-15	200	15	25 mV	I
30-66	30	66	10 mV	I	250-8	250	8	25 mV	I
30-100	30	100	10 mV	I	250-12	250	12	25 mV	I
40-50	40	50	10 mV	I	300-6.6	300	6.6	25 mV	I
40-75	40	75	10 mV	I	300-10	300	10	25 mV	I
50-40	50	40	10 mV	I	400-5	400	5	25 mV	I
50-60	50	60	10 mV	I	400-7.5	400	7.5	25 mV	I
60-33	60	33	10 mV	I					

**5 kW to 15 kW**

Model	Output		Ripple (RMS) Typical	Case Size	Model	Output		Ripple (RMS) Typical	Case Size
	Volts	Amps				Volts	Amps		
5-1000	5	1000	10 mV	II	20-665	20	665	15 mV	III
5-1500	5	1500	10 mV	II	25-265	25	265	10 mV	II
5-2000	5	2000	15 mV	III	25-400	25	400	10 mV	II
5-2500	5	2500	15 mV	III	25-520	25	520	15 mV	III
5-3000	5	3000	15 mV	III	30-220	30	220	10 mV	II
8-800	8	800	10 mV	II	30-330	30	330	10 mV	II
8-1200	8	1200	10 mV	II	30-440	30	440	15 mV	III
8-1600	8	1600	15mV	III	40-166	40	166	10 mV	II
10-660	10	660	10 mV	II	40-250	40	250	10 mV	II
10-1000	10	1000	10 mV	II	40-330	40	330	15 mV	III
10-1300	10	1300	15 mV	III	50-133	50	133	10 mV	II
12.5-530	12.5	530	10 mV	II	50-200	50	200	10 mV	II
12.5-800	12.5	800	10 mV	II	50-265	50	265	15 mV	III
12.5-1060	12.5	1060	15 mV	III	60-110	60	110	10 mV	II
15-440	15	440	10 mV	II	60-166	60	166	10 mV	II
15-660	15	660	10 mV	II	60-220	60	220	15 mV	III
15-880	15	880	15 mV	III	80-62	80	62	25 mV	II
20-330	20	330	10 mV	II	80-125	80	125	25 mV	II
20-500	20	500	10 mV	II	80-187	80	187	25 mV	II

**5 kW to 15 kW (continued)**

Model	Output		Ripple (RMS) Typical	Case Size	Model	Output		Ripple (RMS) Typical	Case Size
	Volts	Amps				Volts	Amps		
100-50	100	50	25 mV	II	250-20	250	20	25 mV	II
100-100	100	100	25 mV	II	250-40	250	40	25 mV	II
100-150	100	150	25 mV	II	250-60	250	60	25 mV	II
130-38	130	38	25 mV	II	300-16	300	16	25 mV	II
130-76	130	76	25 mV	II	300-33	300	33	25 mV	II
130-115	130	115	25 mV	II	300-50	300	50	25 mV	II
150-33	150	33	25 mV	II	400-12	400	12	25 mV	II
150-66	150	66	25 mV	II	400-25	400	25	25 mV	II
150-100	150	100	25 mV	II	400-37	400	37	25 mV	II
200-25	200	25	25 mV	II	600-11	600	11	250 mV	II
200-50	200	50	25 mV	II	600-16	600	16	250 mV	II
200-75	200	75	25 mV	II	600-22	600	22	250 mV	III

**16 kW to 30 kW**

Model	Output		Ripple (RMS) Typical	Case Size	Model	Output		Ripple (RMS) Typical	Case Size
	Volts	Amps				Volts	Amps		
10-1650	10	1650	25 mV	III	100-250	100	250	25 mV	III
10-2000	10	2000	25 mV	III	100-300	100	300	25 mV	III
12.5-1325	12.5	1325	25 mV	III	130-153	130	153	25 mV	III
12.5-1600	12.5	1600	25 mV	III	130-192	130	192	25 mV	III
15-1100	15	1100	25 mV	III	130-230	130	230	25 mV	III
15-1320	15	1320	25 mV	III	150-133	150	133	25 mV	III
20-830	20	830	15 mV	III	150-166	150	166	25 mV	III
20-1000	20	1000	15 mV	III	150-200	150	200	25 mV	III
25-650	25	650	25 mV	III	200-100	200	100	25 mV	III
25-800	25	800	25 mV	III	200-125	200	125	25 mV	III
30-550	30	550	25 mV	III	200-150	200	150	25 mV	III
30-660	30	660	25 mV	III	250-80	250	80	25 mV	III
40-415	40	415	25 mV	III	250-100	250	100	25 mV	III
40-500	40	500	25 mV	III	250-120	250	120	25 mV	III
50-333	50	333	25 mV	III	300-66	300	66	25 mV	III
50-400	50	400	25 mV	III	300-83	300	83	25 mV	III
60-275	60	275	25 mV	III	300-100	300	100	25 mV	III
60-330	60	330	25 mV	III	400-50	400	50	25 mV	III
80-250	80	250	25 mV	III	400-62	400	62	25 mV	III
80-312	80	312	25 mV	III	400-75	400	75	25 mV	III
80-375	80	375	25 mV	III	600-27	600	27	250 mV	III
100-200	100	200	25 mV	III	600-33	600	33	250 mV	III

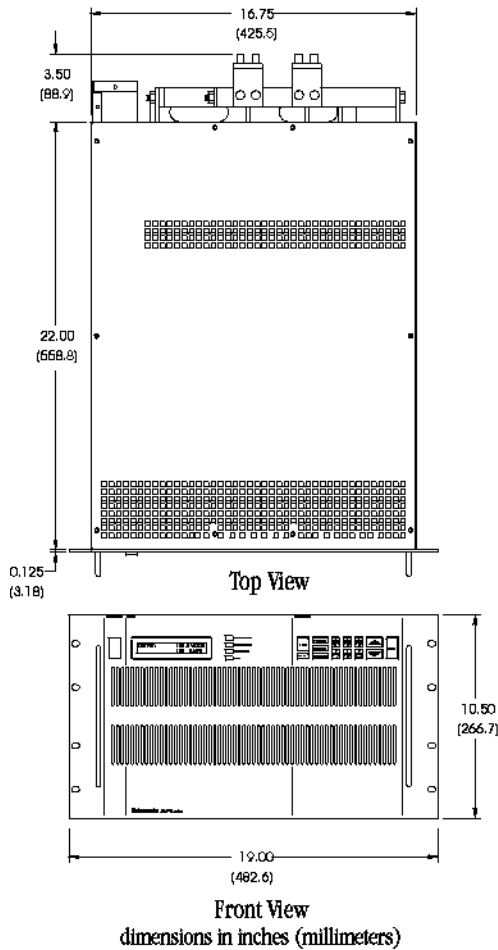

### Input Connections

#10-32 Bronze Threaded Studs

### Output Connections

5-60 Volt Models

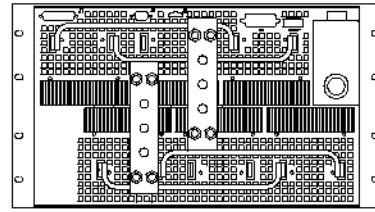

Copper Bus Bars, Nickel Plated

Holes in Bus Bars: 0.410 in.

### Output Connections

80-600 Volt Models

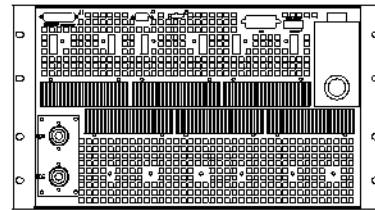

0.625 in. Bronze Threaded Studs

Rear Panel Views

## Case Size III

Note: Applies to select models under 16 kW (see table)

## Options & Accessories

Input Voltage Options	
M1*	360-440 VAC, 47-63 Hz, 3 Phase, 3 wire plus ground
M2*	432-528 VAC, 47-63 Hz, 3 Phase, 3 wire plus ground
M3	190-253 VAC, 47-63 Hz, 3 Phase, 3 wire plus ground
Remote Control Options	
M8	RS 232
M9D	IEEE-488.2
M10	RS 232 and IEEE-488.2
M11	RS 232 and Isolated Analog Programming (consult factory)
M12	IEEE-488.2 and Isolated Analog Programming (consult factory)
M14	RS 232, IEEE-488.2 and Isolated Analog Programming (consult factory)
M51	Isolated Analog Programming (consult factory)
Voltage Down Programming Option	
M17	Down programming option for >80V models (consult factory)

## DHP Model Number Description

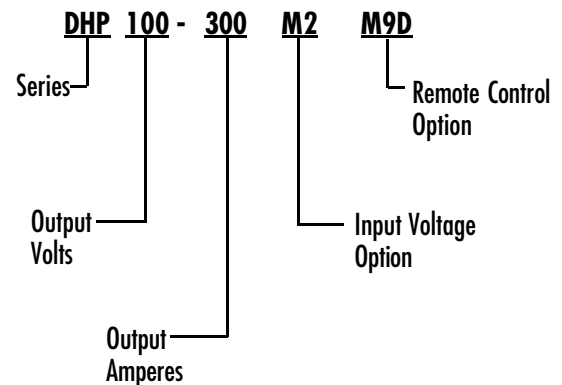

Product specifications are subject to change without notice

**Sorensen**  
Division of **ELGAR**

9250 Brown Deer Road, San Diego California 92121-2294 • 858/450-0085 • 800/525-2024 • Fax: 858/458-0267  
IN EUROPE • Kaap Hoordreef 30 • 3563 AT Utrecht • The Netherlands • +31-30-265-0946 • Fax: +31-30-265-0985  
E-mail: sales@sorensen.com • Web Site: www.sorensen.com