

# Programmable AC/ DC Electronic Load

## 63800 Series

---

Operation & Programming Manual





# Programmable AC/DC Electronic Load 63800 Series Operation & Programming Manual

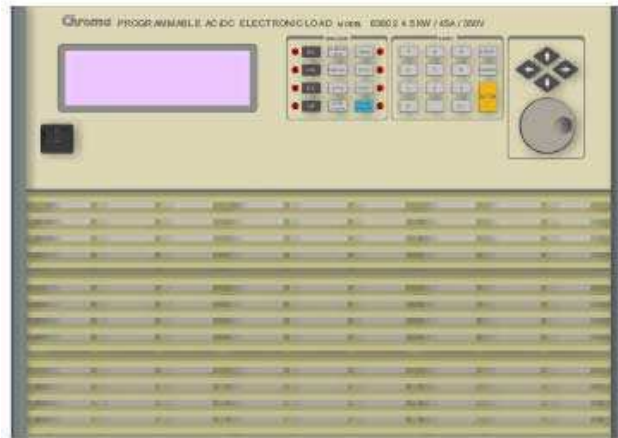

Version 1.2  
October 2009  
P/N A11 001143

# Legal Notices

The information in this document is subject to change without notice.

Chroma ATE INC. makes no warranty of any kind with regard to this manual, including, but not limited to, the implied warranties of merchantability and fitness for a particular purpose. Chroma ATE INC. shall not be held liable for errors contained herein or direct, indirect, special, incidental or consequential damages in connection with the furnishing, performance, or use of this material.

## **CHROMA ATE INC.**

No.66, Hwa-Ya 1<sup>st</sup> Rd., Hwa-Ya Technical Park, Taoyuan Hsien, Taiwan

Copyright Notices. Copyright 2009 Chroma ATE INC., all rights reserved. Reproduction, adaptation, or translation of this document without prior written permission is prohibited, except as allowed under the copyright laws.

# Warranty

All Chroma instruments are warranted against defects in material and workmanship for a period of one year after date of shipment. Chroma agrees to repair or replace any assembly or component found to be defective, under normal use during this period. Chroma's obligation under this warranty is limited solely to repairing any such instrument, which in Chroma's sole opinion proves to be defective within the scope of the warranty when returned to the factory or to an authorized service center. Transportation to the factory or service center is to be prepaid by purchaser. Shipment should not be made without prior authorization by Chroma.

This warranty does not apply to any products repaired or altered by persons not authorized by Chroma, or not in accordance with instructions furnished by Chroma. If the instrument is defective as a result of misuse, improper repair, or abnormal conditions or operations, repairs will be billed at cost.

Chroma assumes no responsibility for its product being used in a hazardous or dangerous manner either alone or in conjunction with other equipment. High voltage used in some instruments may be dangerous if misused. Special disclaimers apply to these instruments. Chroma assumes no liability for secondary charges or consequential damages and in any event, Chroma's liability for breach of warranty under any contract or otherwise, shall not exceed the purchase price of the specific instrument shipped and against which a claim is made.

Any recommendations made by Chroma for use of its products are based upon tests believed to be reliable, but Chroma makes no warranty of the results to be obtained. This warranty is in lieu of all other warranties, expressed or implied, and no representative or person is authorized to represent or assume for Chroma any liability in connection with the sale of our products other than set forth herein.

## **CHROMA ATE INC.**

No. 66 Hwa-Ya 1<sup>st</sup> Rd, Hwa-Ya Technical Park,  
Kuei-Shan Hsiang, Taoyuan Hsien, Taiwan

Tel: 886-3-3279999

Fax: 886-3-3272886

<http://www.chromaate.com>

# Material Contents Declaration

A regulatory requirement of The People's Republic of China defined by specification SJ/T 11364-2006 mandates that manufacturers provide material contents declaration of electronic products, and for Chroma products are as below:

Part Name	Hazardous Substances					
	Lead	Mercury	Cadmium	Hexavalent Chromium	Polybrominated Biphenyls	Polybromodiphenyl Ethers
	Pb	Hg	Cd	Cr <sup>6+</sup>	PBB	PBDE
PCBA	×	○	○	○	○	○
CHASSIS	×	○	○	○	○	○
ACCESSORY	×	○	○	○	○	○
PACKAGE	○	○	○	○	○	○

“○” indicates that the level of the specified chemical substance is less than the threshold level specified in the standards of SJ/T-11363-2006 and EU 2005/618/EC.

“×” indicates that the level of the specified chemical substance exceeds the threshold level specified in the standards of SJ/T-11363-2006 and EU 2005/618/EC.

1. Chroma is not fully transferred to lead-free solder assembly at this moment; however, most of the components used are RoHS compliant.
2. The environment-friendly usage period of the product is assumed under the operating environment specified in each product's specification.

## Disposal

Do not dispose of electrical appliances as unsorted municipal waste, use separate collection facilities. Contact your local government for information regarding the collection systems available. If electrical appliances are disposed of in landfills or dumps, hazardous substances can leak into the groundwater and get into the food chain, damaging your health and well-being. When replacing old appliances with new one, the retailer is legally obligated to take back your old appliances for disposal at least for free of charge.





# Declaration of Conformity

For the following equipment :

**Programmable AC Electronic Load**

(Product Name/ Trade Name)

**63802**

(Model Designation)

**Chroma ATE Inc.**

(Manufacturer Name)

**66 Hwa-Ya 1<sup>st</sup> Rd., Hwa-Ya Technical Park, Kuei-Shan Hsiang, Taoyuan Hsien 333, Taiwan**

(Manufacturer Address)

Is herewith confirmed to comply with the requirements set out in the Council Directive on the Approximation of the Laws of the Member States relating to Electromagnetic Compatibility (89/336/EEC), and the Amendment Directive (92/31/EEC), Low-voltage Directive (73/23/EEC) and the Amendment Directive (93/68/EEC). For the evaluation regarding the Directives, the following standards were applied :

**EN 61326/1997+A1/1998+A2/2001:Electromagnetic Compatibility**

CISPR 11/1997+A1/1999 Class A

EN 61000-3-2/2000, EN 61000-3-3/1995+A1/2001

IEC 61000-4-2/2001, IEC 61000-4-3/2001, IEC 61000-4-4/2001,

IEC 61000-4-5/2001, IEC 61000-4-6/2001, IEC 61000-4-8/2001, IEC 610000-4-11/2001

**EN 61010-1:2001**

The following importer/manufacturer or authorized representative established within the EUT is responsible for this declaration :

**Chroma ATE Inc.**

(Company Name)

**66 Hwa-Ya 1<sup>st</sup> Rd., Hwa-Ya Technical Park, Kuei-Shan Hsiang, Taoyuan Hsien 333, Taiwan**

(Company Address)

Person responsible for this declaration:

**Mr. Terry Cheng**

(Name, Surname)

**T & M BU President**

(Position/Title)

**Taiwan**

**2006.12.08**

(Place)

(Date)

(Legal Signature)



# Declaration of Conformity

For the following equipment :

**Programmable AC/DC Electronic Load 63803**

(Product Name/ Trade Name)

**63803**

(Model Designation)

**Chroma ATE Inc.**

(Manufacturer Name)

**66 Hwa-Ya 1<sup>st</sup> Rd., Hwa-Ya Technical Park, Kuei-Shan Hsiang, Taoyuan Hsien 333, Taiwan**

(Manufacturer Address)

Is herewith confirmed to comply with the requirements set out in the Council Directive on the Approximation of the Laws of the Member States relating to Electromagnetic Compatibility (89/336/EEC), and the Amendment Directive (92/31/EEC), Low-voltage Directive (73/23/EEC) and the Amendment Directive (93/68/EEC). For the evaluation regarding the Directives, the following standards were applied :

**EN 61326-1:2006 Class A**

**EN 61326-1:2006 (industrial locations)**

IEC 61000-4-2:1995+A1:1998+A2:2000,

IEC 61000-4-3:2002, IEC 61000-4-4:2004, IEC 61000-4-5:1995+A1:2000,

IEC 61000-4-6:2003, IEC 61000-4-8:1993+A1:2000, IEC 61000-4-11:2004

**EN 61010-1:2001**

The following importer/manufacturer or authorized representative established within the EUT is responsible for this declaration :

**Chroma ATE Inc.**

(Company Name)

**66 Hwa-Ya 1<sup>st</sup> Rd., Hwa-Ya Technical Park, Kuei-Shan Hsiang, Taoyuan Hsien 333, Taiwan**

(Company Address)

Person responsible for this declaration:

**Mr. Benjamin Huang**

(Name, Surname)

**T & M BU Director**

(Position/Title)

**Taiwan**

**2008.10.27**

(Place)

(Date)

(Legal Signature)





# Declaration of Conformity

For the following equipment :

**AC Electronic Load**

(Product Name/ Trade Name)

**63804**

(Model Designation)

**Chroma ATE Inc.**

(Manufacturer Name)

**66 Hwa-Ya 1<sup>st</sup> Rd., Hwa-Ya Technical Park, Kuei-Shan Hsiang, Taoyuan Hsien 333, Taiwan**

(Manufacturer Address)

Is herewith confirmed to comply with the requirements set out in the Council Directive on the Approximation of the Laws of the Member States relating to Electromagnetic Compatibility (89/336/EEC), and the Amendment Directive (92/31/EEC), Low-voltage Directive (73/23/EEC) and the Amendment Directive (93/68/EEC). For the evaluation regarding the Directives, the following standards were applied :

**EN 61326:1997/A1:1998/A2:2001/A3:2003**

(EN 55011:1998/A1:1999/A2:2002 Class A, and

EN 61000-3-2:2000/A1:2001, EN 61000-3-3:1995/A1:2001, IEC 61000-4-2:1995/A2:2000,

IEC 61000-4-3:1995/A2:2002, IEC 61000-4-4:1995/A2:2001, IEC 61000-4-5:1995/A1:2000,

IEC 61000-4-6:1996/A1:2000, IEC 61000-4-8:1993/A1:2000, IEC 61000-4-11:1994/A1:2000)

**EN 61010-1:2001**

The following importer/manufacturer or authorized representative established within the EUT is responsible for this declaration :

**Chroma ATE Inc.**

(Company Name)

**66 Hwa-Ya 1<sup>st</sup> Rd., Hwa-Ya Technical Park, Kuei-Shan Hsiang, Taoyuan Hsien 333, Taiwan**

(Company Address)

Person responsible for this declaration:

**Mr. Terry Cheng**

(Name, Surname)

**T & M BU President**

(Position/Title)

**Taiwan**

(Place)

**2007.05.28**

(Date)

(Legal Signature)

# SAFETY SUMMARY

The following general safety precautions must be observed during all phases of operation, service, and repair of this instrument. Failure to comply with these precautions or specific WARNINGS given elsewhere in this manual will violate safety standards of design, manufacture, and intended use of the instrument. *Chroma* assumes no liability for the customer's failure to comply with these requirements.



## BEFORE APPLYING POWER

Verify that the power is set to match the rated input of this power supply.



## PROTECTIVE GROUNDING

Make sure to connect the protective grounding to prevent an electric shock before turning on the power.



## NECESSITY OF PROTECTIVE GROUNDING

Never cut off the internal or external protective grounding wire, or disconnect the wiring of protective grounding terminal. Doing so will cause a potential shock hazard that may bring injury to a person.



## FUSES

Only fuses with the required rated current, voltage, and specified type (normal blow, time delay, etc.) should be used. Do not use repaired fuses or short-circuited fuse holders. To do so could cause a shock or fire hazard.



## DO NOT OPERATE IN AN EXPLOSIVE ATMOSPHERE

Do not operate the instrument in the presence of flammable gases or fumes.



## DO NOT REMOVE THE COVER OF THE INSTRUMENT

Operating personnel must not remove the cover of the instrument. Component replacement and internal adjustment can be done only by qualified service personnel.

# SAFETY SYMBOLS



**DANGER** – High voltage.



**Explanation:** To avoid injury, death of personnel, or damage to the instrument, the operator must refer to an explanation in the instruction manual.



**Protective grounding terminal:** To protect against electrical shock in case of a fault. This symbol indicates that the terminal must be connected to ground before operation of equipment.



The **WARNING** sign denotes a hazard. It calls attention to a procedure, practice, or the like, which, if not correctly performed or adhered to, could result in personal injury. Do not proceed beyond a **WARNING** sign until the indicated conditions are fully understood and met.



The **CAUTION** sign denotes a hazard. It may result in personal injury or death if not noticed timely. It calls attention to procedures, practices and conditions.

# Revision History

The following lists the additions, deletions and modifications in this manual at each revision.

Date	Version	Revised Sections
Feb. 2009	1.0	Complete this manual
Apr. 2009	1.1	Modify the fuse spec. of AC Input in the section of <i>"Specifications"</i> .
Oct. 2009	1.2	<p>Add the following sections:</p> <ul style="list-style-type: none"><li>- the section of <i>"Three Phases Parallel Setting"</i></li><li>- the section of <i>"Parallel Subsystem"</i></li><li>- the section of <i>"PHASE Subsystem"</i></li></ul> <p>Modify the following sections:</p> <ul style="list-style-type: none"><li>- "Constant Power Mode" and "DAM Accuracy (&gt;70Hz)" in the section of <i>"Specifications"</i></li><li>- the displayed menus in the section of <i>"Local Operation"</i></li><li>- the displayed menus in the section of <i>"BOTH"</i></li><li>- the displayed menus in the section of <i>"CC Mode"</i></li><li>- the displayed menu in the section of <i>"Setting Timing Mode Values for Transfer Time"</i></li><li>- the displayed menu in the section of <i>"DC Load Simulation"</i></li><li>- the displayed menu in the section of <i>"Short Circuit On/Off"</i></li><li>- the descriptions in the section of <i>"Parallel Setting"</i></li><li>- the descriptions in the section of <i>"Current Subsystem"</i></li><li>- the descriptions in the section of <i>"Power Subsystem"</i></li><li>- the descriptions in the section of <i>"Resistance Subsystem"</i></li></ul>

# Table of Contents

<b>1. General Information .....</b>	<b>1-1</b>
1.1 Introduction .....	1-1
1.2 Overview of Key Features .....	1-1
1.3 Description.....	1-1
1.4 Specifications .....	1-2
1.5 Names of Parts .....	1-5
1.5.1 The Front Panel .....	1-5
1.5.2 The Rear Panel.....	1-7
<b>2. Installation .....</b>	<b>2-1</b>
2.1 Introduction.....	2-1
2.2 Inspection .....	2-1
2.3 Installing .....	2-1
2.3.1 Preparation for Use.....	2-1
2.3.2 Changing Line Voltage .....	2-1
2.3.3 Turn-On Self-Test .....	2-2
2.4 Application Connection.....	2-3
2.4.1 Load Connections.....	2-3
<b>3. Local Operation .....</b>	<b>3-1</b>
3.1 Introduction.....	3-1
3.2 Local/Remote Control.....	3-1
3.3 Modes of Operation .....	3-2
3.4 Local Operation .....	3-3
3.4.1 Setting the Configuration .....	3-3
3.4.2 External ON/OFF .....	3-6
3.4.3 Going To Local .....	3-7
3.4.4 Online Change Loading .....	3-7
3.4.5 Load ON/OFF .....	3-7
3.4.6 The Relationship of Crest Factor and Power Factor.....	3-8
3.4.7 $I_p(\text{max})$ Setting and Automatic Bandwidth Adjustment (ABA) Mode .....	3-10
3.4.8 Lock Mode .....	3-11
3.5 AC Load Simulation.....	3-13
3.6 AC Load Simulation -- Constant Current Mode .....	3-14
3.6.1 BOTH.....	3-15
3.6.2 CF Only.....	3-18
3.6.3 PF Only.....	3-19
3.7 AC Load Simulation -- Constant Resistance Mode .....	3-21
3.8 AC Load Simulation -- Constant Power Mode.....	3-23
3.8.1 BOTH.....	3-24
3.8.2 CF Only.....	3-27
3.8.3 PF Only.....	3-27
3.9 AC Load Simulation -- Rectified Load Mode.....	3-28
3.9.1 RLC Mode.....	3-28
3.9.2 CP Mode.....	3-31
3.9.3 Inrush Current Mode.....	3-33
3.10 AC Load Simulation -- Timing Mode.....	3-36
3.10.1 CC Mode.....	3-38
3.10.2 CR Mode.....	3-43
3.10.3 CP Mode.....	3-44
3.10.4 Rectified Load Mode.....	3-45
3.10.5 Setting Timing Mode Values for Transfer Time .....	3-48

3.11	DC Load Simulation.....	3-51
3.12	DC Load Simulation -- Constant Current Mode.....	3-52
3.13	DC Load Simulation -- Constant Resistance Mode.....	3-54
3.14	DC Load Simulation -- Constant Voltage Mode.....	3-57
3.15	DC Load Simulation -- Constant Power Mode.....	3-58
3.16	DC Load Simulation -- Rectified Load Mode.....	3-60
3.16.1	Crest Factor in Rectified Mode Explanation.....	3-62
3.17	DC Load Simulation -- Timing Mode.....	3-62
3.17.1	CC Mode.....	3-63
3.17.2	CR Mode.....	3-66
3.17.3	CP Mode.....	3-68
3.17.4	CV Mode.....	3-70
3.17.5	Rectified Mode.....	3-72
3.18	Voltage and Current Monitor.....	3-75
3.19	Short Circuit On/Off.....	3-75
3.20	Save/Recall Setting.....	3-76
3.21	Parallel Setting.....	3-79
3.22	Three Phases Parallel Setting.....	3-87
<b>4.</b>	<b>Measurements.....</b>	<b>4-1</b>
4.1	AC Load Simulation.....	4-3
4.1.1	Constant Current Mode.....	4-3
4.1.2	Constant Resistance Mode.....	4-4
4.1.3	Constant Power Mode.....	4-5
4.1.4	Rectified Load Mode.....	4-7
4.1.4.1	RLC Mode.....	4-7
4.1.4.2	CP Mode.....	4-8
4.1.4.3	Inrush Current Mode.....	4-9
4.2	DC Load Simulation.....	4-10
4.2.1	Constant Current Mode.....	4-10
4.2.2	Constant Resistance Mode.....	4-11
4.2.3	Constant Voltage Mode.....	4-12
4.2.4	Constant Power Mode.....	4-12
4.2.5	Rectified Load Mode.....	4-13
<b>5.</b>	<b>Protection Features.....</b>	<b>5-1</b>
5.1	Over Voltage Protection (OVP).....	5-1
5.2	Over Current Protection (OCP).....	5-1
5.3	Over Power Protection (OPP).....	5-1
5.4	Over Temperature Protection (OTP).....	5-1
5.5	Fan Fail.....	5-1
5.6	Out of Frequency Range (FREQ ERR).....	5-2
5.7	Under Operating Voltage Protection (UVP).....	5-2
5.8	Load Fail (LDF).....	5-2
<b>6.</b>	<b>Theory of Operation.....</b>	<b>6-1</b>
6.1	General.....	6-1
6.2	Description of Overall System.....	6-2
<b>7.</b>	<b>Troubleshooting.....</b>	<b>7-1</b>
7.1	General.....	7-1
7.2	Troubleshooting.....	7-1
<b>8.</b>	<b>Remote Operation.....</b>	<b>8-1</b>
8.1	General Information.....	8-1
8.1.1	Setting the GPIB Address and RS-232C Parameters.....	8-1
8.1.2	Wire Connection of RS-232C.....	8-1

8.2	The GPIB Capability of the AC Load .....	8-2
8.3	Introduction to Programming .....	8-2
8.3.1	Conventions .....	8-2
8.3.2	Numerical Data Formats .....	8-2
8.3.3	Boolean Data Format .....	8-3
8.3.4	Character Data Format .....	8-3
8.3.5	Basic Definition .....	8-3
8.4	Traversal of the Command Tree .....	8-4
8.5	Execution Order .....	8-5
8.6	SCPI Command Reference .....	8-5
8.6.1	Common Command Dictionary .....	8-5
8.6.2	Measurement Subsystem .....	8-7
8.6.2.1	Current Measurement .....	8-7
8.6.2.2	Frequency Measurement .....	8-8
8.6.2.3	Power Measurement .....	8-8
8.6.2.4	Resistance Measurement .....	8-9
8.6.2.5	Voltage Measurement .....	8-10
8.6.2.6	Time Measurement .....	8-11
8.6.2.7	RLC Measurement .....	8-12
8.6.3	LOAD Subsystem .....	8-12
8.6.3.1	Current Subsystem .....	8-14
8.6.3.2	Power Subsystem .....	8-16
8.6.3.3	Resistance Subsystem .....	8-17
8.6.3.4	Voltage Subsystem .....	8-18
8.6.3.5	Crest Factor Subsystem .....	8-18
8.6.3.6	Power Factor Subsystem .....	8-19
8.6.3.7	RLC Subsystem .....	8-20
8.6.3.8	Inrush Current Subsystem .....	8-21
8.6.3.9	DC Rectified Subsystem .....	8-22
8.6.3.10	Time Subsystem .....	8-22
8.6.4	System Subsystem .....	8-23
8.6.4.1	Recall Default Subsystem .....	8-23
8.6.4.2	Remote Subsystem .....	8-23
8.6.4.3	Setup Subsystem .....	8-24
8.6.5	Parallel Subsystem .....	8-25
8.6.6	PHASE Subsystem .....	8-25
<b>9.</b>	<b>Status Reporting .....</b>	<b>9-1</b>
9.1	Introduction .....	9-1
9.2	Register Information in Common .....	9-1
9.3	Status Registers .....	9-2
9.3.1	Status Subsystem Commands .....	9-3
9.4	Output Queue .....	9-4
9.5	Standard Event Status .....	9-5
9.6	Status Byte Register .....	9-5
9.7	Service Request Enable Register .....	9-6
<b>Appendix A: RS-232C Connection .....</b>		<b>A-1</b>
<b>Appendix B: Pin Assignment of TTL I/O Signals .....</b>		<b>B-1</b>
<b>Appendix C: Notice .....</b>		<b>C-1</b>





# 1. General Information

## 1.1 Introduction

This manual contains specifications, installation, operation, and programming instructions of 63800 series high power electronic loads. All the machines are tested according to safety standard EN61010-1: TYPE POLLUTION II and INSTALLTION CATEGORY II.

## 1.2 Overview of Key Features

- Local operation on front panel keypad.
- Remote control via GPIB, RS-232C interfaces.
- Photo-couple isolation supplies true floating Load.
- Automatic fan speed control to reduce audio noise.
- Operation modes: CC, CR, CP @ constant load modes; RLC, CP, Inrush Current @ rectified load modes; CC, CR, CP, CV, DC Rectified @ DC load simulation.
- Programmable load value, power factor (PF) and crest factor (CF).
- Minimum input resistance allows load to sink high current even with low input voltage.
- 10 sets of memories to save/recall user-definable setups.
- 16-bit A/D converter with precision measurement.
- Short circuit simulation.
- Isolated voltage and current monitoring waveforms output.

## 1.3 Description

The functions of the 63800 series loads are the same except the variations on input voltage, load current, and power ratings. They provide simulated loading current for the test unit. They can be operated independently in AC load simulation and DC load simulation.

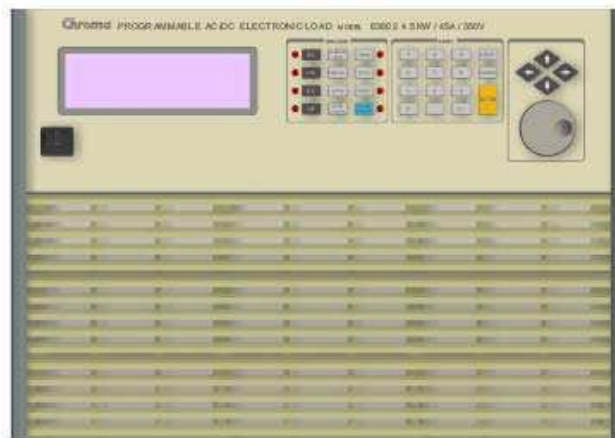

Figure 1-1 The Front Panel of the Electronic Load

There are two groups of keypads on the electronic load front panel shown in Figure 1-1. They are Function keypad and Entry keypad from left to right.

## 1.4 Specifications

\* The specifications of Load are listed from the next page on.

 **Notice**

1. The equipment is for indoor use only.
2. The altitude up to 2000 meters is allowed to use the equipment.
3. All specifications are tested under 20°C ~ 30°C except otherwise stated.
4. The range for operation temperature is 0°C ~ 40°C.
5. The relative humidity is from 10% to 90%.
6. The specifications of current accuracy are tested after the input is applied for 30 seconds.
7. The typical temperature coefficient is 100ppm.



**CAUTION**

This equipment is not intended for performing measurements on CAT III or IV.

## SPECIFICATION

Model	63802	63803	63804
Power	1,800W	3,600W	4,500W
Current	0 ~ 18A <sub>rms</sub> (54 A <sub>peak</sub> )	0 ~ 36A <sub>rms</sub> (108 A <sub>peak</sub> )	0 ~ 45A <sub>rms</sub> (135 A <sub>peak</sub> )
Voltage	50 ~ 350V <sub>rms</sub> (500 V <sub>peak</sub> )	50 ~ 350V <sub>rms</sub> (500 V <sub>peak</sub> )	50 ~ 350V <sub>rms</sub> (500 V <sub>peak</sub> )
Frequency	45 ~ 440Hz, DC	45 ~ 440Hz, DC	45 ~ 440Hz, DC
<b>AC Section</b>			
<b>Constant Current Mode</b>			
Range	0 ~ 18Arms, Programmable	0 ~ 36Arms, Programmable	0 ~ 45Arms, Programmable
Accuracy <sup>*1</sup>	0.1% + 0.2%F.S.	0.1% + 0.2%F.S.	0.1% + 0.2%F.S.
Resolution	2mA	5mA	5mA
<b>Constant Resistance Mode</b>			
Range	2.77Ω ~ 2.5kΩ, Programmable	1.39Ω ~ 2.5kΩ, Programmable	1.11Ω ~ 2.5kΩ, Programmable
Accuracy	0.5% + 0.5%F.S.	0.5% + 0.5%F.S.	0.5% + 0.5%F.S.
Resolution	20μ mho	50μ mho	50μ mho
<b>Constant Power Mode</b>			
Range	1,800W, Programmable	3,600W, Programmable	4,500W, Programmable
Accuracy	0.2% + 0.3%F.S.	0.2% + 0.3%F.S.	0.2% + 0.3%F.S.
Resolution	0.375W	1.125W	1.125W
<b>Crest Factor (under CC, CP modes)</b>			
Range <sup>*2</sup>	1.414 ~ 5.0, Programmable	1.414 ~ 5.0, Programmable	1.414 ~ 5.0, Programmable
Accuracy	(0.5% / Irms) + 1% F.S.	(0.5% / Irms) + 1% F.S.	(0.5% / Irms) + 1% F.S.
Resolution	0.005	0.005	0.005
<b>Power Factor</b>			
Range	0 ~ 1 lead or lag, Programmable	0 ~ 1 lead or lag, Programmable	0 ~ 1 lead or lag, Programmable
Accuracy	1%F.S.	1%F.S.	1%F.S.
Resolution	0.001	0.001	0.001
<b>Rectified Load Mode</b>			
Operating Frequency	45Hz ~ 70 Hz		
RLC mode	Parameter: I <sub>p</sub> (max), R <sub>s</sub> , L <sub>s</sub> , C, R <sub>L</sub>		
Constant Power Mode	Parameter: I <sub>p</sub> (max), Power setting = 200W ~ 1,800W, PF = 0.4 ~ 0.75	Parameter: I <sub>p</sub> (max), Power setting = 200W ~ 3,600W, PF = 0.4 ~ 0.75	Parameter: I <sub>p</sub> (max), Power setting = 200W ~ 4,500W, PF = 0.4 ~ 0.75
Inrush Current Mode	Parameter: I <sub>p</sub> (max), R <sub>s</sub> , L <sub>s</sub> , C, R <sub>L</sub> , Phase		
	80A (peak current)	160A (peak current)	200A (peak current)
Rs Range	0 ~ 9.999Ω	0 ~ 9.999Ω	0 ~ 9.999Ω
Ls Range	0 ~ 9999μH	0 ~ 9999μH	0 ~ 9999μH
C Range	100 ~ 9999μF	100 ~ 9999μF	100 ~ 9999μF
RL Range	2.77 ~ 9999.99Ω	1.39 ~ 9999.99Ω	1.11 ~ 9999.99Ω
<b>DC Section</b>			
Voltage Range	7.5V ~ 500V	7.5V ~ 500V	7.5V ~ 500V
Current Range	0A ~ 18A	0A ~ 36A	0A ~ 45A
Slew Rate	4 ~ 240A/ms	4 ~ 600A/ms	4 ~ 600A/ms

Rise Time	75 $\mu$ s	75 $\mu$ s	75 $\mu$ s
Min. Operating Voltage	7.5V	7.5V	7.5V
Operating Mode	CC, CV, CR, CP, DC Rectified		
Short Circuit Simulation	Use the CR mode loading under max. power rating.		
<b>Constant Current Mode</b>			
Range	0 ~ 18A, Programmable	0 ~ 36A, Programmable	0 ~ 45A, Programmable
Accuracy <sup>*1</sup>	0.1% + 0.2%F.S.	0.1% + 0.2%F.S.	0.1% + 0.2%F.S.
Resolution	2mA	5mA	5mA
<b>Constant Resistance Mode</b>			
Range	2.22 $\Omega$ ~ 1k $\Omega$ , Programmable	1.25 $\Omega$ ~ 1k $\Omega$ , Programmable	1.00 $\Omega$ ~ 1k $\Omega$ , Programmable
Accuracy	0.5% set + 0.5%F.S.	0.5% set + 0.5%F.S.	0.5% set + 0.5%F.S.
Resolution	20 $\mu$ mho	50 $\mu$ mho	50 $\mu$ mho
<b>Constant Power Mode</b>			
Range	1,800W, Programmable	3,600W, Programmable	4,500W, Programmable
Accuracy	0.2% + 0.3%F.S.	0.2% + 0.3%F.S.	0.2% + 0.3%F.S.
Resolution	0.375W	1.125W	1.125W
<b>Constant Voltage Mode</b>			
Range	7.5V ~ 500V, Programmable	7.5V ~ 500V, Programmable	7.5V ~ 500V, Programmable
Accuracy	0.3% + 0.3%F.S.	0.3% + 0.3%F.S.	0.3% + 0.3%F.S.
Resolution	0.01V	0.01V	0.01V
<b>Measurement Section</b>			
DVM Range	500.0V	500.0V	500.0V
DVM Accuracy	0.1% + 0.1%F.S.	0.1% + 0.1%F.S.	0.1% + 0.1%F.S.
DVM Resolution	10 mV	10 mV	10 mV
DAM Range	80.00A	160.00A	200.00A
DAM Accuracy (<70Hz)	0.1% + 0.2%F.S.	0.1% + 0.2%F.S.	0.1% + 0.2%F.S.
DAM Accuracy (>70Hz) <sup>*1</sup>	0.1%(1+CF <sup>2</sup> $\times$ kHz) + 0.2%F.S.	0.1%(1+CF <sup>2</sup> $\times$ kHz) + 0.2%F.S.	0.1%(1+CF <sup>2</sup> $\times$ kHz) + 0.2%F.S.
DAM Resolution	1.0 mA	2.5 mA	2.5 mA
Others parameters <sup>*3</sup>	P(W), S(VA), Q(VAR), CF, PF, Freq, R, I <sub>p-</sub> , I <sub>p+</sub> , THDv		
<b>Others</b>			
Vmonitor	$\pm$ 500V/ $\pm$ 10V (Isolated)	$\pm$ 500V/ $\pm$ 10V (Isolated)	$\pm$ 500V/ $\pm$ 10V (Isolated)
Imonitor	$\pm$ 80A/ $\pm$ 10V (Isolated)	$\pm$ 200A/ $\pm$ 10V (Isolated)	$\pm$ 200A/ $\pm$ 10V (Isolated)
Protection	OCP: 19.2A <sub>rms</sub> ; OVP: 360V <sub>rms</sub> (DC: 510V <sub>DC</sub> ); OPP: 1,920W; OTP	OCP: 38.4A <sub>rms</sub> ; OVP: 360V <sub>rms</sub> (DC: 510V <sub>DC</sub> ); OPP: 3,840W; OTP	OCP: 48A <sub>rms</sub> ; OVP: 360V <sub>rms</sub> (DC: 510V <sub>DC</sub> ); OPP: 4,800W; OTP
Parallel Ability	Yes	Yes	Yes
Remote Interface	GPIB, RS-232 or analog control		
<b>AC Input</b>			
Line Voltage	115/230 Vac	115/230 Vac	115/230 Vac
Amplitude	$\pm$ 15%	$\pm$ 15%	$\pm$ 15%
Fuse	2A, 250V	2A, 250V	2A, 250V
Frequency	47 ~ 63 Hz	47 ~ 63 Hz	47 ~ 63 Hz

Maximum VA	150VA	250VA	250VA
<b>General</b>			
Dimension (H×W×D)	177×430×585 mm 7.0×17.0×23.0 inch	310×430×585 mm 12.2×17.0×23.0 inch	310×430×585 mm 12.2×17.0×23.0 inch
Weight	34kg / 74.89lbs	60kg / 132.16lbs	60kg / 132.16lbs

All specifications are subject to change without notice.

**Note:**

- \*1: Additional Spec:  $0.1\% \times CF^2 \times kHz$
- \*2: The load value of CF is related to characteristic, frequency and output impedance of UUT. When frequency is 440Hz, the load value of CF and the accuracy of the measurement value above 4.3 will over the specification.
- \*3:  $CF = 0.5\% / I_{rms} + 1\%F.S.$

## 1.5 Names of Parts

### 1.5.1 The Front Panel

The front panel of the load includes a 240 × 64 characters LCD display, 8 LED status indicators, and keypads. The LCD display will show which function is being performed when you use the keypads. Some of the keys have two functions. Figure 1-1 shows the front panel of the loads.

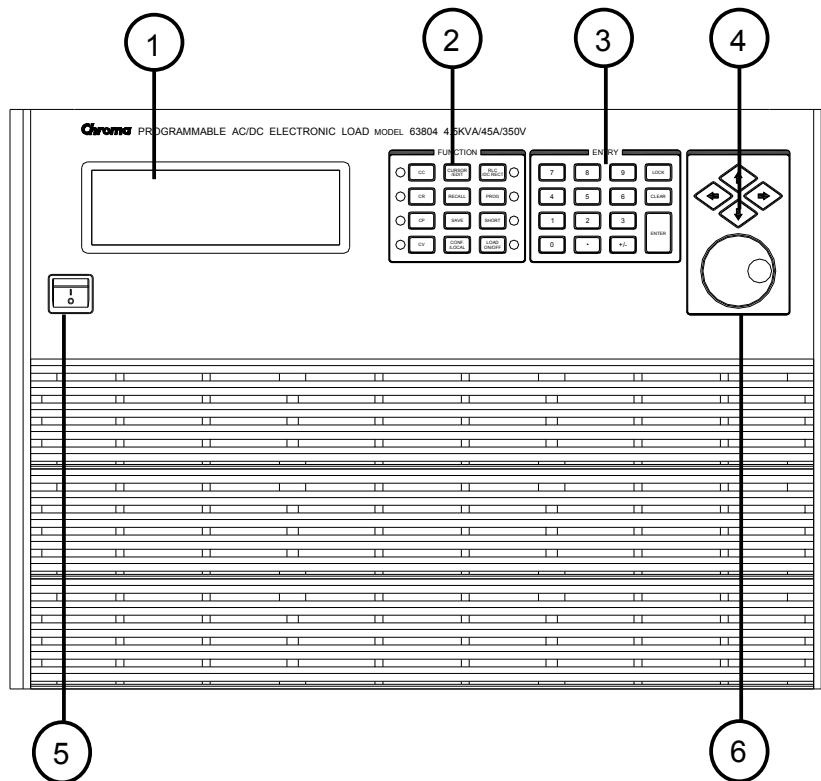









































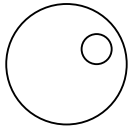

Figure 1-2 The Front Panel of the Electronic Load

Table 1-1 The Description of the Front Panel

Item	Symbol	Description
1		<b>LCD display.</b> The LCD is to display configuration, output setup, and measurement results.
2	<p>    ,  ,   ,  ,  ,   ,   </p>	<p><b>Function key:</b></p> <ol style="list-style-type: none"> <li>Users can choose the load modes by pressing the , , , ,  keys and the LEDs aside these keys will be on.</li> <li>The function of  key is to enable to edit the digit by rotary knob under loading condition.</li> <li>Pressing the  key to recall the saved setting from EEPROM that default of CC, CR, CV, CP and PROG files (1 to 10).</li> <li>Pressing the  key to save all of the present mode settings in the specified files. The save program is from 1 to 10. Saving DEFAULT is to save the status for the next time the Electronic Load is turned on. All saved settings are stored in EEPROM, and will not be lost when ac power is cycled.</li> <li>The  key is to select configuration data for editing. When in remote control state, this key acts as a local key.</li> <li>To select the RLC (DC RECT) mode for editing by pressing  key and the LED aside this key will be on.</li> <li>: There is no function so far.</li> <li>The Load can simulate a short circuit across the input. The short circuit can be enabled when the  key is pressed. When the input is shorted, the LED aside this key will be active.</li> <li>The input can be held on or off by pressing . When the input is turned on, the LED aside this key will be active.</li> </ol>
3	<p>  to , and ,  , , ,   </p>	<p><b>Entry key:</b></p> <ol style="list-style-type: none"> <li>The user can program numeric data by pressing the numeric keys and the decimal  key.</li> <li>The  key can be used to toggle the sign for those parameters for which it is relevant. This is typically the power factor setting.</li> <li>It enables the lock function of rotary or keypad by pressing the  key.</li> <li>To clear the digits entered from keypad. This  key lets you correct wrong digits before they are entered.</li> <li>It executes the entered value or the parameter for the command accessed presently. The parameters you have entered with other keys are displayed but not entered into the Load until you press this key. Before pressing  you can change or abort anything entered into the display previously.</li> </ol>
4	<p> , , ,  </p>	<p><b>Cursor key.</b> These four keys are to move the cursor in different directions respectively.</p>

5		<b>Main Power Switch:</b> It is to power on or off.
6		<b>Rotary knob:</b> The user can input programming data or select options by turning the rotary.

### 1.5.2 The Rear Panel

The Mainframe rear panel includes ports of RS-232, System Bus, GPIB, I/O port, two BNC connectors, a load input socket and an AC LINE socket. Figure 1-2 shows the rear panel of Mainframe 63800.

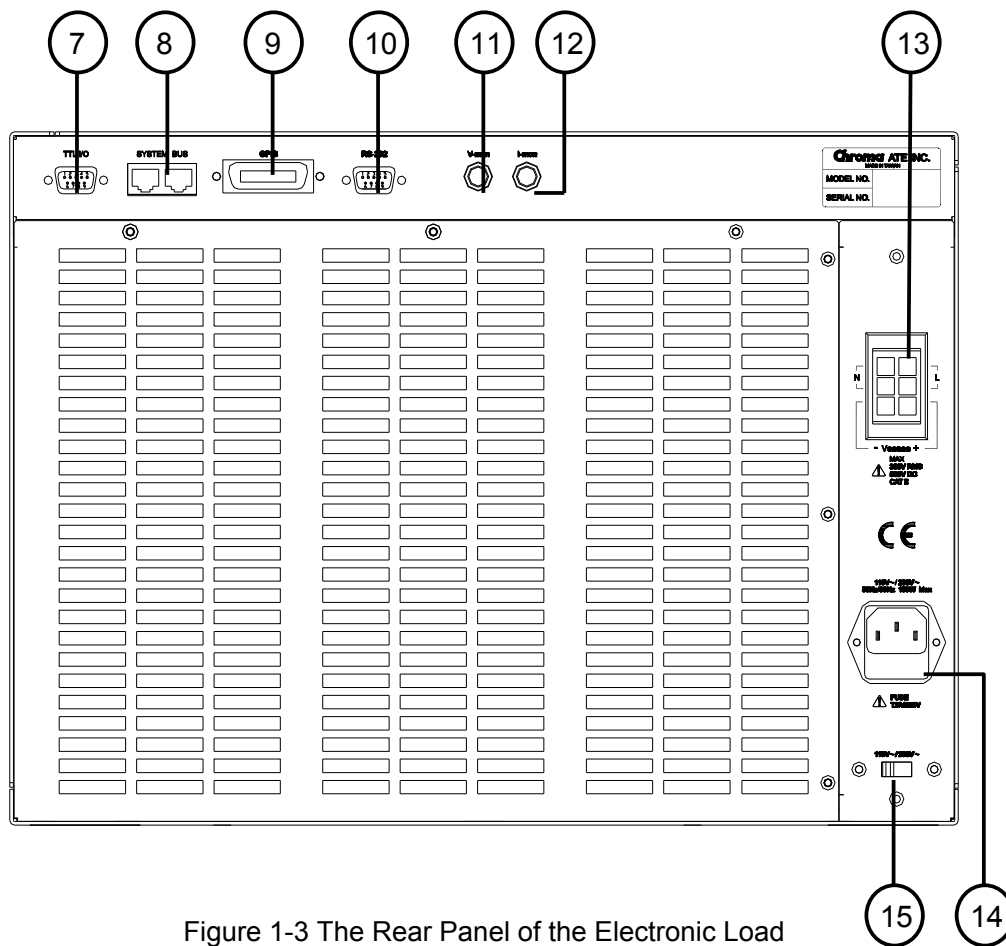

Figure 1-3 The Rear Panel of the Electronic Load

Table 1-2 The Description of the Rear Panel

Item	Name	Description
7	TTL I/O	For system input/output control signal
8	System bus	For master/slave control system data communication
9	GPIB connector	A remote controller using GPIB bus is connected to the AC load through this connector for remote operation.
10	RS-232C connector	The 9-pin, D-type female connector transfers control commands to and from the remote PC for remote operation.
11	Voltage monitor output	Analog output proportional to voltage waveform.
12	Current monitor output	Analog output proportional to current waveform.
13	Load terminal & Voltage sense terminal	Load terminal is connected to source or UUT for loading. In addition, voltage sense terminal senses directly at the terminals of the source to eliminate any voltage drop on the connecting cable.
14	AC input connector	Power line input is connected to the AC source through this connector.
15	AC input voltage switch	It is for switching AC input voltage.



## 2. Installation

### 2.1 Introduction

This chapter describes how to install the 63800 series Load as well as a turn-on check procedure and application considerations.

### 2.2 Inspection

As soon as the instrument is unpacked, inspect any damage that might have occurred in shipping. Keep all packing materials in case that the instrument has to be returned. If any damage is found, please file a claim to the carrier immediately. Do not return the instrument to Chroma without prior approval.

In addition to this manual, be sure that the following items are also received – a power cord, this manual, a load terminal cable and two BNC cables.

### 2.3 Installing

The Electronic Loads can operate well within the temperature range from 0 to 40°C. However, you must install the Electric Load in an area that has enough space around the unit for adequate air flowing through and escaping from the back.

#### 2.3.1 Preparation for Use

In the beginning, the instrument must be connected with an appropriate AC line input. Then, since fans intelligently cool it, it must be installed in sufficient space for circulation of air. It should be used in an area where the ambient temperature does not exceed 40°C.

#### 2.3.2 Changing Line Voltage

The Electronic Load can operate with a 115/230 Vac input as indicated on the rear side of the unit. If the default factory voltage setting does not correspond to your nominal line voltage, set the switch to the correct line voltage as shown in Figure 2-1 before plugging in the power cord and turning on the power.

 **Notice** Line fuses do not need to be changed when the line voltage is changed.

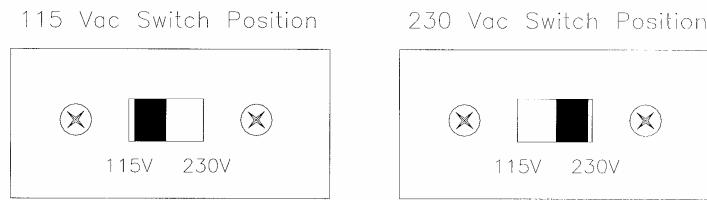

Figure 2-1 Line Voltage Switch

### 2.3.3 Turn-On Self-Test

Check the following before turning on the Load.

1. The unit has been set to the correct line voltage by factory. Refer to the line voltage indicated on the left hand side of the panel.
2. The power cord is connected to the AC input socket.

**WARNING** The power supplies a chassis ground through a third connector. Be sure that your outlet is of three-conductor type with the correct pin connected to ground.

Turn on the Load by the power switch on the front panel and observe the display. Immediately after turning on, the Electronic Load executes a self-test and checks the GPIB interface board and identify the information of the system.

The LCD displays



and then it goes to the output mode setting display.

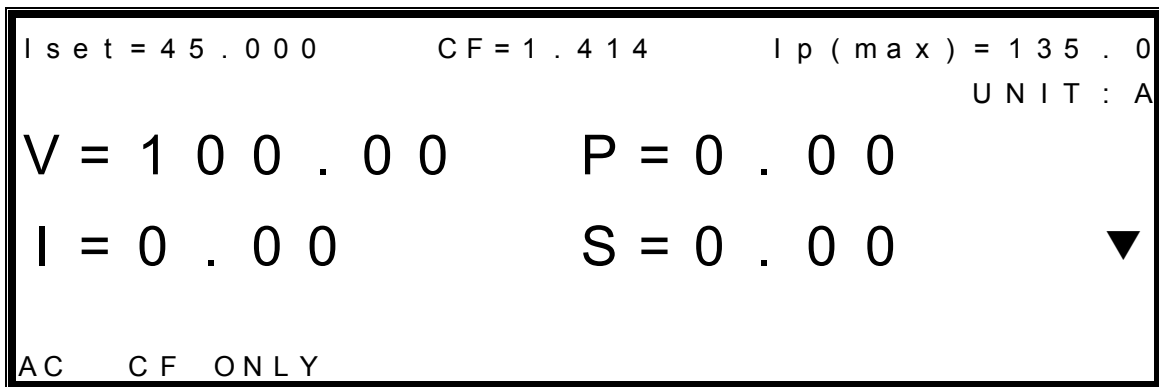

If any error is found in self-test, the display will stop here. In case of failure, please contact Chroma sales or service office.

## 2.4 Application Connection

### 2.4.1 Load Connections

**⚠ WARNING** To satisfy safety requirements, load cables must be large enough not to overheat while carrying the short-circuit output current of the device connected to the Electronic Load.

Because the input source is rectified with the single-phase diode bridge circuit, the load terminals do not have to be identified the input polar direction. The major considerations in making input connections are the current wire size, length and the voltage sense cables.

The minimum current wire size required to avoid overheating may not be enough to maintain good regulation. The wires should be large enough to limit the voltage drop less than 0.5V per lead. The wires should be as short as possible, and bundled or tied together to minimize inductance and noise. The attached load cables are *proposed* for testing.



## 3. Local Operation

### 3.1 Introduction

Chroma 63800 series electronic loads are suitable for design, manufacturing, testing and quality assurance. It contains a processor, GPIB and RS-232C connectors, front panel keypad, display, and power stage. Its built-in remote control function allows you to control, read back current, voltage and status. All of them can be saved in the load EEPROM for future use.

The load contains cooling fans. The fan speed increases or decreases automatically when the load power rises or falls. This feature reduces the overall noise level as the fans do not always run at the maximum speed.

Each load can operate in constant load modes and Rectified load modes. If the application requires a greater power or current capacity than one load can provide, you need to connect the loads in parallel.

The AC load can be configured to operate in local or remote mode. The operation in remote mode through a remote GPIB controller or RS-232C will be described in Chapter 5. In this section the operation in local mode through the keypad on the front panel and testing will be described. The AC load is configured for local operation when it is turned on.

There are two kinds of load simulation for the 63800: AC Load Simulation and DC Load Simulation. The operation is shown as below.

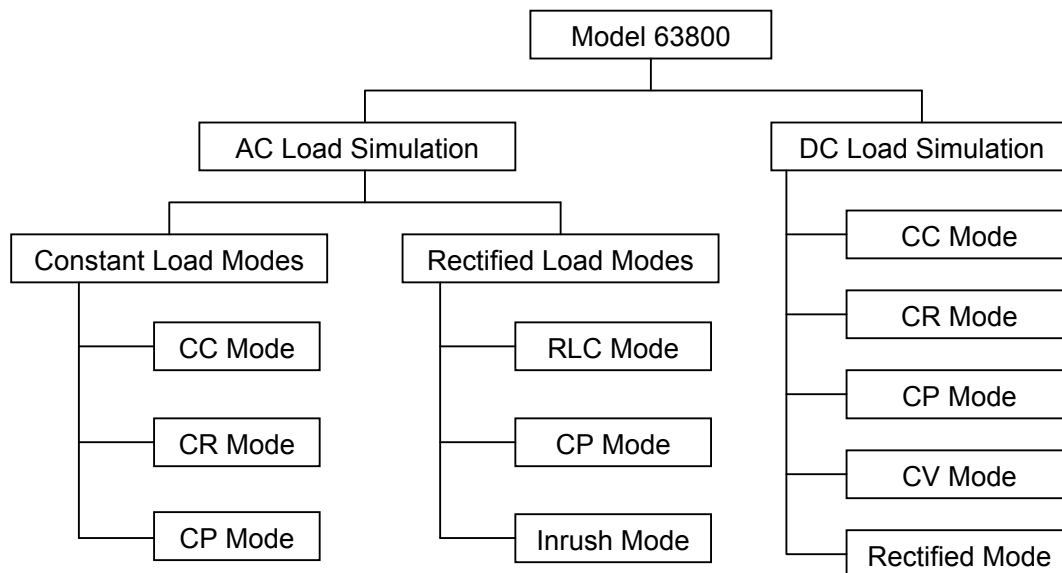

Figure 3-1 Operation Structure

### 3.2 Local/Remote Control

Local (front panel) control is in effect immediately after the power is applied. The front panel

keypad and display allow manual control when Load is used in bench test applications. Remote control goes into effect as soon as the Load receives a command via GPIB, RS-232C. When the remote control is in effect, only the computer can control the Load. The front panel keypad has no effect except the **CONF./LOCAL** key. You can return to local control by pressing **CONF./LOCAL** key.

Most of the functions that perform remotely can be done locally too at the Load front panel. Details of local operation are given in Section 3.4 *Local Operation*. Fundamentals of remote programming are described in the latter part of this manual.

### 3.3 Modes of Operation

In AC load simulation you can select the mode by pressing **CC**, **CR**, **CP** or **RLC/DC RECT** keys under the FUNCTION keypad. In DC load simulation, you can select the mode by pressing **CC**, **CR**, **CP**, **CV** or **RLC/DC RECT** keys under the FUNCTION keypad. The parameters in current, resistance, power or rectified load mode can be programmed easily when the mode is selected.

All data set in any mode will be rescaled to fit the resolution of current/voltage levels, power value, crest factor (CF) or power factor (PF). In local mode any value can be set to the Load from the keypad. There is no upper and lower limit that would cause an error. The Load automatically selects data, which is rescaled from the programmed value, truncates and checks high, low boundary before fitting it into the memory. When the programmed data is over the boundary, the Load will be still at original value. In remote mode the programmed value cannot be over boundary. An error will occur when data is over the maximum or minimum value. The boundary of voltage and current of the load, as well as the power, are shown in Figure 3-3.

The operating ambient temperature for the full load is from 0°C to 40°C, or the OTP will occur for a period of time.

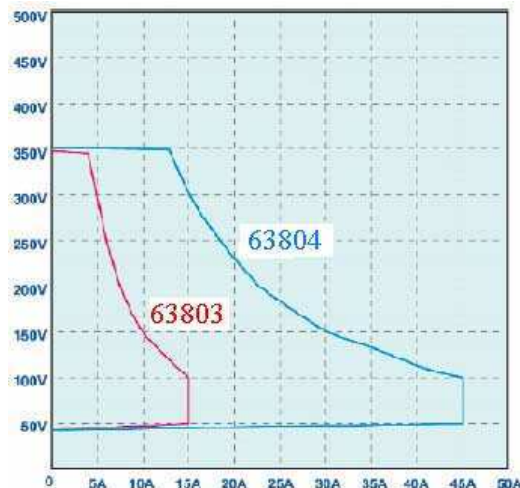

Figure 3-2 Operating Boundary of Power, Voltage and Current

## 3.4 Local Operation

In order to use the front panel keys to control the electronic load, local operation must be in effect. Immediately after the power is applied, local operation will be in effect. When local operation is in effect, you can use the display with keypad on the front panel to control the Load. The display can be used to view the message, including programmed setting, measurement data, and system indication.

**Notice** When you edit setting, the display will blink to let you know which setting is to be edited or has been selected.

In the remote state, the keys on the front panel have no effect. Only remote controller can program the Load. The Load LCD display will show REMOTE message.

**Notice** When setting the load level, the resolution of current, voltage, power, resistance and slew rate will be different from the entered values. The displayed value will remain as the one entered. But the output will be the actual value D/A programmed in the load. These parameters except resistance will be degraded to low values when entered.

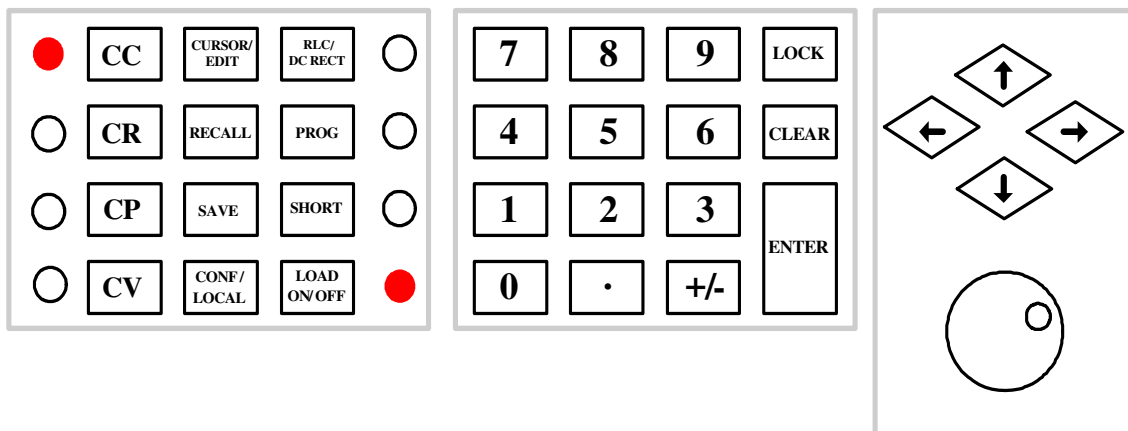

Figure 3-3 63800 Function & Entry Key Overview

### 3.4.1 Setting the Configuration

The Electronic Load provides useful features. To use these powerful features, you must set relevant parameters in accordance with application needs by the configuration setup. This procedure is only needed for initial setup of a test operation. The configuration of the Load is stored in EEPROM. To set configuration you must press the **CONF./LOCAL** key. The display will show as follows:

```

[ CONF ]
CHOOSE = 1   1 . SETUP
              2 . REMOTE
              3 . CALIBRATION
              4 . DISPLAY SELECTION
              5 . FACTORY  DEFAULT
              6 . MODEL   INFORMATION
              7 . PARALLEL MODE
```

### 1. SETUP

There are seven items to setup. All these seven items are shown in the following pages of LCD display.

```

1 - 1 . MODE SELECT      = AC / DC           [ SETUP ]
1 - 2 . SHORT           = OFF / TOGGLE / HOLD
1 - 3 . LOCKTMODE       = ROTARY / KEYPAD / ALL
1 - 4 . SOUND           = ON / OFF
1 - 5 . CF / PF SETTING = BOTH / CF / PF
1 - 6 . TIMING MODE     = OFF / HOLDUP / TRANSFER
1 - 7 . EXTERNAL        = OFF / ON
1 - 8 . ABA MODE        = ENABLE / DISABLE
```

In item 1, if the AC is chosen, the load will operate in AC mode as well as DC mode.

In item 2, if the hold is chosen, “short” function will stop when the user releases the “SHORT” key.

In item 3, if the keypad is chosen, the keypad will be locked when the user presses the “LOCK” key. The keypad will recover when the “LOCK” key is pressed again. So do the other two choices.

In item 4, if the user chooses the “OFF”, the buzzer will become invalid.

In item 5, the user can choose the Sub mode (CF only, PF only, Both). In the Both mode user can chooses the priority of CF or PF and the other one will changed the boundary according to section 3.4.6.

In item 6, if the user chooses the “ON”, the timing mode will be enabled. After the **LOAD ON**, timer stops either the voltage is under cutoff voltage or the timer is over.

In item 7, if the user chooses the EXTERNAL signal “ON”, then the user can program the load ON by the signal, however, the **LOAD ON/OFF** key will become invalid.



In item 8, the user needs to set the  $I_p(\text{max})$  value once if the ABA Mode is "ENABLE".

## 2. REMOTE

Three kinds of remote interfaces can be utilized in 63800 series: GPIB, RS232 and SYSTEM BUS. The interactive window is shown as follows:

```

[ R E M O T E ]
G P I B   A D D R E S S   =   8
RS 2 3 2   P A R A M E T E R S   :
B A U D   R A T E       =   5 7 6 0 0
D A T A   B I T         =   8
S T O P   B I T         =   1

```

## 3. CALIBRATION



There are five items to be calibrated the values of settings and measurements. He who wants to enter into the calibration has to input the password for protecting the calibrated values are changed arbitrarily. The unit had been calibrated before exiting factory, so that users do not need to calibrate during operation. Calibration function is only for Chroma's calibration department, users do not process it.

```

P A S S W O R D : _ _ _ _ _

```

## 4. DISPLAY SELECTION

In this display selection, the user has the choice to select four reading values of measurement shown in the main page, second and third pages are displayed by pressing the direction key ( ,  ) or rotating the rotary knob.

```
[ DISPLAY ]  
DISPLAY SELECTION :  
MAIN PAGE = V / I / P / S  
  
SECOND PAGE = Q / PF / CF / F  
  
THIRD PAGE = + I / - I / THD / R
```

### 5. FACTORY DEFAULT

In this item, users can recall the default settings for all parameters.

```
[ FACTORY DEFAULT ]  
RECALL DEFAULT = NO
```

### 6. MODEL INFORMATION

In this item, the user can view some information of F/W version, S/N, model, and specification.

```
[ MODEL INFORMATION ]  
  
HOST F / W = 1 . 4 1  
  
DSP F / W = 1 . 4 1  
  
MODEL = 6 3 8 0 4
```

## 3.4.2 External ON/OFF

63800 can control Load ON/OFF status through TTL signal. **LOAD ON/OFF** key is invalid

when External ON, Load ON/OFF status can only be controlled through TTL signal. Conversely, when External OFF users can control Load ON or OFF through **LOAD ON/OFF** key.

### 3.4.3 Going To Local

The **CONF./LOCAL** key operates as local key when Electronic Load is in remote mode. You can press **CONF./LOCAL** key to go to local operation when Load is in remote state. In local operation, **CONF./LOCAL** key operates as **CONF** key.

### 3.4.4 Online Change Loading

The Load provides two ways for changing level online. They are convenient for you to change load directly with the rotary knob when LOAD ON. These two operation modes are described below.

By Rotary knob: In LOAD ON, change load with the rotary knob in resolution unit.

When the rotary knob rotates clockwise, it means as follows.

CC mode: raise the current value.

CR mode: raise the resistance value.

CP mode: raise the power value.

When the rotary knob rotates counterclockwise, it means as follows.

CC mode: lower the current value.

CR mode: lower the resistance value.

CP mode: lower the power value.

By CURSOR EDIT: In LOAD ON, press the mode key **CC**, **CR**, or **CP** to make the display show numeric values for the setting. Press **CURSOR EDIT** to see the cursor blinking on the display. Press **◀**, **▶** keys to move the cursor to the digit you want to edit. Change the value by rotary knob. Press the **CURSOR EDIT** key again to disable the cursor.

### 3.4.5 Load ON/OFF

#### Load ON:

After setting the parameter of the load, the **LOAD ON/OFF** key should be pressed to turn on the load, so that the load can sink the current. When the status of the load is "LOAD ON", the LED beside the **LOAD ON/OFF** button will be lightened. Users are able to change the setting values of various parameters arbitrarily during loading. Certainly, the setting values of various parameters need to be within spec. or reasonable range.

#### Load OFF:

The **LOAD ON/OFF** key should be pressed again to turn off the load. When the status of the load is "LOAD OFF", the LED beside the **LOAD ON/OFF** button will be off. Turning off the load does not affect the programmed setting. The load will return to the previous programmed values when the Load is turned on again.

### 3.4.6 The Relationship of Crest Factor and Power Factor

Crest Factor is the peak current divided by RMS current. When a crest factor is set as 1.414, it means that the DSP creates a sinusoidal current waveform.

Power factor is defined as the true power divided by the apparent power. If the PF is not the same as the setting value, the position of the current waveform will be modified to meet the PF value by the DSP. For a resistive load, the power factor is one. If values of  $V_{rms}$  and  $I_{rms}$  are constant, the power factor decrease by the increasing of the crest factor because the effective multiplication of voltage and current is down.

The following relationship of PF and CF is valid for the sinusoidal waveform of the input voltage, because the estimated algorithm is established on that the input voltage waveform and the sunk current waveform are sinusoidal or modified sinusoidal waveforms. The maximum power factor of a determinate crest factor occurs at the maximum overlap of input voltage waveform and sunk current waveform. That is, the peaks value of the voltage and current are at the same time. The minimum power factor occurs at the minimum overlap of input voltage waveform and sunk current waveform. That is, the zero-crossings of the voltage waveform and current waveform are the same.

These two situations are illustrated in Figure 3-4 and Figure 3-5.

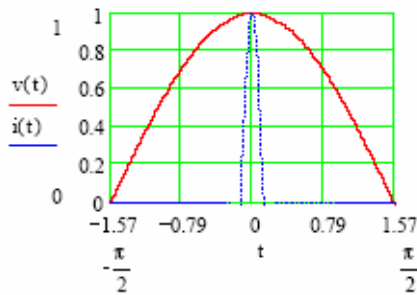

a Determinate CF

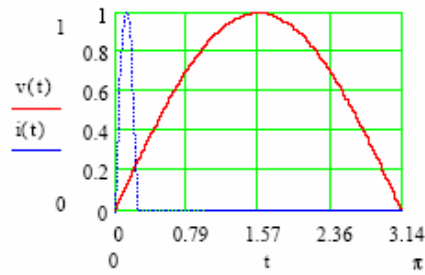

a Determinate CF

According to the algorithm, Figure 3-6 shows the relationship of PF and CF. However, for the minimum operating voltage of the electronic load, the minimum PF through a determinate crest factor will be varied. We have to adjust to appropriate value. The modified value is illustrated on Table 3-1.

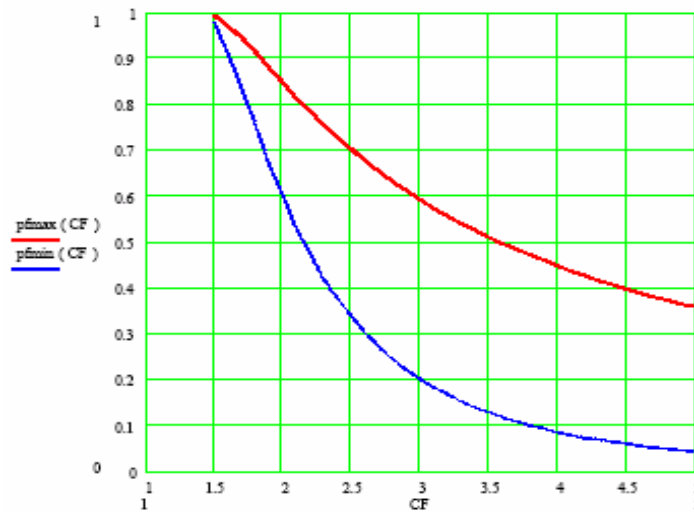

Figure 3-6 The Relationship of PF and CF

Table 3-1 Maximum and Minimum Values of PF in Different CF

CF	PFmax	PFmin (50V <sub>rms</sub> )	PFmin (100V <sub>rms</sub> )	PFmin (200V <sub>rms</sub> )
1.5	0.993	0.992	0.982	0.977
2.0	0.849	0.668	0.634	0.617
2.5	0.703	0.408	0.373	0.356
3.0	0.593	0.266	0.234	0.219
3.5	0.511	0.186	0.158	0.144
4.0	0.449	0.138	0.113	0.100
4.5	0.399	0.107	0.084	0.073
5.0	0.360	0.085	0.065	0.055

If users choose BOTH mode (please refer section 3.6.1) in CC mode (please refer section 3.6) and CP mode (please refer section 3.8) under AC load simulation (please refer section 3.5), thus it is needed to input CF and PF values simultaneously.

It is necessary to set CF and PF priority again in BOTH mode. If users' settings are outside of the range as in Figure 3-6 and Table 3-1, 63800 Electronic Load will modify users' settings to a reasonable range automatically.

### Example 1: (when the priority is CF and the output voltage of UUT is 200V<sub>rms</sub>)

- If users set CF=1.5 and PF=1, however the allowable PF value with CF=1.5 is from 0.977 to 0.993. The system will use a loading with a PF value close to the allowable PF value, in this case a PF value of 0.993 will be used.
- If users set CF=1.5 and PF=0.8, however the allowable PF value reasonable range under CF=1.5 is from 0.977 to 0.993. The system will use a loading with a PF value close to the allowable PF value, in this case a PF value of 0.977 will be used.
- If users set CF=3 and PF=0.1, however the allowable PF value reasonable range under CF=3 is from 0.219 to 0.593. The system will use a loading with a PF value close to the

allowable PF value, in this case a PF value of 0.219 will be used.

- d. If users set CF=3 and PF=0.7, however the allowable PF value reasonable range under CF=3 is from 0.219 to 0.593. The system will use a loading with a PF value close to the allowable PF value, in this case a PF value of 0.593 will be used.

### Example 2: (when the priority is PF and the output voltage of UUT is 200V<sub>rms</sub>)

- a. If users set PF=0.8 and CF=3, however the allowable CF value reasonable range under PF=0.8 is from 1.750 to 2.153. The system will use a loading with a CF value close to the allowable CF value, in this case a CF value of 2.153 will be used.
- b. If users set PF=0.8 and CF=1.5, however the allowable CF value reasonable range under PF=0.8 is from 1.750 to 2.153. The system will use a loading with a CF value close to the allowable CF value, in this case a CF value of 1.750 will be used.
- c. If users set PF=0.5 and CF=5, however the allowable CF value reasonable range under PF=0.5 is from 2.157 to 3.552. The system will use a loading with a CF value close to the allowable CF value, in this case a CF value of 3.552 will be used.
- d. If users set PF=0.5 and CF=1.5, however the allowable CF value reasonable range under PF=0.5 is from 2.157 to 3.552. The system will use a loading with a CF value close to the allowable CF value, in this case a CF value of 2.157 will be used.

## 3.4.7 I<sub>p</sub>(max) Setting and Automatic Bandwidth Adjustment (ABA) Mode

I<sub>p</sub>(max) has to be set for all modes and it has two functions: the 63800 Electronic Load uses the value I<sub>p</sub>(max) set as the reference for testing UUT's impedance, in addition it is the maximum current limit for normal loading. Every time the voltage is gone and appears again (for instance power recovery after changing the UUT), the I<sub>p</sub>(max) has to be reset. 63800 Electronic Load will pop up a window shown as below when the voltage is gone if I<sub>p</sub>(max) has not been set. The below window requests users to enter the I<sub>p</sub>(max) value with the previous value. When users want to change the value I<sub>p</sub>(max), please press **ENTER** key to enter the edit page, then to key in value you want and then press **ENTER** key. If the value is the same as the last time, please press **LOAD ON/OFF** key to sink a loading current directly.

```
      UUT POWER LOSS!!!
    Was UUT type changed?

<ENTER> : YES  <LOAD ON/OFF> : NO
```

If YES, please press **ENTER** key, then you need to re-enter the I<sub>p</sub>(max). After entering the I<sub>p</sub>(max), the loading will be ON automatically without pressing the **LOAD ON/OFF** key.

P l e a s e   r e - e n t e r   I<sub>p</sub> ( m a x ) .  
I<sub>p</sub> ( m a x ) =   0 . 0

If NO, please press **LOAD ON/OFF** key, the AC load will using the previous I<sub>p</sub>(max) value to load ON automatically without pressing the **LOAD ON/OFF** key.

If the users press the **LOAD ON/OFF** under I<sub>p</sub>(max)=0, the system will beep twice to warn the users that their I<sub>p</sub>(max) value is 0, then the system will LOAD ON with zero loading current.

 **Notice** If the voltage is gone and appears again in two seconds, the 63800 Electronic Load will not request users to input again.

 **WARNING** The 63800 Electronic Load uses the value I<sub>p</sub>(max) set as the reference for testing UUT's impedance. Hence, when the value I<sub>p</sub>(max) setting is too high, the UUT may be damaged by the loading current. Otherwise, when the value I<sub>p</sub>(max) setting too low, the test tolerance of UUT's impedance becomes larger and results in the increase of measuring tolerance. Therefore, it is recommended to set I<sub>p</sub>(max) value according to the maximum load current of the UUT.

When the ABA Mode is Disable, the I<sub>p</sub>(max) only need to be set once. It is very dangerous for beginner to use this mode.

 **Notice** The ABA Disable Mode is an advanced mode for users that are familiar with the Chroma AC Load.

### 3.4.8 Lock Mode





63800 Electronic Load provides lock function, it avoids user to touch keypad or rotary unintentionally when operating constantly. Otherwise, the unintentional behavior may cause UUT damage or experiment failure.

Lock function consists of lock keypad, lock rotary and lock all. The following introduces how to operate lock function.

1. Press **CONF./LOCAL** key.
2. Press **1**, then press **ENTER** to enter SETUP.

```

[ CONF ]
CHOOSE = 1   1 . SETUP
              2 . REMOTE
              3 . CALIBRATION
              4 . DISPLAY SELECTION
              5 . FACTORY DEFAULT
              6 . MODEL INFORMATION
              7 . PARALLEL MODE
    
```

3. Move the direction ( ,  ) to "1-3 LOCK MODE".
4. Press the direction key ( ,  ) or rotate the rotary knob to choose "ROTARY", "KEYPAD" or "ALL", then press **ENTER**.

```

1 - 1 . MODE SELECT      = AC / DC      [ SETUP ]
1 - 2 . SHORT           = OFF / TOGGLE / HOLD
1 - 3 . LOCK MODE       = ROTARY / KEYPAD / ALL
1 - 4 . SOUND           = ON / OFF
1 - 5 . CF / PF SETTING = BOTH / CF / PF
1 - 6 . TIMING MODE     = OFF / HOLDUP / TRANSFER
1 - 7 . EXTERNAL        = OFF / ON
1 - 8 . ABA MODE        = ENABLE / DISABLE
    
```

5. Press **CC**, **CR**, **CP** or **RLC/DC RECT** to back to the mode that user want to use.
6. Press **LOCK** to lock the item you select in step 4.

Example: (Use lock mode under CC mode)

```

I s e t = 0 . 5 0 0      C F = 1 . 4 1 4      P F = 1 . 0 0 0
I p ( m a x ) = 1 0 . 0      U N I T : A
V = 0 . 0 0      P = 0 . 0 0
I = 0 . 0 0      S = 0 . 0 0      ▼
AC  P R I O R I T Y : C F      L O C K
    
```

7. Press **LOCK** again to release the item that user selected in step 4 then the window is shown as below.



```

I s e t = 0 . 5 0 0      C F = 1 . 4 1 4      P F = 1 . 0 0 0
I p ( m a x ) = 1 0 . 0      U N I T : A
V = 0 . 0 0      P = 0 . 0 0
I = 0 . 0 0      S = 0 . 0 0      ▼
A C      P R I O R I T Y : C F

```

 **Notice** If user chooses Lock ALL thus all keypads and rotary are disabled except for **LOCK** key.

### 3.5 AC Load Simulation

The 63800 series electronic load has AC/DC simulated functions. The AC load simulation includes constant load mode and rectified load mode and its operation modes are described as below.

In AC mode, the **CC**, **CR**, **CP**, **RLC/DC RECT** keys are used to select the load modes for local control. AC mode and DC mode can be chosen in the 63800 series. Press **CONF./LOCAL** and select the first item, "SETUP", to choose one. In AC mode, the load values, PF and CF are common to CC, and CP modes; CR and RLC mode only set determinate values. It is necessary to set UUT's output maximum current value  $I_p(\max)$  in all modes. The value  $I_p(\max)$  is for 63800 to test UUT's output impedance for getting system optimum.

63800's power-on default value is AC mode.  
If user wants to return to AC mode from DC mode.

1. Press **CONF./LOCAL** key.
2. Press **1**, then press **ENTER** to enter SETUP.

```

[ C O N F ]
C H O O S E = 1      1 . S E T U P
                   2 . R E M O T E
                   3 . C A L I B R A T I O N
                   4 . D I S P L A Y   S E L E C T I O N
                   5 . F A C T O R Y   D E F A U L T
                   6 . M O D E L     I N F O R M A T I O N
                   7 . P A R A L L E L M O D E

```

3. Move the direction ( **▲**, **▼** ) to "1-1 MODE SELECT".

4. Press the direction key ( ◀, ▶ ) to choose “AC”, then press **ENTER**.

1 - 1 .	MODE SELECT	= AC / DC	[ SETUP ]
1 - 2 .	SHORT	= OFF / TOGGLE / HOLD	
1 - 3 .	LOCK MODE	= ROTARY / KEYPAD / ALL	
1 - 4 .	SOUND	= ON / OFF	
1 - 5 .	CF / PF SETTING	= BOTH / CF / PF	
1 - 6 .	TIMING MODE	= OFF / HOLDUP / TRANSFER	
1 - 7 .	EXTERNAL	= OFF / ON	
1 - 8 .	ABA MODE	= ENABLE / DISABLE	

5. Then press **CC**, **CR**, **CP** or **RLC/DC RECT** to enter the CC, CR, CP or Rectified mode.

There are two kinds of AC mode: Constant Load modes and Rectified Load Modes as shown in figure 3-1. Constant Load Modes are divided into three sub-modes of CC, CR and CP modes. Rectified Load Modes are divided into three sub-modes of RLC, CP (base on RLC mode) and Inrush Current modes. The detailed setting descriptions are as follows.

### 3.6 AC Load Simulation -- Constant Current Mode

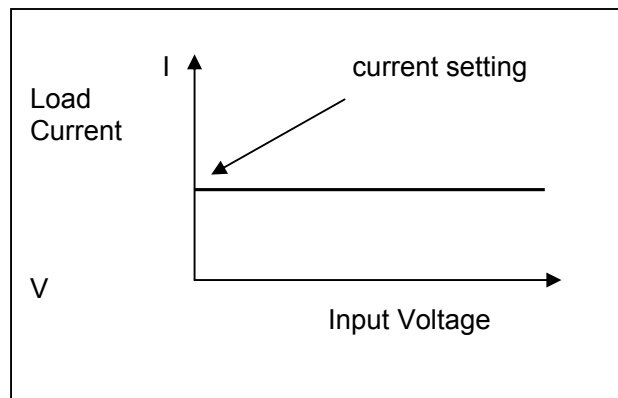

In CC mode, the Load will sink a current according to the programmed value if the input voltage is higher than the minimum operating voltage. The CC mode can be set by pressing **CC** key in the front panel.

The waveform of the current is programmed as a sinusoidal wave synchronized by the zero-crossing waveform of the input voltage. The PF can be set between  $\pm 1$ . The positive PF value means that the voltage lags the current, and the negative PF value means that the voltage leads the current. That is, the peak voltage occurs before the peak current for a negative PF. On the other hand, the peak voltage occurs after the peak current under the positive PF.

To set the condition of the CC mode, press the arrow key to select the setting parameters on the LCD display, including current RMS value, PF, CF,  $I_p(\text{max})$ . The setting values are

restricted that the input voltage is sine waveform or quasi-sine waveform. A limitation exists between PF and CF. If the waveform of the input voltage is a square wave, a special setting is prepared in **RLC/DC RECT**. See Section 3.9.

CF & PF parameters have CF ONLY, PF ONLY and BOTH, these three types in CC mode. If CF only is set, the PF should remain at the CF maximum and cannot be changed. If PF only is set, the CF should remain at the PF minimum and cannot be changed. If BOTH is set, it is necessary to set priority. When CF is set as the priority, the range of PF that can be set is limited to the PF range allowed for the CF value set (according to the Figure 3-6). On the contrary, if PF is set as the priority, the range of CF is limited to the CF range allowed for the PF value set (according to Figure 3-6.)

 **Notice** If the voltage is drawn to 0V under CP mode, it will trigger the warning of Load Fail (LDF). Meanwhile, the loading for the load will be stopped.

 **WARNING** When LDF warning is triggered then press power switch to restart AC load. If AC load can not function normally after restarting, please contact Chroma sales or service office.

 **Notice** The output voltage of UUT will distort because of loading current. If the output voltage of the UUT becomes distortion and drops below 10V due to the loading, the AC load will stop the loading.

### 3.6.1 BOTH

The default value in CC mode is BOTH mode.





The setting methods from other mode switch to BOTH mode are as follows.

1. Press **CONF./LOCAL** key.
2. Press **1**, then press **ENTER** to enter SETUP.

```

[ CONF ]
CHOOSE = 1   1 . SETUP
              2 . REMOTE
              3 . CALIBRATION
              4 . DISPLAY SELECTION
              5 . FACTORY DEFAULT
              6 . MODEL INFORMATION
              7 . PARALLEL MODE

```

3. Move the direction key ( ,  ) to "1-5. CF/PF SETTING".
4. Press the direction key ( ,  ) or rotate the rotary knob to choose "BOTH", then press **ENTER**.

1 - 1 . MODE SELECT	= AC / DC	[ SETUP ]
1 - 2 . SHORT	= OFF / TOGGLE / HOLD	
1 - 3 . LOCK MODE	= ROTARY / KEYPAD / ALL	
1 - 4 . SOUND	= ON / OFF	
1 - 5 . CF / PF SETTING	= BOTH / CF / PF	
1 - 6 . TIMING MODE	= OFF / HOLDUP / TRANSFER	
1 - 7 . EXTERNAL	= OFF / ON	
1 - 8 . ABA MODE	= ENABLE / DISABLE	

- After pressing **ENTER**, a window will pop up to request the user to key in CF and PF priority.
- Press the direction key ( **◀**, **▶** ) or rotate the rotary knob to choose the priority you want then press **ENTER**. If **ENTER** is not pressed, a window will not be popped up thus the priority is the setting value of last time.

CF PF PRIORITY = CF / PF

- Press **CC** key to back to main page.
- Press **LOAD ON/OFF** to run program when the program function is selected.

In the main page, users can press the arrow key to select the setting parameters on the LCD display, including current RMS value, CF, PF, and  $I_p(\max)$ . Users can type the values of current, CF, PF and  $I_p(\max)$  with the Entry keys. The values of CF and PF have interdependent relationship. When **PRIORITY : CF**, PF has the limitation of maximum and minimum. Contrarily, when **PRIORITY : PF**, CF also has the limitation of maximum and minimum. (More detailed information please refers section 3.4.6.)

I s e t = 0 . 5 0 0      C F = 1 . 4 1 4      P F = 1 . 0 0 0  
 I p ( m a x ) = 1 0 . 0      U N I T : A  
**V** = 0 . 0 0      **P** = 0 . 0 0  
**I** = 0 . 0 0      **S** = 0 . 0 0      ▼  
 AC    P R I O R I T Y : C F

The procedures of setting  $I_{set} = 5.000$ ,  $CF = 1.5$ ,  $PF = 0.800$  and  $I_p(max) = 20.0$ , are described as below:

1. Move the cursor by pressing ( ,  ) to the command line of “I<sub>set</sub>=”.

```
I s e t = 0 . 5 0 0      C F = 1 . 4 1 4   P F = 1 . 0 0 0
I p ( m a x ) = 1 0 . 0                               U N I T : A
```

2. Press **5** then press **ENTER** to change the value to “5.000”.

```
I s e t = 5 . 0 0 0      C F = 1 . 4 1 4   P F = 1 . 0 0 0
I p ( m a x ) = 1 0 . 0                               U N I T : A
```

3. Move the cursor by pressing ( ,  ) to the command line of “CF=”.

```
I s e t = 5 . 0 0 0      C F = 1 . 4 1 4   P F = 1 . 0 0 0
I p ( m a x ) = 1 0 . 0                               U N I T : A
```

4. Press **1**, **.**, **5** then press **ENTER** to change the value to “1.500”.

```
I s e t = 5 . 0 0 0      C F = 1 . 5 0 0   P F = 1 . 0 0 0
I p ( m a x ) = 1 0 . 0                               U N I T : A
```

5. Move the cursor by pressing ( ,  ) to the command line of “PF=”.

```
I s e t = 5 . 0 0 0      C F = 1 . 5 0 0   P F = 1 . 0 0 0
I p ( m a x ) = 1 0 . 0                               U N I T : A
```

6. Press **0**, **.**, **8** then press **ENTER** to change the value to “0.800”.

```
I s e t = 5 . 0 0 0      C F = 1 . 5 0 0   P F = 0 . 8 0 0
I p ( m a x ) = 1 0 . 0                               U N I T : A
```

7. Move the cursor by pressing ( ,  ) to the command line of “I<sub>p</sub>(max)=”.

```
I s e t = 5 . 0 0 0      C F = 1 . 5 0 0   P F = 0 . 8 0 0
I p ( m a x ) = 1 0 . 0                               U N I T : A
```

8. Press **2**, **0** then press **ENTER** to change the value to “20.0”.

```

I s e t = 5 . 0 0 0      C F = 1 . 5 0 0      P F = 0 . 8 0 0
I p ( m a x ) = 2 0 . 0      U N I T : A
    
```

9. After setting the parameter of the load, the **LOAD ON/OFF** key should be pressed to turn on the load, so that the load can sink the current. (For More detailed information please refers section 3.4.5.)

**Notice** : If there is an error during the procedure of inputting value, press **CLEAR** to clear at any time and then input again.

### 3.6.2 CF Only

For switching CF only mode, the procedures are as below:

1. Press **CONF./LOCAL** key.
2. Press **1**, then press **ENTER** to enter SETUP. (The display please refers 3.6.1 BOTH mode.)
3. Move the direction key ( **▲**, **▼** ) to “1-5. CF/PF SETTING”.
4. Press the direction key ( **◀**, **▶** ) or rotate the rotary knob to choose “CF”, then press **ENTER**. (The display please refers 3.6.1 BOTH mode.)
5. Then press **CC** to back to main page.

Users can press the arrow key to select the setting parameters on the LCD display, including current RMS value, CF, and  $I_p(\max)$ .

```

I s e t = 0 . 5 0 0      C F = 1 . 4 1 4      I p ( m a x ) = 1 0 . 0
                                     U N I T : A
V = 0 . 0 0      P = 0 . 0 0
I = 0 . 0 0      S = 0 . 0 0      ▼
AC   CF   ONLY
    
```

The procedures of setting  $I_{set} = 5.100$ ,  $CF = 1.51$  and  $I_p(\max) = 20.2$ , are described as below:

1. Move the cursor to the command line of “ $I_{set}$ ”.

```

I s e t = 0 . 5 0 0      C F = 1 . 4 1 4      I p ( m a x ) = 1 0 . 0
I p ( m a x ) = 1 0 . 0      U N I T : A
    
```

2. Press **5**, **.**, **1** then press **ENTER** to change the value to “5.100”.

```
l s e t = 5 . 1 0 0      C F = 1 . 4 1 4      I p ( m a x ) = 1 0 . 0
l p ( m a x ) = 1 0 . 0      U N I T : A
```

3. Move the cursor by pressing ( **◀**, **▶** ) to the command line of “CF=”.

```
l s e t = 5 . 1 0 0      C F = 1 . 4 1 4      I p ( m a x ) = 1 0 . 0
l p ( m a x ) = 1 0 . 0      U N I T : A
```

4. Press **1**, **.**, **5**, **1** then press **ENTER** to change the value to “1.510”.

```
l s e t = 5 . 1 0 0      C F = 1 . 5 1 0      I p ( m a x ) = 1 0 . 0
U N I T : A
```

5. Move the cursor by pressing ( **◀**, **▶** ) to the command line of “I<sub>p</sub>(max)=”.

```
l s e t = 5 . 1 0 0      C F = 1 . 5 1 0      I p ( m a x ) = 1 0 . 0
U N I T : A
```

6. Press **2**, **0**, **.**, **1** then press **ENTER** to change the value to “20.1”.

```
l s e t = 5 . 1 0 0      C F = 1 . 5 1 0      I p ( m a x ) = 2 0 . 1
U N I T : A
```



7. After setting the parameter of the load, the **LOAD ON/OFF** key should be pressed to turn on the load, so that the load can sink the current. (For more detailed information please refer section 3.4.5)

 **Notice** If there is error during the procedure of inputting value, press **CLEAR** to clear at any time and then input again.

### 3.6.3 PF Only

For switching PF only mode, the procedures are as below:

1. Press **CONF./LOCAL** key.
2. Press **1**, then press **ENTER** to enter SETUP. (The display please refers 3.6.1 BOTH mode.)
3. Move the direction key ( **▲**, **▼** ) to “1-5. CF/PF SETTING”.

- Press the direction key ( ,  ) or rotate the rotary knob to choose “PF”. (The display please refers 3.6.1 BOTH mode.)
- Then press **CC** to enter the PF only mode.

Users can press the arrow key to select the setting parameters on the LCD display, including current RMS value, PF, and  $I_p(\max)$ . Users can type the values of current, PF and  $I_p(\max)$  with the Entry keys.

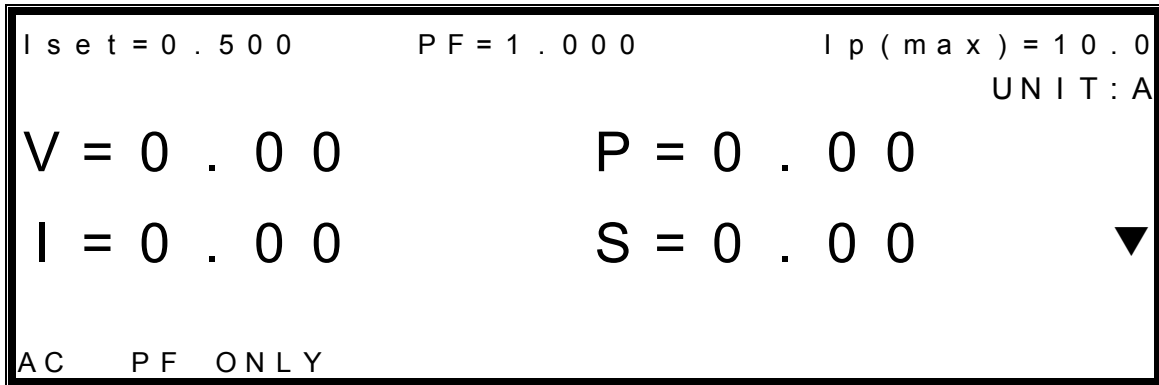

The procedures of setting  $I_{set} = 5.200$ ,  $PF = 0.88$  and  $I_p(\max) = 20.3$ , are described as below:

- Move the cursor to the command line of “ $I_{set}$ ”.

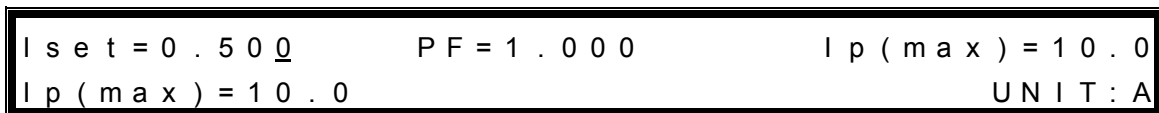

- Press **5**, **.**, **2** then press **ENTER** to change the value to “5.200”.

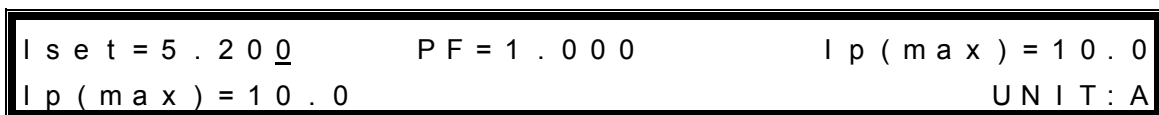

- Move the cursor by pressing ( ,  ) to the command line of “PF”.

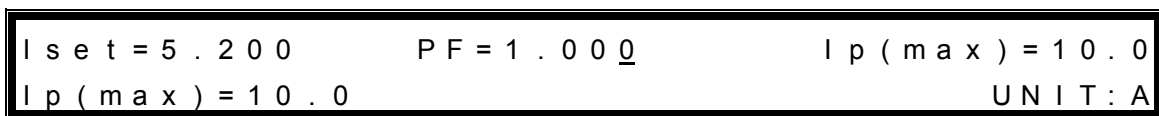

- Press **0**, **.**, **8**, **8** then press **ENTER** to change the value to “0.880”.

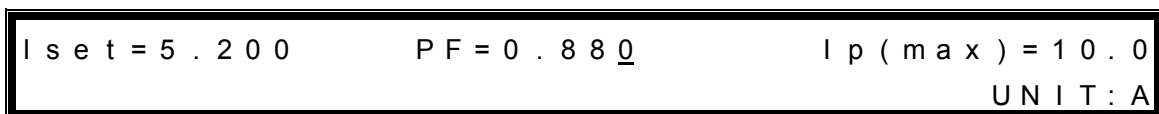

- Move the cursor by pressing ( ,  ) to the command line of “ $I_p(\max)$ ”.



l s e t = 5 . 2 0 0	P F = 0 . 8 8 0	I p ( m a x ) = 1 0 . 0
U N I T : A		

6. Press **2**, **0**, **.**, **3** then press **ENTER** to change the value to “20.3”.

l s e t = 5 . 2 0 0	P F = 0 . 8 8 0	I p ( m a x ) = 2 0 . 3
U N I T : A		

7. After setting the parameter of the load, the **LOAD ON/OFF** key should be pressed to turn on the load, so that the load can sink the current. (For More detailed information please refers section 3.4.5.)

**Notice** If there is error during the procedure of inputting value, press **CLEAR** to clear at any time and then input again.

### 3.7 AC Load Simulation -- Constant Resistance Mode

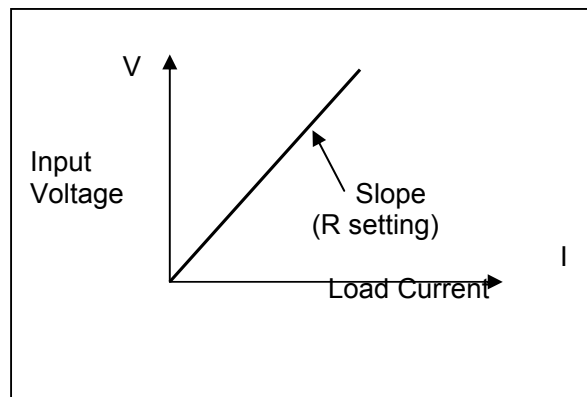

Figure 3-8 Constant Resistance Mode

In CR mode, the Load will sink a current linearly proportional to the input voltage in accordance with the programmed resistance. The waveform of the current is the same as the waveform of the input voltage, so the power factor allowed is 1.

The Electronic Load modules implement constant resistance mode by using CC circuits to regulate the input. The input voltage of the load is regarded as reference for current control. The formula  $I/V = 1/R$ .

V : input voltage.  
 I : controlled parameter to determine the resistance.  
 1/R : conductance, reciprocal of resistance.

The specifications of CR mode accuracy are specified as conductance. The effect on the programmed resistance value is not linear over the resistance range, because resistance is

the reciprocal of conductance. The electronic load is designed for high current applications of CR mode. Therefore, when large resistance is required, accuracy can be improved by reading the voltage and current from the load, calculating the actual resistance, and adjusting the set value.

To calculate the accuracy of programmed value error, the programmed value must be reciprocated first. The error is then applied to the programmed value (conductance), and the result is once again reciprocated. The following example illustrates the worst-case error of CR mode.

Example: 1 to 1000 ohm range of model 63804

The accuracy for this range is specified as 0.5% + 0.5%FS.  
If 5 ohm is programmed, the actual resistance will be

$$\begin{array}{ll} \text{conductance} & : 0.2 + (0.2 \times 0.5\% + 1 \times 0.5\%) & \text{to} & 0.2 - (0.2 \times 0.5\% + 1 \times 0.5\%) \\ \text{resistance} & : 4.854 \Omega & & \text{to} & 5.154 \Omega \end{array}$$

If 100 ohm is programmed, the actual resistance will be

$$\begin{array}{ll} \text{conductance} & : 0.01 + (0.01 \times 0.5\% + 1 \times 0.5\%) & \text{to} & 0.01 - (0.01 \times 0.5\% + 1 \times 0.5\%) \\ \text{resistance} & : 66.445 \Omega & & \text{to} & 202.02 \Omega \end{array}$$

To set programmed CR mode is by pressing **CR**. Users can press the arrow key to select the setting parameters on the LCD display, including resistor value and  $I_{rms(max)}$ .

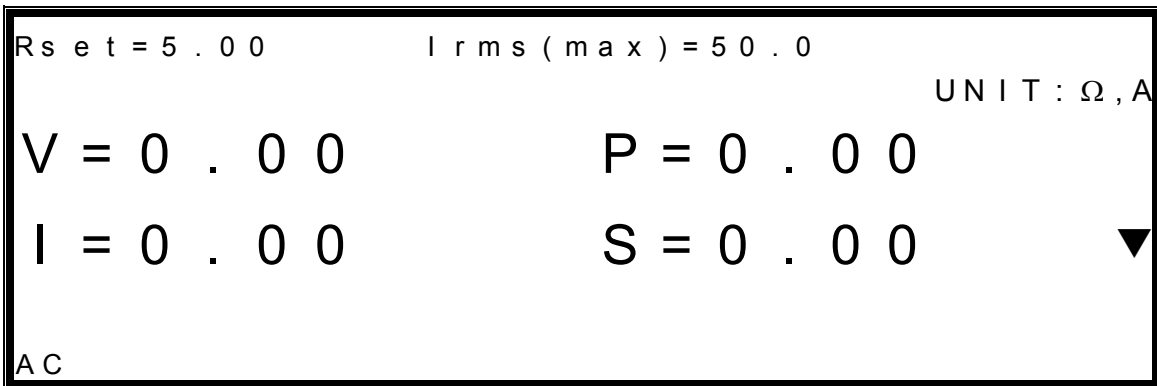

The procedures of setting  $R_{set} = 10.50$  and  $I_{rms(max)} = 20.0$ , are described as below:

1. Move the cursor to the command line of " $R_{set} =$ ".

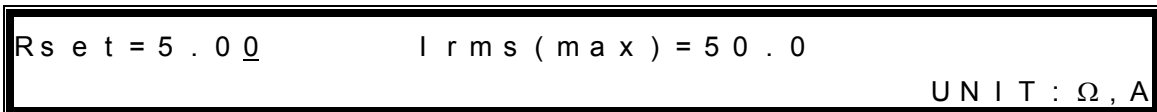

2. Press **1**, **0**, **.**, **5** then press **ENTER** to change the value to "10.50".

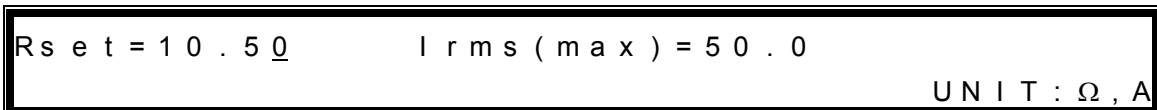

3. Move the cursor by pressing (  $\leftarrow$ ,  $\rightarrow$  ) to the command line of “I<sub>rms</sub>(max)=”.

```
Rs e t = 1 0 . 5 0      I r m s ( m a x ) = 5 0 . 0
                                                                    U N I T : Ω , A
```

4. Press **2**, **0** then press **ENTER** to change the value to “20.0”.

```
Rs e t = 1 0 . 5 0      I r m s ( m a x ) = 2 0 . 0
                                                                    U N I T : Ω , A
```

5. After setting the parameter of the load, the **LOAD ON/OFF** key should be pressed to turn on the load, so that the load can sink the current. (For the detailed information please refers section 3.4.5.)

**Notice** : If there is error during the procedure of inputting value, press **CLEAR** to clear at any time and then input again.

## 3.8 AC Load Simulation -- Constant Power Mode

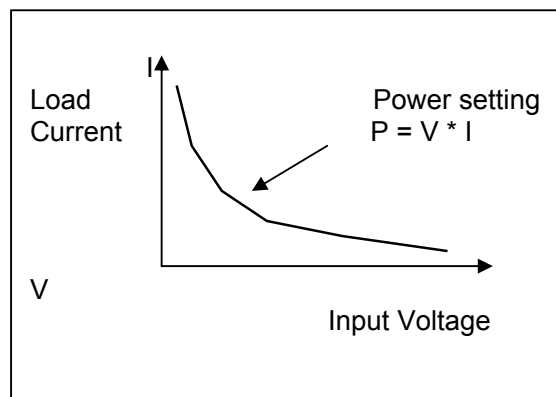

In CP mode, the Load will sink a current according to the programmed power. This mode is operated under the firmware calculation. That is, take the measured V data, divide the Power setting and get the I setting value.

The waveform of the current is programmed as a sinusoidal wave synchronized by the zero-crossing waveform of input voltage. The values of the PF and CF can be programmed in CP mode as well as in CC mode.

In this mode, there are CF only, PF only and BOTH for selection. The following is only focused on the BOTH mode to describe, others about the setting methods of CF only and PF only please refers section 3.6.2 and 3.6.3. CP mode can be set by pressing **CP** key. Users can press the arrow key to select the setting parameters on the LCD display, including current Power value, CF, PF, and I<sub>p</sub>(max).

**Notice** If the voltage is drawn to 0V under CP mode, it will trigger the warning of Load Fail (LDF). Meanwhile, the loading for the load will be stopped.

**WARNING** When LDF warning is triggered then press power switch to restart AC load. If AC load can not function normally after restarting, please contact Chroma sales or service office.

**Notice** The output voltage of UUT will distort because of loading current. If the output voltage of the UUT becomes distortion and drops below 10V due to the loading, the AC load will stop the loading.

### 3.8.1 BOTH

The default value in CP mode is the BOTH mode.

To switch from other modes to BOTH mode, its setting methods are as follows.

1. Press **CONF./LOCAL** key.
2. Press **1**, then press **ENTER** to enter SETUP.

```

[CONF]
CHOOSE = 1    1 . SETUP
               2 . REMOTE
               3 . CALIBRATION
               4 . DISPLAY SELECTION
               5 . FACTORY DEFAULT
               6 . MODEL INFORMATION
               7 . PARALLEL MODE
    
```

3. Move the direction key (▲, ▼) to “1-5. CF/PF SETTING”.
4. Press the direction key (◀, ▶) or rotate the rotary knob to choose “BOTH”, then press **ENTER**.

```

1 - 1 . MODE SELECT      = AC / DC           [SETUP]
1 - 2 . SHORT            = OFF / TOGGLE / HOLD
1 - 3 . LOCK MODE       = ROTARY / KEYPAD / ALL
1 - 4 . SOUND           = ON / OFF
1 - 5 . CF / PF SETTING = BOTH / CF / PF
1 - 6 . TIMING MODE     = OFF / HOLDUP / TRANSFER
1 - 7 . EXTERNAL        = OFF / ON
1 - 8 . ABA MODE       = ENABLE / DISABLE
    
```

- After pressing **ENTER**, meanwhile a window will be popped up to request users to key in the priorities of CF and PF.
- Press the direction key ( **◀**, **▶** ) or rotate the rotary knob to choose the priority you want then press **ENTER**. If **ENTER** is not pressed, a window will not be popped up thus the priority is the setting value last time.

CF PF P R I O R I T Y = C F / P F

- Press **CP** key to back to main page.
- Press **LOAD ON/OFF** to run program when the program function is selected.

In the main page, users can press the arrow key to select the setting parameters on the LCD display, including current RMS value, CF, PF, and  $I_p(\text{max})$ . Users can type the values of power, CF, PF and  $I_p(\text{max})$  with the Entry keys. The values of CF and PF have interdependent relationship. When **PRIORITY : CF**, PF has the limitations of maximum and minimum. Contrarily, when **PRIORITY : PF**, CF also has the limitations of maximum and minimum. (More detailed information please refers section 3.4.6.)

P s e t = 4 5 0 0 . 0	C F = 1 . 4 1 4	P F = 1 . 0 0 0
I p ( m a x ) = 3 0 . 0		U N I T : W , A
V = 0 . 0 0	P = 0 . 0 0	
I = 0 . 0 0	S = 0 . 0 0	▼
A C P R I O R I T Y : C F		

The procedures of setting  $P_{\text{set}} = 2200.0$ ,  $CF = 2.000$ ,  $PF = 0.780$ , and  $I_p(\text{max}) = 25.0$ , are described as below:

- Move the cursor to the command line of " $P_{\text{set}} =$ ".

P s e t = 4 5 0 0 . <u>0</u>	C F = 1 . 4 1 4	P F = 1 . 0 0 0
I p ( m a x ) = 3 0 . 0		U N I T : W , A

- Press **2** , **2** , **0** , **0** then press **ENTER** to change the value to "2200.0".

```
P s e t = 2 2 0 0 . 0      C F = 1 . 4 1 4      P F = 1 . 0 0 0
l p ( m a x ) = 3 0 . 0      U N I T : W , A
```

3. Move the cursor by pressing ( ,  ) to the command line of “CF=”.





```
P s e t = 2 2 0 0 . 0      C F = 1 . 4 1 4      P F = 1 . 0 0 0
l p ( m a x ) = 3 0 . 0      U N I T : W , A
```

4. Press  then press  to change the value to “2.000”.

```
P s e t = 2 2 0 0 . 0      C F = 2 . 0 0 0      P F = 1 . 0 0 0
l p ( m a x ) = 3 0 . 0      U N I T : W , A
```

5. Move the cursor by pressing ( ,  ) to the command line of “PF=”.

```
P s e t = 2 2 0 0 . 0      C F = 2 . 0 0 0      P F = 1 . 0 0 0 0
l p ( m a x ) = 3 0 . 0      U N I T : W , A
```

6. Press , , ,  then press  to change the value to “0.780”.

```
P s e t = 2 2 0 0 . 0      C F = 2 . 0 0 0      P F = 0 . 7 8 0 0
l p ( m a x ) = 3 0 . 0      U N I T : W , A
```



7. Move the cursor by pressing ( ,  ) to the command line of “I<sub>p</sub>(max)=”.

```
P s e t = 2 2 0 0 . 0      C F = 2 . 0 0 0      P F = 0 . 7 8 0
l p ( m a x ) = 3 0 . 0      U N I T : W , A
```

8. Press ,  then press  to change the value to “25.0”.

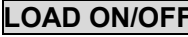
```
P s e t = 2 2 0 0 . 0      C F = 2 . 0 0 0      P F = 0 . 7 8 0
l p ( m a x ) = 2 5 . 0      U N I T : W , A
```

9. After setting the parameter of the load, the  key should be pressed to turn on the load, so that the load can sink the current. (For the detailed information please refers section 3.4.5.)

 **Notice** If there is error during the procedure of inputting value, press  to clear the value at any time and then input again.

### 3.8.2 CF Only

For switching to CF only mode, the procedures are as below:

1. Press **CONF./LOCAL** key.
2. Press **1**, then press **ENTER** to enter SETUP. (The display please refers 3.8.1 BOTH mode.)
3. Move the direction key ( **▲**, **▼** ) to “1-5. CF/PF SETTING”.
4. Press the direction key ( **◀**, **▶** ) or rotate the rotary knob to choose “CF”, then press **ENTER**. (The display please refers 3.8.1 BOTH mode)
5. Then press **CP** to back to main page.

Users can press the arrow key to select the setting parameters on the LCD display, including power value, CF, and  $I_p(\max)$ .

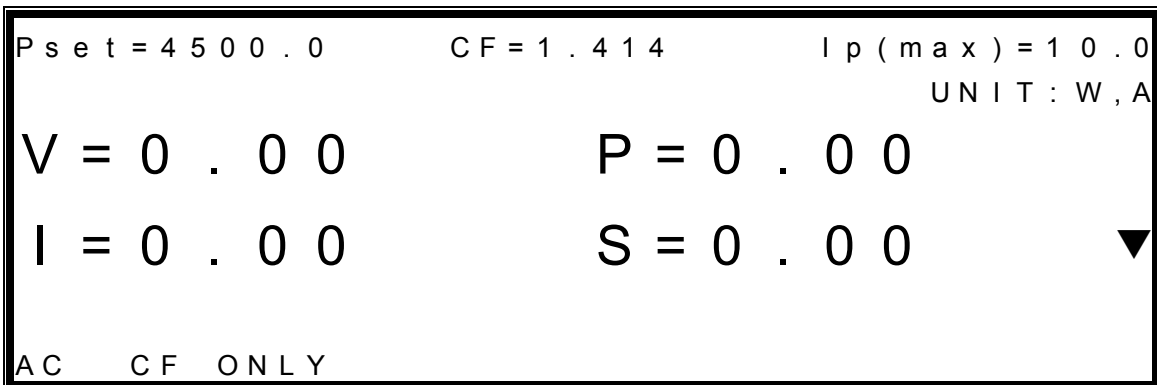

### 3.8.3 PF Only

For switching PF only mode, the procedures are as below:

1. Press **CONF./LOCAL** key.
2. Press **1**, then press **ENTER** to enter SETUP. (The display please refers 3.8.1 BOTH mode.)
3. Move the direction key ( **▲**, **▼** ) to “1-5. CF/PF SETTING”.
4. Press the direction key ( **◀**, **▶** ) or rotate the rotary knob to choose “PF”. (The display please refers 3.8.1 BOTH mode.)
5. Then press **CP** to enter the PF only mode.

Users can press the arrow key to select the setting parameters on the LCD display, including current RMS value, PF, and  $I_p(\max)$ . Users can type the values of current, PF and  $I_p(\max)$  with the Entry keys.

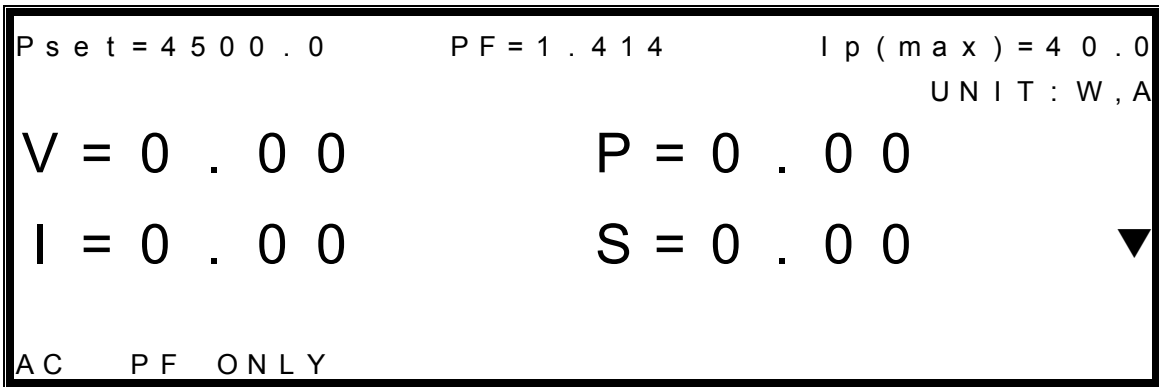

### 3.9 AC Load Simulation -- Rectified Load Mode

The general AC products like UPS and AC SOURCE often use rectified load to test their features as Figure 3-8 shows. Based on the load network, rectified load mode is designed into three sub modes – RLC mode, CP mode and Inrush Current mode.

**Notice** The operating frequency should be lower than 70Hz under Rectified Load Mode.

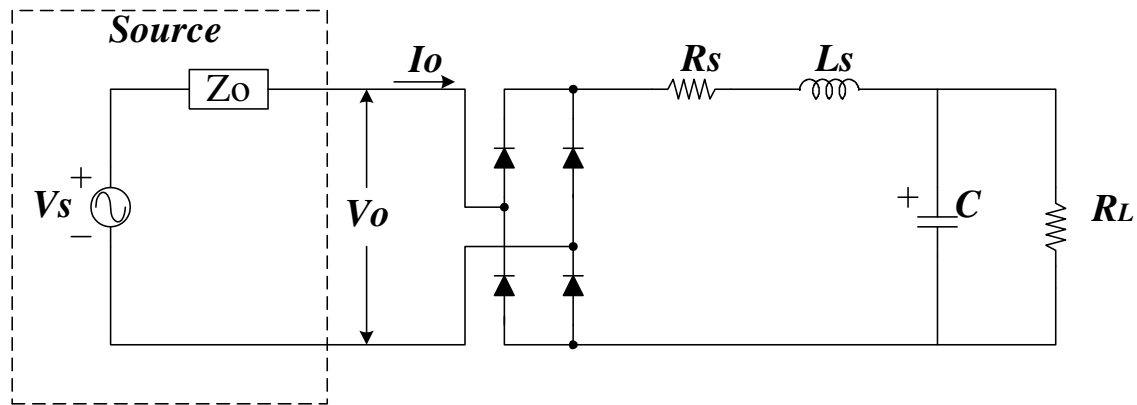

Figure 3-10 Schema of rectified load

#### 3.9.1 RLC Mode

For switching RLC mode, the procedures are as below:

1. Press **RLC/DC RECT** key to go into the Rectified Load Mode.
2. Press **1**, then press **ENTER** to enter RLC mode.



[ RECTIFIED LOAD ]

CHOOSE = 1

1 . R L C    M O D E  
2 . C P      M O D E  
3 . I N R U S H    C U R R E N T

Users are able to set the equivalent series resistance  $R_s$ , equivalent series inductance  $L_s$ , equivalent parallel load capacitance  $C$ , equivalent parallel load resistance  $R_L$  and  $I_{rms(max)}$  parameters for loading when operating in this mode. The UUT  $I_p(max)$  value needs to be set before loading and the parameter range for setting is listed in the specifications.

$R_s = 0.11$        $L_s = 200$        $C = 2000$        $R_L = 5000.00$   
 $I_p(max) = 10.0$       UNIT:  $\Omega$ ,  $\mu H$ ,  $\mu F$ , A  
 $V = 0.00$        $P = 0.00$   
 $I = 0.00$        $S = 0.00$  ▼

AC

The procedures of setting  $R_s = 0.2$ ,  $L_s = 100$ ,  $C = 2300$ ,  $R_L = 4500$ , and  $I_p(max) = 30.0$ , are described as below:

1. Move the cursor to the command line of " $R_s$ ".

$R_s = 0.11$        $L_s = 200$        $C = 2000$        $R_L = 5000.00$   
 $I_p(max) = 10.0$       UNIT:  $\Omega$ ,  $\mu H$ ,  $\mu F$ , A

2. Press **0**, **.**, **2** then press **ENTER** to change the value to "0.20".

$R_s = 0.20$        $L_s = 200$        $C = 2000$        $R_L = 5000.00$   
 $I_p(max) = 10.0$       UNIT:  $\Omega$ ,  $\mu H$ ,  $\mu F$ , A

3. Move the cursor by pressing (**←**, **→**) to the command line of " $L_s$ ".

$R_s = 0.20$        $L_s = 200$        $C = 2000$        $R_L = 5000.00$   
 $I_p(max) = 10.0$       UNIT:  $\Omega$ ,  $\mu H$ ,  $\mu F$ , A

4. Press **1**, **0**, **0** then press **ENTER** to change the value to “100”.

```
Rs = 0 . 2 0      Ls = 1 0 0      C = 2 0 0 0      RL = 5 0 0 0 . 0 0
Ip (max) = 1 0 . 0      UNIT : Ω , uH , uF , A
```

5. Move the cursor by pressing ( **◀**, **▶** ) to the command line of “C=”.

```
Rs = 0 . 2 0      Ls = 1 0 0      C = 2 0 0 0      RL = 5 0 0 0 . 0 0
Ip (max) = 1 0 . 0      UNIT : Ω , uH , uF , A
```

6. Press **2**, **3**, **0**, **0** then press **ENTER** to change the value to “2300”.

```
Rs = 0 . 2 0      Ls = 1 0 0      C = 2 3 0 0      RL = 5 0 0 0 . 0 0
Ip (max) = 1 0 . 0      UNIT : Ω , uH , uF , A
```

7. Move the cursor by pressing ( **◀**, **▶** ) to the command line of “RL=”.

```
Rs = 0 . 2 0      Ls = 1 0 0      C = 2 3 0 0      RL = 5 0 0 0 . 0 0
Ip (max) = 1 0 . 0      UNIT : Ω , uH , uF , A
```

8. Press **4**, **5**, **0**, **0** then press **ENTER** to change the value to “4500”.

```
Rs = 0 . 2 0      Ls = 1 0 0      C = 2 3 0 0      RL = 4 5 0 0 . 0 0
Ip (max) = 1 0 . 0      UNIT : Ω , uH , uF , A
```

9. Move the cursor by pressing ( **◀**, **▶** ) to the command line of “Ip(max)=”.

```
Rs = 0 . 2 0      Ls = 1 0 0      C = 2 3 0 0      RL = 4 5 0 0 . 0 0
Ip (max) = 1 0 . 0      UNIT : Ω , uH , uF , A
```

10. Press **3** , **0** then press **ENTER** to change the value to “30.0”.

```
Rs = 0 . 2 0      Ls = 1 0 0      C = 2 3 0 0      RL = 4 5 0 0 . 0 0
Ip (max) = 3 0 . 0      UNIT : Ω , uH , uF , A
```

11. After setting the parameter of the load, the **LOAD ON/OFF** key should be pressed to turn on the load, so that the load can sink the current. (For more detailed information please refers section 3.4.5.)

 **Notice** If there is error during the procedure of inputting value, press **CLEAR** to clear the value at any time and then input again.

### 3.9.2 CP Mode

The appropriate parameter values of  $R_s$ ,  $L_s$ ,  $C$ ,  $R_L$  can be calculated by the algorithm of  $P_{set}$  and PF settings. The value will be used to execute loading and the loading power will be compensated automatically to be within the error range. The UUT  $I_p(max)$  needs to be set before loading.

For switching to CP mode, the procedures are as below:

1. Press **RLC/DC RECT** key to go into the Rectified Load Mode.
2. Press **2**, then press **ENTER** to enter CP mode.

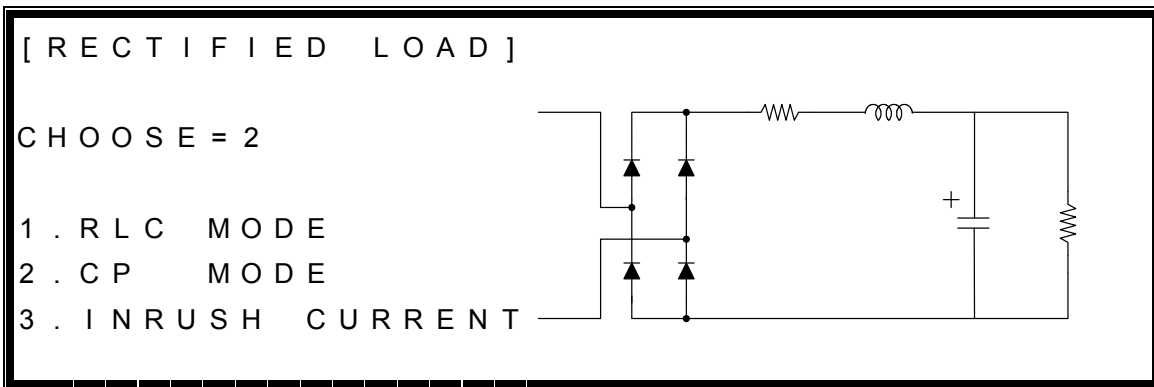

Users can press the arrow key to select the setting parameters on the LCD display, including real power  $P_{set}$ , PF and  $I_p(max)$ .

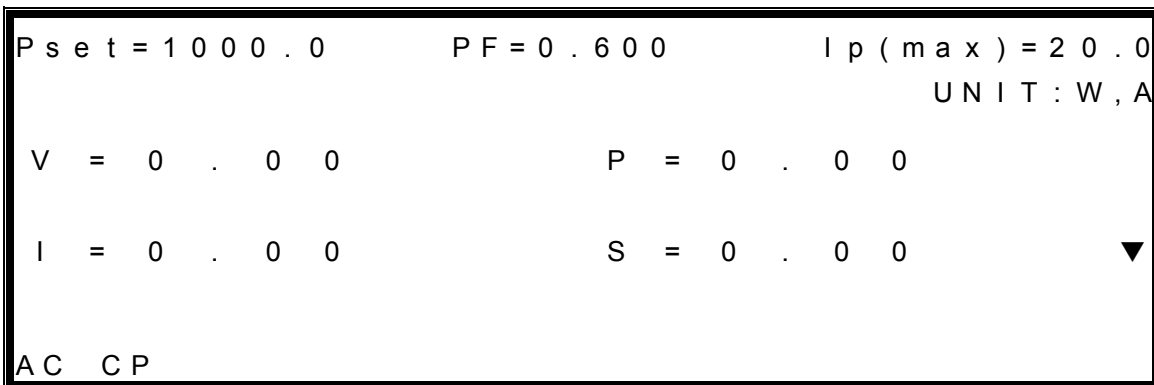

**Notice** The input ranges of  $P_{set}$  and PF are 200W to 3375W and 0.4 to 0.75 in CP mode.

63800 calculates a group of  $R_s$ ,  $L_s$ ,  $C$  and  $R_L$  for loading by  $P_{set}$ , PF values and UUT's impedance which set by users. Users can press **▲** and **▼** to view the values of  $R_s$ ,  $L_s$ ,  $C$  and  $R_L$  as below.

```

P s e t = 1 0 0 0 . 0      P F = 0 . 6 0 0      I p ( m a x ) = 2 0 . 0
                                  U N I T : W , A

I p + = 0 . 0 0      T H D = 0 . 0 0      ▲
I p - = 0 . 0 0      R s = 0 . 0 0 0      L s = 0
                                  C = 0      R L = 0 . 0 0

A C   C P
    
```

The procedures of setting  $P_{set} = 500$ ,  $PF = 0.700$ , and  $I_p(max) = 30.0$ , are described as below:

1. Move the cursor to the command line of “ $P_{set} =$ ”.

```

P s e t = 1 0 0 0 . 0      P F = 0 . 6 0 0      I p ( m a x ) = 2 0 . 0
                                  U N I T : W , A
    
```

2. Press **5**, **0**, **0** then press **ENTER** to change the value to “500.0”.

```

P s e t = 5 0 0 . 0      P F = 0 . 6 0 0      I p ( m a x ) = 2 0 . 0
                                  U N I T : W , A
    
```

3. Move the cursor by pressing ( **◀**, **▶** ) to the command line of “PF=”.

```

P s e t = 5 0 0 . 0      P F = 0 . 6 0 0      I p ( m a x ) = 2 0 . 0
                                  U N I T : W , A
    
```

4. Press **0**, **.**, **7** then press **ENTER** to change the value to “0.700”.

```

P s e t = 5 0 0 . 0      P F = 0 . 7 0 0      I p ( m a x ) = 2 0 . 0
                                  U N I T : W , A
    
```

5. Move the cursor by pressing ( **◀**, **▶** ) to the command line of “ $I_p(max) =$ ”.

```

P s e t = 5 0 0 . 0      P F = 0 . 7 0 0      I p ( m a x ) = 2 0 . 0
                                  U N I T : W , A
    
```

6. Press **3**, **0** then press **ENTER** to change the value to “30.0”.

```

P s e t = 5 0 0 . 0           P F = 0 . 7 0 0           I p ( m a x ) = 3 0 . 0
                                                                    U N I T : W , A

```

7. After setting the parameter of the load, the **LOAD ON/OFF** key should be pressed to turn on the load, so that the load can sink the current. (For the detailed information please refers section 3.4.5.)

**Notice** If there is error during the procedure of inputting value, press **CLEAR** to clear the value at any time and then input again.

When the values of  $P_{set}$  and  $I_p(max)$  are in unreasonable range then 63800 AC/DC Electronic Load will pop up a "Setting Error" warning window is shown as below figure. The window informs that users' settings are unreasonable range, users can press **ENTER** to exit this warning window to reset the values of  $P_{set}$  and  $I_p(max)$ .

```

S e t t i n g   E r r o r ! !
P l e a s e   c h e c k   t h e   s e t t i n g
v a l u e s : P s e t   a n d   I p ( m a x ) .

```

**WARNING** If the setting value of  $P_{set}$  and  $I_p(max)$  are unreasonable range then the AC load will not load the UUT. For example, when voltage is 50Vrms and users set  $P_{set}=1000W$ ,  $I_p(max) = 10Arms$ . If  $P_{set}=1000W$ , the reasonable loading current should be 20Arms. Thus, for the setting of  $I_p(max)=10Arms$  the AC load will not load the UUT, please adjust  $P_{set}$  lower or  $I_p(max)$  higher to the reasonable range value.

### 3.9.3 Inrush Current Mode

The RLC load network (Figure 3-10) can test the inrush current output of UUT. First, input the load network parameter ( $R_s$ ,  $L_s$ ,  $C$ ,  $R_L$ ) and use DSP to control the initial loading position. It can simulate the input angle during maximum inrush current output.  $I_p(max)$  is the parameter needed to be set as well for the subsequent loading. (For the detailed information please refers section 3.4.7.)

For switching to Inrush Current mode, the procedures are as below:

1. Press **RLC/DC RECT** key to go into the Rectified Load Mode.
2. Press **3**, then press **ENTER** to enter Inrush Current mode.

[ RECTIFIED LOAD ]

CHOOSE = 2

1 . R L C    M O D E  
2 . C P     M O D E  
3 . I N R U S H    C U R R E N T

Users can press the arrow key to select the setting parameters on the LCD display, including equivalent series resistance  $R_s$ , equivalent series inductance  $L_s$ , equivalent parallel load capacitance  $C$ , equivalent parallel load resistance  $R_L$ , phase in angle and  $I_p(\max)$ . Users can type the values with the Entry keys.

$R_s = 0 . 1 1$        $L_s = 2 0 0$        $C = 2 0 0 0$        $R_L = 5 0 0 0 . 0 0$   
 $P H A S E = 9 0$        $I_p ( m a x ) = 1 0$       U N I T :  $\Omega$  ,  $\mu H$  ,  $\mu F$  ,  $\cdot$  , A

$V = 0 . 0 0$                        $P = 0 . 0 0$   
 $I = 0 . 0 0$                        $S = 0 . 0 0$                       ▼

A C   I N R U S H

The procedures of setting  $R_s = 0.02$ ,  $L_s = 110$ ,  $C = 2400$ ,  $R_L = 3600$ ,  $P H A S E = 180$  and  $I_p(\max) = 40.0$ , are described as below:

1. Move the cursor to the command line of " $R_s$ ".

$R_s = 0 . 0 \underline{1}$        $L_s = 2 0 0$        $C = 2 0 0 0$        $R_L = 5 0 0 0 . 0 0$   
 $P H A S E = 9 0$        $I_p ( m a x ) = 1 0$       U N I T :  $\Omega$  ,  $\mu H$  ,  $\mu F$  ,  $\cdot$  , A

2. Press **0**, **.**, **0**, **2** then press **ENTER** to change the value to "0.02".

$R_s = 0 . 0 \underline{2}$        $L_s = 2 0 0$        $C = 2 0 0 0$        $R_L = 5 0 0 0 . 0 0$   
 $P H A S E = 9 0$        $I_p ( m a x ) = 1 0$       U N I T :  $\Omega$  ,  $\mu H$  ,  $\mu F$  ,  $\cdot$  , A

3. Move the cursor by pressing (**◀**, **▶**) to the command line of " $L_s$ ".

$R_s = 0 . 0 2$        $L_s = 2 0 \underline{0}$        $C = 2 0 0 0$        $R_L = 5 0 0 0 . 0 0$   
 $P H A S E = 9 0$        $I_p ( m a x ) = 1 0$       U N I T :  $\Omega$  ,  $\mu H$  ,  $\mu F$  ,  $\cdot$  , A

4. Press **1**, **1**, **0** then press **ENTER** to change the value to “110”.

```
Rs = 0 . 0 2      L s = 1 1 0      C = 2 0 0 0      R L = 5 0 0 0 . 0 0
PHASE = 9 0      I p ( m a x ) = 1 0      UNIT : Ω , u H , u F , . , A
```

5. Move the cursor by pressing ( **◀**, **▶** ) to the command line of “C=”.

```
Rs = 0 . 0 2      L s = 1 1 0      C = 2 0 0 0      R L = 5 0 0 0 . 0 0
PHASE = 9 0      I p ( m a x ) = 1 0      UNIT : Ω , u H , u F , . , A
```

6. Press **2**, **3**, **0**, **0** then press **ENTER** to change the value to “2300”.

```
Rs = 0 . 0 2      L s = 1 1 0      C = 2 3 0 0      R L = 5 0 0 0 . 0 0
PHASE = 9 0      I p ( m a x ) = 1 0      UNIT : Ω , u H , u F , . , A
```

7. Move the cursor by pressing ( **◀**, **▶** ) to the command line of “RL=”.

```
Rs = 0 . 0 2      L s = 1 1 0      C = 2 3 0 0      R L = 5 0 0 0 . 0 0
PHASE = 9 0      I p ( m a x ) = 1 0      UNIT : Ω , u H , u F , . , A
```

8. Press **3**, **6**, **0**, **0** then press **ENTER** to change the value to “3600”.

```
Rs = 0 . 0 2      L s = 1 1 0      C = 2 3 0 0      R L = 3 6 0 0 . 0 0
PHASE = 9 0      I p ( m a x ) = 1 0      UNIT : Ω , u H , u F , . , A
```

9. Move the cursor by pressing ( **◀**, **▶** ) to the command line of “PHASE=”.

```
Rs = 0 . 0 2      L s = 1 1 0      C = 2 3 0 0      R L = 3 6 0 0 . 0 0
PHASE = 9 0      I p ( m a x ) = 1 0      UNIT : Ω , u H , u F , . , A
```

10. Press **1**, **8**, **0** then press **ENTER** to change the value to “180”.

```
Rs = 0 . 0 2      L s = 1 1 0      C = 2 3 0 0      R L = 3 6 0 0 . 0 0
PHASE = 1 8 0      I p ( m a x ) = 1 0      UNIT : Ω , u H , u F , . , A
```

11. Move the cursor by pressing ( **◀**, **▶** ) to the command line of “I<sub>p</sub>(max)=”.

```
Rs = 0 . 0 2      L s = 1 1 0      C = 2 3 0 0      R L = 3 6 0 0 . 0 0
PHASE = 1 8 0      I p ( m a x ) = 1 0      UNIT : Ω , u H , u F , . , A
```

12. Press **3**, **0** then press **ENTER** to change the value to “30.0”.

R s = 0 . 0 2	L s = 1 1 0	C = 2 3 0 0	R L = 3 6 0 0 . 0 0
PHASE = 1 8 0	I p ( m a x ) = 3 0	UNIT : Ω , u H , u F , . , A	

13. After setting the parameter of the load, the **LOAD ON/OFF** key should be pressed to turn on the load, so that the load can sink the current. (For the detailed information please refers section 3.4.5.)

**Notice** If there is error during the procedure of inputting value, press **CLEAR** to clear the value at any time and then input again.

The below is the waveform figure of measured inrush current.

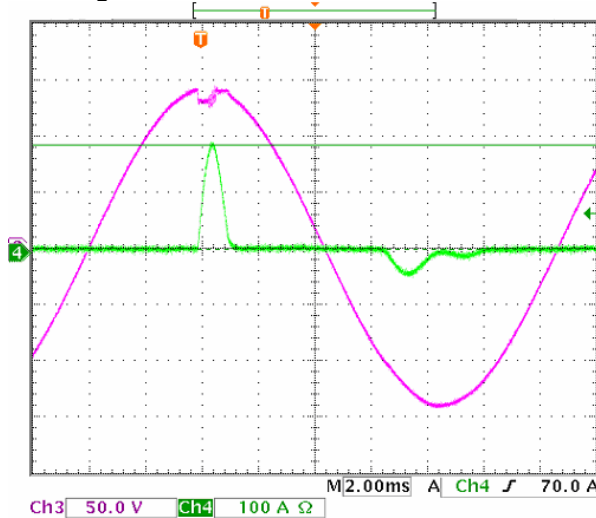

### 3.10 AC Load Simulation -- Timing Mode

Timing mode can be executed in CC, CR, CP and Rectified mode under AC mode. After Load ON, the timer starts to count time. The timing mode has three methods for stopping the count. 1. Load OFF. 2. The UUT’s voltage is lower than the Cutoff voltage set. 3. The timer has reached the time set. Moreover, 63800 also provides the function of measuring transfer time. This function is mainly to measure the UPS’s transfer time from Main power to Battery mode. However, the transfer time can only be used in CR mode under AC mode.

For switching to Timing mode, its setting methods are as follows.





1. Press **CONF./LOCAL** key.
2. Press **1**, then press **ENTER** to enter SETUP.



```

[ CONF ]
CHOOSE = 1   1 . S E T U P
              2 . R E M O T E
              3 . C A L I B R A T I O N
              4 . D I S P L A Y   S E L E C T I O N
              5 . F A C T O R Y   D E F A U L T
              6 . M O D E L   I N F O R M A T I O N
              7 . P A R A L L E L   M O D E

```

3. Move the cursor direction key ( ,  ) to "1-6. TIMING MODE".
4. Press the direction key ( ,  ) or rotate the rotary knob to choose "HOLDUP", then press **ENTER**.

```

1 - 1 . M O D E   S E L E C T   = A C / D C           [ S E T U P ]
1 - 2 . S H O R T               = O F F / T O G G L E / H O L D
1 - 3 . L O C K   M O D E       = R O T A R Y / K E Y P A D / A L L
1 - 4 . S O U N D               = O N / O F F
1 - 5 . C F / P F   S E T T I N G = B O T H / C F / P F
1 - 6 . T I M I N G   M O D E   = H O L D U P / T R A N S F E R / O F F
1 - 7 . E X T E R N A L         = O F F / O N
1 - 8 . A B A   M O D E         = E N A B L E / D I S A B L E

```

5. Press **CC**, **CR** or **CP** key to back to main page of timing mode.

Example: CR mode under Timing mode.

```

R s e t = 2 5 . 0 0 0           I r m s ( m a x ) = 5 0 . 0
T I M E O U T = 0 0 : 0 1 : 0 0   C U T O F F   V = 5 0 . 0 0 0
V = 0 . 0 0
T
H O L D U P   = 0 0 : 0 0 : 0 0 : 0 0 0 m s
A C

```

### 3.10.1 CC Mode

Once under timing mode, if users want to switch to CC mode of timing mode press **CC** key then to enter. There are three sub-modes under CC mode: BOTH, CF ONLY and PF ONLY.

If users want to switch to BOTH mode, its setting methods are as follows.

1. Press **CONF./LOCAL** key.
2. Press **1**, then press **ENTER** to enter SETUP.

```

                                [ CONF ]
CHOOSE = 1    1 . SETUP
                2 . REMOTE
                3 . CALIBRATION
                4 . DISPLAY SELECTION
                5 . FACTORY DEFAULT
                6 . MODEL INFORMATION
                7 . PARALLEL MODE
    
```

3. Move the cursor ( **▲**, **▼** ) to “1-5. CF/PF SETTING”.
4. Press the direction key ( **◀**, **▶** ) or rotate the rotary knob to choose “BOTH”, then press **ENTER**.

```

1 - 1 . MODE SELECT      = AC / DC          [ SETUP ]
1 - 2 . SHORT            = OFF / TOGGLE / HOLD
1 - 3 . LOCK MODE       = ROTARY / KEYPAD / ALL
1 - 4 . SOUND           = ON / OFF
1 - 5 . CF / PF SETTING = BOTH / CF / PF
1 - 6 . TIMING MODE     = HOLDUP / TRANSFER / OFF
1 - 7 . EXTERNAL        = OFF / ON
1 - 8 . ABA MODE        = ENABLE / DISABLE
    
```

5. After pressing **ENTER**, meanwhile a window will be popped up to request users to key in CF and PF priorities. .
6. Press the direction key ( **◀**, **▶** ) or rotate the rotary knob to choose the priority you want then press **ENTER**. If **ENTER** is not pressed, a window will not be popped up thus the priority is the setting value of last time.

C F P F P R I O R I T Y = C F / P F

7. Press **CC** key to back to main page of timing mode.

In the main page, users can press the arrow key to select the setting parameters on the LCD display, including current RMS value, CF, PF, and  $I_p(\text{max})$ . Users can type the values of current, CF, PF and  $I_p(\text{max})$  with the Entry keys. The values of CF and PF have interdependent relationship. When **PRIORITY : CF**, PF has the limitations of maximum and minimum. Contrarily, when **PRIORITY : PF**, CF also has the limitations of maximum and minimum. (More detailed information please refers section 3.4.5.)

```

I s e t = 2 5 . 0 0 0           C F = 1 . 4 1 4           P F = 1 . 0 0 0
I p ( m a x ) = 5 0 . 0       T I M E O U T = 0 0 : 0 1 : 0 0
V = 0 . 0 0                   C U T O F F V = 5 0 . 0 0 0

T
H O L D U P = 0 0 : 0 0 : 0 0 : 0 0 0 m s

A C       P R I O R I T Y : C F

```

The procedures of setting  $I_{\text{set}} = 18.000$ ,  $CF = 1.5$ ,  $PF = 0.800$ ,  $I_p(\text{max}) = 20.0$ , **TIME OUT = 00:20:00** and **CUTOFF V = 110**, are described as below:

1. Move the cursor to the command line of " $I_{\text{set}}="$ .

```

I s e t = 2 5 . 0 0 0           C F = 1 . 4 1 4           P F = 1 . 0 0 0
I p ( m a x ) = 5 0 . 0       T I M E O U T = 0 0 : 0 1 : 0 0
                               C U T O F F V = 5 0 . 0 0 0

```

2. Press **1**, **8** then press **ENTER** to change the value to "18.000".

```

I s e t = 1 8 . 0 0 0           C F = 1 . 4 1 4           P F = 1 . 0 0 0
I p ( m a x ) = 5 0 . 0       T I M E O U T = 0 0 : 0 1 : 0 0
                               C U T O F F V = 5 0 . 0 0 0

```

3. Move the direction by pressing (**◀**, **▶**) to the command line of "CF=".

```
I s e t = 1 8 . 0 0 0      C F = 1 . 4 1 4      P F = 1 . 0 0 0
I p ( m a x ) = 5 0 . 0      T I M E O U T = 0 0 : 0 1 : 0 0
                          C U T O F F   V = 5 0 . 0 0 0
```

4. Press **1**, **.**, **5** then press **ENTER** to change the value to "1.500".

```
I s e t = 1 8 . 0 0 0      C F = 1 . 5 0 0      P F = 1 . 0 0 0
I p ( m a x ) = 5 0 . 0      T I M E O U T = 0 0 : 0 1 : 0 0
                          C U T O F F   V = 5 0 . 0 0 0
```

5. Move the cursor by pressing ( **◀**, **▶** ) to the command line of "PF=".

```
I s e t = 1 8 . 0 0 0      C F = 1 . 5 0 0      P F = 1 . 0 0 0 
I p ( m a x ) = 5 0 . 0      T I M E O U T = 0 0 : 0 1 : 0 0
                          C U T O F F   V = 5 0 . 0 0 0
```

6. Press **0**, **.**, **8** then press **ENTER** to change the value to "0.800".

```
I s e t = 1 8 . 0 0 0      C F = 1 . 5 0 0      P F = 0 . 8 0 0 
I p ( m a x ) = 5 0 . 0      T I M E O U T = 0 0 : 0 1 : 0 0
                          C U T O F F   V = 5 0 . 0 0 0
```

7. Move the cursor by pressing ( **◀**, **▶** ) to the command line of "I<sub>p</sub>(max)=".



```
I s e t = 1 8 . 0 0 0      C F = 1 . 5 0 0      P F = 0 . 8 0 0
I p ( m a x ) = 5 0 . 0      T I M E O U T = 0 0 : 0 1 : 0 0
                          C U T O F F   V = 5 0 . 0 0 0
```

8. Press **2**, **0** then press **ENTER** to change the value to "20.0".

```
I s e t = 1 8 . 0 0 0      C F = 1 . 5 0 0      P F = 0 . 8 0 0
I p ( m a x ) = 2 0 . 0      T I M E O U T = 0 0 : 0 1 : 0 0
                          C U T O F F   V = 5 0 . 0 0 0
```

9. Move the cursor by pressing ( **◀**, **▶** ) to the command line of "TIME OUT=".

```
I s e t = 1 8 . 0 0 0      C F = 1 . 5 0 0      P F = 0 . 8 0 0
I p ( m a x ) = 2 0 . 0      T I M E O U T = 0 0 : 0 1 : 0 0
                          C U T O F F   V = 5 0 . 0 0 0
```

10. Move the cursor by pressing ( ,  ) to the command line of “TIME OUT=00:01:00”.

```
l s e t = 1 8 . 0 0 0          C F = 1 . 5 0 0          P F = 0 . 8 0 0
l p ( m a x ) = 2 0 . 0      T I M E O U T = 0 0 : 0 1 : 0 0
                              C U T O F F   V = 5 0 . 0 0 0
```

11. Press **CLEAR** then press **ENTER** to clear the value to “00:00:00”.

```
l s e t = 1 8 . 0 0 0          C F = 1 . 5 0 0          P F = 0 . 8 0 0
l p ( m a x ) = 2 0 . 0      T I M E O U T = 0 0 : 0 0 : 0 0
                              C U T O F F   V = 5 0 . 0 0 0
```

12. Press **2**, **0** then press **ENTER** to change the value to “00:20:00”.

```
l s e t = 1 8 . 0 0 0          C F = 1 . 5 0 0          P F = 0 . 8 0 0
l p ( m a x ) = 5 0 . 0      T I M E O U T = 0 0 : 2 0 : 0 0
                              C U T O F F   V = 5 0 . 0 0 0
```

13. Move the cursor by pressing ( ,  ) to the command line of “CUT OFF V=”.

```
l s e t = 1 8 . 0 0 0          C F = 1 . 5 0 0          P F = 0 . 8 0 0
l p ( m a x ) = 2 0 . 0      T I M E O U T = 0 0 : 2 0 : 0 0
                              C U T O F F   V = 5 0 . 0 0 0
```

14. Press **1**, **1**, **0** then press **ENTER** to change the value to “110.00”.

```
l s e t = 1 8 . 0 0 0          C F = 1 . 5 0 0          P F = 0 . 8 0 0
l p ( m a x ) = 5 0 . 0      T I M E O U T = 0 0 : 2 0 : 0 0
                              C U T O F F   V = 1 1 0 . 0 0 0
```

15. After setting the parameter of the load, the **LOAD ON/OFF** key should be pressed to turn on the load, so that the load can sink the current. (For detailed information please refer section 3.4.5.)

 **Notice** If there is error during the procedure of inputting value, press **CLEAR** to clear the value at any time and then input again.

For switching to CF only mode, the procedures are as follows.

1. Press **CONF./LOCAL** key.
2. Press **1**, then press **ENTER** to enter SETUP.

3. Move the cursor (▲, ▼) to “1-5. CF/PF SETTING”.
4. Press the direction key (◀, ▶) or rotate the rotary knob to choose “CF”, then press **ENTER**.
5. Then press **CC** to back to main page.

Users can press the arrow key to select the setting parameters on the LCD display, including current RMS value, CF,  $I_p(\max)$ , Timeout and Cutoff voltage. Users can type the values with the Entry keys.

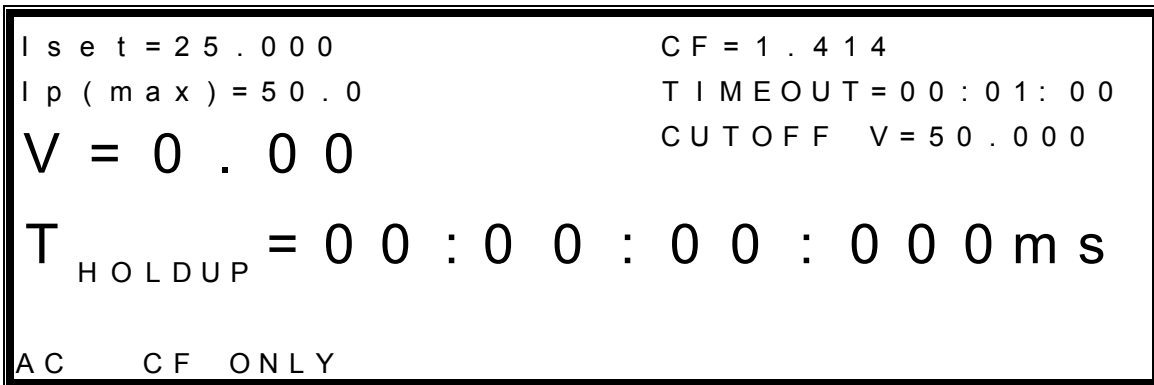

For switching to PF only mode, the procedures are as follows.

1. Press **CONF./LOCAL** key.
2. Press **1**, then press **ENTER** to enter SETUP.
3. Move the cursor (▲, ▼) to “1-5. CF/PF SETTING”.
4. Press the direction key (◀, ▶) or rotate the rotary knob to choose “PF”, then press **ENTER**.
5. Then press **CC** to back to main page.

Users can press the arrow key to select the setting parameters on the LCD display, including current RMS value, PF,  $I_p(\max)$ , Timeout and Cutoff voltage. Users can type the values with the Entry keys.

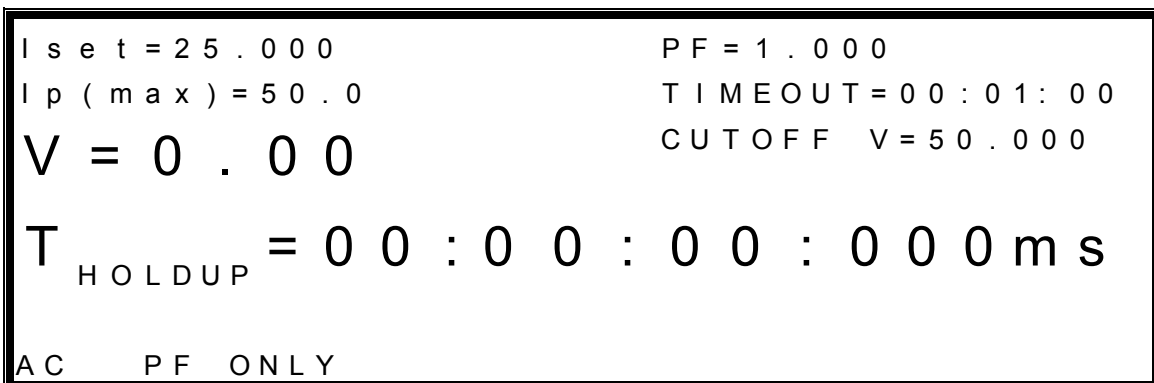

### 3.10.2 CR Mode

Once under timing mode, if users want to switch to CR mode of timing mode press **CR** key then to enter. There are three sub-modes under CC mode: BOTH, CF ONLY and PF ONLY.

**CR mode** page is shown as below. Users can press the arrow key to select the setting parameters on the LCD display, including resistor value,  $I_{rms}(\max)$ , Timeout and Cutoff voltage. Users can type the values with the Entry keys.

```

R s e t = 2 5 . 0 0 0           I r m s ( m a x ) = 5 0 . 0
T I M E O U T = 0 0 : 0 1 : 0 0       C U T O F F   V = 5 0 . 0 0 0
V = 0 . 0 0
T
  H O L D U P = 0 0 : 0 0 : 0 0 : 0 0 0 m s
A C

```

The procedures of setting  $R_{set} = 15.000$ ,  $I_{rms}(\max) = 25.0$ , TIME OUT = 00:00:10 and CUT OFF V = 30, are described as below:

1. Move the cursor to the command line of " $R_{set}="$ ".

```

R s e t = 2 5 . 0 0 0           I r m s ( m a x ) = 5 0 . 0
T I M E O U T = 0 0 : 0 0 : 0 0       C U T O F F   V = 5 0 . 0 0 0

```

2. Press **1**, **5** then press **ENTER** to change the value to "15.000".

```

R s e t = 1 5 . 0 0 0           I r m s ( m a x ) = 5 0 . 0
T I M E O U T = 0 0 : 0 0 : 0 0       C U T O F F   V = 5 0 . 0 0 0

```

3. Move the cursor by pressing (**◀**, **▶**) to the command line of " $I_{rms}(\max)="$ ".

```

R s e t = 1 5 . 0 0 0           I r m s ( m a x ) = 5 0 . 0
T I M E O U T = 0 0 : 0 0 : 0 0       C U T O F F   V = 5 0 . 0 0 0

```

4. Press **2**, **5** then press **ENTER** to change the value to "25.0".

```
R s e t = 1 5 . 0 0 0           I r m s ( m a x ) = 2 5 . 0
T I M E O U T = 0 0 : 0 0 : 0 0   C U T O F F   V = 5 0 . 0 0 0
```

5. Move the cursor by pressing ( ,  ) to the command line of “TIME OUT =”.

```
R s e t = 1 5 . 0 0 0           I r m s ( m a x ) = 2 5 . 0
T I M E O U T = 0 0 : 0 0 : 0 0   C U T O F F   V = 5 0 . 0 0 0
```

6. Press ,  then press  to change the value to “00:00:10”.

```
R s e t = 1 5 . 0 0 0           I r m s ( m a x ) = 2 5 . 0
T I M E O U T = 0 0 : 0 0 : 1 0   C U T O F F   V = 5 0 . 0 0 0
```



7. Move the cursor by pressing ( ,  ) to the command line of “CUT OFF V=”.

```
R s e t = 1 5 . 0 0 0           I r m s ( m a x ) = 2 5 . 0
T I M E O U T = 0 0 : 0 0 : 1 0   C U T O F F   V = 5 0 . 0 0 0
```

8. Press ,  then press  to change the value to “30.000”.

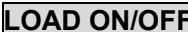
```
R s e t = 1 5 . 0 0 0           I r m s ( m a x ) = 2 5 . 0
T I M E O U T = 0 0 : 0 0 : 1 0   C U T O F F   V = 3 0 . 0 0 0
```

9. After setting the parameter of the load, the  key should be pressed to turn on the load, so that the load can sink the current. (For detailed information please refer section 3.4.5.)

 **Notice** If there is error during the procedures of inputting value, press  to clear the value at any time and then input again.

### 3.10.3 CP Mode

Once under timing mode, if users want to switch to CP mode of timing mode press  key then to enter. There are also have CF ONLY, PF ONLY and Both under CP mode for selection. Its operation methods are the same as CC mode; about the setting method please refer section 3.10.1.

**CP mode** page is shown as below. Users can press the arrow key to select the setting parameters on the LCD display, including power, CF,  $I_p(\max)$ , Time out and Cut off voltage. Users can type the values with the Entry keys.



```

P s e t = 1 0 0 . 0 0           C F = 1 . 4 1 4
I p ( m a x ) = 5 0 . 0       T I M E O U T = 0 0 : 0 1 : 0 0
V = 0 . 0 0                   C U T O F F V = 5 0 . 0 0 0
T H O L D U P = 0 0 : 0 0 : 0 0 : 0 0 0 m s
A C   C F   O N L Y

```

### 3.10.4 Rectified Load Mode

Press **RLC/DC RECT** key to enter AC Rectified mode of timing mode and it is divided into RLC and CP modes. Users can choose 1.RLC MODE or 2.CP MODE.

For entering RLC MODE, users can enter Rectified Load Mode of timing mode by pressing **RLC/DC RECT** key and then select 1.RLC mode and press **Enter**.

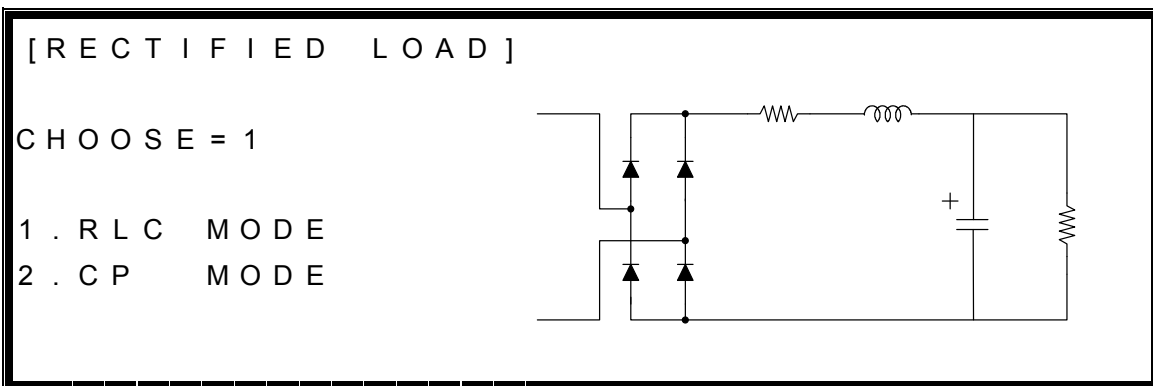

After pressing **Enter**, the page of RLC mode can be seen is shown as below. Users can press the arrow key to select the setting parameters on the LCD display, including equivalent series resistance  $R_s$ , equivalent series inductance  $L_s$ , equivalent parallel load capacitance  $C$ , equivalent parallel load resistance  $R_L$ ,  $I_p(\max)$ , Time out and Cut off voltage. Users can type the values with the Entry keys.

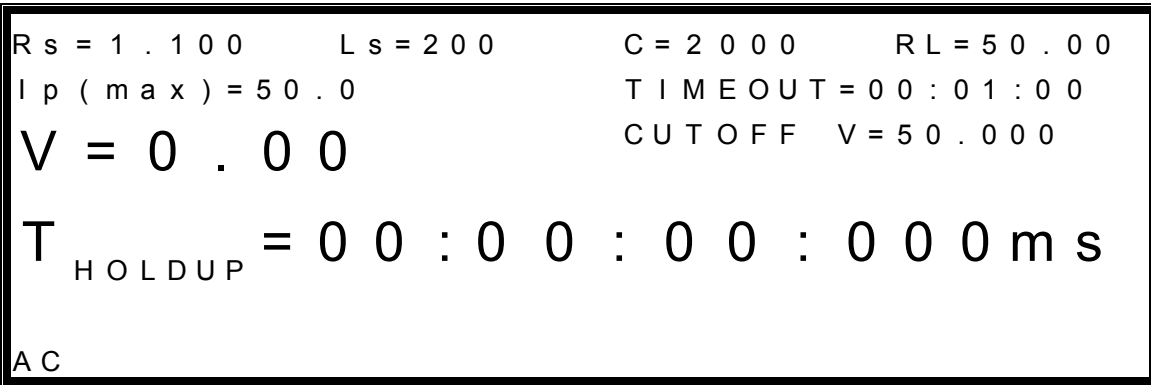

For entering CP MODE, users can enter Rectified Load Mode of timing mode by pressing **RLC/DC RECT** key and then selects 2.CP mode as well as presses **Enter**.

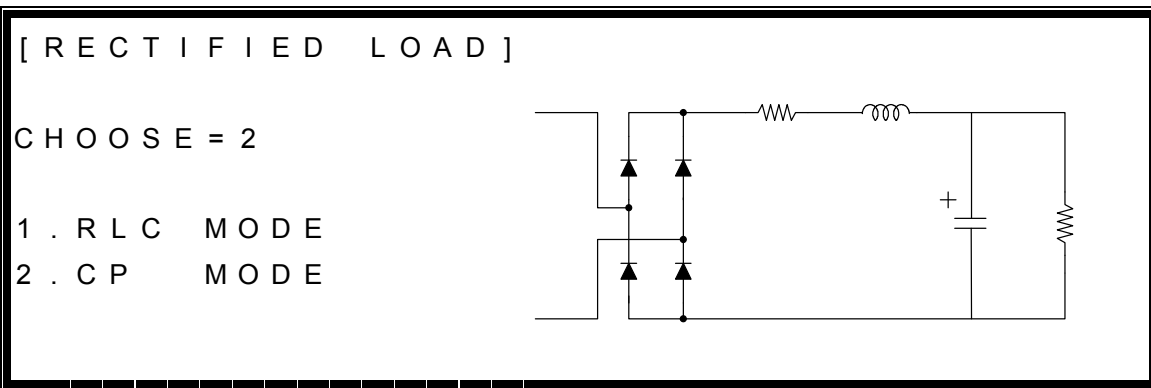

After pressing **Enter**, the page of CP mode can be seen is shown as below. Users can press the arrow key to select the setting parameters on the LCD display, including load power  $P_{set}$ , PF,  $I_p(\max)$ , Time out and Cut off voltage. Users can type the values with the Entry keys.

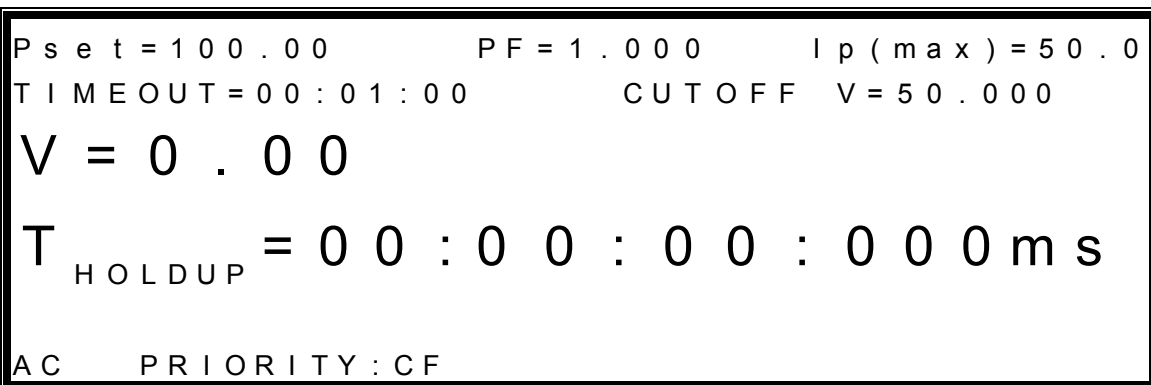

The procedures of setting  $P_{set} = 350.00$ ,  $PF = 0.8$ ,  $I_p(\max) = 35.0$ ,  $TIMEOUT = 00:00:20$  and  $CUTOFF V = 21$ , are described as below:

1. Move the cursor to the command line of " $P_{set} =$ ".

```
P s e t = 1 0 0 . 0 0      P F = 1 . 0 0 0      I p ( m a x ) = 5 0 . 0
T I M E O U T = 0 0 : 0 0 : 0 0      C U T O F F   V = 5 0 . 0 0 0
```

2. Press **3**, **5**, **0** then press **ENTER** to change the value to “350.00”.

```
P s e t = 3 5 0 . 0 0      P F = 1 . 0 0 0      I p ( m a x ) = 5 0 . 0
T I M E O U T = 0 0 : 0 0 : 0 0      C U T O F F   V = 5 0 . 0 0 0
```

3. Move the cursor by pressing (**←**, **→**) to the command line of “PF=”.

```
P s e t = 3 5 0 . 0 0      P F = 1 . 0 0 0      I p ( m a x ) = 5 0 . 0
T I M E O U T = 0 0 : 0 0 : 0 0      C U T O F F   V = 5 0 . 0 0 0
```

4. Press **0**, **.**, **8** then press **ENTER** to change the value to “0.800”.

```
P s e t = 3 5 0 . 0 0      P F = 0 . 8 0 0      I p ( m a x ) = 5 0 . 0
T I M E O U T = 0 0 : 0 0 : 0 0      C U T O F F   V = 5 0 . 0 0 0
```

5. Move the cursor by pressing (**←**, **→**) to the command line of “I<sub>p</sub>(max)=”.

```
P s e t = 3 5 0 . 0 0      P F = 0 . 8 0 0      I p ( m a x ) = 5 0 . 0
T I M E O U T = 0 0 : 0 0 : 0 0      C U T O F F   V = 5 0 . 0 0 0
```

6. Press **3**, **5** then press **ENTER** to change the value to “35.0”.

```
P s e t = 3 5 0 . 0 0      P F = 0 . 8 0 0      I p ( m a x ) = 3 5 . 0
T I M E O U T = 0 0 : 0 0 : 0 0      C U T O F F   V = 5 0 . 0 0 0
```

7. Move the cursor by pressing (**←**, **→**) to the command line of “TIME OUT =”.

```
P s e t = 3 5 0 . 0 0      P F = 0 . 8 0 0      I p ( m a x ) = 3 5 . 0
T I M E O U T = 0 0 : 0 0 : 0 0      C U T O F F   V = 5 0 . 0 0 0
```

8. Press **2**, **0** then press **ENTER** to change the value to “00:00:20”.

```
P s e t = 3 5 0 . 0 0      P F = 0 . 8 0 0      I p ( m a x ) = 3 5 . 0
T I M E O U T = 0 0 : 0 0 : 2 0      C U T O F F   V = 5 0 . 0 0 0
```

9. Move the cursor by pressing (**←**, **→**) to the command line of “CUT OFF V=”.

```

P s e t = 3 5 0 . 0 0      P F = 0 . 8 0 0      I p ( m a x ) = 3 5 . 0
T I M E O U T = 0 0 : 0 0 : 2 0      C U T O F F  V = 5 0 . 0 0 0
    
```

10. Press **2**, **1** then press **ENTER** to change the value to “21.000”.

```

P s e t = 3 5 0 . 0 0      P F = 0 . 8 0 0      I p ( m a x ) = 3 5 . 0
T I M E O U T = 0 0 : 0 0 : 2 0      C U T O F F  V = 2 1 . 0 0 0
    
```

11. After setting the parameter of the load, the **LOAD ON/OFF** key should be pressed to turn on the load, so that the load can sink the current. (The detailed information please refers section 3.4.5.)

**Notice** If there is error during the procedures of inputting value, press **CLEAR** to clear the value at any time and then input again.

### 3.10.5 Setting Timing Mode Values for Transfer Time

For UPS, 63800 series provides a measurement function for the transfer time. The 63800 Electronic Load calculates the transfer time by calculating the time power is disconnected and reconnected. A voltage is below 7.5V is considered as power disconnection and above 7.5V as power reconnection. The below figure is the measurement waveform of off-line UPS transfer time.

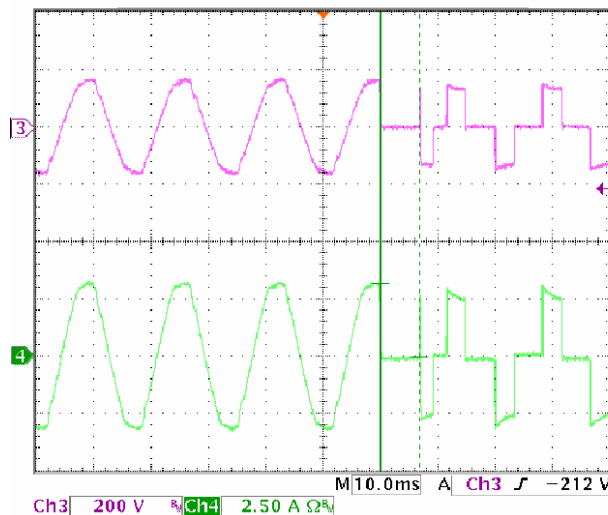





The methods for entering transfer time are described as follows.

1. Press **CONF./LOCAL** key.
2. Press **1**, then press **ENTER** to enter SETUP.

```

[ CONF ]
CHOOSE = 1   1 . SETUP
              2 . REMOTE
              3 . CALIBRATION
              4 . DISPLAY SELECTION
              5 . FACTORY DEFAULT
              6 . MODEL INFORMATION
              7 . PARALLEL MODE

```

3. Move the cursor ( ,  ) to "1-6. TIMING MODE".
4. Press the direction key ( ,  ) or rotate the rotary knob to choose "TRANSFER", then press **ENTER**.

```

1 - 1 . MODE SELECT      = AC / DC      [ SETUP ]
1 - 2 . SHORT           = OFF / TOGGLE / HOLD
1 - 3 . LOCK MODE       = ROTARY / KEYPAD / ALL
1 - 4 . SOUND           = ON / OFF
1 - 5 . CF / PF SETTING = BOTH / CF / PF
1 - 6 . TIMING MODE     = TRANSFER / OFF / HOLDUP
1 - 7 . EXTERNAL        = OFF / ON
1 - 8 . ABA MODE        = ENABLE / DISABLE

```

5. Then press **CR** to back to main page.

```

Rset = 20.00          I rms (max) = 50.0
V = 0.00             I = 0.00
T TRANSFER = 0.00ms
AC TRANSFER

```

 **Notice** This TRANSFER function is only using in AC CR mode of Timing mode as ABA (Auto Bandwidth Adjustment) mode is enabled.

The procedures of setting  $R_{set} = 33.00$ , and  $I_{rms(max)} = 22.0$ , are described as below:

1. Move the cursor to the command line of "R<sub>set</sub>=".

```
R s e t = 2 0 . 0 0           I r m s ( m a x ) = 5 0 . 0
                                U N I T : Ω , A
```

2. Press **3**, **3** then press **ENTER** to change the value to “33.00”.

```
R s e t = 3 3 . 0 0           I r m s ( m a x ) = 5 0 . 0
                                U N I T : Ω , A
```

3. Move the cursor by pressing ( **◀**, **▶** ) to the command line of “I<sub>rms</sub>(max)=”.

```
R s e t = 3 3 . 0 0           I r m s ( m a x ) = 5 0 . 0
                                U N I T : Ω , A
```

4. Press **2**, **2** then press **ENTER** to change the value to “22.0”.

```
R s e t = 3 3 . 0 0           I r m s ( m a x ) = 2 2 . 0
                                U N I T : Ω , A
```

5. After setting the parameter of the load, the **LOAD ON/OFF** key should be pressed to turn on the load, so that the load can sink the current. (The detailed information please refers section 3.4.5.)

 **Notice** If there is error during the procedures of inputting value, press **CLEAR** to clear the value at any time and then input again.

### ● The descriptions of measuring transfer time

1. Set R<sub>set</sub> and I<sub>rms</sub>(max).
2. Load ON by pressing **LOAD ON/OFF**.
3. Remove main power of UPS, to make the UPS to switch from main power mode to battery mode.
4. The results will be shown on LCD display as below page.

```
R s e t = 2 0 . 0 0           I r m s ( m a x ) = 4 5 . 0

V = 2 2 0 . 0           I = 1 1 . 0

T
T R A N S F E R = 5 . 1 5 m s

A C   T R A N S F E R
```

### 3.11 DC Load Simulation

The functions of the 63800 series loads are the same except the variations on input voltage, load current, and power ratings. There are five modes of operation: Constant Current (CC), Constant Resistance (CR), Constant Power (CP), Constant Voltage (CV) and DC Rectified mode (DC RECT).

User can select the mode by pressing **CC**, **CR**, **CP**, **CV** or **RLC/DC RECT** keys under the FUNCTION keypad. The parameters in current, resistance, voltage, power or rectified mode can be programmed easily when the mode is selected.

All data set in CC/CR/CP/CV/Rectified mode will be rescaled to fit the resolution of current/voltage levels or slew rate. In local mode any value can be set to the Load from the keypad. There are no upper and lower limits that would cause an error. The Load automatically selects data, which is rescaled from the programmed value, truncates and checks high, low boundary before fitting it into the memory. When the programmed data is over the boundary, the Load will set the maximum or minimum level for it. In remote mode the programmed value cannot be over boundary. An error will occur when data is over the maximum or minimum value. It is necessary to set UUT's output maximum current value  $I_p(\max)$  in DC all modes. The value  $I_p(\max)$  is for 63800 to test UUT's output impedance for getting system optimum.

Because 63800's power-on default value is AC mode.

If user wants to change to DC mode, the methods are described as below.

1. Press **CONF./LOCAL** key.
2. Press **1**, then press **ENTER** to enter SETUP.

```

                                [ C O N F ]
CHOOSE = 1      1 . S E T U P
                  2 . R E M O T E
                  3 . C A L I B R A T I O N
                  4 . D I S P L A Y   S E L E C T I O N
                  5 . F A C T O R Y   D E F A U L T
                  6 . M O D E L   I N F O R M A T I O N
                  7 . P A R A L L E L   M O D E
```

3. Move the cursor ( **▲**, **▼** ) to "1-1. MODE SELECT".
4. Press the direction key ( **◀**, **▶** ) or rotate the rotary knob to choose "DC", then press **ENTER**.

1 - 1 . MODE SELECT	= DC / AC	[ SETUP ]
1 - 2 . SHORT	= OFF / TOGGLE / HOLD	
1 - 3 . LOCK MODE	= ROTARY / KEYPAD / ALL	
1 - 4 . SOUND	= ON / OFF	
1 - 5 . CF / PF SETTING	= BOTH / CF / PF	
1 - 6 . TIMING MODE	= OFF / HOLDUP / TRANSFER	
1 - 7 . EXTERNAL	= OFF / ON	
1 - 8 . ABA MODE	= ENABLE / DISABLE	

5. Then press **CC**, **CR**, **CP**, **CV** or **RLC/DC RECT** to back to main page of DC mode.

Example: CC mode under DC mode.

I s e t = 4 0 . 0 A	$\int = 1 0 0 A / m s$	$\backslash = 1 0 0 A / m s$
I p ( m a x ) = 1 0 0 . 0 A		
V = 0 . 0 0	P = 0 . 0 0	
I = 0 . 0 0		▼
DC		

DC mode has five kinds of modes for using: CC, CR, CP, CV and Rectified Mode. The detailed setting descriptions are as follows.

### 3.12 DC Load Simulation -- Constant Current Mode

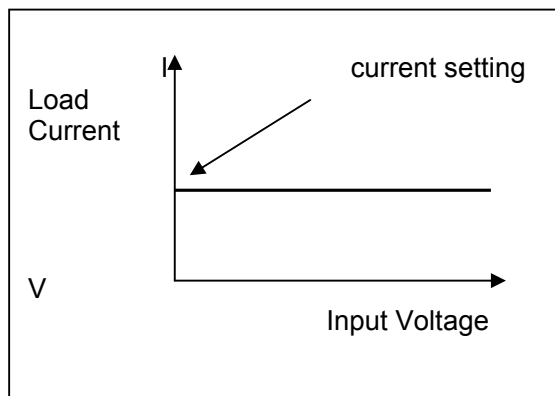



In CC mode, the Load will sink a current in accordance with the programmed value regardless of the input voltage. The CC mode can be set by **CC** key in the front panel, and user need to set the  $I_p(\text{max})$  for load to test UUT output impedance.

Slew Rate (Rise, Fall A/ms):

Slew rate determines the rate of change of the input current from one load level to another. There are two slew rate values, which are rise rate and fall rate.

The CC mode can be set by **CC** key in the front panel, users can press the arrow key to select the setting parameters on the LCD display, including current RMS value, slew rate (rise, fall A/ms), and  $I_p(\text{max})$ . Users can type the values with the Entry keys.

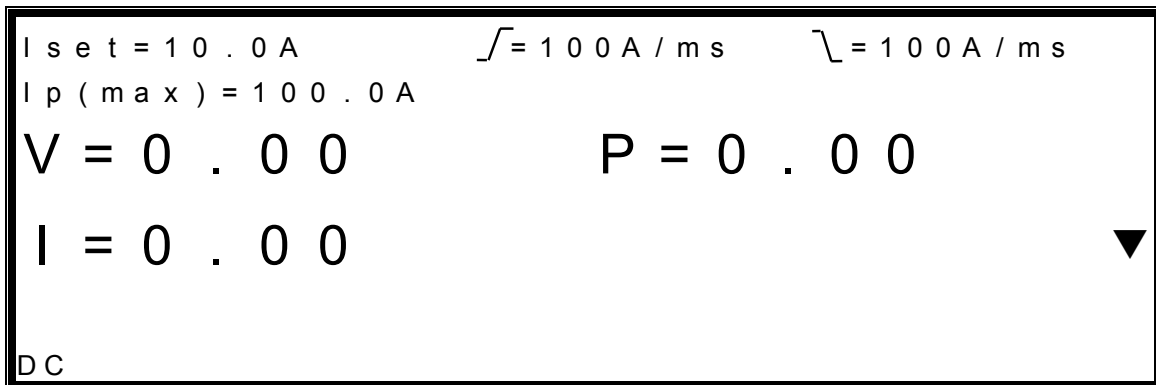

The procedures of setting  $I_{\text{set}} = 18.0$ , **Rising slew rate = 115**, **Falling slew rate = 115**, and  $I_p(\text{max}) = 20.0$ , are described as below:

1. Move the cursor to the command line of " $I_{\text{set}} =$ ".



2. Press **1**, **8** then press **ENTER** to change the value to "18.0".



3. Move the cursor by pressing (**←**, **→**) to the command line of " $\int =$ ".

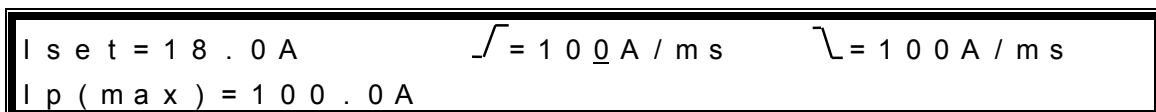

4. Press **1**, **1**, **5** then press **ENTER** to change the value to "115".

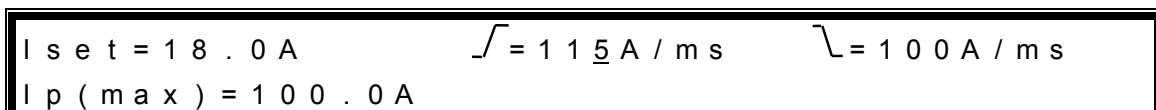

5. Move the cursor by pressing (  $\leftarrow$ ,  $\rightarrow$  ) to the command line of “  $\surd$  =”.

```

I s e t = 1 8 . 0 A       $\surd$  = 1 1 5 A / m s       $\surd$  = 1 0 0 A / m s
I p ( m a x ) = 1 0 0 . 0 A
    
```

6. Press **1**, **1**, **5** then press **ENTER** to change the value to “115”.

```

I s e t = 1 8 . 0 A       $\surd$  = 1 1 5 A / m s       $\surd$  = 1 1 5 A / m s
I p ( m a x ) = 1 0 0 . 0 A
    
```

7. Move the cursor by pressing (  $\leftarrow$ ,  $\rightarrow$  ) to the command line of “I<sub>p</sub>(max)=”.

```

I s e t = 1 8 . 0 A       $\surd$  = 1 1 5 A / m s       $\surd$  = 1 1 5 A / m s
I p ( m a x ) = 1 0 0 . 0 A
    
```

8. Press **2**, **0** then press **ENTER** to change the value to “20.0”.

```

I s e t = 1 8 . 0 A       $\surd$  = 1 1 5 A / m s       $\surd$  = 1 1 5 A / m s
I p ( m a x ) = 2 0 . 0 A
    
```

9. After setting the parameter of the load, the **LOAD ON/OFF** key should be pressed to turn on the load, so that the load can sink the current. (The detailed information please refers section 3.4.5.)

**Notice** If there is error during the procedures of inputting value, press **CLEAR** to clear the value at any time and then input again.

### 3.13 DC Load Simulation -- Constant Resistance Mode

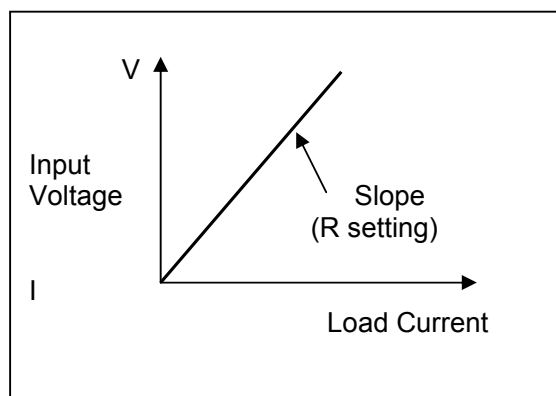

In CR mode, the Load will sink a current linearly proportional to the input voltage in accordance with the programmed resistance. To prevent the load current change caused by the input voltage variation, the power source impedance should be as low as possible. Slew rate determines the rate that the load level changes from one state to another.

Slew Rate (Rise, Fall A/ms):

Slew rate determines the rate at which the current input of changes to a newly programmed value. There are two slew rate values, which are rise rate and fall rate.

The CR mode can be set by **CR** key in the front panel, users can press the arrow key to select the setting parameters on the LCD display, including resistor value, slew rate (rise, fall A/ms), and  $I_p(\max)$ . Users can type the values with the Entry keys.

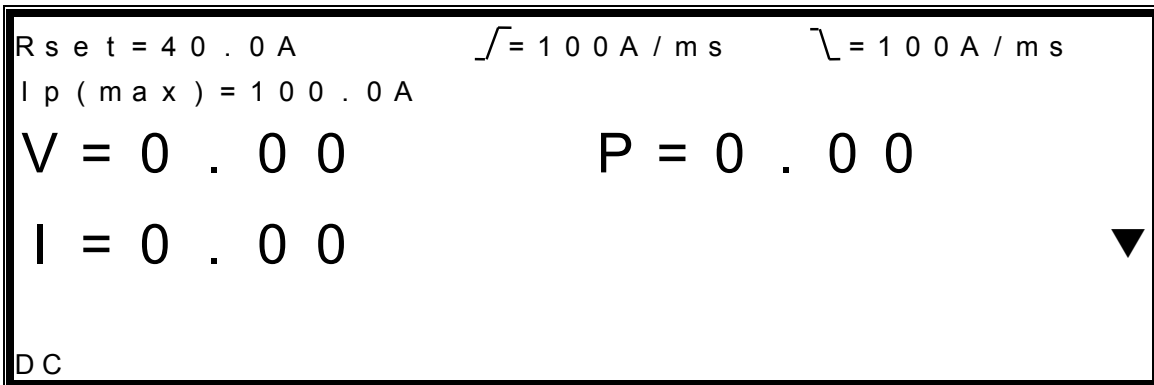

The procedures of setting  $R_{set} = 30.0$ , Rising slew rate = 105, Falling slew rate = 105, and  $I_p(\max) = 25.0$ , are described as below:

1. Move the cursor to the command line of " $R_{set} =$ ".



2. Press **3**, **0** then press **ENTER** to change the value to "30.0".



3. Move the cursor by pressing (**◀**, **▶**) to the command line of " $\nearrow =$ ".

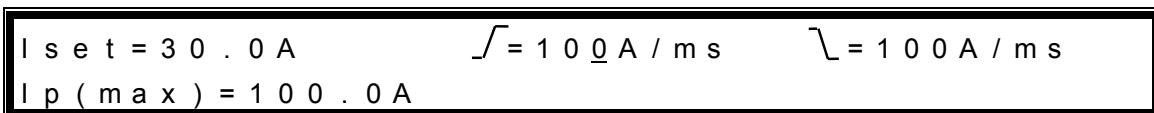

4. Press **1**, **0**, **5** then press **ENTER** to change the value to "105".

```

R s e t = 3 0 . 0 A      √ = 1 0 5 A / m s      √ = 1 0 0 A / m s
I p ( m a x ) = 1 0 0 . 0 A
    
```

5. Move the cursor by pressing ( ,  ) to the command line of “ √ =”.

```

R s e t = 3 0 . 0 A      √ = 1 0 5 A / m s      √ = 1 0 0 A / m s
I p ( m a x ) = 1 0 0 . 0 A
    
```

6. Press , ,  then press **ENTER** to change the value to “105”.

```

R s e t = 3 0 . 0 A      √ = 1 0 5 A / m s      √ = 1 0 5 A / m s
I p ( m a x ) = 1 0 0 . 0 A
    
```

7. Move the cursor by pressing ( ,  ) to the command line of “I<sub>p</sub>(max)=”.

```

R s e t = 3 0 . 0 A      √ = 1 0 5 A / m s      √ = 1 0 5 A / m s
I p ( m a x ) = 1 0 0 . 0
    
```

8. Press ,  then press **ENTER** to change the value to “25.0”.

```

R s e t = 3 0 . 0 A      √ = 1 0 5 A / m s      √ = 1 0 5 A / m s
I p ( m a x ) = 2 5 . 0 A
    
```

9. After setting the parameter of the load, the **LOAD ON/OFF** key should be pressed to turn on the load, so that the load can sink the current. (The detailed information please refers section 3.4.5.)

 **Notice** : If there is error during the procedures of inputting value, press **CLEAR** to clear the value at any time and then input again.

### 3.14 DC Load Simulation -- Constant Voltage Mode

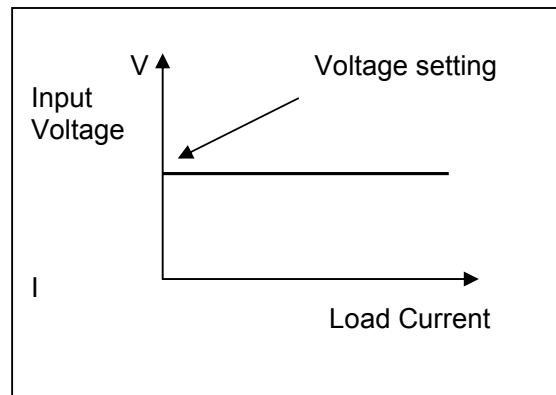

In CV mode the Load will sink current to control the voltage source according to programmed value. User can set the  $V_{set}$  and  $I_{max}$  value in this mode.

CV mode can be entered by pressing the **CV** key. Enter the voltage and current values with the keypad.

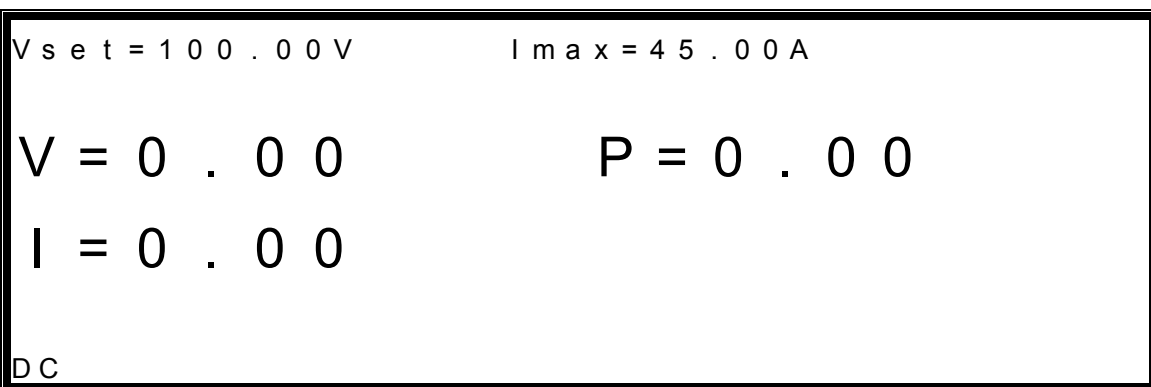

The procedures of setting  $V_{set} = 50.00$ , and  $I_{max} = 21.00$ , are described as below:

1. Move the cursor to the command line of " $V_{set} =$ ".

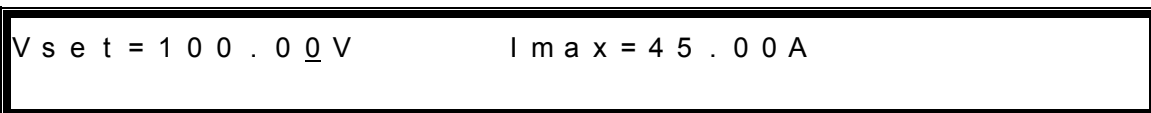

2. Press **5**, **0** then press **ENTER** to change the value to "50.00".

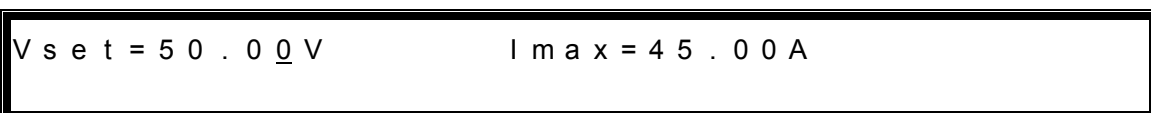

3. Move the cursor by pressing (**◀**, **▶**) to the command line of " $I_{max} =$ ".

V s e t = 5 0 . 0 0 V                      I m a x = 4 5 . 0 0 A

4. Press **2**, **1** then press **ENTER** to change the value to “21.00”.

V s e t = 5 0 . 0 0 V                      I m a x = 2 1 . 0 0 A

5. After setting the parameter of the load, the **LOAD ON/OFF** key should be pressed to turn on the load, so that the load can sink the current. (The detailed information please refers section 3.4.5.)

**Notice** If there is error during the procedures of inputting value, press **CLEAR** to clear the value at any time and then input again.

### 3.15 DC Load Simulation -- Constant Power Mode

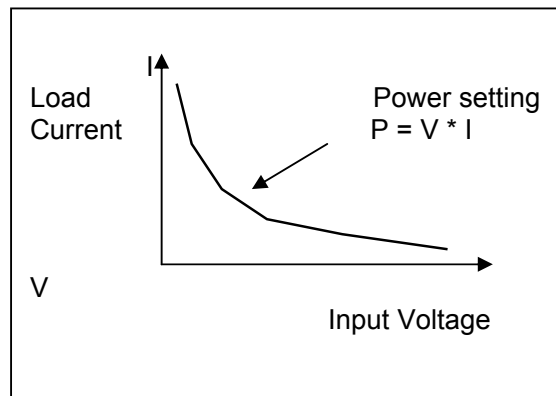

In CP mode, the Load will sink a current according to the programmed power. This mode is operated under the F/W calculation. That is, take the measured V data, divide the Power setting and get the I setting value. Besides, it is needed to aware when the output power over the maximum power can be outputted. The load will show now is already the maximum power on the panel, the warning of loading power can not be higher.

The CR mode can be set by **CP** key in the front panel, users can press the arrow key to select the setting parameters on the LCD display, including power and  $I_p(\text{max})$ . Users can type the values with the Entry keys.

```

P s e t = 2 5 0 0 . 0 0 W      I p ( m a x ) = 1 0 0 . 0 0 A
V = 0 . 0 0                    P = 0 . 0 0
I = 0 . 0 0                    ▼
DC

```

The procedures of setting  $P_{set} = 1550.00$ , and  $I_p(max) = 30.00$ , are described as below:

1. Move the cursor to the command line of " $P_{set}="$ ".

```

P s e t = 2 5 0 0 . 0 0 W      I p ( m a x ) = 1 0 0 . 0 0 A

```

2. Press **1**, **5**, **5**, **0** then press **ENTER** to change the value to "1550.00".

```

P s e t = 1 5 5 0 . 0 0 W      I p ( m a x ) = 1 0 0 . 0 0 A

```

3. Move the cursor by pressing (**←**, **→**) to the command line of " $I_p(max)="$ ".

```

P s e t = 1 5 5 0 . 0 0 W      I p ( m a x ) = 1 0 0 . 0 0 A

```

4. Press **3**, **0** then press **ENTER** to change the value to "30.00".

```

P s e t = 1 5 5 0 . 0 0 W      I p ( m a x ) = 3 0 . 0 0 A

```

5. After setting the parameter of the load, the **LOAD ON/OFF** key should be pressed to turn on the load, so that the load can sink the current. (The detailed information please refers section 3.4.5.)

**Notice** If there is error during the procedures of inputting value, press **CLEAR** to clear the value at any time and then input again.

### 3.16 DC Load Simulation -- Rectified Load Mode

The general DC input/AC output products such as DC to AC inverter; its input current is not always DC. However, the load current is often similar to the current loaded by rectified load, thus this mode is designed to simulate a period of load current under CC mode.

Press **RLC/DC RECT** key to go into the DC Rectified mode, users can set the  $I_{set}$ , CF and select the Line SYNC to be the reference loading frequency, the maximum current value  $I_p(max)$  of UUT is also required to be set.

The load current under rectified mode is shown as Figure 3-15, 3-16 and 3-17. This load current is rectified sine wave so needs to set CF value.

If users do not choose Line SYNC as reference period then set loading frequency is needed as below shown.

$I_{set} = 10.0A$	$CF = 1.414$	LINE SYNC = NO
$F = 120.0Hz$	$I_p(max) = 100.0A$	
$V = 0.00$	$P = 0.00$	
$I = 0.00$	$I_p = 0.00$	
DC RECTIFIED		

If users choose Line SYNC as reference period then 63800 regards the input frequency of power line as load frequency. Moreover, users also can select load current waveform settings of ALL, POSITIVE and NEGATIVE. The three loading current waveforms are described separately as below. If users choose Line SYNC=YES, then users should set the PHASE. The PHASE is the delay angle of loading current which refer to power line voltage.

The loading conditions of the following three figures (Figure 3-15, 3-16 and 3-17) are the waveforms getting from  $V_{source}=60V_{DC}$ ,  $I_{set}=10A$ ,  $CF=2$ , LINE SYNC=YES. The waveform on the top (Channel 1) is DC voltage  $V_{source}$ , on the medium (Channel 2) is power line voltage of frequency 60Hz and on the bottom (Channel 4) is load current.

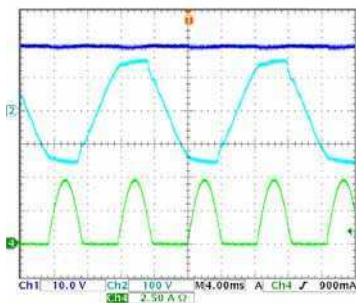

Figure 3-15 All

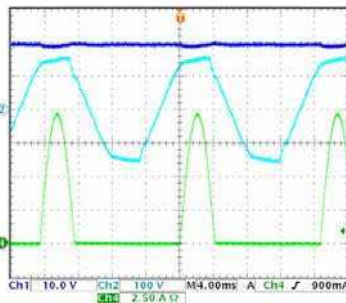

Figure 3-16 Positive

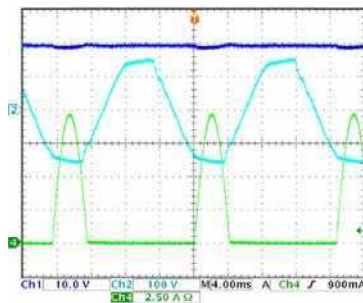

Figure 3-17 Negative



**ALL:** Using the power line frequency as the reference frequency for the load current, for the ALL setting, both positive and negative half period of the power line is loading  $V_{source}$  (UUT). This load frequency is two times of power line frequency (please refers Figure 3-15). For example: power line frequency is 60Hz thus the load frequency of the current is 120Hz.

**Positive:** Using the power line frequency as the reference frequency for the load current, for the Positive setting, the positive half period of the power line is loading  $V_{source}$  (UUT). This load frequency is the same as power line frequency (please refers Figure 3-16). For example: power line frequency is 60Hz thus the load frequency of the current is 60Hz.

**Negative:** Using the power line frequency as the reference frequency for the load current, for the Negative setting, the negative half period of the power line is loading  $V_{source}$  (UUT). This load frequency is the same as power line frequency (please refers Figure 3-17). For example: power line frequency is 60Hz thus the load frequency of the current is 60Hz.

The setting pages of the three kinds of load current waveforms are shown as below.

#### ALL

```

I s e t = 1 0 . 0 0 A      C F = 2 . 0 0 0      L I N E   S Y N C = Y E S
W A V E = A L L          P H A S E = 9 0      I p ( m a x ) = 1 0 0 . 0 A
V = 0 . 0 0              P = 0 . 0 0
I = 0 . 0 0              I p = 0 . 0 0

D C   R E C T I F I E D

```

#### POSITIVE

```

I s e t = 1 0 . 0 0 A      C F = 2 . 0 0 0      L I N E   S Y N C = Y E S
W A V E = P O S I T I V E  P H A S E = 9 0      I p ( m a x ) = 1 0 0 . 0 A
V = 0 . 0 0              P = 0 . 0 0
I = 0 . 0 0              I p = 0 . 0 0

D C   R E C T I F I E D

```

## NEGATIVE

```
I s e t = 1 0 . 0 0 A      C F = 2 . 0 0 0      L I N E   S Y N C = Y E S
W A V E = N E G A T I V E    P H A S E = 9 0      I p ( m a x ) = 1 0 0 . 0 A
V = 0 . 0 0                P = 0 . 0 0
I = 0 . 0 0                I p = 0 . 0 0 0
D C   R E C T I F I E D
```

### 3.16.1 Crest Factor in Rectified Mode Explanation

The load current in rectified mode are shown in Figure 3-15, 3-16 and 3-17; it's a rectified sine wave, therefore the CF value needs to be set.

## 3.17 DC Load Simulation -- Timing Mode

Timing Mode can be executed CC, CR, CP, CV and Rectified mode under the DC mode. The timer starts after Load ON. There are three different conditions for the times to stop.  
1. Load OFF. 2. The UUT voltage drops below the cutoff voltage setting. 3. The timer has reached the time set.

To switch to Timing mode, the methods are as follows.

1. Press **CONF./LOCAL** key.
2. Press **1**, then press **ENTER** to enter SETUP.

```
                                [ C O N F ]
C H O O S E = 1      1 . S E T U P
                    2 . R E M O T E
                    3 . C A L I B R A T I O N
                    4 . D I S P L A Y   S E L E C T I O N
                    5 . F A C T O R Y   D E F A U L T
                    6 . M O D E L   I N F O R M A T I O N
                    7 . P A R A L L E L   M O D E
```

3. Move the cursor ( **▲**, **▼** ) to "1-6. TIMING MODE".
4. Press the direction key ( **◀**, **▶** ) or rotate the rotary knob to choose "HOLDUP", then

press **ENTER**.

```

1 - 1 . M O D E   S E L E C T   = D C / A C           [ S E T U P ]
1 - 2 . S H O R T               = O F F / T O G G L E / H O L D
1 - 3 . L O C K   M O D E       = R O T A R Y / K E Y P A D / A L L
1 - 4 . S O U N D               = O N / O F F
1 - 5 . C F / P F   S E T T I N G = B O T H / C F / P F
1 - 6 . T I M I N G   M O D E    = H O L D U P / O F F / T R A N S F E R
1 - 7 . E X T E R N A L         = O F F / O N
1 - 8 . A B A   M O D E         = E N A B L E / D I S A B L E

```

5. Press **CC**, **CR**, **CV**, **CP** or **RLC/DC RECT** key to return to the main page of timing mode.

Example: CC mode under Timing mode.

```

I s e t = 1 0 . 0 0 0 A      √ = 1 0 0 A / m s      √ = 1 0 0 A / m s
I p ( m a x ) = 5 0 . 0 A    T I M E O U T = 0 0 : 0 0 : 0 0
V = 0 . 0 0                C U T O F F   V = 5 0 . 0 0 0
T
H O L D U P = 0 0 : 0 0 : 0 0 : 0 0 0 m s
DC

```

### 3.17.1 CC Mode

Under timing mode to enter CC timing mode press the **CC** key. In this mode the loading current ( $I_{set}$ ), rise and fall slew rate, maximum current value  $I_p(max)$ , as well as the timeout time and cutoff voltage of the UUT can be set

```

I s e t = 1 0 . 0 0 0 A      √ = 1 0 0 A / m s      √ = 1 0 0 A / m s
I p ( m a x ) = 5 0 . 0 A    T I M E O U T = 0 0 : 0 0 : 0 0
V = 0 . 0 0                C U T O F F   V = 5 0 . 0 0 0
T
H O L D U P = 0 0 : 0 0 : 0 0 : 0 0 0 m s
DC

```

The procedures of setting  $I_{set} = 18.0$ , **Rising slew rate = 115**, **Falling slew rate = 115**,  $I_p(max) = 20.0$ , **Timeout = 24:00:00**, and **Cutoff V = 30**, are described as below:

1. Move the cursor to the command line of " $I_{set}="$ ".

```
I s e t = 1 0 . 0 A      / = 1 0 0 A / m s      \ = 1 0 0 A / m s
I p ( m a x ) = 1 0 0 . 0 A  T I M E O U T = 0 0 : 0 0 : 0 0
C U T O F F   V = 5 0 . 0 0 0
```

2. Press **1**, **8** then press **ENTER** to change the value to "18.0".

```
I s e t = 1 8 . 0 A      / = 1 0 0 A / m s      \ = 1 0 0 A / m s
I p ( m a x ) = 1 0 0 . 0 A  T I M E O U T = 0 0 : 0 0 : 0 0
C U T O F F   V = 5 0 . 0 0 0
```

3. Move the cursor by pressing (**←**, **→**) to the command line of " $/ =$ ".

```
I s e t = 1 8 . 0 A      / = 1 0 0 A / m s      \ = 1 0 0 A / m s
I p ( m a x ) = 1 0 0 . 0 A  T I M E O U T = 0 0 : 0 0 : 0 0
C U T O F F   V = 5 0 . 0 0 0
```

4. Press **1**, **1**, **5** then press **ENTER** to change the value to "115".

```
I s e t = 1 8 . 0 A      / = 1 1 5 A / m s      \ = 1 0 0 A / m s
I p ( m a x ) = 1 0 0 . 0 A  T I M E O U T = 0 0 : 0 0 : 0 0
C U T O F F   V = 5 0 . 0 0 0
```

5. Move the cursor by pressing (**←**, **→**) to the command line of " $\backslash =$ ".

```
I s e t = 1 8 . 0 A      / = 1 1 5 A / m s      \ = 1 0 0 A / m s
I p ( m a x ) = 1 0 0 . 0 A  T I M E O U T = 0 0 : 0 0 : 0 0
C U T O F F   V = 5 0 . 0 0 0
```

6. Press **1**, **1**, **5** then press **ENTER** to change the value to "115".

```
I s e t = 1 8 . 0 A      / = 1 1 5 A / m s      \ = 1 1 5 A / m s
I p ( m a x ) = 1 0 0 . 0 A  T I M E O U T = 0 0 : 0 0 : 0 0
C U T O F F   V = 5 0 . 0 0 0
```

7. Move the cursor by pressing (**←**, **→**) to the command line of " $I_p(max)=$ ".

```

I s e t = 1 8 . 0 A      √ = 1 1 5 A / m s      \ = 1 1 5 A / m s
I p ( m a x ) = 1 0 0 . 0 A    T I M E O U T = 0 0 : 0 0 : 0 0
                                C U T O F F   V = 5 0 . 0 0 0

```

8. Press **2**, **0** then press **ENTER** to change the value to “20.0”.

```

I s e t = 1 8 . 0 A      √ = 1 1 5 A / m s      \ = 1 1 5 A / m s
I p ( m a x ) = 2 0 . 0 A    T I M E O U T = 0 0 : 0 0 : 0 0
                                C U T O F F   V = 5 0 . 0 0 0

```

9. Move the cursor by pressing ( **◀**, **▶** ) to the command line of “TIMEOUT=00:00:00”.

```

I s e t = 1 8 . 0 A      √ = 1 1 5 A / m s      \ = 1 0 0 A / m s
I p ( m a x ) = 2 0 . 0 A    T I M E O U T = 0 0 : 0 0 : 0 0
                                C U T O F F   V = 5 0 . 0 0 0

```

10. Move the cursor by pressing ( **◀**, **▶** ) to the command line of “TIMEOUT=00:00:00”.

```

I s e t = 1 8 . 0 A      √ = 1 1 5 A / m s      \ = 1 0 0 A / m s
I p ( m a x ) = 2 0 . 0 A    T I M E O U T = 0 0 : 0 0 : 0 0
                                C U T O F F   V = 5 0 . 0 0 0

```

11. Press **2**, **4** then press **ENTER** to change the value to “24:00:00”.

```

I s e t = 1 8 . 0 A      √ = 1 1 5 A / m s      \ = 1 1 5 A / m s
I p ( m a x ) = 2 0 . 0 A    T I M E O U T = 0 0 : 0 0 : 0 0
                                C U T O F F   V = 5 0 . 0 0 0

```

12. Move the cursor by pressing ( **◀**, **▶** ) to the command line of “CUTOFF V=”.

```

I s e t = 1 8 . 0 A      √ = 1 1 5 A / m s      \ = 1 1 5 A / m s
I p ( m a x ) = 2 0 . 0 A    T I M E O U T = 2 4 : 0 0 : 0 0
                                C U T O F F   V = 5 0 . 0 0 0

```

13. Press **3**, **0** then press **ENTER** to change the value to “30.000”.

```

I s e t = 1 8 . 0 A      √ = 1 1 5 A / m s      \ = 1 1 5 A / m s
I p ( m a x ) = 2 0 . 0 A    T I M E O U T = 2 4 : 0 0 : 0 0
                                C U T O F F   V = 3 0 . 0 0 0

```

- After setting the parameter of the load, the **LOAD ON/OFF** key should be pressed to turn on the load, so that the load can sink the current. (The detailed information please refers section 3.4.5.)

**Notice** If there is error during the procedures of inputting value, press **CLEAR** to clear the value at any time and then input again.

### 3.17.2 CR Mode

Under timing mode to enter CR timing mode press the **CR** key.

In this mode the loading resistance ( $R_{set}$ ), rise and fall slew rate, maximum current value  $I_p(max)$ , as well as the timeout time and cutoff voltage of the UUT can be set.

```

R s e t = 1 0 . 0 0 0 Ω      √ = 1 0 0 A / m s      √ = 1 0 0 A / m s
I p ( m a x ) = 5 0 . 0 A    T I M E O U T = 0 0 : 0 0 : 0 0
V = 0 . 0 0                C U T O F F V = 5 0 . 0 0 0

T
H O L D U P = 0 0 : 0 0 : 0 0 : 0 0 0 m s

D C
    
```

The procedures of setting  $R_{set} = 27.5$ , Rising slew rate = 160, Falling slew rate = 160,  $I_p(max) = 25.0$ , Timeout = 00:15:00, and Cutoff V = 10.5, are described as below:

- Move the cursor to the command line of " $R_{set} =$ ".

```

R s e t = 1 0 . 0 Ω      √ = 1 0 0 A / m s      √ = 1 0 0 A / m s
I p ( m a x ) = 5 0 . 0 A    T I M E O U T = 0 0 : 0 0 : 0 0
C U T O F F V = 5 0 . 0 0 0
    
```

- Press **2**, **7**, **.**, **5** then press **ENTER** to change the value to "27.5".

```

R s e t = 2 7 . 5 Ω      √ = 1 0 0 A / m s      √ = 1 0 0 A / m s
I p ( m a x ) = 5 0 . 0 A    T I M E O U T = 0 0 : 0 0 : 0 0
C U T O F F V = 5 0 . 0 0 0
    
```

- Move the cursor by pressing (**←**, **→**) to the command line of " $\sqrt{ } =$ ".

R s e t = 2 7 . 5 Ω	$\int = 1 0 \underline{0} A / m s$	$\backslash = 1 0 0 A / m s$
l p ( m a x ) = 5 0 . 0 A	T I M E O U T = 0 0 : 0 0 : 0 0	
	C U T O F F V = 5 0 . 0 0 0	

4. Press **1**, **6**, **0** then press **ENTER** to change the value to “160”.

R s e t = 2 7 . 5 Ω	$\int = 1 6 \underline{0} A / m s$	$\backslash = 1 0 0 A / m s$
l p ( m a x ) = 5 0 . 0 A	T I M E O U T = 0 0 : 0 0 : 0 0	
	C U T O F F V = 5 0 . 0 0 0	

5. Move the cursor by pressing ( **◀**, **▶** ) to the command line of “  $\backslash =$ ”.

R s e t = 2 7 . 5 Ω	$\int = 1 6 0 A / m s$	$\backslash = 1 0 \underline{0} A / m s$
l p ( m a x ) = 5 0 . 0 A	T I M E O U T = 0 0 : 0 0 : 0 0	
	C U T O F F V = 5 0 . 0 0 0	

6. Press **1**, **6**, **0** then press **ENTER** to change the value to “160”.

R s e t = 2 7 . 5 Ω	$\int = 1 6 0 A / m s$	$\backslash = 1 6 \underline{0} A / m s$
l p ( m a x ) = 5 0 . 0 A	T I M E O U T = 0 0 : 0 0 : 0 0	
	C U T O F F V = 5 0 . 0 0 0	

7. Move the cursor by pressing ( **◀**, **▶** ) to the command line of “l<sub>p</sub>(max)=”.



R s e t = 2 7 . 5 Ω	$\int = 1 6 0 A / m s$	$\backslash = 1 6 0 A / m s$
l p ( m a x ) = 5 0 . <u>0</u> A	T I M E O U T = 0 0 : 0 0 : 0 0	
	C U T O F F V = 5 0 . 0 0 0	

8. Press **2**, **5** then press **ENTER** to change the value to “25.0”.

R s e t = 2 7 . 5 Ω	$\int = 1 6 0 A / m s$	$\backslash = 1 6 0 A / m s$
l p ( m a x ) = 2 5 . <u>0</u> A	T I M E O U T = 0 0 : 0 0 : 0 0	
	C U T O F F V = 5 0 . 0 0 0	

9. Move the cursor by pressing ( **◀**, **▶** ) to the command line of “TIMEOUT=00:00:00”.

R s e t = 2 7 . 5 Ω	$\int = 1 6 0 A / m s$	$\backslash = 1 6 0 A / m s$
I p ( m a x ) = 2 5 . 0 A	T I M E O U T = 0 0 : 0 0 : 0 0	
	C U T O F F V = 5 0 . 0 0 0	

10. Move the cursor by pressing ( ,  ) to the command line of “TIMEOUT=00:00:00”.





R s e t = 2 7 . 5 Ω	$\int = 1 6 0 A / m s$	$\backslash = 1 6 0 A / m s$
I p ( m a x ) = 2 5 . 0 A	T I M E O U T = 0 0 : 0 0 : 0 0	
	C U T O F F V = 5 0 . 0 0 0	

11. Press ,  then press **ENTER** to change the value to “00:15:00”.

R s e t = 2 7 . 5 Ω	$\int = 1 6 0 A / m s$	$\backslash = 1 6 0 A / m s$
I p ( m a x ) = 2 5 . 0 A	T I M E O U T = 0 0 : 1 5 : 0 0	
	C U T O F F V = 5 0 . 0 0 0	

12. Move the cursor by pressing ( ,  ) to the command line of “CUTOFF V=”.

R s e t = 2 7 . 5 Ω	$\int = 1 6 0 A / m s$	$\backslash = 1 6 0 A / m s$
I p ( m a x ) = 2 5 . 0 A	T I M E O U T = 0 0 : 1 5 : 0 0	
	C U T O F F V = 5 0 . 0 0 0	

13. Press , , ,  then press **ENTER** to change the value to “10.500”.

R s e t = 2 7 . 5 Ω	$\int = 1 6 0 A / m s$	$\backslash = 1 6 0 A / m s$
I p ( m a x ) = 2 5 . 0 A	T I M E O U T = 0 0 : 1 5 : 0 0	
	C U T O F F V = 1 0 . 5 0 0	

14. After setting the parameter of the load, the **LOAD ON/OFF** key should be pressed to turn on the load, so that the load can sink the current. (The detailed information please refers section 3.4.5.)

 **Notice** If there is error during the procedures of inputting value, press **CLEAR** to clear the value at any time and then input again.

### 3.17.3 CP Mode

Under timing mode to enter CP timing mode press the **CP** key.

In this mode the loading power ( $P_{set}$ ), maximum current value  $I_p(max)$ , as well as the timeout time and cutoff voltage of the UUT can be set.



```

P s e t = 1 0 0 . 0 0 W           I p ( m a x ) = 5 0 . 0 A
T I M E O U T = 0 0 : 0 0 : 0 0   C U T O F F   V = 5 0 . 0 0 0
V = 0 . 0 0
T H O L D U P = 0 0 : 0 0 : 0 0 : 0 0 0 m s
DC

```

The procedures of setting  $P_{set} = 300.00$ ,  $I_p(max) = 16.0$ , Timeout = 00:10:15, and Cutoff V = 9.5, are described as below:

1. Move the cursor to the command line of " $P_{set}="$ ".

```

P s e t = 1 0 0 . 0 0 W           I p ( m a x ) = 5 0 . 0 A
T I M E O U T = 0 0 : 0 0 : 0 0   C U T O F F   V = 5 0 . 0 0 0

```

2. Press **3**, **0**, **0** then press **ENTER** to change the value to "300.00".

```

P s e t = 3 0 0 . 0 0 W           I p ( m a x ) = 5 0 . 0 A
T I M E O U T = 0 0 : 0 0 : 0 0   C U T O F F   V = 5 0 . 0 0 0

```

3. Move the cursor by pressing ( **←**, **→** ) to the command line of " $I_p(max)="$ ".

```

P s e t = 3 0 0 . 0 0 W           I p ( m a x ) = 5 0 . 0 A
T I M E O U T = 0 0 : 0 0 : 0 0   C U T O F F   V = 5 0 . 0 0 0

```

4. Press **1**, **6** then press **ENTER** to change the value to "16.0".

```

P s e t = 3 0 0 . 0 0 W           I p ( m a x ) = 1 6 . 0 A
T I M E O U T = 0 0 : 0 0 : 0 0   C U T O F F   V = 5 0 . 0 0 0

```

5. Move the cursor by pressing ( **←**, **→** ) to the command line of "TIMEOUT=00:00:00".

```

P s e t = 3 0 0 . 0 0 W           I p ( m a x ) = 1 6 . 0 A
T I M E O U T = 0 0 : 0 0 : 0 0   C U T O F F   V = 5 0 . 0 0 0

```

6. Move the cursor by pressing ( **←**, **→** ) to the command line of "TIMEOUT=00: 00:00".

```
P s e t = 3 0 0 . 0 0 W           I p ( m a x ) = 1 6 . 0 A
T I M E O U T = 0 0 : 0 0 : 0 0   C U T O F F V = 5 0 . 0 0 0
```

7. Press **1**, **0** then press **ENTER** to change the value to “00:10:00”.

```
P s e t = 3 0 0 . 0 0 W           I p ( m a x ) = 1 6 . 0 A
T I M E O U T = 0 0 : 1 0 : 0 0   C U T O F F V = 5 0 . 0 0 0
```

8. Move the cursor by pressing ( **◀**, **▶** ) to the command line of “TIMEOUT=00:10:00”.

```
P s e t = 3 0 0 . 0 0 W           I p ( m a x ) = 1 6 . 0 A
T I M E O U T = 0 0 : 1 0 : 0 0   C U T   O F F V = 5 0 . 0 0 0
```

9. Press **1**, **5** then press **ENTER** to change the value to “00:10:15”.

```
P s e t = 3 0 0 . 0 0 W           I p ( m a x ) = 1 6 . 0 A
T I M E O U T = 0 0 : 1 0 : 1 5   C U T O F F V = 5 0 . 0 0 0
```

10. Move the cursor by pressing ( **◀**, **▶** ) to the command line of “CUTOFF V=0”.

```
P s e t = 3 0 0 . 0 0 W           I p ( m a x ) = 1 6 . 0 A
T I M E O U T = 0 0 : 1 0 : 1 5   C U T O F F V = 5 0 . 0 0 0
```

11. Press **9**, **.**, **5** then press **ENTER** to change the value to “9.500”.

```
P s e t = 3 0 0 . 0 0 W           I p ( m a x ) = 1 6 . 0 A
T I M E O U T = 0 0 : 1 0 : 1 5   C U T O F F V = 9 . 5 0 0
```

12. After setting the parameter of the load, the **LOAD ON/OFF** key should be pressed to turn on the load, so that the load can sink the current. (The detailed information please refers section 3.4.5.)

 **Notice** If there is error during the procedures of inputting value, press **CLEAR** to clear the value at any time and then input again.

### 3.17.4 CV Mode

Under timing mode to enter CV timing mode press the **CV** key.

In this mode the loading voltage ( $V_{set}$ ), maximum current value  $I_p(max)$ , as well as the timeout time and cutoff voltage of the UUT can be set.

```

V s e t = 1 0 0 . 0 0 V           I m a x = 5 0 . 0 A
T I M E O U T = 0 0 : 0 0 : 0 0   C U T O F F   V = 5 0 . 0 0 0
V = 0 . 0 0
T H O L D U P = 0 0 : 0 0 : 0 0 : 0 0 0 m s
DC

```

The procedures of setting  $V_{set} = 200.00$ ,  $I_p(max) = 29.0$ , Timeout = 00:00:05, and Cutoff V = 8.5, are described as below:

1. Move the cursor to the command line of " $V_{set}="$ ".

```

V s e t = 2 0 0 . 0 0 V           I p ( m a x ) = 5 0 . 0 A
T I M E O U T = 0 0 : 0 0 : 0 0   C U T O F F   V = 5 0 . 0 0 0

```

2. Press **2**, **0**, **0** then press **ENTER** to change the value to "200.00".

```

V s e t = 2 0 0 . 0 0 V           I p ( m a x ) = 5 0 . 0 A
T I M E O U T = 0 0 : 0 0 : 0 0   C U T O F F   V = 5 0 . 0 0 0

```

3. Move the cursor by pressing ( **◀**, **▶** ) to the command line of " $I_p(max)="$ ".

```

V s e t = 2 0 0 . 0 0 V           I p ( m a x ) = 5 0 . 0 A
T I M E O U T = 0 0 : 0 0 : 0 0   C U T O F F   V = 5 0 . 0 0 0

```

4. Press **2**, **9** then press **ENTER** to change the value to "29.0".

```

V s e t = 2 0 0 . 0 0 V           I p ( m a x ) = 2 9 . 0 A
T I M E O U T = 0 0 : 0 0 : 0 0   C U T O F F   V = 5 0 . 0 0 0

```

5. Move the cursor by pressing ( **◀**, **▶** ) to the command line of "TIMEOUT=00:00:00".

```

V s e t = 2 0 0 . 0 0 V           I p ( m a x ) = 2 9 . 0 A
T I M E O U T = 0 0 : 0 0 : 0 0   C U T O F F   V = 5 0 . 0 0 0

```

6. Press **5** then press **ENTER** to change the value to "00:00:05".

```
V s e t = 2 0 0 . 0 0 V           I p ( m a x ) = 2 9 . 0 A
T I M E O U T = 0 0 : 0 0 : 0 5   C U T O F F   V = 5 0 . 0 0 0
```



7. Move the cursor by pressing ( ,  ) to the command line of "CUTOFF V =".

```
V s e t = 2 0 0 . 0 0 V           I p ( m a x ) = 2 9 . 0 A
T I M E O U T = 0 0 : 0 0 : 0 5   C U T O F F   V = 5 0 . 0 0 0
```

8. Press , ,  then press  to change the value to "8.500".

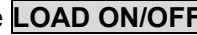
```
V s e t = 2 0 0 . 0 0 V           I p ( m a x ) = 2 9 . 0 A
T I M E O U T = 0 0 : 0 0 : 0 5   C U T O F F   V = 8 . 5 0 0
```

9. After setting the parameter of the load, the  key should be pressed to turn on the load, so that the load can sink the current. (The detailed information please refers section 3.4.5.)

 **Notice** : If there is error during the procedures of inputting value, press  to clear the value at any time and then input again.

### 3.17.5 Rectified Mode

Under timing mode to enter DC rectified timing mode press the  key.

In this mode the loading power  $I_{set}$ , the value CF, Line sync., frequency, maximum current value  $I_p(max)$  of the UUT. The loading timeout time and cutoff voltage can be set. If Line sync. selects YES, the frequency of loading current will load by frequency of the main voltage. On the contrary, the loading current will load by users' inputted frequency.

```
I s e t = 5 . 0 0           C F = 1 . 4 1 4           L I N E   S Y N C = N O
F = 1 2 0           I p ( m a x ) = 5 0 . 0           T I M E O U T = 0 0 : 0 0 : 0 0
V = 0 . 0 0           C U T O F F   V = 5 0 . 0 0 0
T
H O L D U P = 0 0 : 0 0 : 0 0 : 0 0 0 m s
DC
```

The procedures of setting  $I_{set} = 15.00$ ,  $CF = 2.000$ , **Line sync = NO**,  $F = 50$ ,  $I_p(max) = 39.0$ , **Timeout = 00:00:10**, and **Cutoff V = 11.5**, are described as below:

1. Move the cursor to the command line of " $I_{set} =$ ".

```

l s e t = 1 5 . 0 0      C F = 1 . 4 1 4      L I N E   S Y N C = N O
F = 1 2 0      l p ( m a x ) = 5 0 . 0      T I M E O U T = 0 0 : 0 0 : 0 0
                                     C U T O F F   V = 5 0 . 0 0 0

```

2. Press **1**, **5** then press **ENTER** to change the value to "15.00".

```

l s e t = 1 5 . 0 0      C F = 1 . 4 1 4      L I N E   S Y N C = N O
F = 1 2 0      l p ( m a x ) = 5 0 . 0      T I M E O U T = 0 0 : 0 0 : 0 0
                                     C U T O F F   V = 5 0 . 0 0 0

```

3. Move the cursor by pressing ( **←**, **→** ) to the command line of "CF=".

```

l s e t = 1 5 . 0 0      C F = 1 . 4 1 4      L I N E   S Y N C = N O
F = 1 2 0      l p ( m a x ) = 5 0 . 0      T I M E O U T = 0 0 : 0 0 : 0 0
                                     C U T O F F   V = 5 0 . 0 0 0

```

4. Press **2** then press **ENTER** to change the value to "2.000".

```

l s e t = 1 5 . 0 0      C F = 2 . 0 0 0      L I N E   S Y N C = N O
F = 1 2 0      l p ( m a x ) = 5 0 . 0      T I M E O U T = 0 0 : 0 0 : 0 0
                                     C U T O F F   V = 5 0 . 0 0 0

```

5. Move the cursor by pressing ( **←**, **→** ) to the command line of "LINE SYNC =".

```

l s e t = 1 5 . 0 0      C F = 2 . 0 0 0      L I N E   S Y N C = N O
F = 1 2 0      l p ( m a x ) = 5 0 . 0      T I M E O U T = 0 0 : 0 0 : 0 0
                                     C U T O F F   V = 5 0 . 0 0 0

```

6. Press the direction key ( **←**, **→** ) to change the item to "NO" then press **ENTER**.

```

l s e t = 1 5 . 0 0      C F = 2 . 0 0 0      L I N E   S Y N C = N O
F = 1 2 0      l p ( m a x ) = 5 0 . 0      T I M E O U T = 0 0 : 0 0 : 0 0
                                     C U T O F F   V = 5 0 . 0 0 0

```

7. Move the cursor by pressing ( **←**, **→** ) to the command line of "F=".

```

l s e t = 1 5 . 0 0      C F = 2 . 0 0 0      L I N E   S Y N C = N O
F = 1 2 0      l p ( m a x ) = 5 0 . 0      T I M E O U T = 0 0 : 0 0 : 0 0
                                     C U T O F F   V = 5 0 . 0 0 0

```

8. Press **5**, **0** then press **ENTER** to change the value to “50.0”.

```
I s e t = 1 5 . 0 0      C F = 2 . 0 0 0      L I N E   S Y N C = N O
F = 5 0      I p ( m a x ) = 5 0 . 0      T I M E O U T = 0 0 : 0 0 : 0 0
                                         C U T O F F   V = 5 0 . 0 0 0
```

9. Move the cursor by pressing ( **◀**, **▶** ) to the command line of “I<sub>p</sub>(max)=”.

```
I s e t = 1 5 . 0 0      C F = 2 . 0 0 0      L I N E   S Y N C = N O
F = 5 0      I p ( m a x ) = 5 0 . 0      T I M E O U T = 0 0 : 0 0 : 0 0
                                         C U T O F F   V = 5 0 . 0 0 0
```

10. Press **3**, **9** then press **ENTER** to change the value to “39.0”.

```
I s e t = 1 5 . 0 0      C F = 2 . 0 0 0      L I N E   S Y N C = N O
F = 5 0      I p ( m a x ) = 3 9 . 0      T I M E O U T = 0 0 : 0 0 : 0 0
                                         C U T O F F   V = 5 0 . 0 0 0
```

11. Move the cursor by pressing ( **◀**, **▶** ) to the command line of “TIMEOUT=00:00:00”.

```
I s e t = 1 5 . 0 0      C F = 2 . 0 0 0      L I N E   S Y N C = N O
F = 5 0      I p ( m a x ) = 3 9 . 0      T I M E O U T = 0 0 : 0 0 : 0 0
                                         C U T O F F   V = 5 0 . 0 0 0
```

12. Press **5** then press **ENTER** to change the value to “00:00:05”.

```
I s e t = 1 5 . 0 0      C F = 2 . 0 0 0      L I N E   S Y N C = N O
F = 5 0      I p ( m a x ) = 3 9 . 0      T I M E O U T = 0 0 : 0 0 : 0 5
                                         C U T O F F   V = 5 0 . 0 0 0
```

13. Move the cursor by pressing ( **◀**, **▶** ) to the command line of “CUTOFF V =”.

```
I s e t = 1 5 . 0 0      C F = 2 . 0 0 0      L I N E   S Y N C = N O
F = 5 0      I p ( m a x ) = 3 9 . 0      T I M E O U T = 0 0 : 0 0 : 0 5
                                         C U T O F F   V = 5 0 . 0 0 0
```

14. Press **1**, **1**, **5** then press **ENTER** to change the value to “115.00”.

```

I s e t = 1 5 . 0 0      C F = 2 . 0 0 0      L I N E   S Y N C = N O
F = 5 0      I p ( m a x ) = 3 9 . 0      T I M E O U T = 0 0 : 0 0 : 0 5
                                C U T O F F   V = 1 1 5 . 0 0

```

15. After setting the parameter of the load, the **LOAD ON/OFF** key should be pressed to turn on the load, so that the load can sink the current. (The detailed information please refers section 3.4.5.)

 **Notice**

1. If there is error during the procedures of inputting value, press **CLEAR** to clear the value at any time and then input again.
2. If LINE SYNC selected YES thus users need to select frequency (F) as ALL, Positive or Negative. (Please refers section 3.16)

### 3.18 Voltage and Current Monitor

The 63800 series have Voltage and Current monitoring outputs that allow users observe the loading current and the output voltage of UUT via oscilloscope with BNC connectors. These are useful tools when user wants to monitor the voltage and current waveform via scope. Both of the monitoring signals are isolated from the hazardous voltage.

The corresponding relation between voltage and current on the oscilloscope is as below.  
 Voltage: 500V/10V for 63803 and 63804.  
 Current: 80A/10V for 63803, 200A/10V for 63804.  
 The bandwidths of the above voltage and current are 6000kHz.

 **Notice**

- Although both of the monitoring signals are isolated from the hazardous, use power cord without ground to connect to oscilloscope is recommended.

### 3.19 Short Circuit On/Off







The Load can simulate a short circuit at input by setting it on with full-scale current under maximum specified power. The short circuit can be turned on/off from the front panel or via remote control.

Short consists of two modes, Toggle and Hold, the setting methods are as follows.

1. Press **CONF./LOCAL** key.
2. Press **1**, then press **ENTER** to enter SETUP.



```



[ CONF ]
CHOOSE = 1   1 . SETUP
              2 . REMOTE
              3 . CALIBRATION
              4 . DISPLAY SELECTION
              5 . FACTORY DEFAULT
              6 . MODEL INFORMATION
              7 . PARALLEL MODE
    
```

3. Move the cursor ( ,  ) to "1-2. SHORT".
4. Press the direction key ( ,  ) or rotate the rotary knob to choose "TOGGLE" or "HOLD".
5. Then press ,  or , to enter the CC, CR or CP mode.

```

1 - 1 . MODE SELECT      = AC / DC           [ SETUP ]
1 - 2 . SHORT           = OFF / TOGGLE / HOLD
1 - 3 . LOCK MODE       = ROTARY / KEYPAD / ALL
1 - 4 . SOUND           = ON / OFF
1 - 5 . CF / PF SETTING = BOTH / CF / PF
1 - 6 . TIMING MODE     = OFF / HOLDUP / TRANSFER
1 - 7 . EXTERNAL        = OFF / ON
1 - 8 . ABA MODE        = ENABLE / DISABLE
    
```

Under **TOGGLE** mode, press  key then release, and the input is shorted. The LED beside this key will be activated. Press the  key again, and the function will be terminated. Then the load will be under last situation before pressing  key.

Under **HOLD** mode, press  key, and the input is shorted. The LED beside this key will be activated. After release the  keypad, and the function will be terminated. Then the load will be under last situation before pressing  key.

When the input voltage is a sinusoidal wave, a short current waveform will be programmed by the DSP in the short function with a crest factor of 1.414, and power factor of 1. On the other hand, if the input voltage is DC, DSP will program a short DC with full-scale current under maximum specified power.

### 3.20 Save/Recall Setting

The Electronic Load setting can be saved and recalled for various test setups. This avoids the need for repetitive programming for different settings. The present setting of mode



parameters (CC, CR, CP, Rectified), programs and power on status can be saved in EEPROM using the **SAVE** key. Later you can recall the settings from the specified file via **RECALL** key. There are ten files (file = 0 ~ 9) under each mode can be saved.

**Notice** AC Load will automatically load file 0 when it turns on. User defined settings can be stored in file 0 and recalled when AC load turns on. After recalling factory defaults, file 0 will return to the default settings.

### Example 1: (SAVE)

Under CC mode:

1. Press **SAVE** key then pop up a window.
2. Press **0**, then press **ENTER** to save the values in file 0.

```
SAVE FILE OF CC MODE
FILE = 0
SAVE FILE = NO
```

3. Move the cursor by pressing ( **◀**, **▶** ) to the command line of "SAVE FILE =".

```
SAVE FILE OF CC MODE
FILE = 0
SAVE FILE = N0
```

4. Press the direction key ( **◀**, **▶** ) or rotate the rotary knob to choose "YES", then press **ENTER** to save file.

```
SAVE FILE OF CC MODE
FILE = 0
SAVE FILE = YES0
```

### Example 2: (RECALL)

Under CC mode:

1. Press **RECALL** key then pop up a window.
2. Press **0**, then press **ENTER** to recall the values in file 0.

```
RECALL FILE OF CC MODE
FILE = 0
RECALL FILE = NO
```

3. Move the cursor by pressing ( **◀**, **▶** ) to the command line of “RECALL FILE =”.

```
RECALL FILE OF CC MODE
FILE = 0
RECALL FILE = NO
```

4. Press the direction key ( **◀**, **▶** ) or rotate the rotary knob to choose “YES”, then press **ENTER** to recall file.

```
RECALL FILE OF CC MODE
FILE = 0
RECALL FILE = YES
```

## 3.21 Parallel Setting

The AC Load is capable of connecting up to five units in parallel, with CC/CR/CP/RLC modes available under AC and DC operation. Parallel connection is shown as Figure 3-18.

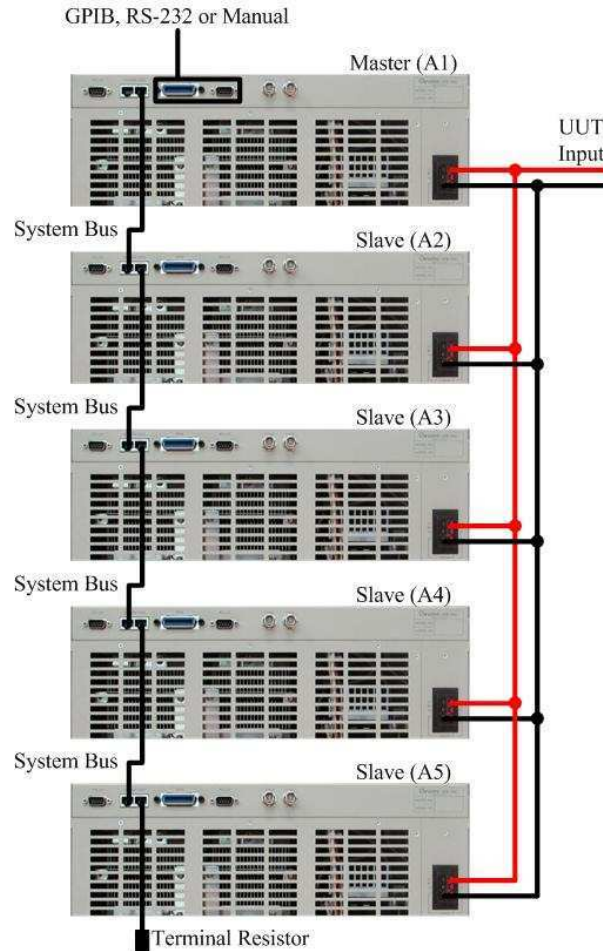

Figure 3-18 Parallel Connection

Under parallel mode, master and slave can be determined by the POSITION setting 1~5. When POSITION = 1, this indicates the current AC Load unit is set as the master unit, when POSITION = 2~5 this indicates that the current AC Load unit is set as a slave unit. The TOTAL UNIT setting on the master unit is required to be set to ensure the load rating of the paralleled AC Loads.

When setting the AC Load for parallel operation, the slave units need to be set up firstly before the master unit is set to ensure the correct TOTAL UNIT setting on the master unit. Below is an example of setting up three AC Load units in parallel.

Select an AC Load and set it as the first slave unit (A2).

1. Press **CONF./LOCAL** key.
2. Press **7**, then press **ENTER** to enter "PARALLEL MODE".

```
                                [ CONF ]
CHOOSE = 1    1 . SETUP
                2 . REMOTE
                3 . CALIBRATION
                4 . DISPLAY SELECTION
                5 . FACTORY DEFAULT
                6 . MODEL INFORMATION
                7 . PARALLEL MODE
```

3. Press the direction key ( ◀, ▶ ) or rotate the rotary knob to choose “PARALLEL”, then press **ENTER**.

```
                                [ PARALLEL ]
OPERATING MODE = PARALLEL / SINGLE
PHASE           = A
POSITION        = 1
TOTAL UNIT      = 1
```

4. Move the cursor ( ▲, ▼ ) to “POSITION”.
5. Press **2**, then press **ENTER**. It sets the first slave POSITION to 2 and its (A2) setting is completed.

```
                                [ PARALLEL ]
OPERATING MODE = PARALLEL / SINGLE
PHASE           = A
POSITION        = 2
```

Select the next AC Load, and set it as the second slave unit (A3).

1. Press **CONF./LOCAL** key.
2. Press **7**, then press **ENTER** to enter “PARALLEL MODE”.

```

[ CONF ]
CHOOSE = 1   1 . SETUP
              2 . REMOTE
              3 . CALIBRATION
              4 . DISPLAY SELECTION
              5 . FACTORY DEFAULT
              6 . MODEL INFORMATION
              7 . PARALLEL MODE

```

3. Press the direction key ( ◀, ▶ ) or rotate the rotary knob to choose “PARALLEL”, then press **ENTER**.

```

[ PARALLEL ]
OPERATING MODE = PARALLEL / SINGLE
PHASE           = A
POSITION        = 1
TOTAL UNIT      = 1

```

4. Move the direction by pressing ( ▲, ▼ ) to “POSITION”.
5. Press **3**, then press **ENTER**. It sets the second slave POSITION to 3 and its (A3) setting is completed

```

[ PARALLEL ]
OPERATING MODE = PARALLEL / SINGLE
PHASE           = A
POSITION        = 3

```

Select the next AC Load and set it as the master unit.

1. Press **CONF./LOCAL** key.

2. Press **7**, then press **ENTER** to enter "PARALLEL MODE".

```
                                [ CONF ]  
CHOOSE = 1    1 . SETUP  
                2 . REMOTE  
                3 . CALIBRATION  
                4 . DISPLAY SELECTION  
                5 . FACTORY DEFAULT  
                6 . MODEL INFORMATION  
                7 . PARALLEL MODE
```

3. Press the direction key ( **◀**, **▶** ) or rotate the rotary knob to choose "PARALLEL", then press **ENTER**.

```
                                [ PARALLEL ]  
OPERATING MODE = PARALLEL / SINGLE  
PHASE           = A  
POSITION        = 1  
TOTAL UNIT      = 1
```

4. Rotate the rotary knob to choose "A", then press **ENTER**.

```
                                [ PARALLEL ]  
OPERATING MODE = PARALLEL  
PHASE           = A  
POSITION        = 1  
TOTAL UNIT      = 1
```

5. Press **1**, then press **ENTER**. POSITION setting 1 indicates the AC load as master.

```

[ P A R A L L E L ]
OPERATING MODE = P A R A L L E L / S I N G L E
PHASE           = A
POSITION        = 1
TOTAL UNIT      = 1

```

6. Press **3**, then press **ENTER**. It sets Total unit to 3 that includes master and slave.

```

[ P A R A L L E L ]
OPERATING MODE = P A R A L L E L / S I N G L E
PHASE           = A
POSITION        = 1
TOTAL UNIT      = 3

```

7. The master (A1) setting is completed. Press **CC**, **CR**, **CP** or **RLC/DC RECT** to return to the mode that the users want to use.

Under CC mode the Master and Slave unit displays are as shown below.

Master unit display

```

I s e t = 9 0 . 0           C F = 1 . 4 1 4           P F = 1 . 0 0 0
I p ( m a X ) = 1 3 5 . 0           U N I T : A
V = 1 0 0 . 0 0           P = 9 0 0 0 . 0
I = 9 0 . 0 0           S = 9 0 0 0 0 0 ▼
AC   P R I O R I T Y : C F

```

First SLAVE unit display

S L A V E   A 2

Second SLAVE unit display

S L A V E   A 3

When the TOTAL UNIT setting on the Master unit is inconsistent with what is detected by the AC Load, the following display will be shown. At the same time, the AC Load loading will be turned off.

I N C O R R E C T   D E V I C E   N U M B E R ! !  
  
P L E A S E   C H E C K   I T   A G A I N !  
  
P R E S S   < E N T E R >   T O   E X I T .

After the AC Load has been set up in parallel mode, it will be saved in the memory (ROM). The AC Load will then start up in parallel mode on subsequent power on. Upon power on, the Master unit will request to check the parallel connection as shown below.



```
MASTER A 1  
PRESS <ENTER> TO CHECK PARALLEL NETWORK.
```

While loading if an AC Load is disconnected from the parallel network, the paralleled units will stop loading, and the following error message will be displayed.

```
COMMUNICATION ERROR  
PRESS <ENTER> TO CHECK PARALLEL NETWORK.
```

To exit parallel mode, press the **CONF./LOCAL** key.

Example, if the AC Load has been set as the slave unit as shown below.

```
SLAVE A 2
```

To change the slave unit from parallel mode back to single unit control the steps are as follows.

1. Press **CONF./LOCAL** key.
2. Press **7**, then press **ENTER** to enter "PARALLEL MODE".

```

[ CONF ]
CHOOSE = 1   1 . SETUP
              2 . REMOTE
              3 . CALIBRATION
              4 . DISPLAY SELECTION
              5 . FACTORY  DEFAULT
              6 . MODEL   INFORMATION
              7 . PARALLEL MODE
```

3. Press the direction key ( ◀, ▶ ) or rotate the rotary knob to choose “SINGLE”, then press **ENTER**.

```

[ PARALLEL ]
OPERATING MODE = SINGLE / PARALLEL
PHASE           = A
POSITION        = 2
```

4. Press **CC**, **CR**, **CP** or **RLC/DC RECT** to return to the mode that the users want to use.

 **Notice** For all AC Loads set to parallel mode, regardless of whether it is a Master or Slave unit, to operate as a single unit, the operation mode must be set as single mode. To return the Master unit to single mode, the steps are the same as described above for the Slave unit.

## 3.22 Three Phases Parallel Setting

Each phase in 3-phase parallel mode can connect 5 sets in parallel, and it only can be operated in CC/CR/CP/RLC/RLC CP modes under AC load. The connection methods of parallel power include Y and Delta connection which are given as Figure 3-19 and Figure 3-20.

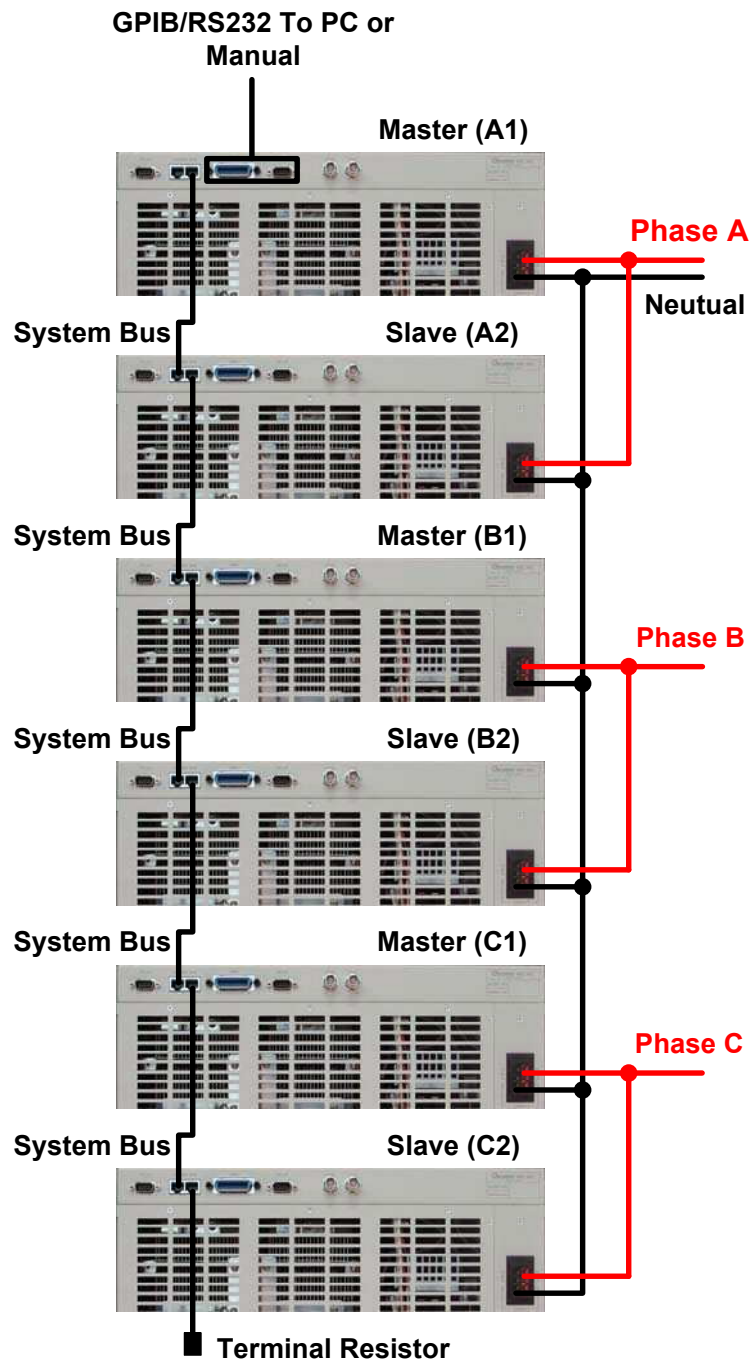

Figure 3-19 Parallel 3-Phase Y connection

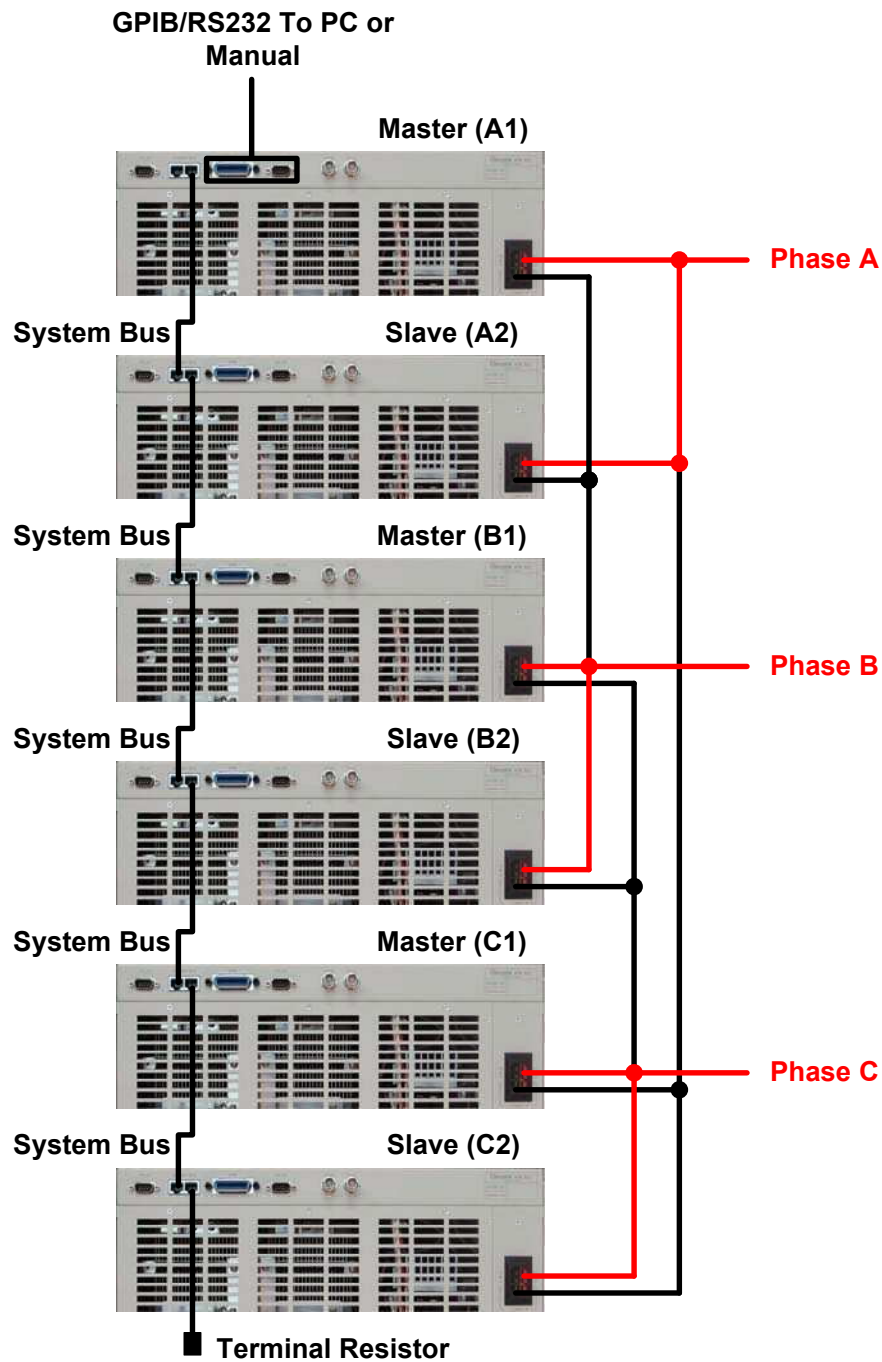

Figure 3-20 Parallel 3-Phase Delta connection

Users can set POSITION to determine master and slave as setting 3-phase parallel mode, POSITION setting is 1 ~ 5. If POSITION = 1, it means the AC load will be set as master. If POSITION = 2 ~ 5, it means AC load will be set as slave. In addition, master needs to set TOTAL UNIT quantity to ensure loading power.

It is needed to start setting from slave of A phase and master/slave of B/C phase as setting 3-phase parallel mode. That is to say, users need to set AC load to slave and Master of B/C phase setting is completed, set master of A phase at last thus master of A phase can

confirm parallel total count. For example, 3-phase two sets of AC load in parallel, the setting methods are as below shown.

**Notice** Set Master(B1, C1) of B/C phase and Slave(A2~A5, B2~B5, C2~C5) of A, B, C three phases firstly, then set Master(A1) of A phase and confirm AC load total count. When the setting is completed, only need to process loading parameter setting in Master (A1), the display page of Master (B1) and Master (C1) only show measurement value of B phase and C phase.

The following illustrates 6 sets of AC load, 3-phase parallel setting methods of each phase with 2 sets of AC load.

### Phase A

Select an AC Load and set it as the slave unit (A2).

1. Press **CONF./LOCAL** key.
2. Press **7**, then press **ENTER** to enter "PARALLEL MODE".

[ CONF ]

CHOOSE = 1      1 . SETUP

                         2 . REMOTE

                         3 . CALIBRATION

                         4 . DISPLAY      SELECTION

                         5 . FACTORY      DEFAULT

                         6 . MODEL      INFORMATION

                         7 . PARALLEL      MODE

3. Press the direction key ( **◀**, **▶** ) or rotate the rotary knob to choose "PARALLEL", then press **ENTER**.

[ PARALLEL ]

OPERATING MODE = PARALLEL / SINGLE

PHASE                      = A

POSITION                    = 1

TOTAL UNIT                 = 1

4. Rotate the rotary knob to choose "A", then press **ENTER**.

```
                                [ P A R A L L E L ]  
OPERATING MODE = P A R A L L E L  
PHASE           = A  
POSITION        = 1  
TOTAL UNIT      = 1
```

5. Press **2**, then press **ENTER**. Set POSITION of A phase slave as 2, A phase slave (A2) setting is completed.

```
                                [ P A R A L L E L ]  
OPERATING MODE = P A R A L L E L  
PHASE           = A  
POSITION        = 2
```

## Phase B

Select the next AC Load, and set it as the B phase Master (B1).

1. Press **CONF./LOCAL** key.
2. Press **7**, then press **ENTER** to enter "PARALLEL MODE".

```
                                [ C O N F ]  
CHOOSE = 1    1 . S E T U P  
               2 . R E M O T E  
               3 . C A L I B R A T I O N  
               4 . D I S P L A Y   S E L E C T I O N  
               5 . F A C T O R Y   D E F A U L T  
               6 . M O D E L     I N F O R M A T I O N  
               7 . P A R A L L E L M O D E
```

3. Press the direction key ( **◀**, **▶** ) or rotate the rotary knob to choose "PARALLEL", then press **ENTER**.

```

[ P A R A L L E L ]
OPERATING MODE = P A R A L L E L / S I N G L E
P H A S E           = A
P O S I T I O N    = 1
T O T A L   U N I T = 1

```

4. Rotate the rotary knob to choose “B”, then press **ENTER**.

```

[ P A R A L L E L ]
OPERATING MODE = P A R A L L E L
P H A S E           = B
P O S I T I O N    = 1

```

5. Press **1**, then press **ENTER**. Set POSITION of B phase master as 1, master (B1) setting is completed.

```

[ P A R A L L E L ]
OPERATING MODE = P A R A L L E L
P H A S E           = B
P O S I T I O N    = 1

```

Select the next AC Load, and set it as the B phase slave unit (B2).

1. Press **CONF./LOCAL** key.
2. Press **7**, then press **ENTER** to enter “PARALLEL MODE”.

```

[ CONF ]
CHOOSE = 1   1 . SETUP
              2 . REMOTE
              3 . CALIBRATION
              4 . DISPLAY SELECTION
              5 . FACTORY DEFAULT
              6 . MODEL INFORMATION
              7 . PARALLEL MODE
```

3. Press the direction key ( ◀, ▶ ) or rotate the rotary knob to choose “PARALLEL”, then press **ENTER**.

```

[ PARALLEL ]
OPERATING MODE = PARALLEL / SINGLE
PHASE           = A
POSITION        = 1
TOTAL UNIT      = 1
```

4. Rotate the rotary knob to choose “B”, then press **ENTER**.

```

[ PARALLEL ]
OPERATING MODE = PARALLEL
PHASE           = B
POSITION        = 1
```

5. Press **2**, then press **ENTER**. Set POSITION of B phase slave as 2, B phase slave (B2) setting is completed.



```

[ P A R A L L E L ]
OPERATING MODE = P A R A L L E L
PHASE           = B
POSITION        = 2

```

### Phase C

Select the next AC Load, and set it as the C phase Master (C1).

1. Press **CONF./LOCAL** key.
2. Press **7**, then press **ENTER** to enter "PARALLEL MODE".

```

[ C O N F ]
CHOOSE = 1   1 . S E T U P
              2 . R E M O T E
              3 . C A L I B R A T I O N
              4 . D I S P L A Y   S E L E C T I O N
              5 . F A C T O R Y   D E F A U L T
              6 . M O D E L   I N F O R M A T I O N
              7 . P A R A L L E L   M O D E

```

3. Press the direction key ( **◀**, **▶** ) or rotate the rotary knob to choose "PARALLEL", then press **ENTER**.

```

[ P A R A L L E L ]
OPERATING MODE = P A R A L L E L / S I N G L E
PHASE           = A
POSITION        = 1
TOTAL UNIT      = 1

```

4. Rotate the rotary knob to choose "C", then press **ENTER**.

```

[ P A R A L L E L ]
OPERATING MODE = P A R A L L E L
PHASE           = C
POSITION        = 1
```

5. Press **1**, then press **ENTER**. Set POSITION of C phase master as 1, master (C1) setting is completed.

```

[ P A R A L L E L ]
OPERATING MODE = P A R A L L E L
PHASE           = C
POSITION        = 1
```

Select the next AC Load, and set it as the C phase slave unit (C2).

1. Press **CONF./LOCAL** key.
2. Press **7**, then press **ENTER** to enter "PARALLEL MODE".

```

[ C O N F ]
CHOOSE = 1   1 . S E T U P
              2 . R E M O T E
              3 . C A L I B R A T I O N
              4 . D I S P L A Y   S E L E C T I O N
              5 . F A C T O R Y   D E F A U L T
              6 . M O D E L   I N F O R M A T I O N
              7 . P A R A L L E L   M O D E
```

3. Press the direction key ( **◀**, **▶** ) or rotate the rotary knob to choose "PARALLEL", then press **ENTER**.

```

[ P A R A L L E L ]
OPERATING MODE = P A R A L L E L / S I N G L E
P H A S E           = A
P O S I T I O N    = 1
T O T A L   U N I T = 1

```

4. Rotate the rotary knob to choose "C", then press **ENTER**.

```

[ P A R A L L E L ]
OPERATING MODE = P A R A L L E L
P H A S E           = C
P O S I T I O N    = 1

```

5. Press **2**, then press **ENTER**. Set POSITION of C phase slave as 2, C phase slave (C2) setting is completed.

```

[ P A R A L L E L ]
OPERATING MODE = P A R A L L E L
P H A S E           = C
P O S I T I O N    = 2

```

Select the next AC Load and set it as the A phase master (A1) unit.

1. Press **CONF./LOCAL** key.
2. Press **7**, then press **ENTER** to enter "PARALLEL MODE".

```

[ CONF ]
CHOOSE = 1   1 . SETUP
              2 . REMOTE
              3 . CALIBRATION
              4 . DISPLAY SELECTION
              5 . FACTORY DEFAULT
              6 . MODEL INFORMATION
              7 . PARALLEL MODE
```

3. Press the direction key ( ◀, ▶ ) or rotate the rotary knob to choose “PARALLEL”, then press **ENTER**.

```

[ PARALLEL ]
OPERATING MODE = PARALLEL / SINGLE
PHASE           = A
POSITION        = 1
TOTAL UNIT      = 1
```

4. Rotate the rotary knob to choose “A”, then press **ENTER**.

```

[ PARALLEL ]
OPERATING MODE = PARALLEL
PHASE           = A
POSITION        = 1
TOTAL UNIT      = 1
```

5. Press **1**, then press **ENTER**. Set POSITION of A phase master as 1.

```

[ P A R A L L E L ]
OPERATING MODE = P A R A L L E L
PHASE           = A
POSITION        = 1
TOTAL UNIT      = 1

```

6. Press **6**, then press **ENTER**. Set TOTAL UNIT as 6.

```

[ P A R A L L E L ]
OPERATING MODE = P A R A L L E L / S I N G L E
PHASE           = A
POSITION        = 1
TOTAL UNIT      = 6

```

7. The master (A1) setting is completed. Press **CC**, **CR**, **CP** or **RLC/DC RECT** to return to the mode that the users want to use.

Under CC mode the Master and Slave unit displays are as shown below.

## PHASE A

A phase Master (A1) unit display

```

I set = 90 . 0           CF = 1 . 4 1 4           P F = 1 . 0 0 0
I p ( m a X ) = 1 3 5 . 0   PHASE   S E L E C T = A + B + C
V = 1 0 0 . 0 0         P = 9 0 0 0 . 0
I = 9 0 . 0 0           S = 9 0 0 0   0   ▼
P R I O R I T Y : C F           M A S T E R   A 1

```



**PHASE C**

C phase Master (C1) unit display

```

I s e t = 9 0 . 0           C F = 1 . 4 1 4           P F = 1 . 0 0 0
I p ( m a X ) = 1 3 5 . 0
V = 1 0 0 . 0 0           P = 9 0 0 0 . 0
I = 9 0 . 0 0           S = 9 0 0 0   0   ▼
P R I O R I T Y : C F           M A S T E R   C 1

```

C phase SLAVE (C2) unit display

```

S L A V E   C 2

```

When the TOTAL UNIT setting on the Master unit is inconsistent with what is detected by the AC Load, the following display will be shown. At the same time, the AC Load loading will be turned off.

```

I N C O R R E C T   D E V I C E   N U M B E R ! !
P L E A S E   C H E C K   I T   A G A I N !
P R E S S   < E N T E R >   T O   E X I T .

```

After the AC Load has been set up in parallel mode, it will be saved in the memory (ROM). The AC Load will then start up in parallel mode on subsequent power on. Upon power on, the Master unit will request to check the parallel connection as shown below.



While loading if an AC Load is disconnected from the parallel network, the paralleled units will stop loading, and the following error message will be displayed.



To exit parallel mode, press the **CONF./LOCAL** key.

Example, if the AC Load has been set as the slave unit as shown below.



To change the slave unit from parallel mode back to single unit control the steps are as follows.

1. Press **CONF./LOCAL** key.
2. Press **7**, then press **ENTER** to enter "PARALLEL MODE".



```

[ CONF ]
CHOOSE = 1   1 . SETUP
              2 . REMOTE
              3 . CALIBRATION
              4 . DISPLAY SELECTION
              5 . FACTORY DEFAULT
              6 . MODEL INFORMATION
              7 . PARALLEL MODE

```

3. Press the direction key ( ◀, ▶ ) or rotate the rotary knob to choose "SINGLE", then press **ENTER**.

```

[ PARALLEL ]
OPERATING MODE = SINGLE / PARALLEL
PHASE           = A
POSITION        = 2

```

4. Press **CC**, **CR**, **CP** or **RLC/DC RECT** to return to the mode that the users want to use.

**Notice** For all AC Loads set to parallel mode, regardless of whether it is a Master or Slave unit, to operate as a single unit, the operation mode must be set as single mode. To return the Master unit to single mode, the steps are the same as described above for the Slave unit.

PHASE SELECT only be displayed in A1. PHASE SELECT can set to A+B+C, A, B, C, this item is for changing setting value of each phase. When A+B+C is selected, if  $I_{set}$ , CF, PF,  $I_p(max)$  changed thus A, B, C three phases will be changed at the same time. When A is selected, if  $I_{set}$ , CF, PF and  $I_p(max)$  are changed thus only A phase will be changed. Similarly, when B is selected, if  $I_{set}$ , CF, PF and  $I_p(max)$  are changed thus only B phase will be changed. When C is selected, if  $I_{set}$ , CF, PF and  $I_p(max)$  are changed thus only C phase will be changed.

I s e t = 9 0 . 0	C F = 1 . 4 1 4	P F = 1 . 0 0 0
I p ( m a X ) = 1 3 5 . 0	P H A S E	S E L E C T = A + B + C
V = 1 0 0 . 0 0	P = 9 0 0 0 . 0	
I = 9 0 . 0 0	S = 9 0 0 0	0 ▼
P R I O R I T Y : C F		M A S T E R A 1

## 4. Measurements

The Load measures current, voltage, and peak current of the UUT. The maximum sampling rate of the ADCs for the voltage and current measurements is about 200,000 samples per second (200 kSPS). Voltage and current measurements are performed with 16-bit resolution of full-scale ratings. Through the detected data of the voltage and current, true power, reactive power, apparent power, frequency, PF, CF, and Voltage THD are calculated by DSP. As well, peak detection of the current is utilized the same ADC.

The definitions of the measuring values are given below:

- True Power (P)

Displays the true power consumed by the load and computed as:

$$W = \frac{1}{T} \int_0^T v * i dt$$

where T represents the period of voltage, v and i represent instantaneous voltage and instantaneous current separately.

- Apparent Power (S)

Displays the apparent power consumed by the load and computed as:

$$S = V_{rms} * I_{rms}$$

where  $V_{rms}$  and  $I_{rms}$  represent the root mean square values of voltage and current separately.

- Reactive Power (Q)

Displays the reactive power consumed by the load and computed as:

$$Q = \sqrt{S^2 - P^2}$$

- Voltage (V)

V displays the root mean square value of voltage and computed as:

$$V = \sqrt{\frac{1}{T} \int_0^T v^2 dt}$$

- Current (I)

I displays the root mean square value of current and computed as:

$$I = \sqrt{\frac{1}{T} \int_0^T i^2 dt}$$

- Power factor (PF)

Displays the power factor of the load and computed as:

$$PF = \frac{P}{S}$$

- Crest factor (CF)

Displays the crest factor of current and computed as:

$$CF = \frac{I_{PK}}{I_{rms}}$$

where  $I_{PK}$  represents the peak value of current.

- Impedance (R)

Displays the impedance of the load and computed as:

$$R = \frac{V_{rms}}{I_{rms}}$$

- Frequency (F)

Displays the frequency of the UUT input voltage.

- Total Harmonic Distortions (THD)

Displays the total harmonic distortions of the UUT input voltage and computed as:

$$THD = \frac{\sqrt{V_{rms}^2 - V_{h1}^2}}{V_{h1}}$$

where  $V_{h1}$  represents the fundamental component of voltage.

 **CAUTION** If the frequency is out of the specification, the measurement will not be in the normal status.

## 4.1 AC Load Simulation

There are two kinds of AC mode: Constant Load modes and Rectified Load Modes are shown as figure 3-1. The detail of Constant Load Modes is divided into three sub-modes of CC, CR and CP modes. The detail of Rectified Load Modes is divided into three sub-modes of RLC, CP (base on RLC mode) and Inrush Current modes. The parameters measured are described separately as follows.

### 4.1.1 Constant Current Mode

There are eleven measurement values under CC mode: V, I, P, S, Q, PF, CF, F,  $I_p^+$ ,  $I_p^-$ , and THD. They are shown as pages below.

Main page:

I s e t = 0 . 5 0 0	C F = 1 . 4 1 4	P F = 1 . 0 0 0	
I p ( m a x ) = 1 0 . 0			U N I T : A
V = 0 . 0 0		P = 0 . 0 0	
I = 0 . 0 0		S = 0 . 0 0	▼
A C P R I O R I T Y : C F			

Second page:

I s e t = 0 . 5 0 0	C F = 1 . 4 1 4	P F = 1 . 0 0 0	
I p ( m a x ) = 1 0 . 0			U N I T : A
Q = 0 . 0 0		C F = 0 . 0 0 0	▲
P F = 0 . 0 0 0		F = 0 . 0 0	▼
A C P R I O R I T Y : C F			

Third page:

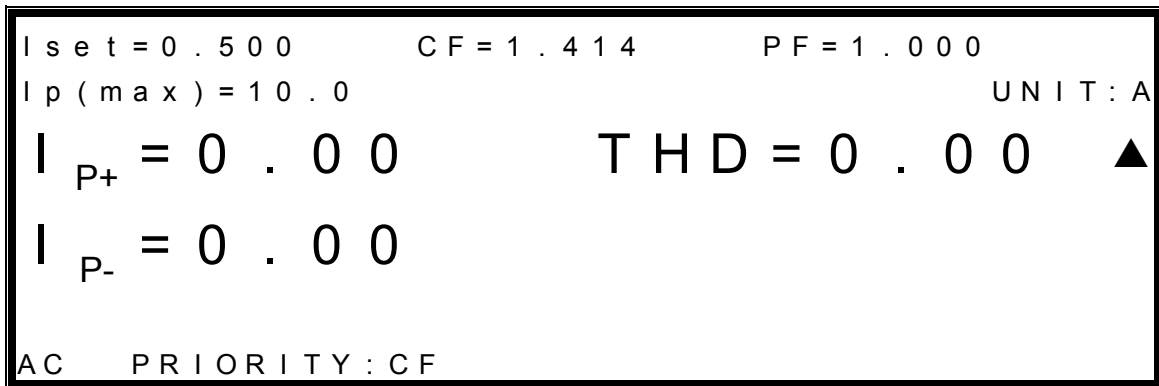

 **Notice** Users can change the orders of the measurement parameters arbitrarily under **CONF/LOCAL** → 4. DISPLAY SELECTION, please refers section 3.4.1 Setting the Configuration.

### 4.1.2 Constant Resistance Mode

There are twelve measurement values under CR mode: V, I, P, S, Q, PF, CF, F, I<sub>p+</sub>, I<sub>p-</sub>, THD, and R. They are shown as pages below.

Main page:

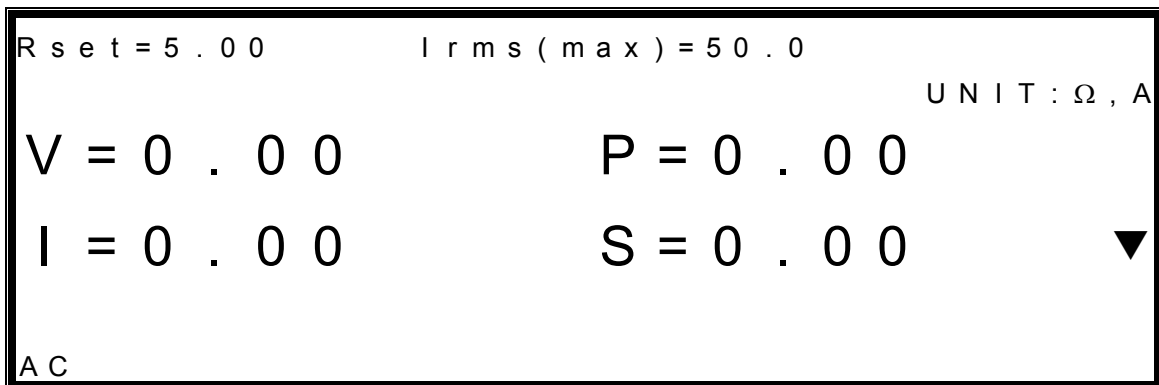

Second page:

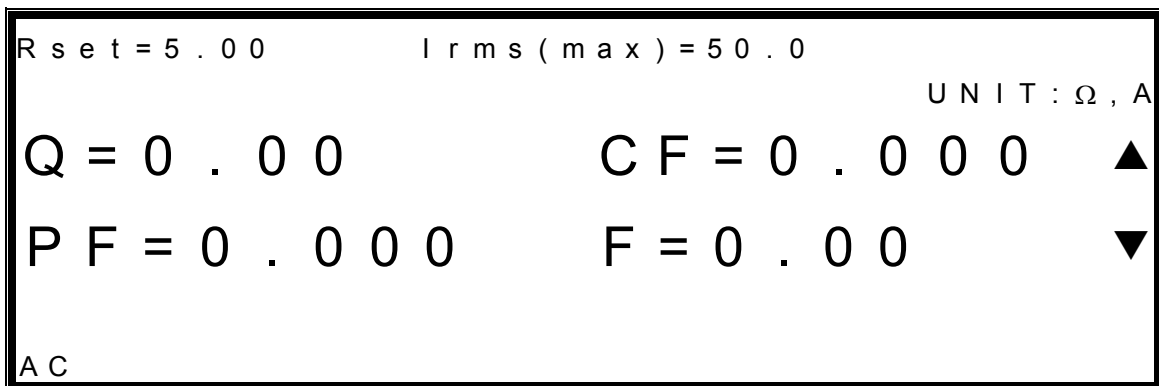

Third page:

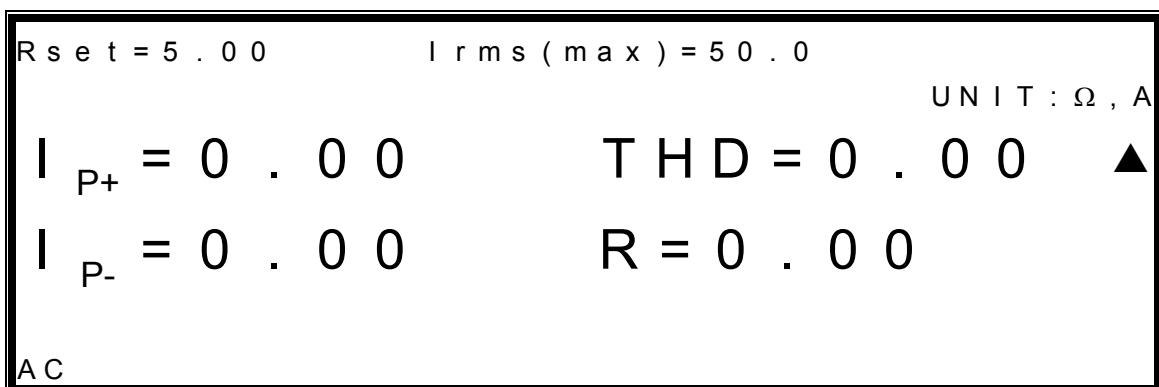

 **Notice** Users can change the orders of the measurement parameters arbitrarily under **CONF/LOCAL** → 4. DISPLAY SELECTION, please refers section 3.4.1 Setting the Configuration.

### 4.1.3 Constant Power Mode

There are eleven measurement values under CP mode: V, I, P, S, Q, PF, CF, F, I<sub>p+</sub>, I<sub>p-</sub>, and THD. They are shown as pages below.

Main page:

```
P s e t = 4 5 0 0 . 0      C F = 1 . 4 1 4      P F = 1 . 0 0 0
I p ( m a x ) = 1 0 . 0      U N I T : W , A
V = 0 . 0 0      P = 0 . 0 0
I = 0 . 0 0      S = 0 . 0 0      ▼
AC  P R I O R I T Y : C F
```

Second page:

```
P s e t = 4 5 0 0 . 0      C F = 1 . 4 1 4      P F = 1 . 0 0 0
I p ( m a x ) = 1 0 . 0      U N I T : W , A
Q = 0 . 0 0      C F = 0 . 0 0 0      ▲
P F = 0 . 0 0 0      F = 0 . 0 0      ▼
AC  P R I O R I T Y : C F
```

Third page:

```
P s e t = 4 5 0 0 . 0      C F = 1 . 4 1 4      P F = 1 . 0 0 0
I p ( m a x ) = 1 0 . 0      U N I T : W , A
Ip+ = 0 . 0 0      T H D = 0 . 0 0      ▲
Ip- = 0 . 0 0
AC  P R I O R I T Y : C F
```



**Notice**

Users can change the orders of the measurement parameters arbitrarily under **CONF/LOCAL** → 4. DISPLAY SELECTION, please refers section 3.4.1 Setting the Configuration.



## 4.1.4 Rectified Load Mode

This mode is developed based on that load network that has three sub modes – RLC mode, CP mode and Inrush Current mode.

### 4.1.4.1 RLC Mode

There are eleven measurement values under RLC mode: V, I, P, S, Q, PF, CF, F,  $I_p^+$ ,  $I_p^-$ , and THD. They are shown as pages below.

Main page:

$R_s = 0.11$	$L_s = 200$	$C = 2000$	$R_L = 5000.00$
$I_p(\max) = 10.0$		UNIT: $\Omega$ , $\mu H$ , $\mu F$ , A	
$V = 0.00$	$P = 0.00$		
$I = 0.00$	$S = 0.00$ ▼		
AC			

Second page:

$R_s = 0.11$	$L_s = 200$	$C = 2000$	$R_L = 5000.00$
$I_p(\max) = 10.0$		UNIT: $\Omega$ , $\mu H$ , $\mu F$ , A	
$Q = 0.00$	$CF = 0.000$ ▲		
$PF = 0.000$	$F = 0.00$ ▼		
AC			

Third page:

```

Rs = 0 . 1 1      Ls = 2 0 0      C = 2 0 0 0      RL = 5 0 0 0 . 0 0
Ip (max) = 1 0 . 0      UNIT : Ω , u H , u F , A
IP+ = 0 . 0 0      THD = 0 . 0 0 ▲
IP- = 0 . 0 0
AC
    
```

 **Notice** Users can change the orders of the measurement parameters arbitrarily under **CONF/LOCAL** → 4. DISPLAY SELECTION, please refers section 3.4.1 Setting the Configuration.

#### 4.1.4.2 CP Mode

There are eleven measurement values under CP mode: V, I, P, S, Q, PF, CF, F, I<sub>p+</sub>, I<sub>p-</sub>, and THD. They are shown as pages below.

Main page:

```

Pset = 1 0 0 0 . 0      PF = 1 . 0 0 0      Ip (max) = 1 0 . 0
UNIT : W , A
V = 0 . 0 0      P = 0 . 0 0
I = 0 . 0 0      S = 0 . 0 0 ▼
AC CP
    
```

Second page:

```

P s e t = 1 0 0 0 . 0      P F = 1 . 0 0 0      I p ( m a x ) = 1 0 . 0
                                  U N I T : W , A
Q = 0 . 0 0      C F = 0 . 0 0 0      ▲
P F = 0 . 0 0 0      F = 0 . 0 0      ▼
AC  CP

```

Third page:

```

P s e t = 1 0 0 0 . 0      P F = 1 . 0 0 0      I p ( m a x ) = 1 0 . 0
                                  U N I T : W , A
IP+ = 0 . 0 0      T H D = 0 . 0 0      ▲
IP- = 0 . 0 0
AC  CP

```



**Notice**

Users can change the orders of the measurement parameters arbitrarily under **CONF/LOCAL** → 4. DISPLAY SELECTION, please refers section 3.4.1 Setting the Configuration.

#### 4.1.4.3 Inrush Current Mode

There are seven measurement values under Inrush current mode: V, I, P, Q, I<sub>p+</sub>, I<sub>p-</sub>, and THD. They are shown as pages below.

Main page:

```

Rs = 0 . 1 1      Ls = 2 0 0      C = 2 0 0 0      RL = 5 0 0 0 . 0 0
PHASE = 9 0      Ip (max) = 1 0      UNIT : Ω , uH , uF , · , A
V = 0 . 0 0      P = 0 . 0 0
I = 0 . 0 0      Q = 0 . 0 0      ▼
AC INRUSH
    
```

Second page:

```

Rs = 0 . 1 1      Ls = 2 0 0      C = 2 0 0 0      RL = 5 0 0 0 . 0 0
PHASE = 9 0      Ip (max) = 1 0      UNIT : Ω , uH , uF , · , A
IP+ = 0 . 0 0      THD = 0 . 0 0      ▲
IP- = 0 . 0 0
AC INRUSH
    
```

 **Notice** Users can change the orders of the measurement parameters arbitrarily under **CONF/LOCAL** → 4. DISPLAY SELECTION, please refers section 3.4.1 Setting the Configuration.

## 4.2 DC Load Simulation

There are five modes of operation: Constant Current (CC), Constant Resistance (CR), Constant Power (CP), Constant Voltage (CV) and DC Rectified mode (DC RECT).

 **CAUTION** Under DC mode, the minimum operating voltage is 7.5Vdc. If the voltage is lower than 7.5V, the 63800 will not be in the normal status.

### 4.2.1 Constant Current Mode

There are five measurement values under CC mode: V, I, P,  $V_{overshoot}$ , and  $V_{undershoot}$ . They are shown as pages below.

Main page:

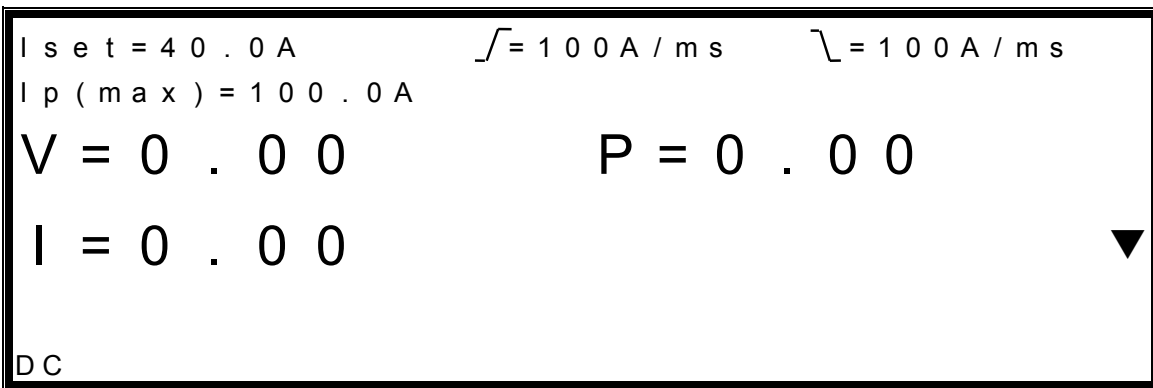

Second page:

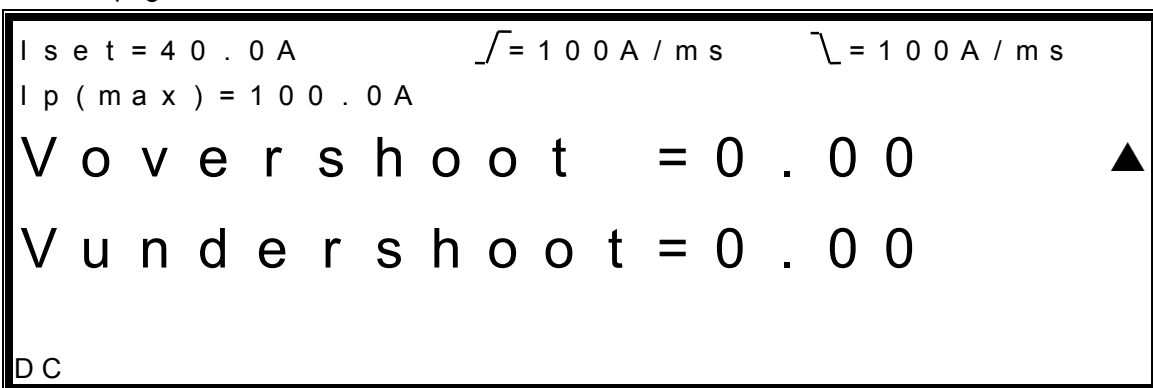

**Notice** Users can change the orders of the measurement parameters arbitrarily under **CONF/LOCAL** → 4. DISPLAY SELECTION, please refers section 3.4.1 Setting the Configuration.

## 4.2.2 Constant Resistance Mode

There are five measurement values under CR mode: V, I, P,  $V_{overshoot}$ , and  $V_{undershoot}$ . They are shown as pages below.

Main page:

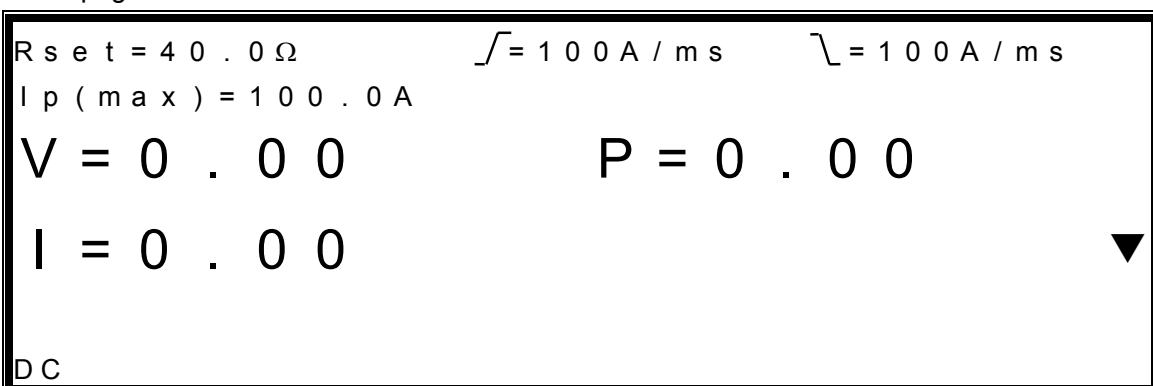

Second page:

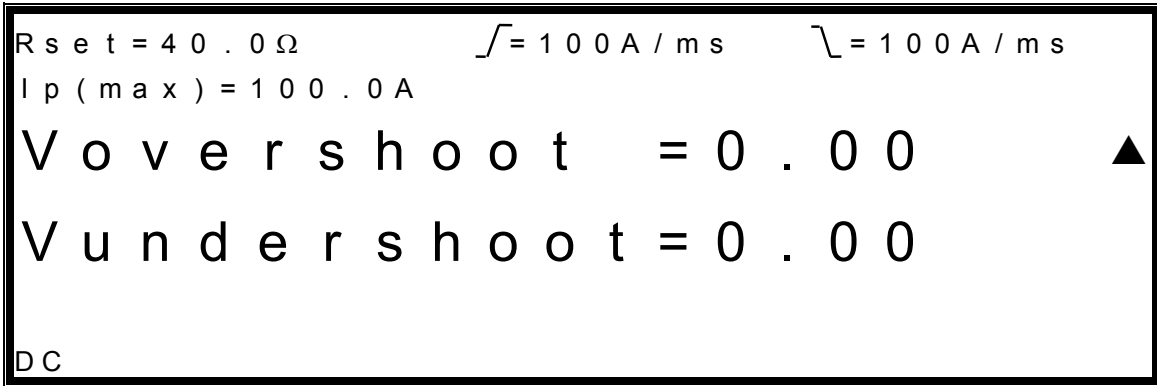



 **Notice** Users can change the orders of the measurement parameters arbitrarily under **CONF/LOCAL** → 4. DISPLAY SELECTION, please refers section 3.4.1 Setting the Configuration.

### 4.2.3 Constant Voltage Mode

There are three measurement values under CV mode: V, I, and P. They are shown as pages below.

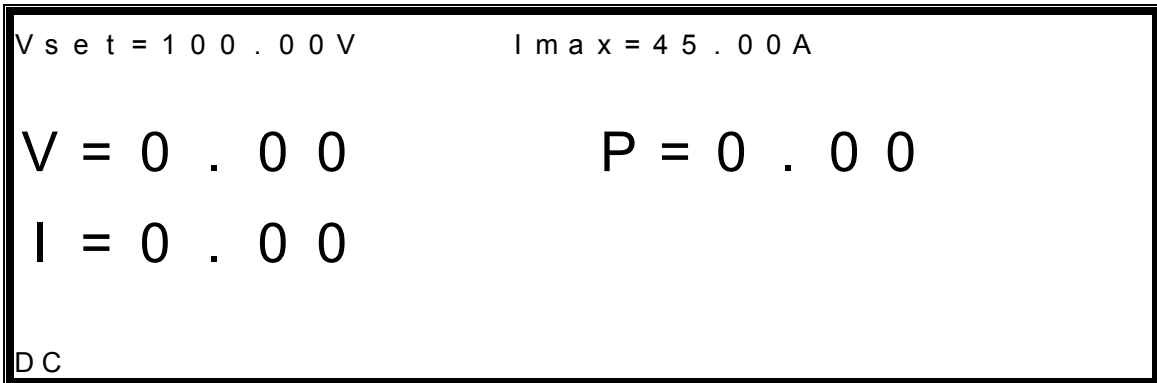
Main page:



 **Notice** Users can change the orders of the measurement parameters arbitrarily under **CONF/LOCAL** → 4. DISPLAY SELECTION, please refers section 3.4.1 Setting the Configuration.

### 4.2.4 Constant Power Mode

There are five measurement values under CP mode: V, I, P,  $V_{overshoot}$ , and  $V_{undershoot}$ . They are shown as pages below.

Main page:

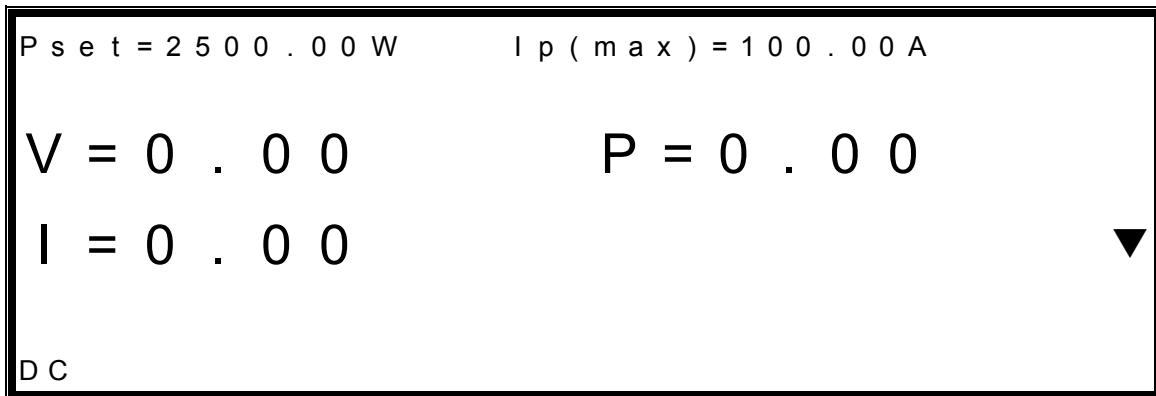

Second page:

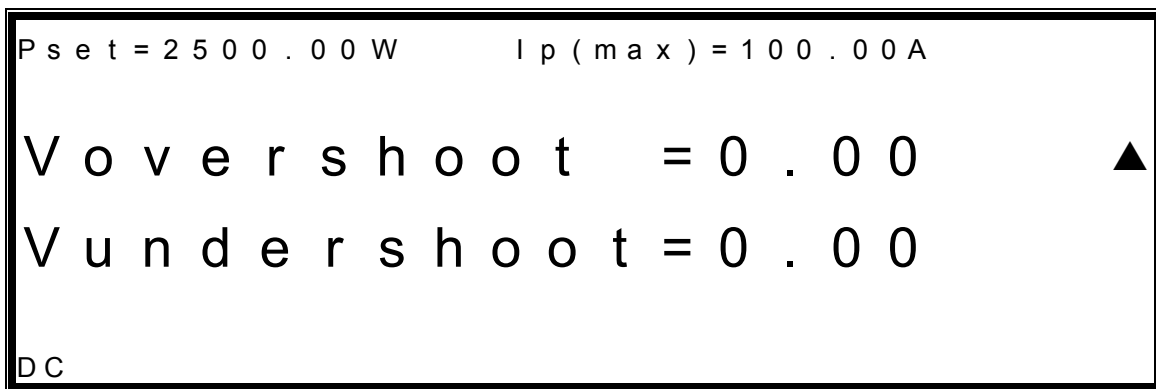

 **Notice** Users can change the orders of the measurement parameters arbitrarily under **CONF/LOCAL** → 4. DISPLAY SELECTION, please refers section 3.4.1 Setting the Configuration.

## 4.2.5 Rectified Load Mode

There are four measurement values under Rectified mode: V, I, P, and  $I_p$ . They are shown as pages below.

Main page:

```
I s e t = 1 0 . 0 0 A      C F = 1 . 4 1 4      L I N E   S Y N C = N O
F = 1 2 0 . 0 H z      I p ( m a x ) = 1 0 0 . 0 A

V = 0 . 0 0              P = 0 . 0 0

I = 0 . 0 0              I p = 0 . 0 0

D C   R E C T I F I E D
```



**Notice**

Users can change the orders of the measurement parameters arbitrarily under **CONF/LOCAL** → 4. DISPLAY SELECTION, please refers section 3.4.1 Setting the Configuration.



## 5. Protection Features

The load includes the protection features: Over power, Over current, Over temperature, Fan fail, Abnormal Alarms for Over Voltage and Load Fail.

Fan speed detection and OTP are built in the hardware circuit. The rest protective features are from estimation of the DSP. The Load's buzzer will beep sound to inform you till protection or alarm status is reset. When any of the protection or alarm occurs, the loading current will turn off.

### 5.1 Over Voltage Protection (OVP)

The over voltage alarm point is set at  $360V_{\text{rms}} / 510V_{\text{DC}}$  which is calculated by DSP. It is specified in the Load specification.

When the over voltage alarm happens, please turn off the power supply of the UUT, or the load will cause a un-recovery damage in this situation because abnormal voltage wears of power devices of the load.

### 5.2 Over Current Protection (OCP)

The protection method is set the protected current at  $3 A_{\text{rms}} / 3 A_{\text{DC}}$  over the full scale current. The value is specified in the Load specification.

### 5.3 Over Power Protection (OPP)

The over power protection is caused by the unconditional driving of the load. Protection level is set at a level above  $4600W @ AC / 4600W @ DC$  of the indicated power. The over power status register bit is set when the OP condition occurs, and will remain set till it is reset.

### 5.4 Over Temperature Protection (OTP)

The Load has an over temperature protection circuit, which will turn off the load if internal temperature exceeds the safe limits. The over temperature status register bit is set when the OT condition occurs, and will remain set till it is reset.

### 5.5 Fan Fail

The Load has a fan fail protection circuit, which will turn off the load if any of the fans is out of order. The fan fail status register bit is set when the condition occurs, and will remain set till it is reset.

## 5.6 Out of Frequency Range (FREQ ERR)

If frequency measurement is out of range (45Hz ~ 440Hz), FREQ ERR (Frequency Error) will be generated and shown on the front panel.

## 5.7 Under Operating Voltage Protection (UVP)

While the load is operated to sink current, the voltage is dropped through the output impedance of the test unit. The load will stop driving the current to protect the load and the test unit. The user has to reduce the value of the current or the value of the crest factor, and the load will operate normally.

## 5.8 Load Fail (LDF)

The LDF warning occurred conditions: 1. The loading when voltage is 0V. 2. Draw the voltage to 0V as loading. 3. Load hardware abnormal. 4. When the voltage and the load current starts oscillating.



### Notice

All of the protections or alarms will latch when they are tripped. When OV, OC, OP and OT protections or alarm occurs, the load will turn off the input, and beep till you remove the condition and reset the protection by pressing **ENTER**. When LDF occurs, users need to press the power switch to restart the AC load. If AC load can not function normally after restarting, please contact Chroma sales or service office.



### CAUTION

To protect the Electronic Load from possible damage, the input voltage must not exceed the maximum input voltage rating specification.

## **6. Theory of Operation**

### **6.1 General**

The AC load consists of 10 printed circuit boards and other components. Each of the PCB has its specific function that will be described in the following subsection.

## 6.2 Description of Overall System

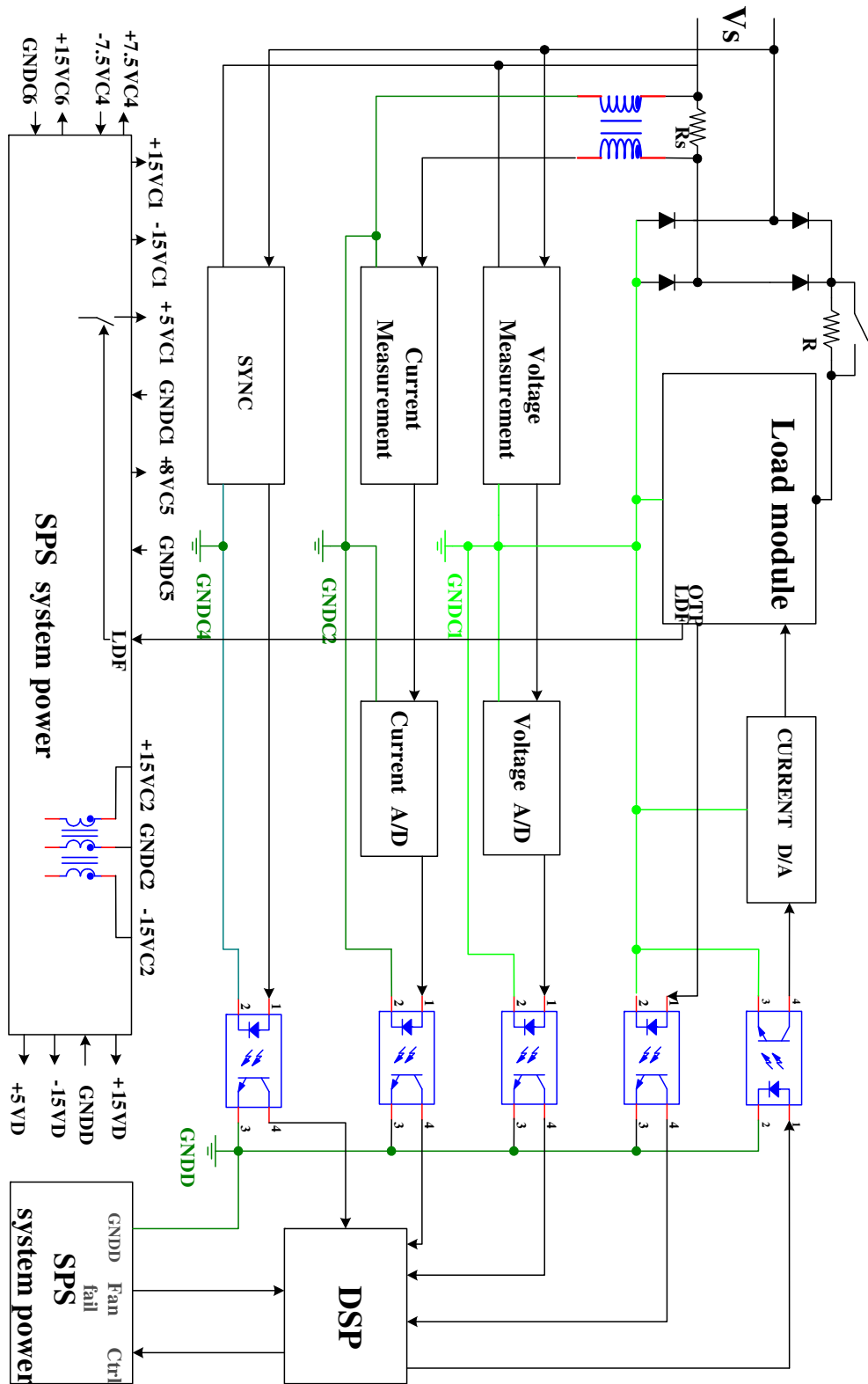

## 7. Troubleshooting

### 7.1 General

This section describes the self-test steps and suggested troubleshooting procedures when AC/DC load does not function normally. If the problem cannot be solved using the information given here, consult the distributor whom you purchased the unit.

### 7.2 Troubleshooting

The following table lists the operating problems and suggests corrective actions:

Problem	Reason	Solution
Poor measurement of V, I.	Aging of components result in deviation of characteristics.	Periodic calibration is required.
Distorted output	1. The input voltage is over specification. 2. The frequency of UUT is over specification.	1. Program the input voltage in the reasonable range. 2. Program the frequency in the reasonable range.
OVER VOLTAGE protection (OVP)	The UUT's output voltage peak is over range.	1. Turn off the power supply of the UUT. 2. Check the output voltage of UUT lower than specification or not.
OVER CURRENT protection (OCP)	The sink current is over specification or I LIMIT.	Reduce the current.
OVER POWER protection (OPP)	The input power is over specification.	Reduce the over power or lower down input voltage/current.
OVER TEMPERAURE protection (OTP)	1. Ambient temperature is too high. 2. Airway is obstructed.	1. Operate the unit 0 ~ 40°C. 2. Unblock the airway.
Fan Fail	1. Fan damaged. 2. Power cord bad contact.	Send the AC/DC load back to Chroma to change and to check the fan.
Out of Frequency Rage (FREQ ERR)	The measurement frequency is out of range.	Make sure the frequency of UUT is in the range.
UNDER operating VOLTAGE protection (UVP)	The output voltage of UUT is too low.	Regulate the output voltage of UUT higher than the specification.
INPUT FAIL protection	The AC/DC load line input voltage is too low or too high.	Measure input voltage, and regulate it if it's over specification.
Cannot control AC load by GPIB	1. The AC/DC load unit address is incorrect. 2. GPIB cable is loose at rear.	1. Update address. 2. Check connection, tighten the screws.



## 8. Remote Operation

### 8.1 General Information

The AC Load can be controlled remotely through the GPIB or the RS-232C port. The GPIB port is commonly used, but the RS-232C port is helpful too.

Technically speaking, the GPIB interface is quite different from the RS-232C interface. The GPIB interface is an 8-bit parallel data bus owning a host of bus commands for synchronization, and up to one Megabyte transfer rate. The RS-232C interface, a series bus with a few handshake lines for synchronization, is less capable, so its requirement is not so much, and the user can write a simple program to do basic remote control easily.

#### 8.1.1 Setting the GPIB Address and RS-232C Parameters

The AC Load is shipped with the GPIB address set at 8. The address can be only changed from the "CONF" functional list menu (please refer to 3.4.1). This menu is also used to select the RS-232C interface, and specify the parameters of RS-232C such as baud rate and parity.

#### 8.1.2 Wire Connection of RS-232C

The AC Load is shipped with the baud rate set at 57600, and with parity set as None. For RS-232C interface, only the signals of TxD and RxD are used for its transfer of data. The RS-232C connector is a 9-pin D subminiature male connector. The following table describes the pins and signals of RS-232C connector.

Pin Number	Input/Output	Description
1	---	+5V
2	Input	RxD
3	Output	TxD
4	Input /Output	Short Switch
5	---	GND
6	Input /Output	Short Switch
7	Output	RTS
8	Input	CTS
9	---	+5V

## 8.2 The GPIB Capability of the AC Load

GPIB Capability	Description	Interface Functions
Talker/Listener	Commands and response messages can be sent and received over the GPIB bus. Status information can be read using a series poll.	AH1, SH1, T6, L4
Service Request	The AC Load sets the SRQ line true if there is an enabled service request condition.	SR1
Remote/Local	The AC Load powers up in local state. In local state, the front panel is operative, and the AC Load responds to the commands from GPIB. In remote state*, all front panel keys except the "<CONF./LOCAL>" key are disabled. Press "<CONF./LOCAL>" key to return the AC Load to local state.	RL1

## 8.3 Introduction to Programming

All commands and response messages are transferred in form of ASCII codes. The response messages must be read completely before a new command is sent, otherwise the remaining response messages will be lost, and a query interrupt error will occur.

### 8.3.1 Conventions

Angle brackets	< >	Items in angle brackets are parameter abbreviations.
Vertical bar		Vertical bar separates alternative parameters.
Square brackets	[ ]	Items in square brackets are optional. For example, FETCH[:SCALar] means that :SCALar may be omitted.
Braces	{ }	Braces indicate the parameters that may be repeated. The notation <A> {<, B>} means that parameter "A" must be entered while parameter "B" may be omitted or entered once or more times.

### 8.3.2 Numerical Data Formats

All data programmed to or returned from the AC Load are ASCII. The data can be numerical or character string.

#### Numerical Data Formats

Symbol	Description	Example
NR1	It is a digit with no decimal point. The decimal is assumed to be at the right of the least significant digit.	123, 0123
NR2	It is a digit with a decimal point.	12.3, .123



### 8.3.3 Boolean Data Format

The Boolean parameter <Boolean> takes only the form ON|OFF.

### 8.3.4 Character Data Format

The character strings returned by query command may take either of the following forms:

<CRD>            Character Response Data: character string with maximum length of 12.  
 <SRD>            String Response Data: character string.

### 8.3.5 Basic Definition

Command Tree Table:

The commands of the AC Load are based on a hierarchical structure, also known as a tree system. In order to obtain a particular command, the full path to that command must be specified. This path is represented in the table by placing the highest node in the farthest left position of the hierarchy. Lower nodes in the hierarchy are indented in the position to the right, below the parent node.

Program Headers:

Program headers are key words that identify the command. They follow the syntax described in subsection 8.6 of IEEE 488.2. The AC Load accepts characters in both upper and lower case without distinguishing the difference. Program headers consist of two distinctive types, common command headers and instrument-controlled headers.

Common Command and Query Headers:

The syntax of common command and query headers is described in IEEE 488.2. It is used together with the IEEE 488.2-defined common commands and queries. The commands with a leading “ \* ” are common commands.

Instrument-Controlled Headers:

Instrument-controlled headers are used for all other instrument commands. Each of them has a long form and a short form. The AC Load only accepts the exact short and long forms. A special notation will be taken to differentiate the short form header from the long one of the same header in this subsection. The short form of the header are shown in characters of upper case, whereas the rest of the header are shown in those of lower case.

Program Header Separator (:):

If a command has more than one header, the user must separate them with a colon ( FETC:CURR? or VOLT:DC 10 ). Data must be separated from program header by one space at least.

Program Message:

Program message consists of a sequence of zero or more elements of program message

unit that is separated by separator elements of program message unit.

Program Message Unit:

Program message unit represents a single command, programming data, or query.

Example : CURR? or LOAD ON.

Program Message Unit Separator ( ; ):

The separator (semicolon ;) separates the program message unit elements from one another in a program message.

Example : CURR 20;CFAC 2<PMT>  
Program Message Terminator (<PMT>):

A program message terminator represents the end of a program message. Three permitted terminators are:

- (1) <END> : end or identify (EOI)
- (2) <NL> : new line which is a single ASCII-encoded byte 0A (10 decimals).
- (3) <NL> <END> : new line with EOI.

Note: The response message is terminated by <NL> <END> for GPIB, and <NL> for RS-232C.

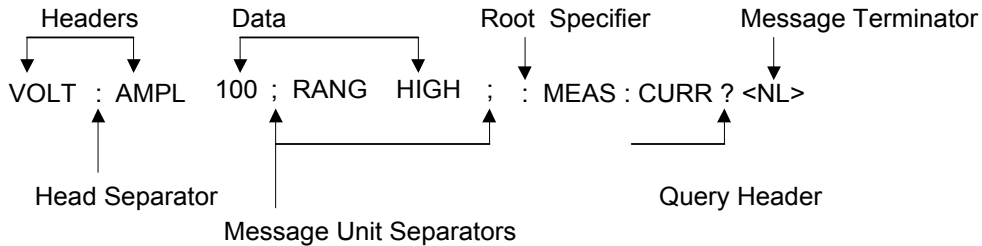

Figure 8-1 The Structure of Command Message

## 8.4 Traversal of the Command Tree

Multiple program message unit elements can be sent in a program message. The first command is always referred to the root node. Subsequent commands are referred to the same tree level as the previous command in a program message. A colon preceding a program message unit changes the header path to the root level.

Example:

LOAD:CURR 10                                    All colons are header separators.  
: LOAD:CURR 10                                Only the first colon is a specific root.  
LOAD:CURR 10; :CFAC 2.2                    Only the third colon is a specific root.

## 8.5 Execution Order

The AC Load executes program messages by the order received. Program message units except coupled commands are executed in order of reception. The execution of coupled commands is deferred until program message terminator is received. A coupled command sets parameters which are affected by the setting of other commands. Problems may arise, because the prior state of the AC Load will affect the response of a coupled parameter to its programming.

## 8.6 SCPI Command Reference

### 8.6.1 Common Command Dictionary

Common commands begin with a “ \* ”, and consist of three letters and/or one “ ? ” (query). Common commands and queries are listed alphabetically.

---

#### **\*CLS            Clear status**

---

Description: This command clears the following registers

1. Standard Event Status register
2. Questionable Status Event
3. Standard Status Byte

Setting Syntax     : \*CLS  
 Setting Parameter : none  
 Query Syntax      : none  
 Response Parameter: none

---

#### **\*ESE<n> Standard event status enabled**

---

Description: This command programs the Standard Event Status Enable Register bits. If one or more of the enable events of the Standard Event Status is set, the ESB of Status Byte Register is set too.

Bit Configuration of Standard Event Status Enabled Register

Bit Position	7	6	5	4	3	2	1	0
Bit Name	---	---	CME	EXE	DDE	QYE	---	OPC
CME = Command error enable				DDE = Device-dependent error				
EXE = Execution error enable				OPC = Operation complete enable				
QYE = Query error enable								

Setting Syntax     : \*ESE  
 Setting Parameter : <NR1>, 0 ~ 255  
 Query Syntax      : \*ESE?  
 Response Parameter: <NR1>, 0 ~ 255

---

#### **\*ESR?            Return standard event status register**

---

Description: The query reads the Standard Event Status Register. Reading the Standard Event Status Register clears it.

Setting Syntax : none  
 Setting Parameter : none  
 Query Syntax : \*ESR?  
 Response Parameter: <NR1>, 0 ~ 255

**\*IDN? Return the AC Load identification string**

---

Description: This Command queries manufacturer's name, model name, serial number and firmware version.

Setting Syntax : none  
 Setting Parameter : none  
 Query Syntax : \*IDN?  
 Response Parameter: Chroma, 63804, 0, 1.00

**\*OPC Set the OPC bit of the Standard Event Status register**

---

Description: This command causes the interface to set the OPC bit of the Standard Event register when the AC Load has completed all pending operations. The query causes the interface to place an ASCII "1" in the output query when all pending operations are complete.

Setting Syntax : \*OPC  
 Setting Parameter : none  
 Query Syntax : \*OPC?  
 Response Parameter: <NR1>

**\*RST Reset command**

---

Description : This command performs device initial setting  
 Setting Syntax : \*RST  
 Setting Parameter : none  
 Query Syntax : none  
 Response Parameter: none

**\*SRE <n> Service request enabled register**

---

Description : This command sets the Service Request Enabled Register.  
 Setting Syntax : \*SRE  
 Setting Parameter : <NR1>, 0 ~ 255  
 Query Syntax : \*SRE?  
 Response Parameter: <NR1>, 0 ~ 255

**\*STB? This query returns the Status Byte Register.**

---

Description : This Command queries the status byte register.

Bits configuration of Status Byte Register

Bit Position	7	6	5	4	3	2	1	0
Condition	--	MSS	ESB	MAV	QUES	--	--	--

ESB = event status byte summary  
 RQS = request for service

MSS = master status summary  
MAV = message available

Setting Syntax : none  
Setting Parameter : none  
Query Syntax : \*STB?  
Response Parameter: <NR1>, 0 ~ 255

## 8.6.2 Measurement Subsystem

### 8.6.2.1 Current Measurement

**MEASure | FETCh**

**[ :SCALar]**

**:CURRent**

**Return RMS / real time value of the current  
(AC Mode / DC Mode)**

**:AMPLitude**

**The highest peak current measurement is held**

**:HOLD**

**:MAX**

**Return peak current**

**:CREStfactor?**

**Return current crest factor**

**:PEAK**

**:NEGative?**

**Return negative peak current**

**:POSitive?**

**Return positive peak current**

**MEASure[:SCALar]:CURRent?**

**FETCh[:SCALar]:CURRent?**

---

Description: Return the RMS / real time (AC Mode / DC Mode) current measured at the input of electronic load.

Query Syntax : MEASure:CURRent?  
FETCh:CURRent?

Response Parameter: <NR2>

Example : MEAS:CURR?

**MEASure[:SCALar]:CURRent:AMPLitude:HOLD**

**FETCh [:SCALar]:CURRent:AMPLitude:HOLD**

---

Description: This command will define the peak current measurement mode. If the hold command is set to ON, the peak current measurement is updated only when the value measured exceed the last measured value. If the hold command is set to OFF, the peak current measurement is updated each cycle. (AC mode only)

Setting Syntax : MEASure[:SCALar]:CURRent:AMPLitude:HOLD  
FETCh [:SCALar]:CURRent:AMPLitude:HOLD

Setting Parameter : 0 | OFF, 1 | ON

Query Syntax : MEASure[:SCALar]:CURRent:AMPLitude:HOLD?  
FETCh [:SCALar]:CURRent:AMPLitude:HOLD?

Response Parameter: <NR1>

Example : MEAS:CURR:AMPL:HOLD ON

**MEASure[:SCALar]:CURRent:AMPLitude:MAX?**

**FETCh[:SCALar]:CURRent:AMPLitude:MAX?**

---

Description: Return the peak current measured at the input of electronic load.

Query Syntax : MEASure:CURRent:AMPLitude:MAX?  
FETCh:CURRent:AMPLitude:MAX?

Response Parameter: <NR2>

Example : MEAS:CURR:AMPL:MAX?

**MEASure[:SCALar]:CURRent:CREStfactor?**

**FETCh[:SCALar]:CURRent:CREStfactor?**

Description: Return the current crest factor of the load. This is the ratio of peak load current to RMS load current.

Query Syntax : MEASure:CURRent:CREStfactor?  
FETCh:CURRent:CREStfactor?

Response Parameter: <NR2>

Example : MEAS:CURR:CREStfactor?

**MEASure[:SCALar]:CURRent:PEAK:NEGative?**

**FETCh[:SCALar]:CURRent:PEAK:NEGative?**

Description: Return the negative peak current measured at the input of electronic load.

Query Syntax : MEASure[:SCALar]:CURRent:PEAK:NEGative?  
FETCh[:SCALar]:CURRent:PEAK:NEGative?

Response Parameter: <NR2>

Example : MEAS:CURR:PEAK:NEG?

**MEASure[:SCALar]:CURRent:PEAK:POSitive?**

**FETCh[:SCALar]:CURRent:PEAK:POSitive?**

Description: Return the positive peak current measured at the input of electronic load.

Query Syntax : MEASure[:SCALar]:CURRent:PEAK:POSitive?  
FETCh[:SCALar]:CURRent:PEAK:POSitive?

Response Parameter: <NR2>

Example : MEAS:CURR:PEAK:POS?

## 8.6.2.2 Frequency Measurement

**MEASure | FETCh**

**[:SCALar]**

**:FREQuency? Return the output frequency**

**MEASure[:SCALar]:FREQuency?**

**FETCh[:SCALar]:FREQuency?**

Description: Return the output frequency in Hertz.

Query Syntax : MEASure[:SCALar]:FREQuency?  
FETCh[:SCALar]:FREQuency?

Response Parameter: <NR2>

Example : MEAS:FREQ?

## 8.6.2.3 Power Measurement

**MEASure | FETCh**

**[:SCALar]**

**:POWer**

**:[REAL] ? Return real power**

**:AMPLitude**

**:MAX? Return peak power**

<b>:APParent?</b>	<b>Return VA</b>
<b>:PFActor?</b>	<b>Return power factor</b>
<b>:REActive?</b>	<b>Return the reactive power</b>

**MEASure[:SCALar]:POWer[:REAL]?****FETCh[:SCALar]:POWer[:REAL]?**

---

Description: Return the true power in Watts (W).

Query Syntax : MEASure[:SCALar]:POWer[:REAL]?  
 FETCh[:SCALar]:POWer[:REAL]?

Response Parameter : <NR2>

Example : MEAS:POW?

**MEASure[:SCALar]:POWer:AMPLitude:MAX?****FETCh[:SCALar]:POWer:AMPLitude:MAX?**

---

Description: Return the peak power measured at the input of electronic load.

Query Syntax : MEASure[:SCALar]:POWer:AMPLitude:MAX?  
 FETCh[:SCALar]:POWer:AMPLitude:MAX?

Response Parameter: <NR2>

Example : MEAS:POW:AMPL:MAX?

**MEASure[:SCALar] :POWer:APParent?****FETCh[:SCALar] :POWer:APParent?**

---

Description: Return the apparent power being dissipated by the load in volt-amperes (VA).

Query Syntax : MEASure[:SCALar] :POWer:APParent?  
 FETCh[:SCALar] :POWer:APParent?

Response Parameter : <NR2>

Example : MEAS:POW:APP?

**MEASure[:SCALar] :POWer:PFActor?****FETCh[:SCALar] :POWer:PFActor?**

---

Description: Return the load power factor. The power factor is computed as:

$$power\ factor = real\ power / apparent\ power$$

Query Syntax : MEASure[:SCALar] :POWer:PFActor?  
 FETCh[:SCALar] :POWer:PFActor?

Response Parameter : <NR2>

Example : MEAS:POW:PFAC?

**MEASure[:SCALar] :POWer:REActive?****FETCh[:SCALar] :POWer:REActive?**

---

Description: These queries return the reactive component of the power being dissipated by the load at the input terminals in VAR.

Query Syntax : MEASure[:SCALar] :POWer:REActive?  
 FETCh[:SCALar] :POWer:REActive?

Response Parameter : <NR2>

Example : MEAS:POW:REAC?

**8.6.2.4 Resistance Measurement****MEASure | FETCh****[:SCALar]****: RESistance? Return the resistance in ohms**

**MEASure[:SCALar]:RESistance?  
FETCh[:SCALar]: RESistance?**

---

Description: Return the RESistance in ohms.  
 Query Syntax : MEASure[:SCALar] :RESistance?  
                   FETCh[:SCALar] : RESistance?  
 Response Parameter: <NR2>  
 Example : MEAS:RES?

### 8.6.2.5 Voltage Measurement

**MEASure | FETCh  
[:SCALar]**

<b>:VOLTage?</b>	<b>Return RMS / real time value of the voltage</b>
<b>:VOLTage</b>	<b>(AC Mode / DC Mode)</b>
<b>:AMPLitude</b>	
<b>:MAX?</b>	<b>Return peak voltage</b>
<b>:DC?</b>	<b>Return average Vdc value of AC voltage of each cycle</b>
<b>:THD?</b>	<b>Return THD</b>
<b>:OVERshoot?</b>	<b>Return overshoot voltage (DC Mode)</b>
<b>:UNDershoot?</b>	<b>Return undershoot voltage (DC Mode)</b>

**MEASure[:SCALar]:VOLTage?  
FETCh[:SCALar]:VOLTage?**

---

Description: Returns RMS/real time(AC Mode/DC Mode) value of the voltage.  
 Query Syntax : MEASure[:SCALar]: VOLTage?  
                   FETCh[:SCALar]: VOLTage?  
 Response Parameter : <NR2>  
 Example : MEAS:VOLT?

**MEASure[:SCALar]:VOLTage:AMPLitude:MAX?  
FETCh[:SCALar]:VOLTage:AMPLitude:MAX?**

---

Description: Return the peak voltage measured at the input of electronic load.  
 Query Syntax : MEASure[:SCALar]:VOLTage:AMPLitude:MAX?  
                   FETCh[:SCALar]:VOLTage:AMPLitude:MAX?  
 Response Parameter: <NR2>  
 Example : MEAS:POW:AMPL:MAX?

**MEASure[:SCALar]:VOLTage:DC?  
FETCh[:SCALar]:VOLTage:DC?**

---

Description: Return the Vdc of alternating current.  
 Query Syntax : MEASure[:SCALar]:VOLTage:DC?  
                   FETCh[:SCALar]:VOLTage:DC?  
 Response Parameter: <NR2>  
 Example : MEAS:VOLT:DC?

**MEASure[:SCALar] : VOLTage: THD?  
FETCh[:SCALar] : VOLTage: THD?**

---

Description: Return the total harmonic distortion of voltage.  
 Query Syntax : MEASure[:SCALar] : VOLTage: THD?  
                   FETCh[:SCALar] : VOLTage: THD?  
 Response Parameter : <NR2>  
 Example : MEAS:VOLT:THD?



**MEASure[:SCALar]:VOLTage:OVERshoot?  
 FETCH[:SCALar]:VOLTage:OVERshoot?**

---

Description: Return the overshoot voltage in DC Mode.

Query Syntax : MEASure[:SCALar]:VOLTage:OVERshoot?  
 FETCH[:SCALar]:VOLTage:OVERshoot?

Response Parameter : <NR2>

Example : MEAS:VOLT:OVER?

**MEASure[:SCALar]:VOLTage:UNDershoot?  
 FETCH[:SCALar]:VOLTage:UNDershoot?**

---

Description: Return the undershoot voltage in DC Mode.

Query Syntax : MEASure[:SCALar]:VOLTage:UNDershoot?  
 FETCH[:SCALar]:VOLTage:UNDershoot?

Response Parameter : <NR2>

Example : MEAS:VOLT:UND?

### 8.6.2.6 Time Measurement

**MEASure | FETCH  
 [:SCALar]  
 :TIME**

**:HOLD** Return the measurement value of hold up time (msec)

**:TRAN** Return the measurement value of transfer time (sec)

**MEASure[:SCALar]:TIME:HOLD?  
 FETCH[:SCALar]:TIME:HOLD?**

---

Description: Return the measurement value of hold up time (msec)

Query Syntax : MEASure[:SCALar]:TIME:HOLD?  
 FETCH[:SCALar]:TIME:HOLD?

Response Parameter : <NR2>

Example : MEAS:TIME:HOLD?

**MEASure[:SCALar]:TIME:TRAN?  
 FETCH[:SCALar]:TIME:TRAN?**

---

Description: Return the measurement value of transfer time (sec)

Query Syntax : MEASure[:SCALar]:TIME:TRAN?  
 FETCH[:SCALar]:TIME:TRAN?

Response Parameter : <NR2>

Example : MEAS:TIME:TRAN?

**MEASure | FETCH  
 [:SCALar]  
 :RLC  
 :SET**

**:CAP** Return the C measurement value of RLC CP mode

**:LS** Return the Ls measurement value of RLC CP mode

**:RL** Return the  $R_L$  measurement value of RLC CP mode

**:RS** Return the Rs measurement value of RLC CP mode

### 8.6.2.7 RLC Measurement

**MEASure[:SCALar]:RLC:SET:CAP?**  
**FETCh[:SCALar]:RLC:SET:CAP?**

---

Description: Return the C measurement value of RLC CP mode  
 Query Syntax : MEASure[:SCALar]:RLC:SET:CAP?  
                   FETCh[:SCALar]:RLC:SET:CAP?  
 Response Parameter : <NR2>  
 Example : MEASure[:SCALar]:RLC:SET:CAP?

**MEASure[:SCALar]:RLC:SET:LS?**  
**FETCh[:SCALar]:RLC:SET:LS?**

---

Description: Return the Ls measurement value of RLC CP mode  
 Query Syntax : MEASure[:SCALar]:RLC:SET:LS?  
                   FETCh[:SCALar]:RLC:SET:LS?  
 Response Parameter : <NR2>  
 Example : MEASure[:SCALar]:RLC:SET:LS?

**MEASure[:SCALar]:RLC:SET:RL?**  
**FETCh[:SCALar]:RLC:SET:RL?**

---

Description: Return the R<sub>L</sub> measurement value of RLC CP mode  
 Query Syntax : MEASure[:SCALar]:RLC:SET:RL?  
                   FETCh[:SCALar]:RLC:SET:RL?  
 Response Parameter : <NR2>  
 Example : MEASure[:SCALar]:RLC:SET:RL?

**MEASure[:SCALar]:RLC:SET:RS?**  
**FETCh[:SCALar]:RLC:SET:RS?**

---

Description: Return the R<sub>s</sub> measurement value of RLC CP mode  
 Query Syntax : MEASure[:SCALar]:RLC:SET:RS?  
                   FETCh[:SCALar]:RLC:SET:RS?  
 Response Parameter : <NR2>  
 Example : MEASure[:SCALar]:RLC:SET:RS?

### 8.6.3 LOAD Subsystem

**LOAD**  
     [:STATus]                    **Set load ON / OFF**  
**[LOAD:]**  
     **ABA**                         **Set ABA mode**  
     **MODE**                     **Set CC / CP / CV / CR mode**  
     **SCIRcuit**                 **Set short ON / OFF**  
     **PROTect**                 **Queue protection status**  
     **CLEar**                    **Reset protection status**

**LOAD[:STATus]**

---

Description: The LOAD command makes the electronic load active/on or inactive/off.  
 Setting Syntax : LOAD[:STATus]?  
 Setting Parameter : 0 | OFF, 1 | ON  
 Query Syntax : LOAD[:STATus]?  
 Response Parameter: 0 | 1

Example : LOAD ON

---

### **[LOAD:]ABA**

Description: ABA Mode setting. If the setting value is set to 'OFF', then the system will not automatically adjust the bandwidth. If the setting value is set to 'ON' the system will automatically adjust the bandwidth upon connecting the UUT to the AC Load. Before drawing a current, the system will calculate the inductance of the UUT to adjust the bandwidth accordingly before loading.

Setting Syntax : [LOAD:]ABA?

Setting Parameter : 0 | OFF, 1 | ON

Query Syntax : [LOAD:]ABA?

Response Parameter: OFF|ON

Example : ABA ON

---

### **[LOAD:]MODE**

Description: This command selects the operating mode for AC/DC voltage input. The electronic load can be programmed to operate for constant current, constant power, constant resistance, constant voltage(DC mode only), RLC(AC mode only), RLC constant power(AC mode only), RLC inrush current(AC mode only), Rectified(DC mode only). The query form returns the load operating mode for AC voltage input mode.

Setting Syntax : [LOAD:]MODE

Setting Parameter : 0 | CURR, 1 | POW, 2 | VOLT, 3 | RES  
4 | RLC, 5 | RLCP, 6 | INRUSH, 7 | RECT

Query Syntax : [LOAD:]MODE?

Response Parameter : CURR, POW, VOLT, RES, RLC, RLCP, INRUSH, RECT

Example : MODE CURR

---

### **[LOAD:]SCIRcuit**

Description: Activate or inactivate short-circuited simulation. (It is only operating in CC/CP/CV/CR Mode.)

Setting Syntax : [LOAD:]SCIRcuit

Setting Parameter : 0 | OFF, 1 | ON

Query Syntax : [LOAD:]SCIRcuit?

Response Parameter : 0 | 1

Example : SCIR ON

---

### **[LOAD:]PROTect?**

Description: This command returns the status of electronic load.

Query Syntax : [LOAD:]PROTect?

Response Parameter : <NR1>

Example : PROT?

Mnemonic	Bit	Value Bit Weight	Meaning
FE	0	1	Under frequency range or over frequency range.
UV	1	2	AC Mode voltage is lower than 45V, DC Mode voltage is lower than 7.5V.
UV	2	4	
OVP	3	8	AC Mode voltage is higher than 350V.
OVPP	4	16	Voltage overshooting, Vpeak is higher than 600V.
OCP	5	32	AC/DC Mode current is higher than 18A(63803) or 45A(63804).
OPP	6	64	AC/DC Mode power is higher than 1800W(63803)or 4500W (63804).
OTP	7	128	Over temperature protection
FANFAIL	8	256	Fan fail
LDF	9	512	Load fail
FREQ ERR	10	1024	Under frequency range or over frequency range.

**[LOAD:] PROTEct:CLE**

Description: This command resets status of electronic load.

Setting Syntax : [LOAD:] PROTEct:CLE

Setting Parameter : none

Example : PROT:CLE

**8.6.3.1 Current Subsystem**

[LOAD:]

CURRent

[:LEVe]

[:AMPLitude]

[:AC]

Set the RMS current

:DC

Set the DC current

[:DC]

:FALL

Set the fall slew rate(DC CC Mode)

:RISE

Set the rise slew rate(DC CC Mode)

:HIGH

Set the maximum RMS current

:MAX

[:LEVe]

[:AMPLitude]

[:AC]

Set the Irms(max) (AC CR Mode)

:DC

Set the Ip(max) (DC Mode)

:PEAK

:MAX

[:LEVe]

[:AMPLitude]

[:AC]

Set the Ip(max) (AC except CR mode)

:LIMit

Return the setting range of current.

**[LOAD:]CURRent [:LEV][:AMPL][:AC]**

Description: This command sets the RMS current of the electronic load. The electronic

load insures that the load current stays constant at the set value.

Setting Syntax : [LOAD:]CURRent [:LEV][:AMPL][:AC]

Setting Parameter : <NR2>, 63804 Range: 0 ~ 45, 63803 Range: 0 ~ 36, 63802 Range:  
0 ~ 18, Unit: A

Query Syntax : [LOAD:]CURRent [:LEV][:AMPL][:AC]?

Response Parameter: <NR2>

Example : CURR 45

#### **[LOAD:]CURR[:LEV][:AMPL]:DC**

Description: This command sets the DC current of the electronic load. The electronic load insures that the load current stays constant at the set value.

Setting Syntax : [LOAD:]CURRent [:LEV][:AMPL]:DC

Setting Parameter : <NR2>, 63804 Range: 0 ~ 45, 63803 Range: 0 ~ 36, 63802 Range:  
0 ~ 18, Unit: A

Query Syntax : [LOAD:]CURRent [:LEV][:AMPL]:DC?

Response Parameter: <NR2>

Example : CURR:DC 45

#### **[LOAD:]CURR[:LEV][:AMPL]:DC:FALL**

Description: This command sets current fall slew rate of constant current mode.

Setting Syntax : [LOAD:]CURR[:LEV][:AMPL]:DC:FALL

Setting Parameter : <NR1>, 63803/63804 Range: 4~600, 63802 Range: 4~240, Unit:  
A/msec

Query Syntax : [LOAD:]CURR[:LEV][:AMPL]:DC:FALL?

Response Parameter: <NR1>

Example : CURR:FALL 200

#### **[LOAD:]CURR[:LEV][:AMPL]:DC:RISE**

Description: This command sets current rise slew rate of constant current mode.

Setting Syntax : [LOAD:]CURR[:LEV][:AMPL]:DC:RISE

Setting Parameter : <NR1>, 63803/63804 Range: 4 ~ 600, 63802 Range: 4 ~ 240, Unit:  
A/msec

Query Syntax : [LOAD:]CURR[:LEV][:AMPL]:DC:RISE?

Response Parameter: <NR1>

Example : CURR:RISE 200

#### **[LOAD:]CURR[:LEV][:AMPL]:HIGH**

Description: This command sets the maximum RMS current. (AC CC mode only) (Don't support parallel mode)

Setting Syntax : [LOAD:]CURR[:LEV][:AMPL]:HIGH

Setting Parameter : <NR1>, 63804 Range: 0 ~ 45, 63803 Range: 0 ~ 36, 63802 Range:  
0 ~ 18, Unit: A

Example : CURR:HIGH 45

#### **[LOAD:]CURR:MAX[:LEV][:AMPL]:AC**

Description:  $I_{rms}(max)$  setting, this command is only operating in AC CR Mode.

Setting Syntax : [LOAD:]CURR:MAX[:LEV][:AMPL]:AC

Setting Parameter : <NR2>, 63804 Range: 0 ~ 45, 63803 Range: 0 ~ 36, 63802 Range:  
0 ~ 18, Unit: A (AC CR Mode)

Query Syntax : [LOAD:]CURR:MAX[:LEV][:AMPL]:AC?

Response Parameter: <NR2>

Example : CURR:MAX 45

**[LOAD:]CURR:MAX[:LEV][:AMPL]:DC**

---

Description:  $I_p$ (max) setting, this command is only operating in DC Mode.  
 Setting Syntax : [LOAD:]CURR:MAX[:LEV][:AMPL]:DC  
 Setting Parameter : <NR2>, 63804 Range: 0 ~ 45, 63803 Range: 0 ~ 36, 63802 Range: 0 ~ 18, Unit: A  
 Query Syntax : [LOAD:]CURR:MAX[:LEV][:AMPL]:DC?  
 Response Parameter: <NR2>  
 Example : CURR:MAX:DC 45

**[LOAD:]CURR:PEAK:MAX[:LEV][:AMPL][:AC]**

---

Description:  $I_p$ (max) setting, this command is only operating in AC CC/CP/RLC/RLC CP/RLC Inrush Mode.  
 Setting Syntax : [LOAD:]CURR:PEAK:MAX[:LEV][:AMPL][:AC]  
 Setting Parameter : <NR2>, 63804 Range: 0 ~ 135, 63803 Range: 0 ~ 108, 63802 Range: 0 ~ 54, Unit: A (AC Mode)  
 <NR2>, 63804 Range: 0 ~ 200, 63803 Range: 0 ~ 160, 63802 Range: 0 ~ 80, Unit: A (Inrush Current Mode)  
 Query Syntax : [LOAD:]CURR:PEAK:MAX[:LEV][:AMPL][:AC]?  
 Response Parameter: <NR2>  
 Example : CURR:PEAK:MAX 135

**[LOAD:]CURR:LIMit?**

---

Description: This command queries the setting range of current. (AC CC mode only) (Don't support parallel mode)  
 Query Syntax : [LOAD:]CURR:LIMit?  
 Response Parameter: 0.000~45.000 (CURR:MAX)  
 Example : CURR:LIM?

**8.6.3.2 Power Subsystem**

**[LOAD:]**

**POWER**

**[:LEVel]**

**[:AMPLitude]**

**[:AC]**

**:DC**

**:HIGH**

**:LIMit?**

**Set the power in watts (AC Mode)**

**Set the power in watts (DC Mode)**

**Set the limit of maximum power**

**Return the setting range of power**

**[LOAD:]POW[:LEV][:AMPL][:AC]**

---

Description: This command sets the AC power of the electronic load in Watts. The electronic load insures that the load power stays constant at the set value.  
 Setting Syntax : [LOAD:]POW[:LEV][:AMPL][:AC]  
 Setting Parameter : <NR2>, 63804 Range: 0 ~ 4500, 63803 Range: 0 ~ 3600, 63802 Range: 0 ~ 1800, Unit: W  
 Query Syntax : [LOAD:]POW[:LEV][:AMPL][:AC]?  
 Response Parameter: <NR2>  
 Example : POW 4500

**[LOAD:]POW[:LEV][:AMPL]:DC**

---

Description: This command sets the DC power of the electronic load in Watts. The

electronic load insures that the load power stays constant at the set value.

Setting Syntax : [LOAD:]POW[:LEV][:AMPL]:DC  
 Setting Parameter : <NR2>, 63804 Range: 0 ~ 4500, 63803 Range: 0 ~ 3600, 63802  
 Range:  
                   0 ~ 1800, Unit: W  
 Query Syntax : [LOAD:]POW[:LEV][:AMPL]:DC?  
 Response Parameter: <NR2>  
 Example : POW:DC 4500

---

#### [LOAD:]POW[:LEV][:AMPL]:HIGH

Description: This command sets the maximum power in watts. (AC CP mode only) (Don't support parallel mode)

Setting Syntax : [LOAD:]POW[:LEV][:AMPL]:HIGH  
 Setting Parameter : <NR1>, 63804 Range: 0 ~ 4500, 63803 Range: 0 ~ 3600, 63802  
 Range:  
                   0 ~ 1800, Unit: W  
 Example : POW:HIGH 45

---

#### [LOAD:]POW:LIMit?

Description: This command queries the setting range of power. (AC CP mode only) (Don't support parallel mode)

Query Syntax : [LOAD:]POW:LIMit?  
 Response Parameter: 0.00 ~ 4500.00 (POW:HIGH)  
 Example : POW:LIM?

### 8.6.3.3 Resistance Subsystem

#### [LOAD:]

RESistance

[:LEVel]

[:AMPLitude]

[:AC]

Set the resistance in ohms (AC Mode)

:DC

Set the resistance in ohms (DC Mode)

[:DC]

:RISE

Set the current rise slew rate of CR

:FALL

Set the current fall slew rate of CR

:LIMit?

Return the setting range of resistance

---

#### [LOAD:]RESistance[:LEVel][:AMPLitude][:AC]

Description: This command sets resistance of the electronic load in Ohms. The electronic load insures that the load resistance stays constant at the set value.

Setting Syntax : [LOAD:]RESistance[:LEVel][:AMPLitude][:AC]  
 Setting Parameter : <NR2>, 63804 Range: 1.11 ~ 1000, 63803 Range: 1.39 ~ 1000, 63802  
                   Range: 2.77 ~ 1000, Unit: Ohm  
 Query Syntax : [LOAD:]RESistance[:LEVel][:AMPLitude][:AC]?  
 Response Parameter: <NR2>  
 Example : RES 10

---

#### [LOAD:]RESistance[:LEVel][:AMPLitude]:DC

Description: This command sets resistance of the electronic load in Ohms. The electronic load insures that the load resistance stays constant at the set value.

Setting Syntax : [LOAD:]RESistance[:LEVel][:AMPLitude]:DC

Setting Parameter : <NR2>, 63804 Range: 1 ~ 1000, 63803 Range: 1.25 ~ 1000, 63802  
Range: 2.22 ~ 1000, Unit: Ohm  
Query Syntax : [LOAD:]RESistance[:LEVel][:AMPLitude]:DC?  
Response Parameter: <NR2>  
Example : RES:DC 10

#### **[LOAD:]RESistance[:LEVel][:AMPLitude]:[DC]:RISE**

---

Description: This command sets current rise slew rate of constant resistance mode.  
Setting Syntax : [LOAD:]RESistance[:LEVel][:AMPLitude]:[DC]:RISE  
Setting Parameter : <NR1>, 63803/63804 Range: 4~600, 63802 Range:4~240, Unit: A/msec  
Query Syntax : [LOAD:]RESistance[:LEVel][:AMPLitude]:[DC]:RISE?  
Response Parameter: <NR1>  
Example : RES:RISE 200

#### **[LOAD:]RESistance[:LEVel][:AMPLitude]:[DC]:FALL**

---

Description: This command sets current fall slew rate of constant resistance mode.  
Setting Syntax : [LOAD:]RESistance[:LEVel][:AMPLitude]:[DC]:FALL  
Setting Parameter : <NR1>, 63803/63804 Range:4~600, 63802 Range:4~240, Unit: A/msec  
Query Syntax : [LOAD:]RESistance[:LEVel][:AMPLitude]:[DC]:FALL?  
Response Parameter: <NR1>  
Example : RES:FALL 200

#### **[LOAD:]RESistance:LIMit?**

---

Description: This command queries the setting range of resistance. (AC CR mode only)  
(Don't support parallel mode)  
Query Syntax : [LOAD:]Res:LIMit?  
Response Parameter: 63804: 1.11 ~ 1000.00, 63803: 1.39 ~ 1000.00, 63802: 2.77 ~  
1000.00  
Example : RES:LIM?

### **8.6.3.4 Voltage Subsystem**

**[LOAD:]**  
**VOLTage**  
**[:LEVel]**  
**[:AMPLitude] Set the RMS voltage**  
**:DC**

#### **[LOAD:]VOLTage[:LEV][:AMPL]:DC**

---

Description: This command sets the DC voltage of the electronic load. The electronic load  
insures that the load voltage stays constant at the set value.  
Setting Syntax : [LOAD:]VOLTage[:LEV][:AMPL]:DC  
Setting Parameter : <NR2>, Range: 7.50 ~ 500.00, Unit: V  
Query Syntax : [LOAD:]VOLTage[:LEV][:AMPL]:DC?  
Response Parameter: <NR2>  
Example : VOLT:DC 20

### **8.6.3.5 Crest Factor Subsystem**

**[LOAD:]**  
**CFAC**



**[[:LEVel]**  
**[:AMPLitude]**  
**[:AC]           Set the Crest Factor (AC CC/CP Mode)**  
**:DC            Set the Crest Factor (DC Rectified Mode)**  
**:LIMit?               Return the setting range of CF**

---

#### **[LOAD:]CFAC[:LEV][:AMPL][:AC]**

Description: This command sets the crest factor of the electronic load. The electronic load will attempt to program the crest factor to a value as close as possible to the set value. The ability to do so will be affected by the mode and the power factor setting.

Setting Syntax : [LOAD:]CFAC[:LEV][:AMPL][:AC]  
 Setting Parameter : <NR2>, Range: 1.414 ~ 5.000  
 Query Syntax : [LOAD:]CFAC[:LEV][:AMPL][:AC]?  
 Response Parameter: <NR2>  
 Example : CFAC 1.414

---

#### **[LOAD:]CFAC[:LEV][:AMPL]:DC**

Description: It sets the value CF, this command is only operating in DC Rectified Mode.

Setting Syntax : [LOAD:]CFAC[:LEV][:AMPL]:DC  
 Setting Parameter : <NR2>, Range: 1.414 ~ 5.000  
 Query Syntax : [LOAD:]CFAC[:LEV][:AMPL]:DC?  
 Response Parameter: <NR2>  
 Example : CFAC:DC 1.414

---

#### **[LOAD:]CFAC:LIMit?**

Description: This command queue the setting range of CF.

Query Syntax : [LOAD:]CFAC:LIMit?  
 Response Parameter: 1.414~5.000  
 Example : CFAC:LIM?

### **8.6.3.6 Power Factor Subsystem**

**[LOAD:]**  
**PFACTOR**  
**[:LEVel]**  
**[:AMPLitude]**  
**[:AC]           Set the power factor**  
**:LIMit               Return the setting range of PF**

---

#### **[LOAD:]PFACTOR[:LEV][:AMPLitude][:AC]**

Description: This command sets the power factor of the electronic load. The electronic load will attempt to set the power factor to the set value. The power factor set range is coupled to the crest factor set value. For a crest factor of 1.414, unity power factor is the only valid value.

Setting Syntax : [LOAD:]PFACTOR[:LEV][:AMPLitude][:AC]  
 Setting Parameter : <NR2>, Range: -1.000 ~ +1.000(AC Mode)  
 Query Syntax : [LOAD:]PFACTOR[:LEV][:AMPLitude][:AC]?  
 Response Parameter: <NR2>  
 Example : PFAC 0.7

---

#### **[LOAD:]PFAC:LIMit?**

Description: This command queries the setting range of PF.

Query Syntax : [LOAD:]PFAC:LIMit?  
Response Parameter: -1.000~1.000  
Example : PFAC:LIM?

### 8.6.3.7 RLC Subsystem

#### [LOAD:]

##### RLC

:CAP	Set the C	(AC RLC Mode)
:LS	Set the $L_s$	(AC RLC Mode)
:RL	Set the $R_L$	(AC RLC Mode)
:RS	Set the $R_s$	(AC RLC Mode)
:POW	Set the power	(AC RLC CP Mode)
:PFAC	Set the power factor	(AC RLC CP Mode)

#### [LOAD:] RLC:CAP

---

Description: It sets the value C, this command is only operating in AC RLC Mode.

Setting Syntax : [LOAD:] RLC:CAP  
Setting Parameter : <NR1>, Range: 100 ~ 9999, Unit: uF  
Query Syntax : [LOAD:] RLC:CAP?  
Response Parameter: <NR1>  
Example : RLC:CAP 470

#### [LOAD:] RLC:LS

---

Description: It sets the value  $L_s$ , this command is only operating in AC RLC Mode.

Setting Syntax : [LOAD:] RLC:LS  
Setting Parameter : <NR1>, Range: 0 ~ 9999, Unit: uH  
Query Syntax : [LOAD:] RLC:LS?  
Response Parameter: <NR1>  
Example : RLC:LS 200

#### [LOAD:] RLC:RL

---

Description: It sets the value  $R_L$ , this command is only operating in AC RLC Mode.

Setting Syntax : [LOAD:] RLC:RL  
Setting Parameter : <NR2>, 63804 Range: 1.11 ~ 9999.99, 63803 Range: 1.39 ~ 9999.99, 63802 Range: 2.77 ~ 9999.99, Unit: Ohm  
Query Syntax : [LOAD:] RLC:RL?  
Response Parameter: <NR2>  
Example : RLC:RL 50

#### [LOAD:] RLC:RS

---

Description: It sets the value  $R_s$ , this command is only operating in AC RLC Mode.

Setting Syntax : [LOAD:] RLC:RS  
Setting Parameter : <NR2>, Range: 0 ~ 9.999, Unit: Ohm  
Query Syntax : [LOAD:] RLC:RS?  
Response Parameter: <NR2>  
Example : RLC:RS 0.1

#### [LOAD:] RLC:POW

---

Description: It sets the value C, this command is only operating in AC RLC CP Mode.

Setting Syntax : [LOAD:] RLC:POW  
Setting Parameter : <NR2>, Range: 200 ~ 4500, Unit: W

Query Syntax : [LOAD:] RLC:POW?  
 Response Parameter: <NR2>  
 Example : RLC:POW 1000

---

#### [LOAD:] RLC:PFAC

Description: It sets the value PF, this command is only operating in AC RLC CP Mode.  
 Setting Syntax : [LOAD:] RLC:PFAC  
 Setting Parameter : <NR2>, Range: 0.400 ~ 0.750(AC RLC CP Mode)  
 Query Syntax : [LOAD:] RLC:PFAC?  
 Response Parameter: <NR2>  
 Example : RLC:PFAC 0.6

### 8.6.3.8 Inrush Current Subsystem

#### [LOAD:]

##### INRush

:CAP	Set the C	(AC RLC Inrush Current Mode)
:LS	Set the $L_S$	(AC RLC Inrush Current Mode)
:RL	Set the $R_L$	(AC RLC Inrush Current Mode)
:RS	Set the $R_S$	(AC RLC Inrush Current Mode)
:PHASe	Set the start phase	(AC RLC Inrush Current Mode)

---

#### [LOAD:] INRush:CAP

Description: It sets the value C, this command is only operating in AC Inrush Current Mode.  
 Setting Syntax : [LOAD:] INRush:CAP  
 Setting Parameter : <NR1>, Range: 100 ~ 9999, Unit: uF  
 Query Syntax : [LOAD:] INRush:CAP?  
 Response Parameter: <NR1>  
 Example : INR:CAP 470

---

#### [LOAD:] INRush:LS

Description: It sets the value LS, this command is only operating in AC Inrush Current Mode.  
 Setting Syntax : [LOAD:] INRush:LS  
 Setting Parameter : <NR1>, Range: 0 ~ 9999, Unit: uH  
 Query Syntax : [LOAD:] INRush:LS?  
 Response Parameter: <NR1>  
 Example : INR:LS00

---

#### [LOAD:]INRush:RL

Description: It sets the value RL, this command is only operating in AC Inrush Current Mode.  
 Setting Syntax : [LOAD:]INRush:RL  
 Setting Parameter : <NR2>, 63804 Range: 1.11 ~ 9999.99, 63803 Range: 1.39 ~ 9999.99, 63802 Range: 2.77 ~ 9999.99, Unit: Ohm  
 Query Syntax : [LOAD:]INRush:RL?  
 Response Parameter: <NR2>  
 Example : INR:RL 50

---

#### [LOAD:]INRush:RS

Description: It sets the value RS, this command is only operating in AC Inrush Current Mode.  
 Setting Syntax : [LOAD:]INRush:RS  
 Setting Parameter : <NR2>, Range: 0 ~ 9.999, Unit: Ohm  
 Query Syntax : [LOAD:]INRush:RS?

Response Parameter: <NR2>  
Example : INR:RS 0.1

#### **[LOAD:] INRush:PHASe**

---

Description: It sets the value phase, this command is only operating in AC Inrush Current Mode.

Setting Syntax : [LOAD:]INRush:PHASe  
Setting Parameter : <NR2>, Range: 0 ~ 359, Unit: Degree  
Query Syntax : [LOAD:]INRush:PHASe?  
Response Parameter: <NR2>  
Example : INR:PHAS 60

### **8.6.3.9 DC Rectified Subsystem**

**[LOAD:]**

**SYNC**

**:DC**

**Select line frequency or set frequency mode  
(DC Rectified mode only)**

**FREQ**

**[:LEVel]**

**[:AMPLitude]**

**:DC**

**Set the frequency**

#### **[LOAD:]SYNC:DC**

---

Description: It sets SYNC mode. When SYNC sets as 1, it indicates the system uses line sync to do synchronization. When SYNC sets as 0, it indicates the system uses the frequency users set to do synchronization. This command is only operating in DC Rectified Mode.

Setting Syntax : [LOAD:]SYNC:DC  
Setting Parameter : 0 | OFF, 1 | ON  
Query Syntax : [LOAD:]SYNC:DC?  
Response Parameter: 0 | 1  
Example : SYNC:DC ON

#### **[LOAD:]FREQ[:LEVel][:AMPLitude]:DC**

---

Description: It sets frequency. When SYNC sets as 0, it indicates the system uses the frequency users set to do synchronization. This command is only operating in DC Rectified Mode.

Setting Syntax : [LOAD:]FREQ[:LEVel][:AMPLitude]:DC  
Setting Parameter : <NR2>, Range: 40 ~ 440, Unit: Hz  
Query Syntax : [LOAD:]FREQ[:LEVel][:AMPLitude]:DC?  
Response Parameter: <NR2>  
Example : FREQ:DC 100

### **8.6.3.10 Time Subsystem**

**[LOAD:]**

**TIME**

**:MODE**

**Select line frequency or set frequency**

**:TOUT**

**:VCUT**

**[LOAD:]TIME:MODE**

---

Description : It sets TIMING mode. When the timing mode is set, user can choose HOLD or TRANSFER mode.

Setting Syntax : **[LOAD:]TIME:MODE**

Setting Parameter : 0|OFF,1|HOLD,2|TRAN

Query Syntax : **[LOAD:]TIME:MODE?**

Response Parameter: OFF,HOLD,TRAN

Example : TIME:MODE HOLD

**[LOAD:]TIME:TOUT**

---

Description : It sets the timeout. When the AC load is load on, the timer will not stop counting until meet the setting value of run time set by users.

Setting Syntax : **[LOAD:]TIME:TOUT**

Setting Parameter : <NR1>, Range: 0 ~ 215999,Unit: Sec

Query Syntax : **[LOAD:]TIME:TOUT?**

Response Parameter: <NR1>

Example : TIME:TOUT 180

**[LOAD:]TIME:VCUT**

---

Description : It sets the cutoff voltage. When the voltage is under the cut off voltage. The timer will stop counting.

Setting Syntax : **[LOAD:]TIME:VCUT**

Setting Parameter : <NR2>, Range: 0 ~ 500.000,Unit: V

Query Syntax : **[LOAD:]TIME:VCUT?**

Response Parameter: <NR2>

Example : TIME:VCUT

## 8.6.4 System Subsystem

### 8.6.4.1 Recall Default Subsystem

**SYSTem****:DEFault****:RECALL****Recall default setting value****CONFigure:DEFault:RECALL**

---

Description: This command recalls default setting value.

Setting Syntax : SYSTem:DEFault:RECALL

Setting Parameter : <NR1>, 0 | OFF | 1 | ON

Example : SYST:DEF:RECA ON

### 8.6.4.2 Remote Subsystem

**SYSTem****:COMMunicate****:GPIB****:ADDRess****Set the GPIB address****:SERial**

<b>:BAUD</b>	Set the RS-232 baud rate
<b>:BITS</b>	Set the RS-232 word length
<b>:SBIT</b>	Set the RS-232 stop bit length
<b>:PARity</b>	Set the RS-232 parity type

#### **SYSTem:COMMunicate:GPIB:ADDRess**

---

Description: This command sets the GPIB address of the electronic load.  
 Setting Syntax : SYSTem:COMMunicate:GPIB:ADDRess  
 Setting Parameter : <NR1>, Range: 1~30  
 Query Syntax : SYSTem:COMMunicate:SERial:BAUD?  
 Response Parameter: <NR1>  
 Example : SYST:COMM:GPIB:ADDR 8

#### **SYSTem:COMMunicate:SERial:BAUD**

---

Description: This command sets the RS-232 baud rate of the electronic load.  
 Setting Syntax : SYSTem:COMMunicate:SERial:BAUD  
 Setting Parameter : 9600 | 19200 | 38400 | 57600  
 Query Syntax : SYSTem:COMMunicate:SERial:BAUD?  
 Response Parameter: 9600 | 19200 | 38400 | 57600  
 Example : SYSTem:COMMunicate:SERial:BAUD 57600

#### **SYSTem:COMMunicate:SERial:BITS**

---

Description: This command sets the RS-232 word length of the electronic load.  
 Setting Syntax : SYSTem:COMMunicate:SERial:BITS  
 Setting Parameter : 7 | 8  
 Query Syntax : SYSTem:COMMunicate:SERial:BITS?  
 Response Parameter: 7 | 8  
 Example : SYST:COMM:SER:BITS 8

#### **SYSTem:COMMunicate:SERial:SBIT**

---

Description: This command sets the RS-232 stop bit length of the electronic load.  
 Setting Syntax : SYSTem:COMMunicate:SERial:SBIT  
 Setting Parameter : 1 | 2  
 Query Syntax : SYSTem:COMMunicate:SERial:SBIT?  
 Response Parameter: 1 | 2  
 Example : SYST:COMM:SER:SBIT 1

#### **SYSTem:COMMunicate:SERial:PARity**

---

Description: This command sets the RS-232 parity type of the electronic load.  
 Setting Syntax : SYSTem:COMMunicate:SERial:PARity  
 Setting Parameter : NONE|ODD|EVEN  
 Query Syntax : SYSTem:COMMunicate:SERial:PARity?  
 Response Parameter: NONE|ODD|EVEN  
 Example : SYST:COMM:SER:PAR NONE

### **8.6.4.3 Setup Subsystem**

#### **SYSTem**

<b>:SETup</b>	
<b>:MODE</b>	Set AC / DC mode for 63800
<b>:CFPF</b>	
<b>:MODE</b>	Set CF only / PF only / ALL mode

**:PRIOrity            Set the CF / PF priority for Both mode****SYSTem:SETup:MODE**

---

Description: Sets the mode of electronic load as AC load mode or DC load mode.

Setting Syntax       : SYSTem:SETup:MODE

Setting Parameter   : <NR1>, 0 | AC, 1 | DC

Query Syntax        : SYSTem:SETup:MODE?

Response Parameter: AC | DC

**SYSTem:SETup:CFPF:MODE**

---

Description: It sets the modes of CF/PF/ALL. This command is only operating in AC CC/CP modes. When this command sets as 0, it indicates the system enter to CF only mode. When this command sets as 1, it indicates the system enter to PF only mode. When this command sets as 2, the system decides the margin setting value of CF PF according to the setting of priority.

Setting Syntax       : SYSTem:SETup:CFPF:MODE

Setting Parameter   : 0 | CF, 1 | PF, 2 | ALL

Query Syntax        : SYSTem:SETup:CFPF:MODE?

Response Parameter: 0 | 1 | 2

**SYSTem:SETup:CFPF:PRIOrity**

---

Description: It sets the priority of CF PF. This command is only operating in AC CC/CP modes. When this command sets as 0, it indicates CF is high priority. When this command sets as 1, it indicates PF is high priority.

Setting Syntax       : SYSTem:SETup:CFPF:PRIOrity

Setting Parameter   : 0 | CF, 1 | PF

Query Syntax        : SYSTem:SETup:CFPF:PRIOrity?

Response Parameter: CF| PF

## 8.6.5 Parallel Subsystem

**PAR**  
**:STAT**

**PAR:STAT**

---

Description: It returns the status of the current parallel mode. When the response parameter is 0, it indicates parallel mode error. When the response parameter is 1, it indicates single phase parallel. When the response parameter is 2, it indicates three phases parallel.

Query Syntax        : PAR:STAT?

Response Parameter: <NR1>, 0 | 1 | 2

Example             : SYST:DEF:RECA ON

## 8.6.6 PHASE Subsystem

**PHASe**  
**:SEL**

**PHASe:SEL**

---

Description: It decides LOAD, MEAS and FETC subsystem commands are belong to three

phases balance (ALL) or three phases unbalance (phase A, B, C) setting. (This command is only for three phases parallel used.)

Setting Syntax : PHAS:SEL

Setting Parameter : ALL, A,B,C

Query Syntax : PHAS:SEL?

Response Parameter: ALL | A | B | C

Example : PHAS:SEL ALL



## 9. Status Reporting

### 9.1 Introduction

This chapter covers the status data structure of Chroma 63800 series electronic load as shown in Figure 9-1 (on the next page). The standard registers, such as the Event Status register group, the Output Queue, the Status Byte and Service Request Enable registers perform standard GPIB functions and are defined in IEEE-488.2 Standard Digital Interface for Programmable Instrumentation. Other status register groups implement the specific status reporting requirements for the electronic load.

### 9.2 Register Information in Common

- *Condition register*

The condition register represents the present status of electronic load signals. Reading the condition register does not change the state of its bits. Only changes in electronic load conditions affect the contents of this register.

- *Enable register*

The Enable register can be programmed to enable which bit in the corresponding Event register is logically ORed into the Channel Summary bit.

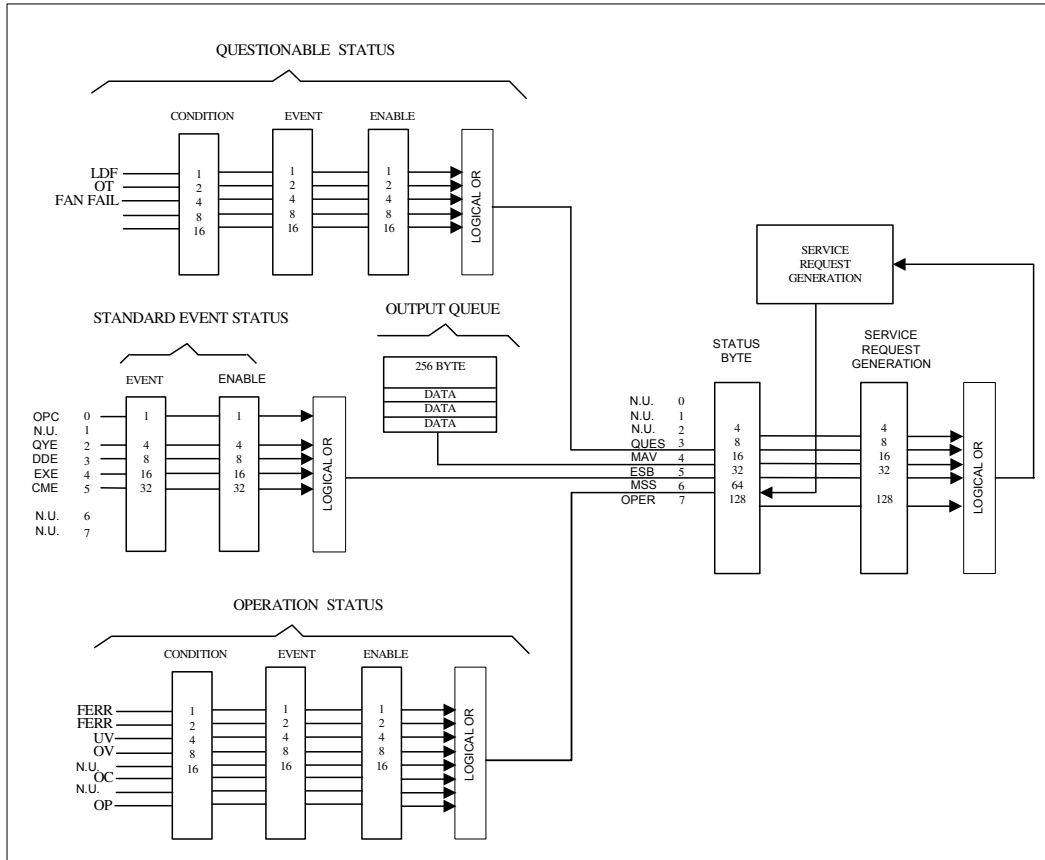

Figure 9-1 The Status Registers of Electronic Load

### 9.3 Status Registers

- The Questionable Status registers inform you one or more questionable status conditions, which indicate certain errors or faults have occurred. Table 9-1 lists the questionable status conditions that are applied to the electronic load.
- When the corresponding bit of Questionable Status Condition register is set, it indicates the condition is true.
- Reading of the Questionable Status Event register will reset it to zero.
- The Questionable status Enable register can be programmed to specify the questionable status event bit that is logically ORed to become Bit 3 (QUES bit) in the Status Byte register.

Table 9-1 Bit Description of Questionable Status

Mnemonic	Bit	Value Bit Weight	Meaning
FE	0	1	Under frequency range or over frequency range.
FE	1	2	Under frequency range or over frequency range.
UV	2	4	AC Mode voltage is lower than 45V, DC Mode voltage is lower than 7.5V.
OV	3	8	AC Mode voltage is higher than 350V.
OC	5	32	AC/DC Mode current is higher than 18A or 45A.
OP	7	64	AC/DC Mode power is higher than 1800W or 4500W.

- The Operation Status registers inform you one or more operation status conditions, which indicate certain errors or faults have occurred. Table 9-2 lists the operation status conditions that are applied to the electronic load.
- When the corresponding bit of Operation Status Condition register is set, it indicates the condition is true.
- Reading of the Operation Status Event register will reset it to zero.
- The Operation Status Enable register can be programmed to specify the operation status event bit that is logically ORed to become Bit 7 (OPER bit) in the Status Byte register.

Table 9-2 Bit Description of Operation Status

Mnemonic	Bit	Value Bit Weight	Meaning
LF	0	1	Load fail
OT	1	2	Over temperature protection
FF	2	4	FAN FAIL

### 9.3.1 Status Subsystem Commands

**STATus:**

**QUESTionable:**

- EVENT** Return the value of the event register
- CONDition** Return the value of the condition register
- ENABLE** Enable specific bits in the Event register

**STATus:QUESTionable:EVENT?**

Description	:	This query is the value of the Questionable Event register. The Event register is a read-only register, which holds all events. Reading the Questionable Event register clears it.
Query Syntax	:	STATus:QUESTionable:EVENT?
Parameters	:	none
Return Parameters	:	<NR1>

**STATus:QUESTionable:CONDition?**

Description	:	This query is the value of the Questionable Condition register. This register is a read-only register, which holds the real time (unlatched) Questionable status of the AC load.
Query Syntax	:	STATus: QUESTionable:CONDition?

Parameters : none  
Return Parameters : <NR1>

#### **STATus:QUEStionable:ENABle**

---

Description : This command set and read the value of the Questionable Enable register. The register is a mask for enabling specific bits from the Questionable Enable register to set the Questionable summary bit (QUES) of the Status Byte register (STB). The Questionable summary bit is the logical OR of all enabled Questionable Event register bit.

Query Syntax : STATus:QUEStionable:ENABle?  
Parameters : <NR1>, 0 ~ 255  
Return Parameters : <NR1> (Register value)

#### **STATus:**

##### **OPERation:**

**EVENT** Returns the value of the event register  
**CONDition** Returns the value of the condition register  
**ENABle** Enable specific bits in the Event register

#### **STATus:OPERation:EVENT?**

---

Description : This query is the value of the Operation Event register. The Event register is a read-only register, which holds all events. Reading the Operation Event register and clears it.

Query Syntax : STATus:OPERation:EVENT?  
Return Parameters : <NR1>

#### **STATus:OPERation:CONDition?**

---

Description : This query is the value of the Operation Condition register. This register is a read-only register, which holds the real time (unlatched) Operation status of the AC load.

Query Syntax : STATus:OPERation:CONDition?  
Return Parameters : <NR1>

#### **STATus:OPERation:ENABle**

---

Description : This command set and read the value of the Operation Enable register. The register is a mask for enabling specific bits from the Operation Enable register to set the Operation summary bit (OPER) of the Status Byte register (STB). The Operation summary bit is the logical OR of all enabled Operation Event register bit.

Query Syntax : STATus:QUEStionable:ENABle?  
Parameters : <NR1>, 0 ~ 255  
Return Parameters : <NR1> (Register value)

## **9.4 Output Queue**

- The Output Queue stores output messages until they are read from the electronic load.
- The Output Queue stores messages sequentially on a FIFO (First-In, First-Out) basis.
- When there is data in the queue, it sets to 4 (MAV bit) in the Status Byte register.

## 9.5 Standard Event Status

- All programming errors that have occurred will set one or more of the error bits in the Standard Event Status register. Table 9-3 describes the standard events that apply to the electronic load.
- Reading of the Standard Event Status register will reset it to zero.
- The Standard Event Enable register can be programmed to specify the standard event bit that is logically ORed to become Bit 5 (ESB bit) in the Status Byte register.

Table 9-3 Bit Description of Standard Event Status

Mnemonic	Bit	Value Bit Weight	Meaning
OPC	0	1	<i>Operation Complete.</i> This event bit generated is responding to the *OPC command. It indicates that the device has completed all selected pending operations.
QYE	2	4	<i>Query Error.</i> The output queue was read when no data were present or the data in the queue were lost.
DDE	3	8	<i>Device Dependent Error.</i> Memory was lost, or self-test failed.
EXE	4	16	<i>Execution Error.</i> A command parameter was outside the legal range or inconsistent with the electronic load's operation, or the command could not be executed due to some operating condition.
CME	5	32	<i>Command Error.</i> A syntax or semantic error has occurred, or the electronic load has received a <GET> within a program message.

## 9.6 Status Byte Register

- The Status Byte register summarizes all of the status events from all status registers. Table 9-4 describes the status events that are applied to the electronic load.
- The Status Byte register can be read with a serial pull or \*STB? query.
- The RQS bit is the only bit that is automatically cleared after a serial poll.
- When the Status Byte register is read with a \*STB? query, Bit 6 of the Status Byte register will contain the MSS bit. The MSS bit indicates that the load has at least one reason for requesting service. \*STB? does not affect the status byte.
- The Status Byte register is cleared by \*CLS command.

Table 9-4 Bit Description of Status Byte

Mnemonic	Bit	Value Bit Weight	Meaning
<b>CSUM</b>	2	4	<i>Channel Summary.</i> It indicates if an enabled channel event has occurred. It is affected by Channel Condition, Channel Event and Channel Summary Event registers.
<b>QUES</b>	3	8	<i>Questionable.</i> It indicates if an enabled questionable event has occurred.
<b>MAV</b>	4	16	<i>Message Available.</i> It indicates if the Output Queue contains data.
<b>ESB</b>	5	32	<i>Event Status Bit.</i> It indicates if an enabled standard event has occurred.
<b>RQS/MSS</b>	6	64	<i>Request Service/Master Summary Status.</i> During a serial pull, RQS is returned and cleared. For an *STB? query, MSS is returned without being cleared.

## 9.7 Service Request Enable Register

The Service Request Enable register can be programmed to specify the bit in the Status Byte register that will generate service requests.

## Appendix A: RS-232C Connection

The RS-232C connector on the rear panel is a 9-pin connector (DB-9, male connector). The RS-232C connector bus signal is defined as below.

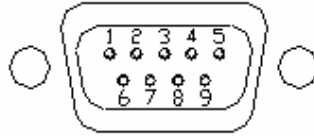

**RS-232C Connector**

Pin Number	Input/Output	Description
1	---	+5V
2	Input	RxD
3	Output	TxD
4	Input /Output	Short Switch
5	---	GND
6	Input /Output	Short Switch
7	Output	RTS
8	Input	CTS
9	---	+5V

**Note:**

- (1) Pin 1 and pin 9 (+5V) are for 63800 series Remote Controller only.
- (2) The short switch pins, pin 4 and pin 6, will be shorted when SHORT key is pressed.





# Appendix B: Pin Assignment of TTL I/O Signals

9-Pin D-Type Male Connector:

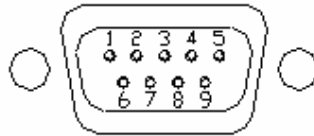

Pin No.	Signal	Pin No.	Signal
1	GND	6	---
2	Load-ON/OFF	7	---
3	Transient-ON/OFF	8	---
4	Fail	9	External Load-ON/OFF
5	Short		

## AC LOAD ON

When AC Load is at the “load on” status, this pin turns into HIGH and turns into LOW when the load is off. It is defined at pin 2 of the TTL I/O. The ground reference of the TTL I/O is at pin 1.

## Transient-ON/OFF

This signal can be used in CC mode (under AC/DC mode). The first cycle of the current sag or surge is occurred under AC mode, this pin will become HIGH as well as the signal will return to LOW. If the current has changed under DC mode, this pin will become HIGH as well as the signal will return to LOW. The ground reference of the TTL I/O is at pin 1.

## Fail

The voltage level of this pin is HIGH if AC load is in normal state. It turns into LOW when AC load is in abnormal status, such as OCP, OVP, OPP, OTP or Fan Fail. It is defined at pin 4 of the TTL I/O. The ground reference of the TTL I/O is at pin 1.

## Short

When short is on, this pin will becomes HIGH, and it becomes LOW when short is off. The ground reference of the TTL I/O is at pin 1.

## External Load ON/OFF

The AC load can be achieved by TTL high signal. When **CONF./LOCAL** is pressed, choose 1, “SETUP”, and then go to item 6, “External load ON/OFF ENABLE”. Enter into this function through the knob. The execution of the “load on/off” will transfer from front panel to pin 9 of TTL I/O. The ground reference of the TTL I/O is at pin 1. The **LOAD ON/OFF** button in front panel will become invalid under this setting.



## Appendix C: Notice

1. CC and CP mode:

- ① When loading under high frequency, for  $CF > 1.8$  and the minimum PF, if the voltage drops under 7.5V, the loading current will decrease automatically to ensure the voltage is kept above 7.5V. At this moment, no warning message will be shown on the display.
- ② The specification for  $I_p(\text{max})$  is 135A, when the  $I_{\text{rms}} \times CF > 135A$ , then both of the  $I_{\text{rms}}$  and CF will not be able to meet the setting values. For example, when setting  $I_{\text{rms}} = 45A$  and  $CF = 4$ , the actual loading may not reach the setting values.
- ③ When there is an inductor in series with the AC load, under high frequency, high current and high CF, OVPP(over shooting) will be occurred. OVPP will be occurred when the  $V_{\text{peak}}$  is over 600V.

2. RLC mode:

When changing the PF value under Load ON, due to the AC Load algorithm, the response time of changing the PF value may be slow, taking as much as 5 seconds before the PF value is changed to the setting value. However, when changing the PF value under Load OFF, the PF value will be immediately set at Load ON. Therefore, we suggest changing the PF value under Load OFF instead of Load ON.