



MODEL 61800 SERIES

KEY FEATURES

- Output power
 - 61830 : 30kVA ; 61845 : 45kVA
 - 61860 : 60kVA ; 61800-100 : 105kVA
- Output voltage: 0~300V, 400V (option *1), 500V (option *2)
- Output frequency: DC, 30Hz-100Hz
- User selectable single phase or three phase output
- Full 4 quadrant, fully regenerative up to 100% of output current rating
- Specifically designed for PV inverter, Smart Grid and EV related test applications
- Programmable slew rate settings for voltage and frequency
- Programmable voltage and current limits
- Turn on, turn off phase angle control
- LIST, PULSE, STEP mode functions for testing Power Line Disturbance (PLD) simulation
- Voltage dips, short interruption and voltage variation simulation
- Harmonics, inter-harmonics waveform synthesizer
- Comprehensive measurement capability, including current harmonics
- Analog programmable interfaces
- Remote interface: GPIB, RS-232, USB and Ethernet
- Parallel output for higher power applications (Three phase only)
- Regenerative AC load function (option*1)
- 120kVA 800V_{LN} XHV function (option*1)

*1: 61830/61845/61860 option

*2: 61800-100 option

REGENERATIVE GRID SIMULATOR MODEL 61800 SERIES

Market demand for Distributed Resource (DR) products such as PV inverters and wind energy systems is steadily growing as the world strives for clean renewable energy sources. This demand has created a need for rigorous regulation testing to standards like UL 1741SA / IEEE 1547 / IEC 62116 which ensure proper and safe operation of on-grid products. It has become critical to manufacturers to conduct these tests in order to prove compliance and to relieve product liability concerns. Chroma's new 61800 family of Grid Simulators has been designed to fulfill these test requirements by providing a full 4 quadrant, fully regenerative, grid simulator with advanced features for compliance, safety and product verification testing.

The 61800 regenerative grid simulator allows users to vary relevant parameters in order to simulate real world grid environments and conditions. Supported variations include frequency, phase angle, voltage amplitude, voltage drops in either single or three phase modes. Unbalanced three phase conditions can easily be simulated. And most importantly, the regenerative feature of the 61800 grid simulator provides an effective energy saving method since energy generated by the unit under test is fed back to the grid instead of dissipated as heat during operation.

The 61800 grid simulator also meets test requirements for smart grid and EV related

test applications, such as Vehicle to Grid (V2G) and Energy Storage System (ESS) testing. The 61800 is also capable of meeting IEC regulatory standards (such as IEC 61000-3-2/-3-3/-3-11/-3-12) requirements for AC supplies.

The 61800 regenerative grid simulator is capable of much more than just product development during R&D. Its extensive features are also valuable during design and quality verification as well as throughout various production stages. Using state-of-the-art digital control technology the 61800 can deliver up to 300VAC at output frequencies ranging from 30Hz to 100Hz. The AC+DC provides support for applications which require a DC offset bias.

The 61800 series is also able to provide precision measurements such as RMS voltage, RMS current, true power, power factor, current crest factor and many others. By applying advanced DSP technology, the 61800 can easily simulate power line disturbance (PLD) using LIST, PULSE and STEP modes. Additional features such as the waveform synthesis function allows users to program various distorted harmonic waveforms that are required by some regulatory standards. GPIB (IEEE488.2), RS-232, USB and Ethernet interface are available to control the 61800 grid simulator remotely.



Chroma



FUNCTIONS AND APPLICATIONS

The 61800 Regenerative Grid Simulator is a full 4 quadrant, full regenerative, AC power supply designed for common electrical product testing such as home appliances, and industrial electronics needing a programmable input source. In addition, the 61800 is designed to simulate grid characteristics for testing PV inverter and on-line UPSs. As shown below, power can be both sink and source from the UUT seamlessly to support different types of applications. In cases where the UUT sources current a detection circuit will sense the excess power and recycled it back to the grid.

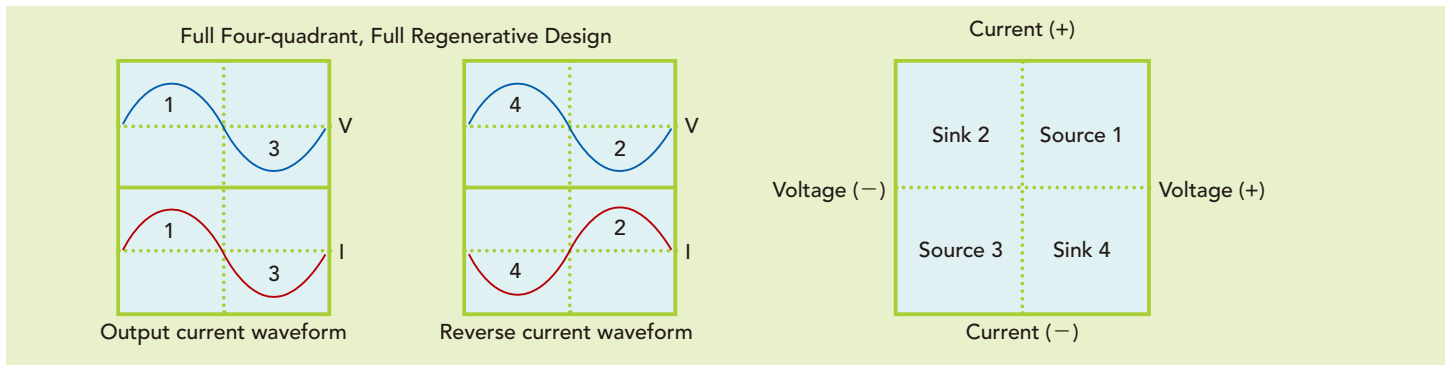
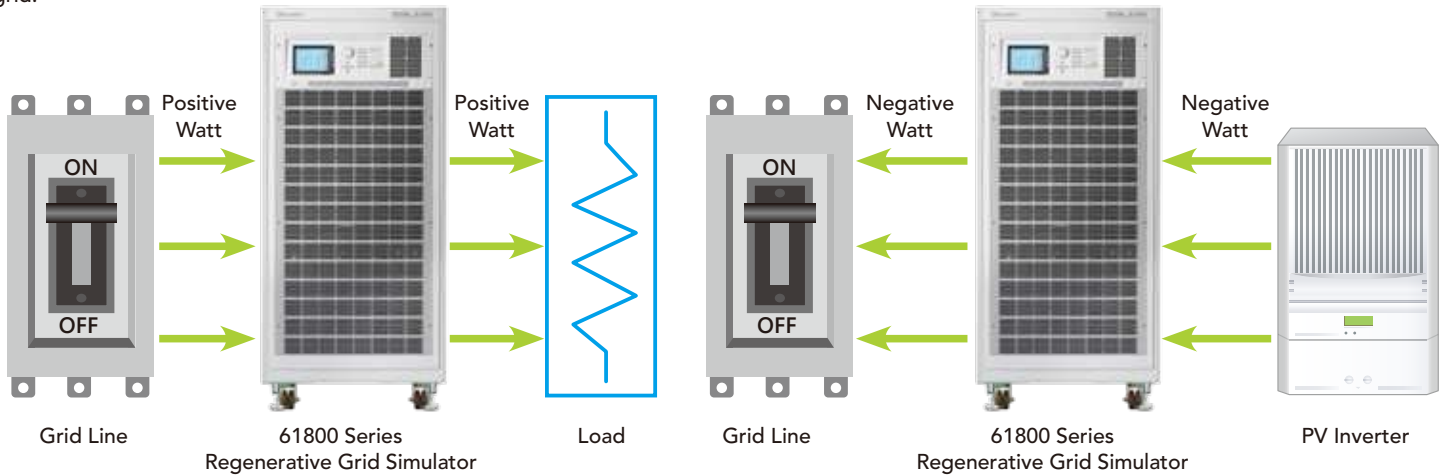

In addition to supplying clean, precise and stable AC voltage for regular applications, the 61800 is capable of simulating various types of distorted voltage waveforms and transient conditions required by product validation testing. These are accomplished as shown below using built-in programmable waveform functions like the LIST/STEP/PULSE modes. The STEP and PUSLE functions allow users to perform single or continuous step changes of output voltage while the LIST mode is a more versatile function as it allows users to compose complex waveforms of up to 100 sequences. Voltage waveforms required by immunity specifications such as IEC 61000-4-11 (short interruption and voltage dropout) can be easily achieved by the 61800 Regenerative Grid Simulator.



STEP Mode

PULSE Mode

LIST Mode

The SYNTHESIS function allows users to create periodic harmonic voltage waveforms of up to 50 orders based on a 50/60Hz fundamental frequency. The INTERHARMONIC function allows users to perform frequency sweeps ranging from 0.01Hz to 2400Hz on top of the 50/60Hz fundamental frequency. This special function assists users in locating resonance points.

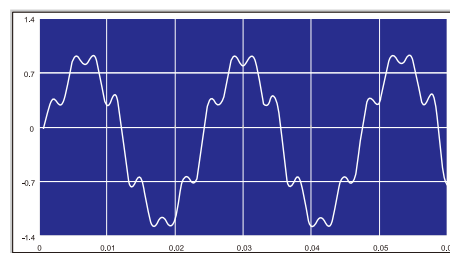

Harmonics Waveform

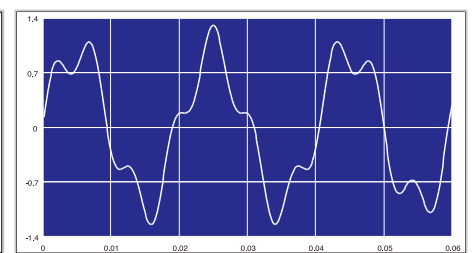

Interharmonics Waveform

The 6.5" Color LCD provides users with an easy to operate interface by integrating parameters and functions on a single display page. The panel is also capable of voltage and current measurement waveform display.



The 61800 series support Master-Slave parallel operation, which allows users for further extend the output power capability by connecting multiple units in parallel for higher power test application. The maximum allowable number of parallel units for models 61830/61845/61860 are up to 5 units with maximum output power rating up to 300kVA.*

*Please contact Chroma sales representative for 61800-100 parallel output implementation and please note it is not applicable to parallel connect 61800-100 with 61830/61845/61860.



61860 : 60kVA x 5 = 300kVA

Implement for Micro Grid Testing

The 61800 Regenerative Grid Simulator is capable of simulating various test conditions such as voltage distortion, frequency variation and more in order to meet Micro Grid test requirements. Most importantly, the regenerative feature of the 61800 series product can sink the power generated by the Discrete Generator (DG) on the micro Grid and feed the power back to the main grid. The input side of 61800 series product has been specifically designed to be isolated from the main grid. Hence additional isolation for a Discrete Generator (DG) on a Micro Grid is not required.

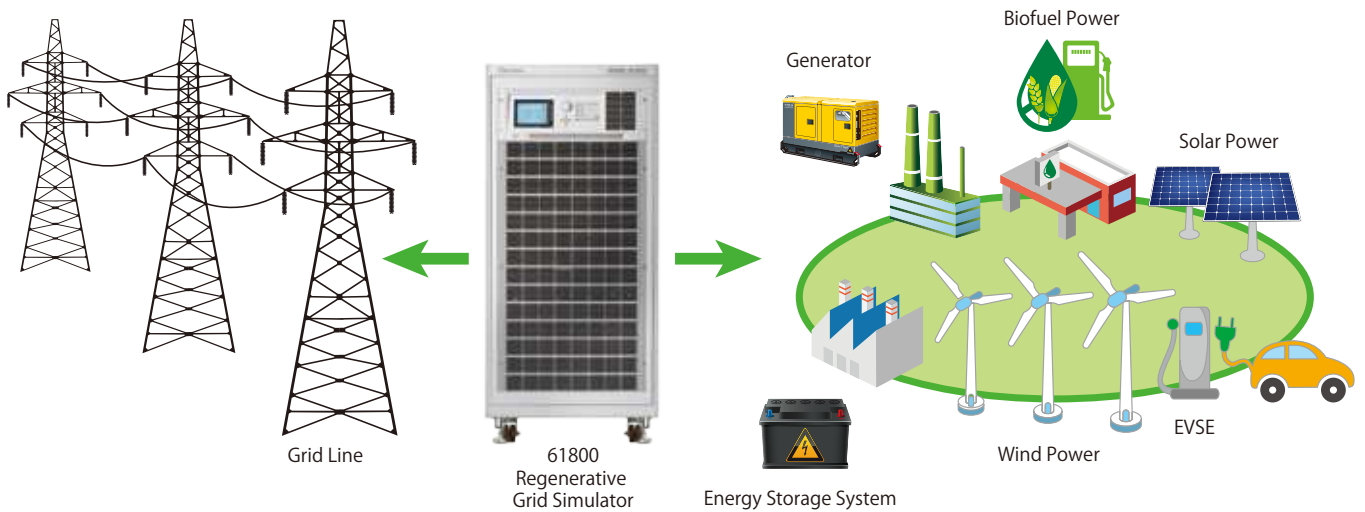

Implement for Grid Tied DG Regulations Testing

The 61800 series Regenerative Grid Simulator is capable of meeting the following regulations designated for Grid Tied Discrete Generator testing for IEEE 1547 / IEC 61000-3-15 / IEC 62116 :

- ✓ Voltage Abnormality Test
- ✓ Anti-islanding Test
- ✓ Immunity Test (IEC 61000-4-11/-4-34)
- ✓ Frequency Abnormality Test
- ✓ Low Voltage Ride Through Test
- ✓ Limit Test (IEC 61000-3-2/-3-3)

Effective Energy Saving Solution

The 61800 Regenerative Grid Simulator provides an effective energy saving solution as the energy generated by a Discrete Generator (DG) is fed back to the grid instead of being dissipated as heat during operation.

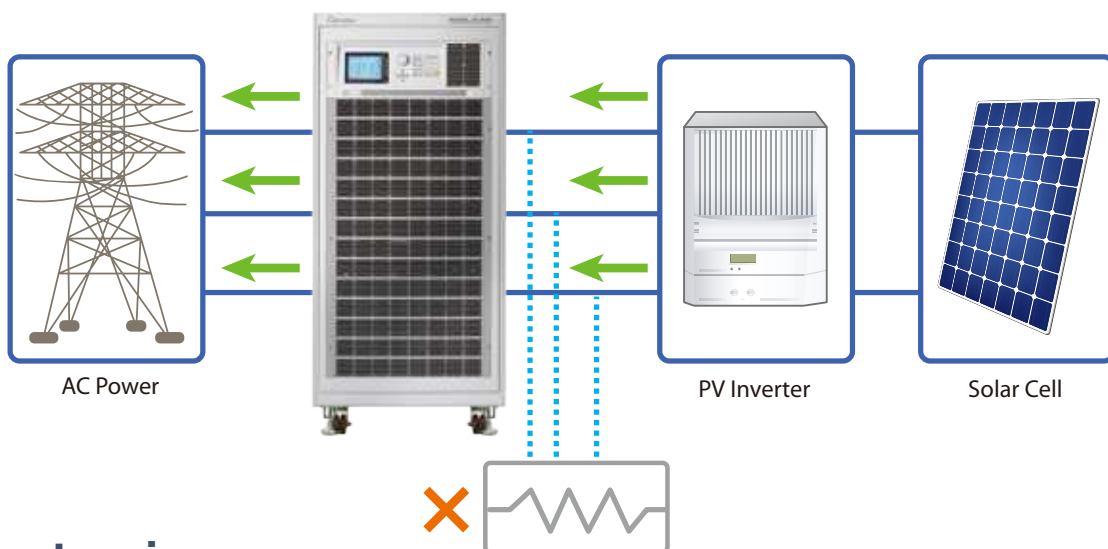

Implement for Low Voltage Ride Through (LVRT) Testing

The Low Voltage Ride Through (LVRT) function of grid tied PV inverter clearly defines that when an abnormality occurs on the main AC grid (such as a voltage drop), the PV inverter must remain operable and sustain the main AC grid for a certain specific time period. For instance : the BDEW standard requires the PV inverter to remain operable and delivering reactive power for at least 150ms when the grid voltage has dropped to 15% of the nominal value.

The 61800 Regenerative Grid Simulator is fully capable of meeting the LVRT test requirements, as the user can program the required transient test conditions through implementation of the LIST mode function, which provides a minimum time resolution setting of 0.1ms. Moreover, the user can also study and evaluate the impact on PV inverter performance due to grid line voltage distortion, by implementing the harmonic synthesis function of the 61800 series product. The frequency resolution of the 61800 is 0.01Hz which meets the BDEW requirement.

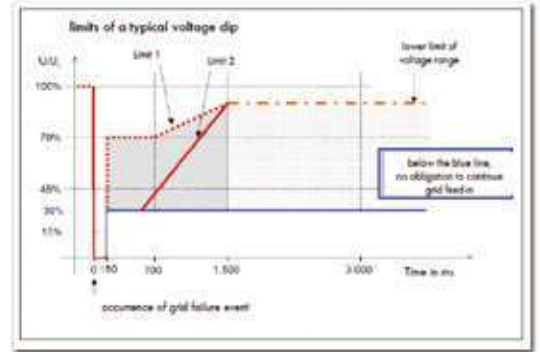

Test number	U/UN	LVRT duration (ms)
1	≤ 0.05	≥ 150
2	0.2 - 0.5	≥ 550
3	0.45 - 0.55	≥ 950
4	0.7 - 0.8	≥ 1400

Implement for Anti-islanding Testing

By incorporating the 61800 Regenerative Grid Simulator with the 8000 ATS and RLC load, the test system is capable of meeting IEEE 1547/IEC 62116 test requirements for Anti-islanding.

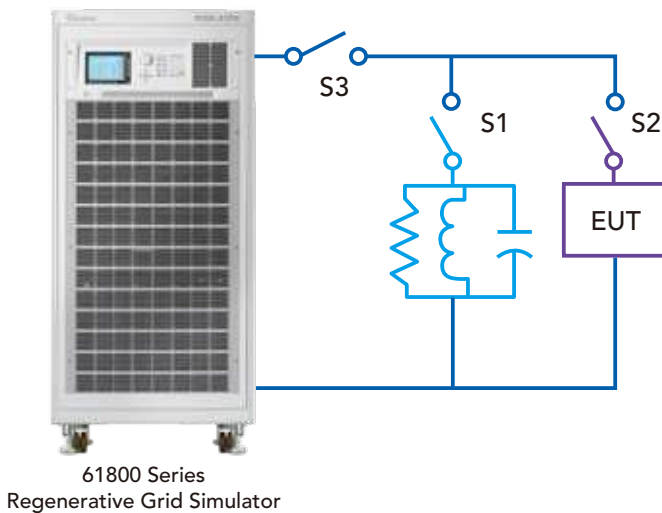

Arbitrary Power Amplifier

The external voltage programming input of the 61800 series Regenerative Grid Simulator allows users to feed any AC+DC waveform from an arbitrary signal generator and to amplify the signal accordingly. It can be used to simulate the real mains supply waveforms observed in the field or implemented with real-time digital simulator for HIL (Hardware In Loop) applications. The delay time from external voltage programming input to actual voltage output is approximately 100 μ s.

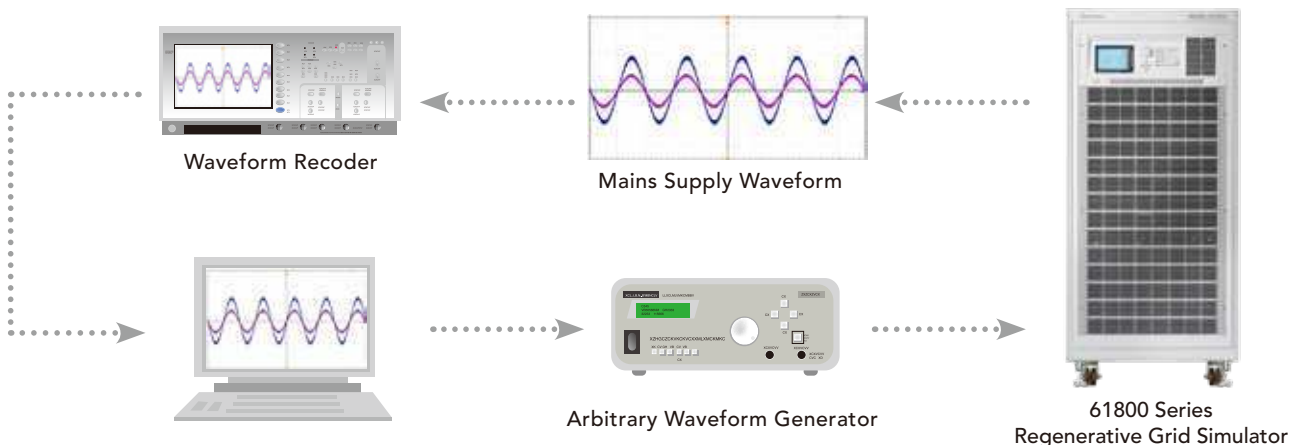

OPTIONAL FUNCTIONS

AC LOAD 3 Phase LOCAL QUIT				Main	
CC-RECTIFIED CONDITION					
#1	I _{ac} = 0.0A	CF = 1.414			
#2	I _{ac} = 0.0A	CF = 1.414			
#3	I _{ac} = 0.0A	CF = 1.414			
MEASUREMENT					
#1	V = 0.00	P _o = 0.0			
#1	I = 0.000	PF = 0.000			
#2	V = 0.00	P _o = 0.0			
#2	I = 0.000	PF = 0.000			
#3	V = 0.00	P _o = 0.0			
#3	I = 0.000	PF = 0.000			
V ₁₂ = 0.00		V ₂₃ = 0.00			
V ₃₁ = 0.00		P _o = 0.0			
CC Rectifier CP Rectifier CR CC Lead/Lag CP Lead/Lag					2017/08/23 15:22:44

The 61800 series further extends its test application capabilities by including optional functions such as B618000: Regenerative AC load function and B618002: 120kVA 800V_{LN} XHV function.

The regenerative AC load function consists of various modes such as CC Rectified mode, CP Rectified mode, CR mode, CC Phase lead/lag mode and CP Phase lead/lag mode.

The Rectified Mode is capable of simulating non-linear rectified loads with characteristics similar to Chroma 63800 series AC load where the voltage and current operate at the 1st and 3rd quadrant. The Rectified Mode supports both CC and CP functions with current, power and CF as parameter settings.

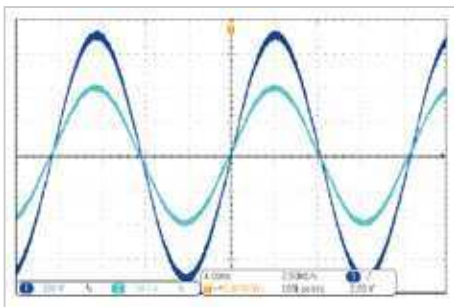

CC Rectified Mode (CF=1.414)

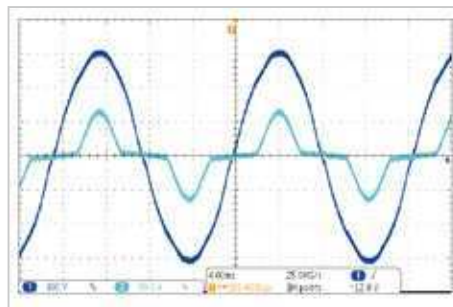

CC Rectified Mode (CF=2)

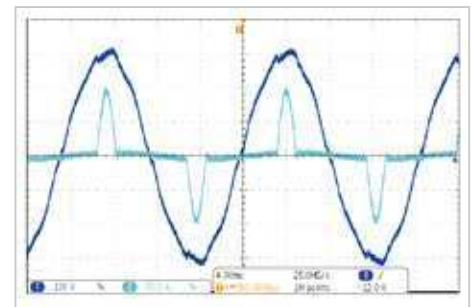

CC Rectified Mode (CF=3)

The phase lead/lag mode with phase angle setting ranging from 90 degree ~ -90 degree will simulate the corresponding voltage and current condition under an inductive or capacitive type load. Please note the current waveform is sinusoidal under the Phase Lead/Lag mode (current, PF and phase angle as parameter settings) and when the phase angle setting is in the range of 90.1 degree ~ 180 degree (-90 degree ~ -180 degree), the 61800 will become a current source. The regenerative AC load function is mainly intended for EVSE charging station, hybrid PV inverter, PCS, UPS, and micro-grid related test applications.

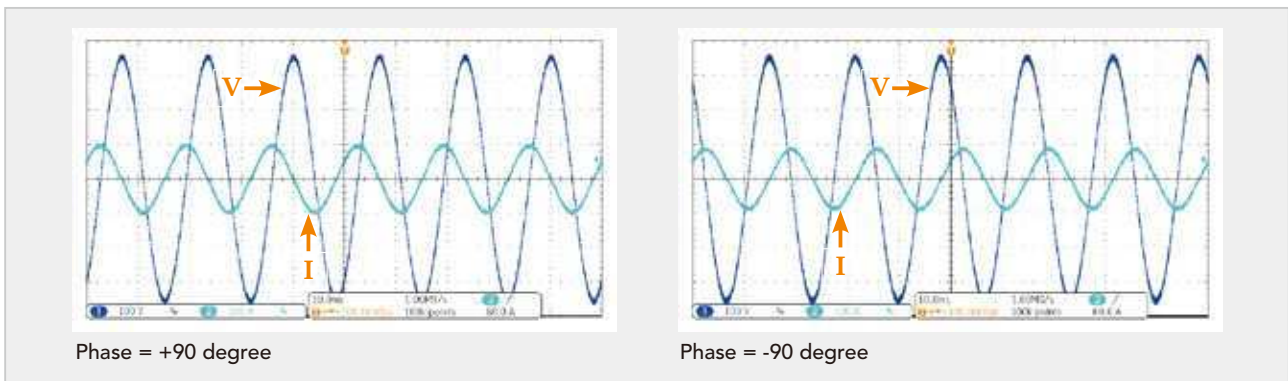

CC Phase Lead/Lag Mode Test

The B618002 120kVA 800V_{LN} XHV option is for achieving high output phase voltage up to 800V_{LN} (1385V_{LL}) by connecting two 61860 in series with high performance output voltage transient capability which is unmatched by the implementation of step up transformer. The B618002 XHV option is mainly intended to meet the test requirement of HV PV inverter with line voltage up to 1000V_{LL}.

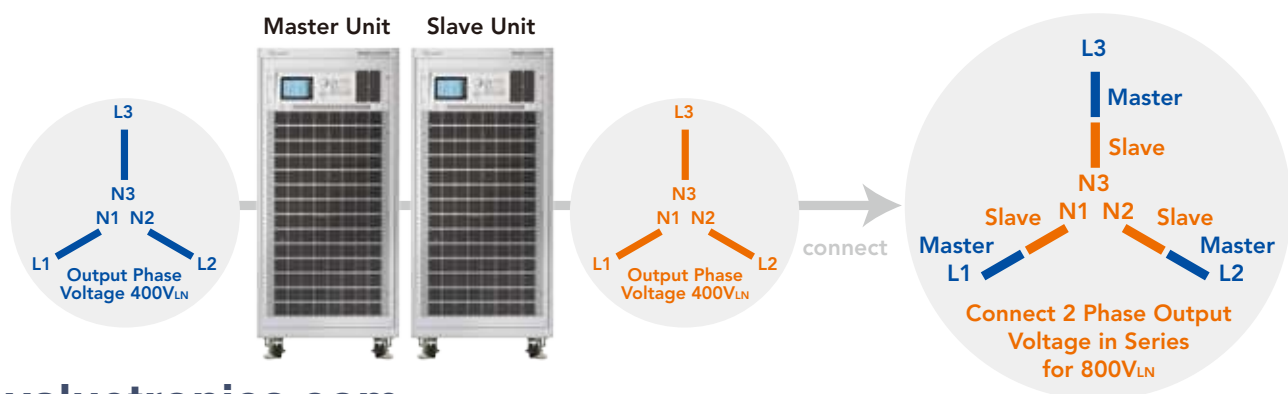

SOFTPANEL

The 61800 Softpanel is a Graphical User Interface specifically designed to provide users with an easy to use interface for configuring the instrument. The intuitive graphical panels provide simple control of the 61800 with just a few clicks of a button. The Softpanel is also equipped with data recording functions allowing multiple measurements to be recorded and saved simultaneously.



Main Operation Menu

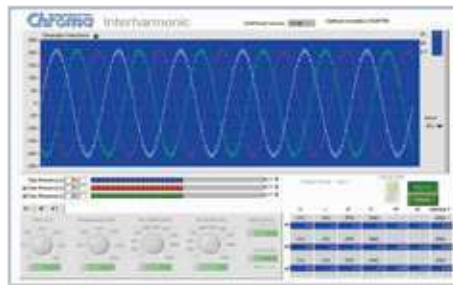

Interharmonic Test



Transient Voltage Programming

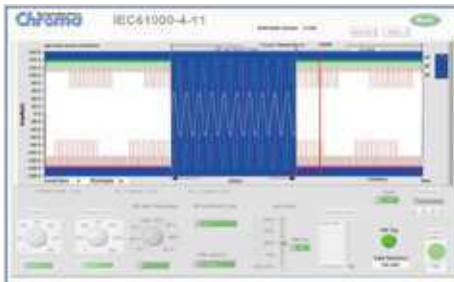

Voltage DIP, Short Interruption, Variation Test



Distorted Waveform Editor



Recording Function

PANEL DESCRIPTION

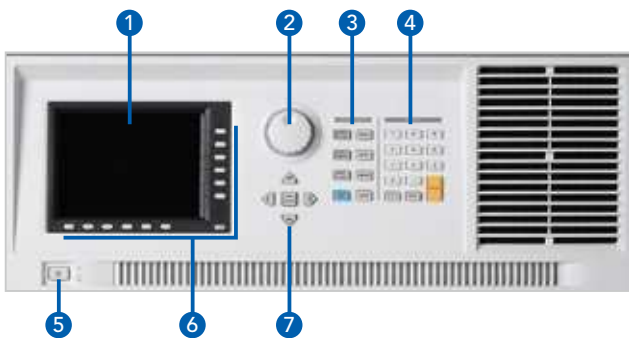

1. LCD Display
 2. Rotary Knob: For adjusting voltage, frequency and other parameter setting
 3. Function Key: Hot keys for quick parameter setting
 4. Numeric Key: For data entry
 5. On/Off Power Switch
 6. Soft Keys: Supports menu driven interface
 7. Cursor movement Keypad
8. External V reference/TTL I/O Port:
External analog signal for voltage control and signals for system integration
 9. Remote Control Port: used for handheld controller
 10. LAN (Ethernet) Port
 11. USB Interface
 12. RS-232 Interface
 13. GPIB Interface
 14. Master/Slave parallel port:
Used when paralleling more than one unit
 15. Remote Sense: For line voltage compensation
 16. Main Power Breaker:
NFB with leakage current detection ability
 17. Input AC power terminal
 18. Output Terminal
 19. USB Host

61830/61845/61860

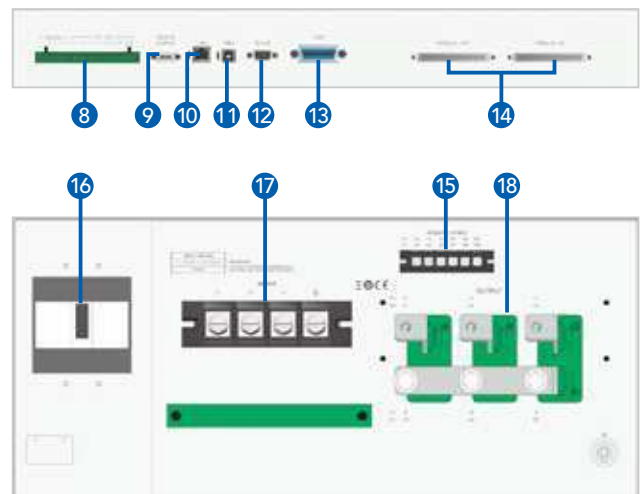

61800-100

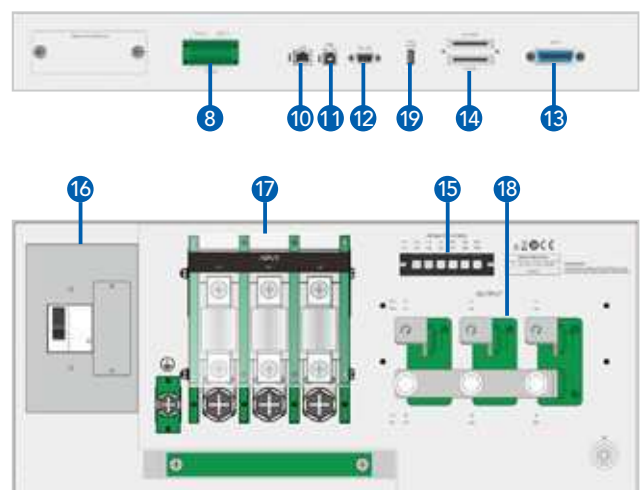

SPECIFICATIONS

Model	61830	61845	61860	61800-100
AC Output Rating				
Output Phase	1 or 3 selectable	1 or 3 selectable	1 or 3 selectable	1 or 3 selectable
Max. Power	30kVA	45kVA	60kVA	105kVA
Per Phase	10kVA	15kVA	20kVA	35kVA
Voltage				
Range	0~300V _{LN} /0~520V _{LL} Option-HV : 0~400V _{LN} /0~693V _{LL}	0~300V _{LN} /0~520V _{LL} Option-HV : 0~400V _{LN} /0~693V _{LL}	0~300V _{LN} /0~520V _{LL} Option-HV : 0~400V _{LN} /0~693V _{LL}	0~300V _{LN} /0~520V _{LL} Option-HV : 0~500V _{LN} /0~866V _{LL}
Accuracy	0.1%+0.2%F.S.	0.1%+0.2%F.S.	0.1%+0.2%F.S.	0.1%+0.2%F.S.
Resolution	0.1V	0.1V	0.1V	0.1V
Distortion	< 0.5% @ 50/60Hz *1 < 0.8% @ 30Hz~100Hz	< 0.5% @ 50/60Hz *1 < 0.8% @ 30Hz~100Hz	< 0.5% @ 50/60Hz *1 < 0.8% @ 30Hz~100Hz	< 0.5% @30-65Hz *2 < 0.8% @65-100Hz
Line regulation	0.10%	0.10%	0.10%	0.10%
Load regulation	0.20%	0.20%	0.20%	0.20%
Max. Current (1-Phase Mode)				
RMS	150A	225A	300A	420A
Peak	450A	675A	900A	1080A
Max. Current (each phase in 3-Phase Mode)				
RMS	50A	75A	100A	140A
Peak	150A	225A	300A	360A
Frequency				
Range	30Hz ~ 100Hz	30Hz ~ 100Hz	30Hz ~ 100Hz	30Hz ~ 100Hz
Accuracy	0.01%	0.01%	0.01%	0.01%
DC Output (1-Phase Mode) *3				
Power	15kW	22.5kW	30kW	52.5kW
Voltage	424V	424V	424V	424V
Current	75A	112.5A	150A	210A
DC Output (3-Phase Mode)				
Power	5kW	7.5kW	10kW	17.5kW
Voltage	424V	424V	424V	424V
Current	25A	37.5A	50A	70A
Harmonics Synthesis Function				
Harmonics range	up to 50 harmonics order @ 50/60Hz fundamental frequency			
Input Rating				
Voltage Operating Range *4	3Ø 200~220V ± 10%V _{LL} , 47~63Hz 3Ø 380~400V ± 10%V _{LL} , 47~63Hz 3Ø 440~480V ± 10%V _{LL} , 47~63Hz	3Ø 200~220V ± 10%V _{LL} , 47~63Hz 3Ø 380~400V ± 10%V _{LL} , 47~63Hz 3Ø 440~480V ± 10%V _{LL} , 47~63Hz	3Ø 200~220V ± 10%V _{LL} , 47~63Hz 3Ø 380~400V ± 10%V _{LL} , 47~63Hz 3Ø 440~480V ± 10%V _{LL} , 47~63Hz	3Ø 200~220V ± 10%V _{LL} , 47~63Hz 3Ø 380~400V ± 10%V _{LL} , 47~63Hz 3Ø 440~480V ± 10%V _{LL} , 47~63Hz
Current	125A Max./Phase (3Ø 200~220V ± 10%V _{LL}) 65A Max./Phase (3Ø 380~400V ± 10%V _{LL}) 58A Max./Phase (3Ø 440~480V ± 10%V _{LL})	190A Max./Phase (3Ø 200~220V ± 10%V _{LL}) 100A Max./Phase (3Ø 380~400V ± 10%V _{LL}) 87A Max./Phase (3Ø 440~480V ± 10%V _{LL})	250A Max./Phase (3Ø 200~220V ± 10%V _{LL}) 130A Max./Phase (3Ø 380~400V ± 10%V _{LL}) 115A Max./Phase (3Ø 440~480V ± 10%V _{LL})	438A Max./Phase (3Ø 200~220V ± 10%V _{LL}) 228A Max./Phase (3Ø 380~400V ± 10%V _{LL}) 200A Max./Phase (3Ø 440~480V ± 10%V _{LL})
Power factor	0.99 (Typical)			> 0.97 (Typical)
Measurement				
Voltage				
Range	0~300V	0~300V	0~300V	0~300V
Accuracy	0.1%+0.2%F.S.	0.1%+0.2%F.S.	0.1%+0.2%F.S.	0.1%+0.2%F.S.
Current				
Range (peak)	150A	225A	300A	360A
Accuracy (RMS)	0.4%+0.3%F.S.	0.4%+0.3%F.S.	0.4%+0.3%F.S.	0.4%+0.3%F.S.
Accuracy (peak)	0.4%+0.6%F.S.	0.4%+0.6%F.S.	0.4%+0.6%F.S.	0.4%+0.6%F.S.
Power				
Accuracy	0.4%+0.4% F.S.	0.4%+0.4% F.S.	0.4%+0.4% F.S.	0.4%+0.4% F.S.
Others				
Efficiency	80% (Typical)			
Protection	OVP, OCP, OPP, OTP, FAN			
Safety & EMC	CE (include EMC & LVD)			
Dimension (H x W x D)	1740 x 780 x 1000 mm / 68.5 x 30.7 x 39.4 inch (include wheel set)	1740 x 780 x 1000 mm / 68.5 x 30.7 x 39.4 inch (include wheel set)	1740 x 780 x 1000 mm / 68.5 x 30.7 x 39.4 inch (include wheel set)	1740 x 780 x 1000 mm / 68.5 x 30.7 x 39.4 inch (include wheel set)
Weight	850kg	850kg	870kg	1000 kg

Note*1 : Maximum distortion is tested on output 250V with maximum current to linear load.

Note*2 : Maximum distortion is tested on output 500V with maximum current to linear load.

Note*3 : The DC function is mainly intended as DC offset for AC+DC output voltage function.

Note*4 : Must be specified at time of order. All inputs are L-L, 3Ø, 3 wire+GND.

All specifications are subject to change without notice.

SPECIFICATIONS - B618000 REGENERATIVE AC LOAD

Optional ACL AC Load Functions	61830	61845	61860
Current (3-phase/per phase)			
Current (RMS)	50A	75A	100A
Current (Peak)	150A _{peak}	225A _{peak}	300A _{peak}
Operating Voltage Range	50~300V _{LN} ; Option-HV: 50~400V _{LN}		
Operating Frequency			
Range	30Hz ~ 100Hz		
Accuracy	0.01%		
Resolution	0.1Hz		
CC Rectified Mode (each phase)			
Range	0~50A	0~75A	0~100A
Accuracy	0.3%R.D. + 0.5%F.S.(above 2A)	0.3%R.D. + 0.5%F.S.(above 2A)	0.3%R.D. + 0.5%F.S.(above 2A)
Resolution	0.1A	0.1A	0.1A
Crest Factor	1.414~3.0	1.414~3.0	1.414~3.0
Resolution	0.001	0.001	0.001
CP Rectified Mode (each phase)			
Range	0~10kW	0~15kW	0~20kW
Accuracy	0.3%R.D. + 0.6%F.S.(above 200W)	0.3%R.D. + 0.6%F.S.(above 200W)	0.3%R.D. + 0.6%F.S.(above 200W)
Resolution	10W	10W	10W
Crest Factor	1.414~3.0	1.414~3.0	1.414~3.0
Resolution	0.001	0.001	0.001
CC Phase Lead/Lag Mode (each phase)			
Range	0~50Arms	0~75Arms	0~100Arms
Accuracy	0.3%R.D. + 0.5%F.S.(above 2A)	0.3%R.D. + 0.5%F.S.(above 2A)	0.3%R.D. + 0.5%F.S.(above 2A)
Resolution	0.1A	0.1A	0.1A
Phase	-90deg ~ +90deg (current source mode: +90.1deg ~ +180deg & -90.1deg ~ -180deg)		
Accuracy	0.6%F.S.(30~70Hz) 1.0%F.S.(71Hz~100Hz)	0.6%F.S.(30~70Hz) 1.0%F.S.(71Hz~100Hz)	0.6%F.S.(30~70Hz) 1.0%F.S.(71Hz~100Hz)
Resolution	0.1deg	0.1deg	0.1deg
CP Phase Lead/Lag Mode (each phase)			
Range	0~10kW	0~15kW	0~20kW
Resolution	10W	10W	10W
Accuracy	0.3%R.D. + 0.6%F.S. (above 200W)	0.3%R.D. + 0.6%F.S. (above 200W)	0.3%R.D. + 0.6%F.S. (above 200W)
Phase	-90deg ~ +90deg (current source mode: +90.1deg ~ +180deg & -90.1deg ~ -180deg)		
Accuracy	0.6%F.S.(30~60Hz) 0.8%F.S.(61Hz~100Hz)	0.6%F.S.(30~60Hz) 0.8%F.S.(61Hz~100Hz)	0.6%F.S.(30~60Hz) 0.8%F.S.(61Hz~100Hz)
Resolution	0.1deg	0.1deg	0.1deg
CR Mode (each phase)			
Range	1~300ohm	1~300ohm	1~300ohm
Accuracy	Convert to current value 0.3%R.D. + 0.7%F.S.(above 2A)	Convert to current value 0.3%R.D. + 0.7%F.S. (above 2A)	Convert to current value 0.3%R.D. + 0.7%F.S. (above 2A)
Resolution	0.1ohm	0.1ohm	0.1ohm

* All specifications are subject to change without notice.

ORDERING INFORMATION

61830 : Regenerative Grid Simulator 30kVA
 61845 : Regenerative Grid Simulator 45kVA
 61860 : Regenerative Grid Simulator 60kVA
 61800-100 : Regenerative Grid Simulator 105kVA
 A618001 : Softpanel for 61800 Series
 A618002 : Terminals for parallel connecting

61830/61845/61860 option :

B618000 : Regenerative AC load function (factory installation)
 B618001 : 400 V_{LN} HV option (factory installation)
 B618002 : 120kVA 800V_{LN} XHV function (factory installation)

61800-100 option :

B618003 : 500 V_{LN} HV option (factory installation)

Get more product and distributor information in Chroma ATE APP



iOS



Android

Search Keyword

61800

HEADQUARTERS
 CHROMA ATE INC.
 66 Huaya 1st Road,
 Guishan, Taoyuan
 33383, Taiwan
 T +886-3-327-9999
 F +886-3-327-8898
 www.chromaate.com
 info@chromaate.com

U.S.A.
 CHROMA SYSTEMS
 SOLUTIONS, INC.
 19772 Pauling,
 Foothill Ranch,
 CA 92610
 T +1-949-600-6400
 F +1-949-600-6401
 www.chromausa.com
 sales@chromausa.com

EUROPE
 CHROMA ATE
 EUROPE B.V.
 Morsestraat 32,
 6716 AH Ede,
 The Netherlands
 T +31-318-648282
 F +31-318-648288
 www.chroma.eu.com
 sales@chromaeu.com

CHROMA ATE GERMANY
 Südtiroler Str. 9, 86165,
 Augsburg, Germany
 T +49-821-790967-0
 F +49-821-790967-600
 www.chroma.eu.com
 sales@chromaeu.com

JAPAN
 CHROMA JAPAN
 CORP.
 888 Nippa-cho,
 Kouhoku-ku,
 Yokohama-shi,
 Kanagawa,
 223-0057 Japan
 T +81-45-542-1118
 F +81-45-542-1080
 www.chroma.co.jp
 info@chroma.co.jp

KOREA
 CHROMA ATE
 KOREA BRANCH
 3F Richtogether
 Center, 14,
 Pangyoeyeok-ro 192,
 Bundang-gu,
 Seongnam-si,
 Gyeonggi-do
 13524, Korea
 T +82-31-781-1025
 F +82-31-8017-6614
 www.chromaate.co.kr
 info@chromaate.com

CHINA
 CHROMA ELECTRONICS
 (SHENZHEN) CO., LTD.
 8F, No.4, Nanyou Tian
 An Industrial Estate,
 Shenzhen, China
 T +86-755-2664-4598
 F +86-755-2641-9620
 www.chroma.com.cn
 info@chromaate.com

SOUTHEAST ASIA
 QUANTEL PTE LTD.
 (A company of Chroma Group)
 46 Lorong 17 Geylang # 05-02
 Enterprise Industrial Building,
 Singapore 388568
 T +65-6745-3200
 F +65-6745-9764
 www.quantel-global.com
 sales@quantel-global.com