

# Programmable AC Source

**61501 / 61502 / 61503 / 61504**

User's Manual

**Chroma**  
www.chromaate.com



# Programmable AC Source 61501/61502/61503/61504 User's Manual



Version 1.6  
January 2010

# Legal Notices

The information in this document is subject to change without notice.

Chroma ATE INC. makes no warranty of any kind with regard to this manual, including, but not limited to, the implied warranties of merchantability and fitness for a particular purpose. Chroma ATE INC. shall not be held liable for errors contained herein or direct, indirect, special, incidental or consequential damages in connection with the furnishing, performance, or use of this material.

## **CHROMA ATE INC.**

No.66 Hwa-Ya 1st Rd., Hwa-Ya Technical Park, Kuei-Shan 33383, Taoyuan County, Taiwan

Copyright Notices. Copyright 2002-2010 Chroma ATE INC., all rights reserved. Reproduction, adaptation, or translation of this document without prior written permission is prohibited, except as allowed under the copyright laws.

# Warranty

All Chroma instruments are warranted against defects in material and workmanship for a period of one year after date of shipment. Chroma agrees to repair or replace any assembly or component found to be defective, under normal use during this period. Chroma's obligation under this warranty is limited solely to repairing any such instrument which in Chroma's sole opinion proves to be defective within the scope of the warranty when returned to the factory or to an authorized service center. Transportation to the factory or service center is to be prepaid by the purchaser. Shipment should not be made without prior authorization by Chroma.

This warranty does not apply to any products repaired or altered by persons not authorized by Chroma, or not in accordance with instructions furnished by Chroma. If the instrument is defective as a result of misuse, improper repair, or abnormal conditions or operations, repairs will be billed at cost.

Chroma assumes no responsibility for its product being used in a hazardous or dangerous manner either alone or in conjunction with other equipment. High voltage used in some instruments may be dangerous if misused. Special disclaimers apply to these instruments. Chroma assumes no liability for secondary charges or consequential damages and in any event, Chroma's liability for breach of warranty under any contract or otherwise, shall not exceed the purchase price of the specific instrument shipped and against which a claim is made.

Any recommendations made by Chroma for use of its products are based upon tests believed to be reliable, but Chroma makes no warranty of the results to be obtained. This warranty is in lieu of all other warranties, expressed or implied, and no representative or person is authorized to represent or assume for Chroma any liability in connection with the sale of our products other than set forth herein.

## **CHROMA ATE INC.**

No. 66 Hwa-Ya 1st Rd, Hwa-Ya Technical Park,  
Kuei-Shan 33383, Taoyuan County, Taiwan  
Tel: 886-3-327-9999  
Fax: 886-3-327-2886  
e-mail: [chroma@chroma.com.tw](mailto:chroma@chroma.com.tw)

<http://www.chromaate.com>

# Material Contents Declaration

A regulatory requirement of The People's Republic of China defined by specification SJ/T 11364-2006 mandates that manufacturers provide material contents declaration of electronic products, and for Chroma products are as below:

Part Name	Hazardous Substances					
	Lead	Mercury	Cadmium	Hexavalent Chromium	Polybrominated Biphenyls	Polybromodiphenyl Ethers
	Pb	Hg	Cd	Cr <sup>6+</sup>	PBB	PBDE
PCBA	×	○	○	○	○	○
CHASSIS	×	○	○	○	○	○
ACCESSORY	×	○	○	○	○	○
PACKAGE	○	○	○	○	○	○

“○” indicates that the level of the specified chemical substance is less than the threshold level specified in the standards of SJ/T-11363-2006 and EU 2005/618/EC.

“×” indicates that the level of the specified chemical substance exceeds the threshold level specified in the standards of SJ/T-11363-2006 and EU 2005/618/EC.

1. Chroma is not fully transitioned to lead-free solder assembly at this moment; however, most of the components used are RoHS compliant.
2. The environment-friendly usage period of the product is assumed under the operating environment specified in each product's specification.

## Disposal

Do not dispose of electrical appliances as unsorted municipal waste, use separate collection facilities. Contact your local government for information regarding the collection systems available. If electrical appliances are disposed of in landfills or dumps, hazardous substances can leak into the groundwater and get into the food chain, damaging your health and well-being. When replacing old appliances with new one, the retailer is legally obligated to take back your old appliances for disposal at least for free of charge.





# Declaration of Conformity

For the following equipment :

**61505 AC SOURCE**

(Product Name/ Trade Name)

**Chroma AC SOURCE 61505 ,61601 ,61602 ,61603 ,61604 ,61501 ,61502 ,61503 ,61504**

(Model Designation)

**Chroma ATE INC.**

(Manufacturer Name)

**66, Hwa-Ya 1<sup>st</sup> Rd., Hwa-Ya Technical Park, Kuei-Shan Hsiang, Taoyuan Hsien 333, Taiwan**

(Manufacturer Address)

Is herewith confirmed to comply with the requirements set out in the Council Directive on the Approximation of the Laws of the Member States relating to Electromagnetic Compatibility Directives (2004/108/EC), For the evaluation regarding the Directives, the following standards were applied :

**EN 61326 : 2006 Class A**

**EN 61326 : 2006(industrial locations)**

IEC 61000-4-2:1995+A1:1998+A2:2000, IEC 61000-4-3:2006

IEC 61000-4-4:2004, IEC 61000-4-5:2005, IEC 61000-4-6:2006

IEC 61000-4-8:2001, IEC 61000-4-11:2004

**EN 61010-1:2001**

The following importer/manufacturer or authorized representative established within the EUT is responsible for this declaration :

**Chroma ATE INC.**

(Company Name)

**66, Hwa-Ya 1<sup>st</sup> Rd., Hwa-Ya Technical Park, Kuei-Shan Hsiang, Taoyuan Hsien 333, Taiwan**

(Company Address)

Person responsible for this declaration:

**Mr. Benjamin Huang**

(Name, Surname)

**T & M BU Director**

(Position/Title)

**Taiwan**

**2009.09.14**

(Place)

(Date)

(Legal Signature)

# Safety Summary

The following general safety precautions must be observed during all phases of operation, service, and repair of this instrument. Failure to comply with these precautions or specific WARNINGS given elsewhere in this manual will violate safety standards of design, manufacture, and intended use of the instrument. *Chroma* assumes no liability for the customer's failure to comply with these requirements.



## BEFORE APPLYING POWER

Verify that the power is set to match the rated input of this power supply.



## PROTECTIVE GROUNDING

Make sure to connect the protective grounding to prevent an electric shock before turning on the power.



## NECESSITY OF PROTECTIVE GROUNDING

Never cut off the internal or external protective grounding wire, or disconnect the wiring of protective grounding terminal. Doing so will cause a potential shock hazard that may bring injury to a person.



## FUSES

Only fuses with the required rated current, voltage, and specified type (normal blow, time delay, etc.) should be used. Do not use repaired fuses or short-circuited fuse holders. To do so could cause a shock or fire hazard.



## DO NOT OPERATE IN AN EXPLOSIVE ATMOSPHERE

Do not operate the instrument in the presence of flammable gases or fumes. The instrument should be used in an environment of good ventilation.



## DO NOT REMOVE THE COVER OF THE INSTRUMENT







Operating personnel must not remove the cover of the instrument. Component replacement and internal adjustment can be done only by qualified service personnel.

### **⚠ WARNING**

1. Lethal voltage. AC source may output 426 V peak voltage.
2. Touching the connected circuit or output terminal on the front or rear panel when power is on may result in death.



# Safety Symbols

	<b>DANGER</b> – High voltage.
	<b>Explanation:</b> To avoid injury, death of personnel, or damage to the instrument, the operator must refer to an explanation in the instruction manual.
	<b>High temperature:</b> This symbol indicates the temperature is now higher than the acceptable range of human. Do not touch it to avoid any personal injury.
	<b>Protective grounding terminal:</b> To protect against electrical shock in case of a fault. This symbol indicates that the terminal must be connected to ground before operation of equipment.
	The <b>WARNING</b> sign denotes a hazard. It calls attention to a procedure, practice, or the like, which, if not correctly performed or adhered to, could result in personal injury. Do not proceed beyond a <b>WARNING</b> sign until the indicated conditions are fully understood and met.
	The <b>CAUTION</b> sign denotes a hazard. It may result in personal injury or death if not noticed timely. It calls attention to procedures, practices and conditions.

## ACOUSTIC NOISE INFORMATION

This product has a sound pressure emission (at the operator's side) < 65dB(A).

# Protection Plates

In order to protect the terminals of the Chroma 61500/61600 AC power source from damage during shift or transportation, users can choose to install the enclosed rear panel protection plates (2 pieces) as an option.

## Installation Instruction:

1. Remove the 4 screws from both sides of the rear panel (Figure 1).
2. Mount the protection plates with the screws included in the bag (Figure 2).

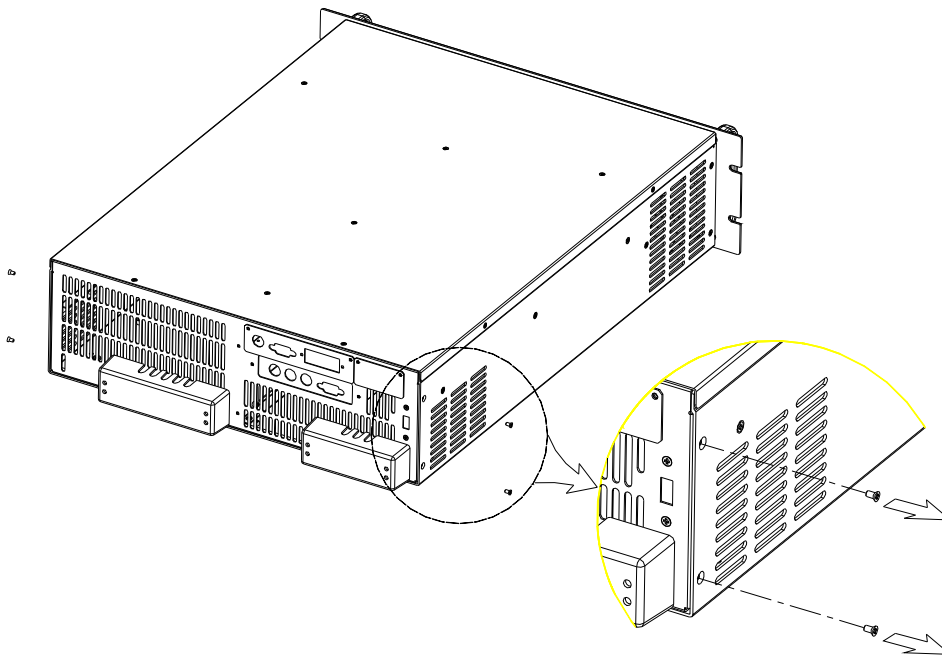

Figure 1

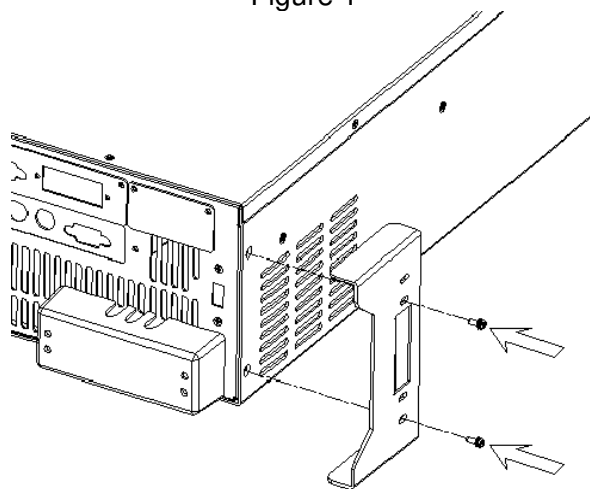

Figure 2

# Revision History

The following lists the additions, deletions and modifications in this manual at each revision.

Date	Version	Revised Sections
Jan. 2002	1.0	Complete this manual.
Jan. 2004	1.1	Modify " <i>Rear Panel</i> " <ul style="list-style-type: none"> <li>"<i>DATALOCK</i>"</li> <li>"<i>COUPLE Mode of Output (AC+DC, AC, DC)</i>"</li> <li>"<i>Programmable Output Impedance</i>"</li> <li>"<i>THREE PHASE MODE</i>"</li> <li>"<i>PARALLEL MODE</i>"</li> <li>"<i>Synthesis Waveform</i>"</li> <li>"<i>Interharmonics Waveform</i>"</li> <li>"<i>The GPIB Capability of the AC Source</i>"</li> </ul>
May 2005	1.2	Change the address and phone no. of Chroma
Aug. 2005	1.3	Modify " <i>Rear Panel</i> " <ul style="list-style-type: none"> <li>"<i>Input Connection</i>"</li> <li>"<i>Remote Sense Connection</i>"</li> <li>"<i>COUPLE Mode of Output (AC+DC, AC, DC)</i>"</li> <li>"<i>THREE PHASE MODE</i>"</li> <li>"<i>PARALLEL MODE</i>"</li> </ul>
June 2007	1.4	Add the following <ul style="list-style-type: none"> <li>- "<i>Material Contents Declaration</i>"</li> <li>- "<i>Protection Plates</i>"</li> <li>- "<i>HIGH VOLTAGE OPTION</i>".</li> <li>- the description of "NOTICE" in the section of "<i>OUTPUT RELAY</i>"</li> </ul> Modify the following chapters <ul style="list-style-type: none"> <li>- the figure 3-1 in the section of "<i>Operation through Keypad and RPG</i>".</li> <li>- "the definition of letters" in the section of "<i>MAIN PAGE (Output Setting and Measurement)</i>".</li> <li>- the content and notice in the section of "<i>RANGE</i>".</li> <li>- "<i>CALIBRATION CHOICE PAGE</i>" in the section of "<i>MANUAL CALI Functional List</i>".</li> <li>- the waveform and table list in the section of "<i>Appendix B Built-in Waveforms</i>".</li> </ul>
Mar. 2008	1.5	Add the following <ul style="list-style-type: none"> <li>- the description in the section of "<i>Slew Rate of Output Transient</i>".</li> <li>- Notice in the section of "<i>HIGH VOLTAGE OPTION</i>".</li> <li>- the description in the section of "<i>Appendix A: Pin Assignment of TTL SIGNAL</i>".</li> </ul> Modify the following sections: <ul style="list-style-type: none"> <li>- Range of OUTPUT IMPEDANCE in the section of "<i>Specifications</i>".</li> <li>- the second page display in the section of "<i>OUTPUT Functional List</i>".</li> <li>- DST17 in the section of "<i>Appendix B Built-in Waveforms</i>".</li> </ul>
Jan. 2010	1.6	Modify the following sections: <ul style="list-style-type: none"> <li>- the description in the section of "<i>Procedures of Power-on</i>".</li> </ul>

- the description in the section of “*Output Voltage and Voltage Measurement Calibration*”.
- the content of “*CE Declaration*”.

# Table of Contents

<b>1.</b>	<b>General Information .....</b>	<b>1-1</b>
1.1	Introduction .....	1-1
1.2	Key Features .....	1-1
1.3	Specifications .....	1-1
1.4	Names of Parts .....	1-3
1.4.1	Front Panel .....	1-3
1.4.2	Rear Panel .....	1-5
<b>2.</b>	<b>Installation.....</b>	<b>2-1</b>
2.1	Inspection .....	2-1
2.2	Preparation for the Use .....	2-1
2.3	Requirements of Input Power .....	2-1
2.3.1	Ratings.....	2-1
2.3.2	Input Connection.....	2-1
2.4	Output Connection.....	2-3
2.5	Remote Sense Connection.....	2-3
2.6	Procedures of Power-on .....	2-4
2.7	I/O Connectors (Option) .....	2-5
<b>3.</b>	<b>Local Operation .....</b>	<b>3-1</b>
3.1	Introduction .....	3-1
3.2	Operation through Keypad and RPG.....	3-1
3.3	MAIN PAGE (Output Setting and Measurement) .....	3-4
3.4	CHOICE PAGE (Functional List Choice) .....	3-5
3.5	SETUP Functional List .....	3-5
3.5.1	RANGE .....	3-6
3.5.2	Vac LIMIT.....	3-7
3.5.3	Vdc LIMIT (+), Vdc LIMIT (-) .....	3-7
3.5.4	I LIMIT, DELAY .....	3-8
3.5.5	OUTPUT RELAY .....	3-9
3.5.6	BUZZER.....	3-9
3.5.7	DATALOCK.....	3-9
3.5.8	Is START, Is INTERVAL .....	3-10
3.6	CONF Functional List .....	3-10
3.6.1	REMOTE INHIBIT.....	3-11
3.6.2	EXT. V, COUPLE.....	3-12
3.6.3	WAVEFORM GENERATOR .....	3-13
3.6.4	POWER ON STATUS.....	3-14
3.6.5	GPIB Address, RS-232C .....	3-15
3.7	OUTPUT Functional List.....	3-15
3.7.1	COUPLE Mode of Output (AC+DC, AC, DC) .....	3-16
3.7.2	OUTPUT DEGREE .....	3-18
3.7.3	Programmable Output Impedance.....	3-18
3.7.4	Slew Rate of Output Transient.....	3-19
3.7.5	HIGH VOLTAGE OPTION .....	3-20
3.7.6	THREE PHASE MODE.....	3-21
3.7.7	PARALLEL MODE .....	3-23
3.8	Save and Recall .....	3-25
3.8.1	Save and Recall Output Setting.....	3-25
3.8.2	Save and Recall System Data .....	3-27
3.9	Protection .....	3-28
<b>4.</b>	<b>Calibration.....</b>	<b>4-1</b>

4.1	Introduction .....	4-1
4.2	MANUAL CALI Functional List.....	4-1
4.2.1	Output Voltage and Voltage Measurement Calibration.....	4-3
4.2.2	Current Measurement Calibration.....	4-5
4.2.3	External Vref Calibration .....	4-7
<b>5.</b>	<b>Application .....</b>	<b>5-1</b>
5.1	General.....	5-1
5.2	List Mode .....	5-1
5.3	Pulse Mode.....	5-4
5.4	Step Mode .....	5-7
5.5	Harmonic Measurement .....	5-9
5.6	Synthesize Waveform.....	5-11
5.7	Interharmonics Waveform.....	5-13
<b>6.</b>	<b>Theory of Operation .....</b>	<b>6-1</b>
6.1	General.....	6-1
6.2	Description of Overall System .....	6-1
<b>7.</b>	<b>Self Test &amp; Troubleshooting.....</b>	<b>7-1</b>
7.1	General.....	7-1
7.2	Self Test .....	7-1
7.3	Troubleshooting .....	7-2
<b>8.</b>	<b>Remote Operation .....</b>	<b>8-1</b>
8.1	General Information.....	8-1
8.1.1	Setting the GPIB Address and RS-232C Parameters.....	8-1
8.1.2	Wire Connection of RS-232C.....	8-1
8.2	The GPIB Capability of the AC Source.....	8-2
8.3	Introduction to Programming .....	8-3
8.3.1	Conventions.....	8-3
8.3.2	Numerical Data Formats .....	8-3
8.3.3	Boolean Data Format.....	8-3
8.3.4	Character Data Format .....	8-3
8.3.5	Basic Definition .....	8-4
8.4	Traversal of the Command Tree.....	8-5
8.5	Execution Order.....	8-5
8.6	The Commands of the AC Source.....	8-6
8.6.1	Common Command Dictionary.....	8-6
8.6.2	Instrument Command Dictionary .....	8-7
8.7	Command Summary.....	8-30
<b>Appendix A</b>	<b>Pin Assignment of TTL Signal .....</b>	<b>A-1</b>
<b>Appendix B</b>	<b>Built-in Waveforms .....</b>	<b>B-1</b>

# 1. General Information

## 1.1 Introduction

The series of Chroma AC source 61501/61502/61503/61504 are high efficiency AC power source which provide sine wave output with low distortion, and accurate measurement of power. The DSP microprocessor generates accurate, stable output voltage and frequency. The PWM design of power stage allows for full volt-ampere into loads. The front panel has both RPG (rotary pulse generator) and keypad controls for setting the output voltage and frequency. The LCD provides a complete operating state of the unit to the user. Remote programming is accomplished either through the GPIB bus or the RS-232C serial port.

## 1.2 Key Features

### A. Configuration

- Local operation from the keypad on the front panel.
- Remote operation via GPIB or RS-232C interface.
- Protection against Over-power, Over-Current, Over-temperature, Fan-fail.
- Temperature-controlled fan speed.
- Built-in output isolation relays.

### B. Input/Output

- Selective output voltage with full scale of 150V/300V/600V/Auto where 600V is for A615003 fixture only.
- Remote control by the use of analog voltage reference.
- Universal of input voltage range 90Vac ~ 250Vac.
- Measurement of V, I, P, CF, PF, Idc, Vdc, Ipk, Is, VA and VAR.
- Remotely inhibited control.
- AC ON/OFF output signal.

## 1.3 Specifications

The operation specifications of the model 61501/61502/61503/61504 are listed below (on the next page). All specifications have been tested according to the standard Chroma test procedures. All specifications are based on a remote sense connection,  $25 \pm 1^\circ\text{C}$ , and resistor load unless specified otherwise.

Model	61501	61502	61503	61504
<b>AC OUTPUT RATING</b>				
Max. power	500 VA	1K VA	1.5K VA	2K VA
Voltage				
Range	150V / 300V / Auto			
Accuracy	0.2%+0.2%F.S.	0.2%+0.2%F.S.	0.2%+0.2%F.S.	0.2%+0.2%F.S.
Resolution	0.1 V	0.1 V	0.1 V	0.1 V
Distortion	0.3% @50/60Hz 1% 15- 1K Hz	0.3% @50/60Hz 1% 15- 1K Hz	0.3% @50/60Hz 1% 15- 1K Hz	0.3% @50/60Hz 1% 15- 1K Hz
Line regulation	0.1%	0.1%	0.1%	0.1%
Load regulation	0.2%	0.2%	0.2%	0.2%
Temp. coefficient	0.02% per degree from 25°C			
Maximum current				
r.m.s.	4A / 2A	8A / 4A	12A / 6A	16A / 8A
peak	24A / 12A	48A / 24A	72A / 36A	96A / 48A
Frequency				
Range	DC, 15-1K Hz	DC, 15-1K Hz	DC, 15-1K Hz	DC, 15-1K Hz
Accuracy	0.15%	0.15%	0.15%	0.15%
<b>DC OUTPUT RATING</b>				
Power	250W	500W	750W	1K W
Voltage	212V / 424V	212V / 424V	212V / 424V	212V / 424V
Current	2A / 1A	4A / 2A	6A / 3A	8A / 4A
<b>OUTPUT IMPEDANCE</b>				
Range	0.0Ω+200uH - 1.0Ω+1.0mH			
<b>HARMONICS &amp; SYNTHESIS SIMULATION</b>				
Bandwidth	50Hz / 60Hz 40 order			
<b>INPUT RATING</b>				
Voltage range	90-250V	90-250V	90-250V	90-250V
Frequency range	47-63 Hz	47-63 Hz	47-63 Hz	47-63 Hz
Current	8A Max.	16A Max.	21A Max.	28A Max.
Power factor	0.97 Min.	0.98 Min.	0.98 Min.	0.98 Min.
<b>MEASUREMENT</b>				
Voltage				
Range	150V / 300V	150V / 300V	150V / 300V	150V / 300V
Accuracy	0.2%+0.2%F.S.	0.2%+0.2%F.S.	0.2%+0.2%F.S.	0.2%+0.2%F.S.
Resolution	0.1 V	0.1 V	0.1 V	0.1 V
Current				
Range (peak)	24A	48A	72A	96A
Accuracy (r.m.s.)	0.4%+0.3%F.S.	0.4%+0.3%F.S.	0.4%+0.3%F.S.	0.4%+0.3%F.S.
Accuracy (peak)	0.4%+0.6%F.S.	0.4%+0.6%F.S.	0.4%+0.6%F.S.	0.4%+0.6%F.S.
Resolution	0.01 A	0.01 A	0.01 A	0.01 A
Power				
Accuracy	0.4%+0.4% F.S.	0.4%+0.4% F.S.	0.4%+0.4% F.S.	0.4%+0.4% F.S.
Resolution	0.1 W	0.1 W	0.1 W	0.1 W
<b>OTHERS</b>				
Efficiency	68 %	77 %	78 %	80 %
Size (H×W×D)	133.35 × 482.6 × 569.5 mm / 5.25 × 19 × 22.42 inch			
Weight	20 kg / 44.05 lbs	20 kg / 44.05 lbs	20 kg / 44.05 lbs	20 kg / 44.05 lbs
Protection	UVP, OCP, OPP, OTP, FAN			



Temperature Range	
Operation	0 °C to 40 °C
Storage	-40 °C to 85 °C
Humidity	30 % to 90 %
Safety & EMC	FCC 15J class A, CE

Remarks

\*1: Maximum distortion is tested on output 125VAC (150V RANGE) and 250VAC (300V RANGE) with maximum current to linear load.

\*2: Load regulation is tested with sinewave and remote sense.

\*3: Efficiency is tested on input voltage 110V.

## 1.4 Names of Parts

### 1.4.1 Front Panel

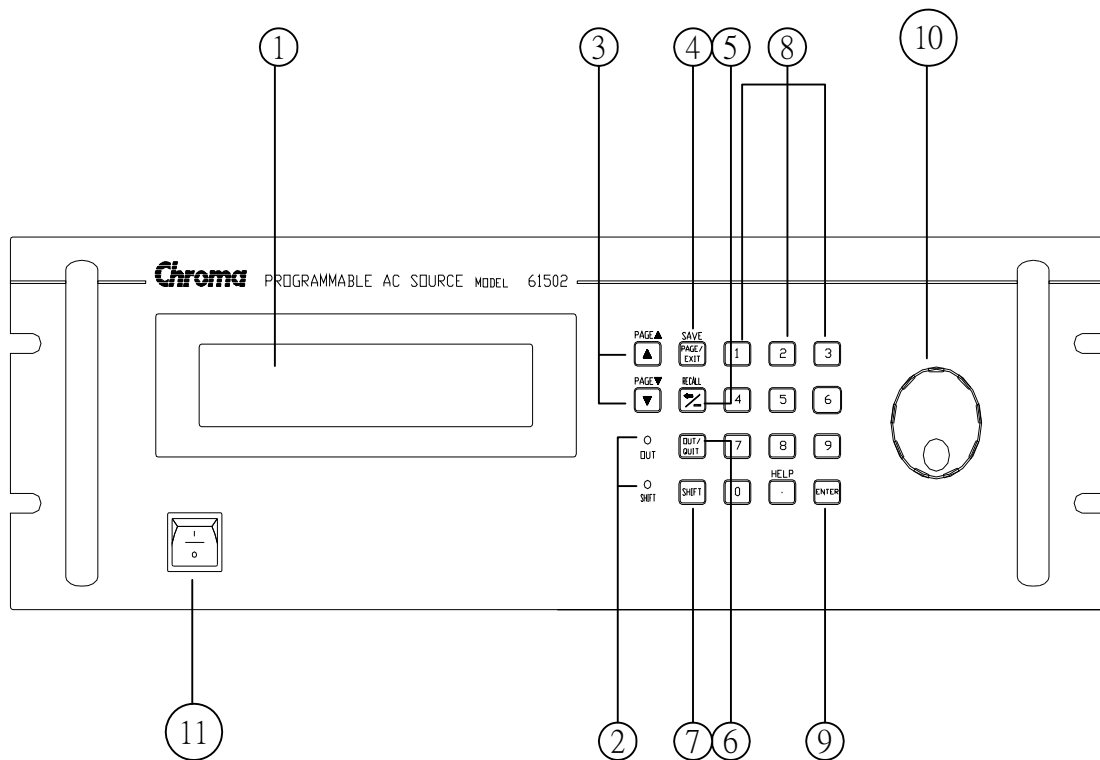



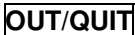

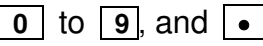





Figure 1-1 Front Panel

Table 1-1 Description of Front Panel

Item	Symbol	Description
1		<b>Display:</b> The LCD is to display configuration, output setup, and measurement results.
2		<b>Indicator LED:</b> "OUT" and "SHIFT", for showing activation of output and shift mode, are available which are located on the keypad area next to the corresponding keys.
3	  -----or----- PAGE ▲ PAGE ▼	<b>Cursor moving keys:</b> These two keys are to move the cursor to different directions respectively. In normal mode, pressing any of these two keys will change the place of the cursor. Under shift mode, these keys enable the LCD display to change to last page or next page if there are ▲ or ▼ patterns in right-down side of display.
4	 -----or----- SAVE	<b>PAGE or EXIT command key:</b> Pressing this key will make the LCD display switching between MAIN PAGE and CHOICE PAGE. Or change to CHOICE PAGE in each functional list. Under shift mode, pressing this key on MAIN PAGE, the uses can save the output setting (see 3.8.1). If pressing the key on CHOICE PAGE, the user can save system data (see 3.8.2).
5	 -----or----- RECALL	<b>Backspace and Minus command key:</b> Pressing this key will erase the keyin number. Or it may show " - ", if no number is in front of cursor. Under shift mode, pressing the key on MAIN PAGE, the user can recall the output setting (see 3.8.1). If pressing the key on CHOICE PAGE, the user can recall system data (see 3.8.2).
6		<b>OUT/QUIT command key:</b> Pressing this key may enable the ac source output voltage or quit the output voltage.
7		<b>Shift mode selection key:</b> Pressing this key will switch the ac source from normal operational mode to the shift mode.
8	 -----or----- HELP	<b>Numeric and decimal keys:</b> The user can program numeric data by pressing the digital keys and the decimal key. Under shift mode, pressing  acts the HELP function. The LCD display will show more information about cursor locating place.
9		<b>ENTER key:</b> It is to confirm the setting of parameters.
10		<b>RPG:</b> The user can input programming data or options by turning the RPG to the desired ones.
11		<b>Main power switch:</b> It is to power on or off.

## 1.4.2 Rear Panel

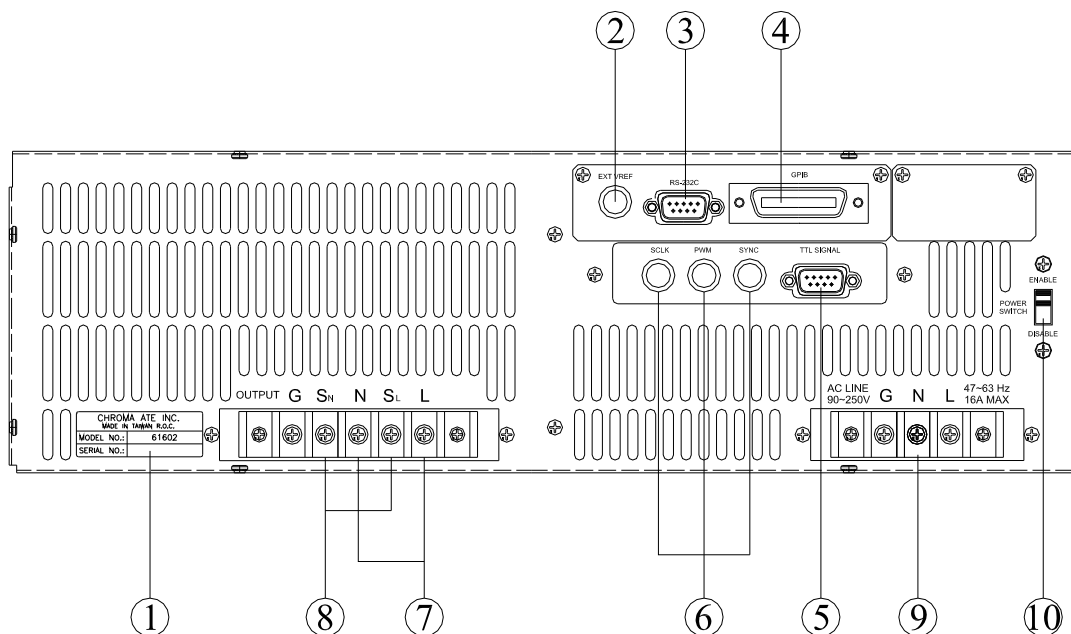

Figure 1-2 Rear Panel

Table 1-2 Description of Rear Panel

Item	Name	Description
1	Label	The label includes model number, series number of the AC source.
2	Ext. Ref.	The BNC connector inputs control waveform amplitude from external analog signal.
3	RS-232C	The 9-pin, D-type female connector transfers control commands to and from the remote PC for remote operation.
4	GPIB Connector	A remote controller using GPIB bus is connected to the AC source through this connector for remote operation.
5	TTL Signal	The 9-pin, female connector transfers control signals (fault_out, remote inhibit, and AC_ON).
6	SCLK, PWM, SYNC	The BNC connectors SCLK and PWM are for AC source parallel connectivity only. SYNC transfers a pulse signal synchronously when output changes. It also sends synchronizing signal for 3-phase mode operation.
7	Output Connector	This connector outputs power to the loading device.
8	Remote Sense Connector	It senses directly at the terminals of the load to eliminate any voltage drop on the connecting cable. Make sure of connecting the terminal "SL" of the remote sense connector to the terminal "L" of the load, and the "SN" to the "N" of the load. Reverse polarity is not allowed.
9	Power Line	Power line input is connected to AC source through this connector.
10	Power Switch	It enables or disables the main power switch. Users can power on or off with the main power switch when the power switch is set to "ENABLE". Conversely the main power switch is inactive when the power switch on the front panel is set to "DISABLE".



## 2. Installation

### 2.1 Inspection

After unpacking the instrument, please inspect any damage that may have occurred during the shipment. Save all packing materials in case the instrument has to be returned one day.

If any damage is found, please file a claim with the carrier immediately. Do not return the instrument to the factory without obtaining the prior RMA acceptance from Chroma.

### 2.2 Preparation for the Use

In the beginning, the instrument must be connected with an appropriate AC line input. Then, since fans intelligently cool it, it must be installed in sufficient space for circulation of air. It should be used in an area where the ambient temperature does not exceed 40°C.

### 2.3 Requirements of Input Power

#### 2.3.1 Ratings

Input Voltage Range	:	90 ~ 250 Vac, single phase
Input Frequency	:	47-63 Hz
Max. Current	:	61501 : 8 A 61502 : 16 A 61503 : 21 A 61504 : 28 A

 **CAUTION** : AC source may be damaged if it is operated at an input voltage that is outside its configured input range.

#### 2.3.2 Input Connection

The input terminal is located at the bottom of the instrument rear panel. The rated withstand temperature of power cord must be at least 85°C or above. The current carried by power line input should be greater than or equal to the maximum rated input current of AC source. See Figure 2-1 and do the following things one by one:

1. Remove the safety cover from the back of AC source.
2. Plug in the power cord to the INPUT terminal of AC source as described below:  
Green or green/yellow wire to the terminal labeled "G".  
White or blue wire to the terminal labeled "N".  
Black or brown wire to the terminal labeled "L".
3. Slide the safety cover over the AC input terminal, and secure the cover with two screws.

**⚠ WARNING** To protect the operators, the wire connected to the GND terminal must be connected to the earth ground. Under no circumstances shall this AC source be operated without an adequate ground connection.

Installation of the power cord must be done by a professional and in accordance with local electrical codes.

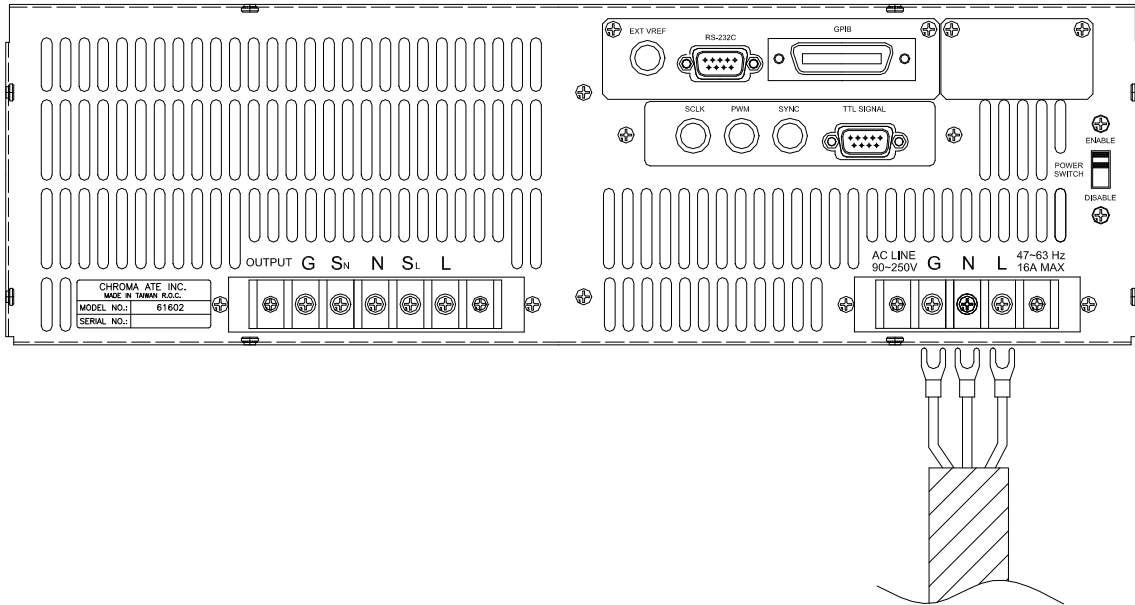

Figure 2-1 Input Connection

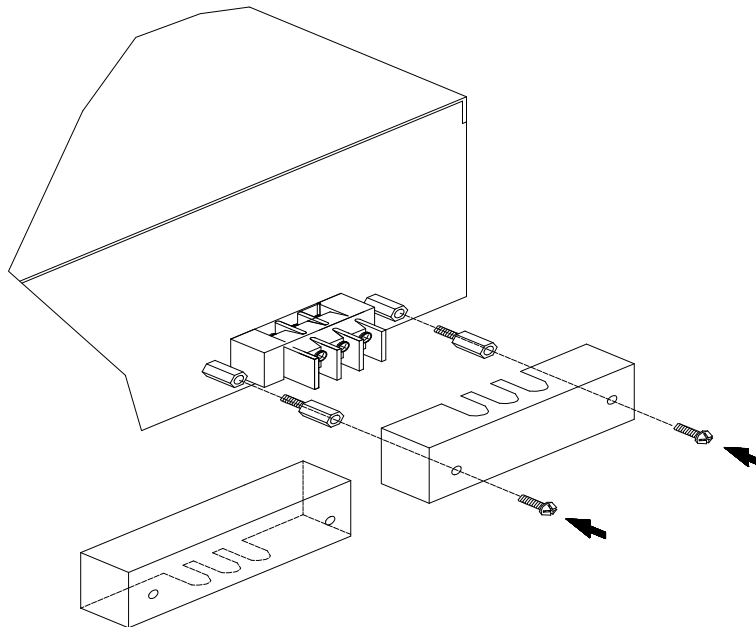

Figure 2-2 Input Terminal Cover

## 2.4 Output Connection

The output terminal block is located on the rear of AC source. Load connecting to the "N" and "L" is done at the output terminals. To meet the safety requirements, the safety cover must be fastened. The wires to the load must be sufficiently large gauges, so they will not overheat while carrying the output current. Please see Figure 2-3 on the next page.

### Notice

Output terminal labeled "L" is the "+" terminal, terminal labeled "N" is the "-" terminal when output voltage contains DC composition.

## 2.5 Remote Sense Connection

The remote sense function of AC source monitors the voltage at the load instead at the output terminal of the AC source. It ensures the delivery of accurate voltage as programmed at the load by automatically compensating the output voltage drop over the connecting cable.

Remove the iron chip from the "SN" and "SL" terminals, connect the remote sense to the load as shown in Figure 2-3. Because the sensing leads carry only a few milliamperes, the wires for sensing are much lighter than the load leads. The sensing leads are part of the feedback path of the AC source, so they must be kept at a low resistance in order to maintain the best performance. Connect the sensing leads carefully so that they will not be open-circuited. If the sensing leads are left unconnected or become open-circuited during operation, the AC source will disable the output. The sensing leads must be a twisted pair to minimize the pickup of external noise. The sensing leads need to be connected to the load as close as possible.

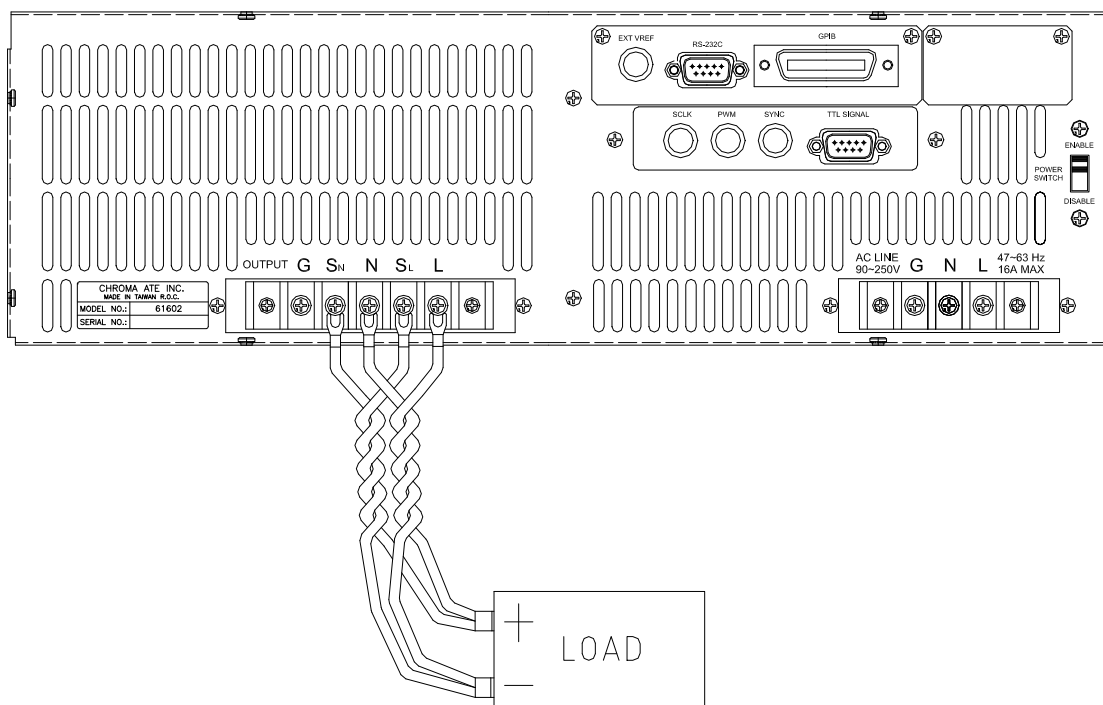

Figure 2-3 Output & Remote Sense Connection

## 2.6 Procedures of Power-on

**⚠ WARNING** Before turning on the instrument, all protective earth terminals, extension cords, and devices connected to the instrument must be connected to a protective earth ground. Any interruption of the protective earth grounding will cause a potential shock hazard that could result in personal injury.

Apply the line power and turn on the power switch on the front panel. The AC source will do a series of self-tests. The LCD on the front panel will light up and display as below:

SELF TEST  
WAIT . . . . .

Meanwhile, the AC source does the memory, data and communication self-test. After the routines of the self-test be done, the display shows the MODEL number, and the serial number of the AC source, and it shows an "OK" at the right side of each test item indicating that the item is no problem. It takes about six seconds to complete the routines of the self-test. Then the display shows the versions of software as below.

MODEL : 61502	SERIAL NO : 123456
1. DISPLAY < OK >	Ver : 1.01
2. WAVEFORM < OK >	Ver : 1.02
3. REMOTE < OK >	Ver : 1.03

If any failure is detected on a certain item, an "ERROR CODE" will be shown at the right side of that item. The error messages and trouble-shooting are shown on 7.2. The test item " 3. REMOTE " shows " < EMPTY > ", if the option board (with GPIB and RS-232) is not connected.

After finishing memory, data and communication self-test, the AC source do the power output self-test. In this procedure, the output relays are in OFF status to sure not harming the load connecting on output terminal. The AC source will output and measure the voltage. If the voltage is abnormal, the power self-test is failed, and the display will show "NG". If it's normal, the display is shown as below as well as it changes to MAIN PAGE automatically.

OUTPUT SELF TEST < OK >



**Notice**

1. The user can do diagnosis if error or NG happens in power-on self-test procedure. Please see 7.2.
2. The inner digital circuit of AC source maybe not reset if turn off power then turn on immediately. Waiting more than 3 seconds is suggested to turn on power after turning off.

## 2.7 I/O Connectors (Option)

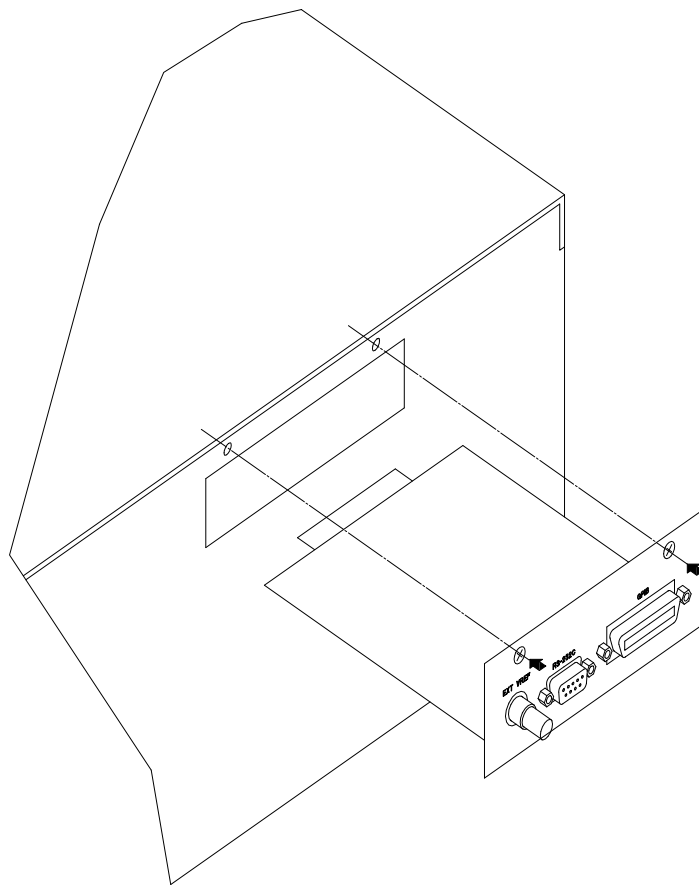

Figure 2-4 Option Board



## 3. Local Operation

### 3.1 Introduction

The AC source can be configured to operate in local or remote mode. The operation in remote mode through a remote GPIB controller or RS-232C will be described in Chapter 8. In this section the operation in local mode through the keypad on the front panel for data entry and test is going to be described. The AC source is configured for local operation when it is turned on.

### 3.2 Operation through Keypad and RPG

The AC source provides the user-friendly programming interface using the keypad and RPG (Rotary Pulse Generator) on the front panel to the user. Each display of the LCD on the AC source represents an operational menu.

The command tree is shown in Figure 3-1. Before describing each menu, the following shows how to use keypad and RPG to set command. When the procedure of power-on is finished (see 2.6), the display will show MAIN PAGE as below.

Vac = 0.0	F = 60.00	Vdc = 0.0	H
V = 0.00	F = 0.00	I = 0.00	▲
P = 0.0	PF = 0.000	CF = 0.00	▼

Press ▲, ▼ to move cursor to choose the item. Use numeric and decimal keys or RPG to set value, then press **ENTER** to confirm. The user can press **PAGE/EXIT** to change to CHOICE PAGE as below. Or press **PAGE/EXIT** again to return to MAIN PAGE.

PAGE CHOICE = 1_			
1. SETUP	2. CONF	3. OUTPUT	4. MANUAL CALI
5. LIST	6. PULSE	7. STEP	8. HAR
9. SYN	10. INTERHAR		

In CHOICE PAGE, the user can press numeric key then **ENTER** to choose the functional lists. After entering each functional list, press ▲, ▼ to move cursor to destination. If number expresses the settings, the user can use numeric and decimal keys or RPG to set value, then press **ENTER** to confirm. If the settings are expressed by words, the user can turn RPG to choice, then press **ENTER** to confirm.

If there are ▲ or ▼ patterns in right-down side of display, it means there are functional list on last page or next page. The user can press **SHIFT** then ▲ or ▼ to change page. If finish the setting, press **PAGE/EXIT** to return to CHOICE PAGE.

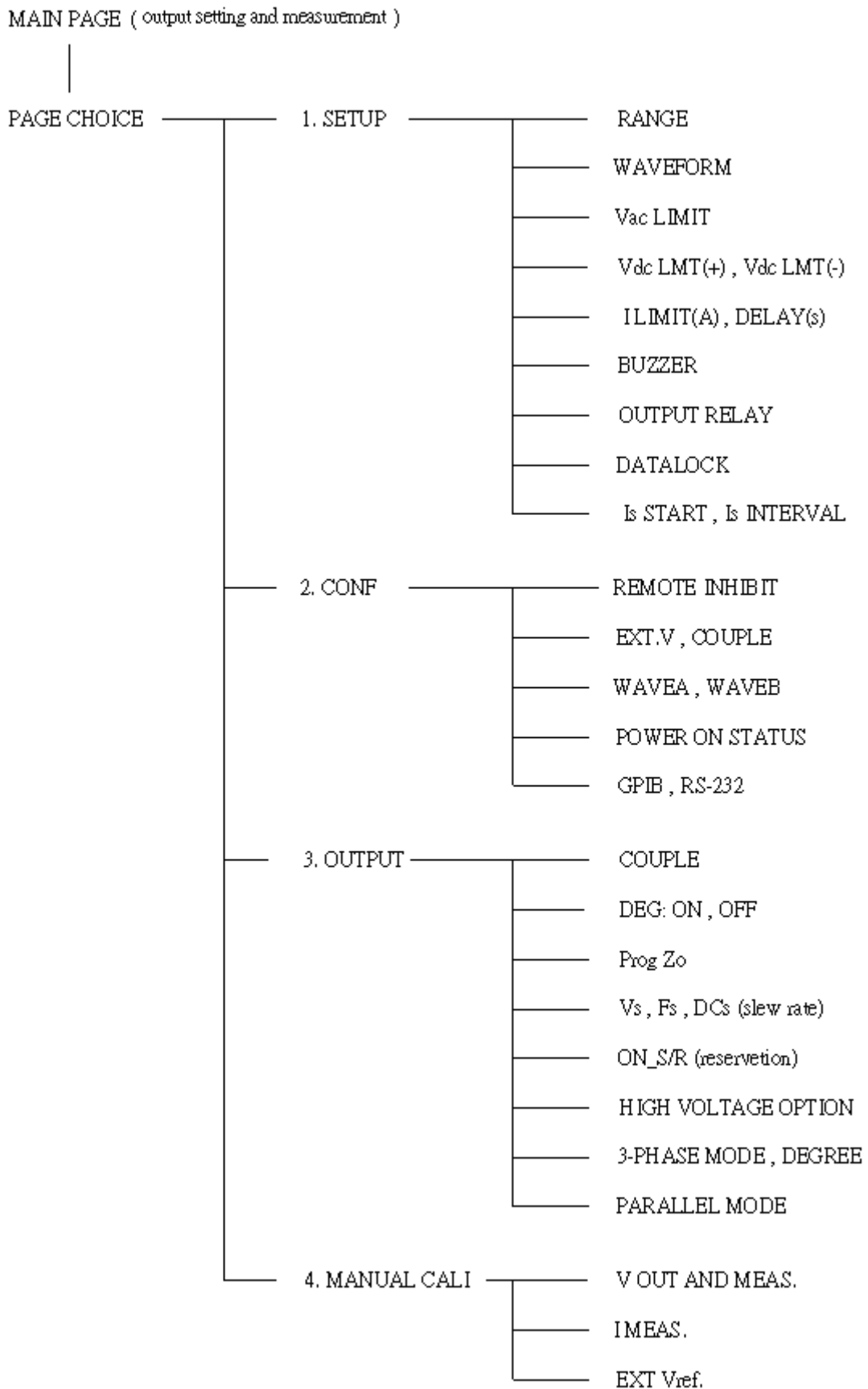

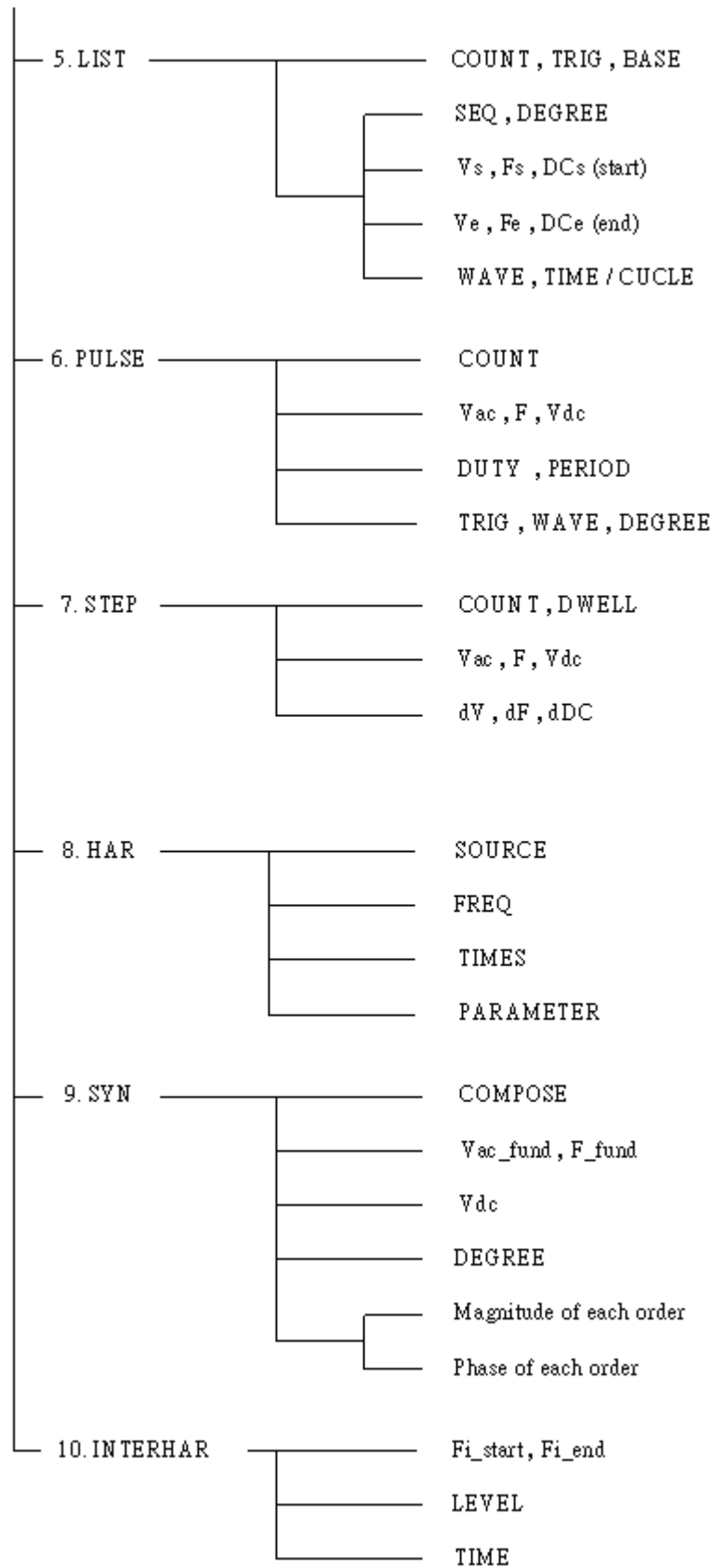

Figure 3-1

### 3.3 MAIN PAGE (Output Setting and Measurement)

When the user turn on the AC source, after self-test steps, the display shows the MAIN PAGE. The upper line of display shows the output settings. The state of default output settings can be set on POWER ON STATUS in CONF functional list (see 3.6.3). The lower lines show the measurements of AC source output. Please see the following.

Vac = 0.0	F = 60.00	Vdc = 0.0	L
V = 0.00	F = 0.00	I = 0.00	▲
P = 0.0	PF = 0.000	CF = 0.00	▼

Press **SHIFT**, then **▲** or **▼** to change to next page. Please see the following.

Vac = 0.0	F = 60.00	Vdc = 0.0	L
Vdc = 0.00	Idc = 0.00	Ip = 0.0	▲
Is = 0.0	VA = 0.0	VAR = 0.0	▼

On the right-up side of display, a letter "L" shows the status of RANGE (see 3.5.1). The definition of letters:

- L : 150V RANGE
- H : 300V RANGE
- H** : 600V RANGE
- A : AUTO RANGE

The definitions of output setting parameters:

- Vac : It is the AC composition of output voltage in Volts.
- F : It is the output frequency in Hertz.
- Vdc : It is the DC composition of output voltage in Volts.

Press **OUT/QUIT** then the AC source output the voltage set in Vac, F, Vdc. Press **OUT/QUIT** again, then the AC source quit the output voltage.

#### Notice

When COUPLE = AC+DC, the output is the combination of Vac and Vdc. But the combination of peak voltage can not exceed the limit of each range (150V RANGE: 212.1V, 300V RANGE: 424.2V). If it is happened, the output voltage will quit to 0V automatically, and show the protection condition.

The definitions of measurement parameters:

- V : It is the measurement readings of Voltage in Volts. (True RMS measurement)
- F : It is the output Frequency in Hertz.
- I : It is the measurement readings of Current in Amperes. (True RMS measurement)
- P : It is the true Power measurement in Watts.
- PF : It is the Power Factor, and its calculation formula = true power/ (Vrms × Irms)
- CF : It is the Crest Factor, and its calculation formula = Ipeak/Irms.
- Vdc : It is the DC composition measurement readings of Voltage in Volts.
- Idc : It is the DC composition measurement readings of Current in Amperes.
- I<sub>p</sub> : It is the peak current measurement in Amperes.
- I<sub>s</sub> : It is I surge, and only measured from the occurrence of output transition as defined in 3.5.8.
- VA : It is Apparent Power in Watts, and its calculation formula = Vrms × Irms.
- VAR : Its calculation formula =  $\sqrt{VA^2 - P^2}$ .

### 3.4 CHOICE PAGE (Functional List Choice)

If displays on MAIN PAGE or on functional list, press **PAGE/EXIT** to change to CHOICE PAGE as below:

PAGE CHOICE = 1\_

1. SETUP   2.CONF   3.OUTPUT   4. MANUAL CALI

5. LIST   6. PULSE   7.STEP   8. HAR   9. SYN

10. INTERHAR

Users can press **0** - **9** or RPG to choose operational list item, then press **ENTER** to confirm it.

The display will switch to MAIN PAGE when press **PAGE/EXIT** on CHOICE PAGE.

### 3.5 SETUP Functional List

On CHOICE PAGE (see 3.4), press **1** then **ENTER**, choose the SETUP functional list.

PAGE CHOICE = 1\_

1. SETUP   2.CONF   3.OUTPUT   4. MANUAL CALI

5. LIST   6. PULSE   7.STEP   8. HAR   9. SYN

10. INTERHAR

RANGE = 150V	WAVEFORM = A	[ SETUP ]
Vac LIMIT = 300V		
Vdc LMT (+) = 424.2 V	Vdc LMT (-) = 0.0V	
I LIMIT (A) = 0.0	DELAY (S) = 0.0	▼

Press **SHIFT**, then **▼** to change to next page.

BUZZER = ON	OUTPUT RELAY = ON	[ SETUP ]
DATALOCK = OFF		
Is START = 0.0	ms	
Is	INTERVAL	= 50.0 ms

### 3.5.1 RANGE

The AC source supplies full range of output voltage with four options of 150V, 300V, 600V or AUTO. Users can set RANGE on SETUP functional list (see 3.5). This parameter controls relays to parallel (150V RANGE) or series (300V RANGE) power stages to obtain more current or higher voltage. The 600V range can only work with A615003 fixture. The AUTO range means that the output range switches automatically between 150V and 300V as required.

To set the range of output voltage as AUTO as below:

1. Move the cursor to the command line of Range.

Range = 300V_
---------------

2. Turn the RPG to change the option from "300V" to "AUTO", then press **ENTER**.

Range = AUTO
--------------

**Notice**

The AC source will set output voltage as 0 V first in order to eliminate voltage spike when range changes. Then, it will set output voltage as set value. It may cause UUT to shut down or get bad if the output is active, when range changes. Besides, the instrument has AUTO RANGE function under FIX. MODE. Other LIST, PULSE, STEP and etc modes are without AUTO RANGE function.



### 3.5.2 Vac LIMIT

The setting of Vac LIMIT will restrict the value of Vac in MAIN PAGE. The user can set Vac LIMIT on SETUP functional list (see 3.5). This command is about user-programmable protection, not hardware protection.

The procedures for setting voltage Vac LIMIT = 120V, are described as below:

1. Move the cursor to the command line of "Vac LIMIT =".
2. Press **[1]**, **[2]**, **[0]** then press **ENTER** to change the value to "120.0".

Vac LIMIT = 300.0\_

Vac LIMIT(A) = 120.0

#### Notice

The setting of Vac LIMIT is not restricted by RANGE, but the Vac on MAIN PAGE is restricted by RANGE. For example, in 150V RANGE, although Vac LIMIT=200V, the largest value of Vac setting is 150V.

### 3.5.3 Vdc LIMIT (+), Vdc LIMIT (-)

Vdc LIMIT (+) and Vdc LIMIT (-) limit the setting value of Vdc on MAIN PAGE. The user can set both on SETUP functional list (see 3.5). The setting value of Vdc cannot be higher than Vdc LIMIT (+), or can not be lower than Vdc LIMIT (-). Vdc LIMIT (+) must be positive or zero, Vdc LIMIT (-) must be negative or zero. This command is about user-programmable protection, not hardware protection.

The procedures of setting Vdc LMT (+)=200V, Vdc LMT (-)=-50V, are described as below:

1. Move the cursor to the command line of "Vdc LIMIT(+)" =".
2. Press **[2]**, **[0]**, **[0]** then press **ENTER** to change the value to "200.0".
3. The cursor moves to the command line of "Vdc LIMIT(-)" = automatically.
4. Press **[← / -]**, **[5]**, **[0]** then press **ENTER** to change the value to "-50.0".

Vdc LMT(+) = 424.2\_ Vdc LMT(-) = 0.0

Vdc LMT(+) = 200.0 Vdc LMT(-) = 0.0\_

Vdc LMT(+) =200.0 Vdc LMT(-) = -50\_

Vdc LMT(+) = 200.0 Vdc LMT(-) = -50.0

#### Notice

1. The setting of Vdc LIMIT is not restricted by RANGE, but the Vdc on MAIN PAGE still restricted by RANGE. For example, in 150V RANGE, although Vdc LIMIT = 250V the largest value of Vdc setting is 212.1V.

2. When AC source output contains Vdc, it's better to restrict the value of Vdc. It may cause damage if output polarity is reverse, especially the load is polar.

### 3.5.4 I LIMIT, DELAY

Limitation of output RMS current, and delay time is the parameter for triggering over current protection. The user can set both on SETUP functional list (see 3.5). The discussion of limitation in this command is about user-programmable protection, not hardware protection.

The procedures of setting Current limit = 4A, Delay time = 1 sec., are described as below:

1. Move the cursor to the command line of "I LIMIT(A) = ".

```
I LIMIT(A) = 0.00_ DELAY(S) = 0.0
```

2. Press **[4]**, then press **ENTER** to change the value to "4.00".

```
I LIMIT(A) = 4_ DELAY(S) = 0.0
```

3. The cursor moves to the command line of "DELAY(S) = " automatically.

```
I LIMIT(A) = 4.00 DELAY(S) = 0.0_
```

4. Press **[1]**, **ENTER** to change the value to "1.0".

```
I LIMIT(A) = 4.00 DELAY(S) = 1.0_
```

#### Notice

1. When " I LIMIT (A) = 0 ", means the limitation of output current is equal to specification.
2. DELAY time is valid for eliminating transient current spike, but not work when the output current is over specification. The resolution is 0.5s.

### 3.5.5 OUTPUT RELAY

There are relays on the output of the AC source for the connection to load. When output relay is “ON”, it means that the output relay is closed in spite of that the output status of the AC source is in QUIT mode. When output relay is “OFF”, it means that the output relay is closed only as the output status is in RUN mode. If the output status is in QUIT mode, the output relay will be opened. The user can set OUTPUT RELAY on SETUP functional list (see 3.5).

To set the output relay as ON as below:

1. Move the cursor to the command of OUTPUT RELAY.

OUTPUT RELAY = OFF\_

2. Turn RPG to set output relay ON, then press **ENTER**.  
A click sound will be produced from the AC source when output relay is activated.

OUTPUT RELAY = ON



Before powering off, please confirm if the AC SOURCE is outputting voltage. For ensure the life of the AC SOURCE, it powered off under outputting status is prohibited strongly.

### 3.5.6 BUZZER

The buzzer of the AC source beeps when the user presses the keypad on the front panel, or turns the RPG knob. If the user does not need it, please turn it off. The user can set BUZZER on SETUP functional list (see 3.5).

To turn off the buzzer as follows:

1. Move the cursor to the command line of “Buzzer=”.

BUZZER = ON\_

2. Turn RPG to change the option from ON to OFF, then press **ENTER**.

BUZZER = OFF

### 3.5.7 DATALOCK

The AC source allows the user to lock data entries, so the pre-defined parameters can be protected from being modified by an unauthorized person. The user can set DATALOCK on SETUP functional list (see 3.5). The user also can set DATALOCK = FUNC to operate “One-key Recall”. It means the user can recall the voltage output setting which stored in the memory (see 3.8.1) only need to press **1** - **9** key directly in Main Page.

The procedures of the setting data lock are shown as below:

1. Move the cursor to the command line of “DATALOCK=”.

DATALOCK = OFF\_

2. Turn RPG to change the option from OFF to ON, then press **ENTER** .

DATALOCK = ON

**Notice**

1. The user must select OFF to unlock.
2. If users use FUNC, please be sure the voltage output settings stored in the memory. Unexpected voltage output may damage the UUT.

### 3.5.8 Is START, Is INTERVAL

Is is the surge peak current of AC source output shown in MAIN PAGE. Is measurement starts at Is START after output voltage transition. The length of measurement time is Is INTERVAL. The user can set both on SETUP functional list (see 3.5).

The procedures of setting Is START = 10 ms, Is INTERVAL = 200 ms, are described as below:

1. Move the cursor to the command line of "Is START = " .

Is START= 0.0\_ ms

2. Press **1**, **0** then press **ENTER** to change the value to "10.0".

Is START = 10.0 ms

3. The cursor moves to the command line of "Is INTERVAL = " automatically.

Is INTERVAL = 50.0\_ ms

4. Press **2**, **0**, **0** then press **ENTER** to change the value to "200.0".

Is INTERVAL = 200.0\_ ms

### 3.6 CONF Functional List

On CHOICE PAGE (see 3.4), press **2** then **ENTER**, choose the CONF functional list.

PAGE CHOICE = 2\_

1. SETUP   2.CONF   3.OUTPUT   4. MANUAL CALI

5. LIST   6. PULSE   7.STEP   8. HAR   9. SYN

10. INTERHAR

```

REMOTE INHIBIT = OFF           [ CONF ]
EXT. V =OFF           COUPLE = AC-AMPLIFIER
WAVE A = SINE
WAVE B = SINE

```

Press **SHIFT**, then **▼** to change to next page.

```

POWER ON STATUS :   Output = OFF   [ CONF ]
Vac = 0.0           F = 60.00      Vdc = 0.0
ADDR = 1           PARITY = NONE
BAUD = 9600

```



The items ADDR, PARITY and BAUD only appear when work with "Optional card."

### 3.6.1 REMOTE INHIBIT

The output of the AC source can be inhibited by the external control or by manual trigger. The remote inhibit signal is received from 9-pin male connector on rear panel TTL SIGNAL (see *Appendix A*). The user can set REMOTE INHIBIT on CONF functional list (see 3.6). There is four states for the feature of remote inhibit: OFF, LIVE, TRIG and EXCITE.

- OFF : It is to disable the feature of remote inhibit.
- LIVE : The output of the AC source will be disabled if TTL signal is LOW, but will be automatically recovered if TTL signal is HIGH.
- TRIG : The output of the AC source will be disabled if TTL signal is LOW, and will remain the state even TTL signal becomes HIGH. The user has to press **OUT/QUIT** to restart the AC source output.
- EXCITE : When users run LIST, PULSE, STEP, SYN, INTERHAR mode (see chapter 5), the trigger on and trigger off commands will be triggered form this TTL signal. A low active pulse signal (at least 60us) triggers the actions by turns.

The procedures of setting from OFF to LIVE are shown as below:

1. Move the cursor to the command of "REMOTE INHIBIT" to set inhibition by the TTL signal from the external control.

```
REMOTE INHIBIT =OFF_
```

2. Turn RPG to change the option from OFF to LIVE, then press **ENTER**.

```
REMOTE INHIBIT =LIVE
```

**Notice**

The remote inhibit is a TTL signal transferred via the special I/O connector. For detailed please refers to pin assignment in *Appendix A Pin Assignment of TTL S*.

### 3.6.2 EXT. V, COUPLE

The AC source allows the user to make use of the controlled analog signal from external devices for the setting of its output. The BNC connector of the EXT Vref on the rear panel lets the user apply signal to the AC source for the setting of output voltage. The user can set EXT. V and COUPLE on CONF functional list (see 3.6). There are two coupling mode to present AC source output from external V reference: AC\_AMPLIFIER and DC\_LEVEL\_CTL.

**AC\_AMPLIFIER:** The output voltage (Vout) is the synthesis of voltage programming on MAIN PAGE and the amplification of external V reference with voltage range from -10 V to 10 V. When Vac=0 and Vdc=0 on MAIN PAGE, Vout can be calculated using the following formula:

$$V_{out} (dc) = V_{ref} (dc) / 10 V_{dc} \times 424.2 V_{dc} \quad (300V \text{ RANGE})$$

$$V_{out} (dc) = V_{ref} (dc) / 10 V_{dc} \times 212.1 V_{dc} \quad (150V \text{ RANGE})$$

or

$$V_{out} (ac) = V_{ref} (ac) / 7.072 V_{ac} \times 300 V_{ac} \quad (300V \text{ RANGE})$$

$$V_{out} (ac) = V_{ref} (ac) / 7.072 V_{ac} \times 150 V_{ac} \quad (150V \text{ RANGE})$$

Example (1): set Vout to 100Vdc:

1. Select RANGE = 300V in SETUP functional list, apply external V= 2.357Vdc, the Vout = 100Vdc.
2. Select RANGE = 150V in SETUP functional list, apply external V= 4.715Vdc, the Vout = 100Vdc.

Example (2): set Vout to 100Vac :

1. Select RANGE = 300V in SETUP functional list, apply external V= 2.357Vac, the Vout = 100Vac.
2. Select RANGE = 150V in SETUP functional list, apply external V= 4.715Vac, the Vout = 100Vac.

**DC\_LEVEL\_CTL :** The output voltage (Vout (ac)) responses linearly proportional to the controlled DC level with voltage ranging from -10 V to 10 V. Vout can be calculated using the following formula:

$$V_{out} (ac) = | V_{ref} (dc) | / 10 V_{dc} \times 300V_{ac} \quad (300V \text{ RANGE})$$

$$V_{out} (ac) = | V_{ref} (dc) | / 10 V_{dc} \times 150V_{ac} \quad (150V \text{ RANGE})$$

Example (1): set Vout to 100Vac :

1. Select RANGE = 300V in SETUP functional list, apply external V= 3.333Vdc ( or -3.333Vdc ), the Vout = 100Vac.
2. Select RANGE = 150V in SETUP functional list, apply external V= 6.667Vdc (or -6.667Vdc), the Vout = 100Vac.

The procedures of setting EXT. V = ON, COUPLE = DC\_LEVEL\_CTL, are described as below:

1. Move the cursor to the command of "EXT. V =".

```
EXT.V = OFF_ COUPLE=AC_AMPLIFIER
```

2. Turn RPG to change the option from OFF to ON, then press **ENTER**.

```
EXT.V = ON COUPLE=AC_AMPLIFIER_
```

3. The cursor moves to the command line of "COUPLE =" automatically.

```
EXT.V = ON COUPLE=DC_LEVEL_CTL
```

4. Turn RPG to select DC\_LEVEL\_CTL, then press **ENTER**.

```
EXT.V = ON COUPLE=DC_LEVEL_CTL_
```

#### Notice

When EXT. V=ON, COUPLE=DC\_LEVEL\_CTL, the output voltage (Vout) will respond to the external control DC voltage level only. The user cannot control Vout amplitude through the keypad on the front panel, until EXT.V=OFF again.

#### WARNING

1. As COUPLE = AC\_AMPLIFIER and the frequency of Vref is over 1000Hz, it might cause AC source damage. The user should obey the formula if  $F > 1000\text{Hz}$  :  

$$V_{\text{ref}} (\text{pk-pk, V}) \times F (\text{Vref, Hz}) < 10000 \text{ VHz.}$$
2. Because of the bandwidth limitation of AC source, the output may distortion. Especially when external V reference consists of high frequency composition.

### 3.6.3 WAVEFORM GENERATOR

The AC source provides the user with two independent sets of waveforms, A and B. Both of the waveforms include sinusoidal, square, clipped sinusoidal, 30 sets of built-in waveforms, and 6 sets of user-defined waveforms.

To set waveform A as square wave:

1. Move the cursor to the command of WAVE A.

```
WAVE A= SINE_
```

2. Turn RPG to change the option to "SQR", then press **ENTER**.

```
WAVE A=SQR_
```

To set waveform B as clipped Sin wave, THD: 10 %

1. Move the cursor to command of WAVE B, choose "CSIN".

```
WAVE B=CSIN_
```

2. Then, LCD display shows the MODE and PERCENT.

```
MODE = AMP_ PERCENT = 0.0 %
```

3. Turn RPG to change the option to “THD”, press **ENTER**.

MODE = THD PERCENT = 0.0\_ %

4. Press **1**, **0** then press **ENTER** to set THD to 10%.

MODE = THD PERCENT = 10.0 %

**Notice**

1. The clipped sine is programmed by “AMPlitude” or “Total Harmonic Distortion”. Programming ranges from 0 to 100% for amplitude (100%: no clipped sine), and from 0 to 43% for THD (0%: no distortion).
2. User-defined waveform is defined on a remote PC and downloaded from it. For detailed of factory DST waveform refer to Appendix B.

**WARNING**

1. When use user-defined waveform, if the waveform frequency is over 1000Hz, it might cause AC source damage.
2. Because of the bandwidth limitation of AC source, the output may distortion. Especially when external V reference consists of high frequency composition.

### 3.6.4 POWER ON STATUS

The AC source allows the user to set the status of the output when power is switched on. The user can set POWER ON STATUS on CONF functional list (see 3.6). After setting, the user should save them before powering off (see 3.8.2).

To set the output is on, as 120 Vac, 50Hz, 10Vdc when power-on.

1. Move the cursor to the line of “POWER ON STATUS: output =”.

POWER ON STATUS: output = OFF\_

2. Turn RPG to output ON, then press **ENTER**.

POWER ON STATUS: output = ON

3. Press **1**, **2**, **0**, **ENTER** to set Vac=120.

Vac = 120.0 F=60.0\_ Vdc = 0.0

4. Press **5**, **0**, then press **ENTER** to set F=50.

Vac = 120.0 F=50.0 Vdc = 0.0

5. Press **1**, **0**, then press **ENTER** to set Vdc=10.

Vac = 120.0 F=50.0 Vdc = 10.0



### 3.6.5 GPIB Address, RS-232C

The AC source offers the mode of remote operation too. The user can set them on CONF functional list (see 3.6). For detailed please refers to Chapter 7. Prior to remote operation the user has to set the GPIB address 10 as below:

1. Move the cursor to the command line of GPIB address.

ADDR = 30\_

2. Press **[1]**, **[0]**, **[ENTER]** to set address 10.

ADDR = 10

**Notice** : Addressing space ranges from 1 to 30.

The AC source offers another remote operation through the RS-232C bus. Communication protocol is set as follows:

To set parity=ODD, baud rate=19200.

1. Move the cursor to the command line of PARITY.

BAUD=9600 PARITY= NONE\_

2. Turn RPG to select ODD, then press **[ENTER]**.

BAUD=9600 PARITY=ODD\_

3. The cursor moves automatically to the setting position of "BAUD". Turn RPG to select "19200", then press **[ENTER]**.

BAUD=19200 PARITY=ODD

**Notice** : The options of baud rate are 9600/19200. The options of parity are EVEN/ODD/NONE.

## 3.7 OUTPUT Functional List

On CHOICE PAGE (see 3.4), press **[3]** then press **[ENTER]**, choose the OUTPUT functional list.

PAGE CHOICE = 3\_

1. SETUP 2.CONF 3.OUTPUT 4. MANUAL CALI

5. LIST 6. PULSE 7. STEP 8. HAR 9. SYN

10. INTERHAR

```

COUPLE = AC+DC_  DEG : ON= 0.0  OFF=IMMED
Prog Zo = OFF      R= 0.00 Ω    L = 0.00 mH
Vs (V/ms) = 0.000  Fs (Hz/ms) = 0.000  ▲
DCs (V/ms) = 0.000  ON S/R = OFF      ▼
    
```

Press **SHIFT**, then **▼** to change to next page.

```

HIGH VOLTAGE OPTION = NONE      [ OUTPUT ]

3-PHASE MODE = OFF              ▲
DEGREE = 0.0
    
```

Press **SHIFT**, then **▼** to change to next page.

```

PARALLEL MODE = OFF_           [ OUTPUT ]
Check the AC sources  1. ONLY ONE MASTER
                     2. SAME RANGE

CHECK OK = NO                  ▲
    
```

### 3.7.1 COUPLE Mode of Output (AC+DC, AC, DC)

There are three couple mode of AC source output: AC+DC, AC and DC. The user can set COUPLE on OUTPUT functional list (see 3.7) to fit the application. Then, the display of MAIN PAGE will change corresponding to the mode.

The procedures of setting from AC+DC to AC are shown as below:

1. Move the cursor to the command of "COUPLE="
2. Turn RPG to change the option from AC+DC to AC, then press **ENTER**.

```
COUPLE = AC+DC_
```

```
COUPLE = AC
```

**Notice**

The DC mode of AC source is applied to doing some voltage tests. The AC source has not such many output capacitors; some features like voltage ripple, load transient, are not as good as DC source. But it can supply positive and negative DC voltage without changing output connector.

**⚠ WARNING**

Chroma 61500 AC source have AC/DC/AC+DC output function, at DC output part, it's still different from really DC source, the reason as below:

1. The big ripple noise at DC output, it is because of AC source have no output capacitor.
2. The AC source output relay will switch off when the current over the specification, it will cause output voltage interruption.  
P.S. Normally the DC source will change to C.C. mode, then the output voltage slow down to 0V.
3. Another major reason is, it cannot accept add/increase large capacitor, more than 20uF at output side directly. It may cause output unstable and damage AC source.

For solving above weak point, we suggest that add a special fixture for sure and protection.

**61500 AC SOURCE**

Figure 3-2

Illustration for fixture:

1. Bridge diode: Because of internal control circuit of AC source, if users connect more than 20uF capacitor at output side, it may cause output unstable. It's better to use bridge diode for isolating external capacitor. Also, it could prevent from wrong connection for polarity of output DC level. But, it will cause 1.6V drop when adds the bridge diode. (The user can compensate the output DC voltage by setting voltage level. For example, the user can program 11.6V in order to get 10 V on the output of fixture board.)
2. L and high frequency capacitor: They can filter high frequency ripple and noise. But it is not necessary if doesn't care ripple noise.
3. C and SW: C is the capacitor with large capacity. It can be added if the UUT doesn't have it. However, it can be off by SW if the UUT already has one or does not care.
4. Discharger resistor and SW: It could discharge the capacitor for avoiding remnant voltage to hit user when output off. But, users need to consider about power consumption, the discharger resistor power should be enough for it.

### 3.7.2 OUTPUT DEGREE

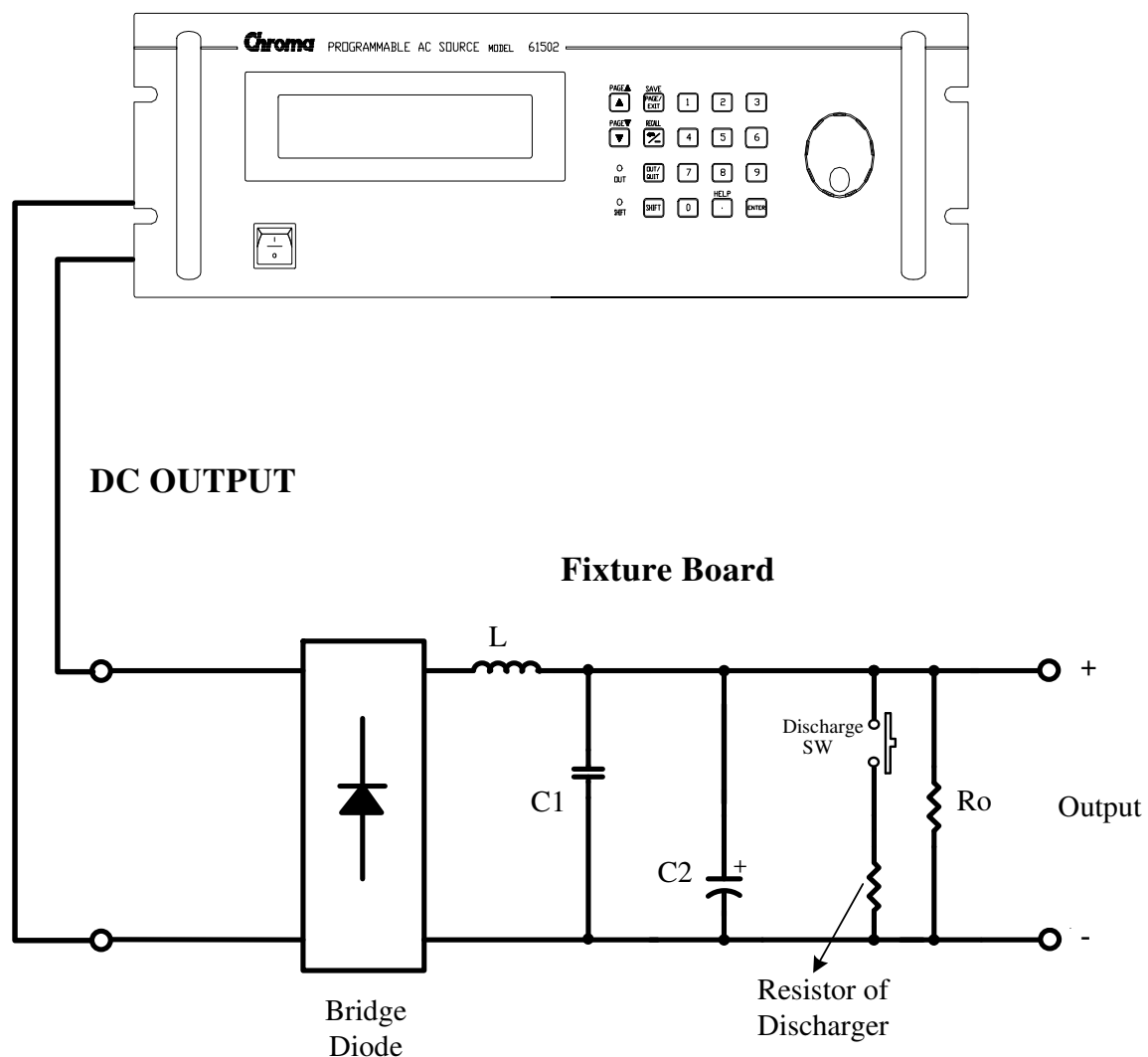
The AC source can control the transition angle of the waveform when it out or quit. The user set DEG ON and OFF to achieve it in OUTPUT functional list (see 3.7)

The procedures of setting output phase angle DEGREE ON = 90 and OFF = 180, are described as below:

1. Move the cursor to the command line of "ON = ".

```
DEG: ON = 0.0_ OFF= IMMED
```

2. Press **9**, **0**, then **ENTER** to change the value to "90.0".

```
DEG: ON = 90.0 OFF= IMMED_
```

3. The cursor moves to the command line of "OFF= " automatically.

4. Press **1**, **8**, **0**, then press **ENTER** to change the value to "180.0".

```
DEG: ON = 90.0 OFF= 180.0
```

#### Notice

⋮ If "OFF=IMMED", the output voltage quits immediately when the user presses **QUIT**. But if a value of degree is set, the output voltage will last until the setting degree. Keyin "OFF= 360" become "OFF= IMMED".

### 3.7.3 Programmable Output Impedance

The AC source's output impedance is low as a good voltage source. But for some tests, the user needs particular output impedance. The AC source can program the output impedance in certain range by setting Prog Zo on OUTPUT functional list (see 3.7).

The procedures for setting output impedance Prog Zo = ON, R = 0.4Ω, and L = 0.8mH, are described as below:

1. Move the cursor to the command line of "Prog Zo = OFF".
2. Turn RPG to change to "ON", then press **ENTER**.
3. The cursor moves to the command line of "R =" automatically.
4. Press **0**, **.**, **4**, then press **ENTER** to change R to "0.4Ω".
5. Press **0**, **.**, **8**, then press **ENTER** to change L to "0.8 mH".

Prog Zo = OFF\_

Prog Zo = ON

R = 0.4\_ Ω    L = 0.00    mH

R = 0.40 Ω    L = 0.8\_    mH

#### Notice

1. When Prog Zo = ON, the AC source reprogram the output waveform to meet the setting by using current feedback. When Prog Zo = OFF, the output impedance is just the original value of AC source.
2. The function of programmable output impedance is no effect for DC output.

#### WARNING

The maximum of R is 1.0Ω, L is 1.0 mH. But if L is larger than 0.5mH and output voltage is low (<100Vac), it's possible to cause AC Source unstable especially when output current is large. Users have to program the inductance to the target level slowly, monitor the output voltage and listen the sound of AC Source whether there are abnormal high frequency voltage output or abnormal voice. If instability happens, disable the output impedance programming and use an external impedance network.

### 3.7.4 Slew Rate of Output Transient

AC source can control the transition waveform of the output by setting COUPLE on OUTPUT functional list (see 3.7). User can set three commands to achieve the transient state of output waveform: Vs (V/ms), Fs (Hz/ms), DCs (V/ms).

Vs : the slew rate of output Vac.

Fs : the slew rate of output frequency.

DCs : the slew rate of output Vdc.

When users run OUT of AC source or change the output setting in MAIN PAGE, the output voltage and frequency will change corresponding to the Vs, Fs, DCs commands.

The procedures of setting Vs (V/ms)=0.2, Fs (Hz/ ms)=0.1, DCs (V/ms)=1, are described as below:

- |  |                     |
|--|---------------------|
| 1. Move the cursor to the command line of "ON_S/R = ".   | ON_S/R=OFF          |
| 2. Turn RPG to set the output to ON and then press <b>ENTER</b> .  | ON_S/R=ON           |
| 3. Move the cursor to the command line of "Vs (V/ms) = ".  | Vs (V/ms) = 0.000_  |
| 4. Press <b>0</b> , <b>.</b> , <b>2</b> , then press <b>ENTER</b> to change the value to "0.2".  | Vs (V/ms) = 0.200   |
| 5. The cursor moves to the command line of "Fs (Hz/ms)=" automatically. Press <b>0</b> , <b>.</b> , <b>1</b> , then press <b>ENTER</b> . | Fs (Hz/ms) = 0.100  |
| 6. The cursor moves to the command line of "DCs (V/ms)=" automatically. Press <b>1</b> , then press <b>ENTER</b> .                       | DCs (V/ms) = 1.000_ |

 **Notice**

1. When user set Vs (V/ms)=0, Fs (Hz/ms)=0, DCs (V/ms)=0, the output transient is in the fastest speed.
2. Vs, Fs DCs have large input range in software programming, but the output can not exactly follow the slew rate when Vs, DCs are too large.
3. When user run **OUT** of AC source, the output will follow the setting to final state. But when user run QUIT, the output will vary to 0 V immediately. If user want to quit the output with the setting slew rate, he must keyin 0 V then press **ENTER**.

### 3.7.5 HIGH VOLTAGE OPTION

For special request, a new 600 Vac option will be added to the Range column in SETUP Function for setting when connected to A615003 fixture. Please be noted that only when work with the A615003 fixture can 600Vac be outputted; or the output voltage is 1/2 of the setting.

The procedures of setting high voltage option:

- |  |                              |
|--|------------------------------|
| 1. Move the cursor to "HIGH VOLTAGE OPTION" command line.          | HIGH VOLTAGE OPTION= NONE    |
| 2. Turn RPG from "NONE" to "A615003" and then press <b>ENTER</b> . | HIGH VOLTAGE OPTION= A615003 |

 **Notice**

Connecting the / FAULT-OUT signal of TTL PIN8 on AC Source rear panel to TTL PIN8 on A615003 rear panel as selecting HIGH VOLTAGE item in OPTION of AC Source 61501 - 61504, thus A615003 can be activated.

### 3.7.6 THREE PHASE MODE

When users need a three-phase AC power, it's allowed to assemble three AC sources to be a three-phase AC power. The user can set 3-PHASE MODE on OUTPUT functional list (see 3.7). The AC source setting as MASTER sends SYNchronized signal to SLAVES to position phase angle. The SLAVES also use the signal to trigger and shut down the output. To send synchronized signal, users have to use a special cable. One terminal of the cable is connected to SYN (in rear panel, BNC connector), it's the MASTER. Another terminals connects to /Remote-Inhibit of TTL signal (in rear panel, 9-Pin D-Type connector, see Appendix A), it's the SLAVE. For more information about the cable, please consult your dealer.

The procedure of using THREE PHASE MODE:

1. Connect the N terminals of AC source outputs. (For 3-phase, Y connection).
2. Connect the cable for synchronism.
3. Power on all AC sources. Keep all in output quit state.
4. Set the 3-PHASE MODE = MATER, DEGREE = 0. And set another AC source 3-PHASE MODE = SLAVE, DEGREE = 240 or 120. Press **PAGE/EXIT** twice to MAIN PAGE. Set the voltage and frequency on each AC source. It is better for all AC sources set the same frequency.
5. Press **OUT/QUIT** at MASTER to start output. Press **OUT/QUIT** again to quit the output. **OUT/QUIT** of SLAVE is no use when 3-phase mode.

To change THREE PHASE MODE from OFF to SLAVE as below:

1. Move the cursor to the command line of "3-PHASE MODE=".

```
3-PHASE MODE = OFF_
```

2. Turn RPG to change the option from OFF to SLAVE, then press **ENTER**.

```
3-PHASE MODE = SLAVE
```

3. The cursor moves to the command line of " DEGREE =" automatically.

```
DEGREE = 0.0_
```

4. Press **1** , **2** , **0**, then press **ENTER**.

```
DEGREE = 120.0
```

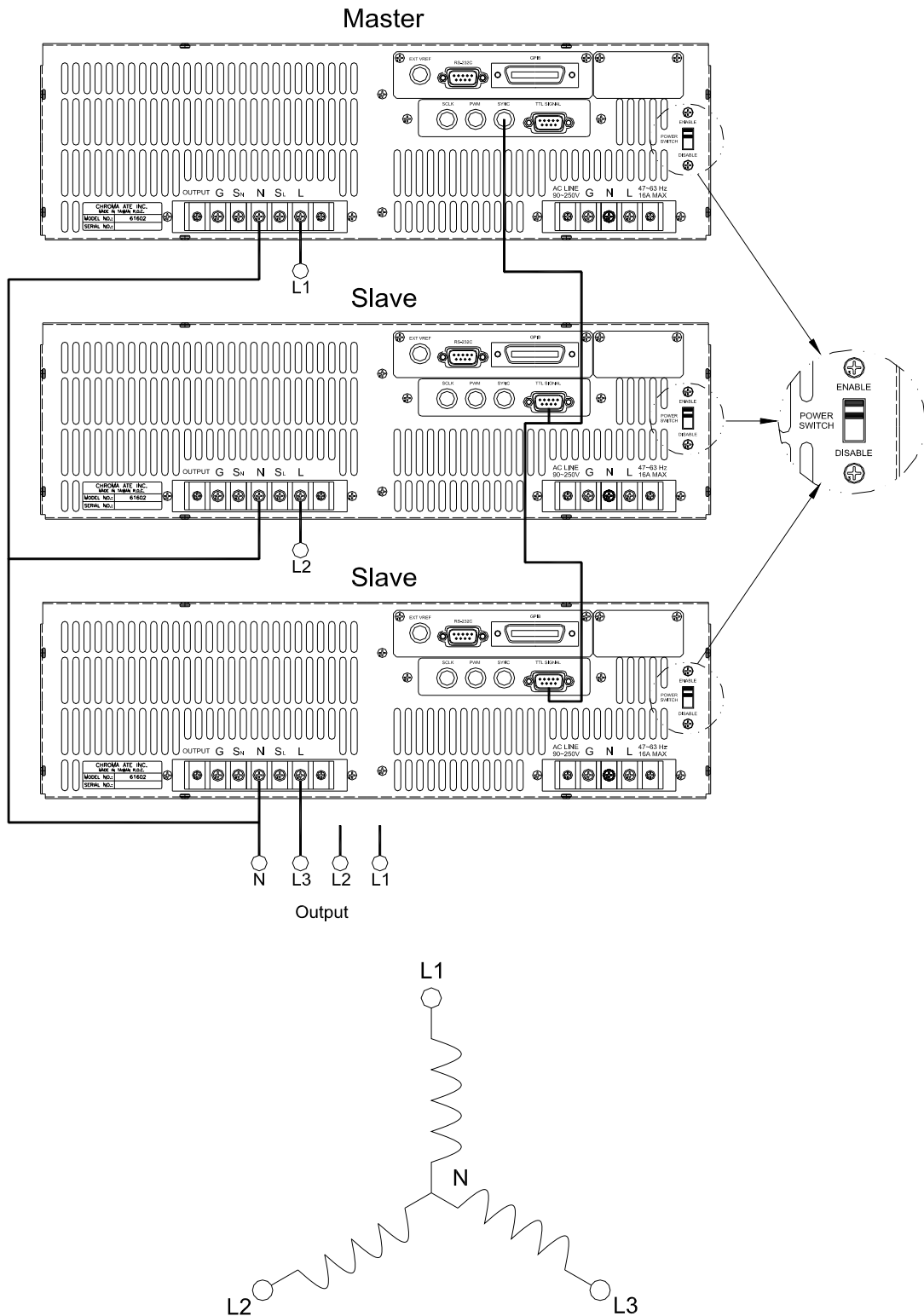

Figure 3-3

**Notice**

1. The DEGREE of MASTER is 0, and the DEGREE of SLAVE is 120, it means the SLAVE is 120 degree ahead of MASTER. The DEGREE of SLAVE 2 is 240, it means the SLAVE is 240 degree ahead of MASTER.



2. The first cycle of SLAVE waveform will be distorted if the DEG ON (output on degree, see 3.7.2) doesn't be set correctly. For example, if the MASTER DEG ON = 90, the DEG ON of SLAVE must be 210 ( $120 + 90 = 210$ ). Another SLAVE must DEG ON = 330 ( $240 + 90 = 330$ ).

#### Notice

1. If the DEG OFF (quit degree, see 3.7.2) of MASTER and SLAVE are IMMED, the MASTER phase angle will quit on zero degree, and the SLAVE will quit on 120 or 240 degree. But if users assign quit degree, for example, if the MASTER DEG OFF = 90, the DEG OFF of SLAVE must be 210 ( $120 + 90 = 210$ ). Another SLAVE must DEG OFF = 330 ( $240 + 90 = 330$ ).
2. The voltage setting of 3-phase output is line-to-neutral  $V_{LN}$  for each phase. If users need the line-to-line voltage  $V_{LL}$ , the  $V_{LN}$  must equal to  $V_{LL} / 1.732$ .

#### Notice

The user can use two units of 61500 AC source to connect in series to get higher voltage by three-phase mode. The phase degree should be set on 180 degree. And the user also needs to set the right DEG ON and OFF to get right phase when output is ON or OFF.

#### WARNING

1. Only one AC source can be set to MASTER, or it may cause damage when run 3-PHASE MODE.
2. Users can not connect L terminals of AC source outputs together, even set the DEGREE = 0 of SLAVE.
3. For safety concern, the 3-phase mode can't save to power-on status.

## 3.7.7 PARALLEL MODE

When the power of one AC source is not enough to drive load, it's allowed to parallel AC sources if they are the same model. Users can set PARALLEL MODE on OUTPUT functional list (see 3.7). The AC source setting as MASTER sends SCLK and PWM signals to SLAVE one. Users program output only in MASTER, and read the measurement individually.

The procedures of paralleling AC source:

1. Set the power switch of MASTER and SLAVE on the rear panel to "DISABLE". Assemble an additional power switch to control the power line input of MASTER and SLAVE.
2. Quit the output of AC sources, set  $V_{out} = 0V$ . Set all to the same RANGE and status of OUTPUT RELAY.
3. Connect SCLK signal (in rear panel, BNC connector) together. Connect PWM signal together, too. Connect the same cable used in 3.7.5 Three Phase Mode.
4. Connect the terminals of AC source outputs (N to N, L to L), then, connect to the load.
5. Set the AC source as MASTER first, set the SLAVE last. After setting, press **PAGE/EXIT** twice to MAIN PAGE.
6. The other settings of AC source cannot be changed when it is in parallel mode.
7. The MASTER can program and run or quit the output; the SLAVE only measures the output of itself.

The procedures of removing PARALLEL MODE:

1. Quit the output of AC source from MASTER. Set  $V_{out} = 0V$ .
2. Don't change the PARALLEL MODE to OFF, power off the MASTER and SLAVE by an additional power switch at the same time.

To change parallel mode OFF to MASTER as below:

1. Move the cursor to the command line of "PARALLEL MODE=".
2. Turn RPG to change the option from OFF to MASTER, then press **ENTER**. After checking PARALLEL MODE setting and RANGE setting, confirm it.
3. The cursor moves to the command line of "CHECK OK" automatically.
4. Turn RPG to change the option from NO to YES, then press **ENTER**.

PARALLEL MODE = OFF\_

PARALLEL MODE = MASTER

CHECK OK = NO\_

CHECK OK = YES

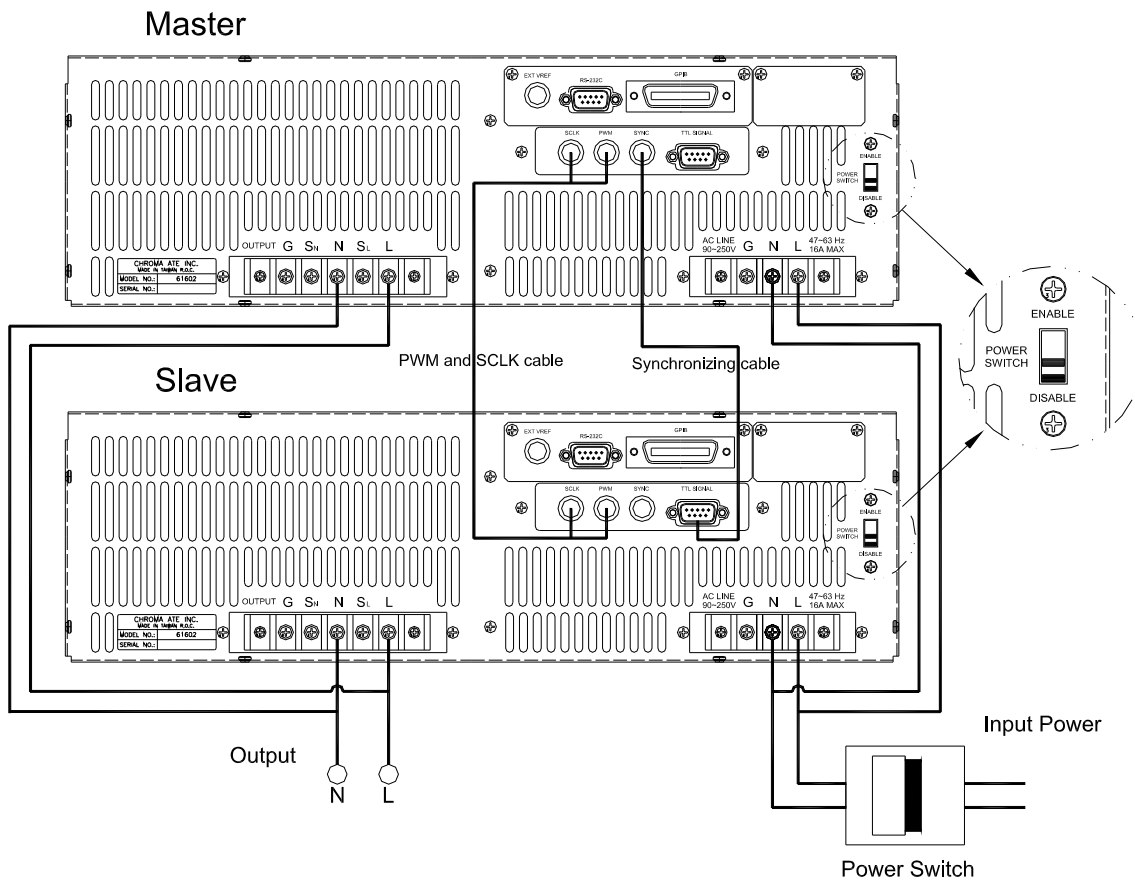

Figure 3-4

**⚠ WARNING**

1. If there is not only one MASTER, or AC sources' RANGE is not the same, it may cause damage of AC source when run parallel mode.
2. In parallel mode, the output power has not to exceed 90% of total power, in order to avoid damage caused by unbalance outputs of AC sources.
3. The procedure to turn off the AC sources is very important. Power off the MASTER and SLAVE at the same time. Or the unit may be damaged.

## 3.8 Save and Recall

The AC source offers two modes for the user to save and recall output setting or system data. They are described in 3.8.1 and 3.8.2

### 3.8.1 Save and Recall Output Setting

The AC source offers nine channels for the user to save a set of frequently used Vac, F, Vdc, and to recall them for later use. For example, in the MAIN PAGE (see 3.3), keyin the output settings as below and save the settings to memory channel 5.

Vac = 230.0	F = 50.00	Vdc = 10.0_	H
V = 0.00	F = 0.00	I = 0.00	▲
P = 0.0	PF = 0.000	CF = 0.00	▼

Press **SHIFT**, then **PAGE/EXIT**, to run the SAVE function. The display will show as below:

CHOICE 1 - 9, PRESS (ENTER) TO SAVE			
1. Vac = 0.0	F = 60.00	Vdc = 0.0	
2. Vac = 120.0	F = 60.00	Vdc = 0.0	
3. Vac = 0.0	F = 60.00	Vdc = 0.0	▼

The cursor stays in channel 1. The user can press **1** - **9** to select channel or use **▲**, **▼**, or press **SHIFT** then **▼** to change page to the destination. The cursor stays in channel 5 after pressing **5**.

CHOICE 1 - 9, PRESS (ENTER) TO SAVE			
4. Vac = 0.0	F = 60.00	Vdc = 0.0	
5. Vac = 0.0	F = 60.00	Vdc = 0.0	▲
6. Vac = 0.0	F = 60.00	Vdc = 0.0	▼

Press **ENTER** to save the output settings to channel 5. The display will show saving status for about 3 seconds. The display is shown as below.

CHOICE 1 - 9, PRESS (ENTER) TO SAVE			
4.	Vac = 0.0	F = 60.00	Vdc = 0.0
<u>5.</u>	Vac = 0.0	F = 60.00	Vdc = 0.0 ▲
Saving now, do not shut down ...			

Then output setting in MAIN PAGE show in channel 5. The display is shown as below.

CHOICE 1 - 9, PRESS (ENTER) TO SAVE			
4.	Vac = 0.0	F = 60.00	Vdc = 0.0
<u>5.</u>	Vac = 230.0	F = 50.00	Vdc = 10.0 ▲
6.	Vac = 0.0	F = 60.00	Vdc = 0.0 ▼

Then, press **PAGE/EXIT** to return to MAIN PAGE.

Recalling from memory channel to MAIN PAGE is shown the following: In MAIN PAGE, press **SHIFT** then **⇐ / -** to run the RECALL function. The display is shown as below:

CHOICE 1 - 9 , PRESS (ENTER) TO RECALL			
<u>1.</u>	Vac = 0.0	F = 60.00	Vdc = 0.0
2.	Vac = 120.0	F = 60.00	Vdc = 0.0
3.	Vac = 0.0	F = 60.00	Vdc = 0.0 ▼

The cursor stays in channel 1. The user can press **1** - **9** to select channel or use **▲**, **▼**, or press **SHIFT** then **▼** to change page to the destination. The cursor stays in channel 2 after pressing **2**. The display is shown as below.

CHOICE 1 - 9 , PRESS (ENTER) TO RECALL			
1.	Vac = 0.0	F = 60.00	Vdc = 0.0
<u>2.</u>	Vac = 120.0	F = 60.00	Vdc = 0.0
3.	Vac = 0.0	F = 60.00	Vdc = 0.0 ▼

Press **ENTER**, the display returns to MAIN PAGE automatically. And the output settings are Vac = 120, F = 60, Vdc = 0, just as the settings saved in memory channel 2.

Vac = 120.0_	F = 60.00	Vdc = 0.00	H
V = 0.00	F = 0.00	I = 0.00	▲
P = 0.0	PF = 0.000	CF = 0.00	▼

If the recalling settings are output of RANGE or over the V LIMIT (see 3.5.2, 3.5.3), the display will show the following:

<p>Conflicting with RANGE or V LIMIT</p> <p style="text-align: right;">&lt;ENTER&gt; to Exit</p>
--

Press **ENTER** to return to recall page. Check if the settings violating the RANGE or V LIMIT.

#### Notice

1. Saving and recalling output settings are acted for MAIN PAGE setting only, the other parameters are ignored.
2. In different couple mode of output (see 3.7.1), the lack of settings will be regular to Vac=0V, F=60Hz, Vdc=0V automatically. For example, in DC output mode, Vac=0V, F=60Hz, Vdc is the setting value in MAIN PAGE as running the SAVE function.

## 3.8.2 Save and Recall System Data

The AC source offers three memory groups for the user to save system data and to recall them for later use. The system data includes all parameters in function list like SETUP (see 3.5), CONF (see 3.6) and OUTPUT (see 3.7). In the CHOICE PAGE (see 3.4), press **SHIFT**, then **PAGE/EXIT**, to run the SAVE function. The displays are shown as below.

PAGE CHOICE = 1_			
1. SETUP	2.CONF	3.OUTPUT	4. MANUAL CALI
5. LIST	6. PULSE	7. STEP	8. HAR
9. SYN	10. INTERHAR		

<p>Save all parameters to Group ( 1 - 3 ) : 1_</p>
--

Press **1** - **3** to choose one group to save, then press **ENTER** to confirm. The display will show the saving status sentence about three seconds as below.

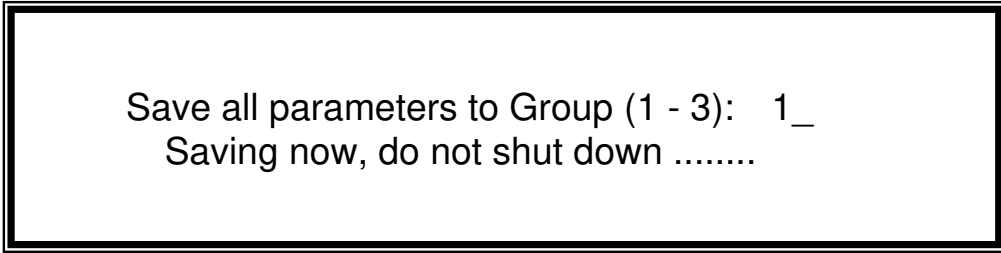

Then, press **PAGE/EXIT** to return to CHOICE PAGE.

Recalling system data from memory group is shown the following: In CHOICE PAGE, press **SHIFT** then **← / -** to run the RECALL function. The display will show as below:

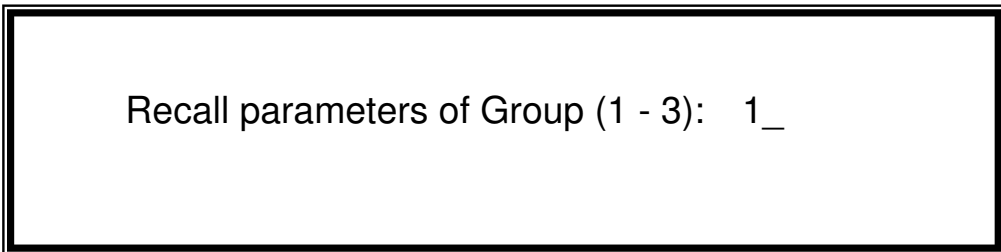

Press **1** - **3** to choose one group to recall, then press **ENTER** to confirm. Then, the display will return to CHOICE PAGE after loading the data.

**Notice**

The AC source has three memory groups: 1, 2, and 3. The memory group 1 keeps power-on defaults. The setup data saved into memory group 1 will be recalled automatically when the AC source is powered on again. Those saved into other memory groups must be recalled manually.

### 3.9 Protection

The AC source provides protection for software and hardware. When protection is happened, the AC source will quit the output and turn off the output relays, then show the condition of protection in display. If any protection is triggered to hold normal output, please remove the errors, then press **ENTER** to unlock the protection so as to resume the normal operation.

Protections for software are listed as below:

Protection	Description
OVER CURRENT	When output current is over the I limit or the current specification.
OVER POWER	When output power is over the specification.
OUTPUT OVP	1. It is feedback open protection, and means that the feedback loop is broken or the output voltage goes wrong. 2. When the out voltage is over the limit of each RANGE. See 3.3.

Protections for hardware are listed as below:

<b>Protection</b>	<b>Description</b>
FAN FAIL	It is fan failure protection, and means that the cooling fan malfunctions.
INT - AD	It is inner AD power stage (see 6.2) protection, and means that the output voltage is over or under the specific value.
INT - DD	It is inner DD power stage (see 6.2) protection, and means that the output voltage is over or under the specific value.
OUTPUT SHORT	It is short protection, and means that the output terminals are shorted.
INPUT FAIL	It is power failure protection, and means that the line input voltage is lower or higher than specification.
OVER TEMP	It is over temperature protection, and will be enabled when the internal temperature of the AC source is too high.





## 4. Calibration

### 4.1 Introduction

The ac source built a simple way to calibrate the output and measurement accuracy without opening cover. Users can do it just follow the procedures step by step. A voltage meter, current meter, suitable load and +5V dc source are needed for while calibration procedure. Connections for these instruments please refer to Figure 4-1. There are three items need to calibrate. But it is not necessary to calibrate all at once. User can just choose one item if needs.

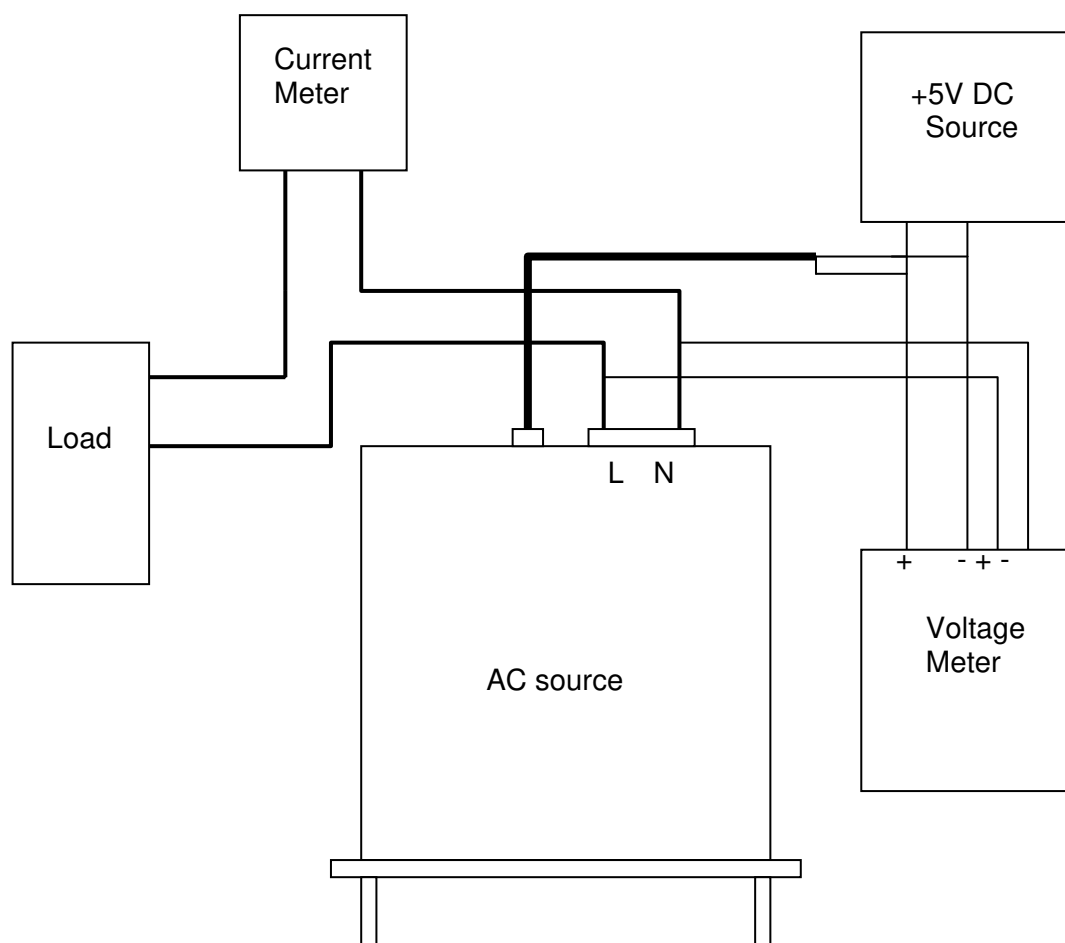

Figure 4-1

### 4.2 MANUAL CALI Functional List

Users can choose " 4. MANUAL CALI " in CHOICE PAGE to enter the calibration procedure. Before showing the calibration items, for safety reason, user must enter password. The password is shown in this manual, in order to confirm the user read the manual before doing the calibration procedure.

PAGE CHOICE = 4\_  
1. SETUP 2.CONF 3.OUTPUT 4. MANUAL CALI  
5. LIST 6. PULSE 7. STEP 8. HAR 9. SYN  
10. INTERHAR

Enter Password: \_  
(You can get password in user's manual! )

Enter Password: \* \* \* \* \_  
(You can get password in user's manual! )

 **Notice**

1. The Password of entering calibration procedure is " 7377 ", then press **ENTER**.
2. Before calibrating the AC source, users should read the procedure in details. Or it may lose some data in memory because of improper operation.

The display changes to CALIBRATION CHOICE PAGE as below after keying the right password.

CALIBRATION CHOICE = 1\_ [ CALIB ]  
1. V OUT AND MEAS. 2. I MEAS.  
3. EXT Vref.

V OUT AND MEAS.: output voltage and voltage measurement accuracy calibration.  
I MEAS.: current measurement accuracy calibration.  
EXT Vref.: external Vref calibration.

## 4.2.1 Output Voltage and Voltage Measurement Calibration

Users can enter CALIBRATION CHOICE page after pressing password, see 4.2. Then, press **1**, **ENTER**, to do the output voltage and voltage measurement calibration.

CALIBRATION CHOICE =   1  

1. V OUT AND MEAS.                      2. I MEAS.

3. EXT V.

Please Remove Load Before Calibrating

Press <ENTER> to start

1. V OUT AND MEAS. ACCURACY CALI    150V RNG

A. KEYIN THE MEASURED Vdc

Vdc offset =                         mV

▼

### Notice

1. The AC Source should be warm up at least 7 minutes before calibrating. Wait the component character stable then do the calibration.
2. The calibration temp. condition should be  $22 \pm 5^{\circ}\text{C}$  when delivery the AC Source.
3. The offset variation is  $\pm 10\text{mV}@22 \pm 5^{\circ}\text{C}$  in temp. range under the AC Source operating normally. The maximum of offset variation is  $400\text{mV}@0 \sim 40^{\circ}\text{C}$ .

In this step A of V OUT AND MEAS. ACCURACY CALI, the user should keyin the AC source's DC output voltage measured by HP 34401A Digital Voltage Meter (DVM) in mV. Then, monitor the reading of DVM, keyin the DC output voltage repeatedly until DC output is less than  $\pm 10$  mV.

### Notice

1. The Vdc offset may be positive or negative. The positive of DVM connect to the line of AC source output, and the negative of DVM connect to the Neutral of AC source output. See Figure 4-1.
2. The load must be off at all steps of V OUT AND MEAS. ACCURACY CALI.

If the users don't key in numeric in step A then can press **SHIFT** and  to enter to step B. Otherwise, the users should go to the confirmation page below to ensure the numerics and units keyed in are correct.

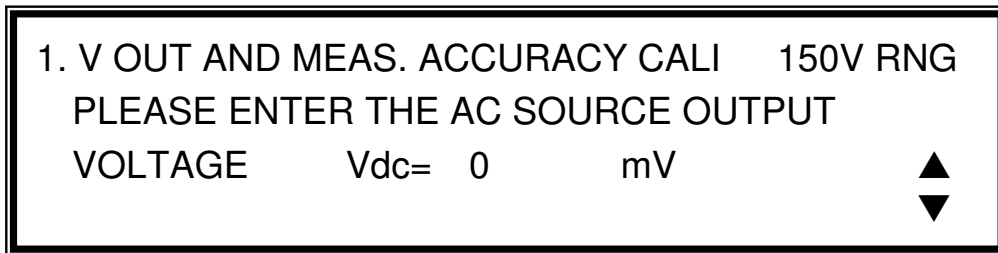

Press **SHIFT** after entering confirmation page, then press  to enter to step B.

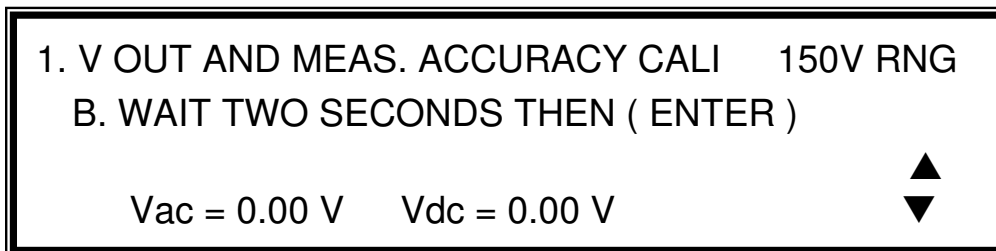

In this step B of V OUT AND MEAS. ACCURACY CALI., the display shows the offset of Vac and Vdc measured by AC source. They are produced by internal components. Wait two seconds then press **ENTER**, then Vac = 0.00, Vdc = 0.00.

 **Notice**

The AC source calibration steps are allowed to do individually, but it is better to follow the calibration procedure step by step (step A, step B ...). Or it may cause output and measurement errors.

Then press **SHIFT**, then  to change to next step.

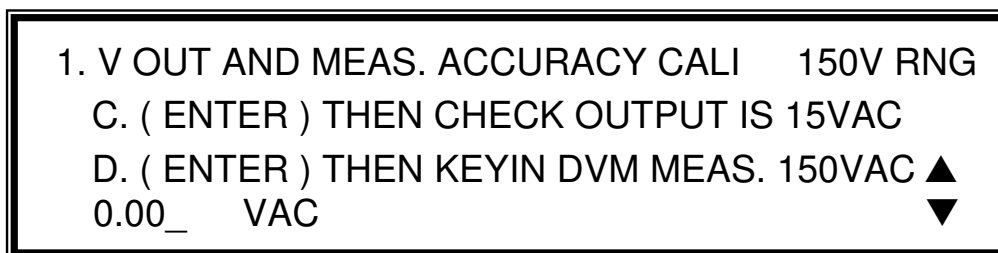

In above step C of V OUT AND MEAS. ACCURACY CALI., the user should not turn on the load. Press **ENTER**, then check the output voltage measured by DVM is about 15VAC. This step is just to make sure the connection is correctly.

Then go to next step D. Press **ENTER**, check the output voltage measured by DVM is about 150VAC. Keyin the exact value measured by DVM, then press **ENTER**.

Then press **SHIFT**, then  to change to next step.

```

1. V OUT AND MEAS. ACCURACY CALI   300V RNG
E. ( ENTER ) THEN CHECK OUTPUT IS 30VAC
F. ( ENTER ) THEN KEYIN DVM MEAS. 300VAC
0.00_  VAC

```

In above step E of V OUT AND MEAS. ACCURACY CALI., the user should not turn on the load. Press **ENTER**, then check the output voltage measured by DVM is about 30VAC. This step is just to make sure the connection is correctly.

Then go to next step F. Press **ENTER**, check the output voltage measured by DVM is about 300VAC. Keyin the exact value measured by DVM, then press **ENTER**.

Step F is the final step of V OUT AND MEAS. ACCURACY CALI. Press **PAGE/EXIT** to exit that page. Then display will show as below. Press **ENTER** to save the calibration results.

```

Press ( ENTER ) to save .
Press ( PAGE/EXIT ) not to save .

```

#### Notice

1. Users can press **PAGE/EXIT** to exit to the calibration choice page at every step.
2. See the above display, if press **PAGE/EXIT** not to save the result, the result of calibration still works, until turn the power off.

## 4.2.2 Current Measurement Calibration

Users can enter CALIBRATION CHOICE page after pressing password, see 4.2. Then, press **2**, **ENTER**, to do the current measurement calibration.

```

CALIBRATION CHOICE =  2
1. V OUT AND MEAS.      2. I MEAS.
3. EXT Vref.

```

Please Remove Load Before Calibrating !

Press <ENTER> to start

2. CURRENT MEAS. ACCURACY CALI 300V RNG  
 A. WAIT TWO SECONDS THEN ( ENTER )  
 lac = 0.00 A Idc = 0.00 A ▼

In above step A of CURRENT MEAS. ACCURACY CALI., the display shows the offset of lac and Idc measured by AC source. They are produced by internal components. Wait a few seconds then press **ENTER**, then lac = 0.00A, Idc = 0.00A.

Then press **SHIFT**, then ▼ to change to next step.

Please Set up Load Then Calibrating !  
 Press <ENTER> to start

2. CURRENT MEAS. ACCURACY CALI 150V RNG  
 B. ( ENTER ) THEN CHECK CURRENT IS 1.6A  
 C. ( ENTER ) THEN KEYIN CURRENT MEAS. 16A  
 0.00 A ▲

In above step B of CURRENT MEAS. ACCURACY CALI., press **ENTER** then AC source will output 12.5VAC. The user should apply suitable load to output, to make the output current measured by current meter (or power analyzer) be about 1.6A (for 61504). The different model shows different current value in display. If the output current is ok after applying load, press **ENTER**, then AC source will output 125VAC. The output current will be 10 times of step B, 16A. Keyin the exact value of current measured by current meter. The output current of step B. and step C. are shown as below:

Model	Step B.	Step C.
61501 (500 VA)	0.4 A	4 A
61502 (1000 VA)	0.8 A	8 A
61503 (1500 VA)	1.2 A	12 A
61504 (2000 VA)	1.6 A	16 A

Step C is the final step of CURRENT MEAS. ACCURACY CALI. Press **PAGE/EXIT** to exit that page. Then display will show as below. Press **ENTER** to save the calibration result.

Press ( ENTER ) to save .  
 Press ( PAGE/EXIT ) not to save .

 **Notice**

1. The resistance of applied load must be constant, so that the load current is proportional to output voltage. If not, the step B of CURRENT MEAS. ACCURACY is insignificant. Users only need to meet the current of step C when output voltage is 125VAC.
2. When doing the procedure of calibration, the protection is removed temporarily. It may cause damage of AC source if applying unsuitable load.

### 4.2.3 External Vref Calibration

Users can enter CALIBRATION CHOICE page after pressing password (see 4.2). Then, press **3**, **ENTER**, to do the external Vref calibration. See detailed as below. It is not necessary to do this item if no option board (GPIB, RS-232 and Vref board) is installed.

```

CALIBRATION CHOICE = 3
1. V OUT AND MEAS.      2. I MEAS.
3. EXT Vref.
  
```

```

Please Remove Load Before Calibrating

Press <ENTER> to start
  
```

```

3. EXTERNAL PROGRAM CALI      150V  RNG
  A. Vref INPUT SHORT
  WAIT TWO SECONDS THEN ( ENTER )
  Vdc = 0.00 V
  
```

In above step A of EXTERNAL Vref CALI., short the external Vref input terminal to make input is 0V, then the display shows the measured Vdc from AC source. They are offset voltages produced by internal components. Wait two seconds then press **ENTER**, then Vdc = 0V.

Then press **SHIFT**, then **▼** to change to next step.

```

3. EXTERNAL PROGRAM CALI      150V  RNG
  B. INPUT EXT. V 5VDC  -  WAIT TWO SECONDS
  KEYIN EXT. V DVM MEAS.
  0.000      VDC      ( ENTER )
  
```

In above step B of EXTERNAL Vref CALI., the user apply +5Vdc to Vref BNC connector from outer DC source. Check the output voltage of AC source is about 106Vdc, then keyin the exact value of input Vref voltage (not AC source output) measured from DVM.

Step B is the final step of EXTERNAL Vref CALI. Press **PAGE/EXIT** to exit that page. Then display will show as below. Press **ENTER** to save the calibration result.

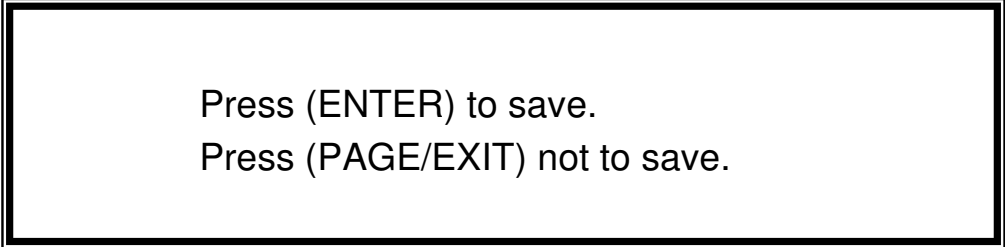

Press (ENTER) to save.  
Press (PAGE/EXIT) not to save.



## 5. Application

### 5.1 General

Not only programming the steady sine output voltage and frequency, the AC source model 61501/61502/61503/61504 provide several powerful functions to simulate all kinds of power line disturbance. Users can make the output change through a number of value in LIST mode (see 5.2), or make the output change to its set value for a specific period of time in PULSE mode (see 5.3), even make the output change to its set value step by step in STEP mode (see 5.4). With these functions, it is easy to simulate such as cycle dropout, transient spike, brown out, etc.

Not only measurements related to power in MAIN PAGE (see 3.3), the AC source model 61501/61502/61503/61504 also provide harmonic measurement up to 40 orders (see 5.5). For modern power testing, the AC source allows users to compose different harmonic components to synthesize harmonic distorted wave-shapes (see 5.6). The AC source also can achieve interharmonics waveform, a sweeping frequency superimposed on a static fundamental wave (see 5.7).

### 5.2 List Mode

On CHOICE PAGE (see 3.4), press **5** then **ENTER**, choose the LIST functional list.

```

PAGE CHOICE = 5_
1. SETUP  2.CONF  3.OUTPUT  4. MANUAL CALI
5. LIST    6. PULSE 7.STEP    8. HAR      9. SYN
10. INTERHAR
  
```

```

COUNT = 0 [ LIST ]
TRIG    = AUTO
BASE    = TIME
<SHIFT> <ENTER> to Execute ▼
  
```

The waveform programming of LIST mode is the assembly of the SEQUENCES. The output waveform will start from SEQ=0, then SEQ by SEQ. The execution will stop until a SEQ which TIME or CYCLE = 0, even the following SEQs have been set will not be executed.

**COUNT** : the whole sequences' executing number of times. COUNT = 0 : infinity.

**TRIG = AUTO / MANUAL** : the way to trigger. AUTO : it will finish all COUNT number when trigger. MANUAL : it will execute sequence waveform for only once. It has the same result in COUNT=1.

**BASE = TIME / CYCLE**: the unit of sequence length.

Press **SHIFT**, then **▼** to change to next page for sequence programming.

SEQ = 0	DEGREE = 0.0	[ LIST ]	
Vs = 0.0	Fs = 60.00	DCs = 0.0	
Ve = 0.0	Fe = 60.00	DCe = 0.0	▲
WAVE = A	TIME = 0.0	ms	▼

**SEQ:** the number of sequence. All sequences must start by zero. The maximal number of SEQ is 99.

**DEGREE:** the phase angle when the sequence starts.

**Vs, Fs, DCs:** the initial waveform when the sequence starts.

**Ve, Fe, DCe:** the final waveform when the sequence ends.

**WAVE = A / B:** to choose waveform (see 3.6.3).

**TIME / CYCLE:** the length of sequence.

After setting sequences, press **PAGE/EXIT** to exit to LIST mode page. Press **SHIFT**, then **ENTER** to change to execution page. The LCD shows **\_TRIG\_ON** is under action, and **\* STOP \*** is the triggering status at present. Press **ENTER** to trigger. Then LCD shows status **\* RUNNING \*** and **TRIG\_OFF** waiting for user to stop the LIST waveform output. The LCD will shows **\* STOP \*** when the AC source executed all sequences and COUNT.

_TRIG_ON	* STOP *	[ LIST ]	
V = 0.00	F = 0.00	I = 0.00	▲
P = 0.0	PF = 0.000	CF = 0.00	▼

_TRIG_OFF	* RUNNING *	[ LIST ]	
V = 0.00	F = 0.00	I = 0.00	▲
P = 0.0	PF = 0.000	CF = 0.00	▼

If the AC Source is in running status, press **OUT/QUIT**, the output will quit waveform to zero voltage. Then, if press **OUT/QUIT** again, the AC source only out the waveform set in MAIN PAGE. Users must press **ENTER** to trigger again. Or if in quit status, users can press **ENTER** to output LIST waveform directly.

The programmed LIST mode waveform will shut down when press **PAGE/EXIT** to exit LIST execution page.

LIST mode example:

COUNT = 1	[ LIST ]
TRIG = AUTO	
BASE = TIME	
<SHIFT> <ENTER> to Execute ▼	

SEQ = 0	DEGREE = 90.0	
[ LIST ]		
Vs = 20.0	Fs = 50.00	DCs = 0.0
Ve = 80.0	Fe = 50.00	DCe = 0.0 ▲
WAVE = A	TIME = 75.0	ms ▼

SEQ = 1	DEGREE = 0.0	
[ LIST ]		
Vs = 20.0	Fs = 50.00	DCs = 0.0
Ve = 20.0	Fe = 50.00	DCe = 100.0 ▲
WAVE = A	TIME = 80.0	ms ▼

SEQ = 2	DEGREE = 0.0	[ LIST ]
Vs = 20.0	Fs = 50.00	DCs = 0.0
Ve = 100.0	Fe = 400.00	DCe = 0.0 ▲
WAVE = A	TIME = 100.0	ms ▼

The output waveform:

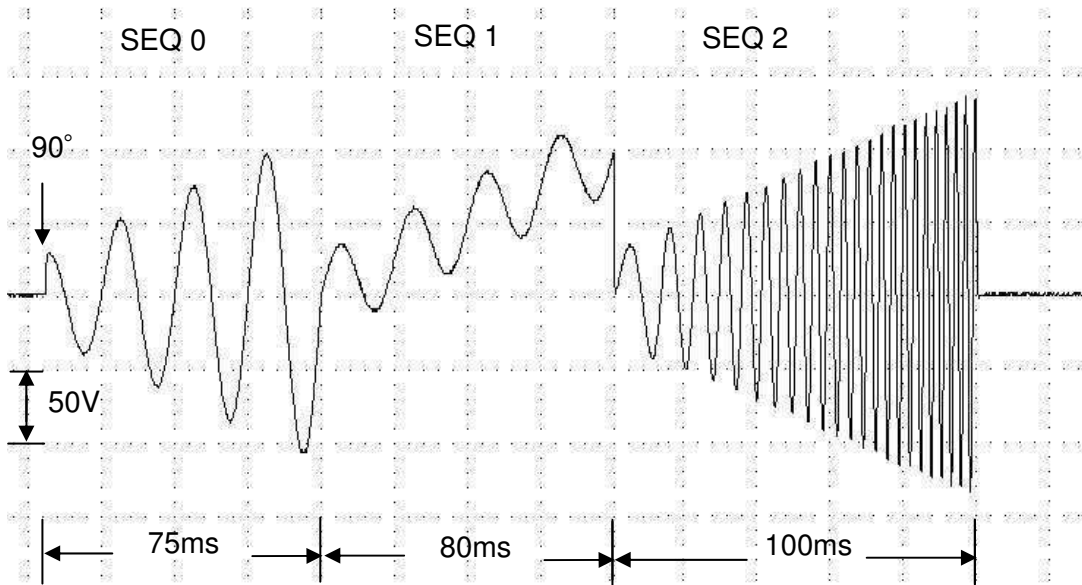

### 5.3 Pulse Mode

On CHOICE PAGE (see 3.4), press **6** then **ENTER**, choose the PULSE functional list.

```

PAGE CHOICE = 6_
1.SETUP  2.CONF  3.OUTPUT  4. MANUAL CALI
5.LIST   6. PULSE 7.STEP   8. HAR    9.SYN
10. INTERHAR
    
```

```

COUNT = 0                                [ PULSE ]
Vac = 0.0      F = 60.00      Vdc = 0.0
DUTY = 0.0    %  PERIOD = 0.0  ms
<SHIFT> <ENTER> to Execute ▼
    
```

Press **SHIFT** , then ▼ to change to next page.

TRIG = AUTO	WAVE = A	[ PULSE ]
DEGREE = 0.0		
<SHIFT> <ENTER> to Execute ▲		

The PULSE mode allows users to program a particular waveform attach to normal output set in MAIN PAGE. The waveform programming is to specify duty percent on top of programmed output, and the transient state.

**COUNT:** the repeat number of pulse.

**Vac, F, Vdc:** the Vac, F and DC output in the duty of period.

**DUTY:** the proportion of pulse in one period.

**PERIOD:** the length of a pulse period.

**TRIG = AUTO / MANUAL:** the way to trigger. AUTO: it will finish all COUNT number when trigger. MANUAL: it will execute pulse waveform for only once. It has the same result in COUNT=1.

**WAVE = A / B:** to choose waveform (see 3.6.3).

**DEGREE:** the output phase angle of pulse.

Press **SHIFT**, then **ENTER** to go to PULSE execution page. The LCD shows **\_TRIG\_ON** is under action, and **\* STOP \*** is the triggering status at present. Press **ENTER** to trigger. Then LCD shows status **\* RUNNING \*** and **TRIG\_OFF** waiting for user to stop the PULSE waveform output. The LCD shows **\* STOP \*** when the AC source executed all COUNT number.

_TRIG_ON	* STOP *	[ PULSE ]
V = 0.00	F = 0.00	I = 0.00 ▲
P = 0.0	PF = 0.000	CF = 0.00 ▼

_TRIG_OFF	* RUNNING *	[ PULSE ]
V = 0.00	F = 0.00	I = 0.00 ▲
P = 0.0	PF = 0.000	CF = 0.00 ▼

If the AC Source is in output status, press **OUT/QUIT**, the output will quit waveform to zero voltage. Then, if press **OUT/QUIT** again, the AC Source only out the waveform set in MAIN PAGE. Users must press **ENTER** to trigger again. Or if in quit status, users can press **ENTER** to output PULSE waveform directly.

The pulse wave will shut down when press **PAGE/EXIT** to exit PULSE execution page.  
PULSE mode example:

In MAIN PAGE:

Vac = 50.0	F = 50.00	Vdc = 0.0	L
V = 0.00	F = 0.00	I = 0.00	▲
P = 0.0	PF = 0.000	CF = 0.00	▼

In PULSE setting page:

COUNT = 3	[ PULSE ]	
Vac = 100.0	F = 50.00	Vdc = 0.0
DUTY = 35.0 %	PERIOD = 100.0 ms	
<SHIFT> <ENTER> to Execute		▼

TRIG = AUTO	WAVE = A	[ PULSE ]
DEGREE = 90.0		
<SHIFT> <ENTER> to Execute		▲

The output waveform:

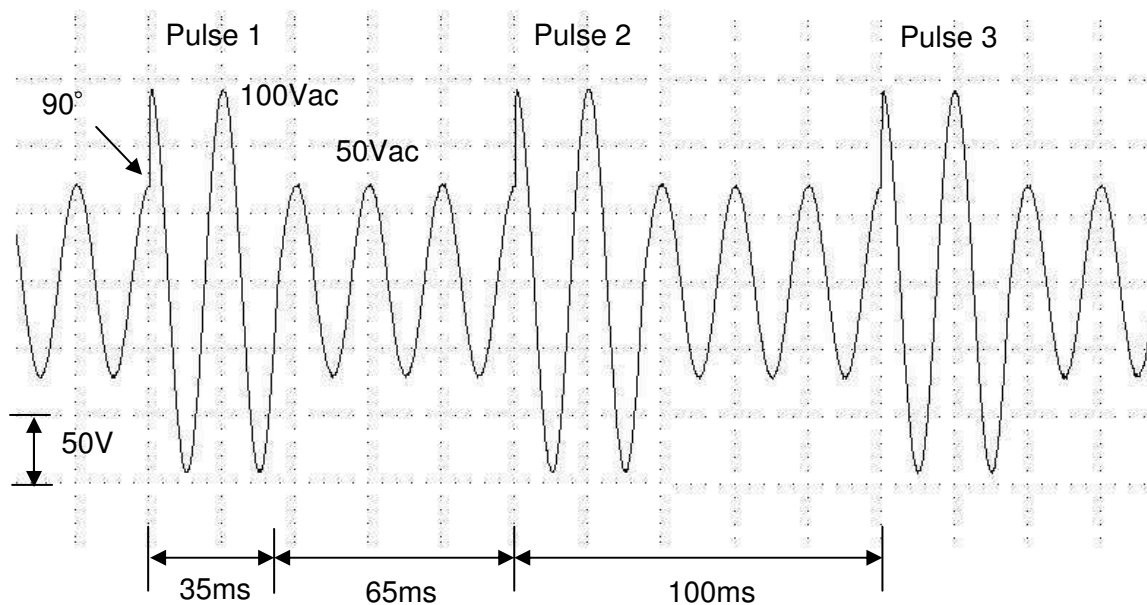

## 5.4 Step Mode

On CHOICE PAGE (see 3.4), press **7** then **ENTER**, choose the STEP functional list.

```

PAGE CHOICE = 7_
1. SETUP  2.CONF  3.OUTPUT  4. MANUAL CALI
5. LIST   6. PULSE 7.STEP   8. HAR    9. SYN
10. INTERHAR
  
```

```

COUNT = 0          DWELL = 0.0          ms [STEP ]
Vac = 0.0           F = 60.00           Vdc = 0.0
dV = 0.0            dF = 0.00           dDC = 0.0
<SHIFT><ENTER> to Execute ▼
  
```

Press **SHIFT**, then ▼ to change to next page.

```

TRIG = AUTO        WAVE = A                [STEP ]
DEGREE = 0.0
<SHIFT><ENTER> to Execute ▲
  
```

The STEP mode offers a easy and automatic-change function to change output waveform in a regular level and time. But the variation between two steps changes rapidly, not gradually. The waveform programming is to set an initial waveform, specify the dwell time and change of every step, and the number of change step. After execution, the output wave will keep on last step.

**COUNT:** the number of each change execute.

**DWELL:** the length of each step.

**Vac, F, Vdc:** the initial value of Vac, F, DC when STEP mode starts to execute.

**dV, dF, dDC:** the difference value of each step. (The negative value is allowed.)

**TRIG = AUTO / MANUAL:** the way to trigger. AUTO: it will finish all COUNT number when trigger. MANUAL: the output waveform will change just one step for each execution.

**WAVE = A / B:** to choose waveform (see 3.6.3).

**DEGREE:** the output phase angle of each step.

Press **SHIFT**, then **ENTER** to go to STEP execution page. The LCD shows **\_TRIG\_ON** is under action, and **\* STOP \*** is the triggering status at present. Press **ENTER** to trigger. Then LCD shows status **\* RUNNING \*** and **TRIG\_OFF** and **TRIG\_PAUSE**. Press ▲ or ▼ to move cursor and press **ENTER** to select. **TRIG\_OFF** is to stop the STEP waveform changing. **TRIG\_PAUSE** is to keep the STEP waveform until **TRIG\_CONTINUE** is selected. The LCD will shows **\* STOP \*** when the AC source executed all COUNT number.

_TRIG_ON		* STOP *		[ STEP ]
V = 0.00	F = 0.00	I = 0.00	▲	
P = 0.0	PF = 0.000	CF = 0.00	▼	

_TRIG_OFF		* RUNNING *		[ STEP ]
TRIG_PAUSE				
V = 0.00	F = 0.00	I = 0.00	▲	
P = 0.0	PF = 0.000	CF = 0.00	▼	

_TRIG_CONTINUE		* PAUSE *		[ STEP ]
V = 0.00	F = 0.00	I = 0.00	▲	
P = 0.0	PF = 0.000	CF = 0.00	▼	

If the AC Source is in output status, press **OUT/QUIT**, the output will quit waveform to zero voltage. Then, if press **OUT/QUIT** again, the AC Source only out the waveform set in MAIN PAGE. Users must press **ENTER** to trigger again. Or if in quit status, users can press **ENTER** to output STEP waveform directly.

The STEP wave will stop to execute when press **PAGE/EXIT** to exit STEP execution page.

When **TRIG = MANUAL**, the LCD shows TRIG\_UP and TRIG\_DOWN. The output waveform is changed to the next step if TRIG\_UP is selected. The output waveform is changed back to last step if TRIG\_DOWN is selected.

_TRIG_UP		* STOP *		[ STEP ]
TRIG_DOWN				
V = 0.00	F = 0.00	I = 0.00	▲	
P = 0.0	PF = 0.000	CF = 0.00	▼	

STEP mode example:

COUNT = 3	DWELL = 60.0	ms	[ STEP ]
Vac = 40.0	F = 50.00	Vdc = 0.0	
dV = 10.0	dF = 50.00	dDC = 20.0	
<SHIFT><ENTER> to Execute			▼



TRIG = AUTO      WAVE = A      [ STEP ]  
 DEGREE = 90.0

<SHIFT><ENTER> to Execute      ▲

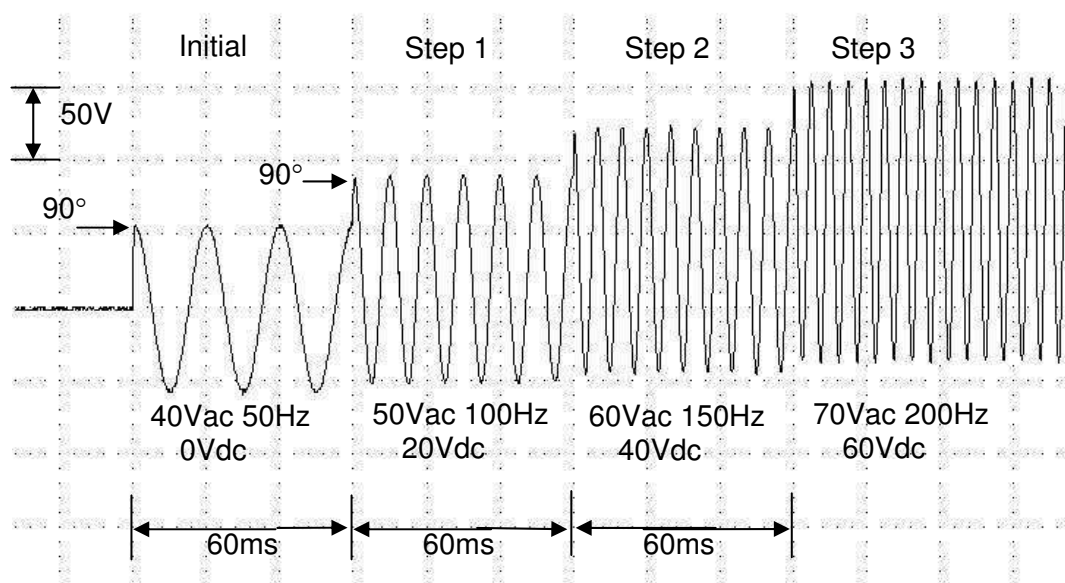

## 5.5 Harmonic Measurement

On CHOICE PAGE (see 3.4), press **8** then **ENTER**, choose the HAR functional list.

PAGE CHOICE = 9\_

1. SETUP   2. CONF   3. OUTPUT   4. MANUAL CALI  
 5. LIST   6. PULSE   7. STEP   8. HAR   9. SYN  
 10. INTERHAR

SOURCE = I      FREQ = 60 Hz      [ HAR ]  
 TIMES = SINGLE      PARAMETER = PERCENT

<SHIFT> <ENTER> to measure

The HARmonic function can calculate the THD, DC, fundamental value of output current or output voltage. It also calculates 2nd ~ 40th order of harmonic value in fundamental frequency 50Hz or 60Hz.

**SOURCE = V / I:** the source of measured data. V: the output voltage. I: the output current.

**FREQ = 50 / 60 Hz:** the fundamental frequency of source.

**TIMES = SINGLE / CONTINUE:** the way of measurement result displayed in LCD. SINGLE: the display will remain the measured data when execute. It takes about 3 second to get the result. CONTINUE: the display will refresh to new measurement data. It takes about 10 second to get a stable new result.

**PARAMETER = PERCENT / VALUE:** the data form of each harmonic order.

PERCENT: the percentage of fundamental value. VALUE: the absolute value.

Press **SHIFT**, then **ENTER** to execute harmonics measurement.

THD = 0.0 %	[ HAR ]
DC = 0.0	
Fundament = 0.0	
	▼

THD : the total harmonic distortion of output wave.

DC : the dc value of output wave.

Fundament : the fundamental value of output wave.

Press **SHIFT**, then ▼ to change to next page.

N	%	N	%	[ HAR ]
2	0.00	3	0.00	
4	0.00	5	0.00	▲
6	0.00	7	0.00	▼

Press **SHIFT**, then ▲ or ▼ to see other harmonic orders. Press **PAGE/EXIT** to go back to HAR set page.

The following figure shows that when PARAMETER set to VALUE.

N	VALUE	N	VALUE	[ HAR ]
2	0.00	3	0.00	
4	0.00	5	0.00	▲
6	0.00	7	0.00	▼

**Notice**

When users press **SHIFT** then **ENTER** to execute harmonics measurement, the AC source will regulate the internal gain by measured data automatically. By this way, the AC source can get more accurate data of each harmonic. Because of this reason, the user had better

- execute harmonics measurement when the load is stable, and not change load when measuring. Or the calculated data may lose accuracy even over-current protection may happen.

## 5.6 Synthesize Waveform

On CHOICE PAGE (see 3.4), press **9** then **ENTER**, choose the SYN functional list.

PAGE CHOICE = 9_	
1. SETUP	2. CONF
3. OUTPUT	4. MANUAL CALI
5. LIST	6. PULSE
7. STEP	8. HAR
9. SYN	
10. INTERHAR	

COMPOSE=VALUE-1	[ SYN ]
Vac_fund = 0.0	F_fund = 60Hz
Vdc = 0.0	DEGREE = 0.0
<SHIFT><ENTER> to Execute ▼	

The 61500 series AC Source offers SYN function to synthesize waveform with harmonic composition up to 40 orders. The fundamental frequency is restricted to 50Hz or 60Hz. Users can easy program the magnitude and phase of each order in LCD display. The following figure is an example.

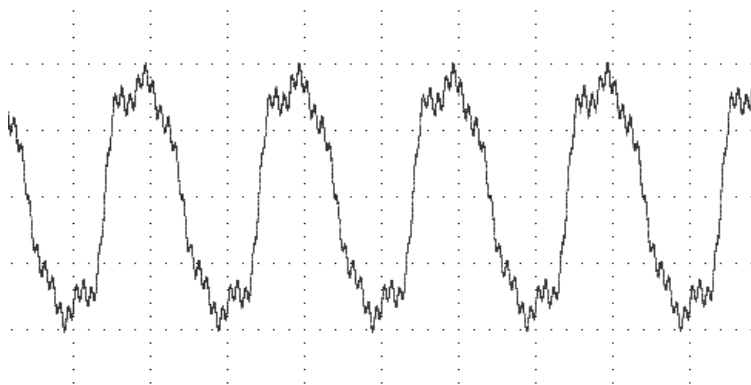

**COMPOSE = VALUE-1 / VALUE-2 / PERCENT-1 / PERCENT-2:** the data form of each harmonic order. VALUE: the absolute value. PERCENT: the percentage of fundamental voltage. Users totally can program 4 kinds of synthesized waveforms to execute.

**Vac\_fund:** the fundamental voltage. The maximum value is limited by RANGE (see 3.5.1).

**F\_fund = 50 / 60Hz:** the fundamental frequency.

**Vdc:** the DC voltage adds to voltage waveform.

**DEGREE:** the start angle of output waveform.

Press **SHIFT**, then ▼ to next page to program the harmonic composition and its phase angle (the range of each phase angle is from 0.0 to 359.9).

N	V	$\theta$	N	V	$\theta$	[ SYN ]
2	0.0	0.0	3	0.0	0.0	
4	0.0	0.0	5	0.0	0.0	▲
6	0.0	0.0	7	0.0	0.0	▼

N	%	$\theta$	N	%	$\theta$	[ SYN ]
2	0.0	0.0	3	0.0	0.0	
4	0.0	0.0	5	0.0	0.0	▲
6	0.0	0.0	7	0.0	0.0	▼

After setting, press **PAGE/EXIT** to go back to SYN set page. Press **SHIFT**, then **ENTER** to go to SYN execution page. The LCD shows **\_TRIG\_ON** is under action, and **\* STOP \*** is the triggering status at present. Press **ENTER** to trigger. Then LCD shows status **\* RUNNING \*** and **TRIG\_OFF** waiting for user to stop the SYN waveform output.

<b>_TRIG_ON</b>			<b>* STOP *</b>	[ SYN ]
V = 0.00	F = 0.00	I = 0.00		▲
P = 0.0	PF = 0.000	CF = 0.00		▼

<b>_TRIG_OFF</b>			<b>* RUNNING *</b>	[ SYN ]
V = 0.00	F = 0.00	I = 0.00		▲
P = 0.0	PF = 0.000	CF = 0.00		▼

If the AC Source is in output status, press **OUT/QUIT**, the output will quit waveform to zero voltage. Then, if press **OUT/QUIT** again, the AC Source only out the waveform set in MAIN PAGE. Users must press **ENTER** to trigger again. Or if in quit status, users can press **ENTER** to output SYN waveform directly.

The synthesized wave will shut down when press **PAGE/EXIT** to exit SYN execution page.

**Notice**

- For practical use and to protect the power stage of AC Source, the composing value or percentage of each order has to be restricted.
  - 2 ≤ order ≤ 10, value ≤ 150V or percentage ≤ 100%.
  - 11 ≤ order ≤ 20, value ≤ 120V or percentage ≤ 50%.
  - 21 ≤ order ≤ 30, value ≤ 80V or percentage ≤ 30%.
  - 31 ≤ order ≤ 40, value ≤ 45V or percentage ≤ 15%.
- If the synthesized waveform is over the limit of voltage, 424V for 300V RANGE or 212V for 150V RANGE, the OUTPUT OVP protection will happen.

## 5.7 Interharmonics Waveform

On CHOICE PAGE (see 3.4), press **10** then **ENTER**, choose the INTERHAR functional list.

```

PAGE CHOICE = 10_
1. SETUP  2.CONF  3.OUTPUT  4. MANUAL CALI
5. LIST   6. PULSE 7. STEP   8. HAR    9. SYN
10. INTERHAR
  
```

```

Fi_start = 0.01  Hz           [ INTERHAR ]
Fi_end   = 2400.0 Hz
LEVEL    = 0.0   %           TIME = 0.00  sec
                                <SHIFT><ENTER> to Execute
  
```

For some tests, the AC source offers a sweeping frequency, with a small magnitude level, that can superimpose on original fundamental output in INTERHAR function. The following figures are the examples.

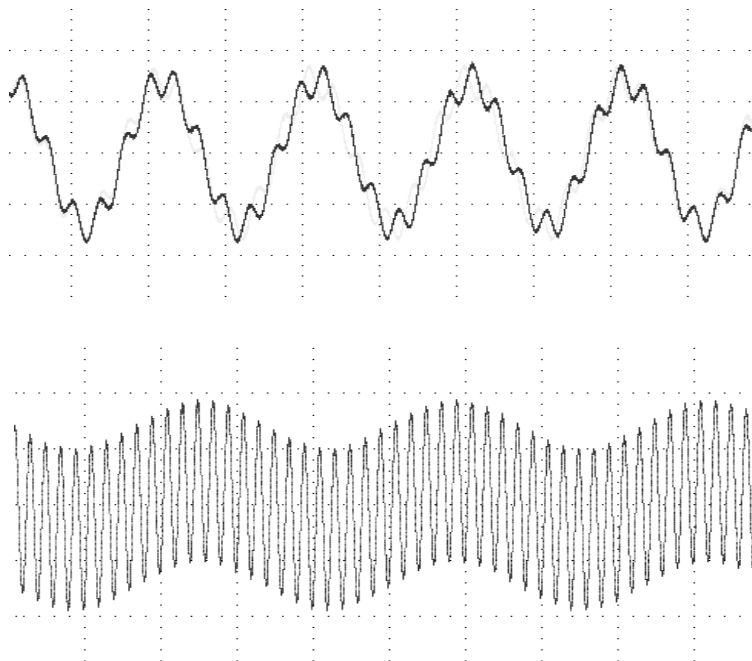

**Fi\_start** : the starting frequency of the sweeping wave. The range is 0.01Hz ~ 2400Hz.  
**Fi\_end** : the ending frequency of the sweeping wave. The range is 0.01Hz ~ 2400Hz.  
**LEVEL** : the r.m.s. magnitude of the sweeping wave in percentage of fundamental voltage set in MAIN PAGE.  
**TIME** : the time interval from Fi\_start to Fi\_end.

Press **SHIFT**, then **ENTER** to go to INTERHAR execution page. The LCD shows **\_TRIG\_ON** is under action, and **\* STOP \*** is the triggering status at present.  $F_i$  is the sweeping frequency. ( $F_i = 0$  means no sweeping wave superimpose on original fundamental output.) Press **ENTER** to trigger. Then LCD shows status **\* RUNNING \*** and **TRIG\_OFF** and **TRIG\_PAUSE**. Press **▲** or **▼** to move cursor and press **ENTER** to select. **TRIG\_OFF** is to stop the INTERHAR waveform. **TRIG\_PAUSE** is to pause the INTERHAR waveform in certain frequency. The frequency will continue to sweep when users move cursor to **TRIG\_CONTINUE** and press **ENTER**. The LCD shows **\* FINISH \*** when the sweeping frequency reaches to  $F_{i\_end}$ .

<b>_TRIG_ON</b>	<b>* STOP *</b>	<b>[ INTERHAR ]</b>	
		$F_i = 0.00$	
V = 0.00	F = 0.00	I = 0.00	▲
P = 0.0	PF = 0.000	CF = 0.00	▼

<b>_TRIG_OFF</b>	<b>* RUNNING *</b>	<b>[ INTERHAR ]</b>	
<b>TRIG_PAUSE</b>		$F_i = 0.00$	
V = 0.00	F = 0.00	I = 0.00	▲
P = 0.0	PF = 0.000	CF = 0.00	▼

<b>TRIG_OFF</b>	<b>* PAUSE *</b>	<b>[ INTERHAR ]</b>	
<b>_TRIG_CONTINUE</b>		$F_i = 0.00$	
V = 0.00	F = 0.00	I = 0.00	▲
P = 0.0	PF = 0.000	CF = 0.00	▼

If the AC Source is in output status, press **OUT/QUIT**, the output will quit to zero voltage. Then, if press **OUT/QUIT** again, the AC source only out the waveform set in MAIN PAGE. Users must press **ENTER** to trigger again. Or if in quit status, users can press **ENTER** to output interharmonics waveform directly.

The INTERHAR waveform will shut down when press **PAGE/EXIT** to exit INTERHAR execution page.

**Notice**

- For practical use and to protect the power stage of AC source, the LEVEL has to be restricted relate to  $F_{i\_start}$  and  $F_{i\_end}$  :
- If  $0.01\text{Hz} \leq F_{i\_start}$  or  $F_{i\_end} \leq 500\text{Hz}$ , LEVEL  $\leq 30\%$ .
- If  $500\text{Hz} < F_{i\_start}$  or  $F_{i\_end} \leq 1000\text{Hz}$ , LEVEL  $\leq 20\%$ .
- If  $1000\text{Hz} < F_{i\_start}$  or  $F_{i\_end} \leq 2400\text{Hz}$ , LEVEL  $\leq 10\%$ .

## 6. Theory of Operation

### 6.1 General

The AC source consists of 10 print circuit boards and other components. Each of the PCB has its specific function that will be described in the following subsection.

### 6.2 Description of Overall System

Figure 6-1 shows the overall system. Main power flows through the A/D, D/D, D/A power stage converter. The A/D power stage is designated as I board, and generates DC voltage from the line input. The DC voltage of A/D output is applied to the D/D power stage. The G board of D/D stage takes power from the A/D output. It generates two isolated DC outputs for D/A power stage. The H board of D/A inverter generates AC output through full bridge controlled by B board. The D/A power stage is through G board relays in parallel or series control to obtain more current and higher voltage.

B board is identified as DSP processor and D/A controller. The DSP processor is applied to control output frequency and voltage, to measure voltage and current through G board, to perform remote control through GPIB, RS-232C or EXT Vref interface on Optional E board, to respond TTL signals through D board. A board is identified as user interface controller. It scans front panel keys through K board, and sends settings and measurement messages on LCD module.

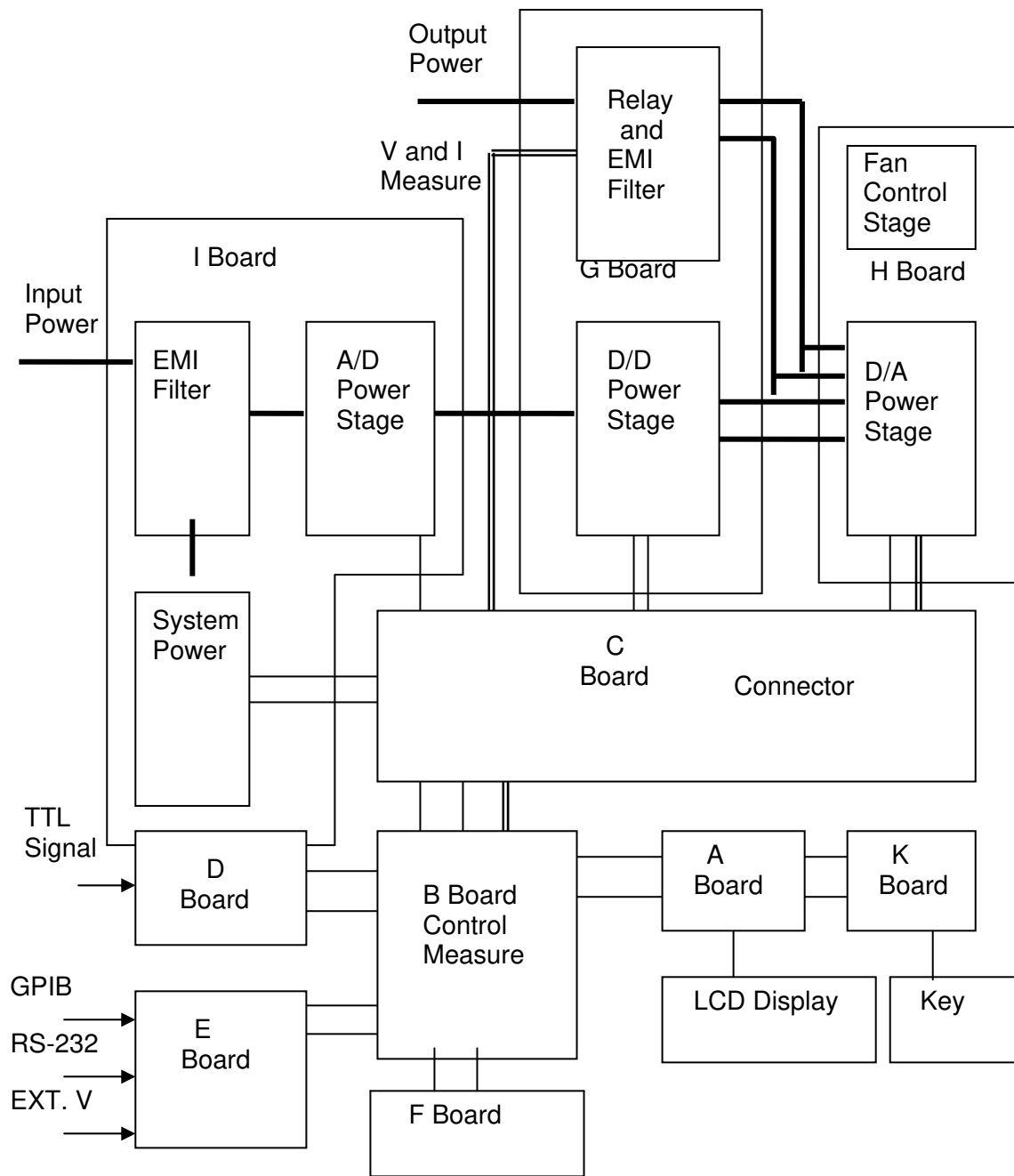

Figure 6-1



## 7. Self Test & Troubleshooting

### 7.1 General

This section describes the self-test steps and suggested troubleshooting procedures when AC source does not function normally. If the problem cannot be solved using the information given here, consult the distributor whom you purchased the unit.

### 7.2 Self Test

When the AC source power-on, it performs a series of self-test. Firstly, it does the memory, data and communication self-test. They contain three items: DISPLAY, WAVEFORM, and REMOTE. If any failure is detected on a certain item, an "error code" will be shown at the right side of that item. The following table shows all the error messages:

Error Code	Description	Remark
Bit 0	SRAM error	0 – OK, 1 - ERROR
Bit 1	CODE error	0 – OK, 1 – ERROR
Bit 2	DATA error	0 – OK, 1 – ERROR
Bit 3	Communication error	0 – OK, 1 - ERROR
Bit 4	Output test result	0 – OK, 1 – ERROR
Bit 5	Reserved	
Bit 6	Reserved	
Bit 7	Reserved	

Example: If error code shows " ERROR = 05 ", the error code in binary is " 0000101".  
The bit 0 and bit 2 are " 1 ". So " ERROR = 05 " means SRAM error and DATA error occurs.

Error Message	Description	Action
SRAM error	SRAM test fail.	Consult your dealer for assistance.
CODE error	Program code test fail.	Consult your dealer for assistance.
DATA error	Data in Flash or EEPROM test fail.	Consult your dealer for assistance.
Communication error	Can not communicate.	<ol style="list-style-type: none"> <li>1. Power off the AC source, wait three seconds, power on again.</li> <li>2. Consult your dealer for assistance.</li> </ol>

After the memory, data and communication self-test, the AC source does the power output self-test. In this procedure, the output relays are in OFF state to sure not harming the load connecting on output terminal. Then, the AC source will check if there is any protection signal sent from hardware. If it does, the display shows " Output self test <NG>". It means the AC source is abnormal. Press **ENTER** to see what protection condition is. If no protection signal, the AC source will program 300Vac and measure the voltage. If the measured voltage is over 300V  $\pm$ 5V, the power self-test is failed, and the display also shows " Output self test <NG> ". Probably AC source has not been calibrated (updated the software especially). Users can do following steps to reassure.

1. Press **ENTER** to ignore the NG.
2. If no PROTECTION, press **PAGE/EXIT** to change to MAIN PAGE.
3. Program a small voltage as 10Vac then press **OUT/QUIT**, see the measurement from LCD display if V is about 10V or not.

If the reading of V is about 10V, the AC source needs to calibrate (see Chapter 4). If the reading does not change apparently or show an unreasonable value, or display shows PROTECTION, the AC source does have some problems. Consult your dealer for assistance.

## 7.3 Troubleshooting

The following table lists the operating problems and suggests corrective actions:

Problem	Reason	Solution
Poor measurement of V, I.	Aging of components result in deviation of characteristics.	Periodic calibration is required. Refer to Chapter 4 Calibration.
Distorted output	1. The AC source output voltage is too low. 2. The rectified load is too large at high frequency.	1. Program higher output voltage. 2. Reduce the load or lower the output frequency.
OVER TEMP protection (OTP)	1. Ambient temperature is too high. 2. Airway is obstructed.	1. Operate the unit 0 ~ 40°C 2. Unblock the airway.
OVER POWER protection (OPP)	The output power is over specification.	Remove the over power or lower down output voltage.
OVER CURRENT protection (OCP)	The output current is over specification or I LIMIT.	Remove the overload or relax the I LIMIT.
OUTPUT SHORT protection	1. The output is shorted. 2. External current reverse.	1. Remove the short. 2. Remove the load.
INPUT FAIL protection (UVP)	The AC source line input voltage is too low or too high.	Measure input voltage, and regulate it if it's over specification.
INT _ AD protection	1. Line input voltage cycle dropout. 2. Instant over current of output. 3. AD power stage damaged.	1. Check the stability of input voltage. 2. Remove the load. 3. If cannot reset the status of protection, consult the dealer for assistance.
INT _ DD protection	1. Line input voltage cycle dropout. 2. Instant over current of output. 3. DD power stage damaged.	1. Check the stability of input voltage. 2. Remove the load. 3. If cannot reset the status of protection, consult the dealer for assistance.
OUTPUT OVP protection	1. Remote sense is open. 2. Output voltage peak is over range.	1. Connect the output to remote sense terminals. 2. Check the settings of Vac and Vdc on MAIN PAGE.
Cannot control AC source by GPIB	1. The AC source unit address is incorrect. 2. GPIB cable is loose at rear.	1. Update address. 2. Check connection, tighten the screws.

## 8. Remote Operation

### 8.1 General Information

The AC source can be controlled remotely through the GPIB or the RS-232C port. The GPIB port is mostly used, but the RS-232C port is helpful too.

Technically speaking, the GPIB interface is quite different from the RS-232C interface. The GPIB interface is an 8-bit parallel data bus owning a host of bus commands for synchronization, and up to one Megabyte transfer rate. The RS-232C interface, a serial bus with a few handshake lines for synchronization, is less capable, so its requirement is not so much, and the user can write a simple program to do basic remote control easily.

#### 8.1.1 Setting the GPIB Address and RS-232C Parameters

The AC source is shipped with the GPIB address which is set at 30. The address can be only changed from the "CONF" functional list menu (please refer to 3.6.4). This menu is also used to select the RS-232C interface, and specify the parameters of RS-232C such as baud rate and parity.

#### 8.1.2 Wire Connection of RS-232C

The AC source is shipped with the baud rate which is set at 9600, and with parity which is set as None. For RS-232C interface, only the signals of TxD and RxD are used for its transfer of data. The RS-232C connector is a 9-pin D subminiature female connector. The following table describes the pins and signals of RS-232C connector.

Pin No.	Input/Output	Description
1	---	No Connection
2	OUTPUT	TxD
3	INPUT	RxD
4	---	No Connection
5	---	GND
6	---	No Connection
7	---	No Connection
8	---	No Connection
9	---	No Connection

Interconnection between the computer (compatible with IBM PC) and the AC source is illustrated below:

PIN	IBM PC	AC Source
1	DCD	No Connection
2	RX ←	TX
3	TX →	RX
4	DTR	No Connection
5	GND	GND
6	DSR	No Connection
7	RTS	No Connection
8	CTS	No Connection
9	RI	No Connection

## 8.2 The GPIB Capability of the AC Source

GPIB Capability	Description	Interface Functions
Talker/Listener	Commands and response messages can be sent and received over the GPIB bus. Status information can be read using a series poll.	AH1, SH1, T6, L4
Service Request	The AC source sets the SRQ line true if there is an enabled service request condition.	SR1
Remote/Local	The AC source powers up in local state. In local state, the front panel is operative, and the AC source responds to the commands from GPIB. In remote state*, all front panel keys except the "<PAGE/EXIT>" key are disabled. Press "<PAGE/EXIT>" key to return the AC source to local state.	RL1

\*Remote State:

The panel shows remote message on the LCD display as below:

Vac = 0.0	F = 60.00	Vdc = 0.0	R H
V = 0.00	F = 0.00	I = 0.00	▲
P = 0.0	PF = 0.000	CF = 0.00	▼

There is an "R" on right up side of LCD display to indicate the AC source is in remote state. In remote state, all front panel keys except the "<PAGE/EXIT>" key are disabled. Press the "<PAGE/EXIT>" key to return the AC source to the local state.

## 8.3 Introduction to Programming

All commands and response messages are transferred in form of ASCII codes. The response messages must be read completely before a new command is sent, otherwise the remaining response messages will be lost, and a query interrupt error will occur.

### 8.3.1 Conventions

Angle brackets	< >	Items in angle brackets are parameter abbreviations.
Vertical bar		Vertical bar separates alternative parameters.
Square brackets	[ ]	Items in square brackets are optional. For example, OOTP [ : STATE] means that : STATE may be omitted.
Braces	{ }	Braces indicate the parameters that may be repeated. The notation <A> {<, B>} means that parameter "A" must be entered while parameter "B" may be omitted or entered once or more times.

### 8.3.2 Numerical Data Formats

All data programmed to or returned from the AC source are ASCII. The data can be numerical or character string.

Numerical Data Formats

Symbol	Description	Example
NR1	It is a digit with no decimal point. The decimal is assumed to be at the right of the least significant digit.	123, 0123
NR2	It is a digit with a decimal point.	12.3, .123
NR3	It is a digit with a decimal point and an exponent.	1.23E+2

### 8.3.3 Boolean Data Format

The Boolean parameter <Boolean> takes only the form ON|OFF.

### 8.3.4 Character Data Format

The character strings returned by query command may take either of the following forms:

<CRD>	Character Response Data: character string with maximum length of 12.
<SRD>	String Response Data: character string.

## 8.3.5 Basic Definition

Command Tree Table:

The commands of the AC source are based on a hierarchical structure, also known as a tree system. In order to obtain a particular command, the full path to that command must be specified. This path is represented in the table by placing the highest node in the farthest left position of the hierarchy. Lower nodes in the hierarchy are indented in the position to the right, below the parent node.

Program Headers:

Program headers are key words that identify the command. They follow the syntax described in subsection 8.6 of IEEE 488.2. The AC source accepts characters in both upper and lower case without distinguishing the difference. Program headers consist of two distinctive types, common command headers and instrument-controlled headers.

Common Command and Query Headers:

The syntax of common command and query headers is described in IEEE 488.2. It is used together with the IEEE 488.2-defined common commands and queries. The commands with a leading “ \* ” are common commands.

Instrument-Controlled Headers:

Instrument-controlled headers are used for all other instrument commands. Each of them has a long form and a short form. The AC source only accepts the exact short and long forms. A special notation will be taken to differentiate the short form header from the long one of the same header in this subsection. The short forms of the header are shown in characters of upper case, whereas the rest of the headers are shown in those of lower case.

Program Header Separator (:):

If a command has more than one header, the user must separate them with a colon (FETC:CURR?, VOLT:DC 10). Data must be separated from program header by one space at least.

Program Message:

Program message consists of a sequence of zero or more elements of program message unit that is separated by separator elements of program message unit.

Program Message Unit:

Program message unit represents a single command, programming data, or query.

Example: `FREQ?, OUTPut ON.`

Program Message Unit Separator ( ; ):

The separator (semicolon ;) separates the program message unit elements from one another in a program message.

Example: `VOLT:AC 110 ; FREQ 120<PMT>`

Program Message Terminator (<PMT>):

A program message terminator represents the end of a program message. Three permitted terminators are:

- (1) <END> : end or identify (EOI)
- (2) <NL> : new line which is a single ASCII-encoded byte 0A (10 decimals).
- (3) <NL> <END> : new line with EOI.

Note: The response message is terminated by <NL> <END> for GPIB, and <NL> for RS-232C.



Figure 8-1 The Structure of Command Message

## 8.4 Traversal of the Command Tree

Multiple program message unit elements can be sent in a program message. The first command is always referred to the root node. Subsequent commands are referred to the same tree level as the previous command in a program message. A colon preceding a program message unit changes the header path to the root level.

Example:

OUTPut : PROTection : CLear	All colons are header separators.
: OUTPut : PROTection : CLear	Only the first colon is a specific root.
OUTPut : PROTection : CLear; : VOLT : AC 100	Only the third colon is a specific root.

## 8.5 Execution Order

The AC source executes program messages by the order received. Program message units except coupled commands are executed in order of reception. The execution of coupled commands is deferred until program message terminator is received. A coupled command sets parameters which are affected by the setting of other commands. Problems may arise, because the prior state of the AC source will affect the response of a coupled parameter to its programming.

For example, assume that the current output voltage range is LOW, a new state is desired with output voltage range HIGH, and amplify 220 Volt. If the commands

```
VOLTage : AC          220<PMT>
VOLTage : RANGeHIGH<PMT>
```

are sent, data out of range error will be produced. Reversing the order, or sending the commands in one program message can avoid such kind of error. For the above example, the program message

VOLTage : AC 220 ; VOLTage : RANGE HIGH<PMT>

can be sent without error.

## 8.6 The Commands of the AC Source

This subsection is going to talk about the syntax and parameters for all commands of the AC source. The examples given for each command are generic.

Syntax Forms	Definitions of syntax are in long form headers, whereas only short form headers appear in examples.
Parameters	Most commands require parameter.
Return Parameters	All queries return a parameter.
Models	If the commands are merely applied to specific models, these models will be listed in the Model only entry. If there is no Model only entry, the command will be applied to all models.

### 8.6.1 Common Command Dictionary

Common commands begin with a “ \* ”, and consist of three letters and/or one “ ? ” (query). Common commands and queries are listed alphabetically.

\*CLS Clear status

This command clears the following registers  
 (1) Questionable Status Event  
 (2) Status Byte  
 (3) Error Queue

\*ESE<n> Standard event status enabled

This command programs the Standard Event register bits. If one or more of the enabled events of the Standard Event register is set, the ESB of Status Byte Register is set too.

Bit Configuration of Standard Event Status Enabled Register

Bit Position	7	6	5	4	3	2	1	0
Bit Name	PON	- - -	CME	EXE	DDE	QYE	- - -	OPC
CME = Command error				DDE = Device-dependent error				
EXE = Execution error				OPC = Operation complete				
PON = Power-on				QYE = Query error				

\*ESE? Return standard event status enabled



\*ESR? The query reads the Standard Event Reading of the register clears it. The bits of configuration are the same as Standard Event Status Enabled Register.

\*IDN? Return the AC source identification string

Return Parameter Chroma ATE 61500,123456,1.00,1.01,1.02

Chroma ATE : Company name

61500 : Model name

123456 : Serial number

1.00, 1.01, 1.02 : Firmware version of display, waveform, remote.

\*RCL<n> Restore the values of the specific group which is previously stored in memory.

Parameter 1 - 3

\*SAV<n> Save the values into the specific group in memory.

Parameter 1 - 3

\* RST Reset the AC source to the initial states. It's better to wait about 7 seconds to send the next command.

\*SRE This command sets conditions of the Service Request Enabled Register. If one or more of the enabled events of the Status Byte Register is set, the MSS and RQS of Status Byte Register are set too.

\*SRE? This query returns the Service Request Enabled Register.

\*STB? This query returns the Status Byte Register.

Bit configuration of Status Byte Register

Bit Position	7	6	5	4	3	2	1	0
Condition	--	MSS RQS	ESB	MAV	QUES	--	--	--

ESB = event status byte summary

QUES = questionable status summary

RQS = request for service

MSS = master status summary

MAV = message available

\* TST? Return the self-test result of the AC source

## 8.6.2 Instrument Command Dictionary

The commands are listed in alphabetical order. Commands followed by question marks (?) take only the query forms. When commands take both the command and query forms, they are noted in the query syntax descriptions.

## 8.6.2.1 FETCH & MEASURE Sub-system

### **FETCh | MEASure**

[ : SCALar]	
: CURRent	
: AC?	Query the rms current
: DC?	Query the DC current level
: AMPLitude : MAXimum?	Query the peak current
: CRESfactor?	Query the current crest factor
: INRush	Query the inrush current
: FREQUency?	Query the frequency
: POWer	
: AC	
[: REAL]?	Query the true power
: APParent?	Query the apparent power
: REACTive	Query the reactive power
: PFACTor?	Query the power factor
: VOLTage	
: ACDC?	Query the rms voltage
: DC?	Query the DC voltage

This command lets the user get measurement data from the AC source. Two measurement commands are available: MEASure and FETCh. MEASure triggers the acquisition of new data before returning data. FETCh returns the previously acquired data from measurement buffer.

#### **FETCh [ : SCALar] : CURRent : AC?**

#### **MEASure [ : SCALar] : CURRent : AC?**

Description	: These queries return the rms current which is being output at the output terminal.
Query Syntax	: FETCh : CURRent : AC?, MEASure : CURRent : AC?
Return Parameters	: <NR2>

#### **FETCh [ : SCALar] : CURRent : DC?**

#### **MEASure [ : SCALar] : CURRent : DC?**

Description	: These queries return the DC current which is being output at the output terminal.
Query Syntax	: FETCh : CURRent : DC?, MEASure : CURRent : DC?
Return Parameters	: <NR2>

#### **FETCh [ : SCALar] : CURRent : AMPLitude : MAXimum?**

#### **MEASure [ : SCALar] : CURRent : AMPLitude : MAXimum?**

Description	: These queries return the absolute value of peak current.
Query Syntax	: FETCh : CURRent : AMPLitude : MAXimum?, MEASure : CURRent : AMPLitude : MAXimum?
Return Parameters	: <NR2>

#### **FETCh [ : SCALar] : CURRent : CRESfactor?**

#### **MEASure [ : SCALar] : CURRent : CRESfactor?**

Description	: These queries return the output current crest factor. It is the ratio of peak output current to rms output current.
Query Syntax	: FETCh : CURRent : CRESfactor?, MEASure : CURRent : CRESfactor?
Return Parameters	: <NR2>

**FETCh [ : SCALAr] : CURRent : INRush?****MEASure [ : SCALAr] : CURRent : INRush?**

Description : These queries return the inrush current which is being output at the output terminal.

Query Syntax : FETCh : CURRent : INRush?, MEASure : CURRent : INRush?

Return Parameters : <NR2>

**FETCh [ : SCALAr] : FREQuency?****MEASure [ : SCALAr] : FREQuency?**

Description : These queries return the output frequency in Hertz.

Query Syntax : FETCh : FREQuency?

MEASure : FREQuency?

Return Parameters : <NR2>

**FETCh [ : SCALAr] : POWer : AC [ : REAL] ?****MEASure [ : SCALAr] : POWer : AC [ : REAL] ?**

Description : These queries return the true power which is being output at output terminals in watts.

Query Syntax : FETCh : POWer : AC?

MEASure : POWer : AC?

Return Parameters : <NR2>

**FETCh [ : SCALAr] : POWer : AC : APParent?****MEASure [ : SCALAr] : POWer : AC : APParent?**

Description : These queries return the apparent power which is being output at output terminals in volt-amperes.

Query Syntax : FETCh : POWer : AC : APParent?

MEASure : POWer : AC : APParent?

Return Parameters : <NR2>

**FETCh [ : SCALAr] : POWer : AC : REACTive?****MEASure [ : SCALAr] : POWer : AC : REACTive?**

Description : These queries return the reactive power which is being output at output terminals in volt-amperes. Reactive power is

computed as:  $VAR = \sqrt{APPARENTPOWER^2 - REALPOWER^2}$

Query Syntax : FETCh : POWer : AC : REACTive?

MEASure : POWer : AC : REACTive?

Return Parameters : <NR2>

**FETCh [ : SCALAr] : POWer : AC : PFACTor?****MEASure [ : SCALAr] : POWer : AC : PFACTor?**

Description : These queries return the power factor which is being output at output terminals. Power factor is computed as:

$PF = TRUE\ POWER / APPARENT\ POWER$

Query Syntax : FETCh : POWer : AC : PFACTor?

MEASure : POWer : AC : PFACTor?

Return Parameters : <NR2>

**FETCh [ : SCALAr] : VOLTage : ACDC?****MEASure [ : SCALAr] : VOLTage : ACDC?**

Description : These queries return the rms voltage which is being output at the output terminals.

Query Syntax : FETCh [ : SCALar] : VOLTage : ACDC?  
 MEASure [ : SCALar] : VOLTage : ACDC?  
 Return Parameters : <NR2>

**FETCh [ : SCALar] : VOLTage : DC?**

**MEASure [ : SCALar] : VOLTage : DC?**

Description : These queries return the DC composition of output voltage which is being output at the output terminals.  
 Query Syntax : FETCh [ : SCALar] : VOLTage : DC?  
 MEASure [ : SCALar] : VOLTage : DC?  
 Return Parameters : <NR2>

### 8.6.2.2 OUTPUT Sub-system

**OUTPut**

[ : STATe]  
 : RELay  
 : SLEW  
     : VOLTage  
         : AC  
         : DC  
     : FREQuency  
 : COUPling  
 : IMPedance  
     : STATe  
     : RESistor  
     : INDuction  
 : MODE  
 : PROTection  
     : CLear

**OUTPut [ : STATe]**

Description : This command enables or disables the output of the AC source. Disable output is to set an output voltage amplitude at 0 Volt.  
 Query Syntax : OUTPut [ : STATe]?  
 Parameters : OFF | ON  
 Return Parameters : OFF | ON

**OUTPut : RELay**

Description : This command sets output relay on or off.  
 Query Syntax : OUTPut : RELay?  
 Parameters : OFF | ON, ON sets the output relay of the AC source on (closed). OFF sets the output relay of the AC source off (open).  
 Return Parameters : OFF | ON

**OUTPut : SLEW : VOLTage : AC**

Description : This command sets the slew rate of the AC output voltage.  
 Query Syntax : OUTPut : SLEW : VOLTage : AC?  
 Parameters : <NR2>, valid range: 0.000V/ms ~ 1200.000V/ms  
 Return Parameters : <NR2>

**OUTPut : SLEW : VOLTage : DC**

Description : This command sets the slew rate of the DC composition voltage.  
 Query Syntax : OUTPut : SLEW : VOLTage : DC?  
 Parameters : <NR2>, valid range: 0.000V/ms ~ 1000.000V/ms  
 Return Parameters : <NR2>

**OUTPut : SLEW : FREQUency**

Description : This command sets the slew rate of the output frequency.  
 Query Syntax : OUTPut : SLEW : FREQUency?  
 Parameters : <NR2>, valid range: 0.000 Hz/ms ~ 1600.000Hz/ms  
 Return Parameters : <NR2>

**OUTPut : COUPLing**

Description : This command selects the couple setting of the output signal.  
 Query Syntax : OUTPut : COUPLing?  
 Parameters : AC | DC | ACDC  
 Return Parameters : AC | DC | ACDC

**OUTPut : IMPedance : STATE**

Description : This command enables or disables the output impedance programming capability of the ac source.  
 Query Syntax : OUTPut : IMPedance : STATE?  
 Parameters : ON | OFF  
 Return Parameters : ON | OFF

**OUTPut : IMPedance : RESistor**

Description : This command sets the resistance of the output impedance.  
 Query Syntax : OUTPut : IMPedance : RESistor?  
 Parameters : <NR2>, valid range: 0.00  $\Omega$  ~ 1.00  $\Omega$   
 Return Parameters : <NR2>

**OUTPut : IMPedance : INDuction**

Description : This command sets the induction of the output impedance.  
 Query Syntax : OUTPut : IMPedance : INDuction?  
 Parameters : <NR2>, valid range: 0.0mH ~ 1.0mH  
 Return Parameters : <NR2>

**OUTPut : MODE**

Description : This command sets the operation mode. "FIXED" MODE is normal used.  
 Query Syntax : OUTPut : MODE?  
 Parameters : FIXED | LIST | PULSE | STEP | SYNTH | INTERHAR  
 Return Parameters : FIXED | LIST | PULSE | STEP | SYNTH | INTERHAR

**OUTPut : PROTEction : CLEAR**

Description : This command clears the latch that disables the output when an overcurrent (OC), overtemperature (OT), overpower (OP) or remote inhibit (RI) is detected. All conditions which have generated the faults must be removed before the latch is cleared.  
 Query Syntax : None  
 Parameters : None  
 Return Parameters : None

### 8.6.2.3 SOURCE Sub-system

#### [SOURce :]

##### CURRent

: LIMit  
 : DELay  
 : INRush  
     : STARt  
     : INTerval

##### FREQuency

[: {CW | IMMEDIATE}]

##### FUNCTion

: SHAPe  
 : SHAPe  
     : A  
     : A  
         : MODE  
         : THD  
         : AMP  
     : B  
     : B  
         : MODE  
         : THD  
         : AMP

##### VOLTage

[: LEVel][: IMMEDIATE][:AMPLitude]  
 : AC  
 : DC  
 : LIMit  
     : AC  
     : DC  
         : PLUS  
         : MINus  
 : RANGe

#### [SOURce :] CURRent : LIMit

Description : This command sets the rms current limit of the AC source for software protection.  
 Query Syntax : [SOURce :] CURRent : LIMit?  
 Parameters : <NR2>, valid range: 0.00 ~ maximum current spec. of the specific model. (unit: A)  
 Return Parameters : <NR2>

#### [SOURce :] CURRent : DELay

Description : This command sets the delay time for triggering over current protection.  
 Query Syntax : [SOURce :] CURRent : DELay?  
 Parameters : <NR2>, valid range: 0.0 ~ 5.0 (unit: 0.5 second)  
 Return Parameters : <NR2>

#### [SOURce :] CURRent : INRush : STARt

Description : This command sets the start time of the inrush current measurement.  
 Query Syntax : [SOURce :] CURRent : INRush : STARt?

Parameters : <NR2>, valid range: 0.0 ~ 999.9 (unit: ms)  
Return Parameters : <NR2>

**[SOURce :] CURRent : INRush : INTerval**

Description : This command sets the measuring interval of the inrush current measurement.  
Query Syntax : [SOURce :] CURRent : INRush : INTerval?  
Parameters : <NR2>, valid range: 0.0 ~ 999.9 (unit: ms)  
Return Parameters : <NR2>

**[SOURce :] FREQuency [: {CW | IMMEDIATE}]**

Description : The command sets the frequency of the output waveform of the AC source in Hz.  
Query Syntax : [SOURce :] FREQuency [: {CW | IMMEDIATE}]?  
Parameters : <NR2>, valid range: 15.00 ~ 1000.00 (unit: Hz)  
Return Parameters : <NR2>

**[SOURce :] FUNCtion : SHAPe**

Description : This command specifies the waveform buffer. There are two buffers for the output of the AC source, so the user must specify the contents of waveform buffer A or B of the AC source.  
Query Syntax : [SOURce :] FUNCtion : SHAPe?  
Parameters : A | B  
Return Parameters : A | B

**[SOURce :] FUNCtion : SHAPe : A**

Description : This command specifies the waveform shape of waveform buffer A.  
Query Syntax : [SOURce :] FUNCtion : SHAPe : A?  
Parameters : SINE | SQUA | CSIN | DST<01..30> | USR<01..06>  
Return Parameters : SINE | SQUA | CSIN | DST<01..30> | USR<01..06>

**[SOURce :] FUNCtion : SHAPe : A : MODE**

Description : This command selects the mode of the value for the clipped sine in waveform buffer A.  
Query Syntax : [SOURce :] FUNCtion : SHAPe : A : MODE?  
Parameters : AMP | THD  
Return Parameters : AMP | THD

**[SOURce :] FUNCtion : SHAPe : A : THD**

Description : This command sets the percentage of THD at which the clipped sine clips in waveform buffer A.  
Query Syntax : [SOURce :] FUNCtion : SHAPe : A : THD?  
Parameters : <NR2>, valid range: 0.0% ~ 43%  
Return Parameters : <NR2>

**[SOURce :] FUNCtion : SHAPe : A : AMP**

Description : This command sets the percentage of peak at which the clipped sine clips in waveform buffer A.  
Query Syntax : [SOURce :] FUNCtion : SHAPe : A : AMP?  
Parameters : <NR2>, valid range: 0.0% ~ 100%  
Return Parameters : <NR2>

**[SOURce :] FUNCtion : SHAPe : B**

Description : This command specifies the waveform shape of waveform buffer B.  
 Query Syntax : [SOURce :] FUNCtion : SHAPe : B?  
 Parameters : SINE | SQUA | CSIN | DST<01..30> | USR<01..06>  
 Return Parameters : SINE | SQUA | CSIN | DST<01..30> | USR<01..06>

**[SOURce :] FUNCtion : SHAPe : B : MODE**

Description : This command selects the mode of the value for the clipped sine in waveform buffer B.  
 Query Syntax : [SOURce :] FUNCtion : SHAPe : B : MODE?  
 Parameters : AMP | THD  
 Return Parameters : AMP | THD

**[SOURce :] FUNCtion : SHAPe : B : THD**

Description : This command sets the percentage of THD at which the clipped sine clips in waveform buffer B.  
 Query Syntax : [SOURce :] FUNCtion : SHAPe : B : THD?  
 Parameters : <NR2>, valid range: 0.0% ~ 43%  
 Return Parameters : <NR2>

**[SOURce :] FUNCtion : SHAPe : B : AMP**

Description : This command sets the percentage of peak at which the clipped sine clips in waveform buffer B.  
 Query Syntax : [SOURce :] FUNCtion : SHAPe : B : AMP?  
 Parameters : <NR2>, valid range: 0.0% ~ 100%  
 Return Parameters : <NR2>

**[SOURce :] VOLTage [: LEVel][: IMMEDIATE][: AMPLitude] : AC**

Description : This command sets the AC composition of output voltage in Volts.  
 Query Syntax : [SOURce :] VOLTage [: LEVel][: IMMEDIATE][: AMPLitude] : AC?  
 Parameters : <NR2>, valid range: 0.0 ~ 150.0 (in low range), 0.0 ~ 300.0 (in high range)  
 Return Parameters : <NR2>

**[SOURce :] VOLTage [: LEVel][: IMMEDIATE][: AMPLitude] : DC**

Description : This command sets the DC composition of output voltage in Volts.  
 Query Syntax : [SOURce :] VOLTage [: LEVel][: IMMEDIATE][: AMPLitude] : DC?  
 Parameters : <NR2>, valid range: -212.1 ~ 212.1 (in low range), -424.2 ~ 424.2 (in high range)  
 Return Parameters : <NR2>

**[SOURce :] VOLTage : LIMit : AC**

Description : This command sets the setting of Vac LIMIT which will restrict the value of Vac.  
 Query Syntax : [SOURce :] VOLTage : LIMit : AC?  
 Parameters : <NR2>, valid range: 0.0 ~ 300.0 (unit: V)  
 Return Parameters : <NR2>



**[SOURce :] VOLTage : LIMit : DC : PLUS**

Description : This command sets the setting of Vdc LIMIT(+) which will restrict the value of Vdc.  
 Query Syntax : [SOURce :] VOLTage : LIMit : DC : PLUS?  
 Parameters : <NR2>, valid range: 0.0 ~ 424.2 (unit: V)  
 Return Parameters : <NR2>

**[SOURce :] VOLTage : LIMit : DC : MINus**

Description : This command sets the setting of Vdc LIMIT(-) which will restrict the value of Vdc.  
 Query Syntax : [SOURce :] VOLTage : LIMit : DC : MINus?  
 Parameters : <NR2>, valid range: 0.0 ~- 424.2 (unit: V)  
 Return Parameters : <NR2>

**[SOURce :] VOLTage : RANGE**

Description : This command sets output voltage range with three options of LOW(150 V), HIGH(300 V), or AUTO.  
 Query Syntax : [SOURce :] VOLTage : RANGE?  
 Parameters : LOW | HIGH | AUTO  
 Return Parameters : LOW | HIGH | AUTO

**8.6.2.4 CONFIGURE Sub-system****[SOURce :]****CONFigure**

: INHibit  
 : EXTernal  
 : COUPling

**[SOURce :] CONFigure : INHibit?**

Description : This command sets REMOTE INHIBIT state. There are three states for the feature of remote inhibit : OFF, LIVE, and TRIG.  
 Query Syntax : [SOURce :] CONFigure : INHibit?  
 Parameters : OFF | LIVE | TRIG  
 Return Parameters : OFF | LIVE | TRIG

**[SOURce :] CONFigure : EXTernal**

Description : This command enables or disables the external controlled analog signal input from external devices.  
 Query Syntax : [SOURce :] CONFigure : EXTernal?  
 Parameters : OFF | ON  
 Return Parameters : OFF | ON

**[SOURce :] CONFigure : COUPling?**

Description : This command sets the coupling mode to present AC source output from external V reference: AC\_AMPLIFIER and DC\_LEVEL\_CTL.  
 Query Syntax : [SOURce :] CONFigure : COUPling?  
 Parameters : AC | DC  
 Return Parameters : AC | DC

### 8.6.2.5 PHASE Sub-system

**[SOURCE :]**  
**PHASe**  
 : ON  
 : OFF

#### **[SOURCE :] PHASe : ON**

Description : This command sets the transition angle of the waveform when it out. Default DEGREE ON is 0 degree.  
 Query Syntax : [SOURCE :] PHASe : ON?  
 Parameters : <NR2>, valid range: 0.0 ~ 359.9  
 Return Parameters : <NR2>

#### **[SOURCE :] PHASe : OFF**

Description : This command sets the transition angle of the waveform when it quit.  
 Query Syntax : [SOURCE :] PHASe : OFF?  
 Parameters : <NR2>, valid range: 0.0 ~ 360.0, 360.0 : means IMMED.  
 Return Parameters : <NR2>

### 8.6.2.6 TRACE Sub-system

**TRACe**  
 : RMS

#### **TRACe**

Description : This command sets waveform data of user-defined. It needs 1024 data points to construct a period of waveform. Users have to normalize the data as the maximum point equal to 32767 or the minimum point equal to -32767.  
 Syntax : **TRACe** <waveform\_name>, <amplitude> {,<amplitude>}  
 Parameters : <waveform\_name>:US<n>, n=1~6, <amplitude>:<NR1>, valid range: -32767 ~ 32767.  
 Example : **TRACe** US1 100 200 ...32767... 500 800 <= 1024 points  
 This command needs about 5 sec to execute.

#### **TRACe : RMS**

Description : This command sets the rms value of user's waveform. Users need to calculate the root mean square value of 1024 data points.  
 Syntax : **TRACe : RMS** <waveform\_name>, <rms>  
 Parameters : <waveform\_name>:US<n>, n=1~6, <rms>:<NR1>, valid range: 0 ~ 32767.  
 Example : **TRACe : RMS** US1 27000

### 8.6.2.7 LIST Sub-system

**[SOURce :]**  
**LIST**  
 : POINTs?  
 : COUNT  
 : DWELI  
 : SHAPe  
 : BASE  
 : VOLTage  
   : AC  
     : START  
     : END  
   : DC  
     : START  
     : END  
 : FREQuency  
   : START  
   : END  
 : DEGRee

**OUTPut**  
 : MODE

**TRIG**  
**TRIG : STATE?**

#### **[SOURce:] LIST : POINTs?**

Description : This command returns the number of sequences of the list mode.  
 Query Syntax : [SOURce:] LIST : POINTs?  
 Parameters : None  
 Return Parameters : <NR1>, valid range: 0 ~ 100

#### **[SOURce :] LIST : COUNT**

Description : This command sets the number of times that the list is executed before it is completed.  
 Query Syntax : [SOURce :] LIST : COUNT?  
 Parameters : <NR1>, valid range: 0 ~ 65535  
 Return Parameters : <NR1>

#### **[SOURce :] LIST : DWELI**

Description : This command sets the sequence of dwell time list points.  
 Query Syntax : [SOURce:] LIST : DWELI?  
 Parameters : <NR2>, ..., <NR2> valid range: 0 ~ 99999999.9 (unit: ms)  
 Return Parameters : <NR2>, ..., <NR2>

#### **[SOURce :] LIST : SHAPe**

Description : This command sets the sequence of waveform buffer list points .  
 Query Syntax : [SOURce:] LIST : SHAPe?  
 Parameters : A|B, ..., A|B  
 Return Parameters : A|B, ..., A|B

**[SOURCE :] LIST : BASE**

Description : This command sets time base of list.  
Query Syntax : [SOURCE:] LIST : BASE?  
Parameters : TIME | CYCLE  
Return Parameters : TIME | CYCLE

**[SOURCE :] LIST : VOLTage : AC : START**

Description : This command sets the sequence of AC start voltage list points.  
Query Syntax : [SOURCE:] LIST : VOLTage : AC : START?  
Parameters : <NR2>, ..., <NR2> valid range: 0.0 ~ 150.0 (in low range), 0.0 ~ 300.0 (in high range)  
Return Parameters : <NR1>, ..., <NR2>

**[SOURCE :] LIST : VOLTage : AC : END**

Description : This command sets the sequence of AC end voltage list points.  
Query Syntax : [SOURCE:] LIST : VOLTage : AC : END?  
Parameters : <NR2>, ..., <NR2> valid range: 0.0 ~ 150.0 (in low range), 0.0 ~ 300.0 (in high range)  
Return Parameters : <NR2>, ..., <NR2>

**[SOURCE :] LIST : VOLTage : DC : START**

Description : This command sets the sequence of DC start voltage list points.  
Query Syntax : [SOURCE:] LIST : VOLTage : DC : START?  
Parameters : <NR2>, ..., <NR2> valid range: -212.1 ~ 212.1 (in low range), -424.2 ~ 414.2 (in high range)  
Return Parameters : <NR1>

**[SOURCE :] LIST : VOLTage : DC : END**

Description : This command sets the sequence of DC end voltage list points.  
Query Syntax : [SOURCE:] LIST : VOLTage : DC : START?  
Parameters : <NR2>, ..., <NR2> valid range: -212.2 ~ 212.1 (in low range), -424.2 ~ 414.2 (in high range)  
Return Parameters : <NR2>, ..., <NR2>

**[SOURCE :] LIST : FREQuency : START**

Description : This command sets the sequence of start frequency list points.  
Query Syntax : [SOURCE:] LIST : FREQuency : START?  
Parameters : <NR2>, ..., <NR2> valid range: 15.00 ~ 1000.00 (unit: Hz)  
Return Parameters : <NR2>, ..., <NR2>

**[SOURCE :] LIST : FREQuency : END**

Description : This command sets the sequence of end frequency list points.  
Query Syntax : [SOURCE:] LIST : FREQuency : END?  
Parameters : <NR2>, ..., <NR2> valid range: 15.00 ~ 1000.00 (unit: Hz)  
Return Parameters : <NR2>, ..., <NR2>

**[SOURCE :] LIST : DEGRee**

Description : This command sets the sequence of phase angle list points.  
Query Syntax : [SOURCE:] LIST : DEGRee?  
Parameters : <NR2>, ..., <NR2> valid range: 0.0 ~ 359.9  
Return Parameters : <NR2>, ..., <NR2>

**OUTPut : MODE**

Description : This command sets the operation mode.  
 Query Syntax : OUTPut : MODE?  
 Parameters : FIXED | LIST | PULSE | STEP | SYNTH | INTERHAR  
 Return Parameters : FIXED | LIST | PULSE | STEP | SYNTH | INTERHAR

**TRIG**

Description : This command sets LIST mode in OFF, ON execution state after setting **OUTPut : MODE LIST**. If users want to change the parameters, it's necessary to set **TRIG OFF** then **OUTPut : MODE FIXED**. Then, set **OUTPut : MODE LIST** again to get ready to set **TRIG ON**.  
 Query Syntax : TRIG : STATE?  
 Parameters : OFF | ON  
 Return Parameters : OFF | RUNNING

**8.6.2.8 PULSE Sub-system****[SOURce :]****PULSe**

: VOLTage  
 : AC  
 : DC  
 : FREQuency  
 : SHAPe  
 : SPHase  
 : COUNT  
 : DCYClE  
 : PERiod

**OUTPut**

: MODE

**TRIG****TRIG : STATE?****[SOURce :] PULSe : VOLTage : AC**

Description : This command sets AC voltage in the duty cycle of PULSE mode.  
 Query Syntax : [SOURce :] PULSE : VOLTage : AC?  
 Parameters : <NR2>, valid range: 0.0 ~ 150.0 (in low range), 0.0 ~ 300.0 (in high range)  
 Return Parameters : <NR2>

**[SOURce :] PULSe : VOLTage : DC**

Description : This command sets the DC voltage in the duty cycle of PULSE mode.  
 Query Syntax : [SOURce :] PULSE : VOLTage : DC?  
 Parameters : <NR2>, valid range: -212.1 ~ 212.1 (in low range), -424.2 ~ 424.2 (in high range)  
 Return Parameters : <NR2>

### [SOURce :] PULSe : FREQuency

Description : This command sets the frequency during the duty cycle of PULSE mode.  
Query Syntax : [SOURce :] PULSE : FREQuency?  
Parameters : <NR2>, valid range: 15.00 ~ 1000.00 (unit: Hz)  
Return Parameters : <NR2>

### [SOURce :] PULSe : SHAPe

Description : This command selects the waveform buffer for PULSE mode.  
Query Syntax : [SOURce :] PULSE : SHAPe?  
Parameters : A | B  
Return Parameters : A | B

### [SOURce :] PULSe : SPHase

Description : This command sets the start phase angle of duty cycle of PULSE mode.  
Query Syntax : [SOURce :] PULSE : SPHase?  
Parameters : <NR2>, valid range: 0.0 ~ 359.9  
Return Parameters : <NR2>

### [SOURce :] PULSe : COUNT

Description : This command sets the number of times that the pulse is executed before it is completed.  
Query Syntax : [SOURce :] PULSE : COUNT?  
Parameters : <NR2>, valid range: 0 ~ 65535  
Return Parameters : <NR2>

### [SOURce :] PULSe : DCYClE

Description : This command sets the duty cycle of PULSE mode.  
Query Syntax : [SOURce :] PULSE : DCYClE?  
Parameters : <NR2>, valid range: 0 % ~ 100 %  
Return Parameters : <NR2>

### [SOURce :] PULSe : PERiod

Description : This command sets the period of the PULSE mode.  
Query Syntax : [SOURce :] PULSE : PERiod?  
Parameters : <NR2>, valid range: 0 ~ 99999999.9 (unit: ms)  
Return Parameters : <NR2>

### OUTPut : MODE

Description : This command sets the operation mode  
Query Syntax : OUTPut : MODE?  
Parameters : FIXED | LIST | PULSE | STEP | SYNTH | INTERHAR  
Return Parameters : FIXED | LIST | PULSE | STEP | SYNTH | INTERHAR

### TRIG

Description : This command sets PULSE mode in OFF execution state after setting **OUTPut : MODE PULSE**. If users want to change the parameters, it's necessary to set **TRIG OFF** then **OUTPut : MODE FIXED**. Then, set **OUTPut : MODE PULSE** again to get ready to set **TRIG ON**.  
Query Syntax : TRIG : STATE?  
Parameters : OFF | ON  
Return Parameters : OFF | RUNNING

### 8.6.2.9 STEP Sub-system

#### [SOURce :]

##### STEP

: VOLTage  
     : AC  
     : DC  
 : FREQuency  
 : SHAPe  
 : SPHase  
 : DVOLTage  
     : AC  
     : DC  
 : DFRequency  
 : DWELI  
 : COUNT

#### OUTPut

: MODE

#### TRIG

#### TRIG : STATE?

#### [SOURce :] STEP : VOLTage : AC

Description : This command sets the initial AC voltage of STEP mode.  
 Query Syntax : [SOURce :] STEP : VOLTage : AC?  
 Parameters : <NR2>, valid range: 0.0 ~ 150.0 (in low range), 0.0 ~ 300.0 (in high range)  
 Return Parameters : <NR2>

#### [SOURce :] STEP : VOLTage : DC

Description : This command sets the initial DC voltage of STEP mode.  
 Query Syntax : [SOURce :] STEP : VOLTage : DC?  
 Parameters : <NR2>, valid range: -212.1 ~ 212.1 (in low range), -424.2 ~ 414.2 (in high range)  
 Return Parameters : <NR2>

#### [SOURce :] STEP : FREQuency

Description : This command sets the initial frequency of STEP mode.  
 Query Syntax : [SOURce :] STEP : FREQuency?  
 Parameters : <NR2>, valid range: 15.00 ~ 1000.00 (unit: Hz)  
 Return Parameters : <NR2>

#### [SOURce :] STEP : SHAPe

Description : This command selects the waveform buffer for STEP mode.  
 Query Syntax : [SOURce :] STEP : SHAPe?  
 Parameters : A | B  
 Return Parameters : A | B

#### [SOURce :] STEP : SPHASE

Description : This command sets the start phase angle of STEP mode.  
 Query Syntax : [SOURce :] STEP : SPHase?  
 Parameters : <NR2>, valid range: 0.0 ~ 359.9  
 Return Parameters : <NR2>

**[SOURce :] STEP : DVOLTage : AC**

Description : This command sets the delta AC voltage in each step.  
Query Syntax : [SOURce :] STEP : DVOLTage : AC?  
Parameters : <NR2>, valid range: 0.0 ~ 150.0 (in low range), 0.0 ~ 300.0 (in high range)  
Return Parameters : <NR2>

**[SOURce :] STEP : DVOLTage : DC**

Description : This command sets the delta DC voltage in each step.  
Query Syntax : [SOURce :] STEP : DVOLTage : DC?  
Parameters : <NR2>, valid range: -212.2 ~ 212.1 (in low range), -424.2 ~ 424.2 (in high range)  
Return Parameters : <NR2>

**[SOURce :] STEP : DFRrequency**

Description : This command sets the delta frequency in each step.  
Query Syntax : [SOURce :] STEP : DFRrequency?  
Parameters : <NR2>, valid range: 0.00 ~ 1000.00 (unit: Hz)  
Return Parameters : <NR2>

**[SOURce :] STEP : DWELI**

Description : This command sets the dwell time in each step.  
Query Syntax : [SOURce :] STEP : DWELI?  
Parameters : <NR2>, valid range: 0 ~ 99999999.9 (unit: ms)  
Return Parameters : <NR2>

**[SOURce :] STEP : COUNT**

Description : This command sets the number of times that the step is executed before it is completed.  
Query Syntax : [SOURce :] STEP : COUNT?  
Parameters : <NR2>, valid range: 0 ~ 65535  
Return Parameters : <NR2>

**OUTPut : MODE**

Description : This command sets the operation mode  
Query Syntax : OUTPut : MODE?  
Parameters : FIXED | LIST | PULSE | STEP | SYNTH | INTERHAR  
Return Parameters : FIXED | LIST | PULSE | STEP | SYNTH | INTERHAR

**TRIG**

Description : This command sets STEP mode in OFF, ON execution state after setting **OUTPut : MODE STEP**. If users want to change the parameters, it's necessary to set **TRIG OFF** then **OUTPut : MODE FIXED**. Then, set **OUTPut : MODE STEP** again to get ready to set **TRIG ON**.  
Query Syntax : TRIG : STATE?  
Parameters : OFF | ON  
Return Parameters : OFF | RUNNING



### 8.6.2.10 Harmonic Sense Sub-system

#### [SOURCE :]

##### CONFigure

: HARMonic  
 : SOURce  
 : TIMes  
 : PARAmeter  
 : FREQUency

##### SENSe

: HARMonic

#### FETCH | MEASure

[ : SCALar]

: HARMonic  
 : THD? Return the % of total harmonic distortion  
 : FUNDamental? Return the fundamental  
 : ARRAY? Return the amplitude of all the harmonic order

#### [SOURCE :] CONFigure : HARMonic : SOURce

Description : This command sets the measurement source of harmonics analysis mode.  
 Query Syntax : [SOURCE :] CONFigure : HARMonic : SOURce?  
 Parameters : VOLT | CURR  
 Return Parameters : VOLT | CURR

#### [SOURCE :] CONFigure : HARMonic : TIMes

Description : This command sets the way of measurement result of harmonics analysis to display in LCD.  
 SINGLE: the display will remain the measurement data when execute.  
 CONTINUE: the display will refresh to new measurement data..  
 Query Syntax : [SOURCE :] CONFigure : HARMonic : TIMes?  
 Parameters : SINGLE | CONTINUE  
 Return Parameters : SINGLE | CONTINUE

#### [SOURCE :] CONFigure : HARMonic : PARAmeter

Description : This command sets the data form of each harmonic order.  
 Query Syntax : [SOURCE :] CONFigure : HARMonic : PARAmeter?  
 Parameters : VALUE | PERCENT  
 Return Parameters : VALUE | PERCENT

#### [SOURCE :] CONFigure : HARMonic : FREQUency

Description : This command sets the fundamental frequency of the source waveform.  
 Query Syntax : [SOURCE :] CONFigure : HARMonic : FREQUency?  
 Parameters : 50Hz | 60Hz  
 Return Parameters : 50Hz | 60Hz

#### SENSe : HARMonic

Description : This command sets the harmonics measurement on/off. "ON" must be executed before each new fetching or measuring. It

takes about 3 seconds to get a result. The parameter must be set to "OFF" if users want to measure other data.

Query Syntax : SENSE : HARMonic?  
 Parameters : ON | OFF  
 Return Parameters : ON | OFF

**FETCh [:SCALAr] : HARMonic : THD?**

**MEASure [:SCALAr] : HARMonic : THD?**

Description : These queries return the % of total harmonic distortion.  
 Query Syntax : FETCh : HARMonic : THD?  
 MEASure : HARMonic : THD?  
 Return Parameters : <NR2>

**FETCh [:SCALAr] : HARMonic : FUNDamental?**

**MEASure [:SCALAr] : HARMonic : FUNDamental?**

Description : These queries return the fundamental of the output current or output voltage.  
 Query Syntax : FETCh : HARMonic : FUNDamental?  
 MEASure : HARMonic : FUNDamental?  
 Return Parameters : <NR2>

**FETCh [:SCALAr] : HARMonic : ARRay?**

**MEASure [:SCALAr] : HARMonic : ARRay?**

Description : These queries return the amplitude of all the harmonic order.  
 Query Syntax : FETCh : HARMonic : ARRay?  
 MEASure : HARMonic : ARRay?  
 Return Parameters : <NR2>

### 8.6.2.11 SYNTHESIS Sub-system

**[SOURce :]**

**SYNThesis**

: COMPose  
 : AMPLitude  
 : PHASe  
 : FUNDamental  
 : DC  
 : FREQuency  
 : SPHase

**OUTPut**

: MODE

**TRIG**

**TRIG : STATE?**

**[SOURce :] SYNThesis : COMPose**

Description : This command sets the data form of each harmonic order.  
 VALUE : the absolute value. PERCENT : the percentage of fundamental voltage. Users can program 4 waveforms to execute.  
 Query Syntax : [SOURce :] SYNThesis : COMPose?  
 Parameters : VALUE1 | VALUE2 | PERCENT1 | PERCENT2  
 Return Parameters : VALUE1 | VALUE2 | PERCENT1 | PERCENT2

**[SOURce :] SYNThesis : AMPLitude**

Description : This command sets the amplitude of each harmonic order. The maximum number of order is 40.

Query Syntax : [SOURce :] SYNThesis : AMPLitude?

Parameters : <NR2>, ..., <NR2>  
valid range:

Order	VALUE	PERCENT
2 ~ 10	0 ~ 150.0	0 ~ 100.00
11 ~ 20	0 ~ 120.0	0 ~ 50.00
21 ~ 30	0 ~ 80.0	0 ~ 30.00
31 ~ 40	0 ~ 45.0	0 ~ 15.00

Return Parameters : <NR2>, ..., <NR2>

**[SOURce :] SYNThesis : PHASe**

Description : This command sets the phase angle of each harmonic order.

Query Syntax : [SOURce :] SYNThesis : PHASe?

Parameters : <NR2>, ..., <NR2> valid range: 0.0 ~ 359.9

Return Parameters : <NR2>, ..., <NR2>

**[SOURce :] SYNThesis : FUNDamental**

Description : This command sets the fundamental AC voltage of SYNTHESIS mode.

Query Syntax : [SOURce :] SYNThesis : FUNDamental?

Parameters : <NR2>, valid range: 0.0 ~ 150.0 (in low range), 0.0 ~ 300.0 (in high range)

Return Parameters : <NR2>

**[SOURce :] SYNThesis : DC**

Description : This command sets the DC voltage which adds to voltage waveform of SYNTHESIS mode.

Query Syntax : [SOURce :] SYNThesis : DC?

Parameters : <NR2>, valid range: -212.1 ~ 212.1 (in low range), -424.2 ~ 424.2 (in high range)

Return Parameters : <NR2>

**[SOURce :] SYNThesis : FREQuency**

Description : This command sets fundamental frequency of SYSTHESIS mode.

Query Syntax : [SOURce :] SYNThesis : FREQuency?

Parameters : 50Hz | 60Hz

Return Parameters : 50Hz | 60Hz

**[SOURce :] SYNThesis : SPHase**

Description : This command sets the start phase angle of SYNTHESIS mode.

Query Syntax : [SOURce :] SYNThesis : SPHase?

Parameters : <NR2>, valid range: 0.0 ~ 359.9

Return Parameters : <NR2>

**OUTPut : MODE**

Description : This command sets the operation mode. The user should quit the output before setting **OUTPut : MODE SYNTH.**

Query Syntax : OUTPut : MODE?  
 Parameters : FIXED | LIST | PULSE | STEP | SYNTH | INTERHAR  
 Return Parameters : FIXED | LIST | PULSE | STEP | SYNTH | INTERHAR

### TRIG

Description : This command sets SYNTHESIS mode in OFF, ON execution state after setting **OUTPut : MODE SYNTH**. If users want to change the parameters, it's necessary to set **TRIG OFF** then **OUTPut : MODE FIXED**. Then, set **OUTPut : MODE SYNTH** again to get ready to set **TRIG ON**.

Query Syntax : TRIG : STATE?  
 Parameters : OFF | ON  
 Return Parameters : OFF | RUNNING

## 8.6.2.12 INTERHARMONICS Sub-system

### [SOURce :]

**INTERharmonics**  
 : FREQuency  
 : START  
 : END  
 : LEVEL  
 : DWELI

### OUTPut

: MODE

### TRIG

**TRIG : STATE?**

**FETCh | MEASure**  
 : INTERharmonics  
 : FREQuency?

Query the sweeping frequency

### [SOURce :] INTERharmonics : FREQuency : START

Description : This command starts frequency of the sweep wave of INTERHARMONICS mode.

Query Syntax : [SOURce :] INTERharmonics : FREQuency : START?  
 Parameters : <NR2>, valid range: 0.01 ~ 2400.00 (unit: Hz)  
 Return Parameters : <NR2>

### [SOURce :] INTERharmonics : FREQuency : END

Description : This command sets the end frequency of the sweep wave of INTERHARMONICS mode.

Query Syntax : [SOURce :] INTERharmonics : FREQuency : END?  
 Parameters : <NR2>, valid range: 0.01 ~ 2400.00 (unit: Hz)  
 Return Parameters : <NR2>

### [SOURce :] INTERharmonics : LEVEL

Description : This command the r.m.s. magnitude of the sweep wave in percentage of fundamental.

Query Syntax : [SOURce :] INTERharmonics : LEVEL?

Parameters : <NR2>, valid range: 0% ~ 30% at 0.01 Hz ~ 500 Hz  
 0% ~ 20% at 500.01 Hz ~ 1000 Hz  
 0% ~ 10% at 1000.01 Hz ~ 2400 Hz

Return Parameters : <NR2>

#### [SOURce :] INTERharmonics : DWELI

Description : This command sets the dwell time of sweep wave.  
 Query Syntax : [SOURce :] INTERharmonics : DWELI?  
 Parameters : <NR2>, valid range: 0.01 ~ 9999.99 (unit: sec)  
 Return Parameters : <NR2>

#### OUTPut : MODE

Description : This command sets the operation mode  
 Query Syntax : OUTPut : MODE?  
 Parameters : FIXED | LIST | PULSE | STEP | SYNTH | INTERHAR  
 Return Parameters : FIXED | LIST | PULSE | STEP | SYNTH | INTERHAR

#### TRIG

Description : This command sets INTERHARMONICS mode in OFF, ON, PAUSE or CONTINUE execution state after setting **OUTPut : MODE INTERHAR**. If users want to change the parameters, it's necessary to set **TRIG OFF** then **OUTPut : MODE FIXED**. Then, set **OUTPut : MODE INTERHAR** again to get ready to set **TRIG ON**.  
 Query Syntax : TRIG : STATE?  
 Parameters : OFF | ON | PAUSE | CONTINUE  
 Return Parameters : OFF | RUNNING | COMPLETE

#### FETCh [:SCALAr] : INTERharmonics : FREQUency?

#### MEASure [:SCALAr] : INTERharmonics : FREQUency?

Description : These queries return the sweeping frequency superimposed on fundamental voltage.  
 Query Syntax : FETCh : INTERHARMonics : FREQUency?  
 MEASure : INTERHARMonics : FREQUency?  
 Return Parameters : <NR2>

### 8.6.2.13 STATUS Sub-system

#### STATus

: PRESet  
 : OPERation  
 [: EVENT]?  
 : ENABle  
 : QUESTionable  
 [: EVENT]?  
 : CONDition  
 : ENABle  
 : NTRansition  
 : PTRansition

**STATus : PRESet**

Description : This command sets the Enable, PTR, and NTR registers of the status groups to their power-on values.  
Query Syntax : STATus : PRESet  
Parameters : None  
Return Parameters : Always zero.

**STATus : OPERation [: EVENT]?**

Description : This command queries the Operation Status register.  
Query Syntax : STATus : OPERation [: EVENT]?  
Parameters : None  
Return Parameters : Always zero.

**STATus : OPERation : ENABLE**

Description : This command sets the Operation Status Enable register. The register is a mask which enables specific bits from the Operation Status register.  
Query Syntax : STATus : OPERation : ENABLE?  
Parameters : <NR1>, valid range: 0 ~ 255  
Return Parameters : <NR1>

**STATus : QUESTIONable [: EVENT]?**

Description : This command queries the Questionable Condition register.  
Query Syntax : STATus : QUESTIONable [: EVENT]?  
Parameters : None  
Return Parameters : Always zero.

**STATus : QUESTIONable : CONDition?**

Description : This query returns the value of the Questionable Condition register, which is a read-only register that holds the real-time questionable status of the AC source.  
Query Syntax : STATus : QUESTIONable : CONDition?  
Parameters : NONE  
Return Parameters : <NR1>, valid range: 0 ~ 511

**STATus : QUESTIONable [: EVENT] ?**

Description : This query returns the value of the Questionable Event register. The Event register is a read-only register which holds all events that are passed by the Questionable NTR and/or PTR filter. If QUES bit of the Service Request Enabled register is set, and the Questionable Event register > 0, QUES bit of the Status Byte register is set too.  
Query Syntax : STATus : QUESTIONable [: EVENT] ?  
Parameters : NONE  
Return Parameters : <NR1>, valid range: 0 ~ 511

**STATus : QUESTIONable : ENABLE**

Description : This command sets or reads the value of the Questionable Enable register. The register is a mask which enables specific bits from the Questionable Event register to set the questionable summary(QUES) bit of the Status Byte register.  
Query Syntax : STATus : QUESTIONable : ENABLE?  
Parameters : <NR1>, valid range: 0 ~ 511  
Return Parameters : <NR1>

**STATus : QUESTIONable : NTRansition**

Description : These commands make the values of the Questionable NTR register set or read.

These registers serve as polarity filters between the Questionable Enable and Questionable Event registers, and result in the following actions:

- \* When a bit of the Questionable NTR register is set at 1, a 1-to-0 transition of the corresponding bit in the Questionable Condition register will cause that bit in the Questionable Event register to be set.
- \* When a bit of the Questionable PTR register is set at 1, a 0-to-1 transition of the corresponding bit in the Questionable Condition register will cause that bit in the Questionable Event register to be set.
- \* If the two same bits in both NTR and PTR registers are set at 0, no transition of that bit in the Questionable Condition register can set the corresponding bit in the Questionable Event register.

Bit Configuration of Questionable Status Register

Bit Position	15-9	8	7	6	5	4	3	2	1	0
Condition	---	OVP	INP	OCP	FAN	SHT	OTP	OPP	INT-DD	INT-AD

OVP : Output voltage protection

INP : Line input protection.

OCP : Over current protection.

FAN : Fan failure.

SHT : Output short protection.

OTP : Over temperature protection.

OPP : Over power protection.

INT-DD : Inner DD power stage protection

INT-AD : Inner AD power stage protection

Query Syntax : STATus : QUESTIONable : NTRansition?

Parameters : <NR1>, valid range: 0 ~ 511

Return Parameters : <NR1>

**STATus : QUESTIONable : PTRansition**

Description : These commands make the values of the Questionable PTR register set or read. Please refer to the description of the previous command.

Query Syntax : STATus : QUESTIONable : PTRansition?

Parameter : <NR1>, valid range: 0 ~ 511

Return parameters : <NR1>

### 8.6.2.14 SYSTEM Sub-system

#### SYSTem

: ERRor?  
 : VERSion?  
 : LOCal  
 : REMote

#### SYSTem : ERRor?

Description : This command queries the error string of the command parser.  
 Query Syntax : SYSTem : ERRor?  
 Parameters : NONE  
 Return Parameters : Response error string:  
     No Error  
     Data Format Error  
     Data Range Error  
     Too Many Errors  
     Execution Error

#### SYSTem : VERSion?

Description : This query requests the AC source to identify itself.  
 Query Syntax : SYSTem : VERSion?  
 Parameters : NONE  
 Return Parameters : 1991.1

#### SYSTem : LOCal

Description : This command can only be used under the control of RS-232C.  
 If SYST : LOC is programmed, the AC source will be set in the LOCAL state, and the front panel will work.  
 Query Syntax : NONE  
 Parameters : NONE  
 Return Parameters : NONE

#### SYSTem : REMote

Description : This command can only be used under the control of RS-232C.  
 If SYST : REM is programmed, the AC source will be set in the REMOTE state, and the front panel will be disabled except the "<PAGE/EXIT> key."  
 Query Syntax : NONE  
 Parameters : NONE  
 Return Parameters : NONE

## 8.7 Command Summary

### Common Commands

\* CLS                   Clear status  
 \* ESE<n>               Standard event status enables  
 \* ESE?                 Return standard event status enables  
 \* IDN?                 Return the AC source identification  
 \* RCL<n>               Recall the AC source file  
 \* RST                  Reset the AC source to the initial states



* SAV<n>	Save the AC source status
* SRE	Set request enable register
* STB?	Return status byte
* TST?	Return the self-test result of the AC source

### Instrument Commands

#### FETCh | MEASure

```
[ : SCALar]
  : CURRent
    : AC?
    : DC?
    : AMPLitude : MAXimum?
    : CRESfactor?
    : INRush
  : FREQuency?
  : HARMonic
    : THD?
    : FUNDamental?
    : ARRay?
  : INTerharmonic
    : FREQuency?
  : POWer
    : AC
      [: REAL]?
      : APParent?
      : REACTive
      : PFACtor?
  : VOLTage
    : ACDC?
    : DC?
```

#### OUTPut

```
[ : STATe]
  : RELay
  : SLEW
    : VOLTage
      : AC
      : DC
    : FREQuency
  : COUPling
  : IMPedance
    : STATe
    : RESistor
    : INDuction
  : MODE
  : PROTection
    : CLear
```

#### [SOURce :]

```
CURRent
  : LIMit
  : DELay
  : INRush
  : START
```

```
      : INTerval
FREQuency
  [ : {CW | IMMEDIATE}]
VOLTagE
  [ : LEVel][ : IMMEDIATE][ : AMPLitude]
    : AC
    : DC
  : LIMit
    : AC
    : DC
      : PLUS
      : MINus
  : RANGe
FUNction
  : SHAPe
  : SHAPe
    : A
    : A
      : MODE
      : THD
      : AMP
    : B
    : B
      : MODE
      : THD
      : AMP

LIST
  : POINts?
  : COUNT
  : DWELI
  : SHAPe
  : BASE
  : VOLTagE
    : AC
      : START
      : END
    : DC
      : START
      : END
  : FREQuency
    : START
    : END
  : DEGRee
PULSe
  : VOLTagE
    : AC
    : DC
  : FREQuency
  : SHAPe
  : SPHase
  : COUNT
  : DCYCLE
  : PERiod
```

STEP  
: VOLTage  
: AC  
: DC  
: FREQuency  
: SHAPe  
: SPHase  
: DVOLTage  
: AC  
: DC  
: DFRequency  
: DWELI  
: COUNT  
SYNThesis  
: COMPose  
: AMPLitude  
: PHASe  
: FUNDamental  
: DC  
: FREQuency  
: SPHase  
INTerharmonics  
: FREQuency  
: START  
: END  
: LEVEL  
: DWELI

**[SOURce :]**  
PHASe  
: ON  
: OFF

**[SOURce :]**  
CONFigure  
: INHibit  
: EXTernal  
: COUPling  
: HARMonic  
: SOURce  
: TIMes  
: PARAmeter  
: FREQuency

**SENSe**  
: HARMonic

**TRACe**  
: RMS

**STATus**  
: OPERation  
[: EVENT]?  
: ENABle

- : QUEStionable
- [: EVENt]?
- : CONDItion
- : ENABle
- : NTRAnsiion
- : PTRAnsiion

**SYSTem**

- : ERRor?
- : VERSion?
- : LOCAl
- : REMote

**TRIG**

**TRIG : STATE?**

# Appendix A Pin Assignment of TTL Signal

9-Pin D-Type Male Connector:

Pin No.	Signal	Pin No.	Signal
1	GND	6	GND
2	/ Remote-Inhibit	7	GND
3	GND	8	/ FAULT-OUT
4	AC-ON	9	---
5	---		

/ Remote-Inhibit: When voltage level of this pin becomes LOW, it can inhibit the output of AC source, or excite the action of mode ( See 3.6.1 ).

AC-ON: When AC source output voltage, this pin will becomes HIGH, and it becomes LOW when quit output.

/ FAULT-OUT: The voltage level of this pin is HIGH if AC source is in normal state. It becomes LOW when AC source is in protection state.

Connecting the / FAULT-OUT signal of TTL PIN8 on AC Source rear panel to TTL PIN8 on A615003 rear panel as turning on the functions of A615003 thus it can be activated.



## Appendix B Built-in Waveforms

**DST01**

Harmonic	%	$\theta$
5	9.8	0
7	15.8	0
8	2.16	0

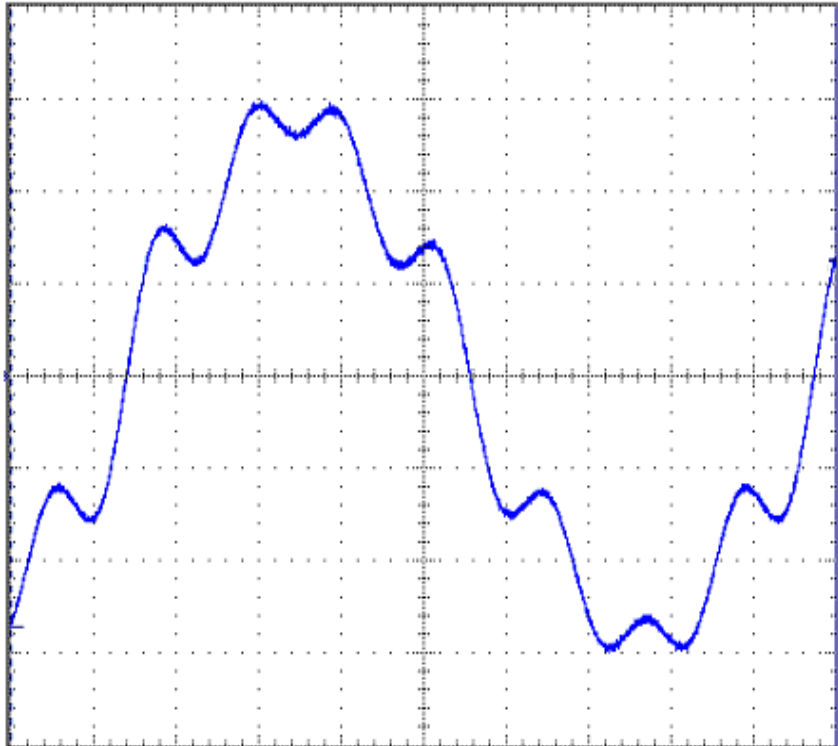
**DST02**

Harmonic	%	$\theta$
3	1.44	0
7	1.47	0
19	1.95	0

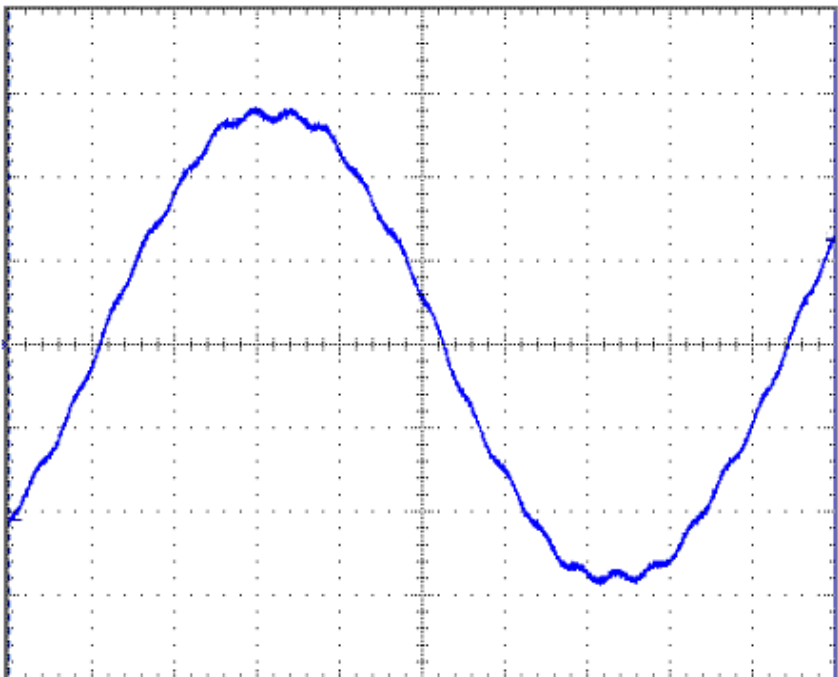

**DST03**

Harmonic	%	$\theta$
3	1.96	0
5	1.37	0
7	1.98	0
23	1.42	0
31	1	0

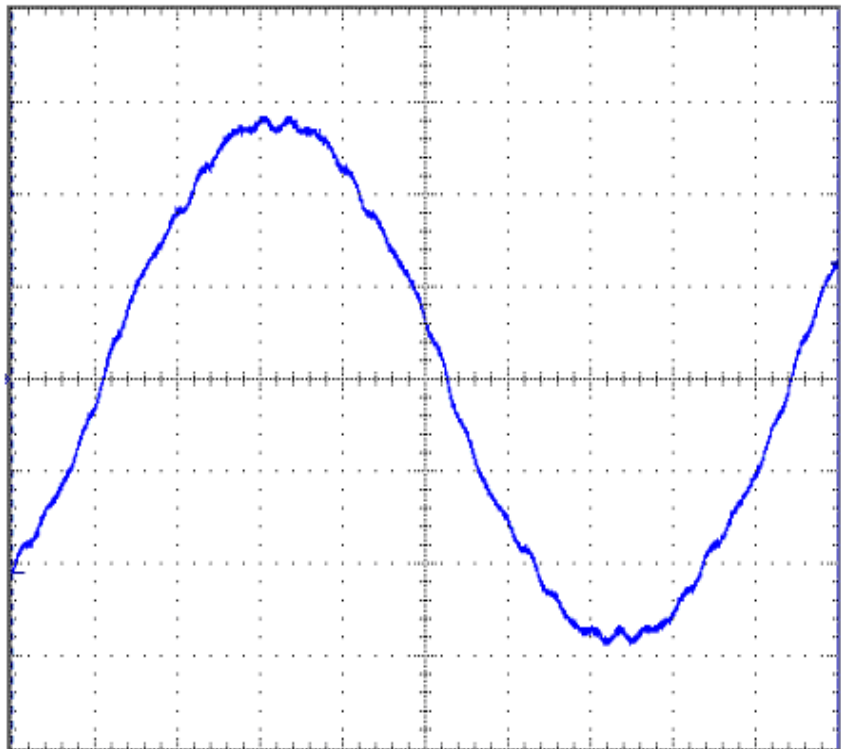

**DST04**

Harmonic	%	$\theta$
3	2.45	0
5	1.88	0
7	2.46	0
23	1.95	0
25	1.09	0
31	1.52	0
33	1.09	0

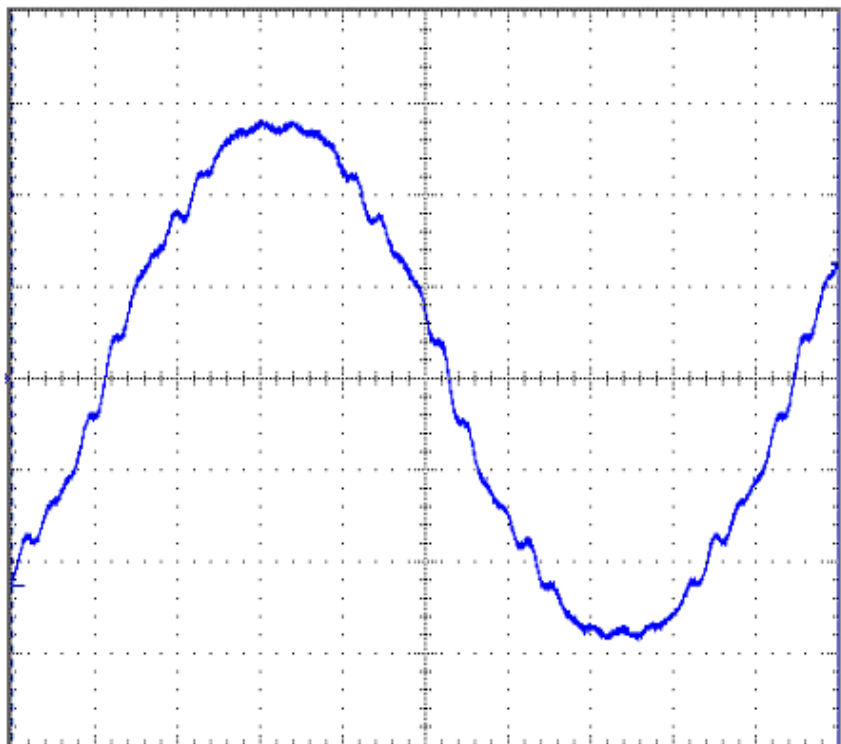



**DST05**

Harmonic	%	$\theta$
3	2.45	0
5	1.88	0
7	2.46	0
23	1.95	0
25	1.09	0
31	1.52	0
33	1.09	0

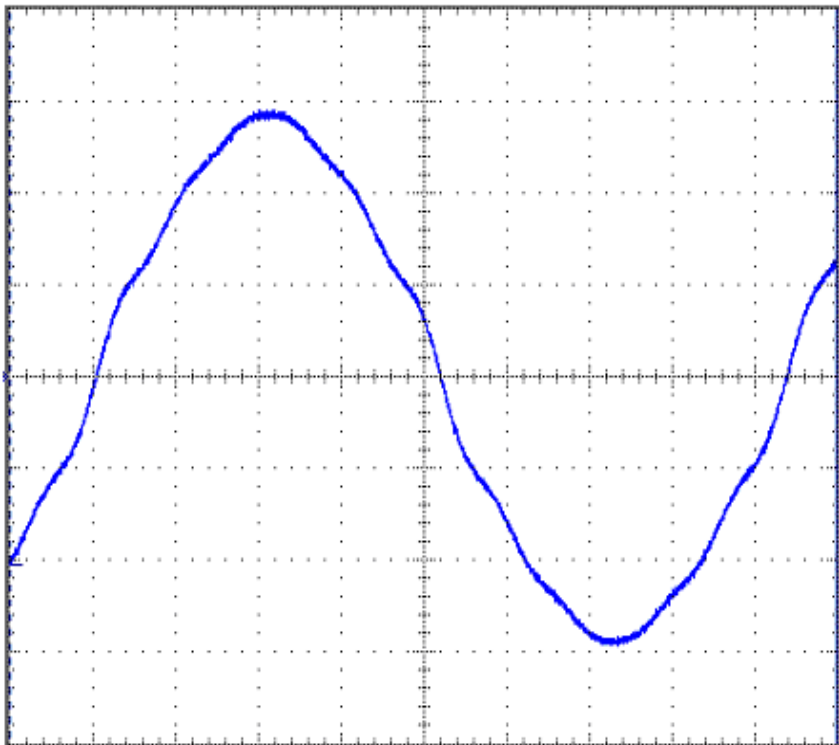
**DST06**

Harmonic	%	$\theta$
3	1.6	0
5	4.17	0
7	3.4	0
15	1.02	0
19	2.92	0

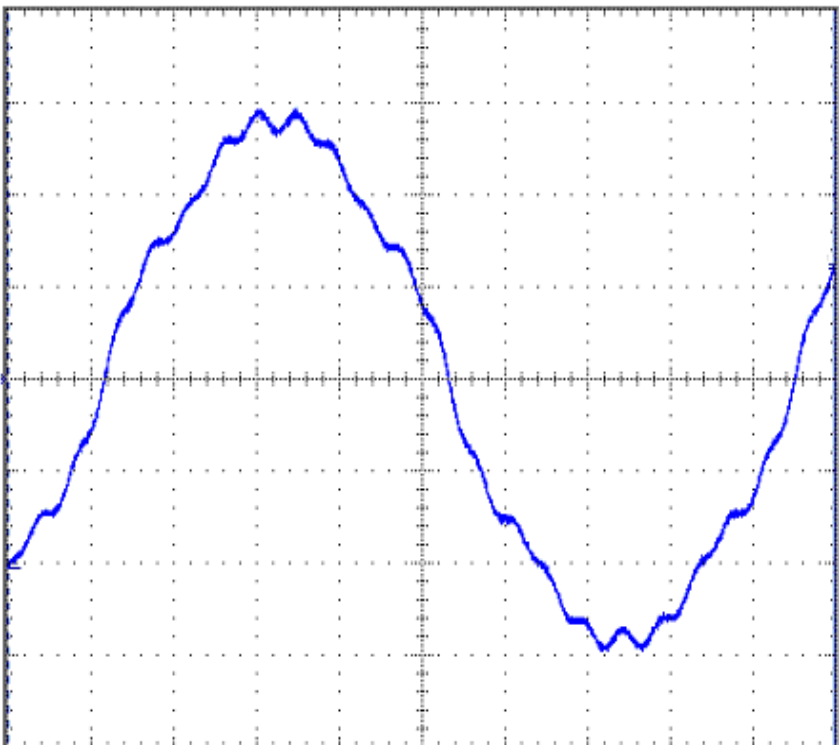

**DST07**

Harmonic	%	$\theta$
3	2.17	0
5	5.59	0
7	2.79	0
9	4.56	0
11	2.92	0
15	1.35	0
21	0.99	0

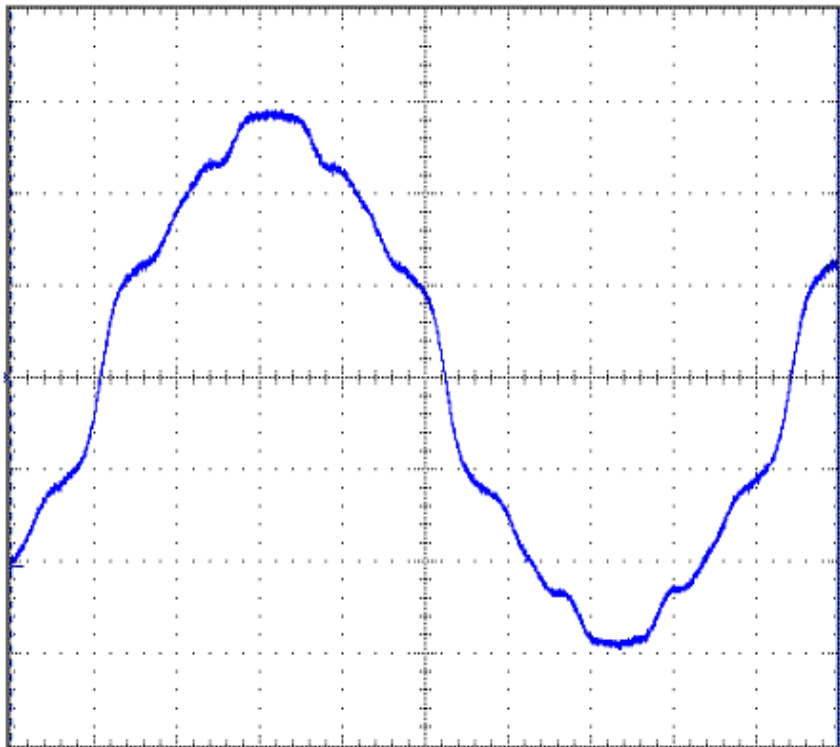

**DST08**

Harmonic	%	$\theta$
3	4.86	0
5	1.58	0
7	2.64	0
11	1.37	0
15	1.95	0
17	1.06	0

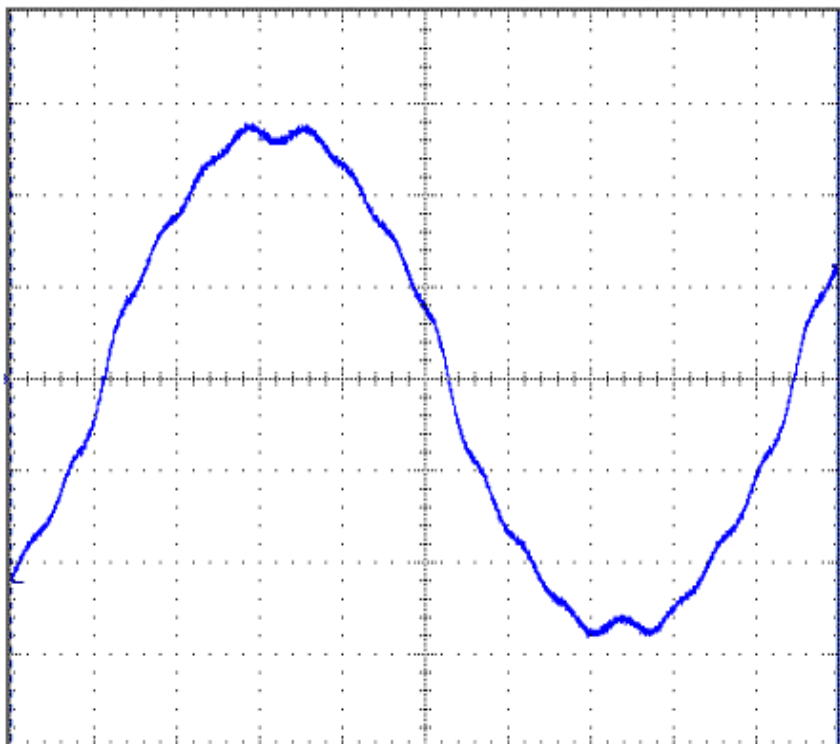

**DST09**

Harmonic	%	$\theta$
3	7.27	0
5	2.39	0
7	4.01	0
11	2.07	0
13	1.03	0
15	2.94	0
17	1.59	0
19	1	0
21	1.04	0
23	1.19	0
25	1.03	0

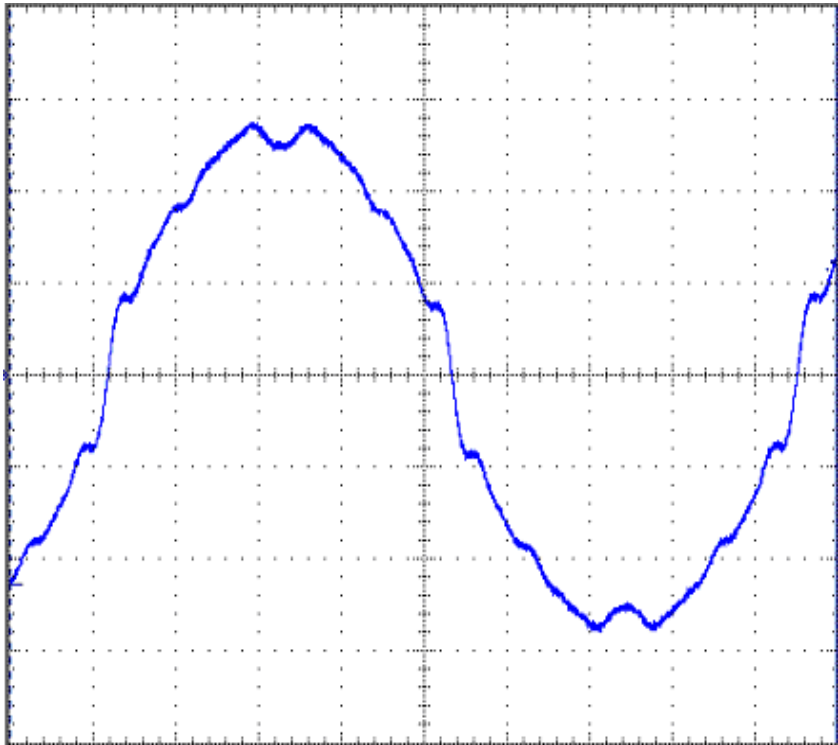
**DST10**

Harmonic	%	$\theta$
3	9.78	0
5	3.19	0
7	5.37	0
9	1.17	0
11	2.76	0
13	1.37	0
15	3.92	0
17	2.13	0
19	1.34	0
21	1.39	0
23	1.59	0
25	1.36	0

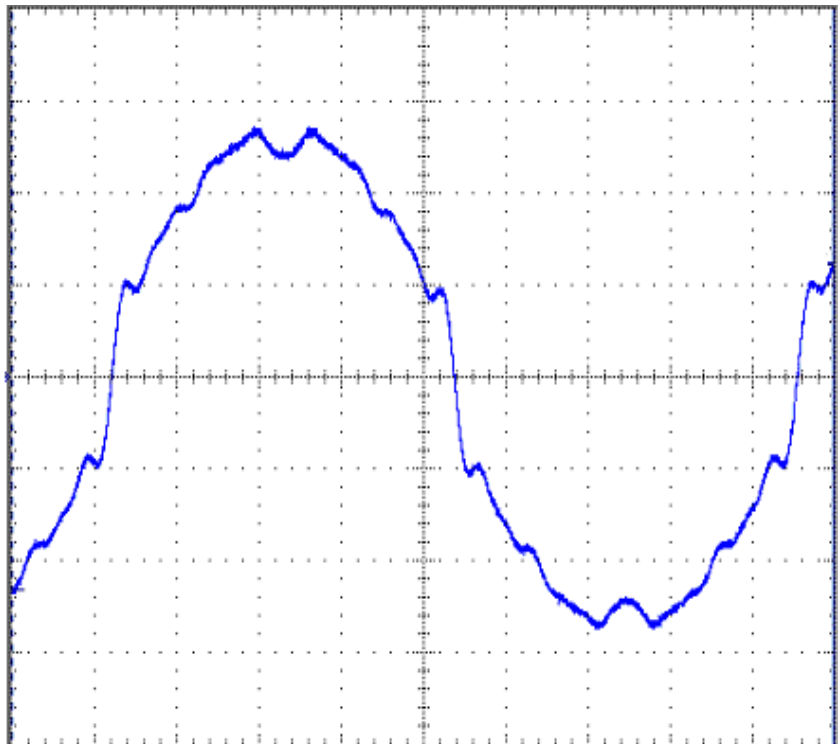

**DST11**

Harmonic	%	$\theta$
3	17.72	0

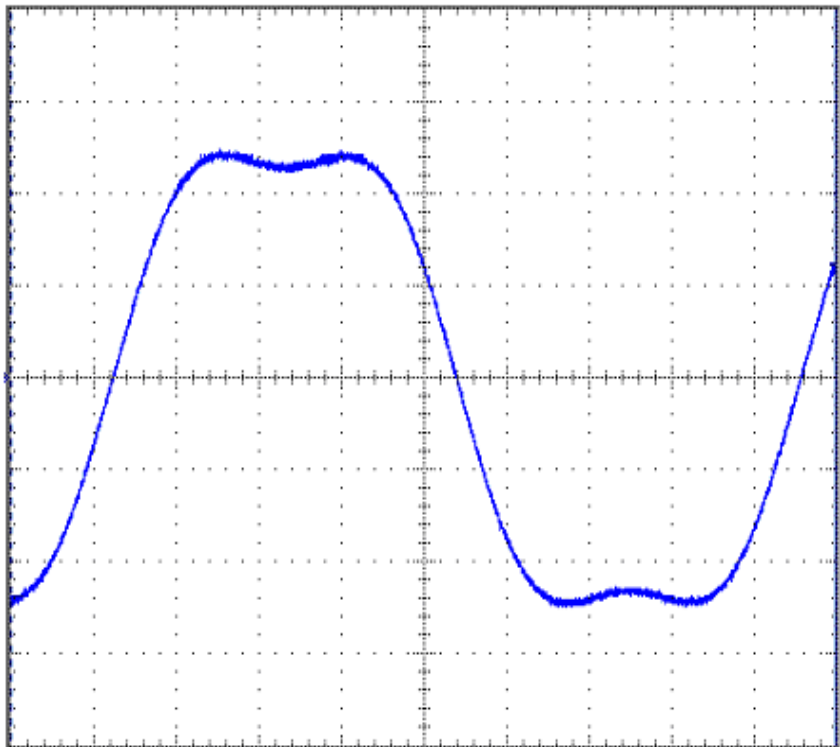

**DST12**

Harmonic	%	$\theta$
3	21.21	0

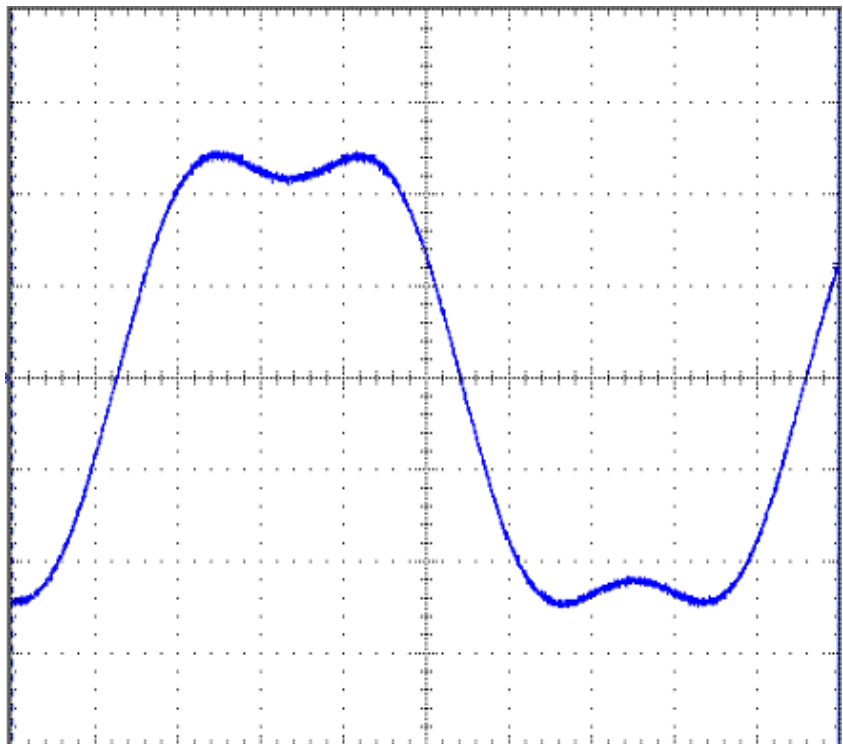

DST13

Harmonic	%	$\theta$
3	24.48	0

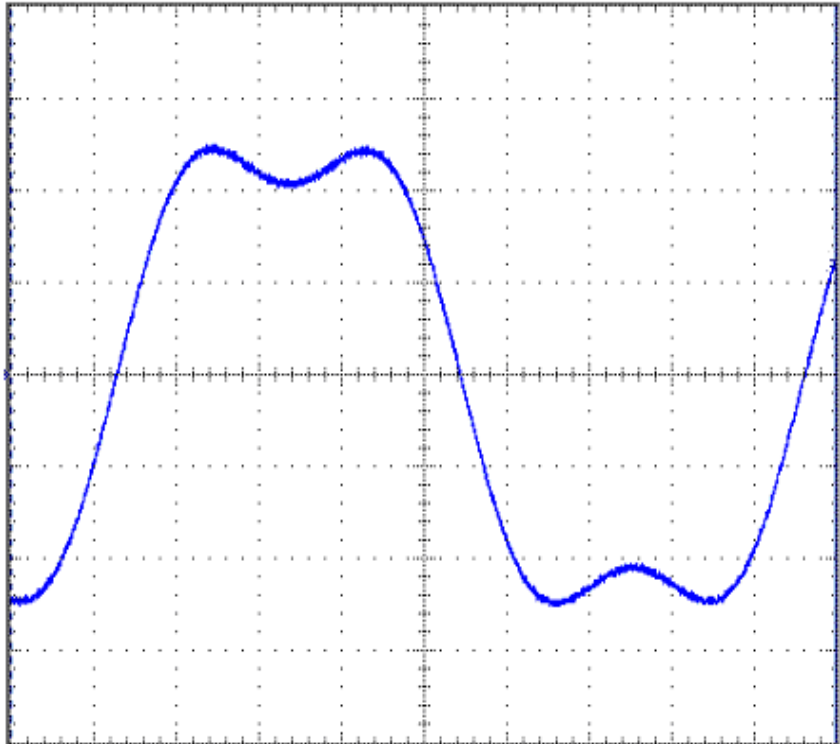

DST14

Harmonic	%	$\theta$
2	2.19	0
5	9.83	0
7	15.76	0
8	2.34	0

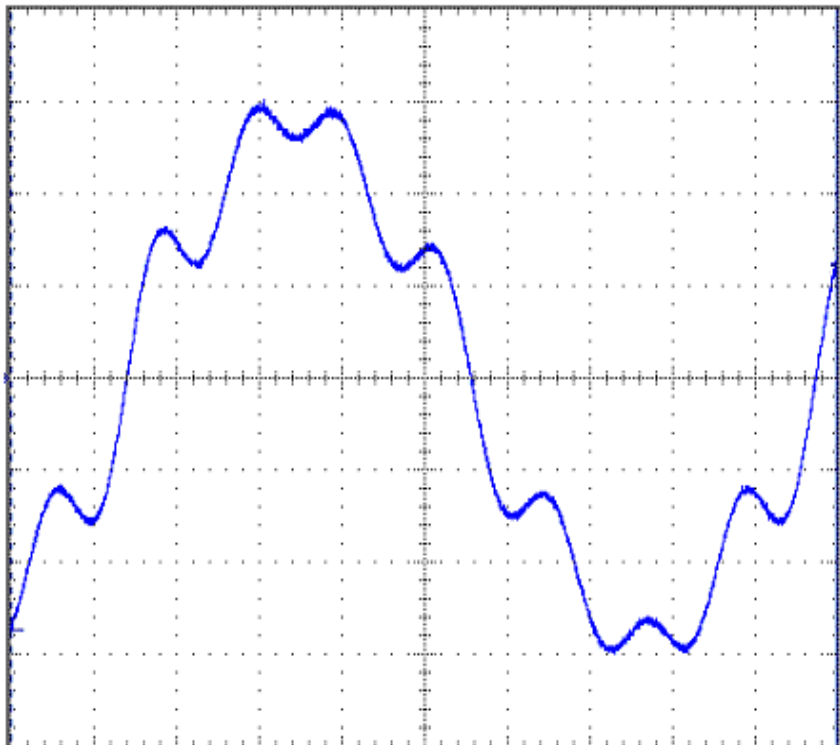

**DST15**

Harmonic	%	$\theta$
2	1.04	0
5	4.9	0
7	7.86	0
8	1.14	0

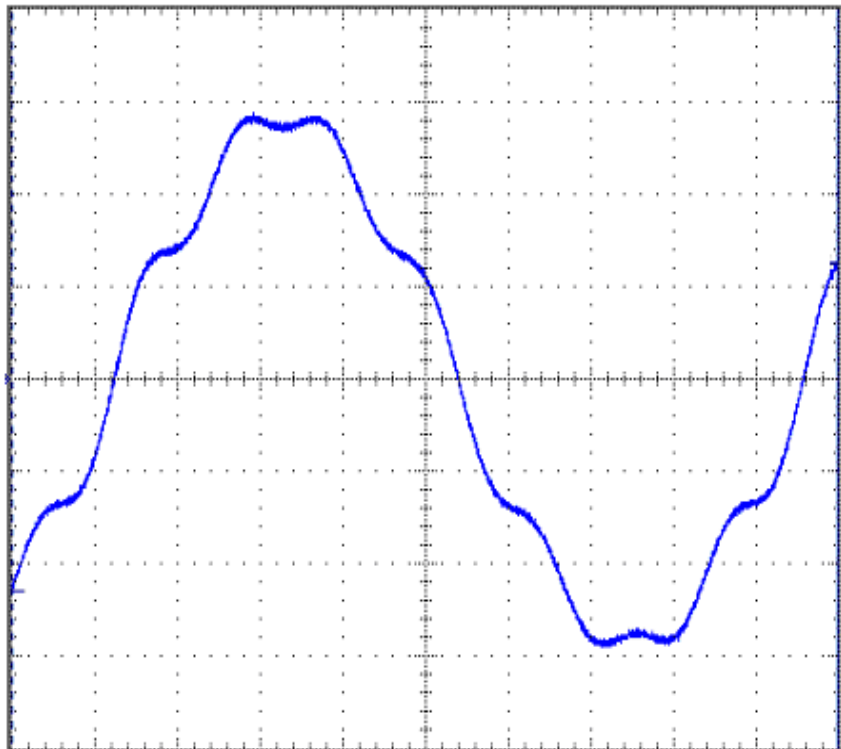

**DST16**

Harmonic	%	$\theta$
5	2.42	0
7	73.91	0

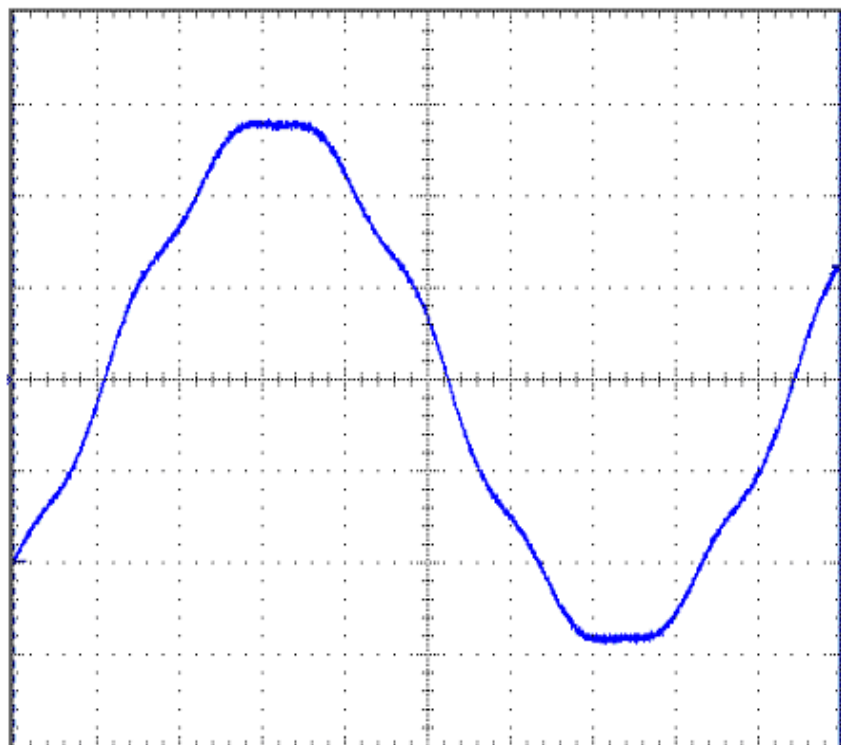

DST17

Harmonic	%	$\theta$
3	11.08	180
5	4.05	0
7	2.03	180
9	1.27	0

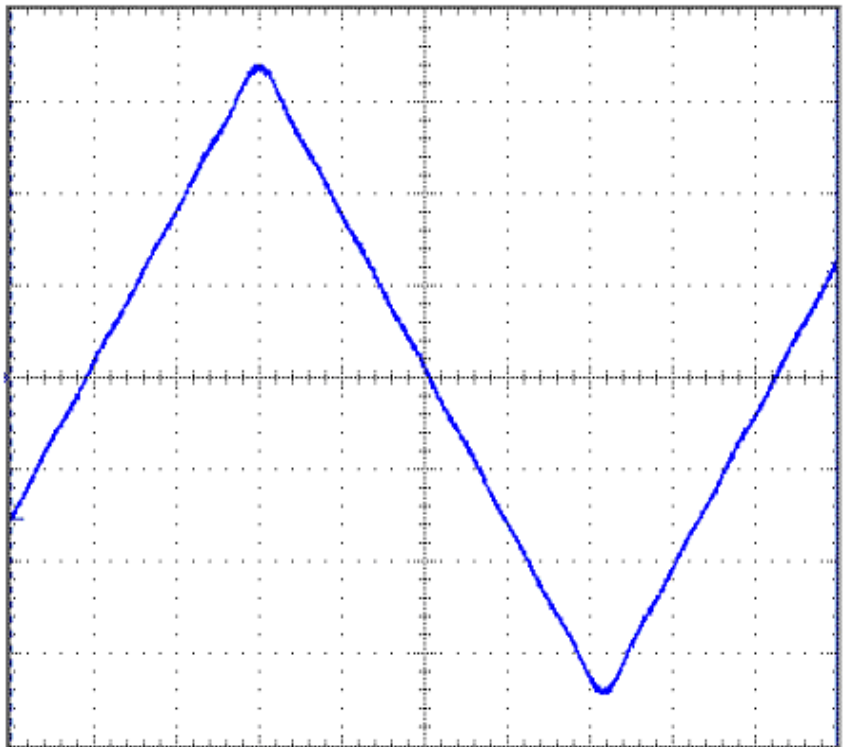

DST18

Harmonic	%	$\theta$
3	7.16	0
5	3.46	180

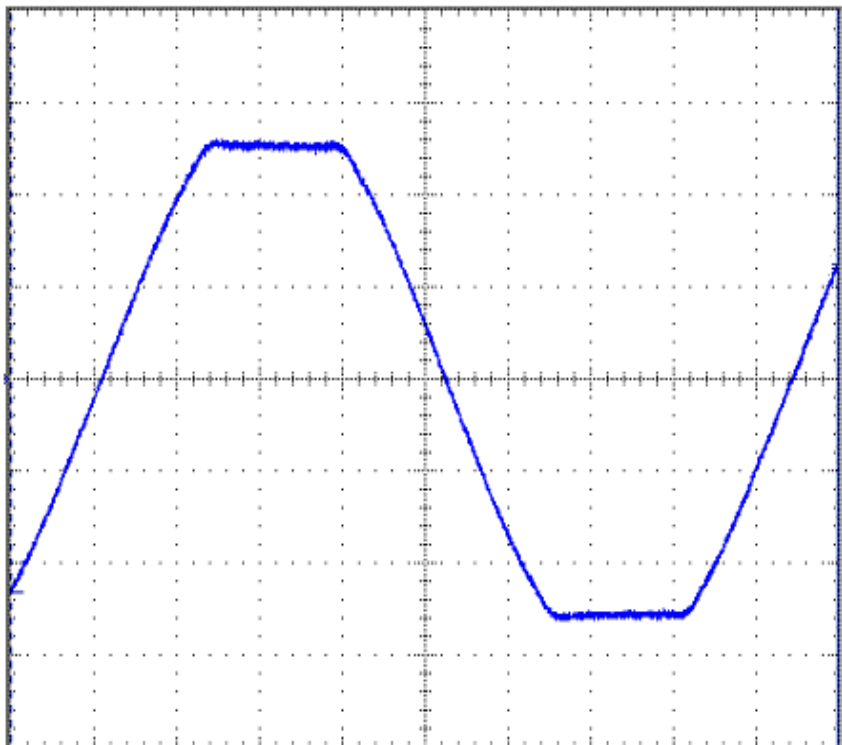

**DST19**

Harmonic	%	$\theta$
3	8.07	0
5	3.55	180
9	0.96	0
13	0.92	180

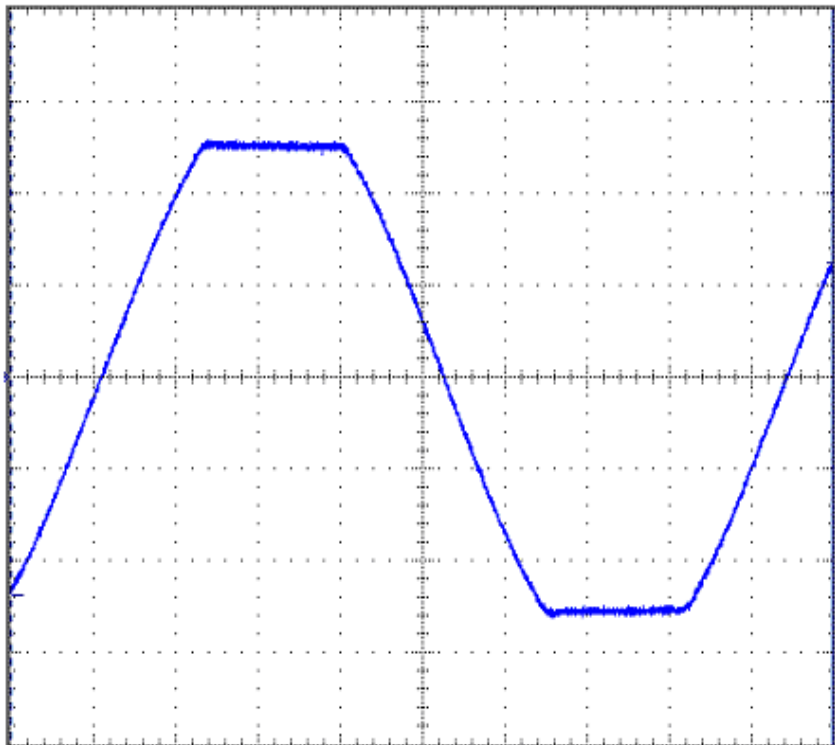

**DST20**

Harmonic	%	$\theta$
3	9.38	0
5	3.44	180
9	1.12	0
13	0.5	180

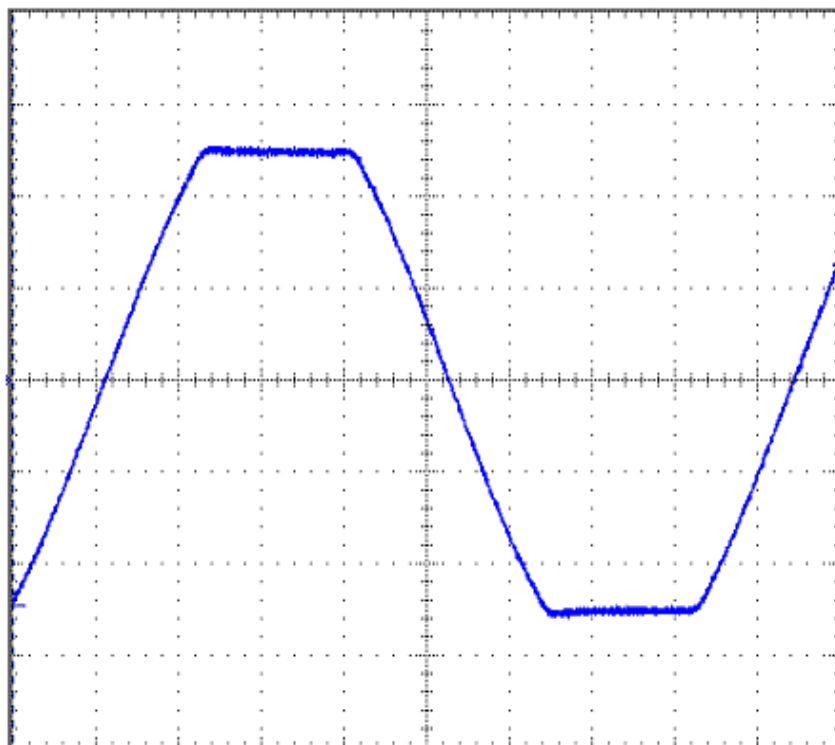



**DST21**

Harmonic	%	$\theta$
3	2.06	180
5	1.77	0
7	1.62	180
9	1.23	0
11	0.91	180
13	0.54	0
23	0.51	0
25	0.53	180

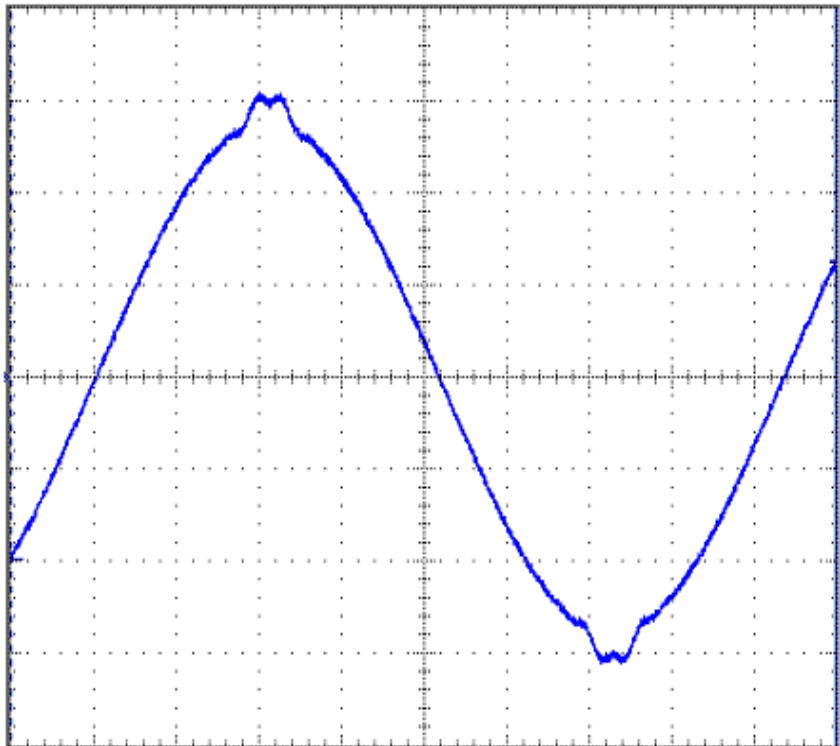
**DST22**

Harmonic	%	$\theta$
3	3.08	180
5	2.72	0
7	2.43	180
9	1.97	0
11	1.41	180
13	0.86	0
21	0.62	180
23	0.73	0
25	0.77	180
27	0.69	0
29	0.56	180

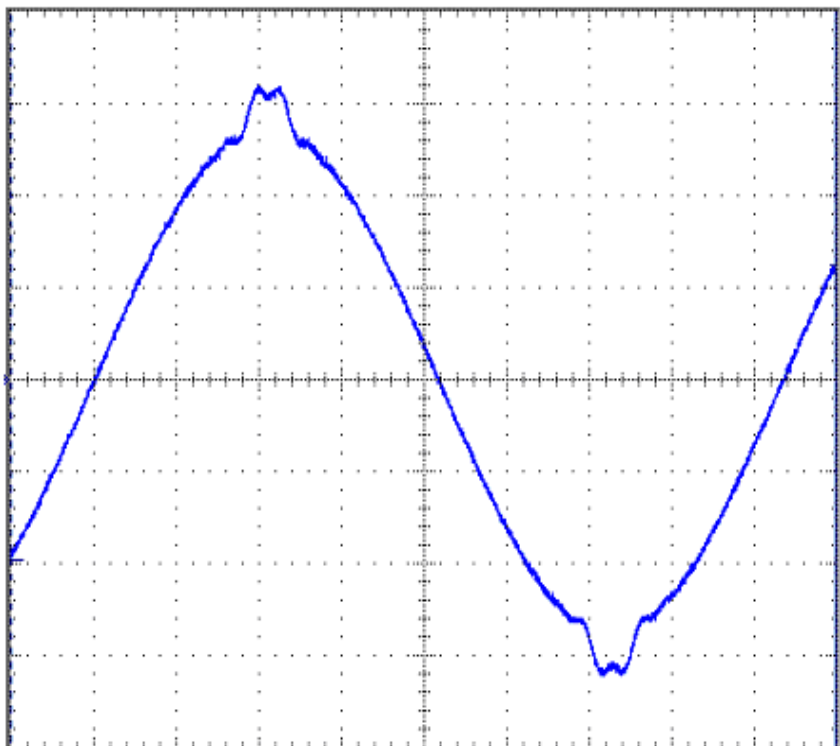

**DST23**

Harmonic	%	$\theta$
2	0.13	180
3	4.28	180
5	3.77	0
7	3.27	180
9	2.57	0
11	1.93	180
13	1.22	0
15	0.55	180
19	0.46	0
21	0.83	180
23	0.97	0
25	1.04	180
29	0.75	180

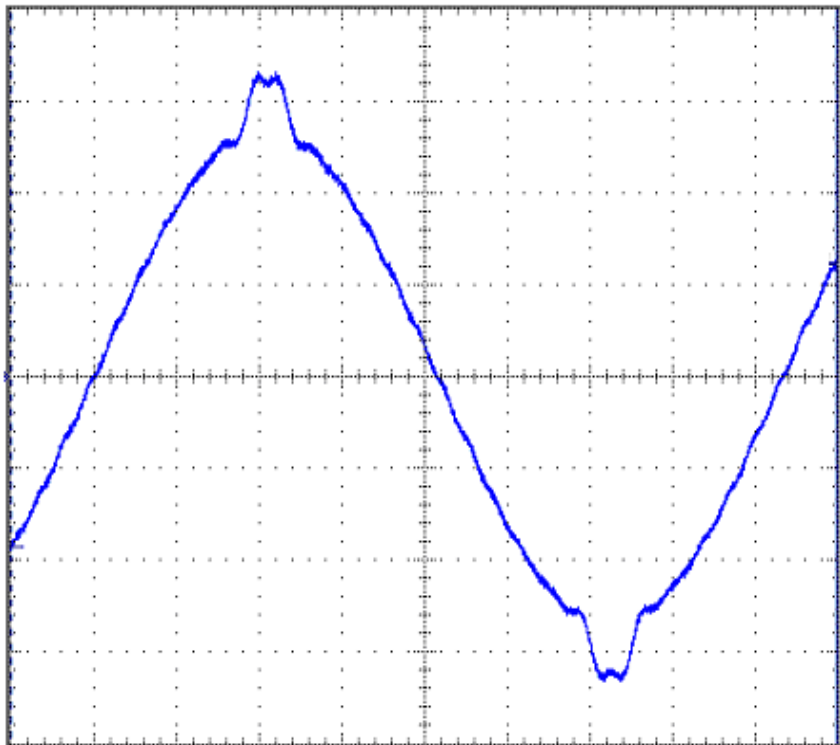

**DST24**

Harmonic	%	$\theta$
3	5.74	180
5	5.11	0
7	4.44	180
9	3.52	0
11	2.63	180
13	1.65	0
15	0.8	180
19	0.61	0
21	1.07	180
23	1.28	0
25	1.35	180
27	1.22	0
29	0.98	180

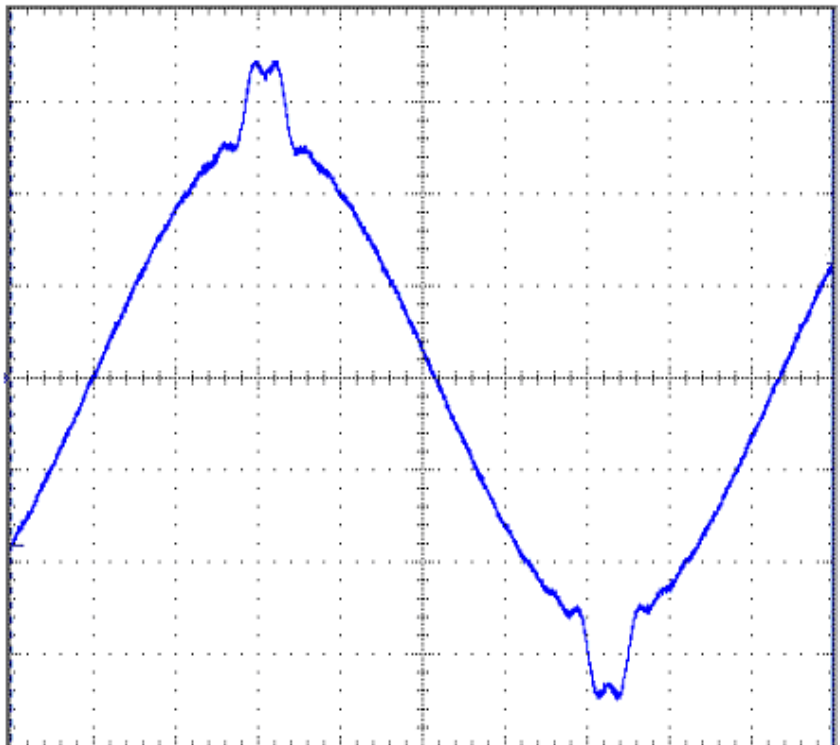

**DST25**

Harmonic	%	$\theta$
3	7.35	180
5	6.6	0
7	5.74	180
9	4.57	0
11	3.41	180
13	2.16	0
15	1.04	180
19	0.74	0
21	1.35	180
23	1.64	0
25	1.73	180
27	1.56	0
29	1.24	180

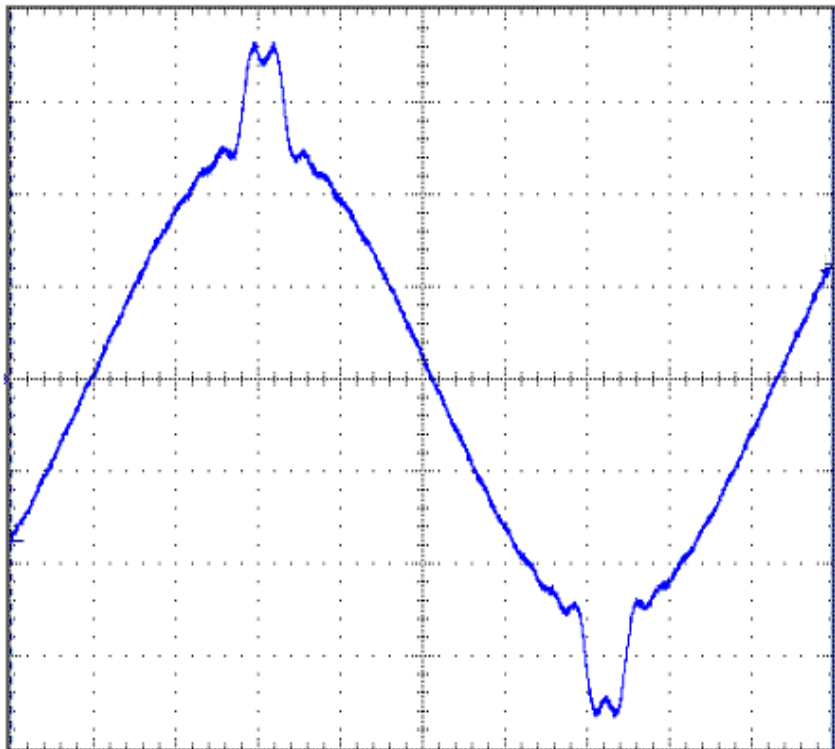
**DST26**

Harmonic	%	$\theta$
5	3.41	0
7	2.55	0
11	9.22	0
13	7.68	0
17	0.9	0
19	0.9	0
23	3.88	0
25	3.56	0
31	0.5	0
35	2.34	0
37	2.21	0

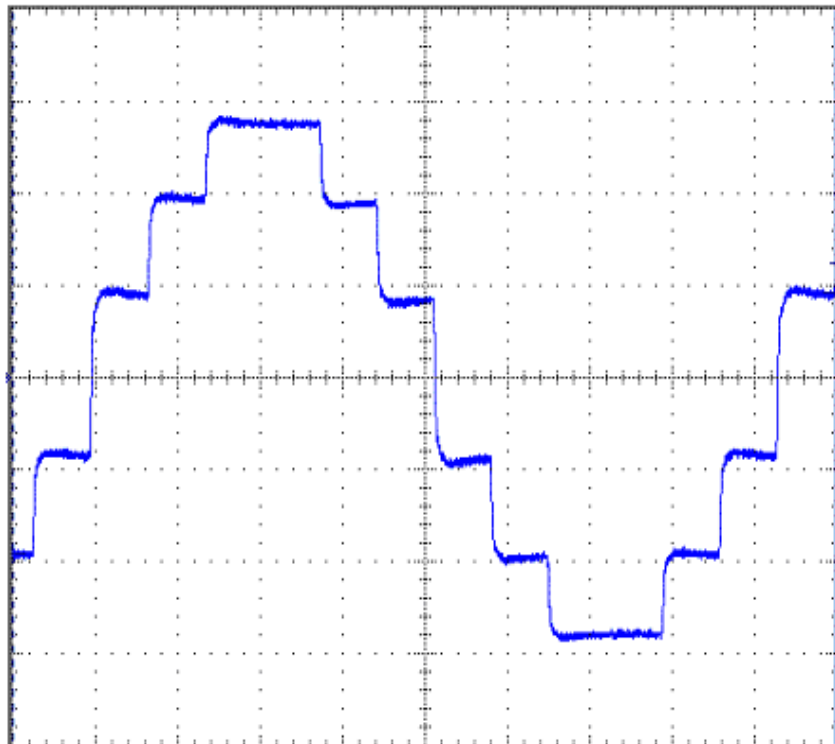

**DST27**

Harmonic	%	$\theta$
21	1.24	0
23	4.91	0
25	2.21	0

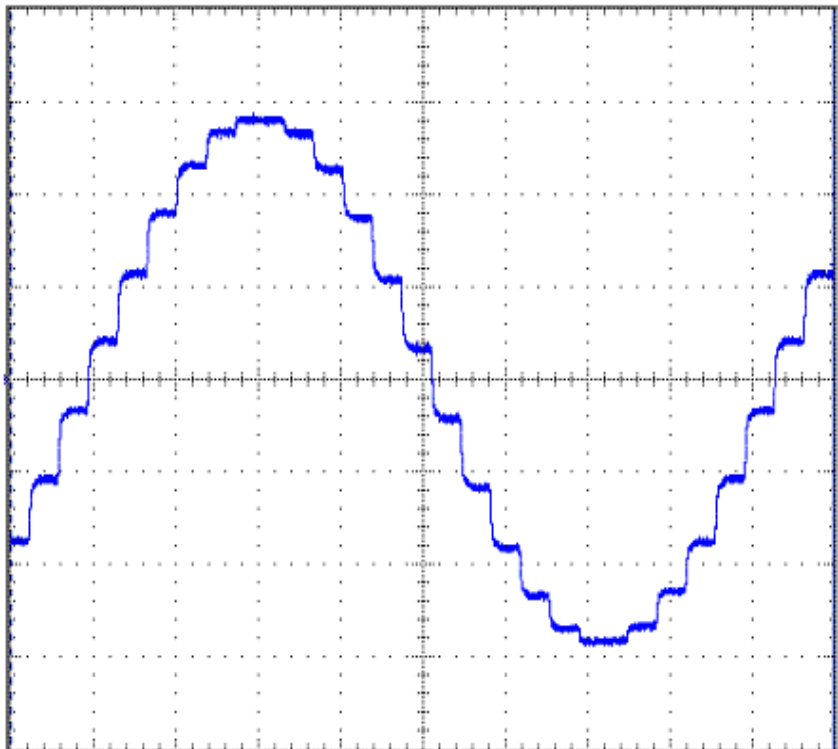

**DST28**

Harmonic	%	$\theta$
3	33.39	0
5	20.01	0
7	13.76	0
9	10.7	0
11	8.39	0
13	7.06	0
15	5.85	0
17	4.86	0
19	4.86	0
21	4.52	0
23	4	0
25	3.49	0
27	2.91	0
29	2.45	0
31	1.94	0
33	1.95	0
35	1.91	0
37	1.89	0
39	1.83	0

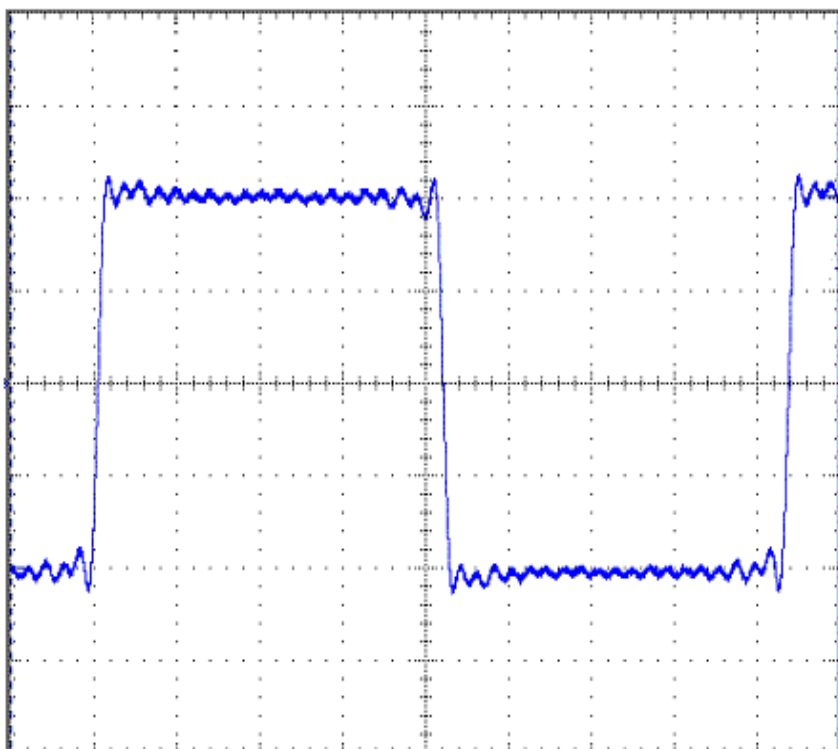

**DST29**

Harmonic	%	$\theta$
3	33.39	0
5	20.01	0
7	13.75	0
9	10.71	0
11	8.37	0
13	7.05	0
15	5.84	0
17	4.84	0
19	4.83	0
21	4.48	0
23	3.93	0
25	0.89	0
27	0.92	0
29	0.94	0
31	0.94	0
33	0.94	0
35	0.93	0
37	0.92	0
39	0.91	0

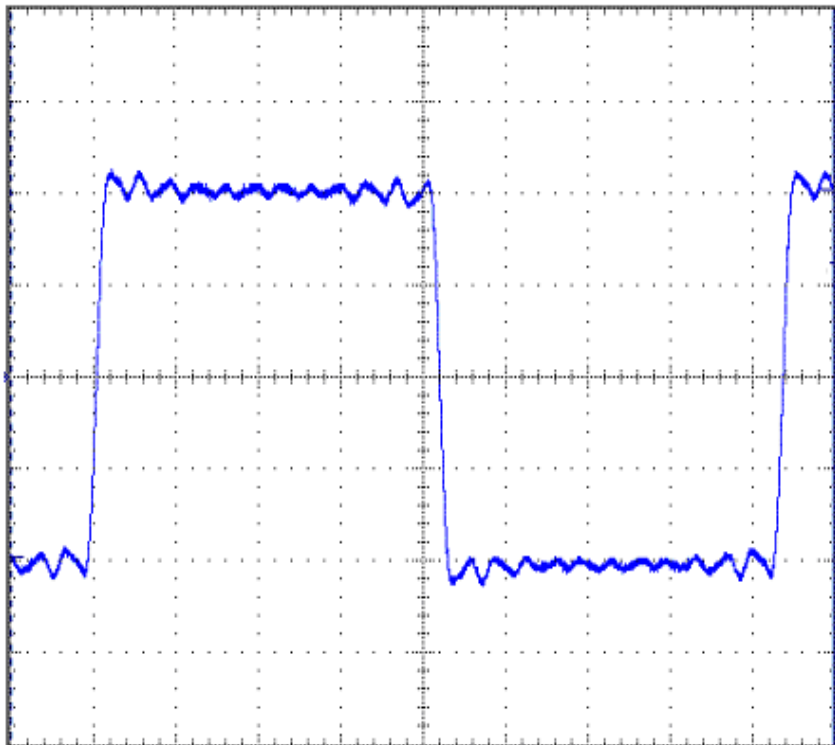
**DST30**

Harmonic	%	$\theta$
3	33.39	0
5	20.01	0
7	13.74	0
9	10.67	0
11	8.33	0
13	6.99	0
15	5.26	0

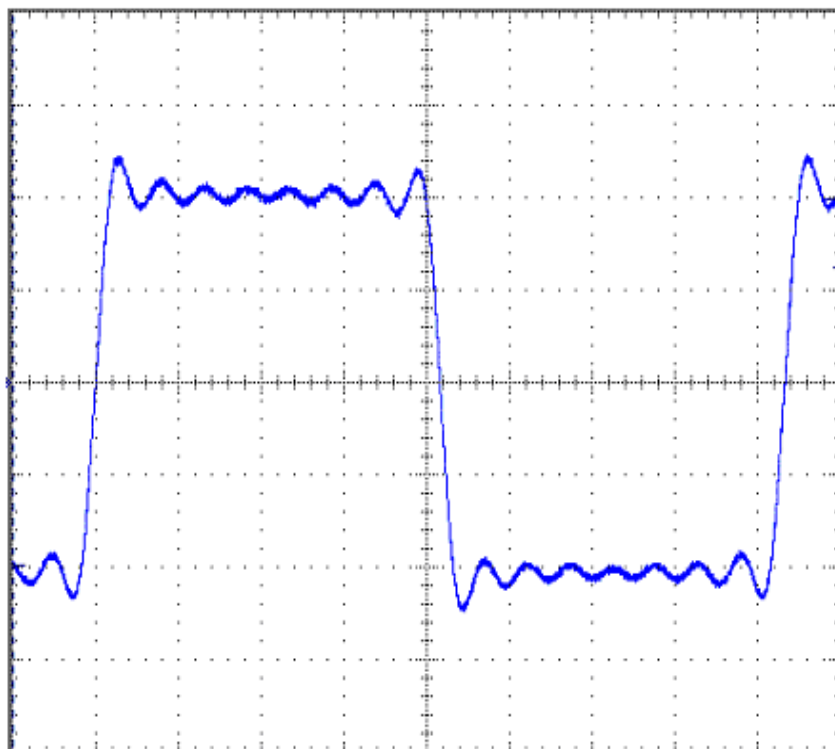



**Headquarters 總公司**

**CHROMA ATE INC. 致茂電子股份有限公司**

66, Hwa-ya 1st Rd., Hwaya Technology Park,

Kuei-shan 33383, Taoyuan, Taiwan

台灣桃園縣33383龜山鄉華亞科技園區華亞一路 66 號

TEL: + 886 - 3 - 327 - 9999

FAX: + 886 - 3 - 327 - 8898

e-mail: [chroma@chroma.com.tw](mailto:chroma@chroma.com.tw)

© Copyright Chroma ATE INC. All rights reserved. Information may be subject to change without prior notice.