

Value / Power

- **Programmable Power, Low Cost**
Cost effective solution for wide range of AC power tests
- **2000 VA Output Power**
Capable of handling most single phase applications
- **16 Hz to 5000 Hz Frequency Range**
Commercial, Military and Avionics applications
- **High Peak Current Capability**
Drives a wide variety of non-linear loads
- **Precision Measurements**
Accurately measures TRMS Volt, TRMS Current, Peak Current, Crest Factor, Real Power and Power Factor
- **Remote Control**
IEEE-488 and RS232C Interface for automated test applications. Includes Windows™ operating software

Affordable AC Power Solutions Model 2001RP



Model 2001RP

Compact AC Power

Offering simple rotary front panel controls, the 2001RP programmable AC power source is ideally suited for a wide range of applications.

Selectable input voltage ranges allow this product to be used anywhere in the world to provide a convenient source of variable utility power for the testing and evaluation of domestic and commercial equipment. All common line voltage and frequency combinations are covered.

In addition, the frequency range extends to 5000 Hz, making these products ideal for commercial and defense avionics applications.

Accurate measurement functions are available as an option to eliminate the need for external test equipment in many test setups. Voltage, current, peak current, power, and power factor can be read directly on the large LCD display or over the bus. Overload protection is provided standard using a programmable current limit function

Easy To Use Controls

Front panel digital rotary encoders are used to set voltage and frequency. These controls have an analog feel, with the precision and reliability of digital circuits. Settings and measurements are read directly on the large, high contrast LCD displays.

Dual output voltage ranges of 150 Vrms L-N and 300 Vrms L-N, provide maximum current at the required voltage.

The output frequency can be varied from 16 Hz up to 5000 Hz to cover commercial, avionics and defense power applications.

Product Development

The precise voltage regulation and wide frequency range of the 2001RP, combined with its easy to use front panel, make it a great general purpose Lab AC source. Built in measurements may be added (option -OP1) to extend the units usefulness for design applications of AC powered products.

Quality Control

For product quality test applications, the 2001RP can be used to simulate line conditions found anywhere in the world. This ensures products destined for export will operate as designed.

Avionics Applications

As an affordable and reliable source of 400 Hz AC power, the 2001RP is well suited for commercial and defense avionics applications. A special Avionics version (-AV option) is available which offers reduced weight and increased output current at 115 V_{RMS}.

Functional Design

The small form factor and low weight of the 2001RP make it convenient to use in a variety of locations. Removable rubber feet protect the work surface if the unit is used in a bench top mode. The 5.25 inch height saves valuable rack space when used in a rack and stack system.



California Instruments

2001RP - For Easy Transient Programming

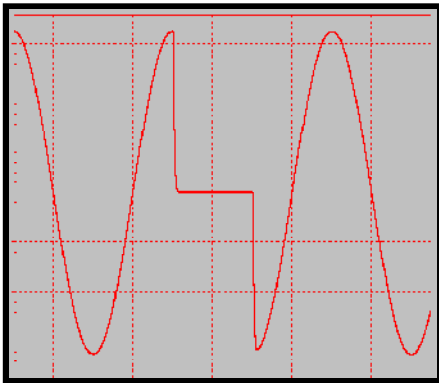

Drop transient causes output voltage to drop to zero for a user specified period

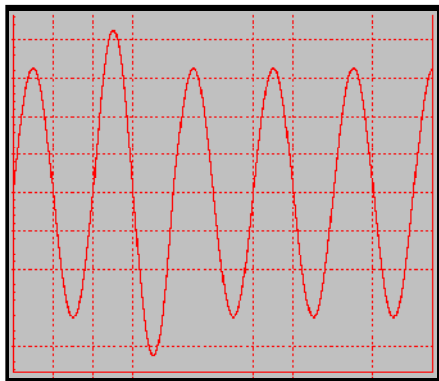

Voltage Surge transient causes output voltage to surge.

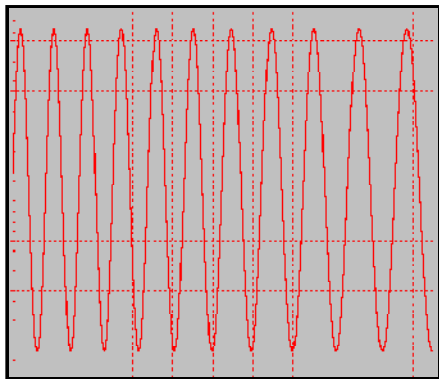

Frequency Sweep transient causes the output frequency to change at a user specified rate.

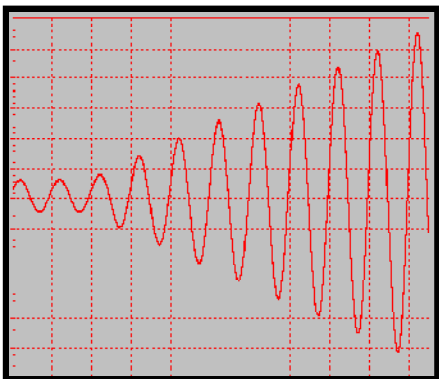

Voltage Sweep transient causes output voltage to change at a programmed rate.

Extensive Transient Control¹

With the addition of the remote control interface option, RP Series units are capable of producing transients with a high degree of user programmability. Setting up transient programs is facilitated by a Windows™ Graphical User Interface program that allows amplitude, frequency and event duration to be programmed from a PC. Time resolution is 1 ms (0.001 sec) with a minimum time interval ranging from 1 to 40 ms, depending on the transient type. Maximum transient time intervals are 9999 seconds. Transient programming allows the effects of common line disturbances such as voltage surges, sags, drop-outs and frequency fluctuations on the unit under test to be evaluated.

Precision Measurements

For bench or automated test equipment (ATE) applications, the 2001RP can be ordered with the -OP1 option, offering both IEEE-488 and RS232C remote control interfaces as well as extended measurements. These measurements are available from the front panel and over the bus. The 2001RP uses closed case calibration for both output and measurement calibration, lowering cost of ownership.

SCPI Protocol Programming Commands

All functions of the 2001RP are programmable over the available IEEE-488 or RS232C interface. For example, the following tasks can be performed over the bus:

- Set voltage to any level
- Change frequency
- Generate voltage dropouts, sags or surges
- Measure TRMS current, peak current, crest factor, TRMS voltage, true power, apparent power and power factor
- Recall eight complete instrument setups from non-volatile memory
- Adjust current limit value
- Lock the front panel to prevent operator interference
- Switch between high and low voltage range
- Drop output voltage at specific phase angles for specified durations

Application Software

Windows™ application software is included with the -OP1 option package. This easy to use graphical interface program provides complete control over all instrument functions using the RS232C or IEEE-488 interface. With enhanced capabilities such as output sequencing, data logging and transient generation, many applications can be addressed without the need to write software.

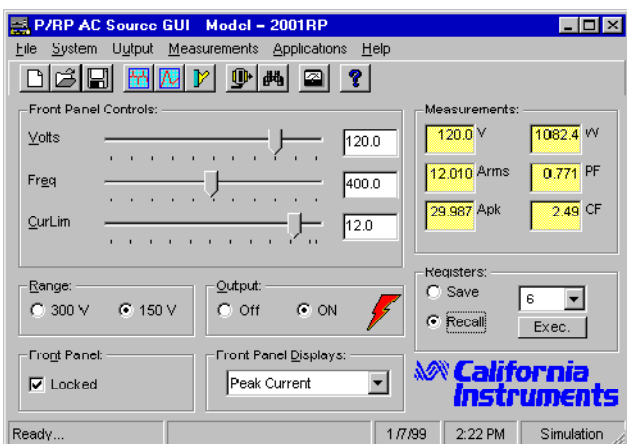

Free Windows™ Graphical User Interface software included with option package OP1.

Note 1: Voltage drop out transients can be programmed at random phase angles or at 0, 90, 180 and 270 degrees.

Specifications

California Instruments

Total Customer Satisfaction is the goal of all California Instruments' employees. It is the driving force behind everything we do. This not only affects the product that you purchase from California Instruments, but everything about your interface with the company. Our applications engineers are ready to assist you with your AC power application. With over 35 years of experience designing and building precision AC power supplies, chances are we can meet your needs and exceed your expectations. The same dedication to customer satisfaction you will find in our applications group also permeates our modern manufacturing facility where our products are carefully built. No unit leaves our factory without being thoroughly tested to ensure quality, reliability and conformance to specifications.

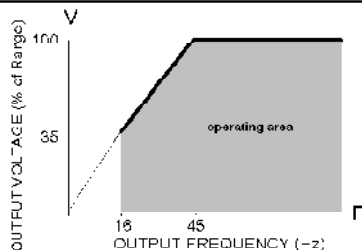
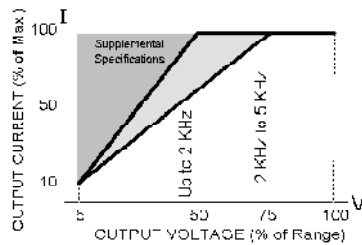

Parameter	2001RP	Unit
Controller		
Type	Programmable	
Controls	Digital Encoders	
Readouts	dual 4 digit LCD's	
Non Volatile Setups (with -OP1 option)	1 (8)	
Output		
AC Power	maximum	2000 VA
Load Connection	floating neutral optional	Rear panel terminal block Universal front panel sockets
Voltage		
High range / Low range		0 - 300 / 0 - 150 V RMS
Accuracy	16 Hz - 100 Hz	± 0.1 % FS
	100 Hz - 5000 Hz	± 0.2 % FS
Resolution		0.1 V
Load Regulation	remote sense	± 0.1 % FS
Line Regulation	10 % Line change	± 0.02 % FS
T.H.D. (into a resistive load)	16 Hz - 100 Hz	0.5 typ./ 1.0 max. %
	100 Hz - 5000 Hz	1.0 typ./ 2.0 max. %
Output Noise		< 0.1 typ. V RMS
Frequency		
Range	(see V-F rating chart)	16 - 5000 Hz
Accuracy		± 0.02 %
Resolution	16.00 Hz - 80.00 Hz	0.01 Hz
	80.1 Hz - 800.0 Hz	0.1 Hz
	800 Hz - 5000 Hz	1 Hz
Current (see I-V rating chart)		
RMS Current	High / Low V range	6.7 / 13.4 A RMS
Peak Current	High / Low V range	22.2 / 44.5 A
Protection		
Adj. Current limit	Resolution	0.1 A RMS
	Modes	Const. Current or Const. Volt
Over Temperature		√
Over Voltage		√
Input		
Connection		Rear panel terminal block
Line Voltage	2 wire + GND	103 - 127 V or 187 - 253 V V RMS
Line Current		< 30 A RMS
Line Frequency		47 - 440 Hz
Holdup Time		10 ms
Isolation	Input to Chassis/Output	1350 / 2200 V
Measurements (* Requires Option -OP1)		
Current	Range Low / High	4.000 / 15.00 A RMS
	Accuracy	0.2 % FS + 0.3 % rdng
	Resolution	0.001 / 0.01 A RMS
Peak Current*	Range Low / High	12.00 / 50.0 A
	Accuracy	0.5 % FS + 0.5 % rdng
	Resolution	0.01 / 0.1 A
Voltage*	Range	0 - 300 V RMS
	Accuracy	0.1 % FS + 0.05 % rdng
	Resolution	0.1 V RMS
Power*	Range Low / High	800 / 2000 W
	Accuracy	0.5 % FS
	Resolution	0.2 W
Power Factor*	Range	0.00 - 1.00
	Resolution	0.01
Remote Control (* Requires Option -OP1)		
Interface*		RS232C and IEEE-488
	IEEE Functions	SH1, AH1, T8, L3, RL2
	RS232C settings	19200,8,n,1
	Command Language	SCPI
Remote Inhibit*	Output shut down	TTL in, active low BNC
Function Strobe*	On V or F change	TTL out, active low BNC
Physical		
Dimensions	HxWxD	5.25 x 19 x 22 inches
	HxWxD	133 x 483 x 560 mm
Weight (net)		73 / 33 lbs / kg
Vibration and Shock		Designed to meet NSTA-1A
Temperature	Operating	0 to 40 °C
	Storage	- 40 to + 85 °C

Note: Specifications shown are valid over an ambient temperature range of 25°±5°C.

Remote Control Option

The 2001RP can be ordered with option package 1 (-OP1) to add a combined RS232C and IEEE-488 remote control interface. Front panel and bus measurements are included with this option.

Ordering Information

Models:

2001RP 2000 VA rack-mount AC Source

Options:

- AV Avionics version.
- L22 Locking knobs
- LZ Low output impedance version, $Z_o < 100 \text{ m}\Omega$.
- OP1 Option package 1:
 - Measurements
 - IEEE-488 / RS232C Interface and GUI software
 - Remote Inhibit input
 - Function Strobe output
- SKT Universal front panel mounted output socket
- RMS Rack Mount Slides

Supplied with:

- Instruction / Programming Manual
- Windows™ Graphical User Interface (with -OP1 option)
- RS232C Serial Cable (with -OP1 option)

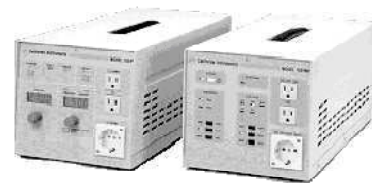

Lower Power Models

For applications requiring less than 2000 VA of output power, models 801RP and 1251RP offer lower power levels at reduced cost. These models are housed in a 3.5 inch high rackmount enclosure and require even less rack height than the 2001RP. Refer to the 801RP/1251RP data sheet for details.

Portable AC Sources

For mobile or bench top applications, 1000 VA and 1250 VA portable AC power sources are available as well. The 1001P and 1251P offer programmable AC power from 16 Hz to 500 Hz at 1000 VA and 1250 VA respectively. For applications that only require fixed voltage and frequency settings, the 1001WP frequency converter provides push button selection of nominal 50 or 60 Hz and 100V, 115V, 220V, 230V and 240 V settings. Refer to the P and WP Series data sheet respectively for details.

Customer Support

For technical support and service, or to discuss your AC power application needs, contact California Instruments Corp. or your local representative.

CE Mark

The 2001RP has been fully tested for compliance with all applicable CE Mark requirements.



2001RP Dimension drawing

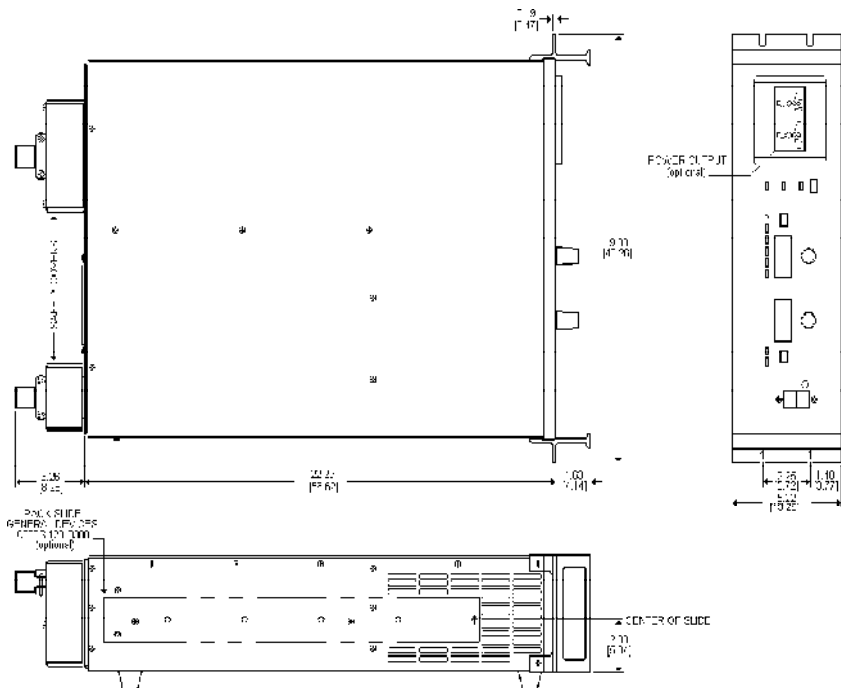

Contact California Instruments:

Toll-Free: 800-4AC-POWER

800-422-7693

FAX: 858-677-0940

Email: sales@calinst.com

Web page: <http://www.calinst.com>

California Instruments

9689 Towne Centre Drive, San Diego, CA 92121-1964 (858) 677-9040

© Copyright 1999, California Instruments Corp. Specifications subject to change without notice

FAX : (858) 677-0940

Printed in the USA.

2001RPDS 12/99