

# Data Sheet

## Programmable DC Power Supplies XLN Series



\*) -GL version

### New Family of High Density System Power Supplies

The B&K Precision XLN series are programmable, single-output DC power supplies, that provide clean power up to 1560 watts in a compact 1U rackmountable package. Comparable supplies from other manufacturers primarily address the ATE market only, while the XLN series is designed for both benchtop users and system integrators.

For benchtop applications, these power supplies offer built-in voltage and current meters displaying setting and output values concurrently, as well as an intuitive user interface with full keypad and rotary knob.

Standard USB, RS485, and optional GPIB and LAN interfaces combined with fast average command processing times of less than 50 ms make the XLN series ideal for ATE applications. Free application software and a complete set of LabVIEW™ drivers are available to provide remote control capabilities, reduce programming time, and increase productivity.

When greater output power is required, up to four XLN models can be connected in series (high current models only) or parallel and synchronized with the RS485 interface. Alternatively, the RS485 interface can be used to daisy chain up to 31 units and to remotely control them from one master PC via USB, GPIB, or LAN interface.

These power supplies are perfectly suited for ATE systems integration, product design and development, product QC and burn-in testing, and other applications requiring excellent regulation, high power, low noise, and a wide range of voltage and current ratings.

### Features & Benefits

- Compact, high density, 1U package
- USB interface (standard), GPIB and LAN (optional)
- External analog programming interface
- List mode: execute test sequences with up to 150 steps from instrument memory
- Average command processing time <50 ms
- Programmable voltage and current slew rate allow for "soft starting" of loads
- Internal memory stores up to 10 instrument settings
- Control up to 31 power supplies from one PC via the RS485 interface
- Remote sense
- Timer-controlled output (1 s to 100 hr)
- Front to rear airflow allows for efficient cooling in high rack density environments
- Application software and LabVIEW™ drivers available
- SCPI-compliant command set
- Extensive protection features: OVP, OCP, OPP, OTP, foldback protection mode, and key-lock function
- Easy to configure master/slave mode for series or parallel connection of up to four units

Features	High Current XLN Models	High Voltage XLN Models
Auxiliary Output	5 V / 1 A	-
Master/Slave Oper.	Parallel/Series	Parallel Only
Display resolution	1 mV/1 mA	10 mV/1 mA
Analog programming	√	√
Analog monitoring	-	√

Specifications	High Current				High Voltage		
	XLN3640	XLN6024	XLN8018	XLN10014	XLN15010	XLN30052	XLN60026
GPIB & LAN version	XLN3640-GL	XLN6024-GL	XLN8018-GL	XLN10014-GL	XLN15010-GL	XLN30052-GL	XLN60026-GL
Output Voltage	0-36 V	0-60 V	0-80 V	0-100 V	5 - 150 V	5 - 300 V	5 - 600 V
Output Current	0-40 A	0-24 A	0-18 A	0-14.4 A	0.04-10.4 A	0.02-5.2 A	0.01-2.6 A
Output Power	1440 W	1440 W	1440 W	1440 W	1560 W	1560 W	1560 W

## Interfaces

### ▲ Front panel operation

#### High current models



Front to back airflow

Bright and easy-to-read display

Numeric keypad

Rotary encoder

#### High voltage models



The numeric keys and rotary knob provide a convenient interface for setting output levels quickly and precisely. Both measured output values and setting values are concurrently displayed on the screen. Additionally, the power supplies provide internal memory for storage of up to 10 different instrument settings that can be set and recalled via both the front panel and remote interfaces.

### ▲ Rear panel configuration

#### High current models

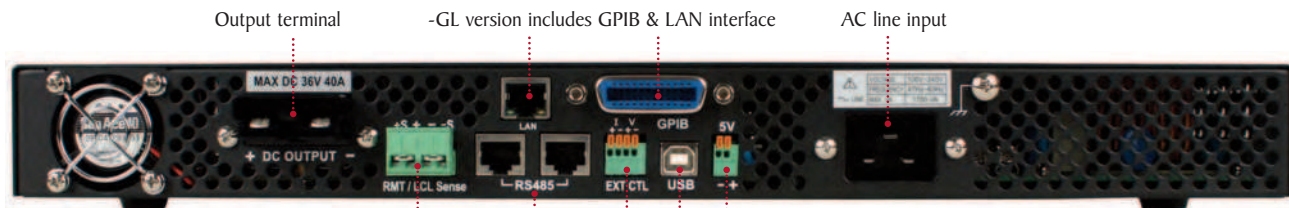

Output terminal

-GL version includes GPIB & LAN interface

AC line input

Remote sense terminal

RS485 interface

External analog control input

USB interface

Auxiliary 5V/1A output

#### High voltage models

-GL version includes GPIB & LAN interface

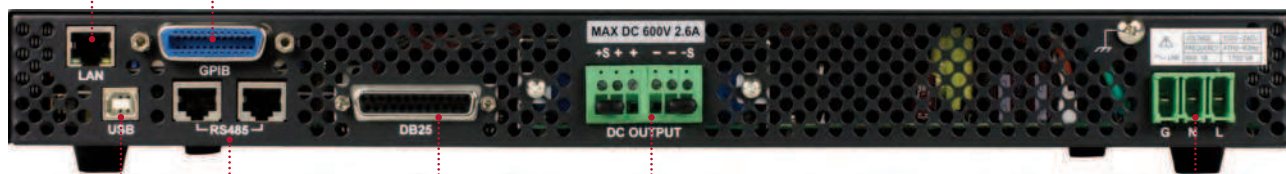

USB interface

RS485 interface

External analog control interface

Output and remote sense terminal

AC line input

## Flexible configuration

### Master/Slave operation

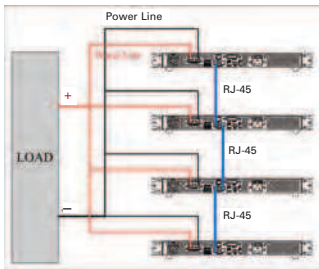

Parallel Configuration

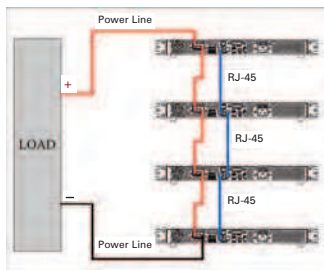

Series Configuration  
(high current models only)

Up to four models with the same rating can be connected in parallel or series (high current models only) and operate in master/slave mode. The RS485 interface is used for communication between the master and slave(s). Once configured, the master will automatically search for and detect slave units, and display the voltage and current of the complete system.

### Fixed 5V/1A output (high current models only)

The high current XLN models offer an additional output with a constant output voltage of 5 V and a maximum output current of 1 A for powering another device.

### Extensive device protection

To protect your DUT, the XLN series provides more safety features than any other system power supply in this category: overvoltage (OVP), overcurrent (OCP), overpower (OPP), and overtemperature (OTP) protection. When a fault occurs, the power supply will turn off the output, sound an alarm, and display an error message. Similarly, with constant voltage-to-constant current (CV-to-CC) or constant current-to-constant voltage (CC-to-CV) foldback protection mode activated, the supply will shut down if load changes force the supply to transition between the two operating modes. The power supply is also able to detect abnormally low AC input power and turn the output off when this condition occurs.

### Remote sense

The remote sense feature can compensate for voltage drop in the load wiring.

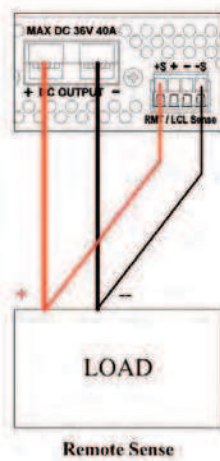

Remote Sense

### Current flow timer for breaker or fuse testing

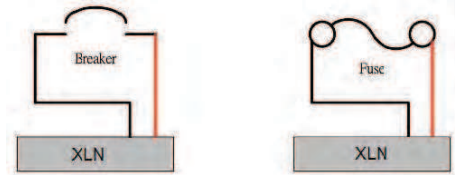





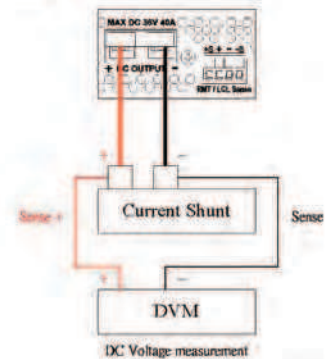

The XLN series can be used to accurately measure the time for a fuse or circuit breaker to open. After the voltage and current levels are set, the On/Off button turns on the output and the time when the fuse/breaker opens is measured to the nearest 100  $\mu$ s. The maximum counting period is one hour.

### Convenient front panel guided calibration

Using a 5 1/2 digit multimeter and a current shunt, voltage and current parameters can be conveniently calibrated from the front panel via the calibration menu.

#### Current Calibration



Rackmount kit (All models)		Output terminal block connectors (High current models only)		AC input power cord	
Ears and Handles	Solder Type Terminal Block	Screw Type Terminal Block	High Current Models	High Voltage Models	
					

High current models include the XLN3640, XLN6024, XLN8018, and XLN10014.  
High voltage models include the XLN15010, XLN30052, and XLN60026.

## Remote access and programming

### System integration

These power supplies offer standard USB along with optional GPIB and LAN interfaces to facilitate test system development and integration. The XLN series supports SCPI IEEE488.2 and come with LabVIEW™ drivers.

### Web server interface

XLN series models with GPIB and LAN interfaces provide a built-in web server that allows users to configure, control, or monitor the basic settings of the power supply from a remote computer using a web browser.



Interface for controlling voltage, current, and output state.

### Telnet interface

The power supply can be controlled with SCPI commands via a Telnet connection over the Ethernet interface. Any computer with a Telnet client can be used to control the power supply.

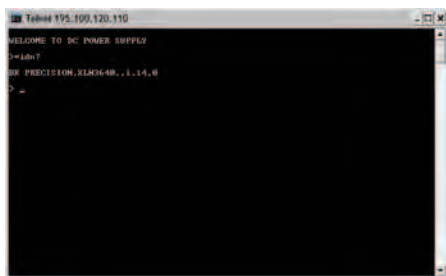

### Multi-unit control

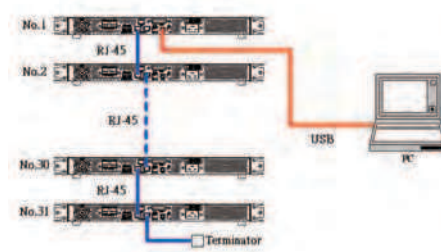

In multi-unit control mode, up to 31 units can be daisy chained via RS485 and controlled from one master unit through the USB, GPIB, or LAN interface.

### External analog programming interface

In addition to front panel or remote interface control, voltage and current values can also be programmed with an analog control signal. The power supplies can be externally controlled from zero to full scale by either an analog voltage source (0-5 V/0-10 V selectable) or resistance (0-5 kΩ, 0-5 kΩ/0-10 kΩ selectable for high voltage models). High voltage models also provide additional functions to the analog programming interface such as the ability to monitor the output voltage and current, check regulation mode (CC or CV), and indicate whether a fault has occurred.

### Test sequence execution in list mode

The list mode feature allows users to download a list of commands to the power supply's internal memory and execute them. Up to 10 sets of programs can be stored with a total of 150 steps allocated among the memory locations. The test sequence can be programmed remotely via the USB, GPIB, or LAN interfaces using SCPI commands or the included application software. Each step's voltage, current, and duration parameters can be set, with sequences configured for single or repeated execution.

### Application software

PC software is provided for creating and executing test sequences in list mode via the USB or GPIB interface.

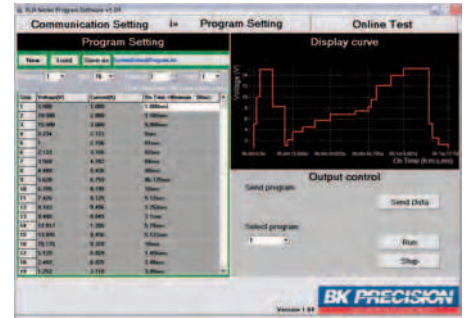

Generate, save, and load program lists. View output characteristic curves and export data to a file.

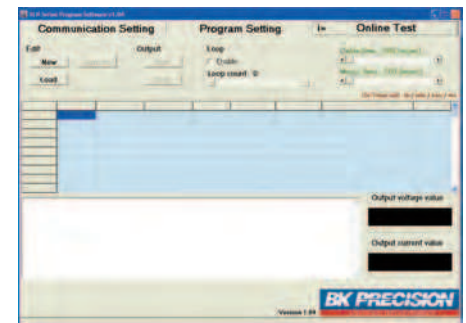

Pass/Fail test monitors maximum and minimum voltage and current values over a specified period of time.

Programmable DC Power Supplies  
XLN Series

Model	XLN3640	XLN6024	XLN8018	XLN10014	XLN15010	XLN30052	XLN60026
<b>Output Rating</b>							
Output Voltage	0-36 V	0-60 V	0-80 V	0-100 V	5-150 V	5-300 V	5-600 V
Output Current	0-40 A	0-24 A	0-18 A	0-14.4 A	0.04-10.4 A	0.02-5.2 A	0.01-2.6 A
<b>Output Protection</b>							
OVP Adjustment Range	2-38 V	3-64 V	4-85 V	5-105 V	5-158 V	5-315 V	5-630 V
OVP Accuracy	200 mV	300 mV	400 mV	500 mV	750 mV	1.5 V	3 V
<b>Line Regulation</b>							
Voltage	≤ 4 mV	≤ 6 mV	≤ 8 mV	≤ 10 mV	≤ 17 mV	≤ 32 mV	≤ 62 mV
Current	≤ 4 mA	≤ 4 mA	≤ 4 mA	≤ 4 mA	≤ 20.8 mA	≤ 10.4 mA	≤ 5.2 mA
<b>Load Regulation</b>							
Voltage	≤ 8 mV	≤ 8 mV	≤ 10 mV	≤ 12 mV	≤ 17 mV	≤ 32 mV	≤ 62 mV
Current	≤ 8 mA	≤ 7 mA	≤ 6.5 mA	≤ 6 mA	≤ 40.4 mA	≤ 20.8 mA	≤ 10.4 mA
<b>Ripple and Noise (20 Hz-20 MHz)</b>							
Normal Mode Voltage (Load ≥ 0.5 % of max load)	≤ 5 mVrms / ≤ 60 mVpp	≤ 6 mVrms / ≤ 70 mVpp	≤ 7 mVrms / ≤ 80 mVpp	≤ 8 mVrms / ≤ 80 mVpp	≤ 10 mVrms / ≤ 100 mVpp	≤ 25 mVrms / ≤ 150 mVpp	≤ 50 mVrms / ≤ 300 mVpp
Normal Mode Current	≤ 90 mA	≤ 70 mA	≤ 50 mA	≤ 40 mA	≤ 15 mA	≤ 10 mA	≤ 5 mA
<b>Programming Resolution</b>							
Programming & Readback	1 mV / 1 mA	1.5 mV / 1 mA	2 mV / 1 mA	2.5 mV / 1 mA	10 mV / 1 mA		
<b>Programming and Readback Accuracy (% output+offset)</b>							
Voltage	0.05 %+10 mV	0.05 %+15 mV	0.05 %+20 mV	0.05 %+25 mV	0.05 %+75 mV	0.05 %+150 mV	0.05 %+300 mV
Current	0.05 %+10 mA	0.05 %+18 mA	0.05 %+7 mA	0.05 %+6 mA	0.1 %+30 mA	0.1 %+15.6 mA	0.1 %+7.8 mA
<b>General</b>							
Average Command Response Time	≤ 50 ms						
Power Factor Correction (PFC)	≥ 0.99 (Full load)						
Efficiency	≥ 80 % (Full load)						
Remote Sense Compensation	2 V				5 V		
Rise Time at Full Load	≤ 15 ms	≤ 20 ms	≤ 25 ms	≤ 30 ms	≤ 100 ms		
Rise Time at No Load	≤ 15 ms	≤ 20 ms	≤ 25 ms	≤ 30 ms	≤ 100 ms		
Fall Time at Full Load	≤ 15 ms	≤ 20 ms	≤ 25 ms	≤ 30 ms	≤ 100 ms		
Fall Time at No Load	≤ 1000 ms				≤ 1000 ms	≤ 2000 ms	≤ 3000 ms
Transient Response Time	≤ 1 ms				≤ 2 ms		
AC Line Rated Input Voltage/Hz	100-240 VAC / 47 Hz-63 Hz						
Tolerance/Variation in Voltage	-15 % to +10 % (10 % power de-rating mode when voltage under 95 VAC)						
Maximum Rated Input Power	1700 VA				1950 VA		
Temperature Ratings	Operation (0 °C - 40 °C) / Storage (-10 °C - 70 °C)						
Standard Interface	USB, RS485, analog interface						
Optional Interface	LAN, GPIB						
Electromagnetic Compatibility	EMC DIRECTIVE 2004/108/EC, EN61326-1 : 2006, CISPR11, Class B, EN 61000-3-2 : 2006, EN 61000-3-3 : 1995 + A1 : 2001 + A2 : 2005, EN 61000-4-2/-3/-4/-5/-6/-11						
Safety	EN61010-1:2001, EU Low Voltage Directive 2006/95/EC						
Dimensions (W x H x D)	16.5" x 1.72" x 17" (420 x 43.6 x 432 mm)				16.5" x 1.74" x 18.1" (420 x 44.2 x 460 mm)		
Weight	19.8 lbs. (9 kg)						
<b>Three-Year Warranty</b>							
Included Accessories	User manual, power cord, rackmount kit, test report & certificate of calibration, terminal blocks for output connectors (high current models only)						