

# INSTRUCTION MANUAL

**BK PRECISION®**

MODEL: 1762



**Triple Output  
DC POWER SUPPLY  
With Dual 4-Digit LED Displays**

**BK PRECISION®**

---

## TEST INSTRUMENT SAFETY

---

### WARNING

Normal use of test equipment exposes you to a certain amount of danger from electrical shock because testing must sometimes be performed where exposed high voltage is present. An electrical shock causing 10 milliamps of current to pass through the heart will stop most human heartbeats. Voltage as low as 35 volts dc or ac rms should be considered dangerous and hazardous since it can produce a lethal current under certain conditions. Higher voltages are even more dangerous. Your normal work habits should include all accepted practices to prevent contact with exposed high voltage, and to steer current away from your heart in case of accidental contact with a high voltage. Observe the following safety precautions:

1. There is little danger of electrical shock from the dc output of this power supply. However, there are several other possible test conditions using this power supply that can create a high voltage shock hazard:
  - a. If the equipment under test is the “hot chassis” type, a serious shock hazard exists unless the equipment is unplugged (just turning off the equipment does not remove the hazard), or an isolation transformer is used.
  - b. If the equipment under test is “powered up” (and that equipment uses high voltage in any of its circuits), the power supply outputs may be floated to the potential at the point of connection. Remember that high voltage may appear at unexpected points in defective equipment. Do not float the power supply output to more than 100 volts peak with respect to chassis or earth ground.
  - c. If the equipment under test is “off” (and that equipment uses high voltage in any of its circuits under normal operation), discharge high-voltage capacitors before making connections or tests. Some circuits retain high voltage long after the equipment is turned off.
2. Use only a polarized 3-wire ac outlet. This assures that the power supply chassis, case, and ground terminal are connected to a good earth ground and reduces danger from electrical shock.
3. Don’t expose high voltage needlessly. Remove housings and covers only when necessary. Turn off equipment while making test connections in high-voltage circuits. Discharge high-voltage capacitors after removing power.

(continued on inside back cover)

**Instruction Manual  
For Model  
1762  
Triple Output DC Power Supplies  
With Dual 4-Digit LED Displays**

***BK PRECISION***<sup>®</sup>

22820 Savi Ranch Parkway  
Yorba Linda, CA 92887  
[www.bkprecision.com](http://www.bkprecision.com)

[www.bkprecision.com](http://www.bkprecision.com)

---

## TABLE OF CONTENTS

---

	<b>page</b>
TEST INSTRUMENT SAFETY-----	inside front cover
INTRODUCTION -----	5
FEATURES -----	7
SPECIFICATIONS-----	8
CONTROLS AND INDICATORS -----	10
General Controls and Indicators -----	10
4-6.5 V Supply Controls and Indicators -----	10
“A” Supply Controls and Indicators -----	12
“B” Supply Controls and Indicators-----	12
Rear Panel Controls -----	13
OPERATING INSTRUCTIONS-----	14
Safety Precautions -----	14
Equipment Precautions-----	14
Independent Use of “A” or “B” Supply-----	14
Hook-up-----	15
Typical Constant Voltage Operation -----	18
Setting Current Limit -----	19
Typical Constant Current Operation -----	20
Constant Voltage/Current Characteristic -----	21
Series Tracking Operation-----	22
Parallel Tracking Operation -----	26
4-6.5 V Power Supply Operation -----	29

	<b>Page</b>
APPLICATION -----	33
General -----	33
Electronics Servicing-----	33
Electronics Manufacturing-----	33
Electronics Design Lab -----	34
Electronics Education -----	34
Battery Charging-----	34
Split Supply-----	34
MAINTENANCE -----	41
Fuse Replacement-----	41
Line Voltage Conversion -----	41
Adjustments -----	42
“A” Supply and “A” Metering Adjustments -----	42
4-6.5 V Supply and 4-6.5 V Metering Adjustments-----	44
“B” Supply and Metering Adjustments -----	44
“B” Series Tracking Adjustment-----	45
Instrument Repair Service -----	45
WARRANTY SERVICE INSTRUCTIONS-----	46
LIMITED TWO-YEAR WARRANTY -----	47

---

## INTRODUCTION

---

This B+K Precision Triple Output DC Power Supply is a high quality, general purpose dc power source. It provides two “main” supplies with a 0-60 volt dc outputs and a “third” output with a 4-6.5 volt dc output. The “main” V supplies are adjustable with both coarse and fine voltage controls for precise stability and are capable of current output of 0-2 amps. The “third” supply has a current output of 0-4 amps, allowing it to handle extensive digital logic circuitry. Two large panel-mounted LED meter displays can monitor either the output current or output voltage of each supply.

The two “main” volt supplies can be operated independently or in one of two tracking modes. In the series tracking mode, the “B” Supply tracks from 5% to 100% of the voltage of the “A” Supply. Maximum current setting of the two supplies can still be set independently when in the series tracking operating mode. In the series tracking mode the “A” and “B” supplies are connected in series, allowing a single output of 0-120 V at up to 2 amps. In the parallel tracking mode, the two supplies are connected together in parallel, allowing a single 0-36 V output at up to 4 amps.

Both “main” volt supplies may be used in constant voltage or constant current applications. The crossover from constant voltage to constant current modes is smooth and automatic. LED’s indicate the “CV” (constant voltage) or “CC” (constant current) mode of operation. In constant current applications, a current limit may be preset. When load variations cause the current to reach the preset limit, the unit then regulates output current rather than output voltage. Current limits are adjustable from 5% to 100% of maximum.

In constant current applications, the maximum voltage may be preset. When load variations cause current to drop below the regulated value, the unit reverts to regulated voltage operation at the preset value.

The “third” V supply is ideal for powering digital logic circuitry. The 0-4 amp capacity allows the supply to be used for large circuits. Built-in overload protection automatically limits the current output to a maximum of 4 amps. An indicator lights when the supply is overloaded.

These models exhibit excellent regulation and low ripple characteristics. The circuit design incorporates a pre-regulator, which greatly reduces internal power dissipation at low output voltages.

Reverse polarity protection prevents accidental damage to the power supply from improper connection to an external voltage, and current limiting protects the equipment being powered, as well as the power supply.

The output is isolated from chassis and earth ground, which permits full flexibility of connections. When needed, the (+) or (-) polarity may be strapped to ground, or either polarity may be floated to an external voltage. Additionally, the two “main” volt supplies can be used as a “split supply” with two positive voltages and a common negative, two negative voltages and a common positive, or one positive, one negative, and a common. All of these configurations can be used with either matching (tracking) or differing (independent) voltages.

---

The features and versatility of the unit, especially the triple output and tracking features, make it an ideal general purpose power supply for engineering lab applications. It can serve as a single or multi-voltage power source, including the bias supply, for breadboard and prototype circuits and equipment. It can provide single or simultaneously varying voltages for circuit evaluation. It can provide tracking (+) and (-) voltages for evaluating differential amplifiers. It may be used as a battery eliminator, or to power individual circuit boards or cards while removed from the system. Its output can be evaluated while powering a breadboard or prototype circuit to determine the circuit's power supply requirements. Its laboratory quality specifications will meet most engineering laboratory requirements.

The same features that make the Model 1762 a good choice for an engineering lab also make it a good choice for most other solid state electronic applications. These applications include service shops; industrial production testing of components, assemblies, and complete equipment; for school laboratories, and home use by electronic hobbyists.

---

## FEATURES

---

### TRIPLE OUTPUT

Operates as three separate power supplies. Each has floating output and is completely isolated from the other two.

### ONE 4 TO 6.5 V SUPPLY

Durable 0-to-4 amp supply is ideal for use with most digital logic circuitry. Adequate current capacity for extensive circuitry.

### TWO 0-60 VOLT SUPPLIES

“A” and “B” supply are continuously variable over their respective voltage ranges with coarse and fine controls. Each supply has a 2 amp current capacity.

### UNIQUE TRACKING FEATURE

The two 0-to-60V supplies can be operated so that the “B” supply tracks the “A” supply. Outputs can be strapped for two positive voltages with a common negative, two negative voltages with a common positive, or one positive and one negative with a neutral common.

### SINGLE 0-120V SUPPLY

Series tracking feature allows use of “A” and “B” supplies as one 0-to-120V 2 amp supply.

### SINGLE 0-60V SUPPLY

Parallel tracking feature allows use of “A” and “B” supply as a 0-to-60 V supply with a 4 amp current capacity (through “A” output terminals).

### CONSTANT VOLTAGE OR CONSTANT CURRENT

The “A” and “B” supplies provide regulated dc voltage output or regulated dc current output. Crossover is smooth and automatic.

### LED DISPLAY

Two large, easy-to-read LED 4-digit displays monitor output voltage or output current of all three supplies. Use of two meters allows simultaneous current and voltage metering when using “A” and “B” supplies in tracking operation. Good visibility in bright or low light.

### LABORATORY QUALITY

Excellent regulation, low ripple.

### PRE-REGULATOR

Limits internal dissipation for higher reliability and efficiency.

### ISOLATED OUTPUT

Either polarity may be floated or grounded.

### OVERLOAD PROTECTION

Fully adjustable current limiting (from 5% to 100% of maximum output current) for “A” and “B” supplies protects circuit under test and the power supply.

### REVERSE POLARITY PROTECTION

Prevents damage to power supply from external voltage of reverse polarity.

---

## SPECIFICATIONS

---

### “A” AND “B” SUPPLIES

Output Voltage Range:

0V to 60V

Output Current Limit Range:

0.1A (5%) to 2.0A (100%).

Load Regulation (Constant Voltage):

$\leq 0.01\% + 3 \text{ mV}$ .

Line Regulation 108 - 132 V (Constant Voltage):

$\leq 0.01\% + 3 \text{ mV}$ .

Ripple (Constant Voltage):

$\leq 1 \text{ mV RMS}$ .

Recovery Time (Constant Voltage):

$\leq 100 \text{ ~S}$ .

Temp. Coefficient (Constant Voltage):

$< 300 \text{ ppm/}^\circ\text{C}$ .

Load Regulation (Constant Current):

$\leq 0.2\% + 3 \text{ mA}$ .

Line Regulation 108 - 132 V (Constant Current):

$\leq 0.2\% + 3 \text{ mA}$ .

Ripple Current (at 108 V for Constant Current):

$\leq 3 \text{ mA RMS}$ .

Tracking (Series) Accuracy:

$\pm 0.2\% + 10 \text{ mV}$ .

Tracking Series, “B” tracks “A”:

5% to 100%.

Panel Meter Accuracy (Volts):

$\pm 0.5\% + 9 \text{ digits.}^*$

Panel Meter Accuracy (Current):

$\pm 0.5\% + 9 \text{ digits.}^*$

(\* see note 1)

### “Third” SUPPLY

Output Voltage Range:

4V to 6.5V

Load Regulation (Constant Voltage):

$\leq 10 \text{ mV}$  (0 to 4A load).

Line Regulation 108 - 132V (Constant Voltage):

$\leq 1 \text{ mV}$ .

Ripple and Noise:

$\leq 2 \text{ mV RMS}$ .

Over Voltage Protection Threshold:

6.8V to 7.3V.

Panel Meter Accuracy:

Same as “A” Supply Meter.



## SPECIFICATIONS

---

### GENERAL

#### Power Requirements:

Domestic: 115 VAC + 10%, 60 Hz.

International: 120/220/230/240 VAC -\* 10%, 50/60 Hz.

#### Power Consumption (Fully Loaded):

Approximately 350 W.

#### Protection:

Reverse polarity protection and current limiting.

#### Dimensions (H x W x D):

5.7" x 10.5" x 15" (145 mm x 267 mm x 381 mm).

#### Weight:

10 kg (21 lbs).

#### Accessories Supplied:

Two earth ground bus straps.

**NOTE:** Specifications and information are subject to change without notice. Please visit [www.bkprecision.com](http://www.bkprecision.com) for the most current product information.

---

#### Note 1:

**Important:** Even with noticeable Thermal Drift, this high resolution power supply will be considerably more accurate than any standard three digit display bench power supply.

**Thermal Drift:** Since this power supply has greater resolution than standard bench power supplies they are more susceptible to Thermal Drift. Thermal Drift occurs on almost every type of power supply but is more apparent on high resolution types. Thermal Drift results in the metering of the power supply to either slowly increase or decrease with the change in the power supply's internal temperature. As the power supply outputs more power its internal temperature will increase causing the metering (primarily the current) to slowly increase. As the power demand is decreased the power supply will cool causing the metering (primarily the current) to slowly decrease. If the power supply remains with a constant output of power for more than fifteen minutes the power supply metering will remain constant and should not continue to drift.

---

## CONTROLS AND INDICATORS

---

### GENERAL CONTROLS AND INDICATORS

8. **POWER Switch.** Turns power on and off.
9. **TRACKING Mode Switches.** Two pushbutton switches that select INDEPendent mode, SERies tracking mode, or PARallel tracking mode as follows:
  - a. When INDEP/TRACK switch is disengaged (out), the unit is in the INDEPendent mode and the “A” and “B” power supplies are completely independent from one another.
  - b. When the INDEP/TRACK switch is engaged (in) and the SER/PAR switch is disengaged (out), the unit is in the TRACKing SERies mode. In this mode, maximum voltage of both supplies is set using the “A” VOLTAGE controls (voltage at output terminals of the “B” supply tracks the voltage at the output terminals of the “A” supply). Also, in this mode of operation the positive terminal (red) of the “B” supply is internally connected to the negative terminal (black) of the “A” supply. This allows the two supplies to be used as one 0-to-60 volt supply.
  - c. When both INDEP/TRACK and SER/PAR switches are engaged (in), the unit is in the TRACKing PARallel mode. In this mode the “A” and “B” supplies are wired together in parallel and both the maximum current and voltage are set using the “A” controls. The “A” and “B” outputs can be used as two individual (but tracking) power supplies or just the “A” output can be used as a 0-to-60 volt supply with a 4 A capability.

1. **0-60V/4-6.5V Switch.** Controls “A”/4-6.5V **LED Display.** When this switch is in the **0-60V** position (out), the LED display monitors the “A” (0-60 V) supply. When this switch is in the **4-6.5V** position (in), the LED display monitors the 4-6.5V supply.
2. **Right V/A Switch.** Selects current or voltage metering mode for the “A” 0-60 V supply or the **4-6.5 V** supply (depending on setting of **0-60 V/4-6.5 V** switch). When in the **A** (amps) position (in), current is read from the “A”/4-6.5 V **LED Display.** When in the **V** (volts) position (out), voltage is read from the “A”/ **4-6.5 V LED Display.**
3. **“A”/4-6.5 V LED Display.** Digital display indicates voltage or current at the 0-60 V “A” supply or the 4-6.5 V supply (depending on the setting of the **Right V/A** and **0-60 V/4-6.5 V** switches).

### 4-6.5 V SUPPLY CONTROLS AND INDICATORS

4. **“-” Terminal (Black).** Negative polarity output terminal for 4-6.5V supply.
5. **“+” Terminal (Red).** Positive polarity output terminal for 4-6.5V supply.
6. **Voltage Level Control.** Adjusts output voltage for 4-6.5V supply. Fully counterclockwise rotation adjusts output voltage to 4V. Clockwise rotation increases voltage to a maximum of 6.5V (full clockwise rotation).
7. **5 A OVERload Indicator.** Lights when load on 4-6.5 Volt supply becomes too large.

## CONTROLS AND INDICATORS

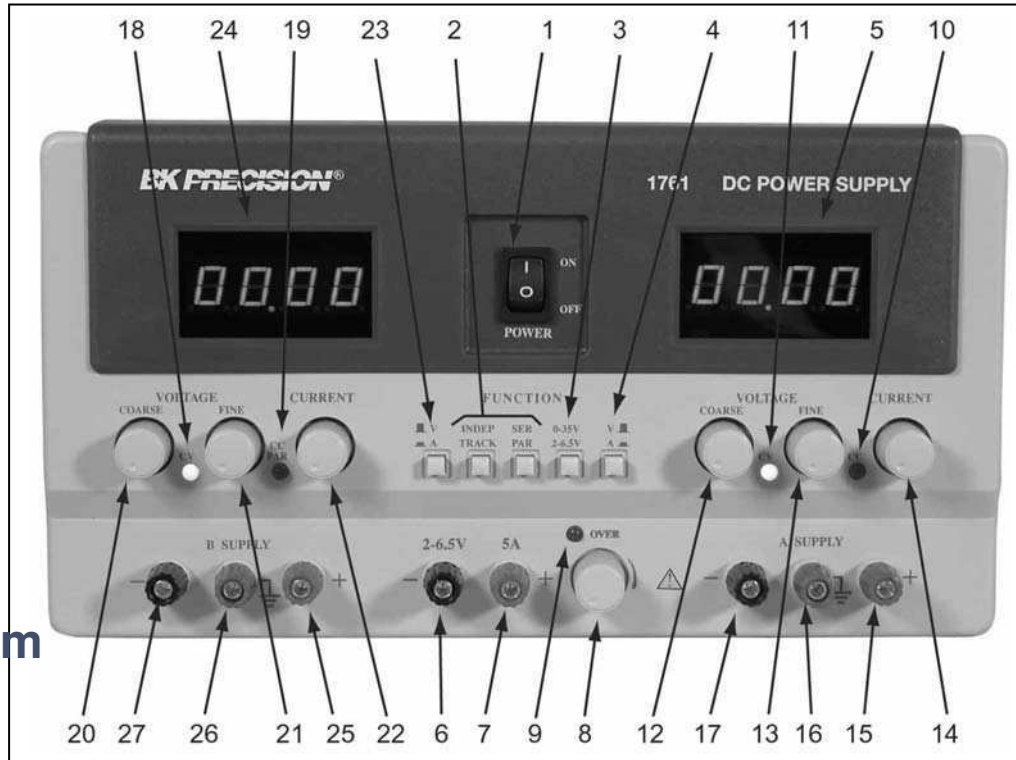

**Fig. 1. Front Panel Controls and Indicators.**

### “A” SUPPLY CONTROLS AND INDICATORS

16. **C.C. (Constant Current) Indicator.** Red LED lights when “A” supply is in the Constant Current mode. The Power Supply regulates the output current at the value set by the “A” **CURRENT** control. In the Parallel Tracking mode, when this indicator is lit, both the “A” and “B” supplies are in the Constant Current mode.
17. **C.V. (Constant Voltage) Indicator.** Green LED lights when the “A” supply is in the Constant Voltage mode. The Power Supply regulates the output voltage at the value set by the “A” **VOLTAGE** controls. In either the Series or Parallel Tracking mode, when this indicator is lit, both the “A” and “B” supplies are in the Constant Voltage mode.
18. **Coarse VOLTAGE Control.** Coarse adjustment of the output voltage of the “A” supply. Also functions as coarse adjustment control for the maximum output voltage of the “B” supply when either parallel or series tracking mode is selected. Read the value on the “A”/4-6.5 V **LED Display** when the voltage (V) and master (0-60 V) metering modes are selected.
19. **Fine VOLTAGE Control.** Fine adjustment of output voltage of the “A” supply. Also functions as fine adjustment control for the maximum output voltage of the “B” supply when either parallel or series tracking mode is selected. Read the value on the “A”/4-6.5 V **LED Display** when the voltage (V) and master (0-60 V) metering modes are selected.

10. **CURRENT Control.** Adjusts current limit of “A” supply in constant voltage mode. Adjusts constant current value of “A” supply in constant current mode. Current can be read from the “A”/4-6.5V **LED Display** when the current (A) and master (0-60V) metering modes are selected.
11. **“+” Terminal (Red).** Positive polarity output terminal for the “A” supply. Also serves as the positive polarity terminal for 4 A parallel and 0-to-60 V series tracking operation.
12. **⏏ Terminal (Green).** Earth and Chassis Ground.
13. **“-” Terminal (Black).** Negative polarity output terminal for the “A” supply. Also serves as the negative polarity terminal for 4 A parallel tracking operation. In series tracking operation, this terminal is internally tied to the (+) positive terminal of the “B” supply.

### “B” SUPPLY CONTROLS AND INDICATORS

14. **C.V. (Constant Voltage) Indicator.** Green LED lights when the “B” supply is in the Constant Voltage mode. The Power Supply regulates the output voltage at the value set by the “B” **VOLTAGE** controls.
15. **C.C. (Constant Current)/PARALLEL Indicator.** Red LED lights when “B” supply is in the Constant Current mode. The Power Supply regulates the output current at the value set by the “B” **CURRENT** control when in the series tracking or **INDEPENDENT** modes. Also lights when the **TRACKING PARALLEL** mode is selected.

## CONTROLS AND INDICATORS

- 25. Coarse VOLTAGE Control.** Coarse adjustment of the output voltage of the “B” supply when the **INDEP**endent mode is selected. Also sets the 5% to 100% tracking in the **SER**ies **TRAC**king mode. Disabled in the **PAR**allel **TRAC**king mode. Read the value on the “B” **LED Display** when the voltage (V) metering mode is selected.
- 26. Fine VOLTAGE Control.** Fine adjustment of output voltage of the “B” supply when the **INDEP**endent mode is selected. Also sets the 5% to 100% tracking in the **SER**ies **TRAC**king mode. Disabled in the **PAR**allel **TRAC**king mode. Read the value on the “B” **LED Display** when the voltage (V) metering mode is selected.
- 27. CURRENT Control.** Adjusts current limit of “B” supply in constant voltage mode. Adjusts current value of “B” supply in constant current mode. Current can be read from the “B” **LED Display** when the current (A) metering mode is selected.
- 28. Left V/A Switch.** Selects current or voltage metering mode for the 0-60 V “B” supply. When in the A (amps) position (in), current is read from the “B” **LED Display**. When in the V (volts) position (out), voltage is read from the “B” **LED Display**.
- 29. “B” LED Display.** Digital display indicates voltage or current of the 0-60 V “B” supply (depending on the setting of the A/V switch).
- 30. “+” Terminal (Red).** Positive polarity output terminal for the “B” supply. In series tracking operation, this terminal is connected to the negative terminal of the “A” supply.

- 20.  $\perp$  Terminal (Green).** Earth and Chassis Ground.
- 21. “-” Terminal (Black).** Negative polarity output terminal for the “B” supply. Also serves as the negative polarity terminal for 0-to-60 V series tracking operation.

## REAR PANEL CONTROLS

- 22. Fuse**
- 23. Power Cord**
- 24. 110/220 Line Voltage Conversion Switch**

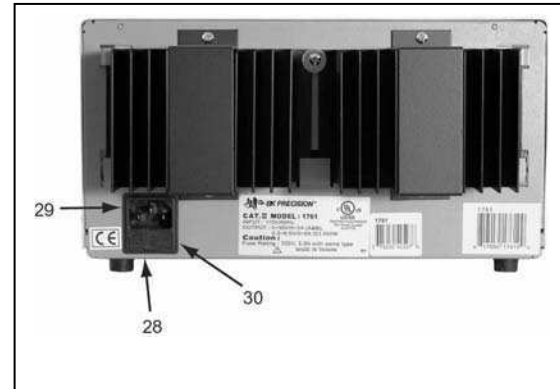

**Fig. 2. Rear Panel Controls.**

---

## OPERATING INSTRUCTIONS

---

### SAFETY PRECAUTIONS

#### CAUTION

*Avoid contacting the heat sink at the rear of the power supply. When the unit is providing large amounts of current at any or all of its outputs, the heat sink can become very hot. Contacting the heat sink when it is hot could result in skin burns or damage to the equipment in contact with them.*

*Use only a polarized 3-wire ac outlet. This assures that the power supply chassis, case, and ground terminal are connected to a good earth ground and reduces danger from electrical shock.*

*There may be great danger of electrical shock if the power supply output is connected to an external high voltage. Some equipment being powered may contain high voltage and present a shock hazard. Observe caution. If the power supply output is floated (referenced to a voltage rather than earth ground) turn off the power supply and the equipment under test when making connections. Never float the power supply to a potential greater than 100 volts peak with respect to earth ground.*

### EQUIPMENT PRECAUTIONS

Avoid using the power supply in ambient temperatures above +40° C. Always allow sufficient air space around the heat sink at the rear of the power supply for effective radiation to prevent internal heat build-up.

Although the power supply is protected against reverse polarity damage, the circuit being powered may not include such protection. Always carefully observe polarity; incorrect polarity may damage the equipment under test.

Do not exceed the voltage rating of the circuit being powered. Many transistors and integrated circuits will not withstand voltage of 60 volts.

There is no need to worry about voltage spikes or overshoot damaging the equipment under test. The voltage between the output terminals of the power supply never exceeds the preset value as the **POWER** switch is turned on or off.

### INDEPENDENT USE OF "A" OR "B" SUPPLY

The "A" and "B" supplies each provide a 0-to-60 volt output at up to 2.0 amps. This procedure covers the use of the "A" and "B" supplies only when they are used independently from one another. When used in the **INDEP**endent operating mode, the operating controls of the two power supplies are completely independent and either supply can be used individually or both can be used simultaneously. Basic operation is covered here. Several variations are covered in the **APPLICATIONS** section of this manual.

### Hook-up

1. Disengage the **INDEP/TRACK** mode switch so that the power supply is in the **INDEP**endent operating mode.
2. Turn off the power supply and the equipment to be powered during hook-up.
3. Connect the positive polarity of the device being powered to the red (+) terminal of the power supply.
4. Connect the negative polarity of the device being powered to the black (-) terminal of the power supply.
5. Fig. 3 illustrates the grounding possibilities when used in the **INDEP**endent mode.
  - a. If the negative polarity of the equipment or circuit being powered is also the chassis or common, it may be grounded to earth by strapping the black (-) terminal to the green ( $\perp$ ) terminal as shown in Fig. 3A.
  - b. Similarly, the positive polarity can be grounded by strapping the red (+) terminal to the green ( $\perp$ ) terminal as shown in Fig. 3B.
  - c. If an earth ground reference is not required, the configuration of Fig. 3C may be used. The scheme in Fig. 3C should also be used where it is not known whether the chassis is common with either the positive or negative polarity.
  - d. If the chassis or common of the equipment being powered is separate from both the positive and negative polarity power inputs, use the connection shown in Fig. 3D.
6. Observe proper polarity. If the circuit being powered is not equipped with reverse polarity protection, damage to the circuit can result from reverse polarity. Use color coded hook-up leads, for convenience in identifying polarity, red for (+) and black for (-).
7. Make sure that the hook-up leads offer sufficient current capability and low resistance between the power supply and the circuits being powered.

## OPERATING INSTRUCTIONS

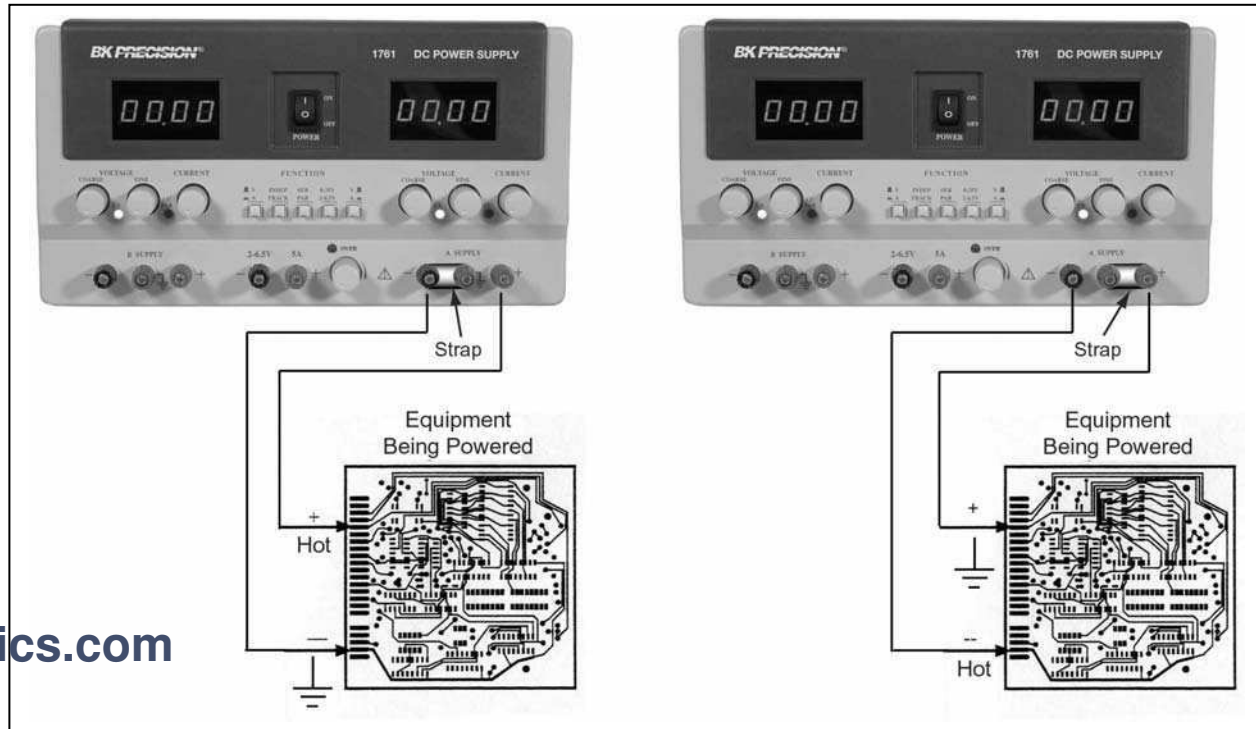

Fig. 3. Independent Operation Grounding Possibilities.



## OPERATING INSTRUCTIONS

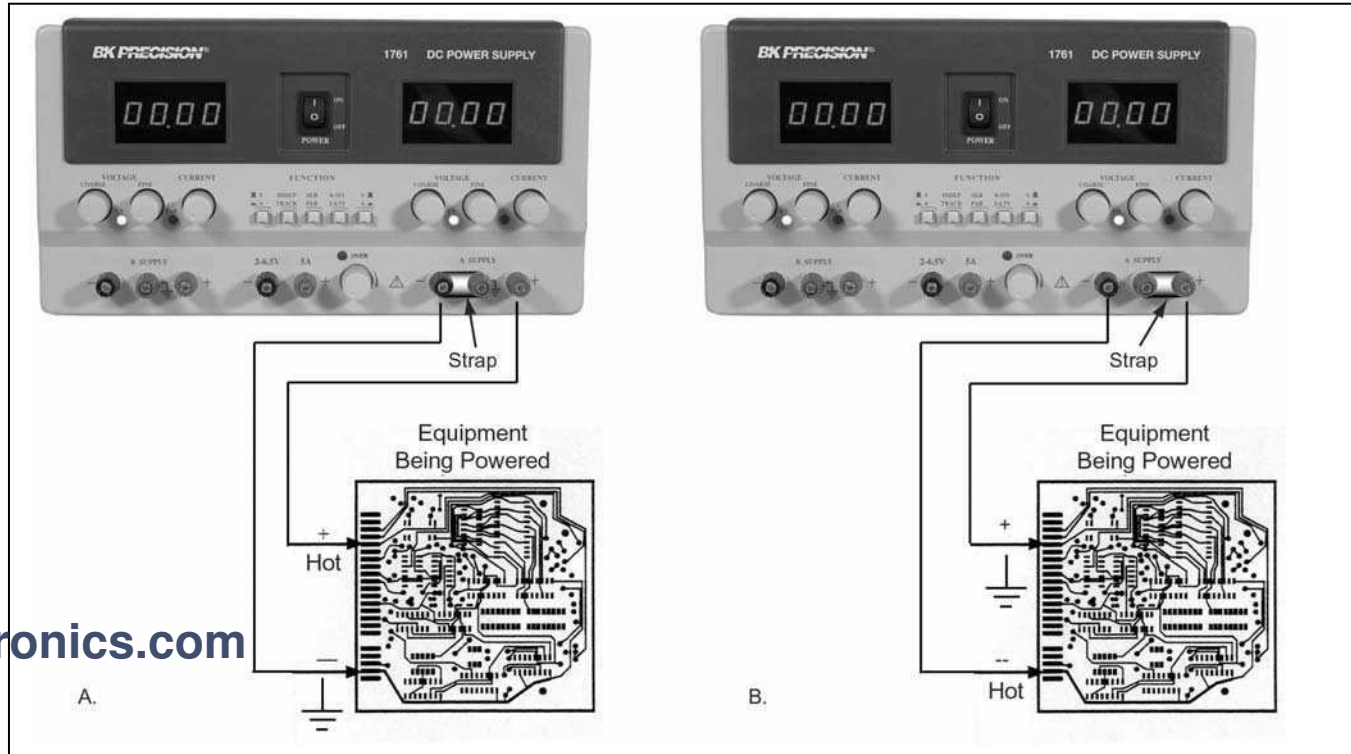

Fig. 3. Independent Operation Grounding Possibilities.

### Typical Constant Voltage Operation

1. Before connecting the device to be powered to the power supply, determine the maximum safe load current for the device to be powered and set the current limit value (see “Setting Current Limit” procedure in this section).
2. Set **Fine VOLTAGE** control to center and **Coarse VOLTAGE** control to minimum (fully counterclockwise).
3. Turn off power supply and connect it to the device to be powered (see “Hook-Up” procedure in this section).
4. Turn on **POWER** switch. The **CV** indicator should light.
5. Set the meter selection switch to the **V** position to select the voltage metering mode.
6. Increase the **VOLTAGE** setting until the LED display reads the desired value. The **Fine** control permits easier setting to a specific value.
7. Set the meter selection switch to the **A** position to select the current metering mode and note the load current on the display.
8. If the load current exceeds the preset current limit, the **CV** indicator will go off and the **CC** indicator will light. In this case, the power supply automatically switches to the constant current mode and further rotation of the **VOLTAGE** control will not increase the output voltage.

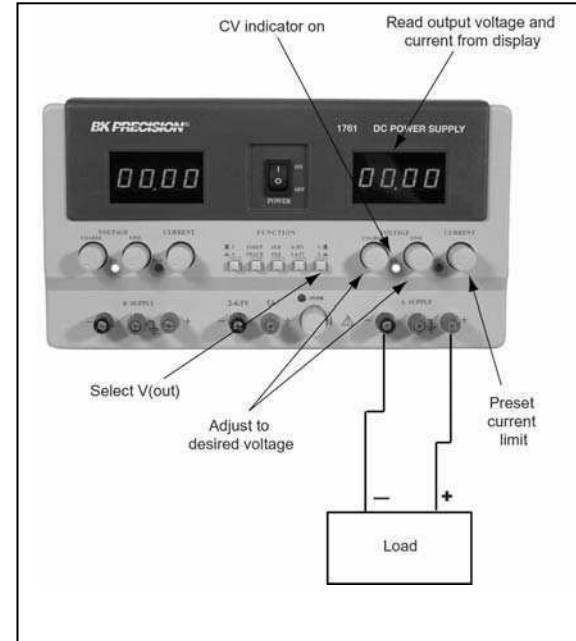

Fig. 4. Typical Constant Voltage Operation.

## OPERATING INSTRUCTIONS

### Setting Current Limit

1. Determine the maximum safe current for the device to be powered.
2. Temporarily short the (+) and (-) terminals of the power supply together with a test lead.
3. Rotate the **Coarse VOLTAGE** control away from zero sufficiently for the **CC** indicator to light.
4. Set the meter selection switch to the **A** position to select the current metering mode.
5. Adjust the **CURRENT** control for the desired current limit. Read the current value on the LED display.
6. The current limit (overload protection) has now been preset. Do not change the **CURRENT** control setting after this step.
7. Remove the short between the (+) and (-) terminals and hook up for constant voltage operation.

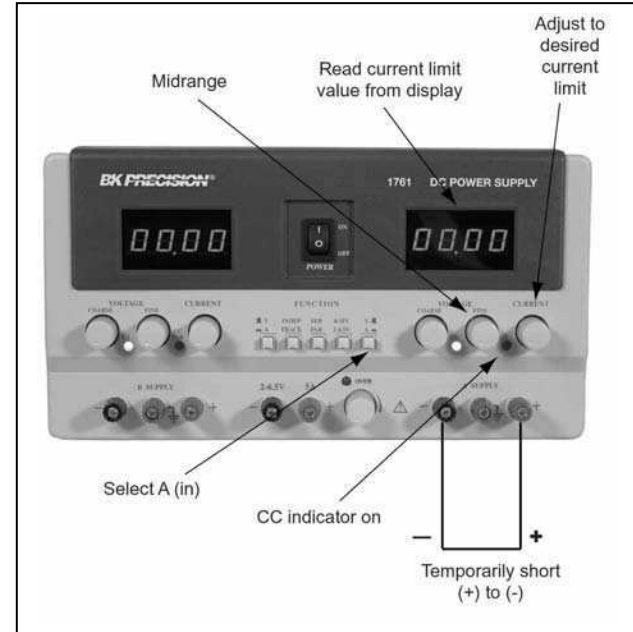

Fig. 5. Setting Current Limit.

### Typical Constant Current Operation

1. Before connecting the device to be powered to the power supply, determine the maximum safe voltage to be applied, set the meter selection switch to the **V** position, and set the **VOLTAGE** controls to obtain that voltage reading on the LED display.
2. Determine the desired constant current value.
3. Set the **CURRENT** control to minimum (fully counterclockwise).
4. Turn off the power supply and connect it to the device to be powered.
5. Turn on the power supply. The **CC** indicator should light if the load is greater than 5% of full scale.

#### NOTE

The CC indicator will not light if the load is less than 5% of full scale or approximately 0.1A.

6. Set the meter selection switch to the **A** position to obtain the current metering mode.
7. Increase the **CURRENT** control setting until the desired constant current value is read on the display, or set the current limit in advance (before connecting the load) as prescribed earlier in the "Setting Current Limit" procedure.
8. If the load current drops below the constant current value, the **CC** indicator will go off and the **CV** indicator will light. In this case, the power supply automatically switches to the constant voltage mode, and further rotation of the **CURRENT** control will not increase the output current.

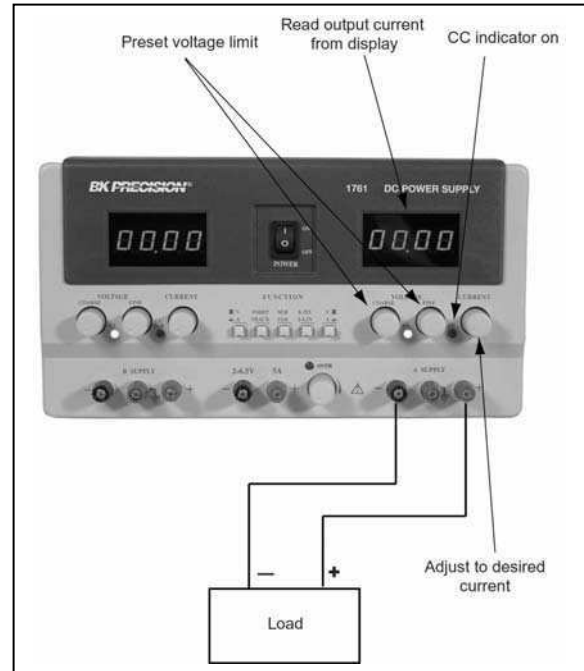

Fig. 6. Typical Constant Current Operation.

## OPERATING INSTRUCTIONS

### Constant Voltage/Constant Current Characteristic

The working characteristic of this power supply is called a constant voltage/constant current automatic crossover type. This permits continuous transition from constant current to constant voltage modes in response to the load change. The intersection of constant voltage and constant current modes is called the crossover point. Fig. 7 shows the relationship between this crossover point and the load.

For example, if the load is such that the power supply is operating in the constant voltage mode, a regulated output voltage is provided. The output voltage remains constant as the load increases, up until the point where the preset current limit is reached. At that point, the output current becomes constant and the output voltage drops in proportion to further increases in load. The crossover point is indicated by the front panel LED indicators. The crossover point is reached when the **CV** indicator goes off and the **CC** indicator comes on.

Similarly, crossover from the constant current to the constant voltage mode automatically occurs from a decrease in load. A good example of this would be seen when charging a 12-volt battery. Initially, the open circuit voltage of the power supply may be preset for 13.8 volts. A low battery will place a heavy load on the supply and it will operate in the constant current mode, which may be adjusted for a 1 amp charging rate. As the battery becomes charged, and its voltage approaches 13.8 volts, its load decreases to the point where it no longer demands the full 1 amp charging rate. This is the crossover point where the power supply goes into the constant voltage mode.

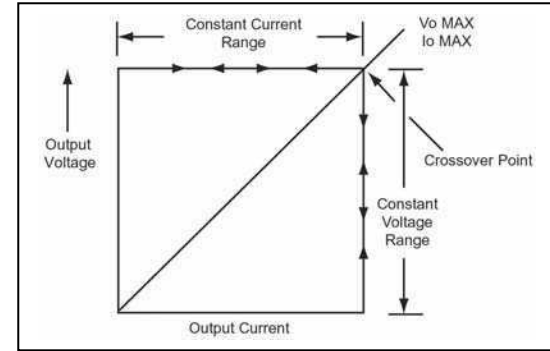

**Figure 7. Constant Voltage/Constant Current Characteristics.**

**SERIES TRACKING OPERATION**

When the series tracking mode of operation is selected, the positive (red) terminal of the “B” supply output is internally connected to the negative (black) terminal of the “A” supply. This allows the power supply to be used as a single 0-to-60 volt power supply simply by using the negative (black) terminal of the “B” supply and the positive (red) terminal of the “A” supply.

In the series tracking mode, the maximum output voltage of both the “A” and “B” supplies can be simultaneously varied with one control. The maximum “B” supply voltage can be set to the same value of the “A” supply by setting the “B” **Coarse** and **Fine VOLTAGE** controls fully clockwise, so that “B” is set to 100% tracking.

Simultaneous metering of both current and voltage can be obtained in this mode of operation by setting one of the displays for current metering and one for voltage metering. In this case, the output voltage (across the two supplies) is actually double the displayed value. For example, if the “B” display is set for voltage metering and the “A” display for current metering, the output voltage across the “A” positive (red) terminal and the “B” negative (black) terminal would be double the reading on the “B” **LED Display** (since both supplies are putting out the same voltage). The actual output current would be the value read from the “A” **LED Display**.

- 8. Set the power supplies to the **TRACKING SERIES** mode by engaging the **INDEP/TRACK** switch and releasing the **SER/PAR** switch.

- 1. Set the **0-60 V/4-6.5 V** switch to the **0-60 V** position, the “B” **V/A** switch to the **V** (voltage metering) position, and the “A” **V/A** switch to the **A** (current metering) position.
- 2. Set the “B” **Coarse** and **Fine Voltage** and **CURRENT** controls to the fully clockwise position. The maximum current is set using the “A” **CURRENT** control. Follow the instructions for “Setting Current Limit” (INDEPENDENT USE OF “A” OR “B” SUPPLY section of this manual) using the “A” **CURRENT** control.
- 3. Adjust the output voltage to the desired level using the “A” **VOLTAGE** controls (remember that the actual output voltage is double the reading on the “B” **LED Display**).
- 4. Turn off the power supply and the equipment to be powered during hook-up.
- 5. Connect the positive polarity of the device being powered to the red (+) terminal of the “A” power supply.
- 6. Connect the negative polarity of the device being powered to the black (-) terminal of the “B” power supply.
- 7. Fig. 8 illustrates the grounding possibilities when the unit is used as a 0-to-60 volt supply.
  - a. If the negative polarity of the equipment or circuit being powered is also the chassis or common, it may be grounded to earth by strapping the black (-) terminal of the “B” supply to the green (⏏) terminal of the “B” supply as shown in Fig. 8A.

## OPERATING INSTRUCTIONS

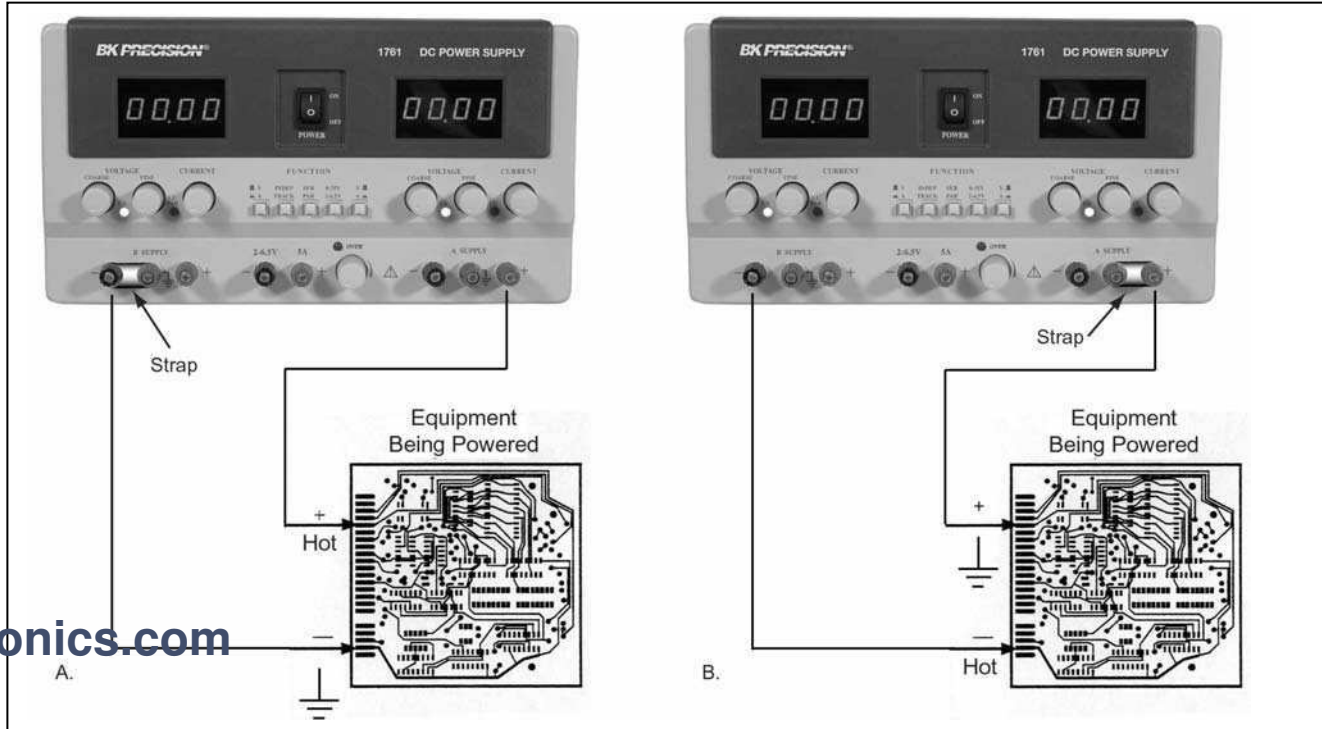

Fig. 8. Series Tracking (0-to-120V) Operation Grounding Possibilities

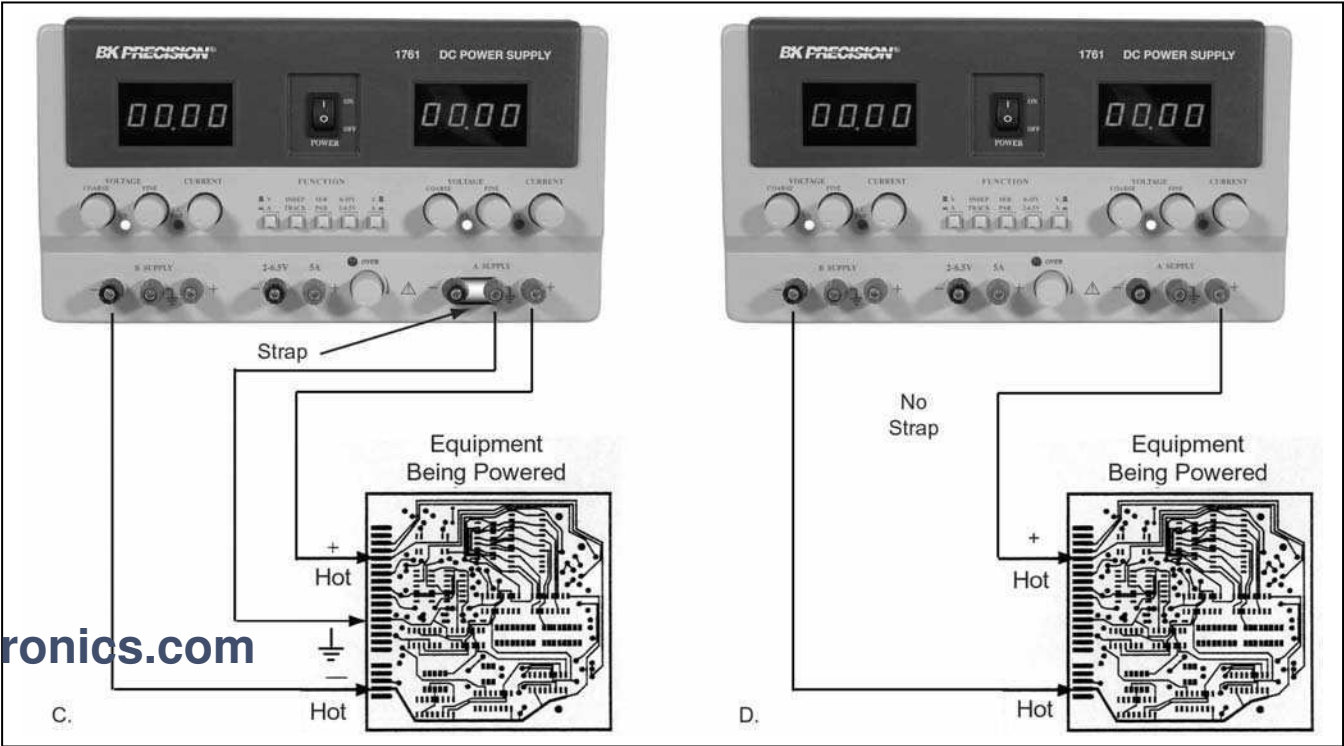
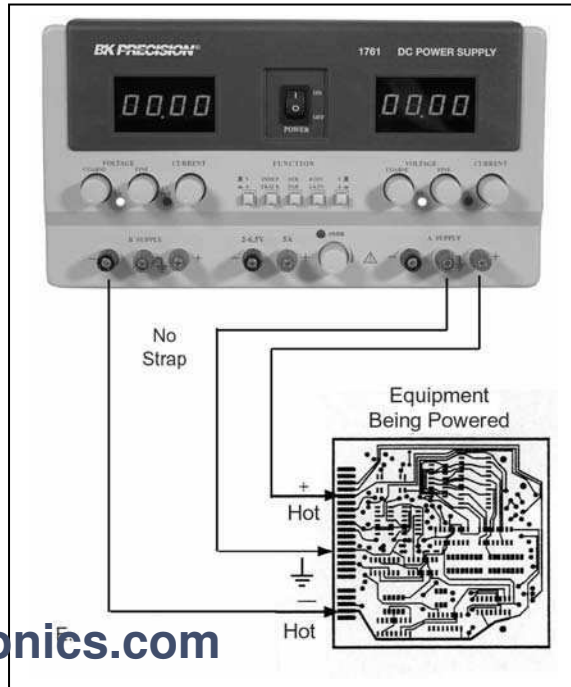

Fig. 8. Series Tracking (0-to-120V) Operation Grounding Possibilities



## OPERATING INSTRUCTIONS



**Fig. 8. Series Tracking (0-to-120V) Operation Grounding Possibilities**

- Similarly, the positive polarity can be grounded by strapping the red (+) terminal of the “A” supply to the green terminal of the “A” supply as shown in Fig. 8B.
- If “split supply” operation is desired, a positive and negative voltage with a center ground can be achieved by strapping the black (-) terminal of the “A” supply to the green ( $\perp$ ) of the “A” supply as shown in Fig. 8C. See the APPLICATIONS section of this manual for more information on “split supply” operation.

### NOTE

If one of the supplied ground straps is to be used, only use it in one of these three ways. Connecting two ground straps could ground both the positive and negative terminals and load down the power supply, causing improper operation.

- If an earth ground reference is not required, the configuration of Fig. 8D may be used. The scheme in Fig. 8D should also be used where it is not known whether the chassis is common with either the positive or negative polarity.
- If the chassis or common of the equipment being powered is separate from both the positive and negative polarity power inputs, use the connection shown in Fig. 8E.

9. Observe proper polarity. If the circuit being powered is not equipped with reverse polarity protection, damage to the circuit can result from reverse polarity. Use color coded hook-up leads, for convenience in identifying polarity, red for (+) and black for (-).
10. Make sure that the hook-up leads offer sufficient current capability and low resistance between the power supply and the circuits being powered.

### PARALLEL TRACKING OPERATION

In the parallel tracking mode of operation, both supplies are strapped together (in parallel). This allows for a 0-60 V supply with a 4 amp current capability. Only the “A” output terminals are used for parallel tracking operation. In the parallel tracking mode, the “B” supply output voltage and current track the “A” supply output voltage and current.

6. Set the power supplies to the **TRACKING PARALLEL** mode by engaging both **TRACKING** switches (**INDEP/TRACK** and **SER/PAR** switches).
7. Set the **0-60V/4-6.5V** switch to the **0-60V** position, the “A” V/A switch to the **V** (voltage metering) position, and the “B” V/A switch to the **A** (current metering) position. Output voltage will now be read from the “A” **LED Display**. Output current is exactly double the value read from the “B” **LED Display** (because each supply is providing the same amount of current).
8. Because both voltage and current of the “B” supply track the “A” supply, the maximum current and voltage are set using the “A” controls. Using the “A” supply output jacks, follow the instructions for “Setting Current Limit” (**INDEPENDENT USE OF “A” OR “B” SUPPLY** paragraph of this section). Remember that the actual current output at the “A” supply output jacks is double the reading on the “B” **LED Display**.

1. Adjust the output voltage to the desired level using the “A” **VOLTAGE** controls.
2. Turn off the power supply and the equipment to be powered during hook-up.
3. Connect the positive polarity of the device being powered to the red (+) terminal of the “A” power supply.
4. Connect the negative polarity of the device being powered to the black (-) terminal of the “A” power supply.
5. Fig. 9 illustrates the grounding possibilities when used in the **TRACKING PARALLEL** mode.
  - a. If the negative polarity of the equipment or circuit being powered is also the chassis or common, it may be grounded to earth by strapping the black (-) terminal to the green ( $\perp$ ) terminal as shown in Fig. 9A.
  - b. Similarly, the positive polarity can be grounded by strapping the red (+) terminal to the green ( $\perp$ ) terminal as shown in Fig. 9B.
  - c. If an earth ground reference is not required, the configuration of Fig. 9C may be used. The scheme in Fig. 9C should also be used where it is not known whether the chassis is common with either the positive or negative polarity.
  - d. If the chassis or common of the equipment being powered is separate from both the positive and negative polarity power inputs, use the connection shown in Fig. 9D.

## OPERATING INSTRUCTIONS

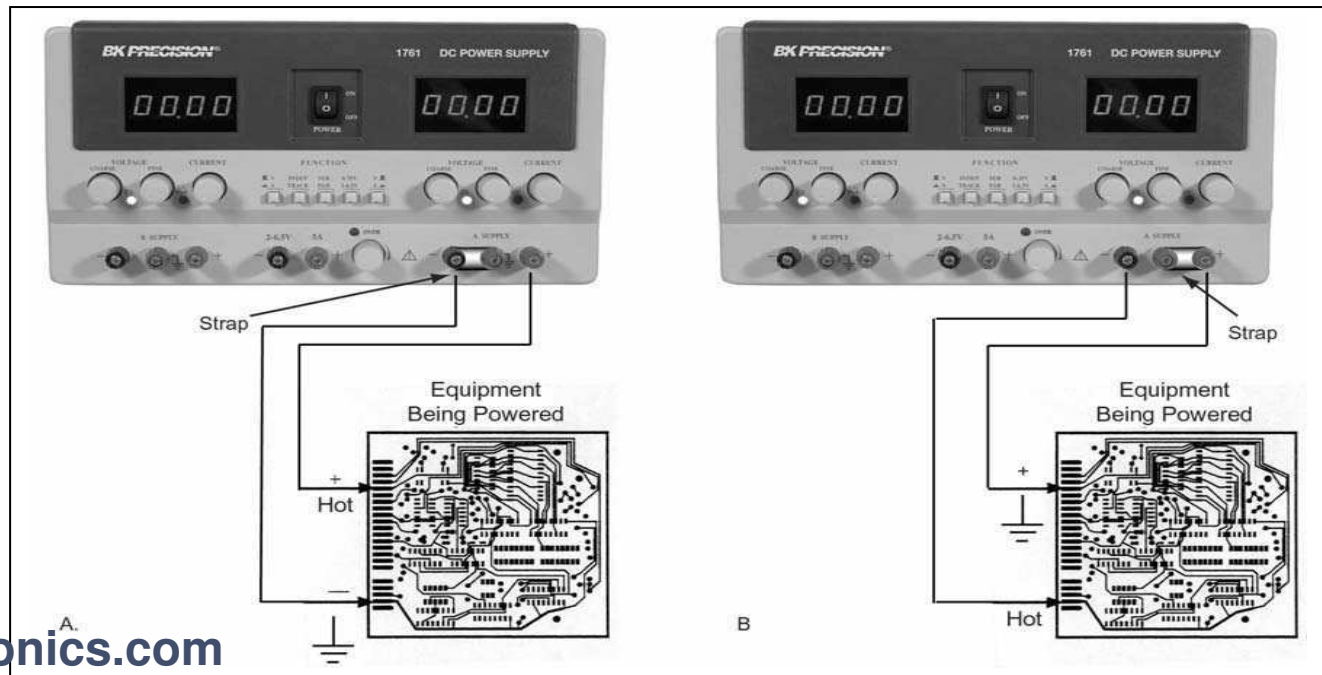

Fig. 9. Parallel Tracking Operation Grounding Possibilities

## OPERATING INSTRUCTIONS

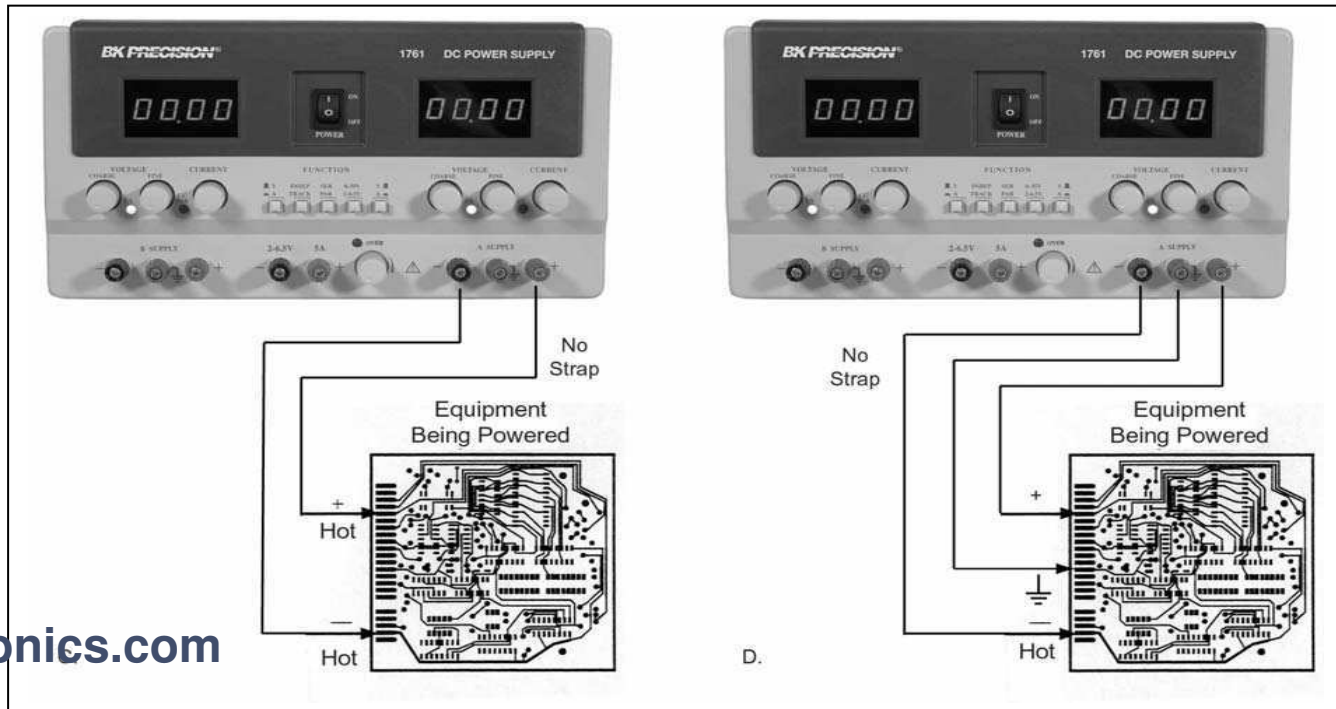

Fig. 9. Parallel Tracking Operation Grounding Possibilities

## OPERATING INSTRUCTIONS

---

9. Observe proper polarity. If the circuit being powered is not equipped with reverse polarity protection, damage to the circuit can result from reverse polarity. Use color coded hook-up leads, for convenience in identifying polarity, red for (+) and black for (-).
10. Make sure that the hook-up leads offer sufficient current capability and low resistance between the power supply and the circuits being powered. 10-amp test leads are available as an optional accessory.

### 4-6.5 V POWER SUPPLY OPERATION

The **4-6.5V** supply provides a 4.0 to 6.5V DC output with a 5 amp current capacity. The supply is ideal for use with TTL circuits.

5. Set the **0-60V/4-6.5V** switch to the **4-6.5V** position and the **Right V/A** switch to the **V** position. This sets the **“A”/4-6.5V Display** to show output voltage of the **4-6.5V** supply.
6. Using the **Voltage Level Control** to adjust the output voltage of the 4-6.5 V supply to the desired level.
7. Turn off the power supply and the equipment to be powered during hook-up.
8. Connect the positive polarity of the device being powered to the red (+) terminal of the **4-6.5V** supply.
9. Connect the negative polarity of the device being powered to the black (-) terminal of the **4-6.5V** supply.

1. Fig. 10 illustrates the grounding possibilities of the **4-6.5V** supply.
  - a. If the negative polarity of the equipment or circuit being powered is also the chassis or common, it may be grounded to earth by connecting a jumper from the black (-) terminal to either green ( $\perp$ ) terminal as shown in Fig. 10A.
  - b. Similarly, the positive polarity can be grounded by connecting a jumper between the red (+) terminal and either green ( $\perp$ ) terminal as shown in Fig. 10B.
  - c. If an earth ground reference is not required, the configuration of Fig. 10C may be used. The scheme in Fig. 10C should also be used where it is not known whether the chassis is common with either the positive or negative polarity.
  - d. If the chassis or common of the equipment being powered is separate from both the positive and negative polarity power inputs, use the connection shown in Fig. 10D.
2. Observe proper polarity. If the circuit being powered is not equipped with reverse polarity protection, damage to the circuit can result from reverse polarity. Use color coded hook-up leads, for convenience in identifying polarity, red for (+) and black for (-).
3. Make sure that the hook-up leads offer sufficient current capability and low resistance between the power supply and the circuits being powered. 10-amp hook-up leads are available as an optional accessory.
4. Set the **Right V/A** switch to the **A** position to monitor the load current.

## OPERATING INSTRUCTIONS

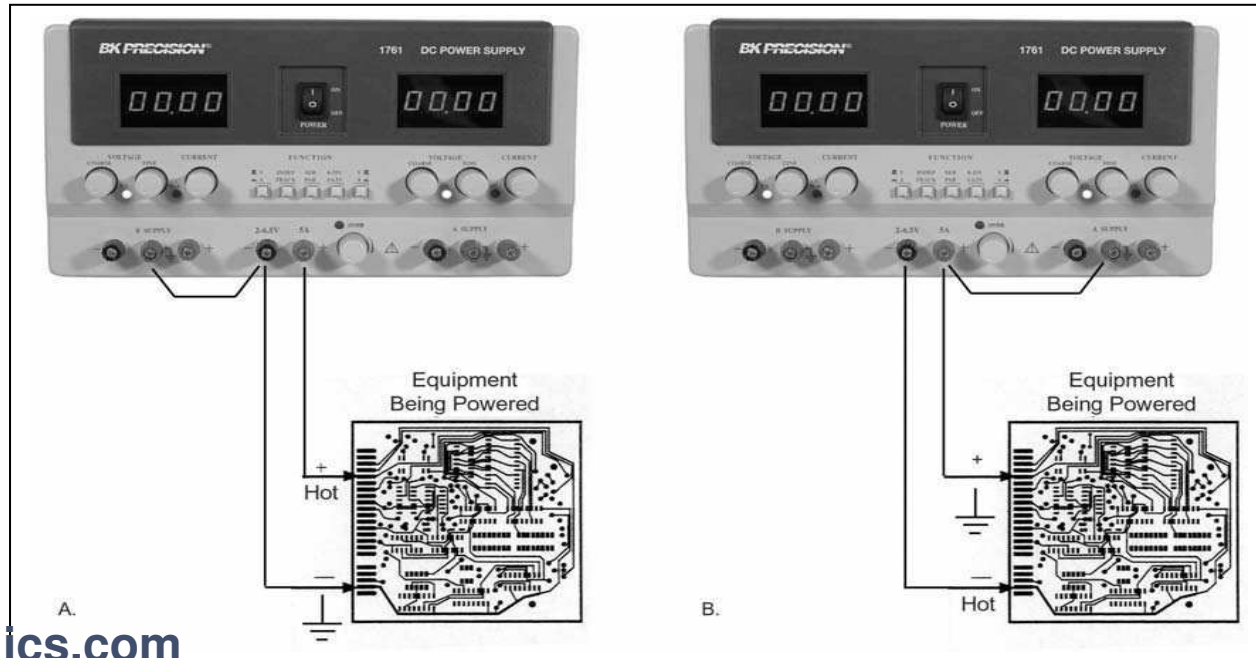

Fig. 10. Grounding Possibilities for 4-6.5 V Power Supply

## OPERATING INSTRUCTIONS

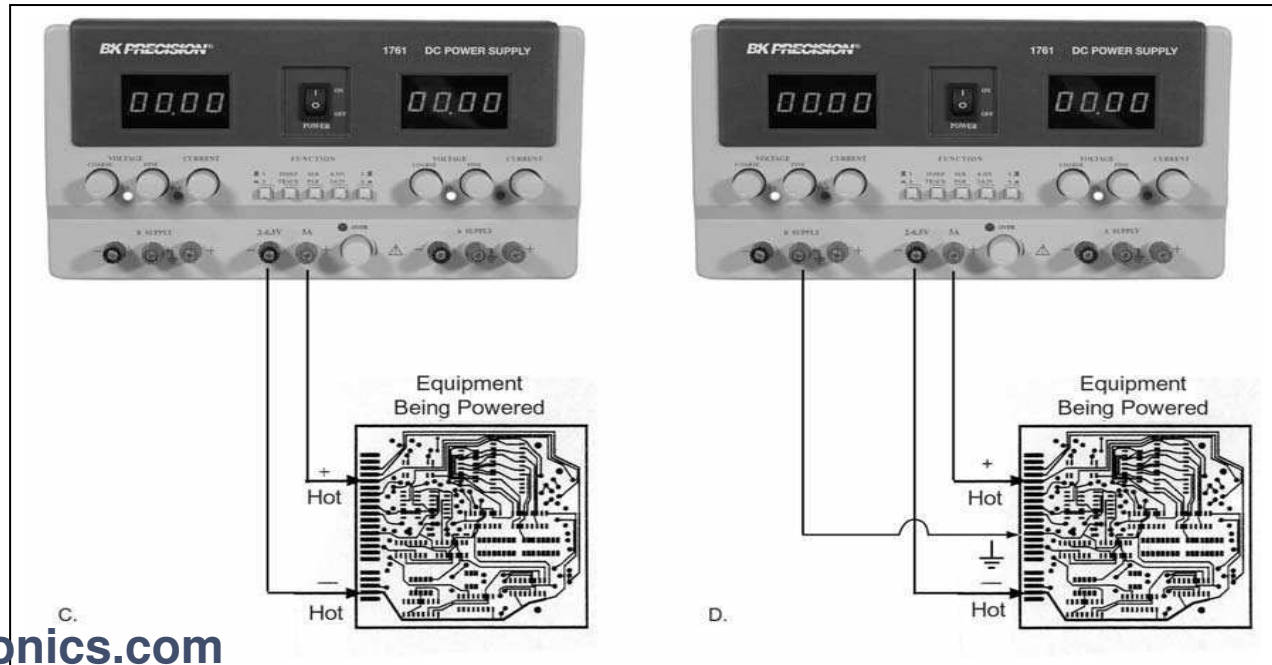

Fig. 10. Grounding Possibilities for 4-6.5 V Power Supply

## OPERATING INSTRUCTIONS

---

10. If the red **OVER**load indicator lights, too much load has been placed on the supply. This will cause voltage and current to drop and prevent proper operation of the **4-6.5V** supply. To correct this situation, the load on the supply must be decreased so that no more than 4 amps of current are required.

### NOTE

If decreasing the load does not cause the overload indicator to turn off, the overvoltage protection circuitry has activated. In order to return the supply to normal operation, the output voltage must be decreased (or the external voltage source must be removed) **and the power must be momentarily shut off.**



---

## APPLICATIONS

---

### GENERAL

The Model 1762 power supply has a very wide variety of applications in electrical and electronics servicing, engineering laboratories, manufacturing and testing facilities, schools, and home hobbying. The “A” and “B” power supply outputs are fully adjustable from 0 to 60 volts and 0 to 2A amps and the 4-6.5V supply is fully adjustable from 4-to-6.5V with a current capability of 0-to-4 amps. This flexibility makes it suitable for most applications requiring a dc power source.

### ELECTRONICS SERVICING

Most electronics troubleshooting and repair is performed on a test bench. This power supply can provide the dc power source to operate a module or circuit board on the test bench when it is removed from its parent equipment. It can be used to power portable, battery-operated equipment and check the effect of low battery voltage. It can power vehicular equipment such as tape players, auto sound systems, CB radios, etc. on the test bench. Parallel tracking supplies up to 4 amps, adequate surge current for most vehicular equipment.

Most automobiles and other vehicles use 12-volt electrical systems. Although the electrical system is normally referred to as a 12-volt system, a fully charged battery voltage when fully charged is approximately 14 volts. The power supply may be set to 14 volts for servicing equipment from vehicles with 12-volt electrical systems. Some trucks use a 24-volt electrical system; bench testing of equipment from these systems should be performed at 28 volts.

Some servicing applications require the injection of a variable dc voltage for certain tests, such as checking the effect of AGC bias in a television receiver. This requires an isolated dc power supply, such as the Model 1762. The equipment being tested may contain its own power supply and operate from ac power. A dc voltage may already be present in the circuit. One polarity of the power supply output is floated to an appropriate point in the circuit, such as the emitter of a transistor. The other polarity of the power supply output is then applied to another point in the circuit, such as the base of that transistor. Varying the power supply voltage then varies the dc bias on the stage, and the effects may be noted. A series limiting resistor is often used to protect the circuits from over dissipation.

### ELECTRONICS MANUFACTURING

In electronics manufacturing facilities, the power supply is often used as a dc power source while testing and adjusting modules, subassemblies, and complete units in the production and assembly area or in the quality control area. The instrument can be used in incoming inspection as a dc power source for testing purchased components and subassemblies.

This power supply is particularly well suited for manufacturing applications because of its ease of operation and its continuous duty rating. When load current or total power dissipation are among the main characteristics to be measured, the total load current and voltage are easily displayed on the LED display. The current limit can be set so that all units which do not meet the load current specification will cause the CC indicator to light, and the unit can be

### ELECTRONICS DESIGN LAB

The technician or engineer working in an engineering laboratory requires a dc power supply to power breadboard and prototype circuits. This power supply is ideal because it monitors output current and voltage, limits current to protect the circuit, is adjustable over a wide range, and has excellent regulation and very low ripple.

Use of the instrument in an engineering laboratory is very similar to that described for servicing electronics equipment and modules, except that lower currents may be prevalent when powering individual circuits. The current limiting feature is very valuable in this application because it can protect unproven circuits from damage.

### ELECTRONICS EDUCATION

The student in an electronics curriculum may use the power supply for powering equipment and circuits as previously described for all other applications. In addition, the power supply can be used in the classroom laboratory to conduct experiments in fundamental electronics. In learning Ohm's law, for example, the relationships of resistance, current, and voltage are easily demonstrated by the use of a power supply.

### BATTERY CHARGING

The power supply can be used as a battery charger to restore the charge in rechargeable batteries such as lead-acid, nickel-cadmium, and some alkaline types. Refer to the battery manufacturer's charging specifications for proper voltage and current settings.

Charging information is sometimes printed on the batteries. Battery charging, at least initially, requires the constant current mode of operation. Before connecting the power supply to the battery, preset the **VOLTAGE** controls to the fully charged terminal voltage specified by the battery manufacturer. Turn off the power supply while connecting the battery. Observe proper polarity and connect as for constant current operation. Adjust the **CURRENT** control for the maximum charging current specified by the battery manufacturer (If the maximum charging current is greater than the power supply's maximum load current, set the **CURRENT** control to maximum). The **CC** indicator will light and the battery will charge at the preset current limit. As the battery approaches full charge, its terminal voltage will approach that of the power supply output and the charging current will taper off. The power supply may automatically switch to **CV** (constant voltage) operation. When this occurs, the power supply will continue to provide a trickle charge.

### SPLIT SUPPLY

Frequently, "split power supplies" are required for amplifier and other electronic circuits. The Model 1762 is ideally suited for "split power supply" operation. This supply can be configured to provide two positive voltages with a common negative, two negative voltages with a common positive, or one positive and one negative with a common ground. In addition, each of these configurations can be obtained with identical or differing voltages.

## APPLICATIONS

### Two Identical Positive Voltages With a Common Negative (Refer To Fig. 11)

Some electronic equipment requires two identical positive voltages with a common negative. A good example of this would be a digital car clock where there are two +12 volt inputs and a common negative. Using both supplies in the parallel tracking mode would provide the simplest hook-up and operation. This type of “split supply” operation is obtained as follows:

1. Connect a ground strap between the “A” supply’s negative terminal and ground.
2. Set the desired voltage and maximum current using the “A” **VOLTAGE** and **CURRENT** controls.
3. Turn off the power supply and the equipment to be powered during hook-up.
4. Connect the positive polarity inputs of the circuit to be powered to the positive (red) terminals of the supplies and connect the common negative input of the circuit to be powered to the “A” supply’s negative (black) or ground (green) terminal.

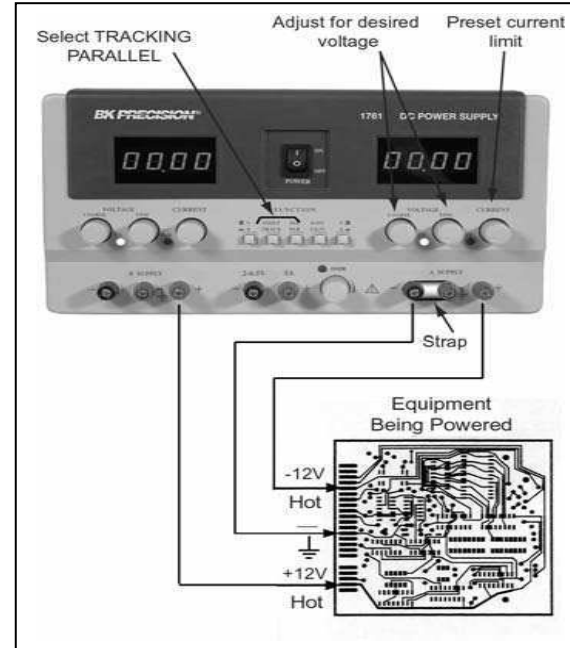
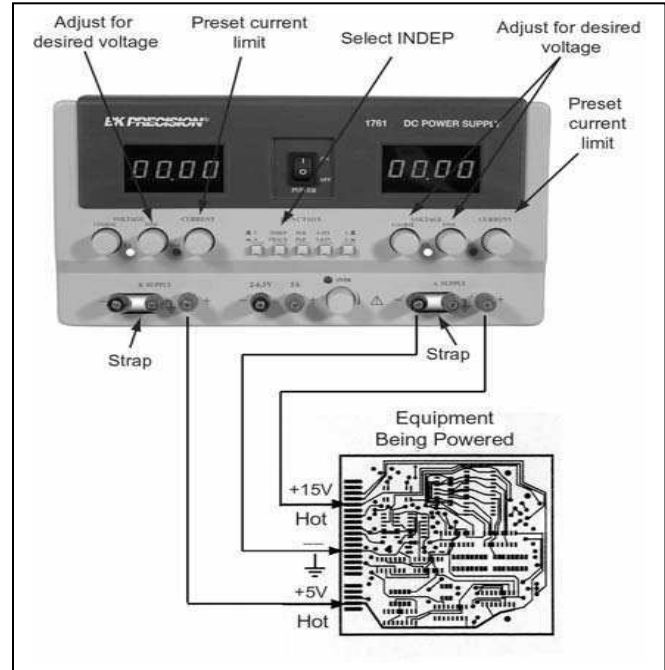

Fig. 11. Typical Hook-Up Using Two Identical Positive Voltages and a Common Negative.

**Two Differing Positive Voltages With a Common Negative (Refer To Fig. 12)**

Many electronic circuits require two different positive voltages with a common negative. A typical example of this would be a device that uses both TTL (+5 V) and analog (typically +15 V) circuitry. Using both supplies, two differing positive voltages with a common negative are obtained as follows:

1. Select the **INDEP**endent operating mode and set up the LED displays so that both displays monitor voltage.
2. Connect the ground straps between each supplies' negative terminal and ground.
3. Independently set the desired voltage and maximum current for the "A" and "B" supplies using the "A" **VOLTAGE** and **CURRENT** controls and the "B" **VOLTAGE** and **CURRENT** controls respectively.
4. Turn off the power supply and the equipment to be powered during hook-up.
5. Connect the positive polarity inputs of the circuit to be powered to the positive (red) terminal of the supply. Connect the common negative input of the circuit to be powered to either the supply's negative (black) or ground (green) terminal.
6. If desired, set the LED displays to monitor current.



**Fig. 12. Typical Hook-Up Using Two Different Positive Voltages and a Common Negative.**

## APPLICATIONS

### Two Identical Negative Voltages With a Common Positive (Refer To Fig. 13)

When the same negative voltage is required at two points in the same circuit and a common positive is needed, perform the following:

1. Connect the ground strap between the positive terminal and the ground of the “A” supply.
2. Set the desired voltage and maximum current using the “A” **VOLTAGE** and **CURRENT** controls.
3. Turn off the power supply and the equipment to be powered during hook-up.
4. Connect the negative polarity inputs of the circuit to be powered to the negative (black) terminals of the supplies. Connect the common positive input of the circuit to be powered to the “A” supply’s positive (red) or ground (green) terminal.

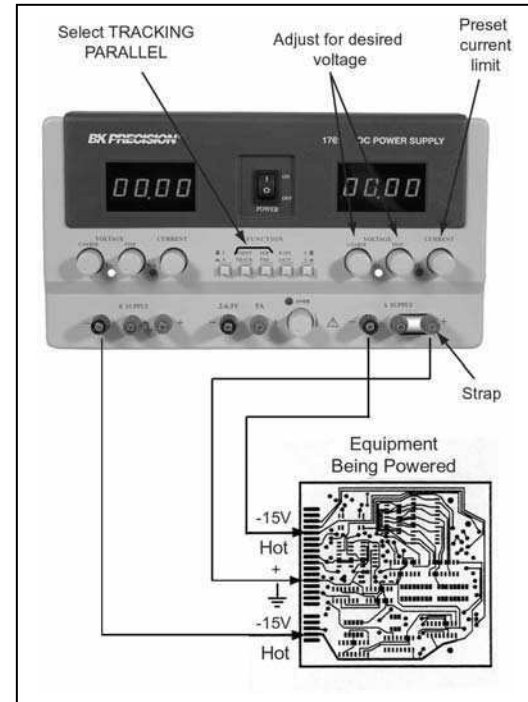
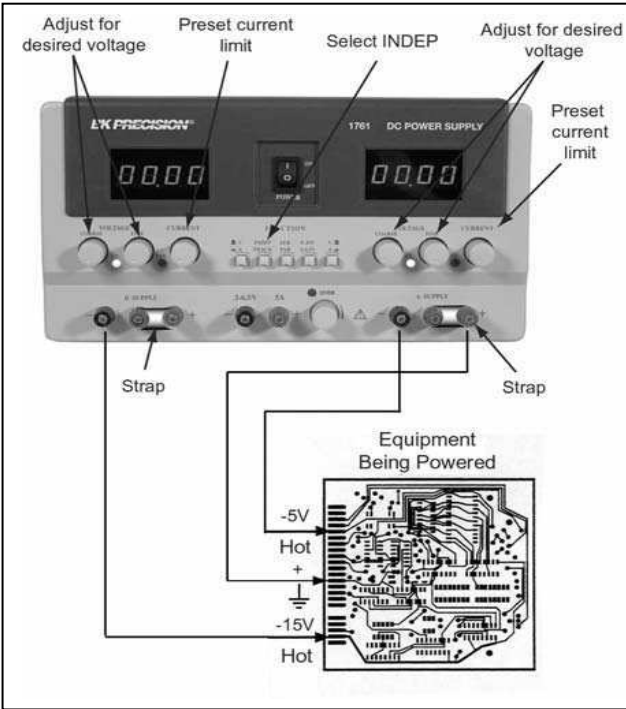

Fig. 13. Typical Hook-Up Using Two Identical Negative Voltages and a Common Positive.

**Two Differing Negative Voltages With a Positive Common (Refer To Fig. 14)**

Using both supplies, two differing negative voltages with a common positive are obtained as follows:

1. Select the **INDEP**endent operating mode and set up the LED displays so that both displays monitor voltage.
2. Connect the ground straps between each supplies' positive terminal and ground.
3. Independently set the desired voltage and maximum current for the "A" and "B" supplies using the "A" **VOLTAGE** and **CURRENT** controls and the "B" **VOLTAGE** and **CURRENT** controls respectively.
4. Turn off the power supply and the equipment to be powered during hook-up.
5. Connect the negative polarity inputs of the circuit to be powered to the negative (black) terminals of the supplies. Connect the common positive input of the circuit to be powered to either supplies' positive (red) or ground (green) terminal.
6. If desired, set the LED displays to monitor current.



**Fig. 14. Typical Hook-Up Using Two Different Negative Voltages and a Common Positive.**

## APPLICATIONS

### Identical Positive and Negative Voltages With a Separate Common (Refer To Fig. 15)

Another typical “split supply” application is when a circuit uses operational amplifiers (op-amps). Typically, identical positive and negative voltages are required to power op-amp circuits. Using both supplies and the series tracking mode of operation, identical positive and negative voltages with a separate common are obtained as follows:

1. Select the **TRACKING SERIES** operating mode and set A/B Metering switch to monitor the “A” supply.
2. Set the desired voltage using the “A” VOLTAGE controls.
3. Connect a ground wire between the “A” supply negative terminal and the GND (green) terminal.
4. Turn off the power supply and the equipment to be powered during hook-up.
5. Connect the positive polarity input of the circuit to be powered to the positive (red) terminal of the “A” supply and connect the negative polarity of the circuit to the negative terminal of the “B” supply. Connect the circuit ground to the ground terminal of the “A” supply, the positive terminal of the “B” supply, or the GND (green) terminal.

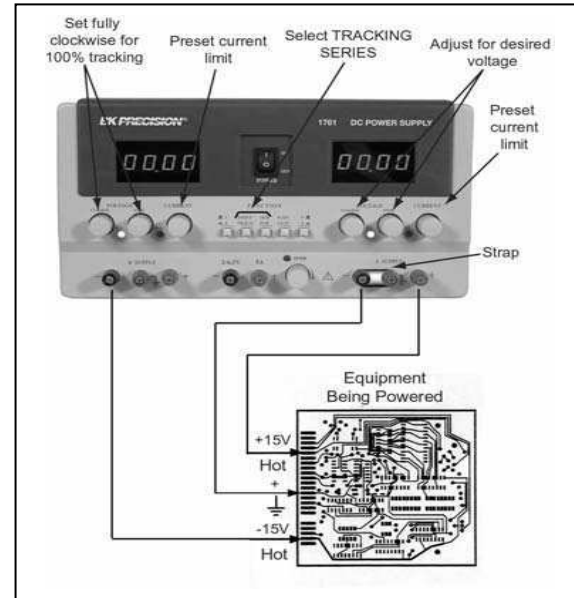

**Fig. 15. Typical Hook-Up Using Identical Positive and Negative Voltages with a Separate Common.**

### Differing Positive and Negative Voltages With a Separate Common (Refer To Fig. 16)

Using both supplies and the series tracking mode of operation, different positive and negative voltages with a separate common utilizing the variable “B tracks A” mode of operation are obtained as follows:

1. Select the **TRACKING SERIES** operating mode and set up the LED displays to monitor voltage.
2. Connect one ground strap between the ground terminal and the negative terminal of the “A” supply and the other between the ground terminal and the positive terminal of the “B” supply.
3. Set the desired voltage for each supply using the **VOLTAGE** controls. Set the maximum current using the **CURRENT** controls.
4. Turn off the power supply and the equipment to be powered during hook-up.
5. Connect the positive polarity input of the circuit to be powered to the positive (red) terminal of the “A” supply and connect the negative polarity of the circuit to the negative terminal of the “B” supply. Connect the circuit ground to the ground terminal of either the “A” or “B” supply.
6. If desired, set the LED displays to monitor current. The load current will usually be different for each of the supplies in this configuration.
7. The advantage of this configuration over the independent one is that if the +12 V “A” supply is varied to simulate a -10% to +10% voltage variation, the -5 V “B” supply will automatically vary the same percentage.

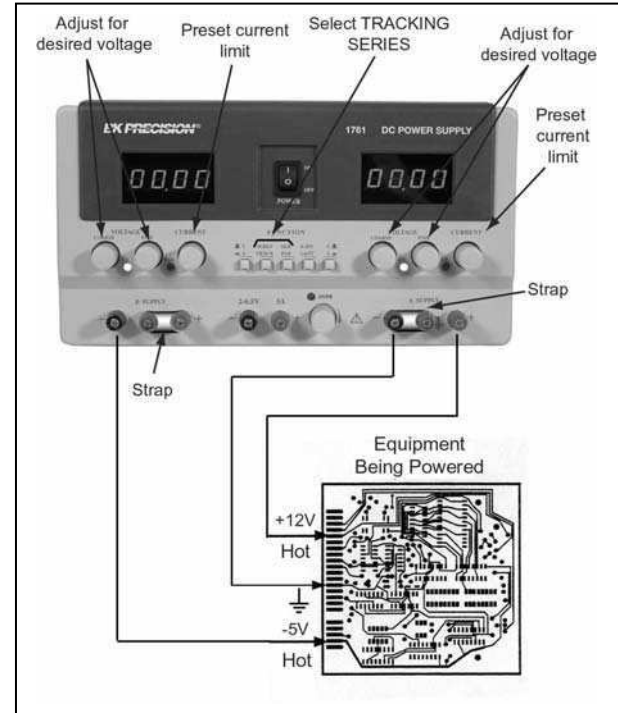

Fig. 16. Typical Hook-Up Using Different Positive and Negative Voltages and a Separate Common.



---

## MAINTENANCE

---

### WARNING

*The following instructions are for use by qualified personnel only. To avoid electrical shock, do not perform any servicing other than contained in the operating instructions unless you are qualified to do so.*

*Line voltage is exposed when the top cover is removed from the power supply, and is present on the fuseholder and power switch even when the unit is turned off.*

### FUSE REPLACEMENT

If the fuse blows, the LED indicator will not light and the power supply will not operate. The fuse should not normally open unless a problem has developed in the unit. Try to determine and correct the cause of the blown fuse, then replace only with a fuse of the correct rating as listed in Table 1. The fuse is located on the rear panel (see Fig. 2).

**Table 1. Fuse Values**

OPERATION	FUSE VALUE	TYPE
120 V	3.0A	Slow Blow
220/230/240 V	1.5A	Slow Blow

### LINE VOLTAGE CONVERSION, INTERNATIONAL UNITS

This power supply can be switched from 110VAC to 220/230/240VAC by a switch located on the rear panel. To select the desired line voltage, simply insert the fuse and fuse holder so that the appropriate voltage is pointed to by the arrow. Be sure to use the proper vale fuse (see label on rear panel).

## MAINTENANCE

### ADJUSTMENTS

This unit was accurately adjusted at the factory before shipment. Readjustment is recommended only if repairs have been made in a circuit affecting adjustment accuracy, or if you have a reason to believe the unit is out of adjustment. However, adjustments should be attempted only if a 4-1/2 digit multimeter with an accuracy of  $\pm 0.1\%$  dcV or better is available (**B+K Precision** Model 391A or equivalent).

If readjustment is required, use the following procedure. All references to left and right are correct when facing the front of the supply. The functions of the adjustments are shown in Table 2 and their locations are shown in Fig. 18.

#### I. "A" SUPPLY AND "A" METERING ADJUSTMENTS

1. Connect an accurate ( $\pm 0.1\%$ ) external 4-1/2 digit multimeter to measure the dc voltage at the output terminals of the "A" SUPPLY.
2. Disengage the **INDEP/TRACK** mode switch (out) so that the power supply is in the **INDEP**endent operating mode.
3. Set the "A" **VOLTAGE** controls (both **Coarse** and **Fine**) to maximum (fully clockwise).
4. Adjust **R6** ("A" SUPPLY +5V REF) on the main circuit board (located on the right rear side of the supply) for a reading as close to **60.40** volts (on the multimeter) as possible.
5. Set the **0-60 V/4-6.5V** switch to the **0-60V** position and the **Right V/A** switch to the **V** position.

Table 2. Functions of Calibration Adjustments

ADJ	FUNCTION OF ADJ	LOCATION OF ADJ
R6	"A" SUPPLY +5 V REF.	MAIN BOARD
R10	"B" SUPPLY +5 V REF.	MAIN BOARD
R119	"B" SUPPLY SERIES TRACKING	MAIN BOARD
R122	4-6.5V A METER & A LIMIT	MAIN BOARD
R133	4-6.5V V METER	MAIN BOARD
R134	4-6.5V 3.9V REF.	MAIN BOARD
R159	4-6.5V 6.8V REF.	MAIN BOARD
R163	"A" SUPPLY A METER	MAIN BOARD
R164	"B" SUPPLY A METER	MAIN BOARD
R304L	"B" SUPPLY V METER	"B" PANEL METER
R304R	"A" SUPPLY V METER	"A" PANEL METER

1. Adjust **R304** ("A" SUPPLY V METER ADJ) on the "A" panel meter board (located on the right side of the supply behind the "A"/4-6.5V LED Display) for a reading of **60.4** volts on the "A"/4-6.5V LED Display.
2. Set the "A" **Coarse VOLTAGE** control for a reading of approximately **05.0** volts on the "A"/4-6.5V LED Display.

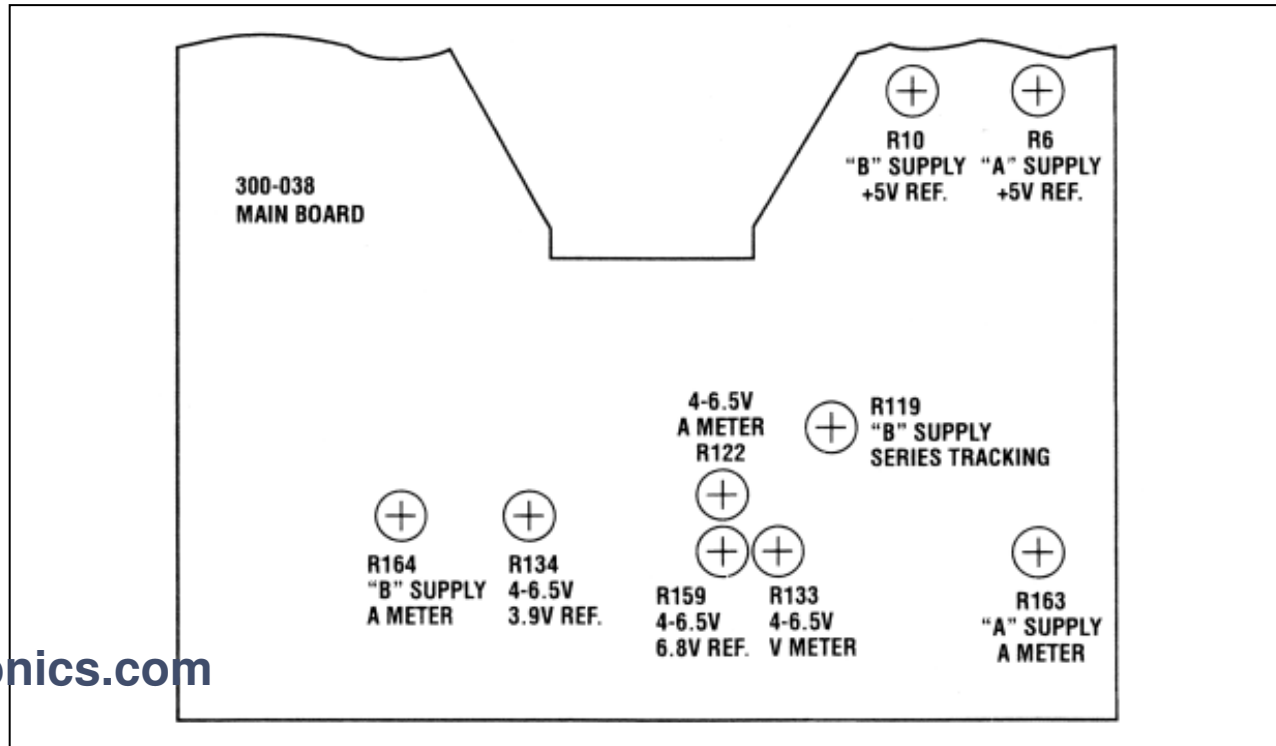

Fig. 18. Location of Adjustments (Main Circuit Board).

## MAINTENANCE

---

3. Set the **Right V/A** switch to the **A** position.
4. Connect the external multimeter across the **“A” SUPPLY** output terminals to read the output current (so that the meter causes a short circuit across the terminals) and adjust the **“A” CURRENT** control so that **2.00** amps is read on the **“A”/4-6.5V LED Display**.
5. Adjust **R163 (‘A’ SUPPLY A METER ADJ)** so that the multimeter also reads 2.00 amps.

### II. 4-6.5V SUPPLY AND 4-6.5V METERING ADJUSTMENTS

5. Set the **0-60V/4-6.5V** switch to the **4-6.5V** position and the **Right V/A** switch to the **V** position.
6. Connect an accurate ( $\pm 0.1\%$ ) external 4-1/2 digit multimeter across the output terminals of the **4-6.5V SUPPLY** to read output voltage and adjust the **4-6.5V** front panel voltage level control to minimum (4V, fully counterclockwise).
7. Adjust **R134 (4-6.5V 3.9V REF)** located on the main board for a reading of **3.90** volts on the external multimeter.
8. Adjust **R133 (4-6.5V V METER ADJ)** located on the main board so that the **“A”/4-6.5V LED Display** reads **3.90** volts.
9. Set the **Right V/A** switch to the **A** position.
10. Fully adjust **R122 (4-6.5V A METER & A LIMIT ADJ)** and **R159 (4-6.5V 6.8V REF)** located on the main board fully clockwise.

1. Connect a 1  $\Omega$  load (rated at 30W or more) and the multimeter in series across the output terminals of the **4-6.5V SUPPLY** to read the output current.
2. Adjust the **4-6.5V** voltage level control to obtain an output of **5.30** amps (read on the multimeter).
3. Adjust **R122 (4-6.5V A METER & A LIMIT ADJ)** so that the **“A”/4-6.5V LED Display** also reads **5.30** amps.
4. Slowly Adjust **R159 (4-6.5V 6.8V REF)** counterclockwise until the **OVER** indicator on the 1762 Front Panel just lights.

### III. “B” SUPPLY AND METERING ADJUSTMENTS

1. Connect an accurate ( $\pm 0.1\%$ ) external 4-1/2 digit multimeter to measure the dc voltage at the output terminals of the **“B” SUPPLY**.
2. Disengage the **INDEP/TRACK** mode switch (out) so that the power supply is in the **INDEP**endent operating mode.
3. Set the **“B” VOLTAGE** controls (both **Coarse** and **Fine**) to maximum (fully clockwise).
4. Adjust **R10 (‘B’ SUPPLY +5V REF)** on the main board for as close to **60.70** volts (on the multimeter) as possible.
5. Set the **Left V/A** switch to the **V** position.
6. Adjust **R304 (‘B’ SUPPLY V METER ADJ)** on the **“B”** panel board (located on the left side of the supply behind the **“B” LED Display**) for a reading of **60.7** volts on the **“B” LED Display**.

7. Set the **“B” Coarse VOLTAGE** control for a reading of approximately **05.0** volts on the **“B” LED Display**.
8. Set the **Left V/A** switch to the **A** position.
9. Connect the external multimeter across the **“B” SUPPLY** output terminals to read the output current (so that the meter causes a short circuit across the terminals) and adjust the **“B” CURRENT** control so that **2.00** amps is read on the **“B” LED Display**.
10. Adjust **R164 (“B” SUPPLY A METER ADJ)** so that the multimeter also reads 2.00 amps.

#### IV. “B” SERIES TRACKING ADJUSTMENT

4. Set the supply to the **TRACKing SERIEs** mode by engaging the **INDEP/TRACK** switch and releasing the **SER/PAR** switch.
5. Set the **“B” VOLTAGE** controls (both **Coarse** and **Fine**) to maximum (fully clockwise).
6. Set the **“A” VOLTAGE** controls (both **Coarse** and **Fine**) to maximum (fully clockwise).

1. Connect the multimeter to the **“A” SUPPLY** outputs and measure the voltage.
2. Disconnect the multimeter from the **“A” SUPPLY** outputs and connect it to the **“B” SUPPLY** outputs.
3. Adjust **R119 (SERIES TRACKING ADJ)** (located on the MAIN board) until the voltage read from the multimeter is the same as it was across the **“A” SUPPLY** output terminals. Return the multimeter to the **“A” SUPPLY** output terminals and verify that the output voltage is identical. If not, repeat this step.

#### INSTRUMENT REPAIR SERVICE

Because of the specialized skills and test equipment required for instrument repair and calibration, many customers prefer to rely upon **B+K Precision** for this service. We maintain a network of **B+K Precision** authorized service agencies for this purpose. To use this service, even if the instrument is no longer under warranty, follow the instructions given in the **WARRANTY SERVICE INSTRUCTION** section of this manual. There is a nominal charge for instruments out of warranty.

## Service Information

**Warranty Service:** Please return the product in the original packaging with proof of purchase to the address below. Clearly state in writing the performance problem and return any leads, probes, connectors and accessories that you are using with the device.

**Non-Warranty Service:** Return the product in the original packaging to the address below. Clearly state in writing the performance problem and return any leads, probes, connectors and accessories that you are using with the device. Customers not on open account must include payment in the form of a money order or credit card. For the most current repair charges please visit [www.bkprecision.com](http://www.bkprecision.com) and click on “service/repair”.

Return all merchandise to B&K Precision Corp. with pre-paid shipping. The flat-rate repair charge for Non-Warranty Service does not include return shipping. Return shipping to locations in North American is included for Warranty Service. For overnight shipments and non-North American shipping fees please contact B&K Precision Corp.

B&K Precision Corp.  
22820 Savi Ranch Parkway  
Yorba Linda, CA 92887  
[www.bkprecision.com](http://www.bkprecision.com)  
714-921-9095

**Include with the returned instrument your complete return shipping address, contact name, phone number and description of problem.**

## Limited Two-Year Warranty

B&K Precision Corp. warrants to the original purchaser that its products and the component parts thereof, will be free from defects in workmanship and materials for a period of two years from date of purchase.

B&K Precision Corp. will, without charge, repair or replace, at its option, defective product or component parts. Returned product must be accompanied by proof of the purchase date in the form of a sales receipt.

To obtain warranty coverage in the U.S.A., this product must be registered by completing a warranty registration form online at [www.bkprecision.com](http://www.bkprecision.com) within fifteen (15) days of purchase.

**Exclusions: This warranty does not apply in the event of misuse or abuse of the product or as a result of unauthorized alterations or repairs. The warranty is void if the serial number is altered, defaced or removed.**

B&K Precision Corp. shall not be liable for any consequential damages, including without limitation damages resulting from loss of use. Some states do not allow limitations of incidental or consequential damages. So the above limitation or exclusion may not apply to you.

This warranty gives you specific rights and you may have other rights, which vary from state-to-state.

B&K Precision Corp.  
22820 Savi Ranch Parkway  
Yorba Linda, CA 92887  
[www.bkprecision.com](http://www.bkprecision.com)  
714-921-9095

Model Number: \_\_\_\_\_

Date Purchased: \_\_\_\_\_

(continued from inside front cover)

4. If possible, familiarize yourself with the equipment being tested and the location of its high voltage points. However, remember that high voltage may appear at unexpected points in defective equipment.
5. Use an insulated floor material or a large, insulated floor mat to stand on, and an insulated work surface on which to place equipment; and make certain such surfaces are not damp or wet.
6. When testing ac powered equipment, the ac line voltage is usually present on some power input circuits such as the on-off switch, fuses, power transformer, etc. “any time” the equipment is connected to an ac outlet.
7. **B+K Precision** products are not authorized for use in any application involving direct contact between our product and the human body, or for use as a critical component in a life support device or system. Here, “direct contact” refers to any connection from or to our equipment via any cabling or switching means. A ”critical component” is any component of a life support device or system whose failure to perform can be reasonably expected to cause failure of that device or system, or to affect its safety or effectiveness.
8. Never work alone. Someone should be nearby to render aid if necessary. Training in CPR (cardio-pulmonary resuscitation) first aid is highly recommended.



***BK PRECISION***<sup>®</sup>

22820 Savi Ranch Parkway  
Yorba Linda, CA 92887  
[www.bkprecision.com](http://www.bkprecision.com)

© 2008 B&K Precision Corp.

**aluetronics.com**

V091608  
Printed in Taiwan