



ATS-1 AUDIO TEST SYSTEM - DUAL DOMAIN
USER'S MANUAL

ATS-1 Dual Domain

User's Manual



Audio 
precision

Firmware Version 3.10

October 1998

Audio Precision Part No. 8211.0042

Copyright © 1998 Audio Precision, Inc. All rights reserved. No part of this document may be reproduced or transmitted in any form or by any means, electronic or mechanical, including photocopying, recording, or by any information storage and retrieval system, without permission in writing from the publisher.

Audio Precision®, System One®, System One + DSP™, System Two™, FASTTEST®, APWIN™, Portable One®, Access™ and Dual Domain® are trademarks or registered trademarks of Audio Precision, Inc.



This mark signifies that the product conforms to all applicable requirements of the European Community. A Declaration of Conformance is included with the user information that describes the specifications used to demonstrate conformity.

Published by:



Audio Precision, Inc.
PO Box 2209
Beaverton, Oregon 97075-2209
U.S. Toll Free: 1-800-231-7350
Tel: (503) 627-0832 Fax: (503) 641-8906
email: techsupport@audioprecision.com
Web: www.audioprecision.com

Printed in the United States of America

CONTENTS

Safety Information	vii
Safety Symbols	viii
Description	1-1
Scope of this manual	1-1
Related documentation	1-2
Introducing the ATS-1 Dual Domain	1-2
Filter Shapes	1-6
Identification of Features and Options	1-8
IMD Option	1-8
Connector Panel Options	1-8
Optional Filters	1-8
Options Label	1-9
Block Diagrams	1-10
Analog Section	1-10
Digital Section	1-12
Analog Generator Output Circuit	1-15
Analog Analyzer Input Circuit	1-17
Getting Started	2-1
Connecting Mains Supply Voltage	2-1
Rackmounting	2-2
Concepts and Terminology	2-2
Analog vs. Digital	2-2
Balanced vs. Unbalanced	2-3
Self Test	2-4
Operational Overview	3-1
Front Panel Controls and Connectors	3-1
FUNCTION Keys	3-1
FREQUENCY Controls	3-2
AMPLITUDE Controls	3-2
INPUT Keys	3-3
OUTPUT Keys	3-3

INSTRUMENT MODE Keys	3-4
RECALL/SAVE Key	3-4
Soft Keys	3-4
LCD Display	3-4
dBm Zero Key	3-5
GPIB Status Indicators	3-5
CONTRAST Control	3-5
MONITOR Operation	3-5
POWER Switch	3-6
Setup Panel	3-10
Screen Saver	3-11
Controlling the Generators	3-12
Generators Overview	3-12
Generator Control Modes	3-13
.	3-15
Analog Generator Mode (A:GEN)	3-15
Digital Audio Generator Mode (D:GEN)	3-16
Digital Sample Rate Generator Mode (D:RATE)	3-17
Digital Jitter Generator Mode (D:JIT)	3-18
Analog Generator Loading	3-19
Digital Status Bits	3-20
Controlling the Analyzer	3-22
Analyzer Overview	3-22
Analog and Digital Modes	3-23
Input Selection Keys	3-24
FUNCTION Keys	3-25
Units	3-26
Analog amplitude units	3-27
Is it dBm or dBu?	3-29
Analog power units	3-30
Time and Frequency units	3-31
Phase units	3-32
Digital Time Units	3-32
Digital amplitude units	3-33
Generator Output and Analyzer Input connectors	3-34
Digital Inputs and Outputs	3-35
Reference Input	3-36
Monitor Outputs	3-38
GPIB Interface	3-39
Power Cord Connector and Line Voltage Selector	3-40

External Connections	3-41
Analog Inputs and Outputs	3-41
XLR Connector Panel	3-45
Unbalanced Connections with the XLR Connector Panel	3-46
Unbalanced Stereo Connections	3-48
BNC Connector Panel	3-49
Function Descriptions	4-1
Amplitude	4-1
Noise	4-4
Level	4-5
THD + N (Total Harmonic Distortion plus Noise)	4-7
Understanding THD + N	4-11
Surprises and Pitfalls in THD + N Measurements	4-13
What Signal is Dominant?	4-13
Selecting Bandwidth	4-13
Changes with Frequency	4-17
Changes with Amplitude	4-18
THD + N at 100% (or 0 dB)	4-19
Isolating Sources of THD + N	4-20
SINAD	4-21
Phase	4-23
IMD	4-26
Ratio	4-28
W + F (Wow and Flutter)	4-30
XTALK (Crosstalk)	4-33
AC Mains (Power Line Monitor)	4-35
Gen Load	4-37
Jitter	4-39
Digital I/O	4-42
Data Check	4-45
Status Bits	4-48
Bargraphs	4-51

Sweeps	4-53
Starting the Sweep	4-56
Continuous Sweeps	4-56
External Sweeps	4-57
Printing	4-57
Saving and Recalling Setups	4-62
Printing Saved Data	4-64
Applications Notes	5-1
Frequency Response of Amplifiers, Mixing Consoles, Etc.	5-1
Audio Transmission Link Testing	5-1
Analog Tape Recorder Alignment and Performance Verification	5-2
Reproduce Mode	5-2
Record-Reproduce Mode	5-3
Compact Disc Players	5-5
Appendix A - Changing Mains Voltage Selection	A-1
Checking the Selected Line Voltage	A-1
Changing the Line Voltage Selection	A-2
Checking the Fuse Block Orientation	A-3
Changing the Fuse Block Orientation	A-4
Checking the Fuses	A-5
Appendix B - Rackmounting	B-1
Fixed Rack Mount	B-2
Slide Rack Mount	B-3
Appendix C - Performing Internal Changes	C-1
Opening the Case	C-1
Changing to Alternate Connector Panels	C-2
Swapping Speaker and Connector Panels	C-3
Option Filter Installation	C-6
Monitor Source Selection	C-7
Appendix D - Specifications	D-1
Index	Index-1

Safety Information

Do NOT service or repair this product unless properly qualified. Servicing should be performed only by a qualified technician or an authorized Audio Precision distributor.

Do NOT defeat the safety ground connection. This product is designed to operate only from a 50/60 Hz AC power source (250 Vrms maximum) with an approved three-conductor power cord and safety grounding. Loss of the protective grounding connection can result in electrical shock hazard from the accessible conductive surfaces of this product.

For continued fire hazard protection, fuses should be replaced ONLY with the exact value and type indicated on the rear panel of the instrument and discussed on page A-5 of this manual. The AC voltage selector also must be set to the same voltage as the nominal power source voltage (100, 120, 230, or 240 Vrms) with the appropriate fuses. Different fuses are required depending on the line voltage.

The International Electrotechnical Commission (IEC 1010-1) requires that measuring circuit terminals used for voltage or current measurement be marked to indicate their Installation Category. The Installation Category is defined by IEC 664 and is based on the amplitude of transient or impulse voltage that can be expected from the AC power distribution network. This product is classified as INSTALLATION CATEGORY II, abbreviated “CAT II” on the instrument front panel.

Do NOT substitute parts or make any modifications without the written approval of Audio Precision. Doing so may create safety hazards.

This product contains lithium batteries. Dispose only in accordance with applicable regulations.

This product is for indoor use - pollution degree 2.

Safety Symbols

The following symbols may be marked on the panels or covers of equipment or modules, and are used in this manual:



WARNING! - This symbol alerts you to a potentially hazardous condition, such as the presence of dangerous voltage that could pose a risk of electrical shock. Refer to the accompanying Warning Label or Tag, and exercise extreme caution.



ATTENTION! - This symbol alerts you to important operating considerations or a potential operating condition that could damage equipment. If you see this marked on equipment, consult the User's Manual or Operator's Manual for precautionary instructions.



FUNCTIONAL EARTH TERMINAL - This symbol marks a terminal that is electrically connected to a reference point of a measuring circuit or output and is intended to be earthed for any functional purpose other than safety.



PROTECTIVE EARTH TERMINAL - This symbol marks a terminal that is bonded to conductive parts of the instrument. Confirm that this terminal is connected to an external protective earthing system.

Scope of this manual

This is the primary operator's manual for the ATS-1 Dual Domain. It describes all aspects of the instrument's features and functionality. For fundamental audio test and measurement information, we refer you to Audio Precision's *Audio Measurement Handbook*, listed on the following page.

This first section is a basic introduction to the physical and electrical characteristics of the instrument, including options. Some simplified diagrams and brief discussion help you gain insight into the instrument performance.

 *This symbol is used throughout this manual to direct you to more information on related topics.*

Section 2 provides instruction and overview for connecting and turning on the instrument, performing a self-test, and gaining insight to the connectors and front-panel display and controls.

Section 3 provides an operational overview, description of all controls and connectors, and discussion of the measurement units that may be displayed. Cable diagrams are also given to aid fabrication of cables for specialized requirements.

Specific measurement functions are described in Section 4, as well as printing capabilities and other operational information.

Using the ATS-1 Dual Domain to perform tests and measurements in specific applications is described in Section 5. Rather than detailed instructions, this section provides insights for the experienced user.

Appendices A, B, and C contain service information. Most of these operations can be performed by the average user, but we urge you to seek assistance if you are not technically qualified to perform them. This manual does not include test, calibration, or repair information.

Appendix D presents the instrument specifications. These specifications are believed correct at the time of printing, but are subject to change or correction, and therefore presented here for reference only. Consult Audio Precision for the latest information.

The ATS-1 Dual Domain can be operated via an IEEE-488 (GPIB) controller. Instructions are given in the *ATS-1 GPIB Programmer's Reference Guide*, listed below.

Related documentation

ATS-1 GPIB Programmer's Reference Guide AP Part No. 8211.0045

Audio Measurement Handbook AP Part No. 8200.AMH1

Introducing the ATS-1 Dual Domain

The Audio Precision ATS-1 Dual Domain is a comprehensive two-channel audio test instrument. It is capable of analog, digital, and cross-domain (analog-to-digital or digital-to-analog) measurements. It features the following measurement functions:

In both analog and digital domains:

- Level (two channels simultaneously)
- Noise or signal-to-noise ratio (wideband, weighted, or selective)
- THD+N (total harmonic distortion plus noise)
- Interchannel phase
- SMPTE/DIN intermodulation distortion (optional)
- Real-time two-channel amplitude ratio (interchannel balance or device gain/loss)
- Real-time frequency-selective crosstalk

In the analog domain:

- Wow and Flutter
- SINAD (ratio of {signal + noise + distortion} to {noise + distortion})
- Phase shift through a device
- Loading (AC resistance of the input of a device connected to the generator output)
- AC mains check (voltage, frequency, and distortion of the AC power line)

In the digital domain:

- Jitter amplitude and frequency
- Digital data activity and integrity
- Sample rate, amplitude, and delay of digital carrier signal
- Status Bits

The ATS-1 Dual Domain can sweep most of these measurements across a user-specified frequency or amplitude range and display a graph of the results. The graph top and bottom values may be set by the user, even after a sweep, with the data dynamically re-scaling. After sweeping, a cursor may be used to provide numeric readout of any point on the graph.

Printer support is provided, allowing printout of high-resolution graphs, fast screen dumps, numerical data from sweeps or self-test, and printout of bargraph displays.

The ATS-1 Dual Domain is capable of generating low-distortion sine and square waveforms, plus an intermodulation distortion test signal (when the intermodulation distortion option is installed).



Figure 1-1. ATS-1 Dual Domain

Measurements may be displayed in a wide variety of units, including the following:

- volts
- dBm (with a user-specified impedance reference)
- dBu
- dBV
- dBr (dB relative to a stored measured value)
- dBg (dB relative to the present generator output amplitude)
- watts (with a user-specified impedance reference)
- FFS (Fraction of Full Scale, for digital measurements)
- dBFS (dB below Full Scale, for digital measurements)
- Hz/kHz
- % or dB for relative measurements

 For information on filter shapes, see page 1-6.

The chosen units are remembered for each measurement function, so when you return to that function the units will be automatically displayed.

Several band-limiting and noise-weighting filters are provided. In the analog domain, the following are available:

- Standard 22 Hz-22 kHz audio bandpass
- 30 kHz and 80 kHz lowpass
- 400 Hz highpass
- Tunable 1/3 octave bandpass
- A-weighting (IEC-A)
- CCIR weighting
- Sockets for two optional filters, selectable from a wide variety

In the digital domain, the following filters are available:

- 22 Hz and 400 Hz highpass
- 15 kHz, 20 kHz, 22 kHz, and Sample Rate/2 lowpass
- A-weighting (ANSI/IEC-A)
- CCIR weighting (two types)
- Tunable 1/13 octave bandpass

The selected filter for each measurement function is remembered, so that next time you use that function the same filter will be selected.

Signals within the audible range can be monitored using the built-in loudspeaker or with user-supplied headphones. An external volume control is provided.

Up to 30 complete panel setups can be stored in internal memory so that common test setups can be easily recalled. This memory persists even when the unit is unplugged. In addition, test setups can be stored with a set of data, so that field test results can be saved for later analysis or printing.

All measurements, settings, and graphs are displayed on a sharp, clear, backlit liquid crystal display.

The ATS-1 may be operated manually from the front panel, or may be programmed via the IEEE-488 computer port. This User's Manual describes manual operation. See the *ATS-1 GPIB Programmer's Reference Manual* for complete documentation on controlling the ATS-1 via IEEE-488.

The ATS-1 Dual Domain can be purchased with or without the IMD option, which allows generation and analysis of intermodulation distortion in both digital and analog domains.

The ATS-1 Dual Domain may also be purchased with the EGZ option, which replaces the 150 Ω generator output impedance with 200 Ω , which is more common in European broadcast.

Other options include a soft carrying case and optional filters for specific band-limiting or weighting applications.

Any installed options are listed on the Options Label on the rear panel.

Filter Shapes

This section shows the shapes of the filters built into the ATS-1 Access. A number of other filter shapes are available as option filters.

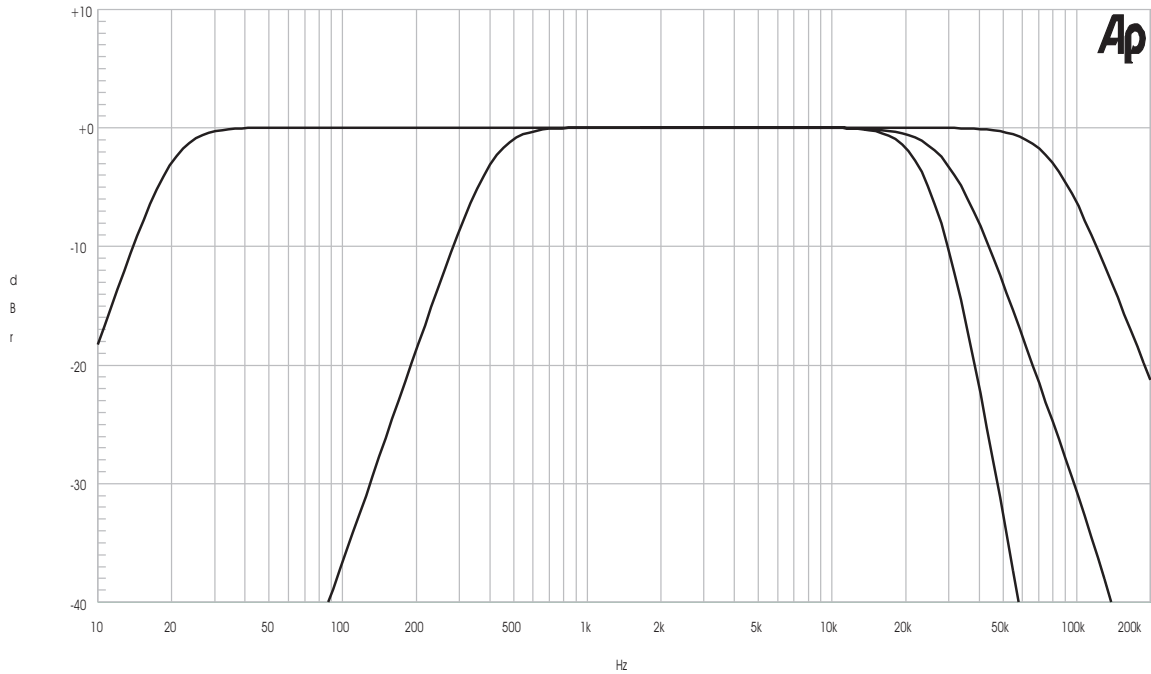

Figure 1-2. Shapes of Bandwidth-limiting filters:

- 22 Hz Highpass,*
- 400 Hz Highpass,*
- 22 kHz Lowpass,*
- 30 kHz Lowpass,*
- 80 kHz Lowpass*

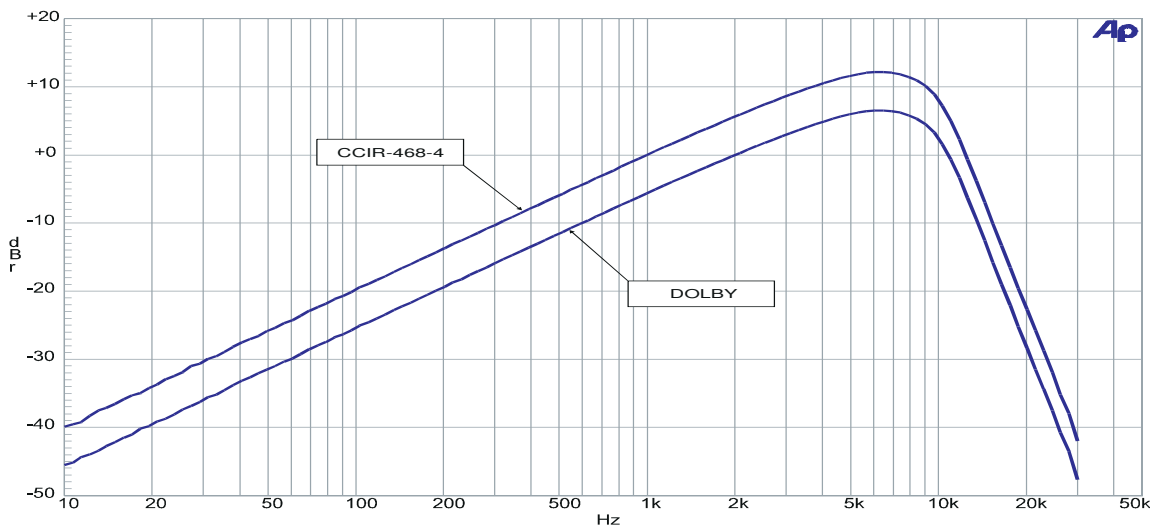

Figure 1-3. Shape of CCIR filter. CCIR-468-4 has the 0 dB point at 1 kHz, while the Dolby curve has the 0 dB point at 2 kHz.

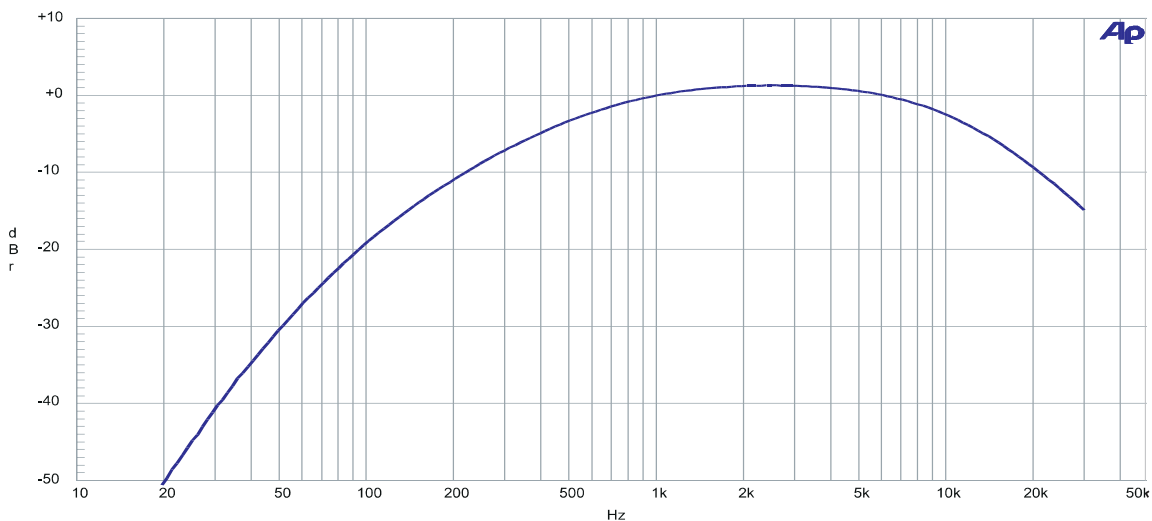

Figure 1-4. Shape of A-weighting filter

Identification of Features and Options

IMD Option

The IMD (Intermodulation Distortion) measurement function is available only if the IMD option has been installed. If present, this option will be marked on the Options label on the rear panel (see page 1-9). If not present, the front-panel IMD button will have no effect.

The IMD measurement function conforms to the SMPTE and DIN testing standards, and is described on page 4-26.

Connector Panel Options

The connector panel normally shipped with the ATS-1 Dual Domain has 3-pin XLR connectors and banana jacks for the generator outputs and analyzer inputs and is mounted on the front. This is the configuration shown in the figures in this manual. Alternatively, the connector panel may be mounted on the rear, and the speaker panel mounted on the front.

Other connector panel options are available, and may be ordered with the instrument or installed later by the user. Connector panel options are:

- BNC and banana jack connectors
- WE-310 tip-ring-sleeve and banana jack connectors
- 1/4-inch phone and banana jack connectors

To install connector panel options or to swap the connector and speaker panels, refer to Appendix C.

Optional Filters

In addition to the built-in filters, the ATS-1 provides two positions for optional filters that can be installed in the field. Refer to Appendix C for cautions and installation procedure.

Options Label

The Options Label (see Figure 1-5) specifies any options that are installed in your Portable One Dual Domain. It is located on the lower center of the rear panel.

The options label is filled out by the manufacturing technician when configuring the instrument for the customer. If the IMD or EGZ options are installed, an X will be placed in the appropriate box.

If option filters are installed, the type of filter will be marked in the appropriate Optional Filters box.

The date of original manufacture will be written in the appropriate box.

If there are any other unique characteristics of the unit, codes will be placed in the 'Special' box. These may be special modifications or requirements from certain upgrade combinations.

ATS-1 Audio Test System
DUAL DOMAIN
 Audio Measurement System

Installed Options:

ATS-IMD Intermod. Distortion Special
 EGZ Euro. Impedances

Optional Filters:

Aux 1:
 Aux 2:

Date of manufacture: FW/DSP Version:

Figure 1-5. Options label

Block Diagrams

This section contains several diagrams to assist your understanding of how the ATS-1 Dual Domain accomplishes its measurement tasks. While knowledge of the internal circuitry is not required for operation of the instrument, it may be more intelligently applied, and its limitations may be better understood, by referring to these diagrams.

Analog Section

Figure 1-6 is a simplified block diagram of the analog section of the ATS-1 Dual Domain.

The generator consists of a sinewave and squarewave generator transformer-coupled to the output connectors. When the IMD option is present, a second sinewave oscillator is added. Its output is summed with the main oscillator to provide the necessary two-tone signal. With the IMD waveform selected, the rear panel Analog Trigger output carries the lower-frequency tone of the IMD tone pair for oscilloscope triggering.

The analog analyzer consists of two identical wide-range autoranging preamplifiers, a principal meter with filters, a secondary meter, a wow and flutter discriminator, and phase and frequency meters.

The principal meter consists of a switchable and tunable bandpass or bandreject filter, additional amplification, built-in high-pass and low-pass filters, built-in CCIR and A-weighting filters, and two sockets for optional filters. The bandreject is used in THD+N and SINAD functions. The bandpass filter is used in the SELECTIVE modes of the AMPLITUDE and NOISE functions and in the XTALK function.

The output of either the principal meter or the wow and flutter discriminator feeds the primary reading detector. The primary detector, depending on the measurement function and setup parameters of that function, may have true RMS, average, or quasi-peak response. The primary reading is normally displayed in the upper-left corner of the display on the Main panel or Analyzer Only panel and graphed with solid lines in sweeps of all functions except PHASE.

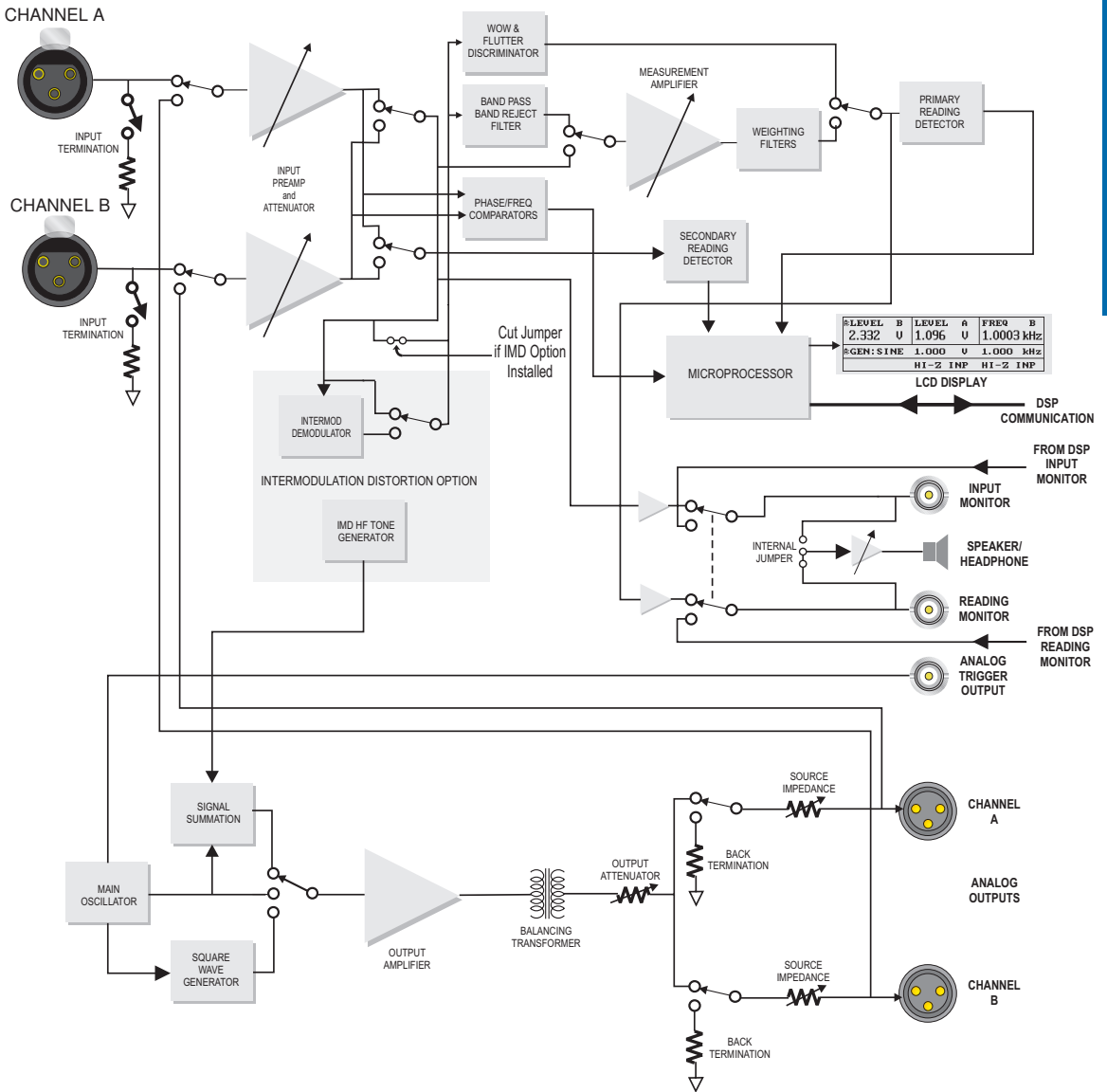

Figure 1-6. Simplified block diagram of the ATS-1 Dual Domain

In LEVEL function the filters, additional amplification, and selectable detectors are excluded from the principal meter circuit so that both meters become identical.

The secondary meter and reading detector have no selectable filters, less gain than the primary meter (10 mV minimum signal for fully-specified performance), and true RMS response only. The measurement of the secondary reading detector is usually displayed in the upper center section of the display. It generally shows the level of the input signal before processing, and its reading may be used to calculate some relative readings such as THD+N when % or dB units are selected.

The AC MAINS function works by measuring the input line voltage through very large resistors connected directly at the power mains input connector.

The signal monitored by the loudspeaker or headphones is normally picked off at the selected input channel, following input ranging but preceding any filtering. An internal cable may be changed to move the pickoff point to the end of the principal meter, following all filtering.

Digital Section

Figure 1-7 shows a simplified block diagram of the digital section of the ATS-1 Dual Domain.

The heart of the digital section is the Motorola 56303 Digital Signal Processor, or DSP. The DSP performs all calculations and controls all other parts of the digital circuitry. It is controlled by the microprocessor in the analog section. A special two-way communication channel links the two microprocessors.

The digital generator signal originates in the DSP, which calculates the waveform samples as required. The samples are sent to the AES/EBU transmitter which formats them into the digital signal stream. The transmitter drives the optical output directly, and the electrical outputs through a variable-voltage driver. The electrical output is transformer-coupled to the balanced (AES/EBU) and unbalanced (SPDIF) outputs.

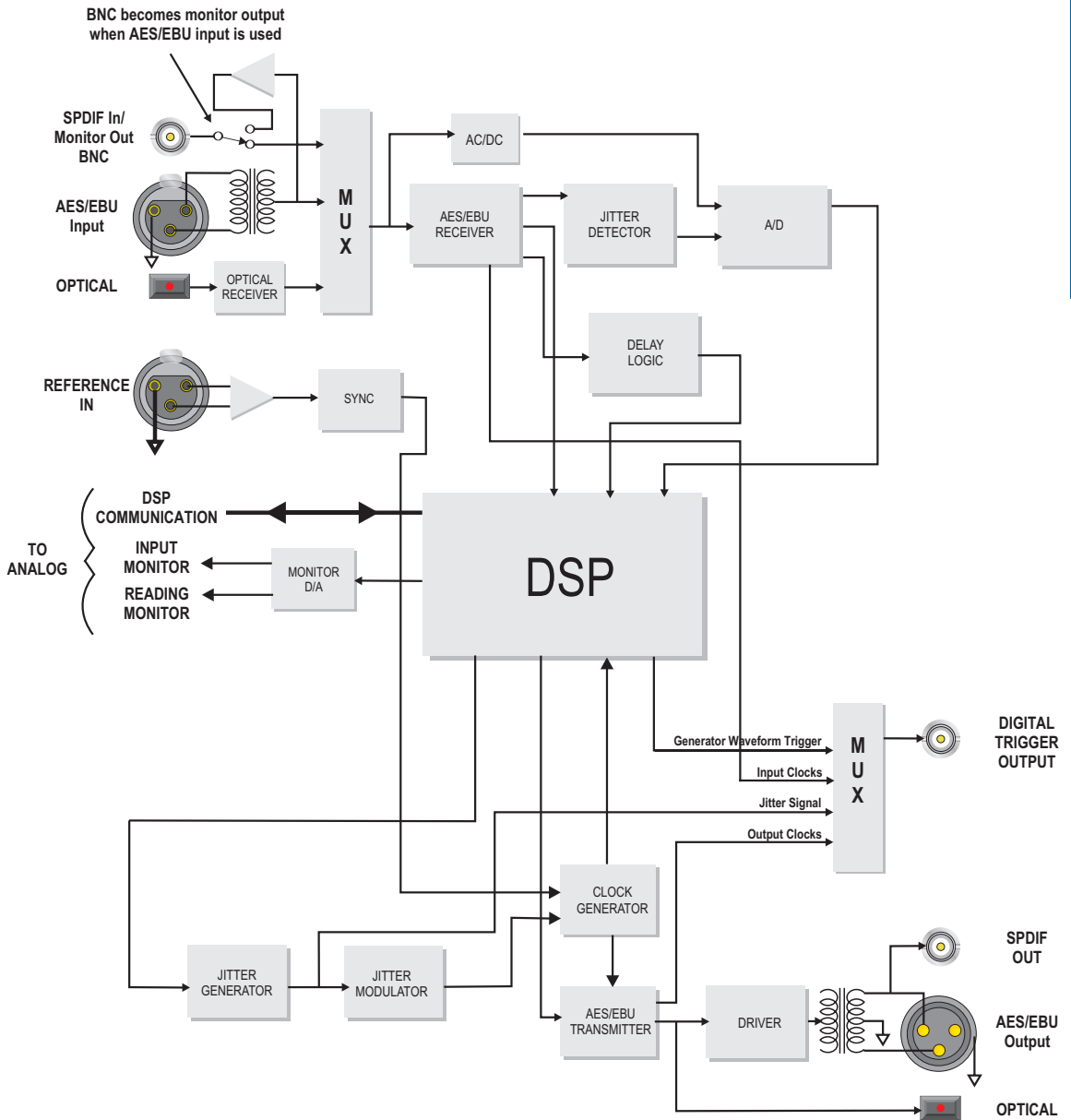

Figure 1-7. Digital block diagram

Jitter is created by the jitter generator. The jitter modulator then modulates the clock signals that drive the AES/EBU transmitter so that the jitter is applied to the output data stream.

The digital analyzer section begins with a multiplexer (MUX) which automatically selects among the digital signal sources. From there, the signal passes into an AES/EBU receiver which collects the data and clock signals from the digital data stream. The data is sent directly to the DSP for calculation of readings based on the embedded audio. The clock signals are used to detect jitter on the interface, to detect the sample rate, and to calculate delay from the output or reference. The jitter detector's output is sent through an A/D converter and converted to values that the DSP can use for jitter readings.

The raw data signal is also sent to an AC-to-DC converter which detects the amplitude of the digital signal and converts it to a DC voltage. This voltage is then sent to an A/D converter, which converts it to digital data which can be used by the DSP to give signal amplitude readings.

The reference input is coupled to a sync detector which extracts the clock signals from the digital stream. These clock signals can be used for delay calculations and to synchronize the output to the reference.

A multiplexer (MUX) chooses which signal is sent to the Digital Trigger Output. Several important clock signals are available, as well as a signal directly from the DSP, which is synchronous with the digitally generated waveform.

The monitor signals are fed by digital audio samples directly from the DSP, which takes the samples from the appropriate point in its calculations according to the measurement function. These signals are converted to analog waveforms by a D/A converter, and then they are sent to the rear panel INPUT MONITOR and READING MONITOR connectors in digital analysis modes.

Analog Generator Output Circuit

Figure 1-8 shows a simplified diagram of the output circuitry of the ATS-1 analog generator.

The power amplifier is transformer-coupled to a balanced, compensated resistive attenuator. This attenuator and an electronically-variable gain control in the generator circuit are both controlled by the instrument microprocessor in order to provide the specific output amplitude selected by the operator. The transformer center-tap is not dc-connected to the instrument ground.

When the 50 Ω unbalanced mode is selected, signal is taken between the transformer center-tap and the high terminal of the transformer. Pin 2 of the generator XLR connectors is hot in unbalanced mode, working against Pin 3 low. An additional 25 Ω source resistance is switched in series with the high terminal in unbalanced mode to preserve the same source impedance as in balanced mode.

When the generator output is turned off, a floating 50 Ω resistor is connected in place of the generator to back-terminate the output connector so that proper noise measurements can be made.

Output impedance selection is made by switching buildout resistors at the output connector.

When generator monitor inputs are used, the connection (labeled GEN MON in the diagram) is made directly across the output connector terminals.

Note that the power amplifier, output transformer, and output attenuator are common to both channels.

1 Description

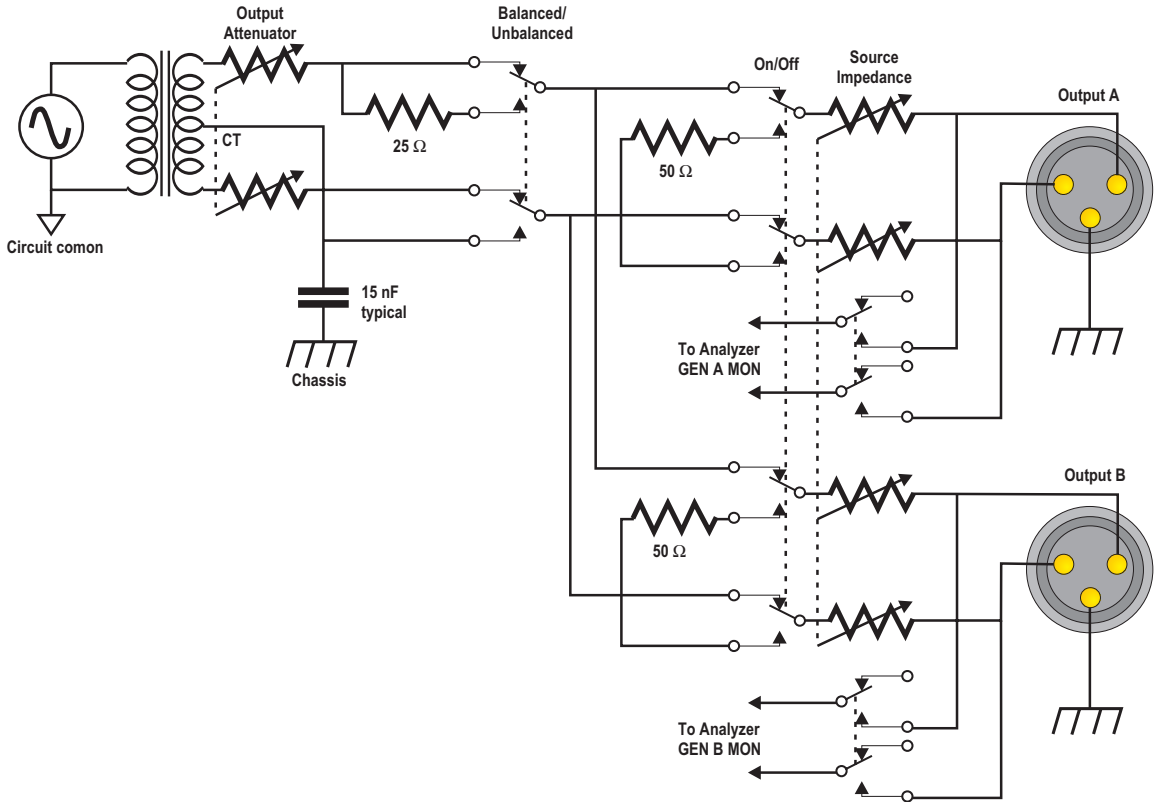

Figure 1-8. Simplified analog generator output circuit

Analog Analyzer Input Circuit

Figure 1-9 is a simplified diagram of one channel of the analog analyzer input.

The circuit is a true instrument-grade differential (balanced) input. Both sides (pins 2 and 3) are loaded with $100\text{ k}\Omega$ to ground, high enough to bridge most audio circuits. The net gain from the input connector to the analyzer proper is set by a combination of compensated resistive attenuators (zero, 20 dB, or 40 dB attenuation) and switchable-gain amplifiers (zero, +10 dB, +20 dB or +30 dB gain). Both the attenuator setting and the amplifier gain are microprocessor-controlled as part of the automatic ranging circuit, to maintain the signal level fed to the remainder of the analyzer at an optimum level for low noise and distortion.

If the $600\ \Omega$ input termination is selected (as shown in Figure 1-9), the application of an input voltage greater than 30 V rms will cause the termination to disconnect to prevent damaging the termination.

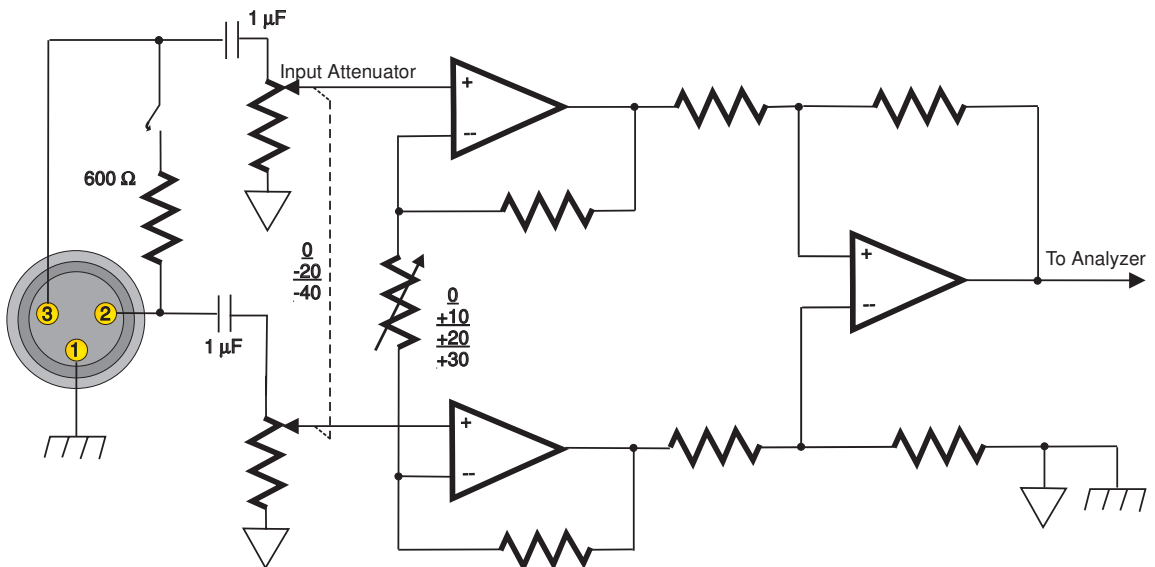

Figure 1-9. Simplified analog analyzer input circuit

1 Description

Getting Started

Connecting Mains Supply Voltage

Before plugging the unit in for the first time, verify that the power supply line voltage selection is correct. The units are configured at the factory for the expected voltage at their intended destination, so usually the voltage will be correct unless the unit has been transported into another area.

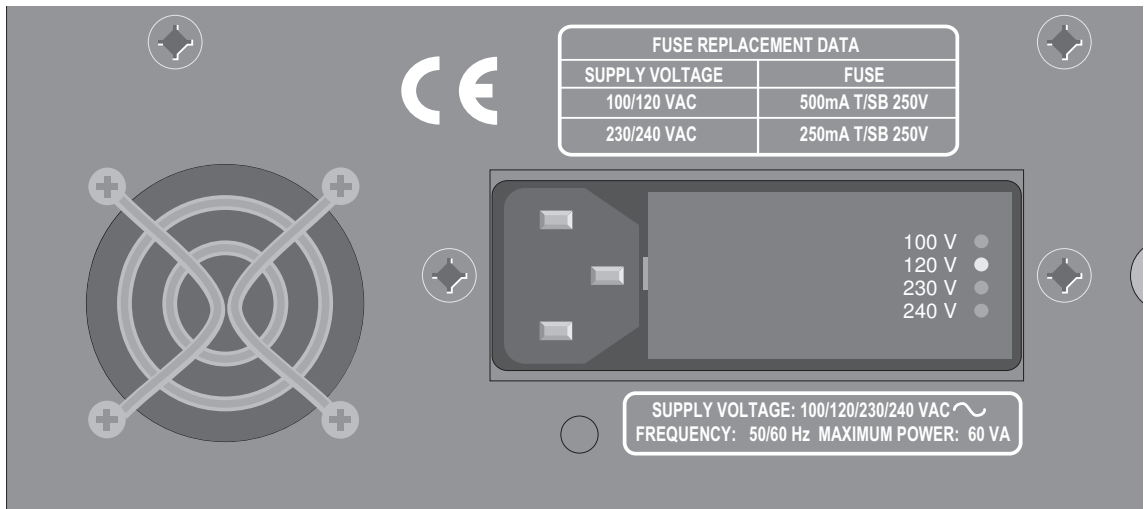

Figure 2-1. Location of voltage indicators on rear panel

The supply voltage indicator is located on the rear panel of the instrument next to the power plug (see Figure 2-1). A small white plastic indicator tip in one of the holes indicates which line voltage is currently selected.

If the selected voltage is not the same as your local line voltage, see Appendix A for changing the line voltage selection.

After verifying or correcting the line voltage selection, connect the line cord from the power outlet to the power cord connector and move the front-panel Power switch to the 'On' position (marked '1').

Rackmounting

The ATS-1 Dual Domain may be rackmounted, either via fixed brackets or with slide-out tracks. Refer to Appendix B for parts required and procedures

Concepts and Terminology

Analog vs. Digital

A major division exists between analog and digital devices. Analog audio devices store and transmit the audio signal directly. Digital audio devices reduce the audio signal to a series of numbers and store or transmit these numbers. Storing and transmitting sound digitally usually results in better sound quality, although the technology for doing this cheaply has only been developed in the last ten years or so.

Sounds can be translated from digital to analog using digital-to-analog converters, also called D/A's. Sounds can also be converted from analog to digital using analog-to-digital converters, also called A/D's (a process commonly known as 'sampling'). Many digital devices have built in A/D's or D/A's to provide analog inputs or outputs or both. Most analog devices only provide analog inputs and/or outputs.

Because of the fundamental differences between analog and digital signals, they cannot be mixed. An analog output can never be connected to a digital input, and a digital output can never be connected to an analog input. An A/D or D/A is required to make the translation.

Whenever an A/D or D/A is used in a measurement instrument to translate from one domain (analog or digital) to the other, there is a penalty in sound quality. Therefore, it is most useful to test any device inputs or outputs directly in their own domain. This is why the ATS-1 Dual Domain has both digital and analog inputs and outputs.

One fundamental difference between analog and digital domains is that a pair of wires (one signal and one ground) can carry only one channel in the analog domain. In the digital domain, a pair of wires can carry many channels of sound. For an analog stereo signal, two

cable connections must be made. For a digital stereo signal, only one cable connection is necessary.

Usually you will want to test all the inputs and outputs of your device under test, whether they are analog or digital. Analog inputs to the device should be connected to the analog outputs of the test instrument. Analog outputs from the device should be connected to the analog inputs of the test instrument. The digital input to the device should be connected to the digital output of the test instrument. The digital output from the device should be connected to the digital input of the test instrument.

If your device has both digital and analog inputs and/or outputs, the digital and analog connections may be made simultaneously. However, you should never connect more than one digital input at a time.

Balanced vs. Unbalanced

Another major division exists between balanced and unbalanced connections. Most consumer devices use unbalanced connections. Most professional devices use balanced connections.

Unbalanced connections only require two wires: one to carry the signal and one to carry the ground. Balanced connections require three wires: two to carry the signal and one to carry the ground.

Balanced connections are generally used in professional applications because of their higher immunity to interference and noise. Unbalanced connections are generally used in consumer applications because they are less expensive.

 For Connector Panel options information, see page 1-8.

 For input and output cable considerations, see page 3-30.

The most common unbalanced connectors are the RCA connector, the BNC connector, and the 1/4" Phone connector.

The most common balanced connector is the XLR connector. XLR connections are almost always balanced, although sometimes the XLR connector can be used in balanced or unbalanced configurations.

Self Test

The ATS-1 Dual Domain has the capability of performing a functional self test. This can be run periodically to make certain that your instrument is operating properly.

Before running the self test, let the instrument warm up for at least an hour. The ATS-1 Dual Domain only performs to specifications after a sufficient warm-up period, and some of the tests may fail if the instrument is not fully warmed up.

To run the self test, you must first go to the Main Panel and select the AC Mains function. To do this, perform the following steps:

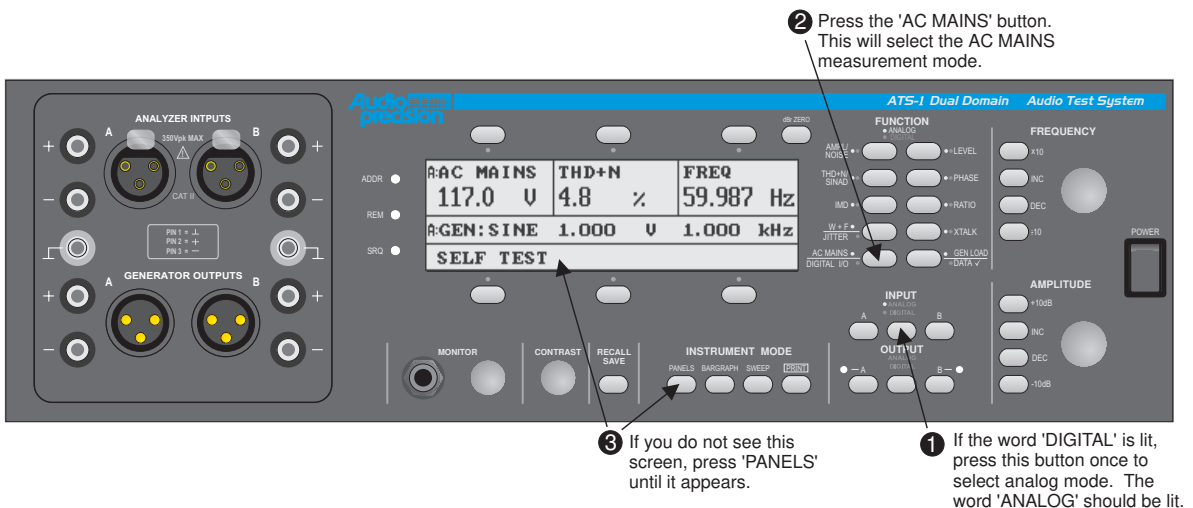

Figure 2-2. Steps to the main panel in AC Mains function

Then press the lower left soft key. The following panel should appear:

SELF TEST	DSP VER 1.00	VERSION 3.10
DISCONNECT GENERATOR OUTPUTS		
START	PRINT	QUIT

Figure 2-3. Self-test panel

The upper right and upper center sections of the display show the current firmware versions.

There are two separate microprocessors built into the ATS-1 Dual Domain: one to run the digital interfaces and measurements and another to run the analog measurements and the display. Each microprocessor has a built-in program to run it. The 'DSP VER' is the version number of the digital program and the 'VERSION' is the version number of the analog program. These version numbers apply to all features of the ATS-1 Dual Domain, not just the self test.

**ATTENTION!**

Always disconnect all cables from the generator outputs before running the self test. Connections to the generator outputs may cause the self test to fail, and may damage the device under test.

The lower left soft key will run the self test. Once the self test begins, the center section of the display (where the generator parameters are normally displayed) will show the number and name of the test being run. The upper center section of the display will show 'RUNNING' to indicate that the self test is in progress.

If an error is encountered, the self test will pause. The upper center section of the display will show 'ERROR' and the value of the data that caused the failure. You may want to write this data down so that you may provide it to support personnel. If you have a printer connected, you may want to press 'PRINT' instead, to print the entire display.

The lower left soft key will change to 'CONTINUE'. When you are done observing the failure, you may press this key to continue with the self test. Alternatively, you may press the lower right soft key ('QUIT') to stop the self test. Pressing QUIT at any time will return you immediately to the Main Panel.

When the self test is finished, you will be returned to the Self Test panel. The center section of the display will show 'PASSED' or 'FAILED' depending on the results of the test.

The lower center soft key ('PRINT') will run the self test and simultaneously send the output to the printer. This runs very much the same as a normal self test except that if an error is encountered, it will not wait for you to press a key before continuing. Following is a sample printer output from a self test.

```

Audio Precision ATS-1 Dual Domain Self Test Version 3.10
Test Number and Description, Low Limit, Measured, High Limit, P/F
TEST 0.01 997 Hz D:THD+N -140.0dB -132.1dB -130.0dB PASS
TEST 0.02 997 Hz D:LEVEL -0.01 dB 0.00 dB 0.01 dB PASS
TEST 0.03 Chan A Data Check PASS
TEST 0.04 Chan B Data Check PASS
TEST 0.05 48k Hz Sample Rate 47999.Hz 48000.Hz 48000.Hz PASS
TEST 0.06 44k Hz Sample Rate 44099.Hz 44100.Hz 44100.Hz PASS
TEST 0.07 32k Hz Sample Rate 31999.Hz 32000.Hz 32000.Hz PASS
TEST 0.08 5.0 Vpp Gen Mon 2.73 Vpp 3.58 Vpp 3.64 Vpp PASS
TEST 0.09 1.0 Vpp Gen Mon 0.51 Vpp 0.69 Vpp 0.76 Vpp PASS
TEST 0.10 0.05UI Jitter Ampl 0.000 UI 0.058 UI 0.111 UI PASS
TEST 0.11 5.0 UI Jitter Ampl 4.001 UI 5.037 UI 6.101 UI PASS
TEST 0.12 0.5 UI Jitter Ampl 0.356 UI 0.495 UI 0.656 UI PASS
TEST 0.13 50 Hz Jit Flatness 0.5 X/Y 0.5 X/Y 0.9 X/Y PASS
TEST 0.14 2k Hz Jit Flatness 0.7 X/Y 1.0 X/Y 1.3 X/Y PASS
TEST 0.15 10kHz Jit Flatness 0.7 X/Y 1.0 X/Y 1.3 X/Y PASS
TEST 0.16 31kHz Jit Flatness 0.7 X/Y 1.0 X/Y 1.3 X/Y PASS
TEST 0.17 RMS Residual Jit -0.050 UI 0.002 UI 0.005 UI PASS
TEST 0.18 Peak Residual Jit -0.050 UI 0.006 UI 0.015 UI PASS
TEST 0.19 Interface Delay -250.0 s 0.000 s 250.0 s PASS
TEST 1.0 100 Hz FREQUENCY 99.500 Hz 99.939 Hz 100.50 Hz PASS
TEST 1.1 1 kHz FREQUENCY 995.00 Hz 999.57 Hz 1.0050kHz PASS
TEST 1.2 10 kHz FREQUENCY 9.9500kHz 10.000kHz 10.050kHz PASS
TEST 1.3 100 kHz FREQUENCY 99.500kHz 100.01kHz 100.50kHz PASS
TEST 2.0A 26.0 V AMPLITUDE 25.480 V 25.957 V 26.520 V PASS
TEST 2.0B 26.0 V AMPLITUDE 25.480 V 25.975 V 26.520 V PASS
TEST 2.1A 15.0 V AMPLITUDE 14.700 V 14.964 V 15.300 V PASS
TEST 2.1B 15.0 V AMPLITUDE 14.700 V 14.965 V 15.300 V PASS
TEST 2.2A 5.0 V AMPLITUDE 4.900 V 4.984 V 5.100 V PASS
TEST 2.2B 5.0 V AMPLITUDE 4.900 V 4.985 V 5.100 V PASS
TEST 2.3A 2.0 V AMPLITUDE 1.960 V 1.993 V 2.040 V PASS
TEST 2.3B 2.0 V AMPLITUDE 1.960 V 1.993 V 2.040 V PASS
TEST 2.4A 1.5 V AMPLITUDE 1.470 V 1.493 V 1.530 V PASS
TEST 2.4B 1.5 V AMPLITUDE 1.470 V 1.493 V 1.530 V PASS
TEST 2.5A 500 mV AMPLITUDE 490.0 mV 498.1 mV 510.0 mV PASS
TEST 2.5B 500 mV AMPLITUDE 490.0 mV 498.2 mV 510.0 mV PASS
TEST 2.6A 200 mV AMPLITUDE 196.0 mV 199.0 mV 204.0 mV PASS
TEST 2.6B 200 mV AMPLITUDE 196.0 mV 199.1 mV 204.0 mV PASS
TEST 2.7A 150 mV AMPLITUDE 147.0 mV 149.3 mV 153.0 mV PASS
TEST 2.7B 150 mV AMPLITUDE 147.0 mV 149.4 mV 153.0 mV PASS
TEST 2.8A 50 mV AMPLITUDE 49.00 mV 49.71 mV 51.00 mV PASS
TEST 2.8B 50 mV AMPLITUDE 49.00 mV 49.69 mV 51.00 mV PASS
TEST 2.9A 10 mV AMPLITUDE 9.800 mV 9.979 mV 10.20 mV PASS
TEST 2.9B 10 mV AMPLITUDE 9.800 mV 9.978 mV 10.20 mV PASS

```

TEST 3.0A	10 Hz FLATNESS	-0.20 dB	-0.02 dB	0.20 dB	PASS
TEST 3.0B	10 Hz FLATNESS	-0.20 dB	-0.03 dB	0.20 dB	PASS
TEST 3.1A	20 Hz FLATNESS	-0.05 dB	0.01 dB	0.05 dB	PASS
TEST 3.1B	20 Hz FLATNESS	-0.05 dB	0.00 dB	0.05 dB	PASS
TEST 3.2A	20 kHz FLATNESS	-0.05 dB	0.01 dB	0.05 dB	PASS
TEST 3.2B	20 kHz FLATNESS	-0.05 dB	0.00 dB	0.05 dB	PASS
TEST 3.3A	50 kHz FLATNESS	-0.20 dB	0.01 dB	0.20 dB	PASS
TEST 3.3B	50 kHz FLATNESS	-0.20 dB	0.01 dB	0.20 dB	PASS
TEST 3.4A	100 kHz FLATNESS	-0.50 dB	-0.01 dB	0.50 dB	PASS
TEST 3.4B	100 kHz FLATNESS	-0.50 dB	0.03 dB	0.50 dB	PASS
TEST 3.5A	120 kHz FLATNESS	-0.50 dB	0.01 dB	0.50 dB	PASS
TEST 3.5B	120 kHz FLATNESS	-0.50 dB	0.06 dB	0.50 dB	PASS
TEST 3.6A	ATTENUATOR COMP	-0.05 dB	-0.02 dB	0.05 dB	PASS
TEST 3.6B	ATTENUATOR COMP	-0.05 dB	-0.02 dB	0.05 dB	PASS
TEST 3.7	SQUAREWAVE RESP	0.980 %	1.00 %	1.02 %	PASS
TEST 4.0	400 Hz HP FILTER	-3.70 dB	-3.05 dB	-2.40 dB	PASS
TEST 4.1	80 kHz LP FILTER	-3.70 dB	-3.31 dB	-2.40 dB	PASS
TEST 4.2	30 kHz LP FILTER	-3.70 dB	-3.25 dB	-2.40 dB	PASS
TEST 4.3	22-22 kHz FILTER	-6.00 dB	-1.56 dB	0.00 dB	PASS
TEST 4.4	22-22 kHz FILTER	-0.50 dB	-0.24 dB	0.50 dB	PASS
TEST 4.5	22-22 kHz FILTER	-0.50 dB	-0.08 dB	0.50 dB	PASS
TEST 4.6	22-22 kHz FILTER	-6.00 dB	-4.41 dB	0.00 dB	PASS
TEST 4.7	SELECTIVE FILTER	-0.50 dB	0.01 dB	0.50 dB	PASS
TEST 4.8	SELECTIVE FILTER	-18.20dB	-17.57dB	-17.20dB	PASS
TEST 5.0	A-WEIGHT FILTER	-20.10dB	-19.06dB	-18.10dB	PASS
TEST 5.1	A-WEIGHT FILTER	-0.20 dB	-0.02 dB	0.20 dB	PASS
TEST 5.2	A-WEIGHT FILTER	-6.50 dB	-2.58 dB	-0.50 dB	PASS
TEST 5.3	CCIR WTG FILTER	-20.80dB	-19.86dB	-18.80dB	PASS
TEST 5.4	CCIR WTG FILTER	-0.20 dB	-0.06 dB	0.20 dB	PASS
TEST 5.5	CCIR WTG FILTER	11.70dB	12.13dB	12.70dB	PASS
TEST 5.6	CCIR WTG FILTER	-1.20 dB	-0.28 dB	1.20 dB	PASS
TEST 5.7	QPK DETECTOR	-0.20 dB	0.07 dB	0.20 dB	PASS
TEST 5.8	AVG DETECTOR	-0.20 dB	-0.08 dB	0.20 dB	PASS
TEST 6.0A	20 Hz THD+N	0.0000%	0.0011%	0.0025%	PASS
TEST 6.1A	1 kHz THD+N	0.0000%	0.0011%	0.0025%	PASS
TEST 6.2A	20 kHz THD+N	0.0000%	0.0013%	0.0025%	PASS
TEST 6.3A	50 kHz THD+N	0.0000%	0.0026%	0.0100%	PASS
TEST 6.4B	20 Hz THD+N	0.0000%	0.0010%	0.0025%	PASS
TEST 6.5B	1 kHz THD+N	0.0000%	0.0011%	0.0025%	PASS
TEST 6.6B	20 kHz THD+N	0.0000%	0.0013%	0.0025%	PASS
TEST 6.7B	50 kHz THD+N	0.0000%	0.0026%	0.0100%	PASS
TEST 6.8	IMD RESIDUAL	0.0000%	0.0010%	0.0025%	PASS
TEST 7.0A	RESIDUAL NOISE	0.000 V	1.343 uV	1.500 uV	PASS
TEST 7.1B	RESIDUAL NOISE	0.000 V	1.221 uV	1.500 uV	PASS
TEST 8.0	20 Hz PHASE	-2.0 deg	0.0 deg	2.0 deg	PASS
TEST 8.1	1 kHz PHASE	-2.0 deg	0.0 deg	2.0 deg	PASS
TEST 8.2	20 kHz PHASE	-2.0 deg	-0.2 deg	2.0 deg	PASS
TEST 9.0	WOW AND FLUTTER	0.950 %	1.003 %	1.050 %	PASS

Passed Self Test 19980828 143342

Operational Overview

Front Panel Controls and Connectors

The ATS-1 Dual Domain front panel controls are grouped as shown in Figure 3-1. Each group is summarized in the following subsections.

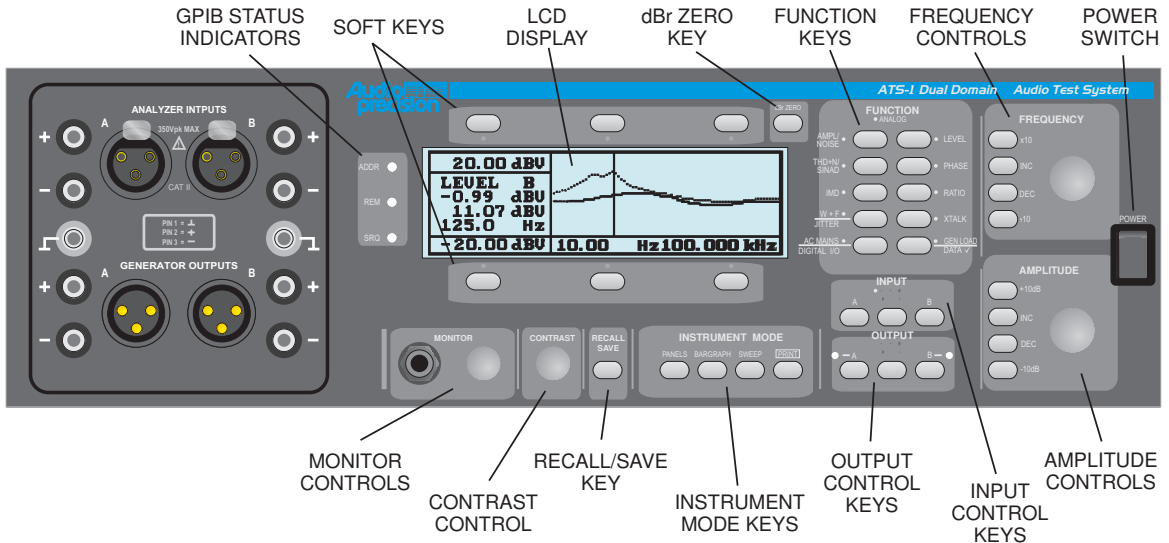

Figure 3-1. ATS-1 Dual Domain front panel key groups

FUNCTION Keys

The FUNCTION keys control the internal configuration of the instrument. Each FUNCTION key corresponds to a particular measurement function, such as Amplitude, THD+N, etc. A few of the FUNCTION keys will invoke a second measurement functions with a second press of the key. The particular measurement function invoked by a FUNCTION key also depends on whether the Analyzer is in analog or digital mode.

The FUNCTION keys and measurement functions are discussed in detail in the section on controlling the Analyzer. See page 3-21.

FREQUENCY Controls

The FREQUENCY controls allow control of frequency-based parameters. Exactly which parameter is controlled by the FREQUENCY controls depends on which panel is displayed, and what parameters are selected.

For example, in the Main panel, the FREQUENCY controls adjust the frequency of the generator. In the Sweep panel, the FREQUENCY controls adjust the start and stop frequencies of the sweep.

 For more information on the Setup panel, see page 3-9.

The x10 and ÷10 keys will cause the selected frequency parameter to increase or decrease by a factor of 10, except when controlling sample rate. When controlling sample rate, the x10 and ÷10 keys will jump among the standard sample rates of 48 kHz, 44.1 kHz, and 32 kHz.

The INC and DEC keys will increment or decrement the frequency parameter by a certain step size. The user can program the step size, choosing either a specific linear step size or choosing 'ISO', which will step among the ISO-standard 1/3 octave values. This setting is made on the Setup panel. Pressing the top right Soft key in this panel will select between ISO and a specific value. When a specific value is selected, the frequency controls can be used to adjust the step value.

When controlling the sample rate, the INC and DEC keys adjust the sample rate in 1 kHz steps.

The FREQUENCY knob can be turned clockwise or counterclockwise for fine adjustment of the frequency parameter. The knob controls the frequency with resolution of 0.04%. One full rotation will change the frequency by about 15%. This may be different for other parameters.

AMPLITUDE Controls

The AMPLITUDE controls allow control of amplitude-based parameters. Exactly which parameter is controlled by the AMPLITUDE controls depends on which panel is displayed, and what parameters are selected.

For example, in the Main panel, the AMPLITUDE controls adjust the amplitude of the generator. In the Sweep panel, if an amplitude-based measurement function is selected, the AMPLITUDE controls adjust the top and bottom amplitude values of the sweep.

The +10 dB and -10 dB keys will cause the selected AMPLITUDE parameter to increase or decrease by a factor of 10 dB.

 For more information on the Setup panel, see page 3-9.

The INC and DEC keys will increment or decrement the AMPLITUDE parameter by a certain step size. The user can program the step size, choosing either a specific linear step size, a specific decibel step size, or '1.00 dB/ISO'. This setting is made on the Setup panel. Pressing the lower right Soft key in this panel will select between 1.00 dB/ISO, a specific volt value, and a specific decibel value. When a specific value is selected, the AMPLITUDE controls can be used to adjust the step value.

If the 1.00 dB/ISO option is selected, the behavior of the INC and DEC keys depends on the selected units. If the units are decibels, the INC and DEC keys will adjust the value by 1 dB steps. If the units are linear, the keys will adjust the value in ISO steps. ISO standard amplitude steps go in the sequence 1.00, 1.25, 1.60, 2.00, 2.50, 3.15, 4.00, 5.00, 6.30, 8.00, 10.00. These same steps are used with other powers of 10 to give values of 10.0, 12.5, etc.

When controlling jitter amplitude, the INC and DEC keys will step through a preprogrammed set of standard values regardless of the setting on the Setup panel.

The AMPLITUDE knob can be turned clockwise or counterclockwise for fine adjustment of the AMPLITUDE parameter. The knob controls amplitude with resolution of 0.0065 dB. One full rotation will change the amplitude by about 36% or 2.7 dB. This may be different for other parameters besides amplitude.

INPUT Keys

 For more information on the Input keys, see page 3-24.

The INPUT keys select between digital and analog analyzer modes, which channel (A or B) will be measured, and whether the input from that channel comes from the external connectors or from an internal path directly from the generator.

OUTPUT Keys

The OUTPUT keys select among the generator control modes and turn each generator channel on and off.

INSTRUMENT MODE Keys

The INSTRUMENT MODE keys select major instrument operational and display modes. The display can show any one of eight different panels, selectable by these keys. Details are included in the section “Navigating the Panels,” as well as throughout this manual.

RECALL/SAVE Key

The RECALL/SAVE key provides access to the Recall/Save panel, which allows storage and recall of up to 30 different test configurations, including test data. The Recall/Save panel looks like this:

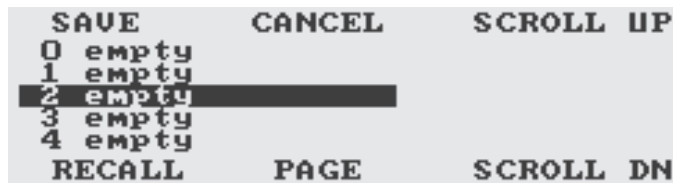

Figure 3-2. Recall/Save panel

For more information on Saving and Recalling test setups, see page 4-62.

Soft Keys

The six keys around the perimeter of the display are called the ‘Soft keys’. The function of these keys depends on what panel is displayed. Directly above or below the key will be a word indicating the function of the key, or the current value of the controlled parameter.

The one exception is the Main panel. On the Main panel, the upper Soft keys change the units of the reading directly below them.

The functions controlled by the Soft keys also may depend on other factors, such as the measurement function currently selected. The specific functions of the Soft keys are discussed in conjunction with each panel.

LCD Display

This is where all readings, graphs, and operating parameters are displayed. The panel also shows the current functions of the lower soft keys. The display contrast is controlled by the CONTRAST

 For more information on Saving and Recalling test setups, see page 4-62.

control. If no buttons are pressed for two hours, the 'screen saver' will be invoked, and the display will darken to preserve the useful lifetime of the display. Pressing any key will turn it on again (but will not execute that key's function).

dBr Zero Key

 For more information on dBr and the reference value, see the section on Units, starting on page 3-26.

The dBr Zero key is used to set the internal dBr reference value to the value of the current measurement. When saving and recalling setups, it provides some additional soft key functions.

GPIB Status Indicators

When the instrument is controlled via the IEEE-488 bus (GPIB), these three front-panel LEDs indicate the GIB status as follows:

- ADDR– Indicates that the instrument is talk addressed or listen addressed by the controller.
- REM– Indicates that the instrument has been addressed and is in remote state or has received the Local Lockout command, locking out any control from the front panel.
- SRQ– Indicates that the instrument has asserted a service request (an SRQ line interrupt) to the controller.

CONTRAST Control

The CONTRAST control adjusts the brightness and viewing angle of the liquid crystal display. If you are having trouble reading the display, adjust this knob until the letters and numbers are easily distinguishable from the background.

To invert the display so that the background is dark and the characters are light, refer to the Setup Panel section, page 3-9.

MONITOR Operation

The ATS-1 Dual Domain has a built-in monitor for audible monitoring of signals, either with stereo headphones or through a built-in speaker that receives the combined A and B channels.

To use stereo headphones, plug them into the MONITOR jack. To use monophonic headphones, a special stereo-to-mono headphone

adapter must be used. When headphones are connected, the internal speaker is disabled.

The MONITOR Knob controls the amplitude of the headphones or the internal monitor speaker.

Normally the speaker or headphones will monitor the input signal, so the signal heard will be the same as the signal at the input. There is a cable connection inside the instrument which allows this to be changed so that the monitor follows the measured signal, after being processed for the reading. To make this change, see Appendix C.

POWER Switch

This front-panel rocker switch controls the AC mains power. The ON position is marked “I,” the OFF position is marked “0.”

Navigating the Panels

The following diagram shows the main panels and how to get to them:

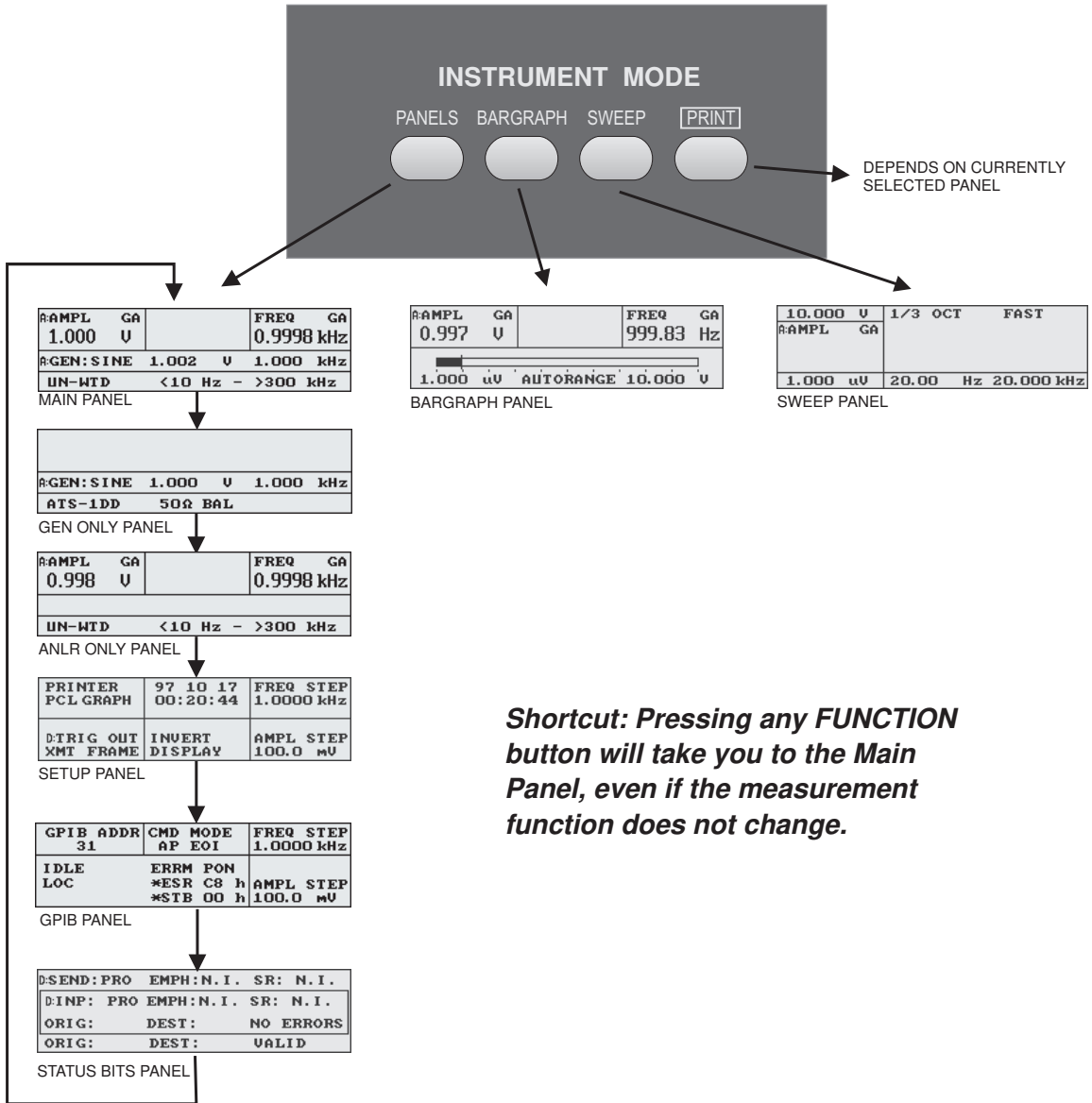

Figure 3-3. Navigating the panels

When the instrument is first powered on, the display defaults to the Main panel. The Main panel looks like this:

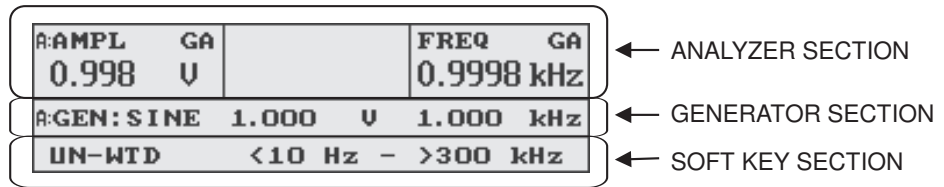

Figure 3-4. Sections of the Main Panel

Along the top is the Analyzer section, which usually shows one, two, or three real-time readings. Across the middle is the Generator section, which shows the operating parameters of the digital or analog generator. The bottom section is for the soft keys, which change function depending on various instrument conditions.

The PANELS key provides access to the Main panel, as well as the Generator Only panel, the Analyzer Only panel, the Setup panel, and the Status Bits panel. Usually the first press of the PANELS key will take you to the Main panel, and subsequent presses of the PANELS key will cycle through the other panels, returning you to the Main panel after all the other panels have been seen.

The BARGRAPH key provides access to the Bargraph panel, which looks like this:



Figure 3-5. Bargraph panel

This panel has up to three real-time readings at the top like the Main panel. The generator and soft key areas have been replaced with a horizontal bargraph. This bargraph shows a real-time analog-like display of a selected reading. See page 4-51 for more discussion of the Bargraph panel.

The SWEEP key provides access to the Sweep panel, which looks like this:

10.000 V	1/3 OCT	FAST
A:AMPL GA		
1.000 μ V	20.00 Hz	20.000 kHz

Figure 3-6. Sweep panel

The Sweep panel is used for stepping through a range of frequencies or amplitudes, taking a reading at each step. A graph is generated from the readings, with the swept parameter on the horizontal axis and the reading on the vertical axis. See page 4-53 for more on sweeps.

The operation of the PRINT key depends on what panel is currently on the screen.

If the PRINT key is pressed while the Sweep panel is displayed, the display will change to the Print panel, which looks like this:

LF/FF	[Graph]	
A:AMPL A		
PCL GRAPH	SCREEN	TABLE

Figure 3-7. Print panel

The Print panel provides a number of features relating to printing of the sweep data. This panel will allow you to print the data as a graph, an exact image of the Sweep Panel (a 'screen dump'), or a table of data. It also allows line feed and form feed control of the printer.

If any panel besides the Sweep Panel is displayed, pressing PRINT will result in an immediate printout of the data on the display. The type of printout will depend on which panel is currently displayed.

For more information on printing and the Print panel, see page 4-57.

Setup Panel

The Setup panel is available by several presses on the PANELS key. It provides access to several parameters relating to the general operation of the instrument. The Setup panel looks like this:

PRINTER PCL GRAPH	97 10 17 00:20:44	FREQ STEP 1.0000 kHz
D:TRIG OUT XMT FRAME	INVERT DISPLAY	AMPL STEP 100.0 mV

Figure 3-8. Setup panel

On the Setup panel are controls for the type of printer output, the date and time, the digital trigger output, display inversion, and the step sizes used by the INC and DEC keys.

The upper left soft key controls the print mode. The proper print mode to select depends on the type of printer connected to the port. The two options are 'PCL Graph' and 'IBM Graph'.

The upper center section of the display shows the real-time clock. The date is shown on top, in the order year-month-day. The time is shown on bottom, in 24-hour format as Hours:Minutes:Seconds.

To set the date or time, press the upper center soft key. The year will be highlighted. The year can be changed using the FREQUENCY controls. The INC and DEC keys will change the year in increments of 1 year. The x10 and ÷10 keys will change the year in increments of 10 years. The FREQUENCY knob may also be used.

When the year is set correctly, press the upper center soft key again. The month will be highlighted, and can be set in a similar fashion. The day, hour, minute, and second can be set with subsequent presses of the soft key. The clock will restart as soon as the soft key is pressed with the seconds highlighted.

The lower left of the display shows the source of output to the digital trigger output. The trigger output can come from a number of sources, controlled by the lower left soft key.

The lower center soft key controls the display inversion. Inverting the display causes the letters to appear white, with a blue background, instead of blue against a white background.

The upper right and lower right sections of the display, and the upper right and lower right soft keys, control the step sizes used by the FREQUENCY and AMPLITUDE INC and DEC keys.

Screen Saver

In order to extend the useful lifetime of the fluorescent backlighting of the screen, the backlight is turned off whenever two hours pass without any button being pressed.

To turn the backlight on again, press any key. The backlight will be turned back on, and the normal function of that button will not be executed.

For situations where the two hour time period is insufficient, the ATS-1 Dual Domain has an eight hour screen saver mode. This mode is entered by pressing the BARGRAPH key and RECALL/SAVE key simultaneously. The display will go dark to acknowledge that eight hour mode has been invoked, and another keypress will be required to turn the backlight back on.

If one key is released before the other, the display will relight, but eight hour mode will still be invoked.

Turning power off and back on will return the unit to the normal two hour screen saver.

Controlling the Generators

Generators Overview

The ATS-1 Dual Domain contains both a digital generator and an analog generator. Both generators operate simultaneously, but they are controlled independently.

The analog generator can generate sine waves from 10 Hz to 120 kHz, with amplitudes from zero up to around 26 Vrms Balanced or 13 Vrms Unbalanced. It can also generate square waves from 20 Hz to 30 kHz with amplitudes from zero to around 34.4 Vpp Balanced or 17.2 Vpp Unbalanced. With the optional intermodulation generation and analysis hardware, it can generate dual-tone intermodulation distortion signals.

It can operate in any of four different output balance and impedance combinations: 50 Ω unbalanced, 50 Ω balanced, 150 Ω balanced, and 600 Ω balanced.

The digital generator can generate digital sine waves from 10 Hz to 47% of the sample rate. The sample rate can range from 28.8 kHz to 52.8 kHz. The digital signal can be output in AES/EBU balanced or unbalanced format, SPDIF-EIAJ unbalanced format, and optical format. Rectangular, triangular or shaped dither can be used.

The digital signal may be generated at any even-numbered word width from 16 to 24 bits. The signal may also have sinusoidal jitter added, at frequencies of 40 Hz to 38.8 kHz and amplitudes from zero to 12.75 UI peak.

Generator Control Modes

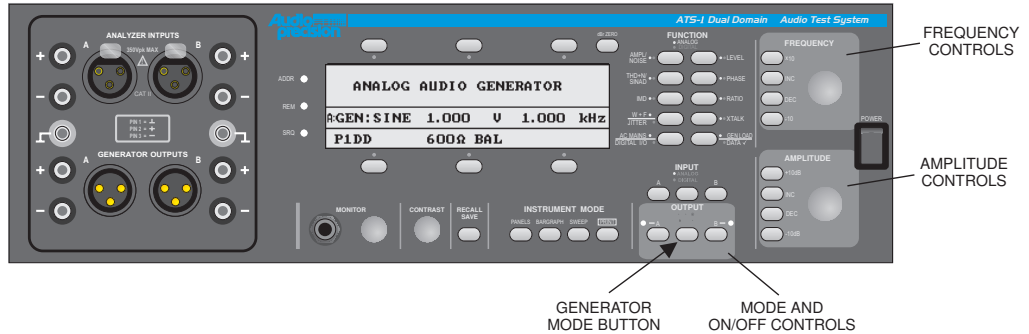

Figure 3-9. Generator Controls

Both the analog and digital generators operate simultaneously.

The ATS-1 Dual Domain has four control modes, which allow control of different attributes of the digital and analog generators:

- Analog Audio Generator Mode (A:GEN) - allows control of the amplitude and frequency of the analog generator
- Digital Audio Generator Mode (D:GEN) - allows control of the amplitude and frequency of the embedded audio signal generated by the digital generator
- Digital Sample Rate Generator Mode (D:RATE) - allows control of the sample rate and the carrier amplitude generated by the digital generator
- Digital Jitter Generator Mode (D:JIT) - allows control of the amplitude and frequency of the jitter applied to the digital generator

For instructions on navigating to a specific panel, see page 3-3.

The mode is changed by the Generator Mode button, marked on Figure 3-9. The generator control mode will change with each press of the Generator Mode button regardless of what panel is displayed, but the changes are only visible on the Main Panel and the Generator Only Panel. The generator section of these panels will change depending on the generator control mode.

The lower soft keys on the Generator Only Panel also change functions depending on the generator control mode. This allows access to functions related to that particular mode.

The following diagram shows the Generator Only panel in each of the four Generator Control Modes. On the Main Panel, only the generator section of the panel will appear as shown. The lower section of the panel, which relates to the lower soft keys, will be different. To use these soft keys, you must use the Generator Only Panel.

To get to the Generator Only Panel, press PANELS until you see one of the screens shown below.

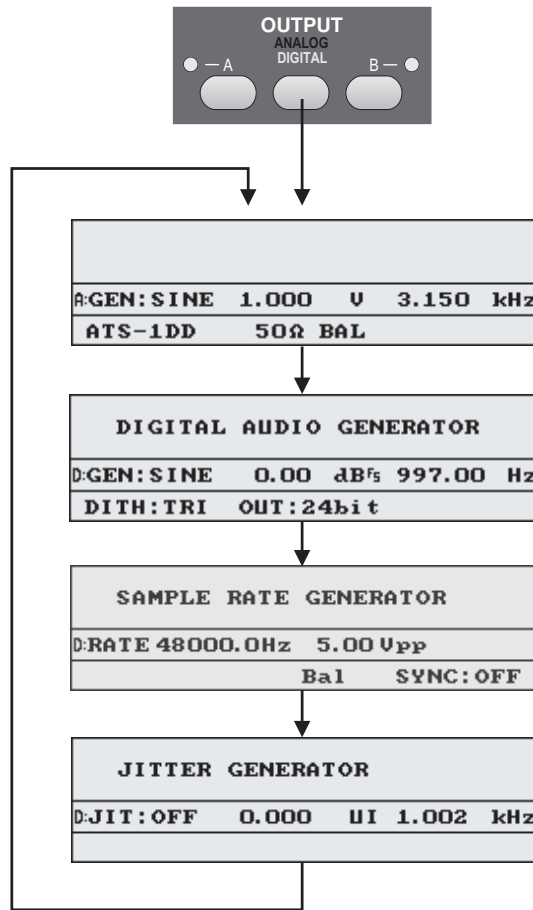



Figure 3-10. Generator control modes (Generator Only panel)

The **OUTPUT On/Off** buttons change function depending on the generator mode. In Analog Generator Mode, the A and B On/Off buttons turn the A and B channels of analog generation on and off. The yellow lights for each channel indicate whether that analog channel is providing output. If the light is on, then the channel is enabled. In any of the digital modes, the A and B On/Off buttons turn the A and B channels of embedded digital audio generation on and off. The yellow lights for each channel indicate whether that digital channel is providing output. If the light is on, then the channel is enabled.

NOTE: Both the analog and digital generators are operational in all of the Generator Control Modes and in all panels. You need not be viewing a generator control panel for the generators to be functioning.

Analog Generator Mode (A:GEN)

 For more information on Frequency and Amplitude controls, see page 3-1.

The Analog Generator Mode allows control of the analog generator. The Amplitude controls will control the amplitude of both channels of the analog output signal. The Frequency controls will control the frequency of both channels of the analog output signal.

The generator section of the panel will display the current amplitude, frequency, and waveform shape.

The waveform shape is controlled by the upper left soft key on the Generator Only panel. Waveform shapes of sine, square, and IMD (if IMD option is installed) are available with subsequent presses of the soft key.

 For discussion of analog generator loading, see page 3-19.

The Generator Only panel also allows control of the output configuration. Subsequent presses of the bottom center soft key permit selection between 40 Ω Unbalanced, 40 Ω Balanced, 150 Ω Balanced, and 600 Ω Balanced configurations.

The upper center soft key allows control of the units for analog generator amplitude.

Digital Audio Generator Mode (D:GEN)

The Digital Gen Mode controls the audio embedded in the digital signal. The Amplitude controls will control the amplitude of both channels of the imbedded audio signal. The Frequency controls will control the frequency of both channels of the imbedded audio signal.

The generator section of the panel will display the current amplitude, frequency, and waveform shape.

The lower left soft key on the Generator Only panel allows selection of the type of dither on the digital audio signal. Subsequent presses of the key allow selection of triangular, rectangular, shaped, or no dither.

The lower center soft key on the Generator Only panel allows selection of the number of bits (word length) of the embedded audio signal. Subsequent presses select 24, 22, 20, 18, or 16 bits.

The upper left soft key on the Generator Only panel allows selection of the digitally generated waveform. The available choices are SINE, SQR, IMD (if IMD option is present), RAND, JTEST, and PASS.

The SINE and SQR selections generate sine and square waves of selectable frequency and amplitude.

The IMD selection (only available if IMD option is present) generates one of a number of common intermodulation distortion test signals. These signals are composed of two sine waves, one at a high frequency and one at a low frequency, combined in a 4:1 amplitude ratio. The frequency combination is shown on the right side of the generator display section and can be selected by the bottom right soft key on the Generator Only panel.

The RAND selection generates a pseudo-random sequence of numbers. It is generally used for data integrity tests using the Data ✓ measurement function.

The JTEST selection generates a sequence that is used for testing for jitter caused by transmission through a cable or other medium.

The PASS selection takes the embedded audio data directly from the digital input and retransmits it without alteration. The status bits are not passed through - the outgoing status bits are set on the Status Bits

 For more information on the Data ✓ function, see page 4-45 .

panel. If the input signal has high jitter or other impairments, these effects will be reduced or eliminated in the retransmission process.

When using PASS mode, the digital generator output sample rate must be programmed to match the incoming sample rate. The output rate must be programmed to within 25 ppm of the incoming rate for the PASS mode to function properly. The output will be synchronized with the input. If you are not certain of the incoming sample rate, measure it using the DIGITAL I/O function.

 For more information on the Digital I/O Function, see page 4-42.

Since the RAND, JTEST, and PASS selections have no amplitude control, and may have very high amplitudes relative to the other selections, the digital generator is automatically turned off when entering any of these waveform types and must be explicitly turned on again after the waveform type is selected.

Digital Sample Rate Generator Mode (D:RATE)

The Digital Rate Mode allows control of the sample rate and signal amplitude of the digital output carrier signal. The Amplitude controls will control the peak-to-peak voltage of the digital carrier signal (that is, the level of the AES/EBU or SPDIF-EIAJ signal itself). The Frequency controls will control the sample rate. The generator section of the panel will display the current sample rate and carrier voltage.

The lower right soft key provides control of the synchronization of the sample rate to an external source or 'house sync'. The synchronization can be off, so that the output sample rate is generated internally, or it can be synchronized to the external reference input.

 For information on connecting to the Reference Input, see page 3-36.

There are three synchronization options. OFF will let the output run free, without being synchronized to the external reference. -REF will synchronize to the external reference, and the output will lead the reference by a user-selectable time interval. +REF will synchronize to the external reference and the output will lag the reference by a user-selectable time interval.

 For more information on the UI unit, see page 3-32.

When either +REF or -REF is selected, a display will appear on the right side of the generator section of the display showing the lead or lag in UI (Unit Intervals). Pressing the upper right soft key will change the amount of lead or lag. The available options are 0, 0.5, 1, 5, 10, or 50 UI.

When the PASS waveform type is selected, the OFF selection is not available because the output is always synchronized to the input. The amount of delay is also not selectable.

 For more information on the Digital I/O function, see page 4-42 .

The reference input can only change the output sample rate by 25 ppm (0.0025 %) from the programmed sample rate. Therefore, the generator sample rate must be set to within 25 ppm of the reference sample rate in order to lock to it. If you are not certain of the reference's exact rate, connect it to the digital input and use the Digital I/O function.

Digital Jitter Generator Mode (D:JIT)

The Jitter Mode allows control over the jitter applied to the digital carrier signal. The Amplitude controls will control the magnitude of the jitter, displayed in the center of the generator section of the panel. The Frequency controls will control the frequency of the jitter, displayed on the right side of the generator section of the panel.

The Generator Only panel provides several other options. The upper left soft key can be used to turn the jitter on and off. The upper center soft key controls the units for the jitter amplitude.

 For a more detailed discussion of units, see page 3-26.

IMPORTANT NOTE: All jitter amplitudes are calibrated in peak values on the ATS-1 Dual Domain. This differs from some other instruments which may generate and measure jitter calibrated in peak-to-peak values. The peak value is generally half of the peak-to-peak value.

Whenever jitter is turned on, and a digital measurement function is selected, a small letter 'J' will appear to the left of the main measurement in the top left corner of the display.

Analog Generator Loading

When a voltage unit (any unit besides dBm) is used, the generator amplitude shown on the panel is the open-circuit voltage. Unless there is no external load, the actual voltage at the load will be less than the open-circuit voltage, since the selected source impedance and the impedance of the load will act as a voltage divider. The following simplified schematic shows this relationship:

 For a more detailed technical diagram of the analog generator, see page 6-7.

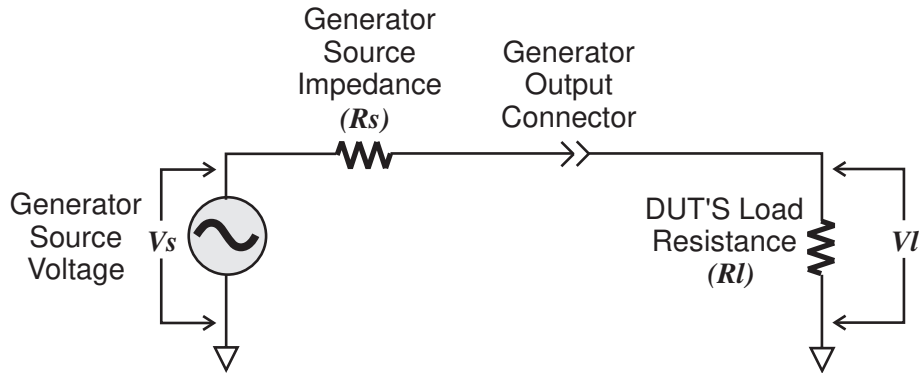



Figure 3-11. Source and Load Impedances

The voltage that will appear across the load can be calculated using the following formula:

$$V_l = V_s \cdot \frac{R_l}{R_l + R_s}$$

where V_l is the voltage across the load, V_s is the source voltage, R_l is the load impedance, and R_s is the source impedance. For example, if you output a 1 volt signal using the 50 Ω source impedance and load it with the analyzer's 100 k Ω load, the voltage across the load will be 0.9995 volts. As long as the load is 4 k Ω or higher, the load voltage will differ from the open-circuit voltage by no more than 0.1 dB. For a 100 k Ω load, typical of many professional audio devices, the 50 Ω source impedance will cause an error of about 0.05 dB.

 For more information about the dBm unit, see page 4-135.

The dBm unit is a unit of power, not voltage. However, the generator is always set in open-circuit voltage. When you are using the dBm unit for generator output, the generator will be set to a voltage that would cause the specified power (in dBm) to be dissipated in a load of 600 Ω . If you are using a load with a different impedance, the power

calculation will not be correct. The generator's source impedance is included in the calculation, so if you change the source impedance of the analog generator, it will change the output voltage of the analog generator.

Part of the analog generator's source impedance is shared between the two channels, so this must be included in the dBm calculations. Any channels that are turned on for generation are assumed to be loaded with the specified impedance. For proper amplitude calibration, make sure that any generator channels which are turned on are also loaded.

 For instructions on navigating to a specific panel, see page 3-3.

The impedance reference used in dBm calculations can be selected on the Analyzer Only panel when dBm units are selected.

Digital Status Bits

The digital carrier signal (AES/EBU or SPDIF-EIAJ) contains not only the embedded audio signal, but a number of status bits. Control of these bits is provided by the Status Bits panel. To reach this panel, press the ATS-1 PANELS button until you see this display:

 For more information on status bits, see page 4-48.

D:SEND:PRO	EMPH:N.I.	SR: N.I.
D:INP: PRO	EMPH:N.I.	SR: N.I.
ORIG:	DEST:	NO ERRORS
ORIG:	DEST:	VALID

Figure 3-12. Status Bits Panel

The center part of this panel, enclosed in the rectangle, shows the incoming status bits. The part of the panel outside the rectangle allows control of the sent status bits. Control is provided by the soft keys.

The upper left soft key controls the Consumer/Professional mode bit. Pressing this soft key will toggle between the two modes. Since the status bits are allocated differently for the two modes, this changes the other available selections. The AES/EBU standard (usually balanced) defines Professional mode, although Consumer mode is sometimes used. The SPDIF-EIAJ standard (usually unbalanced) defines Consumer mode.

The upper center soft key controls the Pre-emphasis indicator bits. These bit can be set to indicate that there is pre-emphasis, or that there is none. Changing this setting does not change the pre-emphasis of the signal itself, only the state of the indicator bit. The ATS-1 Dual Domain does not provide pre-emphasis.

The upper right soft key controls the bits that indicate the sample rate of the data. Sample rates of 48 kHz, 32 kHz, 44.1 kHz, and Not Indicated (N.I.) are available. There is also an AUTO setting, which will set these bits automatically depending on the selected sample rate. Changing this setting does not affect the sample rate, only the state of the sample rate indicator bits.

The lower left soft key changes depending on the Consumer/Professional mode. In Consumer mode, this soft key controls the Copyright bit. This status bit provides copy protection to the program material. It has two states: copy permitted (OK) and copy prohibited (NO). In Professional mode, this soft key controls the indicator of the signal's origin. The origin can be blank, or it can be indicated as coming from an 'AP1D', 'TEST', 'SRC1', 'SRC2', or 'SRC3'.

The lower center soft key is not used in Consumer mode. In Professional mode, it controls the indicator of the signal's destination. The destination can be blank, or it can be indicated as intended for an 'AP1D', 'TEST', 'DES1', 'DES2', or 'DES3'.

The origin and destination indicators can be used to identify the test signal in remote applications. For example, if the ATS-1 Dual Domain is located in a different room from the device under test, these indicators can be used to verify that the signals are correctly routed.

The lower right soft key controls the validity flag. This bit can be used to indicate whether the data is valid or invalid.

Controlling the Analyzer

Analyzer Overview

The ATS-1 Dual Domain analyzer can make a number of measurements in both the analog and digital domains. Most conventional measurements can be taken in either domain.

The instrument is generally configured for only one type of measurement at a time. The type of measurement currently being displayed is determined by the current measurement function. Often a single measurement function will provide measurement of several related parameters.

The ATS-1 Dual Domain analyzer provides the following measurement functions:

In both analog and digital domains:

- Amplitude with high and low pass filters, weighting filters (single channel), and 1/3-octave bandpass filter
- Level (two channels simultaneously)
- Noise or signal-to-noise ratio (wideband, weighted, or selective)
- THD+N (total harmonic distortion plus noise)
- Interchannel phase
- Real-time two-channel amplitude ratio (interchannel balance or device gain/loss)
- Real-time frequency-selective crosstalk

In the analog domain only:

- Wow and Flutter
- SINAD (ratio of {signal + noise + distortion} to {noise + distortion})
- Input-to-output phase shift
- Loading (AC resistance of the input of a device connected to the generator output)
- AC mains check (voltage, frequency, and distortion of the AC power line)

In the digital domain only:

- Jitter
- Digital data integrity
- Sample rate, amplitude, and delay of digital carrier signal
- Status Bits

Analog and Digital Modes

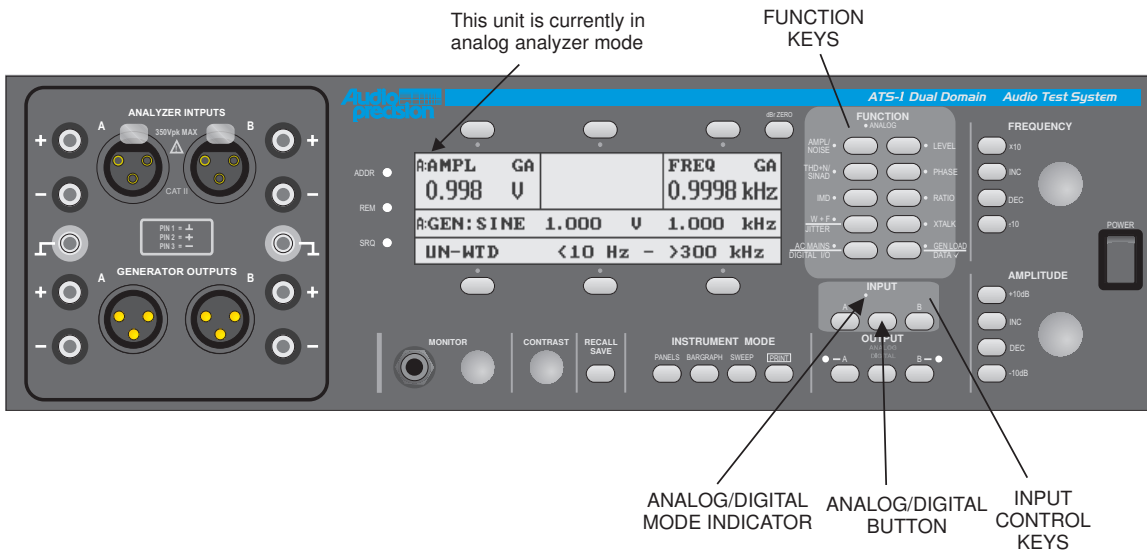

Figure 3-13. Analyzer Control Keys

The Analyzer has two distinct modes: analog and digital. For most measurement functions, the selection of analog or digital mode only determines whether the input to the measurement is analog or digital. A few measurement functions are only available in one domain or the other.

The analog/digital mode switching is controlled by the analog/digital button. The mode can be determined by the analog/digital indicator. The word 'DIGITAL' or 'ANALOG' will be lit, depending on the mode. It can also be determined by the letter in the top left corner of the display. If the analyzer is currently in analog mode, 'A:' will appear. If the analyzer is currently in digital mode, 'D:' will appear.

Note that the analyzer's analog/digital mode is separate from the generator's analog/digital mode. They may both be in analog mode

(for analog domain tests), both in digital mode (for digital domain tests), or one may be in analog and the other in digital (for cross-domain tests).

There is a white dot next to the word 'ANALOG' and a blue dot next to the word 'DIGITAL' on the mode indicator. These dots are used to determine which measurement function will be selected by each FUNCTION button. Most of the FUNCTION buttons choose the same measurement in both analog and digital domains, so they are marked with a dot of each color. Other FUNCTION buttons have a different measurement for the two modes, so one will be marked with a blue dot and the other with a white dot.

Input Selection Keys

The Input Selection keys (to the left and right of the digital/analog button) control what channel is being measured by the analyzer, and whether the signal comes from the analog or digital inputs or the internal generator-monitor (or gen-mon) path. The gen-mon path provides a direct connection from the analog or digital generator to the analyzer for reference measurements.

Most measurements only use a single signal source (channel). For these measurements, pressing the INPUT A button will cause the measurement to be taken from the digital or analog input channel A. Pressing the INPUT A button again will cause the measurement to be taken from the channel A gen-mon path. Pressing the INPUT B button will cause the measurement to be taken from the digital or analog input channel B. Pressing the INPUT B button again will cause the measurement to be taken from the channel B gen-mon path.

Other functions (such as the Level function) take two input sources (channels). These measurements provide different combinations with subsequent presses of the Input Selection buttons. The specific combinations available, and the effect of each button press, are listed with the description of the function.

Since both channels of digital audio travel on the same path, the digital functions do not allow one input channel and one gen-mon channel in multiple-source functions. Both must come from either the input or the gen-mon path. Therefore, there are fewer channel options.

In addition to the gen-mon path, the digital input signal can come from any one of the external digital input connectors (XLR, BNC, or Optical). This selection is made automatically depending on which input has a signal applied to it. Only one digital input should be connected at any time.

When the internal gen-mon paths are used, the generator outputs are still active. Signal may still exist on the output connectors, and measurements may be affected by loading or interference on the generator outputs.

FUNCTION Keys

The FUNCTION keys (marked on Figure 3-1) select the particular measurement to be obtained and displayed. This affects both the displayed measurement and the internal configuration of the instrument.

Most of the FUNCTION buttons choose the same measurement function whether the analyzer is in analog or digital mode. The same measurement will be taken, but from the analog or digital inputs, depending on which mode is selected. These measurements are marked with both a white dot and a blue dot.

Some of the FUNCTION buttons choose different measurements depending on whether analog or digital mode is selected. In this case, each measurement is marked with a white dot or a blue dot, depending on which analog/digital mode is appropriate. The white dot marks the measurement which is available in the analog domain, and the blue dot marks the measurement which is available in the digital domain.

 For more information on the LEVEL function, see page 4-5.

 For more information on the DIGITAL I/O function, see page 4-42.

Some FUNCTION buttons choose two different measurements within the same domain. The first measurement is selected by the first press on the FUNCTION button, and the second by a second press.

Some general setup parameters are located in the Main Panel or Analyzer Only Panel for a specific measurement function, although they apply to all measurement functions. These are the analog input impedance, which can only be controlled in the analog LEVEL function, and the digital interface parameters, which can only be controlled in the DIGITAL I/O function.

Units

The ATS-1 Dual Domain supports a full set of industry-standard units. The following table provides a quick reference to units; the following text gives units details.

Unit	Type	Analog	Digital	Description
%	Amplitude/ Frequency	✓	✓	Relative percentage of two measurements
Δ%	Frequency	✓		Percent deviation from ideal frequency
dB	Amplitude	✓	✓	Relative decibels between two measurements
dBFS	Amplitude		✓	Decibels relative to Full Scale value
dBg	Amplitude	✓		Decibels relative to present generator amplitude
dBm	Power	✓		Decibels relative to 1 milliwatt
dBr	Amplitude	✓	✓	Decibels relative to a preset reference
dBu	Amplitude	✓		Decibels relative to 0.7746 volts
dBV	Amplitude	✓		Decibels relative to 1 Volt
deg	Phase	✓	✓	Basic unit of phase
FFS	Amplitude		✓	Fraction of Full Scale
Hz	Frequency	✓	✓	Basic unit of frequency; cycles per second
ppm	Frequency		✓	Parts per million relative to a reference frequency
s or sec	Time	✓	✓	Basic unit of time
smp	Time		✓	Samples
UI	Time		✓	Unit Intervals
V	Amplitude	✓		Volts; basic unit of amplitude
Vp	Amplitude	✓		Peak voltage (instantaneous)
W	Power	✓		Watts; basic unit of power
X/Y	Amplitude	✓	ü	Ratio of two values

Analog amplitude units

- V (Volts) – Basic unit of amplitude
- V_p – Peak voltage
- dB – Relative decibels of two voltage measurements; depends on measurement function
- dBV – Decibels relative to 1.000 volt
- dBu – Decibels relative to 0.7746 volt
- dB_r – Decibels relative to user-settable voltage value (gain or loss)
- dB_g – Decibels relative to present generator amplitude
- % - Relative percentage of two voltage measurements; depends on measurement function
- X/Y – Pure number resulting from dividing one voltage by another

The analog amplitude units are available when measuring an analog amplitude with a voltmeter and when setting generator amplitude. V (volts) is the most common, and is measured in RMS unless another detector is specified. V_p is the peak instantaneous voltage reached by the waveform each cycle. For a sine wave (the only waveform for which V_p is supported), the value of V_p is 1.414 times V.

All of the dB-based units use decibel calculations. The decibel is a relative unit, which means that a reference is always required. If a reading is 0 dB, then the measured amplitude is the same as the reference amplitude. If the reading is positive dB, then the measured amplitude is larger than the reference amplitude. If the reading is negative dB, then the measured amplitude is smaller than the reference amplitude.

The decibel reading is calculated from the measured amplitude using the following formula:

$$\text{dB} = 20 \log \left(\frac{V}{V_r} \right)$$

where V is the measured amplitude and V_r is the reference amplitude.

For the dBV and dBu units, the reference is a predefined value. For the dBr unit, the reference is specified by the user. For the dBg unit, the reference is always the current generator amplitude. For the dB unit, the reference is another measured amplitude, which depends upon the measurement function.

 For more information on moving among the panels, see page 4-1.

There are two ways to set the reference value for the dBr unit. The first is to press the dBr ZERO button, located near the top right corner of the display. This will set the dBr reference value to the current amplitude of the main measurement (shown in the top left section of the display). The second way is to go to the Analyzer Only panel (by pressing ATS-1 PANELS several times) and then select the dBr unit for the main measurement. The current value of the 0 dBr (the reference value) will be shown across the center of the display, and it may be changed using the AMPLITUDE controls.

The dB unit is available in Ratio, THD+N, and SINAD measurement functions. All of these modes have an implied reference for the main measurement, which is the secondary measurement shown in the upper center of the display. This is the reference value used for the dB calculation.

The % unit can be used for amplitude or frequency measurements. The % unit for amplitude is available in THD+N and SINAD measurement functions. It also uses the secondary measurement, shown in the upper center of the display, for a reference. It calculates what percent the main measurement is of the secondary measurement.

The X/Y unit is available only in Ratio mode. The reading is a raw result of dividing one amplitude reading by another. This is usually used for gain or attenuation through a device.

Is it dBm or dBu?

Many manufacturers' specifications show a value in dBm when the correct unit is dBu. This special section describes the difference between the two, and when each should be used.

In the early years of broadcasting and professional audio, most equipment was connected for maximum power transfer from one device to another. This required matching the output impedance of one device to the input impedance of the next device. Due to the transformer and vacuum tube technology of the day, the standard input and output impedances were $600\ \Omega$. The dBm unit, a measurement of power relative to 1 milliwatt, was used to measure the power transmitted from one device to another.

However, actual power meters are (and always have been) very rare in audio. Most measurements are made with voltmeters. The power can be calculated from a voltmeter measurement if the impedance is known (by calculating the voltage squared divided by the impedance).

Since the early technology almost always used $600\ \Omega$ impedances, early measurement devices assumed this impedance. Although they did not measure power, as long as they assumed that the voltmeter was connected across a $600\ \Omega$ load they could correctly calculate the power in dBm. Since the voltage across a $600\ \Omega$ resistor is 0.7764 volts when it is dissipating one milliwatt, most early meters were calibrated to read 0 dBm when this voltage was applied. But they were not directly measuring the power; if the circuit impedance was not $600\ \Omega$, the power calculation, and therefore the dBm measurement, was not correct.

Modern audio equipment generally has a very low output impedance and a very high input impedance. This transfers a negligible amount of power but the maximum amount of voltage. The dBm, being a power unit, is not appropriate for measurements on these devices. A more appropriate unit is the dBu, which is a unit of voltage. In fact, it is defined as the voltage in decibels relative to 0.7764 volts, which is the voltage across a $600\ \Omega$ resistor dissipating one milliwatt.

Since the old dBm-measuring instruments measured voltage, not power, they only correctly read dBm when the circuit impedance is 600 Ω . However, since they measure voltage, they correctly read dBu no matter what the circuit impedance. Those old meters calibrated in dBm are actually dBu meters.

Unfortunately, the dBm unit is still mistakenly used when the circuit impedance is well over 600 Ω . Modern equipment manufacturers may ask that a +4 dBm signal be applied to a device for calibration when the circuit impedance is 10 k Ω , which would result in a signal amplitude of 5 volts. This may be so large as to overload the input circuitry, causing it to clip. What is really desired is a +4 dBu signal, which is 1.22 volts. This is a much more reasonable level for modern audio equipment.

So how can you tell which specifications are truly dBm and which are dBu? As a general rule, you should read 'dBm' as 'dBu' unless you know you are working with equipment terminated in 600 Ω . If you are using 600 Ω equipment, you can use dBm units. You can easily measure the input impedance of a device using the ATS-1 Dual Domain's Gen Load function.

If you are testing equipment terminated in high impedances, or if you are unsure of the input impedance of the device, it is best to select the minimum impedance for the ATS-1 Dual Domain generator and use the dBu units. In most cases this will be correct, and even in the worst case this will only be off by a fraction of a dB.

 For information about the Gen Load function, see page 4-33.

Analog power units

- W (watts) – Basic unit of power; assumes 8 Ω (or user-settable) load
- dBm – Decibels relative to 1 milliwatt into 600 Ω (or user-settable) load

The ATS-1 Dual Domain cannot directly measure power. However, power can be calculated from amplitude and impedance (or resistance), so if the value of the impedance is provided, a power reading can be obtained from a voltmeter reading. Both of the power units use this technique.

The watts calculation is simply the voltage squared divided by the given impedance.

 For information about the dBm and dBu units, see page 3-29.

The calculation of dBm is slightly more complicated, according to the following formula:

$$\text{dBm} = 10 \log \left(\frac{V^2/R}{P_r} \right)$$

where V is the measured voltage, R is the programmable impedance, and P_r is 1 milliwatt. The log calculation is to the base 10.

 For information on moving among the panels, see page 4-1.

The impedance used for watt calculations is remembered separately from the impedance used for dBm calculations. To set the impedance references, go to the Analyzer Only panel and select dBm or Ω for the main measurement units using the upper left soft key. Then the reference impedance for the selected unit will be shown across the center of the display and the AMPLITUDE controls may be used to change it.

Time and Frequency units

- Hz – hertz, basic unit of frequency (1/sec)
- s or sec – seconds, basic unit of time
- % - percentage variation in frequency
- $\Delta\%$ - percentage deviation from ideal frequency

Hertz (abbreviated Hz) is the basic unit of frequency. It is a count of the number of cycles a waveform goes through in a second. It is the reciprocal of the number of seconds required for one cycle of a waveform.

The % (percent) unit is used in the Wow and Flutter measurement function to measure the variation in frequency. The Wow and Flutter detector measures the frequency variation and reduces it to a number in hertz, according to the selected detector and statistical choices. This variation is then calculated as a percentage of the 3 kHz or 3.15 kHz intended frequency using the following formula:

$$\% = \text{abs} \left(\frac{D}{F} \right) \cdot 100$$

where D is the frequency deviation and F is the intended frequency.

The $\Delta\%$ unit is used to measure a frequency as a percentage difference from another frequency. It is calculated similarly to the %, except that it uses the difference between the measured frequency and the reference for the numerator:

$$\Delta \% = \frac{F - Fr}{Fr} \cdot 100$$

where Fr is the reference frequency and F is the measured frequency.

Phase units

- deg – Degrees, basic unit of phase

Degrees (abbreviated deg) is the basic unit of phase difference between two signals. Phase is generally measured on a 360-degree scale, where 0 degrees means the two signals are in phase, 180 degrees means they are out of phase, and by 360 degrees they are back in phase. However, the scale may be shifted to span any 360-degree area, generally between -360 degrees and $+360$ degrees.

Digital Time Units

- UI – Unit intervals, unit of time in digital signal
- ppm – Parts per million; relative to a certain reference frequency
- smp – Samples, unit of time in digital signal

There are several time units which are specific to digital signals. Digital signals sometimes use normal time units such as Hertz or seconds, but it is often more convenient to think of them in relation to the digital signal itself. The UI unit is one such digital-specific signal. One UI is the minimum amount of time between changes of state in a digital signal. This unit of time can be calculated from the sample time (the reciprocal of the sample rate), divided by the number of channels (generally two), divided by the length of the sample frame (generally 32), divided again by two.

The ppm unit is used when comparing a frequency to a reference frequency when the two are very close. It is similar to percent, but is based on millions instead of hundreds. The formula for ppm is this:

$$\text{PPM} = \frac{F - Fr}{Fr} \cdot 1,000,000$$

where F is the measured frequency and Fr is the reference frequency.

Digital time may also be measured in samples. The time of each sample is the reciprocal of the sample rate.

Digital amplitude units

- FS – Fraction of full scale (usually abbreviated FFS)
- dBFS – Decibels relative to full scale value
- dBr – Decibels relative to user-defined digital value

Since the embedded audio in a digital signal does not have a specific analog amplitude, its amplitude is usually calculated relative to the maximum possible sinewave amplitude that can be represented by the given number of bits. This is 'FS', or 'Full Scale'.

The digital amplitude detectors calculate the amplitude in RMS. FS is the maximum possible RMS value for a sinewave, when the sinewave peaks just touch the minimum and maximum possible numbers. Note that other signals with crest factors higher than sinewaves (such as square waves) can give readings higher than full scale because if they are just touching the minimum and maximum possible numbers, they have an RMS amplitude that is higher than that of a sinewave.

The FFS unit stands for 'Fraction of Full Scale', and is generally a number smaller than one. It is derived by dividing the RMS value of the measured signal by the RMS amplitude of a full-scale sinewave. Therefore a sinewave of the maximum possible amplitude will be 1.000 FFS, while a sinewave of half that amplitude will be 0.500 FFS (or 500 mFFS).

The dBFS unit will calculate the measured amplitude as a decibel value relative to the full-scale amplitude. The formula for this calculation is as follows:

$$\text{dB} = 20 \log \left(\frac{V}{V_r} \right)$$

The digital dBr unit is the same as the analog dBr unit. A digital reference amplitude (relative to Full Scale) is specified by the user, and the measured amplitude is calculated in dB relative to that reference.

The digital dBr reference can be selected in the same way as the analog dBr reference. You may set the reference to be equivalent to the current main measurement reading by pressing the dBr ZERO key near the upper right corner of the display. If you go to the Analyzer Only Panel and select a digital dBr-based unit for the main measurement, using the upper left soft key, the current dBr reference will be shown in the middle of the display and you may change it using the AMPLITUDE controls.

Generator Output and Analyzer Input connectors

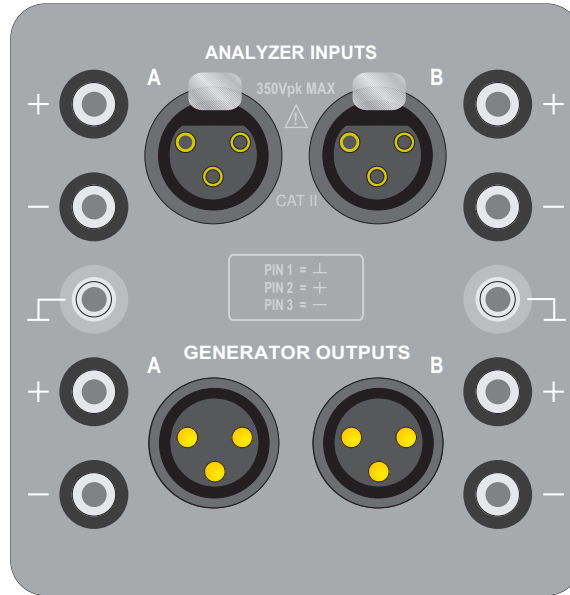

Figure 3-14. Standard XLR Connector Panel

The analyzer's analog inputs and the generators analog outputs are normally mounted on a subpanel mounted on the front of the instrument, and are shown that way in the figures in this manual. However, this subpanel can be interchanged with the speaker panel on the rear if preferred. Refer to Appendix C for procedure.

The connectors on this subpanel are normally three-pin XLR connectors and banana jacks. Panels with alternative connector styles may be substituted when the instrument is ordered, or changed later in the field. The alternative styles include:

- BNC and banana jack connectors;
- WE-310 tip-ring-sleeve and banana jack connectors;
- 1/4-inch phone and banana jack connectors.

Rear Panel Connectors

Figure shows an overview of the rear panel. The following sections describe each connector.

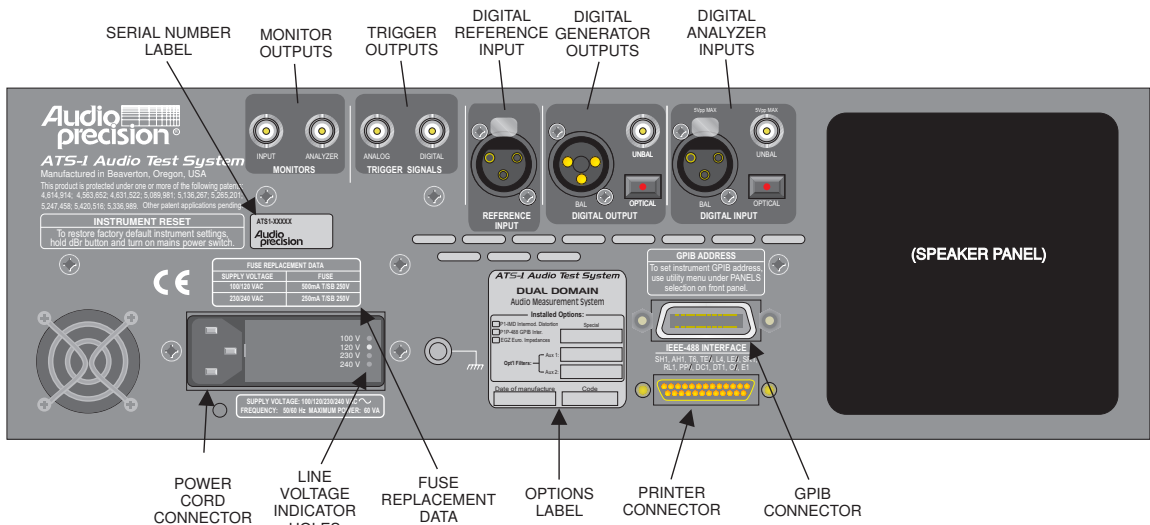

Figure 3-15. Rear panel overview

Digital Inputs and Outputs

The ATS-1 Dual Domain's rear panel includes connectors for XLR, BNC, and optical input and output connections. Digital devices typically use XLR connectors (using the AES/EBU standard) for balanced connections and BNC (using the SPDIF standard) for unbalanced connections. An optical link can also be used.



CAUTION - To avoid serious misoperation of the device under test, do not use the XLR output connector for an unbalanced connection. If your device requires unbalanced input, always use the BNC output connector.

The appropriate ATS-1 Dual Domain digital output should be connected to the digital input of the device under test. The appropriate ATS-1 Dual Domain digital input should be connected to the digital output of the device under test.

Only one of the digital input connectors is used for input at a time. The selection is automatic, depending on which input is active. If your device has several different digital interfaces, and you want to test them all, connect and test each one individually.

When the XLR connector is used for input, the BNC input connector becomes a monitor output. It can be connected to an external oscilloscope for monitoring of the XLR input signal.

The digital generator sends signals to all the digital output connectors simultaneously. There is no way to disable one output while enabling another.

Reference Input

The Reference Input provides an additional input to the digital analyzer. It can be used for synchronizing the digital generator to an external source (or 'house sync'), or for calculation of delay between two digital signal sources.

The Digital Reference Input is a balanced XLR connection. It accepts a standard AES/EBU signal. The data on this connector is ignored - only the synchronization information is used by the ATS-1 Dual Domain.

If you have an unbalanced signal source to be used as a reference, apply it to the Reference Input by connecting either pin 2 or pin 3 to the signal conductor and the other to ground. No changes need to be made on the instrument's front panel to support unbalanced reference inputs.

Synchronization of the digital generator to an external source is controlled by the Generator Only panel in Digital Rate Generator Control Mode. See page 3-17.

Calculation of delay between the external reference and the digital input is accomplished using the DIGITAL I/O measurement function. See page 4-42.

Trigger Outputs

There are two trigger outputs provided on the rear panel of the ATS-1 Dual Domain. One is marked ANALOG, the other DIGITAL.

The analog trigger output provides a constant amplitude 1.0 Volt RMS sine wave that is synchronized to the analog generator output signal. In IMD generator mode, the signal is synchronous with the lower-frequency tone.

The analog trigger output is intended primarily to provide a stable trigger for oscilloscope displays of the monitor signals. The source impedance for this signal is 680 Ω .

The digital trigger output can provide a variety of trigger signals from the digital generator and analyzer. The signal is selected on the Setup Panel. The signal has a high state of approximately 500 mV.

There are eight digital trigger options available:

- RCV FRAME - The falling edge of the trigger signal will occur on the channel 1 preamble of the signal on the digital analyzer input and the rising edge will occur on the channel 2 preamble. The trigger output will go through a complete cycle every frame.
- RCV CLOCK - The trigger signal will be a square wave with a period of 1/2 UI synchronized to the signal on the digital analyzer input.
- JIT GEN - The trigger signal will be a square wave synchronized to the jitter generator signal.
- DGEN WFM - The trigger signal will be a square wave synchronized to the audio waveform embedded in the digital signal.
- RCV ERROR - The trigger signal will be normally low, but will go high whenever the digital receiver's Confidence, Lock, Coding, or Parity flag is set.
- REF FRAME - The falling edge of the trigger signal will occur on the channel 1 preamble of the signal on the reference input and the rising edge will occur on the channel 2 preamble. The trigger output will go through a complete cycle every frame.

- XMT FRAME - The falling edge of the trigger signal will occur on the channel 1 preamble of the signal on the digital generator output and the rising edge will occur on the channel 2 preamble. The trigger output will go through a complete cycle every transmitted frame.
- XMT CLOCK - The trigger signal will be a square wave with a period of $1/2$ UI synchronized to the signal on the digital generator output.

Monitor Outputs

There are two monitor outputs provided on the rear panel of the ATS-1 Dual Domain. These monitors function in both digital and analog analyzer modes. These connectors provide monitor outputs of the signal at the INPUT and after processing for the READING.

The INPUT monitor normally outputs a near-constant-amplitude duplicate of the signal on the input. In Analog Analyzer mode, the output will be a buffered version of the signal at the input to the Analog Analyzer. In Digital Analyzer mode, the output will generally be an analog version (converted by a D/A) of the audio signal embedded in the digital signal used by the Digital Analyzer.

The ANALYZER monitor normally outputs the signal after all filtering and processing, immediately before being detected by the final reading meter. In Analog Analyzer mode, the output will come from the Analog Analyzer reading. In Digital Analyzer mode, the output will come from the Digital Analyzer (after being converted to an analog signal by a D/A).

These signals vary significantly depending on the measurement function, especially in the Digital-specific modes. See the block diagram of the measurement, at the beginning of each measurement function section in the Operation chapter. Each block diagram shows the points in the signal path from which the monitors are taken.

Printer Port

The ATS-1 Dual Domain is equipped with a parallel printer port for connection to a printer. The printer can then be used to print hi-resolution graphs or numerical data from a sweep, and any screen data may be captured and printed.

Most laser, ink-jet, and dot matrix printers are supported.

The printer connector is a female DB-25. Most printers are sold with an interface cable with this type of connector.

 For more information on printer data formats and printing, see page 4-57.

If your printer is not equipped with an interface cable that can connect directly to the parallel port, it probably has either a male DB-25 connector or a Centronics connector on it. An adapter cable must be obtained to connect the printer to the ATS-1 Dual Domain. These adapter cables are very standard and are available from any store that sells computer accessories.

When you connect your printer, you will want to select the data format for printer output, depending on what type of printer you have. This selection is made on the Setup Panel.

GPIB Interface

The ATS-1 Dual Domain provides a GPIB (also called IEEE-488) interface on its rear panel for connection to a host computer. The host computer can then control the instrument for a variety of automated applications.

The computer must be equipped with appropriate GPIB controller hardware (available on a plug-in card) and GPIB control software.

Connection from the host computer to the ATS-1 Dual Domain requires a standard GPIB cable. These same cables may also be used to connect to other devices in a GPIB chain.

Front-panel indicators show the status of the GPIB signals (see Figure 3-1).

For more information on using GPIB, see the ATS-1 GPIB Programmer's Reference Manual.

Power Cord Connector and Line Voltage Selector

The power cord connection and line voltage verification is described on page 2-1. The fuse information and changing the line voltage selection is covered in Appendix A.

External Connections

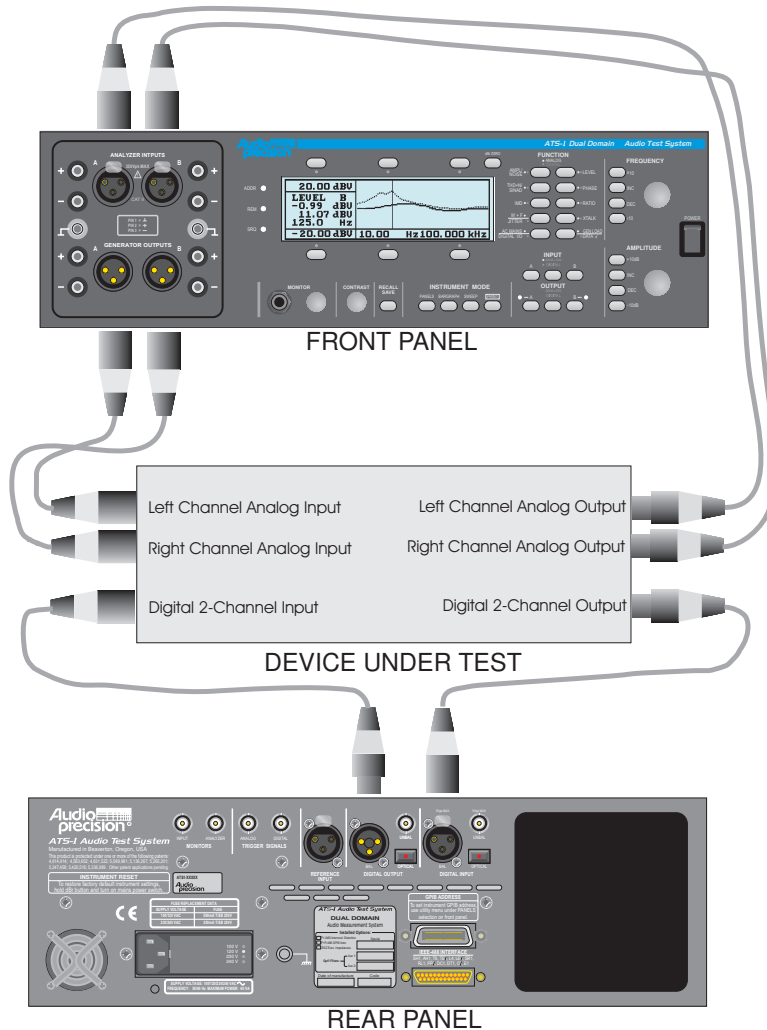

Figure 3-16. Typical connections to analog and digital device

How a device is set up for testing depends on the type and function of the device.

Analog Inputs and Outputs

Electrical connections between a device under test and the test instrument are typically made with test cables. Analog test cables for

the ATS-1 Dual Domain should have XLR connectors on one end for connection to the test instrument. The other end of the cables must have a connector appropriate for the device under test. Adapters may be used to adapt a standard cable to the device or test instrument.

If the device under test uses balanced XLR connectors, the connections can be made directly with XLR cables.

When cables or adapters for unbalanced connectors are used, pin 2 of the XLR connector should connect to the signal conductor and pin 3 of the XLR connector should connect to the ground. Also be sure to select an unbalanced generator configuration (see page 3-42).

The ATS-1 Dual Domain's Generator Outputs should be connected to the analog inputs of the device under test. The Analyzer Inputs should be connected to the analog outputs of the device under test.

For single channel devices, use only the Channel A analog input and output connectors. For stereo (or 2-channel) devices, Channel A is usually used for the Left channel and Channel B for the Right channel.

To simplify connection, analog test cables are often marked with the following color code:

- Left in: Blue (sometimes black is used instead)
- Left out: Yellow
- Right in: Red
- Right out: Green

When you connect your device under test, it is a good idea to select the proper input and output impedances and the balanced/unbalanced configuration for the generator. The input impedances are controlled by the Main Panel in Level mode. Follow these steps to get there:

The lower center soft key controls the termination of the channel A input. The lower right soft key controls the termination of the channel B input. Each input can be selected as 'HiZ' or 'LoZ'. The HiZ selection provides input terminations near 100 k Ω . The LoZ selection provides input terminations of 600 Ω .

In most cases, you will want to use HiZ terminations. The main exception is when you are working with equipment that requires 600 Ω terminations. Check your device's output specifications to see if a termination of 600 Ω is required.

The analog generator's output impedance and balanced/unbalanced configuration is selected on the Generator Only Panel in Analog Generator Control Mode. To get there, follow these steps:

The lower center soft key selects the generator output impedance and configuration. The choices are '40 Ω UNBAL', '40 Ω BAL', '150 Ω BAL' and '600 Ω BAL'.

If your device under test has unbalanced inputs, you should select the 40 Ω unbalanced configuration.

If your device has balanced inputs, the 40 Ω balanced selection is usually the desired choice. The 150 Ω and 600 Ω selections are generally only used with devices that have an equivalent input impedance. Check the input specifications for your device. For devices with higher input impedances, choose 40 Ω .

Only one of the digital input connectors is used for input at a time. The selection is automatic, depending on which input is active. If your device has several different digital interfaces, and you want to test them all, connect and test each one individually.

When the XLR connector is used for input, the BNC input connector becomes a monitor output. It can be connected to an external oscilloscope for monitoring of the XLR input signal.

The digital generator sends signals to all the digital output connectors simultaneously. There is no way to disable one output while enabling another.

The Digital I/O measurement function provides some important information and control of the digital interfaces. Follow these steps to get to the Main Panel in Digital I/O mode:

The upper center area of the screen shows which of the digital inputs is currently selected for input, which is selected automatically.

The upper center soft key controls the digital input termination impedance. The choices are 'HiZ' and 'LoZ'. The HiZ choice will provide a termination impedance $\geq 2.5 \text{ k}\Omega$ on the XLR connector and $\geq 3 \text{ k}\Omega$ on the BNC connector. The LoZ choice will provide a termination impedance of 110Ω on the XLR and 75Ω on the BNC.

In most cases, LoZ is the appropriate choice. The low impedances provided are listed in the interface specifications, so almost all devices will be expecting these terminations. The most common case for using the HiZ option is when the ATS-1 Dual Domain digital input is connected in parallel with another device, and the other device provides proper termination.

Input and Output Cables

Connecting the ATS-1 Plus Dual Domain to a device under test may require construction of special cables. This section describes proper wiring of cable connections and gives examples of cables for common connector applications. In some cases, adapters may be used to adapt one connector type to another, but the electrical connections should follow the examples shown in this section.

XLR Connector Panel

Balanced connections are almost always made with standard XLR-to-XLR cables. These cables may be purchased from Audio Precision and are available from many other sources. Figure 3-17 shows proper electrical connections for balanced connectors. The

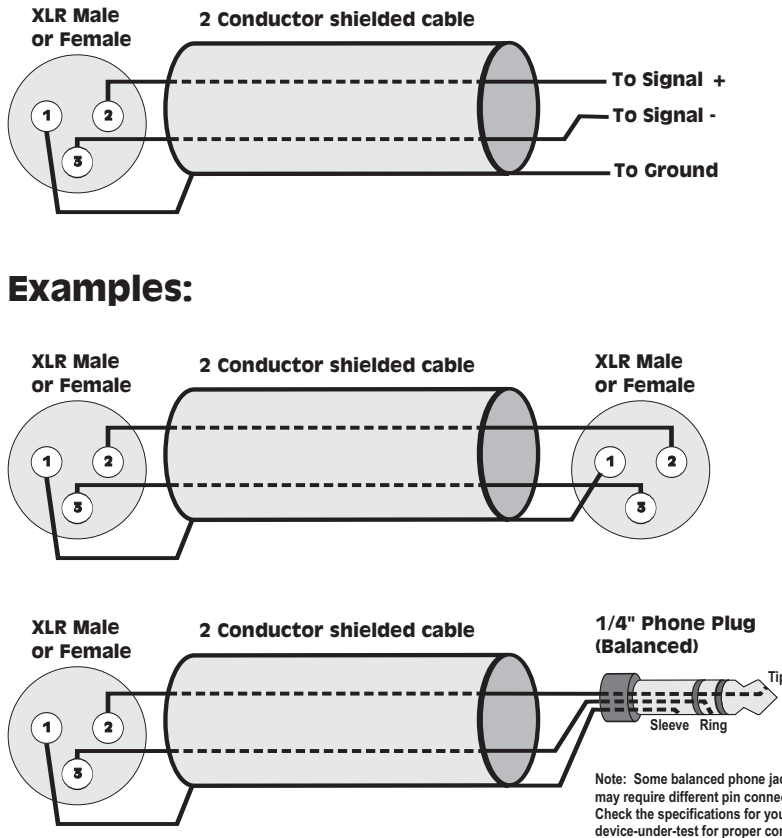
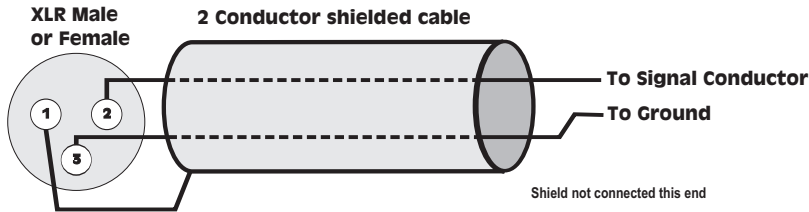

Figure 3-17. Balanced cable connections

generator should be configured for a balanced output (either 50 Ω Bal or 600 Ω Bal) on the Generator panel.

Unbalanced Connections with the XLR Connector Panel

Many devices use unbalanced connectors, such as the RCA (phono) connector, the BNC, or the 1/4" Phone jack.



Examples:

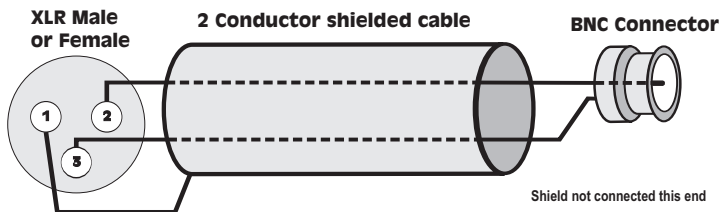
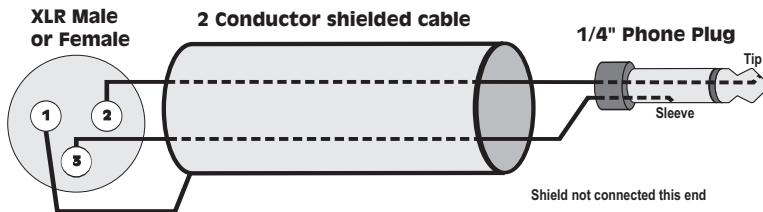
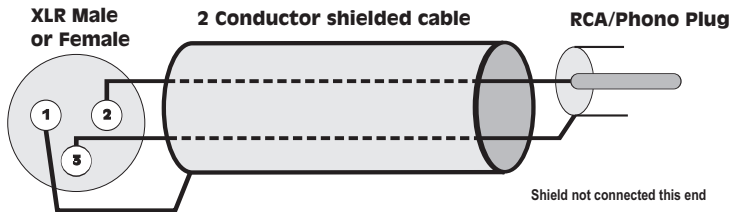
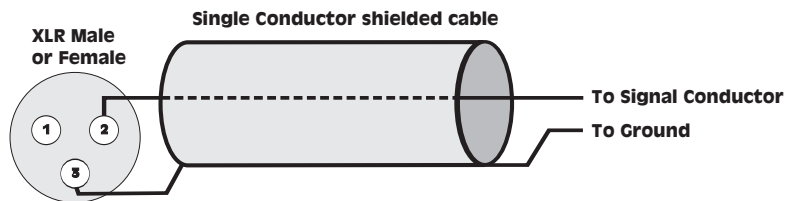

Figure 3-18. Preferred unbalanced cable connections

When connecting an unbalanced device, we recommend that two-conductor shielded cable be used. This offers higher immunity to noise and interference than single-conductor cable. Figure 3-18 shows the preferred cable connections.

In some cases, it may be necessary to use single-conductor cable to adapt to unbalanced devices, as shown in Figure 3-19. This may be because a single-conductor cable is already molded to the desired unbalanced connector or because single-conductor cable is already installed in the testing environment.



Examples:

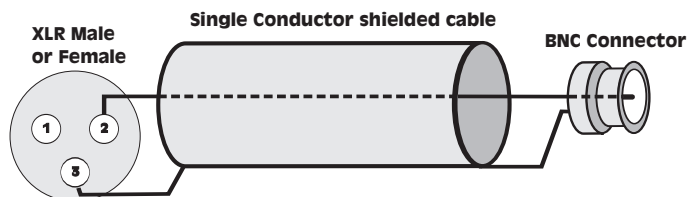
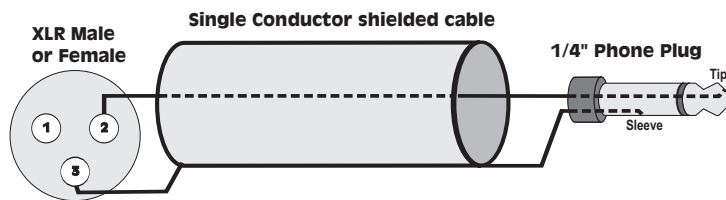
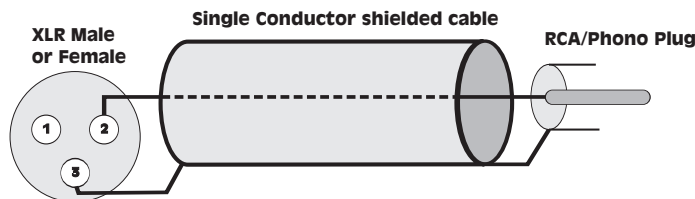

Figure 3-19. Unbalanced connections using single-conductor cable

These cables are considerably more susceptible to interference and grounding problems than the two-conductor cables shown on the previous page. The two-conductor arrangements should be used whenever possible.

Unbalanced Stereo Connections

Some equipment is manufactured with a single jack for two-channel transmission, usually for stereo headphones or microphones. These jacks have three conductors; one signal conductor for each channel,

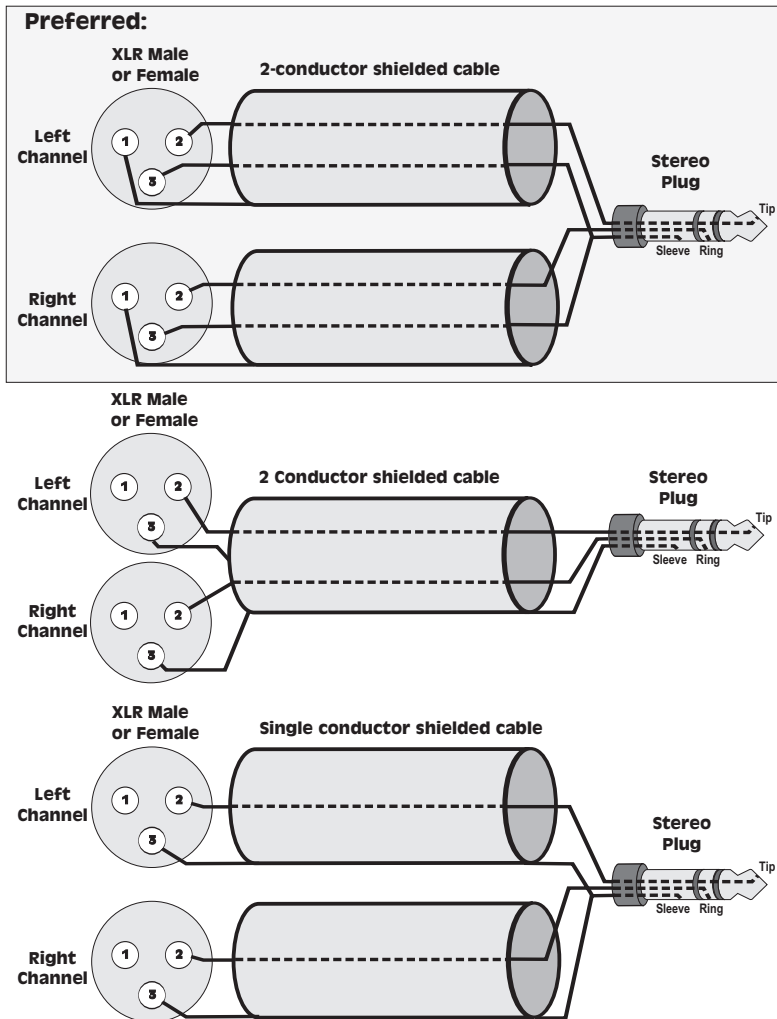

Figure 3-20. Stereo unbalanced cable connections

and a ground which is shared by the two. Since it is a two-channel unbalanced connection, it requires connection to two XLR connectors. The generator should be set to an unbalanced configuration by selecting 50 Ω Unbal on the Generator panel.

See Figure 3-20. The first configuration shown is preferred because it offers the highest immunity to interference and noise. However, it may be difficult to construct because of practical connector limitations. The other two configurations are also valid for testing applications, but are considerably more susceptible to interference and grounding problems.

BNC Connector Panel

The generator can be configured to deliver a balanced or unbalanced output to the connector panel. The BNC connector panel, the standard configuration on the ATS-1 Access and optional for the ATS-1 Dual Domain, has floating BNC connectors. The preferred configuration is a balanced output with a two-conductor shielded cable as shown in Figure 3-21.

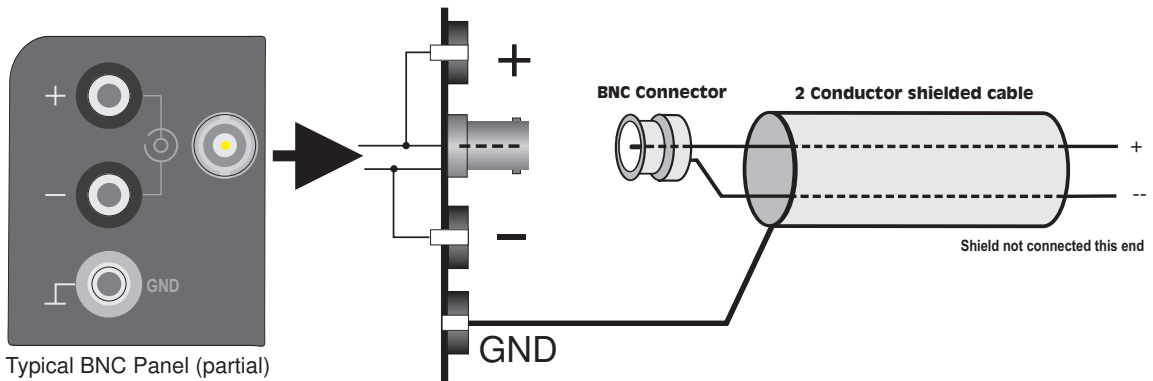

Figure 3-21. Preferred cable connections with BNC connector panel

Often, the cables described above are not available, and single-conductor shielded cable must be used. The shields of these coaxial cables are susceptible to interference. You can often reduce this interference, at the risk of introducing ground loop problems, by grounding the shell of the BNC connectors on the connector panel and using an unbalanced 50 Ω output configuration.

To do this, connect a short jumper from the banana plug connector for the low side (which is the same point as the BNC shell) to the nearby ground connector on the connector panel, as shown in Figure 3-22, and select 50 Ω Unbal on the Generator panel. Note that you have to do this for both channels if both are used.

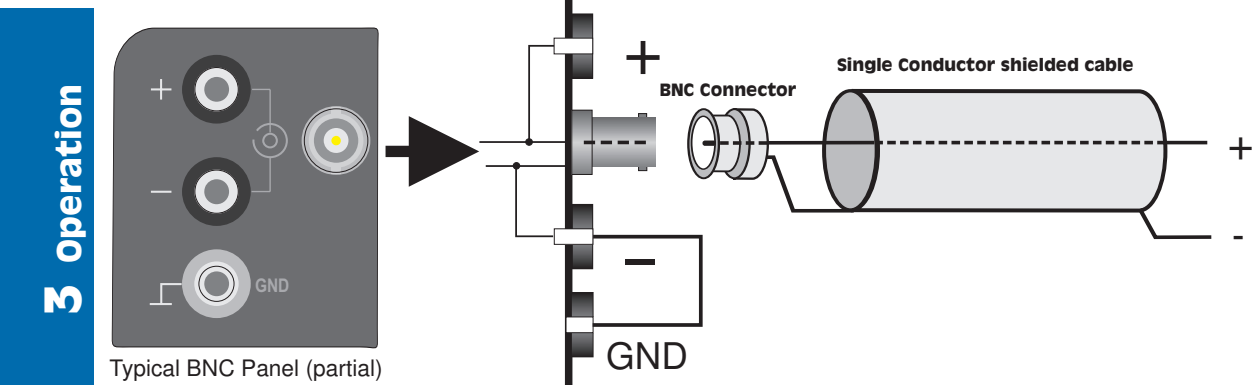

Figure 3-22. Alternate cable connections with BNC connector panel

The same situation exists for the input to the analyzer: the input to each channel is balanced, and the BNC connector shell is floating. You can ground the shell in the manner described above if desired.

Function Descriptions

This section describes each measurement function in detail. The Main Panel for each measurement function is shown, as well as a block diagram of the measurement performed.

For measurements that are the same in both digital and analog domains, only the analog is shown in the block diagram. The digital function is essentially the same, except that it is implemented with DSP.

Amplitude

The Amplitude function is selected by pressing the FUNCTION AMPL/NOISE key. It is available in both analog and digital modes. It provides a measurement of the amplitude of an analog signal or of the audio embedded in a digital signal.

A:AMPL	GA		FREQ	GA
0.994	V		1.0004	kHz
A:GEN:SINE	1.000	V	1.000	kHz
UN-WTD	<10 Hz - >300 kHz			

Figure 4-1. Main Panel in AMPL Function

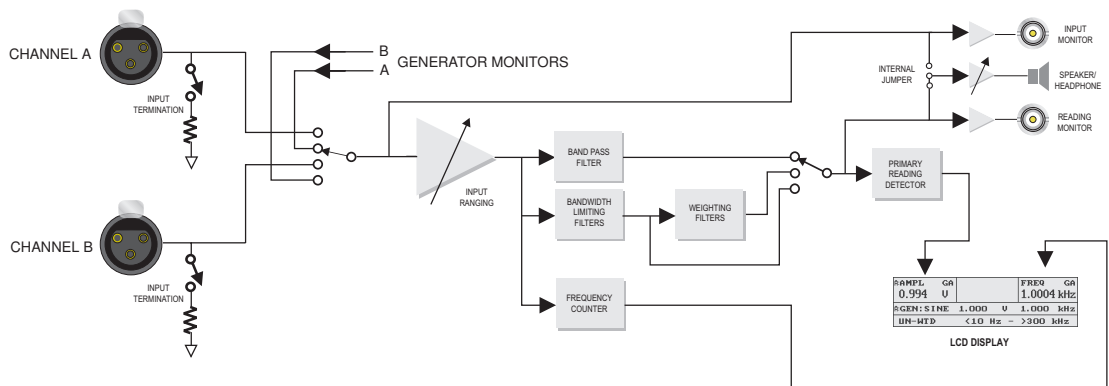



Figure 4-2. Block Diagram of Analog AMPL Measurement

Only one channel can be measured at a time. Pressing either the INPUT A or INPUT B key will select which channel to measure. A second press on the same key will measure the gen-mon signal from the same channel.

 For a more detailed discussion of units, see page 3-26.

If the analyzer is in analog mode, the amplitude can be measured in units of V, dBV, dBu, dBm, dBr, dBg, or W. In digital mode, the available units are FS, dBFS, and dBr. The units are selected by the upper left soft key.

The measured frequency of the input signal is displayed in the upper right corner of the display, or the frequency of the bandpass filter if the SELECTIVE filter is chosen.

The amplitude is measured using true RMS detection except in a few of the filtering modes described below. Several types of filters may also be applied to the amplitude measurement.

The type of filter is selected by the lower left soft key. Three types of filters are available:

- UN-WTD – The ‘unweighted’ selection provides no filtering except selectable bandwidth-limiting:
 - The lower center soft key selects the lower band limit (<10 Hz, 22 Hz or 400 Hz).
 - In analog mode, the lower right soft key selects the upper band limit (>300 kHz, 22 kHz, 22 kHz-QPK, 30 kHz, 80 kHz). The 22 kHz-QPK selection uses the quasi-peak detector instead of the true RMS detector in accordance with CCIR-468. The 22 Hz lower limit is only available if the upper limit is 22 kHz; the <10 Hz lower limit is only available with other upper limits.
 - In digital mode, the lower right soft key selects the upper band limit (15 kHz, 20 kHz, Sample Rate/2, 22 kHz, 22 kHz-QPK). The Sample Rate/2 selection always selects an upper band limit of half the incoming sample rate, and the 22 kHz-QPK selection is the same as in the analog domain.
- SELECTIVE – This selection provides a tunable bandpass filter. In analog mode, the filter has a bandwidth of 1/3 octave; in digital mode, the bandwidth is 5.3% of the tuned frequency.

 The shapes of the bandwidth-limiting filters are shown on page .

 For more information on sweeps, see page 4-53.

No other filtering is provided. The top right corner of the display shows the filter center frequency, which can be adjusted with the FREQUENCY controls. The SELECTIVE filter can be used to create spectrum-analysis sweeps. In this type of measurement, a narrow bandpass is swept across a range of frequencies, taking an amplitude measurement at each step.

- WTD – The ‘weighted’ selection allows selection of a variety of weighting filters with a selectable lower band limit. The lower center soft key selects the lower band limit (<10 Hz or 400 Hz). The lower right soft key selects among the following weighting filters:
 - ANSI/IEC-A – A-weighting filter per IEC 179, true RMS detector
 - CCIR-1k – Weighting per CCIR-468, true RMS detector
 - CCIR-2k – Weighting per CCIR-468, but with 0 dB gain point at 2 kHz rather than 1 kHz, true RMS detector
 - CCIR-QPK – Weighting per CCIR-468, quasi-peak detector
 - CCIR-ARM (analog only) – Weighting filter shape per CCIR-468, but with 0 dB gain point at 2 kHz rather than 1 kHz, average-responding detector per Dolby Bulletin 19/4
 - AUX1 (analog only) – Weighted with optional weighting filter installed in slot 1. If there is no filter in slot 1, the display will read ‘NO AUX1’ and no filter is selected.
 - AUX2 (analog only) – Weighted with optional weighting filter installed in slot 2. If there is no filter in slot 2, the display will read ‘NO AUX2’ and no filter is selected.

Noise

The Noise function is selected by pressing the FUNCTION AMPL/NOISE key twice, or only once if the function was already 'Amplitude'. It is available in both analog and digital modes.

The Noise function is virtually identical to the Amplitude function, except that the reading rate is slowed down to provide more stable readings under noisy conditions.

A:NOISE GA				
-102.8 dBV				
A:GEN: SINE	1.000	V	630.0	Hz
UN-WTD	<10 Hz	-	>300 kHz	

Figure 4-3. Main Panel in NOISE Function

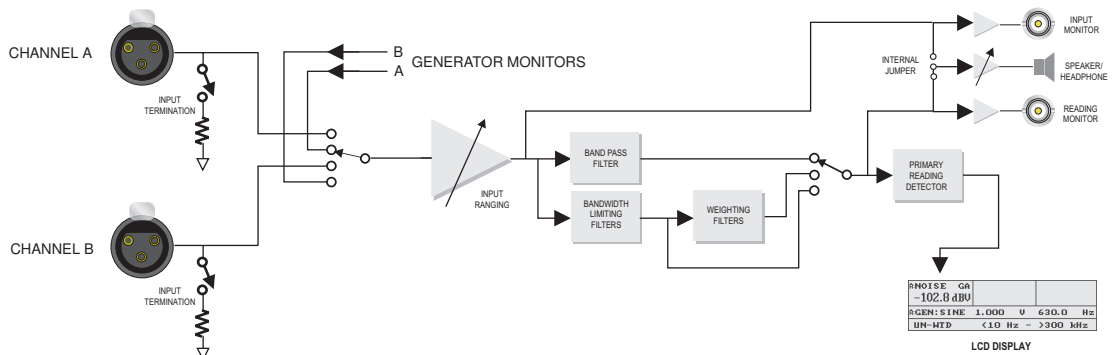

Figure 4-4. Block Diagram of Analog NOISE Measurement

When entering Noise mode, the generator is automatically turned off, since noise tests are usually taken without signal present. However, the generator can be manually turned on if necessary.

In addition to the units listed for the Amplitude function, the top left soft key can be used to select the 'dB' unit. If this unit is selected, and both the generator and analyzer are in analog mode, a special signal-to-noise ratio mode is invoked. This mode turns the generator on and off at regular intervals, making a level measurement in each state. The displayed result is the difference in dB between the two

measurements, which is the signal-to-noise ratio (also called S/N or SNR). This automatic mode can be particularly convenient when making adjustments to a device-under-test to maximize signal-to-noise ratio.

Each measurement function remembers its settings, so returning to that function will invoke the same filter and detector options. Operating convenience for many users is enhanced by setting up Noise and Amplitude functions with different filter and detector selections so that noise can be measured to two different standards simply by pressing the AMPL/NOISE button twice.

Level

The Level function is selected by pressing the FUNCTION LEVEL key. It is available in both analog and digital modes.

The Level function is used to measure the amplitude (level) of two input channels simultaneously, using true RMS detection. The level of

A:LEVEL	GA	LEVEL	A	FREQ	GA
0.994	V	0.000	V	1.0004	kHz
A:GEN: SINE		1.000	V	1.000	kHz
		HI-Z	INP	HI-Z	INP

Figure 4-5. Main Panel in LEVEL Function

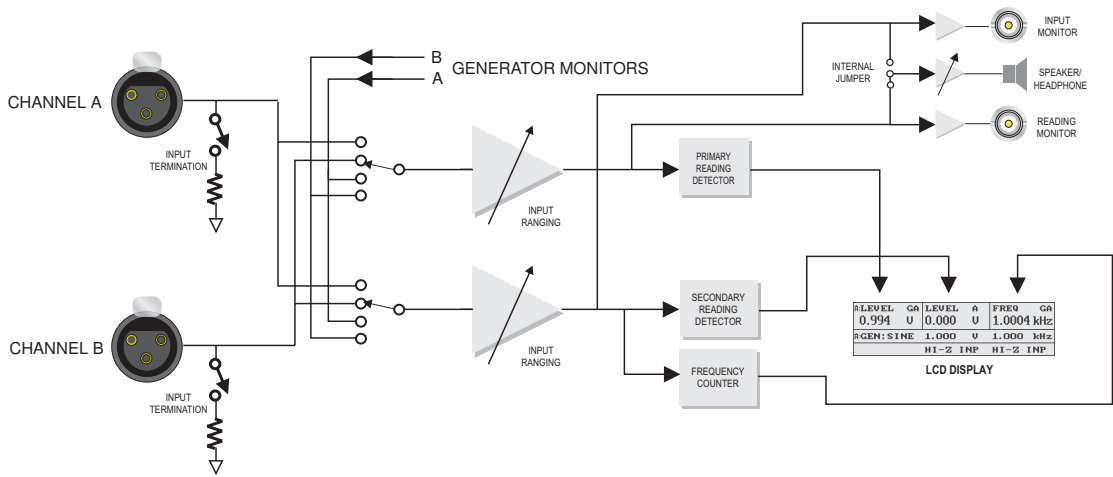

Figure 4-6. Block Diagram of Analog LEVEL Measurement

the selected input channel is shown in the top left of the display. The level of the alternate channel is shown in the top center of the display.

The upper right section of the display can show the frequency of the selected channel or the phase difference between the two channels. The top right soft key makes this selection.

The INPUT A and INPUT B keys are used to select the main and alternate channels for measurement. Subsequent presses of the INPUT A key, for example, will rotate through the following combinations:

- A input for main measurement; B input for alternate measurement
- (analog only) A gen-mon for main measurement; A input for alternate measurement
- A gen-mon for main measurement; B gen-mon for alternate measurement

Pressing the INPUT B key will rotate through a similar set of combinations, except that B will always be the main measurement.

The top center and top left soft keys can be used to select the units for the level measurement. Either soft key changes the units for both measurements.

In analog mode, the bottom center soft key allows selection of high-impedance (around 100 k Ω) or low-impedance (600 Ω) input termination for analog channel A. The bottom right soft key allows the same selection for analog channel B.

The Level function provides the best analog amplitude accuracy of which the Portable One Dual Domain is capable, as long as the measured signal is above about 10 mV. The analog Amplitude function provides wider dynamic range, but at reduced accuracy. In the digital domain there is no accuracy difference between the two modes.

When in Level function, the bargraph panel provides a dual bargraph showing the level of both channels. Similarly, the sweep panel will measure both channels simultaneously, showing the selected channel as a solid line and the alternate channel as a dotted line. Cursor measurements will display the results for both channels.

 For a more detailed discussion of units, see page 3-26.

 For more information on bargraphs, see page 4-51.

 For more information on sweeps, see page 4-53.

THD + N (Total Harmonic Distortion plus Noise)

The THD+N function is selected by pressing the FUNCTION THD+N/SINAD button. It is available in both analog and digital analyzer modes.

The THD+N function uses a notch (bandreject) filter to eliminate the fundamental frequency, and then measures the amplitude of signal remaining. This measurement is known as Total Harmonic Distortion plus Noise, or THD+N.

A:THD+N	GA	LEVEL	GA	GEN-TRACK
-102.9	dB	0.995	V	1.000 kHz
A:GEN:SINE		1.000	V	1.000 kHz
UN-WTD		<10 Hz - 80 kHz		

Figure 4-7. Main Panel in THD+N Function

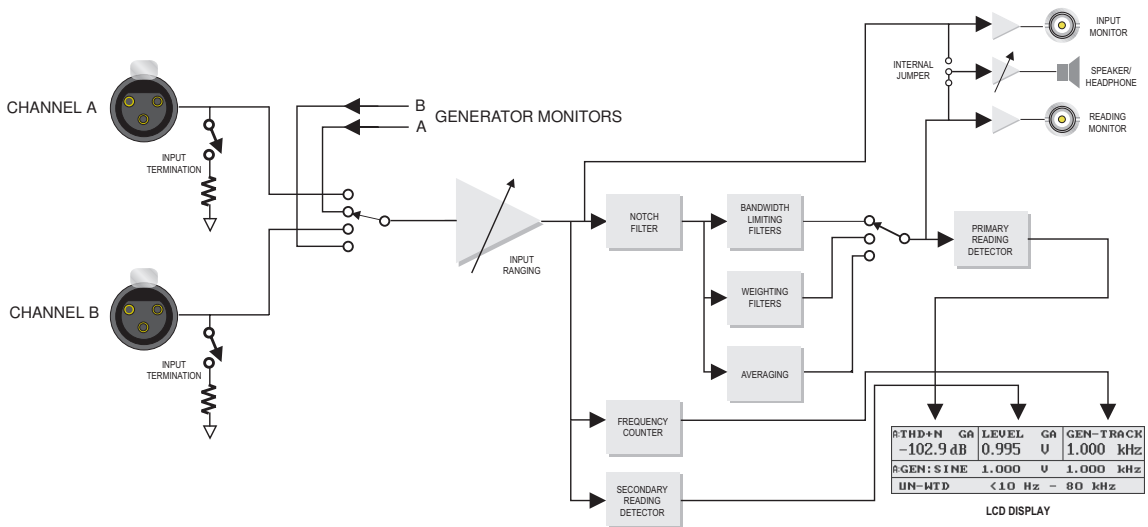



Figure 4-8. Block Diagram of Analog THD+N Measurement

The THD+N reading is shown on the top left of the display. The top left soft key selects the units for the measurement. In addition to the usual relative and absolute amplitude units, % and dB are provided. These units measure the amplitude of the filtered signal relative to the amplitude of the unfiltered signal.

 For a more detailed discussion of units, see page 3-26.

The amplitude of the original signal (before notch filtering) is shown in the top center of the display. The top center soft key is used to select the displayed units.

The top right corner of the display shows the current frequency. The value displayed depends on the notch steering mode, which is selected by top right soft key. This controls the center frequency of the tunable notch filter. Three notch steering modes are available:

- AUTO-TUNE – This causes the notch to be tuned to the incoming frequency, as read by the frequency counter. The display will show the current frequency counter reading.
- GEN-TRACK – This causes the notch to be tuned to either the analog or digital generator frequency. If the Generator Control mode is Analog Audio Generator, then the notch will track the analog generator. If it is one of the digital modes, the notch will track the embedded audio signal on the digital generator.
- FIX-TUNE – This causes the notch to be tuned to a frequency specified by the user. The current tuning frequency will be shown on the upper right of the display, and it may be adjusted with the FREQUENCY controls. This will not give a valid THD+N reading unless it is tuned to the fundamental frequency on the input.

 For more information on Generator Control Modes, see page 3-13.

The AUTO-TUNE mode will automatically tune to an incoming frequency. This is useful when making THD+N measurements on signals generated by the device-under-test or at a remote location. When running generator (internal) frequency sweeps, the notch will automatically tune to the generator frequency, as in GEN-TRACK mode.

Proper operation of AUTO-TUNE requires that the original signal has sufficient amplitude for frequency counting and not too much distortion. For the analog analyzer, the signal amplitude must be greater than about 10 mV within the audio band (20 Hz - 22 kHz) and greater than about 20 mV outside the audio band. The THD must also be less than about 10% THD+N. For the digital analyzer, the signal must be above about -80 dBFS. If the signal amplitude is too low, tuning operation will cease and the display will read 'Low'.

GEN-TRACK mode is generally faster than AUTO-TUNE, especially during sweeps. It can be used to tune to very low-amplitude or very distorted signals. However, it always tunes to the current generator frequency, so it can only be used on signals that originate from the local analog or digital generator.

FIX-TUNE mode can be used if only a single-frequency measurement is required. This is generally used to test single-tone quantization distortion from a CD player, or in conjunction with optional bandpass filters for second and third harmonic distortion measurements.

Since the analog voltmeter used to measure the amplitude before filtering has limited dynamic range, accuracy will suffer when the dB or % unit is used on analog signals below about 10 mV, regardless of the notch steering mode. Since the other measurement units do not rely on the input voltmeter, their accuracy is not compromised. The filter tuning circuit also has hardware nulling which will slow down dramatically for inputs below about 25 mV, regardless of the notch steering mode. The digital analyzer does not have this limitation.

The THD+N is measured using true RMS detection except in a few of the filtering modes described below. Several types of filters may also be applied to the measurement.

The filter and detector combination is selected by the lower left soft key. Three configurations are available:

- UN-WTD – The ‘unweighted’ selection provides no filtering except selectable bandwidth-limiting:
 - The lower center soft key selects the lower band limit (<10 Hz, 22 Hz or 400 Hz).
 - In analog mode, the lower right soft key selects the upper band limit (>300 kHz, 22 kHz, 22 kHz-QPK, 30 kHz, 80 kHz). The 22 kHz-QPK selection uses the quasi-peak detector instead of the true RMS detector in accordance with CCIR-468. The 22 Hz lower limit is only available if the upper limit is 22 kHz; the <10 Hz lower limit is only available with other upper limits.
 - In digital mode, the lower right soft key selects the upper band limit (15 kHz, 20 kHz, Sample Rate/2, 22 kHz, 22 kHz-QPK). The Sample Rate/2 selection always selects an

 *The shapes of the bandwidth-limiting filters are shown on page 6.*

upper band limit of half the incoming sample rate, and the 22 kHz-QPK selection is the same as in the analog domain.

- AVERAGE - The 'Average' selection allows the same band-limiting filters as UN-WTD. Instead of displaying each reading as it is obtained, the average of the eight most recent readings is displayed. This is used to reduce digit bobble, especially when testing distortion in the presence of noise and flutter from analog tape recorders.
- WTD – The 'weighted' selection allows selection of a variety of weighting filters with a selectable lower band limit. The lower center soft key selects the lower band limit (<10 Hz or 400 Hz). The lower right soft key selects among the following weighting filters:
 - IEC-A – A-weighting filter per IEC 179, true RMS detector
 - CCIR-1k – Weighting per CCIR-468, true RMS detector
 - CCIR-2k – Weighting per CCIR-468, but with 0 dB gain point at 2 kHz rather than 1 kHz, true RMS detector
 - CCIR-QPK – Weighting per CCIR-468, quasi-peak detector
 - CCIR-ARM (analog only) – Weighting filter shape per CCIR-468, but with 0 dB gain point at 2 kHz rather than 1 kHz, average-responding detector per Dolby Bulletin 19/4
 - AUX1 (analog only) – Weighted with optional weighting filter installed in slot 1. If there is no filter in slot 1, the display will read 'NO AUX1' and no filter is selected.
 - AUX2 (analog only) – Weighted with optional weighting filter installed in slot 2. If there is no filter in slot 2, the display will read 'NO AUX2' and no filter is selected.

 *The shapes of the weighting filters are shown on page 6.*

Selection of the proper band-limiting filters is of critical importance in THD+N measurements. The dominant signal is often wideband noise when measuring high-quality audio devices, so the specified band-limiting filter must be used if measurements are to correspond to manufacturer's specifications.

The 80 kHz lowpass filter is the most commonly used, since it eliminates wideband noise while passing the 2nd and 3rd harmonics of frequencies within the audio band.

Understanding THD + N

Total Harmonic Distortion plus Noise, or THD+N, is one of the most common and widely used measurements made on audio devices. Virtually every type of device used to produce, transmit, or process audio signals has a THD+N specification.

Fundamentally, THD+N is a measurement of sound that is not supposed to be there. If your device is creating a sound, you want it to create that sound and nothing else. However, all devices create other sounds as well.

The unwanted sounds break down into four basic categories:

- **Harmonic Distortion** - unwanted sound that is related to the desired sound.
- **Random Noise** - unwanted sound caused by random fluctuations in electronic components.
- **Interference** - unwanted sound related to other signals within the device or environment.
- **Hum** - unwanted sound related to the frequency of the main supply voltage.

Harmonic distortion is caused by slight imperfections in the creation or recreation of the sound. These imperfections generally cause unwanted sounds to be generated at whole-number frequency multiples of the desired sound.

Random noise is created by almost every type of electronic component. Noise sounds generally sound like 'ffff...' and are generated regardless of whether there is a desired sound being created or not. Some noise exists at every frequency.

Hum is created by the main supply voltage leaking into the audio signal. It exists at the frequency of the supply voltage and whole-number multiples of this frequency.

Interference is caused by other signals leaking into the sound signal. Crosstalk is a certain type of interference caused by sound leaking in from other audio channels within the device.

The THD+N measurement includes all four types of unwanted sound. If any of these are excessive, it will be noticeable in a THD+N reading. In this way, a single THD+N reading can be a good indication that a device is operating properly.

The THD+N reading alone does not tell you which type of unwanted sound is dominant. If the reading is unexpectedly high, you may need further testing to determine the source of the unwanted sound. More detail on determining which type of unwanted sound is causing the problem is given in the section 'Isolating Sources of THD+N' on page 4-20.

To make a THD+N measurement, we begin by having the device create or reproduce a single sinewave called the ‘fundamental tone’, which represents the desired sound. Some of the unwanted sounds will also be created, so the frequency spectrum may look like this:

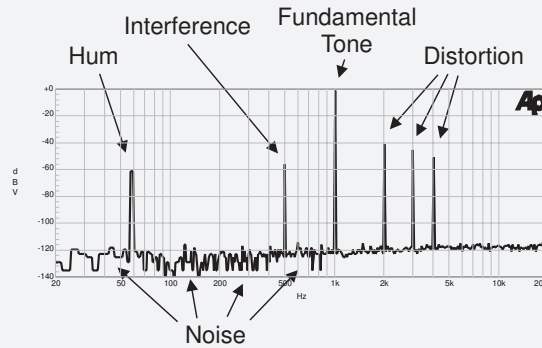

Figure 4-9. THD + N spectrum with fundamental

The signal is measured with a voltmeter at this point. The measurement will be dominated by the amplitude of the fundamental tone, since it is at a high amplitude relative to the unwanted signals.

The signal is then run through a narrow bandreject filter to eliminate the fundamental tone. The spectrum then looks like this:

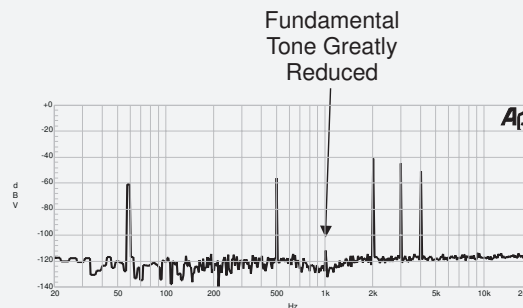

Figure 4-10. THD + N spectrum with fundamental filtered

The fundamental tone has been reduced to a level where it will be insignificant. The filtered signal is then measured with another voltmeter, and the reading is presented as a ratio of the two voltmeter readings.

Notice that the final measurement is ‘wideband’. It measures the total of all the noise sources within the frequency range of interest. It is not specific to the frequency of the fundamental tone. While some devices may create more or less harmonic distortion for different fundamental frequencies, the other sources of unwanted sound will contribute to the reading no matter what fundamental frequency is used.

Surprises and Pitfalls in THD + N Measurements

What Signal is Dominant?

While all types of unwanted sounds are included in the THD+N measurement, they may not all contribute to the overall reading. Like all voltmeter readings on signals that include several frequency components, the highest-amplitude components will dominate the reading.

When comparing two individual signal components such as interference tones or distortion products, the limit is commonly considered to be 10 dB. If one component is 10 dB above the other, only the higher component will be significant to an amplitude reading. However, when there are many lower components, the combination may become significant. For example, random noise can be a significant contribution to a THD+N measurement even though its amplitude at any particular frequency is well below other products. Since noise exists at every frequency, and each frequency has a tiny effect on the overall reading, the combination of all the noise may be quite significant.

Often THD+N tests will be used in conjunction with noise-only tests to be certain that a problem is not hiding underneath a more significant contributor.

The section 'Isolating Sources of THD+N' (page 4-20) explains some strategies for determining which unwanted signal is dominating the reading.

Selecting Bandwidth

Selection of a bandwidth-limiting filter is often of critical importance in THD+N measurements. This is mainly for two reasons:

Noise exists at every frequency. The wider the bandwidth of the measurement, the more noise is included.

Limiting the bandwidth can eliminate other components, which you may or may not want included in the measurement.

The amount of noise included in the measurement will be directly related to the bandwidth. If you are more concerned with distortion and interference products than noise, it is wise to set the upper band limit to allow the highest component of interest but reject noise above that frequency. Most mechanisms that create harmonic distortion concentrate most of the distortion in the second and third multiples (harmonics) of the fundamental. Therefore, for most devices it is reasonable to limit the bandwidth to around four times the highest fundamental frequency of interest.

It is most common to limit the bandwidth to 80 kHz, since this will reject high-frequency noise while passing the second and third harmonics of signals up to 22 kHz, the top of the audible frequency range.

You may want to limit the lower band limit to remove hum from the measurement. Using the 400 Hz highpass filter will eliminate the hum products while passing all fundamentals, interference, distortion products, and noise above 400 Hz.

Following is an example of the use of various bandwidth-limiting filters. The spectrum of the original signal may look like this:

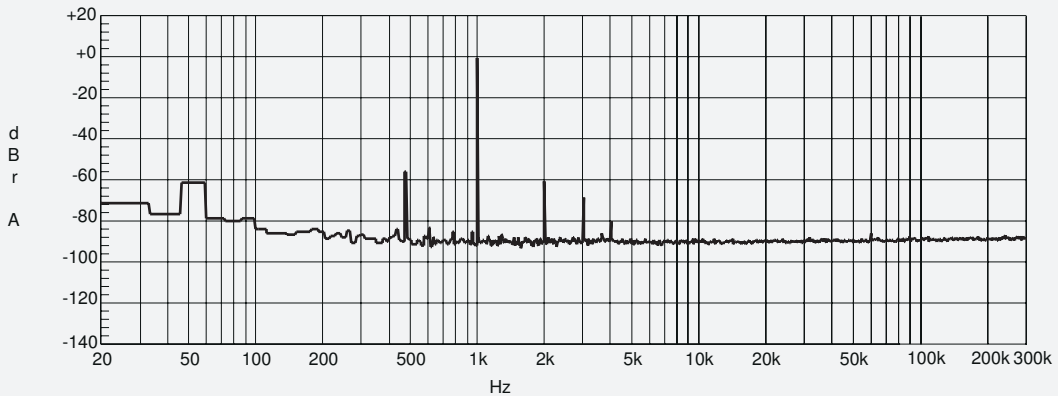

Figure 4-11. Spectrum with no filter

After the bandpass filter eliminates the 1 kHz fundamental tone, we are left with the following:

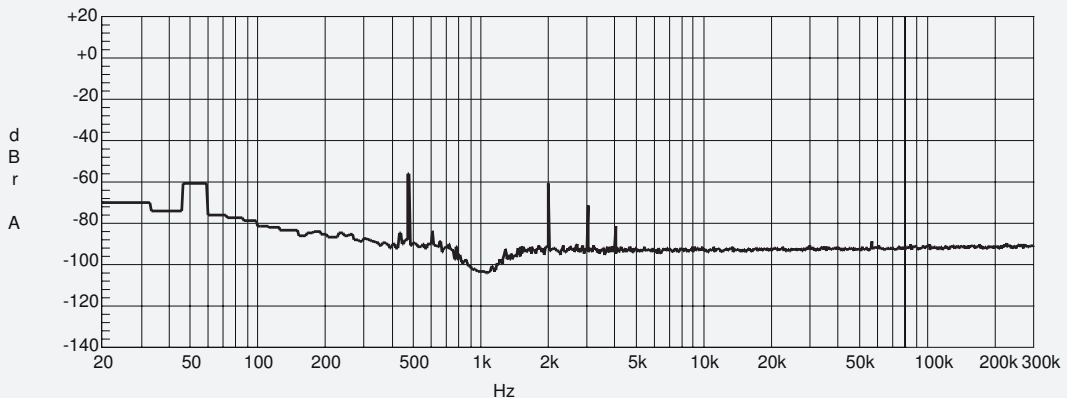

Figure 4-12. Spectrum with fundamental filtered

This signal contains contributions from harmonic distortion (at 2 kHz, 3 kHz, and 4 kHz), an interfering tone (at 490 Hz), random noise, and 60 Hz hum. The THD+N measurement includes all of these, and reads 0.229 %.

If we use the 400 Hz bandpass filter to eliminate the hum, the spectrum of the signal then looks like this:

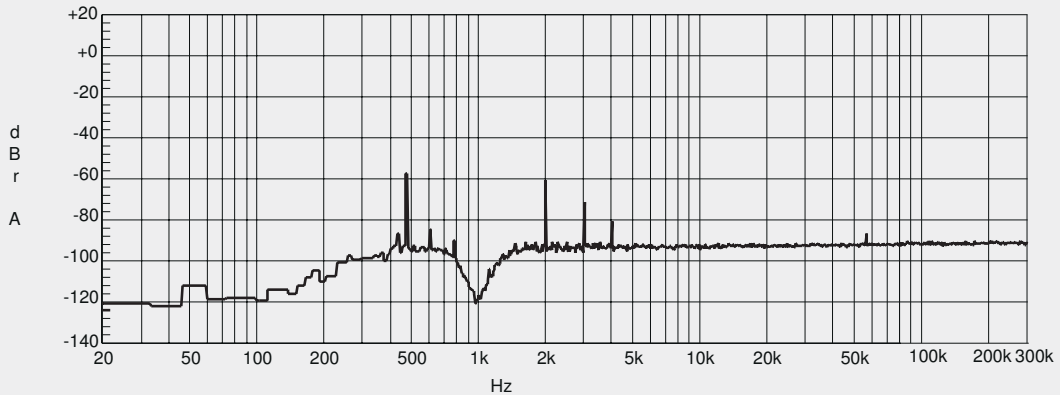

Figure 4-13. Spectrum with 400 Hz bandpass filter applied

The THD+N now measures 0.185 %. From this, we can determine that the hum product was contributing 0.044 % to the THD+N reading.

Next, we can invoke the 22 kHz lowpass filter to eliminate the high-frequency noise. The spectrum now looks like this:

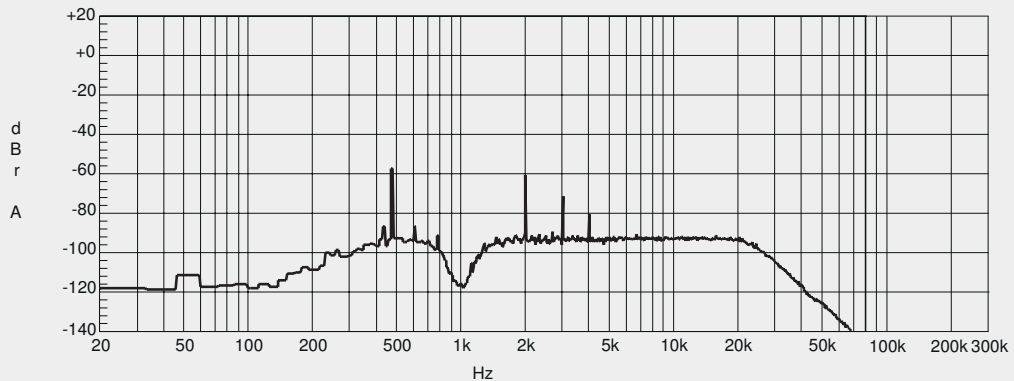

Figure 4-14. Spectrum with 22 kHz lowpass filter added

The THD+N still measures 0.185 %. From this, we can determine that (in this particular case) the high-frequency noise did not make a significant contribution to the measurement. It is dominated by the distortion and interference tones.

Following is the spectrum of a different THD+N measurement. This one comes from a device that generates a significant amount of high-frequency noise. The THD+N measures 0.057 % with a lower band limit of 400 Hz and a high band limit of 300 kHz. The spectrum is shown after the bandreject filtering, which has removed the 1 kHz fundamental.

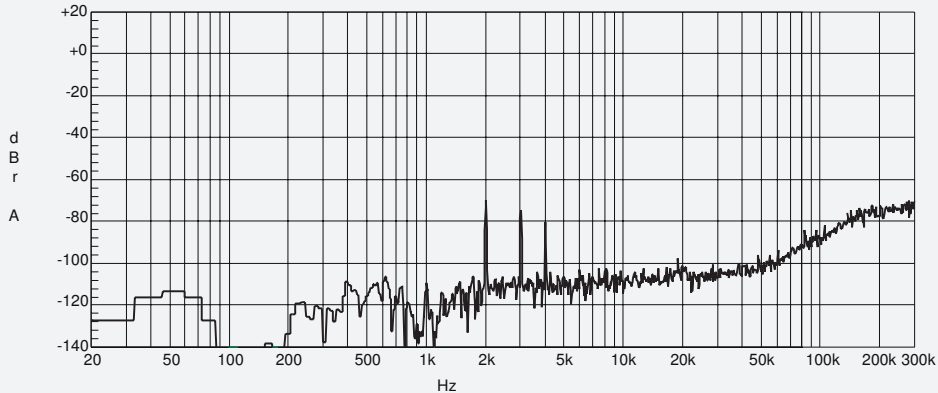

Figure 4-15. Device with HF noise, 1 kHz fundamental filtered

This measurement is dominated by the high-frequency noise, although the distortion products (at 2 kHz, 3 kHz and 4 kHz) are probably contributing. Next, we can invoke the 22 kHz lowpass filter. The spectrum then looks like this:

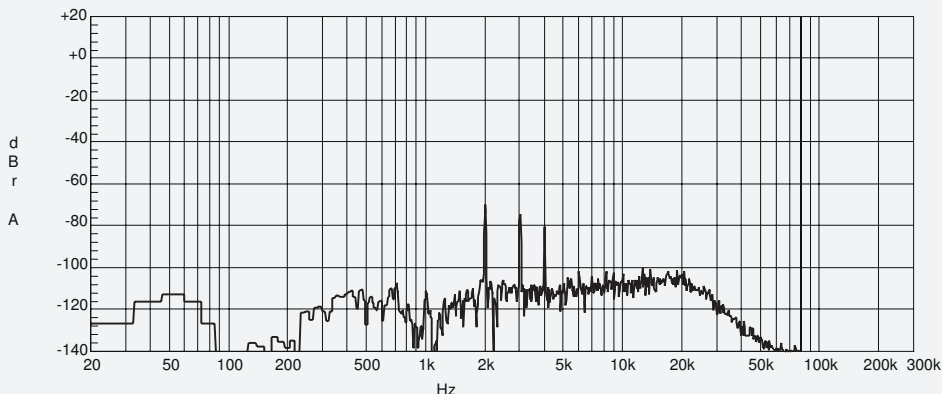

Figure 4-16. Same device with 22 kHz lowpass filter added

The high-frequency noise has been eliminated, and the measurement is now dominated by the distortion products. The THD+N now measures 0.0390 %, which is precisely the theoretical THD for these distortion products. The contribution of the remaining noise (between 400 Hz and 22 kHz) is negligible.

Changes with Frequency

Sometimes THD+N will be very consistent over a range of frequencies except that it will 'drop out' at one frequency, giving a very low reading. This is an indication that the THD+N reading is dominated by significant hum or interference at that frequency. This is common when using a fundamental at 50 or 60 Hz in the presence of significant hum.

For example, you may see a THD+N sweep that looks like this:

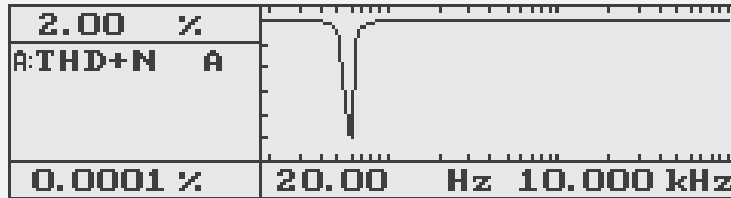

Figure 4-17. THD + N with interfering signal at same frequency as fundamental

If you see this graph, you should immediately suspect that the THD+N reading is dominated by a significant component at the frequency of the dropout.

The reason for this is that the notch (bandreject) filter tracks the fundamental tone. When the fundamental tone is far away from the interfering signal, the interfering signal is included in the THD+N measurement. When the fundamental tone is at the same frequency as the interfering signal, the notch filter removes the interfering signal as well as the fundamental tone. Therefore, the interfering tone is not included in the THD+N measurement at that frequency.

This can be a useful technique for locating a source of interference. If you suspect interference at a certain frequency, make a THD+N measurement with the fundamental at that frequency. If this measurement is much lower than measurements made using other fundamental frequencies, then there is interference at that frequency.

In some cases, you may see an erroneous dropout in a THD+N vs. frequency sweep because of phase cancellation. This is caused by one of the distortion products of the fundamental tone arriving out-of-phase with an interfering tone and canceling it out. When the sweep is run again, the amount of cancellation will vary significantly. If you see an unexpected dropout in a THD+N sweep, it is a good idea to run it several times. If it varies significantly (or disappears) with successive runs of the test, then it is probably a cancellation problem. In this case, the low THD+N reading is incorrect.

Changes with Amplitude

It is fairly common for the THD+N reading to apparently increase as the fundamental tone amplitude decreases, even if the device does not create more distortion or noise at lower amplitudes.

This effect is due to the fact that the THD+N reading is the ratio of the amplitude before filtering to the amplitude after filtering. If the amplitude after filtering is dominated by noise, hum, or interference, it will be essentially constant regardless of the amplitude of the fundamental tone. Therefore, as the amplitude of the fundamental tone decreases there will be an apparent increase in the calculated ratio.

Since all devices create some noise, any device has a 'noise floor'. This is the level of noise that is always created by the device. If the fundamental tone has a lower amplitude than the noise floor, there will be essentially no difference between the level of filtered and unfiltered signals and the THD+N will be 100%.

In some devices, the unwanted signals may actually increase as signal amplitude decreases. If you suspect this, you may want to make an absolute THD+N measurement, which does not include the amplitude before filtering in the measurement. This is accomplished by selecting any unit besides % or dB.

All devices also have a maximum allowable amplitude. If the fundamental tone is above this amplitude, the device will generally 'clip', creating very high distortion. Almost any device will show very high distortion readings at maximum or near-maximum amplitude.

The following graph shows common THD+N characteristics as a function of amplitude:

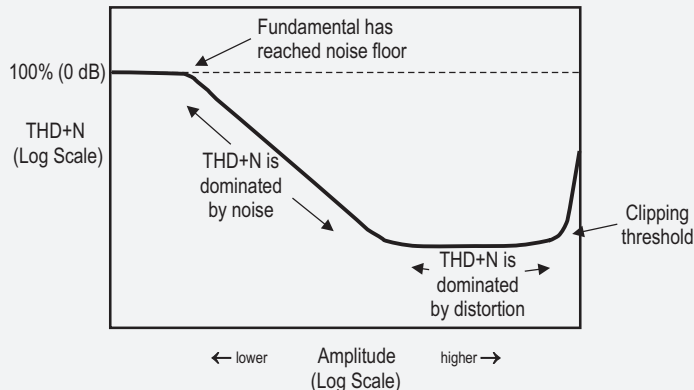

Figure 4-18. THD + N characteristics as a function of amplitude

Note that for some low-distortion devices, the flat area before clipping may shrink or not exist at all. The THD+N measurement may be noise-dominated at all amplitudes below the clipping threshold.

THD+N at 100% (or 0 dB)

If the THD+N reads 100% (or 0 dB), the amplitude of signal is the same before and after the filter. Even if a device is creating a huge amount of distortion or interference, the THD+N should be less than 100% because the signal before the filter should include the fundamental, whereas the signal after the filter should not.

If the amplitude of the fundamental tone is below the noise floor, then both amplitude measurements (before and after the notch filter) will be dominated by noise. The amplitudes will be the same, and the THD+N will read around 100%.

Another common reason for a reading of 100% THD+N is that the notch filter is not correctly tuned to the fundamental frequency. In this case, the signals before and after the filter will be dominated by the fundamental tone, and the filter will be removing nothing except a tiny, insignificant piece of the noise floor.

If your distortion reading is 100%, check the filter tuning mode. AUTO-TUNE should tune correctly as long as there is sufficient signal amplitude for a valid frequency reading. FIX-TUNE will give 100% readings unless the filter is tuned to the frequency of the incoming fundamental tone. GEN-TRACK will give 100% readings if the frequency of the incoming fundamental tone is different from the generator frequency.

Isolating Sources of THD+N

Because the THD+N reading may contain several different types of unwanted sounds, it may sometimes be helpful to be able to isolate which types of sounds are contributing to the measurement.

First, check your device to make certain that the amplitudes are correct and that there are no other sound sources making contributions to the output. Many THD+N problems are the result of this sort of error.

Then limit the low-frequencies using the 400 Hz highpass filter. This filter will eliminate the hum, which is usually at 50 Hz or 60 Hz and multiples of this frequency. If you see a significant difference in the THD+N reading when you engage the 400 Hz filter, then a significant amount of hum is contributing to the reading.

Next, change the reading units to volts (or any other unit besides % or dB). This will reconfigure the instrument to read only the filtered amplitude. Check the THD+N reading and then turn off the generator. If the reading changes significantly, then a significant amount of distortion is contributing to the reading.

If you have run the two previous tests, and found that the dominant source of unwanted sound is neither hum nor distortion, it must be either random noise or interference. To distinguish between these two, run a spectrum-analysis sweep. To do this, change to the AMPL measurement function and choose the SELECTIVE filter using the bottom left soft key. Make sure the analyzer is observing the input signal and turn off the fundamental tone. Then press SWEEP to pull up the sweep panel, set the upper and lower frequency limits (preferably to same limits as the bandwidth of your THD+N measurement), and run the sweep. You may need to adjust the upper and lower graph limits as well.

Choose the largest number of points available (150) and run the sweep. This sweep will tune the bandpass filter to each frequency and measure the amplitude of signal at that frequency. While the bandpass filter is too wide for extremely precise results, it may still reveal the source of the unwanted sound. Wherever there is a significant interference source (including hum), you will see a peak in the graph. If the signal is dominated by random noise, it will be essentially smooth. It may slope gently in one direction or the other, usually upward with increasing frequency.

The SINAD function is selected by pressing the FUNCTION THD+N/SINAD key twice, or only once if THD+N mode has already been selected. It is only available in analog analyzer mode.

The SINAD function is similar to THD+N except that the sign of the result (always in dB) is reversed. For example, a 12 dB SINAD measurement corresponds to a -12 dB THD+N measurement.

A:SINAD	GA	LEVEL	GA	
98.6	dB	0.995	V	OFF
A:GEN:SINE		1.000	V	400.0 Hz
400 Hz		<10 Hz -		>300 kHz

Figure 4-19. Main panel in SINAD function

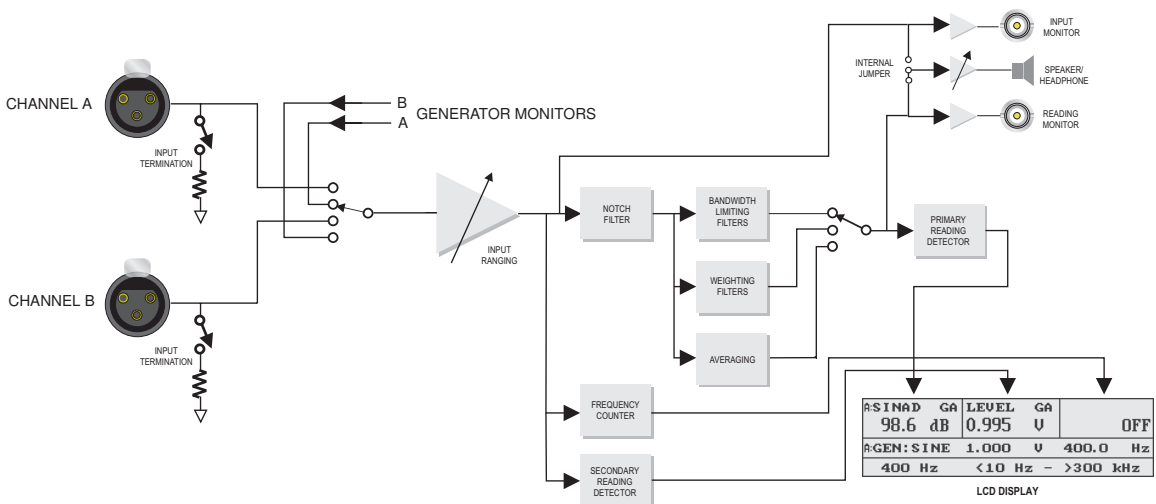

Figure 4-20. Block Diagram of Analog SINAD measurement

The SINAD reading is shown in the top left corner of the display. The units cannot be changed. The top center of the display shows the amplitude of the signal before filtering. The amplitude units may be selected by pressing the top center soft key.

The INPUT A and INPUT B keys select the channel to be measured, and select between the input connectors and the gen-mon path.

The top right soft key selects the notch steering mode. There are three notch steering modes, selected by subsequent presses:

- OFF – In this mode, the filter is tuned to either 400 Hz or 1 kHz, as displayed in the bottom left corner of the display.
- GEN-TRACK – This causes the notch to be tuned to either the analog or digital generator frequency. If the Generator Control mode is Analog Audio Generator, then the notch will track the analog generator. If it is one of the digital modes, the notch will track the embedded audio signal on the digital generator.
- FIX-TUNE – This causes the notch to be tuned to a frequency specified by the user. The current tuning frequency will be shown on the upper right of the display, and it may be adjusted with the FREQUENCY controls. This will not give a valid SINAD reading unless it is tuned to the fundamental frequency on the input.

SINAD measurements are generally taken at 400 Hz or 1 kHz, so these frequencies are designed to be the most convenient. When the notch steering mode is set to 'OFF', the lower left soft key selects between 400 Hz and 1 kHz. Changing this setting changes both the generator and the notch filter to the selected frequency. The generator frequency may then be changed using the FREQUENCY controls, but the notch will remain parked, so the reading will be invalid.

In either GEN-TRACK or FIX-TUNE mode, the upper right section of the display will show the current center frequency of the notch filter. In OFF mode, the current notch frequency is shown above the lower left soft key.

The SINAD mode also provides bandwidth limiting. The lower center soft key selects the lower band limit (<10 Hz, 22 Hz or 400 Hz). The lower right soft key selects the upper band limit (>300 kHz, 22 kHz, 22 kHz-QPK, 30 kHz, 80 kHz). The 22 kHz-QPK selection uses the quasi-peak detector instead of the true RMS detector in accordance with CCIR-468. The 22 Hz lower limit is only available if the upper limit is 22 kHz; the <10 Hz lower limit is only available with other upper limits.

Phase

The Phase function is selected by pressing the FUNCTION PHASE key. It is available in both digital and analog modes.

The Phase mode measures the difference in phase (or time shift) between two sine or square waves. In digital mode, it measures the difference in phase between the two channels of imbedded audio. Both channels must have the same frequency; phase measurements between two signals of different frequencies are meaningless (and the reading will wander continuously).

The upper left corner of the display shows the phase difference. The units are always degrees.

A:PHASE	GA	LEVEL	GA	FREQ	GA
0.0	deg	0.963	V	0.9999	kHz
A:GEN: SINE		1.000	V	1.000	kHz
-270/+90				NOAVERAGE	

Figure 4-21. Main panel in PHASE function

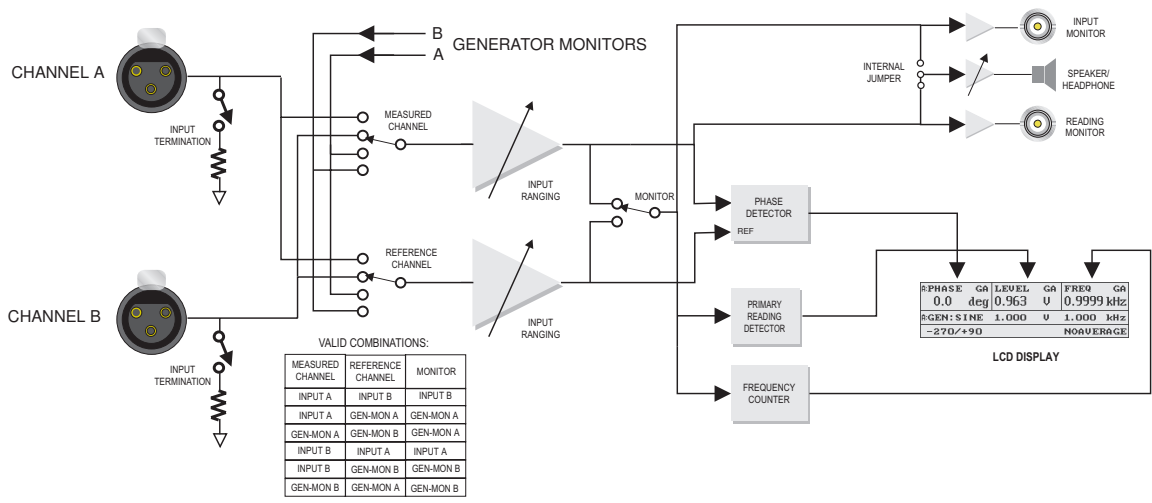

Figure 4-22. Block diagram of Analog Phase measurement

The center of the display shows the amplitude of the selected channel. Pressing the upper center soft key will select among the available units. The usual absolute and relative amplitude units are available.

The phase measurement is always the phase of the selected channel, using another channel as a reference. Pressing the INPUT A button will cycle through the following combinations:

- A-B – This option will measure the phase of input A with input B as a reference.
- A-G (analog only) – This option will measure the phase of input A with the channel A gen-mon path as a reference. This is used to measure phase shift through a device (input to output).
- GA (analog only) – This option will measure the phase of gen-mon channel A with gen-mon channel B as a reference.

Pressing the INPUT B button will cycle through the following combinations:

- B-A – This option will measure the phase of input B with input A as a reference.
- B-G (analog only) - This option will measure the phase of input B with the channel B gen-mon path as a reference. This is used to measure phase shift through a device (input to output).
- GB (analog only) – This option will measure the phase of gen-mon channel B with gen-mon channel A as a reference.

The gen-mon paths are only available in analog modes. This is because both digital channels travel along the same path and therefore if one channel of digital gen-mon is enabled the other will be also. The phase reading would always read zero because the digital generator cannot generate out-of-phase sinewaves.

The lower left soft key controls the range over which the phase measurement is displayed. The allowable ranges are +180 to -180 degrees, -270 to +90 degrees, and -90 to +270 degrees. The latter two ranges should generally be used for polarity checks, where the reading will either be very close to 0 or very close to 180 degrees. If the +180 to -180 degree range is used for these measurements, readings near zero could read on either end of the range.

The lower right soft key controls the averaging of the readings. If it is set to 'NOAVERAGE', the phase readings are updated at a rate of approximately three per second. If it is set to 'AVERAGE', the display shows a running average of the last eight readings, to reduce the effects of digit bobble. The 'AVERAGE' mode is particularly useful when adjusting azimuth in analog tape machines.

In bargraph mode, the AMPLITUDE keys are used to set the endpoints of the graph. After selecting the endpoint to change by pressing the appropriate soft key, the ± 10 dB keys will change the endpoint in increments of 90 degrees. The INC and DEC buttons will change the endpoint in increments of 10 degrees.

To obtain the specified accuracy, analog inputs must have amplitude greater than about 20 mV and must have signal-to-noise ratio greater than about 40 dB. If either input drops below about 8 mV (or below 10% of the selected fixed input range when the bargraph HOLD RANGE function is used) the display will show the word 'Low', and there will be no phase reading. If the S/N ratio in either channel is less than 40 dB, the reading may be unstable, especially at low frequencies.

The IMD measurement function is selected by pressing the FUNCTION IMD button. It is available in both digital and analog modes, but only if the Intermodulation Distortion Option is installed. The ATS-1 Dual Domain can be purchased with or without this option, or the option can be added at a later time.

The IMD measurement conforms to the SMPTE and DIN testing standards. These standards call for a low-frequency tone to be mixed with a high-frequency tone at a 4:1 amplitude ratio. The signal is then sent through the device-under-test. Next the low-frequency tone is filtered out and the high-frequency tone is sent through an AM demodulator. After bandwidth-limiting to 700 Hz, the demodulated signal is measured. This is the intermodulation distortion. It is measured as a percentage or dB difference between the amplitudes of the high-frequency tone and the demodulated remainder.

A:IMD	GA	LEVEL	GA	
0.0010 %		821.7 mV		
A:GEN:IMD	1.000	V	60Hz/7kHz	

Figure 4-23. Main panel in IMD function

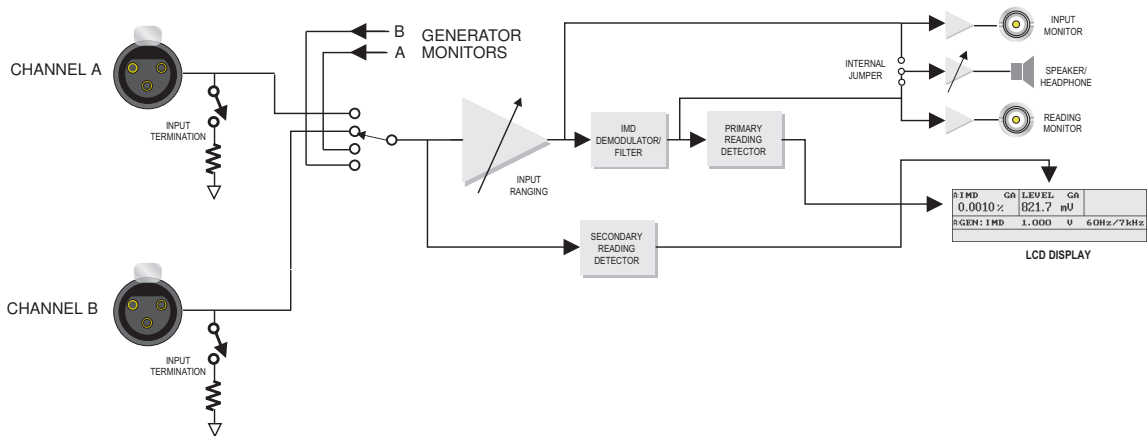



Figure 4-24. Block diagram of the IMD measurement

The upper left corner of the display shows the IMD reading. The units may be selected from % or dB by pressing the top left soft key. The upper center of the display shows the amplitude of the signal before filtering. Pressing the top center soft key selects the units.

The IMD generator waveform is automatically selected when entering IMD measurement function. You may then change the generator waveform if desired, but this will result in an invalid IMD reading. When exiting IMD measurement function, the generator waveform is changed back to sine.

 For more information on navigating among the panels, see page 3-3.

The generator amplitude can be adjusted using the AMPLITUDE controls, but changing the tone frequencies requires the Generator Only Panel. Press the INSTRUMENT MODE PANELS button several times, until you reach this panel:

ANALOG AUDIO GENERATOR			
A:GEN:IMD	1.000	V	60Hz/7kHz
P1DD	600Ω	BAL	

Figure 4-25. Generator only panel with IMD selected

The generator IMD tones can be changed from this panel. The two generated tones are shown in the area of the panel where the generator frequency is normally shown. The low-frequency tone is shown on the left, separated by a slash from the high-frequency tone.

To change the low-frequency tone, press the lower right soft key. This will select among 50 Hz, 60 Hz, 70 Hz and 250 Hz tones. To change the high-frequency tone, press the upper right soft key. This will select between 7 kHz and 8 kHz tones.

Frequency sweeps are not available in IMD mode since the standards define a fixed set of frequencies. Amplitude sweeps are supported.

Although the SMPTE standard calls for a signal with a 60 Hz lower tone and a 7 kHz upper tone, experience suggests that the lower tone should not be a multiple of the line frequency, which in many areas is 60 Hz. Under the DIN standard, a 250 Hz lower tone with an 8 kHz upper tone is a better choice.

Ratio

The Ratio measurement function is selected by pressing the FUNCTION RATIO key. It is available in both analog and digital analyzer modes.

The Ratio measurement measures the RMS amplitude of two inputs and computes the ratio between them. If both channels are connected to a stereo signal, then Ratio measures the stereo balance. If one channel is connected to the output of a device, and the other channel to the gen-mon path of the same signal, then Ratio measures the voltage gain or loss through the device.

A:RATIO	A/G	LEVEL	GA	FREQ	GA
0.00	dB	0.991	V	999.64	Hz
A:GEN:	SINE	1.000	V	1.000	kHz
MODE 1					

Figure 4-26. Main panel in RATIO function

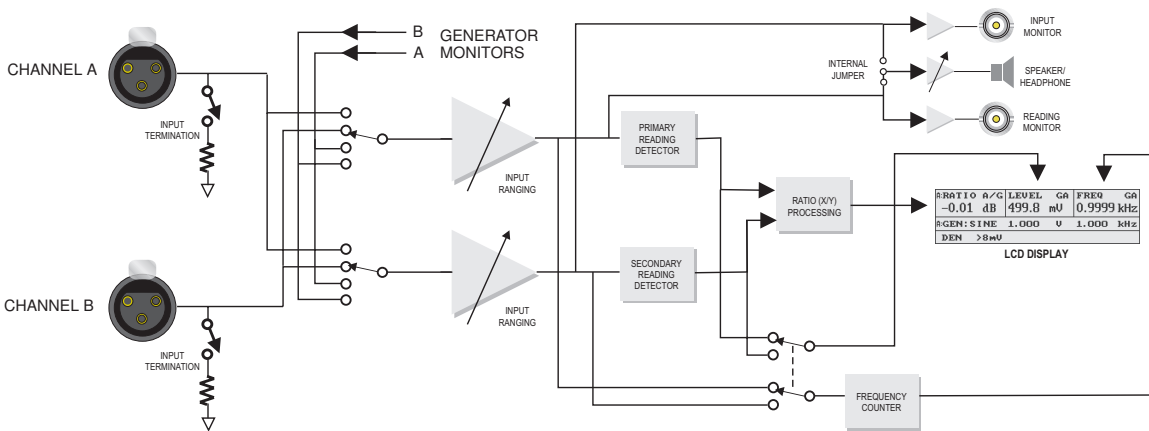

Figure 4-27. Block diagram of analog RATIO measurement

The result is shown in the upper left corner of the display. The upper left soft key is used to select the units for display. The units available are dB and X/Y. The dB selection will compute the amplitude of the selected channel relative to the reference channel. The X/Y selection

will display the amplitude of the selected channel divided by the amplitude of the reference channel.

The upper center section of the display shows the amplitude the reference channel. The upper center soft key selects the display units. The usual set of relative and absolute units are available.

The upper right section of the display can show the frequency of the reference channel or the phase of the selected channel relative to the reference channel. Frequency is displayed in Hz and phase in degrees, in the range of -180 to $+180$ degrees.

The INPUT keys are used to select among the possible combinations of selected channel and reference channel. The INPUT A key will cycle through the following options:

- A/B – The channel A input is selected; B is used as the reference
- A/G (analog only) – The channel A input is selected; gen-mon channel A is used as the reference

The INPUT B key will cycle through a similar set of options, but B will always be selected as the measured channel.

For analog measurements, the lower left soft key is used to optimize the use of the meters. There are two meters used for a ratio measurement, and one of the two loses accuracy below about 8 mV. Therefore, it is necessary to restrict one of the two measured amplitudes to values above 8 mV.

You can choose which amplitude is restricted to higher values using the lower left soft key. If the display reads 'MODE 1', then the channel used for the denominator value (the 'downstairs' value in the fraction) should not be less than 8 mV. If the display reads 'MODE 2', then the channel used for the numerator value (the 'upstairs' value in the fraction) should not be less than 8 mV. MODE 1 is the same as older Portables which did not have this feature.

If both measurements are well above 8 mV, then this setting does not matter. If both are below 8 mV, the reading will never be valid. If the restricted meter reads below 8 mV, the display will read 'Low'. A table summarizing this information is shown on the following page.

Digital Ratio mode does not have this limitation or the Mode option.

The following table shows proper Mode choices in a number of common situations.

Measurement	Ratio	Numerator	Denominator	Mode
Attenuation, Ch. A	A/G	A Input, <8mV	Generator A, >8mV	1
Gain, Ch. A	A/G	A Input, >8mV	Generator A, <8mV	2
Attenuation, Ch. B	B/G	B Input, <8mV	Generator B, >8mV	1
Gain, Ch. B	B/G	B Input, >8mV	Generator B, <8mV	2
Channel Balance	A/B	A Input, >8mV	B Input, >8mV	Either Mode
Channel Balance	B/A	B Input, >8mV	A Input, >8mV	Either Mode
Any	Any	>8mV	>8mV	Either Mode
Any	Any	<8mV	<8mV	Invalid

W + F (Wow and Flutter)

The W+F (Wow and Flutter) measurement function is selected by pressing the FUNCTION W+F key. It is only available in analog analyzer mode.

The W+F function is used to measure wow and flutter (speed variations) in analog tape recorders and turntables. The W+F

A:W+F	GA	LEVEL	GA	FREQ	GA
0.000	%	0.995	V	3.1492 kHz	
A:GEN: SINE		1.000	V	3.150 kHz	
WTD		IEC		PEAK	

Figure 4-28. Main panel in W+F function

measurement supports the IEC (DIN), NAB, and JIS standards.

Wow and flutter is measured by playing a 3 kHz or 3.15 kHz reference tone on the device-under-test. The reference tone is usually pre-recorded on a device with minimal wow and flutter. The recording is then played back, and the output is sent to the ATS-1 Dual Domain for analysis. The instrument determines the amount of speed fluctuation and the amount of speed error.

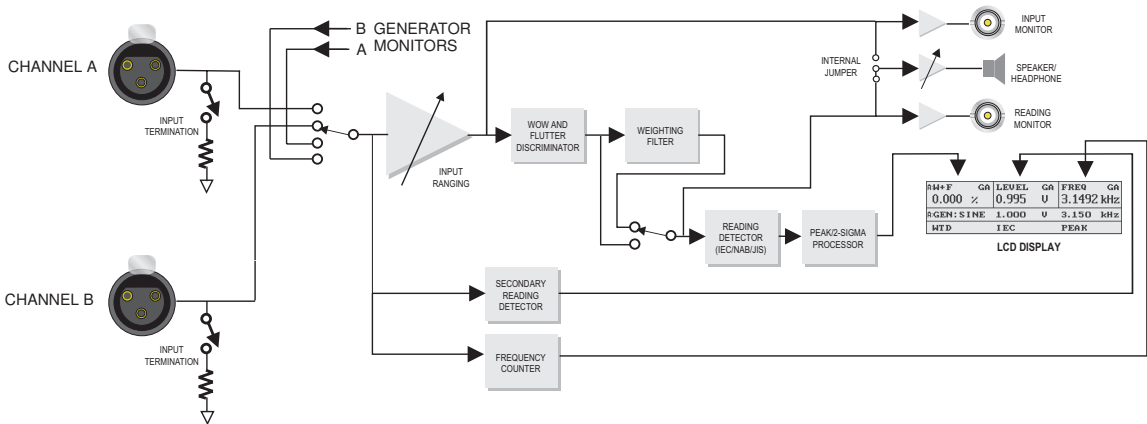

Figure 4-29. Block diagram of Analog Wow and Flutter measurement

The upper left corner of the display shows the wow and flutter reading, which is the amount of fluctuation in the frequency of the incoming tone. The only available unit is percent. If the input frequency is below 2.8 kHz, the display will read 'Lo Fr' (low frequency). If the input frequency is above 3.35 kHz, the display will read 'Hi Fr' (high frequency). No valid W+F readings can be obtained outside of this frequency range.

The upper center section of the display shows the level (amplitude) of the incoming signal. The upper center soft key selects among the usual set of absolute and relative amplitude units.

The upper right section of the display shows the measured frequency of the selected input signal. Pressing the upper right soft key will cycle through the following options:

- **FREQ** - measures the exact measured frequency of the input
- **3.00 kHz** - measures the frequency in units of $\Delta\%$, as a percent deviation from the 3.00 kHz ideal frequency (for use with 3 kHz reference tones)
- **3.15 kHz** - measures the frequency in units of $\Delta\%$, as a percent deviation from the 3.15 kHz ideal frequency (for use with 3.15 kHz reference tones).
- **OFF** - frequency counter is disabled

The lower left soft key allows selection of a weighting filter that approximates the ear's sensitivity to wow and flutter. The 'WTD' selection uses this filter; the 'UN-WTD' selection bypasses it, for a flat response. All the major wow and flutter standards recommend use of this weighting filter.

The lower center soft key selects the standard to which the measurement is made. Presses of the key will cycle through IEC, NAB, and JIS standards. The DIN standard is identical to the IEC standard. The different standards require different test tone frequencies and detector response characteristics. The generator frequency is changed to the tone frequency required by the selected standard, and the proper detector response is selected.

The lower right soft key selects the reading display mode. PEAK and 2σ are supported. Selecting PEAK will give the maximum value of the wow and flutter over about a 1/3 second interval. Selecting 2σ will give the maximum value exceeded no more than 5% of the time (the second-highest reading of a 20-reading group).

The INPUT A button will select input A for measurement. A second press of the button will select gen-mon channel A for measurement. The INPUT B button will select input B for measurement. A second press of the button will select gen-mon channel B for measurement.

Wow and flutter of 3-head tape machines should not be measured during simultaneous record-reproduce mode, since this will result in spectral nulls which can give erroneously low readings.

XTALK (Crosstalk)

The XTALK measurement function is selected by pressing the FUNCTION XTALK key. It is available in both analog and digital analyzer modes.

The Crosstalk measurement function measures the amount of signal that passes from a driven channel (or channels) to a non-driven channel. On a stereo device, this is also referred to as the 'stereo separation'. A bandpass filter is used to tune only the driven frequency; this rejects the effects of wideband noise on the measurement.

A:XTALK	A	LEVEL	B	FREQ	B
-116.3	dB	0.995	V	999.77	Hz
A:GEN:	SINE	1.000	V	1.000	kHz

Figure 4-30. Main panel in XTALK function

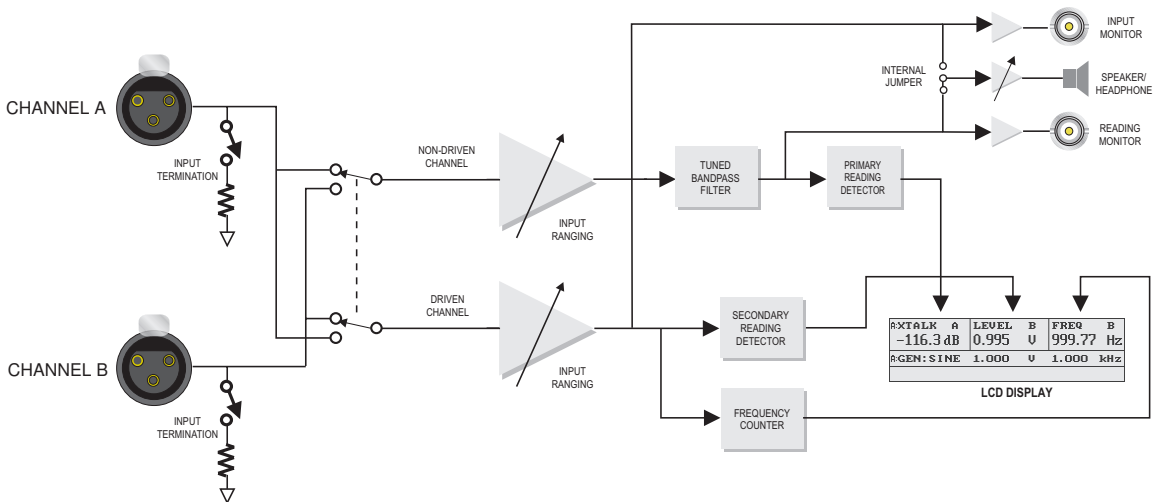

Figure 4-31. Block diagram of Analog Crosstalk measurement

In Crosstalk measurement function, the selected channel is always the non-driven channel, and it is from this channel that the main measurement is taken. The alternate channel is the driven channel, and its amplitude is measured for comparison to the non-driven

channel. The frequency of the driven channel is also measured to determine the proper frequency for the bandpass filter.

The upper left section of the display shows the crosstalk reading, which is the amplitude of the non-driven channel. The upper left soft key selects the display units. The usual absolute and relative amplitude units are available, plus 'dB', which displays the amplitude difference, in decibels, between the driven channel and the non-driven channel.

The upper center section of the display shows the amplitude of the alternate channel. Pressing the upper center soft key selects among the usual absolute and relative amplitude units.

The upper right section of the display shows the frequency of the alternate (driven) channel. This frequency is used to tune the bandpass filter. The upper right soft key turns the reading on or off.

Pressing the INPUT A button will select input A for the main (non-driven) channel, and input B for the alternate (driven) channel. It will also turn generator channel B on and channel A off. Pressing the INPUT B button will select input B for the main (non-driven) channel, and input A for the alternate (driven) channel. It will also turn generator channel A on and channel B off.

The signal on the driven channel must be at least 8 mV for proper functioning of the frequency counter for bandpass tuning. If it is not, both the XTALK reading and the frequency reading will read 'Low'.

No fixed filters are available.

AC Mains (Power Line Monitor)

The AC Mains measurement function is selected by pressing the FUNCTION AC MAINS key. It is only available in analog analyzer mode.

The AC Mains mode monitors the power supply line to the ATS-1 Dual Domain.

A:AC MAINS	THD+N	FREQ
117.0 V	4.8 %	59.987 Hz
A:GEN: SINE	1.000 V	1.000 kHz
SELF TEST		

Figure 4-33. Main panel in AC MAINS function

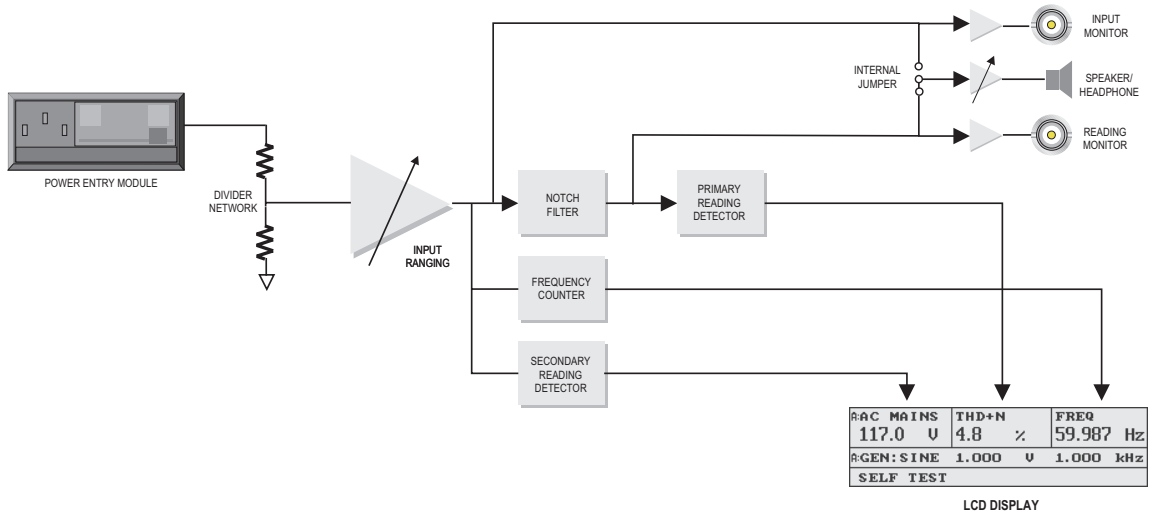

Figure 4-32. Block diagram of AC Mains measurement

The upper left section of the display shows the RMS voltage of the supply line. The only available units are Volts. The upper left soft key has no effect.

The upper center section of the display shows the THD+N (Total Harmonic Distortion plus Noise) of the supply line, with 20 kHz bandwidth limiting. The only available units are percent. The upper center soft key can be used to turn the measurement off.

The upper right section of the display shows the measured frequency of the supply line. The only available units are Hz. The upper right soft key can be used to turn the measurement off.

The sweep function is not available in AC Mains measurement function.

When in AC Mains mode, the signal at the rear panel ANALYZER BNC connector consists of the distortion products following the notch filter.

The bargraph function can be used to monitor the line voltage for extended periods of time. The minimum and maximum values will be tracked, and shown numerically on a printout. The range of the bargraph may be set by using the lower left and right soft keys to highlight one or both endpoints and then using the AMPLITUDE controls.

In AC Mains mode, the Main Panel also provides access to the Self Test. See Appendix F for more detail.

Gen Load

The Gen Load (Device Input Impedance) measurement function is available by pressing the FUNCTION GEN LOAD key. It is only available in analog analyzer mode.

The Gen Load function is used to measure the input impedance of a device-under-test. It does this by generating a signal through the internal 600 Ω source impedance of the generator. Then, the voltage at the output is measured. The input impedance of the device-under-test can then be calculated as a voltage divider.

A:LOAD	A			FREQ	A
595.	OHM			999.75	Hz
A:GEN:	SINE	1.000	V	1.000	kHz

Figure 4-34. Main panel in GEN LOAD function

The upper left section of the display shows the measured input impedance in ohms. No other units are available, and the upper left

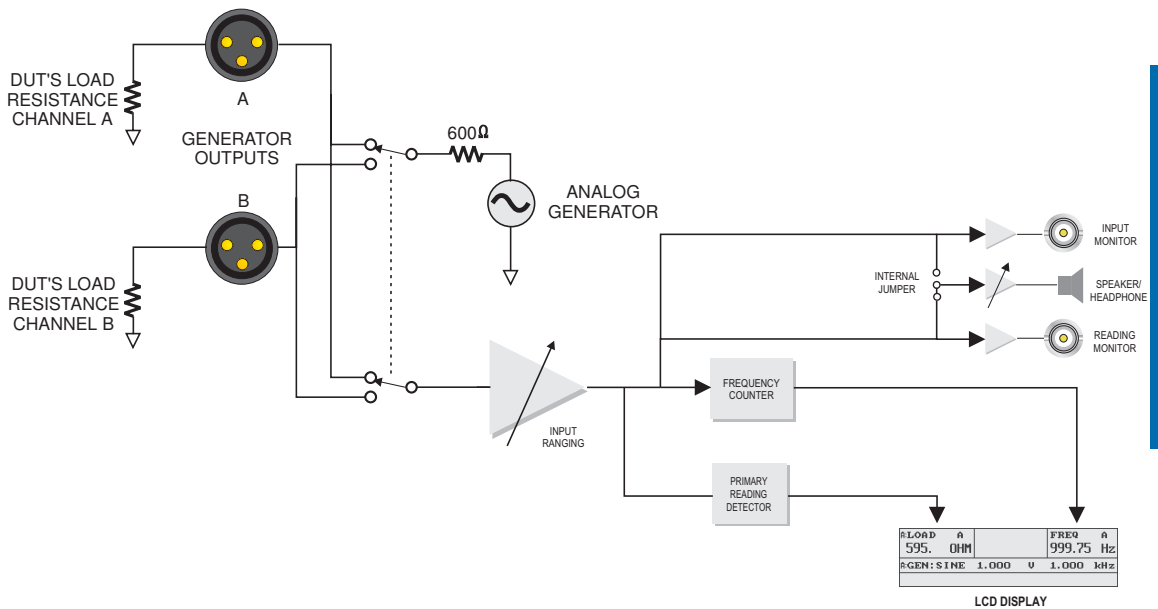

Figure 4-35. Block diagram of generator loading measurement

soft key has no effect. The upper right section of the display shows the

measured frequency of the signal. The only available unit is Hz, but the upper right soft key can be used to turn the reading off.

Because of the nature of the calculation, only one channel can be used at a time. Pressing either the INPUT A or OUTPUT A button will select the A channel, turning on the generator channel A, turning off the generator channel B, and enabling the analyzer channel A. Pressing either the INPUT B or OUTPUT B button will select the B channel, turning on the generator channel B, turning off the generator channel A, and enabling the analyzer channel B.

The measuring technique is quite accurate at low device input impedances, and less sensitive at high impedances. The upper limit of



ATTENTION: Upon entering the Gen Load measurement function, the generator is automatically set to 200 mV amplitude and the output turned on, so be sure that the device can handle this voltage before connecting it and selecting the Gen Load function. After entering Gen Load measurement function, the amplitude can be changed using the AMPLITUDE controls and the frequency can be changed using the FREQUENCY controls.

the measurement's accuracy is about 20 k Ω , so greater impedances are only displayed as '>20k OHM'.

The sweep mode can be used to sweep the measurement over a range of frequencies to obtain a graph of the impedance vs. frequency. One common use of this is in measuring loudspeaker impedance curves.

The voltage divider calculations rely on the assumption that the input impedance of the device-under-test is purely resistive. If it is very reactive, significant errors can result. If the impedance curve shows very sharp peaks or dips, one should suspect that the load is very reactive. A reactive load will have an impedance that varies with frequency.

Jitter

Jitter measurement function is selected by pressing the FUNCTION JITTER button. It is only available in digital analyzer mode.

The Jitter measurement function measures the jitter (time variation) in the transitions of a digital signal. It also measures the peak-to-peak voltage of the digital signal and the frequency of the jitter.

D:JITTER	I	XLR LoZ	I	J FREQ	I
0.484	UI	4.99	V _{pp}	400.46	Hz
D:GEN:SINE		1.0000	F _s	997.00	Hz
UN-WTD		HP: 50 Hz RMS			

Figure 4-36. Main panel in JITTER function

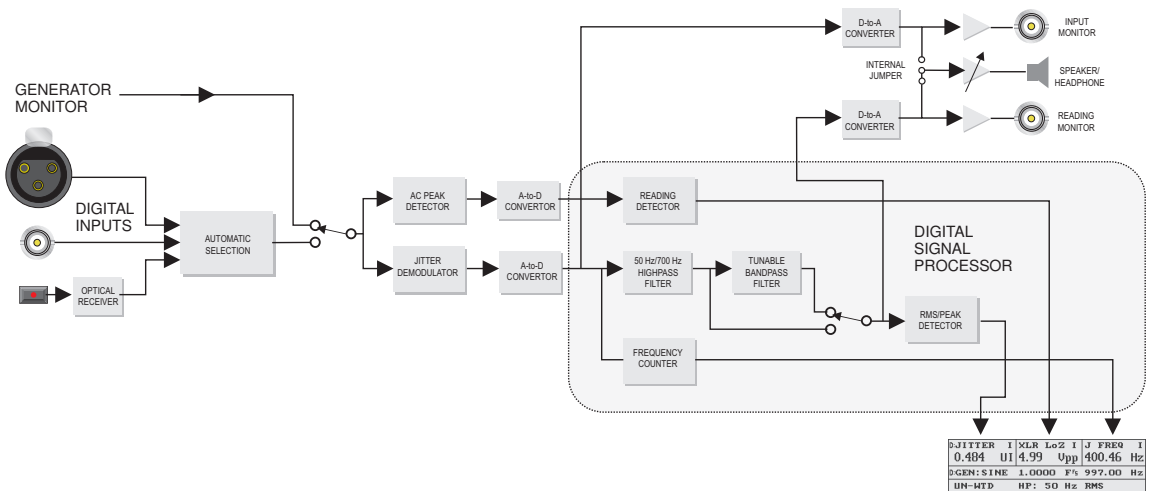

Figure 4-37. Block diagram of Jitter measurement

The upper left section of the display shows the jitter measured on the signal. The upper left soft key selects among the available units, which are seconds (s) and unit intervals (UI).

The upper center section of the display shows the peak-to-peak voltage of the incoming digital signal, in V_{pp}. There are no other units available. The upper center soft key selects the termination impedance of the digital input, either HiZ or LoZ. The HiZ option provides a termination $\geq 2.5 \text{ k}\Omega$ on the AES/EBU XLR input and $\geq 3 \text{ k}\Omega$ on the SPDIF/EIAJ BNC input. The LoZ option provides a

termination of 110 Ω on the AES/EBU XLR input and 75 Ω on the SPDIF/EIAJ BNC input. The LoZ impedances are required by the interface specification, so they should generally be used unless another device connected in parallel with the test instrument is providing termination.

The digital input will come from whichever of the digital input connectors has an active signal on it. Only one digital input signal should be connected at any time.

The lower right soft key controls the detector for the jitter display. The PEAK selection will use a peak detector to measure the jitter and display the peak value of the jitter. The RMS selection will use an RMS detector to measure the jitter, and then calculate the equivalent peak value assuming that the jitter signal is sinusoidal (the 'peak-calibrated RMS value' of the jitter).

IMPORTANT NOTE: All jitter amplitudes are calibrated in peak values on the ATS-1 Dual Domain. This differs from some other instruments which may generate and measure jitter calibrated in peak-to-peak values. The peak value is generally half of the peak-to-peak value.

The lower left soft key selects between 'UN-WTD' (unweighted) and 'SELECTIVE' measurement types. The unweighted selection applies no extra filtering to the jitter signal. The SELECTIVE option applies a narrow bandpass filter to the jitter signal before measurement. The tuning of the filter is shown in the top right corner of the display and may be adjusted using the FREQUENCY controls. This can be used for manual spectrum analysis by adjusting the tuning to find the highest-amplitude components in the jitter.

The RMS detector should always be used with the SELECTIVE filter. This is because the filter reduces the signal to almost a pure sinusoid, the peak value of which is not directly related to the peak value of the jitter on the interface. The RMS detector also reacts to changes more quickly than the PEAK detector.

The PEAK detector should be used when the SELECTIVE filter is not used, since the peak-equivalent is not very meaningful unless the measured signal is sinusoidal. AES standards call for peak-detected jitter measurements.

The lower center soft key controls the low-frequency limit of the jitter detector. It may be limited with a 700 Hz highpass filter or a 50 Hz highpass filter. The 700 Hz highpass filter is used for residual jitter measurements according to AES standards, and the 50 Hz highpass filter is used for jitter response measurements.

The INPUT A and INPUT B buttons toggle between the rear panel inputs (an 'I' is shown in the reading displays) and the internal gen-mon path (a 'G' is shown in the reading displays).

Digital I/O

The Digital I/O measurement function is selected by pressing the DIGITAL I/O button. It is only available in digital analyzer mode.

The Digital I/O measurement function is used to measure the sample rate, voltage, and input-to-output delay of a digital signal.

It also provides several parameters that are relevant to digital audio measurements in the other modes.

D:RATE	G	XLR LoZ	G	DELAY	G
48000.0 Hz		2.98	V _{pp}	24.30	ns
D:GEN: SINE		1.0000	F _s	1.0000 kHz	
REF: STAT		INP: 24bit		OUT BLOCK	

Figure 4-38. Main panel in Digital I/O Function

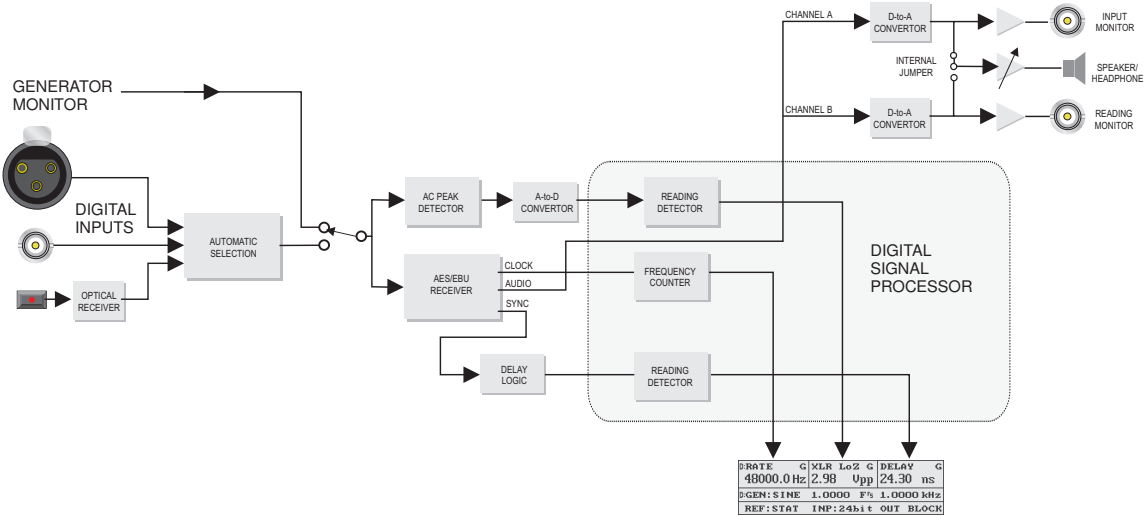



Figure 4-39. Block diagram of Digital I/O measurement

The top left corner of the display shows the incoming sample rate. This can be an absolute measurement or can be calculated as a deviation from the programmed generator rate. The upper left soft key selects between absolute and relative modes. In absolute mode, the units are Hz, which is equivalent to samples per second. In relative mode, the units are ppm, or deviation from ideal in parts per million.

The sample frequency to be used for all digital audio frequency measurements (in all digital measurement functions) is selected by the lower left soft key. There are three options:

- MEAS – The measured sample rate is used to compute audio frequencies. This is the most commonly used, but if the incoming sample rate is very unstable the frequency measurements will be also.
- STAT – The sample rate encoded in the incoming status bits is used to compute audio frequencies. This is a stable value, but not all devices indicate their sample rate in their status bits.
- OUTP – The digital generator sample rate is used to compute audio frequencies. This is used when measuring pitch-shifting devices.

 For more information on the Status Bits, see page 3-20.

The upper center section of the display shows the peak-to-peak voltage of the incoming digital signal, in Vpp. There are no other units available. The upper center soft key selects the termination impedance of the digital input, either HiZ or LoZ. The HiZ option provides a termination $\geq 2.5 \text{ k}\Omega$ on the AES/EBU XLR input and $\geq 3 \text{ k}\Omega$ on the SPDIF/EIAJ BNC input. The LoZ option provides a termination of $110 \text{ }\Omega$ on the AES/EBU XLR input and $75 \text{ }\Omega$ on the SPDIF/EIAJ BNC input. The LoZ impedances are required by the interface specification, so they should generally be used unless another device connected in parallel with the test instrument is providing termination.

 For more information on connecting to the Reference Input, see page 3-36.

The upper right section of the display shows the delay of the signal, either from the ATS-1 Dual Domain output or the Reference Input on the rear panel. The upper right soft key selects among the available units: UI (unit intervals), smp (samples), or s (seconds).

The INPUT A and INPUT B buttons control whether the input comes from the rear panel input or the internal gen-mon path. Since there is no channel to select, both buttons perform the same function. The first press on either button selects the rear panel input, and an 'I' shows in the reading displays. A second press on the same INPUT button will select the gen-mon path, and a 'G' shows in the reading displays.

The lower right soft key controls the reference for the delay measurement. There are four options:

- REF FRAME – Delay is measured from the start of a frame on the reference input to the start of a frame on the input
- OUT FRAME – Delay is measured from the start of a frame on the digital output to the start of a frame on the input
- REF BLOCK – Delay is measured from the start of a channel status block on the reference input to the start of a block on the input
- OUT BLOCK – Delay is measured from the start of a channel status block on the digital output to the start of a block on the input

The lower center soft key controls the number of bits of data (or word length) expected on the digital interface. The options are AUTO, 24, 22, 20, 18, or 16 bits. It should be set to match the number of bits of resolution supported by the device-under-test. This setting affects measurements (particularly THD and noise) in all the digital measurement functions.

 For more information on the Status Bits and Consumer vs Professional mode, see pages 3-20 and 4-48.

In AUTO mode, the resolution is determined by the incoming status bits. The word width status bits are only defined for Professional mode. If your device-under-test uses Professional mode, this is usually the best choice. If your device-under-test uses Consumer mode, the word width will default to 24 bits, which may be erroneous. It is not recommended that you use AUTO in Consumer mode.

When AUTO mode is used, the word length will default to 24 bits if no signal is applied.

The sweep mode is not available in Digital I/O measurement function.

Data Check

The Data Check measurement function is selected by pressing the FUNCTION DATA ✓ button. It is only available in digital analyzer mode.

The Data Check measurement function checks for data errors as digital samples pass through a device-under-test. If the device-under-test modifies the digital data in any way, errors will result. It also shows which bits are active or the actual value of each data bit.

D:ERROR	GA	ERROR	GB	DATA	GA
0		0		3094Fhex	
D:GEN: RAND					
24	00000000	16	00000000	8	00000000
	00000000		00000000		00000000
ACTIVEBIT					

Figure 4-40. Main panel in Data Check function

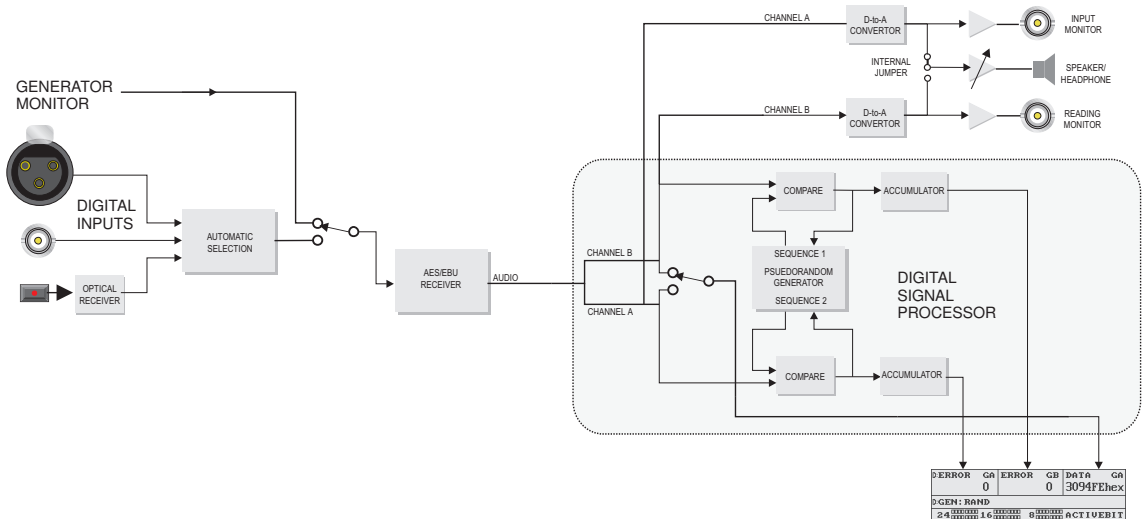

Figure 4-41. Block diagram of Data Check measurement

The upper left section of the display shows the number of data errors on channel A. The upper left soft key selects between real-time and totalize displays. The real-time display will show the number of errors on that channel within a 6000-sample interval. The totalize display

accumulates the errors from one reading cycle to the next, giving the total number of errors since the totalize operation began. The totalize display shows the letter T to the right of the reading. To reset the total, go to real-time display for a moment and then return to totalize.

The upper center section of the display shows the number of data errors on channel B. This functions in the same way as the channel A display.

The upper right section of the display shows the current data on one of the channels. The INPUT A button is used to select the A channel. The INPUT B button is used to select the B channel. A second press on either button selects the internal gen-mon path. The upper right soft key selects whether the data display is shown in decimal or hexadecimal (base-16) number format. Hexadecimal display is marked with the word 'hex' after the number.

The lower section of the display can show two different binary displays of the data, selectable by the lower right soft key. The following are available:

- ACTIVEBIT – Shows which bits are changing state
- ACTUALBIT – Shows the actual value of each bit

The following figure illustrates the appearance of the active bits, inactive bits, '0' value bits and '1' value bits in the two displays:

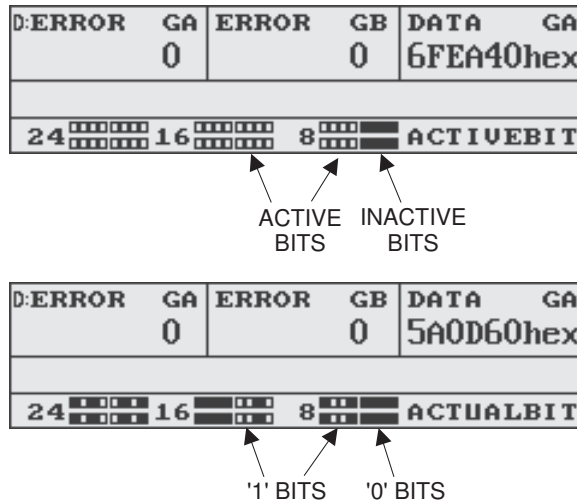

Figure 4-42. Appearance of bits in Data Check mode

The active bits display can be used to detect a number of problems that can exist on a digital interface, such as stuck bits. It can also be used to determine the width of digital words sent by a device.

The digital generator is automatically set to generate a pseudorandom sequence when entering Data Check mode. The pseudorandom sequence assures that every bit combination is exercised in an arbitrary pattern. Other waveforms may be used when checking active bits, but the error counts will be erroneous, as the error analysis expects this particular pseudorandom sequence. The pseudorandom sequence is the same as the one used in Audio Precision's System One BITTEST program, so the two may be used interchangeably as pseudorandom generator and analyzer.

Status Bits

The digital status bits do not have their own measurement function. They are displayed on the Status Bits Panel, which is selected by several presses on the INSTRUMENT MODE PANELS key.

D:SEND:PRO	EMPH:N.I.	SR: N.I.
D:INP: PRO	EMPH:N.I.	SR: N.I.
ORIG:	DEST:	NO ERRORS
ORIG:	DEST:	VALID

Figure 4-43. Status Bits panel

 For more information on setting the Status Bits, see page 3-20.

The perimeter of the display and the soft keys are used to control the outgoing status bits. The center section of the display shows the incoming status bits.

The upper left section of the display shows the Consumer/Professional mode bit. Since the status bits are allocated differently for the two modes, the state of this bit changes the other available selections. The AES/EBU standard (usually balanced) defines Professional mode, although Consumer mode is sometimes used. The SPDIF-EIAJ standard (usually unbalanced) defines Consumer mode.

The upper center section displays the Pre-emphasis indicator bit. This bit can indicate 15/50 μ s pre-emphasis, CCITT J17 pre-emphasis, that there is no pre-emphasis, or that the emphasis is not indicated.

The upper right section displays the bits that indicate the sample rate of the data. Sample rates of 48 kHz, 32 kHz, and 44.1 kHz are available. If the reference source on the Digital I/O panel is set to STAT, then it is from these bits that the instrument will read the reference rate for calculating the frequency of incoming digital audio signals.

The lower area of the display changes depending on the Consumer/Professional mode. In Consumer mode, this displays the Copyright flag. This status bit provides copy protection to the program material. It has two states: copy permitted (OK) and copy prohibited (NO). In Professional mode, this area displays the signal's origin, if the origin is encoded in the status bits. The origin is generally a text string.

 For more information on the Reference Source on the Digital I/O Panel, see page 4-43.

The lower center of the display is not used in Consumer mode. In Professional mode, it displays the signal's destination, if the destination is encoded in the status bits.

The lower right area displays the **error flags**. If any of the following flags are active, the highlighted letter will be shown.

- **Confidence** - This flag is set if the rising or falling edges of the digital signal become too gradual. This is usually caused by long cables or other bandwidth limiting in the transmission.
- **Lock** - This flag is set if the AES receiver is unable to lock onto the incoming sample rate. This usually means the sample rate is unstable or out of the receiver's range.
- **Coding** - This flag indicates a violation of the biphasic encoding rules which are used in digital transmission. According to these rules, the signal cannot remain in a high-voltage or low-voltage state for more than two consecutive unit intervals (UI) except during the preambles. Violation will result in a coding error.
- **Parity** - This flag indicates that the parity bit does not match the parity of the sample. The parity bit is set by the sending device to indicate whether there are an even or odd number of 1's in a subframe. This is then checked against the received data by the receiving device, and if they don't match, the parity flag is set.
- **Validity** - This flag is sent directly from the sending device to indicate whether or not the data is valid. While the use of this bit is not standardized, a common usage in tape recorders (for example) is to set the bit to 'Valid' when the tape is playing and 'Invalid' when the tape is stopped. The flag shown on the Status Bits panel indicates a state of 'Invalid'.

The flags are shown in the lower right area of the display. If there are no error flags set, the display shows 'NO ERRORS'. If there are any error flags, the letter highlighted above is shown. The position is also important, since there are two flags designated with the letter 'C'.

The flags are always shown in the same order (**CLCPV**), where the first 'C' is for the Confidence flag and the second 'C' is for the Coding flag. If any flag is set, its letter will be shown. If the flag is not set, there will be a blank space in its letter position.

The following diagrams show examples of the flags display.

D:SEND:PRO	EMPH:N.I.	SR:N.I.
D:INP:CONS	RESERVED	RESERVED
COPY:OK		CLCPU ERR
ORIG:	DEST:	VALID

Figure 4-44. All Error flags active

D:SEND:PRO	EMPH:N.I.	SR:N.I.
D:INP:CONS	EMPH:NONE	SR44.1kHz
COPY:OK	C	V ERR
ORIG:	DEST:	VALID

Figure 4-45. Confidence and Validity flags active

The incoming Confidence and Validity flags are also shown as part of the main reading in any of the digital measurement functions. If the Confidence flag is active (indicating poor confidence), a small 'C' is shown to the left of the main measurement. If the Validity flag is active (indicating invalid data), a small 'V' is shown to the left of the main measurement. Following is an example of the Confidence and Validity flags in digital AMPL mode:

CONFIDENCE FLAG → VALIDITY FLAG →	D:AMPL	A		FREQ	A
	<small>C</small> 0.00	dB _r s		996.99	Hz
	D:GEN:SINE	0.00	dB _r s	997.00	Hz
	UN-WTD	<10	Hz	-	\$ RATE/2

Figure 4-46. Confidence and Validity flags in reading display

A small 'J' may also appear in this area of the display, indicating that the jitter generator is on. The J appears in the same place as the Validity flag, but the Validity flag takes priority. If the Validity flag indicates invalid data and the jitter generator is on, only the V will be shown.

 For more information on generating jitter, see page 3-18.

Bargraphs

The Bargraph Panel is selected by pressing the INSTRUMENT MODE BARGRAPH key. On the Bargraph Panel, the generator and lower soft key sections of the display are replaced with a horizontal bargraph. The bargraph shows the primary measurement in an analog-type display, with indicators for the minimum and maximum values. The measurement displayed depends on the current measurement function, selected by the FUNCTION keys. Some measurement functions provide two simultaneous bargraphs.

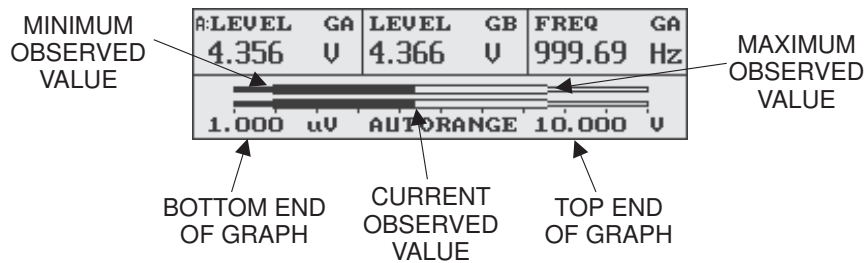

Figure 4-47. Bargraph screen in Level function

The upper section of the display, which shows one, two or three real-time numerical readings, is not affected. The upper soft keys also retain the functions they performed in the Main Panel, as described in the description for each measurement function.

The lower soft keys take on new functions in bargraph mode, so it may be necessary to go to the Main Panel, Generator Only Panel, or Analyzer Only Panel to set some options. The AMPLITUDE and FREQUENCY controls maintain their functions except when setting bargraph endpoints.

The upper and lower endpoints of the bargraph range are shown on the lower left and right of the display. They are set using the lower left and right soft keys and the AMPLITUDE controls. First, the endpoint to change must be highlighted by pressing the corresponding soft key. If desired, both may be highlighted for simultaneous adjustment. When the desired endpoint or endpoints are highlighted, the AMPLITUDE controls adjust the value. The step size of the INC/DEC and ± 10 dB buttons depends on the measurement function selected.

The bargraph is always on a linear scale. There is a tick mark at each 10% of the scale.

The maximum and minimum values measured are shown as an expanded part of the scale (see Figure 4-52). To reset the maximum and minimum values, press the BARGRAPH key. The printout from a bargraph will also show the specific numerical values of maximum, minimum, and current readings.

The center soft key allows the selection of AUTORANGE or HOLDRANGE. In order to obtain the wide dynamic range necessary for measuring audio levels, the amplitude meters are equipped with ranging amplifiers, which automatically prescale the signal so that it is in the best range for measurement. This is called autoranging. When the ranging amplifiers change ranges, the reading may glitch. These glitches can destroy the validity of the maximum and minimum values. The autoranging may be turned off (holdrange mode) to avoid these glitches, and the range will stay as currently selected. The penalty to this is that there will be a maximum limit to the amplitude that can be measured in this range, and the resolution may be limited at low amplitudes. As long as the reading doesn't vary much after entering holdrange mode, the range will be ideal.

The speaker output is taken after the ranging amplifiers, so Holdrange mode will also keep the speaker signal from autoranging. This may be useful for audible monitoring of signals with a wide dynamic range.

Holdrange mode will be maintained after exiting bargraph mode, but autorange will be selected if a new measurement function is chosen.

The units for the bargraph can be changed by pressing the upper right soft key. This will change the units of both the numerical reading and the bargraph. However, the units of the numerical reading may be changed by going to the Main Panel and changing the units there (using the same soft key). When you return to the Bargraph Panel, the bargraph units will be the same as they were before, but the numerical display will show the newly selected units. The ATS-1 Dual Domain remembers separate units for each numerical display and the bargraph for each measurement function.

Sweeps

The Sweep Panel is selected by pressing the INSTRUMENT MODE SWEEP button. The Sweep Panel is used to create graphs of a measurement vs. frequency or amplitude. The frequency or amplitude is stepped through a number of points (or 'swept') across a user-defined range, taking one measurement at each point. The data is simultaneously graphed with the swept parameter on the horizontal axis and the measurement on the vertical axis.

The measurement function cannot be changed while in the Sweep Panel, so the measurement must be selected before pressing the SWEEP button. The Sweep Panel is available for all measurement functions except SINAD, W+F, AC Mains, Digital I/O and Data Check. Only the primary reading (the one in the top left corner of the display) can be graphed in a sweep, except in the LEVEL function. The units of the reading cannot be changed from the Sweep Panel, so the desired units should be selected from the Main Panel beforehand.

The Sweep Panel should look something like this, although it will vary somewhat depending on what measurement function is in effect:

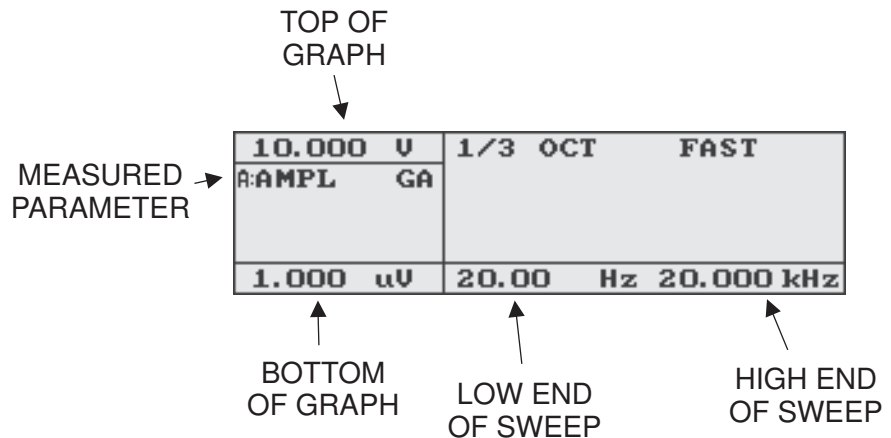

Figure 4-48. Confidence and Validity flags in reading display

The value for the top of the graph is shown in the top left corner of the display. To change it, press the top left soft key to highlight it, then use the AMPLITUDE controls to adjust the value.

The value for the bottom of the graph is shown in the lower left corner of the display. To change it, press the lower left soft key to highlight it, then use the AMPLITUDE controls to adjust the value. Both the top and bottom values of the graph can be highlighted for simultaneous adjustment.

The starting and ending values for the swept parameter are shown at the lower center and lower right of the display. They can also be adjusted by highlighting them and adjusting the AMPLITUDE or FREQUENCY controls, depending upon whether the swept parameter is amplitude or frequency. To change the swept parameter (amplitude or frequency), highlight one of the endpoints and then press one of the INC/DEC or $\pm 10\text{dB}$ buttons for the parameter you want to sweep. For example, if you want to sweep amplitude instead of frequency, highlight the sweep start frequency and press one of the AMPLITUDE buttons to sweep amplitude. The units will change to the base amplitude unit, and you may adjust the starting and ending amplitudes.

The horizontal calibration and step choices will always be logarithmic unless the ratio of upper limit to lower limit is 3:1 or less, or if the lower endpoint is zero. In either of these cases it will be linear.

The vertical calibration will be linear for any decibel units (that is, one dB occupies the same vertical span anywhere on the graph), and for phase measurements. For non-decibel measurements, the calibration will be logarithmic unless the value for the graph bottom is chosen as zero, in which case it will be linear.

The upper center soft key is used to select the number of steps in the sweep. The normally available choices are 3, 5, 10, 15, 30, 75, or 150 steps, or EXTERNAL. Amplitude sweeps also have a 2 dB choice, which will step the generator 2 dB for each point. Frequency sweeps also have a 1/3 OCT choice, which will step to all the ISO-standard 1/3 octave values between the start and end points. Data will always be taken at the end points, whether or not they are ISO-standard values. Sweeps of LEVEL do not have the 150 step choice due to memory limitations. External sweeps are a special type of sweep in which the ATS-1 Dual Domain generator does not perform the stimulus changes – they come directly from the

device-under-test, usually from a test tape or CD. These special sweeps are discussed in detail on page 4-82.

All of the numerical step choices count the number of steps of the swept parameter, not the number of data points on the graph. The number of data points will always be one more than the number of steps.

For all step types except EXTERNAL, the upper right soft key selects the speed of the sweep. The choices are FAST, MEDIUM, and SLOW. FAST is the appropriate choice when testing devices without significant delay between the input and output. Amplifiers, mixing consoles, and equalizers are examples of devices that can generally be tested in FAST mode. If the input-to-output delay is more than about 200 ms, FAST mode should not be used.

MEDIUM sweep speed inserts a time delay of approximately 0.9 sec after changing the generator setting, before the analyzer begins taking data. Its principal intent is for use on a ATS-1 Dual Domain generator feeding an audio transmission link while the analyzer section of another Portable makes EXTERNAL sweep measurements at the receiving end. It can also be used for devices with a moderate delay, such as a satellite relay or an analog tape recorder with a moderate amount of delay between the record and reproduce heads, or for recording test tapes for external response measurements.

SLOW sweep speed inserts a minimum delay of three seconds after changing the generator setting before the analyzer begins taking data. This can be used for very slow transmission links or analog tape recorders with long delays between recording and reproducing heads. It is also important for external measurements that require automatic tuning of the tunable filter (XTALK and THD+N in autotuning mode) before obtaining a valid reading, because extra time must be taken for the frequency reading and filter tuning. It is also intended for recording test tapes for external XTALK and THD+N measurements.

The SLOW setting is always the most reliable; if you are unsure of the time required by your device and measurement, start with SLOW sweep speed. Assuming the data is reasonable, bump the speed up to MEDIUM and compare. If the data is approximately the same, you may step up to MEDIUM, and may also want to try FAST.

Starting the Sweep

When you have made all the necessary settings, press INSTRUMENT MODE SWEEP again to start the sweep. You will see the upper right section of the display change to a graph and you will see points being plotted as the data is taken. The center left section of the display will also show the latest reading, and the value of the swept parameter at that point.

 For information on printing your sweeps, see page 4-57.

If you need to stop the sweep, press SWEEP again.

When the sweep is completed, the 'latest reading' display will disappear.

After the data is taken, you may want to change the horizontal or vertical range of your graph for a better view of the data. To do this, highlight the endpoint or endpoints that you want to change and use the AMPLITUDE or FREQUENCY controls, as appropriate. The graph will resize, and the data will be re-graphed, as you adjust.

You may use a cursor to examine the value of the data at any of the points in the sweep. To do this, rotate either the FREQUENCY or AMPLITUDE knob. A vertical cursor should appear, and as you rotate the knob it should move left or right from one data point to the next. The left center display area shows the value of the swept parameter and the value of the measurement at each point. In the LEVEL measurement function, the amplitude of both channels is displayed.

After running a sweep, the labels for the upper soft keys are replaced by the graph. Pressing one of these buttons will show the labels again.

HINT: If no data is visible on the graph, let the sweep finish. Then use the cursors to find the value of the data and rescale the graph.

Continuous Sweeps

Sweeps can also be made to continuously repeat. To do this, begin the sweep by pressing the SWEEP key and hold it until the first data point is shown in the numerical display. The sweep will repeat until a key is pressed. Only one data set is kept in memory. Each point is replaced as a new point is taken, so the data set always includes the most recent data. Only this data will be saved and recalled.

External Sweeps

External sweeps are a special type of sweep in which the ATS-1 Dual Domain generator does not perform the stimulus changes – they come directly from the device-under-test, usually from a test tape, test CD, or remotely located sweep source.

The analyzer expects an externally-applied sinewave signal to change either upwards or downwards in frequency or amplitude. The signal may change in discrete steps or in a continuous ‘glide’. If a gliding-frequency tone is used, it must change no faster than five seconds per octave (50 seconds for a 20 Hz – 20 kHz sweep).

The ATS-1 Dual Domain will take readings from a number of points during the sweep and plot them on the graph at the measured amplitude or frequency.

Printing

The ATS-1 Dual Domain has the ability to print directly to a printer connected to the external printer port located on the rear panel of the instrument.

The ATS-1 Dual Domain can print a text output of the current settings and readings, exact images (or ‘screen dumps’) of some screens, and tabular, hi-resolution, or ‘screen dump’ printouts from sweep data.

The printer must be compatible with either the Epson/IBM dot-matrix/ink jet standard or the PCL ink jet/laser jet standard.

Before doing any printing, the correct output format for your printer must be selected. This selection takes place on the Setup panel. To get to the Setup Panel, press the PANELS key until you see this screen:

PRINTER PCL GRAPH	97 10 17 00:20:44	FREQ STEP 1.0000 kHz
D:TRIG OUT XMT FRAME	INVERT DISPLAY	AMPL STEP 100.0 mV

Figure 4-49. Setup panel

The upper left soft key selects the type of printer output. The choices are ‘IBM GRAPH’ and ‘PCL GRAPH’.

The IBM GRAPH setting supports Epson® and Epson-compatible ink jet printers, Canon® ink jet printers, and common dot-matrix printers. The PCL GRAPH setting supports all Hewlett-Packard® ink jet and laser printers, and most other laser printers. Some laser printers will require you to select a Hewlett-Packard compatible mode on the printer itself. Almost all common parallel printers are compatible with one setting or the other.

After selecting the printer type and connecting the printer, you may press the INSTRUMENT MODE PRINT button to print the data on the screen. The display colors will invert momentarily while the screen dump takes place. The exact type of printout depends on the currently selected panel.

If you press PRINT while viewing the Main Panel, the Generator Only Panel, or the Analyzer Only Panel, the printout will be a two-line text output of the current readings and generator settings, like this:

```
A:THD+N   GA LEVEL   GA AUTO-TUNE  UN-WTD   <10 Hz - 80 kHz   Ap
0.0007%   0.990 V    999.58 Hz    GEN:SINE  1.000 V 1.000 kHz
```

Figure 4-50. Text printer output of Current measurement

The printout will be the same no matter which of the above panels is displayed.

If you press print from the Setup Panel, the Status Bits Panel, the Bargraph Panel, or the Recall/Save Panel, the printout will be an exact graphical image (or ‘screen dump’) of the current display. For example, the following figure shows a printout from the Setup Panel:

PRINTER PCL GRAPH	97 10 17 00:20:44	FREQ STEP 1.0000 kHz
D:TRIG OUT XMT FRAME	INVERT DISPLAY	AMPL STEP 100.0 mV

Figure 4-51. Screen dump of Setup panel

If you press the PRINT button within the Sweep Panel, the display will change to look something like this:

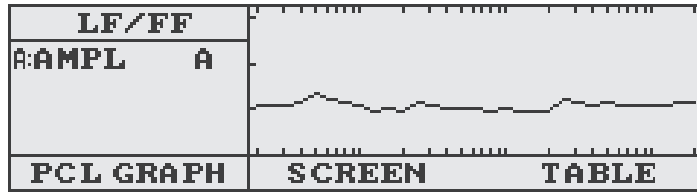

Figure 4-52. Print panel

This panel allows you to print the sweep data four different ways:

- Pressing the lower left soft key will print a high-resolution graph of the sweep data.
- Pressing the lower center soft key will print a screen dump of the Sweep Panel, as it appeared before PRINT was pressed.
- Pressing the lower right soft key will print the sweep data in numerical, tabular form.
- Pressing the PRINT button again will print both the high-resolution graph and the tabular printout.

After pressing any of these buttons, you will be returned to the Sweep Panel with the normal menu items.

Following are examples of the three types of printouts:

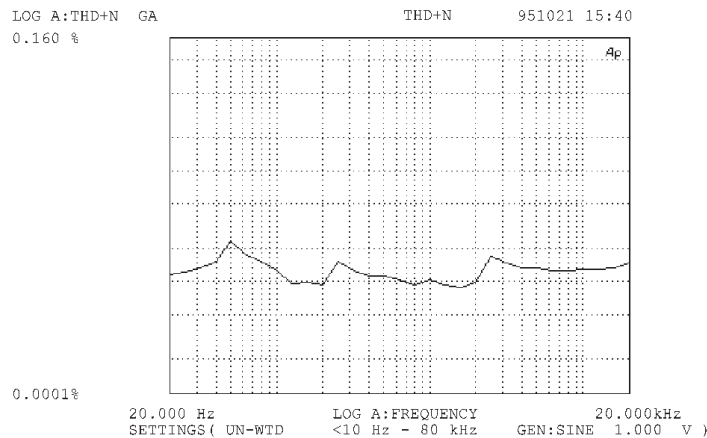

Figure 4-53. High-Resolution graph printout

AGEN FREQ THD+N GA	AGEN FREQ THD+N GA	AGEN FREQ THD+N GA Ap
20.000 Hz 0.0008%	250.00 Hz 0.0010%	3.1500kHz 0.0012%
25.000 Hz 0.0010%	315.00 Hz 0.0010%	4.0000kHz 0.0011%
31.500 Hz 0.0010%	400.00 Hz 0.0009%	5.0000kHz 0.0012%
40.000 Hz 0.0010%	500.00 Hz 0.0009%	6.3000kHz 0.0012%
50.000 Hz 0.0012%	630.00 Hz 0.0009%	8.0000kHz 0.0012%
63.000 Hz 0.0011%	800.00 Hz 0.0009%	10.000kHz 0.0012%
80.000 Hz 0.0010%	1.0000kHz 0.0010%	12.500kHz 0.0013%
100.00 Hz 0.0010%	1.2500kHz 0.0010%	16.000kHz 0.0012%
125.00 Hz 0.0010%	1.6000kHz 0.0010%	20.000kHz 0.0014%
160.00 Hz 0.0010%	2.0000kHz 0.0010%	
200.00 Hz 0.0010%	2.5000kHz 0.0012%	

Figure 4-54. Table printout

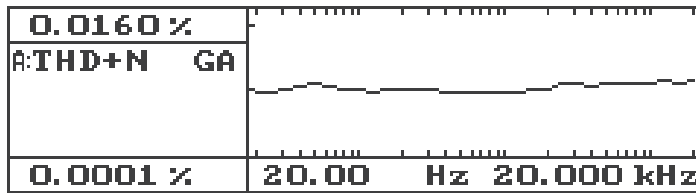

Figure 4-55. Screen dump printout

The upper left soft key is used to send line feeds or form feeds to the printer. A quick press on the button will send a single line feed to the printer, and the display colors will invert momentarily. This will cause the printer to move down one line, usually to separate one printout from the next. Holding the button for about a second will send a form feed to the printer. This will cause the printer to eject the current page and begin a new page. While you are holding the upper left soft key, the display colors will remain inverted. These actions do not return you to the normal Sweep Panel, so they can be repeated several times in succession if desired.

No matter what PRINT mode is chosen, the display colors will invert while the ATS-1 Dual Domain is sending the data to the printer. When the display returns to its normal color scheme, all the data has been sent to the printer, so you may proceed to the next test. Even if the printer is still printing, it has all the data in its own memory, so you can safely do something else with the ATS-1 Dual Domain.

A print of the high-resolution graph usually takes about 30 to 45 seconds, depending on the type of printer. A screen dump usually only takes about 10 seconds, and a table printout is usually even faster, depending on the number of points in the sweep.

The self test does not use the PRINT key for printing the test results. See Appendix F for more details on running and printing the self test.

Saving and Recalling Setups

The ATS-1 Dual Domain has the facility of storing thirty different test setups in memory. Each of these setups stores all the settings necessary to repeat a measurement exactly, so that a commonly-run test can be stored and recalled with only a few keypresses. The current sweep data is also stored, so that field test results can be taken home for printing, or so that a sample set of data is on hand for a repeated test. Each test setup can be given a name of up to 15 characters (letters, numbers, or special symbols) and is automatically stamped with the date and time it was saved.

The Recall and Save facilities are provided by the Recall/Save Panel. To display this panel, press the button marked RECALL SAVE. The following panel should appear:

```

  SAVE          CANCEL          SCROLL UP
0 empty
1 empty
2 empty
3 empty
4 empty
  RECALL      PAGE          SCROLL DN

```

Figure 4-56. Recall/Save panel

This panel shows the names of five of the thirty stored test setups. The central test setup is currently selected, and is highlighted in inverse video. If you press RECALL or SAVE, this is where the setup will be stored, or from where it will be recalled. You can use the upper right and lower right soft keys (marked 'SCROLL UP' and 'SCROLL DOWN') to step through the setups to highlight the one to recall or store. The lower center soft key ('PAGE') will step through the test setups five at a time.

To abandon the recall or save operation, press the upper center soft key ('CANCEL'), and you will be returned to the Main Panel without any changes to the instrument settings or test setup memories.

Pressing the dBr key while in the Recall/Save panel will change the upper left and right soft key functions to support deleting and write-protecting saved setups. Normally, the upper left soft key will delete the setup and the upper right soft key will write-protect the setup, which will prevent the setup from being changed. If the setup is already write-protected, the upper right soft key will change to remove

the write-protection. If the setup has already been deleted, the upper left soft key will change to undelete the setup, restoring it to the menu.

To recall a saved setup, use the PAGE and SCROLL keys to highlight the setup to recall and then press RECALL. The setup will be recalled, all the settings made, and you will be returned to the Main Panel.

To save the current instrument settings, press SAVE. The display will show the Save panel, which will look approximately like this example:

```

  CANCEL      SAVE      INC CHAR
17 AAMPL    /A:FREQ 951112 17:50
  <-  MOVE  ->      DEC CHAR

```

Figure 4-57. Save panel

You may now assign a name to your saved setup. The current name, which is generated automatically, is shown across the center of the display. The first fifteen characters comprise the name, followed by the current date and time.

Notice that one character is highlighted with reversed colors. By default, the first character should be highlighted. You may move the highlight to a different character using the lower left and lower center soft keys or by using the INC and DEC keys in the AMPLITUDE or FREQUENCY sections. You may change the highlighted character using the upper right and lower right soft keys or by twisting the AMPLITUDE or FREQUENCY knob. Using the +10 dB, -10 dB, x10, and ÷10 keys will change the character by steps of 16.

Upper and lower case letters are available, as well as numbers and a few special-purpose symbols. The following characters are available, in the order in which they are shown:

```

! " # $ % & ' ( ) * + , -
/ 0 1 2 3 4 5 6 7 8 9 : ; <
= > ? @ A B C D E F G H I J
K L M N O P Q R S T U V W X
Y Z [ \ ] ^ _ ` a b c d e f
g h i j k l m n o p q r s t
u v w x y z { | } ~
    
```

Figure 4-58. Characters available for naming setups

When you have set the name as desired, press the upper center soft key ('SAVE') to save the setup. If you decide not to save the setup, press the upper left soft key ('CANCEL'). Either choice will return you to the Main Panel.

Printing Saved Data

When you save a setup, the data from the last sweep is also saved. This allows you to take data at a remote location and then print it later.

To print data that has been saved, recall the setup using the steps shown on the previous pages. Then press SWEEP, and the graph will be shown on the display along with the saved data. DO NOT press the SWEEP key again, or the sweep will be repeated and the data destroyed. The data will still be saved in the setup, but you will need to recall the setup again to return to the saved data.

Pressing the PRINT key will display the Print Panel, which will allow you to print the saved data in several different ways. Before printing, the proper print mode must be selected, depending on the type of printer you are using. For information on setting the print mode and the different types of printer output, see the section on Printing, starting on page 4-82.

Frequency Response of Amplifiers, Mixing Consoles, Etc.

For response measurements on most two-channel audio electronics devices, use LEVEL function with dBr units. Set the dBr reference to zero by pressing the “dBr ZERO” button at a midband frequency such as 1 kHz. Use SWEEP mode, set for the desired frequency range horizontally and expected amplitude range vertically. If portions of the graph go off the top or bottom of the screen, wait until the sweep is complete and then change the graph top and/or bottom values. The graph will dynamically re-draw as the top or bottom values are changed.

Audio Transmission Link Testing

To test end-to-end response, THD+N versus frequency, crosstalk versus frequency, etc., requires ATS-1 Dual Domain units at both ends of the link, or a compatible sweeping generator at the “send” end and a ATS-1 Dual Domain at the “receive” end. At the “send” end, set the generator to the desired amplitude and select SWEEP mode. Select the desired frequency resolution and SLOW speed for a dwell time of several seconds at each frequency step if THD+N is to be measured. The MED sweep speed should be sufficiently slow for frequency response and phase versus frequency measurements. The generator can be placed in a continuously-repeating sweeping function by holding down the SWEEP button until the first measurement appears in the numerical display at the left of the “send” unit screen. At the “receive” end, choose the measurement function desired. Select SWEEP mode and EXTERNAL sweep function. Press SWEEP and the analyzer should start acquiring and plotting data from the continuously-stepping generator at the other end of the link.

Analog Tape Recorder Alignment and Performance Verification

Reproduce Mode

LEVEL function with dBu units, with phase displayed in the upper right display, is most convenient for most adjustments of the reproduce section of analog tape recorders. If there is any doubt which tone is being played on the reference tape, the phase display may be temporarily changed to frequency. Bargraph display mode is also desirable for most adjustments.

The reproduce level controls of both channels may be set for the specified line level output while playing the reference fluxivity section of a reference tape.

The reproduce head azimuth may then be adjusted while playing a high-frequency section of the reference tape (typically 8 kHz to 16 kHz). Azimuth should be adjusted first for a maximum amplitude indication on both channels, then finally for an average zero degrees phase shift between the channels. To obtain a bargraph display of phase, it will be necessary to select PHASE function (-180/+180 degrees) rather than measuring phase in LEVEL function. AVERAGE phase display mode is preferable to reduce the visible bobble of phase measurements at high frequencies.

The reproduce treble level (equalization) controls of both channels are then set to produce flat response at a high frequency, typically 10 kHz-14 kHz. Many reference tapes, especially at the lower tape speeds, have the frequency response tones recorded at a level lower than the reference fluxivity level. In such a case, it is convenient to change the LEVEL units from dBu to dBr and press the “dBr ZERO” button to establish the zero dBr reference while playing the mid-band reference frequency (usually 1 kHz) of the frequency response section of tones. Then, at the chosen high-frequency tone, the treble level controls may be set for a zero dBr display.

For a final check of the reproduce frequency response, select EXTERNAL mode in SWEEP mode. EXTERNAL mode will follow an increasing-frequency or decreasing-frequency sequence of tones on the reference tape while ignoring any voice announcements between tones. If dBr units are used, the mid-frequency (usually 1 kHz)

measurement may be established as the zero dBr reference following the test by locating the graphic cursor on this measurement and pressing the “dBr ZERO” button.

Record-Reproduce Mode

For most three-head tape recorders at tape speeds of 7.5 inches per second (19 cm/sec) and faster, the MED sweep speed selects sufficient time delay for the tape to travel from record to reproduce heads for proper measurements. At slower tape speeds or with recorders with very widely-spaced heads, it may be necessary to select the SLOW sweep speed. The record level controls on both channels may be set for specified line output level while driving the line inputs at the specified line level and measuring the outputs in LEVEL mode with dBu units.

For azimuth alignment of the record head in record-reproduce mode (assuming that the reproduce head has already been properly aligned), a repeating three-step (four-point) sweep of phase versus frequency is recommended. Select PHASE function, NO-AVERAGE, SWEEP mode, resolution “3”, with the sweep lower frequency limit at about 1 kHz and the upper limit at about 15 kHz. Select the FAST speed if time delay between heads at the tape speed in use is less than about 200 milliseconds. Select MEDIUM speed for situations with delay between about 200 and 500 milliseconds. Press the SWEEP button and hold it until the first measurement is numerically displayed at the left of the display. The sweep will now repeat continuously. Slowly adjust the record head azimuth for the flattest possible graph (zero phase shift at all frequencies). The graph will curve upwards at higher frequencies with misadjustment in one direction and downwards with misadjustment in the other direction. The advantage of the frequency-sweeping technique is elimination of the ambiguity of phase measurements at high frequencies, where a moderate misalignment can produce an apparent zero degree reading which is really 360 degrees or 720 degrees away from proper alignment. At lower frequencies, very large misalignment would be required for a complete phase rotation. Thus, a flat phase-vs-frequency graph from 1 kHz to high frequencies indicates proper alignment with no chance of accidentally aligning for a complete rotation at 15 kHz.

For record bias adjustments by the overbias technique, use LEVEL mode with dBr units. Set the generator to 10 kHz at 20 dB below normal line level. Start with the recorder bias control at minimum and slowly increase it while looking for a maximum output on the channel being adjusted. When the maximum is found, press the dBr ZERO button. Then, further increase the bias until the level decreases by the specified amount of overbias for the tape type and tape speed in use. Repeat this process for the alternate channel.

The record head azimuth alignment should be re-checked after adjusting bias, since the effective azimuth angle depends both upon the mechanical azimuth and the amount of bias current in the head. It may be necessary to repeat bias and azimuth adjustments more than once to arrive at the final correct values.

For record treble level (equalization) adjustment, LEVEL function with dBr units is the most convenient. A bargraph display with end points of perhaps +5 and -5 dBr is convenient. The generator output should be set 20 dB below normal line level to avoid any possible tape saturation effects. It is convenient to use the x10 and +10 frequency buttons to instantly change the generator frequency from a midband reference frequency to a high-frequency value. For example, the generator can be set to 1 kHz, then quickly changed between 1 kHz and 10 kHz with these buttons while adjusting record treble equalization for equal output at the midband and high frequency. It is also possible to set up a repeating 3-step sweep from 15 or 20 kHz to 1 kHz as described above under record head azimuth adjustment, but in LEVEL function to display response of both channels. Press and hold the SWEEP button until the first measurement point is displayed numerically at the left of the display to start the repeating sweep cycle. Now, the treble equalization may be adjusted on both channels for the best compromise between flat frequency response and extended high-frequency response.

For a final frequency response verification following alignment, change the sweep parameters for a higher-resolution sweep (30 step is typical) across the entire audio band. The resulting graph may be printed for permanent documentation of recorder performance.

For k3 (third harmonic) distortion measurements such as when measuring MOL (maximum output level), install an optional bandpass

filter in one of the auxiliary filter sockets. With a 1 kHz fundamental frequency, for example, a 3 kHz filter (FBP-3000) will be used. Select THD+N function with WTD response and the optional filter selected. The THD+N indication is then 3rd harmonic distortion if the generator frequency is 1 kHz.

Compact Disc Players

All tests of CD players must be made while playing specially-recorded test discs carrying the proper signals.

Frequency response is preferably measured while playing a track with a sweep tone across the entire band. Many test discs have a sweep of about 50 seconds duration across the audio band which is suitable for ATS-1 Dual Domain. LEVEL function with dBr units should be selected. Select SWEEP mode, and further select EXTERNAL mode with the top center soft key and GLIDE with the top right soft key. Play a mid-band (typically 1 kHz or 997 Hz) reference track (often such a signal is recorded at the beginning of the sweep track) and press the “dBr ZERO” button to set the reference. Then, press the SWEEP button to start measurements and start the CD player. ATS-1 Dual Domain will acquire and plot measurements across the audio band. If the following track has a mid-band signal such as 1 kHz, the reversal in direction of frequency change will automatically terminate the test. Alternately, the test may be terminated by pressing the SWEEP button again when the numeric display at the left of the graph or the CD player display indicates that the sweep track is finished. If a test CD with sweep tone is not available, a series of tracks at different frequencies and fixed amplitude may be used.

THD+N versus frequency of CD players is measured in SWEEP EXTERNAL mode and THD+N function, using a series of full amplitude test tracks at different frequencies. The analyzer automatically selects AUTO-TUNE mode so that the THD+N notch filter is steered by the frequency counter. The 22 Hz-22 kHz bandpass filters should be used in this application. Each channel of the CD player must be tested separately, since THD+N function measures only one channel at a time.

NOTES:

Appendix A - Changing Mains Voltage Selection

The ATS-1 Access is configured at the factory for the line voltage at its intended destination, so usually the voltage will be correct unless the unit has been transported into another area. This appendix describes the procedure for changing the voltage setting, which may be necessary under some circumstances.

Checking the Selected Line Voltage

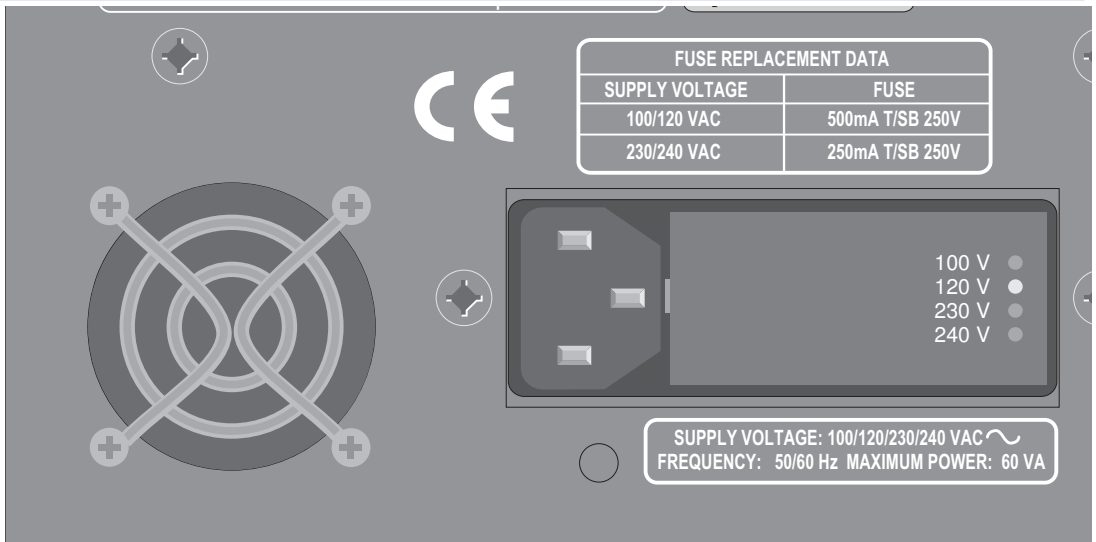

Figure A-1. Location of voltage indicators on rear panel

The supply voltage indicator is located on the rear panel of the instrument next to the power plug. A small white plastic indicator tip identifies the line voltage setting as 100V, 120V, 230V, or 240 V.

The following diagram shows the location of the voltage indicators:

In one of the holes should be a small white plastic indicator tip showing which line voltage is currently selected. If the selected voltage is not the same as the desired line voltage, continue with the next section.

Changing the Line Voltage Selection

To change the line voltage selection, proceed as follows:

1. Remove the cover by inserting a small blade screwdriver (or similar tool) into the Removal notch (shown on the following figure) and prying gently.

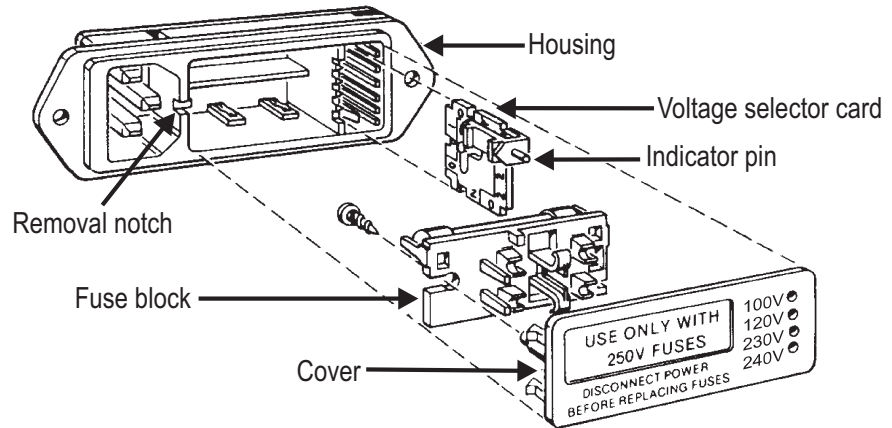

Figure A-2. Exploded Diagram of Power Entry Module

2. Pull the Voltage selector card straight out of the housing using needlenose pliers. Do not pull on the indicator pin.
3. Orient the selector card so that the desired input voltage is readable along the bottom of the card. Then orient the indicator pin to point upward, with the plastic indicator pin assembly seated in one of the notches on the edge of the board. The voltage selector card and indicator pin should now be in one of the positions shown on the following figure.

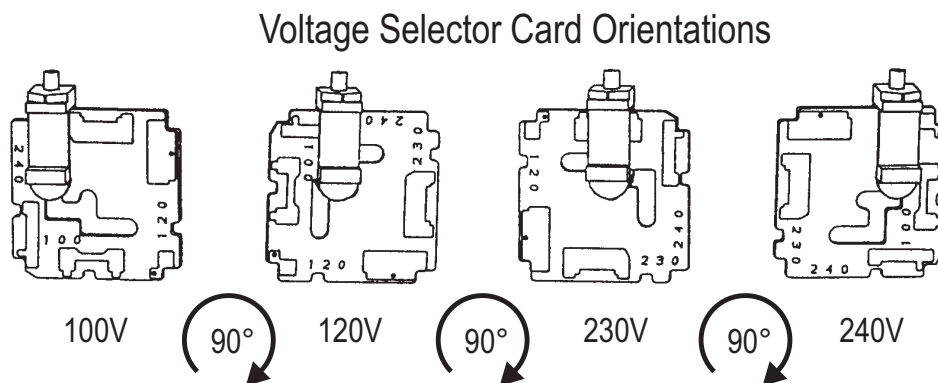

Figure A-3. Proper Orientations for Selector Card

4. Slide the selector card back into the housing, with the printed side of the card facing to the left and the selector pin pointing outward.
5. Be sure to check the fuse ratings and fuse block orientation before connecting power to the unit.

Checking the Fuse Block Orientation

Attached to the rear of the Cover (shown on Figure A-2) is the fuse block. The fuse block can have two orientations. One orientation is for the 100 V and 120 V settings, and the other is for the 230 V and 240 V settings.

You can tell which arrangement is selected by looking at the back of the Cover. If you see two fuses, the fuse block is in the 230/240 V orientation. If you see only one fuse, and a metal jumper bar, the fuse block is in the 100/120 V orientation. These orientations are shown on Figure A-5 (page A-5).

If the fuse block is in the correct orientation for the selected voltage, skip forward to the section on Checking the Fuses (page A-5). If not, continue with the next section, 'Changing the Fuse Block Orientation.'

Changing the Fuse Block Orientation

To change the fuse block orientation (for use when changing from 100/120 V line voltage to 230/240V line voltage or vice-versa):

1. If the Cover is not already removed from the instrument, remove it by inserting a small blade screwdriver (or similar tool) into the Removal notch (shown on Figure A-2) and prying gently.
2. On the back of the cover, loosen the Phillips (cross-head) screw two full turns. Then remove the Fuse Block by sliding it up, then away from the screw and lifting it from the Support Pedestal at the other end. Refer to the following figure:

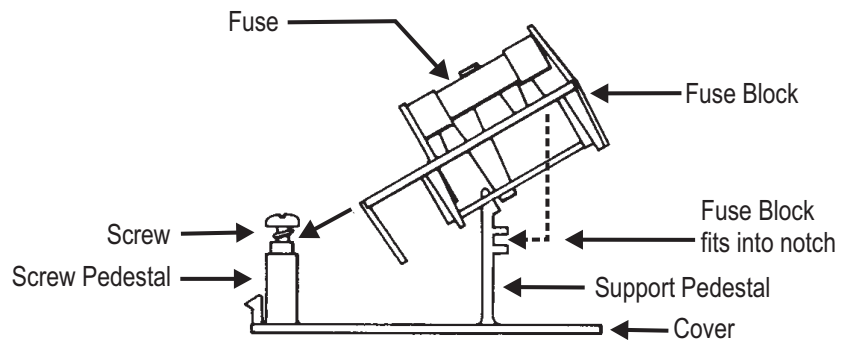

Figure A-4. Insertion/Removal of Fuse Block

3. Invert the Fuse Block and reassemble it. Make sure the the Fuse Block fits into the notch on the Support Pedestal. Also be sure that the cutaway on the Fuse Block fits around the top section of the Screw Pedestal. The Fuse Block should sit flat, parallel to the Cover. Tighten the screw. Figure A-5 shows the two fuse block orientations.
4. Check the fuses as instructed in the next section.

Checking the Fuses

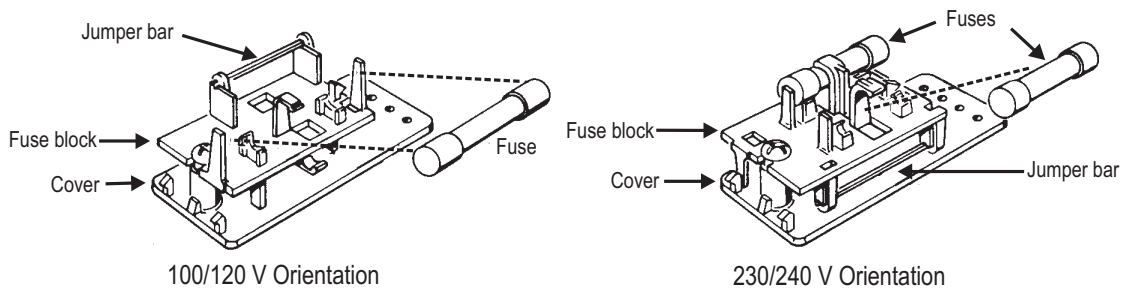

Figure A-5. Fuse Block Orientations

Whenever the line voltage is changed, the fuses should be checked to make certain that their values are correct. To check the fuses, follow these steps:

1. If the Cover (see Figure A-2) is not already removed from the instrument, remove it by inserting a small blade screwdriver (or similar tool) into the Removal notch (shown on Figure A-2) and prying gently.
2. On the back of the Cover you should see the Fuse Block. If it is set for the 100 V or 120 V configuration, you should see one fuse. If it is set for the 230 V or 240 V configuration, you should see two fuses.
3. Check the fuse values. For 100 V or 120 V line voltages, a single 500 mA (1/2 Amp) 250 Volt slow-blow fuse should be used. For 230 V or 240 V line voltages, two 250 mA (1/4 Amp) 250 Volt slow-blow fuses should be used. The ratings for each line voltage are also shown on the rear panel of the instrument.
4. Replace fuses if necessary. Replace Cover, making sure that indicator tip is inserted in correct indicator hole for the selected line voltage (see Figure A-1 for location of indicator holes).

Appendix B - Rackmounting

Two methods of rackmounting are possible: either fixed brackets, or slide track mounting. The slide tracks themselves are not furnished, but the slide mount capability is compatible with the Chassis Trak® Models C-300-S-114 (14-inch rack depth), C-300-S-116 (16-inch rack depth), and C-300-S-118 (18-inch rack depth) rack mounts available from General Devices, Inc.

Note that conversion from bench top to rack mount configuration does not require the removal of the covers. Also note that the top and bottom covers may be removed from a slide rack-mounted ATS-1 without removing the unit from the rack or from the slides.



Figure B-1. Handle parts after removal

1. Remove the handle, handle brackets, two bracket spacers, and the trim panel from the right side of the instrument (see Figure B-1).
2. Remove the trim panel and the four adhesive-backed feet from the left side of the instrument.
3. Remove the four feet and bail from the bottom of the instrument.
4. Align the rack mount spacer to the right side of the instrument. The spacer fits into the recess formed by the covers. Three holes in the spacer align with three matching holes in the chassis; Do not insert screws at this time.

Fixed Rack Mount

- a. Align the right hand rack handle (a painted, formed steel plate 16 inches long) over the spacer mentioned in Step 4. The spacer is now sandwiched between the instrument chassis and the rack handle. See Figure B-3.



Figure B-2. Fixed rackmounting bracket in place

- b. Fasten the rack handle and spacer to the chassis with three 10-32 screws.
- c. Repeat Steps 4, a, and b on the left side of the instrument.
- d. Install the two handles on the brackets if desired, oriented toward the center of the instrument.

Slide Rack Mount



Figure B-3. Slider rack mounting kit, right end

- e. Remove the eight #6-32 flat head screws securing the front edge of the top and bottom covers to the chassis (there are two screws on the right and left sides of each of the top and bottom covers, near the front four corners of the case). See Figure B-3.

- f. Align and secure (with three #10-32 screws) the fixed portion of the Chassis Trak rack mount kit to the chassis, sandwiching the spacer between. See Figure B-4.



Figure B-4. Slide rack mounting hardware in place

- g. Mount the right-hand rack ear bracket, using two #6-32 screws. Note that the right-hand and left-hand rack ear brackets are not identical, the cutpout portion of the proper bracket clears the fixed slide mounted in the previous step. See Figure B-4.
- h. Repeat Steps 4, f, and g on the left side of the instrument.
- i. Install the two handles on the rack ear brackets, oriented toward the center of the instrument.

Appendix C - Performing Internal Changes

The following internal changes have one thing in common: they require the removal of the top and/or bottom covers. Therefore, you may want to consider consolidating your changes, rather than performing them independently if more than one change is desired.

Opening the Case



WARNING - There are dangerous voltages inside the case. It is also possible to damage the instrument if proper techniques are not used. Always refer all servicing to qualified personnel.

If you have not already done so, first disconnect the power cord from the rear of the instrument before performing any of the following procedures.

If the fixed rackmounting brackets have been installed, they must be removed. If the sliding track rackmounting brackets have been installed, they may be left in place; just remove the rack ear brackets near the front panel.

To replace or relocate the connector panel, you need to remove both covers. To install optional filters or change the monitor loudspeaker signal source, you need to remove only the top cover.

Remove four screws from the right side, four screws from the left side, and six screws from the top or bottom of the cover (total of 14 screws for each cover). You may need to also loosen or remove the handle.



ATTENTION: Do NOT touch the components on the circuit boards. They can be easily damaged by static electricity.

Changing to Alternate Connector Panels

The ATS-1 may be factory -configured with any of four connector audio styles: XLR (Cannon), floating BNC, WE310 tip-ring-sleeve, and 1/4" stereo tip-ring-sleeve. Each panel also has banana jacks in parallel with its connectors. To later change to another connector panel with a different connector configuration:

1. Remove the top and bottom covers as described earlier in this section.
2. Clip the cable ties securing the cables from the connector panel to the chassis.
3. Locate the two cables from the Analyzer Input connectors on the panel to the Analyzer circuit board on the top side of the chassis. Observe that each cable connects to the board connector nearest its panel connector. Disconnect these cables from the circuit board.
4. Locate the two cables from the Generator Output connectors on the panel to the Generator circuit board on the bottom side of the chassis. Observe that each cable connects to the board connector nearest its panel connector. Disconnect these cables from the circuit board.
5. Remove the four #6-32 nuts which secure the connector panel to the chassis, and remove the old panel.
6. Mount the new connector panel using the four #6-32 nuts removed in the previous step.
7. Connect the Generator Output channel A cable to the Generator A connector on the bottom circuit board. The wire with white insulation goes to the pin marked + on the circuit board.
8. Connect the Generator Output channel B cable to the Generator B connector on the bottom circuit board. The wire with white insulation goes to the pin marked + on the circuit board.
9. Connect the Analyzer Input channel A cable to the Analyzer A connector on the top circuit board. The wire with white insulation goes to the pin marked + on the circuit board.
10. Connect the Analyzer Input channel B cable to the analyzer B connector on the top circuit board. The wire with white insulation goes to the pin marked + on the circuit board.

11. Loop and dress the excess cable length neatly near the edge of the circuit board and secure them to the chassis with cable ties.
12. Replace the top and bottom covers.
13. Test the new configuration by connecting A output to A input and B output to B input with external cables which do not have a polarity inversion (conductors transposed) between the two ends. Select LEVEL function with PHASE displayed in the upper right display. With both generator outputs on and a 1 kHz 1 volt signal, the measured voltages should agree within the instrument specification and the phase should read nearly zero degrees for all four possible input configuration selections; A-B, A-G, B-1, and B-G.

Swapping Speaker and Connector Panels

The ATS-1 is normally shipped with the Monitor loudspeaker installed on the rear panel and the input/output connector panel installed on the front. You may desire, especially in rackmounted production test systems, to have the input/output connectors at the rear. To interchange the loudspeaker and connector panels, perform the following steps:

1. Remove the top and bottom covers as described earlier in this section.
2. Clip the cable ties securing the cables from the connector panel to the chassis.
3. Locate the two cables from the Analyzer Input connectors on the panel to the Analyzer circuit board on the top side of the chassis. Observe that each cable connects to the board connector nearest its panel connector. Disconnect these cables from the circuit board.
4. Locate the two cables from the Generator Output connectors on the panel to the Generator circuit board on the bottom side of the chassis. Observe that each cable connects to the board connector nearest its panel connector. Disconnect these cables from the circuit board.

5. Remove the four #6-32 nuts which secure the connector panel to the chassis, and remove the old panel.
6. Disconnect the cable from the loudspeaker to the circuit board connector on the bottom side of the chassis at the rear edge of the circuit board (Location A in Figure C-1).
7. Remove the four #6-32 nuts which secure the loudspeaker panel to the chassis, and remove the loudspeaker panel.
8. Mount the loudspeaker panel to the front panel with four #6-32 nuts.
9. Connect the loudspeaker cable to the alternative two-pin circuit board connector on the bottom side of the chassis at the front edge of the circuit board (Location B in Figure C-1). The connector polarity is unimportant.

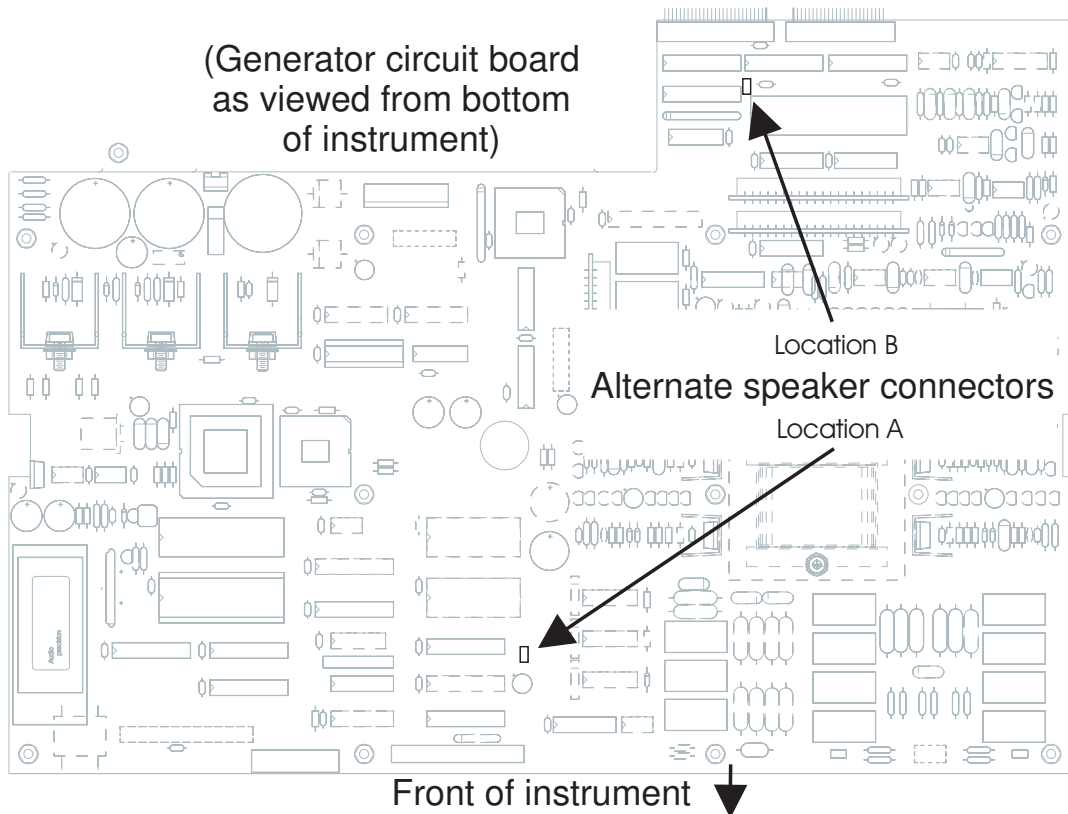

Figure C-1. Alternate Monitor speaker connector locations

10. Mount the cable connector panel to the rear of the chassis using four #6-32 nuts.
11. Connect the generator output channel A cable to the generator A channel connector on the bottom circuit board. The wire with white insulation must go to the pin marked + on the circuit board.
12. Connect the generator output channel B cable to the generator B channel connector on the bottom circuit board. The wire with white insulation must go to the pin marked + on the circuit board.
13. Connect the analyzer input channel A cable to the analyzer A channel connector on the top circuit board. The wire with white insulation must go to the pin marked + on the circuit board.
14. Connect the analyzer input channel B cable to the analyzer B channel connector on the top circuit board. The wire with white insulation must go to the pin marked + on the circuit board.
15. Dress the cables neatly at the edge of the chassis and secure them with cable ties.
16. Replace the top and bottom covers.
17. Test the new configuration by connecting A output to A input and B output to B input with external cables which do not have a polarity inversion (conductors transposed) between the two ends. Select LEVEL function with PHASE displayed in the upper right display. With both generator outputs on and a 1 kHz 1 volt signal, the measured voltages should agree within the instrument specification and the phase should read nearly zero degrees for all four possible input configuration selections; A-B, A-G, B-1, and B-G.

Option Filter Installation

If your ATS-1 was ordered with optional filters, they will have been installed in the FILTER 1 or FILTER 2 sockets at the factory and documentation has been provided with the instrument to indicate what filter is in which socket. If you purchase option filters later to install yourself, the installation process is as follows:

1. Remove the top cover (only) as described earlier.
2. The two sockets for option filters are located near the right rear of the main analyzer circuit board. They are clearly labeled FILTER1 and FILTER 2 on the circuit board. Remove the two screws which secure the filter hold-down bracket, and remove the hold-down bracket. See Figure 0

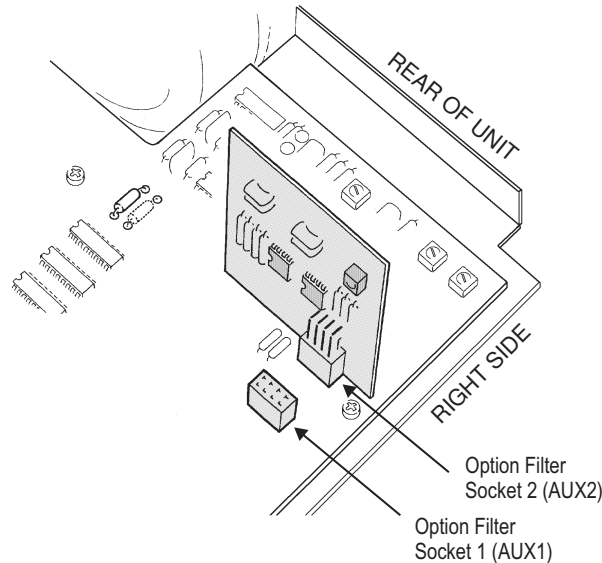

Figure C-2. Location and orientation of option filters

3. Plug the filter(s) into the desired socket(s), then replace the filter hold-down bracket and fasten it with the two screws.
4. Replace the top cover.
5. Reconnect power to the unit and turn it on. Select AMPLITUDE function, INPUT A GEN, and use PANELS mode with analyzer setup parameters displayed to select the newly-installed filter(s). Verify their correct function by measuring their frequency response.

Monitor Source Selection

The ATS-1 Dual Domain has built-in monitor circuitry to allow you to audibly monitor the signal being analyzed. You can hear the sound either from the built-in speaker or through stereo headphones connected to the MONITOR jack on the front panel.

The monitor signal is normally connected to monitor the input signal. The signal is taken from the measurement path immediately after the input ranging, so the signal has a fairly constant amplitude. This is the same signal output by the rear panel 'INPUT' monitor.

Optionally, the monitor signal can be taken from the end of the measurement chain, after all processing and filtering, directly before the final measurement detector. This is the same signal output by the rear panel 'ANALYZER' monitor.

Changing from one monitor source to the other requires changing a cable connection inside the ATS-1 Dual Domain. To make this change, proceed as described on the following page.

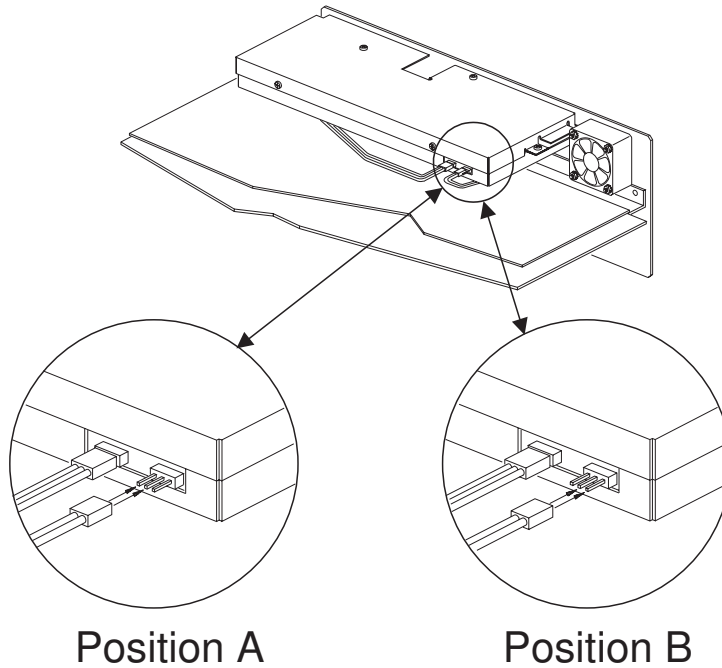

Figure C-3. Cable positions for monitor selection

1. Remove the top cover (only) as described earlier in this section.
2. Locate the digital assembly, which is enclosed in a metal case near the rear of the unit. The cable to be changed is located on the right front corner of the digital assembly, as shown on Figure C-3.
3. The cable connector has three pins that stick out from the metal case. The cable connects to either the left two pins or the right two pins (see Figure C-3). With the cable in Position A, the monitor signal will come from the input. With the cable in Position B, the monitor signal will come from the final processed reading. The polarity of the connection does not matter. Move the cable to the desired position.
4. Replace the top cover.

Appendix D - Specifications

ANALOG SIGNAL OUTPUTS

Low Distortion Sine Wave

Frequency Range	10 Hz to 120 kHz
Frequency Accuracy	±0.5%
Frequency Resolution	0.02%
Amplitude Range (20 Hz - 30 kHz) ¹	
Balanced	0.25 mV to 25.00 Vrms [-70 to +30.17 dBu]
Unbalanced	0.25 mV to 12.50 Vrms [-70 to +24.16 dBu]
Amplitude Range (full frequency range) ¹	
Balanced	0.25 mV to 12.28 Vrms [-70 to +24.00 dBu]
Unbalanced	0.25 mV to 6.14 Vrms [-70 to +18.00 dBu]
Amplitude Accuracy (1kHz)	±0.2dB [±2.3%]
Amplitude Resolution	0.01 dB
Flatness (1 kHz ref)	
10 Hz-20 kHz	±0.05 dB
20 kHz-120 kHz	±0.30 dB
Residual THD+N ²	
25 Hz-20 kHz	≤(0.0025% + 3 μV), 80 kHz BW [-92 dB]
10 Hz-50 kHz	≤(0.010% + 10 μV), >300 kHz BW [-80 dB]

Square Wave

Frequency Range	20 Hz-30 kHz
Frequency Accuracy	Same as Sinewave
Amplitude Range ¹	
Balanced	0.71 mVpp to 34.73 Vpp
Unbalanced	0.71 mVpp to 17.36 Vpp
Amplitude Accuracy	±0.3 dB [±3.5 %] at 400 Hz
Rise/fall time	Typically 2.5 - 3.0 μs

Note 1 Calibration with other amplitude units is based upon an equivalent sinewave having the same Vpp amplitude.

Note 2 System specification including contributions from both generator and analyzer. Generator load must be ≥600 Ω.

SMPTE (or DIN) Test Signals *with option "P1-IMD"*

LF Tone	50, 60, 70, or 250 Hz; all $\pm 1.0\%$
HF Tone Range	7 kHz or 8 kHz ($\pm 1\%$)
Mix Ratio	4:1 (LF:HF)
Amplitude Range ¹	
Balanced	0.71 mVpp to 70.71 Vpp
Unbalanced	0.71 mVpp to 35.35 Vpp
Amplitude Accuracy	$\pm 0.3\text{dB}$ [$\pm 3.5\%$]
Residual IMD ²	0.0015% [-96.5 dB], 60 Hz+7 kHz or 250 +8 kHz

OUTPUT CHARACTERISTICS

Source Configuration	Selectable balanced or unbalanced
Source Impedances	
Balanced	50Ω ($\pm 2\Omega$), $150\Omega^3$ ($\pm 2\Omega$), or 600Ω ($\pm 2\Omega$)
Unbalanced	50Ω ($\pm 2\Omega$)
Max Float Voltage	42 Vpp
Output Current Limit	
Balanced	Typically >75 mA
Unbalanced	Typically >150 mA
Max Output Power	
Balanced	+29.5 dBm into 600Ω ($R_s = 50\Omega$)
Unbalanced	+23.5 dBm into 600Ω ($R_s = 50\Omega$)
Output Related Crosstalk (10Hz-20kHz)	≤ -110 dB or $10\ \mu\text{V}$, whichever is greater

Note 1 Calibration with other amplitude units is based upon an equivalent sinewave having the same Vpp amplitude.

Note 2 System specification including contributions from both generator and analyzer. Generator load must be $\geq 600\ \Omega$.

Note 3 $200\ \Omega$ with option "EURZ".

ANALOG ANALYZER

ANALOG INPUT CHARACTERISTICS

Input Ranges	80 mV to 250 V in 10 dB steps
Maximum Rated Input	350 Vpk, 140 Vrms (dc to 20 kHz); overload protected in all ranges
Input Impedance	
Balanced (each side)	Nominally 100 k Ω // 150-200pF
Unbalanced	Nominally 100 k Ω // 150-200pF
Terminations	Selectable 600 Ω \pm 1%; 1 Watt [+30 dBm] maximum power
CMRR	
80mV-2.5V ranges	\geq 70 dB, 50 Hz-20 kHz
8V-250V ranges	\geq 50 dB, 50 Hz-1 kHz
Input Related Crosstalk	\leq -120 dB or 1 μ V, whichever is greater
10 Hz-20 kHz	

Level Meter Related (both channels)

Measurement Range	10 mV-140 V [-38 dBu to + 45 dBu] for specified accuracy and flatness, useable to <100 μ V
Accuracy (1 kHz)	\pm 0.1 dB + 100 μ V
Flatness (1 kHz ref)	
20 Hz-20 kHz	\pm 0.05 dB
10 Hz-50 kHz	\pm 0.2 dB
50 kHz-120 kHz	\pm 0.50 dB (-3 dB BW typically >300 kHz)

Frequency Meter Related (both channels)

Measurement Range	10 Hz-200 kHz
Accuracy	\pm 0.01% [\pm 100 PPM]
Resolution	5 digits
Minimum Input	25 mV ⁴

Note 4 For fully specified performance. Usable with inputs as low as 10 mV. Readings are disabled for inputs below approximately 7 - 8 mV.

Phase Measurement Related

Measurement Ranges	± 180 , $+90/-270$, or $-90/+270$ deg
Accuracy	
20 Hz-20 kHz	± 2.0 deg
10 kHz-50 kHz	± 5.0 deg
Resolution	0.1 deg
Minimum Input	25 mV, both inputs ⁴

Wideband Amplitude/Noise Function

Measurement Range	$< 1 \mu\text{V}$ -140 Vrms [-118 dBu to + 45 dBu]
Accuracy (1 kHz)	± 0.2 dB [± 2.3 %] unweighted
Flatness (1 kHz ref)	
20 Hz-20 kHz	± 0.05 dB
10 Hz-50 kHz	± 0.2 dB
50 kHz-120 kHz	± 0.5 dB (-3 dB BW typically > 300 kHz)
Bandwidth Limiting Filters	(See Figure D-1)
LF -3 dB	< 10 Hz, 400 Hz $\pm 5\%$ (3-pole)
HF -3 dB	22 kHz $\pm 5\%$ (5-pole) ⁵ , 30 kHz $\pm 5\%$ (3-pole), 80 kHz $\pm 5\%$ (3-pole), or > 300 kHz
Weighting filters	ANSI-IEC "A" per IEC 179 (See Figure D-2) CCIR-QPK per CCIR Rec 468 CCIR-ARM per Dolby Bulletin 19/4 CCIR-1k (rms, 0 dB at 1 kHz) (See Figure D-3) CCIR-2k (rms, 0 dB at 2 kHz) (See Figure D-3)
Optional Filters	up to 2 (Aux 1 and Aux 2)
Detection	RMS ($\tau = 60$ msec), AVG,

Note 4 For fully specified performance. Usable with inputs as low as 10 mV. Readings are disabled for inputs below approximately 7 - 8 mV.

Note 5 Combined with 22 Hz highpass per CCIR Rec 468.

QPk per CCIR Rec 468,	
Residual Noise	
22 Hz-22 kHz BW	$\leq 1.5 \mu\text{V}$ [-114 dBu]
A-weighted	$\leq 1.0 \mu\text{V}$ [-118 dBu]
CCIR-QPk	$\leq 5.0 \mu\text{V}$ [-104 dBu]
Bandpass Amplitude Function	
Tuning Range (f_0)	20 Hz to 120 kHz
Tuning Accuracy	$\pm 2\%$
Bandpass Response	Q=5 (2-pole)
Accuracy (at f_0)	± 0.3 dB, 20 Hz-120 kHz
Residual Noise	
10 Hz-5 kHz	$\leq 0.25 \mu\text{V}$ [-130 dBu]
5 kHz-20 kHz	$\leq 0.5 \mu\text{V}$ [-124 dBu]
20 kHz-200 kHz	$\leq 1.5 \mu\text{V}$ [-114 dBu]
THD+N / SINAD Function	
Fundamental Range	10 Hz to 100 kHz, THD+N mode 400 Hz or 1 kHz, SINAD mode
Measurement Range	<0.001%-100%
Accuracy	± 1 dB, 20 Hz-120 kHz harmonics
Measurement Bandwidth	
LF -3 dB	<10, 22 or 400 Hz
HF -3 dB	22K, 30k, 80k, or >300 kHz; option filters are also functional
Residual THD+N ⁶	
25 Hz-20 kHz	$\leq (0.0025\% + 3.0 \mu\text{V})$, 80 kHz BW [-92 dB]
10 Hz-50 kHz	$\leq (0.010\% + 10 \mu\text{V})$, >300 kHz BW [-80 dB]
Minimum Input	25 mV for specified accuracy in AUTO TUNE mode, 800 μV [-60 dBu] in other modes.
Nulling Time	Typically 2-3 seconds above 25 Hz, Increases in a "1/V" fashion for inputs below 25 mV [-30 dBu]

Note 6 System specification including contribution from generator. Generator residual THD may limit system performance below 25 Hz if output is >20.0 Vrms balanced, or 10.0 Vrms unbalanced.

Crosstalk Function

Frequency Range	10 Hz to 120 kHz
Measurement Range	-140 dB to 0 dB
Accuracy ⁷	±0.5 dB
Residual Crosstalk ⁷	≤-120 dB at 20 kHz, R _s = 600Ω
Minimum Input	25 mV for reference channel ⁸

SMPTE (DIN) IMD Function with option “IMD”

Test Signal Compatibility	Any combination of 40-250 Hz (LF) and 3 kHz-20 kHz (HF) tones, mixed in any ratio from 0:1 to 8:1 (LF:HF)
IMD Measured	Amplitude modulation products of the HF tone. -3 dB measurement bandwidth is typically 20Hz-750Hz
Measurement Range	<0.0025%-20%
Accuracy	±1 dB per SMPTE RP-120-1983, DIN 45403
Residual IMD (V _{in} ≥200mV) ⁹	≤0.0025% [-92 dB], 60 + 7 kHz or 250 + 8 kHz
Minimum Input	100 mV

Ratio Function

Measurement Range	-80 dB to +100 dB, 0.01 dB resolution
Accuracy	±0.1 dB, 20 Hz-20 kHz
Minimum Input	
Mode 1	10 mV [-38 dBu], denominator signal 10 μV [-98 dBu], numerator signal
Mode 2	10 μV [-98 dBu], denominator signal 10 mV [-38 dBu], numerator signal

AC Mains Check Function

Measurement Range	0.85-1.10 of nominal setting
Voltage Accuracy	±1 %

Note 7 Uses the 1/3 octave bandpass filter to enhance the measured range in the presence of wideband noise. Alternate (interfering) channel input must be ≥5 mV.

Note 8 For fully specified performance. Usable with inputs as low as 10 mV. Readings are disabled for inputs below approximately 7 - 8 mV.

Note 9 System specification including contribution from generator.

Gen Load Function

Measurement Range	<1 Ω to 20 k Ω
Accuracy	$\pm[5\% + 0.5\ \Omega]$ for readings <1 k Ω Degrades rapidly above 1 k Ω or with reactive loads
Frequency Range	20 Hz - 20 kHz
Test Voltage	200 mV default. Usable from 10 mV to generator maximum

Wow & Flutter Function

Test Signal Compatibility	2.80 kHz-3.35 kHz
Measurement Range	<0.005% to 3% (single range)
Accuracy (4 Hz)	$\pm(5\%$ of reading + 0.002%)
Detection Modes	IEC/DIN (quasi-peak per IEC-386), NAB (average), JIS (per JIS 5551)
Response Selections	
Weighted	4 Hz bandpass per IEC/DIN/NAB
Unweighted	0.5 Hz-200 Hz
Residual W+F	
Weighted	$\leq 0.005\%$
Unweighted	$\leq 0.01\%$
Minimum Input	25 mV ¹⁰
Settling Time	
IEC/DIN or NAB	Typically 3-6 seconds
JIS	Typically 15-20 seconds

DIGITAL SIGNAL GENERATOR**DIGITAL OUTPUT CHARACTERISTICS**

Output Formats	AES/EBU (per AES3-1992) SPDIF-EIAJ Optical (Toslink [®])
Sample Rates	28.8 kHz-52.8 kHz AES/EBU 57.6 kHz-105.6 kHz with 96 kHz option

Note 10 For fully specified performance. Usable with inputs as low as 10 mV. Readings are disabled for inputs below approximately 7 - 8 mV.

Sample Rate Resolution	1/128 Hz (approx. 0.0078 Hz)
Sample Rate Accuracy	$\pm 0.002\%$ [± 20 PPM] using internal reference, lockable to external reference
Word Width	16 to 24 bits (even values)
Output impedance	
Balanced (XLR)	110 Ω
Unbalanced (BNC)	75 Ω approx.

Sine Wave

Frequency Range	10 Hz to 47% of sample rate (22.56 kHz at 48 ks/sec)
Frequency Resolution	Sample Rate $\div 2^{23}$ (typically 0.006 Hz at 48 ks/sec)
Flatness	± 0.001 dB
Residual Distortion	$\leq 0.00001\%$ [-140 dB]

Square Wave

Frequency Range	10 Hz to 1/6 sample rate (7350 Hz at 44.1 ks/sec, 8000 Hz at 48 ks/sec)
Frequencies available	$f_s \div 4096$ to $f_s \div 6$, in even integer divisors
Even Harmonic Content	$\leq 0.00001\%$ [-140 dB]

SMPTE/DIN IMD Waveform with option "IMD"

Upper Tone Frequency Range	Choice of 7 kHz or 8 kHz
Lower Tone Frequency Range	Choice of 50 Hz, 60 Hz, 70 Hz, or 250 Hz
Flatness	± 0.001 dB
Amplitude Ratio	4:1 (LF:HF)
Residual Distortion	$\leq 0.00001\%$ [-140 dB] at 4:1 ratio

Random Generator Waveform

Waveform	Compatible with BITTEST.AZ1 used with System One
----------	--

Dither (Sine, IMD, and Square waveforms)

Probability Distribution	Triangular or rectangular; independent for each channel
Spectral Distribution	Flat (white) or Shaped (+6 dB/oct, triangular only)
Amplitude	Automatically tracks word width or off

AES/EBU INTERFACE GENERATION

Interface Signal

Amplitude Range	
Balanced (XLR)	0-5.12 Vpp, $\pm(10\% + 80 \text{ mV})$ into 110 Ω in 5 mV steps
Unbalanced (BNC)	0 to 1.28 Vpp, $\pm(8\% + 20 \text{ mV})$ into 75 Ω in 1.25 mV steps
Channel Status Bits	English language decoded, Professional or consumer formats. CRCC implemented Time of Day not implemented Sample Count not implemented
User Bits	set to 0
Validity Flag	Selectable, set or cleared

AES/EBU Impairments

Induced Jitter	Sinewave
Jitter Freq Range	40 Hz to 38.8 kHz
Jitter Freq Accuracy	$\pm 0.0020\%$ [$\pm 20 \text{ PPM}$]
Jitter Amplitude	0-1.28 UI (pk), $\pm(10\% + 0.01 \text{ UI})$ in steps of 0.005 UI or better 1.3-12.75 UI (pk), $\pm 10\%$ in steps of 0.05 UI or better
Jitter Flatness	$\pm 1 \text{ dB}$ ref 500Hz, 50 Hz to 30 kHz
Residual Jitter, peak calibrated	(total generator/analyzer)
RMS response	$\leq 0.005 \text{ UI}$ (700 Hz-30 kHz BW),
Peak response	$\leq 0.015 \text{ UI}$ (700 Hz-30 kHz BW),
Spurious Jitter Products	
Jitter & Ref Delay Off	$\leq 0.0005 \text{ UI}$
Jitter On	$\leq -30 \text{ dB}$ below jitter signal

REFERENCE INPUT CHARACTERISTICS

Input Formats	AES/EBU (per AES 3-1992)
Input Sample Rates	28.8 kHz-52.8 kHz AES/EBU (must equal desired output rate)
Minimum Input Amplitude	400 mVpp
Input Impedance	Nominally 110 Ω
Lock Range	$\pm 0.0025\%$ [$\pm 25 \text{ PPM}$]

Output Delay from Reference -64/+63.5 UI, $\pm(5\% + 0.5 \text{ UI})$, in 0.125 UI steps

DIGITAL ANALYZER

DIGITAL INPUT CHARACTERISTICS

Input Formats (Automatically selected)	AES/EBU (per AES 3-1992) SPDIF-EIAJ Optical (Toslink [®])
Sample Rates	28.8 kHz-52.8 kHz AES/EBU
Word Width	16 to 24 bits (even values)
Input Impedance	
AES/EBU	110 Ω or $\geq 2.5 \text{ k}\Omega$
SPDIF-EIAJ	75 Ω or $\geq 3 \text{ k}\Omega$

EMBEDDED AUDIO MEASUREMENTS

Wideband Level/Amplitude

Range	0 dBFS to -140 dBFS
Frequency Range	<10 Hz-22.0 kHz at 48 ks/sec
Accuracy	$\pm 0.01 \text{ dB}$, $\geq -90 \text{ dBFS}$
Flatness	$\pm 0.01 \text{ dB}$, 15 Hz-22 kHz, with <10 Hz high-pass filter selection
High pass Filters	22 Hz, 2-pole Butterworth 400 Hz, 2-pole Butterworth
Low pass Filters	15 kHz, 6-pole elliptic low-pass 20 kHz, 6-pole elliptic low-pass
Weighting Filters	ANSI-IEC "A" weighting, Type 0 CCIR QPk per CCIR Rec 468 CCIR RMS per AES 17
Residual Noise	-140 dBFS unweighted -142 dBFS A-weighted -134 dBFS CCIR RMS -130 dBFS CCIR QPk -139 dBFS 20 kHz LP -140 dBFS 15 kHz LP

Narrow Band Amplitude

Frequency Range	0.04% to 40% of sample rate (10 Hz-19.2 kHz at 48.0 ks/sec)
Filter Shape	10-pole, Q=19 (BW = 5.3% of f_0)
Residual Noise	≤ -150 dBFS

THD+N Measurements

Fundamental Range	0.02% to 45% of sample rate (10 Hz-22.0 kHz at 48.0 ks/sec)
Residual THD+N	≤ -138 dBFS
High pass Filters	22 Hz, 2-pole Butterworth 400 Hz, 2-pole Butterworth
Low pass Filters	15 kHz, 6-pole elliptic low-pass 20 kHz, 6-pole elliptic low-pass
Weighting Filters	ANSI-IEC "A" weighting, Type 0 CCIR QPk per CCIR Rec 468 CCIR RMS per AES 17

SMPTE (DIN) IMD Function with option "IMD"

Test Signal Compatibility	Any combination of 40-250 Hz (LF) and 3 kHz-20 kHz (HF) tones, mixed in any ratio from 1:1 to 4:1 (LF:HF)
IMD Measured	Amplitude modulation products of the HF tone. -3 dB measurement bandwidth is typically 20 Hz-750 Hz
Measurement Range	$<0.0001\%$ -10%
Accuracy	± 1 dB per SMPTE RP-120-1983, DIN 45403
Residual IMD (0 dBFS)	$\leq 0.0001\%$ [-120 dB], 60 + 7 kHz or 250 + 8 kHz

Frequency Measurements

Range	5 Hz to 47% of sample rate (5 Hz-21.0 kHz at 44.1 ks/sec) (5 Hz-23.0 kHz at 48.0 ks/sec)
Accuracy	$\pm 0.01\%$ of reading or 0.0001% of sample rate, whichever is greater
Resolution	0.003% of reading or 0.0001% of sample rate, whichever is greater

Phase Measurement Related

Measurement Ranges	± 180 , $+90/-270$, or $-90/+270$ deg
Accuracy	± 2.0 deg (20 Hz-20 kHz)
Resolution	0.1 deg

BITTEST measurement

Measurement	Compatible with Random Mode of System One BITTEST.AZ1
-------------	---

DIGITAL INTERFACE MEASUREMENTS

AES/EBU Impairments, real time displays

Input Sample Rate	$\pm 0.002\%$ [± 20 PPM] internal ref, $\pm 0.0001\%$ [± 1 PPM] external ref
Output to Input or Reference Input to Input Delay	Measures status propagation from the AES/EBU output to the input. Range is 0-192 samples (frames), resolution ± 60 ns.
AES/EBU Input Voltage	
Balanced	400 mV to 10.24 Vpp, $\pm(5\% + 50$ mV)
Unbalanced	100 mV to 2.56 Vpp, $\pm(5\% + 12$ mV)
Jitter Amplitude (500 Hz)	(peak sinewave calibrated) 0-5 UI, $\pm(10\% + 0.04$ UI)
Jitter Flatness	± 1.5 dB, 100 Hz-22 kHz (50 Hz HP selection, RMS detection, 48 kHz sample rate)
Residual Jitter, peak calibrated	(analyzer only)
RMS response	≤ 0.005 UI (700 Hz-30 kHz BW)
Peak response	≤ 0.015 UI (700 Hz-30 kHz BW)
Spurious Jitter Products	≤ 0.001 UI (>1.2 kHz) or <-40 dB below jitter signal
Channel Status Bits	English language decoded (Professional or Consumer)
User Bits	Not displayed
Validity Flag	Displayed for selected channel
Parity	Displayed for total signal (both channels combined)
Signal Confidence	Displayed for total signal (both channels combined)
Receiver Lock	Displayed for total signal (both channels combined)

Coding Error	Displayed for total signal (both channels combined)
--------------	---

AUXILIARY SIGNALS

Generator Auxiliary Signals

Analog Sync Output	LSTTL compatible signal that is intended to be used as a trigger for stable oscilloscope displays.
Digital Sync Output:	(600mVpp nominal squarewave)
Selectable from:	
Transmit Frame Sync	Squarewave at the programmed internal sample rate
Receive Frame Sync	Squarewave at the rate of the received AES/EBU signal
Xmit Clock	Squarewave at 256x the programmed internal sample rate
Rcvr Clock	Squarewave at 256x the received sample rate
Jitter Generator	Squarewave at Jitter Frequency
Digital Signal Generator	Squarewave at digital generator frequency for scope trigger
AES Interface Error	Logic low on error detection

Analyzer Signal Monitors

Input Monitor	Buffered version of the analog or digital input signal. Amplitude is typically 0-2.83 Vpp.
Reading	Buffered version of the analog or digital analyzer output signal after all filtering and gain stages. Amplitude is typically 0-2.83 Vpp.

AUDIO MONITOR

Power Output	Typically 1 Watt
--------------	------------------

GENERAL / ENVIRONMENTAL	
Power Requirements	100/120/230/240 Vac (-10%/+6%), 50-60 Hz, 60 VA max
Temperature Range	
Operating	0°C to +40°C
Storage	-20°C to +60°C
Humidity	80% RH to at least +40°C (non-condensing)
Altitude	Up to 2000 meters
EMC ¹¹	Complies with FCC subpart J - Class B Complies with 89/336/EEC, 92/31/EEC, and 93/68/EEC. EN 50081-1 (1992) Emissions Class B EN 50082-1 (1992) Immunity
Safety	Complies with 73/23/EEC and 93/68/EEC EN61010-1 (1993) - IEC 1010-1 (1990) + Amendment 1 (1992) + Amendment 2 (1995) Installation Category II - Pollution Degree 2
Dimensions	16.5 x 6.0 x 13.6 inches [41.9 x 15.2 x 34.5 cm]
Weight	Approximately 20 lbs [9.1 kg]

Note 11 Emission and Immunity levels are influenced by the shielding performance of the connecting cables. The shielding performance of the cable will depend on the internal design of the cable, connector quality, and the assembly methods used. EMC compliance was evaluated using Audio Precision XLR type cables, part number CAB-AES.

!

% unit 3-26 - 3-27, 3-31
 +10 dB key 3-3
 +REF 3-17
 -10 dB key 3-3
 -REF 3-17
 x10 key 3-2
 1.00 dB/ISO 3-3
 2-sigma 4-32
 3-head tape recorder testing 5-3
 20k OHM 4-38

A

A-B (phase measurement) 4-24
 A-G (phase measurement) 4-24
 A-Weighting filter shape (graph) 1-7
 A:GEN 3-15
 AC Mains function 4-35 - 4-36
 AC supply voltage setting 2-1
 ACTIVEBIT 4-46
 ACTUALBIT 4-46
 Adjusting the display 3-5
 Alignment
 tape recorder 5-2
 Alternate Connector Panels C-2
 Amplifier response measurements 5-1
 AMPLITUDE Controls 3-2
 Amplitude function 4-1 - 4-3
 Amplitude sweeps 4-54
 Amplitude units
 Analog 3-27
 Digital 3-33
 Analog analyzer input circuit 1-17 - 1-18
 Analog and digital analyzer modes 3-23
 Analog generator control 3-13, 3-15
 Analog generator loading 3-19
 Analog generator output circuit 1-15 - 1-16
 Analog inputs and outputs 3-41
 Analog trigger output 3-37

Analog vs. digital 2-2
 Analyzer
 Controlling 3-22 - 3-25
 Overview 3-22
 Analyzer inputs 3-41
 Terminations 3-42
 Analyzer mode - analog or digital 3-23
 Analyzer Only panel 3-7
 Analyzer section of Main Panel 3-8
 Audible monitoring 3-6
 AUTO-TUNE 4-8
 AUTORANGE 4-52
 AUX1 4-3, 4-10
 AUX2 4-3, 4-10
 AVERAGE 4-25
 Azimuth adjustments
 tape recorder 4-25, 5-2 - 5-3

B

B-A (phase measurement) 4-24
 B-G (phase measurement) 4-24
 BAL 3-43
 BAL (Balanced configuration) 3-43
 Balanced vs. unbalanced 2-3
 BARGRAPH key 3-8, 4-51
 Bargraph panel 3-8, 4-51
 Bargraphs 4-51 - 4-52
 Bias adjustments
 tape recorder 5-4
 Bits of embedded audio 3-16, 4-44
 Blue dot 3-24
 Brightness 3-5
 Broadcast transmission testing 5-1

C

Capabilities 1-2
 CCIR filter shape (graph) 1-7
 CD player measurements 5-5
 Changing IMD tones 4-27

- Changing to Alternate Connector Panels C-2
 - Checking fuses A-5 - A-6
 - Checking supply voltage setting 2-1
 - CLCPV (error flags) 4-49
 - Clock 3-10
 - Coding flag 4-49
 - Color code for test cables 3-42
 - Confidence flag 4-49
 - Configuring digital input and output 4-42 - 4-44
 - Connecting headphones 3-6
 - Connecting printers 3-39
 - Connecting supply voltage 2-1
 - Consumer/Professional mode 3-20, 4-48
 - Continuous sweeps 4-56
 - CONTRAST Knob 3-5
 - Control modes, generator 3-13
 - Controlling the analyzer 3-22 - 3-25
 - Controlling the generators 3-12
 - Copy protection 4-48
 - Copyright flag 3-21, 4-48
 - Crosstalk function 4-33 - 4-34
 - Cursors 4-56
- D**
- D:GEN 3-16
 - D:JIT 3-18
 - D:RATE 3-17
 - Data Check function 4-45 - 4-47
 - Date, setting 3-10
 - dB unit 3-26 - 3-27
 - dBFS unit 3-26, 3-33
 - dBg Unit 3-26 - 3-27
 - dBm unit 3-26, 3-30
 - dBr key 4-62
 - dBr unit 3-26 - 3-27, 3-33
 - dBu unit 3-26 - 3-27
 - dBV unit 3-26 - 3-27
 - DEC key 3-2
 - Decibels 3-27
 - deg unit 3-26, 3-32
 - Delay between heads, tape recorders 5-3
 - Delta-% unit 3-26, 3-31
 - Destination bits 3-21, 4-49
 - DGEN WFM 3-37
 - Digital and analog analyzer modes 3-23
 - Digital audio generator control 3-13, 3-16
 - Digital configuration 4-42 - 4-44
 - Digital I/O function 4-42 - 4-44
 - Digital input autoselection 3-43
 - Digital inputs and outputs 3-35
 - Digital jitter generator control 3-13, 3-18
 - Digital sample rate generator control 3-13, 3-17
 - Digital trigger output 3-37
 - Digital vs. Analog 2-2
 - DIN IMD standard 4-26
 - DIN wow-and-flutter standard 4-30
 - Display contrast 3-5
 - Display darkening (screen saver) 3-11
 - Distortion 4-7 - 4-20
 - Dither 3-16
 - Divide-by-ten key 3-2
 - Dual bargraph display 4-6
- E**
- End-to-end testing 5-1
 - EQ adjustments
 - tape recorder 5-2
 - Error flags (digital) 4-49
 - EXTERNAL 4-54
 - External sweeps 4-57
- F**
- FAST (sweep speed) 4-55
 - Filter Installation C-6
 - Filter Shapes
 - Shapes, Filter 1-6 - 1-7

- Firmware version 2-5
- FIX-TUNE 4-8, 4-22
- Flags (digital errors) 4-49
- FREQUENCY Controls 3-2
- Frequency response measurements 5-1
- Frequency sweeps 4-54
- Frequency units 3-31
- FS unit 3-26, 3-33
- FUNCTION Keys 3-1, 3-25
- Functions
 - AC Mains 4-35 - 4-36
 - Amplitude 4-1 - 4-3
 - Data Check 4-45 - 4-47
 - Digital I/O 4-42 - 4-44
 - Gen Load 4-37 - 4-38
 - IMD 4-26 - 4-27
 - Jitter 4-39 - 4-41
 - Level 4-5 - 4-6
 - Noise 4-4
 - Phase 4-23 - 4-25
 - Ratio 4-28 - 4-29
 - SINAD 4-21 - 4-22
 - THD+N 4-7 - 4-20
 - W+F 4-30 - 4-32
 - XTALK (Crosstalk) 4-33 - 4-34
- Fuse block orientation A-3
- G**
- GA (phase measurement) 4-24
- Gain measurement 4-28
- GB (phase measurement) 4-24
- Gen Load function 4-37 - 4-38
- Gen-mon path 3-24
- GEN-TRACK 4-8, 4-22
- Generator
 - Balanced/unbalanced configuration 3-43
 - Configuration 3-42
 - Control modes 3-13
 - Controlling 3-12 - 3-21
 - Load measurement 4-37 - 4-38
 - Loading 3-19
 - Output connections 3-41
 - Output impedance 3-43
 - Overview 3-12
- Generator mode button 3-13
- Generator monitor 3-24
- Generator Only panel 3-14
- Generator section of Main Panel 3-8
- GPIB Interface 3-39
- Graphing 4-53 - 4-56
- H**
- Headphone connection 3-6
- High-resolution printouts 4-59
 - Sample 4-60
- HiZ 4-43
 - Digital 3-44, 4-39
- HiZ 3-42
- HOLD RANGE 4-52
- House sync 3-17
- Hz unit 3-26, 3-31
- I**
- IBM GRAPH (printer setting) 4-57
- IEC wow-and-flutter standard 4-30
- IEEE-488 Interface (GPIB) 3-39
- IMD Function 4-26 - 4-27
- IMD tones, changing 4-27
- IMD waveform shape 3-16
- INC key 3-2
- Input circuit, analog analyzer 1-17 - 1-18
- Input impedance measurement 4-37 - 4-38
- INPUT Keys 3-3
- Input mode - analog or digital 3-23
- Input Monitor output 3-38
- Input selection buttons 3-24
- Inputs 3-43

- Analog analyzer 3-41
- Digital analyzer 3-35
- Reference 3-36
- INSTRUMENT MODE Keys 3-4
- Internal jumper for monitor signal source C-7 - C-8
- Introduction 1-2 - 1-5
- ISO standard amplitude steps 3-3

J

- J in digital reading 3-18
- JIS wow-and-flutter standard 4-30
- JIT GEN 3-37
- Jitter
 - Generating 3-18
 - Measuring 4-39 - 4-41
- Jitter function 4-39 - 4-41
- JTEST waveform 3-16

L

- Level function 4-5 - 4-6
- Link testing 5-1
- Loading, generator 3-19
- Lock flag 4-49
- Loss measurement 4-28
- Low display 4-34
- LoZ 3-42, 4-39, 4-43
 - Digital 3-44

M

- Main Panel 3-8
- MEAS (sample frequency) 4-43
- MEDIUM (sweep speed) 4-55
- MODE 1/MODE 2 in ratio function 4-29
- MOL measurements 5-4
- MONITOR jumper C-7 - C-8
- MONITOR Operation 3-5
 - Holding range 4-52
 - Selecting signal source C-7 - C-8

- Monitor outputs 3-38
 - Holding range 4-52
- Monitoring the audio signal 3-6

N

- NAB wow-and-flutter standard 4-30
- Navigating the Panels 3-7
- NOAVERAGE 4-25
- Noise Function 4-4

O

- On/Off buttons 3-15
- Option Filter Installation C-6
- Option Filters
 - Selecting 4-3, 4-10
- Origin bits 3-21, 4-49
- OUT BLOCK (delay reference) 4-44
- OUT FRAME (delay reference) 4-44
- OUTP (sample frequency) 4-43
- Output circuit, analog generator 1-15 - 1-16
- Output configuration (analog) 3-15
- OUTPUT Keys 3-3
- Output On/Off buttons 3-15
- Outputs
 - Analog analyzer 3-41
 - Digital generator 3-35
 - Headphone monitor 3-5
 - Monitor 3-38
 - Trigger 3-37

P

- Panels
 - Analyzer Only 3-7
 - Bargraph 3-8
 - Generator Only 3-14
 - Main 3-8
 - Navigating 3-7
 - Print 3-9, 4-59
 - Recall/Save 3-4, 4-62

- Setup 3-10, 4-57
- Sweep 3-9
- Parity flag 4-49
- PASS waveform 3-16
- PCL GRAPH (printer setting) 4-57
- PEAK 4-32
- Phase function 4-23 - 4-25
- Phase measurement channel selection 4-24
- Phase units 3-32
- Power line monitoring 4-35 - 4-36
- Power switch 2-1
- Power units 3-30
- ppm unit 3-26, 3-32
- Pre-emphasis bit 3-21, 4-48
- PRINT key 3-9, 4-58
- Print panel 3-9, 4-59
- Print samples
 - High resolution 4-60
 - Screen dump 4-59
 - Table sweep 4-60
- Printer configuration 3-10
- Printer port 3-39
- Printing 4-57 - 4-61
 - Speed 4-60
- Priority of digital input selection 3-43
- Professional mode 3-20, 4-48
- Program version 2-5

R

- Rackmounting B-1 - B-4
- RAND waveform 3-16
- Ratio function 4-28 - 4-29
- RCV CLOCK 3-37
- RCV ERROR 3-37
- RCV FRAME 3-37
- Reading Monitor output 3-38
- Real-time clock 3-10
- Rear panel overview 3-35

- RECALL/SAVE Key 3-4, 4-62 - 4-63
- Recall/Save panel 3-4, 4-62
- Recalling and Saving Setups 4-62 - 4-63
- REF BLOCK (delay reference) 4-44
- REF FRAME 3-37
- REF FRAME (delay reference) 4-44
- Reference input 3-36
 - Unbalanced connection 3-36
- Reference tape
 - frequency response 5-2
- Repeating (continuous) sweeps 4-56
- Response, tape recorder 5-2

S

- s unit 3-26, 3-31
- Safety information 1-vii
- Sample rate bits 3-21
- Save panel 4-63
- Saving and recalling setups 4-62 - 4-63
- Screen dump 3-9, 4-57 - 4-58
 - Sample 4-59
- Screen saver 3-11
- sec unit 3-26, 3-31
- Selecting waveforms
 - Analog 3-15
 - Digital 3-16
- SELECTIVE 4-2, 4-10
- Self test
 - Printing 2-6
- Serial number 3-35
- Setting the clock 3-10
- Setting up 2-1 - 2-7
- Setup Panel 3-10, 4-57
- Setups, saving and recalling 4-62 - 4-63
- SINAD function 4-21 - 4-22
- SLOW (sweep speed) 4-55
- smp unit 3-26, 3-32
- SMPTE standard (IMD) 4-26

Speaker monitor 3-6
 Holding range 4-52
 Specifications D-1 - D-14
 Starting sweeps 4-56
 STAT (sample frequency) 4-43, 4-48
 Status bits 3-20, 4-48 - 4-50
 Status Bits function 4-48 - 4-50
 Status Bits panel 3-20, 4-48
 Stereo balance measurement 4-28
 Stereo separation measurement 4-33
 Stopping sweeps 4-56
 Supply voltage indicators 2-1
 Swapping Connector Panel and Loudspeaker C-3 - C-5
 Swapping Connector Panel and Loudspeaker C-3 - C-5 C-2
 Sweep cursors 4-56
 SWEEP key 3-9, 4-53, 4-56
 Sweep panel 3-9, 4-53 - 4-56
 Sweep speed, tape recorder testing 5-3
 Sweeping 4-53 - 4-56
 Continuous (repeating) 4-56
 Symbols available for setup names 4-64
 Synchronizing digital generator 3-17, 3-36

T

T (total) 4-46
 Table printouts 4-59
 Sample 4-60
 Tape recorder alignment 5-2
 Tape recorder azimuth adjustments 5-2 - 5-3
 Tape recorder bias adjustments 5-4
 Tape recorder EQ adjustments 5-2
 Tape recorder inter-head delay 5-3
 Tape recorder measurements 5-2
 Terminations
 Analog 3-42
 Digital 3-44, 4-39

THD+N

100 % reading 4-19
 Changes with amplitude 4-18
 Changes with frequency 4-17
 Isolating sources 4-20
 Selecting bandwidth 4-13
 Understanding 4-11
 What signal is dominant? 4-13
 THD+N Function 4-7 - 4-20
 Third harmonic distortion measurements 5-4
 Time units 3-31 - 3-32
 Time, setting 3-10
 Times-10 key 3-2
 Transmission link testing 5-1
 Trigger Outputs 3-37

U

UI unit 3-26, 3-32
 UN-WTD (Unweighted) 4-2, 4-9, 4-32
 UNBAL (Unbalanced configuration) 3-43
 Unbalanced vs. balanced 2-3
 Units 3-26 - 3-33
 Using cursors 4-56

V

V (Volts) unit 3-26 - 3-27
 V in digital reading 4-50
 Validity flag 3-21, 4-49
 Version of internal programs 2-5
 Voice announcements
 reference tape 5-2
 Voltage gain or loss measurement 4-28
 Vp unit 3-26 - 3-27

W

W (Watts) unit 3-26, 3-30
 W+F Function 4-30 - 4-32
 Waveform shape
 Analog 3-15

Digital 3-16
White dot 3-24
Word length 3-16, 4-44
Wow and Flutter Measurement 4-30 - 4-32
Write-protecting setups 4-62
WTD (weighted) 4-3, 4-10, 4-32

X

X/Y unit 3-26 - 3-27
XMT CLOCK 3-38
XMT FRAME 3-38
XTALK Function 4-33 - 4-34

NOTES:



Audio Precision
PO Box 2209
Beaverton, Oregon 97075-2209
Tel: (503) 627-0832 Fax: (503) 641-8906
US Toll Free: 1-800-231-7350
email: techsupport@audioprecision.com
Web: www.audioprecision.com

www.valuetronics.com