

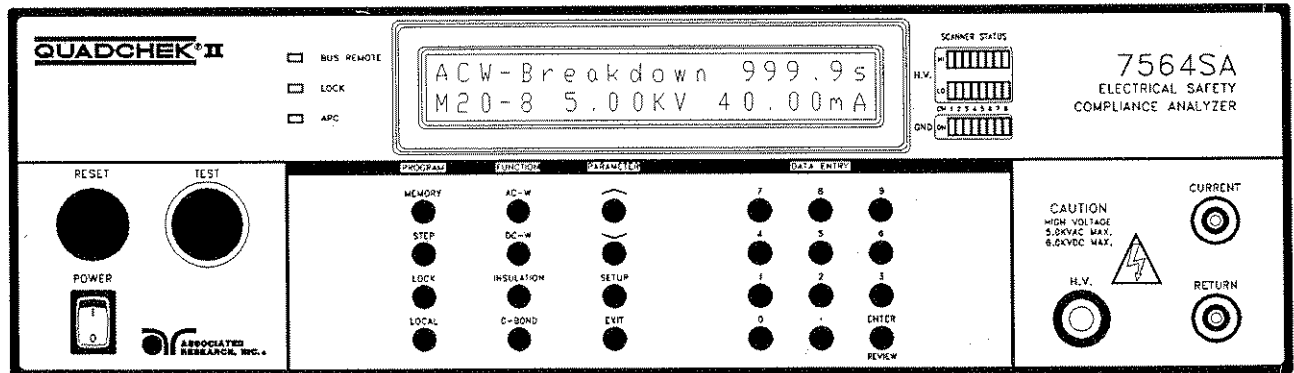

# OPERATION AND SERVICE MANUAL

MODEL 7550DT and 7564SA

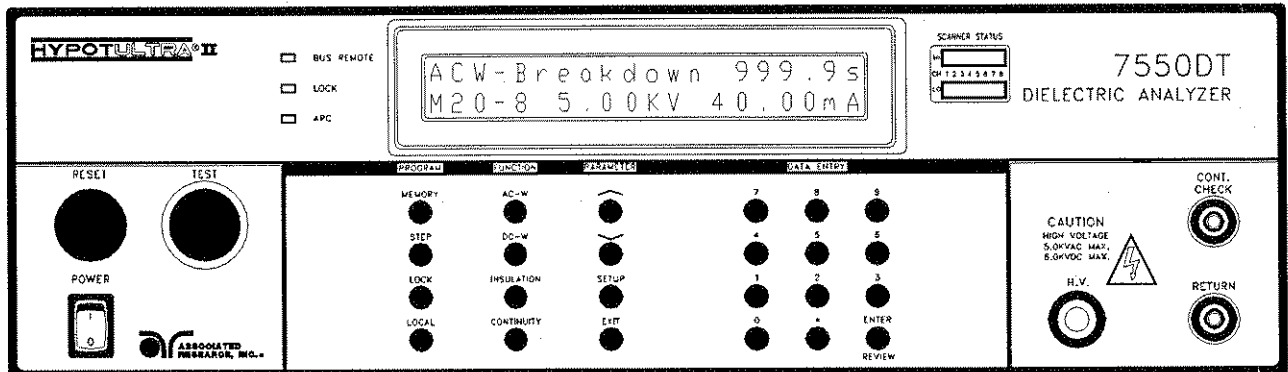

ASSOCIATED RESEARCH, INC.  
 905 CARRIAGE PARK AVENUE  
 LAKE BLUFF, IL., 60044 -2248 U.S.A.

PHONE: 1 (847) 295-3312

FAX: 1 (847) 295-9165

E-MAIL: [info@asresearch.com](mailto:info@asresearch.com)

<http://www.asresearch.com>

FOR TECHNICAL ASSISTANCE

PHONE: 1 (800) 858-TEST (8378)

Item # 37737





Certificate No: 970924-07564100071

Instruments for Electrical  
Safety Testing ... Since 1936

CERTIFICATE OF CALIBRATION

P.O. No: 33911  
Company: OWL ENGINEERING, INC.

Model No: 07564SAC  
Serial No: 100071

Temp.: 70 °F  
Humidity: 50%RH

Calibration date: 09/24/97  
Calibration due: 09/24/98

Associated Research, Inc. certifies that the instrument listed above meets or exceeds published manufacturing specifications. This instrument was calibrated using standards that are traceable to the National Institute of Standards & Technology.

Calibration Note:

Instrument was calibrated according to manufacturer's specification.

The following standards were used to calibrate this equipment:

Asset No	Manufacturer	Model No	Model Description	Cal Date	Next Cal.	Measurement	NIST Test No.
AR 144	Cole - Parmer	3310-40	Thermohygrometer	05/19/97	05/19/98	TEMPERATURE	711004
AR 434	Fluke	8060A	Digital Multimeter	02/25/97	02/25/98	DC CURRENT	811/255765,251971,811/251992,811/25174
AR 434	Fluke	8060A	Digital Multimeter	02/25/97	02/25/98	AC CURRENT	811/255765,251971,811/251992,811/25174
AR 450	ARI	25220	Milli Ohm Load	02/06/97	02/06/98	RESISTANCE	811/256216,251971,DC57,811/251741,811/
AR 481	Hewlett Packard	34401A	Digital Multimeter	12/17/96	12/17/97	DC VOLTAGE	HP REF. CRN0005081
AR 481	Hewlett Packard	34401A	Digital Multimeter	12/17/96	12/17/97	AC VOLTAGE	HP REF. CRN0005081
AR 484	Ross Engineerin	VD30-12.5Y-A	Voltage Divider	05/22/97	05/22/98	AC VOLTAGE	227129,738/255169, 811/255553
AR 484	Ross Engineerin	VD30-12.5Y-A	Voltage Divider	05/22/97	05/22/98	DC VOLTAGE	232596,811/256753, 811/257734-97
AR 517	Hewlett Packard	34330A	30A Current Shunt	06/17/97	06/17/98	AC CURRENT	811/255765,251971,811/251992,811/25174
AR 520	ARI	DTF-10M13G	10M-13.1G Decade R	11/20/96	11/20/97	RESISTANCE	114171,10458-0142-10463

Date calibrated: 09/24/97

Calibrated By: Victor Bogatov

905 Carriage Park Ave., Lake Bluff, Illinois 60044 U.S.A. • Phone: (847) 295-3312  
Fax: (847) 295-9165 • E-mail: info@asresearch.com • http://www.asresearch.com



## 5 YEAR WARRANTY POLICY

Associated Research, Inc., certifies that the instrument listed in this manual meets or exceeds published manufacturing specifications. This instrument was calibrated using standards that are traceable to the National Institute of Standards and Technology (NIST).

Your new instrument is warranted to be free from defects in workmanship and material for a period of (1) year from date of shipment. You must return the "Owners Registration Card" provided within (15) days from receipt of your instrument.

AR recommends that your instrument be calibrated on a twelve month cycle. Instruments purchased and used in the U.S. only, may have their warranty extended in one year increments to a maximum of **(5) years** provided they are returned to AR at least **annually** for calibration and inspection. The annual calibration and inspection must be performed annually each and every year following receipt of instrument. Any instrument not calibrated and inspected annually will not be eligible for extended warranty status. This extended warranty is non-transferable and is offered only to the original purchaser.

A return material authorization (RMA) must be obtained from AR before returning this instrument for warranty service. Please contact our Customer Support Center at 1-800-858-TEST (8378) to obtain an RMA number. It is important that the instrument is packed in its original container for safe transport. If the original container is not available please contact our customer support center for proper instructions on packaging. Damages sustained as a result of improper packaging will not be honored. Transportation costs for the return of the instrument for warranty service must be prepaid by the customer. AR will assume the return freight costs when returning the instrument to the customer. The return method will be at the discretion of Associated Research.

Except as provided herein, Associated Research makes no warranties to the purchaser of this instrument and all other warranties, express or implied (including, without limitation, merchantability or fitness for a particular purpose) are hereby excluded, disclaimed and waived.

Any non-authorized modifications, tampering or physical damage will void your warranty. Elimination of any connections in the earth grounding system or by-passing any safety systems will void this warranty. This warranty does not cover batteries or accessories not of Associated Research manufacture. Parts used must be parts that are recommended by AR as an acceptable specified part. Use of non-authorized parts in the repair of this instrument will void the warranty.



OPERATION AND SERVICE MANUAL

MODEL 7564SA QUADCHEK<sup>®</sup> II  
MODEL 7550DT HypotULTRA<sup>®</sup> II  
Electrical Safety Compliance Analyzers

AC/DC HIPOT WITH INSULATION RESISTANCE TESTER  
AND IEEE-488 (GPIB) INTERFACE or RS-232  
and  
GROUND BOND TESTER on 7564SA  
or  
CONTINUITY TESTER on 7550DT

SERIAL NUMBER

--	--	--	--	--	--	--	--

© Associated Research, Inc., 1997  
905 Carriage Park Avenue, Lake Bluff, Illinois, 60044-2248 U.S.A.

Item # 37737

Printed June 22, 1997  
Ver 1.01





# TABLE OF CONTENTS

<b>SECTION I OPERATORS MANUAL.....</b>	<b>1</b>
SAFETY.....	2
INTRODUCTION.....	7
SPECIFICATIONS.....	13
WHAT'S NEW.....	20
CONTROLS.....	23
INSTALLATION.....	28
QUICK START.....	31
OPERATION.....	34
OPTIONS.....	76
<b>SECTION II SERVICE MANUAL.....</b>	<b>83</b>
CALIBRATION.....	84
PARTS LIST.....	91
SCHEMATICS.....	92



**SECTION 1**  
**OPERATORS MANUAL**

---

## SAFETY PRECAUTIONS REQUIRED FOR HIGH VOLTAGE TESTING!

### GENERAL:

This product and its related documentation must be reviewed for familiarization with safety markings and instructions before operation.

This product is a Safety Class I instrument (provided with a protective earth terminal). Before applying power verify that the instrument is set to the correct line voltage (110 or 220) and the correct fuse is installed.

### SAFETY SYMBOLS:



INSTRUCTION MANUAL SYMBOL. PLEASE REFER TO THE INSTRUCTION MANUAL FOR SPECIFIC WARNING OR CAUTION INFORMATION TO AVOID PERSONAL INJURY OR DAMAGE TO THE PRODUCT



INDICATES HAZARDOUS VOLTAGES MAY BE PRESENT.



CHASSIS GROUND SYMBOL.



CALLS ATTENTION TO A PROCEDURE, PRACTICE, OR CONDITION, THAT COULD POSSIBLY CAUSE BODILY INJURY OR DEATH.



CALLS ATTENTION TO A PROCEDURE, PRACTICE, OR CONDITION, THAT COULD POSSIBLY CAUSE DAMAGE TO EQUIPMENT OR PERMANENT LOSS OF DATA.

**WARNING:** A Hipot produces voltages and currents which can cause **harmful or fatal electric shock**. To prevent accidental injury or death, these safety procedures must be strictly observed when handling and using the test instrument.

## SERVICE AND MAINTENANCE

### User Service

To prevent electric shock do not remove the instrument cover. There are no user serviceable parts inside. Routine maintenance or cleaning of internal parts is not necessary. Any external cleaning should be done with a clean dry or slightly damp cloth. Avoid the use of cleaning agents or chemicals to prevent any foreign liquid from entering the cabinet through ventilation holes or damaging controls and switches, also some chemicals may damage plastic parts or lettering. Schematics, when provided, are for reference only. Any replacement cables and high voltage components should be acquired directly from Associated Research, Inc. Refer servicing to an Associated Research, Inc. authorized service center.

ASSOCIATED RESEARCH, INC.  
905 CARRIAGE PARK AVENUE  
LAKE BLUFF, IL., 60044 -2248 U.S.A.

PHONE: 1 (847) 295-3312  
1 (800) 858-TEST (8378)  
FAX: 1 (847) 295-9165  
E-MAIL : [info@asresearch.com](mailto:info@asresearch.com)  
<http://www.asresearch.com>

### Service Interval

The instrument and its power cord, test leads, and accessories must be returned at least once a year to an Associated Research authorized service center for calibration and inspection of safety related components. Associated Research will not be held liable for injuries suffered if the instrument is not returned for its annual safety check and maintained properly.

### User Modifications

Unauthorized user modifications will void your warranty. Associated Research will not be responsible for any injuries sustained due to unauthorized equipment modifications or use of parts not specified by Associated Research. Instruments returned to Associated Research with unsafe modifications will be returned to their original operating condition at your expense.

## TEST STATION

### Location

Select an area away from the main stream of activity which employees do not walk through in performing their normal duties. If this is not practical because of production line flow, then the area should be roped off and marked for **HIGH VOLTAGE**

**TESTING.** No employees other than the test operators should be allowed inside.

If benches are placed back-to-back, be especially careful about the use of the bench opposite the test station. Signs should be posted: "**DANGER - HIGH VOLTAGE TEST IN PROGRESS - UNAUTHORIZED PERSONNEL KEEP AWAY.**"

#### Power

Dielectric Voltage-Withstand Test Equipment must be connected to a good ground. Be certain that the power wiring to the test bench is properly polarized and that the proper low resistance bonding to ground is in place.

Power to the test station should be arranged so that it can be shut off by one prominently marked switch located at the entrance to the test area. In the event of an emergency, anyone can cut off the power before entering the test area to offer assistance.

#### Work Area

Perform the tests on a nonconducting table or workbench, if possible. If you cannot avoid using a conductive surface, be certain that it is securely grounded to a good earth ground and insulate the high voltage connection from the grounded surface.

There should not be any metal in the work area between the operator and the location where products being tested will be positioned. Any other metal in the work area should be connected to a good ground, never left "floating".

Position the tester so the operator does not have to reach over the product under test to activate or adjust the tester. If the product or component being tested is small, it may be possible to construct guards or an enclosure, made of a non-conducting material such as clear acrylic, such that the item being tested is within the guards or enclosure during the test, and fit them with switches so that the tester will not operate unless the guards are in place or the enclosure closed.

Keep the area clean and uncluttered. All test equipment and test leads not absolutely necessary for the test should be removed from the test bench and put away. It should be clear to both the operator and to any observers which product is being tested, and which ones are waiting to be tested or have already been tested.

Do not perform Hipot tests in a combustible atmosphere or in any area where combustible materials are present.

### **TEST OPERATOR**

#### Qualifications

This instrument generates voltages and currents which can cause **harmful or fatal electric shock** and must only be operated by a skilled worker trained in its use.

The operator should understand the electrical fundamentals of voltage, current, and resistance. They should recognize that the test instrument is a variable high-voltage power supply with the return circuit directly connected to earth ground and therefore, current from the high-voltage output will flow through any available ground path.

#### Safety Procedures

Operators should be thoroughly trained to follow these and all other applicable safety rules and procedures before they begin a test. Defeating any safety system should be treated as a serious offense and should result in severe penalties, such as removal from the Hipot testing job. Allowing unauthorized personnel in the area during a test should also be dealt with as a serious offense.

#### Dress

Operators should not wear jewelry which could accidentally complete a circuit.

#### Medical Restrictions

This instrument should not be operated by personnel with heart ailments or devices such as pacemakers.

### TEST PROCEDURES

#### **!NEVER PERFORM A HIPOT TEST ON ENERGIZED CIRCUITRY OR EQUIPMENT!**

If the instrument has an external safety ground connection be sure that this is connected. Then Connect the return lead **first** for any test regardless of whether the item under test is a sample of insulating material tested with electrodes, a component tested with the high voltage test lead, or a cord-connected device with a two or three prong plug.

Plug in the high voltage test lead only when it is being used. Handle its clip only by the insulator---**never touch the clip directly**. Be certain that the operator has control over any remote test switches connected to the Hipot. Double check the return and high voltage connections to be certain that they are proper and secure.

#### **CAUTION**

On Models 7550DT and 7564SA the return lead of the instrument is not grounded (earthed). This allows for the monitoring of very low leakage levels of current. It is therefore important that the **device under test is never grounded (earthed)** or the current meter will essentially be bypassed and you will get incorrect current meter readings.

#### **WARNING**

**NEVER TOUCH THE ITEM UNDER TEST OR ANYTHING CONNECTED TO IT WHILE HIGH VOLTAGE IS PRESENT DURING THE HIPOT TEST.**

When testing with DC, always discharge the capacitance of the item under test and anything the high voltage may have contacted--such as test fixtures--before handling it or disconnecting the test leads.

**HOT STICK** probes can be used to discharge any capacitance in the item under test as a further safety precaution. A hot stick is a nonconducting rod about two feet long with a metal probe at the end which is connected to a wire. To discharge the device under test, two hot sticks are required. First connect both probe wires to a good earth ground. Then touch one probe tip to the same place the return lead was connected. While holding the first probe in place, touch the second probe tip to the same place where the high voltage lead was connected.

#### KEY SAFETY POINTS TO REMEMBER:

- Keep unqualified and unauthorized personnel away from the test area.
- Arrange the test station in a safe and orderly manner.
- Never touch the product or connections during a test.
- In case of any problem, turn off the high voltage first.
- Properly discharge any item tested with DC before touching connections.



---

## GLOSSARY OF TERMS

(as used in this manual)

**Alternating Current, AC:** Current which reverses direction on a regular basis, commonly in the U.S.A. 60 per second, in other countries 50 times per second.

**Breakdown:** The failure of insulation to effectively prevent the flow of current, sometimes evidenced by arcing. If voltage is gradually raised, breakdown will begin suddenly at a certain voltage level. Current flow is not directly proportional to voltage. Once breakdown current has flown, especially for a period of time, the next gradual application of voltage will often show breakdown beginning at a lower voltage than initially.

**Conductive:** Having a volume resistivity of no more than  $10^3$  ohm-cm or a surface resistivity of no more than  $10^5$  ohms per square.

**Conductor:** A solid or liquid material which has the ability to let current pass through it, and which has a volume resistivity of no more than  $10^3$  ohm-cm.

**Current:** The movement of electrons through a conductor. Current is measured in amperes, milliamperes, microamperes, nanoamperes, or picoamperes. Symbol = **I**

**Dielectric:** An insulating material which is positioned between two conductive materials in such a way that a charge or voltage may appear across the two conductive materials.

**Direct Current, DC:** Current which flows in one direction only. The source of direct current is said to be polarized and has one terminal which is always at a higher potential than the other.

**Hipot Tester:** Common term for dielectric-withstand test equipment.

**Hypot®:** Registered trademark of Associated Research, Inc., for its dielectric-withstand test equipment.

**Insulation:** Gas, liquid or solid material which has a volume resistivity of at least  $10^{12}$  ohm-cm and is used for the purpose of resisting current flow between conductors.

**Insulation Resistance Tester:** An instrument or a function of an instrument capable of measuring resistance's in excess of 200 megohms. Usually employs a higher voltage power supply than used in ohmmeters measuring up to 200 megohms.

**Leakage:** Ac or DC current flow through insulation and over its surfaces, and AC current flow through a capacitance. Current flow is directly proportional to voltage. The insulation and/or capacitance is thought of as a constant impedance, unless breakdown occurs.

**Resistance:** That property of a substance which impedes current and results in the dissipation of power in the form of heat. The practical unit of resistance is the *ohm*. Symbol = **R**

**Trip Point:** The minimum current flow required to cause an indication of unacceptable performance during a dielectric voltage-withstand test.

**Voltage:** Electrical pressure, the force which causes current through an electrical conductor.  
Symbol = **V**

## INTRODUCTION

### **The importance of testing... User safety**

In an era of soaring liability costs, original manufacturers of electrical and electronic products must make sure every item is as safe as possible. All products must be designed and built to prevent electric shock, even when users abuse the equipment or by-pass built in safety features.

To meet recognized safety standards, one common test is the "dielectric voltage-withstand test". Safety agencies which require compliance safety testing at both the initial product design stage and for routine production line testing include: Underwriters Laboratories, Inc. (UL), the Canadian Standards Association (CSA), the International Electrotechnical Commission (IEC), the British Standards Institution (BSI), the Association of German Electrical Engineers (VDE) and (TÜV), the Japanese Standards Association (JSI). These same agencies may also require that an insulation resistance test and high current ground bond test be performed.

### **The Dielectric Withstand (Hipot) Test....**

The principle behind a dielectric voltage - withstand test is simple. If a product will function when exposed to extremely adverse conditions, it can be assumed that the product will function in normal operating circumstances.

The most common applications of the dielectric-withstand test are:

- Design (performance) Testing.... determining design adequacy to meet service conditions.
- Production Line Testing.... detecting defects in material or workmanship during processing.
- Acceptance Testing.... proving minimum insulation requirements of purchased parts.
- Repair Service Testing.... determine reliability and safety of equipment repairs.

The specific technique varies with each product, but basically, during a dielectric voltage - withstand test, an electrical device is exposed to a voltage significantly higher than it normally encounters. The high voltage is continued for a given period of time.

During the test, all "stray" current flow to ground is measured. If, during the time the component is tested, stray current flow remains within specified limits, the device is assumed to be safe under normal conditions. The basic product design and use of the insulating material will protect the user against electrical shock.

The equipment used for this test, a dielectric-withstand tester, is often called a "hipot" (for high potential tester). The "rule of thumb" for testing is to subject the product to twice its

normal operating voltage, plus 1,000 volts.

However, specific products may be tested at much higher voltages than 2X operating voltages + 1,000 volts. For example, a product designed to operate in the range between 100 to 240 volts, can be tested between 1,000 to 4,000 volts or higher. Most "double insulated" products are tested at voltages much higher than the "rule of thumb".

Testing during development and prototype stages is more stringent than production run tests because the basic design of the product is being evaluated. Design tests usually are performed on only a few samples of the product. Production tests are performed on each and every item as it comes off the production line.

The hipot tester must also maintain an output voltage between 100% and 120% of specification. The output voltage of the hipot must have a sinusoidal waveform with a frequency between 40 to 70 Hz and has a peak waveform value that is not less than 1.3 and not more than 1.5 times the root-mean-square value.

#### **Advantages and Disadvantages of AC Testing and DC Testing....**

Please check with the Compliance Agency you are working with to see which of the two type of voltages you are authorized to use. In some cases a Compliance Agency will allow either AC or DC testing to be done. However in other cases the Compliance Agency only allows for an AC test. If you are unsure which specification you must comply with please contact our CUSTOMER SUPPORT GROUP at 1-800-858-TEST (8378).

Many safety agency specifications allow either AC or DC voltages to be used during the hipot test. When this is the case the manufacturer must make the decision on which type of voltage to utilize. In order to do this it is important to understand the advantages and the disadvantages of both AC and DC testing.

#### AC testing characteristics

Most items that are hipot tested have some amount of distributed capacitance. An AC voltage cannot charge this capacitance so it continually reads the reactive current that flows when AC is applied to a capacitive load.

#### AC testing advantages

1. AC testing is generally much more accepted by safety agencies than DC testing. The main reason for this is that most items being hipot tested will operate at AC voltages and AC hipot testing offers the advantage of stressing the insulation alternately in both polarities which more closely simulates stresses the product will see in real use.
2. Since AC testing cannot charge a capacitive load the current reading remains consistent from initial application of the voltage to the end of the test. Therefore,

there is no need to gradually bring up the voltage since there is no stabilization required to monitor the current reading. This means that unless the product is sensitive to a sudden application of voltage the operator can immediately apply full voltage and read current without any wait time.

3. Another advantage of AC testing is that since AC voltage cannot charge a load there is no need to discharge the item under test after the test.

#### AC testing disadvantages

1. A key disadvantage of AC testing surfaces when testing capacitive products. Again, since AC cannot charge the item under test, reactive current is constantly flowing. In many cases the reactive component of the current can be much greater than the real component due to actual leakage. This can make it very difficult to detect products that have excessively high leakage current.
2. Another disadvantage of AC testing is that the hipot has to have the capability of supplying reactive and leakage current continuously. This may require a current output that is actually much higher than is really required to monitor leakage current and in most cases is usually much higher than would be needed with DC testing. This can present increased safety risks as operators are exposed to higher currents.

#### DC testing characteristics

During DC hipot testing the item under test is charged. The same test item capacitance that causes reactive current in AC testing results in initial charging current which exponentially drops to zero in DC testing.

#### DC testing advantages

1. Once the item under test is fully charged the only current flowing is true leakage current. This allows a DC hipot tester to clearly display only the true leakage of the product under test.
2. The other advantage to DC testing is that since the charging current only needs to be applied momentarily the output power requirements of the DC hipot tester can typically be much less than what would be required in an AC tester to test the same product.

#### DC testing disadvantages

1. Unless the item being tested has virtually no capacitance it is necessary to raise the voltage gradually from zero to the full test voltage. The more capacitive the item the more slowly the voltage must be raised. This is important since most DC hipots have failure shut off circuitry which will indicate failure almost immediately if the total

current reaches the leakage threshold during the initial charging of the product under test.

2. Since a DC hipot does charge the item under test it becomes necessary to discharge the item after the test.
3. DC testing unlike AC testing only charges the insulation in one polarity. This becomes a concern when testing products that will actually be used at AC voltages. This is a key reason that some safety agencies do not accept DC testing as an alternative to AC.
4. When performing AC hipot tests the product under test is actually tested with peak voltages that the hipot meter does not display. This is not the case with DC testing since a sinewave is not generated when testing with direct current. In order to compensate for this most safety agencies require that the equivalent DC test be performed at higher voltages than the AC test. The multiplying factor is somewhat inconsistent between agencies which can cause confusion concerning exactly what equivalent DC test voltage is appropriate.

#### **The Insulation Resistance Test....**

Some "dielectric analyzers today come with a built in insulation resistance tester. Typically the IR function provides test voltages from 500 to 1,000 volts DC and resistance ranges from kilohms to gigaohms. This function allows manufacturers to comply with special compliance regulations. BABT, TÜV and VDE are agencies that may under certain conditions require an IR test on the product before a Hipot test is performed. This typically is not a production line test but a performance design test.

The insulation resistance test is very similar to the hipot test. Instead of the go/no go indication that you get with a hipot test the IR test gives you an insulation value usually in Megohms. Typically the higher the insulation resistance value the better the condition of the insulation. The connections to perform the IR test are the same as the hipot test. The measured value represents the equivalent resistance of all the insulation which exists between the two points and any component resistance which might also be connected between the two points.

Although the IR test can be a predictor of insulation condition it does not replace the need to perform a dielectric withstand test.

#### **TYPES OF FAILURES DETECTABLE ONLY WITH A HIPOT TEST**

- Weak Insulating Materials
- Pinholes in Insulation
- Inadequate Spacing of Components
- Pinched Insulation

---

## The Ground Bond Test

The Ground Bonding test determines whether the safety ground circuit of the product under test can adequately handle fault current if the product should ever become defective. A low impedance ground system is critical in ensuring that in the event of a product failure a circuit breaker on the input line will act quickly to protect the user from any serious electrical shock.

International compliance agencies such as CSA, IEC, TÜV, VDE, BABT and others, have requirements calling out this test. This test should not be confused with simple low current continuity tests that are also commonly called out in some safety agency specifications. A low current test merely indicates that there is a safety ground connection, it does not completely test the integrity of that connection.

Compliance agency requirements vary on how different products are to be tested. Most specifications call for test currents of between 10 and 30 amps. Test voltages at these currents are typically required to be less than 12 volts. Maximum allowable resistance readings of the safety ground circuit are normally between 100 and 200 milliohms.

The 7564SA provides up to 30 amps output current at any voltage between 3 and 8 volts through the safety ground of the product under test. Simultaneously the instrument measures the induced voltage across the safety ground circuit to determine the impedance of the ground connection. The meter displays the resistance reading of the ground circuit in milliohms.

The measured values are typically very low so it is extremely important to avoid reading the resistance of the test leads that are used to connect the test instrument to the product under test. If this is not done a device may be tagged as having a safety ground failure when it is actually the combined resistance of the DUT and the test leads that has caused the maximum resistance level to be exceeded. The 7564SA milliohm offset feature can be adjusted to disregard the resistance of the test leads.

<p><b>IF YOU SHOULD HAVE ANY QUESTIONS RELATING TO THE OPERATION OF YOUR INSTRUMENT CALL 1-800-858-TEST(8378) IN THE U.S.A.</b></p>
---



## Model 7564SA / 7550DT Functional Specifications

<b>INPUT</b>	
Voltage	115/230 VAC $\pm$ 15%, Single Phase, User selection
Frequency	47 - 63 Hz
Fuse	6.3 Amp 250V Slo-Blo
<b>DIELECTRIC WITHSTAND TEST MODE</b>	
Output Rating	5 KV @ 40 mA AC 6 KV @ 10 mA DC
Output Adjustment	Range: 0 - 5 KV AC 0 - 6 KV DC Resolution: 1 volt/step Accuracy: $\pm$ (2% of setting + 5 volts)
Ramp-HI	12mA peak maximum, ON/OFF selectable
Charge-LO	Range: 0.0 - 350.0 $\mu$ A DC or Auto set
HI-Limit	AC Range: 0.00 - 40.00 mA Resolution: 0.01 mA/step Accuracy: $\pm$ (2% of setting + 2 counts) DC Range: 0 - 3500 $\mu$ A Resolution: 1 $\mu$ A/step Accuracy: $\pm$ (2% of setting + 2 counts)
LO-Limit	AC Range: 0.000 - 9.999 mA Resolution: 0.001 mA/step Accuracy: $\pm$ (2% of setting + 2 counts) DC Range: 0.0 - 999.9 $\mu$ A Resolution: 0.1 $\mu$ A/step Accuracy: $\pm$ (2% of setting + 2 counts)
Arc Detection	Range: 1 - 9
Failure Detector	Audible and Visual

Voltage Display	Range: 0.00 - 6.00 KV Full Scale Resolution: 10 volt/step Accuracy: $\pm$ (2% of reading + 2 counts)
Current Display	Auto Range AC Range: 0.000 - 3.500mA Resolution: 0.001mA/step Accuracy: $\pm$ (2% of reading + 2 counts) Range: 3.00 mA - 40.00 mA Resolution: 0.01 mA/step Accuracy: $\pm$ (2% of reading + 2 counts) DC Range: 0.0 $\mu$ A - 350.0 $\mu$ A Resolution: 0.1 $\mu$ A/step Accuracy: $\pm$ (2% of reading + 2 counts) Range: 300 $\mu$ A - 3500 $\mu$ A Resolution: 1 $\mu$ A/step Accuracy: $\pm$ (2% of reading + 2 counts)
DC Output Ripple	$\leq$ 4% Ripple RMS at 6 KV DC @ 3.5 mA, Resistive Load
AC Output Wave Form	Sine Wave, Crest Factor = 1.3 - 1.5
Output Frequency	Range: 60 or 50 Hz, User Selection Accuracy: $\pm$ 100 PPM
Output Regulation	$\pm$ (1 % of setting + 5 volts) from no load to full load
Dwell Timer	Range: 0, 0.3 - 999.9 sec (0 = Constant) Resolution: 0.1 sec increments Accuracy: $\pm$ (0.1% + 0.05 sec)
Ramp Timer	Range: AC 0.1 - 999.9 sec DC 0.4 - 999.9 sec Resolution: 0.1 sec increments Accuracy: $\pm$ (0.1% + 0.05 sec)
Ground Continuity Model 7550DT only	Current : DC 0.1 A $\pm$ 0.01A, fixed Max. ground resistance : 1 $\Omega$ $\pm$ 0.1 $\Omega$ , fixed



INSULATION RESISTANCE TEST MODE																			
Output Voltage	Range: 100 - 1000 Volts DC Resolution: 1 volt/step Accuracy: $\pm$ (2% of reading + 2 volts)																		
Short Circuit Current	Maximum: 12mA peak																		
Voltage Display	Range: 0 - 1000 V Resolution: 1 volt/step Accuracy: $\pm$ (2% of reading + 2 counts)																		
Resistance Display	Range: 1 - 9999 M $\Omega$ (4 Digit, Auto Ranging) Resolution: <table border="1" style="margin-left: 20px;"> <thead> <tr> <th></th> <th>500VDC</th> <th>1000VDC</th> </tr> </thead> <tbody> <tr> <td>M<math>\Omega</math></td> <td>M<math>\Omega</math></td> <td>M<math>\Omega</math></td> </tr> <tr> <td>0.001</td> <td>1.000 - 5.388</td> <td>1.000 - 9.999</td> </tr> <tr> <td>0.01</td> <td>1.40 - 53.88</td> <td>2.80 - 99.99</td> </tr> <tr> <td>0.1</td> <td>14.0 - 538.8</td> <td>28.0 - 999.9</td> </tr> <tr> <td>1</td> <td>104 - 9999</td> <td>280 - 9999</td> </tr> </tbody> </table> Accuracy: <ul style="list-style-type: none"> <li><math>\pm</math> (2% of reading + 2 counts) at test voltage 500 - 1000V and 1 - 1000 M<math>\Omega</math></li> <li><math>\pm</math> (8% of reading + 2 counts) at test voltage 500 - 1000V and 1000 - 9999 M<math>\Omega</math></li> <li><math>\pm</math> (8% of reading + 2 counts) at test voltage 100 - 500V and 0 - 1000 M<math>\Omega</math></li> </ul>		500VDC	1000VDC	M $\Omega$	M $\Omega$	M $\Omega$	0.001	1.000 - 5.388	1.000 - 9.999	0.01	1.40 - 53.88	2.80 - 99.99	0.1	14.0 - 538.8	28.0 - 999.9	1	104 - 9999	280 - 9999
	500VDC	1000VDC																	
M $\Omega$	M $\Omega$	M $\Omega$																	
0.001	1.000 - 5.388	1.000 - 9.999																	
0.01	1.40 - 53.88	2.80 - 99.99																	
0.1	14.0 - 538.8	28.0 - 999.9																	
1	104 - 9999	280 - 9999																	
Charge-LO	Range: 0.000 - 3.500 $\mu$ A or Auto Set																		
HI-Limit	Range: 0 - 9999 M $\Omega$ (0 = Off)																		
LO-Limit	Range: 1 - 9999 M $\Omega$																		
Delay Timer	Range: 0, 0.5 - 999.9 sec (0 = Constant) Resolution: 0.1 sec/step Accuracy: $\pm$ (0.1% + 0.05 sec)																		

<b>GROUND BOND TEST MODE</b>		<b>Model 7564SA only</b>
Output Voltage (Open Circuit Limit)	Range:	3.00 - 8.00 Volts AC
	Resolution:	0.01 volt/step
	Accuracy:	$\pm (2 \% \text{ of Setting} + 0.03\text{V})$ O.C. Condition
Output Frequency	Range:	60 or 50 Hz, User Selection
	Accuracy:	$\pm 100$ PPM
Output Current	Range:	3.00 - 30.00 Amps AC
	Resolution:	0.01 Amp/step
	Accuracy :	$\pm (2 \% \text{ of Setting} + 0.02 \text{ A})$
Current Display	Range:	0.00 - 30.00 Amps
	Resolution:	0.01 Amp/step
	Accuracy:	$\pm (3 \% \text{ of Reading} + 0.03 \text{ A})$
Resistance Display	Range:	0 - 600 m $\Omega$
	Resolution:	1 m $\Omega$ /step
	Accuracy:	$\pm (2 \% \text{ of Reading} + 2 \text{ m}\Omega)$
HI-Limit	Range:	0 - 600 m $\Omega$ for 3 - 10 A 0 - 150 m $\Omega$ for 3 - 30 A
	Resolution:	1 m $\Omega$ /step
	Accuracy:	$\pm (2 \% \text{ of Setting} + 2 \text{ m}\Omega)$
LO-Limit	Range:	0 - 600 m $\Omega$ for 3 - 10 A 0 - 150 m $\Omega$ for 3 - 30 A
	Resolution:	1 m $\Omega$ /step
	Accuracy:	$\pm (2 \% \text{ of Setting} + 2 \text{ m}\Omega)$
Dwell Timer	Range:	0, 0.5 - 999.9 sec (0 = Constant)
	Resolution:	0.1 sec/step
	Accuracy:	$\pm (0.1\% + 0.05 \text{ sec})$
Milliohm Offset	Max. Offset Capability:	200 m $\Omega$
	Resolution:	1 m $\Omega$ / step
	Accuracy:	$\pm (2 \% \text{ of Setting} + 2 \text{ m}\Omega)$

<b>GENERAL SPECIFICATIONS</b>	
PLC Remote Control	Input - Test, Reset, Recall memory # 1, # 2 and # 3 Output - Pass, Fail, Test-in-Process
Memory	Allows storage of up to 50 groups different test programs and 8 step/each memory.
Security	Programmable password lockout capability to avoid unauthorized access to test set-up program.
LCD Contrast Setting	9 ranges set by the numeric keys on the front panel.
Buzzer Volume Setting	10 ranges set by the numeric key on the front panel.
Calibration	Software and adjustments are made through front panel.
Mechanical	Bench or rack mount with tilt up front feet.
Dimension	(W x H x D) 17 x 5.8 x 20.3 in. (432 x 147 x 515 mm)
Weight	7564SA without scanner      52.5 lbs      (24 Kgs) 7564SA with built-in scanner      57 lbs      (26 Kgs) 7550DT without scanner      50.5 lbs      (23 Kgs) 7550DT with built-in scanner      55 lbs      (25 Kgs)
Scanner Port	Two Port Maximum including the built-in scanner.
Scanner	High Voltage x 8 Ports (7564SA and 7550DT)
Built-in Option	Ground Bond x 8 Ports (7565SA only)
Real Current Option	Measuring Range: 0-3500 $\mu$ A Resolution & accuracy are same as total current measuring.

**KEY FEATURES & BENEFITS SUMMARY: MODELS 7550DT & 7564SA**

- **The first complete systems to include AC Hipot, DC Hipot, Insulation Resistance and Ground Bond test into a single 19 inch rack mount cabinet**

HypotULTRA II combines the three most common dielectric safety tests (AC Hipot, DC Hipot & IR test) required by agencies such as UL, CSA, IEC, VDE, TÜV, BABT and others into a single instrument which takes up less rack space and enables a single DUT connection. QUADCHEK II includes the same dielectric tests along with a high current Ground Bond test for applications requiring a test of the safety ground circuit.
- **Full GPIB (IEEE 488) or RS232 interfaces as standard features**

All the functions of the instrument can be programmed over either interface which makes the instrument adaptable to any type of automated production environment.
- **The only instruments that offer an optional built-in 8 port scanner and an interface to control up to two external scanners for expansion capabilities up to 16 ports**

These optional scanner configurations are ideal for multi-point testing of a single item or multiple product testing. The high voltage outputs of either the internal or external scanner can be set as high, low or off. A front panel display shows the status of each scanner output port. The scanner for use with the QUADCHEK II also offers 8 ports for high current Ground Bond testing.
- **A single 2 x 20 LCD display provides a clear indication of all test results and setup parameters**

This single easy-to-view and simple-to-interpret LCD display allows the operator to monitor all test activity.
- **All setup parameters can be adjusted through a simple menu driven program with hot keys to quickly access all functions by using the front panel**

The operator is provided with an easy and safe way to set trip currents and output voltages since all parameters are set without high voltage activated. The easy to follow menu ensures that the operator correctly sets up each test mode.
- **Storage of up to 50 setups with 8 steps per setup**

A real benefit for manufacturers that test different products. Each setup can store up to 8 steps which can be configured to perform any of the safety tests. In addition each setup can be linked to the next for setting up as many as 400 steps in sequence.
- **Exclusive CHARGE LO and RAMP HI testing features allow for more effective DC Hipot testing**

The RAMP HI feature allows the user to set a higher trip rate during the ramp to allow for quick charging of the product without nuisance tripping thereby increasing throughput when testing with DC. The CHARGE LO provides the user with the capability to ensure that the device under test is connected correctly.
- **Programmable security password system**

Avoids tampering with settings by only allowing authorized personnel with a user programmable security password to change test parameters.

- **Line and Load regulation** Maintains the output voltage to within 1% of setting even if the load or the line voltage varies. This ensures that the test results remain consistent and within safety agency requirements.
- **PLC remote inputs & outputs** This allows the instruments to be remotely monitored and set up completely through simple PLC control.
- **Up to 40mA of current is available in AC Hipot mode and 3500  $\mu$ A in DC Hipot mode with resolutions of 10 microamps in AC and 1 microamp in DC** This makes these instruments true hipot testers with enough output current to test even highly capacitive loads while allowing them to be versatile enough to monitor leakage current of items with very low leakage measurement requirements.
- **Digitally controlled arc detection system** Allows the operator to select whether low level arcs should be detected and provides the operator with the ability to digitally select and program multiple sensitivity levels.
- **Four wire measurement (Kelvin Method) and milliohm offset capability in the Ground Bond mode** The four wire measurement technique eliminates test lead resistance when using the standard test leads. The milliohm offset function allows the use of longer test leads and test fixtures without compromising test results.

### What's new with QUADCHEK II and HypotULTRA II.

- **Optional built-in 8 port scanner** - These instruments now offer the capability of easily and quickly testing multiple products or multiple points with a single instrument. The HypotULTRA II may be configured with a built-in 8 port high voltage scanner. The QUADCHEK II built-in scanner option includes 8 ports for Ground Bond in addition to 8 high voltage ports. In addition, either instrument includes an interface to allow control of an external and internal scanner or two external scanners for a total of 16 port control through the instrument without any additional interface requirements.
- **HS-8A & HS-16 External Multiplexer Scanners** - Two new optional external scanners are available for either instrument. The HS-8A features 8 high voltage and 8 ground bond ports. The HS-8A may be used alone as an external scanner or in conjunction with the optional internal scanner providing a total of 16 ports. The HS-16 has 16 high voltage and 16 ground bond ports. In addition, it may be controlled by its own built-in GPIB or RS-232 interface providing complete automation control and flexibility.
- **RS-232 Interface** - The standard interface on these new models continues to be GPIB (IEEE-488). However, the instruments are now offered with the option of an RS-232 interface instead of GPIB to maximize their interface flexibility.
- **Single 2 X 20 LCD display** - A single easy to interpret display makes setup of the instrument simple. All functions and test results are clearly displayed without multiple displays and hard to understand abbreviations.
- **Quick access user interface** - To make access to each function of the instrument easier we have now configured the instruments with dedicated "hot keys" that quickly allow the user to step through each mode of the instrument without having to scroll through the entire menu.
- **Enhanced storage capability** - The total number of setup memories have been increased to 50. In addition, each memory can include up to 8 steps which all can be linked together for a maximum of 400 steps in sequence.
- **Exclusive Charge-LO function** - This new function enhances DC hipot testing by ensuring that the DUT is connected properly. A problem with LO-Limit detect circuitry in DC applications is that once the DUT is fully charged steady current is normally well below the range of LO-Limit detect circuitry. This new feature monitors the momentary charging current pulse and uses it to detect whether the DUT is connected. The Charge-LO function has an auto setup mode so the user does not need to make any difficult calculations to determine what the setting should be.

- **Enhanced Milliohm offset** - The milliohm offset function has been added to each step in the memory to allow for different lead lengths when using a scanner to perform multiple ground bond tests.
- **Ramp-HI function** - This is another enhancement for DC hipot testing. During a DC test once the DUT is charged the actual leakage current is very low. Unfortunately, users have not been able to set the trip point this low because unless the ramp time was very slow false failures would occur during the ramp cycle when the DUT draws more current due to charging. The new Ramp-HI function allows the instrument to provide the full 10 mA output during the charge cycle and then monitor a much lower setting during the dwell cycle when the DUT is fully charged.
- **Programmable security password** - Users can now program their own numeric password to lock the front panel and only allow authorized personnel to change test parameters.
- **Lighter weight and reduced size** - Both instruments are now enclosed in a smaller 3U rack mount cabinet to minimize their rack space needs. The weight of both instruments has been reduced to less than 50 pounds.
- **High resolution current metering** - Resolution in AC hipot mode is now 1 microamp and 0.1 microamp in DC hipot mode.
- **High resolution timers** - The ramp and dwell time resolution has been improved to 0.1 second increments.
- **Digitally adjustable arc detection** - The arc detection mode is now menu controlled and can be adjusted over a range of 1 - 9 to allow it to be adjusted for the DUT. In addition, the arc detection sensitivity can now be controlled through the remote interface which makes all functions completely programmable.
- **HypotULTRA II Continuity mode** - A continuity test mode has been added to the HypotULTRA II to comply with UL and other safety agency specifications that call for a basic low current ground continuity test.
- **Fail Stop ON/OFF mode** - This new mode is particularly useful in scanner applications. This allows either instrument to be setup to continue testing after detecting a failure. A display of all final PASS/FAIL results on items tested is provided at the conclusion of the test cycle.
- **Buffer Memory** - This new feature stores the complete test results for up to 8 tests, so that the user can go back and review the complete test results for each step at the end of a test.



- **Enhanced GPIB Functions** - The GPIB remote control has been improved to allow for Service Request Interrupt (SRQ) capability. The instrument is now capable of interrupting or Requesting Service (RQS) from the controller (CIC) for special events such as test failures, aborted tests, GPIB command errors, or to indicate all tests were passed. In addition the GPIB controller can retrieve stored test results from up to 8 different tests that have been stored in the instruments memory as well as, polling the instrument for real time data acquisition.
- **Real Current Option** - The Real Current option allows the user to monitor only the real portion of the leakage current and ignore any reactive components due to capacitance in the device under test. Since the real component is usually much smaller than the reactive current, a doubling of the real current increases the total current by only a small amount. Unless the two components are separated, a doubling of the real leakage current can go virtually undetected by a total current measurement.



**FRONT PANEL CONTROLS**

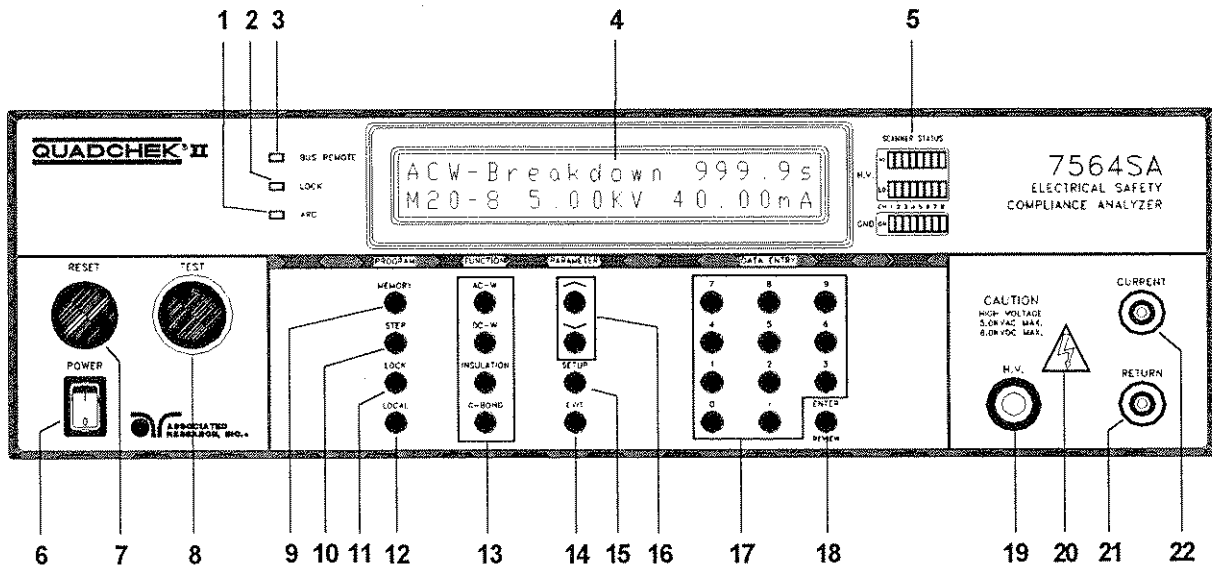

1. **ARC LED:** This indicator will illuminate when the Arc Detector has detected an arcing condition. This indicator will function even when the Arc Fail has been disabled.
2. **LOCK LED:** When the Lock LED is on, the "password" software lockout has been enabled. This means that the users will be unable to access the "program" mode of the instrument to change any settings. When Memory-Lock is OFF the user can change memory locations.
3. **BUS REMOTE LED:** This indicator will light when the instrument is in the Remote Control mode. When the BUS Remote is on the instrument is able to send and receive signals across the GPIB IEEE-488 or RS-232 bus.
4. **LCD DISPLAY:** The 2x20 character display indicates test function, memory and step location, test parameter and failure type as well as test measurements during a test.
5. **SCANNER STATUS LED's:** These LED's indicate the status of the 8 H.V. and 8 G-Bond ports on the internal scanner. G-Bond ports on model 7564SA only.
6. **POWER SWITCH:** Rocker-style switch with international ON ( | ) and OFF ( 0 ) markings.
7. **RESET BUTTON:** This is a momentary contact switch. If an out-of-range leakage current condition, an arc breakdown, HI-limit, LO-Limit or ground bond failure occur you will need to reset the system before you can proceed to the next test. Press and release the red "RESET" button.

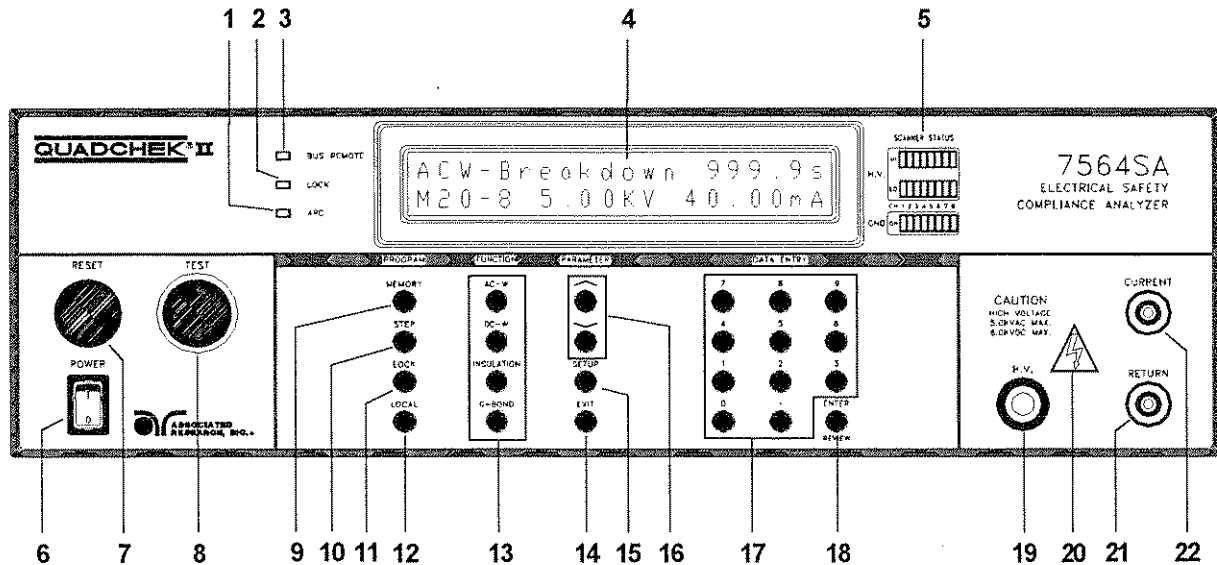

8. **TEST BUTTON:** This is a momentary contact switch. Press the green button to turn on the high voltage output. Also illuminates to indicate a Pass condition.
9. **MEMORY: (PROGRAM KEY)** Use this key to select one of the 50 memories to modify or run stored test parameters.
10. **STEP: (PROGRAM KEY)** Use this key to select one of the 8 locations contained within each memory.
11. **LOCK: (PROGRAM KEY)** Use this key to select key lockout mode. A password may be used when setup in the calibration mode.
12. **LOCAL: (PROGRAM KEY)** Use this key when you wish to go from the Remote operation of the instrument to the Local mode.
13. **FUNCTION KEYS:** Use these keys to select the test function that will be performed for the memory and step indicated. The four selections are:  
**AC-W:** AC Withstand Test  
**DC-W:** DC Withstand Test  
**INSULATION:** Insulation Resistance Test  
**G-BOND:** Ground Bond Test
14. **EXIT: (PARAMETER KEY)** Use this key to exit any menu or to clear an unwanted entry in a parameter field.
15. **SETUP: (PARAMETER KEY)** Use this key to enter the setup menu and view or change the GPIB address, display contrast, alarm volume, PLC remote settings, or the stop on fail setting.

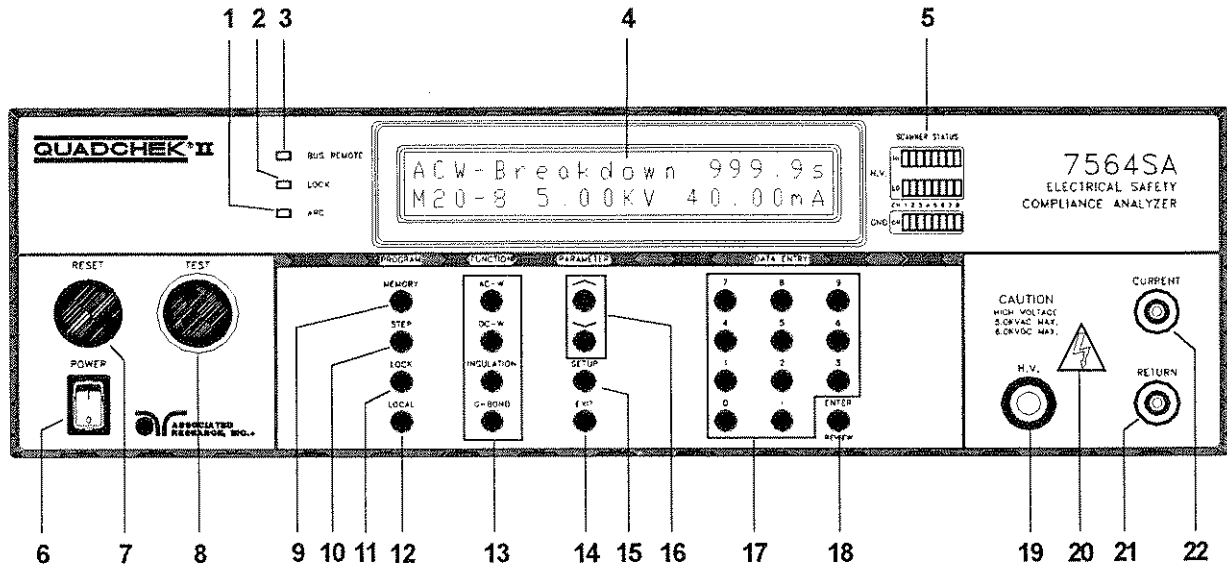

16. **UP-DOWN ARROW KEYS: (PARAMETER KEY)** Use these keys to enter and move through the function parameter menus for AC-W, DC-W, IR, and G-BOND tests.
17. **DATA ENTRY KEYS:** Use these keys to input numeric parameters followed by the ENTER key.
18. **ENTER/REVIEW KEY:** Use this key as an ENTER key to accept numeric data for parameter settings. Or use this key as a REVIEW key to recall up to 8 connected test results after a test has been completed.
19. **HIGH VOLTAGE OUTPUT JACK:** For the connection of the detachable 5 foot (1.52 m) high voltage test lead. The silicone rubber insulation is flexible for easy handling and is rated at 30KVDC. The jack is recessed for safety when this lead is not being used.
20. **HIGH VOLTAGE ON INDICATOR:** This indicator flashes to warn the operator that high voltage is present at the high voltage output terminal.
21. **RETURN OUTPUT JACK:** For the connection of the detachable 5 foot (1.52 m) return test lead. This lead is always used when performing a test. On model 7564SA this jack will carry high current for the Ground Bond test
22. **CURRENT OUTPUT JACK: (Model 7564SA only)** For the connection of the detachable 5 foot (1.52 m) high current output lead used for the ground bond test. This lead is only used for the ground bond test.

**GROUND CONTINUITY JACK: (Model 7550DT only)** For the connection of the detachable 5 foot (1.52 m) low current return lead used for the ground continuity test.

**REAR PANEL CONTROLS**

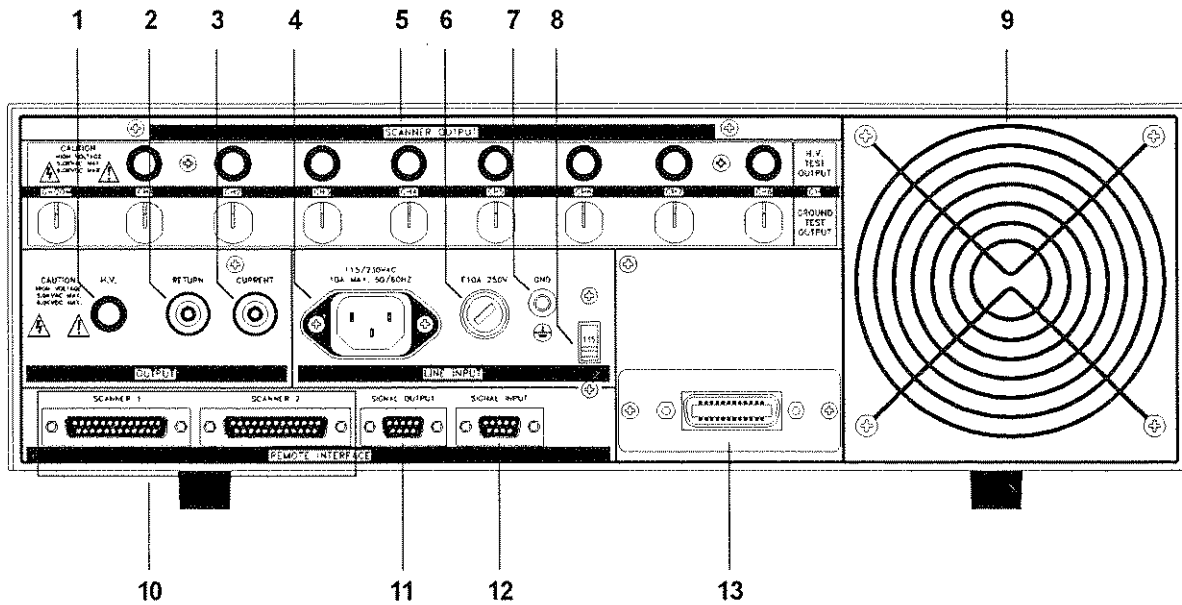

1. **HIGH VOLTAGE OUTPUT JACK:** For the connection of the detachable 5 foot (1.52 m) high voltage test lead. The silicone rubber insulation is flexible for easy handling and is rated at 30KVDC. The jack is recessed for safety when this lead is not being used.
2. **RETURN OUTPUT JACK:** For the connection of the detachable 5 foot (1.52 m) return test lead. This lead is always used when performing a test. On model 7564SA this jack will carry high current for the Ground Bond test
3. **CURRENT OUTPUT JACK:** (Model 7564SA only) For the connection of the detachable 5 foot (1.52 m) high current output lead used for the ground bond test. This lead is only used for the ground bond test.

**GROUND CONTINUITY JACK:** (Model 7550DT only) For the connection of the detachable 5 foot (1.52 m) low current return lead used for the ground continuity test.

4. **INPUT POWER RECEPTACLE:** Standard IEC 320 connector for connection to a standard NEMA style line power (mains) cord.
5. **SCANNER OUTPUTS:** Optional scanner matrix that provides 8 HV/Return connections and 8 Ground Bond connections. Ground Bond available on model 7564SA only
6. **FUSE RECEPTACLE:** To change the fuse unplug the power (mains) cord and turn the fuse receptacle counter-clockwise. The fuse compartment will be exposed. Please replace the fuse with one of the proper rating.

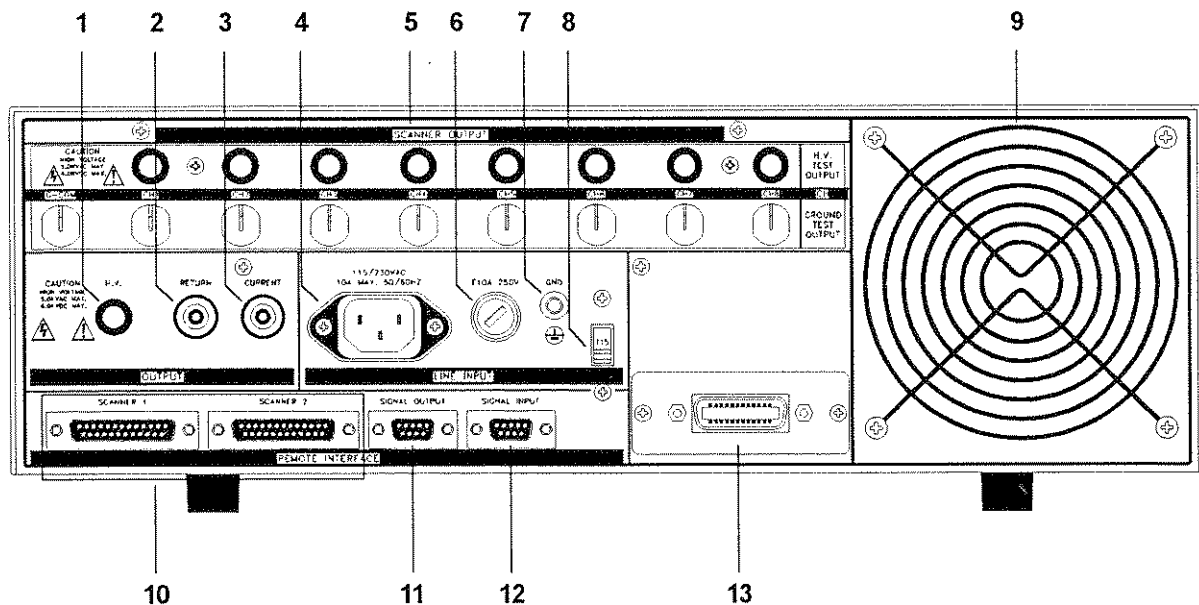

7. **CHASSIS GROUND (EARTH) TERMINAL:** This terminal should be connected to a good earth ground before operation.
8. **INPUT POWER SWITCH:** Line voltage selection is set by the position of the switch. In the up position it is set for 110-120 volt operation, in the down position it is set for 220-240 volt operation.
9. **THERMAL COOLING FAN:** Runs continuously to cool the instrument.
10. **SCANNER 1, SCANNER2 CONNECTORS:** For connection of optional Scanning Matrix HS-8A (or previous model HS-8).
11. **REMOTE SIGNAL OUTPUT:** 9-Pin D subminiature male connector for remote control of test and reset functions as well as program memory selection 1, 2, or 3.
12. **REMOTE SIGNAL INPUT:** 9-Pin D subminiature female connector for monitoring PASS, FAIL, and PROCESSING output relay signals.
13. **GPIB:** Standard connector for interconnection to the IEEE 488 Bus interface. Optional RS-232 interface can be substituted for this interface.

---

## INSTALLATION

### Introduction

This section contains information for the unpacking, inspection, preparation for use and storage of your Associated Research, Inc., product.

### Unpacking and Inspection

Your instrument was shipped in a custom foam insulated container that complies with ASTM D4169-92a Assurance Level II Distribution Cycle 13 Performance Test Sequence.

If the shipping carton is damaged, inspect the contents for visible damage such as dents, scratches or broken meters. If the instrument is damaged, notify the carrier and the Associated Research customer support department immediately. Please save the shipping carton and packing material for the carriers inspection. Our customer support department will assist you in the repair or replacement of your instrument. Please do not return your product without first notifying us and receiving an RMA (return material authorization) number.

### Preparation for Use

#### Instrument Return Connection to DUT

**CAUTION** The output power supplies of this instrument are referenced directly to earth ground. Any conductor that completes a path between the high voltage and earth ground will form a completed circuit. However, the Return lead of instrument is not connected directly to earth ground to eliminate monitoring stray leakage currents that flow to earth ground. The metering circuit monitors only leakage current flowing from the DUT through the Return test lead to the Return connector. Therefore it is crucial that the DUT does not make direct contact with earth ground or the metering circuit and leakage fail detectors will be **Bypassed**.

If the DUT grounding can not be avoided, please consult the factory for information regarding reconfiguring the instrument for Grounded Return. When the instrument Return is grounded, internal and external stray leakage will be monitored due to currents that flow from High Voltage to earth grounded (such as from HV to the chassis of the instrument). This current can not be avoided and will cause errors when trying to monitor very low leakage currents in the microamp range.

#### Power Requirements and Line Voltage Selection

This instrument requires a power source of either 115 volts AC  $\pm$  15%, 47-63 Hz single phase or 230 volts AC  $\pm$  15%, 47-63 Hz single phase. Please check the rear panel to be



sure the proper switch setting is selected for your line voltage requirements before turning your instrument on. In addition please be sure the correct fuse is selected and installed while the instrument is in the off position (see page 26 for fuse changing instructions).

**CAUTION**

Do not switch the line voltage selector switch located on the rear panel while the instrument is on or operating. This may cause internal damage and represents a safety risk to the operator.

**NOTE**

For operation at 115 and 230 Volts AC use a 6.3A slow-blow fuse.

**Power Cable****WARNING**

**BEFORE CONNECTING POWER TO THIS INSTRUMENT, THE PROTECTIVE GROUND (EARTH) TERMINALS OF THIS INSTRUMENT MUST BE CONNECTED TO THE PROTECTIVE CONDUCTOR OF THE LINE (MAINS) POWER CORD. THE MAIN PLUG SHALL ONLY BE INSERTED IN A SOCKET OUTLET (RECEPTACLE) PROVIDED WITH A PROTECTIVE GROUND (EARTH) CONTACT. THIS PROTECTIVE GROUND (EARTH) MUST NOT BE DEFEATED BY THE USE OF AN EXTENSION CORD (POWER CABLE) WITHOUT A PROTECTIVE CONDUCTOR (GROUNDING).**

This instrument is shipped with a three-wire power cable. When this cable is connected to an appropriate AC power source, this cable connects the chassis to earth ground. The type of power cable shipped with each instruments depends on the country of destination.

**Operating Environment**

This instrument may be operated in temperatures from 32° - 113° F (0° - 45° C).

Relative humidity of 0 to 95%.

Altitude up to 15,000 feet (4,600 meters).

**STORAGE AND SHIPMENT****Environment**

This instrument may be stored or shipped in environments with the following limits:

Temperature..... -40° to +75°C

Altitude..... 7,620 meters (25,000 feet)

The instrument should also be protected against temperature extremes which may cause condensation within the instrument.

## Packaging

**Original Packaging:** Please retain all original packaging materials that you originally received. If you are returning your instrument to us for servicing please repackage the instrument in its original container. Contact our customer support department (1-800-858-8378) for a RMA (return material authorization) number. Please enclose the instrument with all options, accessories and test leads. Indicate the nature of the problem or type of service needed. Also, please mark the container "FRAGILE" to insure proper handling. Upon receipt your instrument will be issued an AR service number. Please refer to this number in all correspondence.

**Other Packaging:** If you do not have the original packaging materials please follow these guidelines:

- 1). Wrap the instrument in a bubble pack or similar foam. Enclose the same information as above.
- 2). Use a strong double-wall container that is made for shipping instrumentation. 350 lb. test material is adequate.
- 3). Use a layer of shock-absorbing material 70 to 100 mm (3 to 4 inch) thick around all sides of the instrument. Protect the control panel with cardboard.
- 4). Seal the container securely.
- 5). Mark the container "FRAGILE" to insure proper handling.
- 6). Please refer in all correspondence to your AR service number.

## Field Installation Of Options

There are no field installable options on this instrument.



**QUICK START**

This quick start guide assumes the operator has some familiarity with automated testing and desires to use the "**default**" settings on the instrument. The default settings shown will remain in memory unless you choose to override them with your own test program. The instrument default settings that appear in memories 1-40 are as follows:

**DEFAULTS**

<b>Function</b>	<b>Parameter</b>	<b>Value</b>
ACW	Voltage	1240VAC
	HI-Limit	10.00mA
	LO-Limit	0.000mA
	Ramp Time	1.0s
	Dwell Time	1.0s
	Frequency	60Hz
	Arc Sense	5
	Arc Fail	OFF
	Scanner	000000000000000000
	Connect	OFF
	Continuity (7550DT only)	OFF
DCW	Voltage	1500VDC
	HI-Limit	3500 $\mu$ A
	LO-Limit	0.0 $\mu$ A
	Ramp Time	1.0s
	Dwell Time	1.0s
	Ramp-HI	OFF
	Charge-LO	0.0 $\mu$ A
	Arc Sense	5
	Arc Fail	OFF
	Scanner	000000000000000000
	Connect	OFF
Continuity (7550DT only)	OFF	
IR	Voltage	1000VDC
	Charge-LO	0.000 $\mu$ A
	HI-Limit	0M $\Omega$
	LO-Limit	10M $\Omega$
	Delay	1.0s
	Scanner	000000000000000000
	Connect	OFF

**Defaults cont.**

<b>Function</b>	<b>Parameter</b>	<b>Value</b>
GND	Current	25.00A
	Voltage	6.00V
	HI-Limit	100mΩ
	LO-Limit	0mΩ
	Dwell	1.0s
	Frequency	60Hz
	Scanner	0
	Offset	0mΩ
	Connect	OFF
Setup	PLC Remote	OFF
	Address (GPIB only)	8
	Contrast	5
	Volume	5
	Fail Stop	ON
Calibration	Password	0
	MR-Lock	ON

**Quick Start Instructions Cont.:**

a). Unpack the instrument from its special shipping container. Be sure to save all packaging materials in case you need to return it to the factory for service.

**WARNING** b). Locate a suitable testing area and be sure you have read all safety instructions for the operation of the instrument and suggestions on the test area set-up in the Safety section. Locate a three prong grounded outlet. Be sure the outlet has been tested for proper wiring before connecting the instrument to it.

**CAUTION** c). Check to be sure the correct input line voltage has been selected on the rear panel. Either 115 volts AC or 230 volts AC. Connect the power input plug into its socket on the rear panel of the instrument. Connect the male end of the plug to the outlet receptacle. Please be sure that the safety ground on the power line cord is not defeated and that you are connecting to a grounded power source.

d). Turn on the POWER switch located on the lower left hand side of the front panel. Upon powering the instrument all LEDs on the Front Panel will be lit for visual inspection. For detailed instructions on setting up testing parameters refer to the OPERATION section.

e). If the instrument defaults are acceptable then be sure to connect the appropriate test leads to the device under test (DUT) or test fixture. Be sure to connect this safety ground

to a suitable known good ground before energizing this instrument, Then connect the return lead first (black) to the test fixture or item followed by the high voltage output lead (red). Note: The Return Lead of this instrument is not connected directly to Earth Ground. The DUT must **not** contact Earth Ground directly. See the Installation section for details.

**WARNING**

f). Please check your connections to be sure they are making good contact and that the test station or area is clear of debris and other personnel. **DO NOT TOUCH THE DEVICE UNDER TEST ONCE THE TEST HAS BEEN STARTED.** To initiate the test press the GREEN test button on the front panel. This is a momentary button and does not need to be held in the pressed position during the test. The instrument will then cycle ON and begin the automated test sequence using the defaults. If a failure occurs you will HEAR an audible alarm go off. To stop the alarm you must depress the RED button marked “RESET” This will silence the alarm and reset the instrument to begin another test.

This “RESET” button may also be used as a safety button to quickly ABORT a test and cut off the HIGH VOLTAGE. When HIGH VOLTAGE is present a RED arrow indicator located in the lower right side of the front panel near the high voltage connector will flash until the HIGH VOLTAGE is shut OFF. If the device under test PASSED the test then no audible alarm will sound. You will hear a brief BEEP to let you know the item was successfully tested and it PASSED. In the case of a FAIL condition the instrument will provide a memory of the test results on the display, that will remain until the next test is initiated. Depressing the “RESET” button will prepare the instrument for the next test but will not clear the display until the next test is started or another reset is executed.

## 1. General Setup Procedures

### 1.1 Key Lock setting

Press the “LOCK” key. If the Password is Enabled, the display will show:

Password = _ _ _ _ _ Range : 0 - 9 9 9 9
---

To view the password or enter a new one refer to the calibration procedure. Use the Numeric Key to enter the password and then press the “ENTER” key. The program will switch the Key Lock function from “LOCK” to “UNLOCK” or “UNLOCK” to “LOCK” mode and advance the program to Operation mode automatically. If the instrument is in the Lock mode, the “LOCK” indicator on the front panel will light. If the wrong password is entered, the program will give a warning sound and the display will show:

Password = ERROR Range : 0 - 9 9 9 9
---

And then the program will return to the original screen and wait to enter the new password. If the Password is Disabled (Password is set “0”), the display will show:

Key Lock = O N <ENTER> to Select
-------------------------------------

or

Key Lock = O F F <ENTER> to Select
---------------------------------------

Use the “ENTER” key to select the Key Lock mode, then press the “EXIT” key. The program will switch the Key Lock function from “LOCK” to “UNLOCK” or “UNLOCK” to “LOCK” mode and advance the program to the Operation mode automatically. If the Key Lock function is in the Lock mode, the “LOCK” indicator on the front panel will light.

If the Memory Lock function (MR-Lock) is selected to “ON”, the Memory selection Menu will be disabled when in the Lock Mode. If the MR-Lock is selected to “OFF”, the Memory selection Menu will be enabled when in the Lock Mode. Different memories can be recalled but the test parameters or steps cannot be changed. The MR-Lock default is preset to “ON” at the factory. Please refer to the calibration procedure, on page 84, to set the MR-Lock mode .

### 1.2 Memory Configuration

Each memory location contains 8 separate steps which can be connected sequentially to the next consecutive step. Each step contains 4 separate locations, 1 for each function. Only one function can be selected for each step, but the other three function parameters remain stored in the memory. The following memory map illustrates the separate locations for each function.

## Memory map

Memory 1	Step 1	Step 2	....	Step 8
	ACW	ACW		ACW
	DCW	DCW		DCW
	IR	IR		IR
	G-Bond	G-Bond		G-Bond

Memory 2	Step 1	Step 2	....	Step 8
	ACW	ACW		ACW
	DCW	DCW		DCW
	IR	IR		IR
	G-Bond	G-Bond		G-Bond

·  
·  
·

Memory 50
-----------

Note: On model 7550DT disregard the location for G-Bond parameters. The Continuity parameter is stored within the ACW and DCW functions as a single setting for both modes.

### 1.3 Memory Program selection

Press the “MEMORY” key, the display will show:

Memory = X X Range : 1 - 50
--------------------------------

Use the Numeric Key to enter the Memory location number, and then press the “ENTER” key. The program will recall the test parameters stored in this location and return to the operation mode automatically.

### 1.4 Step Selection

Press the “STEP” key, the display will show the test parameters of the functions selected for that step, i.e. the parameters of AC Withstand Voltage , DC Withstand Voltage, Insulation Resistance or Ground Bond test. Pressing the step key again will advance to the next step in sequence with step 1 following step 8.

Note: When the steps have been interconnected you will see an underbar character on the display just after the step number. This indicates that the step after the active step will run immediately after the active step is completed. The display will show:

ACW Set	XXX.X s
M25-1_ X.XX KV	XX.XX mA

## 2. Function Parameters Setup Procedures

Before going to setup the Test Parameters, make sure that the Keyboard is in the "Unlock" mode, then follow this procedures to setup the Test Parameters.

### 2.1 AC Withstand Voltage test setting

Press the "ACW" key and the display will show:

ACW Set	XXX.X s
MXX-X X.XX KV	XX.XX mA

 Note: X = Numeric

ACW Set : AC Withstand Voltage test setting screen  
XXX.X s : Dwell Time setting  
MXX : Memory Program number  
- X : Test Step number  
X.XX KV : AC Output Voltage setting  
XX.XX mA : AC High-Limit current setting

Use the "∧" or "∨" arrow keys to progress through the test parameters menu. The "∨" key will advance forward and "∧" key will advance backward. The sequential forward menu items are Voltage, HI-Limit, LO-Limit, Ramp Time, Dwell Time, Frequency, Arc Sense, Arc Fail, Scanner Set, Offset, Connect.

#### 2.1.1 AC Output Voltage setting

Advance the menu to the Voltage parameter. The display will show:

Voltage = XXXX V
Range : 0 - 5000

Use the "Numeric" keys to enter the voltage setting, then press the "ENTER" key. The program will store the voltage setting and advance to the High Limit parameter automatically. The unit is "volt" and 1 volt per step.

Press the "EXIT" key to exit from the setting mode to the operation mode if all parameters have been set.

#### 2.1.2 HI-Limit Current setting

Advance the menu to the HI-Limit parameter. The display will show:

HI-Limit = XX.XX mA
Range : 0.00 - 40.00

Use the "Numeric" keys to enter the HI-Limit setting, then press the "ENTER" key. The program will store the HI-Limit setting and advance to the LO-Limit parameter automatically. The unit is "mA" and 0.01 mA per step.

Press the "EXIT" key to exit from the setting mode to the operation mode if all parameters have been set.

### 2.1.3 LO-Limit Current setting

Advance the menu to the LO-Limit parameter. The display will show:

LO-Limit = X.XXX mA Range : 0.000 - 9.999
--

Use the "Numeric" keys to enter the LO-Limit setting, then press the "ENTER" key. The program will store the LO-Limit setting and advance to the Ramp Time parameter automatically. The unit is "mA" and 0.001 mA per step.

Press the "EXIT" key to exit from the setting mode to the operation mode if all parameters have been set.

If the LO-Limit is set to "0", the LO-Limit is disabled.

### 2.1.4 Ramp Time setting

Advance the menu to the Ramp Time parameter. The display will show:

Ramp Time = XXX.X s Range : 0.1 - 999.9
--

Use the "Numeric" keys to enter the Ramp Time setting, then press the "ENTER" key. The program will store the Ramp Time setting and advance to the Dwell Time setting automatically. The unit is "second" and 0.1 second per step.

Press the "EXIT" key to exit from the setting mode to the operation mode if all parameters have been set.

### 2.1.5 Dwell Time setting

Advance the menu to the Dwell Time parameter. The display will show:

Dwell Time = XXX.X s Range : 0.3 - 999.9 0 = Constant
--

Use the "Numeric" keys to enter the Dwell Time setting, then press the "ENTER" key. The program will store the Dwell Time setting and advance to the Frequency selection parameter automatically. The unit is "second" and 0.1 second per step. The display will show the elapsed time during the testing.

Press the "EXIT" key to exit from the setting mode to the operation mode if all parameters have been set.

If the Dwell Time is set to “0”, the timer will continue to count to the maximum test time then reset to “0” and start over automatically. The test will continue until a reset is executed or a failure occurs.

### 2.1.6 Frequency Selection

Advance the menu to the Frequency parameter and the display will show:

Frequency = 60 Hz <ENTER> to Select
--

or

Frequency = 50 Hz <ENTER> to Select
--

Use the “ENTER” key to select the Output Frequency, then press the “^” or “v” key to advance to another test parameter or press the “EXIT” key to exit from the setting mode to the operation mode.

### 2.1.7 Arc Sensitivity setting and Arc Fail selection

Advance the menu to the Arc Sense parameter. The display will show:

Arc Sense = 1 - 9 Range : 1 - 9 9 = High
---

Use the “Numeric” keys to enter the Arc Sense setting, then press the “ENTER” key. The numeric value is proportional to the amount of sensitivity, i.e. “9” is the highest sensitivity. The program will store the Arc Sense setting and advance to the ARC Fail mode selection automatically. The display will show:

Arc Fail = O N <ENTER> to Select
-------------------------------------

or

Arc Fail = O F F <ENTER> to Select
---------------------------------------

Use the “ENTER” key to select the Arc Fail mode, then press the “^” or “v” key to advance the program to another test parameter or press the “EXIT” key to exit from the setting mode to the operation mode.

If the Arc Fail mode is set to “ON”, the program will indicate an arc failure when the arc current is over the setting. The program will shut down the test immediately and the ARC indicator on the front panel will light.

If the Arc Fail mode is set to “OFF”, the program will not indicate an arc failure when the arc current is over the setting. The program will not shut down the test but the ARC indicator on the front panel will light when arcing is present.

### 2.1.8 Scanner Channel setting

Advance the menu to the Scanner Set parameter. The display will show:

Scanner Set CH = 1 - 16 XXXXXXXXXXXXXXXXXXXX
---

Note: X = H, O or L.



Use the “Numeric” keys to enter the status of High, Open or Low for each scanner channel, then press the “ENTER” key. The program will store the Scanner Channel status and advance to the Connection setting automatically. The following table is the cross reference of the numeric keys, which are used for the Scanner channel setting.

Channel Status	Numeric Key	Description
H (High)	1	Connected to High Voltage Output
L (Low)	0	Connected to Return
O (Open)	•	Not connected to High Voltage or Return

The Channel setting will start from Channel 1 on the left end and stop at Channel 16 on the right end. The program will set any unassigned channel(s) to OPEN automatically after pressing the “ENTER” key. Therefore it is necessary to set only the channels that are required for the test.

If the Scanner is not installed, this setting is not necessary.

### 2.1.9 Step Connection setting

Advance the menu to the Connection parameter. The display will show:

Connect =    O N <ENTER> to Select	or	Connect =    O F F <ENTER> to Select
---------------------------------------	----	---

Use the “ENTER” key to select the Step Connection mode, then press “^” or “v” key to advance the program to another test parameter or press the “EXIT” key to exit from the setting mode to the operation mode.

If Connect is set to “ON”, the next step in the sequence will be executed. If Connect is set to “OFF”, the test sequence will stop at this step.

If Step 8 is set to “ON” the test process will be connected to the first step of the next Memory.

### 2.2 DC Withstand Voltage test setting

Press the “DCW” key and the display will show:

DCW Set    XXX.X s MXX-X X.XX KV    XXXXX μA	Note: X = Numeric
---	-------------------

DCW Set    : DC Withstand Voltage test Setting screen  
 XXX.X s    : Dwell Time setting  
 MXX        : Memory Program number  
 - X         : Test Step number  
 X.XX KV    : DC Output Voltage setting

XXXX  $\mu$ A : DC High-Limit current setting

Use the “ $\wedge$ ” or “ $\vee$ ” arrow keys to progress through the test parameters menu. The “ $\vee$ ” key will advance forward and “ $\wedge$ ” key will advance backward. The sequential forward menu items are Voltage, HI-Limit, LO-Limit, Ramp Time, Dwell Time, Charge-LO, Ramp-HI, Arc Sense, Arc Fail, Scanner Set, Offset, Connect.

### 2.2.1 DC Output Voltage setting

Advance the menu to the Voltage parameter. The display will show:

Voltage = XXXX V Range : 0 - 6000
--------------------------------------

Use the “Numeric” keys to enter the voltage setting, then press the “ENTER” key. The program will store the voltage setting and advance to the HI-Limit parameter automatically. The unit is “volt” and 1 volt per step.

Press the “EXIT” key to exit from the setting mode to the operation mode if all parameters have been set.

### 2.2.2 HI-Limit Current setting

Advance the menu to the HI-Limit parameter. The display will show:

HI-Limit = XXXX $\mu$ A Range : 0 - 9999
---

Use the “Numeric” keys to enter the HI-Limit setting, then press the “ENTER” key. The program will store the HI-Limit setting and advance to the Low Limit parameter automatically. The unit is “ $\mu$ A” and 1 $\mu$ A per step.

Press the “EXIT” key to exit from the setting mode to the operation mode if all parameters have been set.

### 2.2.3 LO-Limit Current setting

Advance the menu to the LO-Limit parameter. The display will show:

LO-Limit = XXX.X $\mu$ A Range : 0.000 - 9.999
---

Use the “Numeric” keys to enter the LO-Limit setting, then press the “ENTER” key. The program will store the LO-Limit setting and advance to the Ramp Time parameter automatically. The unit is “ $\mu$ A” and 0.001 $\mu$ A per step.

Press the “EXIT” key to exit from the setting mode to the operation mode if all parameters have been set.

The LO-Limit will be disabled during the Ramp Up period. If the LO-Limit is set to “0”, the LO-Limit is disabled.

#### 2.2.4 Ramp Time setting

Advance the menu to the Ramp Time parameter. The display will show:

Ramp Time = XXX.X s Range : 0.4 - 999.9
--

Use the “Numeric” keys to enter the Ramp Time setting, then press the “ENTER” key. The program will store the Ramp Time setting and advance to the Dwell Time parameter automatically. The unit is “second” and 0.1 second per step.

Press the “EXIT” key to exit from the setting mode to the operation mode if all parameters have been set.

#### 2.2.5 Dwell Time setting

Advance the menu to the Dwell Time parameter. The display will show:

Dwell Time = XXX.X s Range : 0.5 - 999.9 0 = Constant
--

Use the “Numeric” keys to enter the Dwell Time setting, then press the “ENTER” key. The program will store the Dwell Time setting and advance to the Charge-LO parameter automatically. The unit is “second” and 0.1 second per step.

Press the “EXIT” key to exit from the setting mode to the operation mode if all parameters have been set.

If the Dwell Time is set to “0”, the timer will continue to count to the maximum test time then reset to “0” and start over automatically. The test will continue until a reset is executed or a failure occurs.

#### 2.2.6 Charge-LO

Advance the menu to the Charge-LO parameter. The display will show:

Charge-LO = XXX.X $\mu$ A <TEST> to Auto Set
---

The Charge-LO function is used to check if the test cables are connected properly at the beginning of a test. A capacitive DUT will draw charging current on the DC Withstand Voltage test when the Output is activated. If the charging current was lower than the setting, the test cables may not be connected properly.

This instrument can set the Charge-LO value manually or automatically. To set the Charge-LO value manually, use the numeric keys to enter the Charge-LO current

setting and then press the ENTER key . The program will store the Charge-LO setting and advance to the Ramp-HI parameter. The setting range of Charge-LO is from 0.0 to 350.0  $\mu\text{A}$ . The unit is " $\mu\text{A}$ " and 0.1 $\mu\text{A}$  per step.

To use Auto Set, be sure that the test parameter of Output Voltage and Ramp Time have been set to the values that will be used for the Final test and connect the test cables and/or test fixture between the instrument and DUT. If the scanner is to be used then the scanner channel must also be set, and then press the TEST button. The instrument will apply the voltage that has been entered for this memory-step selection.

**WARNING** Please be aware that the program will activate high voltage on the output connector while the Test button is pressed.

The program will read the charging current of DUT and set the Charge-LO current at approximately one half (1/2) of the reading. The display will show:

Charge-LO = XXX.X  $\mu\text{A}$   
<TEST> to Auto Set

The value showing on the display is the Charge-LO setting and is not the reading of the charging current of the DUT.

Then press the " $\wedge$ " or " $\vee$ " key to advance the program to another test parameter or press the "EXIT" key to exit from the setting mode to the operation mode.

### 2.2.7 Ramp-HI

Advance the menu to the Ramp-High parameter. The display will show:

Ramp-HI = ON  
<ENTER> to Select

or

Ramp-HI = OFF  
<ENTER> to Select

Use the "ENTER" key to select the Ramp-HI mode, then press the " $\wedge$ " or " $\vee$ " key to advance the program to another test parameter or press the "EXIT" key to exit from the setting mode to the operation mode.

The Ramp-HI function is active during the Ramp period only. Ramp-HI will allow current higher than the normal HI-Limit current setting of the DC Withstand Voltage test to avoid false failure due to charging current.

### 2.2.8 Arc Sensitivity setting and Arc Fail selection

Advance the menu to the Arc Sense parameter. The display will show:

Arc Sense = 1 - 9  
Range : 1 - 9 9 = High

Use the “Numeric” keys to enter the Arc Sense setting, then press the “ENTER” key. The numeric value is proportional to the amount of sensitivity, i.e. “9” is the highest sensitivity. The program will store the Arc Sense setting and advance to the ARC Fail mode selection automatically. The display will show:

Arc Fail = ON <ENTER> to Select	or	Arc Fail = OFF <ENTER> to Select
------------------------------------	----	-------------------------------------

Use the “ENTER” key to select the Arc Fail mode, then press the “^” or “v” key to advance the program to another test parameter or press the “EXIT” key to exit from the setting mode to the operation mode.

If the Arc Fail mode is set to “ON”, the program will indicate an arc failure when the arc current is over the setting. The program will shut down the test immediately and the ARC indicator on the front panel will light.

If the Arc Fail mode is set to “OFF”, the program will not indicate an arc failure when the arc current is over the setting. The program will not shut down the test but the ARC indicator on the front panel will light only when arcing is present.

### 2.2.9 Scanner Channel setting

Advance the menu to the Scanner Set parameter. The display will show:

Scanner Set CH = 1 - 16 XXXXXXXXXXXXXXXXXX	Note: X = H, O or L.
---	----------------------

Use the “Numeric” keys to enter the status of High, Open or Low for each scanner channel, then press the “ENTER” key. The program will store the scanner channel status and advance to the Connection setting automatically. The following table is the cross reference of the numeric keys, which are used for the scanner channel setting.

Channel Status	Numeric Key	Description
H (High)	1	Connected to High Voltage Output
L (Low)	0	Connected to Return
O (Open)	•	Not connected to High Voltage or Return

The Channel setting will start from Channel 1 on the left end and stop at Channel 16 on the right end. The program will set any unassigned channel(s) to OPEN automatically after pressing the “ENTER” key. Therefore it is necessary to set only the channels that are required for the test.

If the Scanner is not installed, this setting is not necessary.

### 2.2.10 Step Connection setting

Advance the menu to the Connection parameter. The display will show:

Connect = ON <ENTER> to Select	or	Connect = OFF <ENTER> to Select
-----------------------------------	----	------------------------------------

Use the “ENTER” key to select the Step Connection mode, then press the “^” or “v” key to advance the program to another test parameter or press the “EXIT” key to exit from the setting mode to operation mode.

If Connect is set to “ON”, the next step in the sequence will be executed. If Connect is set to “OFF”, the test sequence will stop at this step.

If Step 8 is set to “ON” the test process will be connected to the first step of the next Memory.

### 2.3 Insulation Resistance test setting

Press the “INSULATION” key and the display will show:

IR Set XXX.X s MXX-X XXXX V XXXXX MΩ	Note: X = the numeric
---	-----------------------

IR Set : Insulation Resistance test setting screen  
 XXX.X s : Delay Time setting  
 MXX : Memory Program number  
 -X : Test Step number  
 XXXX V : DC Output Voltage  
 XXXX MΩ : Low-Limit of Insulation Resistance

Use the “^” or “v” arrow keys to progress through the test parameters menu. The “v” key will advance forward and “^” key will advance backward. The sequential forward menu items are Voltage, Charge-LO, HI-Limit, LO-Limit, Delay Time, Scanner Set, Connect.

#### 2.3.1 Output Voltage setting

Advance the menu to the Voltage parameter. The display will show:

Voltage = XXXX V Range : 0 - 6000
--------------------------------------

Use the “Numeric” keys to enter the voltage setting, then press the “ENTER” key. The program will store the voltage setting and advance to the Charge-LO parameter automatically. The unit is “volt” and 1 volt per step.

Press the “EXIT” key to exit from the setting mode to the operation mode if all parameters have been set.

### 2.3.2 Charge-LO

Advance the menu to the Charge-LO parameter. The display will show:

Charge-LO = X.XXX  $\mu$ A  
<TEST> to Auto Set

The Charge-LO function is used to check if the test cables are connected properly at the beginning of a test. A capacitive DUT will draw charging current on the Insulation Resistance test when the Output is activated. If the charging current was lower than the setting, the test cables may not be connected properly.

This instrument can set the Charge-LO value manually or automatically. To set the Charge-LO value manually, use the numeric keys to enter the Charge-LO current setting and then press the "ENTER" key. The program will store the Charge-LO setting and advance to the HI-Limit parameter. The setting range of Charge-LO is from 0.000 to 3.500  $\mu$ A. The unit is " $\mu$ A" and 0.001 $\mu$ A per step.

To use Auto Set, be sure that the test parameter of Output Voltage has been set to the values that will be used for the final test and connect the test cables and/or test fixture between the instrument and DUT. If the scanner is to be used then the scanner channel must also be set. Then press the TEST button. The instrument will apply the voltage that has been entered for this memory-step selection.

**WARNING** Please be aware that the program will activate high voltage on the output connector while the Test button is pressed.

The program will read the charging current of DUT and set the Charge-LO current at approximately one half (1/2) of the reading. The display will show:

Charge-LO = X.XXX  $\mu$ A  
<TEST> to Auto Set

The value showing on the display is the Charge-LO setting and is not the reading of the charging current of DUT.

Then press the " $\wedge$ " or " $\vee$ " key to advance the program to another test parameter or press the "EXIT" key to exit from the setting mode to the operation mode.

### 2.3.3 HI-Limit Current setting

Advance the menu to the HI-Limit parameter. The display will show:

HI-Limit = XXXX M $\Omega$   
Range : 1 - 9999

Use the "Numeric" keys to enter the HI-Limit setting, then press the "ENTER" key. The program will store the HI-Limit setting and advance to the LO-Limit parameter



automatically. The unit is “MΩ” and 1 MΩ per step.

Press the “EXIT” key to exit from the setting mode to the operation mode if all parameters have been set.

#### 2.3.4 LO-Limit Current setting

Advance the menu to the LO-Limit parameter. The display will show:

LO-Limit = XXXX MΩ Range : 1 - 9999
--

Use the “Numeric” keys to enter the LO-Limit setting, then press the “ENTER” key. The program will store the LO-Limit setting and advance to the Delay Time parameter automatically. The unit is “MΩ” and 1 MΩ per step.

Press the “EXIT” key to exit from the setting mode to the operation mode if all parameters have been set.

#### 2.3.5 Delay Time setting

Advance the menu to the Delay Time parameter. The display will show:

Delay Time = XXX.X s Range : 0.5 - 999.9 0 = Constant
--

Use the “Numeric” keys to enter the Delay Time setting, then press the “ENTER” key. The program will store the Delay Time setting and advance to the Scanner Channel parameter automatically. The unit is “second” and 0.1 second per step.

Press the “EXIT” key to exit from the setting mode to the operation mode if all parameters have been set.

Delay Time selects the time when the instrument will compare actual readings to the HI-Limit and LO-limit settings. This delay allows charging current to stabilize before a test judgment is made. The capacitance of the DUT will dictate what delay setting is required to perform an accurate IR measurement.

If the Delay Time is set to “0”, the test will continue until the “RESET” button is pressed. The display will show the measured readings during the test. The timer will continue to count the total test time and then will automatically reset to “0” and start over.

#### 2.3.6 Scanner Channel setting

Advance the menu to the Scanner Set parameter. The display will show:

Scanner Set CH = 1 - 16 XXXXXXXXXXXXXXXXXX
---

Note: X = H, O or L.



Use the “Numeric” keys to enter the status of High, Open or Low for each scanner channel, then press the “ENTER” key. The program will store the Scanner Channel status and advance to the Connection setting automatically. The following table is the cross reference of the numeric keys, which are used for the Scanner channel setting.

Channel Status	Numeric Key	Description
H (High)	1	Connected to High Voltage Output
L (Low)	0	Connected to Return
O (Open)	•	Not connected to High Voltage or Return

The Channel setting will start from Channel 1 on the left end and stop at Channel 16 on the right end. The program will set any unassigned channel(s) to OPEN automatically after pressing the “ENTER” key. Therefore it is necessary to set only the channels that are required for the test.

If the Scanner is not installed, this setting is not necessary.

### 2.3.7 Step Connection setting

Advance the menu to the Connection parameter. The display will show:

Connect = ON <ENTER> to Select	or	Connect = OFF <ENTER> to Select
-----------------------------------	----	------------------------------------

Use the “ENTER” key to select the Step Connection mode, then press the “^” or “v” key to advance the program to another test parameter or press the “EXIT” key to exit from the setting mode to the operation mode.

If Connect is set to “ON”, the next step in the sequence will be executed. If Connect is set to “OFF”, the test sequence will stop at this step.

If Step 8 is set to “ON” the test process will be connected to the first step of the next Memory.

### 2.4 Ground Bond test setting

Press the “GROUND” key and the display will show:

GND Set    XXX.X s MXX-X XX.XX A XXX mΩ	Note: X = the numeric
--	-----------------------

GND Set    : Ground Bond test setting screen  
 XXX.X s    : Dwell Time setting  
 MXX        : Memory Program number  
 -X         : Test Step number  
 XX.XX A    : AC Output Current setting  
 XX.XX mΩ : High-Limit of Ground Continuity Resistance

Use the “^” or “v” arrow keys to progress through the test parameters menu. The “v” key will advance forward and “^” key will advance backward. The sequential forward menu items are Current, Voltage, HI-Limit, LO-Limit, Dwell Time, Frequency, Scanner Set, Offset, Connect.

#### 2.4.1 Output Current setting

Advance the menu to the Current parameter. The display will show:

Current = XX.XX A Range : 3.00 - 30.00
---

Use the “Numeric” keys to enter the Current setting, then press the “ENTER” key. The program will store the Current setting and advance to the Output Voltage parameter automatically. The unit is “amps” and 0.01A per step.

Press the “EXIT” key to exit from the setting mode to the operation mode if all parameters have been set.

#### 2.4.2 Output Voltage setting

Advance the menu to the Voltage parameter. The display will show:

Voltage = X.XX V Range : 3.00 - 8.00
---

Use the “Numeric” keys to enter the voltage setting, then press the “ENTER” key. The program will store the Voltage setting and advance to the HI-Limit parameter automatically. The unit is “volt” and 0.01 volt per step. This setting controls the open circuit voltage and does not take effect when the current is being regulated at the Output Current setting.

Press the “EXIT” key to exit from the setting mode to the operation mode if all parameters have been set.

#### 2.4.3 HI-Limit Ground Resistance setting

Advance the menu to the HI-Limit parameter. The display will show:

HI-Limit = XXX mΩ Range : 0 - 600
--------------------------------------

Use the “Numeric” keys to enter the HI-Limit setting, then press the “ENTER” key. The program will store the HI-Limit setting and advance to the LO-Limit parameter automatically. The unit is “mΩ” and 1 mΩ per step.

Press the “EXIT” key to exit from the setting mode to the operation mode if all parameters have been set.

#### 2.4.4 Low Limit Ground Resistance setting

Advance the menu to the LO-Limit parameter. The display will show:

LO-Limit = XXX mΩ Range : 0 - 600
--------------------------------------

Use the “Numeric” keys to enter the LO-Limit setting, then press the “ENTER” key. The program will store the LO-Limit setting and advance to the Dwell Time parameter automatically. The unit is “mΩ” and 1 mΩ per step.

Press the “EXIT” key to exit from the setting mode to the operation mode if all parameters have been set.

If the LO-Limit is set to “0”, the LO-Limit is disabled.

#### 2.4.5 Dwell Time setting

Advance the menu to the Dwell Time parameter. The display will show:

Dwell Time = XXX.X s Range : 0.5 - 999.9 0 = Constant
--

Use the “Numeric” keys to enter the Dwell Time setting, then press the “ENTER” key. The program will store the Dwell Time setting and advance to the Frequency selection parameter automatically. The unit is “second” and 0.1 second per step. The display will show the elapsed time during the testing.

Press the “EXIT” key to exit from the setting mode to the operation mode if all parameters have been set.

If the Dwell Time is set to “0”, the timer will continue to count to the maximum test time then reset to “0” and start over automatically. The test will continue until a reset is executed or a failure occurs.

#### 2.4.6 Frequency Selection

Advance the menu to the Frequency parameter. The display will show:

Frequency = 60 Hz <ENTER> to Select
--

or

Frequency = 50 Hz <ENTER> to Select
--

Use the “ENTER” key to select the Output Frequency, then press the “^” or “v” key to advance the program to another test parameter setting or press the “EXIT” key to exit from the setting mode to the operation mode.

#### 2.4.7 Scanner Channel setting

Advance the menu to the Scanner Set parameter. The display will show:

Scanner CH =	X
Range: 1-16	0 = OFF

Use the "Numeric" keys to enter the scanner channel number, then press the "ENTER" key. The program will store the scanner channel number and advance to the Offset parameter automatically.

If the Scanner is not installed, it is not necessary to enter this parameter.

Press the "EXIT" key to exit from the setting mode to the operation mode if all parameters have been set.

To operate from the front panel output connectors with the Scanner option installed, the Scanner Channel must be set to "0" to receive accurate readings.

#### 2.4.8 Offset setting

Advance the menu to the Offset parameter. The display will show:

Offset = XXX mΩ
<TEST> to Auto Set

This instrument can set the mΩ offset value by two different methods. One is the Manual Offset and the other is Auto Offset.

For Manual Offset, use the "Numeric" keys to enter the mΩ Offset value and then press the "ENTER" key. The program will store the mΩ Offset setting and advance to the Connect setting. The range of mΩ Offset is from 0 to 200 mΩ. The unit is "mΩ" and 1 mΩ per step.

For Auto Offset, setup the test parameter of Output Voltage, Current and Frequency and connect the test cables and/or test fixture to the instrument first. Then short circuit the ends of the test cables. If the scanner is being used, the scanner channel has to be set. Then press the "TEST" button. The program will activate the test current and frequency that has been set for this memory-step. The display will show:

Offset = XXX mΩ
<TEST> to Auto Set

The display will show the measured mΩ Offset value and the program will use this value for the Offset setting. Each step has its own individual Offset value and must be set separately. This allows the user to compensate for different lead lengths when using a scanner or external fixturing for Ground Bond testing.

Then press the "∧" or "∨" key to advance the program to another test parameter setting or press the "EXIT" key to exit from the setting mode to operation mode.

### 2.4.9 Step Connection setting

Advance the menu to the Connection parameter. The display will show:

Connect = ON <ENTER> to Select	or	Connect = OFF <ENTER> to Select
-----------------------------------	----	------------------------------------

Use the “ENTER” key to select the Step Connection mode, then press the “^” or “v” key to advance the program to another test parameter or press the “EXIT” key to exit from the setting mode to the operation mode.

If Connect is set to “ON”, the next step in the sequence will be executed. If Connect is set to “OFF”, the test sequence will stop at this step.

If Step 8 is set to “ON” the test process will be connected to the first step of the next Memory.

## 3. System Parameter Settings

Use the “SETUP” key to progress through the menu of System Parameters. Successive key presses will advance the menu forward. The sequential forward menu items are: PLC Remote, Address, Contrast, Volume, Fail Stop.

The setting of system parameters affect the operating conditions of the instrument and are separate from the functional settings. The system settings are also global and are not specific to any memory location.

### 3.1 PLC Remote selection

Press the Setup key to advance to the PLC Remote parameter. The display will show:

PLC Remote = ON <ENTER> to Select	or	PLC Remote = OFF <ENTER> to Select
--------------------------------------	----	---------------------------------------

Use the “ENTER” key to select the mode PLC Remote Control.

After selecting PLC Remote mode, press the “SETUP” key to advance to the address setting if the GPIB interface card is installed on this instrument. If this instrument does not have the GPIB interface card, the program will advance to the contrast setting, or press the “EXIT” key to exit from the PLC Remote selection to the operation mode. The instrument will store the selection of PLC Remote automatically.

If the Remote Control is set to “ON”, the test function will be controlled by the “Remote Control” via the remote connectors located on the rear panel. The “TEST” button on the front panel is disabled but the “RESET” button is still enabled.

The remote Memory Program recall functions can be performed only when the PLC Remote is set "ON". In addition, when the PLC remote is set to ON the remote TEST signal input is active while in the Bus Remote Mode.

If the Remote Control is set to "OFF", the operation of the instrument will be controlled by the local "TEST" and "RESET" buttons on the front panel.

### 3.2 GPIB Address setting

If the GPIB interface card is not installed on this instrument, this setup program will not appear on the setup menu.

Press the Setup key to advance the menu to the address parameter. The display will show:

Address =	XX
Range : 0 - 30	

Use the "Numeric" keys to enter the GPIB Address number, then press the "ENTER" key and the display will show the current address immediately.

Press the "SETUP" key to advance to the Contrast setting, or press the "EXIT" key to exit from the address setting to the operation mode. The program will store the address setting automatically.

### 3.3 LCD Contrast setting

Press the Setup key to advance the menu to the Contrast parameter. The display will show:

Contrast =	X
Range : 1 - 9 9 = High	

Use the "Numeric" keys to enter the LCD Contrast level, then press the "ENTER" key. The program will change the LCD Contrast immediately when the "ENTER" key is pressed, so the setting can be viewed.

Change the LCD Contrast again or press the "SETUP" key to advance to the Volume setting, or press the "EXIT" key to exit from the LCD Contrast setting to the operation mode. The program will store the Contrast setting automatically.

The LCD Contrast level is from 1 - 9, a total of 9 levels. Level 1 is the lowest contrast and level 9 is the highest contrast.

### 3.4 Audible Alarm Volume setting

Press the Setup key to advance the menu to the Volume parameter. The display will show:

Volume =	X
Range : 0 - 9	0 = OFF 9 = High

The Audible Alarm Volume level is from 0 - 9, a total 10 levels. Level 0 is used to disable the Audible Alarm. Level 1 is the lowest volume and level 9 is the loudest.

Use the "Numeric" keys to enter the Audible Alarm level, then press the "ENTER" key. The program will provide a sample sound for checking immediately when the "ENTER" key is pressed.

Change the Volume again or press the "SETUP" key to forward to the Fail Stop selection program, or press the "EXIT" key to exit from the Audible Alarm setting to the operation mode. The program will store the Volume setting automatically.

### 3.5 Fail to Stop/Continue selection

Press the Setup key to advance the menu to the Fail Stop parameter. The display will show:

Fail Stop = ON <ENTER> to Select	or	Fail Stop = OFF <ENTER> to Select
-------------------------------------	----	--------------------------------------

Use the "ENTER" key to select the mode of Fail Stop.

After the selection of Fail Stop mode, press the "SETUP" key to advance to the beginning of the menu (PLC Remote), or press the "EXIT" key to exit from the Fail Stop selection to the operation mode. The Program will store the selection of Fail Stop automatically.

This function is used when multiple steps have been connected. If the Fail Stop mode is set "ON", the test process will stop at the step that fails, or at the end of test process. When there are unfinished steps to be completed, pressing the "TEST" button will continue the test process at the next step. Pressing the "RESET" button and then the "TEST" button will start the test process from the first step.

If the Fail Stop is set to "OFF", the instrument will continue to complete the entire test process even if there were failed steps during the test. The display will show the results of each step at the end of test process, as follows:

<b>Test</b>	<b>P</b>	<b>F</b>	<b>P</b>	<b>F</b>	<b>P</b>	<b>F</b>	<b>P</b>	<b>F</b>	<b>P</b>	<b>F</b>	<b>P</b>	<b>F</b>	<b>P</b>	<b>F</b>	<b>P</b>	<b>F</b>
<b>Step</b>	<b>1</b>	<b>2</b>	<b>3</b>	<b>4</b>	<b>5</b>	<b>6</b>	<b>7</b>	<b>8</b>	<b>1</b>	<b>2</b>	<b>3</b>	<b>4</b>	<b>5</b>	<b>6</b>	<b>7</b>	<b>8</b>

The pass fail status is indicated by the letter F (Fail) or P (Pass). The Pass/Fail status of the first memory Program will show on the left end and the second one will be on the right. The pass/fail status of the first 16 steps can be displayed. A maximum of



16 steps will be saved. If more than 16 steps are executed in sequence. Results from those steps greater than 16 cannot be retrieved from memory.

## 4. Operation Procedure

### 4.1 Setup

Before the operation of this instrument, make sure that all Test Parameters have been set properly according to the Test Parameters Setup Procedures. Also check the system setting of Remote Control, LCD Contrast, the Alarm Volume and Fail Stop.

Be sure to connect the appropriate test leads to the device under test (DUT) or test fixture. Be sure to connect the safety ground (on the rear panel) to a suitable known good ground before energizing this instrument. Then connect the return lead first to the test fixture or the DUT followed by the high voltage lead.

Check your connections to be sure they are making good contact and that the test station or area is clear of debris or other personnel.

**WARNING**

**DO NOT TOUCH THE DEVICE UNDER TEST ONCE THE TEST HAS BEEN STARTED.**

### 4.2 Power Up

Turn on the Input Power Switch. The display will show the Trade Mark, Model Number and Version Number first, as follows:

ARI QUADCHEK II  
7564SA VER : X.X

Note: X = Numeric.

Then, all status LEDs will light up, and the Scanner status LEDs will light sequentially if the internal scanner has been installed. The program will then recall the Memory and Step which was last executed.

### 4.3 Settings Screen

The settings screen will show parameter settings of the test that will be performed and the memory locations that they are stored in. This screen can be accessed after a test is Aborted or Passed by pressing the "Reset" key, or after a test failure by pressing the "Reset" key twice. The Function is indicated on the left side of the first line and the mode, or test result, is indicated just to the right of the Function. The timer is always shown on the right side of the first line. The left side of the second line always indicates the Memory and Step that has been selected and an underbar character to the right of the step number indicates that the step has been connected to the next step in sequence. The display will show the underbar as follows for an ACW test, and step 1 connected to step 2:

ACW Set                      XXX.X s  
M25-1\_ X.XX KV      XX.XX mA



The following are examples of the four types of Setting Screens before any test has been executed.

If the first step selected is an AC Withstand test, the display will show:

ACW Set	XXX.X s
M25-1 X.XX KV XX.XX mA	

ACW Set : AC Withstand Voltage test setting screen  
 XXX.X s : Dwell Time setting  
 MXX : Memory Program number  
 - X : Test Step number  
 X.XX KV : AC Output Voltage setting  
 XX.XX mA : AC High-Limit current setting

If the first step selected is a DC Withstand test, the display will show:

DCW Set	XXX.X s
M25-1 X.XX KV XXXX $\mu$ A	

DCW Set : DC Withstand Voltage test setting screen  
 XXX.X s : Dwell Time setting  
 MXX : Memory Program number  
 - X : Test Step number  
 X.XX KV : DC Output Voltage setting  
 XXXX  $\mu$ A : DC High-Limit current setting

If the first step selected is an Insulation Resistance test, the display will show:

IR Set	XXX.X s
M25-1 XXXX V XXXX M $\Omega$	

IR Set : Insulation Resistance test setting screen  
 XXX.X s : Delay Time setting  
 MXX : Memory Program number  
 - X : Test Step number  
 XXXX V : DC Output Voltage  
 XXXX M $\Omega$  : Low-Limit of Insulation Resistance

If the first step selected is a Ground Bond test, the display will show:

GND Set	XXX.X s
M25-1 XX.XX A XXX m $\Omega$	

GND Set : Ground Bond test setting screen  
 XXX.X s : Dwell Time setting  
 MXX : Memory Program number

-X : Test Step number  
 XX.XX A : AC Output Current setting  
 XX.XX mΩ : High-Limit of Ground Continuity Resistance

#### 4.4 Ground Continuity Test (7550DT only)

If you are performing a Ground Continuity Check (in the case of 7550DT) the Ground Continuity must be set to the “ON” (Enabled) position. The ground check cable must be connected properly to the chassis of the DUT. The display will indicate “Ready” before activating the “TEST” button. Otherwise, the instrument will signal a continuity failure when the “TEST” button is activated. When continuity is “ON” and continuity is Good the display will show:

ACW Ready	XXX.X s
M25-1 X.XX KV	XX.XX mA

If you are not performing a “Ground Continuity Check” the Ground Continuity must be set to the “OFF” (Disabled) position. It is not necessary to connect the “Cont. Check” cable since this test will not be performed if the circuit is disabled. The instrument will proceed with the Hipot Test when the “TEST” button is activated.

Press the “TEST” button to activate the test process or press the “MEMORY” key to recall the new Test Parameters for testing.

#### 4.5 Reviewing Test Results

The test results from the first 8 test that are executed can be reviewed by pressing the “Enter/Review” key. Successive key presses will continue advancing to the next result. The results of the last step in the process will be followed by the first step when scrolling through the results.

If two or more memories are connected together (more than an 8 step process) then only the first 8 steps executed in the process will be stored into the results memory. The results from the steps executed after the first 8 steps in the process will not be retrievable. Results can be reviewed at any time before the next test is executed. All 8 buffers are cleared at the start of the next test cycle.

## 5. Displayed Messages

### 5.1 The followings are the displayed messages for the Ground Bond test: (Model 7564SA only)

If the test in process is Aborted with the “RESET” button or remote control, the display will show:

GND Abort	XXX.X s
MXX-X XX.XX A	XXX mΩ

If the test in process is Aborted with the “RESET” button or remote control before

the meter readings are taken, the display will show:

GND Abort	XXX.X s	or	GND Abort	XXX.X s
MXX-X	--- A		MXX-X	XX.XX A
	--- mΩ			--- mΩ

At the beginning of the Ground Bond test, before the meter readings are taken, the display will show:

GND Dwell	XXX.X s
MXX-X	--- A
	--- mΩ

During the Ground Bond test, when the values are being updated in real time, the display will show:

GND Dwell	XXX.X s
MXX-X	XX.XX A
	XXX mΩ

If the DUT failed the HI-Limit of the Ground Bond test and the ground continuity resistance is within the metering range, the display will show:

GND HI-Limit	XXX.X s
MXX-X	XX.XX A
	XXX mΩ

If the DUT failed the HI-Limit of the Ground Bond test and the ground continuity resistance is beyond the metering range, the display will show:

GND HI-Limit	XXX.X s
MXX-X	0.00 A
	> 600 mΩ

If the DUT resistance falls below the LO-Limit of the Ground Bond test, the display will show:

GND LO-Limit	XXX.X s
MXX-X	XX.XX A
	XXX mΩ

When the DUT passed the Ground Bond test when the test process is complete, the display will show:

GND Pass	XXX.X s
MXX-X	XX.XX A
	XXX mΩ

## 5.2 The followings are the displayed messages for the AC Withstand Voltage test:

If the test in process is Aborted with the “RESET” button or remote control, the display will show:

ACW Abort	XXX.X s
MXX-X X.XX KV	XX.XX mA

If the test in process is Aborted with the “RESET” button or remote control before the meter readings are taken, the display will show:

ACW Abort	XXX.X s
MXX-X - . . . KV	- . . . . mA

or

ACW Abort	XXX.X s
MXX-X X.XX KV	- . . . . mA

At the beginning of AC Withstand Voltage test when the voltage begins to ramp but before the meter readings are taken, the display will show:

ACW Ramp	XXX.X s
MXX-X - . . . KV	- . . . . mA

During the AC Withstand Voltage test when the values are being updated in real time during the ramp cycle, the display will show:

ACW Ramp	XXX.X s
MXX-X X.XX KV	XX.XX mA

During the AC Withstand Voltage test when the values are being updated in real time during the dwell cycle, the display will show:

ACW Dwell	XXX.X s
MXX-X X.XX KV	XX.XX mA

If the ramp time is very short and the program has not read the meter readings, the display will show:

ACW Dwell	XXX.X s
MXX-X - . . . KV	- . . . . mA

If the DUT current exceeds the HI-Limit of AC Withstand Voltage test and the leakage current is within the metering range, the display will show:

ACW HI-Limit	XXX.X s
MXX-X X.XX KV	XX.XX mA

If the DUT current exceeds the HI-Limit of AC Withstand Voltage test and the leakage current is not within the metering range, the display will show:

ACW HI-Limit	XXX.X s
MXX-X X.XX KV	> 40 mA

If the DUT current is well beyond the metering range of AC Withstand Voltage test the instrument assumes that the failure is due to a short circuit, the display will show:

ACW Short	XXX.X s
MXX-X - . - - KV	> 40 mA

If the DUT current is well beyond the metering range of AC Withstand Voltage test and an Arcing condition beyond the Arc Sense limit is indicated, the display will show:

ACW Breakdown	XXX.X s
MXX-X X.XX KV	> 40 mA

If the DUT current falls below the LO-Limit of AC Withstand Voltage test the display will show:

ACW LO-limit	XXX.X s
MXX-X X.XX KV XX.XX mA	

If the DUT current is within the metering range of the AC Withstand Voltage test and an Arcing current exceeds the Arc-Sense limit and the Arc function is set to "ON", then an Arc failure has occurred and the display will show:

ACW Arc-Fail	XXX.X s
MXX-X X.XX KV XX.XX mA	

When the DUT passed the AC Withstand Voltage test, when the test process is complete the display will show:

ACW Pass	XXX.X s
MXX-X X.XX KV XX.XX mA	

### 5.3 The followings are the displayed messages for the DC Withstand Voltage test:

If the test in process is Aborted with the "RESET" button or remote control, the display will show:

DCW Abort	XXX.X s
MXX-X X.XX KV XXXX $\mu$ A	

If the test in process is Aborted with the "RESET" button or remote control before the meter readings are taken, the display will show:

DCW Abort	XXX.X s	or	DCW Abort	XXX.X s
MXX-X - . - - KV - - - - $\mu$ A			MXX-X X.XX KV - - - - $\mu$ A	

At the beginning of DC Withstand Voltage test when the voltage begins to ramp but before the meter readings are taken, the display will show:

DCW Ramp	XXX.X s
MXX-X - . . . - KV	----- $\mu$ A

During the DC Withstand Voltage test when the values are being updated in real time during the Ramp cycle, the display will show:

DCW Ramp	XXX.X s
MXX-X X.XX KV	XXXX $\mu$ A

During the DC Withstand Voltage test when the values are being updated in real time during the Dwell cycle, the display will show:

DCW Dwell	XXX.X s
MXX-X X.XX KV	XX.XX $\mu$ A

If the Ramp time is very short and the program has not read the meter readings, the display will show:

DCW Dwell	XXX.X s
MXX-X - . . . - KV	----- $\mu$ A

If the Ramp-HI function is enabled and the leakage current during the Ramp cycle exceeds 10mA, then the display will show:

DCW Ramp-HI	XXX.X s
MXX-X X.XX KV	>9999 $\mu$ A

If the leakage current during the Ramp cycle falls below the Charge -LO setting, then the display will show:

DCW Charge-LO	XXX.X s
MXX-X X.XX KV	XXX.X $\mu$ A

If the DUT current exceeds the HI-Limit of DC Withstand Voltage test and the leakage current is within the metering range, the display will show:

DCW HI-Limit	XXX.X s
MXX-X X.XX KV	XXXX $\mu$ A

If the DUT current exceeds the HI-Limit of DC Withstand Voltage test and the leakage current is not within the metering range, the display will show:

DCW HI-Limit	XXX.X s
MXX-X X.XX KV	> 9999 $\mu$ A

If the DUT current is well beyond the metering range of DC Withstand Voltage test the instrument assumes that the failure is due to a short circuit, the display will show:

DCW Short	XXX.X s
MXX-X - . - - KV	> 9999 $\mu$ A

If the DUT current is well beyond the metering range of DC Withstand Voltage test and an Arcing condition beyond the Arc Sense limit is indicated, the display will show:

DCW Breakdown	XXX.X s
MXX-X X.XX KV	> 9999 $\mu$ A

If the DUT current falls below the LO-Limit of DC Withstand Voltage test and the leakage current is within the metering range, the display will show:

DCW LO-Limit	XXX.X s
MXX-X X.XX KV	XXX.X $\mu$ A

If the DUT current within the metering range of the DC Withstand Voltage test and an Arcing current exceeds the Arc-Sense limit and the Arc functions is set to ON then an Arc failure has occurred and the display will show:

DCW Arc-Fail	XXX.X s
MXX-X X.XX KV	XX.X $\mu$ A

When the DUT passed the DC Withstand Voltage test, when the test process is complete the display will show:

DCW Pass	XXX.X s
MXX-X X.XX KV	XXXX $\mu$ A

#### 5.4 The followings are the displayed messages for the Insulation Resistance test:

If the test in process is Aborted with the “RESET” button or remote control, the display will show:

IR Abort	XXX.X s
MXX-X XXXX V	XXXX M $\Omega$

If the test in process is Aborted with the “RESET” button or remote control before the meter readings are taken, the display will show:

IR Abort	XXX.X s	or	IR Abort	XXX.X s
MXX-X	---- V		MXX-X	XXXX V
	---- MΩ			---- MΩ

At the beginning of Insulation Resistance test when the voltage begins to ramp but before the meter readings are taken, the display will show:

IR Delay	XXX.X s
MXX-X	---- V
	---- MΩ

During the Insulation Resistance test when the values are being updated in real time during the Delay cycle, the display will show:

IR Delay	XXX.X s
MXX-X	XXXX V
	XXXX MΩ

If the leakage current during the Ramp cycle falls below the Charge -LO setting, then the display will show:

IR Charge-LO	XXX.X s
MXX-X	---- V
	---- MΩ

If the DUT current exceeds the HI-Limit of Insulation Resistance test and the resistance is within the metering range, the display will show:

IR HI-Limit	XXX.X s
MXX-X	XXXX V
	XXXX MΩ

If the DUT current exceeds the HI-Limit of Insulation Resistance test and the resistance is not within the metering range, the display will show:

IR HI-Limit	XXX.X s
MXX-X	XXXX V
	> 9999 MΩ

If the DUT current falls below the LO-Limit of Insulation Resistance test and the resistance is within the metering range, the display will show:

IR LO-Limit	XXX.X s
MXX-X	XXXX V
	XXXX MΩ

If the DUT current falls below the LO-Limit of Insulation Resistance test and the resistance is below the metering range, the display will show:

IR LO-Limit	XXX.X s
MXX-X	XXXX V
	< 1MΩ



When the DUT passed the Insulation Resistance test, when the test process is complete the display will show:

IR Pass	XXX.X s
MXX-X	XXXX V XXXX MΩ

## 6. Connection Of Remote I/O

Two 9 pin "D" type connectors are mounted on the rear panel which provide REMOTE-INPUT-OUTPUT control and information. These connectors mate with standard 9 pin "D" subminiature connector provided by the user. The output mates to a male (plug) connector while the input mates to a female (receptacle) connector. For best performance a shielded cable should be used. To avoid ground loops the shield should not be grounded at both ends of the cable. Suggested AMP part numbers for interconnecting to the Remote I/O are shown below.

205204-4	PLUG SHELL WITH GROUND INDENTS
205203-3	RECEPTACLE SHELL
745254-7	CRIMP SNAP-IN PIN CONTACT (for plug)
745253-7	CRIMP SNAP-IN SOCKET CONTACT (for receptacle)
745171-1	SHIELDED CABLE CLAMP (for either plug or receptacle)
747784-3	JACKSCREW SET (2)

### Remote Interface Rear Panel:

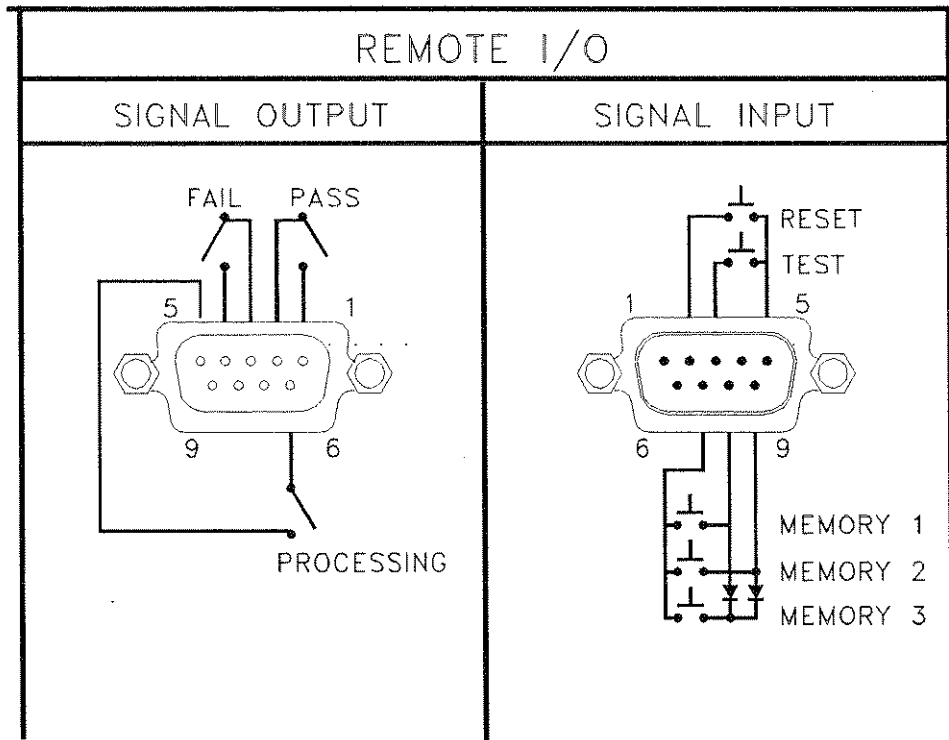

### 6.1 Signal Outputs on Remote I/O

The rear panel connector provides output signals to remotely monitor PASS, FAIL, and PROCESSING conditions. These signals are provided by three normally open internal relays that switch on to indicate the current condition of the tester. These are normally open free contacts and will not provide any voltage or current. The ratings of the contacts are 1A / 250 VAC ( 0.5 ADC ). The signal outputs are provided on the 9 pin female type D connector. Below is a listing that indicates

what conditions activate each pin. When a terminal becomes active the relay closes thereby allowing the external voltage to operate an external device.

Pins 1 and 2 provide the PASS signal.

Pins 3 and 4 provide the FAIL signal.

Pins 5 and 6 provide the PROCESSING signal.

Pins 7, 8, and 9 are blank.

The following describes how the relays operate for each test condition.

**PROCESSING** - The relay contact closes the connection between pin (5) and pin (6) while the instrument is performing a test. The connection is opened at the end of the test.

**PASS** - The relay contact closes the connection between pin (1) and pin (2) after detecting that the item under test passed all tests. The connection is opened when the next test is initiated or the reset function is activated.

**FAIL** - The relay contact closes the connection between pin (3) and pin (4) after detecting that the item under test failed any test. The connection is opened when the next test is initiated or the reset function activated.

## 6.2 Signal Inputs of Remote I/O and Memory Programs

The HypotULTRA II or QUADCHEK II remote connector enables remote operation of the TEST and RESET functions or allows the operator to select one of three pre-programmed tests. When the remote function is (ON) the "TEST" switch on the front panel will be disabled to prevent a test from being activated through the test switch. A normally open momentary switch can then be wired across pins 3 and 5 to allow remote operation of the TEST function. A normally open momentary switch can also be wired across pins 2 and 5 which allows remote operation of the RESET function. For safety the front panel "RESET" switch remains active even when a remote "RESET" switch is connected so that high voltage can be shut down from either location.

The HypotULTRA II or QUADCHEK II also allow access to three MEMORY PROGRAMS through the remote control connector. This gives the user the capability to quickly change parameters and initiate a test remotely. The HypotULTRA II or QUADCHEK II basically operates in a PLC mode by responding to simple switch or relay contact closures. The built in memory programs of the instrument are used to accomplish this. Three internal memory programs can be accessed, by connecting terminals 7, 8 and 9 in different combinations.

### **WARNING**

ACTIVATING MEMORY PROGRAM FUNCTIONS THROUGH THE REMOTE CONNECTOR, SELECTS THE PROGRAM AND STARTS THE TEST WHICH IS PREPROGRAMMED INTO THAT MEMORY

**CAUTION**

DO NOT CONNECT VOLTAGE OR CURRENT TO THE SIGNAL INPUTS, THIS COULD RESULT IN DAMAGE TO THE CONTROL CIRCUITRY.

MEMORY ONE - Momentarily connecting terminal 7 to 8 signals the instrument to immediately begin the test program that is stored in memory one.

MEMORY TWO - Momentarily connecting terminal 7 to 9 signals the instrument to immediately begin the test program that is stored in memory two.

MEMORY THREE - Momentarily connecting terminal 7 to terminals 8 and 9 signals the instrument to immediately begin the test program that is stored in memory three.

**7. Adapter Box Connection**

The following diagram shows how to connect the adapter box to the HypotULTRA II or QUADCHEK II and to the device under test.

7550DT, 7564SA

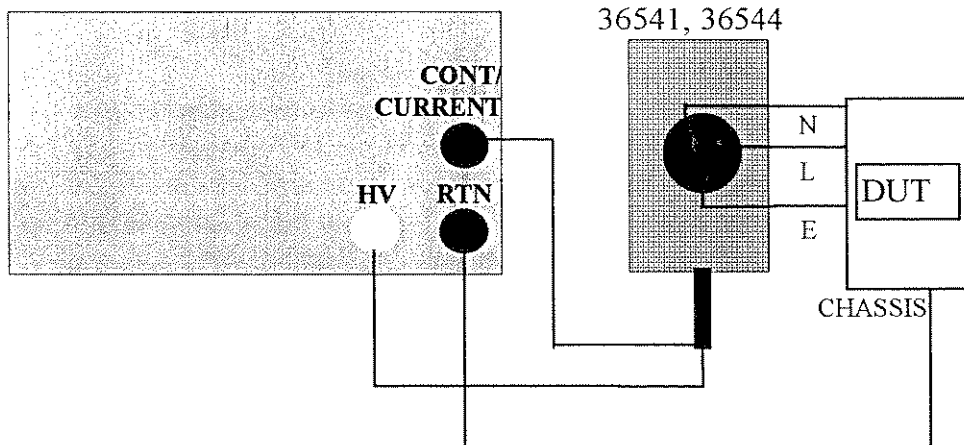

**Test Connections**

The adapter box provides an easy way to connect an item which is terminated in a two or three prong line cord. If you are testing a product which is terminated in a three prong plug, you are also required to perform a continuity or ground bond test on the ground conductor of the DUT to the chassis or dead metal of the product. With HypotULTRA II, you can perform both the hipot and continuity tests at the same time by activating the continuity function on the instrument.

When the HypotULTRA II tests the ground conductor of the line cord, if the resistance of the ground conductor exceeds 1Ω, the hipot will signal a continuity failure. If continuity is present, high voltage is applied to both conductors of the line cord to insure that all current carrying conductors in the primary circuit are tested.

When testing products with two prong plugs, do not activate the continuity circuit.

When the Ground Bond test is selected on the QUADCHEK II the High Current will be applied through the Current lead to the Adapter box and flow back through the Return lead. The resistance is measured and compared to the HI and LO- Limit trip points stored in memory.

## 8. Bus Remote Interface GPIB / RS-232

This section provides information on the proper use and configuration of the GPIB (IEEE-488) remote interface. The RS-232 interface also uses the same command list as the GPIB with the exception of the SRQ functions. Please refer to the Option section of this manual for detail on the RS232 interface.

### 8.1 A Brief History of IEEE-488....

Hewlett-Packard designed in 1965 the Hewlett-Packard Interface Bus (HP-IB) to connect their line of programmable instruments to computers. This bus had high transfer rates (nominally 1 Mbytes/s), and thus quickly gained acceptance. Later, it was accepted as the IEEE Standard 488-1975 and has since evolved into ANSI/IEEE Standard 488.1-1987.

IEEE-488 has expanded over the years and is used with many more types of computers and instruments than just HP. Because of this it is usually referred to as the General Purpose Interface Bus, (GPIB).

### 8.2 GPIB Messages

There are typically two types of messages that GPIB devices use to communicate with other interconnected GPIB devices;

**Interface messages:** often called commands or command messages and Device dependent messages often called data or data messages.

**Data Messages:** contain information such as programming instructions or measurement results. Command Messages perform functions such as initializing the bus and addressing and unaddressing devices.

### 8.3 Functions

A GPIB device can be a Listener, Talker and/or Controller. A Talker sends data messages to one or more Listeners, which receive data. A Controller manages the information flow on the GPIB by sending commands to all devices. The GPIB bus is much like a computer bus except a computer has circuit cards connected via a backplane and the GPIB has stand alone devices connected via a cable.

### 8.4 Signals and Lines

The GPIB consists of 16 signal lines and 8 ground-return or shield drain lines. The 16 signal lines are grouped into 8 data lines, 3 handshake lines and 5 interface management lines.

**Data Lines:** The eight data lines, DI01 through DI08 carry data and command messages. The 7-bit ASCII or ISO code set is used and the eighth bit DI08 is unused.

**Handshake Lines:** The transfer of message bytes between devices is done via three asynchronously control lines. Referred to as three-wire interlocked handshake. This guarantees that message bytes on the data lines are sent and received without

transmission error.

**NRFD** (not ready for data) indicates when a device is ready or not ready to receive a message byte.

**NDAC** (not data accepted) indicates when a device has or has not accepted a message byte.

**DAV** (data valid) tells when the signals on the data lines are stable (valid) and can be accepted safely by devices.

**Interface Management Lines:** Five lines are used to manage the flow of information across the interface.

**ATN** (attention) ATN is driven true by the controller when it uses the data lines to send commands, and drivers ATN false when a Talker can send data messages.

**IFC** (interface clear) IFC is driven by the system controller to initialize the bus and become CIC.

**REN** (remote enable) The REN line is driven by the controller which is used to place devices in remote or local program mode.

**SRQ** (service request) The SRQ line can be driven by any device to asynchronously request service from the Controller.

**EOI** (end or identify) This line has two purposes- the Talker uses this line to mark the end of a message string, and the Controller uses it to tell devices to identify their response in a parallel poll.

## 8.5 GPIB Connector

Connection is usually accomplished with a 24-conductor cable with a plug on one end and a connector at the other end. Devices may be connected in a linear, star or a combination configuration.

The standard connector is the Amphenol or Cinch Series 57 Microribbon or AMP CHAMP type. The GPIB uses negative logic with standard transistor-transistor logic (TTL) levels. When DAV is true, for example, it is a TTL low level ( $\leq 0/8$  V), and when DAV is false, it is a TTL high level ( $\geq 2.0$  V).

### Restrictions and Limitations on the GPIB

A maximum separation of 4 m between any two devices and an average separation of 2 m over the entire bus.

A maximum total cable length of 20 m.

No more than 15 device loads connected to each bus, with no less than two-thirds powered on.

*Note:* A bus extender which is available from numerous manufacturers is available to overcome these limitations.

### 8.6 Interface Functions

The capability of a device connected to the bus is specified by its interface functions. These functions provide the means for a device to receive, process, and send messages over the bus. The interface functions are listed in the chart below. All functions may be controlled over the bus except input voltage which is Selectable on the rear panel.

#### GPIB INTERFACE FUNCTIONS

IEEE-488 INTERFACE	Complete handshake capability Talker/Listener functions Service request capability No remote/local capability No parallel poll capability No device clear capability No device trigger capability No controller capability 3 state driver
CONTROLLABLE ITEMS	Test/Reset control Setting of test status/parameters for test Display Reading Results Reading
DATA CODES	ASCII
DELIMITER	CR + LF (+ EOI)

### 8.7 GPIB Address

Each device on the GPIB (IEEE-488) interface must have a unique address. You can set the address of the 7564SA or 7550DT to any value between 0 and 30. The address is set to " 8 " when the instrument is shipped from the factory. The address can only be set from the front panel. The address is stored in non-volatile memory and does not change when the power has been off or after a remote interface reset.



### 8.8 7550DT/7564SA GPIB Interface Command List

The following commands are used to toggle ON/OFF functions or menu selection items. No other values or parameters are needed to execute these commands. However when using commands that are usable for a certain function only (function specific), the appropriate function select command FC, FD, FE, or FF must be executed first, to access the parameter for that function.

Command	Function	Function Specific
FA	Test	
FB	Reset	
FC	ACW Function Select	
FD	DCW Function Select	
FE	IR Function Select	
FF	GND Function Select (7564SA only)	
FG	ACW/DCW: Continuity On (7550DT Only)	x
FH	ACW/DCW: Continuity Off (7550DT Only)	x
FI	ACW: 60Hz	x
FJ	ACW: 50Hz	x
FK	ACW: Arc Fail On	x
FL	ACW: Arc Fail Off	x
FM	DCW: Arc Fail On	x
FN	DCW: Arc Fail Off	x
FO	GND: 60hz (7564SA only)	x
FP	GND: 50hz (7564SA only)	x
FQ	Connect On	
FR	Connect Off	
FS	Fail Stop On	
FT	Fail Stop Off	
FU	GND: Auto Offset (7564SA only)	x
FV	DCW: Auto Charge-LO	x
FW	IR: Auto Charge-LO	x
F0	Enable "All Pass" SRQ	
F1	Disable "All Pass" SRQ	
F2	Enable "Fail" SRQ	
F3	Disable "Fail" SRQ	
F4	Enable "Abort" SRQ	
F5	Disable "Abort" SRQ	
F6	Enable "Error Command" SRQ	
F7	Disable "Error Command" SRQ	
F8	DCW: Ramp-HI On	x
F9	DCW: Ramp-HI Off	x

The following "S" commands will set test parameters on the instrument that require numeric or alphanumeric input. To execute these commands, the appropriate function must first be selected with the above Function Select command FC, FD, FE, or FF, to have access to the parameter menu.

<b>ACW</b>			
Command	Parameter	Value	Unit
SA	Voltage	0-5000	V
SB	HI-Limit	0.00-40.00	mA
SC	LO-Limit	0.000-9.999	mA
SD	Ramp Time	0.1 - 999.9	S
SE	Dwell Time	0, 0.3 - 999.9	S
SF	Arc Sense	1 - 9	-
SG	Scanner	H=Hi,L=Low,O=Open up to 16 channels	-

<b>DCW</b>			
Command	Parameter	Value	Unit
SI	Voltage	0-6000	V
SJ	HI-Limit	0 - 3500	μA
SK	LO-Limit	0.0 - 999.9	μA
SL	Ramp Time	0.4 - 999.9	S
SM	Dwell Time	0, 0.3 - 999.9	S
SO	Charge-LO	0.0 - 350.0	μA
SP	Arc Sense	1 - 9	-
SQ	Scanner	H=Hi,L=Low,O=Open up to 16 channels	-

<b>IR</b>			
Command	Parameter	Value	Unit
SS	Voltage	100 - 1000	V
ST	Charge-LO	0.000 - 9.999	μA
SU	HI-Limit	0 - 9999	MΩ
SV	LO-Limit	1 - 9999	MΩ
SW	Delay-Time	0, 0.5 - 999.9	S
SX	Scanner	H=Hi,L=Low,O=Open up to 16 channels	-

<b>GND (7564SA only)</b>			
Command	Parameter	Value	Unit
SY	Current	3.00 - 30.00	A
SZ	Volt	3.00 - 8.00	V
S0	HI-Limit	0 - 600	mΩ
S1	LO-Limit	0 - 600	mΩ
S2	Dwell Time	0.5 - 999.9	S
S3	Scanner	1 - 16	Channel
S4	Offset	0 - 200	mΩ

<b>General Operation</b>			
Command	Function	Value	Unit
S5	Memory Select	1 - 50	Integer
S6	Step Select (1-8)	1 - 8	Integer

When the Controller sends a correct "S" or "F" command the instrument will echo back the identical command string if a GPIB read command is sent after the command string.

If an error occurs when the command is sent the instrument will send an ASCII code "15h" after the read command is sent.

The following functions will read data from the instrument when executed. For every command written, a corresponding read command of the appropriate byte length (shown below) must be executed to retrieve the data from the instrument.

Command	Read Data Function	Read Bytes	Description
?1	Step Buffer 1	40	Read the 2 x 20 display results of the first test executed.
?2	Step Buffer 2	40	Read the 2 x 20 display results of the second test executed.
?3	Step Buffer 3	40	Read the 2 x 20 display results of the third test executed.
?4	Step Buffer 4	40	Read the 2 x 20 display results of the fourth test executed.
?5	Step Buffer 5	40	Read the 2 x 20 display results of the fifth test executed.
?6	Step Buffer 6	40	Read the 2 x 20 display results of the sixth test executed.
?7	Step Buffer 7	40	Read the 2 x 20 display results of the seventh test executed.
?8	Step Buffer 8	40	Read the 2 x 20 display results of the eighth test executed.
?A	Ground Bond Offset	5	Read the Ground Offset Setting G-Bond mode must be active.
?B	DCW Charge-LO	5	Read the DCW Charge-LO Setting. DCW mode must be active.
?C	IR Charge-LO	5	Read the IR Charge-LO Setting IR mode must be active.
?D	Remote Reset Status	1	01 hex = Reset ON 00 hex = Reset OFF
?K	LCD Display	40	Read the 2 x 20 display in real time or after the test.

If an error occurs when the command is sent the instrument will send an ASCII code "15h" after the read command is sent.

### 8.9 Example of communicating over the IEEE bus

To write commands over the IEEE bus you must enter the code that is specific to the software language you are using. Then follow the example below:

To set the output voltage across the IEEE bus at 1240 volts do the following. First select the ACW mode by sending the string "FC" then send the string "SA 1240": This tells the instrument to set the AC voltage at 1240 volts. A string is a list of ASCII characters, octal or hex bytes or special symbols, enclosed in double quotes.

If the Test Function has already been selected to ACW mode and you wish to set the ramp time of the ACW test across the IEEE bus at 10 seconds, do the following, send the string “SD 10.00”. This tells the instrument to set the AC Ramp Time at 10.00 seconds.

To set outputs 1 & 2 of the scanner to High, outputs 3 & 4 to Low and outputs 4-8 to Off type in the following string, “SGHLLLOOOO”, after the ACW Test Function has been selected. All ports not being specifically set will automatically be set to “O” open.

To read the 2 x 20 display, first send the string “?K” then send the GPIB command to read 40 bytes. The instrument will send 40 bytes, one byte for each character on the display, including spaces.

### 8.10 Non Volatile Memory

The instrument saves each parameter in non-volatile memory when the parameter is changed. The non-volatile memory has a limited write cycle life, therefore there is a special volatile memory location that is available for programmers who wish to send all parameters before executing each test. Memory 50, step 8 is the memory location that will **NOT** write the parameter to non-volatile memory. Settings written to this location from GPIB mode will be lost when power is shut down. Parameter changes to this location is unlimited and will not effect the life of the internal non-volatile memory chip.

### FOR MORE INFORMATION ON IEEE (GPIB) PLEASE CONTACT:

The Institute of Electrical and Electronic Engineers, Inc.  
345 East 47th Street,  
New York, NY 10017

☎ 1-212-705-7018 (Communications Society of IEEE)

Internet: <http://www.ieee.org>

## Model 7564SA / 7550DT OPTIONS

### Introduction

This section contains a list and descriptions of available factory installed options at the time of this printing. The list of options contains an option code number which can be referenced on the data plate on the rear panel of the unit.

### Data Plate

The option code is contained in the OPT field. The complete model number will include the standard base model number and end with the letter "C" when options are present.

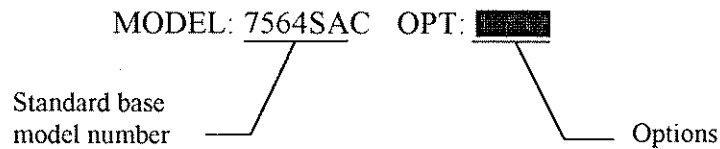

For example your data plate would appear as follows:

standard model (no options) .....	MODEL: 7564SA
fitted with option 01 .....	MODEL: 7564SAC OPT: 01
fitted with option 01 and 02.....	MODEL: 7564SAC OPT: 0102

### 7564SA Options

#### Option List

Code	Description
01	8 Port Scanner
02	Real Current
03	High Resolution IR milliohm meter
04	Grounded Return
05	RS232 Interface
06	Dual Remote Test Switches

### Description

#### 01 8 Port Scanner

The Scanner option provides 8 high voltage ports and 8 ground bond ports on the rear panel. The High Voltage Ports can be set to a High or Low level giving the capability to test from one port to another port or from any port to a common Low or Return point. The ports can be connected in parallel if desired but there is only one leakage current measurement for all ports. The ground bond ports can test only

from one port to the common Return and only one port may be used for each test.

Descriptions for operating the scanner are contained within the standard operating and setup procedures. The additional accessories provided come complete will assembly instructions please refer to these instructions when installing the scanner port connections.

The scanner will provide output to multiple test points and will have the same operation specifications that apply to the standard instrument with the exception of one Ground Bond port limitation. Due to the characteristics of general purpose High Current relays, there is some additional contact resistance that can not be prevented. Although this contact resistance can be Offset using the milliohm offset feature of the instrument, there will be some variation of the contact resistance due to the fact that the relay must open and close. Each relay closure may represent a different resistance value. The Ground Bond ports will have the following characteristics:

Ground Bond Port Resistance Deviation	
Deviation (Relay Contact)	Test Current
6mΩ maximum	≥10A

## 02 Real Current

The Real Current option allows the user to monitor only the real portion of the leakage current and ignore any reactive components due to capacitance in the device under test. It is important to recognize that the total current is the vector sum of the reactive and real current, not the direct addition of the two components. As in a right triangle, the total current is the square root of the sum of the squares of the real and reactive currents.

Since the real component is usually much smaller than the reactive current, a doubling of the real current increases the total current by only a small amount. Unless the two components are separated, a doubling of the real leakage current can go virtually undetected by a total current measurement.

The Associated Research Real Current option allows the operator to view either real or total current. The real current and total current cannot be measured or monitored simultaneously. Independent failure settings for Real and Total current are provided but only one fail detector is active depending on the metering mode of operation. The selection must be made in the menu before the test is run.

## 03 High Resolution IR milliohm meter

This option will allow for lower resistance readings than the standard instrument. The reading resolution is improved to 0.1KΩ from the previous 1MΩ. The minimum reading is 50KΩ and maximum is reduced to 99.99MΩ. The other specifications in other modes remain the same. The following specification refers to the IR test only.



Resistance Display	Range:	0.0500 - 99.99 MΩ (4 Digit, Auto Ranging)		
	Resolution:	500VDC		1000VDC
		MΩ	MΩ	MΩ
		0.0001	0.0500 - 0.1200	0.1000 - 0.2500
		0.001	0.100 - 1.200	0.200 - 2.500
	0.01	1.00 - 99.99	2.00 - 99.99	
	Accuracy:	± (2% of reading + 2 counts) at test voltage 100 - 500V and 0.050 - 9.999 MΩ ± (2% of reading + 2 counts) at test voltage 501 - 1000V and 0.100 - 9.999 MΩ ± (8% of reading + 2 counts) at test voltage 499 - 1000V and 10.00 - 99.99 MΩ		
Charge-LO	Range:	000.0 - 350.0μA or Auto Set		
HI-Limit	Range:	0, 0.05 - 99.99 MΩ (0 = Off)		
LO-Limit	Range:	0.05 - 99.99 MΩ		

#### Calibration

Added DC 10mA page,

Deleted XXX.XMohm & XXXXMohm page

#### 04 Grounded Return

The Grounded Return option allows the user to perform tests on devices that have their chassis earth grounded by the test fixture or the environment. The standard configuration of the 7564SA and 7550DT provide a return connection that is not directly connected to Earth ground. This configuration allows monitoring of very low level leakage current without the stray leakage currents being measured and causing errors in the reading. The Grounded Return option will have some amount of internal leakage current that is proportional to the High Voltage output and can cause small amounts of error depending on the test voltage and physical environment.

#### 05 RS232 Interface

This option may be substituted for the standard GPIB interface. This option provides all of the function control of the GPIB interface with the exception of the SRQ functions. All commands can be found in the GPIB portion of the Operation section of this manual.



The RS232 cabling should be configured as follows for a 9 pin serial port interface:

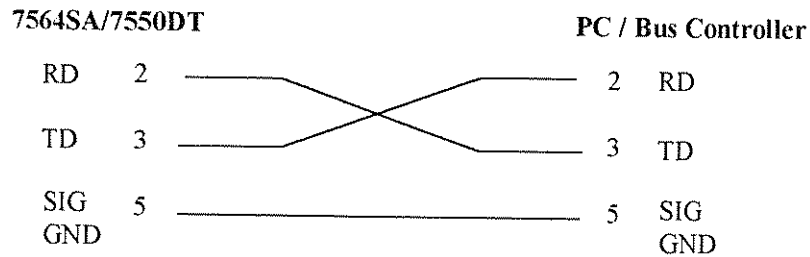

The COM port should have the following configuration. 9600 baud, 8 data bits, 1 stop bit, no parity. This interface does not support XON/XOFF protocol or any hardware handshaking. The controller should be configured to ignore the handshaking lines DTR (pin 4), DSR (pin 6) CTS (pin 8) and RTS (pin 9). If the port can not be configured through software to ignore the lines then the handshake lines should be jumpered together in two different sets. Pins 4 and 6 jumpered together and pins 7 and 8 jumpered together at the controller end of the cable.

When sending command over the RS232 bus the 7564SA/7550DT will echo a response string identical to the string that was sent if the transfer was recognized and accepted by the instrument. This allows for software handshaking, to monitor and control data flow. If there is an error with the command string that is sent, the instrument will respond with 15h or the "NAK" ASCII control code. When requesting data from the instrument, it automatically send the data to the controller input buffer. The controller input buffer will accumulate data being sent from the instrument including the echo response string, until it is read by the controller.

#### 06 Dual Remote Test Switches

The Dual Remote Test Switch option allows the user to configure dual palm switches for safe production line operation. The rear panel remote interface is reconfigured to allow two test switches instead of the standard reset and test inputs. The two test switches have to be pressed within 0.5 seconds to activate the test process. The two test switches must remain closed to continue the test. If either of the test switches are released, the process will be shut down immediately. The functions of the Test and Reset switches on the front panel will be disabled while the dual test switches enabled with the menu selection of Remote On/Off. If the dual test switches are not enabled, the functions of front panel Test and Reset switches will remained the same as the standard instrument.

**7550DT Options****Option List**

<b>Code</b>	<b>Description</b>
01	8 Port Scanner
02	Real Current
04	Grounded Return
05	RS232 Interface

**Description****01 8 Port Scanner**

The Scanner option provides 8 high voltage ports on the rear panel. The High Voltage Ports can be set to a High or Low level giving the capability to test from one port to another port or from any port to a common Low or Return point. The ports can be connected in parallel if desired but there is only one leakage current measurement for all ports.

Descriptions for operating the scanner are contained within the standard operating and setup procedures. The additional accessories provided come complete with assembly instructions. Please refer to these instructions when installing the scanner port connections.

The scanner will provide output to multiple test points and will have the same operation specifications that apply to the standard instrument.

**02 Real Current**

The Real Current option allows the user to monitor only the real portion of the leakage current and ignore any reactive components due to capacitance in the device under test. It is important to recognize that the total current is the vector sum of the reactive and real current, not the direct addition of the two components. As in a right triangle, the total current is the square root of the sum of the squares of the real and reactive currents.

Since the real component is usually much smaller than the reactive current, a doubling of the real current increases the total current by only a small amount. Unless the two components are separated, a doubling of the real leakage current can go virtually undetected by a total current measurement.

The Associated Research Real Current option allows the operator to view either real or total current. The real current and total current cannot be measured or monitored simultaneously. Independent failure settings for Real and Total current are provided but only one fail detector is active depending on the metering mode of operation. The selection must be made in the menu before the test is run.

**04 Grounded Return**

The Grounded Return option allows the user to perform tests on devices that have their chassis earth grounded by the test fixture or the environment. The standard configuration of the 7564SA and 7550DT provide a return connection that is not directly connected to Earth ground. This configuration allows monitoring of very low level leakage current without the stray leakage currents being measured and causing errors in the reading. The Grounded Return option will have some amount of internal leakage current that is proportional to the High Voltage output and can cause small amounts of error depending on the test voltage and physical environment.

**05 RS232 Interface**

Please refer to model 7564SA option section. The configuration is the same for model 7550DT.

This page left blank.

**SECTION 2**  
**SERVICE MANUAL**

---

## CALIBRATION PROCEDURES

### To enter the Calibration Mode

Press the “0” and “1” keys simultaneously and then turn the input power switch on. The program will automatically enter to the calibration mode and the display screen will show:

Calibration Mode ∨ : Forward   ^ : Backward
--

Use the “∨” (Forward) and “^” (Backward) keys to move through the calibration menu. The following instructions follow the sequential Forward scrolling through the menu.

#### 1. Password setting

Press the “∨” key, the program will advance to the Password setting mode. The display will show:

Password   =   0 Range : 0 - 9 9 9 9
---

or

Password   =   X X X X Range : 0 - 9 9 9 9
---

The Password can be any four (4) digit number. If the Password is set to “0”, the keyboard lock out will be selected by the LOCK key on the front panel without a Password. The Password default is preset to “0” at the factory.

#### 2. Memory Lock selection

Press the “∨” key, the program will advance to the Memory Lock selection mode. The display will show:

MR-Lock   =   O N <ENTER> to Select
--

or

MR-Lock   =   O F F <ENTER> to Select
--

If the MR-Lock is selected “ON”, the Memory selection Menu will be disabled when in Lock Mode. If the MR-Lock is selected “OFF”, the Memory selection Menu will be enabled when in Lock Mode. Different memories can be recalled but the test parameters or steps can not be changed. The MR-Lock default is preset to “ON” at the factory.

### 3. AC Hipot, Voltage

Press the “√” key, the program will advance to the AC Voltage calibration of the hipot test. The display will show:

```
ACW Voltage,5000V
<TEST> to Calibrate
```

Connect an AC standard voltage meter which can measure up to 5000V to the output connectors and then press the “TEST” button, the program will automatically generate an output of about 5000VAC and the display will show:

```
HI-Voltage =      V
Enter Standard V-out
```

Use the Numeric keys to enter the standard value of voltage, unit “V”, and then press the “ENTER” key to store the standard value of AC hipot voltage for calibration and display will show:

```
ACW Voltage,5000V      OK
<TEST> to Calibrate
```

### 4. DC Hipot, Voltage

Press the “√” key, the program will advance to the DC Voltage calibration of the hipot test. The display will show:

```
DCW Voltage, 6000V
<TEST> to Calibrate
```

Connect a DC standard voltage meter which can measure up to 6000V to the output connectors and then press the “TEST” button, the program will automatically generate an output of about 6000VDC and the display will show:

```
HI-Voltage =      V
Enter Standard V-out
```

Use the Numeric keys to enter the standard value of voltage, unit “V”, and then press the “ENTER” key to store the standard value of DC hipot voltage for calibration and the display will show:

```
DCW Voltage, 6000V OK
<TEST> to Calibrate
```

### 5. IR test, DC Voltage

Press the “√” key, the program will advance to the DC Voltage calibration of the IR test. The display will show:

```
IR Voltage, 1000V
<TEST> to Calibrate
```

Connect a DC standard voltage meter which can measure up to 1000V to the output connectors and then press the “TEST” button, the program will automatically generate an output of about 1000VDC and the display will show:

```
IR-Voltage =      V
Enter Standard V-out
```

Use the Numeric keys to enter the standard value of DC voltage, unit “V”, and then press the “ENTER” key to store the standard value of IR test voltage for calibration and the display will show:

```
IR Voltage, 1000V      OK
<TEST> to Calibrate
```

### 6. AC Hipot, 40mA current range

Press the “√” key, the program will advance to the AC 40mA range calibration of the hipot test. The display will show:

```
AC 40mA, 100KΩ
<TEST> to Calibrate
```

Connect a resistor about 100KΩ/10W in series with a AC standard Ammeter which can measure up to 10mA to the output leads. The Ammeter should be connected to the return lead, then press the “TEST” button, the program will automatically generate an output of about 1000V/10mA and the display will show:

```
Current =      mA
Enter Standard I-out
```

Use the Numeric keys to enter the standard value of current, unit “mA”, and then press the “ENTER” key to store the standard value of AC 40mA range for calibration and the display will show:

```
AC 40mA, 100KΩ      OK
<TEST> to Calibrate
```



### 7. AC Hipot, 3.5mA current range

Press the “√” key, the program will advance to the AC 3.5mA range calibration of the hipot test. The display will show:

```
AC 3.5mA, 100KΩ
<TEST> to Calibrate
```

Connect a resistor about 100KΩ/10W in series with a AC standard Ammeter which can measure up to 3mA to the output leads. The Ammeter should be connected to the return lead, then press the “TEST” button, the program will automatically generate an output on the output connectors about 300V/3mA and the display will show:

```
Current =      mA
Enter Standard I-out
```

Use the Numeric keys to enter the standard value of current, unit “mA”, and then press the “ENTER” key to store the standard value of AC 3.5mA range of the hipot test and the display will show:

```
AC 3.5mA, 100KΩ      OK
<TEST> to Calibrate
```

### 8. DC Hipot, 3500μA current range

Press the “√” key, the program will advance to the DC 3500μA range calibration of hipot test. The display will show:

```
DC 3500μA, 100KΩ
<TEST> to Calibrate
```

Connect a resistor about 100KΩ/10W in series with a DC standard Ammeter which can measure up to 3000μA to the output leads. The Ammeter should be connected to the return lead, then press the “TEST” button, the program will automatically generate an output of about 300V/3000μA and the display will show:

```
Current =      μA
Enter Standard I-out
```

Use the Numeric keys to enter the standard value of current, unit “μA”, and then press the “ENTER” key to store the standard value of DC 3500μA range of hipot test and the display will show:

```
DC 3500μA, 100KΩ      OK
<TEST> to Calibrate
```

**9. DC Hipot, 350 $\mu$ A current range**

Press the “ $\checkmark$ ” key, the program will advance to the setting and reading of DC 320 $\mu$ A range calibration of the hipot test. The display will show:

DC 350 $\mu$ A, 1M $\Omega$   
 <TEST> to Calibrate

Connect a resistor about 1M $\Omega$ /0.25W in series with a DC standard Ammeter which can measure up to 300 $\mu$ A to the output leads. Connect the Ammeter to the return leads, then press the “TEST” button, the program will automatically generate an output of about 300V/300 $\mu$ A and the display will show:

Current =            $\mu$ A  
 Enter Standard I-out

Use the Numeric keys to enter the standard value of current, unit “ $\mu$ A”, and then press the “ENTER” key to store the standard value of DC 350 $\mu$ A range of the hipot test and the display will show:

DC 350 $\mu$ A, 1M $\Omega$            OK  
 <TEST> to Calibrate

**10. IR test, XXX.XM $\Omega$  range**

Press the “ $\checkmark$ ” key, the program will advance to the XXX.XM $\Omega$  range calibration of the IR test. The display will show:

XXX.XM $\Omega$ ,STD 50M $\Omega$   
 <TEST> to Calibrate

Connect a 50M $\Omega$ /0.25W/1000VDC standard resistor to the output connectors, then press the “TEST” button, the program will automatically calibrate the XXX.X M $\Omega$  range of IR test and the display will show:

XXX.XM $\Omega$ ,STD 50M $\Omega$        OK  
 <TEST> to Calibrate

**11. IR test, XXXXM $\Omega$  range**

Press the “ $\checkmark$ ” key, the program will advance to the XXXXM $\Omega$  range calibration of the IR test. The display will show:

XXXXM $\Omega$ ,STD 50M $\Omega$   
 <TEST> to Calibrate

Connect a 50M $\Omega$ /0.25W/1000VDC standard resistor to the output connectors, then press the “TEST” button, the program will automatically calibrate the XXXX M $\Omega$  range of IR test and the display will show:

XXXXM $\Omega$ , STD 50M $\Omega$ OK <TEST> to Calibrate
---

## 12. Ground Bond, AC Voltage (Model 7564SA only)

Press the “ $\vee$ ” key, the program will advance to the AC Voltage calibration of the Ground bond test. The display will show:

Ground V, 7V <TEST> to Calibrate
-------------------------------------

Connect a AC standard voltage meter which can measure up to 10VAC to the High current and Return output leads, then press the “TEST” button, the program will automatically generate an output of about 7VAC and the display will show:

G-Voltage =      V Enter Standard V-out
--

Use the Numeric keys to enter the standard value of voltage, unit “V”, and then press the “ENTER” key to store the standard value of AC Ground Bond voltage and display will show:

Ground V, 7V      OK <TEST> to Calibrate
---

## 13. Ground Bond, AC Current (Model 7564SA only)

Press the “ $\vee$ ” key, the program will advance to the AC Current calibration of the Ground bond test. The display will show:

Ground A, 30A <TEST> to Calibrate
--------------------------------------

Connect a AC standard Ammeter which can measure up to 30AAC to the High current and Return output leads, then press the “TEST” button, the program will automatically generate an output on the output leads of about 30AAC and the display will show:

G- Current =      A Enter Standard I-out
---

Use the Numeric keys to enter the standard value of current, unit “A”, and then

press the "ENTER" key to store the standard value of AC Ground Bond current and display will show:

Ground A, 30A	OK
<TEST> to Calibrate	

## Replacement Parts List

Rev. - 4/21/97 ECO -

Part Number	Qty.	Reference Designator	Description
<b>Model 7550DT, 7564SA</b>			
37738	1	7440	Main Control Board
37739	1	CHV-04	HV Control Board
37740	1	AMP-270	Main Power Amplifier Board
37741	1	REC-17	Rectifier Board
37742	1	CKB-03	Keypad Board
37743	1	CSW-04	Input Protection Board
37744	1	DSP-06	Display LED Board
37745	1	CGP-03	GPIB Interface Board
37814	1	RS232	RS232 Interface Board
37748	1	CSU-CO2	Scanner Control Board
37804	1	-	LCD Display 22 x 2 Characters
37807	1	-	Reset Switch, Red
37806	1	-	Test Switch, Green
37555	1	-	Power Switch 2P 10A/250V
37750	1	T1	Input Transformer
37751	1	T2	Output High Voltage Transformer
37780	1	-	Fuse 6.3A 250V Slow Blow 20mm
37781	1	-	Fuse Holder 20mm
37571	1	-	Earth Connector
37461	1	-	Feet Kit
37800	2	-	3U Rack Mount Bracket
37801	2	-	3U Rack Mount Handle
33189	1	-	Input Power Cable 10A/7Ft.
37478	2	-	High Voltage Connector
04040A-08	1	-	High Voltage Output Cable
37697	1	IC12	IC Microcontroller 8-bit 20Mhz 89C52
<b>Model 7550DT only</b>			
37778	1	CGC-02	Ground Continuity Check Board
37747	1	CSU-105C	Scanner Matrix Board
37749	1	DSP-07	Scanner Display Board
35999	4	-	Black Banana Jacks
02100A-13	1	-	Return Cable
36544	1	-	Adapter Box HV Domestic
<b>Model 7564SA only</b>			
37746	1	CSU-105A	Scanner Matrix Board
37815	1	DSP-07	Scanner Display Board
37239	2	-	High Current Return Jack
37239	2	-	High Current Output Jack
05002D-37	1	-	Cable Assembly High Current Return
05002D-24	1	-	Cable Assembly High Current Output
36541	1	-	Adapter Box HV, HC Domestic

**SCHEMATIC INDEX**

<b>Drawing Number</b>	<b>Description</b>	<b>Pages</b>
S07550DT	Wiring Diagram	2
S07564SA	Wiring Diagram	2
S37738	Main Control Board	4
S37739	HV Control Board	1
S37740	Main Power Amplifier Board	1
S37741	Rectifier Board	1
S37742	Keypad Board	1
S37743	Input Protection Board	1
S37744	Display LED Board	1
S37745	GPIB Interface Board	1
S37746	Scanner Matrix Board	1
S37748	Scanner Control Board	1
S37749	Scanner Display Board	1
S37778	Ground Continuity Check Board	1
S37814	RS232 Interface Board	1

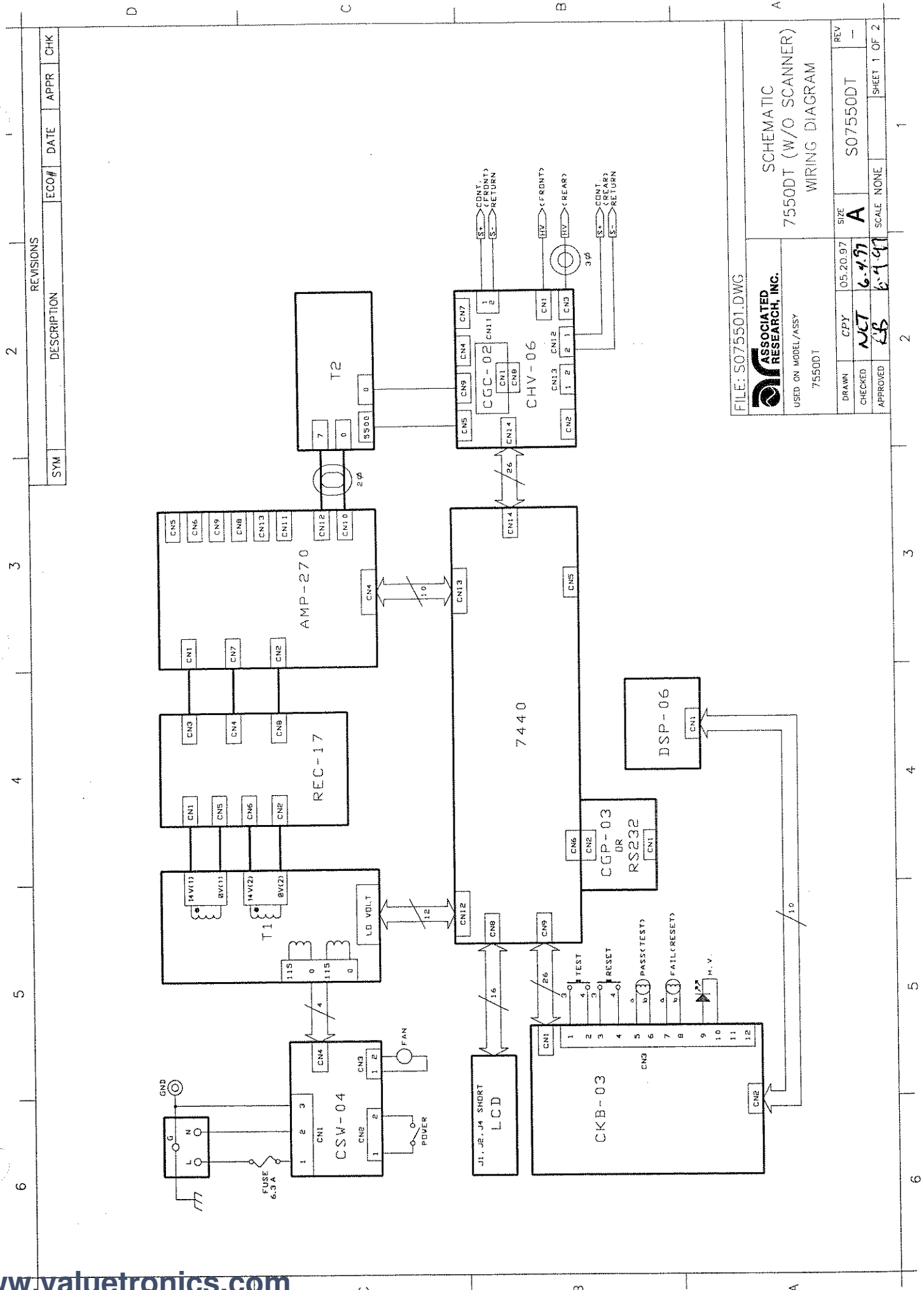

REVISIONS				ECO#	DATE	APPR	CHK
SYM	DESCRIPTION						

FILE: S075501.DWG



USED ON MODEL/ASSY

SCHEMATIC  
7550DT (W/O SCANNER)  
WIRING DIAGRAM

DRAWN	CPY	SIZE	REV
		A	
CHECKED	APPROVED	SCALE	SHEET 1 OF 2
		NONE	

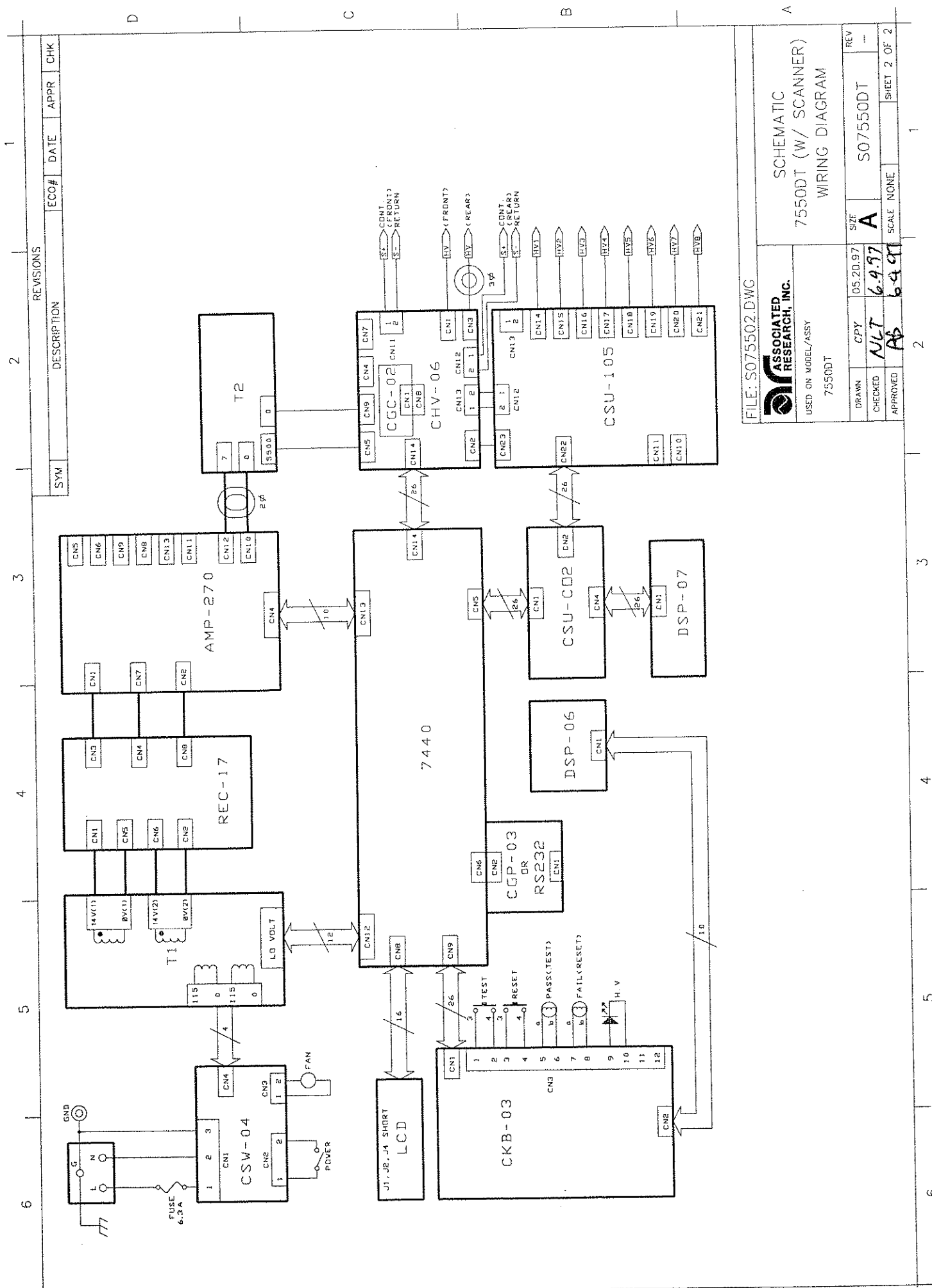

SYM	DESCRIPTION	ECO#	DATE	APPR	CHK

FILE: S075502.DWG

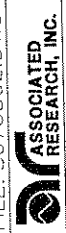

USED ON MODEL/ASSY  
7550DT

SCHEMATIC  
7550DT (W/ SCANNER)  
WIRING DIAGRAM

DRAWN	CPY	05.20.97	SIZE	REV
CHECKED	ALT	6.9.97	A	S07550DT
APPROVED	AB	6.9.97	SCALE	NONE
			SHEET	2 OF 2



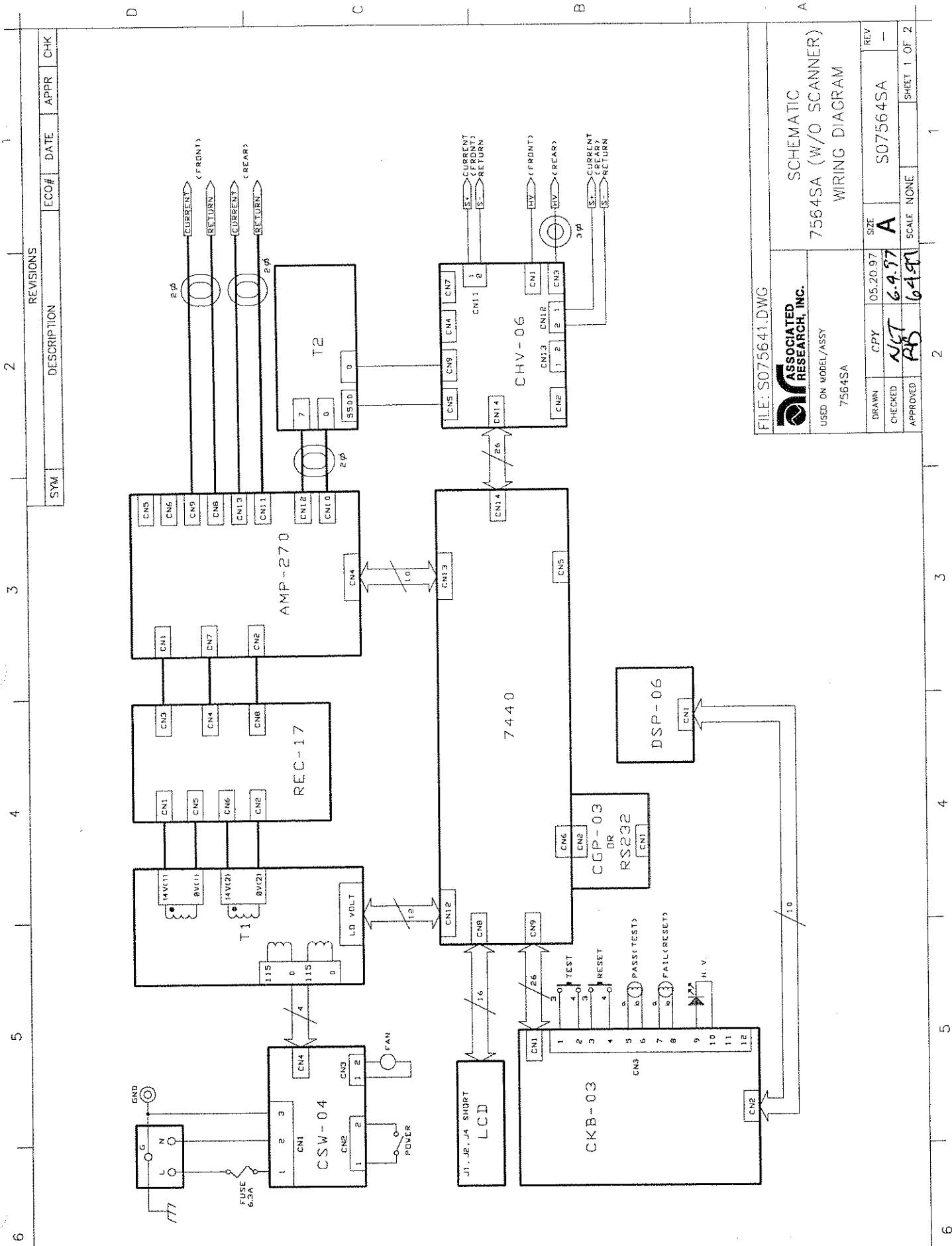

SYM	DESCRIPTION	ECO#	DATE	APPR	CHK

FILE: S075641.DWG



USED ON MODEL/ASSY  
7564SA

SCHEMATIC  
7564SA (W/O SCANNER)  
WIRING DIAGRAM

DRAWN	CPY	SIZE	REV
CHECKED	APPROVED	A	S07564SA
APPROVED	SCALE	NONE	SHEET 1 OF 2

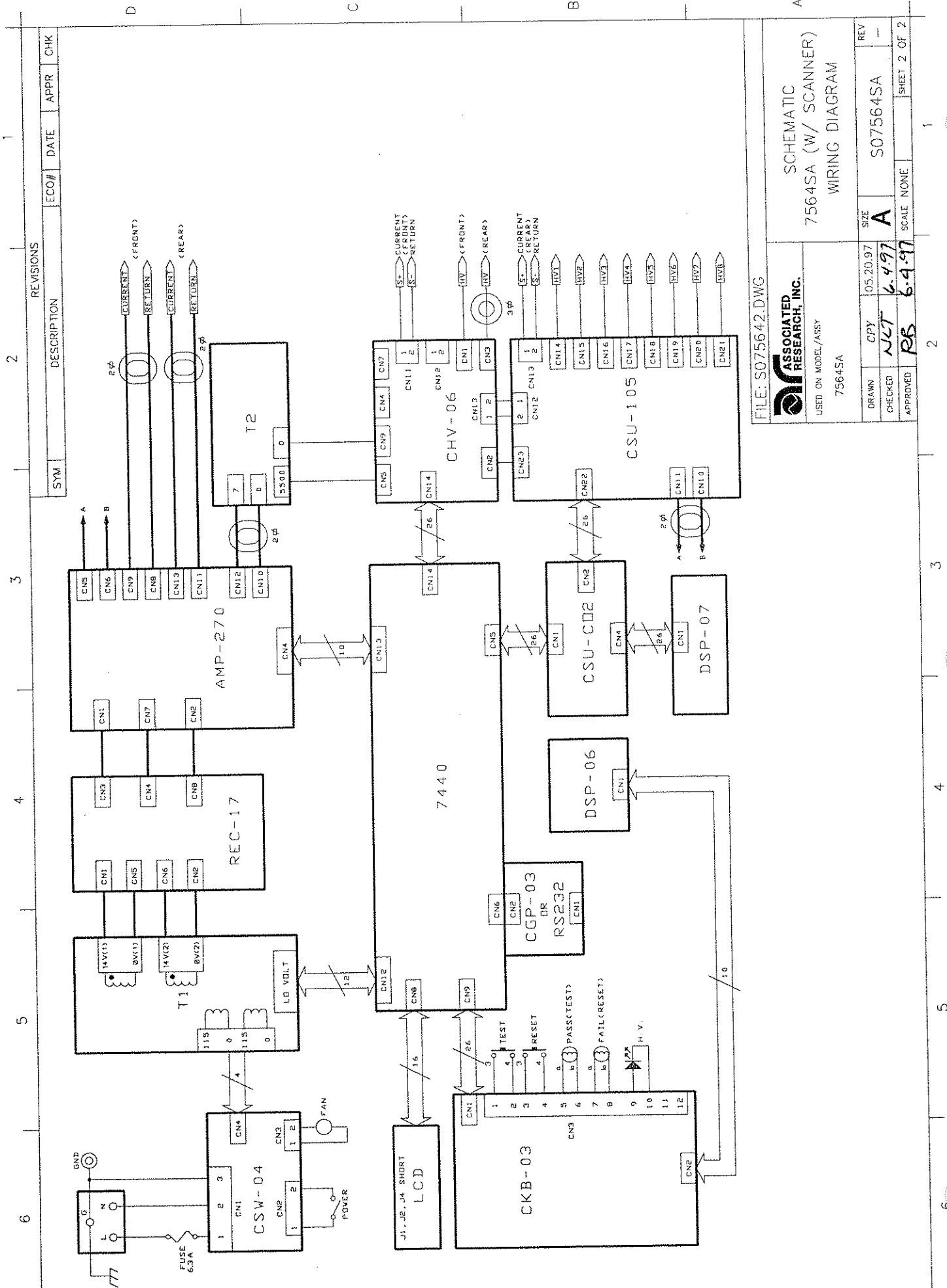



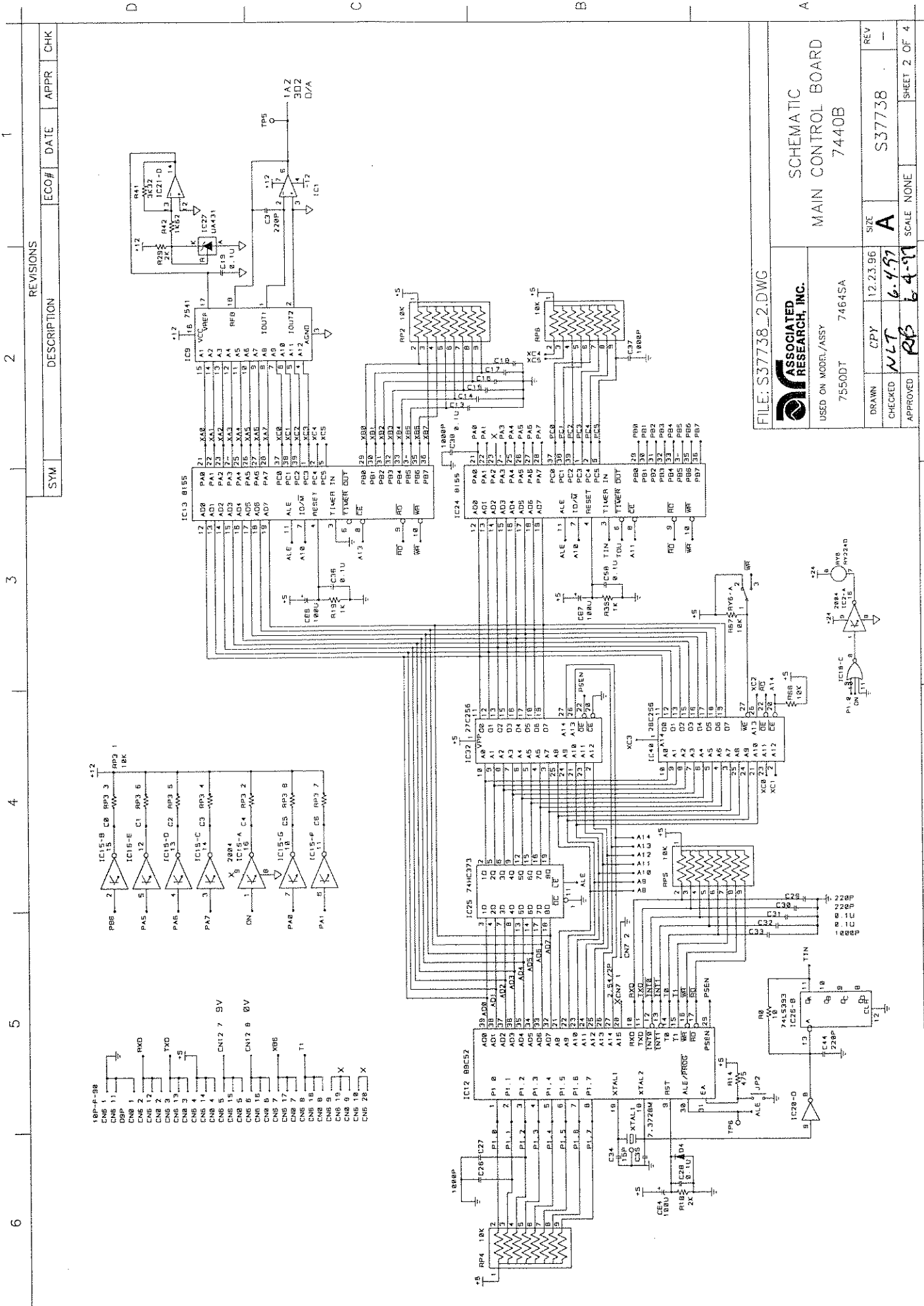

FILE: S37738\_2.DWG

**ASSOCIATED RESEARCH, INC.**

USED ON MODEL/ASSY 7440B

75500DT 74645A

SCHEMATIC MAIN CONTROL BOARD 7440B

DRAWN	CPY	12.23.96	SIZE	REV
CHECKED	WLT	6.4.97	A	S37738
APPROVED	RPS	6.4.97	SCALE	NONE

SHEET 2 OF 4

1	2	3	4	5	6
SYM	DESCRIPTION	ECO#	DATE	APPR	CHK

1

2

3

4

5

6

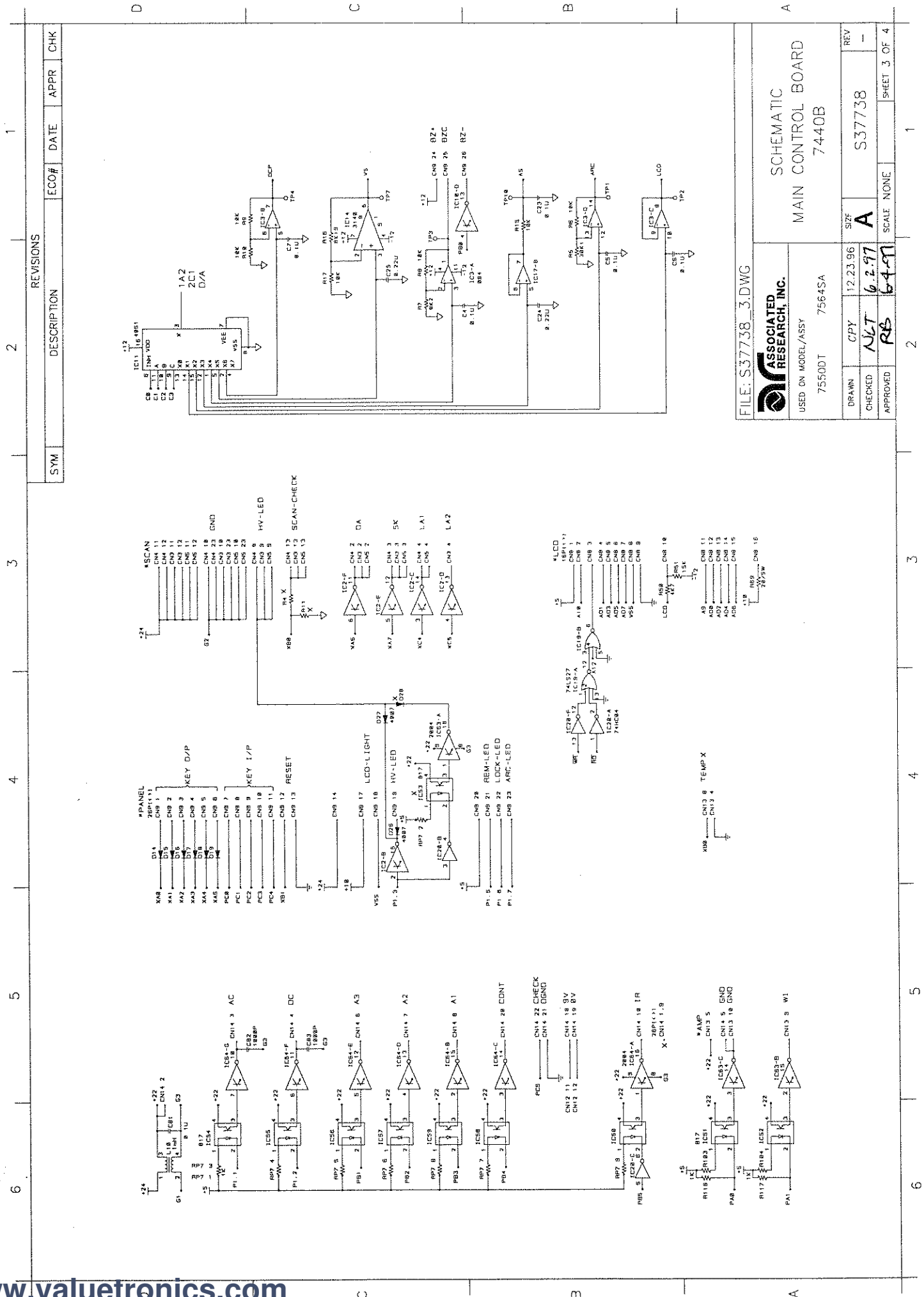

FILE: S37738\_3.DWG

ASSOCIATED RESEARCH, INC.		SCHEMATIC MAIN CONTROL BOARD 7440B	
USED ON MODEL/ASSY		75500T	7564SA
DRAWN	COPY	12.23.96	SIZE A
CHECKED	AKT	6.2.97	
APPROVED	RS	6.4.97	
		SCALE	NONE
		SHEET	3 OF 4

1	2	3	4	5	6
SYMBOL	DESCRIPTION	ECO#	DATE	APPR	CHK

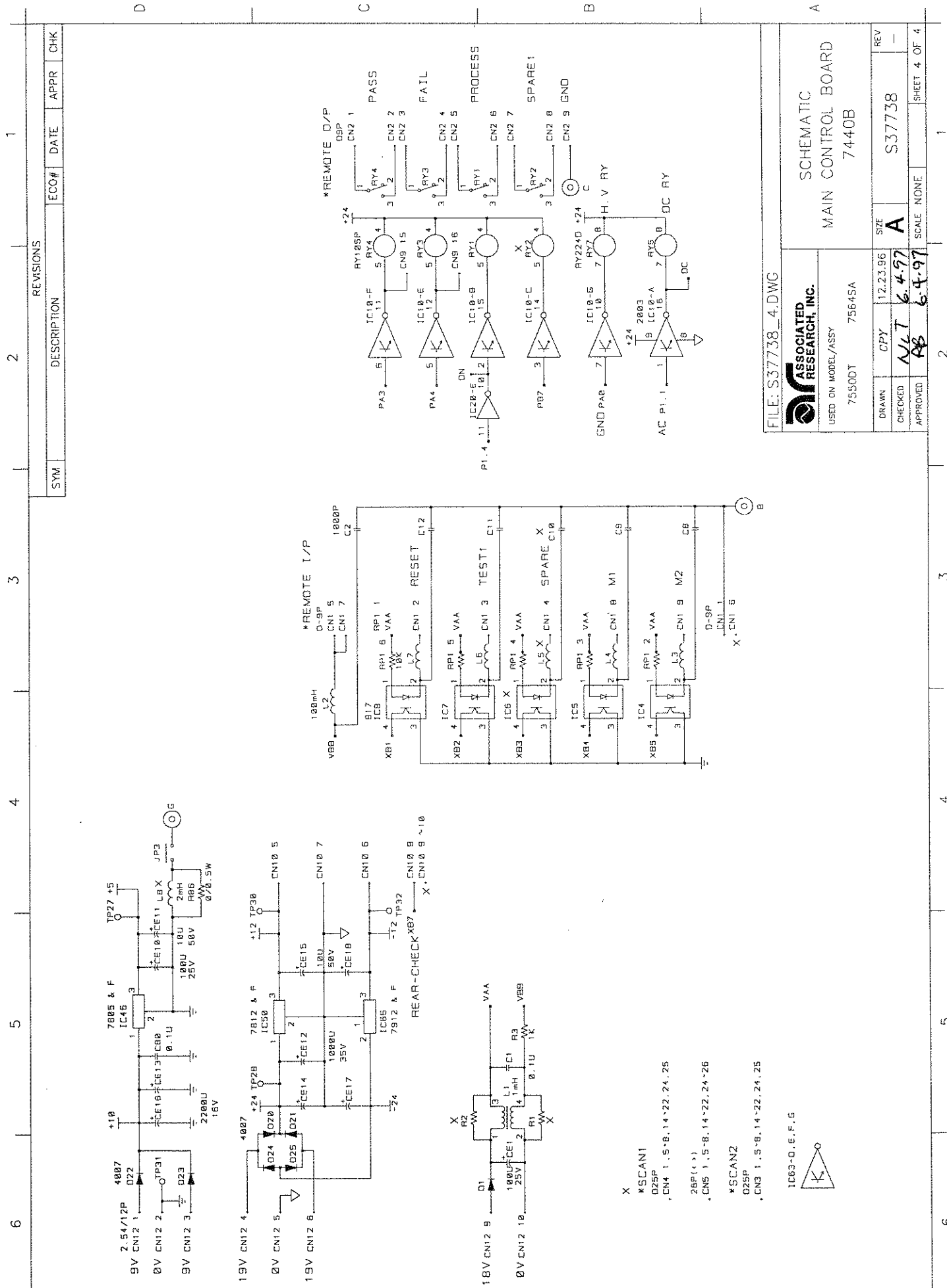

FILE: S37738\_4.DWG

ASSOCIATED RESEARCH, INC.

USED ON MODEL/ASSY  
75500T 75545A

DRAWN	CPY	SIZE	REV
CHECKED	WLT	A	S37738
APPROVED	AB	6.4.97	—

SCHEMATIC  
MAIN CONTROL BOARD  
7440B

SCALE	NONE	SHEET	4 OF 4
-------	------	-------	--------

SYM	DESCRIPTION	ECO#	DATE	APPR	CHK
-----	-------------	------	------	------	-----

REVISIONS	1	2	3	4	5	6
-----------	---	---	---	---	---	---

2	3	4	5	6
---	---	---	---	---

1	2	3	4	5	6
---	---	---	---	---	---

1	2	3	4	5	6
---	---	---	---	---	---

1	2	3	4	5	6
---	---	---	---	---	---

1	2	3	4	5	6
---	---	---	---	---	---

1	2	3	4	5	6
---	---	---	---	---	---

1	2	3	4	5	6
---	---	---	---	---	---

1	2	3	4	5	6
---	---	---	---	---	---

1	2	3	4	5	6
---	---	---	---	---	---

1	2	3	4	5	6
---	---	---	---	---	---

1	2	3	4	5	6
---	---	---	---	---	---

1	2	3	4	5	6
---	---	---	---	---	---

1	2	3	4	5	6
---	---	---	---	---	---

1	2	3	4	5	6
---	---	---	---	---	---

SYM	DESCRIPTION	ECO#	DATE	APPR	CHK

REVISIONS

6 5 4 3 2 1

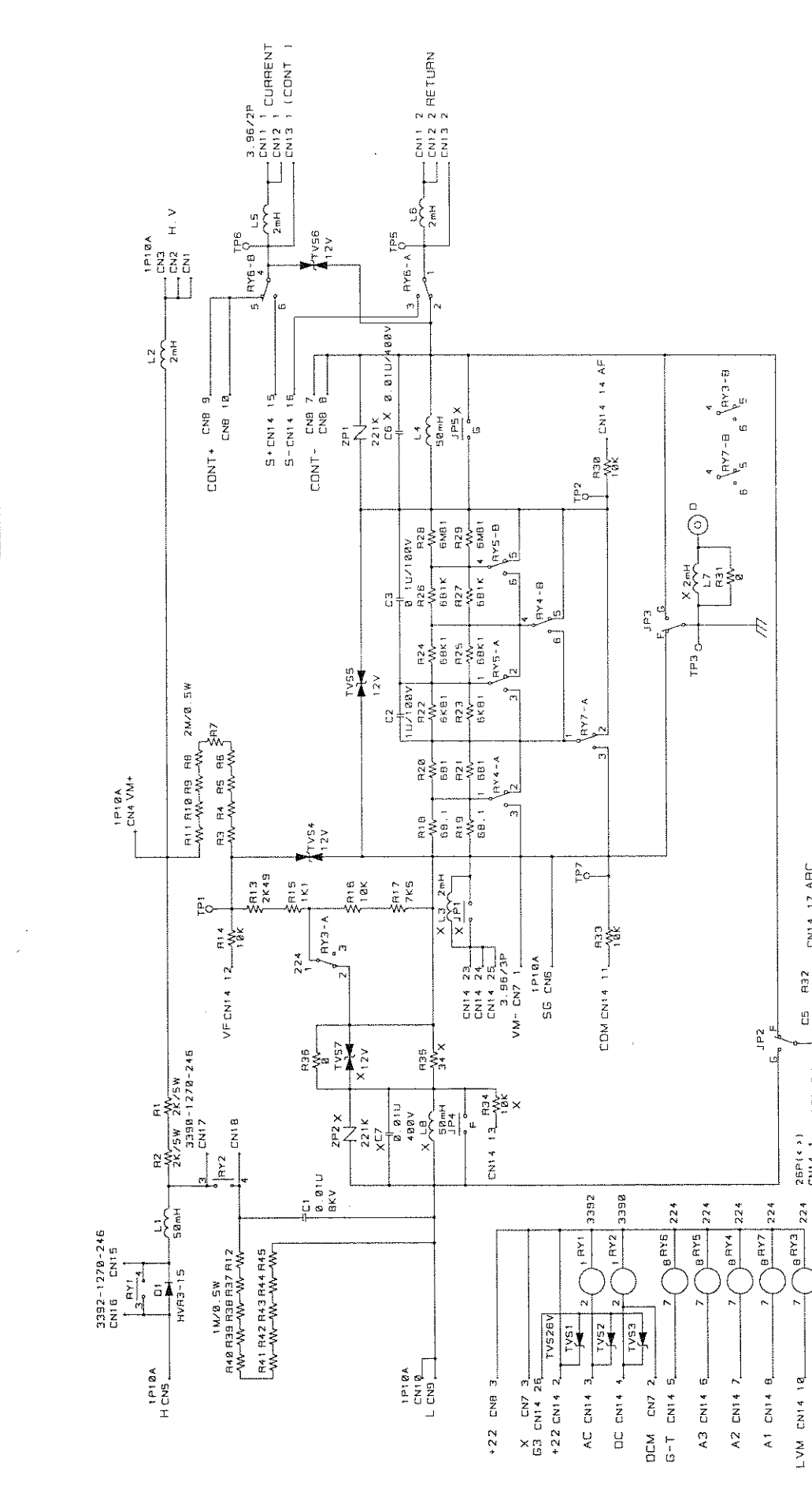

FILE: S37739.DWG		SCHEMATIC	
ASSOCIATED RESEARCH, INC.		HV CONTROL BOARD	
USED ON MODEL/ASSY		CHV-06B	
DRAWN	CPY	SIZE	REV
CHECKED	APPR	A	S37739
APPROVED	SCALE	NONE	SHEET 1 OF 1

6 5 4 3 2 1



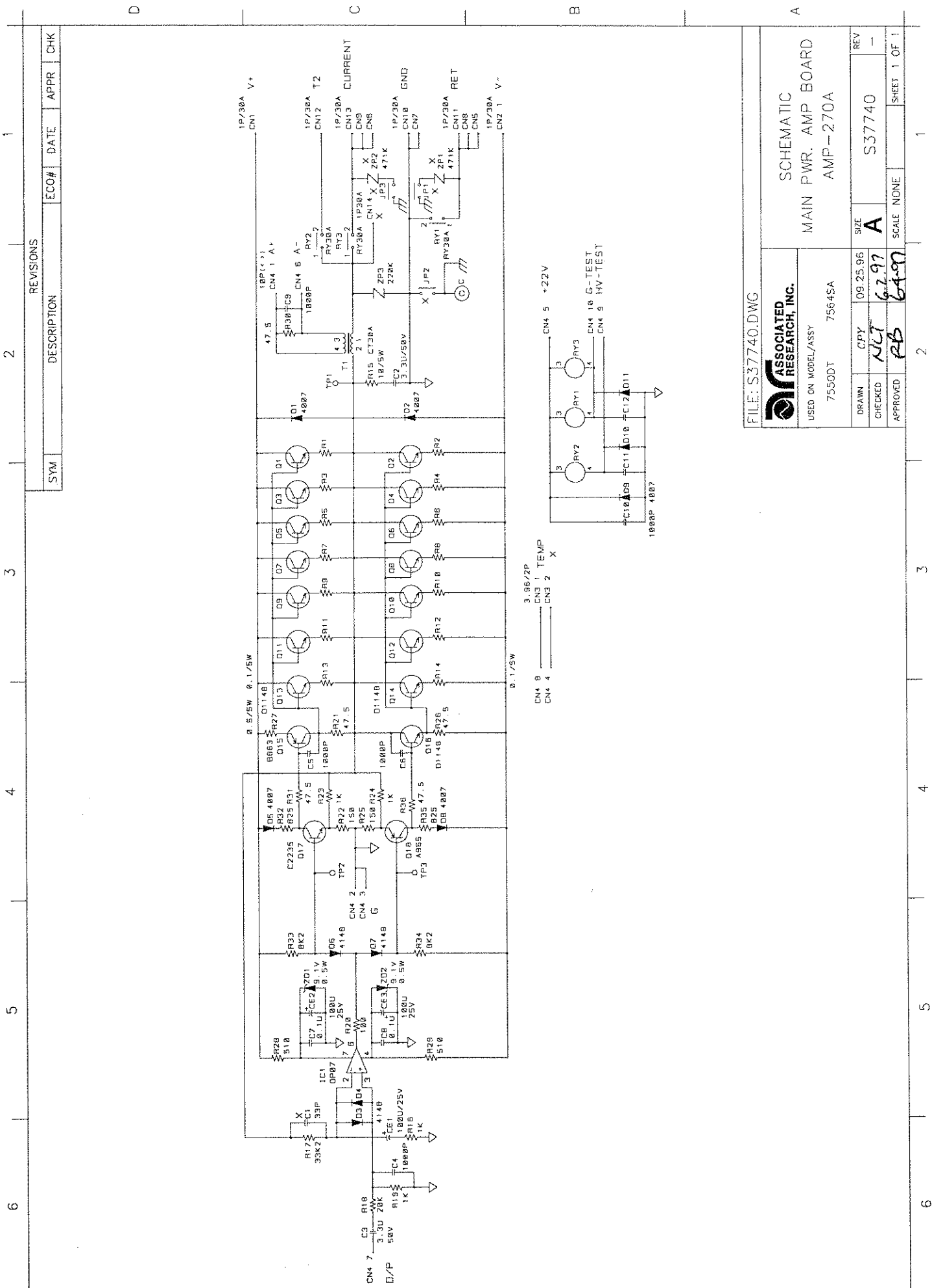

FILE: S37740.DWG

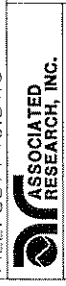

SCHEMATIC  
MAIN PWR. AMP BOARD  
AMP-270A

USED ON MODEL/ASSY	7550DT	7564SA
DRAWN	CPY	SIZE
CHECKED	62.97	A
APPROVED	PB	64.07
SCALE	NONE	
REV	S37740	SHEET 1 OF 1

1 2 3 4 5 6



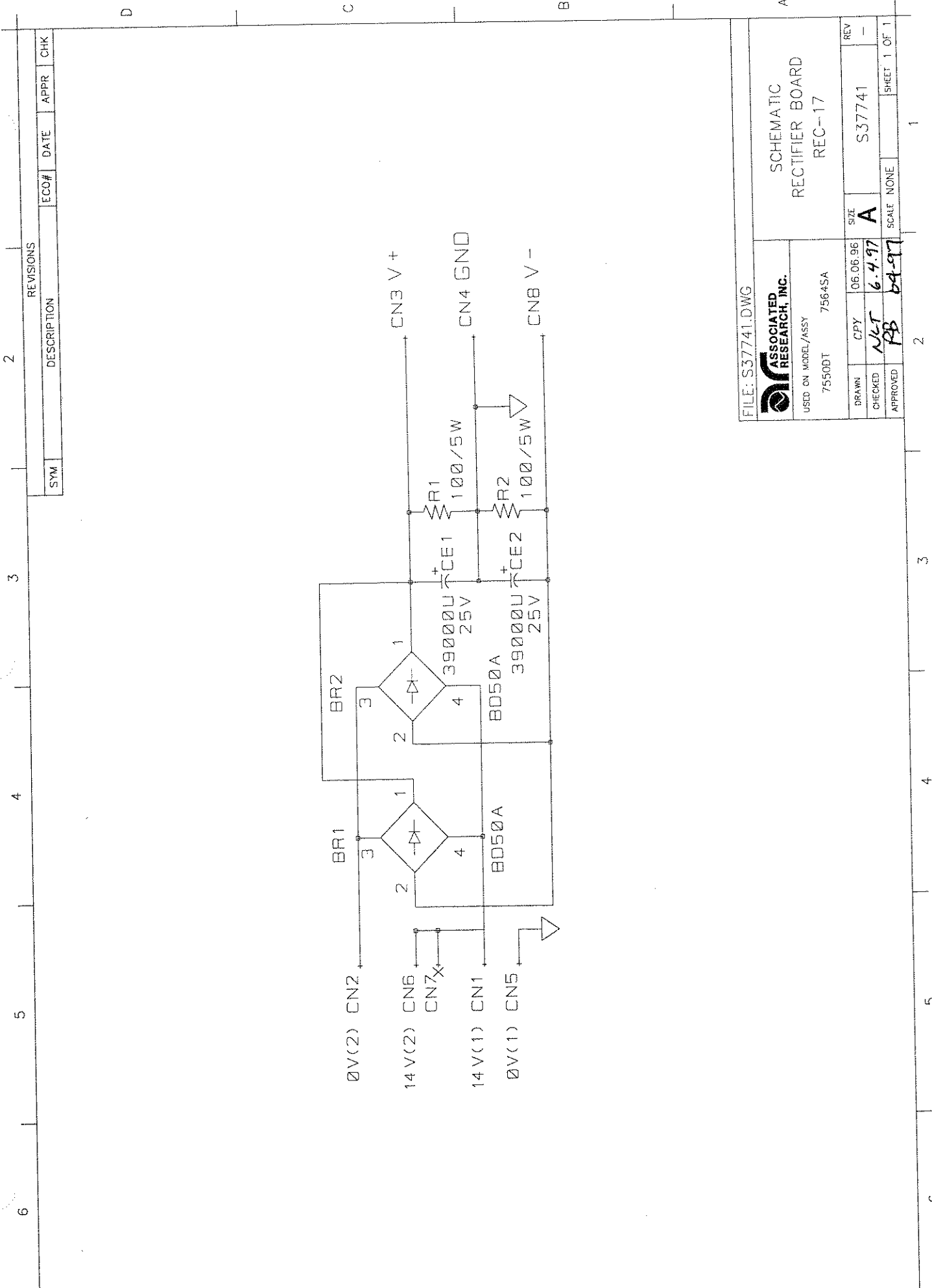

FILE: S37741.DWG



USED ON MODEL/ASSY  
7550DT 7564SA

SCHMATIC  
RECTIFIER BOARD  
REC--17

DRAWN	CPY	06.06.96	SIZE	REV
CHECKED	NLT	6.4.97	A	S37741
APPROVED	PB	64-97	SCALE	NONE
			SHEET	1 OF 1

REVISIONS		ECO#	DATE	APPR	CHK
1					
2	DESCRIPTION				
3					
4					
5					
6					

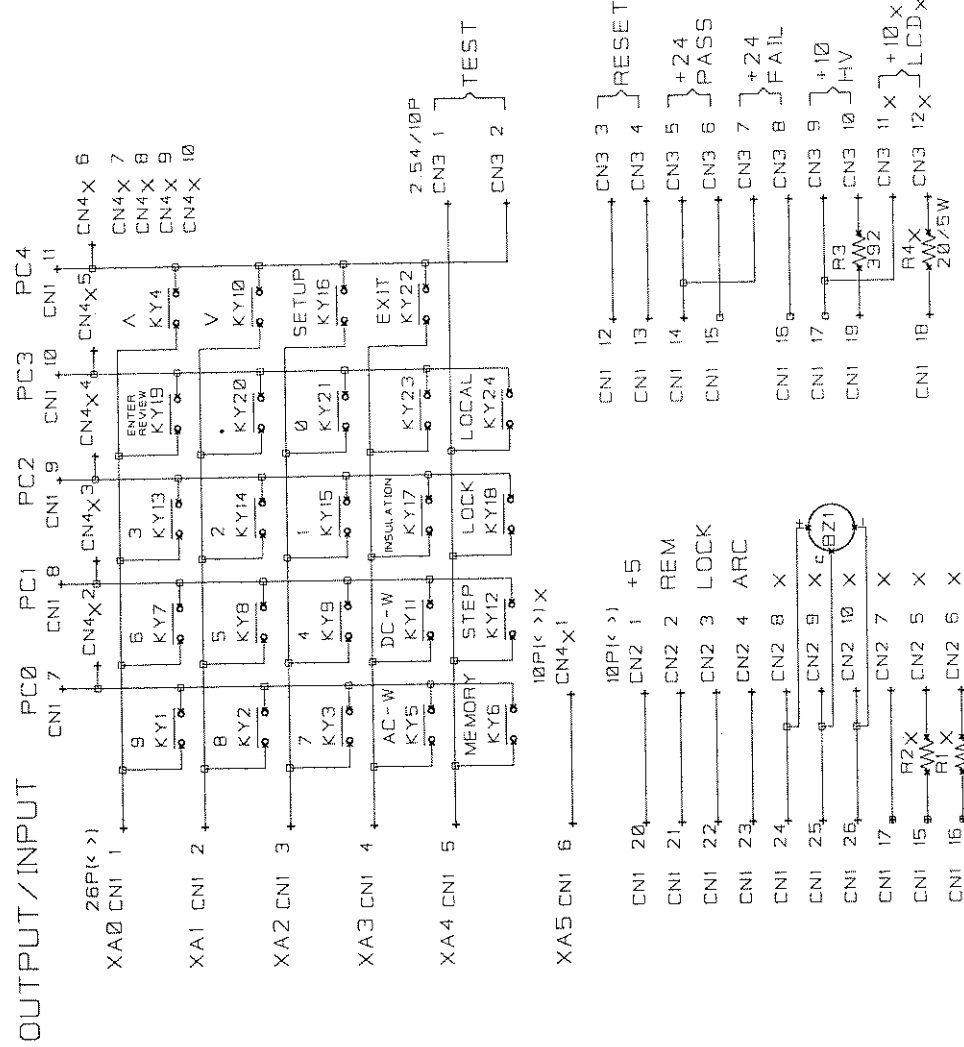

FILE: S37742.DWG



USED ON MODEL/ASSY  
7550DT 7564SA

SCHEMATIC  
KEYPAD BOARD  
CKB-03A

DRAWN	CPY	10.2.96	SIZE	REV
CHECKED	NET	6.4.97	A	S37742
APPROVED	RES	6.4.97	SCALE	NONE
				SHEET 1 OF 1

NOTES:  
1. KY23 NAMED G-BOND FOR 7550DT.  
2. KY23 NAMED CONTINUITY FOR 7564SA.

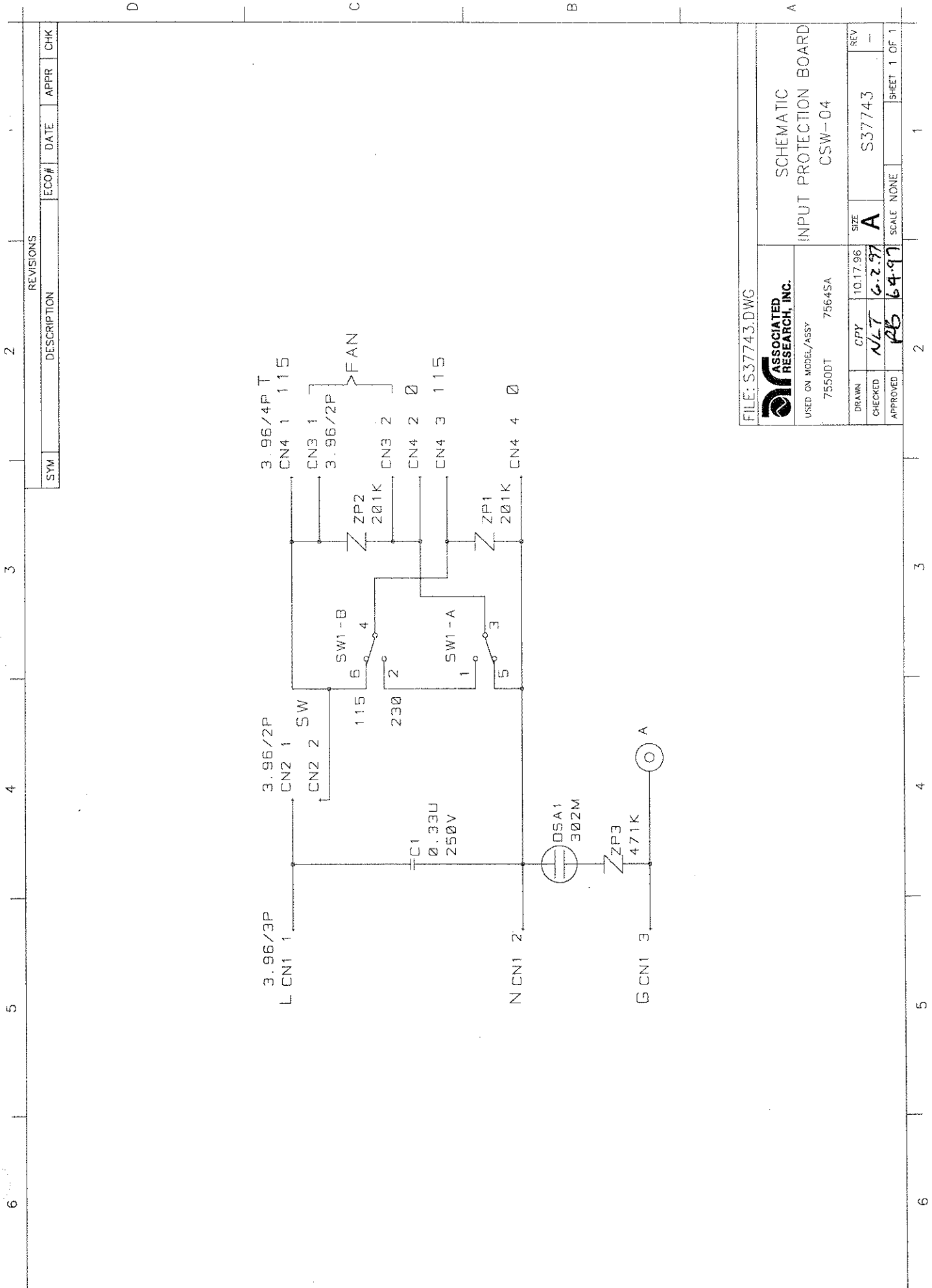

FILE: S37743.DWG

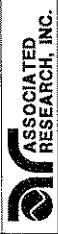

USED ON MODEL/ASSY  
75500T 7564SA

SCHEMATIC  
INPUT PROTECTION BOARD  
CSW-04

DRAWN	CPY	10.17.96	SIZE	REV
CHECKED	NLT	6.2.97	A	S37743
APPROVED	PB	6.9.97	SCALE NONE	SHEET 1 OF 1

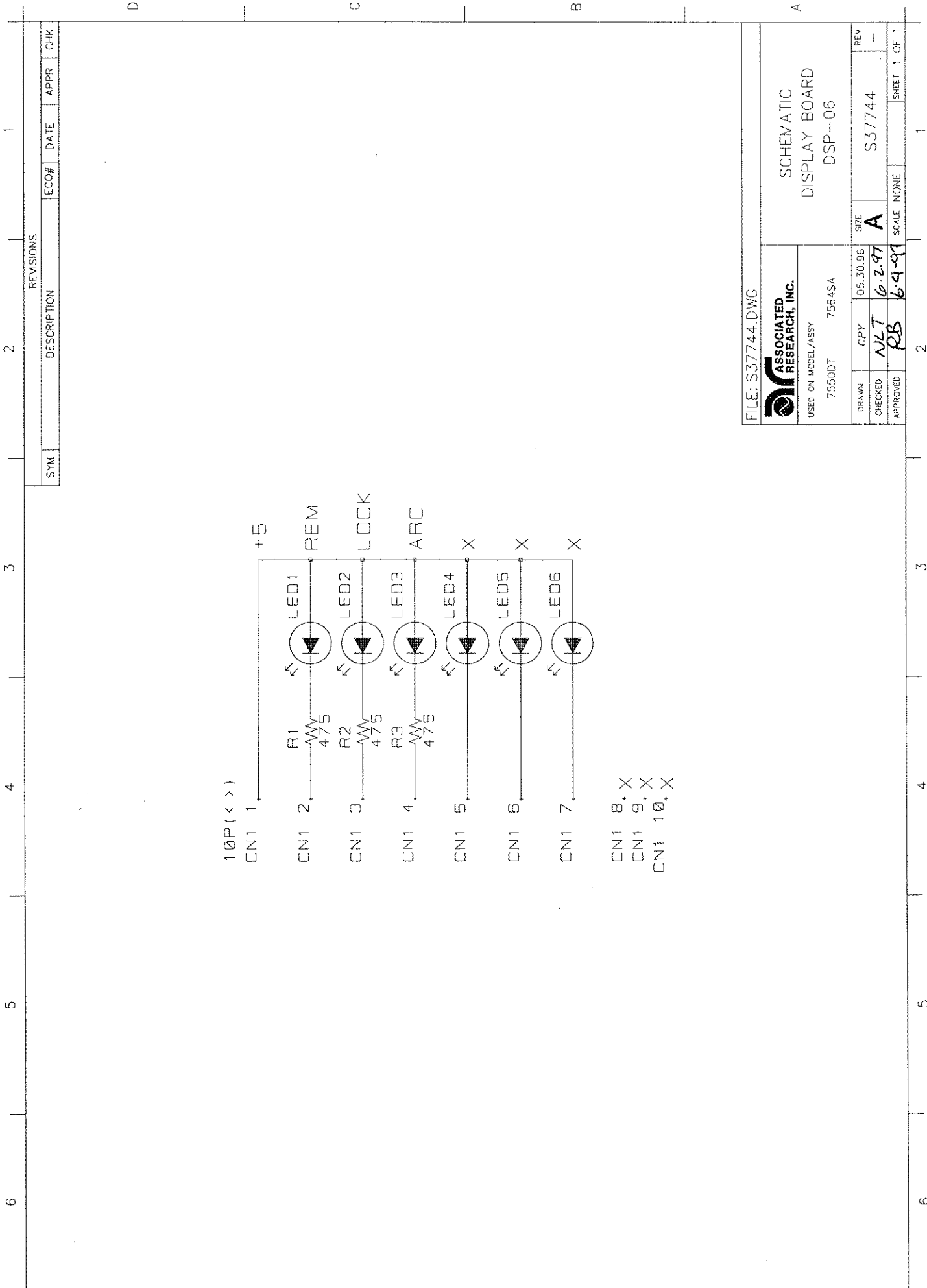

REVISIONS			
SYM	DESCRIPTION	ECO#	DATE

FILE: S37744.DWG

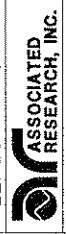

USED ON MODEL/ASSY  
7550DT 7564SA

DRAWN	CPY	SIZE	REV
CHECKED	MLT	A	S37744
APPROVED	RB	SCALE NONE	SHEET 1 OF 1

SCHEMATIC  
DISPLAY BOARD  
DSP---06

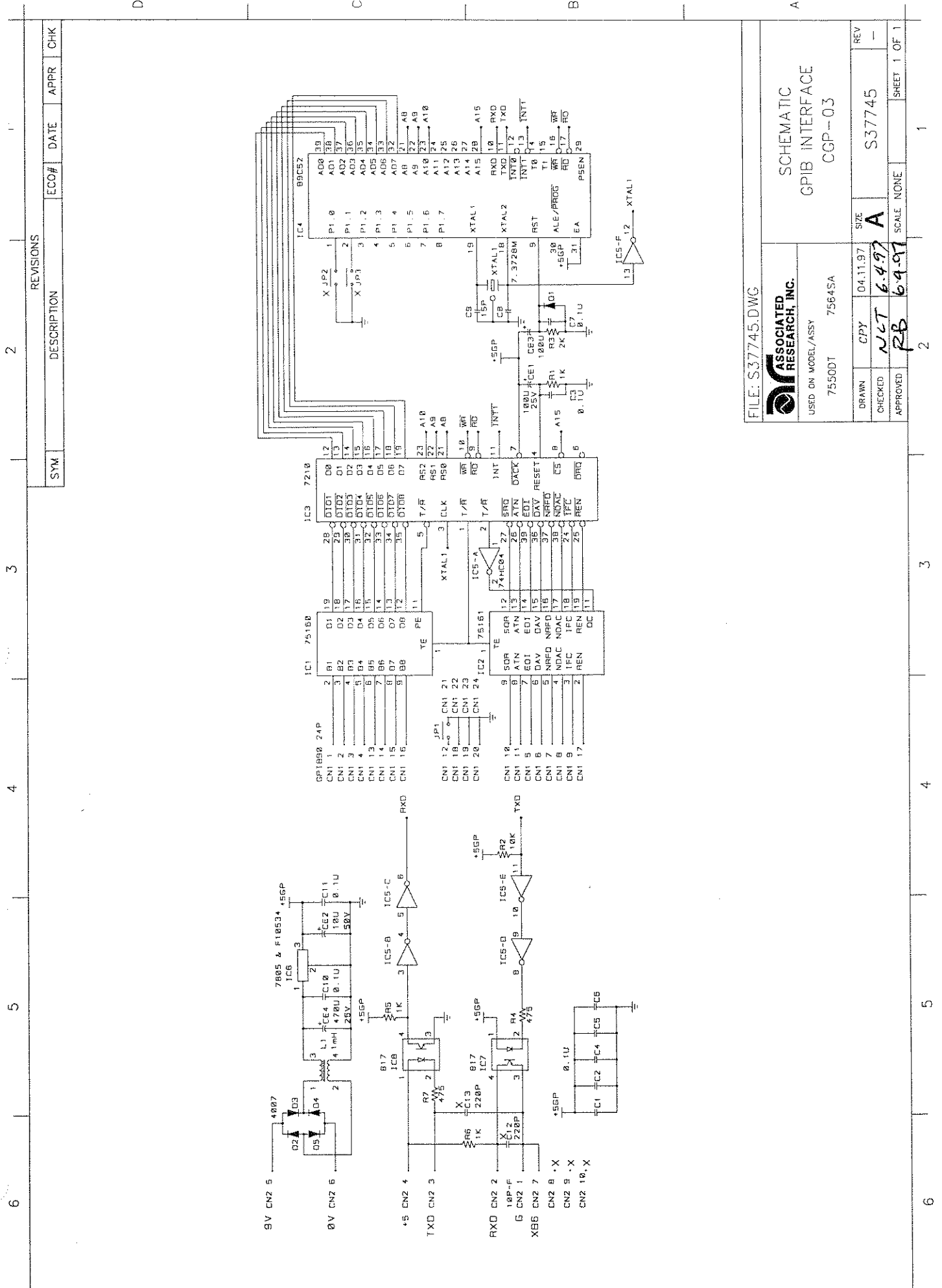

SYM	DESCRIPTION	ECO#	DATE	APPR	CHK

FILE: S37745.DWG



USED ON MODEL/ASSY

SCHEMATIC  
GPIB INTERFACE  
CGP--03

75500T	7564SA	SIZE	REV
DRAWN	CPY	04.11.97	S37745
CHECKED	NCT	6.4.97	A
APPROVED	PB	6.9.97	SCALE NONE
SHEET 1 OF 1			1

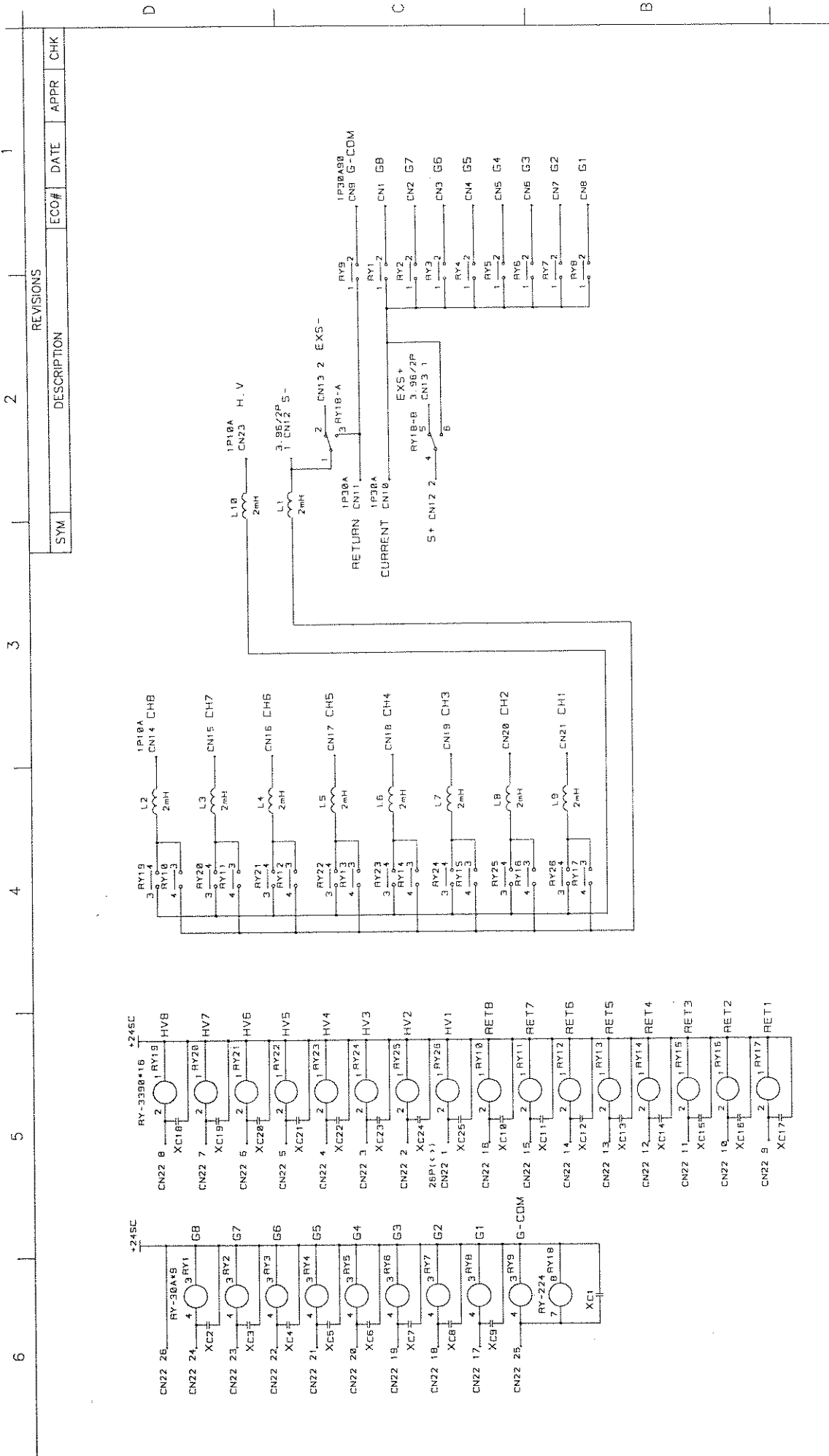

SYM		DESCRIPTION		ECC#	DATE	APPR	CHK
REVISIONS							
1							
2							
3							
4							
5							
6							
1							
2							
3							
4							
5							
6							

FILE: S37746.DWG

**ASSOCIATED RESEARCH, INC.**

USED ON MODEL/ASSY  
7550DT 7564SA

SCHMATIC  
SCANNER MATRIX BOARD  
CSU-105B

DRAWN	CPY	SIZE	REV
CHECKED	6.497	A	S37746
APPROVED	6.4.97	SCALE NONE	SHEET 1 OF 1

NOTES:

- RY1-RY9, RY18, CN9-CN11, CN13 NOT INSTALLED IN 7550DT.
- RY10-RY17, RY19-RY26 HAVE FLYING LEAD CONNECTIONS.

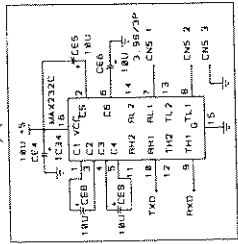
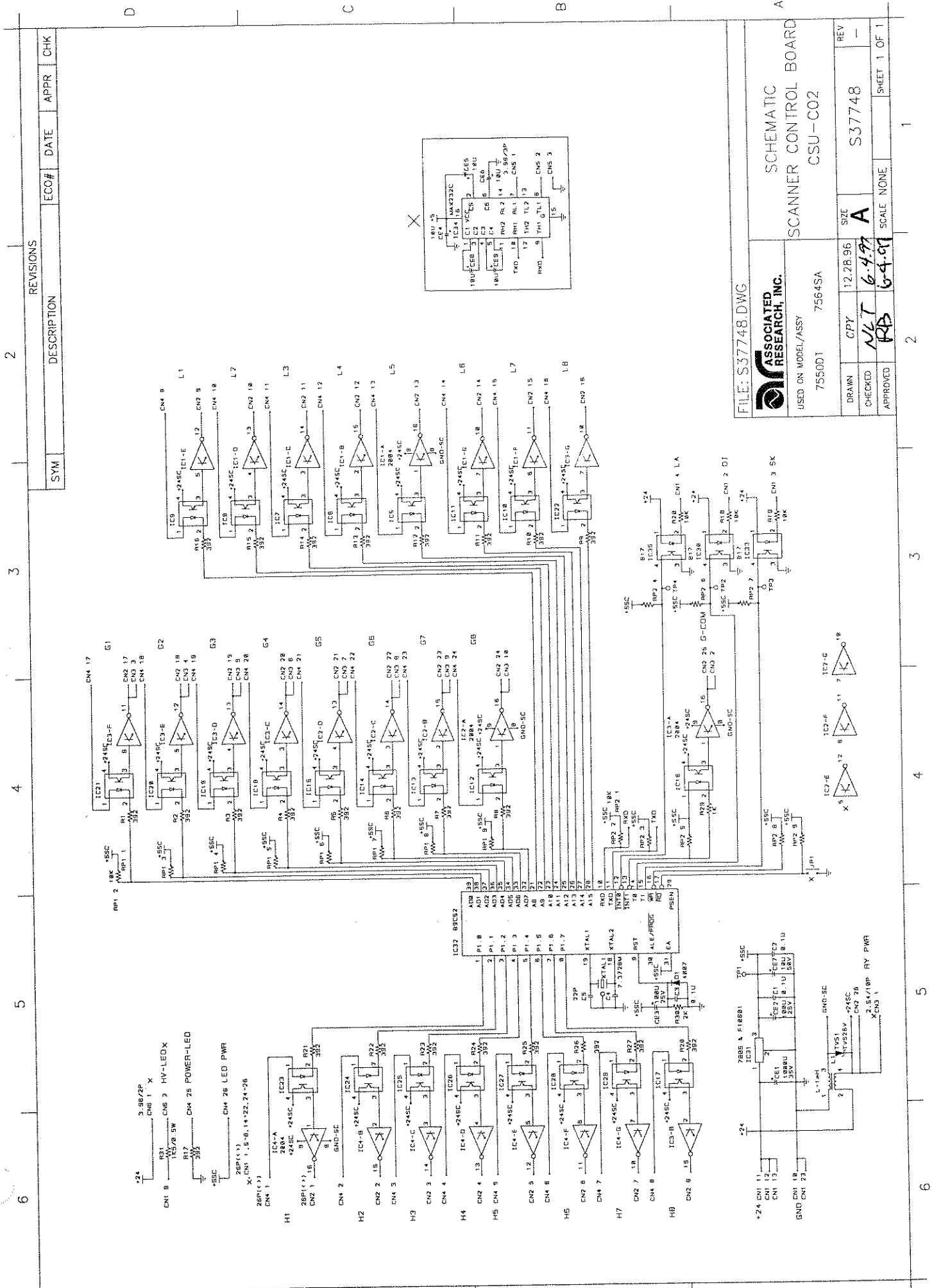

FILE: S37748.DWG



ASSOCIATED RESEARCH, INC.  
USED ON MODEL/ASSY 755001 75645A

SCHEMATIC  
SCANNER CONTROL BOARD  
CSU-C02

DRAWN	CPY	SIZE	REV
CHECKED	6.4.97	A	S37748
APPROVED	6.4.97		SHEET 1 OF 1

REVISIONS	DESCRIPTION	ECO#	DATE	APPR	CHK
2					
3					
4					
5					
6					

1  
2  
3  
4  
5  
6

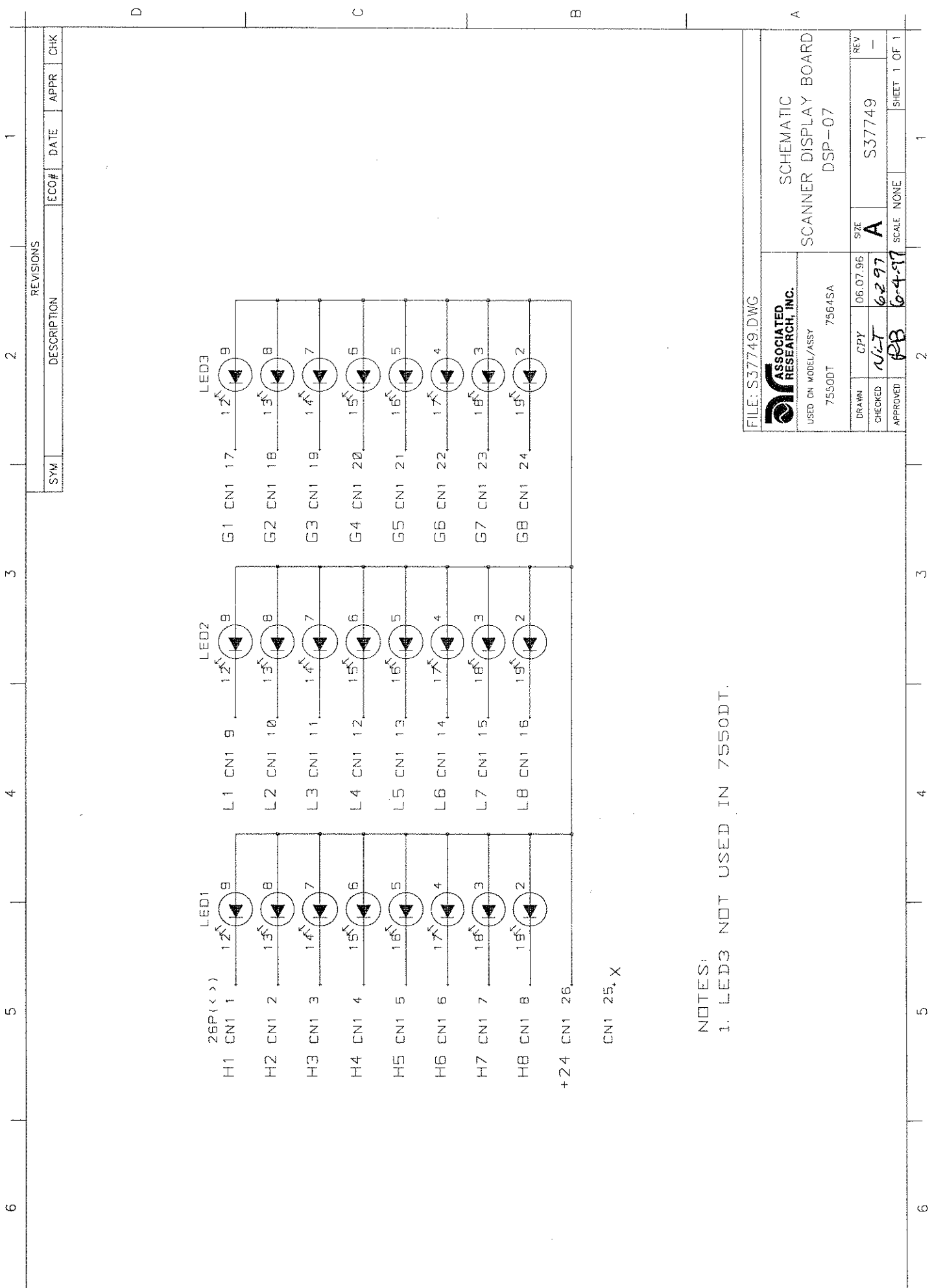

NOTES:  
1. LED3 NOT USED IN 7550DT.

REVISIONS			
SYM	DESCRIPTION	ECCO#	DATE

FILE: S37749.DWG		SCHEMATIC	
ASSOCIATED RESEARCH, INC.		SCANNER DISPLAY BOARD	
USED ON MODEL/ASSY		DSP-07	
7550DT	7564SA		
DRAWN	CPY	SIZE	REV
		A	S37749
CHECKED	NET	6-2-97	
APPROVED	PB	6-4-97	SHEET 1 OF 1



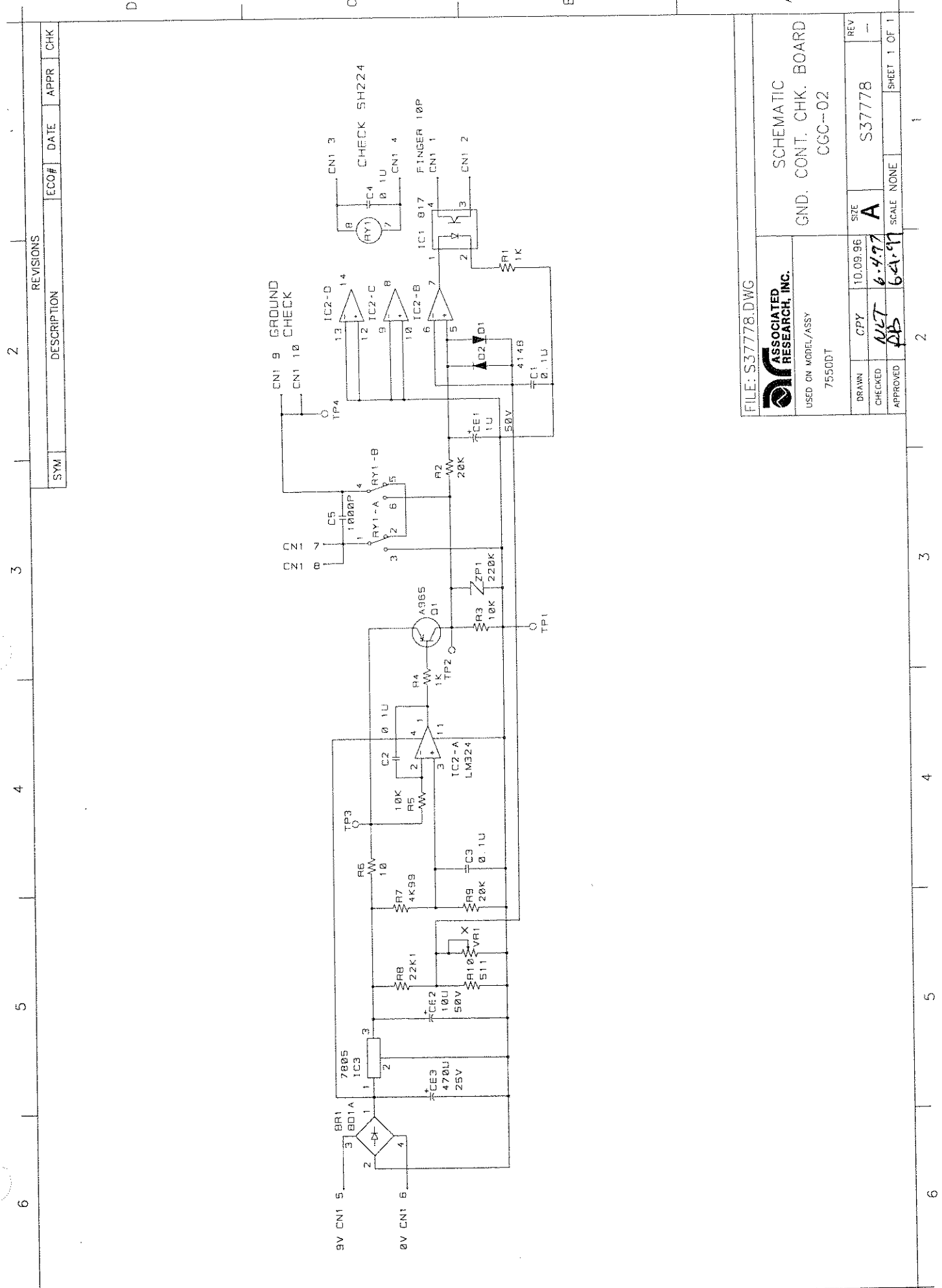

FILE: S37778.DWG



S37778.DWG  
 SCHEMATIC  
 GND. CONT. CHK. BOARD  
 CGC--02

USED ON MODEL/ASSY	7550DT
DRAWN	CPY
CHECKED	6-4-97
APPROVED	6-4-97
DATE	10.09.96
SCALE	NONE
SIZE	A
REV	S37778
SHEET	1 OF 1

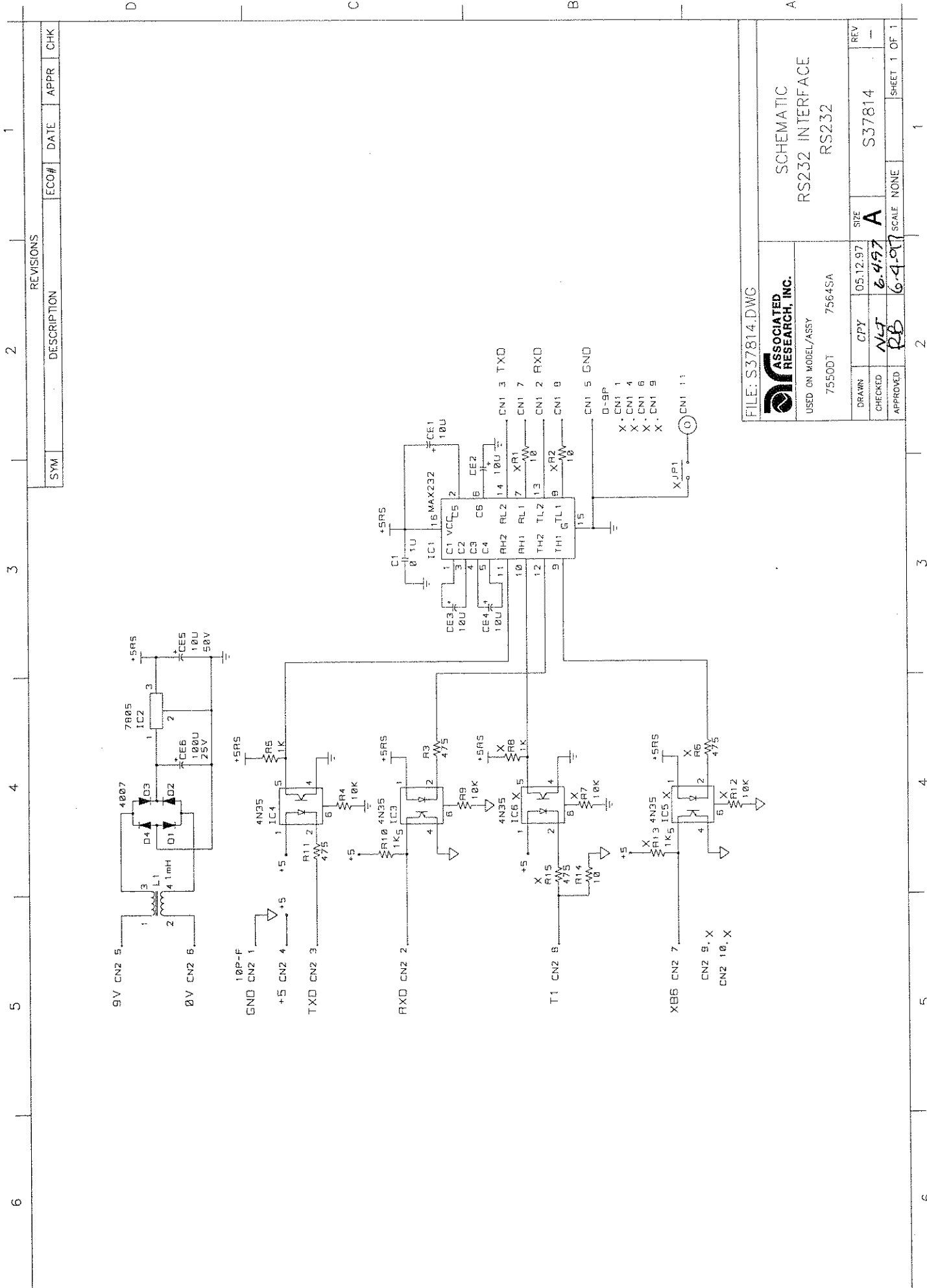

FILE: S37814.DWG



USED ON MODEL/ASSY

SCHEMATIC  
RS232 INTERFACE  
RS232

75500T 7564SA

DRAWN	CPY	SIZE	REV
CHECKED	DATE	SCALE	SHEET 1 OF 1
APPROVED	SCALE	NONE	

05.12.97	A	S37814	-
6.4.97			
6.4.97			



